

Space Shuttle Operational Flight Rules

Volume A

All Flights

Mission Operations Directorate

Final

June 6, 1996

PCN-8

April 22, 1999



National Aeronautics and
Space Administration

Lyndon B. Johnson Space Center
Houston, Texas

GENERAL, AUTHORITY, AND DEFINITIONS	1
FLIGHT OPERATIONS	2
GROUND INSTRUMENTATION	3
TRAJECTORY AND GUIDANCE	4
BOOSTER	5
PROPULSION	6
DATA SYSTEMS	7
GUIDANCE, NAVIGATION, & CONTROL (GN&C)	8
ELECTRICAL	9
MECHANICAL	10
COMMUNICATIONS	11
ROBOTICS	12
AEROMEDICAL	13
SPACE ENVIRONMENT	14
EXTRAVEHICULAR ACTIVITY (EVA)	15
POSTLANDING	16
LIFE SUPPORT	17
THERMAL	18
ACRONYMS AND ABBREVIATIONS	A
CHANGE CONTROL	B
WAIVERS	C

SPACE SHUTTLE OPERATIONAL FLIGHT RULES

ALL FLIGHTS

VOLUME A

FINAL, DATED JUNE 6, 1996
PCN-1, DATED AUGUST 22, 1996
PCN-2, DATED OCTOBER 17, 1996
PCN-3, DATED MARCH 12, 1997
PCN-4, DATED MAY 1, 1997
PCN-5, DATED OCTOBER 30, 1997
PCN-6, DATED MARCH 12, 1998
PCN-7, DATED SEPTEMBER 17, 1998
PCN-8, DATED APRIL 22, 1999

THIS PCN-8 INCORPORATES CHANGES TO THE FOLLOWING RULES BY
THE APPLICABLE CHANGE REQUESTS (CR'S).

RULE NO	CR NO	RULE NO	CR NO
A1.1.3-12	CR 2459B	A5.1.3-4	CR 6785A
A2.1.1-6	CR 6734	A5.1.4-3	CR 6785A
A2.1.1-8	CR 6693A	A5.1.4-4	CR 6791A
A2.1.2-12	CR 6788	A5.1.4-5	CR 6818A
A2.1.3-4	CR 2459B	A5.1.4-6	CR 6791A
A2.1.3-6	CR 6747B	A5.1.4-6	CR 6818A
A2.1.3-10	CR 6747B	A5.1.5-1	CR 6795A
A2.1.3-11	CR 6747B	A5.1.5-2	CR 6792B
A2.1.3-18	CR 6798A	A5.1.5-3	CR 6787B
A2.1.3-18	ED	A5.1.5-8	CR 6793
A2.1.3-21	CR 6747B	A6.1.2-33	CR 6733
A2.1.3-22	CR 6706B		
A2.1.3-25	CR 6732	A7.1.2-1	CR 2459B
A2.1.3-27	CR 6799C	A7.1.2-2	CR 2459B
A2.1.5-15	CR 6847	A7.1.3-8	CR 2459B
A2.1.7-1	CR 2459B	A7.1.3-10	CR 2459B
		A7.1.3-11	CR 2459B
A3.1.1-1	CR 6807	A7.1.3-15	CR 2459B
A3.1.1-2	CR 6809A	A7.1.4-1	CR 2459B
A3.3.1-3	CR 6817	A7.1.5-1	CR 2459B
A4.1.2-4	CR 6789	A8.1.1-18	CR 2459B
A5.1.1-2	CR 6785A	A8.1.2-8	CR 2459B
A5.1.1-8	CR 6790	A8.1.6-1	CR 6750
A5.1.1-12	CR 6785A	A8.1.6-1	CR 2459B
A5.1.1-14	CR 6818A	A9.1.4-4	CR 2568A
A5.1.3-3	CR 6785A		

Verify that this is the correct version before use.

<u>RULE NO</u>	<u>CR NO</u>	<u>RULE NO</u>	<u>CR NO</u>
A10.1.1-1	CR 6824	A17.1.1-3	CR 2497
A10.1.2-1	CR 6814	A17.1.3-3	CR 2498A
A10.1.2-1	CR 6857	A17.1.4-1	CR 2570
A10.1.2-3	CR 6814	A17.1.4-3	CR 2499B
A10.1.2-4	CR 6814	A17.1.4-4	CR 2500
A10.1.2-4	ED		
A10.1.2-6	CR 6814	APPENDIX B	ED
A10.1.2-7	CR 6814		
A10.1.2-7	CR 6824	APPENDIX C	ED
A10.1.2-12	ED		
A10.1.3-1	ED		
A10.1.4-2	ED		
A10.1.5-1	CR 6814		
A10.1.7-1	ED		
A10.1.8-1	CR 6764A		
A10.1.8-5	ED		
A10.1.18-1	CR 6816		
A10.1.18-2	CR 6816		
A10.1.18-3	CR 6816		
A10.1.18-4	CR 6816		
A10.1.18-5	CR 6816		
A10.1.18-6	CR 6816		
A10.1.19-1	CR 6816		
A11.1.1-18	CR 6778		
A11.1.3-1	CR 6778		
A12.1.1-3	CR 6744		
A12.1.1-7	CR 6744		
A12.1.5-4	CR 6744		
A12.1.9-1	CR 6744		
A13.1.2-7	CR 6806A		
A13.1.2-26	CR 6836A		
A13.1.2-27	CR 6835B		
A15.1.1-10	CR 6747B		
A15.1.1-11	CR 6747B		
A15.1.1-13	CR 6747B		
A15.1.1-22	CR 6747B		
A15.1.1-24	CR 6747B		
A15.1.2-2	CR 6755A		
A15.1.2-3	CR 6747B		
A15.1.3-4	CR 6747B		
A15.1.3-5	CR 6747B		
A15.1.3-6	CR 6747B		
A15.1.3-7	CR 6747B		
A15.1.3-8	CR 6747B		
A15.1.3-9	CR 6747B	BOOK MANAGER	<u>WPD 04/22/99</u>
A15.1.4-3	CR 6821A	FINAL QA	<u>mct 04/22/99</u>

Verify that this is the correct version before use.

NEW FLIGHT RULE DESIGNATION

THE NUMBERING SYSTEM HAS BEEN CHANGED TO AN ALPHA NUMERIC DESIGN TO FACILITATE NEW DATABASES FOR MAINTAINING CONFIGURATION MANAGEMENT OF SHUTTLE ALL FLIGHTS DOCUMENT, VOLUME A; SPACE STATION ALL FLIGHTS DOCUMENT, VOLUME B; INTEGRATED SHUTTLE/STATION ALL FLIGHTS DOCUMENT, VOLUME C; SHUTTLE ANNEXES; AND SPACE STATION INCREMENT ANNEXES. THE FORM OF THE NUMBER IS:

A1.1.1-1

THE ALPHA CHARACTER IS THE DESIGNATION OF THE VOLUME.

FIRST NUMERIC IS THE SECTION NUMBER OF THE VOLUME.

SECOND NUMERIC IS THE ELEMENT OF THE VOLUME.

THIRD NUMERIC IS THE PHASE OF THE SECTION.

FOURTH NUMERIC IS THE RULE NUMBER WITHIN THE PHASE.

VOLUME:

- A SPACE SHUTTLE OPERATIONAL FLIGHT RULES - ALL FLIGHTS
- B ISS OPERATIONAL FLIGHT RULES - ALL FLIGHTS
- C INTEGRATED SHUTTLE/STATION OPERATIONAL FLIGHT RULES - ALL FLIGHTS

ANNEX:

- X ANNEXES AND INCREMENT ANNEXES

NOTE: IN ANNEXES, THE "A" PREFIX CHARACTER IS CHANGED TO "X" AND THE TYPICAL ANNEX RULE NUMBER IS: X1.1.1-1.

SECTION:

SECTIONS ARE STANDARDIZED FOR ALL VOLUMES:

1. GENERAL, AUTHORITY, DEFINITIONS
2. FLIGHT OPERATIONS
3. GROUND INSTRUMENTATION
4. TRAJECTORY AND GUIDANCE
5. BOOSTER
6. PROPULSION
7. DATA SYSTEMS
8. GUIDANCE, NAVIGATION, & CONTROL (GN&C)
9. ELECTRICAL
10. MECHANICAL

NEW FLIGHT RULE DESIGNATION

11. COMMUNICATIONS
12. ROBOTICS
13. AEROMEDICAL
14. SPACE ENVIRONMENT
15. EXTRAVEHICULAR ACTIVITY (EVA)
16. POSTLANDING
17. LIFE SUPPORT
18. THERMAL

ELEMENTS:

1. SHUTTLE
2. MULTIPLE ISS PARTNERS
3. INTEGRATED SHUTTLE/ISS
4. RUSSIAN PARTNER (RUSSIAN SEGMENT/SOYUZ/PROGRESS)
5. USOS
6. SPACEHAB
7. JAPANESE PARTNER (JEM)
8. ESA PARTNER (COLUMBUS)
9. SPACELAB
10. CANADIAN PARTNER (ROBOTICS)

PHASE: FLOATS WITHIN THE SECTION

1. OPERATIONS POLICY
2. GENERAL
3. GENERAL DEFINITIONS

RULE NUMBER: CONSECUTIVE NUMBERING SYSTEM AFTER PHASE
DESIGNATION

THE FOLLOWING EXAMPLE IS THE FIRST RULE FROM VOLUME A:

A1.1.1-1 **FLIGHT RULE PURPOSE**

THE FLIGHT RULES OUTLINE PREPLANNED DECISIONS DESIGNED TO MINIMIZE THE AMOUNT OF REAL-TIME RATIONALIZATION REQUIRED WHEN NON-NOMINAL SITUATIONS OCCUR FROM THE START OF THE TERMINAL COUNTDOWN THROUGH CREW EGRESS OR GROUND SUPPORT EQUIPMENT (GSE) COOLING ACTIVATION, WHICHEVER OCCURS LATER.

NEW FLIGHT RULE DESIGNATION

Self-explanatory.

SPACE SHUTTLE OPERATIONAL FLIGHT RULES ANNEX

VOLUME A

ALL FLIGHTS

FINAL, DATED JUNE 6, 1996
PCN-1, DATED AUGUST 22, 1996
PCN-2, DATED OCTOBER 17, 1996
PCN-3, DATED MARCH 12, 1997
PCN-4, DATED MAY 1, 1997
PCN-5, DATED OCTOBER 30, 1997
PCN-6, DATED MARCH 12, 1998
PCN-7, DATED SEPTEMBER 17, 1998
PCN-8, DATED APRIL 22, 1999

PAGE CHANGE NOTICE (PCN) REVISION INSTRUCTION SHEET

THIS PCN-8 REFLECTS CHANGES TO THIS DOCUMENT RELATIVE TO ALL FLIGHTS.
UPDATE THIS DOCUMENT IN ACCORDANCE WITH THE FOLLOWING INSTRUCTIONS.

ADD, REMOVE, OR REMOVE AND REPLACE THE FOLLOWING PAGES:

COVER, VOLUME A	2-129 & 2-130	5-25 & 5-26
	2-130a & 2-130b - ADD	5-27 & 5-28
INSTRUCTION PAGES	2-133 & 2-134	5-29 & 5-30
	2-134a & 2-134b	5-31 & 5-32
CR LIST	2-135 & 2-136	5-33 & 5-34
	2-137 & 2-138	5-69 & 5-70
SIGNATURE PAGE	2-138a & 2-138b	5-71 & 5-72
	2-138c & 2-138d - ADD	5-73 & 5-74
1-i & 1-ii	2-138e & 2-138f - ADD	5-74a & 5-74b - ADD
1-19 & 1-20	2-201 & 2-202	5-75 & 5-76
	2-202a & 2-202b - ADD	5-77 & 5-78
2-i & 2-ii	2-213 & 2-214	5-79 & 5-80
2-19 & 2-20	2-217 & 2-218	5-80a & 5-80b - ADD
2-21 & 2-22		5-80c & 5-80d - ADD
2-23 & 2-24	3-2a & 3-2b	5-85 & 5-86
2-25 & 2-26	3-3 & 3-4	
2-27 & 2-28	3-11 & 3-12	6-97 & 6-98
2-34a & 2-34b	3-12a & 3-12b	6-99 & 6-100
2-34c & 2-34d	3-17 & 3-18	
2-34g & 2-34h		7-5 & 7-6
2-59 & 2-60	4-i & 4-ii	7-25 & 7-26
2-87 & 2-88	4-11 & 4-12	7-31 & 7-32
2-89 & 2-90	4-13 & 4-14	7-33 & 7-34
2-93 & 2-94		7-37 & 7-38
2-107 & 2-108	5-i & 5-ii	7-39 & 7-40
2-109 & 2-110	5-iii & 5-iv	7-45 & 7-46
2-117 & 2-118	5-11 & 5-12	7-49 & 7-50
2-119 & 2-120	5-17 & 5-18	7-51 & 7-52
2-120a & 2-120b - ADD	5-20a & 5-20b	

Verify that this is the correct version before use.

2-121 & 2-122
2-123 & 2-124

5-21 & 5-22
5-23 & 5-24

8-13 & 8-14	12-5 & 12-6
8-65 & 8-66	12-11 & 12-12
8-67 & 8-68	12-13 & 12-14
8-73 & 8-74	12-25 & 12-26
8-74a & 8-74b	12-33 & 12-34
8-75 & 8-76	
	13-i & 13-ii
9-29 & 9-30	13-13 & 13-14
9-31 & 9-32	13-53 & 13-54
	13-55 & 13-56
10-iii & 10-iv	13-57 & 13-58
10-v & 10-vi	13-59 & 13-60
10-1 & 10-2	13-61 & 13-62
10-7 & 10-8	
10-11 & 10-12	15-i & 15-ii
10-12a & 10-12b	15-3 & 15-4
10-13 & 10-14	15-7 & 15-8
10-15 & 10-16	15-9 & 15-10
10-17 & 10-18	15-10a & 15-10b - ADD
10-19 & 10-20	15-19 & 15-20
10-21 & 10-22	15-21 & 15-22
10-22a & 10-22b	15-23 & 15-24
10-23 & 10-24	15-31 & 15-32 - ADD
10-25 & 10-26	15-33 & 15-34 - ADD
10-31 & 10-32	
10-33 & 10-34	17-3 & 17-4
10-34a & 10-34b	17-13 & 17-14
10-39 & 10-40	17-14a & 17-14b - ADD
10-47 & 10-48	17-19 & 17-20
10-51 & 10-52	17-21 & 17-22
10-53 & 10-54	17-22a & 17-22b - ADD
10-55 & 10-56	
10-67 & 10-68	A-15 & A-16
10-69 & 10-70	A-25 & A-26
10-108a & 10-108b-REMOVE	A-27 & A-28
10-108c & 10-108d-REMOVE	
(REMAINDER OF PAGES HAVE	B-i & B-ii
BEEN RENUMBERED.)	B-1 & B-2
10-109 & 10-110	B-3 & B-4
10-111 & 10-112	B-5 & B-6
10-113 & 10-114	B-7 & B-8
10-115 & 10-116	B-9 & B-10
10-117 & 10-118	B-11 & B-12
10-119 & 10-120	
10-121 & 10-122 - ADD	C-1 & C-2
10-123 & 10-124 - ADD	
10-125 & 10-126 - ADD	DISTRIBUTION LIST
10-127 & 10-128 - ADD	
10-129 & 10-130 - ADD	
10-131 & 10-132 - ADD	

Verify that this is the correct version before use.

11-11 & 11-12
11-29 & 11-30

Verify that this is the correct version before use.

SPACE SHUTTLE OPERATIONAL FLIGHT RULES ANNEX

ALL FLIGHTS

VOLUME A

FINAL, PCN-8

PREFACE

THIS DOCUMENT, DATED APRIL 22, 1999, IS PCN-8 TO THE VOLUME A VERSION, DATED JUNE 6, 1996, OF THE SPACE SHUTTLE OPERATIONAL FLIGHT RULES AND IS INTENDED TO BE USED IN CONJUNCTION WITH THE SPACE SHUTTLE OPERATIONAL FLIGHTS RULES ANNEX (NSTS-18308) WHICH CONTAINS THE FLIGHT SPECIFIC RULES. INCLUDED IN THIS PUBLICATION ARE FLIGHT RULE CHANGES APPROVED IN FLIGHT RULES CONTROL BOARD (FRCB) MEETINGS 111, 112, AND 113, HELD ON NOVEMBER 12, 1998, FEBRUARY 11, 1999, AND APRIL 8, 1999, RESPECTIVELY.

THIS DOCUMENT USES A NEW RULE NUMBER SYSTEM DESIGNED TO FACILITATE NEW DATABASES FOR MAINTAINING CONFIGURATION MANAGEMENT OF SHUTTLE ANNEXES, ALL FLIGHTS FLIGHT RULES DOCUMENT, VOLUME A; SPACE STATION INCREMENT ANNEXES; SPACE STATION ALL FLIGHTS DOCUMENT, VOLUME B; AND THE INTEGRATED SHUTTLE/STATION ALL FLIGHTS DOCUMENT, VOLUME C. AN EXPLANATION OF THE NEW NUMBERING SYSTEM IS SHOWN ON PAGE VII.

IT IS REQUESTED THAT ANY ORGANIZATION HAVING COMMENTS, QUESTIONS, OR SUGGESTIONS CONCERNING THESE FLIGHT RULES CONTACT DA8/W. PRESTON DILL, FLIGHT DIRECTOR OFFICE, BUILDING 4 NORTH, ROOM 3027A, PHONE 713-483-5418.

ALL FLIGHT RULES ARE ON THE INTERNET. THE URL IS:
<http://flight.jsc.nasa.gov/rulesindex.html>. THE USERID IS **FLTGUEST**. THE PASSWORD IS AVAILABLE FROM PRESTON DILL AT THE ABOVE ADDRESS AND PHONE NUMBER.

THIS IS A CONTROLLED DOCUMENT AND ANY CHANGES ARE SUBJECT TO THE CHANGE CONTROL PROCEDURES DELINEATED IN APPENDIX B. THIS DOCUMENT IS NOT TO BE REPRODUCED WITHOUT THE WRITTEN APPROVAL OF THE CHIEF, FLIGHT DIRECTOR OFFICE, DA8, LYNDON B. JOHNSON SPACE CENTER, HOUSTON, TEXAS.

Verify that this is the correct version before use.

APPROVED BY:



JEFFREY W. BANTLE
CHIEF, FLIGHT DIRECTOR OFFICE

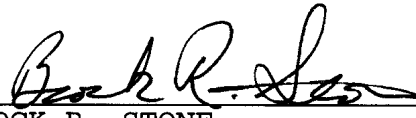

BROCK R. STONE
DIRECTOR, MISSION OPERATIONS



R. D. DITTEMORE
MANAGER, SPACE SHUTTLE PROGRAM

VOLUME A KEY

<u>OLD RULE #</u>	<u>RULE TITLE</u>	<u>NEW RULE #</u>
SECTION 1 - GENERAL AUTHORITY AND DEFINITIONS		
OPERATIONS POLICY		
1-1	FLIGHT RULE PURPOSE	A1.1.1-1
1-2	REAL-TIME OPERATING POLICY	A1.1.1-2
1-3	PROGRAM LIFETIME OPERATING POLICY	A1.1.1-3
1-4	MISSION MANAGEMENT TEAM (MMT) AUTHORITY	A1.1.1-4
1-5	FLIGHT DIRECTOR AUTHORITY	A1.1.1-5
1-6	SHUTTLE COMMANDER AUTHORITY	A1.1.1-6
1-7	FLIGHT CONTROL ROOM (FCR) SURGEON AUTHORITY	A1.1.1-7
1-8	LAUNCH SYSTEMS EVALUATION ADVISORY TEAM (LSEAT) AUTHORITY	A1.1.1-8
1-9	WEATHER DECISION AUTHORITY	A1.1.1-9
1-10	POSTLANDING DECISION AUTHORITY	A1.1.1-10
1-11	POSTLANDING EMERGENCY DECLARATION	A1.1.1-11
1-12	SEARCH AND RESCUE RESPONSIBILITY	A1.1.1-12
1-13	ORBITER EMERGENCY LANDING SITE (ELS) AUTHORITY	A1.1.1-13
1-14	MCC REAL-TIME COMMAND COORDINATION POLICY	A1.1.1-14
GENERAL		
1-20	VEHICLE SYSTEM LIMITS	A1.1.2-1
1-21	INTERIM OR UNCONFIRMED LIMITS	A1.1.2-2
1-22	MANDATORY INSTRUMENTATION REQUIREMENTS	A1.1.2-3
1-23	FAILURE DEFINITION APPLICATION	A1.1.2-4
1-24	CONFLICTING FLIGHT RULES	A1.1.2-5
1-25	INSTRUMENTATION ONBOARD VS. GROUND READOUT PHILOSOPHY	A1.1.2-6
1-26	FLIGHT-CRITICAL MODING	A1.1.2-7
1-27	SHUTTLE OPERATIONAL DATA BOOK (SODB), VOLUME III, DATA USE	A1.1.2-8
1-28	ACTIVITIES DURING YEAR END ROLLOVER/LEAP SECOND INCORPORATION	A1.1.2-9
GENERAL DEFINITIONS		
1-30	AS SOON AS PRACTICAL (ASAP)	A1.1.3-1
1-31	HIGHLY DESIRABLE (HD)	A1.1.3-2
1-32	MANDATORY (M)	A1.1.3-3
1-33	FLIGHT PHASE	A1.1.3-4
1-34	THROTTLE SETTINGS	A1.1.3-5
1-35	LANDING SITES	A1.1.3-6
1-36	LANDING OPPORTUNITIES	A1.1.3-7
1-37	POSTLANDING CREW EGRESS/ESCAPE MODES	A1.1.3-8
1-38	CREW MEDICAL (MED) CONDITIONS	A1.1.3-9
1-39	REMOTE MANIPULATOR SYSTEM (RMS)	A1.1.3-10
1-40	TIME REFERENCE DEFINITIONS	A1.1.3-11

SECTION 2 - FLIGHT OPERATIONS RULES

PRELAUNCH

2-1	PRELAUNCH GO/NO-GO REQUIREMENTS	A2.1.1-1
2-2	ABORT LANDING SITE REQUIREMENTS	A2.1.1-2
2-3	LAUNCH HOLD	A2.1.1-3
2-4	LAUNCH DAY CREW TIME CONSTRAINTS	A2.1.1-4
2-5	PORT MODING/RESTRINGING GUIDELINES	A2.1.1-5
2-6	LANDING SITE WEATHER CRITERIA	A2.1.1-6
2-7	DAY-OF-LAUNCH ET LOAD DATA	A2.1.1-7

ASCENT

2-10	STS ABORT CRITERIA	A2.1.2-1
2-11	ASCENT MODE PRIORITIES FOR PERFORMANCE CASES	A2.1.2-2
2-12	FORWARD RCS USAGE GUIDELINES	A2.1.2-3
2-13	RTLS, TAL, AND AOA ABORTS FOR SYSTEMS FAILURES (CIL)	A2.1.2-4
2-14	USE OF LOW ENERGY GUIDANCE	A2.1.2-5
2-15	ABORT GAP	A2.1.2-6
2-16	CONTINGENCY ASCENTS/ABORTS	A2.1.2-7

VOLUME A KEY

<u>OLD RULE #</u>	<u>RULE TITLE</u>	<u>NEW RULE #</u>
2-17	RANGE SAFETY ARM ACTION	A2.1.2-8
2-18	ABORT LIGHT	A2.1.2-9
2-19	BFS ENGAGE CRITERIA	A2.1.2-10
2-20	NAVIGATION UPDATE CRITERIA	A2.1.2-11
2-21	Q-BAR/G-CONTROL	A2.1.2-12
2-22	ET FOOTPRINT CRITERIA	A2.1.2-13
2-23	ASCENT STRING REASSIGNMENT	A2.1.2-14
2-24	MANUAL THROTTLE CRITERIA	A2.1.2-15
2-25	OMS-1 DELAYED TARGET CRITERIA	A2.1.2-16
2-26	APU SHUTDOWN DELAY CRITERIA	A2.1.2-17
2-27	ARD UPDATE CRITERIA	A2.1.2-18
2-28	ET PHOTOGRAPHY	A2.1.2-19
2-29	REGAIN RCS JETS FOR RTLS ET SEPARATION	A2.1.2-20
ORBIT		
2-30	MISSION DURATION REQUIREMENTS	A2.1.3-1
2-31	EXTENSION DAY REQUIREMENTS	A2.1.3-2
2-32	SYSTEMS REDUNDANCY REQUIREMENTS	A2.1.3-3
2-40	IN-FLIGHT MAINTENANCE (IFM)	A2.1.3-4
2-41	PBD OPERATIONS (CIL)	A2.1.3-5
2-42	EVA GUIDELINES	A2.1.3-6
2-43	CONSUMABLES MANAGEMENT	A2.1.3-7
2-44	PREFERRED ATTITUDE FOR WATER DUMPS	A2.1.3-8
2-45	STRUCTURES THERMAL CONDITIONING	A2.1.3-9
2-50	OMS/RCS PROPELLANT REQUIRED TO COMMIT TO EVA/MMU OPERATIONS	A2.1.3-10
2-51	ORBITER OMS/RCS PROPELLANT REDLINE TO TERMINATE MMU RESCUE	A2.1.3-11
2-52	DPS COMMAND CRITERIA	A2.1.3-12
2-53	PDRS	A2.1.3-13
2-54	OMS/RCS DOWNMODING CRITERIA	A2.1.3-14
2-55	OMS/RCS MANEUVER CRITICALITY	A2.1.3-15
2-56	ENGINE SELECTION CRITERIA	A2.1.3-16
2-60	RENDEZVOUS (RNDZ)/PROXIMITY OPERATIONS (PROX OPS) DEFINITIONS	A2.1.3-17
2-61	RNDZ/PROX OPS GNC SYSTEMS MANAGEMENT	A2.1.3-18
2-62	RNDZ/PROX OPS COMMUNICATION SYSTEMS MANAGEMENT	A2.1.3-19
2-63	RNDZ/PROX OPS NAVIGATION SENSORS REQUIREMENTS	A2.1.3-20
2-64	RNDZ/PROX OPS DPS SYSTEMS MANAGEMENT	A2.1.3-21
2-65	RNDZ/PROX OPS PROPULSION SYSTEMS MANAGEMENT	A2.1.3-22
2-66	RENDEZVOUS MANEUVERS	A2.1.3-23
2-67	RENDEZVOUS MANEUVER SOLUTION SELECTION CRITERIA	A2.1.3-24
2-68	RENDEZVOUS MANEUVER EXECUTION	A2.1.3-25
2-69	RNDZ OPS DELAY	A2.1.3-26
2-70	RNDZ/PROX OPS BREAKOUT	A2.1.3-27
2-71	RENDEZVOUS GUIDANCE	A2.1.3-28
2-73	EMCC/TMCC ACTIVATION	A2.1.3-29
2-74	ORBITER ON-ORBIT HIGH DATA RATE REQUIREMENTS	A2.1.3-30
2-75	PAYLOAD OBJECTIVES VS. PAYLOAD DAMAGE POLICY	A2.1.3-31
2-77	ATTITUDE RESTRICTIONS FOR ORBITAL DEBRIS	A2.1.3-32
2-78	THERMAL CONDITIONING FOR FLIGHT DAY 1 LANDING	A2.1.3-33
DEORBIT		
2-80	DEORBIT GUIDELINES	A2.1.4-1
2-81	EXTENSION DAY GUIDELINES	A2.1.4-2
2-82	DEORBIT DELAY GUIDELINES	A2.1.4-3
2-83	MDF DEORBIT GUIDELINES	A2.1.4-4
2-84	EMERGENCY DEORBIT	A2.1.4-5
2-85	DEROTATION SPEED	A2.1.4-6
2-86	LANDING SITE SELECTION	A2.1.4-7
2-87	LES PRESSURE INTEGRITY CHECK	A2.1.4-8
2-88	LANDING SITE SELECTION FOR AN INFLIGHT EMERGENCY	A2.1.4-9
ENTRY		
2-89	BAILOUT	A2.1.5-1
2-90	GCA CRITERIA	A2.1.5-2
2-91	ENERGY MANAGEMENT	A2.1.5-3

VOLUME A KEY

<u>OLD RULE #</u>	<u>RULE TITLE</u>	<u>NEW RULE #</u>
2-92	ENTRY STRING REASSIGNMENT	A2.1.5-4
2-93	CREW TAKEOVER	A2.1.5-5
2-94	EARLY POWERDOWN	A2.1.5-6
2-95	DEORBIT BURN TERMINATION	A2.1.5-7
2-96	BFS ENGAGE	A2.1.5-8
2-97	CHASE AIRCRAFT OPERATIONS	A2.1.5-9
2-98	ENTRY LOAD MINIMIZATION	A2.1.5-10
2-100	ENTRY DTO/AUTO MODE/CROSSWIND DTO GO/NO-GO	A2.1.5-11
2-101	LANDING DTO'S	A2.1.5-12
2-102	STA/WEATHER AIRCRAFT RUNWAY APPROACH OPERATIONS FOR SITES WITH ONLY ONE RUNWAY	A2.1.5-13
2-103	EMERGENCY LANDING FACILITY CRITERIA	A2.1.5-14
	CONTINGENCY ACTION SUMMARY	
2-200	CONTINGENCY ACTION SUMMARY	A2.1.6-1
	GO/NO-GO	
2-201	ORBITER SYSTEMS GO/NO-GO	A2.1.7-1
	SPACEHAB OPERATIONS MANAGEMENT	
30.1-1	SPACEHAB SAFETY DEFINITION AND MANAGEMENT	A2.6.1-1
30.1-2	REAL-TIME SAFETY COORDINATION	A2.6.1-2
30.1-3	GROUND COMMANDING	A2.6.1-3
30.1-4	SPACEHAB MINIMUM DURATION FLIGHT CRITERIA	A2.6.1-4
30.1-5	POWERING OFF AND REPOWERING SPACEHAB EQUIPMENT	A2.6.1-5
30.1-6	ORBITER/SPACEHAB/EXPERIMENT THERMAL PRIORITIES	A2.6.1-6

VOLUME A KEY

<u>OLD RULE #</u>	<u>RULE TITLE</u>	<u>NEW RULE #</u>
30.1-8	ORBITER-TO-SPACEHAB INTERFACE	A2.6.1-7
30.1-9	FIRE/SMOKE IN SPACEHAB	A2.6.1-8
30.1-10	ORBITAL MANEUVERING SYSTEM/REACTION CONTROL SYSTEM (OMS/RCS) CONSTRAINTS	A2.6.1-9
30.1-11	ELECTRICAL POWER SUBSYSTEM (EPS) CONSTRAINTS	A2.6.1-10
30.1-12	WATER DUMP MANAGEMENT	A2.6.1-11
30.1-13	COMMAND AND DATA SYSTEM CONSTRAINTS	A2.6.1-12
30.1-14	SPACEHAB CAUTION AND WARNING ANNUNCIATION IN MODULE	A2.6.1-13
30.1-15	COMMUNICATIONS CONSTRAINTS	A2.6.1-14
30.1-16	SPACEHAB IN-FLIGHT MAINTENANCE (IFM) PROCEDURES	A2.6.1-15
30.1-17	IFM PROCEDURES ON EXPERIMENTS WITH TOXIC HAZARDS	A2.6.1-16
30.1-18	SAFE ATMOSPHERE REQUIREMENTS PREFLIGHT	A2.6.1-17
30.1-19	EVA	A2.6.1-18
30.1-20	EQUIPMENT EXCHANGE BETWEEN ORBITER CABIN AND SPACEHAB MODULE	A2.6.1-19
30.1-21	SPACEHAB MODULE/TUNNEL SLEEP CONSTRAINTS	A2.6.1-20
30.1-22	COMMANDER (CDR) AND PILOT (PLT) PARTICIPATING AS TEST SUBJECTS	A2.6.1-21
30.1-23	CREW LIMITATIONS IN THE SPACEHAB MODULE	A2.6.1-22
30.1-24	SPACEHAB DEACTIVATION	A2.6.1-23
30.1-25	EXTENSION DAY GROUND RULES	A2.6.1-24
	POWERED/UNPOWERED ASCENT/ENTRY	
30.1-26	LOSS OF SM GPC DURING SPACEHAB ACTIVATION/DEACTIVATION (ACT/DEACT)	A2.6.1-1
30.1-27	LOSS OF PAYLOAD MDM DURING SPACEHAB ACT/DEACT	A2.6.2-2
30.1-28	PAYLOAD MDM HARD FAILURE	A2.6.2-3
30.1-29	LOSS OF SM MAJOR FUNCTION	A2.6.2-4
30.1-30	LOSS OF ORBITER MASTER TIMING UNIT (MTU)/PAYLOAD TIMING BUFFER	A2.6.2-5
30.1-31	PF1 FIRST PAYLOAD MDM CHOICE	A2.6.2-6
30.1-32	ORBITER FREON FLOW PROPORTIONING VALVE (FPV) USAGE	A2.6.2-7
30.1-33	SPACEHAB AIR-TO-GROUND (A/G) USAGE	A2.6.2-8
30.1-34	SPACEHAB CONTINGENCY GROUND COMMANDING	A2.6.2-9
	SPACELAB OPERATIONS MANAGEMENT	
31.1-1	SPACELAB SAFETY DEFINITION AND MANAGEMENT	A2.9.1-1
31.1-2	REAL-TIME SAFETY COORDINATION	A2.9.1-2
31.1-3	GROUND COMMANDING	A2.9.1-3
31.1-4	SPACELAB MINIMUM DURATION FLIGHT CRITERIA	A2.9.1-4
31.1-5	POWERING OFF AND REPOWERING SPACELAB EQUIPMENT	A2.9.1-5
31.1-6	ORBITER/SPACELAB/EXPERIMENTS THERMAL PRIORITIES	A2.9.1-6
31.1-8	ORBITER-TO-SPACELAB PRESSURE INTERFACE MODULE	A2.9.1-7
31.1-9	FIRE/SMOKE IN SPACELAB MODULE	A2.9.1-8
31.1-10	ORBITAL MANEUVERING SYSTEM/REACTION CONTROL SYSTEM (OMS/RCS) CONSTRAINTS	A2.9.1-9
31.1-11	ELECTRICAL POWER DISTRIBUTION SYSTEM CONSTRAINTS	A2.9.1-10
31.1-12	WATER DUMP MANAGEMENT	A2.9.1-11
31.1-13	COMMAND AND DATA SYSTEM CONSTRAINTS	A2.9.1-12
31.1-14	SPACELAB CAUTION AND WARNING (C&W) ANNUNCIATION MODULE	A2.9.1-13
31.1-15	COMMUNICATIONS (COMM) CONSTRAINTS	A2.9.1-14
31.1-16	PAYLOAD IN-FLIGHT MAINTENANCE (IFM) PROCEDURES	A2.9.1-15
31.1-17	IFM PROCEDURES ON EXPERIMENTS WITH TOXIC HAZARDS	A2.9.1-16
31.1-18	SAFE ATMOSPHERE REQUIREMENTS PREFLIGHT	A2.9.1-17
31.1-19	EVA	A2.9.1-18
31.1-20	EQUIPMENT EXCHANGE BETWEEN ORBITER CABIN AND SPACELAB	A2.9.1-19
31.1-21	SPACELAB MODULE/TUNNEL SLEEP CONSTRAINTS	A2.9.1-20
31.1-22	COMMANDER (CDR), PILOT (PLT), AND MISSION SPECIALIST (MS) 2 PARTICIPATING AS TEST SUBJECTS	A2.9.1-21
31.1-23	ORBITER CREW ASSISTING IN THE MODULE	A2.9.1-22
31.1-24	SPACELAB DEACTIVATION	A2.9.1-23
31.1-25	EXTENSION DAY GROUND RULES	A2.9.1-24
31.1-26	LOSS OF SM GPC DURING SPACELAB ACTIVATION/DEACTIVATION (ACT/DEACT)	A2.9.1-25
31.1-27	LOSS OF PAYLOAD/FLEX MDM DURING SPACELAB ACT/DEACT	A2.9.1-26
31.1-28	PAYLOAD/FLEX MDM HARD FAIL	A2.9.1-27

VOLUME A KEY

<u>OLD RULE #</u>	<u>RULE TITLE</u>	<u>NEW RULE #</u>
31.1-29	LOSS OF SM OR GUIDANCE, NAVIGATION, AND CONTROL (GNC) MAJOR FUNCTION	A2.9.1-28
31.1-30	SPACELAB CONSTRAINTS ON RECOVERING MASTER TIMING UNIT (MTU)	A2.9.1-29
31.1-31	PF 1 FIRST CHOICE FOR KU-BAND	A2.9.1-30
31.1-32	ORBITER FREON FLOW PROPORTIONING VALVE (FPV) USAGE	A2.9.1-31
31.1-33	SPACELAB AIR-TO-GROUND (A/G) USAGE	A2.9.1-32
31.1-34	SPACELAB DEACTIVATION CONSTRAINTS	A2.9.1-33
31.1-35	UNPOWERED THERMAL CONSTRAINTS	A2.9.1-34
31.1-36	UNIQUE SUPPORT STRUCTURE THERMAL CONSTRAINT	A2.9.1-35

VOLUME A KEY

<u>OLD RULE #</u>	<u>RULE TITLE</u>	<u>NEW RULE #</u>
SECTION 3 - GROUND INSTRUMENTATION		
GENERAL		
3-1	GROUND REQUIREMENTS OVERVIEW	A3.1.1-1
3-2	HARDWARE/SOFTWARE CRITICALITY	A3.1.1-2
MCC INSTRUMENTATION PRELAUNCH REQUIREMENTS		
3-10	COMPUTERS	A3.1.2-1
3-11	TELEMETRY	A3.1.2-2
3-12	COMMAND	A3.1.2-3
3-13	TRAJECTORY PROCESSING	A3.1.2-4
3-14	MCC INTERNAL VOICE	A3.1.2-5
3-15	DISPLAY	A3.1.2-6
3-16	TIMING	A3.1.2-7
3-17	MCC POWER	A3.1.2-8
45 SPW/GSFC/STDN PRELAUNCH REQUIREMENTS		
3-20	DATA PROCESSORS	A3.1.3-1
3-21	GSFC	A3.1.3-2
3-22	STDN FAILURE DECISION MATRIX	A3.1.3-3
MCC EXTERNAL INTERFACE (VOICE DATA) PRELAUNCH REQUIREMENTS		
3-30	MCC/KSC/45 SPW INTERFACE	A3.1.4-1
3-31	GSFC/STDN INTERFACE	A3.1.4-2
3-32	45 SPW/VAFB INTERFACE	A3.1.4-3
3-33	45 SPW/WSMR INTERFACE	A3.1.4-4
3-34	MCC/GSFC/NGT INTERFACE	A3.1.4-5
3-35	MCC/ASCENT ABORT SITE INTERFACE	A3.1.4-6
NAVAIDS REQUIREMENTS		
3-40	TACAN REDUNDANCY REQUIREMENTS AND ALTERNATE TACAN SELECTION PHILOSOPHY	A3.1.5-1
3-41	MLS	A3.1.5-2
3-42	LANDING AID REQUIREMENTS	A3.1.5-3

SECTION 4 - TRAJECTORY AND GUIDANCE

PRELAUNCH

4-1	PERFORMANCE ANALYSES	A4.1.1-1
4-2	LANDING SITE CONDITIONS	A4.1.1-2
4-3	ORBIT CONJUNCTIONS/CONFLICTS	A4.1.1-3

ASCENT

4-20	KALMAN FILTER SOLUTION	A4.1.2-1
4-21	ARD THRUST UPDATE CRITERIA AND FPR	A4.1.2-2
4-22	USE OF MAXIMUM THROTTLES	A4.1.2-3
4-23	SRB JETTISON	A4.1.2-4
4-24	ABORT MODE RESPONSIBILITY	A4.1.2-5
4-25	DESIGN AND CRITICAL MECO UNDERSPEED DEFINITIONS	A4.1.2-6
4-26	PERFORMANCE BOUNDARIES	A4.1.2-7
4-27	NAVIGATION UPDATES	A4.1.2-8
4-28	AUTO GUIDANCE NO-GO	A4.1.2-9
4-29	MANUAL THROTTLE SELECTION	A4.1.2-10
4-30	FCO ABORT REQUEST	A4.1.2-11
4-31	MANUAL SHUTDOWN CRITERIA	A4.1.2-12
4-32	THRUST LIMITING, HYDRAULIC, OR ELECTRICAL LOCKUP	A4.1.2-13
4-33	OMS-1/OMS-2 EXECUTION	A4.1.2-14
4-34	RANGE SAFETY LIMIT AVOIDANCE	A4.1.2-15

VOLUME A KEY

<u>OLD RULE #</u>	<u>RULE TITLE</u>	<u>NEW RULE #</u>
	ORBIT	
4-50	ONBOARD NAVIGATION MAINTENANCE	A4.1.3-1
4-51	MINIMUM ORBITAL LIFETIME	A4.1.3-2
4-52	OFF-NOMINAL ORBITAL ALTITUDE RECOVERY PRIORITIES	A4.1.3-3
4-53	OMS LEAK/PERIGEE ADJUST	A4.1.3-4
4-60	MINIMUM TIME OF FREE FALL	A4.1.3-5
4-61	COLLISION AVOIDANCE GUIDELINES	A4.1.3-6
4-62	PLS/EOM LANDING OPPORTUNITY REQUIREMENTS	A4.1.3-7
4-63	TIRE SPEED, BRAKING, AND ROLLOUT REQUIREMENTS	A4.1.3-8
4-65	DEORBIT PRIORITY FOR EOM WEATHER	A4.1.3-9

VOLUME A KEY

<u>OLD RULE #</u>	<u>RULE TITLE</u>	<u>NEW RULE #</u>
4-66	AIMPOINT, EVALUATION VELOCITY, AND SHORT FIELD SELECTION	A4.1.3-10
4-67	RUNWAY ACCEPTABILITY CONDITIONS	A4.1.3-11
4-68	LOWER LEVEL MEASURED WIND AND ATMOSPHERIC DATA	A4.1.3-12
ENTRY PLANNING		
4-70	IMU ALIGNMENT	A4.1.4-1
4-71	TARGETING PRIORITIES	A4.1.4-2
4-72	CG PLANNING	A4.1.4-3
4-73	DOWNRACK ERROR	A4.1.4-4
4-74	SUN ANGLE LIMITS AND GLARE CRITERIA FOR INNER AND OUTER GLIDE SLOPES	A4.1.4-5
4-75	HAC SELECTION CRITERIA	A4.1.4-6
4-76	ENERGY DOWNMODING	A4.1.4-7
4-77	MANEUVER EXECUTION MATRIX	A4.1.4-8
ENTRY		
4-80	DELTA-T UPDATE CRITERIA	A4.1.5-1
4-81	DEORBIT BURN COMPLETION	A4.1.5-2
4-82	DELTA STATE UPDATE PHILOSOPHY	A4.1.5-3
4-83	DELTA STATE POSITION UPDATES	A4.1.5-4
4-84	DELTA STATE VELOCITY UPDATES	A4.1.5-5
4-85	NAVIGATION FILTER MANAGEMENT AUTO/INHIBIT/FORCE (AIF)	A4.1.5-6
4-86	ENTRY LIMITS	A4.1.5-7
4-87	ENTRY TAKEOVER RULES	A4.1.5-8
4-88	AERO TEST MANEUVERS	A4.1.5-9
STS RANGE SAFETY RULES AND AGREEMENTS		
	SIGNATURE SECTION	A4.1.6-0
R-0	POLICY	A4.1.6-1
R-1	FLIGHT TERMINATION ACTION	A4.1.6-2
R-2	FLIGHT TERMINATION CRITERIA	A4.1.6-3
R-3	WARNING NOTIFICATION	A4.1.6-4
R-4	FD/FDO REPORTING	A4.1.6-5
	TABLE R-4-I - STS RANGE SAFETY FLIGHT RULES	A4.1.6-6
	TABLE R-4-II.- LOSS OF TELEMETRY/COMMUNICATION FLIGHT RULE SUMMARY	A4.1.6-7

SECTION 5 - BOOSTER

FAILURE DEFINITIONS

5-1	LOSS OF SRB HYDRAULIC POWER UNIT (HPU)	A5.1.1-1
5-2	SSME ENGINE OUT	A5.1.1-2
5-3	STUCK THROTTLE	A5.1.1-3
5-4	DATA PATH FAILURE	A5.1.1-4
5-5	SUSPECT ENGINE	A5.1.1-5
5-6	SSME REDLINE SENSOR FAILED	A5.1.1-6
5-7	SIGNIFICANT ENGINE HELIUM SYSTEM LEAK	A5.1.1-7
5-8	SIGNIFICANT PNEUMATIC SYSTEM HELIUM LEAK	A5.1.1-8
5-9	INSUFFICIENT PNEUMATIC HELIUM ACCUMULATOR PRESSURE	A5.1.1-9
5-10	MPS PROPELLANT DUMPS AND INERTING DEFINITIONS	A5.1.1-10

SRB SYSTEMS MANAGEMENT

5-20	LOSS OF SRB HYDRAULIC POWER UNITS (HPU)	A5.1.2-1
------	---	----------

SSME SYSTEMS MANAGEMENT

5-25	ABORT CUE REQUIREMENT	A5.1.3-1
5-26	AUTO/MANUAL SHUTDOWN	A5.1.3-2
5-27	LIMIT SHUTDOWN CONTROL	A5.1.3-3
5-29	DATA PATH FAIL/ENGINE-ON LIMIT SHUTDOWN CONTROL	A5.1.3-4
5-30	DATA PATH FAIL/ENGINE-OUT ACTION	A5.1.3-5
5-32	MANUAL SHUTDOWN FOR COMMAND/DATA PATH FAILURES	A5.1.3-6
5-33	MANUAL SHUTDOWN FOR HYDRAULIC OR ELECTRICAL LOCKUP	A5.1.3-7

VOLUME A KEY

<u>OLD RULE #</u>	<u>RULE TITLE</u>	<u>NEW RULE #</u>
5-34	MANUAL SHUTDOWN FOR TWO STUCK THROTTLES (NOT DUAL APU FAILURES)	A5.1.3-8
5-35	ENGINE PERFORMANCE DISPERSION	A5.1.3-9
5-36	AC BUS SENSOR ELECTRONICS CONTROL (CIL)	A5.1.3-10
5-38	MANUAL THROTTLEDOWN FOR LO2 NPSP PROTECTION AT SHUTDOWN	A5.1.3-11
5-39	MANUAL SHUTDOWN FOR SUSPECT COMMAND PATH FAILURES	A5.1.3-12
5-40	MECO CONFIRMED	A5.1.3-13
5-42	SSME HYDRAULIC REPRESSURIZATION/POSTLANDING SSME REPOSITIONING	A5.1.3-14
	MPS MANAGEMENT: PRELAUNCH THROUGH MECO	
5-45	PRE-MECO MPS HELIUM SYSTEM LEAK ISOLATION (CIL)	A5.1.4-1
5-46	PRE-MECO MPS HELIUM SYSTEM INTERCONNECTS (CIL)	A5.1.4-2
5-47	PRE-MECO SHUT DOWN OF ENGINES DUE TO MPS HELIUM LEAKS	A5.1.4-3

VOLUME A KEY

<u>OLD RULE #</u>	<u>RULE TITLE</u>	<u>NEW RULE #</u>
5-49	LH2 TANK PRESSURIZATION	A5.1.4-4
5-50	MANUAL THROTTLING FOR LOW LH2 NPSP	A5.1.4-5
5-51	ABORT PREFERENCE FOR SYSTEMS FAILURES	A5.1.4-6
5-52	ET LOW LEVEL CUTOFF SENSOR FAILED DRY	A5.1.4-7
MPS MANAGEMENT: POST-MECO		
5-60	ET SEPARATION INHIBIT FOR 17-INCH DISCONNECT FAILURE (CIL)	A5.1.5-1
5-61	MPS PROPELLANT MANIFOLD OVERPRESSURE (CIL)	A5.1.5-2
5-62	POST-MECO AND ENTRY HELIUM ISOLATION	A5.1.5-3
5-64	MANUAL MPS PROPELLANT DUMP	A5.1.5-4
5-65	NOMINAL, AOA, AND ATO MPS PROPELLANT DUMP FAILURES	A5.1.5-5
5-66	MANUAL VACUUM INERTING REQUIREMENTS (NOMINAL, ATO, AOA)	A5.1.5-6
5-67	REPEAT MPS VACUUM INERT	A5.1.5-7
5-68	LH2 PRESSURIZATION VENT CONTROL	A5.1.5-8
5-69	ENTRY MPS HELIUM PURGING FOR CRITICAL VEHICLE POWER/COOLING	A5.1.5-9
5-71	ENTRY MPS PROPELLANT DUMP FAILURES	A5.1.5-10
5-72	MPS DUMP INHIBIT	A5.1.5-11

SECTION 6 - PROPULSION

FAILURE DEFINITIONS

6-1	OMS/RCS HELIUM TANK	A6.1.1-1
6-2	OMS PROPELLANT TANK (OXIDIZER OR FUEL)	A6.1.1-2
6-3	OMS ENGINE	A6.1.1-3
6-4	OMS N2 SYSTEM	A6.1.1-4
6-5	OMS N2 TANK	A6.1.1-5
6-7	RCS THRUSTER FAILURE	A6.1.1-6
6-8	RCS PROPELLANT TANK (OXIDIZER OR FUEL)	A6.1.1-7
6-9	OMS/RCS CROSSFEED LINE	A6.1.1-8
6-10	OMS/RCS POD HEATER	A6.1.1-9
6-11	RCS JET HEATER	A6.1.1-10
6-12	AFT RCS PROPELLANT TANK FAIL/HELIUM INGESTION	A6.1.1-11

SYSTEMS MANAGEMENT

6-20	OMS N2 TANK FAILURE MANAGEMENT	A6.1.2-1
6-21	OMS/RCS LEAKING HE TANK BURN	A6.1.2-2
6-22	OMS LEAKING HE SYSTEM BURN	A6.1.2-3
6-23	OMS TANK FAIL CROSSFEED OR INTERCONNECT CONSTRAINT (CIL)	A6.1.2-4
6-24	OMS PROPELLANT SETTling REQUIREMENT	A6.1.2-5
6-25	OMS ENGINE BURN TO DEPLETION	A6.1.2-6
6-26	OMS BALL VALVE FAILURE MANAGEMENT	A6.1.2-7
6-27	OMS ENGINE INSTRUMENTATION REQUIREMENT	A6.1.2-8
6-28	RCS MANIFOLD CLOSURE CRITERIA	A6.1.2-9
6-29	RCS LEAKING PROPELLANT TANK BURN	A6.1.2-10
6-30	RCS MANIFOLD/OMS CROSSFEED LINE REPRESSURIZATION (CIL)	A6.1.2-11
6-31	RCS RM FAIL THRUSTER TEST	A6.1.2-12
6-32	CONTINGENCY RCS PROPELLANT AVAILABLE	A6.1.2-13
6-33	OMS/RCS CONTINUOUS VALVE POWER FAILURE MANAGEMENT	A6.1.2-14
6-34	OMS N2 REGULATOR FAILURE MANAGEMENT	A6.1.2-15
6-35	RCS LINE LEAK MANAGEMENT	A6.1.2-16
6-40	OMS FAILURE MANAGEMENT (CIL)	A6.1.2-17
6-41	RCS FAILURE MANAGEMENT	A6.1.2-18
6-42	RCS RM LOSS	A6.1.2-19
6-43	RCS MAXIMUM BURN TIME	A6.1.2-20
6-44	OMS HELIUM INGESTION	A6.1.2-21
6-45	RCS JET DRIVER MANAGEMENT (CIL)	A6.1.2-22
6-46	RCS BLOWDOWN	A6.1.2-23
6-47	CROSSFEED/INTERCONNECT DURING CREW SLEEP	A6.1.2-24
6-48	OMS ENGINE FAILURE MANAGEMENT	A6.1.2-25
6-49	RCS HOT-FIRE CHECK	A6.1.2-26
6-50	RCS VERNIER OPERATION TERMINATION	A6.1.2-27
6-51	OMS ENGINE INLET PRESSURE REQUIREMENTS	A6.1.2-28

VOLUME A KEY

<u>OLD RULE #</u>	<u>RULE TITLE</u>	<u>NEW RULE #</u>
6-52	LEAKING JET MANAGEMENT RULES	A6.1.2-29
6-54	OMS LEAKING INLET LINE PERIGEE ADJUST BURN	A6.1.2-30
6-55	RCS JET REPRIORITIZATION CRITERIA	A6.1.2-31
6-56	FAILED PRCS JET RESELECTION PRIORITY	A6.1.2-32
6-57	OMS ENGINE BELL MOVEMENT DURING ASCENT	A6.1.2-33
6-58	OMS BURN DOWNLIST REQUIREMENT	A6.1.2-34
6-59	PRELAUNCH RCS PVT INITIALIZATION (INIT) TMBU	A6.1.2-35
6-60	OMS GN2 ACCUMULATOR LEAK DETERMINATION	A6.1.2-36

VOLUME A KEY

<u>OLD RULE #</u>	<u>RULE TITLE</u>	<u>NEW RULE #</u>
THERMAL MANAGEMENT		
6-70	GENERAL	A6.1.3-1
6-71	FORWARD RCS MODULE TEMPERATURE MANAGEMENT	A6.1.3-2
6-72	OMS/RCS PODS TEMPERATURE MANAGEMENT	A6.1.3-3
6-73	OMS/RCS CROSSFEED LINES TEMPERATURE MANAGEMENT	A6.1.3-4
6-74	OMS/RCS HEATER MANAGEMENT	A6.1.3-5
6-75	RCS JET TEMPERATURE MANAGEMENT	A6.1.3-6
6-76	ARCS BULK PROPELLANT TEMPERATURE MANAGEMENT	A6.1.3-7
CONSUMABLES MANAGEMENT		
6-80	OMS PROPELLANT MANAGEMENT MATRIX	A6.1.4-1
6-81	OMS PROPELLANT BUDGET GROUND RULES	A6.1.4-2
6-82	CG MANAGEMENT	A6.1.4-3
6-83	RCS ENTRY REDLINE PROTECTION	A6.1.4-4
6-84	OMS PROPELLANT DEFICIENCY FOR DEORBIT	A6.1.4-5
6-85	DEORBIT PLANNING CRITERIA	A6.1.4-6
CONSUMABLES (REDLINES)		
6-90	OMS USABLE PROPELLANT	A6.1.5-1
6-91	RCS USABLE PROPELLANT	A6.1.5-2
6-92	OMS REDLINES (CIL)	A6.1.5-3
6-93	FORWARD RCS REDLINES	A6.1.5-4
6-94	AFT RCS REDLINES	A6.1.5-5
6-95	VIOLATION OF MISSION COMPLETION REDLINES MATRIX	A6.1.5-6
6-96	RCS MINIMIZATION TECHNIQUE PRIORITY	A6.1.5-7
GO/NO-GO CRITERIA		
6-97	OMS/RCS GO/NO-GO CRITERIA (CIL)	A6.1.6-1
<hr/>		
SECTION 7 - DATA SYSTEMS		
GENERAL		
7-1	DPS REDUNDANCY REQUIREMENTS	A7.1.1-1
7-2	PASS/BFS REDUNDANCY	A7.1.1-2
7-3	GNC GPC REACTIVATION PRIORITY	A7.1.1-3
7-4	GNC GPC REDUNDANCY REQUIREMENTS	A7.1.1-4
LOSS/FAILURE DEFINITIONS		
7-10	PASS DPS FAILURE	A7.1.2-1
7-11	BFS DPS FAILURE	A7.1.2-2
7-12	UNRECOVERABLE GPC	A7.1.2-3
7-13	TRANSIENT GPC	A7.1.2-4
7-14	PAYLOAD MDM SERIAL I/O LINK LOSS/FAILURE DEFINITION	A7.1.2-5
SYSTEMS MANAGEMENT		
7-20	REDUNDANT SET FAILURE	A7.1.3-1
7-21	REDUNDANT SET SPLIT	A7.1.3-2
7-22	GPC FAILURE	A7.1.3-3
7-23	DATA PATH FAILURE	A7.1.3-4
7-24	GPC MAJOR FUNCTION CONFIGURATION	A7.1.3-5
7-25	GPC MEMORY WRITE CRITERIA (CIL)	A7.1.3-6
7-26	GPC MEMORY DUMP CRITERIA	A7.1.3-7
7-27	PASS DATA BUS ASSIGNMENT CRITERIA	A7.1.3-8
7-28	I/O RESET	A7.1.3-9
7-29	PASS GPC BCE FAILURE MANAGEMENT	A7.1.3-10
7-30	POWER CYCLING/MANAGEMENT	A7.1.3-11
7-31	MDM PORT MODING	A7.1.3-12
7-32	MMU OPERATIONS	A7.1.3-13
7-33	TIME MANAGEMENT	A7.1.3-14
7-34	IN-FLIGHT MAINTENANCE (IFM)	A7.1.3-15
7-36	POWERED OFF GPC ACTION (101S)	A7.1.3-16

VOLUME A KEY

<u>OLD RULE #</u>	<u>RULE TITLE</u>	<u>NEW RULE #</u>
7-37	SM OPS 4 TRANSITION REQUIREMENTS	A7.1.3-17
7-38	NONUNIVERSAL I/O ERROR ACTION	A7.1.3-18
7-39	GNC 3 ARCHIVE MANAGEMENT	A7.1.3-19
7-40	SPACELAB ON-ORBIT GNC CONFIGURATION	A7.1.3-20
7-41	CONSTRAINTS ON PORT MODING OR I/O RESETS	A7.1.3-21
7-42	DEU EQUIVALENT CRITERIA	A7.1.3-22
	BFS SYSTEMS MANAGEMENT	
7-50	ASCENT/ENTRY BFS MANAGEMENT GUIDELINES	A7.1.4-1

VOLUME A KEY

<u>OLD RULE #</u>	<u>RULE TITLE</u>	<u>NEW RULE #</u>
	GO/NO-GO MATRIX	
7-60	DPS GO/NO-GO MATRIX	A7.1.5-1
	COMMAND AND DATA MANAGEMENT SYSTEM (CDMS) LOSS/FAILURE DEFINITIONS	
31.10-1	SUBSYSTEM COMPUTER (SSC)	A7.9.1-1
31.10-2	EXPERIMENT COMPUTER (EXC)	A7.9.1-2
31.10-3	DDS/REMOTE ACQUISITION UNIT (RAU)/MMU	A7.9.1-3
31.10-4	DATA PATH	A7.9.1-4
	CDMS SYSTEMS MANAGEMENT	
31.11-1	COMPUTER OR IOU FAULT ISOLATION SEQUENCE	A7.9.2-1
31.11-2	OPERATIONS FOR TWO COMPUTERS LOST	A7.9.2-2
31.11-3	COMPUTER RESTART MANAGEMENT	A7.9.2-3
31.11-4	IOU POWER SUPPLY/BUS MANAGEMENT	A7.9.2-4
31.11-5	IOU COUPLER MANAGEMENT	A7.9.2-5
31.11-6	SSIO/EXIO/PCMMU INTERFACE MANAGEMENT	A7.9.2-6
31.11-7	PAYLOAD MDM SERIAL I/O DATA PATH MANAGEMENT	A7.9.2-7
31.11-8	MASS MEMORY UNIT MANAGEMENT	A7.9.2-8
31.11-9	REMOTE ACQUISITION UNIT (RAU) MANAGEMENT	A7.9.2-9
31.11-10	DATA DISPLAY SYSTEM (DDS) MANAGEMENT	A7.9.2-10
31.11-11	TEMPERATURE MANAGEMENT	A7.9.2-11
31.11-12	TIME MANAGEMENT	A7.9.2-12
31.11-13	MEMORY WRITE MANAGEMENT	A7.9.2-13
<hr/>		
	SECTION 8 - GUIDANCE, NAVIGATION, CONTROL, AND AERODYNAMICS (GN&C)	
	GENERAL	
8-1	FCS DOWNMODE	A8.1.1-1
8-2	SSME THRUST VECTOR CONTROL (TVC) HARDOVER	A8.1.1-2
8-5	LOSS OF GNC SYSTEM	A8.1.1-3
8-6	FAULT TOLERANCE PHILOSOPHY	A8.1.1-4
8-7	ACCELEROMETER ASSEMBLIES (AA) FAULT TOLERANCE	A8.1.1-5
8-8	CONTROLLERS/FCS SWITCHING FAULT TOLERANCE	A8.1.1-6
8-9	ENTRY SYSTEMS SINGLE-FAULT TOLERANCE VERIFICATION	A8.1.1-7
8-10	ENTRY SYSTEMS RM DILEMMA	A8.1.1-8
8-11	AFT STATION GNC REDUNDANCY	A8.1.1-9
8-12	POWER/DATA PATH REDUNDANCY	A8.1.1-10
8-13	LOSS OF BFS	A8.1.1-11
8-14	HEAD UP DISPLAY AND CREW OPTICAL ALIGNMENT SIGHT (COAS) ALIGNMENT	A8.1.1-12
8-15	RTLS ET SEPARATION	A8.1.1-13
8-16	POWER MANAGEMENT	A8.1.1-14
8-17	GNC PARAMETERS/LRU FAILURES	A8.1.1-15
8-18	GNC SYSTEMS FAILURES	A8.1.1-16
8-21	EQUIPMENT REQUIRED FOR EMERGENCY AUTOLAND	A8.1.1-17
8-22	LANDING SYSTEMS REQUIREMENTS	A8.1.1-18
8-23	YAW JET DOWNMODE	A8.1.1-19
8-24	ENTRY ELEVON SCHEDULE SELECTION CRITERIA	A8.1.1-20
8-25	SSME REPOSITIONING FOR DRAG CHUTE	A8.1.1-21
	FAILURE DEFINITIONS	
8-30	PHILOSOPHY	A8.1.2-1
8-31	SENSOR FAILURES	A8.1.2-2
8-32	OMS TVC LOSS	A8.1.2-3
8-33	FIRST STAGE LOSS OF CONTROL DEFINITION	A8.1.2-4
8-35	ET SEPARATION RCS REQUIREMENTS	A8.1.2-5
8-36	BFS LRU REQUIREMENTS	A8.1.2-6
8-37	PRELAUNCH IMU HOLD	A8.1.2-7

VOLUME A KEY

<u>OLD RULE #</u>	<u>RULE TITLE</u>	<u>NEW RULE #</u>
8-38	ADI LOSS	A8.1.2-8
8-39	IMU BITE FAILURE DEFINITION	A8.1.2-9
8-40	LOSS OF VERNIER RCS DAP MODE	A8.1.2-10
8-41	SSME SHUTDOWN DUE TO HYDRAULIC SYSTEM FAILURES	A8.1.2-11
MANAGEMENT		
8-45	BEEP TRIM DEROTATION	A8.1.3-1
8-46	SINGLE ENGINE ROLL CONTROL (SERC) FOR RTLS	A8.1.3-2
8-47	RGA SYSTEM MANAGEMENT (CIL)	A8.1.3-3
8-48	PRIORITY RATE LIMITING (PRL) SYSTEMS MANAGEMENT	A8.1.3-4
8-49	FCS CHECKOUT	A8.1.3-5
8-50	CONTROLLERS	A8.1.3-6
8-51	TVC-SSME STOW/ACTUATOR FLUID FILL (REPRESSURIZATION)	A8.1.3-7
8-52	FCS CHANNEL MANAGEMENT	A8.1.3-8

VOLUME A KEY

<u>OLD RULE #</u>	<u>RULE TITLE</u>	<u>NEW RULE #</u>
8-53	HUD/COAS SYSTEM MANAGEMENT	A8.1.3-9
8-54	STAR TRACKER SYSTEM MANAGEMENT (CIL)	A8.1.5-10
8-55	IMU SYSTEM MANAGEMENT	A8.1.5-11
8-56	GNC AIR DATA SYSTEM MANAGEMENT (CIL)	A8.1.5-12
8-57	AEROSURFACE ACTUATOR PROTECTION	A8.1.5-13
8-58	OMS TVC SYSTEM MANAGEMENT	A8.1.5-14
8-59	ENTRY BODY BENDING FILTER SELECTION	A8.1.5-15
GO/NO-GO CRITERIA		
8-60	GNC GO/NO-GO CRITERIA	A8.1.6-1
SECTION 9 - ELECTRICAL		
LOSS/FAILURE DEFINITIONS		
9-500	FUEL CELL (FC) LOSS (CIL)	A9.1.1-1
9-501	FC ALTERNATE H2O SYSTEM LOSS	A9.1.1-2
9-502	ELECTRICAL POWER DISTRIBUTION AND CONTROL (EPDC) SYSTEM (CIL)	A9.1.1-3
9-503	CAUTION AND WARNING (C&W)	A9.1.1-4
FUEL CELL SYSTEMS MANAGEMENT		
9-511	FC POWER LEVEL CONSTRAINTS	A9.1.2-1
9-512	FC PURGE	A9.1.2-2
9-513	FC H2O SYSTEM HEATERS	A9.1.2-3
9-514	FC STANDBY DEFINITION	A9.1.2-4
9-515	FC SHUTDOWN DEFINITION (CIL)	A9.1.2-5
9-516	FC SAFING	A9.1.2-6
9-517	REUSABLE FC	A9.1.2-7
9-518	FC SUSTAINER HEATER	A9.1.2-8
9-519	FC - CELL PERFORMANCE MONITOR (CIL)	A9.1.2-9
9-520	FC COOLANT PUMP FAILURE MANAGEMENT (CIL)	A9.1.2-10
DC POWER DISTRIBUTION AND CONTROL SYSTEMS MANAGEMENT		
9-530	DC BUS VOLTAGE LIMITS	A9.1.3-1
9-531	ESSENTIAL BUS	A9.1.3-2
9-532	POWER REDUCTION GUIDELINES	A9.1.3-3
9-533	MAIN BUS SHORT	A9.1.3-4
9-534	CB/RPC RESET	A9.1.3-5
9-535	CONTROL BUS	A9.1.3-6
9-536	MAIN BUS TIE (CIL)	A9.1.3-7
9-537	CRITICAL PHASE BUS MANAGEMENT	A9.1.3-8
9-538	PRIMARY PAYLOAD BUS MANAGEMENT	A9.1.3-9
9-539	PREFLIGHT TEST BUS MANAGEMENT	A9.1.3-10
AC POWER DISTRIBUTION AND CONTROL SYSTEMS MANAGEMENT		
9-550	AC INVERTER MANAGEMENT	A9.1.4-1
9-551	AC BUS SENSORS SWITCH MANAGEMENT	A9.1.4-2
9-552	AC BUS LOADING	A9.1.4-3
9-553	AC LOAD MANAGEMENT DURING ASCENT	A9.1.4-4
9-554	AC INVERTER THERMAL LIFE	A9.1.4-5
9-555	LOSS OF SINGLE-PHASE AC	A9.1.4-6
9-556	LOSS OF TWO-PHASE AC	A9.1.4-7
9-557	AC POWER TRANSFER CABLE	A9.1.4-8
9-558	MOTOR CONTROL ASSEMBLY (MCA)	A9.1.4-9
9-559	CAUTION AND WARNING (C&W) (CIL)	A9.1.4-10
9-560	HYDRAULIC CIRCULATION PUMP OPERATION	A9.1.4-11
CRYOGENIC LOSS/FAILURE DEFINITIONS		
9-570	O2 (H2) MANIFOLD	A9.1.5-1
9-571	CRYO TANK	A9.1.5-2
9-572	CRYO TANK ANNULUS VACUUM	A9.1.5-3
9-573	CRYO HEATER	A9.1.5-4
9-574	O2 DELTA CURRENT SENSOR	A9.1.5-5

VOLUME A KEY

<u>OLD RULE #</u>	<u>RULE TITLE</u>	<u>NEW RULE #</u>
	CRYOGENIC SYSTEMS MANAGEMENT	
9-580	CRYO HEATER MANAGEMENT FOR ASCENT	A9.1.6-1
9-581	CRYO HEATER MANAGEMENT FOR ORBIT (CIL)	A9.1.6-2
9-582	CRYO TANK HEATER TEMPERATURE MANAGEMENT	A9.1.6-3
9-583	CRYO HEATERS DEACTIVATION	A9.1.6-4
9-584	O2 DELTA CURRENT SENSOR	A9.1.6-5
9-585	CRYO O2/H2 TANK QUANTITY BALANCING	A9.1.6-6
9-586	POWER REACTANT STORAGE AND DISTRIBUTION (PRSD) H2 AND O2 REDLINE DETERMINATION	A9.1.6-7
9-587	CRYO O2 AND H2 PRESSURE MANAGEMENT	A9.1.6-8
9-588	CRYO O2/H2 MANIFOLD VALVES	A9.1.6-9

VOLUME A KEY

<u>OLD RULE #</u>	<u>RULE TITLE</u>	<u>NEW RULE #</u>
9-589	CRYO SYSTEM LEAKS (CIL)	A9.1.6-10
9-590	IMPENDING LOSS OF ALL CRYO	A9.1.6-11
9-591	EDO PALLET MANAGEMENT	A9.1.6-12
	EGIL GO/NO-GO CRITERIA	
9-600	EGIL GO/NO-GO CRITERIA	A9.1.7-1
	SPACEHAB SUPPORT	
30.2-1	SPACEHAB MAIN BUS	A9.6.1-1
30.2-2	SPACEHAB EMERGENCY BUS	A9.6.1-2
30.2-3	SPACEHAB INVERTER	A9.6.1-3
30.2-4	SPACEHAB SUBSYSTEM BUSES	A9.6.1-4
30.2-5	SPACEHAB FIRE/SMOKE DETECTION LOSS	A9.6.1-5
	ELECTRICAL POWER SUBSYSTEM (EPS) MANAGEMENT	
30.3-1	SPACEHAB MAIN BUS MANAGEMENT	A9.6.2-1
30.3-2	SPACEHAB EMERGENCY BUS LOSS	A9.6.2-2
30.3-3	SPACEHAB AC MANAGEMENT	A9.6.2-3
30.3-4	SPACEHAB MAIN DC BUS POWER INTERRUPTION	A9.6.2-4
30.3-5	FUSE/CIRCUIT BREAKER MANAGEMENT	A9.6.2-5
30.3-6	FUEL CELL FAILURE MANAGEMENT	A9.6.2-6
30.3-7	SPACEHAB MINIMUM POWER CONFIGURATION	A9.6.2-7
30.3-8	CAUTION AND WARNING (C&W)	A9.6.2-8
	ELECTRICAL POWER DISTRIBUTION SYSTEM (EPDS) LOSS/FAILURE DEFINITIONS	
31.2-1	SPACELAB MAIN BUS	A9.9.1-1
31.2-2	SPACELAB AUXILIARY BUSES	A9.9.1-2
31.2-3	SPACELAB EMERGENCY BOX BUSES	A9.9.1-3
31.2-4	SPACELAB SUBSYSTEM (SS) OR EXPERIMENT (EXP) ALTERNATING CURRENT (AC) INVERTER	A9.9.1-4
31.2-5	SPACELAB SS (EXP) AC BUS	A9.9.1-5
31.2-6	SPACELAB FIRE/SMOKE PRIMARY DETECTION LOSS	A9.9.1-6
31.2-7	SPACELAB AURAL ANNUNCIATOR LOSS	A9.9.1-7
	EPDS SYSTEM MANAGEMENT	
31.3-1	SPACELAB MAIN BUS MANAGEMENT	A9.9.2-1
31.3-2	SPACELAB EMERGENCY BOX BUSES	A9.9.2-2
31.3-3	SPACELAB SS (EXPERIMENT) AC INVERTER MANAGEMENT	A9.9.2-3
31.3-4	SPACELAB SS EXP AC BUSES	A9.9.2-4
31.3-5	SPACELAB MAIN BUS POWER INTERRUPTION	A9.9.2-5
31.3-6	FUSE/CIRCUIT BREAKER MANAGEMENT	A9.9.2-6
31.3-7	FUEL CELL FAILURE MANAGEMENT	A9.9.2-7
31.3-8	SPACELAB MINIMUM POWER CONFIGURATION	A9.9.2-8
31.3-9	CAUTION AND WARNING (C&W)	A9.9.2-9
31.3-10	SPACELAB AURAL ANNUNCIATOR (SAA)	A9.9.2-10

SECTION 10 - MECHANICAL

AUXILIARY POWER UNIT (APU) LOSS FAILURE DEFINITION

10-1	APU LOSS DEFINITIONS	A10.1.1-1
	APU SYSTEMS MANAGEMENT	
10-2	LOSS OF APU/HYDRAULIC SYSTEM(S) ACTIONS	A10.1.2-1
10-3	APU START/RESTART LIMITS	A10.1.2-2
10-4	APU ENTRY START TIME	A10.1.2-3
10-5	APU OIL/GEARBOX TEMPERATURE/PRESSURE	A10.1.2-4
10-6	APU HIGH SPEED SELECTION/SHIFT	A10.1.2-5
10-7	APU AUTO SHUTDOWN INHIBIT MANAGEMENT	A10.1.2-6
10-8	APU FUEL LEAKS (CIL)	A10.1.2-7
10-9	AOA APU/HYDRAULIC SYSTEM OPERATIONS	A10.1.2-8
10-10	FCS CHECKOUT APU OPERATIONS	A10.1.2-9

VOLUME A KEY

<u>OLD RULE #</u>	<u>RULE TITLE</u>	<u>NEW RULE #</u>
10-11	LOSS OF APU HEATERS/INSTRUMENTATION (CIL)	A10.1.2-10
10-12	APU/FREEZE/THAW	A10.1.2-11
10-13	APU/HYD CONSUMABLES	A10.1.2-12
	HYDRAULIC SYSTEM LOSS/FAILURE DEFINITIONS	
10-40	HYDRAULIC LOSS DEFINITIONS	A10.1.3-1

VOLUME A KEY

<u>OLD RULE #</u>	<u>RULE TITLE</u>	<u>NEW RULE #</u>
	HYDRAULIC SYSTEM MANAGEMENT	
10-41	HYDRAULIC SYSTEM CONFIGURATION	A10.1.4-1
10-42	HYDRAULIC LEAKS	A10.1.4-2
10-43	HYDRAULIC SYSTEM PRESSURE/TEMPERATURE (CIL)	A10.1.4-3
10-44	HYDRAULIC CIRCULATION PUMP OPERATION (CIL)	A10.1.4-4
	WATER SPRAY BOILER (WSB) LOSS/FAILURE DEFINITIONS	
10-70	WSB LOSS DEFINITIONS	A10.1.5-1
	WSB SYSTEM MANAGEMEN	
10-71	WSB CONFIGURATION	A10.1.6-1
10-72	LOSS OF WSB(S) ACTIONS	A10.1.6-2
	LANDING/DECEL SYSTEMS MANAGEMENT	
10-90	NOSE WHEEL STEERING (NWS)	A10.1.7-1
	LANDING GEAR SYSTEMS MANAGEMENT	
10-91	TIRE PRESSURE (CIL)	A10.1.8-1
10-92	DRAG CHUTE OPERATIONS	A10.1.8-2
10-93	DRAG CHUTE DEPLOY CONSTRAINTS	A10.1.8-3
10-94	UNCOMMANDED BRAKE PRESSURE (CIL)	A10.1.8-4
10-96	BRAKING	A10.1.8-5
	MECHANICAL SYSTEMS LOSS/FAILURE DEFINITIONS	
10-100	DRIVE MECHANISMS LOSS DEFINITIONS	A10.1.9-1
	GENERAL MECHANISMS SYSTEMS MANAGEMENT	
10-101	DRIVE MECHANISMS	A10.1.10-1
	PLBD SYSTEMS MANAGEMENT	
10-102	PLBD GENERAL	A10.1.11-1
10-103	PLBD VISUAL CUES	A10.1.11-2
10-104	PLBD CRITICAL LATCHES	A10.1.11-3
10-105	FAILED PLBD GPC SEQUENCE	A10.1.11-4
10-106	PLBD CLEARANCE CONSTRAINTS	A10.1.11-5
10-107	PLBD CLOSE GO/NO-GO	A10.1.11-6
10-108	PLBD OVERLAP	A10.1.11-7
10-109	CONTINGENCY PLBD CLOSURE	A10.1.11-8
10-110	PLBD RULE REFERENCE MATRIX	A10.1.11-9
	RADIATOR SYSTEM MANAGEMENT	
10-120	RADIATOR MECHANICAL	A10.1.12-1
10-121	RADIATOR VISUAL CUES	A10.1.12-2
	ET UMBILICAL DOORS SYSTEMS MANAGEMENT	
10-130	ET UMBILICAL DOOR KEYBOARD ENTRY	A10.1.13-1
10-131	ET UMBILICAL DOORS ON ORBIT	A10.1.13-2
10-132	ET UMBILICAL DOOR CLOSURE DELAY FOR DISCONNECT VALVE FAILURE (CIL)	A10.1.13-3
	VENT DOOR/PAYLOAD RETENTION LATCHES (PRLA) SYSTEMS MANAGEMENT	
10-135	VENT DOOR MANAGEMENT	A10.1.14-1
	PAYLOAD RETENTION LATCHES (PRLA) SYSTEMS MANAGEMENT	
10-137	PRLA'S/AKA'S	A10.1.15-1
	KU-BAND ANTENNA DEPLOY MECHANISM	
10-140	ANTENNA STOW REQUIREMENT (CIL)	A10.1.16-1
10-141	DAP CONFIGURATION FOR ANTENNA STOW	A10.1.16-2
10-142	ANTENNA CONTINGENCY PROCEDURES	A10.1.16-3
10-143	LOSS OF KU-BAND ANTENNA DEPLOYMENT ACTUATOR STOW MOTOR	A10.1.16-4

VOLUME A KEY

<u>OLD RULE #</u>	<u>RULE TITLE</u>	<u>NEW RULE #</u>
	REDUNDANCY	
	STRUCTURAL MANAGEMENT	
10-150	THERMAL WINDOWPANE FAILURE (CIL)	A10.1.17-1
10-151	PRESSURE/REDUNDANT WINDOWPANE FAILURE	A10.1.17-2
10-152	BALLOUT/POSTLANDING EMERGENCY EGRESS PYROTECHNICS MANAGEMENT	A10.1.17-3
	MMACS GO/NO-GO	
10-200	MMACS GO/NO-GO CRITERIA	A10.1.18-1

VOLUME A KEY

<u>OLD RULE #</u>	<u>RULE TITLE</u>	<u>NEW RULE #</u>
VIEWPORT SYSTEMS MANAGEMENT		
30.8-1	VIEWPORT (VP)	A10.6.1-1
30.8-2	CRACKED VIEWPORT	A10.6.1-2
30.8-3	VIEWPORT CONFIGURATION FOR CLOSED SPACEHAB HATCH	A10.6.1-3
30.8-4	LOSS OF VP PRESSURE INTEGRITY	A10.6.1-4
30.8-5	EVA REQUIREMENTS FOR FAILED VP OUTER COVER	A10.6.1-5
MECHANICAL LOSS/FAILURE DEFINITIONS		
31.14-1	PAYLOAD RETENTION LATCH ASSEMBLY (PRLA)	A10.9.1-1
31.14-2	MODIFIED MIDDLEWEIGHT LATCH (MMWL)	A10.9.1-2
31.14-3	LIGHTWEIGHT KEEL LATCH (LWKL)	A10.9.1-3
31.14-4	VIEWPORT (VP)	A10.9.1-4
MECHANICAL SYSTEMS MANAGEMENT		
31.15-1	PRLA DRIVE MOTOR "ON" TIME	A10.9.2-1
31.15-2	PRLA RELEASE INDICATION REQUIREMENTS	A10.9.2-2
31.15-3	MODIFIED MIDDLEWEIGHT LATCH (MMWL) REQUIREMENTS	A10.9.2-3
31.15-4	LIGHTWEIGHT KEEL LATCH (LWKL) REQUIREMENTS	A10.9.2-4
31.15-5	PRLA TEMPERATURE LIMITS	A10.9.2-5
31.15-6	PRLA LATCH/RELEASE DEFINITION	A10.9.2-6
VIEWPORT SYSTEMS MANAGEMENT		
31.16-1	VIEWPORT (VP)	A10.9.3-1
31.16-2	CRACKED VIEWPORT (VP)	A10.9.3-2
31.16-3	LOSS OF VIEWPORT (VP) PRESSURE INTEGRITY	A10.9.3-3
31.16-4	VIEWPORT (VP) EXPERIMENT ACCOMMODATIONS	A10.9.3-4
31.16-5	EVA REQUIREMENTS FOR FAILED VIEWPORT (VP) OUTER COVER	A10.9.3-5
SECTION 11 - COMMUNICATIONS		
SYSTEM MANAGEMENT RULES		
11-1	COMMUNICATIONS DURING ASCENT	A11.1.1-1
11-2	S-BAND/UHF LAUNCH REQUIREMENT	A11.1.1-2
11-3	UPLINK HANDOVER DURING ASCENT FROM KSC	A11.1.1-3
11-4	ORBITER DATA PRIORITY DURING ASCENT/ENTRY	A11.1.1-4
11-5	POSTLANDING S-BAND ANTENNA SELECTION	A11.1.1-5
11-8	MINIMUM COMMUNICATIONS REQUIREMENTS FOR SCHEDULED EVA	A11.1.1-6
11-9	KU-BAND OPERATIONS DURING EVA	A11.1.1-7
11-10	ORBITER S-BAND OPERATIONS DURING EVA	A11.1.1-8
11-13	RECORDER USAGE	A11.1.1-9
11-14	UHF USAGE	A11.1.1-10
11-15	S-BAND FM USAGE	A11.1.1-11
11-16	S-BAND PM USAGE	A11.1.1-12
11-17	S-BAND PAYLOAD USAGE	A11.1.1-13
11-20	CREW ALERT SPC'S	A11.1.1-14
11-21	ELBOW CAMERA/PAYLOAD INTERFERENCE (CIL)	A11.1.1-15
11-22	KU-BAND MANAGEMENT	A11.1.1-16
11-23	PI CHANNELS AND S-BD FREQUENCIES COMPATIBILITIES	A11.1.1-17
11-24	COMSEC USAGE	A11.1.1-18
11-25	UPLINK BLOCK	A11.1.1-19
11-26	UPLINK COMMANDING DURING OPS TRANSITIONS	A11.1.1-20
11-27	CRITICAL UPLINK COMMAND POLICY	A11.1.1-21
11-28	TWO-STAGE COMMAND BUFFER TLM REJECT	A11.1.1-22
SYSTEM FAILURE RULES		
11-32	LOSS OF TWO-WAY VOICE	A11.1.2-1
11-33	LOSS OF BOTH VOICE AND COMMAND	A11.1.2-2
11-34	LOSS OF COMMAND	A11.1.2-3
11-35	LOSS OF TELEMETRY	A11.1.2-4
11-38	LOSS OF KU-BAND	A11.1.2-5
11-39	LOSS OF KU-BAND TEMPERATURE CONTROL (CIL)	A11.1.2-6

VOLUME A KEY

<u>OLD RULE #</u>	<u>RULE TITLE</u>	<u>NEW RULE #</u>
11-40	LOSS OF KU-BAND TEMPERATURE MONITORING CAPABILITY (CIL)	A11.1.2-7
11-43	LOSS OF TRANSPONDERS	A11.1.2-8
11-44	FM SYSTEM IFM GROUND RULE	A11.1.2-9
11-45	LOSS OF TDRS TRACKING CAPABILITY	A11.1.2-10
11-48	LOSS OF S-BAND PREAMPS AND POWER AMPS	A11.1.2-11
11-49	LOSS OF ANTENNA ELECTRONICS	A11.1.2-12
11-50	LOSS OF NSP'S	A11.1.2-13
11-51	LOSS OF COMMUNICATIONS SECURITY (COMSEC)	A11.1.2-14
11-54	AUDIO CENTRAL CONTROL UNIT (ACCU)	A11.1.2-15
11-55	LOSS OF ACCU'S	A11.1.2-16
11-56	LOSS OF THE PLT AND MS ATU'S	A11.1.2-17

VOLUME A KEY

<u>OLD RULE #</u>	<u>RULE TITLE</u>	<u>NEW RULE #</u>
11-57	LOSS OF INTERCOM	A11.1.2-18
11-58	LOSS OF UHF	A11.1.2-19
11-60	LOSS OF GCIL	A11.1.2-20
11-61	LOSS OF RECORDERS	A11.1.2-21
11-62	LOSS OF TV	A11.1.2-22
11-63	LOSS OF TAGS	A11.1.2-23
11-66	PCM MASTER UNIT (PCMMU)	A11.1.2-24
11-67	LOSS OF PCMMU'S	A11.1.2-25
11-71	LOSS OF OI MDM	A11.1.2-26
11-72	LOSS OF ANY OI DSC	A11.1.2-27
GO/NO-GO CRITERIA		
11-80	COMMUNICATIONS GO/NO-GO CRITERIA	A11.1.3-1
DEFINITIONS		
31.12-1	HIGH DATA RATE RECORDER (HRR)	A11.9.1-1
COMMUNICATIONS AND INSTRUMENTATION SYSTEMS MANAGEMENT		
31.13-1	OPERATIONS (OPS) RECORDER MANAGEMENT	A11.9.2-1
31.13-2	HIGH RATE MULTIPLEXER (HRM) VOICE MANAGEMENT	A11.9.2-2
31.13-3	HRR MANAGEMENT	A11.9.2-3
31.13-4	HRM/HRR OPERATION RESPONSIBILITY	A11.9.2-4
31.13-5	HRR TO PAYLOAD RECORDER DOWNMODE	A11.9.2-5
31.13-6	HRM FAILURE CASE	A11.9.2-6
31.13-7	MCC/CREW PRIME OPS OF VIDEO ANALOG SWITCH (VAS)/VIDEO INSTRUMENTATION TAPE RECORDER (VITR)	A11.9.2-7
31.13-8	ORBITER VIDEO CONTROL UNIT (VCU) FAILURE	A11.9.2-8
31.13-9	COMM TEMPERATURE LIMITS TO POWER OFF	A11.9.2-9
SECTION 12 - ROBOTICS		
GENERAL		
12-1	EVA FOR RMS OPERATIONS	A12.1.1-1
12-2	UNATTENDED RMS CONSTRAINTS	A12.1.1-2
12-3	TEMPERATURE CONSTRAINTS (CIL)	A12.1.1-3
12-4	RMS ACTIVITY TERMINATION	A12.1.1-4
12-5	ORBITER AVOIDANCE MANEUVERS CONSTRAINT (CIL)	A12.1.1-5
12-6	OMS/RCS CONSTRAINTS	A12.1.1-6
12-7	RMS IFM D&C KIT	A12.1.1-7
12-8	RMS OPCODE UPLINKS	A12.1.1-8
12-9	RMS MCIU BITE OVERRIDES (CIL)	A12.1.1-9
MPM/MRL LOSS/FAILURE DEFINITIONS		
12-10	MPM/MRL POSITIONING	A12.1.2-1
12-11	MPM FAILED IN TRANSIT	A12.1.2-2
12-12	MRL FAILED IN TRANSIT	A12.1.2-3
MPM/MRL SYSTEMS MANAGEMENT		
12-20	MPM/MRL CYCLING	A12.1.3-1
12-21	MPM DEPLOY/STOW CONSTRAINTS	A12.1.3-2
12-22	MRL CONSTRAINTS	A12.1.3-3
12-23	INADVERTENT MPM CYCLING PROTECTION (CIL)	A12.1.3-4
RMS PREOPERATION SYSTEM MANAGEMENT		
12-30	SHOULDER BRACE OPERATION	A12.1.4-1
12-31	RMS CHECKOUT	A12.1.4-2
RMS DRIVE SYSTEM MANAGEMENT		
12-40	MODE AVAILABILITY DRIVE CONSTRAINT	A12.1.5-1
12-41	FIELD OF VIEW CONSTRAINT (CIL)	A12.1.5-2
12-42	AUTO MODE ENTRY CONSTRAINT (CIL)	A12.1.5-3
12-43	ORBITER PROXIMITY CONSTRAINTS (CIL)	A12.1.5-4

VOLUME A KEY

<u>OLD RULE #</u>	<u>RULE TITLE</u>	<u>NEW RULE #</u>
12-44	INOPERATIVE BRAKE CONSTRAINT (CIL)	A12.1.5-5
12-45	AUTO BRAKES CONSTRAINT (CIL)	A12.1.5-6
12-46	CONTINGENCY STOP (CIL)	A12.1.5-7
12-47	POHS AND LEFT-HANDED COORDINATE SYSTEMS	A12.1.5-8
	END EFFECTOR (EE) LOSS/FAILURE DEFINITIONS	
12-50	EE BACKUP RELEASE	A12.1.6-1
12-51	EE CAPTURE/RIGIDIZE	A12.1.6-2
12-52	EE RELEASE/DERIGIDIZE	A12.1.6-3

VOLUME A KEY

<u>OLD RULE #</u>	<u>RULE TITLE</u>	<u>NEW RULE #</u>
END EFFECTOR SYSTEM MANAGEMENT		
12-60	PAYLOAD GRAPPLE CONSTRAINTS	A12.1.7-1
12-61	EE MODE SWITCH CONSTRAINTS (CIL)	A12.1.7-2
12-62	CAPTURE AND RELEASE PROXIMITY CONSTRAINT (CIL)	A12.1.7-3
12-63	PAYLOAD RELEASE DURING BERTHING	A12.1.7-4
RMS JETTISON SYSTEM MANAGEMENT		
12-70	JETTISON SYSTEM CONSTRAINT	A12.1.8-1
12-71	RMS/PAYLOAD JETTISON	A12.1.8-2
GO/NO-GO CRITERIA		
12-80	RMS GO/NO-GO CRITERIA	A12.1.9-1
SECTION 13 - AEROMEDICAL		
ASCENT		
13-1	ASCENT ABORT	A13.1.1-1
ON-ORBIT		
13-5	EARLY FLIGHT TERMINATION	A13.1.2-1
13-6	ONBOARD MEDICAL KIT	A13.1.2-2
13-7	CABIN PRESSURE	A13.1.2-3
13-8	PPO2 CONSTRAINT	A13.1.2-4
13-9	MINIMUM PPO2 CONSTRAINTS	A13.1.2-5
13-10	100 PERCENT OXYGEN USE CONSTRAINT	A13.1.2-6
13-11	EVA PREBREATHE PROTOCOL	A13.1.2-7
13-12	SCHEDULED AND UNSCHEDULED EVA CONSTRAINTS	A13.1.2-8
13-13	PRIVATE MEDICAL COMMUNICATION (PMC)	A13.1.2-9
13-14	HRPPC PROTOCOLS	A13.1.2-10
13-17	CREW AWAKE TIME CONSTRAINT	A13.1.2-11
13-18	HOT CABIN ATMOSPHERE	A13.1.2-12
13-19	CABIN ATMOSPHERE CONTAMINATION	A13.1.2-13
13-20	BROKEN GLASS/HAZARDOUS SUBSTANCE CONSTRAINT	A13.1.2-14
13-21	ORBITER HAZARDOUS SUBSTANCE SPILL RESPONSE	A13.1.2-15
13-22	SPACEHAB/SPACELAB HAZARDOUS SUBSTANCE SPILL RESPONSE	A13.1.2-16
13-23	HAZARDOUS SPILL LEVEL DEFINITIONS	A13.1.2-17
13-24	MISSION DURATION BUILD-UP CONSTRAINTS	A13.1.2-18
13-25	ACCELERATION RESTRICTIONS ON MEDICAL PROCEDURES	A13.1.2-19
13-26	LOWER BODY NEGATIVE PRESSURE (LBNP)	A13.1.2-20
13-27	LBNP TEST TERMINATION CRITERIA	A13.1.2-21
13-28	INTENSE CYCLE EXERCISE	A13.1.2-22
13-29	SPACELAB CONTINGENCY EGRESS	A13.1.2-23
13-30	ATMOSPHERE PURGING	A13.1.2-24
13-31	NOISE LEVEL CONSTRAINTS	A13.1.2-25
ENTRY		
13-40	ANTI G-SUIT PROTOCOL	A13.1.3-1
13-41	FLUID LOADING	A13.1.3-2
13-42	TANK B WATER CONTINGENCY USE	A13.1.3-3
SECTION 14 - SPACE ENVIRONMENT		
DEFINITIONS		
14-1	UNCONFIRMED ARTIFICIAL EVENT DEFINITION	A14.1.1-1
14-2	CONFIRMED ARTIFICIAL EVENT DEFINITION	A14.1.1-2
14-3	MAJOR SOLAR FLARE DEFINITION	A14.1.1-3
14-4	SOLAR PARTICLE EVENT DEFINITION	A14.1.1-4
14-5	OTHER RADIATION EVENT DEFINITION	A14.1.1-5
14-6	PROJECTED OPERATIONAL DOSE LIMIT VIOLATION DEFINITION	A14.1.1-6

VOLUME A KEY

<u>OLD RULE #</u>	<u>RULE TITLE</u>	<u>NEW RULE #</u>
	MANAGEMENT	
14-10	CREW RADIATION EXPOSURE LIMITS	A14.1.2-1
14-11	UNCONFIRMED ARTIFICIAL EVENT	A14.1.2-2
14-12	CONFIRMED ARTIFICIAL EVENT	A14.1.2-3
14-13	MAJOR SOLAR FLARE	A14.1.2-4
14-14	SOLAR PARTICLE EVENT	A14.1.2-5
14-15	OTHER RADIATION EVENT	A14.1.2-6
14-16	PROJECTED OPERATIONAL DOSE LIMIT VIOLATION	A14.1.2-7

VOLUME A KEY

<u>OLD RULE #</u>	<u>RULE TITLE</u>	<u>NEW RULE #</u>
	GO/NO-GO CRITERIA	
14-20	SPACE ENVIRONMENT GO/NO-GO CRITERIA	A14.1.3-1
SECTION 15 - EXTRAVEHICULAR ACTIVITY (EVA)		
GENERAL		
15-1	EVA TIME DEFINITION	A15.1.1-1
15-2	TERMINATE EVA DEFINITION	A15.1.1-2
15-3	ABORT EVA DEFINITION	A15.1.1-3
15-4	SCHEDULED EVA DEFINITION	A15.1.1-4
15-5	UNSCHEDULED EVA DEFINITION	A15.1.1-5
15-6	CONTINGENCY EVA DEFINITION	A15.1.1-6
15-7	MINIMUM RF COMMUNICATIONS DEFINITION	A15.1.1-7
15-8	OPERATIONAL CAUTION AND WARNING SYSTEM (CWS) DEFINITION	A15.1.1-8
15-9	TWO/ONE-CREWMEMBER EVA GUIDELINES	A15.1.1-9
15-10	EVA CREWMEMBER(S) SUPPORT	A15.1.1-10
15-11	SAFETY TETHER REQUIREMENTS	A15.1.1-11
15-12	HAZARDOUS EQUIPMENT SAFING	A15.1.1-12
15-13	AIRLOCK CONFIGURATION	A15.1.1-13
15-14	SCHEDULED AND UNSCHEDULED EVA CONSTRAINTS	A15.1.1-14
15-15	CONTINGENCY EVA PROTECTION	A15.1.1-15
15-16	EVA TERMINATION FOR CABIN LEAK	A15.1.1-16
15-17	PAYLOAD BAY CONFIGURATION POST-EVA	A15.1.1-17
15-18	PAYLOAD OPERATION/DEPLOY GUIDELINE	A15.1.1-18
15-19	UNSCHEDULED EVA PREPARATION	A15.1.1-19
15-20	ECG TELEMETRY CHECKOUT	A15.1.1-20
15-21	LEAKING RCS THRUSTER/APU AVOIDANCE	A15.1.1-21
15-22	RCS/APU THRUSTER PLUME AVOIDANCE	A15.1.1-22
15-23	EV CREW IN VICINITY OF ACTIVE PAYLOAD RETENTION LATCH ASSEMBLIES	A15.1.1-23
15-24	EVA OPERATIONS IN THE GENERIC PAYLOAD BAY ENVELOPE	A15.1.1-24
15-25	ORBITER EVA OPERATIONS NEAR S-BAND ANTENNAS	A15.1.1-25
LOSS/FAILURE DEFINITIONS		
15-30	EVA CAPABILITY	A15.1.2-1
15-31	EMU GO/NO-GO CRITERIA	A15.1.2-2
15-32	MMU	A15.1.2-3
SYSTEMS MANAGEMENT		
15-40	DENITROGENATION	A15.1.3-1
15-41	EMU CONSUMABLES	A15.1.3-2
15-42	VACUUM TRANSFERS	A15.1.3-3
15-43	MMU CROSSFEED VALVES	A15.1.3-4
15-44	MMU TEMPERATURE CONSTRAINTS	A15.1.3-5
15-45	MMU CHECKOUT	A15.1.3-6
15-46	MMU STOW	A15.1.3-7
15-47	MMU APPROACH/SEPARATION	A15.1.3-8
15-48	MMU OPERATIONAL RANGE	A15.1.3-9
15-49	EMU CONSUMABLES PRE-EVA	A15.1.3-10
15-50	EMU CONSUMABLES REDLINES	A15.1.3-11
15-52	MANIPULATOR FOOT RESTRAINT (MFR) AND PFR ATTACHMENT DEVICE (PAD) GUIDELINES	A15.1.3-12
SECTION 16 - POSTLANDING		
GENERAL		
16-1	CONVOY POSITIONING	A16.1.1-1
16-3	VEHICLE SYSTEM RECONFIGURATION CONSTRAINT	A16.1.1-2
16-4	PRECREW EGRESS TROUBLESHOOTING CONSTRAINT	A16.1.1-3
16-5	VEHICLE SYSTEM MODING CONSTRAINT	A16.1.1-4

VOLUME A KEY

<u>OLD RULE #</u>	<u>RULE TITLE</u>	<u>NEW RULE #</u>
16-6	MEMORY RECONFIGURATION CONSTRAINT	A16.1.1-5
16-7	RECORDER DUMP	A16.1.1-6
16-8	GOM HANDOVER	A16.1.1-7
16-9	CREW EGRESS METHOD DETERMINATION (FOR MODE V EGRESS)	A16.1.1-8
16-10	SSME REPOSITIONING CONSTRAINT	A16.1.1-9
16-15	NORMAL POSTLANDING OPERATIONS	A16.1.1-10
16-16	EXPEDITED POWERDOWN	A16.1.1-11
16-17	EMERGENCY POWERDOWN	A16.1.1-12
16-18	SIDE HATCH OPENING CONSTRAINT	A16.1.1-13

VOLUME A KEY

<u>OLD RULE #</u>	<u>RULE TITLE</u>	<u>NEW RULE #</u>
	COOLING	
16-20	NO GROUND COOLING/EARLY VEHICLE POWER TERMINATION	A16.1.2-1
16-21	EXTENDED COOLING	A16.1.2-2
16-23	FREON LOOP CONFIGURATION	A16.1.2-3
16-24	AMMONIA BOILER MANAGEMENT	A16.1.2-4
	ET UMBILICAL DOOR	
16-25	ET UMBILICAL DOOR POSITIONING	A16.1.3-1
	VENT DOORS	
16-30	VENT DOOR POSITIONING	A16.1.4-1
	APU/HYDRAULIC	
16-35	HYDRAULIC CIRCULATION PUMP OPERATION	A16.1.5-1
16-36	APU REQUIREMENTS	A16.1.5-2
16-37	APU/HYDRAULIC LOAD TEST TERMINATION	A16.1.5-3
16-38	WINDWARD APU OPERATION CONSTRAINT	A16.1.5-4
16-39	EARLY APU SHUTDOWN	A16.1.5-5
	FUEL CELLS	
16-45	FUEL CELL LIFETIME	A16.1.6-1
	CONTAMINATION/FLAMMABILITY	
16-50	CONTAMINATION/FLAMMABILITY/TOXICITY	A16.1.7-1
16-51	EMERGENCY OXYGEN SYSTEM REQUIREMENTS	A16.1.7-2

SECTION 17 - LIFE SUPPORT

SMOKE DETECTION/FIRE SUPPRESSION LOSS DEFINITIONS

9-1	FIRE/POST-FIRE DEFINITIONS	A17.1.1-1
9-2	SMOKE DETECTION LOSS DEFINITION	A17.1.1-2
9-3	FORWARD AVIONICS BAY FIRE SUPPRESSION	A17.1.1-3

SMOKE DETECTION/FIRE SUPPRESSION MANAGEMENT

9-10	MANAGEMENT FOLLOWING LOSS OF SMOKE DETECTION	A17.1.2-1
9-11	MANAGEMENT FOLLOWING LOSS OF FIRE SUPPRESSION IN AN AVIONICS BAY	A17.1.2-2
9-12	FIRE AND POST-FIRE ACTIONS	A17.1.2-3
9-13	MANAGEMENT FOLLOWING HALON DISCHARGE WITHOUT FIRE CONFIRMATION	A17.1.2-4

ATMOSPHERE REVITALIZATION SYSTEM (ARS) AIR LOSS DEFINITIONS

9-20	CABIN FAN	A17.1.3-1
9-21	CABIN ATMOSPHERIC CONTROL	A17.1.3-2
9-22	LOSS OF AVIONICS BAY FAN	A17.1.3-3
9-23	IMU FAN	A17.1.3-4
9-24	AVIONICS BAY COOLING	A17.1.3-5
9-25	REGENERATIVE CO2 REMOVAL SYSTEM (RCRS) LOSS DEFINITION	A17.1.3-6

ARS AIR SYSTEM MANAGEMENT

9-30	CABIN ATMOSPHERE CONTROL	A17.1.4-1
9-31	CABIN TEMPERATURE CONTROL	A17.1.4-2
9-32	CABIN/AVIONICS BAY FAN MANAGEMENT	A17.1.4-3
9-33	MANAGEMENT OF DEGRADED ROTATING EQUIPMENT	A17.1.4-4
9-34	REGENERATIVE CO2 REMOVAL SYSTEM (RCRS) MANAGEMENT	A17.1.4-5
9-35	RCRS MANUAL SHUTDOWN CRITERIA	A17.1.4-6
9-36	LIOH REDLINE DETERMINATION	A17.1.4-7
9-37	MANAGEMENT OF LIOH CANS FOR ADDITIONAL DAYS	A17.1.4-8

PRESSURE CONTROL SYSTEMS (PCS) LOSS DEFINITIONS

VOLUME A KEY

<u>OLD RULE #</u>	<u>RULE TITLE</u>	<u>NEW RULE #</u>
9-40	CABIN PRESSURE INTEGRITY	A17.1.5-1
9-41	8 PSIA CABIN CONTINGENCY 165-MINUTE RETURN CAPABILITY	A17.1.5-2
9-42	PPO2 CONTROL	A17.1.5-3
9-43	N2 SUPPLY	A17.1.5-4
9-44	PPO2 SENSOR LOSS DEFINITION	A17.1.5-5
9-45	LES O2 SUPPLY SYSTEM LOSS DEFINITION	A17.1.5-6

VOLUME A KEY

<u>OLD RULE #</u>	<u>RULE TITLE</u>	<u>NEW RULE #</u>
PCS SYSTEMS MANAGEMENT		
9-50	NORMAL PCS CONFIGURATION	A17.1.6-1
9-51	CABIN PRESSURE RELIEF VALVES	A17.1.6-2
9-52	CABIN VENT VALVES	A17.1.6-3
9-53	CABIN O2 CONCENTRATION	A17.1.6-4
9-54	8 PSIA EMERGENCY CABIN CONFIGURATION	A17.1.6-5
9-55	O2 BLEED ORIFICE MANAGEMENT	A17.1.6-6
9-56	N2 SYSTEM MANAGEMENT	A17.1.6-7
9-57	LOSS OF CABIN INTEGRITY TMAX DEFINITION AND TIG SELECTION	A17.1.6-8
9-58	N2 REDLINE DETERMINATION	A17.1.6-9
9-59	LES O2 SUPPLY SYSTEM LOSS MANAGEMENT	A17.1.6-10
10.2 PSIA CABIN ATMOSPHERE OPERATION		
9-70	CABIN ATMOSPHERE MANAGEMENT	A17.1.7-1
9-71	10.2 PSIA CABIN DEPRESSURIZATION CONSTRAINTS	A17.1.7-2
9-72	CABIN REPRESSURIZATION PRIOR TO DEORBIT	A17.1.7-3
9-73	10.2 PSIA CABIN PRESSURE MANAGEMENT FOR MULTIPLE EVA'S	A17.1.7-4
9-74	14.7 PSIA CABIN REPRESSURIZATION LIMITATION	A17.1.7-5
9-75	10.2 PSIA CABIN TEMPERATURE CONSTRAINT	A17.1.7-6
9-76	PAYLOAD 10.2 PSIA CABIN OPERATIONS	A17.1.7-7
9-78	ATCS (10.2 PSIA CABIN) CONFIGURATION	A17.1.7-8
9-79	CABIN PRESSURE TIME AT 10.2 PSIA	A17.1.7-9
WASTE COLLECTION SYSTEM (WCS)/ VACUUM VENT LOSS DEFINITIONS		
9-90	WCS SEPARATOR	A17.1.8-1
9-91	WCS URINE COLLECTION	A17.1.8-2
9-92	WCS COMMODE	A17.1.8-3
9-93	VACUUM VENT LOSS DEFINITION	A17.1.8-4
WCS/VACUUM VENT MANAGEMENT		
9-100	WCS USAGE CONSTRAINT	A17.1.9-1
9-101	LEAKING WCS WATER LINES	A17.1.9-2
9-102	ALTERNATE FECAL COLLECTION	A17.1.9-3
9-103	ALTERNATE URINE COLLECTION	A17.1.9-4
9-104	VACUUM VENT SYSTEMS MANAGEMENT (CIL)	A17.1.9-5
WASTE WATER LOSS DEFINITIONS		
9-113	WASTE WATER TANK	A17.1.10-1
9-114	WASTE WATER DUMP CAPABILITY	A17.1.10-2
WASTE WATER MANAGEMENT		
9-120	ALTERNATE PRESSURE VALVE MANAGEMENT	A17.1.11-1
9-132	WASTE DUMP NOZZLE ICE FORMATION	A17.1.11-2
9-133	WASTE WATER STORAGE	A17.1.11-3
9-134	MINIMUM WASTE TANK QUANTITY AFTER DUMPING	A17.1.11-4
9-135	WASTE WATER DUMP NOZZLE TEMPERATURE CONSTRAINTS	A17.1.11-5
9-136	WASTE WATER SYSTEM LEAK MANAGEMENT	A17.1.11-6
9-38	OMS & PRCS BURNS WITH FREE H2O IN THE CABIN	A17.1.11-7
SPACELAB/SPACEHAB		
9-260	SPACELAB NITROGEN MANAGEMENT MODULE	A17.1.12-1
EECOM GO/NO-GO CRITERIA		
9-300	EECOM GO/NO-GO CRITERIA	A17.1.13-1
SPACEHAB FIRE/SMOKE DETECTION LOSS DEFINITION		
30.2-5	SPACEHAB FIRE/SMOKE DETECTION LOSS	A17.6.1-1
FIRE/SMOKE MANAGEMENT		
30.3-14	SPACEHAB FIRE/SMOKE DETECTION	A17.6.2-1
SPACEHAB ECS MANAGEMENT		

VOLUME A KEY

<u>OLD RULE #</u>	<u>RULE TITLE</u>	<u>NEW RULE #</u>
30.4-4	SPACEHAB CABIN FAN/AIR LOOP	A17.6.3-1
30.4-5	CABIN ATMOSPHERIC CONTROL	A17.6.3-2
	MODULE ATMOSPHERE MANAGEMENT	
30.5-1	MODULE ATMOSPHERIC CONTROL	A17.6.4-1
30.5-2	CABIN FAN	A17.6.4-2
30.5-3	ATMOSPHERE RECIRCULATION SYSTEM (ARS) FAN	A17.6.4-3
30.5-4	WATER FLOW CONTROL ELECTRONICS UNIT (WFCEU)	A17.6.4-4
30.5-5	PARTIAL PRESSURE OF OXYGEN (PPO2) SENSORS	A17.6.4-5
30.5-6	PARTIAL PRESSURE OF CARBON DIOXIDE (PPCO2) SENSORS	A17.6.4-6

VOLUME A KEY

<u>OLD RULE #</u>	<u>RULE TITLE</u>	<u>NEW RULE #</u>
ATMOSPHERE INTEGRITY		
30.6-1	MODULE PRESSURE INTEGRITY LOSS DEFINITION	A17.6.5-1
30.6-2	MODULE PRESSURE CONTROL LOSS DEFINITION	A17.6.5-2
30.6-3	PPO2 CONTROL LOSS DEFINITION	A17.6.5-3
30.6-4	MODULE PRESSURE INTEGRITY	A17.6.5-4
30.6-5	NEGATIVE PRESSURE RELIEF VALVE COVERS	A17.6.5-5
30.6-6	CABIN DEPRESS VALVE (CDV)	A17.6.5-6
30.6-7	ASCENT/DESCENT INLET STUB	A17.6.5-7
30.6-8	EXPERIMENT VENT VALVE	A17.6.5-8
SPACELAB FIRE/SMOKE DETECTION LOSS DEFINITION		
31.2-6	SPACELAB FIRE/SMOKE PRIMARY DETECTION LOSS	A17.9.1-1
SPACELAB FIRE/SMOKE MANAGEMENT		
31.3-11	SPACELAB FIRE/SMOKE DETECTION	A17.9.2-1
ATMOSPHERE REVITALIZATION SYSTEM (ARS) LOSS/FAILURE DEFINITIONS		
31.6-1	CABIN FAN/AIR LOOP	A17.9.3-1
31.6-2	CABIN ATMOSPHERIC CONTROL	A17.9.3-2
31.6-3	AVIONICS FAN/AIR LOOP	A17.9.3-3
ARS SYSTEM MANAGEMENT		
31.7-1	CABIN ATMOSPHERE CONTROL (ARS AIR CIRCULATION)	A17.9.4-1
31.7-2	CONDENSATE SEPARATOR/TANK	A17.9.4-2
31.7-3	AVIONICS FAN	A17.9.4-3
31.7-4	RACK COOLING ASSEMBLY	A17.9.4-4
31.7-5	TUNNEL FAN	A17.9.4-5
ATMOSPHERE STORAGE AND CONTROL SYSTEM (ASCS) LOSS/FAILURE DEFINITIONS		
31.8-1	CABIN PRESSURE INTEGRITY	A17.9.5-1
31.8-2	CABIN PRESSURE CONTROL	A17.9.5-2
31.8-3	PPO2 CONTROL	A17.9.5-3
ATMOSPHERE STORAGE AND CONTROL SYSTEM (ASCS) MANAGEMENT		
31.9-1	CABIN PRESSURE INTEGRITY	A17.9.6-1
31.9-2	CABIN PRESSURE CONTROL	A17.9.6-2
31.9-3	RELIEF VALVE COVERS	A17.9.6-3
31.9-4	CABIN DEPRESS VALVE	A17.9.6-4
31.9-5	O2 ENRICHMENT CONTROL	A17.9.6-5
31.9-6	LOSS OF O2 PARTIAL PRESSURE CONTROL	A17.9.6-6
31.9-7	SPACELAB N2 SUPPLY MANAGEMENT	A17.9.6-7
31.9-8	SPACELAB POWER TERMINATION	A17.9.6-8
31.9-9	10.2 PSI AFT FLIGHT DECK OPERATIONS	A17.9.6-9
31.9-10	EXPERIMENT VENT VALVE POSITION	A17.9.6-10

SECTION 18 - THERMAL

SUPPLY WASTE WATER LOSS DEFINITIONS

9-110	SUPPLY WATER TANK	A18.1.1-1
9-111	SUPPLY WATER DUMPLINE	A18.1.1-2
9-112	SUPPLY WATER DUMP CAPABILITY	A18.1.1-3

SUPPLY WATER MANAGEMENT

9-121	SUPPLY H2O TANK A MANAGEMENT	A18.1.2-1
9-122	SUPPLY/WASTE WATER CROSSCONNECT	A18.1.2-2
9-124	SUPPLY WATER TANK A OUTLET VALVE MANAGEMENT	A18.1.2-3
9-125	SUPPLY WATER TANK A PRESSURE CONTROL MANAGEMENT	A18.1.2-4
9-126	SUPPLY WATER DUMP	A18.1.2-5

VOLUME A KEY

<u>OLD RULE #</u>	<u>RULE TITLE</u>	<u>NEW RULE #</u>
9-127	SUPPLY WATER DUMP NOZZLE TEMPERATURE CONSTRAINT	A18.1.2-6
9-129	SUPPLY WATER TANKS C AND D REFILL MANAGEMENT	A18.1.2-7
9-130	SUPPLY WATER SYSTEM LEAK MANAGEMENT	A18.1.2-8
9-131	SUPPLY WATER REDLINE	A18.1.2-9
	ARS H2O LOOP LOSS DEFINITIONS	
9-140	ARS WATER LOOP	A18.1.3-1

VOLUME A KEY

<u>OLD RULE #</u>	<u>RULE TITLE</u>	<u>NEW RULE #</u>
	ARS H2O LOOP LOSS MANAGEMENT	
9-150	ARS WATER LOOP	A18.1.4-1
	ACTIVE THERMAL CONTROL SYSTEM (ATCS) LOSS DEFINITIONS	
9-160	FREON COOLANT LOOPS (FCL)	A18.1.5-1
9-161	TOPPING EVAPORATOR	A18.1.5-2
9-162	HIGH-LOAD EVAPORATOR	A18.1.5-3
9-164	FES PRIMARY A (B) CONTROLLER	A18.1.5-4
9-165	FES SECONDARY CONTROLLER	A18.1.5-5
9-166	FES H2O FEEDLINE	A18.1.5-6
9-167	AMMONIA BOILER SUBSYSTEM (ABS)	A18.1.5-7
9-168	RADIATOR FLOW CONTROL ASSEMBLY (RFCA)	A18.1.5-8
	ATCS MANAGEMENT	
9-180	FREON COOLANT LOOPS (FCL)	A18.1.6-1
9-181	FLASH EVAPORATOR SYSTEM (FES)	A18.1.6-2
9-182	AMMONIA BOILER SUBSYSTEM (ABS)	A18.1.6-3
9-183	ABS AMMONIA REDLINE	A18.1.6-4
9-184	RADIATOR FLOW CONTROL ASSEMBLY (RFCA)	A18.1.6-5
	THERMAL HEATER MANAGEMENT	
9-190	TCS HEATER CONFIGURATION	A18.1.7-1
9-191	TCS HEATER REDUNDANCY	A18.1.7-2
9-192	REDUNDANT TCS HEATER VERIFICATION	A18.1.7-3
9-193	TCS HEATER OPERATIONS FOR LOSS OF INSTRUMENTATION	A18.1.7-4
9-194	LOSS OF HEATER SM CAPABILITY	A18.1.7-5
	THERMAL SOFTWARE REQUIREMENT	
9-200	THERMAL SOFTWARE REQUIREMENT	A18.1.8-1
	TPS BONDLINE TEMPERATURES MANAGEMENT	
9-210	THERMAL PROTECTION SYSTEM (TPS) BONDLINE TEMPERATURES	A18.1.9-1
	ATTITUDE MANAGEMENT FOR THERMAL CONTROL	
9-220	ORBITER THERMAL CONSTRAINTS AND ATTITUDE MANAGEMENT (CIL)	A18.1.10-1
	COOLING EQUIPMENT CONSTRAINTS	
9-230	MAXIMUM OFF TIME FOR COOLING EQUIPMENT	A18.1.11-1
	THERMAL GO/NO-GO CRITERIA	
9-300	THERMAL GO/NO-GO CRITERIA	A18.1.12-1
	SPACEHAB WATER LOOP	
30.3-10	SPACEHAB WATER LOOP	A18.6.1-1
30.3-11	WATER LINE HEATERS	A18.6.1-2
30.3-12	WATER LINE HEATER MANAGEMENT	A18.6.1-3
30.3-13	SPACEHAB CONTINGENCY COMMANDING	A18.6.1-4
	ENVIRONMENTAL CONTROL SYSTEM (ECS) MANAGEMENT	
30.4-1	SPACEHAB ENVIRONMENTAL CONTROL AND LIFE SUPPORT (ECLS) REQUIREMENTS	A18.6.2-1
30.4-2	SPACEHAB WATER LOOP MANAGEMENT	A18.6.2-2
30.4-3	ORBITER/SPACEHAB INTEGRATED RULES	A18.6.2-3
	ACTIVE THERMAL CONTROL SYSTEM (ATCS) LOSS/FAILURE DEFINITIONS	
31.4-1	SPACELAB H2O LOOP	A18.9.1-1
31.4-2	SPACELAB FREON LOOP	A18.9.1-2
	ATCS SYSTEMS MANAGEMENT	
31.5-1	SPACELAB ECLS REQUIREMENTS	A18.9.2-1
31.5-2	H2O LOOP MANAGEMENT	A18.9.2-2

VOLUME A KEY

<u>OLD RULE #</u>	<u>RULE TITLE</u>	<u>NEW RULE #</u>
31.5-3	FREON LOOP MANAGEMENT	A18.9.2-3
31.5-4	IGLOO MANAGEMENT PALLET ONLY	A18.9.2-4
31.5-5	ORBITER/SPACELAB INTEGRATED RULES	A18.9.2-5

VOLUME A KEY

OLD RULE #

RULE TITLE

NEW RULE #

THIS PAGE INTENTIONALLY BLANK

FLIGHT RULES

SECTION 1 - OPERATIONS POLICY, GENERAL AND DEFINITIONS

OPERATIONS POLICY

A1.1.1-1	FLIGHT RULE PURPOSE	1-1
A1.1.1-2	REAL-TIME OPERATING POLICY	1-1
A1.1.1-3	PROGRAM LIFETIME OPERATING POLICY	1-2
A1.1.1-4	MISSION MANAGEMENT TEAM (MMT) AUTHORITY	1-2
A1.1.1-5	FLIGHT DIRECTOR AUTHORITY	1-3
A1.1.1-6	SHUTTLE COMMANDER AUTHORITY	1-4
A1.1.1-7	FLIGHT CONTROL ROOM (FCR) SURGEON AUTHORITY	1-4
A1.1.1-8	RESERVED LAUNCH SYSTEMS EVALUATION ADVISORY TEAM (LSEAT) AUTHORITY	1-4
A1.1.1-9	WEATHER DECISION AUTHORITY	1-4
A1.1.1-10	POSTLANDING DECISION AUTHORITY	1-5
A1.1.1-11	POSTLANDING EMERGENCY DECLARATION	1-6
A1.1.1-12	SEARCH AND RESCUE RESPONSIBILITY	1-7
A1.1.1-13	ORBITER EMERGENCY LANDING SITE (ELS) AUTHORITY	1-7
A1.1.1-14	MCC REAL-TIME COMMAND COORDINATION POLICY	1-8

GENERAL

A1.1.2-1	VEHICLE SYSTEM LIMITS	1-12
A1.1.2-2	INTERIM OR UNCONFIRMED LIMITS	1-12
A1.1.2-3	MANDATORY INSTRUMENTATION REQUIREMENTS	1-12
A1.1.2-4	FAILURE DEFINITION APPLICATION	1-13
A1.1.2-5	CONFLICTING FLIGHT RULES	1-13
A1.1.2-6	INSTRUMENTATION ONBOARD VS. GROUND READOUT PHILOSOPHY	1-13

FLIGHT RULES

A1.1.2-7	FLIGHT-CRITICAL MODING	1-15
A1.1.2-8	SHUTTLE OPERATIONAL DATA BOOK (SODB), VOLUME III, DATA USE	1-15
A1.1.2-9	ACTIVITIES DURING YEAR END ROLLOVER/LEAP SECOND INCORPORATION	1-15

GENERAL DEFINITIONS

A1.1.3-1	AS SOON AS PRACTICAL (ASAP)	1-16
A1.1.3-2	HIGHLY DESIRABLE (HD)	1-16
A1.1.3-3	MANDATORY (M)	1-16
A1.1.3-4	FLIGHT PHASE	1-16
A1.1.3-5	THROTTLE SETTINGS	1-18
A1.1.3-6	LANDING SITES	1-18
A1.1.3-7	LANDING OPPORTUNITIES	1-20
A1.1.3-8	POSTLANDING CREW EGRESS/ESCAPE MODES	1-22
A1.1.3-9	CREW MEDICAL (MED) CONDITIONS	1-23
A1.1.3-10	REMOTE MANIPULATOR SYSTEM (RMS)	1-24
A1.1.3-11	TIME REFERENCE DEFINITIONS	1-20
A1.1.3-12	MULTIFUNCTION ELECTRONIC DISPLAY SUBSYSTEM	1-20

FLIGHT RULES

SECTION 1 - OPERATIONS POLICY, GENERAL AND DEFINITIONS

OPERATIONS POLICY

A1.1.1-1 **FLIGHT RULE PURPOSE**

THE FLIGHT RULES OUTLINE PREPLANNED DECISIONS DESIGNED TO MINIMIZE THE AMOUNT OF REAL-TIME RATIONALIZATION REQUIRED WHEN NON-NOMINAL SITUATIONS OCCUR FROM THE START OF THE TERMINAL COUNTDOWN THROUGH CREW EGRESS OR GROUND SUPPORT EQUIPMENT (GSE) COOLING ACTIVATION, WHICHEVER OCCURS LATER.

Self-explanatory.

A1.1.1-2 **REAL-TIME OPERATING POLICY**

- A. MISSION SUCCESS RELATED REAL-TIME DECISIONS WILL BE MADE WITHIN THE FRAMEWORK OF THE ESTABLISHED SHUTTLE OPERATING BASE DOCUMENTED AS FOLLOWS:
1. PREMISSION DECISIONS - STS OPERATIONAL FLIGHT RULES AND STS OPERATIONAL FLIGHT RULES FLIGHT-SPECIFIC ANNEX DEVELOPED USING THE SYSTEM PERFORMANCE CAPABILITIES DOCUMENTED IN THE SHUTTLE OPERATIONAL DATA BOOK (SODB).
 2. PROGRAM CERTIFIED CAPABILITY - REAL-TIME INTERPRETATION OF THE REQUIREMENTS WILL BE MADE CONSISTENT WITH AUTHORITY DEFINED HEREIN.
- B. CREW SAFETY RELATED DECISIONS WILL BE MADE WITHIN THE FRAMEWORK OF ESTABLISHED SHUTTLE OPERATING BASE (PARAGRAPH A ABOVE) WHEN PRACTICAL. WHEN TIME OR CIRCUMSTANCES DO NOT ALLOW STAYING WITHIN THE OPERATING BASE, THE RESPONSIBLE AUTHORITY MAY CHOOSE TO TAKE ANY NECESSARY ACTION TO ENSURE THE SAFETY OF THE SHUTTLE AND CREW.
- C. WHERE POSSIBLE CONTINGENCY MANAGEMENT WILL BE EMPLOYED TO PROVIDE FOR LANDING AT THE PRIMARY OR SECONDARY LANDING SITE AND TO PROVIDE THE MAXIMUM POSSIBLE GUIDANCE, NAVIGATION, AND CONTROL CAPABILITY FOR ENTRY AND LANDING.

Self-explanatory.

FLIGHT RULES

Rule {A1.1.1-5}, FLIGHT DIRECTOR AUTHORITY, references this rule.

A1.1.1-3 PROGRAM LIFETIME OPERATING POLICY

SYSTEMS MANAGEMENT FOR NOMINAL OPERATION WILL OBSERVE THE PROGRAM (MULTIPLE FLIGHT) LIFETIME OPERATING LIMITS AND/OR CONSTRAINTS PER THE SODB. HOWEVER, THOSE LIMITS AND/OR CONSTRAINTS MAY BE VIOLATED FOR CONTINGENCY OPERATIONS AS FOLLOWS:

- A. SINGLE-FLIGHT CONTINGENCY MANAGEMENT LIMITS AND/OR CONSTRAINTS MAY BE USED IF AGREED TO PREFLIGHT OR WITH THE CONCURRENCE OF THE MISSION MANAGEMENT TEAM (MMT) IN REAL TIME.
- B. IF THE SINGLE-FLIGHT LIMITS MUST BE VIOLATED, THE BEST ENGINEERING JUDGEMENT ON THE LIMITS/CONSTRAINTS THAT PROVIDE THE HIGHEST PROBABILITY OF SUCCESSFUL RECOVERY OF THE CREW AND ORBITER WILL BE USED.

Self-explanatory.

A1.1.1-4 MISSION MANAGEMENT TEAM (MMT) AUTHORITY

DURING FLIGHT, THE MMT CHAIRMAN IS RESPONSIBLE FOR NEAR REAL-TIME POLICY DECISIONS AND WILL BE CONSULTED AS SOON AS POSSIBLE WHENEVER OPERATIONS OUTSIDE THE SHUTTLE OPERATING BASE ARE REQUIRED.

Self-explanatory.

FLIGHT RULES

A1.1.1-5 FLIGHT DIRECTOR AUTHORITY

A. THE FLIGHT DIRECTOR IS RESPONSIBLE FOR OVERALL DIRECTION OF SHUTTLE FLIGHTS FROM SOLID ROCKET BOOSTER (SRB) IGNITION UNTIL CREW EGRESS OR GSE COOLING ACTIVATION, WHICHEVER OCCURS LATER:

1. THE FLIGHT DIRECTOR IS RESPONSIBLE FOR REAL-TIME IMPLEMENTATION OF OPERATIONS WITHIN THE FRAMEWORK OF THE SHUTTLE OPERATING BASE (REFERENCE (REF.) RULE {A1.1.1-2}, REAL-TIME OPERATING POLICY).
2. THE FLIGHT DIRECTOR IS RESPONSIBLE FOR PROVIDING RECOMMENDATIONS AND/OR OPTIONS TO THE MMT FOR NEAR REAL-TIME DECISIONS WHEN OPERATING OUTSIDE THE FRAMEWORK OF THE MISSION RULES OR THE SHUTTLE OPERATING BASE.

B. THE FLIGHT DIRECTOR, AFTER ANALYSIS OF THE FLIGHT CONDITION, MAY CHOOSE TO TAKE ANY NECESSARY REAL-TIME ACTION REQUIRED TO ENSURE THE SAFETY OF THE CREW AND SHUTTLE.

C. THE FLIGHT DIRECTOR WILL PROVIDE THE DEFINITIVE LAUNCH WINDOW OPEN, CLOSE, RENDEZVOUS PANE CHANGE AND LOX DRAINBACK TIME. @041097-4911A]

DE. THE FLIGHT DIRECTOR WILL INITIATE THE ABORT REQUEST COMMAND FROM THE MCC.

ED. THE FLIGHT DIRECTOR IS RESPONSIBLE FOR CALLING A LAUNCH "HOLD" FOR ALL PROBLEMS THAT JEOPARDIZE THE ABILITY TO SAFELY MONITOR AND RECOVER THE ORBITER AND CREW AFTER LAUNCH. THIS INCLUDES PROBLEMS IN THE FOLLOWING AREAS: MISSION CONTROL CENTER (MCC), SPACECRAFT TRACKING AND DATA NETWORK (STDN), LANDING AREA FACILITIES, AND ABORT LANDING AREA WEATHER.

FE. THE FLIGHT DIRECTOR IS RESPONSIBLE FOR OVERALL CONTROL OF THE MCC COMMAND UPLINK CAPABILITY.

GF. THE FLIGHT DIRECTOR IS RESPONSIBLE FOR POSTLANDING ORBITER SYSTEMS CONFIGURATION AND SAFING THROUGH CREW EGRESS OR GSE COOLING ACTIVATION, WHICH EVER OCCURS LATER. @041097-4911A]

Self-explanatory.

FLIGHT RULES

A1.1.1-6 SHUTTLE COMMANDER AUTHORITY

- A. THE COMMANDER WILL ASSUME RESPONSIBILITY FOR CONDUCT OF THE FLIGHT WITHIN THE FRAMEWORK OF THE FLIGHT RULES, IF UNABLE TO COMMUNICATE WITH MCC.
- B. THE COMMANDER MAY INITIATE SUCH ACTION AS HE DEEMS ESSENTIAL FOR CREW SAFETY.

Self-explanatory.

Rule {A2.1.5-1}, BAILOUT, references this rule.

A1.1.1-7 FLIGHT CONTROL ROOM (FCR) SURGEON AUTHORITY

- A. THE FCR SURGEON WILL BE CONSULTED ON ALL CONDITIONS WHICH DEAL WITH CREW HEALTH.
- B. THE FCR SURGEON IS RESPONSIBLE FOR EVALUATION OF ANY CHANGE IN CREW HEALTH STATUS AND MAKING RECOMMENDATIONS TO THE FLIGHT DIRECTOR REGARDING ANY REQUIRED CHANGES IN MISSION DURATION OR CREW ACTIVITIES.

A1.1.1-8 RESERVED @[091098-6622C] LAUNCH SYSTEMS EVALUATION ADVISORY TEAM (LSEAT) AUTHORITY

A1.1.1-9 WEATHER DECISION AUTHORITY

- A. THE JOHNSON SPACE CENTER (JSC) MCC FLIGHT DIRECTOR IS RESPONSIBLE FOR LAUNCH ABORT LANDING AND END-OF-MISSION WEATHER DECISIONS AND ASSOCIATED RECOMMENDATIONS TO THE MMT CHAIRMAN.
- B. THE KENNEDY SPACE CENTER (KSC) LAUNCH DIRECTOR IS RESPONSIBLE FOR THE LAUNCH DECISION FOR WEATHER ACCEPTABILITY AT THE LAUNCH PAD FOR ASCENT TRAJECTORY AND ASSOCIATED RECOMMENDATIONS TO THE MMT CHAIRMAN.

Self-explanatory.

FLIGHT RULES

A1.1.1-10 POSTLANDING DECISION AUTHORITY

A. FLIGHT DIRECTOR

THE FLIGHT DIRECTOR IS RESPONSIBLE FOR POSTLANDING ORBITER SYSTEMS CONFIGURATION AND SAFING THROUGH CREW EGRESS OR GSE COOLING ACTIVATION, WHICHEVER OCCURS LATER. THIS INCLUDES:

1. IN-FLIGHT CONTINGENCIES.
2. OFF-NOMINAL AND CONTINGENCY LANDING OPERATIONS (THROUGH CREW EGRESS) AS LONG AS COMMUNICATIONS EXIST BETWEEN THE ORBITER AND MCC-HOUSTON (MCC-H).

The flight director will support postlanding operations by ensuring correct configuration of orbiter systems to allow convoy activities to proceed. Assessment of the external environment to allow safe crew egress and continued postlanding operations is the responsibility of convoy personnel.

B. CONVOY COMMANDER

THE CONVOY COMMANDER IS RESPONSIBLE FOR THE ORBITER SAFETY INSPECTION/HAZARD ASSESSMENT AND ASSOCIATED IMPACT TO CREW EGRESS AND CONVOY OPERATIONS. THE FLIGHT DIRECTOR WILL BE NOTIFIED OF ANY EXPLOSIVE, FLAMMABLE, OR TOXIC CONDITIONS THAT WILL PRECLUDE/DELAY NORMAL CREW EGRESS.

The orbiter inspection/hazard assessment will be accomplished by on-site convoy personnel who are in the best position to determine if unsafe conditions exist (explosive, flammable, toxic, smoke, etc.). Violation of identified "safe criteria" will result in termination of convoy activities and crew egress as recommended by the convoy commander (reference Postlanding Operations Maintenance Instruction (OMI) for hazard assessment criteria).

THIS RULE CONTINUED ON NEXT PAGE

FLIGHT RULES

A1.1.1-10 POSTLANDING DECISION AUTHORITY (CONTINUED)

C. LANDING RECOVERY DIRECTOR (LRD)/GROUND OPERATIONS MANAGER (GOM)

THE LRD OR THE GOM IS RESPONSIBLE FOR THE COORDINATION OF DECLARED POSTLANDING MODE V THROUGH MODE VII EGRESS/ESCAPE MODES PLUS ORBITER POSTLANDING ACTIVITIES POST-MCC HANDOVER.

Coordinating contingency operations at any time during a mission should be accomplished by the person in charge with the most current, reliable information and communications capabilities that ensure the proper resources are employed to save life and property. During a landing at an augmented landing site (ALS), (primary landing site (PLS), secondary landing site (SLS), or transoceanic abort landing (TAL) site), the LRD/GOM is best able to coordinate this effort. At a Department of Defense (DOD) emergency landing site (ELS), this coordination is best handled by the on-scene commander. In certain situations, however, the Flight Director is in the best position to coordinate contingency operations. These are as follows:

- a. *For in-flight emergencies, the flight director (in conjunction with the flightcrew) is best able to determine when a contingency situation exists and is responsible for conduct of the flight until crew egress.*
- b. *When outside the operating radius of an ALS or DOD ELS, the flight director, again in conjunction with the crew, is in the best position to coordinate contingency operations and to see that the appropriate actions are initiated up to and including crew egress.*

A1.1.1-11 POSTLANDING EMERGENCY DECLARATION

OFFICIAL DECLARATION OF A POSTLANDING EMERGENCY (MODE V THROUGH MODE VII) CAN BE MADE BY THE LRD, FLIGHT DIRECTOR, GOM, CONVOY COMMANDER, OR FLIGHTCREW. IN ADDITION FOR ELS LANDINGS, THIS DECLARATION MAY BE MADE BY THE DOD ON-SCENE COMMANDER. TIME AND CIRCUMSTANCES PERMITTING, COORDINATION WITH THE FLIGHT DIRECTOR WILL BE ACCOMPLISHED.

A postlanding emergency (Mode V through Mode VII) should be declared so that everyone involved is aware of the situation and can take the proper actions or precautions to protect both equipment and life. For this reason, the first of the following individuals that would discover that the emergency exists would make the declaration: LRD, flight director, GOM, convoy commander, on-scene commander, or flightcrew. Any of the above individuals have the communication capabilities to ensure that everyone involved is aware of the emergency. If time is available and the circumstances allow, coordination with the flight director will ensure that the most current information concerning the status of the crew and the orbiter is available for dealing with the emergency.

FLIGHT RULES

A1.1.1-12 SEARCH AND RESCUE RESPONSIBILITY

FOR MODE VII, SEARCH AND RESCUE RESPONSIBILITY REVERTS FROM THE LOCAL SITE COMMANDER TO THE APPROPRIATE SEARCH AND RESCUE (SAR) PLAN, WHEN IMPACT IS:

- A. FOR EDWARDS (EDW), OUTSIDE THE BOUNDARIES OF THE BASE.
- B. FOR NORTHRUP (NOR), GREATER THAN 25 NM RADIUS OF THE WHITE SANDS SPACE HARBOR (WSSH) TACAN.
- C. FOR KSC, GREATER THAN 25 NM RADIUS OF THE KSC TACAN, EXCLUDING THE ATLANTIC OCEAN.

Within the local contingency area for KSC, the DOD will support NASA's rescue/recovery operations by providing two helicopters configured for Medivac.

At Edwards Air Force Base (EAFB), the Commander of Air Force Flight Test Center (AFFTC) has complete responsibility for all efforts involving astronaut recovery, fire fighting, and security. The DOD will provide support as necessary.

At WSSH, the DOD has varying degrees of responsibility and basically will provide support for search and rescue within the limitations of their equipment.

All of the above support is provided within the limits of the site as described in this rule. Outside of that limit, search and rescue operations will be conducted in accordance with applicable SAR plans. These plans identify the areas of responsibility and the controlling agencies.

A1.1.1-13 ORBITER EMERGENCY LANDING SITE (ELS) AUTHORITY

FOR ELS LANDINGS, THE FLIGHTCREW HAS ON-SCENE RESPONSIBILITY FOR THE ORBITER UNTIL ARRIVAL OF THE KSC RAPID RESPONSE TEAM (APPROXIMATELY LANDING PLUS 24 HOURS). THE LANDING AND RECOVERY DIRECTOR (LRD) IS RESPONSIBLE FOR ANSWERING ORBITER HANDLING QUESTIONS FROM ELS PERSONNEL.

For a landing at an ELS, the crew will have the responsibility for the orbiter until the KSC Rapid Response Team is able to arrive. The crew will have a checklist to follow and may be able to obtain help from the U. S. Embassy in securing and protecting the orbiter. Communications to the ELS will be provided as best as possible through the JSC Landing Support Officer (LSO), and any questions that the ELS personnel may have regarding the handling of the orbiter will be provided by the person responsible for the recovery, the LRD at KSC.

FLIGHT RULES

A1.1.1-14 MCC REAL-TIME COMMAND COORDINATION POLICY

- A. THE FLIGHT DIRECTOR WILL APPROVE ALL COMMAND OPERATIONS.
©[092293-1547]

The flight director is responsible for the integrity of the command system/process and for insuring that all commands to the shuttle are safely and properly executed.

- B. ROUTINE COMMAND OPERATIONS CAN BE PERFORMED WITHOUT A "GO" FROM THE FLIGHT DIRECTOR FOR EACH ROUTINE FUNCTION.

Thousands of routine commands must be sent to the vehicle each flight to manage comm systems, instrumentation systems, recorders, video systems, etc. Requiring flight director approval for these operations continuously is not appropriate and prevents efficient operations. Risk associated with these routine commands is considered low. The flight director may identify critical time periods where even routine commands require coordination.

- C. NONSTANDARD COMMAND ACTIVITY (NOT OPERATING PER A REVIEWED, APPROVED, AND PUBLISHED PROCEDURE OR ANY EXECUTION OF A PROCEDURE THAT IS NOT ROUTINELY PERFORMED EACH MISSION) MUST BE REVIEWED BY THE FLIGHT CONTROL TEAM AND BE APPROVED BY THE FLIGHT DIRECTOR.

Nonstandard command activity contains increased possibilities for command errors. Flight control team review and flight director approval are the techniques used to reduce the possibility of command errors. These techniques must be utilized whenever a procedure is developed or modified in real time because the standard preflight command procedure review has not been accomplished. These techniques must also be used on infrequently used or modified procedures in order to assure that the procedures are current and compatible with recent changes in shuttle hardware and software as well as ground hardware and software.

- D. ANY REAL-TIME MODIFICATIONS TO PREFLIGHT APPROVED COMMAND PROCEDURES MUST BE REVIEWED BY THE FLIGHT CONTROL TEAM AND APPROVED BY THE FLIGHT DIRECTOR.

Modified procedures need to be reviewed just as the procedures specified in paragraph C above require review.

- E. COMMANDS SHALL ONLY BE BUILT BY CERTIFIED FLIGHT CONTROLLERS AND EXECUTED BY COMMAND CERTIFIED FLIGHT CONTROLLERS.

Command certification is required to reduce command error risk by insuring that personnel are properly trained and certified to accomplish the necessary command functions without error.

THIS RULE CONTINUED ON NEXT PAGE

FLIGHT RULES

A1.1.1-14 **MCC REAL-TIME COMMAND COORDINATION POLICY**
(CONTINUED)

F. ANY ANOMALIES IN COMMAND OPERATIONS WILL BE BROUGHT TO THE ATTENTION OF THE FLIGHT DIRECTOR IMMEDIATELY.

The flight director is responsible for command operations and any deviations from command operations. The flight director is also responsible for maintaining the integrity and safety of command operations. The flight director must be notified immediately of any problems or off-nominal activity with respect to any procedure to assure corrective action coordination and safe resumption of command activity.

G. THE FLIGHT DIRECTOR WILL EXERCISE POSITIVE CONTROL AND BE DIRECTLY INVOLVED THROUGH STATUS AND APPROVAL AT MAJOR STEPS IN ALL NONSTANDARD COMMAND PROCEDURES.

When executing nonstandard or critical commands which create more risk to the vehicle/command operations than routine commanding, the flight director will provide another level of operational awareness and control to assure the safe and proper execution of the required command functions.

H. INCO IS THE PRIME UPLINK OPERATOR AND ALL FLIGHT CONTROL POSITIONS WILL COORDINATE THEIR COMMAND ACTIVITIES THROUGH INCO.

The INCO and the INCO MPSR perform the majority of all commanding to the shuttle and are aware of the systems/uplink and downlink status. Because multiple command operations/operators can lead to command execution problems and errors, all command activities will be coordinated through INCO and the INCO MPSR to reduce the possibility of having command problems.

I. FLIGHT CONTROLLERS REQUESTING COMMAND ACTIVITIES ARE RESPONSIBLE FOR:

1. PROPERLY GENERATING THE COMMAND DATA
2. CLEARLY COMMUNICATING THE COMMAND REQUEST AND COMMANDS TO THE FLIGHT CONTROLLER EXECUTING THE COMMANDS (AS WELL AS THE FLIGHT CONTROL TEAM/FLIGHT DIRECTOR IF REQUIRED)
3. REMAINING IN COMMUNICATION WITH THE EXECUTING FLIGHT CONTROLLER THROUGHOUT THE COMMAND SEQUENCE
4. VERIFYING THE PROPER EXECUTION OF THE REQUIRED COMMANDS PRIOR TO PROCEEDING TO THE NEXT COMMAND (VIA COMMAND TRACK DISPLAYS OR END ITEM FUNCTIONS)

FLIGHT RULES

THIS RULE CONTINUED ON NEXT PAGE

FLIGHT RULES

A1.1.1-14 **MCC REAL-TIME COMMAND COORDINATION POLICY**
(CONTINUED)

5. REPORTING THE RESULTS OF THE COMMAND TO THE FLIGHT DIRECTOR

Responsibilities of the flight controllers must be established to assure that command activities are performed in a safe and proper manner. The INCO and flight control team/flight director may not know all of the ramifications of a particular command sequence and must be informed clearly of the procedure and expectations and risks associated with it.

- J. COMMAND ACTIVITIES TO THE SHUTTLE OR PAYLOADS DURING PERIODS OF CREW SLEEP WILL ONLY BE ALLOWED IN THE FOLLOWING CASES:

1. THE COMMANDS HAVE BEEN PREVIOUSLY COORDINATED WITH THE CREW, EITHER INDIVIDUALLY OR AS PART OF A PAYLOAD COMMAND PLAN.
2. THE COMMANDS ARE NECESSARY TO PREVENT NUISANCE ALARMS THAT WILL DISTURB THE CREW SLEEP.
3. THE COMMANDS ARE THE ROUTINE/CONTINUOUS COMMANDS REQUIRED FOR COMMUNICATIONS CONFIGURATION (E.G., RECORDERS, VIDEO, COMM SYSTEMS MANAGEMENT).
4. STATE VECTOR UPDATES REQUIRED TO MAINTAIN SHUTTLE EMERGENCY DEORBIT CAPABILITY.

In order to mitigate the risk of unanticipated command effects, only necessary commands will be sent during crew sleep periods. Special testing or comm related DTO's are not considered necessary commanding, as well as any other command operations that could result in disturbing the crew and/or disruption of mission activities.

- K. ALL TYPES OF COMMANDS WILL BE COORDINATED WITH THE ORBITER FLIGHTCREW AND MCC FLIGHT DIRECTOR PRIOR TO BEING TRANSMITTED WITH THE EXCEPTION OF:

1. ROUTINE ORBITER COMMUNICATIONS COMMANDS (TRANSPARENT TO CREW).
2. NONHAZARDOUS PAYLOAD COMMANDS (PREFLIGHT APPROVED).

FLIGHT RULES

With the exception of routine communications systems commands and nonhazardous commands, most command uplinks directly affect the systems being used by the flightcrew for control of the vehicle or payload. To ensure that the flightcrew has current status of vehicle or payload systems in the event of loss of communications, and to ensure that the flightcrew and ground are not in competition for use of a particular orbiter or payload facility, the flightcrew shall be informed of the transmission of command uplinks.

GENERAL

A1.1.2-1 VEHICLE SYSTEM LIMITS

SYSTEMS LIMITS LISTED IN THESE RULES INCLUDE THE ACTUAL VEHICLE LIMITS FOLLOWED BY A NUMBER IN () WHICH IS THE NUMBER BIASED FOR INSTRUMENTATION INACCURACIES AND REPRESENTS THE NUMBER ON WHICH FLIGHT CONTROL ACTION WILL BE TAKEN. IN THE EVENT ONLY ONE NUMBER IS INDICATED, IT WILL BE ASSUMED THAT INSTRUMENTATION INACCURACY CANNOT BE INCORPORATED OR IS IRRELEVANT. IN THOSE CASES WHERE TWO SETS OF ENGINEERING UNITS ARE INDICATED, THE SECOND SET WILL BE SEPARATED FROM THE FIRST BY A SLASH; I.E., XX DEG F/YY DEG C (XX DEG F/YY DEG C).

Self-explanatory.

A1.1.2-2 INTERIM OR UNCONFIRMED LIMITS

FLIGHT RULE LIMITS THAT ARE CONSIDERED TO BE INTERIM OR UNCONFIRMED NUMBERS WILL BE UNDERLINED IN THIS PUBLICATION AND IN ALL SUBSEQUENT REVISIONS UNTIL THE NUMBERS ARE CONFIRMED BY THE RESPONSIBLE NASA ORGANIZATION.

Self-explanatory.

A1.1.2-3 MANDATORY INSTRUMENTATION REQUIREMENTS

UNLESS STATED OTHERWISE, MANDATORY INSTRUMENTATION REQUIREMENTS CAN BE SATISFIED BY EITHER ONBOARD OR TELEMETRY CAPABILITY.

Self-explanatory.

FLIGHT RULES

A1.1.2-4 **FAILURE DEFINITION APPLICATION**

FAILURE DEFINITIONS IN THIS DOCUMENT REFER TO LIMITS TO BE APPLIED FOR GO/NO-GO DECISIONS TO CONTINUE BEYOND A PREFERRED DAILY LANDING OPPORTUNITY. SYSTEMS MAY BE USED IN A DEGRADED MODE AS SPECIFIED BY THE MANAGEMENT RULES OR AS DICTATED BY FLIGHT NEED.

Self-explanatory.

A1.1.2-5 **CONFLICTING FLIGHT RULES**

- A. RULES WHICH ARE KNOWN TO HAVE FLIGHT SPECIFIC EXCEPTIONS OR OPTIONS WILL BE NOTED IN THIS DOCUMENT (NSTS-12820) AND DOCUMENTED IN THE FLIGHT SPECIFIC ANNEX (NSTS-18308).
- B. RULES FROM THE "ALL FLIGHTS" DOCUMENT FOR WHICH EXCEPTIONS ARE PROPOSED WHICH HAVE NOT BEEN PREVIOUSLY IDENTIFIED AS EXCEPTIONS OR OPTIONS MUST BE PROCESSED AND APPROVED AS A PERMANENT CHANGE OR AS A DEVIATION TO THE ALL FLIGHTS DOCUMENT.

Flight-specific exceptions or options to the All Flights rules are at the discretion of the lead flight director provided that the All Flights rules permit them. If the All Flights rule does not make provisions for an exception, a change request (CR) must be written to change the rule, and the CR may be approved as either a change or deviation. The annotation in the Annex rationale should reflect the type of rule approval, i.e., stating, "This rule is a flight-specific exception or option (as applicable) to Flight Rule xx.yy-zz" or, "This rule is a flight-specific deviation from Flight Rule xx.yy-zz."

A1.1.2-6 **INSTRUMENTATION ONBOARD VS. GROUND READOUT PHILOSOPHY**

WHERE DISCREPANCIES EXIST BETWEEN ONBOARD AND GROUND READOUTS, DEDICATED ONBOARD METERS WILL BE CONSIDERED PRIME OVER GROUND READOUTS. FOR GENERAL PURPOSE COMPUTER (GPC)-DRIVEN DATA, THE MOST REASONABLE (IF IT CAN BE DETERMINED) OR THE MOST CONSERVATIVE READOUT WILL BE USED. LOSS OF INSTRUMENTATION WHICH PRECLUDES IMPLEMENTATION OF A FLIGHT RULE WILL NOT NECESSARILY CAUSE FLIGHT TERMINATION.

FLIGHT RULES

The purpose of this rule is to minimize the possibility of invoking a flight rule as a result of transducer failures, shifts, or errors introduced in the communications path from the vehicle to the MCC. In general, if the same transducer drives both an onboard meter and a telemetry input, the onboard meter readout, if reasonable, should be more accurate since it is closer to the source. In cases of GPC-driven data (no meter or other analog display), when two readouts (both onboard or onboard and ground) differ but are still reasonable, the more conservative of the two is used as it results in the safest course of action. If a mandatory instrumentation parameter exists which, if lost, would result in invoking a flight rule, it is specifically identified in these rules. In general, instrumentation failures will not cause flight termination since critical systems failure can be monitored by redundant means.

FLIGHT RULES

A1.1.2-7 FLIGHT-CRITICAL MODING

WHERE REDUNDANT CAPABILITIES ARE PROVIDED TO EXECUTE FLIGHT-CRITICAL SWITCHING OR MODING, THE PATHS WILL BE CONFIGURED TO PREVENT LOSS OF A TOTAL CAPABILITY FOR LOSS OF A SINGLE GPC, DATA PATH, OR POWER SOURCE.

Self-explanatory.

A1.1.2-8 SHUTTLE OPERATIONAL DATA BOOK (SODB), VOLUME III, DATA USE

IN CONTINGENCY SITUATIONS, SODB, VOLUME III, DATA IS USED WITH THE BEST ENGINEERING JUDGMENT RECOGNIZING THAT SOME OF THE DATA CONTAINS ENGINEERING ESTIMATES FOR NON-NOMINAL PERFORMANCE EVALUATION AND MAY NOT BE SUPPORTED BY TEST DATA.

A1.1.2-9 ACTIVITIES DURING YEAR END ROLLOVER/LEAP SECOND INCORPORATION

IF POSSIBLE, CRITICAL PHASES OF MISSIONS WILL NOT BE PERFORMED DURING AN OCCURRENCE OF A MASTER TIMING UNIT (MTU) YEAR END ROLLOVER OR AN INCORPORATION OF A LEAP SECOND.

Whenever an MTU year end rollover or leap second incorporation occurs during a flight, the MCC has to perform several off-nominal procedural workarounds including reconfiguring the data dump handler (DDH) (which directly affects near real-time telemetry (NRT) processing and retrieval), manually processing the GSFC TDRS state vectors, and altering the build process for stored program commands (SPC's). Additionally, the 1-second bias to the data as a result of a leap second incorporation during ascent/entry is deemed undesirable by the ground navigation and tracking personnel. Tracking data in the high speed phases of ascent/entry would be 1 second out of sync with the mission operations computer (MOC), and the MCC would have to manually implement a bias to account for the 1 additional second; if this bias is not implemented, the tracking data would be essentially useless. Per the ground navigation personnel, implementation of this bias is not a trivial task. For year end rollover, the same concerns apply, but to a greater degree. Therefore, because of the dependency of several critical mission phases on accurate time, these phases should not be performed during an MTU year end rollover or leap second incorporation. However, if other factors prevent a rescheduling of these critical phases (e.g., weather, next PLS conditions), the risk of performing these critical phases during MTU year end rollover or leap second incorporation will be accepted.

References: MICB CR R21075-053, Level B Groundrules and Constraints Update: Findings: Year End Rollover and Leap Second Phenomena and Their Effects of STS Mission Support (Document No. STSOC-RT-400141).

FLIGHT RULES

GENERAL DEFINITIONS

A1.1.3-1 AS SOON AS PRACTICAL (ASAP)

AS SOON AS PRACTICAL (I.E., AS SOON AS POSSIBLE AND REASONABLE)

Self-explanatory.

A1.1.3-2 HIGHLY DESIRABLE (HD)

A SPACE TRANSPORTATION SYSTEM (STS) OR GROUND SUPPORT ELEMENT THAT ENHANCES ACCOMPLISHMENT OF THE FLIGHT. CONSIDERATION WILL BE GIVEN TO HOLDING THE COUNT FOR THE REPAIR OF AN HD ELEMENT, IF CONVENIENT, BUT IN NO CASE WILL THE LAUNCH BE SCRUBBED.

Self-explanatory.

A1.1.3-3 MANDATORY (M)

AN STS OR GROUND ELEMENT THAT IS REQUIRED TO ENSURE CREW SAFETY, IMPLEMENT LAUNCH GO/NO-GO CRITERIA, LAUNCH ABORT, OR EARLY FLIGHT TERMINATION FLIGHT RULES.

Self-explanatory.

A1.1.3-4 FLIGHT PHASE

- A. PRELAUNCH - PRIOR TO SRB IGNITION.
- B. ASCENT - SRB IGNITION THROUGH ORBITAL MANEUVERING SYSTEM 2 (OMS-2) CUTOFF.
- C. ORBIT - OMS-2 CUTOFF TO DEORBIT MANEUVER IGNITION.
- D. DEORBIT PREPARATION - FROM DEORBIT TIME OF IGNITION (TIG) -3.5 HRS TO DEORBIT TIG.
- E. EXTRAVEHICULAR ACTIVITY (EVA) - START OF AIRLOCK DEPRESSURIZATION THROUGH REPRESSURIZATION AND VERIFICATION OF AIRLOCK INTEGRITY.
- F. ENTRY - DEORBIT MANEUVER IGNITION THROUGH ROLLOUT.

FLIGHT RULES

THIS RULE CONTINUED ON NEXT PAGE

FLIGHT RULES

A1.1.3-4 FLIGHT PHASE (CONTINUED)

- G. POSTLANDING - ROLLOUT THROUGH CREW EGRESS.
- H. TURNAROUND OPERATIONS - POST CREW EGRESS.

Self-explanatory.

A1.1.3-5 THROTTLE SETTINGS

- A. NOMINAL THROTTLE - MAXIMUM SPACE SHUTTLE MAIN ENGINE (SSME) THROTTLE SETTING LEVEL THAT IS ALLOWED DURING A NOMINAL (NOT LOW PERFORMANCE) ASCENT.
- B. ABORT THROTTLE - MAXIMUM CERTIFIED SSME THROTTLE SETTING LEVEL TO BE USED FOR OFF-NOMINAL (LOW PERFORMANCE) ASCENT AND INTACT ABORT MODES.
- C. MAX THROTTLE - MAXIMUM SELECTABLE SSME THROTTLE SETTING LEVEL.

Self-explanatory.

A1.1.3-6 LANDING SITES

- A. PRIMARY LANDING SITE (PLS) - THE PERMISSION SELECTED, NOMINAL END-OF-MISSION (EOM) LANDING SITE OR THE CONUS (EDW, KSC, NOR) LANDING SITE SELECTED DAILY IF REQUIRED FOR EARLY MISSION TERMINATION ("NEXT PLS"). SEE RULE {A4.1.3-7}, PLS/EOM LANDING OPPORTUNITY REQUIREMENTS. ©[113095-1800]
- B. SECONDARY LANDING SITE (SLS) - BACKUP TO THE PRIMARY EOM LANDING SITE USED WHEN THE PRIME EOM LANDING SITE DOES NOT MEET ACCEPTABLE CONDITIONS.
- C. EMERGENCY LANDING SITES (ELS) - LANDING SITES, CARRIED IN THE ONBOARD SOFTWARE OR AVAILABLE FOR UPLINK FROM THE MCC, NOT SUPPORTING PLANNED EOM OR INTACT ABORTS. SEE RULE {A2.1.5-14}, EMERGENCY LANDING FACILITY CRITERIA. ©[113095-1800]
- D. ABORT-ONCE-AROUND (AOA) SITE - THE SITE SELECTED PERMISSION FOR LANDING IN THE EVENT OF AN AOA ABORT. (REF. RULE {A2.1.1-2}, ABORT LANDING SITE REQUIREMENTS). ©[121593-1590]

FLIGHT RULES

THIS RULE CONTINUED ON NEXT PAGE

FLIGHT RULES

A1.1.3-6 LANDING SITES (CONTINUED)

- E. ALTERNATE AOA SITE - THE BACKUP TO THE PRIME AOA SITE; USED WHEN THE PRIME AOA SITE DOES NOT MEET ACCEPTABLE CONDITIONS (REF. RULES {A2.1.1-1F}, PRELAUNCH GO/NO-GO REQUIREMENTS, AND {A2.1.1-2}, ABORT LANDING SITE REQUIREMENTS). @[121593-1590]
- F. TRANSOCEANIC ABORT LANDING (TAL) SITE - THE SITE(S) SELECTED PERMISSION FOR LANDING IN THE EVENT OF A TAL ABORT.
- G. ALTERNATE TAL SITE - THE BACKUP TO THE PRIME TAL SITE; USED WHEN THE PRIME TAL SITE DOES NOT MEET ACCEPTABLE CONDITIONS (REF. A2.1.1-1F, PRELAUNCH GO/NO-GO REQUIREMENTS).
- H. AUGMENTED CONTINGENCY LANDING SITE (ACLS) - A TAL SITE, WHICH IS NO-GO FOR TAL DUE TO WEATHER, REDUNDANCY, OR TOUCHDOWN/ROLLOUT CONDITIONS, THAT IS USED TO FILL CONTINGENCY POWERED FLIGHT PERFORMANCE GAPS AND PROVIDE COVERAGE FOR CERTAIN ASCENT SYSTEMS FAILURES REQUIRING EARLIEST LANDING TIME. WEATHER (EXCEPT AS NOTED BELOW) AND TOUCHDOWN/ROLLOUT CONDITIONS ARE NOT CONSIDERED FOR THESE SITES, AND MINIMUM REQUIRED NAV/LANDING AIDS ARE REDUCED TO A SINGLE-STRING TACAN OR DME, WITH SINGLE-STRING MLS REQUIRED FOR REDUCED CEILING AND VISIBILITY LIMITS AS DEFINED IN RULE {A2.1.1-6}, LANDING SITE WEATHER CRITERIA. FOR NIGHT LANDINGS, RUNWAY EDGE LIGHTING IS ALSO REQUIRED. @[102793-1560] @[113095-1800]

Self-explanatory.

A1.1.3-7 LANDING OPPORTUNITIES

- A. ENTER FIRST DAY PLS - THE PLANNED OPPORTUNITY FOR LANDING ON THE DAY OF LAUNCH IF A SITE IS AVAILABLE, REF. RULE {A2.1.1-2}, ABORT LANDING SITE REQUIREMENTS, OTHERWISE LAND ON FLIGHT DAY 2 PLS. @[121593-1590]
- B. ENTER NEXT PLS - THE NEXT LANDING OPPORTUNITY AT THE PRIMARY LANDING SITE, WHICH SATISFIES LIGHTING, WEATHER, AND CREW CONSTRAINTS.
- C. ENTER ASAP - ENTER AS SOON AS PRACTICAL TO THE NEXT AVAILABLE LANDING SITE (PLS, SLS, OR ELS).

FLIGHT RULES

THIS RULE CONTINUED ON NEXT PAGE

FLIGHT RULES**A1.1.3-7 LANDING OPPORTUNITIES (CONTINUED)**

D. ENTER IMMEDIATELY - ENTER IMMEDIATELY TO AN UNSPECIFIED LANDING AREA.

For some systems failures, the risk of staying on orbit beyond the first flight day is considered to be high enough to justify the increased risk associated with a day 1 entry. These failures are defined in Rule {A2.1.6-1}, CONTINGENCY ACTION SUMMARY.

This set of failures is a subset of the larger group of failures that require entry at the next PLS. This larger set includes all systems failures where deorbit will be planned for the next opportunity to the primary landing site which meets required weather and lighting constraints and allows the crew to have adequate rest and perform a nominal deorbit prep. These failures are listed in the individual sections of this book and are consolidated in Rule {A2.1.7-1}, ORBITER SYSTEMS GO/NO-GO.

Enter ASAP and immediately are self-explanatory. They only apply to the most critical of circumstances where staying on orbit would mean probable loss of the orbiter and crew. These failures are also listed in Rule {A2.1.6-1}, CONTINGENCY ACTION SUMMARY.

A1.1.3-8 POSTLANDING CREW EGRESS/ESCAPE MODES

A. MODE I - UNAIDED PRELAUNCH EGRESS AND ESCAPE. ©[0411896-1881A]

B. MODE II - AIDED PRELAUNCH EGRESS AND ESCAPE, THE FLIGHT CREW IS ASSISTED BY THE CLOSEOUT CREW.

C. MODE III - AIDED PRELAUNCH EGRESS AND ESCAPE, THE FLIGHT CREW IS ASSISTED BY FIRE/RESCUE PERSONNEL.

D. MODE IV - AIDED PRELAUNCH EGRESS AND ESCAPE, THE FLIGHT CREW AND CLOSEOUT CREW ARE ASSISTED BY FIRE/RESCUE PERSONNEL.

EA. MODE V - UNAIDED ~~POSTLANDINGCREW~~ EGRESS AND GROUND-AIDED ESCAPE/EVACUATION.

1. HATCH ON MODE V - NORMAL HATCH OPENING.

2. HATCH JETTISON MODE V - PYROTECHNIC HATCH JETTISON (IMMINENT CREW HAZARD).

3. ESCAPE PANEL MODE V - PYROTECHNIC JETTISON OF WINDOW 8 ESCAPE PANEL (HATCH EGRESS IMPOSSIBLE). ©[0411896-1881A]

THIS RULE CONTINUED ON NEXT PAGE

FLIGHT RULES

A1.1.3-8 CREW EGRESS/ESCAPE MODES (CONTINUED)

FB. MODE VI - AIDED POSTLANDINGCREW EGRESS, ESCAPE, AND EVACUATION WITHIN AN AREA ACCESSIBLE BY THE GROUND CONVOY ELEMENTS. @[041196-1881A]

GC. MODE VII - AIDED POSTLANDINGCREW EGRESS, ESCAPE, AND EVACUATION AT A LOCATION INACCESSIBLE BY THE GROUND CONVOY ELEMENTS.

H. MODE VIII - BAILOUT DURING CONTROLLED, GLIDING FLIGHT. @[041196-1881A]

Self-explanatory.

A1.1.3-9 CREW MEDICAL (MED) CONDITIONS

- A. MED 0 - PATIENT SEVERELY INJURED BEYOND REASONABLE EXPECTATION OF SURVIVAL OR DECEASED.
- B. MED 1 - CONDITION CRITICAL, PATIENT REQUIRES IMMEDIATE CARE AND EVACUATION.
- C. MED 2 - CONDITION FAIR TO POOR, PATIENT'S NEED FOR CARE IS NOT SO ACUTE, BUT WILL REQUIRE CARE BEFORE EVACUATION.
- D. MED 3 - CONDITION GOOD TO FAIR, PATIENT WITH INJURIES WHICH DO NOT REQUIRE HOSPITALIZATION; SOME MEDICAL CARE MAY BE NEEDED, BUT NOT ON A TIME CRITICAL BASIS.

These medical codes are the standard triage codes used by the DOD triage teams and the KSC triage teams. Triage codes should be in universal agreement so accurate reporting of crew medical conditions can occur.

FLIGHT RULES

A1.1.3-10 REMOTE MANIPULATOR SYSTEM (RMS)

- A. STOW/DEPLOY - ROLL THE MANIPULATOR POSITIONING MECHANISM (MPM) INBOARD/OUTBOARD WHILE THE RMS IS CRADLED AND LATCHED.
- B. CRADLE/UNCRADLE - MOVE THE RMS TO/FROM ITS RETENTION LATCHES.
- C. BERTH/UNBERTH - USE THE RMS TO ATTACH/DETACH A PAYLOAD TO/FROM THE PAYLOAD BAY OR PALLET STRUCTURE.
- D. CONTROL MODES:
 - 1. MANUAL AUGMENTED - POINT OF RESOLUTION (POR) IS MANEUVERED BY CONTROL INPUTS VIA THE REMOTE HAND CONTROLLERS (RHC'S).
 - 2. AUTO - POR IS MANEUVERED BY THE GPC TO PREPROGRAMMED POINTS.
 - 3. OPERATOR COMMANDED - COMPUTER COMMANDED MODE WITH POR MANEUVERED TO A POINT LOADED BY THE CREW.
 - 4. SINGLE - JOINTS ARE DRIVEN ONE AT A TIME BY "PLUS" AND "MINUS" DRIVE COMMANDS FROM THE DISPLAYS AND CONTROLS (D&C) PANEL. THE UNDRIVEN JOINTS ARE HELD IN POSITION BY THE GPC.
 - 5. DIRECT - SAME AS "SINGLE" WITH THE EXCEPTION THAT THE UNDRIVEN JOINTS ARE HELD IN POSITION BY THE BRAKES.
 - 6. BACKUP - SAME AS "DIRECT" WITH THE EXCEPTION THAT NO DISPLAYS ARE AVAILABLE AND POWER IS SUPPLIED BY MAIN BUS B VICE MAIN BUS A.

Self-explanatory.

FLIGHT RULES

A1.1.3-11 TIME REFERENCE DEFINITIONS

DAY - ANY 24-HOUR PERIOD

END-OF-MISSION (EOM) ± - TIME REFERENCE RELATING TO THE EOM WHERE THE PLANNED LANDING TIME IS ZERO.

FLIGHT DAY (FD) - TIME REFERENCE RELATING TO A CREWMEMBER'S WORK/REST CYCLE. FD 1 BEGINS AT LAUNCH WITH SUBSEQUENT FD'S BEGINNING AT CREW WAKE UP AND CONTINUING THROUGH CREW SLEEP.

MISSION ELAPSED TIME (MET) - TIME REFERENCE RELATING TO MET, WHERE LAUNCH IS 0/00:00 (D/HH:MM).

Self-explanatory.

A1.1.3-12 MULTIFUNCTION ELECTRONIC DISPLAY SUBSYSTEM

FOR THE MEDS CONFIGURATION: @[040899-2459B]

FLIGHT RULES THAT REFERENCE MCDS ARE ACTUALLY REFERENCING MEDS.

A. FLIGHT RULES THAT REFERENCE A DEU ARE ACTUALLY REFERENCING AN IDP.

B. FLIGHT RULES THAT REFERENCE A DU ARE ACTUALLY REFERENCING AN MDU.

C. FLIGHT RULES THAT REFERENCE PANEL F6, F7, AND F8 FLIGHT INSTRUMENT TAPES AND SUBSYSTEM METERS ARE ACTUALLY REFERENCING THE FUNCTION OF THOSE TAPES AND METERS DISPLAYED ON AN MDU.

D. FLIGHT RULES THAT REFERENCE A FLIGHT INSTRUMENT (ADI, HSI, SPI, ETC) ARE ACTUALLY REFERENCING THE FUNCTION OF THOSE INSTRUMENTS DISPLAYED ON AN MDU.

This flight rule allows existing flight rules to be compatible with MEDS configured vehicles and also allows existing rules to be used with a mixed fleet of MCDS and MEDS. @[040899-2459B]

FLIGHT RULES

SECTION 2 - FLIGHT OPERATIONS

PRELAUNCH

A2.1.1-1	PRELAUNCH GO/NO-GO REQUIREMENTS	2-1
A2.1.1-2	ABORT LANDING SITE REQUIREMENTS	2-7
A2.1.1-3	LAUNCH HOLD	2-10
A2.1.1-4	LAUNCH DAY CREW TIME CONSTRAINTS	2-10
A2.1.1-5	PORT MODING/RESTRINGING GUIDELINES	2-11
A2.1.1-6	LANDING SITE WEATHER CRITERIA	2-12
A2.1.1-7	DAY-OF-LAUNCH ET LOAD DATA	2-34
A2.1.1-8	LAUNCH TIME SELECTION FOR GROUND-UP RENDEZVOUS	2-34 ^b

ASCENT

A2.1.2-1	STS ABORT CRITERIA	2-35
A2.1.2-2	ASCENT MODE PRIORITIES FOR PERFORMANCE CASES	2-36
A2.1.2-3	FORWARD RCS USAGE GUIDELINES	2-44
A2.1.2-4	RTLS, TAL, AND AOA ABORTS FOR SYSTEMS FAILURES (CIL)	2-45
A2.1.2-5	USE OF LOW ENERGY GUIDANCE	2-53
A2.1.2-6	ABORT GAP	2-57
A2.1.2-7	CONTINGENCY ASCENTS/ABORTS	2-58
A2.1.2-8	RESERVED	2-60
A2.1.2-9	ABORT LIGHT	2-60
A2.1.2-10	BFS ENGAGE CRITERIA	2-62
A2.1.2-11	NAVIGATION UPDATE CRITERIA	2-64
A2.1.2-12	Q-BAR/G-CONTROL	2-65
A2.1.2-13	ET FOOTPRINT CRITERIA	2-60 ^b
A2.1.2-14	ASCENT STRING REASSIGNMENT	2-63

FLIGHT RULES

SECTION 2 - FLIGHT OPERATIONS

PRELAUNCH

A2.1.1-1 **PRELAUNCH GO/NO-GO REQUIREMENTS**

LAUNCH WILL BE NO-GO IF THE FOLLOWING CONDITIONS ARE NOT SATISFIED:

- A. MINIMUM STS SUBSYSTEMS CAPABILITY (REF. LAUNCH COMMIT CRITERIA (LCC)).

The vehicle must satisfy certain minimum subsystems capabilities to be GO for launch. Prelaunch OMI's implement checkout requirements specified in the OMRSD. In general, these are designed to demonstrate operation of all testable subsystems within prescribed limits. Any deviation must be accounted for, either by repair, replacement, or a waiver from the MMT. Launch commit criteria are designed to ensure those systems that are monitorable operate within acceptable limits during the final hours in the launch countdown. In certain areas, launch may be permitted with certain equipment losses provided those are well understood to be isolated occurrences and not symptomatic of a potentially generic problem. These instances will be specified in the LCC document.

- B. MINIMUM ONBOARD INSTRUMENTATION REQUIREMENTS (REF. LCC).

The vehicle must satisfy minimum onboard display/control capability via crew display/control equipment as well as minimum telemetry/instrumentation requirements to be GO for launch. These capabilities are required to allow ground and crew monitoring and control of the vehicle systems for critical failures and crew capability to fly the vehicle should it become necessary. These are documented in the Launch Commit Criteria.

- C. VEHICLE PERFORMANCE MARGINS (REF. RULE {A4.1.1-1A}, PERFORMANCE ANALYSIS).

The vehicle must satisfy the propellant reserve performance margins (ref. Rule {A4.1.1-1A}, PERFORMANCE ANALYSIS) in order to be GO for launch. These margins are protected to assure that sufficient propellant reserves cover loading and systems usage dispersions during ascent.

- D. ACCEPTABLE STRUCTURAL LOADS AND DAY-OF-LAUNCH I-LOAD UPDATE (DOLILU) ASSESSMENT (REF. NSTS-08329, VOL. VIII, DOLILU OPERATIONS SUPPORT PLAN (DOSP)). @[091098-6622C]

FLIGHT RULES

~~The generation of the DOLILU I-loads must be consistent with certification groundrules and the launch day environment, and vehicle structural loading must remain within acceptable boundaries to be GO for launch. The assessment is performed at several points in the pre-launch timeframe using balloon-measured upper-level wind data. The DOLILU process launch decision criteria applied to this assessment is specified in the DOSP. ©[091098-6622C] D. ——— STRUCTURAL LOAD LIMITS AS ASSESSED BY THE LAUNCH SYSTEMS EVALUATION ADVISORY TEAM (LSEAT) (REF. NSTS 08211, LSEAT INTEGRATED SUPPORT PLAN).~~

~~Vehicle structural loading must remain within acceptable boundaries to be GO for launch. The analysis is performed at several points in the prelaunch timeframe using balloon measured upper-level wind data; and, if any load indicator is predicted to exceed its rated value, then the launch must be scrubbed unless the violation is assessed and determined to be acceptable.~~

THIS RULE CONTINUED ON NEXT PAGE

FLIGHT RULES**A2.1.1-1 PRELAUNCH GO/NO-GO REQUIREMENTS (CONTINUED)****E. MINIMUM GROUND INSTRUMENTATION REQUIREMENTS.**

SUFFICIENT GROUND INSTRUMENTATION SUPPORT SHALL BE OPERATIONAL AT LAUNCH TO SATISFY A/G VOICE, TELEMETRY, TRACKING, AND COMMAND REQUIREMENTS FOR ASCENT AND REQUIRED ABORT LANDING SITES, REF. RULE {A2.1.1-2}, ABORT LANDING SITE REQUIREMENTS. SPECIFIC EQUIPMENT REQUIREMENTS ARE DEFINED IN FLIGHT RULES SECTION 3.

FOR FIRST DAY PLS LANDING SITES ONLY, EQUIPMENT OUTAGES ARE ALLOWED ONLY IF CRITICAL EQUIPMENT ETRO IS PRIOR TO FIRST DAY PLS DEORBIT DECISION TIME, OR IF FIRST DAY PLS IS NOT REQUIRED, ETRO MUST BE PRIOR TO SECOND DAY PLS DEORBIT DECISION TIME.

Detailed requirements and the facilities necessary to provide support and redundancy for ascent and ascent aborts vary from phase to phase and even within each phase. In general, the requirements are broken down into A/G voice, telemetry, tracking, and command capabilities as high-level requirements. These, in turn, determine the facilities support requirements which are detailed in section 3 for each capability and facility. For mandatory ascent abort landing sites, full capabilities must be functional prior to launch. If an ascent abort landing site is not required, then full capabilities are highly desirable, and loss of any capability will not lead to a launch hold. For a required first day PLS site, equipment outages are allowed if repairs can be guaranteed complete prior to landing. In any event, all required equipment must be planned to be functional at one CONUS site by second day PLS time, or launch is NO-GO.

F. ACCEPTABLE LANDING CONDITIONS FOR REQUIRED ABORT LANDING SITES, REF. RULE {A2.1.1-2}, ABORT LANDING SITE REQUIREMENTS. IF AN ABORT LANDING SITE IS NOT MANDATORY, ACCEPTABLE LANDING CONDITIONS ARE STILL HIGHLY DESIRABLE AT THAT SITE. CONDITIONS WHICH MUST BE MET ARE:

1. NO VIOLATIONS OF THE LANDING SITE WEATHER CRITERIA (REF. RULES {A4.1.1-2}, LANDING SITE CONDITIONS, AND {A2.1.1-6}, LANDING SITE WEATHER CRITERIA). @[111094-1622B]
2. FOR ALL LANDINGS BUT FIRST OR SECOND DAY PLS, NO VIOLATION OF ENTRY ANALYSIS LIMITS INCLUDING:
 - a. APPROACH AND LAND TRANSITION (REF. RULE {A4.1.4-6}, HAC SELECTION CRITERIA)

THIS RULE CONTINUED ON NEXT PAGE

FLIGHT RULES**A2.1.1-1 PRELAUNCH GO/NO-GO REQUIREMENTS (CONTINUED)**

- b. NORMALIZED TOUCHDOWN DISTANCE (REF. RULE {A4.1.3-10}, AIMPOINT, EVALUATION VELOCITY, AND SHORT FIELD SELECTION)
 - c. TIRE SPEED/ROLLOUT/BRAKING LIMITS (REF. RULE {A4.1.3-8}, TIRE SPEED, BRAKING AND ROLLOUT REQUIREMENTS)
 - d. NZ AND Q-BAR CONSTRAINTS (REF. RULE {A4.1.5-7}, ENTRY LIMITS) @[072795-1788B]
3. ACCEPTABLE GROUND NAVAIDS (REF. RULES {A3.1.5-1}, TACAN REDUNDANCY REQUIREMENTS AND ALTERNATE TACAN SELECTION PHILOSOPHY; {A3.1.5-2}, MLS; AND {A2.1.1-6}, LANDING SITE WEATHER CRITERIA). @[111094-1622B]
 4. ACCEPTABLE LANDING AND VISUAL AIDS (REF. RULE {A3.1.5-3}, LANDING AID REQUIREMENTS).
 5. ACCEPTABLE CURRENT AND PREDICTED RUNWAY CONDITIONS (REF. RULE {A4.1.3-11}, RUNWAY ACCEPTABILITY CONDITIONS). @[111094-1622B]
 6. ACCEPTABLE COMMUNICATIONS FROM THE MCC TO THE REQUIRED ASCENT ABORT SITES. (REF. RULES {A3.1.2-5E}, MCC INTERNAL VOICE, AND {A3.1.4-6}, MCC/ASCENT ABORT SITE COMMUNICATIONS). @[111094-1716A]

Prelaunch, the MCC must be able to communicate with the ascent abort landing sites. This insures that there has not been a change in weather or nav/landing aid status. It also insures that anomalies can be passed to the ground support team and that the runway and airspace are clear for a safe landing. This can be accomplished by insuring that at least one of the communications capabilities listed below are available:

- a. Longline (LFP1)
- b. INMARSAT
- c. Commercial Telephone @[111094-1716A]

THIS RULE CONTINUED ON NEXT PAGE

FLIGHT RULES**A2.1.1-1 PRELAUNCH GO/NO-GO REQUIREMENTS (CONTINUED)**

7. DAYLIGHT LANDING UNLESS CREW SPECIFICALLY TRAINED FOR NIGHT LANDING AND RELATED LANDING AIDS FUNCTIONAL (REF. PARAGRAPHS 3 AND 4 ABOVE). EXCEPTIONS ARE ALLOWED FOR AOA (IF NOT REQUIRED) AND FIRST DAY PLS.

Acceptable landing conditions and aids requirements rationale for each of the requirements may be found in the referenced rule. A TAL site is highly desirable if RTLS/two-engine press capability overlap exists since TAL is preferred over RTLS (ref. Rule {A2.1.2-2}, ASCENT MODE PRIORITIES FOR PERFORMANCE CASES) for an engine out performance. TAL capability also provides for performance gap management and extended coverage during ascent for systems aborts that require abort modes other than first day PLS. Rules {A1.1.3-6E} and {A1.1.3-6G}, LANDING SITES, reference this rule.

For all abort landings, the entry analysis using the forecast and measured (ref. Rule {A4.1.3-12}, LOWER LEVEL MEASURED WIND AND ATMOSPHERIC DATA) environmental data must be predicting a safe landing. For first day PLS, prelaunch analysis is not generally performed due to the length of time from prelaunch data collection until actual landing; similarly, only forecast weather is used for first day PLS status, not prelaunch observations. ®[111094-1622B]

If AOA is not required for performance reasons, then systems AOA is an extreme contingency case and crew pilot pool night training is considered adequate. Lighting at first day PLS is not a design groundrule; lighted launch, TAL, and first day PLS cannot all be accomplished for some high inclination missions. Therefore, pilot pool night training is considered acceptable for systems AOA or first day PLS. Also for first day PLS, crew workday is not protected.

Predictions of weather and or equipment availability at the first day PLS site are less accurate due to the time involved (4.5 to 10.5 hours after launch). The requirements to use a first day PLS site are based on performance and systems redundancy requirements. If a first day PLS site is not available, the single engine out abort boundaries are adjusted to ensure that a stable orbit is achieved which will support a delay in landing until flight day 2 when more landing sites and better conditions will be available. The redundancy requirements are considered an acceptable risk (multiple failures of proven highly reliable equipment occurring in short periods of time). Acceptance of this risk allows an on time launch when all conditions other than those at the first day PLS site are acceptable.

THIS RULE CONTINUED ON NEXT PAGE

FLIGHT RULES

A2.1.1-1 PRELAUNCH GO/NO-GO REQUIREMENTS (CONTINUED)

G. THE LAUNCH WILL BE NO-GO IF PRELAUNCH, U.S. SPACE COMMAND ORBIT CONJUNCTIONS (COMBO ANALYSIS), OR EASTERN RANGE (ER) COLLISION AVOIDANCE (COLA) CONFLICTS ARE PREDICTED. LAUNCH HOLD TO THE NEXT EVEN MINUTE IS UTILIZED TO CLEAR CONFLICTS (REF. RULE {A4.1.1-3}, ORBIT CONJUNCTIONS/CONFLICTS, AND LCC 5.6). @[051194-1605]

Responsibility for calling launch holds based on COLA's lies with ER/KSC, while computation of misses between orbits (COMBO) conflict responsibility lies with JSC based on data provided by U.S. Space Command.

U.S. Space Command and ER perform several prelaunch analyses to determine if any such orbital conjunctions may result. The U.S. Space Command COMBO analysis is performed assuming an on-time launch while the ER COLA analysis evaluates the entire launch window. Also, ER analyses are performed only against mannable space vehicles (such as Mir) for the first orbit after liftoff, while U.S. Space Command provides data to JSC for analysis of the entire U.S. Space Command orbiting object catalog for a period of 2 hours after liftoff. If clearance limits are exceeded for a launch at the planned time, the launch must be held until adequate clearance can be assured. For practical considerations, such holds will extend to the even minute. @[051194-1605]

H. ACLS'S ARE NOT REQUIRED FOR LAUNCH COMMIT.

These sites are for contingency cases only and are therefore not required for launch.

I. POSTLAUNCH SEARCH AND RESCUE (SAR) OPERATIONS - THE LAUNCH WILL NOT BE HELD BASED ON SAR WEATHER OR THE FAILURE OF ANY EQUIPMENT THAT WOULD BE USED TO SUPPORT A POSTLAUNCH SAR OPERATION.

Establishing weather/sea state criteria across the total trajectory/range for SAR operations is prohibitive, and we would be NO-GO for launch most of the time. Additionally, the weather and sea state along the total trajectory will probably not be known. Delaying the launch to accommodate repair of a SAR aircraft or other piece of equipment, or to allow improvement in weather conditions in areas for which we may not have an adequate forecast anyway, is not the prudent action. The DOD response for bailout support may be affected.

FLIGHT RULES

A2.1.1-2 ABORT LANDING SITE REQUIREMENTS

CONTINUOUS SINGLE ~~SSME~~ENGINE OUT INTACT ABORT COVERAGE IS REQUIRED THROUGHOUT POWERED FLIGHT (REF. NSTS 07700, VOLUME X, PARAGRAPHS 3.2.1.1.4 AND 3.2.1.5.1.1 THROUGH 3.2.1.5.1.3). PRELAUNCH ANALYSIS MUST DEMONSTRATE THIS CONTINUOUS SINGLE SSME OUT INTACT ABORT COVERAGE EXISTS OR LAUNCH IS NO GO PER RULE {A2.1.1-1}, PRELAUNCH GO/NO-GO REQUIREMENTS. — @J041196-1801A

THIS CONTINUOUS SINGLE SSME OUT INTACT ABORT COVERAGE MUST INCLUDE SYSTEMS FAILURE TOLERANCE, AND BOTH SYSTEMS AND ENVIRONMENTAL PERFORMANCE DISPERSIONS AS REQUIRED.

THIS CONTINUOUS SINGLE ENGINE OUT INTACT ABORT COVERAGE MUST BE TO A FULLY ACCEPTABLE LANDING SITE THROUGHOUT POWERED FLIGHT. THERE CAN BE NO PRELAUNCH PREDICTED SINGLE ~~SSME~~ENGINE OUT ABORT GAP BETWEEN LAST RTLS AND FIRST TAL NOR BETWEEN LAST RTLS OR LAST INTACT TAL CAPABILITY (TO A GO TAL SITE) AND FIRST PRESS CAPABILITY, AND NO GAP IN SINGLE ~~SSME~~ENGINE OUT PROTECTION FOLLOWING FIRST PRESS CAPABILITY NO MATTER WHICH OF THE FOLLOWING CRITERIA IS USED TO DEFINE PRESS CAPABILITY. — @J041196-1801A

- A. AN RTLS LANDING SITE IS REQUIRED FOR LAUNCH COMMIT.
- B. A TAL LANDING SITE IS REQUIRED FOR LAUNCH COMMIT UNLESS THERE IS RTLS AND TWO ENGINE PRESS CAPABILITY OVERLAP. THEN A TAL LANDING SITE IS HIGHLY DESIRABLE.
- C. AN AOA LANDING SITE IS HIGHLY DESIRABLE. AN AOA LANDING SITE IS REQUIRED FOR LAUNCH COMMIT ONLY IF BOTH OF THE FOLLOWING CONDITIONS ARE MET:
 1. AN INTACT SINGLE ENGINE OUT ABORT GAP EXISTS BETWEEN THE LATER OF LAST TWO ENGINE TAL TO A GO TAL SITE OR LAST TWO ENGINE RTLS AND TWO ENGINE PRESS CAPABILITY BASED ON ATO/MINIMUM HP/FD 1 SHALLOW DEORBIT OR ATO/ATO/FD 2 SHALLOW DEORBIT (AS REQUIRED), AND
 2. TWO ENGINE PRESS CAPABILITY BASED UPON AOA STEEP PROVIDES CONTINUOUS SINGLE ENGINE OUT INTACT ABORT COVERAGE THROUGH MECO.

THIS RULE CONTINUED ON NEXT PAGE

FLIGHT RULES

A2.1.1-2 ABORT LANDING SITE REQUIREMENTS (CONTINUED)

D. A FIRST DAY PLS LANDING SITE IS REQUIRED FOR LAUNCH COMMIT UNLESS EITHER OF THE FOLLOWING ARE TRUE, IN WHICH CASE A FIRST DAY PLS LANDING SITE IS HIGHLY DESIRABLE:

1. NO INTACT SINGLE ENGINE OUT ABORT GAP EXISTS BETWEEN THE LATER OF LAST TWO ENGINE TAL TO A GO TAL SITE OR LAST TWO ENGINE RTLS AND FIRST TWO ENGINE PRESS CAPABILITY BASED ON ATO/FD 2 HP/SHALLOW DEORBIT, OR
2. NO INTACT SINGLE ENGINE OUT ABORT GAP EXISTS BETWEEN THE LATER OF LAST TWO ENGINE TAL TO A GO TAL SITE OR LAST TWO ENGINE RTLS AND FIRST TWO ENGINE PRESS CAPABILITY BASED ON AOA STEEP TO A GO AOA LANDING SITE AND TWO ENGINE PRESS CAPABILITY BASED UPON AOA STEEP PROVIDES CONTINUOUS SINGLE ENGINE OUT INTACT ABORT COVERAGE THROUGH MECO.

IF AN ASCENT INTACT ABORT LANDING SITE IS REQUIRED, THEN ALL LANDING SITE REQUIREMENTS, AS SPECIFIED IN THE FLIGHT RULES, MUST BE SATISFIED. IN THE CASE OF LAUNCH COMMIT WITHOUT A TAL OR AOA OR FIRST DAY PLS LANDING SITE, OR WITHOUT ANY COMBINATION OF SITES, THEN A CONTINGENCY OR SYSTEMS ABORT REQUIREMENT WILL BE SATISFIED USING EXISTING RTLS, TAL, ACLS, OR ABORT FROM ORBIT (AFO) CAPABILITY, POSSIBLY TO AN ELS. __
@[041196-1801A]

NOTE: IF FIRST DAY PLS IS NO-GO DUE TO EQUIPMENT OUTAGE (REF. SECTION 3), THEN LAUNCH WILL BE GO ONLY IF ALL REQUIRED EQUIPMENT WILL BE AVAILABLE AT ONE OR MORE CONUS SITES PRIOR TO FD 2 PLS DEORBIT DECISION TIME.

Continuous single engine out intact abort capability to a landing site meeting all requirements must be achieved to commit to launch (ref. Rule {A4.1.1-1D}, PERFORMANCE ANALYSES). Since the only two engine intact abort mode available for the first 2 to 3 minutes of any flight is the RTLS site, GO conditions are mandatory at the RTLS landing site.

TAL is required unless RTLS/two engine press overlaps. Even in those cases, TAL is the preferred abort mode for an engine out during the RTLS/TAL overlap period. Launching without TAL capability should never be a design goal but a real-time fallback if weather or equipment outages at the TAL sites are the only constraints to launch.

THIS RULE CONTINUED ON NEXT PAGE

FLIGHT RULES

A2.1.1-2 ABORT LANDING SITE REQUIREMENTS (CONTINUED)

The ATO single SSME out press boundary represents the earliest time at which an engine failure will result in the achievement of an acceptable MECO underspeed based on one of four cases: AOA steep capability; ATO/minimum Hp with shallow deorbit on flight day 1 capability; ATO/ATO/shallow deorbit on flight day 2 capability; or ET impact in an acceptable area (ref. Rule {A4.1.2-6B}, DESIGN AND CRITICAL MECO UNDERSPEED DEFINITIONS). If the design press boundary is based on AOA steep but no AOA site is available, then intact capability can still be provided as long as no gap exists between last RTLS or TAL and the press boundary based on ATO/minimum Hp for flight day 1/shallow deorbit. If no first day PLS site is available, then continuous single SSME out intact abort capability can still be provided as long as no gap exists between last RTLS or TAL and the press boundary based on AOA steep (press capabilities based on AOA steep and ATO/min Hp/flight day 1 shallow come only a few seconds apart). If neither an AOA or first day PLS site are available, then launch commit may be allowed with some additional risk if there is no gap between last RTLS or TAL and a press boundary based on ATO OMS-1/ATO OMS-2 (this yields an Hp of about 105 nm which is sufficient for safe flight day 2 entry)/ shallow deorbit on flight day 2. The increased RTLS/TAL exposure (4 to 11 seconds) is accepted in order to provide a launch opportunity.

Even if a first day PLS site is not technically available at launch time, equipment outages may be resolved or weather may improve by deorbit decision time.

If a first day PLS landing site is not available, and systems failures requiring early flight termination occur, landing will be supported by RTLS, TAL, and AFO sites. This means that deorbit/landing might be made under ACLS/ELS type conditions: less than normally acceptable weather; lack of nav aids; etc. Systems failures requiring first day PLS are typically multiple failures or structural failures. In some cases, immediate deorbit is required. Should these type failures occur during the on-orbit timeframe, it has always been acceptable to land under ACLS/ELS conditions. In other cases, loss of redundancy in entry critical equipment is cause for a first day PLS. When a first day PLS site is not available, for loss of redundancy that normally calls for first day PLS, the risk of staying on orbit until the next day for improved landing conditions outweighs the risk of loss of critical equipment during the on-orbit wait for 24 hours.

If an abort landing site is required, the sites must fully meet the requirements listed in the flight rules (ref. Rules {A2.1.1-1G} and {A2.1.1-1F}, PRELAUNCH GO/NO-GO REQUIREMENTS, and {A4.1.3-7A}, PLS/EOM LANDING OPPORTUNITY REQUIREMENTS) for: landing site weather conditions including visibility, clouds, winds, turbulence, precipitation, runway/lakebed surface conditions, and resources necessary to measure low-level winds and atmospheric data (not PLS); crossrange, rollout margin, brake energy, navigation aids, and lighting (not PLS); touchdown margin (not PLS); and tracking (not AOA or PLS), telemetry, command, and air-ground voice (for PLS equipment outage ETRO must be before deorbit decision time). ©[072795-1772]

FLIGHT RULES

Rules {A1.1.3-6}, LANDING SITES; {A2.1.1-1}, PRELAUNCH GO/NO-GO REQUIREMENTS; {A3.1.1-1}, GROUND REQUIREMENTS OVERVIEW; {A3.1.3-3}, STDN FAILURE DECISION MATRIX; {A3.1.5-1}, TACAN REDUNDANCY REQUIREMENTS AND ALTERNATE TACAN SELECTION PHILOSOPHY; {A4.1.1-2}, LANDING SITE CONDITIONS; and {A4.1.2-6}, DESIGN AND CRITICAL MECO UNDERSPEED DEFINITIONS, reference this rule.

A2.1.1-3 LAUNCH HOLD

NO MCC COUNTDOWN HOLD WILL BE CALLED AFTER T-31 SECONDS.

After T-31 seconds, launch holds will not be called by the MCC. T-31 seconds is the latest time that an MCC voice call for a launch hold can realistically be acted on in real time. Calling such a hold for MCC-related/non-ground launch sequencer (GLS) recognized problems does not merit the risk of such a launch hold. Backup onboard crew procedures can accomplish most abort functions should the MCC have a problem in the last few seconds before launch. ~~Rule {A3.1.2-4}, TRAJECTORY PROCESSING, references this rule.~~ [@061396 40051](#)

A2.1.1-4 LAUNCH DAY CREW TIME CONSTRAINTS

A. THE MAXIMUM TIME THE CREW WILL REMAIN IN THE VEHICLE IS 5 HOURS 15 MINUTES (EXCLUDING SAFING AND EGRESS TIME) (REF. LCC 3.2B), WHICH ALLOWS 2.5 HOURS OF HOLD TIME AFTER THE EARLIEST PLANNED LAUNCH TIME.

It is impractical to keep the crew in the launch-seat posture for an extended period of time. The crew enters the vehicle about 2 hours 45 minutes before launch; thus, a 2.5-hour launch window is preserved.

B. THE SCHEDULED CREW AWAKE TIME ON LAUNCH DAY WILL NOT NORMALLY EXCEED 16 HOURS. PRELAUNCH HOLD TIME AND POSTLAUNCH ORBITER/PAYLOAD CONTINGENCIES REQUIRING THE USE OF BACKUP TIMELINES WILL BE ACCOMMODATED AS LONG AS THEY DO NOT EXTEND THE CREW DAY BEYOND 18 HOURS.

Abnormally long days will result in crew fatigue and increase the potential for procedural errors that could affect safety or compromise mission success. Without a waiver, crew awake time on launch day will not be premission scheduled for greater than 16 hours. Since the crew is awake about 4 hours 55 minutes before launch, this allows for up to 11 hours 5 minutes of on-orbit activities before the start of the sleep period. If there is a launch hold or orbiter/payload contingencies require the use of backup timelines for deploy opportunities or off-nominal operations, these adjustments will be accommodated as long as the maximum crew day of 18 hours is not exceeded.

FLIGHT RULES

A2.1.1-5

PORT MODING/RESTRINGING GUIDELINES

- A. PORT MODING OR RESTRINGING MAY BE USED PER RULES {A2.1.5-4C}, ENTRY STRING REASSIGNMENT; {A2.1.2-14B.2}, ASCENT STRING REASSIGNMENT; {A7.1.3-10}, PASS GPC BCE FAILURE MANAGEMENT; AND {A7.1.3-12}, MDM PORT MODING, TO REGAIN LOST CAPABILITIES DUE TO GPC FLIGHT-CRITICAL BCE FAILURES. THE RECOVERY TECHNIQUE USED WILL DEPEND UPON THE SPECIFIC FLIGHT PHASE AND FAILURE SCENARIO PRESENT IN THE ORBITER. IN GENERAL, PORT MODING WILL BE ATTEMPTED DURING DYNAMIC PHASES OVER RESTRINGING EXCEPT AS NOTED IN THE REFERENCED RULES.

For flight-critical BCE failures, recovery of lost capability may be attempted via port moding or restringing. Port moding will recover the bypassed FC MDM, but will result in the loss of the other FC MDM on the affected string. Restringing will result in the entire recovery of string capability, but GPC redundancy may be given up.

Port moding is preferred over restringing because of the ease of implementation (crew SPEC entry), port mode reconfiguration is considered to be less hazardous to the PASS redundant set than restring reconfiguration, and the desire to maintain GPC redundancy.

In general, restringing will only be attempted when the appropriate restring criteria is satisfied. Otherwise, port moding may be done to recover lost capability.

- B. A RESTRING WILL BE PERFORMED TO MAINTAIN CRITICAL CAPABILITY FOR THE FOLLOWING POWERDOWNS:
1. LOSS OF AV BAY COOLING (TO RECOVER TWO STRINGS)
 2. LOSS OF CABIN PRESSURE
 3. LOSS OF FLASH EVAPORATOR SYSTEM
 4. LOSS OF TWO FREON LOOPS
 5. LOSS OF TWO FUEL CELLS
 6. LOSS OF TWO H₂O LOOPS

If powerdowns are required during ascent or entry, the GPC's are intentionally moded to STBY then HALT and powered off to maintain either acceptable orbiter power levels or GPC thermal limits. This rule allows for a restring to be performed for the listed powerdowns.

THIS RULE CONTINUED ON NEXT PAGE

FLIGHT RULES

A2.1.1-5 PORT MODING/RESTRINGING GUIDELINES (CONTINUED)

If GPC failures or multiple LRU failures in a subsystem exist, then the current restring rules will be adhered to. Measures will also be taken to ensure that the least number of strings are reassigned (ref. Rules {A2.1.2-14}, ASCENT STRING REASSIGNMENT; and {A2.1.5-4}, ENTRY STRING REASSIGNMENT).

Powerdown procedures have been verified and are officially documented as part of the Space Shuttle Flight Data File (FDF).

A2.1.1-6 LANDING SITE WEATHER CRITERIA

LIMITS APPLY TO DAY AND NIGHT LANDINGS UNLESS OTHERWISE NOTED. THE WEATHER LIMITS CONTAINED IN THIS RULE MUST BE SATISFIED WITH OBSERVATIONS AT THE GO/NO-GO DECISION TIME AND WITH THE FORECAST FOR THE LANDING TIME WITH THE FOLLOWING EXCEPTIONS: Ⓜ
 @[111094-1622B] @[021998-6490A]

1. FIRST—PRELAUNCH EVALUATION OF THE FD1 OR FD2 PLS IS BASED ONLY ON THE FORECAST. Ⓜ]

The prelaunch PLS evaluations use only the forecast because the landing time is at least 5-10 hours after launch.

2. SECOND—CONSIDERATION MAY BE GIVEN TO RELAXING THE REQUIREMENT FOR A GO OBSERVATION AT DECISION TIME IF ANALYSIS CLEARLY INDICATES IMPROVING WEATHER CONDITIONS, AND THE FORECAST STATES THAT ALL WEATHER LIMITS WILL BE MET AT LANDING TIME. Ⓜ]

In some weather situations, the observed weather at decision time may be NO-GO although weather conditions are improving. If there is a high level of confidence, based upon the observed weather trends, that the forecast for landing time is for weather to be within limits, consideration may be given to relaxing the GO requirement at decision time. Examples include: rain showers exhibiting predictable dissipation or movement away from the landing site at decision time; and crosswinds exceeding limits that are forecast to decrease diurnally for a landing near or after sunset. @[021998-6490A]

THE APPROACHES TO BOTH THE PRIME AND BACKUP RUNWAYS AT A GIVEN SITE MUST SATISFY THE CEILING, VISIBILITY, PRECIPITATION, AND THUNDERSTORM PROXIMITY LIMITS LISTED BELOW. WHENEVER AVAILABLE, A WEATHER RECONNAISSANCE FLIGHT WILL PROVIDE A LANDING SITE GO/NO-GO RECOMMENDATION. @Ⓜ]

FLIGHT RULES

~~THE APPROACHES TO BOTH THE PRIME AND BACKUP RUNWAYS AT A GIVEN SITE MUST SATISFY THE CEILING, VISIBILITY, TURBULENCE, THUNDERSTORM, LIGHTNING, AND PRECIPITATION LIMITS.~~

~~WHENEVER AVAILABLE, A WEATHER RECONNAISSANCE (WX RECON) FLIGHT WILL PROVIDE A LANDING SITE GO/NO-GO RECOMMENDATION BASED ON OBSERVATIONS. WX RECON HAS PRIORITY OVER GROUND OBSERVATIONS WHEN DIFFERENCES EXIST. @[111094-1622B]~~

~~The prelaunch PLS evaluations use only the forecast because the landing time is at least 5-10 hours after launch. The backup runway must meet the weather limits to insure an overall evaluation of the landing site. Forecasting capability cannot accurately ensure that a NO-GO condition to one of the backup runways would not result in a NO-GO condition at the prime runway by landing time. The backup runway does not need to meet the surface wind limits because the orbiter will only redesignate for emergencies such as energy management. WX RECON has priority over ground observations in situations where differences exist because WX RECON is making an assessment of the slant range visibility along the approach path while the ground observer is making a meteorological assessment of surface visibility, weather, cloud height, and cloud amount in the area of the landing facility.~~

THIS RULE CONTINUED ON NEXT PAGE

FLIGHT RULES

A2.1.1-6 LANDING SITE WEATHER CRITERIA (CONTINUED)

A. CEILING AND VISIBILITY LIMITS

TABLE A2.1.1-6-I - CEILING AND VISIBILITY LIMITS

CEILING / VISIBILITY (K FT)/(SM)			REDUNDANT MLS	SINGLE STRING-MLS	NO MLS
KSC, EDW, NOR, <u>TAL</u> , AOA, DAILY PLS SELECTION (ALL SITES)	CONCRETE	DAY	≥8/5 (WX RECON REQUIRED)	≥10/7	
		NIGHT		NO-GO	
	LAKEBED	DAY		≥10/7	
		NIGHT		≥15/7	NO GO
<u>RTLS</u> , <u>TAL</u>	CONCRETE	DAY	≥5/4 <u>RTLS</u> ≥5/5 <u>TAL</u> (WX RECON REQUIRED)	≥10/7	
		NIGHT		NO GO	
ACLS / ECAL / ELS			0/0		≥8/5
PREDEORBIT: ONE APU FAILED OR ATTEMPT TWO APU'S PROCEDURE			≥10/7		

@[050495-1776A] | @[041097-4927A] | @[051697-4928B]

1. CEILINGS AND VISIBILITY MUST MEET THE LIMITS LISTED IN TABLE A2.1.1-6-I TO BE GO CONDITIONS. THE MLS REQUIREMENTS APPLY TO THE GROUND AND ORBITER EQUIPMENT.
2. FOR EOM AND INTACT ABORTS, WX RECON MUST CONFIRM THAT THE PAPI'S OR AIMPOINT ARE VISIBLE FROM 8K (5K FOR RTLS, TAL) TO PREFLARE AND THE BALL BAR IS VISIBLE FROM PREFLARE TO FINAL FLARE FOR CEILINGS BELOW 10K FT AND/OR VISIBILITY LESS THAN 7 STATUTE MILES (SM). WX RECON GO/NO-GO RECOMMENDATION (BASED ON CURRENT CONDITIONS) IS REQUIRED FOR CEILINGS AT OR BELOW 8K FT. WX RECON IS NOT REQUIRED FOR AN ACLS OR DAILY PLS SELECTION. @[050495-1776A] | @[051697-4928B]

THIS RULE CONTINUED ON NEXT PAGE

FLIGHT RULES

A2.1.1-6 LANDING SITE WEATHER CRITERIA (CONTINUED)

3. FOR KSC EOM ONLY, NO-GO CONSIDERATION WILL BE GIVEN TO CLOUD LAYERS BELOW 8K FT BEING REPORTED BY GROUND WEATHER OBSERVERS OR WEATHER AIRCRAFT GREATER THAN 2/8 COVERAGE AND LESS THAN OR EQUAL TO 4/8 COVERAGE (SCATTERED) AT THE DEORBIT BURN GO/NO-GO DECISION TIME. @[111094-1622B] @[061396-4008] @[041097-4927A]

The definition of a ceiling is where the cumulative total of cloud cover exceeds more than 50 percent coverage of the sky. Restrictions to visibility include smoke, haze, fog, dust, clouds, and precipitation. The visibility limits are horizontal distances that correspond to slant range visibility from a point on the outer glide slope to the runway threshold. The 7 and 5 SM visibility limits correspond to the 10K and 8K foot altitude points on the outer glide slope respectively. Ceiling and visibility limits ensure that the crew has sufficient time on the outer and inner glide slopes to acquire the runway and the landing aids during preflare and final flare and correct for any navigation dispersions. Therefore, the minimum limits are a function of MLS availability, lighting conditions, and type of runway. Reference rule {A8.1.1-18}, LANDING SYSTEM REQUIREMENTS, for orbiter MLS requirements.

For RTLS-only and TAL, the ceiling limits can be reduced to 5K minimum altitude. ~~The reduction for RTLS is a function of earlier MLS incorporation, guidance I-load changes, and Q-bar limit increases incorporated to provide the same guidance and navigation capability as exists in OPS 3.~~ Testing at AMES/VMS in combination with STA test matrices confirmed guidance was able to correct back to glide slope and centerline by approximately 5K feet assuming flight derived 3-sigma nav errors (+1100 feet in Z and 1400 feet in Y combined with worse case late MLS incorporation) and KSC design winds. STA data indicated acceptable landing parameters could be obtained with ceilings of 3K, 4K, or 5K. The primary difference between 3K and 5K consists of reaction time available on the outer glide slope for the pilot to transition from IFR to VFR conditions prior to initiation of the preflare maneuver at 2,000 ft AGL (3K allows 6 seconds and 5K allows 18 seconds prior to the preflare maneuver). Pilot evaluation concluded that 18 seconds was the minimum acceptable reaction time to safely transition from IMCFR or VMC to VFR prior to the preflare. Since the guidance and navigation capability is similar for RTLS and TAL, the testing applies to both RTLS and TAL. The higher visibility requirement of 5 NM for TAL provides a better view of the majority of the runway length when breaking out of a 5K ceiling. This view of the runway is desirable on a TAL since the CDR is less familiar with the TAL site than the SLF. ~~The higher visibility requirement of 5 NM for TAL provides a better view of the majority of the runway length if breaking out of a 5K ceiling. This view of the runway is desirable on a TAL since the CDR is less familiar with the TAL site than the SLF.~~ A WX Recon GO/NO-GO recommendation by the STA is required when dealing with reduced ceilings to confirm the visibility and to also factor in other weather conditions (turbulence, crosswinds, etc.). Weather minimums/maximms are defined assuming that parameter is the only condition present. Combinations near the limits of ceilings, crosswinds, turbulence, and/or visibility need to be assessed by the WX Recon to ensure acceptable landing conditions. @[050495-1776A] @[051697-4928B]

FLIGHT RULES

Forecast experience and climatological studies indicate that in most KSC weather situations, 2/8 low cloud coverage is a reasonable criteria to expect a continuation of few or scattered (less than or equal to 4/8) low cloud conditions for 1 to 2 hours. Thus, due to the inherent variability and volatility of cloud conditions in the KSC area, strong consideration should be given to this 2/8 low cloud criteria at the deorbit burn GO/NO-GO decision time. However, there are meteorological situations when forecaster confidence of low clouds remaining scattered for touchdown time supports a GO deorbit burn decision when low clouds exceed 2/8 coverage at the deorbit burn GO/NO-GO decision time. ©[061396-4008]

FLIGHT RULES

A2.1.1-6 LANDING SITE WEATHER CRITERIA (CONTINUED)*NO MLS*

Without MLS, visual cues provide the only means to correct navigation dispersions remaining from TACAN/ADTA processing. Flight history has shown that the one-sigma position errors in the onboard state (no piloting dispersions included) just before processing MLS (at approximately 15K feet) are 320 ft u, 446 ft v, 439 ft w, and 703 ft RSS'd. The one-sigma position errors after one cycle of MLS processing the errors are 103 ft u, 58 ft v, 97 ft w, and 153 ft RSS'd. Reference: The Summary of Navigation Errors (STF 660-NAV-620-93-052, November 4, 1993). Therefore, the crew can rely on guidance commands to a lower altitude when using MLS before beginning transition to visual cues.

REDUNDANT AND SINGLE STRING MLS

The runway and orbiter must have redundant MLS for a night landing except for a lakebed runway. Single string MLS is acceptable because navigation dispersions are more tolerable on the larger area provided by the lakebed environment. If the single-string MLS fails, visual cues provide the only means to correct navigation dispersions. Flight Design and Dynamics personnel in cooperation with the Astronaut Office conducted an analysis to determine the night ceiling limit of 15K feet on the lakebed. The Shuttle Mission Simulator (SMS) and Shuttle Training Aircraft (STA) flew several sessions of night landings with dispersed initial conditions and good navigation. The experience gained from these analyses indicated that a ceiling level of 15K feet would be acceptable. This ceiling level will provide sufficient time for the crew to visually acquire the landing area, assess the need to correct dispersions, and take the necessary actions. If MLS were available, this is the approximate altitude when processing would begin. ©[111094-1622B]

[©\[041097-4927A\]](#)

THIS RULE CONTINUED ON NEXT PAGE

FLIGHT RULES

A2.1.1-6 LANDING SITE WEATHER CRITERIA (CONTINUED)

ACLS / ECAL / ELS

The ACLS, ECAL, or ELS limits require accepting additional risk. Emergency deorbit, SSME limits management, and abort gap closure procedures potentially use these sites. Rules {A2.1.4-5E} and {A2.1.4-5F}, EMERGENCY DEORBIT, and {A4.1.3-7}, PLS/EOM LANDING OPPORTUNITY REQUIREMENTS, outline conditions for use of an ELS for emergency deorbit. Rule {A5.1.3-3A2}, LIMIT SHUTDOWN CONTROL, specifies enabling main engine limits at the earliest single-engine capability to reach a prime TAL or ACLS for some cases following an SSME failure. This action precludes exposure to SSME limits-inhibited operation for any longer than necessary. Landing at an ACLS with zero/zero conditions carries less risk than continuing limits-inhibited SSME operation. Rule{A4.1.2-7I.3}, PERFORMANCE BOUNDARIES, specifies the use of an ACLS for abort gap closure. It is reasonable to attempt landing at an ACLS with zero/zero conditions if the attempt carries a reasonable probability of success and the only alternative is a bailout.

ONE APU FAILED (OR ATTEMPT TWO APU'S PROCEDURE)

Flight rules {A2.1.4-7}, LANDING SITE SELECTION, and {A10.1.2-3}, APU ENTRY START TIME, summarize the conditions and rationale for selecting a landing site with one APU failed and using the ATTEMPT TWO APU's start procedure. With two APU's failed, the loss of hydraulic power causes reduced flight control authority, reduced braking, and loss of nose wheel steering. The APU placards assure safe conditions should the orbiter lose a second APU. ©[111094-1622B]

THIS RULE CONTINUED ON NEXT PAGE

FLIGHT RULES

A2.1.1-6 LANDING SITE WEATHER CRITERIA (CONTINUED)

B. SURFACE WINDS AND TURBULENCE LIMITS @111094-1622B]

TABLE A2.1.1-6-II - SURFACE WINDS AND TURBULENCE LIMITS @ED]

SURFACE WIND (KNOTS) AND TURBULENCE		CROSS PEAK	HEAD PEAK	TAIL AVG	TAIL PEAK	GUST	TURB
RTLS		≤15 *	≤25	≤10	≤15	≤10	≤MOD
DAY	EOM, TAL, AOA, DAILY PLS SELECTION	≤15					
NIGHT	EOM, TAL, AOA DAILY PLS SELECTION	≤12					
CROSSWIND DTO		≥10					
NOMINAL DRAG CHUTE DEPLOY		≤15					
LANDING ≥ CDR FD19		≤12					
PREDEORBIT: 1 APU FAILED OR ATTEMPT 2 APU'S PROCEDURE		≤10					
ECAL / ELS		≤15	N/A				≤LGT

* REQUIRES AN STA EVALUATION TO 17 KNOTS AND A GO FROM THE STA PILOT. @041196-1817B] @041196-1871B] @041097-4926] @041097-4890A]

1. SURFACE WINDS AND TURBULENCE MUST MEET THE LIMITS LISTED IN TABLE A2.1.1-6-II TO BE "GO" CONDITIONS. @ED]
2. THE LEVEL OF TURBULENCE SHOULD BE THE PROJECTED/ESTIMATED LEVEL FOR THE ORBITER (C130 OR T38 MAY BE COMPARABLE TO THE ORBITER; C12, C21, AND STA WOULD BE LESS FOR THE ORBITER).
3. STA GO FOR RTLS CROSSWINDS GREATER THAN 15 KNOTS WILL BE BASED ON A USABLE HUD BELOW 1000 FEET (HUD NOT CAGED AND SIGNIFICANT DIGITS FOR EAS AND ALTITUDE VISIBLE) AND ACCEPTABLE PILOT WORKLOAD IN THE PRESENCE OF LOW LEVEL SHEARS AS EVIDENCED BY HDOT, X-DISTANCE, Y-DISTANCE AND Y-DOT AT TOUCHDOWN. CDR'S HUD AND REDUNDANT MLS REQUIRED TO ENSURE ACCURATE HUD DATA AVAILABLE TO THE CREW. @041196-1817B]

At KSC and EDW, the official observation measures the magnitude and direction of the wind every second. The peak wind is the highest wind magnitude measured during the preceding 2, 5, or 10 minutes. The average wind is the average of the wind measurements over the preceding 2 minutes. The peak and average winds are broken down into headwind, tailwind, and crosswind components relative to the runway.

THIS RULE CONTINUED ON NEXT PAGE

FLIGHT RULES

A2.1.1-6 LANDING SITE WEATHER CRITERIA (CONTINUED)

DEFINITION OF GUSTS

The Shuttle Program uses the term gust to define the difference between the peak and average wind. This is different from the meteorological definition of a gust, which is peak to trough. The gust limit applies to the measured wind, not individual wind components. The gust criterion restricts the wind conditions to those that are stable, predictable, and within the orbiter landing performance capability. @[111094-1622B]

HEADWIND @[111094-1622B]

The headwind certification limit is 20 knots steady state with a moderate turbulence model (approximately ± 10 knots) (reference ORBITER VEHICLE END ITEM SPECIFICATION FOR THE SPACE SHUTTLE SYSTEM, Part 1, Performance and Design Requirements, Section 10.1.3.3.1.1.3, Orbiter Entry and Landing Phase; Vehicle Design Environment; Steady State Winds (1K - surface), and Section 10.1.3.3.1.2, Design Vehicle Gust Environments). Headwind affects touchdown energy. Flight rule {A4.1.3-10}, AIMPOINT SELECTION, documents the acceptable touchdown distance.

TAILWIND

Tailwind affects the landing by causing a longer touchdown distance, higher touchdown ground speed, loss of roll out margin, and higher brake energy. The tailwind certification limit is one-half the landing steady state design wind speed (reference ORBITER VEHICLE END ITEM SPECIFICATION FOR THE SPACE SHUTTLE SYSTEM, Part 1, Performance and Design Requirements, Section 10.1.3.3.1.1.3, Orbiter Entry and Landing Phase; Vehicle Design Environment; Steady State Winds (1K - surface)).

CROSSWIND

Crosswind limits are set due to concerns in the following areas: tire wear, main gear tire/strut loads, and orbiter handling qualities. Currently, orbiter handling qualities associated with touchdown are the limiting factor. Previous concerns with orbiter handling qualities in the two point stance were eliminated with the "cost effective" rudder fix combined with beep trim derotation and significantly reduced lateral aerodynamic uncertainties. @[041196-1817B]

The crosswind limit is referenced to peak wind (the maximum wind reported for 2/5/10-minute periods) versus average wind since peak winds tend to persist long enough to be significant with respect to orbiter handling qualities during the final approach, TD, and derotation.

With the incorporation of the new modified tire (which provided a thicker and more durable tread) and the September 1994 regrinding of the KSC surface, tire wear concerns up to 20 kts have been alleviated for all shuttle CONUS runway surfaces. @[041196-1817B]

THIS RULE CONTINUED ON NEXT PAGE

FLIGHT RULES

A2.1.1-6 LANDING SITE WEATHER CRITERIA (CONTINUED)

Main gear tire/strut loads have been certified under nominal conditions (pilot technique and crosswind of 15 kts) with dispersions RSS'd for pilot technique and crosswind up to 20 kts (reference Rule {A10.1.8-1}, TIRE PRESSURE (CIL)). AMES VMS testing in August 1995 indicated main gear strut loads were exceeded for landing in crosswinds greater than 20 knots. Additionally, the sideslip at landing in crosswinds greater than 20 knots exceeded all test data on tire capability. ©[041196-1817B]

Previous AMES VMS evaluation of orbiter handling qualities as a function of crosswind (no systems failures and no aero uncertainties) have shown HQR's of Level I up to steady state crosswind of 12 kts (plus 2-3 kts of turbulence). HQR's increase from Level I to Level II as crosswind increases from 15 to 17.5 kts. For steady state crosswind in the 20-25 kt region, HQR's range from Level II to Level III. Testing with worse case aerodynamic uncertainties resulted in increased handling qualities rating of approximately 1.

The August 1995 AMES VMS testing used dynamic wind profiles and incorporated the "cost effective" rudder fix. Utilization of dynamic wind profiles (shear and turbulence) can shift HQR's from Level I to Level III for landing. August 1995 AMES VMS testing indicated that the most significant area of vehicle control is main gear touchdown when flown in dynamic wind profiles. Due to the infinite number of potential wind profiles, testing cannot determine acceptable shear or turbulence in the presence of crosswinds between 15 and 20 knots. The only tool available for determining an acceptable wind profile at touchdown with respect to shear and turbulence while remaining within vehicle limits is the STA since it will fly through the existing wind conditions (approximately 40 minutes from predicted RTLS landings). The STA is considered conservative due to the lower wing loading and slower roll response. Since testing at AMES indicated that there are some profiles that provide acceptable HQR's in crosswinds up to 20 knots, utilization of the STA would allow launch on the days where the wind profile is considered acceptable by the STA pilot. The STA GO will be based on usability of the HUD (HUD not caged and significant digits for altitude and airspeed visible) and acceptable pilot work load during landing (low level shears that do not degrade landing parameters Hdot, EAS, X-distance, Y-distance and Y-drift rate). Limited flight test data (STS 51-G, 11 kts peak; STS-30, 11 kts ave, 16-19 kts peak; STS-37, 8 kts ave, 9-10 kts peak) are inconclusive but provide indications of handling qualities degradation with increasing crosswind (STS-30 HQR approximately 5; however, its landing was complicated with a NWS S/W anomaly). ©[111094-1622B] ©[041196-1817B]

FLIGHT RULES

~~Windeather~~ forecasting uncertainties, ~~estimated at 2-5 kts~~, must also be considered when determining crosswind limits. EOM crosswind forecast uncertainties (90-minute forecast) for peak winds > 15 knots were presented at AEFTP #134. For KSC EOM, the average crosswind underforecast error is 3.1 knots with a standard deviation of 2.2 knots. For EDW, the average underforecast uncertainty is 5.2 knots with a standard deviation of 3.8 knots. The mission/daily forecast database used in this evaluation indicates that the percentage of time the crosswind at EDW exceeded 20 knots was < 2 percent. The EOM crosswind limit of 15 knots provides mean plus 1 sigma protection at KSC and mean protection at EDW. For RTLS, ~~t~~The SMG forecast database indicates that 1-sigma error on 30-minute forecast is approximately 3 knots. ~~s, and T~~the worst case underforecast during flight support (30-minute forecast) was also 3 knots. Limiting peak crosswind to 17 kts for an RTLS (typically 12-14 kts average) and requiring a "GO" from the STA pilot on the wind profile provides adequate allowance for aerodynamic uncertainties and weather forecasting dispersions while maintaining landing within vehicle limits and Level I/II handling qualities. ©[111094-1622B] ©[041196-1817B] ©[021998-6490A]

THIS RULE CONTINUED ON NEXT PAGE

FLIGHT RULES

A2.1.1-6 LANDING SITE WEATHER CRITERIA (CONTINUED)

Crosswind limits for EDO flights and night landings include a somewhat arbitrary reduction to 12 knots peak to allow for additional piloting margin due to uncertainties in pilot performance degradation from increased exposure to zero-g and reduced depth perception, respectively. AEFTP #138 reviewed flight data for gross landing parameters (Hdot, TD EAS, Y-position, height over threshold, and drift in the two-point attitude) for mission durations out to 18 days (STS-67, STS-78, and STS-80). No degradation was noted; therefore, the EDO duration was set to bracket current flight data. Data previously presented by SD indicated some performance shift for long duration flights; therefore, the AEFTP decided to maintain the crosswind reduction for flights outside of the tested envelope. Night RTLS is allowed to be 17/15 knots peak since zero-g ~~degradation~~ *adaptation* is not a concern and the pilots are very familiar with the landing site. In addition, ~~with respect to RTLS,~~ the CDR/PLT have recent STA flight approaches to the SLF. TAL sites, however, have much shorter and narrower runways than RTLS and pilot familiarity of these runways is significantly less. All other intact aborts, other than RTLS, TAL, and AOA, have significant exposure of the pilot to zero-g and therefore maintain the 12 kt limit for night landings. ©[041196-1817B] ©[041196-1871B] ©[041097-4926] _ ©[021998-6490A1]

CROSSWIND DTO

Reference rule {A2.1.5-11}, ENTRY DTO/AUTOMODE/CROSSWIND DTO GO/NO-GO, for the crosswind DTO requirements. Even though the crosswind DTO limit is 15 knots peak, the 12-knot peak crosswind limit still applies for night landings and mission landing \geq the CDR's flight day 17. ©[041196-1871B]

DRAG CHUTE CROSSWIND LIMITS

Reference rules {A10.1.8-3}, DRAG CHUTE CONSTRAINTS, and {A2.1.5-11}, ENTRY DTO/AUTO MODE/CROSSWIND DTO GO/NO-GO, for the drag chute requirements.

ONE APU FAILED (OR ATTEMPT TWO APU'S PROCEDURE)

Flight rules {A2.1.4-7}, LANDING SITE SELECTION, and {A10.1.2-3}, APU ENTRY START TIME, summarize the conditions and rationale for selecting a landing site with one APU failed and using the ATTEMPT TWO APU's start procedure. With two APU's failed, the loss of hydraulic power causes reduced flight control authority and braking and loss of nose wheel steering. The APU placards assure safe conditions should the orbiter lose a second APU. ©[111094-1622B]

THIS RULE CONTINUED ON NEXT PAGE

FLIGHT RULES

A2.1.1-6 LANDING SITE WEATHER CRITERIA (CONTINUED)

TURBULENCE @[111094-1622B]

Severe turbulence is undesirable due to controllability concerns. Turbulence information comes primarily from WX RECON and TALCOM aircraft or area pilot reports (PIREP). The type of aircraft is a factor when determining the applicability of a PIREP to the orbiter because an aircraft's response to turbulence is a function of wing loading. The shuttle is sensitive to turbulence-caused trajectory deviations below 3000 feet due to the inability to makeup energy loss and achieve the desired touch down point. The PIREP's follow standard definitions for the intensity of the turbulence. The aircraft reactions for the different types of the turbulence, as found in the DOD flight information handbook, are as follows: @[041196-1871B]

Light turbulence - turbulence that momentarily causes slight, erratic changes in altitude and/or attitude.

Moderate turbulence - turbulence that causes changes in altitude and/or attitude, but with the aircraft always remaining in positive control.

Severe turbulence - turbulence that causes large, abrupt changes in altitude and/or attitude. It usually causes large variations in indicated airspeed. Aircraft may be momentarily out of control.

THIS RULE CONTINUED ON NEXT PAGE

FLIGHT RULES

A2.1.1-6 LANDING SITE WEATHER CRITERIA (CONTINUED)

C. THUNDERSTORM, LIGHTNING, AND PRECIPITATION

TABLE A2.1.1-6-III - THUNDERSTORM, LIGHTNING, AND PRECIPITATION

THUNDERSTORM, LIGHTNING, AND PRECIPITATION PROXIMITY LIMITS (NM)		PRELAUNCH (RTL, TAL)	PREDEORBIT (EOM, DAILY PLS) PRELAUNCH (AOA)	REDESIG CRITERIA	ELS, ECAL, ACLS
TSTORM (INCLUDING ATTACHED NONTRANSPARENT ANVILS), AND LIGHTNING	RADIAL FROM CENTER OF PRIME RUNWAY	>20	>30	>15	NONE AT SITE
	LATERAL ALONG APPROACH PATH OUT TO 30 NM	>10	>20	>5	
	VERTICAL FROM TOP OF CLOUD	>2			
DETACHED NONTRANSPARENT ANVIL < 3 HRS OLD	RADIAL FROM CENTER OF PRIME RUNWAY	>15	>20	>15	N/A
	LATERAL ALONG APPROACH PATH OUT TO 30 NM	>5	>10	>5	
	VERTICAL FROM TOP OF CLOUD	>2			
PRECIPITATION *	RADIAL FROM CENTER OF PRIME RUNWAY	>20	>30	> 15	N/A
	LATERAL ALONG APPROACH PATH OUT TO 30 NM	>10	>20	> 5	
	VERTICAL FROM TOP OF CLOUD	>2			
CUMULUS CLOUDS PRODUCED BY SMOKE/FIRE UP TO 1 HR AFTER DETACHING	LATERAL ALONG APPROACH PATH	>0			N/A

* EXCEPTIONS EXIST FOR RTL, SEE A2.1.1-6C.4.A-G. @111298-6734]

1. THUNDERSTORMS (INCLUDING ATTACHED NONTRANSPARENT ANVILS), LIGHTNING, OR PRECIPITATION MUST BE OUTSIDE THE LIMITS LISTED IN TABLE A2.1.1-6-III TO INSURE WEATHER DOES NOT ADVERSELY EFFECT THE ORBITER DURING AN ENTRY AND LANDING. REFERENCE FIGURES A2.1.1-6-I THROUGH A2.1.1-6-V. THE LATERAL OR VERTICAL LIMITS MUST BE MET IN ADDITION TO THE RADIAL LIMIT. @ED]_ @111298-6734]
 - a. RADIAL PROXIMITY LIMITS ARE RELATIVE TO THE CENTER OF THE PRIME RUNWAY. @111094-1622B]

FLIGHT RULES

- b. LATERAL PROXIMITY LIMITS ARE RELATIVE TO THE ORBITER APPROACH PATH OUT TO A RANGE OF 30 NM FROM THE CENTER OF THE PRIME RUNWAY. @[111094-1622B]

THIS RULE CONTINUED ON NEXT PAGE

FLIGHT RULES

A2.1.1-6 LANDING SITE WEATHER CRITERIA (CONTINUED)

- c. VERTICAL CLEARANCES ARE FROM THE TOP OF THE THUNDERSTORM OR SHOWER TO THE ORBITER APPROACH PATH.
2. PRECIPITATION INDICATIONS INCLUDE VISIBLE RAIN OR VIRGA, PRECIPITATION ECHO ON WEATHER RADAR, OR CUMULONIMBUS OR CUMULUS CONGESTUS (TOWERING CUMULUS) CLOUD TYPES.
3. FOR ACLS/ECAL/ELS, PRECIPITATION IS ACCEPTABLE. NO THUNDERSTORMS (INCLUDING ATTACHED NONTRANSPARENT ANVIL) OR LIGHTNING AT THE SITE. @[020196-1808A] @[111298-6734]
4. FOR RTLS, RAIN SHOWERS (EXCLUDING THUNDERSTORMS) WITHIN THE LIMITS LISTED ABOVE ARE ACCEPTABLE IF CONTINUOUS RADAR AND AIRCRAFT SURVEILLANCE INDICATES ALL OF THE FOLLOWING CONDITIONS ARE MET. @[021998-6490A]
 - a. COVERAGE: SHOWERS COVER LESS THAN 10 PERCENT OF THE AREA WITHIN 20 NM OF THE SLF OR MULTIPLE HAC'S ARE CLEAR OF SHOWERS.
 - b. MOVEMENT/DEVELOPMENT: OBSERVED HORIZONTAL MOVEMENT IS CONSISTENT AND NO ADDITIONAL CONVECTIVE DEVELOPMENT IS FORECAST.
 - c. LIGHTNING POTENTIAL: TOPS OF CLOUDS CONTAINING PRECIPITATION DO NOT EXCEED THE +5 DEG C LEVEL AND HAVE NOT EXCEEDED THE -10 DEG C LEVEL WITHIN 2.5 HOURS PRIOR TO LAUNCH.
 - d. INTENSITY: PRECIPITATION IS LIGHT (LESS THAN 30 DBZ) AT ALL LEVELS WITHIN AND BELOW THE CLOUD. @[021998-6490A]
 - e. FOR ANY SHOWER WITHIN 20 MILES OF THE SLF, IF THE SHOWER EXCEEDS PARAGRAPHS 4.c OR 4.d, THEN A 2-NM VERTICAL CLEARANCE FROM THE TOP OF THAT SHOWER AND A 10-NM LATERAL CLEARANCE MUST BE MAINTAINED ALONG THE APPROACH PATHS TO THE OVERHEAD AND STRAIGHT-IN HAC'S AT BOTH ENDS OF THE RUNWAY. @[021998-6490A]

FLIGHT RULES

- f. BOTH ENDS OF THE RUNWAY MEET THE LANDING AND ROLLOUT CRITERIA AND NAVAID REQUIREMENTS SPECIFIED IN RULE {A2.1.1-1}, PRELAUNCH GO/NO-GO REQUIREMENTS.

THIS RULE CONTINUED ON NEXT PAGE

FLIGHT RULES

A2.1.1-6

LANDING SITE WEATHER CRITERIA (CONTINUED)

- g. CONSIDERATION MAY BE GIVEN TO RELAXING THE REQUIREMENT TO MEET ALL FOUR APPROACHES TO BOTH ENDS OF THE RUNWAY AS SPECIFIED IN PARAGRAPHS 4.e AND 4.f ABOVE. THERE SHOULD BE A HIGH LEVEL OF CONFIDENCE THAT AT LEAST TWO HAC APPROACHES (OVERHEAD AND STRAIGHT-IN TO ONE RUNWAY OR STRAIGHT-IN TO BOTH ENDS OF THE RUNWAY) WILL BE ACCEPTABLE AT RTLS LANDING TIME. TREND MONITORING UTILIZING RADAR AND AIRCRAFT SURVEILLANCE SHOULD INDICATE THAT A STABLE AND PREDICTABLE ENVIRONMENT EXISTS. @[021998-6490A]

5. THE ORBITER SHALL NOT PENETRATE A CUMULUS CLOUD THAT IS ATTACHED TO A SMOKE PLUME PRODUCED BY A FIRE. IF THE CUMULUS CLOUD DETACHES FROM THE SMOKE PLUME, 1 HOUR MUST ELAPSE FROM TIME OF DETACHMENT FOR SAFE PENETRATION BY THE ORBITER. @[111298-6734]

The orbiter is not to encounter precipitation on any approach due to decreased visibility, damage to the TPS, and the potential for triggered lightning. Undesirable aspects of thunderstorms include rain (TPS, structure), hail (TPS, structure, control), severe wind shear (structure), turbulence (control, performance, structure), and natural or triggered lightning (structure, electronic/software systems). Environmental design requirements for the orbiter are based on no in-flight penetration of thunderstorms (ref. Appendix 10-10, Volume X, Space Shuttle Level II Program Specification). The participants in the Weather Rules Workshop held at JSC/MSFC in October 1987 developed the thunderstorm, lightning, and precipitation limits based on scientific knowledge, engineering judgment, and experience.

The 20 nm and 15 nm radii around the landing site approximate a 10 nm and 5 nm lateral clearance from all HAC's, respectively. Increasing the radial and lateral limits for EOM, AOA, PLS, and ELS adds protection for the uncertainty associated with a longer forecast. The post-commitment clearances balance the risks associated with a runway redesignation and damage from flying through precipitation or probability of incurring a lightning strike. Clearances are lower for detached ~~opaquenontransparent~~ thunderstorm anvils because the probability for triggered lightning is lower. An attached anvil is part of the thunderstorm and must meet the thunderstorm proximity limits if the anvil is nontransparent. At the January and April 1998 meetings of the Lightning Advisory Panel (LAP), the consensus was that transparent anvil clouds do not pose a triggered lightning threat. An anvil may be considered transparent when higher clouds, blue sky, stars, etc. may be seen and identified from below or when terrain, buildings, etc. may be seen and identified from above. Evaluation of anvils is sometimes difficult and inexact, even with modern remote sensing technology. Water droplets observed on the windscreen of weather aircraft when flying through clouds are definitive evidence of precipitation or virga. @[111298-6734]

THIS RULE CONTINUED ON NEXT PAGE

FLIGHT RULES

A2.1.1-6 LANDING SITE WEATHER CRITERIA (CONTINUED)

At the January and April 1998 meetings of the Lightning Advisory Panel, LAP members stated that applicable research indicated that cumulus clouds formed by fires and smoke pose a threat of triggered lightning if penetrated and should be avoided for up to ~~one~~ hour after the cloud detaches from the source fire or smoke. [111298-6734]

Figures A2.1.1-6-I through A2.1.1-6-V depict the thunderstorm/lightning/rainshower proximity limits for a 28.5 degree inclination flight. The maximum heights marked in the corridor insure that the orbiter clears the top of the thunderstorm for the worst case (i.e., orbiter on the western edge of the region). [111094-1622B] [020196-1808A] [ED]

ACLS/ECAL/ELS LIMITS [111094-1622B] [020196-1808A]

Weather at the site must be acceptable to provide good visibility during final approach, since lateral and longitudinal margins are minimal at ECAL/ELS sites. As long as visibility and ceiling limits are met, there is no constraint for precipitation. ~~Additional constraints for precipitation are solely to avoid thunderstorms and lightning apply only to the landing site. - and to ensure adequate visibility~~ The definition for "none at site" used in the Shuttle Program will mean that no thunderstorm is over the landing airfield. - Note that operational meteorological reporting standards for weather occurring at a site differs slightly from the definition applied for shuttle landings. For thunderstorm and lightning observations (METAR) and forecasts (TAF) used to evaluate the GO/NO-GO status of an ACLS/ECAL/ELS site prior to launch, meteorological reporting standards define "none at site" as: no thunderstorms or lightning within 5 statute miles of the observing (landing) site. [111298-6734]

RTLS PRECIPITATION LIMITS

The short forecast interval for RTLS and availability of radar and weather aircraft allow improved estimation of rain shower movement and characterization of the cloud type. The RTLS shower exception specifies conditions under which launch is acceptable when showers are within the area of the SLF on launch day. SMG developed the conditions specified in this rule to meet orbiter design requirements. Additional launch probability is gained by eliminating the avoidance criteria for showers that do not pose a threat due to lightning, hail, visibility, aerodynamic control, or MLS attenuation. Tile damage that occurs if precipitation is encountered is acceptable. Radial, lateral, and vertical avoidance criteria still apply for any storm that poses a threat to the orbiter. Reference A/E FTP # 109 and 111. [020196-1808A]

FLIGHT RULES

Cloud Top Temperatures and Lightning Avoidance - Clouds that exceed the conditions stated in paragraphs c and d above pose a threat of hail or lightning (natural and triggered). Clouds with < 30 DBZ and tops below the +5 deg C thermal layer do not pose a threat of stored electrical charge. Clouds that have previously extended above the -10 deg C thermal layer must be avoided for 2.5 hours to allow any accumulated charge to dissipate. A 2-nm vertical clearance and a 10-nm lateral clearance must be maintained along the approach paths of the overhead and straight-in HAC's at both ends of the runway for showers exceeding these limits. The Lightning Avoidance Criteria Peer Review Committee reviewed and concurred with these criteria at their KSC meeting in February 1994. ©[021998-6490A]

THIS RULE CONTINUED ON NEXT PAGE

FLIGHT RULES

A2.1.1-6 LANDING SITE WEATHER CRITERIA (CONTINUED)

If the orbiter encounters ice, window damage may occur resulting in reduced visibility (depending on ice population, mass, density, and relative velocity) and RCC coating damage may occur forcing RCC panel replacement. Clouds with tops below the +5 deg C thermal layer are warm enough to assure they do not contain hail.

Light Precipitation - Testing of TPS tiles flown through moderate rainfall (35 to 40 dbz) indicates that significant tile damage will occur if the orbiter encounters ice-free precipitation at velocities below Mach 1 and above touchdown speed. The extent of damage depends on drop size and the angle of incidence between a drop and a tile. Conservative estimates of effects on approach and landing characteristics assuming a worst-case estimate of approximately 2000 damaged tiles (nose and canopy/windshield areas, vertical tail and OMS pod leading edges) show no significant effect on landing performance. A retrim to a slightly higher angle of attack would be the primary noticeable response to flight through rain during landing approach. No structure or control system damage would occur. Testing indicates that damage to RCC does not occur when flown through light rain at speeds below 0.7 Mach. RCC damage is not desirable due to replacement cost and lead time. RCC damage caused by precipitation impact would not affect aerodynamic performance. ©[020296-1808A]

Tile damage could result in a loss of up to 1000 ft of touchdown distance. Typical touchdown distances carry adequate margin to protect this type of energy loss. A dispersed entry that is flown through a shower on a day that predicted touchdown conditions are at the limits specified in rule {A4.1.3-10}, AIMPOINT SELECTION, could result in a vehicle touchdown on the underrun. Consideration should be given to not launching on a low energy day where the capability to avoid showers is low. Otherwise, adequate margin exists within the system to support loss of touchdown energy due to tile damage. ©[020196-180]

Water attenuates microwave signals at MLS frequencies; however, MLS performance is not severely affected. Analysis of MLS link performance with a transmitter power output of 1600 W (the minimum acceptable transmitter power output level) shows that MLS acquires at over 9 nm slant range when a rainfall rate of 10 mm/hr (0.4 in/hr) exists along the entire path between the orbiter and the ground MLS station. Since "light" rainfall is less than 0.4 in/hr, nominal MLS acquisition is protected.

Ceiling and visibility criteria specified in paragraph A of this rule still apply and protect for adequate crew visibility of the PAPI's, aimpoint, and ball bar through clouds and precipitation. WX RECON has primary responsibility for assessing visibility through light precipitation from any showers of concern that do not fall within the field of view used by meteorological observers to evaluate visibility. Ground observers are limited to evaluations using fixed landmarks.

FLIGHT RULES

Area Coverage/Multiple HAC's - While it is acceptable to encounter showers that meet the criteria specified in this rule, it is still more desirable to avoid them if possible. Limiting the number of showers in the vicinity of the SLF minimizes the chances of encountering a shower. If more than 10 percent coverage exists or is forecast but multiple HAC's are clear and will remain clear of showers, the intent of this constraint has been met.

THIS RULE CONTINUED ON NEXT PAGE

FLIGHT RULES**A2.1.1-6 LANDING SITE WEATHER CRITERIA (CONTINUED)**

Movement and Convective Development - Consistent horizontal motion that is linear or near linear and can be tracked is required to accurately forecast future movement. Conditions must be thermodynamically stable. Observed and forecast conditions are the same and expected to remain unchanged throughout the RTLS period.

Paragraph f defines the clearance requirements of showers with lightning potential (tops greater than +5 deg C or returns greater than 30 dbz) which have not demonstrated air to ground lightning strikes. The clearance requirements for lightning potential are the same as those of actual thunderstorms. ©[020196-1808A]

RTLS OBSERVATIONS

Providing a safe approach at RTLS landing time is of prime importance. Most of these weather criteria are treated as macro type events, so the general landing site area is protected. Given the short forecasting time for an RTLS and the use of sophisticated meteorological tools along with aircraft surveillance, it may be possible to treat a given situation as a “micro” event. In relaxing these criteria, it is important to consider the stability/predictability of the situation and the tools used to monitor the area (radar, satellite, aircraft surveillance). ©[021998-6490A]

Rules {A2.1.1-1F}, PRELAUNCH GO/NO-GO REQUIREMENTS; {A2.1.1-2}, ABORT LANDING SITE REQUIREMENTS; {A2.1.3-2}, EXTENSION DAY REQUIREMENTS; {A2.1.4-2}, EXTENSION DAY GUIDELINES; {A2.1.4-5}, EMERGENCY DEORBIT; {A2.1.5-11}, ENTRY DTO/AUTO MODE/CROSSWIND DTO GO/NO-GO; {A3.1.5-2}, MLS; {A4.1.3-7}, PLS/EOM LANDING OPPORTUNITY REQUIREMENTS; {A5.1.3-3}, LIMIT SHUTDOWN CONTROL; {A8.1.1-18}, LANDING SYSTEMS REQUIREMENTS; and {A8.1.6-1}, GNC GO/NO-GO CRITERIA, reference this rule. ©[111094-1622B] ©[020196-1808A]

THIS RULE CONTINUED ON NEXT PAGE

FLIGHT RULES

A2.1.1-6 LANDING SITE WEATHER CRITERIA (CONTINUED)

TABLE A2.1.1-6-I - CEILING AND VISIBILITY LIMITS [ED]

CEILING / VISIBILITY (K FT)/(SM)			REDUNDANT MLS	SINGLE STRING-MLS	NO MLS
KSC, EDW, NOR, AOA, DAILY PLS SELECTION (ALL SITES)	CONCRETE	DAY	≥8/5 (WX RECON REQUIRED)	≥10/7	
		NIGHT		NO-GO	
	LAKEBED	DAY			≥10/7
		NIGHT		≥15/7	NO GO
RTLS, TAL	CONCRETE	DAY	≥5/4 RTLS >5/5 TAL (WX RECON REQUIRED)	≥10/7	
		NIGHT		NO GO	
ACLS / ECAL / ELS			0/0		≥8/5
PREDEORBIT: ONE APU FAILED OR ATTEMPT TWO APU'S PROCEDURE			≥10/7		

[050495-1776A] [041097-4927A] [051697-4928B]

TABLE A2.1.1-6-II - SURFACE WINDS AND TURBULENCE LIMITS [ED]

SURFACE WIND (KNOTS) AND TURBULENCE		CROSS PEAK	HEAD PEAK	TAIL AVG	TAIL PEAK	GUST	TURB
RTLS		≤15 *	≤25	≤10	≤15	≤10	≤MOD
DAY	EOM, TAL, AOA, DAILY PLS SELECTION	≤15					
NIGHT	EOM, TAL, AOA DAILY PLS SELECTION	≤12					
CROSSWIND DTO		≥10 ≤15					
NOMINAL DRAG CHUTE DEPLOY		≤15					
LANDING ≥ CDR FD19		≤12					
PREDEORBIT: 1 APU FAILED OR ATTEMPT 2 APU'S PROCEDURE		≤10					
ECAL / ELS		≤15	N/A				≤LGT

* REQUIRES AN STA EVALUATION TO 17 KNOTS AND A GO FROM THE STA PILOT [041097-4926] [041097-4890A]

THIS RULE CONTINUED ON NEXT PAGE

FLIGHT RULES

A2.1.1-6 LANDING SITE WEATHER CRITERIA (CONTINUED)

TABLE A2.1.1-6-III - THUNDERSTORM, LIGHTNING, AND PRECIPITATION [ED]

<u>THUNDERSTORM, LIGHTNING, AND PRECIPITATION PROXIMITY LIMITS (NM)</u>		<u>PRELAUNCH (RTLS, TAL)</u>	<u>PREDEORBIT (EOM, DAILY PLS) PRELAUNCH (AOA)</u>	<u>REDESIG CRITERIA</u>	<u>ELS, ECAL, ACLS</u>
<u>TSTORM (INCLUDING ATTACHED NONTRANS-PARENT ANVILS), AND LIGHTNING</u>	<u>RADIAL FROM CENTER OF PRIME RUNWAY</u>	<u>>20</u>	<u>>30</u>	<u>>15</u>	<u>NONE AT SITE</u>
	<u>LATERAL ALONG APPROACH PATH OUT TO 30 NM</u>	<u>>10</u>	<u>>20</u>	<u>>5</u>	
	<u>VERTICAL FROM TOP OF CLOUD</u>	<u>>2</u>			
<u>DETACHED NONTRANSPARENT ANVIL < 3 HRS OLD</u>	<u>RADIAL FROM CENTER OF PRIME RUNWAY</u>	<u>>15</u>	<u>>20</u>	<u>>15</u>	<u>N/A</u>
	<u>LATERAL ALONG APPROACH PATH OUT TO 30 NM</u>	<u>>5</u>	<u>>10</u>	<u>>5</u>	
	<u>VERTICAL FROM TOP OF CLOUD</u>	<u>>2</u>			
<u>PRECIPITATION *</u>	<u>RADIAL FROM CENTER OF PRIME RUNWAY</u>	<u>>20</u>	<u>>30</u>	<u>> 15</u>	<u>N/A</u>
	<u>LATERAL ALONG APPROACH PATH OUT TO 30 NM</u>	<u>>10</u>	<u>>20</u>	<u>> 5</u>	
	<u>VERTICAL FROM TOP OF CLOUD</u>	<u>>2</u>			
<u>CUMULUS CLOUDS PRODUCED BY SMOKE/FIRE UP TO 1 HR AFTER DETACHING</u>	<u>LATERAL ALONG APPROACH PATH</u>	<u>>0</u>			<u>N/A</u>

* EXCEPTIONS EXIST FOR RTLS, SEE A2.1.1-6C.4.A-G. [11298-6734]

THIS RULE CONTINUED ON NEXT PAGE

FLIGHT RULES

A2.1.1-6

LANDING SITE WEATHER CRITERIA (CONTINUED)

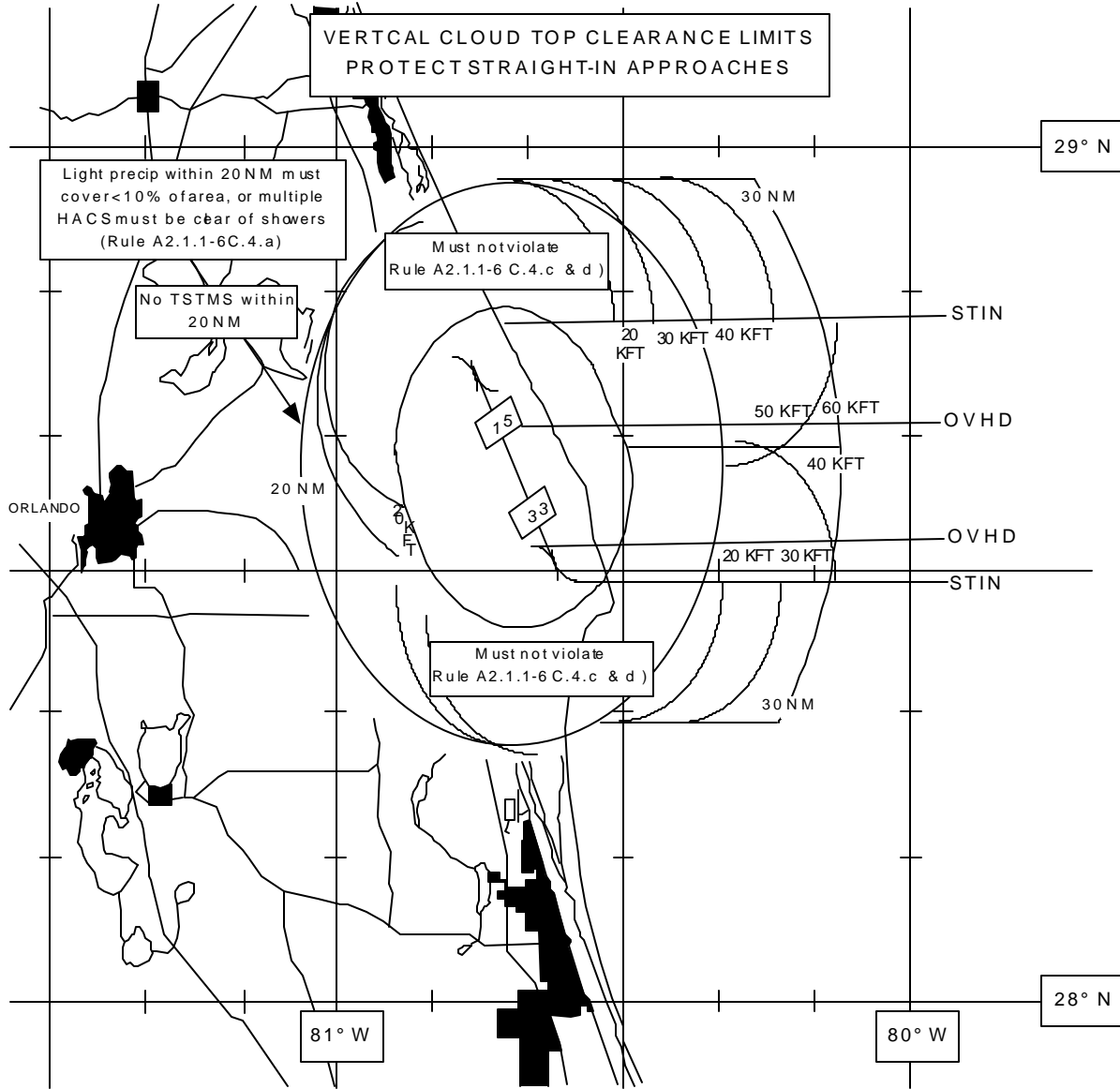

NOTE: VALID FOR 28.45 DEG INCLINATION @ED]

**FIGURE A2.1.1-6-I - VERTICAL CLOUD TOP CLEARANCE LIMITS
PROTECT STRAIGHT IN APPROACHES**

©[081497-6278A]

THIS RULE CONTINUED ON NEXT PAGE

FLIGHT RULES

A2.1.1-6

LANDING SITE WEATHER CRITERIA (CONTINUED)

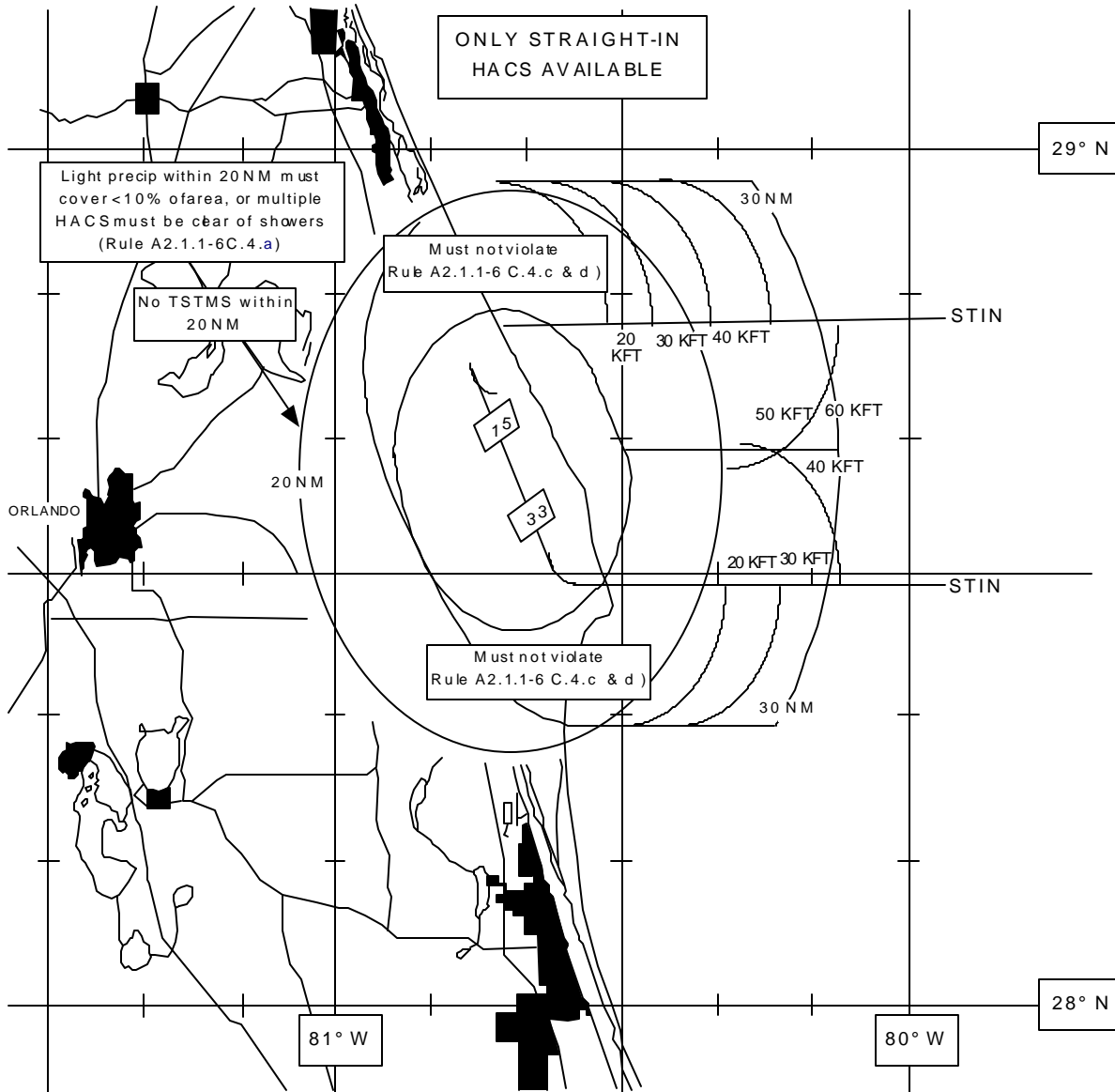

FitRule2cvs

NOTE: VALID FOR 28.45 DEG INCLINATION @ED]

FIGURE A2.1.1-6-II - ONLY STRAIGHT IN HACS AVAILABLE

@[081497-6278A]

THIS RULE CONTINUED ON NEXT PAGE

FLIGHT RULES

A2.1.1-6

LANDING SITE WEATHER CRITERIA (CONTINUED)

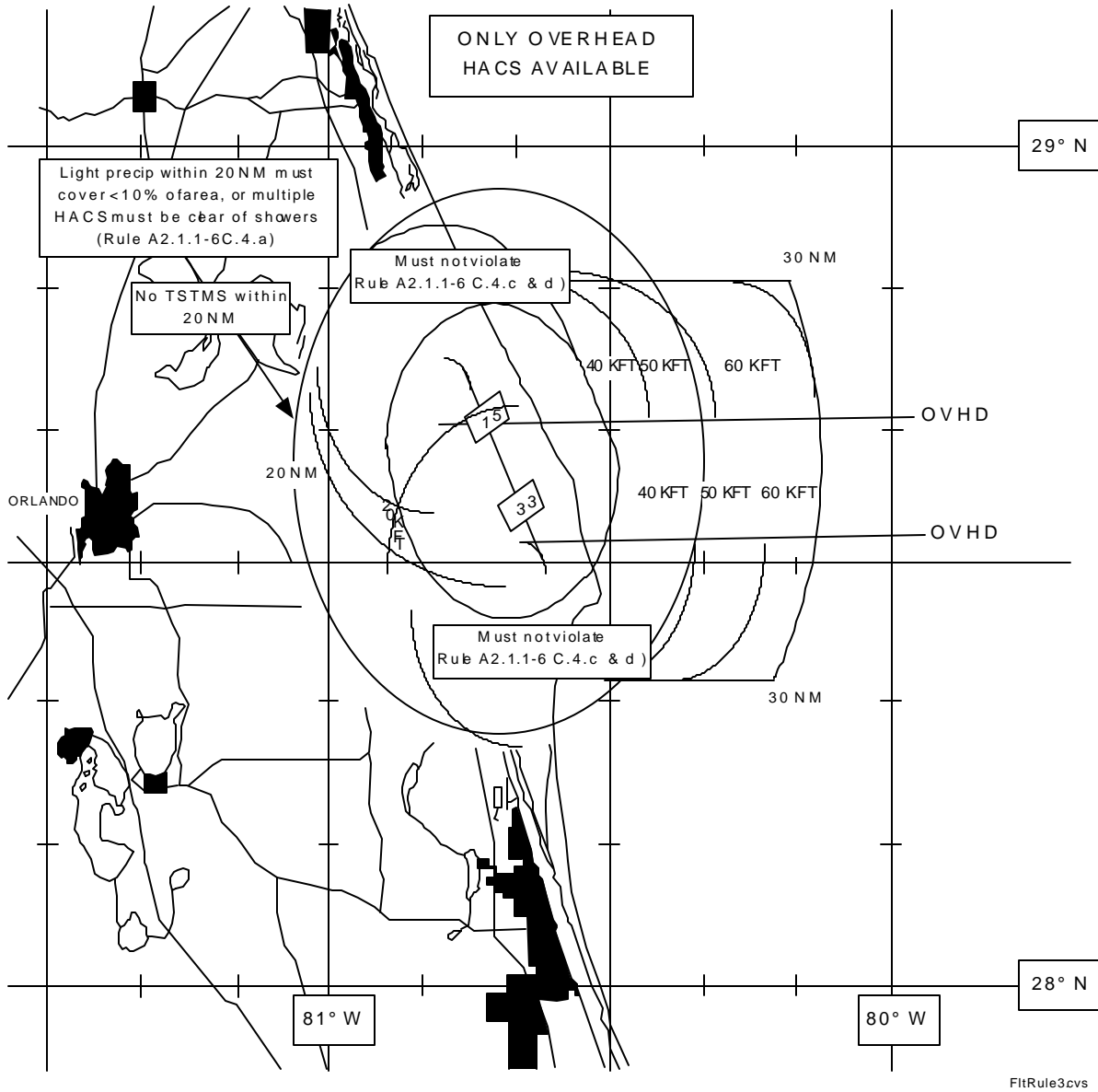

NOTE: VALID FOR 28.45 DEG INCLINATION @ED]

FIGURE A2.1.1-6-III - ONLY OVERHEAD HACs AVAILABLE

@[081497-6278A]

THIS RULE CONTINUED ON NEXT PAGE

FLIGHT RULES

A2.1.1-6

LANDING SITE WEATHER CRITERIA (CONTINUED)

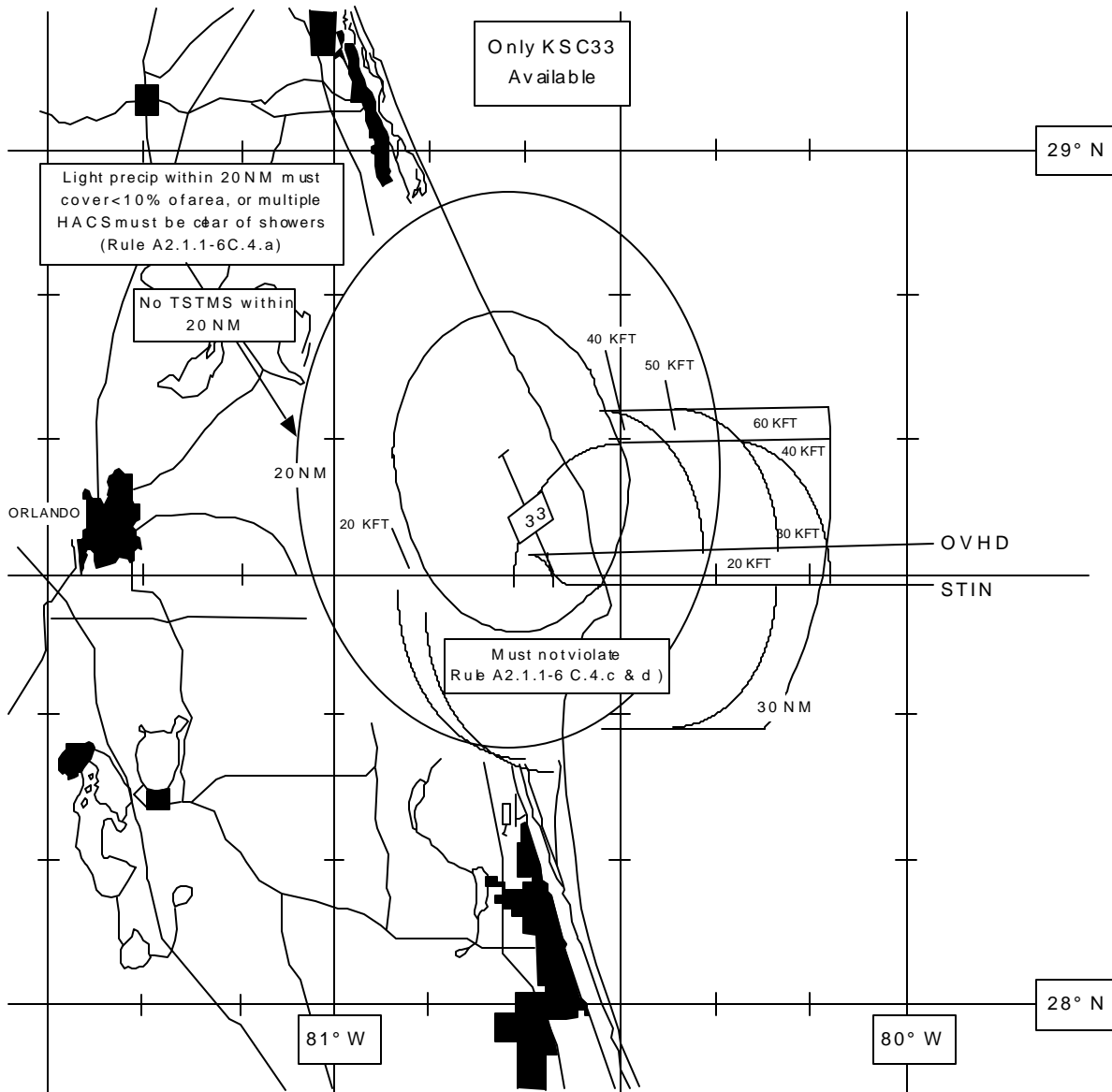

NOTE: VALID FOR 28.45 DEG INCLINATION @ED]

FIGURE A2.1.1-6-IV - ONLY KSC33 AVAILABLE

©[081497-6278A]

THIS RULE CONTINUED ON NEXT PAGE

FLIGHT RULES

A2.1.1-6

LANDING SITE WEATHER CRITERIA (CONTINUED)

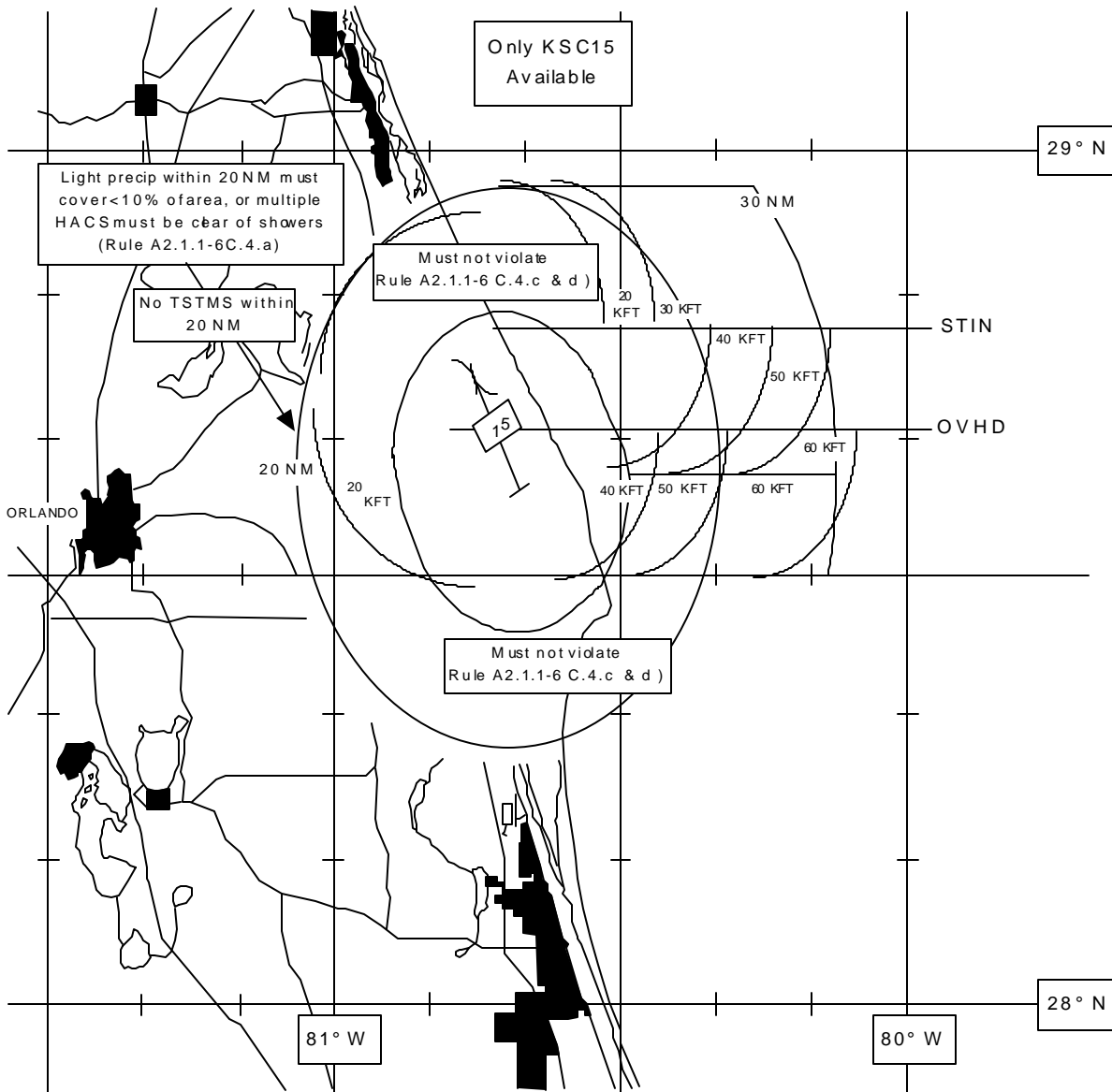

FitRule5cvs

NOTE: VALID FOR 28.45 DEG INCLINATION @ED]

FIGURE A2.1.1-6-V - ONLY KSC15 AVAILABLE

©[081497-6278A]

FLIGHT RULES

A2.1.1-7 DAY-OF-LAUNCH ET LOAD DATA

- A. ACTUAL DAY OF LAUNCH (DOL) ET LOAD DATA FROM THE PLOAD PROGRAM WILL BE USED TO RE-COMPUTE ASCENT PERFORMANCE MARGIN, ARD MASS PROPERTIES, AND ARD FPR BASED ON L-1.75 HOURS (OR LATER) DATA. ©[050495-1729D] ©[081497-6305A]
- B. IF A REVERT HAS OCCURRED, MCC WILL BE NO-GO FOR LAUNCH UNTIL STABLE REPLENISH HAS BEEN RE-ESTABLISHED AND A NEW PLOAD DATA INPUT HAS BEEN RECEIVED AND EVALUATED (APPROXIMATELY 50 MINUTES FOR AN LO2 REVERT OR APPROXIMATELY 25 MINUTES FOR AN LH2 REVERT).
- C. IF PLOAD IS UNAVAILABLE, THE ARD WILL BE CONFIGURED TO REFLECT TARGET TDDP LOAD QUANTITIES AND THE ARD FPR WILL BE RE-CALCULATED WITH INCREASED LOAD UNCERTAINTIES TO ACCOUNT FOR ADDITIONAL DISPERSIONS IN THE ACTUAL LOAD. NOTE: THIS IS VALID ONLY FOR A NOMINAL ET LOADING TIMELINE, UNLESS PROPULSION SYSTEMS COMMUNITY CONCURRENCE IS RECEIVED PER PART D, BELOW.
- D. IF BOTH AN LO2 REVERT HAS OCCURRED AND PLOAD IS UNAVAILABLE, OR IF FOR ANY OTHER REASON LOAD UNCERTAINTY EXISTS WITHOUT PLOAD DATA, MCC WILL BE NO-GO FOR LAUNCH UNTIL THE PROPULSION SYSTEMS COMMUNITY, AS REPORTED BY THE JSC/USA PSIG REPRESENTATIVE IN THE MOIR, IS SATISFIED THAT A TARGET TDDP LOAD HAS BEEN ACHIEVED.

The ~~MSFC HOSC executes the~~ PLOAD program is executed at L-1.75 hours to estimate LO2 and LH2 loads based on ullage pressures and environmental conditions. This data is provided to the flight dynamics team at about L-1.5 hours (subsequent PLOAD run data during extended launch holds will also be incorporated as it becomes available, if necessary). The predicted end-of-replenish quantities are used to calculate DOL ascent performance margin, fuel bias, ARD Main Engine Propellant (MEP) quantity, and vehicle weights. ARD FPR is also recalculated based on the actual load, since the ET load and mixture ratio component of ARD FPR is a function of predicted fuel bias.

If a revert occurs, launch will not be attempted until a valid PLOAD data point can be evaluated (approximately 50 minutes of stable replenish for ullage pressure stabilization and load data transmittal for an LO2 revert, approximately 25 minutes for LH2), to assure an adequate ascent performance margin. The minimum time is that which is required before giving a "GOGO" to pick up the count at T-9 min or T-5 min. These procedures were approved at the PRCB, 1/14/92.

©[050495-1729D] ©[081497-6305A]

THIS RULE CONTINUED ON NEXT PAGE

FLIGHT RULES

A2.1.1-7

DAY-OF-LAUNCH ET LOAD DATA (CONTINUED)

When PLOAD is not available, it is assumed that the load fits within statistical limits of previous load quantities, which historically have been very close to the targeted load specified in the Trajectory Design Data Package (TDDP). In this case, ARD FPR must protect for historical deviations of the reported load from the target load as well as normal PLOAD uncertainties. The historical deviations (reference NSTS 08209, Shuttle Systems Design Criteria; Volume I, Shuttle Performance Assessment Databook; Section 8, Flight Performance Reserve; Table 8.1, System Dispersions for FPR Computation) are root sum squared with the normal PLOAD uncertainties to provide a total load uncertainty that is used to recompute ARD FPR. This increases the ARD FPR by approximately 70 lbs. @[081497-6305A]

For any case involving loss of PLOAD data, a nominal stable replenish timeline is necessary to ensure that the load has reached TDDP target conditions. In the very unlikely event that both an LO2 revert has occurred and the PLOAD program is unavailable, or if for any other reason load uncertainty exists, the propulsion systems community, as reported via the JSC/USA Propulsion Systems Integration Group (PSIG) representative in the MOIR, must be satisfied that a TDDP target load has been achieved before a "GO" can be given to pick up the count. @[081497-6305A]

FLIGHT RULES

A2.1.1-8 LAUNCH TIME SELECTION FOR GROUND-UP RENDEZVOUS

THE MCC-H FLIGHT DYNAMICS OFFICER (FDO) IS RESPONSIBLE FOR ALL COMPUTATIONS RELATED TO LAUNCH WINDOW. FINAL CALCULATIONS WILL BE MADE AT APPROXIMATELY L-2 HOURS. THESE WILL USE THE LATEST AVAILABLE BALLOON/~~LSEAT~~ PERFORMANCE ANALYSIS, LATEST AVAILABLE TARGET TRACKING VECTOR, AND THE FINAL PLOAD ANALYSIS OF ET LOADING. THE FDO SHALL INFORM ~~THE MOD LSEAT REPRESENTATIVE AND~~ THE MCC-H FLIGHT DIRECTOR OF THE LAUNCH WINDOW TIMES. THE FLIGHT DIRECTOR SHALL BE THE SINGLE POINT OF COMMUNICATION FOR THE LAUNCH WINDOW TIMES TO KSC VIA THE NTD. THE ASSOCIATED LAUNCH TARGETING/AUTO DEL PSI COMMAND LOADS WILL BE GENERATED AND UPLINKED TO THE VEHICLE IN THIS TIMEFRAME. AFTER THIS TIME, UPDATES TO WINDOW TIMES AND/OR A NEW COMMAND UPLINK WILL BE REQUIRED IF THE PANE SWITCH WINDOW TIME CHANGES BY MORE THAN 5 SECONDS (IN EITHER DIRECTION) BASED ON THE L-2.25 HR BALLOON ANALYSIS AT APPROXIMATELY L-30. @[081497-6263B] . @[111298-6693]

- A. LAUNCH WINDOW OPEN AND CLOSE TIMES WILL BE COMPUTED TO THE NEAREST SECOND. ON A GIVEN DAY, A RENDEZVOUS LAUNCH WINDOW MAY BE ONLY ONE PLANAR PANE OR THE COMBINATION OF TWO PLANAR PANES. ONLY THE PLANAR PANE WHERE THE PHASE ANGLE IS ACCEPTABLE WILL BE CONSIDERED PART OF THE COMBINED LAUNCH WINDOW. THIS MAY RESULT IN CUTOUTS IN THE LAUNCH WINDOW. CALCULATION OF LAUNCH WINDOW OPEN, CLOSE, AND PANE SWITCH TIMES WILL PROTECT:
1. MPS AND OMS PERFORMANCE MARGIN FOR MISSION SUCCESS AS DEFINED BY FLIGHT RULE {X4.1.1-1}, TRAJECTORY AND GUIDANCE PARAMETERS, PARAGRAPHS A AND B. THIS IS ZERO PREDICTED MPS USABLE RESIDUALS ABOVE THE FLIGHT PERFORMANCE RESERVE AND THE REQUIRED SIGMA DISPERSION. THE SIGMA DISPERSION IS DEFINED IN THE FLIGHT RULE {X4.1.1-1}, TRAJECTORY AND GUIDANCE PARAMETERS.

LAUNCH WINDOW OPEN WILL BE BASED ON LOX DRAINBACK START TIME 4 MINUTES 55 SECONDS BEFORE WINDOW OPENING. LAUNCH WINDOW CLOSE WILL BE BASED ON A HOLD THAT DELAYS LOX DRAINBACK START TIME TO THE MAXIMUM EXTENT POSSIBLE, 4 MINUTES 55 SECONDS BEFORE THE CLOSE OF THE WINDOW. @[081497-6263B]

THIS RULE CONTINUED ON NEXT PAGE

FLIGHT RULES

A2.1.1-8 LAUNCH TIME SELECTION FOR GROUND-UP RENDEZVOUS
(CONTINUED)

FOR 51.6 DEGREE INCLINATION MISSIONS, IF THE PERFORMANCE MARGIN IS LESS THAN 200 POUNDS AT THE OPENING OF THE LAUNCH WINDOW, AN ADDITIONAL ~~10-SECOND~~ DELAY, IF AVAILABLE, WILL BE ADDED TO WINDOW OPEN TIME TO PROTECT FOR PERFORMANCE VARIATION DUE TO WIND PERSISTENCE. @[081497-6263B] @[111298-6693]

2. PROTECT CONTINUOUS SINGLE SSME OUT INTACT ABORT CAPABILITY FOR A LAUNCH AT ANY TIME DURING THE WINDOW.
3. RANGE SAFETY ET DISPOSAL AS SPECIFIED BY FLIGHT RULE {A2.1.3-13}, ET FOOTPRINT CRITERIA.
4. ET YAW STEERING CERTIFICATION LIMIT AROUND OPTIMUM LAUNCH TIME FOR THE PLANAR WINDOW(S).
5. SHUTTLE TO TARGET VEHICLE OMS-2 PHASE ANGLE WINDOW, ASSUMING NOMINAL MECO CONDITIONS, AS DEFINED BY THE RENDEZVOUS PLAN ASSUMPTIONS DOCUMENTED IN THE FLIGHT RULE ANNEX.
6. ACCEPTABLE PERFORMANCE AROUND PANE SWITCH. THE UPLINKED PANE SWITCH TIME WHICH DEFINES THE END OF THE FIRST PANE FOR PERFORMANCE AND AN ASSOCIATED OPENING OF THE SECOND PANE WILL BE COMPUTED BASED ON LOX DRAINBACK STARTING 4 MIN 55 SECONDS PRIOR TO THE PREFERRED LAUNCH TIME AS DEFINED IN PARAGRAPH D BELOW. NOTE THAT THERE MAY BE A LAUNCH WINDOW CUTOUT WHERE THERE IS INSUFFICIENT PERFORMANCE FOR LAUNCH. @[081497-6263B]

THIS RULE CONTINUED ON NEXT PAGE

FLIGHT RULES**A2.1.1-8 LAUNCH TIME SELECTION FOR GROUND-UP RENDEZVOUS
(CONTINUED)****B. UNPLANNED HOLDS INSIDE LOX DRAINBACK @[081497-6263B]**

1. PANE 1 CLOSE AND PANE 2 OPEN WILL BE CALCULATED ASSUMING LOX DRAINBACK (T-4 MINUTES 55 SECONDS) STARTS FOR THE PREFERRED LAUNCH TIME AS DEFINED IN PARAGRAPH D BELOW. PANE 1 CLOSE AND PANE 2 OPEN TIMES WILL BE UPDATED IF LAUNCH IS TO BE ATTEMPTED AT THE WINDOW OPEN TIME.
2. LOX DRAINBACK HOLD TIME REPORTED TO THE NTD WILL BE CALCULATED ASSUMING START OF LOX DRAINBACK 4 MIN 55 SEC PRIOR TO THE PREFERRED LAUNCH TIME AS DESCRIBED IN PARAGRAPH D BELOW. LOX DRAINBACK HOLD TIME WILL BE UPDATED IF LAUNCH IS TO BE ATTEMPTED AT THE WINDOW OPEN TIME. FOR HOLDS BEFORE LOX DRAINBACK STARTS, THIS TIME IS NO LONGER VALID AND IN GENERAL DECREASES. FOLLOWING A SERIES OF HOLDS BEFORE OR DURING LOX DRAINBACK, IF REQUIRED, THE FD WILL COORDINATE A HOLD OR CUTOFF WITH THE NTD TO PREVENT A LAUNCH WITH INSUFFICIENT PERFORMANCE.
3. SSME START BOX TEMPERATURE LIMITS ARE NOT CONSIDERED IN THESE CALCULATIONS. ONCE THE SSME CONTROLLER DETECTS AN OUT OF LIMITS THERMAL CONDITION, AN AUTOMATIC HOLD/CUTOFF WILL OCCUR.

C. ON TWO PLANAR WINDOW PANE DAYS:

1. THERE WILL BE A 10-SECOND LAUNCH WINDOW CUTOUT AT THE UPLINKED PANE SWITCH TIME TO ENSURE PASS/BFS GUIDANCE SYNCHRONIZATION. THIS CUTOUT WILL START 5 SECONDS BEFORE SWITCH TIME AND CONTINUE TO 5 SECONDS PAST SWITCH TIME. FOR SOME PERFORMANCE CASES, THE SECOND PANE OPENING MAY BE FURTHER DELAYED. A COUNTDOWN HOLD WILL BE CALLED TO AVOID LAUNCHING DURING THESE CUTOUTS.
2. WHENEVER POSSIBLE, FLIGHT DAY 3 RENDEZVOUS CAPABILITY WILL BE MAXIMIZED. FD3 CAPABILITY IS ONLY AVAILABLE IN THE FIRST PANE AND SOMETIMES ONLY A PORTION OF THE FIRST PANE. FD3 CAPABILITY WILL BE MAINTAINED TO THE LAST POSSIBLE TIME IN THE COUNTDOWN. @[081497-6263B]

FLIGHT RULES

THIS RULE CONTINUED ON NEXT PAGE

FLIGHT RULES**A2.1.1-8 LAUNCH TIME SELECTION FOR GROUND-UP RENDEZVOUS
(CONTINUED)**

3. IF OPENING OF THE WINDOW ON FD3 RENDEZVOUS CAPABILITY RESULTS IN A TOTAL WINDOW LENGTH OF LESS THAN 5 MINUTES, AND NON-USE OF THE FD3 RENDEZVOUS PHASE WINDOW WOULD RESULT IN A TOTAL WINDOW LENGTH OF 5 MINUTES OR GREATER, THE FD3 LAUNCH WINDOW WILL NOT BE USED. THIS RULE WILL NOT APPLY WHEN FD4 RENDEZVOUS RESULTS IN UNACCEPTABLE IMPACTS TO MISSION SUCCESS. OTHER EXCEPTIONS TO THIS RULE WILL BE DOCUMENTED IN THE FLIGHT RULES ANNEX FOR THOSE FLIGHTS WHERE FD3 CAPABILITY IS EXTREMELY IMPORTANT. @[081497-6263B]
4. FLIGHT DAY 2 RENDEZVOUS CAPABILITY IS HIGHLY DESIRABLE IF MDF OCCURS. REGIONS OF THE LAUNCH WINDOW THAT PRESERVE FD2 RENDEZVOUS WILL BE UTILIZED WHENEVER CONVENIENT.

D. PREFERRED LAUNCH TIME

1. DURING THE T-9 MINUTE HOLD, THE LD, NTD, AND FD WILL MAKE A FINAL DETERMINATION ON THE USE OF PREFERRED LAUNCH TIME. IF THERE ARE INDICATIONS THAT THERE IS A SIGNIFICANT CHANCE OF TROUBLESHOOTING REQUIRED AFTER RESUMPTION OF THE COUNTDOWN AT T-9 MINUTES, THE COUNTDOWN CLOCK WILL BE SET TO WINDOW OPENING AS DEFINED BY PARAGRAPH A OF THIS RULE. OTHERWISE, THE COUNTDOWN CLOCK WILL BE SET TO THE PREFERRED (DELAYED) LAUNCH TIME. IF THE WINDOW OPEN LAUNCH TIME IS SELECTED RATHER THAN THE PREFERRED LAUNCH TIME, A NEW LAUNCH TARGET/AUTO DEL PSI UPLINK WILL BE REQUIRED AND PANE 1 CLOSE, PANE 2 OPEN, AND LOX DRAINBACK HOLD TIME UPDATES WILL BE REQUIRED.
2. PREFERRED LAUNCH TIME MAXIMIZES MPS PERFORMANCE MARGIN AVAILABLE IN CASE UNFORESEEN IN-FLIGHT PERFORMANCE PROBLEMS OCCUR. WHENEVER POSSIBLE, PREFERRED LAUNCH TIME WILL BE THE OPTIMUM LAUNCH TIME FOR THE FIRST PANE OF THE LAUNCH WINDOW. BY DEFINITION, THIS WILL RESULT IN A DECREASE OF TOTAL LAUNCH WINDOW TIME AVAILABLE. @[081497-6263B]

THIS RULE CONTINUED ON NEXT PAGE

FLIGHT RULES**A2.1.1-8 LAUNCH TIME SELECTION FOR GROUND-UP RENDEZVOUS
(CONTINUED)**

3. PREFERRED LAUNCH TIME WILL BE EARLIER THAN OPTIMUM TO MAXIMIZE A TOTAL LAUNCH WINDOW CAPABILITY FOR A HOLD PRIOR TO THE START OF LOX DRAINBACK OF UP TO 5 MINUTES, IF AVAILABLE. @[081497-6263B]
4. PREFERRED LAUNCH TIME WILL BE EARLIER THAN OPTIMUM TO ALLOW FOR A FD3 RENDEZVOUS LAUNCH WINDOW PHASE PANE OF 1 MINUTE, IF AVAILABLE, FOR HOLDS PRIOR TO THE START OF LOX DRAINBACK ASSUMING A TOTAL LAUNCH WINDOW CAPABILITY OF AT LEAST 5 MINUTES AS IN PARAGRAPH 3 ABOVE. IF TOTAL LAUNCH WINDOW OF LESS THAN 5 MINUTES RESULTS, OR FD3 CAPABILITY OF 1 MINUTE IS NOT AVAILABLE, PREFERRED LAUNCH TIME WILL NOT BE DELAYED TO ALLOW A FD3 WINDOW. EXCEPTIONS TO THIS RULE MAY BE DEFINED IN THE FLIGHT SPECIFIC ANNEX.
5. PREFERRED LAUNCH TIME DOES NOT AFFECT WINDOW CLOSE TIME. IF AN UNSCHEDULED HOLD OCCURS AND THE FIRST PANE EXPIRES, USE OF THE SECOND PANE WILL OCCUR BASED ON THE REQUIREMENTS IN PARAGRAPH A OF THIS RULE; THERE WILL BE NO FURTHER DELAY TO OPTIMIZE PERFORMANCE.
- ~~6. THE MCC-H FDO IS RESPONSIBLE FOR ALL COMPUTATIONS RELATED TO LAUNCH WINDOW OPENING AND CLOSING. CALCULATION OF LAUNCH WINDOW WILL PROTECT CONTINUOUS-INTACT ABORT CAPABILITY AND OMS PERFORMANCE MARGIN FOR MISSION SUCCESS. LAUNCH WINDOW OPEN WILL BE BASED ON NOMINAL LOX DRAINBACK START TIME. LAUNCH WINDOW CLOSE WILL BE BASED ON A HOLD THAT DELAYS LOX DRAINBACK START TIME TO THE MAXIMUM EXTENT POSSIBLE. @[041097-4911A]~~
- ~~TO THE NEAREST SECOND, THE EARLIEST LAUNCH TIME, OR WINDOW OPEN TIME, AND THE WINDOW CLOSE, OR LATEST LAUNCH TIME, SHALL BE THE EARLIEST AND LATEST RESPECTIVELY WHICH SATISFY ALL OF THE FOLLOWING CONSTRAINTS.~~
- ~~A. RANGE SAFETY ET DISPOSAL~~
- ~~B. ET YAW STEERING CERTIFICATION LIMIT~~
- ~~C. ZERO MPS PERFORMANCE OVER THE REQUIRED SIGMA DISPERSION DEFINED BY THE FLIGHT RULE ANNEX.~~

FLIGHT RULES

~~FOR HIGH INCLINATION MISSIONS 51.6 DEGREES OR GREATER, IF THE PERFORMANCE MARGIN IS LESS THAN 200 POUNDS AT THE OPENING OF THE LAUNCH WINDOW, AN ADDITIONAL 10 SECONDS WILL BE PROTECTED TO ACCOUNT FOR PERFORMANCE VARIATION DUE TO WINDS.~~

~~THE FDO SHALL INFORM THE MOD LSEAT REPRESENTATIVE AND THE FLIGHT DIRECTOR OF THE LAUNCH WINDOW TIMES. THE JSC FLIGHT DIRECTOR SHALL COMMUNICATE THE LAUNCH WINDOW TIMES TO THE NTD.~~

~~EARLIEST LAUNCH TIME SHALL BE AT THE BEGINNING OF THE LAUNCH WINDOW OR, FOR PERFORMANCE LIMITED CASES, THE EARLIEST ZERO MARGIN LAUNCH TIME FOR THE NO HOLD INSIDE DRAINBACK CASE. IT IS NOT CONSIDERED DESIRABLE TO PICK AN EARLIEST LAUNCH TIME BASED ON ZERO MARGIN WITH A HOLD INSIDE DRAINBACK DUE TO OPERATIONAL COMPLEXITIES. IF THE PERFORMANCE MARGIN AT THE CALCULATED WINDOW OPENING TIME IS LESS THAN 200 POUNDS, THEN 10 SECONDS SHALL BE ADDED TO THE ZERO MARGIN LAUNCH TIME FOR HIGH INCLINATION MISSIONS TO PROTECT FOR THE IMPACT OF WIND VARIATIONS ON PERFORMANCE FROM THE L-4.5 HOUR ASSESSMENT TO THE ACTUAL LAUNCH TIME. LATEST LAUNCH TIME SHALL BE BASED ON THE LONGEST POSSIBLE HOLD TIME PRIOR TO THE START OF LOX DRAINBACK. DELAYS TO LAUNCH TIME TO IMPROVE ASCENT PERFORMANCE FOR EITHER THE NOMINAL OR ENGINE OUT CASES ARE NOT CONSIDERED MORE IMPORTANT THAN MAXIMIZING THE LAUNCH WINDOW. @[041097-4911A]~~

~~PREFERRED LAUNCH TIME SHALL BE CHOSEN BASED ON L-6.25 HR BALLOON ANALYSIS RESULTS. NOTE THAT FUTURE PERFORMANCE VARIATIONS MAY RESULT IN A WINDOW DURATION OF SLIGHTLY LESS THAN 5 MINUTES.~~

The preferred launch time shall be chosen based on L-6.25 hr balloon analysis results in order to provide a stable time for ascent performance analysis processing and overall launch time planning purposes. Hence, further performance variations which reduce the ascent performance margin could reduce the window duration to slightly less than five5 minutes.

FLIGHT RULES

Launch window calculation for ground up rendezvous is a complex series of accommodating various conflicting requirements. Paragraph A of this rule states the mandatory requirements for defining the launch window and is self-explanatory. On launch day, the latest information is used to ensure the maximum precision in calculations. The FD is the single point of contact with KSC to ensure the launch time is set properly. @[081497-6263B]

THIS RULE CONTINUED ON NEXT PAGE

FLIGHT RULES

A2.1.1-8

LAUNCH TIME SELECTION FOR GROUND-UP RENDEZVOUS (CONTINUED)

Normally, the final launch window times are calculated based on the L-4.5 hour balloon data. These calculations are complete about L-2 hours. An update using the L-2.25 hour balloon is possible at about L-30 minutes. Also, if a revert occurs, new PLOAD calculations may require window time recalculation. New times will be passed and new launch target commands sent only if these calculations result in significant changes. Since a 10-second launch window cutoff exists around the pane switch time to ensure PASS/BFS synchronization, both PASS and BFS will always be on the first pane before the cutout, and on the second pane after the cutout. Thus, if the new switch time is more than 5 seconds different than that which is already onboard (i.e., it falls outside the original cutout), either a new command load uplink with a revised pane switch time and associated launch window cutout is required, or the cutout must be extended to the new desired switch time. ©[081497-6263B]

Performance varies through the window as a function of launch time because of the orbital mechanics/rendezvous effects - primarily yaw steering. However, performance decreases with delays after the start of LOX drainback (T-4 min 55 sec). For simplicity, all times transmitted to KSC assume that LOX drainback is started for the selected launch time: in general for the preferred time and in off nominal cases for the window open time. For a combination of problems that result in delays to the start of LOX drainback and also holds after the start of LOX drainback, the FDO calculates ~~new a tabular listing of window open/close times on day of launch~~ based on all factors (ascent performance margin, yaw steering costs, and LOX drainback impact). ~~Due to the volume of information and the training necessary to interpret this listing, these times are not distributed outside the MCC.~~ If the need to use these new times tables arises, the FD is responsible to ensure that launch will occur only when performance is available to support mission success. It is possible that a combination of launch holds before and after the start of LOX drainback could result in an unanticipated single SSME out abort gap opening. This is especially true if an out-of plane TAL site is used. If this is known prelaunch, it will be avoided. If it is unknown until after launch, then Flight Rule {A4.1.2-7I}, PERFORMANCE BOUNDARIES - PERFORMANCE DISPERSIONS/GAPS, applies. ©[111298-6693]

The PASS and BFS can calculate pane switch time differently. This can occur in a window from 4 seconds before the pane switch time to 2 seconds after the switch time. Operationally, this has been rounded to 10 seconds centered on the pane switch time. If launch occurs when the PASS and BFS are using different planar steering, there is no inflight recovery and the BFS will be NO-GO. This condition is avoided by a short launch window cutout at pane swap time. ©[081497-6263B]

THIS RULE CONTINUED ON NEXT PAGE

FLIGHT RULES

A2.1.1-8

LAUNCH TIME SELECTION FOR GROUND-UP RENDEZVOUS (CONTINUED)

Flight Day 3 rendezvous capability (as defined by an acceptable phase angle region inside the orbital plane window pane) is extremely important for most flights. However, FD3 capability does not exist for all launch days. FD4 rendezvous capability is available on every launch day since the longer time allows catch up from greater phase angles. Note that even if launch occurs in a FD3 portion of the window, a FD3 rendezvous can always be cheaply turned into a FD4 rendezvous if time constraints require it. For an MDF mission, a FD2 rendezvous is desirable. However, FD2 phase windows are even shorter than FD3 so they are not generally available. When a FD2 window is available, it should be used providing there are no adverse impacts. ©[081497-6263B]

A 5-minute length window was chosen as being most consistent with the majority of LCC preplanned contingency action resolutions. Therefore, serious and critical evaluation of any requirement to reduce the launch window to less than 5 minutes is required. Flight history has shown that most flights launch at the opening of the launch window. Since FD3 rendezvous is very important, a short FD3 window would suffice on most days. If the use of FD3 window does not unacceptably reduce the total window length, FD3 should be used at opening. The selection of 1 minute of FD3 window is arbitrary.

Since historical data indicates a good track record of on-time launches, and mission success margins are greater at the middle of the window rather than the opening, a preferred launch time is defined so that when there are no overriding considerations, the maximum margin for mission success is available in flight. Note that delaying the launch time also improves multiple SSME out contingency abort landing site coverage which is desirable, but not a window length driver. ©[081497-6263B]

For performance limited 51.6 deg °inclination missions, the launch window open may actually be based on ascent performance. For these cases, 200 pounds of ascent performance margin is desired at the window open to protect for performance variations between the balloon release and launch time. With FDO's launch window/launch performance application, the window open time will be biased, if there is time available in the launch window, to protect this minimum desired performance margin. ©[111298-6693]

FLIGHT RULES

ASCENT

A2.1.2-1 STS ABORT CRITERIA

NOMINAL ASCENT WILL BE CONTINUED FOR STS PROBLEMS EXCEPT FOR:

- A. ENGINE PROBLEMS WHERE REQUIRED PERFORMANCE IS NOT AVAILABLE.
- B. LOSS OF DEORBIT MANEUVER CAPABILITY.
- C. LOSS OF ATTITUDE CONTROL.
- D. CONSUMABLES, COOLING, OR SYSTEMS LIFETIME PROBLEMS THAT WILL NOT SUPPORT THE FOLLOWING FIRST DAY PLS DURATIONS:
 - 1. LOW INCLINATION - DEORBIT ORBIT 3, LANDING ORBIT 4.
 - 2. HIGH INCLINATION - DEORBIT ORBIT 7, LANDING ORBIT 8.

In order to maximize probability of mission success, nominal ascent will be continued unless a specific problem arises which, if not acted upon, jeopardizes the orbiter and/or crew. In these cases, either a pre-MECO abort (RTLS, TAL, ATO) or a post-MECO abort (AOA) will be selected. The specifics of which abort will be selected and the priority of available modes are contained in Rule {A2.1.2-2}, ASCENT MODE PRIORITIES FOR PERFORMANCE CASES, for performance-related failures (paragraph A above) and in Rule {A2.1.2-4}, RTLS, TAL, AND AOA ABORTS FOR SYSTEMS FAILURES (CIL), for systems problems (paragraphs B to D). If the capability to support a first day PLS landing opportunity is lost, or the particular failure is such that conditions could deteriorate so rapidly that the landing opportunity could be lost, then an AOA will be performed as specified in Rule {A2.1.2-4}, RTLS, TAL, AND AOA ABORTS FOR SYSTEMS FAILURES (CIL). First day PLS landing opportunities are selected based on providing sufficient time for pre-deorbit tracking and onboard state vector update while maintaining capability to a CONUS landing site.

Orbit 3 deorbit is typically the last CONUS opportunity for low inclination flights. For high inclination flights, orbit 2 deorbit provides the last ascending first day opportunity to Edwards, while orbit 7 provides the first descending opportunity to Edwards. Orbit 2 deorbit to Edwards is available for both low and high inclinations, but it does not provide sufficient tracking to assure an adequate deorbit state vector. Hence, orbits 3 (low inclination) and 7 (high inclination) are chosen for the PLS opportunities (ref. Ascent Flight Techniques meeting #43).

FLIGHT RULES

A2.1.2-2 ASCENT MODE PRIORITIES FOR PERFORMANCE CASES

- A. DURING POWERED FLIGHT, THE ABORT PRIORITIES FOR PERFORMANCE CASES ARE AS FOLLOWS:
1. PRESS-TO-ORBIT (INCLUDING PRESS-TO-MECO AND PRESS-TO-ATO TRAJECTORIES)
 2. TAL
 3. RTLS
 4. TAL TO AN ACLS (MAY REQUIRE MANUAL SSME SHUTDOWN)
 5. AOA SHALLOW USING ARCS TO THE ARCS PRESS QUANTITY AND CG LIMITED BY THE CONTINGENCY CG ENVELOPE

Powered flight abort priorities were established based on providing the highest probability of safe return of the orbiter and crew. If at all possible, as long as steep deorbit capability can be maintained, the desire is to press to orbit before considering a pre-MECO abort since achieving orbit provides the maximum time to assess and react to problems without incurring additional risks associated with powered flight aborts. Following the option of pressing uphill, the TAL abort (assumed to be flown under auto guidance) is next in priority since it provides the earliest contingency avoidance capability for multiple engine failures and is considered to be more benign than RTLS from an operational point of view. The RTLS abort is next in priority and in the performance case would be used only if TAL were not available (i.e., some systems problems may dictate RTLS over TAL when both modes are available).

Pre-MECO, if TAL capability to the prime site is not available and steep AOA cannot be protected, TAL to an ACLS is selected next in priority since the next lower option (AOA shallow) is considered to be unacceptably sensitive to navigation dispersions. Since an augmented site is required, the abort is not expected to be adversely affected by navigation capability. The tradeoff in this case is that only limited OMS dump time is available for TAL's selected late in powered flight, which may result in violation of the nominal aft CG limit (the contingency limit is still protected) and downweight restrictions. On the other hand, a nominal forward CG violation can result from commitment to AOA shallow, so the CG concern by itself becomes less of a factor. Note that the TAL to an ACLS is still performed under auto guidance, but, in some cases, a manual MECO is performed to achieve the TAL site R-V line with TAL selection occurring post-MECO.

THIS RULE CONTINUED ON NEXT PAGE

FLIGHT RULES

A2.1.2-2 ASCENT MODE PRIORITIES FOR PERFORMANCE CASES (CONTINUED)

- B. PRESS-TO-ORBIT PERFORMANCE DECISIONS WILL BE BASED ON THE ABILITY TO ACHIEVE MECO UNDERSPEED CONDITIONS WHICH SATISFY ESTABLISHED MINIMUM CONSTRAINTS. INCLUDED IN THESE ARE LIMITATIONS ON ET IMPACT LOCATION, POST-MECO PERFORMANCE CAPABILITY, TRAJECTORY ALTITUDE LIMITS, SSME MINIMUM NPSP CONSTRAINTS, AND PROTECTION OF THE CONTINGENCY CG ENVELOPE (REF. RULE {A4.1.2-6}, DESIGN AND CRITICAL MECO UNDERSPEED DEFINITIONS).

Reference Rule {A4.1.2-6}, DESIGN AND CRITICAL MECO UNDERSPEED DEFINITIONS, for rationale.

- C. MAXIMUM THROTTLES WILL BE USED TO REGAIN INTACT ABORT CAPABILITY AND TO CONTINUE THE EXECUTED TAL TO THE SELECTED SITE (REF. RULES {A4.1.2-3, USE OF MAXIMUM THROTTLES; AND {A4.1.2-7F}, {A4.1.2-7H.2}, AND {A4.1.2-7H.3}; PERFORMANCE BOUNDARIES). @[092195-1770A]

Maximum throttle capability is used only in limited cases and is the highest power level available on a flight. Use of the maximum setting places additional stress on the engine and seriously reduces engine lifetime and so should be used only if absolutely necessary. In line with this philosophy, the maximum throttle setting will only be used if it allows the orbiter to regain intact abort capability or will allow continuation of a TAL abort to the originally-selected site when two SSME's have failed (continuing to the originally-selected site at maximum throttle is preferred over committing to a sizable attitude maneuver on a single engine).

- D. POST-MECO (OPS 1), THE ABORT PRIORITIES ARE AS FOLLOWS:
@[120894-1744B]

1. NOMINAL, STEEP DEORBIT [1]
2. ATO/ATO [2], STEEP DEORBIT [3]
3. STEEP DEORBIT
 - a. ATO/MINIMUM HP [4], STEEP DEORBIT FD1 (IF FD1 PLS SITE IS GO) [3] USING ARCS TO THE ARCS PRESS QUANTITY. [5] [6] [7]

OR

- b. ATO/ATO [2], STEEP DEORBIT FD2 (IF FD1 PLS IS NOT AVAILABLE) [3] USING ARCS TO THE ARCS PRESS QUANTITY. [5] [6] [7]

FLIGHT RULES

THIS RULE CONTINUED ON NEXT PAGE

FLIGHT RULES

A2.1.2-2 ASCENT MODE PRIORITIES FOR PERFORMANCE CASES
(CONTINUED)

4. SHALLOW DEORBIT
 - a. ATO/MINIMUM HP [4], SHALLOW DEORBIT FD1 (IF FD1 PLS SITE IS GO) [3] USING ARCS TO THE ARCS PRESS QUANTITY. [5] [6] [7]

OR

- b. ATO/ATO [2], SHALLOW DEORBIT FD2 (IF FD1 PLS IS NOT AVAILABLE) [3] USING ARCS TO THE ARCS PRESS QUANTITY. [5] [6] [7]
5. AOA STEEP USING ARCS TO THE ARCS PRESS QUANTITY [5] AND CG LIMITED BY THE CONTINGENCY CG ENVELOPE (IF AOA SITE IS GO). [6] [7]
6. ATO/MINIMUM HP [4], SHALLOW DEORBIT FD1 TO A NO-GO FD1 PLS SITE [3] USING ARCS TO THE ARCS PRESS QUANTITY. [5] [6] [7]
7. AOA STEEP USING ARCS TO THE ARCS PRESS QUANTITY [5] AND CG LIMITED BY THE CONTINGENCY CG ENVELOPE TO A NO-GO AOA SITE. [6] [7]
8. TAL TO A TAL SITE OR ACLS USING NOMINAL GUIDANCE (REFER TO FIGURE 2.1.2-2-I, REGION A). @[120894-1744B]
9. AOA SHALLOW USING ARCS TO ARCS PRESS QUANTITY [5], AND CG LIMITED BY THE CONTINGENCY CG ENVELOPE.
10. TAL TO A TAL SITE
 - a. REQUIRING LOW ENERGY GUIDANCE (REFER TO FIGURE 2.1.2-2-I, REGION B)
 - b. REQUIRING LOW ENERGY GUIDANCE AND HIGH CROSSRANGE PROCEDURES (REFER TO FIGURE 2.1.2-2-I, REGION C)
 - c. REQUIRING HIGH ENERGY PROCEDURES (REFER TO FIGURE A2.1.2-2-I, REGION D)

THIS RULE CONTINUED ON NEXT PAGE

FLIGHT RULES

A2.1.2-2 ASCENT MODE PRIORITIES FOR PERFORMANCE CASES
(CONTINUED)

11. TAL TO AN ACLS
 - a. REQUIRING LOW ENERGY GUIDANCE (REFER TO FIGURE A2.1.2-2-I, REGION B)
 - b. REQUIRING LOW ENERGY GUIDANCE AND HIGH CROSSRANGE PROCEDURES (REFER TO FIGURE 2.1.2-2-I, REGION C)
 - c. REQUIRING HIGH ENERGY PROCEDURES (REFER TO FIGURE A2.1.2-2-I, REGION D) @[120894-1744B]

12. TAL TO A DOWNRANGE ELS WHICH SATISFIES CRITERIA IN RULE {A2.1.5-14}, EMERGENCY LANDING FACILITY CRITERIA @[120894-1744B]
 - a. WITHIN NOMINAL GUIDANCE CAPABILITY (REFER TO FIGURE A2.1.2-2-I, REGION A)
 - b. REQUIRING LOW ENERGY GUIDANCE (REFER TO FIGURE A2.1.2-2-I, REGION B)
 - c. REQUIRING LOW ENERGY GUIDANCE AND HIGH CROSSRANGE PROCEDURES (REFER TO FIGURE A2.1.2-2-I, REGION C)

13. TAL TO ANY SITE WHICH SATISFIES CRITERIA IN RULE {A2.1.5-14}, EMERGENCY LANDING FACILITY CRITERIA, BUT LIES OUTSIDE NOMINAL AND LOW ENERGY GUIDANCE CAPABILITY (REFER TO FIGURE A2.1.2-2-I, REGIONS D, E, AND F). LANDING ATTEMPTS TO THESE SITES MAY REQUIRE HIGH ENERGY PROCEDURES (REGION D), LOWER ANGLES OF ATTACK DURING THE FIRST PULLOUT (REGION E), OR HIGH CROSSRANGE PROCEDURES (REGION F). THIS DETERMINATION WILL BE MADE IN REAL-TIME BASED ON THE NUMBER OF SITES AND THEIR PROXIMITY TO THE FOOTPRINT IN EACH AREA. @[120894-1744B]

THIS RULE CONTINUED ON NEXT PAGE

FLIGHT RULES

A2.1.2-2

ASCENT MODE PRIORITIES FOR PERFORMANCE CASES
(CONTINUED)

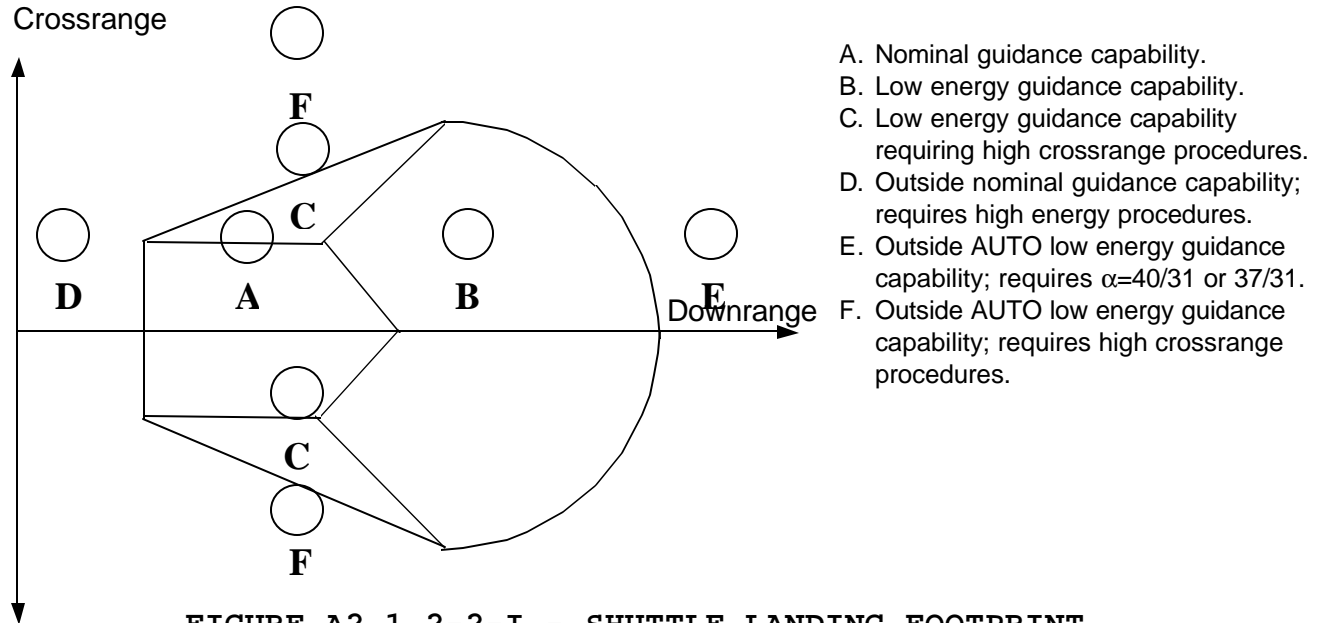

- A. Nominal guidance capability.
- B. Low energy guidance capability.
- C. Low energy guidance capability requiring high crossrange procedures.
- D. Outside nominal guidance capability; requires high energy procedures.
- E. Outside AUTO low energy guidance capability; requires $\alpha=40/31$ or $37/31$.
- F. Outside AUTO low energy guidance capability; requires high crossrange procedures.

FIGURE A2.1.2-2-I - SHUTTLE LANDING FOOTPRINT

(FOR ILLUSTRATION ONLY)

@[120894-1744B]

NOTES:

- [1] DEORBIT DELTA V MUST BE PROTECTED FOR FD 1 AND 2 PLS OPPORTUNITIES.
- [2] OMS-1 TARGET/OMS-2 TARGET.
- [3] DEORBIT DELTA V MUST BE PROTECTED FOR FD 1 OR 2 PLS (AS REQUIRED). @[121593-1590]
- [4] MINIMUM HP THAT WILL ENSURE ORBITAL LIFETIME (ASSUMING 3 SIGMA DRAG AFFECTS) AT LEAST TWO ORBITS BEYOND THE FD 1 PLS OPPORTUNITY AND WILL PROVIDE ADEQUATE GROUND TRACKING ACCURACIES FOR DEORBIT TARGETING AND STATE VECTOR UPDATE.
- [5] ARCS PRESS QUANTITY CORRESPONDING TO THE EXPECTED X AND Y CG.
- [6] OMS-2 MAY BE EXECUTED WITH THE FRCS (REF. RULE {A2.1.2-3}, FORWARD RCS USAGE GUIDELINES). @[120894-1744B]
- [7] IF FRCS USAGE IS ALLOWED BY FLIGHT RULE {A2.1.2-3}, FORWARD RCS USAGE GUIDELINES, THEN ARCS ATTITUDE CONTROL MUST BE PROTECTED FOR THE FRCS BURN. @[120894-1744B]

THIS RULE CONTINUED ON NEXT PAGE

FLIGHT RULES

A2.1.2-2

ASCENT MODE PRIORITIES FOR PERFORMANCE CASES (CONTINUED)

Post-MECO abort priorities were established to provide the highest probability of safe return of the orbiter and crew. Again, the priorities are set up to allow the orbiter to achieve the most desirable uphill/orbital capability available based on propellant available and the known MECO conditions. The first priority is to achieve the nominal mission orbital parameters while maintaining steep deorbit capability (1). This is followed by reducing the orbital altitude, but still protecting steep deorbit (2). Steep capability is maintained since commitment to shallow deorbit unnecessarily trades off the deorbit/entry propellant and trajectory dispersion protection inherent in steep targeting for achievement of mission objectives that in many cases can be adequately accomplished at a lower-than-nominal altitude. The next option (3) accepts reduction in orbit perigee (and hence, orbital lifetime and tracking/navigation quality) in order to achieve at least some on-orbit time. Aft RCS is committed for deorbit burn completion (nominal RCS entry redlines are maintained, however). Again, these trades are made in order to maintain steep deorbit capability. ATO/ATO (Hp approximately 105 nm) gives orbital lifetime for FD2 deorbit. The minimum perigee guarantees a safe deorbit for the FDI PLS opportunity. Time-to-EI constraints do not apply to minimum perigee determinations. Forward RCS may be committed for OMS-2 usage at this priority level (ref. Rule {A2.1.2-3}, FORWARD RCS USAGE GUIDELINES). At the next priority level (4), shallow FDI and FD2 deorbits are allowed. The only remaining method of preserving propellant in addition to that already committed is to allow use of ARCS and violation of the CG to the contingency CG box (priorities 5, 7, and 9). This may allow achievement of minimum orbital conditions or may require a steep or shallow AOA, with the potential in any case of requiring use of a no-go site.

If an AOA cannot be achieved, the site selection priority will be based on site status (TAL vs ACLS vs ELS) and guidance capability when more than one site satisfies the conditions in Rule {A2.1.5-14}, EMERGENCY LANDING FACILITY CRITERIA. Guidance capability will be based on the Descent Design System (DDS) if available or the Downrange Abort Evaluator (DAE). Figure A2.1.2-2-I is included for clarity to illustrate the various regions of dissimilar guidance capability. Nominal guidance refers to OPS 3 entry guidance requiring no manual procedures. Low energy guidance refers to the use of automatic low energy guidance, enabled via Item 3 on the Entry TRAJ display. High crossrange procedures consist of enabling low energy guidance and manually flying a 37-degree angle of attack during the second pullout to minimize wing leading edge temperatures. High energy procedures consist of manual pitch and roll inputs during entry and are contained in section 2 of the Ascent Checklist. ©[120894-1774B]

THIS RULE CONTINUED ON NEXT PAGE

FLIGHT RULES

A2.1.2-2

ASCENT MODE PRIORITIES FOR PERFORMANCE CASES (CONTINUED)

In general, the regions shown in figure A2.1.2-2-I are preferred in the following priority: Nominal entry guidance capability (region A), low energy guidance capability (region B), low energy guidance with high crossrange procedures (region C), and finally high energy procedures (region D). Nominal entry guidance is preferred over low energy guidance since low energy guidance can take the vehicle to its thermal limits. A site in the high crossrange region (region C) is third in priority since it requires the use of low energy guidance to solve the crossrange problem and pitch CSS to prevent potential thermal violations (reference Rule{A 2.1.2-5}, USE OF LOW ENERGY GUIDANCE). High energy procedures are last in priority since they are more complicated and may take the vehicle to its structural and thermal limits. Usually a TAL site has priority over an ACLS, which has priority over an ELS. However, priority will be given to an ACLS within nominal guidance capability (region A) over a TAL site within low energy guidance capability (regions B or C). The risk associated with landing at an ACLS is considered less than the risk associated with the use of low energy guidance. If no TAL site or ACLS lies within nominal guidance capability (region A), priority will be given to a TAL site within low energy guidance capability (region B), followed by a TAL site within low energy guidance capability requiring high crossrange procedures (region C), followed by a TAL site requiring high energy procedures (region D). If no TAL site is available, the same priorities will be given to an ACLS. The use of high energy procedures to a TAL site or ACLS was given priority over an ELS within nominal guidance capability since those sites will have landing aids, nav aids, and ground support. If no TAL site or ACLS is available, then an ELS within nominal guidance capability (region A) will be selected. If no ELS lies within nominal guidance capability, then the site within low energy guidance capability (region B) will be selected. Otherwise, an ELS within low energy guidance capability requiring high crossrange procedures (region C) will be selected.

If there is no site within nominal or low energy guidance capability (outside regions A, B, or C), the site (TAL, ACLS, or ELS) with the best chance of a runway landing will be selected. A landing attempt to this site may require the use of high energy procedures (region D) or a lower angle of attack during the first pullout (region E) or high crossrange procedures (region F) (reference Rule {A2.1.2-5}, USE OF LOW ENERGY GUIDANCE). Since all three of these regions require manual procedures and may take the vehicle to its thermal and structural limits, they are given the same priority. Site status, difficulty of manual procedures, and proximity to guidance capability will be considered when choosing between sites in regions D, E, and F.

Note that these choices can be heavily influenced by landing site status. Since determination of the desired site must be made rapidly, in real time, the engineering judgment of the flight control team will be considered due to the significant tradeoffs which must be made. For example, the preference for ACLS in region A over a TAL site in region B, C, or D could be modified if the ACLS has very bad weather, as opposed to the ACLS being no-go as a TAL site simply due to loss of nav aids redundancy. ©[120894-1774B]

THIS RULE CONTINUED ON NEXT PAGE

FLIGHT RULES

A2.1.2-2 ASCENT MODE PRIORITIES FOR PERFORMANCE CASES (CONTINUED)

Rules {A2.1.2-1}, STS ABORT CRITERIA; {A4.1.2-7C}, PERFORMANCE BOUNDARIES; {A4.1.2-14}, OMS-1/OMS-2 EXECUTION; and {A6.1.2-17}, OMS FAILURE MANAGEMENT (CIL), reference this rule.

- E. POST-MECO (OPS 6 CONTINGENCY ABORT), THE DOWNRANGE SITE HAS PRIORITY WHEN CAPABILITY EXISTS TO MULTIPLE SITES WHICH SATISFY THE CRITERIA IN RULE {A2.1.5-14}, EMERGENCY LANDING FACILITY CRITERIA. @[120894-1744B]

For OPS-6 contingency abort entries (ECAL and Bermuda), powered flight guidance uses an open loop scheme and is therefore not targeted to any particular MECO conditions. In these cases, energy evaluation is not feasible until after the post-MECO pullout maneuver. Even though active guidance begins at transition to OPS 603 at Mach 3.2 (TAEM interface), an accurate energy assessment cannot be made until the trajectory stabilizes. If energy capability overlaps between two sites and both satisfy the criteria in Rule {A2.1.5-14}, EMERGENCY LANDING FACILITY CRITERIA, the further downrange site shall be selected to minimize steering requirements caused by large heading errors. @[120894-1744B]

A2.1.2-3 FORWARD RCS USAGE GUIDELINES

- A. PRE-MECO: FRCS DELTA V CAPABILITY WILL NOT BE CONSIDERED.
- B. POST-MECO: FRCS WILL BE USED FOR OMS-2 TO OBTAIN THE HIGHEST POSSIBLE ABORT MODE PROVIDED THERE IS SUFFICIENT FRCS PROPELLANT TO SUPPORT THE TOTAL DELTA V REQUIRED FOR THE BURN.

Pre-MECO, FRCS delta V capability is not considered as being available to support or provide an abort capability since flight design and techniques do not assure that time and/or trajectory constraints will not preclude its use. Post-MECO, however, these constraints are mitigated by knowledge of the actual trajectory condition, and hence the FRCS may then be committed to help achieve the highest-priority abort option. The basic groundrule in FRCS commitment for OMS-2 is that FRCS critical-burn redundancy is considered sufficient to commit its use at OMS-2 if such usage will result in at least some on-orbit capability (i.e., avoidance of AOA). It is also desirable to avoid any requirement for a flip-around maneuver to complete a burn begun with the FRCS, particularly when the burn is considered critical. Therefore, the FRCS will only be used for OMS-2 if it can provide all the delta V necessary to establish a safe perigee. An additional advantage of using the FRCS in this manner is that usage at OMS-2 (rather than saving it for deorbit completion) may preclude a fast-flip requirement to complete the deorbit burn since extra OMS/ARCS is made available for that maneuver.

Rules {A2.1.2-2D}, ASCENT MODE PRIORITIES FOR PERFORMANCE CASES; and {A6.1.2-17}, OMS FAILURE MANAGEMENT (CIL), reference this rule.

FLIGHT RULES

A2.1.2-4 RTLIS, TAL, AND AOA ABORTS FOR SYSTEMS FAILURES (CIL)

FOR SPECIFIC SYSTEMS FAILURES, AN RTLIS, TAL, OR AOA ABORT WILL BE SELECTED TO PROVIDE THE EARLIEST AVAILABLE LANDING TIME OR TO AVOID REQUIRING A LOST CAPABILITY.

NOTE: WHEN THE SAME ITEM APPEARS IN MORE THAN ONE ABORT OPTION, THE EARLIEST ABORT OPTION AVAILABLE IS SELECTED.

A. AN RTLIS WILL BE PERFORMED FOR THE FOLLOWING:

1. TWO APU/HYD SYSTEMS FAILED AND THE THIRD SYSTEM FAILING.

At least one APU/HYD system is required to land the vehicle; so, with two systems failed and the third failing, the abort mode which affords the earliest landing time is selected (ref. Rule {A10.1.2-1A.3}, LOSS OF APU/HYDRAULIC SYSTEM(S) ACTIONS).

If the third APU/HYD system is nominal, it is preferable to continue to orbit rather than performing an abort. Continuing to orbit allows for time to troubleshoot the two failed systems and possibly regain one or both systems for entry. Additionally, going to orbit will provide the time to take the necessary steps to ensure the best possible conditions (i.e., trajectory, landing site, crew and vehicle health, weather conditions, etc.) for a single APU entry. (Ref. Rule {A10.1.2-1A}, LOSS OF APU/HYDRAULIC SYSTEM (S) ACTIONS.)

2. FAILURE OF A FORWARD WINDSHIELD OR SIDE HATCH ~~LOSS OF~~ THERMAL WINDOWPANE (OUTER PANE) (CIL). [@\[021998-6493\]](#)

An RTLIS abort is selected to minimize the thermal stresses on the remaining windowpanes and surrounding structure. Entry heat loads are less on an RTLIS than on other abort modes or during a normal landing. This provides a better chance of the remaining panes and surrounding structure surviving entry.

Reference rule {A10.1.17-1}, THERMAL WINDOWPANE FAILURE (CIL). [@\[021998-6493\]](#)

3. CABIN LEAK RESULTING IN A DP/DT > -0.15 PSIA/MINUTE.

If a cabin leak develops with a leak rate greater than that specified, then there has been a loss of cabin integrity and the abort mode that affords the earliest landing time should be selected. The -0.15 psia/minute value allows the capability to perform an orbit 3 deorbit and land with a cabin pressure of 8 psi. It is also the value that should cover ascent pressure fluctuations so that an erroneous abort is not called. If the leak rate is less than that specified, continue to MECO and attempt leak isolation. If the leak is not isolated, then an AOA will be performed and there should be enough pad so that if the leak increases the abort can be completed.

FLIGHT RULES

THIS RULE CONTINUED ON NEXT PAGE

FLIGHT RULES

A2.1.2-4 RTLS, TAL, AND AOA ABORTS FOR SYSTEMS FAILURES
(CIL) (CONTINUED)4. IMPENDING LOSS OF ALL O₂ (H₂) CRYO.

If the pressure cannot be maintained in at least one cryo tank and manifold, the fuel cells will eventually stop producing electrical power, no matter what the quantity is in the cryo tanks. Since the amount of time available before "blowdown" of the tanks is dependent on a large number of variables, specific numbers cannot be defined for the purpose of selecting the most preferred abort. Thus, this condition warrants the selection of the abort mode that affords the earliest landing time (ref. Rule {A9.1.6-11}, IMPENDING LOSS OF ALL CRYO).

5. LOSS OF TWO FREON LOOPS.

With the loss of both Freon loops the vehicle has lost all cooling capacity. Fuel cell life becomes the critical factor. Assuming a purge of all three fuel cells and a 12.54 kW (4.18 kW/fuel cell) power level, stack temperature limits will be reached in about 50 minutes and the electrolyte concentration will reach the operational limit of 25 percent in about 75 minutes. At this point, continued operation of the fuel cell is questionable. Without a purge, the fuel cells will flood in about 18 minutes at a power level of 8.0 kW (2.67 kW/fuel cell). The life of the fuel cell would therefore be somewhere between 18 and 50 minutes, thus requiring an abort mode that affords the earliest landing time. This data is supported by Rockwell analysis and the SODB.

6. LOSS OF ANY TWO MAIN BUSES (PRECLUDES EXTERNAL TANK
 (ET) DOOR CLOSE).

The loss of two main electrical buses precludes closing the ET doors. An RTLS will be performed for this failure since it provides a more benign entry heating scenario and allows a better chance of accomplishing a successful landing.

THIS RULE CONTINUED ON NEXT PAGE

FLIGHT RULES

A2.1.2-4 RTL, TAL, AND AOA ABORTS FOR SYSTEMS FAILURES **(CIL) (CONTINUED)**

B. A TAL WILL BE PERFORMED FOR THE FOLLOWING:

NOTE: FOR THE PURPOSES OF SYSTEMS ABORTS, A TAL WILL ONLY BE EXECUTED TO A TAL SITE OR AN AUGMENTED CONTINGENCY LANDING SITE.

1. TWO OMS PROPELLANT TANKS LEAKING/FAILED, DIFFERENT SIDES.

If two OMS propellant tanks are leaking or have failed (different sides), a TAL abort will be selected since uphill capability is not available. A TAL abort is preferred over an RTL for the following reasons:

- a. The TAL entry environment (with the exception of thermal) is less severe than GRTL. RTL ET separation is more demanding because of higher aerodynamic loads; trajectory maneuvers post- ET separation are more time-critical (to maintain reasonable energy level and loads on the vehicle); and 50 degrees angle of attack must be established and maintained.*
- b. Nz is greater during GRTL than TAL entry. This becomes an important factor if the OMS tank landing weight and maneuver constraints are violated. Structural damage to the OMS tank might occur if the OMS maneuver constraint is violated with high Nz.*
- c. The TAL post-MECO dump allows the single engine roll control propellant to be dumped. As a result, less residual propellant remains postdump; therefore, the chance of pod freezeup and postlanding fire is decreased.*

If these failures occur pre-MECO and after last TAL capability to the prime site, a TAL to an ACLS may be performed. If the decision to abort TAL occurs late enough, a manual MECO may be required in order to reach the TAL R/V line. This would be followed by TAL selection post-MECO. There are risks associated with the manual MECO TAL abort not incurred with a pre-MECO TAL selection prior to the last pre-MECO TAL boundary. (1) Manual MECO incurs the risk of missing the targeted MECO VI and creating an under- or over-speed condition. (2) A complete OMS dump is not possible and this may result in violation of landing weight or cg constraints. The risks associated with manual MECO TAL aborts are judged to be less than those associated with continuing toward a nominal MECO with critical systems failures.

If these failures occur after last capability to an ACLS, then post-MECO, if ATO capability does not exist, an AOA or bailout must be performed.

THIS RULE CONTINUED ON NEXT PAGE

FLIGHT RULES

A2.1.2-4 RTL5, TAL, AND AOA ABORTS FOR SYSTEMS FAILURES (CIL) (CONTINUED)

2. LOSS OF TWO OMS HE TANKS THAT WILL NOT SUPPORT HIGHER PRIORITY ABORTS (ATO/SHALLOW, AOA STEEP).

A TAL will be selected for two OMS He tank failures if uphill capability is not available. A TAL abort is preferred over an RTL5 for the reasons listed in a. and b. of paragraph B.1 rationale.

If these failures occur pre-MECO and after last TAL capability to the prime site, a TAL to an ACLS may be performed. If the decision to abort TAL occurs late enough, a manual MECO may be required in order to reach the TAL R/V line. This would be followed by TAL selection post-MECO. There are risks associated with the manual MECO TAL abort not incurred with a pre-MECO TAL selection prior to the last pre-MECO TAL boundary. (1) Manual MECO incurs the risk of missing the targeted MECO VI and creating an underspeed or overspeed condition. (2) A complete OMS dump is not possible and this may result in violation of landing weight or cg constraints. The risks associated with manual MECO TAL aborts are considered much less than those associated with continuing toward a nominal MECO with critical systems failures.

If these failures occur after last capability to an ACLS, then post-MECO, if ATO capability does not exist, an AOA or bailout must be performed.

3. TWO ARCS PROPELLANT TANKS LEAKING, DIFFERENT SIDES, SAME PROPELLANT THAT WILL SUPPORT TAL ET SEPARATION AND ENTRY TO A Q-BAR = 20.

If one pod contains > 75 percent propellant ET separation can be performed (ref. Rule {A6.1.1-11}, AFT RCS PROPELLANT TANK FAIL/HELIUM INGESTION). The leak rate after ET separation must still support Q-bar = 20 to guarantee control until NO YAW JET can be engaged. If either leak rate supports TAL, the proper course of action is to abort TAL. If the leak rate does not support TAL, this case becomes the same as two propellant tanks failed.

Two propellant tanks failed same propellant does not allow any type of certified control mode from EI to Q-bar = 20. By pressing uphill, time is gained to allow complex procedure and/or software changes to take place to help provide control until a Q-bar = 20 (i.e., DAP or procedure changes that will allow forward RCS control in pitch and yaw). With the OI-8 NO YAW JET software, a certified entry from a Q-bar = 20 to touchdown is now available. An uphill abort cutting off at minimum H_p which requires the least total delta-V for the insertion and deorbit burns, and ensures orbital lifetime at least two orbits beyond the first day PLS is selected to maximize the amount of OMS remaining to protect for interconnect operations post-deorbit burn.

4. TWO APU/HYD SYSTEMS FAILED AND THE THIRD SYSTEM FAILING.

See rationale for paragraph A.1.

FLIGHT RULES

THIS RULE CONTINUED ON NEXT PAGE

FLIGHT RULES

A2.1.2-4 RTLS, TAL, AND AOA ABORTS FOR SYSTEMS FAILURES
(CIL) (CONTINUED)

5. CABIN LEAK RESULTING IN A DP/DT > -0.15 PSIA/MINUTE.

See rationale for paragraph A.3.

6. IMPENDING LOSS OF ALL O₂ (H₂) CRYO.

See rationale for paragraph A.4.

7. LOSS OF TWO FREON LOOPS.

See rationale for paragraph A.5.

8. LOSS OF RTLS ET SEPARATION CAPABILITY (WHEN AN RTLS WOULD HAVE BEEN CALLED FOR) BASED ON RCS JET FAILURES WHICH STILL ALLOW ET SEPARATION ON A TAL.

Combinations of failures could result in the loss of RCS jets such that an RTLS ET separation could not be accomplished for an RTLS abort case. In this situation, a TAL would be performed and the additional 11 minutes of flight time would have to be accepted.

9. THREE ET LOW LEVEL SENSORS FAILED DRY IN THE SAME TANK AND ARMING MASS WILL NOT SUPPORT AOA STEEP.

If multiple low level sensors fail indicating the "dry" state in the same tank such that at the time the arming mass is reached MECO would occur in a contingency downrange abort region, a TAL will be performed to avoid the downrange contingency abort. If the arming mass supports an AOA capability, assuming -2-sigma ME performance, then an AOA will be performed.

C. AN AOA WILL BE PERFORMED FOR THE FOLLOWING:

1. TWO OMS PROPELLANT TANKS LEAKING/FAILED, DIFFERENT SIDES, POST-MECO.

See rationale for paragraph B.1.

2. LOSS OF TWO OMS HE TANKS IF ATO SHALLOW CAPABILITY DOES NOT EXIST.

See rationale for paragraph B.2.

THIS RULE CONTINUED ON NEXT PAGE

FLIGHT RULES

A2.1.2-4 RTLS, TAL, AND AOA ABORTS FOR SYSTEMS FAILURES (CIL) (CONTINUED)

3. TWO ARCS PROPELLANT TANKS LEAKING, DIFFERENT SIDES, SAME PROPELLANT, POST-MECO THAT WILL SUPPORT ENTRY TO A Q-BAR = 20.

See rationale for paragraph B.3.

4. TWO APU/HYDRAULIC SYSTEMS FAILED AND THE THIRD SYSTEM FAILING

See rationale for paragraph A.1.

5. AN AOA WILL BE PERFORMED FOR A CABIN LEAK RESULTING IN A DP/DT > -0.02 PSIA/MINUTE (GROUND CALL) OR FOR LOSS OF COMMUNICATION A DP/DT > -0.08 PSIA/MINUTE (CREW CALL).

A value of -0.08 psia/minute will be used for crew loss of communication procedures because it creates a C&W alarm, and therefore cues the crew to a possible cabin leak and to crosscheck with a cabin pressure decrease. The C&W dp/dt limit is set at -0.08 psi/minute to prevent nuisance alarms during the period from lift off to MECO when cabin pressure is transient due to LES helmet flow, thermal and external drop effects.

A leak rate in the range -0.02 < -EQdp/dt < -0.15 < -0.02 psi/minute will allow continuing to orbit and then performing leak isolation procedures to determine whether the leak can be stopped. A leak rate of -0.02 would allow a landing at the next PLS. However, an AOA will be performed to provide additional margin should the leak rate increase. This leak rate is small enough to allow conservatism, but also large enough to not be masked by the post-MECO transient (approximately -0.02) so that a NO-GO call for APU shutdown can be made for a real leak. ~~If the leak cannot be~~ For leak rates < -0.02 isolated, then stay time will be determined by Rule ~~110~~{A17.1.5-1B}, CABIN PRESSURE INTEGRITY. ©[081497-1873]

6. IMPENDING LOSS OF ALL O₂(H₂) CRYO.

See rationale for paragraph A.4.

7. LOSS OF TWO FREON LOOPS.

See rationale for paragraph A.5.

THIS RULE CONTINUED ON NEXT PAGE

FLIGHT RULES

A2.1.2-4 RTL, TAL, AND AOA ABORTS FOR SYSTEMS FAILURES (CIL) (CONTINUED)

8. LOSS OF TWO WATER LOOPS.

An AOA will be performed for the loss of two water loops since the avionics temperatures cannot be managed for the extended period of time required for first day PLS. The avionics can be managed to allow an AOA while maintaining the required temperature levels.

9. THREE ET LOW LEVEL SENSORS FAILED DRY IN THE SAME TANK IF THE EXPECTED -2-SIGMA CUTOFF VELOCITY SUPPORTS.

See rationale for paragraph B.9. Rules {A2.1.2-1}, STS ABORT CRITERIA; {A2.1.4-5}, EMERGENCY DEORBIT; {A4.1.2-7C}, PERFORMANCE BOUNDARIES; {A9.1.6-11}, IMPENDING LOSS OF ALL CRYO; {A10.1.2-1A 2}, LOSS OF APU/HYDRAULIC SYSTEM (S) ACTIONS; {A16.1.1-12A}, EMERGENCY POWERDOWN, reference this rule.

A2.1.2-5 USE OF LOW ENERGY GUIDANCE

- A. IF THE OPS 3 ENTRY PULLOUT LOADS ARE PREDICTED TO EXCEED 3.5 G'S, OPS 6 AUTO CONTINGENCY GUIDANCE WILL BE USED FOR ENTRY. @[120894-1663]
- B. AUTO NOMINAL GUIDANCE WILL BE USED WHENEVER THE LANDING SITE IS WITHIN THE NOMINAL GUIDANCE CAPABILITY. (REFERENCE FIGURE A2.1.2-5-I). (ALPHA PROFILE 43/40).
- C. AUTO LOW ENERGY GUIDANCE MAY BE ENABLED WHENEVER THE LANDING SITE IS OUTSIDE THE NOMINAL GUIDANCE CAPABILITY. (ALPHA PROFILE 42/31).
- D. AUTO LOW ENERGY GUIDANCE MAY BE ENABLED AND MANUAL PITCH FLOWN THROUGH THE FIRST PULLOUT IF THE DOWNRANGE TO THE LANDING SITE EXCEEDS THE AUTO LOW ENERGY GUIDANCE CAPABILITY. THE MCC WILL RECOMMEND AN ALPHA OF 40 OR 37 DEGREES FOR THE FIRST PULLOUT TO MAXIMIZE RANGING AND MEET THERMAL CONSTRAINTS. (ALPHA PROFILE 40/31 OR 37/31). IF NO COMM, AN ALPHA OF 40 DEGREES IS FLOWN MANUALLY THROUGH THE FIRST PULLOUT FOR MECO INERTIAL VELOCITIES LESS THAN 21.2 K FPS (20.4 FOR INCLINATIONS > 39 DEGREES).

THIS RULE CONTINUED ON NEXT PAGE

FLIGHT RULES

A2.1.2-5 USE OF LOW ENERGY GUIDANCE (CONTINUED)

E. AUTO LOW ENERGY GUIDANCE MAY BE ENABLED AND A MANUAL PITCH OF 37 DEGREES FLOWN THROUGH THE SECOND PULLOUT FOR THE FOLLOWING SCENARIOS. (ALPHA PROFILE 42/37).

1. IF THE LANDING SITE IS OUTSIDE THE CROSSRANGE CAPABILITY OF NOMINAL GUIDANCE IN THE REGION OF THERMAL CONCERN.
2. IF THE LANDING SITE IS BEYOND THE CAPABILITY OF NOMINAL GUIDANCE AND THE MECO VELOCITY IS GREATER THAN THE AUTO LOW ENERGY GUIDANCE HIGH VELOCITY LIMIT.

THE MCC WILL DO A REAL-TIME THERMAL ASSESSMENT OF ALPHA 42/31 TO DETERMINE IF THE SECOND PULLOUT CAN BE COMPLETED IN AUTO. PITCH CONTROL CAN BE RETURNED TO AUTO AT THE COMPLETION OF THE SECOND PULLOUT OR ON AN MCC CALL.

NOTE: REFERENCE RULE {A2.1.4-9}, LANDING SITE SELECTION FOR AN INFLIGHT EMERGENCY ©[120894-1663]

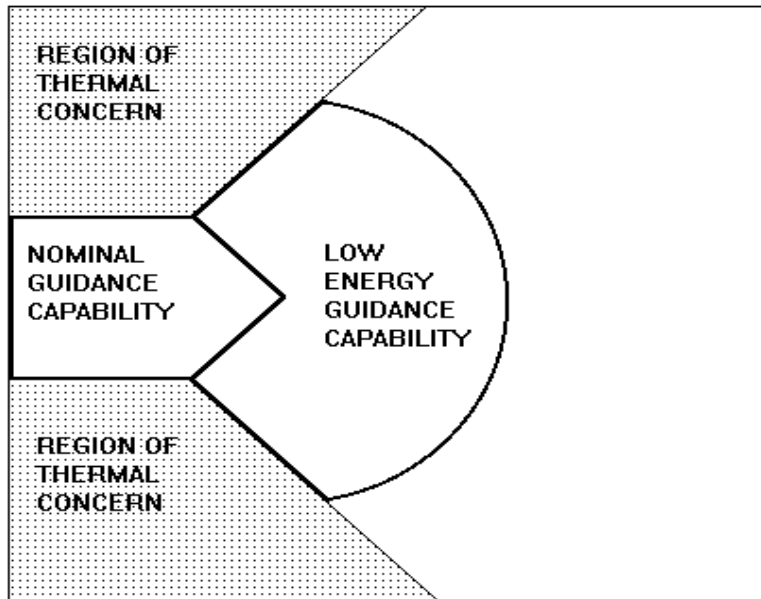

FIGURE 2-14-I - GENERIC DOWNRANGE ABORT EVALUATOR (DAE) DEPICTION

©[120894-1663]

FLIGHT RULES

THIS RULE CONTINUED ON NEXT PAGE

FLIGHT RULES

A2.1.2-5 USE OF LOW ENERGY GUIDANCE (CONTINUED)

OPS 3 VS OPS 6 - For a large MECO underspeed, entry pullout loads determine whether to use OPS 6 Contingency Guidance or OPS 3 Low Energy Guidance. The MCC uses the Downrange Abort Evaluator (DAE) or a real-time plot of flight path angle versus velocity to assess the 3.5 g limit and make a real time call to inform the crew of the best type of entry. For loss of COMM, the crew uses the TAL velocity boundary on the three engine out portion of the contingency abort cue card to determine whether to use an OPS 6 or OPS 3 entry. If three engines fail simultaneously before this velocity boundary, an OPS 6 entry will be used since an OPS 3 entry will result in more than a 3.5 g pullout. This simple velocity boundary is not accurate for performance dispersions or sequential engine failures.

Low Energy Guidance - OPS 3 Low Energy Guidance uses a 42/31 alpha profile and modified roll command logic to extend the orbiter's downrange and crossrange capability during entry and increase the probability of making a landing site that would be unobtainable using nominal entry guidance. A 42-degree alpha is maintained during the initial pullout to avoid thermal damage and minimize the second pullout temperatures. Alpha is lowered to 31 degrees during the second pullout to extend the downrange capability without exceeding the thermal limits. The wing leading edge temperature must not exceed 3320 deg F at any time or 3220 deg F for more than 40 seconds. STSOC Transmittals DFD-92-510-041 and DFD-92-510-107 document the high inclination and generic low alpha thermal assessments. The low energy stretch footprint computed by the Downrange Abort Evaluator (DAE) defines the region where auto low energy guidance will make the site without violating thermal constraints.

Single Engine Limits and gap management take low energy guidance capability into account when determining performance boundaries. Reference rules {A4.1.2-7}, PERFORMANCE BOUNDARIES, and {A5.1.3-3}, LIMIT SHUTDOWN CONTROL.

Low Energy Guidance and Manual Pitch Control in the First Pullout - Manual pitch control may be used in conjunction with auto low energy guidance to increase downrange capability by flying a lower alpha in the first pullout. The MCC can evaluate the thermal acceptability of alpha 40 and 37 degrees through the first pullout. Reference A/E FTP #49, 9/15/88; #79, 6/21/91; and #87, 2/21/92.

High Crossrange in Region of Thermal Concern - For landing sites outside the nominal guidance crossrange capability, using the automatic low energy logic will improve the chance of making a site by trading downrange for crossrange but may exceed thermal limits. While it is known that the area beside the nominal footprint contains small regions that violate thermal limits, the exact definition of the regions is not available. For this reason, the conservative course of action is to plan to fly the second pullout at an alpha of 37 degrees. The MCC will do a real-time thermal evaluation at alpha 42/31 to determine if the second pullout can be completed in auto. Pitch control can be returned to auto when the pullout is complete or on an MCC call.

THIS RULE CONTINUED ON NEXT PAGE

FLIGHT RULES

A2.1.2-5 USE OF LOW ENERGY GUIDANCE (CONTINUED)

High MECO Velocities - High MECO velocities that require low energy guidance to make a landing site could exceed thermal limits during the second pullout. Flying the second pullout at an alpha of 37 degrees will avoid any thermal problem. The MCC will do a real-time thermal evaluation at alpha 42/31 to determine if the second pullout can be completed in auto. Pitch control can be returned to auto when the pullout is complete or on an MCC call.

Rule {A4.1.2-7}, PERFORMANCE BOUNDARIES, references this rule. @[120894-1663]

A2.1.2-6 ABORT GAP

ASCENTS WILL BE CONTINUED TO ORBIT WITH INTACT ABORT GAPS PROVIDED THREE-SSME UPHILL PERFORMANCE REMAINS ACCEPTABLE. REFERENCE RULE {A4.1.2-7I}, PERFORMANCE BOUNDARIES, FOR GAP CLOSURE OPTIONS AND UPHILL PERFORMANCE CRITERIA. @[ED]

Powered flight can continue through an intact abort gap provided three-engine performance is assured. Mission design and flight rules preclude launching with a known single-engine-out abort gap; however, one may arise during powered flight due to performance problems such as an SSME throttle stuck in the first-stage throttle bucket or Pc sensor shifts. In these cases, if performance with the existing SSME configuration is still able to achieve acceptable MECO conditions, then the risk of losing an SSME in the abort gap is accepted rather than commit to a three-engine pre-MECO abort. This risk is reasonable because the actual need for an abort has not yet arisen; the abort itself (RTLS or TAL) carries risks of its own; and the abort in most cases will not recover single-engine-failure protection. Also, the gap will normally be closed to the extent possible (ref. Rule {A4.1.2-7I}, PERFORMANCE BOUNDARIES); hence, any remaining gap will probably be of short duration. @[ED]

FLIGHT RULES

A2.1.2-7 CONTINGENCY ASCENTS/ABORTS

CONTINGENCY ASCENTS/ABORTS RESULT FROM THOSE SITUATIONS WHERE STRUCTURAL FAILURES OR MULTIPLE SYSTEMS/SSME FAILURES HAVE OCCURRED. IN SUCH INSTANCES, ACTION WILL BE TAKEN TO PROVIDE THE HIGHEST PROBABILITY OF A SAFE RETURN OF THE CREW AND ORBITER. THESE CASES WILL USUALLY RESULT IN ONE OR MORE OF THE FOLLOWING:

- A. CREW BAILOUT/ORBITER DITCH DUE TO THE LOSS OF MULTIPLE SSME'S IN A REGION WHERE NO ACCEPTABLE LANDING SITE IS AVAILABLE.
- B. AN ATTEMPT TO LAND AT AN RTLS, TAL, AOA, OR ACLS DUE TO STRUCTURAL OR MULTIPLE ORBITER SYSTEMS PROBLEMS WHICH NECESSITATE LANDING AT THE EARLIEST POSSIBLE TIME.
- C. AN ATTEMPT TO LAND AT AN RTLS, TAL, AOA, ELS, OR ACLS DUE TO MULTIPLE SSME FAILURES OR SINGLE SSME FAILURES COUPLED WITH OTHER ORBITER FAILURES (SUCH AS THE LOSS OF AN OMS ENGINE) WHICH RESULT IN SEVERE ASCENT PERFORMANCE LOSS. CONTINGENCY OR INTACT ABORT PROCEDURES (DEPENDING ON THE PARTICULAR FAILURES AND THE TIME OF EXECUTION) WILL BE PERFORMED AS REQUIRED PER THE ASCENT CHECKLIST AND ASSOCIATED CUE CARDS FOR THE FAILURES DESCRIBED ABOVE, BUT IN ANY CASE, THE OPERATIONS WILL BE CONSIDERED "CONTINGENCY" IN NATURE.

NOTE: CONTINGENCY ABORTS DUE TO TOTAL SSME THRUST LOSS IN A "BLACK ZONE" OF THE FLIGHT PROFILE, SO DESIGNATED DUE TO THE CHANCES OF SURVIVABILITY, WILL RESULT IN VIOLATION OF VEHICLE Q-BAR, G-LOADING, AND/OR THERMAL LIMITS. LOSS OF TWO SSME'S PRIOR TO EARLIEST SINGLE ENGINE DITCH AVOIDANCE CAPABILITY (REF. RULE {A4.1.2-7}, PERFORMANCE BOUNDARIES) MAY RESULT IN VEHICLE LOSS OF CONTROL OR ET RUPTURE DUE TO LOW ALTITUDE TRAJECTORY AND THERMAL CONDITIONS. MANUAL FLIGHT PROCEDURES WILL BE USED IN THESE CASES TO ATTEMPT TO SEPARATE FROM THE ET FOR SUBSEQUENT BAILOUT PRIOR TO ANY LOSS OF CONTROL.

THIS RULE CONTINUED ON NEXT PAGE

FLIGHT RULES

A2.1.2-7

CONTINGENCY ASCENTS/ABORTS (CONTINUED)

This rule addresses the general conditions and actions that result in contingency ascent/abort cases. These cases involve structural type failures such as the loss of cabin pressure integrity, propellant tank leaks, etc.; or multiple orbiter systems failures such as the loss of both Freon loops, the loss of both water loops, etc.; or the loss of multiple SSME's or single SSME, in conjunction with other orbiter failures such as the loss of an OMS engine. The execution of a contingency ascent/abort may or may not result in the use of intact abort procedures or a landing at an RTLS, TAL, or AOA site. While this type of abort would use these sites when possible, landing at an augmented contingency landing site (ACLS) or an ELS may be required. If none of these are available, then a crew bailout may be necessary. While some scenarios will allow an intact abort to be completed after a second SSME failure, these are still considered a contingency abort from a programmatic standpoint.

Crew procedures for flying contingency aborts are contained in the ascent checklist but are only used if intact abort procedures will not suffice for a given situation. In general, contingency abort procedures are not certified/verified to the level of intact abort procedures. Certain regions of the ascent trajectory profile (black zones) may not be survivable if a contingency abort has to be executed due to multiple SSME failures since violations of orbiter or ET constraints on Q-bar, G-level, and heating will occur. Earliest ditch avoidance capability refers to the first time that loss of two SSME's will still allow flight to continue under converged guidance and, at the same time, will not cause the subsequent trajectory to droop below 265,000 feet. This is the altitude below which loss of control may occur or the ET may rupture due to overheating. In these regions, should a contingency abort be required, manual special procedures may be used in an attempt to achieve ET separation and at least a subsequent bailout capability.

Rule {A2.1.6-1}, CONTINGENCY ACTION SUMMARY; and ~~{A4.1.2-11}, FCO ABORT REQUEST,~~ references this rule. [@J081497-6307.1](#)

FLIGHT RULES

A2.1.2-8 RESERVED @[053096 PRCB-4001]

A2.1.2-9 ABORT LIGHT

A. ABORT REQUEST COMMANDS ARE TRANSMITTED FROM MCC, VIA PUSHBUTTONS LOCATED ON THE FD, FDO, AND EASTERN RANGE/45th SPACE WING FCO CONSOLES, WHICH ILLUMINATE THE ABORT REQUEST LIGHT ON THE COMMANDER'S PANEL. THE ABORT COMMAND WILL BE TRANSMITTED AT THE SAME TIME THAT THE ABORT REQUEST IS VOICED TO THE CREW OVER A/G TO INDICATE ONE OF THE FOLLOWING ABORT MODES OR ACTIONS IS REQUIRED: @[081497-6307]

1. RTLS
2. TAL
3. ATO
4. AOA
5. CONTINGENCY ABORT
6. MANUAL MECOSSME CUTOFF (SECOND STAGE ONLY) @[081497-6307]

AFTER THE ABORT REQUEST IS RECEIVED AND EXECUTED BY THE CREW, THE ABORT LIGHT WILL BE TURNED OFF VIA GROUND COMMAND.

B. ABORT REQUEST CUES - THE GROUND WILL BASE ABORT REQUEST TRANSMISSIONS ON AT LEAST TWO INDEPENDENT CUES (I-E.G., TELEMETRY DATA, CREW VOICE REPORTS, FDO PERFORMANCE INDICATIONS, ACTUAL OR IMMINENT RANGE SAFETY LIMIT LINE VIOLATIONS). LIKEWISE, TWO CUES ARE REQUIRED FOR THE CREW TO TAKE THE NECESSARY ACTION TO ABORT THE FLIGHT (I-E.G., PHYSIOLOGICAL CUES, ILLUMINATED ABORT LIGHT, ILLUMINATED RANGE SAFETY ARM LIGHT, VOICE REPORT OVER A/G, COCKPIT INDICATIONS). THIS RULE ASSUMES NO FAILURES WHICH MAY MASK SECONDARY INDICATIONS OF ABORT REQUIREMENT. @[081497-6307]

C. CREW ACTION:

1. FIRST STAGE - EXECUTE ANY AVAILABLE ABORT MODE (NOTE - AT PRESENT, NO FIRST STAGE ABORT EXISTS).

FLIGHT RULES

2. SECOND STAGE - EXECUTE RECOMMENDED ABORT MODE (RTL, TAL, ATO, CONTINGENCY, MANUAL MECO)

THIS RULE CONTINUED ON NEXT PAGE

FLIGHT RULES

A2.1.2-9 ABORT LIGHT (CONTINUED)

3. POST-MECO - AOA, TAL, DOWNRANGE ABORT/CONTINGENCY

This rule documents the conditions under which the abort light command will be issued, the cue requirements for requesting or initiating an abort, and the actions to be taken during each ascent phase. Assuming no other known failures are present which may mask malfunction indications, two independent cues are required before an abort will be requested or initiated in order to provide at least one confirming indication that an abort is required.

If an abort is necessary, the abort light command will be issued for all ascent abort modes. It was agreed that the abort command would be sent at the time that the abort request is passed to the crew as opposed to the time at which the abort is initiated. In most cases, these events are concurrent; however, in the RTLS/TAL overlap region it is usually desirable to delay abort initiation until close to the last RTLS boundary. The abort light will be reset (turned off) via ground command so that it may be used again if necessary to request a subsequent AOA and also to remove the bright light source in the case of night launches. As part of the 1996 ET Range Safety System removal effort, the Eastern Range/45th Space Wing Flight Control Officer (FCO) was provided with two redundant abort light switches in the event a range safety limit line is violated. Note that in most cases, however, MCC/flight crew action will already have taken place before FCO activation of the light is required. @081497-6307]

Paragraph C serves to delineate the abort options available for each ascent flight phase.

@081497-6307]

A2.1.2-10 BFS ENGAGE CRITERIA

A. LOSS OF REDUNDANT SET (REF. RULE {A7.1.2-1A}, PASS DPS FAILURE) .

Loss of the redundant set will result in a loss of vehicle control. Control may be regained by engaging the BFS.

B. LOSS OF CONTROL :

1. LOSS OF PASS CAPABILITY TO CONTROL THE VEHICLE DUE TO GPC/MDM/LRU FAILURES (BFS MUST RECOVER CRITICAL CAPABILITY) .

Combinations of GPC/MDM/LRU failures may cause the flight control system to use bad system inputs resulting in loss of vehicle control. The BFS should only be engaged if it will pick up at least one IMU, control over two FCS channels, and satisfy the LRU constraints stated in Rule {A8.1.2-6}, BFS LRU REQUIREMENTS.

THIS RULE CONTINUED ON NEXT PAGE

FLIGHT RULES

A2.1.2-10 BFS ENGAGE CRITERIA (CONTINUED)

2. LOSS OF CONTROL DUE TO DIVERGENT TRAJECTORY. AFTER MET 1 MINUTE 30 SECONDS, CONTROL STICK STEERING (CSS) MAY BE ATTEMPTED BEFORE BFS ENGAGE.

During first stage, loss of control may occur very quickly due to the control authority of the SRB's. Early in the STS program it was determined that the crew could not manually control the vehicle during first stage load relief, which occurs during the high Q-bar region, even though CSS is available in PASS. Therefore, prior to high Q-bar, the crew should engage the BFS to regain lost system capability which may recover vehicle control. After MET 1 minute 30 seconds, CSS control is an option the crew has available to regain vehicle control. If CSS does not recover vehicle control, then engaging BFS is the last option available since it will place the vehicle control under different software commands. (Note: only AUTO flight control mode is available in the BFS during powered flight, MM 102 and 103). The FCS downmoding (AUTO to CSS or even BFS engage) is an onboard call. Rule {A8.1.2-4}, FIRST STAGE LOSS OF CONTROL DEFINITION, defines the vehicle rates and attitude errors for loss of control.

- C. ROLL MANEUVER NOT INITIATED AS SCHEDULED.

Since the onboard displays are inadequate for the crew to manually execute the roll/pitch profile through the critical high Q phase with the PASS, the BFS must be engaged if the roll maneuver is not initiated at the planned I-loaded value of relative velocity (ref. Rule {A4.1.2-9A}, AUTO GUIDANCE NO-GO). The BFS has an auto capability during powered flight.

- D. PRE-MECO, FOR SET SPLITS SUBJECT TO THE CRITERIA LISTED IN RULE {A7.1.3-2A}, REDUNDANT SET SPLIT.

PASS GPC set splits are considered to be a low probability failure mode and are also complex to deal with in the short amount of time available or in the presence of other failures. In many instances, BFS engage is the quickest and simplest approach to avoiding catastrophic results (e.g., when they result in multiple command path failures to SSME's near MECO). Circumstances where PASS reconfiguration is preferred over BFS engage are detailed in Rule {A7.1.3-2 A}, REDUNDANT SET SPLIT, which also contains the procedures required in those cases.

Rule {A7.1.3-2}, REDUNDANT SET SPLIT, references this rule.

FLIGHT RULES

A2.1.2-11 NAVIGATION UPDATE CRITERIA

WHEN AN INDEPENDENT NAVIGATION SOURCE IS AVAILABLE, NAVIGATION UPDATES WILL BE INITIATED TO PROVIDE ACCEPTABLE MECO CONDITIONS AND MAINTAIN THE HIGHEST ASCENT PRIORITY MODE AVAILABLE. IF NAVIGATION UPDATES CANNOT BE PERFORMED, MECO WILL BE COMMANDED MANUALLY (REF. RULE {A4.1.2-12}, MANUAL SHUTDOWN CRITERIA). @[121296-4177D]

Orbiter navigation velocity errors not corrected until post-MECO cause an almost one for one OMS penalty during OMS-1. This penalty may cause downmoding to a lower ascent priority mode because of OMS propellant budget limitations. To avoid sacrifice of mission objectives, error limits are established for execution of pre-MECO navigation updates (ref. Rule {A4.1.2-8A}, NAVIGATION UPDATES). If a navigation update cannot be performed due to the unavailability of an independent navigation source, loss of command capability, or insufficient time prior to MECO, then the manual shutdown criteria (ref. Rule {A4.1.2-12}, MANUAL SHUTDOWN CRITERIA) will be used to ensure an acceptable cutoff. @[121296-4177D]

FLIGHT RULES

A2.1.2-12 Q-BAR/G-CONTROL

- A. A FAILURE OF ALL THREE ENGINES TO THROTTLE DOWN FOR Q-BAR CONTROL IN FIRST STAGE OR G-CONTROL IN SECOND STAGE IS CAUSE FOR MANUAL THROTTLE TO OBSERVE THE RESPECTIVE Q-BAR AND G LIMITS. FAILURE OF A SINGLE ENGINE TO THROTTLE IN THE SAME REGIONS REQUIRES NO ACTION. FAILURE OF TWO ENGINES TO THROTTLE IN SECOND STAGE IS CAUSE TO MANUALLY SHUT DOWN ONE OF THE NONTHROTTLING ENGINES.

The ascent profile is designed to constrain the maximum Q-bar and g's to their respective limits. During the thrust bucket, the throttles are reduced to ensure that the maximum dispersed Q-bar will not exceed the structural specification limit (approximately 820 psf). Should all three of the SSME's fail to throttle down, manual throttledown is required to avoid structural damage.

The g-control region of second stage adjusts the throttles to ensure that no more than approximately 3g will be experienced. This limit was selected to protect vehicle and payload structure. Therefore, should none of the SSME's throttle down at initiation of the g-control region, the crew will manually throttle to maintain approximately 3g.

For failure of a single SSME to throttle down in either the thrust bucket or in the g-control regions, no action will be required by the crew to manually throttle. Analysis conducted in 1996~~4~~ (reference [Shuttle Loads and Structural Dynamics Panel Minutes for August 31, 1998](#)~~RI/Downey memo 92MA1056~~) showed that there will be an approximately 4 percent exceedance of the wing certified limit load during maximum Q-bar should a throttle be stuck high before the thrust bucket. This stuck throttle condition is not a design requirement and has been documented with a FMEA/CIL in accordance with NSTS 07700, Volume X requirements. The risk due to the increased loads is acceptable because a safety factor greater than one is maintained. During the g-control region, the healthy SSME's will throttle lower than normal and the maximum g's will be approximately 3.5. This is in violation of NSTS 07700, Volume X. To cover this case, a waiver was approved to accept a one-time high-G exceedance of up to 3.6 g's. Should this occur, post-flight analysis and inspection of the orbiter will be required.
 @[041097-4910A] @[111298-6788]

Failure of two engines to throttle down when the g-control region is reached will definitely lead to a violation of the 3g limit (in excess of 4g). The good engine will only throttle down to the minimum percent (approximately 67 percent). Therefore, one of the appropriate nonthrottling engines will be shut down to allow the remaining good engine to control g's with the other stuck engine.

Refer to the Ascent Flight Techniques meeting #53 minutes, ~~and~~ [RI/Downey memo 92MA1056](#), [and Shuttle Loads and Structural Dynamics Panel Minutes for August 31, 1998](#), ~~8/31/98~~ for further background. @[041097-4910A] @[111298-6788]

Rule {A2.1.2-15}, MANUAL THROTTLE CRITERIA, references this rule.

FLIGHT RULES

THIS PAGE INTENTIONALLY BLANK

FLIGHT RULES

A2.1.2-13 ET FOOTPRINT CRITERIA

DESIGN MECO CONDITIONS AND ABORT MODE BOUNDARIES MUST PROVIDE AN ET IMPACT POINT (IP) FOOTPRINT, INCLUDING 3-SIGMA DISPERSIONS, WHICH SATISFIES THE FOLLOWING CONSTRAINTS:

- A. NOMINAL MECO TARGET: THE ET IP FOOTPRINT IS MAINTAINED AT A MINIMUM OF 200 NM FROM ALL FOREIGN LAND MASSES AND 25 NM FROM THE PERMANENT ICE SHELF. ALSO, THE ET IP FOOTPRINT MUST BE MAINTAINED AT LEAST 25 NM FROM U.S. ISLANDS. @[092195-1777A]
- B. TAL MECO TARGETS: THE ET IP FOOTPRINT IS MAINTAINED A MINIMUM OF 25 NM OFF ALL FOREIGN LAND MASSES.
- C. RTLS MECO TARGETS: THE ET IP FOOTPRINT IS MAINTAINED A MINIMUM OF 25 NM FROM ANY LAND MASSES.
- D. EARLIEST SINGLE SSME OUT "PRESS" TRAJECTORIES (PRESS-TO-MECO AND PRESS-TO-ATO): THE ET IP FOOTPRINT WILL BE MAINTAINED OFF CRITICAL LAND MASSES. CRITICAL LAND MASSES INCLUDE:
 1. FOR DIRECT INSERTION 28.5-DEGREE INCLINATIONS: AFRICAN MAINLAND AND MADAGASCAR
 2. FOR DIRECT INSERTION 39-DEGREE INCLINATIONS: AFRICAN MAINLAND
 3. FOR DIRECT INSERTION 51.6-DEGREE INCLINATIONS: AFRICAN MAINLAND AND THE MIDDLE EAST @[092195-1777A]
 4. FOR DIRECT INSERTION 57-DEGREE INCLINATIONS: EUROPEAN AND ASIAN MAINLANDS
 5. ALL OTHER INCLINATIONS AND INSERTION TYPES WILL BE ANALYZED ON A MISSION-SPECIFIC BASIS. @[092195-1777A]

THIS RULE CONTINUED ON NEXT PAGE

FLIGHT RULES

A2.1.2-13 ET FOOTPRINT CRITERIA (CONTINUED)

E. ET FOOTPRINT CONSTRAINTS WILL NOT APPLY TO THE FOLLOWING CASES:

1. MULTIPLE SSME-OUT CASES
2. SINGLE SSME-OUT CASES COUPLED WITH ANY OF THE FOLLOWING:
 - a. ANY LOSS OF OMS DUMP CAPABILITY (PROPELLANT OR ENGINE)
 - b. ANY AFT RCS PROPELLANT LEAK/FAILURES
 - c. ANY OTHER SSME(S) STUCK IN THE THROTTLE BUCKET

The premission-defined MECO targets and design underspeed MECO conditions are selected such that they will not violate Eastern Range (ER) guidelines on ET IP or State Department requirements. These guidelines specify that a 3-sigma dispersion footprint be used for application of the ET IP limitation criteria.

Nominal MECO target: The nominal MECO targets must meet the strictest constraints on the ET IP footprint. The 200 nm limit from any foreign land mass must be satisfied through the ascent flight design process. This limit will preclude infringement of the territorial boundaries of all foreign land masses, ensuring no property or human damage occurs from ET debris. The 25 nm limit applies to the permanent ice shelf which, although not very populated, must be avoided for environmental protection. A lateral clearance of 25 nm is used to protect U.S. islands; the potential for high density of shipping vessels and other small craft in these waters makes this margin prudent for a planned ET disposal. This limit was previously 45 nm prior to the incorporation of OI-21 flight software, which eliminated worst-case guided MECO lateral dispersions caused by a side engine out late in the nominal trajectory. The 45 nm ensured a 25 nm clearance for these cases; however, the extra margin is no longer required. ©[092195-1777A]

TAL and RTLS MECO targets: Once an abort or failure has occurred, the ET IP constraints are less strict. The TAL and RTLS restrictions on the ET IP footprint ensure that no land mass impact damage occurs, although with little additional margin.

FLIGHT RULES

“PRESS” trajectories: The earliest PRESS, single SSME-out, trajectories (earliest capability to continue the ascent to an orbital condition: AOA, ATO, or nominal mission altitude) must protect only critical land masses from ET IP debris. For these cases, no margin is added to the 3-sigma footprint beyond the critical land mass boundaries. Critical land masses are determined through JSC, ER, and State Department agreements considering the political relations with the U.S. and population density. The 1990 ACTA Incorporated 28.5-degree inclination hazards analysis shows casualty expectation orders of magnitude for Madagascar of 10⁻². For this reason, Madagascar is considered a critical land mass. An abort will be recommended if the ET IP footprint violates the PRESS trajectory limitations.

THIS RULE CONTINUED ON NEXT PAGE

FLIGHT RULES

A2.1.2-13 ET FOOTPRINT CRITERIA (CONTINUED)

Additionally, if the ET footprint signifies a risk to the eastern U.S. coastline, real-time action will be taken to correct the trajectory (ref. Rule {A4.1.6-9}, RANGE SAFETY LIMIT AVOIDANCE ACTIONS).

When multiple performance-related failures occur, as noted above in paragraph E, ET IP constraints will no longer be protected due to substantial risks to the flightcrew and vehicle. With the exception of the OMS engine failure, SSME stuck in the throttle bucket, and multiple SSME-out cases, the remaining cases are the result of a vehicle structural failure (extent unknown).

It is more hazardous to perform a TAL abort (in order to protect ET IP) without some knowledge of the control capability losses due to this failure. By pressing to orbit, there is a greater chance of assessing the damage and determining any new crew procedures, if required. Multiple SSME-out cases are considered to be contingency cases, and for that reason the ET constraints are no longer protected. An OMS engine failure is typically detected after an OMS dump (ATO abort) because ET IP protection has already been initiated. Here, a TAL abort is considered hazardous as a TAL abort would require a second abort declaration and the initiation of a second (contingency) dump which would necessitate manual procedures. These cases are considered in-flight contingencies, outside the program recognized failure cases.

Rules {A4.1.1-1}, PERFORMANCE ANALYSES; {A4.1.2-6A}, DESIGN AND CRITICAL MECO UNDERSPEED DEFINITIONS; and {A4.1.2-7E}, PERFORMANCE BOUNDARIES, reference this rule.

A2.1.2-14 ASCENT STRING REASSIGNMENT

A. PRE-MECO, RESTRINGING WILL BE PERFORMED TO REGAIN SSME THROTTLE COMMAND CAPABILITY NECESSARY TO AVOID AN RTLS/TAL/CONTINGENCY ABORT, SUBJECT TO THE FOLLOWING:

1. IF THE BFS IS NOT AVAILABLE, RESTRINGING WILL NOT BE PERFORMED TO AVOID AN RTLS OR TAL ABORT PROVIDED A RESTRING IS NOT REQUIRED TO SUPPORT THE ABORT.
2. RESTRINGING WILL BE PERFORMED TO AVOID A CONTINGENCY ABORT INDEPENDENT OF THE BFS STATUS.

NOTE: THE LAST TIME A RESTRING CAN BE COMPLETED TO REGAIN UPHILL CAPABILITY WILL BE DETERMINED IN REAL TIME.

THIS RULE CONTINUED ON NEXT PAGE

FLIGHT RULES

A2.1.2-14 ASCENT STRING REASSIGNMENT (CONTINUED)

The SSME's are throttled down for maximum dynamic pressure control in first stage. If an SSME experiences a command path failure while in the thrust bucket, the ARD will be used to evaluate the effect of the stuck throttle on vehicle performance. On performance critical missions, an RTLS or TAL may be required even though the remaining two SSME's have nominal performance; a contingency abort may be required when a separate SSME has failed or is operating with off-nominal performance. Therefore, restringing will be performed to regain SSME throttle command capability if doing so will regain uphill capability or avoid an RTLS, TAL, or contingency abort. The BFS is normally required to protect against the low probability occurrence that the restringing action may result in loss of the PASS set. If the BFS is not available and a restringing is required to support the abort (pre- or post-ET SEP), no advantage exists with aborting RTLS/TAL instead of restringing to regain throttle capability. For these cases, restringing is acceptable to regain throttle command capability and avoid the abort independent of the BFS status.

The last time a restringing can be completed to regain uphill capability will be determined by the FDO. This time will change as a function of the winds of the day, SRB performance, SSME performance, and SSME throttle setting of the nonthrottling engine. Therefore, this time will be determined by the ARD in real time.

B. POST-MECO:

1. PRE-ET SEPARATION: RESTRING WILL ONLY BE PERFORMED IF REQUIRED TO REGAIN THE APPROPRIATE NUMBER OF RCS JETS REQUIRED FOR RTLS ET SEPARATION OR NOM/TAL ET SEPARATION.

ET separation cannot be performed without sufficient RCS jet control authority. RTLS ET separation is especially critical because of the increased number of RCS jets required for mated coast and ET separation. Additionally, for either RTLS or TAL, delaying ET separation is not an option. For nominal conditions, ET separation can be delayed allowing more time to configure for the restringing.

2. POST-ET SEPARATION:
 - a. RESTRING WILL NOT BE PERFORMED PRIOR TO ACHIEVING A SAFE ORBIT EXCEPT FOR THE FOLLOWING:
 - (1) RESTRING TO MAINTAIN SINGLE-FAULT TOLERANCE.
 - (2) RESTRING TO REGAIN INSIGHT FOR AN UNRELATED CRITICAL SYSTEM FAILURE WHERE THE FAILED STRING MASKS THE SYSTEM PROBLEM ANALYSIS.

THIS RULE CONTINUED ON NEXT PAGE

FLIGHT RULES

A2.1.2-14 ASCENT STRING REASSIGNMENT (CONTINUED)

- (3) IF UNDERSPEED CONDITIONS EXIST SUCH THAT AN OMS-1 BURN IS REQUIRED AT MECO PLUS 2 MINUTES, RESTRING WILL NOT BE PERFORMED PRIOR TO OMS-1 UNLESS REQUIRED TO MAINTAIN BOTH OMS ENGINES.

The desire is to rely upon system fault tolerance capability (BFS is counted as a level of redundancy) during the uphill phases of the mission when a safe orbit has not yet been established and thereby reduce the risks that may be associated with restringing (possible GPC failure, set split, etc.). Additionally, because the timeline is leading into a quiescent orbit phase (versus a more dynamic entry phase), greater emphasis is placed on the existing systems capability, as long as fault tolerance exists, rather than restringing to regain full capability.

For off-nominal MECO conditions where the OMS-1 TIG is required at MECO plus 2 minutes, restring will not be attempted in order to focus attention on the critical OMS-1 burn and preclude restring error from jeopardizing OMS-1 execution. The exception to this rule is when less than two OMS engines are available. Because of the large underspeed both OMS engines are required in order to overcome large drag effects and achieve the desired targets. Downmoding to the RCS four +X jets may not be an option because of the magnitude of the required delta V and the low thrust/long burn time requirements associated with the RCS.

- b. RESTRING WILL BE PERFORMED AT THE NORMAL OPS TRANSITION TIME FOR AOA OR TAL.

The OPS transition software is designed to perform restrings and is a certified capability.

- c. RESTRINGING WILL NOT BE PERFORMED WITHOUT PRIOR MCC COORDINATION.

The MCC is prime for determining when restringing is required as a result of multiple failures and the resulting GPC/string assignments required to satisfy critical capability and systems fault tolerance as identified in the preceding rules. The MCC is prime for determining the acceptability of restringing based upon the failure signature and conditions and for determining an acceptable data bus reassignment configuration. As a minimum, voice description of the failure and identification of the proposed bus reassignment must be coordinated with the MCC prior to performing any restring.

THIS RULE CONTINUED ON NEXT PAGE

FLIGHT RULES

A2.1.2-14 ASCENT STRING REASSIGNMENT (CONTINUED)

- D. RESTRINGING GPC/STRING COMBINATIONS WILL BE SELECTED WHICH MOVE THE LEAST NUMBER OF STRINGS.

The greater the number of strings moved during a restring attempt, the more complicated the restring process. With this in mind, "good" strings should not be taken from "good" GPC's unless there is no other method of regaining critical capability.

- E. RESTRINGING WILL BE PERFORMED TO REGAIN CRITICAL CAPABILITY INDEPENDENT OF THE BFS STATUS. FOR CASES WHERE RESTRINGING IS ACCEPTABLE TO REGAIN FAULT TOLERANCE (REF. PARAGRAPH B2 (1)), AN ENGAGEABLE BFS MUST BE AVAILABLE.

The BFS is normally required when restringing is performed as a precaution against the low probability occurrence that the restring action may result in loss of the PASS set. However, when the vehicle has sustained failures such that less than critical capability remains (a capability which must be maintained or a loss of crew/vehicle will result), restringing will be performed to regain the needed capability independent of the BFS status in order to maintain the flying status of the orbiter.

If the BFS is not available and less than critical capability remains, restring is allowed to recover the PASS capability to control the orbiter. If the BFS is available and conditions are such that either a BFS engage or a dynamic restring will recover the critical capability, restring will be attempted if time permits completion of the restring while still maintaining the BFS engage option.

Rules {A2.1.1-5}, PORT MODING/RESTRINGING GUIDELINES; {A2.1.2-20}, REGAIN RCS JETS FOR RTLS ET SEPARATION; {A7.1.3-2}, REDUNDANT SET SPLIT; {A7.1.3-8C.4}, PASS DATA BUS ASSIGNMENT CRITERIA; {A7.1.4-1}, ASCENT/ENTRY BFS MANAGEMENT GUIDELINES; and {A8.1.2-5}, ET SEPARATION RCS REQUIREMENTS reference this rule.

FLIGHT RULES

A2.1.2-15 MANUAL THROTTLE CRITERIA 2-66
 A2.1.2-16 OMS-1 DELAYED TARGET CRITERIA 2-66
 A2.1.2-17 APU SHUTDOWN DELAY CRITERIA 2-67
 A2.1.2-18 ARD UPDATE CRITERIA 2-67
 A2.1.2-19 ET PHOTOGRAPHY 2-67
 A2.1.2-20 REGAIN RCS JETS FOR RTLS ET SEPARATION 2-69

ORBIT

A2.1.3-0 VEHICLE SYSTEMS REDUNDANCY DEFINITIONS 2-70
 A2.1.3-1 MISSION DURATION REQUIREMENTS 2-70
 A2.1.3-2 EXTENSION DAY REQUIREMENTS 2-79
 A2.1.3-3 SYSTEMS REDUNDANCY REQUIREMENTS 2-83
 A2.1.3-4 IN-FLIGHT MAINTENANCE (IFM) 2-89
 A2.1.3-5 PBD OPERATIONS (CIL) 2-99
 A2.1.3-6 EVA GUIDELINES 2-100
 A2.1.3-7 CONSUMABLES MANAGEMENT 2-106
 A2.1.3-8 PREFERRED ATTITUDE FOR WATER DUMPS 2-113
 A2.1.3-9 STRUCTURES THERMAL CONDITIONING 2-116
 A2.1.3-10 RESERVED 2-123
 A2.1.3-11 RESERVED 2-125
 A2.1.3-12 DPS COMMAND CRITERIA 2-126
 A2.1.3-13 PDRS 2-128
 A2.1.3-14 OMS/RCS DOWNMODING CRITERIA 2-130
 A2.1.3-15 OMS/RCS MANEUVER CRITICALITY 2-131
 A2.1.3-16 ENGINE SELECTION CRITERIA 2-134
 A2.1.3-17 RENDEZVOUS (RNDZ)/PROXIMITY OPERATIONS
 (PROX OPS) DEFINITIOS 2-134
 A2.1.3-18 RNDZ/PROX OPS GNC SYSTEMS MANAGEMENT 2-135
 A2.1.3-19 RNDZ/PROX OPS COMMUNICATION SYSTEMS
 MANAGEMENT 2-122

FLIGHT RULES

A2.1.2-15 MANUAL THROTTLE CRITERIA

MANUAL THROTTLE CONTROL WILL BE PERFORMED WHEN REQUIRED TO PROTECT SYSTEMS LIMITS, GUIDANCE SOFTWARE PERFORMANCE, OR MISSION CAPABILITY. REFERENCE RULES [{A2.1.2-12}](#), [Q-BAR/G-CONTROL](#); [{A4.1.2-10}](#), MANUAL THROTTLE SELECTION; [{A5.1.3-11}](#), MANUAL THROTTLEDOWN FOR LO₂ NPSP PROTECTION AT SHUTDOWN; [{A5.1.4-2D.1}](#), PRE-MECO MPS HELIUM SYSTEM INTERCONNECTS; AND [{A5.1.4-5}](#), MANUAL THROTTLING FOR LOW LH₂ NPSP, FOR SPECIFIC CASES INVOLVING MANUAL THROTTLE. @[090894-1676A] @[041097-4910A]

Normally, all SSME throttling action will be commanded by the flight software. However, manual throttling can relieve certain failure conditions, some potentially catastrophic, which are not protected by software; examples include low SSME NPSP, an unstable guidance solution, or any generic failure of the software throttling logic itself. In addition, manual throttle can be used to maximize performance in propellant-critical TAL cases as well as to avoid a TAL or RTLS abort when design underspeed is limited by NPSP. In these scenarios, the use of manual throttle control is preferred to the alternatives. The referenced rules spell out the background and criteria for manual throttle usage in each case.

A2.1.2-16 OMS-1 DELAYED TARGET CRITERIA

THE OMS-1 BURN WILL UTILIZE DELAYED TARGET FOR:

- A. MAIN PROPULSION SYSTEM (MPS) PROPELLANT DISCONNECT VALVE FAILED OPEN.
- B. ANY OMS PROPELLANT FAIL/LEAK OR OMS HE TANK FAIL.
- C. TWO OMS ENGINES FAILED.

NOTE: UNDERSPEED MECO CONDITIONS MAY REQUIRE USE OF ON-TIME (MECO + 2) OMS-1 TARGETS.

Delayed targets are designed for nominal or small underspeed MECO conditions only. Larger underspeeds (mission-dependent) may require on-time targets to remain within orbiter delta V capability.

For OMS propellant or helium tank leaks/failures, significant delta V capability will be lost. Also, loss of two OMS engines implies that all the delta V maneuvers will be accomplished with the RCS 4 +X thrusters. Performing delta V maneuvers with the RCS requires a significant amount of additional propellant to compensate for the reduced engine efficiency of the RCS jets as compared to the OMS engines. For these cases, a delayed ATO OMS-1 burn is performed to minimize delta V requirements for insertion and deorbit and allow time for a thorough assessment of the delta V capability remaining.

FLIGHT RULES

FLIGHT RULES

A2.1.2-17 APU SHUTDOWN DELAY CRITERIA

IF ORBIT CAPABILITY IS QUESTIONABLE, THE APU'S WILL REMAIN "ON" WITH THE HYDRAULIC PUMPS DEPRESSURIZED UNTIL THE DECISION IS MADE TO CONTINUE TO ORBIT.

⑥ED]

A2.1.2-18 ARD UPDATE CRITERIA

FOR SSME FAILURE CONDITIONS CAUSING PERFORMANCE DISPERSIONS, ADJUSTMENTS WILL BE MADE TO MIXTURE RATIO, POWER LEVEL, SPECIFIC IMPULSE, AND/OR FLIGHT PERFORMANCE RESERVE VALUES IN THE MCC ABORT REGION DETERMINATOR (ARD) PROGRAM.

Rule {A4.1.2-5}, ABORT MODE RESPONSIBILITY, states that the MCC is prime for abort mode determination. Pre-MECO, the primary tool used to fulfill this responsibility is the ARD processor, which resides in the SDPC computer. Its predictions of abort capability are contingent upon accurate modeling of SSME performance parameters and usable ET propellant remaining. Certain SSME failure conditions such as Pc sensor shifts, valve drift following lockup, etc., can cause the actual SSME performance to vary considerably from that assumed by the ARD; therefore, capability is provided to manually update the applicable performance data in real time. SSME parameters are updated per recommendation from the MCC Booster officer, while FPR adjustments are made by the Flight Dynamics team based on the predicted LOX or LH2 unusable quantity at MECO. Such adjustments are necessary to preserve protection at the 2-sigma level when propellants are being consumed at a non-nominal mixture ratio.

A2.1.2-19 ET PHOTOGRAPHY

THE MANEUVERS FOR ET PHOTOGRAPHY WILL BE CANCELED FOR THE FOLLOWING REASONS:

- A. OMS OR RCS PROPELLANT OR HELIUM SYSTEMS LEAKS OR TANK FAILURES.
- B. KNOWN LOSS OF AN OMS ENGINE.
- C. LOSS OF MULTIPLE PRIMARY RCS JETS.
- D. KNOWN LOSS OF VERNIER RCS ATTITUDE CONTROL WHICH WOULD RESULT IN A PROPELLANT-CRITICAL MISSION.
- E. MECO UNDERSPEED > 26 FPS.

THIS RULE CONTINUED ON NEXT PAGE

FLIGHT RULES

A2.1.2-19 ET PHOTOGRAPHY (CONTINUED)

F. ATO PRE-MECO OMS DUMP HAS BEEN EXECUTED.

G. ET IN DARKNESS AT PHOTOGRAPHY TIME (EACH METHOD EVALUATED SEPARATELY).

There are two methods of photographing the ET. Method 1 utilizes automatic cameras in the ET umbilical wells of the orbiter and requires a +X translation immediately following the -Z separation burn. The +X maneuver requires about 120 pounds of RCS propellant. Method 2 utilizes crew handheld cameras and requires an orbiter pitch maneuver following the MPS dump. Method 2 is only effective on direct insertion flights since the photographs are at too great a distance for any detail following an OMS-1 burn. Method 2 requires about 70 pounds of aft RCS and 30 pounds of forward RCS propellant.

Significant failures in the OMS and RCS systems (propellant or helium leaks or tank failures or OMS engine failure or MECO underspeeds requiring an OMS-1 on a direct insertion flight or the dumping of propellant) results in a loss of delta-V capability and the ET photography propellant may be needed to accomplish flight-critical maneuvers (e.g., OMS-1, deorbit) or for entry control.

The loss of multiple primary RCS jets requires conservatism in the use of the remaining jets since they are required for on-orbit and entry control.

Loss of the vernier RCS attitude control capability due to MDM or electrical bus failure can result in significant mission impact depending on the mission. For those missions where loss of VRCS results in the loss of high-priority objectives, the ET photograph should be canceled to maximize high-priority objectives.

Consideration of lighting at ET photography time is not a constraint for launch. ET photography typically is scheduled on all flights where at least part of the launch window allows sunlight for the photos. Photos of the ET in darkness are not useful. If lighting changes during the launch window, ET photography can be planned and trained for but will be canceled if sunlight will not be present at the same time photos are to be taken. Each of the two methods will be evaluated on its own lighting conditions.

If the ET separation will be in darkness, the +X translation should not be executed because this translation increases the distance between the orbiter and the ET for photos using method. @072398-6530 1

Three-sigma navigation errors can result in MECO underspeeds of up to 26 fps. Greater underspeeds indicate significant performance anomalies requiring care in the expenditure of propellant. Therefore, any maneuver associated with ET photography ~~this DTO~~ (translations or rotations) should be deleted for underspeeds greater than 26 fps. @072398-6530 1

FLIGHT RULES

A2.1.2-20 REGAIN RCS JETS FOR RTLS ET SEPARATION

DURING RTLS, FOR THE LOSS OF MORE THAN ONE RCS JET USED FOR MATED COAST RATE DAMPING, ET SEPARATION, OR ATTITUDE CONTROL THROUGH THE ALPHA RECOVERY PHASE, RECOVERY WILL BE ATTEMPTED IF THE FAILURE IS DUE TO DPS FAILURES OR LOSS OF RCS RM. RESTRING WILL BE PERFORMED POST-MECO/PRE-ET SEP PER RULE {A2.1.2-14, ASCENT STRING REASSIGNMENT. ALL OTHER ACTIONS WILL BE ACCOMPLISHED ASAP (PREFERABLY PRE-MECO).

Recent aerodynamic studies show that early RCS jet aerodynamic models were incomplete with respect to jet failure effects for RTLS ET separation. With worst case aero assumptions and generic mass properties, a successful RTLS ET separation can be accomplished with little more than 1-sigma aero variations, and in that case large attitude errors will be incurred. It is nearly certain that the crew would engage the BFS if large attitude errors occurred in a dynamic time frame.

While either dynamic restringing or the use of RCS jets without redundancy management automatic deselection is subject to certain risks, the probabilities have been judged to be much less likely than the 1-sigma aero variations that are described above. Additionally, BFS engage at ET separation with strings down in the PASS has been documented by several BFS DR's that lead to catastrophic failure.

Therefore, the lowest risk option when multiple RCS jets are lost prior to ET separation on an RTLS is to perform the actions required to regain (or prevent loss of) the jets required for attitude control in the dynamic phases. The jets involved are the down, part of the up, and all of the left and right firing jets (loss of +X, -X, and +Z forward jets is no impact). Actions would include: reselecting jets that have been erroneously deselected for loss of instrumentation (oxidizer or fuel injector temperature, chamber pressure, manifold valved discretes); or inhibiting RM from deselection in the future; or flight-critical string port mode; or dynamic restring. All actions except restring would be performed ASAP. Restring would be performed immediately post-MECO/pre-ET sep as described in Rule {A2.1.2-14B.1}, ASCENT STRING REASSIGNMENT. Rule {A8.1.2-5}, ET SEPARATION RCS REQUIREMENTS, should be understood to protect only 1-sigma aero variations for RTLS abort ET separation conditions. This rule defines what action will be taken operationally to improve protection for aero variations.

Only appropriate actions will be taken, e.g., restring is only to be used in the cases where it will restore the jets (GPC failure, GPC port failure).

There are other situations (i.e., MDM total failure, RJD half-box failure, manifold leaks, etc.) that cannot be solved by any of these options. Reference Rules {A2.1.2-14}, ASCENT STRING REASSIGNMENT, and {A8.1.2-5}, ET SEPARATION RCS REQUIREMENTS.

FLIGHT RULES

ORBIT

A2.1.3-0 VEHICLE SYSTEMS REDUNDANCY DEFINITIONS

- A. TWO-FAULT TOLERANT (FAIL OPERATIONAL/FAIL SAFE) - THE CONDITION OF AN ORBITER SYSTEM WHERE IT IS FULLY CAPABLE OF PERFORMING ITS CRITICAL FUNCTIONS WITH THE ABILITY TO SUSTAIN ANY TWO FAILURES (WITHIN THE SYSTEM) AND STILL HAVE THE CAPABILITY TO SAFELY DEORBIT AND LAND THE ORBITER. [@\[101796-4561A\]](#)
- B. ONE-FAULT TOLERANT (FAIL SAFE) - THE CONDITION OF AN ORBITER SYSTEM WHERE IT IS FULLY CAPABLE OF PERFORMING ITS CRITICAL FUNCTIONS WITH THE ABILITY TO SUSTAIN ANY ONE FAILURE AND STILL HAVE THE CAPABILITY TO SAFELY DEORBIT AND LAND THE ORBITER.
- C. ZERO-FAULT TOLERANT (FAIL CRITICAL) - THE CONDITION OF AN ORBITER SYSTEM WHERE THE SYSTEM IS FULLY CAPABLE OF PERFORMING ITS CRITICAL FUNCTIONS BUT IS UNABLE TO SUSTAIN ONE OR MORE ADDITIONAL FAILURES AND STILL HAVE THE CAPABILITY TO SAFELY DEORBIT AND LAND THE ORBITER.
- D. UNFLYABLE - A SYSTEM CONDITION WHERE THE ORBITER IS INCAPABLE OF PERFORMING A SUCCESSFUL ENTRY AND LANDING. [@\[101796-4561A\]](#)

A2.1.3-1 MISSION DURATION REQUIREMENTS

THE FOLLOWING CRITERIA WILL APPLY TO PREMISSION AND REAL-TIME MISSION DURATION DECISIONS:

- A. NOMINAL EOM LANDING WILL OCCUR NO EARLIER THAN THE BEGINNING OF THE FIFTH DAY OF FLIGHT (APPROXIMATELY 96 HOURS). [@\[101796-4561A\]](#)

To aid in postmission orbiter turnaround planning in support of the number of shuttle flights possible in a year, it was necessary to define the constraints for a nominal mission. For a nominal mission, the minimum duration is designed to ensure a high probability of having a healthy crew for entry and landing, such that an EOM landing would not be attempted or planned prior to FD5. This provides a reasonable amount of exposure of the crew to zero-g for SAS conditioning.

THIS RULE CONTINUED ON NEXT PAGE

FLIGHT RULES

A2.1.3-1 MISSION DURATION REQUIREMENTS (CONTINUED)

B. THE FLIGHT WILL NORMALLY CONTINUE TO NOMINAL END OF MISSION (NEOM) FOR THE FIRST FAILURE WHICH IMPACTS AN ENTRY-CRITICAL SYSTEM. IF THE SYSTEM IS NO LONGER FAIL-SAFE, A THOROUGH TECHNICAL REVIEW OF THE FAILURE MODE AND REMAINING SYSTEMS CAPABILITY WILL BE CONDUCTED TO DETERMINE WHETHER NEOM IS APPROPRIATE. @101796-4561A]

IF THIS ASSESSMENT DETERMINES THAT A GENERIC FAILURE OR GENERIC GROUND PROCESSING PROBLEM HAS OCCURRED AND MAY AFFECT THE REMAINING SYSTEMS, TERMINATE THE FLIGHT PLS.

A single failure in any system which leaves that system with single-fault tolerance is an acceptable configuration to continue to NEOM. For single failures that result in less than fail-safe redundancy, a real-time assessment of the failure mode, remaining systems' capability, health, history, and redundancy will be completed to exonerate generic failures, common ground processing errors, etc. The APU/hydraulic system is not fail safe after the loss of one system since the orbiter is not certified for single APU operations. After the first failure, the IMU and FCS are fail safe with the exception of certain "smart failures" to occur during a certain timeframe during entry. For the IMU, FCS channel, or associated MDM, the risk will be re-assessed based on the latest run-time and failure history.

A risk assessment of the IMU, FCS, APU/hydraulic system, and MDM was completed by the AEFTP in 1996 (reference AEFTP #131 and 6/96 AEFTP splinter meeting). This assessment was quantitative for those items which have a sufficient statistical failure database, but relied on engineering judgment for other items. This assessment concluded that the relative risk of remaining on-orbit to NEOM rather than returning MDF for the first failure in these systems is less than the launch risks and orbital debris risks. This risk is acceptable as long as the remaining systems are good and generic problems are exonerated.

The following should be considered when making a flight determination decision: crew and vehicle health, vehicle mass properties, weather, trajectory, and landing site.

Reference rule {A2.1.7-1}, ORBITER SYSTEMS GO/NO-GO, for the number of failures in each system which result in early mission termination. Reference Rules {A2.1.4-7}, LANDING SITE SELECTION; {A10.1.2-1A}, LOSS OF APU/HYDRAULIC SYSTEM(S) ACTIONS; and {A10.1.2-3A}, APU ENTRY START TIME. @101796-4561A]

THIS RULE CONTINUED ON NEXT PAGE

FLIGHT RULES

A2.1.3-1

MISSION DURATION REQUIREMENTS (CONTINUED)

~~2. IN GENERAL, THE FLIGHT WILL CONTINUE TO NOMINAL END OF MISSION FOR THE FIRST FAILURE WHICH IMPACTS AN ENTRY-CRITICAL SYSTEM IF THE ORBITER REMAINS FAIL-SAFE IN THAT SYSTEM; OTHERWISE, THE FLIGHT WILL BE TERMINATED NEXT PLS. SYSTEMS WILL BE EVALUATED ON A CASE BY CASE BASIS FOR EXCEPTIONS WHICH REQUIRE TERMINATION OF THE FLIGHT AT MINIMUM DURATION FLIGHT (MDF) TIME. REFERENCE RULE {A2.1.7-1}, ORBITER SYSTEMS GO/NO-GO, FOR NUMBER OF FAILURES IN EACH SYSTEM WHICH RESULTS IN AN MDF.~~

~~FOR ANY FAILURE WHICH WOULD RESULT IN AN MDF, CONSIDERATION WILL BE GIVEN TO REMAINING ON ORBIT UNTIL NOMINAL END OF MISSION, PROVIDED THERE HAS BEEN A REVIEW OF THE REMAINING SYSTEM CAPABILITY, FAULT-TOLERANCE, FAILURE POSSIBILITIES, AND OTHER APPROPRIATE DATA, AND THE TECHNICAL, OPERATIONAL, SAFETY, AND MANAGEMENT COMMUNITIES AGREE THAT IT IS A SAFE AND REASONABLE COURSE OF ACTION FOR THE GIVEN FAILURE, REMAINING SYSTEMS' CAPABILITY, AND SPECIFIC RISKS INVOLVED. @041196-3197}~~

~~a. EXCEPTIONS WHICH RESULT IN AN MDF FOR THE FIRST FAILURE ARE~~

~~(1) IMU~~

~~(2) ELEVON, RUDDER, SPEED BRAKE, OR BODY FLAP CHANNEL~~

~~(3) MDM~~

~~(4) APU/HYDRAULIC SYSTEM~~

~~b. FOR A SECOND FAILURE AFFECTING ANY ENTRY-CRITICAL SYSTEM~~

~~(1) TERMINATE THE FLIGHT NEXT PLS IF THE AFFECTED SYSTEM HAS LOST ALL FAULT TOLERANCE OR IF THE FAILURE IS CONSIDERED TO BE GENERIC.~~

~~THIS RULE CONTINUED ON NEXT PAGE~~

FLIGHT RULES

~~A2.1.3-1~~ MISSION DURATION REQUIREMENTS (CONTINUED)

- ~~(2) CONTINUE THE FLIGHT TO MDF IF THE ORBITER IS ONLY SINGLE FAULT TOLERANT IN ORDER TO ACCOMPLISH DEPLOYMENT OF A PRIMARY PAYLOAD AND TO ENSURE CREW ADAPTATION, BOTH OF WHICH REDUCES THE OVERALL RISK TO THE CREW AND ORBITER.~~

~~NOTE: AN MDF WILL LAST APPROXIMATELY 72 HOURS AND LANDING WILL OCCUR AT THE PLS PRIOR TO THE END OF THE FLIGHT DAY 4.~~

~~e. MDF GENERIC PAYLOAD RULES~~

- ~~(1) THE DEORBIT OPPORTUNITY WILL NOT BE DELAYED FOR THE PURPOSE OF ACCOMPLISHING PAYLOAD OBJECTIVES.~~
- ~~(2) FIRST PRIORITY WILL BE THE ACCOMPLISHMENT OF THE MINIMUM MISSION SUCCESS OBJECTIVES OF THE PRIMARY PAYLOAD(S).~~
- ~~(3) LOWER PRIORITY MISSION OBJECTIVES WILL BE CONSIDERED IN THE PRIORITY ORDER AS STATED FOR A NOMINAL MISSION.~~
- ~~(4) SIGNIFICANT CONTINGENCY OPERATIONS, E.G., AN UNSCHEDULED EVA OR A CONTINGENCY RENDEZVOUS, WILL BE UNDER TAKEN ONLY IF ALL THE FOLLOWING ARE MET:~~
- ~~(a) IT IS NEEDED TO ACCOMPLISH A MINIMUM MISSION SUCCESS OBJECTIVE FOR A PRIMARY PAYLOAD.~~
 - ~~(b) THE OPERATION WOULD NOT RESULT IN AN IMPACT TO THE MINIMUM MISSION SUCCESS OF ANOTHER PRIMARY PAYLOAD.~~
 - ~~(c) RULE {A13.1.2-8}, SCHEDULED AND UNSCHEDULED EVA CONSTRAINTS, IS SATISFIED.~~

FLIGHT RULES

~~A single failure in an avionics system which leaves that system with single fault tolerance is an acceptable configuration to continue to nominal end of mission. Multiple failures in an avionics system, even though it remains single fault tolerant, may be indicative of a generic failure, and exposure to additional failures should be minimized by early termination of the mission.~~

~~THIS RULE CONTINUED ON NEXT PAGE~~

FLIGHT RULES

~~A2.1.3-1~~ MISSION DURATION REQUIREMENTS (CONTINUED)

Flight critical and payload MDM's are exceptions to the single failure rule because loss of a single MDM reduces redundancy in multiple systems, increasing the risk that a single LRU failure in any one of several systems could put the orbiter at a zero fault tolerant level of redundancy.

The IMU's and flight control system (FCS) command channels are exceptions because they are a three and four LRU system, respectively, which cannot sustain greater than two failures and still be able to fly entry. Following a second IMU or FCS channel failure, the system is zero fault tolerant and vulnerable to an LRU, MDM, or GPC failure while a system such as the AA's/RGA's are only vulnerable to next LRU failure. The FCS needs one IMU and two FCS command channels to perform entry. The loss of three FCS command channels on any aerosurface places the FCS in an uncertified flight control mode.

The APU/hydraulic systems are an exception because there is marginal capability to land with a single APU given appropriate weather placards. The following should be considered when making a flight determination decision: crew and vehicle health, vehicle mass properties, weather, trajectory, and landing site. Reference Rules {A2.1.4 7}, LANDING SITE SELECTION; {A10.1.2-1A}, LOSS OF APU/HYDRAULIC SYSTEM(S) ACTIONS; and {A10.1.2-3A}, APU ENTRY START TIME.

CE. FOR A SECOND FAILURE AFFECTING ANY ENTRY-CRITICAL SYSTEM @101796-4561A1

11. TERMINATE THE FLIGHT NEXT PLS IF THE AFFECTED SYSTEM HAS LOST ALL FAULT TOLERANCE OR IF THE FAILURE IS CONSIDERED TO BE GENERIC.
22. CONTINUE THE FLIGHT TO MDF IF THE ORBITER IS ONLY SINGLE-FAULT TOLERANT IN ORDER TO ACCOMPLISH DEPLOYMENT OF A PRIMARY PAYLOAD AND TO ENSURE CREW ADAPTATION, BOTH OF WHICH REDUCES THE OVERALL RISK TO THE CREW AND ORBITER.

NOTE: AN MDF WILL LAST APPROXIMATELY 72 HOURS AND LANDING WILL OCCUR AT THE PLS PRIOR TO THE END OF THE FLIGHT DAY 4.

Multiple failures in an entry critical system, even though it remains single-fault tolerant, may be indicative of a generic failure; Exposure to additional failures should be minimized by early termination of the mission.

DD. MDF GENERIC PAYLOAD RULES

FLIGHT RULES

11. THE DEORBIT OPPORTUNITY WILL NOT BE DELAYED FOR THE PURPOSE OF ACCOMPLISHING PAYLOAD OBJECTIVES.

22. FIRST PRIORITY WILL BE THE ACCOMPLISHMENT OF THE MINIMUM MISSION-SUCCESS OBJECTIVES OF THE PRIMARY PAYLOAD(S).

33. LOWER PRIORITY MISSION OBJECTIVES WILL BE CONSIDERED IN THE PRIORITY ORDER AS STATED FOR A NOMINAL MISSION. [@101796-4561A1](#)

THIS RULE CONTINUED ON NEXT PAGE

FLIGHT RULES

A2.1.3-1 MISSION DURATION REQUIREMENTS (CONTINUED)

4. SIGNIFICANT CONTINGENCY OPERATIONS, E.G., AN UNSCHEDULED EVA OR A CONTINGENCY RENDEZVOUS, WILL BE UNDERTAKEN ONLY IF ALL THE FOLLOWING ARE MET: @101796-4561A1
- aa. IT IS NEEDED TO ACCOMPLISH A MINIMUM MISSION-SUCCESS OBJECTIVE FOR A PRIMARY PAYLOAD.
- bb. THE OPERATION WOULD NOT RESULT IN AN IMPACT TO THE MINIMUM MISSION SUCCESS OF ANOTHER PRIMARY PAYLOAD.
- ce. RULE {A13.1.2-8}, SCHEDULED AND UNSCHEDULED EVA CONSTRAINTS, IS SATISFIED.
- EE. A NEXT PLS DEORBIT WILL BE EXECUTED AT THE EARLIEST PRACTICAL TIME TO A CONUS LANDING SITE FOR FAILURES WHICH PLACE THE ORBITER SYSTEM AT THE ZERO-FAULT TOLERANT LEVEL OR RESULT IN A CONDITION WHERE ONE MORE FAILURE CAUSES A SEVERE ORBITER CONFIGURATION MANAGEMENT CONDITION. CONUS LANDING SITE SELECTION SHALL PROVIDE FOR:
11. LANDING SITE PRIORITY (REF. RULE {A2.1.4-7}, LANDING SITE SELECTION)
- aa. PLS
- bb. SLS
- ce. ANY CONUS SITE
22. EOM LANDING CONSTRAINTS (CROSSRANGE, LIGHTING, WEATHER, AND BACKUP OPPORTUNITIES)
33. CREW SCHEDULE CONSTRAINTS
44. A NOMINAL DEORBIT PREPARATION TIMELINE IF POSSIBLE; OTHERWISE, A MINIMUM OF 3.5 HOURS DEORBIT PREPARATION @101796-4561A1

THIS RULE CONTINUED ON NEXT PAGE

FLIGHT RULES

A2.1.3-1 MISSION DURATION REQUIREMENTS (CONTINUED)

FF. IF A FAILURE OCCURS THAT WOULD NORMALLY CAUSE AN MDF BUT THE TIME OF FAILURE IS PAST 72 HOURS FLIGHT DURATION, A LANDING WILL BE ACCOMPLISHED AT THE NEXT PLS OPPORTUNITY THAT PROVIDES ADEQUATE TIME FOR THE NORMAL EOM TIMELINE FOR VEHICLE STOWAGE AND ENTRY PREPARATION. [@101796-4561A1](#)

Since a failure that would cause declaration of an MDF is a reason to shorten a normal flight, further operations of a payload/experiment are not sufficient reason to continue. The flight would be terminated at the next PLS that affords time to accomplish adequate stowage for entry and also allow the crew to have a sufficient sleep period.

GG. FOR SOME FAILURE SITUATIONS AND/OR VIOLATION OF GO/NO-GO CRITERIA FOR FLIGHT CONTINUATION, IT IS SAFER TO REMAIN IN ORBIT INSTEAD OF ENTERING AT THE NEXT LANDING OPPORTUNITY. THAT IS, IF THE ADDITIONAL TIME CAN BE USED TO:

11. BETTER UNDERSTAND THE FAILURE AND ITS IMPLICATION ON ENTRY

22. VERIFY SYSTEMS CONFIGURATION PROCEDURES AND PERFORMANCE PRIOR TO ENTRY

33. PROVIDE ADEQUATE TIME FOR CREW REST THE NIGHT BEFORE ENTRY

44. PROVIDE THE OPPORTUNITY TO ACCOMPLISH ACTIVITIES THAT COULD ENHANCE ORBITER ENTRY/LANDING CONDITIONS [@101796-4561A1](#)

Rules {A2.1.4-2}, EXTENSION DAY GUIDELINES; {A7.1.5-1}, DPS GO/NO-GO CRITERIA; {A8.1.1-4B}, FAULT TOLERANT PHILOSOPHY; and {A17.1.13-1}, EECOM GO/NO-GO CRITERIA, reference this rule.

FLIGHT RULES

A2.1.3-2 EXTENSION DAY REQUIREMENTS

A. ALL STS FLIGHTS ARE REQUIRED TO HAVE 2 EXTENSION DAYS. EXTENSION DAYS WILL BE UTILIZED AS FOLLOWS:

1. ONE OF THE 2 EXTENSION DAYS IS UTILIZED PRIMARILY FOR ACHIEVING ACCEPTABLE LANDING WEATHER CONDITIONS (REF. RULES {A2.1.1-6}, LANDING SITE WEATHER CRITERIA; {A4.1.3-7A.3}, PLS/EOM LANDING OPPORTUNITY REQUIREMENTS; AND {A4.1.3-11}, RUNWAY ACCEPTABILITY CONDITIONS). ©[111094-1622B]

An extension day must be allocated in orbiter resources to allow for improvement in weather conditions forecast at the PLS. A 1-day extension on orbit is preferred to preclude loss of postflight payload samples/data and to maintain full postlanding ground processing support at the PLS.

2. THE OTHER EXTENSION DAY (DEORBIT WAVE-OFF) IS UTILIZED FOR AN ORBITER SYSTEMS CONTINGENCY WAVE-OFF.

A second extension day must be allocated to allow for orbiter system problems which cause an unsafe or compromised configuration for entry. The 1-day wave-off (which includes a deorbit preparation) allows time to understand a problem or to arrive at the best entry configuration.

B. REAL-TIME CONSIDERATIONS TO EXTEND THE FLIGHT FOR ADDITIONAL PAYLOAD OPERATIONS MUST INCLUDE 2 EXTENSION DAY CAPABILITY.

The orbiter should not be exposed to unsafe/compromised entry conditions to further payload data return

C. IF ORBITER SYSTEMS CONFIGURATION MEETS EOM CRITERIA, THEN IN ORDER TO PROTECT FOR AN UNSCHEDULED EVA: ©[090894-1670B]

1. PAYLOAD OR STS ARTICLES WHICH HAVE DEMONSTRATED STOW REDUNDANCY AND MUST BE MECHANICALLY SECURED FOR A SAFE ENTRY/LANDING WILL BE ALLOWED TO OPERATE UNSECURED UNTIL:
 - a. THE BEGINNING OF THE LAST NON-ENTRY CREW WORKSHIFT PRIOR TO ENTRY FOR CREW DUAL WORKSHIFT (24-HOUR CYCLE) FLIGHTS.
 - b. THE BEGINNING OF PRESLEEP ON THE SLEEP SHIFT PRIOR TO DEORBIT DAY FOR CREW SINGLE WORKSHIFT FLIGHTS (APPROXIMATELY TIG - 19 HOURS).

FLIGHT RULES

THIS RULE CONTINUED ON NEXT PAGE

FLIGHT RULES**A2.1.3-2 EXTENSION DAY REQUIREMENTS (CONTINUED)**

2. ARTICLES WHICH HAVE NOT DEMONSTRATED STOW REDUNDANCY WILL BE STOWED AT LEAST 1 DAY EARLIER THAN THE TIMES DEFINED IN PARAGRAPH C.1 IN ORDER TO SUPPORT A LANDING ON THE NOMINAL EOM NO LATER THAN THE BEGINNING OF THE CREW WORKDAY PRIOR TO ENTRY.
3. (FLIGHT SPECIFIC EXCEPTION) EXCEPTIONS TO THESE TIMELINES, IN ORDER TO ACHIEVE MANDATORY PAYLOAD MISSION OBJECTIVES, MUST BE JUSTIFIED IN THE FLIGHT SPECIFIC ANNEX. @[090894-1670B]

If the orbiter systems meet EOM criteria, it is an acceptable risk to allow a payload to operate late in flight which may require an unscheduled EVA to occur on nominal EOM day to safe that payload for entry. For this case, a landing would occur on the first extension day. If, however, a payload or STS article has had a failure in one of its redundant stow or jettison systems, then it must be mechanically secured on the morning of EOM-1 to allow for the potential of an unscheduled EVA on the end of that day to secure the article. A nominal deploy (release) of a drive mechanism which uses a different actuator/motors/motor windings to deploy and stow (or release/latch) does not verify the integrity of the drive mechanism's stow (latch) capability. Therefore, allowing operation of this type of system late in flight is not warranted.

For dual-crew workshift flights, allowing a payload or STS article to operate unsecured until the beginning of the last non-entry team work shift (approximately deorbit TIG-12 hours). This usually allows for sufficient time to begin work on an unscheduled EOM day EVA, with entry occurring on the first extension day. The specific timeline invoked, however, should consider the number of articles to be secured, the time required for the EVA task(s), crew sleep shifting, and assignment of EVA/IVA crews. A 14.7 psi protocol is normally used, and the total EVA task time requires about 12 hours (for a 2-hour EVA, with equipment checks and post-EVA activities). @[090894-1670B]

On single-crew workshift flights, EVA work to secure an unsafe payload or STS article must begin prior to the last sleep period. EVA would occur on nominal EOM with entry on the first extension day. A 10.2 psi cabin is usually established for 12 hours in support of approximately 9 hours of EVA related tasks (from equipment checks to post-EVA, including a 2-hour EVA). Delaying article stowage until the morning of entry and performing a 14.7 psi EVA may also be possible if required; but this timeline is not the preferred.

Reference rule {A2.1.3-3A.9}, SYSTEMS REDUNDANCY REQUIREMENTS.

Rule {A12.1.1-4}, RMS ACTIVITY TERMINATION, references this rule. @[090894-1670B]

THIS RULE CONTINUED ON NEXT PAGE

FLIGHT RULES

A2.1.3-2 EXTENSION DAY REQUIREMENTS (CONTINUED)

D. IF, AT THE BEGINNING OF THE CREW WORKDAY PRIOR TO ENTRY, THE FORECAST FOR THE WEATHER CRITERIA ELEMENTS IN RULE {A2.1.1-6}, LANDING SITE WEATHER CRITERIA, VIOLATES THE LIMITS AT EOM PLUS 1 DAY FOR THE PRIME AND SECONDARY LANDING SITES, THEN ALL ARTICLES WHICH MUST BE MECHANICALLY SECURED FOR A SAFE ENTRY/LANDING, WILL BE SECURED FOR THE REMAINDER OF THE FLIGHT. @[090894-1670B] @[111094-1622B]

Any forecast for weather criteria that violates the limits given in Rule {A2.1.1-6}, LANDING SITE WEATHER CRITERIA, for the landing on EOM plus 1 day at the primary and secondary landing sites makes a potential EVA on EOM unacceptable. Since the EOM plus 1 day deorbit opportunity is not expected to be available, this rule ensures that an EVA to secure mechanical devices does not preclude using the nominal deorbit opportunity, leaving the orbiter with only the one chance to deorbit on EOM plus 2 days. Securing mechanical devices early allows a nominal deorbit with a short contingency EVA on the nominal EOM minus 1 day to secure devices that cannot be made safe for entry using nominal procedures.

E. THE KU-BAND DEPLOYED ASSEMBLY WILL BE STOWED, AND/OR THE MPM'S AND MRL'S WILL BE STOWED AND LATCHED, AS SOON AS PRACTICAL IF SYSTEMS FAILURES HAVE RESULTED IN LOSS OF STOW/LATCH REDUNDANCY. @[090894-1670B]

1. STOW/LATCH OPERATIONS MAY BE DELAYED IN ORDER TO COMPLETE MANDATORY PAYLOAD MISSION OBJECTIVES, AS JUSTIFIED IN THE FLIGHT ANNEX.
2. ANY STOW/LATCH OPERATION DELAYS WILL PROTECT FOR AN EOM-1 DAY EVA.

The Ku-Band deployed assembly (antenna dish, gimbal motors, and deployed electronics), and/or the MPM's and MRL's (2 of 3), must be stowed/latched in order to close the Payload Bay Doors for entry. Without redundant stow/latch capability, this equipment is zero-fault tolerant to a jettison scenario. Therefore, if stow/latch redundancy is not available, these mechanisms should be secured as soon as possible in order to minimize the time of exposure to the next failure which would require a jettison.

THIS RULE CONTINUED ON NEXT PAGE

FLIGHT RULES

A2.1.3-2 EXTENSION DAY REQUIREMENTS (CONTINUED)

The Ku-Band is essential in achieving high priority mission objectives during flights where payload data cannot be permanently stored on on-board media. Stowing the antenna immediately after stow redundancy has been lost would preclude downlinking this high priority payload data, and therefore, compromise mission success. Likewise, stowing/latching the MPM's/MRL's immediately after redundancy has been lost could also preclude mission success. For these flights, exceptions may be justified in the Flight Rules Annex. However, because of the cost and replaceability of these mechanisms (the Ku-Band deployed assembly is approximately \$20 million and irreplaceable), achieving even mandatory payload mission objectives does not warrant the risk of losing an antenna or RMS. Therefore, Ku-Band and MPM/MRL operations will be discontinued in enough time to protect for an EOM-1 day EVA. @[090894-1670B]

Reference rules {A10.1.16-1A}, ANTENNA STOW REQUIREMENT (CIL); {A12.1.3-2A}, MPM DEPLOY/STOW CONSTRAINTS; and {A12.1.3-3}, MRL CONSTRAINTS.

Rules {A6.1.5-3A}, OMS REDLINES (CIL); and {A15.1.1-14C}, SCHEDULED AND UNSCHEDULED EVA CONSTRAINTS, reference this rule. @[051194-1612A]

A2.1.3-3 SYSTEMS REDUNDANCY REQUIREMENTS

A. SYSTEMS MANAGEMENT FOR MISSION DURATION

1. EVA WILL BE CONSIDERED AS A LEVEL OF REDUNDANCY FOR THE FOLLOWING ORBITER SYSTEMS FAILURES IN ORDER TO ACCOMPLISH:
 - a. HIGH PRIORITY FLIGHT OBJECTIVES (AS DEFINED IN THE FLIGHT SPECIFIC ANNEX).

PAYLOAD DEPLOYMENT RETRIEVAL SYSTEM (PDRS) - END EFFECTOR (EE) RELEASE, MPM STOW, MRL LATCHES, SHOULDER BRACE RELEASE, AND RMS CRADLE (REF. RULE {A2.1.3-13C}, PDRS).

- b. MDF

PAYLOAD BAY DOOR (PLBD) - CLOSE DRIVE CAPABILITY DUE TO ELECTRICAL OR MECHANICAL FAILURE (REF. RULE {A10.1.11-94H}, PLBD RULE REFERENCE MATRIX ~~REDUNDANT CLOSE CAPABILITY~~). @[121296-3194B]

THIS RULE CONTINUED ON NEXT PAGE

FLIGHT RULES

A2.1.3-3 SYSTEMS REDUNDANCY REQUIREMENTS (CONTINUED)

EVA capability is considered an acceptable backup to system redundancy for completion of high priority flight objectives in the following areas:

- a. *Crews are trained to EVA-release the end effector from a payload. This means that, if all capability to release a payload is lost except one, the activity will be continued relying on the EVA release, should the last remaining mode fail.*

EVA procedures also exist to overcome total electrical failure of the MPM's and MRL's and can back up system redundancy.

In all of the above cases, the orbiter is still fail safe as payload/RMS jettison capability is available should it be required before the EVA could be implemented to fix a problem.

- b. *EVA procedures and tools are available to protect against total failure of PLBD drive and can be used to back up system redundancy. An EVA for these tasks is protected against in all the consumable redlines. [Reference Rule \[A10.1.11-9H\], PLBD RULE REFERENCE MATRIX. @\[121296-3194B\]](#)*

2. GPC REDUNDANCY REQUIREMENTS:

- a. CONTINUE TO END OF MISSION IF NO MORE THAN ONE GPC HAS FAILED. @[101096-4516]

This will allow a DPS configuration of at least one G2, one SM, a BFS, and one computer left to be configured as a redundant G2 or G3FD, depending on the flight requirements.

- b. MINIMUM DURATION FLIGHT CAN BE SUPPORTED IF NO MORE THAN TWO GPC'S HAVE FAILED. @[101096-4516]

The minimum GPC requirements to sustain orbit activities are a G2 GPC, an SM GPC, and a BFS GPC, i.e., three GPC's total. A subsequent GPC failure leaves only two GPC's, which would be used as a single PASS GPC and a BFS GPC for reentry. Because a BFS GPC is designed as a backup for a generic PASS software failure, a BFS GPC is always maintained as long as two good GPC's exist. The case of three remaining GPC's is considered a fail-safe case; i.e., with an additional failure, a PASS GPC is still available for vehicle control. Spare GPC usage ([if manifested](#)) is not considered for meeting requirements because of concerns about potential generic GPC failures that arise when two GPC's have failed. @[092195-1798] @[121296-3194B]

3. FOR FLIGHT-CRITICAL SYSTEM GENERIC FAILURES, TERMINATE THE FLIGHT AT THE NEXT PLS OPPORTUNITY.

If it is determined that there is a generic fault (i.e., two units fail with identical failure signatures) with a flight-critical system, then it is prudent to land at the next PLS opportunity in order to minimize exposure to subsequent failures.

FLIGHT RULES

THIS RULE CONTINUED ON NEXT PAGE

FLIGHT RULES

A2.1.3-3 SYSTEMS REDUNDANCY REQUIREMENTS (CONTINUED)

4. OMS PROPELLANT IS NOT REQUIRED TO PROTECT ONE OMS-TO-RCS DOWNMODING IF BOTH OMS ENGINES ARE AVAILABLE. OMS PROPELLANT IS REQUIRED TO PROTECT DEORBIT TO OMS STEEP ENTRY TARGETS.

Protecting one OMS-to-RCS downmoding requires saving additional OMS propellant to compensate for the reduced engine efficiency of the RCS jets as compared to the OMS engines. Programmatic guidelines do not allow loading this additional propellant, so redlining this quantity may result in cancellation of planned on-orbit activities. With two good OMS engines, fail-safe redundancy for the deorbit burn is maintained without requiring RCS deorbit capability. Propellant required to deorbit to steep targets using the OMS engines will be protected.

5. ELECTRICAL POWER REDUNDANCY:
 - a. THE FLIGHT WILL CONTINUE FOR A SINGLE FAILURE WHICH RESULTS IN LOSS OF ELECTRICAL POWER REDUNDANCY TO MULTIPLE ENTRY-CRITICAL LRU'S.
 - b. THE FLIGHT WILL BE TERMINATED NEXT PLS IF A SINGLE ELECTRICAL FAILURE IN CONJUNCTION WITH ANY OTHER EXISTING FAILURE WOULD RESULT IN AN UNFLYABLE CONDITION.
6. A NEXT PLS DEORBIT WILL BE EXECUTED FOR INSTRUMENTATION LOSSES WHICH PREVENT MONITORING OF CRITICALITY 1 FAILURES FOR WHICH THE PROGRAM RETENTION RATIONALE REQUIRES MONITORING.

The retention rationale for some criticality 1 failures is the ability to monitor that system and take action prior to a potentially catastrophic event. Therefore, loss of monitoring mandates termination of the flight at the next PLS because rationale for retention of a criticality 1 failure no longer exists.

7. ENTRY CONSUMABLES MUST BE PROTECTED AGAINST WORST CASE ENVIRONMENTAL AND AERODYNAMIC VARIATIONS.
8. ORBITER SYSTEMS TROUBLESHOOTING/IFM'S HAVE PRIORITY OVER PDRS AND PAYLOAD OPERATIONS IF CONFLICTS CANNOT BE AVOIDED (I.E., ACTIVITY SCHEDULING OR INTERRUPTION OF REQUIRED ORBITER SERVICES).

The prime objective on every flight is crew safety.

THIS RULE CONTINUED ON NEXT PAGE

FLIGHT RULES

A2.1.3-3 SYSTEMS REDUNDANCY REQUIREMENTS (CONTINUED)

9. STOW REDUNDANCY DEMONSTRATION: ©[090894-1670B]
- a. A PAYLOAD OR STS ARTICLE THAT HAS DEPLOYED NOMINALLY ON DUAL MOTORS, AND HAS SUSTAINED NO MECHANICAL, COMMAND, OR ELECTRICAL FAILURES WHICH WOULD PRECLUDE DUAL MOTOR STOW, WILL BE ASSUMED TO HAVE DEMONSTRATED STOW REDUNDANCY.
 - b. STOW REDUNDANCY WILL STILL BE ASSUMED TO HAVE BEEN DEMONSTRATED WHERE A PROCEDURAL WORKAROUND IS AVAILABLE FOR ELECTRICAL/COMMAND PATH FAILURES THAT WOULD NORMALLY PRECLUDE DUAL MOTOR STOW OPERATIONS.

A nominal deploy (release) of a drive mechanism which uses the same actuator/motors/motor windings to deploy and stow (or release/latch) will verify the integrity of that drive mechanism's capability to stow (latch). Although drive mechanisms typically use different switch contacts, motor control assembly (MCA) relays, and electrical/command paths for deploy and stow (release/latch) operations, these unlike components are thoroughly tested during ground turnaround. And due to the nature of mechanical equipment, performing a nominal stow using these stow path components does not necessarily guarantee dual motor operation during the following stow sequence. Therefore, stow redundancy can be sufficiently demonstrated by verifying a nominal deploy, without the requirement to actually perform a stow operation. Failed-on microswitches, or other failure scenarios, which may be overcome by an SSR, malfunction, or IFM procedure (EVA procedures not included), do not actually inhibit dual motor stow capability. Therefore, these type failures will not be cause for early stowage of the affected drive mechanism, or for additional demonstration of stow redundancy.

Rule {A2.1.3-2C}, EXTENSION DAY REQUIREMENTS, references this rule. ©[090894-1670B]

THIS RULE CONTINUED ON NEXT PAGE

FLIGHT RULES

A2.1.3-3 SYSTEMS REDUNDANCY REQUIREMENTS (CONTINUED)

B. PAYLOAD OPERATIONS

ONCE THE DECISION HAS BEEN MADE FOR EARLY FLIGHT TERMINATION, PAYLOAD OPERATIONS MAY CONTINUE UNTIL DEORBIT MINUS 6 HOURS PROVIDED THAT THE OPERATIONS WOULD NOT JEOPARDIZE DEORBIT CAPABILITY. PAYLOAD OR SPACE SHUTTLE ARTICLES WHICH MUST BE MECHANICALLY SECURED FOR SAFE ENTRY/LANDING WILL BE SECURED PRIOR TO PRESLEEP ON DEORBIT MINUS 2 DAYS. IF STOW REDUNDANCY CAN BE DEMONSTRATED, OPERATIONS WILL BE ALLOWED TO CONTINUE UNTIL THE MORNING OF DEORBIT MINUS 1 DAY.

If a payload activity has no failure mode that could delay PLBD closing, there is no risk associated with allowing it to operate until deorbit minus 6 hours. If, however, the payload or space shuttle article must be mechanically or operationally secured prior to PLBD closure, then this operation should begin early enough to conduct an EVA (if required) without extending beyond the selected deorbit opportunity. This correlates to securing 2 days prior to deorbit which allows for an EVA on deorbit minus 1 day. If the potential of having to do an EVA has been significantly reduced (i.e., by demonstrating stow redundancy), then operation may continue until the morning of deorbit minus 1 day. Stowing in the morning will allow time for troubleshooting any unforeseen difficulties.

Rules {A9.1.1-4}, CAUTION AND WARNING (C&W) (CIL); and {A17.1.22-1}, EECOM GO/NO-GO CRITERIA, reference this rule.

FLIGHT RULES

A2.1.3-4 IN-FLIGHT MAINTENANCE (IFM)

A. DEFINITIONS:

1. SCHEDULED IN-FLIGHT MAINTENANCE (IFM) IS ACCOMPLISHED ON A PERIODIC (NOT NECESSARILY TIMELINED) BASIS TO KEEP EQUIPMENT OPERATIONAL AND EXTEND ITS LIFE. SCHEDULED IFM TASKS INCLUDE INSPECTION, CLEANING, AND REPLACING FILTERS AND CONSUMABLES. SPECIFICALLY EXCLUDED FROM THIS DEFINITION ARE REPAIR TYPE ACTIVITIES TO CORRECT OR WORK AROUND MALFUNCTIONS.

Examples of this type of maintenance are filter cleaning, LiOH canister replacement, and calibration of equipment.

2. UNSCHEDULED IFM IS UNDERTAKEN AS A RESULT OF ANOMALIES AND SPECIFICALLY INCLUDES TEST, MEASUREMENT, INSPECTION, AND REPAIR TYPE ACTIVITIES TO CORRECT OR WORK AROUND MALFUNCTIONS.

Definitions of categories of maintenance provide common terms for activities which may be constrained by flight rules. For example, scheduled maintenance is planned and approved preflight and usually accomplished without real-time consultation with the MCC-H. Unscheduled maintenance, which is conducted as a result of a hardware malfunction, is usually reviewed real time by the MCC-H whether or not it was preflight approved. This real-time review is conducted to determine orbiter/crew safety impacts.

B. IMPLEMENTATION OF IFM

1. SCHEDULED IFM:

- a. IN GENERAL, SCHEDULED MAINTENANCE IS PERFORMED AS REQUIRED WITHOUT CONSULTING MCC. EXCEPTIONS TO THIS RULE MAY BE REQUIRED FOR EQUIPMENT WHICH CANNOT BE ISOLATED FROM THE ORBITER ELECTRICAL POWER SYSTEM, AIR REVITALIZATION SYSTEM, PRESSURE CONTROL SYSTEM, OR THERMAL SYSTEM. THOSE SCHEDULED IFM PROCEDURES WHICH REQUIRE MCC NOTIFICATION PRIOR TO IMPLEMENTATION WILL BE NOTED IN THE FLIGHT SPECIFIC FLIGHT RULE ANNEX.

Scheduled maintenance is usually considered a routine task. These procedures are reviewed preflight for impact on orbiter systems. In the interest of safety, some procedures may require MCC notification prior to implementation.

THIS RULE CONTINUED ON NEXT PAGE

FLIGHT RULES

A2.1.3-4 IN-FLIGHT MAINTENANCE (IFM) (CONTINUED)

- b. SCHEDULED IFM PROCEDURES ON ORBITER HARDWARE WILL BE PERFORMED BY THE CDR, PLT, OR MISSION SPECIALISTS. PAYLOAD HARDWARE MAY BE MAINTAINED BY PAYLOAD SPECIALISTS.

CDR's, PLT's, and MS's undergo training specific to orbiter scheduled maintenance.

2. UNSCHEDULED IFM:

- a. UNSCHEDULED IFM PROCEDURES ON ORBITER HARDWARE WILL BE PERFORMED BY THE CDR, PLT, OR MISSION SPECIALISTS. REPAIR PROCEDURES ON PAYLOAD HARDWARE MAY BE PERFORMED BY PAYLOAD SPECIALISTS IF THE CDR/PLT OR MS IS COGNIZANT OF THIS ACTIVITY.

CDR's, PLT's, and MS's have an experience and training base to assess the overall impact of a repair procedure on hardware in general and the orbiter in particular.

- b. UNSCHEDULED IFM PROCEDURES SHALL BE INITIATED ONLY WITH THE APPROVAL OF MCC-H. WHEN COMMUNICATION WITH THE MCC-H IS NOT POSSIBLE AND THE CDR DETERMINES THE SITUATION TO BE CRITICAL, REPAIR MAY BE PERFORMED TO ENSURE THE INTEGRITY OF THE ORBITER OR SAFETY OF THE CREW. SPECIFIC PAYLOAD REPAIR PROCEDURES MAY BE EXEMPTED FROM THIS RULE PREFLIGHT FOR EQUIPMENT ISOLATED FROM THE ORBITER ELECTRICAL POWER SYSTEM, AIR REVITALIZATION SYSTEM, PRESSURE CONTROL SYSTEM, OR THERMAL SYSTEM. THESE EXEMPTIONS WILL BE NOTED IN THE MISSION SPECIFIC FLIGHT RULES ANNEX.

Repair procedures are written preflight assuming particular hardware configurations, interrelationships, and sequences of hardware failures. In the interest of safety, the procedure is reviewed real time by the MCC-H to ensure that the assumptions under which it was written actually exist during on-orbit operations.

THIS RULE CONTINUED ON NEXT PAGE

FLIGHT RULES

A2.1.3-4

IN-FLIGHT MAINTENANCE (IFM) (CONTINUED)

- c. UNSCHEDULED IFM PROCEDURES WILL BE PERFORMED ONLY IF ADEQUATE TECHNICAL DOCUMENTATION AND POSSIBLY REPRESENTATIVE HARDWARE ARE AVAILABLE. MCC-H WILL DETERMINE THE ADEQUACY OF THIS DOCUMENTATION/HARDWARE WHICH MAY INCLUDE, BUT IS NOT LIMITED TO, TECHNICAL DRAWINGS, FLIGHT LIKE HARDWARE, AND CLOSEOUT PHOTOS.

IFM procedures are always verified to the maximum extent possible. Past orbiter flight experience has shown that, when working to repair hardware, line drawings and specifications are not adequate to ensure that the final equipment closeout is known. On numerous occasions, preflight closeout photo documentation has revealed the presence of safety wire, ground straps, and other articles which could pose a hazard or cause permanent damage to the hardware. Closeout photos in the context of this rule include interior views of hardware taken during equipment fabrication/assembly as well as final module/pallet installation.

3. GENERAL:

- a. WHEN MULTIPLE IFM'S ARE REQUIRED, THE FOLLOWING PRIORITY WILL BE USED IN THEIR IMPLEMENTATION. MISSION SPECIFIC EXCEPTIONS WILL BE NOTED IN THE FLIGHT RULE ANNEX.

(1) ORBITER SYSTEMS.

(2) SPACELAB SYSTEMS (WHEN APPLICABLE).

(3) EXPERIMENTS/PAYLOADS.

Self-explanatory.

- b. AN IFM WILL BE PERFORMED ASAP TO REGAIN THE REDUNDANCY AND/OR CAPABILITY NECESSARY TO SATISFY THE "CONTINUE TO EOM" GO/NO-GO REQUIREMENTS. IFM TO ESTABLISH ORBITER FAIL-SAFE CAPABILITY WILL HAVE PRIORITY OVER ALL FLIGHT ACTIVITIES AND WILL BE PERFORMED ASAP. FOR EXISTING VALIDATED IFM REPAIR PROCEDURES, IF TIME DOES NOT PERMIT COMPLETION PRIOR TO THE NEXT PLS OPPORTUNITY, A "GO" WILL BE GIVEN ASSUMING A SUCCESSFUL COMPLETION. (FOR REAL-TIME DEVELOPED IFM'S, CONSIDERATION WILL BE GIVEN TO DECLARING A "GO" PRIOR TO COMPLETION).

FLIGHT RULES

THIS RULE CONTINUED ON NEXT PAGE

FLIGHT RULES

A2.1.3-4 IN-FLIGHT MAINTENANCE (IFM) (CONTINUED)

There is a high level of confidence in existing, validated IFM's. Therefore, the orbiter will remain on orbit, assuming the IFM will be successful, rather than terminate the mission for lack of time to complete the IFM. The confidence level may not be as great for real-time developed IFM's; therefore, the GO to stay on orbit is not automatic, but instead, depends on the level of confidence in the procedure.

- c. ON ENTRY DAY, PRIOR TO BEGINNING DEORBIT PREPARATION (DEORBIT TIG MINUS 4.0 HOURS), AN IFM WILL BE PERFORMED ONLY IF REQUIRED TO REGAIN THE REDUNDANCY AND/OR CAPABILITY NECESSARY TO SATISFY THE MINIMUM ENTRY REQUIREMENTS. AN IFM WILL NOT BE ATTEMPTED DURING DEORBIT PREPARATION EXCEPT FOR THE FOLLOWING SCENARIOS:

(1) AN RHC OR DDU WILL BE REPLACED IF FAILURES IN THESE SYSTEMS RESULT IN THE LOSS OF TWO RHC CHANNELS PRIOR TO ENTERING OPS 3.

~~(2) ENTRY WILL BE DELAYED IF REQUIRED FOR INSTALLATION OF THE CARRY ON GPC (IF MANIFESTED) IF TWO GPC'S HAVE FAILED. @1002195-1798~~

(23) ENTRY WILL BE DELAYED TO DO AVIONICS BAY FAN CHANGEOUT IF BOTH FANS HAVE FAILED IN AVIONICS BAYS 1 OR 2 AND A FAN CHANGEOUT MAY RECOVER COOLING IN THAT AVIONICS BAY. @101096-45161

IFM's require use of equipment and tools which are normally stowed. Their use affects the stowage timeline and other activities related to preparing the orbiter for entry. Rationale for the above exceptions is contained under the appropriate system in paragraph C.

- d. IFM PROCEDURES ON EXPERIMENTS WITH TOXIC HAZARDS - NO IFM PROCEDURES WILL BE INITIATED ON AN EXPERIMENT KNOWN TO REPRESENT A TOXIC HAZARD WITHOUT MCC-H CONCURRENCE. PROTECTIVE EQUIPMENT MAY BE REQUIRED (REF. RULE {A13.1.2-15}, ORBITER HAZARDOUS SUBSTANCE SPILL RESPONSE). PAYLOAD EQUIPMENT THAT REPRESENTS A TOXIC HAZARD WILL BE IDENTIFIED IN THE FLIGHT RULE ANNEX.

A real-time assessment of the possibility of repairing and the risk of exposing the crew to a toxic substance during the repair will be required. The IFM may require that the cleanup equipment specified in Rule {A13.1.2-15}, ORBITER HAZARDOUS SUBSTANCE SPILL RESPONSE, be used to minimize risk of crew exposure to toxic substance.

FLIGHT RULES

THIS RULE CONTINUED ON NEXT PAGE

FLIGHT RULES

A2.1.3-4 IN-FLIGHT MAINTENANCE (IFM) (CONTINUED)

C. SYSTEMS REPLACEMENT CRITERIA:

1. ANY FORWARD CRT WILL BE REPLACED WITH THE AFT CRT (N/A FOR MEDS VEHICLES). @101096-4516] @021397-4763] @040899-2459B]

An IFM to replace any forward CRT with the aft CRT is required for entry to ensure at least two CRT's are available: One to monitor/control (item entry deselect/select) entry LRU's and PASS software, and the other to monitor/control orbiter systems via BFS software. CRT 3 satisfies the redundancy issues since it can be used by either the CDR or PLT. @021397-4763]

2. ANY MDU CAN BE REPLACED WITH ANY OTHER MDU.

Because of the large number of MDU's (11), an IFM to replace a failed aft MDU with a forward MDU may aid the crew in critical aft station operations (RNDZ, dock/undock) without losing any capability in the forward cockpit. Because of the simple and low risk MDU IFM (45 minutes), the MDU can be reinstalled in the forward cockpit after the critical aft operations.

32. A KEYBOARD (1 OR 2) WILL BE REPLACED WITH THE AFT KEYBOARD.

The same rationale is used for the keyboard 1 or 2 IFM as for CRT's and also satisfies the requirement for fail-safe redundancy in entry-critical LRU's.

43. A SPECIFIC KEY ON (KEYBOARD 1 OR 2) WILL BE REPLACED WITH THE "ACK" OR "MSG RST" KEY FROM THE AFT KEYBOARD.

If a specific key in one of the forward keyboards is identified as failed, replacing that key with the ACK key from the aft keyboard can restore the keyboard to full operational status. Since the ACK key is only used to acknowledge fault messages by stopping them from flashing and turning off alarm tones, the aft keyboard may continue to be used even if the ACK key has been removed. As an alternative to the ACK key, the MSG RST key may be used. Forward keyboards are required for entry purposes, while no requirement exists for the aft keyboard. An IFM on a forward keyboard key will be done when required, while an IFM on an aft keyboard may be done.

54. A DEU (1, 2, OR 3) WILL BE REPLACED WITH DEU 4.

IFM for DEU replacement rationale is the same as the CRT's except DEU 3, due to its location, is capable of being replaced whereas CRT 3 cannot. @040899-2459B]

THIS RULE CONTINUED ON NEXT PAGE

FLIGHT RULES

A2.1.3-4 IN-FLIGHT MAINTENANCE (IFM) (CONTINUED)

65. AN ADI (LEFT OR RIGHT) WILL BE REPLACED WITH THE AFT ADI (N/A FOR MEDS VEHICLES). @[101096-4516] @[040899-2459B]

An IFM to replace a failed ADI with the aft ADI is required for entry for the minimum required fail-safe capability and to allow the mission to continue past PLS. At least one ADI is required to ensure manual takeover capability is available high in the entry profile where the HUD is not available. In addition, the ADI is a prime pilot tool used to monitor the performance of the auto entry guidance to ascertain if a takeover is required.

76. AN RHC (LEFT OR RIGHT) WILL BE REPLACED WITH THE AFT RHC IF MORE THAN ONE CHANNEL IS FAILED ON THE SAME CONTROLLER. @[101096-4516]

Although the loss of two RHC channels does not violate minimum entry requirements (system is still fail-safe), an RHC will be changed out to increase redundancy anytime prior to OPS 3 transition due to its criticality in the CSS/takeover role for entry/landing.

87. THE FORWARD THC WILL BE REPLACED WITH THE AFT THC.

An IFM to replace the forward THC with the aft THC is required to ensure at least fail-safe redundancy is available for manual translational control for the deorbit burn.

98. A DDU (LEFT OR RIGHT) WILL BE REPLACED WITH AFT DDU.

An IFM to replace a failed DDU is required for entry to allow use of the ADI in non MEDS configured vehicles (ref. paragraph 6 for ADI entry criticality). This IFM may also be performed if necessary to regain RHC redundancy (ref. paragraph 7).

109. THE LEFT OR RIGHT HUD WILL BE REPLACED WITH THE SPARE HUD. FOR FLIGHTS WHICH DO NOT CARRY A SPARE HUD, REPLACEMENT OF THE LEFT HUD WITH THE RIGHT HUD WILL BE PERFORMED, TIME PERMITTING, IF A NIGHT LANDING IS PLANNED. @[040899-2459B]

HUD replacement is considered highly desirable for entry in cases where visibility is restricted on the outer glide slope or for night landings. If a night landing is planned and no spare is available, the right HUD can be moved to the left side to provide the CDR with an operable HUD. The decision to perform the IFM will be based on consideration of the severity of the situation (e.g., weather, day or night, etc.). Reference: Memorandum CB-89-265.

THIS RULE CONTINUED ON NEXT PAGE

FLIGHT RULES

A2.1.3-4 IN-FLIGHT MAINTENANCE (IFM) (CONTINUED)

~~1110~~. AN OPS RECORDER (1 OR 2) WILL BE REPLACED WITH THE PAYLOAD RECORDER IF BOTH OPS RECORDERS HAVE FAILED.
@[101096-4516] @[\[040899-2459B\]](#)

OPS recorder replacement is required only if both OPS recorders 1 and 2 have failed. The OPS recorder is required up to the deorbit burn to ascertain systems problems which occur during LOS.

~~1211~~. THOSE CASES WHEN A FAILED PAYLOAD RECORDER WILL REQUIRE A PAYLOAD RECORDER REPLACEMENT WILL BE DEFINED IN THE FLIGHT SPECIFIC FLIGHT RULES ANNEX.
@[101096-4516]

OPS recorder or PL recorder IFM criticality is addressed by the flight specific Annex rules. The payload or certain flight specific orbiter DTO's affect the criticality of entry related data requirements.

~~1312~~. AN ACCU (1 OR 2) WILL BE REPLACED WITH BYPASS CONNECTOR J4.

An IFM to bypass a failed ACCU is required to ensure redundant voice links for entry and to determine whether next PLS must be declared. A failed IFM would be cause for next PLS with one ACCU down.

~~1413~~. TRANSPONDER (1 OR 2) BYPASS WILL BE CONSIDERED IF ONE FAILED. THE BYPASS WILL BE PERFORMED IF BOTH HAVE FAILED.

An IFM to recover S-band downlink telemetry is required if both transponders have failed. If one is failed, consider expenditure of crew time to perform the IFM to ensure redundancy.

~~1514~~. IF BOTH AVIONICS FANS IN AV BAY 1 OR 2 HAVE FAILED, ENTRY WILL BE DELAYED TO REPLACE ONE FAN WITH A FAN FROM ANOTHER AV BAY. @[\[040899-2459B\]](#)

AV bay fan replacement is done to recover cooling for two GPC's which provide redundancy for entry.

THIS RULE CONTINUED ON NEXT PAGE

FLIGHT RULES

A2.1.3-4 IN-FLIGHT MAINTENANCE (IFM) (CONTINUED)

1615. THE PF1/PF2 MDM'S WILL BE SWAPPED ONLY IF REQUIRED TO CLOSE PLBD'S. PLBD MOTOR OPERATION UTILIZING THE IFM PIN KIT WILL BE USED IN LIEU OF SWAPPING PL MDM'S IF, AFTER THE MDM'S ARE SWAPPED, THE PLBD MOTOR IFM WOULD STILL BE REQUIRED TO CLOSE AND/OR LATCH THE DOORS. @[101096-4516] [@\[040899-2459B\]](#)

Due to the potential for connector pin damage during demate/mate operations, replacement or swapping of PL MDM's is only considered for PLBD closure. No consideration is made to swap PL MDM's for mission success reasons. The PLBD motor operation IFM is a collection of pin kit procedures to recover PLBD motor functions lost as a result of a failed PL MDM, and the motor driven by the other PL MDM has hard failed. If swapping PL MDM's will not recover all the necessary functions to close and latch the doors, the pin kit procedures will be used to regain the lost functions in lieu of swapping the MDM's.

1716. FOR FLIGHT CRITICAL MDM'S - FF4 WILL BE SWAPPED WITH FF1, FF2, OR FF3 AFTER POWER CYCLING AND PORT MODING FAILS TO CLEAR A NON-GPC CAUSED "I/O ERROR FFX" OR TOTAL OUTPUT CARD FAILURE AND IT RESULTS IN THE LOSS OF: @[101096-4516] [@\[040899-2459B\]](#)

- a. A SECOND IMU.
- b. A SECOND ACCELEROMETER ASSEMBLY (AA) (AA4 MUST BE FAILED).

Where previous LRU failures would cause a loss of at least fail-safe redundancy in an entry critical system, it is considered viable to replace FF1, FF2, or FF3 with FF4. The operation would be accomplished to recover an IMU for redundancy in onboard navigation for entry. The same is true for an AA to regain redundancy for entry control.

Rules {A7.1.3-10C}, PASS GPC BCE FAILURE MANAGEMENT; {A7.1.3-15D}, IN-FLIGHT MAINTENANCE (IFM); and {A8.1.1-7}, ENTRY SYSTEMS SINGLE-FAULT TOLERANCE VERIFICATION; reference this rule.

FLIGHT RULES

A2.1.3-5 PBD OPERATIONS (CIL)

LAUNCH DAY LANDING PLBD OPS:

- A. IF A LANDING IS REQUIRED AND SUPPLY/WASTE WATER WILL SUPPORT FES OPERATIONS UNTIL ENTRY, NO ATTEMPT WILL BE MADE TO OPEN ONE OR BOTH OF THE PLBD'S. @[020196-1804A]

For launch day landings at the first available PLS, the supply and waste water tanks are loaded such that there is sufficient water for FES operations; therefore, there is no requirement to incur the risks associated with opening the PLBD's, thus eliminating an increase in the crew workload during this timeframe.

- B. IF A LANDING IS REQUIRED AFTER PREDICTED EXHAUSTION OF SUPPLY AND WASTE WATER FOR THE FES, THE PLBD'S MAY BE OPENED.

For launch day landings after the first PLS opportunity, insufficient supply/waste water may have been loaded to support FES operations to entry. If the first PLS opportunity is NO-GO or likely to be NO-GO, then PLBD opening will be required. This situation may result in having to open the PLBD without close redundancy.

- C. FOR PROBLEMS PROHIBITING NECESSARY HEAT REJECTION, THE PLBD'S MAY BE OPENED (TIME PERMITTING) WITHOUT REGARD TO CLOSE-MOTOR REDUNDANCY, FES WATER SUPPLY AVAILABILITY, OR MET OF LANDING. @[020196-1804A]

For cases where there are cooling problems and opening the PLBD's is required to alleviate heating of entry-critical equipment, the PLBD's should be opened to provide the increased cooling capability. This may be necessary even though redundant door closure does not exist and/or the timeline/crew workload would be increased.

FLIGHT RULES

A2.1.3-6 EVA GUIDELINES

A. EVA WILL NORMALLY BE PERFORMED BY TWO EVA CREWMEMBERS; HOWEVER, ONE MAN EVA MAY BE PERFORMED IN THESE CIRCUMSTANCES:

1. CONTINGENCY EVA.

Two crewmembers are always required for EVA to ensure that, if one EVA crewmember should experience trouble, the other is available to provide assistance. For contingency EVA, this rule is waived since the safety of the orbiter is involved and the risk of a one man EVA is therefore acceptable.

2. SCHEDULED EVA - A SCHEDULED EVA MAY BE PERFORMED BY A SINGLE CREWMEMBER IF:

- a. A SINGLE CREWMEMBER CAN EXECUTE THE TASK(S) ASSIGNED.
- b. THE SECOND CREWMEMBER IS ABLE TO GO TO VACUUM AND REMAIN ON THE SERVICE AND COOLING UMBILICAL (SCU) FOR POSSIBLE RESCUE.
- c. THE SCHEDULED EVA TASK(S) MUST BE CAPABLE OF BEING TERMINATED AT ANY POINT AND LEAVE THE PLB IN AN ENTRY COMPATIBLE CONFIGURATION.

3. UNSCHEDULED EVA - AN UNSCHEDULED EVA TO MEET HIGH PRIORITY MISSION OBJECTIVES OR TO PREVENT JETTISON OF A PAYLOAD MAY BE ACCOMPLISHED BY A SINGLE CREWMEMBER IF THE FOLLOWING CRITERIA ARE MET:

- a. A SINGLE CREWMEMBER CAN EXECUTE THE TASK(S) ASSIGNED.
- b. THE SECOND CREWMEMBER MUST BE ABLE TO GO TO VACUUM AND REMAIN ON SERVICE AND COOLING UMBILICAL (SCU) FOR POSSIBLE RESCUE.
- c. THE UNSCHEDULED EVA TASK(S) MUST BE CAPABLE OF BEING TERMINATED AT ANY POINT AND LEAVE THE PLB IN AN ENTRY COMPATIBLE CONFIGURATION.

4. AN EVA WILL BE DEFINED IN THE FLIGHT SPECIFIC ANNEX AS BEING CAPABLE OF BEING ACCOMPLISHED BY A SINGLE CREWMEMBER.

FLIGHT RULES

THIS RULE CONTINUED ON NEXT PAGE

FLIGHT RULES

A2.1.3-6 EVA GUIDELINES (CONTINUED)

B. IF CONTINGENCY EVA SUCCESSFULLY RESTORES PLBD'S, LATCHES, ETC., TO NORMAL OPERATION (E.G., FOREIGN OBJECT REMOVED), THE EVA WILL BE TERMINATED AND THE FLIGHT COMPLETED AS PLANNED.

If a contingency EVA is successful in restoring complete orbiter capability, there is no added risk to remaining on orbit and accomplishing the full mission duration.

C. FOR EVA, DENITROGENATION WILL BE ACCOMPLISHED IN ACCORDANCE WITH AEROMED RULE {A13.1.2-7}, EVA PREBREATHE PROTOCOL.

Self-explanatory.

D. EVA/ORBITER ATTITUDE, AND ATTITUDE CONTROL CONSTRAINTS:

1. DURING SIDE-TO-SUN ATTITUDE, THE SUN SIDE FORWARD RADIATOR PANEL WILL BE STOWED.
2. DURING TOP SUN ATTITUDE, CREWMEMBERS WILL AVOID THE AREA WITHIN 15 FEET ABOVE DEPLOYED RADIATORS.

For a side-to-Sun attitude during the EVA, the forward radiators must be stowed to preclude exposing a crewmember to the focusing effect of the Sun shining through the gap between the door and radiator. Short term exposure could produce thermal gradients which could overload the EMU capability to control the thermal environment, and longer term exposure could cause suit degradation. The same type of focusing effects are experienced at approximately 15 feet above the radiator when the vehicle is in a top Sun attitude and are potentially more severe.

E. MINIMUM COMMUNICATIONS REQUIREMENTS FOR SCHEDULED EVA:

IN ORDER TO COMMIT TO OR CONTINUE A SCHEDULED EVA, EACH EVA CREWMEMBER MUST HAVE TWO-WAY COMMUNICATIONS WITH THE ORBITER EITHER DIRECTLY OR VIA THE OTHER EVA CREWMEMBER.

It is difficult to be totally aware of the condition of an EVA crewmember by visual inspection. Minimum communication is required to ensure crew status and safety throughout the EVA period.

F. EVA WILL BE TERMINATED FOR MALFUNCTIONS WHICH RESULT IN SECONDARY OXYGEN PACK (SOP) O2 FLOW.

FLIGHT RULES

Malfunctions which result in SOP flow indicate no other source of oxygen can supply total requirements for continued operation of the suit/EMU. Regardless of whether or not the primary life support system (PLSS) is functioning properly, SOP flow depletes the EVA crewmember's backup source of oxygen and is therefore cause to terminate the EVA. [@J021199-6747B1](#)

~~THIS RULE CONTINUED ON NEXT PAGE~~

FLIGHT RULES

~~A2.1.3-6~~ EVA GUIDELINES (CONTINUED)

~~G. PRCS AND VRCS CONSTRAINTS — PRCS AND VRCS THROUGHSTERS WHOSE PLUME COULD IMPINGE UPON THE EMU/MMU CREWMEMBER DURING PLANNED FREE FLIGHT OUTSIDE THE PAYLOAD BAY, WILL BE DISABLED DURING THE EXPOSURE PERIOD.~~

RCS thruster plume impingement could have two effects: (1) If the EVA crewmember is close enough, the plume is hot enough to burn the suit material; and (2) all of the supplied propellant may not be consumed creating a potential for unburned mmH to be deposited on the suit. If this is then brought back into the orbiter cabin, the entire crew will be exposed to mmH which is highly toxic in even very small concentrations.

~~H. IF, DURING MMU FREE FLIGHT, THE MMU BECOMES DISABLED, ORBITER ACTIVE RESCUE WILL BE PERFORMED.~~

Orbiter active rescue is always preferred because of the potential failure of the second MMU increasing overall risk, thus creating difficult rescue geometry and increasing the probability for propellant reserved for rescue being depleted prior to both MMU's being recovered.

Rules {A15.1.1-9}, TWO/ONE CREWMEMBER EVA GUIDELINE; and {A15.1.1-15}, CONTINGENCY EVA PROTECTION, reference this rule.

FLIGHT RULES

THIS PAGE INTENTIONALLY BLANK

FLIGHT RULES

A2.1.3-7 CONSUMABLES MANAGEMENT

A. REDLINES WILL BE MANAGED TO ASSURE THAT THE FOLLOWING RESERVES ARE PROTECTED:

In order to achieve acceptable consumables margins (cryo or OMS/RCS) required to continue on-orbit flight operations, flight activities requiring the limited consumable may be reduced/deleted. The capabilities that must be protected along with the potential activities that are candidates for deletion are identified.

1. DEORBIT CAPABILITY - OMS/RCS PROPELLANTS WILL NORMALLY BE MANAGED TO PROVIDE THE CAPABILITY TO DEORBIT TO STEEP TARGETS. HOWEVER, SHALLOWING TARGETS IS ALLOWED TO PROTECT ITEMS 2 THROUGH 8 BELOW.

NOTE: PROPELLANT RESERVED TO PROTECT THE DEORBIT WAVE-OFF EXTENSION DAY (PARAGRAPH 9 BELOW) MAY BE COMMITTED TO PROVIDE STEEP DEORBIT TARGET CAPABILITY. @[051194-1612A]

Deorbit capability is protected to allow safe return of the orbiter. The table addresses consumable limitations and not deorbit methods. Other rules identify actions required for the loss of one OMS, etc.

2. EOM DEORBIT PREPARATION.

Consumables required to successfully perform one nominal deorbit preparation are protected.

3. POST-DEORBIT AND ENTRY USAGE (EXCEPT PTI'S).

Consumables required to support orbiter operations from deorbit burn cutoff through landing are protected. PTI's are not considered as mandatory and, if scheduled, appear as a tradable item in the Flight Rules Annex priority table.

4. CONTINGENCY RESERVES (SYSTEM MALFUNCTION OR FLIGHT CONTINGENCY).

Consumables are reserved to protect against certain anomalies in order to guarantee system capabilities. For example, OMS/RCS propellant is redlined to account for attitude dispersions during the deorbit burn associated with an OMS engine failure.

5. X/Y CG BALLAST - RESERVES CONSUMABLES TO MAINTAIN THE ORBITER CG WITHIN ESTABLISHED LIMITS.

Self-explanatory.

FLIGHT RULES

THIS RULE CONTINUED ON NEXT PAGE

FLIGHT RULES

A2.1.3-7 CONSUMABLES MANAGEMENT (CONTINUED)

6. DISPERSION ALLOWANCE (PERFORMANCE VARIATION).

Self-explanatory.

7. MEASUREMENT ERROR.

Self-explanatory.

8. TRAPPED RESIDUALS.

Self-explanatory.

9. DEORBIT WAVE-OFF EXTENSION DAY - INCLUDES CONSUMABLES RESERVED TO BACK OUT OF THE DEORBIT PREPARATION CONFIGURATION, MAINTAIN ATTITUDE CONTROL FOR ANOTHER DAY ON ORBIT UTILIZING PRIMARY JETS (ONE IMU ALIGNMENT, -ZLV ATTITUDE), PLUS ALLOW NORMAL DEORBIT PREPARATION ACTIVITIES. @[051194-1612A]

Deorbit wave-off extension day: Consumables required to support a deorbit wave-off, 24 hours of orbit stay time, plus an additional deorbit preparation are protected.

10. POSTLANDING REQUIREMENTS.

Self-explanatory.

11. 24-HOUR FLIGHT EXTENSION DAY - RESERVES CONSUMABLES FOR ORBITER MAINTENANCE ACTIVITIES WITH NORMAL SYSTEMS CONFIGURATIONS. THIS INCLUDES 24 HOURS OF ATTITUDE CONTROL UTILIZING VERNIER JETS (ONE IMU ALIGNMENT, -ZLV ATTITUDE REFERENCE RULE {A6.1.5-3D}, OMS REDLINES (CIL)). THE 24-HOUR FLIGHT EXTENSION DAY MAY BE GIVEN UP FOR HIGHER PRIORITY ACTIVITIES (REF. PARAGRAPH C). @[051194-1612A]

B. VIOLATION OF THE RESERVES IDENTIFIED IN PARAGRAPH A WILL BE CAUSE TO SCHEDULE ENTRY AT THE NEXT PLS OPPORTUNITY (EXCEPT FOR LOSS OF THE 24-HOUR FLIGHT EXTENSION DAY CAPABILITY).

THIS RULE CONTINUED ON NEXT PAGE

FLIGHT RULES

A2.1.3-7 CONSUMABLES MANAGEMENT (CONTINUED)

C. FOR CONSUMABLES CONTINGENCIES, FLIGHT ACTIVITIES IN ORDER OF PRIORITY (HIGHEST FIRST) ARE AS FOLLOWS:

<u>PRIORITY</u>	<u>FLIGHT ACTIVITY</u>
1.	TARGET 45 DEGREES TO 90 DEGREES PREBANK.
2.	TARGET 0 DEGREES TO 45 DEGREES PREBANK.
3.	SHORTEN MISSION TO LESS THAN MDF. [1]
4.	RAISE ORBIT TO MINIMUM ALTITUDE REQUIRED TO ALLOW MINIMUM PAYLOAD DEPLOY ACTIVITIES. [2]
5.	DELETE 24-HOUR FLIGHT EXTENSION DAY. [3]
6.	DELETE FLIGHT SPECIFIC ACTIVITIES (MDF PLUS 2 DAY EXTENSION CAPABILITY REMAIN HIGHER PRIORITY THAN FLIGHT SPECIFIC ACTIVITIES).[4]

NOTE: EXCEPT FOR THE 24-HOUR FLIGHT EXTENSION DAY, CONSUMABLES RESERVED IN PARAGRAPH A HAVE HIGHER PRIORITY THAN THE ABOVE TABLE.

NOTES:

- [1] SHORTEN IN INCREMENTS OF NEXT DAILY PLS OPPORTUNITIES.
- [2] REFERENCE FLIGHT RULES ANNEX, SECTION A2, PAYLOAD FLIGHT OPERATIONS, FOR MINIMUM DEPLOY ALTITUDE AND DEPLOYABLE PAYLOAD PRIORITIES.
- [3] ASSUMES VERNIER JET CONTROL, ONE IMU ALIGNMENTS/DAY, PLUS -ZLV +XVV ATTITUDE CONTROL (REF. RULES {A6.1.5-3}, OMS REDLINES (CIL); {A6.1.5-4}, FORWARD RCS REDLINES; AND {A6.1.5-5}, AFT RCS REDLINES). ©[051194-1612A]

THIS RULE CONTINUED ON NEXT PAGE

FLIGHT RULES

A2.1.3-7

CONSUMABLES MANAGEMENT (CONTINUED)

[4] REFERENCE FLIGHT RULES ANNEX. DECREASING THE PAYLOAD DEPLOY SEPARATION MANEUVER TO THE MINIMUM REQUIRED DELTA V MAY BE ACCEPTABLE TO ACHIEVE MAJOR FLIGHT SPECIFIC OBJECTIVES (REFERENCE FLIGHT RULES ANNEX, SECTION X4, FOR PRIORITIES). MINIMUM SEPARATION DELTA V REQUIREMENTS ARE:

IUS	10 FPS
SYNCOM	6 FPS
PAM DII	3 FPS
PAM	2 FPS

When insufficient consumables are available to complete planned mission activities, the priority table is used to determine the remaining capability by deleting items from the bottom and moving upwards. A discussion of each priority follows:

Priority 6. Delete flight-specific activities: All flight specific activities are prioritized in the Flight Rules Annex. The priority of each activity considering specific flight objectives is established prelaunch. Implementation of the Flight Rule Annex priority table must be completed before deleting high priority activities identified in this table.

Priority 5. Delete 24-hour flight extension day: The 24-hour flight extension day provides the capability to delay the deorbit burn for 24 hours if weather, etc., make landing on the planned day unacceptable. Consumables budgeted for the 24-hour extension assume VRCS control and minimum orbiter maintenance activities (IMU align, etc.). Because the consumables reserved for the extension are minimal, deleting priority 5 will not normally provide the capability to achieve higher priority objectives.

Combined with the deorbit preparation/wave-off capability reserved at a higher level than the priority table, the 24-hour extension capability provides a total capability of three deorbit opportunities and two deorbit preparations. It is the intent to maintain the 24-hour extension capability at a high priority to account for unforeseen weather problems (due to the unpredictability of the weather and forecasting uncertainty).

Priority 4. Raise orbit to minimum altitude required to allow minimum payload deploy activities: Because deploying the payload is highly desirable to reduce orbiter entry weight, decrease required deorbit consumables, and provide for improved c.g. and flight control margins, if the possibility exists where deleting the 24-hour extension day will allow sufficient propellant to reach the minimum payload deploy altitude, then payload deploy will have priority over extension day requirements.

Priority 3. Shorten mission to less than MDF: All activities will be deleted to protect MDF requirements.

FLIGHT RULES

THIS RULE CONTINUED ON NEXT PAGE

FLIGHT RULES

A2.1.3-7 CONSUMABLES MANAGEMENT (CONTINUED)

Priority 2. Target 0 to 45 degrees prebank: Flight Techniques concluded that the minimal propellant gained as a result of committing to a prebank for the deorbit burn did not warrant the increased procedural/crew task complexity associated with the prebank (reference Entry Techniques minutes DA8-86-59).

Priority 1. Target 45 to 90 degrees prebank: Committing to a prebank greater than 45 degrees introduces considerable impact to the orbiter as a result of the increased thermal environment. Consequently, prebank greater than 45 degrees will only be utilized to protect the minimum requirements established as a higher priority than the priority table.

The following rules reference this rule:

{A2.1.3-22A.5}, RNDZ/PROX OPS PROPULSION SYSTEMS MANAGEMENT;

{A6.1.2-17}, OMS FAILURE MANAGEMENT (CIL);

{A6.1.4-1}, OMS PROPELLANT MANAGEMENT MATRIX;

{A6.1.4-4}, RCS ENTRY REDLINE PROTECTION;

{A6.1.4-5}, OMS PROPELLANT DEFICIENCY FOR DEORBIT;

{A6.1.5-3D}, OMS REDLINES (CIL);

{A6.1.5-4}, FORWARD RCS REDLINES;

{A6.1.5-5}, AFT RCS REDLINES;

{A6.1.5-6}, VIOLATION OF MISSION COMPLETION REDLINES MATRIX;

{A9.1.6-7C},

P

OWER REACTANT STORAGE AND DISTRIBUTION (PRSD) H2 AND O2 REDLINE DETERMINATION. [ED]

FLIGHT RULES

A2.1.3-8

PREFERRED ATTITUDE FOR WATER DUMPS

A. TO MINIMIZE RECONTACT POTENTIAL OF HIGH VELOCITY WATER PARTICLES WITH THE ORBITER OR PAYLOADS, SPECIFIC DUMP ATTITUDES ARE PREFERRED DURING SUPPLY/WASTE WATER DUMPS. THE REQUIRED ATTITUDE DEPENDS ON THE ORBITER POSITION RELATIVE TO THE PAYLOAD. THAT POSITION IS DEFINED AS BEING IN ONE OF FOUR REGIONS IN THE PAYLOAD CENTERED LVLH FRAME DEPICTED IN THE FOLLOWING DIAGRAM.

PREFERRED ATTITUDE FOR WATER DUMPS

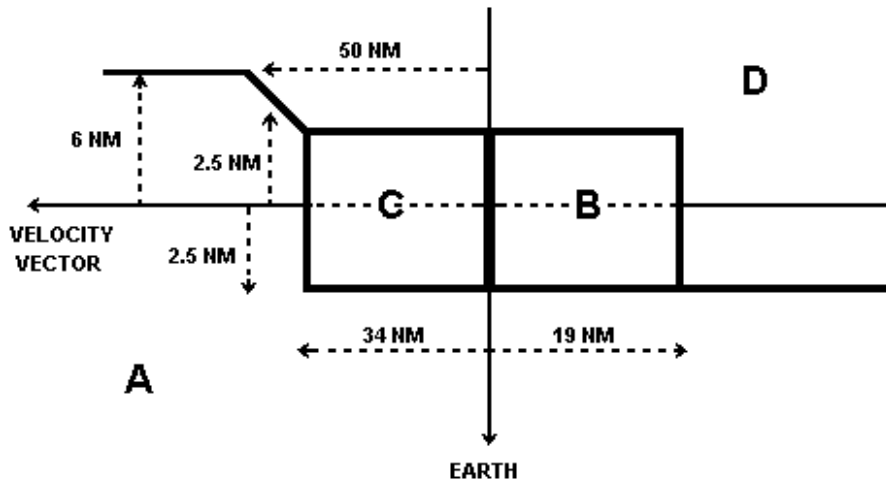

REGION	DUMP ATTITUDE	RESTRICTIONS
A	+YVV (RETROGRADE DUMP)	THE ORBITER RELATIVE APOGEE MUST BE BELOW THE BOUNDARY OF REGION A. THE ORBITER MUST REMAIN WITHIN REGION A FOR THE DURATION OF THE DUMP.
B	+YVV (RETROGRADE DUMP)	THE ORBITER MUST BE IN A STATIONKEEPING OR SLOW SEPARATION SITUATION AND REMAIN WITHIN REGION B FOR THE DURATION OF THE DUMP.
C	+Y 40 DEG OUT OF PLANE FROM VV (BIASED RETROGRADE DUMP)	THE ORBITER MUST BE IN A STATIONKEEPING OR SLOW SEPARATION SITUATION AND REMAIN WITHIN REGION C FOR THE DURATION OF THE DUMP.
D	-Y 20 DEG OUT OF PLANE FROM VV (BIASED RETROGRADE DUMP)	THE ORBITER RELATIVE PERIGEE MUST BE ABOVE THE BOUNDARY OF REGION D. THE ORBITER MUST REMAIN WITHIN REGION D FOR THE DURATION OF THE DUMP.
ORBITER ALONE	+YVV (RETROGRADE DUMP)	INCLUDES PAYLOAD ATTACHED CASE.

THIS RULE CONTINUED ON NEXT PAGE

FLIGHT RULES

A2.1.3-8 PREFERRED ATTITUDE FOR WATER DUMPS (CONTINUED)

- B. THE FOLLOWING GUIDELINES ARE TO BE USED FOR THE CASE OF INTERSECTING ORBITS WHICH DO NOT SATISFY REGIONS A, B, C, OR D ABOVE.
1. IF THE ORBITS INTERSECT WITH THE ORBITER BEHIND THE PAYLOAD AND THE ORBITER IS MOVING AWAY FROM THE PAYLOAD OR CLOSING AT LESS THAN 50 NM/REV, THEN THE DUMP ATTITUDE WILL BE -Y, 20 DEG OUT OF PLANE FROM +VV (BIASED POSIGRADE).
 2. IF THE ORBITS INTERSECT WITH THE ORBITER AHEAD OF THE PAYLOAD AND THE ORBITER IS MOVING AWAY FROM THE PAYLOAD OR CLOSING AT LESS THAN 50 NM/REV, THEN THE DUMP ATTITUDE WILL BE -Y, 20 DEG OUT-OF-PLANE FROM -VV (BIASED RETROGRADE).
 3. DUMPS FOR CASES 1 AND 2 SHOULD BE COMPLETED AT LEAST TWO ORBITS BEFORE THE POINT OF CLOSEST APPROACH.
- C. GENERIC ATTITUDE RECOMMENDATIONS CANNOT BE MADE FOR ORBITAL GEOMETRIES WHICH DO NOT MEET THE CONDITIONS LISTED ABOVE.

These recommendations were approved at the On-Orbit Flight Techniques Panel #120. The major ground rules and assumptions are listed below:

- a. *Particle ejection velocity is assumed to be between 30 and 100 ft/sec. Measurements from an STS-29 supply dump video show particle velocities of 30-75 ft/sec. It is also known that waste dump rates are typically 3.3 lb/min, compared to 2.5 lb/min for supply dumps. Since each dump uses the same nozzle, the maximum velocity for a waste dump is assumed to increase in proportion to the flowrate. Thus, the maximum velocity is $3.3/2.5 \times 75 = 100$ ft/sec.*
- b. *The distribution of particle ejection angles is such that 95 percent of the particles are ejected within a 10 degree half-cone angle of the orbiter -Y axis. An additional 10 degree half-cone angle is protected in these recommendations.*
- c. *The boundaries protect a 1 nm radius sphere of position uncertainty for both the orbiter and payload.*
- d. *All particles are assumed to experience more atmospheric drag than either the orbiter or the payload.*

Retrograde dumps preclude particle recontact because differential drag aids in moving particles downward and forward.

Posigrade dumps may result in an eventual return of particles due to differential drag. Some particles may travel to the vicinity of the payload on the first orbit. The intensity of recontact is minimized by the following effects which act to disperse the particle cloud:

FLIGHT RULES

- a. *Differential drag among particles of different sizes.*
- b. *Out-of-plane velocity of particles minimizes time in plane.*
- c. *Particles sublimate over time.*

FLIGHT RULES

A2.1.3-9 STRUCTURES THERMAL CONDITIONING

A. IF ANALYSIS SHOWS THAT ALL THERMAL CONSTRAINTS ARE SATISFIED (THROUGH EI, INCLUDING WAVEOFFS) PRIOR TO EXECUTION OF THE DEORBIT PREP ATTITUDE SEQUENCE DEFINED BELOW, REAL-TIME THERMAL ANALYSIS OF THE NOMINAL AND WAVEOFF DEORBIT ATTEMPTS IS NOT REQUIRED. @J050495-1768A]

NOTE: THE BENDING-EFFECT TEMPERATURE (BET) PROFILE WILL BE PREDICTED ON A FLIGHT-SPECIFIC BASIS TO DETERMINE THE MAXIMUM TIME TO PLBD CLOSURE.

TIG --4:40 MNVR TO IMU ALIGNMENT AND VERIFICATION
ATTITUDES (ANY INERTIAL) @J072398-6645]

TIG - 4:00 MNVR TO TAIL SUN/COLD SOAK ATTITUDE COMPLETE
BIASED -XSI: PITCH +184, YAW 0,
OMICRON 270 FOR + BETA
90 FOR - BETA

~~TIG --2:58 MNVR TO IMU ALIGNMENT AND VERIFICATION--~~
~~ATTITUDES (ANY INERTIAL) @J050495-1768A]~~

TIG - 2:55 RAD BYPASS, FES CHECKOUT @J072398-6645]

TIG - 2:40 PLBD CLOSING

TIG - ≈2:25* MNVR TO THERMAL/COMM ATTITUDE WITH THE
FOLLOWING GENERIC REQUIREMENTS: @J072398-6645]--
(INTERIM):

1. SUN LOS VECTOR AT -X BODY AXIS ± 30 DEGREES IN YAW AND ± 5 DEGREES IN PITCH (SUN TO STARBOARD DESIRED).
2. ROLL ORIENTATION ABOUT THE SUN VECTOR SELECTED TO OPTIMIZE S-BAND COMM. DESIRE TO BE PLB TO SPACE AT NOON. @J050495-1768A]

TIG - :2015** MNVR TO DEORBIT BURN ATTITUDE (ANY) @J072398-6645]

TIG + ≈:05 MNVR TO EI ATTITUDE (ANY)

* MNVR TO THE THERMAL/COMM ATTITUDE AT THE EARLIEST OPPORTUNITY FOLLOWING PAYLOAD BAY CLOSURE IMU ALIGN AND VERIFY TO IMPROVE ORBITER THERMAL CONDITIONING FOR ENTRY. @J072398-6645]

FLIGHT RULES

** FOR WAVEOFFS WHICH ARE DECLARED AFTER THE START OF DEORBIT PREP, THE ADDITIONAL TIME WILL BE SPENT IN THE COMM ATTITUDE. IF WAVEOFF IS DECLARED AFTER THE MNVR TO THE D/O BURN ATTITUDE, MNVR BACK TO THE COMM ATTITUDE UNTIL THE NEXT D/O TIG-~~2015~~ MINUTES. ©[050495-1768A] |
[@\[072398-6645\]](#)

THIS RULE CONTINUED ON NEXT PAGE

FLIGHT RULES

A2.1.3-9 STRUCTURES THERMAL CONDITIONING (CONTINUED)

B. IF THE ABOVE SEQUENCE IS NOT FOLLOWED, FLIGHT-SPECIFIC ANALYSIS IS REQUIRED. FLIGHT-SPECIFIC ANALYSIS OF NOMINAL DEORBIT PREP PLUS WAVEOFF ATTITUDES WILL EVALUATE THE FOLLOWING SEQUENCES:

1. NOMINAL:

	XSI	IMU	COMM	DEORBIT	EI	
	- IMU -	- XSI -	- COMM -	- DEORBIT -	- EI -	@[072398-6645]
	PLBD		EOM			
	CLOSE		TIG			

2. NOMINAL + 1 REV:

	XSI	IMU	COMM	COMM	DEORBIT	EI	
	- IMU -	- XSI -	- COMM -	- COMM -	- DEORBIT -	- EI -	@[072398-6645]
	PLBD		EOM		EOM+1 REV		
	CLOSE		TIG		TIG		

3. NOMINAL + 2 REVS:

	XSI	IMU	COMM	COMM	COMM	DEORBIT	EI	
	- IMU -	- XSI -	- COMM -	- COMM -	- COMM -	- DEORBIT -	- EI -	@[072398-6645]
	PLBD		EOM		EOM+1 REV		EOM+2 REVS	
	CLOSE		TIG		TIG		TIG	

WORST-CASE EI BONDLINE LIMITS (FROM ALL POSSIBLE DEORBIT OPPORTUNITIES) WILL BE USED.

DETAILS REGARDING THE USE OF COMPUTER ANALYSIS TO EVALUATE DEORBIT ATTITUDE SEQUENCES ARE PROVIDED IN FLIGHT RULES {A18.1.9-1}, THERMAL PROTECTION SYSTEM (TPS) BONDLINE TEMPERATURES, AND {A18.1.10-1}, ORBITER THERMAL CONSTRAINTS AND ATTITUDE MANAGEMENT (CIL).

THIS RULE CONTINUED ON NEXT PAGE

FLIGHT RULES

A2.1.3-9 STRUCTURES THERMAL CONDITIONING (CONTINUED)

C. THE FOLLOWING GUIDELINES FOR PRE-ENTRY THERMAL CONDITIONING SHOULD BE USED FOR INITIAL PREFLIGHT PLANNING PURPOSES:

<u>BETA ANGLE AT START OF THERMAL CONDITIONING</u>	<u>10 HOURS OF:</u>	<u>FOLLOWED BY:</u>
0 TO ~ 60 DEGREES	-ZLV, PTC OR ±XLV, ±ZVV	NORMAL DEORBIT ATL SEQUENCE AS DEFINED IN PARAGRAPH A
> ~ 60 DEGREES	PTC	NORMAL DEORBIT ATL SEQUENCE AS DEFINED IN PARAGRAPH A

@[050495-1768A]

FLIGHT-SPECIFIC ANALYSIS OF THE ON-ORBIT TIMELINE WILL DETERMINE WHETHER SPECIAL THERMAL CONDITIONING IS NEEDED PRIOR TO DEORBIT PREP. IF FLIGHT-SPECIFIC THERMAL CONDITIONING IS REQUIRED, IT WILL BE DOCUMENTED IN THE FLIGHT RULES ANNEX. @[050495-1768A]

Depending on the flight-specific attitude timeline, it is possible that the deorbit prep attitude sequence described in paragraph a will not satisfy all orbiter or payload thermal constraints. This is especially true for high beta or attitude intensive missions. Attitudes during the last sleep and postsleep period are typically -ZLV, unless payload desires drive otherwise. If analysis of an attitude timeline predicts violations, then attitudes prior to deorbit prep may need to be modified to improve the predicted temperatures. Typical conditioning attitudes could be a specific LVLH orientation, solar inertial attitude, PTC, etc. The durations and orientations of these conditioning attitudes will be worked on a flight-specific basis, and the plan will be documented in the flight-specific annex.

D. DEORBIT BURN WILL NOT BE DELAYED IF A TPS BONDLINE TEMPERATURE IS ABOVE ITS FLIGHT-SPECIFIC LIMIT, PROVIDED ALL OF THE FOLLOWING ARE MET:

1. NO TPS BONDLINE VIOLATIONS WERE PREDICTED FOR THE PLANNED DEORBIT SEQUENCE.

FLIGHT RULES

2. RADIATOR COLDSOAK AND COMM ATTITUDES IN DEORBIT PREP HAVE BEEN CHOSEN TO MINIMIZE SOLAR EXPOSURE ON THE TPS BOND LINES. (THE COMM ATTITUDE MAY BE BIASED FROM TAIL-SUN AS SPECIFIED IN PARAGRAPH A TO MAINTAIN TDRS COMM.)
@[050495-1768A]

THIS RULE CONTINUED ON NEXT PAGE

FLIGHT RULES**A2.1.3-9 STRUCTURES THERMAL CONDITIONING (CONTINUED)**

3. IF, IN DEORBIT PREP, OFF-NOMINAL ATTITUDES AND/OR TIMES ARE REQUIRED DUE TO FAILURES OR OTHER UNEXPECTED SITUATIONS, THE PLANNED ATTITUDE TIMELINE IS RESUMED AS SOON AS CONDITIONS ALLOW. @[050495-1768A]
4. THE FLIGHT SPECIFIC EXCEEDENCE IS NO GREATER THAN 5 DEG OR HAS BEEN APPROVED BY THE MER.

Flight-specific limits on bondline temperatures at entry interface (EI) are defined in each flight-specific annex. These limits must be met when the attitude timeline is analyzed and bondline temperatures are predicted at EI. However, if a temperature is actually above its limit prior to the deorbit burn, the burn is not waved off, because reasonable actions are taken ahead of time to attempt to preclude violations. Any surprise violations should be very small, possibly even due to instrumentation error (which is not protected).

The flight-specific bondline limits protect orbiter thermal/structural certification envelopes (with 1.4 factor of safety (FOS) during "design entry" mechanical loading). The bondline temperature upper limits are in place to protect a gradient temperature. Since the method of gradient protection is generic, and the limits protect for design cases plus 1.4 FOS, it is considered less risk to proceed with a small violation than to wave off deorbit burn. On STS-55, a 3-degree violation of V09T1012 occurred at entry interface. More detailed assessment by Engineering indicated that in this case there was actually approximately 20 degrees margin at TAEM and touchdown (the points really being protected).

A cold attitude(s) will be used for radiator coldsoak and "comm attitude", to reduce bondline temperatures to the extent possible during deorbit prep. It is typically difficult, however, to satisfy the bondline limits, even when cold attitudes are chosen such as tail-sun or nose-sun. If bondline solar exposure is already minimized, there would be little or no corrective action available so nothing is gained by delaying the deorbit burn. STEP will be the primary tool used by the MCC to analyze the nominal attitude timeline. Any predicted violations (which include STEP accuracy biases) will be resolved either by (1) changing attitudes, including those prior to deorbit prep if necessary, or (2) by comparing STEP predictions to previous flight data in similar beta angles and attitudes, or to other thermal models, and "outvoting" the STEP prediction. The rationale for Rule {A18.1.9-1}, THERMAL PROTECTION SYSTEM (TPS) BONDLINE TEMPERATURES, provides more information on STEP analysis and biases.

Instrumentation error is not protected for the bondline temperature sensors. Instrumentation error is not considered in the structural analyses which are used to generate the EI limit models, nor are any other uncertainties. When analyzing structural stress, it is generally not known whether a positive or negative error causes worse structural gradients, so only "actual" temperatures are used. Analysis of all possible uncertainty combinations would require prohibitively large numbers of simulations. Also, inclusion of instrumentation error would cause frequent limit exceedences.

THIS RULE CONTINUED ON NEXT PAGE

FLIGHT RULES

A2.1.3-9 STRUCTURES THERMAL CONDITIONING (CONTINUED)

If real-time deviations from the planned attitude timeline are required (for reasons such as single star tracker IMU aligns, missed stars, time taken to troubleshoot a failure, etc.), they will take priority and will not be rushed or canceled in favor of bondline thermal limits. However, the orbiter will return to the planned cold attitude as soon as the situation allows, and deorbit burn will proceed as planned. ©[050495-1768A]

A small limit exceedence of up to 5 degrees is acceptable to the technical community without further discussion. Exceedences greater than 5 degrees should be understood or accepted given whether it could realistically be brought back into tolerance by further activity prior to deorbit. ©[050495-1768A]

Documentation: Ascent/Entry Flight Techniques #111, 3/25/94; Orbiter CCB 6/14/94, 8/9/94; Engineering Judgment. ©[050495-1768A]

E. ADEQUATE THERMAL CONDITIONING IS PROVIDED FOR EMERGENCY ABORTS FROM ORBIT BY MAINTAINING NORMAL THERMAL LIMITS AND BY ENSURING THAT THE PROJECTED MISSION PROFILE OF BENDING EFFECT TEMPERATURE (BET) REMAINS LESS THAN 200 DEG F. THERE ARE NO BONDLINE TEMPERATURE CONSTRAINTS FOR EMERGENCY DEORBIT.

Maintaining BET < 200 deg F ensures that PLBD closing can be accomplished for anytime deorbit opportunities. Typical bondline temperature constraints for EI protect for a 1.4 factor of safety above design structural loads. Since typical entry loads are well below design loads, it is not necessary to protect the 1.4 factor of safety over design entry loads in the event of an emergency deorbit.

DOCUMENTATION: SODB, pg 3.4.1.1-5, and NASA JSC Memo ES2-93-096.

Rule {A18.1.10-1}, ORBITER THERMAL CONSTRAINTS AND ATTITUDE MANAGEMENT (CIL), references this rule.

Reference Rule {A10.1.11-6}, PLBD CLOSE GO/NO-GO, for BET definition and constraints.

FLIGHT RULES

A2.1.3-10

RESERVED @021199-6747B) OMS/RCS PROPELLANT REQUIRED TO COMMIT TO EVA/MMU OPERATIONS

~~A. TO BE "GO" FOR MMU EVA, OMS/RCS PROPELLANT MUST BE AVAILABLE TO PERFORM THE FOLLOWING:~~

- ~~1. FRCS DEORBIT REDLINE (REF. RULE {A6.1.5-4A}, FORWARD RCS REDLINES).~~
- ~~2. NOMINAL ARCS ENTRY REDLINE (REF. RULE {A6.1.5-5A.1}, AFT RCS REDLINES).~~
- ~~3. OMS DEORBIT REDLINE (REF. RULES {A6.1.5-3A}, OMS REDLINES (CIL); AND {A6.1.5-5A.2}, AFT RCS REDLINES) MODIFIED TO SHALLOW THE DEORBIT TARGETS TO PERFORM TO THE MAXIMUM OF 45 DEGREES PREBANK AND TO PERFORM EVA (REF. RULE {X2.1.5-2}, PROPELLANT USAGE VS FLIGHT ACTIVITY). @ED]~~

~~OMS and RCS deorbit redlines must be protected in order to remain on orbit. Violation of propellant redlines is cause to enter at the next PLS opportunity. The Flight Rules Annex for a specific flight may allow shallowing deorbit burn targets to 45 degrees prebank in order to accomplish the EVA.~~

- ~~4. ONE DAY ATTITUDE CONTROL FOR ENTRY STOWAGE FOLLOWING A RESCUE (NOMINALLY VRCS 1 DEGREE DB, ZLV +XVW WITH ONE IMU ALIGN). @054194-1612A]~~
- ~~5. DEORBIT PREPARATION.~~

~~Following an EVA, up to 1 day of attitude control may be required to reach the next PLS deorbit opportunity. Propellant must also be available to cover a nominal deorbit preparation. Propellant budgets for 1 day attitude control and deorbit preparation are documented in Rules {A6.1.5-1}, OMS USABLE PROPELLANT; {A6.1.5-2}, RCS USABLE PROPELLANT; and {A6.1.5-3}, OMS REDLINES (CIL).~~

- ~~6. PROPELLANT FOR ACTIVITIES SCHEDULED DURING NOMINAL EVA.~~

~~Propellant must be available to complete EVA activities in order to initiate an EVA. Mean propellant usages will be covered.~~

~~THIS RULE CONTINUED ON NEXT PAGE~~

FLIGHT RULES

THIS PAGE INTENTIONALLY BLANK

FLIGHT RULES

A2.1.3-11

~~RESERVED @[021199-6747B] ORBITER OMS/RCS PROPELLANT
REDLINE TO TERMINATE MMU RESCUE~~

~~A. THE FRCS WILL BE USED TO DEPLETION AS EVIDENCED BY
MULTIPLE FAIL-OFF JETS. RESCUE WILL CONTINUE USING ARCS
ONLY.~~

~~*The FRCS system is not critical for deorbit or entry. This propellant will be sacrificed in order to complete an MMU rescue attempt. Multiple jet failures are indicative of helium ingestion through the jets following propellant depletion. A single jet failure may be unrelated to propellant depletion.*~~

~~B. THE MMU RESCUE WILL BE TERMINATED WHEN OMS/ARCS PROPELLANT
DECREASES TO THE TOTAL OF:~~

~~1. ARCS:~~

~~a. NO YAW JET ARCS ENTRY REDLINE (MACH 10) (REF. RULE
{A6.1.5-5A.3}, AFT RCS REDLINES).~~

~~b. DEORBIT PREPARATION USING PRCS TAIL-ONLY CONTROL
(302 LB). @[051194-1612A]~~

~~c. ONE DAY ATTITUDE HOLD -ZLV YPOP 10 DEGREES
DEADBAND WITH ONE IMU ALIGN USING PRCS ALT TAIL-
ONLY CONTROL (63 LB). @[051194-1612A]~~

~~d. PREBANK REQUIREMENTS (150 LB).~~

~~THIS RULE CONTINUED ON NEXT PAGE~~

FLIGHT RULES

A2.1.3-12 DPS COMMAND CRITERIA

- A. GPC MEMORY WRITE PROCEDURES CAN BE USED IN FLIGHT TO MODIFY DATA AND CODE IN BOTH THE PASS AND BFS.

The Orbiter Avionics Software Board (OASCB) has authorized the use of GPC memory write procedures to modify data or code in PASS or BFS. This is allowed to restore orbiter capabilities lost because of real-time orbiter hardware problems or to correct software problems that do not require a recompilation of the software.

- B. THE USE OF GPC MEMORY WRITE PROCEDURES ARE SUBJECT TO THE GUIDELINES DEFINED BY RULE {A7.1.3-6}, GPC MEMORY WRITE CRITERIA (CIL).

All GPC memory procedures must adhere to rigorous verification prior to their use to ensure crew and vehicle safety. Reference Rule {A7.1.3-6}, GPC MEMORY WRITE CRITERIA (CIL), for such guidelines, as well as the different types of GPC memory write procedures.

THIS RULE CONTINUED ON NEXT PAGE

FLIGHT RULES

A2.1.3-12 DPS COMMAND CRITERIA (CONTINUED)

C. DEU EQUIVALENT COMMANDING DURING CREW SLEEP WILL NOT BE PERFORMED UNTIL ALL OF THE FOLLOWING REQUIREMENTS HAVE BEEN MET: @[072795-1775A]

1. CONFIRMED PERIOD OF AOS AND GOOD COMM BOTH BEFORE AND AFTER SCHEDULED COMPLETION OF THE DEU EQUIVALENT COMMAND LOAD.

A valid downlist is required for the MCC to be able to verify DEU equivalent command execution. In addition, an active downlist is required from the destination GPC or major function for the ground command processing software to verify the uplink and automatically send the buffer execute command. A period of good comm is required so that the crew can be contacted in the event of an off nominal situation. During maneuvers, there may be brief periods of LOS or bad comm while the vehicle changes attitudes. These brief periods are acceptable, as long as the resultant attitude is confirmed to have good comm.

2. THE MCC MUST BE ABLE TO VERIFY ALL DEU EQUIVALENT LOADS VIA METHODS OTHER THAN SCRATCHPAD LINE RESPONSE.

Due to the timing differences between the downlist cycle and when the GPC polls the DEU, the possibility exists such that all uplinked commands may not be seen on the downlisted scratchpad line. Since there is a requirement for ground confirmation of all DEU loads, there must be an alternate way to verify the uplink through end item telemetry feedback's. @[072795-1775A]

3. DEU EQUIVALENT LOADS SHOULD AVOID CONTAINING ITEM SERIES WHICH MUST BE UPLINKED AT A SPECIFIC TIME OR WITHIN A SPECIFIC TIME INTERVAL. @[072795-1775A]

Due to the dynamic nature of commanding and the requirement for good comm and AOS to allow the MCC to properly verify the execution of each DEU equivalent load, there may be times when the ground cannot uplink a required load at a specific time. Therefore, the MCC should not be constrained by specific time requirements for DEU equivalent loads. There may be occasions where this cannot be avoided, but time specific loads need to be closely analyzed for any risks associated with delaying their uplink.

THIS RULE CONTINUED ON NEXT PAGE

FLIGHT RULES

A2.1.3-12 DPS COMMAND CRITERIA (CONTINUED)

4. IF A SERIES OF DEU EQUIVALENT LOADS ARE PLANNED, THE IMPACT OF NOT COMPLETING ALL UPLINKS MUST BE EVALUATED. FUTURE MANEUVER LOADS, CREW ALERT SPC'S, AND/OR CREW BAILOUT ATTITUDES MUST BE USED AS REQUIRED TO PROVIDE AN APPROPRIATE LEVEL OF PROTECTION FOR UNEXPECTED LOSS OF COMMUNICATION.

Due to the dynamic nature of commanding and the requirement for good comm and AOS to allow the MCC to properly verify the execution of each DEU equivalent load, there may be times when the ground cannot uplink a required load at a specific time. Because of this, there exists the potential to be in a specific orbiter configuration longer than originally intended. The MCC must have evaluated all associated risks (e.g., comm, thermal, payload constraints, etc.) with these situations and analyzed the cost/benefit tradeoff before proceeding with the uplink of the first load.

Based on the complexity of the desired DEU equivalent load(s) there may or may not be a desire to use a crew alert SPC to wake the crew at some time in the future in case an off nominal situation were to occur. The SPC would be set to time out far enough in advance to allow the MCC to clear it once they were able to verify the correct orbiter configuration after the DEU equivalent execution was complete. The crew should be notified prior to sleep of any potential bailout attitudes in the event they are awakened by an SPC and cannot establish communications with the MCC.

5. DPS DEU EQUIVALENT COMMANDING ARE SATISFIED PER RULE {A7.1.3-22}, DEU EQUIVALENT CRITERIA. ©[072795-1775A]

A2.1.3-13 PDRS

- A. NORMAL PDRS OPERATIONS WILL CEASE AND THE RMS WILL BE CRADLED IF BACKUP PLUS ONE OTHER SINGLE JOINT MODE IS NOT AVAILABLE TO DRIVE EACH JOINT.

Reference Rule {A12.1.1-1}, EVA FOR RMS OPERATION, for rationale.

- B. ANY ORBITER FAILURE THAT REQUIRES A NEXT PLS DEORBIT OPPORTUNITY IS CAUSE TO TERMINATE RMS ACTIVITIES IMMEDIATELY.

In the event of a next PLS situation, the orbiter must be configured for entry as soon as possible, which requires that the RMS be cradled, latched, and stowed prior to PLBD closing. If critical operations are being performed, such as berthing a payload, the situation may allow for those operations to be completed depending on the time available prior to deorbit.

THIS RULE CONTINUED ON NEXT PAGE

FLIGHT RULES

A2.1.3-13 PDRS (CONTINUED)

C. EVA IS CONSIDERED A BACKUP CAPABILITY FOR THE FOLLOWING RMS FUNCTIONS FOR THE ACCOMPLISHMENT OF HIGH PRIORITY OBJECTIVES AS DEFINED IN THE FLIGHT SPECIFIC ANNEX:

1. END EFFECTOR RELEASE.
2. MPM STOW/DEPLOY.
3. MRL LATCHES.
4. SHOULDER BRACE RELEASE.
5. RMS CRADLE.

EVA techniques exist to accomplish the above activities. For high priority objectives, it may be acceptable to continue with the redundant method of accomplishing these operations requiring an EVA. Operating under these conditions is still safe since the arm can be jettisoned if an EVA cannot be performed.

D. NORMALLY DURING CREW SLEEP PERIODS OF NON-RMS OPERATIONS, THE RMS WILL BE CRADLED AND LATCHED AND THE SYSTEM LEFT IN THE TEMPERATURE MONITOR MODE.

This is the safest configuration should an emergency entry be required and protects against RMS or MRL failures. There is no system constraint against leaving the arm out other than as noted in paragraph E.

E. CONSIDERATION WILL BE GIVEN TO PARKING THE RMS DURING CREW SLEEP PERIODS IF A PAYLOAD CANNOT BE BERTHED AND DEORBIT IS NOT PLANNED WITHIN 24 HOURS.

In the event of a PRLA failure or some other failure which prevents berthing the payload, the RMS/payload may be positioned and left with the brakes on during crew sleep. Various factors must be considered in order to accept this including payload inertias which have an important effect on DAP stability. In addition, when large payloads are attached to the arm with the brakes on, PRCS control jet firings can result in large arm movements which are not annunciated as failures. MCC must be able to monitor joint movement during the sleep period.

THIS RULE CONTINUED ON NEXT PAGE

FLIGHT RULES

A2.1.3-13 PDRS (CONTINUED)

F. PRIOR TO RMS AND/OR PAYLOAD JETTISON, AN EVA MAY BE PERFORMED TO AID PAYLOAD BERTHING, ARM CRADLE, AND/OR STOWAGE OF THE RMS WHEN ALL OTHER ATTEMPTS HAVE FAILED.

EVA techniques are available for RMS cradle and latch as well as the MPM. In addition, EVA techniques may be possible for releasing, berthing, and latching of the payload in the event of a failed RMS. In essence, this rule gives authority to attempt any method to berth the payload and/or cradle the arm prior to payload and/or arm jettison.

G. ONCE THE MPM'S ARE DEPLOYED, PROVIDING THERE IS DUAL-MOTOR STOW CAPABILITY, THE MPM'S MAY BE LEFT DEPLOYED UNTIL THE RMS MISSION OPERATIONS ARE COMPLETED.

Reference Rule {A12.1.6-2}, EE CAPTURE/RIGIDIZE, for rationale.

Rule {A2.1.3-3}, SYSTEMS REDUNDANCY REQUIREMENTS, references this rule.

A2.1.3-14 OMS/RCS DOWNMODING CRITERIA

A. OMS/RCS DOWNMODING IS DEFINED AS THE CHANGING OF THE OMS/RCS ENGINE CONFIGURATION(S) SO AS TO ALLOW CONTINUATION OF A DELTA V MANEUVER:

1. DUAL REDUNDANCY DOWNMODE (TRIPLE DOWNMODE) PROTECTION IS DEFINED AS THE CAPABILITY TO CHANGE THE BURN CONFIGURATION FROM THE OMS ENGINES TO ONE OMS ENGINE AND FURTHER DOWNMODE TO RCS WHILE STILL RETAINING THE ABILITY TO COMPLETE THE PLANNED MANEUVER.

2. SINGLE REDUNDANCY DOWNMODE IS DEFINED AS TWO OMS, ENGINES DOWNMODE TO ONE OMS ENGINE, ONE OMS ENGINE DOWNMODE TO RCS, OR RCS RM DOWNMODE TO MAINTAIN TWO \pm X JETS.

B. DOWNMODING FROM TWO OMS ENGINES TO ONE OMS ENGINE IN RESPONSE TO AN ENGINE FAILURE IS ALLOWED UTILIZING OMS CROSSFEED AS REQUIRED.

THIS RULE CONTINUED ON NEXT PAGE

FLIGHT RULES

A2.1.3-14 OMS/RCS DOWNMODING CRITERIA (CONTINUED)

- C. FOR ONE OMS ENGINE MANEUVER DOWNMODING TO RCS, THE BURN CAN BE CONTINUED USING OMS PROPELLANT (ON-ORBIT ONLY IF RCS WAS INTERCONNECTED DURING THE OMS BURN) OR RCS PROPELLANT TO RCS JETS AS LONG AS DEORBIT PROPELLANT REQUIREMENTS ARE PROTECTED.

Due to lifetime concerns, single OMS engine burns will be planned when possible in order to increase OMS engine lifetime. Additionally, because a sufficiently large TIG slip capability exists during the orbit-critical burns, utilizing the RCS to provide a downmode capability is reasonable as long as sufficient RCS margin is available to perform the minimum required separation delta V. Declaring the RCS as a viable downmode option decreases the number of times two OMS engines will be scheduled for on-orbit-critical burns (i.e., increases lifetime).

Only the minimum separation delta V is obtained by the RCS to complete the burn (subsequent to an OMS engine failure). Minimum propellant resources are expended to satisfy safety criteria while optimizing remaining propellant (OMS and RCS) available to protect RCS steep deorbit requirements.

On-orbit, downmoding from two $\pm X$ jets to a different set of two $\pm X$ jets by RCS RM is allowable for crew safety-critical burns since the downmode provides the same single failure protection as the OMS/OMS and OMS/RCS downmodes.

A2.1.3-15 OMS/RCS MANEUVER CRITICALITY

- A. DELTA V MANEUVERS CRITICAL FOR CREW SAFETY WILL BE TARGETED SUBJECT TO THE FOLLOWING GUIDELINES:
1. OMS-1, OMS-2, AND DEORBIT BURNS WILL BE PERFORMED USING TWO OMS ENGINES UTILIZING DUAL OR SINGLE-DOWNMODE CAPABILITY (AS AVAILABLE) IF REQUIRED TO MEET DELTA V REQUIREMENTS.
 2. SPACECRAFT SEPARATION BURNS WILL BE PLANNED SUCH THAT A SINGLE-DOWNMODE CAPABILITY (OMS OR RCS) EXISTS TO MEET MINIMUM DELTA V REQUIREMENTS.

FLIGHT RULES

B. FLIGHT SUCCESS DELTA V MANEUVERS ARE DEFINED AS THOSE MANEUVERS ~~ESSENTIAL TO WHICH ARE CRITICAL FOR~~ FLIGHT SUCCESS ~~WHICH THAT~~ CANNOT BE ~~POSTPONED RESCHEDULED BEYOND~~ THE SPECIFIED (I.E., ONE REV LATER OR TIG SLIP). A SINGLE DOWNMODE ACTION WILL BE ACCOMPLISHED IF REQUIRED TO COMPLETE A FLIGHT SUCCESS DELTA V MANEUVER IF A PROPELLANT SYSTEM FAILURE DOES NOT EXIST, AND PROPELLANT IS AVAILABLE TO COVER RCS STEEP DEORBIT DELTA V REQUIREMENTS. @[121296-4213]

THIS RULE CONTINUED ON NEXT PAGE

FLIGHT RULES

A2.1.3-15 OMS/RCS MANEUVER CRITICALITY (CONTINUED)

C. NONCRITICAL DELTA V MANEUVERS ARE DEFINED AS ALL THOSE MANEUVERS WHICH DO NOT FALL IN THE CATEGORIES DEFINED IN PARAGRAPHS A AND B. DOWNMODING TO COMPLETE A NONCRITICAL BURN IS NOT ALLOWED.

For all maneuvers critical for crew safety, engine downmode capability is required to maintain fail-safe engine redundancy during the burn. Single OMS engine burns with downmode capability to the RCS +X jets are preferable to dual OMS engine burns, minimizing OMS engine starts, and increasing OMS engine lifetime. Sufficiently large delta V maneuvers such as OMS-1, OMS-2, and the deorbit burn will be performed using two OMS engines in order to avoid any OMS valve reconfiguration during a nominal burn (i.e., crossfeeding halfway through the burn so that OMS propellant remains balanced) and to reduce the amount of OMS propellant required for the burn if the downmode option is utilized. [ED]

For spacecraft separation burns, downmoding will be performed only to satisfy the minimum delta V requirement necessary to avoid any orbiter damage from the spacecraft PKM firing. Following an OMS engine failure, propellant redlines must be redefined to protect RCS steep deorbit capability and propellant may not be available to complete the separation maneuver to the nominal delta V requirement.

Downmoding will be performed on flight success delta V maneuvers only for OMS engine failures providing preburn analysis shows that sufficient propellant is available to protect RCS steep deorbit delta V requirements. For a propellant system failure or an engine failure and insufficient propellant remaining to protect RCS steep deorbit capability, the burn must be terminated and deorbit will be attempted at the next PLS opportunity. The Flight Rules Annex may redefine the deorbit propellant requirement to allow RCS deorbit to 45-degree prebank targets.

Downmoding will not be performed on noncritical burns so that propellant redlines can be redefined prior to committing propellant to a delta V maneuver unnecessarily.

FLIGHT RULES

A2.1.3-16 ENGINE SELECTION CRITERIA

ENGINE SELECTION WILL BE BASED UPON OMS/RCS DOWNMODING CRITERIA, MANEUVER CRITICALITY, AND THE SPECIFIC DELTA V REQUIREMENTS FOR THE MANEUVER:

- A. DELTA V < 6 FPS - PERFORM MANEUVER WITH RCS. DOWNMODING PROTECTION IS PROVIDED BY JET REDUNDANCY.
- B. DELTA V >6 FPS - PREFERENCE WILL BE GIVEN TO SELECTING A SINGLE OMS ENGINE CONFIGURATION VERSUS TWO OMS ENGINES, SUBJECT TO MANEUVER CRITICALITY AND PROCEDURAL COMPLEXITY CONCERNS, IN ORDER TO ACCOMMODATE ENGINE LIFETIME CONSIDERATIONS. RCS MAY BE USED IF APPLICABLE.

For large delta V maneuvers (> 6 fps) OMS engines are selected over RCS jets in order to reduce propellant consumption and minimize burn residuals. RCS jets are used for smaller delta V maneuvers (< 6 fps) to avoid unnecessary OMS engine starts when propellant savings will be negligible. Also, for small OMS burns (< 6 seconds) guidance runs open-loop so postburn residuals may be large. If following these guidelines creates unnecessary procedural complexity (e.g., burns planned originally using the RCS system must be switched real time to OMS burns), it is acceptable to use RCS jets for delta V maneuvers of greater than 6 fps provided the additional propellant necessary is available.

Rule {A2.1.3-22E.3}, RNDZ/PROX OPS PROPULSION SYSTEMS MANAGEMENT, references this rule.

A2.1.3-17 RENDEZVOUS (RNDZ)/PROXIMITY OPERATIONS (PROX OPS) DEFINITIONS

- A. RNDZ OPS ARE DEFINED TO INCLUDE ALL ORBITER RNDZ MANEUVERS AND ASSOCIATED RNDZ ACTIVITIES TERMINATING WITH THE INITIATION OF PROX OPS.
- B. PROX OPS BEGIN AT THE COMPLETION OF RNDZ OPS WHEN THE ORBITER RANGE TO THE TARGET IS <1000 FEET AND THE LVLH RELATIVE VELOCITY IS <1 FPS IN EACH AXIS.

RNDZ OPS utilize closed loop guidance, navigation, and control to achieve a desired relative state. PROX OPS is a post-RNDZ activity where different techniques used to "control" the orbiter trajectory than those used during RNDZ OPS. These techniques rely on crew visual observations and piloting techniques to achieve a desired relative state. These definitions are provided for reference.

FLIGHT RULES

A2.1.3-18 RNDZ/PROX OPS GNC SYSTEMS MANAGEMENT

FAILURE TO MAINTAIN THE FOLLOWING CAPABILITIES WILL PRECLUDE APPROACH CLOSER THAN 250200 FEET FROM A TARGET. IF THE FOLLOWING CAPABILITY IS NOT MAINTAINED WHILE OPERATING WITHIN 250200 FEET OF A TARGET, A MANEUVER TO 250200 FEET WILL BE PERFORMED UNTIL THE LOST CAPABILITY CAN BE REGAINED: [@\[021199-6798A\]](#)

A. ROTATION AND TRANSLATION CAPABILITY IN EACH AXIS. MINIMUM JET REQUIREMENTS FOR TRANSLATION ARE AS FOLLOWS:

1. +X - ONE AFT-FIRING JET IN EACH AFT POD [1] [@\[081497-6283A\]](#)
2. -X - ONE FORWARD-FIRING JET
3. ±Y - ONE FORWARD YAW JET PER SIDE, ONE FORWARD DOWN JET PER SIDE, AND ONE AFT YAW JET PER SIDE [3] [\[4\]](#)
4. -Z - ONE DOWN-FIRING JET IN THE FORWARD MODULE AND EACH AFT POD [3] [\[4\]](#)
5. NORMAL +Z - ONE UP-FIRING JET IN THE FORWARD MODULE AND EACH AFT POD
6. LOW +Z - TWO FORWARD-FIRING JETS AND ONE AFT-FIRING JET PER POD [2]

NOTES:

- [1] IF THE ORBITER IS UNDER ACTIVE ATTITUDE CONTROL, ONLY ONE JET TOTAL IS REQUIRED, BUT PROPELLANT CONSUMPTION WILL BEIS GREATER DUE TO RESULTANT CROSS-COUPLING.
- [2] LOW +Z IS DESIRABLE BUT NOT NORMALLY REQUIRED- LOW Z ATTITUDE CONTROL IS UNAFFECTED BY LOSS OF THESE JETS.
- [3] DAP LOGIC WILL INHIBIT Y TRANSLATIONS IF BOTH FORWARD SIDE-FIRING OR DOWN-FIRING JETS ON EITHER SIDE ARE NOT AVAILABLE. [@\[081497-6283A\]](#)
- [4] FOR DOCKING MISSIONS, POST CONTACT THRUST (PCT) REQUIRES ONE FORWARD DOWN-FIRING JET PER SIDE AND ONE DOWN-FIRING JET IN EACH AFT POD (FOUR JETS TOTAL). THESE JET REQUIREMENTS ARE SATISFIED AS LONG AS ±Y AND -Z TRANSLATION CAPABILITIES EXIST. [@\[021199-6798A\]](#) @[ED]

THIS RULE CONTINUED ON NEXT PAGE

FLIGHT RULES

A2.1.3-18

RNDZ/PROX OPS GNC SYSTEMS MANAGEMENT (CONTINUED)

If the above capabilities are not maintained outside of ~~250200~~ feet while approaching a target, proximity operations PROX OPS inside ~~250200~~ feet will be postponed until reconfiguration regains the lost capability. A minimum range of 250 feet is used because the ISS approach corridor begins at 250 feet, and it would not be prudent to approach within the corridor without full control capability. For other rendezvous targets, this minimum range is somewhat arbitrary, and 250 feet is used for consistency across all rendezvous flights. @021199-6798A]

Proximity operations PROX OPS within ~~inside~~ ~~250200~~ feet of a target vehicle requires complete rotation and translation capability. Rotation is required for attitude ~~control~~ hold while maneuvering the orbiter to the target vehicle and can be achieved with either VRCS or PRCS. Translation (PRCS only) is required to properly achieve a relative position to the target vehicle. Satisfying the minimum jet requirements for translation listed above also ensures that full PRCS attitude control is available for both Low Z and Norm Z modes (rotational control requires a subset of the jets used for translation). Failure to maintain full capability ~~would~~ jeopardize crew safety, loads margins, and mission success. The number of jets required for each group is specified.

Low Z capability is desirable for some target vehicles in order to ~~minimize~~ ~~avoid~~ plume impingement on the target vehicle from the up-firing PRCS jets during attitude hold or +Z translations. ~~Some payloads may require Low +Z.~~ @081497-6283A]

Low Z is defined in terms of two capabilities:

- a. Translation: Simultaneous plus and minus X jets will fire in response to a +Z THC command.
- b. Attitude control: The DAP will not command any up-firing jets (TAIL-ONLY option for pitch control selected on SPEC 20 is overridden by Low Z, resulting in forward down-firing jets being commanded for pitch-up control). Therefore, one forward down-firing jet on each side and one down-firing jet in each aft pod is required to maintain pitch and roll control (yaw requirements are unchanged). The Low Z mode will be deselected and the DAP will mode to FREE if the IMU ATT DG flag is set BAD.

Docking missions require Post Contact Thrusting (PCT) for successful capture. PCT capability is ensured as long as the minimum jet requirements for translation listed above are satisfied. @021199-6798A]

THIS RULE CONTINUED ON NEXT PAGE

FLIGHT RULES

A2.1.3-18 RNDZ/PROX OPS GNC SYSTEMS MANAGEMENT (CONTINUED)

- B. AFT CONTROLLERS REQUIRE AS A MINIMUM ONE CONTACT/CHANNEL PER AXIS (EXCEPT FOR -Z THC WHICH REQUIRES TWO CONTACTS).

The aft RHC is required to have one channel per axis in order to retain complete rotation capability. The loss of the forward RHC is not a constraint due to the difficulty in performing proximity operations from the forward station. The aft THC is required to have at least one contact per axis per direction (i.e., +X, -X, +Y, -Y, +Z, -Z) in order to retain complete translation capability using normal procedures. It is possible in some cases to perform THC operations from the forward station, but exclusive use of the forward station should not be planned.

Reference rationale for paragraph C.2 for the -Z THC.

- C. Z TRANSLATION MUST BE ONE-FAULT TOLERANT. THIS REQUIRES AS A MINIMUM:

1. PLUS Z TRANSLATION

- a. SUFFICIENT JETS TO MAINTAIN +Z TRANSLATION FOR THE LOSS OF ANY SINGLE JET OR MANIFOLD. EITHER NORMAL +Z OR LOW +Z ARE ACCEPTABLE FOR BRAKING AND SEPARATION MANEUVERS.
- b. TWO +Z TRANSLATION CONTACTS. ONE CONTACT IN EACH THC IS REQUIRED IF ONLY TWO CONTACTS REMAINING.

2. MINUS Z TRANSLATION

TWO -Z TRANSLATION CONTACTS FOR ANY THC WHICH IS POWERED ON. ONLY ONE CONTACT IS REQUIRED IF THE OTHER AVAILABLE CONTACT IS FAILED OFF.

+Z translation capability must be retained at all times in order to be able to back away from the target vehicle should failures cause the loss of critical system redundancy. Backing away to 200 feet gives the crew time to reconfigure their systems, if possible, to allow for safe continuation of PROX OPS. Continuing PROX OPS without one-fault tolerance in the +Z translation direction is a risk to the safety of the crew/vehicle should subsequent failures cause the loss of vehicle control in close proximity. One +Z contact is required in each THC to maintain one-fault tolerance, since neither a single contact in one THC nor two contacts on a single THC provide any fault tolerance. If two contacts were on one THC and none on the other, the crew would have insufficient time to resolve and correct a dilemma (should one of the two fail low) thereby providing no-fault tolerance. It is understood in the two-contact case that a fail high of the remaining contact on either THC would result in jets firing to achieve a +Z translation which would cause plume impingement on the payload.

FLIGHT RULES

THIS RULE CONTINUED ON NEXT PAGE

FLIGHT RULES

A2.1.3-18

RNDZ/PROX OPS GNC SYSTEMS MANAGEMENT (CONTINUED)

A fail "on" of the last remaining -Z translation contact in a powered THC will drive the orbiter toward the target with six PRCS jets. Commanding either THC in the +Z direction would cancel the +Z THC output but would not provide the intended backaway since a plus and minus command in the same axis would be algebraically summed to zero resulting in no selected output. Should a failed-on contact occur while prime selected, the flight controller power for the affected THC must be powered off to eliminate the erroneous THC command and allow the crew the capability to command a backaway maneuver along the +Z axis using the other THC. Since there may not be time to accomplish this while in proximity to a target, two contacts for a powered THC are required to be fail-safe (i.e., failure of one contact at the two-level results in a dilemma and therefore no erroneous commanding of jets).

For a fail-off of one of the two remaining contacts there is no single failure which would result in translation toward the target. For this case operating with only one good contact is allowed and the flight controller power can remain on and the sense switch in the preferred position. If one of the last two remaining contacts fails high, however, the next failure (fail-on or comm fault of good contact) will result in translation toward the target. For this case either the flight controller must be powered off or the sense switch placed in a different position to avoid the next failure in the orbiter -Z direction.

It should be noted that for the aft THC different contacts would be involved depending upon which sense is selected and taking into account the fact that, due to a fit problem, the aft THC is installed 90 degrees clockwise. For example, if the -Z sense is selected, the +X THC axis (-Z orbiter translation axis, +X on crew display) must have at least two contacts to be fail safe. If the -X sense is selected, the -Y THC axis (-Z orbiter translation axis, -Y on crew display) must have at least two contacts. For the forward THC,

the -Z THC axis must be redundant. If the DAP is in translation NORM, failure of the last -Z contact will command six PRCS jets ON until either the flight controller power is turned off or until either THC is deflected (and held out of detent) in the +Z direction. If the DAP is in translation PULSE, six PRCS jets will fire to achieve the translation rate increment loaded on the DAP CONFIG display. Deflection and release of either THC in the +Z direction will result in another pulse in the -Z direction (toward the target). Subsequent cycling of either THC in the +Z direction will result in more pulses toward the target.

D. TWO IMU'S. (CONSIDERATION WILL BE GIVEN TO CONTINUING NOMINAL V-BAR OPERATIONS WITH ONE IMU.)

Two IMU's are required to commit to TI. Since TI is the first burn which targets for an intercept trajectory, the orbiter systems should be healthy enough to support the requirements of the rendezvous.

FLIGHT RULES

Post TI to V-bar arrival (PROX OPS), two IMU's are required to ensure a safe post-breakout trajectory. The RNDZ breakout sequence was not designed to cover trajectory dispersions due to failed IMU accelerometers. The velocity output at the two-level is the average of the two remaining IMU's. If one of the two IMU's has bad velocity output, the state vector will be corrupted. It would be very difficult to quickly determine the damage done to the state vector should one IMU fail. RNDZ sensors may not correct the vector quickly enough to ensure an adequate breakout trajectory.

THIS RULE CONTINUED ON NEXT PAGE

FLIGHT RULES

A2.1.3-18

RNDZ/PROX OPS GNC SYSTEMS MANAGEMENT (CONTINUED)

The RNDZ breakout also uses IMU attitude to correctly perform the breakout. If the IMU attitudes are incorrect, the breakout may not be executed in the proper direction.

Plus or minus R-bar approaches will not be considered on less than two IMU's because of the separation dynamics. For an R-bar approach, the separation sequence requires two burns, the first to ensure no immediate recontact and a second posigrade burn to ensure no long-term recontact concern. The second separation burn requires an IMU to provide the posigrade reference.

PROX OPS imposes similar requirements as the TI to V-bar phase, in that a correct reference is required to correctly perform the breakout. Thus, two IMU's are required to ensure a safe breakout.

One exception to the two-IMU requirement is nominal PROX OPS on the V-bar. The breakout for this situation is a posigrade burn executed manually, and not relying on the IMU's to provide a thrust direction. It is assumed that IMU drift would not take the orbiter far enough out of attitude to degrade the breakout maneuver and the crew can use the Earth horizon as a reference check that the IMU's are good.

Loss of two IMU's is cause to invoke next PLS. This should be the reason for terminating PROX OPS, not that the loss of the last IMU will result in loss of vehicle control. Manual control will still exist with the loss of all IMU's. Loss of IMU reference will mode the DAP to MAN; PULSE in rotation and translation. Low Z will also be automatically deselected.

E. STRINGING SUCH THAT FOR THE LOSS OF ONE GPC THE FOLLOWING FUNCTIONS ARE MAINTAINED:

1. EITHER LOW +Z OR NORMAL +Z TRANSLATION CAPABILITY
2. IMU REFERENCE (IF TWO IMU'S AVAILABLE)

It is important to remember to string such that a GPC failure can be sustained without loss of +Z translation capability (Low +Z or Normal +Z) for backaway operations or IMU reference.

Two GNC GPC's are required for operations within 200 feet. This requirement is stated in DPS Rule {A2.1.3-21}, RNDZ/PROX OPS DPS SYSTEMS MANAGEMENT. While this DPS rule is standalone, the GNC reasons to maintain two GNC GPC's are to retain fail-safe redundancy in the hand controllers and jets.

FLIGHT RULES

THIS PAGE INTENTIONALLY BLANK

FLIGHT RULES

A2.1.3-19 RNDZ/PROX OPS COMMUNICATION SYSTEMS MANAGEMENT

- A. THE KU-BAND SYSTEM WILL BE USED IN RADAR MODE DURING RNDZ/PROX OPS, BUT MAY BE USED IN COMMUNICATIONS MODE DURING PERIODS WHEN RADAR DATA IS NOT REQUIRED. @[061396-1961]

The Ku-band system can be switched between radar and communications mode as necessary.

- B. WHILE IN RADAR MODE, IF THE AZIMUTH ANGLE EXCEEDS 30 DEGREES FROM THE ORBITER -Z AXIS, THE KU WILL BE PLACED IN AUTO TRACK. WHILE IN THIS NO-SEARCH ZONE, A MANUAL SEARCH SHOULD ONLY BE INITIATED UPON MCC GO. @[061396-1961]

Radar scans should not be initiated for beta gimbal angles greater than ± 38 degrees (reference SODB, Communications and Tracking Subsystems - Constraints and Limitations page 3.4.5.2-6). An azimuth angle of 30 degrees satisfies this beta gimbal limit, and is independent of the elevation angle. While in this "No Search Zone," a manual search can be initiated upon evaluation by the MCC of the actual beta gimbal angles.

Reference {A11.1.1-16}, KU-BAND MANAGEMENT. @[061396-1961]

FLIGHT RULES

A2.1.3-20	RNDZ/PROX OPS NAVIGATION -SENSORS REQUIREMENTS	2-123
A2.1.3-21	RNDZ/PROX OPS DPS SYSTEMS MANAGEMENT	2-124
A2.1.3-22	RNDZ/PROX OPS PROPULSION SYSTEMS MANAGEMENT	2-125
A2.1.3-23	RENDEZVOUS MANEUVERS	2-131
A2.1.3-24	RENDEZVOUS MANEUVER SOLUTION SELECTION CRITERIA	2-132
A2.1.3-25	RENDEZVOUS MANEUVER EXECUTION	2-134
A2.1.3-26	RNDZ OPS DELAY	2-135
A2.1.3-27	RNDZ/PROX OPS BREAKOUT	2-136
A2.1.3-28	RENDEZVOUS GUIDANCE	2-139
A2.1.3-29	EMCC/TMCC ACTIVATION	2-144
A2.1.3-30	ORBITER ON-ORBIT HIGH DATA RATE REQUIREMENTS	2-143
A2.1.3-31	PAYLOAD OBJECTIVES VS. PAYLOAD DAMAGE POLICY	2-145
A2.1.3-32	ATTITUDE RESTRICTIONS FOR ORBITAL DEBRIS ..	2-145
A2.1.3-33	THERMAL CONDITIONING FOR FLIGHT DAY 1 LANDING	2-148
A2.1.3-34	POCC THROUGHPUT COMMAND RATES	2-150

DEORBIT

A2.1.4-1	DEORBIT GUIDELINES	2-151
A2.1.4-2	EXTENSION DAY GUIDELINES	2-153
A2.1.4-3	DEORBIT DELAY GUIDELINES	2-154
A2.1.4-4	MDF DEORBIT GUIDELINES	2-156
A2.1.4-5	EMERGENCY DEORBIT	2-157
A2.1.4-6	DEROTATION SPEED	2-163
A2.1.4-7	LANDING SITE SELECTION	2-160
A2.1.4-8	LES PRESSURE INTEGRITY CHECK	2-176
A2.1.4-9	LANDING SITE SELECTION FOR AN INFLIGHT EMERGENCY	2-177

FLIGHT RULES

FLIGHT RULES

A2.1.3-20

RNDZ/PROX OPS ~~NAVIGATION SENSORS~~ REQUIREMENTS@[091098-6707B]

A. DATA FROM THE KU RADAR, -Z/-Y STAR TRACKER, OR COAS (IN ORDER OF PRIORITY FROM HIGHEST TO LOWEST) MUST BE INCORPORATED INTO THE ONBOARD NAVIGATION FILTER DURING DAY OF RENDEZVOUS OPERATIONS BETWEEN NC AND MANUAL TAKEOVER. —
@[091098-6706B]

The intent of this rule is two fold. First, it identifies that Ku, Star Tracker, and COAS systems are required for rendezvous operations at a higher priority than other users (Comm, IMU align, etc.). Second, it identifies that rendezvous may not be possible within the pre-mission defined limits of the propellant budget without the incorporation of data from one of these systems into the onboard navigation system. Continuation of the rendezvous without having incorporated this data will likely lead to reaching the breakout criteria specified in Rule {A2.1.3-27}, RNDZ/PROX OPS BREAKOUT. Rendezvous may be possible without these sensors given a wide margin of error in the propellant budget.

Rendezvous maneuvers prior to the actual day of rendezvous do not require onboard navigation sensors and are targeted strictly off ground-based solutions.

~~PRIOR TO TI, THE RNDZ MAY BE DELAYED IF REGAINING A HIGHER PRIORITY SENSOR IS POSSIBLE. —~~

PRIOR TO TI, THE RNDZ MAY BE DELAYED IF REGAINING A HIGHER PRIORITY SENSOR IS POSSIBLE.

Regaining a higher priority sensor will result in a more accurate onboard navigation filter state which will, in turn, result in a higher probability of a successful rendezvous and a more propellant-efficient manual phase. Rendezvous delays up through and including Ti can be achieved with aft propellant usage only and hence may be worthwhile if doing so allows for the recovery of a more accurate rendezvous sensor, resulting in the savings of forward propellant during the manual phase. Rendezvous Delay is described in Rule {A2.1.3-26}, RNDZ OPS DELAY.

B. THE KU SYSTEM, IF AVAILABLE, WILL BE CONFIGURED FOR RADAR OPERATIONS DURING MANUAL PHASE UNTIL THE CDR DEEMS THAT IT IS NOT REQUIRED TO SUPPORT PILOTING OPERATIONS GIVEN THE AVAILABILITY OF OTHER RANGING SENSORS (HHL OR TCS). AT THIS TIME, THE KU SYSTEM MAY BE CONFIGURED FOR COMM.

The Ku radar system is the prime range/range rate sensor during the manual phase until reliable HHL or TCS data becomes available. @[091098-6707B]

FLIGHT RULES

A2.1.3-21 RNDZ/PROX OPS DPS SYSTEMS MANAGEMENT

- A. THREE GNC GPC'S ARE PREFERRED FOR RNDZ/PROX OPS. TWO GNC GPC'S ARE REQUIRED AT TI AND WITHIN 250200 FEET OF THE TARGET VEHICLE: [@J021199-6798A](#)

Three GNC GPC's are preferred for rendezvous/prox ops to simplify recovery procedures if a GNC GPC fails during the period when rendezvous nav is enabled. If a GNC GPC fails, a restring to the remaining two GPC's recovers all LRU redundancy, still meets rendezvous GPC requirements, and does not affect rendezvous nav functions as long as the target set is not changed.

TI is the starting point for requiring redundant GNC GPC's because this is the first burn which puts the orbiter on an intercept course with the target. This means that continuous control of the orbiter is required to preclude a collision with the target. Single fault-tolerance for control of braking and separation maneuvers is required, and redundant GNC GPC's meet this requirement. Prior to TI, the orbiter is not on an intercept course and momentary loss of control is not critical; therefore, single fault-tolerance is not required.

1. FOR LOSS OF ONE GNC GPC OUT OF A TWO GNC GPC REDUNDANT SET WHEN FURTHER THAN 250200 FEET FROM TARGET, RECONFIGURATION TO A TWO-GNC REDUNDANT SET WILL BE DELAYED TO THE NEXT OPERATIONALLY CONVENIENT POINT.

The crew is very busy flying the manual phase of rendezvous operations. Reconfiguration would interfere (and may promote errors) with the manual task and, therefore, will be delayed to the next convenient point as long as the orbiter-to-target distance is greater than 250200 feet.

2. LOSS OF ONE GNC GPC OUT OF A TWO GNC GPC REDUNDANT SET DURING PROX OPS WITHIN 250200 FEET WILL RESULT IN A BACKOUT MANEUVER AWAY FROM THE TARGET OUT TO A DISTANCE OF 250200 FEET UNTIL RECONFIGURATION TO A TWO-GNC REDUNDANT SET IS COMPLETED.

The fail-safe status afforded by two GNC GPC's is required for close proximity of the orbiter to other objects. Loss of one of the two GNC GPC'S within 250200 feet is reason to terminate PROX OPS and back away from the target due to the possibility of vehicle contact with the target on the next failure (no longer fail-safe). A distance of at least 250200 feet provides a safety margin before attempting to reconfigure. [@J021199-6798A](#)

THIS RULE CONTINUED ON NEXT PAGE

FLIGHT RULES

A2.1.3-21

RNDZ/PROX OPS DPS SYSTEMS MANAGEMENT
(CONTINUED)

3. FOR LOSS OF ONE GNC GPC OUT OF A THREE GNC GPC REDUNDANT SET DURING PROX OPS, RESTRING TO REMAINING TWO GNC GPC'S WHEN POSSIBLE.

When starting with a three GNC GPC set, loss of a single GPC is not critical. A simple restring can be performed to regain the lost string(s) without disruption of rendezvous nav operations. With the standard stringing configuration for three GPC's (ref. Rule {A7.1.3-8C.2.b}, PASS DATA BUS ASSIGNMENT CRITERIA) loss of a single GPC does not require immediate action.

- B. IN A TWO GNC GPC SET CONFIGURATION FOR GNC OR SM GPC FAILURES, THE FREEZE-DRY GPC (G2FD) MAY BE RECONFIGURED AS GNC OR SM. IF G3 ARCHIVE HAS BEEN LOST AND A G3FD GPC HAS BEEN CONFIGURED, THE G3FD MAY BE GIVEN UP IF TWO G3 SOURCES (MMU 1, MMU 2) ARE AVAILABLE.

Recovery of a redundant GNC GPC is done to provide fail-safe vehicle control during rendezvous or PROX OPS. Recovery of an SM function is done to provide rendezvous radar antenna initialization, insight into or control of payloads, and GPC control for PDRS usage. The G2FD GPC may be given up without regard to the number of available sources of entry software because of G3 archive capability as long as there are two other sources of PASS G3 software. Two sources are considered to be an adequate level of redundancy for obtaining G3 software.

Reference Rule {A7.1.1-1C}, DPS REDUNDANCY REQUIREMENTS.

- C. IN A THREE GNC GPC SET CONFIGURATION FOR AN SM GPC FAILURE, ONE OF THE GNC GPC'S MAY BE RECONFIGURED AS AN SM GPC.

Since only two GNC GPC's are required for providing a fail-safe capability during the critical maneuvers of RNDZ/Prox Ops, it is allowable to give up one of the three GNC GPC's to recover the SM function.

FLIGHT RULES

THIS PAGE INTENTIONALLY BLANK

FLIGHT RULES

A2.1.3-22 RNDZ/PROX OPS PROPULSION SYSTEMS MANAGEMENT

A. RNDZ/PROX OPS ACTIVITIES WILL BE TERMINATED AND A BREAKOUT MANEUVER WILL BE PERFORMED WHEN PROPELLANT AVAILABLE DECREASES TO THE TOTAL OF:

1. DEORBIT REDLINES:
 - a. OMS DEORBIT REDLINE (REF. RULE {A6.1.5-3A}, OMS REDLINES).
 - b. FRCS DEORBIT REDLINE (REF. RULE {A6.1.5-4A}, FORWARD RCS REDLINES).
 - c. ARCS ENTRY REDLINE (REF. RULE {A6.1.5-5}, AFT RCS REDLINES).

OMS and RCS deorbit redlines must be protected in order to continue any on-orbit operations. Violation of these redlines is cause to enter at the next PLS opportunity.

2. DEORBIT PREPARATION.

Propellant is required for a nominal deorbit preparation.

3. PROPELLANT REQUIRED FOR ORBITER MAINTENANCE (ATTITUDE CONTROL -ZLV +XVV OR THERMAL PROTECT ATTITUDE IF REQUIRED, 1 DEGREE VRCS, ONE IMU ALIGN/DAY) FOR 1 DAY.
@[051194-1612A]

Following a successful rendezvous or an aborted rendezvous, propellant must be available for attitude control until the next PLS deorbit opportunity (which could be up to 24 hours away).

4. RNDZ/PROX OPS BREAKOUT MANEUVER.

If it is necessary to abort a rendezvous attempt when in close proximity to the target, a breakout maneuver is required in order to establish a safe separation rate from the target. The exact nature of the breakout maneuver is dependent upon the relative position to the target, but the maneuver usually entails several RCS translations. The worst case breakout propellant requirements will be covered in the terminate quantities.

5. HIGHER PRIORITY ACTIVITIES (REF. RULE {A2.1.3-7}, CONSUMABLES MANAGEMENT TABLE).

Propellant must be available to complete all post-rendezvous activities of higher priority than the rendezvous in order to continue with the rendezvous. Activities are listed in order of priority in Rule {A2.1.3-7}, CONSUMABLES MANAGEMENT, table.

FLIGHT RULES

THIS RULE CONTINUED ON NEXT PAGE

FLIGHT RULES

A2.1.3-22 RNDZ/PROX OPS PROPULSION SYSTEMS MANAGEMENT
(CONTINUED)

6. PROPELLANT REQUIRED TO COVER RETURN OF THE PAYLOAD INCLUDING:
- a. X OR Y CG BALLAST (IF REQUIRED).

For payloads planned on being berthed in the payload bay, either for repair and redeploy or for return to Earth, OMS or RCS propellant may be required as ballast in order to maintain the orbiter CG within the acceptable envelope as outlined in Flight Rule {A4.1.4-3}, CG PLANNING.

- b. THERMAL PROTECT ATTITUDE AS REQUIRED.

Certain payloads may have thermal constraints which would necessitate maintaining the orbiter in attitudes and/or deadbands that require more than the nominal -ZLV 1 degree deadband propellant allocation. This item also applies to any payload planned on being berthed in the payload bay either temporarily or for return. ©[051194-1612A]

- c. INCREASED DEORBIT VEHICLE WEIGHT (INCLUDES WEIGHT OF PAYLOAD).

OMS propellant required for deorbit will be calculated using the vehicle weight with the payload onboard. This guarantees enough propellant to deorbit safely with the payload onboard. Again, the weight of any payload planned on being berthed in the payload bay either temporarily or for return will be considered as part of the deorbit vehicle weight.

- B. IF EITHER FORWARD OR AFT QUANTITIES DECREASE TO THE RNDZ/PROX OPS TERMINATION QUANTITIES, THEN IT IS ACCEPTABLE TO ADJUST REDLINES BY THE USE OF NOSE-ONLY OR TAIL-ONLY PRCS CONTROL FOR ACTIVITIES (INCLUDING NON-RENDEZVOUS ACTIVITIES) NOMINALLY PLANNED FOR NOSE/TAIL CONTROL.

Certain activities budgeted using nose/tail control may be switched to tail-only control if the aft propellant is available. These activities include the deorbit wave-off extension day included in the OMS/RCS deorbit redlines, deorbit preparation, and one day of attitude control. Nose-only pitch/yaw control may also be utilized when aft propellant is critical. The breakout maneuver may not be adjusted. ©[051194-1612A]

THIS RULE CONTINUED ON NEXT PAGE

FLIGHT RULES**A2.1.3-22 RNDZ/PROX OPS PROPULSION SYSTEMS MANAGEMENT
(CONTINUED)**

- C. TO CONTINUE RNDZ OPS, PROPELLANT MUST BE AVAILABLE TO COVER THE "GO FOR TI" AS DEFINED IN PARAGRAPH I AND THE MCC PREDICTED REQUIREMENTS FOR THE REMAINING MANEUVERS UP TO TI.

In order to continue a rendezvous, propellant must be available to ensure a reasonable chance of completion. When it is clear that adequate propellant is not available to complete a "best day" rendezvous, RNDZ OPS should be terminated and propellant can be made available for lower priority activities which would have been canceled in order to complete the rendezvous. The "GO for TI" requirements represent the minimum amount of propellant required to complete a rendezvous from TI through target retrieval. Propellant required to complete all of the required phasing maneuvers up to TI is also covered here, based upon maneuver delta V's as calculated by the Flight Dynamics Officer. Because the "Continue RNDZ Ops" quantities are based on minimum propellant requirements from TI through grapple, rendezvous maneuvers may continue to be performed with only a minimal chance of a successful rendezvous.

- D. RENDEZVOUS WILL NOT BE ATTEMPTED IF THE FRCS IS NOT AVAILABLE.

FRCS propellant is necessary in order to maintain attitude in close proximity to the target (stationkeep). The FRCS is also required to perform a safe breakout maneuver. Without the FRCS it is not safe to remain in close proximity to the target. Additionally, terminal phase requires frequent small multi-axis translations which are not practical without the FRCS.

- E. THE FOLLOWING GUIDELINES WILL BE USED WHEN EXECUTING RENDEZVOUS BURNS UP TO AND INCLUDING TI:
1. IF TOTAL DELTA V IS LESS THAN 4 FPS, BURN WILL BE PERFORMED MULTI-AXIS.
 2. IF TOTAL DELTA V IS BETWEEN 4 AND 6 FPS, A MANEUVER TO BURN ATTITUDE MAY BE PERFORMED AND THE BURN ACCOMPLISHED USING AFT RCS +X JETS.
 3. IF TOTAL DELTA V IS GREATER THAN 6 FPS, THE BURN MAY BE ACCOMPLISHED USING OMS ENGINE(S). OMS ENGINE GUIDELINES ARE ESTABLISHED PER FLIGHT RULE {A2.1.3-16B}, ENGINE SELECTION CRITERIA. (AFT RCS +X MAY BE USED IF MARGINS EXIST.)

THIS RULE CONTINUED ON NEXT PAGE

FLIGHT RULES

A2.1.3-22 RNDZ/PROX OPS PROPULSION SYSTEMS MANAGEMENT (CONTINUED)

The above guidelines for rendezvous burn execution have been established to ensure optimum use of OMS and RCS propellant. These guidelines are incorporated in the Rendezvous Flight Data File to assist the crew in burn execution and can be overridden by the MCC depending upon OMS/RCS propellant margins/system problems.

- a. *Because the crew has no way to determining the forward RCS contribution to the rendezvous burn, the 4 fps criteria (equates to 2 fps forward RCS usage) was established to determine if a maneuver to burn attitude is required.*
- b. *With rendezvous burns between 4 and 6 fps the attitude maneuver will be performed and the burn accomplished using aft RCS +X jets. This is performed to increase fwd RCS propellant availability. The OMS engines are not used because guidance is locked out if the OMS burns are 6 seconds or less (6-second countdown is used).*
- c. *OMS engine(s) will be used if delta V requirements are greater than 6 fps (per Flight Rule {A2.1.3-16B}, ENGINE SELECTION CRITERIA, guidelines). Aft RCS +X jets may be used straight feed or interconnected if propellant margins exist.*

F. IF RENDEZVOUS MANEUVERS, UP TO AND INCLUDING TI, ARE TARGETED TO USE MORE THAN 2 FPS (50 LB) FROM THE FORWARD RCS, A MANEUVER TO BURN ATTITUDE MAY BE PERFORMED SO THAT THE BURN WILL BE ACCOMPLISHED USING OMS OR AFT RCS PROPELLANT.

During rendezvous/PROX OPS mission profiles, the FRCS system is usually propellant-critical with the aft RCS and OMS systems having sufficient margins. It is usually desirable to save as much FRCS propellant as possible to maximize the chances for mission success (rendezvous completion) without altering the planned mission profile (deletion of mission events). Rendezvous burns that require more than 2 fps (50 lb) from the forward RCS will normally incorporate a maneuver to burn attitude. Burn targets will be computed by onboard software, and the burn performed using aft RCS or OMS propellants to minimize forward RCS use. (Maneuvering to and from the burn attitude takes approximately 6 lb (VRCS) and 17 lb (PRCS).) Since attitude maneuvers can disturb the orbiter state vector, which is critical during rendezvous profiles, the decision to maneuver will be a tradeoff between disturbing the orbiter state and saving FRCS. If forward RCS mission completion redline margins allow a multi-axis burn, a maneuver to burn attitude may not be required. The 2 fps (50 lb) constraint was selected to provide a compromise between increasing forward RCS propellant availability and avoiding excess maneuvering.

G. NOSE/TAIL PRIMARY JET CONTROL WILL BE SELECTED POST-NCC BURN FOR THE LOSS OF VERNIER JET CONTROL CAPABILITY.

FLIGHT RULES

Nose/tail control is required post-NCC in order to maintain coupled jet firings for rotational attitude control. With nose-only or tail-only rotational attitude control, translation is induced which may significantly impact predicted TI and midcourse corrections.

THIS RULE CONTINUED ON NEXT PAGE

FLIGHT RULES**A2.1.3-22 RNDZ/PROX OPS PROPULSION SYSTEMS MANAGEMENT
(CONTINUED)**

- H. TO BE GO FOR TI DELAY, PROPELLANT MUST BE AVAILABLE TO COVER THE TOTAL OF:
1. TERMINATION QUANTITIES AS DEFINED IN PARAGRAPH A.
 2. ORBITER MAINTENANCE FOR THE DELAY PERIOD (USUALLY ONE OR TWO ORBITS).
 3. MCC PREDICTED TI-DELAY PLUS NEW TI USAGE.
 4. MEAN USAGE FROM POST-TI TO RV-BAR (REF. FLIGHT RULE ANNEX) . - @021199-6706B1
 5. MEAN USAGE FROM RV-BAR TO GRAPPLE/DOCK, IF SCHEDULED (REF. FLIGHT RULE ANNEX)

Delaying TI may be desired when time is required to better understand an orbiter problem. From a propellant standpoint, delaying TI is only acceptable when the delay does not significantly impact the chance of a successful rendezvous. For this reason, mean propellant usages are covered in this rule from post-TI through grapple as opposed to the minimum usages covered in the "GO for TI" call. Additional propellant is also required to perform a maneuver (usually at the nominal TI opportunity) to maintain a safe distance from the target for the period of the delay and to perform a subsequent TI burn. If insufficient propellant exists to be go for TI delay, then either a breakout maneuver must be performed or the reason to delay TI must be waived. It is not acceptable to reduce the TI delay requirement by going to minimum usages for terminal phase and PROX OPS. The Flight Rules Annex is referenced in order to identify the details of the manual phase V-bar profile.

- I. TO BE GO FOR TI, PROPELLANT MUST BE AVAILABLE TO COVER THE TOTAL OF
1. TERMINATION QUANTITIES AS DEFINED IN PARAGRAPH A
 2. USAGE FOR MCC PREDICTED TI
 3. THEORETICAL-MINIMUM-MEAN MINUS 3 SIGMA USAGE POST-TI TO RV-BAR ARRIVAL @021199-6706B1, ~~6 FPS (75 LB FRCS, 75 LB AFT)~~

THIS RULE CONTINUED ON NEXT PAGE

FLIGHT RULES

A2.1.3-22 RNDZ/PROX OPS PROPULSION SYSTEMS MANAGEMENT (CONTINUED)

4. ~~THEORETICAL MINIMUM MEAN MINUS 3 SIGMA USAGE FROM FOR RV-BAR ARRIVAL THROUGH GRAPPLE/DOCK: @J021199-6706B~~
~~, IF SCHEDULED (25 LB FRCS, 25 LB AFT FOR V-BAR APPROACH; 75 LB FRCS, 75 LB AFT FOR R-BAR APPROACH)~~

The "GO for TI" propellant requirements are based upon the minimum amount of propellant required to complete a rendezvous prior to the TI burn. Mean minus 3 sigma protection based on Monte Carlo analysis provides a slim chance at being able to complete the rendezvous. If any chance exists that the rendezvous can be successfully complete, TI will be performed and the rendezvous will be continued until the terminate quantities are violated or violation of the terminate quantities becomes imminent in accordance with this rule and paragraph A.

- J. POST-TI, IF THE NEXT PLANNED MANEUVER VIOLATES THE TERMINATION QUANTITIES AS DEFINED IN PARAGRAPH A, THE RENDEZVOUS WILL BE TERMINATED.

When it is obvious that termination quantities will be violated before completion of the rendezvous, there is no reason to continue the rendezvous.

- K. FOR DEPLOY/RELEASE MISSIONS TO BE GO FOR FREE FLYER RELEASE/RETRIEVE, PROPELLANT MUST BE AVAILABLE TO COVER THE TOTAL OF:
1. TERMINATION QUANTITIES AS DEFINED IN PARAGRAPH A.
 2. ORBITER MAINTENANCE FOR THE PLANNED DURATION OF FREE FLIGHT.
 3. MCC PREDICTED DELTA V FOR PAYLOAD SEPARATION AND REQUIREMENTS FOR THE REMAINING MANEUVERS THROUGH TI.
 4. AT LEAST MEAN USAGE POST-TI TO RV-BAR (UP TO MEAN +TØ 3 SIGMA USAGE ~~) (REF. PER FLIGHT RULES ANNEX)~~).
 5. ~~5. AT LEAST MEAN USAGE FROM THE~~ RV-BAR THROUGH GRAPPLE (UP TO MEAN +TØ 3 SIGMA USAGE ~~) (REF. PER FLIGHT RULES ANNEX)~~).

FLIGHT RULES

Before releasing a retrievable free flyer (e.g., SPARTAN), propellant must be available to ensure a reasonable likelihood of the return of the free flyer. As such, at least mean usages will be covered for all rendezvous maneuvers and PROX OPS activities ~~in order to guarantee this capability~~. The Flight Rules Annex may redefine this requirement to require enough propellant to complete a rendezvous with up to 3-sigma usage. [\[021199-6706B\]](#)

THIS RULE CONTINUED ON NEXT PAGE

FLIGHT RULES

A2.1.3-22 RNDZ/PROX OPS PROPULSION SYSTEMS MANAGEMENT (CONTINUED)

L. DURING A FAILED GRAPPLE/DOCKING ATTEMPT, TO PROTECT A RE-RENDEZVOUS CAPABILITY ON A SUBSEQUENT FLIGHT DAY, PROPELLANT MUST BE AVAILABLE TO COVER THE TOTAL OF: @J021199-6706B]

The quantities indicated below are intended to provide guidelines for use after a failure to grapple/dock or during a grapple/docking attempt that is not proceeding smoothly. These quantities are required to entertain the option of a re-rendezvous on a subsequent day. These numbers can be used to generate a “re-rendezvous bingo” quantity at which grapple/dock activities should be terminated for that day and a separation burn performed. Once the separation burn is performed and the re-rendezvous sequence is underway, propellant minimums to complete the re-rendezvous are outlined in Paragraph I of this rule.

If propellant quantities are below the re-rendezvous bingos, then re-rendezvous is most likely not possible and the ongoing attempts to grapple/dock should continue until a successful grapple/docking is achieved or the terminate quantities as indicated in Paragraph A of this rule are reached.

1. TERMINATION QUANTITIES AS DEFINED IN PARAGRAPH A.

Propellant must be protected to break out from the subsequent rendezvous, to provide a safe deorbit, and allow for the completion of higher priority mission activities.

2. MCC PREDICTED USAGE TO TERMINATE CURRENT GRAPPLE/DOCK ACTIVITIES AND SEPARATE.

Predicted usage to terminate the ongoing grapple/dock activities is based on a real-time assessment of these activities. For example, if a flyaround alignment is underway in an attempt to grapple a rotating free-flyer, propellant to arrest the orbiter’s rotation rate, maneuver to the separation burn attitude, and separate must be protected. The separation burn will consist of the appropriate breakout per Rule {A2.3.3-27C}, RNDZ/PROX OPS BREAKOUT.

3. MCC PREDICTED DELTA V FOR THE RE-RENDEZVOUS MANEUVERS THROUGH TI.

Mean re-rendezvous prop costs are included in the flight specific rendezvous propellant budget (Rndz-03 Flight Design product). @J021199-6706B]

THIS RULE CONTINUED ON NEXT PAGE

FLIGHT RULES

A2.1.3-22

RNDZ/PROX OPS PROPULSION SYSTEMS MANAGEMENT (CONTINUED)

4. AT LEAST MEAN USAGE POST-TI THROUGH GRAPPLE/DOCK. BASED ON A REAL-TIME ASSESSMENT OF GRAPPLE/DOCKING ACTIVITIES, UP TO MEAN + 3 SIGMA USAGE MAY BE PROTECTED. @021199-6706B]

At least mean usage is protected for all rendezvous maneuvers and prox ops activities to ensure a reasonable chance of being able to re-rendezvous. Protecting only minimum usage post-Ti through grapple/docking is not recommended as it would significantly reduce the probability of being able to re-rendezvous before reaching the propellant terminate quantities, although it would reduce the propellant requirements by approximately 200 lb (1/3 fwd and 2/3 aft). In fact, depending on prop availability and a real-time assessment of the ongoing grapple/dock activities, it may be prudent to protect more than mean propellant (up to 3 sigma) for all re-rendezvous maneuvers and prox ops activities. For example, if the ongoing grapple/docking activities have little chance for success due to the nature of the problem, then separating with 3 sigma protection will maximize prop availability for the subsequent grapple/docking attempt after troubleshooting steps have been performed. However, if a successful grapple/docking is imminent, then continuing below 3 sigma protection may allow the grapple/docking to be completed without assuming the risk of a re-rendezvous attempt. Protecting 3 sigma usage post-Ti through grapple/dock increases the propellant minimums by approximately 200 lb over mean usage (1/3 fwd and 2/3 aft). Post-Ti through grapple/dock prop costs (mean and sigmas) are included in the flight specific rendezvous propellant budget (Rndz-03 Flight Design product).

5. CONTINGENCY PROX OPS PROPELLANT AS APPROPRIATE GIVEN THE NATURE OF THE FAILURE.

Depending on the nature of the difficulty that led to the failure to grapple/dock, additional propellant should be protected for prox ops contingencies during the subsequent grapple/docking attempt (i.e. orbiter/target flyaround alignment, extended stationkeeping, etc.). Propellant requirements for contingency prox ops activities are included in the flight specific rendezvous propellant budget (Rndz-03 Flight Design product).

6. ORBITER ATTITUDE MAINTENANCE FOR THE PLANNED DURATION OF FREE FLIGHT THROUGH GRAPPLE/DOCK.

Propellant for orbiter attitude maintenance during the re-rendezvous sequence must be protected. @021199-6706B]

FLIGHT RULES

A2.1.3-23 RENDEZVOUS MANEUVERS

- A. THE GROUND WILL COMPUTE TARGETS FOR ALL MANEUVERS UP TO AND INCLUDING TI. ADDITIONALLY, THE GROUND WILL PROVIDE THE INITIAL ORBIT TARGETING BASETIME (TI TIG) USED FOR NCC, TI, AND MC1 MANEUVERS.
- B. THE ORBITER WILL COMPUTE TARGETS FOR NCC AND SUBSEQUENT MANEUVERS. THE ORBITER WILL REDEFINE THE ORBIT TARGETING BASETIME (MC2 TIG) FOR THE MC2, MC3, AND MC4 MANEUVERS.

NOTE: FLIGHT SPECIFIC MANEUVER DEFINITIONS AND TARGETING CRITERIA ARE SPECIFIED IN THE FLIGHT RULE ANNEX (REF. RULE {X4.1.2-1}, ORBITAL MANEUVER CRITICALITY,).

Because of its relative navigation capability (ST, COAS, and RR), the orbiter is considered prime for all maneuvers from NCC to intercept. Typical criteria for TIG selection and maneuver targeting are given in the table. It should be emphasized that these data are flight-specific I-loads to orbit targeting (SPEC 34).

For pre-NCC maneuvers, the ground is the only system capable of targeting rendezvous maneuvers; due to software, orbit targeting (SPEC 34) can only target two-impulse maneuvers. The rendezvous maneuver sequence is designed to allow orbit targeting to compute NCC and subsequent maneuvers because the orbiter relative navigation systems can provide the most accurate states for the orbiter and target. For NCC and TI, the ground will provide an independently targeted solution for comparison with the orbiter solution. The solution will be selected per Rule {A2.1.3-24}, RENDEZVOUS MANEUVER SOLUTION SELECTION CRITERIA.

The NCC, TI, and MC1 maneuvers are scheduled relative to the initial basetime (TI TIG), which is usually a few minutes prior to orbital noon. This time is provided by the ground because the orbiter does not have the capability to compute it. For MC2, MC3, and MC4, the orbiter will redefine the basetime (MC2 TIG) automatically with orbit targeting. MC2 must be targeted at least once for this to occur.

FLIGHT RULES

A2.1.3-24 RENDEZVOUS MANEUVER SOLUTION SELECTION CRITERIA

A. GROUND SOLUTIONS WILL BE EXECUTED FOR ALL MANEUVERS UP TO NCC.

Reference Rule {A2.1.3-23}, RENDEZVOUS MANEUVERS, for rationale.

B. THE SOLUTIONS FOR THE NCC AND TI MANEUVERS WILL BE SELECTED ACCORDING TO THE FOLLOWING PRIORITIES:

1. ONBOARD FILTER SOLUTION IF, FOR THE PRESENT SENSOR IN ACQUISITION (RR, ST), 40 NAVIGATION MARKS HAVE BEEN ACCEPTED WITH A STATE VECTOR POSITION UPDATE LESS THAN 0.5K FEET FOR THE LAST FOUR MARKS. IF COAS, THIS CRITERION DOES NOT APPLY (REF. PARAGRAPH B.2).

The onboard filtered solution, with sufficient relative navigation data incorporated, consists of the most accurate and current relative state information and, therefore, should be considered the best solution. Sufficient navigation data is indicated by premission analysis to be greater than 40 marks in the current sensor pass and position updates of less than 0.5k feet for the last four measurement cycles. This is not the definition of the absolute best solution, but it ensures that the onboard solution will be more accurate than ground solution. Four consecutive marks with state vector position errors less than 0.5k feet was added to this criterion to eliminate transient effects and to ensure stability in the filtered state.

Obtaining and incorporating 40 COAS navigation marks are unrealistic, time-consuming, manual tasks. Statistical studies show that, after the first few COAS marks, updates to the filtered state are random and do not significantly contribute to the knowledge of the relative state. Therefore, since the COAS can never meet these criteria for sufficient navigation data, proceeding to paragraph B.2 forces a comparison with the ground solution.

2. ONBOARD FILTERED SOLUTION IF IT AGREES WITH THE GROUND SOLUTION.

NOTE: MANEUVER SOLUTIONS ARE DEFINED TO BE IN AGREEMENT IF, FOR EACH AXIS, THE DELTA V DIFFERS BY NO MORE THAN THE PREMISSION ONBOARD MINUS GROUND 3 SIGMA COMPARISONS LIMITS.

THIS RULE CONTINUED ON NEXT PAGE

FLIGHT RULES

A2.1.3-24 RENDEZVOUS MANEUVER SOLUTION SELECTION CRITERIA
(CONTINUED)

3. ONBOARD PROPAGATED SOLUTION IF IT AGREES WITH THE GROUND SOLUTION.

NOTE: MANEUVER SOLUTIONS ARE DEFINED TO BE IN AGREEMENT IF, FOR EACH AXIS, THE DELTA V DIFFERS BY NO MORE THAN THE PERMISSION ONBOARD MINUS GROUND 3 SIGMA COMPARISONS LIMITS.

The onboard filtered and propagated solutions will be better than the ground solution because they will have been computed on at least the ground initialization state vector plus any IMU-sensed delta velocities. These solutions may contain additional improvements:

- a. The filtered solution, even without sufficient relative navigation data as defined in paragraph B.1, will be as good or better than the propagated or ground solutions because it may have some relative navigation data incorporated in it.*
- b. The propagated solution will be as good as or better than the ground solution because it may have been computed on a filtered state vector containing relative navigation data from a previous sensor pass that has been saved via a filter to propagator transfer.*

4. GROUND SOLUTION.

Agreement with the ground solution serves as a gross quality check for the onboard solution and, therefore, only needs to fall within the 3-sigma comparison limits.

The ground solution would be performed as a last resort.

- C. ONBOARD SOLUTIONS WILL BE EXECUTED FOR POST-TI MIDCOURSE MANEUVERS.

The ground has no capability to improve the relative state information between the orbiter and target for the midcourse correction maneuver computations. This is due to ground tracking uncertainties and the relatively close proximity of the two vehicles. Hence, the orbiter solution for these maneuvers will always be selected.

Rule {A2.1.3-23}, RENDEZVOUS MANEUVERS, references this rule.

FLIGHT RULES

A2.1.3-25 RENDEZVOUS MANEUVER EXECUTION

A. ALL MANEUVERS COMPONENTS WILL BE TRIMMED TO VGO < 0.2 FPS IN ALL AXES.

Based on flight experience, the required trim, < 0.2 fps, is the best trim accuracy achievable by the crew on a consistent basis. This accuracy is required during rendezvous to keep deviations from premission and real-time planned profiles to a minimum.

B. MIDCOURSE MANEUVERS, MC1, MC2, AND MC3, AS WELL AS THE OUT-OF-PLANE NULL WILL ALWAYS BE EXECUTED. —@[021199-6732]

Midcourse maneuvers are designed to correct the orbiter intercept trajectory based on the most current relative state information. Even with no additional relative state sensor data, these maneuvers correct for trim errors from previous burns and attitude maneuver effects that are sensed via the accelerometers. Additionally, executing MC1 reduces the probability of experiencing targeting alarms and/or significant TIG slips at MC2 as a result of these dispersion effects. Executing MC2 with its elevation angle constraint reduces dispersions at the manual phase take-over point. The radar fail correction burn “rule of thumb” used in the radar fail procedures at MC3 + 2 min is most valid when the MC3 burn is executed, resulting in a more benign manual phase and slightly lower prop usage (ref. Orbit Flight Techniques #166 on June 26, 1998). The out-of-plane null is performed when the orbiter is at the out-of-plane node which is the optimum point to null out-of-plane motion.

This rule is a result of the implementation of the ORBT Rendezvous Profile baselined during Orbit FTP #161, February 14, 1997.

C. MC4 WILL NOT BE PERFORMED IN RADAR FAILED CASES.

The radar fail procedures have the CDR begin manual piloting immediately after MC3, so MC4 should not be performed in this case. The onboard navigation state is not accurate enough to support a targeted intercept of the R-bar when the radar is failed.

1. IN THE EVENT THAT RADAR DATA BECOMES AVAILABLE POST-MC2, THE DATA MAY BE INCORPORATED INTO THE NAV FILTER BUT WILL NOT BE USED FOR ORBITER POINTING OR TARGETING. RADAR FAILED PROCEDURES WILL CONTINUE TO BE PERFORMED UNLESS MCC DEEMS THAT THE ONBOARD RELATIVE STATE IS SUFFICIENTLY CONVERGED AND THAT THE TRAJECTORY WOULD BENEFIT FROM A TARGETED MC4 BURN.

@[021199-6732]

THIS RULE CONTINUED ON NEXT PAGE

FLIGHT RULES

A2.1.3-25

RENDEZVOUS MANEUVER EXECUTION

In the event that a previously failed (or unavailable) radar system becomes available after MC2-, then radar failed procedures will continue to be executed including the MC3 + 2 minute radar failed correction burn based on target position in the -Z COAS. Since the radar failed correction burn is dependent on orbiter pointing (i.e., position of target in -Z COAS), the radar data may be incorporated into the FLTR vector only if the PROP vector has been selected as the UPP source on RelNav (SPEC 33) so as not to impact the target track attitude. At this point, the radar failed procedures are at least as good as executing MC3 and MC4 off an onboard relative state that may not be completely converged. The ground has the authority to return the crew to nominal MC3 and MC4 targeting making use of the new radar sensor data if it can be shown in real time that the onboard relative state is sufficiently converged and the trajectory would benefit from targeted burns. In general, targeted burns will benefit trajectories that are short of the targeted MC4 point while radar failed procedures are better suited for long trajectories. @021199-6732]

This rule is a result of the implementation of the ORBT Rendezvous Profile baselined during Orbit FTP #161, February 14, 1997.

~~B. MIDCOURSE MANEUVERS, EXCEPT MC2 AND THE OUT-OF-PLANE NULL, WILL NOT BE EXECUTED UNLESS:~~

- ~~1. ADDITIONAL TARGET SENSOR DATA HAS BEEN OBTAINED SINCE THE PREVIOUS MANEUVER OR,~~
- ~~2. A PREVIOUS BURN WAS KNOWN TO HAVE BEEN BAD.~~

Midcourse maneuvers are designed to correct the orbiter intercept trajectory based on the most current relative state information. Since no additional relative state is available, these maneuvers will only correct for trim errors and attitude maneuver effects. But errors in the onboard navigated state statistically cause maneuver solution errors as large as the computed maneuver. Hence, there is no real benefit to executing these maneuvers, and they should be deleted to save propellant. MC2 is an exception to this rule. It is executed on an elevation angle to ensure that the manual control trajectory is "standard." The out of plane null maneuver is another exception since it removes planar errors detected prior to TI. TI does not remove those errors, but rather sets up the node at this maneuver point.

~~D~~E. LAMBERT GUIDANCE BURNS MUST BE COMPLETED BY T1 TIG + 90 SECONDS. @[121296-4112A] @021199-6732]

1. IF THE START OF A BURN IS DELAYED SUCH THAT IT CANNOT BE COMPLETED BY T1 TIG + 90 SECONDS, THE BURN WILL BE RETARGETED PRIOR TO STARTING THE BURN.

FLIGHT RULES

2. IF A BURN IN PROGRESS IS NOT COMPLETE (I.E., VGO'S STILL > 0.2 FPS) BY T1 TIG + 90 SECONDS, THC INPUTS WILL BE STOPPED AND THE BURN WILL BE RETARGETED PRIOR TO COMPLETION.

Due to limitations in the onboard guidance software, Lambert guided burns should be completed within 90 seconds of the T1 TIG. This constraint is necessary because errors in the Lambert guidance solution increase as the time between T1 TIG and burn completion increases. At T1 TIG + 90 seconds, the worst case errors can be slightly larger than trim errors (0.2 fps) and can grow rapidly after that. ©[121296-4112A]

THIS RULE CONTINUED ON NEXT PAGE

FLIGHT RULES

A2.1.3-25

RENDEZVOUS MANEUVER EXECUTION

Flight history shows that rendezvous burns are usually complete 30 to 40 seconds after burn start. With rare exceptions, a burn started soon after TIG should be easily completed by $T1\ TIG + 90$ seconds. If the start is delayed to the point its completion by $T1\ TIG + 90$ seconds is in doubt, the burn should be retargeted prior to execution. When retargeted, the onboard software automatically computes a new $T1\ TIG$ equal to "current time + 1 minute." The burn must now be completed by the new $T1\ TIG + 90$ seconds. In the unlikely event that a burn was started on time but not completed at $T1\ TIG + 90$ seconds, THC inputs should be terminated and the burn retargeted prior to completion.

Because $T1\ TIG$ can be easily reset to a future time by simply retargeting the burn, this rule places no constraint on the total time a burn can slip past the planned TIG. The total slip capability is determined by the MCC on a burn by burn basis and is usually constrained by: 1) excess propellant usage; 2) Lambert targeting/guidance constraints that are not addressed in this rule, such as 180 degree transfers; or 3) links to ground targeted maneuvers such as the link between T_i and T_i delay. Other unique constraints are also possible.

Error in the burn solution arises from the fact that Lambert Cyclic Guidance (LCG) models the effects of gravitational oblateness (J_2) in a fashion inconsistent with Lambert Targeting. This inconsistency and its effects on guidance performance are thoroughly documented in the references listed below. Reference Rockwell Transmittal Form # 660-NAV-710-96-037, "Lambert Cyclic Guidance Error Analysis," J.L.Goodman, 13 May 1996; and Rockwell Transmittal Form # D250-300-24, "STS-69 SPARTAN NCC Burn Guidance Performance," J.L.Goodman, 27 Sept 1995. @[121296-4112A]

FLIGHT RULES

A2.1.3-26 RNDZ OPS DELAY

- A. FOR DELAYS PRIOR TO TI, IF CONVENIENT, THE NOMINAL MANEUVERS WILL BE ADJUSTED TO SLOW PHASING SO THAT THE ORBITER ARRIVES AT THE TI POINT AT THE DESIRED DELAY TIME. OTHERWISE, THE NOMINAL RENDEZVOUS PLAN WILL BE EXECUTED UNTIL TI WHERE A DELAY WILL BE DONE.

The most efficient way, from a propellant standpoint, to delay a rendezvous is to slow the catch-up rate such that the orbiter will rendezvous with the target at the desired time, in an integral number of orbits. Desirable lighting conditions will be maintained since there is an integral number of orbits. This can be done at any preplanned phasing maneuver (NC), typically with no propellant penalty, or an additional maneuver can be inserted into the rendezvous profile. Mission activities and propellant budgets will determine which option to use.

In order to efficiently perform a phasing adjustment, an apogee point must be available prior to TI where the perigee can be raised and the catchup rates slowed. Any point other than apogee will necessitate a larger burn and fuel consumption. Communication availability and time to adjust the maneuver must also be considered. If any problems in these areas arise, it is no longer convenient to adjust phasing, and a TI delay should therefore be executed.

- B. FOR SHORT TI DELAYS (ONE OR TWO ORBITS), MANEUVERS WILL BE EXECUTED TO RETURN TO THE TI POINT WITH THE DESIRED LIGHTING CONDITIONS. FOR LONG TI DELAYS (GREATER THAN TWO ORBITS), MANEUVERS WILL BE EXECUTED TO GUARANTEE A SAFE OPENING RATE OF AT LEAST 1 NM PER ORBIT.

TI is the last convenient point to delay the rendezvous. This delay may be desirable to recover lost capability prior to committing to intercept. For short delays, the ground will compute a phasing maneuver to return to the TI position based on the most current onboard relative state. Desirable lighting conditions will be maintained since there is an integral number of orbits between the original and new TI maneuvers.

A long delay requires an opening rate to eliminate the need for the crew to continuously monitor the target. Long delays usually involve at least one crew sleep cycle. In this case, if propellant is available, the delay maneuver is targeted to a point in the following morning equivalent to where the original final phasing maneuver was executed. This range minimizes the possibility of awakening the crew to execute a trajectory control maneuver; shorter ranges may require interruption of crew sleep. In this manner, the second rendezvous trajectory will be similar to the original trajectory.

There is a propellant penalty for executing a TI delay. The magnitude of this penalty is dependent on the specific mission profile and delay scenario.

Rule {A2.1.3-20}, RNDZ/PROX OPS ~~NAVIGATION SENSORS~~ REQUIREMENTS, references this rule. [@\[091098-6707B\]](#)

FLIGHT RULES

A2.1.3-27 RNDZ/PROX OPS BREAKOUT

- A. PRIOR TO TI, A GROUND-COMPUTED BREAKOUT MANEUVER WILL BE EXECUTED, IF NECESSARY, TO GUARANTEE A SAFE MISS DISTANCE BETWEEN THE ORBITER AND TARGET.

Prior to Ti, dispersions and the lack of a standard rendezvous profile prevent designing a "canned" breakout maneuver. The ground will compute a maneuver, if required, to ensure the orbiter avoids the target by a safe distance. Possibly not executing a preplanned rendezvous maneuver will provide an acceptable miss distance.

- B. BETWEEN TI AND STABLE AT ~~500~~ 600 FEET ON THE +RBAR, THE BREAKOUT MANEUVER WILL BE A 3-FPS RETROGRADE MULTI-AXIS MANEUVER. INITIATION OF THIS MANEUVER WILL BE AS FOLLOWS: ©[091098-6705A] ©[040899-6799C]

A single 3-fps retrograde breakout maneuver is required between Ti and the point of stability at 5600 feet on the +Rbar to ensure safe relative motion. Prior to visual acquisition of the target and commencement of the manual phase, this maneuver provides an orbiter CG to target CG miss distance of at least 500 feet (to allow for vehicle dimensions) based on Monte Carlo analysis. The 3-sigma dispersion ellipse will maintain at least a 500-foot miss distance if the breakout is initiated due to failure to acquire the target per the sub-parts below.

After visual acquisition of the target, the pilot is allowed to continue the rendezvous to the manual takeover point and begin to affect the relative motion of the orbiter with respect to the target via manual piloting techniques. This breakout should still provide safe relative motion all the way to Rbar arrival assuming the manual phase has been flown in a nominal manner (i.e., the braking gates have been followed and the target has been maintained within the COAS). However, after the manual phase has commenced, it is the responsibility of the CDR to ensure that the breakout is adequate and positive clearance with the target exists. Assuming a nominally flown manual phase, this maneuver provides an orbiter CG to target CG miss distance of approximately 370 ft if executed at the minimum 500 ft range. This satisfies the "rule of halves" groundrule and constraint for separations which, for this case, would require at least a 250 ft miss distance. ©[040899-6799C]

A maneuver to burn attitude is prohibited because of the delay in initiating the maneuver and the loss of target acquisition while still on an intercept trajectory. Since this retrograde breakout maneuver can occur anytime from Ti through Rbar arrival and the orbiter is in a -Z target track attitude, propellant to cover the breakout maneuver for the range of orbiter attitudes during the terminal phase must be protected. Worst case prop usage for this breakout maneuver is 80 lb fwd (at Rbar arrival) and 40 lb aft (45 deg below Vbar). Prop requirements for the maneuver are independent of the Low Z transition range since the breakout maneuver will be a pure -X burn when the orbiter is in the Low Z regime. ©[091098-6705A]

THIS RULE CONTINUED ON NEXT PAGE

FLIGHT RULES

A2.1.3-27 RNDZ/PROX OPS BREAKOUT (CONTINUED)

1. FOR INSUFFICIENT PROPELLANT OR ORBITER CONTINGENCIES REQUIRING BREAKOUT, THE BREAKOUT CAN BE INITIATED ANYTIME POST-TI. IF POSSIBLE, THE BREAKOUT SHOULD BE INITIATED BETWEEN MC1 AND MC2.

Since relative perigee occurs between MC1 and MC2, the effects of the retrograde maneuver will be maximized. @[091098-6705A]

2. IF NO TARGET SENSOR DATA (RR, ST, COAS) HAS BEEN INCORPORATED INTO NAV AND UTILIZED FOR BURN EXECUTION DURING THE RENDEZVOUS, THE BREAKOUT MANEUVER MUST BE EXECUTED WITH TIG NO LATER THAN MC2+20 MINUTES UNLESS THE TARGET IS ACQUIRED VISUALLY OR WITH THE RADAR.
@[091098-6705A]

With no target sensor data, the actual relative position between the orbiter and the target is not known with sufficient accuracy to warrant completion of the rendezvous. The breakout maneuver may be delayed to a point no later than MC2+20 minutes to allow the maximum time for crew visual acquisition of the target while maintaining the 3 sigma miss distance of 500 ft.

Note that this breakout point will be operationally implemented 2 minutes earlier than defined in this rule to provide enough time for the crew to execute the Rendezvous Breakout procedure such that TIG occurs at MC2+20 min per this rule.

3. IF GOOD TARGET SENSOR DATA (RR, ST, COAS) HAS BEEN INCORPORATED INTO NAV AND UTILIZED FOR BURN EXECUTION DURING THE RENDEZVOUS, THE BREAKOUT MANEUVER MUST BE EXECUTED WITH TIG NO LATER THAN MC2+24 MINUTES UNLESS THE TARGET IS ACQUIRED VISUALLY OR WITH THE RADAR.

With good target sensor data, trajectory dispersions are reduced, and as a result, the breakout maneuver may be delayed beyond MC2+20 min (per paragraph 2) to a point no later than MC2+24 minutes while still providing an acceptable miss distance. "Good" sensor data means that at least one full star tracker pass has occurred prior to MC2 resulting in small state vector updates. The quality of the sensor pass will be evaluated in real time by the MCC, and the go to delay the breakout point from MC2+20 min to MC2+24 min will be per ground call. Note that the MC2+20 min point will always occur in orbital daylight, so this extra 4 minutes is not particularly valuable (it is very unlikely that the target would be visually acquired at MC2+24 min but not visually acquired at MC2+20 min). Time from MC2 is used as a reference since the MC2 TIG is variable.

Note that this breakout point will be operationally implemented 2 minutes earlier than defined in this rule to provide enough time for the crew to execute the Rendezvous Breakout procedure such that TIG occurs at MC2+24 min per this rule. @[091098-6705A]

FLIGHT RULES

THIS RULE CONTINUED ON NEXT PAGE

FLIGHT RULES

A2.1.3-27 RNDZ/PROX OPS BREAKOUT (CONTINUED)

4. IF THE TARGET IS ACQUIRED VISUALLY OR WITH THE RADAR PER PARAGRAPHS 2 OR 3 ABOVE AND IT IS MORE THAN 30 DEG FROM THE ORBITER -Z AXIS, THE BREAKOUT MANEUVER SHOULD BE EXECUTED. IF MISSION DURATION DOES NOT ALLOW FOR THE POSSIBILITY OF RERENDEZVOUS, THEN THE MANUAL APPROACH MAY CONTINUE ON A BEST EFFORT BASIS.

Even if the crew visually acquires the target, certain off-nominal cases, particularly no sensor cases, can lead to trajectory dispersions that are unrecoverable via manual piloting techniques, or the manual recovery will expend more prop than a breakout and rendezvous. Target displacement from the orbiter -Z axis is a key indicator to the dispersed nature of the trajectory and hence the flyability of the approach. Target displacement of 30 deg or more is significantly greater than that seen in the 3-sigma radar fail trajectories used in the generation of the rendezvous propellant budget, and it would not be prudent to continue with the rendezvous in this case if a rendezvous capability exists. Rendezvous on another day provides the opportunity to troubleshoot the sensor/systems problems that led to the failure of the first rendezvous or to adjust rendezvous timing and procedures to maximize ground navigation effectiveness in an effort to increase the probability of a successful rendezvous. If mission duration cannot accommodate a rendezvous, the approach may continue on a best effort basis with a high probability that the rendezvous cannot be completed due to exceedance of propellant bingo constraints.

This rule is a result of the implementation of the ORBT Rendezvous Profile baselined during Orbit FTP #161, February 14, 1997. @[091098-6705A]

C. THE SHUTTLE NOSE IN-PLANE BREAKOUT MAY BE EXECUTED WHEN THE SHUTTLE STATE SATISFIES THE FOLLOWING CONDITIONS:
@[040899-6799C]

SHUTTLE IS WITHIN 500 FT (CG TO CG) OF THE TARGET VEHICLE.

SHUTTLE X AND Z BODY AXES ARE IN THE ORBITAL PLANE OF THE TARGET VEHICLE.

THE TARGET VEHICLE IS IN A STABLE POSITION ON THE SHUTTLE -Z AXIS. @[040899-6799C]

~~B. BETWEEN TI AND V-BAR ARRIVAL, THE BREAKOUT MANEUVER SEQUENCE WILL BE A 3 FPS OUT-OF-PLANE MANEUVER AWAY FROM THE TARGET PLANE (NOMINALLY ORBITER ±Y BODY AXIS) FOLLOWED 15 MINUTES LATER BY A 3 FPS RETROGRADE MANEUVER (ORBITER +X BODY AXIS). INITIATION OF THE SEQUENCE WILL BE AS FOLLOWS:-~~

FLIGHT RULES

~~*There is a single breakout maneuver sequence between TI and V bar arrival which is a 3 fps out of plane maneuver away from the target plane followed 15 minutes later by a 3 fps retrograde maneuver. This sequence provides an orbiter CG to target CG miss distance of at least 500 feet (to allow for vehicle dimensions). The 2 sigma dispersion ellipse will maintain at least a 500 foot miss distance.*~~

~~*The note "nominally orbiter $\pm Y$ body axis" is included to define the propellant source for the out of plane maneuver (bingos). This note assumes a Y POP, Z target track orbiter attitude. A maneuver to burn attitude is prohibited because of the delay in initiating the sequence and the loss of target acquisition while still on an intercept trajectory. Similarly, the note "orbiter +X body axis" is included for the retrograde maneuver which is always executed in burn attitude. @ED]*~~

- ~~1. FOR INSUFFICIENT PROPELLANT OR ORBITER CONTINGENCIES REQUIRING BREAKOUT, THE BREAKOUT SEQUENCE CAN BE INITIATED ANYTIME POST TI. IF POSSIBLE, THE BREAKOUT SHOULD BE INITIATED BETWEEN MC1 AND MC2.~~

~~*For reasons other than target sensor data, the breakout maneuver sequence should be initiated between MC1 and MC2 to maximize the miss distance. @ED]*~~

~~**THIS RULE CONTINUED ON NEXT PAGE**~~

FLIGHT RULES

~~A2.1.3-27 RNDZ/PROX OPS BREAKOUT (CONTINUED)~~

- ~~2. IF NO TARGET SENSOR DATA (RR, ST, COAS) HAS BEEN OBTAINED BY ORBITAL SUNSET, THE BREAKOUT SEQUENCE WILL BE INITIATED AT ORBITAL SUNSET.~~

~~*With no target sensor data, the actual relative position between the orbiter and the target is not known with sufficient accuracy to warrant completion of the rendezvous. The breakout sequence initiation is delayed until orbital sunset to allow the maximum time for post TI sensors to acquire the target.*~~

~~*FOR INFORMATION ONLY: From orbital sunset until MC2, the out of plane maneuver does not contribute to the miss distance and could be deleted in propellant critical situations, but, the retrograde maneuver must be executed.*~~ @ED]

- ~~3. IF ONLY PRE-TI TARGET SENSOR DATA (RR, ST, COAS) HAS BEEN OBTAINED, THE BREAKOUT SEQUENCE WILL BE INITIATED NO LATER THAN MC2 PLUS 20 MINUTES UNLESS THE TARGET IS ACQUIRED VISUALLY OR WITH THE RADAR.~~

~~*With pre-TI target sensor data, trajectory dispersions are reduced. The sequence initiation can be delayed until MC2 plus 20 minutes and still provide an acceptable miss distance. MC2 even time is used as a reference since the base time is updated at MC2.*~~ @ED]

- ~~4. IF POST-TI TARGET SENSOR DATA (RR, ST, COAS) HAS BEEN OBTAINED, THE BREAKOUT SEQUENCE WILL BE INITIATED NO LATER THAN MC2 PLUS 25 MINUTES UNLESS THE TARGET IS ACQUIRED VISUALLY OR WITH THE RADAR.~~

~~*With post-TI target sensor data, the trajectory dispersions are reduced even more and the sequence initiation can be delayed until MC2 plus 25 minutes while still providing an acceptable miss distance. If breakout decision is delayed past MC2 plus 25 minutes, the 500 foot clearance cannot be guaranteed.*~~ @ED]

- ~~5. TO CONTINUE THE RENDEZVOUS PAST MC2 PLUS 25 MINUTES, VISUAL ACQUISITION OR RENDEZVOUS RADAR IS REQUIRED. SUBSEQUENTLY, IF BOTH OF THESE ARE LOST, THE SEQUENCE WILL BE INITIATED ASAP.~~

~~*Manual control requires acquisition of the target either visually or with radar. Loss of both requires the rendezvous to be terminated.*~~ @ED]

THIS RULE CONTINUED ON NEXT PAGE

FLIGHT RULES**A2.1.3-27 RNDZ/PROX OPS BREAKOUT (CONTINUED)**

THE IN-PLANE BREAKOUT MANEUVER SEQUENCE WILL BE AS FOLLOWS: @J040899-6799C]

1. IF WITHIN 75 FT INTERFACE TO INTERFACE, THE SHUTTLE CREW WILL NULL THE CLOSING RATE, THEN BACK OUT BY INITIATING AND MAINTAINING AT LEAST 0.1 FT/SEC OPENING RATE WHILE MAINTAINING THE TARGET VEHICLE POSITIONED NEAR THE SHUTTLE -Z BODY AXIS.

For ranges inside 75 ft, a backout must be initiated to provide adequate clearance to complete the breakout sequence. For ISS flights, this would involve performing a Corridor Backout.

2. WHEN RANGE IS GREATER THAN 75 FT INTERFACE TO INTERFACE, PERFORM AT LEAST A 1.5 FPS BURN IN THE "CLOCKWISE" DIRECTION (+X ORBITER BODY BURN IF OMICRON IS 0, -X ORBITER BODY BURN IF OMICRON IS 180 DEGREES). FOLLOWING THE BURN, MODE TO INERTIAL HOLD.

This X burn results in the orbiter opening from the target vehicle. Moding the DAP to INRTL results in an orbiter attitude profile that, when coupled with the relative motion, maintains the target vehicle near the orbiter -Z body axis. This relative orientation minimizes plume loads on the target when the DAP is in Low Z mode. The 1.5 fps burn was sized to ensure that the orbiter is at least 1000 ft from the target after 22 min at which time Low Z is deselected and the maneuver to attitude for the next burn commences. Since this breakout exposes the target vehicle to possible direct PRCS firings just outside of 1000 ft, it is not adequate for target vehicles that require Low Z protection outside 1000 ft.

3. AT 30 MINUTES AFTER THE ±X BURN, PERFORM A 3 FPS OUT-OF-PLANE AND 3.5 FPS POSIGRADE/RETROGRADE BURN USING THE +X RCS JETS. AT 22 MINUTES AFTER THE ±X BURN, DESELECT LOW Z AND INITIATE THE MANEUVER TO BURN ATTITUDE.

This final burn needs to be performed 30 minutes after the ±X burn to provide a safe trajectory. The size of this burn (4.6 ft/sec RSS) was designed to provide a safe trajectory for all initial conditions that satisfy the conditions of applicability for this breakout. The breakout also allows for the selection of either a posigrade or retrograde component to provide flexibility for subsequent mission objectives. The burn combines the out-of-plane and posigrade/retrograde components and is performed as a +X burn with a maneuver to attitude in order to save propellant. Time is allotted to allow a worst case 180 deg maneuver to attitude at 0.5 deg/sec. @J040899-6799C]

THIS RULE CONTINUED ON NEXT PAGE

FLIGHT RULES

A2.1.3-27 RNDZ/PROX OPS BREAKOUT (CONTINUED)

D. THE RBAR BREAKOUT MAY BE EXECUTED WHEN THE SHUTTLE STATE SATISFIES THE FOLLOWING CONDITIONS: @[040899-6799C]

SHUTTLE IS WITHIN 500 FT (CG TO CG) OF THE TARGET VEHICLE.

SHUTTLE X AND Z BODY AXES ARE IN THE ORBITAL PLANE OF THE TARGET VEHICLE.

THE SHUTTLE IS POSITIONED ON THE \pm RBAR WITH THE TARGET VEHICLE IN A STABLE POSITION ON THE SHUTTLE -Z BODY AXIS.

THE RBAR BREAKOUT MANEUVER SEQUENCE WILL BE AS FOLLOWS:

1. IF WITHIN 75 FT INTERFACE TO INTERFACE, THE SHUTTLE CREW WILL NULL THE CLOSING RATE, THEN BACK OUT BY INITIATING AND MAINTAINING AT LEAST 0.1 FT/SEC OPENING RATE WHILE MAINTAINING THE TARGET VEHICLE POSITIONED NEAR THE SHUTTLE -Z BODY AXIS.

For ranges inside 75 ft, a backout must be initiated to provide adequate clearance to complete the breakout sequence. For ISS flights, this would involve performing a Corridor Backout.

2. WHEN RANGE GREATER THAN 75 FT INTERFACE TO INTERFACE, PERFORM A 3 FPS +X OR -X TRANSLATION.

This +X or -X burn results in either retrograde or posigrade motion relative to the target vehicle. The direction of the burn should be selected based on subsequent mission objectives. The burn will result in the orbiter phasing away from the target vehicle at approximately 8 nm/rev. @[040899-6799C]

THIS RULE CONTINUED ON NEXT PAGE

FLIGHT RULES

A2.1.3-27 RNDZ/PROX OPS BREAKOUT (CONTINUED)

E. THE VBAR BREAKOUT MAY BE EXECUTED WHEN THE SHUTTLE STATE SATISFIES THE FOLLOWING CONDITIONS: @J040899-6799C]

SHUTTLE IS WITHIN 500 FT (CG TO CG) OF THE TARGET VEHICLE.

SHUTTLE X AND Z BODY AXES ARE IN THE ORBITAL PLANE OF THE TARGET VEHICLE.

THE SHUTTLE IS LOCATED ON THE \pm VBAR WITH THE TARGET VEHICLE IN A STABLE POSITION ON THE SHUTTLE -Z BODY AXIS.

THE VBAR BREAKOUT MANEUVER SEQUENCE WILL BE AS FOLLOWS:

1. IF WITHIN 75 FT INTERFACE TO INTERFACE, THE SHUTTLE CREW WILL NULL THE CLOSING RATE, THEN BACK OUT BY INITIATING AND MAINTAINING AT LEAST 0.1 FT/SEC OPENING RATE WHILE MAINTAINING THE TARGET VEHICLE POSITIONED NEAR THE SHUTTLE -Z BODY AXIS.

For ranges inside 75 ft, a backout must be initiated to provide adequate clearance to complete the breakout sequence. For ISS flights, this would involve performing a Corridor Backout.

2. WHEN RANGE GREATER THAN 75 FT INTERFACE TO INTERFACE, MODE TO INERTIAL HOLD AND PERFORM A 1 FPS RADIAL BURN WITH THE +X OR -X JETS. IF THE SHUTTLE IS ON THE +VBAR, PERFORM THE BURN RADIAL UP. IF THE SHUTTLE IS ON THE -VBAR, PERFORM THE BURN RADIAL DOWN.

This +X or -X burn results in a trajectory that lofts the orbiter above (for +Vbar) or below (for -Vbar) the target. Moding the DAP to INRTL results in an orbiter attitude profile that, when coupled with the relative motion, maintains the target vehicle near the orbiter -Z body axis in order to protect the target vehicle from jet plume loads during the subsequent burn.

3. AT 22 MINUTES AFTER THE RADIAL BURN, PERFORM A 3 FPS +X OR -X TRANSLATION.

This +X or -X burn results in either retrograde or posigrade motion relative to the target vehicle. The direction of the burn should be selected based on subsequent mission objectives. The burn will result in the orbiter phasing away from the target vehicle at approximately 8 nm/rev. @J040899-6799C]

NASA - JOHNSON SPACE CENTER

FLIGHT RULES

THIS RULE CONTINUED ON NEXT PAGE

FLIGHT RULES

A2.1.3-27 **RNDZ/PROX OPS BREAKOUT (CONTINUED)**

F. THE FLYAROUND BREAKOUT MAY BE EXECUTED WHEN THE SHUTTLE STATE SATISFIES THE FOLLOWING CONDITIONS:

SHUTTLE IS WITHIN 500 FT (CG TO CG) OF THE TARGET VEHICLE.

SHUTTLE X AND Z BODY AXES ARE IN THE ORBITAL PLANE OF THE TARGET VEHICLE.

THE SHUTTLE IS PITCHING AT A CONSTANT RATE LESS THAN 0.2 DEG/SEC WITH THE TARGET VEHICLE IN A STABLE POSITION ON THE SHUTTLE -Z AXIS.

THE FLYAROUND BREAKOUT MANEUVER SEQUENCE WILL BE AS FOLLOWS:

1. CONTINUE FLYAROUND PROCEDURE TO NEXT RBAR CROSSING.
2. PERFORM A 3 FPS +X OR -X PRCS TRANSLATION.

The simplest and most expedient way to break out from a flyaround is to continue the flyaround to the next Rbar crossing and perform a single +X or -X burn, resulting in either retrograde or posigrade motion relative to the target vehicle. The direction of the burn should be selected based on subsequent mission objectives. If it is desirable to minimize the use of forward propellant when performing the breakout, then performing the Shuttle Nose In-Plane Breakout (paragraph C) may be better depending on the orientation of the orbiter during the flyaround and the desired breakout direction.

G. IF A BREAKOUT IS DESIRED ASAP AND THE SHUTTLE STATE DOES NOT SATISFY THE CONSTRAINTS OF PARAGRAPHS C THROUGH F, THEN PERFORM THE FOLLOWING 1-2-3 BREAKOUT (AKA SEP MANEUVER, ORB OPS CHECKLIST):

1. MANUALLY ROTATE THE ORBITER SUCH THAT THE TARGET IS VISIBLE THROUGH THE OVERHEAD WINDOW.

The target must be positioned near the orbiter -Z axis so that the crew can acquire it with either the KU radar or the HHL and null any closing rate with orbiter +Z translations. ©[040899-6799C]

THIS RULE CONTINUED ON NEXT PAGE

FLIGHT RULES

A2.1.3-27 RNDZ/PROX OPS BREAKOUT (CONTINUED)

2. NULL ANY CLOSING RATE AND ESTABLISH A 1 FPS OPENING RATE IN NORM Z. THIS BURN MAY BE PERFORMED IN LOW Z (ON MCC CALL, IF PROP AVAILABLE) IN ORDER TO PROVIDE PLUME PROTECTION TO THE TARGET VEHICLE. @[040899-6799C]

This 1 fps opening rate ensures short term relative motion will not result in a collision with the target vehicle. Although use of Low Z for this burn provides plume protection to the target vehicle, the prop requirements are so high that it should only be performed in Low Z if MCC deems that prop is available to support it.

3. 22 MIN AFTER THE 1 FPS OPENING BURN, PERFORM A 2 FPS MULTI-AXIS OUT-OF-PLANE BURN IN NORM Z. IN TIME CRITICAL SITUATIONS, THIS BURN CAN BE PERFORMED 2 MIN AFTER THE OPENING BURN.

Since this 2 fps out-of-plane burn is performed multi-axis, it is possible that a significant component of the burn will be directed at the target vehicle. Waiting 22 minutes to perform this burn maximizes the out-of-plane separation of the orbiter from the target as a result of the initial opening burn, thus minimizing plume impingement on the target vehicle. In time critical situations, however, this out-of-plane burn can be performed almost immediately after the initial opening burn with the possibility of significantly pluming the target vehicle. Use of Norm Z is required to avoid the excessive cross-coupling resulting from performing a multi-axis burn in Low Z.

4. 15 MIN AFTER THE OUT-OF-PLANE BURN, PERFORM A 3 FPS POSIGRADE BURN IN NORM Z.

Coasting 15 min after execution of the 2 fps out-of-plane burn results in the orbiter moving approximately 1500 ft out-of-plane, well outside the Low Z range for most target vehicles. Burning posigrade will then allow the orbiter to phase behind the target to set up for a subsequent rendezvous, if desired. Three fps ensures that the resultant posigrade component after the completion of the 1-2-3 burn sequence is at least 2 fps, which provides a safe separation rate of approximately 5 nm/rev. @[040899-6799C]

THIS RULE CONTINUED ON NEXT PAGE

FLIGHT RULES

A2.1.3-27 RNDZ/PROX OPS BREAKOUT (CONTINUED)

THIS BREAKOUT IS NOT PROTECTED IN THE RNDZ/PROX OPS
TERMINATE QUANTITY. @[040899-6799C]

Plume impingement analysis does not protect for breakout scenarios. However, all the above prox ops breakout sequences have been designed to use "common sense" piloting techniques to minimize plume impingement on the target vehicle and provide safe relative motion. The breakouts outlined in paragraphs C through F are optimized to cover the nominal operating regimes of the orbiter while in proximity operations. If outside these normal regimes, then the breakout procedure described in paragraph G (ref. SEP MANEUVER, Orbit Ops Checklist) will provide safe relative motion for any initial condition at the cost of more propellant and possible plume impingement of the target vehicle. Propellant for this breakout will not be protected given the extremely low probability of requiring such a breakout (ref. Flight Rule {A2.1.3-22}, RNDZ/PROX OPS PROPULSION SYSTEMS MANAGEMENT). Furthermore, it is typically more propellant efficient to fly the orbiter to a state that satisfies the constraints of one of the paragraphs C through F, then execute the applicable breakout. The above breakouts were approved at a Splinter Generic Orbit Flight Techniques meeting held on March 26, 1999. @[040899-6799C]

FLIGHT RULES

A2.1.3-28 RENDEZVOUS GUIDANCE

- A. THE ONBOARD ORBITER AND TARGET NAVIGATION STATES WILL BE INITIALIZED BY GROUND UPLINK PRIOR TO INITIATION OF RNDZ NAVIGATION.

An onboard software restriction prohibits enabling rendezvous navigation if the timetag of the target state vector is older than 15 hours. The target state vector timetag I-load is zero; therefore, without a ground uplink of the target state vector, rendezvous navigation cannot be enabled.

It is also desirable for both the ground and the onboard to have the most accurate orbiter and target state vectors available, hence the most accurate relative state vector to initialize rendezvous navigation for the first navigation sensor tracking interval. This allows the filter to rapidly determine the "true" state and prevents undesirable transients caused by large updates.

- B. THE PROPAGATED STATE VECTOR WILL BE SELECTED FOR USER PARAMETER PROCESSING (UPP) STATE VECTOR UNTIL THE BEGINNING OF THE FIRST RELATIVE TRACKING INTERVAL. THE FILTER STATE VECTOR WILL BE SELECTED:
1. IF 10 ST MEASUREMENTS HAVE BEEN ACCEPTED WITH THE LAST STATE VECTOR POSITION UPDATE <1.0K FEET, OR,
 2. IF 10 RR MEASUREMENTS HAVE BEEN ACCEPTED WITH THE LAST STATE VECTOR POSITION UPDATE <0.3K FEET, OR,
 3. IF 3 COAS MEASUREMENTS HAVE BEEN ACCEPTED.

Accepting 10 ST or RR measurements prior to selecting the filtered state vector for the UPP prevents filtered vector transients from reaching the UPP. This delay also allows the crew time to take appropriate action to prevent the use of a filtered state which may have incorporated bad measurements. Since COAS processing takes longer, only three marks are taken prior to selecting the filtered state vector.

- C. FOR ALL TRACKING INTERVALS, MEASUREMENT INCORPORATION WILL BE INHIBITED PRIOR TO SENSOR ACQUISITION.

Inhibiting data prior to sensor acquisition prevents marks from being immediately incorporated. This allows the crew time to assess the quality of the sensor data prior to its incorporation into the filtered state vector.

THIS RULE CONTINUED ON NEXT PAGE

FLIGHT RULES

A2.1.3-28 RENDEZVOUS GUIDANCE (CONTINUED)

- D. ST MEASUREMENTS WILL NOT BE INCORPORATED INTO THE FILTERED STATE UNTIL PROPER TARGET LOCK IS VERIFIED. IF AFTER FOUR CONSECUTIVE MEASUREMENT CYCLES (31 SECONDS), THE RESIDUAL VALUES CHANGE <0.05 DEGREE PER CYCLE AND THE RATIO VALUES ARE <1.0 , THEN THE AUTO/INHIBIT/FORCE OPTION FOR ANGLES WILL BE SELECTED TO AUTO.

In target track attitude hold, the target should remain essentially stationary in the ST field of view; a star will have an angular rate of 0.5 degree per cycle. If the residuals are continuously changing by more than 0.05 degree per cycle, the object being tracked is most likely a star. Monitoring four consecutive measurement cycles (31 seconds) allows the data quality to be assessed and ensures that the ST has not locked onto a false target.

- E. RR MEASUREMENTS WILL BE INCORPORATED INTO THE FILTERED STATE AS FOLLOWS. IF AFTER FOUR CONSECUTIVE MEASUREMENT CYCLES (31 SECONDS) THE RESIDUAL VALUES ARE STABLE AND THE RATIO VALUES ARE <1.0 THEN THE AUTO/INHIBIT/FORCE OPTION WILL BE SELECTED TO AUTO. RADAR DATA WILL NOT BE INCORPORATED INTO NAVIGATION AT RANGES GREATER THAN 135K FEET.

Four consecutive measurement cycles (31 seconds) allow transients to settle and the crew to assess the quality of the data. Stable measurements are an indirect indication that the radar sensor is locked onto the target with the main lobe instead of a side lobe. Ratios <1.0 indicate that the measurements, if accepted by selecting AUTO, will not be rejected by the navigation filter. At ranges greater than 135k feet, the radar range becomes biased due to eclipsing of the return signal.

- F. WHENEVER EITHER RR ANGLE EXCEEDS 30 DEGREES FROM THE -Z AXIS, RADAR ANGLE MEASUREMENTS WILL BE INHIBITED.

Angle data is considered valid only within a 30-degree half-cone of the -Z axis.

- G. THE FOLLOWING PRIORITIZED ACTIONS WILL BE TAKEN IF SUCCESSIVE SENSOR MEASUREMENTS ARE REJECTED BY RESIDUAL EDITING (RATIO VALUES >1.0) AT THE START OF A TRACKING INTERVAL:

1. BREAK LOCK AND REACQUIRE TARGET (ST ONLY).

If residual editing continuously occurs, most likely the ST has either locked onto a star, has a malfunction, or very large relative state errors are present. To prevent bad measurements from being incorporated into the filtered state vector, breaking lock and reacquiring the target is the desirable first step since it does not update anything in the relative navigation state.

FLIGHT RULES

THIS RULE CONTINUED ON NEXT PAGE

FLIGHT RULES

A2.1.3-28 RENDEZVOUS GUIDANCE (CONTINUED)

2. REINITIALIZE COVARIANCE.

If the covariance matrix has been reduced (e.g., measurement incorporation, wrong covariance uplinked), reinitializing the covariance will expand it and allow larger updates to be incorporated into the filtered state. Incorporating these larger updates should correct the relative state vector which will stop the residual editing.

3. FORCE UP TO THREE MEASUREMENTS.

If covariance reinitialization is not sufficient to prevent residual editing, data can be forced into the filtered state. Three consecutive measurements should correct the relative state vector sufficiently to stop the residual editing. If measurements continue to be edited, a generic problem may exist; and forcing more measurements, most likely, will not improve the situation.

4. FILTER RESTART (PROPAGATOR TO FILTER TRANSFER).

A filter restart eliminates all data incorporated into the filtered state vector since the last filtered to propagated state vector transfer. This is a last resort procedure to correct the rendezvous navigation relative state.

H. FOR ALL BUT THE INITIAL TRACKING INTERVAL, A FILTERED TO PROPAGATED STATE VECTOR TRANSFER WILL BE PERFORMED AFTER SUCCESSFUL SENSOR LOCK-ON TO THE TARGET BUT PRIOR TO DATA INCORPORATION.

A filtered to propagated state vector transfer is done to maintain a good backup state vector (propagated) for restart purposes in the event that the filtered state vector subsequently incorporates bad sensor data. Sensor lock-on is an independent means of evaluating the filtered state vector prior to executing the transfer. A transfer is not required prior to the first sensor pass because the filtered state vector and the propagated state vector are identical at that time.

I. IF FILTER MINUS PROPAGATOR CHANGES BY MORE THAN 40K FEET WITHIN AN ST PASS, THEN ALL OF THE FOLLOWING WILL BE DONE:

1. SELECT PROPAGATED STATE VECTOR FOR UPP.
2. INHIBIT ANGLES.
3. FILTER RESTART (PROPAGATED TO FILTERED STATE VECTOR).
4. BREAK TRACK AND USE NOMINAL PROCEDURES TO REACQUIRE.

FLIGHT RULES

If filtered minus propagated state changes by more than 40k feet during a single ST pass, the ST data is considered bad and has corrupted the filtered state. These actions will recover rendezvous navigation to a point equivalent to the beginning of the ST tracking interval.

FLIGHT RULES

A2.1.3-29 EMCC/TMCC ACTIVATION

IN THE EVENT THAT THE EMERGENCY MISSION CONTROL CENTER (EMCC) OR TEMPORARY MISSION CONTROL CENTER (TMCC) MUST BE ACTIVATED, THE FLIGHTCREW WILL BEGIN ORDERLY TERMINATION OF ANY PAYLOAD-RELATED OR HAZARDOUS ACTIVITY. WHEN THE ACTIVITY HAS BEEN TERMINATED, THE ORBITER WILL BE MANEUVERED TO +XVV, -ZLV AND REMAIN IN THIS ATTITUDE UNTIL FURTHER INSTRUCTIONS FROM THE EMCC/TMCC. FLIGHT SPECIFIC EXCEPTIONS AND CRITERIA FOR ORDERLY TERMINATION MAY BE IDENTIFIED IN THE FLIGHT SPECIFIC ANNEX.

When the EMCC or TMCC is required to be utilized, a major portion of the real-time telemetry monitoring, flight planning, and data analysis capability provided by the MCC is not available. In addition, the capability to provide payload data to the POCC/payload customer may be lost. With the loss of these MCC capabilities, the ground cannot provide adequate support to safely execute a nominal flight plan and must use the reduced facilities provided by the EMCC/TMCC to monitor orbiter systems. The selected attitude is thermally benign and restrictions on attitude maneuvers significantly reduces the support required for ground monitoring.

FLIGHT RULES

A2.1.3-30 ORBITER ON-ORBIT HIGH DATA RATE REQUIREMENTS

THE ORBITER ON-ORBIT HIGH DATA RATE REQUIREMENTS ARE SUMMARIZED BELOW. PAYLOAD DATA SHALL BE GIVEN UP IF REQUIRED TO SATISFY THE ORBITER HIGH DATA RATE REQUIREMENT. IF HIGH DATA RATE CANNOT BE ACHIEVED DUE TO SYSTEMS PROBLEMS, THE LISTED ACTIVITIES MAY STILL BE ACCOMPLISHED.

<u>ORBITER OPERATION</u>	<u>HIGH DATA RATE REQUIREMENT</u> [1]		
	<u>OI</u>	<u>GNCSM</u>	<u>SM</u>
<u>MMACS</u>			
FCS CHECKOUT	M	NR	NR
<u>EECOM</u>			
BONDLINE TEMP MONITORING	[2]	NR	NR
<u>PROP</u>			
OMS BURNS (TIG MINUS 5 TO TIG PLUS 5) (SEE RULE {A6.1.2-34}, OMS BURN DOWNLIST REQUIREMENT)	<u>NRM</u>	<u>MNR</u>	NR
<u>RMS</u>			
RMS C/O	NR	NR	M
RMS TROUBLESHOOTING	NR	NR	M
RMS OPS (<u>PORT ARM SELECTED</u>)	NR	NR	<u>HDM</u>
<u>FDO/RNDZ</u>			
PROX OPS	NR	HD	NR
RNDZ OPS (SENSORS, TARGETING)	NR	HD	NR
<u>EVA</u>			
DURING EVA	<u>NR</u>	<u>NR</u>	<u>M</u>
	HD	NR	NR
<u>@061297-62001</u>			

(M = MANDATORY, NR = NOT REQUIRED, HD = HIGHLY DESIRABLE)

NOTES:

- [1] HIGH DATA RATE MAY BE REQUIRED ANYTIME FOR FAILURE ANALYSIS OR TROUBLESHOOTING.
- [2] MUST HAVE HIGH DATA RATE PERIODICALLY TO CHECK TEMPERATURES. ONCE PER ORBIT IS TYPICALLY THE MAXIMUM REQUIREMENT. ACTUAL FREQUENCY DEPENDS ON THE ATTITUDES BEING FLOWN AND THE BETA ANGLE.

FLIGHT RULES

THIS RULE CONTINUED ON NEXT PAGE

FLIGHT RULES

A2.1.3-30

ORBITER ON-ORBIT HIGH DATA RATE REQUIREMENTS (CONTINUED)

EECOM - All orbiter TPS measurements lost except V09T1524A cabin upper skin center line. Data is used to determine flight rule impacts for:

Payload bay door closing vehicle gradients (Rule {A10.1.11-6A}, PLBD CLOSE GO/NO-GO).

Entry prep maximum temperatures (Rule {A18.1.9-1A.b}, THERMAL PROTECTION SYSTEM (TPS) BONDLINE TEMPERATURE). [ED]

Anytime minimum temperatures for glassy transition of RTV (Rule {A18.1.10-1A}, ORBITER THERMAL CONSTRAINTS AND ATTITUDE MANAGEMENT).

FDO/RNDZ - Rendezvous loses data required to verify proper configuration. Prime NAV and sensor evaluation job can still be performed. This applies to PROX OPS only if a universal pointing fly-around is being performed. Rendezvous data lost:

Universal pointing - body vector, target ID, MNVR attitude, attitude error.

DAP configuration - attitude and rate deadbands, translational pulse size, discrete MNVR rate.

Guidance mode - Lambert or external delta V, TV roll.

Star tracker status - Shuttle position, track indications, star present.

Navigation - Uplink timetags associated with onboard vectors.

RMS - Virtually all RMS data lost in SM low data rate. This includes all data required to analyze failures.

EVA - Data is highly desirable for biomed.

All requirements were reviewed at Orbit Flight Techniques #106.

FLIGHT RULES

A2.1.3-31 PAYLOAD OBJECTIVES VS. PAYLOAD DAMAGE POLICY

- A. THE HARDWARE FOR ANY PAYLOAD WILL NOT BE JETTISONED SOLELY TO ACCOMPLISH MISSION SUCCESS OBJECTIVES FOR ANOTHER PAYLOAD.
- B. CONSIDERATION WILL BE GIVEN TO ALLOWING HARDWARE DAMAGE TO A PAYLOAD TO OCCUR IF THIS ALLOWS ACCOMPLISHING MANDATORY MISSION SUCCESS OBJECTIVES OF ANOTHER PAYLOAD AS LONG AS SUCH DAMAGE DOES NOT PRESENT AN ORBITER OR CREW SAFETY CONCERN.

A payload can be reflown if its mission success objectives cannot be met, but this is a significant expense to the program. It may be worth the impact of repairing damage to one payload as opposed to reflaying a payload which will not meet its objectives. Such an option should be considered. Each case must be looked at individually to determine if hardware damage is an appropriate tradeoff. The jettisoning of hardware has such severe implications to the agency as a whole that it is judged not appropriate for any mission-success objective gain.

A2.1.3-32 ATTITUDE RESTRICTIONS FOR ORBITAL DEBRIS

- A. TIME IN THE FOLLOWING ATTITUDES WILL BE MINIMIZED IN PREFLIGHT PLANNING AND IN REAL TIME:
 - 1. -ZVV (PAYLOAD BAY FORWARD).
 - 2. +XVV, +ZLV OR ±YLV (NOSE FORWARD, PAYLOAD BAY UP OR OUT OF PLANE).
- B. -ZLV WILL BE THE NORMAL ORBITER ATTITUDE UNLESS PAYLOAD OR ORBITER REQUIREMENTS DICTATE OTHERWISE. TIME IN +XVV WILL BE MINIMIZED.

FOR THE PURPOSE OF THIS RULE, THE ORBITER WILL BE CONSIDERED TO BE IN ONE OF THE ABOVE ATTITUDES IF THE -Z(X) AXIS IS CLOSER TO ONE OF THE REFERENCED LVLH AXES (+V, +R, ±H) THAN TO ANY OTHER.

IF MORE THAN 48 HOURS CUMULATIVE TIME IN THESE ATTITUDES IS PLANNED, FLIGHT-SPECIFIC EXCEPTIONS WILL BE DOCUMENTED IN THE FLIGHT-SPECIFIC ANNEX.

FLIGHT RULES

Both the Rockwell orbital debris study and the JSC Space and Life Sciences studies looked at various shuttle attitudes and assessed the risk of catastrophic damage due to orbital debris and micrometeoroids. The JSC study also assessed the probable window replacements and radiator repairs required from various attitudes. Data was presented to Orbit Flight Techniques Panel meeting number 131 on August 14, 1992. Numbers are for a 160 nm orbit. This rule addresses relative risk of different attitudes and not absolute risk.

THIS RULE CONTINUED ON NEXT PAGE

FLIGHT RULES

A2.1.3-32

ATTITUDE RESTRICTIONS FOR ORBITAL DEBRIS (CONTINUED)

There are two fundamental reasons to restrict attitudes. One is the risk of catastrophic damage from debris; the other is not a catastrophic risk, but will much more likely cause damage that will result in turnaround impacts and increased costs. The major turnaround drivers are the windows and the radiators.

The -ZVV attitude, regardless of the yaw about the Z axis, is the worst attitude from a catastrophic damage perspective. The risk was between three and five times greater in -ZVV than the best attitude which is -ZLV, -XVV (bay down, tail forward). The -ZVV attitudes were noticeably more risky than other attitudes in both studies. Other attitudes fall in between the two, but the uncertainty in the studies was judged great enough to not put any restrictions on other attitudes than -ZVV with regard to critical damage from orbital debris.

The radiator damage is 16 times worse in -ZVV than in -ZLV. Window damage is also worse in -ZVV (20 times worse) with +XVV (nose forward) being a close second. The +XVV attitude is relatively safe from catastrophic damage.

Time in attitude is an important factor. The longer the time in the attitude, the greater the risk. Forty-eight hours was chosen somewhat arbitrarily. Forty-eight hours results in an expectation of less than 0.5 window replacements and 15 radiator dings. Some flights will have objectives that justify the increased risk of these attitudes. These must be documented as exceptions in the flight-specific annex.

Time in the listed attitudes will be minimized in real time, but it is impractical to compute and police the 48-hour number or any other number in real time.

Many attitudes will not be purely in one of the directions spelled out above. Thus the orbiter -Z (and X for part B) axis will be considered to be pointed in the direction of the LVLH axis that it is closest to.

FLIGHT RULES

A2.1.3-33 THERMAL CONDITIONING FOR FLIGHT DAY 1 LANDING

IN THE EVENT THAT A FDI LANDING IS REQUIRED, PRE-ENTRY THERMAL CONDITIONING WILL BE ON A "BEST-EFFORT" BASIS, CONSISTENT WITH OTHER ATTITUDE REQUIREMENTS. FLIGHT-SPECIFIC END-OF-MISSION BONDLINE LIMITS SHOULD BE MET IF POSSIBLE. THE FOLLOWING GENERIC GUIDELINES SHOULD BE USED FOR THE PERIOD BETWEEN OMS-2 AND D/O BURN (BRIEF EXCURSIONS FOR IMU ALIGN, ETC. ARE ACCEPTABLE) :

	ATTITUDE GUIDELINES *	
	$0 < \beta < 60$	$60 < \beta < 90$
REV 3 D/O BURN	ORBIT: -ZLV -YVV (+BETA) (1HR 28M) ZLV +YVV (-BETA) D/O COMM: TAIL SI, SUN 45° STBD (1HR 05M) BAY-EARTH AT NOON	ORBIT: -ZLV -YVV (+BETA) (1HR 28M) -ZLV +YVV (-BETA) D/O COMM: NOSE SI, (1HR 05M) BAY-EARTH AT NOON
REV 4 D/O BURN	ORBIT: -ZLV -YVV (+BETA) (1HR 23M) -ZLV +YVV (-BETA) D/O COMM: TAIL SI, SUN 30° STBD (2HR 10M) BAY-EARTH AT NOON	ORBIT: -ZLV -YVV (+BETA) (1HR 23M) -ZLV +YVV (-BETA) D/O COMM: TAIL SI, SUN 40° STBD (2HR 10M) BAY-EARTH AT NOON
REV 5 D/O BURN	ORBIT: -ZLV -YVV (+BETA) (1HR 18M) -ZLV +YVV (-BETA) THEN: ORB RATE, SUN 45° STBD OF TAIL (1HR 30M) D/O COMM: TAIL SI, SUN 30° STBD (2HR 10M) BAY-EARTH AT NOON	ORBIT: -ZLV -YVV (+BETA) (2HR 48M) -ZLV +YVV (-BETA) D/O COMM: TAIL SI, SUN 40° STBD (2HR 10M) BAY-EARTH AT NOON
REV 6 D/O BURN	ORBIT: -ZLV -YVV (+BETA) (1HR 18M) -ZLV +YVV (-BETA) THEN: ORB RATE, SUN 45° STBD OF TAIL (3HR 00M) D/O COMM: TAIL SI, SUN 30° STBD (2HR 10M) BAY-EARTH AT NOON	ORBIT: -ZLV -YVV (+BETA) (2HR 48M) -ZLV +YVV (-BETA) THEN: ORB RATE, SUN 40° STBD OF TAIL (1HR 30M) D/O COMM: TAIL SI, SUN 40° STBD (2HR 10M) BAY-EARTH AT NOON
REV 7 D/O BURN	ORBIT: -ZLV -YVV (+BETA) (1HR 48M) -ZLV +YVV (-BETA) THEN: ORB RATE, SUN 45° STBD OF TAIL (4HR 00M) D/O COMM: TAIL SI, SUN 30° STBD (2HR 10M) BAY-EARTH AT NOON	ORBIT: -ZLV -YVV (+BETA) (3HR 28M) -ZLV +YVV (-BETA) THEN: ORB RATE, SUN 40° STBD OF TAL (2HR 20M) D/O COMM: TAIL SI, SUN 40° STBD (2HR 10M) BAY-EARTH AT NOON

FLIGHT RULES

For a launch day deorbit, time may not be available to meet all thermal constraints, due to other constraints such as landing opportunity, burn attitudes, IMU alignment and verification, and communications. Within these other constraints, attitudes will be chosen to meet thermal constraints, such as tail-sun for bondlines or biased starboard-sun for OMS Ox Hi Point Bleedline QD and aft-firing RCS thrusters. ®[092195-1787B]

THIS RULE CONTINUED ON NEXT PAGE

FLIGHT RULES

A2.1.3-33 THERMAL CONDITIONING FOR FLIGHT DAY 1 LANDING (CONTINUED)

* TABLE NOTES:

"ORBIT AND THEN" REFERS TO THE TIME FROM NOMINAL PLBD OPENING ATTITUDE (1:12) UNTIL MANEUVER TO DEORBIT IMU ATTITUDE (OR DEORBIT COMM ATTITUDE FOR REV 3).

TIMES IN PARENTHESES SHOW THE ATTITUDE DURATIONS WHICH WERE ASSUMED AND ANALYZED. THESE TIMES ALSO REFLECT THE DESIRED DURATIONS. IF MORE (LESS) ATTITUDE TIME IS AVAILABLE BETWEEN THE ACTUAL OMS-2 AND DEORBIT COMM ATTITUDES, THE 'ORBIT' ATTITUDE MAY BE LENGTHENED (SHORTENED). IF TWO ATTITUDES ARE SHOWN, I.E., 'ORBIT' AND 'THEN', THE DURATIONS MAY BE ADJUSTED PROPORTIONALLY.

ORB RATE DEFINITION: ORBITER WILL ROTATE ABOUT A SUN POINTING VECTOR OF P=180, Y=40 OR 45 AT ORBIT RATE, KEEPING THE ORBITER BOTTOM TOWARD SPACE DURING ROTATION (I.E., EQUIVALENT TO OMICRON 90 FOR POSITIVE BETA AND OMICRON 270 FOR NEGATIVE BETA AT NOON).

-ZLV AND ORB RATE ATTITUDES REQUIRE GNC OPS 2 SOFTWARE. IF GNC OPS 2 IS NOT AVAILABLE, "THERMALLY SIMILAR" SOLAR INERTIAL ATTITUDES WILL BE SELECTED.

Documentation: CCB 2/28/95, 5/16/95, SODB Volume V. @[092195-1787B]

A2.1.3-34 POCC THROUGHPUT COMMAND RATES

THE MISSION OPERATIONS COMPUTER (MOC) WILL BE CONFIGURED VIA THE POCC INPUT RATE CONTROL (I87 MED) TO ALLOW ONLY ONE POCC THROUGHPUT COMMAND PER SECOND TO BE OUTPUT INTO THE ORBITER UPLINK DATA STREAM. @[121197-6398]

The Network Signal Processor (NSP) interface with the Flight Software (FSW) Systems Management (SM) command application may require as much as 960 msec to completely process a single uplinked payload throughput command (PTC) without error. The POCC INPUT RATE CONTROL adjusts the rate at which commands will be accepted into the MOC. By setting this control to one command per second, first word/last word (FW/LW) rejects of commands by the SM GPC caused by too rapid payload commanding can be eliminated. Any setting of this control above one command per second, even if the commands are routed to the same vehicle address, will allow the potential for onboard rejects of commands to exist. See Section 6.2.2.5 of the Space Shuttle Computer Program Development Specifications (CPDS) - SS Downlist/Uplink Software Requirements (SS-P-0002-140).

Rejection of commands, for whatever reason, requires analysis of the command system to ensure that it remains intact with no failures. By eliminating this source of command rejects, resources can be more efficiently used. Limitation of payloads to one PTC per second should not present a significant impact if command timelines are planned appropriately. @[121197-6398]

FLIGHT RULES

DEORBIT

A2.1.4-1 DEORBIT GUIDELINES

- A. LOSS OF ALL REDUNDANCY IN DEORBIT METHODS WILL BE CAUSE TO DEORBIT AT THE NEXT PLS OPPORTUNITY
1. LOSS OF ONE OMS ENGINE AND ONE RCS +X JET
 2. LOSS OF TWO OMS ENGINES
 3. INSUFFICIENT PROPELLANT TO SUPPORT TWO METHODS OF STEEP DEORBIT

When all redundancy in deorbit methods has been lost, the orbiter is fail-critical with respect to deorbit capability. Deorbit must be performed at the next opportunity to avoid prolonged exposure to the failure of the remaining deorbit method.

Three deorbit methods are considered in assessing the ability to remain on orbit: the left OMS engine, the right OMS engine, and the four +X RCS jets. The availability of a deorbit method is based upon two criteria: the health of the hardware and the availability of sufficient propellant to satisfy the deorbit delta V requirements through the respective engine(s).

While a three +X RCS deorbit is possible, the increased burn arc and the imbalance in thrust (creating a yawing moment which must be countered by the RCS yaw jets) make the deorbit propellant requirement prohibitively large.

- B. IF INSUFFICIENT PROPELLANT EXISTS TO PROVIDE TWO METHODS OF STEEP DEORBIT CAPABILITY, MISSION DURATION MAY BE EXTENDED BEYOND THE NEXT PLS IF THE DEORBIT DELTA V CAPABILITY CAN BE IMPROVED AS A RESULT OF THE FOLLOWING (WHILE PROVIDING AT LEAST TWO METHODS OF DEORBIT):
1. PAYLOAD DEPLOY.
 2. DECREASE IN DEORBIT DELTA V REQUIREMENTS.

NOTE: IF PAYLOAD DEPLOY IS CONSIDERED AS AN OPTION TO IMPROVE THE OVERALL DELTA V CAPABILITY, SUFFICIENT PROPELLANT MUST BE AVAILABLE TO PROTECT TWO METHODS OF DEORBIT ASSUMING THE PAYLOAD IS NOT DEPLOYED IN ORDER TO PASS THE NEXT PLS OPPORTUNITY.

THIS RULE CONTINUED ON NEXT PAGE

FLIGHT RULES

A2.1.4-1 DEORBIT GUIDELINES (CONTINUED)

Consideration should be given to remaining on orbit if two methods (steep or shallow) of deorbit capability will be available and improved deorbit capability guaranteed at the next day PLS and activities beneficial to orbiter safety can be achieved.

The gain in delta V more than makes up the additional propellant cost for an additional 24 hours on orbit plus deploy operations and the minimum separation required for each payload. The net gain in delta V for all deploys is positive thereby adding additional capability for deorbit. The heavier the payload, the greater the increase in delta V.

For an ATO or elliptical orbit, the deorbit delta V may decrease with on-orbit stay time. For some ATO's, the shallow deorbit delta V on day 1 is greater than the steep deorbit delta V on day 2. For this case, staying on orbit 24 hours may gain steep deorbit delta V capability eliminating any risk due to a shallow entry.

C. IF OMS PROPELLANT IS NOT AVAILABLE TO ACCOMPLISH OMS DEORBIT TO STEEP TARGETS, TWO STAGE DEORBIT BURNS ARE ACCEPTABLE TO MAINTAIN DEORBIT STEEP CAPABILITY WHEN SUFFICIENT PROPELLANT IS AVAILABLE (IN ACCORDANCE WITH RCS JET REDUNDANCY REQUIREMENTS AS SPECIFIED IN RULE {A6.1.4-5}, OMS PROPELLANT DEFICIENCY FOR DEORBIT).

If propellant is not available in the OMS to complete a steep deorbit burn, a perigee adjust burn may be planned using the forward or aft RCS, reducing the OMS propellant requirement for deorbit. Reserving propellant for a two-stage deorbit is only acceptable when sufficient RCS jet redundancy exists as stated in Rule {A6.1.4-5}, OMS PROPELLANT DEFICIENCY FOR DEORBIT.

Rules {A6.1.2-17}, OMS FAILURE MANAGEMENT (CIL); and {A6.1.2-25}, OMS ENGINE FAILURE MANAGEMENT, reference this rule.

FLIGHT RULES

A2.1.4-2 EXTENSION DAY GUIDELINES

- A. IF MANDATORY LANDING AIDS, GROUND TRACKING, COMMAND, VOICE, OR TELEMETRY EQUIPMENT AT THE PLS (REF. SEC. 3, GROUND INSTRUMENTATION REQUIREMENTS) ARE NOT AVAILABLE OR IF WEATHER CONDITIONS AT THE PLS ARE OBSERVED AND/OR FORECAST TO BE UNACCEPTABLE FOR LANDING, A WAVE-OFF OF 24 HOURS OR MORE MAY BE PERFORMED TO ACHIEVE A LANDING AT THE PRIMARY LANDING SITE IF ALL OF THE FOLLOWING CONDITIONS ARE MET:
1. THE ORBITER EXCEEDS MDF SYSTEMS CONFIGURATION STATUS.
 2. CONSUMABLES PROVIDE FOR AT LEAST A 48-HOUR MISSION EXTENSION (WAVE-OFF 24 HOURS TO THE NEXT PLS OPPORTUNITY WITH AN ADDITIONAL 24 HOURS MORE FLIGHT DURATION TO ALLOW RECOVERY FROM ANY ORBITER SYSTEM FAILURES).
 3. THE WEATHER FORECASTS INDICATE THERE IS A HIGH PROBABILITY THAT THE WEATHER AT THE PRIMARY LANDING SITE (WHILE MAINTAINING REASONABLE OPTIONS AT THE SECONDARY LANDING SITE) WILL BE ACCEPTABLE ON A LANDING OPPORTUNITY PRIOR TO 24 HOURS BEFORE THE EXPIRATION OF CONSUMABLES.
 4. ORBITAL ALTITUDE ALLOWS AT LEAST A 48-HOUR MISSION EXTENSION.
 5. ANY MANDATORY EQUIPMENT OUTAGE HAS AN ETRO THAT WILL SUPPORT A PLS LANDING PRIOR TO 24 HOURS BEFORE EXPIRATION OF CONSUMABLES.
- B. IF THE EXTENSION DAY GUIDELINES ABOVE CANNOT BE MET AND THE PLS IS NOT AVAILABLE, THEN AN SLS LANDING WILL BE IMPLEMENTED.

It is desirable to land at the primary landing site if possible. Mission extension is acceptable to accomplish this goal. If the PLS weather is unacceptable, either observed at the decision time or forecast for landing time (ref. Rule {A2.1.1-6}, LANDING SITE WEATHER CRITERIA, and Rule {A4.1.4-6}, HAC SELECTION CRITERIA), then consideration will be given to a mission extension to achieve a PLS landing. Similarly, for an outage of mandatory equipment supporting a landing at the PLS (ref. rules in Section 3, GROUND INSTRUMENTATION REQUIREMENTS).

THIS RULE CONTINUED ON NEXT PAGE

FLIGHT RULES

A2.1.4-2 EXTENSION DAY GUIDELINES (CONTINUED)

It is programmatically desirable to land at the primary landing site. Diversion to alternate sites results in significant additional postflight work and may involve some risk to orbiter or payload hardware reusability. If the orbiter system status and consumables will support continued flight, then continuing to attempt landings at the PLS is preferable to early diversion to an SLS. However, when orbiter systems status is such that an MDF or PLS is required (systems redundancy is compromised) or if consumables cannot support an additional 48-hour flight extension, then the risk incurred by continuing the flight outweighs the programmatic advantages of a landing at the primary site. The consumables and orbital altitude must support the 24-hour extension to the next PLS opportunity and an additional 24-hour mission lifetime if an orbiter systems problem occurs late in the preparations for deorbit that requires a day to fix.

Reference Rule {A2.1.3-1}, MISSION DURATION REQUIREMENTS.

Rules {A4.1.4-6}, HAC SELECTION CRITERIA, and, {A2.1.4-7} LANDING SITE SELECTION, reference this rule.

A2.1.4-3 DEORBIT DELAY GUIDELINES

- A. DELAY A MAXIMUM OF ONE ORBIT TO UNDERSTAND, VERIFY, RECONFIGURE, OR (WHERE A REASONABLE PROBABILITY EXISTS) TO FIX A PROBLEM ASSOCIATED WITH A BASIC GROUND OR VEHICLE CAPABILITY, INCLUDING ADDITIONAL FAULT TOLERANCE.
- B. CONSIDERATION WILL BE GIVEN TO EXTENDING 1 DAY TO REGAIN REDUNDANCY IN AN ENTRY-CRITICAL SYSTEM PROVIDED FAIL-SAFE REDUNDANCY EXISTS IN ALL OTHER SYSTEMS CRITICAL TO ENTRY/LANDING.
- C. ON ENTRY DAY, DELAY A MAXIMUM OF 1 DAY TO PROVIDE A SINGLE-FAULT TOLERANT PASS SYSTEM, A BFS, ACCEPTABLE NAVIGATION, PLBD CLOSURE, OR MANDATORY GROUND CAPABILITY.
- D. AN INTERNAL OMS, RCS, OR APU LEAK RESULTING IN THE VIOLATION OF MINIMUM THERMAL OPERATING CONSTRAINTS RESULTING FROM THE LOSS OF THE POD OR APU IS CAUSE FOR A DEORBIT DELAY.

THIS RULE CONTINUED ON NEXT PAGE

FLIGHT RULES

A2.1.4-3 DEORBIT DELAY GUIDELINES (CONTINUED)

- E. FOR A SINGLE GPC FAILURE PRIOR TO DEORBIT PREPARATION OR FOR MULTIPLE GPC FAILURES PRIOR TO TIG, UNLESS OTHER FACTORS DICTATE DEORBIT ON THE SCHEDULED DAY, ENTRY WILL BE DELAYED UP TO 24 HOURS TO ALLOW FOR RECOVERY, ANALYSIS, AND POSSIBLE IFM TO INSTALL THE CARRY-ON SPARE GPC (IF MANIFESTED). FOR A SINGLE GPC FAILURE DURING DEORBIT PREPARATION, ENTRY MAY BE DELAYED ONE ORBIT TO ALLOW FOR GPC RECOVERY. @[092195-1798]

It is desired to have all GPC's for use during entry. Some GPC failures may be recovered by an IPL, but such a transient GPC may fail again and therefore use of a transient GPC shall be avoided if possible. It is also undesirable to assign two flight-critical strings to a single GPC which would be required if entering with only three PASS GPC's. During the deorbit preparations, however, backing out of the deorbit preparation requires systems reconfiguration which entails inherent risks of its own. At that point, it is better to use a transient GPC or continue without it if it cannot be recovered. The failure of two or more GPC's is a more serious case that implies a significant loss of redundancy; therefore, entry will be delayed a day to allow for the best attempt at GPC recovery which could include a changeout of one of the failed GPC's if a spare is manifested. @[092195-1798]

Rule {A7.1.3-7B}, GPC MEMORY DUMP CRITERIA, references this rule. @[092195-1798]

- F. A CONFIRMED OMS LEAK MAY DELAY DEORBIT.
- G. THE FLIGHT WILL NOT BE EXTENDED PAST THE NEXT PLS OPPORTUNITY UNLESS ORBITAL LIFETIME CAN BE GUARANTEED THROUGH THE LAST PLS OPPORTUNITY OF THE FOLLOWING DAY. A REAL-TIME DETERMINATION OF THE MINIMUM 24-HOUR PERIGEE WILL BE MADE FOR OFF-NOMINAL ORBITS.

The 24-hour minimum orbital lifetime is required to ensure crew and vehicle safety if extending past the next PLS opportunity. As perigee approaches the entry interface altitude, the drag buildup significantly increases orbital decay and is thermally more severe on the vehicle. At these low altitudes, the MCC modeling of the orbit is also greatly deteriorated. Exposure to very low altitudes would eventually result in an uncontrolled reentry, which would likely result in loss of crew and vehicle.

- H. FOR PROPELLANT LEAKS THAT OCCUR AFTER LOS AND PRIOR TO THE DEORBIT BURN, THE FOLLOWING ACTIONS WILL APPLY:
1. OMS LEAK - A PERIGEE ADJUST MANEUVER WILL BE PERFORMED AT THE NOMINAL DEORBIT TIG.

THIS RULE CONTINUED ON NEXT PAGE

FLIGHT RULES

A2.1.4-3 DEORBIT DELAY GUIDELINES (CONTINUED)

2. RCS LEAK - THE DEORBIT BURN WILL BE DELAYED TO ASSESS THE THERMAL ENVIRONMENT.

A perigee adjust is performed on an OMS leak in order to minimize the deorbit delta V. Since the thermal effects of an OMS or RCS leak cannot be predicted, the deorbit burn will be delayed to evaluate whether the pod thermal environment can support deorbit. A leak can result in OMS and RCS feedlines freezing, rendering both systems unusable for deorbit and entry.

- I. DEORBIT MAY BE DELAYED TO ACHIEVE A PLS LANDING IF THE WEATHER CONDITIONS ARE UNACCEPTABLE OR MANDATORY GROUND EQUIPMENT IS NOT AVAILABLE.

It is desirable to land at the primary landing site if possible. Mission extension is acceptable to accomplish this goal.

Rule {A7.1.3-7D}, GPC MEMORY DUMP CRITERIA, references this rule.

A2.1.4-4 MDF DEORBIT GUIDELINES

AN ENTRY PREPARATION TIMELINE WILL PROVIDE FOR ENTRY STOWAGE AND PREPARATION ON THE AFTERNOON OF ENTRY MINUS 1 DAY FOR THE FOLLOWING:

- A. MDF.
- B. A NEXT PLS IF REQUIRED DUE TO A CONDITION WHICH REQUIRES MDF, BUT AFTER MDF OBJECTIVES HAVE BEEN SATISFIED.

FLIGHT RULES

A2.1.4-5 EMERGENCY DEORBIT

A. EMERGENCY DEORBIT IS REQUIRED FOR:

1. LOSS OF TWO FREON LOOPS.

If both loops are lost, an abort from orbit is required because there is absolutely no cooling of the vehicle. The fuel cell stack temperature will reach the specification limit of 250 deg F within approximately 50 minutes. In addition, the electrolyte concentration will reach the 25 percent operational limit in approximately 75 minutes. At this point, continued operation of the fuel cells is questionable. This assumes a simultaneous purge of all three fuel cells and a 12.54 kWh (4.18 kWh/fuel cell) power level. Without the purge, the fuel cells will flood in approximately 18 minutes based on an 8.0 kWh (2.67 kWh/fuel cell) power level (ref. Rule {A2.1.2-4}, RTLS, TAL, AND AOA ABORTS FOR SYSTEMS FAILURES (CIL)).

DOCUMENTATION: DUAL FREON LOOP FAILURE ENTRY ANALYSIS, Rockwell International IL # 388-301-79-018, 7/21/81, and SODB table 3.4.4.1-1.

2. ANY OF THE FOLLOWING THAT WILL NOT SUPPORT A NEXT PLS:

a. CABIN LEAK.

Cabin pressure integrity is lost when O2 and N2 consumables are not enough to maintain the cabin pressure at 14.7 psia to the next PLS opportunity while protecting the 165-minute hole-in-the-cabin contingency requirement. If a cabin leak is such that the consumables will not maintain the minimum metabolic pressure (8.0 psia) until the next PLS, the only option left is an emergency deorbit.

DOCUMENTATION: Engineering judgment.

b. IMPENDING LOSS OF ALL O2 (H2) CRYO.

If the pressure cannot be maintained in at least one cryo tank and manifold, the fuel cells will eventually stop producing electrical power, no matter what the quantity is in the cryo tanks. Therefore, this condition warrants the selection of the earliest abort opportunity (ref. Rule [A9.1.6-11], IMPENDING LOSS OF ALL CRYO).

DOCUMENTATION: Engineering judgment.

c. LEAKING PROPELLANT FROM THE REMAINING DEORBIT BURN SYSTEM.

Capability will be lost to successfully complete the deorbit burn.

THIS RULE CONTINUED ON NEXT PAGE

FLIGHT RULES**A2.1.4-5 EMERGENCY DEORBIT (CONTINUED)**

- d. TWO ARCS PROPELLANT TANKS LEAKING, SAME PROPELLANT AND EITHER LEAK RATE SUPPORTS ENTRY TO A Q-BAR = 20 FOR A DAYLIGHT LANDING AT AN ELS (IF A NIGHT LANDING AND NO LANDING AIDS DELAY DEORBIT).

If the leak rate supports entry to a Q-bar = 20 for any ELS, perform an emergency deorbit to that site. This action would provide entry control until NO YAW JET selection. The risk of an ELS landing without landing aids at night is considered to be higher than proposed options of procedure/software changes to provide control from EI to Q-bar = 20. Therefore, for a night landing without landing aids, the deorbit will be delayed.

- e. LOSS OF TWO APU/HYDRAULIC SYSTEMS AND THE THIRD SYSTEM FAILING.

Loss of last hydraulic system will result in loss of aerosurface control required for entry (ref. Rule {A10.1.2-1}, LOSS OF APU/HYDRAULIC SYSTEM (S) ACTION).

- f. LOSS OF TWO WATER LOOPS.

Thermal analysis indicates that, if two water loops are lost, cabin conditions will become intolerable within 2 hours of the failure. Cabin temperatures approach 90° F and relative humidity reaches 100 percent. Avionics temperatures exceed their loss of cooling operate periods and must be powered down. The cabin conditions can be relieved by performing cabin depress/repress (DEP/REP) cycles. The 4-hour time to landing is based on a crew of seven with an N2 quantity of 262 lb. Crew exposure to the extreme cabin conditions is the primary driver for terminating the flight. The DEP/REP cycles provide relief from the high heat and humidity by dumping the excessive heat and humidity overboard and replacing the air with cool, dry N2 and O2.

DOCUMENTATION: Lockheed Technical memorandum, G189A ECLSS ANALYSIS OF THE LOSS OF TWO WATER LOOPS AFO (TIG >2.5), to be published. Document no. LESC-24843.

- B. IN THE EVENT AN EMERGENCY DEORBIT IS REQUIRED, ORBITER CONSUMABLES LIFETIME IS THE PRIMARY CONSIDERATION. WHEN CHOOSING BETWEEN VARIOUS ELS OPPORTUNITIES, BOTH OF THE FOLLOWING CRITERIA MUST BE SATISFIED, AS A MINIMUM: ©[120894-1744B]

1. ENTRY CROSSRANGE < UNDISPERSED CROSSRANGE LIMIT.

THIS RULE CONTINUED ON NEXT PAGE

FLIGHT RULES

A2.1.4-5 EMERGENCY DEORBIT (CONTINUED)

2. LANDING FACILITY REQUIREMENTS AS SPECIFIED IN RULE {A2.1.5-14}, EMERGENCY LANDING FACILITY CRITERIA.

Consumables lifetime will limit the emergency landing site choices available. If no landing site is available within time limits, then a bailout is required.

The undispersed entry crossrange limit represents the total vehicle crossrange capability, assuming perfect onboard navigation, design winds and atmosphere, and nominal vehicle energy, control, and response. Landing sites outside this limit are not achievable on an average (zero sigma) day and; therefore, deorbiting to such a site is not much better than a bailout.

Minimum ground equipment, including night landing equipment, is specified in rule {A2.1.5-14}, EMERGENCY LANDING FACILITY CRITERIA.

- C. WHEN ALL THE CRITERIA IN PARAGRAPH B ARE MET AND A CHOICE BETWEEN SITES CAN STILL BE MADE, THEN THE FOLLOWING PRIORITIES APPLY (NOTE: IF TIME PERMITS, CONSIDERATION WILL BE GIVEN TO ADDITIONAL CRITERIA AS SPECIFIED IN RULE {A4.1.3-7}, PLS/EOM LANDING OPPORTUNITY REQUIREMENTS):

1. NASA CONUS:

- a. EDW
- b. KSC
- c. NOR

NOTE: A NIGHT LANDING AT A NASA CONUS SITE EQUIPPED WITH NAV-LANDING AIDS AND XENON LIGHTS IS PREFERRED OVER A DAYLIGHT LANDING TO ANY OTHER SITE BELOW.

2. TAL SITES PRIOR TO RELEASE FROM LAUNCH SUPPORT @[120894-1744B]
3. DOD: @[120894-1744B]
 - a. HICKAM AFB, HAWAII
 - b. ANDERSEN AFB, GUAM
 - c. MORON, SPAIN (POST-RELEASE FROM TAL SUPPORT)

THIS RULE CONTINUED ON NEXT PAGE

FLIGHT RULES

A2.1.4-5 EMERGENCY DEORBIT (CONTINUED)

- d. DIEGO GARCIA, CHAGOS ISLANDS
 - e. OTHER DOD, LISTED IN NSTS-07700, VOLUME X, BOOK 3
4. NON-DOD WITH UHF COMM AVAILABLE:
- a. KING KHALID, SAUDI ARABIA
 - b. ZARAGOZA, SPAIN (POST-RELEASE FROM TAL SUPPORT)
 - c. OTHER NON-DOD WITH UHF, LISTED IN NSTS-07700, VOLUME X, BOOK 3
5. ALL OTHER NON-DOD (NO UHF):
- a. BEN GUERIR, MOROCCO (POST-RELEASE FROM TAL SUPPORT)
 - b. BANJUL, THE GAMBIA (POST-RELEASE FROM TAL SUPPORT)
 - c. OTHER NON-DOD WITHOUT UHF, LISTED IN NSTS-07700, VOLUME X, BOOK 3
6. OTHER SITES NOT LISTED IN NSTS-07700, VOLUME X, BOOK 3

First priority for emergency deorbit landings are the NASA CONUS sites. The only time a night landing is preferred over daylight for emergency deorbit is when it can be made at a CONUS site equipped with operational nav aids, landing aids, and xenon lights. TAL sites are not staffed after release of launch support; however, for failures very early in the mission which require an emergency deorbit, any TAL site which is still available and staffed would be preferred over an ELS. Sites with permanent DOD presence are next since ELS augmentation for emergency deorbit use has been eliminated. Further priorities are based upon available landing site security, control, and communications. Ben Guerir and Banjul are ranked very low as they have no UHF support and minimal (at best) security and control after TAL launch support is gone. ©[120894-1744B]

D. EMERGENCY DEORBIT PROTECTION REQUIREMENTS: ©[120894-1744B]

1. EMERGENCY DEORBIT CAPABILITY WILL NOT BE PROTECTED UNLESS THERE IS A FAILURE OR SUSPECTED PROBLEM THAT MAY LEAD TO ONE OF THE CASES LISTED IN PARAGRAPH A ABOVE.

THIS RULE CONTINUED ON NEXT PAGE

FLIGHT RULES

A2.1.4-5 EMERGENCY DEORBIT (CONTINUED)

2. EMERGENCY DEORBIT PROTECTION WILL REQUIRE TERMINATING AN ACTIVITY OR CONFIGURATION IF:
 - a. A SINGLE FAILURE OR SITUATION (ORBITER OR PAYLOAD), ALTHOUGH NOT CAUSE IN THEMSELVES FOR AN EMERGENCY DEORBIT, COULD PROHIBIT A SAFE ENTRY/LANDING CONFIGURATION.
 - b. A SINGLE FAILURE WOULD REQUIRE A CONTINGENCY EVA IN A TIME-CRITICAL SITUATION TO PROVIDE A SAFE ENTRY/LANDING CONFIGURATION. @[120894-1744B]

Rules {A6.1.2-18}, RCS FAILURE MANAGEMENT; {A8.1.6-1}, GNC GO/NO-GO CRITERIA; {A8.1.6-ID.9}, GNC GO/NO-GO CRITERIA and {A16.1.1-12A}, EMERGENCY POWERDOWN, reference this rule.

E. EMERGENCY LANDING SITE NOTIFICATION: @[120894-1744B]

SHOULD AN EMERGENCY LANDING BE REQUIRED, NOTIFICATION WILL BE PROVIDED AS SOON AS POSSIBLE TO THE INTENDED LANDING SITE BY MCC/GROUND PERSONNEL THROUGH STATE DEPARTMENT-APPROVED CHANNELS. HOWEVER IN SOME CASES, IT MAY NOT BE POSSIBLE TO PROVIDE ADVANCED NOTIFICATION PRIOR TO THE DEORBIT/ATTEMPTED LANDING. WHEN SELECTING THE LANDING SITE, CONSIDERATION WILL BE GIVEN TO THOSE SITES THAT HAVE AN ORBITER COMPATIBLE UHF SYSTEM IN ORDER TO PROVIDE LANDING NOTIFICATION BY THE CREW DURING DESCENT IF POSSIBLE.

SHOULD NOTIFICATION OF THE SELECTED LANDING SITE NOT BE POSSIBLE, THE DECISION ON WHETHER TO ATTEMPT THE LANDING OR BAILOUT WILL BE THE RESPONSIBILITY OF THE CDR BASED ON LANDING SITE CONDITIONS AT THE TIME OF ARRIVAL WITH RESPECT TO WEATHER, AIRCRAFT TRAFFIC, RUNWAY CONDITIONS, ETC.
@[120894-1744B]

In order to reduce the risk to the orbiter crew and the general public/civilian population should an emergency landing be required, it is necessary that an intended landing site be notified of an attempted landing as soon as possible. This will allow the airspace and runways to be cleared as well as emergency equipment to be prepared. Notification may be via state department prearranged channels, NASA agreed to communication channels, or possibly via communication directly with the orbiter. As a last resort, a landing may be attempted at a site that has not been notified, with the final decision on whether to attempt the landing or bailout resting with the CDR based on conditions at the time of arrival.

FLIGHT RULES

FLIGHT RULES

A2.1.4-6 DEROTATION SPEED

- A. NOMINAL DEROTATION WILL BE TARGETED FOR 185 KEAS USING BEEP TRIM.
- B. IN THE EVENT OF A BEEP TRIM FAILURE, THE CDR WILL INITIATE MANUAL DEROTATION BY APPROXIMATELY 175 KEAS AND TARGET FOR A 1-2 DEG/SEC RATE.
- C. FOR A LEAKING/FLAT MAIN GEAR TIRE, BEEP TRIM DEROTATION MAY BE DELAYED TO NO SLOWER THAN 165 KEAS TO ACHIEVE A 10 KT DELTA FROM THE ACTUAL DRAG CHUTE DEPLOY VELOCITY. ©[041097-4009E]

Nominal derotation is initiated by the crew using beep trim at 185 KEAS on both concrete and lakebed runways and for all vehicles. Based on a nominal 195 KEAS lightweight MLG touchdown, the drag chute is deployed ~~1-second later and immediately after touchdown.~~ Flight data and testing at Ames (1/96 and 7/96) show that, to ensure disreef prior to NGTD, the chute should be deployed 10 knots prior to ~~derotation-is initiated 1-second after the chute deployment.~~ If the drag chute is deployed at 195 knots (post MGTD)deploy leads derotation by one second, the chute will be in the full-open configuration just prior to nose gear touchdown, thus reducing the slapdown loads. Faster touchdowns result in more time spent in the 2-pt attitude hold stance waiting for the velocity to decelerate to the nominal chute deploy/vehicle derotation cues. Although a nominal drag chute deploy and derotation sequence will usually result in a chute disreef prior to NGTD, dispersions in touchdown speed, chute deploy, and derotation velocities may result in chute disreef after NGTD. Derotation may therefore be delayed until 10 knots below the actual chute deploy velocity to ensure maximum load relief for a leaking/flat tire. The 165 KEAS minimum derotation velocity protects nose gear slap down loads, assuming no beep trim failures. (Reference AEFTP Splinter, October 8, 1996.) ©[041097-4009E]

Reference Rules {A4.1.3-8A}, TIRE SPEED, BRAKING, AND ROLLOUT REQUIREMENTS, and {A10.1.8-1}, TIRE PRESSURE (CIL). ©[050495-1774A]

FLIGHT RULES

A2.1.4-7 LANDING SITE SELECTION

NORMAL LANDING SITE SELECTION WILL BE BASED ON THE FOLLOWING PRIORITIES. ALL REQUIREMENTS FOR ACCEPTABLE WEATHER, LIGHTING CONDITIONS, RUNWAY/LAKEBED CONDITIONS, AND ENTRY CONSTRAINTS MUST BE SATISFIED FOR A SITE/RUNWAY TO BE USED.

NOTE: REFERENCE THE FLIGHT-SPECIFIC FLIGHT RULE ANNEX FOR ANY EXCEPTIONS TO THE FOLLOWING LANDING SITE PRIORITIES DUE TO SPECIAL CIRCUMSTANCES/REQUIREMENTS.

A. RTLS/TAL PRIORITIES:

RTLS [1]	
INCLINATION < 39°	INCLINATION > 39°
KSC 15	KSC 33
KSC 33	KSC 15

NOTE: [1] FOR INCLINATIONS OF EXACTLY 39 DEGREES, THERE IS NO DIFFERENCE IN DOWNMODE RANGING BETWEEN KSC 15/33. RUNWAY WILL BE CHOSEN BASED ON WEATHER, SURFACE WINDS, TOUCHDOWN/ROLLOUT MARGINS, ETC. @[020196-1802A]

TAL			
28.5	39	51.6	57
BANJUL (BYD)	BEN GUERIR (BEN)	ZARAGOZA (ZZA)	ZARAGOZA (ZZA)
BEN GUERIR (BEN)	MORON (MRN)	MORON (MRN)	MORON (MRN)
MORON (MRN)	ZARAGOZA (ZZA)	BEN GUERIR (BEN)	BEN GUERIR (BEN)
	BANJUL (BYD) *		

@[020196-1802A]

* BYD IS GENERALLY NOT SUPPORTED FOR 39 DEGREE INCLINATION EVEN THOUGH IT MAY BE AVAILABLE FROM A PERFORMANCE STANDPOINT.

RUNWAY SELECTION FOR RTLS OR TAL SHOULD BE IN PRIORITY ORDER OF GO RUNWAYS. HOWEVER, IF A RUNWAY APPROACHES FLIGHT RULE LIMITS OR OTHER CONDITIONS MAKE A RUNWAY LESS DESIRABLE (I.E., SUN GLARE, STA EVALUATION, ETC.), THEN CONSIDERATION MAY BE GIVEN TO SELECTING A LOWER PRIORITY RUNWAY. @[020196-1802A]

NASA - JOHNSON SPACE CENTER

FLIGHT RULES

THIS RULE CONTINUED ON NEXT PAGE

FLIGHT RULES

THIS PAGE INTENTIONALLY BLANK

FLIGHT RULES

A2.1.4-7 LANDING SITE SELECTION (CONTINUED)

Runway priorities for RTLS are based solely on energy downmode capability. For inclinations less than 39 degrees, GRTLS range-to-go analysis has shown that a larger range recovery capability exists for an OVHD KSC 15 downmode to STIN KSC 33 than OVHD KSC 33 downmode to STIN KSC 15.

TAL runway priorities were determined based on the site that provides the best single-engine coverage once a TAL abort has been selected.

B. THE RUNWAY PRIORITIES FOR EOM, AOA, AND SYSTEMS FAILURE CASES ARE BASED ON THE ORBITER TOUCHDOWN WEIGHT, CG LOCATION, AND THE EDWARDS LAKEBED HARDNESS LEVEL. THE CONE INDEX SHALL BE USED TO DETERMINE WHICH WEIGHT VERSUS CG CHART TO USE.

<u>CONE INDEX</u> (CI) LAKEBED	<u>HARDNESS CHART</u>
CI \geq 3600	HARD
2700 \leq CI < 3600	MEDIUM
1800 \leq CI < 2700	SOFT

NOTE: LAKEBED RUNWAYS ARE UNACCEPTABLE IF THE SURFACE STRENGTH IS LESS THAN A CONE INDEX OF 1800. @[041196-1879A]

THIS RULE CONTINUED ON NEXT PAGE

FLIGHT RULES

A2.1.4-7

LANDING SITE SELECTION (CONTINUED)

FLIGHT RULES

Landing Regions Chart for Hard Lakebed Hardness

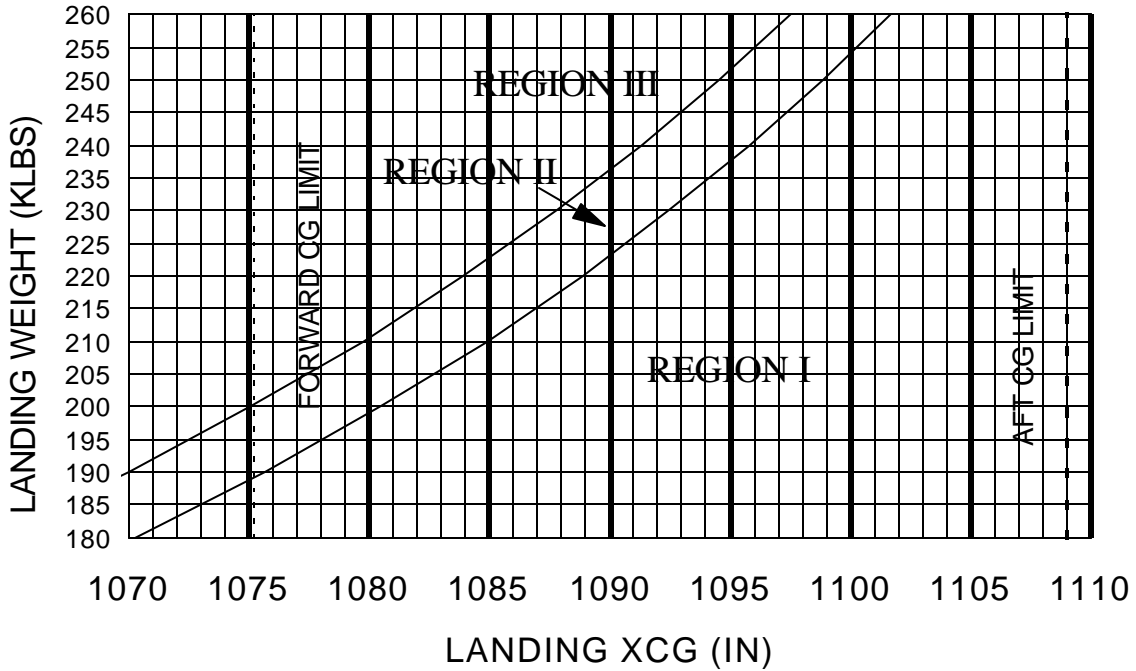

Landing Regions Chart for Hard Lakebed Hardness

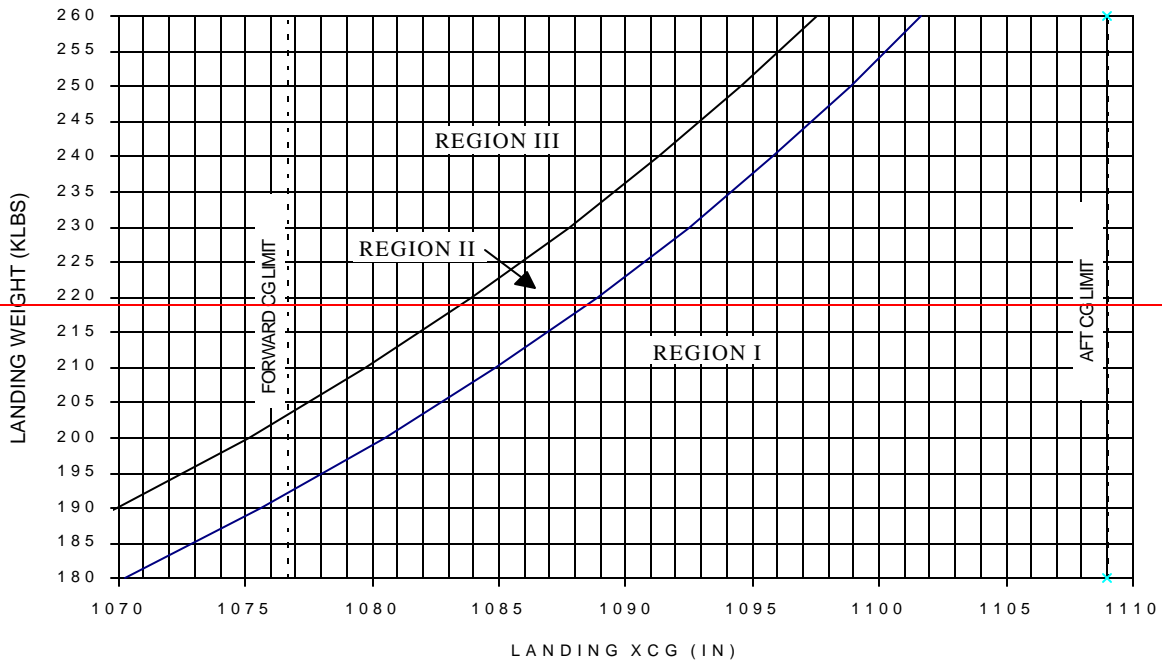

[@\[091098-6714.1\]](#)

FLIGHT RULES

THIS RULE CONTINUED ON NEXT PAGE

FLIGHT RULES

A2.1.4-7

LANDING SITE SELECTION (CONTINUED)

Landing Regions Chart for Medium Lakebed Hardness

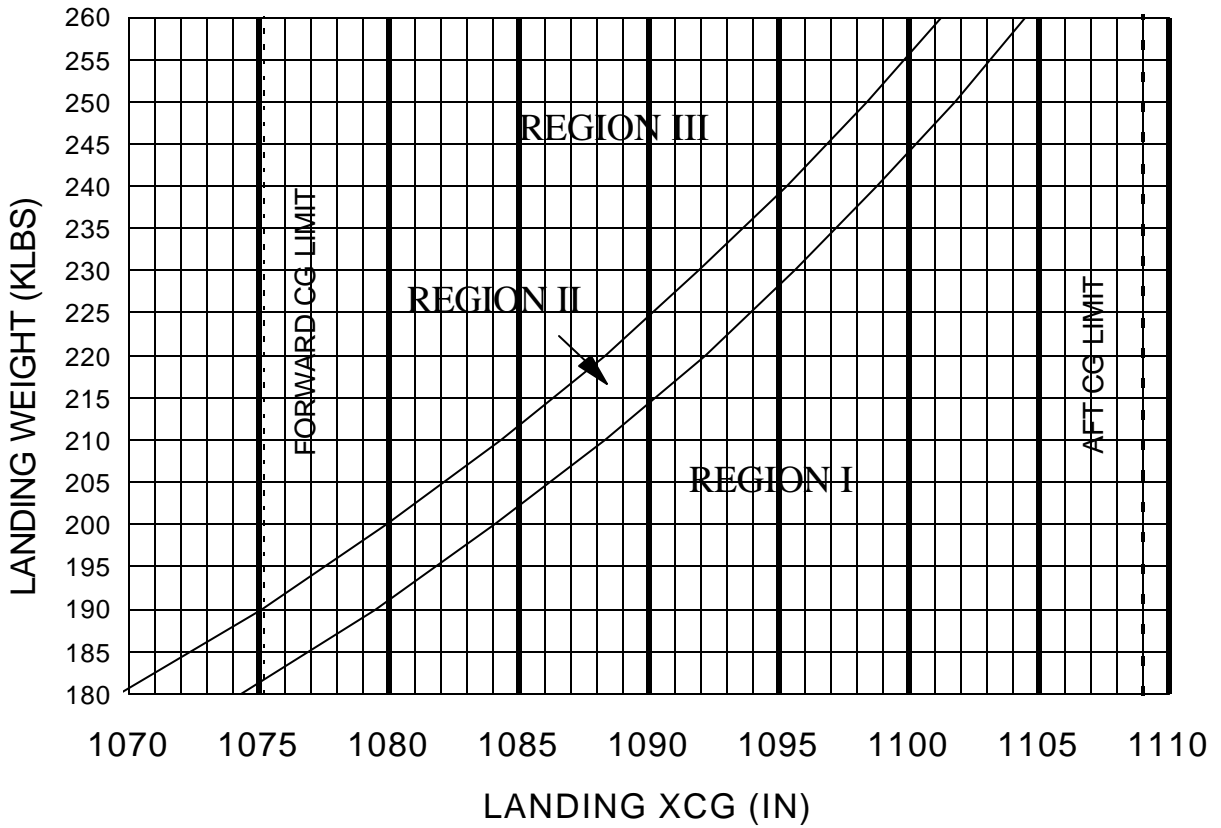

[©\[091098-6714.1\]](#)

THIS RULE CONTINUED ON NEXT PAGE

FLIGHT RULES

A2.1.4-7

LANDING SITE SELECTION (CONTINUED)

Landing Regions Chart for Soft Lakebed Hardness

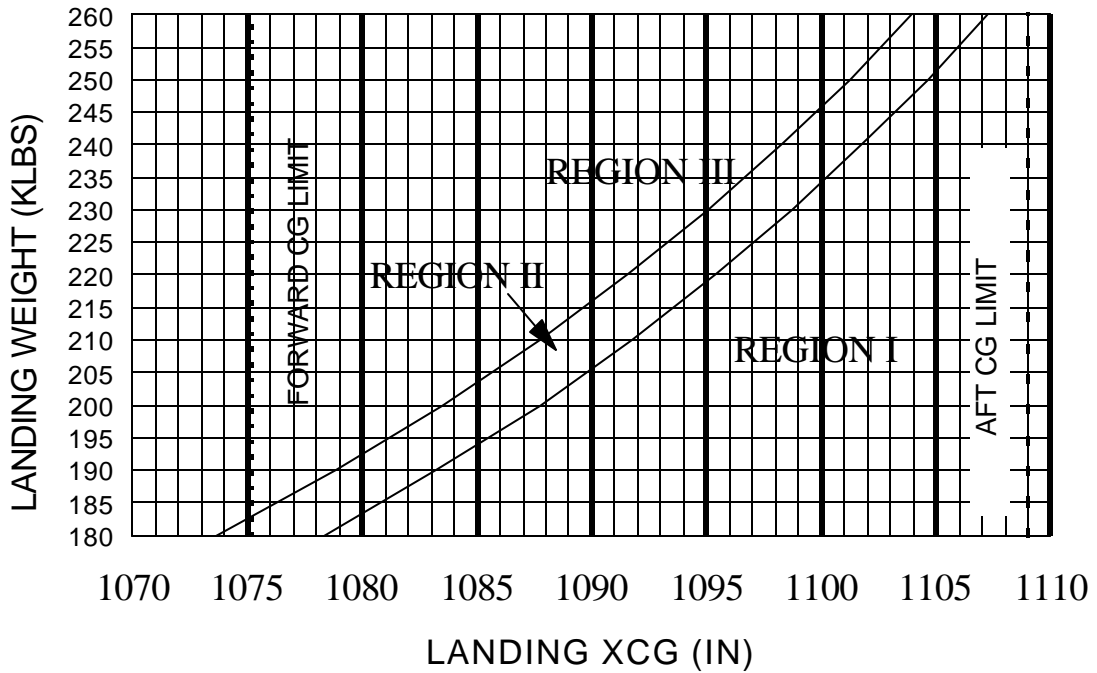

[\[091098-6714\]](#)

THIS RULE CONTINUED ON NEXT PAGE

FLIGHT RULES

A2.1.4-7 LANDING SITE SELECTION (CONTINUED)

Mass Moment Equation:

$$MM \text{ (ft-lb)} = \text{(vehicle weight (lb))} \times \text{(1172.3 - vehicle CG (in))} / 12$$

Moment Equation:

$$M \text{ (ft-lb)} = \text{vehicle weight (lb)} \times \text{(1172.3 - vehicle CG (in))} / 12$$

~~Region I: $M \leq 1.40 M \text{ ft-lb}$~~

~~Region II: $1.40 M \text{ ft-lb} < M \leq 1.55 M \text{ ft-lb}$~~

~~Region III: $M > 1.55 M \text{ ft-lb}$~~

	<u>Mass Moment</u> <u>(Million ft-lb)</u>		
	<u>For Hard Lakebed Runway</u>	<u>For Medium Lakebed runway</u>	<u>For Soft Lakebed Runway</u>
<u>Region I/II Boundary</u>	<u>1.53</u>	<u>1.47</u>	<u>1.41</u>
<u>Region II/III Boundary</u>	<u>1.62</u>	<u>1.54</u>	<u>1.48</u>

©[041196-1879A]

The orbiter landing weight and CG location determine to a great extent the nose gear loads that will be present at nose gear touchdown. Protection of the nose gear loads is a determining factor in the runway selection process. If the landing weight/CG falls within Region I, then nose gear loads are not a concern and the EDW lakebed is considered the prime runway. If the vehicle weight/CG falls within Region II, then landing on the lakebed is acceptable, but a concrete runway will be considered prime. If the vehicle weight/CG falls within Region III, landing on the lakebed is not desirable due to the possible nose gear loads that will be present at nose gear touchdown. In Region I the 90k lb nose gear design load is protected to a 99.7 percent confidence level (approximately 3 sigma). In Region II the 90k lb nose gear load will be protected to a 97.5 percent confidence level (approximately 2 sigma) and a nose gear load of 109k lb (reserve energy load tested per FAA requirements, gear expected to fail at 111k lb) will be protected to a 99.95 percent confidence level (greater than 3 sigma). In Region III, the 90k lb load cannot be protected to at least a 97.5 percent confidence (2 sigma) level, so concrete runways are necessary to provide the most derotation margin.

FLIGHT RULES

In addition, the lakebed surface strength also has a significant impact on the nose gear loads. The lakebed surface strengths for different lakebed runways are determined seasonally at EAFB using a cone penetrometer to determine soil strength (Cone Index). Lakebed hardness will be determined using the 0 to 6-inch cone index for the region between 2000 feet and 8000 feet from the threshold. Derotation is expected to occur in this region. The Landing Support Office will maintain cone index data and will classify each lakebed runway using three lowest consecutive cone index values. ©[041196-1879A]

The three discrete lakebed strengths were used to develop the new charts in the rule for determining the boundaries between each region as a function of weight and CG. These new limits were based on the OI-23 elevon mods, a new lakebed rolling **m**model, beep trim, and new derotation cues. The results of the analysis with these updates were presented and approved at the October 1995 AEFTP meeting. ©[041196-1879A]

THIS RULE CONTINUED ON NEXT PAGE

FLIGHT RULES

A2.1.4-7 LANDING SITE SELECTION (CONTINUED)

C. AOA PRIORITIES

NOTE: AOA PRIORITIES ARE MODIFIED BY INCLINATION. AT 28.5 AND 39 DEGREE INCLINATIONS, ALL AOA SITES ARE AVAILABLE FOR SELECTION. AT 57 DEGREES, ONLY NOR IS AVAILABLE, AND AT 51.6 DEGREES, NOR AND KSC ARE AVAILABLE. @[020196-1802A]

REGION I (DAYLIGHT)	REGION II (ALL) REGION I (NIGHT)	[1] [1]	REGION III (ALL)	[1]
EDWARDS LAKEBED	EDWARDS 22/04		EDWARDS 22/04	
EDWARDS 22/04	EDWARDS LAKEBED		KSC	
KSC	KSC		NORTHROP	
NORTHROP	NORTHROP		EDWARDS LAKEBED	

NOTE: [1] LIGHTED RUNWAY REQUIRED IF NIGHT.

Since AOA landings are typically heavyweight, the Edwards complex provides more margin in the event of landing/rollout or vehicle energy problems. For high inclination missions, Northrup may be the only AOA landing site available due to the large crossrange required to land at Edwards or KSC. (ref. Rule {A4.1.3-7}, PLS/EOM LANDING OPPORTUNITY REQUIREMENTS). @[111094-1622B]

Region I: For Region I, nose gear derotation loads are not a concern, so the Edwards lakebed is the primary landing site. (Note, the availability of landing aids may result in preferring a specific concrete runway over a specific lakebed runway (ref. A/E FTP #73, November 27, 1990)). The EDW concrete runway is acceptable prior to defaulting to another AOA landing site. KSC is acceptable for an AOA and is superior to Northrup from a facilities standpoint.

FLIGHT RULES

Region II/Region I - Night: The Edwards concrete runway is prime for Region II AOA landings since historical and analytical data indicate that the EDW lakebed has a higher rolling coefficient of friction which increases the derotation rate and thus the nose gear load at touchdown. The nose gear structural design limit is 90k lb. Above this limit there exists the possibility of structural damage requiring detailed inspections. A concrete runway landing is preferred to provide more derotation margin, but the above priority is set up to provide reasonable protection against high nose gear derotation loads while still allowing the EDW lakebed to be used. Some slight risk of exceeding the 90 k lb design load is accepted while still protecting against nose gear failure to greater than a 3-sigma level. For night landings, only runways with xenon lighting are acceptable. Edwards concrete runway is also preferred at night due to possible dust obscuration problems associated with a night lakebed landing.

THIS RULE CONTINUED ON NEXT PAGE

FLIGHT RULES

A2.1.4-7 LANDING SITE SELECTION (CONTINUED)

Region III: In this region, the 90k lb design nose gear derotation load cannot be protected to a 2-sigma level and the possibility of exceeding this load on the Edwards lakebed is considered high enough to require that we attempt to minimize the derotation risk by using runways that have the least rolling coefficient of friction. Rationale for night lighting is as for Region II.

D. EOM PRIORITIES

REGION I (DAYLIGHT)	REGION II (ALL) [1] REGION I (NIGHT) [1]	REGION III (ALL) [1]
KSC (PLS)	KSC (PLS)	KSC (PLS)
EDWARDS LAKEBED	EDWARDS 22/04	EDWARDS 22/04
EDWARDS 22/04	EDWARDS LAKEBED	NORTHROP
NORTHROP	NORTHROP	EDWARDS LAKEBED

NOTE: [1] LIGHTED RUNWAY REQUIRED IF NIGHT.

Due to the advantages in vehicle turnaround, the Space Shuttle Program has directed that nominal end of mission (EOM) landings utilize KSC as the first priority landing site, when possible.

After KSC, the EOM runway selection priority is based on the same rationale as for AOA landings (ref. paragraph C).

Reference Rule {A4.1.3-9}, DEORBIT PRIORITY FOR EOM WEATHER.

Reference Rule {A2.1.4-2}, EXTENSION DAY GUIDELINES, for cases where the PLS is NO-GO.

THIS RULE CONTINUED ON NEXT PAGE

FLIGHT RULES

A2.1.4-7 LANDING SITE SELECTION (CONTINUED)

E. SYSTEMS FAILURE PRIORITIES [7] [9]

SYSTEM FAILURES [1]	REGION I	REGION II	REGION III
1 IMU	EDWARDS LAKEBED COMPLEX PREFERRED (NOT MANDATORY)		
1 APU/HYD SYSTEM [8]	PRIORITY OF LANDING SITES WITHIN WX PLACARDS [2]		
	EDWARDS LAKEBED EDWARDS 22/04 KSC NORTHROP	EDWARDS 22/04 KSC NORTHROP EDWARDS LAKEBED	EDWARDS 22/04 KSC NORTHROP
LEAKING/FLAT TIRE [3]	EDWARDS 22/04 (PLS) [4] [6] → NORTHROP		
NWS FAILED (ALL)	EDWARDS LAKEBED (PLS) EDW 22/04 (PLS) KSC NORTHROP	EDWARDS 22/04 (PLS) EDWARDS LAKEBED (PLS) KSC NORTHROP	EDWARDS 22/04 KSC NORTHROP
2 APU/HYD SYSTEMS	PRIORITY OF LANDING WITHIN WX PLACARDS: [2] EDWARDS LAKEBED NORTHROP EDW 22/04 [6]		NORTHROP EDW 22/04 [6]
2 IMU'S 2 NORM/LAT AA'S 2 RGA'S 2 ADTA'S 2 FCS CHANNELS (SAME SURFACE) 4 RHC CHANNELS (PITCH OR ROLL)	EDW LAKEBED EDW 22/04 [5] [6] NORTHROP	EDW LAKEBED EDW 22/04 [5] [6] NORTHROP	EDW 22/04 [5] [6] NORTHROP

NOTES:

- [1] ALL FAILURES OCCUR PRIOR TO DEORBIT BURN.
- [2] WX PLACARDS ARE AS FOLLOWS:
 - A. CEILING - GREATER THAN OR EQUAL TO 10K FEET
 - B. VISIBILITY - GREATER THAN OR EQUAL TO 7 STATUTE MILES
 - C. CROSSWIND - LESS THAN OR EQUAL TO 10 KNOTS (PEAK)
 - D. NO GREATER THAN LIGHT TURBULENCE
 - E. ACCEPTABLE ROLLOUT MARGIN/BRAKE ENERGY ON HALF BRAKES WITHOUT NOSEWHEEL STEERING (DIFFERENTIAL BRAKING) (REF. RULE {A10.1.2-3A}, APU ENTRY START TIME)
- [3] RULE {A10.1.8-1}, TIRE PRESSURE (CIL), DEFINES TIRE FAILURE CRITERIA.
- [4] IF THE PRIMARY LANDING SITE IS NO-GO AND IF THE FORECAST CONDITIONS ARE PREDICTED TO IMPROVE, DEORBIT WILL BE DELAYED, IF PRACTICAL.
- [5] EDW LAKEBED MUST BE DRY AND LOAD BEARING. THERE IS NO CONSTRAINT DUE TO VEHICLE WEIGHT/CG. LIMITS. THE LAKEBED WILL BE USED ONLY AS AN EMERGENCY DOWNMODE IF FLIGHT CONTROL OR VEHICLE ENERGY IS INSUFFICIENT TO LAND ON EDW 22/04.
- [6] EDW 22/04 RUNWAY SHOULDERS DRY AND LOADBEARING.
- [7] LIGHTED RUNWAY REQUIRED AT NIGHT.

FLIGHT RULES

- [8] IT IS ACCEPTABLE TO PRESS TO KSC (WITHIN WEATHER PLACARDS) IF D/O PREP ALREADY ACCOMPLISHED AT TIME OF FAILURE. THE MOST IMPORTANT FACTOR IN DETERMINING THE LANDING SITE IS THE STABILITY OF THE WEATHER.
- [9] REFERENCE RULE {A2.1.4-2}, EXTENSION DAY GUIDELINES, FOR WAVE-OFF CRITERIA.

THIS RULE CONTINUED ON NEXT PAGE

FLIGHT RULES

A2.1.4-7**LANDING SITE SELECTION (CONTINUED)**

1 IMU: A subsequent failure in one of the two remaining IMU's could result in an unresolvable IMU dilemma. Landing at a lakebed complex provides more energy downmode options should the vehicle navigation state be corrupted. Due to the low probability of an unresolvable dilemma and the availability of the MCC to solve dilemmas utilizing tracking data, it is not necessary to require a lakebed complex landing.

1 APU: For a second APU failure, the resulting potential system losses (nosewheel steering, braking capability, control effectiveness at derotation, etc.) require more stringent weather placards to assure a safe landing. Since the control degradation and systems losses would only be apparent during approach and landing, derotation, and rollout, it is prudent to pick the best runway within the stated weather placards. As long as the weather placards are observed, the vehicle will be able to sustain the loss of a second APU regardless of which landing site is chosen. The EDW complex is preferred over KSC since the weather is generally more predictable at EDW. However, KSC is acceptable if deorbit prep has already been accomplished because the weather at a site an hour away is much more quantifiable than the weather at a site 2.5 hours or even a day away. The stability of the weather within the placards is the key consideration if more than one landing site is within placards. For Region III vehicle weight/cg, the Edwards lakebed will not be considered as a landing site due to the risk of derotating with two APU's failed. For Region II, Northrup is higher priority than Edwards lakebed because it is believed to have a harder surface and lower tire rolling friction.

LEAKING/FLAT TIRE: If a tire has lost enough pressure or is leaking such that it is considered degraded, sufficient load-carrying capability of that tire may not exist (ref. Rule {A10.1.8-1}, TIRE PRESSURE (CIL)). Total loss of that tire may occur when the highest tire load application period is reached. Edwards 22/04 was selected as the highest priority because the vehicle is more easily controlled for blown tire cases on concrete runways (concrete runways have a lower strut coefficient of friction than lakebed runways). Based on Northrup hardness data, Northrup should be acceptable for blown tire cases. The off-runway environment for EDW 22/04 (when not dry and load bearing) and KSC is unacceptable should loss of control and runway departures occur. Edwards lakebed data is insufficient, but the predicted coefficient of friction is significantly higher than concrete. This high coefficient of friction would result in potentially excessive strut loads and nose gear touchdown rates.

NWS FAILED (ALL): With the loss of NWS, only one method of directional control remains and the Edwards complex is a higher priority than KSC due to the off-runway conditions at KSC. If another failure or unexpected directional control problem occurs during rollout (i.e., partial loss of braking capability), the Edwards lakebed (Region I) and Edwards concrete runway when the shoulders are dry and load bearing (Regions II and III) provide greater areas for lateral vehicle excursions than KSC. In addition, the occurrence of unexpected weather events is more likely in the more dynamic KSC weather environment. KSC is an acceptable backup site for landings without NWS since differential braking is adequate for performing the nominal rollout steering task and will not cause excessive tire wear with the new tire.

THIS RULE CONTINUED ON NEXT PAGE

FLIGHT RULES

A2.1.4-7

LANDING SITE SELECTION (CONTINUED)

2 APU's: If two APU/hydraulic systems are lost, it is desirable to provide significant lateral and longitudinal margins while providing a surface that is hard enough to control nose gear derotation. The wide and long landing area at Northrup and Edwards lakebeds provide an increased margin for error in touchdown position over that of a concrete runway which should minimize pilot inputs on final. Additionally, the Northrup surface is believed to be harder and to have lower tire rolling friction than the Edwards lakebed runways. There is no concern over the nose gear derotation rate on the Edwards lakebed with a Region I vehicle (ref. Ascent/Entry Flight Techniques #69, July 20, 1990); but, for Region II and III vehicles, AMES VMS studies have shown that the Edwards lakebed is not acceptable due to the increased derotation rate and the decrease in aerosurface capability to control the derotation. With only one APU remaining for flight control, an evaluation of appropriate weather conditions, including upper level and surface winds, is critical in the planned landing site selection criteria. Although Northrup represents a better runway selection, weather conditions adverse to single APU operations may force selection (for Region II and III vehicles) of Edwards 22/04 as the planned landing site (assuming more favorable weather conditions).

2 IMU's, 2 NORM/LAT AA's, 2 RGA's, 2 ADTA's, 2 FCS CHANNELS, 4 RHC CHANNELS: The AA's, RGA's, and FCS channels provide feedback to the orbiter flight control loops. The IMU's are used to propagate the vehicle navigation state vector. By landing on a lakebed runway, the margin for error in orbiter vehicle control is increased should a subsequent failure allow bad data in the flight control system or the nav state. With only two RHC channels available, the next failure could impact orbiter control capability. Default (nav-derived) air data may be used by flight control for a subsequent ADTA failure, so landing on a lakebed increases the margin for error induced by flying on nav-derived gains. Edwards 22/04 is available as second priority for Region I and II vehicles, provided that an emergency downmode to the lakebed is available. For Region III vehicles, the risk of nose gear strut damage while landing on the lakebed is greater than the risk of having a third avionics system failure. It is prudent, however, to have the lakebed available and ready to support an emergency landing, if required. Landings at Edwards complex also provides the potential for contingency site landings (i.e., Rosemond, etc.)

F. PREDEORBIT LANDING SITE EVALUATION

1. AFTER DEORBIT MINUS 2.5 HOURS, IF UNACCEPTABLE WEATHER CONDITIONS EXIST (OBSERVED OR FORECAST) OR ENTRY REQUIREMENTS CANNOT BE SATISFIED (TAEM, A/L, TOUCHDOWN, ROLLOUT, ETC.), THE AFFECTED LANDING SITE MAY BE ELIMINATED AS A PRIMARY OPTION.

THIS RULE CONTINUED ON NEXT PAGE

FLIGHT RULES

A2.1.4-7 LANDING SITE SELECTION (CONTINUED)

2. AFTER DEORBIT MINUS 1.5 HOURS, ONLY A SINGLE LANDING SITE WILL CONTINUE TO BE EVALUATED. OTHER LANDING SITE OPTIONS MAY BE REEVALUATED IN THE EVENT OF A DEORBIT WAVE-OFF.

The above guidelines will allow the evaluation of multiple runways at multiple landing sites for multiple deorbit opportunities without significantly compromising the required evaluation of the actual runway where landing will occur. It is always prudent to eliminate landing site/runway options as they become unlikely to remain within limits. This is especially true after deorbit minus 2.5 hours, the standard time at which deorbit pads will be voiced to the crew. Up until deorbit minus 1.5 hours, sufficient time is available to evaluate multiple landing sites for the nominal deorbit as well as preliminary evaluation of landing sites on the next deorbit. Due to multiple wind sets, landing sites, runways, aimpoints, etc. being evaluated, a total team focus on the primary runway on the last orbit prior to deorbit is necessary.

Rules {A2.1.3-1}, MISSION DURATION REQUIREMENTS, and {A2.1.1-6}, LANDING SITE WEATHER CRITERIA, reference this rule.

A2.1.4-8 LES PRESSURE INTEGRITY CHECK

DEORBIT WILL NOT BE DELAYED FOR FAILURE OF ANY LAUNCH/ENTRY SUIT (LES) PRESSURE INTEGRITY CHECK.

LES pressure integrity is not required for the present bailout scenario. In addition, beyond verifying the proper connections, there is little that the crew could do during flight to locate the source of a leak in an LES or to repair it.

FLIGHT RULES

A2.1.4-9 LANDING SITE SELECTION FOR AN INFLIGHT EMERGENCY

- A. AN INFLIGHT EMERGENCY WILL BE DECLARED AND AN ATTEMPT WILL BE MADE TO PERFORM AN EMERGENCY LANDING IF A LANDING AT THE TARGETED SITE IS IMPOSSIBLE. @[120894-1744B]

NOTE: THE DETERIORATION OF WEATHER (WINDS, TURBULENCE, CEILING, PRECIPITATION, ETC.) AND/OR LANDING AND ROLLOUT MARGINS, WHICH RESULT IN FLIGHT RULE EXCEEDANCES POST-DEORBIT BURN, ARE NOT CAUSE TO REDESIGNATE FROM THE TARGETED SITE.

- B. LANDING WILL BE ATTEMPTED AT AN EMERGENCY LOCATION THAT MEETS THE FOLLOWING CRITERIA:
1. THE LANDING FIELD IS WITHIN THE ENERGY CAPABILITY OF THE ORBITER AS DEFINED IN RULE {A2.1.5-1}, BAILOUT.
 2. THE LANDING FIELD FACILITIES SATISFY THE REQUIREMENTS DOCUMENTED IN RULE {A2.1.5-14}, EMERGENCY LANDING FACILITY CRITERIA.
- C. TIME PERMITTING, WITH MULTIPLE SITES OF SIMILAR ENERGY CAPABILITY, SELECTION OF THE EMERGENCY LANDING FIELD WILL BE BASED ON THE FOLLOWING PRIORITY:
1. ANOTHER NASA AUGMENTED LANDING SITE
 2. A DOD AIRFIELD WITH COMPATIBLE SHUTTLE UHF COMMUNICATIONS
 3. A DOD AIRFIELD WITHOUT COMPATIBLE SHUTTLE UHF COMMUNICATIONS
 4. A COMMERCIAL AIRFIELD WITH COMPATIBLE SHUTTLE UHF COMMUNICATIONS
 5. A COMMERCIAL AIRFIELD WITHOUT COMPATIBLE SHUTTLE UHF COMMUNICATIONS

FLIGHT RULES

Should orbiter or facility problems be encountered which make landing at the designated NASA landing field impossible, the actions to be taken are identified in order of priority in an attempt to save the crew and orbiter (national resource), while at the same time minimizing public exposure to additional risk. During entry should the need arise, an "inflight emergency" (as declared by all aircraft if in trouble) will be declared. and a landing at an ELS will be attempted if energy is sufficient to reach the landing site (reference Rule {A2.1.5-1}, BAILOUT) and the facility meets the minimum requirements (reference Rule {A2.1.5-14}, EMERGENCY LANDING FACILITY CRITERIA). ©[120894-1744B]

THIS RULE CONTINUED ON NEXT PAGE

FLIGHT RULES

A2.1.4-9

LANDING SITE SELECTION FOR AN INFLIGHT EMERGENCY (CONTINUED)

Weather forecasts for shuttle landings are made by well-trained, experienced meteorologists with the best tools available and within 90 minutes of landing. At the A/E FTP #73, the results of a multimonth study of forecasting accuracy showed that these forecasts were extremely accurate and in the very small percentage of cases where a GO prediction turned into a NO-GO situation, the violations were minor and survivable. It is inconceivable that these forecasts would be in error by a degree that would entail greater risk by continuing to the landing site than would be incurred by diverting to an emergency field with its lack of facilities, navigation aids, trained personnel, and flightcrew familiarity.

Diverting from the targeted site will not be done just for deteriorating weather conditions which will violate weather flight rules or landing and rollout margin reductions. We will accept the nonoptimum conditions rather than divert to another site since it is believed that this option provides less risk to the orbiter and crew as well as the general public. ©[120894-1744B]

Should it be necessary to divert from the primary landing field, another NASA augmented landing field will be selected if available. Otherwise, site selection will be based on facility type (DOD vs commercial) and the availability of compatible shuttle UHF communications. The facility priority has been selected to minimize risk to the general public. ©[120894-1744B]

FLIGHT RULES

ENTRY

A2.1.5-1	BAILOUT	2-174
A2.1.5-2	GCA CRITERIA	2-177
A2.1.5-3	ENERGY MANAGEMENT	2-178
A2.1.5-4	ENTRY STRING REASSIGNMENT	2-179
A2.1.5-5	CREW TAKEOVER	2-183
A2.1.5-6	EARLY POWERDOWN	2-183
A2.1.5-7	DEORBIT BURN TERMINATION	2-184
A2.1.5-8	BFS ENGAGE	2-184
A2.1.5-9	CHASE AIRCRAFT OPERATIONS	2-184
A2.1.5-10	ENTRY LOAD MINIMIZATION	2-186
A2.1.5-11	ENTRY DTO/AUTO MODE/CROSSWIND DTO GO/NO-GO	2-187
A2.1.5-12	LANDING DTO'S	2-207
A2.1.5-13	STA/WEATHER AIRCRAFT RUNWAY APPROACH OPERATIONS FOR SITES WITH ONLY ONE RUNWAY .	2-200
A2.1.5-14	EMERGENCY LANDING FACILITY CRITERIA	2-201
<u>A2.1.5-15</u>	<u>SINGLE-STRING GPS OPERATIONS (OI-26B FLIGHT S/W)GPS OPERATIONS ON THE BFS</u>	<u>2-202</u>

CONTINGENCY ACTION SUMMARY

A2.1.6-1	CONTINGENCY ACTION SUMMARY	2-203
----------	--------------------------------------	-------

ORBITER SYSTEMS GO/NO-GO

A2.1.7-1	ORBITER SYSTEMS GO/NO-GO	2-221
----------	------------------------------------	-------

FLIGHT RULES

ENTRY

A2.1.5-1 BAILOUT

- A. THE CDR IS RESPONSIBLE FOR BAILOUT ACTION.
- B. THE MCC WILL EVALUATE ALL POSSIBLE ENERGY MANAGEMENT ACTIONS PRIOR TO RECOMMENDING BAILOUT. @[120894-1744B]
- C. THE FOLLOWING DEFINITIONS APPLY TO THE BAILOUT REGIONS DEFINED BELOW:
1. MCC MAX RANGE LINE: THIS LINE IS GENERATED ON LANDING DAY AND BASED ON A STRAIGHT-IN APPROACH TO THE MINIMUM ENTRY POINT HAC, WITH MAXIMUM L/D STRETCH TECHNIQUES AND ACTUAL WINDS AND ATMOSPHERIC CONDITIONS.
 2. MCC RTLS MINIMUM ENERGY LINE: THIS LINE IS GENERIC FOR ALL FLIGHTS AND ASSUMES A FORWARD CG, MID-WEIGHT, HEAVYWEIGHT I-LOADS, COLD ATMOSPHERE, AND NO WINDS.
 3. MCC BAILOUT LINE: THIS LINE IS GENERIC FOR ALL FLIGHTS AND REPRESENTS A BEST-ON-BEST MAXIMUM CAPABILITY, BASED ON 3 SIGMA FAVORABLE WINDS, MAXIMUM HAC SHRINK, AND MAXIMUM ORBITER L/D.
- D. AN MCC BAILOUT RECOMMENDATION WILL BE MADE BASED ON THE FOLLOWING CRITERIA, USING THE BEST AVAILABLE SITE, RUNWAY, AND STATE VECTOR SOURCE, AND WITHOUT REGARD TO TOUCHDOWN, BRAKE ENERGY AND ROLLOUT MARGIN PLACARDS:
1. GREEN: BAILOUT NOT REQUIRED (CALL ONLY REQUIRED IF TRANSITIONING FROM THE "YELLOW" REGION).
 - a. EOM LANDINGS: ORBITER ENERGY/WEIGHT ABOVE THE MAX RANGE LINE.
 - b. ALL OTHER LANDINGS: ORBITER ENERGY/WEIGHT ABOVE THE MCC RTLS MINIMUM ENERGY LINE. @[120894-1744B]

THIS RULE CONTINUED ON NEXT PAGE

FLIGHT RULES

A2.1.5-1 BAILOUT (CONTINUED)

2. YELLOW: BAILOUT IF DEEMED NECESSARY BY THE CDR; MCC CONTINUES TO MONITOR. @[120894-1744B]
 - a. EOM LANDINGS: ORBITER ENERGY/WEIGHT BELOW THE MAX RANGE LINE AND ABOVE THE MCC BAILOUT LINE.
 - b. ALL OTHER LANDINGS: ORBITER ENERGY/WEIGHT BELOW THE MCC RTLS MINIMUM ENERGY LINE AND ABOVE THE MCC BAILOUT LINE.

3. RED: MCC RECOMMENDS BAILOUT.

ORBITER ENERGY/WEIGHT BELOW THE MCC BAILOUT LINE.

- D. IF POSSIBLE, BAILOUT WILL BE DECLARED NO LOWER THAN 50K FT ALTITUDE (70K FT FOR ECAL).
- E. NORMALLY, ZERO DEGREES OF BANK WILL BE USED FOR BAILOUT GUIDANCE "FREEZE" CONDITIONS. HOWEVER, THE MCC MAY PROVIDE A DESIRED BANK ANGLE (UP TO 10 DEG) IF REQUIRED TO AVOID ORBITER IMPACT IN POPULATED AREAS.
- F. IF BAILOUT IS DECLARED FOR ECAL, A TURN SHALL BE EXECUTED TO A HEADING OF 120 DEG, UNLESS FDO DETERMINES IN REAL TIME A HEADING MORE FAVORABLE FOR SAR OPERATIONS (E.G., PARALLEL THE COAST, ETC.)

Reference Rule {A1.1.1-6}, SHUTTLE COMMANDER AUTHORITY, for CDR responsibilities.

The MCC has more accurate evaluation tools with which to determine energy capability and uses radar tracking data (when available) as the prime state vector source. All energy management and recovery procedures will be evaluated prior to any bailout recommendation being issued by the MCC. Three bailout zones, green, yellow, and red, have been identified for MCC bailout recommendation, based on areas delineated on FDO Energy/Weight versus Range-to-go displays.

The bailout green zone is defined as that area above the MCC maximum ranging capability line which is generated for EOM on landing day, based on a straight-in approach to the minimum entry point HAC, with maximum L/D stretch techniques and actual winds and atmospheric conditions. For all other cases, this flight and landing day-specific actual capability line does not exist, and the MCC RTLS minimum energy line will be used. This line is generic for all flights and assumes a forward CG, mid-weight, heavyweight I-loads, cold atmosphere, and no winds. These two lines generally lie very close together. In the green region, bailout is not required. A green zone call is not made unless the vehicle has recovered from the yellow zone below. @[120894-1744B]

FLIGHT RULES

THIS RULE CONTINUED ON NEXT PAGE

FLIGHT RULES

A2.1.5-1 BAILOUT (CONTINUED)

The bailout yellow zone is defined as that area below the MCC maximum ranging capability line, described above (again, when a max range line is not available, the generic MCC RTLS minimum energy line will be used), but above the MCC bailout line. The bailout line is generic for all flights and represents a best-on-best maximum capability, based on 3 sigma favorable winds, maximum HAC shrink, and maximum orbiter L/D. In this region, the a "bailout yellow zone" call will be made. Requests are likely to be made for runway/HAC redesignation, stretch techniques, and relaxation of Nz, surface wind, touchdown point, and rollout margin constraints to increase available runways. Below the maximum ranging capability line, there is less than a 50 percent chance of reaching the field. In this region, the MCC will only advise the crew of the energy situation and continue to monitor their progress in making up the energy shortfall. A final bailout decision is the CDR's call. ©[120894-1744B]

The bailout red zone is defined as that area below the MCC bailout line described above. In this region, there is no chance of reaching the runway threshold and the MCC will recommend bailout. To provide adequate time for bailout operations, bailout will be declared at an altitude no lower than 50K ft, if possible. For ECAL trajectories, 70K ft is used to allow adequate time to execute a maximum turn of 180 deg prior to initiating bailout, thus ensuring bailout over water.

The MCC will recommend a bank angle in order to improve recovery effectiveness or to steer away from populated areas. Analysis has shown that a bank angle of greater than 10 deg can cause the vehicle to turn a full 360 deg of heading with impact occurring in the crew bailout landing area. If bailout is required during an ECAL, a turn to a standard heading of 120 deg will be made to avoid orbiter land impact and to provide search and rescue (SAR) forces with a consistent heading with which to begin rescue operations, unless the FDO can determine a more favorable heading based on knowledge of the positions and potential ranging capability of the SAR forces. ©[120894-1744B]

A2.1.5-2 GCA CRITERIA

IF THE TRAJECTORY DIVERGES AND APPROACHES ENERGY LIMITS POST-TRACKING, CSS WILL BE SELECTED AND GCA PERFORMED. AUTO GUIDANCE WILL BE RESELECTED WHEN ENERGY AND NAVIGATION ARE WITHIN LIMITS, THE GCA WILL ALSO BE TERMINATED WHEN THE CREW TAKES OVER AFTER VISUAL ACQUISITION OF THE RUNWAY. ©[120894-1663]

Generally, the entry trajectory can get into an off-nominal emergency situation by (1) incorporating erroneous navigation data into guidance and flight control, and (2) selecting an incorrect or invalid landing site. Performing GCA provides a possibility of making the runway.

FLIGHT RULES

A2.1.5-3 ENERGY MANAGEMENT

IF INSUFFICIENT OR EXCESS ENERGY EXISTS TO ACHIEVE THE TARGETED APPROACH TO THE SELECTED RUNWAY, THE FOLLOWING OPTIONS WILL BE EVALUATED FOR CORRECTION OF THE ENERGY ERROR.

- A. OVERHEAD/STRAIGHT-IN HAC RESELECTION
- B. NOMINAL/MINIMUM ENTRY POINT SELECTION
- C. RUNWAY REDESIGNATION - MAY RESULT IN VIOLATION OF TOUCHDOWN, BRAKING, AND/OR ROLLOUT MARGIN CONSTRAINTS
- D. GROUND CONTROLLED APPROACH (GCA)

Several options are available to correct a bad energy situation. These options include HAC reselection (overhead/straight-in), runway redesignation, final approach entry point downmoding (NEP/MEP), or GCA. No action will be recommended until data shows that the energy error is large enough that the prime selected runway/HAC cannot be achieved or will cause the vehicle to exceed H-dot or g-limits while following auto guidance.

Runway redesignation or HAC reselection are both very powerful methods of changing the required range-to-go (energy requirements). These two methods are preferred since valid guidance commands are available. Runway redesignation may be recommended over HAC reselection, based on the amount of energy correction required. The approach direction relative to the runway layout will define which is the most effective option for correcting the energy error (range error). Redesignation may result in selection of a runway which violates some of the touchdown, rollout, or brake energy constraints. Reaching the runway final approach within an acceptable energy corridor has priority over satisfying the touchdown and rollout constraints. All efforts will be made to redesignate to runways which satisfy the touchdown and rollout criteria.

Downmoding the final approach entry point (NEP to MEP) does provide valid guidance commands; however, the MEP selection greatly reduces the amount of time available for trajectory corrections on final approach. (NEP intercepts final approach at approximately 12K feet; MEP is at approximately 6K feet.) Once each of the above options have been evaluated and excessive energy error persists, a GCA will be required. The GCA may include HAC or runway reselection and will require action outside of the current guidance capability in order to correct the range error.

FLIGHT RULES

A2.1.5-4 ENTRY STRING REASSIGNMENT

- A. PRIOR TO MM 304, RESTRINGING WILL BE PERFORMED TO REGAIN FULL CAPABILITY FOLLOWING A GPC FAILURE.

The timeframe between post-deorbit burn and the transition to MM 304 is generally quiet from a computer point of view and crew workload. As such, the risk of restringing is considered to be low. Consequently, restringing will be performed to regain full capability for the dynamic phases of entry (MM 304/305).

- B. RESTRING GPC/STRING COMBINATIONS WILL BE SELECTED WHICH MOVE THE LEAST NUMBER OF STRINGS WHILE SATISFYING CRITICAL CAPABILITY OR ONE-FAULT TOLERANT REQUIREMENTS AS IDENTIFIED IN PARAGRAPH C.

The greater the number of strings moved during a restring attempt, the more complicated the restring process. With this in mind, "good" strings should not be taken from "good" GPC's unless there is no other method of satisfying the identified requirements in orbiter systems.

- C. DURING ENTRY/GRTLS (MM 304, 305, 602, AND 603), RESTRINGING WILL BE PERFORMED AS FOLLOWS (TIME PERMITTING) TO REGAIN THE FOLLOWING CRITICAL SYSTEMS CAPABILITY:

Certain systems capabilities are required to be maintained for safety considerations where the BFS cannot provide additional systems capability.

1. NOSE WHEEL STEERING (FOR RTLS/TAL/AOA (KSC) OR ANY SITE WITH KNOWN DIRECTION CONTROL PROBLEMS).

NWS is required to maintain lateral control during rollout at landing sites where the lateral runway environment is limited. BFS engage at touchdown to recover NWS is an option. However, it was determined to attempt restring during entry to regain NWS and accept risk of BFS engage as a result of the restring instead of nominally engaging the BFS for this case at NGTD. Reference Rule {A10.1.7-1A}, NOSE WHEEL STEERING (NWS), for NWS directional control requirements.

2. ASA COMMAND (MAINTAIN TWO ELEVON, RUDDER, AND SPEEDBRAKE; MAINTAIN ONE BODY FLAP).

Two elevon, rudder, and speedbrake FCS command channels (each of which have four command channels) are required since flying with only one FCS channel on an actuator is an uncertified flight control mode. Only one of three body flap command channels is required to maintain acceptable drive capability. Control may be available long enough to allow restring procedures to be completed to regain the required FCS channels rather than defaulting over to the BFS.

THIS RULE CONTINUED ON NEXT PAGE

FLIGHT RULES

A2.1.5-4 ENTRY STRING REASSIGNMENT (CONTINUED)

3. VENT DOORS:

- a. FORWARD/AFT VENT DOORS IF REQUIRED TO REGAIN THE CAPABILITY TO OPEN AT LEAST ONE SIDE OF THE FWD AND AFT COMPARTMENTS FOR SUFFICIENT VENTING.

Data presented at the Ascent/Entry Flight Techniques Panel (A/E FTP) #43 (August 1988) showed that adequate venting margins could be maintained if at least one side of the forward and aft compartments are opened by 70,000 feet altitude. Failures resulting in loss of open capability on both sides of the forward or aft compartments would result in structural failure and loss of crew/vehicle. Therefore, a critical bus reassignment prior to or at TAEM to regain the open capability on at least one side should be performed, when applicable.

- b. MIDBODY VENT DOORS: @[051194-1586A]

- (1) FOR LOSS OF MORE THAN TWO MIDBODY VENT DOORS
OR
(2) FOR LOSS OF OPPOSING MIDBODY VENT DOORS

JSC Engineering presented a venting analysis of the modified vent door configuration (vents 4 and 7 deleted) at the A/E FTP #87 (February 1992). The data showed that positive structural margins exist for a nominal entry trajectory, even after two midbody vent doors have failed closed. This analysis was performed only for scenarios that could result from two electrical/avionics failures. Because opposite vent door failures (i.e., left/right 5) require more than two failures, they were not specifically analyzed, but to assure adequate venting, a restring should be performed. JSC Engineering also presented data which suggested that opposite forward and aft compartment vent doors are redundant to each other in providing adequate venting for a nominal entry. @[051194-1586A]

The A/E FTP #87 members concluded that a critical bus reassignment should only be performed after loss of more than two midbody vents has occurred for either vehicle configuration. Restringing for these cases provides the most prudent venting management plan, trading the effects of a potentially dispersed entry trajectory with the potential risks of a dynamic restring of flight-critical buses.

- D. RESTRINGING WILL NOT BE PERFORMED WITHOUT PRIOR MCC COORDINATION.

FLIGHT RULES

The MCC is prime for determining when restringing is required as a result of multiple failures and the resulting GPC/string assignments required to satisfy critical capability and systems fault tolerance as identified in the preceding rules. The MCC is prime for determining the acceptability of restringing based upon the failure signature and conditions and for determining an acceptable data bus reassignment configuration. As a minimum, voice description of the failure and identification of the proposed bus reassignment must be coordinated with the MCC prior to performing any restring.

THIS RULE CONTINUED ON NEXT PAGE

FLIGHT RULES

A2.1.5-4 ENTRY STRING REASSIGNMENT (CONTINUED)

E. FOR A SINGLE GPC FAILURE, RESTRINGING WILL NOT BE PERFORMED AFTER EI MINUS 5 MINUTES.

EI minus 5 minutes was selected as the last time for which restringing would be performed as a result of a single GPC failure in order to allow recovery time prior to EI to regain PASS capability should the restring be unsuccessful.

F. RESTRINGING WILL NOT BE PERFORMED AFTER HAC INTERCEPT.

Crew workload increases after HAC acquisition as concentration is directed towards the immediate landing tasks. Restringing will not be performed during this timeframe so as not to divert crew attention away from the critical landing phase tasks. Although no fault tolerance exists, the exposure to the next failure is minimized since the time between HAC intercept and touchdown is relatively short.

G. RESTRINGING WILL BE PERFORMED TO REGAIN CRITICAL CAPABILITY INDEPENDENT OF THE BFS STATUS. FOR CASES WHERE RESTRINGING IS ACCEPTABLE TO REGAIN FAULT TOLERANCE (REF. PARAGRAPH A), AN ENGAGEABLE BFS MUST BE AVAILABLE.

The BFS is normally required when restringing is performed as a precaution against the low probability occurrence that the restring action may result in loss of the PASS set. However, when the vehicle has sustained failures such that less than critical capability remains (a capability which must be maintained or a loss of crew/vehicle will result), restringing will be performed to regain the needed capability independent of the BFS status in order to maintain the flying status of the orbiter.

If the BFS is not available and less than critical capability remains, restring is allowed to recover the PASS capability to control the orbiter. If the BFS is available and conditions are such that either a BFS engage or a dynamic restring will recover the critical capability, restring will be attempted if time permits completion of the restring while still maintaining the BFS engage option.

Rules {A2.1.1-5}, PORT MODING/RESTRINGING GUIDELINE; {A7.1.3-4}, DATA PATH FAILURE;{A7.1.3-8}, PASS DATA BUS ASSIGNMENT CRITERIA;{A7.1.3-12}, MDM PORT MODING; {A7.1.4-1}, ASCENT/ENTRY BFS MANAGEMENT GUIDELINES; and {A10.1.2-5}, APU HIGH SPEED SELECTION/SHIFT reference this rule.

FLIGHT RULES

A2.1.5-5 CREW TAKEOVER

CREW TAKEOVER (DOWNMODING FROM AUTO TO CSS) PRIOR TO NOMINAL TAKEOVER ALTITUDE WILL BE PERFORMED FOR THE FOLLOWING REASONS ONLY (REF. RULE {A4.1.5-8}, ENTRY TAKEOVER RULES):

- A. TO AVOID LOSS OF CONTROL OF THE VEHICLE.
- B. TO PRESERVE THE TRAJECTORY WITHIN THE TARGETED RUNWAY LANDING CAPABILITY.

Whenever the crew must override the guidance limitations to maintain adequate energy capability for reaching the prime selected runway, the CSS mode must be selected. Whether under GCA control or manually flying with visual assistance, the crew must select CSS and bypass the onboard guidance commands.

C. DELTA STATE UPDATES:

- 1. ANY POSITION AND VELOCITY DELTA STATE.
- 2. A POSITION-ONLY DELTA STATE BETWEEN M5 AND TAEM (M2.5 FOR EOM/AOA, M3.2 FOR RTLS).

CSS mode is required for all position/velocity delta states to avoid severe attitude transients once the onboard NAV is updated. For position-only delta states between M5 and TAEM; CSS must be selected to avoid strong attitude transients. The entry guidance will very aggressively attempt to remove energy errors by TAEM interface (M2.5 for EOM and AOA, and M3.2 for RTLS). Above M5, the guidance has more time to correct energy errors. Therefore, position delta states above M5 should not cause severe transients. After the energy has converged close to nominal, the crew can reselect auto.

A2.1.5-6 EARLY POWERDOWN

EARLY POWERDOWNS ARE DEFINED AS REMOVAL OF POWER FROM THE ORBITER ELECTRICAL BUSES PRIOR TO EOM POWERDOWN. EARLY POWERDOWN WILL BE ACCOMPLISHED FOR ELS LANDINGS, FAILURE OF THE COOLING CART, ANY ORBITER MALFUNCTIONS THAT CONSTITUTE A SAFETY HAZARD (E.G., FUEL LEAK), OR THE THREAT OF SIGNIFICANT ORBITER EQUIPMENT DAMAGE. IN ALL CASES, THIS WILL BE WITHOUT REGARD TO THE INTEGRITY OF ANY RETURNED PAYLOAD.

FLIGHT RULES

A2.1.5-7 DEORBIT BURN TERMINATION

THE DEORBIT BURN WILL BE TERMINATED (PRIOR TO EXCEEDING A SAFE PERIGEE AS PROVIDED ON THE DEORBIT/ENTRY/LANDING (DEL) PAD FOR THE FOLLOWING FAILURES:

- A. OMS PROPELLANT TANK (ABOVE SINGLE TANK COMPLETION HP ON DEL PAD).
- B. PASS REDUNDANT SET FAIL OR RS SPLIT FOR WHICH RECOVERY HAS NOT BEEN ATTEMPTED.
- C. IMU DILEMMA.
- D. TWO MAIN BUSES.
- E. TWO OMS ENGINES (IF RCS DOWNMODE CAPABILITY DOES NOT EXIST).

The deorbit burn will be terminated for systems failures which preclude controllability or the ability to perform a safe entry. Loss of fault-tolerance will not be cause for terminating the deorbit burn.

For failure of both OMS engines, propellant may not be available to complete the deorbit burn with the RCS +X jets to the original targets. The deorbit burn must be terminated and retargeted to shallower targets. This retargeting will require a 24-hour deorbit delay.

A2.1.5-8 BFS ENGAGE

BFS WILL BE ENGAGED IN ENTRY FOR THE FOLLOWING:

- A. LOSS OF REDUNDANT SET.
- B. LOSS OF CONTROL.

Reference Rule {A7.1.2-1}, PASS DPS FAILURE. ©[071494-1636]

A2.1.5-9 CHASE AIRCRAFT OPERATIONS

- A. T-38 CHASE AIRCRAFT WILL BE UTILIZED ON AN "AS REQUIRED" BASIS.

T-38 chase aircraft can be used to provide photo documentation of orbiter condition and damage prior to touchdown and rollout, visual inspection for fluids, flames, gear door damage, etc., backup for altitude and airspeed, visual call to orbiter crew in case of wind screen obscurations, and downlink TV to NASA/PAO.

FLIGHT RULES

THIS RULE CONTINUED ON NEXT PAGE

FLIGHT RULES

A2.1.5-9 CHASE AIRCRAFT OPERATIONS (CONTINUED)

- B. T-38 CHASE RENDEZVOUS WILL BE DISCONTINUED IF:
1. VISUAL/RADAR CONTACT NOT ESTABLISHED WITHIN 1 MINUTE OF ORBITER RENDEZVOUS POINT AT 40K FEET MSL
 2. VISUAL CONTACT NOT ESTABLISHED WHEN WITHIN 4 NM AS REPORTED BY RADAR CONTROLLER DIRECTING THE INTERCEPT
 3. CHASE RENDEZVOUS NOT COMPLETE BY PREFLARE
 4. VISUAL CONTACT LOST AFTER RENDEZVOUS

The T-38 chase aircraft will break off from the rendezvous attempt when it is considered unsafe to continue. Attempting a join-up without visual contact could result in vehicle collision or create a situation that would cause the orbiter to maneuver to avoid impact. Chase aircraft procedures are found in Aircraft Operating Procedures, Volume 1, T-38A Aircraft.

- C. CHASE AIRCRAFT WILL MAINTAIN A MINIMUM LATERAL SEPARATION OF 200 FEET FROM THE ORBITER DURING THE AUTOLAND PORTION OF THE LANDING APPROACH.

The orbiter autoland flight path characteristics are unpredictable and may be abrupt. A 200-foot T-38 chase aircraft separation will allow the chase pilot adequate time to safely avoid unexpected orbiter maneuvers.

A2.1.5-10 ENTRY LOAD MINIMIZATION

IF IT IS REQUIRED TO MINIMIZE ENTRY LOADS, THE FOLLOWING STEPS WILL BE CONSIDERED:

- A. DELETE ENTRY TEST MANEUVERS.
- B. SELECT RUNWAY AND HAC TO MINIMIZE TAILWIND COMPONENT AT HAC INTERCEPT.
- C. SELECT AN SLS IF SIGNIFICANT WINDS AND/OR TURBULENCE CANNOT BE AVOIDED AT THE PLS.

Reference Rule {A10.1.11-3B}, PLBD CRITICAL LATCHES.

FLIGHT RULES

A2.1.5-11 ENTRY DTO/AUTO MODE/CROSSWIND DTO GO/NO-GO

<u>FAILURE OF</u>	<u>AERO PTI DTO NO-GO</u>	<u>AUTO MODE NO-GO [1]</u>	<u>XWIND DTO NO-GO [10]</u>
<u>APU/HYD</u>			
1 APU [3]			X
2 APU [3]	X		X
<u>DISPLAYS</u>			
2 ADI'S	X		
CDR HUD (IF NO PAPI'S AND BALL BAR)			X
<u>CONTROLLERS</u>			
RHC: 1 LCH			X
L RHC			X
2L AND 2R [3]	X		X
RPTA: 2L OR 2R			X [9]
<u>GNC</u>			
2 AA'S (LAT) [3]	X		X
2 AA'S (NORM) [12]	X (<M 2.5)	X (<M 2.5)	
2 RGA'S [3]	X		X
2 IMU (OR 1 IMU + BITE) [3]	X		X
2 ADTA'S	[5]		X
ADTA NOT INCORP		X (<M 2) [7]	
FCS CH: 2 ELEV [3]	X		X
2 S/B [3]	X		X
2 RUD [3]	X		X
2 BF [3]	X		X
R DDU: 2 POWER SUPPLY (A, B, OR C)			X
LOSS OF WOW/WONG NO SSME REPOSITIONING			X
<u>DPS</u>			
GPC 1 (NOT RSTNG)			X
GPC 2 (NOT RSTNG)			X
GPC 3 (NOT RSTNG)			X
2 GPC (RSTNG)	X		
2 GPC (NOT RSTNG)	X	X (<M 2.5) [12]	X
FF1			X
FF2			X
FF3			X
2 FF	X	X (<M 2.5) [12]	X
2 FA	X		X
<u>AFT RCS</u>			
LEAK	X		
2 YAW JETS ON SAME SIDE	X		
1 YAW JET AND CG OUTSIDE NOM LIMITS	X		
2 P JETS, SAME SIDE, SAME DIR	X (q<40)		
MIN RCS QTY	X		
<u>FWD RCS (FWD RCS DTO ONLY)</u>			
2 YAW JETS SAME SIDE	X		
MIN FWD RCS QTY [2]	X		
LEAK	X		
LOSE LK DETECT [8]			
LOSE FAIL OFF DETECT [8]			
LOSS OF FRCS GAUGING	X		
PROP BULK TK TEMP <70° F	X		

FLIGHT RULES

@[090894-1562] @[111094-1690B] @[041196-1782A] [@\[041097-4890A\]](#)

THIS RULE CONTINUED ON NEXT PAGE

FLIGHT RULES

A2.1.5-11 ENTRY DTO/AUTO MODE/CROSSWIND DTO GO/NO-GO
(CONTINUED)

<u>FAILURE OF</u>	<u>AERO PTI DTO</u> <u>NO-GO</u>	<u>AUTO MODE</u> <u>NO-GO [1]</u>	<u>XWIND DTO</u> <u>NO-GO [10]</u>
<u>LANDING/DECEL</u>			
<u>TIRE (LEAK)</u>			X
<u>ISOL VLV</u>			X
<u><100% BRAKES</u>			X
<u>NWS</u>			X
<u>XRANGE > DTO XRANGE LIMIT</u>			
• <u>PRIOR TO FIRST ROLL REVERSAL</u>	X		
• <u>AFTER FIRST ROLL REVERSAL</u>	[6]		
<u>TRIM/RATES</u>			
<u>AIL > +1.5°</u>	X		X
<u>ELEV > 3° (FROM EXPECTED)</u>	X		X
<u>RATES (PTI)</u>			
<u>PITCH > 3 DEG/SEC</u>	[13]		
<u>YAW > 3 DEG/SEC</u>	[13]		
<u>ROLL > 7 DEG/SEC</u>	[13]		
<u>DOWNMODE</u>			
<u>FCS PROBLEM [3]</u>	X	X	X
<u>AOA</u>	X		X
<u>ENERGY OFF NOMINAL</u>			
<u>ROLL REF. ALERT</u>	X		
<u>ABOVE UPPER TRAJ LINE</u>	X		
<u>NAV PROBLEM REQ MCC GCA OR VEL</u>	X	X	
<u>AND POS UPDATE</u>			
<u>NO A/L BY 6K</u>		X	
<u>PLB</u>			
<u>PLBD LATCHES</u>	X [4]		
<u>DATA</u>			
<u>OPS RECORDERS</u>	X (LOS)		
<u>GROUND SYSTEMS</u>			
<u>NO RUNWAY AIMPOINT</u>			X
<u>XWIND</u>			
<u><10 KNOTS PEAK</u>			X
<u>>15 KNOTS PEAK</u>			X
<u>>10 KNOTS GUST</u>			X
<u>VENT DOORS (FWD RCS DTO ONLY)</u>			
<u>ANY OPEN VENT DOOR (FWD, MID,</u>	[20]		
<u>AFT)</u>			

©[111094-1690B] ©[041196-1782A] ©[041097-4890A]

THIS RULE CONTINUED ON NEXT PAGE

FLIGHT RULES

A2.1.5-11 ENTRY DTO/AUTO MODE/CROSSWIND DTO GO/NO-GO
(CONTINUED)

NOTES:

- [1] GROUND OR CREW CALL.
- [2] PROVIDED BY FLIGHT-SPECIFIC ANNEX.
- [3] RETARGET TO REQUIRED RUNWAY IF AVAILABLE (REF. RULE {A2.1.4-7}, LANDING SITE SELECTION).
- [4] CRITICAL LATCH RULE {A10.1.11-3B}, PLBD CRITICAL LATCHES, APPLIES.
- [5] PTI's AUTOMATICALLY INHIBITED BELOW M = 2.5 WITHOUT AIR DATA.
- [6] GROUND CALL REQUIRED FOR INITIATION OF PTI's (REF. RULE {A4.1.5-9}, AERO TEST MANEUVERS). VALID TELEMETRY REQUIRED FOR EVALUATION OF ORBITER ENERGY STATE AND DRAG PROFILE.
- [7] RESERVED @[041196-1782A]
- [8] DESELECT AFFECTED JET.
- [9] RESERVED @[041196-1782A]
- [10] CONSIDER RUNWAY REDESIGNATION (>M 6) TO AVOID CROSSWIND LANDING.
- [11] RESERVED.
- [12] PITCH AUTO MODE NO-GO FOR M < 2.5.
- [13] PTI's AUTOMATICALLY TERMINATED WHEN RATE LIMITS EXCEEDED.
- [14] RESERVED
- [15] RESERVED
- [16] RESERVED
- [17]~~[17]~~ ~~TABLE REFLECTS LRU REQUIREMENTS FOR DEPLOYMENT PRIOR TO NGTD TO FULFILL DTO NO. 521.~~
RESERVED @[041097-4890A]
- [18] RESERVED @[111094-1690B]
- [19]~~[19]~~ ~~DRAG CHUTE DEPLOY IS ACCEPTABLE PROVIDED EITHER 100 PERCENT BRAKES OR NWS IS AVAILABLE PRE-NGTD-
DEPLOY AND POST-NGTD-DEPLOY.~~ RESERVED @[041097-4890A]
- [20] FWD RCS DTO IS GO. H₂ CONCENTRATIONS PREDICTED TO BE WELL BELOW FLAMMABILITY HAZARD.

THIS RULE CONTINUED ON NEXT PAGE

FLIGHT RULES

A2.1.5-11 ENTRY DTO/AUTO MODE/CROSSWIND DTO GO/NO-GO (CONTINUED)

a. *AERO PTI DTO NO-GO:*

The AERO PTI and Xwind DTO's will not be performed when navigation or flight control systems are fail critical. Maintaining single-fault tolerance for AUTO flight control, and allowing an acceptable crew workload are required for performing the DTO's. In addition to be GO for the Xwind DTO, single-fault tolerance is required for the CDR's displays and controls.

(1) *APU/HYD*

2 APU - If two APU/HYD systems are lost, the remaining system must supply all necessary loading to perform entry. PRL will limit the available hydraulic power in an optimum management scheme in order to prevent overloading the single remaining system. Data has shown that entry PTI's place a short duration high load on a hydraulic system. For this reason, aero PTI'S should not be performed in order to minimize stress on the single APU/HYD system.

(2) *DISPLAYS*

(a) *ADI*

AERO PTI DTO:

The ADI is required to monitor vehicle attitude and rates for crew takeover.

(b) *CDR HUD*

XWIND DTO:

The CDR relies on the HUD for critical landing data and cues. Flying is more difficult without this instrument, and landing in high crosswinds increases the level of difficulty. The CDR's HUD is not required if PAPI's and ball bar are available, since these landing aids provide guidance for the approach and glide slope.

THIS RULE CONTINUED ON NEXT PAGE

FLIGHT RULES

A2.1.5-11 ENTRY DTO/AUTO MODE/CROSSWIND DTO GO/NO-GO
(CONTINUED)

(3) *CONTROLLERS*

(a) *RHC*

L RHC-ONE CHNL FAILED L RHC FAILED

XWIND DTO:

The left RHC is either zero-fault tolerant or failed. It is very desirable for the CDR to manually control the vehicle during approach and landing. For this reason, the PLT will not execute the DTO. If the PLT must fly (left RHC failed), then it is prudent to redesignate, if possible, to a runway with more nominal conditions.

TWO RHC CHNL'S FAILED EACH SIDE

AERO PTI DTO, XWIND DTO:

The next failure could cause vehicle control problems since the output from the remaining two channels is summed. The additional maneuvers associated with the DTO's increase the possibility of having vehicle control problems with the next failure. For these failures, at least one of the flight controller power switches should be turned OFF, and both when not being used (ref. Rule {A8.1.3-6}, CONTROLLERS).

(b) *RPTA*

TWO RPTA CHNL's FAILED ONE SIDE

XWIND DTO:

The RPTA channels are zero-fault tolerant and the DTO is NO-GO since NWS must be powered off (ref. Rule {A10.1.7-1E}, NOSE WHEEL STEERING (NWS)).

THIS RULE CONTINUED ON NEXT PAGE

FLIGHT RULES

A2.1.5-11 **ENTRY DTO/AUTO MODE/CROSSWIND DTO GO/NO-GO**
(CONTINUED)

(4) GNC

(a) AA's

TWO LATERAL AA's FAILED

AERO PTI DTO:

The AA lateral feedback is used for turn coordination to reduce the effects of IMU errors. It is also used in the roll/yaw channel to help form the lateral (Ny) command. The next failure could cause bad vehicle control.

XWIND DTO:

The lateral AA feedback is zero-fault tolerant and the DTO is NO-GO since NWS must be powered off (ref. Rule {A10.1.7-1E}, NOSE WHEEL STEERING (NWS)).

(b) TWO NORMAL AA's FAILED

AERO PTI DTO, AUTO MODE:

The NORM AA feedback is used by guidance to form the Nz command for flight control in MM 305. After two failures the system is zero-fault tolerant in AUTO. The crew is required to fly CSS in pitch in MM 305 (ref. Rule {A8.1.1-5}, ACCELEROMETER ASSEMBLIES (AA) FAULT TOLERANCE), and aero PTI's are automatically inhibited while in CSS.

(c) RGA's

AERO PTI DTO, XWIND DTO:

The system is zero-fault tolerant for feeding bad vehicle rate data to the flight control system. It is not prudent to perform the DTO's since the added maneuvers increase the risk for control problems with the next failure.

THIS RULE CONTINUED ON NEXT PAGE

FLIGHT RULES

A2.1.5-11 **ENTRY DTO/AUTO MODE/CROSSWIND DTO GO/NO-GO**
(CONTINUED)

(d) *IMU's*

AERO PTI DTO, XWIND DTO:

After the second IMU failure or when one of the remaining two IMU's has a BITE, the system is fail critical. In either case, the next failure can cause navigation and flight control to use bad IMU data. The additional maneuvers associated with the DTO's increase the probability of vehicle control problems with the next failure.

(e) *ADTA's*

TWO ADTA's FAILED

XWIND DTO:

The system is zero-fault tolerant because the next failure requires the crew to fly theta limits. Manual flying is more difficult with no air data, and the higher crosswinds increase the piloting task.

ADTA NOT INCORPORATED

AERO PTI DTO, AUTO MODE:

If AD is not incorporated into G&C below M=2.5, aero PTI's are automatically inhibited. If below M=2.0 and AD is not incorporated into G&C, the crew is required to fly CSS in the pitch axis to control theta limits. Manual speedbrake is required below 5k feet (ref. Rule {A8.1.5-12}, GNC AIR DATA SYSTEMS MANAGEMENT (CIL)). Note that the XWIND DTO is NO-GO if it is known that AD will not be incorporated and it is still possible to redesignate.

(f) *FCS CHNL's*

AERO PTI DTO, XWIND DTO:

The system is zero-fault tolerant for being in an uncertified flight control mode. The additional maneuvers associated with the DTO's incur more risk with the next failure.

THIS RULE CONTINUED ON NEXT PAGE

FLIGHT RULES**A2.1.5-11 ENTRY DTO/AUTO MODE/CROSSWIND DTO GO/NO-GO
(CONTINUED)***(g) RIGHT DDU**XWIND DTO:*

The right DDU provides power for NWS. With two power supplies failed the DTO is NO-GO since NWS must be powered off (ref. Rule {A10.1.7-1E}, NOSE WHEEL STEERING (NWS)).

*(h) LOSS OF WOW/WONG**XWIND DTO:*

The crosswinds further complicate the piloting task for loss of WOW or WONG. Both WOW and WONG are required in order to enable NWS, activate AUTO load relief, and enter the rollout DAP mode at nose gear TD. A known loss of WOW or WONG requires the crew to manually set the WOW and WONG discrettes by pushing the SRB or ET Sep pushbutton after nose gear TD. Potential delays in enabling NWS and increased piloting task cause the DTO to be NO-GO.

As a result of OI-21 WOW modifications, the only two-failure scenarios of concern involve the loss of both WONG discrettes (MDM, BUS, or the discrettes themselves).

(5) AFT RCS

- (a) Once a leak is detected, the PTI's will be inhibited. This action prevents the PTI's from occurring while performing leak troubleshooting. The leak procedures isolate a leg of RCS jets at a time thus minimizing the amount of jets available for attitude control. Inhibiting the PTI's ensures that any off-nominal perturbations that could possibly occur during PTI execution will be prevented. If a nonisolatable leak is present or the NO-GO criteria is violated due to isolation of the leak (minimum RCS quantity, loss of jets), no further PTI's will be performed.*
- (b) Due to the loss of fail-safe redundancy for orbiter control, the PTI's will not be performed.*
- (c) RCS quantity checks are performed at different points during entry. The minimum quantity includes 3-sigma entry usage at the check and PTI usage to the next check. PTI's will be inhibited to protect 3-sigma entry redlines. ©[041196-1782A]*

THIS RULE CONTINUED ON NEXT PAGE

FLIGHT RULES**A2.1.5-11 ENTRY DTO/AUTO MODE/CROSSWIND DTO GO/NO-GO**
(CONTINUED)**(6) FWD RCS**

- (a) *Loss of two FWD RCS yaw jets on the same side would result in unbalanced jet firings during PTI's. The entry command SOP software will prevent the PTI's from occurring as long as RCS RM has deselected the jets. If the FRCSS yaw jets have become unavailable prior to entry, the PTI's will not be enabled* ©[090894-1562].
- (b) *FWD RCS quantity checks are performed at different points during entry. The minimum quantity includes PTI usage to the next check and ensures positive propellant flow from the FWD RCS.*

	<i>Tank residual required to prevent screen breakdown</i>
677 lb	<i>(FWD RCS tanks not designed for entry use)</i>
+ 84 lb	<i>Gauge error</i>
761 lb	<i>Total tank</i>
-307 lb	<i>Hardware trapped</i>
454 lb	<i>Minimum usable FWD RCS</i>
+PTI lb	<i>PTI usage</i>
XXX lb	<i>Total quantity check</i>

- (c) *Once a leak is detected, the PTI's will be inhibited. This action ensures that the PTI's will not occur during leak isolation. Leak troubleshooting consists of securing the entire system. If the leak is nonisolatable or the minimum FWD RCS quantity is violated or minimum jets violated, the PTI's will remain inhibited.*
- (d) *For the loss of RCS RM, the jets will be deselected and not utilized for the PTI's. Per Rule {A6.1.2-19}, RCS RM LOSS, jets with loss of RM will only be selected if required for attitude hold or to maintain fail-safe redundancy. Because of the risk of firing jets without RM and the low priority of FWD RCS PTI's, the jets will not be reselected to perform PTI's.*
- (e) *FWD RCS gaging is required to monitor the propellant quantity to ensure that minimum FWD RCS quantity will not be violated.*
- (f) *The FWD RCS bulk propellant temperature must be 70 deg F or greater at deorbit TIG. This is required to prevent ZOT's from occurring during PTI's. This is an MCC call since the crew has no insight into the parameter during OPS-3.* ©[090894-1562]

THIS RULE CONTINUED ON NEXT PAGE

FLIGHT RULES

A2.1.5-11 ENTRY DTO/AUTO MODE/CROSSWIND DTO GO/NO-GO
(CONTINUED)

- (7) *TRIM/RATES/CG* @[041196-1782A]

TRIM

- (a) *AILERON TRIM* > ± 2.0 DEGREES @[041196-1782A]

AERO PTI DTO:

The aileron trim saturation limit is 3.0 degrees. When the trim reaches 2.0 degrees, the PTI's should be inhibited to avoid possible control problems or high RCS usage. Based on SES analysis and previous flight data, 2.0 degrees is a comfortable margin for control, while not being too restrictive. @[041196-1872A]

- (b) *ELEVON TRIM* > 3.0 DEGREES (FROM EXPECTED)

AERO PTI DTO:

The elevator schedule has a 1-degree deadband. Performing PTI's with large elevator trim could increase the level of difficulty in trimming the vehicle. Three degrees off schedule is a sufficiently large elevator trim limit to permit aero maneuvers in any reasonable flight condition, yet provides adequate safety margins for control.

XWIND DTO:

This elevon trim condition indicates that the vehicle is in an off-nominal configuration which may lead to additional problems. It is prudent then to NO-GO the XWIND DTO and avoid complicating the situation during A/L and rollout.

- (c) *VEHICLE RATES (PTI)*

AERO PTI DTO:

These limits are in the software and will automatically inhibit (terminate) any PTI in progress. The additional maneuvers associated with the PTI's could make it more difficult for the FCS to damp the rates and regain good control.

THIS RULE CONTINUED ON NEXT PAGE

FLIGHT RULES

A2.1.5-11 ENTRY DTO/AUTO MODE/CROSSWIND DTO GO/NO-GO
(CONTINUED)

(d) CG

AERO PTI DTO:

With the X or Y CG out of the nominal CG box, continuous firing of ARCS jets may be required to maintain attitude control. To ensure maximum control authority in an uncertified configuration, as well as to save propellant, PTI's will not be performed.

©[041196-1782A]

(8) DOWNMODE

FCS PROBLEM

AERO PTI DTO, AUTO MODE, XWIND DTO:

If the vehicle is experiencing problems with the FCS, due to multiple systems failures and/or unpredicted effects of the environment, then all flight control DTO's are NO-GO, and the crew should fly CSS, if required. The risks associated with performing the DTO's are too great while vehicle control is off-nominal.

(9) PLB

PLBD LATCHES - It is acceptable to perform an entry with any one latch gang (bulkhead or centerline) failed open. Entry loads should be minimized (per Rule {A10.1.11-3B}, PLBD CRITICAL LATCHES, and SODB 3.4.2.3). Aero PTI's will not be performed in order to ensure a nominal entry.

(10) DATA

According to the sponsor of the aero PTI DTO, the crew cannot evaluate the results from onboard indications. Either real-time or recorded telemetry is required. This is in agreement with the DTO requirements as documented in NSTS 16725, Flight Test and Supplementary Objectives Document.

THIS RULE CONTINUED ON NEXT PAGE

FLIGHT RULES

A2.1.5-11 ENTRY DTO/AUTO MODE/CROSSWIND DTO GO/NO-GO
(CONTINUED)

b. *XWIND DTO NO-GO*

(1) *APU/HYD*

1 APU and 2 APU

Loss of one APU/HYD system places the orbiter a single failure away from performing entry/rollout on a single system. Orbiter handling qualities have been demonstrated to be degraded when only a single APU/HYD system is operating. If only one APU/HYD system remains, conditions that could adversely affect the already degraded handling qualities should be avoided if possible. Therefore, if one or two APU/HYD systems are lost, the crosswind DTO should be NO-GO.

(2) *LANDING/DECEL*

(a) *TIRE (LEAK)*

For a confirmed main gear tire leak, a landing with a crosswind from the side of the affected tire is desirable. If a leak is confirmed in a main or nose gear tire, the load-carrying capability of that tire is reduced.

(b) *BRAKE ISOL VLV*

Loss of the ability to open one brake isolation valve puts the orbiter one failure away from having only 50 percent braking capability. Full braking capability is required for the crosswind DTO in order to ensure good control of the vehicle in high crosswind conditions.

THIS RULE CONTINUED ON NEXT PAGE

FLIGHT RULES

A2.1.5-11 ENTRY DTO/AUTO MODE/CROSSWIND DTO GO/NO-GO
(CONTINUED)

(c) <100 PERCENT BRAKES

Full braking capability is required for the crosswind DTO in order to ensure good control of the vehicle in high crosswind conditions.

(d) NWS

NWS is the primary means of steering the vehicle during rollout. In a strong crosswind, differential braking may not be sufficient to maintain directional control.

(3) XWIND

(a) <108 KNOTS ~~STDY STATE~~ PEAK @J041097-4890A1

Winds less than 108 knots are not within the DTO limits and would not produce conditions appropriate for collecting the required DTO data.

~~(b) >12 KNOTS STDY STATE~~

~~*Ames VMS testing shows acceptable orbiter control in 12 knots steady state crosswinds (however, statistics show that a 12 knot steady state crosswind peaks >15 knots, violating the nominal crosswind limits).*~~

(eb) >15 KNOTS PEAK

Crosswinds greater than 15 knots peak violate nominal crosswind limits.

(#c) >10 KNOTS GUST @J041097-4890A1

Crosswinds with gusts greater than 10 knots above the steady-state wind violate nominal limits.

THIS RULE CONTINUED ON NEXT PAGE

FLIGHT RULES

A2.1.5-11 ENTRY DTO/AUTO MODE/CROSSWIND DTO GO/NO-GO (CONTINUED)

c. *DPS*

In general, DPS failures that cause aero PTI DTO, auto mode, and crosswind DTO to be NO-GO are driven by various failures in the GNC, MMACS, and/or PROP systems.

GPC 1 (NOT RSTNG), GPC 2 (NOT RSTNG), FF1, FF2 - Crosswind DTO is NO-GO due to loss of a left RHC channel, and for vehicles without improved NWS, loss of GPC NWS.

GPC 3 (NOT RSTNG), FF3 - Crosswind DTO is NO-GO due to loss of a left RHC channel.

2 GPC (RSTNG) - Aero PTI DTO is NO-GO due to the inherent risk of another GPC failure which would cause GNC systems violations for the DTO.

2 GPC (NOT RSTNG), 2 FF - Aero PTI DTO, auto mode (<M2.5), and crosswind DTO are all NO-GO due to multiple GNC LRU failures.

2 FA - Aero PTI DTO and crosswind DTO are NO-GO due to multiple GNC LRU failures. The aero PTI DTO is also NO-GO due to two aft jets being down.

For additional technical information concerning the rationale for aero PTI DTO, auto mode, and crosswind DTO NO-GO requirements, refer to the rationale for the GNC, MMACS, and PROP systems.

~~d. DRAG CHUTE DTO NO GO~~

~~(1) APU/HYD~~

~~2 APU Drag chute DTO is NO GO if two APU's have failed due to the decreased aero-surface control response and the possible impact on NWS and braking. The DTO is still GO for the loss of one APU, as the effect of this loss is minimal on vehicle control. With a single APU down, it is not deemed necessary to protect for the next failure (a second APU failing) as the APU would have to fail between chute deploy and nose gear touchdown, while being in INHIBIT.~~

~~(2) DISPLAY~~

~~No display requirements.~~

~~(3) CONTROLLERS~~

~~No controller constraints to the drag chute DTO.~~

FLIGHT RULES

~~— For scenarios in which a controller is one failure away from outputting erroneous commands to the flight control system (one remaining channel on an RHC or RPTA), it is acceptable to deploy the drag chute for the purposes of the DTO. The rationale is that if the next failure does not occur, the vehicle is controlled nominally and there is no risk to deploying the drag chute. If the failure does occur, the probability of a loss of control is high, with or without the drag chute.~~

~~— For scenarios in which the controller function can be lost with the next failure (two remaining channels on an RHC and one subsequently fails causing a dilemma), both crewmen have been trained in the derotation and rollout task. There is no additional risk created by deploying the drag chute during a handover of the piloting task between crewman.~~

~~THIS RULE CONTINUED ON NEXT PAGE~~

FLIGHT RULES**A2.1.5-11 ENTRY DTO/AUTO MODE/CROSSWIND DTO GO/NO-GO
(CONTINUED)**~~(4) GNC~~

- ~~— (a) 2 AA's (lat.) The next lateral AA failure can input a hardover or high bias into the NWS system, resulting in loss of vehicle control. Therefore, NWS must be powered off (for NEOM). If the braking system is fully operational, the drag chute DTO will be performed with the NWS system off. (Ref. Rule {A10.1.7 1E}, NOSE WHEEL STEERING (NWS).)~~
- ~~— (b) 2 RGA's The next RGA failure (any axis) can put false rate feedback into the flight control system, significantly affecting derotation and rollout control.~~
- ~~— (c) R DDU: 2 PWR SUPPLIES Loss of NWS position feedback transducers (nose wheel steering powered off). Acceptable for drag chute deploy if 100 percent brakes are available. (Ref. Rule {A10.1.7 1E}, NOSE WHEEL STEERING (NWS).)~~
- ~~— (d) 2 FCS CHANNELS (same surf. except BF) Next FCS channel problem could result in a stalled actuator during final and derotation. The subsequent degradation of vehicle control capability could cause significant problems in controlling any drag chute transients.~~
- ~~— (e) KNOWN WOW/WONG DILEMMA A WOW dilemma at MGTD will inhibit the transition to derotation flight control gains, flat turn mode, and derotation HUD. Two WONG discrettes set at MGTD will cause a WOW dilemma. The crew procedurally backs up WOW/WONG at NGTD, so this failure is not a constraint to drag chute deploy post NGTD. The probability of this failure is greatly reduced with the incorporation of redundant WOW (>2 failures on main gear).~~
- ~~— (f) NO SSME REPOSITIONING Potential damage to center SSME engine bell (due to riser cord abrasion) outweighs requirement for DTO data (ref. Rule {A8.1.1 21}, SSME REPOSITIONING FOR DRAG CHUTE).~~

~~(5) DPS~~

- ~~— (a) 2 GPC's (rstrng) Loss of a third GPC during rollout will freeze actuators until the BFS is engaged (all channels are in OVERRIDE).~~
- ~~— (b) 2 GPC's (not rstrng) Loss of two FCS channels, two AA's, and two RGA's.~~
- ~~— (c) 2 FF Loss of two lateral AA's (NO GO NWS). Acceptable if 100 percent brakes are available.~~
- ~~— (d) 2 FA Loss of 2 FCS channels.~~

THIS RULE CONTINUED ON NEXT PAGE

FLIGHT RULES

~~A2.1.5-11 ENTRY DTO/AUTO MODE/CROSSWIND DTO GO/NO GO~~ ~~(CONTINUED)~~

~~(6) AFT/FWD RCS~~

~~— No RCS constraints to drag chute DTO.~~

~~(7) LANDING/DECEL~~

~~— In the event of a tire leak, a nominal drag chute deploy will be performed. The DTO will be NO GO, as Ames (6/93) data indicates that a nominal deploy will provide maximum main gear load savings. In addition, the vehicle handling qualities may be different because of the tire leak, and pure DTO data may not be obtainable. — @ [141094-1690B]~~

~~— <100 percent Brakes or Loss of NWS — Either 100 percent brakes or NWS should be available for lateral/directional control when deploying the drag chute. This concern applies for post NGTD deployments as well as pre NGTD deployments.~~

~~(8) EPS~~

~~— No electrical bus constraints to the drag chute DTO.~~

~~(9) X RANGE > DTO X RANGE LIMIT~~

~~— This constraint does not apply to the drag chute DTO.~~

~~(10) TRIM/RATES~~

~~— No constraints to drag chute DTO.~~

~~(11) DOWNMODE~~

~~— FCS Problem — Drag chute deploy should not be performed if the FCS system is showing anomalous behavior that could cause derotation control problems (stuck speedbrake, sluggish elevon). There are no concerns for post NGTD deployments.~~

~~(12) ENERGY OFF NOMINAL~~

~~— No constraints to the drag chute DTO. For high energy landings, it is desirable to deploy the drag chute to decrease rollout distance and braking energy. Low energy landings are constrained by a requirement to delay drag chute deploy until after NGTD if MGTD is slow (<175 knots EAS) (ref. Rule (A10.1.8 2), DRAG CHUTE OPERATIONS). — @ [141094-1690B]~~

~~(13) PLB/DATA/GROUND SYSTEMS~~

~~— No constraints to the drag chute DTO.~~

FLIGHT RULES

~~THIS RULE CONTINUED ON NEXT PAGE~~

FLIGHT RULES

~~A2.1.5-11 ENTRY DTO/AUTO MODE/CROSSWIND DTO GO/NO-GO
(CONTINUED)~~

~~(14) CROSSWIND~~

~~— The drag chute DTO will only be performed if the runway crosswind is \leq 10 knots peak. ©[111094-1690B]~~

~~(15) VENT DOORS (FWD RCS DTO ONLY)~~

~~— Engineering analyzed a nominal entry with the FWD RCS PTI (DTO 250) performed and an RTLS abort with a FWD RCS dump. The results show that H_2 concentrations are below the NASA established H_2 flammability hazard limits for both a nominal entry vent door configuration and a left or right vent door 1/2 failed open scenario. Mid/aft compartment H_2 concentrations, as a result of ingestion through failed mid/aft vent doors, would be even less than for the FWD compartment. Reference AEFTP #100, May 1993. ©[041097-4890A]~~

FLIGHT RULES

A2.1.5-12 LANDING DTO'S

- A. BRAKING OR NOSE WHEEL STEERING DTO TASKS MAY BE PERFORMED ON DAYLIGHT LANDINGS REGARDLESS OF THE WEIGHT/CG OR FLIGHT DURATION. @[111894-1690B]
- B. BRAKING DTO TASKS MAY BE PERFORMED ON NIGHT LANDINGS SO LONG AS THEY INVOLVE ONLY VARIATIONS IN BRAKING PROFILE OR DECELERATION LEVEL. NO DTO STEERING TASKS USING DIFFERENTIAL BRAKING WILL BE PERFORMED ON NIGHT LANDINGS. @[111894-1690B]
- C. NO DTO STEERING TASKS USING DIFFERENTIAL BRAKING OR NWS WILL BE PERFORMED ON NIGHT LANDINGS. @[111894-1690B]
- D. CROSSWIND LANDING DTO'S ABOVE 12 KNOTS PEAK WILL NOT BE PERFORMED ON NIGHT LANDINGS OR EXTENDED DURATION ORBITER (EDO) FLIGHTS. @[111894-1690B]

Braking or nose wheel steering testing is acceptable during daylight landings since vehicle weight and CG have minimal effects on the rollout piloting task, and visual cues are available to the crew to assess test inputs/results. Braking tests at night are acceptable if they only involve basic braking functions such as varying the deceleration levels or specific braking profile. Steering task DTO's involving either differential braking or nosewheel steering are not acceptable at night due to the loss of visual cues and runway shadowing effects which put the crew and orbiter at unnecessary additional risk. The crosswind limit for EDO or night flights has been set at 12 knots regardless of where you land. You may land with a crosswind between 8 and 12 knots and still meet the crosswind DTO requirements, but the peak wind will not be allowed to exceed 12 knots and approach the 15-knot normal crosswind DTO limit. @[ED]

~~E. THE CROSSWIND DTO MAY RESULT IN EXCEPTIONS TO RULE {A10.1.8-2}, DRAG CHUTE DEPLOY TECHNIQUES.~~

E. THE CROSSWIND DTO MAY RESULT IN EXCEPTIONS TO RULE {A10.1.8-2}, DRAG CHUTE DEPLOY TECHNIQUES.

If the crosswind DTO is GO per Rule {A2.1.5-11}, ENTRY DTO/AUTO MODE/CROSSWIND DTO ~~GO/NO-GO~~, the drag chute will be deployed after NGTD, as stated in the applicable Flight Rule Annex. @[041097-4890A] GO/NO-GO, the drag chute will be deployed after NGTD, as stated in the applicable Flight Rule Annex. @[041097-4890A]

THIS RULE CONTINUED ON NEXT PAGE

FLIGHT RULES

A2.1.5-12 LANDING DTO'S (CONTINUED)

F. LANDING AND ROLLOUT DTO'S WILL NOT BE PERFORMED ON ABORTS (RTLS, TAL, AOA, FD1 PLS) UNLESS THEY ARE DATA GATHERING ONLY, INVOLVE NO CREW ACTIONS, AND POSE NO ADDITIONAL RISK TO THE CREW OR VEHICLE. HOWEVER, DATA FROM ANY ABORT LANDING MAY BE USED TO SATISFY PROGRAM DTO OBJECTIVES.
@[100997-6294A]

Programmatic risk is high during an abort. Additional risk or crew distraction should not be incurred for the sake of engineering data that can more safely be obtained on another flight. However, some DTO's are data gathering only and are transparent to the crew; these are allowed. Some DTO's cannot be avoided (e.g., crosswind landings) during aborts and thus will be accomplished anyway. This rule means that off-nominal crew actions (such as delayed drag chute deploy for the crosswind DTO) will not be performed. @[100997-6294A]

FLIGHT RULES

A2.1.5-13 STA/WEATHER AIRCRAFT RUNWAY APPROACH OPERATIONS FOR SITES WITH ONLY ONE RUNWAY

A. PRELAUNCH (RTLS/TAL)/PREDEORBIT (AOA/EOM)

STA AND/OR WEATHER AIRCRAFT APPROACHES TO PLANNED LANDING SITES WITH ONLY ONE RUNWAY (OPPOSITE END MAY OR MAY NOT BE AVAILABLE) MAY BE PERFORMED AS REQUIRED TO ASSESS NAVAID/VISIBILITY STATUS. ONCE THE FINAL GO FOR LAUNCH OR THE DEORBIT BURN HAS BEEN GIVEN, THESE OPERATIONS WILL BE TERMINATED UNLESS REQUIRED PER PARAGRAPH B.

B. POSTLAUNCH (RTLS/TAL)/POSTDEORBIT BURN (AOA/EOM)

POSTLAUNCH OR POSTDEORBIT BURN, STA OR WEATHER AIRCRAFT APPROACHES TO THE SELECTED RUNWAY AT LANDING SITES WITH ONLY ONE RUNWAY (OPPOSITE END MAY OR MAY NOT BE AVAILABLE), WILL ONLY BE DONE IF CONDITIONS MAKE SUCH AN APPROACH NECESSARY. APPROACHES WILL BE MINIMIZED AND WILL BE PERFORMED TO REDUCE THE RISK OF RUNWAY LOSS DUE TO AIRCRAFT PROBLEMS ON APPROACH. TO REQUIRE AN APPROACH POSTLAUNCH OR POSTDEORBIT, A CHANGE OR CONCERN IN ONE OR MORE OF THE FOLLOWING AREAS MUST EXIST:

1. VISIBILITY.
2. NAVAID STATUS/CAPABILITY.

For the case where a landing facility has only one runway (availability of its alternate end does not matter), approaches to landing runways are still performed prelaunch or predeorbit burn to aid in assuring that landing flight rules are met with respect to navaid and visibility status. Such approaches are not considered a threat to landing prior to launch or the deorbit burn.

Once committed to a runway, approaches to that runway or its alternate end, should not be done unless necessary to confirm the ability to land on that runway. There is no reason to continue to shoot approaches to the selected runway if conditions have not changed since the commitment to use the runway. If changes are suspected, however, additional approaches may be performed. If required, they will be done such that risk of losing the runway due to approach aircraft problems will be minimized in order to preserve shuttle landing capability. Techniques to accomplish this include breaking off an approach early or runway flybys vice approaches.

FLIGHT RULES

A2.1.5-14 EMERGENCY LANDING FACILITY CRITERIA

THIS RULE DOCUMENTS THE MINIMUM ACCEPTABLE LANDING FACILITY REQUIREMENTS FOR COMMITMENT TO AN EMERGENCY LANDING VERSUS BAILOUT. IT APPLIES FOR ALL LANDINGS. @[120894-1744B]

- A. RUNWAY AT LEAST 8500 FT LONG AND 148 FT WIDE.
- B. RUNWAY COORDINATES RESIDENT IN THE ONBOARD SOFTWARE OR AVAILABLE FOR UPLINK.
- C. OPERATIONAL TACAN OR DME WITHIN 50 NM OF THE SITE, AVAILABLE FOR INCORPORATION INTO THE NAV (MAY REQUIRE UPLINK).
- D. AIRSPACE AND RUNWAY CLEAR.
- E. CONFIRMATION OF FACILITY READINESS FOR ORBITER LANDING VIA MCC OR CREW VOICE CONTACT WITH THE AIRFIELD.
- F. ACCEPTABLE WEATHER FOR ORBITER EMERGENCY LANDING OPERATIONS (REFERENCE RULE {A2.1.1-6}, LANDING SITE WEATHER CRITERIA).
- G. ACCEPTABLE LIGHTING FOR ORBITER EMERGENCY LANDING OPERATIONS. IF LANDING AT NIGHT WITHOUT XENONS, THE FOLLOWING MINIMUM REQUIREMENTS APPLY:
 - 1. OPERATIONAL RUNWAY EDGE LIGHTS
 - 2. ONE HUD OPERATIONAL

Due to the inherent hazards of an orbiter landing, especially at a non-augmented facility, adequate site readiness must be ensured before a landing will be attempted. The runway to be used must be of sufficient length and width to accommodate a safe orbiter landing. The 148 ft value corresponds to the narrowest approved ELS runways in NSTS-07700, Volume X, Book 3. The 8500 ft length is based on limited Descent Design System rollout simulations assuming short field speedbrake, touchdown at 195 knots, drag chute deploy at main gear touchdown, initiation of derotation at 175 knots, and brakes at 10 fps deceleration at nose gear touchdown. Refer to STF #DFD-94-530-007 for rollout analysis. The runway must be resident in the onboard software or available for uplink to allow guidance and navigation aids to be used.

FLIGHT RULES

An operational TACAN or DME is required to provide sufficient onboard navigation accuracy. The coordinates must be resident in the onboard software or available for uplink to allow incorporation into the navigation state. Fifty miles distance from the TACAN to the field is based on Monte Carlo analysis of various TAL scenarios. Redundancy in the TACAN or its power supply is desirable but not required. @[120894-1744B]

THIS RULE CONTINUED ON NEXT PAGE

FLIGHT RULES

A2.1.5-14 EMERGENCY LANDING FACILITY CRITERIA (CONTINUED)

The airspace and the chosen runway must be clear. MCC or crew voice contact with the airfield is required to ensure that the facility is prepared for the landing. In order to reduce the risk to the orbiter, crew, and the general public/civilian population, it is necessary that an intended landing site be notified of an attempted landing as soon as possible. This will allow the airspace and runways to be cleared as well as emergency equipment prepared. Notification may be via state department prearranged channels, NASA agreed to communication channels, or via communication directly with the orbiter crew. ©[120894-1744B]

Acceptable weather for orbiter landing operations is required. These criteria are documented in rule {A2.1.1-6}, LANDING SITE WEATHER CRITERIA.

Restrictions are placed on night landings due to a significant loss of visual cues. As a minimum, runway edge lights and a HUD must be operational to assist in visually acquiring the runway and the outer glide slope (if MLS is not available) and to provide a visual reference during braking and rollout (regardless of MLS status).

Rules {A2.1.4-5}, EMERGENCY DEORBIT, and {A2.1.4-9}, LANDING SITE SELECTION FOR AN INFLIGHT EMERGENCY, reference this rule. ©[120894-1744B]

FLIGHT RULES

A2.1.5-15 SINGLE STRING GPS OPERATIONS ON THE BFS (OI-26B- FLIGHT SOFTWARE ©[072398-6586A] ©[040899-6847]

- A. THE GPS A/I/F FLAGS WILL REMAIN IN INHIBIT FOR ANY CERTIFIED FLIGHT MODE (NOMINAL ASCENT, ATO, AOA, TAL, RTLS, ORBIT, AND NOMINAL ENTRY). GPS USE IN THE PASS AND/OR BFS IN OTHER THAN THE INHIBIT MODE MAY BE CONSIDERED FOR CONTINGENCY CASES WHERE ITS USE COULD PREVENT A CREW BAILOUT AND LOSS OF THE ORBITER. ©[072398-6586A] ©[040899-6847]

The PASS and BFS have been certified for flight only if the GPS to NAV and GPS to G&C auto/inhibit/force flags remain in the inhibit position. ~~Limited~~ Testing has been performed to confirm the PASS and BFS continue to function with incorporation of GPS; however, full certification testing has not been completed. Performance testing of GPS data incorporated into the onboard navigation has not been completed. Potential contingency scenarios in which GPS may be used could include, but are not limited to, a contingency landing to a site with no ground TACAN or DME and no radar tracking support; loss of command capability combined with multiple onboard problems resulting in an unacceptable navigation state requiring a manual delta state update; multiple IMU problems resulting in a runaway navigation state which is not manageable with delta state updates. In OPS 1 and Major Mode (MM) 601, ~~4/6~~, GPS is only available for incorporation in the BFS. Contingency use of GPS in OPS 1 and MM 601 ~~4/6~~ in the BFS would require CSS in the PASS to fly out the BFS ADI digital errors, unless the commander deemed it necessary to engage in order to fly the vehicle. If possible, contingency use of GPS should be delayed until OPS 3 or MM 602/603. GPS state vector accuracies can be degraded during powered flight due to external tank blockage of GPS satellite signals. BFS navigation updates with GPS during powered flight would only be required to correct extreme errors which could result in unsafe MECO conditions. The GPS DTO objectives expected to be performed on single string GPS missions may call for the GPS A/I/F function to be in a position other than inhibit. If so, the flight specific flight rules annex will document the exception to this rule and specify the conditions under which the DTO objectives will be performed. ©[040899-6847]

- B. EXCEPTIONS TO THIS RULE WILL BE DOCUMENTED IN THE FLIGHT SPECIFIC FLIGHT RULES ANNEX. ©[072398-6586A]

FLIGHT RULES

THIS PAGE INTENTIONALLY BLANK

FLIGHT RULES

CONTINGENCY ACTION SUMMARY

A2.1.6-1 CONTINGENCY ACTION SUMMARY

FAILURE	M A N U A L S S M E S / D	F A S T S E P	R T L S	T A L	A O A	A T O	B A I L O U T	ENTER FIRST DAY PLS [84]	ENTER ASAP (PLS, SLS ELS) [1]	ENTER IMMED. [1]	MAX DEORBIT DELAY	
											1 ORB	24 HR
A. GROUND INSTRUMENTATION												
1. <u>REMOTE STATIONS</u>												
a. EDW LANDING												
(1) LOSS OF DFRF, GDS, AND TDR (HDR AND LDR) [2]											X	X
(2) LOSS OF ALL DFRF, GDS, AND TDRS VOICE (S-BAND AND UHF) [2]											X	X
(3) LOSS OF DFRF, GDS, AND TDRS CMD											X	
b. KSC LANDING												
(1) LOSS OF MIL, PDL, AND TDRS TLM (HDR AND LDR) [2]											X	X
(2) LOSS OF MIL, PDL, AND TDRS VOICE (S-BAND AND UHF) [2]											X	X
(3) LOSS OF MIL, PDL, AND TDRS CMD											X	
c. NOR LANDING												
(1) LOSS OF ALL UHF AND TDRS S BAND VOICE [2]											X	X
(2) LOSS OF TDRS TLM [2]											X	X
(3) LOSS OF TDRS CMD											X	
2. <u>TRACK</u>												
a. LOSS OF DUAL TRACK SOURCES TO 100K FT ALT											X	X
b. LOSS OF ALL LANDING AREA											X	
3. <u>MCC</u>												
a. LOSS OF MOC AND DSC [3]											X	X
b. LOSS OF ALL TPC'S											X	X
c. LOSS OF ALL A/G CAPABILITY											X	X

©[121593-1590]

FLIGHT RULES

THIS RULE CONTINUED ON NEXT PAGE

FLIGHT RULES

A2.1.6-1

CONTINGENCY ACTION SUMMARY (CONTINUED)

FAILURE

	M A N U A L S S M E S / D	F A S T S E P	R T L S	T A L	A O A	A T O	B A I L O U T	ENTER FIRST DAY PLS	ENTER ASAP (PLS, SLS ELS)	ENTER IMMED.	MAX DEORBIT DELAY	
											1 ORB	24 HR
B. TRAJECTORY/GUIDANCE												
1. <u>TRAJECTORY</u>												
a. PERFORMANCE VIOLATIONS [5]			X	X	X	X	X					
b. PROTECT ATO CAPABILITY	X											
c. PROTECT 3 ENGINE RTLS GUIDANCE MECO	X											
d. ONBOARD PREDICTED MECO 2 SEC DIFFERENT THAN GND (CONFIRMED BY NAV VEL ERRORS) (MAN C/O ON GND COMP VALUE)	X											
e. CG OUTSIDE OF NOMINAL BOUNDARY												X
f. CG OUTSIDE CONTINGENCY BOUNDARY				[9]	[9]	[9]						
g. MNVR COMP DOES NOT INCLUDE AT LEAST 1 REPEAT STDN SITE PASS FOLLOWING A PERIGEE ADJUST MNVR											X	X
h. PREDICTED DOWNTRACK ERROR AT EI >20 NM											X	X
i. EOM WEATHER FORECAST VIOLATIONS [38]											X	X
2. <u>RANGE SAFETY</u>												
a. RSO ARM CMD RECEIVED [7]		X					X					
b. DEVIATION TOWARDS LIMIT LINE [7]	X	X	X	X		X	X					
C. MPS												
1. MANUAL THROTTLE REQUIRED FOR LH2 NPSP												
2. He TK LOST (<750 PSI) W/LMT S/D INH	X		X	X	X	X						
3. CMD PATH FAIL	X											
4. DATA PATH FAIL WITH UNVERIFIED CMD PATH	X											
5. CMD AND DATA PATH FAIL	X											
6. 2 STUCK THROTTLE W/3 SSME'S ON [8]	X											
7. 1 STUCK THROTTLE W/3 SSME'S ON [6]	X											
8. 3 ET LOW LVL SENS FAIL DRY SAME TNK				X	[31]							

©[121593-1590]

FLIGHT RULES

THIS RULE CONTINUED ON NEXT PAGE

FLIGHT RULES

A2.1.6-1

CONTINGENCY ACTION SUMMARY (CONTINUED)

FAILURE	M A N U A L S S M E S / D	F A S T S E P	R T L S	T A L	A O A	A T O	B A I L O U T	ENTER FIRST DAY PLS	ENTER ASAP (PLS, SLS ELS)	ENTER IMMED.	MAX DEORBIT DELAY	
											1 ORB	24 HR
D. OMS/RCS								[84]	[1]	[1]		
<u>1. OMS</u>												
a. LOSS OF 1 OMS He TK PRIOR TO OMS 1												[11]
b. 2 OMS He TK FAIL												
(1) PRIOR TO OMS 1				X	X							[44]
(2) BETWEEN OMS 1 AND OMS 2								[62]				[12][15]
c. 1 OMS PROP TK LK/FAIL OR 2 TKS SAME SIDE LK/FAIL												
(1) BEFORE OMS 2					[34]	[11]		X				
(2) BEFORE DEORBIT TIG												[15][16]
(3) AFTER DEORBIT TIG BUT BEFORE HP < PROP FAIL HP												[56]
(3) AFTER DEORBIT TIG BUT BEFORE HP < PROP FAIL HP												[14][15]
d. 2 OMS PROP TK LK/FAIL, DIFF SIDE				X	[15] [23]			x	[13]			
e. 2 OMS ENG FAIL												[56]
(1) BEFORE OMS 1						[11]		X				
(2) AFTER OMS 1								X				
(3) AFTER DEORBIT TIG BUT BEFORE HP < SAFE HP												[18]
f. 1 OMS FAIL AND 1 + X RCS JET FAIL								X				
g. 1 OMS INLET LINE OR 2 SAME SIDE												
(1) BEFORE OMS-2								X				[25]
(2) BEFORE DEORBIT TIG												[15][63]
h. 2 OMS INLET LINES, DIFF SIDES, SAME PROPELLANT					[15] [23]							[56]
i. 2 OMS INLET LINES, DIFF SIDES, DIFF PROPELLANT						[11]		X				[56]
<u>2. RCS</u>												
a. 2 AFT RCS He/PROP TK LK/FAIL-DIFF SIDE												
(1) DIFF PROP								X				[19]
(2) SAME PROP					[13]	[13]	X	X	[13]			
b. 2 AFT JETS SAME AXIS/POD FL'D OFF BY RM									[70]			[56]
c. 1 AFT RCS He/PROP TK LK/FAIL OR 2 TKS SAME SIDE LK/FAIL								X				[56] [59]

FLIGHT RULES

@[121593-1590]

THIS RULE CONTINUED ON NEXT PAGE

FLIGHT RULES

A2.1.6-1

CONTINGENCY ACTION SUMMARY (CONTINUED)

FAILURE

	M A N U A L S S M E S / D	F A S T S E P	R T L S	T A L	A O A	A T O	B A I L O U T	ENTER FIRST DAY PLS	ENTER ASAP (PLS, SLS ELS)	ENTER IMMED.	MAX DEORBIT DELAY	
											1 ORB	24 HR
E. DPS								[84]	[1]	[1]		
1. LOSS OF 1 GPC											X	
2. REDUNDANT SET FAILURE OR GPC SPLITS[20][5]								[4]				X [30]
3. LOSS OF BFS WITH A 2 OR MORE GPC PASS SET												X
4. LOSS OF 2 GPC'S (SPARE AVAILABLE)												X
5. LOSS OF 2 PL MDM'S								[41]				
6. LOSS OF 2 FA MDM'S								[65]				
7. LOSS OF 2 FF MDM'S								[66]			X	X
8. GPC BITE (MULTIPLE GPC'S)											X	X
9. LOSS OR FF1 AND (FF3 OR FF4) (KSC) OR LOSS OF FF2 AND (FF3 OR FF4) (KSC) [81]											X	X
10. LOSS OF 2 MMU'S [83]												
F. EECOM												
1. FIRE (AV BAY OR CABIN) [58]								X	X			
2. <u>ARS/PCS</u>												
a. LOSS OF 2 CABIN FANS [60][39]								X	X			
b. LOSS OF AV BAY COOLING IN BAY 1 OR 2 [30]											X	X
c. LOSS OF AV BAY COOLING IN BAY 3 [30]											X	
d. LOSS OF 3 OF 6 AV BAY FANS [74]								X				
e. LOSS OF 3 IMU FANS								X				
f. LOSS OF CABIN PRESS INTEGRITY [37]			X	X	X			X		X		
g. LOSS OF PPO2 CONTROL [78]								X	X			
h. LOSS OF 1 H2O LOOP								X				
i. LOSS OF 2 H2O LOOPS [28]					X			[77]				

@[090894-1675]

THIS RULE CONTINUED ON NEXT PAGE

FLIGHT RULES

A2.1.6-1

CONTINGENCY ACTION SUMMARY (CONTINUED)

FAILURE	M A N U A L S S M E S / D	F A S T S E P	R T L S	T A L	A O A	A T O	B A I L O U T	ENTER FIRST DAY PLS	ENTER ASAP (PLS, SLS ELS)	ENTER IMMED.	MAX DEORBIT DELAY	
											1 ORB	24 HR
F. EECOM (CONCLUDED)								[84]	[1]	[1]		
2. <u>ATCS</u>												
a. LOSS OF 1 FREON LOOP								X				
b. LOSS OF 2 FREON LOOPS			[40]	[40]	[40]				[29]			
c. LOSS OF FES (TOPPING AND HI LOAD EVAPS) [24][26]											[57]	[57]
d. LOSS OF HI LOAD EVAP								[49]				
e. RESERVED												
f. FREON TO CABIN H2O LOOP LEAK								X				
g. LOSS OF 2 RFCA'S								[52]				
G. EGIL												
1. <u>CRYO</u>												
a. LOSS OF ALL CRYO O2 TANKS OR ALL CRYO H2 TANKS IMPENDING [51]			X	X	X				X			
b. H2 MANIFOLD OR TANK LEAK [43]											X	X
2. <u>FUEL CELL</u>												
a. LOSS OF 2 FUEL CELLS [32]								X				
b. FC PRIMARY H2O FLOW TO ECLSS (3) [72]								X				
3. <u>EPDC</u>												
a. MN A AND B [46]			X									[53]
b. MN B AND C [46]			X									[53]
c. MN A AND C [46]			X									[53]
d. ANY MN, AC, OR CNTL BUS								[61]				
e. MULTI-F ON AN AC BUS (NOT SHORTED)											X	[69]
f. CNTL CA1 [71]												X

[@J020196-1810A1](#)

THIS RULE CONTINUED ON NEXT PAGE

FLIGHT RULES

A2.1.6-1

CONTINGENCY ACTION SUMMARY (CONTINUED)

FAILURE	M A N U A L S S M E S / D	F A S T S E P	R T L S	T A L	A O A	A T O	B A I L O U T	ENTER FIRST DAY PLS	ENTER ASAP (PLS, SLS ELS)	ENTER IMMED.	MAX DEORBIT DELAY	
											1 ORB	24 HR
H. MMACS								[84]	[1]	[1]		
1. <u>APU/HYD/WSB</u>												
a. LOSS OF 2 WSB								[48]				
b. LOSS OF 1 APU/HYD											[42]	[76]
c. LOSS OF 2 APU/HYD	[82]							[48]				[76]
d. DELETED												
e. LOSS OF 2 APU/HYD AND 3RD FAILING	[82]		X	X	X			X	X			
f. LOSS OF 2 LND GEAR DEPLOY								X				
METHODS												
2. <u>MECHANICAL</u>												
a. PBD CENTERLINE NOT WITHIN LIMITS [50]												X
b. ANY PBD LATCH GANG FAILED CLOSED								X				
c. LOSS OF ONE MOTOR ON TWO DIFFERENT PBD C/L OR BULKHEAD LATCH GANGS								X				
d. PBD C/L OR BULKHEAD LATCH GANG FAILS IN TRANSIT (NOT CLEAR OF ROLLERS)								X				
e. STARBOARD PBD FAILS IN TRANSIT (READY -TO-LATCH INDICATORS PRESENT								X				
f. CONFIRMED TIRE LEAK [79]								X				
g. LOSS OF NWS												[76]
3. <u>STRUCTURAL</u>												
a. THERMAL WINDOWPANE FAILURE			X									
b. PRESSURE OR REDUNDANT WINDOWPANE FAILURE								X				

THIS RULE CONTINUED ON NEXT PAGE

FLIGHT RULES

A2.1.6-1

CONTINGENCY ACTION SUMMARY (CONTINUED)

FAILURE	M A N U A L S S M E S / D	F A S T S E P	R T L S	T A L	A O A	A T O	B A I L O U T	ENTER FIRST DAY PLS	ENTER ASAP (PLS, SLS ELS)	ENTER IMMED.	MAX DEORBIT DELAY	
											1 ORB	24 HR
I. COMM												
1. LOSS OF ALL A/G VOICE											X	X
2. LOSS OF BOTH A/G VOICE AND CMD [36]							[64]	X			X	X
3. LOSS OF TLM (HDR AND LDR)											X	
4. RESERVED												
5. LOSS OF CMD											X	
J. GNC/AERO												
1. TVC PROBLEM RESULTING IN HARDOVER ACTUATOR [35]	X											
2. <u>LOSS OF CONTROL</u>												
a. IN 1ST STG AND NOT REGAINED BY BFS [54]		X					X					
b. IN 2ND STG AND NOT REGAINED BY MAN TVC OR BFS ENGAGE [27]		X					X					
3. LOSS OF 4 OF 6 RHC CH											[21] [56] [76]	[55]
4. LOSS OF 2 AA's (LAT), 2 RGA's, OR 2 ADTA's (CONCRETE RUNWAY)											[76] [56]	
5. LOSS OF 3 AA's (LAT) 3 RGA's, OR 3 ELEV/BF FDBK's (SAME SURFACE)								X			[76] [56]	
6. LOSS OF 2 FCS CHANNELS (SAME SURFACE) (CONCRETE RUNWAY)								X			[76] [56]	
7. LOSS OF 3 ADTA's								X			[75] [76]	
8. LOSS OF 2 IMU's								X			[56] [76]	[22]
9. IMU DILEMMA												[53] [21]
10. <u>LOSS OF 1 IMU, 1 TACAN, OR 1 MLS</u>											[56] [XY]	

©[041196-1914]

LEGEND	
X	= PERFORM CONTINGENCY ACTION
[]	= NOTE
()	= QUANTITY

FLIGHT RULES

THIS RULE CONTINUED ON NEXT PAGE

FLIGHT RULES

A2.1.6-1 CONTINGENCY ACTION SUMMARY (CONTINUED)

NOTES:

- [1] CERTAIN RAPID ENTRY CONDITIONS COULD REQUIRE ENTRY PRIOR TO MCC AND LANDING SITE NOTIFICATION.
- [2] COMM DATA LINES TO SUPPORT LISTED REQUIREMENTS ALSO MANDATORY.
- [3] 24 OF 64 DTE CHANNELS MANDATORY.
- [4] ASSUMES THREE UNRECOVERABLE GPC'S.
- [5] ACCEPT HIGHEST ABORT MODE AVAILABLE.
- [6] REFERENCE RULE {A5.1.3-7}, MANUAL SHUTDOWN FOR HYDRAULIC OR ELECTRICAL LOCKUP.
- [7] SECOND STAGE ONLY (REF. RULES {A4.1.6-9}, RANGE SAFETY LIMIT AVOIDANCE ACTIONS.
- [8] REFERENCE RULE {A5.1.3-8}, MANUAL SHUTDOWN FOR TWO STUCK THROTTLES (NOT DUAL APU FAILURES).
- [9] TAL/AOA IS ACCEPTED TO PROTECT THE CONTINGENCY CG BOX. IF TAL/AOA DUMP MGMT WILL NOT RECOVER CG, CONTINUE UPHILL.
- [10] TO ALLOW TESTING JETS PRIOR TO ENTRY.
- [11] IF PRIOR TO OMS-1, PERFORM DELAYED ATO. FOR DIRECT INSERTION CUTOFF OMS-2 AT MINIMUM Hp. FOR DELAYED ATO, THE RAISE ORBIT MANEUVER WILL NOMINALLY BE PLANNED FOR TTA = 2 (TIME TO APOGEE).
- [12] AFTER OMS-1. CUTOFF OMS-2 AT MINIMUM Hp.
- [13] WHERE LEAK IN BOTH SIDES SAME PROPELLANT. IF LEAK RATE SUPPORTS (PROPELLANT ONLY) (IF RCS MUST SUPPORT TO A Q-BAR = 20).
- [14] AFTER DEORBIT TIG, TERMINATING BURN FOR THIS FAILURE REQUIRES DEORBIT 24 HOURS LATER.
- [15] SHALLOW ENTRY IF REQUIRED.
- [16] IF LEAK, PERFORM PERIGEE ADJUSTMENT AT PLANNED DEORBIT TIG IF LEAK RESULTS IN PROJECTED VIOLATION OF POD THERMAL CONSTRAINTS.
- [17] THIS Hp ALLOWS DEORBIT OPPORTUNITY 24 HOURS LATER WITH WORST CASE ATT PROFILE (PTC).
- [18] DEORBIT DELAY ONLY REQUIRED IF RCS DOWNMODE CAPABILITY DOES NOT EXIST.
- [19] IF BOTH LEAKS IN SAME SIDE OR BOTH SIDES LEAKING BUT DIFFERENT PROPELLANT, PERFORM NOM.
- [20] IF UNABLE TO OBTAIN VIABLE GNC 3 OPERATION, ENTER ON BFS.
- [21] FAILURE PRECLUDES SINGLE FAULT TOLERANCE. DELAY TO VERIFY RM DECLARED FAILURES OR TO RESOLVE A DILEMMA CASE (REF. RULE {A8.1.1-7}, ENTRY SYSTEMS SINGLE-FAULT TOLERANCE VERIFICATION; AND RULE {A8.1.1-8}, ENTRY SYSTEMS RM DILEMMA).
- [22] A ONE-ORBIT WAVE-OFF MAY OR MAY NOT ALLOW SUFFICIENT TIME TO REGAIN SINGLE-FAULT TOLERANCE. IN MANY CASES, DELAYING UP TO ONE DAY WILL BE NECESSARY IN ORDER TO ALLOW SYSTEM COMPENSATION/RECONFIGURATION (REF. RULE {A8.1.1-7}, ENTRY SYSTEMS SINGLE-FAULT TOLERANCE VERIFICATION).
- [23] POST-MECO OMS-1/OMS-2, SHALLOW ENTRY IF REQUIRED.
- [24] IF NECESSARY TO RECONFIGURE TO REDUCED POWER LEVEL.
- [25] AFTER OMS-1, CHECKOUT OMS-2 WHEN MINIMUM Hp. NEXT PLS DEORBIT WITH MIXED CROSSFEED IF REQUIRED.

FLIGHT RULES

THIS RULE CONTINUED ON NEXT PAGE

FLIGHT RULES

A2.1.6-1 CONTINGENCY ACTION SUMMARY (CONTINUED)

- [26] GO TO ORBIT AND OPEN PLBD's ASAP.
- [27] ATTITUDE ERROR (>3 DEGREES IN PITCH OR YAW OR >10 DEGREES IN ROLL) WITHOUT CONVERGING RATES OR RATES GREATER THAN 3 DEG/SEC WITHOUT CORRESPONDING ATTITUDE ERRORS (REF. RULE {A8.1.1-1}, FCS DOWNMODE).
- [28] IMMEDIATE POWERDOWN REQUIRED.
- [29] POWER DOWN TO SURVIVAL POWER LEVEL.
- [30] DELAY IF REQUIRED TO RECONFIGURE DPS TO TWO PASS AND ONE BFS OR ALLOW 3.5 HOURS OF GPC COOLDOWN TO REGAIN ALL GPC'S.
- [31] IF A 2-SIGMA CONFIDENCE LEVEL OF ACHIEVING AOA CAPABILITY EXISTS. (REF. RULE {A5.1.4-7}, ET LOW LEVEL CUTOFF SENSOR FAILED DRY).
- [32] POWER DOWN FOR SINGLE FC ENTRY.
- [33] RESERVED.
- [34] IF INSUFFICIENT DELTA V AVAILABLE TO ACHIEVE ATO, PERFORM AOA SHALLOW OMS-1,-2.
- [35] REFERENCE RULE {A8.1.1-2}, SSME THRUST VECTOR CONTROL (TVC) HARDOVER.
- [36] REFERENCE RULES {A11.1.2-2A AND B}, LOSS OF BOTH VOICE AND COMMAND.
- [37] WITH CABIN AT 14.7 PSIA AND BOTH 14.7 PSI REGULATORS CLOSED, DP/DT DECAY RATE > 0.15 PSI/MIN, RTLS OR TAL. IF ≤ 0.15 AND > 0.02 PSI/MIN PLS OR AOA (REF. RULE {A17.1.5-1}, CABIN PRESSURE INTEGRITY). @[ED]
- [38] OTHER OPTIONS AND PRIORITIES PER RULE {A4.1.3-9}, DEORBIT PRIORITY FOR EOM WEATHER.
- [39] LOSS OF BOTH CABIN FANS WILL REQUIRE IMMEDIATE POWERDOWN AND EXTENSIVE HARDWARE CYCLING TO OBTAIN ORBIT AND ENTRY.
- [40] LIMITING TIME OF ~18 MINUTES (BASED ON 2.76 KWH/FC FOR FC FLOOD WITHOUT PURGING).
- [41] ASSUMES PLBD NOT OPEN.
- [42] REF. RULE {A10.1.2-3A}, APU ENTRY START TIME.
- [43] DELAY DEORBIT TO DEplete A LEAKING H2 TANK OF ANY SIZE. IF TANK CANNOT BE DEPLETED OR IF LEAK IS IN MANIFOLD, DELAY DEORBIT TO ALLOW PRESSURE BLOWDOWN TO REDUCE LEAK RATE TO <1 LB/HR. REFERENCE RULE {A9.1.6-10C.1}, CRYO SYSTEM LEAKS (CIL).
- [44] DELAYED ATO IF SUFFICIENT PROPELLANT AVAILABLE IN BLOWDOWN. FOR DELAYED ATO, THE RAISE ORBIT MANEUVER WILL NOMINALLY BE PLANNED FOR TTA = 2 (TIME TO APOGEE).
- [45] RESERVED
- [46] RTLS UNTIL NEGATIVE RETURN BECAUSE OF INABILITY TO CLOSE ET DOORS.
- [47] RESERVED
- [48] IF DEPLOYABLE PAYLOADS ARE ONBOARD, PERFORM NEXT PLS ENTRY AFTER ATTEMPTS HAVE BEEN MADE TO DEPLOY THE PAYLOADS. OTHERWISE ENTER FIRST DAY PLS (REF. RULES {A10.1.2-1A.2}, LOSS OF APU/HYDRAULIC SYSTEM(S) ACTIONS, AND {A10.1.6-2}, LOSS OF WSB(S) ACTIONS.
- [49] IF FREEZEUP SUSPECTED, REMAIN ON ORBIT TO ATTEMPT TO THAW OUT THE HI-LOAD EVAPORATOR.
- [50] THE SIMULTANEOUS CLOSE PROCEDURE IS AN OPTION FOR THE EXCESSIVE OVERLAP CASE(REF. RULE {A10.1.11-7}, PLBD OVERLAP).
- [51] SELECT ABORT MODE WITH SHORTEST RETURN TIME.

FLIGHT RULES

THIS RULE CONTINUED ON NEXT PAGE

FLIGHT RULES

A2.1.6-1 CONTINGENCY ACTION SUMMARY (CONTINUED)

- [52] IF BOTH LOOPS FAILED IN BYPASS OR MEDIUM FLOW.
- [53] AFTER DEORBIT TIG, TERMINATE BURN FOR FAILURE IF $H_p > \text{SAFE } H_p$. REQUIRES DEORBIT 24 HOURS LATER.
- [54] RATES $> 5 \text{ DEG/SEC}$ IN PITCH OR YAW. REFERENCE RULE {A8.1.2-4}, FIRST STAGE LOSS OF CONTROL DEFINITION. @ED]
- [55] AT LEAST ONE CHANNEL REQUIRED EACH SIDE. REFERENCE RULE {A8.1.6-1}, GNC GO/NO-GO CRITERIA.
- [56] IF ONE ORBIT DELAY NOT AVAILABLE, DELAY 1 DAY. FOR PROPELLANT LEAKS, IT MAY BE NECESSARY TO DELAY LONGER THAN ONE ORBIT IN ORDER TO ALLOW POD THERMAL ENVIRONMENT TO SUPPORT ENTRY.
- [57] IF TIG BETWEEN 45 AND 15 MINUTES AND ONE REV LATE DEORBIT IS AVAILABLE, REOPEN PLB DOORS AND WAVE OFF ONE REV. IF RADS ARE COLD SOAKED AND ONE REV LATE DEORBIT NOT AVAILABLE, UTILIZE THE COLD SOAK TO CONTINUE WITH PLANNED TIG. IF RADS ARE NOT COLD SOAKED AND ONE REV LATE IS NOT AVAILABLE, REOPEN PLB DOORS AND WAVE OFF 1 DAY. @J020196-1810A]
- [58] IF TOXIC COMBUSTION PRODUCTS CANNOT BE SATISFACTORILY REMOVED FROM THE CABIN ATMOSPHERE, THE CREW WILL REMAIN ON QDMLES UNTIL ORBITER EGRESS. EOM IS BASED UPON AVAILABLE N2 CONSUMABLES FOR MAINTAINING THE O2 CONCENTRATION WITHIN ACCEPTABLE LIMITS. REF. RULE {A13.1.2-13}, CABIN ATMOSPHERE CONTAMINATION.
- ON ASCENT, FIRST DAY PLS WILL ONLY BE NECESSARY IF THE CABIN ATMOSPHERE CANNOT BE CLEANED UP. FOR AV BAY FIRE, THE EXTENT OF THE DAMAGE TO EQUIPMENT AND WIRE BUNDLES IS UNKNOWN; THEREFORE, EVEN IF THE ATMOSPHERE HAS BEEN CLEANED UP, A NEXT DAY PLS WILL BE PERFORMED TO MINIMIZE THE RISK OF THE OCCURRENCE OF AN ADDITIONAL FIRE OR ARC TRACKING. @J072795-1779]
- [59] PROPELLANT LEAK ONLY.
- [60] ELS WILL PROBABLY BE REQUIRED IF THE NEXT PLS OR SLS IS GREATER THAN 8 HOURS. AS LONG AS CABIN ENVIRONMENT IS ACCEPTABLE, A PLS WILL BE TARGETED. @J020196-1810A]
- [61] CAUSES LOSS OF ONE MOTOR IN EACH OF TWO SEPARATE PLBD LATCH GANGS (REF. RULE {A10.1.11-9B}), PLBD RULE REFERENCE MATRIX). DC AND AC SUB-BUSES THAT CAUSE THIS FAILURE ARE:
- MNA MPC1, MMC1, MMC3
MNB MPC2, MMC2, MMC4
MNC MPC3, MMC2, MMC4
AC1 MMC1, MMC3
AC2 MMC2, MMC4
AC3 MMC2, MMC4
- [62] ENTER FIRST DAY PLS UNLESS DELTA V IMPROVEMENT POSSIBLE.
- [63] PERFORM PERIGEE ADJUST BURN SEPARATION.
- [64] ORBIT 2 DEORBIT REQUIRED. (REF. RULE {A11.1.2-2}, LOSS OF BOTH VOICE AND COMMAND.)
- [65] RESULTS IN LOSS OF TWO FCS CHANNELS.
- [66] EXCEPT COMBINATION OF MDM'S FF4 AND ANY OTHER FF MDM. OTHERWISE, THE FAILURE OF ANY COMBINATION OF MDM'S FF1, FF2, OR FF3 WILL RESULT IN THE LOSS OF TWO IMU'S. MDM IFM MAY BE PERMITTED TO MEET IMU REQUIREMENT. REFERENCE RULE {A7.1.3-15}, IN-FLIGHT MAINTENANCE (IFM). @J090894-1684]
- [67] RESERVED
- [68] REFERENCE RULE {A9.1.4-17.B}, AC POWER TRANSFER CABLE.
- [69] IF REQUIRED TO MAINTAIN TWO-FC ENTRY CAPABILITY.

FLIGHT RULES

[70] FIRST DAY PLS FOR CONFIRMED, UNRECOVERABLE LOSS OF TWO AFT RCS PITCH JETS, SAME AXIS, SAME POD (N/A YAW JETS).

THIS RULE CONTINUED ON NEXT PAGE

FLIGHT RULES

A2.1.6-1 CONTINGENCY ACTION SUMMARY (CONTINUED)

- [71] LOSS OF CNTL CA1 LOSES BFS ENGAGE CAPABILITY FOR GPC 3 AND 5. A DELAY WILL BE INVOKED TO SWITCH BFS MACHINES. REFERENCE RULE {A7.1.4-2B}, ON-ORBIT BFS MANAGEMENT GUIDELINES.
- [72] LOSS OF COMPLETE PRIMARY SYSTEM MAY HAVE RESULTED FROM FREEZING OF THE FC H2O RELIEF PANEL. THIS COULD ALSO CAUSE LOSS OF OVERBOARD RELIEF AND LEAVE ONLY THE ALTERNATE SYSTEM FOR FC H2O REMOVAL. REFERENCE RULE {A9.1.7-1}, EGIL GO/NO-GO CRITERIA.
- [73] RESERVED
- [74] ENTER NEXT PLS IF A SINGLE ELECTRICAL FAILURE (AC BUS) COULD CAUSE THE LOSS OF AIR COOLING TO TWO AVIONICS BAYS.
- [75] DELAY TO VERIFY POWER, MDM, AND BITE RELATED FAILURES, AND TO ASSESS THE RISKS OF FLYING THETA LIMITS VS. INCORPORATING THE LAST ADTA (REF. RULE {A8.1.1-7}, ENTRY SYSTEMS SINGLE-FAULT TOLERANCE VERIFICATION, AND RULE {A8.1.5-12B}, GNC AIR DATA SYSTEM MANAGEMENT (CIL)).
- [76] DELAY TO TARGET FOR REQUIRED RUNWAY (REF. RULE {A2.1.4-7}, LANDING SITE SELECTION).
- [77] A LANDING WILL BE REQUIRED WITHIN 4 HOURS OF THE FAILURE.
- [78] PLS REQUIRED IF AUTO/MANUAL PPO2 CONTROL CANNOT MAINTAIN AEROMED MINIMUM (REF. RULE {A13.1.2-5A.1}, MINIMUM PPO2 CONSTRAINTS) AND LESS THAN 30 PERCENT O2 AT TOUCHDOWN. ELS REQUIRED IF 40 PERCENT O2 IS EXPECTED TO BE EXCEEDED PRIOR TO NEXT PLS TOUCHDOWN.
- [79] ENTER NEXT PLS IF TIRE PRESSURE WILL BE £ 275 PSI MAIN, 260 PSI NOSE AT NEXT PLS LANDING OPPORTUNITY PLUS 2 DAYS.
- [80] RESERVED
- [81] IF REQUIRED TO RETARGET TO EDWARDS/NOR (REFERENCE RULE {A10.1.7-1B}, NOSE WHEEL STEERING (NWS) @[090894-1684]
- [82] REFERENCE RULE {A8.1.2-11}, SSME SHUTDOWN DUE TO HYDRAULIC SYSTEM FAILURES.
- [83] FOR LOSS OF 2 MMU's DURING ASCENT, CONSIDERATION WILL BE GIVEN TO PERFORMING THOSE MISSION OBJECTIVES THAT DO NOT REQUIRE MASS MEMORY RESIDENT FUNCTIONS (i.e., GNC 2, SM, SM ROLL-IN DISPLAYS, OR TELEMETRY/DECOM FORMAT LOADS).
- [84] REFERENCE RULE {A2.1.1-2}, ABORT LANDING SITE REQUIREMENTS. IF FD 1 LANDING SITE IS GO, LAND FD 1. IF FD 1 LANDING SITE IS NO-GO, IF POSSIBLE, DELAY DEORBIT TO FD 2. @[121593-1590]
- [XY] IF HIGH-SPEED C-BAND RADAR NOT SCHEDULED FOR ENTRY, DELAY AS REQUIRED TO SCHEDULE (REF. RULE {A3.1.1-1},~~3-4~~, GROUND REQUIREMENTS OVERVIEW). IF MLS FAILURE, DELAY ONLY IF MLS REQUIRED PER RULE {A3.1.5-2},~~3-4~~, MLS. @[041196-1914]

FLIGHT RULES

ORBITER SYSTEMS GO/NO-GO

A2.1.7-1 ORBITER SYSTEMS GO/NO-GO

FOR LOSS OF THE FOLLOWING:	MDF	NXT PLS
PROP		
OMS ENG	-	2↓
OMS PROP TNK LK	-	X↓
OMS ENG and 1 +X PRCS JET	-	X↓
OMS ENG and < RCS STEEP DEORB CAP	-	X↓
OMS/RCS FLOW PATH (XFD)	1↓	2↓
AFT RCS He OR PROP TNK LK	-	X↓
AFT PRCS MANIFOLDS	-	2↓ SAME SIDE
OMS INLET LNE LEAK	-	1↓
DPS		
GPC's	2↓	3↓
MDM's SAME TYPE: (FF, FA, or PL)	-	2↓
MMU	2↓	-
FWD KEYBOARD (I)	-	1↓
DEU/CRT (4)	2↓	2FWD ↓ (I)
IDP (4)	2↓	2FWD ↓ (I) [14]
MDU (11)		
ADC (4)		
GNC		
RHC CHAN (LFT OR RT) (I)	2↓ SAME SIDE	5↓
THC (LFT) and OMS ENG (I)	-	X↓ +X ONLY
SBTC (LFT OR RT) (CHAN)	3↓ ONE SIDE	5↓ AD NOT AVAILABLE TO G&C
	1↓ OTHER SIDE	
FCS MODE AUTO SW	-	2↓ ONE SIDE and 1↓ OTHER SIDE
FCS MODE B/F	2↓	2↓ ONE SIDE and 1↓ OTHER SIDE
SBTC (LFT OR RT) T/O SW	3↓ ONE SIDE and 1↓ OTHER SIDE	5↓ AD NOT AVAILABLE TO G&C
STAR TRACKER	2↓	1↓ AND
COAS OR ATT REF OR DAP PULSE PB(2)		1↓
ADTA	2↓	3↓
ADI (LFT AND RT) (2)	1↓ [13]	-
AFT ADI (1)	- [13]	-
HUD/AMI (4)	2↓ [13]	3↓ [13]
HUD/AVVI (4)	2↓ [13]	3↓ [13]
HUD/FWD ADI (4)	2↓ [13]	3↓ [13]
HUD (2)	-	-
HSI (2)	- [13]	-
SPI(1)	- [13]	-
G-METER (1)	- [13]	-
AFT RCS	-	2↓ SAME AXIS SAME SIDE
ELEV, RUD, S/B OR BF ACT CHAN	-	2↓ SAME ACT
ELEV OR BF POSN FDBK	2↓	3↓ SAME ACT
ELEV PRI DELTA P	2↓	3↓ SAME ELEV
AA (LAT)	2↓	3↓
IMU	-	2↓
CG ANOMALY AND 1 YAW JET	-	X↓
RGA	2↓	3↓
TACAN	2↓	3↓

[@\[101796-4561A\]](#) [@\[040899-2459B\]](#)

THIS RULE CONTINUED ON NEXT PAGE

NASA - JOHNSON SPACE CENTER

FLIGHT RULES

A2.1.7-1 ORBITER SYSTEMS GO/NO-GO (CONTINUED)

FOR LOSS OF THE FOLLOWING:	MDF	NXT PLS
COMM		
VOICE (3) (A/G 1,2,UHF)	-	2↓
COMMAND (2)	2↓	
VOICE + COMMAND	-	ALL↓
PCMMU (2)	1↓	2↓
NSP (2)	1 D/L↓	2↓ (U/L OR D/L)
XPONDER (2) I	2 D/L↓	2 U/L↓ OR 2 D/L+ (I)↓
ACCU (2) (I)	2↓	1↓(I)↓
TELEMETRY	-	ALL↓
EECOM		
FES (TOPPER)	1↓	-
FES (HI-LOAD)	-	1↓
FES PRIMARY CNTLR	2↓	3↓
FES FEED LINE	-	2↓
FREON LOOP	-	1↓
FREON LOOP LEAK		[12]
FREON PUMPS	-	2↓ (IF FCL 1 PMP B AND FCL 2 PMP A)
RFCA (FAIL IN BYPASS/MIN FLOW)	1↓	2↓
H2O LOOP	-	1↓
H2O LOOP LEAK	1↓	-
HX LEAK (FREON TO CABIN H2O)	-	1↓
HX LEAK (EXCEPT FREON TO CABIN H2O)	1↓	-
CABIN FANS	1↓	2↓ (LANDING REQUIRED WITHIN 8 HRS)
AV BAY COOLING	[1]	- [3][4]
IMU FANS	-	2↓
H2O TANKS (SUPPLY)	-	2↓
H2O TANK (WASTE)	-	(ULLAGE WILL DETERMINE EOM)
CAB PRESS INTEGRITY	-	X↓
165 MIN, 8 PSI RTN	-	X↓
PPO2 CNTL	-	X↓
CO2 CNTL	-	X↓
CAB T CNTL	-	X↓
CAB HUM CNTL	-	X↓
RCRS	[7]	[7]
SPLY H2O DMP	-	X↓ (ULLAGE WILL DETERMINE EOM)
WST H2O DMP	-	X↓ (ULLAGE WILL DETERMINE EOM)
WCS (ALL FECAL OR ALL URINE COLLECTION CAPABILITY)	[6]	[6]
SMOKE DETECTION (AV BAY 3A)		2↓ [2]
SMOKE DETECTION (CABIN)		3↓ [9]
FIRE DETECTED /SUPPRESSED		[10][11]
HALON DISCHARGE (W/O FIRE CONFIRMATION)	[11]	
EGIL		
H2 OR O2 TANKS	-	2↓ [8]
O2, H2 MANIFOLDS	1↓	2↓
FUEL CELL	1↓	2↓
FC COMMOM VENT LINE BLOCKAGE	-	X↓
FUEL CELL O2 PURGE	-	- (PERFORMANCE WILL DETERMINE EOM)
FUEL CELL PRIMARY H2O FLOW TO ECLSS	2↓	3↓
PRI & B/U C&W	-	2↓

FLIGHT RULES

@[020196-1810A] @[061396-3104A]

THIS RULE CONTINUED ON NEXT PAGE

FLIGHT RULES

A2.1.7-1

ORBITER SYSTEMS GO/NO-GO (CONTINUED)

FOR LOSS OF THE FOLLOWING:	MDF	NXT PLS
EGIL - Continued		
MAIN DC BUSES		
DA1, DA2, OR DA3	-	1↓
FPC1 OR FPC2 OR FCP3	1↓	-
FLC2 OR FLC3	1↓	-
MPC1, MPC2, OR MPC3	-	1↓
MNA MMC 1 OR 3	-	1↓
MNB MMC 2 OR 4	-	1↓
MNC MMC 2 OR 4	-	1↓
MNC 016	1↓	-
CONTROL BUSES		
AB1, AB2, AB3, BC1, BC2, BC3, CA1, CA2, OR CA3	-	1↓ (ANY CONTROL BUS)
	-	1↓
ESSENTIAL BUSES		
1BC DA1, 1BC MPC1, OR 1BC FD	1↓ (FC1 LOST)	-
2CA DA1, 2CA MPC1, OR 2CA FD	1↓ (FC2 LOST)	-
3AB DA1, 3AB MPC1, OR 3AB FD	1↓ (FC 3 LOST)	-
AC INVERTERS OR NONSHORTED BUS (2 OF 3 PHASES)	X(I)	-
AC BUSES		
ANY AC PHASE (SHORT)	-	1↓
AC1 MMC 1 OR 3	-	1↓
AC2 MMC 2	-	X↓
AC2 MMC 4	-	X↓
AC3 MMC 2 OR 4	-	1↓
AC2 OR AC3 (ANY PHASE)	-	1↓ + CAB FAN
MMACS		
APU OR HYD	-	2↓
WSB	-	2↓
LDG GEAR DPLY METHODS	-	2↓
PBD DRIVE MTRS	1 CLS ↓	2 OPEN ↓
PBD NOT OPEN	1 C/L ↓	X↓
PRESS/REDUN WNDW FL	-	X↓
CONFIRMED TIRE LEAK	-	[5]

@[101796-4561A] @ED 1

LEGEND

-	= NO REQUIREMENT
↓	= (DOWN ARROW) SYSTEM/CAPABILITY LOSS
1↓	= ONE SYSTEM INOPERATIVE
X↓	= ANY NUMBER OF SYSTEM/CAPABILITIES LOST
(I)	= IFM CAPABILITY EXISTS

NOTES:

- [1] MDF FOR LOSS OF COOLING TO TWO GPC's (DUE TO UNACCEPTABLE TEMPERATURE).
- [2] PLS FOR POWERDOWN OF C&W. C&W MAY REMAIN POWERED IF IT WAS NOT THE SOURCE OF A POTENTIAL FIRE INDICATION AND IF THE AVIONICS BAY IS EXPOSED TO THE CABIN FOR USE OF THE CABIN SMOKE DETECTORS. REF RULES {A17.1.2-1A.3}, MANAGEMENT FOLLOWING LOSS OF SMOKE DETECTION, AND {A17.1.13-1A}, EECOM GO/NO-GO CRITERIA. @[090894-1675]
- [3] PLS FOR LOSS OF COOLING TO THE C&W.

FLIGHT RULES

- [4] ENTER NEXT PLS IF A SINGLE ELECTRICAL FAILURE (AC BUS) COULD CAUSE THE LOSS OF AIR COOLING TO AVIONICS BAYS.

THIS RULE CONTINUED ON NEXT PAGE

FLIGHT RULES

A2.1.7-1 ORBITER SYSTEMS GO/NO-GO (CONTINUED)

- [5] ENTER NEXT PLS IF TIRE PRESSURE WILL BE \leq 275 PSIG (290 PSIA) MAINS, 260 PSIG (275 PSIA) NOSE AT NEXT PLS LANDING OPPORTUNITY PLUS 2 DAYS. @[090894-1675]
- [6] THE NUMBER OF ALTERNATE WASTE COLLECTION BAGS, NUMBER OF CREW AND THEIR DEFECATION/ URINATION RATE WILL DETERMINE EOM.
- [7] QUANTITY OF LIOH CANISTERS AND CREW SIZE WILL DETERMINE EOM. A MINIMUM OF 2 DAYS OF UNUSED LIOH MUST BE HELD IN RESERVE TO PASS A PLS OPPORTUNITY. REF. RULE {A17.1.4-7}, LIOH REDLINE DETERMINATION. @[092293-15316]
- [8] EDO PALLET TANKS ARE EXEMPT FROM THIS RULE UNLESS THE FAILURES ARE DETERMINED TO BE GENERIC.
- [9] PLS, UNLESS AT LEAST ONE CREWMEMBER REMAINS AWAKE IN ORBITER CABIN TO MONITOR SMOKE CONDITIONS AT ALL TIMES. REF RULE {A17.1.2-1B}, MANAGEMENT FOLLOWING LOSS OF SMOKE DETECTION.
- [10] ELS OR PLS IS REQUIRED BASED UPON AVAILABLE N2 FOR O2 CONTROL SINCE CREW MUST REMAIN ON QDM/LES IF TOXIC COMBUSTION PRODUCTS CANNOT BE SATISFACTORILY REMOVED FROM THE CABIN ATMOSPHERE. REF RULE {A13.1.2-13C, CABIN ATMOSPHERE CONTAMINATION. FOR AV BAY FIRES, THE EXTENT OF THE DAMAGE TO EQUIPMENT AND WIRE BUNDLES IS UNKNOWN; THEREFORE, EVEN IF THE ATMOSPHERE HAS BEEN CLEANED UP, A PLS WILL BE PERFORMED TO MINIMIZE THE RISK OF THE OCCURRENCE OF AN ADDITIONAL FIRE OR ARC TRACKING.
- [11] EOM IS BASED UPON HALON EXPOSURE CRITERIA. REF RULE {A13.1.2-13}, CABIN ATMOSPHERE CONTAMINATION. @[090894-1675]
- [12] FOR A LEAKING FREON LOOP WHICH WILL SUPPORT NEXT PLS BUT NOT THE FOLLOWING PLS, A PLS WILL BE DECLARED IN ORDER TO ACHIEVE A NOMINAL D/O PREP AND ENTRY. A LOSS OF ONE FREON LOOP ENTRY REQUIRES A POWERDOWN TO 14 KW. @[061396-3104A]
- [13] NA FOR MEDS CONFIGURED VEHICLES. @[040899-2459B]
- [14] IDP'S ARE REQUIRED FOR PASS AND BFS INTERFACE AND TO DISPLAY THE ADI, AMI, AND AVVI. @[040899-2459B]

FLIGHT RULES

SPACEHAB OPERATIONS MANAGEMENT

A2.6.1-1 SPACEHAB SAFETY DEFINITION AND MANAGEMENT . 2-218

A2.6.1-2 REAL-TIME SAFETY COORDINATION 2-219

A2.6.1-3 GROUND COMMANDING 2-220

A2.6.1-4 SPACEHAB MINIMUM DURATION FLIGHT CRITERIA . 2-222

A2.6.1-5 POWERING OFF AND REPOWERING SPACEHAB
EQUIPMENT 2-223

A2.6.1-6 ORBITER/SPACEHAB/EXPERIMENT THERMAL
PRIORITIES 2-223

A2.6.1-7 ORBITER-TO-SPACEHAB INTERFACE 2-223

A2.6.1-8 FIRE/SMOKE IN SPACEHAB 2-225

A2.6.1-9 ORBITAL MANEUVERING SYSTEM/REACTION CONTROL
SYSTEM (OMS/RCS) CONSTRAINTS 2-229

A2.6.1-10 ELECTRICAL POWER SUBSYSTEM (EPS)
CONSTRAINTS 2-229

A2.6.1-11 WATER DUMP MANAGEMENT 2-231

A2.6.1-12 COMMAND AND DATA SYSTEM CONSTRAINTS 2-232

A2.6.1-13 SPACEHAB CAUTION AND WARNING ANNUNCIATION
IN MODULE 2-232

A2.6.1-14 COMMUNICATIONS CONSTRAINTS 2-233

A2.6.1-15 SPACEHAB IN-FLIGHT MAINTENANCE (IFM)
PROCEDURES 2-233

A2.6.1-16 IFM PROCEDURES ON EXPERIMENTS WITH TOXIC
HAZARDS 2-236

A2.6.1-17 SAFE ATMOSPHERE REQUIREMENTS PREFLIGHT 2-236

A2.6.1-18 EVA 2-236

A2.6.1-19 EQUIPMENT EXCHANGE BETWEEN ORBITER CABIN
AND SPACEHAB MODULE 2-239

A2.6.1-20 SPACEHAB MODULE/TUNNEL SLEEP CONSTRAINTS . . 2-240

A2.6.1-21 COMMANDER (CDR) AND PILOT (PLT)
PARTICIPATING AS TEST SUBJECTS 2-240

A2.6.1-22 CREW LIMITATIONS IN THE SPACEHAB MODULE . . . 2-241

FLIGHT RULES

A2.6.1-23 SPACEHAB DEACTIVATION 2-241
 A2.6.1-24 EXTENSION DAY GROUND RULES 2-245

POWERED/UNPOWERED ASCENT/ENTRY

A2.6.2-1 LOSS OF SM GPC DURING SPACEHAB
 ACTIVATION/DEACTIVATION (ACT/DEACT) 2-247
 A2.6.2-2 LOSS OF PAYLOAD MDM DURING SPACEHAB
 ACT/DEACT 2-247
 A2.6.2-3 PAYLOAD MDM HARD FAILURE 2-248
 A2.6.2-4 LOSS OF SM MAJOR FUNCTION 2-249
 A2.6.2-5 LOSS OF ORBITER MASTER TIMING UNIT
 (MTU)/PAYLOAD TIMING BUFFER 2-249
 A2.6.2-6 PF1 FIRST PAYLOAD MDM CHOICE 2-251
 A2.6.2-7 ORBITER FREON FLOW PROPORTIONING VALVE
 (FPV) USAGE 2-252
 A2.6.2-8 SPACEHAB AIR-TO-GROUND (A/G) USAGE 2-253
 A2.6.2-9 SPACEHAB CONTINGENCY GROUND COMMANDING 2-255

SPACELAB OPERATIONS MANAGEMENT

A2.9.1-1 SPACELAB SAFETY DEFINITION AND MANAGEMENT . 2-256
 A2.9.1-2 REAL-TIME SAFETY COORDINATION 2-256
 A2.9.1-3 GROUND COMMANDING 2-257
 A2.9.1-4 SPACELAB MINIMUM DURATION FLIGHT CRITERIA . 2-260
 A2.9.1-5 POWERING OFF AND REPOWERING SPACELAB
 EQUIPMENT 2-261
 A2.9.1-6 ORBITER/SPACELAB/EXPERIMENTS THERMAL
 PRIORITIES 2-261
 A2.9.1-7 ORBITER-TO-SPACELAB PRESSURE INTERFACE
 MODULE 2-261
 A2.9.1-8 FIRE/SMOKE IN SPACELAB MODULE 2-262
 A2.9.1-9 ORBITAL MANEUVERING SYSTEM/REACTION CONTROL
 SYSTEM (OMS/RCS) CONSTRAINTS 2-269
 A2.9.1-10 ELECTRICAL POWER DISTRIBUTION SYSTEM
 CONSTRAINTS 2-270

FLIGHT RULES

A2.9.1-11	WATER DUMP MANAGEMENT	2-272
A2.9.1-12	COMMAND AND DATA SYSTEM CONSTRAINTS	2-272
A2.9.1-13	SPACELAB CAUTION AND WARNING (C&W) ANNUNCIATION MODULE	2-273

NASA - JOHNSON SPACE CENTER

FLIGHT RULES

A2.9.1-14 COMMUNICATIONS (COMM) CONSTRAINTS 2-274

A2.9.1-15 PAYLOAD IN-FLIGHT MAINTENANCE (IFM)
PROCEDURES 2-274

A2.9.1-16 IFM PROCEDURES ON EXPERIMENTS WITH TOXIC
HAZARDS 2-274

A2.9.1-17 SAFE ATMOSPHERE REQUIREMENTS PREFLIGHT 2-275

A2.9.1-18 EVA 2-275

A2.9.1-19 EQUIPMENT EXCHANGE BETWEEN ORBITER CABIN
AND SPACELAB 2-279

A2.9.1-20 SPACELAB MODULE/TUNNEL SLEEP CONSTRAINTS .. 2-281

A2.9.1-21 COMMANDER (CDR), PILOT (PLT), AND MISSION
SPECIALIST (MS) 2 PARTICIPATING AS TEST
SUBJECTS 2-282

A2.9.1-22 ORBITER CREW ASSISTING IN THE MODULE 2-282

A2.9.1-23 SPACELAB DEACTIVATION 2-283

A2.9.1-24 EXTENSION DAY GROUND RULES 2-288

A2.9.1-25 LOSS OF SM GPC DURING SPACELAB
ACTIVATION/DEACTIVATION (ACT/DEACT) 2-289

A2.9.1-26 LOSS OF PAYLOAD/FLEX MDM DURING SPACELAB
ACT/DEACT 2-289

A2.9.1-27 PAYLOAD/FLEX MDM HARD FAIL 2-290

A2.9.1-28 LOSS OF SM OR GUIDANCE, NAVIGATION, AND
CONTROL (GNC) MAJOR FUNCTION 2-290

A2.9.1-29 SPACELAB CONSTRAINTS ON RECOVERING MASTER
TIMING UNIT (MTU) 2-291

A2.9.1-30 PF 1 FIRST CHOICE FOR KU-BAND 2-291

A2.9.1-31 ORBITER FREON FLOW PROPORTIONING VALVE
(FPV) USAGE 2-292

A2.9.1-32 SPACELAB AIR-TO-GROUND (A/G) USAGE 2-293

A2.9.1-33 SPACELAB DEACTIVATION CONSTRAINTS 2-295

A2.9.1-34 UNPOWERED THERMAL CONSTRAINTS 2-295

A2.9.1-35 UNIQUE SUPPORT STRUCTURE THERMAL CONSTRAINT2-296

FLIGHT RULES

THIS PAGE INTENTIONALLY BLANK

FLIGHT RULES

SPACEHAB OPERATIONS MANAGEMENT

A2.6.1-1 SPACEHAB SAFETY DEFINITION AND MANAGEMENT

A. DEFINITIONS: @[102793 -1552]

1. **RAPID SAFING** - SPACEHAB MEETS THE RAPID SAFING CRITERIA THROUGH IMPLEMENTATION OF CONTINGENCY DEACTIVATION/EGRESS PROCEDURES.
2. **UNSAFE** - ONLY TWO INHIBITS CAN BE VERIFIED TO A CATASTROPHIC HAZARD.
3. **HAZARDOUS** - ONLY ONE INHIBIT CAN BE VERIFIED TO A CATASTROPHIC HAZARD.
4. **SAFE** - AT LEAST THREE INHIBITS REMAIN TO A CATASTROPHIC HAZARD, TWO OF WHICH MUST BE MONITORABLE.

B. GENERALIZED RESPONSES TO UNSAFE/HAZARDOUS CONDITIONS:

1. **RAPID SAFING** - FOR SPACEHAB, RAPID SAFING IS USED IN THE CONTEXT OF SECURING THE MODULE/EXPERIMENTS FOR A SAFE ENTRY AS DEFINED IN RULE {A2.6.1-23}, SPACEHAB DEACTIVATION. @[102793 -1552]
2. **UNSAFE** - NO IMMEDIATE ACTION IS REQUIRED. IF POSSIBLE, RESTORATION OF THE SAFE CONDITION WILL NORMALLY BE ATTEMPTED, BUT SUCH ACTION WILL NOT BE ALLOWED TO JEOPARDIZE MISSION SUCCESS.
3. **HAZARDOUS** - QUICK RESPONSE IS MANDATORY: TAKE POSITIVE ACTION TO RESTORE THE SYSTEM TO NO WORSE THAN AN UNSAFE CONDITION. IF UNSUCCESSFUL, TERMINATE THE EXPERIMENT AS SOON AS POSSIBLE (ASAP).

ACTUAL SAFETY REQUIREMENTS FOR SUBSYSTEMS ARE DEFINED IN THE FLIGHT SPECIFIC ANNEX.

FLIGHT RULES

A2.6.1-2

REAL-TIME SAFETY COORDINATION

- A. ANY SPACEHAB PAYLOAD FAILURE WHICH POSES AN IMMEDIATE THREAT TO ORBITER SYSTEMS OR CREW HEALTH (SPECIFICALLY: BROKEN GLASS, TOXIC SPILLS, SMOKE/FIRE, ANIMAL WASTE, AND FREE WATER) WILL BE COORDINATED BY THE CREW DIRECTLY WITH THE MISSION CONTROL CENTER (MCC). THE MCC WILL IMMEDIATELY NOTIFY THE MULTIPURPOSE CONTROL CENTER (MPCC). IF THE MCC DEEMS NECESSARY, ADDITIONAL COORDINATION WITH THE MPCC MAY BE REQUIRED.

This approach allows the MCC to prioritize, coordinate, and address the immediate health threat to the crew. All payload-specific questions will be relayed to the MPCC whichever is appropriate. It is understood that the crew will work the appropriate onboard contingency procedures to reduce the immediate threat without talking to the ground first. Crew indication of an electrical short is fire/smoke (covered in paragraph A), popped circuit breaker (covered in paragraph B), or maintained increase in current (covered in paragraph B). For coordination of electrical problems/shorts, reference Rule {A9.6.2-5}, FUSE/CIRCUIT BREAKER MANAGEMENT.

- B. ANY PAYLOAD FAILURES WHICH ORIGINATE FROM PAYLOAD HARDWARE AND DO NOT POSE AN IMMEDIATE THREAT TO ORBITER SYSTEMS OR CREW HEALTH AS DEFINED IN PARAGRAPH A WILL BE COORDINATED BY THE CREW DIRECTLY WITH THE MPCC. THE MPCC WILL IMMEDIATELY NOTIFY THE MCC OF ANY SITUATION AFFECTING SAFETY (I.E., LOSS OF CONTAINMENT LEVEL, LOSS OF REDUNDANCY, POTENTIAL SHORT WITHIN PAYLOAD HARDWARE, ETC.). IF THE SITUATION IS NOT WITHIN THE SCOPE OF THE PERMISSION-DEFINED FLIGHT RULES AND PROCEDURES, NO ACTION (OTHER THAN REMOVAL OF THE HAZARD POTENTIAL) WILL BE TAKEN WITHOUT FULL AND PRIOR COORDINATION WITH THE MCC.

Safety related payload failures which can be addressed directly between the crew and MPCC are those which originate in payload equipment and which do not affect the atmosphere leading to an immediate threat to orbiter systems or crew health. These payload-originated failures must be specifically addressed in permission-defined flight rules and procedures. Although the MCC Flight Director is ultimately responsible for the safety of the orbiter/Spacehab and crew, it is recognized that the MPCC has the expertise on and sufficient data/insight into the payload hardware. As soon as the MPCC is cognizant of a payload safety situation; however, the MCC must be notified for further assessment of orbiter/Spacehab and crew impacts. The only action(s) which may be taken that is (are) not in the scope of the permission defined flight rules or procedures and without prior coordination with the MCC is (are) to eliminate the hazard cause(s) (i.e., remove power, etc.). For coordination of electrical problems/shorts, reference Rule {A9.6.2-5}, FUSE/CIRCUIT BREAKER MANAGEMENT.

FLIGHT RULES

- C. FLIGHT-SPECIFIC EXCEPTIONS OR PAYLOAD HAZARDS NOT COVERED BY THE ABOVE REQUIREMENTS ARE DOCUMENTED IN THE FLIGHT SPECIFIC ANNEX.

A2.6.1-3 GROUND COMMANDING

- A. ALL PAYLOAD COMMANDING WILL BE COORDINATED WITH HOUSTON FLIGHT THROUGH HOUSTON PAYLOADS.

HOUSTON FLIGHT is responsible for all commanding to the shuttle vehicle, and all commanding must be done with the cognizance of HOUSTON FLIGHT. The specific coordination tasks and configuration authority is usually delegated on Spacehab missions to the Instrumentation And Communications Officer, call sign HOUSTON INCO, HOUSTON PAYLOADS, and their support personnel. Payload commanding will be identified premission with MPCC command windows reflected in the command timeline. Nominally, the Payload Operations Control Center (POCC) will only be enabled during these premission-defined windows. If off-nominal conditions arise real time which necessitate sending commands outside the premission-defined windows, coordination between the MPCC and HOUSTON PAYLOADS will be required to discuss these changes to the Command Timeline during the Tracking and Data Relay Satellite (TDRS) pre-pass briefing and/or just prior to the command sequence. As a minimum, the need to use a premission scheduled command window will be identified to HOUSTON PAYLOADS during the TDRS pre-pass briefing.

- B. NOMINALLY, MPCC COMMANDING AND MCC COMMANDING TO THE SAME GENERAL PURPOSE COMPUTER (GPC) TWO-STAGE BUFFER WILL BE MANAGED SO THAT ONLY ONE IS COMMANDING AT A TIME.

This method of commanding is the most efficient use of the orbiter and MCC command systems by avoiding command rejects and retransmissions. In order to avoid two-stage buffer contention, the MPCC will normally be disabled during MCC commanding to the same GPC two-stage buffer. HOUSTON INCO will notify HOUSTON PAYLOADS when MCC commanding to the two-stage buffer is complete and MPCC commanding can resume.

- C. IF COMMAND VOLUMES ARE SUCH THAT COMMAND COORDINATION IS A SIGNIFICANT DETRIMENT TO MISSION SUCCESS, CONSIDERATION WILL BE GIVEN TO ENABLING THE MPCC FOR SIMULTANEOUS (SIMO) COMMANDING THROUGHOUT EACH TDRS PASS UNDER THE FOLLOWING CONDITIONS. SIMO COMMANDING MUST BE APPROVED BY HOUSTON FLIGHT.
1. ALL MPCC HAZARDOUS COMMANDING WILL BE COORDINATED WITH HOUSTON PAYLOADS PRIOR TO COMMAND INITIATION.
 2. THE COMMANDING PARTY IS RESPONSIBLE FOR DETECTING AND RETRANSMITTING ANY LOST COMMANDS.

FLIGHT RULES

3. MPCC COMMANDING WILL NOT BE PLANNED TO OCCUR DURING CRITICAL ORBITER COMMANDING.

THIS RULE CONTINUED ON NEXT PAGE

FLIGHT RULES

A2.6.1-3 GROUND COMMANDING (CONTINUED)

4. LARGE COMMAND BLOCKS (MCC OR MPCC) WILL BE COORDINATED.

SIMO commanding includes two or more POCC's enabled for commanding at the same time or one or more POCC's enabled for commanding while the MCC is commanding. SIMO commanding is possible, with the risk that contention over the two-stage buffer by either throughput or two-stage commands may result in the systems management (SM) GPC rejecting one of the commands. Such commands will not be forwarded to the payload or Spacehab subsystem and may be lost. Either the MPCC or the MCC INCO can detect lost commands and retransmit them. This method of commanding is less desirable than a more structured method where contention over the two-stage buffer is procedurally avoided. If the overhead of the coordination is judged to be a significant impact to payload operations and the overhead of retransmitting the commands is judged to be less, consideration will be given to SIMO commanding. Due to safety considerations, hazardous commands must always be coordinated. To avoid loss of critical orbiter or Spacehab subsystem commands, POCC commanding will be planned around these critical commands. Since large blocks of commands require more command system time, more care must be used to avoid two-stage buffer contention and loss of these types of commands; therefore, large command blocks will still require coordination.

Reference: Rule {A2.6.2-8}, SPACEHAB CONTINGENCY GROUND COMMANDING, if applicable.

A2.6.1-4 SPACEHAB MINIMUM DURATION FLIGHT CRITERIA

FOR AN ORBITER FREON LOOP TO SPACEHAB WATER LOOP LEAK, A MINIMUM DURATION FLIGHT (MDF) WILL BE INSTITUTED.

An MDF is called for a heat exchanger leak between dissimilar fluids because the possibility exists that a generic problem, such as corrosion, exists in the heat exchanger. This problem could eventually result in a total loss of the heat exchanger and orbiter due to the subsequent loss of two Freon loops. The risk of losing the heat exchanger does not warrant a next primary landing site (PLS) but does warrant an MDF.

Reference Rule {A18.6.2-3}, ORBITER/SPACEHAB INTEGRATED RULES.

FLIGHT RULES

A2.6.1-5 POWERING OFF AND REPOWERING SPACEHAB EQUIPMENT

- A. SPACEHAB EQUIPMENT/COMPONENT WILL BE POWERED OFF IF IT HAS FAILED AND HAS ON/OFF CAPABILITY. REFERENCE FAILURE DEFINITION IN SPACEHAB SUPPORT.

Failed equipment will be powered off to prevent possible intermittent operation and/or shorting. Powering off failed equipment also saves power. Equipment powered by the Emergency Bus cannot be powered off unless both the PL AUX and PL AFT B busses are powered off.

- B. SPACEHAB EQUIPMENT NOT CONCERNED WITH SAFETY MAY BE OPERATED OUTSIDE THE QUALIFICATION LIMITS BASED ON CUSTOMER CALL.

Operation to the qualification limits may result in unpredictable operation and/or violation of lifetime limits. The Spacehab customer has chosen to allow for equipment operations (ops) outside of qualification limits based on preflight test experience.

- C. REPOWERING SPACEHAB EQUIPMENT AFTER FAILURE OR AFTER EXCEEDING QUALIFICATION TEST LIMITS WILL BE ON MCC CALL ONLY.

The MCC has the ability to evaluate data on the equipment. Consideration must be given to possible damage to orbiter systems or further damage to the affected equipment if repowered. MCC may give consideration to an inflight maintenance (IFM) procedure, trend data, etc., after careful review.

A2.6.1-6 ORBITER/SPACEHAB/EXPERIMENT THERMAL PRIORITIES

IF CONFLICTS OCCUR, ORBITER THERMAL LIMITS WILL NORMALLY BE PROTECTED AT THE EXPENSE OF SPACEHAB THERMAL LIMITS. SPACEHAB HAS PRIORITY OVER EXPERIMENTS.

The orbiter thermal limits must always take precedence over Spacehab to ensure the capabilities of the orbiter.

A2.6.1-7 ORBITER-TO-SPACEHAB INTERFACE

- A. FOR THOSE OPERATIONS WHICH REQUIRE THE ORBITER INNER AIRLOCK HATCH OR THE SPACEHAB D HATCH TO BE CLOSED AND LATCHED, ALL CREWMEMBERS ARE REQUIRED TO REMAIN ON THE ORBITER SIDE OF THE CLOSED AND LATCHED HATCH.

There is no air exchange between the orbiter and the Spacehab module with the hatch(es) closed. In addition, conditions could occur, such as an airlock leak or hatch malfunction, which could trap a crewmember in the Spacehab module.

FLIGHT RULES

- B. ONCE OPENED DURING ACTIVATION, THE D HATCH WILL REMAIN OPEN UNTIL THE DEACTIVATION PROCEDURE AT MISSION CONCLUSION, UNLESS REQUIRED TO BE CLOSED FOR EXTRAVEHICULAR ACTIVITY (EVA) OPERATIONS.

FLIGHT RULES

A2.6.1-8 FIRE/SMOKE IN SPACEHAB

A. FLIGHT CREW RESPONSIBILITIES

1. THE SPACEHAB-TRAINED CREWMEMBER(S) WILL ACCOMPLISH ALL REQUIRED SAFING AND EMERGENCY SPACEHAB PROCEDURES. ONLY THE TWO SPACEHAB SUBSYSTEM TRAINED CREWMEMBERS WILL ACCOMPLISH THE PROCEDURES REQUIRED INSIDE THE MODULE.

The Spacehab-trained crewmembers are most knowledgeable in performing Spacehab, especially emergency, procedures.

2. THE COMMANDER (CDR) AND PILOT (PLT) WILL EXIT THE SPACEHAB MODULE AT THE INITIAL SMOKE DETECTOR WARNING.

Should smoke incapacitate a portion of the crew (i.e., the Spacehab crewmember(s)), evacuating the CDR and PLT will guarantee the availability of healthy crewmembers to accomplish entry and landing.

B. FIRE/SMOKE CONFIRMATION

1. CONFIRMATION OF SMOKE DETECTION, AS DEFINED IN RULE {A17.6.2-1}, SPACEHAB FIRE/SMOKE DETECTION, IS REQUIRED PRIOR TO FIRE SUPPRESSION SYSTEM (FSS) OR PORTABLE FIRE EXTINGUISHER(S) DISCHARGE.

A secondary cue is mandatory for FSS or portable extinguisher discharge. Rule {A17.6.2-1}, SPACEHAB FIRE/SMOKE DETECTION, defines the cues required to confirm fire/smoke and ensures that action is not taken for a failed sensor.

2. VISIBLE SMOKE AND/OR FIRE IS A CONFIRMED EMERGENCY WITH OR WITHOUT SMOKE DETECTOR WARNING.

Self-explanatory.

C. SPACELAB EMERGENCY BREATHING SYSTEM (SEBS) ON SPACEHAB

1. SEBS WILL BE PARTIALLY DONNED AT THE INITIAL WARNING.
2. THE SEBS WILL BE DONNED AND ACTIVATED ONLY IF THE FIRE/SMOKE IS CONFIRMED AS DEFINED IN PARAGRAPH B.1.
3. SEBS WILL BE UTILIZED BY THE CREWMEMBER(S) UNTIL THEY EXIT FROM THE SPACEHAB MODULE AND HAVE CLOSED AND LATCHED THE SPACEHAB D HATCH.

THIS RULE CONTINUED ON NEXT PAGE

FLIGHT RULES**A2.6.1-8 FIRE/SMOKE IN SPACEHAB (CONTINUED)**

Partially donned means that the SEBS shall be unstowed and be readied for use without actually putting on the face mask. Hydrogen cyanide (HCN), hydrogen fluoride (HF), hydrogen bromide (Hbr), and carbon monoxide (CO) are four potentially toxic thermal degradation products of Halon 1301, insulation, and paint. Levels exceeding the spacecraft maximum allowable concentration criteria (SMAC) could be produced from discharging a single fire suppression system (FSS) bottle on a fire.

Reference All Flights Rule {A13.1.2-13B}, CABIN ATMOSPHERE CONTAMINATION.

D. ELECTRICAL POWER/FANS

1. AT THE FIRST INDICATION OF FIRE/SMOKE, THE ATMOSPHERIC RECIRCULATION SYSTEM (ARS) FAN WILL BE DEACTIVATED AND PL ISO VLV WILL BE CLOSED.
2. IF UNPOWERING AFFECTED EQUIPMENT OR USE OF A PORTABLE FIRE EXTINGUISHER DOES NOT EXTINGUISH A FIRE, SPACEHAB MAIN BUS POWER WILL BE REMOVED AS SOON AS POSSIBLE FOLLOWING CONFIRMATION OF FIRE IN THE MODULE. POWER IS REMOVED BY ARMING THE FSS.
3. THE SPACEHAB AFT PL MN B BUS WILL REMAIN POWERED AFTER THE FSS BOTTLES ARE DISCHARGED.

Removal of power to the ARS fan and closing the PL ISO VLV is necessary to determine smoke source (Spacehab or orbiter), will reduce the chance of a fire spreading, will reduce the circulation of fumes and smoke into the orbiter. A Spacelab analysis showed that crew movement had a negligible effect on overall cabin atmosphere with the fans off. By analogy, toxic gases, fumes, etc., in the Spacehab module will likely only propagate by diffusion.

Removal of main power eliminates the most likely source of the fire and removes power from the cabin fan. AFT PL MN B power is required for the water line heaters. Also reference paragraph G.1a of this rule.

E. PORTABLE FIRE EXTINGUISHER DISCHARGE

IF POSSIBLE, INITIAL DISCHARGE WILL BE LIMITED TO A PORTABLE EXTINGUISHER IN THE SUSPECTED AND/OR CONFIRMED FIRE AREA.

This is to limit the exposure to Halon 1301 to the crewmembers that are in the Spacehab module yet provide adequate fire suppression in the affected area.

THIS RULE CONTINUED ON NEXT PAGE

FLIGHT RULES

A2.6.1-8 FIRE/SMOKE IN SPACEHAB (CONTINUED)

F. SPACEHAB SECURING/STOWING

1. SPACEHAB SECURING/STOWING WILL BE LIMITED TO THAT WHICH IS REQUIRED FOR A SAFE ORBITER ENTRY AND LANDING CONFIGURATION.

Self-explanatory. Required stow items will be listed on the Spacehab fire/smoke cue card.

2. SPACEHAB SECURING MUST INCLUDE OPENING OF THE SPACEHAB MANUAL CABIN DEPRESS VALVE.

Remote depressurization of the Spacehab module requires that the manual valve be open; depressurization will be required if the FSS system does not suppress the fire.

G. SPACEHAB REPOWERING/REVISIT

1. AFTER FSS DISCHARGE
 - a. SPACEHAB WILL REMAIN UNPOWERED (EXCEPT FOR THE AFT PL MN B BUS) FOR THE REMAINDER OF THE FLIGHT.

After Spacehab FSS discharge, fire suppression capability is limited to the orbiter hand-held fire extinguishers (if not previously used) or depressurization of the module which does not require main power. The AFT PL MN B bus provides power to the H₂O loop line heaters to prevent freezing.

- b. SPACEHAB WILL NOT BE REVISITED.

The unknown combustion byproducts concentration resulting from a fire requiring the FSS discharge as well as the resultant Halon concentration precludes revisiting the module for any reason.

2. AFTER PORTABLE FIRE EXTINGUISHER DISCHARGE:
 - a. THE MODULE MAY REMAIN POWERED UNLESS THE PORTABLE FIRE EXTINGUISHER WAS UNSUCCESSFUL OR THERE IS AN INDICATION OF A FIRE STILL IN PROGRESS.
 - b. THE SPACEHAB MODULE WILL NOT BE REVISITED.

THIS RULE CONTINUED ON NEXT PAGE

FLIGHT RULES

A2.6.1-8 FIRE/SMOKE IN SPACEHAB (CONTINUED)

3. FOR AN ACCIDENTAL DISCHARGE OF A SINGLE PORTABLE FIRE EXTINGUISHER ANYWHERE IN THE SPACEHAB MODULE OR FOR A SINGLE FIXED LEAKING PORTABLE FIRE EXTINGUISHER OR FSS BOTTLE WITH NO SMOKE/FIRE CONFIRMATION, THE CREW MAY BE EXPOSED TO THE HABITABLE ENVIRONMENT FOR 72-100 HOURS. REAL-TIME DISCUSSION OF MISSION DURATION OR EXTENSION WILL BE DEPENDENT UPON SUCH FACTORS AS CREW SYMPTOMS AND/OR PERFORMANCE. @[032595-1763A]

The above criterion was established based upon information from NASA's Halon 1301 Human Inhalation Study (reference JSC 23845, August 1989), the National Research Council (NRC), and JSC Toxicology Group. The human study involved exposing eight volunteers to Halon 1301 for a period of 24 hours at a concentration of 1 percent (10,000 ppm). The effects on both physiology and performance were studied using a computerized battery of tests on reaction time, decision-making, etc. No significant changes in any physiological parameters were noted. There were no alterations of any blood counts or chemistries, no pulmonary function changes, no cardiac dysrhythmias, and no mental status changes. There were no significant biological decrements in performance recorded from the pre-exposure baselines. Based on this study, exposure of crewmembers to Halon concentration levels above 1 percent is not recommended.

As a result of recommendations published in the "Documentation of the Spacecraft Maximal Allowable Concentration Values on Bromotrifluoromethane" (White Paper; JSC Toxicology Group), the NRC approved revised SMAC levels for Halon 1301 on November 18, 1993. These guidelines state that for 24-hour exposure, the SMAC level is 0.35 percent (3500 parts per million), and for 7-day exposure, the SMAC level is 0.18 percent (1800 ppm). The JSC Toxicology Group sponsored the mentioned study and established SMAC levels with approval from the NRC.

Discharge of a portable fire extinguisher and/or a single fixed leaking fire extinguisher into the open Spacehab module will produce an equilibration with the habitable environment. Habitable environment is defined as the orbiter crew cabin volume plus the Spacehab module volume. A Halon 1301 level of approximately 0.20 percent to 0.26 percent (2000 ppm to 2600 ppm) will be achieved, and based on the SMAC values mentioned above, the crewmembers can be exposed to this environment for 72-100 hours.

A real-time decision to possibly land earlier than nominal EOM will be made by MCC after the crew has been exposed to Halon 1301. Although a concentration of 0.20 percent is less than the 24-hour SMAC value but slightly greater than the 7-day SMAC value for exposure to Halon 1301, the actual mission duration or extension is dependent upon such factors as crew symptoms and/or performance.

Reference Rule {A13.1.2-13}, CABIN ATMOSPHERE CONTAMINATION. @[032395-1763A]

THIS RULE CONTINUED ON NEXT PAGE

FLIGHT RULES

A2.6.1-8 FIRE/SMOKE IN SPACEHAB (CONTINUED)

4. AFTER DEPRESSURIZATION:
 - a. SPACEHAB WILL REMAIN UNPOWERED FOR THE REMAINDER OF THE FLIGHT (EXCEPT FOR AFT PL MN B BUS).
 - b. ORBITER ATTITUDE CONTROL FOR THERMAL MANAGEMENT TO AVOID FREEZING AND OVERPRESSURIZING THE PAYLOAD HEAT EXCHANGER WILL BE REQUIRED.
 - c. SPACEHAB WILL NOT BE REPRESSURIZED.
 - d. ORBITER CONSUMABLES WILL NOT BE USED TO REPRESS THE SPACEHAB MODULE AFTER A DEPRESS.

After depressurization, the state and operational capability of the avionics is unknown.

A2.6.1-9 ORBITAL MANEUVERING SYSTEM/REACTION CONTROL SYSTEM (OMS/RCS) CONSTRAINTS

ORBITAL MANEUVERING SYSTEM/REACTION CONTROL SYSTEM (OMS/RCS) CONSTRAINTS ARE EXPERIMENT COMPLEMENT DEPENDENT AND ARE DOCUMENTED IN THE FLIGHT SPECIFIC ANNEX.

A2.6.1-10 ELECTRICAL POWER SUBSYSTEM (EPS) CONSTRAINTS

- A. POWER MANAGEMENT - ON-ORBIT SPACEHAB POWER LEVELS WILL BE MANAGED BY THE SPACEHAB OPERATIONS DIRECTOR (SHOD) AND WILL BE MAINTAINED WITHIN PREFLIGHT ALLOCATED QUANTITIES.

Spacehab is allotted a specific quantity of energy preflight in the Payload Integration Plan (PIP) and may use this energy as long as the Spacehab operations do not compromise normal orbiter operations.

- B. WHEN SPACEHAB IS REQUIRED TO BE POWERED DURING ASCENT/ENTRY, THE ASCENT/ENTRY ORBITER CONFIGURATION WILL INCLUDE:
 1. FUEL CELLS CONNECTED TO THEIR RESPECTIVE BUSES
 2. PRIMARY PAYLOAD POWER - ON (PROVIDING POWER TO SPACEHAB)

FLIGHT RULES

3. PAYLOAD AUX A - ON AND PAYLOAD AFT MN B - ON
(PROVIDING EMERGENCY POWER IN THE SPACEHAB FOR SMOKE
DETECTION/SUPPRESSION)

THIS RULE CONTINUED ON NEXT PAGE

FLIGHT RULES

A2.6.1-10 ELECTRICAL POWER SUBSYSTEM (EPS) CONSTRAINTS (CONTINUED)

4. PAYLOAD CABIN MN A (B) (PROVIDING POWER TO THE STANDARD SWITCH PANEL (SSP))

Payload Primary provides power to the Spacehab power subsystem; this subsystem then provides power to subsystems and experiments requiring power on ascent/entry as negotiated in the PIP. The Payload AUX A and Payload AFT MN B orbiter buses provide redundant power to Spacehab's emergency buses. The emergency buses are required on ascent/entry for fire/smoke detection, fire suppression, and the Caution and Warning (C&W) system.

- C. THE ON-ORBIT ORBITER CONFIGURATION FOR THE ORBITER TO SPACEHAB WILL BE:

1. FUEL CELLS CONNECTED TO THEIR RESPECTIVE BUSES
2. PAYLOAD PRIMARY POWER - ON (PROVIDING POWER TO SPACEHAB)
3. AUX A AND PAYLOAD AFT MN B - ON (PROVIDING EMERGENCY POWER IN THE SPACEHAB FOR SMOKE DETECTION/FIRE SUPPRESSION)
4. PAYLOAD AC 3 POWER - ON (PROVIDING POWER TO SPACEHAB)
5. PAYLOAD CABIN MN A (B) (PROVIDING POWER TO THE SSP)

Payload Primary provides power to the Spacehab power subsystem; this subsystem then provides dc power to subsystems and experiments. The payload AUX A and payload AFT MN B orbiter buses provide redundant power for fire/smoke detection, C&W sensors and fire suppression.

A2.6.1-11 WATER DUMP MANAGEMENT

- A. SPACEHAB HAS NO WATER DUMP CONSTRAINTS.
- B. FLASH EVAPORATOR SYSTEM (FES) OPERATION WILL BE INHIBITED DURING SPACEHAB GRAVITY GRADIENT OPS.

FLIGHT RULES

A2.6.1-12 COMMAND AND DATA SYSTEM CONSTRAINTS

- A. FOR A NONRECOVERABLE LOSS OF THE DATA MANAGEMENT UNIT (DMU), SPACEHAB ACTIVITIES WILL CONTINUE. HOWEVER, THE WATER LINE HEATERS WILL BE TURNED ON TO PREVENT FREEZING.

Loss of the DMU results in loss of all Payload Data Interleaver (PDI) data to the Multifunction CRT Display System (MCDS), Payload General Support Computer (PGSC) and downlink and loss of all subsystem control capabilities (except that which is routed through the orbiter multiplexer/demultiplexer (MDM.)) All experiment data to the DMU would also be lost. However, safety critical monitoring and control is all routed through the PL MDM and Caution and Warning Electronics Assembly (CWEA). Water line heaters are turned on because a DMU failure results in loss of water pump monitoring capability.

- B. FOR LOSS OF THE MODULE SYSTEMS PGSC CAPABILITY, SPACEHAB OPERATIONS WILL CONTINUE.

The PGSC is used for backup monitoring only. Primary monitoring still exists at the MCDS, as well as through the Fault Detection and Annunciation (FDA) and CWEA systems. Ground monitoring via the PDI downlink is also still available.

- C. PDI DECOM LOSS

1. FOR LOSS OF PDI DECOM 1 OR 2, THE TELEMETRY DOWNLINK LOAD(S)/DOWNLINK FORMAT LOAD(S) (TFL(S)/DFL(S)) FOR SUPPORT OF SPACEHAB WILL INITIALLY BE LOADED.
2. A PDI IFM WILL BE CONSIDERED TO INSTALL THE SPARE PDI.

If enough time is available prior to EOM, it is better to install the spare PDI than continue to operate with the complex TFL/DFL swapping procedure.

A2.6.1-13 SPACEHAB CAUTION AND WARNING ANNUNCIATION IN MODULE

LOSS OF ALL CAUTION AND WARNING ANNUNCIATION CAPABILITY IN THE SPACEHAB MODULE IS NOT CAUSE TO TERMINATE SPACEHAB ACTIVITIES PROVIDED:

- A. ANNUNCIATION CAPABILITY EXISTS IN THE ORBITER AND,
- B. VOICE COMMUNICATION BETWEEN THE ORBITER AND SPACEHAB IS AVAILABLE.

FLIGHT RULES

All emergency safety parameters are redundantly monitored by the orbiter GPC and CWEA. In addition, both of these monitoring systems cause annunciating in both Spacehab and the orbiter. Loss of the Spacehab C&W annunciating capability is therefore only loss of redundancy. The orbiter crew would alert the Spacehab crew of any emergencies.

A2.6.1-14 COMMUNICATIONS CONSTRAINTS

LOSS OF VOICE COMMUNICATION BETWEEN THE ORBITER AND SPACEHAB CREWMEMBERS IS NOT CAUSE TO TERMINATE SPACEHAB OPERATIONS PROVIDED CAUTION & WARNING ANNUNCIATION CAPABILITY STILL EXISTS IN SPACEHAB.

Loss of voice communication does not present a hazard to the crew if caution and warning alarms are still available from the audio control system (ACS). Spacehab operations would be impacted, but may be continued in the best possible manner. Coordination can be carried out by voice calls down the tunnel or possibly by using a wireless crew comm unit (WCCU) connected in the airlock. Running a comm hard line through the tunnel is not an option as it would interfere with hatch operations if a module evacuation was required.

A2.6.1-15 SPACEHAB IN-FLIGHT MAINTENANCE (IFM) PROCEDURES

- A. IN SUPPORT OF ALL FLIGHTS RULE {A2.1.3-4}, IN-FLIGHT MAINTENANCE (IFM), THE FOLLOWING ARE LISTS OF SPACEHAB UNSCHEDULED IFM PROCEDURES WHICH HAVE BEEN PERMISSION COORDINATED AND REQUIRE REAL-TIME MCC APPROVAL ONLY PRIOR TO IMPLEMENTATION.
1. FAN CHANGEOUT (IFM-1.1)
 2. FAN FILTER CLEANING (IFM-1.2)
 3. MANUAL OPERATION OF H₂O BYPASS VALVES (IFM-2.1)
 4. WATER FLOW CONTROL ELECTRONICS UNIT (WFCEU) SOFTWARE LOAD (IFM-2.2)
 5. WATER LEAK CHECK (IFM-2.3) @[111094-1725]
 6. FUSE CHANGEOUT (IFM-3.1)
 7. INVERTER CHANGEOUT (IFM-4.1)
 8. EXPERIMENT CONNECTOR PANEL (EXCP) OUTLET VOLTAGE (IFM-5.1)
 9. EXCP DC POWER OUTLET RECOVERY (IFM-5.2)
 10. VIDEO RECOVERY (IFM-5.3)
 11. CABLE FUNCTIONALITY CHECK (IFM-5.4) @[111094-1725]

FLIGHT RULES

- 12. DC UTILITY POWER CABLE INSTALLATION (IFM-6.1)
- 13. INVERTER POWER RECOVERY (IFM-7.1)
- 14. RACK 1 DC POWER RECOVERY (IFM-7.2)

THIS RULE CONTINUED ON NEXT PAGE

FLIGHT RULES

A2.6.1-15 **SPACEHAB IN-FLIGHT MAINTENANCE (IFM) PROCEDURES**
(CONTINUED)

15. RACK 2 DC POWER RECOVERY (IFM-7.3)
16. DATA MANAGEMENT UNIT (DMU), LIGHTS, PAYLOAD TIMING BUFFER (PTB) POWER RECOVERY (IFM-7.4)
17. ATMOSPHERIC RECIRCULATION SYSTEM (ARS) FAN POWER RECOVERY (IFM-7.5)
18. CABIN FAN POWER RECOVERY (IFM-7.6)
19. RACK 1 AC POWER RECOVERY (IFM-7.7)
20. MAIN POWER KILL SIGNAL DISCONNECT (IFM-7.8)
21. HATCH LATCH DISCONNECT (IFM-9.1)
22. HATCH HINGE DISCONNECT (IFM-9.2)

EXPERIMENT IFM'S ARE DOCUMENTED IN THE FLIGHT SPECIFIC ANNEX.

These IFM's have been reviewed preflight and identified as acceptable; however, because of their nature, implementation must be coordinated with the MCC.

B. THE FOLLOWING ARE LISTS OF SPACEHAB SCHEDULED IFM PROCEDURES WHICH DO NOT REQUIRE REAL-TIME APPROVAL OR COORDINATION PRIOR TO IMPLEMENTATION. @[051194-1626]

1. FAN CLAMP REMOVAL (IFM-1.3)
2. FAN CLAMP REPLACEMENT (IFM-1.4) @[051194-1626]

C. ALL REAL-TIME DEVELOPED SPACEHAB/EXPERIMENT IFM PROCEDURES WILL BE COORDINATED AND APPROVED BY THE MCC.

Implementation of unplanned IFM's may require activities which, if not properly reviewed and coordinated, could result in an array of unsafe conditions. Therefore, unplanned IFM activity must be coordinated with MCC to ensure the safety of the orbiter, payloads, and crew. If no previous IFM work has been done, a minimum of 24 hours may be expected before an experiment IFM may be approved and uplinked.

FLIGHT RULES

A2.6.1-16 IFM PROCEDURES ON EXPERIMENTS WITH TOXIC HAZARDS

NO IFM PROCEDURES WILL BE INITIATED BY THE CREW ON AN EXPERIMENT KNOWN TO REPRESENT A TOXIC HAZARD UNTIL CONCURRENCE FOR THE REPAIR PROCEDURE IS OBTAINED FROM THE MCC FLIGHT DIRECTOR. SPACEHAB EVACUATION AND/OR PROTECTIVE EQUIPMENT MAY BE REQUIRED (SEE RULE {A13.1.2-16}, SPACEHAB/SPACELAB HAZARDOUS SUBSTANCE SPILL RESPONSE). ALL PAYLOAD EXPERIMENTS/SAMPLES CONTAINING HAZARDOUS MATERIALS ARE DEFINED IN THE FLIGHT SPECIFIC ANNEX. ©[111094-1715]

A real-time assessment of the possibility of repairing an experiment and the risk of exposing the crew to a toxic substance during the repair will need to be made. The IFM may require that the cleanup equipment specified in Rule {A13.1.2-16}, SPACEHAB/SPACELAB HAZARDOUS SUBSTANCE SPILL RESPONSE, be used to minimize risk of crew exposure to toxic substances.

A2.6.1-17 SAFE ATMOSPHERE REQUIREMENTS PREFLIGHT

THE SPACEHAB ATMOSPHERE IS CERTIFIED SAFE FOR CREW ENTRY FOR 72 HOURS FROM THE TIME GROUND VENTILATION IS REMOVED.

Off-gassing analyses by MDSSC have shown that the atmosphere of a closed Spacehab module develops unacceptably high levels of toxic gases after 72 hours and may not be certified for crew ingress after 72 hours.

A2.6.1-18 EVA

A. EVA PREBREATHING FOR UNSCHEDULED EVA'S WILL BE DONE AT 14.7 POUNDS PER SQUARE INCH (PSI) WHEN THE DURATION OF THE EVA IS LESS THAN 4 HOURS. OTHERWISE, IT WILL BE ACCOMPLISHED USING THE 12 HOUR 10.2 PSI PROTOCOL DESCRIBED IN ALL FLIGHTS RULE {A13.1.2-7B}, EVA PREBREATHE PROTOCOL.

A 14.7 prebreathe may minimize impact to certain Spacehab experiment complements while allowing access to the module during the prebreathe operation. Using the 14.7 protocol, the Spacehab hatch can remain open until 40 minutes prior to completion of EVA prebreathe. This allows time to close the Spacehab hatch, airlock/tunnel adapter vent duct configuration, and final EVA hardware configuration prior to airlock depress. Performing prebreathes at 10.2 psi provides several advantages over performing the prebreathe at 14.7 psi. A primary benefit of a 10.2 psi prebreathe is a significant reduction in crew in-suit prebreathe time thus increasing crew availability and reducing impacts to the overall flightcrew timeline and other payloads. The 10.2 psi prebreathe is also better from a crew in-suit comfort standpoint (i.e., the in-suit duration is significantly shorter). ©[051194-1627A]

THIS RULE CONTINUED ON NEXT PAGE

FLIGHT RULES

A2.6.1-18 EVA (CONTINUED)

- B. PREBREATHING AT 10.2 PSI CAN BE DONE WITH THE SPACEHAB MODULE AT 14.7 PSI AND THE SPACEHAB HATCH CLOSED OR WITH THE SPACEHAB AT 10.2 PSI. THE STRATEGY WILL BE DETERMINED ON A MISSION SPECIFIC BASIS AND PROVIDED BY THE SHOD IN REAL TIME. EXCEPTIONS TO THIS RULE ARE DOCUMENTED IN THE FLIGHT SPECIFIC ANNEX. @[051194-1627A]

Spacehab/McDonnell Douglas (MDSSC) analysis shows that module open or closed-hatch operations at 10.2 will reduce cooling capabilities. Freon flow to the payload heat exchanger will be reduced in order to keep the orbiter cabin within temperature limits. This is accomplished by moving one of the orbiter's Freon flow proportioning valves (FPV's) from the nominal on-orbit payload heat exchanger position to the interchanger position. This will reduce the cooling capability in the Spacehab water loop.

Spacehab may be able to operate at the reduced pressure (and cooling level) of 10.2 psi if these conditions are compatible with experiment science and hardware requirements, and if overall module thermal loads allow. The benefit of open hatch operations at 10.2 psi is increased crew access time to the module during prebreathe.

Assessment of 10.2 psi prebreathe strategy will be conducted on a flight specific basis.

- C. FOR AN EVA, THE ASCENT/DESCENT INLET STUB WILL BE OPENED AND THE MODULE CONFIGURED FOR A SAFE ENTRY AS REQUIRED BY PAYLOAD SAFETY.

The ascent/descent inlet stub is opened to allow the ARS fans to provide additional module air circulation to increase heat rejection capability. Both the ARS and cabin fans remain ON for the duration of orbiter EVA ops. The module is configured for safe entry in the event the module cannot be re-entered after the EVA.

- D. SPACEHAB LEAK DURING EVA

SCHEDULED/UNSCHEDULED EVA

1. IF A SPACEHAB CABIN LEAK OCCURS DURING AIRLOCK/TUNNEL ADAPTER DEPRESS WHICH IS NOT UNDERSTOOD OR WHICH IS PREDICTED TO REDUCE CABIN PRESSURE BELOW 10.2 POUNDS PER SQUARE INCH ABSOLUTE (PSIA) BEFORE NOMINAL EVA COMPLETION TIME, THE EVA/AIRLOCK DEPRESS WILL BE TERMINATED.
2. IF A SPACEHAB CABIN LEAK OCCURS DURING EVA, THE EVA WILL BE TERMINATED AND THE AIRLOCK/TUNNEL ADAPTER REPRESSURIZED BEFORE THE SPACEHAB IS PREDICTED TO REACH 10.2 PSIA.

FLIGHT RULES

THIS RULE CONTINUED ON NEXT PAGE

FLIGHT RULES

A2.6.1-18 EVA (CONTINUED)

CONTINGENCY EVA

3. IF THE EVA IS AN ORBITER CONTINGENCY EVA, IT WILL CONTINUE AND THE SPACEHAB WILL BE UNPOWERED PRIOR TO REACHING 10 PSIA.

The Spacehab systems are certified to operate above a cabin pressure greater than or equal to 10 psia. For example, a leak rate of 7.3 lb/hr for 4 hours based on 14.7 equivalent will bring the cabin to 10 psia.

- E. EXPERIMENT IMPACTS TO A 10.2 PSI PREBREATHE ARE DOCUMENTED IN THE FLIGHT SPECIFIC ANNEX. @[111094-1724]

A2.6.1-19 EQUIPMENT EXCHANGE BETWEEN ORBITER CABIN AND SPACEHAB MODULE

- A. ELECTRICAL EQUIPMENT OR EXPERIMENTS, SELF-POWERED OR FACILITY-POWERED, SHALL NOT BE TRANSFERRED BETWEEN THE ORBITER AND SPACEHAB UNLESS CERTIFIED FOR USE IN BOTH LOCATIONS. APPROVED EQUIPMENT WILL BE IDENTIFIED IN PARAGRAPH B.

Equipment may only be used in areas where it has been approved from an electromagnetic compatibility standpoint. In addition, power budgeting/planning can only be accomplished effectively if equipment movement strategy is coordinated preflight via this rule.

- B. SPACEHAB SUBSYSTEM GENERIC EQUIPMENT
 1. WIRELESS CREW COMMUNICATION SYSTEM (WCCS)
 2. SPACEHAB AUDIO GROUND ISOLATOR (SAGI)
 3. HANDHELD MICROPHONE
 4. VACUUM CLEANER AND ACCESSORIES (CABLE AND ATTACHMENT)

EXCEPTIONS TO THIS RULE ARE DOCUMENTED IN THE FLIGHT SPECIFIC ANNEX.

FLIGHT RULES

A2.6.1-20 SPACEHAB MODULE/TUNNEL SLEEP CONSTRAINTS

A. NO CREWMEMBERS SHALL SLEEP IN THE SPACEHAB-TO-ORBITER TUNNEL.

In the event it was necessary to rapidly evacuate the module, a sleeping crewmember either tethered or in a sleeping bag would pose a hazard. In addition, the tunnel does not offer the same amount of protection for radiation that is provided by the module or orbiter cabin.

B. CREWMEMBERS MAY SLEEP IN THE SPACEHAB MODULE IF:

1. SPACEHAB SYSTEM DATA IS BEING NOMINALLY TRANSMITTED TO THE ORBITER'S SM GPC AND TELEMETERED TO THE GROUND.
2. THE CAUTION AND WARNING LINK BETWEEN THE ORBITER AND SPACEHAB IS OPERATIONAL.
3. ALL SPACEHAB SAFETY-RELATED SENSORS ARE OPERATIONAL.
4. THE AUDIO LINK BETWEEN THE ORBITER AND SPACEHAB IS OPERATIONAL.
5. MODULE STOWAGE HAS BEEN CONFIGURED IN A SAFE ENTRY CONFIGURATION.
6. CREW NOTIFIES MCC THAT PERSONNEL ARE SLEEPING IN THE MODULE. @[051194-1629]

Nominal safety monitoring is via the SM GPC and the Caution and Warning Electronics Assembly (CWEA). Ground monitoring of safety parameters provides a further safety monitoring capability. The audio link to the Spacehab is desirable for communication in the case of a contingency commencing during sleep. The module should be configured such that rapid egress could be performed.

A2.6.1-21 COMMANDER (CDR) AND PILOT (PLT) PARTICIPATING AS TEST SUBJECTS

THE CDR AND PLT MAY PARTICIPATE AS TEST SUBJECTS ON A VOLUNTEER BASIS AND AS NEGOTIATED PREFLIGHT. THE CDR MAY NOT PARTICIPATE AS A TEST SUBJECT IN ANY EXPERIMENT OF A PROVOCATIVE OR DISORIENTING NATURE. THE CDR AND PLT MAY NOT SIMULTANEOUSLY PARTICIPATE IN ANY EXPERIMENT THAT IS PHYSICALLY RESTRAINING.

FLIGHT RULES

The CDR may not participate in any experiment which might compromise the CDR's ability to command and fly the orbiter. Either the CDR or PLT must always be available to handle emergencies or other actions.

A2.6.1-22 CREW LIMITATIONS IN THE SPACEHAB MODULE

- A. UP TO FOUR CREWMEMBERS MAY BE PERMITTED IN THE MODULE BASED ON REAL TIME EVALUATION OF RELATIVE HUMIDITY AND CABIN TEMPERATURE.

Spacehab is designed to reject 1400 watts of waste heat from air cooled experiments with two crewmembers in the module. MDSSC/Spacehab analysis shows that each additional crewmember over the design value of two will decrease the available experiment air heat rejection accommodations by 115 watts minimum and 265 watts maximum (if WFCEU controlling by dew point). Each additional crewmember is expected to increase module dew point by about 1 deg F. Increases in oxygen (O₂) consumption and carbon dioxide (CO₂) show no immediate concern for nominal operations.

- B. ORBITER CREWMEMBERS MAY ASSIST IN OPERATIONS IN THE SPACEHAB MODULE OR SERVE AS TEST SUBJECTS (SUBJECT TO RULE {A2.6.1-21}, COMMANDER (CDR) AND PILOT (PLT) PARTICIPATING AS TEST SUBJECTS) AS NEGOTIATED PREFLIGHT.

Preflight coordination will guarantee that the workloads of the orbiter crewmembers is acceptable and that Rule {A2.6.1-21,} COMMANDER (CDR) AND PILOT (PLT) PARTICIPATING AS TEST SUBJECTS, is not violated.

A2.6.1-23 SPACEHAB DEACTIVATION

SPACEHAB DEACTIVATION WILL PROCEED BY ONE OF THE FOLLOWING METHODS DEPENDING ON CIRCUMSTANCES:

- A. NOMINAL DEACTIVATION - SECURING OF THE SPACEHAB BY NOMINAL CHECKLIST PROCEDURES (1 HOUR IN DURATION). THE NOMINAL DEACTIVATION WILL BE DONE FOR:
1. NOMINAL END-OF-MISSION DEACTIVATION
 2. ANY FAILURE THAT RESULTS IN A PRIMARY LANDING SITE (PLS) WITH DEORBIT TIME OF IGNITION (TIG) OCCURRING BEYOND 12 HOURS.

Nominal deactivation requires 1 hour and it is scheduled in the Flight Plan. A PLS TIG greater than 12 hours away will allow the crew to perform the desirable, nominal module deactivation.

FLIGHT RULES

3. LOSS OF MODULE PRESSURE SUCH THAT > 12 HOURS IS
AVAILABLE ON ORBIT (DP/DT \approx 0.02 OR LESS) @[121593-1587]

The nominal procedure will include equipment stowage, nominal deactivation of experiments, and an orderly reconfiguration to the Spacehab entry configuration. @[111094-1726]

THIS RULE CONTINUED ON NEXT PAGE

FLIGHT RULES

A2.6.1-23 SPACEHAB DEACTIVATION (CONTINUED)

B. THIRTY-MINUTE CONTINGENCY DEACTIVATION - SECURING OF SPACEHAB AND EXPERIMENT HARDWARE IN MINIMUM TIME WITHOUT INCURRING DAMAGE TO SPACEHAB, AND WHEN POSSIBLE, EXPERIMENT EQUIPMENT. SPACEHAB 30-MINUTE CONTINGENCY DEACTIVATION PROCEDURES WILL BE DONE FOR:

1. ANY FAILURE THAT RESULTS IN A PLS WITH DEORBIT TIG OCCURRING BETWEEN 3.5 TO 12 HOURS.
2. UNRECOVERABLE LOSS OF THE ATMOSPHERIC RECIRCULATION SYSTEM (ARS) FAN AND CABIN FAN.
3. LOSS OF MODULE PRESSURE SUCH THAT BETWEEN 3.5 HRS AND 12 HRS IS AVAILABLE ON-ORBIT ($DP/DT \approx 0.02$ TO 0.07 PSI/MIN).

Thirty-minute contingency deactivation is intended to perform as much of the normal deactivation of the module as possible. It also provides a balance between deactivating the module in a shorter-than-nominal time and preserving equipment (and science, if possible). The procedure will include critical entry stowage, an abbreviated but orderly Spacehab shutdown, safing of experiments, and if time permits, quick experiment preservation actions.

C. RAPID SAFING CONTINGENCY DEACTIVATION - SECURING OF SPACEHAB AND EXPERIMENT HARDWARE ON THE CRITICAL ENTRY STOWAGE LIST AND SAFING ACTIONS SUCH THAT SPACEHAB AND ORBITER HARDWARE WILL NOT BE DAMAGED DURING ENTRY/LANDING. THIS DEACTIVATION PROCEDURE WILL BE DONE FOR:

1. AN ORBITER/MODULE LEAK SUCH THAT BETWEEN 1 HR AND 3.5 HRS IS AVAILABLE ON ORBIT ($DP/DT \approx 0.08$ TO 0.18)
2. SPACEHAB MODULE TOXIC SPILL (LEVEL 4 ONLY)
3. CONFIRMED SPACEHAB MODULE FIRE (IF TIME PERMITS, ELSE EMERGENCY)
4. ADDITIONS WILL BE ADDRESSED IN THE FLIGHT SPECIFIC ANNEX BASED ON EXPERIMENT COMPLEMENT

The Rapid Safing Contingency Deactivation is intended to establish a safe entry configuration. It provides a balance between deactivating the module in a shorter-than-nominal time and saving equipment. The procedure will include critical entry stowage and safing systems and experiments. For orbiter leaks, the module will be configured to support the orbiter.

THIS RULE CONTINUED ON NEXT PAGE

FLIGHT RULES

A2.6.1-23 SPACEHAB DEACTIVATION (CONTINUED)

D. EMERGENCY DEACTIVATION - IMMEDIATE EGRESS AND CLOSURE OF THE HATCH WITHOUT ANY OTHER ACTIVITIES. SPACEHAB EMERGENCY DEACTIVATION PROCEDURES WILL BE DONE FOR:

1. ORBITER PROBLEMS REQUIRING EMERGENCY DEORBIT
2. FOR AN ORBITER/MODULE LEAK SUCH THAT < 1 HR IS AVAILABLE ON ORBIT ($DP/DT \approx 0.18$ OR LARGER)
3. FOR SPACEHAB MODULE FIRE (IF UNABLE TO PERFORM RAPID SAFING CONTINGENCY DEACTIVATION)
4. DISCHARGE OF THE HALON SYSTEM (ALL BOTTLES)

Safe return of the crew is paramount in these cases. Only payload procedures required for safe entry (crew module egress and hatch closure) are allowed in these time critical situations. No attempt is made to prevent damage to the module or experiments. An emergency deactivation will include removal of all main ac and dc power as soon as possible.

For a cabin leak of this magnitude, no other activity should be performed other than quick verification of possible leak sources in the module, egress the module, closure of the appropriate hatches to attempt to isolate the leak, and return to the orbiter to prepare for emergency deorbit. For orbiter leaks, the module will be configured to support the orbiter. The leak rate greater than -0.2 psi/min (orbiter and Spacehab volumes) represents a leak where 8 psia cannot be sustained based on the 8 psi regulators (150 lb/hr nitrogen (N_2)) and the oxygen flow provided from the direct oxygen port (20 lb/hr).

E. ORBITER ATTITUDE CONTROL FOR THERMAL MANAGEMENT TO PREVENT FREEZING OF THE SPACEHAB WATER COOLANT LOOP AND/OR ORBITER HEAT EXCHANGER WILL BE REQUIRED FOR ANY DEACTIVATION REQUIRING REMOVAL OF PAYLOAD AFT B POWER.

The AFT PL B also powers the Spacehab water line heaters. Removal of Payload AFT B power will require orbiter attitude control for thermal management since freezing in the payload heat exchanger can result in a subsequent orbiter Freon coolant loop leak and a PLS.

FLIGHT RULES

A2.6.1-24 EXTENSION DAY GROUND RULES

A. AN "EXTENSION DAY" IS DEFINED AS AN ADDITIONAL FLIGHT DAY RESULTING FROM WEATHER CONDITIONS AT THE PLANNED LANDING SITE. AN "EXTRA FLIGHT DAY" IS DEFINED AS AN ADDITIONAL DAY OF PAYLOAD FLIGHT OPERATIONS.

B. GROUP B POWERDOWN WILL BE INITIATED AFTER COMPLETION OF POST INSERTION ACTIVITIES TO CONSERVE CONSUMABLES.

C. POWER LEVELS

THE SPACEHAB AND ITS EXPERIMENTS WILL BE POWERED DOWN TO THE GREATEST EXTENT POSSIBLE (MINIMUM POWER CONFIGURATION) DURING EXTENSION DAYS EXCEPT TO THE EXTENT NECESSARY TO SUPPORT ENTRY DEVELOPMENT TEST OBJECTIVES (DTO'S). THE MINIMUM POWER LEVEL FOR A GIVEN FLIGHT WILL BE DEFINED IN THE FLIGHT SPECIFIC ANNEX. FLIGHT SPECIFIC CONSTRAINTS ON SPACEHAB ACTIVITIES OTHER THAN REQUIRED BY POWER LEVELS AND CONSUMABLES ARE DEFINED IN THE FLIGHT SPECIFIC ANNEX.

The amount of consumables remaining at the nominal end of flight does not allow for operations of experiments without degrading the capability of the orbiter to remain in orbit. For those cases which require that additional power be provided to allow for preservation of experiment samples/data, the consumable must be allocated preflight and thus affect the mission duration.

D. CONSUMABLES

NO SPACEHAB EXPERIMENT ACTIVITIES WHICH REQUIRE ORBITER CONSUMABLES WILL NORMALLY BE PLANNED. FLIGHT-SPECIFIC OPTIONS ARE DEFINED IN THE FLIGHT SPECIFIC ANNEX.

Extension days would generally be required only for weather, orbiter, and/or landing site problems that would benefit from extra time before landing. To prevent further complications, the Spacehab/experiments should be maintained in a safe, deactivated state. This should not impact the Spacehab/experiments since all payload activities should have already been completed by the nominal end of mission. In addition, the crew must be available to perform necessary orbiter activities to ensure a safe return.

THIS RULE CONTINUED ON NEXT PAGE

FLIGHT RULES

A2.6.1-24 EXTENSION DAY GROUND RULES (CONTINUED)

E. THE EXTENSION DAY ATTITUDE WILL NOMINALLY BE -ZLV. DIRECTION OF VELOCITY VECTOR AND ANY EXCEPTIONS WILL BE EVALUATED AS REQUIRED. EXCEPTIONS TO THIS RULE ARE DOCUMENTED IN THE FLIGHT SPECIFIC ANNEX. ©[072695-1778]

The -ZLV attitude will normally provide a stable thermal environment for the orbiter and Spacehab module during an extension day and is accomplished with a minimum amount of propellant for attitude maintenance. With radiators deployed, the -ZLV attitude will provide sufficient orbiter heat rejection when flying with any beta angle. With radiators stowed, the -ZLV attitude may be acceptable, or a flight-specific attitude can be determined. If a cooler attitude is required, the orbiter can execute passive thermal control (PTC) which gives the advantage of providing a consistent thermal environment for the entire vehicle. ©[072695-1778]

FLIGHT RULES

POWERED/UNPOWERED ASCENT/ENTRY

A2.6.2-1 LOSS OF SM GPC DURING SPACEHAB ACTIVATION/DEACTIVATION (ACT/DEACT)

POWERED ASCENT/ENTRY @[111094-1733]

- A. LOSS OF THE SYSTEMS MANAGEMENT (SM) GPC DURING SPACEHAB ACTIVATION OR DEACTIVATION WILL NOT REQUIRE SUSPENSION OF SPACEHAB ACTIVITIES. CONSIDERATION WILL BE GIVEN TO WHICH EXPERIMENTS COULD BE OPERATED IN THE ASCENT/ENTRY CONFIGURATION.

When Spacehab is powered during ascent/entry, the water pump, ARS fan, and several experiment power outlets are already activated. Spacehab operations can continue in this configuration.

UNPOWERED ASCENT/ENTRY

- B. LOSS OF THE SYSTEMS MANAGEMENT (SM) GPC DURING SPACEHAB ACTIVATION OR DEACTIVATION WILL REQUIRE SUSPENSION OF SPACEHAB ACTIVITIES UNTIL THE SM GPC IS RECOVERED. @[111094-1733]

Spacehab activation and deactivation are achieved via the SM GPC MCDS and otherwise cannot be performed.

A2.6.2-2 LOSS OF PAYLOAD MDM DURING SPACEHAB ACT/DEACT

POWERED ASCENT/ENTRY @[111094-1734]

- A. LOSS OF PAYLOAD FLEX (PF) MDM, PF1, DURING SPACEHAB ACTIVATION WILL NOT REQUIRE SUSPENSION OF SPACEHAB ACTIVITIES. CONSIDERATION WILL BE GIVEN TO WHICH EXPERIMENTS COULD BE OPERATED IN THE ASCENT/ENTRY CONFIGURATION.

When Spacehab is powered during ascent/entry the water pump and ARS fan are already activated. Spacehab operations can continue in this configuration.

THIS RULE CONTINUED ON NEXT PAGE

FLIGHT RULES

A2.6.2-2 LOSS OF PAYLOAD MDM DURING SPACEHAB ACT/DEACT (CONTINUED)

UNPOWERED ASCENT/ENTRY

- B. LOSS OF PAYLOAD MDM PF1 DURING SPACEHAB ACTIVATION PRIOR TO WATER PUMP, ARS FAN, AND CABIN FAN ACTIVATION OR DEACTIVATION WILL REQUIRE SUSPENSION OF SPACEHAB ACTIVITIES UNTIL THE RECOVERY ATTEMPT IS COMPLETE.

Spacehab activation and deactivation are achieved via Payload MDM 1 (PF1) and otherwise cannot be nominally performed.

- C. LOSS OF PAYLOAD MDM PF2 DURING SPACEHAB ACTIVATION OR DEACTIVATION WILL NOT REQUIRE SUSPENSION OF SPACEHAB ACTIVITIES. @[111094-1734]

Spacehab activation and deactivation do not require Payload MDM PF2.

A2.6.2-3 PAYLOAD MDM HARD FAILURE

- A. LOSS OF PAYLOAD MDM 1 (PF1) BEFORE ACTIVATION WILL RESULT IN AN INABILITY TO ACTIVATE SPACEHAB. ALL FLIGHTS RULE {A7.1.3-15D}, IN-FLIGHT MAINTENANCE (IFM), SPECIFIES THAT A PF MDM WILL ONLY BE SWAPPED TO REGAIN PLBD CLOSE CAPABILITY. CONSIDERATION MAY BE GIVEN TO WHICH EXPERIMENTS COULD BE OPERATED IN THE ASCENT/ENTRY CONFIGURATION.
- B. LOSS OF EITHER PAYLOAD MDM AFTER ACTIVATION AND BEFORE DEACTIVATION IS NOT CAUSE TO TERMINATE SPACEHAB ACTIVITIES.

Caution and warning parameters, which are nominally redundantly monitored by the CWEA directly and via the PF1-GPC-PF2 string, are still monitored by the CWEA if either PF MDM fails. Significant command capability, including that used during the nominal deactivation process (ARS fan, cabin fan, and water pump reconfiguration for powered entry), is lost if PF1 is lost. However, some operations may still be conducted. Safety-related redundant command capability for fire suppression still exists (Standard Switch Panel and C3A5).

FLIGHT RULES

A2.6.2-4 LOSS OF SM MAJOR FUNCTION

TEMPORARY LOSS OF SM MAJOR FUNCTION AFTER SPACEHAB ACTIVATION AND BEFORE SPACEHAB DEACTIVATION IS NOT A CONSTRAINT TO CONTINUING SPACEHAB OPERATIONS IF:

- A. THE SPACEHAB-TO-CWEA INTERFACE IS OPERATING NOMINALLY.
- B. ALL OF THE FOLLOWING SAFETY SENSORS ROUTED TO THE CWEA ARE OPERATIONAL:
 - 1. FIRE/SMOKE DETECTORS A AND B
 - 2. CABIN FAN DELTA P - SENSOR 2 @[051194-1630]
 - 3. ARS FAN DELTA P - SENSOR 2

If the SM interface is down, one of two redundant methods of monitoring safety-critical parameters is lost. Module operations may continue if the CWEA is still monitoring safety parameters and the sensors feeding the CWEA (two fire/smoke, ARS and cabin fan delta P) are nominal. Note that monitoring of SM GPC parameters is still available on the ground and via the PGSC in the module. Redundancy for partial pressure of oxygen (PPO2) and total cabin pressure is provided by the orbiter sensors via hardware caution and warning. @[051194-1630]

Loss of SM also eliminates a significant amount of command capability; however, redundant methods are still available for fire suppression. It is anticipated that little SM commanding will be required for mission success after module activation.

A2.6.2-5 LOSS OF ORBITER MASTER TIMING UNIT (MTU)/PAYLOAD TIMING BUFFER

POWERED AND UNPOWERED ASCENT/ENTRY @[111094-1735]

- A. LOSS OF THE MTU DURING SPACEHAB ACTIVATION OR DEACTIVATION IS NOT A CONSTRAINT TO CONTINUING SPACEHAB ACTIVITIES; HOWEVER, NOMINAL ACTIVATION/DEACTIVATION CANNOT BE PERFORMED. CONSIDERATION WILL BE GIVEN TO WHICH EXPERIMENTS CAN OPERATE IN THE ASCENT/ENTRY CONFIGURATION.

Loss of the MTU results in loss of a clock signal to the Payload Signal Processor (PSP), which causes loss of commanding to Spacehab. PSP commanding is required to perform a nominal Spacehab activation and deactivation. Operations may still be conducted in the ascent/entry configuration. If Spacehab is unpowered during ascent, operations may still be conducted using SSP and MDM commanding.

FLIGHT RULES

THIS RULE CONTINUED ON NEXT PAGE

FLIGHT RULES

A2.6.2-5 LOSS OF ORBITER MASTER TIMING UNIT (MTU)/PAYLOAD TIMING BUFFER (CONTINUED)

B. LOSS OF THE MTU AFTER SPACEHAB ACTIVATION AND BEFORE SPACEHAB DEACTIVATION IS NOT A CONSTRAINT TO CONTINUING SPACEHAB ACTIVITIES; HOWEVER, THE FOLLOWING IMPACTS OCCUR:

1. LOSS OF UPLINK COMMANDING IS DOCUMENTED IN THE FLIGHT SPECIFIC ANNEX.

PSP commanding is lost when the MTU fails. All uplink commanding for Spacehab and experiments is through the PSP.

2. LOSS OF GREENWICH MEAN TIME (GMT) TIMETAG INFORMATION INSERTED BY THE DMU INTO THE PDI DATA STREAM.

The GMT timetag is inserted into the PDI data stream by the DMU for subsystem information. It is not used onboard Spacehab.

3. LOSS OF GMT AND MISSION ELAPSED TIME (MET) TO SPACEHAB EXPERIMENTS IS DOCUMENTED IN THE FLIGHT SPECIFIC ANNEX.

The MTU is the only source of GMT and MET to Spacehab and experiments. This could cause degraded experiment results. @[111094-1735]

A2.6.2-6 PF1 FIRST PAYLOAD MDM CHOICE

IF A CHOICE EXISTS BETWEEN PF1 AND PF2, SPACEHAB PREFERS PF1.

If PF1 is lost, all GPC and MDM control to Spacehab is lost. Additionally, MDM parameters are no longer routed to the GPC for Fault Detection and Annunciation (FDA) limit sensing. The impact of losing PF1 is greater than the impact of losing PF2.

FLIGHT RULES

A2.6.2-7

ORBITER FREON FLOW PROPORTIONING VALVE (FPV) USAGE

THE TWO ORBITER FREON FPV'S WILL NOMINALLY BE USED ACCORDING TO THE FOLLOWING PLAN:

- A. PRELAUNCH: ONE FPV IN THE INTERCHANGER (ICH) POSITION AND ONE FPV IN THE PAYLOAD HEAT EXCHANGER (PLHX) POSITION AS REQUIRED BY THE PAYLOAD UNTIL FLIGHT-SPECIFIC LAUNCH MINUS TIME SPECIFIED IN THE FLIGHT SPECIFIC ANNEX. THEN BOTH FPV'S ARE PLACED IN ICH FOR ASCENT.

Both FPV's must be in ICH for ascent. However, cold soaking the Spacehab module prelaunch via one FPV in PLHX keeps the predicted module temperatures acceptable until post insertion. Moving the FPV back to the ICH position still guarantees a nominal crew cabin temperature at ingress and during ascent. For STS-57, one FPV was maintained in the ICH position and one FPV was left in PLHX until L-6 hours.

- B. ON-ORBIT 14.7 PSI OPS: AFTER SUCCESSFULLY REACHING ORBIT WHEN THE ORBITER IS THERMALLY STABLE, ONE FPV WILL BE PLACED IN PLHX POSITION UNTIL DEORBIT PREP. THE SECOND FPV WILL ONLY BE TAKEN TO PLHX IF REQUIRED TO SATISFY PAYLOAD THERMAL REQUIREMENTS. AT DEORBIT PREP, BOTH FPV'S WILL BE RETURNED TO ICH FOR ENTRY AND LANDING. FOR EXTENSION DAYS, AN FPV IS NOT REQUIRED AS LONG AS SPACEHAB REMAINS IN THE ENTRY CONFIGURATION. @[111094-1728A]

If the cabin is at 14.7 psi, marginal cooling exists for orbiter systems if both FPV's are given to the payload. To provide sufficient cooling to the orbiter, only one FPV should be in the PLHX position unless both are required to avoid violating payload thermal limits. In the entry configuration, Spacehab thermal loads are lower such that an FPV is not required. If Spacehab is reconfigured; however, (i.e. hatch opened) then an FPV will be required. @[111094-1728A]

- C. ON-ORBIT 10.2 PSI ORBITER OPS: ONE FPV WILL BE IN ICH AND ONE WILL BE IN PLHX AND A FES PRIMARY CNTLR MUST BE ACTIVATED.

Due to reduced cooling capability at 10.2 psi, the orbiter requires at least one of the FPV valves to be placed in interchanger. @[111094-1728A]

Reference All Flights Rule {A17.1.7-8A}, ATCS (10.2 PSIA) CABIN CONFIGURATION.

FLIGHT RULES

- D. POSTLANDING: BOTH FPV'S WILL BE IN THE "ICH" POSITION UNTIL REQUESTED FOR PAYLOAD COOLING AT THE FLIGHT-SPECIFIC POSTLANDING TIME SPECIFIED IN PARAGRAPH E. THEN ONE FPV IS PLACED INTO THE "PLHX" POSITION FOR THE DURATION OF EARLY EXPERIMENT RETRIEVAL OPERATIONS. EXCEPTIONS TO THIS RULE ARE DOCUMENTED IN THE FLIGHT SPECIFIC ANNEX.

Moving one FPV to PLHX allows Spacehab to maintain module temperature during early experiment sample retrieval operations.

A2.6.2-8 SPACEHAB AIR-TO-GROUND (A/G) USAGE

- A. THE STANDARD ORBITER A/G CHANNEL (A/G 1) WILL BE USED FOR ANY DISCUSSIONS RELATED TO SPACEHAB SUBSYSTEMS. THE SSP CAPCOM WILL BE THE GROUND COMMUNICATOR.

Since the module is integrated to the orbiter, it is necessary that any systems issues be discussed on A/G 1 which all Space Shuttle Program (SSP) flight control team members monitor. In addition, this strategy guarantees that emergency/time critical issues are discussed on the prime A/G loop.

- B. A/G 2 WILL BE USED FOR ANY DISCUSSIONS RELATED TO SPACEHAB EXPERIMENTS. A SPACEHAB CREW INTERFACE COORDINATOR (CIC) WILL BE THE GROUND COMMUNICATOR.

Spacehab is responsible for all experiment procedures and the experiment flight data file. Therefore, the most efficient communication path is directly between the crew and the CIC. The CIC will be in the JSC POCC.

- C. ANY SAFETY-RELATED ISSUES, INCLUDING THOSE RELATED TO EXPERIMENTS, WILL BE CONDUCTED ON THE PRIME A/G LOOP (A/G 1).

Self-explanatory.

- D. ROUTINE CONVERSATIONS DURING SPACEHAB EXPERIMENTS OPERATIONS BETWEEN THE CIC AND THE CREW ON A/G 2 WILL NORMALLY BE INITIATED BY CREW REQUEST. THE FOLLOWING RESTRAINTS SHALL APPLY TO CIC PROTOCOL AND A/G 2 USAGE.
1. THE VOICE PROTOCOL SHALL BE THE SAME AS THAT USED BY THE JSC CAPCOM.
 2. THE SPACEHAB OPERATIONS DIRECTOR (SHOD) IS RESPONSIBLE FOR APPROVING ALL CALLS INITIATED FROM THE GROUND TO THE CREW.

FLIGHT RULES

3. DIRECT EXPERIMENTER CALLS TO THE CREW ON A/G 2 SHALL BE UPON CREW REQUEST ONLY.
4. THE CALL SIGN FOR THE SPACEHAB POCC SHALL BE "SPACEHAB POCC."
5. PORTABLE AUDIO DATA MODEM (PADM) OPERATIONS WILL TAKE PRECEDENCE OVER ROUTINE SPACEHAB A/G 2 USAGE.

THIS RULE CONTINUED ON NEXT PAGE

FLIGHT RULES

A2.6.2-8 SPACEHAB AIR-TO-GROUND (A/G) USAGE (CONTINUED)

6. EXCEPTIONS TO THIS RULE ARE DOCUMENTED IN THE FLIGHT SPECIFIC ANNEX.

Past flight crew comments on overuse of A/G by payloads point out the need for more rigid control of the traffic and voice protocol. In addition, use of the PADM adds complexity to the scheduled use of one of the A/G links. With the many users as well as the many experimenters on a Spacehab flight, careful definition of the A/G 2 usage is required. This rule represents an agreed to baseline with the customer for Spacehab flights.

A2.6.2-9 SPACEHAB CONTINGENCY GROUND COMMANDING

- A. CONTINGENCY COMMANDS (PRESTORED IN THE MISSION OPERATIONS COMPUTER (MOC)) TO SWITCH ENVIRONMENTAL CONTROL SYSTEM (ECS) FANS OR WATER COOLING PUMPS DURING ASCENT/ENTRY WILL BE UPLINKED TO ASSURE AIR CIRCULATION THROUGH THE MODULE SMOKE SENSORS AND TO AVOID A MODULE OVERTEMPERATURE.
- B. FOR A DECLARED SPACEHAB FAN FAILURE OF THE FAN IN USE (EITHER ARS OR CABIN FAN) DURING (ASCENT) POWERED FLIGHT, THE REMAINING FAN WILL BE COMMANDED ON AND THE FAILED FAN WILL BE COMMANDED OFF ASAP AFTER MAIN ENGINE CUT OFF (MECO).
- C. FOR A WATER PUMP FAILURE DURING (ASCENT) POWERED FLIGHT, THE ALTERNATE PUMP WILL BE COMMANDED ON POST-MECO.

Air flow is required for fire/smoke detection. Loss of temperature control in the module would jeopardize subsystem/experiment health and delay crew ingress of the module on Flight Day 1 (FD1).

Reference: All Flights Rule {A2.6.1-3}, GROUND COMMANDING.

FLIGHT RULES

SPACELAB OPERATIONS MANAGEMENT

A2.9.1-1 SPACELAB SAFETY DEFINITION AND MANAGEMENT

A. DEFINITIONS: @[102793 -1552]

RAPID SAFING - SPACELAB MEETS THE RAPID SAFING CRITERIA THROUGH IMPLEMENTATION OF CONTINGENCY DEACTIVATION/EGRESS PROCEDURES.

B. GENERALIZED RESPONSES TO UNSAFE/HAZARDOUS CONDITIONS:

RAPID SAFING - FOR SPACELAB, RAPID SAFING IS USED IN THE CONTEXT OF SECURING THE MODULE/EXPERIMENTS FOR A SAFE ENTRY AS DEFINED IN RULE {A2.9.1-23C}, SPACELAB DEACTIVATION. @[102793-1552]

A2.9.1-2 REAL-TIME SAFETY COORDINATION

A. ANY SPACELAB PAYLOAD FAILURE WHICH POSES AN IMMEDIATE THREAT TO ORBITER SYSTEMS OR CREW HEALTH (SPECIFICALLY: BROKEN GLASS, TOXIC SPILLS, SMOKE/FIRE, ANIMAL WASTE, AND FREE WATER) WILL BE COORDINATED BY THE CREW DIRECTLY WITH THE MCC. THE MCC WILL IMMEDIATELY NOTIFY THE POCC. IF THE MCC DEEMS NECESSARY, ADDITIONAL COORDINATION WITH THE POCC MAY BE REQUIRED.

This approach allows the MCC to prioritize, coordinate, and address the immediate health threat to the crew. All payload-specific questions will be relayed to the POCC. It is understood that the crew will work the appropriate onboard contingency procedures to reduce the immediate threat without talking to the ground first. Crew indication of an electrical short is fire/smoke (covered in paragraph A), popped circuit breaker (covered in paragraph B), or maintained increase in current (covered in paragraph B). For coordination of electrical problems/shorts, reference Rule {A9.9.2-6}, FUSE/CIRCUIT BREAKER MANAGEMENT.

THIS RULE CONTINUED ON NEXT PAGE

FLIGHT RULES

A2.9.1-2 REAL-TIME SAFETY COORDINATION (CONTINUED)

- B. ANY PAYLOAD FAILURES WHICH ORIGINATE FROM PAYLOAD HARDWARE AND DO NOT POSE AN IMMEDIATE THREAT TO ORBITER SYSTEMS OR CREW HEALTH AS DEFINED IN PARAGRAPH A WILL BE COORDINATED BY THE CREW DIRECTLY WITH THE POCC. THE POCC WILL IMMEDIATELY NOTIFY THE MCC OF ANY SITUATION AFFECTING SAFETY (I.E., LOSS OF CONTAINMENT LEVEL, LOSS OF REDUNDANCY, POTENTIAL SHORT WITHIN PAYLOAD HARDWARE, ETC.). IF THE SITUATION IS NOT WITHIN THE SCOPE OF THE PERMISSION-DEFINED FLIGHT RULES AND PROCEDURES, NO ACTION (OTHER THAN REMOVAL OF THE HAZARD POTENTIAL) WILL BE TAKEN WITHOUT FULL AND PRIOR COORDINATION WITH THE MCC.

Safety related payload failures which can be addressed directly between the crew and POCC are those which originate in payload equipment and which do not affect the atmosphere leading to an immediate threat to orbiter systems or crew health. These payload-originated failures must be specifically addressed in permission-defined flight rules and procedures. Although the MCC Flight Director is ultimately responsible for the safety of the orbiter/Spacelab and crew, it is recognized that the POCC has the expertise on and sufficient data/insight into the payload hardware. As soon as the POCC is cognizant of a payload safety situation; however, the MCC must be notified for further assessment of orbiter/Spacelab and crew impacts. The only action(s) which may be taken that is (are) not in the scope of the permission defined flight rules or procedures and without prior coordination with the MCC is (are) to eliminate the hazard cause(s) (i.e., remove power, etc.). For coordination of electrical problems/shorts, reference Rule {A9.9.2-6}, (Spacelab) FUSE/CIRCUIT BREAKER MANAGEMENT.

- C. FLIGHT SPECIFIC EXCEPTIONS TO THE ABOVE RULES ARE DEFINED IN THE FLIGHT SPECIFIC ANNEX. @ED]

A2.9.1-3 GROUND COMMANDING

- A. ALL PAYLOAD COMMANDING WILL BE COORDINATED WITH HOUSTON FLIGHT THROUGH HOUSTON PAYLOADS.

FLIGHT RULES

HOUSTON FLIGHT is responsible for all commanding to the shuttle vehicle, and all commanding must be done with the cognizance of HOUSTON FLIGHT. The specific coordination tasks and configuration authority is usually delegated on Spacelab missions to HOUSTON INCO and HOUSTON PAYLOADS and their support personnel. Payload commanding will be identified permission with POCC command windows reflected in the command timeline. Nominally, the POCC will only be enabled during these permission-defined windows. If off-nominal conditions arise real time which necessitate sending commands outside the permission-defined windows, coordination between the POCC and HOUSTON PAYLOADS will be required to discuss these changes to the Command Timeline during the TDRS pre-pass briefing and/or just prior to the command sequence. As a minimum, the need to use a permission scheduled command window will be identified to HOUSTON PAYLOADS during the TDRS pre-pass briefing.

THIS RULE CONTINUED ON NEXT PAGE

FLIGHT RULES

A2.9.1-3 GROUND COMMANDING (CONTINUED)

- B. NOMINALLY, POCC COMMANDING AND MCC COMMANDING TO THE SAME GPC TWO-STAGE BUFFER WILL BE MANAGED SO THAT ONLY ONE IS COMMANDING AT A TIME.

This method of commanding is the most efficient use of the orbiter and MCC command systems by avoiding command rejects and retransmissions. In order to avoid two-stage buffer contention, the POCC will normally be disabled during MCC commanding to the same GPC two-stage buffer. HOUSTON INCO will notify HOUSTON PAYLOADS when MCC commanding to the two-stage buffer is complete and POCC commanding can resume.

- C. IF COMMAND VOLUMES ARE SUCH THAT COMMAND COORDINATION IS A SIGNIFICANT DETRIMENT TO MISSION SUCCESS, CONSIDERATION WILL BE GIVEN TO ENABLING THE POCC FOR SIMULTANEOUS (SIMO) COMMANDING THROUGHOUT EACH TDRS PASS UNDER THE FOLLOWING CONDITIONS. SIMO COMMANDING MUST BE APPROVED BY HOUSTON FLIGHT.

1. ALL POCC HAZARDOUS COMMANDING WILL BE COORDINATED WITH HOUSTON PAYLOADS PRIOR TO COMMAND INITIATION.
2. THE COMMANDING PARTY IS RESPONSIBLE FOR DETECTING AND RETRANSMITTING ANY LOST COMMANDS.
3. POCC COMMANDING WILL NOT BE PLANNED TO OCCUR DURING CRITICAL ORBITER COMMANDING.
4. LARGE COMMAND BLOCKS (MCC OR POCC) WILL BE COORDINATED.

SIMO commanding includes two or more POCC's enabled for commanding at the same time or one or more POCC's enabled for commanding while the MCC is commanding. SIMO commanding is possible, with the risk that contention over the two-stage buffer by either throughput or two-stage commands may result in the SM GPC rejecting one of the commands. Such commands will not be forwarded to the payload or Spacelab subsystem and may be lost. Either the POCC or the MCC INCO can detect lost commands and retransmit them. This method of commanding is less desirable than a more structured method where contention over the two-stage buffer is procedurally avoided. If the overhead of the coordination is judged to be a significant impact to payload operations and the overhead of retransmitting the commands is judged to be less, consideration will be given to SIMO commanding. Due to safety considerations, hazardous commands must always be coordinated. To avoid loss of critical orbiter or Spacelab subsystem commands, POCC commanding will be planned around these critical commands. Since large blocks of commands require more command system time, more care must be used to avoid two-stage buffer contention and loss of these types of commands; therefore, large command blocks will still require coordination.

FLIGHT RULES

A2.9.1-4

SPACELAB MINIMUM DURATION FLIGHT CRITERIA

MODULE

- A. FOR AN ORBITER FREON LOOP TO SPACELAB WATER (H₂O) LOOP LEAK, THE SPACELAB MODULE WILL BE EGRESSED AND A MINIMUM DURATION FLIGHT (MDF) WILL BE INSTITUTED.

An MDF is called for a heat exchanger leak between dissimilar fluids because the possibility exists that a generic problem, such as corrosion, exists in the heat exchanger. This problem could eventually result in a total loss of the heat exchanger and orbiter due to the subsequent loss of two Freon loops. The risk of losing the heat exchanger does not warrant a next primary landing site (PLS) but does warrant an MDF.

Egress of the Spacelab module is performed to avoid the crew being exposed to toxic Freon 21. Several components in the water loop are incompatible with Freon 21 and may fail to seal or function. These material incompatibilities, in addition to relatively high pressures in the water loop (caused by the Freon loop leaking into the water loop), increase the chances of the water loop developing an external leak into the cabin and exposing the crew to Freon 21.

Reference: Shuttle Operations Data Book (SODB), Volume III, Section 4.6.1.2.1.2.

PALLET ONLY

- B. FOR A SPACELAB FREON AND ORBITER FREON LOOP TO LOOP LEAK, A MINIMUM DURATION FLIGHT WILL BE INSTITUTED.

An MDF is called for a heat exchanger leak between dissimilar fluids because the possibility exists that a generic problem, such as corrosion, exists in the heat exchanger. This problem could eventually result in a total loss of the heat exchanger and orbiter due to the subsequent loss of two Freon loops. The risk of losing the heat exchanger does not warrant a next PLS but does warrant an MDF.

- C. ADDITIONS TO THIS RULE ARE DOCUMENTED IN THE FLIGHT SPECIFIC ANNEX.

FLIGHT RULES

A2.9.1-5 POWERING OFF AND REPOWERING SPACELAB EQUIPMENT

- A. SPACELAB EQUIPMENT WILL BE POWERED OFF IF IT HAS FAILED.
③ED]

Failed equipment will be powered off to prevent possible intermittent operation or shorting. Powering off failed equipment also saves power and cryogenics.

- B. SPACELAB EQUIPMENT WILL BE POWERED OFF TO PREVENT EXCEEDANCE OF QUALIFICATION LIMITS.

Operation to the qualification limits may result in violating program lifetime limits and operation beyond qualification limits may cause damage to Spacelab systems and/or equipment. Qualification limits are given in Rule {A9.9.2-3E}, SPACELAB SS (EXPERIMENT) AC INVERTER MANAGEMENT; Rule {A7.9.2-11}, TEMPERATURE MANAGEMENT; and Rule {11.9.2-9}, COMM TEMPERATURE LIMITS TO POWER OFF.

- C. REPOWERING SPACELAB EQUIPMENT AFTER FAILURE OR AFTER EXCEEDING QUALIFICATION TEST LIMITS WILL BE ON MCC CALL ONLY.

Waiting for a call from MCC allows time for evaluation of the data available on the equipment. Consideration must be given to possible IFM's, trend data, etc., after careful review. Additional consideration must be given to possible damage to orbiter systems, Spacelab systems, or further damage to the affected equipment if repowered.

A2.9.1-6 ORBITER/SPACELAB/EXPERIMENTS THERMAL PRIORITIES

IF CONFLICTS OCCUR, ORBITER THERMAL LIMITS WILL NORMALLY BE PROTECTED AT THE EXPENSE OF SPACELAB THERMAL LIMITS. SPACELAB HAS PRIORITY OVER EXPERIMENTS.

The orbiter thermal limits must always take precedence over the Spacelab to ensure the capability to close the payload bay doors is maintained in support of a contingency deorbit.

A2.9.1-7 ORBITER-TO-SPACELAB PRESSURE INTERFACE MODULE

FOR THOSE OPERATIONS WHICH REQUIRE THE ORBITER INNER AIRLOCK HATCH OR TUNNEL ADAPTER TO TUNNEL HATCH TO BE CLOSED AND LATCHED, ALL CREWMEMBERS ARE REQUIRED TO REMAIN ON THE ORBITER SIDE OF THE CLOSED AND LATCHED HATCH.

Conditions can occur, such as an airlock leak or hatch malfunction, which could trap a crewmember(s) in the Spacelab module. Additionally, the Spacelab module is uncertified as a safe place to be located during entry/landing.

FLIGHT RULES

A2.9.1-8 FIRE/SMOKE IN SPACELAB MODULE

A. FLIGHT CREW RESPONSIBILITIES

1. DUAL SHIFT

- a. THE ON-DUTY MISSION SPECIALIST (MS), PAYLOAD SPECIALIST (PS), AND ORBITER CREWMEMBER WILL ACCOMPLISH ALL REQUIRED EMERGENCY PROCEDURES. ONLY ONE MS AND ONE PS WILL ACCOMPLISH THOSE PROCEDURES IN THE MODULE.
- b. OTHER CREWMEMBERS WILL EXIT THE SPACELAB MODULE AT THE INITIAL SMOKE DETECTOR WARNING.

2. SINGLE SHIFT

- a. THE ON-DUTY MISSION SPECIALIST (MS'S) AND ORBITER CREWMEMBER WILL ACCOMPLISH ALL REQUIRED EMERGENCY PROCEDURES. ONLY THE MS'S WILL ACCOMPLISH THOSE PROCEDURES IN THE MODULE.
- b. THE TWO PAYLOAD SPECIALISTS (PS'S) WILL EXIT THE SPACELAB MODULE WITH THE MIDDECK CREW SEATS, IF APPLICABLE, AT THE INITIAL SMOKE DETECTOR WARNING.

The orbiter crew and on-duty MS's are trained to accomplish all safing of Spacelab systems in the event of an emergency condition. The PS's have not received such training and will evacuate to the orbiter ASAP. In the event that smoke incapacitated a portion of the crew doing the emergency deactivation procedures, a full set of off-duty crewmembers is available to accomplish the entry/landing.

B. FIRE/SMOKE CONFIRMATION

1. CONFIRMATION OF SMOKE DETECTION, AS DEFINED IN RULE {A17.9.2-1}, SPACELAB FIRE/SMOKE DETECTION, OR A VISUAL INDICATION IS REQUIRED PRIOR TO FIRE SUPPRESSION SYSTEM (FSS) OR PORTABLE FIRE EXTINGUISHER BOTTLE(S) DISCHARGE.
2. VISIBLE SMOKE AND/OR FIRE IS A CONFIRMED CONTINGENCY SITUATION WITH OR WITHOUT SMOKE DETECTOR WARNING.

FLIGHT RULES

A secondary cue is mandatory for FSS discharge. Rule {A17.9.2-1}, SPACELAB FIRE/SMOKE DETECTION, defines the cues required to confirm fire/smoke and ensures that action is not taken for a sensor failure.

THIS RULE CONTINUED ON NEXT PAGE

FLIGHT RULES

A2.9.1-8 FIRE/SMOKE IN SPACELAB MODULE (CONTINUED)

C. SPACELAB EMERGENCY BREATHING SYSTEM (SEBS):

1. SEBS WILL BE PARTIALLY DONNED AT THE INITIAL WARNING.
2. THE SEBS WILL BE DONNED AND ACTIVATED ONLY IF FIRE/SMOKE IS CONFIRMED AS DEFINED IN PARAGRAPH B.1.
3. SEBS WILL BE UTILIZED BY THE CREWMEMBER(S) UNTIL THEY EXIT FROM THE SPACELAB MODULE AND HAVE CLOSED/LATCHED THE MODULE/TUNNEL ADAPTER HATCH.

In the context of this rule, partially donned means that the SEBS shall be unstowed and be readied for use without actually putting on the face mask. Hydrogen cyanide (HCN), hydrogen fluoride (HF), hydrogen bromide (HBr), and carbon monoxide (CO) are four potentially toxic thermal degradation products of Halon 1301, insulation, and paint. Levels exceeding the spacecraft maximum allowable concentration criteria (SMAC) limit could be produced from the discharge of a single FSS bottle on a fire. The total amount of HF, HBr, and CO produced depends on the thermal level of the fire. HF and HBr act instantaneously on the mucous membranes of the eye and respiratory tract causing eye irritation with temporary blindness, coughing, and wheezing. Bronchitis and pneumonia may develop hours later. The effects of these two Halogen compounds are additive in their toxicity. Levels of CO and Halon 1301 may exceed toxic levels in the immediate vicinity of the fire and cause crewmember incapacitation.

D. ELECTRICAL POWER/FANS:

1. AT THE FIRST CONFIRMATION OF FIRE/SMOKE, THE CABIN, AVIONICS, AND TUNNEL FANS WILL BE DEACTIVATED.
2. SPACELAB MAIN BUS POWER WILL BE REMOVED AS SOON AS POSSIBLE FOLLOWING CONFIRMATION OF FIRE IN THE MODULE.
3. THE SPACELAB EMERGENCY BUS WILL REMAIN POWERED AFTER THE FSS BOTTLES ARE DISCHARGED FOR A SUFFICIENT TIME TO DETERMINE IF THE SPACELAB MUST BE DEPRESSURIZED.

Removal of main power eliminates the most likely source of fire. Removal of main power is desirable prior to Halon discharge to eliminate the potential for Halon escaping the most likely areas for the cause of the fire and to reduce the chance for the spread of fire by deactivation of the avionics fan.

THIS RULE CONTINUED ON NEXT PAGE

FLIGHT RULES**A2.9.1-8 FIRE/SMOKE IN SPACELAB MODULE (CONTINUED)**

With all fans off, the Spacelab cabin is effectively convection free. Crew movement was addressed by the analysis and was determined to have a negligible effect on overall cabin atmospheric convection with the fans off. With no convection effects, any toxic gases produced as a result of the fire/smoke and Halon suppression will propagate solely by diffusion. Calculation of diffusion rates by Marshall Space Flight Center (MSFC) for HCN, one of the most active of the combustion products, revealed that the velocity drastically decreases in proportion to distance traveled from the point of combustion. For a combustion product level of 100 mg/m³ (which is 100 times the SMAC for a 7-day exposure) produced by the combustion, the velocity at different distances is as follows:

<u>Horizontal distance, cm</u>	<u>Velocity, cm/s</u>
0.01	2420.200
1.00	24.200
10.00	2.420
100.00	0.242
200.00	0.121
400.00	0.0611

This study indicates that even if the gas travels at an average of these velocities, it would take at least 1 hour for the first traces of gas to propagate down the 31.8-foot transfer tunnel. Therefore, with all the fans off, there is no immediate concern about gas transport into the orbiter, and there is adequate time available for the module safing crewmembers to evacuate the module and close the tunnel adapter hatch.

E. FSS BOTTLE/PORTABLE FIRE EXTINGUISHER DISCHARGE :

1. INITIAL DISCHARGE WILL BE LIMITED TO THE "INDICATED" FSS LOCATION(S) (LEFT, RIGHT, SUBFLOOR, CENTERLINE).

This is to limit the exposure of Halon 1301 to crewmembers in the Spacelab module, yet provide adequate fire suppression in the affected area (see paragraph G.2 for additional rationale).

2. AFTER THE SPACELAB IS ISOLATED FROM THE ORBITER, THE REMAINING FSS BOTTLES WILL BE DISCHARGED IF THERE ARE INDICATIONS THAT THE FIRE HAS NOT BEEN SUPPRESSED.

An FSS bottle discharged in the affected rack is designed to fully control combustion in that location. If this is inadequate for some reason, increase in the cabin pressure or change in the PPO₂ will be used as indication that further fire suppression is required and all the FSS bottles will be discharged. If all the FSS bottles are inadequate, then the Spacelab module will be depressurized. Refer to Rule {A17.9.2-1}, SPACELAB FIRE/SMOKE DETECTION, for further actions.

FLIGHT RULES

3. FOR CENTERLINE RACKS OR RACKS NOT PROTECTED BY FSS BOTTLES, THE PORTABLE FIRE EXTINGUISHER WILL BE UTILIZED.

THIS RULE CONTINUED ON NEXT PAGE

FLIGHT RULES

A2.9.1-8 FIRE/SMOKE IN SPACELAB MODULE (CONTINUED)

F. SPACELAB SECURING/STOWING:

1. SPACELAB SECURING/STOWING WILL BE LIMITED TO THAT WHICH IS REQUIRED FOR A SAFE ORBITER ENTRY AND LANDING CONFIGURATION.
2. SPACELAB SECURING MUST INCLUDE VERIFICATION OF THE SPACELAB MANUAL CABIN DEPRESS VALVE OPEN POSITION TO ALLOW SPACELAB DEPRESSURIZATION TO BE CONTROLLED FROM THE ORBITER.

The items secured or stowed are only those which might break loose and damage the module/orbiter in high-load entry cases. These items will be defined for each flight in the Spacelab fire/smoke cue card. Remote depressurization control is required to extinguish a fire in the module if the FSS bottles are inadequate.

G. SPACELAB REPOWERING/REVISIT AFTER DISCHARGE OF EITHER FIXED FSS BOTTLES OR A PORTABLE FIRE EXTINGUISHER WITH CONFIRMATION OF SMOKE/FIRE: @[050495-1764A]

1. AFTER MULTIPLE FSS BOTTLE DISCHARGE:
 - a. THE SPACELAB MAIN BUS WILL REMAIN UNPOWERED FOR THE REMAINDER OF FLIGHT.

When smoke/fire has been confirmed and fixed FSS bottles are discharged, the main power is removed from the Spacelab to eliminate the most likely source of the fire; therefore, it will not be repowered for any reason. Furthermore, if all the Halon bottles had been discharged to suppress the fire, the only means of fire suppression remaining is to depressurize the Spacelab module which is not desirable due to structural lifetime implications. @[050495-1764A]

- b. THE SPACELAB WILL NOT BE REVISITED.

The CO concentration resulting from a fire requiring multiple bottle discharge as well as the Halon 1301 concentration level from multiple FSS bottles, which is on the order of 4.5 to 5 percent, precludes revisit of the Spacelab module for any reason. In addition, Halon 1301 is poorly absorbed by the charcoal in the lithium hydroxide (LiOH) and ambient temperature catalytic oxidizer (ATCO) canisters and cannot be effectively removed from the habitable environment. Habitable environment is defined as the orbiter crew cabin volume plus the Spacelab module volume. @[050495-1764A]

THIS RULE CONTINUED ON NEXT PAGE

FLIGHT RULES**A2.9.1-8 FIRE/SMOKE IN SPACELAB MODULE (CONTINUED)**

It should be noted that results from On-Orbit Flight Techniques have indicated that, with the exception of CO, the burn products from a large amount of material can be reduced to a safe level of concentration within 6 hours. CO is not removed by the LiOH canisters, so it is also important to determine how much was released and whether it was possible to load an ATCO canister prior to evacuation of the Spacelab module. Therefore, it is primarily the Halon 1301 concentration constraint that precludes the revisit of the module. This is based on human studies that have shown adverse central nervous system effects beginning at concentrations greater than 1 percent. In addition, the studies have shown that adverse cardiovascular reactions occur at concentrations greater than 5 percent.

2. SINGLE FSS BOTTLE/PORTABLE FIRE EXTINGUISHER DISCHARGE
 - a. ALL POWER BUSES EXCEPT THE EMERGENCY BUS WILL BE UNPOWERED.
 - b. THE MODULE WILL NOT BE REVISITED.

Discharge of a portable fire extinguisher into an experiment rack or into the open Spacelab module atmosphere will produce a rapid equilibration with the module atmosphere. A Halon 1301 concentration of approximately 0.3 percent (3000 ppm) will be rapidly achieved in the Spacelab module; a concentration of approximately 0.14 percent - 0.18 percent (1400 - 1800 ppm) will be achieved in the habitable environment (habitable environment is defined as the orbiter crew cabin volume plus the Spacelab module volume). Even though the 0.3 percent is well below the tested limit of 1 percent, it is still a constraint after all burn products except CO have been removed from the atmosphere by the Spacelab LiOH since no specific tests have been conducted beyond 24 hours at lesser concentrations. @[050495-1764A]

- H. FOR PLANNED OR ACCIDENTAL DISCHARGE OF A PORTABLE FIRE EXTINGUISHER INTO THE OPEN SPACELAB MODULE ATMOSPHERE, A FIXED FSS BOTTLE INTO ANY OF THE SPACELAB "INDICATED" FSS LOCATIONS, OR DETECTION OF A LEAKING PORTABLE FIRE EXTINGUISHER/FIXED FSS BOTTLE, WITH NO SMOKE/FIRE CONFIRMATION, THE CREW MAY BE EXPOSED TO THE HABITABLE ENVIRONMENT UNTIL NOMINAL END OF MISSION. REAL-TIME DISCUSSION OF MISSION DURATION OR EXTENSION WILL BE DEPENDENT UPON SUCH FACTORS AS CREW SYMPTOMS AND/OR PERFORMANCE. @[050495-1764A]

THIS RULE CONTINUED ON NEXT PAGE

FLIGHT RULES

A2.9.1-8 FIRE/SMOKE IN SPACELAB MODULE (CONTINUED)

The above criterion was established based upon information from NASA's Halon 1301 Human Inhalation Study (reference JSC-23845, August 1989), the National Research Council (NRC), and JSC Toxicology Group. The human study involved exposing eight volunteers to Halon 1301 for a period of 24 hours at a concentration of 1 percent (10,000 ppm). The effects on both physiology and performance were studied using a computerized battery of tests on reaction time, decision-making, etc. No significant changes in any physiological parameters were noted. There were no alterations of any blood counts or chemistries, no pulmonary function changes, no cardiac dysrhythmias, and no mental status changes. There were no significant biological decrements in performance recorded from the pre-exposure baselines. Based on this study, exposure of crewmembers to Halon concentration levels above 1 percent is not recommended.

As a result of recommendations published in the "Documentation of the Spacecraft Maximal Allowable Concentration Values on Bromotrifluoromethane" (White Paper; JSC Toxicology Group), the NRC approved revised SMAC levels for Halon 1301 on November 18, 1993. These guidelines state that for 24-hour exposure, the SMAC level is 0.35 percent (3500 parts per million), and for 7-day, 30-day, and 180-day exposure, the SMAC level is 0.18 percent (1800 ppm). The JSC Toxicology Group sponsored the mentioned study and established SMAC levels with approval from the NRC.

Discharge of a portable fire extinguisher into the open Spacelab module will produce an equilibration with the habitable environment. Habitable environment is defined as the orbiter crew cabin volume plus the Spacelab module volume. A Halon 1301 level of approximately 0.14 percent (1400 ppm) will be achieved, and based on the SMAC values mentioned above, the crewmembers can be exposed to this environment until nominal end of mission.

Discharge of a fixed FSS extinguisher or a portable fire extinguisher into the left/right experiment racks, centerline racks, or the subfloor will produce an equilibration with the habitable environment. A Halon 1301 level of approximately 0.18 percent (1800 ppm) will be achieved in approximately 100 hours, and based on the SMAC values mentioned above, the crewmembers can be exposed to this environment for 7 days or longer from the time of discharge.

A real-time decision to possibly land earlier than nominal EOM will be made by MCC after the crew has been exposed to Halon 1301. Although Halon concentrations of 0.14 - 0.18 percent are less than or equal to the above mentioned SMAC values for exposure to Halon 1301, the actual mission duration or extension is dependent upon such factors as crew symptoms and/or performance. ©[05/04/95-1764A]

A2.9.1-9 ORBITAL MANEUVERING SYSTEM/REACTION CONTROL SYSTEM (OMS/RCS) CONSTRAINTS

ORBITAL MANEUVERING SYSTEM/REACTION CONTROL SYSTEM (OMS/RCS) CONSTRAINTS ARE EXPERIMENT COMPLEMENT DEPENDENT AND ARE DOCUMENTED IN THE FLIGHT SPECIFIC ANNEX.

FLIGHT RULES

A2.9.1-10 ELECTRICAL POWER DISTRIBUTION SYSTEM CONSTRAINTS

- A. POWER MANAGEMENT - ON-ORBIT SPACELAB EXPERIMENT POWER LEVELS WILL BE MANAGED BY THE PAYLOAD OPERATIONS DIRECTOR (POD) AND WILL BE MAINTAINED WITHIN ACCEPTABLE ORBITER CRYOGENIC CONSUMABLE PREDICTIONS, HEAT REJECTION CAPABILITY, AND VOLTAGE MARGINS AS DETERMINED BY THE MCC FLIGHT DIRECTOR.

Spacelab is allotted a specific quantity of energy determined preflight and may use this energy as long as the Spacelab operations do not compromise the normal orbiter system operations.

- B. THE FOLLOWING SPACELAB EQUIPMENT MAY BE MANAGED TO CONSERVE ELECTRICAL POWER CONSUMPTION:
1. PAYLOAD RECORDER
 2. VIDEO SYSTEM COMPONENTS
 3. EITHER DATA DISPLAY SYSTEM (DDS)
 4. WORK BENCH LIGHTS
 5. MODULE LIGHTS
 6. EXPERIMENT INVERTER

These pieces of equipment are not always essential for nominal Spacelab operation and; therefore, may be powered on and off as needed to reduce electrical power loads. The experiment inverter may be turned off when single inverter operations do not adversely affect subsystem and/or experiment operations.

- C. WHEN SPACELAB IS REQUIRED TO BE POWERED DURING ASCENT/ENTRY, THE ASCENT/ENTRY CONFIGURATION FOR THE ORBITER TO SPACELAB WILL BE:
1. PAYLOAD PRIMARY MAIN BUS C (MNC) - ON (PROVIDING POWER TO THE SPACELAB) . @[111094-1697A]

Payload primary MNC is the standard power source for payload power.

MODULE

2. AUX PAYLOAD MNA/MNB - ON

When the Spacelab module is powered, smoke detection/suppression capability must exist. The AUX busses provide emergency power in the Spacelab for smoke detection/suppression.

THIS RULE CONTINUED ON NEXT PAGE

FLIGHT RULES

A2.9.1-10 ELECTRICAL POWER DISTRIBUTION SYSTEM CONSTRAINTS
(CONTINUED)

D. THE ON-ORBIT CONFIGURATION FOR THE ORBITER TO SPACELAB WILL BE:

1. PAYLOAD PRIMARY MNC - ON (PROVIDING POWER TO THE SPACELAB).

Rationale same as for paragraph C.1. [ED]

2. MNB TIED TO MNC.

For a fully activated Spacelab on orbit, MNB is tied to MNC in accordance with orbiter All Flights Rule {A9.1.3-7A.4, MAIN BUS TIE (CIL), covering extended on-orbit operation of a payload requiring ≥ 4 kW. [111094-1697A]}

After a powerdown of orbiter equipment to accommodate the payload power requirements, the orbiter will still require approximately 4 kW power per fuel cell (FC). With the addition of a payload power demand of 4 kW on a single fuel cell, about 1 kW of the total load will shift to the other FC due to the dioded load sharing. The total load remaining on the fuel cell will be approximately 7 kW which is the SODB maximum limit for continuous power from a fuel cell. Therefore, payload power demands greater than 4 kW require two buses tied so that additional load can be shared between two FC's.

DOCUMENTATION: SODB, 3.4.4.1.2 and engineering judgment.

3. AUX PAYLOAD MNA/MNB ON [111094-1697A]

AUX PAYLOAD MNA/MNB is required to provide emergency power in the Spacelab module for smoke detection/fire protection.

4. EXCEPTIONS TO THIS RULE ARE DOCUMENTED IN THE FLIGHT SPECIFIC ANNEX. [111094-1697A]

E. SPACELAB POWER SYSTEM RECONFIGURATION AND/OR MALFUNCTION PROCEDURES WILL BE COORDINATED WITH THE POD TO ALLOW EXPERIMENT SAFING IF TIME PERMITS.

Any Spacelab power system reconfiguration and/or malfunction could interrupt power to an experiment. Such an unexpected interruption of power could cause damage to the experiment. The POD should be notified of any Spacelab power system reconfiguration or troubleshooting if the time needed to do so would not adversely affect the systems actions required. This information would make it possible for the POD to direct the appropriate experiment safing actions to be performed. A controlled safing procedure would increase the probability of future successful experiment operations.

FLIGHT RULES

A2.9.1-11 WATER DUMP MANAGEMENT

- A. WITHIN H₂O MANAGEMENT CONSTRAINTS, WATER DUMPS WILL BE INHIBITED DURING ANY TIME PERIODS THAT SPACELAB EXPERIMENTS REQUIRE MICROGRAVITY CONTROL PERIODS OR A PAYLOAD HAS CONTAMINATION RESTRAINTS.

The above is a general rule. Normally all water dump inhibits will be coordinated with the POD.

- B. EXCEPTIONS TO THIS RULE ARE DOCUMENTED IN THE FLIGHT SPECIFIC ANNEX.

A2.9.1-12 COMMAND AND DATA SYSTEM CONSTRAINTS

- A. THE SUBSYSTEM AND EXPERIMENT COMPUTER FUNCTIONS ARE NOT A CONSTRAINT TO SAFE CONTINUATION OF THE FLIGHT.

While the subsystem (SS) and experiment (EXP) data processing assembly (DPA) are essential to the mission success of any Spacelab flight, the loss of either or both does not impact crew safety in any way. Class 1 and 2 Spacelab parameters are redundantly monitored by the orbiter SM GPC via PL or Flexible (FLEX) multiplexer/demultiplexer (MDM), so no loss of function is incurred, only a loss of redundancy.

- B. FOR ORBITER-SPACELAB SERIAL I/O LINK FAILURES, ORBITER RECONFIGURATION TO ISOLATE AND RECOVER THE LOSS WILL BE ATTEMPTED PRIOR TO ANY SPACELAB RECONFIGURATION.

By troubleshooting the orbiter side of these serial interfaces (pulse code modulation master unit (PCMMU) and PL MDM) first, Spacelab experiment operations are impacted to a lower degree. In the case of the PCMMU interface, the MCC will lose Spacelab subsystem data if a PCMMU switch occurs during troubleshooting, but the POCC will incur no loss of science data from their high rate multiplexer (HRM) link. In the case of the PL MDM interface, MDM port moding and other troubleshooting on the orbiter side may temporarily cause a loss of Spacelab commanding and state vector transfers, but science data may not be impacted. Spacelab subsystem input/output (SSIO) and experiment input/output (EXIO) coupler switching to regain a PCMMU or MDM interface will be negotiated for a timely recovery based on minimal operations impact. ©[071494-1642A]

THIS RULE CONTINUED ON NEXT PAGE

FLIGHT RULES

A2.9.1-12 COMMAND AND DATA SYSTEM CONSTRAINTS (CONTINUED)

C. IN-FLIGHT SOFTWARE MAINTENANCE:

Reference: Letter of Agreement for In-Flight Software Maintenance Support for Spacelab, DF/83-91, 9/27/83.

1. SPACELAB COMPUTER MEMORY WRITES (PATCHES) MAY BE PERFORMED WHEN REQUIRED TO REGAIN OPERATIONAL CAPABILITY NECESSARY TO SATISFY FLIGHT AND EXPERIMENT OBJECTIVES.

When recovery of normal baselined operations is unsuccessful through the use of standard procedures and system reconfigurations, the in-flight modification of software (patching) will be considered.

2. MCC WILL SUPERVISE IMPLEMENTATION OF ALL MEMORY WRITES.

The MCC is responsible for the health/maintenance of the space shuttle and Spacelab subsystems in flight with the command and data management system (CDMS) console operators responsible for all CDMS reconfiguration. Hence, all software patching commands requiring physical addressing will be supervised by the MCC CDMS operators after concurrence by the Flight Director.

3. ALL MEMORY WRITES WILL BE VERIFIED BY THE HUNTSVILLE OPERATIONS SUPPORT CENTER (HOSC) PRIOR TO IMPLEMENTATION.

Most of the system support and all of the simulation support required for detailed software analysis, patch assembly, and verification resides at the MSFC HOSC during flight. Examination of possible areas to modify software and the transfer of the final patch data to the MCC will occur over established MCC/HOSC communication routes.

A2.9.1-13 SPACELAB CAUTION AND WARNING (C&W) ANNUNCIATION MODULE

LOSS OF SPACELAB MODULE CAUTION AND WARNING ANNUNCIATION CAPABILITY IN THE SPACELAB MODULE IS NOT CAUSE TO TERMINATE SPACELAB ACTIVITIES PROVIDED ANNUNCIATION EXISTS IN THE ORBITER.

All Class 1 and 2 emergency-type parameters are redundantly monitored by the subsystem computer operating system (SCOS) in Spacelab and SM in the orbiter. In addition, both of these monitoring systems cause annunciating in both Spacelab and the orbiter. Loss of the Spacelab module C&W annunciating capability is therefore only a loss of redundancy, not of function. The orbiter crew would be able to alert the Spacelab crew of any emergencies.

FLIGHT RULES

A2.9.1-14 COMMUNICATIONS (COMM) CONSTRAINTS

- A. THE KU-BAND SYSTEM IS NOT A CONSTRAINT TO CONTINUATION OF THE FLIGHT. EXCEPTIONS TO THIS RULE ARE DOCUMENTED IN THE FLIGHT SPECIFIC ANNEX.

The loss of the Ku-band system does not represent a safety hazard. All safety-related activities can be carried out via the S-band system. Loss of the Ku-band system may be a severe impact to payload operations and mission objectives but by itself is no reason to terminate the flight early.

SPACELAB MODULE

- B. LOSS OF VOICE COMM BETWEEN THE ORBITER AND SPACELAB CREWMEMBERS IS NOT CAUSE TO TERMINATE SPACELAB OPERATIONS.

The loss of voice comm between the orbiter and the Spacelab module does not by itself represent a safety hazard. Orbiter caution and warning tones are still available via the dedicated speaker in the module and Spacelab tones are available from the Spacelab aural annunciator (SAA). Coordination can be carried out by voice calls down the tunnel or very probably by using a wireless crew comm unit (WCCU) connected in the airlock. Communication with the POCC would only be possible via a WCCU connected in the airlock. Spacelab operations may be impacted but may be continued in the best possible way. Running a comm hardline through the tunnel is not an option as it would interfere with hatch operations if a module evacuation was required.

A2.9.1-15 PAYLOAD IN-FLIGHT MAINTENANCE (IFM) PROCEDURES

IN SUPPORT OF ALL FLIGHTS RULE {A2.1.3-4}, IN-FLIGHT MAINTENANCE (IFM), PAYLOAD UNSCHEDULED IFM PROCEDURES WHICH HAVE BEEN PRE-MISSION COORDINATED AND REQUIRE ONLY REAL-TIME APPROVAL PRIOR TO IMPLEMENTATION AS WELL AS IFM PROCEDURES WHICH DO NOT REQUIRE REAL-TIME APPROVAL OR COORDINATION PRIOR TO IMPLEMENTATION ARE DOCUMENTED IN THE FLIGHT SPECIFIC ANNEX.

A2.9.1-16 IFM PROCEDURES ON EXPERIMENTS WITH TOXIC HAZARDS

SPACELAB MODULE

NO IFM PROCEDURES WILL BE INITIATED BY THE CREW ON AN EXPERIMENT KNOWN TO REPRESENT A TOXIC HAZARD UNTIL CONCURRENCE FOR THE REPAIR PROCEDURE IS OBTAINED FROM THE MCC FLIGHT DIRECTOR. SPACELAB EVACUATION AND/OR PROTECTIVE EQUIPMENT MAY BE REQUIRED (SEE RULE {A13.1.2-16}, SPACEHAB/SPACELAB HAZARDOUS SUBSTANCE SPILL RESPONSE). ALL PAYLOAD EXPERIMENTS/SAMPLES CONTAINING HAZARDOUS MATERIALS ARE DEFINED IN THE FLIGHT SPECIFIC ANNEX. ©[111094-1715]

FLIGHT RULES

A2.9.1-17 SAFE ATMOSPHERE REQUIREMENTS PREFLIGHT

SPACELAB MODULE

THE SPACELAB MODULE ATMOSPHERE IS CERTIFIED SAFE FOR CREW ENTRY A MAXIMUM OF 30 HOURS AFTER THE SCHEDULED LIFT-OFF TIME IF TRACE CONTAMINANT REMOVAL IS PROVIDED TO THE MODULE AIR PRELAUNCH.

Preflight trace contamination removal is provided either by an external air source or by a module air circulation system as specified in Operations and Maintenance Requirements and Specifications (OMRS) P430 requirements RP430 DB.211 and RP430 DB.212. The OMRS requirements are based on outgassing studies by MSFC and JSC and provide safe contaminant levels for a 24-hour launch hold and a 6-hour on-orbit delay prior to Spacelab entry.

A2.9.1-18 EVA

A. THE FLIGHT SUCCESS EVA PLANNING CONSTRAINTS ARE LISTED BELOW. (FLIGHT-SPECIFIC ADDITIONS TO THIS RULE ARE DOCUMENTED IN THE FLIGHT SPECIFIC ANNEX.) @[022493-1476]

1. NO SCHEDULED EVA WILL BE PERFORMED PRIOR TO MISSION ELAPSED TIME (MET) 72 HOURS.

During adaptation to zero-g conditions, moving about may provoke symptoms of illness. The activity associated with putting on a suit would increase the chance of an EVA crewmember being ill and potentially endanger the crewmember with vomitus in the suit.

2. UNSCHEDULED EVA'S:
 - a. NO UNSCHEDULED EVA SHALL OCCUR DURING THE FIRST 24 HOURS OF FLIGHT.
 - b. AN UNSCHEDULED EVA MAY BE PERFORMED PRIOR TO MET 72 HOURS ONLY IF AN ASSESSMENT OF CREW HEALTH HAS BEEN ACCOMPLISHED BY THE FLIGHT CONTROL ROOM (FCR) SURGEON AND APPROVED BY THE FLIGHT DIRECTOR.

A symptomatic crewmember may be able to safely perform an unscheduled EVA before MET 72 hours. An accurate assessment of the health status of the EVA crew can be made by the FCR surgeon during private medical conference.

THIS RULE CONTINUED ON NEXT PAGE

FLIGHT RULES**A2.9.1-18 EVA (CONTINUED)**

3. IN THE EVENT THAT A SPACELAB MODULE, OR PAYLOAD FAILURE WOULD PLACE AN ELEMENT OR SUBSYSTEM ONE FAILURE AWAY FROM AN UNSCHEDULED EVA, A SUCCESSFUL EXTRAVEHICULAR MOBILITY UNIT (EMU) CHECKOUT MUST BE CONDUCTED PRIOR TO CONTINUING OPERATIONS TO EOM MINUS 2 DAYS (REFERENCE ALL FLIGHTS RULE {A15.1.1-15}, CONTINGENCY EVA PROTECTION, AND RULE {A15.1.1-19}, UNSCHEDULED EVA PREPARATION). @[022493-1476]

If an EMU failed during checkout, the remaining EMU must be preserved for the support of orbiter contingency EVA's and; therefore, no unscheduled EVA is available. In this case, the Spacelab Module, or payload must cease operation and be placed in a safe entry configuration.

4. NO SCHEDULED OR UNSCHEDULED EVA SHALL BE PERFORMED ON ENTRY DAY. @[022493-1476]
- a. FOR A FLIGHT USING A SINGLE CREW SHIFT, A SCHEDULED OR UNSCHEDULED EVA MAY BE PERFORMED ON THE DAY BEFORE ENTRY ONLY IF AIRLOCK INGRESS IS COMPLETED NOT LATER THAN CREW SLEEP MINUS 7 HOURS.
- b. FOR A FLIGHT USING DUAL SHIFT OPERATIONS, A SCHEDULED OR UNSCHEDULED EVA MAY BE PERFORMED ON THE DAY BEFORE ENTRY ONLY IF AIRLOCK INGRESS IS COMPLETED NOT LATER THAN CREW SLEEP (NONENTRY TEAM) MINUS 4.5 HOURS.

An EVA may be done on the day before entry if there is adequate time post-EVA to perform required activities. These activities include airlock repress, post-EVA, EMU maintenance recharge, post-EVA entry prep, cabin stow, and presleep. Seven hours is considered the minimum amount of time to accomplish these activities for a single shift flight. FCS C/O, RCS hot fire, and cabin repress activities must also be performed but can be overlapped with post-EVA and cabin stow activities. For an unscheduled EVA on the day before entry, it will be necessary to perform this EVA as a "quick response" EVA (i.e., the EMU C/O and cabin depress will need to be done on the day prior to the EVA). For a dual shift flight, 4.5 hours is considered the minimum due to cabin stow occurring on entry day for the nonentry team.

- B. ANY EXPERIMENT WHICH CREATES A HAZARD TO CREW SAFETY DURING EVA WILL BE DISCONTINUED DURING EVA.

Self-explanatory.

THIS RULE CONTINUED ON NEXT PAGE

FLIGHT RULES

A2.9.1-18 EVA (CONTINUED)

C. PREBREATHING REQUIREMENTS:

MODULE

1. EVA PREBREATHING WILL BE ACCOMPLISHED PER THE PREBREATHE PROTOCOL IN ALL FLIGHTS RULE {A13.1.2-7A.2}, EVA PREBREATHE PROTOCOL (IN-SUIT OPTION).

PALLET

2. EVA PREBREATHING FOR PALLET FLIGHTS WILL BE ACCOMPLISHED PER THE PREBREATHE PROTOCOL IN ALL FLIGHTS RULE {A13.1.2-7A.2}, EVA PREBREATHE PROTOCOL (10.2 PSI CABIN OPTIONS), EXCEPT AS DESCRIBED IN PARAGRAPH C3. REFERENCE RULE {A17.9.6-9, 10.2 PSI AFT FLIGHT DECK OPERATIONS. @[022493-1478A]}

All breathing options in paragraphs 1 and 2 produce the same denitrogenation of all crewmembers (R=1.65). The R value is the ratio of tissue nitrogen (N₂) prior to decompression to the final ambient pressure. The R value is a measure of risk for decompression sickness. The oxygen (O₂) prebreathe displaces nitrogen from the tissues and blood thus lowering the risk of decompression sickness at low ambient pressure. The 10.2 psi cabin option is always preferred and will be used unless a specific flight carries equipment that cannot be exposed to a 10.2 psi cabin atmosphere and must continue to operate throughout the EVA.

Prebreathe for module operations will normally use in-suit prebreathe rather than lowering the cabin to 10.2 psi because not all of the aft flight deck hardware can operate at 10.2 psi cabin pressure. The DDS is required to control/monitor Spacelab experiments left operating in the Spacelab module during the time the Spacelab hatch is closed during EVA. Reference paragraph N. For Spacelab pallet EVA cases, 10.2 psi prebreathe protocol requires the Spacelab DDS's be powered down for thermal reasons. This precludes nominal pallet operations and science gathering via the aft flight deck (AFD) DDS during the prebreathe period. Using POCC commanding would allow experiment operations to continue during the 10.2 psi prebreathe period. The crew would not have insight into any experiment failures during this operational mode. However, they would have insight into pallet operations via the GPC. The POCC would have to assume full responsibility for initiating the appropriate reaction to any experiment anomalies with the exception of any flight-specific experiment safety-critical commanding or monitoring. Such experiment operations must be approved through the MCC and shall be specifically addressed in flight-specific flight rules. Once EVA actually begins, the Spacelab pallet and experiment operations would have to be terminated. @[022493-1478A]

THIS RULE CONTINUED ON NEXT PAGE

FLIGHT RULES

A2.9.1-18 EVA (CONTINUED)

3. THE 14.7 PSI PREBREATHE PROTOCOL SHALL BE CONSIDERED OVER THE 10.2 PSI PREBREATHE PROTOCOL FOR THE CASE IN PARAGRAPH a BELOW.
 - a. AN END-OF-MISSION EVA REQUIRED TO STOW THE PAYLOAD WHERE THE NEED FOR THE EVA WAS DISCOVERED ON EOM MINUS 1 DAY.
 - b. EXCEPTIONS TO THIS OPTION ARE DOCUMENTED IN THE FLIGHT SPECIFIC ANNEX.

If the need for the EVA is discovered late (i.e., at the nominal stow time at EOM minus 12 hours), the 14.7 psi protocol allows for the EVA and a landing on EOM plus 1 day (only 1 extension day required for the EVA). The 10.2 psi protocol requires extra time and allows a landing no sooner than EOM plus 2 days (uses both extension days). The 14.7 psi protocol will be used rather than use both extension days for the EVA.

The 10.2 psi protocol requires the Spacelab DDS's be powered down for thermal reasons. This precludes science data gathering during the prebreathe period. Once EVA begins, experiment operations would have to be terminated. ©[022493-1478A]

MODULE

- M. EVA WILL NOT BE PERFORMED WITH A CREWMEMBER(S) IN THE SPACELAB MODULE.

Conditions can occur, such as an airlock leak, Spacelab module leak, or hatch malfunction, which could trap a crewmember(s) in the Spacelab module. Additionally, the Spacelab module is uncertified as a safe place to be located during entry/landing.

MODULE

- N. FOR AN EVA, DUAL SHIFT OPERATION MAY CONTINUE UP UNTIL APPROXIMATELY 1 HOUR FROM EVA EGRESS. AT THAT TIME, ALL SPACELAB EXPERIMENTS WHICH CANNOT RUN UNATTENDED OR BE MONITORED/CONTROLLED BY THE AFT FLIGHT DECK DDS (IF FLOWN) WILL BE TERMINATED AND POWERED DOWN. IN ADDITION, THOSE SPACELAB STOWAGE ACTIONS REQUIRED FOR A SAFE ORBITER ENTRY AND LANDING CONFIGURATION WILL BE ACCOMPLISHED PRIOR TO SPACELAB TUNNEL HATCH CLOSURE.

THIS RULE CONTINUED ON NEXT PAGE

FLIGHT RULES

A2.9.1-18 EVA (CONTINUED)

In the event the tunnel is unable to be repressurized or the tunnel adapter hatch is unable to be reopened, the Spacelab module and certain experiments can be powered down by the aft flight deck DDS or ground command. For the same conditions, Spacelab stowage of certain items is required to preclude damage to the Spacelab module, or possibly the orbiter, for high-entry load conditions.

MODULE

- O. EVA PREBREATHING FOR AN ORBITER CONTINGENCY EVA (WITH THE SPACELAB MODULE CLOSED OUT) WILL BE ACCOMPLISHED PER THE PREBREATHE PROTOCOL IN ALL FLIGHTS RULE {A13.1.2-137B}, EVA PRE-BREATHE PROTOCOL.

Reference All Flights Rule {A13.1.2-11B}, EVA PREBREATHE PROTOCOL, rationale.

- P. EXCEPTIONS TO THIS RULE ARE DOCUMENTED IN THE FLIGHT SPECIFIC ANNEX.

A2.9.1-19 EQUIPMENT EXCHANGE BETWEEN ORBITER CABIN AND SPACELAB

MODULE

ELECTRICAL EQUIPMENT OR EXPERIMENTS, SELF-POWERED OR FACILITY-POWERED, SHALL NOT BE TRANSFERRED BETWEEN THE ORBITER CABIN AND THE SPACELAB UNLESS CERTIFIED FOR USE IN BOTH LOCATIONS. APPROVED EQUIPMENT WILL BE IDENTIFIED IN THE FLIGHT SPECIFIC ANNEX.

This includes orbiter government furnished equipment (GFE), orbiter middeck (MDK) experiments, and Spacelab middeck experiments (SMIDEX). The concern is for power budgeting and for electromagnetic compatibility.

Conducted and radiated emissions of portable equipment must be compared against the conducted and radiated susceptibility of the equipment in all the locations where it is used. This will avoid potential data loss, equipment upset, and damage. Approved equipment will be identified in the flight specific annex.

References:

- a. GFE: SL-E-0002, NSTS Electromagnetic Interference Characteristics, requirements for equipment. (Does not require Spacelab certification.)
- b. MDK: NSTS 21000-IDD-MDK, Shuttle/Payload Interface Definition Document for Middeck Experiments. (Does not require Spacelab certification.)

FLIGHT RULES

THIS RULE CONTINUED ON NEXT PAGE

FLIGHT RULES

A2.9.1-19 EQUIPMENT EXCHANGE BETWEEN ORBITER CABIN AND SPACELAB (CONTINUED)

- c. *SPAH: Spacelab Payload Accommodation Handbook, SLP-2104.*
- d. *MSFC 521B: Electromagnetic Compatibility Requirements on Spacelab Payload Equipment.*
- e. *SMIDEX: JSC-23418, Spacelab Middeck Experiments Accommodations Handbook. (Requires MDK certification.)*

A2.9.1-20 SPACELAB MODULE/TUNNEL SLEEP CONSTRAINTS

MODULE

- A. NO CREWMEMBER SHALL SLEEP IN THE SPACELAB-TO-ORBITER TUNNEL.

In the event it was necessary to rapidly evacuate the module, a sleeping crewmember either tethered or in a sleeping bag would pose a hazard. In addition, the tunnel does not offer the same amount of protection for radiation that is provided by the module or orbiter cabin.

- B. CREWMEMBERS MAY SLEEP IN THE SPACELAB MODULE IF:
1. THE CDMS SYSTEM IS ACTIVE FOR GROUND MONITORING OF SPACELAB SYSTEMS.
 2. THE MODULE STOWAGE HAS BEEN CONFIGURED IN A SAFE ENTRY CONFIGURATION.

Since there is no orbiter fault detection annunciation (FDA) monitoring of experiment parameters, the CDMS needs to be active to provide FDA/annunciation. In addition, SN/space radiation has a model for the Spacelab module and there is no appreciable difference in the amount of radiation provided compared to the orbiter cabin. The Payload Safety Panel requires that the module be in a safe entry configuration such that rapid egress can be accomplished according to Rule {A2.9.1-23}, SPACELAB DEACTIVATION.

FLIGHT RULES

A2.9.1-21 COMMANDER (CDR), PILOT (PLT), AND MISSION SPECIALIST (MS) 2 PARTICIPATING AS TEST SUBJECTS

THE CDR, PLT, AND MS2 MAY PARTICIPATE AS TEST SUBJECTS ON A VOLUNTEER BASIS AND AS NEGOTIATED PREFLIGHT. THE CDR MAY NOT PARTICIPATE AS A TEST SUBJECT IN ANY EXPERIMENT OF A PROVOCATIVE OR DISORIENTING NATURE. THE CDR AND PLT MAY NOT SIMULTANEOUSLY PARTICIPATE IN ANY EXPERIMENT THAT IS PHYSICALLY RESTRAINING (RECOVERY TIME, IF ANY, MUST BE INCLUDED). MS2 MAY NOT PARTICIPATE AS A TEST SUBJECT IN ANY EXPERIMENT OF A PROVOCATIVE, DISORIENTING, OR PHYSICALLY RESTRAINING NATURE WHILE MS2 IS THE ON-DUTY ORBITER CREWMEMBER ON DUAL-SHIFT FLIGHTS.

This is to ensure that the CDR, PLT, or MS2 is always available to handle emergencies or other actions. Crews participate on a volunteer basis and typically the CDR, PLT, and MS2 do not participate in experiments that are provocative or disorienting anyway. This rule allows the PLT and MS2 to do so if they wish but forbids the CDR to do so. Participation in experiments that are physically restraining is allowed as long as both the CDR and PLT do not do so at the same time. This rule is to ensure an orbiter crewmember is always available. This rule assumes the normal pairing of orbiter crewmembers on dual-shift flights, the CDR and PLT together and MS2 on the other shift.

A2.9.1-22 ORBITER CREW ASSISTING IN THE MODULE

THE ORBITER CREWMEMBERS (CDR, PLT, MS2) MAY ASSIST IN OPERATIONS IN THE SPACELAB MODULE OR SERVE AS TEST SUBJECTS (SUBJECT TO RULE {A2.9.1-22}, COMMANDER (CDR), PILOT (PLT), AND MISSION SPECIALIST (MS) 2 PARTICIPATING AS TEST SUBJECTS) AS NEGOTIATED PREFLIGHT.

THE ORBITER CABIN WILL NORMALLY BE ATTENDED BY A NASA (NONPAYLOAD SPECIALIST) CREWMEMBER. THE CABIN MAY BE LEFT UNATTENDED (ENTIRE WAKING CREW IN MODULE) FOR BRIEF PERIODS (MAXIMUM OF 30 MINUTES) PROVIDED ALL OF THE FOLLOWING CONDITIONS ARE MET BY AT LEAST ONE OF THE WAKING ORBITER CREWMEMBERS (MS2, PLT, OR CDR).

- A. COMM IS CONFIGURED SO THE CREWMEMBER IS ON A HEADSET AND CAN HEAR ORBITER ALERT TONES AND THE MCC (EITHER A/G 1 OR A/G 2).

THIS RULE CONTINUED ON NEXT PAGE

FLIGHT RULES

A2.9.1-22 ORBITER CREW ASSISTING IN THE MODULE (CONTINUED)

- B. THE CREWMEMBER IS NOT PHYSICALLY RESTRAINED IN ANY WAY AND CAN IMMEDIATELY RETURN TO THE ORBITER CABIN.

This rule is intended to allow orbiter crewmembers to assist the crew in the module. Often on Spacelab flights, the orbiter crew is lightly loaded and the module crew is very busy. Using the orbiter crew for photography (as on STS-42) or as an extra pair of hands (as on STS-50) can be very valuable. Note that this rule allows the entire crew to be in the module at the same time or the entire crew that is awake (others sleeping in the sleep stations on the middeck) to be in the module at the same time.

These restrictions are designed so the CDR or PLT or MS2 is always available to respond to orbiter contingencies without delay. The crewmember must be on a headset since that allows tones or the MCC to be heard while in the tunnel away from the speakers. The crew normally uses the wireless comm system in the orbiter which also works in the module. This allows the crew to hear orbiter alert tones (Master Alarm, SM Alert) through two routes, the speaker in Spacelab and the headset. Klaxon and siren are audible via dedicated speakers in the module and orbiter cabin.

Experience on orbit has shown a crewmember can translate from the module to the flightdeck in less than 30 seconds. This is similar (maybe faster) than the response if the entire crew were asleep on a single-shift flight. Procedurally, the on-duty crewmember will notify the MCC when leaving the orbiter cabin unattended. The MCC will alert the duty crewmember of any problems that might cause an alarm, "catch up" on any pending actions before the crewmember leaves the orbiter cabin, and hold any non-time-critical items until the crewmember returns.

A2.9.1-23 SPACELAB DEACTIVATION

SPACELAB DEACTIVATION WILL PROCEED BY ONE OF THE FOLLOWING METHODS DEPENDING ON CIRCUMSTANCES:

- A. NORMAL DEACTIVATION – SECURING OF THE SPACELAB BY NOMINAL CHECKLIST PROCEDURES. A PROCEDURE WHICH ACCOMPLISHES THE ABOVE SHOULD BE DONE FOR THE FOLLOWING:
1. NOMINAL END-OF-MISSION DEACTIVATION
 2. ANY FAILURE THAT RESULTS IN A PRIMARY LANDING SITE (PLS) WITH DEORBIT TIME OF IGNITION (TIG) OCCURRING BEYOND 12 HOURS.

This method of deactivation requires approximately 2.5 hours and is a scheduled activity in the crew's timeline. If greater than 12 hours is available to the next PLS TIG, this type of deactivation should be employed to ensure an orderly powerdown and preparation for entry.

FLIGHT RULES

THIS RULE CONTINUED ON NEXT PAGE

FLIGHT RULES

A2.9.1-23 SPACELAB DEACTIVATION (CONTINUED)

B. CONTINGENCY DEACTIVATION - SECURING OF THE SPACELAB/PAYLOAD HARDWARE IN MINIMUM TIME WITHOUT INCURRING DAMAGE TO THE SPACELAB EQUIPMENT AND, WHERE POSSIBLE, THE EXPERIMENTS. SPACELAB CONTINGENCY DEACTIVATION PROCEDURES WILL BE ACCOMPLISHED AS FOLLOWS:

1. THIRTY-MINUTE CONTINGENCY DEACTIVATION - THIS CATEGORY OF PROCEDURE SHALL INCLUDE CRITICAL ENTRY STOWAGE, ORDERLY SPACELAB DEACTIVATION, SAFING OF EXPERIMENTS, AND, IF TIME PERMITS, QUICK SCIENCE/HARDWARE PRESERVATION ACTIONS. A PROCEDURE WHICH ACCOMPLISHES THE ABOVE SHOULD BE DONE FOR THE FOLLOWING:
 - a. ANY FAILURE THAT RESULTS IN A PLS WITH DEORBIT TIG OCCURRING WITHIN 3.5 TO 12 HOURS
 - b. LOSS OF SPACELAB MODULE WATER LOOP COOLING
 - c. LOSS OF SPACELAB PALLET FREON LOOP COOLING

A 30-minute deactivation of Spacelab is required for any failure requiring a PLS TIG between 3.5 and 12 hours. This category of procedure is intended to perform as much of a normal deactivation of the module as 30 minutes allows. Any equipment normally required for entry will be placed in its entry configuration prior to completing this procedure. The deactivation of the Spacelab should occur in parallel with preparations for entry at the next PLS.

MODULE @[111094-1699]

Loss of cooling due to the module water loop will require a powerdown of the module because of the limited capability of the Spacelab avionics to operate without thermal control. There is no mission duration impact with this situation other than loss of primary mission objectives. This powerdown is documented in the Spacelab Module Malfunction Procedures (EPS SSR-3).

PALLET @[111094-1699]

For loss of the Spacelab pallet Freon loop (mission-dependent equipment), pallet avionics receiving cooling from this loop will have to be powered down. These line replaceable units (LRU's) are mission-dependent and documented in the mission-specific powerdown procedures in EPS SSR-4.

THIS RULE CONTINUED ON NEXT PAGE

FLIGHT RULES**A2.9.1-23 SPACELAB DEACTIVATION (CONTINUED)**

2. RAPID SAFING DEACTIVATION - THIS CATEGORY OF PROCEDURE WILL INCLUDE ONLY THE CRITICAL ENTRY STOWAGE AND SPACELAB/PAYLOAD SYSTEMS SAFING ACTIONS SUCH THAT SPACELAB/ORBITER HARDWARE WILL NOT INCUR DAMAGE DURING ENTRY/LANDING. A PROCEDURE THAT ACCOMPLISHES THE ABOVE SHOULD BE DONE FOR THE FOLLOWING:
- a. AN ORBITER/MODULE LEAK > -0.08 PSI/MIN
AND ≤ 0.2 PSI/MIN
 - b. SPACELAB MODULE FIRE/SMOKE
 - c. SPACELAB MODULE TOXIC SPILL
 - d. THOSE ORBITER ANOMALIES WHICH RESULT IN RAPID PAYLOAD SAFING (LOSS OF TWO CABIN FANS, TWO WATER LOOPS, TWO FUEL CELLS, OR TWO FREON LOOPS)

Payload procedures implemented in this time-critical situation deal with safing payload elements such that no safety-related conditions exist for entry and Spacelab/orbiter systems will not be damaged by payload equipment. All payload and Spacelab systems safing steps, along with crew egress of the module, must be complete within 10 minutes.

For the cabin leak case, crew egress and Spacelab hatch closure must be accomplished as soon as possible to determine the source of the leak. The procedure executed for this contingency is the Spacelab Expedited Egress cue card located in the Spacelab Ops Checklist. A leak rate greater than -0.08 psi/min (orbiter and Spacelab volumes) represents a leak larger than the 0.45-inch hole contingency reserve of nitrogen can accommodate.

For a visible fire or smoke condition in the Spacelab module, two crewmembers will don the SEBS while completing contingency actions and egressing the module. This procedure is documented as the Spacelab Fire cue card, located in the Spacelab Ops Checklist. The orbiter anomalies that require rapid payload safing are defined in the Orbit Pocket Checklist.

For a toxic spill inside the Spacelab module, two crewmembers will don the SEBS immediately and all crewmembers will egress the module as soon as possible. Steps may be taken by the two crewmembers on SEBS to clean up the spill. Until the MCC can make a determination of the impact of the toxic spill, the crew will execute the Spacelab Fire cue card where an alarm is present but there is no visible fire or smoke (Spacelab Ops Checklist). The orbiter anomalies that require rapid payload safing are defined in the Orbit Pocket Checklist. Reference Rule {A13.1.2-16, SPACEHAB/SPACELAB HAZARDOUS SUBSTANCE SPILL RESPONSE.

THIS RULE CONTINUED ON NEXT PAGE

FLIGHT RULES

A2.9.1-23 SPACELAB DEACTIVATION (CONTINUED)

C. EMERGENCY DEACTIVATION - THIS CATEGORY OF PROCEDURE WILL NOT INCLUDE ANY ACTIVITY OTHER THAN FOR MODULE MISSIONS, IMMEDIATE EGRESS, AND CLOSURE OF THE AIRLOCK HATCH AND, FOR PALLET MISSIONS, ONLY THE STEPS REQUIRED TO CLOSE THE PAYLOAD BAY DOORS. EMERGENCY DEACTIVATION IS REQUIRED FOR THE FOLLOWING:

1. IN RESPONSE TO ORBITER PROBLEMS REQUIRING EMERGENCY DEORBIT.
2. AN ORBITER/MODULE CABIN LEAK > -0.2 PSI/MIN.

This rule addresses failures which affect the safe return of the crew. Only payload procedures required for payload bay door closure are allowed in this time-critical situation, and no attempt is made to prevent damage to the module, pallet, or experiment equipment. An emergency deactivation of either the module or pallet will include removal of power from the payload as soon as possible.

For a cabin leak of this magnitude, no other activity should be performed other than quick verification of possible leak sources in the module, all crewmembers egressing the Spacelab module, closing the appropriate hatches to attempt to isolate the leak, and returning to the orbiter to prepare for an emergency deorbit. The leak rate greater than -0.2 psi/min (orbiter and Spacelab volumes) represents a leak where 8 psia cannot be sustained based on the capability of the 8 psi regulators (150 lb/hr N_2) and the oxygen flow provided from the direct oxygen port (20 lb/hr). For pallet only missions, orbiter rules will dictate the size of the cabin leak where an emergency deactivation of the Spacelab pallet is required.

FLIGHT RULES

A2.9.1-24 EXTENSION DAY GROUND RULES

A. AN "EXTENSION DAY" IS DEFINED AS AN ADDITIONAL FLIGHT DAY RESULTING FROM WEATHER CONDITIONS AT THE PLANNED LANDING SITE. AN "EXTRA FLIGHT DAY" IS DEFINED AS AN ADDITIONAL DAY OF PAYLOAD FLIGHT OPERATIONS. @[022493-1482]

B. GROUP B POWERDOWN WILL BE INITIATED AFTER COMPLETION OF POST INSERTION ACTIVITIES TO CONSERVE CONSUMABLES.

C. POWER LEVELS

THE SPACELAB AND ITS EXPERIMENTS WILL BE POWERED DOWN TO THE GREATEST EXTENT POSSIBLE (MINIMUM POWER CONFIGURATION) DURING EXTENSION DAYS EXCEPT TO THE EXTENT NECESSARY TO SUPPORT ENTRY DTO'S. THE POWER CONFIGURATION IS DEFINED IN RULE {A9.9.2-8A} AND RULE {A9.9.2-8B}, SPACELAB MINIMUM POWER CONFIGURATION. THE MINIMUM POWER LEVEL FOR A GIVEN FLIGHT AND FLIGHT-SPECIFIC CONSTRAINTS ON SPACELAB ACTIVITIES OTHER THAN REQUIRED BY POWER LEVELS AND CONSUMABLES ARE DEFINED IN THE FLIGHT SPECIFIC ANNEX. @[022493-1482] @[ED]

The amount of consumables remaining at the nominal end of flight do not allow for operations of experiments without degrading the capability of the orbiter to remain in orbit. For those cases which require that additional power be provided to allow for preservation of experiment samples/data, the consumable must be allocated preflight and thus affect the mission duration.

D. CONSUMABLES

NO SPACELAB EXPERIMENT ACTIVITIES WHICH REQUIRE ORBITER CONSUMABLES WILL NORMALLY BE PLANNED. FLIGHT-SPECIFIC OPTIONS ARE DEFINED IN THE FLIGHT SPECIFIC ANNEX. @[022493-1482]

Extension days would generally be required only for weather, orbiter, and/or landing site problems that would benefit from extra time before landing. To prevent further complications, the Spacelab/experiments should be maintained in a safe, deactivated state. This should not impact the Spacelab/experiments since all payload activities should have already been completed by the nominal end of mission. In addition, the crew must be available to perform necessary orbiter activities to ensure a safe return.

THIS RULE CONTINUED ON NEXT PAGE

FLIGHT RULES

A2.9.1-24 EXTENSION DAY GROUND RULES (CONTINUED)

E. THE EXTENSION DAY ATTITUDE WILL NOMINALLY BE -ZLV. DIRECTION OF VELOCITY VECTOR AND ANY EXCEPTIONS WILL BE EVALUATED AS REQUIRED. EXCEPTIONS TO THIS RULE ARE DOCUMENTED IN THE FLIGHT SPECIFIC ANNEX. ©[072695-1778]

The -ZLV attitude will normally provide a stable thermal environment for the orbiter and Spacelab module during an extension day and is accomplished with a minimum amount of propellant for attitude maintenance. With radiators deployed, the -ZLV attitude will provide sufficient orbiter heat rejection when flying with any beta angle. With radiators stowed, the -ZLV attitude may be acceptable, or a flight-specific attitude can be determined. If a cooler attitude is required, the orbiter can execute passive thermal control (PTC) which gives the advantage of providing a consistent thermal environment for the entire vehicle. ©[072695-1778]

A2.9.1-25 LOSS OF SM GPC DURING SPACELAB ACTIVATION/DEACTIVATION (ACT/DEACT)

LOSS OF THE SYSTEMS MANAGEMENT (SM) GPC DURING SPACELAB ACTIVATION OR DEACTIVATION WILL REQUIRE SUSPENSION OF SPACELAB ACTIVITIES UNTIL SM IS RECOVERED.

Spacelab activation and deactivation is achieved via SM specialist displays and otherwise cannot be nominally performed. Discontinuing act/deact operations for recovery of an SM GPC causes no Spacelab subsystem safety concerns.

A2.9.1-26 LOSS OF PAYLOAD/FLEX MDM DURING SPACELAB ACT/DEACT

- A. LOSS OF A PAYLOAD MDM DURING SPACELAB ACTIVATION OR DEACTIVATION WILL REQUIRE SUSPENSION OF SPACELAB ACTIVITIES UNTIL THE RECOVERY ATTEMPT IS COMPLETE.
- B. LOSS OF A FLEX MDM DURING SPACELAB ACTIVATION OR DEACTIVATION WILL REQUIRE SUSPENSION OF SPACELAB ACTIVITIES UNTIL THE RECOVERY ATTEMPT IS COMPLETE.

Spacelab activation and deactivation is achieved via PL/FLEX MDM discrete and serial commands and otherwise cannot be nominally performed. Discontinuing act/deact operations while recovering the PL/FLEX MDM causes no Spacelab subsystem safety concerns.

FLIGHT RULES

A2.9.1-27 PAYLOAD/FLEX MDM HARD FAIL

- A. UNRECOVERABLE LOSS OF EITHER PAYLOAD MDM WILL NOT PREVENT SPACELAB ACTIVATION OR DEACTIVATION.
- B. UNRECOVERABLE LOSS OF EITHER FLEX MDM WILL NOT PREVENT SPACELAB ACTIVATION OR DEACTIVATION.

The Spacelab remote application and advisory box (RAAB)-PAYLOAD/FLEX MDM interface has been designed with command redundancy to allow Spacelab act/deact to be successfully completed with either PL/FLEX MDM, although the configuration will be off nominal and nonredundant.

©[071494-1642A]

A2.9.1-28 LOSS OF SM OR GUIDANCE, NAVIGATION, AND CONTROL (GNC) MAJOR FUNCTION

- A. TEMPORARY LOSS OF SM OR GNC MAJOR FUNCTION AFTER SPACELAB ACTIVATION AND BEFORE SPACELAB DEACTIVATION IS NOT A CONSTRAINT TO CONTINUING SPACELAB OPERATIONS.

The SM major function is essential to all of orbiter and Spacelab; therefore, there exists a high priority to regain this function. The temporary loss would be for 15 minutes. The on-orbit mission time loss to take down Spacelab (deactivate and activate) would be longer than the SM recovery time. The SCOS software does monitor the class 2 (C&W) parameters, but it is not certified to provide a C&W alert signal. This violation of the engineering design criticality assigned to the SCOS software will be minimal.

Class 1 parameters are not affected. Additionally, all Spacelab commanding (ground and crew) and the SM displays of Spacelab data will be lost for the recovery period. For a GNC major function loss, the state vector transfers will be lost during the recovery period, but Spacelab displays and data will be available using the SM major function.

- B. SPACELAB OPERATIONS ARE NOT A CONSTRAINT TO RECOVERY OF EITHER THE SM OR GNC MAJOR FUNCTION.

It is not desirable for Spacelab to constrain in any way recovery of orbiter capability. This rule states such constraints are not acceptable. Recovery of GNC or SM major function has priority for orbiter safety concerns (i.e., possible loss of vehicle control or insight into system management).

FLIGHT RULES

A2.9.1-29 SPACELAB CONSTRAINTS ON RECOVERING MASTER TIMING UNIT (MTU)

- A. THERE IS NO SPACELAB SYSTEMS CONSTRAINT TO MAINTENANCE OR RECOVERY FROM LOSS OF ORBITER MTU.

For an orbiter MTU loss, the Spacelab computers fault down to internal timekeeping hardware and software, collectively called the real-time clock (RTC), and Spacelab HRM and video timetags are no longer available. The Spacelab computer RTC's are very accurate, and any drift is automatically corrected/synchronized with the PCMMU bite status register (BSR) pulse by software and can be compensated from the ground or onboard. The ground will primarily do any updates to relieve the crew of this activity. Once recovery of the MTU has been completed, both CDMS SS and EXP DPA's can be commanded back to their respective MTU interfaces via onboard Spacelab DDS item entries or ground uplink. The loss of the MTU or payload timing buffer will result in the HRM and video timetags becoming static. (The timetags in the experiment computer operating system (ECOS) experiment computer input/output (ECIO) stream will be okay as described above.) Spacelab operations may be continued as long as lack of timetags is not a problem.

- B. EXCEPTIONS TO THIS RULE ARE DOCUMENTED IN THE FLIGHT SPECIFIC ANNEX.

A2.9.1-30 PF 1 FIRST CHOICE FOR KU-BAND

IF A CHOICE EXISTS BETWEEN PF1 AND PF2, PF1 WILL BE RETAINED TO MAINTAIN KU-BAND CAPABILITY.

The Ku-band system gets GPC pointing information from the PF1 MDM. If this MDM is lost, the Ku-band may be lost unless configured properly at the time of failure (some configuration commands must be sent via the PF1 MDM). If configured properly, the Ku-band could be used by orbiter pointing (controlling the orbiter attitude to point the Ku-band antenna at the TDRS satellite) or, if a TDRS forward link was available, by the crew performing acquisitions and reacquisitions manually.

This failure would not impact the Ku-band's ability to stow but would be a severe impact to Spacelab operations. The loss of PF2 is a much smaller impact to Spacelab and is no greater impact to the orbiter than PF1. For this reason, PF1 will be chosen if a choice exists.

FLIGHT RULES

A2.9.1-31 ORBITER FREON FLOW PROPORTIONING VALVE (FPV) USAGE

THE TWO ORBITER FREON FPV'S WILL NOMINALLY BE USED ACCORDING TO THE FOLLOWING PLAN: @[102793-1550A]

- A. PRELAUNCH: ONE FPV IN THE INTERCHANGER (ICH) POSITION AND ONE FPV IN THE PAYLOAD HEAT EXCHANGER (PL HX) POSITION AS REQUIRED BY THE PAYLOAD UNTIL FLIGHT-SPECIFIC LAUNCH MINUS TIME SPECIFIED IN THE FLIGHT SPECIFIC ANNEX. THEN BOTH FPV'S ARE PLACED IN ICH FOR ASCENT.

Both FPV's must be in ICH for ascent. However, cold soaking the Spacelab module prelaunch via one FPV in PL HX keeps the predicted module temperatures acceptable until post insertion. Moving the FPV back to the ICH position still guarantees a nominal crew cabin temperature at ingress and during ascent.

- B. ON-ORBIT 14.7 PSI OPS: AFTER SUCCESSFULLY REACHING ORBIT WHEN THE ORBITER IS THERMALLY STABLE, ONE FPV WILL BE PLACED IN PL HX POSITION UNTIL DEORBIT PREP. THE SECOND FPV WILL ONLY BE TAKEN TO PL HX IF REQUIRED TO SATISFY PAYLOAD THERMAL REQUIREMENTS. AT DEORBIT PREP, BOTH FPV'S WILL BE RETURNED TO ICH FOR ENTRY AND LANDING.

If the cabin is at 14.7 psi, marginal cooling exists for orbiter systems if both FPV's are given to the payload. To provide sufficient cooling to the orbiter, only one FPV should be in the PL HX position unless both are required to avoid violating payload thermal limits.

Reference Rule {A18.9.2-1}, SPACELAB ECLS REQUIREMENTS. @[071494-1660]

- C. ON-ORBIT 10.2 PSI ORBITER OPS: ONE FPV WILL BE IN ICH AND ONE WILL BE IN PL HX AND A FES PRIMARY CONTROLLER (CNTLR) MUST BE ACTIVATED.

Due to reduced cooling capability at 10.2 psi, the orbiter requires at least one of the FPV valves to be placed in interchanger. The Spacelab will be isolated from the orbiter (hatch closed) and at 14.7 psia during orbiter 10.2 operations.

Reference All Flights Rule {A17.1.7-8A}, ATCS (10.2 PSIA CABIN) CONFIGURATION.

- D. POSTLANDING: BOTH FPV'S WILL BE IN THE "ICH" POSITION UNTIL REQUESTED FOR PAYLOAD COOLING AT THE FLIGHT-SPECIFIC POSTLANDING TIME SPECIFIED IN THE FLIGHT SPECIFIC ANNEX. THEN ONE FPV IS PLACED INTO THE "PLHX" POSITION FOR THE DURATION OF EARLY EXPERIMENT RETRIEVAL OPERATIONS.

FLIGHT RULES

Moving one FPV to PLHX allows Spacelab to maintain module temperature during early experiment sample retrieval operations.

A2.9.1-32 SPACELAB AIR-TO-GROUND (A/G) USAGE

- A. THE STANDARD ORBITER A/G CHANNEL (A/G 1) WILL BE USED FOR ANY DISCUSSIONS RELATED TO SPACELAB SUBSYSTEMS. THE SSP CAPCOM WILL BE THE GROUND COMMUNICATOR.

Since the module is integrated to the orbiter, it is necessary that any systems issues be discussed on A/G 1 which all SSP flight control team members monitor. In addition, this strategy guarantees that emergency/time critical issues are discussed on the prime A/G loop.

- B. A/G 2 WILL BE USED FOR ANY DISCUSSIONS RELATED TO SPACELAB EXPERIMENTS. A SPACELAB CREW INTERFACE COORDINATOR (CIC) WILL BE THE GROUND COMMUNICATOR.

Spacelab is responsible for all experiment procedures and the experiment flight data file. Therefore, the most efficient communication path is directly between the crew and the CIC. The CIC will be in the JSC POCC.

- C. ANY SAFETY-RELATED ISSUES, INCLUDING THOSE RELATED TO EXPERIMENTS, WILL BE CONDUCTED ON THE PRIME A/G LOOP (A/G 1).

Self-explanatory.

- D. ROUTINE CONVERSATIONS DURING SPACELAB EXPERIMENTS OPERATIONS BETWEEN THE CIC AND THE CREW ON A/G 2 WILL NORMALLY BE INITIATED BY CREW REQUEST. THE FOLLOWING RESTRAINTS SHALL APPLY TO CIC PROTOCOL AND A/G 2 USAGE.
1. THE VOICE PROTOCOL SHALL BE THE SAME AS THAT USED BY THE JSC CAPCOM.
 2. THE PAYLOAD OPERATIONS DIRECTOR (POD) OR HIS DESIGNATED REPRESENTATIVE IS RESPONSIBLE FOR APPROVING ALL CALLS INITIATED FROM THE GROUND TO THE CREW.
 3. DIRECT EXPERIMENTER CALLS TO THE CREW ON A/G 2 SHALL BE UPON CREW REQUEST ONLY.
 4. THE CALL SIGN FOR THE SPACELAB POCC SHALL BE "MARSHALL POCC."

FLIGHT RULES

5. PADM OPERATIONS WILL BE INTEGRATED INTO ROUTINE
SPACELAB A/G 2 USAGE DURING THE REPLANNING CYCLE.

THIS RULE CONTINUED ON NEXT PAGE

FLIGHT RULES

A2.9.1-32 SPACELAB AIR-TO-GROUND (A/G) USAGE (CONTINUED)

6. EXCEPTIONS TO THIS RULE ARE DOCUMENTED IN THE FLIGHT SPECIFIC ANNEX.

Past flights crew comments on overuse of A/G by payloads point out the need for more rigid control of the traffic and voice protocol. In addition, use of the Portable Audio Data Modem (PADM) adds complexity to the scheduled use of one of the A/G links. With the many users as well as the many experimenters on a Spacelab flight, careful definition of the A/G 2 usage is required. This rule represents an agreed to baseline with the customer for Spacelab flights.

A2.9.1-33 SPACELAB DEACTIVATION CONSTRAINTS

PALLET

FINAL SPACELAB PALLET FREON LOOP ACTIVATION SHOULD BE COMPLETED AFTER PLBD CLOSURE AND PRIOR TO OPS 3 TRANSITION.
@[071494-1651]

The Spacelab High Data Rate Recorder (HDRR) electronics unit will exceed its lower thermal limit if left unpowered for more than 3 hours in a cold attitude (-XSI or Inertial Measurement Unit (IMU) align verification)) without the Freon loop activated. Keeping the Freon pump activated after Spacelab pallet deactivation until PLBD closure allows the orbiter to remain in a cold attitude in the event door closure is delayed. Deactivation of the Freon pump is required prior to the OPS 3 transition since the required SPEC (224) is only available in OPS 2. The EOM attitude sequence is developed to thermally condition the orbiter prior to the deorbit burn. Delaying the Freon pump deactivation prevents deviations in EOM attitude sequence and orbiter thermal conditioning. @[071494-1651]

A2.9.1-34 UNPOWERED THERMAL CONSTRAINTS

IF THE EQUIPMENT IN THE PAYLOAD BAY MUST BE UNPOWERED, SPECIAL ORBITER ATTITUDES MAY BE REQUIRED TO PROTECT SPACELAB/EXPERIMENT THERMAL CONSTRAINTS.

Spacelab/experiments may be damaged by abnormally hostile conditions during flight. Power may be used by the Spacelab/experiment to provide thermal control. If such power is not available, the orbiter may be required to fly attitudes that would achieve a non-hostile thermal environment for the Spacelab/experiments and protect them from damage.

FLIGHT RULES

A2.9.1-35 UNIQUE SUPPORT STRUCTURE THERMAL CONSTRAINT

WHEN A UNIQUE SUPPORT STRUCTURE IS FLOWN, THE PAYLOAD ENTRY THERMAL CONSTRAINT WILL BE SATISFIED BY ORBITER ENTRY THERMAL CONDITIONING OR AS DEFINED IN THE FLIGHT SPECIFIC ANNEX.

Any unique support structure flown as part of a Spacelab mission should be compatible with the standard orbiter thermal entry conditioning. Any unique payload thermal constraints must be documented in the flight specific annex.

FLIGHT RULES

A2.1.1-6

LANDING SITE WEATHER CRITERIA (CONTINUED)

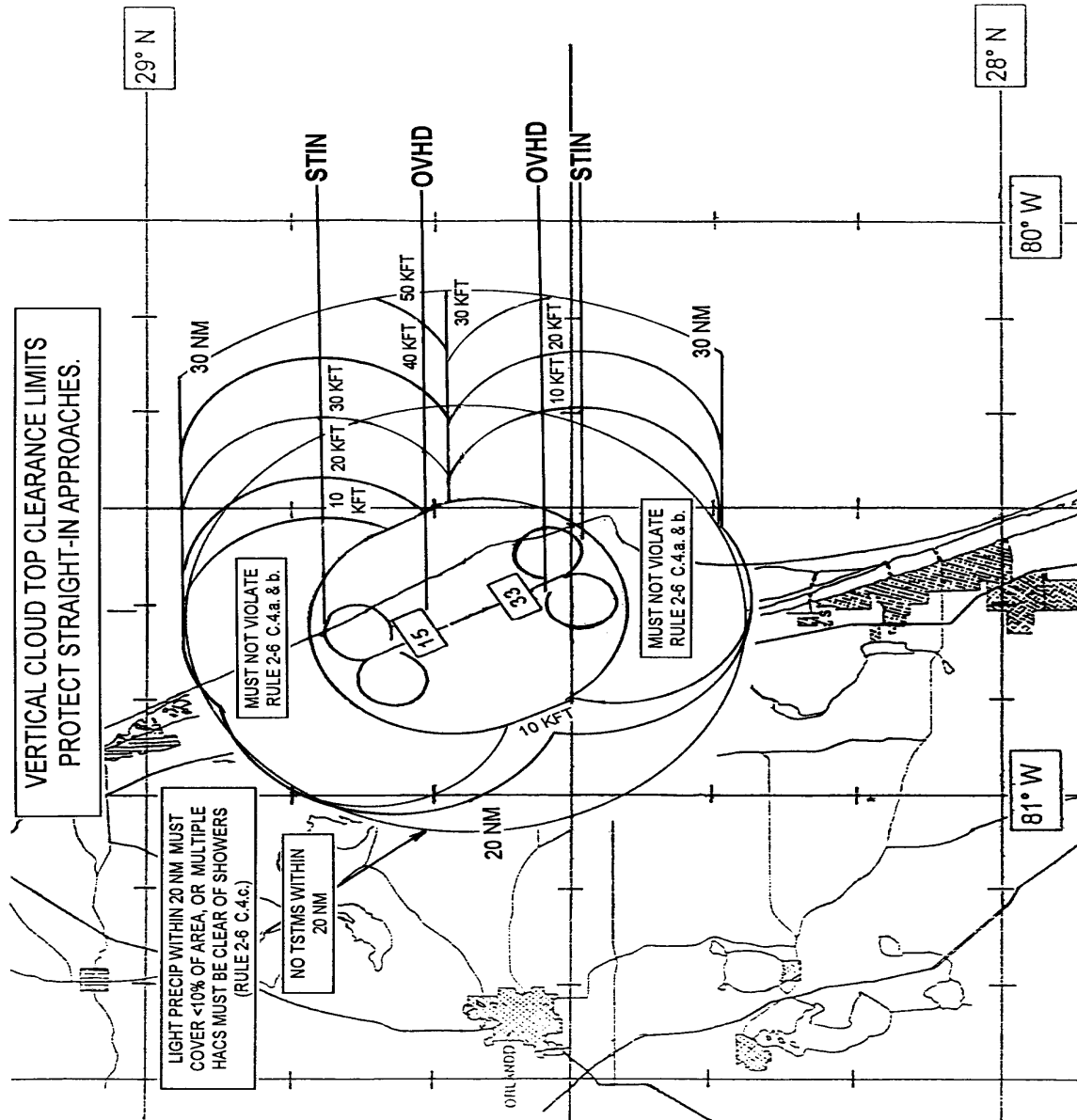

FIGURE A2.1.1-6-I - VERTICAL CLOUD TOP CLEARANCE LIMITS PROTECT STRAIGHT IN APPROACHES

THIS RULE CONTINUED ON NEXT PAGE

FLIGHT RULES

A2.1.1-6

LANDING SITE WEATHER CRITERIA (CONTINUED)

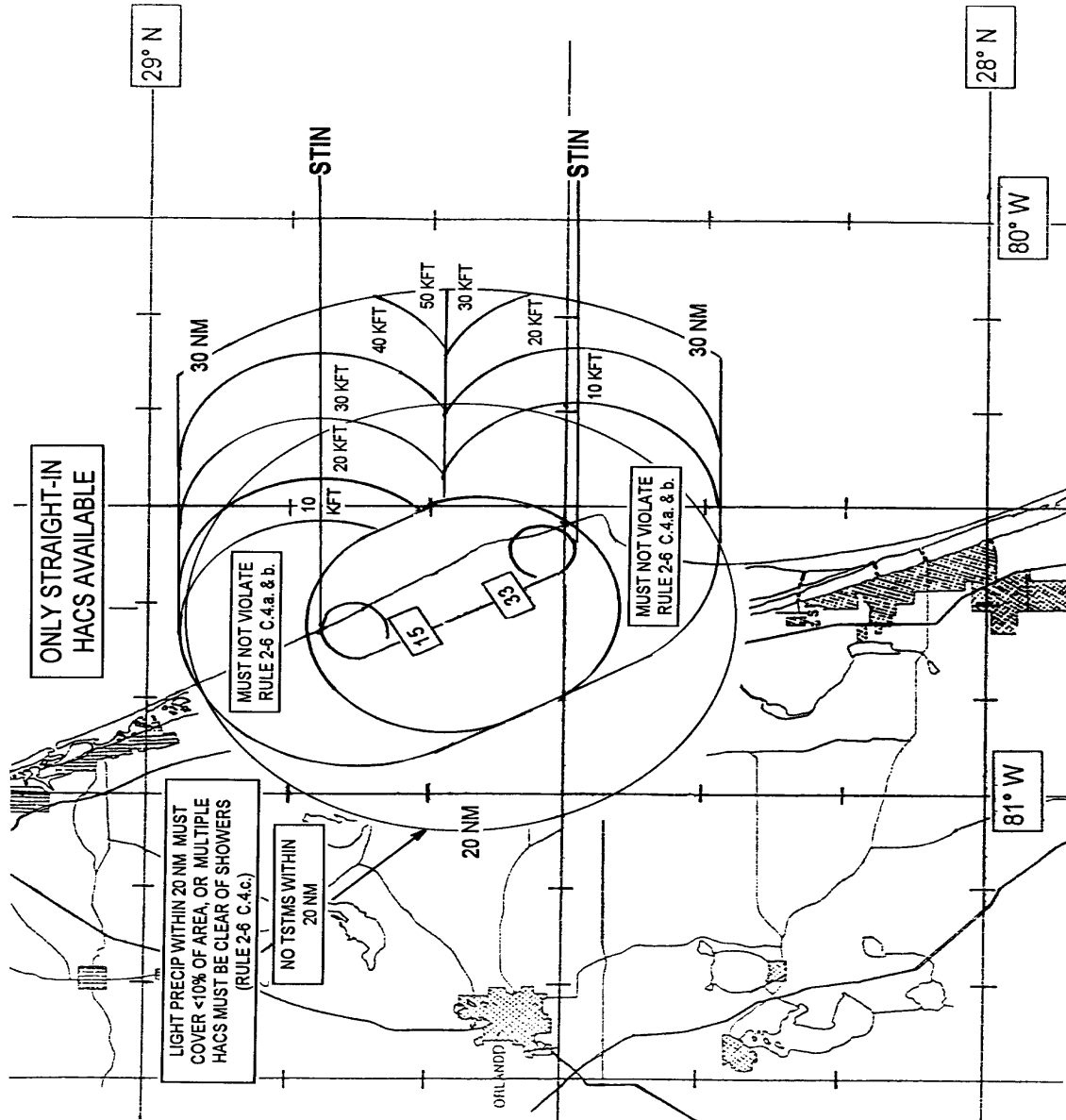

FIGURE A2.1.1-6-II - ONLY STRAIGHT IN HACs AVAILABLE

THIS RULE CONTINUED ON NEXT PAGE

FLIGHT RULES

A2.1.1-6

LANDING SITE WEATHER CRITERIA (CONTINUED)

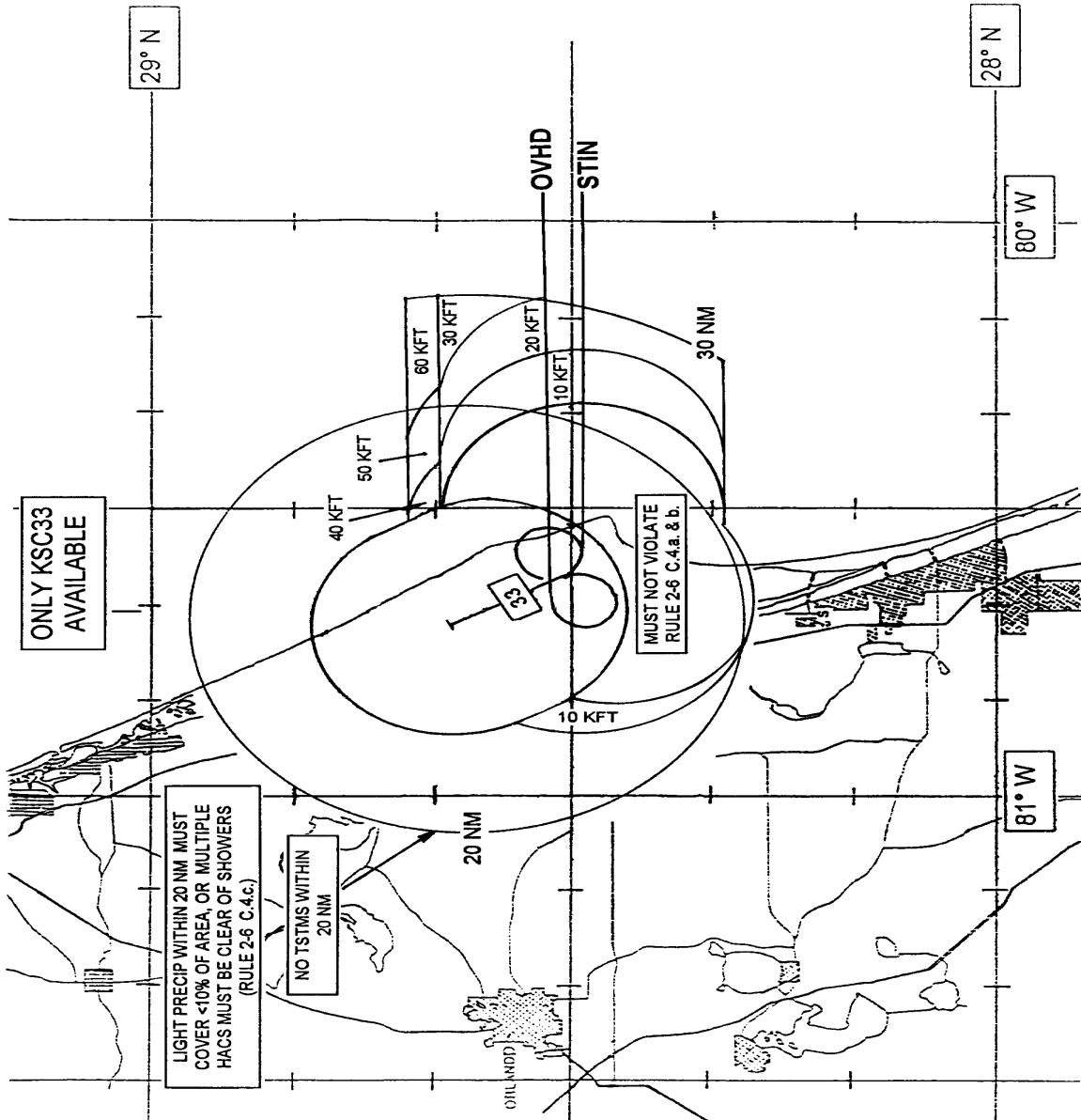

FIGURE A2.1.1-6-IV - ONLY KSC33 AVAILABLE

THIS RULE CONTINUED ON NEXT PAGE

FLIGHT RULES

A2.1.1-6

LANDING SITE WEATHER CRITERIA (CONTINUED)

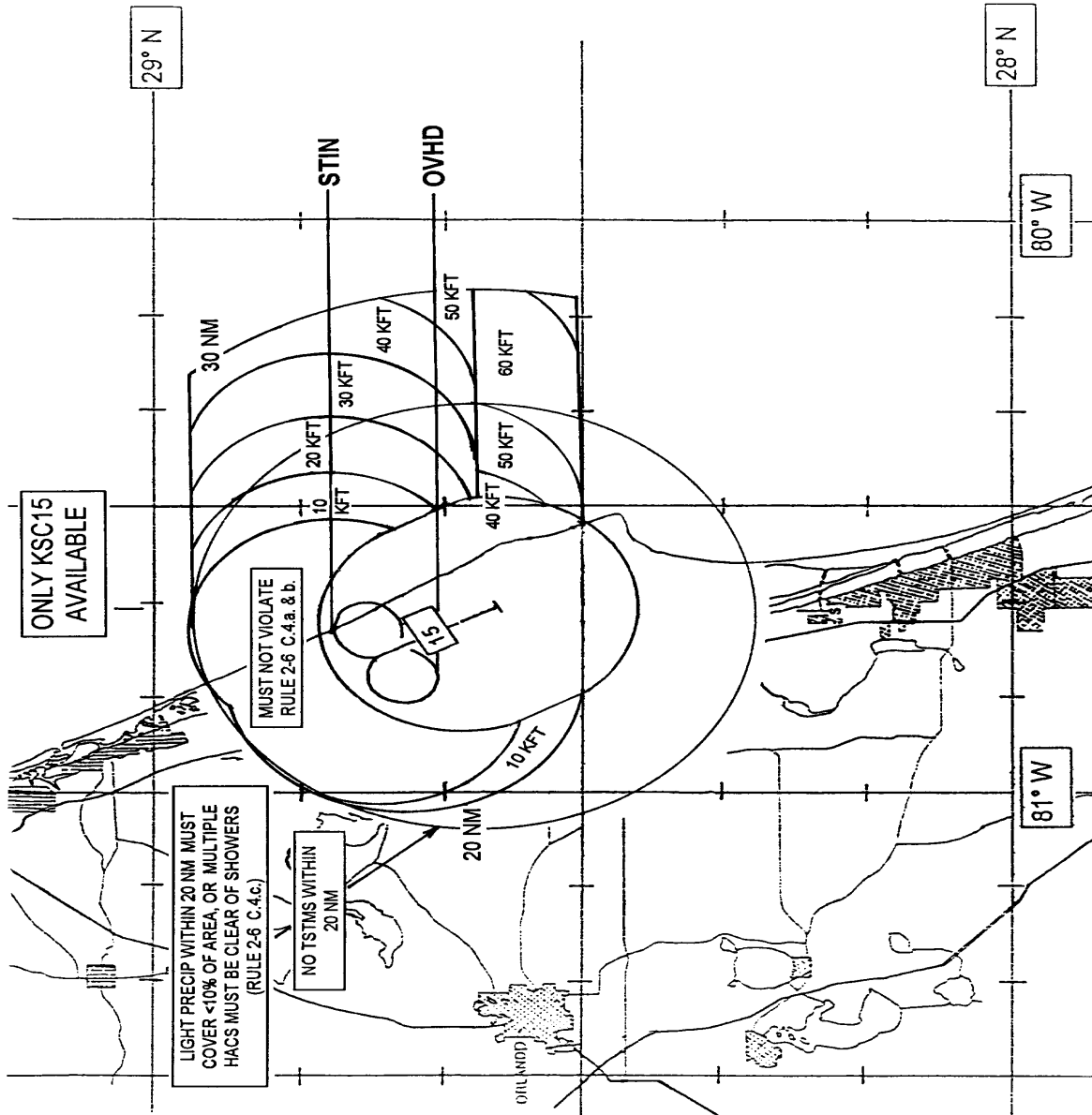

FIGURE A2.1.1-6-V - ONLY KSC15 AVAILABLE

FLIGHT RULES

SECTION 3 - GROUND INSTRUMENTATION REQUIREMENTS

GENERAL

A3.1.1-1	GROUND REQUIREMENTS OVERVIEW	3-1
<u>A3.1.1-2</u>	<u>MISSION CONTROL CENTER (MCC) REDUNDANCY REQUIREMENTS</u>	<u>3-12</u>
<u>A3.1.1-3</u>	<u>MOC/DSC ABENDS</u>	<u>3-18</u>

MCC INSTRUMENTATION PRELAUNCH REQUIREMENTS

<u>A3.1.2-1</u>	<u>RESERVED</u>	<u>3-13</u>
<u>A3.1.2-2</u>	<u>RESERVED</u>	<u>3-14</u>
<u>A3.1.2-3</u>	<u>RESERVED</u>	<u>3-12</u>
A3.1.2-4	TRAJECTORY PROCESSING	3-12
A3.1.2-5	MCC INTERNAL VOICE	3-14
A3.1.2-6	RESERVED	3-15
A3.1.2-7	RESERVED	3-15
A3.1.2-8	MCC POWER	3-16a

45 SPW/GSFC/STDN PRELAUNCH REQUIREMENTS

A3.1.3-1	RESERVED	3-16d
A3.1.3-2	GSFC	3-16d
A3.1.3-3	STDN FAILURE DECISION MATRIX	3-17

MCC EXTERNAL INTERFACE (VOICE DATA) PRELAUNCH REQUIREMENTS

A3.1.4-1	MCC/KSC/45 SPW INTERFACE	3-21
A3.1.4-2	GSFC/STDN INTERFACE	3-21
A3.1.4-3	45 SPW/VAFB INTERFACE	3-23
A3.1.4-4	45 SPW/WSMR INTERFACE	3-23
A3.1.4-5	MCC/GSFC/NGT INTERFACE	3-23

FLIGHT RULES

A3.1.4-6 MCC/ASCENT ABORT SITE INTERFACE 3-24

NAVAIDS REQUIREMENTS

A3.1.5-1 TACAN REDUNDANCY REQUIREMENTS AND ALTERNATE
TACAN SELECTION PHILOSOPHY 3-25

A3.1.5-2 MLS 3-33

A3.1.5-3 LANDING AID REQUIREMENTS 3-34

FLIGHT RULES

SECTION 3 - GROUND INSTRUMENTATION REQUIREMENTS

GENERAL

A3.1.1-1 GROUND REQUIREMENTS OVERVIEW

THE VARIOUS EQUIPMENT LISTINGS IN THIS SECTION ARE REQUIRED TO PROVIDE THE FOLLOWING MCC/STDN CAPABILITY:

The launch is protected for the loss of critical MCC/STDN equipment.

The MCC/STDN equipment provides the ability to collect, process, and display the parameters utilized for enforcement of vehicle systems rules; provides the means for uplinking a command response; and provides the means to communicate between flightcrew and flight control teams.

A. ASCENT:

1. COMMAND, TELEMETRY, ~~TRACKING~~, AND A/G VOICE (S-BAND AND UHF) ARE REQUIRED: [@121296-4177D1](#)

The launch is protected for the loss of critical MCC/STDN equipment.

~~Protection is afforded from a launch with unplanned coverage gaps due to MCC/STDN equipment outages.~~

~~Command is required to allow state vector updates in case of navigation systems problems and to provide uplink remedies to other systems problems which require off-nominal systems configurations that can most effectively be accomplished or only accomplished from the ground. provide uplink remedies to systems problems which require off-nominal systems configurations that can be most effectively accomplished or only accomplished from the ground.~~

Telemetry is required for verification of successful commanding and for identification of vehicle subsystem rule violations. [@121296-4177D1](#)

A/G voice is required for abort request and abort region calls and to respond to observed vehicle systems rule violations.

Rule {A3.1.2-3}, COMMAND, references this rule.

THIS RULE CONTINUED ON NEXT PAGE

FLIGHT RULES

A3.1.1-1 GROUND REQUIREMENTS OVERVIEW (CONTINUED)

- a. TRACKING ~~IS HIGHLY DESIRABLE~~REQUIRED FROM EITHER ONE S-BAND AND ONE C-BAND, OR TWO C-BANDS FROM LIFT-OFF THROUGH MECO PLUS 1 MINUTE. ©[121296-4177D]

Dual source tracking is desired to allow monitoring of the health of onboard navigation during powered flight, to provide delta state uplink capability to correct extreme onboard navigation errors which could result in unsafe or mission-limiting MECO conditions for an ascent to orbit or an RTLS, and to provide an independent ground navigation source for ascent performance boundary calls. To obtain an accurate post-MECO ground filter vector, a minimum of 1 minute of tracking post-MECO is required for processor convergence. An accurate post-MECO ground filter vector may be used to update onboard nav before OMS-2 if required to significantly decrease delta-V cost due to planar error for ground-up rendezvous flights, or before OMS-1 or OMS-2 if the gain in delta-V capability would prevent ascent capability downmoding.

Ground tracking through MECO+2 is highly desirable rather than mandatory because flight history and Mean Time Between Failure (MTBF) data show that the probability of either software or hardware failures corrupting onboard nav during ascent are extremely small. MTBF studies for the Hains IMU's, GPC's, and MDM's indicate a probability of loss of two IMU's to be on the order of 10^{-10} . Although recovery of corrupted onboard nav by means of a powered flight delta state is theoretically possible, and would be attempted if required, success at all times during the ascent is not a certainty. With regard to onboard nav errors which are not large enough to pose a safety concern, but which could affect the mission, the history of post-MECO state vector updates shows that although there are worthwhile paybacks in propellant margin, their absence would not adversely impact propellant budgets.

Reference A/E FTP #135 (November 12, 1996) which addressed ascent tracking requirements.

Reference Rules {A4.1.2-8A}, NAVIGATION UPDATES, ASCENT PRE-MECO; {A4.1.2-8C}, PRTLS; {A4.1.2-8B}, ASCENT POST-MECO AND PRE-OMS-1; {A4.1.2-8E}, POST-MECO PRIOR TO A COMMIT TO ORBIT; and {A4.1.2-8F}, RENDEZVOUS. ©[121296-4177D]

THIS RULE CONTINUED ON NEXT PAGE

FLIGHT RULES

A3.1.1-1 GROUND REQUIREMENTS OVERVIEW (CONTINUED)

- b. HIGH DATA RATE (HDR) TELEMETRY IS REQUIRED FROM LIFT-OFF THROUGH ~~LAUNCH SITE LOS. HDR OR LOW DATA RATE (LDR) TELEMETRY IS REQUIRED FROM LAUNCH SITE LOS THROUGH~~ MECO PLUS 2 MINUTES. [@\[021199-6807\]](#)

Precludes launch if MIL and PDL or JDI cannot support HDR telemetry; ~~or BDA cannot support at least LDR telemetry~~. MCC capability to detect, analyze, and troubleshoot systems failures and analyze guidance and navigation performance during this phase requires the availability of telemetry. [@\[021199-6807\]](#)

Rules {A3.1.2-2}, TELEMETRY; and {A3.1.4-2A.1, 2 and 7}, GSFC/STDN INTERFACE, reference this rule.

- c. COMMAND IS REQUIRED FROM LIFT-OFF THROUGH MECO PLUS 1 MINUTE.

NOTE: "UHF ONLY" CAPABILITY IS ACCEPTABLE IF S-BAND UPLINK LOST DUE TO SRB PLUME EFFECTS.

Command is required to provide an uplink remedy for systems problems such as the ground to update the state vector in the case of navigational systems problems, as well as to provide an uplink remedy for other systems problems such as NSP failures or DPS system failures which can be fixed by port moding. Other off-nominal situations may also require communication mode changes and/or S-band antenna management from the ground. Command capability for a nominal launch is used to optimize communication conditions as well as provide a critical backup capability for systems problems which, if not corrected, could cause loss of data and voice and, in case of navigational problems, loss of performance capability. The time period "...through MECO plus 1 minute..." allows the MCC to switch to the TDRS mode at the earliest possible time (due to ET blockage) in the event that the nominally loaded MSPC will not execute properly. [@\[121296-4177D\]](#)

An exception to this rule is for missions when the PDL command system is not mandatory (ref. Rule {A3.1.3-3}, STDN FAILURE DECISION MATRIX). This is due to MIL UHF being a reliable voice link through the SRB plume (approx. MET 1:00 minute).

- d. TWO-WAY A/G VOICE (S-BAND AND UHF) IS REQUIRED FROM LIFT-OFF THROUGH MECO PLUS 2 MINUTES.

Redundant A/G voice is necessary for abort request and abort region calls and to rapidly convey verbal responses to observed subsystem anomalies and rule violations. The availability of both S-band and UHF ensures that ground station handovers as well as most onboard and ground subsystem failures will not result in disruption of A/G voice capability causing critical calls to be missed. The time period, through MECO plus 2 minutes, allows the MCC to pass OMS-1 status to the crew.

Rule {A3.1.2-5B}, MCC INTERNAL VOICE, references this rule.

FLIGHT RULES

THIS RULE CONTINUED ON NEXT PAGE

FLIGHT RULES

THIS PAGE INTENTIONALLY BLANK

FLIGHT RULES

A3.1.1-1 GROUND REQUIREMENTS OVERVIEW (CONTINUED)

2. COMMAND, ~~LDR~~ TELEMETRY, AND A/G VOICE (S-BAND OR UHF) REQUIRED POST-OMS-1 FOR STANDARD INSERTION AND POST-MECO FOR DIRECT INSERTION (MINIMUM OF 5 MINUTES REQUIRED PRIOR TO OMS-2). [@\[021199-6807.1\]](#)

~~Allows countdown to proceed if downrange support stations (i.e., Dakar, Madrid, TDRSS, or Oakhanger) can only provide LDR telemetry, command, plus either S band or UHF voice.~~

Command is required for uplink of off-nominal systems configurations required due to systems failures. Telemetry is required to determine whether an AOA is necessary because of violation of a systems rule. @[121296-4177D]

Rules {A3.1.2-3}, COMMAND, and {A3.1.4-2A.1 and 2}, GSFC/STDN INTERFACE, reference this rule.

B. RTLS:

1. DUAL TRACKING CAPABILITY (TWO C-BANDS OR ONE C-BAND AND ONE S-BAND) IS HIGHLY DESIRABLE FROM MECO TO 100K FEET. @[121296-4177D]

The MOC trajectory processor Kalman filter cannot meet ground accuracy requirements with only one source of tracking data; the filter requires at least two sources. The 100k-foot altitude constraint was chosen to allow sufficient time to assess the vehicle energy conditions and to update onboard nav state (after nominal TACAN acquisition) in order to correct a violation of delta state limits. Dual tracking capability also allows time to GCA to within guidance limits prior to TAEM. @[121296-4177D]

2. TELEMETRY IS REQUIRED POST-MECO TO LANDING.

Telemetry of flight-critical systems provides the ability to determine system rule violations and provide systems-related updates through landing. @[121296-4177D]

3. COMMAND REQUIRED POST-MECO THROUGH 100K FEET.

Command capability allows for delta state uplink through 100k feet. @[121296-4177D]

THIS RULE CONTINUED ON NEXT PAGE

FLIGHT RULES

A3.1.1-1 GROUND REQUIREMENTS OVERVIEW (CONTINUED)

4. A/G VOICE REQUIRED POST-MECO THROUGH LANDING.

A/G voice is required for system reconfiguration calls.

C. TAL:

1. TDRS TELEMETRY REQUIRED POST-MECO THROUGH LANDING.
2. TDRS A/G VOICE REQUIRED POST-MECO THROUGH LANDING.

The declaration of a TAL abort results in procedures that involve additional risk. MCC support is required and will normally be available throughout the TAL. This increased insight into systems performance and additional expertise significantly increases the probability of a successful landing with a vehicle that has already had a major systems failure. A/G voice is required to coordinate any recommendations to the crew and to relay to the crew final weather, runway, landing aid, and major systems status. The launch will be delayed to regain TDRS capability. This does not imply that a launch will not occur if the capability was lost with no possibility of recovery (i.e., the TDRS hard failed).

- D. AOA (IF REQUIRED, REF. RULE {A2.1.1-2}, ABORT LANDING SITE REQUIREMENTS), FIRST OR SECOND DAY PLS, AND EOM DEORBIT:

NOTE: FOR PLS/EOM, EQUIPMENT MUST BE AVAILABLE AT DEORBIT DECISION TIME. @121593-1590]

1. TELEMETRY IS REQUIRED POST TDRS AOS TO LANDING. ~~(FOR AOA TO EDW GDS IS CONSIDERED ACCEPTABLE).~~ @041196-1914] @072398-6565A]

The availability of telemetry allows the systems expertise and greater systems monitoring capability available in the MCC to be used to detect systems failures and rule violations during the entry. In the event that a delta state is uplinked, it allows proper onboard verification to be performed through 100k feet (tracking not required below 100k feet). ~~For the loss of TDRS and DFRC, Goldstone is acceptable since it will provide coverage to below 30k feet.~~ @072398-6565A]

2. EOM ONLY: FOR COMMIT TO LAUNCH, EOM DUAL TRACKING CAPABILITY (TWO C-BANDS OR ONE S-BAND AND ONE C-BAND) ABOVE 100K FT IS HIGHLY DESIRABLE WHEN ALL CAPABILITIES LISTED BELOW ARE AVAILABLE PRIOR TO DEORBIT TIG). IF DURING THE MISSION ANY OF THE FOLLOWING CAPABILITIES ARE LOST, EOM DUAL TRACKING CAPABILITY BECOMES MANDATORY FOR COMMIT TO DEORBIT:

FLIGHT RULES

- a. IMU'S: FULL REDUNDANCY (THREE LRU'S AND ASSOCIATED DPS AND EPS FUNCTIONALITY). @[041196-1914]

THIS RULE CONTINUED ON NEXT PAGE

FLIGHT RULES

A3.1.1-1 GROUND REQUIREMENTS OVERVIEW (CONTINUED)

- b. ONBOARD TACAN: FULL REDUNDANCY (THREE LRU'S AND ASSOCIATED DPS AND EPS FUNCTIONALITY). @[041196-1914]
 - c. ONBOARD MLS: FULL REDUNDANCY (THREE LRU'S AND ASSOCIATED DPS AND EPS FUNCTIONALITY) REQUIRED IF MLS IS REQUIRED FOR LANDING (REF RULE {3.1.5-2}, MLS).
 - d. GROUND TACAN STATIONS: TWO STATIONS AVAILABLE AND CONFIRMED OPERATIONAL WITHIN SPECIFICATIONS (REF RULE {A8.1.2B.2}, SENSOR FAILURES). FAA/USAF SPECIFICATIONS ARE NOT ADEQUATE (REF NSTS 07700, VOL X, BOOK 3, PARAGRAPH 1.3.1.1.1).
3. EOM: S-BAND TRACKING IS HIGHLY DESIRABLE IN THE ABSENCE OF C-BAND TRACKING.

In order to maximize launch probability by alleviating C-Band tracking data scheduling conflicts with the Eastern Range Operations Control Center (ROCC), the mandatory requirement for scheduling dual source high speed tracking for EOM is eliminated, provided that sufficient redundancy is available (TACAN and IMU) to correct the NAV state prior to violation of entry guidance limits. If sufficient redundancy is lost during the mission, dual source high speed tracking becomes mandatory for commit to deorbit. The MOC trajectory processor Kalman filter cannot meet ground accuracy requirements with only one source of tracking data. The filter requires at least two sources. The 100k-feet altitude constraint was chosen to allow sufficient time to assess the vehicle energy conditions and to update onboard nav state (after nominal TACAN acquisition) in order to correct a violation of delta state limits. This requirement also allows time to GCA to within guidance limits prior to TAEM.

With three functioning IMU's and the associated DPS/EPS equipment, the first failure is fully protected by redundancy management. When two IMU's are available, 95 percent of the cases involving the second failure are properly resolved by the IMU RM which uses the IMU BITE logic.

With three functioning onboard TACAN transceivers and their associated DPS equipment, the first failure is fully protected by redundancy management. When two TACAN's are available, 90 percent of the cases involving the second failure are covered with TACAN self-test.

FLIGHT RULES

With three functioning onboard MLS transceivers and their associated DPS equipment, the first failure is fully protected by redundancy management. When two MLS's are available, a dilemma between the LRU's will remain unresolved unless a BITE had been previously set against one of the LRU's. If the dilemma is unresolved, MLS may not process at all (for range/azimuth dilemmas) or only partially process (for elevation dilemmas). For days when MLS is required as defined in Rule {3.1.5-2}, MLS, ground tracking is required to resolve dilemmas in order to make the MLS useable. Reference Rule {8.1.1-18A}, LANDING SYSTEMS REQUIREMENTS. ©J041196-19141

THIS RULE CONTINUED ON NEXT PAGE

FLIGHT RULES

A3.1.1-1 GROUND REQUIREMENTS OVERVIEW (CONTINUED)

To ensure that valid TACAN data are available, both primary and secondary ground stations must be confirmed to be within programmatically required limits (NASA operational requirements of 1 degree and 0.3 mile per Rule {8.1.2.-2B2},, SENSOR FAILURES, rather than FAA/DOD certification (2.5 degrees and 0.5 mile per NSTS 07700, Vol X specification). With the pre-deorbit ground station checks, full single fault tolerance exists. If both the primary and the secondary ground station were to fail after deorbit, the MCC can uplink another TACAN station. ©[041196-1914]

Any failure in either the onboard IMU's, TACAN's, MLS's, or TACAN ground stations which results in loss of single fault tolerance for entry will require that high speed tracking be provided for EOM.

S-band data is highly desired because it may provide insight in the case of a TACAN bias, although it cannot by itself be used as a source of "ground truth."

In relaxing the tracking data requirement from mandatory to highly desirable, it is understood and acknowledged to be an acceptable risk to rely totally on TACAN as required to achieve a safe landing. If the normal ceiling limit exists, and TACAN data is not processed by navigation, and no independent valid tracking data are present, the vehicle is unlikely to achieve the runway.

4. AOA/PLS: DUAL TRACKING CAPABILITY ABOVE 100K FEET IS HIGHLY DESIRABLE BUT IS NOT SCHEDULED FOR AOA AND PLS DEORBIT.
5. FD1 PLS ONLY: AT LEAST ONE TDRS OR TWO C-BAND RADAR PASSES ARE REQUIRED TO SUPPORT PRE-DEORBIT STATE VECTOR ACCURACY.

For AOA and PLS deorbits, best effort callup of high speed tracking resources is accepted (ref. rule {A3.1.3-3}, STDN FAILURE DECISION MATRIX). The time between launch and landing for an AOA deorbit is short enough to consider onboard navigation autonomous, and although best effort tracking callup will be requested, it is not mandatory. There is a high probability of obtaining PLS tracking support from KSC or EDW area radars on a best effort basis if the ranges are given more than 3 hours advance notice. There is little chance of obtaining such support for a NOR PLS deorbit unless the request is made during duty hours. Tracking support is virtually assured at all three CONUS sites, given 24 hours notice (ref. AEFTP #82 minutes).

Post MECO tracking is required for flight day 1 deorbit cases in order to insure the onboard state vector meets deorbit burn accuracy requirements. For high inclination launches (57 deg. and 51.6 deg.), at least one TDRS is required for orbit 3 cases, because the groundtracks for orbits 1 through 3 do not permit adequate C-Band coverage (ref. Rules {A4.1.3-1}, ONBOARD NAVIGATION MAINTENANCE, and {A3.1.3-3}, STDN FAILURE DECISION MATRIX - Note [2]). ©[041196-1914]

FLIGHT RULES

Rules {A3.1.1-2}, MISSION CONTROL CENTER (MCC) REDUNDANCY REQUIREMENTS, and {A3.1.1-3}, MOC/DSC ABENDS, reference this rule. ©[051697-6008A]

FLIGHT RULES

~~A3.1.1-2~~ HARDWARE/SOFTWARE CRITICALITY

~~WHEN A CAPABILITY IS DEFINED AS MANDATORY, THE HARDWARE AND SOFTWARE REQUIRED TO PROVIDE THAT CAPABILITY ASSUMES A MANDATORY STATUS ALSO.~~

Self explanatory.

~~A3.1.1-3~~ BUILDING 30 SOUTH MISSION CONTROL CENTER (MCC) HARDWARE REDUNDANCY ~~@{061396-4002A}~~

~~ALL HARDWARE DEVICES WHICH ENABLE MANDATORY DATA TO TRAVERSE THE MCC BUILDING 30 SOUTH LOCAL AREA NETWORKS (LANS) ARE REQUIRED TO MEET THE FOLLOWING REDUNDANCY REQUIREMENTS: @{061396-4002}@{061396-4002A}~~

~~A. PRIOR TO T MINUS 5 MINUTES REDUNDANCY IS MANDATORY.~~

~~B. AFTER T MINUS 5 MINUTES REDUNDANCY IS NOT MANDATORY. [1]~~

~~NOTE: [1] AFTER T MINUS 5 MINUTES, ONLY ONE DEVICE REDUNDANCY IS NOT MANDATORY, BUT THE CIRCUMSTANCES WHICH CAUSED THE OTHER DEVICES TO FAIL MUST BE UNDERSTOOD ENOUGH TO HAVE CONFIDENCE THAT THE REMAINING DEVICE WILL NOT BE AFFECTED BY THE ANOMALY. @{061396-4002A}~~

Each piece of hardware below has at least one level of redundancy to protect against loss of the mandatory functions. Both the prime and (one) backup units are considered mandatory for launch prior to T minus 5 minutes. After T minus 5 minutes (APU start), rather than cause a countdown hold/recycle, the risk of launching without redundancy is acceptable. @{061396-4002}

FLIGHT RULES

~~A3.1.1-4~~ 30S MCC NETWORK SERVERS @~~[061396-4002A]~~

- ~~A. AUSPEX CM READ ONLY SERVERS #1 AND #2 — ONE OF TWO MANDATORY AFTER T-5 MINUTES. @~~[061396-4002]~~ @~~[061396-4002A]~~~~

The Auspex CM Server contains platform system services software (PSS), certified application software, and also provides configuration management. Loss of both prime and backup units result in loss of the ability to configure workstations or start new displays/applications.

- ~~B. NETWORK SERVICES (ALSO KNOWN AS NAME SERVERS) #1 AND #2 — ONE OF TWO MANDATORY AFTER T-5 MINUTES. @~~[061396-4002A]~~~~

The Network Services servers provide NIS, DNS, and NRS surrogates. Loss of both servers result in loss of the ability to initiate new data transfers between devices.

- ~~C. DEC ALPHA USER READ/WRITE SERVERS #1 AND #2 (ALSO KNOWN AS HIGH AVAILABILITY SERVERS) — ONE OF TWO MANDATORY AFTER T-5 MINUTES. @~~[061396-4002A]~~~~

The CM Read/Write Server contains home directories, read/write files generated by certified application software, and the trusted computing base (password file). Loss of both CM Read/Write Servers will prevent new logins and potentially impact user applications/displays. @~~[061396-4002]~~

~~A3.1.1-5~~ USER LAN(S) TO COMMON LAN INTERFACE

- ~~A. WHITE LAN TO COMMON LAN BRIDGES — ONE OF TWO MANDATORY AFTER T-5 MINUTES. @~~[061396-4002A]~~~~

- ~~B. SUPPORT LAN TO COMMON LAN BRIDGES — ONE OF TWO MANDATORY AFTER T-5 MINUTES. @~~[061396-4002A]~~~~

Both the White and Support LAN's have prime and backup bridges connecting each to the Common LAN. Loss of both the prime and backup bridges for either LAN would result in loss of data flow to all workstations on the subnet.

~~A3.1.1-6~~ MANDATORY SERVER TO COMMON LAN INTERFACE

~~COMMON LAN CONCENTRATORS CONNECTING MANDATORY SERVERS TO THE COMMON LAN — ONE OF TWO MANDATORY FOR EACH SERVER AFTER T-5 MINUTES. @~~[061396-4002A]~~~~

Each server's LAN connectivity is provided via prime and backup concentrators. Loss of both concentrators result in loss of that server's network connectivity. @~~[061396-4002]~~

FLIGHT RULES

~~A3.1.1-7~~ USER LAN(S) TO WORKSTATION INTERFACE

- A. ~~WHITE LAN CONCENTRATORS CONNECTING THE DEC ALPHA WORKSTATIONS TO THE WHITE LAN — ONE OF TWO MANDATORY FOR EACH MANDATORY WORKSTATION AFTER T-5 MINUTES. — @061396-4002} — @061396-4002A}~~
- B. ~~SUPPORT LAN CONCENTRATORS CONNECTING THE DEC ALPHA WORKSTATIONS TO THE SUPPORT LAN — ONE OF TWO MANDATORY FOR EACH MANDATORY WORKSTATION AFTER T-5 MINUTES. — @061396-4002A}~~

Each workstation's LAN connectivity is provided via prime and backup concentrators. Loss of both concentrators would result in loss of that workstation's network connectivity.

~~A3.1.1-8~~ FEP TO COMMON LAN DATA FLOW/CONNECTIVITY

- A. ~~GIGASWITCHES A AND B — ONE OF TWO MANDATORY AFTER T-5 MINUTES. — @061396-4002A}~~

The Gigaswitch (also known as data distribution function (DDF)) provides the Operations Support Team (OST) controllers the capability to switch data between the Common LAN, the MOC, and the FEP's. Loss of both Gigaswitches would result in loss of data flow between the front end processors and the user workstations/MOC.

- B. ~~COMMON LAN TO DDF BRIDGES — ONE OF TWO MANDATORY AFTER T-5 MINUTES. — @061396-4002A}~~

LAN connectivity for the Gigaswitches is provided via Common LAN bridges. Loss of both bridges would result in loss of that Gigaswitch's connectivity. — @061396-4002}

~~A3.1.1-9~~ FEP TO EXTERNAL CENTER DATA FLOW/CONNECTIVITY

~~CONSOLIDATED DATA SELECT SWITCH (CDSS) CAPABILITY TO PROVIDE SWITCHPATHS FOR MANDATORY DATA — MANDATORY. — @061396-4002}~~

The CDSS provides the Operations Support Team (OST) controllers the capability to switch data between the external centers (GSFC, Sunnyvale, STDN, etc.) and the MCC FEP's. The CDSS is considered one device, but has built in redundancy. Loss of CDSS switching capability would result in loss of mandatory command, telemetry, S band air to ground voice, and S band tracking data flow between the MCC and the external networks/centers. — @061396-4002}

FLIGHT RULES

~~A3.1.1-10~~ FEP TO MOC DATA FLOW/CONNECTIVITY

~~MCC HOST INTERFACE (MHI) — ONE OF TWO MANDATORY AFTER T-5 MINUTES. @0613496-4002 @061396-4002A1~~

Loss of both MHI would result in loss of mandatory command, MOC telemetry, and S-band tracking data.

~~A3.1.1-11~~ MOC TO COMMON LAN DATA FLOW/CONNECTIVITY

~~A. ESCON DIRECTOR — ONE OF TWO MANDATORY AFTER T-5 MINUTES. @061396-4002A1~~

~~B. CHANNEL ATTACH UNIT (CAU) (ALSO KNOWN AS FORMATION BOX) — ONE OF FOUR MANDATORY AFTER T-5 MINUTES.~~

~~C. MULTICAST SERVER — ONE OF FIVE MANDATORY AFTER T-5 MINUTES.~~

~~D. DYNATECH SWITCHES #1 AND #2 — ONE OF TWO MANDATORY AFTER T-5 MINUTES. @061396-4002A1~~

~~A3.1.1-2~~ MISSION CONTROL CENTER (MCC) REDUNDANCY REQUIREMENTS

~~A. THE MCC MUST PROVIDE COMMAND, TELEMETRY, TRAJECTORY PROCESSING, AND VOICE IN ACCORDANCE WITH FLIGHT RULE {A3.1.1-1}, GROUND REQUIREMENTS OVERVIEW, TO BE GO FOR LAUNCH. WHEN A CAPABILITY IS DEFINED AS MANDATORY, THE HARDWARE AND SOFTWARE REQUIRED TO PROVIDE THAT CAPABILITY ASSUMES A MANDATORY STATUS ALSO. @051797-6008A1~~

Reference rationale for Rule {A3.1.1-1}, GROUND REQUIREMENTS OVERVIEW.

~~B. REDUNDANCY IS NOT MANDATORY FOR LAUNCH AS LONG AS THE FAILURE MODE IS UNDERSTOOD, AND THERE IS CONFIDENCE THAT THE REMAINING DEVICE WILL NOT BE AFFECTED BY THE ANOMALY.~~

The risk of launching without redundancy is acceptable rather than cause a countdown hold/scrub for the day. The reliability of the remaining systems will support ascent requirements. If redundancy is not available for a critical function, the probability of the second failure occurring, resulting in loss of the critical function, is approximately 1 in 200 over 40 minutes; the least reliable are the MOC and DSC. Forty minutes meets all requirements defined in flight rule {A3.1.1-1}, GROUND REQUIREMENTS OVERVIEW, including sufficient coverage for OMS-2 targeting, RTLS, and TAL coverage through landing.

FLIGHT RULES

If the failure mode is not understood and/or could affect the redundant device (i.e., software problem or generic failure), a launch hold is required to resolve the problem.

C. CONSIDERATION WILL BE GIVEN TO HOLDING THE LAUNCH COUNT OUTSIDE OF T-5 TO REGAIN REDUNDANCY AS LONG AS THE HOLD WILL NOT RESULT IN A LAUNCH SCRUB FOR THE DAY.

If redundancy can be regained without causing a launch scrub, it would be prudent to hold the launch in order to regain the redundancy prior to launch. @[051697-6008A]

THIS RULE CONTINUED ON NEXT PAGE

FLIGHT RULES

A3.1.1-2 MISSION CONTROL CENTER (MCC) REDUNDANCY REQUIREMENTS (CONTINUED)

D. THE FOLLOWING MCC DEVICES ARE MANDATORY FOR LAUNCH: @[051697-6008A]

1. MCC NETWORK SERVERS:

- a. AUSPEX CM READ ONLY SERVERS - ONE OF TWO MANDATORY
- b. NETWORK SERVICES (NAME SERVERS) - ONE OF TWO MANDATORY
- c. DEC ALPHA USER READ/WRITE SERVERS (HIGH AVAILABILITY SERVERS) - ONE OF TWO MANDATORY

The Auspex CM server contains platform system (PS) software, certified application software, and also provides configuration management. Loss of both prime and backup units result in loss of the ability to configure workstations or start new displays/applications.

The name servers provide Network Information Services, Domain Name Service, and Network Registration Service surrogates. Loss of both servers results in loss of the ability to initiate new data transfers between devices.

The read/write server contains home directories, read/write files generated by certified application software, and the trusted computing base (password file). Loss of both read/write servers will prevent new logins and potentially impact user applications/displays.

2. CONCENTRATORS: MANDATORY SERVER TO COMMON LAN INTERFACE AND USER LAN(S) TO WORKSTATION INTERFACE

- a. COMMON LAN CONCENTRATORS CONNECTING MANDATORY SERVERS TO THE COMMON LAN - ONE OF EACH REDUNDANT PAIR MANDATORY
- b. WHITE LAN CONCENTRATORS CONNECTING THE DEC ALPHA WORKSTATIONS TO THE WHITE LAN - ONE OF EACH REDUNDANT PAIR MANDATORY [1]
- c. SUPPORT LAN CONCENTRATORS CONNECTING THE DEC ALPHA WORKSTATIONS TO THE SUPPORT LAN - ONE OF EACH REDUNDANT PAIR MANDATORY [1] @[051697-6008A]

THIS RULE CONTINUED ON NEXT PAGE

FLIGHT RULES

A3.1.1-2 MISSION CONTROL CENTER (MCC) REDUNDANCY REQUIREMENTS (CONTINUED)

3. BRIDGES: USER LAN (S) TO COMMON LAN INTERFACE @J051607-6008A]
- a. WHITE LAN TO COMMON LAN BRIDGES - ONE OF TWO MANDATORY [1]
- b. SUPPORT LAN TO COMMON LAN BRIDGES - ONE OF TWO MANDATORY [1]

NOTE: [1] FOR PARTIAL OR TOTAL LOSS OF THE SUPPORT LAN OR WHITE LAN, A LAUNCH HOLD WILL BE INVOKED AT T-5 MINUTES UNTIL THE AFFECTED USERS ARE RECONFIGURED ON AN ALTERNATE LAN. THE LAUNCH COUNT MAY RESUME AFTER MANDATORY CAPABILITY IS REGAINED.

Each server's LAN connectivity is provided via prime and backup concentrators. Loss of both concentrators results in loss of that server's connectivity to the LAN. Similarly, each workstation's LAN connectivity is provided via prime and backup concentrators. Loss of both concentrators would result in loss of that workstation's network connectivity.

The white and support LAN's have prime and backup bridges connecting each to the common LAN. Loss of both the prime and backup bridges for either LAN would result in loss of data flow to all workstations on the subnet.

Contingency plans, defined in the FCOH, are in place for total loss of the support LAN or white LAN. For partial or total loss of the support or white LAN, the affected LAN users will move to their designated backup workstation which is supported by a different LAN (SVO, MOIR, MISSION 30 LAN's are available). This LAN will provide the same capability as the Support LAN. A launch hold will be invoked until the affected users reconfigure the alternate workstations to provide nominal support. When reconfiguration is complete, launch count may resume. The failure mode must be understood and must not affect the alternate LAN before resuming launch count. Tests of the contingency plans were run on April 29, 1997. Assuming the failure mode was understood and the decision was made to move to alternate workstations, approximately 9 (18) minutes was required for all support (white) LAN users to reconfigure to alternate workstations. All mandatory launch requirements can be met (command, telemetry, trajectory processing, and voice) from the alternate workstations. @J051697-6008A]

THIS RULE CONTINUED ON NEXT PAGE

FLIGHT RULES

A3.1.1-2 MISSION CONTROL CENTER (MCC) REDUNDANCY
REQUIREMENTS (CONTINUED)

4. FEP DATA FLOW/CONNECTIVITY TO COMMON LAN, EXTERNAL CENTERS, AND MOC @[051697-6008A]
 - a. FEP TO COMMON LAN CONNECTIVITY
 - (1) GIGASWITCHES - ONE OF TWO MANDATORY
 - (2) COMMON LAN TO GIGASWITCH BRIDGES - ONE OF TWO MANDATORY
 - b. FEP TO EXTERNAL CENTERS: CONSOLIDATED DATA SELECT SWITCH (CDSS) - ONE OF ONE MANDATORY (BUILT IN REDUNDANCY)
 - c. FEP TO MOC: MCC HOST INTERFACE (MHI) - ONE OF TWO MANDATORY

The gigaswitch provides network connectivity between the common LAN, MHI, and FEP's. Loss of both gigaswitches would result in loss of data flow between the FEP's and the workstations and MOC.

The CDSS provides the OST the capability to switch data between the external centers (GSFC, Sunnyvale, STDN, etc.) and the MCC FEP's. The CDSS is completely redundant (power, controllers, etc.) with the exception of the chassis. Loss of the CDSS would result in loss of mandatory command, telemetry, S-band air-to-ground voice, and highly desirable S-band tracking data flow between the MCC and the external network/centers.

5. MOC DATA FLOW/CONNECTIVITY TO COMMON LAN
 - a. ESCON DIRECTOR - ONE OF TWO MANDATORY
 - b. ~~3172 CONTROLLERFORMATION BOX (CHANNEL ATTACH UNIT (CAU))~~ - ONE OF FOUR MANDATORY @[072398-65661]
 - c. MULTICAST SERVER - ONE OF FIVE MANDATORY
 - d. DYNATECH SWITCH - ONE OF TWO MANDATORY

Loss of both prime and backup units of the above devices would result in loss of mandatory event, generalized data retrieval (GDR), emulated DTE, command, trajectory, and workstation MED data between the MOC and the workstations. @[051697-6008A]

THIS RULE CONTINUED ON NEXT PAGE

FLIGHT RULES

A3.1.1-2 MISSION CONTROL CENTER (MCC) REDUNDANCY REQUIREMENTS (CONTINUED)

6. HOST COMPUTERS: MOC & DSC - ONE OF ~~THREE~~ MANDATORY @051697-6008A] @072398-6567]

The MOC is required for processing of mandatory command and trajectory data. A second computer, the DSC, is brought up during the final 8 hours of countdown to provide failover protection against loss of the MOC. A third host computer is available. ~~In~~ In the event of a MOC or DSC failure, it would take 45 minutes to configure this computer as a MOC or DSC. ~~All~~ All efforts will be made to bring up the third computer to ~~dyadic mode to~~ avoid a launch scrub/hold. @072398-6567]

7. FEP'S
- a. UPLINK FEP - ONE OF THREE MANDATORY
 - b. DOWNLINK FEP - ONE OF THREE MANDATORY
 - c. GROUND-TO-GROUND FEP - ONE OF TWO MANDATORY

The uplink and downlink FEP (actually one hardware box) is required to process telemetry, A/G voice, and commands. A single uplink/downlink FEP is mandatory to support these functions. The ground-to-ground FEP processes site status (not mandatory) and mandatory tracking data.

8. ABORT SWITCH INTERFACE: ONE OF THREE (WFCR-28, WFCR-10, SVO-9) WORKSTATIONS MANDATORY @121197-6394A]

Removal of the ET range safety flight termination system resulted in additional flight crew responsibility as agents of the 45th Space Wing Commander for public safety during second stage flight. During this timeframe, crew-initiated manual MECO replaces range safety command destruct capability. One of the elements agreed upon to satisfy this requirement is to provide the FCO with the capability to illuminate the orbiter abort light via pushbutton, as an independent method for the FCO to communicate a manual MECO requirement to the crew. Since these redundant pushbuttons interface with the MCC command system via the FD, FDO, and SVO workstations, one of these workstations is required for launch commit. @121197-6394A]

9. COMMAND UPLINK CAPABILITY: INCO, COMM SUPPORT, INST, OR DATA COMM - ONE OF FOUR MANDATORY

Command uplink capability is mandatory and can be accomplished from any of the four command positions. Each command position has both hardware and software command capability by which command can be uplink. @051697-6008A]

THIS RULE CONTINUED ON NEXT PAGE

FLIGHT RULES

A3.1.1-2 **MISSION CONTROL CENTER (MCC) REDUNDANCY**
REQUIREMENTS (CONTINUED)

10. DIGITAL VOICE INTERCOMMUNICATION SYSTEM (DVIS) -
MANDATORY @[051697-6008A]

DVIS provides mandatory A/G, internal, and external voice.

11. MASTER TIMING UNIT - ONE OF TWO MANDATORY

The FEP's rely upon the timing system for proper operations. Failure of both MTU's would result in degradation of telemetry, commanding, digital A/G, and tracking data processing to an unacceptable level. Analog UHF A/G voice would function without the MTU. @[051697-6008A]

12. COMMAND DEVICES - ONE OF FOUR MANDATORY @[040899-6809A]

Command capability is mandatory for launch. The four command devices are the primary command server, backup command server, MOC, and DSC. If the primary command server fails, a manual fail-over to the backup command server will restore command capability in less than 1 minute. If the command server system is failed (both prime and backup), a fallback to MOC commanding will restore command capability in 1-10 minutes depending on individual flight controllers' time to reconfigure to MOC commanding. @[040899-6809A]

FLIGHT RULES

A3.1.1-3 MOC/DSC ABENDS

THE FOLLOWING CRITERIA APPLY FOR ABEND OCCURRENCES IN THE MOC AND/OR DSC (AS LONG AS ALL PROCESSES APPEAR TO FUNCTION NORMALLY) : @[051697-6008A]

- A. SINGLE OR SEVERAL ABENDS OF THE SAME TYPE IN ONE COMPUTER THAT CLEAR - GO.
- B. SINGLE OR SEVERAL ABENDS OF THE SAME TYPE IN BOTH COMPUTERS THAT CLEAR - GO.
- C. CONTINUOUS ABENDS IN ONE OR BOTH COMPUTERS - THE AFFECTED COMPUTER IS CONSIDERED FAILED.

IF ABENDS OCCUR WITH SECONDARY INDICATIONS OF COMPUTER PROBLEMS (SUCH AS ABENDS OF DIFFERENT TYPES, EXCESSIVE CPU USAGE, CORRUPTED TELEMETRY, COMMAND, OR TRAJECTORY PROCESSING, ETC.), THE AFFECTED COMPUTER IS CONSIDERED FAILED.

The MOC is required for processing of mandatory telemetry, command, and trajectory data (reference Flight Rule {A3.1.1-1F}, GROUND REQUIREMENTS OVERVIEW).

Abends can occur in the MOC and DSC with no impact to processing. If one or more abends of the same type occur, abends are not continuous, and do not affect computer processing, the computer is not considered failed and launch is GO. For cases A and B above, a selectover and/or CPU-to-CPU will not be performed. If continuous abends occur, abends of different types occur (for example, an OCB followed by an OCI indicating an attempt to overwrite memory), CPU usage is excessive, or the abends affect computer processing, the affected computer is considered failed. If this situation occurs in the MOC, a selectover will be performed. In addition, a CPU-to-CPU will be completed if time permits (15 minutes). If this situation occurs in both the MOC and DSC, a turnaround to a previous checkpoint is required. @[051697-6008A]

FLIGHT RULES

THIS PAGE INTENTIONALLY BLANK

FLIGHT RULES**MCC INSTRUMENTATION PRELAUNCH REQUIREMENTS****A3.1.2-1** RESERVED @[051697-6008A] COMPUTERSA. ~~HOST COMPUTERS: @[061396-4003]~~

1. ~~PRIOR TO T MINUS 5 MINUTES — TWO MANDATORY (MOC AND DSC).~~
2. ~~AFTER T MINUS 5 MINUTES — ONE MANDATORY (MOC). [1]~~

~~NOTE: [1] AFTER T MINUS 5 MINUTES, ONLY ONE MOC IS MANDATORY, BUT THE CIRCUMSTANCES WHICH CAUSED THE OTHER COMPUTER TO FAIL MUST BE UNDERSTOOD ENOUGH TO HAVE CONFIDENCE THAT THE REMAINING MOC WILL NOT BE AFFECTED BY THE ANOMALY.~~

The mission operations computer (MOC) is required for processing of mandatory telemetry, command, and trajectory data. A second computer, the dynamic standby computer (DSC), is brought up during the final 4 hours of countdown to provide failover protection against loss of the MOC. Prior to T minus 5 minutes (APU start), critical MCC commanding and telemetry processing require the immediate availability of the MOC/DSC pair to preclude an MCC initiated unplanned hold at T minus 5 minutes. After T minus 5 minutes, rather than cause a countdown hold/recycle if one host computer fails, the risk of launching with only the MOC is accepted since the reliability of the system is such that it will support all ascent requirements. Efforts to obtain a backup computer will be continued.

B. ~~UPLINK, DOWNLINK AND GROUND TO GROUND FRONT END PROCESSORS (U/L, D/L, AND G/G FEP): @[113095-1805A]~~

1. ~~PRIOR TO T MINUS 5 MINUTES — REDUNDANCY IS MANDATORY.~~
2. ~~AFTER T MINUS 5 MINUTES — REDUNDANCY IS NOT MANDATORY.~~

~~NOTE: AFTER T MINUS 5 MINUTES, ONLY ONE U/L, D/L, AND G/G FEP IS MANDATORY, BUT THE CIRCUMSTANCES WHICH CAUSED THE REDUNDANT SYSTEM MUST BE UNDERSTOOD ENOUGH TO HAVE CONFIDENCE THAT THE SINGLE REMAINING PROCESSOR WILL NOT BE AFFECTED BY THE ANOMALY. @[113095-1805A]~~

THIS RULE CONTINUED ON NEXT PAGE

FLIGHT RULES

~~A3.1.2-1~~ COMPUTERS (CONTINUED)

~~An FEP is required for processing of mandatory telemetry, A/G voice, commands, and S-band tracking data. A single front end processor is capable of processing a real time telemetry stream, A/G voice, S-band tracking data, and maintaining command capability. After T minus 5 minutes (APU start), rather than cause a countdown hold/recycle, the risk of launching without redundancy is acceptable since the reliability of the FEP is such that it will support all telemetry, A/G voice, command, and tracking requirements. Efforts to obtain a redundant system will be continued.~~
~~@{113095-1805A}~~

A3.1.2-2 RESERVED @051697-6008A TELEMETRY

~~MCC CAPABILITY TO RECEIVE AND PROCESS HDR TELEMETRY —
MANDATORY.~~

~~Rationale same as for Rule {A3.1.1-1A.1.b}, GROUND REQUIREMENTS OVERVIEW.~~

FLIGHT RULES

A3.1.2-3 RESERVED @[051697-6008A] COMMAND

A3.1.2-4 TRAJECTORY PROCESSING @[061396-4005A]

A. HIGH-SPEED TRAJECTORY DETERMINATION:

1. HIGH SPEED S-BAND - MANDATORYHIGHLY DESIRABLE @[061297-6004]
2. HIGH SPEED C-BAND - MANDATORYHIGHLY DESIRABLE
3. KALMAN FILTER PROCESSING - MANDATORYHIGHLY DESIRABLE
@[061297-6004]

B. ARD/AME PROCESSING - MANDATORY

C. EPHEMERIS MAINTENANCE PROCESSING - MANDATORY

D. ORBIT DETERMINATION PROCESSING:

1. LOW SPEED TRACKING DATA - MANDATORY
2. BATCH RADAR PROCESSING - MANDATORY

THIS RULE CONTINUED ON NEXT PAGE

FLIGHT RULES

A3.1.2-4 TRAJECTORY PROCESSING (CONTINUED)

- E. DEORBIT PLANNING PROCESSING - MANDATORY
- F. ENTRY PROFILE PROCESSING - MANDATORY
- G. COMMAND/TRAJECTORY INTERFACE PROCESSING - MANDATORY
- H. TRAJECTORY/TELEMETRY AND TELEMETRY/TRAJECTORY INTERFACE PROCESSING - MANDATORY
- I. HIGH SPEED ENTRY RGO AND TAEM PROCESSING - MANDATORY
- J. ALL SUPPORTING TABLES AND PROCESSING - MANDATORY
- K. RENDEZVOUS TARGETING PROCESSING - MANDATORY FOR RENDEZVOUS FLIGHT @[061396-4005A]
- L. LAUNCH WINDOW/LAUNCH TARGETING PROCESSING - MANDATORY UNTIL THE LAUNCH TARGET COMMANDS HAVE BEEN GENERATED. THIS ONLY APPLIES TO GROUND-UP RENDEZVOUS AND INERTIALLY TARGETED FLIGHTS. @[061396-4005A]

All mandatory trajectory processing is required to be operational prior to launch, including support processors as well. Any loss of trajectory processing will be assessed in real time in order to determine applicability of the lost capability to the flight at hand.

M. DOLILU STRUCTURAL LOADS AND TRAJECTORY ANALYSIS TOOLS - MANDATORY UNTIL THE DOLILU I-LOAD HAS BEEN TRANSFERRED INTO THE MCC COMMAND SYSTEM; THEREAFTER, HIGHLY DESIRABLE (REF. RULE {A4.1.1-4}, DOLILU OPERATIONS) . @[091098-6622C]

DOLILU and Loads assessments are nominally run concurrently by JSC and USA/Systems Integration. In the event that JSC fails to complete analysis after the MCC I-load transfer, USA/Systems Integration becomes prime for providing the remaining prelaunch assessments. This contingency condition is considered acceptable to proceed based on the joint system checkouts that have occurred (L-3 week, L-2 day, and completed launch day verifications). @[091098-6622C]

- N. DESCENT DESIGN SYSTEM (DDS) - MANDATORY @[061396-4005A]

FLIGHT RULES

A3.1.2-5 MCC INTERNAL VOICE

LOSS OF INTERNAL VOICE LOOPS FD, A/G 1, OIS 232 AND FLIGHT CONTROL OFFICER (FCO), WOULD NOT CAUSE A LAUNCH HOLD BECAUSE OF SUFFICIENT AVAILABLE WORKAROUNDS:

A. MCC FLIGHT CONTROL TEAM COORDINATION CAPABILITY - ONE OF THREE MANDATORY:

1. FD
2. AFD CONF
3. LOOP CONFERENCING

One common voice loop between all MCC flight control team members is required for expedient communication of system conditions/anomalies.

B. A/G TALK CAPABILITY - TWO OF FOUR MANDATORY:

1. A/G 1
2. A/G 2
3. A/G UHF
4. OTHER LOOP WITH KEYING CAPABILITY

Two MCC voice loops with keying capability are required to provide continuous S-band A/G and UHF A/G (ref. Rule {A3.1.1-1A}.1.d, GROUND REQUIREMENTS OVERVIEW).

C. COMMUNICATIONS INTERFACE WITH LAUNCH TEST DIRECTORS - ONE OF FOUR MANDATORY:

1. OIS 131
2. OIS 232
3. FD (EXTENDED TO LAUNCH SITE)
4. OTHER LOOP PATCHING TO LAUNCH SITE

One MCC voice loop (extended to launch site long lines) is required to call an MCC-initiated countdown hold.

D. COMMUNICATIONS INTERFACE WITH FCO - TWO OF FOUR MANDATORY:
@[101096-4550]

1. FCO PVT LINE
2. FD (EXTENDED TO FCO)
3. FCO PRIME
4. OTHER LOOP PATCHING TO FCO LONG LINE

THIS RULE CONTINUED ON NEXT PAGE

FLIGHT RULES

A3.1.2-5 MCC INTERNAL VOICE (CONTINUED)

A minimum of two MCC voice loops, extended to the Eastern Range 45th Space Wing, are required for FD and FDO voice communication with the FCO. Removal of the ET Range Safety Flight Termination System resulted in additional flightcrew responsibility as agents of the 45th Space Wing Commander for public safety during second stage flight, with crew-initiated manual MECO replacing range safety command destruct capability. Redundant FCO/MCC communications is therefore mandatory to provide the interaction and situational awareness necessary to implement this requirement. ©[101096-4550]

Rules {A3.1.4-1C} and D, MCC/KSC/45 SPW INTERFACE, reference this rule.

E. COMMUNICATIONS CAPABILITY WITH REQUIRED ASCENT ABORT SITES
- 1 OF 3 MANDATORY: ©[111094-1716A] ©[ED]

1. LONGLINE (LFP1)
2. INMARSAT
3. COMMERCIAL TELEPHONE

Prelaunch, the MCC must be able to communicate with the required ascent abort landing sites (ref. Rule {A2.1.1-2}, ABORT LANDING SITE REQUIREMENTS). This insures that there has not been a change in weather or nav/landing aid status. It also insures that anomalies can be passed to the ground support team and that the runway and airspace are clear for a safe landing. This can be accomplished by insuring that at least one of the communications capabilities listed above are available. ©[111094-1716A]

[©\[051697-6008A\]](#)

A3.1.2-6 RESERVED ©[061396-4004]

A3.1.2-7 RESERVEDTIMING MASTER TIMING UNIT - ONE OF TWO MANDATORY.

~~Various mandatory MCC data processing equipment (TPC, NOM, MDM, and DTE) relies upon the timing system for proper operations. Failure of both MTU's would result in loss of telemetry, commanding, digital A/G, and tracking data processing. Analog A/G voice will function as normal.~~

[©\[051697-6008A\]](#)

FLIGHT RULES

A3.1.2-8 MCC POWER

A. BUILDING 30M POWER BUSES ©[061396 4006A]

BUS A1, A2, B1, B2 - THREE OF FOUR MANDATORY.

All mandatory MCC equipment can be configured to operate on any three of the four power buses. Equipment which cannot tolerate a 20-second power outage is configured on bus A1 or A2. These buses are supported with online UPS (uninterrupted power supply) (critical A power) during ascent. Equipment which can tolerate a 20-second power outage is configured on bus B1 or B2. These buses are supported with backup offline (20-second startup) diesel generators (critical B power) during ascent. ©[061396 4006A]

B. BUILDING 30S POWER BUSES

1. POWER BUSES AX1, AX2 - ONE OF TWO MANDATORY.
(SEE NOTE #1)

NOTE #1: IF ONLY ONE POWER BUS IS AVAILABLE, IT MUST HAVE A NON-INTERRUPTIBLE POWER SUPPLY (EITHER UPS OR A RUNNING DIESEL) FEED.

2. POWER BUSES BX1, BX2 - ONE OF TWO MANDATORY.
3. POWER BUSES CX1, CX2 - ONE OF TWO MANDATORY
(SEE NOTE #2)

NOTE #2: MANDATORY FOR FLIGHTS WITH POCC WORKSTATION REQUIREMENTS ONLY; SEE THE FLIGHT SPECIFIC ANNEX.
©[061396-4006B]

All equipment on the A and B buses can be configured entirely onto either single bus, with each capable of carrying the entire load. The AX1 and AX2 buses are supported with UPS (uninterrupted power supply). The BX1 and BX2 buses are backed up with diesels (20-second startup).

The AX buses provide power for most mandatory technical equipment and emergency lighting in the MCC. The BX buses provide power to IPS system, utility outlets, AX1 and AX2 uninterruptable power supplies, and back-up power feed to the AX buses in case of a UPS failure. The CX buses provide power to the third floor POCC consoles.

THIS RULE CONTINUED ON NEXT PAGE

FLIGHT RULES

A3.1.2-8 **MCC POWER (CONTINUED)**

C. BUILDING 30S AIR HANDLERS @[061396-4006A]

1. SOFT AIR HANDLERS - ONE OF THREE MANDATORY
2. HARD AIR HANDLERS - ONE OF THREE MANDATORY

The hard air handlers provide cooling to the FCR, SVO, GOSR, CDE and fifth floor areas of building 30S. The soft air handlers provide cooling to all other areas not supplied by hard air handlers. One of each type air handler is required to adequately provide cooling for mission essential hardware and personnel. @[061396 4006A]

FLIGHT RULES

THIS PAGE INTENTIONALLY BLANK

FLIGHT RULES

45 SPW/GSFC/STDN PRELAUNCH REQUIREMENTS

A3.1.3-1 RESERVED @[051607-6008A] ~~DATA PROCESSORS~~

A3.1.3-2 GSFC

A. MESSAGE SWITCHES - ONE OF TWO MANDATORY @[121593-1582]

These computers route mandatory telemetry, command, tracking and configuration data between MCC and tracking stations. Each message switcher can handle the total traffic rate.

~~B. FLIGHT DYNAMICS FACILITY (FDF) COMPUTERS - ONE OF TWO MANDATORY @[121593-1582]~~

~~*These computers process MCC provided intercenter vectors (ICV's) and generate acquisition data for S band and C band tracking stations and the Space Network (SN) facility. Each computer can handle the processing load.*~~

CB. NETWORK CONTROL CENTER (NCC) COMPUTERS - ONE OF TWO MANDATORY @[121593-1582] @[051697-6008A]

For TDRSS to support TAL aborts, acquisition data must be generated and sent to WSGT for TDRS pointing. The NCC computers and associated equipment manage this acquisition message data for forwarding to WSGT.

FLIGHT RULES

A3.1.3-3

STDN FAILURE DECISION MATRIX

SITE	TYPE	CALL SIGN	ROMT	PRELAUNCH [1]		
				ASCENT/RTLS	AOA [10]	1ST DAY PLS [10]
JONATHON DICKSON	S-BD	JDIS	TLM/V	1 OF 2 M		
PONCE DE LEON	S-BD 14	PDLS	TLM/V CMD/V UHF			
MERRITT ISLAND	S-BD 30 OR S-BD 30	MILS OR MILXS	UHF	M [16]	M (KSC)	M (KSC)
			TLM/V CMD/V			
			TRK			
	FPO-14 MCB-17	MLAC MLMC	TRK TRK	2 OF 5 M	NOT SCHEDULED ACCEPT BEST EFFORT CALLUP	NOT SCHEDULED ACCEPT AS BEST EFFORT CALLUP
PATRICK	FPO-14	PATC	TRK			
CANAVERAL	FPS-16 MOTR	CNVC CMTC	TRK TRK			
WALLOPS	S-BD 30	WLPS	TLM/V CMD/V	1 OF 3 M [14]		
			TRK	HD		
			FPO-6 FPS-16 FPS-16	WLPC WLRC WLIC		
BERMUDA ISLAND	FPO-6	BDQC	TRK	HD [4]		
			UHF	HD		
NEW HAMPSHIRE	S-BD 46	NHS	CMD/V TLM/V	1 OF 3 M [14]		

@[072795-1722] @[ED]] @[121296-4177D] @[072398-6565A] @[021199-6817]

TDRSS	S-BD	ANY TDRS TDR-E	TRK TLM/V CMD/V	POST MECO 28.5° INCL	POST MECO 39° INCL	POST MECO 57°, 51.6° INCL	EDW AOA [10]	NOR AOA [10]	TAL	1ST DAY PLS [10]
								HD	HD	M [2]
				M	M	1 OF	[8]	[6]	M	SAME AS AOA FOR EDW/NOR PLS
OAKHANGER	S-BD 60	TCSS	CMD/V TLM/V UHF [3] TRK			2M		M		

@[072795-1722] @[061396-3198] @[072398-6565A]

THIS RULE CONTINUED ON NEXT PAGE

FLIGHT RULES

A3.1.3-3

STDN FAILURE DECISION MATRIX (CONTINUED)

SITE	TYPE	CALL SIGN	RQMT	PRELAUNCH		
				ASCENT/RTLS	AOA [10]	1ST DAY PLS [10]
DRYDEN	S-BD 12	DFRF	TLM/V		1 OF 2 M (EDW) 1 OF 2 M (EDW)	SAME AS AOA AS AOA FOR EDW PLS FOR EDW PLS
			CMD/V UHF [3]		[7][7]	
					1 OF 2 M (EDW) [8] OF 3 M (EDW) [8]	
NORTHROP STRIP	UHF OMNI	SAL	UHF		1 OF 2 M [6]	
PT. PILLAR	MPS-36 FPQ-6	PPMC PTPC	TRK TRK			SAME AS AOA FOR EDW PLS
VANDENBURG	FPQ-14	VDHC	TRK			
	TPQ-18	VDBC	TRK			
	FPS-16	VDSC	TRK			
	FPS-16	VDFC	TRK			
SAN NICHOLAS ISLAND	FPS-16	SNIC	TRK			
	FPS-16	SNFC	TRK			
	FPS-16	SNSC	TRK			
PT. MUGU	FPS-16	PMPC	TRK			
	FPS-16	PMFC	TRK			
	FPS-16	PMSC	TRK			
EDWARDS/ DRYDEN	FPS-16	FRCC	TRK			
	FPS-16	FRFC	TRK			
	FPS-16	EAFC	TRK			
	FPS-16	EFFC	TRK			
MT. LEMMON	CAPRI	MTLC	TRK			
SCOTT PEAK	FPS-16	SPKC	TRK			
WHITE SANDS MISSILE RANGE	FPS-16	HOLC	TRK			
	FPS-16	WHSC	TRK			
	FPS-16	WSSC	TRK			

@[121593-1590] @[072795-1772] @[121296-4177D] @[072398-6565A]

THIS RULE CONTINUED ON NEXT PAGE

FLIGHT RULES

A3.1.3-3 STDN FAILURE DECISION MATRIX (CONTINUED)

NOTES:

- [1] ASCENT, RTLS, TAL, AOA, AND PLS (AS REQUIRED, REF. RULE {A2.1.1-2}, ABORT LANDING SITE REQUIREMENTS) COLUMNS MUST BE SATISFIED FOR LAUNCH.
- [2] ONE TDRS REQUIRED TO INSURE PRE-BURN STATE VECTOR ACCURACY FOR ORBIT 3 DEORBIT. @[072795-1722]
- [3] ONE S-BAND OR ONE UHF LINK.
- [4] 28.5 DEGREES 39 DEGREES INCLINATION.
- [5] 57 DEGREES 51.6 DEGREES INCLINATION. @[072795-1722]
- [6] FOR NOR AOA, ONE OF TWO MANDATORY (TDRS VOICE, SAL UHF VOICE).
- ~~[7] FOR EDW AOA/PLS, ONE OF THREE MANDATORY: (TDRS, DFRF, GDY) COMMAND AND TELEMETRY.~~
- [7] FOR EDW AOA/PLS, ONE OF TWO MANDATORY (TDRS, DFRF) COMMAND AND TELEMETRY. @[072398-6565A]
- [8] FOR EDW AOA/PLS, ONE OF THREE MANDATORY (TDRS VOICE, DFRF S-BAND VOICE, DFRF UHF VOICE).
- [9] RESERVED @[121296-4177D]
- [10] ABORT LANDING SUPPORT REQUIREMENTS ARE NEEDED IF ABORT CAPABILITY IS REQUIRED, REFERENCE RULE {A2.1.1-2}, ABORT LANDING SITE REQUIREMENTS. MANDATORY EQUIPMENT AT REQUIRED SITES MUST BE FUNCTIONAL AT LAUNCH. FOR FIRST DAY PLS, OUTAGES ARE ALLOWED IF ETRO IS PRIOR TO DEORBIT DECISION TIME. LAUNCH IS NOT ALLOWED IF CRITICAL EQUIPMENT ETRO DOES NOT SUPPORT FD 2 PLS.
- [11] RESERVED
- [12] FOR MISSIONS WITH AN INCLINATION OF 28.5 DEGREES, PDL S-BAND AND UHF UPLINK IS HIGHLY DESIRABLE. @[121296-4177D]

MIL UHF, which is mandatory, is not blocked by the SRB plume.

Although Bermuda and Wallops tracking provide for a ground filter vector through nominal MECO, this capability is rated highly desirable rather than mandatory because the accuracy of the onboard navigation, demonstrated by flight history, makes the expense of slipping a launch for lack of Bermuda or Wallops tracking unjustifiable. Currently, the rendezvous propellant budget protects for OMS-2 targeting dispersions to achieve a successful rendezvous. Bermuda or Wallops tracking data for independent ground processing may be critical to the evaluation of future proposed orbiter upgrades (e.g., Embedded GPS/INS). @[121296-4177D]

- [13] FOR MISSIONS WITH AN INCLINATION GREATER THAN 28.5 DEGREES, PDL S-BAND OR UHF UPLINK IS MANDATORY.

~~[14] FOR MISSIONS WITH INCLINATION OF 57 DEGREES, BDA/WLPS/NHS IS ONE OF THREE MANDATORY.~~

[14] FOR MISSIONS WITH INCLINATION OF 57 DEGREES, WLPS/NHS IS ONE OF TWO MANDATORY. @[072398-6565A]

- [15] RESERVED @[121296-4177D]

- [16] MIL HIGH GAIN TRACKABLE UHF ANTENNA IS REQUIRED TO COVER RTLS UHF COMM FROM MET +6 UNTIL ET SEP. @[061396-3196A]

MIL S-band and UHF uplink are blocked by the SRB plume. @[121296-4177A]

FLIGHT RULES

Rules {A2.1.1-2}, ABORT LANDING SITE REQUIREMENTS; {A3.1.1-1A.1}, GROUND REQUIREMENTS OVERVIEW; and {A3.1.4-2}A and B, GSFC/STDN INTERFACE, reference this rule.

FLIGHT RULES

MCC EXTERNAL INTERFACE (VOICE DATA) PRELAUNCH REQUIREMENTS

A3.1.4-1 MCC/KSC/45 SPW INTERFACE

- A. 7.2-KB LAUNCH/LANDING RADAR CIRCUIT - ONE OF TWO HIGHLY DESIRABLE. @[061297-6004]

These circuits provide launch/landing C-band tracking data from 45 SPW/CCC to the MCC. These are redundant circuits providing backup capability; each one capable of carrying the total traffic. @[061297-6004]

- B. 9.6 KB WIND DATA CIRCUIT - ONE OF TWO MANDATORY. ~~[1]~~@ED]

NOTE: ~~[1]~~-CHANGES TO HD AFTER STRUCTURAL GO/NO-GO DECISION IS MADE. @ED]

These circuits support processing of ascent structural loads. There are two redundant circuits providing backup capability; each one capable of carrying the total traffic.

- C. 9.6 KB FCO ABORT SWITCH INTERFACE CIRCUITS @[101096-4551]

1. PRIOR TO T-5 MINUTES - TWO OF TWO MANDATORY
2. AFTER T-5 MINUTES - ONE OF TWO MANDATORY

Removal of the ET Range Safety Flight Termination System resulted in additional flightcrew responsibility as agents of the 45th Space Wing Commander for public safety during second stage flight. During this timeframe, crew-initiated manual MECO replaces range safety command destruct capability. One of the elements agreed upon to satisfy this requirement is to provide the FCO with the ability to illuminate the orbiter cockpit abort light via pushbutton, as an independent method for the FCO to communicate a manual MECO requirement to the crew. Since these redundant pushbuttons interface with the MCC command system via the FD and FDO backup workstations, the circuits which connect these workstations with the ROCC FCO console pushbuttons become required for launch commit as stated in this flight rule. @[101096-4551]

- D. FCO INTERFACES:

1. VOICE INTERFACE - TWO OF FOUR MANDATORY:
 - a. FDO/FCO PRIVATE LINE
 - b. FCO PRIME LOOP
 - c. FD LOOP
 - d. OTHER LOOP PATCHING TO FCO LONG LINE

THIS RULE CONTINUED ON NEXT PAGE

FLIGHT RULES

A3.1.4-1 MCC/KSC/45 SPW INTERFACE (CONTINUED)

2. CONTROLLABILITY VERIFICATION - TWO OF FIVE MANDATORY:
 - a. 45 SPW RANGE SAFETY TELEMETRY DISPLAY SYSTEM (RTDS)
 - b. CONTROLLABILITY LIGHT (GNC CONSOLE TO FCO)
 - c. FCO PRIME LOOP
 - d. FDO/FCO PRIVATE LINE
 - e. FD LOOP

During second stage flight, removal of the ET Range Safety Flight Termination System resulted in additional flightcrew responsibility as agents of the 45th Space Wing Commander for public safety, with crew-initiated manual MECO replacing range safety command destruct capability. Redundant FCO/MCC communications are therefore mandatory to provide the interaction and situational awareness necessary to implement this requirement. @[101096-4551]

During first stage, rRange safety mission rules outline flight termination criteria and provide the FCO with the ability to determine shuttle controllability status in the event of complete loss of communication with MCC. ~~Therefore, only one FCO to MCC voice loop is considered mandatory to be GO for launch. However, fF~~For purposes of making the controllability determination, range safety launch commit criteria require at least two pathways by which vehicle control status may be confirmed. The available sources include the items listed under paragraph DC.2 of this rule. @[101096-4551]

ED. KSC TEST DIRECTORS VOICE INTERFACE - ONE OF THREE MANDATORY:

1. OIS 131
2. OIS 232/212
3. FD

NOTE: OIS 232 IS USED PRIOR TO T MINUS 20 MINUTES AND OIS 212 IS USED AFTER T MINUS 20 MINUTES AS THE PRIMARY VOICE COMMAND CHANNEL.

Same rationale as Rule {A3.1.2-5C}, MCC INTERNAL VOICE.

FLIGHT RULES

THIS PAGE INTENTIONALLY BLANK

FLIGHT RULES

A3.1.4-2 GSFC/STDN INTERFACE

A. SITE TO GSFC:

- ~~1. 224-KB CIRCUITS - ONE OF ONE MANDATORY: @061396-3198]~~
~~—MAD~~

~~This circuit supports mandatory telemetry. Reference Rule {A3.1.3-3}, STDN FAILURE DECISION MATRIX, for mandatory sites and Rules {A3.1.1-1A.1.b} and {A3.1.1-1A.2}, GROUND REQUIREMENTS OVERVIEW, for HDR/LDR telemetry requirements.~~

21. MIL/PDL ONLY 224-KB CIRCUIT - ONE OF TWO MANDATORY. @072398-6565A]

One of two redundant circuits is required to support mandatory telemetry from MIL/PDL. Reference Rule {A3.1.3-3}, STDN FAILURE DECISION MATRIX, for mandatory site requirements and Rules {A3.1.1-1A.1.b} and {A3.1.1-1A.2}, GROUND REQUIREMENTS OVERVIEW, for HDR/LDR telemetry requirements.

23. MIL 9.6-KB S-BAND HIGH SPEED TRACKING DATA CIRCUIT - HIGHLY DESIRABLE. @061297-6004] @072398-6565A]

This circuit supports high speed S-band tracking data from MIL.

35. 224-KB CIRCUITS: @061396-3198] ~~@092398-6565A]~~
~~a. GDS - ONE OF ONE MANDATORY. [4]~~
~~b. DFRF - ONE OF ONE MANDATORY. -[4]-@092398-6565A] @ED]~~

NOTE: ~~[4]~~MANDATORY ONLY WHEN THE SITE IS THE ONLY SOURCE FOR LANDING TELEMETRY (REF. RULE {A3.1.3-3}, STDN FAILURE DECISION MATRIX). @ED]

One circuit is required from each site which is mandatory for telemetry.

- ~~6. BDA TELEMETRY CIRCUIT:~~
~~—224-KB - ONE OF ONE MANDATORY.~~

~~BDA requires one of one (224 kb) circuit to support telemetry (ref. Rules {A3.1.1-1A.1.b}, GROUND REQUIREMENTS OVERVIEW, and {A3.1.3-3}, STDN FAILURE DECISION MATRIX).~~

B. GSFC TO SITE:

- ~~1. 224-KB COMMAND CIRCUIT - ONE OF ONE MANDATORY:~~

FLIGHT RULES

- a. ~~MAD~~
- b. ~~CDS~~

~~This circuit is required to support uplink command and S-band voice (ref. Rule {A3.1.3-3}, STDN FAILURE DECISION MATRIX).~~

- 12. 224-KB/56-KB VOICE/COMMAND CIRCUITS, MIL/PDL ONLY - ONE OF TWO MANDATORY. @[061396-3198] @[072398-6565A]

The prime voice command circuit from GSFC to MIL/PDL is a 224-kb line, with a 56-kb circuit as backup. The circuit is required to provide uplink command and voice.

- 23. UHF ANALOG A/G VOICE CIRCUITS: @[061396-3198]

- a. ~~MIL~~ - ONE MANDATORY

~~MIL and BDA are the only sites which UHF A/G and S-band A/G are both mandatory (ref. Rule {A3.1.3-3}, STDN FAILURE DECISION MATRIX). The UHF A/G must be sent to GSFC/STDN via analog circuits.~~ MIL is the only site which UHF A/G and S-band A/G are both mandatory (ref. Rule {A3.1.3-3}, STDN FAILURE DECISION MATRIX). The UHF A/G must be sent to GSFC/STDN via analog circuits. @[072398-6565A]

THIS RULE CONTINUED ON NEXT PAGE

FLIGHT RULES

A3.1.4-2 GSFC/STDN INTERFACE (CONTINUED)

~~4. BDA VOICE/COMMAND CIRCUIT - @092398-6565A]~~

~~224-KB ONE OF ONE MANDATORY.~~

BDA requires the single 224 kb circuit to support mandatory command/voice.

35. DFRF 224-KB COMMAND/VOICE CIRCUIT - ONE OF TWO MANDATORY. -[6] @092398-6565A]@072398-6565A] @ED]

NOTE: [6]-----MANDATORY ONLY WHEN DFRF IS THE ONLY SOURCE FOR LANDING COMMAND OR S-BAND VOICE (REF. RULE {A3.1.3-3}, STDN FAILURE DECISION MATRIX). @ED]

This circuit provides the data path for command and S-band voice from GSFC to DFRF.

64. WLPS 224 - KB CIRCUIT @061396-3198]@092398-6565A @072398-6565A]

WLPS TLM/CMD/VOICE MANDATORY PER RULE {A3.1.3-3}, STDN FAILURE DECISION MATRIX. @121593-1579]

A3.1.4-3 45 SPW/VAFB INTERFACE

9.6-KB LANDING RADAR CIRCUIT - ONE OF TWO HIGHLY DESIRABLE. -[1] @061297-6004] @ED]

NOTE: [1]-----ONLY USED FOR EDW AOA/PLS. @ED]

This circuit supports high speed tracking data from the west coast for EDW AOA/PLS. @061297-6004]

A3.1.4-4 45 SPW/WSMR INTERFACE

2.4-KB LANDING RADAR CIRCUIT - ONE OF TWO HIGHLY DESIRABLE. -[1] @061297-6004] @ED]

NOTE: [1]-----ONLY USED FOR NOR AOA/PLS. @ED]

This circuit supports high speed tracking data from WSMR for NOR AOA or daily prime opportunity. @061297-6004].

FLIGHT RULES

THIS PAGE INTENTIONALLY BLANK

FLIGHT RULES

A3.1.4-5 **MCC/GSFC/NGT INTERFACE**

WB MDM NETWORK (BROADCAST MODE) - ONE OF TWO MANDATORY.

The MCC/GSFC and MCC/NGT satellite data links (WB MDM networks) provide the data interface for the GSTDN and TDRSS networks, respectively. Mandatory telemetry, command, S-band track, and S-band voice are routed via these links. There are two completely redundant MDM systems to provide backup capability. One of two is required to provide mandatory data.

A3.1.4-6 **MCC/ASCENT ABORT SITE INTERFACE**

COMMUNICATIONS CAPABILITY WITH REQUIRED ASCENT ABORT SITES - ONE OF THREE MANDATORY: @[111094-1716A]

- A. LONGLINE (LFP1)
- B. INMARSAT
- C. COMMERCIAL TELEPHONE

Prelaunch, the MCC must be able to communicate with the required ascent abort landing site, (ref. Rule {A2.1.1-2} ABORT LANDING SITE REQUIREMENTS). This insures that there has not been a change in weather or nav/landing aid status. It also insures that anomalies can be passed to the ground support team and that the runway and airspace are clear for a safe landing. This can be accomplished by insuring that at least one of the communications capabilities listed above are available. @[111094-1716A]

FLIGHT RULES

NAVAIDS REQUIREMENTS

A3.1.5-1 TACAN REDUNDANCY REQUIREMENTS AND ALTERNATE TACAN SELECTION PHILOSOPHY

A. REDUNDANCY REQUIREMENTS @[020196-1807B]

1. REDUNDANT TACAN TRANSPONDER CAPABILITY IS MANDATORY FOR LAUNCH COMMIT AT THE FOLLOWING SITES:

- a. RTLS
- b. PRIMARY TAL IF REQUIRED
- c. AOA IF REQUIRED
- d. FIRST DAY PLS IF REQUIRED (ETRO FOR EQUIPMENT OUTAGE MUST BE PRIOR TO DEORBIT DECISION)

NOTE: REF RULE {A2.1.1-2}, ABORT LANDING SITE REQUIREMENTS FOR ABORT SITE LAUNCH COMMIT REQUIREMENTS.

2. REDUNDANT TACAN TRANSPONDER CAPABILITY IS MANDATORY FOR PLS (OTHER THAN FIRST DAY PLS), MDF, AND END OF MISSION DEORBIT COMMIT (REF RULE {A4.1.3-7}, PLS/EOM LANDING OPPORTUNITY REQUIREMENTS).
3. THE REDUNDANT TACAN TRANSPONDER REQUIREMENT CAN BE SATISFIED BY ONE GROUND STATION WITH DUAL STRING (DS) TRANSPONDERS OR BY TWO STATIONS WITH SINGLE-STRING (SS) TRANSPONDER CAPABILITY. @[020196-1807B]

Rules {A2.1.1-2}, ABORT LANDING SITE REQUIREMENTS, and {A2.1.1-1F.3}, PRELAUNCH GO/NO-GO REQUIREMENTS, reference this rule. @[121593-1590]

Flight-specific ascent abort landing sites are specified for each flight in the Flight Rules Annex (ref. Rule A3.2-1, EOM ENTRY DTO/RUNWAY SELECTION PRIORITIES).

Landing sites and TACAN's are loaded in the onboard software and can be changed in OPS 3 only. Uplink of an acceptable alternate TACAN may be performed to meet redundancy requirements for OPS 3 entries. TACAN requirements for EOM and other landing opportunities are not considered in the decision to launch. @[020196-1807B]

THIS RULE CONTINUED ON NEXT PAGE

FLIGHT RULES

A3.1.5-1 TACAN REDUNDANCY REQUIREMENTS AND ALTERNATE TACAN SELECTION PHILOSOPHY (CONTINUED)

RTLS

TACAN processing is required to protect the guidance-imposed navigation entry constraints for an RTLS. An offline analysis that assumed a launch on time using IMU's and ADTA with nominal performance characteristics and random noise showed that 3-sigma navigation performance violated the entry guidance constraints of downtrack and crosstrack at altitudes of 85k feet and 40k feet, respectively.

TAL (IF REQUIRED) ©[121593-1590]

TACAN is required to protect against navigation dispersions for TAL because neither delta state nor GCA is available without ground tracking. TACAN is the primary source to correct downtrack and crosstrack errors in the navigation state. ©[020196-1807B]

Redundant TACAN transponder capability near the selected TAL site is mandatory for launch to provide adequate navigation. If weather conditions are unacceptable at the primary TAL site, then redundant TACAN transponder capability becomes mandatory near the secondary site.

AOA/FIRST DAY PLS (IF REQUIRED)

Although an AOA landing site is not normally required for launch commit (ref. Rule {A2.1.1-2}, ABORT LANDING SITE REQUIREMENTS), the TACAN requirements are shown in the event that an AOA site is required. Redundant TACAN transponder capability is required for the primary AOA landing site only. The navigation state conditions are worse for AOA compared to RTLS or TAL because the vector is 1 hour older and the vehicle requires one or two OMS burns. For a first day PLS, the site may be considered go if equipment outage resulting in less than single-fault tolerance has an ETRO prior to deorbit decision time. ©[121593-1590] ©[020196-1807B]

B. IN GENERAL, PROGRAM APPROVED TACAN'S (LISTED BELOW FOR END OF MISSION AND INTACT ABORT SITES; NOT IN ORDER OF PRIORITY) THAT MEET THE CRITERIA IN PARAGRAPH C WILL BE USED TO MEET THE REDUNDANCY REQUIREMENTS. CONSIDERATION WILL BE GIVEN TO OTHER TACAN'S THAT MEET THE CRITERIA IN PARAGRAPH C IF THEY PROVIDE A NAVIGATION IMPROVEMENT OVER AN APPROVED TACAN. ©[020196-1807B]

1. KENNEDY SPACE CENTER:

- TITUSVILLE, TTS (DS)
- PATRICK, COF (SS)
- ORMOND BEACH, OMN (SS)

FLIGHT RULES

- LAKELAND, LAL (SS) ©[020196-1807B]

THIS RULE CONTINUED ON NEXT PAGE

FLIGHT RULES

**A3.1.5-1 TACAN REDUNDANCY REQUIREMENTS AND ALTERNATE
TACAN SELECTION PHILOSOPHY (CONTINUED)**

- ORLANDO, ORL (SS) @[020196-1807B]

NOTE: THE ORLANDO TACAN IS NOT GENERALLY AVAILABLE IN ONBOARD FLIGHT SOFTWARE AND THUS CANNOT GENERALLY BE USED FOR RTLS AND REQUIRES UPLINK FOR OPS 3.

2. EDWARDS AFB:

- EDWARDS, EDW (SS)
- LAKE HUGHES, LHS (SS)
- CHINA LAKE, NID (DS)
- GORMAN, GMN (SS)
- PALMDALE, PMD (SS)
- POMONA, POM (SS)

3. NORTHRUP:

- WHITE SANDS SPACE HARBOR, SNG (SS)
- HOLLOMAN AFB, HMN (SS)
- TRUTH OR CONSEQUENCES, TCS (SS)

4. BANJUL:

- YUNDUM INTL, BYD (DS) @[020196-1807B]

5. BEN GUERIR:

- BEN GUERIR, BEN (DS)

6. MORON

- MORON, MRN (SS)
- ROTA, AOG (DS) @[020196-1807B]

THIS RULE CONTINUED ON NEXT PAGE

FLIGHT RULES**A3.1.5-1 TACAN REDUNDANCY REQUIREMENTS AND ALTERNATE
TACAN SELECTION PHILOSOPHY (CONTINUED)**

7. ZARAGOZA: @[020196-1807B]

- ZARAGOZA, ZZA (DS)

Program approved TACAN's refer to those TACAN's listed in NSTS 07700, Volume X, Book 3, controlled by the PRCB, approved by the SASCB for use in the onboard I-loads, or contained in this flight rule. When selecting an alternate TACAN station to meet redundancy requirements, priority will generally be given to program approved TACAN's that meet the criteria in paragraph C. If no program approved TACAN's meet the criteria or other TACAN's that meet the criteria provide a navigation improvement, non-program approved TACAN's may be used to meet the redundancy requirements. Note that in most cases, there will be no program approved alternate TACAN station since both NSTS 07700 and the onboard I-loads only include a primary and secondary TACAN for each site. KSC is the only listed site that has more than two approved stations since KSC appears twice in the onboard landing site table (two primary and two secondary stations) and because Orlando TACAN is the secondary TACAN for Orlando runways.

C. ALTERNATE TACAN'S THAT SATISFY THE FOLLOWING CRITERIA (NOT IN PRIORITY ORDER) MAY BE UPLINKED IN OPS 3 TO MEET THE REDUNDANCY REQUIREMENTS IN PART A.

NOTE: THESE CRITERIA APPLY TO GROUND STATIONS REQUIRED FOR LAUNCH COMMIT AND COMMIT TO DEORBIT. REFER TO RULE {A2.1.5-14}, EMERGENCY LANDING FACILITY CRITERIA, FOR ELS MINIMUM REQUIREMENTS.

1. NO COCHANNEL INTERFERENCE PREDICTED BELOW 130K FT ALTITUDE.

NOTE: IN SOME CASES, COCHANNEL INTERFERENCE MAY BE ELIMINATED BY POWERING OFF THE INTERFERING STATION(S) FOR THE PERIOD OF SHUTTLE OPERATIONS.

2. TACAN MUST BE OPERATING PRIOR TO LAUNCH OR DEORBIT COMMIT AS APPLICABLE PER PARAGRAPH A

3. WITHIN 50 NM OF THE RUNWAY.

4. POWER LEVEL \geq 1.5K WATTS. @[020196-1807B]

THIS RULE CONTINUED ON NEXT PAGE

FLIGHT RULES

A3.1.5-1 TACAN REDUNDANCY REQUIREMENTS AND ALTERNATE TACAN SELECTION PHILOSOPHY (CONTINUED)

5. DMA TACAN DATABASE COORDINATES MUST BE AVAILABLE AS A MINIMUM. SURVEY DATA IS HIGHLY DESIRABLE, BUT NOT MANDATORY. @[020196-1807B]
6. NASA OR FFA CERTIFIED AND ACCURATE WITHIN 0.3 NM/DEGREE (REF RULE {A8.1.2-2}, SENSOR FAILURES. CONSIDERATION WILL BE GIVEN TO THE USE OF A TACAN WHICH HAS BEEN EVALUATED VIA GPS EQUIPPED STA BUT WHICH HAS NOT BEEN COMPLETELY CERTIFIED. @ED 1

Alternate TACAN's may be uplinked in OPS 3 to satisfy the redundancy requirements for OPS 3 entries. The process of selecting an alternate TACAN begins with the TACAN Cochannel Interference Document (RSOC 88-0030) which includes several potential TACAN stations for space shuttle landing sites. This document contains cochannel interference data which is generated assuming a nominal range-altitude profile, constant power level of 3.5 KW, and an approximation for the shape of the parabolic TACAN signal propagation. This interference data along with the expected groundtrack can be used to approximate the altitude below which a given TACAN station is clear of interference and to determine which TACAN stations must be powered off to reduce or eliminate interference. In addition to the cochannel interference data, the TACAN Cochannel Interference Document lists the type of station (TACAN, VORTAC, VORDME, or DME), data source (survey or DMA database), and the distance and direction from the runway.

Once an acceptable TACAN or VORTAC is identified based on runway proximity and cochannel interference, the operating hours and power level are verified to ensure the TACAN will be available during entry. TACAN's used to meet the redundancy requirements must be operational prior to launch commit for RTLS, TAL (if required), and AOA (if required). If first day PLS is required, the TACAN(s) must have an ETRO prior to deorbit decision time. For PLS, MDF, and end of mission, the TACAN(s) used to meet the redundancy requirements must be operating prior to deorbit commit and until touchdown. The TACAN(s) must be available throughout entry to touchdown to ensure continuous TACAN processing.

A maximum distance of 50 nm from the TACAN to the runway is required to ensure TACAN lock-on until MLS acquisition. The groundtrack proximity may also be considered in the alternate TACAN selection process. The minimum power level of 1.5K watts and cochannel interference requirements were chosen to obtain TACAN lock-on by 130K ft, which is the altitude at which 3 sigma downtrack error will exceed the guidance constraints if TACAN data is not processed. Interfering TACAN's may be powered off if possible to eliminate predicted interference below 130K ft.

FLIGHT RULES

Although survey data is preferred, it is not required, providing data is available from the DMA TACAN database. Recent requests for survey data have shown that non-survey coordinates provided by DMA are accurate within about 1000 ft. Past TACAN measurement data quality observed during shuttle missions and flight tests may also be considered in the alternate TACAN selection process.

®[020196-1807B]

THIS RULE CONTINUED ON NEXT PAGE

FLIGHT RULES

A3.1.5-1

TACAN REDUNDANCY REQUIREMENTS AND ALTERNATE TACAN SELECTION PHILOSOPHY (CONTINUED)

The FAA or NASA certification requirements are contained in NSTS 07700, Volume X, Book 3. The FAA accuracy requirements are outside those required by space shuttle navigation. Therefore, an FAA controlled TACAN must also meet the 0.3 nm/degree accuracy requirements contained in Rule {A8.1.2-2}, SENSOR FAILURES. ©[020196-1807B]

- D. IF A TACAN GROUND STATION FAILS AFTER LAUNCH OR DEORBIT AND A TACAN THAT MEETS THE CRITERIA IN PARAGRAPH C DOES NOT EXIST, OTHER ALTERNATES (DME'S INCLUDED) MAY BE CONSIDERED FOR UPLINK TO PROVIDE SOME FORM OF BACKUP CAPABILITY.

The criteria in paragraph C is provided to ensure an acceptable TACAN is used to meet the redundancy requirements for commit to launch or commit to deorbit. However, if a TACAN fails after launch or deorbit and a TACAN that meets the criteria in paragraph C does not exist, the best alternate including DME's may be uplinked. Although this alternate may not protect 3 sigma navigation performance, it provides some form of backup capability. ©[020196-1807B]

FLIGHT RULES

A3.1.5-2

MLS

REDUNDANT MLS CAPABILITY IS REQUIRED FOR THE FOLLOWING:

- A. REDUCED CEILING, VISIBILITY, OR INCREASED RTLS CROSSWIND LIMITS (REF. RULE {A2.1.1-6}, LANDING SITE WEATHER CRITERIA) FOR DAYLIGHT, CONCRETE RUNWAY LANDINGS. @[111094-1622B] @[041196-1817B]

Because MLS provides improved navigation and position accuracy with respect to the runway, a reduction in ceiling, visibility or an increase in RTLS crosswind requirements is allowed. However, because of the dependence on MLS during the critical landing phase with reduced ceilings/visibility, combined with the more stringent navigation requirements for concrete runways, single-fault tolerant capability must exist to guarantee MLS availability. Redundant MLS capability can be either the standard primary/backup MLS ground station or two collocated single-string MLS Jr. stations. The relatively less stringent navigation requirements for lakebed runways make it possible to relax the redundancy requirement to zero-fault tolerant. One-sigma onboard navigation position errors improve from approximately 840 feet without MLS to approximately 210 feet after the first MLS measurement, decreasing to less than 50 feet 1-sigma by touchdown. Detailed definitions of ceiling, visibility and RTLS crosswinds are covered in Rule {A2.1.1-6}, LANDING SITE WEATHER CRITERIA. @[111094-1622B] @[041196-1817B]

- B. NIGHT LANDINGS ON ALL CONCRETE RUNWAYS OR NIGHT LANDINGS ON LAKEBED RUNWAYS WITH CEILINGS LESS THAN THOSE SPECIFIED IN RULE {A2.1.1-6}, LANDING SITE WEATHER CRITERIA. @[111094-1622B]

MLS is required due to the loss of visual cues and the related degradation of the crew's ability to visually compensate for navigation dispersions during night landing operations. Because of this requirement, single-fault tolerant capability must exist to guarantee MLS availability (ref. paragraph A rationale) for landings on concrete runways where large lateral dispersions at touchdown are less tolerable than for lakebed runways.

For lakebed landings only, single-string MLS is acceptable if the lowest ceiling is at or above those specified in the Rule {A2.1.1-6}, LANDING SITE WEATHER CRITERIA. The increased ceiling provides additional time for the crew to compensate for navigation dispersions using visual cues. In addition, the larger area provided by the lakebed environment makes navigation dispersions resulting from the possible failure of the single-string MLS more tolerable. @[111094-1622B]

Rules {A2.1.1-1F.3}, PRELAUNCH GO/NO-GO REQUIREMENTS; {A2.1.1-2}, ABORT LANDING SITE REQUIREMENTS; and {A8.1.6-1}, GNC GO/NO-GO CRITERIA, reference this rule. @[111094-1622B]

FLIGHT RULES

A3.1.5-3 LANDING AID REQUIREMENTS

A. DAYLIGHT LANDING AID REQUIREMENTS :

	CONCRETE	LAKEBED
AIMPOINT [1]	1	1
	OF	OF
PAPI	2	2
BALL BAR	TAL SITES: M CONUS: HD [2]	HD

NOTES:

[1] IF AIMPOINT ONLY, LEFT HUD IS REQUIRED.

[2] HD FOR CONUS LANDING SITES IF EITHER MLS IS AVAILABLE OR AIMPOINT/PAPI AND LEFT HUD ARE AVAILABLE.

B. NIGHT LANDING AID REQUIREMENTS :

	CONCRETE	LAKEBED
PAPI	M	M
BALL BAR	M	M
XENON	M	M
RUNWAY EDGE LIGHTS/ REFLECTORS	M	M
APPROACH LIGHTS	HD	HD

NOTE: RUNWAY REMAINING MARKERS ARE MANDATORY FOR NIGHT LANDINGS ON CONCRETE RUNWAYS ONLY.

PAPI lights are required at the proper aimpoint position (nominal or close in as recommended) for all lighting and surface conditions. The exception is a daylight landing where the use of an aimpoint and a HUD will substitute for a PAPI. PAPI lights allow the pilot to visually acquire the proper outer glide slope with a good degree of accuracy. In daylight, the use of an aimpoint and a HUD (visual glide slope information provided by onboard navigation) will provide the crew with similar cues to the outer glide slope.

Ball bars are mandatory for TAL sites because of the reduced runway length and width (< 300 feet) as compared to CONUS runways. Without the ball bar, the reduced width of the runway can result in a false visual perception of being too high above the glide slope which can lead to descending through the inner glide slope and landing short of the runway.

For CONUS/concrete runways where the visual scene is “as trained to”, a ball bar is only highly desirable. An MLS or aimpoint plus HUD provides sufficient cues to allow an accurate transition to the inner glide slope.

THIS RULE CONTINUED ON NEXT PAGE

FLIGHT RULES

A3.1.5-3 LANDING AID REQUIREMENTS (CONTINUED)

A ball bar is not mandatory for daylight lakebed landings due to the longitudinal margins available at lakebed runways.

Runway remaining markers (RRM's) are only mandatory for night concrete landings. The length of concrete runways and night conditions necessitate the need for RRM's due to the reduced margin of error in determining runway remaining. These markers give the pilot a visual cue to the rollout distance remaining and the brake profile required to stop on the field.

Runway lighting is required for night landings in order for the pilot to see the runway on approach and touchdown. Edge lighting is required for a visual cue to the lateral margin during rollout. Approach lights are not mandatory as the PAPI/ball bar requirements suffice for centerline/threshold targeting cues.

Rules {A2.1.1-1}, PRELAUNCH GO/NO-GO REQUIREMENTS; and {A2.1.1-2}, ABORT LANDING SITE REQUIREMENTS, reference this rule. ©[121593-1590]

FLIGHT RULES

THIS PAGE INTENTIONALLY BLANK

FLIGHT RULES

SECTION 4 - TRAJECTORY AND GUIDANCE

PRELAUNCH

A4.1.1-1	PERFORMANCE ANALYSES	4-1
A4.1.1-2	LANDING SITE CONDITIONS	4-3
A4.1.1-3	ORBIT CONJUNCTIONS/CONFLICTS	4-5
A4.1.1-4	DOLILU OPERATIONS	4-4a

ASCENT

A4.1.2-1	KALMAN FILTER SOLUTION	4-5
A4.1.2-2	ARD THRUST UPDATE CRITERIA AND FPR	4-6
A4.1.2-3	USE OF MAXIMUM THROTTLES	4-9
A4.1.2-4	RESERVEDSRB JETTISON	4-14
A4.1.2-5	ABORT MODE RESPONSIBILITY	4-14
A4.1.2-6	DESIGN AND CRITICAL MECO UNDERSPEED DEFINITIONS	4-19
A4.1.2-7	PERFORMANCE BOUNDARIES	4-22
A4.1.2-8	NAVIGATION UPDATES	4-45
A4.1.2-9	AUTO GUIDANCE NO-GO	4-51
A4.1.2-10	MANUAL THROTTLE SELECTION	4-53
A4.1.2-11	RESERVED	4-61
A4.1.2-12	MANUAL SHUTDOWN CRITERIA	4-63
A4.1.2-13	THRUST LIMITING, HYDRAULIC, OR ELECTRICAL LOCKUP	4-63
A4.1.2-14	OMS-1/OMS-2 EXECUTION	4-66

FLIGHT RULES

SECTION 4 - TRAJECTORY AND GUIDANCE

PRELAUNCH

A4.1.1-1 PERFORMANCE ANALYSES

LAUNCH WILL NOT BE ATTEMPTED IF:

- A. THE PREDICTED USABLE MPS RESIDUALS AT NOMINAL MECO ARE LESS THAN 2 SIGMA PLUS THE MEAN IN-FLIGHT MPS FLIGHT PERFORMANCE RESERVE (FPR).
- B. THE PREDICTED USABLE MPS RESIDUALS PLUS MPS-EQUIVALENT OMS AND RCS ABOVE THE MISSION-SPECIFIC REQUIREMENTS, AS SPECIFIED IN THE FLIGHT-SPECIFIC ANNEX, ARE LESS THAN 3 SIGMA PLUS THE MEAN IN-FLIGHT MPS FPR.

THE PREDICTED USABLE MPS RESIDUALS PLUS MPS-EQUIVALENT OMS AND RCS ABOVE THE MISSION-SPECIFIC REQUIREMENTS, AS SPECIFIED IN THE FLIGHT-SPECIFIC ANNEX, ARE LESS THAN 3 SIGMA PLUS THE MEAN IN-FLIGHT MPS FPR.

NOTE: FOR DIRECT INSERTION FLIGHTS WHERE ALL OF THE PRIMARY MISSION OBJECTIVES (AS DEFINED IN THE FLIGHT-SPECIFIC ANNEX) CAN BE ACHIEVED FROM A 1-SIGMA MECO UNDERSPEED WITHOUT RAISING THE ORBIT, ONLY PARAGRAPH A ABOVE APPLIES.

NOTE: IF THE PRIMARY MISSION OBJECTIVES CANNOT BE ACHIEVED FROM A 1-SIGMA MECO UNDERSPEED WITHOUT RAISING THE ORBIT, RCS (BOTH FORWARD AND AFT) MARGINS MAY BE COMMITTED ALONG WITH THE OMS MARGIN TO RAISE THE ORBIT. IF THIS IS DONE, THE PRIMARY MISSION OBJECTIVES MAY BE DELAYED TO FLIGHT DAY 2 OR LATER. THIS WILL BE EVALUATED ON A FLIGHT-SPECIFIC BASIS AND DOCUMENTED IN THE FLIGHT-SPECIFIC ANNEX.

THIS RULE CONTINUED ON NEXT PAGE

FLIGHT RULES**A4.1.1-1 PERFORMANCE ANALYSES (CONTINUED)**

C. THE ET IP CONSTRAINTS AS DEFINED IN RULE {A2.1.2-13A}, ET FOOTPRINT CRITERIA, ARE NOT SATISFIED.

Trajectory analysis, using day of launch winds and ET loading estimates, provides performance margins and launch hold capability after the initiation of LOX drainback. To be GO for launch, considering the hold capability, this trajectory analysis must not predict use of any of the mean plus 2 sigma in-flight MPS flight performance reserve (FPR). The use of MPS equivalent OMS propellant above that required to accomplish the specific mission will be allowed to cover up to 1 sigma of the required 3 sigma MPS margin. If the predicted MPS equivalent OMS available plus the MPS residuals at MECO are still less than 3 sigma plus the mean in-flight MPS FPR, launch will be NO-GO. The sigma level (2 or 3 as applicable) plus mean FPR is a propellant level that reflects potential uncertainties in all ascent subsystems at the specified sigma level. We are willing to launch with a slightly increased possibility of low level cutoff (2 sigma vs. 3 sigma) provided the extra sigma is covered in excess OMS such that the nominal mission is protected by 3 sigma, but we are not willing to launch with a guided MECO protection level of less than 2 sigma. On direct insertion flights, should a 2-sigma day occur, OMS propellant cannot be used to make up for the 1-sigma.

MPS shortfall at MECO without scheduling at least one additional OMS burn after OMS-2, with its associated mission objective timeline and tracking impacts. Therefore, as long as the mission objectives can be accomplished from the resulting lower orbit, only 2-sigma MPS plus the mean inflight MPS FPR (reference paragraph {A4.1.1-1A}, PERFORMANCE ANALYSES) need be protected.

If the primary mission objective cannot be achieved without raising the orbit, one or more maneuvers will be required. OMS and RCS margins may be used to raise the orbit. The addition of RCS increases the hold time available inside of drainback. However, commitment of RCS to making up part of the 1 sigma may require several maneuvers to be executed and may cause the primary mission objective to be delayed past flight day 1. Therefore, a flight-specific assessment must be done preflight to determine whether the impact of committing the RCS margins is acceptable. The commitment of RCS may be the difference between being able to launch and a launch scrub. It is acceptable to commit RCS prelaunch because the probability of actually having to use it are very small (i.e., requires greater than 2 sigma bad day). Margins are defined as the quantities in excess of the mission completion redlines (ref. Rules {A6.1.5-3}, OMS REDLINES (CIL); {A6.1.5-4}, FORWARD RCS REDLINES; and {A6.1.5-5}, AFT RCS REDLINES) plus lower priority flight activities as defined in the Flight Specific Rule Annex.

Independent of the capability to support the designed mission, ET protection must be maintained off land as prescribed by Rule {A2.1.2-13A}, ET FOOTPRINT CRITERIA. As MPS performance capability is degraded through day-of-launch loadings/winds, holds within drainback, and/or late mass property updates, the designed ET footprint will move up range.

THIS RULE CONTINUED ON NEXT PAGE

FLIGHT RULES

A4.1.1-1 PERFORMANCE ANALYSES (CONTINUED)

D. ANY SINGLE-ENGINE-OUT INTACT ABORT GAP IS PREDICTED TO EXIST BASED ON LAUNCH DAY WINDS AND PERFORMANCE ASSESSMENTS. GAP CLOSURE METHODS AS OUTLINED IN RULE {A4.1.2-7I}, PERFORMANCE BOUNDARIES, SHALL NOT BE EMPLOYED PRELAUNCH TO CLOSE AN EXPECTED GAP. @ED]

The launch will not be attempted with a known abort gap. If launch is allowed to proceed with a known gap during intact abort coverage, there will be a period of time during which no intact abort mode will be available. Should an engine fail during this time, loss of mission, vehicle, and crew may result. Options exist for closing an abort gap, such as commitment to AOA shallow, maximum SSME throttles, and relaxing dispersion tolerances. These options are intended only to close a gap that arises post-lift-off due to some unanticipated performance difficulty. They should not be used to allow a launch to proceed since a safety compromise arises from each option.

Rules {A2.1.1-1C}, PRELAUNCH GO/NO-GO REQUIREMENTS, and {A2.1.1-2}, ABORT LANDING SITE REQUIREMENTS, reference this rule. @[121593-1590]

A4.1.1-2 LANDING SITE CONDITIONS

LAUNCH WILL NOT BE ATTEMPTED IF ANY REQUIRED ASCENT ABORT LANDING SITE (REF. RULE {A2.1.1-2}, ABORT LANDING SITE REQUIREMENTS) RUNWAY AND LANDING CONDITIONS ARE NOT SATISFACTORY. THE LANDING CONDITIONS REQUIRED ARE DEFINED IN RULE {A2.1.1-6}, LANDING SITE WEATHER CRITERIA, AND {A4.1.3-7A}, PLS/EOM LANDING OPPORTUNITY REQUIREMENTS. REDESIGNATION TO ALTERNATE SITES, IF ANY, MAY BE USED TO SATISFY RUNWAY AND LANDING CONDITIONS. @[121593-1590] @[111094-1622B]

NOTE: TAL, AOA, AND FIRST DAY PLS SITES MAY NOT BE REQUIRED FOR LAUNCH COMMIT (REF. RULE {A2.1.1-2}, ABORT LANDING SITE REQUIREMENTS). SHOULD ALL AOA SITES BE NO-GO, PRESS BOUNDARIES WILL BE BASED UPON ATO/MINIMUM Hp/FD 1 SHALLOW DEORBIT USING ARCS-TO-ARCS PRESS QUANTITY. IF A FIRST DAY PLS LANDING SITE IS UNAVAILABLE, THEN THE PRESS BOUNDARY WILL BE BASED UPON ATO/ATO/FD 2 SHALLOW DEORBIT USING ARCS-TO-ARCS PRESS QUANTITY (REF. RULE {A4.1.2-6B}, DESIGN AND CRITICAL MECO UNDERSPEED DEFINITIONS), AND ANY SYSTEMS ABORT WILL USE EXISTING TAL/ABORT FROM ORBIT (AFO) CAPABILITY.

Continuous single engine out intact abort landing sites must be available to support an abort condition during ascent. Without these sites, the payload, orbiter and crew may be lost in an abort situation. The redesignation provision documents the capability to employ weather alternate landing sites as a means of satisfying weather, runway, and equipment requirements.

FLIGHT RULES

THIS RULE CONTINUED ON NEXT PAGE

FLIGHT RULES

A4.1.1-2 LANDING SITE CONDITIONS (CONTINUED)

If a TAL, AOA and/or first day PLS site is not available, increased exposure to an RTLS or TAL abort results, but intact capability is still provided. The press boundaries would be based on AOA or first day or second day PLS depending on the availability of landing sites. It is assumed that weather would not prevent a second day PLS since all three CONUS sites would be available. However, non-standard press boundaries incur somewhat increased TAL exposure for single SSME out. This increased TAL exposure is accepted in order to provide a launch capability. Systems failures requiring early flight termination will be supported by TAL and AFO sites. In some cases, systems failures involving loss of redundancy normally requiring first day PLS will result in second day PLS landings incurring additional risk of failure of the last entry critical system. Rule {A2.1.1-1F.1}, PRELAUNCH GO/NO-GO REQUIREMENTS, references this rule. @121593-1590]

A4.1.1-3 ORBIT CONJUNCTIONS/CONFLICTS

IF U.S. SPACE COMMAND PRELAUNCH COMPUTATION OF MISSES BETWEEN ORBITS (COMBO) ANALYSIS PREDICTS AN ON-ORBIT CONJUNCTION WITHIN 5 KM IN THE RADIAL AND OUT-OF-PLANE DIRECTIONS AND 15 KM IN THE DOWNTRACK DIRECTION DURING THE FIRST 2 HOURS OF THE NOMINAL MISSION, LAUNCH WILL BE HELD UNTIL THE NEXT EVEN MINUTE TO ASSURE CLEARANCE. FOR LAUNCH SLIPS, ADDITIONAL COMBO ANALYSIS WILL BE REQUESTED AND FURTHER HOLDS WILL BE SCHEDULED IN ACCORDANCE WITH THIS FLIGHT RULE. LAUNCH WILL ONLY BE HELD IF RESULTS ARE AVAILABLE PRIOR TO 5 MINUTES BEFORE THE L-9-MINUTE RESUMPTION OF THE COUNT.

The launch will not be conducted into known conditions of potential conflict with an orbiting object. If such conditions are predicted to occur prior to 2 hours MET for the nominal orbit, it is prudent to delay the lift-off to the next even minute to assure sufficient clearance from the object. This action minimizes risk at a minimal cost prior to picking up the count at L-9 minutes. After that, holding launch for such a low probability event would not be prudent. The 5-minute pad is to allow the conjunction information to be evaluated, passed on to the FD, and a hold requested if required.

Notification of potential conflicts can come as early as L-1 day. Additional tracking is taken on the object(s), and subsequent COMBO runs are made to determine if the risk persists. If the risk does persist, a launch slip to the next even minute will eliminate that risk.

Providing COMBO analysis through 2 hours MET and slipping launch for the predicted misses as specified in the rule are based on orbiter insertion errors and trajectory dispersions. The orbiter state errors beyond that time are so large (until sufficient tracking can be taken) that it makes no sense to perform the analysis. Also, 2 hours was chosen because any potential conjunctions after that would be computed with an actual post OMS-2 state vector that the MCC provides U.S. Space Command. The results of the post OMS-2 COMBO analysis would be available by 1:30 MET, allowing at least 1/2 hour to plan a maneuver if required.

FLIGHT RULES

Rule {A2.1.1-1G}, PRELAUNCH GO/NO-GO REQUIREMENTS, references this rule. (Reference Ascent/Entry Flight Techniques Panel Meeting #101, 6/18/93). ©[051194-1605]

FLIGHT RULES

A4.1.1-4 DOLILU OPERATIONS

THE DAY OF LAUNCH I-LOAD UPDATE (DOLILU) OPERATIONS AND STRUCTURAL LOADS EVALUATION WILL BE PERFORMED BY THE MCC-H WITH VERIFICATION FROM USA/SYSTEMS INTEGRATION. THE LOADS AND DOLILU OFFICER (LDO) HAS PRIMARY RESPONSIBILITY TO REPORT FACILITY AND PROCESSOR STATUS AS WELL AS GO/NO-GO EVALUATION TO THE FD AND MOD WHO PROVIDE THAT INFORMATION TO THE NTD OR MMT AS APPROPRIATE. @[091098-6622C]

TO BE GO FOR LAUNCH, THE DOLILU COMMAND LOADS MUST BE BUILT FROM DAY OF LAUNCH JIMSPHERE MEASURED WIND INFORMATION, UPLINKED AND VERIFIED ONBOARD PRIOR TO LAUNCH, AND THE FINAL LAUNCH WIND ANALYSIS PERFORMED PRIOR TO LAUNCH MUST SHOW THAT THE LOADS AND ASCENT TRAJECTORY PARAMETERS ARE WITHIN ESTABLISHED LIMITS. VALID CORRELATION OF MCC-H AND USA/SYSTEMS INTEGRATION RESULTS IS REQUIRED. IT IS HIGHLY DESIRABLE TO HAVE GO EVALUATIONS FROM BOTH MCC-H AND USA/SYSTEMS INTEGRATION FOR ALL WIND ANALYSES BUT EXCEPTIONS ARE LISTED BELOW:

TO BE GO FOR LAUNCH, THE DOLILU COMMAND LOADS MUST BE BUILT FROM DAY OF LAUNCH JIMSPHERE MEASURED WIND INFORMATION, UPLINKED AND VERIFIED ONBOARD PRIOR TO LAUNCH, AND THE FINAL LAUNCH WIND ANALYSIS PERFORMED PRIOR TO LAUNCH MUST SHOW THAT THE LOADS AND ASCENT TRAJECTORY PARAMETERS ARE WITHIN ESTABLISHED LIMITS. VALID CORRELATION OF MCC-H AND USA/SYSTEMS INTEGRATION RESULTS IS REQUIRED. IT IS HIGHLY DESIRABLE TO HAVE GO EVALUATIONS FROM BOTH MCC-H AND USA/SYSTEMS INTEGRATION FOR ALL WIND ANALYSES, BUT EXCEPTIONS ARE LISTED BELOW:

- A. DISCREPANCIES IN PROCESSOR INTEGRITY RULES OR EXPERIENCE RULES WILL BE RESOLVED BY THE FLIGHT CONTROL TEAM IF POSSIBLE. NOTIFICATION WILL BE MADE TO THE MMT. UNRESOLVED DISCREPANCIES IN THESE RULES REQUIRE A LAUNCH NO-GO.
- B. VIOLATION OF THE SYSTEMS CONSTRAINT RULES IS A LAUNCH NO-GO UNLESS RESOLVED BY THE APPLICABLE PROGRAM ELEMENTS AT THE MMT LEVEL.
- C. DISCREPANCIES BETWEEN THE RESULTS FROM THE MCC-H PROCESSES AND THE USA/SYSTEMS INTEGRATION PROCESSES WILL BE RESOLVED AS FOLLOWS:

FLIGHT RULES

1. FOR ALL DISCREPANCIES THAT FALL WITHIN COMPARISON CRITERIA, MCC-H RESULTS ARE CONSIDERED PRIME FOR MAKING THE GO/NO-GO EVALUATION. @J091098-6622CJ

THIS RULE CONTINUED ON NEXT PAGE

FLIGHT RULES

A4.1.1-4 DOLILU OPERATIONS (CONTINUED)

2. IF THE DISCREPANCY FAILS COMPARISON CRITERIA AND IS CAUSED BY A WIND FEATURE, A SUBSEQUENT WIND ASSESSMENT SHALL BE USED TO CLEAR THE DISCREPANCY. THE FINAL WIND ASSESSMENT SHALL BE REQUIRED TO PASS COMPARISON CRITERIA PRIOR TO CLEARING THE VEHICLE FOR LAUNCH. @J091098-6622C]
 3. IF THE DISCREPANCY FAILS COMPARISON CRITERIA AND IS CAUSED BY AN ERROR FROM EITHER THE JSC OR USA/SYSTEM INTEGRATION DOLILU SUPPORT ELEMENT, THEN THE GO/NO-GO EVALUATION SHALL BE BASED ON THE CORRESPONDING NON-FAILED ELEMENT.
 4. IF THE CAUSE FOR THE MISCOMPARE IS UNRESOLVED, THE LAUNCH IS NO-GO REGARDLESS OF EITHER SYSTEM'S GO/NO-GO EVALUATION RESULTS.
- D. FOR FAILURE OF MCC-H PROCESSOR AFTER THE DOLILU I-LOAD HAS BEEN TRANSFERRED TO THE MCC COMMAND SYSTEM, LAUNCH MAY PROCEED IF USA/SYSTEMS INTEGRATION IS ABLE TO PROVIDE RESULTS AND THEY ARE GO.
- E. FOR FAILURE OF USA/SYSTEMS INTEGRATION PROCESSOR AFTER THE L-6:15 HR COMPARE WITH MCC-H IS COMPLETE, LAUNCH MAY PROCEED IF THE MCC-H CONTINUES TO BE ABLE TO PROVIDE RESULTS AND THEY ARE GO.

To be GO for launch, the DOLILU I-loads and trajectory must pass all structural loads and trajectory constraints. These constraints are based on SSP vehicle constraints, and there are no means available for the DOLILU process to clear these violations. Therefore, any systems constraint rule or structural loads violation is reported to the MMT as a NO-GO, requiring an MMT waiver for launch to proceed.

Trajectory experience rules are parameter envelopes and are based on the DOLILU-II certification database. Launch day upper wind conditions may cause an experience envelope exceedance. If the reason for the exceedance is identified and acceptable to the flight control team, then rationale to launch may be written by the LDO as a DOLILU exception and processing may proceed. @J091098-6622C]

THIS RULE CONTINUED ON NEXT PAGE

FLIGHT RULES

A4.1.1-4 DOLILU OPERATIONS (CONTINUED)

At JSC only, processor integrity rules evaluate the DOLILU I-load generation processor for convergence and comparison with the trajectory simulation. Singularities inherent in the numerical iteration scheme used to generate the I-loads may result in processor non-convergence and are the result of random wind conditions. If a processor integrity rule fails, DOLILU processing may proceed using an I-load generated from another launch day balloon (L-6:15 or L-3:25) if the reason for the rule failure is understood and no additional processor rule failure occurs (ref. NSTS-08329, Vol. VIII, DOLILU Operations Support Plan (DOSP)). ~~©[091098-6622C]~~ ~~©[091098-6622C]~~

A miscompare of USA/Systems Integration and JSC may indicate that there is an error in one of the two processes or that the environment (wind measurement) is not sufficiently stable to allow a valid constraint evaluation to be made. The source of the miscompare must be understood prior to launch.

The DOLILU process uses independent verification (JSC and USA/Systems Integration) of the trajectory and structural loads as one means to control the risks associated with DOLILU operations (ref. Integration Hazard Report INTG-180E). However, a successful launch day comparison between the two for the L-6:15 balloon is sufficient for processing to proceed with only one location's evaluation. This comparison as well as the system verification check-outs that have occurred prior to day of launch are adequate to insure verification integrity. An additional requirement is for JSC to have generated and transferred a DOLILU I-load to the MCC for uplink. ~~©[091098-6622C]~~ ©[091098-6622C]

FLIGHT RULES

THIS PAGE INTENTIONALLY BLANK

FLIGHT RULES

ASCENT

A4.1.2-1 KALMAN FILTER SOLUTION

FOR PURPOSES OF IMPLEMENTING THE LAUNCH - POWERED FLIGHT ONLY - AND LANDING FLIGHT RULES, THE KALMAN FILTER SOLUTION IS CONSIDERED TO BE VALID IF:

The purpose of this rule is to establish quantitative criteria for declaring the Kalman filter solution a valid source for comparing and evaluating the onboard state vector.

- A. AT LEAST TWO AGREEING RADAR SOURCES ARE BEING PROCESSED, OR ONE RADAR HAS BEEN CONFIRMED PRIOR TO THE DUAL SOURCE LOSS.

The Kalman filter processor is designed for multiple radar data processing to achieve accuracy requirements. Since the ground solution is considered the valid source when disagreement occurs between the ground and the onboard, confirmation of data being processed is necessary for confidence in the ground solution.

- B. LESS THAN 20 PERCENT OF THE DATA IS BEING EDITED FROM EITHER SOURCE.

Editing of incoming radar data is indicative of noisy or invalid data. The 20 percent criterion was selected by navigation analysts as a conservative editing limit based on preflight analysis and postflight evaluation for purposes of maintaining the integrity of the ground state solution.

- C. THE STANDARD DEVIATIONS OF ANGLE AND RANGE RESIDUALS ARE LESS THAN THE 2-SIGMA EXPECTED VALUES.

Data statistics are computed in the Kalman processor based upon a prior knowledge about the data sources. The rule criterion was selected by navigation analysts as a conservative standard for solution validity evaluation based on preflight analysis and postflight evaluation.

- D. THE ESTIMATED BIAS IS LESS THAN 300 FEET FOR RANGE AND 0.5 MILLI-RADIAN FOR ANGLES.

Rationale is the same as for paragraph C above.

FLIGHT RULES

A4.1.2-2

ARD THRUST UPDATE CRITERIA AND FPR

- A. AN UPDATE TO THE ARD NOMINAL MAIN ENGINE THRUST VALUE WILL BE PERFORMED BY 4:00 MET IF THE ARD ACTUAL MODE NOMINAL MARGIN TREND RATE EARLY IN SECOND STAGE EXCEEDS A REAL-TIME, ARD-COMPUTED DEADBAND. FOLLOWING A THRUST UPDATE, PROTECTION WILL BE MAINTAINED FOR STATISTICAL DISPERSIONS IN ALL ARD FLIGHT PERFORMANCE RESERVE (FPR) COMPONENTS, AS DETAILED IN PARAGRAPH C BELOW. @[050495-1729D]

When properly modeling vehicle performance, the ARD prediction of current nominal capability (nominal delta V margin) does not vary with time. However, when SSME characteristics and/or vehicle mass properties are mismodeled (i.e., when systems dispersions are present), the nominal margin will trend up or down with time. Analysis shows that at the flight-derived 2 sigma level, an SSME thrust dispersion results in a trend which is significantly larger than the trend due to all other performance-related variables combined. Therefore, it is probable that a trend outside this "deadband" is caused by improper SSME thrust modeling. Abort mode boundary accuracy is heavily dependent on accurate systems modeling and; therefore, the ARD thrust value will be updated in real time, using an empirical relationship between thrust error and trend rate. The deadband is derived from the delta V margin trend due to the root sum square (RSS) of 2 sigma inert weight error, 2 sigma ET LH2 loading error, and the thrust error which could be "masked" by the other dispersions. The update does not eliminate the trend; it merely reduces it to the region where the remaining trend could be due to other factors for which protection is maintained via the ARD FPR. Reference paragraph C of this rule and its associated rationale for thrust sigma-level and deadband values. Implementation details are documented in the Ascent FDO Console handbook (JSC-23255, volume V) and the ARD Support Console Handbook (JSC-24541).

- B. THE ARD SOLUTION WILL BE CONSIDERED INVALID IF THRUST UPDATE REQUIREMENTS EXCEED THE 3-SIGMA SPECIFICATION THRUST DISPERSION LEVEL (10,392 LB CLUSTER, OR 0.74 PERCENT PER SSME) AS DEFINED IN NSTS 07700, VOL X, WITHOUT A CONFIRMING INDICATION. IN THIS CASE, THE ARD WILL BE DECLARED NO-GO AND THE PERMISSION CUE CARD VELOCITIES WILL BE USED FOR MODE BOUNDARY DETERMINATION, BASED UPON THE BEST AVAILABLE STATE VECTOR SOURCE.

FLIGHT RULES

Use of this update procedure will generally result in the highest-accuracy ARD solution possible. However, dispersions outside the SSME system specification thrust limit ($\pm 6,000$ lbs/eng RSS, or 10,392 lbs for the cluster) without a secondary cue are highly unlikely. It then becomes probable that the mis-modeling seen in the ARD is due to a ground configuration problem. If this occurs, the ARD solution will be bypassed in favor of abort mode boundaries based on pre-mission-computed inertial velocities. Potential secondary cues include: Off-nominal onboard thrust factor, differences between the onboard-computed and the prelaunch-expected MECO times (provided the ARD solution agrees with the prelaunch value), SSME system status and failure conditions reported by the Booster Systems Engineer, etc. ®[050495-1729D]

THIS RULE CONTINUED ON NEXT PAGE

FLIGHT RULES

A4.1.2-2 ARD THRUST UPDATE CRITERIA AND FPR (CONTINUED)

C. THE ARD FPR IS CONFIGURED TO PROTECT FOR SYSTEM DISPERSIONS THAT ADVERSELY AFFECT ARD MODELING OF VEHICLE PERFORMANCE. PROTECTION IS PROVIDED FOR ITEMS LISTED BELOW AT THE SPECIFIED STATISTICAL DISPERSION LEVELS. SYSTEM DISPERSIONS ARE OBTAINED FROM A HISTORICAL DATABASE OF FLIGHT-DERIVED DISPERSIONS MAINTAINED IN TABLE 8.1 OF THE SHUTTLE PERFORMANCE ASSESSMENT DATABASE (SPAD, NSTS-08209, VOL I).
 ©[050495-1729D]

ARD FPR COMPONENT	PROTECTION LEVEL (MEAN PLUS)	TYPICAL CONTRIBUTION
ET LOAD ERROR, VAPOR PRESSURE, SSME MIXTURE RATIO	2 SIGMA	29 PERCENT
ORBITER AND ET INERT WEIGHT	2 SIGMA	42 PERCENT
SSME SPECIFIC IMPULSE	2 SIGMA	23 PERCENT
SSME THRUST	2 SIGMA UNTIL 4:00 MET; THEN 4.24-APPROX 1 SIGMA *	7 PERCENT
SSME THRUST SHAPE	2 SIGMA	< 1 PERCENT

* [COMPUTED VIA FLIGHT DESIGN/MCC ARD RECONFIGURATION PROCESS](#) ©[080896-4209]

EACH ARD FPR COMPONENT IS COMPUTED INDEPENDENTLY FOR AN ENGINE-OUT AT THE PRESS-TO-ATO BOUNDARY ("AOA FPR"), WITH THE TOTAL AMOUNT DETERMINED BY ROOT-SUM-SQUARING THE SIGMA COMPONENTS AND ADDING THE MEANS. OTHER ABORT BOUNDARIES REQUIRING A SIGNIFICANTLY DIFFERENT FPR QUANTITY (E.G., NEGATIVE RETURN, SINGLE-ENGINE PRESS, AND THE PERFORMANCE CALL) ARE ADJUSTED VIA ARD BIASES.

ARD FPR differs from TDDP FPR, used for pre-flight performance assessment, for several reasons. Pre-flight FPR protects for the total performance impact, from liftoff to MECO, of system dispersions that adversely affect the trajectory. ARD FPR, on the other hand, protects for ARD real-time performance prediction errors caused by system dispersions. For each ARD execution cycle (2 sec), the ARD FPR must protect for future performance degradation due to a dispersion, as well as any MPS propellant mass track errors induced by a dispersion up to the current time. This causes ARD FPR to be a function of MET. Sigma components are RSS'ed and the means are added for the total FPR quantity versus time. The FPR at predicted press-to-ATO MET is loaded into the ARD. This closely matches the FPR quantity for two-engine TAL and press-to-MECO boundaries. Adjustments to ARD biases (Flight Design Product ASAB-25) for negative return, single-engine press, performance low/nominal, and other calls are required since the FPR quantity and/or sigma protection levels are different for these calls. Typical values for ARD and TDDP FPR are approximately 2,400 lbs and 3,800 lbs, respectively. ©[050495-1729D]

FLIGHT RULES

THIS RULE CONTINUED ON NEXT PAGE

FLIGHT RULES

A4.1.2-2 ARD THRUST UPDATE CRITERIA AND FPR (CONTINUED)

The SPAD lists flight-derived dispersions that degrade ascent performance in Table 8.1 of Vol 1. These statistics are obtained from post-flight reconstruction analysis of actual systems performance (e.g., SSME thrust, vehicle weight, SRB burnrate, etc.). Pre-flight prediction is compared to post-flight reconstructed performance over multiple flights to obtain dispersion statistics that are used in FPR calculations. The following dispersions listed in SPAD Table 8.1 are not included in ARD FPR since they take place in first stage (i.e., the effects of the dispersions are visible to the ARD through the post-staging state vector): SRB burnrate, SRB Isp, and collectors (forces and moments used to closely match first stage reconstructed trajectory to the best estimated trajectory (BET)). The remaining dispersions are included in ARD FPR, and the effects of each on ARD performance prediction are described below: ©[050495-1729D]

ET load, vapor pressure & SSME mixture ratio: This FPR component is identical to pre-flight ET load, vapor pressure, and mixture ratio protection used in generating TDDP FPR. This specifies the total performance impact of a 2 sigma plus mean combination of these dispersions. Therefore, it is not a function of mission elapsed time. The exact value used is a function of fuel bias at MECO, as predicted from pre-launch reported load or ARD real-time propellant imbalance computations during an SSME performance case.

Orbiter & ET inert weight: This component is calculated by determining the effect of a 2 Sigma plus mean inert weight error on delta V available. This is specified by the rocket equation and is a function of MET (i.e., ET propellant remaining). When calculated in this manner, this component protects for future performance degradation caused by the dispersion. The past performance impact of this dispersion is reflected in the state vector used by the ARD each cycle.

SSME specific impulse (Isp): This item protects for ARD delta V available and exhaust velocity (Vex) errors caused by a 2 sigma plus mean Isp dispersion. The rocket equation is used to calculate the delta V available error caused by the flowrate difference up to current time. Also, the effects of Vex error (a function of Isp dispersion) in the rocket equation are determined. The sum of these composes the ARD Isp protection, and is a function of MET.

SSME thrust: This item protects for ARD delta V available errors (caused by flowrate error) computed from the rocket equation as a function of time. Prior to 4:00 MET, 2 sigma plus mean protection is required. After this time, a thrust update is performed for thrust errors beyond a magnitude specified by the thrust update deadband (~~approx 4.5 fps/min for automatic thrust update logic, 5 fps/min for manual updates~~). Since thrust errors beyond the deadband are modeled after this point, no FPR protection beyond the deadband is required. A study was conducted to determine the maximum thrust error that could be hidden within the deadband. Other dispersions masking the thrust errors were considered also, but only those causing early ARD boundary errors (i.e., FPR consumption scenarios) were analyzed. The maximum combination ~~was~~ is determined each time FPR dispersion levels are re-derived and is converted to a thrust sigma level (approximately 1-24 sigma; past ©[050495-1729D] ©[080896-4209]

THIS RULE CONTINUED ON NEXT PAGE

FLIGHT RULES

A4.1.2-2 ARD THRUST UPDATE CRITERIA AND FPR (CONTINUED)

values have ranged from 0.88 to 1.24) which is used in the ADR FPR computation from 4:00 MET to MECO. The actual sigma level is documented in Flight Design product ASCT-22A, ARD MCC Trajectory Inputs and Support Tables, and ASCT-47, Final MCC Trajectory Inputs (the day-of-launch version of ASCT-22A). The Ascent FDO's will informally keep the Flight Director Office aware of any change in this value in the course of standard pre-mission preparation. ©[050495-1729D] _ ©[080896-4209]

SSME thrust shape: This item is specified in the SPAD for a nominal mission profile only (i.e., no engine out). It accounts for differences between predicted (cubic polynomial) and reconstructed thrust magnitude in the throttle bucket and during 3g throttling and fine countdown. Since it is calculated for pre-flight FPR, it specifies the total performance impact of this dispersion and is not a function of MET. Since no 3g throttle phase occurs on an engine-out trajectory (for which ARD FPR is designed), the quantity specified in the SPAD is multiplied by 1/3 to account for the approximate time that this dispersion is present (i.e., the throttle bucket), since the 3g throttling/fine countdown time is approximately 60 sec in duration, and the throttle bucket is about 30 sec long. SSME thrust shape is the smallest component of ARD FPR. ©[051045-1729D]

Reference: 5/29/91 and 6/25/91 FOIG, 6/27/91 Level II PRCB, and Ascent/Entry Flight Techniques Panel Meeting #80, 7/19/91, #87 2/21/92, and #95 11/20/92; ~~TDDP Rev 95-01~~. ©[050495-1729D] ©[080896-4209A]

A4.1.2-3 USE OF MAXIMUM THROTTLES

MAXIMUM THROTTLES WILL BE ENABLED (SPEC 51 ITEM 4) FOR THE FOLLOWING CONDITIONS: ©[092195-1770A]

- A. IF AN ENGINE-OUT OCCURS DURING FIRST STAGE BUT AFTER THROTTLE UP, WITH THE THROTTLE OF ONE REMAINING SSME STUCK IN THE THRUST BUCKET, MAX THROTTLE WILL BE ENABLED ASAP PROVIDED RTLS CAPABILITY WILL EXIST AFTER MAX THROTTLE ENABLING. ©[092195-1770A]

For an SSME-out during first stage and a remaining engine stuck in the bucket, the resulting trajectory will be depressed and performance will be much lower than normal. To avoid PEG guidance convergence difficulties in the RTLS flyback solution, max throttles should be enabled ASAP. If max throttles are not enabled, the low altitude drag effects can produce an early RTLS flyback, an extended period of nonconverged steering, and/or unstable throttle commands during flyback. Enabling max throttles increases the altitude at RTLS selection, thus reducing the flyback guidance problems. Additionally, the higher altitude and H-dot reduces the SSME plume heating on the aft end of the vehicle. ©[092195-1770A]

THIS RULE CONTINUED ON NEXT PAGE

FLIGHT RULES

A4.1.2-3 USE OF MAXIMUM THROTTLES (CONTINUED)

- B. IF AN ENGINE-OUT OCCURS DURING FIRST STAGE, MAX THROTTLE WILL BE ENABLED PRIOR TO RTLS SELECTION IF THE H-DOT AT SRB STAGING IS LESS THAN THE PRTLs MINIMUM PERFORMANCE CONSTRAINT (SEE H-DOT VS. VREL PLOT). MAX THROTTLE IS REQUIRED TO AVOID TOTAL PRESSURE (P_{TOTAL}) PROBLEMS FOR DEPRESSED STAGING CONDITIONS.

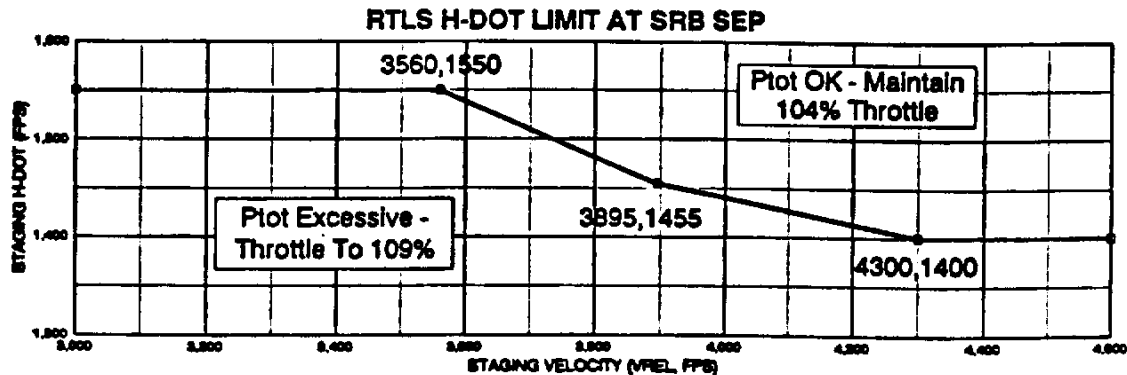

Initiation of a two-SSME RTLS from a depressed trajectory with low vehicle acceleration requires a large velocity to be gained to satisfy the target MECO conditions. The resultant trajectory drops to low altitudes during flyback phase. The low altitude leads to an increase in dynamic pressure and resultant P_{total} deflecting the SSME plume, which causes heating problems on the aft end of the vehicle. An analysis has been performed to determine altitude rates at SRB jettison which represent the minimal depressed trajectories that would cause PRTLs flyback heating problems on the aft end of the orbiter. The H-dot versus Vrel plot shows this region over the range of possible velocities, and is applicable to all flights. This altitude rate is called the PRTLs minimum performance constraint and is based on 20 psf P_{total} during flyback.

The 20 psf criteria applies only to off-nominal contingency situations where engine-out staging conditions are outside the one-sigma systems dispersion boundaries. Single engine-out/one-sigma systems dispersion cases are protected to the dispersed P_{total} limit (4 psf), which provides additional thermal protection for vehicle reusability. The 20 psf criteria was baselined for contingency RTLS aborts in 1982 at Ascent Flight Techniques #5 and approved again at the June 1987 SIR. The abort panel examined contingency RTLS heating concerns during 1989 and found ET umbilical tray heating constraints were violated. However, no ET critical 1 failures were identified with a 20 psf P_{total} . The Orbiter Project Office has not yet assessed orbiter heating with a P_{total} greater than the dispersed (non-contingency) limit. The October 4, 1989, PRCB recommended remaining with the 20 psf P_{total} limit rather than the dispersed limit primarily to reduce the need for throttling up to 109 percent during contingency cases.

FLIGHT RULES

THIS RULE CONTINUED ON NEXT PAGE

FLIGHT RULES

A4.1.2-3 USE OF MAXIMUM THROTTLES (CONTINUED)

Thus, if an SSME failure occurs during first stage and the observed altitude rate at SRB staging is less than the minimum performance constraint, maximum throttle will be enabled by item entry prior to selection of RTLS abort. An increase in vehicle acceleration decreases the flyback interval thereby reducing the gravitational losses which allows more effective thrust to satisfy the target conditions. The heating concerns are reduced by increasing the altitude prior to flyback.

Rule {A2.1.2-2C}, ASCENT MODE PRIORITIES FOR PERFORMANCE CASES, references this rule.

C. ABORT GAP CLOSURE @ [092195-1770A]

Maximum throttles may be used to eliminate or reduce gaps in "intact abort" capability. Ref. rule {A4.1.2-7H}, PERFORMANCE BOUNDARIES, for maximum throttle priority for the specific gap to be closed.

D. TO AVOID POST TAL SELECTION SITE REDESIGNATION WHEN OPERATING ON A SINGLE SSME

Maximum throttles may be used to allow the earliest opportunity to continue to the prime TAL site, rather than redesignating to an inplane ACLS, following the loss of a second main engine. Ref. rules {A4.1.2-7F.2.e}, PERFORMANCE BOUNDARIES, and {A2.1.2-2C}, ASCENT MODE PRIORITIES FOR PERFORMANCE CASES, for additional rationale.

E. TO MINIMIZE EXPOSURE TO A CONTINGENCY ABORT OR CREW BAILOUT SITUATION: @ [092195-1770A]

For the following cases, the additional risk associated with operating the main engines at 109 percent power level is acceptable in order to provide the crew and vehicle a chance to reach a runway (i.e., SE LIMITS or RTLS SE PRESS). Operationally, the increased internal engine pressures and temperatures at 109 percent do increase the likelihood of having an SSME failure (ref AEFTP #108 charts, 12/17/93; AEFTP #124 charts, 06/02/95; and AEFTP #125 charts, 08/04/95). However, commanding the engines to 109 percent power level while the vehicle is in an abort gap is considered less risky than a contingency abort or crew bailout.

1. DURING A TWO ENGINE RTLS OR TAL ABORT WITH A NON-ISOLATABLE MPS HELIUM LEAK PER RULE {A5.1.4-2}, PRE-MECO MPS HELIUM SYSTEM INTERCONNECTS.

When one engine has failed and another is suspect, maximum throttles may be enabled to reduce the time to MECO and minimize exposure to a contingency abort. In this case, the risk of the suspect engine failing prior to single engine capability outweighs the increased likelihood of having an SSME failure due to the increased pressures and temperatures associated with operating the engines at 109 percent power level. @ [092195-1770A]

FLIGHT RULES

THIS RULE CONTINUED ON NEXT PAGE

FLIGHT RULES

A4.1.2-3 USE OF MAXIMUM THROTTLES (CONTINUED)

2. ECAL, BDA, AND DROOP CONTINGENCY ABORTS

Maximum throttles will be used in contingency abort scenarios to increase the probability of reaching a landing site. The risk of crew bailout outweighs the risk of operating the remaining engine at 109 percent power level.

3. IF THE ENGINES ARE COMMANDED TO 104 PERCENT POWER LEVEL DURING RTLS FLYBACK

Once powered pitcharound is complete, the throttle command is initialized to 100 percent for a two engine RTLS and 72 percent for a three engine RTLS. These values are initial settings only and are adjusted during flyback phase to achieve the desired amount of propellant remaining at MECO. If it appears that there will be too much propellant remaining, the throttle command will be reduced. Conversely, if it appears that there will be too little propellant remaining, the throttle command will be increased but limited to 104 percent. If the throttle command is at the limit of 104 percent, maximum throttles will be enabled to allow guidance to command a power level up to 109 percent. It should be noted that guidance will only command the level required to reach the mass target and may not throttle up to the new limit of 109 percent. ©[092195-1770A]

A4.1.2-4

~~RESERVED ©[021199-6798] SRB JETTISON THE SRB SEPARATION SEQUENCE IS INITIATED WHEN MET BECOMES GREATER THAN AN I-LOADED SRB SEPARATION SEQUENCE INITIATION TIME. THE INITIATION TIME IS SELECTED TO BE LESS THAN THE EARLIEST POSSIBLE TIME THE SENSED PC FROM A FAST BURNING SRB WILL DECAY TO 50 PSIA, MINUS A MAXIMUM I-LOADED SRB SEPARATION CUE DIFFERENTIAL TIME THAT COVERS ANY PC MISMATCH. UPON INITIATION, THE SEQUENCE MONITORS THE LEFT AND RIGHT SRB PC SENSORS TO DETERMINE IF THE PRIMARY SEPARATION CUE HAS BEEN ACHIEVED; THAT IS, TO DETERMINE IF BOTH LEFT AND RIGHT PC'S HAVE DECAYED TO 50 PSIA. A BACKUP OR SECONDARY SEPARATION CUE IS WHEN MET BECOMES GREATER THAN THE LATEST POSSIBLE TIME (I-LOADED SRB SEPARATION BACKUP CUE TIME) THE SENSED PC OF A SLOW BURNING SRB WILL DECAY TO 50 PSIA.~~

In the event of multiple Pe sensor failures to the high state, the SRB separation backup cue time serves as the separation cue. Protection against multiple sensor failures to the low state requires recording the times at which the left and right SRB Pe measurements drop below 50 psia and calculating the resulting time differential. If the calculated differential exceeds an I-loaded maximum SRB separation cue differential time, the separation cue becomes the SRB separation backup cue time to prevent a separation attempt with excessive SRB thrust.

FLIGHT RULES

~~THIS RULE CONTINUED ON NEXT PAGE~~

~~A4.1.2-4 SRB JETTISON (CONTINUED)~~

~~The physical separation process begins once either the primary (Pc) or the backup (timer) separation cue is issued. Pyro initiator controller (PIC) arm and GN&C moding functions occur at appropriate times. Following delays to allow the SRM nozzle actuators to null and SRB thrust time to decay to an acceptable level, the vehicle dynamic state is compared with limit criteria (rates, Q-bar) which define the capability of the vehicle to perform a safe separation. If limit criteria are met, separation is commanded automatically. If the limit criteria are exceeded, automatic separation is inhibited. The crew may override this inhibit via the SRB separation mode switch and the SRB separation initiate pushbutton.~~

~~Reference: FSSR Sequence Reqs, SD76 SH 0026B, 1 May 79, paragraph 4.115.~~

~~A. IF VEHICLE RATES ARE WITHIN LIMITS, THE CREW WILL OVERRIDE INHIBIT OF SRB SEPARATION 5 SECONDS AFTER SEPARATION INHIBIT COMES ON.~~

~~If vehicle rates are within SRB separation limits and a separation inhibit occurs, it should be overridden 5 seconds later. The Q-bar I load value for SRB separation inhibit is 63 psf. This value protects the SRB separation system design limit of 75 psf against navigation derived Q-bar errors. Dispersion studies, including one engine out, indicate the actual Q-bar at nominal staging time will be 30 to 35 psf worst case. It is nearly impossible to violate the I load value and initiate a separation inhibit, even in the presence of large percentile navigation derived Q-bar errors. In addition, studies indicate that retention of the SRB's for 5 seconds in this timeframe allows actual Q-bar to drop approximately 20 psf.~~

~~B. IF VEHICLE RATES ARE NOT WITHIN LIMITS, BUT ARE CONVERGING, THE CREW WILL NOT OVERRIDE SEPARATION INHIBIT. FOR DIVERGING VEHICLE RATES, THE CREW WILL OVERRIDE 5 SECONDS AFTER THE SEPARATION INHIBIT COMES ON.~~

~~If vehicle rates are not within limits, but are converging, it is preferable to allow the automatic separation sequence to initiate within limits that have been verified rather than attempt crew intervention outside these limits. Convergence must be established and the automatic separation sequence initiated prior to violating an intact abort mode (RTLS/TAL or RTLS/AOA) overlap through retention of the SRB's.~~

~~Retention of the SRB's beyond the nominal separation time creates a 1 second for 1 second reduction in the abort mode overlap. Therefore, if vehicle rates are diverging the crew will override 5 seconds after the separation inhibit comes on. Five seconds preserve the abort mode overlap for worst case separation delays (separation backup cue time) and is referenced from separation inhibit on as a prevention for overriding the inhibit too early.~~

~~References: CA4(3) 78-04, Ascent Flight Techniques Meeting #10 minutes, February 14, 1979; and CA4-78-19, Ascent Flight Techniques Meeting #14 Minutes, April 18, 1979.~~

FLIGHT RULES

FLIGHT RULES

THIS PAGE INTENTIONALLY BLANK

FLIGHT RULES

A4.1.2-5 ABORT MODE RESPONSIBILITY

THE GROUND IS PRIME FOR ABORT MODE DETERMINATION.

Until such time that the orbiter GPC's have the memory capability to contain a completely autonomous version of the ARD program and autonomous navigation, the MCC ARD will remain the prime tool for determining abort capabilities. Current onboard abort mode determination capabilities are based on premission flight design data for predicted ascent performance and groundrule flight performance reserves. The crew is only provided with cue card values of inertial velocity that define designed mode boundaries and two tick marks on the ascent traj display that define negative return and two-engine press-to-MECO; all of which are intended for use only in no-communication situations.

The real-time MCC ARD program was defined and implemented with the flexibility to handle all performance-related ascent abort situations. Those situations include:

- a. Complete failure of one or more SSME at any time.*
- b. Performance dispersions visible in the vehicle state (e.g., dispersions in aerodynamics, atmospheric, SRB, performance, winds aloft, time-variant ISP, guidance/navigation/control, and mass track).*
- c. Performance dispersions not visible in the vehicle state (e.g., SSME performance dispersions, OMS/RCS propellant leaks contained onboard).*

The MCC ARD can define multiple or single SSME abort capabilities throughout ascent for any combination of the above-mentioned situations, utilizing either the HSTD filter or telemetry for the current vehicle state. The MCC ARD can also predict downmode abort capabilities through powered flight.

By virtue of the MCC ARD's flexibility in assessing in real time the orbiter's abort capabilities, the independent ground radar tracking, and the current lack of an equivalent autonomous onboard version of the ARD, the ground is therefore prime for all abort mode determinations.

Rule {A2.1.2-18}, ARD UPDATE CRITERIA, references this rule.

FLIGHT RULES

A4.1.2-6 DESIGN AND CRITICAL MECO UNDERSPEED DEFINITIONS

A. PERFORMANCE ASSESSMENTS THAT INDICATE ORBITAL CAPABILITY SHALL BE BASED ON THE ABILITY TO ACHIEVE EITHER THE DESIGN MECO UNDERSPEED OR THE CRITICAL MECO UNDERSPEED. THE FOLLOWING CONSTRAINTS DEFINE THE DESIGN MECO UNDERSPEED:

1. ET IMPACT CONSTRAINTS - CRITICAL LAND MASSES SHALL BE PROTECTED FROM THE 3-SIGMA ET IP FOOTPRINT (REF. RULE {A2.1.2-13}, ET FOOTPRINT CRITERIA).

2. MINIMUM PERFORMANCE CAPABILITY - THE MAXIMUM UNDERSPEED WHICH WILL SUPPORT THE EARLIEST PRESS TIME WITH EITHER:
 - a. AN AOA WITH STEEP TARGETS USING ARCS-TO-ARCS PRESS QUANTITY

OR

- b. AN ATO/MINIMUM HP WITH SHALLOW DEORBIT ON FD 1 USING ARCS-TO-ARCS PRESS QUANTITY (REF. RULE {A6.1.5-5E}, AFT RCS REDLINES). @[121593-1590]

OR

- c. AN ATO/ATO/SHALLOW DEORBIT ON FD 2 USING ARCS-TO-ARCS PRESS QUANTITY (REF. RULE {A6.1.5-5E}, AFT RCS REDLINES) ADJUSTED FOR USAGE TO FD 2, INCLUDING ATO DUMP CONSTRAINTS, IF REQUIRED.

NOTE: REF. RULE {A2.1.1-2}, ABORT LANDING SITE REQUIREMENTS, TO DETERMINE THE BASIS FOR DESIGN UNDERSPEED.

ALL OPTIONS WILL PROTECT THE CG TO THE CONTINGENCY CG ENVELOPE. IF AOA DEFINES THE PRESS BOUNDARY, THE LANDING SITE THAT PROVIDES THE EARLIEST PRESS TIME (PROVIDED IT IS "GO") WILL BE ASSUMED REGARDLESS OF THE LANDING SITE PRIORITIES. @[121593-1590]

THIS RULE CONTINUED ON NEXT PAGE

FLIGHT RULES

A4.1.2-6

**DESIGN AND CRITICAL MECO UNDERSPEED DEFINITIONS
(CONTINUED)**

3. MINIMUM ALTITUDE CONSTRAINT - THE MAXIMUM UNDERSPEED SHALL BE LIMITED TO A VALUE WHICH PROTECTS AGAINST LOW-ALTITUDE (< 55 NM) TRAJECTORY CONDITIONS BETWEEN MECO AND OMS-2 TIG.
4. MINIMUM SSME NPSP CONSTRAINTS - THE MAXIMUM UNDERSPEED SHALL BE LIMITED TO A VALUE WHICH PROTECTS AGAINST VIOLATION OF SSME NPSP REQUIREMENTS DURING THE MECO SHUTDOWN SEQUENCE.

NOTE: MANUAL THROTTLING MAY BE USED TO SATISFY NPSP LIMITS IF THE RESULTING ADDITIONAL UNDERSPEED CAPABILITY MAINTAINS ALL OTHER REQUIRED PROTECTION. REF. RULE {A4.1.2-10F} AND G, MANUAL THROTTLE SELECTION, FOR MANUAL THROTTLE CRITERIA.

5. CG PROTECTION - THE SPECIFICATION CG ENVELOPE, RULE {A4.1.4-3}, CG PLANNING, WILL BE RELAXED TO THE CONTINGENCY ENVELOPE IN ORDER TO CONTINUE TO ORBIT.

- B. CRITICAL UNDERSPEED IS DEFINED AS MAXIMUM UNDERSPEED CAPABILITY WITHOUT REGARD TO ET IMPACT PROTECTION OR FLIGHT SOFTWARE MECO PREP THROTTLING FOR NPSP (I.E., ALLOWS MANUAL THROTTLING). CRITICAL UNDERSPEED IS UNRELATED TO AND DOES NOT PROTECT CRITICAL LAND MASSES.

REFERENCE RULE {X4.1.1-1}, TRAJECTORY AND GUIDANCE PARAMETERS, FOR THE FLIGHT-SPECIFIC DESIGN AND CRITICAL MECO UNDERSPEEDS.

The design MECO underspeed is usually based on ATO/Min Hp/FD 1 shallow deorbit. In some cases, the design underspeed is based on AOA steep capability. In either case, flight design techniques minimize the time difference between these two boundaries so the loss of an AOA site is not a significant performance risk. However, the loss of a first day PLS site would incur an additional 4 to 11 seconds of TAL exposure. This is a real-time option only and is never part of the "design." This delayed two engine press boundary would be based on ATO/ATO/FD 2 shallow capability. The use of an ATO OMS-2 yields an Hp of about 105 nm which gives substantial margin for orbital lifetime for FD 2 deorbit. RCS press quantities are also modified to include usage to FD 2 deorbit. Systems failures requiring early flight termination will be supported by TAL and AFO sites. Reference Rule {A2.1.1-2}, ABORT LANDING SITE REQUIREMENTS. ©[121593-1590]

THIS RULE CONTINUED ON NEXT PAGE

FLIGHT RULES

A4.1.2-6

DESIGN AND CRITICAL MECO UNDERSPEED DEFINITIONS (CONTINUED)

The landing site that provides the earliest press time is assumed in the minimum performance capability, assuming that the landing site meets all constraints to make it GO. This is done regardless of the landing site priority in order to yield the earliest press time. Since the press calls protect for two-sigma low ascent performance, there is statistically a low probability that an AOA would be required for an SSME-out at the press boundary. Therefore, the Ascent/Entry Flight Techniques Panel determined it appropriate to use the landing site that provides the earliest press time in the assumptions for the press calls, even though it may not be the prime AOA site.

Design underspeed protection of auto MECO prep throttling is provided to satisfy SSME NPSP requirements without any action by the crew. It was determined early in the STS program that, for single-engine-out operation, this underspeed limit is 500 fps, driven by flight software I- and K-loads which determine when the SSME's are commanded to minimum power level. Nominal flight design will protect this constraint in the two-engine press boundaries and associated OMS dump design.

However, if a failure scenario arises in which the 500 fps limit will be exceeded, yet it is still possible to meet the other uphill capability constraints (generally, this requires multiple failures), then manual throttling to minimum power level may be used to assure that NPSP limits are satisfied. This, in turn, avoids a TAL or RTLS abort and may even provide a minimum mission capability. Flights where this technique is available typically involve either high MECO velocity targets or high OMS loads, or both.

Rules {A2.1.1-1}, PRELAUNCH GO/NO-GO REQUIREMENTS; {A2.1.1-2}, ABORT LANDING SITE REQUIREMENTS; {A2.1.2-2B}, ASCENT MODE PRIORITIES FOR PERFORMANCE CASES; and {A4.1.2-7}, PERFORMANCE BOUNDARIES, reference this rule. @[121593-1590] @[ED]

FLIGHT RULES

A4.1.2-7 PERFORMANCE BOUNDARIES

A. PERFORMANCE NOMINAL/LOW

NOMINAL PERFORMANCE IS DEFINED AS HAVING AN ARD PREDICTED NOMINAL DELTA VELOCITY MARGIN WHICH ENSURES A GUIDED MECO (NO LOW LEVEL CUTOFF) WITH A 3-SIGMA LEVEL OF CONFIDENCE. LOW PERFORMANCE INDICATES LESS THAN A 3-SIGMA GUIDED MECO PROBABILITY.

This assessment is performed in order to determine whether an SSME with a locked throttle (hydraulic or electric) must be manually shut down prior to MECO in order to avoid potential violation of NPSP requirements. If the ARD predicts an underspeed for the current nominal mission mode, then a guided MECO is not assured, and a low-level cutoff is possible. Since the software low-level cutoff timers assume all engines are at the cutoff power level, an engine stuck at a higher level will consume more propellant than the timers protect and may deplete before safe shutdown is achieved. Therefore, if performance is low per this rule, the stuck engine will be manually shut down early, well prior to any depletion possibility. The remaining engines can then be shut down safely from the two-engine cutoff power level. The performance assessment is protected at the 3-sigma level (vs. 2-sigma for most performance boundaries) due to the potentially catastrophic nature of a depletion cutoff.

B. TWO-ENGINE (PRIME TAL) (I.E., TWO-ENGINE BEN GUERIR)

THIS BOUNDARY REPRESENTS THE EARLIEST TIME AFTER WHICH AUTO GUIDANCE WILL ACHIEVE THE DESIRED PRIME TAL RANGE-VELOCITY TARGETS WITHIN CROSSRANGE LIMITATIONS AT MECO. ASSUMPTIONS: SINGLE ENGINE OUT, PROTECTION OF 2-SIGMA MPS FPR, PROTECTION OF 3-SIGMA ENTRY DISPERSIONS, ABORT THROTTLES, AND 15-SECOND ABORT DECISION DELAY.

The first TAL boundary protects 2-sigma FPR as a trade between assurance of a guided MECO and increased exposure to RTLS, which is lower in abort priority. The likelihood of an underspeed is only increased a small amount in backing from 3-sigma to 2-sigma, and the 3-sigma entry protection maintained implicitly in the R-V line can easily accommodate the additional underspeed should a 3-sigma low ascent day actually occur.

THIS RULE CONTINUED ON NEXT PAGE

FLIGHT RULES

A4.1.2-7 PERFORMANCE BOUNDARIES (CONTINUED)

C. RTLS BOUNDARIES:

1. NEGATIVE RETURN

THIS BOUNDARY REPRESENTS THE LAST OPPORTUNITY TO ABORT RTLS AND STILL ACHIEVE THE DESIRED MECO RANGE-VELOCITY TARGETS. ASSUMPTIONS: SINGLE ENGINE OUT, PROTECTION OF 3-SIGMA MPS FPR, PROTECTION OF 3-SIGMA ENTRY DISPERSIONS, ABORT THROTTLES, AND 15-SECOND ABORT DECISION DELAY.

The negative return boundary protects 3-sigma MPS FPR in order to ensure that an underspeed is not incurred during an RTLS abort. An underspeed during RTLS can adversely affect the ET separation conditions so severely that this protection is warranted. The single-engine-out, 3-sigma entry dispersions, abort throttles, and 15-second decision delay are self-explanatory and are consistent with other abort mode boundary calls.

2. IF AN ENGINE FAILS PRIOR TO THE TWO-ENGINE TAL CALL, AN RTLS ABORT WILL BE SELECTED AT THE LATER OF THE FOLLOWING:

a. 2:30 MET.

b. ASAP AFTER THE MCC HAS CONFIRMED THAT TWO-ENGINE TAL CAPABILITY DOES NOT EXIST (IF THE ENGINE FAILED CLOSE TO THE PERMISSION TWO-ENGINE TAL TIME) BUT NOT LATER THAN 3:40 MET.

Onboard software will not initiate RTLS aborts prior to the SRB separation command at approximately 2:05 MET. Initiation of RTLS aborts prior to 2:30 MET causes guidance to fly at a flight control limit until alpha and beta constraints for ET heating control are released at that time. Because of these limits, the only apparent changes seen by the crew are the CRT display titles, which change from ASCENT to RTLS. Delaying selection until 2:30 MET gives the ground time to confirm the engine-out, allows time for transients due to separation to damp out and for second stage guidance to stabilize, and allows sufficient time for completion of the RTLS fuel dissipation phase. If RTLS is clearly the only abort mode available, selection at 2:30 MET (or the engine-out time, if after 2:30 MET) also maximizes RTLS performance capability by lofting the vehicle as soon as possible following the engine failure.

FLIGHT RULES

Some missions are designed such that two-engine TAL capability is reached in first stage or very early in second stage (before 2:30 MET). In these cases, it is desirable to wait until after a good second-stage ARD solution can be obtained to evaluate two-engine TAL capability before committing to an RTLS, because ARD margins in first stage may not be indicative of true performance capability due to the open-loop nature of first stage guidance. 3:40 MET was chosen since it is at this time that RTLS aborts are initiated following an engine-out after the two-engine TAL call (ref. paragraph C.3 above). In most cases, however, the ARD should be computing a good solution by 2:30 MET.

THIS RULE CONTINUED ON NEXT PAGE

FLIGHT RULES

A4.1.2-7 PERFORMANCE BOUNDARIES (CONTINUED)

3. FOR RTLS ABORTS AFTER THE TWO-ENGINE TAL CALL, RTLS SELECTION WILL OCCUR AT 3:40 MET.

For any RTLS abort (three-engine or two-engine) after the two-engine TAL call, the RTLS abort will be delayed allowing for any systems problems that may dictate TAL over RTLS. The RTLS selection should be made at least 10 seconds prior to negative return in order to preserve the two-engine RTLS capability as well as keep the TAL option as long as possible. As most all shuttle flights have negative return occurring from approximately 3:50 to 4:05 MET, the 3:40 MET RTLS abort initiation will preserve the two-engine case and provide a standard time for late RTLS selection.

Note: During the RTLS/TAL overlap region, the RTLS abort will be performed for systems failures requiring quick return to ground. The TAL abort will be initiated for performance cases.

4. RTLS AND TAL CAPABILITY.

FOR A FAILURE REQUIRING AN ABORT IN THE REGION WHERE RTLS AND TAL CAPABILITY OVERLAP, THE TAL PREFERENCE OVER RTLS MAY BE REVERSED FOR SPECIFIC SYSTEM FAILURES (REF. RULE {A2.1.2-4}, RTLS, TAL, AND AOA ABORTS FOR SYSTEMS FAILURES (CIL)).

There is normally an overlap between first two-engine TAL and last RTLS capabilities. Preference of one abort over the other is dictated by Rule {A2.1.2-2}, ASCENT MODE PRIORITIES FOR PERFORMANCE CASES, which is written from a performance standpoint. However, certain failures in orbiter systems may make one mode preferable over the other due to considerations beyond simple performance capability. In these cases, if there is a conflict between the preferred systems abort and the abort priorities rule, the systems abort may be selected since the ability to support the performance abort from a systems standpoint may not exist.

5. SINGLE ENGINE PRESS (RTLS).

THIS BOUNDARY REPRESENTS THE EARLIEST TIME THAT SINGLE ENGINE COMPLETION OF AN RTLS ABORT CAN BE FLOWN VIA AUTO CONTINGENCY ABORT SOFTWARE. THIS BOUNDARY OCCURS WHEN THE VEHICLE H-DOT OF +100 FPS IS REACHED, ASSUMING AN UPRANGE VELOCITY.

The 100-fps positive H-dot is an empirically derived value which protects the orbiter's capability to maintain a positive flight path angle, following a second engine out, such that powered pitchdown and ET separation can be accomplished before dynamic pressure builds up to a point that recontact with the ET would occur after separation.

THIS RULE CONTINUED ON NEXT PAGE

FLIGHT RULES**A4.1.2-7 PERFORMANCE BOUNDARIES (CONTINUED)**

D. PRESS-TO-ATO.

THIS BOUNDARY REPRESENTS THE EARLIEST TIME AFTER WHICH AUTO GUIDANCE WILL ACHIEVE THE DESIGN UNDERSPEED (REF. RULE {A4.1.2-6}, DESIGN AND CRITICAL MECO UNDERSPEED DEFINITIONS) AT MECO. ASSUMPTIONS: SINGLE ENGINE OUT, PROTECTION OF 2-SIGMA MPS FPR, ABORT THROTTLES, PRE-MECO ATO SELECTION (MAY INVOKE A PRE-MECO OMS DUMP, ABORT MECO TARGETS, AND/OR VARIABLE IY STEERING), AND 15-SECOND ABORT DECISION DELAY.

The design underspeed is used as the criteria that must be met for single engine out cases to "press" uphill. This underspeed protects critical land masses from ET impact per NASA and ESMC agreements. Reference Rule {A2.1.2-13}, ET FOOTPRINT CRITERIA, for ET impact constraints.

The MPS FPR assumed is 2 sigma. For most flights, the design underspeed is based on the largest underspeed than can support either AOA steep or ATO/Min Hp with a FD 1 shallow deorbit or ATO/ATO with a FD 2 shallow deorbit (not a premission design option). Protecting only 1-sigma FPR would not be conservative enough because it would significantly increase the probability of getting an underspeed larger than the design underspeed. ©[121593-1590]

If the MECO underspeed is larger than the design underspeed, an AOA shallow may be required. As of March 1990, AOA shallow was still not a certified abort mode. Protecting 3-sigma FPR would be too conservative and would significantly delay picking up "press" capability with only a slight statistical improvement in the likelihood of meeting the design underspeed.

The press-to-ATO boundary is assessed only when flight design has baselined a pre-MECO ATO OMS dump. The I-loads must be in the flight software to allow the ATO dump to occur. The addition of an ATO dump allows earlier "press" capability. Therefore, most flights now have an ATO dump baselined. However, this dump is not designed with FD 2 considerations. Press may be delayed to provide performance for FD 2 Hp deorbit costs. ©[121593-1590]

E. PRESS-TO-MECO.

THIS BOUNDARY REPRESENTS THE EARLIEST TIME AFTER WHICH AUTO GUIDANCE WILL ACHIEVE THE DESIGN UNDERSPEED, (REF. RULE {A4.1.2-6}, DESIGN AND CRITICAL MECO UNDERSPEED DEFINITIONS) AT MECO. ASSUMPTIONS: SINGLE ENGINE OUT, PROTECTION OF 2-SIGMA MPS FPR, ABORT THROTTLES.

Reference the rationale for paragraph D for an explanation of why the design underspeed is used and why 2-sigma MPS FPR is protected. The difference between these two boundaries in most cases is the ATO OMS dump.

THIS RULE CONTINUED ON NEXT PAGE

FLIGHT RULES**A4.1.2-7 PERFORMANCE BOUNDARIES (CONTINUED)****F. SINGLE ENGINE TAL BOUNDARIES**

NOTE: IN ALL THE TAL ABORT BOUNDARY DEFINITIONS, AN ELS MAY BE REPLACED BY AN ACLS OR PRIME TAL SITE AND AN ACLS MAY BE REPLACED BY A PRIME TAL SITE.

1. IF NO PRIOR TAL ABORT DECLARED OR TAL SELECTED TO AN IN-PLANE SITE:

a. DROOP (PRIME TAL OR ACLS - 109):

THE DROOP BOUNDARY REPRESENTS THE EARLIEST TIME AFTER WHICH A TWO-SSME-OUT TRAJECTORY WILL NOT FALL BELOW 265,000 FEET AND TAL GUIDANCE WILL CONVERGE TO THE SELECTED/REDESIGNATED SITE'S MECO TARGETS PRIOR TO THE DESIRED MECO TIME. THIS BOUNDARY ASSUMES TWO SSME'S OUT, MAX THROTTLE, AND 15-SECOND ABORT DECISION DELAY. THE WEATHER AT THE SITE WILL NOT BE A CONSIDERATION WHEN ASSESSING THIS BOUNDARY.

This boundary is the earliest time that TAL guidance can be used on a two-engine-out trajectory. It ensures that the minimum droop altitude will not be violated. Analysis has shown that trajectories that droop below 265,000 feet could result in ET rupture due to aerodynamic heating. If, upon TAL droop declaration, guidance is unconverged, the crew's procedures call for flying manually until guidance does converge. (The likelihood of unconverged guidance in this region was significantly reduced by incorporation of the OI-21 low-thrust-to-weight guidance CR.) This boundary does not ensure the capability to reach a runway. Therefore, the weather at the targeted site is not considered when evaluating this boundary.

b. SINGLE ENGINE LIMITS:

THIS BOUNDARY REPRESENTS THE EARLIEST TIME AFTER WHICH THE DESIRED ACLS OR TAL SITE CAN BE ACHIEVED. ASSUMPTIONS: MAX THROTTLE, A 15-SECOND ABORT DECISION DELAY, MAX RANGING USING LOW ENERGY GUIDANCE (REFERENCE RULE {A2.1.2-5}, USE OF LOW ENERGY GUIDANCE) AND 2-SIGMA ASCENT PERFORMANCE, AND UNDISPERSED ENTRY PERFORMANCE. THIS BOUNDARY IS CONTINGENT UPON THE WEATHER/NAVAID STATUS AT THE SITE AS PER RULE {A2.1.1-6}, LANDING SITE WEATHER CRITERIA.
@[120894-1663]

Self-explanatory.

THIS RULE CONTINUED ON NEXT PAGE

FLIGHT RULES

A4.1.2-7

PERFORMANCE BOUNDARIES (CONTINUED)

- c. SINGLE ENGINE (PRIME TAL OR ACLS - 104) (e.g., SINGLE BANJUL - 104):

THIS BOUNDARY REPRESENTS THE EARLIEST TIME AFTER WHICH AUTO GUIDANCE WILL ACHIEVE THE DESIRED SITE RANGE-VELOCITY TARGETS WITHIN CROSSRANGE LIMITATIONS AT MECO. (THE DESIRED SITE IS THE ONE THAT PROVIDES THE EARLIEST SINGLE-ENGINE CAPABILITY.) ASSUMPTIONS: PROTECTION OF 2-SIGMA MPS FPR, PROTECTION OF AT LEAST ZERO-SIGMA ENTRY DISPERSIONS, ABORT THROTTLE, AND A 15-SECOND ABORT DECISION DELAY. THE WEATHER AT THE SITE WILL NOT BE A CONSIDERATION WHEN ASSESSING THIS BOUNDARY.

Self-explanatory. These cases, by definition, reach the range-velocity (R-V) target line, however they do so at a lower velocity than the design point. For this reason, entry dispersions are not explicitly protected, although for any given mission the protection level for these constraints (first roll reversal velocity, constant drag phase length, and equilibrium glide boundary margin) may vary from less than 1-sigma to more than 3-sigma (reference 5/18/94 Abort Panel Splinter Meeting). @[120894-1741]

- d. NEGATIVE (PRIME TAL) (e.g., NEGATIVE BEN GUERIR):

THIS BOUNDARY REPRESENTS THE LAST OPPORTUNITY TO ABORT TO THE PRIME TAL SITE AND STILL ACHIEVE THE DESIRED MECO RANGE-VELOCITY TARGETS WITHIN CROSSRANGE LIMITATIONS. ASSUMPTIONS: TWO SSME'S AT ABORT THROTTLE, PROTECTION OF 2-SIGMA MPS FPR, PROTECTION OF 3-SIGMA ENTRY DISPERSIONS, AND A 15-SECOND ABORT DECISION/TAL RESELECTION DELAY.

Self-explanatory.

2. IF TAL ABORT PREVIOUSLY DECLARED TO AN OUT-OF-PLANE SITE:

- a. DROOP (PRIME TAL OR ACLS - 109) (e.g., DROOP BANJUL - 109):

THIS BOUNDARY IS THE SAME AS IN PARAGRAPH F.1 ABOVE.

- b. SINGLE ENGINE LIMITS:

THIS BOUNDARY IS THE SAME AS IN PARAGRAPH F.1 ABOVE.

FLIGHT RULES

THIS RULE CONTINUED ON NEXT PAGE

FLIGHT RULES

A4.1.2-7 PERFORMANCE BOUNDARIES (CONTINUED)

- c. SINGLE ENGINE (PRIME TAL OR ACLS - 104) (E.G., SINGLE ENGINE BANJUL - 104):

THIS BOUNDARY IS THE SAME AS IN PARAGRAPH F.1 ABOVE.

- d. NEGATIVE (ACLS) (E.G., NEGATIVE BANJUL):

THIS BOUNDARY REPRESENTS THE LAST OPPORTUNITY TO ABORT TO THE ACLS AND STILL ACHIEVE THE ACLS WITHIN CROSSRANGE LIMITATIONS USING LOW-ENERGY GUIDANCE. ASSUMPTIONS: PROTECTION OF 0-SIGMA MPS FPR, PROTECTION OF 0-SIGMA ENTRY DISPERSIONS, MAX THROTTLE, AND A 15-SECOND RESELECTION/ DECISION DELAY. @[120894-1663]

This boundary assumes 0 sigma for both MPS FPR and entry dispersions in order to allow the latest capability to redesignate to make it to an ACLS. Not doing this would possibly create a second engine out gap. This boundary will not be assessed if the SINGLE ENGINE TAL - 109 boundary has been reached.

- e. SINGLE ENGINE (PRIME TAL - 109) (E.G., SINGLE ENGINE BEN GUERIR - 109):

THIS BOUNDARY REPRESENTS THE EARLIEST TIME AFTER WHICH AUTO GUIDANCE WILL ACHIEVE THE RANGE-VELOCITY TARGETS AT MECO FOR THE PRIME SITE. ASSUMPTIONS: PROTECTS 2-SIGMA MPS FPR, PROTECTS AT LEAST ZERO-SIGMA ENTRY DISPERSIONS, AND MAX THROTTLE. @[120894-1741]

This boundary is different from the single engine TAL boundaries for the in-plane cases because it assumes max throttles versus nominal throttles. Using max throttles allows the earliest opportunity to continue to the prime TAL site and not have to risk possible control problems caused by a large yaw maneuver required to head to the ACLS. Reference Flight Rule {A2.1.2-2C}, ASCENT MODE PRIORITIES FOR PERFORMANCE CASES, for more details on using max throttles for this case. If this boundary has not been reached yet and the NEGATIVE ACLS boundary has been crossed, this call will be made on 0 sigma MPS to close the gap. These cases, by definition, reach the range-velocity (R-V) target line; however, they do so at a lower velocity than the design point. For this reason, entry dispersions are not explicitly protected, although for any given mission, the protection level for these constraints (first roll reversal velocity, constant drag phase length, and equilibrium glide boundary margin) may vary from less than 1-sigma to more than 3-sigma (reference 5/18/94 Abort Panel splinter meeting). @[120894-1741]

FLIGHT RULES

THIS RULE CONTINUED ON NEXT PAGE

FLIGHT RULES

A4.1.2-7 PERFORMANCE BOUNDARIES (CONTINUED)

3. LAST AUTO TAL:

THIS BOUNDARY REPRESENTS THE LAST OPPORTUNITY TO ABORT TO AN ACLS/PRIME TAL SITE, REMAIN IN AUTO, AND STILL ACHIEVE THE DESIRED MECO RANGE-VELOCITY TAL TARGETS (WITHIN CROSSRANGE LIMITATIONS IF APPLICABLE). ASSUMPTIONS: ONE SSME AT ABORT THROTTLE; TWO OR THREE SSME'S AT 65 PERCENT THROTTLE, PROTECTION OF 3-SIGMA ENTRY DISPERSIONS, 15 SECOND ABORT DECISION DELAY, AND PROTECTION OF THE CONTINGENCY CG BOX.

4. LAST LATE TAL:

THIS BOUNDARY REPRESENTS THE LAST OPPORTUNITY TO MANUALLY MECO AT A VELOCITY WHICH WILL ALLOW FOR AN ENTRY TO AN ELS/ACLS. ASSUMPTIONS: MANUAL MECO, PROTECTION OF THE CONTINGENCY CG BOX, AND POST-MECO ROLL TO HEADS-UP.

G. SINGLE ENGINE OPS 3: @[120894-1743A]

THIS BOUNDARY REPRESENTS THE EARLIEST TIME THAT THE CREW WILL PERFORM THE 2 ENGINE OUT DROOP PROCEDURE FOLLOWING A SECOND SSME FAILURE.

1. IF LAST ECAL/BDA CAPABILITY OCCURS AFTER THE DROOP BOUNDARY (REF. PARAGRAPH F.1.a), THE SINGLE ENGINE OPS 3 BOUNDARY WILL BE BASED ON THE EARLIEST OF THE FOLLOWING:
 - a. LAST ECAL/BDA CAPABILITY (WITHOUT REGARD TO WEATHER)
 - b. THE SINGLE ENGINE LIMITS BOUNDARY (REF. PARAGRAPH F.1.b)
 - c. FIRST DOWNRANGE ELS LOW ENERGY CAPABILITY. THIS ELS CAPABILITY ASSUMES THE FOLLOWING:
 - (1) MAXIMUM THROTTLES,
 - (2) 2 SIGMA LOW MPS PERFORMANCE,
 - (3) USE OF AUTO LOW ENERGY GUIDANCE FOR ENTRY (REF. RULE {A2.1.2-5} FOR LOW ENERGY GUIDANCE),

FLIGHT RULES

THIS RULE CONTINUED ON NEXT PAGE

FLIGHT RULES**A4.1.2-7****PERFORMANCE BOUNDARIES (CONTINUED)**

(4) THE ELS MEETS MINIMUM EMERGENCY LANDING FACILITY CRITERIA (REF. RULE {A2.1.5-14}, EMERGENCY LANDING FACILITY CRITERIA. @[120894-1743A]

2. IF LAST ECAL/BDA CAPABILITY OCCURS BEFORE THE DROOP BOUNDARY, THE SINGLE ENGINE OPS 3 BOUNDARY WILL BE BASED ON DROOP. @[120894-1743A]

This boundary allows the use of ECAL capability past the point where droop capability begins, and reflects the priority of ECAL over droop/bailout as set by the A/E FTP in July 1994. This delays the point where the two engine out second stage procedure ends. This option allows the crew to use the ECAL procedures and attempt a landing versus doing the two engine out droop procedure which results in a bailout. This option on a high inclination mission is much preferred over bailout in the North Atlantic Ocean. Another consideration in this boundary is the first ELS capability with "stretch" (use of low energy guidance). However, if the ELS weather does not meet the minimum weather criteria for an ELS, it is unusable as an ELS and the ELS capability will not be considered in the determination of the boundary. A landing at an ELS is considered preferable over landing at ECAL/BDA because of the automated entry procedures and the slightly more benign entry conditions. The Single Engine Limits boundary is the first capability to a TAL or ACLS using "stretch" (use of low energy guidance). This has a higher priority over an ECAL.

If ECAL/BDA capability ends prior to droop then this call will be based on droop capability.
@[120894-1743A]

H. SINGLE ENGINE PRESS-TO-MECO: @[120894-1743A]

THIS BOUNDARY REPRESENTS THE EARLIEST TIME AFTER WHICH AUTO GUIDANCE WILL ACHIEVE THE CRITICAL UNDERSPEED (REF. RULE {A4.1.2-6}, DESIGN AND CRITICAL MECO UNDERSPEED DEFINITIONS) AT MECO. ASSUMPTIONS: TWO ENGINES OUT, PROTECTION OF 2-SIGMA MPS FPR, AND ABORT THROTTLE.

The single-engine press-to-MECO (SEPTM) boundary is based on critical, rather than design, underspeed since ET impact constraints protected in the design underspeed do not apply to multiple-engine-out scenarios (ref. Rule {A2.1.2-13E}, ET FOOTPRINT CRITERIA). Abort throttles are assumed since Rule {A2.1.2-2C}, ASCENT MODE PRIORITIES FOR PERFORMANCE CASES, implies that we will not use max throttle to avoid a TAL downmode as long as auto TAL is available, and normally SEPTM occurs well prior to the last TAL. 2-sigma FPR is protected per the rationale for the other uphill boundaries.

THIS RULE CONTINUED ON NEXT PAGE

FLIGHT RULES**A4.1.2-7 PERFORMANCE BOUNDARIES (CONTINUED)**

I. PERFORMANCE DISPERSIONS/GAPS: @[120894-1743A]

1. UPHILL CAPABILITY CONSISTS OF HAVING AN ARD-PREDICTED UNDERSPEED WHICH IS LESS THAN EITHER THE DESIGN OR CRITICAL UNDERSPEED, WHICHEVER APPLIES TO THE GIVEN CASE AS PROVIDED BY RULE {A2.1.2-13E}, ET FOOTPRINT CRITERIA. ASSESSMENT ASSUMES ABORT THROTTLES, PROTECTION OF 2-SIGMA MPS FPR, AND MAY INCLUDE A PRE-MECO ATO ABORT IF APPLICABLE.

Uphill capability as defined will guarantee AOA steep or ATO day 1 or day 2 shallow D/O capability as well as the other items listed in Rule {A4.1.2-6}, DESIGN AND CRITICAL MECO UNDERSPEED DEFINITIONS, and will keep the ET from impacting on critical land masses as defined in Rule {A2.1.2-13D}, ET FOOTPRINT CRITERIA. An RTLS or TAL abort will be required if the ARD predicted underspeed is greater than that which protects critical land masses or the critical underspeed, whichever is most constraining. As in the press boundaries (ref. paragraphs D, E, and G), protection of 2-sigma MPS FPR is required in order to account for possible ascent performance dispersions. @[121593-1590]

2. TAL/RTLS GAP MANAGEMENT FOR LOSS OF UPHILL CAPABILITY WITH THREE ENGINES OPERATING:
 - a. IF AN ENGINE IS STUCK IN THE THROTTLE BUCKET OR IF MORE THAN ONE ENGINE IS SUSPECT, A TAL ABORT TO THE PRIME SITE WILL BE INITIATED UPON REACHING THE EARLIER OF THE FOLLOWING:
 - (1) TWO-ENGINE PRIME TAL CAPABILITY (TWO AT 104 PERCENT) PLUS EITHER OF THE FOLLOWING:
 - (a) TWO-ENGINE ACLS TAL CAPABILITY, EVALUATED FOR A GOOD ENGINE OUT (ASSUMPTIONS: 2-SIGMA MPS FPR, MAX THROTTLES, MAX RANGING USING LOW ENERGY GUIDANCE. @[120894-1663])
 - (b) TWO-ENGINE NEGATIVE RETURN, EVALUATED FOR A GOOD ENGINE OUT (ASSUMPTIONS: 3-SIGMA MPS FPR, MAX THROTTLES, MAX UNDERSPEED TO THE R/V LINE)

OR

THIS RULE CONTINUED ON NEXT PAGE

FLIGHT RULES**A4.1.2-7 PERFORMANCE BOUNDARIES (CONTINUED)**

(2) NEGATIVE RETURN MINUS 10 SECONDS (TWO AT 104 PERCENT)

NOTE: EVALUATION OF THE CAPABILITY TO THE ACLS WILL BE INDEPENDENT OF THE ACLS GO/NO-GO STATUS.

A TAL or RTLS abort will be required for loss of uphill capability. In the TAL/RTLS overlap region either of the two abort modes may be utilized. If more than one engine is suspect, there is considerable risk of multiple engine failures. Therefore, TAL is the preferred abort mode because of reduced powered flight time and earlier single engine completion capability.

For cases with an engine stuck in the throttle bucket, an RTLS is undesirable for several reasons. With three engines operating, the RTLS fuel dissipation attitude is not readjusted for subsequent engine failures, and the resulting altitude versus range profile and time of powered pitcharound may be incorrect, with the most significant contributor being the impact on the altitude profile during fuel dissipation phase. Therefore, the failure of a healthy engine during the RTLS fuel dissipation phase may result in a MECO underspeed. For the failure of a healthy engine after powered pitcharound, sufficient performance may not be available on the remaining 1-2/3 engines, again resulting in a MECO underspeed. For example, analysis showed that late in the STS-26 RTLS profile (at approximately 9 minutes MET) there existed only a 10- to 20-second window where a single engine failure would result in acceptable MECO conditions.

For these reasons, a TAL abort will be performed. RTLS capability will be maintained as long as operationally practical, without affecting subsequent TAL performance, by delaying TAL selection until both 1-2/3 engine ACLS TAL capability and 2 good engine prime TAL capability are available.

The ACLS evaluation will be made assuming maximum throttles and low-energy guidance in order to allow TAL selection, and therefore avoid an RTLS, at the earliest possible time while still protecting for any one engine failure. The low-energy guidance capability correlates directly to a specific underspeed for each TAL site and inclination. Two-sigma MPS performance will be protected to provide a level of confidence that an acceptable underspeed will result. @[120894-1663]

If 1-2/3 engine negative return occurs prior to 1-2/3 engine ACLS TAL capability, the TAL abort call will be based on that time since a contingency abort is then the only option should a good engine fail. This evaluation is made using maximum throttles and the maximum allowable underspeed to the R/V line in order to extend 1-2/3 engine RTLS capability as long as possible prior to entering the single-engine-out abort gap. This underspeed, 300 fps, correlates to the minimum time constraint of 12 seconds from powered pitchdown to MECO, ensuring acceptable ET SEP conditions. Three-sigma MPS FPR is protected to provide confidence that this underspeed will not be exceeded, since the data used to determine this boundary is produced during the design cycle and does not account for day-of-launch conditions. The consequences of violating RTLS ET SEP constraints can be catastrophic.

FLIGHT RULES

When an abort gap exists between negative return and two-engine prime TAL capability, the TAL abort is still preferred and the gap will be accepted since the RTLS would result in an abort gap a few seconds after initiation, as explained above.

THIS RULE CONTINUED ON NEXT PAGE

FLIGHT RULES**A4.1.2-7 PERFORMANCE BOUNDARIES (CONTINUED)**

This rule is only applicable during powered flight; therefore, the GO/NO-GO status of the ACLS is not a factor since pre-MECO selection of this site serves only to minimize exposure to a pre-MECO contingency abort (similar to the droop criteria). The actual landing site will be selected post-MECO.

- b. FOR ALL OTHER CASES, IF A TAL/RTLS ABORT GAP EXISTS (TWO-SSME CAPABILITY) AT NEGATIVE RETURN MINUS 10 SECONDS, AN RTLS ABORT WILL BE EXECUTED AT THAT TIME. OTHERWISE, A TAL ABORT WILL BE INITIATED AT TWO-ENGINE TAL CAPABILITY.

An RTLS abort will be required for single engine failures which occur prior to two-engine TAL capability as the performance loss will not support any other intact abort mode. With the loss of uphill capability, an RTLS or TAL abort will have to be performed. If two-engine prime TAL capability is not achieved prior to negative return, an RTLS abort is executed in order to avoid flying a single-engine-out intact abort gap. Without stuck throttles or suspect engines, the RTLS profile is flown without the problems outlined in paragraphs H.2a. A post-RTLS abort engine failure will be handled by guidance successfully with no single-engine-out intact abort gaps. The abort decision is made 10 seconds prior to negative return in order to provide time for the TAL capability evaluation to be made. With two-engine TAL capability, the TAL abort will be executed at the two-engine TAL boundary. In this case, the systems RTLS capability is traded away in order to provide earliest two-engine-out capability.

Reference Ascent FTP # 42, March 1988.

3. GAP MANAGEMENT FOR POSITIVE UPHILL CAPABILITY:

NOTE: IF APPLICATION OF THE FOLLOWING MEASURES FAILS TO CLOSE THE GAP, IT WILL STILL BE FLOWN THROUGH PROVIDED UPHILL CAPABILITY REMAINS ON THE CURRENT ENGINE CONFIGURATION. SHOULD AN ENGINE(S) SUBSEQUENTLY FAIL IN THE GAP, A CONTINGENCY PROCEDURE WILL BE REQUIRED SUCH AS ACCEPTING PLS LANDING AT A NO-GO SITE, AN AUTO TAL TO ANY AVAILABLE SITE EVEN IF THE SITE HAS BEEN DECLARED NO-GO FOR INTACT ABORT PURPOSES, ACCEPTING TAL/LATE TAL TO AN ELS, ATTEMPTING AN ABORT TO AN EAST COAST SITE OR BERMUDA ISLAND, OR BAILOUT. @[121593-1590]

THIS RULE CONTINUED ON NEXT PAGE

FLIGHT RULES

A4.1.2-7

PERFORMANCE BOUNDARIES (CONTINUED)

HYPOTHETICAL SSME CONFIGURATION	GAP BEING CLOSED	ACLS STATUS	PRIORITIES
<p>[1]</p> <p style="text-align: center;">O N E E N G I N E D O W N</p>	<p>LAST RTLS TO 1ST PRIME TAL</p>	DOWN	<ol style="list-style-type: none"> 1. MAX THROTTLES [2] 2. MAX RANGING USING LOW ENERGY GUIDANCE TO PRIME TAL SITE 3. NOMINAL PERFORMANCE
		UP	<ol style="list-style-type: none"> 1. ACLS AT ABORT THROTTLES [2] 2. MAX THROTTLES [2] 3. MAX RANGING USING LOW ENERGY GUIDANCE 4. NOMINAL PERFORMANCE
	<p>LATER OF: LAST RTLS OR LAST PRIME TAL TO 1ST PRESS</p>	DOWN	<ol style="list-style-type: none"> 1. ACCEPT CRITICAL USPD 2. COMMIT OMS BALLAST TO CONTINGENCY CG LIMIT 3. ACCEPT AOA/PLS TO NO-GO SITE 4. MAX THROTTLES [2] 5. ACCEPT UNDERSPEED TO AOA SHALLOW LIMIT 6. MAX RANGING USING LOW ENERGY GUIDANCE TO PRIME TAL SITE 7. NOMINAL PERFORMANCE
		UP	<ol style="list-style-type: none"> 1. ACCEPT CRITICAL USPD 2. COMMIT OMS BALLAST TO CONTINGENCY CG LIMIT 3. ACCEPT AOA/PLS TO NO-GO SITE 4. ACCEPT ACLS TO EXTEND INTACT TAL COVERAGE [2] 5. MAX THROTTLES [2] 6. ACCEPT UNDERSPEED TO AOA SHALLOW LIMIT 7. MAX RANGING USING LOW ENERGY GUIDANCE TO ACLS OR PRIME 8. NOMINAL PERFORMANCE

@[121593-1590] @[120894-1663]

THIS RULE CONTINUED ON NEXT PAGE

FLIGHT RULES

A4.1.2-7

PERFORMANCE BOUNDARIES (CONTINUED)

HYPOTHETICAL SSME CONFIGURATION	GAP BEING CLOSED	ACLS STATUS	PRIORITIES
[1] [3] T W O E N G I N E S D O W N	LAST AUTO TAL (PRIME OR ACLS) TO 1ST SINGLE ENGINE PRESS	DOWN	1. COMMIT OMS BALLAST TO CONTINGENCY CG LIMIT 2. ACCEPT AOA/PLS TO NO-GO SITE 3. MAX THROTTLE [2] 4. ACCEPT UNDERSPEED TO AOA SHALLOW LIMIT 5. NOMINAL PERFORMANCE
		UP	1. COMMIT OMS BALLAST TO CONTINGENCY CG LIMIT 2. ACCEPT AOA/PLS TO NO-GO SITE 3. MAX THROTTLE [2] 4. ACCEPT LATE TAL OUT TO LAST LATE TAL VI [2] 5. ACCEPT UNDERSPEED TO AOA SHALLOW LIMIT 6. NOMINAL PERFORMANCE

@{121593-1590 }

NOTES:

- [1] IN ALL CASES, IT IS PRESUMED THAT SSME SHUTDOWN NPSP CONSTRAINTS WILL BE PROTECTED VIA EITHER THE FLIGHT SOFTWARE MECO PREPARATION THROTTLING OR THE PRE-MECO MANUAL THROTTLEDOWN PROCEDURE.
- [2] THESE OPTIONS WILL BE EXECUTED PRE-MECO, ALL OTHERS WILL BE SELECTED BASED ON POST-MECO EVALUATION.
- [3] FOR THE TWO-ENGINE-OUT CASE, CRITICAL UNDERSPEED IS ALREADY COMMITTED IN THE SINGLE-ENGINE PRESS BOUNDARY PER PARAGRA PH {A4.1.2-7H}, PERFORMANCE BOUNDARIES, AND, HENCE, DOES NOT CONTRIBUTE TO SINGLE-ENGINE GAP CLOSURE PRIORITIES. @ED]

FLIGHT RULES

Gap closure priorities are established to balance exposure to contingency abort against acceptance of flight conditions which otherwise are undesirable for a variety of individual reasons. Gaps in intact abort capability may arise during powered flight due to a number of possible systems or environmental problems including stuck throttles, degraded SSME performance (i.e., Pc sensor shift), low-performing SRB's, unacceptable TAL weather, etc. In such cases, options which increase available delta V are brought into play in order to either close or minimize the gap. These options include both pre-MECO and post-MECO commitments. In general, the post-MECO options and pre-MECO "theoretical" options (those whose effects cannot be directly measured pre-MECO but are related to assumed capabilities) are preserved as long as some other directly-measurable option exists such as use of maximum throttles, commitment of OMS ballast, or acceptance of larger MECO underspeed; otherwise, we would be relying

THIS RULE CONTINUED ON NEXT PAGE

FLIGHT RULES

A4.1.2-7

PERFORMANCE BOUNDARIES (CONTINUED)

on capabilities that are not certain to exist until the true MECO state is determined. This general rule is traded against factors such as weather, program-approved abort site usage, and risk to vehicle and crew in order to establish the precise priorities for the individual gap closure scenarios. Specifically,

- a. Auto TAL to the ACLS (if available per rules and performance) may be utilized to close any intact abort gap before committing to maximum throttles (per Program Office agreement that we will not use maximum throttles to avoid the ACLS). Otherwise, if the ACLS is down, it reverts to ELS status and becomes the lowest-priority option.*
- b. ET footprint encroachment on critical land masses will be accepted before any other direct gap closure action is taken (such as use of max throttles or commitment of OMS ballast); however, if a TAL option exists to a Space Shuttle Program-recognized TAL site, TAL will be accepted before allowing the ET footprint to impact critical areas. The additional stress placed on the SSME's by operation at maximum throttle is considered more hazardous than the concerns associated with possible ET impact on critical land masses.*

Note that waiving ET constraints is a no-impact decision in terms of risk to the shuttle vehicle itself; therefore, when applicable, this is the first option used.

- c. OMS ballast may be committed after ET impact limits are waived but prior to use of maximum throttle. Use of OMS ballast can result in a vehicle CG outside the nominal envelope limits to which operation is certified, but keeps it within the contingency envelope which preserves adequate thermal and control margins. Thus, this mode is considered safer than maximum throttle operation. It is, however, an action that directly affects the shuttle itself (albeit a relatively benign effect); therefore, it is prioritized after waiver of ET impact constraints.*
- d. Accept press to a less than fully GO AOA or PLS site. ©[121593-1590]*
- e. Maximum throttle is the last pre-MECO directly-measurable option in terms of recovery of programmatic "intact abort" capability. Since other options involve post-MECO commitments, revert to contingency (non-intact abort) operations and/or trade off probability of success. Use of maximum throttle is allowed at this point to minimize exposure to these other regimes. This is consistent with the groundrule that maximum throttles will only be utilized to regain intact capability or to avoid a post-TAL-selection site redesignation.*
- f. Since the remaining options all involve only post-MECO commitments (with the exception of Late TAL execution), their priority regarding pre-MECO gap closure is fairly meaningless - in reality, no commitment of any kind is made until the true MECO condition is evaluated. Therefore, operationally, the total delta-V effect of the remaining priorities will be committed all at once if it becomes necessary to further close a gap. However, to determine the total gap closure delta V available, the individual items considered are as follows, in the order in which we would prefer to have to utilize them:*

FLIGHT RULES

THIS RULE CONTINUED ON NEXT PAGE

FLIGHT RULES

A4.1.2-7

PERFORMANCE BOUNDARIES (CONTINUED)

- (1) *Late TAL capability to either a prime TAL site or ACLS will be utilized to close a gap between last Auto TAL and earliest steep AOA; i.e., prior to commitment to AOA-Shallow. Therefore, if AOA-Shallow and Late TAL capabilities overlap, the “press” boundary will be based on reaching the end of the Late TAL window. The Late TAL will not, of course, be actually executed unless the assumed performance loss occurs.*
- (2) *When applicable, allowable MECO underspeed will be increased to the AOA-Shallow limit. AOA-Shallow is highly undesirable due to the more severe entry thermal environment and the sensitivity to navigation dispersions (target line is close to skipout boundary and ranging becomes highly sensitive to flight path angle). While it nominally results in recovery of vehicle and crew, AOA-Shallow is not considered a certified intact abort from a programmatic point of view.*
- (3) *Low energy guidance extends TAL capability to MECO underspeed conditions off the R-V line. AOA-Shallow is considered higher priority than low energy guidance because AOA-Shallow has been subjected to much more thorough engineering analysis, is less stressful thermally, provides for help from the MCC in dealing with entry navigation dispersions, and the AOA-Shallow boundary is more clearly defined. ©[120894-1663]*
- (4) *All MPS performance reserves will be assumed available for delta-V purposes (“nominal performance”). To this point, performance boundaries have been predicated on protection of 2-sigma reserves, thus providing a high confidence that we do not commit to a mode which statistically probable systems and performance dispersions will not allow to be successfully completed. Committing to boundaries on nominal performance assures only a 50 percent chance of being correct; thus it forms the lowest-priority option.*

Rules {A2.1.1-6}, LANDING SITE WEATHER CRITERIA; {A2.1.2-2C}, ASCENT MODE PRIORITIES FOR PERFORMANCE CASES; {A2.1.2-5}, USE OF LOW-ENERGY GUIDANCE; {A2.1.2-6}, ABORT GAP; {A2.1.2-7}, CONTINGENCY ASCENTS/ABORTS; {A4.1.1-1B}, PERFORMANCE ANALYSES; {A4.1.1-2}, LANDING SITE CONDITIONS; {A4.1.2-3}, USE OF MAXIMUM THROTTLES; {A5.1.3-3}, LIMIT SHUTDOWN CONTROL; and {A5.1.4-7}, ET LOW LEVEL CUTOFF SENSOR FAILED DRY, reference this rule. ©[120894-1663] ©[111094-1622B]

Rule {A5.1.4-5}, MANUAL THROTTLING FOR LOW LH2 NPSH, references this rule. ©[071494-1646A]

FLIGHT RULES

A4.1.2-8 NAVIGATION UPDATES

A. ASCENT PRE-MECO

WHEN AN INDEPENDENT NAVIGATION SOURCE IS AVAILABLE, A NAVIGATION UPDATE WILL BE EXECUTED TO ALLOW ITS INCORPORATION PRIOR TO MECO MINUS 30 SECONDS TO PRESERVE MECO CONDITIONS NECESSARY FOR A NOMINAL FLIGHT. DELTA STATE UPDATES WILL BE INITIATED FOR THE FOLLOWING GROUND MINUS ONBOARD VELOCITY DIFFERENCES: @121296-4177D

- | | |
|--------------------------|---|
| 1. DELTA U DOT > 50 FPS | 3. DELTA V DOT > 40 FPS |
| 2. DELTA U DOT < -50 FPS | 4. DELTA V DOT < -NOMINAL
(REF. RULE {X4.1.1-1},
TRAJECTORY AND GUIDANCE
PARAMETERS) |

To the extent possible, it is desirable to maintain the onboard navigated state to provide MECO conditions acceptable for nominal flight execution. However, it is undesirable to update the onboard navigation with a reasonable probability of degrading the onboard state. The onboard powered flight navigation evaluation is performed by the delta state processor which determines the ground filter minus onboard state differences. Preflight analysis has established a 3-sigma uncertainty in the delta state velocity differences of 30 fps per axis. Estimated onboard velocity error at MECO resulting from a 3-sigma IMU performance is 20 fps worst axis. Definition of update limits equal to the sum of the 3-sigma delta state and IMU uncertainties provides reasonable assurance that an update will improve the onboard state. Because of the OMS budget limitation, nominal flight execution is most sensitive to downtrack velocity errors (i.e., underspeed MECO). To reduce the probability of ascent downmoding, the downtrack velocity update limit is defined by the RSS of the 3-sigma delta state and IMU uncertainties. For ascent performance critical missions, the downtrack velocity update limit is defined by the underspeed magnitude at MECO which would allow continuation of a nominal orbit insertion. Nominal flight execution is relatively insensitive to crosstrack errors, requiring no update limit. Thus, a delta state update will be initiated for apparent radial velocity errors exceeding ± 50 fps or downtrack velocity errors exceeding +40 fps or -X fps where X represents the allowable underspeed magnitude for nominal insertion with a maximum value of -40 fps. The update will be incorporated at least 30 seconds prior to MECO to allow the second stage guidance to adjust the steering solution to regain the desired target conditions.

Rule {A2.1.2-11}, NAVIGATION UPDATE CRITERIA, references this rule.

THIS RULE CONTINUED ON NEXT PAGE

FLIGHT RULES

A4.1.2-8 NAVIGATION UPDATES (CONTINUED)

B. ASCENT POST-MECO AND PRE-OMS-1

WHEN AN INDEPENDENT NAVIGATION SOURCE IS AVAILABLE, A PRE-OMS-1 NAVIGATION UPDATE WILL BE PERFORMED IF THE GROUND EVALUATION OF THE MANEUVER DELTA V REQUIRED TO ACHIEVE THE SELECTED ASCENT MODE UTILIZING CURRENT ONBOARD NAVIGATION EXCEEDS DELTA V AVAILABLE. @121296-4177D

In the AME evaluation of the desired ascent mode for OMS-1, the initial cycle assumes OMS-1 and -2 execution utilizing the current onboard navigated state. If the delta velocity requirement exceeds that available, then the AME automatically recycles to determine the delta velocity requirement assuming the OMS-1 and -2 execution utilizing the ground filter state. If the required delta velocity on the recycle is less than that available, then a pre-OMS-1 update is performed to prevent ascent downmoding.

C. PRTL5

WHEN AN INDEPENDENT NAVIGATION SOURCE IS AVAILABLE, A NAVIGATION UPDATE WILL BE EXECUTED PRIOR TO POWERED PITCHDOWN (MINUS 20 SECONDS) TO PRESERVE MECO CONDITIONS NECESSARY FOR ET SEPARATION AND GLIDE RETURN TO LAUNCH SITE. A DELTA STATE UPDATE WILL BE INITIATED FOR ANY OF THE FOLLOWING GROUND MINUS ONBOARD POSITION AND VELOCITY DIFFERENCES: @121296-4177D

- | | |
|------------------------------|------------------------------|
| 1. DELTA U > +11,000 FT | 5. DELTA V > +27,000 FT |
| 2. DELTA U < -7000 FT | 6. DELTA V < -7000 FT |
| 3. DELTA U DOT < +100 FPS | 7. DELTA V DOT > +100 FPS |
| 4. DELTA U DOT > -50 FPS | 8. DELTA V DOT < -40 FPS |

FLIGHT RULES

The powered flight phase of an RTLS must deliver the vehicle to a state from which the glide phase can be successfully performed to return to the runway and land. Thus, during flyback phase of an RTLS, the onboard navigation must be maintained to preserve an acceptable energy condition at MECO. Analytical studies have been performed to determine the maximum position and velocity errors allowable to obtain cutoff within the 3-sigma energy boundaries of the target range/velocity line. The energy boundaries allow for wind and aero dispersions during the glide return. Deviation of the allowable navigation errors are documented in MDTSCO Transmittal Memo 1.4-TM-D1332-152, dated June 16, 1980. The resulting error envelope is defined by limits in radial and downtrack position and velocity. The position error limits are +11,000/-7,000 feet in the radial axis and +27,000/-7,000 feet in the downtrack axis. The velocity error limits are +100/-50 fps in the radial axis and +100/-40 fps in the downtrack axis. If any ground minus onboard position or velocity difference exceeds the corresponding limit, a delta state update will be executed at least 20 seconds prior to powered pitchdown to allow adjustment of the steering solution to satisfy target conditions at pitchdown initiation.

THIS RULE CONTINUED ON NEXT PAGE

FLIGHT RULES

A4.1.2-8 NAVIGATION UPDATES (CONTINUED)

D. BFS

A BFS NAVIGATION UPDATE WILL BE PERFORMED BY VECTOR TRANSFER AFTER EACH PASS UPDATE TO ENSURE ACCEPTABLE NAVIGATION STATUS RELATIVE TO THE PASS.

During powered ascent, the PASS and BFS independently navigate the current vehicle state. Because of differences in IMU selection logic, the resultant states may not agree. Thus, if a PASS update is required, the uplinked deltas may not be appropriate for correcting the BFS state. To properly correct the BFS via uplink would require switching the telemetry input to the delta state processor, a minimum delay of 20 seconds to allow the back difference logic to determine the BFS velocity deltas, and an additional delay of 15 to 20 seconds for command generation and uplink execution. Should a BFS engage be required during this time, vehicle transients would likely occur. To avoid disruption of the PASS monitoring and reduce the exposure to potential vehicle transients, it is desirable to perform a vector transfer to the BFS after each PASS update.

E. POST-MECO PRIOR TO A COMMIT TO ORBIT:

A NAVIGATION UPDATE WILL BE PERFORMED AT MECO PLUS 12 MINUTES IF THE ONBOARD AND GROUND FILTER SOLUTIONS FOR SEMI-MAJOR AXIS DIFFER BY MORE THAN 12,000 FEET AND ONE OF THE FOLLOWING IS SATISFIED:

1. ONBOARD ERROR INDICATED BY A CHANGE IN THE ONBOARD/GROUND FILTER SEMI-MAJOR AXIS COMPARISON BETWEEN MECO AND MECO PLUS 12 MINUTES WHICH EXCEEDS 6000 FEET.
2. HIGH SPEED TRAJECTORY SOLUTION DEVIATION FROM THE ONBOARD DURING ASCENT.

A navigation update will be performed prior to OMS-2 for a declared or probable AOA to protect an onboard downtrack error exceeding 20 nm at entry interface. The primary monitoring parameter is the difference in the onboard and ground knowledge of orbital semi-major axis, delta alpha. At MECO +12 minutes, a 12,000 feet delta alpha uncertainty indicates a 20 nm downtrack uncertainty will exist at entry interface. The allowable threshold should be reduced by the ground solution uncertainty to establish a delta alpha update limit. The ground solution at MECO +12 minutes is based on the resultant ascent high speed filter output plus OMS-1 maneuver confirmation. Assuming 3-sigma IMU for maneuver confirmation, the ground solution uncertainty is 9,600 feet. As a result, the update limit for delta alpha should be 2,400 feet. However, a limit value this tight would result in a 90 percent probability of performing an uplink and a 40 percent chance of degrading the onboard state. To reduce the probability of having to do an uplink, the limit value is specified as 12,000 feet.

FLIGHT RULES

To decrease the chance of degrading the onboard state, secondary cues will be used to confirm a delta alpha difference is due to an onboard error. Thus, for a declared or potential AOA, a navigation

THIS RULE CONTINUED ON NEXT PAGE

FLIGHT RULES

A4.1.2-8 NAVIGATION UPDATES (CONTINUED)

update will be uplinked shortly after MECO +12 minutes if the ground and onboard difference in delta alpha exceeds 12,000 feet and an onboard error is indicated by one of the following conditions:

- a. The delta alpha comparison changes by more than 6,000 feet between MECO and MECO +12 minutes.*
- b. Onboard trajectory deviation from the high speed tracking solution during powered ascent.*

F. FOR RENDEZVOUS MISSIONS, A STATE VECTOR UPDATE WILL ONLY BE PERFORMED PRE-OMS-2 FOR MECO CROSSTRACK VELOCITY (WDOT) DIFFERENCES BETWEEN THE GROUND AND ONBOARD VECTORS GREATER THAN 6 FT/SEC, PROVIDED THAT THE FOLLOWING CRITERIA ARE MET:

1. DETERMINATION OF A GOOD GROUND NAVIGATION STATE VECTOR, BASED UPON A MINIMUM OF 30 SECONDS OF GOOD QUALITY POST-MECO TRACKING DATA.
2. DETERMINATION THAT THE STATE VECTOR UPDATE WILL DECREASE THE NPC DELTA V BY 6 FT/SEC OR MORE.

For rendezvous missions, the OMS propellant budget provides for a nominal plane change (NPC) maneuver to correct out-of-plane dispersions. Out-of-plane dispersions resulting from navigation errors incurred during ascent can be partially corrected by OMS-2 steering, resulting in a savings of propellant required for the NPC maneuver. In-plane dispersions are far less costly to the propellant budget, since they can be corrected with later phasing maneuvers. In an attempt to minimize the NPC propellant requirement and thus increase the propellant margins for rendezvous, a state vector update may be performed prior to OMS-2.

Flight data has shown the post-MECO ground state vector accuracy to be within 3 ft/sec in the crosstrack velocity component, provided that no anomaly in the ground tracking or the ground navigation processing occurred after MECO. The standard deviation of the onboard state vector crosstrack error at MECO computed from flight data is about 10 ft/sec. If telemetry is available during powered flight, onboard crosstrack differences in both position and velocity can be observed during ascent. This, together with the confirmation of a good post-MECO ground state vector, provides a good assurance that the state vector update will improve the onboard state vector in the crosstrack component.

The ground navigation HSTD processor requires time to converge to a good state vector solution after the change to free flight processing mode following MECO. Sixty seconds of tracking data processing is desirable to provide an accurate state vector for onboard uplink. If the convergence time is less than 30 seconds, performing a state vector update for the purpose of removing out-of-plane dispersions should not be considered.

FLIGHT RULES

FDO procedures performed pre-OMS-2 include the determination of the differences in the NPC delta V between using the onboard and ground state vector. The 6 ft/sec threshold was based on the ground state vector accuracy. @[012694-1555]

A4.1.2-9 **AUTO GUIDANCE NO-GO**

AUTO GUIDANCE WILL BE DECLARED NO-GO AND BFS ENGAGE INITIATED FOR CONDITION A, MANUAL GUIDANCE/THROTTLE WILL BE INITIATED FOR CONDITIONS IN PARAGRAPHS B THROUGH D:

Within ascent guidance, multiple tasks and subtasks are executed in a designed sequence. The execution may be based on time, sensed trajectory condition, or mission event. Some tasks have an internal check to ensure the logical solution is reasonable and within a predefined tolerance of desired target conditions. If a task or subtask fails to get executed in the design sequence, the ascent guidance function is considered unreliable. Likewise, if a task fails to satisfy an internal solution check for an unreasonable number of consecutive cycles, the guidance function is considered failed.

Rule {A2.1.2-10}, BFS ENGAGE CRITERIA, references this rule.

A. ROLL MANEUVER NOT INITIATED AS SCHEDULED.

Initially in first stage flight, the boost guidance task will command a constant pad attitude. The constant command is maintained until the relative velocity exceeds the I-load value for PPOLY2. The termination of vertical rise is indicated by a command roll maneuver to rotate the Orbiter tail downrange. Failure to initiate the roll maneuver at the corresponding relative velocity indicates incorrect subtask sequencing within the boost guidance task. For this failure, the BFS will be engaged since the onboard displays are inadequate for the crew to manually execute the roll/pitch profile through the critical high Q-bar regime.

B. GUIDANCE NOT CONVERGED FOR 10 SECONDS DURING MM 103 AND MM 601 AFTER INITIAL CONVERGENCE.

During the standard ascent mode (MM 103) and the return-to-launch site mode (MM 601), internal checks are made with the PEG task to ensure the current steering solution and resultant predicted burnout state are converged within an acceptable envelope of the desired target conditions. At the initiation of each mode, the convergence checks are nominally passed within two or three guidance cycles (4 to 6 seconds). After initial convergence, a sudden change in the actual acceleration (engine failure) will cause the convergence checks to nominally fail for one guidance cycle. Allowing two guidance cycles as pad, 10 seconds is the longest reasonable interval for PEG to fail convergence. Failure to achieve convergence for more than 10 seconds indicates an internal problem which prevents the PEG solution from satisfying the target conditions. Manual guidance/throttle will be initiated for this failure.

C. THROTTLE COMMAND NOT DECREASED TO MAINTAIN 3g ACCELERATION.

FLIGHT RULES

During second stage guidance, the g-limiting task determines the average acceleration experienced since the previous guidance cycle. If the sensed acceleration exceeds an I-load limit value ALIM2, g-limiting is activated to decrease the throttle command proportional to the acceleration error. The throttle command is decremented until the sensed acceleration decreases below another I-load limit, ALIM1.

THIS RULE CONTINUED ON NEXT PAGE

FLIGHT RULES

A4.1.2-9 AUTO GUIDANCE NO-GO (CONTINUED)

A constant throttle command with acceleration exceeding ALIM2 indicates the g-limiting task is not being executed. Manual guidance/throttle will be initiated for this failure.

Rules {A2.1.2-15C}, MANUAL THROTTLE CRITERIA, and {A4.1.2-10}, MANUAL THROTTLE SELECTION, reference this rule. ©[092195-1770A]

D. STATIC OR INCREASING T_{GO} FOR 10 SECONDS DURING MM 104 AND MM 105.

During the orbit insertion guidance, there is no direct onboard indication of a PEG convergence problem. If the PEG solution is not obtaining the desired target conditions, the solution is modified to determine a new required velocity change. An increasing time-to-go (TGO) for five guidance cycles indicates unreasonable modifications within the PEG solution. A static TGO for 10 seconds indicates the PEG task has not been executed for five guidance cycles. Manual guidance will be initiated for this failure.

Rule {A2.1.2-15A}, MANUAL THROTTLE CRITERIA, references this rule.

A4.1.2-10 MANUAL THROTTLE SELECTION

MANUAL THROTTLE WILL BE INITIATED FOR THE FOLLOWING CONDITIONS:

A. FAILURE TO INITIATE/TERMINATE THRUST BUCKET COMMANDS FOR FIRST STAGE α CONTROL.

During first stage flight, the boost throttling task provides an open-loop throttle command to limit maximum dynamic pressure and gain desired performance. When the relative velocity exceeds an I-load value of QPOLYJ, the throttle command is set to an I-load value of THROTJ if SRB performance is nominal, and the segment index J is incremented by 1. For off nominal SRB performance, adaptive guidance throttling adjusts either THROT2 or THROT3 depending on whether performance is high or low. If SRB performance is high, the THROT2 level (throttle command between about Mach 0.4 and 0.7) is reduced (approximately 21 percent for 3 sigma hot SRB's). If SRB performance is low, the THROT3 level (throttle command between about Mach 0.7 and Mach 1.3) is increased (approximately 6 percent for 3 sigma cold SRB's). Since there is no crew insight onboard into SRB performance, manual throttles should not be invoked at QPOLY2 or QPOLY3 simply to match the nominal throttle bucket based on the THROTJ I-loads. ©[092195-1770A]

Manual throttles shall only be invoked if guidance fails to throttle back at QPOLY3 or fails to throttle up to maximum power level at QPOLY4. If manual throttles are invoked during the throttle bucket, throttles shall remain under manual control until second stage guidance has been evaluated and declared "GO". ©[092195-1770A]

THIS RULE CONTINUED ON NEXT PAGE

FLIGHT RULES

A4.1.2-10 MANUAL THROTTLE SELECTION (CONTINUED)

- B. FAILURE TO ACHIEVE FUEL DISSIPATION THROTTLE COMMAND ON INITIATION OF RTLS.

The current throttle command for the fuel dissipation phase of powered RTLS is established by the SSME-out safing task or the RTLS initialization task depending on the number of active SSME's. If a SSME failure has previously occurred, the throttle command should have been set to an I-load value KMAX by the SSME-out safing task. If no engine failure has occurred, the RTLS initialization task sets the throttle command to a level equal to two thirds of KMAX. Thus, if the current throttle command in the RTLS fuel dissipation phase is not equal to KMAX (two SSME's active) or two thirds KMAX (three SSME's active), then the SSME-out safing task or RTLS initialization task was not properly executed. ©[092195-1770A]

- C. INITIATION OF A TWO-SSME RTLS WITH ONE SSME THROTTLE STUCK IN THE THRUST BUCKET. RETURN TO AUTO THROTTLE WILL BE INITIATED DURING FLYBACK PHASE ON GROUND CALL AFTER CONFIRMATION OF GUIDANCE CONVERGENCE.

During the fuel dissipation phase of an RTLS, the PEG flyback predictions assumes a vehicle thrust acceleration equivalent to a desired throttle command. With two engines active with one throttle stuck at the thrust bucket level, the actual vehicle acceleration is less than assumed. After the powered pitcharound (i.e., flyback initiation), the PEG guidance senses the lower acceleration and becomes unconverged as it attempts to adjust the steering solution. During this interval, it is possible (although unlikely) for PEG to issue an erroneous MECO command. As a precaution to protect against an inadvertent shutdown, manual throttle must be selected prior to flyback initiation. Since there is no direct indication of when flyback initiation will occur, manual throttle should be selected at initiation of RTLS. To avoid a manual MECO, a ground call for return to AUTO throttle will be made after guidance has reconverged with a stable solution.

- D. INCORRECT THROTTLE COMMAND FOR TAL OMS DUMP CONTROL.
©[092195-1770A]

Beginning with OI-8D, flight software provides for an automatic throttledown following TAL abort selection in order to maximize capability to complete the pre-MECO OMS dump. This throttling action is cued by two site-specific I-loads that define the threshold throttledown velocities for either two- or three-engine operation. If the appropriate throttledown command is not issued, the software is not performing correctly, and manual throttle will be exercised to perform the same function. Alternately, when an SSME failure is not recognized by guidance, the throttle-down may be erroneously commanded based on the three-engine throttle down velocity. Manual throttles may be used to prevent or correct this erroneous throttle-down. This philosophy is consistent with paragraphs A and B above. ©[092195-1770A]

THIS RULE CONTINUED ON NEXT PAGE

FLIGHT RULES

A4.1.2-10 MANUAL THROTTLE SELECTION (CONTINUED)

E. THROTTLE COMMAND NOT DECREASED TO MAINTAIN 3-G ACCELERATION.

The 3-g acceleration-limiting logic is provided to assure that vehicle loads do not exceed design constraints. Therefore, manual throttle will be invoked to protect this limit if the flight software fails to do so. Reference the rationale for Rule {A4.1.2-9C}, AUTO GUIDANCE NO-GO, for further background.

F. ANY TIME CSS IS SELECTED.

As a conservative guideline, any time the AUTO guidance is unacceptable for vehicle attitude control, it should not be allowed to control the main engines. If the vehicle attitude is not maintained to satisfy the guidance solution, the guidance may go unconverged and potentially could issue an undesired MECO command. Thus, to avoid an inadvertent shutdown, manual throttle should be selected whenever CSS takeover is initiated.

Rule {A2.1.2-15A}, MANUAL THROTTLE CRITERIA, references this rule.

G. THROTTLES WILL BE MANUALLY COMMANDED TO THE MINIMUM POWER LEVEL AT 2 PERCENT PROPELLANT REMAINING IF THE EXPECTED MECO UNDERSPEED EXCEEDS THE VALUE ASSURING EXECUTION OF FLIGHT SOFTWARE MECO PREP THROTTLING:

1. TWO OR THREE ENGINES ON: 500 FPS
2. ONE ENGINE ON: 250 FPS @[092195-1770A]

Flight software MECO preparation throttling is triggered by K-loaded timing values. When the guidance-computed TGO becomes less than TGO_FCD K-load, the MPS guidance cutoff task begins cyclic execution. This task determines when to command the SSME's to the cutoff power level, and assumes that they will remain at that setting for K-load DT_MIN_K seconds. However, the software also assumes a guided MECO will result and has no way of compensating for an impending early (low-level) cutoff. Therefore, for predicted MECO underspeeds greater than a threshold value, a low-level shutdown may be commanded before the engines reach the desired cutoff throttle setting. In such instances, the throttles will be manually retarded to the minimum power level shortly before MECO to provide the required safe shutdown configuration.

Under most circumstances, the onboard propellant remaining computation is sufficiently accurate to use as a throttledown cue. Ascent/Entry Flight Techniques #62 determined in January 1990 that 2 percent propellant remaining provided a generic value that covered both the pre-MECO dump and no-dump cases. However, the flight software computation is inaccurate when off-nominal mixture ratios are involved, due to the buildup of unusable LOX or LH₂; the software senses the extra mass but does not recognize it as unusable. Likewise, the onboard mass estimation algorithm in first stage assumes all

FLIGHT RULES

THIS RULE CONTINUED ON NEXT PAGE

FLIGHT RULES

A4.1.2-10 MANUAL THROTTLE SELECTION (CONTINUED)

engines are operating at the commanded power level; therefore, an engine locked before the bucket will consume more propellant than the mass tracking function accounts for. This leads to the second stage software believing it has more propellant than is actually available.

Although the resultant mass dispersions are a function of the size and direction of the mixture ratio upset or the depth and length of the bucket, the 2 percent propellant remaining cue still provides sufficient time to throttle down. (Reference Flight Rule {A5.1.3-11}, MANUAL THROTTLEDOWN FOR LO₂ NPSP PROTECTION AT SHUTDOWN.)

H. FOR LOW LH2 NPSP PER FLIGHT RULE {A5.1.4-5}, MANUAL THROTTLING FOR LOW LH2 NPSP.

Rule {A5.1.4-5}, MANUAL THROTTLING FOR LOW LH2 NPSP, addresses scenarios requiring manual throttles. Manual throttles will be maintained and a manual MECO required for the flow control valve anomaly case. Uphill capability will be evaluated at each throttle setting. Two-engine and single-engine performance boundaries will be made based on minimum power level as time permits. Since this dynamic throttle profile is difficult to model, two-engine and single-engine capability may not be evaluated accurately until the failure actually occurs.

Manual throttles will be selected prior to aborting TAL for a LH2 leak. OI-8D software (STS-38 and subs) automatically throttles the engines down if TAL is selected above an I-loaded inertial velocity. To prevent the software from throttling the engines down when there is an LH2 tank leak, manual throttles are selected prior to selecting TAL. Once TAL is selected, the throttles will be returned to auto where they will stay at 104 percent until 3 g's are reached. Three-g throttling may cause engine failures but this is an accepted risk to avoid vehicle structural damage. Operating the SSME's at 104 percent results in a higher inertial velocity at MECO than if the SSME's had been throttled down to 67 percent. ©[092195-1770A]

I. A TAL UNDERSPEED IS PREDICTED AND CAN BE REDUCED BY FLYING AT A LOWER THROTTLE SETTING. THROTTLES WILL BE RETARDED TO MINIMUM POWER LEVEL WHEN THE PERFORMANCE GAIN IS MAXIMIZED.

The slope of the TAL range-velocity target line results in a point in the powered flight trajectory where MPS propellant margins may be increased by flying at a reduced throttle setting. As the throttle is retarded, the powered flight time is extended which in turn results in a MECO position which is farther downrange than would have occurred at a higher power level. The farther downrange position equates to less distance to the TAL site at MECO, and hence, a lower MECO target velocity. This in turn translates to increased MPS margin since less delta V is required to reach the smaller target velocity. Early in powered flight, gravity losses at the lower throttle are large and offset any R-V target benefit; however, eventually sufficient velocity is achieved such that the inverse is true; i.e., the smaller target velocity offsets the gravity losses, which diminish with time and the square of the current velocity.

FLIGHT RULES

THIS RULE CONTINUED ON NEXT PAGE

FLIGHT RULES

A4.1.2-10 MANUAL THROTTLE SELECTION (CONTINUED)

In real time, the MCC ARD can determine when this boundary condition is reached, and subsequently when the performance gain is maximized. The FDO will then call for throttledown to minimize the R-V underspeed. Improving proximity to the R-V line in this manner reduces the likelihood of requiring low-energy guidance during entry, and is especially critical for out-of-plane sites where high crossrange severely limits underspeed tolerance. ©[120894-1663]

Note that this procedure will not be utilized unless an underspeed is predicted at the current power level.

Rules {A4.1.2-6}, DESIGN AND CRITICAL MECO UNDERSPEED DEFINITIONS; and {A5.1.3-11}, MANUAL THROTTLE DOWN FOR LO₂ NPSP PROTECTION AND SHUTDOWN, reference this rule.

J. THREE ENGINES RUNNING AND TWO STUCK THROTTLES PRIOR TO TAL OR RTLS ABORT.

1. TAL: SELECT MANUAL THROTTLES, ABORT TAL, SELECT AUTO THROTTLES.
2. RTLS: SELECT MANUAL THROTTLES, MINIMUM THROTTLES, WAIT 10 SECONDS, ABORT RTLS, SELECT AUTO THROTTLES.

For TAL, it is undesirable to throttle down the good engine due to the guidance transients which may occur and the fact that little time would be gained to perform the abort dump. Therefore, manual throttles will be selected to prevent an automatic throttledown when TAL is declared. This action is not required if TAL is declared early enough that automatic throttling will not occur at abort selection. However, since there is no disadvantage to selecting manual throttles for this short period of time, manual throttles will always be selected for consistency. AUTO throttles will be reselected after TAL is declared.

For three-engine RTLS cases with two stuck throttles, minimum throttles will be selected prior to abort selection. Doing so will allow guidance to converge on the correct average thrust level and will reduce the probability of an early PPA. For guidance to have enough time to converge, minimum throttle levels must be achieved at least 10 seconds prior to RTLS selection. If not, an early PPA may occur, resulting in MECO conditions that are not optimized. AUTO throttles should be reselected at some point prior to PPA, but are not mandatory prior to RTLS selection.

Reference Rules {A5.1.3-8}, MANUAL SHUTDOWN FOR TWO STUCK THROTTLES (NOT DUAL APU FAILURES); and {A8.1.2-11}, SSME SHUTDOWN DUE TO HYDRAULIC SYSTEM FAILURES.

THIS RULE CONTINUED ON NEXT PAGE

FLIGHT RULES

A4.1.2-10 MANUAL THROTTLE SELECTION (CONTINUED)

K. TO MAINTAIN THROTTLES AT 109 PERCENT POWER LEVEL DURING THE FLYBACK PHASE OF AN RTLS ABORT.

When maximum throttles are enabled (SPEC 51 Item 4), guidance replaces the maximum power level (KMAX) of 104 percent with 109 percent. However, during the flyback phase, the commanded power level (KCMD) is not simply set to KMAX but is adjusted to achieve the desired mass conditions at MECO (assuming CSS or manual throttles did not occur anytime during flyback). For two engines running, the typical throttle command during flyback is about 100 percent and is unaffected by KMAX. Therefore, if 109 percent power level is desired during the flyback phase of an RTLS abort, manual throttles are required.

Reference Rule {A4.1.2-3E.1}, USE OF MAXIMUM THROTTLES, Paragraph E.1; and Rule {A5.1.4-1D.3}, PRE-MECO MPS HELIUM SYSTEM INTERCONNECTS (CIL), Paragraph D.3.

L. IF A LOWER SSME POWER LEVEL IS REQUIRED SUBSEQUENT TO ENABLING MAXIMUM THROTTLES.

When maximum throttles are enabled (SPEC 51 Item 4), guidance replaces the maximum power level (KMAX) of 104 percent with 109 percent. If throttle selection is auto and 3-g throttling is not active, the commanded power level (KCMD) is set to the new maximum power level of 109 percent (except during RTLS flyback phase, see paragraph K. above). If a lower power level is required subsequent to enabling maximum throttles, manual throttles must be selected and the lower power level commanded manually. (Note, if throttle selection is auto, the fine count throttle setting will be commanded regardless if maximum throttles have been enabled). A second SPEC 51 Item 4 will not reset the maximum or commanded power level to 104 percent. Therefore, the lower power level must be commanded manually. Once the desired power level is reached, throttles can be returned to auto. However, a subsequent engine failure with auto throttles selected will result in the commanded power level being reset to 109 percent.

Rule {A2.1.2-15A}, MANUAL THROTTLE CRITERIA, references this rule.

FLIGHT RULES

A4.1.2-11

RESERVED~~FCO ABORT REQUEST~~ @[081497-6307.1

FLIGHT RULES

~~THE FLIGHT DYNAMICS OFFICER (FDO) WILL TRANSMIT AN ABORT REQUEST IN RESPONSE TO A CODED VERBAL REQUEST FROM THE FCO. THIS PROCEDURE WILL BE EXECUTED IF RANGE SAFETY FLIGHT TERMINATION CRITERIA HAVE BEEN VIOLATED AND SUPPORTIVE TRAJECTORY DEVIATIONS ARE OBSERVED IN THE MCC. (REF. RULE {A2.1.2-9}, ABORT LIGHT.)~~

~~The FDO provides the direct real-time interface with the FCO for ascent status reports and discussions on potential flight termination. Normally, abort requests (via the abort light) are transmitted by the Flight Director. However, as described in {A2.1.2-7}, CONTINGENCY ASCENTS/ABORTS, and its rationale, no provision is made for crew escape in the programmed delay between execution of the range safety ARM and FIRE commands, with the exception of the case where loss of communications with the crew has occurred and trajectory deviations are such that range safety destruct action is imminent (ref. rule {A4.1.6-9}, RANGE SAFETY LIMIT AVOIDANCE ACTIONS). Therefore, if the FCO indicates to the FDO that the ARM command has been sent, it is imperative that abort request transmission proceed immediately if the crew is to be provided maximum time to react to the impending destruct action. To facilitate such transmission, the FDO console is equipped with an abort switch which will be used for purposes of implementing this rule. Crew and MCC actions regarding violations of Range Safety criteria are further detailed in Rules {A2.1.2-7}, CONTINGENCY ASCENTS/ABORTS; {A4.1.6-9}, RANGE SAFETY LIMIT AVOIDANCE ACTIONS; and {A4.1.6-0}, RANGE SAFETY FLIGHT RULES.~~

~~As further background, the FCO is continuously monitoring the ascent trajectory on displays at his console. These displays depict limit lines which define trajectory conditions which, if violated, could result in endangerment of populated areas on the ground. Prior to violating the limit lines, the FCO will inform the MCC that the vehicle is flying outside the expected envelope. During first stage, this communication will be carried out directly over the FD loop, and the FD will advise the FCO as to vehicle control status based on the GNC Officer's assessment. If the vehicle remains under control, the FCO will permit limit lines to be violated; otherwise, destruct action will be taken as a flight termination line is reached. During second stage, the controllability consideration is no longer in effect. Instead, the MCC will initiate actions to preclude limit line violations as described under Rule {A4.1.2-15}, RANGE SAFETY LIMIT AVOIDANCE. If these actions do not alleviate the trajectory deviation, the FCO will send functions as a flight termination line is crossed. Second stage communications regarding the need for such corrective measures and the results thereof will be carried out primarily between the FCO and the FDO over FCO-specific communication loops, with FD participation as warranted.~~

~~Further details regarding the specifics of the interfaces and communications just described can be found in the rule references given. @[092293-1543]~~

FLIGHT RULES

A4.1.2-12 MANUAL SHUTDOWN CRITERIA

IF THE ONBOARD PREDICTED MET OF MECO IS 2 SECONDS DIFFERENT THAN THE GROUND PREDICTED MET OF MECO AND IF CONFIRMED BY OBSERVED NAVIGATION VELOCITY ERRORS, A MANUAL SHUTDOWN WILL BE INITIATED AT THE GROUND-COMPUTED TIME.

If the ground predicted MET of MECO is 2 seconds different than the onboard predicted MET of MECO, a manual shutdown will be initiated on the ground-computed value to maintain the capability to achieve a nominal mission. A difference in the onboard and ground predicted times indicates an auto MECO will not achieve the target cutoff conditions. An early cutoff may require downmoding because of OMS performance limitations. A late cutoff may cause the desired thrust direction for OMS-1 to be radially downward and/or retrograde. The uncertainty in the ground prediction is estimated to be ± 0.9 second. This value is the RSS of the computational uncertainties of ± 0.6 second for 3-sigma ground navigation accuracy, and ± 0.5 second for onboard response to throttledown commands. Allowing a 1-second pad to ensure detection of a true onboard error and rounding to a whole number, a 2-second tolerance is enforced.

REFERENCE: CA4-79, Ascent Flight Techniques Meeting #35, dated March 27, 1979. Rule {A2.1.2-11}, NAVIGATION UPDATE CRITERIA, references this rule.

A4.1.2-13 THRUST LIMITING, HYDRAULIC, OR ELECTRICAL LOCKUP

A. BASED ON RECOMMENDATION FROM THE BOOSTER SYSTEM ENGINEER, AN ABORT REGION DETERMINATOR (ARD) ADJUSTMENT WILL BE MADE FOR:

1. THRUST LIMITING FLAG SET.
2. Pc SENSOR SHIFT.
3. ELECTRONIC LOCKUP.
4. HYDRAULIC LOCKUP.
5. HPOT EFFICIENCY LOSS.
6. LH₂ FLOW METER SENSOR SHIFT.
7. LPFT DISCHARGE TEMPERATURE SHIFT.
8. NOZZLE LEAKS.

The ARD FPR is designed to cover only those SSME failures that are not detectable with engine instrumentation, but are sufficient to cause performance degradation. Therefore, it is necessary to model in the ARD those failures with performance impacts that exceed FPR coverage. Reference Rule {A5.1.3-9}, ENGINE PERFORMANCE DISPERSION.

THIS RULE CONTINUED ON NEXT PAGE

FLIGHT RULES

A4.1.2-13 THRUST LIMITING, HYDRAULIC, OR ELECTRICAL LOCKUP
(CONTINUED)

B. A PERFORMANCE-LIMITED SSME WILL BE SHUT DOWN EARLY, OR A MAIN ENGINE CONTROLLER CHANNEL TURNED OFF, BASED ON BOOSTER SYSTEMS ENGINEER (BSE) CONFIRMATION OF THE FAILURE AND ARD PERFORMANCE EVALUATION FOR THE FOLLOWING CASES:

1. LOW MIXTURE RATIO:

Preservation of the ATO region by early shutdown of an SSME has priority over a possible abort downmode to an AOA.

IF THE FOLLOWING CRITERIA ARE MET, THE AFFECTED SSME WILL BE SHUT DOWN EARLY TO PROTECT 3-SIGMA ATO CAPABILITY OR THE DESIGN UNDERSPEED, WHICHEVER IS THE MOST CONSTRAINING:

- a. THE ACTUAL NOMINAL MARGIN INDICATES LOSS OF ATO CAPABILITY.

The ARD's actual mode nominal margin is a prediction of MECO underspeed on a 2-sigma bad day. This prediction can be used to determine if ATO capability exists. This rule refers to the design underspeed as a criterion for pressing uphill with a performance-limited SSME. In addition, the dispersed-performance protection level (3-sigma) is stated explicitly for uphill capability assessment.

- b. THE HYPOTHETICAL AOA MARGIN (REFLECTING THE SICK ENGINE OUT) IS DECREASING.

The ARD's hypothetical mode AOA margin is the indicator of when continued sick engine operation will degrade performance. As long as the margins are increasing, the three-engine configuration is improving MECO conditions. When the margins start trailing off, the sick engine is degrading uphill capability. If the hypothetical nominal margin is greater than the actual nominal value; i.e. it is better to have two healthy engines than two healthy and one sick, the bad engine will be shut down.

- c. THE HYPOTHETICAL NOMINAL MARGIN IS GREATER THAN THE ACTUAL NOMINAL MARGIN.

Rationale is the same as for paragraph b above.

THIS RULE CONTINUED ON NEXT PAGE

FLIGHT RULES

A4.1.2-13 THRUST LIMITING, HYDRAULIC, OR ELECTRICAL LOCKUP (CONTINUED)

2. Pc SENSOR SHIFT (HIGH OR LOW)

FOR A Pc SENSOR SHIFT THE AFFECTED MAIN ENGINE CONTROLLER CHANNEL WILL BE TURNED OFF BY THE CREW TO PROTECT 3-SIGMA ATO CAPABILITY (i.e., AVOID AOA) OR THE DESIGN UNDERSPEED, WHICHEVER IS THE MOST CONSTRAINING. THIS PROCEDURE WILL NOT BE IMPLEMENTED IF IT WILL CAUSE ENGINE SHUTDOWN OR NOT CORRECT THE PERFORMANCE DISPERSION (REF. RULE {A5.1.3-9}, ENGINE PERFORMANCE DISPERSION, FOR CASES THAT CAUSE ENGINE SHUTDOWN).

Large Pc shift can cause mixture ratio excursions that will result in a LOX or LH₂ depletion prior to ATO capability. Generally, the bad Pc sensor can be isolated and turned off with the other sensor returning the mixture ratio to a nominal value. This rule refers to the design underspeed as a criterion for pressing uphill with a performance-limited SSME. In addition, the dispersed-performance protection level (3-sigma) is stated explicitly for uphill capability assessment.

3. HYDRAULIC OR ELECTRICAL LOCKUP

AN SSME IN HYDRAULIC OR ELECTRICAL LOCKUP WHEN COUPLED WITH LOW VEHICLE PERFORMANCE MAY BE MANUALLY SHUT DOWN TO PREVENT A VIOLATION OF THE ENGINE LO₂ NET POSITIVE SUCTION PRESSURE (NPSP) REQUIREMENTS NEAR MECO. IF THE ARD PREDICTED DELTA V MARGIN AFTER SRB SEPARATION INDICATES LOW PERFORMANCE, THE NONTHROTTLING ENGINE WILL BE SHUT DOWN AT $V_I > 23K$ FPS. ~~USING THE AC POWER SWITCHES AND SHUTDOWN PB. THE ARD DELTA V MARGIN WILL INSURE AT LEAST A 3-SIGMA CONFIDENCE OF MAKING A GUIDED MECO.~~ @061297-48921

For low performance in first stage with one or more engines in hydraulic or electrical lockup, there is potentially insufficient LOX at MECO to support the stuck engine's shutdown from the higher throttle level. This results in a LOX depletion and subsequent uncontained engine damage.

C. FOR A THREE-ENGINE RTLS, AUTO GUIDANCE WILL BE PRESERVED BY SHUTTING DOWN PERFORMANCE-LIMITED SSME WHEN THE PROBLEM IS IDENTIFIED BUT NOT LATER THAN POWERED PITCHDOWN (PPD) MINUS 40 SECONDS TO PROTECT A 3-SIGMA GUIDED MECO (RTLS MARGIN > 0 FPS). CRITERIA FOR ET SEPARATION PROPELLANT CONDITIONS WILL NOT BE CONSIDERED WHEN DETERMINING SSME SHUTDOWN REQUIREMENTS DURING AN RTLS.

FLIGHT RULES

Manual throttle, manual guidance, and early manual turnaround during an RTLS is more risky than shutdown of a performance-limited SSME. There is no real-time determination of propellant conditions at ET separation currently available. It is highly desirable to protect a 3-sigma guided MECO. This will be done at the possible expense of executing an RTLS ET separation with a slightly heavier tank.

A4.1.2-14 **OMS-1/OMS-2 EXECUTION**

THE OMS-1 AND/OR OMS-2 TARGETS AND TIG WILL BE SELECTED TO ACHIEVE THE HIGHEST PRIORITY MISSION MODE POSSIBLE. ALLOWABLE UNDERSPEEDS FOR EXECUTION OF NOMINAL TARGETS WILL ENSURE ACCOMPLISHMENT OF HIGH PRIORITY MISSION OBJECTIVES. THE AME WILL BE USED TO DETERMINE THE HIGHEST PRIORITY MISSION MODE THAT CAN BE ACHIEVED.

For standard insertion flights, the nominal OMS-1 and OMS-2 targets are designed to be performance optimized. The nominal targets will be executed and the nominal flight profile flown only if there is sufficient fuel available to perform the required on-orbit burns and the deorbit burn. Otherwise, the highest priority mission mode that can be supported by the fuel available will be executed. (Reference Rule {A2.1.2-2D}, ASCENT MODE PRIORITIES FOR PERFORMANCE CASES.)

For direct insertion flights, a range of underspeeds will result in no OMS-1 being required but the apogee is lower than nominal. For these cases, assuming no OMS leaks have occurred, it is desired to circularize at the resulting pre-OMS-2 apogee altitude with the OMS-2 burn. The details for this case with and without OMS propellant problems are in Flight Rule {A4.1.3-3}, OFF-NOMINAL ORBITAL ALTITUDE RECOVERY PRIORITIES, and its rationale.

The AME will be used in real time to determine the highest priority mission mode that can be achieved. Actual post-MECO state vectors and actual OMS quantities are used by the AME. Should the MOC be unavailable, the backup method for determining the correct targets is the crew chart in the Ascent Checklist.

FLIGHT RULES

ORBIT

A4.1.3-1 ONBOARD NAVIGATION MAINTENANCE 4-50

A4.1.3-2 MINIMUM ORBITAL LIFETIME 4-50

A4.1.3-3 OFF-NOMINAL ORBITAL ALTITUDE RECOVERY
PRIORITIES 4-51

A4.1.3-4 OMS LEAK/PERIGEE ADJUST 4-54

A4.1.3-5 MINIMUM TIME OF FREE FALL 4-65

A4.1.3-6 COLLISION AVOIDANCE GUIDELINES 4-65

A4.1.3-7 PLS/EOM LANDING OPPORTUNITY REQUIREMENTS . . . 4-66

A4.1.3-8 TIRE SPEED, BRAKING, AND ROLLOUT
REQUIREMENTS 4-71

A4.1.3-9 DEORBIT PRIORITY FOR EOM WEATHER 4-77

A4.1.3-10 AIMPOINT, EVALUATION VELOCITY, AND SHORT
FIELD SELECTION 4-78

A4.1.3-11 RUNWAY ACCEPTABILITY CONDITIONS 4-84

A4.1.3-12 LOWER LEVEL MEASURED WIND AND ATMOSPHERIC
DATA 4-85

ENTRY PLANNING

A4.1.4-1 IMU ALIGNMENT 4-88

A4.1.4-2 DEORBIT BURN TARGETING PRIORITIES 4-90

A4.1.4-3 CG PLANNING 4-84

A4.1.4-4 DOWNTRACK ERROR 4-89

A4.1.4-5 SUN ANGLE LIMITS AND GLARE CRITERIA FOR
INNER AND OUTER GLIDE SLOPES 4-90

A4.1.4-6 HAC SELECTION CRITERIA 4-90

A4.1.4-7 ENERGY DOWNMODING 4-94

A4.1.4-8 MANEUVER EXECUTION MATRIX 4-95

A4.1.4-9 ORBITER LANDING WEIGHT 4-98

FLIGHT RULES

ORBIT

A4.1.3-1 ONBOARD NAVIGATION MAINTENANCE

ADEQUATE NAVIGATION AND MANEUVER DEFINITION WILL BE MAINTAINED ONBOARD TO PROVIDE RUNWAY LANDING CAPABILITY AFTER LOSS OF COMMUNICATION.

This rule reflects a management decision to provide for safe deorbit and landing capability in the event of a total loss of communications between the vehicle and the ground. The on-orbit navigation state must be maintained within the defined uncertainty. The maximum acceptable downtrack error is 20 nm, predicted to deorbit TIG. Twenty nm is thought to be the maximum safe energy error that can be steered out after 130,000 feet altitude (see rationale for Rule {A4.1.4-1}, IMU ALIGNMENT). The current onboard state vector is propagated to the next day prime deorbit TIG to determine if the resulting state is within limits. Periodic state vector updates are uplinked to the vehicle whenever the propagated downtrack error approaches the limit.

A4.1.3-2 MINIMUM ORBITAL LIFETIME

THE DEORBIT MANEUVER WILL BE SCHEDULED AT LEAST 48 HOURS PRIOR TO ORBITAL DECAY TO EI TO PROVIDE 24-HOUR WAVE-OFF CAPABILITY. THE ATTITUDE PROFILE WILL BE PLANNED AND ORBIT ADJUST MANEUVERS SCHEDULED, AS REQUIRED, TO MEET THE DESIRED ORBITAL LIFETIME. THE PERIGEE ALTITUDE AT DEORBIT TIG SHALL NOT BE LESS THAN 80 NM.

Uncertainties in the MCC atmospheric model and onboard state vector integration make it difficult to model orbital decay at low altitudes. Planning a deorbit within 24 hours of decay to EI is considered unsafe due to these uncertainties. Protecting 48 hours beyond the deorbit TIG provides a 1 day wave-off capability to cover potential systems problems or forecasted bad weather at the time of the deorbit/landing.

Although perigee altitudes less than 80 nm may be acceptable based on orbital lifetime if the apogee altitude were high enough, uncertainties in the models and vector integration resulted in the determination of 80 nm as the lowest acceptable perigee at the planned time of deorbit.

When a time-critical estimation of the minimum perigee is required, the determination of the minimum perigee will be made utilizing a generic H_a versus H_p plot using the following "worst case" decay assumptions: 30 percent drag uncertainty, 200,000 lb orbiter weight, 2500 ft² frontal area, 28.5 degree inclination, 0 degree argument of perigee, and 240 by 10⁻²² watts/m²/hertz solar flux (f10.7).

FLIGHT RULES

If time permits, a real-time assessment of the minimum perigee altitude will be performed based on the actual apogee, orbiter weight, inclination, planned attitude timeline, solar flux, and a 30 percent drag uncertainty.

(Ref. Entry Flight Techniques Panel Minutes #34.)

A4.1.3-3 OFF-NOMINAL ORBITAL ALTITUDE RECOVERY PRIORITIES

NOTE: IF THE PROPELLANT MARGINS ALLOW FOR THE COMPLETION OF THE RENDEZVOUS PROFILE FOLLOWING INSERTION TO AN OFF-NOMINAL ORBIT, THEN THIS RULE DOES NOT APPLY.

A. RECOVERY OPTIONS FROM A 105 NM CIRCULAR ATO ORBIT, IN ORDER OF PRIORITY ARE:

1. USE OMS-3 AND OMS-4 TO OBTAIN NOMINAL ORBIT IF PROPELLANT IS AVAILABLE. STEEP DEORBIT CAPABILITY MUST BE PROTECTED FROM THE NOMINAL ORBIT.
2. CIRCULARIZE AS HIGH AS POSSIBLE AT AN ORBITAL ALTITUDE WHICH PROTECTS STEEP DEORBITS AND SATISFIES MISSION CONSTRAINTS. REFERENCE THE FLIGHT RULES ANNEX FOR FLIGHT-SPECIFIC ALTITUDE REQUIREMENTS.
3. RAISE ORBIT ELLIPTICALLY ONLY IF MANDATORY PAYLOAD CONSTRAINTS HAVE JUSTIFIED PREFLIGHT THAT THIS IS REQUIRED. IN THIS CASE, STEEP DEORBIT CAPABILITY TO ALL CONUS OPPORTUNITIES MUST BE PROTECTED THROUGH EOM PLUS 2 DAYS AND ELS DEORBIT OPPORTUNITY GAPS MUST NOT EXCEED 4.5 HOURS.

B. RECOVERY OPTIONS FOR DIRECT INSERTION INTO LOWER THAN NOMINAL ORBITS:

1. IF NO PROPELLANT PROBLEMS EXIST, CIRCULARIZE AT APOGEE ALTITUDE WITH OMS-2 (105 NM MINIMUM). FOR LARGER MECO UNDERSPEEDS WHICH REQUIRE AN OMS-1, CIRCULARIZE AT 105 NM. USE THE PRIORITIES IN PARAGRAPH A TO RECOVER FROM THE LOWER ORBIT.

FLIGHT RULES

2. IF PROPELLANT PROBLEMS DO EXIST, RAISE PERIGEE TO THE MINIMUM PERIGEE WITH OMS-2. CONSIDERATION WILL BE GIVEN TO RAISING PERIGEE ABOVE THE MINIMUM, DEPENDING ON PROPELLANT AVAILABILITY, MISSION REQUIREMENTS, AND DEORBIT REQUIREMENTS. REFERENCE FLIGHT RULE {X4.1.1-1}, TRAJECTORY AND GUIDANCE PARAMETERS, FOR THE FLIGHT-SPECIFIC MINIMUM HP.

THIS RULE CONTINUED ON NEXT PAGE

FLIGHT RULES

A4.1.3-3

OFF-NOMINAL ORBITAL ALTITUDE RECOVERY PRIORITIES (CONTINUED)

The above is the Space Shuttle Program position on recovering from insertion into an ATO orbit and was agreed upon at the On-orbit Flight Techniques Meeting #78. It is much more desirable from the STS operations point of view to raise the orbit to a circular orbit. This eliminates the large variations in deorbit delta V that are possible from an elliptical orbit. It is quite possible not to have the delta V available to deorbit to an emergency landing site (ELS) from an elliptical orbit which has been optimized for a continental United States (CONUS) landing. Also, the deorbit delta V varies from one opportunity to the next as well as one day to the next due to the apsidal rotation. The deorbit delta V from a circular orbit is fairly constant throughout the flight. The fairly constant deorbit cost makes it much easier to handle propellant budget redlines in real time. For relatively small MECO underspeeds on a direct insertion, if there are no propellant problems, the plan to circularize at the current apogee altitude with OMS-2 was recommended for two reasons. First, it allows us to execute the STS preference of going into a circular orbit. Also, it is more efficient to circularize at the apogee altitude and deorbit from there than it is to fly the nominal mission. Therefore, for the MECO underspeed cases with apogee greater than 105 nm, the plan to use OMS-2 to circularize at the apogee altitude results in "creating" more OMS propellant for on-orbit activities. If propellant problems do exist, the rule calls for raising perigee to the minimum perigee (min Hp) in order to minimize propellant usage. The min Hp guarantees orbit stay capability up through the flight day 1 PLS opportunity. If the perigee is only raised to the min Hp, it may have to be raised higher at a later time to satisfy Rule {A4.1.3-2}, MINIMUM ORBITAL LIFETIME.

The elliptical orbit constraints were reviewed and approved at the Entry Flight Techniques Panel Meeting #40. Because of the large amount of analysis required to support flying in an elliptical orbit, it was recommended that this be done only in cases where the mandatory payload requirements have justified preflight that this is required. It was determined that a 4.5-hour gap in ELS deorbit capability was an acceptable compromise since "anytime" deorbit capability from the resulting elliptical orbit may not be available. Typical gaps in ELS deorbit opportunities from a circular orbit average 1 hour long. It was felt by the community that, for mandatory payload requirements, we could increase the exposure to gaps to three orbits without an ELS deorbit opportunity. The three orbits were then converted to time to make it easier to implement. It was agreed that we should protect steep deorbit capability to all CONUS sites from the elliptical orbits. This would allow the standard protection desired for a thermally safe entry and protect for deorbit to one of the other CONUS sites should weather make the PLS NO-GO. This deorbit capability must be provided for all the possible days of the mission to allow for an early or delayed landing.

DOCUMENTATION: Orbit Flight Techniques Panel Meeting #78 and Entry Flight Techniques Panel Meeting #40.

Rule {A4.1.2-14}, OMS-1/OMS-2 EXECUTION, references this rule.

FLIGHT RULES

A4.1.3-4 OMS LEAK/PERIGEE ADJUST

A. FOR THE CASE OF AN OMS PROPELLANT TANK LEAK, AN OMS BURN TO DEPLETION WILL BE EXECUTED AS FOLLOWS:

1. IF PROPELLANT FROM THE GOOD POD CAN SUPPORT NEXT PLS DEORBIT WITH STEEP TARGETS FROM THE CURRENT ORBIT, THE LEAKING PROPELLANT WILL BE BURNED OUT OF PLANE IMMEDIATELY.
2. IF PROPELLANT FROM THE GOOD POD CAN SUPPORT AT LEAST ONE CONUS DEORBIT OPPORTUNITY WITH SHALLOW TARGETS BUT NOT WITH STEEP TARGETS FROM THE CURRENT ORBIT, A PERIGEE ADJUST MANEUVER WILL BE PERFORMED IMMEDIATELY IF:
 - a. IT WILL REDUCE THE DEORBIT DELTA V ON THE PRIME AND BACKUP (IF AVAILABLE) DEORBIT OPPORTUNITIES TO THE PLS WITHIN THE NEXT 48 HOURS (MINIMUM OF ONE PLS OPPORTUNITY EACH DAY FOR THE NEXT 2 DAYS), AND
 - b. THE DEORBIT DELTA V AFTER THE PERIGEE ADJUST MANEUVER IS SUPPORTABLE WITH THE NONLEAKING OMS PLUS ARCS ABOVE AFT QUANTITY 1 (NO FRCS).

OTHERWISE, AN OUT-OF-PLANE MANEUVER WILL BE PERFORMED IMMEDIATELY.

3. IF THE PROPELLANT FROM THE GOOD POD CANNOT SUPPORT AT LEAST ONE CONUS DEORBIT OPPORTUNITY WITH SHALLOW TARGETS FROM THE CURRENT ORBIT, A PERIGEE ADJUST MANEUVER WILL BE PERFORMED IMMEDIATELY WITH THE FOLLOWING EXCEPTION:

IF THE LEAK RATE IS EXTREMELY SLOW AND BOTH THE LEAK RATE AND POD THERMAL ENVIRONMENT ARE STABLE, PERFORM PERIGEE ADJUST AT THE OPTIMUM PERIGEE ADJUST TIG. HOWEVER, ANY INCREASE IN LEAK RATE OR CHANGE IN THERMAL ENVIRONMENT INDICATIVE OF POD FREEZEUP REQUIRES AN IMMEDIATE BURN.

FLIGHT RULES

4. THE PROPELLANT FROM THE GOOD POD INCLUDES OMS FROM THE NON-LEAKING SIDE PLUS ARCS TO OMS TANK FAIL QUANTITY FOR SHALLOW OR AFT QUANTITY 1 FOR STEEP (PROTECTING FOR 48-HOUR ON-ORBIT STAY ON VRCS, ONE DEORBIT PREPARATION, AND TWO 15-SECOND ULLAGE BURNS), PLUS FRCS. FRCS WILL NOT BE CONSIDERED FOR USE DURING THE DEORBIT BURN, BUT MAY BE USED DURING A PERIGEE ADJUST.

THIS RULE CONTINUED ON NEXT PAGE

FLIGHT RULES

A4.1.3-4 OMS LEAK/PERIGEE ADJUST (CONTINUED)

5. FOR THE CASE OF AN OMS PROPELLANT TANK LEAK WITHIN FOUR ORBITS OF DEORBIT, COMPLETION OF THE PERIGEE ADJUST WITH THE FRCS WILL BE AN MCC CALL.
 6. FOR THE CASE OF AN OMS PROPELLANT TANK LEAK WITHIN TWO ORBITS OF DEORBIT, IF THE MCC IS UNABLE TO CONFIRM A VALID ONBOARD STATE VECTOR AFTER THE BURN, DEORBIT WILL BE DELAYED UNTIL THE GROUND TRACKING STATE VECTOR USED FOR THE DEORBIT MANEUVER COMPUTATION INCLUDES AT LEAST ONE REPEAT OF ANY TRACKING STATION.
- B. FOR THE CASE OF AN OMS PROPELLANT TANK LEAK DURING THE TIMEFRAME OF A PAYLOAD DEPLOY, THE ACTIONS FOR THE DIFFERENT UPPER STAGES ARE LISTED BELOW:
1. IUS DEPLOY:
 - a. IF THE LEAK IS DETECTED PRE-UMBILICAL RELEASE, RESTOW AND BURN THE LEAKING SYSTEM TO DEPLETION PRIOR TO CONTINUING DEPLOY OPERATIONS. PARAGRAPH A OF THIS RULE WILL BE USED TO DETERMINE THE REQUIRED BURN. THE DETERMINATION OF SHALLOW DEORBIT CAPABILITY WILL ASSUME THAT THE PAYLOAD WILL BE DEPLOYED PRIOR TO DEORBIT.
 - b. IF THE LEAK IS DETECTED POST-UMBILICAL RELEASE, PERFORM EMERGENCY DEPLOY PROCEDURES UP TO EXECUTING THE MANEUVER TO THE SEPARATION BURN ATTITUDE. THEN:
 - (1) IF THE GOOD SYSTEM WILL SUPPORT DEORBIT TO SHALLOW TARGETS FROM THE POSTDEPLOY/MINIMUM SEPARATION ORBIT, PERFORM MINIMUM SEPARATION ASAP FROM THE LEAKING SYSTEM (SEND MASTER SAFE IF MINIMUM SEPARATION NOT COMPLETED). THEN, BURN LEAKING SYSTEM TO DEPLETION ASAP OUT-OF-PLANE.
 - (2) IF THE GOOD SYSTEM WILL NOT SUPPORT DEORBIT TO SHALLOW TARGETS FROM THE POSTDEPLOY/MINIMUM SEPARATION ORBIT, SEND "MASTER SAFE". THEN PERFORM "RECOVERY FROM MASTER SAFE" THROUGH RCS ENABLE. THEN:

FLIGHT RULES

THIS RULE CONTINUED ON NEXT PAGE

FLIGHT RULES

A4.1.3-4

OMS LEAK/PERIGEE ADJUST (CONTINUED)

- (a) IF THE LEAK IS EXTREMELY SLOW AND THERE ARE NO POD THERMAL EFFECTS BEING SEEN (BOTH ARE MCC CALLS), REPLACE THE NOMINAL/MINIMUM SEPARATION WITH AN ASAP 2 FPS RETROGRADE MANEUVER. THEN PERFORM PERIGEE ADJUST AT THE OPTIMAL PERIGEE ADJUST TIG.
- (b) IF THE CREW HAS NO CONTACT WITH MCC, OR IF MCC DETERMINES THE LEAK IS FAST OR POD THERMAL EFFECTS ARE SEEN, PERFORM PERIGEE ADJUST ASAP.
- (c) ASAP FOLLOWING THE PERIGEE ADJUST (EITHER AT OPTIMAL TIG OR THE ASAP TIG), IF THE PERIGEE ADJUST WAS ≥ 57 FPS, MANEUVER TO IUS VIEWING ATTITUDE AND COMPLETE "RECOVERY FROM MASTER SAFE" PROCEDURE TO RESTART MISSION SEQUENCING. IF IN CONTACT WITH MCC, CONSIDERATION WILL BE GIVEN TO LOWERING PERIGEE BELOW 95 NM (90 NM MINIMUM) TO OBTAIN 57 FPS FROM THE LEAKING POD.
- (d) IF PERIGEE ADJUST DELTA V IS < 57 FPS, MASTER SAFE RECOVERY WILL ONLY BE ON MCC CALL.

2. PAM-D, PAM-D2, OR FRISBEE DEPLOY:

- a. IF THE LEAK IS DETECTED PREDEPLOY, ABORT THE DEPLOY AND PERFORM OMS BURN TO DEPLETION. PARAGRAPH A WILL BE USED TO DETERMINE THE REQUIRED BURN. THE DETERMINATION OF SHALLOW DEORBIT CAPABILITY WILL ASSUME THE PAYLOAD WILL BE DEPLOYED PRIOR TO DEORBIT.

THIS RULE CONTINUED ON NEXT PAGE

FLIGHT RULES

A4.1.3-4

OMS LEAK/PERIGEE ADJUST (CONTINUED)

- b. IF THE LEAK IS DETECTED POSTDEPLOY, BURN THE LEAKING OMS PROPELLANT ACCORDING TO THE FOLLOWING GUIDELINES. PARAGRAPH A WILL BE USED TO DETERMINE THE REQUIRED BURN. IF THE LEAKING OMS IS TO BE BURNED OUT OF PLANE, PERFORM A MINIMUM SEPARATION MANEUVER ASAP AFTER DEPLOY, THEN PROCEED TO BURN THE LEAKING PROPELLANT OUT OF PLANE IMMEDIATELY. IF THE LEAK RATE IS FAST AND THE LEAKING OMS PROPELLANT IS TO BE BURNED RETROGRADE, TIG CAN BE NO EARLIER THAN DEPLOY PLUS 15 MINUTES AND A MINIMUM DELTA V OF 18 FPS IS REQUIRED. CONSIDERATION WILL BE GIVEN TO LOWERING PERIGEE BELOW 95 NM (90 NM MINIMUM) TO OBTAIN 18 FPS. IF THE LEAK RATE IS EXTREMELY SLOW AND THE GOOD POD CANNOT SUPPORT ANY CONUS DEORBIT TO SHALLOW TARGETS, THE FOLLOWING ACTIONS WILL BE PERFORMED:
- (1) FOR ASCENDING NODE DEPLOYMENTS, REPLACE SEPARATION MANEUVER WITH A MINIMUM SEPARATION MANEUVER, GO TO WINDOW PROTECTION ATTITUDE (WPA), AND THEN BURN RETROGRADE AT THE NEXT OPTIMUM PERIGEE ADJUST TIG.
 - (2) FOR DESCENDING NODE DEPLOYMENTS, REPLACE SEPARATION MANEUVER WITH A PERIGEE ADJUST MANEUVER AT THE NEXT OPTIMUM PERIGEE ADJUST TIG (18 FPS MINIMUM).

3. RMS DEPLOY: TBD

The basic philosophy that is reflected in these rules is that the safety of the orbiter and the crew are first priority. Since the leak rate and thermal effects of an OMS propellant tank leak cannot be reliably predicted, the leaking propellant must be dumped ASAP. Reliable leak rates cannot be predicted because of the inability to determine or predict whether helium and/or propellant is leaking from the tank. In addition, if the propellant tank pressure decays to below the tank fail limit (fuel = 216 psia, oxidizer = 151 psia), there is no guarantee (regardless of the leak rate) that the tank can be repressurized to above these limits. If the repressurization does not work, the tank is considered failed and is unusable for the perigee adjust. Since thermal effects of a leak cannot be predicted, the propellant must be dumped to prevent the pod from the possibility of freezing, thus rendering both the OMS and RCS systems unusable. The rate of propellant sublimation varies as a function of which propellant is leaking, the location of the leak, the distribution of the propellant within the pod, and the thermal environment. As a result, the sublimation rate cannot be reliably predicted. Therefore, if the pod were to freeze there is no way to determine when the RCS will be available for entry.

FLIGHT RULES

THIS RULE CONTINUED ON NEXT PAGE

FLIGHT RULES

A4.1.3-4**OMS LEAK/PERIGEE ADJUST (CONTINUED)**

The determination of steep capability includes OMS from the nonleaking side, FRCS, and ARCS to AFT quantity 1. Flight Rule {A2.1.3-7}, CONSUMABLES MANAGEMENT, indicates that deorbit will be shallowed to protect entry usage. Therefore, for steep capability to exist, the full entry usage must be protected. For determination of shallow deorbit capability, the ARCS may be used to the OMS tank fail quantity. OMS tank fail quantity does not protect the total entry requirements. However, this propellant will be used to achieve a shallow deorbit to CONUS, if required.

If the good pod can support deorbit to a CONUS site using steep targets, the leaking OMS should always be burned out of plane (OOP) regardless of the leak rate as soon as possible. This will result in having many CONUS deorbit opportunities available that can be supported (to steep targets) with the remaining propellant after the leaking OMS burn.

The delta V of the perigee adjust maneuver is intended to obtain $H_p = 95$ nm and to reduce the propellant to the point where leakage into the pod will be minimized. This technique will usually result in one of two cases: (a) propellant not depleted at targeted H_p or (b) depletion of propellant and engine cutoff before reaching 95 nm. If the fuel is depleted before the perigee reaches 95 nm, the FRCS may be used to attempt to achieve the target perigee altitude at a later time.

If fuel remains after reaching the 95 nm target, an out-of-plane burn will be performed to reduce the propellant to the minimum safe quantity.

If the propellant available in the "good pod" can support a PLS deorbit with shallow targets but not steep targets, the leaking propellant may be burned either out-of-plane or retrograde. An out-of-plane burn everywhere in the orbit would guarantee at least shallow deorbit capability to the PLS. However, if the perigee adjust is performed in the right portion of the orbit, the deorbit delta V can be decreased. This would then allow a steeper than a shallow entry.

Therefore, a retrograde window is computed by determining where a perigee adjust will decrease the deorbit delta V to the PLS on the prime and backup opportunities. This window is also constrained by the amount of propellant available in the nonleaking OMS and the ARCS above AFT quantity 1 which will be used to support the deorbit. FRCS is not included in determining the window because it would require the use of a "fast flip" during the deorbit burn which is highly undesirable. The inverse of the retrograde window, the OOP TIG window, is what is actually provided to the crew on the trajectory message. If the "good pod" can support shallow but not steep deorbit and TIG for the leaking OMS burn is in the OOP TIG window, the crew will burn out-of-plane.

For high altitude flights, all the OMS on the leaking side may not be enough to get perigee down to 95 nm. In these cases, the maximum delta V available from the OMS will be used to lower perigee as much as possible and this value will be used in determining the OOP TIG window.

THIS RULE CONTINUED ON NEXT PAGE

FLIGHT RULES

A4.1.3-4

OMS LEAK/PERIGEE ADJUST (CONTINUED)

However, if shallow deorbit capability does not exist from the good OMS pod, it is imperative that a perigee adjust be performed from the leaking pod. The perigee adjust burn must be performed immediately in order to guarantee deorbit with one exception: If the leak rate is "slow" enough to guarantee supporting the optimum perigee adjust opportunity, and the pod thermal environment will also support, the burn will be performed at the optimum point to enhance CONUS landing capability. For this case, a maneuver to an LVLH retrograde burn attitude will be performed immediately and maintained. If there is any uncertainty in the leak rate computations or pod thermal environment will not support the opportunity, the perigee adjust will be performed immediately in order to guarantee deorbit to a landing site. Any leaks detected by the crew through the FDA is considered a fast leak. It is possible that the only deorbit capability available after the perigee adjust is performed is to a southern hemisphere ELS. The crew will be informed whether shallow deorbit capability currently exists.

The ground will also send up the delta times from the ascending node for the opening and the closing of the OOP TIG window. The crew will use this information for the case of an OMS leak while out of communications coverage with the ground. If the TIG is inside the OOP TIG window, the crew will execute the OMS burn out of plane. Otherwise, the OMS burn will be a perigee adjust maneuver. If the OMS burn is performed out of plane, the FRCS may be burned retrograde at the optimum perigee adjust TIG on a later orbit.

If the engine cutoff occurs before the desired perigee, it may or may not be desirable to complete the burn with the FRCS if deorbit will occur within the next four orbits. This is dependent upon the position in the orbit where the perigee adjust is executed. If perigee is in the wrong place in the orbit, completing the burn with the FRCS may actually increase the deorbit delta V. However, if the perigee adjust is executed near the optimum TIG, it will be better to complete in order to lower the deorbit delta V. The FDO will have to determine in real time whether completion on the FRCS is required.

If at the perigee adjust maneuver the orbiter state is well known, then one orbit of tracking is not required because onboard guidance and navigation will properly model the maneuver and a confirmation of the maneuver on the ground will be performed. In this case, onboard GNC is believed to be good.

Experience has shown that one orbit of tracking data will provide a state vector of sufficient quality upon which to compute a deorbit maneuver. Therefore, if after completion of the perigee adjust burn insufficient time is available to obtain the necessary tracking, the deorbit maneuver will be slipped to provide enough time to obtain the vector.

THIS RULE CONTINUED ON NEXT PAGE

FLIGHT RULES

A4.1.3-4

OMS LEAK/PERIGEE ADJUST (CONTINUED)

For the case of an OMS leak during the timeframe of a deploy, the most expedient means of dumping the leaking propellant will be executed. With a deployed payload, concern is not only with the actual perigee adjust maneuver and the resulting deorbit considerations, but must also take into consideration the separation dynamics between the payload and the orbiter. When possible, restowing or aborting the deploy eliminates having to solve critical problems simultaneously. Therefore, the procedures have been written to use the most conservative approach in all cases to optimize the chances of getting the orbiter ready to perform the OMS burn ASAP. For the cases where the deploy is aborted, the same logic discussed above will be used in determining whether to burn out of plane retrograde. The reason for assuming the payload will be deployed prior to deorbit is that it is not justified to protect for multiple payload failures that will not allow for deployment or jettison while working an OMS leak. Also, the delta V available increases due to decreased orbiter weight. This serves to increase the chance that shallow deorbit capability will exist from the current orbit and not force a retrograde burn. A retrograde burn performed in the wrong phase in the orbit could force a southern hemisphere landing. This maximizes the chance for a deorbit to a CONUS site. For the cases where the payload is ready for deploy, it was determined that it is best to proceed with the deploy in order to decrease the orbiter weight and therefore increase the efficiency of the remaining propellant.

*For the IUS cases, once the payload is elevated at 29 degrees, restowing the IUS uses functions that have just been verified to operate while deploy requires the additional use of umbilical release and SUPER*ZIP functions. Once the umbilicals have been released, however, it is best to proceed with the deploy since the payload is almost ready for deploy. Performing the perigee adjust postdeploy places the orbiter in front of and below the IUS at SRM-1 TIG. A minimum of 57 fps is required from the perigee adjust in order to ensure orbiter safety. This minimum delta V would ensure a closest-point-of-approach (CPA) distance of no less than 30 nm between the orbiter and the IUS post-SRM-1. This assumes a worst case pointing error at SRM-1 of 1.8 degrees for the IUS. Failure to obtain the minimum delta V would place the orbiter closer than 30 nm to the IUS at CPA and would require the IUS to be master safed.*

When an OMS leak is detected postdeploy for a spin-stabilized deployable (PAM-D, PAM-D2, and Frisbee), separation dynamics must be considered. If the leaking OMS is to be burned out of plane, performing a minimum separation burn (posigrade) ASAP after the deploy will provide acceptable separation dynamics. The leaking OMS can then be burned out of plane with no consequences. If the leaking OMS is to be burned retrograde, separation dynamics dictate that a retrograde burn not be performed prior to deploy plus 15 minutes. If the leak rate is fast, the separation burn is replaced with a perigee adjust burn of at least 18 fps (to protect for the 10X tile erosion limit) at the nominal separation TIG. If the leak rate is extremely slow, the perigee adjust should be burned at the optimum TIG to enhance the CONUS landing capability. For a descending deploy, this can be accomplished by replacing the nominal separation burn with a perigee adjust (18 fps minimum) at the optimum TIG. For an ascending deploy, the optimum perigee adjust TIG is after PKM ignition. Therefore, a minimum separation burn must be performed at the nominal separation TIG to protect for the 10X tile erosion limit, and a perigee adjust can be performed at the next optimum perigee adjust TIG.

FLIGHT RULES

THIS RULE CONTINUED ON NEXT PAGE

FLIGHT RULES

A4.1.3-4 OMS LEAK/PERIGEE ADJUST (CONTINUED)

If executing the perigee adjust after a deploy requires less than the above stated minimum delta V's to reach 95 nm, consideration will be given in real time to taking perigee as low as 90 nm using delta V from the leaking pod in order to achieve the minimum delta V. This consideration will protect for 48-hour orbit lifetime from the resulting orbit and will not normally be exercised if it jeopardizes the ability to deorbit to a CONUS site by increasing the required deorbit delta V.

Rule {A6.1.2-17P}, OMS FAILURE MANAGEMENT (CIL), references this rule.

A4.1.3-5 MINIMUM TIME OF FREE FALL

TIME BETWEEN DEORBIT MANEUVER CUTOFF AND 400K FEET MUST BE \geq 9 MINUTES.

The minimum time required for execution of the checklist procedures between deorbit burn cutoff and EI is 9 minutes. These procedures include maneuvering to the EI minus 5 minute attitude, powering down the OMS gimbals, executing the FRCS dump (when required), verifying switch positions, and starting the remaining APU's.

A4.1.3-6 COLLISION AVOIDANCE GUIDELINES

A COLLISION AVOIDANCE MANEUVER WILL BE PERFORMED FOR A CONJUNCTION PREDICTED BY THE UNITED STATES SPACE COMMAND IF THE PREDICTED MISS DISTANCE IS LESS THAN 2 km (1.1 NM) RADIALLY, 5 KM (2.7 NM) DOWNTRACK, AND 2 KM (1.1 NM) OUT-OF-PLANE AND IF THE MANEUVER DOES NOT COMPROMISE EITHER PRIMARY PAYLOAD OR MISSION OBJECTIVES. PROPELLANT REDLINES WILL NOT BE BUDGETED FOR ANY POTENTIAL MANEUVERS.

During real time, USSPACECOM's Computation of Misses Between Orbits (COMBO) program predicts close conjunctions between the orbiter and any other orbiting object that can be tracked. This includes deployed payloads and payloads that have no control system or are uncontrollable. The results of this are sent to the JSC MCC. A study was performed to determine the probability of collision for a predicted conjunction. The probability is a function of tracking uncertainties and predicted miss distances. The results showed the probability of collision to be small. Due to this, compromising either primary payload or mission objectives cannot be justified. However, if there are no perturbations to either primary payload or mission objectives, it is best to maneuver for any conjunction with a greater than 1 in 100,000 chance of collision. An acceptable risk of 1 in 100,000 is based on the frequency of conjunctions and the level of risk taken by other space shuttle elements. The ellipsoid stated in the rule guarantees this risk.

FLIGHT RULES

A4.1.3-7

PLS/EOM LANDING OPPORTUNITY REQUIREMENTS

A. ALL OF THE FOLLOWING CRITERIA ARE REQUIRED FOR A PLS (OTHER THAN FIRST DAY PLS, REF. RULE {A2.1.1-1F}, PRELAUNCH GO/NO-GO REQUIREMENTS) MDF, OR EOM LANDING OPPORTUNITY (NOT IN PRIORITY ORDER):

1. NASA CONUS SITE: KSC, EDW, NOR. FOR NO-COMM PLS PLANNING, EDW IS PREFERRED.

Only the three prime NASA CONUS sites should be considered for PLS or EOM. The daily PLS planning results in a crew message for no-comm execution if total communications are lost; ref. Rule {A11.1.2-2}, LOSS OF BOTH VOICE AND COMMAND. In the case of other problems, ground evaluation of the landing site can be made very shortly before deorbit burn. However, for the no-comm case, the crew may be required to execute a deorbit to a site that was picked many hours previously. Since EDW weather is in general much more stable than KSC and additional lateral and longitudinal margins are available in the case of poor navigation (likely for a no-comm entry) or other orbiter systems problems, EDW is the preferred no-comm PLS site when all other considerations are equal. @[ED]

2. WIND AND WEATHER CONDITIONS (REF. RULE {A2.1.1-6}, LANDING SITE WEATHER CRITERIA) @[120894-1622B]
3. ACCEPTABLE ENTRY ANALYSIS INCLUDING:

NOTE: ENTRY ANALYSIS IS NOT PERFORMED FOR DAILY NO-COMM PLS SELECTION.

- a. APPROACH AND LAND TRANSITION (REF. RULE {A4.1.4-6}, HAC SELECTION CRITERIA).
- b. NORMALIZED TOUCHDOWN DISTANCE (REF. RULE {A4.1.3-10}, AIMPOINT, EVALUATION VELOCITY, AND SHORT FIELD SELECTION). @[072795-1788A]
- c. MAXIMUM TIRE SPEED, ROLLOUT MARGIN, AND BRAKE ENERGY CONSTRAINTS (REF. RULE {A4.1.3-8}, TIRE SPEED, BRAKING, AND ROLLOUT REQUIREMENTS).

THIS RULE CONTINUED ON NEXT PAGE

FLIGHT RULES

A4.1.3-7

PLS/EOM LANDING OPPORTUNITY REQUIREMENTS (CONTINUED)

- d. NZ AND Q-BAR CONSTRAINTS (REF. RULE {A4.1.5-7}, ENTRY LIMITS). @[072795-1788A]

Rule {A4.1.3-12}, LOWER LEVEL MEASURED WIND AND ATMOSPHERIC DATA, requires accurate lower level atmospheric data that is used for analysis of the entry trajectory to ensure safety. The main gear tires are certified to 225 knots groundspeed. This constraint may limit the allowable tailwind based on the predicted EAS and density altitude. Violation of brake energy and rollout constraints may result, in dispersed cases, in runway departure or excessive braking requirements that could lead to tire fires. Rule {A2.1.1-6A}, LANDING SITE WEATHER CRITERIA, references this rule. Since the no-comm PLS landing would be executed many hours after the site had been selected, entry analysis using environmental observations are not relevant and therefore will not be performed. @[071494-1621A] @[120894-1622B]

4. ENTRY CROSSRANGE LESS THAN DISPERSED OR THE THERMAL CROSSRANGE LIMIT, WHICHEVER IS MORE CONSTRAINING.

The dispersed crossrange limit represents the vehicle capability to converge to nominal conditions by TAEM interface (Mach 2.5) assuming 3-sigma combinations of navigation, atmosphere, energy, and winds. All planned and acceptable entries must have a crossrange which is less than the dispersed crossrange limit. Landing sites with crossrange between the dispersed and undispersed limits should not be considered. (Ref. Rule {X4.1.1-1}, TRAJECTORY AND GUIDANCE PARAMETERS.)

The flight specific thermal crossrange limit protects the upper surface thermal constraints for high crossrange entries. During high crossrange entries, the orbiter maintains a roll angle for a long period of time to reduce crossrange prior to the first roll reversal. Heading rates incurred by non-zero roll attitudes will be sensed by the FCS pitch rate gyros as small positive pitch rates. As a result, the FCS will maintain an angle of attack somewhat less than that desired as it attempts to compensate for this pseudo pitch rate. This results in increased heating to the upper surface, which may result in excessive structural temperatures. The actual thermal crossrange limit is flight specific. (Ref. Rule {X4.1.1-1}, TRAJECTORY AND GUIDANCE PARAMETERS.) @[071494-1621A]

5. SUFFICIENT GROUND EQUIPMENT SUPPORT INCLUDING REDUNDANCY MUST BE PROVIDED TO SATISFY A/G VOICE, TELEMETRY, TRACKING, AND COMMAND REQUIREMENTS AND FULL REDUNDANCY TO NAVIGATION AIDS AS SPECIFIED IN SECTION 3. NOTE: TRACKING SUPPORT IS NOT SCHEDULED FOR THE DAILY PLS OPPORTUNITY. IF A PLS IS REQUIRED, TRACKING SUPPORT WILL BE ON A "BEST EFFORT" BASIS.

THIS RULE CONTINUED ON NEXT PAGE

FLIGHT RULES

A4.1.3-7

PLS/EOM LANDING OPPORTUNITY REQUIREMENTS (CONTINUED)

6. DAYLIGHT LANDING (SUNRISE MINUS 15 MINUTES TO SUNSET PLUS 15 MINUTES) UNLESS THE CREW IS SPECIFICALLY TRAINED FOR NIGHT LANDING.

All crews receive pilot pool training for night landing, and an emergency landing at an augmented landing site is reasonably assured of success. However, unless the crew is specifically trained for night landing, the additional risk should be avoided.

7. CREW SCHEDULING CONSTRAINTS MUST BE MET FOR PLS PLANNING, AT LEAST 7 HOURS BUT NOT GREATER THAN 16 HOURS, BETWEEN THE SCHEDULED WAKE-UP AND LANDING TIME FOR BOTH SHIFTS IF THE FLIGHT IS DUAL SHIFT. FOR DAILY PLS SELECTION, THE CONSTRAINT MAY BE RELAXED TO AT LEAST 5 HOURS BETWEEN SCHEDULED WAKEUP (CDR AND PLT ONLY) AND LANDING TIME IF THIS GIVES A BACKUP (ONE ORBIT LATE) OPPORTUNITY.

The Crew Scheduling Constraints Document (Appendix K of the Space Shuttle Crew Procedures Management Plan) contains the 7 to 16 hour wakeup-to-landing workday limit. That same document also gives limits to shifting crew sleep times. For next PLS situations, a backup opportunity is important since the use of the PLS will be driven by a systems failure that dictates coming out of orbit that day. Therefore, the orbit late increases the probability of landing on that day, allowing a wave-off for further systems anomalies, vehicle configuration, or weather violations. The minimum of 5 hours between scheduled wakeup and landing ensures the full deorbit preparation timeline (4 hours) plus the additional hour between deorbit and landing. Other activities, such as cabin stowage and postsleep would have to overlap with the deorbit preparation or be provided by a shift in the crew sleep period.

- B. RULE {A2.1.4-7}, LANDING SITE SELECTION, WILL BE USED TO CHOOSE BETWEEN SITES THAT MEET ALL REQUIREMENTS IN PART A. THE FOLLOWING ADDITIONAL CRITERIA LISTED BELOW, IN ORDER OF PRIORITY, WILL BE USED TO FURTHER CHOOSE BETWEEN LANDING SITES/OPPORTUNITIES:

1. BACKUP (ONE ORBIT LATE) OPPORTUNITY TO ANY CONUS SITE.

A one-orbit late landing opportunity to any of the three CONUS landing sites is particularly important in determining the daily PLS site since next PLS rules are driven by orbiter system failures that dictate coming out of orbit that day.

2. BACKUP OPPORTUNITY TO THE PLS.

FLIGHT RULES

A backup opportunity to the PLS is desirable since all of the ground facilities and team are on station and prepared for the landing and the higher priority site would be achieved in the event of a wave-off for one orbit.

THIS RULE CONTINUED ON NEXT PAGE

FLIGHT RULES

A4.1.3-7

PLS/EOM LANDING OPPORTUNITY REQUIREMENTS (CONTINUED)

3. POSTLANDING OPERATIONS.

If all of the above criteria are met at more than one site, the site will be selected based on the post-landing convoy, payloads, and vehicle turnaround support. Also note that many orbiter malfunctions in entry critical systems have specific landing site requirements and this may drive the landing selection at a higher priority than this rule.

4. ENTRY CROSSRANGE < DTO CROSSRANGE LIMIT.

On flights which have entry aerodynamic DTO's/PTI's manifested, the site or opportunity that will allow these tests to be performed is desired. The DTO crossrange is more constraining than the dispersed crossrange limit in an attempt to account for the dispersion imposed on the crossrange due to guidance lockout during the execution of the PTI's. The DTO crossrange limit is last on the priority list due to the maturity of the aerodynamic data base resulting from a long history of successful entry DTO flights. Reference Rule {X4.1.1-1}, TRAJECTORY AND GUIDANCE PARAMETERS for the limit.

Rule {A2.1.1-6}, LANDING SITE WEATHER CRITERIA, references this rule. @[120894-1622B]

C. FOR DAILY PLS FOR NO-COMM DEORBIT PLANNING, TO MAINTAIN A CONUS LANDING SITE, CONSIDERATION MAY BE GIVEN TO THE FOLLOWING: RELAXATION OF WEATHER CRITERIA TO ACLS CONDITIONS (REF. RULE {A2.1.1-6}, LANDING SITE WEATHER CRITERIA), REASONABLE MODIFICATIONS TO CREW SCHEDULING CONSTRAINTS, NIGHT LANDING, AND SMALL VIOLATIONS OF DISPERSED CROSSRANGE. @[120894-1622B]

Relaxation to ACLS weather conditions, small variances to crew sleep scheduling, acceptance of night landing, and small exceedances of dispersed crossrange may be allowed to pick a CONUS site for the no-comm next PLS opportunity. Since the weather forecasts are for several hours in the future, there is the opportunity for improvement. Landing at one of the CONUS sites (ref. Rule {A2.1.4-7}, LANDING SITE SELECTION) generally provides communications, command, tracking, landing aids, and ground site support. Also, facilities are available to mate the orbiter to the SCA, thereby minimizing any vehicle turnaround and scheduling impacts. Additionally, CONUS landings avoid the political and logistical ramifications of landing in a foreign country. Somewhat degraded conditions are acceptable for daily PLS planning rather than picking a non-CONUS site even including the ACLS sites such as Ben Guerir, Hawaii, or Guam.

FLIGHT RULES

A4.1.3-8 TIRE SPEED, BRAKING, AND ROLLOUT REQUIREMENTS

TIRE SPEED, BRAKE ENERGY, AND ROLLOUT MARGIN CONSTRAINTS ARE DEFINED AS FOLLOWS: @[072795-1788B]

Rollout margin and brake energy limits are identified in order to ensure that the orbiter can stop within the runway limitations. The touchdown tire speed limit, in combination with the crosswind limits (ref. Rule {A2.1.1-6}, LANDING SITE WEATHER CRITERIA), provides protection against tire failure during touchdown and rollout. Rollout margin is meant to account for the environmental and procedural variations that can directly impact the vehicle stopping distance. Brake energy limits protect the capability of the brakes to stop the orbiter (ref. Entry FTP Meeting #35, 9/11/87). @[072795-1788B]

A. CALCULATION ASSUMPTIONS:

1. THE PREDICTED TOUCHDOWN TIRE SPEED IS COMPUTED AT THE EVALUATION TOUCHDOWN EAS. @[072795-1788B]
2. DRAG CHUTE IS NOT CONSIDERED. @[050495-1745D]
3. DEROTATION IS ASSUMED AT 180 KEAS AT 2.2 DEGREES/SEC, REF RULE {A2.1.4-6}, DEROTATION SPEED. @[050495-1745D]
4. BRAKING INITIATION IS AFTER MIDFIELD AT 140 KGS OR AT 5000 FEET REMAINING, WHICHEVER IS FIRST, AT A MAXIMUM DECELERATION OF 9 FT/SEC/SEC. THE FOLLOWING EXCEPTIONS ARE ALLOWED:
 - a. IF BRAKE ENERGY IS VIOLATED, IT IS ACCEPTABLE TO DELAY BRAKE APPLICATION TO 120 KGS AS LONG AS ROLLOUT MARGIN ALLOWS AND BRAKE APPLICATION IS NOT DELAYED PAST 5000 FT REMAINING. THIS IS PREFERRED OVER RUNWAY REDESIGNATION.
 - b. IF ROLLOUT MARGIN IS VIOLATED, IT IS ACCEPTABLE TO BEGIN BRAKE APPLICATION AS SOON AS NOSE GEAR TOUCHDOWN OCCURS BUT NOT EARLIER THAN 225 KGS, AND AS LONG AS BRAKE ENERGY IS NOT VIOLATED. @[050495-1745D]

THIS RULE CONTINUED ON NEXT PAGE

FLIGHT RULES

A4.1.3-8 TIRE SPEED, BRAKING, AND ROLLOUT REQUIREMENTS (CONTINUED)

- B. TIRE SPEED - PREDICTED GROUND SPEED NOT TO EXCEED 214 KGS AT THE EVALUATION TOUCHDOWN EAS. (REF RULE {A4.1.3-10}, AIMPOINT, EVALUATION VELOCITY, AND SHORT FIELD SELECTION). @[072795-1788B]

Rule {A4.1.3-12}, LOWER LEVEL MEASURED WIND AND ATMOSPHERIC DATA, requires accurate lower level atmospheric data than is used for analysis of the entry trajectory to insure safety. The 214 KGS predicted touchdown speed limit is based on providing a minimum of 11 KTS margin from the 225 KGS orbiter tire certification limit given in the Orbiter Vehicle End Item Specification. The 11 KTS margin is derived from the RSS of air data system (3 sigma), winds (3 sigma), and piloting (< 1 sigma) dispersions. The short field speedbrake logic may be used to gain tire speed margin if the predicted tire speed with nominal speedbrake logic is > 214 KGS, but £ 225 KGS (ref. Rule {A4.1.3-10}, AIMPOINT, EVALUATION VELOCITY, AND SHORT FIELD SELECTION). The probability of exceeding the 225 KGS certification limit depends on the landing site, touchdown evaluation velocity, wind, atmospheric conditions and persistence, ADTA errors/biases, and pilot-induced dispersions. Full 3 sigma protection does not always exist for this limit, nor does it exist for tailscrape. The 214 KGS operational limit and the short field speedbrake option were chosen because they provide a good balance between protecting for high speed landings, and for low speed tailscrape/derotation concerns. Using the short field option provides an additional 10 KTS protection against high speed landings, but at the expense of reducing tailscrape margin (ref. AEFTP #121, 1-20-95).

During tire certification, off-limits testing on the dynamometer indicated tire margin at groundspeeds greater than 225 KTS. However, the dynamometer is not a good predictor of tire wear, and the off-limits testing was not sufficient to be acceptable for certification by the vendor. Severe damage was observed (loss of tread prior to peak load), but the tire held air after multiple landings. Convair 990 tests on the modified surface at KSC and the cleaned EDW concrete runway have also demonstrated some minimal tire wear margin at certification limits. As expected, there is very significant increase in tire wear with speed beyond the certification limit and with higher crosswind. Results of several "worst-on-worst" cases at 225 KGS with 20 KTS steady state crosswind on the Edwards runway were mixed; some passed and some failed. Additional high speed tests were made at speeds up to 240 KGS, and 15 KTS crosswind, after which the tire continued to hold air. Engineering analysis indicates these test conditions represent the absolute tire wear limit. The tire vendor agrees that the Convair 990 data is the best available for predicting tire wear, but will not support using the results of these tests to increase the certified limit for this tire (ref. SPRCB, 5-31-95). @[072795-1788B]

- C. BRAKE ENERGY - ALL CASES MUST MEET THE BRAKE ENERGY LIMITS BELOW (WORST BRAKE) : @[072795-1788B]

NOTE: FOR APPLICATION OF THIS RULE, ABORTS INCLUDE RTLS, TAL, AND AOA. @[050496-1774A] @[050495-1745D]

THIS RULE CONTINUED ON NEXT PAGE

FLIGHT RULES

A4.1.3-8 TIRE SPEED, BRAKING, AND ROLLOUT REQUIREMENTS (CONTINUED)

1. OPERATIONAL NWS - BOTH CONSTRAINTS BELOW MUST BE SATISFIED:
 - a. 42M FT-LB WITH NWS (82M FT-LB FOR ABORTS).
 - b. 70M FT-LBS WITHOUT NWS (ASSUMING DIFFERENTIAL BRAKING) ON AT LEAST ONE "GO" RUNWAY AT THE LANDING SITE (82M FT-LB FOR ABORTS).
2. TOTAL FAILURE OF NWS:
 - a. IF PRE-DEORBIT - 42M FT-LB ASSUMING DIFFERENTIAL BRAKING.
 - b. IF POST-COMMIT TO DEORBIT AND EXPECTED BRAKE ENERGY PREDICTED TO EXCEED 42M FT-LB, THEN RUNWAY REDESIGNATION (SAME COMPLEX) WILL BE CONSIDERED PRIOR TO MACH 6 IN ORDER TO REDUCE THE CROSSWIND.

To be conservative, the drag chute shall not be used in the brake energy calculations. Engagement of the barrier is to be avoided, if possible. Therefore, in the calculation of brake energy, neither of these devices is considered. @[050495-1745D]

Flight experience shows a potential of about 5 KEAS delay on the initiation of derotation from the desired speed of 185 KEAS using beep trim. Derotation initiation is assumed to be 180 KEAS. Desired commanded rate is 1.5 deg/sec, but actual results from flight data show that 2.2 deg/sec average derotation rate results. Together, these constants define the earliest nose gear touchdown speed and, thus, the earliest speed at which brakes should be applied. Failure of beep trim resulting in a delayed manual derotation is an additional failure that is not considered in this analysis but is thought to be a small effect in any case that can be covered by either drag chute or other dispersions. @[050495-1745D]

Brake energy must not exceed limits for the same cases that the rollout margin has been met. Flight experience on STS-39 demonstrated an average maximum deceleration rate of 9.5 ft/sec² with the carbon-carbon brakes. The 9.0 ft/sec² assumption is conservative to allow for systems variations. Crews train for braking initiation at 140 knots or midfield, whichever is later. Exceptions to this is when braking has not begun and the vehicle reaches the 5k feet remaining marker. The crew will always begin braking at the 5k-foot marker, regardless of groundspeed. From flight experience, it has been demonstrated that the crew can safely delay braking initiation until 120 knots groundspeed. Also, the orbiter brakes and associated equipment (anti-skid) are certified to 225 (ref. CR 26-621-0055) kgs so under extreme circumstances braking may be allowed up to that speed provided the nose gear is down. @[050495-1745D]

FLIGHT RULES

THIS RULE CONTINUED ON NEXT PAGE

FLIGHT RULES

A4.1.3-8

TIRE SPEED, BRAKING, AND ROLLOUT REQUIREMENTS (CONTINUED)

The 42M ft-lb limit for EOM was determined to protect against tire blowout plug deflating the tire shortly after wheel stop (ref. BF Goodrich Engineering Report ER-5448, FSC 97153). The 82M ft-lb limit for aborts allows for the generally heavier weight of payload return and shorter abort runways (ref. Specification - Structural Carbon Brake Assembly, MLG, Orbiter MC621-0075). This higher limit is also allowed for a contingency return on FD 1 with the typically heavyweight vehicle. The risk of a tire fire is incurred for brake energies above 70M ft-lb (ref. Carbon Brake Development Test Summary - Engineering Report 6055, 8/21/87). This limit will be used for the non-abort case where a late failure takes away nosewheel steering capability. Brake energy capability of 82M ft-lb has been demonstrated in testing.

Crosswinds directly increase the brake energy when differential braking is used for lateral control during rollout. Also, for loss of NWS, brake application at speeds above 140 knots will be required for lateral control which also adds to the brake energy.

After commitment to the deorbit burn, the options available for reducing the brake energy are limited. Should the NWS fail after this commitment, runway redesignation will be considered prior to Mach 6. Redesignation will not be considered if the brake energy reduction is not significant or if the alternate runway is less desirable for other reasons (no landing aids, runway conditions, etc.). Runway redesignation will not be recommended later than Mach 6 in order to protect against inducing a trajectory energy error which is not corrected by TAEM interface.

D. ROLLOUT MARGIN ©[072795-1788B]

THE MINIMUM REQUIRED ROLLOUT MARGIN FOR A SITE TO BE "GO" ARE AS FOLLOWS:

NOTE: FOR ROLLOUT MARGIN VIOLATIONS, SHORT FIELD SPEED BRAKE SHOULD BE USED IF IT WILL MAKE A RUNWAY GO FOR ROLLOUT MARGIN, AND IT REMAINS GO FROM THE BRAKE ENERGY, TOUCHDOWN MARGIN, AND TOUCHDOWN SPEED REQUIREMENTS. ©[050495-1745D]

1. FOR RUNWAYS WITHOUT A BARRIER:

PREDICTED ROLLOUT MARGIN \geq 2000 FEET MEASURED FROM THE END OF THE USABLE OVERRUN

THIS RULE CONTINUED ON NEXT PAGE

FLIGHT RULES

A4.1.3-8 TIRE SPEED, BRAKING, AND ROLLOUT REQUIREMENTS (CONTINUED)

2. RUNWAY WITH A BARRIER:

PREDICTED ROLLOUT MARGIN \geq 0 FEET FROM THE BARRIER

NOTE: THE USE OF THE SHORTFIELD SPEEDBRAKE SHOULD BE CONSIDERED IF THE ROLLOUT MARGIN IS LESS THAN 600 FEET USING THE NOMINAL SPEEDBRAKE RETRACT OPTION. ©[050495-1745D]

Monte Carlo analysis in April 1992 and reconfirmed in October 1994 determined that less than 1000 feet (600 feet) are required to protect for the environmental and procedural variations in order to prevent crossing the end of the defined runway. This analysis accounted for landing gear deploy altitude variations, trajectory errors at preflare, 3-sigma ADTA errors, density altitude variations, surface wind changes, and variations in the design head/tail upper level wind profile. Also assumed was perfect execution of the braking procedures as described in paragraph A. However, the 1000-foot margin was chosen to provide additional protection for other procedural variations and dispersions outside those used in the Monte Carlo analysis. ©[050495-1745D]

For runways without a barrier, an equivalent overrun of 1000 feet is protected. This overrun protects for loss/decreased braking or stopping capability or significant dispersions which result in a longer rollout. Therefore, a 2000-foot margin is required from the end of the usable overrun (load-bearing surface). At Ben Guerir, consideration will be given to use of the 1500 feet of packed dirt when it is dry and load bearing.

Engaging the barrier is undesirable because it can possibly result in damage to the main gear doors, air data probes, and a limited number of tiles. However, barrier engagement is safe at speeds up to 100 kgs. This rule would, on a nominal day with no dispersions and nominal drag chute deployment, result in an orbiter stopping more than 1400 feet from the barrier. On a nondispersed day when the drag chute fails, this rule would allow an orbiter stop at the barrier (no engagement). Barrier engagement would occur only on a day when the drag chute fails and dispersions result in a long rollout. Since barriers are only present at TAL sites, and the resultant damage to orbiter tiles, gear doors, ADTA, etc. is only a turnaround issue, the risk of barrier engagement is considered acceptable in order to launch on a given day.

Rules {A2.1.1-1}, PRELAUNCH GO/NO-GO REQUIREMENTS, {A4.1.3-7}, PLS/EOM LANDING OPPORTUNITY REQUIREMENTS; {A10.1.2-3A}, APU ENTRY START TIME, and {A10.1.4-1}, HYDRAULIC SYSTEM CONFIGURATION, reference this rule. ©[050495-1745D] ©[072795-1788B]

FLIGHT RULES

A4.1.3-9 DEORBIT PRIORITY FOR EOM WEATHER

FORECAST VIOLATIONS (REF. RULE {A2.1.1-6}, LANDING SITE WEATHER CRITERIA) AT THE NOMINAL EOM TIME WILL RESULT IN SELECTION OF ONE OF THE FOLLOWING OPTIONS LISTED IN ORDER OF PRIORITY: ©[120894-1622B]

- A. DEORBIT TO PLS AT NOMINAL EOM TIME OR ONE OR MORE ORBITS LATE TO ALTERNATE RUNWAYS (IF REQUIRED FOR WINDS, SUN ANGLE, OR ISOLATED CLOUD COVERAGE).
- B. DEORBIT TO PLS EARLY ON EOM DAY.
- C. DEORBIT TO PLS 24 HOURS LATE.
- D. DEORBIT TO PLS DAILY OPPORTUNITY PRIOR TO NOMINAL EOM DAY.
- E. DEORBIT TO SLS.
- F. RELAX WEATHER CRITERIA.

Deorbit to the primary landing site is always desirable due to convoy/ground operations support and crew familiarity. Options A through D provide a priority list of options to deorbit to the primary landing site. Should it not be possible to deorbit to the primary site, the secondary landing site will be utilized (option E). Weather criteria will be relaxed real time should both the primary and secondary landing sites be unacceptable.

Rule {A2.1.4-7}, LANDING SITE SELECTION, and Rule {A2.1.6-1}, CONTINGENCY ACTION SUMMARY, reference this rule.

FLIGHT RULES

A4.1.3-10 AIMPOINT, EVALUATION VELOCITY, AND SHORT FIELD SELECTION

- A. AIMPOINT SELECTION - AIMPOINT EVALUATION WILL ASSUME AUTO SPEEDBRAKE AND WILL NOT MODEL ANY MANUAL PROCEDURES DESIGNED TO INCREASE TOUCHDOWN DISTANCE. ©[072795-1788B]
1. IF THE PREDICTED TOUCHDOWN POINT USING THE NOMINAL AIMPOINT IS < 1000 FEET PAST THE RUNWAY THRESHOLD, THEN THE CLOSE-IN AIMPOINT WILL BE SELECTED.
 2. IF THE PREDICTED TOUCHDOWN POINT IS < 1000 FEET PAST THE RUNWAY THRESHOLD FOR BOTH THE NOMINAL AND CLOSE-IN AIMPOINTS, THE RUNWAY IS NO-GO. FOR DAYLIGHT LAKEBED LANDINGS ONLY, IF AFTER APPLYING ALL TECHNIQUES (CLOSE-IN AIMPOINT, ALTERNATE RUNWAY) THE PREDICTED TOUCHDOWN POINT IS STILL < 1000 FEET, CONSIDERATION SHALL BE GIVEN TO RELAXING THE 1000-FOOT CONSTRAINT RATHER THAN DELAYING DEORBIT OR SELECTING AN ALTERNATE LANDING SITE.
 3. FOR RTLS WITH LIGHT RAIN SHOWERS IN THE APPROACH CORRIDOR (FLIGHT RULE {A2.1.1-1C.4}), IF THE PREDICTED TOUCHDOWN POINT IS < 2000 FEET PAST THE RUNWAY THRESHOLD FOR BOTH NOMINAL AND CLOSE-IN AIMPOINTS, THE RUNWAY IS NO-GO.

NOTE: MANUAL SPEEDBRAKE RETRACTION AT 3000 FEET AGL MAY BE CONSIDERED TO ACHIEVE THE 2000-FOOT MINIMUM TOUCHDOWN ENERGY.
©[020196-1808A]

This rule is designed as a planning guide and represents crew and flight controller inputs developed over many flights. All of these criteria were discussed at Flight Techniques and other meetings.

A TD point 1000 feet from the runway threshold was selected to accommodate variations in actual TD point from prelanding predictions due to off-nominal EAS, landing gear deploy altitude, and deviations from the forecast wind profile. With the increased margins available on a lakebed runway, the risks of landing closer to the threshold are significantly reduced. Therefore, engineering judgment may be used to accept a TD point of less than 1000 feet in order to avoid an otherwise NO-GO situation on a lakebed runway if no increased risk is identified. Factors involved in making this assessment include visibility restrictions, underrun characteristics (hardness, surface conditions, obstructions, etc.), the availability of landing aids, wind persistence predictions, and pilot (e.g., STA) judgment and recommendations. Due to visibility restrictions at night, however, the 1000-foot criterion always applies to night landings on lakebed runways.

FLIGHT RULES

THIS RULE CONTINUED ON NEXT PAGE

FLIGHT RULES

A4.1.3-10

AIMPOINT, EVALUATION VELOCITY, AND SHORT FIELD SELECTION (CONTINUED)

There are two aimpoints used to locate the base of the outer glide slope, one at 7500 feet from the threshold (nominal) and one at 6500 feet from the threshold (close-in). Aimpoint selection is based on an evaluation of the predicted TD point and speedbrake setting using current and forecast winds, density altitude, and orbiter weight. The descent design system (DDS) and the Approach and Landing Plan (ALP) processor are used to compute these parameters. ©[072795-1788B]

Tile damage due to showers encountered during fly back could result in a loss of up to 1000 ft of touchdown distance. Typical touchdown distances carry adequate margin to protect this type of energy loss. A dispersed entry that is flown through a shower on a day that predicted touchdown conditions are at the limits specified in Rule {A4.1.3-10}, AIMPOINT EVALUATION VELOCITY, AND SHORT FIELD SELECTION, could result in a vehicle touchdown on the edge of the underrun. The touchdown distance is increased for RTLS to handle the tile damage combined with the other ©[020196-1808A]

4. IF THE PREDICTED SPEEDBRAKE RETRACT CALCULATION INDICATES THAT THE SPEEDBRAKE WILL BE COMMANDED CLOSED (15 PERCENT) AT BOTH 3000 FEET AGL AND 500 FEET AGL USING THE NOMINAL AIMPOINT, THEN THE CLOSE-IN AIMPOINT MAY BE SELECTED TO ACHIEVE A PREDICTED TOUCHDOWN POINT CLOSER TO THE GUIDANCE TARGET (NOMINALLY 2500 FEET) AND POSSIBLY GAIN ADDITIONAL SPEEDBRAKE, PROVIDED THAT ROLLOUT MARGIN AND BRAKE ENERGY CONSTRAINTS (REF. RULE {A4.1.3-8}, TIRE SPEED, BRAKING, AND ROLLOUT REQUIREMENTS) ARE STILL SATISFIED. ©[072795-1788B]_©[020196-1808A]_©[101096-4210]

Approach and landing guidance was designed to control the orbiter's TD energy state by modulating the speedbrake. Using the speedbrake retract I-loads, guidance will command a speedbrake position that should result in a targeted energy state at TD of 195 knots EAS (205 KEAS heavyweight) at 2500 feet past the runway threshold. At 3000 feet AGL, if guidance predicts that the TD energy state will be less than that targeted, the speedbrake will be commanded fully closed. In this case, selecting the close-in aimpoint will provide an additional 1000 feet of energy margin at TD and may result in carrying a small amount of speedbrake for energy control. The preference for open speedbrake and touchdown as close as possible to the 2500 foot guidance target does not preclude considering either aimpoint for other reasons, such as conditions which result in a different aimpoint recommendation from the STA. Rollout margin and brake energy requirements, as specified in Rule {A4.1.3-8}, TIRE SPEED, BRAKING, AND ROLLOUT REQUIREMENTS, must still be satisfied after selection of the close-in aimpoint. If selection of the close-in aimpoint results in violation of these criteria, the nominal aimpoint will be used. ©[101096-4210]

THIS RULE CONTINUED ON NEXT PAGE

FLIGHT RULES

A4.1.3-10 AIMPOINT, EVALUATION VELOCITY, AND SHORT FIELD SELECTION (CONTINUED)

B. EVALUATION VELOCITY AND SHORT FIELD SELECTION - THE THREE EVALUATION TOUCHDOWN VELOCITIES ASSOCIATED WITH THE TWO SPEEDBRAKE RETRACT OPTIONS ARE DEFINED IN THE FOLLOWING TABLE :

TABLE {A4.1.3-10-I} - EVALUATION TD EAS AND SHORT FIELD SELECTION

SPDBRK RETRACT OPTION	CONDITIONS/SELECTION CRITERIA	EVALUATION TD EAS-KTS			
		-20°OGS (LIGHTWEIGHT)		-18°OGS (HEAVYWEIGHT)	
	I-LOAD SET:				
	LANDING WEIGHT - KLB:	WT<200	200≤WT≤220 [3]	220 [3]<WT<245	WT ≥ 245
NOMINAL	NOMINAL EVALUATION TD EAS	195 [1]		205 [1]	
	IF THE TD POINT AT 195 KEAS <1000 FT FOR BOTH NOMINAL AND CLOSE-IN AIMPOINTS	185	N/A	N/A	
	IF ASCENT INTACT ABORT SITE TD MARGIN IS THE ONLY FACTOR CONSTRAINING LAUNCH	N/A		195	N/A
SHORT FIELD	WILL BE SELECTED TO ACHIEVE THE NECESSARY ROLLOUT MARGIN, BRAKE ENERGY, OR TIRE SPEED LIMITS.	185 [1]		195 [1]	205 [2]

- [1] GUIDANCE TARGETS FOR 2500 FT DOWNRANGE.
- [2] THIS OPTION CANNOT BE USED FOR TIRE SPEED MARGIN, BUT MAY BE USED FOR ROLLOUT MARGIN OR BRAKE ENERGY. FOR THIS WEIGHT ONLY, THE TOUCHDOWN TARGET IS 1500 FEET DOWNRANGE.
- [3] GLIDESLOPE IS BASED ON THE WEIGHT SWITCHPOINT I-LOAD WHICH IS NOMINALLY 220 KLBS, BUT MAY BE SLIGHTLY MORE OR LESS ON A FLIGHT-SPECIFIC BASIS. REF THIS RATIONALE. @[072795-1788B]

The intent of modeling the TD prediction so that it assumes auto speedbrake and does not model manual procedures such as high EAS on the outer glide slope is to ensure that nonstandard procedures are not used in order to make the touchdown conditions GO. @[072795-1788B]

There are also two speedbrake retract options, nominal and short field, which are used to control touchdown tire speed, rollout margin, and /or brake energy. The short field logic dissipates 1000 feet of touchdown energy, which can be equated to a reduction of 10 knots in touchdown speed. The rollout margin, brake energy, and tire speed parameters are also computed by DDS and ALP during real-time approach and landing analysis.

THIS RULE CONTINUED ON NEXT PAGE

FLIGHT RULES

A4.1.3-10

AIMPOINT, EVALUATION VELOCITY, AND SHORT FIELD SELECTION (CONTINUED)

The touchdown speed prediction is a function of which I-load set (heavyweight or lightweight) onboard guidance has selected, and the speedbrake retract option (nominal or short field). The weight switch point I-load which distinguishes a lightweight vehicle from a heavyweight vehicle is normally 220,000 lbs. During pre-flight design, when the predicted weight is near 220,000 lbs, the switch point I-load may be either 222,000 or 218,000 lbs to make the flight-day I-load more predictable. With the normal speedbrake retract option selected, guidance will target all lightweight vehicles to touch down at 195 kts, and all heavyweight vehicles to touch down at 205 kts. With the short field speedbrake retract option selected, guidance will target lightweight TD at 185 KEAS and heavyweight at 195 KEAS. The intent is to use the same flight rule evaluation touchdown speed in approach and landing analysis as is used in onboard guidance. The touchdown speed design targets provide an energy reserve which takes into account such factors as tailscape, nose gear slapdown limits, atmospheric effects, manual procedures, and orbiter center-of-gravity. Evaluation speeds may vary from the guidance target for very light or very heavy vehicles, and for other operational concerns as discussed below.

The short field speedbrake retract logic was designed to permit landing and stopping safely on the shorter TAL runways. It may also be selected on any landing opportunity to provide additional tire speed margin on hot or tailwind days. When the short field option is selected, guidance will decrease the targeted TD energy by 1000 ft, which is equivalent to landing 10 kts slower at the nominal 2500 ft downrange TD distance. For operational and training reasons, selecting the short field option for any reason should cue the CDR to target TD speed at 185 KEAS for lightweight landings, or 195 KEAS for heavyweight landings (provided that the weight is < 245,000 lbs).

Because of the reduced nose gear slapdown loads with weights less than 200,000 lbs, it is acceptable to plan for a touchdown of 185 kts rather than 195 kts. However, operationally, it is desirable to land at 195 knots rather than 185 knots for lightweight cases to reduce the number of landing speeds that crews must train for. For this reason, with an orbiter weight less than 200k lbs, both the nominal and close-in aimpoints will be evaluated at 195 knots prior to evaluation of 185 knots as the targeted TD EAS. Use of 185 knots is preferable to delaying deorbit (Ascent/Entry Splinter Flight Techniques Panel, Landing/Rollout #1, June 20, 1990). ©[072795-1788B]

THIS RULE CONTINUED ON NEXT PAGE

FLIGHT RULES

A4.1.3-10

AIMPOINT, EVALUATION VELOCITY, AND SHORT FIELD SELECTION (CONTINUED)

For the heavyweight case, it may be preferable to evaluate touchdown at 195 knots if inadequate TD margin is achieved at 205 knots at the intact abort site, rather than delay a launch. For landing weights ³ 245k lbs, TD evaluations should use a touchdown speed of 205 keas due to orbiter tailscrape restrictions. ©[072795-1788B]

The short field logic should only be selected to achieve the necessary tire speed margin, rollout margin, or brake energy limits, and not to improve TD margin. Using short field to improve touchdown conditions essentially reduce the touchdown energy, which is in conflict with the decisions of the 1991 landing performance panel.

If entry analysis shows TD ground speed > 214 kts using the short field option, that runway will be NO-GO for landing. When the short field logic is selected for tire speed margin, the crew will be notified of the 10 kt slower target/evaluation TD EAS.

Reference Rule {A4.1.3-8}, TIRE SPEED, BRAKING, AND ROLLOUT REQUIREMENTS. Rule {A2.1.1-6}, LANDING SITE WEATHER CRITERIA, references this rule. ©[072795-1788B]

FLIGHT RULES

A4.1.3-11 RUNWAY ACCEPTABILITY CONDITIONS

A. THE FOLLOWING CONDITIONS WILL NO-GO USE OF ANY RUNWAY TO WHICH THEY APPLY. CONDITIONS ARE ASSESSED OVER THE ENTIRE SURFACE OF THE RUNWAY. @[111094-1622B]

1. STANDING WATER, SNOW, OR ICE
2. WET OR SLUSHY SURFACE MATERIAL (LAKEBEDS)
3. STRUCTURAL FAILURES (BREAKTHROUGH, POTHOLE, FISSURE)

Moisture, standing water, snow or ice on the runway may result in hydroplaning, loss of traction, and loss of brake effectiveness. Wet, slushy lakebed surface materials thrown up during landing and roll out can result in orbiter damage. Due to the large load bearing requirements of the orbiter, structural failures are not acceptable on any surface type. Fissures or cracks, which may lead to or be evidence of structural failures, are not allowable. Potholes are not acceptable owing to the possibility of tire or strut damage caused by impact. Reference Entry FTP #42.

B. THE FOLLOWING INSPECTIONS ARE REQUIRED TO EVALUATE LAKEBED RUNWAY STATUS FOLLOWING PERIODS OF PRECIPITATION. CRITERIA FOR RUNWAY ACCEPTABILITY ARE DOCUMENTED IN THE PRD.

1. LAKEBED RED FOR LESS THAN 7 CONSECUTIVE DAYS -- VISUAL INSPECTION
2. LAKEBED RED FOR 7 OR MORE CONSECUTIVE DAYS -- AUTOMATED CONE PENETROMETER (ACP) TEST
3. EVIDENCE OR SUSPICION OF FISSURING IN THE PROXIMITY OF A RUNWAY -- SURFACE INTERFACE RADAR (SIR) TEST AND ACP OF RADAR ANOMALIES

The Airfield Manager in conjunction with the Ground OPS Manager determines the status of a lakebed runway. The Launch and Landing PRD, Vol. 1, Section 6000, documents the certification of lakebed runways after a period of significant wetting. Water on the lakebed for 7 or more consecutive days lowers the subsurface soil bearing strength to the point where it may not be strong enough to support an Orbiter landing. The ACP is an inexpensive test to evaluate runway bearing strength, which takes about 4 hours from call up to completion.

Rules {A2.1.1-1}, PRELAUNCH GO/NO-GO REQUIREMENTS; {A2.1.1-2}, ABORT LANDING SITE REQUIREMENTS; {A2.1.3-2}, EXTENSION DAY REQUIREMENTS; and {A4.1.3-7}, PLS/EOM LANDING OPPORTUNITY REQUIREMENTS, reference this rule. @[111094-1622B]

FLIGHT RULES

A4.1.3-12 LOWER LEVEL MEASURED WIND AND ATMOSPHERIC DATA

A. LOW LEVEL WINDS @[111094-1622B]

LOWER LEVEL MEASURED WINDS (0 TO 10K FEET) ARE USED TO ASSESS TOUCHDOWN, ROLL OUT, AND BRAKE ENERGY CONDITIONS IN ORDER TO SUPPORT COMMIT TO LAUNCH OR DEORBIT DECISIONS.

1. PRELAUNCH: A SOURCE FOR ACCURATE LOWER LEVEL MEASURED WINDS IS MANDATORY FOR RTLS, TAL AND AOA(IF REQUIRED) WITH THE FOLLOWING EXCEPTIONS: WITH THE FOLLOWING EXCEPTIONS: @[020196-1799A]

IF A SOURCE FOR LOWER LEVEL WINDS IS NOT AVAILABLE AT BEN GUERIR, BEN 36 WITH CLOSE-IN AIMPOINT WILL BE USED UNLESS UNUSUAL WIND CONDITIONS ARE SUSPECTED.

2. PREDEORBIT: A SOURCE FOR ACCURATE LOW LEVEL MEASURED WINDS IS MANDATORY FOR FD1 OR FD2 PLS, NEXT PLS, AND EOM.

NOTE: FOR AOA OR FD1 PLS TO NORTHRUP, STANDARD BALLOON DATA IS NOT AVAILABLE. FOR THESE CASES, THE WIND PROFILERS DATA (IF AVAILABLE) AND FORECAST WINDS WITH THE 62 STANDARD ATMOSPHERE WILL BE USED FOR TOUCHDOWN AND ROLLOUT ANALYSIS. @[020196-1799A]

B. ATMOSPHERIC CONDITIONS

A SOURCE FOR ACCURATELY MEASURING ATMOSPHERIC CONDITIONS FROM 0 TO 10K FEET IS MANDATORY WHEN INVERSIONS ARE SUSPECTED IN ORDER TO OBTAIN A MORE DETAILED AND RELIABLE FORECAST NEEDED TO SUPPORT COMMIT TO LAUNCH AND DEORBIT DECISIONS FOR EOM AND INTACT ABORT SITES.

FLIGHT RULES

A source of accurately measured wind conditions at the landing site is necessary to support detailed landing analysis of touchdown, roll out, and brake energy conditions as part of the prelaunch GO/NO-GO decision process. The measured wind data at the landing site is also crucial to support an accurate and detailed forecast of the low-level altitude winds (0 to 10K feet). Sources that can provide this type of detailed wind measurements include radio theodolites, rawinsondes, and jimspheres. Since wind persistence is a function of the dynamics of the atmosphere, the number of wind measurements required will remain an SMG decision. When temperature inversions or wind shears are suspected, a source for accurately measuring atmospheric conditions is needed to support a more detailed forecast. Without measured atmospheric data, but with low-level local wind measurements, a wind shear could be detected and/or possibly be forecast based on previous measurements and other weather observation equipment.

THIS RULE CONTINUED ON NEXT PAGE

FLIGHT RULES

A4.1.3-12

LOWER LEVEL MEASURED WIND AND ATMOSPHERIC DATA (CONTINUED)

The detailed landing analysis of both forecast and current conditions is critical for short runways such as TAL sites. If weather conditions are favorable in that no low-level shears are suspect, the requirement for measured atmospheric data is waived, but detailed wind measurements are still required to support the landing analysis. The Ben Guerir exception minimizes the use of the Moron TAL site, which has a shorter runway and smaller ascent abort window. Although low-level wind data are mandatory to determine speedbrake setting, touchdown location, brake energy, aimpoint selection, etc., the special Flight Rules FRCB (September 6, 1988) determined that these data are not mandatory for BEN 36 because of the extensive overrun available on this end of the runway. ©[111094-1622B]

In order to save money, the Program agreed not to release balloons at Northrup in the prelaunch timeframe. If Northrup is the prime AOA site, touchdown and rollout analysis will be based on the forecast winds aloft which are made from the balloon data from the semi-daily releases from Holliman AFB. If the White Sands wind profilers data are available, it will be used for the touchdown and rollout analysis. Furthermore, analysis showed that the 62 standard and the monthly mean atmosphere showed only slight differences in the touchdown and rollout constraints. Therefore, for procedural simplicity, it was decided that the 62 standard atmosphere would be used. ©[020196-1799A]

Rules {A2.1.1-1}, PRELAUNCH GO/NO-GO REQUIREMENTS; {A2.1.1-2}, ABORT LANDING SITE REQUIREMENTS; and {A4.1.3-7}, PLS/EOM LANDING OPPORTUNITY REQUIREMENTS reference this rule. ©[111094-1622B]

FLIGHT RULES

ENTRY PLANNING

A4.1.4-1 IMU ALIGNMENT

DEORBIT WILL NOT BE ATTEMPTED IF THE IMU ATTITUDE ERROR AT ENTRY INTERFACE IS PREDICTED TO BE GREATER THAN 0.5 DEGREE FOR NOMINAL DEORBIT, DEORBIT WILL BE DELAYED IF THE ERROR IS > 0.25 DEGREE, IN ORDER TO PERFORM AN IMU ALIGNMENT TO CORRECT ERRORS TO < 0.25 DEGREE. FOR CONTINGENCY SITUATIONS, ERRORS BETWEEN 0.25 DEGREE AND 0.5 DEGREE ARE ACCEPTABLE.

Acceptable IMU attitude errors for entry were derived based on two factors, the post-blackout navigation downtrack error and the angle of attack errors.

a. *Navigation downtrack error - An analysis presented at Entry Flight Techniques Panel Meeting #6 on 11/9/77 established IMU alignment error limits as follows:*

- (1) *For a contingency in which exceeding system performance margins is necessary during entry, the maximum IMU RSS misalignment allowed at EI is 0.5 degree (flight safety limit; STS-4, EFTP 3). A misalignment at EI of 0.5 degree would result in navigation errors that, although corrected at TACAN acquisition (~M7), would result in adjustments to the entry trajectory that could exceed the venting control limit of 300 psf in the transonic region (ref. Rule {A4.1.5-7A}.2, ENTRY LIMITS). Errors greater than 0.5 degree will violate the 342 psf flight control design limit for dynamic pressure in the M5 to M3 region. The 0.5 degree misalignment corresponds to a downrange error of 10 nm at an altitude of 130,000 feet, which violates the delta state update limits (ref. Rule {A4.1.5-4B}, DELTA STATE POSITION UPDATES), but is within the TACAN capability to correct. @ED 1*
- (2) *The 0.25 degree RSS limit is intended to protect system performance margins during entry. A maximum misalignment at EI of 0.25 degree under worst case conditions protects the limiting parameter, a dynamic pressure of 300 psf, that conforms to compartment venting constraints in the transonic region. The 0.25 degree misalignment corresponds to a downrange error of approximately 6 nm at an altitude of 130,000 feet, which is within TACAN capability to correct and does not violate the delta state update criteria.*

FLIGHT RULES

- b. *Angle of attack errors - Another consideration was angle of attack error. An extensive series of runs was made on the SPS $\text{\AE}1$ and FSL to define the loss of control boundary as a function of angle of attack errors. Results of these studies were presented at Flight Techniques. Angle of attack errors can come from IMU alignment errors and winds. Tolerance to angle of attack errors is a function of aerodynamic variations, FCS response, and RCS jet authority/availability. With worst case winds, three-sigma AERO variations, and two yaw RCS jet failures, simulation runs indicated a potential loss of control. Therefore, it was required to minimize the IMU contribution to angle of attack error, 0.5 degree was deemed to be the maximum allowable with 0.25 degree highly desirable.*

THIS RULE CONTINUED ON NEXT PAGE

FLIGHT RULES

A4.1.4-1 IMU ALIGNMENT (CONTINUED)

Rules {A4.1.3-1}, ONBOARD NAVIGATION MAINTENANCE; {A4.1.4-4}, DOWNTRACK ERROR; Rule {A8.1.1-12}, HEADSUP DISPLAY AND CREW OPTICAL ALIGNMENT SIGHT (COAS) ALIGNMENT; {A8.1.3-9E}, HUD/COAS SYSTEM MANAGEMENT; and {A8.1.5-11}B, E, G, H, I, and J, IMU SYSTEM MANAGEMENT, reference this rule.

~~A4.1.4-2~~ TARGETING PRIORITIES

A4.1.4-2 DEORBIT BURN TARGETING PRIORITIES

A. THE DEORBIT BURN WILL BE TARGETED TO MEET AS MANY OF THE FOLLOWING OBJECTIVES AS POSSIBLE, IN ORDER OF PRIORITY FROM HIGHEST TO LOWEST, USING THE AVAILABLE OMS PROPELLANT, AS DEFINED BY RULE {A6.1.4-6}, DEORBIT PLANNING CRITERIA, WHILE KEEPING THE CG IN THE NOMINAL BOX AS DEFINED BY RULE {A4.1.4-3}, CG PLANNING. @[081497-4178B]

1. STEEP TARGETS WITH 3-SIGMA N-CYCLES
2. OMS TANK LANDING CONSTRAINTS (< 21.2 PERCENT OX, 21.1% PERCENT FU)
3. LANDING WEIGHT ≤ FLIGHT RULE LIMIT
4. RCS COMPLETION AT SAFE HP
5. TWO MIN TIG SLIP FOR NO-FAIL DEORBIT
6. OMS TANK FAIL HPS ≥ SAFE HP
7. ONE DOWNMODE OPTION FROM TIG THROUGH CUTOFF
8. MAXIMIZE TIG SLIP UP TO 5 MIN FOR ONE ENGINE FAIL CASE
9. AOS DURING THE BURN

B. IF STEEP TARGETS CANNOT BE ACHIEVED WITH THE AVAILABLE OMS, THE FOLLOWING ACTIONS WILL BE TAKEN IN ORDER OF PRIORITY TO ACHIEVE STEEP TARGETS WITH 3-SIGMA N-CYCLES.

1. TARGET USING MAXIMUM POSSIBLE OMS, DOWN TO ZERO USABLE OMS (AS DEFINED IN RULE {A6.1.5-1}, OMS USABLE PROPELLANT) IN THE CRITICAL OMS SYSTEM. @[081497-4178B]

FLIGHT RULES

~~A. THE FOLLOWING TECHNIQUES, IN ORDER OF PRIORITY, WILL BE USED TO TARGET THE DEORBIT BURN:~~

- ~~1. STEEP TARGETS WITH THE NOMINAL N-CYCLES AND PROVIDE RCS DOWNMODING AT TIC.~~
- ~~2. STEEP TARGETS WITH THE 3-SIGMA N-CYCLES AND PROVIDE RCS DOWNMODING AT TIC.~~
- ~~3. STEEP TARGETS WITH THE 3-SIGMA N-CYCLES.~~
- ~~4. PERFORM A FORWARD RCS TRANSLATION TO LOWER PERIGEE. IT IS HIGHLY DESIRABLE TO PERFORM THIS TRANSLATION NO LATER THAN TWO ORBITS PRIOR TO DEORBIT. THE TRANSLATION MAY BE DONE IF WITHIN TWO ORBITS OF DEORBIT ONLY IF TELEMETRY COVERAGE WILL PROVIDE VALID MANEUVER CONFIRMATION.~~
- ~~5. ARCS COMPLETION DOWN TO AFT QUANTITY 1.~~
- ~~6. TARGET TO USE PREBANK UP TO 90 DEGREES WITH THE 3-SIGMA N-CYCLES.~~
- ~~7. SHALLOW TARGETS (90 DEGREES PREBANK) AND BACKOFF N-CYCLES DOWN TO THE VALUE WHICH PROVIDES 3-SIGMA PROTECTION FROM SKIPOUT (N-CYCLES=2).~~
- ~~8. ARCS COMPLETION DOWN TO AFT QUANTITY 2.~~

THIS RULE CONTINUED ON NEXT PAGE

FLIGHT RULES

A4.1.4-2 DEORBIT BURN TARGETING PRIORITIES (CONTINUED)

2. CG MANAGEMENT TECHNIQUES SHOULD BE UTILIZED TO MAXIMIZE THE AVAILABLE PROPELLANT WHILE MAINTAINING THE C-G- WITHIN NOMINAL LIMITS (REF RULE {A4.1.4-3}, C-G- PLANNING) @081497-4178B)
- ~~B. CONTINGENCIES REQUIRING RAPID RETARGETING WILL BE TARGETED TO THE OMS OPTIMUM SOLUTION.~~
3. PERFORM A MULTI-STAGE DEORBIT BY EXECUTING AN FRCS AND/OR ARCS PERIGEE ADJUST WITH PROPELLANT ABOVE THE MCR PER FRULE {A6.1.4-5}, OMS PROPELLANT DEFICIENCY FOR DEORBIT. IT IS HIGHLY DESIRABLE THAT THIS MANEUVER(S) OCCUR AT LEAST TWO ORBITS PRIOR TO DEORBIT TIG. IT MAY BE PERFORMED < TWO ORBITS BEFORE DEORBIT IF TELEMETRY COVERAGE WILL PROVIDE FOR MANEUVER CONFIRMATION.
4. IF IT IS NOT POSSIBLE TO PERFORM A PERIGEE ADJUST PRIOR TO DEORBIT, COMPLETE THE BURN WITH AFT RCS DOWN TO AFT QTY 1 AND, IF REQUIRED, ALL FRCS REMAINING POST BURN. OPERATIONALLY, THE AFT RCS CAN BE BURNED SIMULTANEOUSLY WITH THE OMS.
- C. IF STEEP TARGETS WERE NOT ACHIEVED THROUGH THE ACTIONS IN PARAGRAPH B, OTHER CONUS DEORBIT OPPORTUNITIES SHOULD BE CONSIDERED IF THE REQUIRED DEORBIT DELTA-V WOULD ALLOW THE ACHIEVEMENT OF STEEP TARGETS. IF STEEP TARGETS TO A CONUS SITE CANNOT BE ACCOMPLISHED, THE FOLLOWING ACTIONS WILL BE TAKEN TO ACHIEVE SHALLOW TARGETS.
1. TARGETED PREBANK UP TO 90 DEGREES WITH 3-SIGMA N-CYCLES
2. TARGETED PREBANK OF 90 DEGREES WITH MINIMUM N-CYCLES TO PREVENT SKIPOUT (N-CYCLE = 2)
3. INCREASE THE AMOUNT OF RCS PROPELLANT AVAILABLE FOR A PERIGEE ADJUST OR ARCS COMPLETION SUCH THAT ONLY TANK EXPULSION EFFICIENCY (FRULE {A6.1.5-5A}, AFT RCS REDLINES, ON-ORBIT SINGLE AFT RCS POD QUANTITY REDLINE) IS PROTECTED POST DEORBIT.
4. IF POSSIBLE, INCREASE THE AVAILABLE PROPELLANT BY EXPANDING THE C-G- LIMITS TO THE CONTINGENCY BOX.

FLIGHT RULES

5. BURN THE OMS TANKS TO DEPLETION. @[081497-4178B]

~~NOTE: VEHICLE CG MANAGEMENT CONSTRAINTS CAN INFLUENCE DEORBIT TARGETING OPTIONS. REFERENCE RULE {A4.1.4-3C}, CG PLANNING.~~

~~This rule establishes the methods which will be used to target the deorbit burn in order to achieve an acceptable entry. The order has been established to minimize the impact to crew safety and maximize vehicle integrity.~~

~~The first four steps have no impact on vehicle integrity.~~

~~The first step is the prime method used. Targeting the deorbit burn to try to protect RCS downmoding at TIG has been standard procedure since the beginning of the Space Shuttle Program. This is usually done by planning the TIG to be 1 minute prior to the RCS optimum TIG when propellant permits.~~

~~If RCS downmoding is not available, targeting with the nominal N cycles, then the 3-sigma N cycles will be used. While changing to the 3-sigma N cycles may not be enough to achieve RCS downmoding at TIG, it will decrease the deorbit delta V required and enhance RCS completion post TIG.~~

~~An N cycle is defined as the number of guidance cycles after the initiation of closed-loop guidance before the first non-zero roll command. The 3-sigma N cycles reduce the entry dispersion-protection level from the nominal, but still protects for the 3-sigma entry dispersions. The nominal and 3-sigma N cycle are flight specific since the inclination and seasonal effects are factors used to define the specific N cycle. Reducing the targeted number of N cycles from the nominal to the 3-sigma N cycles result in a slightly shallower entry condition at EI and decrease in the deorbit delta V. Targeting with the 3-sigma N cycles will still assure nominal entry heating levels, correct convergency onto the drag profile, and protection of recovery prebank capability.~~

~~If the delta V available is greater than that required to deorbit with the OMS at the OMS optimum TIG but not enough to support RCS downmoding, the TIG will still be planned as early as possible prior to the OMS optimum TIG. However, in this case the TIG will be no earlier than the RCS optimum TIG minus 1 minute. Backing up TIG from the OMS optimum point and targeting with the 3-sigma N cycles are done to allow RCS downmoding to be achieved as soon as possible during the deorbit burn.~~

~~Priority 4 reduces the required deorbit delta V by performing a perigee adjust at least two orbits prior to deorbit using the forward RCS. This allows for both burn confirmation and collection of some tracking data to take out the resulting trajectory dispersions.~~

THIS RULE CONTINUED ON NEXT PAGE

FLIGHT RULES

A4.1.4-2 DEORBIT BURN TARGETING PRIORITIES (CONTINUED)

6. INCREASE THE AMOUNT OF RCS PROPELLANT AVAILABLE FOR A PERIGEE ADJUST OR ARCS COMPLETION SUCH THAT ONLY AFT QTY 2 (FRULE {A6.1.5-5D}, AFT RCS REDLINES, AFT RCS QUANTITY 1 AND 2) IS PROTECTED POST DEORBIT. @[081497-4178B]

D. CONTINGENCIES REQUIRING RAPID TARGETING WILL BE TARGETED TO THE PRIMARY THRUSTERS OPTIMUM SOLUTION, OR THE 2 OMS/1 OMS CROSSOVER POINT IF 2 OMS ARE AVAILABLE.

This rule establishes the methods that will be used to target the deorbit burn in order to achieve an acceptable entry. The order has been established to minimize the impact to crew safety and maximize vehicle integrity.

Paragraph A:

The deorbit maneuver TIG will be chosen to meet as many of the objectives listed in paragraph A as possible, in order of priority. The TIG will occur no earlier than RCS optimum minus 1 minute, and no later than the two OMS optimum.

All targeting in paragraphs A and B uses 3-sigma N-cycles. An N-cycle is defined as the number of guidance cycles after the initiation of closed loop guidance before the first non-zero roll command. Three sigma N-cycles are flight specific since the inclination and seasonal effects are factors used to define the specific N-cycle. The 3-sigma N-cycle provides protection from getting zero N-cycles with a minimum initial bank of 25 degrees at closed loop guidance initiation, in the presence of 3-sigma dispersions. Targeting with steep targets and the 3-sigma N-cycles will assure nominal entry heating levels, correct convergence onto the drag profile, and protection of recovery prebank capability.

OMS propellant quantities at landing should be less than 21.2 percent oxidizer, 21.122 percent fuel to prevent exceeding OMS/RCS pod structural loads. (Ref. SODB, Volume I, Shuttle Systems Performance and Constraints Data, Section 3.4.3.3, OMS Constraints/Limitations.) Violation of the tank landing weight constraint may cause structural damage. @[081497-4178B]

THIS RULE CONTINUED ON NEXT PAGE

FLIGHT RULES

A4.1.4-2 DEORBIT BURN TARGETING PRIORITIES (CONTINUED)

Priority A.4 protects RCS completion at Safe Hp. If a failure(s) disabled both OMS engines below Safe Hp, the burn could be completed with the remaining propellant through the RCS jets. If a failure(s) disabled both OMS engines prior to Safe Hp, the shuttle would be in an orbit with at least 48 hours of lifetime, and the deorbit burn could be retargeted to optimize for the RCS engines.
 ©[081497-4178B]

Two minutes of no-fail TIG slip protects for a case like a switch misconfiguration where no actual failures have occurred.

The OMS Tank Fail Hp's are the altitudes at which an OMS tank can fail and the targets can still be achieved using all of the remaining resources (remaining OMS, recovery prebank to the 2950 degree Fahrenheit wing leading edge temperature limit, ARCS to Aft Qty 1, and FRCS). If the tank fail Hp is below Safe Hp, there is a window where the orbiter is too low to stop the burn (Safe Hp), but too high to complete the burn using the remaining propellant. It is desirable that this window not exist; therefore, Tank Fail Hp should remain above Safe Hp if possible.

One downmode option from TIG through cutoff means that the burn can be completed in the event that the primary engines are lost (i.e., 2 OMS to 1 OMS, or 1 OMS to RCS).

The most efficient place to burn in the event that an OMS engine is lost is at the 1 OMS optimum point. TIG may be backed up from this point to gain TIG slip or comm if higher priority objectives can still be accomplished.

Paragraph B:

The actions in paragraph B allow steep targets to be achieved while still protecting the nominal RCS entry propellant redlines. The maximum usable OMS as defined by the critical system will be used for deorbit in order to protect steep targets. The burn will be targeted to cutoff when the 0 lbs usable quantity has been reached in either system, thereby protecting the tanks from being depleted.

CG management techniques as defined in Rule {A4.1.4-3}, CG PLANNING, may allow more propellant to be made available for the deorbit burn. For planning purposes, the CG at Mach 3.5 must be maintained within the nominal box ~~of +1.5 inches Y CG and 1076.7 to 1109 inches X CG.~~
 ©[091098-6717]

The ARCS and/or FRCS perigee adjust at least two orbits prior to deorbit allows both burn confirmation and collection of some tracking data to take out the resulting trajectory dispersions. The RCS perigee adjust is acceptable within two orbits of deorbit if a valid burn confirmation can be performed. Accurate ground modeling of the burn is achievable with this confirmation, assuring valid state vector confidence to target the subsequent deorbit burn.

FLIGHT RULES

If a perigee adjust could not be performed prior to deorbit, ARCS completion with propellant down to AFT Quantity 1 and, if required, a fast flip to burn the FRCS to depletion is preferred over targeting a shallow entry because it preserves steep targets with no impact to vehicle integrity.

©[081497-4178B]

THIS RULE CONTINUED ON NEXT PAGE

FLIGHT RULES

A4.1.4-2 DEORBIT BURN TARGETING PRIORITIES (CONTINUED)

Paragraph C: ©[081497-4178B]

Prior to implementing the actions in paragraph C, it may be best to deorbit to another CONUS opportunity if steep targets can be achieved. Wave off capability and orbital geometry will be the deciding factors in whether this is a feasible option. The actions in paragraph C allow for shallow targets which reduce the propellant required for deorbit. ©[081497-4178B]

Targeted prebank up to 90 degrees shallows the targets and reduces the propellant required for deorbit. This targeting priority assures drag profile convergence, but results in higher vehicle heat loads and compromises recovery prebank capability. The heat load induced by a shallow entry increases with crossrange; therefore, low crossrange opportunities should be utilized if a heat load analysis cannot be performed.

In a time critical situation, once it has been determined that some amount of prebank is required, targeting 90 degrees prebank should be considered because pre-mission products are already available. If a prebank other than 90 degrees is selected, then recovery prebank tables must be generated in real time, using a time consuming and rarely exercised procedure.

The use of minimum N-cycle in conjunction with a targeted prebank of 90 degrees will further reduce the deorbit delta-V. The use of minimum N-cycles provides protection from skipout, which is defined as zero N-cycles with an initial bank of 60 deg at closed loop guidance initiation, in the presence of 3-sigma dispersions. The resulting entry is thermally more severe and converges on the drag profile later in the entry phase.

The aft RCS propellant tanks are not certified for use below 20% percent during zero-G operation. If used below 20% percent prior to $N_z = 0.05g$, there is a risk that the tanks may fail, leaving no RCS propellant available for entry control.

Expanding the C-G- box out to the contingency limits may allow access to propellant that was previously limited by the Y C-G- limit. The contingency box may allow expansion from the nominal Y C-G- limit but for the forward end of the X C-G- box, the nominal and contingency limits are the same.

Burning the OMS tanks to depletion may destroy the engines and will only be performed after all other targeting options have been exhausted.

ARCS completion down to AFT Quantity 2 only protects low Q-bar attitude control to the point where no-yaw jet capability is possible ($N_z = 0.05g$).

Paragraph D:

FLIGHT RULES

In emergency targeting or contingency targeting cases, the primary thrusters optimum solution, or the 2 OMS/I OMS crossover solution, will be used because it can be quickly executed within the limitations of the current deorbit targeting processor. Time may not be available for a detailed analysis of the targeting. @[081497-4178B]

FLIGHT RULES

A4.1.4-3 CG PLANNING

A. CG ENVELOPE:

1. CONTINGENCY CG ENVELOPE.
2. NOMINAL CG ENVELOPE ~~(N/A FOR RTLS)~~: [@\[091098-6715\]](#)

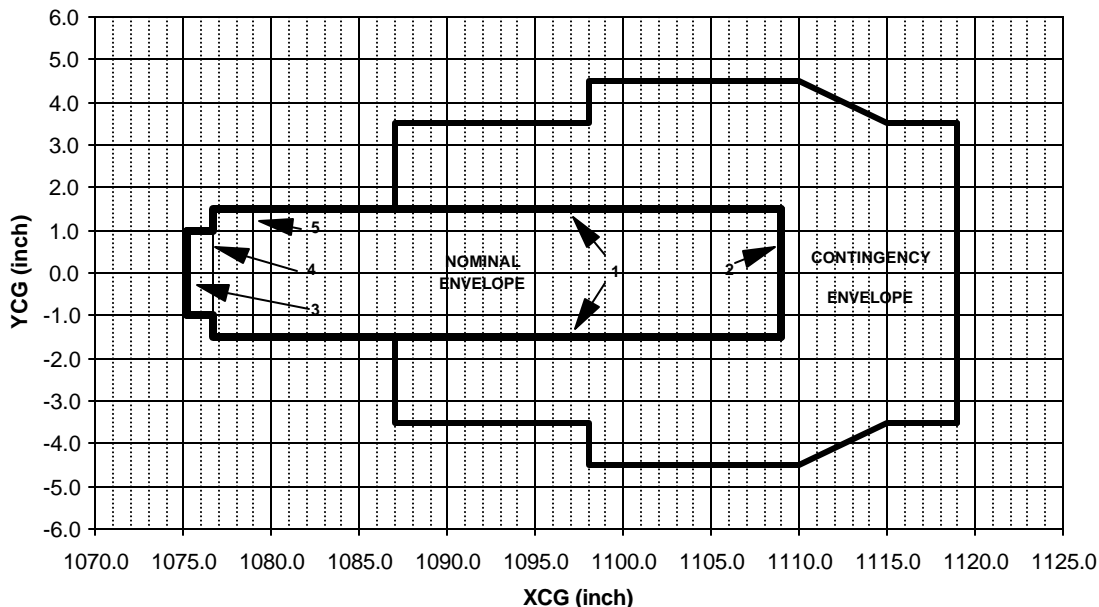

NOTES:

- [1] VERIFIED AERO BOUNDARY.
- [2] DESIGN ENVELOPE AFT LIMIT.
- [3] ~~FORWARD LIMIT FOR EOM, ATO, AND AOA FLIGHT MANIFEST FORWARD LIMIT (X=1075.2+076.7 INCHES).~~
- [4] ~~FORWARD LIMIT FOR GRTLS FOR ANGLE OF ATTACK < 30 DEGREES AND FOR TAL (X=1076.7 INCHES).~~
- [5] ~~FORWARD LIMIT FOR GRTLS FOR ANGLE OF ATTACK > 30 DEGREES (X=1079.0 INCHES).~~
- [64] NOMINAL CG ENVELOPE REFLECTS A 1-INCH UNCERTAINTY FOR X CG AND A 0.5-INCH UNCERTAINTY FOR Y CG. [@\[091098-6715\]](#)

The contingency CG envelope represents the loss of control CG boundary for OMS tank fail cases. Vehicle control beyond the nominal CG envelope, yet within the contingency CG boundary, assumes all four yaw jets are available. Due to elevon saturation, there must be no jet failures to ensure vehicle control within the contingency envelope.

No structural or thermal assessments of the vehicle have been made for CG conditions beyond the nominal envelope. Entry at these conditions could result in significant damage to the airframe and/or thermal protection system even when the vehicle is within limit flight conditions.

THIS RULE CONTINUED ON NEXT PAGE

FLIGHT RULES

A4.1.4-3 CG PLANNING (CONTINUED)

The X CG values which correspond to the Y CG values of 3.5 inches and 4.5 inches represent the breakpoints of the generic elevon schedules. The boundaries of the contingency CG box include an uncertainty of ± 1.0 inch for X CG at the forward end of the contingency box. The uncertainty for the Y CG is ± 0.5 inch.

The contingency CG envelope boundaries were derived from an analysis matrix which included: fixed mass properties; light and heavyweight vehicles; 0 and 30 percent turbulence models; and aero variations of nominal LVAR 9, LVAR 19, bent airframe, and pitching moment.

This rule also contains the nominal CG envelope that was developed to trade off the X vs. Y CG location, when required during real-time operations, in conjunction with orbiter CG management rules. In addition, the CG envelope is used preflight to evaluate the projected end of mission CG location and, if required, adjust planning to assure that the CG is within the given boundaries. The nominal CG envelope reflects the prelaunch measurement errors (± 1 inch for X, ± 0.5 inch for Y).

The CG boundaries, as they exist today, have evolved since prior to STS-1 and are a result of many iterations of analyses performed by both the JSC and Rockwell International Corporation (RIC) aerodynamic communities, and of numerous Entry Flight Techniques discussions. The shape and dimensions of the boundaries have changed many times as a function of the assumptions made and the orbiter aerodynamic data used in their generation, and they may continue to change and expand as more is learned about the orbiter capabilities.

In general, the Y limits plus and minus are constrained by lateral trim requirements. The forward X limits represent lateral-directional stability constraints and the aft X limits represent longitudinal trim requirements as constrained by thermal limits on the body-flap and elevons. The lateral trim and stability requirements for Y CG were based on flight control system performance with the following aerodynamics stress case: 1.5 yaw jets for trim, 3-sigma lateral variation set 19, L/D tolerance, auto bodyflap, +0.00025 Clo and -0.00025 Cno bent airframe coefficients, 3-degree aileron trim, 15-degree angle of attack, and 275 psf dynamic pressure at Mach 3.5, using Flight Assessment AERO Data (FAD) 14 from STS 41-D. ©[081497-4178B]

AERO/FCS stress testing has certified the CG limits to ± 2 inches Y CG for X CG's from and 1075.7 to 1110 inches X CG, and to ± 1.5 inches Y CG for X CG's from 1074.2 to 1075.7, thus exceeding the original certified end item (CEI) CG specification. However, because of mass properties uncertainties of approximately ± 1 inch in X CG and ± 0.5 inch in Y CG, the CG boundaries depicted in the flight rule nominal CG envelope are observed at Mach 3.5 for planning purposes; that is, ± 1.5 inches Y CG for X CG's from and 1076.7 to 1109 inches and ± 1 inch Y CG for X CG's from 1075.2 to 1076.7. ©[081497-4178B] ©[091098-6715]

The increase to the forward X CG limit and the associated Y CG limit was a result of analysis presented by Boeing North American Flight Control and Loads groups at the 145th Ascent/Entry Flight Techniques on December 19, 1997. ©[091098-6715]

FLIGHT RULES

THIS RULE CONTINUED ON NEXT PAGE

FLIGHT RULES

A4.1.4-3 CG PLANNING (CONTINUED)

- B. THE PLANNED ORBITER CG THROUGHOUT THE ENTRY PROFILE MUST BE WITHIN THE CG LIMITS. THE COMPUTATION OF THE CG ASSUMES NOMINAL CONSUMABLE USAGE, ENTRY MANEUVERS, AND A FORWARD SHIFT OF OMS PROPELLANT DURING ENTRY.

For real-time and preflight planning purposes, this rule states the assumptions involved for computation of the nominal EOM orbiter CG's (SODB, Volume II, section 3.0, Constraints and Limitations). The CG is to be calculated using a typical consumables profile which reflects the most realistic entry conditions.

- C. EOM PLANNING - ONLY THE CG MANAGEMENT TECHNIQUES LISTED IN PARAGRAPHS D THROUGH F WILL BE USED TO MANAGE THE EOM CG WITHIN THE CONTINGENCY CG ENVELOPE (REF. PARAGRAPH A). CONSIDERATION WILL BE GIVEN TO EXTENDING THE FLIGHT, IF ADDITIONAL MANAGEMENT WILL MINIMIZE VIOLATION OF THE NOMINAL CG ENVELOPE. @[081497-4179B]

Paragraph A represents the certified operational envelope, and analysis of performance beyond this envelope is not complete. It is of the highest priority to contain the entry CG within the orbiter control trim capability. All CG management techniques will be used to protect this constraint.

Staying in orbit longer will allow use of orbit management techniques. These tools include generation of extra water and use of additional ARCS propellant.

- D. X CG MANAGEMENT TECHNIQUES INCLUDE THE FOLLOWING:

1. RETAINING OR DUMPING ADDITIONAL POTABLE WATER.

Keeping/dumping potable water can move the X CG about 1 inch for every 375 lb of water retained/dumped for a 220,000-lb orbiter. Water dumps move the X CG further aft.

2. OPTIMIZING THE CRYO MANAGEMENT PLAN (REF. RULE {A9.1.6-6}, CRYO O2/H2 TANK QUANTITY BALANCING)

The cryo management plan can be optimized to produce a more aft CG. This is accomplished by maintaining mission margin in the center manifold, or by using the forward tanks earlier than planned.

3. RETAINING OR DUMPING FRCS. WHEN CG AND LANDING WEIGHT CONSTRAINTS ARE MET, THE FRCS WILL BE DUMPED TO ZERO. @[081497-4179B]

FLIGHT RULES

Since the FRCS tanks are significantly forward of the vehicle X CG, retaining/dumping forward propellant is a powerful tool for control of the X CG. For a 220,000-lb orbiter, the X CG can be changed by about 1 inch for every 280 lb of FRCS retained/dumped. FRCS dumps move the X CG aft. If an FRCS dump does not cause the CG envelope to be violated, then the dump should be performed. Dumping the FRCS to zero will keep landing weight to a minimum and aid in vehicle processing time.

THIS RULE CONTINUED ON NEXT PAGE

FLIGHT RULES

A4.1.4-3 CG PLANNING (CONTINUED)

4. MANAGEMENT OF OMS PROPELLANT USAGE IN DEORBIT TARGETING (REFERENCE RULE {A4.1.4-2}, TARGETING PRIORITIES, FOR PRIORITIES): @081497-4179B1

a. INCREASE OMS PROPELLANT USAGE TO MOVE THE C-G- FORWARD.

Backing up TIG from the optimum one OMS or two OMS TIG will use extra OMS propellant and move the X CG forward. For a 220,000-lb orbiter, 620 lb of OMS propellant usage will move the X CG forward by 1 inch. If additional propellant usage is required for CG control, the out-of-plane wasting technique can also be used to increase propellant usage.

b. DECREASE OMS PROPELLANT USAGE TO MOVE THE C.G. AFT.

OMS propellant can be retained by burning at the optimum OMS time. Burning at the optimum leaves most OMS available in the aft, short of targeting with a prebank. Targeted prebank can be used to decrease the deorbit propellant usage even more. For a 220,000-lb orbiter, 620 lb of OMS propellant retention moves the X CG aft by 1 inch. (Reference Rule {A4.1.4-2}, TARGETING PRIORITIES, for priorities.) @081497-04179 @081497-4179B1

54. OMS BALLAST MANAGEMENT - OMS BALLAST WILL BE RETAINED TO PROTECT THE FORWARD LIMIT OF THE CG ENVELOPE AT ANY POINT IN THE ENTRY PROFILE. THE AMOUNT OF OMS USED FOR BALLASTING WILL BE DETERMINED ASSUMING:

- a. OMS PROPELLANT USED TO THE BALLAST BASELINE UNUSABLE QUANTITY (REF- A/E FLIGHT TECHNIQUES #67, MAY 1990) RULE {A6.1.5-1}, OMS-USABLE PROPELLANT).
- b. NOMINAL ARCS PROPELLANT USAGE TRAPPED PLUS GAUGE ERROR TO EI PLUS SPECIFIC ENTRY REDLINE (REF- RULE {A6.1.5-5}, AFT RCS REDLINES).
- c. FRCS DUMPED TO ZERO, UNLESS THE CAPABILITY TO PERFORM THE DUMP IS LESS THAN SINGLE FAULT TOLERANT.

FLIGHT RULES

OMS ballast is required when the X CG violates the forward end of the CG envelope. The OMS ballast required for forward X CG protection may not be used for the deorbit burn ~~unless trades are required with paragraph C~~. Usages beyond the nominal profile will move the X CG forward. Therefore, the forward CG limit will be protected for the full entry redline. The OMS ballast is nominally computed assuming the FRCS is dumped to zero. Consideration should be given to depleting the FRCS prior to the deorbit burn if the post burn dump has been jeopardized by previous failures. @~~081497-04179~~ @~~081497-4179B~~

THIS RULE CONTINUED ON NEXT PAGE

FLIGHT RULES

A4.1.4-3 CG PLANNING (CONTINUED)

E. Y CG MANAGEMENT TECHNIQUES INCLUDE THE FOLLOWING:

1. MANAGING THE ARCS PROPELLANT BY UTILIZING THE RCS CROSSFEED CAPABILITY. RCS CROSSFEED WILL NOT BE USED TO IMPROVE THE ORBITER CG DURING DEORBIT AND ENTRY.

Use of the RCS crossfeed capability is effective for lateral control of the CG. Propellant from one aft pod may be used to feed the thrusters of both aft pods. RCS crossfeed is also used to balance RCS propellants or null the Y CG. For a 220,000-lb orbiter, 225 lb of ARCS can change the Y CG by 0.1 inch. To preclude tying OMS and RCS tanks, the RCS crossfeed will not be done during the deorbit burn and entry because the same set of propellant crossfeed lines would need to be used in the case of OMS engine failure or an RCS downmode during the deorbit burn.

2. MANAGING THE OMS PROPELLANT BY UTILIZING THE FOLLOWING PROCEDURES:

- a. USING OMS CROSSFEED DURING SINGLE OMS ENGINE BURNS.

NOTE: OMS CROSSFEED MAY BE USED TO MANAGE OMS PROPELLANT WHEN DOWNMODING FROM A TWO-ENGINE BURN TO A SINGLE ENGINE AS A RESULT OF AN ENGINE FAILURE.

Using the OMS crossfeed capability allows control of the Y CG at a rate of about 0.1 inch for every 225 lb of OMS for an orbiter weighing 220,000 lb.

- b. USING OMS MIXED CROSSFEED FOR OMS PROPELLANT TANK FAILURES. THIS REQUIRES MEMORY READ/WRITE PROCEDURES.

If fuel or oxidizer is trapped in a tank, it is possible to control the Y CG by using fuel or oxidizer from a good pod with fuel or oxidizer from the failed pod. However, a memory read/write procedure is required to properly control the valves.

- c. PERFORMING A PORTION OF A TWO ENGINE BURN FROM A SINGLE POD FOR A SPECIFIED DELTA V.

This provides a powerful means of CG control, and procedurally, the crew can reconfigure to straight feed for the remaining portion of the burn.

THIS RULE CONTINUED ON NEXT PAGE

FLIGHT RULES

A4.1.4-3 CG PLANNING (CONTINUED)

F. COMBINATION X CG AND Y CG MANAGEMENT TECHNIQUES INCLUDE THE FOLLOWING:

1. USING THE OMS PROPELLANT TO ALTER THE CG'S BY MODIFYING THE PROPELLANT PLAN OR MAGNITUDE OF THE SCHEDULED OMS MANEUVERS.

Changing the tanks which are used for a given burn controls the ~~propellant fuel~~ imbalance and lateral CG, while changing the magnitude of the burn alters the total propellant load. For an orbiter weighing 220,000 lb, each 225 lb of left-right imbalance causes a Y CG shift of about 0.1 inch. Each 620 lb of OMS will change the X CG by about 1 inch. @081497-4179B1

2. USING THE OMS/RCS INTERCONNECT.

The left and right pod interconnect schedule can be modified to achieve the desired Y CG. OMS imbalance can be managed by feeding OMS to ~~an~~RCS ~~tank~~ to minimize the Y CG imbalance. Recall that, for a 220,000-lb orbiter, 225 lb of OMS retention can shift the Y CG by about 0.1 inch. X CG management can be affected via interconnect of RCS with OMS for attitude control maneuvers, thus controlling the X CG using nominal mission ops. OMS usage affects the X CG more than the RCS. For a 220,000-lb orbiter, 620 lb of OMS interconnect will affect the X CG by about 1 inch.

@120393-ED] ~~@081497-04179B1~~ @081497-4179B1

A4.1.4-4 DOWNTRACK ERROR

DEORBIT WILL NOT BE ATTEMPTED WITH ORBITER STATE VECTOR DOWNTRACK ERRORS IN EXCESS OF 20 NM.

Prior to STS -1, analysis was performed and presented to Flight Techniques that indicated a 20 nm downtrack error was the maximum that could be steered out by AUTO guidance between 130,000 feet and TAEM interface in the presence of three-sigma lift-to-drag variations and worst case winds. The requirement to recover the energy error between 130,000 feet and TAEM interface was chosen because neither TACAN acquisition nor delta state update could be guaranteed to occur above 130,000 feet and because of large uncertainties in energy recovery capability (due to winds and lift-to-drag variations) after TAEM interface. This rule and Rule {A4.1.4-1}, IMU ALIGNMENT, are correlated.

Rule {A8.1.6-1}, GNC GO/NO-GO CRITERIA, and Rule {A11.1.2-2}, LOSS OF BOTH VOICE AND COMMAND, reference this rule. @ED]

FLIGHT RULES

A4.1.4-5 SUN ANGLE LIMITS AND GLARE CRITERIA FOR INNER AND OUTER GLIDE SLOPES

A. SUN ANGLE LIMITS

FOR A RUNWAY TO BE GO, SUN POSITION ON FINAL MUST NOT BE WITHIN 10 DEGREES OF CENTERLINE IN AZIMUTH AND FROM 0 TO 20 DEGREES ELEVATION.

These criteria were established to preclude direct sunlight from obstructing the crew's vision on final approach.

B. SUN GLARE CRITERIA

FOR INNER AND OUTER GLIDESLOPES, SUN GLARE PREDICTIONS WILL BE CONSIDERED IN RUNWAY SELECTION IF MORE THAN ONE ACCEPTABLE RUNWAY IS AVAILABLE. THE PRESENCE OF SUN GLARE DOES NOT MAKE A RUNWAY NO-GO.

Sun glare occurs when the film of dirt from SRB separation and Sun angle on cabin windows causes diffuse forward scattering of sunlight. The worst scattering occurs when the Sun is at an angle of 40 degrees from the normal to the window. Glare drops in intensity for angles greater than or less than this. Sun glare is predicted if the Sun position on final approach is between 30 and 50 degrees from the normals to the CDR's or the PLT's front windows. Flight experience indicates that glare may be a problem, and it may in some cases create enough of a nuisance to justify trying to avoid it, assuming winds and weather permit and nav aids and landing aids criteria are met. Sun glare should, therefore, be considered in runway selection when more than one choice of runway is available, but it should not have the weight of a GO/NO-GO criterion. The very large angular extent of the glare zones and the impossibility of accurately predicting its severity would restrict landing opportunities if Sun glare were a GO/NO-GO criterion.

FLIGHT RULES

A4.1.4-6 HAC SELECTION CRITERIA

A. FOR THOSE APPROACHES THAT TRANSITION TO APPROACH AND LANDING GUIDANCE BY 9,000 FT ALTITUDE, THE OVERHEAD HAC APPROACH IS GENERALLY PREFERRED OVER THE STRAIGHT-IN HAC APPROACH. @021998-65101

USE TABLE A4.1.4-6-I BELOW TO DETERMINE IF OTHER HAC SELECTION OPTIONS SHOULD BE CONSIDERED. THE 6-DEGREE-OF-FREEDOM (DOF) SIMULATION RESULTS (WHEN AVAILABLE) WILL TAKE PRECEDENCE OVER 3-DOF RESULTS.

TABLE A4.1.4-6-I - OVERHEAD HAC EVALUATION CRITERIA

3-DOF		6-DOF		HAC SELECTION OPTION
<u>MAX HAC ALT ERROR LOW (FT)</u>	<u>MAX QBAR (PSF)</u>	<u>MAX HAC ALT ERROR LOW (FT)</u>	<u>MAX QBAR (PSF)</u>	
<u>≥ 3,700</u>	<u>≥ 290 [1]</u>	<u>≥ 4,500</u>	<u>≥ 315 [1]</u>	<u>OVERHEAD HAC NO-GO [2]</u>
<u>≥ 2,700</u>	<u>N/A</u>	<u>≥ 3,500</u>	<u>N/A</u>	<u>STRAIGHT-IN HAC PREFERRED [3]</u>
<u>≥ 1,700</u>	<u>N/A</u>	<u>≥ 2,500</u>	<u>N/A</u>	<u>DELAYED CSS PREFERRED [4]</u>
<u>< 1,700</u>	<u>< 290 [1]</u>	<u>< 2,500</u>	<u>< 315 [1]</u>	<u>NO RESTRICTIONS</u>

NOTES:

[1] THE QBAR CRITERION APPLIES ONLY TO HAC'S ≥ 300 DEG. FROM HAC INITIATION TO 20,000 FT ALTITUDE AGL.

[2] THE OVERHEAD HAC IS NO-GO IF EITHER THE ALTITUDE ERROR OR QBAR CRITERION IS VIOLATED.

[3] THE STRAIGHT-IN HAC IS PREFERRED OVER THE OVERHEAD HAC TO PROVIDE A MORE BENIGN TRAJECTORY. HOWEVER, IF THE OVERHEAD HAC IS SELECTED, REFER TO [4] BELOW.

[4] NOMINAL CSS ACTIVATION SHOULD BE DELAYED UNTIL THE ONBOARD HAC ALTITUDE ERROR LOW IS NO LONGER DIVERGING (APPROXIMATELY 180 DEG HAC TURN REMAINING).

The approach and landing guidance transition altitude is an indication of the ability to control energy around the HAC based on the input upper level winds and atmosphere. Before transitioning to approach and landing guidance, four constraints must be satisfied. These constraints are altitude, lateral position, Qbar, and flight path angle limits referenced to the outer glideslope profile. The earliest altitude to transition is 10,000 ft, and 9,000 ft is considered high enough to preclude significant trajectory deviations on the outer glideslope. The evaluation will be performed by Flight Dynamics Entry Analysis tools using measured and forecasted wind data and AUTO flight control/AUTO speedbrake.

THIS RULE CONTINUED ON NEXT PAGE

FLIGHT RULES

A4.1.4-6 HAC SELECTION CRITERIA (CONTINUED)

Overhead HAC's are generally preferred over straight-in HAC's because they provide the best geometry for allowing clean-up of the onboard navigation state by TACAN and because they provide an energy downmode option. However, Table A4.1.4-6-I provides special considerations for HAC selection that provide margin to compensate for the severe conditions of the day. These conditions and corresponding criteria were presented to the Ascent/Entry Flight Techniques Panel #137 on February 27, 1997, and were developed in response to an analysis that showed TAEM guidance may be unable to limit HAC max Qbar and/or altitude error low for larger HAC's (over approximately 300 degrees) due to Nz limiting. ©[021998-6510]

The Qbar limit for HAC's ≥ 300 deg specified in Table A4.1.4-6-I is an additional constraint to the Qbar limit for Mach < 1 specified in Flight Rule {A4.1.5-7A.2}, ENTRY LIMITS. These constraints provide 3-sigma protection against violating the certified structural and GN&C Qbar limit of 375 psf (333 KEAS) in the subsonic region as defined in SODB Volume V. For smaller HAC turns (under 300 degrees), Flight Rule {A4.1.5-7A.2}, ENTRY LIMITS, provides adequate Qbar protection because the vehicle will not encounter Nz command limiting, and Qbar will stay within the guidance I-loaded Qbar limit of 350 psf (321 KEAS).

The altitude error low constraints defined in Table A4.1.4-6-I were the result of an analysis done using a modified Monte Carlo technique that varied the vehicle navigation state, navigation sensor inputs and atmosphere, but did not vary the winds. The 6-DOF 50-cycle Monte Carlo results showed that at a predicted altitude error low of 5,000 ft or more, all 50 cases experienced a HAC shrink, a significant percentage of which were full HAC shrink, and some cases were seen where the HAC phase was delayed. Although many of the cases were able to achieve a nominal approach and landing guidance transition, an altitude error low of 5,000 ft is being set as the limit of entry guidance capability due to the extremely dynamic nature of the resulting trajectory and its sensitivity to additional dispersions. Exceeding the 4,500 ft (6-DOF) maximum altitude error low criteria results in greater than an approximately 80 percent chance of triggering a HAC shrink at KSC 15 (approximately 50 percent at EDW 04), but provides 500 ft of protection from the 5,000 ft limit. Exceeding the 3,500 ft (6-DOF) maximum altitude error low criterion results in greater than 35 percent chance (approximately 1-sigma protection) of triggering a HAC shrink, but provides 1,500 ft of protection from the 5,000 ft limit. These backoffs provide margin to protect for limitations in the analysis which cannot take into account wind persistence or the full range of real-world HAC geometries, runway directions, and wind direction and magnitudes. The 3,700 ft overhead NO-GO and 2,700 ft straight-in preferred 3-DOF limits from Table A4.1.4-6-I are based on an average 3-DOF to 6-DOF TAEM simulation bias of 800 ft determined during this same analysis.

The intent of delaying nominal CSS activation is to avoid unnecessary trajectory perturbations for HAC's that are predicted to be dynamic and/or have low performance margin. Analysis of HAC altitude errors from a small sample of flights (four) with large HAC's indicates CSS flight results in trajectories with maximum HAC altitude errors low approximately 2,000 ft greater than 3-DOF real-time predictions. The 1,700 ft limit (3-DOF) in Table A4.1.4-6-I provides 2,000 ft of CSS dispersion protection against exceeding the 3,700 ft maximum altitude error low limit (3-DOF) used to NO-GO overhead HAC's. ©[021998-6510]

FLIGHT RULES

THIS RULE CONTINUED ON NEXT PAGE

FLIGHT RULES

A4.1.4-6

HAC SELECTION CRITERIA (CONTINUED)

Predicted altitude errors low in excess of 2,500 ft (6-DOF) are indicative of guidance Nz limiting which results in a nose-low pitch attitude. Any additional nose-low pitch attitude errors beyond the guidance Nz command while guidance is Nz limited will likely result in substantial performance degradation (faster airspeed, higher Nz, greater altitude rate, more roll, steeper flight path angle, etc.). The most performance-critical region of TAEM is HAC initiation, so it is especially prudent to minimize deviations from guidance during the initial portion of the HAC. Once the guidance Nz command is no longer limited, the vehicle's pitch attitude will get shallower and the HAC altitude error will stop diverging and soon begin to converge. However, it is not necessary to wait until the HAC altitude error is converging to engage CSS, since substantial performance degradation is unlikely after the vehicle's pitch attitude has shallowed. The best tools for determining if the altitude is diverging from its reference are onboard, so identifying when CSS can be taken is best performed by the crew. @J021998-65101

The 3-DOF evaluation will be accomplished with the Descent Design System (DDS) and the 6-DOF evaluation will be accomplished with the Spacecraft Trajectory Analysis and Mission Planning Simulation (STAMPS). In the event that there is a conflict in meeting the criteria in Table A4.1.4-6-I between the 3-DOF and 6-DOF evaluations, the results of the 6-DOF evaluation will be favored due to the higher fidelity of the processor (reference STF no. DFD-97-4235-016, dated March 12, 1997).

Note: Adjusting for the nose-low pitch attitude due to guidance Nz command limiting by manually biasing the guidance Nz command and pitching up is not recommended because of the potential for violating the GN&C upper angle of attack defined in the SODB Volume V. @J021998-65101

B. IF ~~NONE~~NEITHER OF THE OPTIONS IN PARAGRAPH A ALLOWS TRANSITION TO APPROACH AND LANDING GUIDANCE BY 9,000 FEET ALTITUDE, THEN CONSIDER A 24-HOUR WAVE-OFF AND/OR USE OF THE SECONDARY LANDING SITE TO ACHIEVE NOMINAL APPROACH AND LANDING GUIDANCE TRANSITION, CONSISTENT WITH RULE {A2.1.4-2}, EXTENSION DAY GUIDELINES. @J021998-65101

Delaying 1 day increases the probability of going to the PLS and of having acceptable heading alignment phase guidance capability.

C. IF NONE OF THE OPTIONS IN PARAGRAPH A OR B ALLOWS TRANSITION TO APPROACH AND LANDING GUIDANCE BY 9,000 FEET ALTITUDE, THEN CONSIDER USE OF THE HIGHEST PRIORITY RUNWAY/HAC OPTION THAT MEETS THE TRANSITION CRITERIA BY 6,000 FEET ALTITUDE. @J021998-65101

FLIGHT RULES

Transition to approach and landing guidance is forced at 5,000 feet altitude, whether or not the four transition constraints have been met. A 6,000-foot transition altitude indicates the AUTO system satisfied the four constraints late in the transition period, which should allow for acceptable landing conditions even with additional dispersions. ©[061297-6006]

Rule {A2.1.4-2}, EXTENSION DAY GUIDELINES, references this rule. ©[061297-6006]

FLIGHT RULES

A4.1.4-7 ENERGY DOWNMODING

THE STRAIGHT-IN OR MINIMUM ENERGY POINT (MEP) OPTION WILL BE SELECTED WHEN A VALID KALMAN FILTER SOLUTION OF ENERGY CROSSES THE ENERGY VERSUS R-GO DOWNMODE CRITERIA. THE MEP SHOULD NOT BE SELECTED BETWEEN HAC INTERCEPTION AND REACHING THE 180-DEGREE POINT ON THE SPIRAL. THE ONBOARD ALERT WILL BE HONORED IF THE MCC SOLUTION IS UNAVAILABLE.

MEP selection is an energy downmode option which will decrease R-GO by approximately 6 miles. This call should be made only when the ground Kalman filter solution is valid. The ground solution is prime for calling the straight-in or MEP options. If MEP is selected between HAC intercept and 180-degree point on the HAC, guidance may add 360 degrees to the HAC causing unexpected approach geometry and more energy problems.

A4.1.4-8 MANEUVER EXECUTION MATRIX

MODE	MNVR	OVERBURN SHUTDOWN CRITERIA	EARLY C/O MNVR COMP CRITERIA	RCS TRIM ALL AXES	MNVR INHIBIT OR TERMINATION CRITERIA [1]	MANUAL TAKEOVER CRITERIA [1]
NOM & ATO	OMS-1	T _{GO} = 0	ALWAYS COMPLETE	≤ 2 FPS	NONE	IGN ATTITUDE ERROR > 5 DEG OR 5 DEG DEVIATION DURING MNVR
	OMS-2		H _p > MIN H _p	NONE		
AOA	OMS-1	T _{GO} = 0	ALWAYS COMPLETE	STEEP: ≤ 2 FPS TGT	NONE	IGN ATTITUDE ERROR > 5 DEG OR 5 DEG DEVIATION DURING MNVR
	OMS-2			[2] T _{GO} = 0		
ORBITAL CRITICAL	ALL	T _{GO} = 0	[3] COMPLETE	≤ 0.2 FPS	DELAY UNTIL IGN ATT ERROR < 5 DEG BUT BURN NO LATER THAN END OF TIG SLIP WINDOW	IGN ATTITUDE ERROR > 5 DEG OR 5 DEG DEVIATION DURING MNVR
ORBITAL NON-CRITICAL	ALL	T _{GO} = 0	NONE	≤ 2 FPS	IGN ATTITUDE ERROR > 5 DEG OR 5 DEG DEVIATION DURING MNVR	NONE
DEORBIT	ALL	[2] T _{GO} = 0	ALWAYS COMPLETE IF H _p < SAFE H _p	STEEP: ≤ 2 FPS TGT PREBANK: ≤ 0.5 FPS	IGN ATTITUDE DEVIATION > 5°	5 DEG ATTITUDE DEVIATION DURING MNVR

@[011295-1691]

NOTES:

[1] ENGINE OUT TRANSIENTS NOT INCLUDED.

[2] IF ANY IMU ACCELEROMETER FAILED, SHUTDOWN:

2 OMS
BT + 5 SECONDS

1 OMS
BT + 10 SECONDS

@[011295-1691]

FLIGHT RULES

- [3] FOR PAYLOAD SEPARATION MANEUVERS, ALWAYS COMPLETE TO AT LEAST MINIMUM SEPARATION DELTA VELOCITY. AFTER MINIMUM SEPARATION DELTA V IS ACHIEVED, BURN IS NONCRITICAL.

THIS RULE CONTINUED ON NEXT PAGE

FLIGHT RULES

A4.1.4-8

MANEUVER EXECUTION MATRIX (CONTINUED)

OVERBURN SHUTDOWN CRITERIA - December 1979 Flight Techniques determined that a 3-sigma low OMS engine performance would increase a nominal deorbit 2-OMS burn duration by approximately 3 seconds (6 seconds for 1-OMS) and that a 2000 micro-G accelerometer error would increase the maneuver time by 5 seconds (10 seconds for 1-OMS). The onboard guidance will account for off-nominal OMS engine performance and adjust the burn time as necessary to achieve the targeted conditions assuming a good navigation state. However, if IMU accelerometer errors are present, the velocity to be gained will be updated incorrectly such that the targeted conditions may not be met. If the accelerometer error is in the direction to result in an underburn, the burn will be completed using the RCS jets. If the accelerometer error is in the direction to result in an overburn, a manual shutdown will be performed at the pre-burn TGO plus 5 seconds for 2-OMS (10 seconds for 1-OMS) to avoid overburns greater than 20 fps. ©[011295-1691]

Terminating at $T_{GO} = 0$ is sufficient for on-orbit and uphill maneuvers. If the maneuver is targeted and cannot be overburned, any residuals will need to be trimmed.

EARLY C/O MNVR COMP CRITERIA - Nominal, ATO, and AOA OMS-1 maneuver completion is required to attain a safe insertion orbit. Nominal OMS-2 completion to a perigee of Min Hp (ref. Rule {X4.1.1-1}, TRAJECTORY AND GUIDANCE PARAMETERS) is required for a safe orbital lifetime of 24 hours, assuming OMS-1 apogee of 150 nm or, 3 orbits assuming OMS-1 apogee of 105 nm. An AOA OMS-2 is a deorbit and, since perigee is already less than Safe Hp, the maneuver must be completed to attain EI targets.

Any orbital maneuvers considered critical should be completed due to the criticality. Also, based on the definition of a critical maneuver, it cannot be rescheduled. Therefore, if the maneuver is not completed at that time, severe consequences may result. A payload separation maneuver is critical for crew safety. Therefore, the maneuver should be completed to at least a minimum separation to guarantee less than 10X tile damage.

A noncritical maneuver should not be completed manually since it can be rescheduled if necessary. Also, this allows time to determine the failure which caused the maneuver to terminate early.

Deorbit burns that cut off at a perigee greater than Safe Hp will be retargeted for a subsequent deorbit one orbit later or up to 24 hours later since the orbital lifetime allows the delay. Deorbit burns that cut off at perigee less than Safe Hp should be completed at all costs to attain EI conditions since the perigee is unsafe for orbital lifetimes of reasonable lengths to retarget.

RCS TRIM - Ascent and deorbit burns are large and all uphill and EI targets will be met within allowable tolerances if the delta V imparted is within 2 fps. Specifically, a 2 fps underburn for deorbit equates to a 30 nm energy error at EI, which is an acceptable error, well within guidance capability to converge by $M = 12$. Uphill delta-V accuracy requirements are even less critical, and 2 fps is deemed very achievable.

THIS RULE CONTINUED ON NEXT PAGE

FLIGHT RULES

A4.1.4-8 MANEUVER EXECUTION MATRIX (CONTINUED)

Critical orbital maneuvers should be completed to 0.2 fps due to their criticality and since the maneuver cannot be rescheduled to make up for the trim errors. Additionally, it is important to trim payload separation maneuvers to within 0.2 fps of the design limit to meet tile damage limit criteria.

It is not necessary to trim noncritical orbital maneuvers precisely. Two fps was selected since PEG-7 guidance can achieve this for an OMS burn without any RCS trimming.

MANUAL TAKEOVER, MNVR INHIBIT, OR TERMINATION CRITERIA - A 5-degree attitude deadband is the largest available, and an ignition attitude error or deviation greater than this indicates flight control malfunction. Nominal ATO and AOA OMS-1 and -2 are time-critical burns sequenced such that the ignition attitude may not have been attained. For out-of-attitude cases or attitude deviations during the maneuver, the maneuver should still be performed (i.e., not inhibited or terminated), but performed manually. The deorbit burn attitude is entered in a controlled, timely manner, and the maneuver can be postponed for an unacceptable attitude error. A maneuver inhibit should be accomplished for attitude errors greater than 5 degrees. If ignition has occurred, maneuver completion is important, and a manual takeover should be performed for deviations greater than 5 degrees.

Critical maneuvers should be completed once started. Payload separation maneuvers should be completed to at least minimum separation delta-velocity. This is due to the definition of a critical burn. Critical maneuvers should not be executed until the vehicle attitude error is less than 5 degrees or until the end of the TIG slip window, whichever occurs first. If the attitude error during the maneuver drifts outside 5 degrees, the crew should take over and manually steer the vehicle towards the correct attitude.

Noncritical orbital maneuvers should not be executed if the vehicle is not in attitude. Also, if the vehicle drifts out of attitude during the maneuver, the maneuver should be terminated. A later maneuver can be scheduled to correct errors imparted to the trajectory if necessary.

A4.1.4-9 ORBITER LANDING WEIGHT

A. THE FOLLOWING CONDITIONS ARE ASSUMED FOR THE CALCULATION OF THE ORBITER EOM LANDING WEIGHT: @081497-4179B

The resulting calculations of X CG, Y CG, and landing weight are reported as the expected EOM conditions. The X CG and Y CG data used from this step are used in the DEL PAD.

1. THE PLANNED DEORBIT BURN IS SUCCESSFUL AND THE DESIRED OMS BALLAST REMAINS ONBOARD AS THE RESIDUAL.

Assumes a nominal deorbit burn and entry for EOM conditions. @081497-4179B

THIS RULE CONTINUED ON NEXT PAGE

FLIGHT RULES

A4.1.4-9 ORBITER LANDING WEIGHT (CONTINUED)

2. THE NOMINAL ARCS QUANTITY IS USED DURING ENTRY. @081497-4179B]

The nominal ARCS quantity used should be the planned usage for the particular mission and does not necessarily agree with the redline shown in Rule {A6.1.5-5}, AFT RCS REDLINES.

3. A SUCCESSFUL FRCS DUMP, IF PLANNED.

Self-explanatory.

4. NOMINAL EOM NON-PROPELLANT CONSUMABLES USAGE.

The nominal non-propellant consumables for the flight is shown in the Fluids Budget of the SODB flight specific Amendment Data Submittal.

B. LANDING WEIGHT CONSTRAINTS:

IF THE CALCULATED LANDING WEIGHT EXCEEDS THE FOLLOWING LIMITS, THE ORBITER WEIGHT MUST BE BROUGHT WITHIN LIMITS BY FRCS DUMP AND REDUCTION OF OMS REMAINING (BUT NOT LESS THAN THE MINIMUM TANK CONSTRAINT). @[041196-1789B]

1. ASCENT ABORT AND EOM LANDING WEIGHT LIMITS:

<u>FLIGHT PHASE:</u>	<u>INCLINATION</u>			
	<u>28.5°</u>	<u>39.0°</u>	<u>51.6°</u>	<u>57.0°</u>
<u>RTLS</u>	<u>248K LBS</u>	<u>248K LBS</u>	<u>245K LBS</u>	<u>242K LBS</u>
<u>TAL</u>	<u>248K LBS</u>	<u>248K LBS</u>	<u>244K LBS</u>	<u>241K LBS</u>
<u>AOA</u>	<u>248K LBS</u>	<u>248K LBS</u>	<u>233K LBS</u>	<u>233K LBS</u>
<u>ATO (DAY 1)</u>	<u>240K LBS</u>	<u>233K LBS</u>	<u>230K LBS</u>	<u>230K LBS</u>
<u>NOMINAL EOM</u>	<u>233K LBS</u>	<u>233K LBS</u>	<u>233K LBS</u>	<u>233K LBS</u>

@[101096-4211A] @[081497-4179B]

THIS RULE CONTINUED ON NEXT PAGE

FLIGHT RULES

A4.1.4-9 ORBITER LANDING WEIGHT (CONTINUED)

2. UNPLANNED PAYLOAD RETURN WEIGHT MUST BE \leq ATO LANDING WEIGHT, AND DEORBIT OPPORTUNITIES MUST MEET THE ORBITER THERMAL CRITERIA FOR NOMINAL EOM. @[041196-1789B] @[081497-4179B]
3. FLIGHT SPECIFIC EXCEPTIONS TO ANY OF THE ABORT OR END OF MISSION LANDING WEIGHT LIMITS WILL BE DOCUMENTED IN THE FLIGHT SPECIFIC ANNEX WITH ASSOCIATED SSP WAIVERS OBTAINED, AS REQUIRED.
- * NOTE: THE ATO LANDING WEIGHT LIMITS ARE REDUCED TO PROTECT THE ENTIRE XCG ENVELOPE FOR ALL ATO OPPORTUNITIES AND ALL SEASONS. HEAVIER LANDING WEIGHTS MAY BE ACCEPTABLE BUT MUST BE EVALUATED ON A MISSION-SPECIFIC BASIS. @[101096-4211A]

Any flight with a manifest that results in an intact abort or EOM landing weight greater than currently certified limits must have a waiver specifying the limit for that flight. The 230 KLB high inclination ATO weight limit protects for shallow deorbit on the most thermally stressful ATO deorbit opportunities for all seasons and all XCG's. ATO deorbit opportunities may exist for which a 233 KLB downweight would be acceptable, but to exceed the 230 KLB limit, these opportunities must be determined by pre-flight analysis and be documented in the flight rules annex. Flight-specific exceptions to the landing weight limits are documented in Flight Rules Annex rule {X4.1.1-1}, TRAJECTORY AND GUIDANCE PARAMETERS. When OMS ballast techniques are required, the first priority is protecting the forward X CG limit; therefore, the OMS ballast required for protecting forward X CG may not be reduced to achieve the landing weight limit. OMS propellant in excess of the ballast may be used to reduce the orbiter landing weight. (Ref. PRCB S40522J.) Early mission termination may result in a landing weight that slightly exceeds the unplanned payload return limit due to nonpropulsive consumables still onboard. @[101096-4211A]

The thermal cross range limit for end-of-mission deorbit opportunities is determined preflight. In the event of early mission termination and unplanned payload return, a thermal evaluation will be conducted for the available deorbit opportunities, if time permits (i.e., next PLS or MDF). Deorbit opportunities will be selected for crossrange and approach geometry which result in thermally acceptable entries. If none of the available deorbit opportunities are within thermal limits, the opportunity with the minimum thermal violation will be selected. The landing weight capability limits are defined in NSTS 07700, Volume III (updated by PRCBD NO. S052638Q). The NSTS 07700, Volume X landing weight limits, which are certification requirements, will eventually become the new landing weight limits once certification and/or the orbiter thermal envelope expansion occurs. The orbiter thermal limits are documented in SOD, Volume V (NSTS 08934), Orbiter Flight Capabilities Envelopes. @[041196 1789B] @[101096-4211A]

FLIGHT RULES

~~Rule {A6.1.5-5}, AFT RCS REDLINES; and Rule {A4.1.5-7}, ENTRY LIMITS, reference this rule.
©[081497-4179B]a4.1.4~~

~~1. THE FOLLOWING CONDITIONS ARE ASSUMED FOR THE CALCULATION OF THE ORBITER EOM LANDING WEIGHT:~~

~~The resulting calculations of X CG, Y CG, and landing weight are reported as the expected EOM conditions. The X CG and Y CG data used from this step are used in the DEL PAD.~~

~~a. THE PLANNED DEORBIT BURN IS SUCCESSFUL AND THE DESIRED OMS BALLAST REMAINS ONBOARD AS THE RESIDUAL.~~

~~Assumes a nominal deorbit burn and entry for EOM conditions.~~

~~b. THE NOMINAL ARCS QUANTITY IS USED DURING ENTRY.~~

~~The nominal ARCS quantity used should be the planned usage for the particular mission and does not necessarily agree with the redline shown in Rule {A6.1.5-5}, AFT RCS REDLINES.~~

~~this rule continued on next page~~

FLIGHT RULES

~~a4.1.4.3 — CG PLANNING (continued)~~

~~c. — A SUCCESSFUL FRCS DUMP, IF PLANNED.~~

~~Self-explanatory.~~

~~d. — NOMINAL EOM NON PROPELLANT CONSUMABLES USAGE.~~

~~The nominal non-propellant consumables for the flight is shown in the Fluids Budget of the SODB flight specific Amendment Data Submittal.~~

~~2. — LANDING WEIGHT CONSTRAINTS:~~

~~— IF THE CALCULATED LANDING WEIGHT EXCEEDS THE FOLLOWING LIMITS, THE ORBITER WEIGHT MUST BE brought within limits BY FRCS DUMP AND REDUCTION OF OMS REMAINING (BUT NOT LESS THAN THE MINIMUM TANK CONSTRAINT). — [041196-1789B]~~

~~a. — ascent abort and eom landing weight limits:~~

~~[101096-4211A]~~

~~b. — UNPLANNED PAYLOAD RETURN WEIGHT MUST BE £ ATO LANDING WEIGHT, AND DEORBIT OPPORTUNITIES MUST MEET THE ORBITER THERMAL CRITERIA FOR NOMINAL eom. — [041196-1789B]~~

~~this rule continued on next page~~

FLIGHT RULES

~~a4.1.4.3 — CG PLANNING (continued)~~

~~c. — FLIGHT SPECIFIC EXCEPTIONS TO ANY OF THE ABORT OR END OF MISSION LANDING WEIGHT LIMITS WILL BE DOCUMENTED IN THE FLIGHT SPECIFIC ANNEX WITH ASSOCIATED SSP WAIVERS OBTAINED, AS REQUIRED. @ [041196 1789B]~~

~~* NOTE: — THE ATO LANDING WEIGHT LIMITS ARE REDUCED TO PROTECT THE ENTIRE XCG ENVELOPE FOR ALL ATO OPPORTUNITIES AND ALL SEASONS. HEAVIER LANDING WEIGHTS MAY BE ACCEPTABLE BUT MUST BE EVALUATED ON A MISSION SPECIFIC BASIS. @ [101096 4211A]~~

~~Any flight with a manifest that results in an intact abort or EOM landing weight greater than currently certified limits must have a waiver specifying the limit for that flight. The 230 KLB high inclination ATO weight limit protects for shallow deorbit on the most thermally stressful ATO deorbit opportunities for all seasons and all XCG's. ATO deorbit opportunities may exist for which a 233 KLB downweight would be acceptable, but to exceed the 230 KLB limit, these opportunities must be determined by pre-flight analysis and be documented in the flight rules annex. Flight specific exceptions to the landing weight limits are documented in Flight Rules Annex rule (X4.1.1-1), TRAJECTORY AND GUIDANCE PARAMETERS. When OMS ballast techniques are required, the first priority is protecting the forward X CG limit; therefore, the OMS ballast required for protecting forward X CG may not be reduced to achieve the landing weight limit. OMS propellant in excess of the ballast may be used to reduce the orbiter landing weight. (Ref. PRCB S40522J.) Early mission termination may result in a landing weight that slightly exceeds the unplanned payload return limit due to nonpropulsive consumables still onboard. @ [101096 4211A]~~

~~The thermal cross range limit for end-of mission deorbit opportunities is determined preflight. In the event of early mission termination and unplanned payload return, a thermal evaluation will be conducted for the available deorbit opportunities, if time permits (i.e., next PLS or MDF). Deorbit opportunities will be selected for crossrange and approach geometry which result in thermally acceptable entries. If none of the available deorbit opportunities are within thermal limits, the opportunity with the minimum thermal violation will be selected. The landing weight capability limits are defined in NSTS 07700, Volume III (updated by PRCBD NO. S052638Q). The NSTS 07700, Volume X landing weight limits, which are certification requirements, will eventually become the new landing weight limits once certification and/or the orbiter thermal envelope expansion occurs. The orbiter thermal limits are documented in SOD, Volume V (NSTS 08934), Orbiter Flight Capabilities Envelopes. @ [041196 1789B] @ [101096 4211A]~~

FLIGHT RULES

ENTRY

A4.1.5-1	DELTA-T UPDATE CRITERIA	4-98
A4.1.5-2	DEORBIT BURN COMPLETION	4-99
A4.1.5-3	DELTA STATE UPDATE PHILOSOPHY	4-101
A4.1.5-4	DELTA STATE POSITION UPDATES	4-102
A4.1.5-5	DELTA STATE VELOCITY UPDATES	4-103
A4.1.5-6	NAVIGATION FILTER MANAGEMENT AUTO/INHIBIT/FORCE (AIF)	4-104
A4.1.5-7	ENTRY LIMITS	4-114
A4.1.5-8	ENTRY TAKEOVER RULES	4-120
A4.1.5-9	AERO TEST MANEUVERS	4-121

RANGE SAFETY FLIGHT RULES

A4.1.6-0	SIGNATURE SECTION	4-116
A4.1.6-1	POLICY	4-117
A4.1.6-2	DEFINITIONS	4-120
A4.1.6-3	FCO TO MCC WARNING NOTIFICATION	4-128
A4.1.6-4	MCC TO FCO REPORTING	4-130
A4.1.6-5	CONTROLLABILITY	4-136
A4.1.6-6	FLIGHT TERMINATION/MANUAL MECO EVALUATION .	4-139
A4.1.6-7	FLIGHT TERMINATION/MANUAL MECO CRITERIA ...	4-141
A4.1.6-8	FLIGHT TERMINATION/MANUAL MECO ACTION	4-144
A4.1.6-9	RANGE SAFETY LIMIT AVOIDANCE ACTIONS	4-146

FLIGHT RULES

THIS PAGE INTENTIONALLY BLANK

FLIGHT RULES

ENTRY

A4.1.5-1 DELTA-T UPDATE CRITERIA

A DOWNTRACK CORRECTION TO THE STATE VECTOR AND A BFS NAVIGATION VECTOR TRANSFER WILL BE PERFORMED BETWEEN DEORBIT AND 300,000 FEET IF A VALID DELTA-T SOLUTION EXISTS, NAVIGATION SYSTEM ANOMALIES INDICATE A HIGH LIKELIHOOD OF NAVIGATION ERRORS, AND THE INSTANTANEOUS DOWNTRACK ERROR COMPUTED BY THE DELTA-T PROCESSOR IS GREATER THAN 8 NM. FOR ERRORS LESS THAN 8 NM, NO UPDATE WILL BE REQUIRED.

An entry navigation Monte Carlo analysis performed from TIG through touchdown, utilizing the Oracle entry navigation simulation, indicated that there is no onboard navigation requirement for delta-T update for navigation downtrack error less than 8 nm (see minutes for Ascent/Entry Flight Techniques Panel Meeting #71 held September 21, 1990). Eight nm is the expected 3-sigma downrange error resulting from the sensor error models and initial navigation error assumptions selected for this study. These initial conditions have been used consistently for Oracle studies since before STS-1. The maximum downtrack error observed at EI for STS-1 through STS-31 was 2 nm.

Studies performed using the Entry Navigation Reconstruction program indicate that, due to unmodeled aerodynamic accelerations, the incorporation of large delta-T corrections several minutes after initial IMU processing can result in a diverging navigation state. This study indicated that 300,000 feet represents a minimum safe altitude for incorporating delta-T updates.

At least one C-band radar is required for the generation of the delta-T downtrack correction. In order for the computed delta-T to be considered valid, agreement between the AOS and LOS computed values is required. Data processed from a second independent C-band source, if available, can be used to confirm the presence of a large onboard state error. The accuracy of the delta-T solution is degraded by the presence of large radial or crosstrack errors. The Ground Navigation Officer will analyze the C-band tracking data residuals and signature to determine whether the delta-T correction will be valid.

Large onboard navigation state errors observed during the delta-T tracking pass can be caused by an inaccurate onboard navigation state vector prior to deorbit, multiple IMU failures, poor IMU performance, or the erroneous execution of navigation related crew procedures. The presence of a large onboard navigation state error should be presaged by such a problem.

FLIGHT RULES

A4.1.5-2 DEORBIT BURN COMPLETION

THE FOLLOWING TECHNIQUES, IN ORDER OF PRIORITY, WILL BE UTILIZED IN THE EVENT OF DELTA V DEFICIENCY AT OMS CUTOFF FOR THE DEORBIT MANEUVER.

- A. TRIM WITH THE ARCS, NOT TO EXCEED ARCS QUANTITY 1.
- B. TRIM WITH THE FORWARD RCS TO DEPLETION.
- C. PREBANK TO THE REDESIGNATION CONTINGENCY LIMIT FOR THE PRIME LANDING SITE (PROTECTS THERMAL CONSTRAINT OR NO GREATER THAN 135-DEGREE PREBANK).
- D. REDESIGNATE TO THE BACKUP SITE (IF AVAILABLE) WITH PREBANK TO THE REDESIGNATION CONTINGENCY LIMIT (NORTHROP FOR EDWARDS PLS).
- E. TRIM WITH THE AFT RCS, NOT TO EXCEED ARCS QUANTITY 2.
- F. PREBANK AS REQUIRED UP TO 180 DEGREES.

This rule was developed in various working group meetings to define the procedures for completing the deorbit burn after all OMS downmode options have been exercised and ARCS fuel to the ARCS entry redline has been used. The deorbit burn completion cue cards incorporate the techniques, according to the defined priorities.

ARCS propellant is budgeted, including entry DTO's, PTI's, etc., in option A for burn completion. If the targets can be accomplished using the fuel down to ARCS quantity 1, the vehicle integrity and crew safety have not been compromised. This ARCS option is preferred to the FRCS because no large attitude change is required, nor is the execution of the more complicated FRCS burn procedure required.

Option B is trimming with the FRCS. This propellant, if not used for trimming the burn, is either dumped prior to entry or maintained for ballast. Use of the FRCS fuel is preferred over an equivalent prebank. The thermal effects of the prebank are considered more severe than execution of the FRCS trim procedures.

Options C and D incorporate use of the prebank to obtain atmospheric capture while maintaining ARCS quantity 1 fuel. Use of the prebank stresses the TPS. Option C limits the prebank to the redesignation limit while maintaining the capability to land at the prime site. The redesignation limit will not be greater than 135 degrees of prebank, or exceedance of a thermal limit based on 35 mission wing leading edge reuse temperature constraint (TBD degrees F). Current analysis tools use a simplified thermal model which overpredicts wing leading edge temperature by 150 degrees F. For analysis purposes, the wing leading edge thermal limit will be 2950 degrees F. Option D calls for a prebank to the redesignation limit to the backup

FLIGHT RULES

THIS RULE CONTINUED ON NEXT PAGE

FLIGHT RULES

A4.1.5-2 DEORBIT BURN COMPLETION (CONTINUED)

landing site (if available). Vehicle turnaround may be lengthened due to the lack of postlanding support at the backup landing site. The computations of L OMS Hp, R OMS Hp, PRI Hp, and B/U Hp will assume the delta Hp due to prebank to the redesignation limit, regardless of whether a backup site is available or not.

Option E uses fuel below the ARCS entry redline, down to ARCS quantity 2. This provides enough fuel for attitude control to $Q\text{-bar} = 20$ psf. After $Q\text{-bar} = 20$, aerodynamic control is possible but risky without the yaw jets. NO YAW JET is now a certified entry mode.

The last option calls for using prebank between the redesignation limit up to the maximum of 180 degrees. This is the last resort since the use of maximum prebank and no yaw jet control after $Q\text{-bar} = 20$ psf indicate that the capability to reach the landing site, vehicle stability, TPS integrity, and crew safety are being compromised. Preserving this prebank (from the redesignation limit to 180 degrees) as the very last option also provides some margin in case the FRCS burn does not provide the delta V predicted.

A4.1.5-3 DELTA STATE UPDATE PHILOSOPHY

- A. VELOCITY DELTA STATE UPDATES WILL REQUIRE CSS MODE TO PREVENT EXCESSIVE TRANSIENT MANEUVERS.

If a total delta state update is sent, the velocity components put a step function into the flight control system. The transients caused by the step function can cause large maneuvers which could overstress the vehicle or cause loss of control. Going CSS when a velocity delta state is incorporated allows the crew to manually filter transients.

- B. POSITION DELTA STATE UPDATES OCCURRING NEAR TAEM INTERFACE ($M = 5$ TO $M = 2.5$ FOR EOM AND AOA AND $M = 5$ TO $M = 3.2$ FOR RTLS) WILL REQUIRE CSS TO PREVENT EXCESSIVE TRANSIENT MANEUVERS.

Entry guidance is targeted towards a specific set of end conditions at TAEM interface. For any given position error, the correction needed to satisfy the interface conditions grows as you approach TAEM. Going CSS for a delta state update close to TAEM interface allows the crew to filter the guidance commands to keep from overstressing the vehicle.

- C. DELTA STATE UPDATES WILL NORMALLY NOT BE PERFORMED AFTER HAC ACQUISITION. HOWEVER, IF VISUAL CONTACT WITH THE RUNWAY CANNOT BE MAINTAINED BY THE CREW, DELTA STATE UPDATES WILL BE CONTINUED AS LONG AS THE ONBOARD STATE VECTOR CAN BE IMPROVED.

FLIGHT RULES

After HAC intercept, a delta state update will not be performed if the crew has visual contact with runway because transients caused by a delta state could prove distracting. Also, the external data sources (TACAN, BARO, MLS) would need to be deselected in order to allow the ground processor to compute the proper corrections.

A4.1.5-4 DELTA STATE POSITION UPDATES

- A. FOR POSITION COMPONENT EXCEEDANCE, A THREE-COMPONENT (POSITION ONLY) UPDATE WILL BE EXECUTED.
- B. POSITION REQUIREMENTS:

	RTLS			EOM			
	DELTA POSITION (FT)			DELTA POSITION (FT)			
	X	Y	Z	X	Y	Z	
H > 100K FT...	18K	18K	6K	H > 130K FT..	48K	48K	12K
H < 100K FT...	6K	6K	3K	H < 130K FT..	6K	6K	6K
				H < 90K FT..	6K	6K	3K

This rule contains the criteria for performing a position-only delta state update to correct the onboard navigation for both GRTLS and end of mission. The delta state processor is a ground processor that compares the onboard vector to time-correlated radar tracking data and outputs the deltas in runway Cartesian coordinates. This data is observed on the ground as three components of position and three components of velocity. The position update limits were set in order to meet guidance imposed navigation accuracy requirements (ref. STS 81-0366, appendix A, Navigation Performance Requirements). These accuracy requirements were identified to ensure auto guidance capability to achieve the runway after correcting the onboard navigation state. The guidance requirements are ramp functions of altitude, but in order for a ground operator to observe six error components on a constantly updating digital display and compare them to variable error limits, it was necessary to simplify the update criteria. When the errors observed in the onboard state exceed the limits defined in this rule, a delta state update is initiated on the ground. For GRTLS, the two tier set of limits was chosen with a breakpoint at 100,000 feet altitude, since it is desired to remove state errors before TAEM initiation. The limits above 100,000 feet altitude are tighter than for EOM, since there is little ranging control exercised in GRTLS until TAEM, which is initiated at M=3.2 or around 92,000 feet altitude. For EOM, the guidance requirements dictate that the errors be under control and decreasing with altitude by around 130,000 feet, the point at which TACAN's are usually incorporated into the onboard navigation state. Therefore, this point was chosen as the breakpoint for the EOM three-tier update criteria.

FLIGHT RULES

The third tier was added for EOM to allow a further breakdown of allowable altitude error. Instead of a delta-Z limit of 3k feet at an altitude of 130,000 feet, a 6k-foot error is permitted between 130,000 and 90,000 feet, and then the 3k limit applies below 90,000 feet altitude. This additional limit may preclude the likelihood of an unnecessary delta state update to correct a delta-Z error that could be reduced by the use of DRAG processing in the more accurate lower region of the onboard altitude atmospheric model. TACAN processing will not have much effect on the altitude error unless the orbiter passes over the TACAN ground station so that the majority of the range measurement is altitude rather than downtrack and crosstrack.

Rule {A4.1.4-1}, IMU ALIGNMENT, and Rule {A4.1.5-6}, NAVIGATION FILTER MANAGEMENT AUTO/INHIBIT/FORCE (AIF), reference this rule.

A4.1.5-5 DELTA STATE VELOCITY UPDATES

DUE TO ONBOARD DRAG ALTITUDE UPDATING, THE DELTA STATE VELOCITY COMPONENTS ARE NOT SUFFICIENTLY ACCURATE TO MONITOR THE ONBOARD VELOCITY ERRORS; THEREFORE, THE ONBOARD VELOCITY ERRORS WILL BE EVALUATED USING THE RADAR HIGH SPEED FILTER VELOCITY ERRORS. AN ONBOARD VELOCITY UPDATE WILL BE PERFORMED FOR A VELOCITY ERROR > 75 FPS IN ANY COMPONENT. RADAR VELOCITY 3 SIGMA UNCERTAINTIES OF UP TO 60 FPS COULD RESULT IN ONBOARD VELOCITY ERRORS OF UP TO 135 FPS PRIOR TO A GROUND UPDATE. IF A VELOCITY UPDATE IS REQUIRED, DRAG ALTITUDE UPDATING WILL BE INHIBITED TO ASSURE VALID COMPUTATION OF PROPAGATED VELOCITY ERRORS, AND A SIX-COMPONENT UPDATE (POSITIONS AND VELOCITIES) WILL BE EXECUTED.

An update of onboard velocity will be performed for velocity errors > 75 fps in any runway component. This number was chosen to meet a flight control system requirement when the FCS is using navigation-derived air data, while at the same time, considering the radar 3-sigma velocity uncertainty of 60 fps. Drag altitude updating of the onboard navigation must be inhibited prior to computing a velocity delta state since it corrupts the computation of velocity errors in the delta state processor. Two sets of state vector errors are available on a ground display in runway coordinates. The output of the high speed radar filter is referred to as local deltas, whereas, the output of the delta state processor is referred to as propagated deltas. The local deltas represent the current state errors. The propagated deltas represent the expected state errors at some time in the future; these deltas are used to generate a delta state update. They are computed assuming that the state errors are linear, that the current velocity errors are constant over some short period of time, and that the update will be applied at the end of that time. Since the velocity errors are computed from changes in position, any external update, such as drag altitude updating, will mask the true state error and cause the velocity delta to be wrong. Therefore, external navigation aids have to be inhibited prior to computing a delta state update involving velocities. Any time a velocity update is required, a position and velocity delta update will be executed, since velocity errors will also cause position errors.

FLIGHT RULES

A4.1.5-6 NAVIGATION FILTER MANAGEMENT AUTO/INHIBIT/FORCE (AIF)

This rule provides direction to the crew and ground for the management of external sensor data incorporation into the navigation filter. It assumes that the crew AIF switches are initially in INHIBIT for TACAN and BARO and in AUTO for drag altitude processing. The rule is presented in matrix form to facilitate correlation of various situations to the action to be taken for those situations.

A. TACAN-INITIAL PROCESSING (INITIALLY IN INHIBIT):

	RATIO <1	RATIO >1		1-LOCK
		BAD TACAN	BAD STATE VECTOR	
EARLY NO COMM (V _{REL} > 6000 [1] FPS H > 130K FT)	REMAIN IN INHIBIT	REMAIN IN INHIBIT	REMAIN IN INHIBIT	REMAIN IN INHIBIT
COMM	GROUND CALL; AUTO [3]	GROUND CALL; INHIBIT IF STATION, SWITCH TO B/U CH IF LRU, Δ STATE UPDATE AS REQD	GROUND CALL; Δ STATE OR FORCE RETURN TO AUTO WHEN RATIO <1	GROUND CALL; DESELECT MISSING TACAN'S (RESELECT NON- FAILED TACAN LRU'S WHEN 2 LOCK)
LATE NO COMM (V _{REL} < 6000 FPS, H < 130K FT)	 AUTO	TROUBLESHOOT TO DETERMINE CAUSE OF EDITING A. SWITCH GROUND STATIONS B. CHECK IMU STATUS C. OBSERVE RESIDUAL, RATIO BEHAVIOR D. MONITOR WITH HSI		WAIT UNTIL V _{REL} <5500 FPS [2] THEN DESELECT MISSING TACAN'S (DO NOT FORCE)
		AUTO	FORCE	

NOTES:

- [1] FOR RTLS, V_{REL} < 6500 FPS.
- [2] FOR RTLS, V_{REL} < 4700 FPS.
- [3] EVEN THOUGH THE RATIO IS < 1, TACAN DATA WILL NOT BE ACCEPTED IF GROUND RADAR INDICATES THAT INCORPORATION OF DATA WILL DEGRADE THE NAVIGATION STATE. (REFERENCE RULE {A8.1.2-2}, SENSOR FAILURES.)

THIS RULE CONTINUED ON NEXT PAGE

FLIGHT RULES

A4.1.5-6

NAVIGATION FILTER MANAGEMENT AUTO/INHIBIT/FORCE (AIF) (CONTINUED)

This matrix defines the actions to be taken for initial TACAN processing. For a nominal entry, the TACAN AIF switch is in INHIBIT and the TACAN transceivers are turned to the primary site TACAN channel with the rotary switch in the GPC position. When two TACAN LRU's have locked up, RM passes data to the navigation filter; but, because the AIF control is in INHIBIT, the data will not be processed by navigation. This configuration allows the ground to evaluate the TACAN data compared to radar tracking data and to give the crew a GO to mode the AIF switch to AUTO, so that navigation may process TACAN if it is acceptable. This plan also protects the validity of the ground delta state computation in the event that a ground- initiated vector update is required. (The ground delta state processor requires that external data not be taken in since it assumes that the state errors are linear). The early NO-COMM row of the rule matrix supports this mode of operation by having the crew wait for COMM in order to have ground assistance. However, there is a limit to how long the crew should wait before they try to independently troubleshoot the lack of good TACAN data. For EOM, this limit was chosen to be about 130k feet, which corresponds to a V_{rel} of approximately 6000 fps. At this altitude, it is becoming more urgent to correct the vehicle state since the footprint is shrinking (for RTLS, 130k feet altitude corresponds to a V_{rel} of approximately 6500 fps)

In the COMM row, for TACAN data that agrees with the navigation, the ratios will be less than one. Upon ground evaluation of the TACAN data and of the onboard vector compared to tracking data, a GO will be given for the crew to go to AUTO. However, if the ground evaluation shows that incorporation of the TACAN data will degrade the navigation state, the TACAN data will be held out until it will improve the onboard state. Analysis shows that ground station biases greater than 0.3 nm. in range or 1 degree in bearing can result in position delta state limit violations (ref. Rule {A4.1.5-4}, DELTA STATE POSITION UPDATES) in the absence of all other navigation error sources. If the ground determines that the TACAN data compared to the tracking data indicates a bias on all three LRU's greater than 0.3 nm or 1 degree, the recommendation will be to try another ground station. If, at the TACAN 2-LRU level, the average LRU measurement error (based on tracking) is greater than 0.3 nm or 1 degree and RM limits are not exceeded, the larger biased LRU will be deselected. Multiple LRU biases can escape RM detection and still significantly degrade the navigation state. LRU deselection will be performed only if that action will reduce the bias in the selected measurement to less than 0.3 nm or 1 degree.

One of two failures can cause the ratios to be greater than one. Either the TACAN or the state vector could be at fault. If the ground-station-to-tracking compares are good, then the fault lies with the onboard system. If the fault lies with the onboard system and the delta state update criteria are exceeded, an update will be initiated. If the ground determines that the vehicle state is erroneous and the TACAN residuals indicate that forcing the data will correct the state error, then the crew will be advised to force the data until the ratio is less than one at which time they will be advised to return to AUTO. Otherwise, a delta state update will be performed.

THIS RULE CONTINUED ON NEXT PAGE

FLIGHT RULES

A4.1.5-6

NAVIGATION FILTER MANAGEMENT AUTO/INHIBIT/FORCE (AIF) (CONTINUED)

The final entry in the COMM row deals with only one LRU locking up. At initial acquisition, the onboard redundancy management requires that two LRU's be locked on before data is passed to navigation. If only one LRU locks on, the crew/ground should verify that the data is good for that LRU, and the crew should deselect the missing LRU's to override the two-lock requirement. Once data is processed initially, the range two-lock restriction is satisfied, but two LRU's are still required to be locked on prior to processing bearing data. Therefore, it is advisable to wait until two LRU's are locked on prior to reselecting non-failed LRU's. This provides RM protection for both range and bearing. However, if the ground deems it necessary to process data from one LRU, then this procedure would be used and, during the period of one LRU lock, the ground would carefully monitor the quality of the data from the single LRU.

In the NO-COMM case, the crew must make decisions in the operations of the AIF controls independently from the ground. The NO-COMM case may be assumed by the crew if they are entering to a landing site that has no COMM with the ground or to a site that has COMM, but COMM has not been established by $V_{ref}=6000$ fps. If the TACAN deltas on the HSD look good and the ratios are less than one, then the crew should mode the AIF switch to AUTO. If the ratio is greater than one, the crew must use onboard displays to determine whether the TACAN or state vector is bad. The following procedures are available to the crew:

- a. Switch ground stations - The onboard I-loads for the TACAN table are such that, with the rotary switch in the GPC position, the landing site TACAN should be acquired. If data is not acquired or if the ratio is greater than one, the crew may execute item 5 on GN: SPEC 50 to select the alternate or backup TACAN and evaluate that data. If the ratios for the alternate station are less than one, then the problem is probably with the prime TACAN ground station. If the ratios are greater than one, it would probably indicate a bad navigation state, although there is a very small probability that two or more LRU's would fail in the same manner.*
- b. Check IMU status - If the IMU mission performance has been nominal and a good IMU alignment was performed pre-deorbit, and no IMU failures have occurred during entry, it is unlikely that the navigation state could be in error by a sufficient magnitude to cause ratios greater than one. Therefore, the TACAN data should be suspect. However, if the IMU's have had problems or an alignment was not performed pre-deorbit, or an IMU has failed RM during entry, the crew should suspect that the navigation state is in error.*
- c. Observe residual/ratio behavior - If the residuals/ratios are steady or show a constant trend, it is likely that the navigation state is in error. If the residuals/ratios are erratic, it is likely that the TACAN data is erroneous.*
- d. Monitor with HSI - The crew can select raw TACAN data to drive the HSI and compare the range and bearing with the navigated position and a visual estimate of the real position. This would be a difficult procedure since the values on the HSI will be continually changing and the magnitude of the errors would have to be so large that the source of the error should have already been detected by one of the other methods.*

FLIGHT RULES

THIS RULE CONTINUED ON NEXT PAGE

FLIGHT RULES

**A4.1.5-6 NAVIGATION FILTER MANAGEMENT AUTO/INHIBIT/FORCE
(AIF) (CONTINUED)**

The final situation in the NO-COMM row is the case where only one LRU locks on. In this case, the crew should wait as long as possible before the footprint shrinks to the point that the state error really has to be removed (5500 fps for EOM and 4700 fps for GRTLS). At this point, the nonlocked on LRU's should be deselected and the data from the single LRU passed to navigation by moding the AIF switch to AUTO. It should not be moded to FORCE to protect the navigation from bad TACAN data.

B. TACAN - POST CONVERGENCE (INITIALLY IN AUTO):

	RATIO <1	RATIO >1	
		BAD TACAN	BAD STATE VECTOR
COMM	GROUND CALL; AUTO	GROUND CALL; INHIBIT IF STATION, SWITCH TO B/U CH IF LRU, Δ STATE UPDATE IF REQ'D. (BACK TO AUTO IF RATIO <1)	REMAIN IN AUTO PERFORM A ZERO Δ STATE UPDATE. IF RATIO STILL >1; FORCE
NO COMM	GROUND CALL; AUTO	TROUBLESHOOT TO DETERMINE CAUSE OF EDITING A. OBSERVE RESIDUAL, RATIO BEHAVIOR B. CHECK IMU STATUS C. MONITOR WITH HSI D. SWITCH TACAN STATIONS	
		REMAIN IN AUTO	REMAIN IN AUTO PERFORM A ZERO Δ STATE UPDATE. IF RATIO STILL >1; FORCE

FLIGHT RULES

This rule shows the actions to be taken once TACAN data has been processed by navigation. For a nominal entry, the crew action would be to remain in AUTO for either COMM or NO-COMM since the ratio should not grow above one. If, for any reason, the ratio does become greater than one, then the ground or the crew can utilize the same techniques to isolate the problem as were used at initial acquisition. If the problem is bad TACAN data, the actions are the same as at initial acquisition. If the problem is the navigation state, the procedures change slightly in that a zero delta state update is performed prior to applying the same procedure used for the initial acquisition case. This is done to reinitialize the covariance if TACAN data has already been processed and it is required to force TACAN in order to fix the navigation state, since the processing of TACAN data might have converged the covariance matrix to the point where even forcing the TACAN data would not remove the state errors.

THIS RULE CONTINUED ON NEXT PAGE

FLIGHT RULES

A4.1.5-6 NAVIGATION FILTER MANAGEMENT AUTO/INHIBIT/FORCE
(AIF) (CONTINUED)

C. BARO (INITIALLY INHIBIT) :

	RATIO <1	RATIO >1		NOT PASSING RM
		BAD BARO	BAD STATE VECTOR	
COMM	GROUND CALL; AUTO [1]	GROUND CALL; REMAIN IN INHIBIT	GROUND CALL: FORCE	GROUND CALL; PRIME SELECT
NO COMM	AUTO	TACAN OK: REMAIN IN INHIBIT NO TACAN: IF RATIO STEADY, FORCE IF RATIO ERRATIC, AUTO		WAIT UNTIL M <0.9, THEN PRIME SELECT (DO NOT FORCE)

NOTE:

- [1] EVEN THOUGH THE RATIO IS < 1, BARO DATA WILL NOT BE ACCEPTED IF THE GROUND RADAR INDICATES THAT INCORPORATION OF THE DATA WILL DEGRADE THE NAVIGATION STATE.

This matrix shows the actions to be taken to manage the processing of baro altitude data in the navigation. Initially, the BARO AIF switch will be in INHIBIT. The ground will evaluate the baro data and, if the ratio is less than one and the data will improve the navigated altitude channel, then the crew will be advised to mode the AIF switch to AUTO. If comparison to radar indicates that the baro data will degrade the navigation altitude channel, then the crew will be asked to hold off incorporating baro until the ground determines that the data will improve the navigation state. If the baro data is bad and the ratio is > 1, the crew will be advised to remain in INHIBIT until the data improves or the delta state limit is exceeded. If the onboard state is bad, the ground will observe the error and baro residual; and, if the errors are such that forcing the data will improve the state, the crew will be asked to mode the AIF switch to FORCE until the ratio becomes less than one, at which time they should return to AUTO. Otherwise, a delta state update will be initiated. If RM is not passing data to navigation, the ground will assist the crew in deselecting ADTA's if required, evaluate the data, and have the crew mode to AUTO.

FLIGHT RULES

In the NO-COMM case, the crew should go to AUTO around $M=2.5$ when the ratio is < 1 and onboard evaluation indicates valid baro data. Going to AUTO earlier does not provide any benefit to navigation since baro data is not processed by navigation until $V_{rel}=2500$ fps. If the ratio is > 1 and valid TACAN data is being processed, then the AIF switch should remain in INHIBIT. If TACAN data is not being processed, the requirement for baro data is even stronger, but the only method of crew evaluation is to monitor the baro residuals on the horizontal situation display. If they appear steady and reasonable considering past navigation performance, the crew should mode the AIF control to FORCE until the ratio becomes < 1 and then return to AUTO. If they are erratic or unreasonable based on past navigation performance, the AIF switch should be left in AUTO. The final situation in the NO-COMM row is the case where RM is not passing valid data. The crew should evaluate the ADTA's and prime select the best data source when subsonic. The AIF switch should be moded to AUTO in order to edit the data, should the ratio become greater than one.

THIS RULE CONTINUED ON NEXT PAGE

FLIGHT RULES

A4.1.5-6

NAVIGATION FILTER MANAGEMENT AUTO/INHIBIT/FORCE (AIF) (CONTINUED)

TACAN and BARO data will be incorporated to PASS and BFS after MCC GO. Processing sensors to both systems ensures the best BFS state vector should an engage be required and eliminates multiple state vector transfers during periods of high crew workload. Analysis shows that, if the BFS is engaged near touchdown with the BFS NAV errors experienced on some flights, achieving the runway may not be possible.

Shuttle flight history and FAA TACAN reliability data assert that a sudden sensor bias or failure less than RM and filter edit criteria but large enough to degrade NAV is unlikely, especially after STA prelanding checks and after MCC has determined the data good. BARO system failures are more likely to occur during probe deploy before data is available for ground evaluation. Additional protection against such failures is provided by a tight postprocessing covariance matrix which prevents errors from growing rapidly, affording sufficient time to inhibit the bad sensor on MCC call.

Analysis has shown that, even while processing sensors to PASS and BFS, two-level IMU diagnosing capability is retained. If, at the IMU 2 level and processing sensors, one IMU's performance is worse than the other, the MCC can identify the worse-performing IMU by evaluating differences between the individual PASS (three-string NAV) states and radar tracking. The difference in PASS and BFS selection schemes (averaging versus low-number-select) allows evaluation by observation of PASS and BFS select states.

If radar tracking is not available as in a TAL, ELS or ground filter NO-GO, the MCC has the same data available to the crew. The ground may assist to the best of its ability, but sensor incorporation without radar tracking is a crew call. In this situation, TACAN and BARO will be incorporated to PASS and BFS since no advantage can be gained by withholding sensor data from either system.

THIS RULE CONTINUED ON NEXT PAGE

FLIGHT RULES

A4.1.5-6

NAVIGATION FILTER MANAGEMENT AUTO/INHIBIT/FORCE (AIF) (CONTINUED)

- D. DRAG ALTITUDE - INCORPORATION OF DRAG ALTITUDE DATA INTO NAVIGATION IS MANDATORY. THE DRAG AIF CONTROL WILL BE INITIATED IN THE AUTO MODE. IF REPETITIVE DATA EDITING OCCURS, THE AIF CONTROL WILL BE SWITCHED TO THE FORCE MODE. HOWEVER, FOR GRTLS DATA INCORPORATION IS NOT MANDATORY. THE AIF CONTROL WILL BE INITIATED AND LEFT IN AUTO MODE.

Incorporation of drag altitude into navigation is mandatory. Drag updating begins during blackout when the ground can offer no assistance in evaluating the data or aiding the crew in deciding to allow drag altitude to update the navigation state. Since the drag altitude is derived from IMU data, the validity of the measurement is dependent on the quality of the IMU data. Since there is no way for the crew to independently evaluate the IMU data, it was decided to set the drag AIF switch to AUTO. If the combined navigation/drag updating performance is within 8 sigma, which is equivalent to about 80,000 feet altitude, the drag will pass the edit criteria and will be incorporated into the navigation state without incident. If the performance is worse than 8 sigma, editing will occur and the crew procedure will be to mode the AIF switch to FORCE to incorporate the drag altitude and thus bound the altitude error growth. For GRTLS, drag altitude would probably never be edited, since the IMU performance from the time of lift-off to execution of the GRTLS would not degrade to the point to cause editing. Further, on a GRTLS, TACAN data is acquired very high in the trajectory or just after drag processing is initiated; and, since TACAN is a more powerful measurement source, it would correct the state such that drag editing should not occur. Also, tracking data should be available and any error that would cause drag data to be edited would result in a violation of the delta state update criteria. For these reasons, it was decided to leave the drag AIF switch in the AUTO mode.

FLIGHT RULES

A4.1.5-7 ENTRY LIMITS

A. THE FOLLOWING LIMITS ARE APPLICABLE TO THE ENTRY AND LANDING FLIGHT PHASES. THE CG MUST BE KEPT WITHIN NORMAL LIMITS (REFERENCE RULE {A4.1.4-3}, CG PLANNING). THE MCC WILL MONITOR THE PARAMETERS BELOW AND ADVISE THE CREW TO PREVENT EXCEEDENCES. @[050495-1531B]

1. NZ LIMITS (THE MOST CONSTRAINING OF THE FOLLOWING): @[091098-6716A]

a. ORBITER WEIGHT \leq 211 KLB: THE NZ LIMIT IS 2.5 G.

b. ORBITER WEIGHT $>$ 211 KLB: THE NZ LIMIT IS DETERMINED AS FOLLOWS:

$$NZMAX = 4.563 - (9.778 \times 10^{-6} \times WT)$$

c. $1076.7 > \text{ORBITER XCG} \geq 1075.2$, $QBAR \geq 325$, $MACH < 1$, THE NZ LIMIT IS DETERMINED AS FOLLOWS:

$$NZMAX = 4.71 - (0.0068 \times QBAR), \text{ WHERE } QBAR \text{ IS DETERMINED FROM PREDICTIONS/PREDICITONS MADE BY 6-DOF STAMPS SIMULATION.}$$

NOTE: ~~e.~~ FOR PRE-DEORBIT PLANNING PURPOSES, A 0.2 g LOAD FACTOR BIAS IS SUBTRACTED FROM THE ABOVE STRUCTURAL LIMITS TO PROTECT FOR DISPERSIONS AND ASYMMETRY DURING A ROLLING MANEUVER.

Orbiter normal load factor limits are defined in the SODB (JSC-08934) Volume V. The MCC will evaluate the planned entry profile to ensure these load factor limits are not exceeded. When in the CSS, the crew must implement active load factor monitoring and avoidance procedures when required. The MCC will advise the crew of what limits to protect. To protect for wind dispersions on the heading alignment cone (HAC), the operational Nz limit is reduced by a bias for planning purposes. The value of the bias is derived by averaging differences between flight and real-time predicted data.

The analysis performed by Boeing North American Flight Control and Loads groups (presented at the 145th Ascent/Entry Flight Techniques on December 19, 1997) to expand the forward X CG limit resulted in an additional constraint on Orbiter NZ limit. For flights predicted to be in this region, the NZ limit is also a function of Qbar. The operational NZ limit will be the most constraining. "The X CG is evaluated at Mach=3.5." -@[091098-6716A] @[091098-6716A]

FLIGHT RULES

THIS RULE CONTINUED ON NEXT PAGE

FLIGHT RULES

A4.1.5-7

ENTRY LIMITS (CONTINUED)

ORBITER NORMAL LOAD FACTOR LIMITS

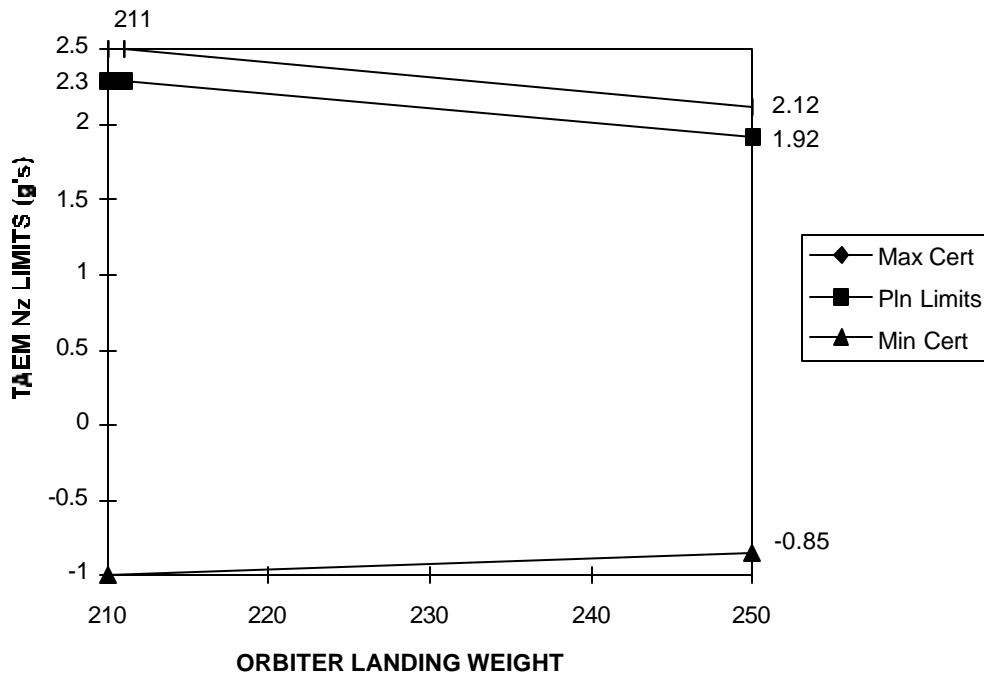

2. $Q\text{-BAR} < 350 \text{ PSF (321 KEAS) FOR MACH} < 1$

$Q\text{-BAR} < 330 \text{ PSF (312 KEAS) DURING LANDING GEAR DEPLOYMENT}$

The Q-bar restrictions are designed to protect the structural integrity of the orbiter and to ensure flight within the integrated guidance, navigation, and control envelopes. The Q-bar profile gives a good indication of whether or not the guidance is being stressed in trying to fly the reference profile. For real-time evaluation purposes, evaluation of the subsonic region is important because it includes the dynamics of flying the HAC with the winds of the day. The certified Q-bar limit of 375 psf in the subsonic region is documented in SODB Volume V. The TAEM guidance will limit normal acceleration commands to stay within the maximum Q-bar limit which is I-loaded to 350 psf. This provides for the 25 psf Air Data System accuracy listed in the SODB. The 350 psf limit is used DOL/DOE because it indicates a stressed trajectory, protects for events not being simulated (CSS, wind persistence), and it protects against flying a trajectory which could indicate an airspeed > 321 KEAS (350 psf).

During approach and landing, guidance indirectly controls dynamic pressure by controlling the equivalent airspeed, which is related to dynamic pressure. The 330 psf (312 KEAS) limit on maximum dynamic pressure at gear deploy is covered in the SODB 3.4.2.1-6.

FLIGHT RULES

THIS RULE CONTINUED ON NEXT PAGE

FLIGHT RULES

A4.1.5-7

ENTRY LIMITS (CONTINUED)

Angle of Attack Boundaries - MM304 Only

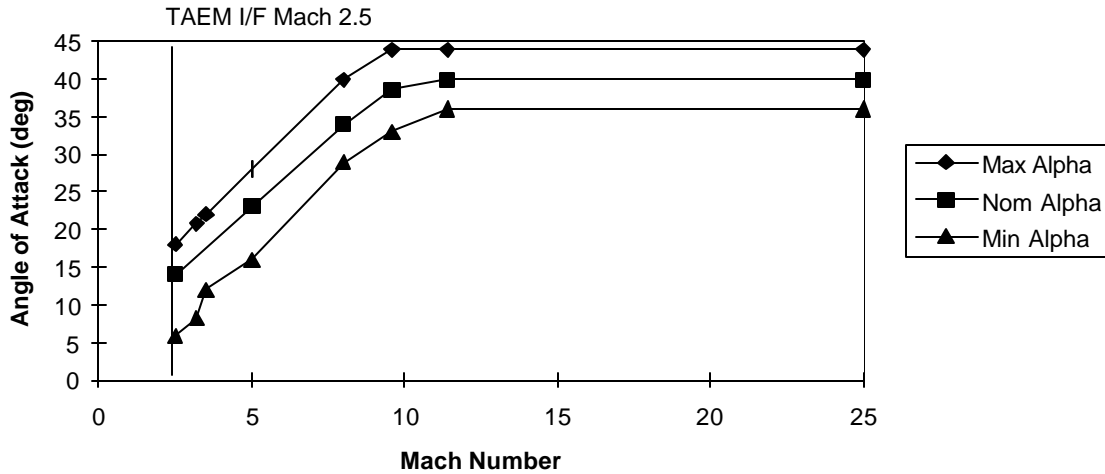

MACH	MAX ALPHA	MIN ALPHA	MACH	MAX ALPHA	MIN ALPHA
2.5	18.0	6.0	0.0	20.0	-4.0
3.2	20.8	8.2	0.2		-4.0
3.5	22.0	12.0	0.5		0.0
5.0	28.0	16.0	0.6	20.0	
8.0	40.0	28.9	0.8	15.0	
9.6	44.0	33.0	1.1		4.0
11.4	44.0	36.0	2.0	15.0	4.0
25.0	44.0	36.0	2.5	18.0	6.0

Angle of Attack Boundaries - MM305 Only

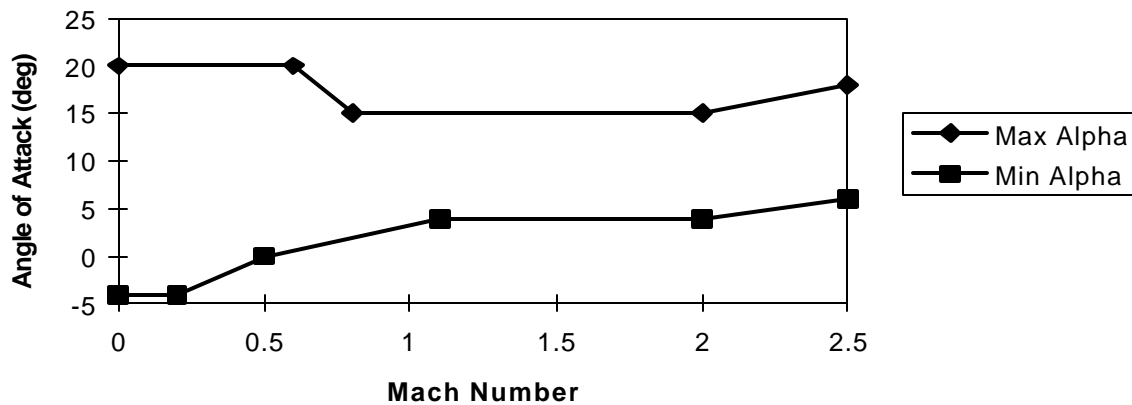

THIS RULE CONTINUED ON NEXT PAGE

FLIGHT RULES

A4.1.5-7 ENTRY LIMITS (CONTINUED)

B. THESE ATTITUDE CONSTRAINTS WILL NOT BE EXCEEDED IN AUTO OR CSS MODE. THE MCC WILL MONITOR THESE PARAMETERS AND ADVISE THE CREW TO PREVENT EXCEEDENCES.

1. ANGLE OF ATTACK (ALPHA DEG) VERSUS MACH NUMBER.
2. IF STEADY STATE SIDESLIP EXCEEDS 2 DEGREES AND ONE OR MORE YAW JETS FIRE CONTINUOUSLY OR IF THE SIDESLIP EXCEEDS THE TWO-JET CAPABILITY PER THE "BETA ESTIMATOR" (SCALED AY), THE CREW WILL MANUALLY TRIM TO REDUCE RCS JET FIRING ($2 < M < 12$).

The orbiter must be operated within the specified angle of attack constraints to maintain control in pitch and roll/yaw axes, to meet structural requirements during venting, to assure hinge moment limits for aerosurfaces are not exceeded, and to remain within guidance limits due to interaction with roll angle in solving range and drag equations.

Large steady state sideslip can lead to loss of control. If jets are required to maintain vehicle trim, they will have reduced effectiveness during dynamic flight phases where their force is required; reduced stability margins and control problems may result. Also, there will be a large increase in RCS propellant usage. ©[050495-1531B]

Rule {A4.1.3-7}, PLD/EOM LANDING OPPORTUNITY REQUIREMENTS, references this rule.

FLIGHT RULES

A4.1.5-8

ENTRY TAKEOVER RULES

CONDITION	ACTION	CRITERIA FOR AUTO RE-ENGAGE [1]	REMARKS
A. $ROL_{REF} < ROL_{REF} \text{ LIMIT}$ (\downarrow) PRIOR TO THE FIRST BANK REVERSAL	CSS ROLL/YAW; INITIATE FIRST BANK REVERSAL WHEN DELTA AZIMUTH $\geq 5^\circ$	FIRST BANK REVERSAL COMPLETION	PROTECTS AGAINST TARGET MOVING OUT OF THE TOE OF THE FOOTPRINT FOR LOW L/D ENTRY (ONBOARD CALL).
B. S-BAND AOS TO M=2.5; 1. NAV ERRORS RESULTING IN TRAJECTORY DISPERSIONS WHICH ARE UNCORRECTABLE BY AUTO GUIDANCE BY M=4 OR RESULT IN GREATER THAN 10 NM RANGE ERROR AT TAEM INTERFACE. 2. TRAJECTORY DISPERSIONS WHICH ARE UNCORRECTABLE BY AUTO GUIDANCE.	CSS PITCH, AND ROLL/YAW; GCA; REDESIGNATE HAC/RUNWAY	NAV ERRORS REDUCED TO WITHIN DELTA STATE UPDATE LIMITS AND TRAJECTORY RETURNED TO WITHIN GUIDANCE LIMITS	ASSURES TRAJECTORY IS WITHIN THE TAEM CAPABILITY TO ACHIEVE AN ACCEPTABLE RUNWAY (GROUND CALL).
C. BETWEEN M=2 AND M=2.5 TRAJECTORY DISPERSIONS WHICH, IF UNCORRECTED, WILL RESULT IN INSUFFICIENT ENERGY TO REACH THE TARGETED RUNWAY OR EXCESS ENERGY IN VIOLATION OF THE AUTO GUIDANCE S-TURN CAPABILITY.	CSS PITCH, AND ROLL/YAW; GCA; REDESIGNATE HAC/RUNWAY	NAV ERRORS REDUCED TO WITHIN DELTA STATE UPDATE LIMITS AND TRAJECTORY RETURNED TO WITHIN GUIDANCE LIMITS	TAKEOVER IS REQUIRED TO MAINTAIN TRAJECTORY TO ACHIEVE AN ACCEPTABLE RUNWAY. THE CRITERIA FOR CHANGING RUNWAYS WILL BE BASED ON LOSS OF MANUAL CAPABILITY TO ACHIEVE THE TARGETED RUNWAY (~25 NM DISPERSION AT M=2.5) (GROUND CALL).
D. M=2.5 TO AUTOLAND INTERFACE: NAV ERRORS THAT EXCEED THE TAEM PERFORMANCE FOOTPRINT (TOTAL FOOTPRINT MINUS WIND ALLOWANCE).	CSS ROLL/YAW; GCA TO AUTOLAND INTERFACE OR CREW VISUAL TAKEOVER	NAV ERRORS REDUCED TO WITHIN DELTA STATE UPDATE LIMITS AND TRAJECTORY RETURNED TO WITHIN GUIDANCE LIMITS	MANUALLY RETURNS TRAJECTORY TO AN ACCEPTABLE AUTOLAND INTERFACE (GROUND CALL).
E. <u>FOUR (4) YAW JETS FAILED (SAME SIDE); AFTER QBAR > 10 AND PRIOR TO MACH 1.</u>	<u>CSS ROLL/YAW (NO YAW JET MODE)</u>	<u>RECOVERY OF A YAW JET AND SELECTION OF AUTO ENTRY ROLL MODE</u>	<u>CSS IS FORCED UPON NO YAW JET ENTRY ROLL MODE SELECTION; AUTO NO YAW JET IS NOT A CERTIFIED FLIGHT CONTROL MODE AND MAY RESULT IN LOW-FREQUENCY BANK OSCILLATIONS.</u>
F. PRIOR TO: 1. DELTA STATE UPDATES INCLUDING VELOCITY COMPONENTS ANYTIME, OR POSITION ONLY COMPONENTS IF M=5 TO TAEM 2. FORCED AIR DATA TO NAV 3. AIR DATA INCORPORATION TO GNC AFTER M=2.5	1. CSS PITCH, ROLL/YAW 2. <u>CSS PITCH, ROLL/YAW</u> 3. CSS PITCH	COMPLETION OF EVENT AND RECONVERGENCE OF GUIDANCE NEEDLES	POTENTIAL FOR TRANSIENT INTO FCS WITH IMPACT TO VEHICLE CONTROL
G. PRIOR TO MSBLS ACQ IF MCC HAS TM AND CONFIRMS LATERAL NAV ERRORS > 8000 FT OR H ERRORS > 500 FT	CSS PITCH, ROLL/YAW	INCORPORATION OF MSBLS	POTENTIAL TRAJECTORY TRANSIENT
H. FAILURE OF AUTOLAND GUIDE TO ENGAGE PRIOR TO 6000 FT ALT	CSS PITCH, ROLL/YAW	NONE	MANUAL LANDING IS PREFERRED
I. FOR UNEXPLAINED OR UNCOMFORTABLE TRANSIENTS OR TRAJECTORY CONDITIONS	CSS PITCH, ROLL/YAW	CREW OPTION	NONE

[@J021998-6513A\]](#)

NOTE: [1] AUTO RE-ENGAGE IS NOT CONSIDERED TO BE A REQUIREMENT AFTER TAEM INTERFACE (M=2.5).

The rationale for each condition is contained in the rule under the remarks.

FLIGHT RULES

A4.1.5-9 AERO TEST MANEUVERS

AERO TEST MANEUVERS WILL NOT BE ATTEMPTED IF THE CROSSRANGE AT ENTRY INTERFACE IS GREATER THAN THE DTO CROSSRANGE LIMIT (REF. RULE {X4.1.1-1}, TRAJECTORY AND GUIDANCE PARAMETERS) UNTIL THE FIRST ROLL REVERSAL HAS BEEN COMPLETED AND THE ORBITER ENERGY STATE AND DRAG PROFILE ARE NOMINAL. VALID TELEMETRY IS REQUIRED FOR EVALUATION OF THE ORBITER ENERGY STATE.

For the purposes of this rule, any PTI that inhibits entry guidance is considered an aero test maneuver. Since entry guidance is locked out, there is no attempt to follow the optimal energy profile or to respond to roll reversals. High crossrange at entry interface requires optimum bank angle and energy control to ensure a manageable energy state at TAEM interface. If energy is nominal and the orbiter is on the nominal drag profile, guidance will be able to manage energy properly, even under given dispersions. Valid telemetry is needed to verify that the energy and drag profiles are within limits.

Rule {A2.1.6-1}, ENTRY DTO/AUTO MODE/CROSSWIND DTO GO/NO-GO, references this rule.

FLIGHT RULES

RANGE SAFETY FLIGHT RULES

A4.1.6-0 SIGNATURE SECTION

THE ENCLOSED RANGE SAFETY FLIGHT RULES HAVE BEEN JOINTLY NEGOTIATED AND AGREED TO BY NASA AND THE EASTERN RANGE. ANY SUBSEQUENT CHANGES TO THESE RULES WILL REQUIRE RE-EXECUTION OF THIS CONCURRENCE PAGE. @[053096 PRCB-4001]

~~@[081497-6306A] EFFECTIVITY: FIRST FLIGHT ET-RSS HAS BEEN DEACTIVATED.~~

COMMANDER, 45TH SPACE WING

MANAGER, SPACE SHUTTLE PROGRAM

DATE

DATE

FLIGHT RULES

A4.1.6-1 POLICY

- A. MEMORANDUM OF AGREEMENT (MOA) 15E-2-8, BETWEEN THE 45TH SPACE WING (45 SW) AND THE JOHN F. KENNEDY SPACE CENTER (KSC) FOR MISSILE/SPACE VEHICLE SAFETY ON KSC AND THE EASTERN RANGE (ER), EFFECTIVE NOVEMBER 2, 1995, DELINEATES THE AGENCY RESPONSIBLE FOR MISSILE/SPACE VEHICLE FLIGHT AND GROUND SAFETY FOR LAUNCHES FROM THE ER AND KSC AND IDENTIFIES CERTAIN RESPONSIBILITIES ASSOCIATED WITH MISSILE/SPACE VEHICLE MISHAPS. RANGE SAFETY REQUIREMENTS ARE CONTAINED IN EWR 127-1, MARCH 31, 1995. @[053096 PRCB-4001]
- B. RANGE SAFETY POLICIES AND PROCEDURES ARE SPECIFIED IN SECTION 1 OF EWR 127-1. CONSISTENT WITH SECTION 1.4, SPECIFICALLY PARAGRAPHS 1.4.1 AND 1.4.1.3, THE 45 SW COMMANDER HAS AUTHORIZED REMOVAL OF THE RANGE SAFETY SYSTEM (RSS) FROM THE EXTERNAL TANK (ET) FOR PRESENTLY DESCRIBED STS FLIGHT CONFIGURATIONS, PAYLOADS, AND TRAJECTORIES, BASED ON A RISK ASSESSMENT WHICH ASSUMES THE VEHICLE IMPACT POINT WILL BE STOPPED BEFORE REACHING WELL DEFINED LIMIT LINES. ANY FUTURE STS FLIGHT VEHICLE MODIFICATIONS AND/OR NEW TRAJECTORIES MUST BE ANALYZED TO ENSURE PUBLIC RISKS HAVE NOT INCREASED BEYOND ACCEPTABLE LEVELS. IN THE EVENT OF AN UNACCEPTABLE PUBLIC RISK INCREASE, FLIGHT DESIGN MODIFICATIONS OR INSTALLATION OF A RANGE SAFETY FLIGHT OR THRUST TERMINATION SYSTEM WILL BE REQUIRED TO REDUCE THE RISK TO AN ACCEPTABLE LEVEL. THE 45 SW COMMANDER RETAINS OVERALL RESPONSIBILITY FOR PUBLIC SAFETY IN ACCORDANCE WITH EWR 127-1, SECTION 1.3.1. THE FLIGHT CREW COMMANDER (CDR) AND PILOT (PLT) BECOME AGENTS OF THE 45 SW COMMANDER FOR PUBLIC SAFETY DURING THE PORTION OF FLIGHT AFTER SOLID ROCKET BOOSTER SEPARATION AND PRIOR TO MAIN ENGINE CUTOFF. THIS AGENT RELATIONSHIP NECESSITATES THAT ALL CDR'S AND PLT'S RECEIVE INITIAL AND RECURRING TRAINING THAT IS APPROVED BY THE 45 SW AND DOCUMENTED AS PART OF THE NASA CERTIFICATE OF FLIGHT READINESS (COFR) PROCESS. 45 SW RANGE SAFETY FLIGHT PLAN APPROVAL IS CONTINGENT UPON APPROVED AND DOCUMENTED TRAINING AS EVIDENCED IN THE COFR PROCESS.

FLIGHT RULES

C. THE FOLLOWING MISSION RULES SUPPLEMENT EWR 127-1 AND THE RANGE SAFETY OPERATIONS REQUIREMENTS DOCUMENT AND OPERATIONS SUPPLEMENT. THESE RULES IMPLEMENT THE U.S. AIR FORCE (USAF) POLICY OF ADVANCING THE NATION'S COMMITMENT TO LEADERSHIP IN THE EXPLORATION AND USE OF SPACE AT MINIMUM RISK TO THE FLIGHT CREWS, GENERAL PUBLIC, AND PROPERTY. THEY PROVIDE ACTION GUIDANCE TO PERSONNEL RESPONSIBLE FOR EXECUTING THIS POLICY. @[053096 PRCB-4001]

FLIGHT RULES

|

FLIGHT RULES

A4.1.6-2

DEFINITIONS @[081497-6306A] ~~FLIGHT TERMINATION ACTION~~

THIS SECTION CENTRALIZES DEFINITIONS RELATED TO THESE FLIGHT RULES TO FACILITATE CLARITY IN THE RULES THEMSELVES. @[053096 PRCB-4001]

- A. FLIGHT TERMINATION SYSTEM (FTS): THE FTS NEUTRALIZES SOLID ROCKET BOOSTER (SRB) THRUST WITH A SINGLE LINEAR SHAPED CHARGE PER SRB WHICH SPLITS THE SOLID ROCKET MOTOR CASES. ANALYSIS SHOWS THAT THIS ACTION ALSO CAUSES DISPERSAL OF THE EXTERNAL TANK (ET) PROPELLANTS. THE FLIGHT TERMINATION SYSTEM IS PROTECTED FROM UNAUTHORIZED COMMANDS BY THE DIGITAL RANGE SAFETY COMMAND SYSTEM (DRSCS). THE DRSCS "ARM" AND "FIRE" COMMANDS ARE FORMATTED BY CRYPTO HARDWARE IN THE ER RANGE OPERATIONS CONTROL CENTER (ROCC). THE COMMANDS ARE RECEIVED AND DECODED BY FLIGHT INTEGRATED RECEIVER DECODERS (IRD'S) IN EACH SRB. THE CODES FOR A PARTICULAR FLIGHT BECOME UNCLASSIFIED AT SRB SPLASHDOWN OR UPON TRANSMISSION OF COMMANDS ANY TIME AFTER SRB IGNITION. THE "ARM" COMMAND, WHICH IS PREPARATORY TO THE "FIRE" COMMAND, ACTIVATES A WARNING LIGHT IN THE ORBITER AND IRREVERSIBLY CHARGES THE PYROTECHNIC INITIATOR CONTROLLERS (PIC'S). WHEN FLIGHT TERMINATION ACTION IS REQUIRED, THE FCO WILL TRANSMIT THE "FIRE" COMMAND IMMEDIATELY AFTER THE "ARM" COMMAND.
- B. VEHICLE PERFORMANCE DATA: FOR THE PURPOSE OF THESE RULES, VEHICLE PERFORMANCE DATA ARE DEFINED AS FOLLOWS:
1. VEHICLE BEHAVIOR DATA
 - a. PRIMARY CUE: REMOTE TELEVISION PRESENTATION TO FCO
 - b. SECONDARY CUE: RADAR SKIN TRACK A-SCOPE DISPLAY (MINIMUM OF TWO CONFIRMING SITES), OR VERBAL BREAKUP REPORT FROM EITHER THE AIRBORNE OR GROUND VISUAL OBSERVERS.

FLIGHT RULES

- c. TERTIARY CUES: REAL-TIME TELEMETRY (HIGH ATTITUDE RATES OR PREMATURE SEPARATION INDICATORS FOR SRB'S OR ET), THE SOLID ROCKET BOOSTER TRACKING SYSTEM (INDICATIONS OF SEPARATION RATES BETWEEN SRB'S AS SHOWN BY TRAJECTORY DETERMINATION DATA), OR SIMULTANEOUS LOSS OF S-BAND DOWNLINK AND AT LEAST ONE C-BAND TRANSPONDER. @[053096 PRCB-4001]

THIS RULE CONTINUED ON NEXT PAGE

FLIGHT RULES

A4.1.6-2

DEFINITIONS ~~FLIGHT TERMINATION ACTION~~
(CONTINUED) @[081497-6306A]

2. TRAJECTORY DETERMINATION DATA: TRAJECTORY DETERMINATION WILL BE BASED ON RADAR TRACKING, OPTICAL TRACKING, AND TELEMETRY (NAVIGATION AND GUIDANCE) DATA THAT HAVE BEEN SELECTED BY THE ROCC REAL-TIME PROCESSORS. @[053096 PRCB-4001]
- C. CONTROLLABILITY LIMITS: THE VEHICLE IS DEFINED TO BE UNCONTROLLABLE IF PITCH OR YAW RATES GREATER THAN FIVE DEGREES/SECOND ARE EXPERIENCED FOR FIVE SECONDS.
- D. CONTROLLABILITY WARNING LIGHT: A WARNING LIGHT ON THE FCO CONSOLE ACTIVATED BY THE JSC GUIDANCE, NAVIGATION AND CONTROL (GNC) OFFICER WHEN THE VEHICLE IS DETERMINED TO BE OUT OF CONTROL. THE LIGHT SERVES TO MINIMIZE FCO RESPONSE TIME IN SITUATIONS INVOLVING AN UNCONTROLLABLE VEHICLE, AND IS APPLICABLE ONLY DURING FIRST STAGE.
- E. ABORT REQUEST COMMAND: THE ABORT REQUEST SWITCH, LOCATED ON THE FD, FDO, AND FCO CONSOLES, INITIATES TRANSMISSION OF COMMANDS FROM THE MCC COMMAND SYSTEM TO ILLUMINATE THE ABORT LIGHT IN THE ORBITER COCKPIT.
- F. ABORT LIGHT: A WARNING LIGHT IN THE ORBITER COCKPIT, ILLUMINATED VIA THE ABORT REQUEST COMMAND, WHICH SERVES AS A CUE FOR THE FLIGHT CREW TO TAKE SOME ABORT ACTION. FOR IMMINENT RANGE SAFETY MECO LINE VIOLATIONS, THE REQUIRED CREW ACTION IS A MANUAL MECO PER THE PROCEDURES DESCRIBED IN THESE RULES.
- G. FIRST STAGE: ORBITER POWERED FLIGHT FROM SRB IGNITION THROUGH SRB SEPARATION.
- H. SECOND STAGE: ORBITER POWERED FLIGHT AFTER SRB SEPARATION.
- I. AMBER ZONE: CALLED BY THE FCO WHEN THE TRAJECTORY EXCEEDS THE 3-SIGMA VERTICAL OR LATERAL ENVELOPE IN FIRST STAGE. INVOKES THE CONTROLLABILITY RULE, AND IS ONLY APPLICABLE IN FIRST STAGE.
- J. IIP: INSTANTANEOUS, VACUUM IMPACT POINT.

FLIGHT RULES

K. ILL: IMPACT LIMIT LINE. THE PRIMARY AND SECONDARY ILL'S PROTECT THE IMMEDIATE LAUNCH AREA AND OTHER LAND MASSES AGAINST DEBRIS FOOTPRINT ENCROACHMENT DURING FIRST STAGE.
@[053096 PRCB-4001]

THIS RULE CONTINUED ON NEXT PAGE

FLIGHT RULES

A4.1.6-2 DEFINITIONS (CONTINUED) @081497-6306A ~~A4.1.6-2~~
~~FLIGHT TERMINATION ACTION (CONTINUED)~~

- L. SRB NLE: THAT TIME FROM LIFTOFF ON A NOMINAL TRAJECTORY (i.e., WITHIN THE 3-SIGMA TRAJECTORY ENVELOPE) BEYOND WHICH BREAKAWAY SRB'S CAN "NO LONGER ENDANGER" LAND UNDER ANY SUBSEQUENT SRB BEHAVIOR. @053096 PRCB-4001]
- M. FCO: FCO IN THESE RULES REFERS TO EITHER THE ER FLIGHT CONTROL OFFICER (FCO) OR THE SENIOR FCO (SFCO). WHERE APPLICABLE, THE SPECIFIC INDIVIDUAL POSITION IS IDENTIFIED IN THESE RULES.
- N. MCC: THE MISSION CONTROL CENTER AT JSC. AS USED IN THESE RULES, MCC ALSO REFERS TO THE FLIGHT DIRECTOR (FD), SPACECRAFT COMMUNICATOR (CAPCOM), AND/OR FLIGHT DYNAMICS OFFICER (FDO) PERSONNEL LOCATED IN THE MCC. PRIMARY COMMUNICATION BETWEEN THE FCO AND THE MCC IS CARRIED OUT WITH THE FDO. WHERE APPLICABLE, THE SPECIFIC INDIVIDUAL POSITION IS IDENTIFIED IN THESE RULES.
- O. MECO LINES AND GATES: MECO LINES, WHICH ARE APPLICABLE ONLY IN SECOND STAGE, IDENTIFY AREAS UPON WHICH THE VEHICLE'S IIP MAY NOT ENCROACH. THEY ARE REPRESENTED AS SOLID LINES ON FCO AND MCC DISPLAYS. SINCE OVERFLIGHT OF SOME LAND MASS IS ALWAYS REQUIRED FOR THE STS VEHICLE TO ACHIEVE ORBIT, SOME MECO LINES WHICH STRICTLY PROTECT ALL AREAS OF THESE LAND MASSES ARE PRESENTED AS DASHED LINES ON THE DISPLAYS AND ARE REFERRED TO AS GATES. FOR STS FLIGHTS, THREE GATES ARE APPLICABLE, AS DESCRIBED BELOW:
1. HATTERAS GATE (APPLICABLE FOR HIGH-INCLINATION MISSIONS ONLY): THE HATTERAS GATE PROTECTS POPULATED ISLANDS AND EXTENSIVE MARITIME TRAFFIC OFF THE COAST OF NORTH CAROLINA.
 2. NEWFOUNDLAND GATE (APPLICABLE FOR HIGH-INCLINATION MISSIONS ONLY): THE NEWFOUNDLAND GATE PROTECTS THIS LOW POPULATION CANADIAN PROVINCE. NOMINAL OR NEAR-NOMINAL FLIGHTS WILL ROUTINELY PASS THROUGH THIS GATE.
 3. AFRICAN GATE (APPLICABLE FOR ALL MISSIONS): THE AFRICAN GATE PROTECTS THE LAND MASSES OF AFRICA, EUROPE, AND SOUTH AMERICA. NOMINAL OR NEAR-NOMINAL FLIGHTS WILL ROUTINELY PASS THROUGH THIS GATE. @053096 PRCB-4001]

FLIGHT RULES

THIS RULE CONTINUED ON NEXT PAGE

FLIGHT RULES

A4.1.6-2 DEFINITIONS (CONTINUED) @081497-6306A ~~A4.1.6-2~~
~~FLIGHT TERMINATION ACTION (CONTINUED)~~

- P. DESTRUCT LINES: EQUIVALENT TO MECO LINES, BUT APPLICABLE DURING THE SHORT TIME LATE IN FIRST STAGE (FROM T+120 SEC TO SRB SEP) WHEN THE FTS IS STILL AVAILABLE FOR USE. THESE LINES ALSO APPLY IN FIRST STAGE IF VALID FOOTPRINT DATA IS LOST PER RULE {A4.1.6-7}, FLIGHT TERMINATION/MANUAL MECO CRITERIA, PART C.4. @053096 PRCB-4001]
- Q. CODEWORDS: THERE ARE THREE STS-RELATED CODEWORDS, AS DESCRIBED BELOW. CODE WORDS, WHEN USED, ARE EXCHANGED OVER THE FD AND FCO PRIME LOOPS.
1. UNCONTROLLABLE: THIS UNIQUE CODE WORD WILL BE USED BY THE FD TO ADVISE THE FCO THAT THE VEHICLE IS UNCONTROLLABLE.
 2. MANUAL MECO: THIS UNIQUE CODE WORD WILL BE USED BY THE FCO TO ADVISE THE MCC THAT AN IMMEDIATE MANUAL MECO IS REQUIRED.
 3. ARM/FIRE: THIS UNIQUE CODE WORD WILL BE USED BY THE FCO TO ADVISE THE MCC THAT THE FTS HAS BEEN ACTIVATED.
- R. COMMUNICATION CIRCUITS: THREE PRIMARY COMMUNICATION CIRCUITS ARE USED BETWEEN THE FCO AND THE MCC: THE FD LOOP, THE FCO PRIME LOOP, AND THE FCO PRIVATE LINE. WHERE TWO REDUNDANT LOOPS ARE LISTED IN THESE RULES, OTHER LOOP/LONG LINE PATCHING MAY BE USED TO PROVIDE THIS REDUNDANCY IF NECESSARY. @081497-6306A]
- S. VEHICLE BREAKUP: SEPARATION OF VEHICLE PARTS AS DETERMINED VISUALLY OR BY RADAR TRACK OF MULTIPLE TARGETS.
- T. CATASTROPHIC FAILURE: VEHICLE PITCHES OVER OR BREAKS UP, AS SHOWN BY VEHICLE PERFORMANCE DATA.

FLIGHT RULES

- U. VARIABLE IY: AN ABORT-TO-ORBIT (ATO) TARGETING METHOD USED ON SOME MISSIONS IN WHICH THE VEHICLE STEERS TO AN ORBITAL PLANE/INCLINATION LOWER THAN THE NOMINAL TO IMPROVE DOWNRANGE PERFORMANCE. IF EXCURSION TOWARD A RANGE SAFETY LIMIT LINE OCCURS DUE TO THE ORBITAL PLANE TARGET BEING CORRUPTED, AN ATO ABORT WHICH INVOKES VARIABLE IY CAN POTENTIALLY ELIMINATE THE RANGE SAFETY PROBLEM.
- V. CSS: MANUAL SHUTTLE FLIGHT CONTROL (CONTROL STICK STEERING), AS OPPOSED TO AUTO-GUIDANCE FLIGHT CONTROL.

THIS RULE CONTINUED ON NEXT PAGE

FLIGHT RULES

A4.1.6-2 DEFINITIONS (CONTINUED) @081497-6306A ~~A4.1.6-2~~ ~~FLIGHT TERMINATION ACTION (CONTINUED)~~

W. BFS ENGAGE: FLIGHT CREW ACTIVATION OF THE BACKUP FLIGHT SYSTEM (BFS), USED FOR TOTAL FAILURE OF THE QUAD-REDUNDANT PRIMARY AVIONICS SOFTWARE SYSTEM (PASS). @053096 PRCB-4001]

A4.1.6-3 FCO TO MCC WARNING NOTIFICATION

THE VEHICLE'S FLIGHT MAY DEVIATE SIGNIFICANTLY FROM NOMINAL AND STILL REMAIN WITHIN SAFE LIMITS. IF THE CRITERIA BELOW ARE EXCEEDED, THE FCO WILL WARN THE MCC, AND THE MCC WILL RESPOND WITH CALLS OR REQUESTED CREW ACTION. VIOLATION OF THESE CRITERIA INDICATES THAT THE VEHICLE IS DEVIATING SIGNIFICANTLY FROM ITS NOMINAL TRAJECTORY. @053096 PRCB-4001]

A. TRAJECTORY EXCEEDS 3-SIGMA (LATERAL OR VERTICAL) IN FIRST STAGE:

1. FCO MAKES AN "AMBER ZONE" CALL ON BOTH THE FD AND FCO PRIME LOOPS. THE CONTROLLABILITY RULE IS INVOKED.
2. AFTER AN AMBER ZONE CALL, A PROMPT CONTROL STATUS RESPONSE IS REQUIRED FROM THE FD TO THE FCO ON THE FD LOOP. IF THE VEHICLE IS UNDER CONTROL, THE FD WILL RESPOND "GOOD CONTROL." IF THE VEHICLE IS UNCONTROLLABLE, THE FD WILL RESPOND VIA CODEWORD, AND THE JSC GNC OFFICER WILL RESPOND WITH THE CONTROLLABILITY WARNING LIGHT.

B. POST-SRB SEP, TRAJECTORY EXCEEDS 3-SIGMA LATERAL:

1. FCO MAKES TRAJECTORY DEVIATION CALLS ON THE FCO PRIME LOOP.
2. FDO RESPONDS WITH TRAJECTORY ASSESSMENT CALLS.
3. IF THE TRAJECTORY CONTINUES TO DEVIATE TOWARD A MECO LINE, THE PROXIMITY TO THE LINE WILL BE EVALUATED:
 - a. FCO WILL CALL "HALFWAY TO THE LINE" WHEN THE IIP IS APPROXIMATELY HALFWAY BETWEEN THE 3-SIGMA LEFT/RIGHT TRAJECTORY AND THE NEAREST MECO LINE.

FLIGHT RULES

- b. FREQUENT ESTIMATES OF TIME REMAINING UNTIL MECO LINE VIOLATION WILL BE PROVIDED BY FDO ON THE FD LOOP BASED ON MCC PREDICTOR BUG SOFTWARE.

THIS RULE CONTINUED ON NEXT PAGE

FLIGHT RULES

A4.1.6-3 FCO TO MCC WARNING NOTIFICATION (CONTINUED)

4. IF TRAJECTORY DEVIATIONS CONTINUE AFTER ACTION BY THE MCC (REFERENCE RULE {A4.1.6-9}, RANGE SAFETY LIMIT AVOIDANCE ACTIONS), MANUAL MECO PROCEDURES PREPARATION WILL BE INITIATED BY THE MCC WHEN THE IIP IS 3015 SECONDS FROM THE MECO LINE. @053096 PRCB-4001]_ @081497-6306A]
5. IF MECO HAS NOT YET OCCURRED UPON IIP CONTACT WITH A MECO LINE, FCO WILL INITIATE THE ABORT REQUEST COMMAND (ABORT LIGHT) AS AN INDICATION TO THE CREW THAT AN IMMEDIATE MANUAL MECO IS REQUIRED. THE MANUAL MECO CODEWORD WILL BE VERBALLY TRANSMITTED TO THE MCC SIMULTANEOUSLY ON THE FD AND FCO PRIME LOOPS. @053096 PRCB-4001]

A4.1.6-4 MCC TO FCO REPORTING

THE MCC WILL ADVISE THE FCO OF OFF-NOMINAL VEHICLE PERFORMANCE OR OF EVENTS THAT SIGNIFICANTLY AFFECT RANGE SAFETY AS THEY OCCUR. THE INFORMATION WILL BE PROVIDED BY THE FDO ON THE FCO PRIME LOOP WITH THE FCO PRIVATE LINE AS BACKUP, EXCEPT AS SPECIFICALLY NOTED BELOW:

- A. CONTROLLABILITY STATUS (FIRST STAGE ONLY): MADE BY FD ON THE FD LOOP, USING EITHER THE WORDS "GOOD CONTROL," IF THE VEHICLE IS UNDER CONTROL, OR USING THE CODEWORD TO INDICATE UNCONTROLLABLE. IF THE VEHICLE IS UNCONTROLLABLE, THE JSC GNC OFFICER WILL ALSO RESPOND WITH THE CONTROLLABILITY WARNING LIGHT.
- B. ANY DECISION TO ABORT THE FLIGHT: ATO, TAL, RTLS, ANY CONTINGENCY ABORT, FAST SEPARATION, ETC.
- C. ANY SSME FAILURE.
- D. ANY CONDITIONS WHICH COULD RESULT IN ET LAND IMPACT, PLUS A PREDICTED IMPACT LOCATION, IN AS NEAR REAL-TIME AS POSSIBLE.
- E. WHEN RANGE SAFETY LIMIT AVOIDANCE ACTIONS ARE BEING IMPLEMENTED (RULE {A4.1.6-9}, RANGE SAFETY LIMIT AVOIDANCE ACTIONS), FREQUENT ESTIMATES OF TIME TO VIOLATION WILL BE PROVIDED BY THE FDO ON THE FD LOOP. WHEN THE IIP IS 3015 SEC FROM THE MECO LINE, MANUAL MECO PROCEDURES WILL BE INITIATED. @081497-6306A]

FLIGHT RULES

F. ANY OTHER PERTINENT INFORMATION. ©[053096 PRCB-4001]

FLIGHT RULES

~~THE VEHICLE'S FLIGHT MAY DEVIATE SIGNIFICANTLY FROM NOMINAL AND STILL REMAIN WITHIN SAFE LIMITS. IF THE CRITERIA BELOW ARE EXCEEDED, THE FCO/SFCO WILL WARN THE FD/FDO. VIOLATION OF THE CRITERIA INDICATES THAT THE VEHICLE IS DEVIATING SIGNIFICANTLY FROM ITS NOMINAL TRAJECTORY. THE FOLLOWING WILL BE USED AS A BASIS FOR WARNING NOTIFICATION:~~

- ~~A. DURING SRB BURN, THE TRAJECTORY EXCEEDS THE 3-SIGMA ENVELOPE ON THE VP OR IP DISPLAYS. FCO MAKES "AMBER ZONE" CALL.~~
- ~~B. IF, AFTER SRB SEPARATION, THE IIP EXCEEDS THE LATERAL 3-SIGMA LEFT OR RIGHT TRAJECTORY, THE FCO/SFCO WILL NOTIFY THE FDO THAT THE VEHICLE HAS DEVIATED SIGNIFICANTLY FROM THE NOMINAL. THE FCO WILL USE THE WORDS "AMBER ZONE". THE FD/FDO WILL AT THIS TIME INITIATE ACTION, INCLUDING SSME SHUTDOWN IF NECESSARY, TO PRECLUDE VIOLATION OF THE FLIGHT TERMINATION LINE. IF THE VEHICLE CONTINUES TO DEVIATE AND APPROACHES A FLIGHT TERMINATION LINE, THE FCO/SFCO WILL ADVISE THE FDO WHEN THE IIP IS APPROXIMATELY HALFWAY BETWEEN THE 3-SIGMA LEFT/RIGHT TRAJECTORY AND THE NEAREST SINGLE FLIGHT TERMINATION LINE. THE FCO WILL USE THE WORDS: "HALFWAY TO THE LINE." DURING THE ACTIVITY, THE FCO/SFCO WILL PROVIDE THE FD/FDO WITH FREQUENT ESTIMATES OF TIME REMAINING UNTIL FLIGHT TERMINATION LINE VIOLATION. IF TRAJECTORY DEVIATIONS CONTINUE AFTER ACTION BY THE FD/FDO, THE FCO WILL NOTIFY THE MCC WHEN THE IIP IS 15 SECONDS FROM THE DESTRUCT LINE. AT THAT TIME, THE MCC WILL CALL FOR A MANUAL MECO. FOR LOSS OF COMMUNICATIONS WITH THE CREW, FCO WILL SEND THE "ARM" COMMAND 15 SECONDS FROM THE DESTRUCT LINE AS A CUE FOR THE CREW TO INITIATE A MANUAL MECO. THE FCO WILL TAKE FLIGHT TERMINATION ACTION IF THE IIP CONTACTS THE TERMINATION LINE.~~

~~THIS RULE CONTINUED ON NEXT PAGE~~

FLIGHT RULES

~~A4.1.6-3 FLIGHT TERMINATION CRITERIA (CONTINUED)~~

~~C. THE WORDS "AMBER ZONE" WILL BE USED BY THE FCO/SFCO ON THE FD LOOP TO INFORM THE FD/FDO THAT THE 3-SIGMA TRAJECTORY LIMITS (STEEP OR LATERAL) HAVE BEEN EXCEEDED. DURING THE SRB THRUSTING PERIOD, "AMBER ZONE" WILL BE THE FD/FDO/GNC CUE THAT THE CONTROLLABILITY RULE IS BEING INVOKED, AND A PROMPT CONTROL STATUS REPORT WILL BE PROVIDED TO THE FCO BY THE FD. THE FCO WILL MAKE THE "AMBER ZONE" CALL ON THE FD AND THE FCO/FDO LOOPS. THE FD RESPONSE WILL BE MADE ON THE FD LOOP. A UNIQUE CODE WORD WILL BE USED BY THE FD TO ADVISE THE FCO THAT THE VEHICLE IS UNCONTROLLABLE. A UNIQUE CODE WORD WILL BE USED BY THE FCO TO ADVISE THE FD/FDO THAT THE "ARM" COMMAND IS BEING TRANSMITTED. CODE WORDS, WHEN USED, WILL BE EXCHANGED OVER THE FD LOOP. OTHERWISE, THE COMMUNICATIONS DESCRIBED ABOVE WILL BE CARRIED OUT OVER THE FCO/FDO LOOP.~~

~~THIS RULE CONTINUED ON NEXT PAGE~~

FLIGHT RULES

~~A4.1.6-3 FLIGHT TERMINATION CRITERIA (CONTINUED)~~

~~D. OVERFLIGHT OF SOME LAND MASS IS ALWAYS REQUIRED FOR THE STS VEHICLE TO ACHIEVE ORBIT. SOME TERMINATION LINES WHICH STRICTLY PROTECT ALL AREAS OF THESE LAND MASSES ARE PRESENTED AS DASHED LINES ON THE FCO DISPLAYS AND ARE REFERRED TO AS "GATES." FOR STS FLIGHTS, THREE GATES ARE APPLICABLE: THE HATTERAS GATE AND NEWFOUNDLAND GATE FOR HIGH INCLINATION LAUNCHES AND THE AFRICAN GATE FOR EASTERLY LAUNCHES. FCO/FD/FDO ACTIONS FOR THESE GATES ARE DEFINED BELOW:~~

FLIGHT RULES

- ~~1. THE HATTERAS GATE PROTECTS POPULATED ISLANDS AND EXTENSIVE MARITIME TRAFFIC OFF THE COAST OF NORTH CAROLINA. ALTHOUGH THE NOMINAL AND LATERAL 3-SIGMA LEFT IIP TRAJECTORY DOES NOT PENETRATE THE HATTERAS GATE, IT IS UNDERSTOOD THAT THE STS VEHICLE CAN BE OUTSIDE 3 SIGMA AND REMAIN CONTROLLABLE. A VEHICLE THAT PARALLELS THE NOMINAL BUT VIOLATES THE HATTERAS GATE WILL NOT REQUIRE TERMINATION ACTION. HOWEVER, THE FCO WILL ADVISE THE FD/FDO OF THE DEVIATION PER RULE {A4.1.6-4B}, WARNING NOTIFICATION. FOR A VEHICLE WHOSE IIP FIRST DEVIATES OUTSIDE THE 3-SIGMA RIGHT TRAJECTORY AND THEN CORRECTS TO THE LEFT WITH THE IIP APPROACHING THE HATTERAS GATE IN A PERPENDICULAR OR NEAR-PERPENDICULAR IIP TRACE, THE FCO WILL FIRST MAKE AN "AMBER ZONE" CALL AND THEN WILL PROVIDE THE FDO WITH FREQUENT ESTIMATES OF TIME REMAINING TO THE HATTERAS GATE. IF THE VEHICLE STATUS IS UNKNOWN OR RECOVERABLE OR PROCEEDING TO AN ABORT CONTINGENCY, THE IIP WILL BE ALLOWED TO PASS THROUGH HATTERAS GATE. IF, AFTER EXECUTION OF AVAILABLE RECOVERY OPTIONS (NAVIGATION UPDATES, CREW MANUAL CONTROL, DOWNMODE TO BFS, OR ABORT SELECTION), THE VEHICLE STATUS IS CONFIRMED UNRECOVERABLE (THAT IS, THE THRUST VECTOR CANNOT BE COMMANDED EITHER MANUALLY OR AUTOMATICALLY), THE FD/FDO WILL INITIATE SSME SHUTDOWN TO PRECLUDE VIOLATION OF THE HATTERAS GATE. WHILE LIMIT LINE AVOIDANCE ACTIONS ARE BEING TAKEN, FLIGHT TERMINATION WILL NOT BE INVOKED UNTIL VIOLATION OF THE STANDARD (SOLID) TERMINATION LINE.~~

~~THIS RULE CONTINUED ON NEXT PAGE~~

FLIGHT RULES

~~A4.1.6-3 FLIGHT TERMINATION CRITERIA (CONTINUED)~~

- ~~2. THE NEWFOUNDLAND GATE PROTECTS LAND MASSES WITH LOW POPULATION AREAS. NOMINAL OR NEAR-NOMINAL FLIGHTS WILL ROUTINELY PASS THROUGH THIS GATE. IF THERE IS IRREFUTABLE EVIDENCE THAT THE VEHICLE IS NON-NOMINAL AND CANNOT PROCEED TO AN ACCEPTABLE CONTINGENCY ABORT MODE AS DETERMINED BY THE FLIGHT DIRECTOR, THE FCO/FD/FDO WILL REACT PER PARAGRAPH B.~~

- ~~3. THE AFRICAN GATE PROTECTS THE LAND MASSES OF AFRICA, EUROPE, AND SOUTH AMERICA. NOMINAL OR NEAR-NOMINAL FLIGHTS WILL ROUTINELY PASS THROUGH THIS GATE. IF THERE IS IRREFUTABLE EVIDENCE THAT THE VEHICLE IS NON-NOMINAL AND CANNOT PROCEED TO AN ACCEPTABLE CONTINGENCY ABORT MODE AS DETERMINED BY THE FLIGHT DIRECTOR, THE FCO/FD/FDO WILL REACT PER PARAGRAPH D1, EXCEPT SSME'S WILL BE SHUT DOWN AT THE AFRICAN GATE. @[092293-1543]~~

A4.1.6-5 CONTROLLABILITY

- A. THIS RULE APPLIES ONLY DURING THE SRB THRUSTING PERIOD, AFTER LAUNCH TOWER CLEARANCE. @[053096 PRCB-4001]

- B. THE USAF AND NASA, IN CONSIDERING THE NATIONAL INTERESTS IN THE SHUTTLE PROGRAM AND THE CONSEQUENCES OF FLIGHT TERMINATION ACTION, HAVE JOINTLY AGREED TO THE FOLLOWING (REFERENCE MOA 15E-2-8):
 1. THE NON-PUBLIC RISKS ASSOCIATED WITH CONTINUED FLIGHT OF A CONTROLLABLE VEHICLE IF THE PRIMARY IMPACT LIMIT LINE IS VIOLATED HAVE BEEN ASSESSED BY THE USAF AND ACCEPTED BY NASA FOR KSC, AND BY THE 45 SW FOR CAPE CANAVERAL AIR STATION (CCAS).

 2. THE PUBLIC RISKS ASSOCIATED WITH FLIGHT BEYOND THE SECONDARY ILL ARE UNACCEPTABLE.

 3. IF THE VEHICLE IS DECLARED TO BE UNDER CONTROL AND IS SUBSEQUENTLY DECLARED UNCONTROLLABLE, THE FCO WILL TAKE ACTION WHEN THE APPLICABLE FLIGHT TERMINATION LINE IS VIOLATED (PRIMARY OR SECONDARY).

FLIGHT RULES

C. GENERAL

1. ALTHOUGH THE ACTUAL TRAJECTORY MAY DEVIATE SIGNIFICANTLY FROM THE NOMINAL DURING THE SRB THRUSTING PERIOD, THE VEHICLE MAY NOT EXCEED CONTROLLABILITY LIMITS.
2. AS LONG AS THE MCC CAN CONFIRM TO THE FCO THAT THE CONTROLLABILITY LIMITS HAVE NOT BEEN EXCEEDED, OR IN THE CASE OF LOSS OF COMMUNICATION BETWEEN THE MCC AND THE FCO, THE FCO CAN DETERMINE THAT THESE LIMITS HAVE NOT BEEN EXCEEDED, THE FCO WILL ALLOW THE FLIGHT TO CONTINUE EVEN IF THE PRIMARY ILL IS VIOLATED.
3. IF NEITHER THE MCC NOR THE FCO CAN DETERMINE THE PITCH OR YAW RATES, THE FCO WILL ASSUME THAT THE LIMITS HAVE NOT BEEN EXCEEDED AND ALLOW THE FLIGHT TO CONTINUE EVEN IF THE PRIMARY ILL IS VIOLATED.
4. FLIGHT TERMINATION ACTION WILL BE TAKEN BY THE FCO WHEN, BASED ON ASSESSMENT OF ALL AVAILABLE DATA, THE SECONDARY ILL FLIGHT TERMINATION CRITERIA ARE VIOLATED, REGARDLESS OF THE CONTROLLABILITY STATUS.
@053096 PRCB-4001]

THIS RULE CONTINUED ON NEXT PAGE

FLIGHT RULES

A4.1.6-5 CONTROLLABILITY (CONTINUED)

D. DECLARATION OF LOSS-OF-CONTROL: THERE ARE TWO EQUIVALENT METHODS BY WHICH THE MCC CAN COMMUNICATE LOSS OF CONTROL TO THE FCO, AS FOLLOWS: @[053096 PRCB-4001]

1. THE CONTROLLABILITY WARNING LIGHT. VERBAL CONFIRMATION OF LOSS-OF-CONTROL WILL ACCOMPANY LIGHT ACTIVATION.

2. VERBAL NOTIFICATION OF LOSS-OF-CONTROL, GIVEN BY THE FD VIA CODE WORD TO THE FCO OVER THE FD LOOP.

E. LOSS OF TWO SSME'S: UNDER THE FOLLOWING CONDITIONS THE FCO WILL USE DISCRETION, BIASED TOWARDS NO ACTION:

1. LOSS OF TWO SSME'S IS CONFIRMED EARLY IN FLIGHT.

2. THE VEHICLE REMAINS CONTROLLABLE.

3. THE VEHICLE STAYS WITHIN THE MISSION-SPECIFIC TWO-ENGINE-OUT DELTA-AZIMUTH ENVELOPE.

4. THE VEHICLE TRANSITIONS THROUGH THE REGION OF MAXIMUM DYNAMIC PRESSURE (MAX Q) WITHOUT BREAKUP.

5. THE DEBRIS FOOTPRINT APPROACHES OR JUST CROSSES THE SECONDARY ILL LATE IN THE SRB BURN.

6. THE FCO CONFIRMS THAT THE VEHICLE IIP IS STILL MOVING DOWN RANGE. @[053096 PRCB-4001]

FLIGHT RULES

A4.1.6-6 FLIGHT TERMINATION/MANUAL MECO EVALUATION

A. GENERAL @[053096 PRCB-4001]

1. THE FCO WILL EVALUATE ALL DATA SOURCES (E.G., RADARS, TELEMETRY, OPTICAL TRACKERS, FORWARD OBSERVER, TV, ETC.) PLUS INFORMATION RECEIVED FROM THE MCC TO DETERMINE THE REQUIRED ACTION.
2. TIME PERMITTING, A DECISION TO INITIATE FLIGHT TERMINATION WILL BE REACHED AFTER COORDINATION BETWEEN THE FCO AND THE SFCO.
3. TIME PERMITTING, THE MCC WILL BE ADVISED OF IMPENDING FLIGHT TERMINATION PRIOR TO INITIATION OF THE FLIGHT TERMINATION COMMANDS.
4. IN ALL INSTANCES, THE FCO WILL MAKE A DECISION CONCERNING CONTINUED FLIGHT OR TERMINATION BASED ON INTERPRETATION OF REAL-TIME EVENTS AND STS MISSION RULES, ALL AVAILABLE DATA SOURCES, AND SOUND JUDGMENT.

B. LOSS OF DATA/COMMUNICATIONS

1. TOTAL LOSS OF ALL FCO VEHICLE PERFORMANCE DATA: THE FCO WILL BE UNABLE TO DETERMINE IF FLIGHT TERMINATION/MANUAL MECO CRITERIA ARE VIOLATED AND WILL NOT TAKE FLIGHT TERMINATION/MANUAL MECO ACTION. IF MCC STILL HAS DATA, RANGE SAFETY LIMIT AVOIDANCE ACTIONS (RULE {A4.1.6-9}, RANGE SAFETY LIMIT AVOIDANCE ACTIONS) WILL CONTINUE TO BE TAKEN, INCLUDING MANUAL MECO IF NECESSARY.
2. TOTAL LOSS OF ALL MCC DATA: THE MCC WILL BE UNABLE TO DETERMINE THE VEHICLE STATUS.
 - a. IF FCO STILL HAS DATA, FCO WILL PROVIDE MCC WITH ESTIMATES OF TIME TO MECO LINE VIOLATION, INCLUDING "3015 SEC TO THE LINE." AT THAT TIME, IF COMM IS AVAILABLE, MCC WILL INITIATE MANUAL MECO PROCEDURES. CALL TO CREW, "15 SEC TO THE LINE, -- PREPARE FOR MANUAL MECO." — @[053096 PRCB-4001] @[081497-6306A]

THIS RULE CONTINUED ON NEXT PAGE

FLIGHT RULES

A4.1.6-6 FLIGHT TERMINATION/MANUAL MECO EVALUATION (CONTINUED)

- b. FCO WILL INITIATE THE ABORT REQUEST COMMAND (ABORT LIGHT) IF THE IIP CONTACTS A MECO LINE AS AN INDICATION TO THE CREW THAT AN IMMEDIATE MANUAL MECO IS REQUIRED. THE MANUAL MECO CODEWORD WILL BE VERBALLY TRANSMITTED TO THE MCC SIMULTANEOUSLY ON THE FD AND FCO PRIME LOOPS AS A SECOND INDICATION, IF COMM IS AVAILABLE. @[053096 PRCB-4001]
3. AFTER TOWER CLEAR AND PRIOR TO SRB SEP
- a. AMBER ZONE AND LOSS OF FCO/MCC COMM: THE FCO WILL DETERMINE BY REAL-TIME TELEMETRY IF THE VEHICLE IS CONTROLLABLE AND ACT IN ACCORDANCE WITH RULE {A4.1.6-5}, CONTROLLABILITY.
- b. LOSS OF TELEMETRY AT MCC AND ROCC: THE VEHICLE WILL BE ASSUMED TO BE UNDER CONTROL AND VIOLATION OF THE PRIMARY ILL WILL BE ALLOWED. MCC WILL ATTEMPT TO CONFIRM CONTROLLABILITY WITH THE ORBITER CREW AND ADVISE THE FCO.
- c. LOSS OF FCO/MCC COMM AND FCO TELEMETRY: THE VEHICLE WILL BE ASSUMED TO BE UNDER CONTROL AND VIOLATION OF THE PRIMARY ILL WILL BE ALLOWED.
4. LOSS OF FCO/MCC COMM AFTER SRB SEP: FCO WILL REQUIRE MCC/CREW ACTION IN ACCORDANCE WITH RULES {A4.1.6-7}, FLIGHT TERMINATION/MANUAL MECO CRITERIA, PART E, AND {A4.1.6-8}, FLIGHT TERMINATION/MANUAL MECO ACTION.
5. RADAR INDICATES BREAKUP AND TELEMETRY INDICATES VEHICLE UNDER CONTROL: THE VEHICLE WILL BE ASSUMED TO BE INTACT AND THE FCO WILL ACT IN ACCORDANCE WITH RULE {A4.1.6-5}, CONTROLLABILITY.
- C. CONFLICTING DATA: IN THE EVENT OF A CONFLICT IN MECO LINE PROXIMITY ASSESSMENT BETWEEN THE MCC AND FCO WHEN BOTH HAVE VALID TRAJECTORY DETERMINATION DATA, THE FCO IS PRIME FOR DETERMINATION OF BOTH THE PROXIMITY TO THE LINE AND THE POTENTIAL REQUIREMENT FOR MANUAL MECO. @[053096 PRCB-4001]

FLIGHT RULES

A4.1.6-7 FLIGHT TERMINATION/MANUAL MECO CRITERIA

FLIGHT TERMINATION ACTION AND FLIGHT TERMINATION CRITERIA, AS SPECIFIED IN EWR 127-1, ARE SUPERSEDED BY THIS RULE. FLIGHT TERMINATION WILL BE INITIATED, OR A MANUAL MECO REQUESTED, BY THE FCO ONLY IF CONTINUATION OF THE FLIGHT VIOLATES THE CRITERIA SPECIFIED IN THIS RULE. @053096 PRCB-4001]

A. PRIOR TO SRB IGNITION: AFTER SSME IGNITION, PAD ABORTS ARE POSSIBLE. FIRE OR OTHER CATASTROPHIC EVENTS MAY BE APPARENT FROM VEHICLE BEHAVIOR DATA. UNDER NO CIRCUMSTANCES WILL THE FCO TAKE FLIGHT TERMINATION ACTION PRIOR TO SRB IGNITION.

B. SRB IGNITION TO TOWER CLEAR (7 SEC): IF A CATASTROPHIC FAILURE OCCURS, THE FCO WILL TAKE FLIGHT TERMINATION ACTION TO PREVENT INTACT IMPACT, CONTAIN THE SRB'S, AND DISPERSE THE ET PROPELLANTS.

C. TOWER CLEAR TO SRB NLE:

1. THE FCO WILL TAKE FLIGHT TERMINATION ACTION WHEN TRAJECTORY DETERMINATION SOURCES INDICATE THAT THE VEHICLE HAS VIOLATED FLIGHT TERMINATION CRITERIA, SUBJECT TO RULE {A4.1.6-5}, CONTROLLABILITY.

2. IF A CATASTROPHIC FAILURE OCCURS, THE FCO WILL TAKE FLIGHT TERMINATION ACTION TO PREVENT INTACT IMPACT, CONTAIN THE SRB'S, AND DISPERSE THE ET PROPELLANTS.

a. FOR VEHICLE PITCH OVER, A FLIGHT TERMINATION DECISION WILL BE BASED ON TRAJECTORY DETERMINATION DATA CONFIRMED WITH MCC INDICATION OF NEGATIVE HDOT (DOWNWARD ALTITUDE RATE), OR THE PRIMARY VEHICLE BEHAVIOR DATA CUE.

b. FOR VEHICLE BREAKUP, A FLIGHT TERMINATION DECISION WILL BE BASED ON THE PRIMARY VEHICLE BEHAVIOR DATA CUE, TWO SECONDARY VEHICLE BEHAVIOR DATA CUES, OR BOTH ONE SECONDARY AND ONE TERTIARY VEHICLE BEHAVIOR DATA CUE. @053096 PRCB-4001]

THIS RULE CONTINUED ON NEXT PAGE

FLIGHT RULES**A4.1.6-7 FLIGHT TERMINATION/MANUAL MECO CRITERIA**
(CONTINUED)

3. FOR STS MISSIONS EQUIPPED WITH THE SRB RADAR BEACON TRACKING SYSTEM (SRBTS), FLIGHT TERMINATION ACTION WILL BE DELAYED TO ALLOW MAXIMUM SEPARATION OF THE ORBITER AND THE SEPARATED ELEMENTS IF POSITIVE TRACK OF BOTH SRB'S CONFIRMS THE SRB'S ARE NOT ENDANGERING PUBLIC SAFETY AND THE DEBRIS ELLIPSE HAS MOVED OFF LAND. @[053096 PRCB-4001]
4. IF CONSIDERED VALID BY THE FCO, THE DEBRIS ELLIPSE DISPLAY WILL BE THE SOLE CRITERIA FOR DETERMINING FLIGHT TERMINATION LINE VIOLATION. IF THE DEBRIS ELLIPSE DISPLAY IS CONSIDERED TO BE INVALID BY THE FCO, ALL OTHER VALID DISPLAYS MUST CONFIRM THE FLIGHT TERMINATION CRITERIA VIOLATION. FLIGHT TERMINATION ACTION UNDER THESE CRITERIA IS SUBJECT TO RULE {A4.1.6-5}, CONTROLLABILITY.
- D. SRB NLE TO SRB SEPARATION: THE FCO WILL TAKE FLIGHT TERMINATION ACTION WHEN TRAJECTORY DETERMINATION SOURCES INDICATE THAT THE VEHICLE HAS VIOLATED FLIGHT TERMINATION CRITERIA, SUBJECT TO RULE {A4.1.6-5}, CONTROLLABILITY.
- E. SRB SEPARATION TO MECO: THE FCO WILL CALL FOR MANUAL MECO ONLY WHEN VALID TRAJECTORY DETERMINATION SOURCES INDICATE A MECO LINE IS VIOLATED. A MANUAL MECO CALL WILL BE PRECEDED BY NOTIFICATION IN ACCORDANCE WITH FLIGHT RULE {A4.1.6-3}, FCO TO MCC WARNING NOTIFICATION, AND WILL BE EXECUTED PER RULE {A4.1.6-8}, FLIGHT TERMINATION/MANUAL MECO ACTION.
- F. LANDMASS OVERFLIGHT GATES
1. A NOMINAL VEHICLE THAT VIOLATES A GATE WILL NOT REQUIRE MANUAL MECO ACTION, AND THE IIP WILL BE ALLOWED TO PASS THROUGH THE GATE.
2. WHILE LIMIT LINE AVOIDANCE ACTIONS ARE BEING TAKEN, MANUAL MECO WILL NOT BE INVOKED UNTIL VIOLATION OF A SOLID MECO LINE. @[053096 PRCB-4001]

THIS RULE CONTINUED ON NEXT PAGE

FLIGHT RULES

A4.1.6-7 FLIGHT TERMINATION/MANUAL MECO CRITERIA (CONTINUED)

3. IF THERE IS IRREFUTABLE EVIDENCE THAT THE VEHICLE IS NON-NOMINAL AND CANNOT PROCEED TO AN ACCEPTABLE INTACT OR CONTINGENCY ABORT MODE AS DETERMINED BY THE MCC, THE MCC/CREW WILL REACT PER RULE {A4.1.6-9}, RANGE SAFETY LIMIT AVOIDANCE ACTIONS. IF, AFTER EXECUTION OF AVAILABLE RECOVERY OPTIONS, THE VEHICLE STATUS IS CONFIRMED UNRECOVERABLE, MANUAL MECO WILL BE INITIATED TO PRECLUDE VIOLATION OF THE GATE. @053096 PRCB-4001]
4. IF THE VEHICLE STATUS IS UNKNOWN OR RECOVERABLE OR PROCEEDING TO AN ACCEPTABLE INTACT OR CONTINGENCY ABORT, THE IIP WILL BE ALLOWED TO PASS THROUGH THE GATE.

G. EXCLUSIONS FOR GUIDANCE MODE TRANSITION

1. THIS RULE IS DESIGNED TO PROTECT A VEHICLE AGAINST FLIGHT TERMINATION ACTION DURING THE TRANSITION FROM USE OF THE DEBRIS FOOTPRINT DESTRUCT CRITERIA, WITH ITS ASSOCIATED ILL'S, TO THE USE OF THE IIP/DESTRUCT LINE CRITERIA, WHICH OCCURS AT APPROXIMATELY T + 120 SEC. THE FTS IS STILL AVAILABLE FOR USE UNTIL SRB SEP (APPROXIMATELY T + 125 SEC), AT WHICH TIME THE DESTRUCT LINES BECOME MANUAL MECO LINES.
2. A CONTROLLABLE VEHICLE NOT IN VIOLATION OF EITHER THE BACKUP ILL IN THE IMMEDIATE LAUNCH AREA OR THE SINGLE ILL'S WHICH EXTEND UP THE COAST FROM THE LAUNCH AREA MAY SUBSEQUENTLY BE IN VIOLATION OF THE IIP DESTRUCT/MECO LINE AFTER IT IS DISPLAYED AT APPROXIMATELY T + 120 SECONDS. NEITHER FLIGHT TERMINATION ACTION NOR MANUAL MECO ACTION WILL BE REQUIRED IF THE FOLLOWING CRITERIA ARE SATISFIED:
 - a. VEHICLE ATTITUDES ARE STABLE.
 - b. THE IIP IS NOT MOVING FURTHER INTO THE VIOLATION REGION.
 - c. THE IIP BEGINS TO MOVE TOWARD THE NON-VIOLATION REGION FOLLOWING SRB SEPARATION AND INITIATION OF SECOND STAGE GUIDANCE. @053096 PRCB-4001]

FLIGHT RULES

A4.1.6-8

FLIGHT TERMINATION/MANUAL MECO ACTION

- A. ~~A.—FLIGHT TERMINATION ACTION~~GENERAL: FLIGHT TERMINATION ACTION IS APPLICABLE DURING FIRST STAGE ONLY AND IS ACCOMPLISHED VIA FCO COMMAND ACTIVATION OF THE FTS. ~~@[081497-6306A]~~
- B. MANUAL MECO PROCEDURE: ~~IN SECOND STAGE,~~ MANUAL MECO ACTION IS APPLICABLE DURING SECOND STAGE ONLY AND IS PERFORMED BY THE FLIGHT CREW UPON DIRECTION ~~FROM~~ OF THE MCC OR FCO, AS SPECIFIED BELOW. ~~CRITERIA FOR EITHER ACTION ARE SPECIFIED IN RULE (A4.1.6-7), FLIGHT TERMINATION/MANUAL MECO CRITERIA. @[053096 PRCB-4001]~~
1. THE FDO WILL CALL "15 SEC TO MANUAL MECO" WHEN THE IIP IS 30 SECONDS FROM THE MECO LINE.
 2. AT THAT TIME, CAPCOM WILL CALL TO CREW "15 SECONDS TO MANUAL MECO, RETURN TO AUTO {IF CSS}, PREPARE FOR MANUAL MECO." THE RETURN TO AUTO FLIGHT CONTROL ALLOWS ACTIVATION OF AUTO THREE-SSME OUT CONTINGENCY LOGIC.
 3. ONCE A GOOD ONBOARD CONFIGURATION IS CONFIRMED, MCC WILL CALL FOR "MANUAL MECO NOW." FD AND/OR FDO WILL SEND THE ABORT REQUEST COMMAND (ABORT LIGHT) AS AN ADDITIONAL CUE.
 4. IF FOR ANY REASON, THE IIP CONTACTS THE MECO LINE, THE FCO WILL INITIATE THE ABORT REQUEST COMMAND (ABORT LIGHT) AND WILL TRANSMIT THE MANUAL MECO CODEWORD (REF. PARAGRAPH D, BELOW) TO THE MCC AT THAT TIME.
- C. TWO CUES ARE REQUIRED FOR THE CREW TO INITIATE MANUAL MECO. IMMEDIATE MANUAL MECO ACTION IS REQUIRED WHEN ANY OF THE FOLLOWING CRITERIA ARE MET:
1. "FIFTEEN SEC TO MANUAL MECO" CALL AND "MANUAL MECO NOW" CALL.
 2. "FIFTEEN SEC TO MANUAL MECO" CALL AND ABORT LIGHT. NOTE: IF THE ABORT LIGHT WAS ALREADY ON WHEN "15 SEC TO MANUAL MECO" CALL WAS MADE, MANUAL MECO ACTION WILL BE TAKEN AFTER 15 SEC.
 3. ABORT LIGHT ON AND "MANUAL MECO NOW" CALL. @[053096 PRCB-4001]

FLIGHT RULES

4. ANY OTHER CUES AS APPROPRIATE. @[081497-6306A]

THIS RULE CONTINUED ON NEXT PAGE

FLIGHT RULES

A4.1.6-8 FLIGHT TERMINATION/MANUAL MECO ACTION (CONTINUED)

D. MANUAL MECO CODEWORD @[081497-6306A]

1. THE MANUAL MECO CODEWORD IS USED BY THE FCO TO INDICATE TO THE MCC THAT AN IMMEDIATE MANUAL MECO IS REQUIRED. WHEN USED, IT IS TRANSMITTED VERBALLY OVER BOTH FD AND FCO PRIME LOOPS SIMULTANEOUSLY.
2. UPON MCC RECEIPT OF THE CODEWORD, CAPCOM WILL IMMEDIATELY NOTIFY THE CREW WITH THE FOLLOWING CALL: "MANUAL MECO NOW, MANUAL MECO NOW." @[053096 PRCB-] @[081497-6306A]

A4.1.6-9 RANGE SAFETY LIMIT AVOIDANCE ACTIONS

THE FOLLOWING PRIORITIZED ACTIONS WILL BE TAKEN BY THE MCC AND/OR CREW IN ORDER TO PRECLUDE VIOLATION OF RANGE SAFETY DESTRUCT CRITERIA. @[053096 PRCB-4001]

A. FIRST STAGE:

1. STATE VECTOR UPDATE, IF TRAJECTORY DEVIATION IS DUE TO ERRONEOUS ONBOARD NAVIGATION.
2. ENGAGE CSS (APPLICABLE ONLY AFTER 90 SECONDS MET) AND MANUALLY FLY AWAY FROM LIMIT LINES AS DESCRIBED UNDER PART B.3 BELOW.
3. BFS ENGAGE, IF TRAJECTORY DEVIATION IS DUE TO ERRONEOUS GUIDANCE.

NOTE: BFS ENGAGE WILL ONLY BE USED IF IT IS KNOWN THAT IT WILL CORRECT THE DEVIATION. BFS ENGAGE SEVERELY LIMITS POTENTIAL SECOND STAGE ACTIONS.

THIS RULE CONTINUED ON NEXT PAGE

FLIGHT RULES

A4.1.6-9 RANGE SAFETY LIMIT AVOIDANCE ACTIONS
(CONTINUED)

B. SECOND STAGE:

1. STATE VECTOR UPDATE, IF TRAJECTORY DEVIATION IS DUE TO ERRONEOUS ONBOARD NAVIGATION.
2. PRE-MECO ATO ABORT SELECTION, IF VARIABLE IY IS ENABLED.
3. ENGAGE CSS AND MANUALLY FLY AWAY FROM LIMIT LINES. MCC WILL PROVIDE YAW STEERING COMMANDS OVER AIR-TO-GROUND. FDO IS PRIME FOR DETERMINATION OF YAW STEERING COMMANDS. NOTE: THIS OPTION IS NO LONGER AVAILABLE AFTER A BFS ENGAGE.
4. PRE-MECO TAL OR RTLS ABORT SELECTION (SELECT HIGHEST APPLICABLE ABORT PRIORITY MODE).

NOTE: PRIORITY OF CSS AND TAL/RTLS SELECTION OVER BFS IN SECOND STAGE MAY BE WAIVED IF IT IS KNOWN THAT BFS WILL RECOVER AUTO GUIDANCE TO CORRECT TARGET CONDITIONS. @[053096 PRCB-4001]

5. BFS ENGAGE. @[053096 PRCB-4001]

NOTE: BFS ENGAGE WILL ONLY BE CONSIDERED IF IT IS KNOWN THAT IT WILL CORRECT THE DEVIATION AND IF MORE THAN ONE SSME IS RUNNING. SINGLE-SSME FLIGHT ON THE BFS IS NOT POSSIBLE, AND AUTO, THREE-SSME OUT CONTINGENCY LOGIC IS NOT AVAILABLE IN THE BFS.

6. MANUAL MECO: REFERENCE RULE {A4.1.6-8}, FLIGHT TERMINATION/MANUAL MECO ACTION. @[081497-6306A]

FLIGHT RULES

THIS PAGE INTENTIONALLY BLANK

FLIGHT RULES

RANGE SAFETY FLIGHT RULES

A4.1.6-0 SIGNATURE SECTION

THE ENCLOSED RANGE SAFETY FLIGHT RULES HAVE BEEN JOINTLY NEGOTIATED AND AGREED TO BY NASA AND THE EASTERN RANGE. ANY SUBSEQUENT CHANGES TO THESE RULES WILL REQUIRE RE-EXECUTION OF THIS CONCURRENCE PAGE. @[053096 PRCB-4001]

~~@[081497-6306A] EFFECTIVITY: FIRST FLIGHT ET-RSS HAS BEEN DEACTIVATED.~~

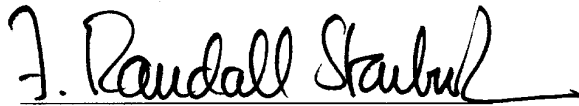

COMMANDER, 45TH SPACE WING
F. RANDALL STARBUCK
Brigadier General, USAF
Commander

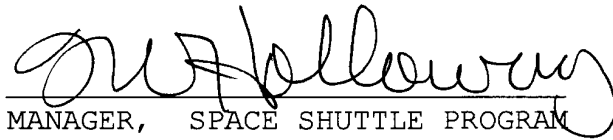

MANAGER, SPACE SHUTTLE PROGRAM

22 Sp 97

DATE

9-5-97

DATE

FLIGHT RULES

SECTION 5 - BOOSTER

FAILURE DEFINITIONS

A5.1.1-1	LOSS OF SRB HYDRAULIC POWER UNIT (HPU)	5-1
A5.1.1-2	SPACE SHUTTLE MAIN ENGINE OUT	5-1
A5.1.1-3	STUCK THROTTLE	5-11
A5.1.1-4	DATA PATH FAILURE	5-14
A5.1.1-5	SUSPECT ENGINE	5-15
A5.1.1-6	SSME REDLINE SENSOR FAILED	5-16
A5.1.1-7	SIGNIFICANT ENGINE HELIUM SYSTEM LEAK	5-18
A5.1.1-8	SIGNIFICANT PNEUMATIC SYSTEM HELIUM LEAK . . .	5-20
A5.1.1-9	INSUFFICIENT PNEUMATIC HELIUM ACCUMULATOR PRESSURE	5-20
A5.1.1-10	MPS PROPELLANT DUMPS AND INERTING DEFINITIONS	5-21
A5.1.1-11	SSME ONE REDLINE SENSOR FAILURE AWAY FROM AN ERRONEOUS SHUTDOWN	5-22
A5.1.1-12	<u>RESERVED</u>	5-20a
A5.1.1-13	SPACE SHUTTLE MAIN ENGINE TYPES	5-20b
<u>A5.1.1-14</u>	<u>LH2 ULLAGE LEAK</u>	<u>5-21</u>

SRB SYSTEMS MANAGEMENT

A5.1.2-1	LOSS OF SRB HYDRAULIC POWER UNITS (HPU)	5-22
----------	---	------

SSME SYSTEMS MANAGEMENT

A5.1.3-1	ABORT CUE REQUIREMENT	5-23
A5.1.3-2	AUTO/MANUAL SHUTDOWN	5-23
A5.1.3-3	LIMIT SHUTDOWN CONTROL	5-23
A5.1.3-4	DATA PATH FAIL/ENGINE-ON LIMIT SHUTDOWN CONTROL	5-39
A5.1.3-5	DATA PATH FAIL/ENGINE-OUT ACTION	5-35

FLIGHT RULES

A5.1.3-6 MANUAL SHUTDOWN FOR COMMAND/DATA PATH FAILURES 5-36

A5.1.3-7 MANUAL SHUTDOWN FOR HYDRAULIC OR ELECTRICAL LOCKUP 5-39

A5.1.3-8 MANUAL SHUTDOWN FOR TWO STUCK THROTTLES (NOT DUAL APU FAILURES) 5-42

A5.1.3-9 ENGINE PERFORMANCE DISPERSION 5-45

A5.1.3-10 AC BUS SENSOR ELECTRONICS CONTROL (CIL) 5-46

A5.1.3-11 MANUAL THROTTLEDOWN FOR LO2 NPSP PROTECTION AT SHUTDOWN 5-47

A5.1.3-12 MANUAL SHUTDOWN FOR SUSPECT COMMAND PATH FAILURES 5-48

A5.1.3-13 MECO CONFIRMED 5-49

A5.1.3-14 SSME HYDRAULIC REPRESSURIZATION/POSTLANDING SSME REPOSITIONING 5-49

MPS MANAGEMENT: PRELAUNCH THROUGH MECO

A5.1.4-1 PRE-MECO MPS HELIUM SYSTEM LEAK ISOLATION (CIL) 5-51

A5.1.4-2 PRE-MECO MPS HELIUM SYSTEM INTERCONNECTS (CIL) 5-53

A5.1.4-3 PRE-MECO SHUT DOWN OF ENGINES DUE TO MPS HELIUM LEAKS 5-58

A5.1.4-4 LH2 TANK PRESSURIZATION (CIL) 5-70

A5.1.4-5 LIMIT SHUTDOWN CONTROL AND MANUAL THROTTLING FOR LOW LH2 NPSP 5-72

A5.1.4-6 ABORT PREFERENCE FOR SYSTEMS FAILURES 5-74a

A5.1.4-7 ET LOW LEVEL CUTOFF SENSOR FAILED DRY 5-75

MPS MANAGEMENT: POST-MECO

A5.1.5-1 ET SEPARATION INHIBIT FOR 17-INCH DISCONNECT FAILURE (CIL) 5-76

A5.1.5-2 MPS PROPELLANT MANIFOLD OVERPRESSURE (CIL) . 5-77

A5.1.5-3 POST-MECO AND ENTRY HELIUM ISOLATION 5-80a

FLIGHT RULES

A5.1.5-4	MANUAL MPS PROPELLANT DUMP	5-81
A5.1.5-5	NOMINAL, AOA, AND ATO MPS PROPELLANT DUMP FAILURES	5-81
A5.1.5-6	MANUAL VACUUM INERTING REQUIREMENTS (NOMINAL, ATO, AOA)	5-84
A5.1.5-7	REPEAT MPS VACUUM INERT	5-85
A5.1.5-8	LH2 PRESSURIZATION VENT CONTROL	5-85
A5.1.5-9	ENTRY MPS HELIUM PURGING FOR CRITICAL VEHICLE POWER/COOLING	5-85
A5.1.5-10	ENTRY MPS PROPELLANT DUMP FAILURES (CIL) ...	5-86
A5.1.5-11	MPS DUMP INHIBIT (CIL)	5-89

FLIGHT RULES

THIS PAGE INTENTIONALLY BLANK

FLIGHT RULES

SECTION 5 - BOOSTER

FAILURE DEFINITIONS

A5.1.1-1 LOSS OF SRB HYDRAULIC POWER UNIT (HPU)

BOTH HYDRAULIC SUPPLY PRESSURES ON THE SAME SRB ARE 1000 PSIG OR LESS. @[041196-1874A]

The SRB TVC system has a lock-out style valve which will actuate to the lock position when the hydraulic supply pressure is 1000 to 600 psig. Two hydraulic power units are installed per SRB, and both can supply hydraulic power to the TVC actuators. Source pressure is switched from the primary HPU to the secondary HPU when the hydraulic supply pressure reaches 2050 ±150 psig. This switchover effectively loses one HPU. However, TVC is not lost until pressure drops below 1000 psig. (Reference System Handbook Drawing 9.14 and USBI documents 10SPC-0055, rev B, section 4.2.2.10, and 10MNL-00458).

Note: Above 1000 psig, the lock-out valve opens, and TVC is still available. @[041196-1875A]

A5.1.1-2 SPACE SHUTTLE MAINSME ENGINE OUT @[121197-6472A]

PREMATURE ENGINE SHUTDOWN IS CAUSED BY AN ENGINE LIMIT EXCEEDED, DUAL CONTROLLER ELECTRONICS FAILURES, OR A COMBINATION OF A SINGLE CHANNEL LIMIT EXCEEDED AND A CONTROLLER ELECTRONIC FAILURE. THE CUES FOR DETERMINING AN ENGINE SHUTDOWN ARE DEFINED IN PARAGRAPHS A, B, C, AND D OF THIS RULE. THE SHUTDOWN SOFTWARE LIMITS ARE DEFINED IN PARAGRAPH E. THE AVIONIC FAILURE COMBINATIONS ARE DEFINED IN PARAGRAPH F.

ENGINE OUT DETERMINATION WILL BE BASED ON THE FOLLOWING CUES:

A. ONBOARD (WITH VALID SSME DATA):

1. RED MAIN ENGINE STATUS LIGHT IS ILLUMINATED.
2. PC < 30 PERCENT (METER)

THIS RULE CONTINUED ON NEXT PAGE

FLIGHT RULES

A5.1.1-2 SPACE SHUTTLE MAINSSME ENGINE OUT (CONTINUED)

3. SSME FAIL L (C,R)

Two cues are required for calls that may cause an abort. The MPS dedicated display driver sequence in the flight software illuminates the red status light if the SSME is in the shutdown or post-shutdown phase. The SSME operations sequence in the flight software uses power level < 30 percent as the indication that the SSME has shut down. The 30 percent value represents a power level below which the engine cannot operate. The PASS SSME fail message is generated by the GAX when the engine fail flag is set by the SSME OPS sequence. The flag is set when either the engine status word shows shutdown or post shutdown phase, or a data path failure has occurred and the engine safing command flag has been set.

B. MCC (WITH VALID SSME DATA):

AT LEAST TWO OF THE FOLLOWING CUES ARE REQUIRED:

1. SSME FAILURE IDENTIFIER (FID) "013" INDICATING SSME SHUTDOWN FOR REDLINE VIOLATION.
2. SHUTDOWN OR POST-SHUTDOWN PHASE (REFLECTED IN ENGINE STATUS WORD).
3. PC < 900 PSIA.
4. SSME FAIL L (C,R)

Two cues are required for calls that may cause an abort. A FID 013 issued by the SSME controller represents an engine shutdown due to a redline exceedance. The redline that was exceeded is defined by the delimiter part of the FID. Shutdown and post-shutdown phases are set in the engine status word when the SSME controller commands shutdown. Pc of 900 psia corresponds to approximately 30 percent power level. The PASS SSME fail message is generated by the GAX when the engine fail flag is set by the SSME OPS sequence. The flag is set when either the engine status word shows shutdown or post shutdown phase, or a data path failure has occurred and the engine safing command flag has been set. [@121197-6472A1](#)

C. ONBOARD (WITH SSME DATA PATH FAILURE):

AT LEAST THREE OF THE FOLLOWING ARE REQUIRED:

1. G-LEVEL DECREASE (ON DEDICATED DISPLAY G-METER OR BFS CRT TRAJECTORY DISPLAY G-LINE).
2. A HELIUM, DP/DT FAULT MESSAGE FOLLOWED BY CONSTANT ENGINE HELIUM TANK PRESSURE (IF NO PREVIOUS FAULT MESSAGE FOR A HELIUM LEAK).

FLIGHT RULES

3. MPS H₂ OUT P L (C,R)

THIS RULE CONTINUED ON NEXT PAGE

FLIGHT RULES

A5.1.1-2 SPACE SHUTTLE MAINSSME ENGINE OUT (CONTINUED)

4. MPS O₂ OUT T L (C,R)

During second stage when the first, second, and third one, two, or three engines shut down in sequence, the g-level decreases by 33, 50, and 100 percent, respectively. During first stage, the SRB thrust far exceeds the SSME thrust making it difficult to detect an engine shutdown based upon changes in vehicle acceleration. If the engine did not previously have a helium leak, the crew will get a helium DP/DT fault message, followed by constant helium tank pressure on the affected engine. If the tank pressure remains constant, no helium is being used and; therefore, the engine has shut down. In OI-22 and subs, the crew will get fault messages for both the GH₂ outlet pressure and GO₂ outlet temperature dropping below 1050 psia and 125 deg F, respectively. Because both of these parameters are channelized through the same OI MDM and powered from the same OI DSC, the two fault messages could be generated by a single MDM or DSC failure. For this reason, the crew must use three of the four cues when determining an engine out behind a data path failure. ©[020196-1812]@[121197-6472A]

D. MCC (WITH SSME DATA PATH FAILURE) :

AT LEAST TWO OF THE FOLLOWING CUES ARE REQUIRED :

1. A SUDDEN DROP IN ACCELERATION OR THRUST FACTOR AS DETERMINED FROM TELEMETRY DATA. (THRUST FACTOR AVAILABLE IN SECOND STAGE ONLY).
2. ORBITER GH₂ OUTLET PRESSURE < 800 (1050) PSIA OR ORBITER GO₂ OUTLET TEMPERATURE < 260 DEG (300 DEG) F.
3. A HELIUM DP/DT FAULT MESSAGE FOLLOWED BY CONSTANT ENGINE HELIUM TANK PRESSURE (IF NO PREVIOUS FAULT MESSAGE FOR A HELIUM LEAK).
4. A DROP IN SECOND STAGE PERFORMANCE AS DETERMINED BY THE ARD.

FLIGHT RULES

Two cues are required for calls that may cause an abort. For an engine failure in second stage, an abrupt drop in vehicle acceleration will result. The GH_2 outlet pressure and GO_2 outlet temperature are orbiter parameters that can be used to determine the status of an engine. Both the GH_2 and GO_2 limits are set to correspond to an engine power level of approximately 30 percent. This is well below the power level that an engine can operate. Flight data from STS 51-F indicates the GO_2 outlet temperature was < 125 deg F for about 15 seconds post engine shutdown. The GO_2 outlet temperature did rise again post shutdown to a value of approximately 300 deg F. Since both orbiter parameters are channelized through the same OI MDM and powered from the same OI DSC, the two are grouped together as one engine out cue. If an engine did not previously have a helium leak, the crew will get a DP/DT fault message while the engine initiates shutdown purges. Once the helium purges have terminated, the engine will no longer use helium and; therefore, the helium tank pressure will remain constant. Thrust factor (FT FACTOR) is a second stage guidance downlisted parameter from the vehicle and is calculated by dividing the expected thrust by the calculated thrust. If an engine shuts down behind a data path failure, the thrust factor will drop to a value less than 1.0. If an engine fails in first stage, thrust factor is not available, but the second stage performance as determined by the ARD would reflect the loss in performance from the engine shutdown. ©[032395-1765A] ©[020196-1812] ©[121197-6472A]

THIS RULE CONTINUED ON NEXT PAGE

FLIGHT RULES

A5.1.1-2 SPACE SHUTTLE MAINSME ENGINE OUT (CONTINUED)

E. ENGINE LIMIT EXCEEDED AND SHUTDOWN SENSOR FAILURE
DEFINITIONS:

PARAMETERS (A)	QUALIFICATION/ REASONABLENESS TESTING (C)	SHUTDOWN LIMITS (D)	NOTES (B)
HPFTP COOLANT LINER PRESSURE SENSORS A & B (PSIA) (E)	>4500 PSIA <1800 PSIA	PHASE II, BLOCK I, & IIA: >CNTL CAL LIMIT NO LOWER LIMIT	[1] [6] [3] [10] [4]
HPFT TURBINE DISCH TEMP THERMOCOUPLE SENSORS A2, A3, B2 & B3 (°R) (F)	A2 (A3,B2,B3)> 2650° R A2-A3 > 50° R (D/Q LWR) B2-B3 > 50° R (D/Q LWR) DOWN TO 1 ON BOTH/EITHER: (B AVG - AX) >150° R (D/Q AX) (A AVG - BX) > 150° R (D/Q BX) AX-BY > 150° R (D/Q LWR)	PHASE II & BLOCK I: CH A >1960°R CH B >1960°R BLOCK IIA & BLOCK II: CH A >1860°R CH B >1860°R NO LOWER LIMIT	[1] [3] [7] [4] [9] [11]
HPOT TURBINE DISCH TEMP THERMOCOUPLE SENSORS A2, A3, B2 & B3 (°R) (G)	A2 (A3,B2,B3)> 2650° R A2-A3 > 50° R (D/Q LWR) B2-B3 > 50° R (D/Q LWR) DOWN TO 1 ON BOTH/EITHER: (B AVG - AX) >150° R (D/Q AX) (A AVG - BX) > 150° R (D/Q BX) AX-BY > 150° R (D/Q LWR)	PHASE II & BLOCK I: >1760°R BLOCK IIA & BLOCK II: >1660°R <720° R	[1] [3] [9] [4] [11]
HPOTP SECONDARY SEAL PRESSURE SENSORS A & B (PSIA) (H)	>300 PSIA <4 PSIA	PHASE II: >100 PSIA NO LOWER LIMIT	[1] [2] [3] [4]
HPOTP INTERMEDIATE SEAL PRESSURE SENSORS A & B (PSIA) (I)	>650 PSIA <0 PSIA	NO UPPER LIMIT PHASE II: <170 PSIA OR BLOCK I, IIA, & II: <159 PSIA	[1] [5] [3] [4]
MCC PC SENSOR AVERAGE SENSORS A & B (PSIA) (J)	BRIDGE 1 - BRIDGE 2 ≥ 125 PSI PC CHANNEL AVG ≥3500 PSI ≤1000 PSI	NO UPPER LIMIT ALL ENGINE TYPES: PC CHANNEL AVG < PC REF - 200 PSI (STEADY STATE) AND PC REF - 400 PSI (DURING THROTTLING OR WHEN ≤ 75% RPL)	[1] [8] [3] [4]

@[111094-1732] @[032395-1765A] @[092195-1792B] @[020196-1812] @[121197-6472A]

THIS RULE CONTINUED ON NEXT PAGE

FLIGHT RULES

A5.1.1-2 SPACE SHUTTLE MAINSSME ENGINE OUT (CONTINUED)

NOTES:

- [1] MUST EXCEED LIMIT OR FAIL REASONABLENESS FOR 60 MSEC.

A parameter must be over its redline or reasonableness limit for three consecutive 20 msec controller cycles before action is taken by the controller. This requirement prevents action from being taken on a data hit.

- [2] THE HPOTP SECONDARY SEAL PRESSURE REDLINE IS ONLY ACTIVE ON THE PHASE II SSME. THIS REDLINE IS NOT PRESENT ON THE BLOCK I SSME, BLOCK IIA SSME, OR THE BLOCK II SSME. @[032395-1765A] @[121197-6472A]
- [3] SHUTDOWN FOR AN OUT-OF-LIMIT CONDITION INITIATED BY MAIN ENGINE CONTROLLER IF LIMIT ENABLED. LIMIT INHIBIT/ENABLE OPERATIONS DEPENDENT ON THE POSITION OF THE MAIN ENGINE LIMIT SHUTDOWN SWITCH.

This indicates that, if the limit shutdown logic is enabled, then a redline violation will result in an SSME shutdown.

- [4] IF ALL SENSORS FAIL REASONABLENESS, THAT REDLINE IS DELETED. @[092195-1792B]

Redline monitoring is no longer performed because the redline sensors have failed.

- [5] THE HPOTP INTERMEDIATE SEAL PRESSURE LOWER REDLINE IS 170 PSIA ON THE PHASE II SSME AND IS 159 PSIA ON THE BLOCK I SSME, BLOCK IIA SSME, AND THE BLOCK II SSME. @[032395-1765A] @[020196-1812]
- [6] THE REDLINE UPPER LIMIT IS CALCULATED IN REAL TIME BY CONTROLLER SOFTWARE AND IS A FUNCTION OF ENGINE POWER LEVEL. THEREFORE, THE LIMITS AT 67, 100, 104, AND 109 PERCENT POWER LEVELS ARE APPROXIMATELY 2436, 3543, 3677, AND 3846 PSIA FOR A PHASE II SSME, ~~AND~~ 2447, 3559, 3694, AND 3862 PSIA FOR A BLOCK I SSME, AND 2243, 3254, 3392 (@104.5), AND 3530 PSIA FOR A BLOCK IIA SSME, RESPECTIVELY. THIS REDLINE HAS BEEN DELETED FOR THE BLOCK II SSME. @[111094-1732] @[092195-1792B] @[121197-6472A]

THIS RULE CONTINUED ON NEXT PAGE

FLIGHT RULES

A5.1.1-2 SPACE SHUTTLE MAINSSME ENGINE OUT (CONTINUED)

The HPFTP coolant liner pressure varies with actual chamber pressure.

- [7] THIS REDLINE MAY BE REVISED ON A FLIGHT-BY-FLIGHT BASIS TO ENSURE COMPARABLE MARGIN ON CHANNEL A AND CHANNEL B BETWEEN THE PREDICTED NOMINAL VALUE AND THE REDLINE VALUE. IF A CHANNEL A TO B BIAS IS ADDED, THEN THIS BIAS IS CARRIED OVER INTO THE REASONABLENESS CALCULATIONS FOR THE INTERCHANNEL CHECKS. @[092195-1792B]

Some flight SSME HPFTP's may operate at a lower temperature. Engines with these turbopumps may have their channel A redline adjusted downward to provide the same 100 deg R difference between the main stage operating temperature and the redline as present on other HPFTP's. @[111094-1732]

- [8] THE INTRACHANNEL CHECK AND THE CHANNEL AVERAGE MUST BE WITHIN THE SPECIFIED LIMITS IN ORDER TO BE PROCESSED BY THE CONTROLLER'S SHUTDOWN LIMIT LOGIC. THESE REASONABLENESS CHECKS ARE IN ADDITION TO THE NORMAL SENSOR MONITORING PERFORMED FOR IGNITION CONFIRMED AND CONTROL LOOP PROCESSING QUALIFICATION.

The MCC Pc channels will be disqualified for control purposes for an intrachannel difference of greater than 75 psi. The MCC Pc redline logic incorporates two reasonableness criteria to ensure that only valid pressures will be used.

- [9] THE LOGIC FOR THE HPFT AND THE HPOT DISCHARGE TEMPERATURE WAS MODIFIED BY THE IMPLEMENTATION OF THE THERMOCOUPLES. THE THERMOCOUPLE MODIFICATION UTILIZES TWO SENSORS PER CHANNEL FOR A TOTAL OF FOUR SENSORS PER REDLINE. @[092195-1782B] @[092195-1782B]

The sensor processing logic was modified to accommodate the different failure modes for the thermocouple sensors (versus the previous resistive thermal devices-RTD's) and to handle the additional number of sensors. The additional sensors were added to increase reliability against sensor failures resulting in pad aborts, erroneous in-flight shutdown, or the loss of redline protection. @[121197-6472A]

- [10] THE HPFTP COOLANT LINER PRESSURE REDLINE IS ONLY AVAILABLE FOR THE PHASE II, ~~AND THE~~ BLOCK I, ~~AND~~ BLOCK IIA ENGINE TYPES. @[121197-6472A]

The Block II SSME uses a Pratt & Whitney HPFTP/AT which does not have a coolant liner.

- [11] A COLD JUNCTION REFERENCE TEMPERATURE (T_{CJ}) IS PROVIDED FOR EACH CONTROLLER CHANNEL TO PROCESS THE HOT GAS THERMOCOUPLE SENSOR DATA. THE T_{CJ} IS USED TO CALIBRATE THE TEMPERATURE MEASUREMENT INPUT. EACH CHANNEL HAS A SINGLE RTD T_{CJ} WHICH IS USED FOR BOTH THE HPOT AND HPFT TEMPERATURE MEASUREMENTS. IF ONE CHANNEL'S T_{CJ} IS DISQUALIFIED, THE OTHER CHANNEL'S T_{CJ} WILL BE USED FOR BOTH CHANNELS. IF BOTH T_{CJ} S ARE DISQUALIFIED, THE LAST QUALIFIED VALUE WILL BE USED FOR SENSOR PROCESSING.

Thermocouple measurements require a cold junction reference temperature to provide accurate readings. The controller and its software was modified to accommodate the addition of these two transducers, which are required for use with the thermocouples.

FLIGHT RULES

THIS RULE CONTINUED ON NEXT PAGE

FLIGHT RULES

A5.1.1-2 SPACE SHUTTLE MAINSSME ENGINE OUT (CONTINUED)

- (A) *PARAMETERS* - This table covers parameters which the SSME controller qualifies, monitors, and uses to shut down the engine.
- (B) *CONTROLLER SHUTDOWN PROCESSING* - All qualified sensors must vote for shutdown for action to proceed. ©[092195-1792B]
- (C) ~~QUALIFICATION~~-REASONABLENESS TESTING - Qualification, also known as Reasonableness testing, is required to qualify the sensors for application to shutdown logic. The values chosen screen out sensors with identified sensor problems. ©[121197-6472A]
- (D) *SHUTDOWN LIMITS* - Redline parameters are monitored to assure that the engine is performing within safe operating conditions. Limits are set to guard against uncontained SSME damage. The limits are based upon test stand data, flight experience, and engineering analysis. The engine redline design criteria was defined by MSFC and approved by Level II.
- (E) *HPFTP COOLANT LINER PRESSURE* ©[092195-1792B]

Phase II, Block I, and Block IIA SSME's - The redline limit was selected to prevent buckling of the coolant liner and subsequent stalling of the HPFTP. This limit was derived from an uncontained failure of SSME 0108 during a ground test. The exhaust turnaround duct buckled, the HPFTP stalled, and the low pressure fuel duct ruptured. Based upon this incident and analysis, the buckling pressure has been determined to be 595 psid with the delta pressure being measured between the coolant liner cavity and the turnaround duct. The redline was set to protect for a delta pressure of 400 psi and has been verified by lab tests. The reasonableness limits of 4500 and 1800 psi were established because they bracket the sensor range.

- (F) *HPFT TURBINE DISCHARGE TEMPERATURE* ©[092195-1792B]

~~Thermocouple and Resistive Thermal Device Sensors~~ - The limit was derived from analysis and protects against stress rupture of the HPFT blades due to high temperature operation. This redline was developed following uncontained failures on engines 0204 and 2013 during ground testing. These failures were attributed to turbine blade failure which resulted in HPFTP seizure and low pressure fuel duct rupture. Subsequent analysis determined a 2160 deg R maximum turbine blade root temperature capability for 109 percent power level. This temperature equates to a 2060 deg R turbine exhaust temperature. The 1960 deg R limit provides a 100 deg R margin for the Phase II and Block I SSME's. The 1860 deg R limit provides a 200 deg R margin for the Block IIA and Block II SSME's. This reduction for the Block IIA and Block II SSME's still leaves satisfactory margin from nominal operating conditions to the redline, due to the reduced temperature environment facilitated by the large throat MCC (reference 8/15/97 Ascent/Entry Flight Techniques Panel). The channel A location on some HPFTP's may run cooler, thus necessitating a lower redline value (potentially as low as 1850 deg R for the Phase II and Block I or 1750 deg R for the Block IIA and Block II). ©[111094-1732] ©[121197-6472A]

FLIGHT RULES

THIS RULE CONTINUED ON NEXT PAGE

FLIGHT RULES

A5.1.1-2 SPACE SHUTTLE MAINSSME ENGINE OUT (CONTINUED)

~~Thermocouple Sensors~~—The upper reasonableness limit of 2650 deg R guards against open circuits and analog-to-digital (A/D) converter failures. The intrachannel and interchannel reasonableness limits are screens for internal short circuits. An absolute lower limit is not feasible since a short will result in an in-range failure signature. If only one sensor remains, only the open circuit failure mode is detectable. @[092195-1792B] @[121197-6472A]

(G) HPOT TURBINE DISCHARGE TEMPERATURE @[092195-1792B]

~~Thermocouple and Resistive Thermal Device Sensors~~—The upper redline limit was derived from analysis to protect the heat exchanger from overheating and rupturing leading to catastrophic failure. The limit of 1760 deg R provides a 100 deg margin (1860 deg R is based on meeting one mission life capability; i.e., until nominal predicted MECO)-for the Phase II, and Block I SSME's. The 1660 deg R limit provides a 200 deg R margin for the Block IIA and Block II SSME's. This reduction for the Block IIA and Block II SSME's still leaves satisfactory margin from nominal operating conditions to the redline, due to the reduced temperature environment facilitated by the large throat MCC (reference 8/15/97 Ascent/Entry Flight Techniques Panel). The lower redline limit of 720 deg R provides protection against inadvertent deep throttling of the engine, which causes ice formation in the HPOT turbine, subsequent turbine imbalance, and potential catastrophic HPOTP failure. @[121197-6472A]

~~Thermocouple Sensors~~—The reasonableness limit of 2650 deg R guards against open circuits and A/D converter failures. The intrachannel and interchannel reasonableness limits are screens for internal short circuits. An absolute lower limit is not feasible since a short will result in an in-range failure signature. If only one sensor remains, only the open circuit failure mode is detectable. ~~Resistive Thermal Device Sensors~~—The reasonableness limit of 2650 deg R guards against open circuits and A/D converter failures. The lower reasonableness limit of 150 deg R protects against A/D converter failures. @[092195-1792B] @[121197-6472A]

(H) HPOTP SECONDARY SEAL PRESSURE

PHASE II SSME - The redline limit was derived from analysis to prevent the LO₂ from the HPOTP pump combining with the hot fuel-rich turbine gas in the seal purge cavity. The redline protects against failures of the HPOTP primary or secondary turbine seals. The limit is set to ensure that the HPOTP intermediate seal cavity pressure is greater than the HPOTP secondary seal cavity pressure by 9 psi during main stage, with a minimum seal purge flow rate and a maximum seal gap. Both reasonableness tests provide protection against avionics failures of the pressure sensor system. @[032395-1765A] @[092195-1792B]

BLOCK I SSME, BLOCK IIA SSME, and BLOCK II SSME - Due to significant design changes in the alternate HPOTP seal package on these engines, this transducer and its redline have been eliminated. Rationale for this is the oxidizer and secondary H₂ drain pressure margins are large, and a secondary labyrinthine (lab) seal analysis at more than six times its maximum possible operating clearance showed helium barrier delta pressure is insensitive to lab seal clearance changes. @[032395-1765A] @[121197-6472A]

FLIGHT RULES

THIS RULE CONTINUED ON NEXT PAGE

FLIGHT RULES

A5.1.1-2 SPACE SHUTTLE MAINSSME ENGINE OUT (CONTINUED)

(I) *HPOTP INTERMEDIATE SEAL PRESSURE -*

PHASE II SSME_- The redline limit was derived from analysis to prevent the LO₂ from the HPOTP pump combining with the hot fuel-rich turbine gas in the purge cavity. This redline guards against excessive seal wear or loss of helium purge by ensuring that the HPOTP intermediate seal cavity pressure is greater than the HPOTP secondary seal cavity pressure by 9 psi during main stage under the worst seal gap condition. Both reasonableness tests provide protection against avionics failures of the pressure sensor system. @[032395-1765A] @[092195-1792B] @[121197-6472A]

BLOCK I SSME, BLOCK IIA SSME, and BLOCK II SSME - The redline limit was derived from analysis to prevent LO₂ from the alternate HPOTP pump combining in the purge cavity with H₂ from the fuel cooled roller and ball bearing package. This redline guards against excessive seal wear or loss of helium purge by ensuring that the HPOTP intermediate seal cavity pressure is greater than the HPOTP O₂ cavity and secondary H₂ cavity pressures by 10 psi during main stage under the worst seal gap condition. Both reasonableness tests provide protection against avionics failures of the pressure sensor system. @[032395-1765A] @[092195-1792B] @[121197-6472A]

- (J) *MCC PC SENSOR AVERAGE - The redline was initially added to protect the engine against the type of failure seen on engine 2106, in which a burnthrough of the bellows section of the high pressure oxidizer turbopump turbine section occurred. This failure was caused by an oxidizer preburner failure and resulted in a bypass of hot gas flow from the turbine directly into the hot gas manifold which caused a massive drop in MCC Pc. The original redline limit of 400 psi below the commanded Pc was chosen based upon the amount of damage sustained by the engine 2106 high-pressure oxidizer turbopump at the time the engine was shut down by a facility redline. The MCC Pc redline was updated for STS-89 and subsequent flights to 200 psi below the commanded Pc during steady state operations, while retaining the 400 psi during throttling and when power level is less than or equal to 75 percent RPL. This update was based upon the amount of damage sustained by engine 0524 which experienced a nozzle failure and uncontained shutdown during test 901-933. @[121197-6472A]*

FLIGHT RULES

The intrachannel reasonableness limit (|Bridge 1 - Bridge 2| £ 125 psi) protects against single-bridge failures. Due to hardware and software limitations in the controller for sampling sensor inputs, the delta value must be set large enough to account for differences in the actual MCC Pc if the actual MCC Pc is decreasing rapidly due to a real engine combustion problem. If the value is set too tight, the actual MCC Pc could drop greater than the reasonableness limit between sampling the bridge 1 and bridge 2 sensor measurements. A smaller value could allow one or both MCC Pc channels to be erroneously disqualified. If both channels are disqualified, the MCC Pc redline is disabled at a time it is most needed. The redline qualification limit was increased from 75 psi to 125 psi in response to the catastrophic failure of development SSME 0212 (test 904-44), during which the actual decay rate of the MCC Pc was 105 psi between input samples of the A1/A2 and B1/B2 Pc pairs. The channel average upper reasonableness limit protects against an off-scale high sensor pair or input electronics failure. The lower limit protects against a failed low sensor pair or input electronics failure.

[@121197-6472A1](#)

THIS RULE CONTINUED ON NEXT PAGE

FLIGHT RULES

A5.1.1-2 SPACE SHUTTLE MAINSSME ENGINE OUT (CONTINUED)

F. SSME INSTRUMENTATION/ELECTRONICS FAILURE MATRIX:

	CHANNEL B [1]									
CHANNEL A [1]	DCU/ CIE B [3]	IE B [3]	OE B [3]	PS B [3]	HPOT TURB DISCH T CH B2 & B3 (TC) [2] OR CH-B (RTD) [6]	HPOTP IMSL P B [2]	HPOTP SEC SEAL P B [2] [4]	HPFTP COOL LINER P B [2] [5]	HPFT TURB DISCH T CH B2 & B3 (TC) [2] OR CH-B (RTD) [6]	MCC PC B AVG [2]
DCU/CIE A [3]	X			X						
IE A [3]		X		X	☒	☒	☒	☒	☒	☒
OE A [3]			X	X						
PS A [3]	X	X	X	X	☒	☒	☒	☒	☒	☒
HPOT TURB DISCH T A2 & A3 (TC) [2] CH-A (RTD) [6]		☒		☒	☒					
HPOTP IMSL P A [2]		☒		☒		☒				
HPOTP SEC SEAL P A [2] [4]		☒		☒			☒			
HPFTP COOLANT LINER P A [2] [5]		☒		☒				☒		
HPFT TURB DISCH T A2 & A3 (TC) [2] CH-A (RTD) [6]		☒		☒					☒	
MCC PC A AVG [2]		☒		☒						☒

@[030994-1614A] @[032395-1765A] @[092195-1792B] @[121197-6472A]

NOTES:

- [1] CHANNEL A FAILURES WHEN ALIGNED WITH SPECIFIC CHANNEL B FAILURES THAT CAUSE SHUTDOWN ARE DENOTED BY X OR ☒.
- [2] ALL QUALIFIED SENSORS EXCEED REDLINE LIMIT, AND PASS REASONABLENESS CHECKS. @[030994-1614A] @[092195-1792B] @[121197-6472A]
- [3] LOSS OF CONTROLLER REDUNDANCY.
- [4] DOES NOT APPLY TO THE BLOCK I SSME, BLOCK IIA SSME, OR THE BLOCK II SSME @[032395-1765A]
- [5] DOES NOT APPLY TO THE BLOCK II SSME. @[121197-6472A]

LEGEND:

- X SHUTDOWNS THAT CANNOT BE INHIBITED. PNEUMATIC SHUTDOWN WILL OCCUR BEHIND A DATA PATH FAILURE. @[030994-1614A]
- ☒ SHUTDOWNS THAT CAN BE INHIBITED USING MAIN ENGINE LIMIT SHUTDOWN SWITCH.

FLIGHT RULES

THIS RULE CONTINUED ON NEXT PAGE

FLIGHT RULES

A5.1.1-2 SPACE SHUTTLE MAIN ENGINE OUT (CONTINUED)

This matrix identifies failures which result in loss of controller redundancy and in premature engine shutdown. Shutdown caused by dual controller failures cannot be prevented even if the limit shutdown monitoring is inhibited. In these cases when the second failure occurs, the engine will immediately shut down via the controller's fail-safe pneumatic shutdown sequence. Shutdowns caused by redline violations can be inhibited manually by the limit shutdown monitoring switch or automatically by the GPC software after an engine out or data path failure.

Rules {A5.1.1-5}, SUSPECT ENGINE; {A5.1.1-6}, SSME REDLINE SENSOR FAILED; {A5.1.1-11}, SSME ONE REDLINE SENSOR FAILURE AWAY FROM AN ERRONEOUS SHUTDOWN; ~~{A5.1.1-12}, UNSTABLE SSME;~~ {A5.1.1-13}, SPACE SHUTTLE MAIN ENGINE TYPES; {A5.1.3-9}, ENGINE PERFORMANCE DISPERSION; and {A5.1.3-10B}, AC BUS SENSOR ELECTRONICS CONTROL, reference this rule. @[121197-6482B] @[121197-6472A] @[111298-6785A]

A5.1.1-3 STUCK THROTTLE

FAILURE OF A MAIN ENGINE TO THROTTLE COULD BE CAUSED BY COMBINATIONS OF ENGINE AND AVIONICS FAILURES WHICH CAUSE THE ENGINE OPERATING MODE TO CHANGE TO ELECTRICAL OR HYDRAULIC LOCKUP, OR BY ORBITER AND MAIN ENGINE AVIONICS FAILURES CAUSING A COMMAND PATH FAILURE.

A. ELECTRICAL LOCKUP

THE ENGINE PROPELLANT VALVES ARE ACTIVELY CONTROLLED AT THEIR LAST COMMANDED POSITION THAT EXISTED PRIOR TO LOSS OF BOTH SENSOR CHANNELS OF EITHER THE LH₂ FLOWMETER TRANSDUCERS OR MAIN COMBUSTION CHAMBER PRESSURE TRANSDUCER PAIRS.

The SSME valves are controlled to their last commanded values to minimize mixture ratio excursions. Mixture ratio is a function of measured main combustion chamber pressure (P_c) and LH₂ flowrate. The mass flowrate is calculated from measured volumetric flowrate and calculated fuel density (as calculated from LPFT discharge pressure and temperature). Should the LPFT discharge pressure or temperature be disqualified, a "fixed" density value for the LH₂ density will be used. Should both channels of either the measured P_c or volumetric flowrate be disqualified, or a combination of loss of controller redundancy and a loss of the remaining channel's P_c or volumetric flowrate, the engine enters into the "electrical lockup" mode and all valves are maintained at their last commanded position until shutdown is commanded. If the controller implements the shutdown, it will be a hydraulic shutdown. If the crew must manually shut down the engine (ref. Rules {A5.1.3-7}, MANUAL SHUTDOWN FOR HYDRAULIC OR ELECTRICAL LOCKUP, and {A5.1.3-8}, MANUAL SHUTDOWN FOR TWO STUCK THROTTLES (NOT DUAL APU FAILURES), the shutdown will be a hydraulic shutdown. Reference Computer Program CEI, Block II, SSME Controller Operational Program, CP406R0002. @[030994-1614A]

FLIGHT RULES

THIS RULE CONTINUED ON NEXT PAGE

FLIGHT RULES

A5.1.1-3 STUCK THROTTLE (CONTINUED)**B. HYDRAULIC LOCKUP**

ALL FIVE ENGINE PROPELLANT VALVES ARE HYDRAULICALLY ISOLATED AT THEIR LAST POSITION WHEN BOTH CHANNELS OF SERVOACTUATORS HAVE BEEN DISQUALIFIED FOR ANY COMBINATION OF THE FOLLOWING FAILURES: ISSUANCE OF A SERVOACTUATOR ERROR INDICATION INTERRUPT (SEII), FAILURE OF THE DIGITAL-TO-ANALOG CONVERTER (DAC) TEST, FAILURE OF THE SERVOACTUATOR MODEL, OR LOSS OF CONTROLLER REDUNDANCY. THE SEII LIMIT IS 6 PERCENT FOR CHANNEL A AND 10 PERCENT FOR CHANNEL B.

Hydraulic isolation of the valves minimizes, but does not prevent, valve drift which could result in further deviations from nominal valve positions causing loss of performance and/or possible engine shutdown. One hydraulic system supplies hydraulic actuation to the five engine valves (a different hydraulic system for each engine). Each valve has a redundant servocontrol system. Channel A is normally controlling unless it has been disqualified. Channel A disqualification could be due to loss of channel A power, loss of channel A input or output electronics, failure of the SEII 6 percent test (expressed in terms of percent full range valve travel), failure of the output electronics (OE) DAC test, or failure of the channel A servoactuator model. The SEII test compares the actual valve position to the expected valve position based on an internal servoactuator model. The OE DAC test verifies that each DAC's output voltage level is equal to its last commanded value, and that the command decoder addresses the correct OE DAC by proper decoding of the four LSB's of the OE storage register. The servoactuator model/ monitor test verifies proper operation of the hardware and software associated with SEII's. Channel B disqualifications could be due to the same type of failures listed for channel A, except channel B uses an SEII test limit of 10 percent error comparison instead of 6 percent to take into account the switchover transient from channel A to B. Should both channels be disqualified, the SSME enters into "hydraulic lockup." In this mode, the engine might experience loss of performance due to valve drift. If this occurs and a redline limit is exceeded, the engine will be pneumatically shut down. If a redline is not exceeded, then shutdown of the engine will be accomplished by engine pneumatics when a manual or commanded shut down occurs. Reference Computer Program CEI, Block II, SSME Controller Operational Program, CP406R0002.

THIS RULE CONTINUED ON NEXT PAGE

FLIGHT RULES

A5.1.1-3 STUCK THROTTLE (CONTINUED)

C. COMMAND PATH FAILURE

LOSS OF COMMAND CAPABILITY FROM THE GPC TO AN SSME ON AT LEAST TWO COMMAND CHANNELS. @[030994-1614A]

Without GPC commands, the SSME will not be able to accomplish the following functions: change throttle settings, inhibit/enable shutdown limits, respond to shutdown commands, or perform an LO₂ dump. Shutdown commands could be issued by guidance software, from a low level cutoff, or from a manual shutdown pushbutton. Each controller normally requires two of three valid command paths from the GPC's to control the SSME (start commands require three of three functional command paths). SSME controller software change RCN 4354 implemented in version OI-6 and subs added the capability for the engine to accept a shutdown enable/shutdown command pair on a single channel under special circumstances: an internal timer has expired (currently set at 512.86 seconds from engine start); limits have never been inhibited; the shutdown enable/shutdown command pair come in on the same channel, sequentially (with no other command in-between); and a valid command is not concurrently being received on the other two channels. Shutdown of the SSME without GPC control is accomplished by the removal of ac power to the controller. This action activates the fail-safe engine pneumatic system, shutting the engine down safely. A data path failure will also result from this action, requiring the crew to push the affected engine's shutdown pushbutton to inform guidance of an engine out and to safe the engine by closing the LH₂ and LO₂ prevalves. Reference Computer Program CEI, Block II, SSME Controller Operational Program, CP406R0002. @[030994-1614A]

A5.1.1-4 DATA PATH FAILURE

LOSS OF ALL PRIMARY AND SECONDARY DATA FROM THE SSME CONTROLLER TO GPC'S.

Since TREF, engine status word and average Pc values are present in both the primary and secondary data, the loss of both data types from the controller is required for the GPC to acknowledge a data path failure. This failure is identified by the GPC SSME SOP software. The loss of both data paths will prevent onboard and ground monitoring of all SSME data. (Ref. FSSR for SSME SOP).

FLIGHT RULES

A5.1.1-5 SUSPECT ENGINE

A SUSPECT ENGINE IS A RESULT OF ANY OF THE FOLLOWING FAILURE CONDITIONS:

- A. ALL QUALIFIED REDLINE SENSORS ON A PARAMETER SHIFT IN THE SAME DIRECTION, WITH AT LEAST ONE, BUT NOT ALL, QUALIFIED SENSORS VIOLATING THE REDLINE LIMIT(S). ©[092195-1795]

If all redline sensors pass their reasonableness limits, at least one, but not all, are violating their redline limit(s) and all non-voting sensors have shifted toward their redline(s), the SSME can continue to operate but will shut down if the remaining qualified sensors exceed their shutdown limits. The fact that all qualified sensors have moved toward their redlines indicates that something is wrong with the engine and that shutdown could occur at any moment. Reference rule {A5.1.1-2E}, paragraph E, SPACE SHUTTLE MAIN ~~SSME~~ ENGINE OUT, for reasonableness/qualification limits and redline limits. ①ED 1

- B. ALL QUALIFIED SENSORS EXCEED THE LIMITS FOR A PARTICULAR REDLINE AFTER SHUTDOWN MONITORING IS INHIBITED.

If all qualified sensors exceed limits with the shutdown monitoring inhibited, the SSME is approaching the failure situation which the limits were designed to prevent. The redline will only remain inhibited as long as the vehicle is in an abort region gap. While the limits are inhibited, the engine may fail at any moment with uncontained engine damage and loss of vehicle and crew, since the shutdown limit protection is not available for this case. Reference rule {A5.1.1-2E}, SPACE SHUTTLE MAIN ~~SSME~~ ENGINE OUT, for redline limits. Reference rule {A5.1.3-3}, LIMIT SHUTDOWN CONTROL, for re-enabling boundaries. ©[092195-1795] ①ED 1

- C. NONISOLATABLE MPS HELIUM LEAK

Using the MPS helium leak isolation procedure, the crew can determine if isolating a given leg will stop the leak. If the procedure does not stop the leak, it is nonisolatable and may result in SSME shutdown due to HPOT intermediate seal pressure dropping below the redline. The SSME with a helium leak is considered suspect since its leak rate could increase at any time and thus could cause the engine to shut down earlier than predicted by the MCC. Reference rule {A5.1.4-3}, PRE-MECO SHUT DOWN OF ENGINES DUE TO MPS HELIUM LEAKS. ©[032395-1766]

- D. LOW LH₂ NPSP

If LH₂ NPSP is low enough to require manual throttling or cause a TAL due to an LH₂ tank ullage leak or failed closed GH₂ flow control valves, at least one SSME may be approaching a redline limit shutdown due to high HPFTP turbine discharge temperatures. Reference rules {A5.1.4-5}, MANUAL THROTTLING FOR LOW LH₂ NPSP, and {A5.1.4-6}, ABORT PREFERENCE FOR SYSTEMS FAILURES.

THIS RULE CONTINUED ON NEXT PAGE

FLIGHT RULES

A5.1.1-5 SUSPECT ENGINE (CONTINUED)

- E. DRIFTING PERFORMANCE WITH ALL QUALIFIED CHANNELS OF ANY GIVEN REDLINE PARAMETER APPROACHING THEIR REDLINE LIMITS.

An engine in hydraulic lockup is expected to drift. This performance drift should elevate HPOTP turbine discharge temperatures which may eventually exceed the redline causing the engine to shutdown. Nozzle leaks and HPOTP efficiency loss cases may cause redline exceedance and subsequent shutdown due to violation of one of the turbine temperature redlines or the MCC Pc low redline. MCC Pc shifts and FFM shifts may cause a redline exceedance (probably one of the turbine temperatures) and subsequent shutdown. Electric lockups due to large FFM shifts can cause a redline exceedance (due to turbine temperatures or the MCC Pc redline). Reference rule {A5.1.1-2}, paragraph E, SPACE SHUTTLE MAINSSME ENGINE OUT, for redline limits.

[@ED 1](#)

Rules {A4.1.2-7}, PERFORMANCE BOUNDARIES; {A5.1.4-6}, ABORT PREFERENCE FOR SYSTEMS FAILURES; and {A8.1.3-2}, SINGLE ENGINE ROLL CONTROL (SERC) FOR RTLS, reference this rule. @[092195-1770A] @[092195-1795]

A5.1.1-6 SSME REDLINE SENSOR FAILED

AN SSME REDLINE SENSOR WILL BE DECLARED FAILED PER THE FOLLOWING CRITERIA: @[092195-1794] @[121296-4624]

- A. AN SSME REDLINE SENSOR IS DECLARED FAILED IF IT WAS DISQUALIFIED BY THE SSME CONTROLLER DUE TO VIOLATION OF ITS REDLINE QUALIFICATION LIMIT. IN ADDITION, A MCC PC CHANNEL SHALL BE CONSIDERED FAILED IF IT HAS FAILED ITS CONTROL INTRACHANNEL QUALIFICATION LIMIT.

Once an SSME redline sensor has been disqualified, it can no longer be used by the SSME controller software for redline monitoring (reference rule {A5.1.1-2}, paragraph E, SPACE SHUTTLE MAINSSME ENGINE OUT, for qualification limits). In the case of MCC Pc, failure of the control intrachannel qualification monitor (the pressure delta between the two bridges exceeds 75 psia) is also indicative of a sensor failure unless a real engine failure has occurred, such as an HPOTP efficiency loss, even though it can still be used for redline monitoring. The redline intrachannel qualification delta is larger (125 psia) to account for the case of a real engine failure dropping the Pc so quickly that the delta between bridges could exceed the 75 psia in the time it takes the controller to read in the two values. The control intrachannel check is included in the failure criteria because that channel could degrade at any time and violate the redline intrachannel check. @ED 1

Rule {A5.1.1-11}, SSME ONE REDLINE SENSOR FAILURE AWAY FROM AN ERRONEOUS SHUTDOWN, references this rule. @[121296-4624]

FLIGHT RULES

THIS RULE CONTINUED ON NEXT PAGE

FLIGHT RULES

A5.1.1-6 SSME REDLINE SENSOR FAILED (CONTINUED)

B. IF THE FLIGHT CONTROLLERS CAN POSITIVELY IDENTIFY THE SENSOR FAILURE MODE(S), AS BEING THE CAUSE OF AN ENGINE SHUTDOWN, THE AFFECTED SSME REDLINE SENSOR(S) WILL BE DECLARED FAILED. @[092195-1794]

If instrumentation failure(s) can be positively identified as the cause of an engine shutdown, the sensor(s) whose behavior triggered the shutdown will be declared failed. A sensor could fail such that it votes for shutdown but does not fail its qualification limit. Real-time analysis of the affected sensor(s) must be performed by the flight controllers to distinguish sensor failures from real engine hardware failures. @[092195-1794]

Rule {A5.1.3-3}, LIMIT SHUTDOWN CONTROL, references this rule.

A5.1.1-7 SIGNIFICANT ENGINE HELIUM SYSTEM LEAK

TANK PRESSURE DECAY RATE (DP/DT) > 20 PSIA OVER 3 SECONDS, OR AN INDICATED HELIUM USAGE WHICH IS GREATER THAN 0.055 LBM/SEC AFTER AN MET OF 1 MINUTE. @[090894-1676A]

NOTE: DECAY RATE CORRESPONDS TO THE BFS DECAY RATE COMPUTATION AND THE INDICATED HELIUM USAGE IS BASED ON MCC MASS FLOW RATE COMPUTATIONS.

Tank pressure decay rate (DP/DT) > 20 psia/3 seconds is twice the nominal value of approximately 10 psia/3 seconds. This value takes into account normal data noise and the 10 psi data granularity and represents the minimum value usable to detect helium leaks on board the vehicle. In addition to the DP/DT computation, the MCC uses a mass flow rate computation (lbm/sec) in order to detect helium leaks. The maximum nominal mainstage usage for the engine HPOTP IMSL purge is 0.047 lbm/sec (ref. SSME-to-Orbiter ICD 13M15000). Usage above 0.047 lbm/sec is indicative of an off-nominal condition in the associated MPS helium system supply.

Small leaks which are above 0.047 lbm/sec and below the crew alarm criteria (approximately 0.087 lbm/sec) will not be isolated prior to an MET of 1 minute. Action to isolate small helium leaks is not taken within the first minute after liftoff because the ground computation requires 20 seconds of data after liftoff for proper initialization and because additional time is required by the MCC for leak evaluation. Also, a leak of this size which is isolated shortly after an MET of 1 minute will probably not violate the single regulator zero-g shutdown requirements. However, continued usage at this rate may significantly reduce the helium available to support engine shutdown at MECO.

Even though helium usage above 0.047 is off nominal, MCC action is only taken for leaks with a usage above 0.055 lbm/sec or greater. This number accounts for noise in the ground computation and protects nominal MECO helium requirements.

FLIGHT RULES

Rule {A5.1.4-1}, PRE-MECO MPS HELIUM SYSTEM LEAK ISOLATION, references this rule.
@[090894-1676A]

FLIGHT RULES

A5.1.1-8 SIGNIFICANT PNEUMATIC SYSTEM HELIUM LEAK

ANY LEAK IN THE PNEUMATIC TANK SYSTEM OR PNEUMATIC ACCUMULATOR WHICH WILL ANNUNCIATE THE CREW SYSTEMS MANAGEMENT (~~C&W ALARM-SM~~) ALERT (PNEU TK P < 3800.0 PSIA) PRIOR TO MECO -30 SECONDS.
 @[090894-1676A] @[021199-67901]

An attempt is made to isolate leaks in the MPS pneumatic helium supply in order to conserve helium for LO₂ prevalve closure at MECO. Furthermore, if the leak is isolated, the pneumatic helium supply will be available to support the operation of a leaking MPS helium engine supply.

Isolation will only be performed if the leak is large enough to annunciate the crew ~~C&W alarm-SM~~ Alert prior to MECO -30 seconds. @[021199-67901]

Rule {A5.1.4-1}, PRE-MECO MPS HELIUM SYSTEM LEAK ISOLATION, references this rule.
 @[090894-1676A]

A5.1.1-9 INSUFFICIENT PNEUMATIC HELIUM ACCUMULATOR PRESSURE

A PNEUMATIC ACCUMULATOR PRESSURE WHICH IS LESS THAN 700 PSIA.
 @[090894-1676A]

Seven hundred psia is the minimum actuation pressure which will ensure proper LO₂ and LH₂ prevalve closure timing at MECO. Pressures of 400 to 500 psia will fully position the valves; however, timing requirements may not be satisfied (ref. SODB, Vol. ii, Section 4.3.1). Four of six test cases of three engine prevalve closures at an initial pressure of 400 psia were within the timing specification of 1.15 seconds maximum closing time. Of the two that violated requirements, one was 0.03 seconds slow and the other was 0.06 seconds slow (reference PSIG telecon charts, 5/19/93).

It is critical that the LO₂ prevalues close within timing constraints at MECO. LO₂ prevalve closure and the injection of helium into the pogo accumulator are used to maintain pressure on the engine high pressure oxidizer turbopump, preventing pump cavitation during the shutdown sequence.

Rule {A5.1.4-1}, PRE-MECO MPS HELIUM SYSTEM LEAK ISOLATION, references this rule.
 @[090894-1676A]

FLIGHT RULES

A5.1.1-10 MPS PROPELLANT DUMPS AND INERTING DEFINITIONS

A. MPS PROPELLANT DUMP

A PRESSURIZED MPS LO₂ AND UNPRESSURIZED LH₂ MPS PROPELLANT DUMP PERFORMED IN MM 104 FOR NOMINAL, ATO, AND AOA MISSIONS THAT IS NORMALLY AUTOMATIC, BUT CAN BE STARTED OR DELAYED MANUALLY. @[092195-1791]

B. MPS GH₂ INERT @[092195-1791]

A MANUAL INERTING PROCEDURE OF GH₂ THROUGH THE PRESS LINE VENT VALVE PERFORMED AFTER THE MPS POWERDOWN AND ISOLATION PROCEDURE FOR NOMINAL, ATO, AND AOA MISSIONS. @[111094-1719]

C. AUTOMATED MPS VACUUM INERT @[092195-1791]

AN LH₂ AND LO₂ INERTING PROCEDURE PERFORMED AFTER THE MPS PROPELLANT DUMP FOR NOMINAL, ATO, AND AOA MISSIONS THAT IS NORMALLY AUTOMATIC, BUT CAN ALSO BE PERFORMED MANUALLY.

D. MANUAL MPS VACUUM INERT @[092195-1791]

A MANUAL INERTING OF THE LH₂ OR LO₂ FEEDLINE SYSTEM WHICH IS PERFORMED DUE TO AN AVIONICS FAILURE THAT PREVENTS AN EFFICIENT NOMINAL AUTOMATED MPS VACUUM INERT. THE MANUAL MPS VACUUM INERT IS PERFORMED AFTER MPS DUMP STOP + 20 MINUTES SUCH THAT THE AUTOMATED COMMANDS AND THE CREW'S SWITCH THROWS WILL NOT COINCIDE.

E. POST OMS-2 MPS LH₂ VACUUM INERT

A MANUAL INERTING OF LH₂ FEEDLINE SYSTEM AND LH₂ HIGH POINT BLEED LINE PERFORMED DURING THE POST OMS-2 RECONFIGURATION FOR NOMINAL AND ATO MISSIONS. THIS PROCEDURE IS PERFORMED IN ADDITION TO THE MANUAL MPS VACUUM INERT AS DESCRIBED IN RULES {A5.1.5-6}, MANUAL VACUUM INERTING REQUIREMENTS (NOMINAL, ATO, AOA), AND {A5.1.5-7}, REPEAT MPS VACUUM INERT, WHEN THESE RULES ARE INVOKED.

THIS RULE CONTINUED ON NEXT PAGE

FLIGHT RULES**A5.1.1-10 MPS PROPELLANT DUMPS AND INERTING DEFINITIONS
(CONTINUED)**

F. REPEAT MPS VACUUM INERT

A MANUAL INERTING OF THE LH₂ AND/OR LO₂ FEEDLINE SYSTEM ON ORBIT WHICH ASSUMES THAT A NOMINAL AUTOMATED AND POST OMS-2 MPS INERT OCCURRED AND WERE INEFFECTIVE.

G. ENTRY MPS PROPELLANT DUMP @[092195-1791]

AN MPS LH₂ AND LO₂ PROPELLANT DUMP/INERTING STARTED AUTOMATICALLY IN MM 303 FOR NOMINAL, ATO, AOA, AND TAL MISSIONS, AND IN MM 602 FOR AN RTLS ABORT.

The non-contingency dumping and inerting of propellants are done to ensure there are no propellants in the manifolds prior to landing. The orbiter center of gravity is affected by dumping the residual MPS propellants. The hazard from venting LH₂ during entry and ingesting it into the aft compartment is removed by dumping the residual LH₂.

**A5.1.1-11 SSME ONE REDLINE SENSOR FAILURE AWAY FROM AN
ERRONEOUS SHUTDOWN**

A. AN SSME WILL BE DECLARED ONE REDLINE SENSOR FAILURE AWAY FROM AN ERRONEOUS SHUTDOWN IF ONLY ONE OF THE HPFTP COOLANT LINER PRESSURE TRANSDUCERS (PHASE II AND BLOCK I SSME ONLY), ONE OF THE HPOTP SECONDARY SEAL PRESSURES (PHASE II SSME ONLY), OR ONE OF THE HPOTP INTERMEDIATE SEAL PRESSURE TRANSDUCERS, IS QUALIFIED FOR REDLINE SHUTDOWN PROCESSING. @[121296-4624]

NOTE: AN SSME IS NOT DECLARED ONE REDLINE SENSOR FAILURE AWAY FROM AN ERRONEOUS SHUTDOWN IF ONLY ONE OF THE TWO SSME MCC PC CHANNELS IS DISQUALIFIED.

The HPFTP coolant liner pressure redline (Phase II and Block I SSME only), the secondary seal pressure redline (Phase II SSME only), and the intermediate seal pressure redline each have two pressure transducers per redline (single transducer per controller channel). Therefore, if one or more transducers are disqualified for either a controller failure (input electronics or power supply, reference Rule {A5.1.1-2}, SPACE SHUTTLE MAINSSME ENGINE OUT) or a sensor failure (reference Rule {A5.1.1-6}, SSME REDLINE SENSOR FAILED), causing any remaining pressure redline to have a single qualified transducer, the engine will be considered one redline sensor failure away from an erroneous shutdown. This definition is used by Rule {A5.1.3-3}, LIMIT SHUTDOWN CONTROL, but only after the criteria outlined there (e.g., at least one redline sensor has failed) has been met. @[121296-4624] @ED 1

FLIGHT RULES

THIS RULE CONTINUED ON NEXT PAGE

FLIGHT RULES

A5.1.1-11 SSME ONE REDLINE SENSOR FAILURE AWAY FROM AN ERRONEOUS SHUTDOWN (CONTINUED)

No single main combustion chamber pressure (MCC Pc) transducer failure can cause an engine to shut down on the MCC Pc redline when only one channel remains. Engine shutdown is prevented because of the way the MCC Pc transducers are qualified (redline processing is performed on channel pairs). An MCC Pc channel must have a channel average between 1000 and 3500 psia, and the two transducers on the channel must be within 125 psia of each other, for the channel to be qualified to vote for shutdown, reference Rule {A5.1.1-2}, SPACE SHUTTLE MAIN SSME ENGINE OUT. The channel is disqualified for redline processing if either of these conditions is not met. The redline is violated if all qualified channel averages are 400 psia less than reference Pc (defined by the SSME controller for a given SSME power level). If one of the Pc transducers drifts high, with only one channel remaining, the controller channel's two Pc sensors will be disqualified for thrust control processing. This disqualification will occur when the delta between the two channels reaches 75 psia. This will place the SSME in electrical lockup. Additionally, if the sensor continues to drift such that delta between the two sensors is 125 psia, the controller channel's Pc transducers will be disqualified for redline shutdown processing. This disqualification will occur prior to the 400 psia redline being violated. For cases where both transducers are on the remaining channel drift, (thermal isolator problem or lee jet/sense tube problem), the engine will continually rebalance in response to the drifting Pc. If the drift is severe enough, the engine may exceed the 400 psia engine redline. In either case, SSME redline limits should be reenabled as specified in Rule {A5.1.3-3}, LIMIT SHUTDOWN CONTROL. @ED 1

B. AN SSME IS DECLARED ONE REDLINE SENSOR FAILURE AWAY FROM AN ERRONEOUS SHUTDOWN IF ONLY ONE HPOT TURBINE DISCHARGE TEMPERATURE (TDT) TRANSDUCER IS QUALIFIED FOR REDLINE SHUTDOWN PROCESSING.

C. AN SSME IS NOT DECLARED ONE REDLINE SENSOR FAILURE AWAY FROM AN ERRONEOUS SHUTDOWN IF ONLY ONE HPFT TURBINE DISCHARGE TEMPERATURE TRANSDUCER IS QUALIFIED FOR REDLINE SHUTDOWN PROCESSING.

Once a sensor has been disqualified, it can no longer be used by the SSME controller software for redline monitoring. Reference Rule {A5.1.1-2E}, SPACE SHUTTLE MAIN SSME ENGINE OUT, for information on qualification/reasonableness testing. There are known thermocouple failure modes that can cause a sensor to fail below the lower HPOT turbine discharge temperature redline, but above the qualification limit. Therefore, the HPOT turbine discharge temperature redline will be considered one redline sensor failure away from an erroneous shutdown if only one qualified HPOT turbine discharge temperature Sensor is qualified. Because there is no lower HPFT turbine discharge temperature redline limit, an SSME is not declared one redline sensor failure away from an erroneous shutdown if only one qualified HPFT turbine discharge temperature transducer is qualified for shutdown. @[121296-4624] @ED 1

THIS RULE CONTINUED ON NEXT PAGE

FLIGHT RULES

A5.1.1-11 SSME ONE REDLINE SENSOR FAILURE AWAY FROM AN ERRONEOUS SHUTDOWN (CONTINUED)

A failure causing one turbine discharge temperature to remain qualified, but vote for shutdown on the upper redline, can result in SSME shutdown - if there are three or less qualified transducers at the redline location. This can occur because the redline logic disqualifies the “lower” transducers. Reference Rule {A5.1.1-2E}, SPACE SHUTTLE MAINSSME ENGINE OUT, for information on qualification/reasonableness testing. The only known thermocouple failure mode, where the thermocouple fails in-qualification-range high while violating the upper redline limit, is a “smart” failure in the SSME controller thermocouple sensor signal conditioning pre-amp circuit. This failure mode has a very low probability of occurrence (reference the special Rocketdyne briefing on this topic to the Shuttle Program Manager on 11/9/95). The entire thermocouple turbine discharge temperature redline processing philosophy of disqualifying the “lower” transducer depends on this low probability. Since the redline processing philosophy does not protect for this case, this flight rule does not protect for this case either. @ED]

Rules {A5.1.1-2}, SPACE SHUTTLE MAINSSME ENGINE OUT; {A5.1.1-6}, SSME REDLINE SENSOR FAILED; and {A5.1.3-3}, LIMIT SHUTDOWN CONTROL, reference this rule. ©[121296-4624] @ED]

A5.1.1-12 RESERVED @[111298-6785A] ~~UNSTABLE SSME~~

FLIGHT RULES

A5.1.1-13 SPACE SHUTTLE MAIN ENGINE TYPES

	<u>HPOTP</u>	<u>MCC</u>	<u>HPFTP</u>
<u>PHASE II</u>	<u>ROCKETDYNE</u>	<u>STANDARD</u>	<u>ROCKETDYNE</u>
<u>BLOCK I/IA</u>	<u>P&W</u>	<u>STANDARD</u>	<u>ROCKETDYNE</u>
<u>BLOCK IIA</u>	<u>P&W</u>	<u>LARGE THROAT</u>	<u>ROCKETDYNE</u>
<u>BLOCK II</u>	<u>P&W</u>	<u>LARGE THROAT</u>	<u>P&W</u>

@{121197-6472A}

THERE ARE MANY HARDWARE DIFFERENCES ASSOCIATED WITH THE VARIOUS SSME TYPES. ONLY THE DIFFERENCES WITH SIGNIFICANT BOOSTER SYSTEMS FLIGHT CONTROLLER OPERATIONAL IMPACTS ARE LISTED HERE.

FROM THE BOOSTER SYSTEMS FLIGHT CONTROLLER'S PERSPECTIVE, THE BLOCK I AND THE BLOCK IA OPERATIONAL CHARACTERISTICS ARE IDENTICAL. FOR THE PURPOSES OF THE FLIGHT RULES, THE NOMENCLATURE 'BLOCK I' WILL BE USED FOR BOTH.

FOR BLOCK I/IIA/II: INCORPORATION OF THE PRATT AND WHITNEY (P&W) ALTERNATE HPOTP IN PLACE OF THE ROCKETDYNE BASELINE HPOTP ELIMINATES THE SECONDARY SEAL REDLINE AND LOWERS THE INTERMEDIATE SEAL REDLINE (REF RULE {A5.1.1-2}, SPACE SHUTTLE MAIN ENGINE OUT).

FOR BLOCK IIA/II: INCORPORATION OF THE LARGE THROAT MCC IN PLACE OF THE STANDARD THROAT MCC REDUCES THE OVERALL OPERATING PRESSURES AND TEMPERATURES AT A GIVEN POWER LEVEL AND LOWERS THE HPOTP AND HPFTP TURBINE DISCHARGE TEMPERATURE REDLINES (REF RULE {A5.1.1-2}, SPACE SHUTTLE MAIN ENGINE OUT).

FOR BLOCK II: INCORPORATION OF THE PRATT AND WHITNEY ALTERNATE HPFTP IN PLACE OF THE ROCKETDYNE BASELINE HPFTP ELIMINATES THE COOLANT LINER REDLINE (REF RULE {A5.1.1-2}, SPACE SHUTTLE MAIN ENGINE OUT).

DETAILS OF THESE CHANGES ARE COVERED IN BOOSTER SYSTEMS' CONSOLE TOOLS AND DOCUMENTATION.

Rule {A5.1.1-2}, SPACE SHUTTLE MAIN ENGINE OUT, references this rule. @ {121197-6472A}

FLIGHT RULES

A5.1.1-14 LH2 ULLAGE LEAK

FOR A BLOCK IIA SSME CLUSTER, AN ET LH₂ ULLAGE LEAK IS CHARACTERIZED BY ALL OF THE FOLLOWING: ©[040899-6818A]

- A. LH₂ ULLAGE PRESSURE IS STEADILY DECAYING BELOW 32.6 (32.2) PSIA, AND
- B. THE GH₂ 2-INCH DISCONNECT PRESSURE IS GREATER THAN 448 (436418) PSIA.

The ET LH₂ ullage pressure is maintained by the three flow control valves (FCV's) in the orbiter GH₂ pressurization system. The set point for the GH₂ FCV signal conditioners is 33.0 psia. A 0.4 psi signal conditioner deadband encompassing the set point results in actual activation values as low as 32.6 psia or as high as 33.4 psia. A significant LH₂ ullage leak or an orbiter GH₂ pressurization system anomaly (reference #Rule {A5.1.4-5}, LIMIT SHUTDOWN CONTROL AND MANUAL THROTTLING FOR LOW LH₂ NPSP) will cause the LH₂ ullage pressure to drop below 32.6 psia (32.2 psia indicated when a 0.4 psi worst case transducer bias is included). The orbiter GH₂ pressurization system will respond by opening the three GH₂ FCV's in an attempt to increase ullage pressure. The FCV's have been shimmed, such that an open FCV provides 70 percent flow through the valve and 31 percent flow when the valve is commanded closed. These settings are also referred to as the 'high flow' and 'low flow' positions, respectively.

It is important to establish the difference between an ullage leak and an orbiter GH₂ pressurization system anomaly since the required actions are different (reference #Rule {A5.1.4-6}, ABORT PREFERENCE FOR SYSTEMS FAILURES). The 2-inch disconnect pressure cue is sufficient to distinguish between an ullage leak and an orbiter GH₂ pressurization system anomaly once the LH₂ ullage pressure has decayed below the lower limit of the control band with all three GH₂ FCV's open. If the GH₂ 2-inch disconnect pressure is consistent with the expected value for three open FCV's (high flow position), then the LH₂ ullage pressure problem is determined to be the result of an LH₂ ullage leak. If the GH₂ 2-inch disconnect pressure is below that expected for three open FCV's, then the cause of the low ullage pressure is an orbiter GH₂ pressurization system anomaly.

A value for the 2-inch disconnect pressure was chosen at the lowest expected value for three flow control valves open and above the predicted value for ~~two~~one flow control valves failed closed (low flow position) to avoid erroneously calling an ullage leak. Data provided by BNA/Houston (reference PSIG telecon November 10, 1998), on all flights since the reshimming of the flow control valves (70 percent/31 percent), showed that the lowest 2-inch disconnect pressure seen to date for three flow control valves open at mission power level was 452 psia on STS-89. This was a Block IIA cluster flight, which has shown to provide the least amount of ullage pressurization gas; ~~therefore, all other engine configurations are enveloped by this case.~~ Subtracting out a one sigma dispersion (4 psia) and a ~~worst case~~3 percent instrumentation error (~~1230~~ psia) yields a 2-inch disconnect pressure value of 436418 psia.

FLIGHT RULES

This disconnect pressure cue is only valid at the mission power level with three SSME's running. This cue also assumes a Block IIA SSME cluster flight since the significantly higher 2-inch disconnect pressures associated with the non-Block IIA SSME cluster flights could cause one FCV failed closed (low flow position) to be misdiagnosed as an ullage leak.

Rule {A5.1.4-5}, LIMIT SHUTDOWN CONTROL AND MANUAL THROTTLING FOR LOW LH₂ NPSP, references this rule. ©[040899-6818A]

FLIGHT RULES

SRB SYSTEMS MANAGEMENT

@[021694-ED]

A5.1.2-1 LOSS OF SRB HYDRAULIC POWER UNITS (HPU)

FOR THE LOSS OF TWO HPU'S ON ONE SRB, THE FLIGHT WILL BE CONTINUED UNTIL LOSS OF VEHICLE CONTROL.

The loss of two HPU's on one SRB results in no TVC control on that SRB. This may result in loss of control depending on nozzle position. There is no manual control available; therefore, there is no crew action that can be taken.

FLIGHT RULES

SSME SYSTEMS MANAGEMENT

A5.1.3-1 ABORT CUE REQUIREMENT

ANY ENGINE CONDITION THAT CAUSES AN ABORT DECISION WILL BE CONFIRMED USING TWO CUES.

Two cues are required so that a single instrumentation failure will not cause an erroneous abort decision.

A5.1.3-2 AUTO/MANUAL SHUTDOWN

MANUAL SHUTDOWN OF AN ENGINE WILL NOT BE ATTEMPTED IF AUTOMATIC LIMIT SHUTDOWN CAPABILITY IS ENABLED AND AN ENGINE IS APPROACHING A SHUTDOWN LIMIT. AN EXCEPTION TO THIS RULE IS WHEN EXCESSIVE HELIUM LEAKAGE REQUIRES A MANUAL ENGINE SHUTDOWN AS DISCUSSED IN RULE {A5.1.4-3}, PRE-MECO SHUT DOWN OF ENGINES DUE TO MPS HELIUM LEAKS. @[032395-1766]

The automatic limit shutdown system was designed to prevent a catastrophic failure of an engine. Due to response times and the complexity of the SSME, the ground and crew will not try to interfere with this system.

A5.1.3-3 LIMIT SHUTDOWN CONTROL

A. PREMATURE MAIN ENGINE SHUTDOWN @[121296-4625]

~~THE MAIN ENGINE LIMIT SHUTDOWN CONTROL CAPABILITY WILL BE MANAGED USED TO INHIBIT A LIMIT SHUTDOWN DURING THE TIME PERIOD WHERE A SUBSEQUENT ENGINE LOSS WOULD RESULT IN LOSS OF VEHICLE. FOR ENGINE-OUT CONDITIONS, UTILIZE LIMIT SHUTDOWN CONTROL AS FOLLOWS:~~ @[121296-4625] @[111298-6785A]

1. INHIBITED AT ONE ENGINE-OUT

GPC AUTOMATICALLY COMMANDS INHIBIT TO THE REMAINING TWO ENGINES.

The main engine limit shutdown switch is a three-position switch: ENABLE, AUTO, and INHIBIT. At lift-off, the switch is in the AUTO position, and the limit shutdown control logic is enabled on all three engines. After one engine-out occurs, the main engine limit shutdown control capability on the two remaining engines is automatically inhibited. @[111298-6785A]

FLIGHT RULES

~~After one engine out occurs, the main engine limit shutdown control capability on the two remaining engines is automatically inhibited. This prevents the engine controller from commanding a shutdown of a second engine for violation of a redline whether the violation is real or an instrumentation problem. If one of the remaining engines were to shut down, a manual contingency abort would have to be performed unless Single Engine Press to MECO, Single Engine TAL, or Droop capability exists. The risk of an engine failing catastrophically while the limits are inhibited is considered to be less than the risk associated with the manual contingency abort. @[121296-4625]~~

THIS RULE CONTINUED ON NEXT PAGE

FLIGHT RULES

A5.1.3-3 LIMIT SHUTDOWN CONTROL (CONTINUED)

2. WITH ONE ENGINE OUT AND BFS NOT ENGAGED, THE MAIN ENGINE LIMIT SHUTDOWN SOFTWARE WILL BE REENABLED BY PLACING THE MAIN ENGINE LIMIT SHUTDOWN SWITCH TO "ENABLE" THEN "AUTO." REENABLING WILL BE BASED UPON THE FOLLOWING CONDITIONS:

- a. ~~THE CREW WILL MANUALLY REENABLE THE LIMITS AS SOON AS POSSIBLE FOLLOWING THE ENGINE OUT. @111298-6785A] IF THE MCC DETERMINES NO ENGINE REDLINE SENSORS ARE FAILED, REENABLE THE MAIN ENGINE LIMIT SHUTDOWN SOFTWARE WHEN THE FOLLOWING BOUNDARY IS REACHED: @092495-4793] @124296-4625]~~

~~RTLS — SINGLE ENGINE RTLS BOUNDARY~~

~~TAL, AOA, ATO, NOM — SINGLE ENGINE DROOP BOUNDARY~~

The reenabling of the main engine limit shutdown software is required to regain, as soon as possible, the engine redline shutdown protection in the event of a second engine failure. The reenabling of the main engine limit shutdown software will be accomplished by taking the main engine limit shutdown switch to ENABLE then to AUTO. This allows one of the running engines to shut down due to a limit violation while automatically inhibiting the main engine limit shutdown control capability on the one remaining engine. Single-engine flight control capability would then take the vehicle to MECO.

The philosophy of when to reenable the main engine limit shutdown software attempts to balance the risk of an engine failing catastrophically while the limits are inhibited against the risk associated with a two engine-out contingency abort. ~~a second engine shutdown due to sensor failures against the capability of achieving a runway or, if no runway can be reached, against achieving a safe bailout attit~~

A meeting was held with the Shuttle Program Manager on September 10, 1998, to discuss the risks. Insufficient data is available to perform a risk trade since 1) The likelihood of an SSME running safely above a redline limit is unknown, and 2) The likelihood of surviving a contingency abort and the associated ET separation, flight control, thermal, crew bailout, and rescue is also unknown. The two engine-out contingency abort risks were accepted over running an SSME with limits inhibited. The risk of running an SSME with limits inhibited was accepted over the three engine-out contingency abort. Based on this philosophy, the main engine limit shutdown software will remain enabled (or reenabled) for one engine-out cases and inhibited for all two engine-out cases. @121296-4625] @111298-6785A]

The September 15 and November 18, 1987, and June 2, 1995, Ascent/Entry Flight Techniques panels reviewed the failure history of the redline sensors and came to the conclusion that the engine redline sensors are reliable and should, in general, be trusted to not cause an inadvertent shutdown.

FLIGHT RULES

- b. IF THE MCC DETERMINES ONE OF THE REDLINE SENSORS IS FAILED AND:

THIS RULE CONTINUED ON NEXT PAGE

FLIGHT RULES

A5.1.3-3

LIMIT SHUTDOWN CONTROL (CONTINUED)

- (1) EITHER OF THE REMAINING ENGINES IS ONE REDLINE SENSOR FAILURE AWAY FROM AN ERRONEOUS SHUTDOWN, ~~REENABLE~~ THE MAIN ENGINE LIMIT SHUTDOWN SOFTWARE WILL BE INHIBITED UNTIL WHEN THE FOLLOWING BOUNDARY IS REACHED AND THEN REENABLED: @[121296-4625] @[111298-6785A]

RTLS - SINGLE ENGINE RTLS BOUNDARY

TAL, AOA, ATO, NOM - SINGLE ENGINE LIMITS BOUNDARY FOR A PRIME TAL SITE OR OTHER AUGMENTED TAL/CONTINGENCY SITE IF WEATHER OR LANDING AIDS PERMIT (REFERENCE RULE {A2.1.1-6}, LANDING SITE WEATHER CRITERIA). IF WEATHER AND/OR LANDING AIDS DO NOT PERMIT, REENABLE AT SINGLE ENGINE PRESS.
@[092195-1793]

- (2) NEITHER OF THE REMAINING ENGINES IS ONE REDLINE SENSOR FAILURE AWAY FROM AN ERRONEOUS SHUTDOWN, REENABLE THE MAIN ENGINE LIMIT SHUTDOWN SOFTWARE AS SOON AS POSSIBLE. WHEN THE FOLLOWING BOUNDARY IS REACHED: @[092195-1793] @[121296-4625]

~~RTLS - SINGLE ENGINE RTLS BOUNDARY~~

~~TAL, AOA, ATO, NOM - SINGLE ENGINE DROOP BOUNDARY~~

@[121296-4625]

FLIGHT RULES

The MCC is responsible for evaluating sensor failures since the flight crew has no visibility into the sensor health. Software flags issued by the onboard main engine controller sensor reasonableness software or previously observed failure modes would be used by the MCC as criteria to say that a sensor had failed. If, previous to the first engine shutdown, a sensor failure were detected and then the engine shut down based on the remaining redline sensor, that second failure would not be counted as a sensor failure unless the flight controllers could positively identify the sensor failure mode. A subsequent sensor failure on another running engine would have to occur before two sensor failures could be counted. This type of situation occurred on STS 51-F. All sensor failures on STS 51-F were detected by the onboard main engine sensor reasonableness software. This software also informed the flight controllers of the failures via the downlisted failure identifier data words. @111298-6785A

THIS RULE CONTINUED ON NEXT PAGE

FLIGHT RULES

A5.1.3-3

LIMIT SHUTDOWN CONTROL (CONTINUED)

The main engine limit shutdown software will be enabled at an appropriate boundary with one sensor failure on one of the three engines, because one sensor failure does not indicate a trend for a generic failure of the sensors. If either of the remaining two engines is one sensor failure away from an erroneous shutdown, limits will remain inhibited until an ~~single engine~~ abort boundary is reached. The limits will be reenabled when an abort boundary (as defined in Rule {A4.1.2-7}, PERFORMANCE BOUNDARIES) is reached such that a single-engine abort can be accomplished to the desired site. On an RTLS, this abort boundary is Single Engine RTLS (which is designated by the "two-out red on the TRAJ display" call). If neither of the remaining engines is one sensor failure away from an erroneous shutdown, limits can be reenabled as soon as possible. This allows the redlines to provide the earliest protection against a real engine hardware failure. @111298-6785A]

On a TAL, AOA, ATO, or nominal profile, this abort boundary is Single Engine Limits if weather or landing aids permit. Otherwise, the limits will be reenabled at Single Engine Press (ref. Rule {A2.1.1-6}, LANDING SITE WEATHER CRITERIA). With one sensor failure and either of the remaining engines one sensor failure away from shutting down erroneously, the risk of an engine shutdown due to another sensor failure is higher than that due to an actual engine failure if the limits were reenabled. Because of this increased risk of an engine shutdown caused by sensor failures, the exposure to bailout is not acceptable unless the next sensor failure will not cause an erroneous shutdown. For these reasons, the limits are inhibited until the single engine limits boundary to minimize the need for a contingency abort and crew bailout. @121296-4625]

c. IF THE MCC DETERMINES TWO OR MORE OF THE SAME TYPE (TEMPERATURE OR PRESSURE) ENGINE REDLINE SENSORS HAVE FAILED AND:

- (1) EITHER OF THE REMAINING ENGINES IS ONE REDLINE SENSOR FAILURE AWAY FROM AN ERRONEOUS SHUTDOWN, THE MAIN ENGINE LIMIT SHUTDOWN SOFTWARE WILL BE INHIBITED THROUGH MECO., ~~EITHER BY NOT REENABLING OR BY PLACING THE MAIN ENGINE LIMIT SHUTDOWN SWITCH TO "INHIBIT" IF LIMITS WERE PREVIOUSLY REENABLED.~~
- (2) NEITHER OF THE REMAINING ENGINES IS ONE REDLINE SENSOR FAILURE AWAY FROM AN ERRONEOUS SHUTDOWN, REENABLE THE MAIN ENGINE LIMIT SHUTDOWN SOFTWARE AS SOON AS POSSIBLE ~~WHEN THE FOLLOWING BOUNDARY IS REACHED:~~

~~RTLS — SINGLE ENGINE RTLS BOUNDARY~~

~~— TAL, AOA, ATO, NOM — SINGLE ENGINE DROOP BOUNDARY~~

FLIGHT RULES

~~d. IF AN ENGINE EXCEEDS REDLINES WITH LIMITS INHIBITED AND STABILITY OF THE EXCEEDANCE EXISTS, REENABLING OF THE MAIN ENGINE LIMIT SHUTDOWN SOFTWARE WILL BE DELAYED UNTIL THE SINGLE ENGINE LIMITS BOUNDARY. OTHERWISE, MAIN ENGINE LIMIT SHUTDOWN SOFTWARE WILL BE REENABLED AT THE SINGLE ENGINE DROOP BOUNDARY. @[092195-1793] @[121296-4625]~~

The shutdown sensors on the same redline will be suspected of having a generic problem if more than one sensor fails (two or more sensors failed on the same type of redline). If either remaining engine is one sensor failure away from an erroneous shutdown, limits will remain inhibited through MECO in order to prevent the next sensor failure from shutting down a good engine. The two failures could occur on one or more engines including the failed engine. If neither engine is one sensor failure away from an erroneous shutdown, then limits are reenabled as soon as possible. This allows the earliest possible protection by the redline sensors against a real engine hardware failure. @[121296-4625] @[111298-6785A]

THIS RULE CONTINUED ON NEXT PAGE

FLIGHT RULES

A5.1.3-3 LIMIT SHUTDOWN CONTROL (CONTINUED)

3. WITH ONE ENGINE OUT AND BFS ENGAGED, THE MAIN ENGINE LIMIT SHUTDOWN SOFTWARE WILL BE INHIBITED THROUGH MECO BY THE BFS AUTOMATIC COMMAND. @[121296-4625] @[111298-6785A]

The main engine limit shutdown control will be inhibited on two remaining engines if the BFS is engaged. The BFS does not have single-engine flight control software and therefore cannot control the vehicle with two engines shut down. If the engine shuts down after the BFS is engaged, the BFS will automatically command inhibit to the remaining engines. If the engine shuts down while on the PASS, limits subsequently reenabled, and then BFS engaged, the BFS will again automatically command inhibit to the remaining engines since the BFS reevaluates and responds to engine out status when engaged.

4. WITH TWO ENGINES OUT, THE MAIN ENGINE LIMIT SHUTDOWN SOFTWARE WILL REMAIN INHIBITED THROUGH MECO.

Since three engine-out contingency aborts contain "black zones" and are more severe than the two-engine contingency aborts, limits will remain inhibited on the last running engine.

Rules {A2.1.1-6}, LANDING SITE WEATHER CRITERIA; {A2.1.2-5}, USE OF LOW-ENERGY GUIDANCE; and {A5.1.3-4}, DATA PATH FAIL/ENGINE-ON LIMIT SHUTDOWN CONTROL, reference this rule. @[120894-1663]

B. STUCK THROTTLE IN THE THRUST BUCKET

IF A STUCK THROTTLE CONDITION OCCURS DURING MAX Q THROTTLING SUCH THAT THE POWER LEVEL IS LESS THAN THE NOMINAL FLIGHT POWER LEVEL, THE MAIN ENGINE LIMIT SHUTDOWN SOFTWARE WILL REMAIN ENABLED. BE MANUALLY INHIBITED BY PLACING THE MAIN ENGINE LIMIT SHUTDOWN SWITCH TO "INHIBIT". REENABLING WILL REQUIRE PLACING THE SWITCH TO "ENABLE" THEN "AUTO" AND WILL BE BASED UPON THE FOLLOWING CONDITIONS: @[121296-4625]

1. IF ENGINE THROTTLE CAPABILITY IS RECOVERED VIA RESTRICTING (REF. RULE {A2.1.2-14}, ASCENT STRING REASSIGNMENT), REENABLE ASAP.

FLIGHT RULES

- ~~2. IF ENGINE THROTTLE CAPABILITY IS NOT RECOVERABLE, REENABLE WHEN THE FIRST ABORT CAPABILITY (RTLS, ACLS, TAL) IS ACHIEVED ASSUMING A GOOD ENGINE OUT OR WHEN DROOP CAPABILITY EXISTS ASSUMING A GOOD ENGINE OUT (ONE TWO/THIRDS ENGINE PERFORMANCE), WHICHEVER OCCURS FIRST.~~

~~When an engine experiences a stuck throttle in the thrust bucket, performance may be reduced sufficiently that an abort gap may will occur between RTLS capability and any downrange abort capability. Uphill capability may also be lost. Main engine limit shutdown software remains enabled to allow for the stuck engine to shut down if it exceeds redline limits. In the case of a hydraulic lock-up, valve drift may occur resulting in potential redline limit exceedance; therefore, the main engine limit shutdown software remains enabled. It has been accepted that tThe loss of a good engine could result in a 1 and 2/3 RTLS contingency abort. ~~which is considered to be more severe than a two engine out downrange contingency abort but less severe than a three engine out contingency abort.~~ ~~in this gap will result in loss of vehicle. Therefore, the main engine limit shutdown software is manually inhibited to prevent an inadvertent shutdown due to sensor failures.~~~~

@{121296-4625}

- C. ~~WITH ONE ENGINE OUT AND ONE OF THE REMAINING ENGINES HAS A NON-ISOLATABLE MPS HELIUM LEAK IF THE VEHICLE IS IN AN ABORT GAP AND PNEUMATIC HELIUM AND/OR A FAILED ENGINE'S HELIUM IS AVAILABLE TO SUSTAIN SAFE ENGINE OPERATION (REF. RULE {A5.1.4-2}, PRE-MECO MPS HELIUM SYSTEM INTERCONNECTS (CIL)), THE MAIN ENGINE LIMIT SHUTDOWN SOFTWARE WILL BE INHIBITED BASED ON THE FOLLOWING: @111298-6785A~~

THIS RULE CONTINUED ON NEXT PAGE

FLIGHT RULES

A5.1.3-3

LIMIT SHUTDOWN CONTROL (CONTINUED)

1. PRIOR TO THE SINGLE ENGINE LIMITS (TAL ABORT) OR SINGLE ENGINE RTLS (RTLS ABORT) BOUNDARY: @[111298-6785A]

WHEN THE PNEUMATIC HELIUM AND/OR FAILED ENGINE'S MPS HELIUM TANK PRESSURE REACHES 1150 PSIA FOLLOWING THE INTERCONNECT TO THE LEAKING SYSTEM'S HELIUM OR WHEN BOTH LEAKING ENGINE'S HELIUM REGULATOR PRESSURES ARE BELOW 715 (679) PSIA

2. OTHERWISE, NO ACTION REQUIRED.

~~IF THE SINGLE ENGINE LIMITS (TAL ABORT) OR SINGLE ENGINE RTLS (RTLS ABORT) BOUNDARY IS REACHED WITHOUT INTERCONNECTING TO THE NON-LEAKING, RUNNING ENGINE'S HELIUM, THE MAIN ENGINE LIMIT SHUTDOWN SOFTWARE WILL BE REENABLED.~~

IF THE SINGLE ENGINE LIMITS (TAL ABORT) OR SINGLE ENGINE RTLS (RTLS ABORT) BOUNDARY IS REACHED WITHOUT INTERCONNECTING TO THE NON-LEAKING, RUNNING ENGINE'S HELIUM, THE MAIN ENGINE LIMIT SHUTDOWN SOFTWARE WILL BE REENABLED.

~~IF HELIUM FROM THE NON-LEAKING, RUNNING ENGINE IS REQUIRED TO SUPPORT THE LEAKING ENGINE'S OPERATION (REF. RULE {A5.1.4-2}, PRE MECO MPS HELIUM SYSTEM INTERCONNECTS (CIL)), THE MAIN ENGINE LIMIT SHUTDOWN SOFTWARE WILL REMAIN INHIBITED THROUGH MECO. @[090894-1676A] @[121296-4625]~~

IF HELIUM FROM THE NON-LEAKING, RUNNING ENGINE IS REQUIRED TO SUPPORT THE LEAKING ENGINE'S OPERATION (REF. RULE {A5.1.4-2}, PRE MECO MPS HELIUM SYSTEM INTERCONNECTS (CIL)), THE MAIN ENGINE LIMIT SHUTDOWN SOFTWARE WILL REMAIN INHIBITED THROUGH MECO. @[090894-1676A]@[121296-4625]

FLIGHT RULES

For the case of two engines running (one with a non-isolatable MPS helium leak), the main engine limit shutdown software will be reenabled by the crew per paragraph A.2.a. If the leaking engine cannot support the SE Limits or SE RTLS boundary with an interconnect from pneumatic and/or the failed engine's helium, the leaking engine will be allowed to operate below the HPOTP IMSL redline to avoid a two engine-out contingency abort (per Rules {A5.1.4-2}, PRE-MECO MPS HELIUM SYSTEM INTERCONNECTS, and {A5.1.4-3}, PRE-MECO SHUTDOWN OF ENGINES DUE TO MPS HELIUM LEAKS). To operate below the redline, limits must be inhibited. The MCC will call for the main engine limit shutdown switch to "inhibit" when the pneumatic helium and/or failed engine's helium tank pressure reaches 1150 psia following the interconnect to the leaking system or when the leaking system's regulator pressures are below 715 (679) psia. The 1150 psia tank pressure cue was selected as the operational cue corresponding to the crew's MPS helium tank pressure C&W (not the pneumatic helium tank pressure C&W) while ensuring that the HPOTP IMSL redline limit is not exceeded prior to inhibiting the limits. It also minimizes the amount of time that the remaining engines are exposed to main engine limits being inhibited. The 715 (679) psia regulator pressure cue was selected as a backup cue for large MPS helium leaks to ensure that the HPOTP IMSL redline limit is not exceeded before main engine shutdown limits are inhibited. The main engine limit shutdown software will be reenabled upon reaching the first single engine abort landing site capability, which is either SE Limits or SE RTLS (ref. AEFTP #107, 11/4/93), if an interconnect from a running engine has not been performed. This represents the earliest time after which an attempt can be made to reach a landing site with a good engine out. @111298-6785A

THIS RULE CONTINUED ON NEXT PAGE

FLIGHT RULES

A5.1.3-3 LIMIT SHUTDOWN CONTROL (CONTINUED)

The main engine limit shutdown software will *beremain* inhibited if *atthe non-leaking*, running engine's helium has been interconnected to a leaking engine (no *three* engine-out *intact* abort capability). Keeping limits inhibited in this configuration will allow the main engine with the leaking MPS helium supply to continue to operate below the normal HPOTP IMSL redline. Running the engine below the normal redline is an acceptable risk while the vehicle is in an *intact* abort gap since the only alternative is an early *MECOengine-out* and the loss of the vehicle and crew. @[121296-4625] @[111298-6785A]

Reference Rule {A5.1.4-3}, PRE-MECO SHUT DOWN OF ENGINES DUE TO MPS HELIUM LEAKS. @[090894-1676A]

D. IF FLOW CONTROL VALVE FAILURES OR AN ULLAGE GAS LEAK CAUSE A LOW LH₂ NPSP CONDITION, THE MAIN ENGINE LIMIT SHUTDOWN SOFTWARE WILL BE MANUALLY ENABLED BY PLACING THE MAIN ENGINE LIMIT SHUTDOWN SWITCH TO "ENABLE" PER FLIGHT RULE {A5.1.4-5}, MANUAL THROTTLING FOR LOW LH₂ NPSP. @[121296-4625]

Reference Rule and rationale {A5.1.4-5}, MANUAL THROTTLING FOR LOW LH₂ NPSP.

E. IF A DATA PATH FAILURE OCCURS ON AN ENGINE THAT IS CONFIRMED RUNNING, THE MAIN ENGINE LIMIT SHUTDOWN SOFTWARE WILL BE REENABLED PER FLIGHT RULE {A5.1.3-4}, DATA PATH FAIL/ENGINE-ON LIMIT SHUTDOWN CONTROL.

Reference Rule and rationale {A5.1.3-4}, DATA PATH FAIL/ENGINE-ON LIMIT SHUTDOWN CONTROL.

F. IF A GPC SET SPLIT OCCURS AND THE MAIN ENGINE LIMIT SHUTDOWN SOFTWARE ON TWO ENGINES IS AUTOMATICALLY INHIBITED, THE MAIN ENGINE LIMIT SHUTDOWN SOFTWARE WILL BE MANUALLY ENABLED.

In a set split condition, two GPC's will not see data from one of the engines and will automatically inhibit the main engine limit shutdown software on the other two engines. If limits are reenabled by taking the main engine limit shutdown switch to ENABLE then AUTO, the limits would be automatically inhibited on the next cycle. Therefore, the main engine limit shutdown switch will only be taken to ENABLE. Reference Rule and rationale {A5.1.3-4}, DATA PATH FAIL/ ENGINE-ON LIMIT SHUTDOWN CONTROL.

THIS RULE CONTINUED ON NEXT PAGE

FLIGHT RULES

A5.1.3-3 LIMIT SHUTDOWN CONTROL (CONTINUED)

G. FOR LOSS OF TVC CONTROL ON AN OPERATING MAIN ENGINE, THE MAIN ENGINE LIMIT SHUTDOWN SOFTWARE WILL BE INHIBITED (THREE ENGINES RUNNING) UNTIL TWO-ENGINE TAL CAPABILITY IS ACHIEVED OR, ON AN RTLS, UNTIL AFTER POWERED PITCH-AROUND (PPA) IS COMPLETE.

The risk of running an engine with the main engine limits inhibited is accepted over the risk of loss of control during the RTLS powered pitch around (PPA) as a result of a gimbaling engine failure. If a main engine has lost TVC capability, the failure of a gimbaling engine could result in a loss of control, even if single-engine roll control (SERC) is active. Since an RTLS trajectory is much more demanding than an uphill or TAL case from a control standpoint, avoiding an RTLS abort is highly desirable. Additionally, if the loss of TVC is due to hydraulic system failures, the engines in hydraulic lockup could fail due to valve drift, so a trajectory that provides the earliest possible single-engine capability is desirable. If a three-engine RTLS is performed, the main engine limit shutdown software will be inhibited until after PPA, since a loss of control is very possible if PPA is attempted with one gimbaling and one nongimbaling engine. ©[121296-4625] ©[111298-6785A]

Reference rule {A8.1.2-11}, SSME SHUTDOWN DUE TO HYDRAULIC SYSTEM FAILURES.

H. DURING A THREE ENGINE RTLS ABORT, TIME PERMITTING, THE MAIN ENGINE LIMIT SHUTDOWN SWITCH WILL BE TOGGLED TO INHIBIT, ENABLE, AND BACK TO AUTO. THIS ACTION WILL BE DELAYED AS LONG AS POSSIBLE, BUT MUST BE COMPLETED PRIOR TO AN MET OF 8 MINUTES. ~~IF A MAIN ENGINE OUT OCCURS AFTER ABORT SELECTION BUT PRIOR TO THE MANUAL ACTION, THE CREW WILL NO LONGER BE REQUIRED TO TAKE THE MAIN ENGINE LIMIT SHUTDOWN SWITCH TO INHIBIT. THE MAIN ENGINE LIMIT SHUTDOWN SOFTWARE IS AUTOMATICALLY INHIBITED BY THE GPC SOFTWARE AFTER AN ENGINE OUT AND WILL BE MANUALLY RE-ENABLED WHEN THE SINGLE ENGINE RTLS BOUNDARY IS REACHED.~~ ©[090894-1679A] ©[121296-4625] ©[111298-6785A]

FLIGHT RULES

A GPC or manual toggle of the main engine limit shutdown software to inhibit will be required on a three engine RTLS abort due to the incorporation of single command channel shutdown logic in the main engine controller software. The intent of this is to protect the vehicle and crew from exposure to a latent orbiter/main engine command path failure at MECO (catastrophic). This is accomplished by reducing the normal 2 of 3 shutdown command channel agreement criteria to 1 of 3 shutdown command channel acceptance processing. The software, which is invoked after a mission specific timer has expired, will allow acceptance and execution of the following two sequential commands, shutdown-enable followed by a shutdown command on a single command channel. Should a limit's inhibit command be processed and accepted by the controller prior to the execution of the single command channel logic, single command channel processing will no longer be performed. The mission specific timer is calculated by subtracting 5.5 seconds (3 sigma dispersion) from the predicted MECO time referenced to SSME start. That is, the predicted MECO time in MET plus the time from the last SSME start (6.36 seconds) minus 3 sigma dispersion (5.5 seconds). ©[091098-6710A]

THIS RULE CONTINUED ON NEXT PAGE

FLIGHT RULES

A5.1.3-3

LIMIT SHUTDOWN CONTROL (CONTINUED)

Toggling of the main engine limit shutdown switch on a three engine RTLS is performed in order to preclude the possibility of losing all main engines due to a failed-to-sync GPC after the controller timer has expired. Normally, exposure to this condition is either minimized (to approximately 5 seconds) by projected MECO times on the order of 511 seconds on uphill missions and TAL aborts, or eliminated by a main engine out (the GPC's command inhibit on the remaining engines and the single command channel shutdown processing is disabled). However, the time of exposure to a three engine out condition may be significant (120 seconds) on a systems RTLS abort. This exposure results from the extended main engine burntime (MECO at approximately 630 seconds MET) and the absence of an engine-out limits inhibit command. Consequently, the main engine limit shutdown software will be manually toggled to inhibit in order to minimize exposure to a failed-to-sync GPC. This action will be delayed as long as possible in order to retain main engine shutdown capability, and to possibly eliminate an unnecessary action, should a main engine out occur prior to the expiration of the controller timer. The cue of 8 minutes provides margin prior to expiration of the timer. @[090894-1679A] @[121296-4625] @[091098-6710A]

FLIGHT RULES

A5.1.3-4 DATA PATH FAIL/ENGINE-ON LIMIT SHUTDOWN CONTROL

WITH A DATA PATH FAILURE AND THE ENGINE CONFIRMED ON BY THE MCC, THE MAIN ENGINE LIMIT SHUTDOWN CONTROL CAPABILITY WILL BE MANAGED IN THE FOLLOWING MANNER: @[121296-4594A]

A data path failure occurs when the GPC's (PASS or BFS) either do not see the main engine time reference word (TREF) updating or when the two main engine identification words (ID words 1 & 2) are not one's complements. If this occurs in the controlling GPC's, the controlling GPC's will automatically inhibit the main engine limit shutdown software on the other two main engines. However, the GPC software will not inhibit the limits on the engine with the data path failure. This response occurs because the GPC's assume the engine has failed behind the data path failure.

A. BFS NOT ENGAGED:

1. THE MAIN ENGINE LIMIT SHUTDOWN SOFTWARE WILL BE REENABLED BY PLACING THE MAIN ENGINE LIMIT SHUTDOWN SWITCH TO "ENABLE" THEN "AUTO".

Once the MCC confirms that the engine with the data path failure is running, the crew will remove the inhibits by manually placing the main engine limit shutdown switch to ENABLE, then AUTO. This switch movement causes the main engine limit shutdown software to be reenabled on all running engines.

2. FOR AN ~~SUBSEQUENT~~ ENGINE OUT: @[111298-6785A]
 - a. IF THE ENGINE THAT SHUT DOWN WAS THE ONE THAT HAD THE ~~ORIGINAL~~ DATA PATH FAILURE ~~AND THE ORBITER IS IN AN ABORT GAP~~, THE MAIN ENGINE LIMIT SHUTDOWN SOFTWARE WILL ~~REMAIN ENABLED~~ ~~BE INHIBITED BY PLACING THE MAIN ENGINE LIMIT SHUTDOWN SWITCH TO "INHIBIT."~~ ~~THE LIMITS MAY THEN BE REENABLED AS SPECIFIED IN RULE {A5.1.3-3}, LIMIT SHUTDOWN CONTROL.~~

If the ~~subsequent~~ engine that shuts down is the engine with the data path failure, the GPC's will not automatically inhibit the main engine limit shutdown software. The main engine limit shutdown software will remain enabled to allow for a second engine out ~~crew will have to manually place the main engine limit shutdown switch to INHIBIT if the appropriate boundary had not been reached for single engine capability~~ (ref Rule {A5.1.3-3}, LIMIT SHUTDOWN CONTROL). @[121296-4594A] _ @[111298-6785A]

THIS RULE CONTINUED ON NEXT PAGE

FLIGHT RULES

A5.1.3-4 DATA PATH FAIL/ENGINE-ON LIMIT SHUTDOWN CONTROL

- b. IF THE ENGINE THAT SHUT DOWN WAS NOT THE ONE WITH THE ~~ORIGINAL~~-DATA PATH FAILURE, THE PASS WILL AUTOMATICALLY INHIBIT LIMITS. LIMITS WILL REMAIN INHIBITED UNTIL MECO. @[121296-4594A] @[111298-6785A]

If the ~~subsequent~~ engine that shuts down did not have the data path failure, the limit shutdown control capability of the two remaining engines will automatically be inhibited by the PASS GPC's. In this case, however, the limits will remain inhibited until MECO. The reason is that, if the limits were reenabled and the remaining engine with the good data path exceeds a redline and shuts down, MECO confirmed conditions would be satisfied by having two engines with main combustion chamber pressure less than 30 percent power level and one engine with a data path failure. MECO command would be sent, resulting in the shutdown of the engine with the data path failure. This early MECO could result in an unacceptable underspeed. @[121296-4594A]

B. BFS ENGAGED:

1. THE MAIN ENGINE LIMIT SHUTDOWN SOFTWARE WILL BE ~~RE~~ENABLED BY PLACING THE MAIN ENGINE LIMIT SHUTDOWN SWITCH TO "ENABLE" (UNLESS THE BFS AUTOMATICALLY REENABLED LIMITS UPON BFS ENGAGE) . @[111298-6785A]

If the data path failure occurs before BFS engage, when the BFS is engaged, all data path failure flags are reset in the BFS software. The BFS immediately attempts to establish communication with the engines. However, if this is not successful a data path failure is annunciated on that engine. At this point, the BFS software automatically inhibits the main engine limit shutdown software on the other two engines. If the data path failure occurs after BFS engage, the BFS will inhibit limits on the other two engines. Once the MCC confirms the engine with the data path failure is running, the crew will remove the inhibits by manually placing the main engine limit shutdown switch to ENABLE to prevent running the engines for the remainder of the flight with limits inhibited. The BFS main engine limit shutdown switch logic does not work the same way it does in the PASS (in the BFS, ENABLE/AUTO will cause the limits to go back to inhibit).

The BFS will automatically reenable limits if the data path failure is recovered when the BFS is engaged. @[121296-4594A]

THIS RULE CONTINUED ON NEXT PAGE

FLIGHT RULES

A5.1.3-4 DATA PATH FAIL/ENGINE-ON LIMIT SHUTDOWN CONTROL

2. FOR A SUBSEQUENT ENGINE OUT: @[121296-4594A]

THE MAIN ENGINE LIMIT SHUTDOWN SOFTWARE WILL BE INHIBITED BY PLACING THE MAIN ENGINE LIMIT SHUTDOWN SWITCH TO "INHIBIT" (UNLESS THE BFS AUTOMATICALLY INHIBITED LIMITS AT ENGINE OUT). LIMITS WILL REMAIN INHIBITED UNTIL MECO.

If the BFS has been engaged, a subsequent engine shutdown will require the limits to be inhibited because BFS does not have single engine roll control logic (ref Rule {A5.1.3-3}, LIMIT SHUTDOWN CONTROL). BFS will automatically inhibit limits if the engine that shut down did not have a previous data path failure, had a data path failure at shutdown, or had a previous data path failure prior to BFS engage but was recovered upon BFS engage. Limits will have to be manually inhibited by taking the main engine limit shutdown switch to INHIBIT if the engine that shut down had a non-recovered data path failure prior to shutdown.

Rules {A5.1.3-2}, AUTO/MANUAL SHUTDOWN, {A5.1.3-3}, LIMIT SHUTDOWN CONTROL, and {A5.1.3-13}, MECO CONFIRMED, reference this rule. @[121296-4594A]

FLIGHT RULES

A5.1.3-5 DATA PATH FAIL/ENGINE-OUT ACTION

IF THE MCC CONFIRMS THAT AN ENGINE WITH A DATA PATH FAILURE HAS SHUT DOWN, THAT ENGINE'S SHUTDOWN pb WILL BE PUSHED TO MODE THE GUIDANCE AND FLIGHT CONTROL LOGIC AND TO CLOSE THE ASSOCIATED PREVALVES.

SHOULD THE SAFING FUNCTION OF THE pb BE INOPERATIVE DUE TO SHUTDOWN pb OR CONTROL BUS PROBLEMS, THE APPROPRIATE MDM PER THE TABLE BELOW WILL BE POWER CYCLED/COMM FAULTED FOR 1 SECOND TO ALLOW THE pb TO OPERATE. THE POWER CYCLED/COMM FAULTED MDM MAY BE REGAINED VIA AN I/O RESET POST SAFING. [@021397-48231](#)

<u>S/D pb CONTACT</u>	<u>CONTROL BUS</u>	<u>MDM</u>
CTR A	AB1	FF1
CTR B	AB2	FF2
LEFT A	BC2	FF2
LEFT B	CA2	FF3
RT A	CA3	FF3
RT B	BC3	FF4

The GPC guidance software will not know an engine has shut down prematurely if the data path ~~from~~ that engine has also failed. Pushing the corresponding shutdown pb will set the safing command in the GPC for that engine. When the safing command is set, the SSME OPS sequence will close the prevalves and set the engine fail flag for that engine. Closing the prevalves is essential to isolate the failed engine if the engine failure caused damage to the engine propellant supply lines. There is a potential for a fire or propellant loss with the prevalves open. The engine fail flag is used by the ascent guidance software to ~~mode~~adjust the guidance and targeting functions to correspond to the number of SSME's that are operating. This ~~adjustment~~ is required for proper control of the vehicle.

If the two contacts on the shutdown pb disagree, the safing command will not be set. A contact disagreement can be caused by a failure of a contact, the loss of the fuse to a contact, or the loss of the control bus providing power to a contact. Power cycling/Comm faulting the MDM associated with that contact will cause the failed contact to be comm faulted; this will allow the safing command to be set when the pb is pushed. For FF 1, 2 or 3, the power cycle must be of approximately 1 second in duration before moding guidance. This is to ensure that the MDM is off long enough to be comm faulted, yet repowered quickly to avoid caging the associated IMU. The comm faulted MDM can be recovered with an I/O reset after the appropriate shutdown pb is pushed and guidance has been moded. [@021397-48231](#) ~~Since loss of a control bus is the only detectable failure, comm faulting will only be attempted for this failure mode.~~

FLIGHT RULES

A5.1.3-6 MANUAL SHUTDOWN FOR COMMAND/DATA PATH FAILURES

MANUAL SHUTDOWN OF AN AFFECTED ENGINE WILL BE PERFORMED PRIOR TO OR AT MECO FOR THE FOLLOWING COMMAND AND/OR DATA PATH FAILURE CASES:

A. COMMAND PATH FAILURE.

1. NOMINAL/ATO/AOA:

- a. THREE ENGINES ON - SHUT DOWN AT VI = 23K FPS USING THE AC POWER SWITCHES AND SHUTDOWN PB.
- b. TWO ENGINES ON - SHUT DOWN AT VI = 24.5K FPS USING THE AC POWER SWITCHES AND SHUTDOWN PB.
- c. MCC CONFIRMS COMMAND PATH FAILURE BY NO THROTTLING OF AFFECTED ENGINE WHEN THE ENGINES ARE COMMANDED TO THROTTLE.

2. RTLS:

TWO OR THREE ENGINES ON - SHUT DOWN DURING POWERED PITCHDOWN AT ALPHA = -1 USING THE AC POWER SWITCHES AND SHUTDOWN PB. @[032395-1759]

3. TAL:

TWO OR THREE ENGINES ON - SHUT DOWN AT VI = 22.5K FPS USING AC POWER SWITCHES AND SHUTDOWN PB.

In the case of a command path failure, the only way to shut down an engine is with the engine ac power switches. Shutting down with the ac power switches also creates a data path failure. Therefore, the shutdown pushbutton is pushed to tell guidance that an engine is out. The engine is shut down approximately 30 seconds before MECO to prevent depleting LO₂ through an SSME and causing uncontained engine damage. A velocity which equates to MECO minus 30 seconds also gives guidance time to compensate for late engine out and converge to the proper MECO targets. The only exception is an RTLS where the engine is shut down during powered pitchdown at alpha = -1 degrees. On a three- or two-engine abort RTLS, if an engine is shut down at TGO £ 60 seconds, guidance will not mode to the target set corresponding to the remaining number of engines. @[032395-1759A]

THIS RULE CONTINUED ON NEXT PAGE

FLIGHT RULES

A5.1.3-6

MANUAL SHUTDOWN FOR COMMAND/DATA PATH FAILURES (CONTINUED)

The cue of alpha = -1 degree (approx MECO-5 sec) was chosen to allow SSME shutdown to begin prior to predicted MECO while the LO₂ is still under G's from the other engine(s). This alleviates LO₂ net positive suction pressure concerns for the high pressure oxidizer turbopump (HPOTP). Alpha = -1 degree also protects for 1-sigma aerodynamic dispersions. Although sizable transients can be expected subsequent to engine shutdown, flight control has been demonstrated to null these transients prior to ET separation (in some cases ET separation inhibits of approximately 1 second will occur, reference AEFTP #87 and #122 minutes). On a three-engine press-to-MECO case, MECO minus 30 seconds occurs at a VI = 23 kfps. On a two-engine press-to-MECO case, MECO minus 30 seconds occurs at a VI = 24.5 kfps. On a TAL abort, MECO minus 30 seconds occurs at a VI = 22.5 kfps. ©[032395-1759A]

B. DATA PATH FAILURE

1. MCC DECISION (PRIME)

NOMINAL/ATO/AOA/TAL/RTLS:

- a. NO ACTION REQUIRED.
- b. MCC CONFIRMS COMMAND PATH OPERATIONAL BY GH₂ OUTLET PRESSURE COMPARISON TO POWER LEVEL COMMAND.

2. ONBOARD DECISION (NO COMMUNICATION).

NOMINAL/ATO/AOA/TAL/RTLS:

CREW ACTION SAME AS FOR COMMAND PATH FAILURE.

For a data path failure, the engine will accept throttling and MECO commands so that no action is required. The crew cannot tell the difference between a data path failure and a command/data path failure. The two failures that caused the data path failure may also have caused a command path failure (i.e., two controller interface adapters (CIA's), or a CIA and a multiplexer interface adapter (MIA) in the EIU). Unless the command capability is verified by the MCC, the crew will assume a command and data path failure and will take the same action as a command path failure. The MCC can verify the command path status by observing that the GH₂ outlet pressure changes with the throttle command. If an engine throttles down when commanded, its command path is operational.

THIS RULE CONTINUED ON NEXT PAGE

FLIGHT RULES

A5.1.3-6 MANUAL SHUTDOWN FOR COMMAND/DATA PATH FAILURES (CONTINUED)

C. COMMAND AND DATA PATH FAILURE.

1. MCC DECISION (PRIME)

NOMINAL/ATO/AOA/TAL/RTLS:

a. ACTION SAME AS COMMAND PATH FAIL

b. MCC CONFIRMS CASE BY NO CHANGE IN GH2 OUTLET PRESSURE ON THE AFFECTED ENGINE WHEN ENGINE COMMANDED TO THROTTLE.

2. ONBOARD DECISION (NO COMMUNICATION)

NOMINAL/ATO/AOA/TAL/RTLS:

CREW ACTION SAME AS FOR COMMAND PATH FAILURE.

The loss of an EIU or the loss of an MIA and a CIA or the loss of two CIA's will cause a data path failure and a command path failure on the same engine.

This is a very serious failure mode because this failure will close the LO₂ prevalves on an operating engine if preventative action is not taken. A water-hammer effect could occur which would rupture the LO₂ feedline and result in uncontained engine damage and loss of vehicle. At MECO, the GPC logic assumes an engine with a data path failure does not have a command path loss (i.e., the GPC assumes the engine accepted and complied with the shutdown command); therefore, the prevalves are commanded closed. To prevent this catastrophic shutdown of the engine at MECO, the engine ac power switches must be used to shut down the engine before MECO is commanded. The ac power switches will shut down the engine; the pushbutton is then pressed to mode guidance.

Rules {A2.1.2-10D}, BFS ENGAGE CRITERIA; {A5.1.4-3}, PRE-MECO SHUT DOWN OF ENGINES DUE TO MPS HELIUM LEAKS; {A5.1.3-8}, MANUAL SHUTDOWN FOR TWO STUCK THROTTLES (NOT DUAL APU FAILURES); {A5.1.3-9}, ENGINE PERFORMANCE DISPERSION; {A5.1.3-12}, MANUAL SHUTDOWN FOR SUSPECT COMMAND PATH FAILURES; and {A7.1.3-2}, REDUNDANT SET SPLIT, reference this rule. @[032395-1766] @[061296-6147A]

FLIGHT RULES

A5.1.3-7 MANUAL SHUTDOWN FOR HYDRAULIC OR ELECTRICAL LOCKUP

AN SSME IN HYDRAULIC OR ELECTRICAL LOCKUP WHEN COUPLED WITH LOW VEHICLE PERFORMANCE MAY HAVE TO BE MANUALLY SHUT DOWN TO PREVENT A VIOLATION OF THE ENGINE LO₂ NPSP REQUIREMENTS NEAR MECO. MANUAL SHUTDOWN WILL BE REQUIRED UNDER THE FOLLOWING CONDITIONS FOR ANY ENGINE LOCKED UP ABOVE THE MINIMUM ~~AT A~~ POWER LEVEL (KMIN) ~~- GREATER THAN 65 PERCENT.~~ @061297-6171]

A. NOMINAL/ATO/AOA:

1. THREE ENGINES ON:

a. ONE STUCK THROTTLE:

(1) IF THE ARD-PREDICTED DELTA-V MARGIN AFTER SRB SEPARATION INDICATES THAT THE VEHICLE PERFORMANCE IS NOMINAL, NO MANUAL SHUTDOWN OF A HYDRAULICALLY OR ELECTRICALLY LOCKED UP ENGINE WILL BE REQUIRED.

(2) IF THE ARD-PREDICTED DELTA-V MARGIN AFTER SRB SEPARATION INDICATES LOW PERFORMANCE, THE NONTHROTTLING ENGINE WILL BE SHUT DOWN AT $V_I \geq 23K$ FPS USING THE SHUTDOWN PB. THE ARD DELTA-V MARGIN WILL ENSURE A 3-SIGMA CONFIDENCE OF MAKING A GUIDED MECO.

(3) NO COMM - ASSUME LOW PERFORMANCE AND SHUTDOWN AT $V_I \geq 23K$ FPS USING THE SHUTDOWN pb.

b. TWO STUCK THROTTLES - (REF. RULE {A5.1.3-8}, MANUAL SHUTDOWN FOR TWO STUCK THROTTLES (NOT DUAL APU FAILURES)).

2. TWO ENGINES ON - NO ACTION REQUIRED.

B. RTLS AND TAL - NO ACTION REQUIRED.

FLIGHT RULES

In the MCC, the flight dynamics officer will evaluate the vehicle's capability to reach the nominal MECO targets by evaluating the ARD-predicted delta-V margin. Delta-V margin is defined as the difference between the delta-V available from the external tank propellant remaining and the delta-V required to execute a guided MECO. The delta-V margin threshold used to make the "performance nominal" call will ensure at least a 3-sigma confidence of making a guided MECO. If, after SRB separation, the velocity margin is indicating less than the 3-sigma propellant margin, then a low level cutoff may occur, and the flight dynamics officer will report that the vehicle performance is low.

THIS RULE CONTINUED ON NEXT PAGE

FLIGHT RULES

A5.1.3-7

MANUAL SHUTDOWN FOR HYDRAULIC OR ELECTRICAL LOCKUP (CONTINUED)

When vehicle performance is low, manual shutdown of an engine in hydraulic or electrical lockup is only required for a three-engine nominal, ATO, or AOA mission. The three-engine LO₂ low level timer is designed for three engines shutting down from the ~~minimum 67 percent~~ power level (as defined by the I-load KMIN - currently 67 percent power level). If one engine is stuck above the minimum power level ~~65 percent~~, the LO₂ net positive suction pressure (NPSP) and post shutdown LO₂ mass requirements may be violated. Therefore, an LO₂ depletion cutoff at power levels greater than that accounted for by the low level timers could cause high pressure oxidizer pump overspeed resulting in uncontained engine damage. By shutting down the stuck engine prior to MECO, the two remaining engines will throttle to 91 percent power level for fine count. The low level timer for the two-engine case is designed for two engines shutting down from 91 percent. [@061297-61711](#)

For the two-engine-on case with stuck throttles at any power level, the technical community determined that the NPSP would not be severely violated and the minimum post shutdown LO₂ mass requirements would be satisfied. Therefore, no action was required. (Ref. the 24th PSIG in November 1983 and the May 21, 1984, Ascent Flight Techniques.) For an RTLS or TAL abort, the LO₂ residuals should be sufficient enough to prevent an LO₂ low level shutdown.

Shutdown of an engine in either a hydraulic or electric lockup will be performed by shutdown pushbutton only. The shutdown pushbutton method for manual shutdown of an engine in either hydraulic or electric lockup minimizes the exposure to the unnecessary risk of a pneumatic shutdown in the case of the electrically locked-up engine and simplifies crew procedures in the case of the hydraulically locked-up engine.

If an engine is locked up and there is no communication with the crew, the crew will assume low first stage performance.

FLIGHT RULES

A5.1.3-8 MANUAL SHUTDOWN FOR TWO STUCK THROTTLES (NOT DUAL APU FAILURES)

A. THREE ENGINES RUNNING:

1. NOMINAL/ATO - MANUALLY SHUT DOWN ONE ENGINE AT $V_I \geq 23K$ FPS.
2. TAL - MANUALLY SHUT DOWN ONE ENGINE AT $V_I \geq 22.5K$ FPS. ENABLE MANUAL THROTTLES PRIOR TO ABORT SELECTION TO MAINTAIN NOMINAL POWER LEVEL. ©[082593-1464C]
3. RTLS - BEFORE SELECTING RTLS, MANUAL THROTTLES WILL BE ENABLED AND MINIMUM THROTTLES SELECTED. AT LEAST 10 SECONDS OF MINIMUM THROTTLE LEVEL IS DESIRED PRIOR TO RTLS SELECTION. AUTO THROTTLES WILL BE RESELECTED ANYTIME PRIOR TO POWERED PITCH-AROUND (PPA). IF BOTH ENGINES WITH STUCK THROTTLES ARE AT MORE THAN 85 PERCENT, MANUALLY SHUT DOWN ONE ENGINE 2 MINUTES PRIOR TO MECO. ©[082593-1464C]

SHUTDOWN PRIORITY: (1) COMMAND PATH FAIL, (2) HYDRAULIC LOCKUP, (3) ELECTRICAL LOCKUP

B. TWO ENGINES RUNNING - NO ACTION REQUIRED.

For dual command path failures, reference Rule {A5.1.3-6}, MANUAL SHUTDOWN FOR COMMAND/DATA PATH FAILURES. For dual hydraulic failures, ref. Rule {A8.1.2-11}, SSME SHUTDOWN DUE TO HYDRAULIC SYSTEM FAILURES.

If two of three operating engines have stuck throttles, manual shutdown of an engine will be required to prevent violation of LO_2 NPSP limits and 3.5g acceleration limits. These limits cannot be violated with only two engines operating. Also, these limits cannot be violated on a three-engine RTLS if at least one of the stuck throttles is less than or equal to 85 percent. Above 85 percent, shutting down an engine 2 minutes prior to MECO ensures that these limits will not be violated.

For all RTLS cases with two stuck throttles, minimum throttles will be selected prior to abort selection. Doing so will allow guidance to converge on the correct average thrust level and will reduce the probability of an early PPA. For guidance to have enough time to converge, minimum throttle levels must be achieved at least 10 seconds prior to RTLS selection. If not, an early PPA may occur, resulting in MECO conditions that are not optimized. AUTO throttles should be reselected at some point prior to PPA, but are not mandatory prior to RTLS selection. ©[082593-1464C]

FLIGHT RULES

THIS RULE CONTINUED ON NEXT PAGE

FLIGHT RULES

A5.1.3-8

MANUAL SHUTDOWN FOR TWO STUCK THROTTLES (NOT DUAL APU FAILURES) (CONTINUED)

For TAL, it is undesirable to throttle down the good engine due to the guidance transients which may occur and the fact that little time would be gained to perform the abort dump. Therefore, manual throttles will be selected to prevent an automatic throttledown when TAL is declared. This action is not required if TAL is declared early enough that automatic throttling will not occur at abort selection. However, since there is no disadvantage to selecting manual throttles for this short period of time, manual throttles will always be selected for consistency. AUTO throttles will be reselected after TAL is declared. ©[082593-1464C]

Shutdown priorities are established to protect against the maximum risk. Command path failure means the engine will not automatically shut down at MECO, which is catastrophic. Hydraulic lockup means shutdown requires the nonredundant pneumatic system. Electric lockup results in a nominal shutdown.

Shutdown will be performed on the command path failed engine using the ac power switches and shutdown pushbutton. Shutdown of an engine in either a hydraulic or electric lockup will be performed by shutdown pushbutton only. The shutdown pushbutton method for manual shutdown of an engine in either hydraulic or electric lockup minimizes the exposure to the unnecessary risk of a pneumatic shutdown in the case of the electrically locked-up engine and simplifies crew procedures in the case of the hydraulically locked-up engine.

Rule {A2.1.6-1}, Note 8, CONTINGENCY ACTION SUMMARY, and {A4.1.2-10}, MANUAL THROTTLE SELECTION, reference this rule. ©[092195-1770A]

FLIGHT RULES

A5.1.3-9 ENGINE PERFORMANCE DISPERSION

- A. SHOULD A PERFORMANCE DISPERSION CASE ARISE, THE ARD PROGRAM IN THE MCC WILL BE ADJUSTED ASAP WITH THE FOLLOWING INFORMATION:
1. AFFECTED ENGINE CAUSING THE PERFORMANCE DISPERSION
 2. TIME OF OCCURRENCE
 3. MODE AND LEVEL OF THE PERFORMANCE DISPERSION CONDITION INCLUDING ACTUAL AND ADJUSTMENTS (UPDATES PROVIDED POST-SRB STAGING IF REQUIRED).
- B. AN ENGINE PERFORMANCE EVALUATION CAN ONLY BE MADE WHEN THE ENGINE COMMANDED THRUST LEVEL IS KNOWN AND THE ENGINE IS IN A STEADY-STATE CONDITION. THE PERFORMANCE DISPERSION CASES ARE AS FOLLOWS:
1. PC SENSOR SHIFTED HIGH/LOW ≥ 25 PSIA:
 - a. FOR PC SENSOR SHIFT HIGH, THE LOWEST PC PAIR WILL BE USED.
 - b. FOR PC SENSOR SHIFT LOW, THE HIGHEST PC PAIR WILL BE USED.
 - c. FOR A PC SENSOR SHIFT, THE AFFECTED MAIN ENGINE CONTROLLER CHANNEL WILL BE POWER CYCLED FOR 1 SECOND ~~TURNED OFF~~ BY THE CREW IF BASED ON THE FACT THAT AN ATO CANNOT BE ACHIEVED. THIS PROCEDURE WILL NOT BE IMPLEMENTED IF IT WILL CAUSE ENGINE SHUTDOWN OR NOT CORRECT THE PERFORMANCE DISPERSION AS DEFINED BELOW: - @061297-6147A]
 - (1) LIMIT ~~ERRONEOUSLY~~ EXCEEDED ON ANY REMAINING SHUTDOWN SENSOR(S) ON OTHER CHANNEL SO THAT IT ~~(CAUSES ENGINE SHUTDOWN)~~.
 - (2) LOSS OF OTHER CHANNEL'S DCU, INPUT ELECTRONICS, OR OUTPUT ELECTRONICS (CAUSES ENGINE SHUTDOWN).
 - (3) WHEN IN ELECTRICAL LOCKUP OR WHEN CHANNEL POWER CYCLE DOWN ~~CAUSES ELECTRICAL LOCKUP~~. @061297-6147A]

THIS RULE CONTINUED ON NEXT PAGE

FLIGHT RULES

A5.1.3-9

ENGINE PERFORMANCE DISPERSION (CONTINUED)

(4) WHEN IN HYDRAULIC LOCKUP OR WHEN CHANNEL POWER CYCLE DOWN CAUSES HYDRAULIC LOCKUP. @[061297-6147A]

NOTE: IT IS ACCEPTABLE TO CAUSE A MOMENTARY OR PERMANENT SSME COMMAND PATH FAILURE, BECAUSE THE SSME CAN STILL REBALANCE TO CORRECT FOR THE PERFORMANCE CASE. @[061297-6147A]

2. LPFT DISCHARGE TEMP SENSOR SHIFTED LOW ≥ 2 DEG R.
3. ELECTRICAL LOCKUP:
 - a. AN ARD ADJUSTMENT WILL BE MADE IF THE ENGINE IS LOCKED UP WITH A SIGNIFICANT PERFORMANCE HIT DUE TO A PC OR LH₂ FLOWMETER ERROR. THE MINIMUM DETECTABLE FLOWMETER ERROR IS 300 GALLONS PER MINUTE (GPM).
 - b. THE EFFECT OF VEHICLE ACCELERATION ON THE PERFORMANCE WILL BE APPROXIMATED.
4. LH₂ FLOWMETER SHIFT HIGH/LOW ≥ 300 GPM.
5. HYDRAULIC LOCKUP:
 - a. THE PERFORMANCE OF THE LOCKED UP ENGINE WILL BE COMPUTED IN REAL TIME AND THE ARD ADJUSTED ACCORDINGLY. IF THE VALVES ARE DRIFTING, THE PREDICTED AVERAGE PERFORMANCE FOR THE TIME OF OPERATION IN LOCKUP WILL BE COMPUTED IN REAL TIME.
 - b. THE EFFECT OF VEHICLE ACCELERATION ON THE PERFORMANCE WILL BE APPROXIMATED.
6. NOZZLE LEAKS WITH THRUST-LIMITING FLAG SET.

THIS RULE CONTINUED ON NEXT PAGE

FLIGHT RULES

A5.1.3-9 ENGINE PERFORMANCE DISPERSION (CONTINUED)

7. HPOT EFFICIENCY LOSS WITH THRUST-LIMITING FLAG SET.

The engine performance dispersion rule defines the failures and criteria necessary before a performance update is made to the ARD. The method of detecting these performance problems is defined in the main engine console cue cards. Updates to the ARD consist of Pc, Isp, and mixture ratio numbers. The ARD uses these SSME performance parameters to predict abort mode capabilities real time. A change in any of these parameters could affect the abort boundaries significantly. The chamber pressure, HPOT turbine discharge temperature, and HPOT discharge pressure are the primary cues for determining performance cases. Mixture ratio and Pc shifts are caused by anomalies in the respective control loops such as pump problems, or sensor shifts. For the Pc sensor shift cases, the rule is clarifying that the properly functioning sensor is the one used in Booster and FDO performance tables. That is, for a Pc sensor shift high case, the lower Pc is the accurate value and the one used to determine the ARD adjustment. A shift of 25 psia is the minimum detectable shift.

A shifted Pc sensor can so adversely impact engine performance that an ATO cannot be achieved. For such cases, FDO will call for the controller channel with the malfunctioning sensor to be power cycled. Booster must be ready to identify the channel and switch to be cycled by the crew. The controller channel that has been power cycled will remain available for command and data transfer, but the controller IE (sensor data to the controller) and OE (control to the valve servo-actuators and servo-switches) on that channel will be disqualified.

Disqualification of a shifted Pc sensor's IE will restore engine operation to nominal thrust and mixture ratio conditions. This action should not be taken if it will cause engine shutdown or not correct the performance dispersion. Cases that would cause engine shutdown consist of redline shutdown sensor(s) violating redline limits on the remaining channel or loss of the remaining channel's DCU, IE, or OE. Reference {Rule A5.1.1-2}, SPACE SHUTTLE MAIN SSME-ENGINE OUT, paragraphs E and F. If the engine is in electrical or hydraulic lockup or when channel power cycle causes electric or hydraulic lockup, disqualifying the faulty sensor (channel) will not correct the dispersion since the engine valves cannot be repositioned. It is acceptable to create a momentary or permanent command path failure, should the controller channel remain powered down, because it is not necessary for the controller to have good GPC commands in order to control SSME thrust (Pc) and mixture ratio. The SSME with the command path failure must be shut down prior to MECO based on the cues listed in Flight Rule {A5.1.3-6}, MANUAL SHUTDOWN FOR COMMAND/DATA PATH FAILURES. ©[061297-6147A] ©[ED] 1

A performance adjustment to the ARD will only be made for a shift low of the LPFT discharge temperature sensor. The temperature cannot realistically get colder. The LPFT discharge temperature at lift-off is 43 deg R. The minimum detectable error is 2 deg R to cover instrumentation accuracy and to ensure sufficient change in the engine parameters for failure identification.

FLIGHT RULES

If electrical lockup was caused by Pc sensor failures, the actual Pc will be calculated from HPOT discharge pressure. Then the mixture ratio and specific impulse will be calculated real time for the ARD update. If lockup was caused by LH₂ flowmeter sensor failures, the engine parameters will be evaluated to quantify the sensor error. The minimum detectable flowmeter error is 300 GPM.

THIS RULE CONTINUED ON NEXT PAGE

FLIGHT RULES

A5.1.3-9

ENGINE PERFORMANCE DISPERSION (CONTINUED)

The SSME controller software uses a closed loop calculation to control mixture ratio and power level. The mixture ratio calculation is based on the measured volumetric flowrate from the LH₂ flowmeter. A shift in the flowmeter will cause the controller to calculate incorrect values for LH₂ mass flowrate and mixture ratio. The controller will then attempt to return the calculated mixture ratio to the nominal value by adjusting the SSME valves. This will cause the real mixture ratio to be off-nominal. A flow-meter shift low will cause the controller to increase LH₂ flow, creating an actual low mixture ratio condition. A flowmeter shift high will cause the controller to decrease the LH₂ flow, creating an actual high mixture ratio condition.

For an engine in hydraulic lockup, the mixture ratio and specific impulse will be calculated real time. If the performance is changing with time due to valve drift, the average engine performance during operation in lockup will be predicted real time using a computer program. The drift rate will be assumed to be linear. Ground testing of hydraulic lockup has shown that significant valve drift can occur on an engine in hydraulic lockup.

*Anytime an engine is in hydraulic or electrical lockup, the OPOV and FPOV valves can no longer adjust the engine performance in response to vehicle acceleration effects. The overall average performance of an engine in lockup is dependent upon what the acceleration was at the time the engine entered lockup. Therefore, the vehicle acceleration effect on performance will be approximated. This approximation is based upon data (SODB **TBD**) where the LO₂ inlet conditions were varied to simulate acceleration effects.*

An ARD update will be made for a nozzle leak or HPOT efficiency loss only when the engine has entered the thrust-limiting mode. This mode limits the maximum opening of the OPOV which is used in the thrust control loop. Nozzle leaks and HPOT efficiency loss failures that are not bad enough to cause the engine to go into the thrust-limiting mode cannot be distinguished from each other. In these cases, the OPOV will be able to open to maintain P_c; however, the HPOT efficiency loss failure will not result in engine operation with off-nominal performance. The nozzle leak failure will result in off-nominal performance because, unlike the HPOT efficiency loss failure, fuel will be lost overboard. (Any fuel leak below the fuel flowmeter is called a nozzle leak because leakage from the nozzle tubes is the most likely leak source based upon the SSME experience.) If the nozzle leaks and HPOT efficiency loss failures are bad enough to result in thrust-limiting, the nozzle leak or HPOT efficiency loss failures can be identified, the resulting performance quantified, and the ARD updated.

THIS RULE CONTINUED ON NEXT PAGE

FLIGHT RULES

A5.1.3-9 ENGINE PERFORMANCE DISPERSION (CONTINUED)

The SSME Project Office acknowledges that there are "Overall Call Uncertainties" associated with each of the off-nominal SSME performance cases. Uncertainties exist in mixture ratio, power level, and Isp values. Subsequent to the quantification of an off-nominal performance case, mixture ratio, power level, and Isp are passed to the Flight Dynamics Officer and are used to update the Abort Region Determinator (ARD). The uncertainties associated with each of these parameters, for each of the performance cases, are documented in MSFC letter EE21/095-016 (Review of Booster Real-time Software (BRTS) Algorithm's, D. R. Goslin to B. R. Stone, March 17, 1995). On February 6, 1996, the Integration Control Board (ICB) made the decision not to protect these uncertainties (ICB Item WACMO0167, Booster Console Uncertainty on ARD Performance). Therefore, ARD Flight Propellant Reserve (FPR) will not reflect these uncertainties. @041196 1877]

Rules {A4.1.2-13}, THRUST LIMITING, HYDRAULIC, OR ELECTRICAL LOCKUP; {A5.1.1-2}, SPACE SHUTTLE MAIN ENGINE OUT; and {A5.1.3-6}, MANUAL SHUTDOWN FOR COMMAND/DATA PATH FAILURES reference this rule. @061297-6147A] @ED 1

A5.1.3-10 AC BUS SENSOR ELECTRONICS CONTROL (CIL)

THE ORBITER AC BUS SENSOR ELECTRONICS POWER SWITCH WILL BE PLACED TO "OFF" FOR THE FOLLOWING ENGINE FAILURE CASES:

- A. ENGINE OUT (REF. RULE {A9.1.4-2}, AC BUS SENSORS SWITCH MANAGEMENT) @121296-4624]
- B. LOSS OF SSME CONTROLLER REDUNDANCY (REF. RULE {A5.1.1-2}, SPACE SHUTTLE~~SPACE SHUTTLE~~ MAIN ENGINE OUT) @ED 1
- C. ALL QUALIFIED REDLINE SENSORS ON A SINGLE REDLINE, ON A SINGLE CHANNEL, VOTING FOR SHUTDOWN. @121296-4624]

There are single point failures in the ac bus sensor electronics that can cause loss of a single phase of an ac bus which powers the SSME controllers. After an engine failure or electrical/avionics failures that leave an engine one failure away from shutdown, the bus overvoltage protection is less important than keeping an engine running. Therefore, the sensor monitoring electronics power is terminated by moving three switches (AC BUS SNSR) on panel R1 to OFF.

FLIGHT RULES

THIS PAGE INTENTIONALLY BLANK

FLIGHT RULES

A5.1.3-11 MANUAL THROTTLEDOWN FOR LO₂ NPSP PROTECTION AT SHUTDOWN

MANUAL THROTTLING TO THE MINIMUM SSME POWER LEVEL WILL BE PERFORMED TO PROTECT MECO LO₂ NPSP REQUIREMENTS WHEN LO₂ LOW-LEVEL CUTOFF IS PREDICTED TO OCCUR BEFORE FINE COUNT THROTTLEDOWN. MANUAL THROTTLING TO THE MINIMUM POWER LEVEL WILL BE PERFORMED ~~BY THE CREW~~ WHEN THE ONBOARD PROPELLANT REMAINING COMPUTATION REACHES 2 PERCENT, AND THE MCC FLIGHT DYNAMICS OFFICER (FDO) IS PREDICTING A VELOCITY UNDERSPEED AT MECO WHICH IS GREATER THAN THE FOLLOWING: @[071494-1645] @[121296-4630B]

- A. TWO OR THREE ENGINES ON: 500 FT/SEC
- B. ONE ENGINE ON: 250 FT/SEC

THE CREW WILL ~~ALWAYS~~ PERFORM SSME THROTTLEBACK FOR THE ONE ENGINE-ON CASE EXCEPT FOR CERTAIN CONTINGENCY ABORT CASES (AS DOCUMENTED ON THE CONTINGENCY ABORT CUE CARDS IN THE ASCENT CHECKLIST FLIGHT DATA FILE) OR UNLESS INSTRUCTED TO DO OTHERWISE BY THE MCC. @[071494-1645] @[121296-4630B]

If FDO is predicting a low-level cutoff prior to the guidance software issuing the fine count command (ref. rationale of Rule {A4.1.2-10G}, MANUAL THROTTLE SELECTION), the engines will shut down at an unsafe power level. This will cause the LO₂ NPSP to be well below the required value, possibly causing uncontained engine damage at shutdown. For two or three engine-on cases, analysis indicates that the vehicle acceleration near MECO will be sufficient to prevent SSME shutdown prior to fine count as long as the predicted underspeed (based on 2 sigma MPS propellant protection) is no greater than 500 ft/sec. Because of low vehicle acceleration, analysis of the single engine-on case indicates that SSME requirements will not be violated as long as the predicted underspeed (based on 2 sigma MPS propellant protection) at MECO is less than 250 ft/sec. The two/three engine-on case assumes a vehicle mass of 379,000 lbs at MECO minus 10 seconds and the one engine-on case assumes 368,000 lbs (the difference is based on the additional 11,000 lbs MPS propellant needed for the two engine-on case, which will also protect the three engine-on case). Both cases assume that the thrust provided by a single engine at 104 percent is 488,800 lbf. The 500 ft/sec and 250 ft/sec cues are derived from using the $F = M \cdot A$ equation, as well as those used by the fine count throttle logic in the guidance software (reference NASA memorandum DF6-94-08, dated 5/11/94). If the predicted underspeed is greater than allowed for either case, manual throttling will be performed to the minimum power level, thereby reducing the NPSP requirements prior to reaching a low-level cutoff condition. The minimum throttle level was selected because it provides the best LO₂ NPSP shutdown conditions. The throttledown cue of 2 percent propellant remaining was selected to allow sufficient time to perform the manual throttling while minimizing any performance impact.

THIS RULE CONTINUED ON NEXT PAGE

FLIGHT RULES

A5.1.3-11 MANUAL THROTTLEDOWN FOR LO2 NPSP PROTECTION AT SHUTDOWN (CONTINUED)

Analysis (reference Ascent/Entry Flight Techniques Panel #91, 7/17/92) shows that most of the error in the onboard propellant remaining computation occurs on the two-engine-out press-to-MECO abort when no OMS dump is performed. Engine performance problems also contribute to the propellant remaining error. The worst case engine problem is low specific impulse (Isp). Worst-on-worst analysis with two engines out simultaneously at the press-to-MECO boundary and the third engine running with an Isp which is 10 seconds below nominal shows that the 2 percent cue still provides sufficient time to throttle the engine down before low-level cutoff occurs. ©[071494-1645]

After throttledown, the crew will be prepared to perform a manual MECO at the desired MECO velocity should it be reached prior to the low-level cutoff.

The crew will not always throttleback for the one engine-on case. For certain contingency aborts, the software determines and performs fine count throttles (throttleback) as required for MECO. No manual throttles are required in these cases as documented on the contingency abort cue cards in the ascent checklist flight data file. ©[121296-4630B]

Rule {A2.1.2-15}, MANUAL THROTTLE CRITERIA, references this rule.

A5.1.3-12 MANUAL SHUTDOWN FOR SUSPECT COMMAND PATH FAILURES

AN ENGINE WITH SUSPECT COMMAND CAPABILITY FOR SHUTDOWN WILL BE MANUALLY SHUT DOWN PRIOR TO MECO USING THE SAME CUES LISTED FOR A COMMAND PATH FAILURE IN FLIGHT RULE {A5.1.3-6}, MANUAL SHUTDOWN FOR COMMAND/DATA PATH FAILURES.

An engine may have a suspected command path failure if both MIA's 1 and 4 of the respective EIU have been simultaneously bypassed by the GPC's. This signature is indicative of a possible dual poweron reset failure in the EIU and should be treated as a command path failed engine, even if reaction to throttle commands is subsequently verified. Although throttle commands will probably be regained, the EIU is not considered trustworthy enough to risk another loss of command capability for engine shutdown at MECO.

FLIGHT RULES

A5.1.3-13 MECO CONFIRMED

THE THREE MAIN ENGINE SHUTDOWN PUSHBUTTONS WILL BE PUSHED SIMULTANEOUSLY AT MECO FOR MULTIPLE COMMAND/DATA FAILURE CASES TO SET THE MECO CONFIRMED FLAG. THIS FLAG IS REQUIRED TO START THE ET SEPARATION SEQUENCE. IF MECO CONFIRMED IS NOT OBTAINED AFTER SHUTDOWN PUSHBUTTONS ARE PRESSED, IT WILL BE OBTAINED BY MANUALLY PROCEEDING TO OPS 104.

The SSME operations sequence will check for one data path failure on one engine and the chamber pressure less than 30 percent on the other two engines. If two engines experience a data path failure, the software will never pass this check and MECO confirm will not be issued. To work around this problem, the crew can push the three shutdown pushbuttons after MECO to set the MECO confirm logic. The MECO confirm logic must be satisfied to start the ET separation sequence.

An alternate method to obtain MECO confirmed is for the crew to key in OPS 104 PRO. This will be required if an avionics or switch problem has disabled a shutdown pushbutton. Normally, the pushbutton is preferred over OPS 104 PRO for greater simplicity.

*Reference Rule {A5.1.3-4}, DATA PATH FAIL/ENGINE-ON LIMIT SHUTDOWN CONTROL.
@[121296-4594A]*

A5.1.3-14 SSME HYDRAULIC REPRESSURIZATION/POSTLANDING SSME REPOSITIONING

A. ON-ORBIT/ENTRY-1 DAY REPRESSURIZATION

APPLICATION OF MPS HELIUM TO SSME VALVE ACTUATORS IS NOT REQUIRED DURING HYDRAULIC REPRESSURIZATION AND SSME REPOSITIONING WHEN THE TVC ACTUATORS DRIFT OUT OF POSITION PER FLIGHT RULE {A8.1.3-7}, TVC-SSME STOW/ACTUATOR FLUID FILL (REPRESSURIZATION).

B. ENTRY/POSTLANDING REPOSITIONING

MPS HELIUM WILL BE PROVIDED TO THE ENGINES DURING HYDRAULIC REPRESSURIZATION AND SSME REPOSITIONING. THIS ENSURES THAT ENGINE VALVES DO NOT DRIFT OPEN. HOWEVER, LACK OF HELIUM IS NOT A CONSTRAINT AGAINST PERFORMING EITHER PROCEDURE.

FLIGHT RULES

Hydraulic pressure is applied to the TVC actuators to prevent SSME movement during on-orbit, entry, and postlanding operations. Maintaining helium pressure on the closed side of the engine valves will keep the valves from opening when hydraulic pressure is applied to the TVC actuators. Keeping the valves closed prevents engine contamination during entry and postlanding. On-orbit SSME contamination is unlikely; therefore, the application of helium for on-orbit TVC drift is not required. This will also reduce MPS helium regulator cycles.

FLIGHT RULES

MPS MANAGEMENT: PRELAUNCH THROUGH MECO

A5.1.4-1 PRE-MECO MPS HELIUM SYSTEM LEAK ISOLATION (CIL)

- A. MPS ENGINE SYSTEM HELIUM LEAK ISOLATION WILL BE PERFORMED FOR ANY SIGNIFICANT LEAK (PER RULE {A5.1.1-7}, SIGNIFICANT ENGINE SYSTEM HELIUM LEAK) AS LONG AS THE ATTEMPT TO ISOLATE THE LEAK WILL NOT CAUSE THE ENGINE TO SHUT DOWN.
 ©[090894-1676A]

If an MPS engine helium system experiences a helium leak the crew will perform a helium leak isolation procedure. However, since certain power bus failures will result in helium leg A isolation valves failing closed (MNA, APC4 or ALC1; MNB, APC5 or ALC2; or MNC, APC6 or ALC3 failure will close the center, left, or right SSME isolation valve, respectively), the crew must be reminded not to attempt leak isolation for these cases. The closing of the leg B isolation valve will stop helium flow to the engine and cause an SSME redline limit shutdown due to low HPOTP intermediate seal (IMSL) purge pressure. The shutdown may cause engine damage since both regulator isolation valves are closed. No helium will be available for SSME IMSL purging during the shutdown sequence.

- B. AN ATTEMPT WILL BE MADE TO ISOLATE ANY SIGNIFICANT PNEUMATIC SYSTEM LEAK (REF. RULE {A5.1.1-8}, SIGNIFICANT PNEUMATIC SYSTEM HELIUM LEAK).

A significant pneumatic system helium leak could result in insufficient pressure for prevalve actuation at MECO. The LO₂ prevalues are required to close at MECO in order to maintain pressure at the HPOTP pump inlet. This prevents pump cavitation and overspeed which could result in uncontained SSME damage. An attempt is made to isolate the pneumatic helium supply so the remaining helium can be used to pressurize the pneumatic accumulator and support prevalve closure at MECO.

- C. IF AN MPS PNEUMATIC HELIUM SYSTEM LEAK/ISOLATION CAUSES INSUFFICIENT PNEUMATIC HELIUM ACCUMULATOR PRESSURE (REF. RULE {A5.1.1-9}, INSUFFICIENT PNEUMATIC HELIUM ACCUMULATOR PRESSURE), THE SYSTEM WILL BE RECONFIGURED AT MECO-30 SECONDS.

Seven hundred psia in the pneumatic accumulator is the minimum non-resupplied pressure which will close all the LO₂ prevalues within timing constraints at MECO. If the pneumatic helium supply has been isolated due to a leak or is used to support the mainstage operation of an engine with a helium leak, the pneumatic accumulator pressure may fall below 700 psia. Should the accumulator pressure fall below 700 psia for any reason, the pneumatic helium isolation valves, the left engine helium crossover valve and, if necessary, the engine interconnect valves, will be reconfigured to repressurize it. This will be accomplished at MECO minus 30 seconds and ensures that 700 psia is available in the pneumatic accumulator until the start of prevalve closure at MECO.

FLIGHT RULES

Note: Taking the interconnect out-open to open on an engine when the pneumatic tank is depleted will not cause a large enough flow transient to cause the engine to shut down (documented by RI Downey internal letter number 287-100-93-259, dated 11/09/93). ©[090894-1676A]

FLIGHT RULES

A5.1.4-2 PRE-MECO MPS HELIUM SYSTEM INTERCONNECTS (CIL)

- A. THE INTERCONNECT OF THE PNEUMATIC HELIUM SYSTEM, OR THE HELIUM SYSTEM OF AN ENGINE WHICH HAS SHUT DOWN, TO A RUNNING ENGINE WILL BE ACCOMPLISHED IN THE FOLLOWING MANNER : @[090894-1676A]

If a helium leak develops and the decay rate is such that the engine will not meet zero-g shutdown requirements or will cause an early shutdown, the helium system of an engine which has previously shut down and/or the pneumatic helium system, will be interconnected to that engine's system. This action may allow the engine to meet the zero-g shutdown requirements and will maintain engine operation as long as possible. Similar action is taken if the leak has been isolated and the system will not meet shutdown requirements. A tank pressure of 1020 psia (900 psia required + 115 psia instrumentation error + 5 psia to round to a value actually displayed onboard and in the MCC) is the minimum value, including instrumentation error, which will support the normal operating range of the helium system regulators. The difference between the actual requirement, 1020 psia, and the C&W value, 1150 psia, results from a change in the estimated instrumentation error of the helium tank pressure transducers, 250 psia reduced to 170 psia (ref. PSIG telecon charts, 5/19/93). For failure cases, two sigma versus three sigma dispersions are protected. As a result, 115 psia is used as the actual instrumentation error of the helium system transducers (0.67 X 170). The change in calculated instrumentation error did not warrant a change to the onboard software or hardware caution and warning. @[050495-1767B] @[100997-6298]

*Dropping helium system regulator outlet pressure is also used to detect potential SSME HPOTP intermediate seal (IMSL) purge pressure violations. If both helium regulators have been in steady state operation between 715 psia and 785 psia outlet pressure, a sudden decrease in outlet pressure may be indicative of a system failure. Action is taken as soon as both regulator outlet pressures fall below 715 (679) psia in an attempt to prevent the engine from shutting down. Six hundred and seventy nine psia equates to the minimum normal regulator outlet pressure, 715 psia, minus 36 psia instrumentation error. With regard to helium system leaks, a regulator outlet pressure below 715 psia does not indicate that the regulator is malfunctioning. Low outlet pressures are indicative of helium system leaks which result in high helium mass flow rates or supply tank depletion resulting in low inlet pressures to the system regulators. Taking action at 679 psia not only prevents premature helium system interconnecting, but also gives some assurance that another helium system can be interconnected to the leaking supply before the engine interface pressure reaches the expected shutdown value of 518 psia for the Phase II SSME, or 576 psia for the BLOCK I SSME, **BLOCK IIA SSME**, and the BLOCK II SSME (reference SODB data requests R1 1507 and R1-1640, respectively). @[050495-1767B] @[020196-1812] @[121197-6472A]*

THIS RULE CONTINUED ON NEXT PAGE

FLIGHT RULES

A5.1.4-2 PRE-MECO MPS HELIUM SYSTEM INTERCONNECTS (CIL) (CONTINUED)

1. FOR A NON-ISOLATABLE UPPER SYSTEM LEAK, HELIUM SYSTEM INTERCONNECTS WILL BE PERFORMED AS LATE AS PRACTICAL, BUT ABOVE THE MINIMUM ENGINE TANK PRESSURE REQUIRED TO SUPPORT THE ENGINE SHUTDOWN MODE PER RULE {A5.1.4-3}, PRE-MECO SHUTDOWN OF ENGINES DUE TO MPS HELIUM LEAKS. IF THE REQUIRED SHUTDOWN PRESSURE TO SUPPORT THE UPPER SYSTEM LEAK IS LESS THAN 1020 PSIA, THE INTERCONNECT WILL OCCUR NO LATER THAN 900 PSIA (1020 PSIA) TANK PRESSURE ON THE AFFECTED ENGINE OR WHEN BOTH HELIUM SYSTEM REGULATOR PRESSURES ARE BELOW 715 (679) PSIA. @[050495-1767B]

When a non-isolatable upper system leak occurs, it is best to perform helium interconnects as close to the minimum shutdown requirement as possible. If the interconnect is performed too early and the system leak is a tank leak, helium in the leaking tank will no longer be used to support engine operation and will therefore be wasted.

2. FOR A NON-ISOLATABLE LOWER SYSTEM LEAK, OR EXTENDED ENGINE BURN TIMES REQUIRING INTERCONNECTING, HELIUM SYSTEM INTERCONNECTS WILL BE PERFORMED AS SOON AS PRACTICAL, AND ABOVE THE MINIMUM ENGINE TANK PRESSURE REQUIRED TO SUPPORT THE ENGINE SHUTDOWN MODE PER RULE {A5.1.4-3}, PRE-MECO SHUTDOWN OF ENGINES DUE TO MPS HELIUM LEAKS. IF THE REQUIRED SHUT DOWN PRESSURE TO SUPPORT THE LOWER SYSTEM LEAK IS LESS THAN 1020 PSIA, THE INTERCONNECT WILL OCCUR NO LATER THAN 900 PSIA (1020 PSIA) TANK PRESSURE ON THE AFFECTED ENGINE OR WHEN BOTH HELIUM SYSTEM REGULATOR PRESSURES ARE BELOW 715 (679) PSIA. @[050495-1767B]

When a non-isolatable lower system leak occurs, helium system interconnects must be performed above the minimum tank pressure needed to support engine shutdown. For lower system leaks; however, helium interconnects can be performed immediately after leak identification. A leak below the regulator will have the same mass flow rate after the interconnect that it had prior to the interconnect. Interconnecting early allows the reconfiguration to take place while the crew is in a low g environment.

If the predicted MECO time is extended due to low ascent performance or an abort requirement such that interconnecting is necessary to meet shutdown requirements, the pneumatic system or the helium system of a failed engine can be interconnected to a running engine in the same manner used for non-isolatable lower system leaks. @[090894-1676A]

FLIGHT RULES

THIS RULE CONTINUED ON NEXT PAGE

FLIGHT RULES**A5.1.4-2 PRE-MECO MPS HELIUM SYSTEM INTERCONNECTS (CIL)
(CONTINUED)**

3. FOR SINGLE REGULATOR OPERATION OF THE MPS HELIUM SYSTEM, HELIUM SYSTEM INTERCONNECTS WILL BE PERFORMED AS SOON AS PRACTICAL, AND ABOVE THE MINIMUM TANK PRESSURE REQUIRED TO SUPPORT THE SINGLE REGULATOR SHUTDOWN MODE PER RULE {A5.1.4-3}, PRE-MECO SHUTDOWN OF ENGINES DUE TO MPS HELIUM LEAKS. IF THE REQUIRED PRESSURE TO SUPPORT THE SINGLE REGULATOR SHUTDOWN MODE IS LESS THAN 1020 PSIA, THE INTERCONNECT WILL OCCUR NO LATER THAN 900 PSIA (1020) OR WHEN BOTH HELIUM SYSTEM REGULATOR PRESSURES ARE BELOW 715 (679) PSIA. ©[050495-1767B]

If a helium system is operating on a single regulator, due to an isolated leak or any other system failure, the resulting mass flow rate of helium through the system is nominal. Therefore, helium system interconnects may be accomplished as soon as convenient. When operating on a single regulator, all shut down modes must protect for single regulator operation. A single regulator providing helium flow to an engine must flow the equivalent helium of two operating regulators. Higher pressures must be maintained at the regulator inlet in order to ensure that shutdown pressure and mass flow rate requirements are satisfied.

4. IN THE NO-COMM CASE, THE CREW WILL INTERCONNECT AT A SYSTEM PRESSURE OF 1150 PSIA OR WHEN BOTH HELIUM SYSTEM REGULATOR PRESSURES ARE BELOW 715 (679) PSIA.

*In the loss of comm case, crew action is taken at 1150 psia. 1150 psia is the C&W limit. The alarms and tones annunciated at 1150 psia are a good reminder to the crew that action needs to be taken. If the tank pressure reaches this value and continues to fall, the engine HPOTP IMSL purge redline limit may be violated. Action is taken at 1150 psia (1020 psia plus 130 psia crew response margin) to preclude an early engine out situation while making as much use of available helium as possible. The engine IMSL seal limit should not be violated until the pressure decays to below approximately 518 psia at the engine interface for the Phase II SSME (ref. SODB Vol. 3, Section 4.3.1) or 576 psia at the engine interface for the BLOCK I SSME, **BLOCK IIA SSME**, and the BLOCK II SSME (ref. SSME test 901-835 and the 09-13-95 PSIG). ©[050495-1767B] ©[020196-1812] ©[100997-6298] [©\[121197-6472A\]](#)*

- B. IF REQUIRED, THE ENTIRE PNEUMATIC SYSTEM WILL BE USED TO SUSTAIN THE OPERATION OF AN ENGINE.

Sufficient helium margin should be available in the other two helium systems to satisfy the zero-g requirements for prevalve actuation, SSME pogo system post-charge, shutdown and entry environmental purges, and entry MPS manifold pressurization. ©[090894-1676A]

THIS RULE CONTINUED ON NEXT PAGE

FLIGHT RULES

A5.1.4-2 PRE-MECO MPS HELIUM SYSTEM INTERCONNECTS (CIL)
(CONTINUED)

C. AFTER THE PNEUMATIC SYSTEM HAS BEEN INTERCONNECTED, MANUAL HELIUM INTERCONNECTS FROM ENGINE-TO-ENGINE WILL BE USED TO SUSTAIN THE OPERATION OF AN ENGINE WITH AN MPS HELIUM SYSTEM LEAK FOR THE FOLLOWING CASES: @[090894-1676A] @[100997-6298]

If an engine helium supply is depleting due to a leak, interconnecting another engine helium system will be allowed for two cases. In both cases, the pneumatic helium system is interconnected first in an attempt to sustain that engine's operation.

1. IF THE VEHICLE IS IN A REGION WHERE AN ABORT CAN BE PERFORMED TO A LANDING SITE WITH A SUBSEQUENT ENGINE OUT AND THE INTERCONNECTED PNEUMATIC HELIUM SYSTEM IS INSUFFICIENT TO SUPPORT ZERO-G SHUTDOWN REQUIREMENTS, INTERCONNECTING IS ALLOWED ONLY FROM A PREVIOUSLY SHUT DOWN ENGINE PER CUES IN PARAGRAPH A.

ABORT CAPABILITY TO A LANDING SITE IS DEFINED AS THE SINGLE ENGINE LIMITS BOUNDARY FOR A TAL ABORT OR THE SINGLE ENGINE RTLS BOUNDARY FOR AN RTLS ABORT (REF. AEFTP #107, 11/19/93).

In the first case, if abort capability to a landing site is available with a subsequent engine out and the leaking engine is predicted to shut down prior to MECO, or not meet zero-g shutdown requirements, interconnecting is allowed from a previously shut down engine only. This will not only maximize the leaking engine run time but may also re-establish zero-g shutdown capability.

2. IF THE VEHICLE IS IN A REGION WHERE AN ABORT CANNOT BE PERFORMED TO A LANDING SITE, WITH A SUBSEQUENT ENGINE OUT, AND THE INTERCONNECTED PNEUMATIC HELIUM SUPPLY WILL NOT MAINTAIN ENGINE OPERATION THROUGH THE ABORT GAP, INTERCONNECTING FROM ANOTHER ENGINE IS ALLOWED WITH THE FOLLOWING PRIORITY:

- a. THREE SSME'S ON - NOT APPLICABLE @[121197-6472A]

~~NOT COVERED @ED~~

- b. TWO SSME'S ON

- (1) A PREVIOUSLY SHUT DOWN ENGINE PER CUES IN PARAGRAPH A. @[100997-6298]

THIS RULE CONTINUED ON NEXT PAGE

FLIGHT RULES

A5.1.4-2

PRE-MECO MPS HELIUM SYSTEM INTERCONNECTS (CIL)
(CONTINUED)

- (2) THE NON-LEAKING, RUNNING SSME, AS LONG AS THE TOTAL FLOWRATE OF THE LEAKING SYSTEM IS LESS THAN 0.310 LBM/SEC AND OTHER SOURCES OF HELIUM HAVE BEEN INTERCONNECTED, AND EITHER THE TANK PRESSURES ON ALL SYSTEMS REACH 500 PSIA OR THE AFFECTED SSME HPOTP IMSL PRESSURE REACHES 70 PSIA. THE INTERCONNECT VALVE OF THE RUNNING SSME WITH THE NON-LEAKING SUPPLY WILL BE TAKEN TO OUT/OPEN FOR 15 SECONDS (ONE TIME ONLY) AND THEN TO THE GPC POSITION. MANUAL SHUTDOWN OF THE LEAKING SSME WILL BE PERFORMED PER RULE {A5.1.4-3}, PRE-MECO SHUT DOWN OF ENGINES DUE TO MPS HELIUM LEAKS, INSTEAD OF INTERCONNECTING A RUNNING SSME A SECOND TIME. @[100997-6298] @[121197-6472A]

c. ONE SSME ON

ALL PREVIOUSLY SHUT DOWN ENGINES PER CUES IN PARAGRAPH A.

For the two engine on case, if the leaking engine supply, the previously shut down engine supply, and the pneumatic supply are insufficient to obtain single engine abort capability to a landing site, interconnecting is allowed, within certain limits, from the remaining engine which has a good MPS helium supply in an attempt to regain landing site abort capability. Helium margin in the non-leaking, running SSME, MPS supply will be used to support the operation of an SSME with a leaking supply. Interconnecting in this case will result in one MPS supply supporting two SSME's, one at an off-nominal flowrate. Consequently, the interconnect of a running supply will only be performed if the total flowrate of the leaking supply is less than 0.310 lbm/sec. The 0.310 lbm/sec total flowrate requirement is a generic value which will provide at least 15_-seconds, and at most 1.5 minutes, of additional runtime for the SSME with the leaking supply. Total flow rates above 0.310 lbm/sec make it extremely likely that either a second SSME will fail prior to reaching a certified abort boundary, or that helium available to the last SSME will be depleted to a level which is below MECO requirements. By not interconnecting for large leaks, three SSME out contingency aborts are avoided and a crew survival path is maintained by two SSME out abort coverage. @[100997-6298] @[121197-6472A]

THIS RULE CONTINUED ON NEXT PAGE

FLIGHT RULES

A5.1.4-2

PRE-MECO MPS HELIUM SYSTEM INTERCONNECTS (CIL) (CONTINUED)

Numerous assumptions had to be made in order to cover this case with a generic rule. The assumptions are: the time at which the single engine abort boundary is reached depending on the first SSME failure time, the resulting required MECO runtime on the last SSME, where three SSME out blackzones occur for the TAL and RTLS aborts, when the MPS helium leak occurs and the type of leak, whether or not helium is available from the first failed SSME, and the lack of preference of an OPS 6 contingency abort to an OPS 3 contingency abort. All of these variables were assigned generic values and discussed at Ascent Entry Flight Techniques #135 on 10/18/96. AEFTP was also made aware that a realtime or non-realtime redefinition of any of these variables might result in an outcome which varies from current predictions. However, in any case it is agreed that helium from the last SSME should be interconnected to a leaking supply in an attempt to reach a runway, as long as three SSME out blackzones are protected. @[100997-6298]

Because an attempt is being made to avoid a contingency abort due to insufficient MPS helium, the interconnect from one SSME supply to another will be performed as late as is reasonably possible. Once the leaking system reaches 500 psia (500 psia is a generic tank pressure which, with SSME limits inhibited, should insure that crossover margin is maintained in the SSME HPOT IMSL package) or an HPOTP IMSL pressure of 70 psia (70 psia provides 10 psia interconnect margin against the Block I/IIA/II SSME limit of 60 psia in rule {A5.1.4-3C}.2.a, PRE-MECO SHUT DOWN OF ENGINES DUE TO MPS HELIUM LEAKS), the running, non-leaking SSME supply will be interconnected for 15 seconds. This will keep the SSME running while the pneumatic system is repressurized. An interconnect cue of 500 psia in the tank or 70 psia in the IMSL package should also prevent the SSME HPOT IMSL pressure from decaying below 60 psia while the SSME is operating. The interconnect action also increases the likelihood that the last running SSME with a non-leaking MPS helium supply will retain sufficient helium in its supply to support guided MECO once the second SSME with a leaking MPS helium supply shuts down. @[121197-6472A]

The interconnect is broken by taking the interconnect switch of the engine with the non-leaking helium system to the GPC position. If the leaking helium supply has been depleted due to a tank leak, or an upper system leak exists, breaking the interconnects in this manner allows the pneumatic system to remain interconnected to the engine with a leaking helium supply in order to support its shutdown. @[100997-6298]

THIS RULE CONTINUED ON NEXT PAGE

FLIGHT RULES**A5.1.4-2 PRE-MECO MPS HELIUM SYSTEM INTERCONNECTS (CIL)
(CONTINUED)**

D. IF A NON-ISOLATABLE MPS HELIUM LEAK ~~EXISTS~~~~DEVELOPS~~ IN THE SUPPLY OF ONE OF TWO RUNNING SSME'S WHILE THE VEHICLE IS IN AN ABORT GAP, THE FOLLOWING ACTIONS WILL BE TAKEN:
 @[050495-1753A] @[100997-6298]

1. NOMINAL/ATO/AOA

MAXIMUM SSME THROTTLES IS NOT MANDATORY FOR THESE CASES.

The only abort gap which usually exists for these cases occurs between the PRESS-TO-ATO boundary and the SINGLE ENGINE LIMITS boundary. Since the time between these boundaries is less than 1.5 minutes, it is extremely unlikely that an interconnect from a running engine to a running engine will be required. Consequently, the maximum time spent at 109 throttles (at most 1.5 minutes) will not significantly reduce the predicted MECO time. @[050495-1753A]

2. TAL:

a. REGARDLESS OF THE MPS HELIUM INTERCONNECT STATUS, THE SSME'S WILL BE IMMEDIATELY THROTTLED TO 109 PERCENT POWER LEVEL AFTER THE ISOLATION PROCEDURE IS COMPLETED AND MPS HELIUM LEAK IS DETERMINED TO BE NON-ISOLATABLE. @[100997-6298]

For this case, the additional risk associated with operating the main engines at 109 power level is acceptable in order to provide the crew and vehicle a chance to reach a runway (i.e., SE LIMITS). Commanding the engines to 109 percent power level, while the vehicle is in an abort gap with a helium leak on one of two running SSME supplies, maximizes the use of the remaining helium by reducing the time required to achieve abort capability to a landing site. Furthermore, the increased power level does not increase helium usage in the engine HPOTP IMSL purge package (usage remains unchanged from 67-109 percent power level) and should have no negative effect on the size of the leak in the MPS helium system. Operationally, the increased internal engine pressures and temperatures at 109 percent do increase the likelihood of having an SSME failure (ref. AEFTP #108 charts, 12/17/93). However, because the run time remaining on the last engine to MECO cannot be determined (its helium supply was compromised), the main engines will remain at 109 percent power level until the 2 percent propellant remaining in the ET cue is reached (reference rule {A5.1.3-11}, MANUAL THROTTLEDOWN FOR LO₂ NPSP PROTECTION AT SHUTDOWN) or until the manual MECO (reference rule {A5.1.4-3}, PRE-MECO SHUT DOWN OF ENGINES DUE TO MPS HELIUM LEAKS). @[090894-1676A]

THIS RULE CONTINUED ON NEXT PAGE

FLIGHT RULES

A5.1.4-2 PRE-MECO MPS HELIUM SYSTEM INTERCONNECTS (CIL) (CONTINUED)

- b. IF SINGLE ENGINE TAL 104 ABORT CAPABILITY IS ACHIEVED OR IS PREDICTED TO BE ACHIEVED WITHOUT INTERCONNECTING A RUNNING ENGINE SUPPLY, SSME THROTTLES MAY BE RETURNED TO 104 PERCENT POWER LEVEL. @[100997-6298]

If single engine TAL 104 abort capability is achieved, or is predicted to be achieved, after throttling the SSME's to 109 percent power level and without interconnecting a running, non-leaking SSME helium supply, ~~but prior to performing a running engine to running engine interconnect~~, sufficient helium will be available in the non-leaking MPS helium system to complete a single engine abort at 104 or 109 percent power level. Single engine TAL 104 is when the Flight Dynamics Officer determines that 109 percent power level is no longer required for single engine abort completion. Per the rationale of paragraph D.2.a, it is desirable that the SSME throttle setting be returned to 104 percent whenever possible. ~~ED~~] ~~050495-1767B~~

3. RTLS:

THE SSME'S WILL BE IMMEDIATELY MANUALLY THROTTLED TO -109 PERCENT POWER LEVEL AFTER THE ISOLATION PROCEDURE IS COMPLETED AND THE MPS HELIUM LEAK IS DETERMINED TO BE NON-ISOLATABLE. IF IT IS SUBSEQUENTLY DETERMINED BY THE MCC THAT THE ABORT CAN BE COMPLETED WITHOUT COMPROMISING THE NON-LEAKING SUPPLY OF A RUNNING SSME, MAIN ENGINE THROTTLES WILL BE RETURNED TO AUTO PRIOR TO POWERED PITCH AROUND INITIATION/COMPLETION. OTHERWISE, AUTO SSME THROTTLES WILL BE RESELECTED AT THE COMPLETION OF POWERED PITCH AROUND. ~~SSME THROTTLES WILL REMAIN AT 109 PERCENT POWER LEVEL.~~ ~~050495-1753A~~ @[100997-6298]

THIS RULE CONTINUED ON NEXT PAGE

FLIGHT RULES

A5.1.4-2

PRE-MECO MPS HELIUM SYSTEM INTERCONNECTS (CIL) (CONTINUED)

If a non-isolatable MPS helium leak ~~exists~~~~develops~~ in the supply of one of two running SSME's while performing an RTLS abort, the likelihood that the associated SSME will shut down early, prior to reaching single engine abort capability, increases significantly. The probability that the shut down requirements of the last SSME are violated at MECO also increases significantly. Both possibilities are further compounded on the RTLS case by predicted MECO times which may extend by as much as 3 minutes longer than the nominal uphill MECO. Furthermore, since the maximum SSME operating time is defined at liftoff by the prelaunch loading of MPS helium, the SSME burn time cannot be extended to alleviate these concerns. The only available option is to use a higher main engine power level in order to minimize the predicted MECO time. ~~Recent a~~Analysis by flight design indicates that using 109 percent throttles on an RTLS abort can decrease the MECO time by as much as 55 seconds, assuming 109 is maintained throughout the trajectory (reference Ascent Abort Panel briefing charts, 10/6/94, "RTLS MECO Time Reduction for MPS Helium Leaks"). The resulting decrease in predicted MECO time may be the difference between a crew bailout and an intact abort landing. However, it must be noted that the trade off of using 109 percent throttles during the RTLS flyback phase is that, the ET separation QBAR is decreased by approximately 1.5 psf over the designed RTLS condition, and the ET separation MPS propellant residuals are increased by approximately 0.5 percent over the designed RTLS condition. Since manual throttles must be maintained until the ~~initiation~~~~completion~~ of powered pitch around in order to stay at 109 throttles during flyback, the GPC's will not perform mass control throttling (auto throttles required) and the resulting separation conditions are slightly off-nominal. These conditions are considered acceptable when compared to violations which may occur on an alternative contingency abort. To further minimize violations of the designed QBAR and residual constraints for this case, SSME throttles will be returned to the AUTO position prior to powered pitch around ~~initiation~~ if the MCC determines that the abort can be completed without compromising the non-leaking helium supply of a running SSME while in auto throttles. This action allows the GPC's to perform mass control throttling during flyback, thereby controlling ET separation conditions. If the MCC cannot determine abort capability prior to ~~powered pitch around initiation~~PPA, then manual throttles at 109 percent are maintained until ~~powered pitch around~~PPA is complete. ~~Although fine mass control will not be performed, after PPA completion, SSME throttles are~~ returning ~~ed~~ to auto throttles; ~~after powered pitch around completion minimizes crew actions during the pitch around maneuver and~~ ~~allowing~~ the engines to remain at 109 percent ~~power level~~ until the fine count throttle command is received from guidance near MECO. Flight design analysis indicates that for cases involving manual throttling after ~~powered pitch around~~PPA ~~initiation~~~~completion~~, the ET separation QBAR and MPS residual violations are minimized when the maximum SSME throttle setting is used during flyback. ~~Returning to AUTO throttles after PPA is complete may allow the SSME's to shut down from the fine count throttle setting.~~ For these cases, there are no LO₂ NPSP concerns since there are always MPS residuals in the ET, and significant NPSP violations only occur during LO₂ low level cutoff. Consequently, SSME shut down from the fine count throttle setting is a preferred, not a mandatory, condition. ©[050495-1753A]

FLIGHT RULES

Rules [{A2.1.2-15}](#), [MANUAL THROTTLE CRITERIA](#); [{A4.1.2-3}](#), *USE OF MAXIMUM THROTTLES*; [{A5.1.1-5}](#), *SUSPECT ENGINES*; [{A5.1.3-3}](#), *LIMIT SHUTDOWN CONTROL*; and [{A5.1.4-6}](#), *ABORT PREFERENCE FOR SYSTEM FAILURES*, reference this rule. ©[092195-1770A]

©[ED] [@100997-6298.1](#)

FLIGHT RULES

A5.1.4-3 **PRE-MECO SHUT DOWN OF ENGINES DUE TO MPS HELIUM
LEAKS**

A. IF ALLOWABLE HELIUM INTERCONNECTS, PER RULE {A5.1.4-2}, PRE-MECO MPS HELIUM SYSTEM INTERCONNECTS, WILL NOT SATISFY ZERO-G SHUTDOWN REQUIREMENTS PER PARAGRAPH E, BUT WILL SATISFY SHUTDOWN REQUIREMENTS AT THE CUES BELOW, THE AFFECTED ENGINE WILL BE SHUT DOWN MANUALLY (PUSH-BUTTON ONLY IF POSSIBLE), AS FOLLOWS: @[090894-1676A]

1. MCC DECISION (PRIME)

a. NOMINAL/ATO/AOA

(1) THREE ENGINES ON: VI = 23 KFPS

(2) TWO ENGINES ON: VI = 24.5 KFPS

THIS RULE CONTINUED ON NEXT PAGE

FLIGHT RULES**A5.1.4-3 PRE-MECO SHUT DOWN OF ENGINES DUE TO MPS HELIUM
LEAKS (CONTINUED)**

b. TAL

TWO OR THREE ENGINES ON VI = 22.5 KFPS

c. RTLS

TWO OR THREE ENGINES ON: ALPHA = -1 DEGREES
@[032395-1759A]

In this case, the engine will run with the helium system leak, but the helium supply pressure may not be able to support the zero-g shutdown requirements at MECO. The required helium supply pressure for a safe shutdown will depend upon the number of helium regulators operating, the helium leak rate, and type of shutdown (i.e., hydraulic or pneumatic). If the requirements for a pre-MECO hydraulic, pneumatic, or single regulator shutdown will be satisfied subsequent to the cues mentioned in paragraph C, manual action is taken to shut the engine down while still protecting shutdown requirements. The engine is shut down approximately 30 seconds before MECO at a velocity which equates to MECO minus 30 seconds. This gives guidance time to adjust to the late engine out and converge on the proper MECO targets. The only exception to this is the RTLS abort where the engine is shut down during powered pitch down (alpha equals -1 degree).
@[032395-1759A]

The shutdown pushbutton is used for engine shutdown instead of the AC power switches in order to shut the engine down hydraulically. A pre-MECO hydraulic shutdown requires less helium than a pre-MECO pneumatic shutdown and also retains post-MECO LO₂ dump capability through the affected engine. It also avoids the zero fault tolerant pneumatic shutdown mode. @[090894-1676A]

2. ONBOARD DECISION (NO COMMUNICATION) @[090894-1676A]

a. IF A NON-ISOLATABLE MPS HELIUM LEAK EXISTS, THE CREW WILL SHUT DOWN THE AFFECTED ENGINE AT THE APPROPRIATE BOUNDARY LISTED IN PARAGRAPH A1.

If a leak develops in an engine helium supply and the crew cannot communicate with the MCC, shutting the affected engine down early may prevent the violation of shutdown helium requirements on that engine. With no communication with the ground the crew has no way to tell when the helium requirements will be violated. The helium margin which exists in each supply at liftoff will very likely keep shutdown requirements from being violated at the cues listed.

THIS RULE CONTINUED ON NEXT PAGE

FLIGHT RULES

**A5.1.4-3 PRE-MECO SHUT DOWN OF ENGINES DUE TO MPS HELIUM
LEAKS (CONTINUED)**

- b. IF AN MPS HELIUM SYSTEM IS OPERATING ON A SINGLE REGULATOR, THE CREW CANNOT COMMUNICATE WITH THE MCC, AND THE HELIUM SYSTEM TANK PRESSURE ON THAT SUPPLY IS LESS THAN 2163 (2300) PSIA AT MECO-60 SECONDS, THE CREW WILL SHUT DOWN THE AFFECTED ENGINE AT THE APPROPRIATE CUE LISTED ABOVE IN PARAGRAPH A1.

1963 psia is the minimum engine system tank pressure which will support MECO requirements while operating on a single regulator (ref. paragraph E). In this configuration, approximately 200 psia of helium (10 psia/3 sec x 60 sec) is used between the velocity cues mentioned in paragraph A1 and MECO. Therefore, if the affected engine tank pressure is less than 2163 psia (1963 psia + 200 psia) at MECO minus 1 minute, MECO shutdown requirements will not be satisfied and the engine is shut down pre-MECO. The crew shutdown cue of 2300 psia is derived by adding 115 psia instrumentation error and rounding up to the nearest hundred (1963 psia + 200 psia + 115 psia instrumentation error + 22 psia rounding = 2300 psia).

- B. IF AN ENGINE HELIUM SUPPLY DEVELOPS A LEAK WITHIN 60 SECONDS OF MECO, WITH OR WITHOUT COMMUNICATION WITH THE MCC, THE CREW WILL USE THE SHUTDOWN PUSHBUTTON TO SHUT DOWN THE AFFECTED ENGINE PRIOR TO MECO. @[041196-1876]

When helium system leaks develop late in flight, sufficient time to evaluate MECO capability may not exist. Since pre-MECO engine shutdowns consume less helium than zero-g shutdowns, it is safer to shut the affected engine down prior to MECO. Shutting the engine down soon after a helium system leak occurs also gives guidance software time to converge on the correct MECO velocity targets. @[090894-1676A]

- C. IF ENGINE AND PNEUMATIC HELIUM SYSTEMS INTERCONNECTS TO AN ENGINE WITH A LEAKING MPS HELIUM SUPPLY ARE INSUFFICIENT TO SUPPORT ENGINE SHUT DOWN AT THE CUES OUTLINED IN PARAGRAPH A1, ENGINE SHUTDOWN PRIOR TO THOSE CUES MUST BE ACCOMPLISHED IN THE FOLLOWING MANNER WHILE TWO OR THREE ENGINES ARE RUNNING: @[090894-1676A] @[ED]

1. IF NO RUNNING ENGINE SUPPLIES HAVE BEEN INTERCONNECTED:

THIS RULE CONTINUED ON NEXT PAGE

FLIGHT RULES

A5.1.4-3 PRE-MECO SHUT DOWN OF ENGINES DUE TO MPS HELIUM LEAKS (CONTINUED)

- a. THE LEAKING ENGINE WILL BE ALLOWED TO SHUT DOWN ON THE ENGINE HPOTP INTERMEDIATE SEAL (IMSL) PURGE REDLINE AS LONG AS THE ENGINE HYDRAULIC SYSTEM IS FUNCTIONAL AND THE SSME REDLINE LIMITS ARE ENABLED.

On the Phase II SSME, an HPOTP IMSL purge redline violation will always occur when the intermediate seal pressure falls below 170 psia. However, the minimum helium system/engine interface pressure required to prevent an HPOTP IMSL violation decreases over the duration of engine operation. As the turbine/pump shaft heats up, the intermediate seal gap becomes smaller. Consequently, lower interface pressures will keep the HPOTP IMSL purge pressure above 170 psia. If the helium system regulator outlet pressure at the start of shutdown is below the minimum helium system regulator outlet pressure, the resulting helium purge flow rates may be significantly reduced during the shutdown sequence. If two engine abort capability to a landing site exists, while three engines are running, or single engine abort capability to a landing site exists, while two engines are running, a leaking engine will be allowed to shut down on the HPOTP IMSL purge redline. Although minor engine erosion may occur during the shutdown sequence due to reduced helium pressure, the shutdown will be contained and engine run time is maximized. ©[050495-1767B]

On the BLOCK I SSME, BLOCK IIA SSME, and the BLOCK II SSME, an HPOTP IMSL purge redline violation will always occur when the intermediate seal pressure falls below 159 psia. The alternate HPOTP used on these engines has a true controlled gap IMSL package. Due to this feature, the minimum helium system/engine interface pressure required to prevent an HPOTP IMSL violation does not change over the duration of engine operation. ©[050495-1767B] ©[020196-1812] _ ©[121197-6472A]

- b. IF A HYDRAULIC SHUTDOWN CANNOT BE PERFORMED, MANUAL SHUTDOWN WILL BE PERFORMED AT THE MINIMUM REQUIRED PNEUMATIC SHUTDOWN HELIUM INTERFACE PRESSURE PER PARAGRAPH E1 OR E2 OF THIS RULE.

If hydraulic shutdown capability is lost for any reason, the pneumatic shutdown requirements must be manually protected in order to prevent a catastrophic shutdown from occurring. ©[090894-1676A] ©[100997-6298]

2. IF A RUNNING SSME WITH A NON-LEAKING HELIUM SUPPLY HAS BEEN INTERCONNECTED TO A RUNNING SSME WITH A LEAKING MPS HELIUM SUPPLY (ABORT GAP). ©[090894-1676A]

FLIGHT RULES

For this case, the desired single engine abort capability is unattainable. However, a contingency abort may still be performed. Getting as far down range as possible prior to MECO improves ET separation conditions and decreases orbiter pull-out loads; hence, both engines will be allowed to run as long as possible. Shutting the leaking engine down before the good engine may allow both engines to shut down in a contained manner, since the leaking engine will be shut down under g's and therefore consume less helium during the sequence.

THIS RULE CONTINUED ON NEXT PAGE

FLIGHT RULES

A5.1.4-3

**PRE-MECO SHUT DOWN OF ENGINES DUE TO MPS HELIUM
LEAKS (CONTINUED)**

- a. THE LEAKING ENGINE WILL BE SHUT DOWN AT AN HPOTP IMSL PURGE PRESSURE (ON ALL QUALIFIED SENSORS) OF :

PHASE II SSME : 40 PSIA

BLOCK I, IIA, AND II SSME : 60 PSIA

@[100997-6298] @[121197-6472A]

Phase II SSME: Shutting down the engine with the leaking supply at an HPOTP IMSL pressure of 40 psia keeps that engine running as long as feasible (a positive barrier pressure exists as measured between the IMSL and SECONDARY SEAL cavities) while the vehicle is in an abort gap. 40 psia, as measured by the IMSL transducers, equates to approximately 25 psia in the IMSL cavity. The nominal pressure in the secondary seal cavity is 12 psia. This results in a pressure differential of 13 psid across the carbon seals. A similar barrier pressure margin exists across the carbon seal to the oxygen (pump side) drain. Allowing the engine with the leaking MPS helium supply to run to an IMSL pressure of 40 psia is a worst case scenario which assumes that the desired abort boundary has not been achieved, and that the turbopump seal packages are intact. @[050495-1767B]

BLOCK I SSME, BLOCK IIA SSME, and BLOCK II SSME: Shutting down the engine with the leaking supply at an HPOTP IMSL pressure of 60 psia keeps that engine running as long as feasible (a positive barrier pressure exists between the IMSL and the O₂ and H₂ cavities) while the vehicle is in an abort gap. 60 psia, as measured by the IMSL transducers, equates to approximately 42 psia in the IMSL cavity. The nominal pressure in the O₂ cavity is 16 psia and the nominal pressure in the H₂ cavity is 25 psia. This results in a pressure differential of 26 and 17 psid across the carbon seals. Allowing the engine with the leaking MPS helium supply to run to an IMSL pressure of 60 psia is a worst case scenario which assumes that the desired abort boundary has not been achieved and that the engine seal packages are intact. @[050495-1767B] @[020196-1812] @[100997-6298] @[121197-6472A]

THIS RULE CONTINUED ON NEXT PAGE

FLIGHT RULES

**A5.1.4-3 PRE-MECO SHUT DOWN OF ENGINES DUE TO MPS HELIUM
LEAKS (CONTINUED)**

- b. THE NON-LEAKING, RUNNING ENGINE WILL BE ALLOWED TO RUN UNTIL MECO OR 1150 PSIA, WHICHEVER COMES FIRST. IF A MANUAL SHUTDOWN IS REQUIRED, IT WILL BE WITH THE SHUT DOWN PUSHBUTTON ONLY. @[090894-1676A]_@[100997-6298]

The interconnect from the engine with the non-leaking MPS helium supply to the engine with the leaking MPS helium supply will be broken at 1250 psia on the non-leaking system. This will result in nominal helium usage to the engine with the good supply. After the interconnect is broken, the non-leaking engine should run approximately 30-40 seconds prior to being shutdown at 1150 psia. Although 1288 psia is the minimum helium system tank pressure which will support zero-g shut down of an engine with two good regulators and no helium system leak, the last engine will be allowed to run until the MPS supply pressure reaches the crew C&W limit of 1150 psia. Allowing the engine to run to 1150 psia provides a clear engine shutdown cue for the crew (C&W alarm at 1150) and also takes advantage of any instrumentation error/margin which may exist in the onboard measurement system and the ground predicted shut down requirements respectively. @[100997-6298]

Reference Rule {A5.1.4-2}, PRE-MECO MPS HELIUM SYSTEM INTERCONNECTS (CIL), for interconnect procedures.

- D. IF AN MPS HELIUM SYSTEM IS OPERATING ON A SINGLE REGULATOR AND DOES NOT MEET THE ZERO-G SHUTDOWN REQUIREMENTS OF THE ASSOCIATED ENGINE AS PREDICTED BY THE MCC, THE ENGINE WILL BE SHUT DOWN PER PARAGRAPHS A OR C ABOVE, WHILE PROTECTING THE SINGLE REGULATOR SHUTDOWN REQUIREMENTS OF PARAGRAPH E.6 BELOW.

When an MPS helium system is operating on a single helium regulator, the supply may not meet the MECO (zero-g) shutdown requirements of the affected engine. If it is predicted that the MECO requirements, as stated in paragraph E.6 below, will be violated, the engine must be shut down early according to paragraphs A.1, C.1 or C.2 above. @[090894-1676A]

THIS RULE CONTINUED ON NEXT PAGE

FLIGHT RULES

A5.1.4-3 PRE-MECO SHUT DOWN OF ENGINES DUE TO MPS HELIUM LEAKS (CONTINUED)

E. HELIUM SYSTEM REQUIREMENTS FOR ENGINE SHUTDOWN @ [090894-1676A]

1. MINIMUM SHUTDOWN PRESSURES FOR AN ENGINE WITH A LOWER SYSTEM MPS HELIUM LEAK.

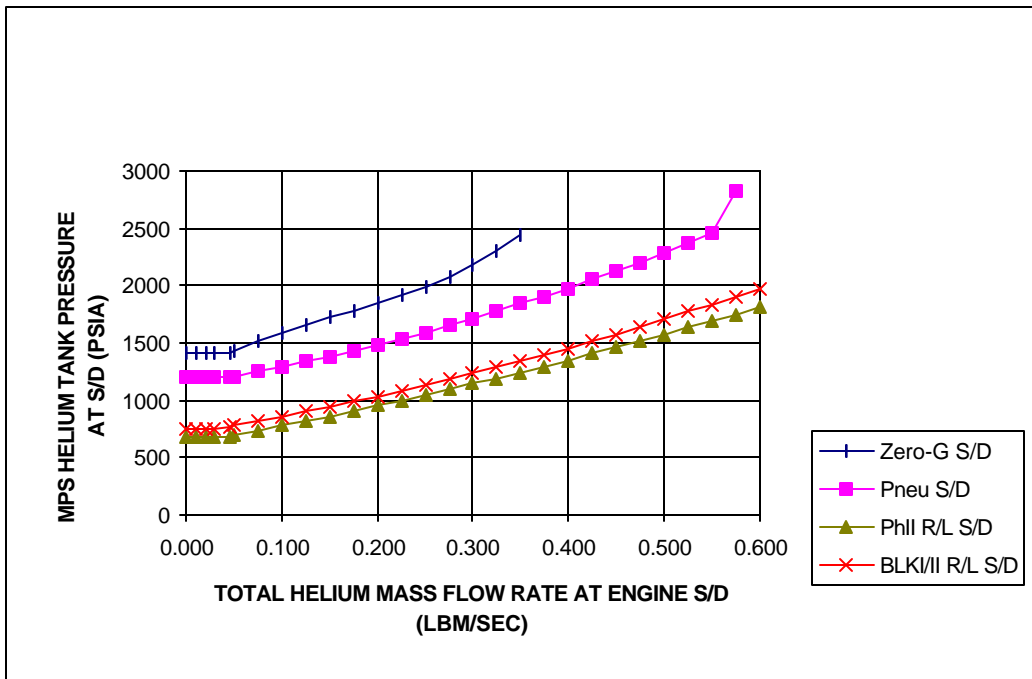

SINGLE REG: 1963 (2078) PSIA

SINGLE REG: 1457 (1572) PSIA

- ◆ ZERO G S/D, 630 PSIA AT S/D +7 SEC
- PNEU S/D, 529 PSIA AT S/D +7 SEC
- ▲ PHASE II SSME:
REDLINE S/D, 518 PSIA AT S/D
SINGLE REG: 600 (715) PSIA
- × BLOCK I SSME, BLOCK IA SSME, AND BLOCK II SSME:
REDLINE S/D, 576 PSIA AT S/D
SINGLE REG: 679 (794) PSIA

@ [050495-1767B] @ [020196-1812] @ [121197-6472A]

THIS RULE CONTINUED ON NEXT PAGE

FLIGHT RULES

A5.1.4-3 PRE-MECO SHUT DOWN OF ENGINES DUE TO MPS HELIUM LEAKS (CONTINUED)

A lower system MPS helium leak is a leak downstream of the system regulators. The resulting leak rate should be constant. Lower system leaks are isolatable only when they occur between the regulator and the downstream check valve.

The zero-g line represents the minimum supply pressure to support a hydraulic or pneumatic shutdown at MECO (zero-g) with two system regulators, with or without a lower system MPS helium leak. This requirement is the ICD value of 630 psia interface pressure at shutdown plus 7 seconds (ref. SSME-to-Orbiter ICD 13M15000). The pneumatic shutdown line represents the minimum supply pressure to support a pre-MECO pneumatic shutdown with two system regulators, with or without a lower system leak. This requirement is based on an analytical value of 529 psia interface pressure at shutdown plus 7 seconds. The redline shutdown curve is the minimum supply pressure at which the HPOTP IMSL purge redline will be violated with one or two system regulators, with or without a lower system leak. For the Phase II SSME, this value is 518 psia interface pressure at shutdown and is based on an analysis and minimal test data (reference SODB data request R1-1507). For the BLOCK I SSME, BLOCK IIA SSME, and the BLOCK II SSME, this value is 576 psia interface pressure at shutdown and is based on SSME test 901-835 (reference SODB data request R1-1640). The minimum pressure which will support the expected shutdown mode and mass flow rate should always be protected. These curves include 115 psia instrumentation error. @[090894-1676A] @[020196-1812] @[121197-6472A]

THIS RULE CONTINUED ON NEXT PAGE

FLIGHT RULES

A5.1.4-3

PRE-MECO SHUT DOWN OF ENGINES DUE TO MPS HELIUM LEAKS (CONTINUED)

2. MINIMUM SHUTDOWN PRESSURES FOR AN ENGINE WITH AN UPPER SYSTEM MPS HELIUM LEAK. @[090894-1676A]

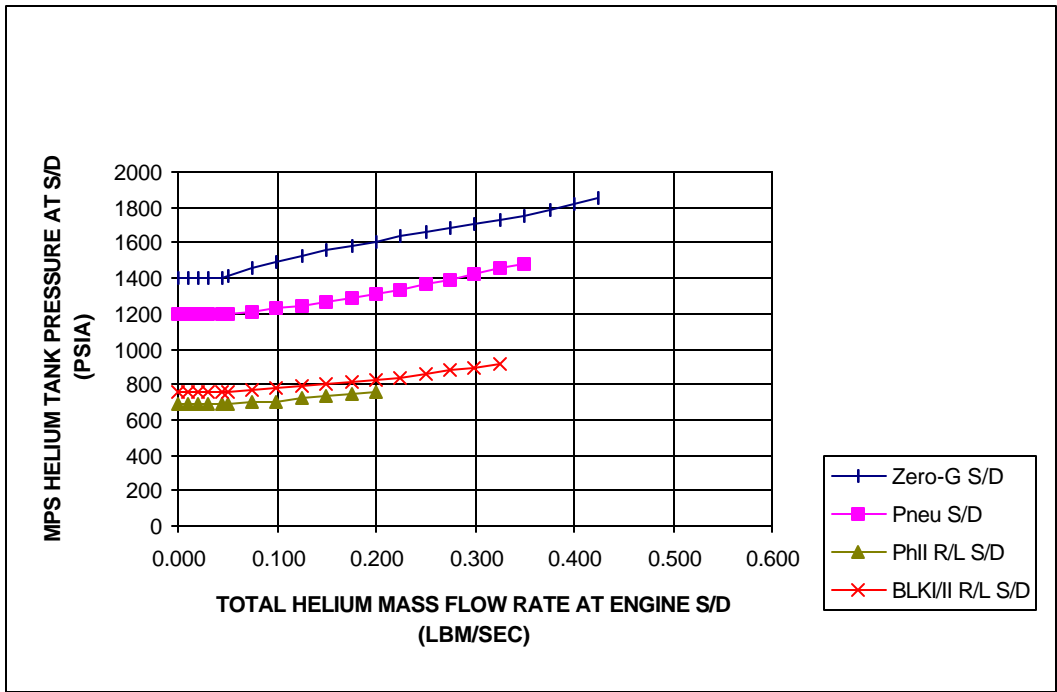

- ◆ ZERO G S/D, 630 PSIA AT S/D +7 SECONDS
 PNEU TK: 2800 (2915) PSIA (3 ENGINES S/D)
 PNEU TK: 2357 (2472) PSIA (1 ENGINE S/D)
- PNEU S/D, 529 PSIA AT S/D + 7 SECONDS
 PNEU TK: 2036 (2151) PSIA
- ▲ PHASE II SSME:
 REDLINE S/D, 518 PSIA AT S/D
 PNEU TK: 600 (715) PSIA
- × BLOCK I SSME, BLOCK IIA SSME, AND BLOCK II SSME:
 REDLINE S/D, 576 PSIA AT S/D
 PNEU TK: 639 (754) PSIA

@[050495-1767B] @[020196-1812] @[121197-6472A]

THIS RULE CONTINUED ON NEXT PAGE

FLIGHT RULES

A5.1.4-3 PRE-MECO SHUT DOWN OF ENGINES DUE TO MPS HELIUM LEAKS (CONTINUED)

An MPS upper system helium leak is a leak upstream of the system regulators. The resulting leak rate should decay over time. Upper system leaks are isolatable only when they occur between the helium isolation valve and the downstream regulator.

The zero-g line represents the minimum supply pressure to support a hydraulic or pneumatic shutdown at MECO (zero-g) with two system regulators, with or without an upper system leak. This requirement is the ICD value of 630 psia interface pressure at shutdown plus 7 seconds (ref. SSME-to-Orbiter ICD 13M15000). The pneumatic shutdown line represents the minimum supply pressure to support a pre-MECO pneumatic shut down with two system regulators, with or without an upper system leak. This requirement is based on an analytical value of 529 psia interface pressure at shutdown plus 7 seconds. The redline shutdown curve is the minimum supply pressure at which the HPOTP IMSL purge redline will be violated with one or two system regulators, with or without an upper system leak. For the Phase II SSME, this value is 518 psia interface pressure at shutdown and is based on analysis and minimal test data (reference SODB data request R1-1507). For the BLOCK I SSME, BLOCK IIA SSME, and the BLOCK II SSME, this value is 576 psia interface pressure at shutdown and is based on SSME test 901-835 (reference SODB data request R1-1640). The minimum pressure which will support the expected shutdown mode and mass flow rate should always be protected. These curves include 115 psia instrumentation error. @[050495-1767B] @[121197-6472A]

3. IF THE ENGINE CAN SHUT DOWN HYDRAULICALLY BUT HPOTP IMSL REDLINE SHUT DOWN CAPABILITY IS LOST FOR ANY REASON, A MANUAL SHUTDOWN MUST PROTECT THE MINIMUM INTERFACE PRESSURES FOR A PRE-MECO HYDRAULIC SHUT DOWN AS SHOWN ABOVE IN PARAGRAPH E. @[090894-1676A]

If both HPOTP IMSL purge pressure transducers have failed or the redline limit software is not available for any reason, a redline engine shutdown will never occur. Manual action must be taken above the minimum hydraulic shutdown interface pressure.

4. IF A PNEUMATIC SHUT DOWN IS REQUIRED FOR ANY REASON, A MANUAL SHUT DOWN MUST PROTECT THE MINIMUM INTERFACE PRESSURES FOR A PRE-MECO PNEUMATIC SHUTDOWN PER PARAGRAPH E.

For all ~~four~~ three SSME types (Phase II, BLOCK I, BLOCK IIA, and BLOCK II), it takes significantly more helium to support a pre-MECO pneumatic shutdown than it does to support a pre-MECO hydraulic shutdown. Consequently, pre-MECO pneumatic shutdown capability must be manually protected for all cases where hydraulic engine function has been lost or for which a pneumatic shutdown will occur. @[050495-1767B] @[121197-6472A]

THIS RULE CONTINUED ON NEXT PAGE

FLIGHT RULES

A5.1.4-3

**PRE-MECO SHUT DOWN OF ENGINES DUE TO MPS HELIUM
LEAKS (CONTINUED)**

5. IF THE PNEUMATIC SYSTEM ALONE WILL BE USED TO SUPPORT THE SHUTDOWN HELIUM REQUIREMENT OF AN ENGINE, AND THE ENGINE SYSTEM HAS TWO OPERATIONAL REGULATORS AND NO DOWNSTREAM HELIUM LEAK, THE FOLLOWING NUMBERS MUST BE PROTECTED:

- | | | | |
|----|----------------------------------|---|-------------------------------------|
| a. | ZERO-G | - | 2800.0 (2915.0) PSIA
(3 ENG S/D) |
| | | - | 2357.0 (2472.0) PSIA
(1 ENG S/D) |
| b. | PRE-MECO PNEUMATIC | - | 2036.0 (2151.0) PSIA |
| c. | PRE-MECO HYDRAULIC: | | |
| | PHASE II SSME | - | 600.0 (715.0) PSIA |
| | BLOCK I, <u>IIA, AND II</u> SSME | - | 639.0 (754.0) PSIA |

@[050495-1767B] @[020196-1812] @[121197-6472A]

If the MPS supply system has an upper system leak, the pneumatic system will be interconnected to the engine as late in the flight as is practical, but above the minimum tank pressure required to support engine shut down. After the interconnect is performed a determination is made as to whether or not the leak is an upper system leak or a tank leak. If the leak is found to be a tank leak, the pneumatic tank only numbers must be protected. The leak in the tank may deplete all of the engine system helium before the pneumatic tank and engine tank equalize in pressure. If this is the case, the pneumatic tank alone must support engine shutdown. @[090894-1676A]

THIS RULE CONTINUED ON NEXT PAGE

FLIGHT RULES

A5.1.4-4 LH₂ TANK PRESSURIZATION (CIL)

THE ET LH₂ TANK ULLAGE PRESSURE WILL BE MANUALLY CONTROLLED USING THE LH₂ ULLAGE PRESSURE SWITCH WHEN THE LH₂ ULLAGE PRESSURE IS < 27.7 (28.0) PSIA. THE PRESSURIZATION WILL BE CONTROLLED SO THAT THE ULLAGE PRESSURE DOES NOT EXCEED 35 (34.0) PSIA TO AVOID THE LOW CRACKING PRESSURE OF THE TANK VENT/RELIEF VALVE. @101096-4474A]

The pressurization flow control system consists of three tank ullage pressure sensors, signal conditioners ~~in for~~ the orbiter flow control valve electronics, and three gaseous hydrogen flow control valves. Each ullage pressure sensor is wired to a signal conditioner which in turn controls the GH₂ pressurant flow from ~~a particular~~ its respective engine. Each control system is single string; i.e., ullage pressure no. 1 feeds only the electronics for the center SSME, no. 2 to the left SSME, and no. 3 to the right SSME. The flow control valves are used to maintain the LH₂ tank ullage pressure between in a control band of 32 and to 34 psia. The signal conditioners use 33.0 psia as the set point for the ullage pressure. Failure of one flow control valve to the closed position (low flow) to operate does not cause the ullage pressure to drop below 28.0 psia or violate the SSME NPSP ICD. However, the pressure cannot be maintained above 28.0 psia when two flow control valves fail closed. to operate. Additionally, failure of one flow control valve to the open position (high flow) does not cause the ullage pressure to rise to the LH₂ tank vent valve relief setting of 36 psia Also, the SSME NPSP ICD may be violated. (reference: SODB, volume I, section 5.3.3-December 22, 1995 PSIG and Rockwell action item 951208-02). @101096-4474A] @021199-6791A]

FLIGHT RULES

There are several failure modes associated with the LH₂ tank pressurization flow control system. This flight rule addresses the case of two ullage pressure sensors failed high (i.e., above the ullage pressure where the flow control valve is commanded closed) which will cause their respective flow control valves to remain closed. The remaining flow control system will not maintain the tank pressure. When the true tank pressure decays to 28.0 psia on the remaining good sensor, a class 3 BFS alert will be set. (The 28.0 psia value was reviewed and approved as DCR 35981A and DCR 3586 at the July 11, 1996/11/96 SASC.B.) An LH₂ ullage pressure of 28.0 psia is the value at which manual action will be taken. This pressure includes crew response time and one sigma dispersions of the instrumentation error: 0.21 psia (reference Booster SCP 2.2.1). Additionally, this lower value of 28.0 psia protects the minimum ullage pressure to support the NPSP requirement of 27.7 (reference December 22, 1995 PSIG and Rockwell action item 951208-02, chart 1-18). In response to the alert, the crew will use the LH₂ ullage pressure switch to open the flow control valves by overriding the electronics on all flow control valves. The tank pressure should then increase. However, the pressure could go through the control band and reach the tank ventrelief valve relief setting of 36 ± 1 psig. Therefore, the value of 34.0 psia was chosen as the value at which the crew would close the flow control valves before venting could occur. If venting occurs while the vehicle is in first stage, a fire could propagate along the side of the external tank (reference PRCB presentation 2/10/February 10, 1987 and the 32nd PSIG). The high flow setting of the -1301 FCV's (70 percent instead of 100 percent used with the -0361) allows for manual action to be taken prior to staging. For this failure case, venting GH₂ is not a concern due to a gradual pressure recovery when the switch is placed in the high flow position during first stage (reference May 8, 1996 PSIG and action item-941005-03 Rev 3). @[101096-4474A] @[021199-6791A]

THIS RULE CONTINUED ON NEXT PAGE

FLIGHT RULES

A5.1.4-4 LH₂ TANK PRESSURIZATION (CIL) (CONTINUED)

Other failure modes of the GH₂ pressurization system include: ~~a mechanical failure the closure of~~ two flow control valves, a flow restriction in ~~either an the two SSME GH₂ repressurization flow control paths~~ or in the main pressurization line, a hole in the side of the LH₂ tank or a vent relief valve not closed. However, the LH₂ ullage pressure switch cannot correct conditions caused by these failure modes. For these cases, all three ullage pressures could decay below 28.0 psia since the sensors are accurately reading the decaying tank pressure. If the pressure decay continues, the minimum NPSP of the engines will be violated. @[101096-4474A] @[021199-6791A]

Rules {A4.1.2-7H}, PERFORMANCE BOUNDARIES, and {A5.1.4-5}, MANUAL THROTTLING FOR LOW LH₂ NPSP, reference this rule. @[071494-1646A]

A5.1.4-5 LIMIT SHUTDOWN CONTROL AND MANUAL THROTTLING FOR LOW LH₂ NPSP @[040899-6818A]

- A. ~~THIS RULE IS APPLICABLE IF THE STEPS TAKEN IN RULE {A5.1.4-4}, LH₂ TANK PRESSURIZATION, WERE INEFFECTIVE. MAIN ENGINE LIMIT SHUTDOWN SOFTWARES WILL BE MANUALLY ENABLED UPON RECOGNITION OF EITHER MULTIPLE GH₂ FLOW CONTROL VALVES FAILED CLOSED OR FOR AN LH₂ ULLAGE TANK LEAK OR FOR ANY ORBITER GH₂ PRESSURIZATION SYSTEM ANOMALY EXCEPT ONE GH₂ FLOW CONTROL VALVE FAILED CLOSED.~~

For LH₂ net positive suction pressure (NPSP) decaying below the ICD requirement, the engines will eventually violate their high pressure fuel turbopump (HPFTP) turbine discharge temperature (TDT) redlines. ~~The~~ Low LH₂ NPSP causes the fuel turbopumps to cavitate, ~~which~~ resulting in turbine overspeed and increased discharge temperatures. Cavitation is possible on all SSME's; therefore, the main engine limit shutdown software will be manually enabled to allow any number of engines to shut down for HPFT TDT redline exceedance.

- B. ORBITER GH₂ FLOW CONTROL VALVE PRESSURIZATION SYSTEM ANOMALY

FLIGHT RULES

~~IF ULLAGE PRESSURE IS STEADILY DECAYING BELOW THE CONTROL BAND AND IS NOT THE RESULT OF AN ULLAGE LEAK (PER RULE {A5.1.1-14}, LH₂ ULLAGE LEAK), THE ENGINES WILL BE MANUALLY THROTTLED MANUALLY FOR TWO OR THREE CH₂ FLOW CONTROL VALVES FAILED-CLOSED PER THE STEPS GIVEN BELOW. THE FIRST MANUAL THROTTLE STEP THROTTLING WILL BE BASED ON THE SETTINGS LISTED IN THE TABLE BELOW WHEN THE LH₂ NPSP DROPS BELOW 3.5 PSI OR THE HPFTP TDT'S INCREASE TO WITHIN 75 DEG R BELOW THEIR REDLINES. SUBSEQUENT MANUAL THROTTLE STEPS WILL BE BASED ON THE TABLE BELOW WHEN THE LH₂ NPSP AGAIN DROPS BELOW 3.5 PSI, WHEN THE HPFTP TDT'S INCREASE TO WITHIN 75 DEG R BELOW THEIR REDLINES, OR WHEN VEHICLE ACCELERATION EXCEEDS 3.0 G'S. THE ENGINES WILL BE THROTTLED TO THE NEXT LOWER STEP EACH TIME THE TEMPERATURE OR NPSP AGAIN EXCEEDS LIMITS. @ED] @040899-6818A~~

<u>STEP</u>	<u>THROTTLE SETTING (PERCENT)</u>
1	95
2	80
3	67

THIS RULE CONTINUED ON NEXT PAGE

FLIGHT RULES

A5.1.4-5 LIMIT SHUTDOWN CONTROL AND MANUAL THROTTLING FOR LOW LH₂ NPSP (CONTINUED)

ONCE INITIATED, MANUAL THROTTLES WILL BE MAINTAINED UNTIL MECO. A MANUAL MECO WILL BE REQUIRED.

A GH₂ pressurization system anomaly could be caused by either multiple flow control valves failed closed or a plugged GH₂ pressurization leg. Coverage of the highly unlikely GH₂ plugged pressurization leg failure mode is a result of PRCB Directive S050270DP, "Main Propulsion System (MPS) Critical Items List (CIL) Submittal Waiver Request," November 9, 1998. @J040899-6818A]

Underspeeds resulting from two GH₂ flow control valves failed closed or a plugged GH₂ pressurization leg for specific engine configurations, or three GH₂ flow control valves failed closed in all cases, will potentially result in loss of crew and vehicle due to either early engine shutdowns (due to LH₂ NPSP) or ET structural failure. Manually throttling to a lower throttle setting increases the supplied NPSP by lowering LH₂ pressure losses across the LH₂ manifolds and lines and also reduces the SSME NPSP requirement for engine operation. The combination of higher supplied NPSP and reduced NPSP requirement enables continued engine operation.

The severity of the LH₂ NPSP loss is not only dependent upon the GH₂ pressurization system failure mode but also upon the engine configuration and power level for a particular mission. Analysis shows that two GH₂ flow control valves failed closed on a nominal, ATO, or AOA mission using three Block I or Phase II SSME's at 104 percent will not result in a LH₂ NPSP degradation which requires throttling (reference February 19, 1997 PSIG, Action Item 970205-01). Analysis also shows that missions using specific combinations of Block I and Block II SSME's may require throttling if two flow control valves are failed closed. Further analysis suggests that throttling may be expected for those missions using three Block IIA/II SSME's if two flow control valves are failed closed or one of the SSME's pressurization legs becomes plugged such that there is 0 percent flow from that leg.

A GH₂ pressurization leg refers to the series of hardware in the GH₂ pressurization line that carries flow from each SSME's LPFTP turbine outlet to the 2-inch pressurization line that provides ullage pressure to the ET LH₂ tank. Each engine contains a check valve, a filter, and a flow control valve (reference SSSH 10-12). The hardware in these lines could potentially fail closed or, in the most extreme case, become plugged by contamination. @J040899-6818A]

THIS RULE CONTINUED ON NEXT PAGE

FLIGHT RULES

A5.1.4-5

LIMIT SHUTDOWN CONTROL AND MANUAL THROTTLING FOR LOW LH₂ NPSP (CONTINUED)

There are three possible scenarios resulting in a plugged GH₂ pressurization system leg. The first scenario involves the filter upstream of the flow control valve becoming plugged, resulting in 0 percent flow to the associated valve. The second and third scenarios are an obstruction, or mechanical failure, of the check valve upstream of the flow control valve or an obstruction of the flow control valve itself. This would result in 0 percent flow being provided from that engine to the 2-inch pressurization line. Since flow from all three pressurization legs is required to maintain ullage pressure above 32.6 psia, all three flow control valves will be commanded open as the system attempts to maintain pressure in the ET LH₂ tank. However, since flow in a single leg is obstructed, ullage pressure will steadily decay below the control band as the fuel volume in the ET LH₂ tank decreases. ©[040899-6818A]

The value of 3.5 psi for the LH₂ NPSP was chosen as the primary cue to avoid LH₂ NPSP regions where severe cavitation occurs and HPFTP turbine temperatures increase exponentially. The HPFTP is expected to run to a LH₂ NPSP of 1.0 to 2.0 psi before cavitation becomes critical. The ground LH₂ NPSP computation assumes a 3 sigma worst case LH₂ inlet temperature of 37.2 deg R from liftoff until MECO. The use of this worst case temperature provides for 2 sigma protection (i.e., a 0.8 psi bias) in the ground NPSP computation. The ground computation uncertainties are a result of measurement inaccuracies in ullage pressure, head pressure, frictional losses, and vapor pressure used in the derivation of NPSP. On average, the actual vehicle NPSP will be 0.8 psi higher than the NPSP value displayed by the MCC ground computation. HPFTP TDT's were selected as a backup cue in case an HPFTP starts to severely cavitate at a higher LH₂ NPSP value than expected. Both temperature limits (channels A and B) are calculated by subtracting 75 deg R from the redlines. Larger margins from the redline may overlap the nominal operating temperature range and provide false cues for action (ref. PSIG Flight Rule Reviews on 2/25/88, 3/23/88, and 11/17/93). ©[071494-1646A]

The cue of 3.0 g's of acceleration was selected to ensure protection of vehicle acceleration limits (3.0 g). Various vehicle configurations or GH₂ pressurization system failure modes may or may not result in exceedance of vehicle acceleration limits. However, if a 3.0 g acceleration limit is used as an auto or manual throttling cue for all cases, vehicle structural limits are protected at all times. Reference Rule {A2.1.2-12}, Q-BAR/G-CONTROL. Three-g is not used as a cue for the first manual throttle step since leaving throttles in auto will throttle at 3.0 g's. Once manual throttles are taken for an NPSP or HPFTP TDT cue, throttles will remain in manual and 3.0 g's will be protected in addition to the NPSP and HPFTP TDT cues.

Throttling in three steps was selected to minimize crew/MCC impact and workload. The steps approximately divide the action equally into thirds. The first step, 95 percent, was originally chosen to avoid the Rocketdyne HPFTP impeller resonance region (i.e., 88 to 92 percent). This is no longer a concern as a result of a redesign of the impeller. The throttle setting of 95 percent was retained for training simplicity. The second step, 80 percent, is midway between the first step and the minimum power level. The last step, 67 percent, is the minimum power level and further commanded power reduction is not possible. ©[040899-6818A]

FLIGHT RULES

THIS RULE CONTINUED ON NEXT PAGE

FLIGHT RULES

A5.1.4-5 LIMIT SHUTDOWN CONTROL AND MANUAL THROTTLING FOR LOW LH₂ NPSP (CONTINUED)

C. LH₂ ~~ULLAGE TANK~~ LEAK @[040899-6818A]

MANUAL THROTTLES WILL BE SELECTED IMMEDIATELY FOLLOWED BY A TAL ABORT TO THE MOST IN-PLANE SITE (GO TAL SITE OR ACLS). AFTER TAL SELECTION, THE THROTTLES WILL BE RETURNED TO AUTO.

If a GH₂ flow control valve anomaly cannot be identified, the cause of the low LH₂ NPSP will be assumed to be an LH₂ tank leak. For an Throttling for low LH₂ NPSP due to an LH₂ ullage leak (reference Rule {A5.1.1-14}, LH₂ ULLAGE LEAK), ~~LH₂ tank leak~~ or an open LH₂ vent/relief valve, ~~throttling for low LH₂ NPSP~~ delivers less ullage pressurization gas causing LH₂ NPSP to decay faster than keeping the engines at 104 percent.

GPC software automatically throttles the engines down if TAL is selected above an I-loaded inertial velocity. To prevent the software from throttling the engines down when there is an LH₂ ~~ullage tank~~ leak, manual throttles are selected prior to selecting TAL. Once TAL is selected, the throttles will be returned to AUTO where they will stay at 104 percent until 3 g's are reached. Three-g throttling may cause engine shutdowns, but this is an accepted risk to avoid vehicle structural damage. @[071494-1646A]

Since there is no way to accurately predict when engine shutdown will occur for this case, it is important to reach multiple engine-out capability and an acceptable MECO as soon as possible. The earliest multi-engine out abort site, either ACLS or TAL, will always be the preferred one for this case (reference rule {A4.1.2-7}, PERFORMANCE BOUNDARIES).

The main engine ~~SSME redline~~ limit shutdown software will be manually enabled upon recognition of this failure to protect against multiple engine shutdowns without limits enabled.

Rules {A2.1.2-12}, Q-BAR/G-CONTROL; {A2.1.2-15}, MANUAL THROTTLE CRITERIA; {A2.1.56-15}, CONTINGENCY ACTION SUMMARY; {A4.1.2-7}, PERFORMANCE BOUNDARIES; {A4.1.2-10}, MANUAL THROTTLE SELECTION; {A5.1.1-14}, LH₂ ULLAGE LEAK; {A5.1.4-4}, LH₂ TANK PRESSURIZATION; {A5.1.4-6}, ABORT PREFERENCE FOR SYSTEMS FAILURES; and {A5.1.3-3}, LIMIT SHUTDOWN CONTROL, reference this rule. @[092195-1770A] @[040899-6818A]

FLIGHT RULES

A5.1.4-6

ABORT PREFERENCE FOR SYSTEMS FAILURES

- A. ~~GLH₂ ULLAGE GAS LEAK OR THREE FLOW CONTROL VALVES FAILED CLOSED~~ [@J040899-6818A](#)

IF LOW LH₂ NPSP OCCURS DUE TO AN EXTERNAL TANK LH₂ ULLAGE ~~GAS LEAK, OR DUE TO THREE GH₂ FLOW CONTROL VALVES FAILED CLOSED~~, A TAL ABORT WILL BE PERFORMED TO A TAL OR ACLS BASED ON WHICHEVER PROVIDES THE EARLIEST MULTIPLE ENGINE-OUT CAPABILITY. ~~@ED]~~

- B. GH₂ PRESSURIZATION SYSTEM ANOMALIES

IF THE LOW LH₂ NPSP OCCURS DUE TO THREE GH₂ FLOW CONTROL VALVES FAILED CLOSED, A TAL ABORT WILL BE PERFORMED TO A TAL OR ACLS BASED ON WHICHEVER PROVIDES THE EARLIEST MULTIPLE ENGINE-OUT CAPABILITY. THIS IS THE ONLY GH₂ PRESSURIZATION SYSTEM ANOMALY FOR WHICH AN ABORT WILL BE PERFORMED. REFERENCE RULE {A5.1.4-5}, LIMIT SHUTDOWN CONTROL AND MANUAL THROTTLING FOR LOW LH₂ NPSP.

A TAL abort is preferred over RTLS because TAL MECO conditions are satisfied sooner than RTLS MECO conditions. If an LH₂ ullage ~~gas~~ leak occurs, throttling will not be performed for low LH₂ NPSP (see rationale for Rule {A5.1.4-5C}, LIMIT SHUTDOWN CONTROL AND MANUAL THROTTLING FOR LOW LH₂ NPSP). Once an ullage ~~gas~~ leak occurs, it is possible for the leak to worsen. In this case, the NPSP may deteriorate much faster than the failed ~~closed~~ flow control valve case. There is no method to predict when engine shutdown will occur. It is important to reach multiple engine-out capability and MECO conditions as soon as possible. The earliest MECO conditions and multiple engine-out capabilities are available during a TAL abort or an abort to an ACLS. If an intact abort is not performed, the risk of a bailout or other contingency condition will increase. [@J021199-6791A](#)

An abort will not be performed for two flow control valves failed closed or for a plugged GH₂ pressurization system leg. The flow control valves are normally open valves (must be powered closed). The close Ppower will cycle the valves as required to satisfy the ullage pressure control band (reference: Rule {A5.1.4-4}, LH₂ TANK PRESSURIZATION). It is assumed that the failure will occur during power cycling. With two valves failed closed, the third valve will not be power-cycled. Therefore, the third valve will remain open (unpowered) and nominal MECO conditions may be achieved by implementing Rule {A5.1.4-5}, LIMIT SHUTDOWN CONTROL AND MANUAL THROTTLING FOR LOW LH₂ NPSP. For a plugged GH₂ pressurization leg, the other two flow control valves will operate and nominal MECO conditions may be achieved by implementing Rule {A5.1.4-5}, LIMIT SHUTDOWN CONTROL AND MANUAL THROTTLING FOR LOW LH₂ NPSP. If three flow control valves are failed closed, a TAL abort will be selected. [@J040899-6818A](#)

THIS RULE CONTINUED ON NEXT PAGE

FLIGHT RULES

A5.1.4-6 ABORT PREFERENCE FOR SYSTEMS FAILURES

B. ENGINE-TO-ENGINE HELIUM INTERCONNECT

A TAL ABORT TO EITHER A TAL OR ACLS, BASED ON WHICHEVER PROVIDES THE EARLIEST MULTIPLE ENGINE-OUT CAPABILITY, WILL BE PERFORMED IF THE HELIUM SYSTEM FROM A RUNNING ENGINE IS INTERCONNECTED TO A LEAKING ENGINE HELIUM SUPPLY IN ORDER TO ACHIEVE INTACT ABORT CAPABILITY (REF. RULE {A5.1.4-2C}, PRE-MECO MPS HELIUM SYSTEM INTERCONNECTS (CIL) @[090894-1676A]

Because of the severity of the helium leak which requires the implementation of Rule {A5.1.4-2C}, PRE-MECO MPS HELIUM SYSTEM INTERCONNECTS (CIL), adequate helium may not be available to support three-engine operation to nominal MECO. In this case, it is possible that a non-leaking engine as well as the leaking engine could shut down due to inadequate helium. Therefore, it is important to reach multiple engine-out capability and MECO conditions as soon as possible. This will be accomplished by performing a TAL abort or an abort to an ACLS. @[090894-1676A] _
[@\[021199-6791A\]](#)

Rule {A5.1.1-14}, LH₂ ULLAGE LEAK, references this rule. @[040899-6818A]

FLIGHT RULES

A5.1.4-7 ET LOW LEVEL CUTOFF SENSOR FAILED DRY

THE FAILURE TO THE DRY STATE OF THREE OR MORE ET PROPELLANT LOW LEVEL SENSORS ON THE SAME TANK WILL REQUIRE A TAL ABORT TO BE PERFORMED (TO A TAL, OR ACLS IF NO TAL SITE IS AVAILABLE) IF UPHILL CAPABILITY DOES NOT EXIST (REF. RULE {A4.1.2-7H.1}, PERFORMANCE BOUNDARIES). A PREFLIGHT EVALUATION WILL BE REQUIRED TO DETERMINE UPHILL CAPABILITY FOR THIS FAILURE. [@021397-4824](#)

NOTE: THREE OR MORE "DRY" INDICATIONS WILL CAUSE PREMATURE MECO IF THE LOW LEVEL ARM COMMAND IS PRESENT PRIOR TO REACHING THE REQUIRED MECO TARGET. TWO SENSORS INDICATING "DRY" WILL NOT REQUIRE AN ABORT.

Propellant low level shutdown software is provided to protect the vehicle from an uncontrolled engine failure which would be caused by the depletion of either LO₂ or LH₂ propellant to a running engine. The software logic requires two qualified sensors to indicate dry after the arming mass is reached in order to start the low level timer and issue the MECO command. On the first pass after the arming mass is reached, the software will disable one dry low level sensor. On the next pass, the software will command MECO if two other low level sensors on the same tank are failed dry. Therefore, three sensors dry when the arming mass is reached will result in an early MECO which may require a TAL or ACLS abort. The failure of two sensors will not cause a premature MECO when the arming mass is reached, since one will be disabled. The crew will be required to abort TAL (or ACLS if no TAL site is available) on some performance-critical missions (as determined by flight design) to prevent a MECO from occurring in a region where no abort capability exists. [@021397-4824](#)

Rule {A2.1.6-1}, Note 31, CONTINGENCY ACTION SUMMARY, references this rule.

FLIGHT RULES

MPS MANAGEMENT: POST-MECO

A5.1.5-1 ET SEPARATION INHIBIT FOR 17-INCH DISCONNECT FAILURE (CIL)

A. NOMINAL

IF AN ET/ORBITER 17-INCH DISCONNECT VALVE IS NOT VERIFIED CLOSED, ET SEPARATION WILL BE DELAYED UNTIL MECO PLUS 6 MINUTES TO ALLOW THRUST DECAY FROM THE OPEN VALVE AND THUS PREVENT RECONTACT BETWEEN THE ET AND ORBITER. THE MPS PROPELLANT DUMP WILL BE AUTOMATICALLY PERFORMED DURING THE WAIT PERIOD. FOR AN UNDERSPEED AT MECO WHICH REQUIRES THE OMS-1 BURN TO BE PERFORMED PRIOR TO MECO PLUS 6 MINUTES, ET SEPARATION WILL BE PERFORMED AT OMS-1 TIG MINUS 1 MINUTE 30 SECONDS OR IMMEDIATELY IF REQUIRED, AND THE MPS DUMP WILL BE MANUALLY DELAYED UNTIL AFTER SEPARATION. @[030994-1618B]

BOTTOM-SUN WILL BE REQUIRED FOR THERMAL CONDITIONING (REFERENCE RULE {A10.1.13-3}, ET UMBILICAL DOOR CLOSURE DELAY FOR DISCONNECT VALVE FAILURE (CIL)). @[021199-6795A]

B. RTLS/TAL

ET SEPARATION IS AUTOMATIC FOR 17-INCH DISCONNECT VALVE FAILURE.

The ET separation sequence software in the GPC's will inhibit ET separation automatically if it does not receive at least one of the two close position indications from each of the orbiter 17-inch disconnect valves. The closed position indicators may not show closed for real valve failures or loss of insight. This prevents a recontact problem which could occur between the ET and the orbiter after separation due to the large venting force (>10,000 lbf) of the open 17-inch valve (reference SODB, volume 1, section 3.4.3.1).

THIS RULE CONTINUED ON NEXT PAGE

FLIGHT RULES

A5.1.5-1 ET SEPARATION INHIBIT FOR 17-INCH DISCONNECT FAILURE (CIL) (CONTINUED)

The crew will perform a manual separation 6 minutes after the nominal separation time. This waiting period allows the tank and the Orbiter manifold to vent to a level where the venting force < 1800 lbf, which is considered safe for separation (reference SODB, volume 1, section 3.4.3.1). For underspeeds at MECO, which require an OMS-1 to be performed prior to MECO plus 6 minutes, ET separation has to be performed 1 minute 30 seconds prior to OMS-1 ignition. The 1 minute 30 second time was selected to ensure that the crew had sufficient time to prepare for the OMS-1 ignition (reference SODB, volume 1, section 3.4.3.1). The MPS dump will be manually delayed by placing the MPS Propellant Dump Sequence Switch in the STOP position if the separation time would occur during the scheduled MPS dump. The switch is taken back to the GPC position after the ET SEP -Z translation to allow the automated MPS dump to commence. The MPS dump is delayed since performing the MPS dump during ET separation is not a certified separation mode. Time criticality during an RTLS and TAL aborts necessitates an automatic ET separation for OI-22 and subsequent software. The RTLS ET separation software allows 6 seconds of venting. Recontact damage will be risked on an RTLS to avoid rapid degradation of ET separation conditions and possible loss of control. The TAL ET separation software allows 15 seconds of venting to avoid recontact while minimizing the time to OPS 3 transition. TAL aborts incorporate an I-loaded software timer expiration (MSID V97U9717C) to sequence automatic ET separation while RTLS aborts use a hardcoded software constant for separation.

The LO₂ MPS manifold repressurization valves are not commanded open after a 17-inch LO₂ disconnect failure to prevent excessive loss of helium during the MPS dump. The LH₂ MPS manifold repressurization valves are not opened during this timeframe.

Rule {A10.1.13-3}, ET UMBILICAL DOOR CLOSURE DELAY FOR DISCONNECT VALVE FAILURE (CIL), references this rule. ©[021199-6795A]

A5.1.5-2 MPS PROPELLANT MANIFOLD OVERPRESSURE (CIL)

A. AN MPS PROPELLANT MANIFOLD OVERPRESSURE CONDITION (> 312 (249) PSIA FOR LO₂ OR > 66 (60) PSIA FOR LH₂) WILL BE RELIEVED BY THE FOLLOWING METHODS:

1. PRE-MPS DUMP
 - a. THE MPS PROPELLANT DUMP WILL AUTOMATICALLY BE STARTED IMMEDIATELY IF THE LH₂ MANIFOLD PRESSURE IS BETWEEN 60 AND 90 PSIA AND NOT COMMFAULTED.
 - b. IF THE LH₂ MANIFOLD PRESSURE EXCEEDS THE C&W LIMIT OF 65 PSIA OR THE LO₂ MANIFOLD PRESSURE EXCEEDS THE C&W LIMIT OF 249 PSIA, THE CREW WILL MANUALLY START THE MPS DUMP.

FLIGHT RULES

THIS RULE CONTINUED ON NEXT PAGE

FLIGHT RULES

A5.1.5-2 MPS PROPELLANT MANIFOLD OVERPRESSURE (CIL) (CONTINUED)

2. POST-MPS DUMP, PRE-MPS VACUUM INERT

THE LH₂ OUTBOARD FILL/DRAIN AND TOPPING VALVES WILL BE AUTOMATI-CALLY OPENED IF THE LH₂ MANIFOLD PRESSURE IS BETWEEN 60 AND 90 PSIA AND NOT COMMFAULTED. THE LH₂ OUTBOARD FILL/DRAIN AND TOPPING VALVES WILL AUTOMATICALLY BE CLOSED AT MPS DUMP START + 18 MINUTES. IF IT-THE OUTBOARD FILL/DRAIN DOES NOT FAILS-TO CLOSE, THE SOFTWARE WILL COMMAND THE LH₂ INBOARD FILL/DRAIN VALVE CLOSED. @[111094-1730A] @[021199-6792B]

3. POST-MPS VACUUM INERT

BOTH-THE AFFECTED LO₂ ORAND LH₂ OUTBOARD FILL/DRAIN VALVES WILL BE MANUALLY OPENED IMMEDIATELY. THISESE VALVES WILL BE CLOSED AFTER THE SYSTEM HAS BEEN INERTED.

An overpressure condition may be caused by dual failures in the LH₂ system. Because of the characteristics of the LO₂ system, it is highly unlikely that a real overpressure condition will occur without multiple (> 2) system failures. Heat soak back will vaporize any fluid propellants, increasing the pressure in the lines. On the LO₂ side, the pressure can be relieved by either the MPS propellant dump or vacuum inerting. On the LH₂ side, the pressure can be relieved by MPS propellant dump, vacuum inerting, or opening the LH₂ backup dump valves in OPS 1. An automatic dump will be performed to avoid reaching proof pressure (66 psig) if the software limit (greater than 60 psia and less than 90 psia) is reached before the scheduled MPS dump occurs. If either C&W limit is reached before the scheduled MPS propellant dump, a manual MPS dump will be performed as a backup to the software. If the LH₂ manifold pressure is between 60 and 90 psia after the MPS dump terminates but prior to the nominal automated vacuum inert start (dump start + 17 minutes),and prior to the automated LH₂-MPS vacuum inert, will be started by the software will open the LH₂-outboard fill/drain valve to inert the system and relieve the pressure. If either the LO₂ or LH₂ C&W limit is reached after the first vacuum inert, both the affected LO₂ and-or LH₂ outboard fill/drain valves will be opened manually to relieve the pressure. Only the outboards are opened since the inboards should already be open. Procedures in the Orbit Pocket Checklist have the crew open Both-outboards are opened-all the fill/drain valves since the crew does not have time to determine which system has the overpressure condition. The LO₂ manifold pressure C&W limit (249 psia) is approximately midway between the relief (190 psig) and proof (312 psig) pressures (ref. SODB, volume I, section 4.3). The LH₂ manifold pressure C&W limit (65 psia) is set to avoid having the crew and software both initiating the MPS dump although the system delays in starting the MPS dump could allow the LH₂ manifold pressure to exceed the C&W limit. Rule {A5.1.5 -5C}, NOMINAL, AOA, AND ATO MPS PROPELLANT DUMP FAILURES, references this rule. @[111094-1730A] @[021199-6792B]

FLIGHT RULES

THIS RULE CONTINUED ON NEXT PAGE

FLIGHT RULES

A5.1.5-2 MPS PROPELLANT MANIFOLD OVERPRESSURE (CIL) (CONTINUED)

- B. ~~IF THE LH₂ MANIFOLD PRESSURE TRANSDUCER FAILS BETWEEN GREATER THAN 60 AND 90 PSIA PRELAUNCH, THE MPS DUMP SWITCH WILL BE PLACED IN THE "STOP" POSITION PRIOR TO LIFTOFF (IF POSSIBLE). AFTER LIFTOFF, IF THE LH₂ MANIFOLD PRESSURE TRANSDUCER FAILS GREATER THAN 60 PSIA, IN THIS RANGE DURING POWERED FLIGHT, THE MPS DUMP SWITCH WILL BE TAKEN TO "STOP" PRIOR TO BETWEEN MECO CONFIRMED AND MECO CONFIRMED + 20 SECONDS PER A GROUND CALL. THE MPS DUMP SWITCH WILL BE PLACED IN "STARTGPC" AT AFTER ET SEPARATION (PREFERABLY NO EARLIER THAN APPROXIMATELY MECO + 2 MINUTES). TAKING THE DUMP SWITCH TO "STOP" IS NOT REQUIRED ON AN RTLS OR TAL ABORT. @021199-6792B1~~

If the manifold pressure transducer fails prelaunch or during powered flight in the range of 60-90 psia, the software will automatically start the MPS dump at MECO CONFIRMED + 20 seconds which may overlap with ET separation. An MPS dump during ET separation is currently an uncertified mode. By placing the MPS dump sequence switch in the STOP position, the automated dump is delayed until the switch is taken back to STARTGPC. The dump switch is taken to the ~~stop~~ STOP position for an LH₂ manifold pressure greater than 60 psia because a biased transducer could read above 90 psia during prelaunch or powered flight but would fall into the 60-90 psia range when the manifold pressure is reduced due to the backup dump valves opening or the loss of head from the ET. Taking the dump switch to the ~~stop~~ STOP position during powered flight on a RTLS or TAL abort would be ineffective because the software ignores the switch position. If the failure occurs during powered flight, the MPS dump sequence switch will not be moved until after MECO CONFIRMED to prevent inadvertently moving an engine power switch. After ET separation, the software will be allowed to initiate the MPS dump. Procedurally, waiting to move the switch back to the START position GPC until approximately MECO + 2 minutes prevents the MPS dump from perturbing the vehicle while the MCC is determining the state vector. The manifold overpressurization concern is only on the LH₂ system since hydrogen expands at a much faster rate than LO₂. Pressurization of LO₂ is much slower than LH₂ and has to reach a much higher pressure before line rupture will occur. Action (manual or automatic) for loss of the manifold pressure transducer on the LO₂ system is not required since there are no realistic failure modes in the LO₂ system which could cause a true pressure exceedance. If the LH₂ manifold pressure fails greater than 60 psia prelaunch, time permitting, KSC will direct the crew to place the MPS dump switch in the STOP position. - @021199-6792B1

Rule {A5.1.5-4B}, MANUAL MPS PROPELLANT DUMP, references this rule.

THIS RULE CONTINUED ON NEXT PAGE

FLIGHT RULES

A5.1.5-2 MPS PROPELLANT MANIFOLD OVERPRESSURE (CIL) (CONTINUED)

- C. IF THE LH₂ RELIEF ISOLATION VALVE FAILS CLOSED POST-MECO, THE LH₂ BACKUP DUMP VALVES WILL BE MANUALLY OPENED PRIOR TO ANY OMS BURN WITH A TIG BEFORE AUTOMATED VACUUM INERT START (APPROXIMATELY MECO + 19 MINUTES) MPS DUMP COMPLETION. [@\[021199-6792B\]](#)

If the LH₂ relief isolation valve does not open, the LH₂ manifold cannot be relieved through the relief isolation valve. The nominal pressure buildup post-MECO is not expected to reach the manifold relief setting with a nominal MPS dump and vacuum inert. If the manifold pressure builds up greater than 60 psia, the software will automatically start the MPS dump or vacuum inert to relieve the pressure. The backup dump valves will be manually opened if an OMS burn is expected to occur prior to the nominal automatic vacuum inert start time of approximately MECO + 19 minutes. The OMS burn will cause more sublimation of the LH₂ residuals than normal, resulting in a pressure buildup that may reach the relief setting. Although the software will automatically provide pressure relief if needed, the backup dump valves are opened to prevent the pressure rise from nearing the proof pressure of the manifold (66 psig). The valves will be left open and the software will command the valves closed upon transition to OPS2 or OPS3.

- D. IF AUTOMATIC LH₂ VENT, DUMP, AND RELIEF CAPABILITY IS LOST AS A RESULT OF DUAL GPC/FA MDM FAILURES (GPC'S/FA MDM'S 1 AND 3, 1 AND 4, OR 3 AND 4), THE CREW WILL MANUALLY OPEN THE LH₂ RELIEF ISOLATION VALVE IMMEDIATELY POST-MECO.

Certain dual GPC/FA MDM failure combinations occurring during ascent will prevent the LH₂ relief isolation valve as well as the LH₂ backup dump valves and LH₂ fill/drain valves from opening after MECO. Without a relief path, the LH₂ manifold pressure will rapidly rise to a dangerous pressure level in seconds. During the STS-1 flight, where the LH₂ backup dump valves were not commanded open at 10.4 seconds after MECO as they are now, the LH₂ manifold pressure went from 34 psig before 17-inch disconnect closure to the 44 - 50 psig relief band within 15 seconds. The LH₂ manifold burst pressure is 83 psig. The crew can manually open the LH₂ relief isolation valve with a single switch throw on panel R4. Pressure rise on the LO₂ side is not a major concern as a result of the slower pressure rise rate, higher manifold burst pressure, and the available leak path through the SSME oxidizer pump seal packages. For any dual GPC/FA MDM failures, the onboard procedure has the crew take both the LO₂ and LH₂ relief isolation valve switches to open for procedural simplicity (other dual failure cases require the LO₂ relief isolation valves to be manually opened). [@\[030994-1618B\]](#) [@\[021199-6792B\]](#)

FLIGHT RULES

A5.1.5-3 POST-MECO AND ENTRY HELIUM ISOLATION

A. MPS ENGINE OR PNEUMATIC HELIUM REGULATOR PRESSURE > 800 (810) PSIA AND THE: @021199-6787B]

1. VENT DOORS CLOSED: CLOSE THE ASSOCIATED MPS HELIUM ISOLATION VALVE ASAP.
2. VENT DOORS OPEN: CLOSE THE ASSOCIATED MPS HELIUM ISOLATION VALVE AS TIME PERMITS.

Analysis indicates an MPS helium regulator failed open can cause an overpressurization of the aft compartment in approximately 17 seconds if the vent doors are closed. This overpressurization will not result in a loss of the vehicle. However, the safety factor for the 1307 Bulkhead will be reduced to 1.31 during entry and structural damage will likely occur which will require the vehicle to be taken out of service for thorough inspection and refurbishment as necessary (reference Rockwell International Analysis PCIN R76186, July 15, 1988).

Crew action is required above 800 psig when the relief valve begins to flow helium into the aft compartment. Since any action will be taken where the ambient pressure is near zero psia, 800 psia will be equivalent to 800 psig. Crew caution and warning is set to 810 psia for the MPS helium regulator pressures. 810 psia is sufficiently close to 805 psia (the relief valve cracking pressure of 800 psig plus 5 psia for transducer accuracy) that action can be taken at the crew caution and warning cue while still maintaining adequate margin to 850 psig where the relief valve goes full open.

With the vent doors open, no action is required. The vent doors close on a TAL at ET SEP command. During an RTLS, the vent doors close at the MM 602 transition. During the nominal or ATO entry, the vent doors close at the transition to MM 304. During an AOA, the vent doors are manually closed just prior to the MM 304 transition. For all of these entry profiles, the vent doors open at Mach 2.4.

Entry MPS helium regulator shifts are most likely to occur during periods of high flow demand such as when the MPS helium isolation valves open at the transition to MM 303 or when the MPS helium blowdown valves open at Mach 5.3. For simplicity, the crew procedure for MPS helium regulator shifts call for the immediate isolation of the associated MPS helium isolation valve(s) on entry prior to Mach 2.4. After Mach 2.4, MCC may direct the crew to close the associated MPS helium regulator valves, time permitting. Training in the nominal helium leak isolation procedure will allow the crew to react to the caution and warning system in less than 15 seconds. @021199-6787B]

THIS RULE CONTINUED ON NEXT PAGE

FLIGHT RULES

A5.1.5-3

POST-MECO AND ENTRY HELIUM ISOLATION

B. FOR ALL OTHER POST-MECO AND ENTRY HELIUM OR PNEUMATIC SYSTEM LEAKS, THE SYSTEM WILL BE ISOLATED AS TIME PERMITS. POST-ISOLATION, AN ATTEMPT WILL BE MADE TO MANUALLY RECONFIGURE THE MPS HELIUM SYSTEM TO SUPPORT THE ENTRY PURGE IF TIME PERMITS. @021199-6787B]

If a leak occurs on an engine or pneumatic helium system, the affected system will be isolated as time permits. Helium is required for manifold pressurization during the MPS dump and entry, for valve actuation, and for the entry aft compartment purge. Since the crew has no insight into the configuration of the MPS helium system interconnect valves, it is likely that the crew will need assistance from MCC in order to isolate any post-MECO helium leak. These procedures may be complicated and will be performed as time permits.

For nominal missions, if a leak occurs prior to the MPS dump, the leak may be isolated and the helium system subsequently reconfigured to support the MPS dump. On entry, if time permits after the leak is isolated, the helium system may be manually reconfigured to support the entry purge. The entry purge is highly desirable for the nominal end of mission but is considered mandatory during aborts. If a hazardous gas leak is evident in the aft compartment or OMS pods, the entry purge will be required. Also, contamination may be ingested into the evacuated MPS manifolds if the helium pressurization is not performed. The contamination in the lines would require cleaning before the next flight which would increase the vehicle's turnaround time.

During an RTLS abort, post-MECO isolation may not be performed. Because of the limited flight duration and the crew workload, there may not be adequate time to reconfigure the MPS helium system to support the entry purge.

C. IF ALL CAUTION AND WARNING IS LOST FOR ANY MPS HELIUM REGULATOR PRESSURE TRANSDUCER(S):

1. NOMINAL/ATO:

a. PRIOR TO MACH 2.4: MCC WILL HAVE THE CREW CLOSE THE ASSOCIATED MPS HELIUM ISOLATION VALVE(S).

b. AFTER MACH 2.4: NO ACTION REQUIRED. @021199-6787B]

THIS RULE CONTINUED ON NEXT PAGE

FLIGHT RULES

A5.1.5-3

POST-MECO AND ENTRY HELIUM ISOLATION

2. AOA/TAL/RTL: NO ACTION REQUIRED. ©[021199-6787B]

Without hardware or software caution and warning, it is unlikely that MCC could diagnose an MPS helium regulator failed open and tell the crew to close the associated MPS helium isolation valve before the aft compartment is overpressurized (17 seconds). For a nominal or ATO entry, if hardware and software caution and warning is unavailable, the crew will preemptively close the associated MPS helium isolation valve(s). Caution and warning may be lost due to the loss (or bias) of the MPS helium regulator pressure transducer, loss of the associated OI DSC or OI MDM, or loss of the BFS.

After the vent doors open at Mach 2.4, the overpressurization of the aft compartment is no longer a concern and preemptively closing the MPS helium isolation valve(s) to protect for a potential MPS helium regulator failed open is not required. Preemptive helium isolation is also not required on the AOA, TAL, or RTL entry. Protecting for the additional, unrelated failure of an MPS helium regulator following the loss of caution and warning will not be performed because of the relatively short exposure period and high crew workload during aborts.

Preemptive closure of MPS helium isolation valves for the loss of caution and warning will require an MCC call except for a failure of the BFS GPC. The BFS FAIL crew procedure in the Entry Pocket Checklist and Ascent/Entry Systems Procedures directs the crew to close the MPS helium B isolation valves and the pneumatic helium isolation valves since caution and warning for these pressure transducers is only available in the BFS. This procedure does not differentiate between a nominal and abort entry profiles. ©[021199-6787B]

FLIGHT RULES

THIS PAGE INTENTIONALLY BLANK

FLIGHT RULES

A5.1.5-4 MANUAL MPS PROPELLANT DUMP

THE MPS DUMP WILL BE MANUALLY DELAYED BY TAKING THE MPS DUMP SWITCH TO "STOP" UNTIL AFTER ET SEPARATION FOR THE FOLLOWING FAILURE CASES IN ORDER TO AVOID PERFORMING THE DUMP DURING THE SEPARATION:

- A. AFT RCS LEAK.
- B. FORWARD RCS LEAK.
- C. MPS FEEDLINE DISCONNECT FAILURE(S) WITH AN OMS-1 TIG PRIOR TO MECO + 6 MINUTES.
- D. ET SEPARATION SWITCH FAILED IN THE "MAN" POSITION AND LH₂ MANIFOLD PRESSURE TRANSDUCER FAILED BETWEEN 60-90 PSIA. ©[071494-1657]

Since performing the MPS dump during ET separation is uncertified, action will be taken to avoid having the two events coincide due to concerns of orbiter-ET recontact. The cases involving the RCS leaks and the feedline disconnect failure(s) are covered by crew procedures. The ET SEP-MAN case was considered to be too unlikely to be specifically covered by the crew procedures, but is covered by the action taken per Rule {A5.1.5-2B}, MPS PROPELLANT MANIFOLD OVERPRESSURE. ©[071494-1657]

A5.1.5-5 NOMINAL, AOA, AND ATO MPS PROPELLANT DUMP FAILURES

- A. MPS DUMP SWITCH FAILURE - IF THE DUMP SWITCH IS NEEDED TO DELAY THE MPS DUMP AND IS UNAVAILABLE DUE TO A CONTROL BUS FAILURE, THE AFFECTED CONTACT WILL BE COMM FAULTED BY POWER CYCLING THE APPROPRIATE MDM PER THE TABLE BELOW. ©[021397-4825]

<u>SW CONTACT</u>	<u>CONTROL BUS</u>	<u>MDM</u>
A	AB3	FF1
B	BC3	FF2

FLIGHT RULES

The MPS dump sequence switch can no longer be used to manually control the dump if the switch fails redundancy management. The dump switch is only used as a backup to starting the dump for an LH₂ manifold overpressure case or to delay the automated dump until after ET separation. If the dump switch is needed to delay the MPS dump and one of the contacts is failed due to loss of either control bus AB3 or BC3, the affected contact could be taken out of the switch RM logic by ~~power cycling comm faulting~~ either MDM FF1 or FF2. The MDM could be recovered as soon as the dump switch is moved after ~~this the comm fault~~ procedure is worked. Rule {A5.1.5-6A}, MANUAL VACUUM INERTING REQUIREMENTS (NOMINAL, ATO, AOA) references this rule.

@[111094-1720B] [@\[021397-4825\]](#)

THIS RULE CONTINUED ON NEXT PAGE

FLIGHT RULES

A5.1.5-5 NOMINAL, AOA, AND ATO MPS PROPELLANT DUMP FAILURES (CONTINUED)

B. LH₂ DUMP FAILURES - AN LH₂ DUMP WILL BE PERFORMED BY MANUALLY OPENING THE LH₂ BACKUP DUMP VALVES FOR ANY OF THE FOLLOWING FAILURES:

1. LH₂ OUTBOARD FILL/DRAIN VALVE FAILURE TO OPEN.
2. LH₂ INBOARD FILL/DRAIN VALVE FAILURE TO OPEN.

The LH₂ propellant dump is a 120-second unpressurized dump through the LH₂ fill/drain valves, the LH₂ topping valve, and the LH₂ backup dump valves. If the LH₂ outboard fill/drain valve fails closed during the dump, approximately 57 lbm of hydrogen will remain at the end of the dump. If the LH₂ inboard valve fails closed, approximately 6 lbm of hydrogen will remain. For these cases, the LH₂ backup dump valves will be taken to the open position until the transition to OPS 2. This will allow all but 3 lbm of hydrogen to be vented off. At the 3 lbm point, the hydrogen is below the triple point and removal of remaining hydrogen is not possible. Upon transition to OPS 2 or 3, the LH₂ back up dump valves will be commanded closed and the sublimation of LH₂ will cause the manifold pressure to increase. If the LH₂ relief valve is failed closed (max. cracking pressure 55 psig), the manifold pressure may exceed 100 psia. This pressure is above the 83 psia burst pressure of the manifold and will require the crew to pro to OPS 303 via OPS 301. This will allow the software to open the LH₂ backup dump valves. Once the manifold pressure returns to normal, the vehicle may be transitioned back to OPS 2. Currently, no ops code exists to open the LH₂ backup dump valves via real-time command (RTC), and due to the fact that the pressure will rise from the max relief setting to the burst pressure in a relatively short amount of time (approximately 1.0 hours), the decision was made not to pursue a GPC memory read/write (GMEM). In the case of an AOA, the manifold pressure should not reach burst pressure prior to the OPS 303 transition. ©[111094-1720B]

C. LO₂ DUMP FAILURES - IF AN INCOMPLETE LO₂ DUMP OCCURS, THE SOFTWARE WILL NOT PERFORM THE LO₂ VACUUM INERT IF THE LO₂ MANIFOLD PRESSURE IS COMM_FAULTED OR UNTIL IT VENTS BELOW 30 PSIA. IF THE PRESSURE DOES DECAY PRIOR TO THE END OF THE 1-MINUTE AUTOMATED MPS LH₂ VACUUM INERT PROCEDURE, THE SOFTWARE WILL INITIATE THE MPS LO₂ VACUUM INERT. OTHERWISE, THE CREW WILL MANUALLY PERFORM THE LO₂ VACUUM INERT AFTER THE MANIFOLD PRESSURE HAS VENTED BELOW 30 PSIA (AS DESCRIBED IN RULE {A5.1.5-6}, MANUAL VACUUM INERTING REQUIREMENTS (NOMINAL, ATO, AOA)). ©[111094-1730A] [@\[021397-4825\]](#)

The LO₂ is dumped through the SSME main oxidizer valves. There is no secondary dump path available during the dump. However, after dump termination, residuals will vent through the engine high pressure oxidizer pump seals, and the relief system will protect the manifold from overpressurization.

THIS RULE CONTINUED ON NEXT PAGE

FLIGHT RULES

A5.1.5-5 NOMINAL, AOA, AND ATO MPS PROPELLANT DUMP FAILURES (CONTINUED)

LO₂ manifold pressure will be less than 30 psia if a propellant dump was performed successfully. However, if two or three engine main oxidizer valves were not able to open for the dump, the residual oxidizer could result in a manifold pressure greater than 30 psia. Opening the LO₂ fill/drain valves when the manifold pressure is greater than 30 psia will cause the vehicle to roll significantly as was experienced during a dump detailed test objective on STS 51-D. The roll was due to the oxidizer flow force at the LO₂ outboard fill/drain valve and flow impingement on the wing. Manually opening the fill/drain valves will not be delayed if the manifold pressure is high enough to trigger the crew alert of 249 psia (refer to Rule {A5.1.5-2}, MPS PROPELLANT MANIFOLD OVERPRESSURE).

The reason the LO₂ vacuum inerting can be delayed is that the LO₂ prevalves remain open after the dump which allows the pressure to vent through the engine high pressure oxidizer pump seals. After the pressure decays below 30 psia, the software or crew can then perform vacuum inerting without any vehicle control problems. The software can only perform the automated LO₂ vacuum inert between MPS Dump Start +17 minutes and MPS Dump Start + 18 minutes. For a nominal and ATO mission, there should be sufficient time to allow the pressure decay and then perform the LO₂ vacuum inert. However, on an AOA, there may not be sufficient time to vent below 30 psia. For this case, the LO₂ manifold will be inerted automatically in MM 304 by the MPS entry dump sequence. Rule {A5.1.5-6C}, MANUAL VACUUM INERTING REQUIREMENTS (NOMINAL, ATO, AOA) references this rule. ©[111094-1720B] ©[111094-1730A]

A5.1.5-6 MANUAL VACUUM INERTING REQUIREMENTS (NOMINAL, ATO, AOA)

- A. FOR NOMINAL/ATO MISSIONS, A MANUAL LO₂ VACUUM INERTING WILL BE PERFORMED BY THE CREW IF THE LO₂ MANIFOLD PRESSURE IS GREATER THAN 30 PSIA AFTER THE SCHEDULED TERMINATION OF THE AUTOMATED LH₂ VACUUM INERTING. MANUAL LO₂ VACUUM INERTING WILL BE PERFORMED WHEN THE LO₂ MANIFOLD PRESSURE VENTS BELOW 30 PSIA. REFERENCE A5.1.5-5A, NOMINAL, AOA, AND ATO MPS PROPELLANT DUMP FAILURES. ©[111094-1718A]

If the LO₂ manifold pressure is greater than 30 psia (but less than 312 (249) psia) (ref. Rule {A5.1.5-2}, MPS PROPELLANT MANIFOLD OVERPRESSURE (CIL)), the software will not perform the LO₂ vacuum inerting unless the manifold pressure vents below 30 psia within 1 minute after the start of the LH₂ vacuum inert. If the LO₂ automatic vacuum inert is not performed, the crew will manually perform the inert after the LO₂ pressure has decayed below 30 psia (reference Rule {A5.1.5-5}, NOMINAL, AOA, AND ATO MPS PROPELLANT DUMP FAILURES, for rationale regarding the 30 psia constraint).

THIS RULE CONTINUED ON NEXT PAGE

FLIGHT RULES

5.1.5-6 MANUAL VACUUM INERTING REQUIREMENTS (NOMINAL, ATO, AOA) (CONTINUED)

- B. ON A SYSTEMS AOA, THE MANUAL MPS VACUUM INERT PROCEDURE MAY BE REQUIRED IF OPS 3 IS ENTERED PRIOR TO INITIATION OF THE AUTOMATIC MPS VACUUM INERT.

On a systems AOA, there may not be sufficient time for the software to initiate the vacuum inert and the crew must manually perform the vacuum inert to insure no residuals, since no entry dump/inert will be performed.

- C. FOR ANY GPC, FA MDM, OR BCE STRING 2C FAILURE, THE MANUAL MPS VACUUM INERT WILL BE PERFORMED. THIS WILL BE DONE AFTER MPS DUMP STOP + 20 MINUTES AND THE LO₂ MANIFOLD PRESSURE IS LESS THAN 30 PSIA. ADDITIONALLY, THE LH₂ BACKUP DUMP VALVES MAY BE USED TO INERT THE LH₂ SYSTEM IN OPS 1, IF THE LH₂ OUTBOARD FILL/DRAIN OR LH₂ INBOARD FILL AND DRAIN VALVES DO NOT OPEN. REFERENCE A5.1.5-5B, NOMINAL, AOA, AND ATO MPS PROPELLANT DUMP FAILURES. ©[092195-1791]

This is done due to loss of GPC command capability to at least one fill/drain valve or verification of the LO₂ manifold pressure. Any LO₂ inlet pressure can be used by the MCC as a backup to the LO₂ manifold pressure if the corresponding LO₂ pre valve is open. The crew's manifold pressure meter on panel F7 should also be available to determine the LO₂ manifold pressure. If manual action to open the LH₂ fill/drain valves is unsuccessful, the system can be inerted by opening the LH₂ backup dump valves. However, because the backup LH₂ switch is read by software only in GNC OPS 1, the valves must be opened prior to leaving OPS 1. ©[ED]

- D. IF A MANUAL VACUUM INERTING IS REQUIRED, THE MCC WILL REQUEST, WHENEVER POSSIBLE, THAT THE CREW PERFORM THE PROCEDURE ON THE AFFECTED SYSTEM(S) ONLY LO₂/LH₂. ©[111094-1718A]

Although several crew LO₂/LH₂ vacuum inerting procedures are integrated in order to cover single failure cases which affects both systems, it is preferable that the procedures be performed on only the affected system(s) whenever possible. Performing the manual vacuum inert for only the affected system will minimize cycling of the MPS fill/drain valves and should, consequently, maximize the useful life of the MPS hardware. ©[111094-1718A] ©[ED]

FLIGHT RULES

A5.1.5-7 REPEAT MPS VACUUM INERT

THE MPS VACUUM INERTING WILL BE REPEATED ON ORBIT FOR SUSPECTED LO₂ OR LH₂ RESIDUALS. THE APPARENT INCREASE IN THE LH₂ OR LO₂ MANIFOLD AND INLET PRESSURES IS NOT SUFFICIENT JUSTIFICATION TO REPEAT THE PROCEDURE DUE TO THE INHERENT THERMAL DRIFT IN THESE TRANSDUCERS.

Vacuum inerting will be repeated if propellants are believed to remain in the manifolds. Propellant remaining could be the result of an incomplete MPS dump or vacuum inert, or of frozen propellants becoming trapped in screens and/or crevices in the MPS manifolds.

Thermal drift of the transducers under non-cryogenic conditions may cause false indications of a pressure rise which does not exist. The transducers are vehicle-unique; therefore, previous flight data is used to determine the thermal drift. In addition, preflight ambient transducer readings are used to determine real manifold pressures.

A5.1.5-8 LH2 PRESSURIZATION VENT CONTROL

~~THE LH₂ PRESSURIZATION LINE VENT MUST BE CLOSED AT LEAST 30 SECONDS PRIOR TO ET/ORBITER UMBILICAL DOOR CLOSURE.~~ AFTER THE ET/ORBITER UMBILICAL DOOR IS CLOSED, THE LH₂ PRESSURIZATION LINE VENT WILL NOT BE OPENED TO AVOID VENTING LH₂ INTO THE UMBILICAL CAVITY. [@J021199-6793.1](#)

Damage to the door or cavity may occur if the LH₂ pressurization line vent is opened while line pressure is high and the vent door is closed (ref. SODB, volume I, section 3.4.3.1-6.).

A5.1.5-9 ENTRY MPS HELIUM PURGING FOR CRITICAL VEHICLE POWER/COOLING

THE ENTRY MPS HELIUM PURGE AND MANIFOLD REPRESSURIZATION WILL BE INHIBITED FOR CRITICAL POWER/COOLING CASES (I.E., LOSS OF TWO FUEL CELLS OR TWO FREON LOOPS). THE ENTRY PURGE WILL BE PERFORMED FOR RTLS AND TAL ABORT CASES.

The loss of two Freon loops or the loss of two fuel cells will require that critical power and cooling be conserved. For these failure cases, power reductions in all systems are required to accomplish a safe entry. MPS valves that are normally closed valves will be positioned to the CLOSE position.

This reconfiguration will save approximately 234 watts. The lack of repressurization during entry may result in contamination of the MPS propellant lines requiring cleaning during vehicle turnaround.

FLIGHT RULES

The MPS entry purge for RTLS and TAL abort cases is required to purge the system of hazardous residual MPS propellants.

FLIGHT RULES

A5.1.5-10

ENTRY MPS PROPELLANT DUMP FAILURES (CIL)

©[020196-1813A]

A. NOMINAL/ATO/AOA/TAL:

IF ONE DUMP PATH FOR EACH PROPELLANT IS ABLE TO DUMP RESIDUALS, NO ACTION IS REQUIRED. IF NO DUMP PATHS ARE AVAILABLE, THE REQUIRED ACTION DEPENDS UPON THE FOLLOWING:

1. NOMINAL/ATO:

NO ACTION IS REQUIRED.

During nominal/ATO missions, automatic software or crew procedures will insure dumping and/or inerting of the LO₂ and LH₂ residuals prior to entry. A complete LH₂ dump can be done if either the LH₂ backup dump valves or LH₂ fill/drain valves are open. A complete LO₂ dump can be done if two or three SSME's perform LO₂ dumps, or if the LO₂ fill/drain valves are both open (reference Rockwell Internal Letter no. 287-104-87-004, dated January 8, 1987).

2. AOA/TAL:

- a. LH₂ - IN MM 304, IF GPC/MDM FAILURES CAUSE ALL LH₂ DUMP PATHS TO BE LOST, THE AFFECTED LH₂ FILL/DRAIN VALVE(S) WILL BE MANUALLY OPENED. IF THE SOFTWARE CANNOT CLOSE THE LH₂ OUTBOARD FILL/DRAIN OR THE LH₂ INBOARD FILL/DRAIN AND TOPPING VALVES, AN ATTEMPT WILL BE MADE TO MANUALLY CLOSE THE LH₂ OUTBOARD FILL/DRAIN VALVE AFTER DUMP COMPLETION, BUT PRIOR TO A RELATIVE VELOCITY (V_{REL}) OF 5300 FT/SEC.

In the LH₂ system, there are single GPC/MDM failures which result in the loss of GPC control of the LH₂ fill/drain valves and the LH₂ topping valve. In these cases, the affected LH₂ fill/drain valve(s) will be manually opened on a TAL only if the LH₂ backup dump valves are not open. Sufficient time exists to dump LH₂ residuals through the backup LH₂ valves for AOA or TAL aborts, leaving approximately 3 lbs of hydrogen residuals (per Rockwell International internal letter 287-100-94-164, dated August 9, 1994). There are also combinations of GPC/MDM failures which result in the loss of all LH₂ dump paths. On a TAL abort, the crew will manually open the affected LH₂ fill/drain valve(s). The LH₂ backup dump valves cannot be manually opened in these cases because the switch is software driven and only read in OPS 1. An attempt will be made to close the LH₂ outboard fill/drain valves in order to preserve helium for the aft compartment purge and to prevent contamination of the LH₂ manifold. The velocity cue used to close the valve represents an altitude at which possible ignition of residual LH₂ can occur. ©[111094-1730A]

THIS RULE CONTINUED ON NEXT PAGE

FLIGHT RULES

A5.1.5-10

ENTRY MPS PROPELLANT DUMP FAILURES (CIL)
(CONTINUED)

- b. LO₂ - IN MM 304, IF GPC/MDM FAILURES CAUSE LOSS OF ONE OF THE FILL/DRAIN VALVES AND LESS THAN TWO SSME'S ARE ABLE TO DUMP LO₂, THE AFFECTED LO₂ FILL/DRAIN VALVE WILL BE MANUALLY OPENED WHEN MACH < 20 AND THE FIRST ROLL MANEUVER IS COMPLETED. IF THE SOFTWARE CANNOT CLOSE EITHER THE LO₂ INBOARD OR OUTBOARD FILL/DRAIN VALVES, AN ATTEMPT WILL BE MADE TO MANUALLY CLOSE THE LO₂ OUTBOARD FILL/DRAIN VALVE AFTER DUMP COMPLETION, BUT PRIOR TO A V_{REL} OF 5300 FT/SEC.

In the LO₂ system, there are single GPC/MDM failures which result in the loss of GPC control of the LO₂ fill/drain valves. In these cases, the affected LO₂ fill/drain valve(s) will be opened manually on a TAL if less than two SSME's are able to dump LO₂. The manual opening of the fill/drain valve(s) must be performed when there is sufficient control authority of the vehicle aerosurfaces to provide vehicle control. The Mach cue used to manually open the valve(s) is the same as the one used in the GPC software. An attempt will be made to close the LO₂ outboard fill/drain valve in order to preserve helium for the aft compartment purge and to prevent contamination of the LO₂ manifold. The velocity cue used is the same as that for LH₂, per paragraph A2a, for procedural simplicity.

B. RTLS:

1. LH₂ - IN MM 602, IF A DUMP PATH IS UNAVAILABLE THROUGH THE LH₂ INBOARD AND OUTBOARD FILL/DRAIN VALVES DUE TO GPC/MDM FAILURES, THE AFFECTED LH₂ FILL/DRAIN VALVE(S) WILL BE MANUALLY OPENED TO INSURE THIS DUMP PATH IS AVAILABLE. IF THE SOFTWARE CANNOT CLOSE EITHER THE LH₂ OUTBOARD FILL/DRAIN VALVE OR THE LH₂ INBOARD FILL/DRAIN AND TOPPING VALVES, AN ATTEMPT WILL BE MADE TO MANUALLY CLOSE THE LH₂ OUTBOARD FILL/DRAIN VALVE AFTER DUMP COMPLETION, BUT PRIOR TO A V_{REL} OF 3800 FT/SEC.

NOTE: AN EXPEDITED POWERDOWN/MODE V EGRESS WILL BE REQUIRED IF A DUMP PATH THROUGH THE LH₂ FILL/DRAIN VALVES CAN NOT BE ACQUIRED (REFERENCE RULE {A16.1.1-11F}, EXPEDITED POWERDOWN). @[020196-1813A]

THIS RULE CONTINUED ON NEXT PAGE

FLIGHT RULES

A5.1.5-10

ENTRY MPS PROPELLANT DUMP FAILURES (CIL)
(CONTINUED)

In the LH₂ system, there are GPC/MDM failures which result in the loss of GPC control of the LH₂ fill/drain valves and the LH₂ topping valve. The failure of the LH₂ outboard fill/drain valve will result in an incomplete LH₂ dump on RTLS aborts. Analysis has shown that approximately 40.8 pounds of LH₂ residuals will remain in the MPS LH₂ manifold if the only LH₂ dump path is through the backup LH₂ valves (reference Rockwell internal letter 287-100-04-164, dated August 9, 1994). Venting LH₂ residuals will preclude normal convoy operations (reference rule {A16.1.1-11F}, EXPEDITED POWERDOWN). In order to avoid this ground hazard, the affected LH₂ fill/drain valve(s) will be opened. An attempt will be made to close the LH₂ outboard fill/drain valves in order to preserve helium for the aft compartment purge and to prevent contamination of the LH₂ manifold. The velocity cue used to close the LH₂ outboard fill/drain valve represents an altitude at which possible ignition of residual LH₂ can occur. ©[111094-1730A]

2. LO₂ - IN MM 602, IF EITHER OF THE LO₂ FILL/DRAIN VALVES IS FAILED CLOSED DUE TO A GPC/MDM FAILURE AND LESS THAN TWO SSME'S ARE ABLE TO DUMP LO₂, THE AFFECTED LO₂ FILL/DRAIN VALVE(S) WILL BE MANUALLY OPENED WHEN Q-BAR IS GREATER THAN 20 PSF AND A MISSION SPECIFIC TIMER HAS EXPIRED. IF THE LO₂ INBOARD OR OUTBOARD VALVE IS NOT CONFIRMED CLOSED AT THE END OF THE LO₂ DUMP, AN ATTEMPT WILL BE MADE TO MANUALLY CLOSE THE LO₂ OUTBOARD FILL/DRAIN VALVE AT A V_{REL} OF 3800 FT/SEC.

In the LO₂ system, there are single GPC/MDM failures which result in the loss of GPC control of the LO₂ fill/drain valves. In these cases, the fill/drain valves will be opened manually on a RTLS if less than two SSME's are able to dump LO₂. The manual opening of the fill/drain valves must be performed when there is sufficient control authority of the vehicle aerosurfaces to provide vehicle control. The cue used to manually open the valves is the same as the one used in the GPC software. For most flights, the mission specific timer value is set to 0 seconds. For other missions which are c.g. critical, the opening of the MPS LO₂ inboard and outboard fill/drain valves are delayed until an I-loaded timer value (66 seconds) expires after the 20 psf Q-bar cue is reached. The LO₂ mass remaining in the LO₂ manifold moves the vehicle's center of gravity aft during entry, thereby increasing stability for specific RTLS aborts. An attempt will be made to close the LO₂ outboard fill/drain valves in order to preserve helium for the aft compartment purge and to prevent contamination of the LO₂ manifold. The velocity cue used is the same as that for LH₂, per paragraph B1, for procedural simplicity.

FLIGHT RULES

A5.1.5-11 MPS DUMP INHIBIT (CIL) @020196-1813A]

A. INSIGHT INTO ENGINE INLET CONDITIONS AVAILABLE:

IF A PROPELLANT LEAK IS DETECTED PRE-MECO ON ANY ENGINE WHICH SHUTS DOWN (MANUAL OR CONTROLLER INITIATED) PRIOR TO MECO, IT WILL BE ISOLATED FROM DUMPING IMMEDIATELY FOLLOWING MECO. THIS DUMP INHIBIT DECISION WILL BE BASED ON THE FOLLOWING:

1. LO₂ INLET PRESSURE < 40 PSIA,

FOR A DUMP INHIBIT OF THE LO₂ SYSTEM, AN EARLY APU SHUTDOWN WILL BE REQUIRED FOR TAL AND RTLS ABORTS (REFERENCE FLIGHT RULE {A16.1.5-5A}, EARLY APU SHUTDOWN) . @020196-1813A]

2. LH₂ INLET PRESSURE < 30 PSIA.

FOR A DUMP INHIBIT OF THE LH₂ SYSTEM, AN EMERGENCY POWERDOWN/MODE V EGRESS WILL BE REQUIRED FOR TAL AND RTLS ABORTS (REFERENCE FLIGHT RULES {A16.1.1-12B.2}, EMERGENCY POWERDOWN). AN EARLY APU SHUTDOWN WILL OCCUR AS A RESULT OF THE EMERGENCY POWERDOWN. @020196-1813A]

FLIGHT RULES

For nominal, RTLS, TAL, ATO, and AOA missions, the dump inhibit will be performed immediately post-MECO on the affected SSME if insight into the engine inlet conditions is available and the above criteria are met. The dump inhibit is performed by manually closing the associated prevalve and powering down that engine's controller. To minimize dump and vacuum inert impacts, only the associated prevalve will be closed on the side which was determined to be leaking. The engine controller is powered off to close the bleed and hydraulic valves. These actions will prevent excessive leakage of propellant into the aft compartment during the MPS propellant dump, thereby minimizing a potentially hazardous condition in the aft compartment (reference the PSIG Flight Rule Review of 2/25/88). Causes for early shutdown include redline limit shutdown, multiple loss of controller avionics, and manual shutdown for a MPS helium leak, a hydraulic or electrical lockup, or a command path failure. Since flight data indicates that the pump inlet pressures drop below the above limits after MECO, an engine propellant leak cannot be detected if a low level cutoff occurs. The low pressure fuel pump discharge pressure can be used as a backup to the LH₂ inlet pressure and would also use 30 psia as the dump inhibit criterion. If a breach of one or more of the LH₂ propellant lines has occurred, the possibility exists of uncontained/uncontrolled LH₂ propellant in the aft, which constitutes a flammability and explosion hazard on a RTLS or TAL abort. This condition requires the most expeditious powerdown of the vehicle (emergency powerdown) and crew egress (Mode V) possible. An LO₂ leak is not considered as hazardous as an LH₂ leak and therefore does not require an emergency powerdown and Mode V egress. However, both kinds of leaks do warrant an early APU shutdown after an RTLS or TAL abort in order to eliminate an ignition source in a hydrogen or oxygen enriched environment. These postlanding actions are not required after a nominal, ATO, or AOA mission since no uncontained residuals will remain in the aft compartment at the time of landing.

THIS RULE CONTINUED ON NEXT PAGE

FLIGHT RULES

A5.1.5-11 MPS DUMP INHIBIT (CIL) (CONTINUED)

Rules {A16.1.1-12B.2}, EMERGENCY POWERDOWN, and {A16.1.5-5A}, EARLY APU SHUTDOWN, reference this rule. ©[020196-1813A]

B. INSIGHT INTO ENGINE INLET CONDITIONS UNAVAILABLE:

1. NOM/ATO/AOA:

FOR ANY ENGINE WHICH SHUTS DOWN (MANUAL OR CONTROLLER INITIATED) PRIOR TO MECO, THE MPS DUMP INHIBIT WILL BE PERFORMED IMMEDIATELY POST-MECO ON THE PROPELLANT SYSTEM(S) ON WHICH INSIGHT HAD BEEN LOST. THIS ACTION WILL BE TAKEN ON A TIME PERMITTING BASIS TO MINIMIZE POTENTIAL LEAKAGE. THE LPFP DISCHARGE PRESSURE CAN BE USED AS A BACKUP CUE TO ASSESS LH2 INLET CONDITIONS.

Loss of insight into the inlet pressures (and the LPFP discharge pressure for the fuel side) results in the inability to assess the inlet conditions. Therefore, the dump will be inhibited for any engine shut down prior to MECO for the nominal case, an ATO, or an AOA if the inlet condition(s) cannot be assessed (at the time of shutdown) due to avionics failures since a contained shutdown cannot be guaranteed. In the case where there was no leakage, any residuals trapped in the engine by the dump inhibit procedure will have time to bleed out prior to landing.

2. TAL/RTLS:

THE MPS DUMP INHIBIT WILL NOT BE PERFORMED.

Due to the extremely low probability of a noncatastrophic, uncontained shutdown, and the additional failure to lose insight, the cases of survivable shutdowns with leakage hidden due to loss of insight on a TAL and RTLS will not be covered. If the MPS dump is inhibited for the RTLS and TAL cases due to loss of insight and no leakage existed, it would induce an unnecessary risk of trapped LH₂ residuals (approximately 26 lbs. LH₂ on a RTLS and approximately 8 lbs. LH₂ on a TAL abort, at touchdown). These amounts of LH₂ are enough to cause a venting concern for the convoy and preclude normal convoy operations and would require as a minimum an expedited powerdown and Mode V egress per Rule {A16.1.1-11F}, EXPEDITED POWERDOWN. However, if leakage was assumed, an emergency powerdown and Mode V egress would be performed per part A of this rule. ©[020196-1813A]

FLIGHT RULES

SECTION 6 - PROPULSION

FAILURE DEFINITIONS

A6.1.1-1	OMS/RCS HELIUM TANK	6-1
A6.1.1-2	OMS PROPELLANT TANK (OXIDIZER OR FUEL)	6-1
A6.1.1-3	OMS ENGINE	6-6
A6.1.1-4	OMS N2 SYSTEM	6-13
A6.1.1-5	OMS N2 TANK	6-13
A6.1.1-6	RCS THRUSTER FAILURE	6-14
A6.1.1-7	RCS PROPELLANT TANK (OXIDIZER OR FUEL)	6-16
A6.1.1-8	OMS/RCS CROSSFEED LINE	6-18
A6.1.1-9	OMS/RCS POD HEATER	6-19
A6.1.1-10	RCS JET HEATER	6-20
A6.1.1-11	AFT RCS PROPELLANT TANK FAIL/HELIUM INGESTION	6-21

SYSTEMS MANAGEMENT

A6.1.2-1	OMS N2 TANK FAILURE MANAGEMENT	6-24
A6.1.2-2	OMS/RCS LEAKING HE TANK BURN	6-24
A6.1.2-3	OMS LEAKING HE SYSTEM BURN	6-19
A6.1.2-4	OMS TANK FAIL CROSSFEED OR INTERCONNECT CONSTRAINT (CIL)	6-19
<u>A6.1.2-5</u>	<u>OMS PROPELLANT SETTLING REQUIREMENT</u>	<u>6-21</u>
<u>A6.1.2-6</u>	<u>OMS ENGINE BURN TO DEPLETION</u>	<u>6-22</u>
<u>A6.1.2-7</u>	<u>OMS BALL VALVE FAILURE MANAGEMENT</u>	<u>6-23</u>
<u>A6.1.2-8</u>	<u>OMS ENGINE INSTRUMENTATION REQUIREMENT</u>	<u>6-24</u>
<u>A6.1.2-9</u>	<u>RCS MANIFOLD CLOSURE CRITERIA</u>	<u>6-28</u>
<u>A6.1.2-10</u>	<u>RCS LEAKING PROPELLANT TANK BURN</u>	<u>6-31</u>

FLIGHT RULES

SECTION 6 - PROPULSION ORBITAL MANEUVERING SYSTEM/REACTION CONTROL SYSTEM (OMS/RCS)

FAILURE DEFINITIONS

A6.1.1-1 OMS/RCS HELIUM TANK

AN OMS AND/OR HELIUM TANK IS CONSIDERED LOST IF:

- A. OMS PRESSURE < 390 (640) PSIA, RCS PRESSURE < 400 (456) PSIA.

The fail limit is defined as a low helium tank pressure such that the regulated outlet pressure is insufficient to maintain the propellant tank pressure within normal operating range.

The OMS fail limit is 390 psia. At that helium pressure a single engine flow rate will result in lower than nominal propellant tank pressures (below 250 psia). Off-nominal testing has shown that under a single engine flow rate the helium tank pressure decreased to 180 psia before a chamber pressure of 80 percent was reached. However, the 390 psia limit guarantees nominal regulator performance (390 psia corresponds to the regulator spec inlet pressure). Reference SODB constraint 4.3.3.2.1.e.1 for the 390 psia limit.

The RCS fail limit is 400 psia. At this helium pressure a four-jet flow rate will result in lower than nominal propellant tank pressures (below 245 psia). Reference SODB constraint 4.3.2.3.3-f.2 for the 400 psia limit.

- B. ALL PRESSURIZATION PATHS CLOSED.

If both valves or regulators are failed closed, no passageway exists for He to pressurize the propellant tank. Therefore, the He tank is effectively lost.

A6.1.1-2 OMS PROPELLANT TANK (OXIDIZER OR FUEL)

AN OMS PROPELLANT TANK IS CONSIDERED LOST IF:

- A. PREBURN - FUEL INLET PRESSURE < 208 (216) OR OXIDIZER INLET PRESSURE < 143 (151) OR BOTH FUEL AND OXIDIZER INLET PRESSURE < 158 (166) PSIA OR PROPELLANT QUANTITY ≤ 3 PERCENT.

FLIGHT RULES

A low fuel inlet pressure (< 208) preburn will result in reduced fuel flow at the OMS engine during the burn. The fuel is used as a coolant for the engine combustion chamber, and with reduced flow, the cooling jacket temperature will increase. At ignition, a low fuel inlet pressure (208 psia) will result in the violation of the onboard OMS fuel injector temperature fault detection annunciation (FDA) limit (260 deg F). Within approximately 10 to 20 seconds, the injector temperatures will increase to a dangerous level causing possible chamber wall burn through. Consequently, for confirmed low fuel inlet pressure as defined in the Flight Rules, the affected propellant feed system will be considered failed.

THIS RULE CONTINUED ON NEXT PAGE

FLIGHT RULES

A6.1.1-2

OMS PROPELLANT TANK (OXIDIZER OR FUEL) (CONTINUED)

A low oxidizer pressure less than normal but > 143 psia preburn will cause the engine to burn cooler than normal (fuel rich mixture ratio results in a cooler burn). However, with oxidizer inlet pressure < 143 psia, the chamber pressure violates the FDA limit of 80 percent and may cause unstable combustion and chamber wall hot spots. Therefore, this engine should not be started to prevent possible chamber wall burn through.

When both of the oxidizer and fuel inlet pressures are low (i.e., operating in a blowdown condition), the OMS engines can be burned until the inlet pressures reach 158 psia because the mixture ratio remains fairly constant. Although the chamber FDA limit is violated, the engine can be safely operated until both the oxidizer and fuel inlet pressures decrease below the 158 psia value, the chamber pressure decreases below 72 percent, or the fuel injector temperature reaches 260 deg F.

The OMS propellant tank is also considered failed (unusable) when propellant quantities are < 3 percent. This is to prevent the propellant tank from reaching depletion levels during a burn and ingesting helium into the OMS engine. The ingestion of helium into the OMS engine could result in unstable operation. For a propellant-critical situation, the engine can be operated until tank depletion without risk of uncontained engine damage. The 3 percent quantity is derived as follows: 2.3 percent trapped propellant in the tank plus > 0.7 percent gauge error (0.7 percent gauge error only applies for total quantities less than 5.0 percent). The 3 percent value should be utilized only during the burn while monitoring the OMS hardware quantity gauging system.

B. ALL ASSOCIATED TANK ISOLATION VALVES FAILED CLOSED.

Restriction of a propellant path from the propellant tanks to the OMS engine is an effective loss of the propellant tank.

C. PROPELLANT TEMPERATURE < 40 DEG (44 DEG) F OR > 100 DEG (96 DEG) F.

The engine design specification is 40 deg to 100 deg F propellant. These temperatures define an envelope for which it is known to be safe to start and operate the OMS engine. Engine testing has been limited to this temperature range and engine performance is unknown beyond this range. High propellant (fuel) temperature may result in propellant boiling in the cooling jacket causing unknown performance. It is also believed that low propellant temperatures could cause large Pc spikes at engine start. (Reference SODB, volume I, paragraph 4.3.3.D.)

THIS RULE CONTINUED ON NEXT PAGE

FLIGHT RULES

A6.1.1-2 OMS PROPELLANT TANK (OXIDIZER OR FUEL)
(CONTINUED)

D. RESTRICTION IN OXIDIZER FEED SYSTEM: PC < 76 (80) PERCENT, OMS RM ENGINE SELECT DOWN ARROW ("↓") ON MANEUVER EXECUTE DISPLAY (POST-MECO ONLY), AND OXIDIZER INLET PRESSURE < 128 (136) PSIA.

An oxidizer restriction may cause Pc and total vehicle acceleration to decrease below the OMS RM limit triggering the down arrow. The oxidizer feed restriction can be confirmed, during the burn, with a low oxidizer inlet pressure which corresponds to the Pc limit of 80 percent. (Reference SODB paragraph 3.4.3.3-11a for minimum Pc, and SODB request response R921 for inlet pressure verification.)

E. RESTRICTION IN FUEL FEED SYSTEM: OMS FUEL INJECTOR TEMPERATURE > 260 DEG (260 DEG) F* AND FUEL INLET PRESSURE LESS THAN OR EQUAL TO THE LOWER FAIL LIMIT.

* NORMAL OPERATING TEMPERATURE PLUS INSTRUMENTATION ACCURACY WILL NOT MEET FAILURE LIMIT.

ENGINE SERIAL #	FU IN P LOWER FAIL LIMIT (PSI)
101	199 (207)
105	201 (209)
106	196 (204)
107	193 (201)
108	206 (214)
109	204 (212)
110	199 (207)
111	201 (209)
113	200 (208)
114	192 (200)
115	197 (205)
116	203 (211)

The fuel flow through the engine cooling jacket may be reduced by a fuel restriction, causing hot spots in the combustion chamber. Without proper engine cooling, the probability exists for an engine burn through, creating a hazard to the surrounding structure and pod. In addition, a restriction in the fuel feed line system would result in an oxidizer rich mixture ratio with a higher combustion temperature. SODB data indicates a need for engine specific fuel inlet pressures as cues for OMS propellant tank failures. Instrumentation inaccuracy of 8 psi must be protected to adequately protect the OMS engine. SODB, volume III (CAUTION: SODB, volume III, contains engineering estimates for non-nominal performance evaluation. Data may not be supported by test.), table 4.3.3 contains engine-specific data and should be used to determine tank failure limits.

FLIGHT RULES

THIS RULE CONTINUED ON NEXT PAGE

FLIGHT RULES

A6.1.1-2 OMS PROPELLANT TANK (OXIDIZER OR FUEL) (CONTINUED)

A 260 deg F fuel injector temperature at the cooling jacket outlet clearly identifies an off-nominal situation, yet is sufficiently removed from the failure limit to allow time for crew action. The low fuel inlet pressure indicates that the restriction is upstream of the transducer. A restriction large enough to result in a decreased fuel inlet pressure and high fuel injector temperature beyond the defined limits results in the failure of the propellant tank to support further OMS/RCS activities.

Rule {A6.1.3-5}, OMS/RCS HEATER MANAGEMENT, references this rule.

F. OXIDIZER AND FUEL BOTH IN BLOWDOWN (LOSS OF HE TANK), OMS RM ENGINE SELECT DOWN ARROW ("↓") ON MANEUVER EXECUTE DISPLAY AND PC < 68 (72) PERCENT.

Test results have determined that with both the oxidizer and fuel tanks in blowdown, the OMS engines can be safely operated below the 80 percent Pc alarm with an acceptable propellant mixture ratio. When Pc drops below 68 percent, unstable combustion occurs. (Reference SODB, paragraph 3.4.3.3-11b.)

G. PROPELLANT LEAK UPSTREAM OF BALL VALVES, PC < 76 (80) PERCENT AND OMS RM ENGINE SELECT DOWN ARROW ("↓") ON MANEUVER EXECUTE DISPLAY.

A propellant leak large enough to cause low Pc and decayed acceleration during an OMS engine burn, as indicated by a down arrow, identifies an OMS propellant system failure. Even though the leak may be isolated, the engine and associated propellant system can not be used since the leak would affect crossfeed (ref. SODB, paragraph 3.4.3.3-11a).

A6.1.1-3 OMS ENGINE

AN OMS ENGINE IS CONSIDERED LOST IF:

A. AN ENGINE BALL VALVE POSITION < 47 (70) PERCENT THAT RESULTS IN AN ENGINE PC < 76 (80) PERCENT AND AN OMS DOWN ARROW ("↓") ON THE MANEUVER EXECUTE DISPLAY.

OMS engine Pc must be > 76 (80) percent (100 psia) when not in ullage blowdown (reference SODB, volume I, paragraph 3.4.3.3) or Pc must be > 68 (72) percent (90 psia) in ullage blowdown (reference SODB, volume I, paragraph 3.4.3.3 to ensure safe engine operation. A ball valve position of 47 percent causes sufficient blockage of propellant flow to result in an engine Pc = 76 percent (100 psia). Although ball valve position > 47 percent results in safe engine operation, a conservative 70 percent (ref. SODB, volume I, paragraph 3.4.3.3) is required to clearly identify ball valves not in a normal position. This ball valve failure confirms that the problem is an engine failure and not a propellant tank failure.

FLIGHT RULES

THIS RULE CONTINUED ON NEXT PAGE

FLIGHT RULES

A6.1.1-3 OMS ENGINE (CONTINUED)

B. OMS ENGINE FEEDLINE TEMPERATURE < 30 DEG (38 DEG) F
OR > 125 DEG (117 DEG) F.

Test data have demonstrated that engine starts are acceptable with propellant temperatures at these limits as long as the bulk propellant tank temperature is within limits. Operation with bulk propellant outside of these limits is untested and uncertified. Problems that would probably be encountered are rough combustion, insufficient cooling, and excessive high chamber pressure which could overstress the engine chamber. (Reference SODB, paragraph 4.3.3.4.)

C. FUEL RESTRICTION: OMS FUEL INJECTOR TEMPERATURE > 260 DEG (260 DEG) F* AND FUEL INLET PRESSURE GREATER THAN OR EQUAL TO THE UPPER FAIL LIMIT.

* NORMAL OPERATING TEMPERATURE PLUS INSTRUMENTATION ACCURACY WILL NOT MEET FAILURE LIMIT.

ENGINE SERIAL #	FU IN P UPPER FAIL LIMIT (PSI)
101	230 (222)
105	235 (227)
106	228 (220)
107	227 (219)
108	238 (230)
109	238 (230)
110	234 (226)
111	232 (224)
113	228 (220)
114	229 (221)
115	233 (225)
116	233 (225)

Fuel is used to cool the OMS engine combustion chamber. The fuel injector temperature is measured after the fuel has passed through the regenerative cooling jacket. Normally this temperature is 220 deg F during a burn. The 260 deg limit was selected to positively identify that the engine was operating in an anomalous manner. At all temperatures below 260 deg F, engine operation is safe. However, as the fuel injector temperature exceeds this limit, combustion chamber wall burn through becomes increasingly likely. Since chamber pressure is largely unaffected by the loss of cooling, only fuel inlet pressure can confirm that a fuel restriction exists. A higher-than-normal fuel inlet pressure is indicative of a restriction in the fuel flow downstream of the engine ball valves. SODB data indicates a need for engine-specific fuel inlet pressures as a secondary cue for OMS engine failure. Instrumentation inaccuracy of 8 psi must be protected to prevent the crew concluding fuel injector temperature transducer failure when an OMS engine failure has occurred.

FLIGHT RULES

SODB, volume III, table 4.3.3 (CAUTION: SODB volume III contains engineering estimates for non-nominal performance evaluation. Data may not be supported by test.) contains engine-specific data and should be used to determine engine failure limits.

THIS RULE CONTINUED ON NEXT PAGE

FLIGHT RULES**A6.1.1-3 OMS ENGINE (CONTINUED)**

- D. PROPELLANT LEAK DOWNSTREAM OF BALL VALVES, PC < 76 (80) PERCENT, AND OMS RM ENGINE SELECT DOWN ARROW ("↓") ON MANEUVER EXECUTE DISPLAY OR FUEL INJECTION TEMP > 260 DEG F.

A propellant leak large enough to cause low Pc and decayed acceleration, as indicated by the down arrow or fuel injector temperature high, during a burn results in the loss of the affected engine. (Reference SODB, volume I, paragraphs 3.4.3.3 and 3.4.4.3.)

- E. PREVIOUS FUEL OR OXIDIZER DEPLETION CUTOFF.

Although WSTF tests with a fuel depletion cutoff did not damage an OMS engine, there is significant risk that engine damage may occur during shutdown. This is due to the loss of engine cooling when fuel no longer passes through the cooling jacket around the combustion chamber. Uncontained damage did not occur during WSTF tests but zero-g effects are unknown.

It is not desirable to reuse an OMS engine following an oxidizer depletion cutoff. A period of time is required for oxidizer from a different propellant source to reach the engine during the first engine start following oxidizer depletion cutoff. During this time, unburned fuel accumulates in the combustion chamber because of the very low vapor pressure of monomethylhydrazine. When the oxidizer reaches the injector, extremely rough combustion will result. Uncontained engine damage could result.

There have not been any tests to verify reuse of an engine which has experienced a previous oxidizer or fuel depletion cutoff.

Reference: SODB 3.4.3.3. Rule {A6.1.2-6}, OMS ENGINE BURN TO DEPLETION, references this rule.

- F. PRE-MECO PC ≤ 76 (80) PERCENT CONFIRMED BY ENGINE BALL VALVE POSITION < 47 (70) PERCENT OR OXIDIZER INLET PRESSURE > 235 (227) PSIA.

The crew will get a class 2 alarm at Pc < 76 (80) percent, but there is no MNVR EXEC display or ENG SEL down arrow pre-MECO to indicate loss of acceleration. Therefore, oxidizer inlet pressure or ball valve position is checked for an additional indication of an engine failure. The rationale used for paragraphs A and C (CAUTION: SODB, volume III, contains engineering estimates for non-nominal evaluation. Data may not be supported by test.) applies here also. (Reference SODB, volume I, 3.4.3.3, table 3.4.3.3 and SODB request response R921.)

THIS RULE CONTINUED ON NEXT PAGE

FLIGHT RULES

A6.1.1-3 OMS ENGINE (CONTINUED)

G. OXIDIZER RESTRICTION: PC < 76 (80) PERCENT, OMS RM ENGINE SELECT DOWN ARROW ("↓") ON MANEUVER EXEC DISPLAY, AND OXIDIZER INLET PRESSURE > 235 (227) PSIA.

The engine can also fail if the oxidizer injector is restricted, which causes the upstream oxidizer inlet pressure to increase. Operating at this low oxidizer inlet pressure will result in an engine failure indicated by low Pc and acceleration. (Reference SODB, volume I, paragraph 3.4.3.3. A request has been submitted for inlet pressure verification.)

H. OMS BALL VALVE POSITION > 0 PERCENT (FAILED OPEN RANGE LOWER LIMIT) AND < 47 (70) PERCENT POSTBURN AND INSTRUMENTATION FAILURE CANNOT BE POSITIVELY IDENTIFIED.

ENGINE SERIAL #	OMS BALL VALVE FAILED OPEN RANGE LOWER LIMIT	
	BV1 %	BV2 %
101	6	5
105	3	5
106	4	6
107	6	6
108	4	5
109	4	6
110	3	4
111	6	4
113	4	4
114	5	3
115	3	3
116	2	4

For failure definition purposes, the OMS ball valves are considered a functionally integral part of the OMS engine. OMS ball valve position indicators are single-point instrumentation on the series ball valves. To distinguish an instrumentation failure from a hardware failure, it is necessary to examine the time-ordered history of the anomaly.

The normal position of the ball valves when not operating is 0 percent open (decimals of percent open are rounded). If the ball valves are failed to < 47 percent, the affected OMS Pc will be < 80 percent which is the level at which the engine is considered failed. (Refer to rationale of Rule {A6.1.2-7}, OMS BALL VALVE FAILURE MANAGEMENT.) The position indicators have an instrumentation accuracy of 5 percent.

THIS RULE CONTINUED ON NEXT PAGE

FLIGHT RULES

A6.1.1-3 OMS ENGINE (CONTINUED)

In order to avoid declaring an engine failed due to instrumentation accuracy effects, the ball valve will be considered closed if the indicated position is less than or equal to 5 percent. The failed open range lower limits listed in the above table are based on this value of 5 percent, plus an engine-specific error. This additional error is caused by the generic scale and generic bias factor used to convert the voltage measured by the hardware to a percent open. These generic factors are used for all engines and vary slightly from the individual scale and bias factors associated with each engine. For example, the value of 4 percent shown for ball valve 1 of engine 109 is the result of adding the scale and bias factor error of -1 percent to the instrumentation error of 5 percent. When that ball valve is closed, it should indicate within the range of -6 to 4 percent.

Note that flow through the valve begins at 10 percent. If the failed open range lower limit is exceeded, then the valve is failed open and a flow path through that valve may exist. Since there are two ball valves in series, should any single ball valve be open > 10 percent postburn, the other ball valve in that series will prevent propellant leakage into the engine proper.

If an instrumentation failure cannot be positively identified, the engine is considered failed. The affected engine will be used for deorbit only, and then, only if the other engine is failed. If the ball valve position is more than 47 percent open, an acceptable OMS Pc will be obtained during any subsequent engine operation. (Reference SODB, volume I, paragraph 3.4.3.3-17, and Flight Rules {A6.1.1-3A}, OMS ENGINE and {A6.1.2-7}, OMS BALL VALVE FAILURE MANAGEMENT.)

I. OMS GN₂ SYSTEM FAILURE (REF. RULE {A6.1.1-4}, OMS N₂ SYSTEM) .

Reference Rule {A6.1.1-4}, OMS N₂ SYSTEM, for rationale. Rules {A6.1.2-6}, OMS ENGINE BURN TO DEPLETION; and {A6.1.2-7}, OMS BALL VALVE FAILURE MANAGEMENT, reference this rule.

FLIGHT RULES

A6.1.1-4 OMS N2 SYSTEM

THE OMS N₂ SYSTEM IS CONSIDERED LOST IF:

INSUFFICIENT N₂ REGULATOR PRESSURE TO OPERATE ENGINE BALL VALVES:

- A. N₂ REGULATOR PRESSURE < 283 (299) PSIA WITH ENGINE PRESSURE VALVE CLOSED.
- B. N₂ REGULATOR PRESSURE < 244 (260) PSIA WITH ENGINE PRESSURE VALVE OPEN (ASSUMES N₂ TANK PRESSURE EQUAL TO N₂ REGULATOR PRESSURE)

An OME is considered failed if ball valves cannot be guaranteed to fully open. The engine can be used in a contingency if ball valves can be guaranteed to open > 90 percent. With the engine pressurization valve closed, the pressure below the valve must be above 283 psia to move the ball valve rack assembly. With the pressurization valve open, allowing the large tank volume to pressurize the accumulator, the ball valve rack will only require 244 psi. (Both the regulator pressure and tank pressure must be above 244 psia.) Performance drops off drastically at lower N₂ or accumulator pressures. Instrumentation accuracy is 16 psi on the accumulator pressure. (Reference SODB, volume I, table 4.3.3-3.)

Rules {A6.1.1-3I}, OMS ENGINE; {A6.1.2-1}, OMS N₂ TANK FAILURE MANAGEMENT; {A6.1.2-15}, OMS N₂ REGULATOR FAILURE MANAGEMENT; and {A6.1.2-17}, OMS FAILURE MANAGEMENT (CIL), reference this rule.

A6.1.1-5 OMS N2 TANK

AN OMS N₂ TANK IS CONSIDERED LOST IF:

- A. PRESSURE < 309 (469) PSIA (NO PURGE AVAILABLE).

An OMS N₂ tank failure is defined as insufficient GN₂ pressure to allow a nominal engine start with no purge and a subsequent accumulator only start with the GN₂ tank isolation valve closed. A GN₂ tank pressure of 309 psia (283 psi for an accumulator start and 26 psi for a nominal no purge start) will provide sufficient pressure to accomplish this requirement with a 100 percent ball valve opening on both burns. (Reference SODB, volume I, paragraph 3.4.3.3.14.)

- B. REGULATOR FAILED CLOSED.
- C. FAILED CLOSED CHECK VALVES.
- D. OMS ENGINE PRESSURE VALVE FAILED CLOSED.

FLIGHT RULES

Any one of these conditions has isolated the tank from the ball valve rack assembly, effectively failing the tank. Rule {A6.1.2-1}, OMS N₂ TANK FAILURE MANAGEMENT, references this rule.

A6.1.1-6 RCS THRUSTER FAILURE

AN RCS THRUSTER IS CONSIDERED LOST IF:

A. FAILED ON - FIRES IN ABSENCE OF GPC "ON" COMMAND.

A thruster is "failed-on" when it fires in the absence of an "ON" command from the GPC. This failure will occur if the injector valve power (driver output) from the RJD fails high or if both the oxidizer and fuel thruster valves fail open. The failure is detected by RCS RM when an RJD output discrete is present with the absence of the GPC jet command B for three consecutive cycles. The failure is confirmed on the ground via the analog chamber pressure (Pc) and/or vehicle rates, and propellant consumption.

The BFS fail-on jet is detected by RM when the affected jet Pc discrete is present (> 36 psia) with no GPC command B for three consecutive cycles and fuel manifold valve open discrete indicates true.

B. FAILED OFF - DOES NOT FIRE IN PRESENCE OF GPC "ON" COMMAND.

A thruster is "failed-off" when the jet does not fire in the presence of an "ON" command from the GPC. This failure will occur when the RJD output discrete fails low (which can be caused by any of a number of upstream failures) or one of the thruster valves fails closed. The failure is detected by RCS RM when the Pc discrete is zero (indicating Pc < 26 psia as sensed by the RJD electronics) in the presence of a GPC command B for three consecutive cycles. The failure is confirmed on the ground via analog Pc, RJD output discrete, jet injector temperature, or vehicle rates.

C. FAILED LEAK - LOSS OF PROPELLANT THROUGH THRUSTER VALVE AS CONFIRMED BY PRIMARY OXIDIZER INJECTOR TEMPERATURE < 30 DEG F OR FUEL INJECTOR TEMPERATURE < 20 DEG F; OPS 2 VERNIER INJECTOR TEMPERATURE (OXIDIZER OR FUEL) < 130 DEG F.

A jet is "failed-leak" if either injector valve (oxidizer or fuel) fails to close completely or if propellant leaks through a deformed or damaged thruster valve seal. Seal leakage is the most common form of jet leak. The failure is detected both on the ground and by RCS RM when either injector temperature falls below RCS RM limits for three consecutive cycles. The RM limits are established as specified in the SODB. The failure is confirmed on the ground via the injector temperature signature or RCS quantity telemetry. The vernier injector temperatures are assumed to track together; therefore, action will be taken when the first of either fuel or oxidizer is < 130 deg F.

FLIGHT RULES

During entry, residual fuel may be held against the injector on the primary upfiring jets by gravity. This is why the fuel limit is lower than the oxidizer limit. Vernier jet injector temperature sensors are located on a large mass of metal which acts as a heat source. Because of the location, these sensors respond more slowly to leaks than do the primary jet sensors. The vernier leak limit is set to accommodate these conditions.

FLIGHT RULES

A6.1.1-7 RCS PROPELLANT TANK (OXIDIZER OR FUEL)

AN RCS PROPELLANT TANK IS CONSIDERED LOST IF:

A. PRESSURE IS < 185 (190) PSIA.

To maintain primary jet inlet pressures greater than 175 psia, the tank pressure must remain above 185 psia. With lower than normal inlet pressures (< 175), the chamber pressure during a firing becomes significantly higher than the inlet pressure. This results in a high frequency "chug" or combustion instability which causes hot spots on the chamber wall and in extreme cases may cause the chamber wall to fail. Reference SODB 3.4.3.2.10.a.

The vernier jets have a lower but undefined operational limit where the lower pressure can lead to the accumulation of carbon deposits in the chamber pressure tube. Blockage of the Pc tube may result in false fail-off jet indications.

B. ARCS:

1. ARCS (ENTRY ONLY) AND FRCS: PROPELLANT QUANTITY < 0 PERCENT.

Propellant gauge quantity reflects usable propellant. Trapped propellant and gauge error are not included in the gauge quantity. For the FRCS, the gauge error propellant is available for contingency operations to 1.5 percent below a gauge reading of 0 percent (ref. Rule {A6.1.2-13}, CONTINGENCY RCS PROPELLANT AVAILABLE).

2. ARCS ON ORBIT: PROPELLANT QUANTITY < 20 PERCENT.

The on-orbit aft RCS tank failure limit is based upon the on-orbit expulsion efficiency of the RCS tank (78 percent of the design tank volume; ref. SODB 4.3.2.2.1.f.2). The on-orbit expulsion efficiency of the RCS is significantly less than the entry expulsion efficiency because the aft RCS tanks were designed to operate most efficiently during entry g-loading. Propellant can be expelled on orbit to 16 percent PVT gauge quantity (provided PVT gauging is perfectly accurate). Protecting for gauge error (50 lbs OX, 34 lbs FU), the minimum quantity on orbit becomes 20 percent. The 20 percent of propellant will be available for control during entry (post EI: $g > 0.05$), since expulsion efficiency during this period increases to 96.5 percent of the design tank volume.

C. ASSOCIATED TANK ISOLATION VALVES FAILED CLOSED.

No passageway exists for propellant to flow from the tank to the jets, effectively failing the tank.

THIS RULE CONTINUED ON NEXT PAGE

FLIGHT RULES

A6.1.1-7 **RCS PROPELLANT TANK (OXIDIZER OR FUEL)**
(CONTINUED)

D. ARCS PROPELLANT TEMPERATURE IS < 50 DEG (52 DEG) F OR > 100 DEG (98 DEG) F.

The concern with violating the upper limit is that the oxidizer viscosity and adhesion to the acquisition screens allows a lower pressure to pull helium into the lower compartment and then to the jets. Violating the lower limit increases the restriction of fuel flow in the channels. During high flow demands, the large delta pressure across the screens occurs near the tank outlet. This large delta pressure breaks down the screen and pulls helium into the lower compartment. (Reference SODB, volume I, table 3.4.3.2.)

E. FRCS PROPELLANT TEMPERATURE < 40 DEG (42 DEG) F OR > 100 DEG (98 DEG) F.

Tank certification constraint (reference SODB, volume I, table 3.4.3.2).

F. PROPELLANT ACQUISITION DEVICE BREAKDOWN.

Confirmed evidence of propellant acquisition device breakdown will be cause to declare that RCS tank failed. Multiple jet fail-offs on the same feed system (e.g., multiple LRCS jet fail-offs while feeding from the LRCS) are the indication that a breakdown has occurred in either the screens or bulkhead of the RCS tank. Helium ingestion resulting from the tank failure may be cleared using propellant from either the good RCS feed system or the OMS. The tank will not be used except as a last resort during entry. Rule {A6.1.5-5}, AFT RCS REDLINES, references this rule.

FLIGHT RULES

A6.1.1-8 OMS/RCS CROSSFEED LINE

THE OMS/RCS CROSSFEED LINE IS CONSIDERED LOST IF:

- A. OMS/RCS CROSSFEED TEMPERATURE < 40 DEG (48 DEG) F OR > 125 DEG (117 DEG) F.

It takes approximately 10 seconds from ignition to reach thermal equilibrium in an OMS engine and regenerative cooling jacket. A crossfed OME will use the propellant from the feedlines and all of the propellant in the crossfeed lines during this thermal startup phase. It takes approximately 6 seconds (10 seconds for OV-102) to burn the feedline and crossfeed line propellant through an OME.

The OME starts with propellant below 30 deg F or OME steady state operation with propellant below 40 deg F may result in rough combustion and excessive high chamber pressure which could overstress the engine chamber. Propellant temperatures below 40 deg F may also affect structural components such as service couplings and transducer fittings. Below 30 deg F, there is a concern that the oxidizer may freeze, rupturing or blocking propellant lines. RCS jet operation with propellant below 40 deg F may result in rough combustion. For RCS crossfeed during entry, the lower limit is 68 deg (70 deg) F to protect against ZOT's (refer to Flight Rule {A6.1.3-7}, ARCS BULK PROPELLANT TEMPERATURE MANAGEMENT).

OME startup with propellant above 125 deg F reduces engine cooling effectiveness, resulting in violation of injector temperature limits. Localized "hot spots" of propellant may develop in stagnant crossfeed lines. This is caused by non-uniformity's in line heater installation coupled with non-synchronous heater cycling. Hot spots can be tracked and confirmed during periods of interconnect. Hot spots less than 125 deg F are acceptable for OME and RCS steady state operation. Refer to SODB table 3.4.3.3.

- B. NO FLOW PATH EXISTS.

The OMS/RCS crossfeed lines are considered failed when no flow path exists. Dual valve failure or a line leak could result in a flow path loss.

- C. CROSSFEED LINE PRESSURE IS < 15 (49) PSI OXIDIZER OR < 1 (35) PSIA FUEL (AS INDICATED BY RCS MANIFOLD PRESSURES) AS A RESULT OF PROPELLANT LEAKAGE.

Pressure less than 49 psia oxidizer or 35 psia fuel as a result of propellant leakage is cause to declare the crossfeed line failed. A known leaking line resulting in violation of the above limits will not be repressed unless staged repress techniques increase pressures to within acceptable limits. The OMS crossfeed line pressure will be checked via RCS manifold pressures until additional pressure transducers are installed. Any attempt to repressurize the leaking line risks structural damage as a result of excessive surge pressures.

FLIGHT RULES

For a crossfeed pressure less than the above limit as a result of thermal affects, the crossfeed line may be repressed according to the Flight Rules restrictions.

A6.1.1-9 **OMS/RCS POD HEATER**

LOSS OF REDUNDANT CRITICAL HEATER CIRCUITS IN THE OMS POD NECESSARY TO MAINTAIN CG CONTROL, PROPELLANT REDLINES, AND RCS ATTITUDE CONTROL FOR ENTRY IS CAUSE FOR ENTRY AT THE NEXT PLS IF THE ENVIRONMENT CANNOT MAINTAIN THERMAL REDLINES:

CRITICAL HEATER LOCATION	EQUIPMENT
A. KEEL WEB, INNER "Y" WEB	OMS/RCS TANKS, RCS HE LINES
B. RCS HOUSING HEATERS	RCS PROPELLANT LINES
C. (2 OF 3) - UPPER "Y" WEB, OUTBOARD "Y" WEB, GSE SERVICE PANEL	RCS MANIFOLD LINES
D. OME COVER	OME PROPELLANT FEEDLINES
E. OME COMPARTMENT	OME PROPELLANT FEEDLINES GN ₂ TANK AND ACCUMULATOR

All critical OMS/RCS heater circuits are redundant. For the loss of both A and B heaters, vehicle attitude may be used to maintain an acceptable thermal environment. The heater circuitry protects all equipment that contains propellant. The propellant temperatures must be maintained for each piece of equipment according to the Flight Rules. Violation of the thermal redlines will be cause for deorbit at the next PLS.

Reference Thermal Management Section of the Flight Rules for recommended attitudes.

* Part C says "(2 of 3)" because all three heaters provide heating for the same vicinity.

FLIGHT RULES

A6.1.1-10 RCS JET HEATER

AN RCS JET HEATER IS CONSIDERED LOST IF:

- A. PRIMARY THRUSTER - BOTH OXIDIZER AND FUEL INJECTOR TEMPERATURES DECREASE TOGETHER TO BELOW 50 DEG (55 DEG) F.

Normal heater operations will keep the jets above 60 deg F. In the event of a jet heater failure, the colder temperatures may result in shrinkage of the injector valve seats causing jet leakage. To prevent seat shrinkage, the jet should be kept above 50 deg F; and to prevent RM from deselecting the jet, the temperatures should be kept above the thermal leak limit (fuel > 20 deg F, oxidizer > 30 deg F). The jets may be warmed by hot-firing the jets for at least 2 seconds (firing a cold jet less than 2 seconds may cause the jet to leak). Reference SODB, volume I, paragraph 3.4.3.2.13.a.

B. VERNIER THRUSTERS:

1. INADEQUATE JET HEATER OPERATION - THRUSTER HAS NOT BEEN FIRED IN AT LEAST 1.5 HOURS AND BOTH OXIDIZER AND FUEL INJECTOR TEMPERATURES DROP BELOW 130 DEG F AND DECREASE FROM 130 DEG TO 90 DEG F AT A RATE OF LESS THAN 15 DEG F PER HOUR WITH NO INCREASE IN THE JET CHAMBER PRESSURE.
2. HEATER FAILED OFF - BOTH OXIDIZER AND FUEL INJECTOR TEMPERATURES DROP BELOW 130 DEG F AND DECREASE FROM 130 DEG TO 90 DEG F AT A RATE OF LESS THAN 2 DEG F PER MINUTE WITH NO INCREASE IN THE JET CHAMBER PRESSURE.

Normal operating temperatures for vernier jets are above 140 deg F. However, some attitudes (e.g., gravity gradient) which do not require vernier jet firings may allow a vernier jet to cool to below 130 deg F, even without a heater failure, because the heaters are undersized. For inadequate jet heater operation or a failed vernier heater, the vernier minimum injector temperature can be reduced from 130 deg to 90 deg F if the conditions set forth in this rule are met. Failure to meet these conditions indicates a vernier jet leak. Cooler temperatures are less likely to cause the verniers to leak than the primaries because of the conical valve seat design. The 90 deg F coldsoak limit will prevent seal shrinkage which would result in propellant leakage. It is possible that a slow temperature decay rate is due to a leak that is contained within the vernier thrust chamber. If the chamber pressure increases, it is probable that the vernier has leaked, the jet throat has frozen closed, and the leak has continued. In this case, firing the affected thruster may cause damage in the pod.

FLIGHT RULES

Vernier jet injector temperatures less than 130 deg F indicate either inadequate heater operation, a heater failure, or an injector leak. Inadequate heater operation or a heater failure will allow both fuel and oxidizer temperatures to decay together. Jet injector leaks will cause the injector temps to decay much faster than for a heater failure. Also, the leaking injector temperature (oxidizer or fuel) will decay further than the nonleaking injector temperature. However, an instrumentation contact resistance may cause false readings greater than 15 deg F delta oxidizer and fuel temperatures masking any 5 deg F or greater delta created by a leak. Therefore, delta temperature cannot be used to distinguish leaks from heater failures. Reference Rule {A6.1.2-29}, LEAKING JET MANAGEMENT RULES; and SODB, volume I, paragraph 3.4.3.2.13.b.

A6.1.1-11 AFT RCS PROPELLANT TANK FAIL/HELIUM INGESTION

A. MATRIX:

PRE-MECO TANK QUANTITY (PERCENT)	RTL5	ASCENT	ORBIT	ENTRY
QTY >75	<ul style="list-style-type: none"> NOM ET SEP 	<ul style="list-style-type: none"> NOM ET SEP 	<ul style="list-style-type: none"> NOM ORBIT OPS 	<ul style="list-style-type: none"> NOM ENTRY
QTY <75	<ul style="list-style-type: none"> XFEED FROM GOOD RCS FOR ET SEP AFFECTED POD AVAIL FOR GRTLS IF REQ'D 	<ul style="list-style-type: none"> XFEED FROM GOOD RCS FOR ET SEP POST-OMS-1 INTERCONNECT FROM OMS 	<ul style="list-style-type: none"> PRIMARY JETS: INTERCONNECT FROM OMS OR XFEED FROM GOOD RCS VERNIER JETS: NOM ORBIT OPS 	<ul style="list-style-type: none"> AFFECTED POD AVAIL POST-EI

B. RULES:

1. AN RCS TANK WILL BE CONSIDERED FAILED FOR ET SEPARATION IF PRE-MECO TANK QUANTITY < 75 PERCENT. ET SEPARATION WILL BE PERFORMED IN CROSSFEED FROM GOOD RCS.

An analysis has been completed based upon the RCS tank redesign (addition of abort helium diffusers and deletion of abort ducts) and recertification of the ARCS tanks. The analysis has shown that a gauge quantity of less than 75 percent prior to MECO results in a gas "short" to the lower compartment (L/C) and large quantities of gas will transfer to the L/C prior to the start of mated coast external tank separation (MC/ET SEP). Usage from tanks in this condition should be avoided during MC/ET SEP by crossfeeding from the good side to prevent possible jet fail because of helium ingestions. Reference SODB, volume I, paragraph 3.4.3.2-14.c.

2. AN RCS TANK SUSPECTED TO HAVE INGESTED HE:

FLIGHT RULES

- a. CAN BE USED DURING ENTRY (POST-EI) WITH NO RESTRICTIONS OTHER THAN TO ACCOUNT FOR INCREASED TANK RESIDUALS (LOSS OF PROPELLANT PRIOR TO MECO WILL INCREASE TANK RESIDUALS BY 11 PERCENT).

The additional gas that transfers to the L/C will impact the tank entry expulsion efficiency by as much as 11 percent. However, during entry the gravitational force will hold the propellant over the tank outlet preventing helium ingestion and allowing use of the tank.

THIS RULE CONTINUED ON NEXT PAGE

FLIGHT RULES

A6.1.1-11 AFT RCS PROPELLANT TANK FAIL/HELIUM INGESTION
(CONTINUED)

- b. CAN BE USED FOR VERNIER JET OPERATIONS.
- c. WILL NOT BE USED FOR PRIMARY JET ORBIT OPERATIONS.

Since the vernier jets do not result in an excessive delta pressure across the RCS bulkhead screens to cause screen breakdown, verniers may be used for on-orbit operations. Rule {A2.1.2-4}, RTL, TAL, AND AOA ABORTS FOR SYSTEM FAILURES (CIL), references this rule.

FLIGHT RULES

SYSTEMS MANAGEMENT

A6.1.2-1 OMS N₂ TANK FAILURE MANAGEMENT

FOR A FAILED OMS N₂ TANK, THE ASSOCIATED ENGINE WILL NOT BE USED UNTIL THE DEORBIT BURN IN ORDER TO CONSERVE THE FINAL ENGINE RESTART. IF N₂ REGULATOR PRESSURE > 366 (382) PSIA, TWO STARTS ARE POSSIBLE.

With an N₂ tank failure, a minimum of one OMS start remains in the accumulator. This start will be saved for the final engine burn in order to maintain OMS engine redundancy while on orbit. If the accumulator pressure is sufficient to support two OMS burns (N₂ regulator pressure > 366 (382) psi, 83 psi for the first start (no purge), and 283 psi for the last start and 16 psi instrumentation), the engine may be burned if subsequent failures dictate. A pressure of 366 (382) assumes that sufficient time is allowed between burns to allow the N₂ tank to return to equilibrium. Both burns will be 100 percent ball valves open. (Ref. Rules {A6.1.1-4}, OMS N₂ SYSTEM; {A6.1.1-5}, OMS N₂ TANK; and {A6.1.2-15}, OMS N₂ REGULATOR FAILURE MANAGEMENT.) (Reference SODB, volume I, paragraph 3.4.3.3.15 and 4.3.3.1.d.)

A6.1.2-2 OMS/RCS LEAKING HE TANK BURN

FOR A LEAKING OMS/RCS HELIUM TANK, A BURN MAY BE SCHEDULED TO INCREASE THE PROPELLANT ULLAGE VOLUME.

It is important to increase the ullage volume for He tank leaks so that the delta velocity (V) lost with a He tank failure is minimized. If OMS propellant tank quantities are below 39 percent, the OMS tanks can be used in the blowdown mode (no He tank support) with little or no loss of capability. Ascent procedures for OMS He tank leaks have been developed to maximize blowdown capability by performing a contingency abort dump using the leaking OMS propellant. Post-OMS-2 quantities are sometimes below 39 percent and will not require a blowdown maximization burn. If post-OMS 2 quantities are above 39 percent, a maximum blowdown burn should be performed. After evaluating the total delta velocity available it may be desirable to perform a perigee adjust burn to achieve maximum blowdown. The RCS propellant tanks reach maximum blowdown at 22 (OX) and 23 (FU) percent. Maximum blowdown procedures for use on orbit are documented in the MALF PROC titled "LEAKING He RCS BURN" and in the Orbit Pocket titled, "OUT OF PLANE OMS PRPLT/He BURN" for the OMS. Next PLS may be required if propellant margins dictate.

Rule {A6.1.2-17B}, OMS FAILURE MANAGEMENT (CIL), references this rule.

FLIGHT RULES

A6.1.2-3 OMS LEAKING HE SYSTEM BURN

DURING OMS BURNS, A LEAKING HELIUM SYSTEM MAY BE USED TO FEED BOTH ENGINES TO INCREASE PROPELLANT ULLAGE VOLUME.

As long as the helium tank pressure supports a nominal propellant tank pressure, a leaking helium tank can be used to feed both OMS engines. This configuration attempts to maximize the blowdown delta V capability in the affected OMS system prior to the helium tank being declared failed. No risk of damage to the OMS engines exists because a good propellant feed source is always used. Starting two OMS engines from one pod is acceptable.

A6.1.2-4 OMS TANK FAIL CROSSFEED OR INTERCONNECT CONSTRAINT (CIL)

THE OMS CROSSFEED OR INTERCONNECT MODE WILL NOT BE USED TO FEED FROM A FAILED OR A SUSPECTED FAILED OMS PROPELLANT TANK AS LONG AS SHALLOW TARGETS, TANK LANDING WEIGHT CONSTRAINTS, AND CG LIMITS ARE PRESERVED. IF ANY OF THE ABOVE CONSTRAINTS ARE VIOLATED, THE INTERCONNECT MODE MAY BE USED TO ATTEMPT AN RCS +X PERIGEE ADJUST.

A. ABOVE MINIMUM SAFE PERIGEE (SAFE HP), THE INTERCONNECT MODE MAY BE USED TO ATTEMPT AN RCS +X PERIGEE ADJUST. @J072398-6692A]

The only case of propellant blockage to date (STS-1) demonstrated that the screens present in the system are adequate to prevent migration of contaminants. STS-1 data showed that 50 percent of the OMS oxidizer inlet filter was blocked by contaminants with small traces downstream. The blockage may allow flow rate sufficient to support a +X translation while not supporting an OMS flow rate (+X OX=3.9 lb/sec and FU=2.4 lb/sec compared to OMS OX=12 lb/sec and FU=7.2 lb/sec, reference SODB tables 4.3.2-1 and 4.3.3-1 for flow rates). Troubleshooting can be performed by interconnecting to the L(R) RCS 1/2 leg. The OMS propellant might be able to support an RCS flow rate, thus avoiding an undesirable entry, (OMS propellant fail is not protected and can mean a shallow deorbit and no-yaw jet entry). For propellant contamination in the OMS to reach the RCS jets, it must pass through seven screens (two on each ac-motor valve and one at the inlet to the jet). This rule will also allow determination of a leak downstream of the ball valves that would appear as a propellant fail.

CIL retention rationale (FMEA 03-3-4002-1) addresses the case of propellant filter screens blocked by contamination. However, the conclusion of the March 9, 1995, PRCB was that by the time of the deorbit burn, the system has proved itself free of contaminants. Even so, propellant lines may be frozen by a small, undetected leak (ref. AEFTP #141, August 15, 1997), resulting in a propellant fail condition. For any OMS propellant fail (actual or suspected) above minimum safe perigee (safe hp), the CIL requirement is to stop the burn and troubleshoot the problem via interconnect. @J072398-6692A]

FLIGHT RULES

THIS RULE CONTINUED ON NEXT PAGE

FLIGHT RULES

A6.1.2-4

OMS TANK FAIL CROSSFEED OR INTERCONNECT CONSTRAINT (CIL) (CONTINUED)

B. BELOW MINIMUM SAFE PERIGEE (SAFE HP), OMS CROSSFEED MAY BE ATTEMPTED FROM THE FAILED SYSTEM AFTER THE GOOD SYSTEM USABLE PROPELLANT HAS BEEN USED. @J072398-6692A]

Once below safe Hp, the deorbit burn must be completed. The best immediate response is to terminate propellant wasting, ensuring the delta V from the remaining OMS is utilized efficiently. Still, because OMS propellant fail is not protected (Ref. All Flights Rule {A6.1.5-3B}, OMS REDLINES (CIL)), attempting completion of the deorbit burn using only the remaining systems (Good OMS + Aft RCS + Fwd RCS) will most likely violate one or more of the constraints listed above. It is prudent, therefore, to attempt a crossfeed from the failed system but only when the good system is nearly empty (i.e., 4 percent quantity remaining.) In that way, if the crossfeed is unsuccessful, almost no delta V has been lost in the attempt. However, if the failure proves not to have been a propellant failure, or if the blockage is below the crossfeed tee, the crossfeed will be successful and the deorbit burn can be completed normally. RCS interconnect to the failed system below minimum safe perigee should not be attempted since, should the interconnect not succeed, there is not sufficient time available to execute the necessary recovery procedures (staged manifold repress, failed jet recovery, etc.). @J072398-6692A]

A6.1.2-5

OMS PROPELLANT SETTLING REQUIREMENT

AN RCS SETTLING BURN (15 SECONDS 2 +X JETS) IS REQUIRED PRIOR TO EACH OMS ENGINE RESTART IF THE OMS PROPELLANT TANK (OXIDIZER OR FUEL) AFT QUANTITY < 11 PERCENT.

If the OMS aft quantity is less than 11 percent, bulkhead screens have been uncovered allowing helium to enter into the tanks aft compartment. The next OMS burn could pull this helium into the OMS engine unless a 15-second RCS +X burn is performed prior to the OMS burn. The RCS +X burn forces the propellant over the outlet tube of the tank, preventing helium ingestion and improper mixture ratio shifts.

FLIGHT RULES

A6.1.2-6 OMS ENGINE BURN TO DEPLETION

FOR A LEAKING PROPELLANT PERIGEE ADJUST BURN OR FOR A DEORBIT BURN, AN OMS ENGINE MAY BE BURNED TO DEPLETION (PC = 80 PERCENT). THE ENGINE WOULD BE USED SUBSEQUENTLY ONLY IF IT IS THE ONLY DEORBIT METHOD AVAILABLE. (REF. RULE {A6.1.1-3E}, OMS ENGINE.)

Critical OMS burns (leaking OMS perigee adjust and deorbit) may be continued to a depletion level (defined as an 80 percent chamber pressure and an OMS engine “-” on the MNVR EXECUTE display) to maximize delta V and minimize the residuals in the leaking tank. OMS propellant gage quantity will not be used as a cutoff cue since the hardware readings are unreliable. Consequently, no effort will be made to stop the burn prior to exhausting the propellant in the lines.

During depletion, the Pc decreases. The presence of a single propellant mixing with helium pressurant in the chamber prevents the Pc from reading zero. However, the Pc will fall below the fault detection threshold (80 percent) resulting in an alert. During WSTF tests to depletion in a one-g environment, engine damage did not occur. There are substantial unknowns regarding zero-g operations and crew response time to the failure to minimize damage. If engine damage occurs during the depletion cutoff, off-nominal mixture ratios may cause uncontained engine damage when the engine is restarted. Because of this potential for engine damage an engine which has failed due to depletion of either propellant (OX or FU) will not be reused unless mandatory and then only for the deorbit burn.

(Reference SODB, 3.4.3.3.)

FLIGHT RULES

A6.1.2-7

OMS BALL VALVE FAILURE MANAGEMENT

AN OMS ENGINE WITH A FAILED OPEN BALL VALVE INDICATING GREATER THAN THE FAILED OPEN RANGE LOWER LIMIT (FLIGHT RULE {A6.1.1-3H}, OMS ENGINE) BUT < 47 (70) PERCENT POSTBURN WILL NOT BE USED UNLESS THE OTHER ENGINE HAS FAILED, AND THEN ONLY FOR THE DEORBIT BURN. HOWEVER, IF THE FAILED OPEN BALL VALVE INDICATES > 47 (70) PERCENT, THE ENGINE IS NOT CONSIDERED FAILED BUT WILL BE USED ONLY FOR THE DEORBIT BURN.

Each OMS engine has two ball valves in series (V1 and V2) for both the oxidizer and fuel lines. Instrumentation for V1 on both the oxidizer and fuel is measured by one potentiometer while both V2 valves are measured by another. Either V1 or V2 failed closed will prevent propellant from feeding the engines.

If postburn and either ball valve indicates open (after a nominal OMS burn cutoff), either the instrumentation has shifted high or the valve has failed partially open. There are no problems with burning an engine with failed instrumentation since the valves function properly. The lower limit of the failed open range is engine specific and is listed in Flight Rule {A6.1.1-3H}, OMS ENGINE. If the ball valve position is between the lower limit and 70 percent there is no guarantee that the affected ball valve will open properly. The possibility of engine hard start or combustion instability then exists, with the result of structural failure and/or chamber burn through.

If the other engine is failed, it is preferable to attempt to burn the engine with the failed ball valves, relying on them to open greater than 70 percent, rather than to attempt a 4 +X deorbit. Should the ball valves fail to open sufficiently, the 4 +X deorbit downmode is still available. With the 4 +X deorbit there is no downmode.

In any case, whenever a burn is attempted using an engine with failed open ball valves, the crew should be prepared to cut off the burn by closing the appropriate tank isolation valves if a generic problem keeps both sets of ball valves from closing.

If the ball valve indicates > 70 percent open, even a real valve problem will support a nominal engine flow rate. Consequently, the engine can be used for the deorbit burn. (Reference SODB, volume I, paragraph 3.4.3.3-17.) Rule {A6.1.1-3}, OMS ENGINE, references this rule.

FLIGHT RULES

A6.1.2-8

OMS ENGINE INSTRUMENTATION REQUIREMENT

- A. LOSS OF OMS ENGINE FUEL INJECTOR TEMPERATURE INDICATION (MDM FAIL, TRANSDUCER FAIL, ETC.) INSTRUMENTATION (PC FAIL-HIGH OR FUEL INJECTOR TEMPERATURE FAIL-HIGH/LOW) WILL BE CAUSE TO NO-GO FURTHER USE OF THE AFFECTED ENGINE FOR NONCRITICAL OMS BURNS IF THE OTHER OMS ENGINE IS STILL AVAILABLE. THE AFFECTED ENGINE WILL BE USED FOR CRITICAL BURNS TO MEET DOWNMODING CRITERIA ~~USED FOR OMS-1, OMS-2, AND DEORBIT~~ PROVIDED ALL OTHER ENGINE PARAMETERS REMAIN WITHIN NORMAL OPERATING LIMITS. @091098-6366]

The OMS Pc and fuel injector temperature are primary cues for monitoring engine health and analyzing engine failures. When the OMS Pc transducer has failed high, the L, R, OMS Pc message and the down arrow on the maneuver execute display will not be annunciated; the down arrow is driven by both Pc and acceleration low. With the crew FDA nonoperational during burns, the inlet pressures must be monitored continuously and if a subsequent problem was detected, the crew would be unable to discern instrumentation from a real performance failure. Therefore, it is prudent to discontinue use of the affected engine except for critical burns.

The fuel injector temperature is a primary cue for monitoring engine health and analyzing engine failure. During normal engine operation, the nominal fuel inlet pressure often exceeds the documented engine fail limit. -Without the fuel injector temperature, the crew monitoring capability is severely degraded and an engine failure ~~cannot be distinguished from a propellant failure.~~ may be impossible to distinguish from nominal engine operation. If the OMS engine is burned and a failure occurs, the engine and associated propellant systems would be suspect and could not be used without possible damage to the good engine or OMS pod.

For critical crew safety burns, such as OMS-1, -2, and deorbit, the affected engine will be used with the remaining good engine (two-engine burn) to provide a downmode capability. For safety critical on-orbit ~~critical~~ burns, such as an inertial upper stage (IUS) separation, the good engine should be used with downmode to RCS. If there is no remaining good engine, the FRCS -X jets can be used. For mission critical on-orbit burns that are too large for an RCS downmode, both engines can be used.

Other eEngine parameters also include Pc, ~~fuel injector temperature~~, oxidizer and fuel inlet pressures.

- B. THE FOLLOWING CRITERIA WILL BE USED TO DETERMINE SYSTEM STATUS FOR LOSS OF OMS INLET PRESSURE INSIGHT (MDM FAIL, TRANSDUCER FAIL, ETC.) IN COMBINATION WITH A FUEL INJECTOR TEMP HIGH ANNUNCIATION OR A PC LOW ANNUNCIATION (CONFIRMED BY DOWN ARROW OR GIMBAL MOVEMENT; NO CONFIRMATION IS AVAILABLE DURING PRE-MECO DUMPS).

FLIGHT RULES

AN ENGINE FAILURE WILL BE ASSUMED IF ~~THE~~ ALL OF THE FOLLOWING CONDITIONS ARE MET:

1. FAILURE OCCURS DURING POWERED FLIGHT.
2. PROPELLANT SYSTEM AND ENGINE PERFORMED NOMINALLY ON THE PREVIOUS FLIGHT.
33. NO INTRUSION WAS MADE INTO THE OMS FEEDLINES DURING VEHICLE TURNAROUND. @[091098-6366]

~~PROPELLANT SYSTEM AND ENGINE PERFORMED NOMINALLY ON THE PREVIOUS FLIGHT AND A PROPELLANT FAIL WILL BE ASSUMED.~~

THIS RULE CONTINUED ON NEXT PAGE

FLIGHT RULES

A6.1.2-8

**OMS ENGINE INSTRUMENTATION REQUIREMENT
(CONTINUED)**

OTHERWISE, A PROPELLANT FAILURE WILL BE ASSUMED UNTIL DATA REVIEW CAN CONCLUSIVELY DIAGNOSE THE FAILURE. @091098-6366]

This flight rule documents the decisions made at the March 9, 1995, ~~3/9/95~~ PRCB stemming from the ROMS Oxidizer Inlet pressure bias observed prior to the liftoff of STS-66- (PCIN S062105).

Thirty hours before the scheduled liftoff of STS-66, the ROMS OX inlet pressure ~~was observed to - biased up approximately 6 psia. However, per Launch Commit Criteria (LCC), this is a NO-GO condition until the transducer is replaced. The OMS inlet pressure is the primary cue to determine and confirm engine fail, propellant fail, or instrumentation fail for FUEL INJECTOR TEMP HIGH and PC LOW FDA. Without this insight, the proper system diagnosis cannot be performed and the worst case, propellant fail, is assumed. Because of the launch impact of replacing the OMS Inlet Pressure transducers on the pad, the decision was made by the PRCB to waive the LCC. The decision was based on 1) the affected pod had considerable flight time without incident, 2) previous flight data indicated no problems, and 3) the propellant tank and feedline plumbing had not been breached during vehicle turnaround. The procedures were updated so that any ROMS PC annunciation during pre-MECO dumps would be assumed an engine failure. Post-MECO, any ROMS PC annunciation in combination with a failed acceleration check would be assumed to be a propellant failure to allow time for evaluation.~~

After STS-66, the PRCB elected to permanently change the LCC based on the rationale above. The PRCB discussions centered on internal contamination that could cause a blockage of the system resulting in a propellant failure. However, there are external conditions that can induce a blockage within the system. For example, if a propellant line has a small leak, the leaked propellant could freeze the OME inlet line. Engineering analysis shows that less than 1 pound of fuel can freeze a 3-foot length of oxidizer feedline. A leak could develop that would be small enough that it would go undetected in tank pressure decay for some time and yet be sufficient to freeze the feedline. This condition is not applicable to powered flight because any leaked propellant would pool at the bottom of the pod and not affect the feedlines. If a detectable amount of propellant is leaked, it is understood that the pod could be adversely affected and a real-time evaluation of the situation would be required.

It should be noted that there are cases where, if an engine fail was assumed when an actual propellant fail has occurred, the loss of vehicle and crew would result. @091098-6366]

THIS RULE CONTINUED ON NEXT PAGE

FLIGHT RULES

A6.1.2-8

OMS ENGINE INSTRUMENTATION REQUIREMENT (CONTINUED)

CB. FOR LOSS OF AN OMS ENGINE PRESSURIZATION VALVE POSITION INDICATION, THE AFFECTED ENGINE WILL BE USED ONLY FOR OMS-1 AND DEORBIT UNLESS USE OF THE ENGINE IS REQUIRED TO MEET OMS/RCS DOWNMODING CRITERIA, OR IF PROPER ENGINE PRESSURIZATION VALVE OPERATION CAN BE VERIFIED BY AN INCREASE IN THE OMS GN₂ REGULATOR PRESSURE AND/OR DECREASE IN THE GN₂ TANK PRESSURE PRIOR TO IGNITION.

For ~~OMS on-orbit~~ burns, proper pressurization valve operation is required in order to ensure one start capability for the affected engine is retained for the deorbit burn. For OMS-1 the valve is assumed to be open for confirmed instrumentation losses because redundant hardwired command paths are used. The risk of using the last start if the valve is actually closed (dual failure) is accepted since the burn is critical for orbit insertion.

For burns other than OMS-1 and deorbit, it is prudent not to use the affected engine if the burn can be accomplished without it. The engine may be used, however, if proper valve operation can be verified, or if required to meet OMS/RCS downmoding requirements as defined by Rule ~~[[A2.1.3-15]]~~, OMS/RCS MANEUVER CRITICALITY. For instance, the engine may be used for OMS-2 if proper valve operation has been verified prior to insight being lost as a result of an MDM FA3 or FA4 failure since a subsequent MDM FA1 or FA2 power failure would fail the other OME and four +X capability. If the OMS engine pressurization valve is actually failed closed, two OMS starts may still be available due to the initial, higher than normal regulator pressure available prelaunch, assuming the ARM/PRESS switch is taken to ARM ~~arm~~ before the purge. @1091098-6366 1

FLIGHT RULES

A6.1.2-9 RCS MANIFOLD CLOSURE CRITERIA

RCS MANIFOLDS MAY BE CLOSED FOR THE FOLLOWING CONDITIONS:

RCS manifolds are nominally open. Manifolds that have been closed may cause complications if they are reopened after the manifold pressure significantly decreases due to a temperature change or a leak. A high pressure spike will be transmitted through the manifold when the manifold valve is reopened. If the pressure spikes are large enough, thruster valve bounce may occur resulting in propellant leakage.

Therefore, the manifolds are only cycled for the following identified cases.

** Note: There is no concern with vernier manifold pressure spikes and no concern with rupturing the primary manifold bellows. (Some test data indicate primary thruster valves may only bounce if helium gas is in the injector valve.)*

A. SYSTEM LEAK TROUBLESHOOTING.

Current leak isolation procedures require manifold isolation valves to be closed. In the event of a manifold leak, the manifold valve must be closed to prevent any further leakage. If the leak was not in the manifold, the manifold valve can be reopened with no damage to the failed system.

B. ISOLATION OF RM INDICATED FAILED-ON JET (FOR VERIFIED FAILED ON JET, MANIFOLD WILL NOT BE OPENED).

For an RCS jet failed on, the associated manifold valve must be closed to prevent excessive propellant usage and attitude control problems.

For false fail-on indications, the manifold can be reopened. MCC should then consult Rule {A6.1.2-19}, RCS RM LOSS.

For real fail-on jets the manifold will be evacuated when closed. If the failure has been cleared and the affected manifold is required to be GO for on-orbit operations, a GMEM procedure is available to repressurize the evacuated manifold. Consult Rule {A6.1.2-11}, RCS MANIFOLD/OMS CROSSFEED LINE REPRESSURIZATION (CIL).

THIS RULE CONTINUED ON NEXT PAGE

FLIGHT RULES**A6.1.2-9 RCS MANIFOLD CLOSURE CRITERIA (CONTINUED)**

C. ISOLATION OF RM INDICATED LEAKING JET.

1. IF DIVERGENCE OCCURS BETWEEN OXIDIZER AND FUEL QUANTITIES.
2. IF CORRESPONDING NONLEAKING INJECTOR TEMPERATURE DROPS BELOW 40 DEG F.
3. IF INJECTOR TEMPERATURES AND CHAMBER PRESSURE SIGNATURES INDICATE BOTH INJECTOR VALVES ARE LEAKING.
4. IF LEAK RATE IS OF THE MAGNITUDE THAT RESULTS IN PLUGGING OF THE CHAMBER THROAT AS INDICATED BY CHAMBER PRESSURE AND INJECTOR TEMPERATURES.

Normally no action is taken if a jet should fail leak. The injector valves are pressure assisted by design. Maintaining system pressure on the valve provides the best seal possible at the injector valve seat which may help seal the leak. Also, it is undesirable to close the manifold isolation valve because of the loss of additional RCS jets on that manifold (RCS RM declares the jets unavailable if manifold isolation valves are closed). If the manifold isolation valve were to be closed, the isolated manifold pressure would quickly decrease because of the leak.

The manifold isolation valve shall be closed if any of the following conditions are met:

- a. *To isolate the leaking jet from the system should a divergence be detected between the oxidizer and fuel quantities.*
- b. *To prevent ZOTS from occurring if both injector valves should start leaking—~~The primary thruster propellant valves are certified to provide acceptable sealing to 40 deg F. Due to the evaporative cooling effect of the initial propellant leak, the temperature of the nonleaking engine valve will tend to decrease. Should the second propellant valve begin to leak due to cold temperature, the resulting dual propellant leak can have very undesirable effects, such as valve ZOT.~~—The minimum temperature reached by the nonleaking valve is primarily a function of the leak rate of the leaking valve. Thus, ~~for a leaking jet, the nonleaking valve/injector temperature differential cannot be determined. The 40 deg F limit represents best engineering judgment for the minimum acceptable injector temperature for the nonleaking valve.~~Should the second propellant valve begin to leak due to cold temperature, the resulting dual propellant leak can have very undesirable effects, such as valve ZOT. @[091098-6708.1]*
- c. *To prevent off-nominal combustion in the chamber due to both valves leaking, as evidenced by injector temperature and chamber pressure. @[091098-6708.1]*

FLIGHT RULES

- d. *To prevent second valve leakage due to initial valve leakage causing blockage of the chamber throat. Blockage of the chamber throat will cause pressure to build up on the outside portion of the seal of the nonleaking valve, thus reducing its sealing force.*

THIS RULE CONTINUED ON NEXT PAGE

FLIGHT RULES**A6.1.2-9 RCS MANIFOLD CLOSURE CRITERIA (CONTINUED)**

D. SYSTEM SECURING AS A RESULT OF POWERDOWNS.

Orbiter failures resulting in powerdown of electrical buses may cause the loss of RCS jet heaters and/or jet injector temperatures. Loss of the jet heaters will allow the jets to cool and the injector valve Teflon seals to shrink. ~~When~~ injector temperatures reach approximately 470 deg F, leakage may occur preventing future use of the jet (ref. Rule {A6.1.3-62-29}, RCS JET TEMPERATURE MANAGEMENT/LEAKING JET MANAGEMENT RULES). Special hot fire procedures could be utilized to warm the jets but may be impractical because of the numerous jets affected. The manifold valves can be closed reducing propellant leakage into the jet. @091098-67081

E. UNRECOVERABLE LOSS OF:

1. COMMAND PATH TO ALL JETS ON A MANIFOLD.
2. ELECTRICAL POWER (BOTH REDUNDANT SOURCES) TO A REACTION JET DRIVER (RJD).
3. RJD FUNCTION TO ALL ITS ASSOCIATED JETS.

These three cases lose all jets on a single manifold. No additional jets can be lost because of the manifold closure. Thus no additional capability is lost and the manifold will remain closed to protect against leaks or jet failures.

A6.1.2-10 RCS LEAKING PROPELLANT TANK BURN

FOR RCS PROPELLANT TANK LEAKS, A PERIGEE ADJUST OR OUT-OF-PLANE MANEUVER WILL BE EXECUTED IMMEDIATELY. PROPELLANT MAY BE DUMPED TO DEPLETION.

Thermal effects of a propellant leak and propellant sublimation rates vary as a function of which propellant is leaking, the location of the leak, the distribution of the propellant within the pod, and the thermal environment. As a result, to preclude propellant feedlines from freezing thus rendering the entire pod unusable, the propellant will be dumped immediately. If the tank is dumped to depletion, MALF RCS SSR-7 will be used to clear the helium from the propellant lines. (OMS tank leaks are handled in a similar manner.) This leak philosophy was agreed upon at the July 13, 1987, Flight Rules PRCB.

FLIGHT RULES

A6.1.2-11	RCS MANIFOLD/OMS CROSSFEED LINE REPRESSURIZATION (CIL)	6-29
A6.1.2-12	RCS RM FAIL THRUSTER TEST	6-36
A6.1.2-13	CONTINGENCY RCS PROPELLANT AVAILABLE	6-37
A6.1.2-14	OMS/RCS CONTINUOUS VALVE POWER FAILURE MANAGEMENT	6-37
A6.1.2-15	OMS N2 REGULATOR FAILURE MANAGEMENT	6-38
A6.1.2-16	RCS LINE LEAK MANAGEMENT	6-38
A6.1.2-17	OMS FAILURE MANAGEMENT (CIL)	6-40
A6.1.2-18	RCS FAILURE MANAGEMENT	6-73
A6.1.2-19	RCS RM LOSS	6-82
A6.1.2-20	RCS MAXIMUM BURN TIME	6-87
A6.1.2-21	OMS HELIUM INGESTION	6-88
A6.1.2-22	RCS JET DRIVER MANAGEMENT (CIL)	6-88
A6.1.2-23	RCS BLOWDOWN	6-89
A6.1.2-24	CROSSFEED/INTERCONNECT DURING CREW SLEEP	6-89
A6.1.2-25	OMS ENGINE FAILURE MANAGEMENT	6-91
A6.1.2-26	RCS HOT-FIRE CHECK	6-91
A6.1.2-27	RCS VERNIER OPERATION TERMINATION	6-92
A6.1.2-28	OMS ENGINE INLET PRESSURE REQUIREMENTS	6-93
A6.1.2-29	LEAKING JET MANAGEMENT RULES	6-94
A6.1.2-30	OMS LEAKING INLET LINE PERIGEE ADJUST BURN	6-95
A6.1.2-31	RCS JET REPRIORITIZATION CRITERIA	6-96
A6.1.2-32	FAILED PRCS JET RESELECTION PRIORITY	6-97
A6.1.2-33	OMS ENGINE BELL MOVEMENT DURING ASCENT	6-98
A6.1.2-34	OMS BURN DOWNLIST REQUIREMENT	6-101
A6.1.2-35	PRELAUNCH RCS PVT INITIALIZATION (INIT) TMBU	6-101
A6.1.2-36	OMS GN2 ACCUMULATOR LEAK DETERMINATION	6-102

FLIGHT RULES

A6.1.2-11 RCS MANIFOLD/OMS CROSSFEED LINE REPRESSURIZATION (CIL)

A. RCS MANIFOLD REPRESSURIZATION MANAGEMENT:

1. GENERAL:

- a. MANIFOLDS WILL BE REPRESSURIZED DIRECTLY FROM THE TANK VOLUME USING THE MANIFOLD ISOLATION VALVE ANYTIME BOTH THE MANIFOLD PRESSURES > 130 PSIA.

Tests conducted at WSTF revealed that when repressurization of a manifold was attempted with an initial manifold pressure < 50 psia and the tank pressure approximately 245 psia, the thruster valves bounced, leaking propellant into the combustion chamber. The uncontrolled leaking of oxidizer or fuel into the chamber can lead to oxidizer/fuel detonation in the injector passage (ZOT's). The concern is that the fuel will stay in the oxidizer injector passages and will not vaporize prior to the oxidizer reaching the jet (vapor pressure: oxidizer = 15 psi; fuel = 0 psi). Consequently, combustion will take place in the injector instead of the chamber, leading to thruster valve damage and propellant leaks. Based on these concerns and the test results, it was agreed in flight techniques to use special procedures (stage repress) if time permits for repressurization of manifolds where both the oxidizer and fuel manifold pressure < 130 psia (130 = 50 pressure + 50 pad + 30 instrumentation). Repress via the manifold isolation valve will be performed only if mandatory for attitude control during time-critical phases. There is no restriction against repressing manifolds if the manifold pressure > 130 psia.

- b. SIMULTANEOUS REPRESSURIZATION OF MORE THAN ONE SET (OXIDIZER AND FUEL) OF EVACUATED MANIFOLDS FROM AN RCS TANK IS NOT ALLOWED.

Simultaneous repressurization of evacuated manifolds is not allowed. Two evacuated manifolds repressed at WSTF resulted in an RCS tank bulkhead delta pressure > 7.0 psid (spec limit = 3.7 psid). This could result in damage to the bulkhead, resulting in broken screens, helium gas ingestion into the jets, jet failure, and subsequent loss of the tank.

- c. VERNIER MANIFOLDS WILL BE REPRESSURIZED USING THE MANIFOLD ISOLATION VALVE IF THE VERNIER JETS ARE OTHERWISE AVAILABLE FOR NORMAL ON-ORBIT OPERATIONS.

There is no constraint against repressing a vernier manifold. The vernier thruster valves are solenoid, not pilot operated, and do not bounce when subjected to large pressure spikes. The vernier alignment bellows spec limit was exceeded during repress tests at WSTF, but resulted in no damage. As long as the vernier jet capability is not precluded by another system failure, vernier manifolds will be repressed as required.

THIS RULE CONTINUED ON NEXT PAGE

FLIGHT RULES**A6.1.2-11 RCS MANIFOLD/OMS CROSSFEED LINE REPRESSURIZATION
(CIL) (CONTINUED)**

- d. LEAKING LINES WILL NOT BE REPRESSURIZED UNLESS MANDATORY FOR VEHICLE CONTROL.

The risks associated with leaking propellant into an OMS pod or forward RCS module do not warrant feeding a leak if the flow path is not mandatory to maintain vehicle control. Leaking lines should not be repressed to gain redundancy. The corrosive effects of oxidizer (N₂O₄), along with structural integrity (bulkhead delta P) concerns and toxicity, make it undesirable to feed an OX leak unless mandatory. The fire, explosive, and toxicity hazards of the fuel (mmH) make it undesirable to feed a fuel leak unless mandatory. Leakage of either propellant in a vacuum environment may cause freezing of other pod components resulting in loss of additional propulsion capability.

2. INDIVIDUAL OXIDIZER OR FUEL MANIFOLD PRESSURE < 130 PSIA:

MANIFOLDS WILL BE REPRESSURIZED DIRECTLY FROM THE TANK USING THE MANIFOLD ISOLATION VALVE EXCEPT IF CAUSED BY A JET FAIL LEAK OR PROPELLANT LEAK. MANIFOLD(S) WILL BE REPRESSURIZED IF REQUIRED FOR ET SEPARATION OR ENTRY CONTROL.

ANYTIME IF MANDATORY TO MAINTAIN ATTITUDE CONTROL.

Repressing a manifold where an individual oxidizer or fuel manifold pressure < 130 psia and the other pressure > 130 psia is allowed using the manifold isolation valve. For this case, the expected valve bounce will only occur on the affected propellant manifold, leaking only oxidizer or fuel into the chamber. The presence of one propellant does not represent a ZOT risk if the propellant sublimates and clears the chamber before further jet use. Oxidizer will clear the chamber in approximately 10 seconds while fuel takes 1 to 2 minutes.

Manifolds will not be repressed on orbit if the manifold pressure decay was caused by a propellant leak. Repressing the manifold may increase the leak rate. For jet leaks, manifolds may be repressed in an attempt to put pressure on the injector valve, possibly sealing the leak. These manifolds can be repressed during entry if mandatory for control.

3. BOTH OXIDIZER AND FUEL MANIFOLD PRESSURE < 130 PSIA:

- a. AN EVACUATED MANIFOLD CAUSED BY A JET FAIL-ON WILL NOT BE REPRESSURIZED UNLESS THE FAILURE HAS BEEN CLEARED.

THIS RULE CONTINUED ON NEXT PAGE

FLIGHT RULES**A6.1.2-11 RCS MANIFOLD/OMS CROSSFEED LINE REPRESSURIZATION
(CIL) (CONTINUED)**

b. MANIFOLDS WILL BE REPRESSURIZED DIRECTLY FROM THE TANK USING THE MANIFOLD ISOLATION VALVE:

(1) ANYTIME IF MANDATORY TO MAINTAIN ATTITUDE CONTROL.

(2) DURING NOMINAL/RTLS ASCENT IF REQUIRED FOR ET SEPARATION. (SEE RULE {A8.1.2-5}, ET SEPARATION RCS REQUIREMENTS.)

NOTE: MANIFOLDS WILL NOT BE REPRESSED TO REGAIN REDUNDANCY. MULTIPLE MANIFOLDS WILL BE REPRESSED IF REQUIRED FOR ET SEPARATION OR ENTRY CONTROL.

c. INADVERTENT EVACUATED MANIFOLDS WILL BE REPRESSURIZED ON ORBIT USING A READ/WRITE PROCEDURE IF REQUIRED TO BE GO TO STAY ON ORBIT.

d. A STAGED REPRESSURIZATION PROCEDURE WILL BE USED ON ORBIT TO REPRESSURIZE MANIFOLDS AT VAPOR PRESSURE (LIQUID IN LINES).

A staged repressurization or read/write procedure will be used on orbit to repressurize desired manifolds where both the oxidizer and fuel manifold pressures are < 130 psia. The staged repressurization procedure is only effective if liquid exists in the lines and will not work for an evacuated manifold. The manifold is repressurized using the line volume between the tank isolation valves and the manifold isolation valves until a manifold pressure > 130 psia is achieved. (If the manifold pressure is not above vapor pressure after the first cycle of the staged repressurization procedure, the manifold may be partially evacuated and the staged repressurization procedure will not work.) Repressurization directly from the tank is acceptable after manifold pressures are > 130 psia. The read/write procedure allows the inadvertent evacuated manifold to be repressurized on orbit without the risk of a ZOT occurring. The GMEM procedure consists of opening the oxidizer tank isolation valve prior to the fuel isolation valve, allowing the oxidizer to sublime before the fuel arrives at the jet. These procedures will not be attempted in time-critical phases. Deorbit preparation OPS 3 transition has been baselined as the point at which these special procedures will no longer be utilized. The manifold isolation valve will be used to repressurize a manifold directly from the tank volume during time-critical phases. Confirmed jet fail-on evacuated manifolds will not be repressurized due to excessive propellant consumption and the possibility of further jet and RCS propellant tank damage. However, jet fail-on evacuated manifolds will be repressurized if the failures have been cleared (no driver out command with the RJD power on). The inadvertent evacuated manifold repressurized actions should be used in this case.

FLIGHT RULES

THIS RULE CONTINUED ON NEXT PAGE

FLIGHT RULES

**A6.1.2-11 RCS MANIFOLD/OMS CROSSFEED LINE REPRESSURIZATION
(CIL) (CONTINUED)**

B. OMS/RCS CROSSFEED LINE REPRESSURIZATION MANAGEMENT (CIL):

	FUEL PRESSURE		
	> 130 PSIA	< 130 PSIA AND > 35 PSIA	< 35 PSIA
OXID PRESSURE > 130 PSIA	[1]	[1]	[3] [4]
OXID PRESSURE < 130 PSIA AND > 49 PSIA	[1]	[2] [5]	[4] [6]
OXID PRESSURE < 49 PSIA	[3] [4]	[4] [6]	[4] [6]

NOTES:

- [1] NOMINAL OPERATIONS ALLOWED.
- [2] CROSSFEED LINE AVAILABLE FOR INTERCONNECT/CROSSFEED OPERATIONS SUBJECT TO RCS MANIFOLD REPRESS CONSTRAINTS.
- [3] REPRESSURIZATION OF RCS MANIFOLDS ALLOWED FROM THE RCS USING THE MANIFOLD ISOLATION VALVES ONE MANIFOLD AT A TIME. (REF. PARAGRAPH A.)
- [4] REPRESSURIZATION OF CROSSFEED NOT ALLOWED UNLESS CRITICAL FOR CREW SAFETY.
- [5] REPRESSURIZATION OF RCS MANIFOLDS ALLOWED USING RCS OR OMS STAGED REPRESSURIZATION PROCEDURE. (REF. PARAGRAPH A.)
- [6] REPRESSURIZATION OF RCS MANIFOLDS ALLOWED USING RCS STAGED REPRESSURIZATION PROCEDURES ONLY. (REF. PARAGRAPH A.)

1. RCS MANIFOLD PRESSURES WILL BE USED ON ORBIT TO DETERMINE THE GO/NO-GO STATUS OF THE CROSSFEED LINE PRIOR TO REPRESSURIZATION DIRECTLY FROM THE PROPELLANT TANK.

FLIGHT RULES

All 10 manifolds are used because analysis indicates if the crossfeed pressure were at a minimum because of thermal cycles, the pressure contained in the volume of 10 manifolds is sufficient to bring the crossfeed pressure up to within acceptable limits without a special staged repressurization procedure. There are pressure transducers on the crossfeed lines; however, when the lines are isolated, thermal cycles cause the pressures of the hydraulically locked-up lines to cycle significantly. The crossfeed line pressure transducers have a large instrumentation error (34 psia); and, when the lines are isolated, the fuel line pressure frequently indicates below the sum of the vapor pressure (1 psia) and the instrumentation error. The RCS manifold pressures are, therefore, used as a pressure check at the time of interconnect or crossfeed. Note that when the RCS manifolds are opened to the crossfeed lines, the RCS tank isolation and OMS crossfeed valves are closed, alleviating the concern of a pressure surge from a large pressurant source and ullage. An average pressure of all oxidizer manifolds will be used as the oxidizer crossfeed line pressure for evaluation. An average will also be used for the fuel crossfeed line pressure. Instrumentation bias must also be considered prior to averaging the pressures.

THIS RULE CONTINUED ON NEXT PAGE

FLIGHT RULES**A6.1.2-11 RCS MANIFOLD/OMS CROSSFEED LINE REPRESSURIZATION
(CIL) (CONTINUED)**

- a. OXIDIZER OR FUEL MANIFOLD PRESSURES < 15 (49) PSIA OXIDIZER OR < 1 (35) PSIA FUEL. THE CROSSFEED LINE WILL BE CONSIDERED FAILED FOR FURTHER ON-ORBIT OPERATIONS UNLESS CRITICAL FOR CREW SAFETY. DEORBIT WILL BE SCHEDULED AT THE NEXT PLS.

If the oxidizer pressure is < 49 psia and/or the fuel pressures < 35 psia, repress of the OMS crossfeed line from a high pressure tank is not allowed. A staged repressurization may be attempted to increase the crossfeed pressures to within acceptable limits. If the staged repressurization is unsuccessful, the crossfeed line will be declared failed. The pressure limits are based on an instrumentation error of 34 psia and vapor pressure of 15 psia for the oxidizer and one for the fuel. WSTF tests have verified that repressurizing a crossfeed line at pressures less than propellant vapor pressure is known to create unacceptable large surge pressures and must be avoided if possible. (Reference SODB 3.4.3.3.17.)

Flight Rules require two methods of deorbit capability to be go past the next PLS. Because of the crossfeed line failure, there will be no downmode capability for an OMS engine failure during the deorbit burn. (Reference Rule {A6.1.5-6}, VIOLATION OF MISSION COMPLETION REDLINES MATRIX.)

- b. OXIDIZER AND FUEL MANIFOLD PRESSURES > 15 (49) PSIA OXIDIZER OR > 1 (35) PSIA FUEL. THE CROSSFEED LINE IS AVAILABLE FOR INTERCONNECT/CROSSFEED OPERATIONS SUBJECT TO RCS MANIFOLD REPRESSURIZATION CONSTRAINTS. (REF. PARAGRAPH A.)

For crossfeed pressures > 49 psia oxidizer or > 35 psia fuel, there are no crossfeed line constraints. However, the RCS manifolds require a staged repressurization when both propellants are < 130 psia. The staged repressurization procedure will prevent surge pressures from bouncing the jet injector valves and causing a ZOT. An OMS staged repressurization procedure exists that allows the repressurization of all 10 RCS manifolds simultaneously rather than one at a time. (Ref. paragraph A.)

2. THE OMS CROSSFEED LINE WILL BE USED INDEPENDENT OF THE CROSSFEED LINE PRESSURE FOR MANEUVERS CRITICAL FOR CREW SAFETY, ABORT PROPELLANT DUMPS, OR IF REQUIRED, TO MAINTAIN ATTITUDE CONTROL.

Any interconnect or crossfeed required for crew safety will be executed without regard to the crossfeed line pressure.

THIS RULE CONTINUED ON NEXT PAGE

FLIGHT RULES

A6.1.2-11 RCS MANIFOLD/OMS CROSSFEED LINE REPRESSURIZATION (CIL) (CONTINUED)

3. THE OMS CROSSFEED LINE WILL NOT BE USED TO SUPPORT MISSION SUCCESS ACTIVITIES (CROSSFEED/INTERCONNECT) UNTIL AN ACCEPTABLE CROSSFEED LINE PRESSURE HAS BEEN VERIFIED.

The OMS crossfeed line will not be used to support mission success activities (crossfeed/interconnect) until a satisfactory pressure check has been performed. This includes on-orbit crossfeed burns (planned or as a result of an engine failure). The risk of structural damage as a result of excessive surge pressures (i.e., no crossfeed pressure check) will only be accepted if the crossfeed is required to maintain crew safety.

Rules {A2.1.2-4B.3}, RTLS, TAL, AND AOA ABORTS FOR SYSTEMS FAILURES CIL); and {A6.1.2-9}, RCS MANIFOLD CLOSURE CRITERIA, reference this rule.

A6.1.2-12 RCS RM FAIL THRUSTER TEST

FOR RM FAIL-OFF, VERNIER THRUSTERS WILL BE TESTED AFTER THE FIRST FAILURE. PRIMARY THRUSTERS, FOR UNKNOWN FAILURES, WILL BE TESTED IN ORDER TO MAINTAIN FAIL-SAFE REDUNDANCY.

Vernier thrusters will be hot fired for failures where the cause is unknown in an attempt to regain vernier control. Vernier jets are required for propellant conservation such that mission objectives can be completed and mission success achieved. Primary jets will not be hot fired after the first failure because of redundant jet availability and to avoid any unnecessary risks associated with the hot fire. If multiple failures make troubleshooting desirable because of loss of fail-safe redundancy, the primary jets may be hot fired, depending on the suspected failure. For example, if it is suspected that hot firing might result in loss of the entire manifold of jets, the test will not be performed. For suspected instrumentation failures, the jet may be hot fired after the first failure. The risk is low if the data indicate an instrumentation problem, plus accomplishing the hot fire may reduce vehicle turnaround time postlanding.

For real fail leak jets, the affected jet will not be hot fired because of possible ice in the chamber and injector plate. Reference Rule {A6.1.2-29}, LEAKING JET MANAGEMENT RULES.

FLIGHT RULES

A6.1.2-13 CONTINGENCY RCS PROPELLANT AVAILABLE

DURING CONTINGENCY OPERATION INCLUDING OMS ENGINE FAILURE, OMS TANK FAILURE AND RENDEZVOUS BREAKOUT MANEUVER, THE FRCS MAY BE USED TO 1.5 PERCENT BELOW THE ONBOARD GAGE READING OF ZERO PERCENT.

SODB paragraph 4.3.2.3 (III) (CAUTION: SODB, volume III, contains engineering estimates for non-nominal performance evaluation. Data may not be supported by test.) indicates that a gauge reading of 1.5 percent below zero assures gas free propellant (no helium ingestion) flow to thrusters with reasonable risk. This assumes a factor of safety of 1.0 on tank expulsion performance and actual worst case gauging error (based on WSTF test data). Rule {A6.1.1-7}, RCS PROPELLANT TANK (OXIDIZER OR FUEL), references this rule.

A6.1.2-14 OMS/RCS CONTINUOUS VALVE POWER FAILURE MANAGEMENT

WHEN DETECTED, CONTINUOUS POWER TO AN OMS/RCS AC MOTOR VALVE WILL BE REMOVED ACCORDING TO THE FOLLOWING GUIDELINES:

- A. BY PLACING THE APPROPRIATE SWITCH IN GPC, OR
- B. IF "A" IS UNSUCCESSFUL AND CONTINUOUS POWER OCCURRED DURING A NONCRITICAL RECONFIGURATION PERIOD, BY PULLING THE APPROPRIATE AMC POD BUS CIRCUIT BREAKERS.

CIRCUIT BREAKERS PULLED UNDER "B":

- 1. WILL BE RESET DURING CRITICAL RECONFIGURATION PERIODS.
- 2. MAY BE RESET IF VALVE MOVEMENT IS REQUIRED.

A CRITICAL RECONFIGURATION PERIOD IS DEFINED AS MM 102 TO 105, MM 302 THROUGH THE OPS 9 TRANSITION, RENDEZVOUS, OR ORBIT BURNS REQUIRING A NON-STRAIGHTFEED DOWNMODE.

Continuous power is detectable only through ground monitoring of MCA logic status discretes. A reading of "0" for an unexpected length of time indicates the presence of a continuous power situation. Analysis indicates that continuous power on a valve in conjunction with a fuel leak through the valve bellows may result in auto-decomposition of mmH. Since bellows leaks are not detectable in flight, removing power minimizes the potential hazard. Tests to date have not yet resulted in auto-decomposition of mmH. Therefore, during critical reconfiguration periods where immediate OMS/RCS valve movement is required, the circuit breakers will be reset. Use of the switch to remove power is preferred over pulling the circuit breakers, since it affects only a single valve. Pulling of the AMC pod bus circuit breakers affects only OMS/RCS valve functions.

FLIGHT RULES

A6.1.2-15 OMS N2 REGULATOR FAILURE MANAGEMENT

AN OMS ENGINE WITH INSUFFICIENT OMS N₂ ACCUMULATOR PRESSURE (N₂ REG PRESS < 283 (299) PSIA) TO OPEN BOTH BALL VALVES FULLY WILL NOT BE USED UNLESS THE OTHER ENGINE HAS FAILED AND THEN ONLY FOR THE DEORBIT BURN. IF THE OTHER OMS ENGINE HAS FAILED, N₂ ACCUMULATOR PRESSURE ON THE REMAINING OME MUST SUPPORT 90 PERCENT BALL VALVE OPENING (N₂ REG PRESS > 270 (270) PSIA).

Lower than 100 percent ball valve opening will result in off-nominal start characteristics. The risk of using an engine with < 100 percent ball valve opening is only acceptable if it is the last OME available for the deorbit burn. If an OMS engine has failed and the other will support 90 percent opening (N₂ Reg P > 270 (270) psia), then the risk versus risk tradeoff is between 90 percent OME ball valve opening (no regulator pressure instrumentation) and RCS deorbit. The 90 percent OME is preferable in this case. If the last remaining OME can only support < 90 percent, then an RCS deorbit must be performed since performance drops off drastically at lower N₂ or accumulator pressures. At 228 psia with pressurization valves open (246 psia if closed), the ball valves only open to 70 percent with greater than 1/2 second transition time. Engine starting characteristics are unacceptable with this slow opening time. Reference Rules {A6.1.1-4}, OMS N2 SYSTEM; and {A6.1.2-1}, OMS N₂ TANK FAILURE MANAGEMENT. (Reference SODB, volume I, 3.4.3.3.14, and volume III, table 4.3.3.)

A6.1.2-16 RCS LINE LEAK MANAGEMENT

RCS LINE LEAKS WILL NOT BE REPRESSURIZED IN MM 602, 304 (POST Q-BAR = 20), AND 305 TO RECOVER RCS YAW JETS IF NO YAW JET DAP MODE IS AVAILABLE. RCS LINE LEAKS WILL BE REPRESSURIZED TO RECOVER FAIL CRITICAL JET REQUIREMENTS FOR ET SEPARATION AND PRIOR TO Q-BAR = 20 AFTER ALL OTHER OPTIONS HAVE BEEN ATTEMPTED (E.G., RESTRING, PORTMODE, ETC.)

FLIGHT RULES

GNC Flight Rule {A8.1.1-19}, YAW JET DOWNMODE, addresses entry yaw jet downmode for multiple failures. This rule ~~allows use of one yaw jet followed by~~prescribes ~~No Y~~yaw ~~J~~jet selection if ~~all four jets are failed on either side~~excessive jet firings/RCS usage occurs ~~(vehicle control is not an issue)~~. No yaw jet DAP mode is a certified flight control mode, and without numerous failures further downmode will not be required. Leaking oxidizer (N_2O_4) or fuel (MMH) may create a greater flammability hazard due to the operation of the APU's. Fuel (MMH) has demonstrated a fire potential when leaked onto the internal thermal blankets. The vent doors must be opened for a nonisolated N_2O_4 leak during entry which will result in major vehicle damage and subsequent extended downtime for repairs. Additionally, leaking oxidizer (N_2O_4) will cause corrosion of internal components potentially requiring replacement. Flight Rules {A.16.1.5-4}, APU SHUTDOWN FOR FUEL/OXIDIZER LEAKS (oxidizer); and {A16.1.1-11}, EXPEDITED POWERDOWN (fuel), address the off nominal postlanding impacts for leaking propellants into the pods. Due to the nature of the propellants and the uncertainty of a successful repressurization, all other options should be pursued prior to attempting repressurization of a leaking line. If no other option exists, then the line will be repressed and the leak supported to a $Q\text{-bar} = 20$. At $Q\text{-bar} = 20$ no yaw jet DAP mode will be selected and the leaking RCS isolated. [@J021998-6485B1](#)

FLIGHT RULES

A6.1.2-17 OMS FAILURE MANAGEMENT (CIL)

(ASSUMES NOMINAL MECO)

FAILURE MATRIX	STD	STD	STD/DIRECT	DIRECT
	L/O TO OMS-1	OMS-1 TO OMS -2	OMS-2 TO DEORBIT	L/O TO OMS-2
1 OMS HE TANK LEAK	A	A	B	A
1 OMS HE TANK FAIL	C	D	E	C
2 OMS HE TANK LEAK/FAIL	F	G	H	F
1 OMS HE LEG LEAK	I	I	I	I
2 OMS HE LEG LEAK	J	J	J	J
1 OMS GN2 TANK LEAK/FAIL	K	K	K	K
2 OMS GN2 TANK LEAK/FAIL	L	L	L	L
1 OMS GN2 ACCUMULATOR LEAK	M	M	M	M
2 OMS GN2 ACCUMULATOR LEAK	N	N	N	N
1 OMS PROP TANK LEAK	O	O	P	O
1 OMS PROP TANK FAIL	O	O	O	O
2 OMS PROP TANK LEAK/FAIL	R	R	R	R
1 OMS INLET LINE LEAK	S	S	T	S
2 OMS INLET LINE LEAK	U	U	U	U
1 OMS ENGINE FAIL	V	V	V	V
2 OMS ENGINE FAIL	W	W	W	W

NOTES:

- [1] USE OMS ENGINE IN BLOWDOWN UNTIL OMS CHAMBER PRESSURE < 72 PERCENT ON ENGINE BEING SUPPLIED BY LEAKING POD, THEN SEGP.
- [2] DELAYED ATO OMS-1 WITH NOMINAL MECO DOES NOT REQUIRE OMS-2 BURN.
- [3] REPRESSURIZE LEAKING TANK. BURN IF FUEL INLET PRESSURE > 216 PSIA, OXIDIZER PRESSURE > 151 PSIA.
- [4] ENTER FIRST DAY PLS.
- [5] ENTER NEXT PLS.
- [6] CUTOFF AT MINIMUM HP WHICH REQUIRES THE LEAST TOTAL DELTA V FOR THE INSERTION AND DEORBIT BURNS AND ENSURES ORBITAL LIFETIME AT LEAST TWO ORBITS BEYOND THE FIRST DAY PLS. (REF. RULE {X4.1.1-1}, TRAJECTORY AND GUIDANCE PARAMETERS.)
- [7] IF TANK IS FAILED PERFORM ALL BURNS SEGP.

OMS CONFIGURATION	DEORBIT
TEGP - TWO ENGINES GOOD POD	
TETP - TWO ENGINES TWO PODS (NORMAL CONFIGURATION)	NOMINAL DEORBIT: NOMINAL (STEEP) TARGETS
TELP - TWO ENGINES LEAKING POD	
SETP - SINGLE ENGINE TWO PODS (CROSSFEED IN BURN)	
SESP - SINGLE ENGINE SINGLE POD (MAY BE CROSSFEED)	
SELP - SINGLE ENGINE LEAKING POD	
SEGP - SINGLE ENGINE GOOD POD	

FLIGHT RULES

THIS RULE CONTINUED ON NEXT PAGE

FLIGHT RULES

A6.1.2-17 OMS FAILURE MANAGEMENT (CIL) (CONTINUED)

FAILURE DEFINITION

OMS HE TANK LEAK/FAIL:

- HE TANK LEAK IF PRESSURE > 640 PSI AND DECREASING WHEN NOT BURNING.
- HE TANK FAIL IF PRESSURE < 640 PSI.
- FULL BLOWDOWN IF PROPELLANT TANK QUANTITY ≤ 39 PERCENT.

MAXIMUM BLOWDOWN IF PROPELLANT TANK QUANTITY APPROXIMATELY EQUAL TO 39 PERCENT (ENGINE SPECIFIC). @J072398-6518A]

- OMS PROPELLANT TANK LANDING WEIGHT CONSTRAINT IS EOM QUANTITY ~~←~~ APPROXIMATELY ~~-22-~~ PERCENT PER POD.

ACTION SUMMARY

- A. ONE OMS HE TANK~~SINGLE~~ LEAK PRIOR TO OMS-2:

STD:

1. IF HE TANK LEAK RATE ~~INDICATES HE TANK~~ WILL NOT SUPPORT OMS-1 TELP TO A QUANTITY SUFFICIENT TO PROTECT THE OMS PROPELLANT LANDING WEIGHT CONSTRAINT:—
 - a. CONTINUE PRE-MECO OMS-ASSIST/ATO OMS DUMP ~~S~~TELP.
 - b. PERFORM PRE-MECO OMS DUMP UNTIL AFFECTED POD MAXIMUM~~FULL~~ BLOWDOWN OR HE TANK PRESSURE —≤ 640 PSI.
 - c. DELAYED ATO OMS-1 [2], TEGP, RAISE ORBIT WITHIN REDLINES.
 - d. IF NO OMS DUMP, OR DUMP NOT COMPLETED AND HE TANK WILL SUPPORT OMS-1 TETP, PERFORM NOMINAL OMS-1 TELP; GO TO PARAGRAPH D. IF HE TANK WILL NOT SUPPORT OMS-1 TETP, GO TO PARAGRAPH C. @J072398-6518A]
 - e. DEORBIT TETP [1].

THIS RULE CONTINUED ON NEXT PAGE

FLIGHT RULES

A6.1.2-17 OMS FAILURE MANAGEMENT (CIL) (CONTINUED)

2. IF HE TANK LEAK RATE ~~INDICATES HE TANK~~ WILL SUPPORT OMS-1 TELP TO A QUANTITY SUFFICIENT TO PROTECT THE OMS PROPELLANT LANDING WEIGHT CONSTRAINT: @[072398-6518A]
 - a. IF NO PRE-MECO ATO OMS DUMP REQUIRED, NOMINAL OMS-1 TELP. IF AFFECTED POD FULL BLOWDOWN ACHIEVED, NOMINAL OMS-2 TEGP; OTHERWISE STEP 3.
 - b. IF PRE-MECO ATO OMS DUMP REQUIRED, CONTINUE ATO DUMP TELP. IF NOT AT MAXIMUM BLOWDOWN AND HE TANK PRESSURE > 640 PSI, DELAYED ATO OMS-1 [2], TELP; OTHERWISE PERFORM DELAYED ATO OMS-1 [2], TEGP.
 - c. RAISE ORBIT WITHIN REDLINES.
3. IF HE TANK LEAK RATE ~~INDICATES HE TANK~~ WILL SUPPORT OMS-2 TETP, PERFORM OMS-2 TELP UNTIL AFFECTED POD MAXIMUMFULL BLOWDOWN OR UNTIL HE TANK PRESSURE ≤ 640 PSI. OTHERWISE; IF RATE INDICATES HE WILL NOT SUPPORT OMS-2 TETP, PERFORM ~~OUT-OF-PLANE~~ DUMP POST OMS-1 TELP UNTIL AFFECTED POD MAXIMUMFULL BLOWDOWN OR HE ~~T~~TANK PRESSURE ≤ 640 PSI.
4. ~~NOMINAL~~ DEORBIT TETP [1].

DIRECT:

1. IF HE TANK LEAK RATE WILL SUPPORT OMS-2 TELP TO A QUANTITY SUFFICIENT TO PROTECT THE LANDING WEIGHT CONSTRAINT:
 - a. CONTINUE PRE-MECO OMS-ASSIST/ATO OMS DUMP STTELP.
 - b. NOMINAL OMS-2 TELP UNTIL AFFECTED POD MAXIMUM BLOWDOWN OR UNTIL HE TANK PRESSURE ≤ 640 PSI.
 - c. IF HE TANK PRESSURE > 640 PSI POST OMS-2, PERFORM DUMP TELP UNTIL AFFECTED POD MAXIMUM BLOWDOWN OR HE TANK PRESSURE ≤ 640 PSI.
 - d. CREW WORKLOAD PERMITTING, AN EARLIER DUMP TO MAXIMUM BLOWDOWN MAY BE PERFORMED TO OPTIMIZE DELTA V CAPABILITY. @[072398-6518A]

FLIGHT RULES

THIS RULE CONTINUED ON NEXT PAGE

FLIGHT RULES

A6.1.2-17 OMS FAILURE MANAGEMENT (CIL) (CONTINUED)

2. IF HE TANK LEAK RATE INDICATES HE TANK WILL SUPPORT POST-MECO OUT-OF-PLANE DUMP TELP TO A QUANTITY SUFFICIENT TO PROTECT THE OMS PROPELLANT TANK LANDING WEIGHT CONSTRAINT: @[072398-6518A]
 - a. CONTINUE PRE-MECO OMS-ASSIST/ATO OMS DUMP STTELP.
 - b. PPPERFORM OUT-OF-PLANE DUMP TELP ASAP POST-MECO UNTIL AFFECTED POD MAXIMUMFULL BLOWDOWN OR HE TANK PRESSURE ≤ 640 PSI.
 - c. OMS-2 TEGP, CUTOFF AT MINIMUM HP [6], RAISE ORBIT WITHIN REDLINES.
 - d. CREW WORKLOAD PERMITTING, AN EARLIER DUMP TO MAXIMUM BLOWDOWN MAY BE PERFORMED TO OPTIMIZE DELTA V CAPABILITY.

3. IF RATE INDICATES HE TANK LEAK RATE WILL NOT SUPPORT POST-MECO OUT-OF-PLANE DUMP TELP TO A QUANTITY SUFFICIENT TO PROTECT THE OMS PROPELLANT TANK LANDING WEIGHT CONSTRAINT:
 - a. CONTINUE PRE-MECO OMS-ASSIST/ATO OMS DUMP STTELP.
 - b. PERFORM PRE-MECO OMS DUMP UNTIL AFFECTED POD MAXIMUMFULL BLOWDOWN OR HE TANK PRESSURE ≤ 640 PSI.
 - c. IF NO PRE-MECO OMS DUMP OR DUMP NOT COMPLETE AND HE PRESSURE > 640 PSI, PERFORM POST-MECO OUT-OF-PLANE DUMP TELP.
 - d. OMS-2 TEGP, CUTOFF AT MINIMUM HP [6], RAISE ORBIT WITHIN REDLINES.

4. NOMINAL DEORBIT TETP [1].

B. ONE OMS HE TANKSINGLE LEAK AFTER OMS-2:

STD/DIRECT:

1. CONTINUE OMS ACTIVITIES WITHIN REDLINES. USE OMS ACTIVITIES TO MAXIMIZE BLOWDOWN.

FLIGHT RULES

2. ~~NOMINAL~~-DEORBIT TETP [1] [@\[072398-6518A\]](#)

THIS RULE CONTINUED ON NEXT PAGE

FLIGHT RULES

A6.1.2-17 OMS FAILURE MANAGEMENT (CIL) (CONTINUED)

C. ONE OMS HE TANKSINGLE FAILURE PRIOR TO OMS-1: [@072398-6518A](#)

STD:

1. CANCEL PRE-MECO OMS-ASSIST/ATO OMS DUMP.
2. DELAYED ATO OMS-1 [2], TEGP.
3. RAISE ORBIT WITHIN REDLINES.
4. DEORBIT~~7~~ TETP [1]

DIRECT:

1. CANCEL PRE-MECO OMS-ASSIST/ATO OMS DUMP.
2. OMS-2 TEGP, CUTOFF AT MIN~~SAFE~~ HP [6].
3. RAISE ORBIT WITHIN REDLINES.
4. DEORBIT~~7~~ TETP [1].

D. ONE OMS HE TANKSINGLE FAILURE BETWEEN OMS-1 AND OMS-2:

STD:

1. OMS-2 TEGP, CUTOFF AT MIN~~SAFE~~ HP [6].
2. CONTINUE OMS ACTIVITIES WITHIN REDLINES.
3. ~~NOMINAL~~-DEORBIT TETP [1].

E. ONE OMS HE TANKSINGLE FAILURE POST OMS-2:

STD/DIRECT:

1. CONTINUE OMS ACTIVITIES WITHIN REDLINES.
2. ~~NOMINAL~~-DEORBIT~~7~~ TETP [1]. [@072398-6518A](#)

THIS RULE CONTINUED ON NEXT PAGE

FLIGHT RULES

A6.1.2-17 OMS FAILURE MANAGEMENT (CIL) (CONTINUED)

F. TWO OMS HE TANKS~~DOUBLE~~ LEAKING/FAILED PRIOR TO OMS-1: @072398-6518A]

STD:

1. CONTINUE PRE-MECO OMS-ASSIST/ATO OMS DUMP TETP.
2. IF LEAKING AND RATES INDICATE BOTH HE TANKS WILL SUPPORT OMS-2, NOMINAL OMS-1 AND -2; OTHERWISE STEP 3.
3. PERFORM PRE-MECO OMS DUMP TETP TO MAXIMUMFULL BLOWDOWN OR HE TANK PRESSURE \leq 640 PSI, DELAYED ATO OMS-1 [2]. ~~RAISE ORBIT WITHIN REDLINES, DEORBIT TETP [1].~~
4. IF EITHER HE TANK FAILED PRIOR TO PRE-MECO OMS DUMP, OR PREMATURE OMS DUMP TERMINATION RESULTS IN INSUFFICIENT DELTA V TO ACHIEVE ATO SHALLOW OR AOA STEEP (OMS+ARCS), THEN TAL/~~LATE~~-TAL TO AN ACLS. IF POST-MECO, AOA SHALLOW IF SUFFICIENT DELTA V AVAILABLE (OMS+RCS). IF INSUFFICIENT DELTA V AVAILABLE FOR AOA SHALLOW, ~~LATE~~-TAL TO AN/ACLS/ELS.

5. IF AT OMS-2 TIG:

- NEITHER HE TANK PRESSURE \leq 640, TETP
- EITHER HE TANK PRESSURE \leq 640, SINGLE ENGINE, NON-FAILED POD
- BOTH HE TANK PRESSURE \leq 640, SESP

CUT OFF AT HP \geq MINIMUM HP. RAISE ORBIT WITHIN REDLINES, DEORBIT TETP [1] IF AVAILABLE.

DIRECT:

1. CONTINUE PRE-MECO OMS-ASSIST/ATO OMS DUMP.
2. PERFORM PRE-MECO OMS DUMP TETP TO MAXIMUMFULL BLOWDOWN OR HE TANK PRESSURE \leq 640 PSI. ~~, OMS-2 TETP, CUTOFF AT MINIMUM HP [6]. RAISE ORBIT WITHIN REDLINES, DEORBIT TETP [1].~~
3. IF PRE-MECO DUMP NOT COMPLETE OR POST-MECO AND BOTH HE PRESSURE $>$ 640 PSI, PERFORM POST-MECO ~~OUT-OF-PLANE~~ DUMP TETP TO MAXIMUMFULL BLOWDOWN OR HE TANK PRESSURE \leq 640 PSI. ~~@072398-6518A] OMS-2 TETP, CUTOFF AT MINIMUM HP. RAISE ORBIT WITHIN REDLINES, DEORBIT TETP.~~

FLIGHT RULES

THIS RULE CONTINUED ON NEXT PAGE

FLIGHT RULES

A6.1.2-17 OMS FAILURE MANAGEMENT (CIL) (CONTINUED)

4. IF EITHER HE TANK FAILED PRIOR TO PRE-MECO OMS DUMP, OR PREMATURE OMS DUMP TERMINATION RESULTS IN INSUFFICIENT DELTA V TO ACHIEVE ATO WITH SHALLOW OR AOA STEEP (OMS+ARCS), THEN TAL/~~TAL TO AN ACLS/LATERAL~~. IF POST-MECO, AOA SHALLOW IF SUFFICIENT DELTA V AVAILABLE (OMS+RCS). IF INSUFFICIENT DELTA V AVAILABLE FOR AOA SHALLOW, ~~LATE~~-TAL TO AN ACLS/ELS.

~~@072398-6518A]~~ -

5. IF AT OMS-2 TIG:

- NEITHER HE TANK PRESSURE \leq 640, TETP
- EITHER HE TANK PRESSURE \leq 640, SINGLE ENGINE, NON-FAILED POD
- BOTH HE TANK PRESSURE \leq 640, SESP

CUT OFF AT HP \geq MINIMUM HP. RAISE ORBIT WITHIN REDLINES, DEORBIT TETP [1] IF AVAILABLE.

- G. TWO OMS HE TANKS~~DOUBLE FAILURE~~ FAILED BETWEEN OMS-1 AND OMS-2:

STD:

1. PERFORM OMS-2 WITHIN REDLINES (FRCS, ARCS, OR SELP), TETP,~~CUT OFF AT MINIMUM HP [6].~~

2. CONTINUE ON-ORBIT ACTIVITIES WITHIN REDLINES.

- ~~32. DEORBIT TETP, [1] IF AVAILABLE. DEORBIT 1ST DAY PLS UNLESS DV IMPROVEMENT REQUIRED (REF. RULE {A2.1.4-1}, DEORBIT GUIDELINES).~~

- H. TWO OMS HE TANKS FAILED ~~DOUBLE FAILURE~~ POST OMS-2:

STD/DIRECT:

1. CONTINUE OMS ACTIVITIES WITHIN REDLINES.
2. ~~NOMINAL~~-DEORBIT, TETP [1]. @072398-6518A]

THIS RULE CONTINUED ON NEXT PAGE

FLIGHT RULES

A6.1.2-17 OMS FAILURE MANAGEMENT (CIL) (CONTINUED)

FAILURE DEFINITION

OMS HE LEG LEAK:

- HE TANK PRESSURE DECREASING WITH HE PRESS/VAP ISOLATION VALVE OPEN WHILE NOT BURNING.

ACTION SUMMARY

I. ONE OMS HE LEG ~~SINGLE~~ LEAK: @J072398-6518A1

STD/DIRECT:

1. CONTINUE OMS-ASSIST/ATO DUMP TETP. PERFORM OMS-1 TELP UNTIL AFFECTED POD MAXIMUMFULL BLOWDOWN OR OMS HE TK P < 640 PSI.
2. PERFORM OMS-2 TELP UNTIL AFFECTED POD MAXIMUMFULL BLOWDOWN OR OMS HE TK P < 640 PSI.
3. USE ON-ORBIT ACTIVITIES TO MAXIMIZE BLOWDOWN.
4. CONTINUE OMS ACTIVITIES WITHIN REDLINES. ONLY BLOWDOWN CAPABILITY IN AFFECTED POD WILL BE CONSIDERED IN REDLINE DETERMINATION.
5. NOMINAL-DEORBIT TETP [1].

J. TWO OMS HE LEG LEAKS:

STD/DIRECT:

1. CONTINUE OMS-ASSIST/ATO OMS DUMP TETP. PERFORM OMS-1 TETP.
2. PERFORM OMS-2 TETP.
3. USE ON-ORBIT ACTIVITIES TO MAXIMIZE BLOWDOWN.
4. CONTINUE OMS ACTIVITIES WITHIN REDLINES. ONLY BLOWDOWN CAPABILITY WILL BE CONSIDERED IN REDLINE DETERMINATION.
5. NOMINAL-DEORBIT TETP [1]. @J072398-6518A1

FLIGHT RULES

THIS RULE CONTINUED ON NEXT PAGE

FLIGHT RULES**A6.1.2-17 OMS FAILURE MANAGEMENT (CIL) (CONTINUED)**FAILURE DEFINITIONOMS GN₂ TANK LEAK/FAIL:

- GN₂ TANK LEAK IF PRESSURE DECREASING WHEN GN₂ PRESS VALVE NOT OPEN IN ARM/PRESSURE. @(072398-6518A)
- GN₂ TANK FAIL IF PRESSURE < 470 PSI.

ACTION SUMMARYK. ONE OMS GN₂ TANK SINGLE LEAK/FAIL:

STD/DIRECT:

1. PERFORM/CONTINUE PRE-MECO OMS-ASSIST/ATO OMS DUMP SEGP IF AFFECTED GN₂ PRESSURE < 470 PSI AT TIG. OTHERWISE, PERFORM ALL TANK FAILED. FOR PRE-MECO ABORT DUMPS, ATTEMPT TETP.
2. PERFORM NOMINAL-OMS-1, OMS-2, AND ON-ORBIT BURNS:
 - a. TETP IF AFFECTED/BOTH GN₂ PRESSURE > 470 PSI AT TIG.
 - b. SESEGP (GOOD ENGINE) IF AFFECTED EITHER-GN₂ PRESSURE < 470 PSI AT TIG, AND-CROSSFEED AS REQUIRED.
3. NOMINAL-DEORBIT TETP. @(072398-6518A)

L. TWO OMS GN₂ TANKS LEAKING/FAILED: @(072398-6518A)

STD:

1. CANCEL PRE-MECO OMS-ASSIST/ATO OMS DUMP IF BOTH TANKS FAILED. FOR OTHER PRE-MECO ABORT DUMPS, ATTEMPT-TETP.
2. IF LEAK RATE INDICATES EITHER GN₂ PRESSURE > 470 PSI AT TIG, TREAT AS SINGLE LEAK/FAIL. (SEE PARAGRAPH K.)

FLIGHT RULES

3. IF BOTH GN₂ PRESSURES < 470 PSI AT TIG, PERFORM DELAYED ATO OMS-1 [2] SINGLE ENGINE (OMS ENG - ARM POST IGN), RAISE ORBIT WITHIN REDLINES. ~~NOMINAL~~ DEORBIT, TETP IF BOTH GN₂ REG PRESSURES > 299 PSIA, OTHERWISE SESP. @072398-6518A]

THIS RULE CONTINUED ON NEXT PAGE

FLIGHT RULES**A6.1.2-17 OMS FAILURE MANAGEMENT (CIL) (CONTINUED)**

DIRECT:

1. CANCEL PRE-MECO OMS-ASSIST/ATO OMS DUMP IF BOTH TANKS FAILED. FOR OTHER PRE-MECO ABORT DUMPS, ATTEMPT-TETP. @[072398-6518A]
2. IF LEAK RATE INDICATES EITHER GN₂ PRESSURE > 470 PSI AT TIG, TREAT AS SINGLE LEAK/FAIL. (SEE PARAGRAPH K.)
3. IF BOTH GN₂ PRESSURES < 470 PSI AT TIG, PERFORM OMS-2 SINGLE ENGINE, CUT OFF AT MIN HP [6] SINGLE-ENGINE- (OMS ENG - ARM POST IGN). RAISE ORBIT WITHIN REDLINES. 7-NOMINAL-DEORBIT7 TETP IF BOTH GN₂ REG PRESSURESPS > 299 PSIA, OTHERWISE SESP. @[072398-6518A]

FAILURE DEFINITIONOMS GN2 ACCUMULATOR LEAK

- OMS GN₂ ACCUMULATOR PRESSURE DECREASING.

ACTION SUMMARY

- M. ONE OMS GN2 ACCUMULATOR~~SINGLE~~ LEAK:

STD/DIRECT:

1. IF LEAK RATE IS CONFIRMED TO BE ≤ 14 PSIA/SEC WITH ENGINE PRESS VALVE CLOSED (≤ 5 PSIA/SEC WITH P VALVE OPEN) AND N₂ ACCUMULATOR PRESSURE ≥ 260 PSIA PREBURN (P VALVE OPEN): @ED]
 - a. NOMINAL-OMS-1 TETP, OMS-2 SESGP (GOOD ENGINE), CROSSFEED AS REQUIRED.
 - b. PERFORM ON-ORBIT OMS BURNS SESGP (GOOD ENGINE), WITHIN REDLINES. @[072398-6518A]

THIS RULE CONTINUED ON NEXT PAGE

FLIGHT RULES**A6.1.2-17 OMS FAILURE MANAGEMENT (CIL) (CONTINUED)**

~~e. NOMINAL DEORBIT TETP.~~

~~d.c.~~ IF THE LEAK RATE WILL NOT SUPPORT THE ENTIRE DEORBIT BURN (PLUS REPRESS) SINGLE (LEAKING) ENGINE, SELF OR IF THE LEAK RATE IS INCREASING, THEN THE ENGINE IS NOT A VALID DEORBIT MODE AND RCS STEEP DEORBIT MUST BE REDLINED. @072398-6518A

d. THE LEAKING ENGINE MAY BE USED FOR THE DEORBIT BURN IF THE LEAK RATE WILL SUPPORT SINGLE (LEAKING) ENGINE COMPLETION FROM AN HP \geq SAFE HP (IF THE GOOD ENGINE FAILS ABOVE THIS HP, TERMINATE AND REPLAN THE BURN). OTHERWISE, DEORBIT GOOD ENGINE WITH RCS STEEP AS THE DOWNMODE. @072398-6518A

2. IF LEAK RATE IS UNKNOWN OR IS > 14 PSIA/SEC WITH ENGINE PRESS VALVE CLOSED (> 5 PSIA/SEC WITH P VALVE OPEN) OR GN₂ ACCUMULATOR PRESSURE < 260 PSIA PREBURN (P VALVE OPEN): @ED]

- AFFECTED OMS ENGINE IS CONSIDERED FAILED (SEE PARAGRAPH V).

N. TWO OMS GN2 ACCUMULATOR LEAKS OMS 1/2 AND DIRECT:

STD/DIRECT:

1. IF BOTH LEAK RATES ARE CONFIRMED TO BE ≤ 14 PSIA/SEC WITH ENGINE PRESS VALVE CLOSED (≤ 5 PSIA/SEC WITH P VALVE OPEN) AND N₂ ACCUMULATOR PRESSURE ≥ 260 PSIA PREBURN (P VALVE OPEN): @ED]

a. DELAYED ATO OMS-1 [2], TETP.

b. RCS STEEP DEORBIT MUST BE REDLINED. PERFORM ON-ORBIT BURNS RCS. RAISE ORBIT WITHIN REDLINES ~~(RCS STEEP DEORBIT MUST BE REDLINED)~~.

c. A LEAKING ENGINE MAY BE USED FOR THE DEORBIT BURN IF THE LEAK RATE WILL SUPPORT SINGLE ENGINE COMPLETION FROM AN HP \geq SAFE HP (IF AN ENGINE FAILS ABOVE THIS HP, TERMINATE AND REPLAN THE BURN). OTHERWISE, DEORBIT SINGLE ENGINE WITH RCS STEEP AS THE DOWNMODE. ~~NOMINAL DEORBIT TETP.~~ @072398-6518A

THIS RULE CONTINUED ON NEXT PAGE

FLIGHT RULES

A6.1.2-17 OMS FAILURE MANAGEMENT (CIL) (CONTINUED)

2. IF EITHER LEAK RATE IS UNKNOWN OR IS > 14 PSIA/SEC WITH ENGINE PRESS VALVE CLOSED (> 5 PSIA/SEC WITH P VALVE OPEN) OR GN₂ ACCUMULATOR PRESSURE < 260 PSIA PREBURN (P VALVE OPEN): @ED]

- AFFECTED OMS ENGINE IS CONSIDERED FAILED (SEE PARAGRAPHS V AND W).

FAILURE DEFINITION

OMS PROPELLANT TANK LEAK/FAIL:

- PROPELLANT TANK LEAK IF FUEL INLET PRESSURE ≥ 216, OXIDIZER INLET PRESSURE ≥ 151 AND DECREASING.
- PROPELLANT TANK FAILED IF FUEL INLET PRESSURE < 216 OXIDIZER INLET PRESSURE < 151 AND NOT REPRESSIBLE, OR QUANTITY ≤ 3 PERCENT, OR BLOCKAGE, OR CONTAMINATION.

ACTION SUMMARY

O. ONE OMS PROPELLANT TANK SINGLE LEAK/FAIL PRIOR TO END OF OMS-2 (CIL): @072398-6518A@072396518A ↓

STD [7]:

1. CONTINUE PRE-MECO OMS ASSIST/ATO OMS DUMP SELP. IF TANK FAILED, CANCEL/DUMP.
2. DELAYED ATO OMS-1 TETP [2] ~~—~~ [3] POST DELAYED ATO OMS-1, PERFORM ~~OUT-OF-PLANE~~ DUMP SELP TO DEPLETION. USE FRCS TO RAISE HP IF REQUIRED TO INCREASE ORBITAL LIFETIME FOR PROPELLANT SUBLIMATION. DEORBIT [4] MIXED CROSSFEED. OTHERWISE IF INSUFFICIENT PROPELLANT FOR ATO, PERFORM AOA SHALLOW OMS-1, -2.
3. IF AFTER OMS-1, CUTOFF OMS-2 AT MIN HP [6], TETP [3] PERFORM ~~OUT-OF-PLANE~~ DUMP SELP [3] TO DEPLETION.
4. DEORBIT [4] SEGP WITH MIXED CROSSFEED IF REQUIRED AND AVAILABLE. @072398-6518A

THIS RULE CONTINUED ON NEXT PAGE

FLIGHT RULES

A6.1.2-17 OMS FAILURE MANAGEMENT (CIL) (CONTINUED)

DIRECT [7]:

1. CONTINUE PRE-MECO OMS ASSIST/ATO OMS DUMP SELP. IF TANK FAILED, CANCEL DUMP. @072398-6518A1
2. POST-MECO, PERFORM ~~OUT-OF-PLANE~~-DUMP SELP [3] TO DEPLETION.
3. OMS-2 SEGP, CUT OFF AT MIN HP [6].
4. DEORBIT [4] MIXED CROSSFEED IF REQUIRED AND - AVAILABLE.

P. ONE OMS PROPELLANT TANK~~SINGLE~~ LEAK POST-OMS-2:

STD/DIRECT:

1. CANCEL ON-ORBIT BURNS.
2. PERFORM OMS BURN TO DEPLETION AT NEXT OPPORTUNITY, SELP [3], IN ACCORDANCE WITH RULE {A4.1.3-4}, OMS LEAK/PERIGEE ADJUST.
3. DEORBIT [4] SEGP.

Q. ONE OMS PROPELLANT TANK~~SINGLE~~ FAIL POST OMS-2 (CIL):

STD/DIRECT :

1. DURING DEORBIT, CUTOFF BURN IF HP \geq PROPELLANT FAIL HP.
2. DEORBIT [5], SEGP WITH MIXED CROSSFEED IF REQUIRED - AND AVAILABLE. @072398-6518A1

THIS RULE CONTINUED ON NEXT PAGE

FLIGHT RULES

A6.1.2-17 OMS FAILURE MANAGEMENT (CIL) (CONTINUED)

R. TWO OMS PROPELLANT TANKS LEAKING/FAILED [3]: [@J072398-6518A](#)

STD:

1. SAME SIDE, TREAT AS SINGLE LEAK/FAIL (SEE PARAGRAPHS O, P, AND Q).
2. DIFFERENT SIDES:
 - a. TAL IF PRIOR TO LAST TAL BOUNDARY. AFTER TAL BOUNDARY AND PRE-MECO, ~~LATE-TAL~~ TO AN ACLS.
 - b. IF POST-MECO, OPTIMUM AOA OMS-1, AOA OMS-2 [3] (MIXED CROSSFEED IF AVAILABLE; COMPLETE WITH RCS IF NECESSARY).

DIRECT:

1. SAME SIDE, TREAT AS SINGLE LEAK/FAIL (SEE PARAGRAPHS O, P, AND Q).
2. DIFFERENT SIDES:
 - a. TAL IF PRIOR TO LAST TAL BOUNDARY; AFTER TAL BOUNDARY AND PRE-MECO, ~~LATE-TAL~~ TO AN ACLS. [@J072398-6518A1](#)
 - b. IF POST-MECO, AOA OMS-2 (MIXED CROSSFEED IF AVAILABLE; COMPLETE WITH RCS IF NECESSARY).

THIS RULE CONTINUED ON NEXT PAGE

FLIGHT RULES**A6.1.2-17 OMS FAILURE MANAGEMENT (CIL) (CONTINUED)**FAILURE DEFINITIONOMS INLET LINE LEAK:

INLET LINE LEAK IF INLET PRESSURE DECREASING OR ZERO WITH TANK ISOLATION AND CROSSFEED VALVES CLOSED (SYSTEM SECURE IS ASSUMED~~IMPLIED TO DETERMINE THIS FAILURE MODE~~). @[\[072398-6518A\]](#)

ACTION SUMMARY

S. ONE OMS INLET LINE~~SINGLE~~ LEAK PRIOR TO OMS-2:

STD:

1. SECURE POST-MECO.
2. DELAYED ATO OMS-1 TETP [2].~~---~~[3]. POST DELAYED ATO OMS-1, SECURE. USE FRCS TO RAISE ORBIT IF REQUIRED TO INCREASE ORBITAL LIFETIME FOR PROPELLANT SUBLIMATION. PERFORM ~~OUT-OF-PLANE~~ DUMP SELP [3] IF REQUIRED TO SATISFY CG ENVELOPE OR OMS TANK LANDING WEIGHT CONSTRAINT. DEORBIT [4] MIXED CROSSFEED IF REQUIRED AND AVAILABLE.
3. IF AFTER OMS-1, ~~CUTOFF~~-OMS-2 SEGP CUTOFF AT MIN HP [6]-~~SEGP~~. PERFORM ~~OUT-OF-PLANE~~ DUMP SELP [3] IF REQUIRED TO SATISFY CG ENVELOPE OR OMS TANK LANDING WEIGHT CONSTRAINT.
4. DEORBIT [4] SEGP WITH MIXED CROSSFEED IF REQUIRED AND AVAILABLE.

DIRECT:

1. SECURE POST-MECO.
2. OMS-2 SEGP, CUT OFF AT MIN HP [6].
3. POST OMS-2, PERFORM ~~OUT-OF-PLANE~~ DUMP SELP [3] IF REQUIRED TO SATISFY CG ENVELOPE OR OMS TANK LANDING WEIGHT CONSTRAINT.
4. DEORBIT [4] SEGP WITH MIXED CROSSFEED IF REQUIRED AND -
AVAILABLE. ~~@[\[072396518A\]](#)~~ @[\[072398-6518A\]](#)

FLIGHT RULES

THIS RULE CONTINUED ON NEXT PAGE

FLIGHT RULES**A6.1.2-17 OMS FAILURE MANAGEMENT (CIL) (CONTINUED)**

T. ONE OMS INLET LINES~~SINGLE~~ LEAK POST OMS-2: @072398-6518A~~@072398-6518A~~

STD/DIRECT:

1. PERFORM PERIGEE ADJUST BURN SELP [3]. IF PROPELLANT REMAINS POST PERIGEE ADJUST BURN, PERFORM ~~OUT-OF-PLANE~~ DUMP SELP [3] IF REQUIRED TO SATISFY CG ENVELOPE OR OMS TANK LANDING WEIGHT CONSTRAINT (REF. RULE {A6.1.2-30}, OMS LEAKING INLET LINE PERIGEE ADJUST BURN).
2. DEORBIT [5] SEGP WITH MIXED CROSSFEED IF REQUIRED AND AVAILABLE~~-[5]~~.

U. TWO OMS INLET LINES LEAKINGS:

STD:

1. SAME SIDE, TREAT AS SINGLE LEAK (SEE PARAGRAPHS S AND T) EXCEPT PERFORM UPHILL BURN SEGP. 7 DO NOT REPRESS. @072398-6518A
2. DIFFERENT SIDES, SAME PROPELLANT:
 - a. IF PRE-MECO, SAME AS TWO TANK LEAKS (SEE PARAGRAPH R).
 - b. IF POST-MECO, OPTIMUM AOA OMS-1 TETP [3]. AOA OMS-2 TETP [3] (COMPLETE WITH RCS IF NECESSARY).
3. DIFFERENT SIDES, DIFFERENT PROPELLANTS:
 - a. IF PRE-MECO, SAME AS TWO TANK LEAKS (SEE PARAGRAPH R).
 - b. IF POST-MECO, DELAYED ATO OMS-1 TETP [2] [3]. POST DELAYED ATO OMS-1, SECURE. USE FRCS TO RAISE ORBIT IF REQUIRED TO INCREASE ORBITAL LIFETIME FOR PROPELLANT SUBLIMATION. DEORBIT [4] MIXED CROSSFEED 4+X (COMPLETE WITH RCS IF NECESSARY).

THIS RULE CONTINUED ON NEXT PAGE

FLIGHT RULES

A6.1.2-17 OMS FAILURE MANAGEMENT (CIL) (CONTINUED)

DIRECT:

1. SAME SIDE, TREAT AS SINGLE LEAK (SEE PARAGRAPHS S AND T) EXCEPT PERFORM UPHILL BURNS SEGP. DO NOT REPRESS. [@072398-6518A1](#)
2. DIFFERENT SIDES, SAME PROPELLANT:
 - a. IF PRE-MECO, SAME AS TWO TANK LEAKS (SEE PARAGRAPH R).
 - b. IF POST-MECO, SECURE. AOA OMS-2 TETP [3] (COMPLETE WITH RCS IF NECESSARY).
3. DIFFERENT SIDES, DIFFERENT PROPELLANT:
 - a. IF PRE-MECO, SAME AS TWO TANK LEAKS (SEE PARAGRAPH R).
 - b. IF POST-MECO, SECURE. OMS-2 TETP [3] CUTOFF AT MIN HP [6]. DEORBIT [4] MIXED CROSSFEED 4+X (COMPLETE WITH RCS IF NECESSARY).

THIS RULE CONTINUED ON NEXT PAGE

FLIGHT RULES

A6.1.2-17 OMS FAILURE MANAGEMENT (CIL) (CONTINUED)

FAILURE DEFINITION

OMS ENGINE FAIL:

ACTION SUMMARY

V. ONE OMS ENGINE~~SINGLE~~ FAILURE: @[072398-6518A]

STD/DIRECT:

1. PERFORM ~~NOMINAL~~-OMS-1-~~OMS-2~~, SESP, CROSSFEED AS REQUIRED.
2. PERFORM OMS-2 AND ON-ORBIT OMS BURNS WITHIN REDLINES (RCS STEEP DEORBIT MUST BE REDLINED).

W. TWO OMS ENGINES FAILED: @[072398-6518A]

STD:

1. USE OMS INTERCONNECT TO RCS +X JETS.
2. IF PRIOR TO OMS-1, PERFORM DELAYED ATO OMS-1, [2]; IF BETWEEN OMS-1 AND OMS-2, CUT OFF OMS-2 AT MIN HP [6].
3. DEORBIT [4].

DIRECT:

1. USE OMS INTERCONNECT TO RCS +X JETS.
2. IF PRIOR TO OMS-2, CUT OFF OMS-2 AT MIN HP [6].
3. DEORBIT [4].

THIS RULE CONTINUED ON NEXT PAGE

FLIGHT RULES**A6.1.2-17 OMS FAILURE MANAGEMENT (CIL) (CONTINUED)**

~~FOR OMS He TANK LEAK/FAIL~~ @J072398-6518A]

A. ONE OMS HELIUM TANK~~SINGLE~~ LEAK PRIOR TO OMS-2: ~~@J072398-6518A]~~

STD:

Since pre-MECO ATO dumps ~~may be~~ required for ascent performance (i.e., to avoid TAL), the dump will be continued whenever possible.

If the leak rate cannot support OMS-1 TELP to a quantity sufficient to protect the OMS propellant landing weight constraint (EOM quantity < 22 percent per OMS tank), a pre-MECO OMS dump to maximum blowdown will be performed.

Utilizing the ~~contingency~~ dump software to increase the OMS blowdown available prior to helium tank failure results in the capability to achieve an ATO orbit with steep deorbit and nominal CG's versus an ATO orbit with shallow deorbit and 1.9 Y CG using forward RCS and aft RCS propellant to quantity-1 supplement (no dump and He tank fails pre-OMS-1). Mission Control Center (MCC) is prime to recommend the pre-MECO dump based on a leak rate evaluation and time to MECO. ~~- OMS He TK P LOW dump procedure burns both OMS engines from the leaking pod. This procedure does not attempt to feed 24 RCS jets from one OMS pod, since analysis indicates that this is unacceptable.~~

If no pre-MECO dump is performed or the dump is terminated early and the affected He tank can support nominal OMS-1 TETP, then nominal OMS-1 will be performed, TELP, in order to maximize blowdown available prior to He tank fail. The OMS BURN MONITOR cue card, He P LOW will be utilized by the crew for the burn. Since not enough time is ~~not~~ available to reconfigure TELP prior to ignition, the burn will be initiated TETP, then reconfigured to a TELP burn. The burn will be continued TELP until He tank fail or maximum blowdown. At that time, the crew will reconfigure to TEGP for the remainder of the burn. If no pre-MECO dump to maximum blowdown is performed or the dump is terminated early and the affected He tank cannot support OMS-1, go to single He tank fail prior to OMS-1. An ATO orbit can still be achieved. @J072398-6518A]

If the leak rate indicates the helium tank will support nominal OMS-1 TELP to a quantity sufficient to protect the OMS propellant tank landing weight constraint (22 percent), OMS-1 will be performed TELP until He tank fail or until maximum blowdown has been achieved. If maximum blowdown is achieved, no additional OMS propellant is trapped onboard, and therefore allows the EOM quantity < 22 percent. If the amount of He required to support OMS-1 TELP to a quantity sufficient to protect the landing weight constraint is less than the amount of He required for the entire OMS-1 TELP, protecting the landing weight constraint rather than the entire OMS-1 TELP increases the chances of allowing nominal OMS-1 to be performed, and decreases the requirement for the pre-MECO dump to maximum blowdown.

THIS RULE CONTINUED ON NEXT PAGE

FLIGHT RULES

A6.1.2-17 OMS FAILURE MANAGEMENT (CIL) (CONTINUED)

Using the leaking He tank for OMS-1 rather than dumping pre-MECO has two advantages:

- a. No pre-MECO crew actions required.
- b. Using the delta V for OMS-1 rather than dumping pre-MECO results in a net gain of delta V.

In the case where the He required to support OMS-1 TELP to a quantity sufficient to protect the landing weight constraint is more than the amount of He required for the entire OMS-1 TELP, the landing weight must still be protected.

If full blowdown has been achieved post-OMS-1, OMS-2 will be performed TEGP. If not ~~in full~~~~at maximum~~ blowdown post-OMS-1 and the leak rate indicates the tank will support OMS-2 TETP, the burn will be performed TELP. The OMS BURN MONITOR cue card He P LOW will be utilized by the crew for the burn. The burn will be initiated TELP until He tank fail or maximum blowdown is achieved. At that time, the crew will reconfigure to TEGP for the remainder of the burn. If the leak rate will not support OMS-2 TETP, ~~an out-of-plane~~ dump will be performed TELP ASAP post-OMS-1. Again, the dump will be continued until He tank fail or maximum blowdown is achieved. [@072398-6518A1](#)

If a pre-MECO ATO dump is required and the leak rate will support nominal OMS-1 TELP to a quantity sufficient to support the landing weight constraint (22 percent), the ATO dump should be performed. Since ATO targets will be used, a ~~n out-of-plane~~ dump TELP to maximum blowdown or He tank fail will be performed ASAP post-MECO.

~~3. No dump, He supports OMS-1 TETP:~~

~~4. Leak rate supports OMS-1 TELP to a quantity sufficient to protect landing weight constraint:~~

~~*Limited by Y CG = 1.5 inches~~

~~Delta V requirements (STS 41-B delta V's):~~

~~A. SINGLE LEAK PRIOR TO OMS-2:~~

~~DIRECT:~~

~~If performing a Since pre-MECO OMS assist/ATO dumps are required for ascent performance (i.e., to avoid TAL) ATO dump will increase available blowdown, the dump will be continued whenever possible.~~

FLIGHT RULES

If the leak rate indicates the He tank will support nominal OMS-2 TELP to a quantity sufficient to protect the OMS tank landing weight constraint (22 percent), perform nominal OMS-2 TELP until affected pod ~~maximum~~full blowdown or He tank fail. If the He tank is not failed and the pod is not ~~in full~~at maximum blowdown post-OMS-2, a ~~out-of-plane~~ dump will be performed postburn in order to maximize blowdown in the affected pod. ~~Using the leaking pod for OMS-2 rather than dumping results in a net gain of delta V. A nominal mission can be achieved without violating Y CG limits or landing weight constraint. If performing an earlier pre- or post-MECO dump will result in a net increase in delta V available for the mission, then consideration may be given to doing so, crew workload permitting. It is possible a nominal mission can be achieved without violating Y CG limits or landing weight constraints.~~ ©[072398-6518A]

THIS RULE CONTINUED ON NEXT PAGE

FLIGHT RULES

A6.1.2-17 OMS FAILURE MANAGEMENT (CIL) (CONTINUED)

If the leak rate cannot support OMS-2 TELP, however, a dump must be performed in order to maximize blowdown prior to He tank fail. If the leak rate will support ~~a post-MECO dump TELP OMS-1 out of plane dump TELP~~ to a quantity sufficient to protect the OMS landing weight constraint (22 percent), perform ~~same an out of plane OMS-1 dump TELP~~ until He tank fail or maximum blowdown is achieved. A ~~“post-MECO OMS-1 out of plane dump”~~ implies the leak rate should support a dump to at least 49 percent at MET 15:00 minutes. 49 percent remaining provides enough ullage in the tank to use the tank in blowdown mode to 22 percent. 49 percent applies to engine no. 106 only. The quantity is, of course, engine specific and may vary ± 2 percent. The leak rate is extrapolated to MET 15:00 minutes. Fifteen minutes was chosen in order to provide the crew sufficient time to set up and complete the dump. The dump should be started ASAP post-MECO and should continue until He tank fail or maximum blowdown is achieved. Dumping post-MECO is generally preferred because it precludes any pre-MECO crew action. Still, if performing the dump pre-MECO will result in a net increase in delta V available, and if crew workload permits, consideration may be given to doing so. ©[072398-6518A]

Cutoff at minimum Hp which requires the least total delta V for the insertion and deorbit burns and ensures orbital lifetime at least two orbits beyond the first day PLS.

(Ref. Rule {X4.1.1-1}, TRAJECTORY AND GUIDANCE PARAMETERS.)

If the leak rate will not support ~~a post-MECO OMS-1 out of plane dump TELP~~ to a quantity sufficient to protect the OMS tank landing weight constraint, a pre-MECO dump to maximum blowdown ~~utilizing the should contingency dump software will be performed. For this case, the pre-MECO dump increases the OMS blowdown capability prior to He tank fail, thus resulting in a net increase in delta V available. As a result, an ATO orbit can be achieved with steep deorbit and Y CG within the limits. If no dump is performed prior to He tank fail, an ATO orbit can be achieved with steep deorbit and Y CG within the limits only if supplemented with RCS~~

~~NOTE: Without RCS supplement, an ATO orbit with shallow day 2 deorbit and Y CG within limits can be achieved.~~

~~Delta V available:~~

~~Assumptions: Full load, initial Y CG = 0, 1700 lb RCS EI Mach 1, vehicle weight 250,000 lb ± 5 fps/percent, (aft quantity 1, 2 calculation consider propellant required for 2 days attitude hold, IMU aligns, and deorbit preparation).~~

B. ONE OMS HELIUM TANK SINGLE LEAK POST-OMS-2:

STD/DIRECT:

Full blowdown may exist post OMS-2. If full blowdown does not exist, nominal orbit activities and/or an OMS burn may be used to maximize blowdown (ref. Rule {A6.1.2-2}, OMS/RCS LEAKING He TANK BURN).

C. ONE OMS HELIUM TANK SINGLE FAILURE PRIOR TO OMS-1:

FLIGHT RULES

STD:

If a He tank fail occurs prior to OMS-1, only blowdown delta V is available in that system (approximately 15 fps for a full OMS load). Pre-flight analysis, based on OMS load and mass properties, determines the resulting abort mode capability on a flight specific basis.~~only 15 fps is available in the failed pod (assuming a full OMS load). An ATO orbit with shallow deorbit can be achieved with forward and aft RCS to aft quantity-1 supplement and YCG = 1.9 inches. The alternative to ATO shallow is TAL AOA shallow.~~

If a pre-MECO OMS assist or ATO dump is required, the dump will be terminated in order to prevent exceeding the.~~Otherwise, the YCG will exceed the limit considerably.~~ ©[072398-6518A]

Although the YCG is 0.4 inch outside the boundary, an ATO orbit is highly desirable over a pre-MECO abort. As a result, the ATO option was chosen.

NOTE: Without RCS supplement, an ATO orbit with shallow deorbit can be achieved with OMS only. The resulting YCG shift is 3 inches.

THIS RULE CONTINUED ON NEXT PAGE

FLIGHT RULES

A6.1.2-17

OMS FAILURE MANAGEMENT (CIL) (CONTINUED)

DIRECT: [@072398-6518A](#)

If an OMS assist or ATO OMS dump is required and an OMS He tank failure has occurred, the OMS assist or ATO OMS dump must be terminated. If the ATO dump is completed, ~~in this case~~ the Y CG will considerably exceed the limit.

-

If a He tank fail occurs prior to OMS-2, blowdown delta V is available in that system (approximately 15 fps for a full OMS load). Pre-flight analysis, based on OMS load and mass properties, determines the resulting abort mode capability on a flight specific basis. ~~only 175 fps OMS delta V is available (assuming a full OMS load). The OMS delta V is limited by Y CG limits. A 190 by minimum Hp orbit can be achieved with forward and aft RCS supplement to aft quantity 1 without violating the Y CG limits. Enough delta V exists to achieve steep deorbit on day 2. If however, a day 1 deorbit must be accomplished, shallow targets must be used if the Y CG limit is to be satisfied. Without RCS supplement, an ATO orbit with shallow day 2 deorbit can be achieved without violating the Y CG limit.~~

D. ONE OMS HELIUM TANK SINGLE FAILURE BETWEEN OMS-1 AND OMS-2.

OMS-2 is cut off at minimum safe Hp in order to assess available delta V to achieve steep deorbit and an acceptable orbit altitude.

E. ONE OMS HELIUM TANK SINGLE FAILURE POST-OMS-2:

STD/DIRECT:

Full blowdown may exist post-OMS-2. ~~If full blowdown does not exist,~~ OMS redlines must be assessed to determine whether all orbit activities can be accomplished.

F. TWO OMS HELIUM TANKS DOUBLE LEAKING/FAILED PRIOR TO OMS-1:

STD OMS 1/2:

If both He leak rates will support OMS-1 and OMS-2, nominal OMS-1, -2 will be performed TETP. ~~Post OMS 2, 300 fps OMS blowdown delta V is available. Steep deorbit targets can be achieved with 15 fps RCS supplement.~~

FLIGHT RULES

If both He tanks will not support OMS-1 and OMS-1, 2, the ~~aborted contingency~~ dump software will be utilized to increase the OMS blowdown prior to He tank fail. MCC is prime to recommend the pre-MECO dump based on an evaluation of both the leak rate and time to MECO. ~~This evaluation will also determine whether to inhibit or enable the interconnect option. For the double leak case, the OMS He TANK P-LOW procedure must be modified to allow the OMS engines (and possibly 24 RCS jets) to fire using OMS propellant from both pods.~~ Performing the pre-MECO dump may result in the capability to achieve an ATO orbit with steep deorbit and nominal CG's versus aborting pre-MECO. [@\[072398-6518A\]](#)

THIS RULE CONTINUED ON NEXT PAGE

FLIGHT RULES

A6.1.2-17

OMS FAILURE MANAGEMENT (CIL) (CONTINUED)

If either He tank fails or a partial dump is performed, insufficient delta V may exist to achieve an ATO shallow or AOA steep. In this case, an abort will be performed according to the abort priorities (reference Rule {A2.1.2-2A}, ASCENT MODE PRIORITIES FOR PERFORMANCE CASES) TAL, if prior to last TAL boundary. After TAL boundary, ~~late~~ TAL to an ACLS. ~~If~~ failures occur post-MECO, utilize optimum AOA shallow targets (minimum delta V requirement) if sufficient OMS blowdown plus ARCS to the PRESS QTY is available. If sufficient delta V is not available, a ~~late~~ TAL to an ACLS/ELS is required~~invoked~~. @[072398-6518A]

Delta V available:

~~Assumptions: Full load, initial Y CG = 0, 1700 lb RCS EI Mach 1, (aft quantity 1, 2 calculations consider propellant required for 2 days attitude hold, IMU aligns, and deorbit preparation).~~

- ~~1. Both attitude leak rates support OMS 2:~~
- ~~2. Both pods at maximum blowdown:~~

DIRECT:

- ~~3. Both He tanks fail prior to dump:~~
~~Delta V requirements (STS 41-B delta V's):~~

If pre-MECO OMS dump is required, continue dump TETP. For OMS assist/ATO dumps, when at maximum blowdown or He tank pressure < 640 psi, reconfigure dump to SEGP until remaining system at maximum blowdown or He tank pressure < 640 psi.

If both OMS He tanks are leaking, the aborted contingency dump software will be utilized to increase the OMS blowdown prior to He tank fail. MCC is prime to recommend the pre-MECO dump based on an evaluation of both the leak rate and time to MECO. ~~This evaluation will also determine whether to inhibit or enable the interconnect option. For the double leak case, the OMS He TANK P-LOW procedure must be modified to allow the OMS engines (and possibly 24 RCS jets) to fire using OMS propellant from both pods. Performing the pre-MECO dump may result in the capability to achieve an ATO orbit with steep deorbit and nominal CG's versus aborting pre-MECO.~~

If either He tank fails or a partial dump is performed, insufficient delta V may exist to achieve an ATO shallow or AOA steep. In this case, an abort will be performed according to the abort priorities (reference Rule {A2.1.2-2A}, ASCENT MODE PRIORITIES FOR PERFORMANCE CASES). TAL, if prior to last TAL boundary. After TAL boundary and pre-MECO, ~~late~~ TAL to an ACLS. Post-MECO, AOA-shallow will be performed if sufficient delta V is available. OMS blowdown delta V with aft RCS supplement to AFT PRESS QTY will be used. If insufficient delta V is available for an AOA shallow, a ~~Late~~-TAL to an ACLS/ELS must be performed.

FLIGHT RULES

If uphill capability available (due to OMS load or pre-MECO dump) and either He tank pressure will be < 640 psi post-OMS-2, perform OMS-2 SESP. This will preserve the remaining system for deorbit. Determination of which system to use for OMS-2 is situation dependent. In general, if one He system will support through OMS-2, that system should be used. This will preserve the engine for a second start without violating OMS engine start box constraints (ref SODB Vol III, Para. 4.3.3.14). Target consideration for OMS-2 should include post-burn start box, cg and tank landing weight constraints.

~~Note in this case, the leak rate is not checked. If the leak rates were checked to see if the rates could support OMS-2, the case would be as follows:~~

~~If both He leak rates will support OMS-2, nominal OMS-2 will be performed TETP. -Note: Nominally, maximum blowdown will not exist post-OMS-2, thus an additional dump may be required post-OMS 22. ©[072398-6518A]~~

~~(i.e., assuming a full OMS load and OMS-2 delta V=278 fps, 68 percent OMS remains per pod postburn. At this quantity, only 100 fps blowdown delta V exists per pod). If no out of plane dump is performed post OMS-2, shallow targets can be achieved with forward and aft RCS supplement to aft quantity 1. Since forward and aft RCS supplement must be used and only shallow targets can be met, the pre MECO dump was considered the best option. (Recall, with the pre MECO dump, an ATO orbit can be achieved with steep deorbit and nominal CG's.)~~

~~Delta V available:~~

~~Assumptions: Full load, initial Y CG = 0, 1700 lb RCS EI Mach 1 (aft quantity 1, 2 calculation consider propellant required for 2 days attitude hold, IMU aligns, and deorbit preparation).~~

THIS RULE CONTINUED ON NEXT PAGE

FLIGHT RULES

A6.1.2-17

OMS FAILURE MANAGEMENT (CIL) (CONTINUED)

1. ~~Both leak rates support OMS-2:~~
 2. ~~Both pods at maximum blowdown:~~
 3. ~~Both He tanks fail prior to dump:~~
- ~~Delta V requirements (STS-51-D delta V's):~~

G. TWO OMS HELIUM TANKS DOUBLE FAILED BETWEEN OMS-1 AND OMS-2:
 @[072398-6518A]

STD:

Insufficient delta V exists to continue nominal ascent. Enough delta V may exist in the OMS pods supplemented with RCS to deorbit steep from minimum Hp. If steep targets cannot be met, shallow deorbit will be performed. Rationale in paragraph F also applies to this scenario.

Delta V available:

Assumptions: ~~Full load, initial Y CG = 0, 1700 lb RCS EI Mach 1, vehicle weight 250,000 lb ³5-fps/percent, (aft quantity 1, 2 calculation consider propellant required for 2 days attitude hold, IMU aligns, and deorbit preparation).~~

Both fail post OMS-1:

Delta V requirements:

H. TWO OMS HELIUM TANKS DOUBLE FAILED POST-OMS-2:

STD/DIRECT:

If ~~full maximum blowdown~~ ~~blowdown~~ exists post-OMS-2, some portion of the ~~a nominal~~ mission ~~can may~~ be supported. If maximum full blowdown does not exist, shallow deorbit may be required with RCS supplement. OMS redlines must be assessed to determine whether ~~all~~ orbit activities can be accomplished.

OMS HELIUM LEG LEAK

I. ONE OMS HELIUM LEG SINGLE LEAK:

STD/DIRECT:

FLIGHT RULES

The intent of this rule is to maximize the blowdown available in the affected system with as few represses as possible. Each time the helium isolation valves are opened ~~to~~, repressing the leaking leg, there is a possibility that the sudden increase in pressure in that leg will completely fracture the helium line, causing total loss of that helium tank. After OMS-1 and/or -2, the affected system should be at or below maximum blowdown. If the leak occurs on orbit, orbit activities would be used to bring the remaining propellant quantity down to maximum blowdown. However, if interconnect operations are used towards this end, only that blowdown capability predicted to be available at the next PLS TIG can be included in the planning for that deorbit. This is to avoid relying on a repressurization from the leaking helium leg to meet the deorbit redlines.

J. TWO OMS HELIUM LEG LEAKS: @072398-6518A]

Same as single leak rationale.

THIS RULE CONTINUED ON NEXT PAGE

FLIGHT RULES

A6.1.2-17 OMS FAILURE MANAGEMENT (CIL) (CONTINUED)

OMS GN₂ TANK -LEAK/FAIL @[\[072398-6518A\]](#)

K. ONE OMS GN₂ TANK ~~SINGLE~~-LEAK/FAIL:

STD/DIRECT:

As long as the GN₂ tank can support an engine burn without affecting the accumulator pressure and subsequent one start capability, the affected OMS engine is available. GN₂ tank failures do not impact abort dumps since only one start is required for the OMS dump. If the GN₂ tank has failed, the [OMS assist or](#) ATO dump should be performed SEGP to save the last start for OMS or deorbit.

L. TWO [OMS GN₂ TANK LEAKING/FAILED](#):

STD/DIRECT:

GN₂ tank failures do not impact abort dumps since only one start is required for the OMS dump. [An OMS assist or](#) ATO dump is canceled to reserve the OMS starts for OMS-1 and deorbit. @[\[072398-6518A\]](#)

As long as the GN₂ tank can support an engine burn without affecting the accumulator pressure and subsequent one start capability, the affected OMS engine is available. If both OMS GN₂ tanks are failed prior to the scheduled burn, use one of the remaining OMS starts for OMS-1 and save the other start for the deorbit burn. After a safe orbit has been achieved, a tail-Sun attitude may be selected to warm up the OMS accumulator in an attempt to gain another OMS start (N₂ REG P > 299 is sufficient N₂ to operate engine ball valves).

Previous rules specified performing OMS-1 4+X for this case. The rule was changed to perform OMS-1 using one of the two remaining starts for the following reasons:

- a. *Provides redundancy (downmode from OMS to 4+X). If burn initially performed 4+X and a +X jet failure occurs, the remaining jets may not have the capability to perform uphill OMS-1 due to lack of thrust.*
- b. *Depending on the OMS-1 delta V, 4+X thrust may be insufficient to accomplish the burn (large underspeed cases).*
- c. *Saves propellant.*
- d. *Have the capability to change attitude while on orbit to warm up OMS GN₂ accumulator and increase the pressure to greater than 299 psi (299 allows one additional start).*

THIS RULE CONTINUED ON NEXT PAGE

FLIGHT RULES

A6.1.2-17 OMS FAILURE MANAGEMENT (CIL) (CONTINUED)

OMS GN₂ ACCUMULATOR LEAK @072398-6518A]

M. ONE OMS GN₂ ACCUMULATOR SINGLELEAK:

STD/DIRECT:

WSTF testing has shown that, if a GN₂ leak occurs through the purge valves at a rate of £ 14 psia/sec with the engine press valve closed (£ 5 psia/sec with P valve open), sufficient cooling will be provided to the affected OMS engine and chamber wall burn through will not occur. As a result, the affected OMS engine can be used, but only for OMS-1 and deorbit. In addition, the GN₂ accumulator pressure must be > 260 psia preburn (ref. Rule {A6.1.1-4}, OMS N₂ SYSTEM). The engine will not be used for OMS-2 and on-orbit burns to preclude increasing the leak rate each time the purge valves are used and to preserve GN₂ for the deorbit burn.

Note that the WSTF data indicated a leak rate of 14 psia/sec through the purge valves will not significantly affect engine startup, operation, or shutdown. However, leak rates > 14 psia/sec were not tested due to concerns that the GN₂ tank did contain enough supply to support larger leak rates for an appreciable (deorbit-sized) OMS burn. There are also concerns of engine cooling at higher leak rates; however, no data or analysis exists to validate these concerns.

If the leak rate cannot support the deorbit burn, SELP If the engine will not support the entire deorbit burn SETP, then it is not considered a valid deorbit downmode (ref Rule {X2.1.3-14}, OMS/RCS DOWNMODING CRITERIA) and RCS steep deorbit must be redlined. Otherwise, if RCS steep deorbit is not redlined and the good OMS engine fails during the deorbit burn, the burn cannot be completed SELTP and RCS 4+X steep deorbit capability would not exist. In addition, if the leak rate increases, RCS steep deorbit must be redlined since there is no way to guarantee that the rate will not increase again and exceed 14 psia/sec. ~~@ED~~

If RCS steep deorbit must be redlined, nominal OMS-1 and OMS-2 will be performed only if sufficient OMS and RCS propellant margin is available to cover RCS deorbit from the nominal orbit. Propellant trade-offs as defined in Rule {A2.1.3-7}, CONSUMABLES MANAGEMENT, must also be considered when calculating the redline. If sufficient margin does not exist to cover RCS deorbit to steep targets, perform delayed ATO OMS-1 and OMS-2. Raise orbit within redlines. These calculations are performed preflight and are based on nominal MECO delta V's obtained from FDO's prior to flight. @072398-6518A]

THIS RULE CONTINUED ON NEXT PAGE

FLIGHT RULES

A6.1.2-17

OMS FAILURE MANAGEMENT (CIL) (CONTINUED)

~~If the leak rate > 14 psia/sec, sufficient cooling may not be provided to the engine and chamber wall burnthrough might result. For this case, the affected OMS engine will be considered failed (reference paragraph V). @ED]~~

If the leak rate cannot support the deorbit burn leaking engine, two pods from an HP > safe HP, then a two OMS engines to one OMS engine downmode will not be available to complete the burn should the good engine fail. For this case, the leaking engine will experience a GN₂ depletion shutdown, and a subsequent downmode to RCS will be required. To avoid a GN₂ depletion shutdown (which carries a risk of unstable combustion), it is prudent in this case to not use the leaking engine for deorbit but instead to plan the burn SETP using the non-leaking engine. This not only provides a valid downmode to RCS for a subsequent engine failure but allows the use of existing procedures (one OME burn card, etc.). Attempting TETP downmode to RCS is not recommended due to the complications associated with real-time modification of procedures and downmode cues. @072398-6518A]

If the leak rate will support SETP from greater than safe Hp, then the engine may be used for deorbit with the condition that if the good engine fails above safe Hp but prior to having SETP completion, the burn must be stopped. @072398-6518A]

(Ref. SODB, Volume I, Paragraph 3.4.3.3-15.) @ED]

N. TWO OMS GN₂ ACCUMULATOR LEAKS

OMS 1/2 AND DIRECT:

Delayed ATO targets are chosen for two GN₂ accumulator leaks in order to preserve the remaining GN₂ for the deorbit burn. The orbit may be raised using RCS jets within redlines. Sufficient GN₂ to complete the deorbit burn single engine must be available in each OMS pod in order to raise the orbit.

(Ref. SODB, Volume I, Paragraph 3.4.3.3-15.) @ED] @072398-6518A]

THIS RULE CONTINUED ON NEXT PAGE

FLIGHT RULES

A6.1.2-17

OMS FAILURE MANAGEMENT (CIL) (CONTINUED)*(Ref. SODB, volume I, paragraph 3.4.3.3 15.) @ [ED]*OMS PROPELLANT TANK LEAK/FAIL @ [072398-6518A]O. ONE OMS PROPELLANT TANK SINGLE LEAK/FAIL PRIOR TO END OF OMS-2:

STD:

Since pre-MECO ATO dumps ~~may be~~ required for ascent performance, the ATO dump should be continued SELP to avoid a TAL abort. The dump will burn a portion of the leaking propellant which prevents this propellant from being trapped onboard. Dumping the leaking propellant provides more ullage in the good tank ~~on~~ the affected pod. The ullage is required to allow mixed crossfeed. FDO must analyze the amount of propellant dumped during the ATO dump to determine whether an AOA or an ATO abort is feasible. The amount of delta V remaining (limited by the leak, quantity of propellant dumped, and Y CG) must quickly be calculated to determine whether sufficient delta V is available to perform delayed ATO OMS-1, -2 and deorbit shallow. RCS supplement should be considered (ref. Rules {A2.1.2-2}, ASCENT MODE PRIORITIES FOR PERFORMANCE CASES; and {A2.1.2-3}, FORWARD RCS USAGE GUIDELINES). If an AOA or ATO orbit cannot be achieved, a TAL abort must be performed.

Since delayed ATO targets required ~~less~~ delta V than nominal OMS-1 ~~cutoff at 10~~, delayed ATO targets are used. OMS-1 is performed TETP for the following reasons: (1) cannot perform burn SELP because OMS-1 is a critical burn and redundancy is required, (2) cannot perform burn TELP because bad propellant WILL NOT be fed into a good system, (3) ~~cannot do not~~ perform burn entirely out of the good pod since it is desirable to use as much leaking propellant as possible. Post-delayed ATO OMS-1, the leaking pod should be dumped ~~out of plane~~ to depletion. Dumping the leaking pod prevents this propellant from being trapped onboard. As a result, more delta V is available from the good OMS pod without a Y CG impact. Post-delayed ATO OMS-1 Ha and Hp are usually high enough to provide sufficient stay capability to preclude a requirement for OMS-2 (assuming nominal MECO). Since a propellant leak may cool the pod to where an orbit 3 deorbit is not feasible, a safe orbit altitude which allows a 48-hour stay capability to sublimate leaked propellant may be required. If the pod thermal environment indicates freeze-up may occur and the current orbit does not provide 48-hour stay capability, raise orbit with FRCS. Deorbit using mixed crossfeed if required and available with RCS supplement. ~~For the case listed below, deorbit steep targets are met with Y CG within limits. This case assumes mixed crossfeed, forward, and aft RCS to quantity 1 are used.~~

If the tank fails at OMS-1 ignition, complete the burn SEGP. Deorbit using mixed crossfeed (if available and required).

FLIGHT RULES

Note that consideration may be given to executing the deorbit burn using mixed crossfeed if doing so will optimize overall performance and vehicle health (CG impacts, tank landing constraints, etc.). [@\[072398-6518A\]](#)

THIS RULE CONTINUED ON NEXT PAGE

FLIGHT RULES

A6.1.2-17

OMS FAILURE MANAGEMENT (CIL) (CONTINUED)

[THIS RULE CONTINUED ON NEXT PAGE](#)

FLIGHT RULES**A6.1.2-17 OMS FAILURE MANAGEMENT (CIL) (CONTINUED)**

~~DIRECT: ©[072398-6518A] If the tank fails at OMS 1 ignition, complete the burn SEGP. Deorbit using mixed crossfeed (if available and required). The Y CG shift resulting from performing delayed ATO OMS 1 SEGP is 2. If the deorbit burn is done solely out of the good pod (i.e., no mixed crossfeed or RCS supplement), the deorbit burn will result in an additional Y CG shift of 1.7 inches (assuming shallow deorbit targets). The net Y CG shift is 3.7 inches.~~

~~Delta V available:~~

~~Assumptions: Full load, initial Y CG = 0, 1700 lb RCS EI Mach 1, vehicle weight = 250,000 lb ³5 fps/percent, (aft quantity 1, 2 calculation consider propellant required for 2 days attitude hold, IMU aligns, and deorbit preparation).~~

~~1. Tank fail:~~

~~2. Tank supports DATA OMS 1, no out of plane dump:~~

~~3. Tank supports DATA OMS 1, out of plane dump to depletion:~~

*~~*Limited by Y CG~~*

THIS RULE CONTINUED ON NEXT PAGE

FLIGHT RULES

A6.1.2-17 ~~OMS FAILURE MANAGEMENT (CIL) (CONTINUED)~~

Delta V requirements (STS 41-B delta V's):

For cases where the amount of OMS delta V available from the non-leaking side, supplemented with RCS delta V above the Aft Press Quantity, is insufficient to protect a Press-to-Orbit (ref. Rule {A2.1.2-2}, ASCENT MODE PRIORITIES FOR PERFORMANCE CASES) which includes AOA Steep and ATO to Min Hp with FPLS or FD2 deorbit to shallow targets (ref. Rule {A.1.2-7}, PERFORMANCE BOUNDARIES), a TAL abort must be declared. This case will typically occur for those missions that have the combination of a small OMS load, large ballast requirements, and large delta V requirements for the described scenario. Analysis must be performed post-dump to determine whether the trapped propellant on the leaking side might be able to offset any aft RCS ballast requirements.

Since pre-MECO ATO dumps ~~may be~~ required for ascent performance, the ATO dump should be continued SELP to avoid a TAL abort. The dump will burn a portion of the leaking propellant which prevents this propellant from being trapped onboard. Dumping the leaking propellant provides more ullage in the good tank ~~on~~ the affected pod. The ullage is required to allow mixed crossfeed. FDO must analyze the amount of propellant dumped during the ATO dump to determine whether an AOA or an ATO abort is feasible. The amount of delta V remaining (limited by the leak, quantity of propellant dumped, and Y CG) must quickly be calculated to determine whether sufficient delta V is available to perform delayed ATO OMS-1, -2 and deorbit shallow. Forward and aft RCS supplement to aft quantity-1 should be considered. If an AOA Steep or ATO orbit cannot be performed, a TAL abort must be performed.

Direct insertion ascent implies that an OMS-1 burn is nominally not performed. Since OMS-2 is not performed until approximately 43 minutes into the flight, the leaking propellant will be dumped ~~out of plane~~ ASAP post-MECO. Dumping the propellant prevents the weight of the propellant from being trapped onboard. As a result, all of the propellant in the good pod can be used without a Y CG impact. In addition, dumping the propellant ~~reduces~~ eliminates the ~~likelihood~~ possibility of freezing the entire pod.

Since no propellant will be available for use in the leaking pod, OMS-2 will be performed SEGP. Cut off at minimum Hp which requires the least total delta V for the insertion and deorbit burns and ensures orbital lifetime at least two orbits beyond the first day PLS (ref. Rule {X4.4.1-1}, TRAJECTORY AND GUIDANCE PARAMETERS). Deorbit ~~first day~~ PLS if the leaking pod thermal environment allows. Most likely, pod thermal will indicate that an orbit 3 deorbit is not feasible. ~~e. If all of the leaking propellant is dumped, steep deorbit targets can be met with no RCS supplement and Y CG within limits.~~

If tank fail occurs prior to post-MECO dump or at OMS-2 ignition (all propellant trapped onboard), steep day 2 deorbit targets ~~may~~ be accomplished with RCS supplement and Y CG within limits.

Note that consideration may be given to executing the deorbit burn using mixed crossfeed if doing so will optimize overall performance and vehicle health (CG impacts, tank landing constraints, etc.). @[072398-6518A]

FLIGHT RULES

THIS RULE CONTINUED ON NEXT PAGE

FLIGHT RULES

A6.1.2-17

OMS FAILURE MANAGEMENT (CIL) (CONTINUED)

[THIS RULE CONTINUED ON NEXT PAGE](#)

FLIGHT RULES

~~A6.1.2-17 OMS FAILURE MANAGEMENT (CIL) (CONTINUED)~~

Delta V available:

Assumptions — Full load, initial Y CG = 0, 1700 lb RCS EI Mach 1, vehicle weight — 250,000 lb — 3.5 fps/percent, (aft quantity 1, 2 calculation consider propellant required for 2 days attitude hold, IMU aligns, and deorbit propellant).

- 1. — Tank fail, no prop dumped:*
 - 2. — Tank dumped to depletion post MECO:*
- *Limited by Y CG*

Delta V requirements (STS 51-D delta V's):

P. ONE OMS PROPELLANT TANK SINGLE LEAK POST-OMS-2: @072398-6518A]

STD/DIRECT:

A perigee adjust or out-of-plane burn is performed immediately in accordance with Flight Rule {A4.1.3-4}, OMS LEAK/PERIGEE ADJUST. Propellant should be dumped to depletion (- on crew display) in order to reduce the amount of propellant leaked into the pod ~~prevent the pod from freezing~~ and to minimize the amount of propellant that is trapped onboard.

~~THIS RULE CONTINUED ON NEXT PAGE~~

FLIGHT RULES

A6.1.2-17 OMS FAILURE MANAGEMENT (CIL) (CONTINUED)

Q. ONE OMS PROPELLANT TANKS~~SINGLE~~ FAIL POST-OMS-2:

STD/DIRECT:

For a propellant tank failure during the deorbit burn, the deorbit burn must be terminated if the perigee is above a value calculated by FDO that will allow completion of the OMS burn. If above this PRPLT FAIL Hp, insufficient delta V remains in the OMS and RCS to complete the planned deorbit burn.

R. TWO OMS PROPELLANT TANKS LEAKING/FAILED:

STD:

For two OMS leaks in the same pod, treat as a single leak/fail realizing mixed crossfeed is not an option, see paragraphs O, P, and Q rationale.

For two OMS leaks on different sides, abort according to the abort priorities (ref. Flight Rule {A2.1.2-2A}, ASCENT MODE PRIORITIES FOR PERFORMANCE CASES). TAL, if prior to last TAL boundary. After TAL boundary and pre-MECO, a ~~late~~-TAL to an ALCS will be performed. If the leaks occur post-MECO, perform optimum AOA OMS-1 shallow OMS-2. Use mixed crossfeed if available in order to keep the Y CG within limits. Aft RCS supplement to AFT PRESS QTY should also be used.

Note that consideration may be given to executing the deorbit burn using mixed crossfeed if doing so will optimize overall performance and vehicle health (CG impacts, tank landing constraints, etc.). @[072398-6518A]

THIS RULE CONTINUED ON NEXT PAGE

FLIGHT RULES

A6.1.2-17 OMS FAILURE MANAGEMENT (CIL) (CONTINUED)

If two OMS leaks occur, different propellants and different sides, an ATO will not be attempted. Previously, delayed ATO was attempted if either leak rate supported delayed ATO OMS-1. A delayed ATO is not an option for the two leaks-different propellants and different sides. Consider the following scenarios:

- a. *Two OMS leaks, different propellant, different sides, and one leak rate supports delayed ATO OMS-1; delayed ATO OMS-2 is performed with RCS. 160 fps is required to satisfy shallow targets. No OMS delta V is available, however, since one pod was not used for OMS-1. As a result, no blowdown is available for mixed crossfeed deorbit from this pod. 44 fps RCS delta V was used for OMS-2. Therefore, only 57 fps RCS delta V remains. AS A RESULT, IF ONE LEAK RATE SUPPORTS DELAYED ATO OMS-1, THE DELAYED ATO IS NOT A VIABLE OPTION.*
- b. *Two OMS leaks, different propellant, different sides, and both leak rates support delayed ATO OMS-1; delayed ATO OMS-2 is performed with RCS. 160 fps is required to satisfy shallow targets. Only 70 fps is available in the OMS (limited by the amount of blowdown available in the good tanks for mixed crossfeed). 44 fps RCS delta V was used for OMS-2. Therefore, only 57 fps RCS delta V remains. The total delta V available is 127 fps, not enough to satisfy the 160 fps required for shallow deorbit. AS A RESULT, IF BOTH LEAK RATES SUPPORT DELAYED ATO OMS-1, THE DELAYED ATO IS STILL NOT A VIABLE OPTION.*
- c. *Two OMS leaks, different propellant, different sides, and both leak rates support nominal OMS-1; OMS-2 cutoff at 100 nm is performed with RCS. 130 fps is required to satisfy shallow targets. Only 90 fps is available in the OMS (limited by the amount of blowdown available in the good tanks for mixed crossfeed). 88 fps RCS delta V was used for OMS-2. Therefore, only 13 fps RCS delta V remains. The total delta V available is 103 fps, not enough to satisfy the 130 fps required for shallow deorbit. AS A RESULT, IF BOTH LEAK RATES SUPPORT NOMINAL OMS-1, NOMINAL OMS-1, OMS-2 CUTOFF AT 100 NM IS NOT A VIABLE OPTION.*

For two OMS leaks same propellant, the earliest abort option will be chosen since no OMS mixed crossfeed is available.

THIS RULE CONTINUED ON NEXT PAGE

FLIGHT RULES

A6.1.2-17 OMS FAILURE MANAGEMENT (CIL) (CONTINUED)

DIRECT:

For two OMS leaks in the same pod, treat as a single leak/fail realizing mixed crossfeed is not an option, see paragraphs O, P, and Q rationale.

For two OMS leaks on different sides, abort according to the abort priorities (reference Rule {A2.1.2-2A}, ASCENT MODE PRIORITIES FOR PERFORMANCE CASES). TAL, if prior to last TAL boundary. After TAL boundary and pre-MECO, ~~late~~TAL to an ACLS. If the leaks occur post-MECO, an AOA must be performed. AOA delta V costs vary according to MECO Ha. As a result, RCS supplement may or may not be required. Again, mixed crossfeed will be used if required and available in order to maintain Y CG within limits. [@J072398-6518A1](#)

Similar to the standard insertion case, an ATO will not be considered for the two leak case. Again, with two OMS leaks, insufficient blowdown delta V exist post-OMS-2 for a shallow deorbit.

THIS RULE CONTINUED ON NEXT PAGE

FLIGHT RULES

A6.1.2-17 OMS FAILURE MANAGEMENT (CIL) (CONTINUED)

OMS INLET LINE LEAK

S. ONE OMS INLET LINE~~SINGLE~~ LEAK PRIOR TO OMS-2: [@J072398-6518A1](#)

STD:

~~Due to crew reach and visibility constraints, an OMS leak probably cannot be secured pre-MECO (although an attempt may be made) and will be treated as a tank leak (see paragraph O).~~ Post-MECO, the leak will be secured to minimize propellant leakage into the pod. Since delayed ATO targets require less delta V than nominal OMS-1 with cutoff at $H_p = 100$, a delayed ATO OMS-1 is performed. OMS-1 is performed TETP for the following reasons: (1) should not perform SELP because OMS-1 is a critical burn and redundancy is required, (2) cannot perform burn TELP because bad propellant WILL NOT be fed into a good system, (3) do not perform burn SEGP since it is desirable to use as much propellant from the leaking system as possible. Post-delayed ATO OMS-1 H_a and H_p are usually high enough to provide sufficient stay capability to preclude a requirement for OMS-2 (assuming nominal MECO). Since a propellant leak may cool the pod to a point where a rev. 3 deorbit is not possible, an orbit altitude which allows 48-hour stay capability for propellant sublimation may be required. If the pod thermal environment indicates freeze-up may occur and the current orbit does not provide 48-hour stay capability, raise orbit with FRCS. In order to minimize repress cycles on the inlet line, ~~an out-of-plane~~ dump will be performed only if necessary to satisfy Orbiter CG envelope or OMS tank landing weight constraint. Deorbit using mixed crossfeed if required ~~and available with~~ forward and aft RCS supplement. Note that consideration may be given to executing the deorbit burn using mixed crossfeed if doing so will optimize overall performance and vehicle health (CG impacts, tank landing constraints, etc.).

If the inlet line repress fails at OMS-1, perform OMS-1 SEGP. Propellant tank fail rules now apply (see paragraphs O and Q).

~~Delta V available: See paragraph O.~~

DIRECT:

~~Due to crew reach and visibility constraints, an OMS leak probably cannot be secured pre-MECO (although an attempt may be made) and will be treated as a tank leak (see paragraph K).~~ If the delta V available supports continuing to MECO, Post-MECO, the leak will be secured to minimize propellant leakage into the pod. Direct insertion implies that an OMS-1 is nominally not performed. To avoid a repress of the inlet line, OMS-2 is performed SEGP cutoff at minimum H_p . As in the OMS 1/2 case, ~~a an out-of-plane dump~~ dump will be performed only if necessary to satisfy the Orbiter CG envelope or the OMS tank landing weight constraint. Deorbit using mixed crossfeed if required with forward and aft RCS supplement.

FLIGHT RULES

Note that consideration may be given to executing the deorbit burn using mixed crossfeed if doing so will optimize overall performance and vehicle health (CG impacts, tank landing constraints, etc.).

If the inlet line repress fails, propellant tank fail rules apply (see paragraphs O and Q). @[072398-6518A]

Delta V available: See paragraph O.

THIS RULE CONTINUED ON NEXT PAGE

FLIGHT RULES

A6.1.2-17 OMS FAILURE MANAGEMENT (CIL) (CONTINUED)

T. SINGLE-ONE OMS INLET LINE LEAK POST OMS-2: @J072398-6518A1

STD/DIRECT:

A perigee adjust burn is performed at the next opportunity to lower Orbiter altitude using the leaking propellant. Rule {A6.1.2-30}, OMS LEAKING INLET LINE PERIGEE ADJUST BURN, provides additional guidelines on the scheduling of the perigee adjust burn. If propellant remains after the perigee adjust burn, an out-of-plane dump may be performed if required to satisfy the Orbiter CG envelope or the OMS tank landing.

U. TWO OMS INLET LINES LEAKING:

STD:

For two OMS inlet line leaks in the same pod, treat as a single leak. Mixed crossfeed is not an option (see paragraphs S and T).

For two OMS inlet line leaks, different sides same propellant, an ATO will not be attempted since mixed crossfeed is not an option. Pre-MECO, the leaks will be treated as tank leaks. ~~(crew cannot close tank isolation valves due to reach and visibility constraints and therefore an inlet line leak cannot be confirmed).~~ Post-MECO, optimum AOA targets will be used to minimize OMS propellant requirements. Attempt AOA OMS-1 and OMS-2 TETP.

For two OMS inlet line leaks, different sides different propellants, an ATO will be attempted since 4+X mixed crossfeed is available. A delayed ATO OMS-1 will be performed. Deorbit 4+X mixed crossfeed with aft RCS supplement to aft quantity-1.

DIRECT:

For two OMS inlet line leaks in the same pod, treat as a single leak. Mixed crossfeed is not an option (see paragraphs S and T).

For two OMS inlet line leaks, different sides, same propellant, an ATO will not be attempted since mixed crossfeed is not an option. The leaks will be secured post-MECO to minimize leakage into the pod and an AOA OMS-2 TETP will be ~~attempted~~ performed with RCS supplement if required.

For two OMS inlet line leaks, different sides, different propellant, an ATO will be attempted since 4+X mixed crossfeed is available. The leaks will be secured post-MECO to minimize leakage into the pod and an OMS-2 cutoff at minimum Hp will be performed. Deorbit 4+X mixed crossfeed with RCS supplement if required. @J072398-6518A1

THIS RULE CONTINUED ON NEXT PAGE

FLIGHT RULES

A6.1.2-17 OMS FAILURE MANAGEMENT (CIL) (CONTINUED)

OMS ENGINE FAILURE:

V. ONE OMS ENGINE~~SINGLE~~ FAILURE: @[072398-6518A]

STD/DIRECT:

If sufficient OMS and RCS propellant margin is available to redline RCS steep deorbit from the nominal orbit, then nominal OMS-1 and OMS-2 will be performed. Propellant trade-offs as defined in Rule {A2.1.3-7}, CONSUMABLES MANAGEMENT, must also be considered when calculating the redline. If sufficient margin does not exist to cover RCS deorbit to steep targets, perform delayed ATO OMS-1 and OMS-2. If the failure occurs during OMS-1, nominal OMS-1 must be completed. Perform OMS-2 cutoff at minimum Hp. Raise orbit within redlines.

These calculations are performed preflight and based on nominal MECO delta V's obtained from FDO's prior to flight.

W. TWO OMS ENGINES FAILED:

STD/DIRECT:

RCS +X is the ~~last~~next option for translation after both OMS engines have failed. RCS 4+X uses more OMS propellant than the OMS engines for an equivalent delta V due to Isp differences. Therefore, an ATO to minimum Hp is performed to minimize the delta V requirements. Deorbit is scheduled first day or next PLS opportunity because the next failure results in the loss of deorbit capability. @[072398-6518A]

Rule {A6.1.2-36}, OMS GN₂ ACCUMULATOR LEAK DETERMINATION, references this rule.

FLIGHT RULES

THIS PAGE INTENTIONALLY BLANK

FLIGHT RULES

A6.1.2-18

RCS FAILURE MANAGEMENT

<u>FAILURE MATRIX</u>	L/O TO OMS-1	OMS-1 TO OMS-2	OMS-2 TO DEORBIT
1 OR 2 FRCS HE TANK LEAK.....	A	A	B
1 OR 2 FRCS HE TANK FAIL.....	C	C	D
1 OR 2 FRCS PROP TANK LEAK....	E	E	E
1 OR 2 FRCS PROP TANK FAIL.....	F	F	F
1 ARCS HE TANK LEAK/FAIL.....	G	G	H
2 ARCS HE TANK LEAK/FAIL.....	I	I	I
1 ARCS PROP TANK LEAK/FAIL.....	J	J	J
2 ARCS PROP TANK LEAK/FAIL.....	K	K	K

NOTES:

- [1] WITH FRCS SECURED, LOSE VERNIER CONTROL.
- [2] ENTER FIRST DAY PLS.
- [3] ENTER NEXT PLS.
- [4] CUT OFF AT MINIMUM HP WHICH REQUIRES THE LEAST TOTAL DELTA V FOR THE INSERTION AND DEORBIT BURNS AND ENSURES ORBITAL LIFETIME AT LEAST TWO ORBITS BEYOND THE FIRST DAY PLS.

THIS RULE CONTINUED ON NEXT PAGE

FLIGHT RULES

A6.1.2-18 RCS FAILURE MANAGEMENT (CONTINUED)

FAILURE DEFINITION

FRCS HE TANK LEAK/FAIL:

- HE TANK LEAK IF PRESSURE > 456 PSI AND DECREASING ABNORMALLY.
- HE TANK FAIL IF PRESSURE < 456 PSI.
- FULL BLOWDOWN IF PROPELLANT TANK QUANTITY < 23 PERCENT.

ACTION SUMMARY

- A. ONE OR TWO HE SYSTEM LEAK PRIOR TO OMS-2:
1. PRE-MECO SECURE, RATE DAMP WITH ARCS.
 2. USE FRCS FOR ET SEPARATION, CANCEL +X TRANSLATION.
 3. USE UNTIL HE FAILED, THEN SECURE FRCS [1].
 4. USE RCS PROPELLANT CONSERVATION TECHNIQUES.
- B. ONE OR TWO LEAK POST-OMS-2:
1. PERFORM -X TRANSLATION OR FRCS DUMP TO ACHIEVE MAXIMUM BLOWDOWN UNTIL HE TANK FAIL.
 2. DESELECT FRCS JETS [1] UNLESS REQUIRED FOR HIGH PRIORITY ACTIVITIES.
 3. USE RCS PROPELLANT CONSERVATION TECHNIQUES.
 4. RESELECT FRCS JETS PRIOR TO DEORBIT.
 5. SECURE FRCS WHEN PROPELLANT TANK PRESSURE \leq 190 PSI.

THIS RULE CONTINUED ON NEXT PAGE

FLIGHT RULES

A6.1.2-18 RCS FAILURE MANAGEMENT (CONTINUED)

C. ONE OR TWO FAIL PRIOR TO OMS-2:

1. PRE-MECO SECURE, RATE DAMP WITH ARCS.
2. USE FRCS FOR ET SEPARATION, CANCEL +X TRANSLATION.
3. POST-ET SEPARATION, SECURE FRCS [1]
4. USE RCS PROPELLANT CONSERVATION TECHNIQUES.

D. ONE OR TWO FAIL POST-OMS-2:

1. DESELECT FRCS JETS [1] UNLESS REQUIRED FOR HIGH PRIORITY ACTIVITIES.
2. USE RCS PROPELLANT CONSERVATION TECHNIQUES.
3. RESELECT FRCS JETS PRIOR TO DEORBIT.
4. SECURE FRCS WHEN PROPELLANT TANK PRESSURE \leq 190 PSI.

FRCS is critical for ET separation. Since very little blowdown capability exists at launch, the mated coast rate damping is performed using the ARCS maximizing the FRCS capability for ET separation. The MCC can determine if the helium tank will support a nominal mated coast/ET separation and will advise crew to open FRCS pre-MECO (maximizing blowdown) if the capability exists; otherwise the crew will perform mated coast with the ARCS. Once the helium tank has failed, the FRCS capability is drastically reduced. Therefore, propellant conservation techniques must be utilized to stretch mission duration. Sufficient blowdown capability is available to perform a successful ET separation.

Post-OMS-2, time is available to attempt a maximum blowdown burn to maximize FRCS capability for high priority on-orbit activities which require FRCS, in the entry preparation and deorbit burn timeframes.

The full blowdown quantity of 23 percent assumes use of the propellant tank to a pressure of 190 psi. (Reference SODB 4.3.2.1.)

THIS RULE CONTINUED ON NEXT PAGE

FLIGHT RULES

A6.1.2-18 RCS FAILURE MANAGEMENT (CONTINUED)

FAILURE DEFINITION

FRCS PROPELLANT TANK LEAK/FAIL:

- PROPELLANT TANK LEAK IF QUANTITY DECREASE ABNORMAL.
- PROPELLANT TANK FAIL IF QUANTITY \leq 0 PERCENT OR PRESSURE \leq 190 PSI.

ACTION SUMMARY

E. ONE OR TWO LEAK:

1. SECURE, IF LEAK RATE CAN SUPPORT MATED COAST/ET SEPARATION, USE FRCS FOR MATED COAST AND ET SEPARATION. OTHERWISE, RATE DAMP WITH ARCS.
2. USE FRCS FOR ET SEPARATION. CANCEL +X TRANSLATION.
3. PERFORM FRCS DUMP TO DEPLETION, THEN SECURE FRCS [1].
4. USE RCS PROPELLANT CONSERVATION TECHNIQUES.

NOTE: IF THE LEAK RATE RESULTS IN A QTY < 52 PERCENT AT MECO, AND MECO CONDITIONS EXIST WHICH PROVIDE A DELAYED ET SEP CAPABILITY WITHOUT IMPACTING ORBITER PERFORMANCE (N/A RTLS, TAL), PERFORM DELAYED ET SEP (MECO + 6 MINUTES).

This rule allows using the FRCS to 0 percent versus performing a NO FRCS ET SEP by optimizing FRCS capability for ET SEP. The A/E FTP #48, 9/9/88, judged the risk of using the FRCS for ET SEP (when the computed quantity at MECO is < 52 percent) to be lower than the uncertified NO FRCS ET SEP procedure. Delaying ET SEP (MECO + 6 minutes) provides additional time to allow possible FRCS screen rewetting to occur. Rewetting the screens may prevent jet fail off's due to helium ingestion. If an RTLS, TAL, or underspeed conditions exist at MECO, an on-time ET SEP will be performed.

Same as paragraph A except apply propellant tank and perform FRCS dump to depletion. Dumping propellant overboard versus allowing propellant to leak into the FRCS module minimizes on-orbit cool down or postlanding fire hazard.

THIS RULE CONTINUED ON NEXT PAGE

FLIGHT RULES

A6.1.2-18 RCS FAILURE MANAGEMENT (CONTINUED)

F. ONE OR TWO FAIL:

1. SECURE 1 [1], RATE DAMP WITH ARCS.
2. PERFORM NO JET ET SEPARATION, CANCEL +X TRANSLATION.
3. USE RCS PROPELLANT CONSERVATION TECHNIQUES.

Loss of the FRCS for ET separation requires the use of a special technique to separate from the external tank.

FAILURE DEFINITION

ARCS HE TANK LEAK/FAIL:

- HE TANK LEAK IF PRESSURE > 456 PSI AND DECREASING ABNORMALLY.
- HE TANK FAIL IF PRESSURE < 456 PSI.
- FULL BLOWDOWN IF PROPELLANT TANK QUANTITY < 24 PERCENT.

ACTION SUMMARY

G. ONE LEAK/FAIL PRIOR TO OMS-2:

1. RATE DAMP AND ET SEPARATION IN NORMAL CONFIGURATION, CANCEL +X TRANSLATION.
2. WHEN HE TANK PRESSURE < 456 PSI PRE/DURING OMS-1 CROSSFEED FROM GOOD SIDE. POST-OMS-1, INTERCONNECT FROM OMS.
3. NOMINAL DEORBIT [2].
4. PRE-EI, CROSSFEED FROM GOOD SIDE.

The full blowdown quantity of 24 percent assumes use of the propellant tank to a pressure of 190 psi. (Reference SODB 4.3.2.1.)

Use mated coast/ET separation to increase the blowdown capability if the helium tank has not yet failed. If helium tank has failed, good pod RCS can be used for ET separation. However, the RCS entry redline has been violated due to loss of RCS in affected pod. Use OMS interconnect capability to conserve the remaining RCS for entry at the next PLS opportunity. Stay in interconnect configuration through OMS-2 and the deorbit burn.

THIS RULE CONTINUED ON NEXT PAGE

FLIGHT RULES

A6.1.2-18 RCS FAILURE MANAGEMENT (CONTINUED)

H. ONE LEAK/FAIL POST-OMS-2:

1. INTERCONNECT FROM OMS.
2. IF LEAKAGE CANNOT SUPPORT NEXT PLS OPPORTUNITY, CROSSFEED FROM LEAKING RCS AND PERFORM +X TRANSLATION TO MAXIMUM BLOWDOWN. WHEN HE TANK FAILED OR MAXIMUM BLOWDOWN, INTERCONNECT FROM OMS THROUGH THE DEORBIT BURN. CROSSFEED FROM GOOD RCS FOR ENTRY.
3. IF LEAK CAN SUPPORT NEXT PLS, PRIOR TO DEORBIT, RECONFIGURE ARCS TO NORMAL FEED. IF HE TANK PRESSURE < 456 PSI, CROSSFEED FROM GOOD SIDE FOR ENTRY.
4. NOMINAL DEORBIT [3] [2].

Interconnect to OMS is required to enable MCC to establish a reliable leak rate. Once leak rate is determined, then the decision to perform a maximum blowdown burn or wait to the next PLS opportunity can be made. Regardless of the decision, stay in interconnect configuration to conserve RCS propellant in the good pod. Save affected pod blowdown for entry preparation and deorbit.

I. TWO LEAK/FAIL:

1. IF ON SAME SIDE, TREAT AS SINGLE LEAK/FAIL. SEE PARAGRAPHS G AND H.
2. IF LEAKING, CONTINUE TO USE TO MAXIMIZE ULLAGE UNTIL HE TANK FAILED.
3. IF SAME PROPELLANT, UPHILL ABORT [4].
4. IF DIFFERENT PROPELLANT, INTERCONNECT FROM OMS TO SAVE RCS ULLAGE, NOMINAL DEORBIT, [2], [3] USE MIXED CROSSFEED FOR ENTRY.

Same as paragraph H. If same propellant in different pods, mixed crossfeed cannot be utilized to support entry.

With the OI-8 NO YAW JET software, a certified entry from a Q-bar = 20 to touchdown is now available. With this capability, previous abort calls for dual RCS He/propellant tank fail/leak can be avoided if control can be guaranteed through a Q-bar = 20. OMS interconnect is utilized from MECO until prior to EI for attitude control to minimize RCS propellant requirements.

THIS RULE CONTINUED ON NEXT PAGE

FLIGHT RULES

A6.1.2-18 RCS FAILURE MANAGEMENT (CONTINUED)

The two He tank fail same propellant TAL abort case was eliminated. Sufficient blowdown is available to supply propellant requirements for EI to a $Q\text{-bar} = 20$ (available blowdown = 160 lb; required from EI to $Q\text{-bar} = 20 \gg 127$ lb (based on review of GNC entry data). An uphill abort cutting off at minimum H_p , which requires the least delta V for the insertion and deorbit burns and ensures orbital lifetime at least two orbits beyond the first day PLS, is selected to maximize the amount of OMS remaining to protect for interconnect operations post-deorbit burn. OMS remaining post-deorbit burn must be ³ 10.3 percent (SODB 3.4.3.3.7.C) plus any expected usage.

The action is the same for one or both helium tanks leaking as for two He tanks failed. The rationale deals with the time to maximize blowdown in the leaking system(s). The time from MECO until a $Q\text{-bar} = 20$ on a TAL is 374 seconds (6.25 minutes) where if applied to a normal ascent would allow time to increase blowdown capability.

Two propellant tanks failed same propellant does not allow any type of certified entry. Since no control can be guaranteed, the most prudent action is the one that allows the most time and the most benign environment. By pressing uphill, time is gained to allow complex procedure and/or software changes to take place to help provide control until a $Q\text{-bar} = 20$ (i.e., DAP or procedure changes that will allow forward RCS control in pitch and yaw). A delayed ATO is selected to maximize the amount of OMS remaining to protect for interconnect operations post-deorbit burn.

For the cases of one propellant tank fail and the other leaking or both leaking same propellant yields a more complex case. If one pod contains 75 percent or more, ET separation can be performed in a timely and safe manner. The leak rate after ET separation must still support $Q\text{-bar} = 20$ to guarantee control until NO YAW JET can be engaged. If the leak rate supports TAL, the proper course of action is to abort TAL. If the leak rate does not support TAL, this case becomes the same as two propellant tanks failed.

THIS RULE CONTINUED ON NEXT PAGE

FLIGHT RULES

A6.1.2-18 RCS FAILURE MANAGEMENT (CONTINUED)

FAILURE DEFINITION

ARCS PROPELLANT TANK LEAK/FAIL:

- PROPELLANT TANK LEAK IF QUANTITY DECREASE ABNORMAL.
- PROPELLANT TANK FAILURE IF QUANTITY < 0 PERCENT OR PRESSURE < 190 PSI.
- NOMINAL OR ABORT ET SEPARATION: PROPELLANT TANK FAILURE IF QUANTITY < 75 PERCENT.

ACTION SUMMARY

J. ONE LEAK/FAIL:

1. PRE/DURING OMS-1, IF FAILED, CROSSFEED FROM GOOD RCS FOR ET SEP, CANCEL +X TRANSLATION.
2. POST-OMS-1, IF FAILED, INTERCONNECT FROM OMS.
3. PERFORM NOMINAL OMS-1 AND OMS-2.
4. PERFORM PERIGEE ADJUST OR OUT-OF-PLANE BURN IMMEDIATELY.
5. NOMINAL DEORBIT, [3], [2].
6. IF FAILED, PRE-EI, CROSSFEED FROM GOOD RCS.

Crossfeed from good RCS to guarantee ET separation is accomplished. Then interconnect from OMS to conserve good pod RCS propellants. There is no reduction in the OMS delta V capability so a nominal ascent can be completed. However, deorbit will occur at the next PLS opportunity due to the violation of the RCS entry redline.

THIS RULE CONTINUED ON NEXT PAGE

FLIGHT RULES

A6.1.2-18 RCS FAILURE MANAGEMENT (CONTINUED)

K. TWO LEAK/FAIL:

1. IF ON SAME SIDE, TREAT AS SINGLE FAILURE, SEE PARAGRAPH J.
2. INTERCONNECT FROM OMS, CANCEL +X TRANSLATION. POST-EI, FEED FROM RCS.
3. IF SAME PROPELLANT, SELECT RETURN, PRIORITY:
 - TAL/LATE TAL (IF LEAK RATE SUPPORTS ET SEPARATION AND ENTRY TO A Q-BAR = 20).
 - AOA (IF POST-MECO AND LEAK RATE SUPPORTS AN ENTRY TO A Q-BAR = 20).
 - ELS (IF LEAK RATE SUPPORTS AN ENTRY TO A Q-BAR = 20 CONSISTENT WITH RULE {A2.1.4-5}, EMERGENCY DEORBIT CAPABILITY REQUIREMENTS).
 - UPHILL ABORT [4].
4. IF DIFFERENT PROPELLANT, INTERCONNECT FROM OMS TO RCS TO SAVE RCS PROPELLANT. NOMINAL ENTRY, [3]. USE MIXED CROSSFEED FOR ENTRY.

The rationale is the same as that for paragraphs I and J.

FLIGHT RULES

A6.1.2-19

RCS RM LOSS

RCS RM LOSS	VERNIER JETS	PRIMARY JETS	
	ORBIT DAP	ORBIT/TRANS DAP	AEROJET/GRTLS DAP
FAIL OFF DETECTION	RESELECT IF AUTO DESELECTED CONTINUE TO USE WITHOUT "FAIL OFF" DETECTION	CHANGE AFFECTED JET TO LAST PRIORITY RESELECT IF AUTO DESELECTED AT SEAT INGRESS: IF YAW JET DESELECT	CHANGE AFFECTED JET TO LAST PRIORITY IF YAW JET DESELECT [2] OTHERWISE RESELECT
FAIL LEAK DETECTION	IF L5L AND/OR R5R DESELECT AFFECTED JET CONTINUE TO USE VRCS IF DOWNFIRING VRCS JET, SELECT PRCS, CLOSE AFFECTED VRCS MANIFOLD	CHANGE AFFECTED JET TO LAST PRIORITY RESELECT IF AUTO DESELECTED AT SEAT INGRESS: IF YAW JET DESELECT	CHANGE AFFECTED JET TO LAST PRIORITY IF YAW JET DESELECT [2] OTHERWISE RESELECT
FAIL ON DETECTION	CONTINUE TO USE DURING CREW AWAKE PERIODS SELECT PRCS TAIL ONLY FOR CREW SLEEP AND VERNIER RJD-OFF	CHANGE AFFECTED JET TO LAST PRIORITY SET MANIFOLD STATUS TO "CLOSED" IF FAIL-SAFE REDUNDANCY EXISTS AFFECTED RJD-OFF [1] AT SEAT INGRESS: AFFECTED RJD-ON SET MANIFOLD STATUS TO "OPEN" IF YAW JET DESELECT	CHANGE AFFECTED JET TO LAST PRIORITY IF YAW JET DESELECT [2]
TOTAL RM (MDM INPUT OR BCE BYPASS)	SELECT PRIMARY JETS CLOSE AFFECTED VRCS MANIFOLDS VERNIER RJD-OFF	CHANGE AFFECTED JET TO LAST PRIORITY LEAVE MANIFOLD STATUS "CLOSED" IF FAIL-SAFE REDUNDANCY EXISTS AFFECTED RJD-OFF [1] FOR OMS-1,2 OR DEORBIT SET MANIFOLD STATUS TO "OPEN" AND AFFECTED RJD-ON TO REGAIN ANY AFFECTED ± JETS AT SEAT INGRESS: AFFECTED RJD-ON	CHANGE AFFECTED JET TO LAST PRIORITY LEAVE MANIFOLD STATUS "CLOSED" IF FAIL-SAFE REDUNDANCY EXISTS

NOTES:

- [1] JETS MAY BE MADE AVAILABLE FOR HIGH PRIORITY ACTIVITIES REQUIRING MULTIPLE JETS AND/OR REDUNDANCY.
- [2] JETS MAY BE RESELECTED TO MAINTAIN FAIL-SAFE REDUNDANCY.

THIS RULE CONTINUED ON NEXT PAGE

FLIGHT RULES

A6.1.2-19 RCS RM LOSS (CONTINUED)

A. VERNIER JETS

1. ORBIT DAP:

a. FAIL OFF

The vernier jets will continue to be used after the loss of fail-off protection. In the event of an undetected fail off of a vernier jet, drifting attitude control problems may result, but there are no system problems associated with additional firing on a vernier fail-off jet.

b. FAIL LEAK

WSTF testing has demonstrated that propellant leakage into the chamber may freeze and block the small vernier chamber. If the failure went undetected and the jet were allowed to fire, the blockage could cause severe damage. Therefore, for loss of failed leak protection, the jet will be deselected. If the remaining vernier jets have good RM and are adequate to maintain attitude control, vernier control may be selected; otherwise, primary jets must be selected.

c. FAIL ON

During active attitude hold, a vernier jet failed on would force the orbiter outside the DAP deadbands. Opposing jets would then fire to correct the attitude until the failed-on jet was stopped (i.e., manifold closure or RJD driver poweroff) or the propellant was depleted. Normally, the RCS RM would annunciate the failure but with loss of RM there would be no alarm. During crew awake periods, numerous jet firings would alert the crew to take corrective action before significant propellant loss occurs. However, during crew sleep, the failure could go undetected for several hours depleting the RCS tanks. Therefore, during crew sleep the vernier jets would not be used for loss of fail-on RM. Primary jets will be selected in the tail-only control mode to eliminate cabin noise associated with the firing of the FRCS thrusters.

d. TOTAL RM

An MDM comm fault or BCE bypass would cause loss of total RM on a pair of vernier jets (e.g., L5L and L5D). This would be at least equivalent to the worst case of loss of fail leak RM and therefore cause the loss of verniers and selection of primary jets.

THIS RULE CONTINUED ON NEXT PAGE

FLIGHT RULES

A6.1.2-19 RCS RM LOSS (CONTINUED)

B. PRIMARY JETS

For any loss of RM protection during any DAP phase the affected jet will be changed to the lowest priority. The lowest priority jet will not fire during normal orbit/trans DAP operations. Jet availability (reselect/deselect) will be managed to minimize the use of the jet. For orbit/trans DAP, the affected jet (all axes) will remain available (reselected) to provide system redundancy should multiple failures (additional jet loss) occur. This allows the jet to be available without requiring crew actions during a time-critical phase.

For Aerojet/GRTLS DAP, only an affected yaw jet will be deselected. This prevents the affected yaw jet from being fired during roll reversals. The DAP commands all available yaw jets to provide attitude control. All other jet axes will remain available to provide system redundancy, since these jets will not fire while in lowest priority during normal operations of the Aerojet/GRTLS DAP.

RCS manifolds will not be closed due to the loss of RM protection on primary jets. Complications that may result from manifold closure are more probable than the failures due to loss of RM, such as manifold pressure decay resulting in jet leaks or possible staged repress procedures.

Firing jets with loss of fail leak or fail off detection may result in zots, valve damage, or contamination. This minimal risk is accepted to provide vehicle control capability should multiple failures occur.

1. ORBIT/TRANS DAP:

The orbit and trans DAP require one jet/direction/pod to maintain attitude control. Fail-safe redundancy (two jets/direction/pod) is required for time and safety critical events (RNDZ, deploy).

Action for loss of fail off, leak, on, or total RM will usually be delayed until after ET SEP or OMS-1 in order to minimize crew activity during the ascent phase.

a. FAIL OFF/LEAK

The affected jet will remain available and be put into last priority. The orbit and trans DAP will only fire one jet/direction/pod for rotational control. For translation the DAP may fire more than one jet/direction/pod. Multiple failures may require the use of the affected jet to maintain fail safe redundancy for time/safety critical events. The jet will be available without further crew action.

THIS RULE CONTINUED ON NEXT PAGE

FLIGHT RULES

A6.1.2-19 **RCS RM LOSS (CONTINUED)**

b. *FAIL ON*

The affected manifold status will be set to “closed” and the RJD powered off. This will eliminate any chance of an undetected fail-on jet.

For high priority events which require the affected jet, such as -X jets for low-Z translations, the affected jet can be reselected and RJD power turned on. The risk of a jet fail-on is considered acceptable to achieve mission success activities.

While in the trans DAP for entry, manifold status actions may be performed to prepare for Aerojet DAP and deorbit burn.

c. *TOTAL RM*

The affected manifold status will be left “closed” and the RJD powered off. This will eliminate any possible chance of an undetected fail-on jet.

With an MDM comm fault or BCE bypass, the manifold status will be set to “closed” automatically. For OMS-1, -2 or deorbit any affected manifold with $\pm X$ jets will be set to “open” and associated RJD powered on. The risk of an undetected jet failure will be accepted to ensure RCS X jets are available for OMS-1, -2 or deorbit.

While in the trans DAP for entry, RJD actions may be performed to prepare for aerojet DAP and deorbit burn.

THIS RULE CONTINUED ON NEXT PAGE

FLIGHT RULES

A6.1.2-19 RCS RM LOSS (CONTINUED)

2. AEROJET/GRTLS DAP:

Entry requires three yaw jets/pod and two pitch jets/direction/pod for the aft RCS to maintain fail-safe redundancy.

a. FAIL OFF/LEAK/ON

The Aerojet/GRTLS DAP will fire four yaw jets if available during roll reversals. Therefore a yaw jet with loss of fail off, leak or on detection will be deselected and placed in last priority. For subsequent/multiple failures the jet may be reselected per the reselection priority table (Rule {A6.1.2-32}, FAILED PRCS JET SELECTION PRIORITY).

The possibility of firing three pitch jets in the Aerojet/GRTLS DAP exists; however, the probability of firing the last priority jet is small enough that it is an accepted risk not to deselect a pitch jet that has lost RM detection. Therefore, the pitch jet will be placed in last priority and reselected if it was autodeselected.

The affected jet may remain available if it is not a yaw jet. Multiple failures may require the use of the jet to maintain fail-safe redundancy. The jet will be available without further crew actions.

b. TOTAL RM

The affected manifold status will be set to "closed" and the RJD powered off. These actions provide a conservative approach to compensate for the loss of all three detection methods. Jets may be reselected, if necessary, depending on the cause of the failure and based on the criteria in Rule {A6.1.2-32}, FAILED PRCS JET SELECTION PRIORITY.

FLIGHT RULES

A6.1.2-20 RCS MAXIMUM BURN TIME

- A. THE OPERATIONAL LIMIT FOR CONTINUOUSLY FIRING PRCS JETS IS 150 SECONDS. THE CONTINUOUS FIRING LIMIT FOR VERNIER RCS JETS IS 125 SECONDS. THE VERNIER JETS ALSO HAVE A SEPARATE CONSTRAINT OF NO MORE THAN 1000 "ON" COMMANDS PER HOURS. [@\[072398-6690\]](#)

The limiting component of the primary thrusters is the titanium canister because it is heat-load sensitive. Exceeding temperature limits could damage adjacent components. The limiting component for the vernier thrusters is the aluminum structure since it too is heat-load sensitive. The 1000 "ON" commands limitation is driven by the PC transducer which could fail due to overheating leading to a false failoff. The 150/125-second firing limits are driven by a qualification limit and not by any data that shows damage occurs at these durations. (Ref. SODB, volume I, paragraph 3.4.3.2). Additional analysis data shows that the PRCS thrusters could be fired for 250 seconds and that the VRCS thrusters could be fired for 275 seconds without violating thermal limits even with entry heating immediately following the firing. (Ref. SODB, volume III, 4.3.3.16). For on-orbit conditions where an extended cooldown period is available consideration may be given to raising the limits to the limits become 400/450/710 seconds for primary and vernier jets respectively, with associated cooldowns of 2100/1400 seconds (35 minutes/23 minutes 20 seconds) 35/25 minutes. (Ref. SODB, Volume III, Paragraph 4.3.2.9. 35/25 minutes). (Caution: SODB, Volume III contains engineering estimates for non-nominal performance evaluation. Data may not be supported by test.)

- B. A SINGLE MISSION CONTINGENCY FIRING OF 800 SECONDS FOR ARCS (+X) THRUSTERS AND 300 SECONDS FOR FRCS (-X) THRUSTERS IS PERMISSIBLE.

~~A MAXIMUM BURN DURATION OF 800 SECONDS FOR ARCS (+X) THRUSTERS AND 300 SECONDS FOR FRCS (-X) THRUSTERS CONTINGENCY BACKUP DEORBIT BURN IS PERMISSIBLE.~~

The 800/300-second constraints represent the maximum +X/-X burn time that can be used in a contingency without capability that will not result in structural damage to the jet support structure and beams because of thermal soakback due to overheating. (Reference SODB, Volume I, Paragraph 3.4.3.2). Additional thermal analysis shows that a 1050-second (17 minutes 30 seconds) ARCS and 400-second FRCS thruster firing may ~~also~~ be permissible. For these durations, the limiting component for the ARCS thrusters is the Kapton wire insulation. If the temperature limit is exceeded, it could jeopardize the capability to refire the jet if a 3500-second (58 minute 20 second) 1-hour cooldown period is not allowed. The limiting component for the FRCS thrusters is the Inconel thermal barrier spring. If the limit is exceeded, the elasticity of the spring will be degraded and its life span shortened. (Ref. SODB, Volume III, Paragraph 4.3.3.2.916. Caution: SODB, Volume III contains engineering estimates for non-nominal performance evaluation. Data may not be supported by test.) [@\[072398-6690\]](#)

FLIGHT RULES

A6.1.2-21 OMS HELIUM INGESTION

FOR HELIUM INGESTION INTO THE OMS PROPELLANT TANK AFT COMPARTMENT AS REFLECTED IN AN OMS PROPELLANT TANK AFT QUANTITY DECREASE OF > 1.0 PERCENT FOR ANY SINGLE BURN WHEN OMS TANK QUANTITY > 45 PERCENT, OMS/RCS INTERCONNECT FROM THAT POD WILL NOT BE PERFORMED EXCEPT FOR DEORBIT.

The OMS bulkhead screen should not allow more than 1 percent of helium gas to enter the aft compartment for a single OMS burn. Experience to date has shown little or no gas transfer. A decrease in the aft quantity gauge > 1 percent during a burn when the propellant level covers the bulkhead screen indicates screen breakdown has occurred and further use of that tank without propellant settling burns is prohibited.

OMS tank propellant quantity less than 45 percent, RCS interconnect propellant usage may result in a decrease in OMS aft quantity (the forward compartment propellant may not be in contact with the bulkhead screen). With OMS propellant quantity less than 30 percent, there is no propellant remaining in the forward compartment and all usage will come from the aft compartment. In these cases, a decrease in the aft compartment quantity is not indicative of a screen failure. (Reference SODB, volume I, paragraph 3.4.3.3.)

A6.1.2-22 RCS JET DRIVER MANAGEMENT (CIL)

- A. THE PRIMARY JET RJD CONFIGURATION WILL BE ALL ON DURING CREW AWAKE PERIODS INCLUDING PROXIMITY OPERATIONS, PAYLOAD DEPLOYMENT, AND RENDEZVOUS MANEUVERS. THE PRIMARY RJD'S WILL BE POWERED OFF DURING CREW SLEEP PERIODS AND EVA OUTSIDE THE PAYLOAD BAY.
- B. IF VERNIER JET CAPABILITY IS LOST, CREW SLEEP PERIODS WILL BE FLOWN PRCS, TAIL ONLY OPTION PRIMARY CONTROL WITH ALL RJD'S POWERED ON.
- C. IF A FAILURE IS DETECTED IN THE RJD LOGIC POWER CIRCUIT VIA MCC TELEMETRY, THE AFFECTED RJD POWER WILL REMAIN POWERED ON FOR CREW SLEEP PERIODS.

RJD system testing has resulted in a failure rate of one failure every 10 billion hours. With the possibility of failure so low, the RJD configuration will be all on during crew awake periods. If a failure were to occur, crew accessibility would allow prompt corrective action. During sleep periods, the RJD's will be powered off because of the crew response time to failures while sleeping in the middeck. For extravehicular activities (EVA's) outside the payload bay, plume impingement activities are the concern.

FLIGHT RULES

Failure of the RJD logic power circuit as detected by RJD logic switch telemetry has no immediate effect on the operation of the affected jets. However, if RJD power is removed per the normal presleep procedure, the jets will be permanently lost. In this instance, the risk of a failure causing an RCS jet to fail on is considered more acceptable than a definite loss of two manifolds of RCS jets. It is considered prudent to sleep in tail-only PRCS control. Rule {A15.1.1-22}, RCS/APU THRUSTER PLUME AVOIDANCE, references this rule.

A6.1.2-23 RCS BLOWDOWN

THE FORWARD AND AFT RCS WILL NOT BE OPERATED IN BLOWDOWN MODE TO TROUBLESHOOT A REGULATOR PATH IF A REDUNDANT PRESSURE PATH EXISTS.

There will be no troubleshooting for an RCS regulator flow path unless additional failures restrict the remaining flow path. Crew actions and flight impact are independent of the failure mode determined by troubleshooting the system. It is not prudent to expose the system to off-nominal operating conditions during troubleshooting when no real procedural advantage can be realized.

A6.1.2-24 CROSSFEED/INTERCONNECT DURING CREW SLEEP

RCS CROSSFEED OR OMS/RCS INTERCONNECT WILL BE UTILIZED DURING CREW SLEEP PERIODS FOR THE LOSS OF SINGLE ARCS POD LEAK DETECTION CAPABILITY.

During crew sleep periods, by crossfeeding or interconnecting to a good system (RCS or OMS respectively), use of the system with no leak detection capability available can be avoided and the feeding system leak detection capability can be utilized.

Because of SMS limitations and inability to model thermal effects, training in propellant leak detection has typically been limited to annunciation of pressure decays with no associated temperature decrease. For small leaks, we feel that temperature will be our only indication. For large leaks, cooling will certainly accompany the pressure decay. Therefore, with the existing temperature sensors and associated FDA, we believe the primary means for leak detection will be thermal monitoring.

The philosophy to terminate interconnect prior to crew sleep was changed prior to STS 41-B because of newly identified crossfeed line surge pressure concerns and the desire to minimize the number of times the interconnect mode was established. In addition, a better understanding of the pod thermal effects as a result of propellant leakage resulted in an increased confidence that small leaks would be more readily detectable through thermal indications rather than the standard pressure decay (reference APU HYDRAZINE LEAK ON STS 41-A). Consequently, we feel that maintaining interconnect operations during sleep periods can be accomplished safely while at the same time maintaining an adequate leak detection capability with associated crew FDA.

FLIGHT RULES

During crew-awake periods, the RCS propellant tank pressure FDA may be used to provide leak detection by isolating the helium tank and forcing the RCS to operate in a blowdown mode. This allows propellant to be used from the degraded system while still providing leak detection capability. Also, because the RCS has much less ullage than the OMS, less propellant would be leaked prior to annunciation when operating with the RCS in blowdown than when interconnected from the OMS.

FLIGHT RULES

A6.1.2-25 OMS ENGINE FAILURE MANAGEMENT

FOR THE LOSS OF ONE OMS ENGINE :

- A. THE REMAINING GOOD OMS WILL BE USED FOR ON-ORBIT BURNS ONLY IF THE FIRST FAILURE CAN BE IDENTIFIED AS AN ENGINE FAILURE AND IS UNDERSTOOD.

As long as the first failure is confirmed to be an engine failure, the affected pod's propellant will be available for use through the remaining good engine via crossfeed operation. Engine versus propellant failures must be determined prior to future crossfeed operations to protect against contamination affecting the remaining good OMS engine.

- B. RCS 4 +X JETS WILL BE HOT-FIRED PRIOR TO COMMITTING TO CONTINUE TO NOMINAL EOM UNLESS THE JETS HAVE PREVIOUSLY FIRED.

For the loss of an OMS engine, the good OMS engine and the RCS 4 +X jets are considered the remaining two deorbit methods (sufficient propellant to redline RCS steep deorbit must be available). If either of the remaining deorbit methods is lost, a next PLS must be invoked since zero fault tolerance exists (ref. Rule {A2.1.4-1}, DEORBIT GUIDELINES). If the 4 +X RCS jets have not fired previously, the health of the jets is unknown. As a result, if the jets have not fired, in order to gain confidence in the +X jets, the jets should be hot-fired. Since these jets are hot-fired the day before entry in the normal hot-fire procedure, the normal hot-fire procedure should be rescheduled to an earlier time.

A6.1.2-26 RCS HOT-FIRE CHECK

ALL ENTRY-CRITICAL JETS (OTHER THAN FIRST PRIORITY ON-ORBIT JETS) WILL BE HOT-FIRED ONCE DURING THE MISSION.

The hot-fire test is performed to verify that all primary jets needed for deorbit or entry are operating properly. The number one priority orbit DAP jets are fired during normal orbit ops and will not need to be fired again during the hot-fire test.

A special hot-fire test will be required for the first flight of a new vehicle to test all jets including the forward up-firing jets since these jets are not normally fired and need to be tested.

FLIGHT RULES

A6.1.2-27

RCS VERNIER OPERATION TERMINATION

RCS VERNIER THRUSTER OPERATION SHALL BE TERMINATED AND SYSTEM OPERATION PERFORMED ON PRIMARY THRUSTERS WHENEVER:

- A. THE RCS FUEL TANK PRESSURE IS 20 (20)* PSID GREATER THAN THE OXIDIZER TANK PRESSURE. VERNIER OPERATION MAY BE RESUMED WHEN FUEL/OXIDIZER TANK PRESSURE DELTA < 20 (20) PSID.

NOTE: *ZERO INSTRUMENTATION ERROR IS USED SINCE SECONDARY REGULATOR OPERATION PLUS INSTRUMENTATION INACCURACY COULD EXCEED CONSTRAINTS.

Vernier thruster test data have demonstrated that low oxidizer/fuel mixture ratio (less than 1.6) shifts the main combustion from the center to near the wall of the chamber which results in high combustion chamber temperatures. Tests conducted at an oxidizer/fuel mixture ratio of 1.3 resulted in severe damage to the vernier thruster chamber protective coating. The test duration was equivalent to approximately one mission day. Continued operation at this mixture ratio would have resulted in chamber burnthrough. By limiting the differential of the oxidizer and fuel propellant tank pressures to 20 psid, the mixture ratio for the vernier thruster will not be less than 1.5. Tests were conducted at a mixture ratio of 1.5 for an equivalent of approximately 3 mission days with no detectable coating damage. Also, 20 psid allows vernier operation when the He system is operating on the secondary regulator (including system tolerances 2-sigma).

- B. THE HIGH-LOAD FLASH EVAPORATOR IS OPERATING FOR MORE THAN 20 MINUTES.

On STS-2, overtemperatures in the VRCS thrusters occurred during lengthy operation of the flash evaporator. The propulsive vent holds the DAP to one side of the deadband. The DAP continues to cycle the same jets at such a frequency that the thrusters do not have an opportunity to cool down. The best way to protect the vernier thrusters from overheating is to configure the DAP to the PRCS when the high load evaporator will be run for more than 20 or 30 minutes. Reference STS-3 Orbit Flight Techniques meeting number 14, March 30, 1982.

- C. THE VRCS DAP MODE IS LOST.

Reference Flight Rule {A8.1.2-10}, LOSS OF VERNIER RCS DAP MODE, to determine the status of the VRCS DAP mode following the loss of the six VRCS jets.

FLIGHT RULES

A6.1.2-28

OMS ENGINE INLET PRESSURE REQUIREMENTS

AN OMS ENGINE WILL NOT BE USED FOR NONCRITICAL ON-ORBIT BURNS IF THE FUEL INLET PRESSURE < 244 PSIA OR OXIDIZER INLET PRESSURE < 244 PSIA OR N₂ TANK PRESSURE < 563 PSIA.

The OMS engine inlet pressure requirements preserve blowdown capability in an OMS system that has incurred a previously undetected failure of the pressurization system. The engine inlet pressure limits represent the bottom of the regulator band (252 psia) minus 2 percent instrumentation error (8 psia). If either inlet pressure cannot be repressed to above 244 psia, the system can be operated further in blowdown. However, the blowdown capability should be preserved for critical burns.

The nominal start envelope limits are 239 and 238 psia for the fuel and oxidizer inlet pressures, respectively (reference SODB, volume I, figure 4.3.3). The N₂ criteria represents the following:

- | | | | |
|-----|---|-----------------|--------------------------------------|
| (1) | Engine start | 26 psia | (ref. SODB, volume I, fig. 4.3.3) |
| (2) | Purge | 94 psia | |
| (3) | Accumulator start at 100 percent ball valve opening | 283 psia | (ref. SODB, volume I, table 3.4.3.3) |
| (4) | Instrumentation error | <u>160</u> psia | |
| | Total = | 563 psia | |

The limits defined in this rule are used in the FDF for noncritical on-orbit OMS burns.

FLIGHT RULES

A6.1.2-29 LEAKING JET MANAGEMENT RULES

A. PRIMARY JETS:

1. A LEAKING JET WILL NOT BE DESELECTED UNLESS THE INJECTOR TEMPERATURE VIOLATES THE RCS RM LIMIT OR PROPELLANT LEAKAGE IMPACTS CONTAMINATION SENSITIVE ORBIT ACTIVITIES.
2. FOR A LEAKING JET THAT HAS BEEN DESELECTED BY RCS RM, THE JET CAN BE RESELECTED AND USED ON A NONINTERFERENCE BASIS (NO IMPACT TO MISSION EVENTS) ONCE THE OXIDIZER AND FUEL INJECTOR TEMPERATURES WARM UP > 65 DEG F.
3. A LEAKING JET THAT HAS BEEN ANNUNCIATED "FAIL LEAK" ON TWO SEPARATE OCCASIONS WILL BE CHANGED TO THE LOWEST JET PRIORITY AND REMAIN DESELECTED UNLESS REQUIRED TO MAINTAIN ATTITUDE CONTROL. DURING ENTRY IF BOTH OF THE INJECTOR TEMPERATURES > 65 DEG F, THE JET WILL BE RESELECTED AS REQUIRED TO MAINTAIN FAIL-SAFE REDUNDANCY.

In three different leak cases (FIL on STS-4, R4U and L2D on STS-6), the leak always started coincident with the jet being fired. A sharp decay in the injector temperature occurs until thermal equilibrium is obtained or until the leak has stopped. Subsequent firing of the affected jet after the leak has stopped and warmed up to normal temperatures does not necessarily restart the leak as evidenced with FIL and R4U. These two cases showed no further leakage even after repeated jet use. Data have indicated that the leak will eventually stop and the temperatures warm up without firing the jet, i.e., applying pressure to jet injector valve may result in leak stoppage due to valve seat design and compression of valve into Teflon seat. The leaks that we have seen to date have been very small, on the order of 0.1 to 0.3 lb/hr or less than 100 cc/hr propellant leakage. It is felt that these sizes of leaks do not represent any impact to mission operations. However, the system will be configured to minimize any jet leakage that may occur by taking advantage of redundant jets and preclude further firing of the affected jet. Firing a leaking primary jet (RCS RM declared failed leak) presents no hardware concerns if the injector temperatures > 65 deg F. WSTF tests showed that with the injector temperatures < 65 deg F (ref. SODB, volume I, paragraph 3.4.3.2-12a), ZOT's could occur that may increase the jet leak and require a manifold be closed. However, if the primary jet is required for control during entry, the risk of further damage to the jet is low compared to the crew risk if not reselected.

THIS RULE CONTINUED ON NEXT PAGE

FLIGHT RULES

A6.1.2-29 LEAKING JET MANAGEMENT RULES (CONTINUED)

B. VERNIER JETS:

~~1.~~—LEAKING VERNIER JETS WILL CONTINUE TO BE USED UNLESS DESELECTED BY RCS RM. SUBSEQUENT RESELECTION AND USE IS ONLY ALLOWED IF THE INJECTOR TEMPERATURES HAVE BEEN GREATER THAN THE RM LIMIT FOR 3 HOURS VERIFYING THAT NO ICE REMAINS IN THE INJECTOR. ~~@J091098-67081~~

A vernier jet known to be leaking will be used until the injector temperatures violate the RCS RM leak limit and is automatically deselected. Until this limit is violated, there are no risks associated with firing the jet. Conversely, after the RM limit has been violated, the leak freezes and plugs the small chamber quickly. Subsequent jet firings may result in possible uncontained damage.

Reference ~~1~~ SODB Volume 1, Paragraphs 3.4.3.2.12.b and 3.4.3.2.13.b.

~~2.~~—~~VERNIER JETS THAT HAVE BEEN DESELECTED DUE TO INADEQUATE JET HEATER OPERATION OR TO A FAILED OFF HEATER (REF. RULE {A6.1.1-10B}, RCS JET HEATER) WILL BE RESELECTED AND FIRED, PROVIDED THAT THE INJECTOR TEMPERATURE IS \geq 90 DEG F.~~

~~Once it has been determined that the deselected jet(s) is not leaking, the injector temperature lower limit may be decreased from 130 deg to 90 deg F. The 130 deg F temperature limit was selected to protect against leaking propellant freezing and plugging the combustion chamber. If there is no leak then the lower temperature limit becomes 90 deg F, which prevents seal shrinkage/propellant leakage due to "coldsoak" effects. After a jet fires, residual oxidizer and fuel in the injectors evaporate, taking heat away from the injectors. This "coldsoak" of the jet may result in seal shrinkage, particularly after isolated pulse firings.~~

~~3.~~—~~THE FIRST FIRING OF A VERNIER JET (WHERE THE INJECTOR TEMPERATURE(S) $<$ 130 DEG F) MUST BE $>$ 10 SECOND DURATION TO ENSURE ADEQUATE THERMAL SOAKBACK EFFECTS, RESULTING IN INJECTOR TEMPERATURES $>$ 130 DEG F.~~

~~To warm the injector from 90 deg F to above the RCS RM limit, a 10 second firing will be required. After the injector temperatures are sufficiently above the RM limit, RCS jet RM must be toggled to allow subsequent leak detection.~~

~~Reference 1—SODB volume 1, 3.4.3.2.12.b and 3.4.3.2.13.b.~~

*~~Reference 2—STS 51-C SPAN MER Mission Action Request, Min. VRCS
—Jet Temp (Ref. GG), No. 003, GMT 025/22:00.~~*

FLIGHT RULES

Rules {A6.1.1-10B}, RCS JET HEATER; {A6.1.2-9D}, RCS MANIFOLD CLOSURE CRITERIA; {A6.1.2-12}, RCS RM FAIL THRUSTER TEST; and {A6.1.2-32}, FAILED PRCS JET RESELECTION PRIORITY, reference this rule. [@\[091098-6708\]](#)

FLIGHT RULES

A6.1.2-30 OMS LEAKING INLET LINE PERIGEE ADJUST BURN

FOR AN OMS INLET LINE LEAK WHICH HAS BEEN ISOLATED ON ORBIT, A PERIGEE ADJUST OR OUT-OF-PLANE BURN WILL BE PERFORMED AS SOON AS PRACTICAL TO ASSURE TIME FOR POSTBURN PROPELLANT SUBLIMATION. MISSION-CRITICAL EVENTS MAY BE COMPLETED PRIOR TO THE PERIGEE ADJUST BURN ONLY IF THE EVENT CANNOT BE COMPLETED AFTER THE PERIGEE ADJUST BURN AND IF THE EVENT DOES NOT RESULT IN A NET LOSS OF DELTA V CAPABILITY.

OMS inlet line leaks which have been isolated must be repressurized prior to performing a burn. The repressurization will create a surge which could cause the leak to increase, and as a result, it is unknown how much delta V may be available from the leaking system. Therefore, the remaining RCS and good OMS propellant must be conserved until after the burn. Also, the earlier the burn, the more time for propellant sublimation

Rule {A6.1.2-17T}, OMS FAILURE MANAGEMENT (CIL), references this rule.

FLIGHT RULES

A6.1.2-31

RCS JET REPRIORITIZATION CRITERIA

- A. A SUSPECT PRIMARY JET WILL BE CHANGED TO LAST PRIORITY FOR THE FOLLOWING CONDITIONS:
1. CONFIRMATION OF OFF-NOMINAL OPERATING CONDITIONS (LOW PC, THRUST).
 2. SUSPECT INSTRUMENTATION (OXIDIZER/FUEL INJECTOR TEMPERATURE DELTA > 25 DEG LOW, BIASED PC WITH DELTA > 25 PSIA FROM NOMINAL).
- B. A VERNIER JET WITH SUSPECT INSTRUMENTATION (LOW PC) MAY BE DESELECTED DURING CREW SLEEP PERIODS TO AVOID NUISANCE ALARMS.

Low Pc confirmed with low rates (indicating low-thrust) identifies a real jet problem. Further use of the affected jet could create hot spots along the thruster wall damaging the jet.

Injector temperatures and Pc are used for determining jet leaks and jet fail-offs. Biased instrumentation could mask a real problem and, if the jet is fired, create a large jet leak or unstable combustion.

A jet placed in last priority will not be called on to fire unless the DAP determines it to be necessary due to additional jet failures in the associated direction. If the crew deselects the jet, it becomes one additional action required by the crew if the jet is later required. For entry, a yaw jet will be deselected because the DAP will command all available yaw jets to fire during roll reversals.

With either case, it is prudent to discontinue use of the jet when other jets are available. The affected jet will be placed in last priority so that if it is needed for achieving mission objectives, it can be used.

Vernier jets with suspect instrumentation may be deselected for sleep to avoid possible fail-off nuisance alarms. The affected jet must be hot fired to determine whether it is a real problem or instrumentation problem. For real problems, the jet will only be used for mission success. For instrumentation problems the jet will be used except for sleep.

FLIGHT RULES

A6.1.2-32 FAILED PRCS JET RESELECTION PRIORITY

FOR MULTIPLE PRIMARY JET/RM FAILURES RESULTING IN JET DESELECTION AND PRIORITY CHANGES, JET WILL BE RESELECTED, AS REQUIRED, TO PROVIDE ATTITUDE CONTROL OR FAIL-SAFE REDUNDANCY IN THE FOLLOWING ORDER (HIGHEST RESELECT FIRST):

- A. JET WHICH HAS BEEN ANNUNCIATED FAIL LEAK, AND BOTH INJECTOR TEMPERATURES > 65 DEG F.
- B. JET WITH DEGRADED INSTRUMENTATION.
- C. JET WITHOUT FAIL-ON RM.
- D. JET WITH DEGRADED OR LOSS OF FAIL-OFF RM.
- E. JET WITH DEGRADED OR LOSS OF FAIL LEAK RM.
- F. JET WITH LOSS OF TOTAL RM.
- G. JET WHICH HAS BEEN ANNUNCIATED FAIL LEAK TWICE AND BOTH INJECTOR TEMPERATURES > 65 DEG F.
- H. JET WHICH HAS BEEN ANNUNCIATED FAIL-OFF.
- I. JET WHICH HAS BEEN ANNUNCIATED FAIL LEAK AND INJECTOR TEMPERATURES < 65 DEG F (POSSIBLY STILL LEAKING).

The redundancy in primary jets allows a single jet failure to be deselected with little or no impact to the vehicle capability. If no capability is lost, it would be desirable to deselect the jet since subsequent failures may go undetected. For the second jet failure, fail-safe redundancy can be lost since two pitch jets and three yaw jets are required and only three pitch and four yaw jets are available. To maintain fail-safe redundancy, it may be worth the risk to reselect the jet and be exposed to a subsequent failure going undetected. After all, the jet with failed instrumentation or the jet that has stopped leaking are healthy and if used will be exposed to the same failures as a jet with no problem.

The priority for choosing which jet to reselect is provided in this rule starting with a jet with good RM and only slightly degraded instrumentation. Jets with no fail on RM will be reselected next since the chances of a failed-on jet are minimal compared to fail-off jets. Loss of leak RM would create more of a problem since a leaking jet undetected could cause the leak to increase. Loss of total RM (ON, OFF, LEAK) increases the chances of a failed jet being undetected.

THIS RULE CONTINUED ON NEXT PAGE

FLIGHT RULES

A6.1.2-32 FAILED PRCS JET RESELECTION PRIORITY (CONTINUED)

Jets which have leaked once, but stopped as indicated by injector temperatures > 65 deg F, may be reselected and used on a noninterference basis (reference SODB, volume I, paragraph 3.4.3.2-12a). (See Flight Rule {A6.1.2-29}, LEAKING JET MANAGEMENT RULES.) Jets which have leaked twice, but stopped as indicated by injector temperatures > 65 deg F, may be reselected according to the priority listing above. For a jet that has failed leak, experience has shown that there are no means for determining whether the jet will leak again and be declared fail leak by RM. These jets will be selected before a jet that has failed off since these jets are known to be healthy. Since the failed-off jet status has not changed, the failed-off jet will most likely fail off.

Jets that have been annunciated fail off will have RM toggled so that it may be declared fail off again, if the failure is still present. Reselecting the jet would not be a safety hazard.

Jets which have been annunciated fail leak and may be still leaking will not be reselected except to maintain attitude control since firing a leaking jet may cause injector seal leakage to increase.

Rule {A6.1.2-19}, RCS RM LOSS, references this rule.

A6.1.2-33 OMS ENGINE BELL MOVEMENT DURING ASCENT

- A. FOR OMS TVC MOVEMENT CONFIRMED BY TWO SOURCES DURING THE HIGH QBAR REGION (REF. RULE {A8.1.2-3C}, OMS TVC LOSS), THE AFFECTED OMS ENGINE WILL BE CONSIDERED FAILED FOR ALL PURPOSES INCLUDING ABORT PROPELLANT DUMPS. THE OMS ENGINEARM/PRESS SWITCH WILL BE IMMEDIATELY MODED TO THE "OFF" POSITION TO PRECLUDE ANY SUBSEQUENT FIRING. ~~—@111298-67331~~
- B. FOR TVC MOVEMENT SUSPECTED DURING THE HIGH Q-BAR REGION BUT NOT CONFIRMED DUE TO MOVEMENT INDICATED BY ONLY ONE SOURCE, THE AFFECTED OMS ENGINE WILL BE CONSIDERED FAILED FOR ATO, OMS ASSIST, AND ON-ORBIT BURNS PENDING FURTHER TROUBLESHOOTING. THE OMS ENGINEARM/PRESS SWITCH WILL BE PLACED IN THE "OFF" POSITION PRIOR TO OMS ASSIST OR FOLLOWING MECO.

~~PRE-MECO, THE ENGINE WILL BE USED FOR RTLS, TAL, AND CONTINGENCY DUMPS. ATO DUMPS WILL ONLY BE PERFORMED IF REQUIRED TO ACHIEVE UPHILL CAPABILITY (I.E., AVOID TAL, N/A ET IMPACT CONSTRAINTS). POST-MECO ON ORBIT, THE ENGINE WILL ONLY BE USED IN CONTINGENCY CASES IF REQUIRED FOR ORBITER OR CREW SAFETY, NOT FOR MISSION SUCCESS. @111298-67331 OTHERWISE, THE ENGINE WILL BE CONSIDERED FAILED PENDING FURTHER TROUBLESHOOTING.~~

FLIGHT RULES

THIS RULE CONTINUED ON NEXT PAGE

FLIGHT RULES

A6.1.2-33

OMS ENGINE BELL MOVEMENT DURING ASCENT

(CONTINUED) [ED]

The consequences of using an OMS engine which has suffered engine bell damage due to aerodynamic forces can be severe (reference System Briefs “OMS Gimbal Position Constraints During Ascent Max G”). Clearly, such an engine should be disabled ASAP. Further note that since some abort propellant dumps and OMS Assist start both OMS engines immediately, the OMS engine ARM/PRESS switch must be in the OFF position prior to abort selection to prevent the engine from firing. Therefore, for confirmed thrust vector control (TVC) movement during the high Q-bar region of ascent, the engine will be considered failed (including OMS Assist OMS-1, OMS-2, and abort dumps). [@111298-6733.1](#)

However, the consequences of performing an abort dump without using an OMS engine are not risk free. ~~Some flights may be designed which require an ATO dump to achieve uphill capability for an SSME failure during a defined window. If the dump is not performed, a downrange abort is required~~ During RTLS, TAL, and contingency aborts, the resultant vehicle CG (both X and Y) may be unacceptable for flight control, the total vehicle weight may be significantly above the design factor of safety for g forces around the HAC or for touchdown, and the OMS propellant tank may be significantly above the constraint for both the g forces around the HAC and landing. For all these cases possible loss of vehicle could occur.

Additionally, there are other cases, extreme MECO underspeeds or loss of other OMS engine and RCS capability, where the results would be catastrophic if the affected engine were not used.

Therefore, if the TVC movement during the high Q-bar region cannot be confirmed with two sources, the engine bell will be considered ~~suspect but not failed~~ for OMS Assist, ATO and On-orbit burns only. The ~~suspect~~ engine bell will be used for RTLS, TAL, and contingency aborts where maximum dumping is required to avoid violating constraints which may result in loss of vehicle. - ~~The suspect engine bell will also be used for ATO aborts which require the dump to achieve uphill capability. ATO dumps that are designed to protect ET impact constraints and will not be performed~~ (ref. Rule {A2.1.2-13E}, ET FOOTPRINT CRITERIA). [@111298-6733.1](#)

During orbit, the suspect engine bell will not be used if other methods of propulsion are available. Rule {A8.1.2-3}, OMS TVC LOSS, references this rule.

FLIGHT RULES

A6.1.2-34 OMS BURN DOWNLIST REQUIREMENT

DURING OMS BURNS IN OPS 2 AND 3, 44.8 KBPS HIGH RATE GNC DOWNLIST DATA IS REQUIRED (EITHER REAL-TIME OR RECORDED AND DUMPED) EVEN IF THIS CAUSES TEMPORARY LOSS OF PAYLOAD DATA OR REAL-TIME LOW DATA RATE DOWNLINK.

There are parameters (e.g., OMS Pc, inlet pressure, etc.) that are not available in LDR OPS 2 and 3 GNC downlist that are mandatory to determine failure modes in the OMS system. If these data are not available either real time or in postburn dumps, relatively minor anomalies may result in severe mission action being required to cover the worst case failure mode since the exact mode cannot be determined. For example, in certain circumstances, the difference between an OMS engine failure and an OMS propellant system failure cannot be determined. The consequences of an OMS engine failure are loss of redundancy and possible mission termination; the consequences of an OMS propellant system failure include very shallow deorbit burns with RCS completions to the minimum requirements for entry control, plus Y CG offsets that may be unacceptable from the flight control standpoint. The inconvenience of not having a short period of real-time data or payload data (less than 2 minutes) is greatly outweighed by the consequences of not having OMS data to resolve anomalies during burns. Rule {A2.1.3-30}, ORBITER ON-ORBIT HIGH DATA RATE REQUIREMENTS, references this rule.

A6.1.2-35 PRELAUNCH RCS PVT INITIALIZATION (INIT) TMBU

RCS PVT INIT TMBU WILL BE UPLINKED PREFLIGHT IF THE I-LOADED WEIGHT OF HE INITIAL (WHI) RCS QUANTITIES DIFFER FROM THE ACTUAL LOADED RCS QUANTITIES BY GREATER THAN 3 PERCENT (HIGHER OR LOWER). ALL RCS QUANTITIES WILL BE CORRECTED WHEN AN UPLINK IS REQUIRED FOR ONE OR MORE QUANTITIES OUT OF LIMITS.

I-loaded WHI's, which are used to calculate the RCS usable quantities, are based on standard temperatures, pressures, and propellant loadings. Changes in temperatures, pressures, forward RCS propellant off-loading, off-nominal helium loads (still within LCC limits), and transducer biases or failures can affect the quantity readings. With these conditions present, it is possible to get false leak messages or degraded leak detection due to incorrect quantity readings. Preflight RCS PVT INIT TMBU's are sent to the BFS computer to update the BFS quantity gauging WHI constants. The updated constants reflect the actual temperatures, pressures, and propellant loadings in the RCS systems and adjust and finely tune the RCS quantity readings. The 3 percent uplink criteria was developed to minimize preflight uplinks (PVT INIT) and still provide reasonable leak detection protection. Currently, leak alarms are annunciated when the delta between the oxidizer and fuel quantities is 9.5 percent. With the 3 percent criteria a leak alarm will not be annunciated until a 12.5 percent oxidizer/fuel delta (169 lb oxidizer or 106 lb fuel). On orbit both the PASS (OPS 2) and BFS (OPS 3) RCS WHI constants will be updated via TMBU/UPLINK to reflect the actual usable RCS quantities remaining.

FLIGHT RULES

If an uplink is required prelaunch to correct quantities that differ from actual by 3 percent, WHI's will be uplinked to correct all RCS quantities. Once a prelaunch TMBU is required, the risk of building and sending the TMBU is not dependent on the number of constants being updated.

A6.1.2-36

OMS GN₂ ACCUMULATOR LEAK DETERMINATION

A LEAKING OMS GN₂ ACCUMULATOR MAY BE REPRESSURIZED TO DETERMINE THE LEAK RATE.

Since the leak rate is so critical in determining health of the OMS engine, the accumulator may be repressurized to determine the leak rate. If a leak occurs through the purge valves, each time the purge valves are used this leak rate may increase. Since the affected OMS engine may be used for OMS-1 and a purge will occur at OMS-1 cutoff, the leak rate should be checked before the deorbit burn to ensure the rate has not increased to beyond acceptable limits.

(Reference Rule {A6.1.2-17M}, OMS FAILURE MANAGEMENT (CIL)), ©ED 1

FLIGHT RULES

THERMAL MANAGEMENT

A6.1.3-1	GENERAL	6-102
A6.1.3-2	FORWARD RCS MODULE TEMPERATURE MANAGEMENT .	6-103
A6.1.3-3	OMS/RCS PODS TEMPERATURE MANAGEMENT	6-104
A6.1.3-4	OMS/RCS CROSSFEED LINES TEMPERATURE MANAGEMENT	6-105
A6.1.3-5	OMS/RCS HEATER MANAGEMENT	6-106
A6.1.3-6	RCS JET TEMPERATURE MANAGEMENT	6-112
A6.1.3-7	ARCS BULK PROPELLANT TEMPERATURE MANAGEMENT	6-112

CONSUMABLES MANAGEMENT

A6.1.4-1	OMS PROPELLANT MANAGEMENT MATRIX	6-114
A6.1.4-2	OMS PROPELLANT BUDGET GROUND RULES	6-115
A6.1.4-3	CG MANAGEMENT	6-118
A6.1.4-4	RCS ENTRY REDLINE PROTECTION	6-119
A6.1.4-5	OMS PROPELLANT DEFICIENCY FOR DEORBIT	6-119
A6.1.4-6	DEORBIT PLANNING CRITERIA	6-120

CONSUMABLES (REDLINES)

A6.1.5-1	OMS USABLE PROPELLANT	6-121
A6.1.5-2	RCS USABLE PROPELLANT	6-123
A6.1.5-3	OMS REDLINES (CIL)	6-123
A6.1.5-4	FORWARD RCS REDLINES	6-132
A6.1.5-5	AFT RCS REDLINES	<u>6-131</u>
A6.1.5-6	VIOLATION OF MISSION COMPLETION REDLINES MATRIX	<u>6-140</u> 6-157
A6.1.5-7	RCS MINIMIZATION TECHNIQUE PRIORITY ..	<u>6-141</u> 6-159
A6.1.5-8	OMS/RCS GO/NO-GO CRITERIA (CIL)	<u>6-142</u> 6-160

FLIGHT RULES

THIS PAGE INTENTIONALLY BLANK

FLIGHT RULES

THERMAL MANAGEMENT

A6.1.3-1 GENERAL

- A. IF INSTRUMENTATION IS LOST FOR VERIFICATION OF HEATER OPERATION, THE REDUNDANT SET (A OR B) WILL NOT BE BROUGHT ONLINE WITH THE EXCEPTION OF THE OMS/RCS CROSSFEED HEATERS.

The loss of insight into the heater operations does not make the heater suspect. The heater in use has been proven functional and there is no reason to switch to the redundant heater set with unknown operation.

The pod heaters are designed differently than the crossfeed heaters. If both sets of pod heaters are powered on possible heater patch delamination could occur since the patches (A and B) are laid on top of each other. The crossfeed line heaters are wrapped around the line, with A and B circuits wrapped together in a single "rope" heater. Consequently, both heaters can be powered on simultaneously to protect for failed-off heaters without risking damage to heater elements. The crossfeed line heaters also have series redundant thermostats for overtemperature protection.

- B. THE HEATERS WILL BE CYCLED TO THE REDUNDANT SET (A OR B) AT LEAST ONCE DURING THE MISSION.

Ensures two functioning heater systems.

- C. RCS PRIMARY THRUSTERS HEATERS WILL BE OFF FOR ASCENT, UNLESS THE AMBIENT TEMPERATURE AT THE LAUNCH SITE IS < 50 DEG F. THE HEATERS WILL BE ENABLED FOR ALL OTHER FLIGHT PHASES OF THE MISSION. VERNIER THRUSTER HEATERS WILL BE ENABLED PRIOR TO LAUNCH AND TURNED OFF FOR ENTRY.

Primary jet heaters are powered off for ascent to provide additional power savings.

For cold launch conditions where the ambient temperature at the launch site is < 50 deg F (reference OMRSD, general requirements, 9.2.5), the primary heaters may be powered on during ascent to preclude launch commit criteria (LCC) violations (injector temperature £ 64 deg F) (reference LCC page 6.3-28). The LCC limits preclude jet valve seat shrinkage and subsequent jet leakage during ascent.

Primary heaters can only be turned on if the ascent electrical load for the particular mission is small enough to allow the additional power consumption. However, if power requirements do not permit, heaters should be left on until T-20 minutes.

THIS RULE CONTINUED ON NEXT PAGE

FLIGHT RULES

A6.1.3-1 GENERAL (CONTINUED)

Vernier jet heaters are on prelaunch through ascent to ensure proper operating temperature for on-orbit operations. They are turned off for entry since the jets are not used, and to prevent overtemping.

Jet heaters may be turned off in flight for contingency powerdowns.

- D. IN THE EVENT THAT ONE SET OF HEATERS IS NOT OPERATING IN ITS HEATER CONTROL RANGE AND THE THERMAL ENVIRONMENT CONDITIONS ARE NOT A FACTOR, THAT SET WILL BE TURNED OFF AND THE OTHER SET TURNED ON. IF THE APPROPRIATE TEMPERATURE INDICATES THAT THE HEATER IS THEN OPERATING WITHIN ITS HEATER CONTROL RANGE, THEN THE FIRST SET OF HEATERS WILL BE DECLARED FAILED.

After switching to another heater set which controls the thermal environment within normal limits, the first set of heaters is declared failed because no other factors were involved.

- E. ANY HEATER SET (A OR B) THAT IS FAILED ON WILL BE CONTROLLED BY MANUAL OPERATION AND STILL BE CONSIDERED OPERATIONAL IF THE OTHER SET FAILS.

Failed-on heaters are not considered failed because they can manually be controlled by cycling power on and off

Rule {A6.1.3-5}, OMS/RCS HEATER MANAGEMENT, references this rule.

A6.1.3-2 FORWARD RCS MODULE TEMPERATURE MANAGEMENT

WHEN NO SM MACHINE IS RUNNING, FRCS HEATERS WILL BE OFF. MANUAL CYCLING OF HEATER SWITCHES WILL BE MCC CALL.

The forward pod will stay within acceptable limits for a sufficient period of time without the heaters being powered on. The concern is that a failed-on heater will result in overtemping manifold lines without being annunciated by SM.

FLIGHT RULES

A6.1.3-3

OMS/RCS PODS TEMPERATURE MANAGEMENT

- A. ONE OF THE REDUNDANT SETS OF POD HEATERS WILL BE USED TO MAINTAIN ACCEPTABLE THERMAL CONDITIONS IN THE PODS. BOTH SETS OF HEATERS WILL NOT BE USED SIMULTANEOUSLY.

The OMS pod heaters are operated only one circuit at a time. The concern is that the heater patches will overtemperature and debond from the structure if both sets of heaters are operated concurrently. This would result in heater circuit failures in both circuits since both circuits are contained in each heater patch and the patches must be on the structure to work properly.

- B. DURING OPS 1, ALL POD HEATERS WILL BE TURNED OFF. MANUAL CYCLING OF HEATER SWITCHES WILL BE ON MCC CALL.

The OMS pods are warmed by hot GN₂ prelaunch. The heaters are off during ascent phase to reduce the power level in the event a power failure would occur during launch. Further, since the switches are not accessible during ascent, corrective action could not be taken for a heater failed on.

- C. ALL POD HEATERS WILL BE TURNED OFF AT CREW SEAT INGRESS FOR ENTRY AND WILL REMAIN OFF THROUGH ENTRY.

The OMS pods heaters are not required during entry due to aero heating. Also, the heaters are off during entry to reduce the power level in the event a power failure would occur during entry.

- D. WHEN THERE IS NO ONBOARD THERMAL VISIBILITY INTO THE PODS (NO SM AND NO BFS), ALL POD HEATERS WILL BE OFF. MANUAL CYCLING OF HEATER SWITCHES WILL BE ON MCC CALL.

An undetected fail-on heater may damage pod components. The ground will monitor the pod temperatures and cycle the heaters as required to maintain temperatures within limits.

FLIGHT RULES

A6.1.3-4 OMS/RCS CROSSFEED LINES TEMPERATURE MANAGEMENT

- A. DURING ASCENT, FROM LIFT-OFF UNTIL POST OMS-2, BOTH (A AND B) SETS OF HEATERS WILL BE ON.

The crossfeed line heaters are wrapped around the line, with A and B circuits wrapped together in a single "rope" heater. Consequently, both heaters can be powered on simultaneously to protect for failed-off heaters without risking damage to heater elements. The crossfeed line heaters also have series redundant thermostats for overtemp protection.

- B. DURING ON-ORBIT PERIODS, ONE OF THE REDUNDANT HEATERS (A OR B) WILL BE ON.

Heaters are required to maintain the crossfeed line thermal conditions within acceptable limits for interconnect and crossfeed operations.

- C. BOTH (A AND B) SETS OF HEATERS WILL BE TURNED ON AT CREW SEAT INGRESS FOR ENTRY AND WILL REMAIN ON THROUGH ENTRY.

The crossfeed line heaters are wrapped around the line, with A and B circuits wrapped together in a single "rope" heater. Consequently, both heaters can be powered on simultaneously to protect for failed-off heaters without risking damage to heater elements. The crossfeed line heaters also have series redundant thermostats for overtemp protection.

- D. WHEN THERE IS NO ONBOARD THERMAL VISIBILITY INTO THE CROSSFEED LINES (NO SM AND NO BFS), BOTH (A AND B) SETS OF HEATERS WILL BE TURNED ON.

The heater operation cannot be verified without instrumentation. Therefore both A and B heaters are turned on to provide fail-safe protection.

FLIGHT RULES

A6.1.3-5 OMS/RCS HEATER MANAGEMENT

THE PARAMETERS MARKED IN THE TABLES WITH SINGLE ASTERISKS ARE LOCATED NEAR HEATER THERMOSTATS, AND ARE USED TO MONITOR HEATER OPERATION. THE NOMINAL TEMPERATURE RANGE FOR EACH HEATER IS VEHICLE/POD SPECIFIC. THE RANGE DEPENDS ON THE TESTED SET POINTS OF THE CONTROLLING THERMOSTATS, AS DOCUMENTED IN THE SPACE SHUTTLE SYSTEMS HANDBOOK DRAWINGS 11.7 THROUGH 11.9. THE TEMPERATURE INDICATED BY THE OI PARAMETER NEAR THE HEATER THERMOSTAT MAY VARY SLIGHTLY OUTSIDE THE SET POINT RANGE DUE TO THE DIFFERENCE IN LOCATION BETWEEN THE OI PARAMETER AND THE THERMOSTAT, AND DUE TO THE EFFECT OF VEHICLE ATTITUDE.

THE PARAMETERS USED TO MONITOR COMPONENT TEMPERATURES SHOULD NOMINALLY REMAIN WITHIN THE SYSTEM REDLINES:

FWD RCS HEATERS

HEATER/COMPONENT	OI PRIMARY PARAMETER	OI BACKUP PARAMETER	SYSTEM REDLINE (°F)	RESPONSE/NOTE
FU FWD RCS	V42T1306A*	V42T1308A	40- 150 **	
FU FILL LN	V42T1304A		-30-150	
FU TK T	V42T1300C		40-150 ***	
FU HE TK	V42T1104C		-160-125 -160-150	PROP QTY >85% PROP QTY ≤85%
OX FWD RCS	V42T1206A*	V42T1208A	40-150 **	
OX FILL LN	V42T1204A		20-150	
OX TK T	V42T1200C		40-150 ***	
OX HE TK	V42T1100C		-160-125 -160-150	PROP QTY >85% PROP QTY ≤85%

NOTE: A OR B HTRS ONLY, NOT BOTH.

- * CONTROL PARAMETER NEAREST THERMOSTAT. SPEC HTR THERMOSTAT RANGE 55 DEG-70 DEG F (MINIMUM 6 DEG F DB).
- ** THESE ARE ON-SERVICE LINES WHICH HAVE AN UPPER LIMIT OF 150 DEG F. HOWEVER, THEY ARE USED TO MONITOR MANIFOLD LINES WHICH HAVE AN UPPER LIMIT OF 100 DEG NOMINALLY AND 150 DEG F FOR A 5-SECOND TRANSIENT.
- *** 100 DEG F UPPER LIMIT FOR BULK PROPELLANT TEMPERATURE. TEMPERATURE SENSOR IS ON TANK SKIN WHICH HAS UPPER LIMIT OF 150 DEG F FOR LOCALIZED REGIONS.

THIS RULE CONTINUED ON NEXT PAGE

FLIGHT RULES

A6.1.3-5

OMS/RCS HEATER MANAGEMENT (CONTINUED)

RIGHT/LEFT OMS/RCS POD HEATERS

HEATER COMPONENT	OI PRIMARY PARAMETER	OI BACKUP PARAMETER	SYSTEM REDLINE (°F)	RESPONSE/NOTE
'Y' WEB OME COMPARTMENT HTRS				
UPPER Y WEB	V43T5703A * (4703A)		**	
OUTBOARD Y WEB	V43T5702A *		**	
INBOARD Y WEB ***	V43T5704A *	V43T5705A * (4705A)	20-150	
ENG SERV PNL OME COMPARTMENT HTRS	V43T5707A* (4707A)		20-150	
OME COVER	V43T5720A * (4720A)	V43T5216A (4216A)	**	
OX INLT T	V43T5216A (4216A)		30-125	
FU FDLN T	V43T5642A (4642A)		30-125	
OX BPV T	V43T5641A (4642A)		30-125	
FU INJ T	V43T5643A (4643A)		NA-260	

NOTE: BOTH A AND B POD HTRS SHOULD NOT USED SIMULTANEOUSLY.

* CONTROL PARAMETER NEAREST THERMOSTAT. SPEC HTR THERMOSTAT RANGE 55 DEG - 75 DEG F (MIN 6 DEG DB).

** PARAMETER MEASURES STRUCTURE TEMPERATURE ONLY, AND IS USED TO VERIFY HEATER PERFORMANCE. THE TEMPERATURE OF COMPONENTS AND FLUID WARMED BY HEATERS MAY VARY FROM SENSED TEMPERATURE

*** INCLUDES OX DRAIN PANEL.

THIS RULE CONTINUED ON NEXT PAGE

FLIGHT RULES

A6.1.3-5

OMS/RCS HEATER MANAGEMENT (CONTINUED)

RIGHT/LEFT OMS/RCS POD HEATERS

HEATER/COMPONENT	OI PRIMARY PARAMETER	OI BACKUP PARAMETER	SYSTEM REDLINE (°F)	RESPONSE/NOTE
OMS HE TK	V43T5111C (4111C)		-160-200	
RCS OX HE	V42T3100C (2100C)	V42T3104C (FU) (2104C)	-160-125 -160-150	PROP QTY >85% PROP QTY ≤85%
RCS FU HE	V42T3104C (2104C)	V42T3100C (OX) (2100C)	-160-125 -160-150	PROP QTY >85% PROP QTY ≤85%
GSE SERV PNL	V43T5706A* (4706A)		20-150	
RCS HOUSING HEATERS				
DRAIN PNL	V42T3304A * (2304A)	V42T3305A * (2305A)	**	
VERNIER PNL	V43T5701A * (4701A)	V43T5711A * (4711A)	**	
OX MANF1 TEMP	V42T3204A (2204A)		40-150 ***	
VERN OX FDLN	V42T3560A (2560A)		40-200	

NOTES:

- * CONTROL PARAMETER NEAREST THERMOSTAT. SPEC HTR THERMOSTAT RANGE 55 DEG - 75 DEG F (MIN 6 DEG DB).
- ** PARAMETER MEASURES STRUCTURE TEMPERATURE ONLY, AND IS USED TO VERIFY HEATER PERFORMANCE. THE TEMPERATURE OF COMPONENTS AND FLUID WARMED BY HEATERS MAY VARY FROM SENSED TEMPERATURE.
- *** 70 DEG F LOWER LIMIT DURING ENTRY FOR ZOT PREVENTION. UPPER LIMIT IS 100 DEG F NOMINALLY, AND 150 DEG F FOR A 5-SECOND TRANSIENT.

THIS RULE CONTINUED ON NEXT PAGE

FLIGHT RULES

A6.1.3-5

OMS/RCS HEATER MANAGEMENT (CONTINUED)

RIGHT/LEFT OMS/RCS POD HEATERS

HEATER/COMPONENT	OI PRIMARY PARAMETER	OI BACKUP PARAMETER	SYSTEM REDLINE (°F)	RESPONSE/NOTE
KEEL WEB HTRS				
RCS OX PRESS PNL	V43T5700A* (4700A)	V43T5710A* (4710A)	20-150	
OX/HE TEST PNL	V43T5708A (4708A)	V43T5718A (4718A)	20-150	
RCS OX TK	V42T3200C (2200C)	V42T3300C (2300C)	50 ** - 150 ***	
RCS FU TK	V42T3300C (2300C)	V42T3200C (2200C)	50 ** - 150 ***	
OMS OX TK	V43T5215A (4215A)	V43T5315A (4315A)	40-150 ***	
OMX FU TK	V43T5315A (4315A)	V43T5215A (4215A)	40-150 ***	

NOTE: BOTH A AND B POD HTRS SHOULD NOT BE USED SIMULTANEOUSLY .

* CONTROL PARAMETER NEAREST THERMOSTAT. SPEC HTR THERMOSTAT RANGE, A HTRS 55 DEG - 75 DEG F, B HTRS 70 DEG - 90 DEG F (MIN 6 DEG DB).

** 70 DEG F LOWER LIMIT DURING ENTRY FOR ZOT PREVENTION.

*** 100 DEG F UPPER LIMIT FOR BULK PROPELLANT, BASED ON EXPULSION EFFICIENCY. TEMPERATURE SENSOR IS LOCATED ON TANK SKIN WHICH HAS UPPER LIMIT OF 150 DEG F FOR LOCALIZED REGIONS.

**** 100 DEG F UPPER LIMIT FOR BULK PROPELLANT. TEMPERATURE SENSOR IS LOCATED ON TANK SKIN WHICH HAS AN UPPER LIMIT OF 150 DEG F.

THIS RULE CONTINUED ON NEXT PAGE

FLIGHT RULES

A6.1.3-5

OMS/RCS HEATER MANAGEMENT (CONTINUED)

AFT FUSELAGE HEATERS

HEATER/COMPONENT	OI PRIMARY PARAMETER	OI BACKUP PARAMETER	SYSTEM REDLINE (°F)	RESPONSE/NOTE
XFD FLOW LINES				
OX XFD LN C **	V43T6242A *		40-125	
OX XFD LN L **	V43T6243A *		40-125	
OX XFD LN R **	V43T6244A *		40-125	
AFT XFD L TEMP **	V43T218A *		40-125	
AFT XFD R TEMP **	V43T6219A *		40-125	
DRAW AND BLEED LINES				
LH OX LP DL HTRS **	V43T6236A *		20-150	
RH OX LP DL HTRS **	V43T6237A *		20-150	
AFT FU HP B L HTRS	V43T6238A *		-30-150	
AFT OX HP B L HTRS	V43T6239A *		20-150	
BHD FU HP B L HTRS	V43T6234A *		-30-150	
BHD OX HP B L HTRS	V43T6235A *	V43T6239A ***	20-150	

NOTE: BOTH A AND B XFD HTRS CAN BE USED SIMULTANEOUSLY.

- * CONTROL PARAMETER NEAREST CONTROL THERMOSTAT, SPEC HTR THERMOSTAT RANGE 55 DEG - 75 DEG F. EACH HEATER CIRCUIT ALSO HAS AN OVERTEMP THERMOSTAT, RANGE 70 DEG - 90 DEG F.
- ** TEMPERATURE SENSOR IS ON OX LINE, BUT THERMOSTAT CONTROLS BOTH OX AND FU HEATERS.
- *** PARAMETERS MAY BE USED TO VERIFY HEATER OPERATION, BUT MAY VARY SIGNIFICANTLY FROM THE ACTUAL TEMPERATURE OF THE BHD OX HP BL COMPONENT DUE TO INFLUENCE OF ORBITER ATTITUDE.

THIS RULE CONTINUED ON NEXT PAGE

FLIGHT RULES

A6.1.3-5 OMS/RCS HEATER MANAGEMENT (CONTINUED)

The heater matrix allows a determination to be made on the health of the OMS/RCS heater system. The different heater systems are shown down to the heater/component level. The instrumentation used to verify the operation of each heater is defined.

Operating outside of the nominal temperature range (vehicle/pod and attitude-dependent) may identify a heater failure condition (refer to Rule {A6.1.3-1D}, GENERAL (thermal management)). The thermostat set points SSSH drawings are supplied by the Operational Space Shuttle Orbiter Heater Systems Book, JSC-18549, which is maintained by the JSC/ES311 Thermal Branch.

Several of the parameters in the tables monitor heater operation by close proximity to the heater thermostat. If the indicated temperature of such a parameter exceeds the thermostat set point range by 5 deg F or more, then this must be explained by the influence of sensor location with respect to the thermostat and/or by the vehicle attitude, else the heater will be declared failed.

The OMS and RCS thermal redlines are defined in the SODB tables 3.4.3.2-1 and 3.4.3-1. If a parameter directly measures the temperature of a component that has SODB constraints, then these constraints are listed in this rule under SYSTEM REDLINE. In several cases (as noted with asterisks in the SYSTEM REDLINE column), the parameter is mounted on the pod structure and is used to monitor heater performance only. These structure temperatures do not necessarily reflect the temperature of components that are warmed by the monitored heaters.

The crossfeed flow lines and drain/bleed lines are all wrapped with rope-type heaters. The thermal status of each section of crossfeed line is monitored by the temperature parameters near the thermostat for that section of line. Although these parameters measure the line temperatures directly, the configuration of the rope heaters may allow warm spots to develop in the line away from any temperature parameter. For this reason, the fault detection annunciation (FDA) limits for these temperature parameters are well within the system redlines, allowing action to be taken before the redlines are violated anywhere in the lines. These FDA limits are documented in SSSH drawing 11.9, HTR AFT OMS/RCS.

Rule {A17.1.19-1B}, ORBITER THERMAL CONSTRAINTS AND ATTITUDE MANAGEMENT (CIL), references this rule.

FLIGHT RULES

A6.1.3-6 RCS JET TEMPERATURE MANAGEMENT

A. PRIMARY JETS: @091098-6708.1

1. IN THE EVENT OF A FAILED-OFF PRIMARY AN-RCS JET HEATER FAILURE, THE AFFECTED THRUSTER MAY BE FIRED MANUALLY OR CHANGED TO FIRST PRIORITY, OR ORBITER ATTITUDE MAY BE CHANGED TO MAINTAIN INJECTOR TEMPERATURES > 42 (47) DEG F (50 DEG AT VALVE SEAT). AN ACCEPTABLE OPERATING TEMPERATURE.

The 50 deg F limit (ref. Shuttle Operational Data Book (SODB) volume I, table 3.4.3.2-1, note L) protects against increased risk of valve leakage. The corresponding injector temperature limit is derived from thermal math model analysis data for the case of a heater failed off and exposure to deep space. If the jet is exposed to some solar heating (but not enough to alleviate the leakage concern), then the injector/valve temperature differential may diminish slightly; however, since the rule assumes worst-case instrumentation error (5 deg F), the 50 deg valve limit is reasonably protected.

Note that a A-primary RCS jet heater is considered failed when the injector temperatures reach 55 deg F (reference Rule {A6.1.1-10}, RCS JET HEATER). Firing the RCS-jet periodically will maintain the injector within operating limits. (Testing has shown that a 2-second firing will increase the jet injector temperature approximately 16 deg F.) If planned orbit activities would result in single minimum duration pulse firings, hot-fire the jet for a minimum of 2 seconds prior to changing the jet to first priority. A minimum duration pulse firing with the injector temperatures £ 55 deg F can cause a jet-result-in-jet-fail leak due to cold Teflon thruster valve seats not seating properly (ref. Reference SODB, volume I, paragraph 3.4.3.2.13).

2. PRCS JETS MAY NOT BE FIRED IF INJECTOR TEMPERATURES EXCEED 162 (157) DEG F (150 DEG F AT VALVE SEAT) FOR A SUSTAINED PERIOD (EXCEPT AS DEFINED IN PARAGRAPH A.3 OF THIS RULE). TO STAY BELOW THIS OPERATIONAL THERMAL LIMIT:

b.a. ORBITER ATTITUDE MAY BE CHANGED

ORBITER ATTITUDE MAY BE CHANGED.

b.b. THE AFFECTED JET(S) MAY BE PLACED IN LAST PRIORITY

THE AFFECTED JET(S) MAY BE PLACED IN LAST PRIORITY.

b.c. A FAILED-ON HEATER MAY BE SWITCHED OFF @091098-6708.1

FLIGHT RULES

A FAILED-ON HEATER MAY BE SWITCHED OFF. @[091098-67081

THIS RULE CONTINUED ON NEXT PAGE

FLIGHT RULES

A6.1.3-6

RCS JET TEMPERATURE MANAGEMENT (CONTINUED)

FLIGHT RULES

The 150 deg F limit (ref. SODB volume I, table 3.4.3.2-1, note L) protects against permanent deformation and damage to the Teflon valve seat due to the combined effects of high closing seat loads and degraded Teflon strength at the higher temperature. In turn, this protects against resulting valve leakage and reduced valve lifetime. The 157 deg F injector temperature limit is derived from the 150 deg F valve limit +12 deg F injector/valve differential (based on Rockwell-Downey thermal analysis) -5 deg F instrumentation error. Unrestricted thruster firings with valve seat temperatures above 150 deg F are not permitted. In this case, any DAP/RM configuration that could result in the firing of the affected primary thrusters is forbidden. Depending on the heat source (Sun, heat of combustion, or failed heater), a variety of actions may be performed, as appropriate, to keep a thruster operational. Note that the crew does not have insight into jet injector temperatures on board, so these actions must be initiated by the ground. Every reasonable effort will be made to do this in a timely manner such that jet firings above the operational limit may be avoided. [091098-6708]

3. PRCS JETS MAY BE FIRED IF INJECTOR TEMPERATURES HAVE EXCEEDED 162 (157) DEG F, BUT ONLY IF:

a.

ALL JETS IN THE GROUP (SAME POD AND DIRECTION) HAVE EXCEEDED THIS OPERATIONAL LIMIT.

b. THE DAP IS CONFIGURED TO ENSURE A MINIMUM FIRING DURATION OF 400 MSEC.

The main concern with thruster operation above 157 deg F is the load imparted on the valve seat as the poppet closes. Since the real concern is at valve closing, increasing the minimum "on time" reduces the valve seat temperature to an acceptable level at shutdown. However, immediately following the firing, the temperatures will rise quickly back up due to thermal soak back effects. If a thruster needs to be fired, a minimum "on time" of 400 msec may be used to preclude valve seat degradation. (ref. SODB volume III, paragraph 4.3.2.7. Note that SODB volume III contains engineering data which may not be supported by test.)

A thruster which has exceeded the operational limit of 157 deg F due to a high duty cycle will be placed in last priority in favor of a colder, redundant jet in the same group. If all jets in a group exceed the operational limit and use of the jet group is still required, then the DAP will be configured accordingly. This approach, documented in CHIT 013, was successfully utilized during STS-77 rendezvous activities. One re-prioritization was required for both of the first priority +X jets, but the redundant +X jets did not reach their operational limit for the remainder of the rendezvous and no further actions were required.

THIS RULE CONTINUED ON NEXT PAGE

FLIGHT RULES

A6.1.3-6

RCS JET TEMPERATURE MANAGEMENT (CONTINUED)

4. ONE OF THE FOLLOWING ACTIONS WILL BE TAKEN TO PREVENT INJECTOR TEMPERATURES FROM EXCEEDING 187 (182) DEG F (175 DEG F AT VALVE SEAT): @091098-6708]

a.

FLIGHT RULES

ORBITER ATTITUDE WILL BE CHANGED. IF DOING SO WILL VIOLATE MISSION REQUIREMENTS, THEN RCS JET INJECTORS MAY BE EXPOSED TO TEMPERATURES UP TO 207 (202) DEG F (195 DEG F AT VALVE SEAT) FOR UP TO 12 HOURS PER SHUTTLE MISSION. @091098-6708]

- b. A FAILED-ON HEATER WILL BE SWITCHED OFF.

The 175 deg F limit (ref. SODB volume I, table 3.4.3.2-1, note L) protects against permanent deformation and damage (cold flow) to the Teflon seat from extended exposure to high temperatures and seal loads at system pressure. The 182 deg F injector temperature limit is derived from the 175 deg F valve limit +12 deg F injector/valve differential (based on Rockwell-Downey thermal analysis) -5 deg F instrumentation error.

The 195 deg F limit (ref. SODB volume I, table 3.4.3.2-1, note L) is a contingency value intended to accommodate predicted peak temperatures during continuous exposure to solar radiation. The 12-hour constraint is a cumulative total and is not "reset" if the thruster injector temperatures decrease to below the limit for any amount of time.

B. VERNIER JETS:

1. IN THE EVENT OF A FAILED-OFF VERNIER RCS JET HEATER OR INADEQUATE DUTY CYCLES, THE FOLLOWING STEPS MAY ~~WILL~~BE TAKEN ~~IN THE PRIORITY LISTED~~ TO INCREASE FIRING FREQUENCY AND DURATION, IF REQUIRED TO PREVENT A FALSE RM FAIL LEAK ANNUNCIATION:

- a. ~~A.~~BIAS THE ATTITUDE.
- b. DESELECT AFT YAW VERNIERS.
- c. ~~B.~~TIGHTEN THE DEADBAND.

~~Both~~ These methods have been employed on many previous flights. ~~It~~ However, it has been shown that biasing the attitude (and taking advantage of gravity gradient torque) and deselecting the aft yaw verniers ~~is~~ are ~~a~~ better long-term methods of raising jet temperatures (as determined from STS-62 and STS-94) because ~~this~~ both methods causes certain targeted jets to fire more frequently while allowing others to fire less frequently. Tightening the deadband increases jet firing frequency (which is undesirable for microgravity payloads) and unless the deadband is severely tightened may not solve the problem. Ref. ~~R~~Rule {A6.1.1-10B} ~~B~~, RCS JET HEATER, for relevant failed-heater definitions. @091098-6708]

THIS RULE CONTINUED ON NEXT PAGE

FLIGHT RULES

A6.1.3-6

RCS JET TEMPERATURE MANAGEMENT (CONTINUED)

2. A VERNIER JET THAT HAS INCURRED A FALSE RM FAIL LEAK ANNUNCIATION DUE TO A FAILED-OFF JET HEATER OR INADEQUATE DUTY CYCLES MAY BE USED WITHOUT ONBOARD LEAK RM UNDER THE FOLLOWING CONDITIONS: @091098-67081

a.

FLIGHT RULES

JET IS USED DURING AOS PERIODS ONLY.

- b. THE JET INJECTOR TEMPERATURES ARE > 90 DEG F AND < 140 DEG F.
- c. THE JET INJECTOR TEMPERATURES HAVE NOT DECREASED > 20 DEG F PER MINUTE AT ANY TIME IN THE PAST HOUR.

~~b. THE FIRST FIRING IS > 10 SEC, UNLESS THIS WILL VIOLATE MISSION REQUIREMENTS~~

Due to inadequate or failed heater operations, the forward vernier jets may cool during extended periods of low activity resulting in a violation of the 130 deg F RCS RM leak detection limit and a false leak annunciation. False annunciation can be distinguished from an actual leak based on ground data evaluation. The 130 deg F limit protects against leaking propellant freezing and plugging the combustion chamber and is not applicable if there is no leak; therefore, once it has been determined that a deselected jet is not leaking, it may be used without onboard RM as long as the injector temperatures remain above 90 deg F, which protects against seal shrinkage and propellant leakage (ref. Rule {A6.1.1-10B}, RCS JET HEATER).

Use of the jet must be confined to AOS periods since the MCC is now prime for leak detection, and the crew does not have onboard insight into jet injector temperatures. If/when the injector temperatures recover and are sufficiently above the RM limit (upon reaching 140 deg F), RM must be toggled for the jet so as to re-enable automatic onboard leak detection. For vernier operation below the RM limit, engineering analysis (ref. Marquardt Report No. TM05-V009, June 1980) has determined that a leak will be indicated by an injector temperature drop of more than 20 deg F per minute. In this case, the MCC will immediately instruct the crew to cease use of the jet (via jet deselection or DAP configuration).

Note that a 10-second steady-state firing will warm a vernier jet injector from 90 deg F to above the 130 deg F RM limit (ref. SODB volume 1, paragraph 3.4.3.2.13). Such a firing is particularly advisable after vernier injector temperatures have dropped significantly below 130 deg F (for example, when a deorbit backout and 24-hour waiveoff are declared and verniers are reactivated hours after their heaters have been turned off), and it is desired to immediately re-enable RCS RM. [091098-6708]

~~In this scenario, the potential for "coldsoak" effects from isolated pulse jet firings, which cause the evaporation of residual propellant and the removal of heat from the injectors, must be accounted for when protecting the 90 deg F limit. On the other hand, during microgravity payload operations, vernier injector temperatures do not typically drop much below 130 deg F. Since the 90 deg limit is not seriously threatened in this case, and since a 10-second firing would degrade the microgravity environment and compromise mission objectives, this action is not required.~~

FLIGHT RULES

A6.1.3-7 ARCS BULK PROPELLANT TEMPERATURE MANAGEMENT

VEHICLE ATTITUDE WILL BE CHANGED ON A NONINTERFERENCE BASIS TO PROVIDE ARCS BULK PROPELLANT TANK TEMPERATURE THERMAL CONDITIONING WHENEVER THE ARCS TANK TEMPERATURE IS < 68 DEG (70 DEG) F. IF AN ATTITUDE CHANGE IMPACTS HIGH PRIORITY FLIGHT OBJECTIVES, THE ARCS TANK TEMPERATURE LIMIT MAY BE REDUCED TO 65 DEG (67 DEG) F BEFORE ACTION IS REQUIRED. THE FOLLOWING ATTITUDES ARE DESIRABLE TO PROVIDE THERMAL CONDITIONING TO INCREASE PROPELLANT TEMPERATURES:

- A. NOSE SUN 10 DEGREES PITCHUP.
- B. NOSE SUN.
- C. TAIL SUN.
- D. BOTTOM SUN.

FOR HIGH BETA ANGLE (> 60 DEGREES) BOTTOM SUN WOULD BE PREFERRED OVER TAIL SUN TO AVOID ORBITER MANEUVERING ENGINE (OME) LINE TEMPERATURE CONSTRAINTS.

Rules {A6.1.1-8A}, OMS/RCS CROSSFEED LINE; and {A17.1.19-1B}, ORBITER THERMAL CONSTRAINTS AND ATTITUDE MANAGEMENT (CIL), reference this rule.

Propellant temperatures must be maintained above the 70 deg F limit to avoid possible ZOT's during entry jet firings below 70,000 feet. WSTF testing has shown that 65 deg F propellant temperatures caused minor ZOT's without creating jet leaks. Similar tests with propellant temperatures at 60 deg F have caused several ZOT's which resulted in liquid leakage at the jet.

THIS RULE CONTINUED ON NEXT PAGE

FLIGHT RULES

A6.1.3-7

ARCS BULK PROPELLANT TEMPERATURE MANAGEMENT (CONTINUED)

Because of the entry ZOT concern, the 70 deg F bulk propellant constraint will be protected if it can be done without violating mission objectives. If the mission objectives prevent the proper vehicle attitude required to maintain the 70 deg F limit, the bulk propellant constraint will be reduced to 67 deg F (65 deg plus 2 deg F instrumentation accuracy) with the understanding that an increased risk of ZOT's exists during entry. The decision to reduce the bulk propellant constraint will be a real-time call and will not be used as a premission planning tool. Because the 67 deg F limit resides in SODB, volume 3, the engineering community (MER) will be notified of the plan to reduce the bulk propellant temperature constraint and given the associated rationale.

To prevent cold tank temperatures, the vehicle can be oriented (OMS pods are in the shade) causing the heater to cycle on. Top to Sun and side to Sun attitudes prevent heater cycles and result in a decay in tank temperature. Changing attitudes will not result in immediate heater activation since heater thermostats are located on the warm pod deck (4 to 6 hours for first cycle). The following table was generated from flight data and will help determine which attitude provides the required response.

<i>Attitude</i>	<i>Equil. temp</i>	<i>(° F)Rise rate (° F/day)</i>
<i>Nose Sun 10° Up</i>	<i>74</i>	<i>5</i>
<i>Nose Sun</i>	<i>74</i>	<i>No data</i>
<i>Tail Sun *</i>	<i>75</i>	<i>>1</i>
<i>Bottom Sun *</i>	<i>75</i>	<i>>1</i>

**High beta angles will cause bondline temperature limit concerns.*

FLIGHT RULES

CONSUMABLES MANAGEMENT

A6.1.4-1

OMS PROPELLANT MANAGEMENT MATRIX

ITEM TO BE PROTECTED	NOMINAL AME [1]	ATO		PLS DAILY GO/NO-GO	PROP REQUIREMENTS [11]		
		AME [1]	RAISE ORB		LEFT	RIGHT	TOTAL
1. DISPERSIONS [8]	√	√	√	√	[8]	[8]	[8]
2. ENG OUT	√	√	√	√	62	62	124
3. TRAPPED [9]	√	√	√	√	399.5 (445) [10]	399.5 (445) [10]	799 (890) [10]
4. DEORBIT WAVE-OFF	√ [2]		√ [2]	√ [2]	110	110	220
5. Y CG	√		√ [4]	√ [4]		TBD IN REAL TIME	
6. X CG	√		√ [3]	√ [3]			
7. OMS 1	√	√					
8. OMS 2	√	√					
9. OMS 3, ATO			√				
10. OMS 4, ATO			√				
11. PYLD SEP	√		√				
DEORBIT:							
12. DEORBIT TARGET	STEEP	SHALLOW	STEEP [5]	STEEP [5]			
13. DOWNMODE [6]	ONE ONLY [7]	NONE	ONE ONLY [7]	ONE ONLY [7]			
14. TIG SLIP	1-RCS ATO		1-RCS	1-RCS			
15. RESULT IF NOT PROTECTED		A0A	105 CIRC	DEORBIT PLS			

©[051194-1612A]

[1] OMS ½ EXECUTION.

[7] 1-RCS TIG SLIP PROTECTED ONLY AFTER OMS ENGINE FAILURE

[2] OMS PORTION OF THE DEORBIT WAVE-OFF EXTENSION DAY MUST BE PROTECTED IN THE ARCS IF OMS NOT AVAILABLE.

[8] OMS DISPERSIONS ARE DEFINED AS THE RSS OF (A) FLOW RATE AND MR ERROR, AND (B) LOADING ERROR. (REF. RULE {A6.1.5-1}, OMS USABLE PROPELLANT.)

[3] FORWARD RCS DUMP MAY BE USED TO OPTIMIZE CG.

[9] TRAPPED RESIDUALS INCLUDE LINE AND TANK TRAPPED.

[4] SEE RULE {A6.1.4-3B}, CG MANAGEMENT.

[10] NUMBERS IN PARENTHESIS APPLY TO OV-102.

[5] SEE RULE {A2.1.3-7}, CONSUMABLES MANAGEMENT, FOR PROPELLANT VS. FLIGHT ACTIVITY TRADEOFF.

[11] REF. RULES {A6.1.5-3}, OMS REDLINES (CIL); {A6.1.5-4}, FORWARD RCS REDLINES; AND {{A6.1.5-5}, AFT RCS REDLINES.

[6] ONE DOWNMODE IS 2-1 OR 1-RCS.

NOTE: CHECKMARKS CANNOT BE "ADDED" TO COMPUTE TOTAL BUDGET FOR ANY GIVEN MISSION MODE. √ = ITEM MUST BE PROTECTED TO EXECUTE STATED MODE. IF IT IS NOT, DOWNMODE IS IN "RESULT" ROW.

©[051194-1612A]

FLIGHT RULES

The OMS propellant matrix details the propellant required to be protected in order to fly to nominal, ATO, or AOA targets as well as the daily PLS GO/NO-GO. These requirements are protected by the abort maneuver evaluator (AME) during ascent and by the OMS propellant redlines during orbit. The ground rules are documented in Rule {A6.1.4-2}, OMS PROPELLANT BUDGET GROUND RULES.

A6.1.4-2

OMS PROPELLANT BUDGET GROUND RULES

- A. COMMITTING TO A NOMINAL ASCENT WILL BE CONSERVATIVE WITH REGARD TO OMS PROPELLANT EXPENDED. DISPERSIONS IN OMS ENGINES FOR FLOW RATE, MIXTURE RATIO, OMS TRAPPED, ONE ENGINE FAILURE, AND GAGING ERROR WILL BE ACCOMMODATED WHILE MAINTAINING NOMINAL ENTRY X AND Y CG, PAYLOAD SEPARATION REQUIREMENTS, AND OMS STEEP DEORBIT TARGETS, WITH PARTIAL PROPULSION DOWNMODING CAPABILITY (2-1 OMS).

Ascent to nominal targets will occur only if propellant is available for the above items. For cases where insufficient propellant exists to continue to nominal targets, ATO/AOA capability will be evaluated. Because an ATO orbit can be reevaluated and subsequently raised to an orbit on a future revolution depending upon the OMS propellant available, the requirements are conservative towards the nominal targets.

- B. ALL OMS PROPELLANT WILL BE USED TO AVOID AN AOA EXCEPT THE PROPELLANT BUDGETED FOR OMS SHALLOW TARGETS (INCLUDES 90 DEGREES PREBANK). OMS TRAPPED, DISPERSIONS, AND OMS ENGINE FAIL.

Since an AOA is not desirable due to increased trajectory dispersion sensitivity, high crew work load, and assured loss of mission, an AOA will be avoided if at all possible. In order to avoid an AOA, more OMS propellant is committed to achieve an ATO. OMS shallow deorbit, OMS dispersions, and OMS engine fail will be protected in the AME. Since aft RCS to RCS PRESS QTY is committed to achieve an AOA or ATO, during propellant critical situations it is expected that OMS depletion will occur during the deorbit burn and four +X RCS will be used to complete the burn. As a result, OMS engine fail propellant must be protected to protect this sequential shutdown during the deorbit burn. If propellant is not available to protect the above items, an AOA will be selected by the AME.

- C. OMS TANK FAILURE PROTECTION IS NOT REQUIRED TO CONTINUE THE NOMINAL ASCENT, TO CONTINUE PAST THE FIRST DAY PLS OR WHEN RAISING AN ATO ORBIT. OTHERWISE, ALL THE PROPELLANT CONSERVATISM INVOLVED IN COMMITTING TO THE NOMINAL ORBIT WILL BE OBSERVED PLUS CG MANAGEMENT AT EI/MACH 3.5, WHILE MAINTAINING OMS STEEP DEORBIT TARGETS WITH PARTIAL PROPULSION DOWNMODING CAPABILITY (2-1 OMS).

FLIGHT RULES

Decision was made to delete the tank fail requirement because of the low probability of occurrence and because the large tank fail redline did not provide sufficient propellant margins for on-orbit activities.

Although tank fail redlines can be protected during the early part of a flight, there is not sufficient propellant during the latter part. The Flight Director will be advised of the tank fail status but there has been no requirement to protect a tank failure since STS-3.

THIS RULE CONTINUED ON NEXT PAGE

FLIGHT RULES

A6.1.4-2 OMS PROPELLANT BUDGET GROUND RULES (CONTINUED)

In the event of an OMS tank leak, a perigee adjust burn will be performed ASAP to make use of the leaking propellant.

- D. OMS PROPELLANT PREVIOUSLY ALLOCATED FOR A DEORBIT WAVEOFF EXTENSION DAY MAY BE COMMITTED TO SUPPORT THE DEORBIT BURN. @[051194-1612A]

The probability of a failure occurring that requires the deorbit burn to be terminated above safe H_p is low. The failures identified are redundant set fail, GPC splits, two main buses, IMU dilemma, and an OMS propellant tank fail. Because of this low probability, the propellant allocated for the deorbit wave-off extension day may be used in calculating deorbit burn targets. If the deorbit burn should be terminated above the safe H_p , the deorbit wave-off extension day propellant requirements could be obtained from the margins in the ARCS (if any margins are available) or by using OMS propellant below the 5 percent remaining (flight rule {A6.1.4-6}, DEORBIT PLANNING CRITERIA) to the redlined OMS trapped/dispersion value. If the deorbit waveoff extension day capability cannot be obtained from these sources, the propellant allocated for the deorbit burn must be used to provide the deorbit waveoff extension day capability (results in shallow deorbit targets). @[051194-1612A]

- E. NOMINALLY, OMS AND RCS PROPELLANT WILL BE BUDGETED FOR A DEORBIT WAVE-OFF EXTENSION DAY. IF OMS PROPELLANT IS NOT AVAILABLE, AFT RCS PROPELLANT WILL BE BUDGETED FOR THE DEORBIT WAVE-OFF EXTENSION DAY. @[051194-1612A]

The OMS will be interconnected to the RCS jets to provide the extension day using tail-only ALT control and deorbit preparation using nose-tail control. RCS is budgeted for wave-off, until interconnect is established, and entry preparation (TIG - 30 minutes). @[051194-1612A]

Rule {A6.1.4-1}, OMS PROPELLANT MANAGEMENT MATRIX, references this rule.

FLIGHT RULES

A6.1.4-3 CG MANAGEMENT

- A. OMS BALLAST FOR X CG MANAGEMENT IS NOT REQUIRED TO CONTINUE PAST THE FIRST DAY PLS IF FORWARD RCS PROPELLANT IS AVAILABLE TO DUMP POST-DEORBIT BURN.

The CG can be moved aft by two methods: (1) allocating OMS propellant for CG management versus delta V (“liquid ballast”), or (2) performing an FRCS dump after the deorbit burn. Either method can improve the CG for entry aerodynamics but the latter is preferred because it does not require additional propellant to be saved to EOM.

- B. OMS PROPELLANT WILL BE MANAGED IN AN ATTEMPT TO ACHIEVE A ZERO Y CG OFFSET. CHANGES IN THE NOMINAL INTERCONNECT SCHEDULE MAY BE MADE IN ORDER TO IMPROVE THE Y CG PRIOR TO DEORBIT.

The OMS propellant will be budgeted such that the left and right pod imbalance will achieve the desired Y CG. This may be achieved by feeding from either OMS system during on-orbit RCS activities or during OMS burns.

The left and right pod interconnect schedule will be modified to achieve the desired imbalance for CG management.

Rule {A6.1.4-1}, OMS PROPELLANT MANAGEMENT MATRIX, references this rule.

- C. THE PROJECTION OF PROPELLANT USAGE RESULTING IN VIOLATION OF THE CG ENVELOPE (REF. RULE {A4.1.4-3}, CG PLANNING) AT THE NEXT PLS WILL BE CAUSE FOR ENTRY AT THE NEXT PLS OPPORTUNITY.

If propellant usage cannot be budgeted to assure a satisfactory CG at the next PLS, entry will be performed at the next PLS prior to violating the CG envelope.

FLIGHT RULES

A6.1.4-4 RCS ENTRY REDLINE PROTECTION

THE OMS/RCS INTERCONNECT WILL BE USED TO PROTECT THE RCS ENTRY REDLINES EVEN AT THE EXPENSE OF STEEP DEORBIT PROTECTION.

OMS tank fail protection is not required to continue to the nominal end of mission. However, if tank fail protection is available, it will be traded off to protect the RCS entry redlines.

The OMS propellant is not available to feed the RCS jets during entry due to tank feed limitations (location of propellant). The RCS can be used to supply deorbit delta V and entry attitude control. Therefore, the OMS is used on-orbit in an OMS/RCS interconnect mode to protect RCS redlines realizing that the RCS can be used to supplement the deorbit delta V required. The deorbit targets are shallowed to 45 deg prebank to achieve the priority mission or to 90 deg prebank to protect the RCS entry requirements. This can be seen in the Propellant Consumables Management Table (ref. Rule {A2.1.3-7}, CONSUMABLES MANAGEMENT).

Rule {A6.1.5-4D}, FORWARD RCS REDLINES, references this rule.

A6.1.4-5 OMS PROPELLANT DEFICIENCY FOR DEORBIT

IF INSUFFICIENT PROPELLANT EXISTS IN THE OMS TO MEET THE REQUIRED DEORBIT TARGETS, IT IS ACCEPTABLE TO REDLINE PROPELLANT IN THE RCS TO PERFORM A TWO-STAGE DEORBIT TO THE REQUIRED TARGETS ONLY IF THERE IS FAIL-SAFE JET REDUNDANCY FOR TRANSLATION IN THE AFFECTED RCS.

Additional propellant can be redlined in the RCS in the event of an OMS/RCS problem (i.e., isolatable propellant or helium leak or high usage) resulting in insufficient OMS propellant to achieve the steep deorbit targets. Rather than performing a single stage burn such that the crew must downmode to RCS in a time-critical period, a two-stage deorbit is preferred. This provides steep deorbit capability while maintaining at least four revs between burns for guidance and crew planning. However, this is acceptable only if fail-safe redundancy exists in the RCS jets which means 4+X or 3-X jets are required prior to the first stage of the deorbit. If a two-stage deorbit is required, RCS propellant will be redlined to protect 2 + X for the RCS perigee adjust. This provides downmode capability from 4+X to 2 + X to protect for a +X jet failure during the burn. 2 + X is protected since this capability is cheaper than 3 + X. (Ref. Rule {A2.1.3-7}, CONSUMABLES MANAGEMENT, for propellant trade-offs.)

Rules {A2.1.4-1B.4}, DEORBIT GUIDELINES; and {A6.1.5-5C}, AFT RCS REDLINES, reference this rule.

FLIGHT RULES

A6.1.4-6

DEORBIT PLANNING CRITERIA

FOR DEORBIT PLANNING PURPOSES, OMS PROPELLANT CAN BE USED TO SUPPORT RCS DOWNMODE CAPABILITY AND/OR PROTECT VEHICLE CG/LANDING WEIGHT CONSTRAINTS PROVIDED THAT THE OMS REMAINING POST-DEORBIT BURN (NO FAILURES) IS GREATER THAN 5 PERCENT PER POD.

RCS downmode protection is not required as long as two OMS engines are available. If OMS propellant margin is available to support RCS downmode, deorbit planning will protect RCS downmode capability subject to the constraints identified in this rule. To provide for TIG SLIP, RCS downmode capabilities and to protect vehicle CG and downweight constraints, additional OMS propellant (above the OMS deorbit optimal requirements) may be required. Backing up TIG requires additional delta V to satisfy deorbit targets. The 5 percent propellant remaining constraint in each OMS tank (403 lb oxygen, 245 lb fuel) provides optimum delta V capability while protecting the worst case OMS dispersions which could occur in either the straight feed or crossfeed OMS burn configurations. The 5 percent remaining constraint also prevents inadvertent engine depletion. Engine depletion during zero gravity (either oxygen or fuel) is undesirable during nominal deorbit conditions because it may result in damage to the OMS engines. This damage to the OMS engine is contained damage and will not damage the orbiter. OMS engine replacement will be required.

Rules {A4.1.4-3C.3}, CG PLANNING; and {A6.1.4-2}, OMS PROPELLANT BUDGET GROUND RULES, reference this rule.

FLIGHT RULES

CONSUMABLES (REDLINES)

A6.1.5-1 OMS USABLE PROPELLANT

A. OMS GAGED PROPELLANT IS DEFINED AS THE AMOUNT OF OMS PROPELLANT LOADED PER POD MINUS THE LINE TRAPPED:

$$\text{LINE TRAPPED: } 50.5 \frac{\text{OX}}{(80)*} - 26.5 \frac{\text{FU}}{(43)*}$$

NOTE: *NUMBERS IN PARENTHESIS APPLY TO OV-102.

B. OMS USABLE PROPELLANT IS DEFINED AS THE OMS GAGED PROPELLANT MINUS THE FOLLOWING RESIDUALS:

$$\begin{array}{l} \text{TANK TRAPPED: } \frac{\text{OX}}{212} - \frac{\text{FU}}{110} \\ \text{DISPERSIONS: } (\text{REF. PARAGRAPH C}) \quad (\text{REF. PARAGRAPH C}) \end{array}$$

C. OMS DISPERSIONS ARE DEFINED AS THE RSS OF (1) FLOW RATE AND MIXTURE RATIO ERROR BASED ON NOMINAL LOAD WITH 2 PERCENT ERROR AND (2) LOADING UNCERTAINTY. DISPERSIONS ARE CALCULATED AS FOLLOWS:

1. a = FLOW RATE AND MIXTURE RATIO ERROR.

$$a = 0.02 (\text{OX (FU) GAGED LBS PROPELLANT} - \text{OX (FU) TANK TRAPPED}).$$

2. b = LOADING UNCERTAINTY:

BENCHMARK	RESIDUALS	WSP AVAIL	LOADING UNCERTAINTY
GOOD	N/A	N/A	40 LB OX, 24 LB FU
OUT-OF-SPEC	N/A	N/A	81 LB OX, 49 LB FU
NO	N/A	YES	81 LB OX, 49 LB FU
NO	AFT GAGE	NO	1.5 PERCENT, PROP LOADED PLUS 40 LB OX, 24 LB FU
NO	CALCULATED	NO	1.5 PERCENT PROP LOADED

THIS RULE CONTINUED ON NEXT PAGE

FLIGHT RULES**A6.1.5-1 OMS USABLE PROPELLANT (CONTINUED)**RESIDUALS

IF | AFT GAGE RESIDUALS - CALCULATED RESIDUALS | < 1
PERCENT

THEN USE,

RESIDUALS = AFT GAGE RESIDUALS

OTHERWISE USE,

RESIDUALS = CALCULATED RESIDUALS

DISPERSION (OX (FU) PER POD) = $(A^2 + B^2)^{1/2}$.

Since the OMS tank and line-trapped propellant cannot be burned, it must be accounted for when calculating usable propellant. Since OMS dispersions may or may not be in the tank, this propellant must also be accounted for when calculating usable propellant. The OMS tank and line-trapped quantities are documented in SODB, volume II, section 4.1.

The calculation for loading uncertainty is based on whether KSC gets a "benchmark" while loading. The "benchmark" is defined as the point at which the total quantity updates after the forward probe gets wet. A "good benchmark" is a benchmark that occurs at 45 ± 0.5 percent (quantity of propellant in tank is determined by a flowmeter). A "benchmark out-of-spec" is a benchmark that occurs greater than 45.5 percent or less than 44.5 percent. "No benchmark" is when the forward probe does not give a quantity reading.

The primary loading method uses the onboard OMS gages. Only for the no-benchmark loading cases are the wet sense point (WSP) and residuals considered. The WSP is the first edge of the forward probe which senses propellant. There is a delay between the forward probe getting wet and the total quantity gage update. The update is not triggered until a voltage threshold in the totalizer electronics is met. Normally this delay is not important, but for a no-benchmark case, the WSP is determined by interpreting graphical data of total quantity gage output versus time. These graphs show a distinct change in voltage which correlates to wetting of the forward probe.

The loading uncertainty for the good benchmark is defined as 40 lb OX and 24 lb FU equal to 0.5 percent of a full load. This 0.5 percent is the advertised accuracy of the onboard OMS gages. The out-of-spec benchmark adds an additional 0.5 percent for a total uncertainty of 81 lb and 49 lb. For the first of the three no-benchmark loading cases, the WSP is known. The confidence in loading with the WSP is considered equal to that of the out-of-spec case; therefore, the loading uncertainty is 81 lb OX and/or 49 lb FU.

THIS RULE CONTINUED ON NEXT PAGE

FLIGHT RULES**A6.1.5-1 OMS USABLE PROPELLANT (CONTINUED)**

For the next two no-benchmark cases, the WSP could not be determined, so a residuals check is made. The residuals check determines the confidence in the aft gages. If the absolute difference between the calculated residuals and aft gage residuals is less than 1 percent, then there is confidence in the aft gages (i.e., the aft gage and onboard totalizer is tracking the GSE). The problem; therefore, lies in the forward probe. Subsequently, the loading uncertainty retains the initial 40 lb and 24 lb, then adds 1.5 percent more loading uncertainty; that is, 1.5 percent of the remaining propellant to be loaded using the GSE flowmeters. This 1.5 percent additional loading uncertainty is the advertised accuracy of the GSE gages. The tanks are not drained and refilled because of the amount of work involved, the aft gages are working, and the 1.5 percent additional propellant is conservative.

In the final no-benchmark cases, the WSP is unknown and the absolute difference of the residuals is greater than 1 percent (i.e., the aft gage and onboard totalizer are not tracking the GSE). The problem lies in the totalizer, or both the aft and forward probes. In this case, the tanks are drained and the loading is restarted with zero percent residuals. Rules {A2.1.3-10A}, OMS/RCS PROPELLANT REQUIRED TO COMMIT TO EVA/MMU OPERATIONS; {A4.1.4-3K.1}, CG PLANNING; {A6.1.5-3}, OMS REDLINES (CIL); {A6.1.5-8}, OMS/RCS, GO/NO-GO CRITERIA (CIL), reference this rule.

A6.1.5-2 RCS USABLE PROPELLANT

RCS USABLE PROPELLANT IS DEFINED AS THE AMOUNT OF RCS PROPELLANT LOADED MINUS THE FOLLOWING RESIDUALS:

ARCS	<u>OX</u>	<u>FU</u>
TANK TRAPPED	58	33
GAGE ERROR	50	34
LINE TRAPPED	<u>59</u>	<u>39</u>
LBS / POD	167	106

FRCS	<u>OX</u>	<u>FU</u>
TANK TRAPPED	139	84
GAGE ERROR	50	34
LINE TRAPPED	<u>38</u>	<u>21</u>
LBS / POD	227	139

Since the propellant trapped in the tank and lines cannot be burned, this propellant must be accounted for when calculating RCS usable propellant. Since the gage error may or may not be in the tank, this propellant must also be accounted for when calculating RCS usable propellant. (Reference SODB, volume II, table 4.2.) Rule {A2.1.3-10A}, OMS/RCS PROPELLANT REQUIRED TO COMMIT TO EVA/MMU OPERATIONS, references this rule.

FLIGHT RULES**A6.1.5-3** **OMS REDLINES (CIL)****A. OMS DEORBIT REDLINE:** @[091098-6711B]

OMS DEORBIT REDLINE IS DEFINED AS ENOUGH PROPELLANT TO COVER:

<u>TANK TRAPPED</u>	<u>644</u>
<u>DISPERSIONS AND UNCERTAINTIES</u>	<u>TBD</u>
<u>OMS STEEP DELTA V</u>	<u>TBD</u>
<u>DEORBIT WAVE-OFF EXTENSION DAY</u>	<u>156</u>
<u>OMS ENGINE FAIL</u>	<u>106</u>
<u>24-HR FLIGHT EXTENSION DAY</u>	<u>64</u>
<u>ADDITIONAL DEORBIT OPPORTUNITIES</u>	<u>TBD</u>
<u>CG BALLAST (IF REQUIRED)</u>	<u>TBD</u>

DEORBIT AND THE DEORBIT DISPERSIONS AND UNCERTAINTIES ARE THE RSS OF LOADING UNCERTAINTY AND DISPERSIONS IN OMS ENGINE FLOWRATE AND MIXTURE RATIO. THE OMS STEEP DELTA V MUST PROTECT THE PRIMARY EOM DEORBIT OPPORTUNITY AND AT LEAST ONE PLS AND ONE SLS OPPORTUNITY FOR BOTH EOM +1 AND EOM +2 DAYS. IF ADDITIONAL DEORBIT ATTEMPTS ARE PROTECTED, AS DOCUMENTED IN THE FLIGHT RULE ANNEX, THEN OMS STEEP DELTA V MUST ALSO PROTECT THESE ADDITIONAL OPPORTUNITIES. OMS STEEP DELTA V WILL BE COMPUTED WITH 3-SIGMA N-CYCLE PROTECTION. EXTENSION DAYS, NOMINAL DEORBIT PREPARATION, AND ADDITIONAL DEORBIT ATTEMPTS MUST BE PROTECTED IN THE AFT RCS IF NOT PROTECTED IN THE OMS. OMS ENGINE FAILURE FOR THE DEORBIT WAVE-OFF EXTENSION DAY MAY BE GIVEN UP IN ORDER TO ACCOMPLISH HIGHER PRIORITY ACTIVITIES AS DOCUMENTED IN THE FLIGHT RULE ANNEX. IF OMS ENGINE FAILURE IS PROTECTED, THE ADDITIONAL SINGLE ENGINE RESIDUALS (77 LB) ARE ACCOUNTABLE AS BALLAST. VIOLATION OF THE OMS DEORBIT REDLINE IS CAUSE FOR DEORBIT AT NEXT PLS IF NO FURTHER PROPELLANT TRADE-OFFS CAN BE ACCOMPLISHED AS LISTED IN RULE {A2.1.3-7}, CONSUMABLES MANAGEMENT. @[091098-6711B]

THIS RULE CONTINUED ON NEXT PAGE

FLIGHT RULES

A6.1.5-3

OMS REDLINES (CIL) (CONTINUED)

~~OPPORTUNITY INTO THE THIS RULE CONTINUED ON NEXT PAGE~~

FLIGHT RULES

~~A6.1.5-3 OMS REDLINES (CIL) (CONTINUED)~~

~~THIS ONLY 1 HOUR THIS RULE CONTINUED ON NEXT PAGE~~

FLIGHT RULES

~~A6.1.5-3 OMS REDLINES (CIL) (CONTINUED)~~

~~THIS RULE CONTINUED ON NEXT PAGE~~

FLIGHT RULES

~~A6.1.5-3 OMS REDLINES (CIL) (CONTINUED)~~

~~TRADABLE THIS RULE CONTINUED ON NEXT PAGE~~

FLIGHT RULES

~~A6.1.5-3 OMS REDLINES (CIL) (CONTINUED)~~

~~AFTER THIS RULE CONTINUED ON NEXT PAGE~~

FLIGHT RULES**A6.1.5-3 ~~OMS REDLINES (CIL) (CONTINUED)~~**

644 - Propellant which cannot be extracted by the propellant acquisition system.
 ©[091098-6711B]

TBD Dispersions - Dispersions for flow rate, mixture ratio, and loading errors must be taken into account (ref. Rule {A6.1.5-1}, OMS USABLE PROPELLANT).

TBD OMS Steep - OMS steep delta V will be based on targeting constraints which require enough N-cycles (guidance cycles from closed-loop guidance initiation to the first non-zero roll command (ref. Rule {A4.1.4-2}, TARGETING PRIORITIES) to protect 3-sigma entry dispersions. Note that real-time planning may reflect a delta V which protects more N-cycles, if propellant is available. In order to guarantee that there is sufficient propellant to perform an OMS steep deorbit, standard redlines must protect a delta V sufficient to deorbit at nominal end of mission, or EOM plus 1 day, or EOM plus 2 days (ref. Rule {A2.1.3-2}, EXTENSION DAY REQUIREMENTS.) Standard redlines protect two attempts over 3 days; thus, the OMS steep delta V must cover the planned EOM opportunity and the cheapest PLS and SLS opportunity for EOM +1 and +2. This level of protection is referred to as 1-0-1 deorbit opportunities. If greater than 1-0-1 deorbit attempts are protected, OMS steep delta V may need to be increased. In that case, for the planned EOM opportunity, OMS steep delta V should cover the planned and one orbit late opportunities to the PLS. For EOM +1 and +2, the cheapest combination of a PLS opportunity with a one orbit late SLS opportunity should be protected.

156 - Standard redlines protect as much of the deorbit wave-off extension day and 24-hour flight extension day propellant as is operationally convenient in the OMS. This helps to assure that the aft RCS deorbit redline is protected at a higher priority than OMS steep deorbit propellant, because any excess usage during these extension days will come from the OMS. However, any or all of this propellant can be protected in the aft RCS in order to maximize capability and/or minimize crew workload. The extension day portion of the deorbit wave-off extension day protects 56 lb and is based on using Nose/Tail ALT control. An additional 100 pounds of propellant are normally redlined in the OMS to perform a partial deorbit preparation after the extension day. This propellant covers the period from the start of deorbit preparation activities at TIG-4:40 to TIG-0:30 minutes. The remainder of the deorbit prep is normally redlined in the aft RCS. The 156 lb must be increased to 321 lb if tail only control is required. The deorbit (systems) wave-off extension day propellant cannot be traded against other orbit activities. ©[091098-6711B]

THIS RULE CONTINUED ON NEXT PAGE

FLIGHT RULES

A6.1.5-3

OMS REDLINES (CIL) (CONTINUED)

- 106 - Reference Rockwell International Internal Letter IL P&AS-DLJ-77-032, the OMS portion of OMS engine failure protection consists of out-of-plane thrusting during gimbal retrim (15 lb per pod) and increased tank residuals due to less favorable orientation of the propellant with respect to the acquisition screens (38.4 lb per pod). These increased tank residuals must be protected, especially after the loss of one OMS engine. However, because the residual propellant (77 lb) remains in the tank, it may be counted toward the CG ballast requirement. The original OMS engine failure requirement, as documented in the letter referenced above, also protected 14 lb of fuel per pod to account for the OMS crossfeed mixture ratio shift. This protection is no longer required since current propellant management procedures account for actual engine performance including crossfeed. Because the deorbit wave-off extension day is reserved specifically for orbiter contingencies (ref Rule {A2.1.3-2}, EXTENSION DAY REQUIREMENTS), the risk of having a major orbiter systems failure followed by an OMS engine fail is small. On a flight specific basis, it may be worth accepting that risk in order to accomplish high priority objectives, as documented in the Flight Rule Annex. If OMS engine fail protection is given up, then the deorbit wave-off extension day propellant should be distributed in the OMS and aft RCS to cover the equivalent of OMS engine failure propellant in each system at the nominal EOM deorbit burn. This implicit protection will be lost if the extension day propellant is used. Once an OMS engine failure occurs, then explicit OMS engine failure protection is mandatory. @[091098-6711B]
- 64 - In order to protect against unforeseen weather that results in unacceptable deorbit/landing conditions, 64 lb of propellant is redlined in the OMS (or Aft RCS) to allow a 24-hour flight extension day using VRCS. This flight extension day includes sufficient propellant to repeat all deorbit prep activities prior to Rad Bypass/FES Checkout, allowing the wave-off decision to be delayed until TIG - 3:00 hours. The 24-hour flight extension day requires 75 lb if accomplished N/T ALT and 164 lb if accomplished T/O ALT. Unlike the propellant redlined for the deorbit wave-off extension day, the 24-hour flight extension day is tradable against on-orbit activities per the established priorities detailed in Rule {A2.1.3-7}, CONSUMABLES MANAGEMENT, and Rule {A6.1.5-6}, VIOLATION OF MISSION COMPLETION REDLINES MATRIX. @[091098-6711B]

THIS RULE CONTINUED ON NEXT PAGE

FLIGHT RULES

A6.1.5-3 OMS REDLINES (CIL) (CONTINUED)

TBD D/O Attempts - Propellant for additional deorbit attempts, such as extra orbits of attitude hold in the deorbit burn configuration or an additional deorbit prep, may be protected on a flight specific basis as documented in the Flight Rule Annex. The extra propellant required to convert the OMS portion of the 24-Hour Flight Extension Day to a nominal Deorbit Wave-Off Extension Day is 85 lb (157 lb for tail only control). Propellant for extra deorbit attempts is typically reserved in the Aft RCS, but may be protected in the OMS, Aft RCS, or both. ©[091098-6711B]

TBD CG Ballast - Propellant may be redlined to act as ballast to maintain the X and Y CG within limits. The amount of propellant required for CG ballast (ref. Rule [A4.1.4-3], CG PLANNING) is determined during preflight analysis and updated in real time. Ballast will be protected in the OMS, the Aft RCS, or both. Care must be taken in apportioning ballast because OMS and ARCS propellant are not equivalent for ballast purposes. CG ballast cannot be traded against other orbit activities. CG ballast can be traded against other redline items only if the ballast requirement changes for extension day deorbit opportunities.

B. OMS TANK FAIL:

—OMS TANK FAIL IS NOT PROTECTED.

There is no requirement to protect for an OMS tank failure.

C. OMS REDLINE FOR RCS DEORBIT (CIL):

AFTER THE LOSS OF ONE OMS ENGINE, ADDITIONAL OMS PROPELLANT WILL BE REDLINED TO PROTECT 4+X RCS DEORBIT TO STEEP TARGETS. IF INSUFFICIENT OMS PROPELLANT IS AVAILABLE, ADDITIONAL RCS PROPELLANT MUST BE REDLINED. IF INSUFFICIENT OMS AND RCS PROPELLANT IS AVAILABLE TO PROTECT 4+X RCS DEORBIT TO STEEP TARGETS, DEORBIT WILL BE PLANNED FOR THE NEXT PLS OPPORTUNITY.

If RCS propellant must be used to supplement OMS propellant during a deorbit burn, a two-stage deorbit burn is preferred in order to simplify execution of the actual deorbit burn. ©[091098-6711B]

THIS RULE CONTINUED ON NEXT PAGE

FLIGHT RULES**A6.1.5-3 OMS REDLINES (CIL) (CONTINUED)****D. OMS MISSION COMPLETION REDLINE: @[091098-6711B]**

THE OMS MISSION COMPLETION REDLINE IS DEFINED AS THE OMS DEORBIT REDLINE PLUS THE REMAINING FLIGHT PLAN ACTIVITIES. REFERENCE RULE {A6.1.5-6}, VIOLATION OF MISSION COMPLETION REDLINES MATRIX, FOR ACTIONS REQUIRED FOR VIOLATION OF THE OMS MISSION COMPLETION REDLINE.

Self-explanatory.

E. OMS ENTRY REDLINE:

—THERE IS NO OMS REQUIREMENT FOR ENTRY.

The OMS tanks cannot be used during entry because of the tank design constraints.

Rules {A2.1.3-7A.11} and {A2.1.3-7C}, CONSUMABLES MANAGEMENT; {A2.1.3-10A}, OMS/RCS PROPELLANT REQUIRED TO COMMIT TO EVA/MMU OPERATIONS; {A2.1.3-22A.1}, RNDZ/PROX OPS PROPULSION SYSTEMS MANAGEMENT; {A4.1.1-1B}, PERFORMANCE ANALYSES; and {A6.1.4-1}, OMS PROPELLANT MANAGEMENT MATRIX, reference this rule. @[091098-6711B]

A6.1.5-4 FORWARD RCS REDLINES**A. FORWARD RCS DEORBIT REDLINE**

~~THE FRCS DEORBIT REDLINE IS DEFINED AS ENOUGH PROPELLANT AT DEORBIT IGNITION TO COVER A DEORBIT WAVE-OFF EXTENSION DAY WHICH IS COMPOSED OF A DEORBIT WAVE-OFF (17 LB), AN EXTRA DAY ON ORBIT USING VERNIER JETS (24 LB), AND A DEORBIT PREPARATION USING PRIMARY JETS (69 LB) PLUS PROVIDE THE FRCS PORTION OF ATTITUDE CONTROL FOR AN OMS ENGINE FAILURE (12 LB). VIOLATION OF THE FRCS DEORBIT REDLINE IS CAUSE FOR ENTRY AT THE NEXT PLS OPPORTUNITY IF OMS OR RCS PROPELLANT IS NOT AVAILABLE TO PROTECT TAIL-ONLY ATTITUDE CONTROL. @[051194-1612A]~~

~~FORWARD RCS PROPELLANT IS NOT REQUIRED FOR ENTRY. HOWEVER, SUFFICIENT PROPELLANT IS REDLINED TO PROTECT FOR THE DEORBIT WAVE-OFF EXTENSION DAY CONSISTENT WITH THE OMS REDLINES. @[051194-1612A]~~

~~THE 17 LB FOR THE WAVEOFF WILL SUSTAIN NOSE-TAIL CONTROL FOR 1.5 HOURS UNTIL VERNIER CONTROL CAN BE ESTABLISHED.~~

FLIGHT RULES

~~THE 24 LB FOR THE EXTRA DAY USING VERNIER JETS WILL ALLOW THE FOLLOWING ACTIVITIES:~~

- ~~A. TWO MANEUVERS TO -ZLV, +XVV.~~
- ~~B. 16 HOURS 25 MINUTES OF ATTITUDE HOLD (-ZLV, +XVV, VRCS, 1-DEGREE DEADBAND).~~
- ~~C. ONE IMU ALIGN (INCLUDES THE MANEUVER TO THE ALIGN-ATTITUDE).~~
- ~~D. ONE MANEUVER TO -XSI.~~
- ~~E. 1 HOUR 55 MINUTES OF ATTITUDE HOLD (-XSI, VRCS, 1-DEGREE DEADBAND). @[051194-1612A]~~

~~THE 69 LB THAT IS RESERVED FOR THE DEORBIT PREPARATION IS BASED ON THE FOLLOWING ACTIVITIES:~~

- ~~A. RADIATOR BYPASS AT TIC-3:00.~~
- ~~B. ONE IMU ALIGN (INCLUDING THE MANEUVER TO THE ALIGN-ATTITUDE).~~
- ~~C. ONE IMU VERIFICATION (INCLUDING THE MANEUVER TO ATTITUDE).~~
- ~~D. 2 HOURS 35 MINUTES OF ATTITUDE HOLD (-XSI, HI LOAD-EVAPORATOR ON, 3-DEGREE DEADBAND).~~
- ~~E. ONE MANEUVER TO BURN ATTITUDE.~~
- ~~F. 5 MINUTES OF ATTITUDE HOLD WITH ONE APU ON.~~

~~THIS RULE CONTINUED ON NEXT PAGE~~

FLIGHT RULES

~~A6.1.5-4 FORWARD RCS REDLINES (CONTINUED)~~

~~IF AN OMS ENGINE FAILS DURING THE DEORBIT BURN, THE FRCS WILL CONTROL THE ATTITUDE EXCURSIONS THAT WILL OCCUR WHILE THE OMS ENGINE GIMBALS TO THE CORRECT THRUST VECTOR FOR A SINGLE ENGINE BURN. PROPELLANT IS REDLINED TO PROTECT FOR THIS CONTINGENCY.~~

~~B. FORWARD RCS REDLINE FOR RCS DEORBIT~~

~~RCS DEORBIT IS ONLY REDLINED AFTER AN OMS ENGINE FAILURE. IF RCS DEORBIT MUST BE REDLINED, THE FRCS REDLINE FOR RCS DEORBIT IS DEFINED AS ENOUGH FRCS PROPELLANT TO PROVIDE FORWARD ATTITUDE CONTROL DURING AN RCS DEORBIT. VIOLATION OF THE FRCS REDLINE FOR RCS DEORBIT IS CAUSE FOR ENTRY AT THE NEXT PLS OPPORTUNITY IF OMS/ARCS PROPELLANT IS NOT AVAILABLE TO PROTECT TAIL ONLY ATTITUDE CONTROL DURING AN RCS DEORBIT.~~

~~IF AN RCS DEORBIT IS NECESSARY, FRCS PROPELLANT IS REQUIRED TO MAINTAIN ATTITUDE CONTROL DURING THE BURN. THE ATTITUDE CONTROL CAN BE ACCOMPLISHED FROM THE AFT PODS IF NECESSARY (TAIL ONLY CONTROL) BUT FRCS IS REDLINED, IF AVAILABLE, TO DECREASE THE AMOUNT OF AFT OMS/RCS PROPELLANT REQUIRED FOR THE DEORBIT BURN.~~

~~C. FORWARD RCS REDLINE FOR OMS TANK FAIL~~

~~NOMINALLY, 0 PERCENT FRCS PROPELLANT IS ALLOCATED TO SUPPLEMENT THE AFT RCS TO PROTECT FOR AN OMS TANK FAILURE. IF FRCS IS REQUIRED FOR OMS TANK FAIL PROTECTION, PROPELLANT MUST BE REDLINED TO ACCOUNT FOR AFT RCS ATTITUDE CONTROL DURING X TRANSLATION (3 LB FRCS: 1 LB ARCS RATIO IS ASSUMED), PLUS THE MANEUVER TO X BURN ATTITUDE (60 LB FRCS, 50 LBS/POD ARCS).~~

~~TANK FAIL COVERAGE IS NOT NORMALLY PROTECTED. HOWEVER, FRCS DELTA V IS AVAILABLE FOR USE IF REQUIRED TO SUPPLEMENT THE AFT RCS/OMS.~~

~~THIS RULE CONTINUED ON NEXT PAGE~~

FLIGHT RULES

~~A6.1.5-4 FORWARD RCS REDLINES (CONTINUED)~~

~~D. FORWARD RCS MISSION COMPLETION~~

~~THE FRCS MISSION COMPLETION REDLINE IS DEFINED AS THE FRCS DEORBIT REDLINE, PLUS ENOUGH PROPELLANT TO COVER A 24 HOUR FLIGHT EXTENSION DAY USING VERNIER JET CONTROL (28 LB), PLUS THE REMAINING FLIGHT PLAN ACTIVITIES (INCLUDING NOMINAL DEORBIT PREPARATION). SEE RULE {A6.1.4-4}, RCS ENTRY REDLINE PROTECTION, FOR ACTIONS REQUIRED AS A RESULT OF VIOLATION OF THE FRCS MISSION COMPLETION REDLINE. @051194-1612A}~~

~~A MINIMUM AMOUNT OF PROPELLANT FOR A 24 HOUR FLIGHT EXTENSION DAY IS REDLINED IN THE FRCS MCR IN CASE AN EXTRA DAY ON ORBIT IS REQUIRED DUE TO UNACCEPTABLE DEORBIT OR LANDING CONDITIONS. THE 28 LB THAT IS PROTECTED IN THE FRCS MCR IS BASED ON THE FOLLOWING ACTIVITIES: @051194-1612A}~~

~~A. TWO MANEUVERS TO -ZLV, +XVV.~~

~~B. ONE IMU ALIGN (INCLUDING THE MANEUVER TO ATTITUDE).~~

~~C. 19 HOURS 55 MINUTES ATTITUDE HOLD (-ZLV, +XVV, VRCS, 1-DEGREE DEADBAND).~~

~~D. MANEUVER TO -XSI ATTITUDE.~~

~~E. 2 HOURS 55 MINUTES OF -XSI ATTITUDE HOLD. @051194-1612A}~~

~~THE FOLLOWING RULES REFERENCE THIS RULE:~~

~~{A2.1.3-7C}, CONSUMABLES MANAGEMENT;~~

~~{A2.1.3-10A}, OMS/RCS PROPELLANT REQUIRED TO COMMIT TO EVA/MMU OPERATIONS;~~

~~{A2.1.3-22A.1}, RNDZ/PROX OPS PROPULSION SYSTEM MANAGEMENT;~~

~~{A4.1.1-1B}, PERFORMANCE ANALYSES;~~

~~{A4.1.4-3I}, CG PLANNING;~~

~~{A6.1.4-1}, OMS PROPELLANT MANAGEMENT MATRIX.~~

~~4FORWARD RCS REDLINES~~THE FRCS DEORBIT REDLINE IS DEFINED AS ENOUGH PROPELLANT TO COVER: @091098-6711B

FLIGHT RULES

<u>NOMINAL DEORBIT PREPARATION</u>	<u>57</u>
<u>OMS ENGINE FAIL ATTITUDE CONTROL</u>	<u>12</u>
<u>DEORBIT WAVE-OFF EXTENSION DAY</u>	<u>110</u>
<u>24-HR FLIGHT EXTENSION DAY</u>	<u>32</u>
<u>ADDITIONAL DEORBIT OPPORTUNITIES</u>	<u>TBD</u>
<u>DEORBIT SUPPLEMENT (IF REQUIRED)</u>	<u>TBD</u>
<u>CG BALLAST (IF REQUIRED)</u>	<u>TBD</u>

@[091098-6711B]

THIS RULE CONTINUED ON NEXT PAGE

FLIGHT RULES

A6.1.5-4 FORWARD RCS REDLINES (CONTINUED)

OMS ENGINE FAILURE AFTER A DEORBIT WAVE-OFF EXTENSION DAY AND/OR THE 24-HR FLIGHT EXTENSION DAY MAY BE GIVEN UP FOR HIGHER PRIORITY ACTIVITIES AS DOCUMENTED IN THE FLIGHT RULE ANNEX. ADDITIONAL DEORBIT ATTEMPTS MAY BE PROTECTED AS DOCUMENTED IN THE FLIGHT RULE ANNEX. VIOLATION OF THE FRCS DEORBIT REDLINE IS CAUSE FOR DEORBIT AT NEXT PLS IF INSUFFICIENT PROPELLANT IS AVAILABLE TO PROTECT THE OMS AND ARCS DEORBIT REDLINES USING TAIL-ONLY CONTROL. @[091098-6711B]

- 57 - Reserved for nominal deorbit prep.
- 12 - If an OMS engine fails during the deorbit burn, the FRCS will control the attitude excursions that will occur while the OMS engine gimbals to realign the thrust vector through the CG. Propellant is normally redlined to protect for this contingency. FRCS is not necessarily required if sufficient aft propellant is redlined to control the attitude excursion using tail only control. The requirement for OMS engine fail protection after a deorbit wave-off extension may be deleted in order to accomplish higher priority activities as documented in the Flight Rule Annex. If so, engine fail protection should still be provided at nominal end of mission using the deorbit wave-off extension allotment or the FRCS contingency propellant (ref. Rule {A6.1.2-13}, CONTINGENCY RCS PROPELLANT AVAILABLE).
- 110 - The deorbit wave-off extension day consists of 66 lb for a deorbit prep plus 11 lb for the waveoff, which will sustain nose-tail control for 1 hour until vernier control can be established, plus 33 lb for the extra day Nose/Tail ALT.
- 32 - Sufficient propellant for a 24-hour flight extension day is normally redlined in case an extra day on orbit is required due to unacceptable entry weather conditions. This vernier flight extension day includes the propellant required to repeat the deorbit prep activities prior to Rad Bypass/FES Checkout, which allows the wave-off decision to be delayed until TIG - 3:00 hours. The 24-hour flight extension day requires 58 lb if accomplished N/T ALT. The 24-hour flight extension day may be deleted in favor of higher priority activities as documented in the Flight Rule Annex.
- TBD D/O Attempts - Propellant for additional deorbit attempts, such as extra orbits of attitude hold in the deorbit burn configuration or an additional deorbit prep, may be protected as specified in the Flight Rule Annex. One orbit of Nose/Tail Trans DAP with FES will cost 17 lb Fwd RCS while 54 lb are required to upgrade the 24-hour flight extension day to a nominal deorbit wave-off extension day. @[091098-6711B]

FLIGHT RULES

THIS RULE CONTINUED ON NEXT PAGE

FLIGHT RULES

A6.1.5-4 FORWARD RCS REDLINES (CONTINUED)

TBD D/O Supplement - *If Forward RCS propellant is required to supplement the OMS deorbit steep propellant, either for +X translation, +Z translation, or for attitude hold during aft RCS +X translation, then this propellant, as well as any associated maneuvers, must be protected.* @[091098-6711B]

TBD CG Ballast - *Propellant may be redlined to act as ballast to maintain the X and Y CG within limits. The amount of propellant required for CG ballast (ref. All Flights Rule {A4.1.4-3}, CG PLANNING) is determined during preflight analysis and updated in real time. CG ballast cannot be traded against other orbit activities. CG ballast can be traded against other redlined items only if the ballast requirement changes for extension day deorbit opportunities.*

B. FORWARD RCS REDLINE FOR OMS TANK FAIL

FRCS DELTA V IS NOT CONSIDERED WHEN DETERMINING OMS TANK FAIL CAPABILITY. IF FRCS PROPELLANT IS TO BE USED FOR A PERIGEE ADJUST AFTER AN OMS TANK FAIL, SUFFICIENT AFT RCS PROPELLANT MUST BE REDLINED TO ACCOUNT FOR ATTITUDE CONTROL DURING THE -X TRANSLATION (TBD), PLUS TWO VERNIER MANEUVERS (6 LB FRCS, 19 LBS AFT).

Forward RCS cannot be committed to the deorbit burn when computing OMS tank fail capability, e.g., steep vs. shallow, in-plane vs. out-of-plane dump, etc. (ref. Flight Rule {A4.1.3-4}, OMS LEAK/PERIGEE ADJUST). However, FRCS delta V is available for a -X perigee adjust if required to supplement the Aft RCS/OMS. OPS 2 2-X with forward pitch control requires 2.5 lb of Aft RCS attitude hold per fps.

C. FORWARD RCS MISSION COMPLETION REDLINE

THE FRCS MISSION COMPLETION REDLINE IS DEFINED AS THE FRCS DEORBIT REDLINE PLUS THE REMAINING FLIGHT PLAN ACTIVITIES. SEE RULE {A6.1.4-4}, RCS ENTRY REDLINE PROTECTION, FOR ACTIONS REQUIRED AS A RESULT OF VIOLATION OF THE FRCS MISSION COMPLETION REDLINE. @[091098-6711B]@[091098-6744A]

Rules {A2.1.3-7C}, CONSUMABLES MANAGEMENT; {A2.1.3-10A}, OMS/RCS PROPELLANT REQUIRED TO COMMIT TO EVA/MMU OPERATIONS; {A2.1.3-22A.1}, RNDZ/PROX OPS PROPULSION SYSTEM MANAGEMENT; {A4.1.1-1B}, PERFORMANCE ANALYSES; {A4.1.4-3I}, CG PLANNING; and {A6.1.4-1}, OMS PROPELLANT MANAGEMENT MATRIX, reference this rule.

FLIGHT RULES

A6.1.5-5 AFT RCS REDLINES

~~A. AFT RCS ENTRY REDLINE:~~

~~1. NOMINAL ARCS ENTRY REDLINE~~

~~THE TOTAL AFT RCS REQUIRED FOR ENTRY IS DEPENDENT UPON ORBITAL INCLINATION. THE REDLINE IS DEFINED AS 1405 LB AT DEORBIT IGNITION FOR ORBITAL INCLINATIONS OF 28.45 TO \leq 30 DEGREES AND 1605 LB FOR ORBITAL INCLINATIONS OF $>$ 30 TO 57 DEGREES. THE AFT RCS WILL BE MANAGED TO MAINTAIN BALANCE BETWEEN THE LEFT AND RIGHT RCS. THE AFT RCS REDLINES ARE DEFINED AS:~~

	ORBITAL INCLINATION (DEG)
160	28.45 TO \leq 30 $>$ 30 TO 57

~~160 Required to support attitude control from the deorbit burn to entry interface.~~

~~1100/1300 The amount of aft RCS required to perform an entry from EI to Mach 1 given a specific orbital inclination. Reference A/E Flight Techniques #60. Predicted mean entry should be £ 710 lb for low inclinations and £ 900 lb for high inclinations.~~

~~70 If an left or right OMS engine failure should occur during the deorbit burn, 70 lb are required to perform single OMS engine attitude control (reference STSOC Transmittal Form No. 330-320-352).~~

THIS RULE CONTINUED ON NEXT PAGE

FLIGHT RULES~~A6.1.5-5 AFT RCS REDLINES (CONTINUED)~~~~3. AEROCAPTURE ARCS REDLINE:~~~~THE TOTAL AFT RCS REQUIRED FOR AEROCAPTURE ENTRY IS 306 LB. THE REDLINE IS DEFINED AS FOLLOWS:~~

DEORBIT TO EI	160 LB
EI TO NO YAW JET SEL	146 LB
TOTAL ARCS PROP	306 LB

The aerocapture RCS redlines define the minimum amount of aft RCS propellant required to control the vehicle from deorbit to the point at which the aerosurfaces alone can maintain control. That is the point when the NO YAW JET option can be selected (after the first prebank maneuver at a Q-bar of approximately 20 psf, reference Rule (A4.1.5-7C), ENTRY LIMITS). The 146 lb protects RCS control from EI to Q-bar = 20 with 30 percent turbulence, worst case aero, a 240k lb vehicle and a vehicle X CG of 1076.7 inches. Given the best conditions, approximately 90 lb will be used in this timeframe. The propellant protected by this redline has nothing to do with aerocapture, but is used (see aft RCS quantity 2 below) to define how much propellant may be used for the deorbit burn and still have enough propellant left to maintain control up to where NO YAW JET control can be selected.

~~4. ON-ORBIT SINGLE AFT RCS POD QUANTITY REDLINE:~~~~THE MINIMUM QUANTITY OF PROPELLANT REQUIRED IN A SINGLE AFT RCS SYSTEM IS DEFINED AS FOLLOWS:~~

ON ORBIT TANK FAIL LIMIT	440 LB
DEORBIT TO EI USAGE	160 LB
EI TO 0.05G USAGE	68 LB
TOTAL ARCS PROP PER POD	668 LB (30.3 PERCENT)

The on-orbit single aft RCS pod quantity redline represents the minimum quantity required per side to protect for an RCS tank failure and still guarantee a no yaw jet entry. This quantity assumes that OMS propellant will not be available after the deorbit burn for OMS to RCS interconnect (quantity < 11 percent per pod, ref. SODB 3.4.3.3.6d). Deorbit to EI (160 lb) and EI to .05g (68 lb) propellant usages must come out of the remaining RCS system. During this time period, since there is no appreciable acceleration on the vehicle, the on-orbit ARCS tank failure limit (ref. Rule (A6.1.1-7), RCS-PROPELLANT TANK (OXIDIZER OR FUEL)) applies. At Q-bar = 20, NO YAW JET may be selected and RCS propellant is no longer required. The 440 lb of trapped propellant will become available once the entry g load on the vehicle builds up to the .05g level.

~~THIS RULE CONTINUED ON NEXT PAGE~~

FLIGHT RULES

~~A6.1.5-5 AFT RCS REDLINES (CONTINUED)~~

- ~~5. VIOLATION OF THE NOMINAL ARCS ENTRY REDLINE (PARAGRAPH A.1) OR THE ON-ORBIT SINGLE AFT RCS POD QUANTITY REDLINE (PARAGRAPH A.4) WILL BE CAUSE TO ENTER AT THE NEXT PLS OPPORTUNITY.~~

To be go for the next PLS GO/NO-GO, the combined left and right AFT RCS predicted quantities at the next day PLS deorbit TIG time must protect the nominal RCS Entry Redline. If after executing all propellant conservation and redline options within the Flight Rule limitations the redlines cannot be protected, then a NO-GO for the next PLS must be declared and the current day's PLS must be executed.

System failures could result in imbalance between left and right RCS usable quantities (i.e., maximum blowdown burn after a helium tank leak) while the total ARCS usable is greater than the nominal RCS Entry Redlines. However, if either RCS system cannot individually protect the NO-YAW JET entry redline, a NO-GO for the next day PLS must be declared and the current day PLS executed. The philosophy is that RCS tank fail protection must be available to be GO for another day on orbit. Propellant must be available to protect an RCS tank failure and still support a NO-YAW JET entry.

~~B. MISSION COMPLETION REDLINE~~

~~THE AFT RCS MISSION COMPLETION REDLINE IS DEFINED AS THE NOMINAL ARCS ENTRY REDLINE PLUS ENOUGH PROPELLANT TO PERFORM THE REMAINING FLIGHT PLAN (INCLUDING NOMINAL DEORBIT PREPARATION). ©[051194-1612A]~~

The mission completion redline is the amount of RCS propellant required to perform the flight plan activities, PTI's, DTO's, and the entry redline requirements. ©[051194-1612A]

~~C. AFT RCS REDLINE FOR RCS DEORBIT~~

~~RCS DEORBIT IS ONLY REDLINED AFTER AN OMS ENGINE FAILURE. IF INSUFFICIENT OMS PROPELLANT IS AVAILABLE TO PROTECT RCS DEORBIT, ADDITIONAL RCS PROPELLANT WILL BE REDLINED (REF. RULE {A6.1.4-5}, OMS PROPELLANT DEFICIENCY FOR DEORBIT). IF INSUFFICIENT OMS AND AFT RCS PROPELLANT IS AVAILABLE TO PROTECT DEORBIT TO STEEP TARGETS, ENTRY WILL BE PLANNED FOR THE NEXT PLS OPPORTUNITY.~~

RCS deorbit capability is only protected after an OMS engine has failed. The goal is to protect all the propellant for an RCS deorbit in the OMS tanks and then conduct the deorbit burn while interconnected OMS to RCS. As a result, any aft attitude control propellant that is required during the RCS deorbit burn will be drawn from the OMS tanks. So if sufficient OMS propellant is available to perform the deorbit burn, no ARCS propellant above the normal entry redlines is required.

FLIGHT RULES

[THIS RULE CONTINUED ON NEXT PAGE](#)

FLIGHT RULES

~~A6.1.5-5 AFT RCS REDLINES (CONTINUED)~~

~~If ARCS propellant will be used to supplement OMS propellant during a deorbit burn, the intent is to try to plan a two-stage deorbit burn to reduce the possibility of helium ingestion into the RCS thrusters during the propellant feed switch from the OMS to RCS tanks. The deorbit burn will not be shallowed to increase on-orbit stay time.~~

~~D. AFT RCS QUANTITY 1 AND 2:~~

- ~~1. AFT RCS QUANTITY 1 IS DEFINED AS SUFFICIENT AFT RCS PROPELLANT TO GUARANTEE AT EI: 1100 LB FOR ORBITAL INCLINATIONS OF 28.45 TO ≤ 30 DEGREES AND 1300 LB FOR ORBITAL INCLINATIONS OF > 30 TO 57 DEGREES. AFT RCS PROPELLANT ABOVE AFT RCS QUANTITY 1 WILL BE USED DURING THE DEORBIT BURN FOR DELTA-V PURPOSES, IF REQUIRED, PRIOR TO CONSIDERING USE OF FWD RCS PROPELLANT, REDESIGNATION, OR PREBANK. AFT RCS QUANTITY 1 IS DEFINED AS:~~

~~If OMS propellant is depleted during the deorbit burn prior to the completion of the targeted delta-V, the crew will use the aft RCS propellant through the +X jets until either the desired targets are achieved, or until the aft RCS propellant quantity decreases to "aft RCS quantity 1". If deorbit targets still have not been achieved, the crew will utilize the aft Hp, primary Hp, and backup Hp cues (calculated by MCC) to determine the actions required to complete the deorbit burn. These actions may include shallowing deorbit targets requiring prebank, utilizing the FRCS X jets which requires a fast flip maneuver and attitude hold gas and/or redesignation. Since these tools may be used the propellant requirement is included in the definition of "aft RCS quantity 1". The propellant required to control the vehicle during the forward RCS X translation is a function of FRCS propellant available and is calculated by the PROP console prior to deorbit. The amount of propellant required for CG ballast (if any) to protect the nominal CG box (ref. Rule {A4.1.4-3}, CG PLANNING) will be determined during preflight analysis for AOA/orbit 3 scenarios. Preflight analysis will also determine nominal end-of-mission ballast requirements, which may be updated during real-time operations. Ballast will be protected in the RCS for AOA/orbit 3 and for EOM may be protected in the OMS or RCS, or divided between the two systems.~~

~~THIS RULE CONTINUED ON NEXT PAGE~~

FLIGHT RULES

A6.1.5-5 AFT RCS REDLINES (CONTINUED)

- ~~2. AFT RCS QUANTITY 2 IS DEFINED AS SUFFICIENT AFT RCS PROPELLANT TO PROTECT AEROCAPTURE REQUIREMENTS AT EI (146 LB). AFT RCS PROPELLANT AVAILABLE ABOVE AFT RCS QUANTITY 2 WILL BE USED DURING THE DEORBIT BURN, IF REQUIRED, FOR DELTA V PURPOSES ONLY IF FORWARD RCS PROPELLANT, REDESIGNATION, AND PREBANK WILL NOT ALLOW COMPLETION. AFT RCS WILL BE USED NO LOWER THAN AFT RCS QUANTITY 2 TO SUPPORT DEORBIT DELTA V. AFT RCS QUANTITY 2 IS DEFINED AS THE TOTAL OF:~~

~~If, using all the aft RCS available above aft RCS quantity 1, all the forward RCS available, redesignation (if available), and prebank to 90 degrees, insufficient delta V is available to complete the deorbit targets, aft RCS is continued to be used. However, to run completely out of aft RCS during the deorbit burn is catastrophic. A minimum amount of aft RCS must be protected to maintain vehicle control to the regime where the aerosurfaces have at least some probability of maintaining control. When completing a deorbit burn, if the aft RCS propellant available decreases to aft RCS quantity 1, and the other tools are insufficient to complete the targets (as calculated by the MCC and provided in the form of PRI Hp, B/U Hp), rather than flip around, the crew procedures call for continuing to use aft RCS through the +X jets. Note that time is not available to flip to use FRCS to depletion, then flip back to complete with ARCS, even though this is probably the optimum use of the propellant. Crew procedures call for continued use of ARCS until the delta V requirements decrease to the point that the other tools (FRCS, redesignation, prebank) can complete the target (again, this is in the form PRI and B/U Hp). At that time (or when aft RCS propellant decreases to ARCS quantity 2), the procedures call for execution of the other options; flip to use FRCS to depletion, redesignation, prebank, note that all three options will be fully utilized. Therefore, the aft RCS propellant requirements for these additional tools must be protected. As in the case of ARCS quantity 1, the FRCS attitude control propellant is calculated in the MCC prior to deorbit. No ballast is required to be protected in aft RCS quantity 2. This is due to the fact that a propellant failure is the most likely reason for using ARCS below aft RCS quantity 1, in which case the propellant in the failed tank can be used as ballast. Also, completion of the deorbit burn is a higher priority than a total ballast requirement.~~

~~THIS RULE CONTINUED ON NEXT PAGE~~

FLIGHT RULES**A6.1.5-5 AFT RCS REDLINES (CONTINUED)**

~~E. THE AFT RCS PRESS QUANTITY IS DEFINED AS THE AMOUNT OF ARCS PROPELLANT THAT MUST BE PROTECTED TO GUARANTEE NOMINAL ENTRY REDLINES ON AN AOA OR AN ATO WITH SHALLOW DEORBIT ON FLIGHT DAY 1. ARCS USABLE PROPELLANT AVAILABLE ABOVE THE ARCS PRESS QUANTITY CAN BE COMMITTED TO ACHIEVE THE AOA OR ATO SHALLOW. THE ARCS PRESS QUANTITY IS DEFINED AS FOLLOWS:~~

~~290/1428/769/628 Aft RCS usage required for mated coast/ET SEP through the maneuver to the deorbit burn on an AOA (reference STS 61-E ELDON). Usage of MECO to deorbit for the ATO case is dependent on when the FD 1 or FD 2 deorbit opportunity occurs. Usage required for mated coast /ET SEP through the maneuver to deorbit burn will be protected. FD 2 assumes OPS 2 and the use of ALT DAP. @[121593-1590]~~

~~160 Required to support attitude control from the deorbit burn to entry interface.~~

~~1100/1300 The amount of aft RCS required to perform an entry from EI to Mach 1 given a specific orbital inclination. Reference A/E Flight Techniques #60. Predicted mean entry should be ≤ 710 lb for low inclinations and ≤ 900 lb for high inclinations.~~

THIS RULE CONTINUED ON NEXT PAGE

FLIGHT RULES

~~A6.1.5-5~~ ~~AFT RCS REDLINES (CONTINUED)~~

~~70~~ ~~If a left or right OMS engine failure should occur during the deorbit burn, 70 lb are required to perform single OMS engine attitude control.~~

~~CG ballast~~ ~~The amount of CG ballast (if required) will be determined during preflight analysis for the AOA scenario. This ballast will be protected in the RCS. The nominal CG box (ref. Rule [A4.1.4-3], CG PLANNING) will be used for ballast determination to protect AOA steep, and the contingency CG box will be used to protect AOA shallow.~~

~~150~~ ~~For an AOA shallow or an ATO with shallow deorbit on flight day 1, propellant must be protected for a prebank maneuver. A prebank is not required for the AOA steep case.~~

FLIGHT RULES

~~THIS PAGE INTENTIONALLY BLANK~~

FLIGHT RULES~~A6.1.5-5 AFT RCS REDLINES (CONTINUED)~~~~F. ENGAGE NO YAW JET QUANTITY~~

~~DURING ENTRY, BETWEEN Q BAR = 20 AND MACH 7, WHEN THE TOTAL AMOUNT OF AFT RCS USABLE PROPELLANT FALLS BELOW 10 PERCENT (220 LBS), NO YAW JET WILL BE ENGAGED. BELOW MACH 7, NO YAW JET WILL BE ENGAGED WHEN THE TOTAL AMOUNT OF AFT RCS USABLE PROPELLANT FALLS BELOW 0 PERCENT.~~

With the certification of NO YAW JET software for contingency use, propellant is no longer required for control at the low Mach numbers. In fact, NO YAW JET can be flown from Q bar = 20 through Mach 1 without any RCS propellant with a high level of confidence. Under one extreme set of test cases (X CG 0.5 inch forward of the 1076.7 inch X CG limit, Y CG 0.5 inch outside of the 1.5 inch Y CG limit, bent airframe and worst case aero), some control problems were encountered in the Mach 12 to Mach 8 region. Given this one extreme case and a degree of uncertainty as to the reliability of the aero data base which was used to evaluate the new software, it was considered prudent to hold back a small amount of RCS propellant (10 percent) as insurance against any control problems encountered while in the NO YAW JET mode. After engagement of the NO YAW JET software, if control becomes questionable, the crew can secure from NO YAW JET and use this propellant to reestablish control. Inside Mach 7, 10 percent of RCS propellant should be sufficient to maintain control through Mach 1 and NO YAW JET should not be required. If, however, RCS quantities fall below 0 percent in this timeframe, NO YAW JET can be selected.

~~G. AFT RCS OMS TANK FAIL QUANTITY~~

~~THE AFT RCS OMS TANK FAIL QUANTITY IS DEFINED AS THE AMOUNT OF ARCS PROPELLANT THAT MUST BE PROTECTED FOR OMS TANK FAIL DETERMINATION. ARCS USABLE PROPELLANT AVAILABLE ABOVE THE AFT RCS OMS TANK FAIL QUANTITY CAN BE COMMITTED TO ACHIEVING OMS TANK FAIL DELTA V. THE AFT RCS OMS TANK FAIL QUANTITY IS DEFINED AS FOLLOWS:~~

ON-ORBIT TANK FAIL LIMIT	880 LB
DEORBIT TO EI	160 LB
EI TO Nz 0.05G	68 LB
PREBANK	150 LB
VRCS EXTENSION DAY	84 LB
NOMINAL DEORBIT PREPARATION	168 LB
TWO ULLAGE BURNS	188 LB
MANEUVERS TO BURN ATTITUDE	48 LB
ENGINE FAIL	70 LB
USAGE TO DEORBIT TIC -3 HOURS	TBD IN REAL TIME
ATTITUDE HOLD FOR FRCS TRANS	TBD IN REAL TIME
CG BALLAST (IF REQUIRED)	TBD IN REAL TIME

FLIGHT RULES

~~THIS RULE CONTINUED ON NEXT PAGE~~

FLIGHT RULES**A6.1.5-5 AFT RCS REDLINES (CONTINUED)**

The AFT RCS OMS TANK FAIL QUANTITY protects the on-orbit ARCS tank certification limit which, in turn, protects enough propellant to perform a nominal entry. All ARCS propellant available above this quantity will be committed to achieve OMS tank fail protection. By not protecting the full EI to Mach 1 propellant requirements, it is possible that NO YAW JET will have to be engaged if worst case entry conditions are present (bent airframe, wind and turbulence, and aero variations). However, the RCS propellant gained to commit to OMS tank fail may prevent a southern hemisphere ELS in the event of an OMS propellant tank leak.

880 lb The ON ORBIT TANK FAIL LIMIT applies until the G load on the vehicle reaches 0.05G. This propellant is then available for entry control (ref. Flight Rule (A6.1.1-7), RCS PROPELLANT TANK (OXIDIZER OR FUEL).

160 lb Required to support attitude control from the deorbit burn to entry interface.

68 lb The EI to Nz of 0.05G propellant must be protected above the ON ORBIT TANK FAIL LIMIT to ensure attitude hold propellant is available until 0.05G when the propellant trapped on orbit becomes usable.

150 lb A prebank maneuver will be performed in an OMS tank fail case since OMS tank fail capability is defined as a shallow deorbit.

84 lb A vernier extension day is protected to allow for propellant sublimation prior to deorbit.

168 lb Protects nominal deorbit preparation.

188 lb Two 15 second ullage burns are protected. The first ullage burn is required for either the perigee adjust or the dump out of plane. The second ullage burn is required for the perigee adjust case where the leaking propellant tank is not depleted during the perigee adjust maneuver.

48 lb MANEUVERS TO BURN ATTITUDE (two primary maneuvers and one vernier maneuver) are required for the leaking OMS perigee adjust burn, the out of plane burn to depletion, and the FRCS perigee adjust.

70 lb Since one engine will have failed at the end of the leaking OMS depletion burn, the ensuing deorbit burn will generally be performed with a single engine; accordingly, propellant for single engine roll control must be protected. Furthermore, if RCS completion is required during the deorbit burn, propellant is needed for the maneuver to RCS 4+X attitude. The 70 lb protects both of these requirements.

THIS RULE CONTINUED ON NEXT PAGE

FLIGHT RULES

A6.1.5-5 AFT RCS REDLINES (CONTINUED)

~~USAGE TO DEORBIT TIG 3 HOURS This number will be determined real time based on the NPLS deorbit TIG.~~

~~ATTITUDE HOLD FOR FRCS TRANS This number will be determined real time based on the amount of FRCS propellant available. It is assumed that a fast flip will not be necessary during the deorbit burn. The PRCS will be used for a perigee adjust burn prior to deorbit.~~

A. AFT RCS DEORBIT REDLINE: @I091098-6711B]

THE TOTAL AFT RCS REQUIRED FOR DEORBIT IS DEPENDENT UPON ORBITER X CG LOCATION. THE AFT RCS DEORBIT REDLINE IS DEFINED AS ENOUGH PROPELLANT TO COVER:

<u>ORBITER X CG (IN)</u>	<u>≤ 1095</u>	<u>> 1095</u>
<u>NOMINAL DEORBIT PREP</u>	<u>162</u>	<u>162</u>
<u>USAGE DEORBIT TO EI</u>	<u>160</u>	<u>160</u>
<u>99.5 PERCENT USAGE EI TO MACH 1</u>	<u>1175</u>	<u>1375</u>
<u>OMS ENGINE FAIL</u>	<u>70</u>	<u>70</u>
<u>DEORBIT WAVE-OFF AND MIN ENTRY PREP</u>	<u>81</u>	<u>81</u>
<u>DEORBIT SUPPLEMENT (IF REQUIRED)</u>	<u>TBD</u>	<u>TBD</u>
<u>ADDITIONAL DEORBIT ATTEMPTS</u>	<u>TBD</u>	<u>TBD</u>
<u>CG BALLAST (IF REQUIRED)</u>	<u>TBD</u>	<u>TBD</u>
<u>PREBANK (IF REQUIRED)</u>	<u>150</u>	<u>150</u>

NOMINAL DEORBIT PREP, DEORBIT WAVE-OFF AND MIN ENTRY PREP, AND ADDITIONAL DEORBIT ATTEMPTS MUST BE PROTECTED IN THE OMS IF NOT PROTECTED IN THE ARCS. THE EI TO MACH 1 USAGE PROTECTION MAY BE REDUCED TO THE 97.5 PERCENT LEVEL IN ORDER TO ACCOMPLISH HIGHER PRIORITY ACTIVITIES AS DOCUMENTED IN THE FLIGHT RULE ANNEX. OMS ENGINE FAILURE MAY BE GIVEN UP FOR THE DEORBIT WAVE-OFF EXTENSION DAY IN ORDER TO ACCOMPLISH HIGHER PRIORITY ACTIVITIES AS DOCUMENTED IN THE FLIGHT RULE ANNEX. VIOLATION OF THE AFT RCS DEORBIT REDLINE IS CAUSE TO DEORBIT AT NEXT PLS IF NO FURTHER PROPELLANT TRADE-OFFS CAN BE ACCOMPLISHED AS LISTED IN RULE {A2.1.3-7}, CONSUMABLES MANAGEMENT.

162 - Aft portion of nominal deorbit prep. Tail only control requires 298 lb.

160 - Required to support attitude control from the deorbit burn to entry interface. This is mean usage and is confirmed by actual flight data.
@I091098-6711B]

FLIGHT RULES

THIS RULE CONTINUED ON NEXT PAGE

FLIGHT RULES

A6.1.5-5

AFT RCS REDLINES (CONTINUED)

- 1175/1375 - The amount of Aft RCS required to perform an entry from EI to Mach 1 given a specific orbiter X CG location, reference A/E Flight Techniques #150. The X CG constraint applies throughout the entry profile (ref. Rule [A4.1.4-3], CG PLANNING), but because the X CG moves forward from EI to Mach 1, the X CG at EI is used to determine the redline. These numbers were chosen to provide 99.5 percent WRAP DAP protection based on Weissman's estimator for non-normal distributions. The Monte Carlo data were generated with STS-1 through STS-89 (less STS-4) reconstructed flight atmospheres using both SES and SDAP simulators. ©[091098-6711B]
- 1080/1080 - As documented in the Flight Rule Annex, the EI to Mach 1 usage protection may be reduced to 97.5 percent (approximately 2 sigma) in order to accomplish high priority mission success activities. Note that the actual CG dependent 97.5 percent protection requirement is 1079 lb for X CG > 1095, and 926 lb for X CG ≤ 1095. However, the latter provides insufficient protection above the ARCS ON ORBIT TANK FAIL quantity (880 lb, ref. Rule [A6.1.1-7], RCS PROPELLANT TANK (OXIDIZER OR FUEL)). Because the consequences of violating this constraint are a potential loss of vehicle control, 200 lb are protected for EI to 0.05g (148 lb) where the on orbit tank fail constraint no longer applies. This provides approximately 99.5 percent protection for this region and will also suffice, when combined with the prebank allotment, for the case of a targeted shallow entry. This results in a minimum RCS quantity at EI of 1080 lb (CG independent).
- 70 - If an OMS engine failure should occur during the deorbit burn, 70 lb of Aft RCS usage are required to perform single OMS engine attitude control (reference STSOC Transmittal Form No. 330-320-352). This number should be increased to 82 lb if tail only control is required. OMS engine fail protection may be given up for the deorbit wave-off extension day in order to accomplish high priority mission success activities as documented in the Flight Rule Annex. If OMS engine fail protection is given up, then the deorbit wave-off extension day propellant should be redistributed in the OMS and Aft RCS in order to retain the equivalent of the OMS engine failure propellant in each system at nominal end of mission. This implicit protection will be lost if the deorbit wave-off extension day is used. If an OMS engine has previously failed, then this allotment must be redlined in the Aft RCS or OMS to provide roll control during the deorbit burn. ©[091098-6711B]

THIS RULE CONTINUED ON NEXT PAGE

FLIGHT RULES

A6.1.5-5

AFT RCS REDLINES (CONTINUED)

- 81 - Normally, the propellant required for a deorbit prep backout and the last 30 minutes of a subsequent deorbit preparation is protected in the Aft RCS deorbit redline. This consists of 43 lb that is budgeted to support PRCS attitude control for 1 hour until the RCS system can be interconnected to the OMS, and 38 lb to perform the last 30 minutes of deorbit preparation. This propellant can be protected in the OMS if required. The equivalent quantity for tail only control is 147 lb. ©[091098-6711B]
- TBD D/O Supplement - If aft RCS propellant is required to supplement the OMS deorbit steep propellant, either for +X translation, +Z translation, or for attitude hold during FRCS -X translation, this propellant, plus any associated maneuvers, must be protected.
- TBD D/O Attempts - Propellant for additional deorbit opportunities, such as extra orbits of attitude hold in the deorbit burn configuration or an additional deorbit prep, may be protected on a flight specific basis as documented in the Flight Rule Annex. One orbit of nose tail Trans DAP with FES will cost 65 lb aft (113 lb tail only control). The additional propellant required to add a backout and nominal deorbit prep to the 24-hour flight extension day is 166 lb aft; typically 81 lb Aft RCS and 85 lb OMS (147 lb Aft RCS and 157 OMS for tail only control). Any or all of his propellant may be protected in the OMS.
- TBD CG Ballast - Propellant may be redlined to act as ballast to maintain the X and Y CG within limits. The amount of propellant required for CG ballast (ref. Rule [A4.1.4-3], CG PLANNING) is determined during preflight analysis and updated in real time. Ballast will be protected in the OMS, the Aft RCS, or both. Note that OMS and ARCS propellant cannot be traded 1:1 for ballast purposes. CG ballast cannot be traded against other orbit activities. CG ballast can be traded against other redlined items if the ballast requirement changes for extension day deorbit opportunities.
- 150 - If the OMS targets are shallowed, an extra 150 lb of Aft RCS propellant must be redlined to perform the prebank maneuvers. The size of the prebank maneuver is not a factor; a 1-degree prebank maneuver is estimated to use as much propellant as a 90-degree prebank. A shallow deorbit causes the vehicle to enter the atmosphere at a shallower angle than usual and is more prone to “skip” off the atmosphere back into orbit. To avoid skipping off the atmosphere, the vehicle is rolled (“banked”) so that the lift from the orbiter wings is minimized. This increases the sink rate and decreases the possibility of skipping back out of the atmosphere. The consequences of skipping back out are likely to be catastrophic - at the least, the planned landing site would be missed. ©[091098-6711B]

NASA - JOHNSON SPACE CENTER

FLIGHT RULES

THIS RULE CONTINUED ON NEXT PAGE

FLIGHT RULES

A6.1.5-5 AFT RCS REDLINES (CONTINUED)

B. MISSION COMPLETION REDLINE @[091098-6711B]

THE AFT RCS MISSION COMPLETION REDLINE IS DEFINED AS THE NOMINAL ARCS DEORBIT REDLINE PLUS ENOUGH PROPELLANT TO EXECUTE THE REMAINING FLIGHT PLAN ACTIVITIES.

The mission completion redline is the amount of RCS propellant required to perform the flight plan activities, PTI's, DTO's, while still protecting the deorbit redline requirements.

C. AEROCAPTURE ARCS REDLINE:

THE TOTAL AFT RCS REQUIRED FOR AEROCAPTURE ENTRY IS 460 LB. THIS INCLUDES DEORBIT TO EI USAGE (160 LB) AND MEAN SHALLOW EI TO QBAR 20 USAGE (300 LB).

The aerocapture RCS redline defines a theoretical minimum amount of Aft RCS propellant required to control the vehicle from deorbit to the point at which NO YAW JET option can be selected (Qbar=20 psf, ref All Flights Rule {A4.1.5-7C}, ENTRY LIMITS). 300 lb protects mean RCS usage for a shallow entry from EI to Qbar=20 based on data supplied by DM after AEFTP #150. The propellant protected by this redline is used (see Aft RCS Quantity 2 below) to define the maximum propellant that may be used for the deorbit burn in an emergency and still have some chance for a successful entry.

D. ON ORBIT AFT RCS SINGLE POD QUANTITY REDLINE:

<u>ARCS ON ORBIT TANK FAIL</u>	<u>440</u>
<u>MEAN USAGE DEORBIT TO EI</u>	<u>160</u>
<u>MEAN USAGE STEEP EI TO 0.05G</u>	<u>96</u>
<u>TOTAL</u>	<u>696</u>

THE ON-ORBIT AFT RCS SINGLE POD QUANTITY REDLINE IS THE MINIMUM QUANTITY ALLOWED IN EACH AFT RCS SYSTEM DURING ORBIT OPERATIONS. LEFT AND RIGHT RCS PROPELLANT WILL BE MANAGED TO ENSURE THIS QUANTITY IS NOT VIOLATED PRIOR TO NOMINAL EOM. VIOLATION OF THIS REDLINE IS CAUSE FOR DEORBIT AT NEXT PLS.

System failures could result in an imbalance between left and right RCS usable quantities (i.e., maximum blowdown burn after a helium tank leak) while the total ARCS usable is greater than the nominal RCS Deorbit Redlines. However, if either RCS system cannot individually protect the NO YAW JET entry redline, a PLS must be executed. RCS tank fail protection is required in order to stay on orbit. @[091098-6711B]

THIS RULE CONTINUED ON NEXT PAGE

FLIGHT RULES

A6.1.5-5

AFT RCS REDLINES (CONTINUED)

The ON-ORBIT AFT RCS SINGLE POD QUANTITY REDLINE represents the minimum quantity required per side to protect for an RCS tank failure and still guarantee a no yaw jet entry. This quantity assumes that OMS propellant will not be available after the deorbit burn for OMS to RCS interconnect (quantity < 11 percent per pod, ref. SODB 3.4.3.3.6d). Deorbit to EI (160 lb) and EI to .05g (96 lb) propellant usages must come out of the remaining RCS system. During this time period, since there is no appreciable acceleration on the vehicle, the ARCS ON-ORBIT TANK FAIL limit (ref. All Flights Rule {A6.1.1-7}, RCS PROPELLANT TANK (OXIDIZER OR FUEL)) applies. The 440 lb of trapped propellant will become available once the entry g-load on the vehicle increases to the 0.05g level. At $Q_{bar} = 20$, NO YAW JET may be selected and RCS propellant is no longer required. @091098-6711B]

FLIGHT RULES

E. AFT RCS QUANTITY 1 IS DEFINED AS SUFFICIENT AFT RCS PROPELLANT TO GUARANTEE 1134 LB AT EI AND PROVIDES 97.5 PERCENT CONFIDENCE FOR SHALLOW EI TO 0.05G USAGE ABOVE ARCS ON ORBIT TANK FAIL. AFT RCS PROPELLANT ABOVE AFT RCS QUANTITY 1 WILL BE USED DURING THE DEORBIT BURN FOR DELTA-V PURPOSES PRIOR TO USE OF FWD RCS PROPELLANT, REDESIGNATION, OR PREBANK. AFT RCS QUANTITY 1 IS DEFINED AS:

<u>ARCS ON ORBIT TANK FAIL</u>	<u>880</u>
<u>97.5 PERCENT SHALLOW USAGE FROM EI TO NZ</u>	<u>254</u>
<u>0.05G</u>	
<u>PREBANK</u>	<u>150</u>
<u>USAGE DEORBIT TO EI</u>	<u>160</u>
<u>ATTITUDE HOLD FOR FRCS (-X) TRANS</u>	<u>TBD</u>
<u>FAST FLIP</u>	<u>100</u>
<u>CG BALLAST (IF REQUIRED)</u>	<u>TBD</u>

If OMS propellant is depleted during the deorbit burn prior to the completion of the targeted delta V, the crew will use the Aft RCS propellant through the +X jets until either the desired targets are achieved, or until the Aft RCS propellant quantity decreases to "Aft RCS Quantity 1." If deorbit targets still have not been achieved, the crew will utilize the aft Hp, target Hp, and flip Hp cues (calculated by MCC) to determine the actions required to complete the deorbit burn. These actions may include requiring prebank, utilizing the FRCS -X jets which requires a fast flip maneuver and attitude hold propellant, and/or redesignation. Since these tools will not be used until after the +X translation, their propellant requirement is included in the definition of "Aft RCS Quantity 1." The propellant required to control the vehicle during the FRCS -X translation is a function of FRCS propellant available and is calculated by the PROP console prior to deorbit. The amount of propellant required for CG ballast (if any) to protect the nominal CG box (ref. Rule {A4.1.4-3}, CG PLANNING) will be determined during preflight analysis for AOA/Orbit 3 scenarios. Preflight analysis will also determine nominal end-of-mission ballast requirements, which may be updated during real-time operations. Ballast will normally be protected in the RCS for AOA/Orbit 3, and in the OMS for EOM, but may be protected in the OMS or RCS, or divided between the two systems.

©[901-98-6711B]

THIS RULE CONTINUED ON NEXT PAGE

FLIGHT RULES

A6.1.5-5 AFT RCS REDLINES (CONTINUED)

Per A/E Flight Techniques Meeting #150, lowering the EI to Mach 1 usage protection to 97.5 percent confidence is preferred over fast flip, redesignation, or prebank. Even so, a steep entry cannot be guaranteed in a case where AQI is applied, and a shallow entry uses more propellant in the EI to Nz=0.05g region. To provide 97.5 percent protection from EI to Nz=0.05g for a shallow entry requires 254 lb over and above the 880 lb ARCS ON-ORBIT TANK FAIL quantity (ref. All Flights Rule {A6.1.1-7}, RCS PROPELLANT TANK (OXIDIZER OR FUEL). The total EI to Mach 1 requirement is 1134 lb. and may be reduced to 1028 lb if steep targets are achieved (see section H, Aft Hp Quantity). Note that this may provide slightly less than the 97.5 percent EI to Mack 1 usage and so may require the use of NO YAW JETS if worst case entry conditions are encountered.

©[091098-6711B]

F. AFT RCS QUANTITY 2 IS DEFINED AS SUFFICIENT AFT RCS PROPELLANT TO PROTECT AEROCAPTURE REQUIREMENTS. AFT RCS PROPELLANT AVAILABLE ABOVE AFT RCS QUANTITY 2 WILL BE USED FOR DELTA V PURPOSES ONLY IF FORWARD RCS PROPELLANT, REDESIGNATION, AND PREBANK ARE NOT SUFFICIENT. AFT RCS WILL BE USED NO LOWER THAN AFT RCS QUANTITY 2 TO SUPPORT DEORBIT. AFT RCS QUANTITY 2 DOES NOT GUARANTEE A SUCCESSFUL ENTRY. AFT RCS QUANTITY 2 IS DEFINED AS:

<u>DEORBIT TO EI</u>	<u>160</u>
<u>EI TO QBAR ≥ 20</u>	<u>300</u>
<u>PREBANK</u>	<u>150</u>
<u>ATT HOLD FOR FRCS TRANS</u>	<u>TBD</u>
<u>FAST FLIP</u>	<u>100</u>

©[091098-6711B]

THIS RULE CONTINUED ON NEXT PAGE

FLIGHT RULES

A6.1.5-5

AFT RCS REDLINES (CONTINUED)

If, using all the Aft RCS available above Aft RCS Quantity 1, all the forward RCS available, redesignation (if available), and prebank to 90 degrees, insufficient delta V is available to complete the deorbit burn, additional Aft RCS must be used. However, to run completely out of Aft RCS during the deorbit burn is also catastrophic. Some minimum amount of Aft RCS must be protected to maintain vehicle control until the aerosurfaces have some chance of maintaining control. When completing a deorbit burn, if the Aft RCS propellant available decreases to Aft RCS Quantity 1, and the other resources cannot meet the target (as calculated by the MCC and provided in the form of aft Hp, target Hp, and flip Hp), rather than flip, crew procedures will continue to use Aft RCS through the +X jets. Note that time is not available to flip to use FRCS to depletion and then flip back to complete with ARCS, even though this is probably the optimum use of the propellant. Crew procedures continue to use ARCS until the delta V requirement decreases to the point that the other tools (FRCS, redesignation, and prebank) can meet the target. At that time (or when Aft RCS propellant decreases to Aft RCS Quantity 2), the procedures execute the other options; first flip to use FRCS to depletion, then redesignation and prebank. All three options will be fully utilized; therefore, the Aft RCS propellant requirements for these additional options must be protected. As in the case of Aft RCS Quantity 1, the FRCS attitude control propellant is calculated in the MCC prior to deorbit. No ballast is protected in Aft RCS Quantity 2 because a propellant failure is the most likely reason for using aft RCS below Aft RCS Quantity 1, in which case the propellant trapped in the failed tank can serve as ballast. Further, completion of the deorbit burn is a higher priority than any ballast requirement. ©[091098-6711B]

Aft Quantity 2 does not protect the ARCS ON ORBIT TANK FAIL limit (ref. All Flights Rule {A6.1.1-7}, RCS PROPELLANT TANK). Below 20 percent remaining, with Nz < 0.05g, the Aft RCS Tanks may not be able to supply propellant to the RCS jets.

FLIGHT RULES

G. THE AFT RCS PRESS QUANTITY IS DEFINED AS THE AMOUNT OF ARCS PROPELLANT THAT MUST BE PROTECTED IN ORDER TO PROVIDE 97.5 PERCENT ENTRY CONFIDENCE FOR AN AOA OR ATO. ARCS USABLE PROPELLANT IN EXCESS OF THE ARCS PRESS QUANTITY IS COMMITTED TO THE PRESS TO ATO CALL. THE ARCS PRESS QUANTITY IS DEFINED AS:

<u>ARCS ON ORBIT TANK FAIL</u>	<u>880</u>
<u>USAGE EI TO NZ 0.05G SHALLOW/STEEP</u>	<u>254/148</u>
<u>PREBANK (IF REQUIRED)</u>	<u>150</u>
<u>USAGE DEORBIT TO EI</u>	<u>160</u>
<u>OMS ENGINE FAIL ATTITUDE CONTROL</u>	<u>70</u>
<u>USAGE MECO TO DEORBIT/AOA/ORBIT 3/ORBIT</u>	<u>259/427/495/52</u>
<u>7/FD2</u>	<u>5</u>
<u>CG BALLAST (IF REQUIRED)</u>	<u>TBD</u>

880 - At $N_z=0.05g$, the ARCS ON-ORBIT TANK FAIL constraint (ref. All Flights Rule {A6.1.1-7}, RCS PROPELLANT TANK (OXIDIZER OR FUEL) is released and 880 lb of additional Aft RCS becomes available to support entry usage. ©[091098-6711B]

THIS RULE CONTINUED ON NEXT PAGE

FLIGHT RULES

A6.1.5-5 AFT RCS REDLINES (CONTINUED)

- 254/148 - Data presented at A/E Flight Techniques #150 showed 254 lb required for shallow EI to $N_z=0.05g$ usage with 97.5 percent protection. For a steep entry, 148 lb of EI to $N_z=0.05g$ usage provides the same level of protection. @091098-6711B]

- 150 - For an AOA or ATO shallow, prebank must be protected. Prebank is not required for a steep entry.

- 160 - Required to support attitude control from the deorbit burn to entry interface.

- 70 - For a press case, the OMS engines are deliberately burned to depletion. The OMS engine fail propellant will be used to control the attitude transients resulting from sequential OME shutdown during the depletion sequence. This quantity cannot not be traded against any other events or activities (ref. All Flights Rule {A6.1.4-2}, OMS PROPELLANT BUDGET GROUNDRULES).

- 259/427/495/525 - Aft RCS usage required for mated coast/ET SEP through the maneuver to the deorbit burn. Usage from MECO to deorbit for the ATO case is dependent on when the FD1 or FD2 deorbit opportunity occurs. FD2 assumes OPS 2 and vernier jets.

- CG Ballast - The amount of CG ballast required will be determined during preflight analysis. This ballast will nominally be protected in the RCS. The nominal CG box (ref. Rule {A4.1.4-3}, CG PLANNING) is used for AOA steep ballast determination and the contingency CG box is used for AOA shallow.

H. AFT HP QUANTITY

AFT HP QUANTITY IS THE AMOUNT OF PROPELLANT RESERVED IN AFT QUANTITY 1 FOR FAST FLIP, AFT ATT HOLD FOR FRCS (-X) TRANSLATION, PREBANK, AND EXTRA USAGE DURING A SHALLOW ENTRY. THIS PROPELLANT CAN BE USED TO COMPLETE THE DEORBIT BURN IF IT IS SUFFICIENT TO COMPLETE THE STEEP TARGET REQUIREMENT. AFT HP IS COMPUTED AS FOLLOWS:

<u>FAST FLIP</u>	<u>100</u>
<u>AFT ATT HOLD FOR FRCS (-X) TRANSLATION</u>	<u>TBD</u>
<u>EI TO 0.05G REDUCTION FOR STEEP ENTRY</u>	<u>106</u>
<u>PREBANK</u>	<u>150</u>

Fast flip and shallow targets are less desirable than steep targets. If burning the aft propellant reserved for these activities will allow the steep target to be met, that is the preferred action. 97.5 percent protection for shallow EI to $N_z=0.05g$ requires 254 lb while equivalent protection for a steep entry only requires 148 lb. The difference is 106 lb. @091098-6711B]

NASA - JOHNSON SPACE CENTER

FLIGHT RULES

THIS RULE CONTINUED ON NEXT PAGE

FLIGHT RULES**A6.1.5-5 AFT RCS REDLINES (CONTINUED)****I. ENGAGE NO YAW JET QUANTITY @[091098-6711B]**

DURING ENTRY, BETWEEN QBAR=20 AND MACH 6, WHEN THE TOTAL AMOUNT OF AFT RCS USABLE PROPELLANT FALLS BELOW 10 PERCENT (220 LBS), NO YAW JET WILL BE ENGAGED. BELOW MACH 6, NO YAW JET WILL BE DISENGAGED. NO YAW JET WILL NOT BE RE-ENGAGED BELOW MACH 6 UNLESS MULTIPLE RCS JETS FAIL OFF (PROPELLANT DEPLETION).

According to study results presented at the A/E Flight Techniques #150, less than 132 lb (6 percent) is required for the Mach 6 to Mach 1 regime. To reduce the likelihood of a time critical RCS crossfeed being required, the number actually protected is 10 percent or 220 lb. Above Mach 6, once 10 percent total (L+R) quantity is reached, NO YAW JET will be selected, preserving the 220 lb for any control problems which might be encountered in NO YAW JET. Once Mach 6 is reached, the 220 lb remaining should be more than adequate to complete a normal entry, so AUTO will be selected to lower the crew workload.

J. AFT RCS OMS TANK FAIL QUANTITY

THE AFT RCS OMS TANK FAIL QUANTITY IS DEFINED AS THE AMOUNT OF ARCS PROPELLANT THAT MUST BE RESERVED FOR OMS TANK FAIL DETERMINATION. ONLY ARCS USABLE PROPELLANT IN EXCESS OF THE AFT RCS OMS TANK FAIL QUANTITY CAN BE COMMITTED TO DEORBIT DELTA V. THE AFT RCS OMS TANK FAIL QUANTITY IS DEFINED AS:

<u>ARCS ON ORBIT TANK FAIL</u>	<u>880 LB</u>
<u>97.5 PERCENT SHALLOW USAGE EI TO NZ</u>	<u>254 LB</u>
<u>0.05G</u>	
<u>PREBANK</u>	<u>150 LB</u>
<u>DEORBIT TO EI</u>	<u>160 LB</u>
<u>ENGINE FAIL</u>	<u>70 LB</u>
<u>NOMINAL DEORBIT PREPARATION</u>	<u>162 LB</u>
<u>USAGE TO DEORBIT TIG - 5 HOURS</u>	<u>TBD IN REAL TIME</u>
<u>VRCS EXTENSION DAY</u>	<u>64 LB</u>
<u>ATTITUDE HOLD FOR FRCS TRANS</u>	<u>TBD IN REAL TIME</u>
<u>MANEUVERS TO FRCS BURN ATTITUDE</u>	<u>TBD IN REAL TIME</u>
<u>TWO ULLAGE BURNS</u>	<u>188 LB</u>
<u>MANEUVERS TO OMS BURN ATTITUDE</u>	<u>39 LB</u>
<u>CG BALLAST (IF REQUIRED)</u>	<u>TBD IN REAL TIME</u>

The aft RCS OMS Tank Fail Quantity is used to determine whether a leaking OMS propellant burn will be done retrograde or out-of-plane (ref. All Flights Rule {A4.1.3-4}, OMS LEAK/PERIGEE ADJUST). @[091098-6711B]

FLIGHT RULES

THIS RULE CONTINUED ON NEXT PAGE

FLIGHT RULES

A6.1.5-5 AFT RCS REDLINES (CONTINUED)

880 lb - The ARCS ON-ORBIT TANK FAIL limit applies until the G-load on the vehicle reaches 0.05G. This propellant is then available for entry control (ref. All Flights Rule {A6.1.1-7}, RCS PROPELLANT TANK (OXIDIZER OR FUEL). All ARCS propellant available above this quantity will be committed to OMS tank fail protection. By not protecting the full EI to Mach 1 propellant requirements, it is possible that NO YAW JET will have to be engaged if worst case entry conditions are present (bent airframe, wind and turbulence, and aero variations). However, the RCS propellant gained to commit to OMS tank fail may prevent a southern hemisphere ELS after an OMS propellant tank leak. @091098-6711B]

254 lb - The EI to Nz of 0.05G usage must be protected above the ARCS ON-ORBIT TANK FAIL limit to ensure attitude hold propellant is available until 0.05G when the propellant trapped on orbit becomes usable; 254 lb provides 97.5 percent protection for a shallow entry.

150 lb - A prebank maneuver will be performed in an OMS tank fail case since the determination of OMS tank fail capability is based on shallow deorbit.

160 lb - Required to support attitude control from the deorbit burn to entry interface.

70 lb - Since one engine will have failed at the end of the leaking OMS depletion burn, the ensuing deorbit burn will generally be performed with a single engine; accordingly, propellant for roll control must be protected. Furthermore, if RCS completion is required during the deorbit burn, propellant is needed for the maneuver to RCS 4+X attitude. The 70 lb protects both of these requirements.

162 lb - Protects a nominal deorbit prep with no additional thermal conditioning.

USAGE TO DEORBIT TIG-5 HOURS - Determined real time based on the actual NPLS TIG.

64 lb - A vernier extension day is protected to allow for propellant sublimation prior to deorbit.

ATTITUDE HOLD FOR FRCS TRANS - Determined real time based on the amount of FRCS propellant available. This will not be the standard 1:3 since fast flip is not to be used during the deorbit burn. Instead, the FRCS will be used for a perigee adjust burn prior to deorbit (ref. All Flights Rule {A4.1.3-4}, OMS LEAK/PERIGEE ADJUST). This will require 2.5 lb Aft RCS per fps.

MANEUVERS TO FRCS BURN ATTITUDE - If an FRCS -X perigee adjust is to be performed after an OMS tank fail, two vernier maneuvers (19 lb) are required to maneuver to and from the -X burn attitude. @091098-6711B]

THIS RULE CONTINUED ON NEXT PAGE

FLIGHT RULES

A6.1.5-5 AFT RCS REDLINES (CONTINUED)

188 lb - Two 15-second ullage burns are protected. The first ullage burn is required for either the perigee adjust or the dump out of plane. The second ullage burn is required if the leaking propellant tank is not depleted during a perigee adjust burn. @[091098-6711B]

39 lb - MANEUVERS TO BURN ATTITUDE (two primary maneuvers) are required for the leaking OMS perigee adjust burn and the subsequent out-of-plane burn to depletion. @[091098-6711B]

CG Ballast - The amount of propellant, if any, to protect the contingency CG box (ref. Rule {A4.1.4-3}, CG PLANNING) required for CG ballast will be determined real time, based on the next PLS deorbit TIG. Ballast will be protected in the OMS or the RCS, or divided between the two systems.

Rules {A2.1.3-7.3}, CONSUMABLES MANAGEMENT; {A2.1.3-10A.2} and {A2.1.3-10A.3}, OMS/RCS PROPELLANT REQUIRED TO COMMIT TO EVA/MMU OPERATIONS; {A2.1.3-11B.1.a}, ORBITER OMS/RCS PROPELLANT REDLINE TO TERMINATE MMU RESCUE; {A2.1.3-22A.1}, RNDZ/PROX OPS PROPULSION SYSTEMS MANAGEMENT; {A4.1.1-1B}, PERFORMANCE ANALYSES; {A4.1.2-6}, DESIGN AND CRITICAL MECO UNDERSPEED DEFINITIONS; {A4.1.4-3C.10}, {A4.1.4-3D.4}, {A4.1.4-3I}; {A4.1.4-3K.1.b}; and {A4.1.4-3K.2.b}, CG PLANNING; {A6.1.4-1} (Note 11), OMS PROPELLANT MANAGEMENT MATRIX; and {A8.1.1-19}, YAW JET DOWNMODE, reference this rule.

FLIGHT RULES

A6.1.5-6

VIOLATION OF MISSION COMPLETION REDLINES MATRIX

MISSION COMPLETION REDLINE VIOLATED	ACTION
LEFT OR RIGHT OMS	<ol style="list-style-type: none"> 1. PERFORM FLIGHT PLAN INTERCONNECTED FROM GOOD OMS TO THE TOTAL OMS MISSION COMPLETION REDLINE. 2. PERFORM RCS FLIGHT PLAN ACTIVITIES NORMALLY SCHEDULED FOR INTERCONNECT WITH RCS PROPELLANTS IF AVAILABLE ABOVE THE MISSION COMPLETION REDLINE. 3. DELETE FLIGHT PLAN ACTIVITIES AS DEFINED IN RULE {A6.1.5-7}, RCS MINIMIZATION TECHNIQUE PRIORITY.
LEFT OR RIGHT AFT RCS	<ol style="list-style-type: none"> 1. INTERCONNECT TO OMS MISSION COMPLETION REDLINE. 2. CROSSFEED FROM OTHER RCS UNTIL TOTAL RCS (LEFT AND RIGHT) MISSION COMPLETION REDLINE. 3. DELETE FLIGHT PLAN ACTIVITIES AS DEFINED IN RULE {A6.1.5-7}, RCS MINIMIZATION TECHNIQUE PRIORITY.
FORWARD RCS	<ol style="list-style-type: none"> 1. DECREASE FRCS SUPPLEMENT TO OMS/RCS DEORBIT REDLINE IF PROPELLANT AVAILABLE ABOVE OMS/RCS MISSION COMPLETION REDLINE. 2. DELETE FLIGHT PLAN ACTIVITIES AS DEFINED IN RULE {A6.1.5-7}, RCS MINIMIZATION TECHNIQUE PRIORITY.

The table describes what action can be taken when the mission completion redline (MCR) has been violated. These actions attempt to regain propellant margins required to continue to the nominal end of mission.

LEFT OR RIGHT OMS MCR:

The first action to maintain positive propellant margins would be to crossfeed to the OMS pod with margin to protect the total OMS MCR (left and right)

The second is to cancel planned interconnects. This requires the interconnect propellant to be budgeted in the RCS, increasing the RCS MCR and reducing the OMS MCR. Again the total OMS MCR is protected.

The third action to take is to minimize RCS usage as described in Rule {A6.1.5-7}, RCS MINIMIZATION TECHNIQUE PRIORITY.

LEFT OR RIGHT AFT RCS MCR:

FLIGHT RULES

The first action required to lower the RCS MCR can be to interconnect to an OMS pod with margin above the MCR. Secondly, if one pod has more propellant than the other the lower RCS pod can be fed from the higher RCS pod. This protects the total (left and right) MCR. Thirdly, the mission extension propellant budget can be reduced according to Rule {A2.1.3-7}, CONSUMABLES MANAGEMENT. Fourthly,, implement minimized techniques in Rule {A6.1.5-7}, RCS MINIMIZATION TECHNIQUE PRIORITY, and if needed delete flight plan activities according to the Propellant Usage versus Flight Activity table.

THIS RULE CONTINUED ON NEXT PAGE

FLIGHT RULES

A6.1.5-6 VIOLATION OF MISSION COMPLETION REDLINES MATRIX (CONTINUED)

FORWARD RCS MCR:

The first action when the forward RCS MCR has been violated will be to reduce the supplement to the OMS/RCS deorbit redline. The OMS supplement was used for tank fail protection in earlier flights (tank fail requirements have since been eliminated) and is now used only after failures dictate. During an RCS deorbit, selecting tail-only control during the 4 +X deorbit eliminates the need for forward RCS propellant thus reduces the FRCS deorbit redline while increasing the OMS/RCS deorbit redline due to the lower ISP associated with the 4 +X deorbit. The second action will be to minimize RCS usage as defined in Rule {A6.1.5-7}, RCS MINIMIZATION TECHNIQUE PRIORITY. Rules {A6.1.2-11}, RCS MANIFOLD/OMS CROSSFEED LINE REPRESSURIZATION (CIL); and {A6.1.5-3D}, OMS REDLINES (CIL), reference this rule.

A6.1.5-7 RCS MINIMIZATION TECHNIQUE PRIORITY

RCS minimization techniques will be utilized after redline margins have been exhausted in each of the five OMS/RCS systems (FRCS, LRCS, RRCS, LOMS, ROMS). Redlines are protected by redlining additional propellant in the remaining tanks if margins exist.

A. UTILIZE NOSE-ONLY/TAIL-ONLY CONTROL MODES.

If margins exist in either the forward or aft tanks, attitude control can be performed using either the nose-only or tail-only control technique. This reduces propellant usage in either the aft or forward RCS to protect the deorbit redline. Nose-only control mode requires aft RCS for roll control.

B. VERNIER OR PRIMARY CONTROL WIDE DEADBANDS.

Widening deadbands during periods of attitude hold will reduce total propellant consumption. Care must be taken not to impact specific mission objectives requiring tight deadbands.

C. DELETE MISSION ACTIVITIES AS REQUIRED (REF. FLIGHT RULE ANNEX SECTION X3, FOR PRIORITIES).

If further propellant consumption is required, DTO's will be deleted from the Flight Plan starting with the lowest priority defined in the Flight Rule Annex, section X3.

D. GRAVITY GRADIENT/FREE DRIFT DURING CREW AWAKE PERIODS.

In an attempt to remain on orbit for the priority flight, gravity gradient or free drift will be selected during crew awake periods.

E. MINIMIZE ENTRY PREPARATION.

FLIGHT RULES

Entry preparation is a relatively high usage phase 4 hours prior to deorbit. Releasing pre-entry checkout requirements would be the last resort to protect propellant for the entry or deorbit phase. Rule {A6.1.5-6}, VIOLATION OF MISSION COMPLETION REDLINES MATRIX, references this rule.

A6.1.5-8 OMS/RCS GO/NO-GO CRITERIA (CIL)

FAILURE	CONTINUE NOMINAL ASCENT IF:	INVOKE MDF IF:	ENTER NEXT PLS IF:
A. OMS			
....1. HE TANK (2).....[4] [1]	0 ↓		
2. PROP TANK (4).....	0 ↓		1 ↓
3. N2 TANK (2).....	1 ↓		
4. ENGINE (2).....	1 ↓		2 ↓ [6]
5. CRITICAL OMS POD HEATERS		[5]	[5]
6. OMS INLET LINE.....	0 ↓		1 ↓
B. RCS			
1. HE AND PROP TANK.....			
a. FWD (FU & OX TANKS).....		[2] [3]	[2] [3]
b. AFT (FU & OX TANKS, 1 POD) (2)	2 ↓		1 ↓
2. RCS MANIFOLD.....			
a. FWD (PRIMARY).....	[3]	[3]	[3]
b. AFT PRIMARY (4).....			2 ↓
3. +X JETS (PRIMARY).....			[6]
C. CROSSFEED			
OMS/RCS CROSSFEED.....			
2 FLOW PATHS (2).....		1 ↓ [7]	2 ↓

LEGEND:

	NO REQUIREMENT
	REQUIRED
()	QUANTITY
[]	NOTE REFERENCE

NOTES:

- [1] FOR LOSS OF HE TK, USE ENGINE IN BLOWDOWN UNTIL PC = 68 (72 PERCENT).
- [2] FWD RCS NOT REQUIRED IF AFT POD HAS FULL CA PABILITY FOR RCS DEORBIT.
- [3] MAINTAIN CG CONTROL WITH AFT PODS.
- [4] OMS HE TANKS NOT REQUIRED IF BLOWDOWN GREATER THAN TANK FAIL LIMIT.
- [5] ENTRY REQUIRED PRIOR TO PREDICTED VOLATION OF THERMAL LIMITS.

FLIGHT RULES

- [6] LOSS OF 1 OMS ENGINE AND 1 +X PRCS JET OR 1 OMS ENGINE AND LESS THAN RCS STEEP CAPABILITY IS CAUSE FOR A NEXT PLS ENTRY (CIL).
- [7] ONLY IF PROCEDURAL WORKAROUNDS ARE NOT AVAILABLE TO PROTECT THE REMAINING FLOW PATHS (CIL).

RULE {A8.1.6-1}, GNC GO/NO-GO CRITERIA, references this rule.

THIS RULE CONTINUED ON NEXT PAGE

FLIGHT RULES

A6.1.5-8 OMS/RCS GO/NO-GO CRITERIA (CIL) (CONTINUED)

The rationale for this matrix is explained in three categories as follows:

- a. Continue nominal ascent if:*
- b. Invoke MDF if:*
- c. Enter next PLS if:*

CONTINUE NOMINAL ASCENT IF:

- *1 OMS ENGINE LOST:*
 - *Nominal ascent can be continued with the remaining engine; there has been no loss of delta V capability.*
- *1 OMS N₂ TANK LOST:*
 - *Nominal ascent can be continued on the remaining engine; there has been no loss of delta V capability.*
- *2 AFT RCS He OR PROP TANK LEAK:*
 - *Leaves only the good system for entry control and ET separation; loss of the good system means no control during early entry.*

INVOKE MDF IF:

- *1 OMS/RCS FLOW PATH (XFD) LOST:*
 - *An MDF is required only if procedural workarounds are not available to guarantee the remaining flow path (i.e., open the remaining crossfeed valve to guarantee crossfeed capability). If no workaround is available, then single fault tolerance remains to protect against engine/RCS propellant failures that require crossfeed.*

THIS RULE CONTINUED ON NEXT PAGE

FLIGHT RULES

A6.1.5-8 OMS/RCS GO/NO-GO CRITERIA (CIL) (CONTINUED)

ENTER NEXT PLS IF:

- 2 OMS ENGINES LOST:
 - Only deorbit method is RCS, next failure means loss of deorbit capability (fail critical for deorbit).
- 1 OMS PROP TANK LEAK:
 - OMS tank failure no longer covered through end of mission. Failure means loss of deorbit capability (fail critical for deorbit).

Propellant budgeting for any flight is such that the loss of an OMS propellant tank early in flight (post-OMS-2) may not leave sufficient propellant between the good OMS, FRCS, and ARCS (above the entry redline) to achieve the shallow target line deorbit. Similarly, for the loss of both OMS engines plus one or more +X jets, there may be enough propellant to achieve the steep deorbit targets.

- 1 OMS INLET LINE LEAK:
 - Due to high pressure surges during repress of the OMS inlet line, it may not be possible to use the propellant for deorbit. In this case, the inlet line leak will be treated as an OMS propellant tank fail. The only guaranteed deorbit method is the good OMS engine supplemented by the FRCS and aft RCS.
- 1 AFT RCS He OR PROP TANK LEAK:
 - Leaves only the good system for entry control; loss of the good system means no control during early entry (fail critical for entry control).
- 2 AFT RCS MANIFOLD LOST - SAME SIDE:
 - Next RCS jet lost could result in no control for entry/no RCS downmode for deorbit (fail critical for entry control/fail safe for deorbit since propellant not available for 2 +X deorbit).
- 2 OMS/RCS FLOW PATH (XFD) LOST:
 - Failure of OMS engine is same as OMS tank failure which is loss of deorbit capability (fail critical for deorbit).
 - Failure of RCS prop tank or He tank is loss of RCS jets on same side, which is no control for entry (fail critical for entry).

THIS RULE CONTINUED ON NEXT PAGE

FLIGHT RULES

A6.1.5-8

OMS/RCS GO/NO-GO CRITERIA (CIL) (CONTINUED)

NOTE

- *1 OMS ENGINE AND 1 +X RCS JET LOST:*
 - *Only the remaining OMS engine and three +X jets are available to provide deorbit capability. Flight rules define four +X jets to steep targets as the only acceptable RCS deorbit method. Three +X jets can provide a deorbit capability if sufficient propellant is available. Because flight rules do not recognize three -X jets as a deorbit option; loss of one +X jet and one OMS engine require a deorbit at the next PLS, because only one deorbit method remains (fail critical).*

- *1 OMS ENGINE AND < RCS STEEP DEORBIT PROPELLANT REQUIREMENTS:*
 - *RCS steep propellant is redlined for the loss of one OMS engine per Rule {A6.1.5-1}, OMS USABLE PROPELLANT. Unavailability of the propellant necessary for an RCS steep deorbit in conjunction with the loss of one OMS engine leaves only one safe deorbit method and results in a next PLS deorbit (loss of deorbit redundancy). RCS shallow targets may be acceptable on a flight-specific basis if defined in the Flight Rule Annex Priority Table.*

- *2 OMS/RCS FLOW PATH (CROSSFEED) LOST:*
 - *Failure of OMS engine is same as OMS tank failure which is loss of deorbit capability (fail critical for deorbit).-Failure of RCS propellant tank or He tank is loss of RCS jets on same side, which is no control for entry (fail critical for entry).*

FLIGHT RULES

SECTION 7 - DATA SYSTEMS

GENERAL

A7.1.1-1	DPS REDUNDANCY REQUIREMENTS	7-1
A7.1.1-2	PASS/BFS REDUNDANCY	7-3
A7.1.1-3	GNC GPC REACTIVATION PRIORITY	7-3
A7.1.1-4	GNC GPC REDUNDANCY REQUIREMENTS	7-4

LOSS/FAILURE DEFINITIONS

A7.1.2-1	PASS DPS FAILURE	7-5
A7.1.2-2	BFS DPS FAILURE	7-9
A7.1.2-3	UNRECOVERABLE GPC	7-13
A7.1.2-4	TRANSIENT GPC	7-14
A7.1.2-5	PAYLOAD MDM SERIAL I/O LINK LOSS/FAILURE DEFINITION	7-15

SYSTEMS MANAGEMENT

A7.1.3-1	REDUNDANT SET FAILURE	7-16
A7.1.3-2	REDUNDANT SET SPLIT	7-16
A7.1.3-3	GPC FAILURE	7-19
A7.1.3-4	DATA PATH FAILURE	7-19
A7.1.3-5	GPC MAJOR FUNCTION CONFIGURATION	7-20
A7.1.3-6	GPC MEMORY WRITE CRITERIA (CIL)	7-24
A7.1.3-7	GPC MEMORY DUMP CRITERIA	7-29
A7.1.3-8	PASS DATA BUS ASSIGNMENT CRITERIA	7-30
A7.1.3-9	I/O RESET	7-38

FLIGHT RULES

A7.1.3-10	PASS GPC BCE FAILURE MANAGEMENT	7-38
A7.1.3-11	POWER CYCLING/MANAGEMENT	7-41
A7.1.3-12	MDM PORT MODING	7-42
A7.1.3-13	MMU OPERATIONS	7-44
A7.1.3-14	TIME MANAGEMENT	7-45
A7.1.3-15	IN-FLIGHT MAINTENANCE (IFM)	7-47
A7.1.3-16	POWERED OFF GPC ACTION (101S)	7-40
A7.1.3-17	SM OPS 4 TRANSITION REQUIREMENTS	7-40
A7.1.3-18	NONUNIVERSAL I/O ERROR ACTION	7-40
A7.1.3-19	GNC 3 ARCHIVE MANAGEMENT	7-42
A7.1.3-20	SPACELAB ON-ORBIT GNC CONFIGURATION	7-43
A7.1.3-21	CONSTRAINTS ON PORT MODING OR I/O RESETS . . .	7-43
A7.1.3-22	DEU EQUIVALENT CRITERIA	7-44

BFS SYSTEMS MANAGEMENT

A7.1.4-1	ASCENT/ENTRY BFS MANAGEMENT GUIDELINES	7-46
A7.1.4-2	ON-ORBIT BFS MANAGEMENT GUIDELINES	7-49

GO/NO-GO MATRIX

A7.1.5-1	DPS GO/NO-GO MATRIX	7-52
----------	-------------------------------	------

**SPACELAB COMMAND AND DATA MANAGEMENT SYSTEM
(CDMS) LOSS/FAILURE DEFINITIONS**

A7.9.1-1	SUBSYSTEM COMPUTER (SSC)	7-52
A7.9.1-2	EXPERIMENT COMPUTER (EXC)	7-53
A7.9.1-3	DDS/REMOTE ACQUISITION UNIT (RAU)/MMU	7-53
A7.9.1-4	DATA PATH	7-53

FLIGHT RULES

SPACELAB CDMS SYSTEMS MANAGEMENT

A7.9.2-1	COMPUTER OR IOU FAULT ISOLATION SEQUENCE . . .	7-55
A7.9.2-2	OPERATIONS FOR TWO COMPUTERS LOST	7-59
A7.9.2-3	COMPUTER RESTART MANAGEMENT	7-62
A7.9.2-4	IOU POWER SUPPLY/BUS MANAGEMENT	7-62
A7.9.2-5	IOU COUPLER MANAGEMENT	7-64
A7.9.2-6	SSIO/EXIO/PCMMU INTERFACE MANAGEMENT	7-66
A7.9.2-7	PAYLOAD MDM SERIAL I/O DATA PATH MANAGEMENT	7-67
A7.9.2-8	MASS MEMORY UNIT MANAGEMENT	7-67
A7.9.2-9	REMOTE ACQUISITION UNIT (RAU) MANAGEMENT . . .	7-67
A7.9.2-10	DATA DISPLAY SYSTEM (DDS) MANAGEMENT	7-69
A7.9.2-11	TEMPERATURE MANAGEMENT	7-71
A7.9.2-12	TIME MANAGEMENT	7-72
A7.9.2-13	MEMORY WRITE MANAGEMENT	7-72

FLIGHT RULES

THIS PAGE INTENTIONALLY BLANK

FLIGHT RULES

SECTION 7 - DATA SYSTEMS

GENERAL

A7.1.1-1 DPS REDUNDANCY REQUIREMENTS

THE MINIMUM DPS REDUNDANCY REQUIREMENTS TO CONTINUE TO EOM ARE :

This rule provides a guideline for continuing nominal mission activities with less than a fullup complement of DPS resources, equipment, and capabilities. The objective is to maintain sufficient resources such that one additional failure can be sustained without jeopardizing vehicle safety, while protecting against a generic failure in both the primary and redundant systems (either hardware or software).

- A. NO MORE THAN ONE ~~ONBOARD~~ GPC HAS BEEN DECLARED UNRECOVERABLE . [@\[101096-4516\]](#)

~~“Onboard GPC” refers to the five operating computers and the carry on spare GPC (if manifested). If one GPC fails, the DPS system is still fail-operational. With one GPC failed, there is no reason to believe the failure is more than an isolated incident; there is no increased risk to the orbiter or crew safety associated with staying to the nominal end of mission. @[092195-1798]_@[101096-4516]~~

~~Although the successful replacement of the failed unit may regain system redundancy, it does not negate the loss of one of five (six) GPC's. A second GPC failure may indicate a generic problem with an increase in risk to orbiter and crew safety. For this reason, a second GPC failure is reason for not going to nominal end of mission even though the orbiter would still be fail-operational for entry. @[092195-1798] @[101096-4516]~~

- B. DATA PATHS NECESSARY TO SUPPORT REQUIRED LRU AND DISPLAY REDUNDANCY .

Each discipline has LRU and display redundancy requirements for continuing nominal mission activities; consequently, this was written to provide data bus capability if they require it to maintain critical systems redundancy.

- C. TWO INDEPENDENT SOURCES OF DEORBIT PASS SOFTWARE ARE REQUIRED AND ARE DEFINED AS ONE OF THE FOLLOWING :

1. TWO MASS MEMORY UNITS (MMU'S)
2. ONE GNC MAJOR FUNCTION GNC 3 ARCHIVE GPC (FREEZE DRIED GNC 3 GPC)AND ONE MMU

The PASS deorbit software (GNC OPS 3) is available from the following sources: MMU 1, MMU 2, a previously G3 archived GPC, or a freeze-dried GNC 3 GPC on orbit. The allowable combinations of sources always includes one MMU.

FLIGHT RULES

Rules {A2.1.3-21B}, RNDZ/PROX OPS DPS SYSTEMS MANAGEMENT; and {A7.1.3-5E.1.d}, GPC MAJOR FUNCTION CONFIGURATION, reference this rule.

THIS RULE CONTINUED ON NEXT PAGE

FLIGHT RULES

A7.1.1-1 DPS REDUNDANCY REQUIREMENTS (CONTINUED)

- D. AT LEAST ONE MMU TO PROVIDE GPC INITIAL PROGRAM LOAD (IPL) AND DEU LOAD CAPABILITY.

This rule provides software reload capability for maintaining GPC and DEU redundancy, and recovery for failed GPC's.

A7.1.1-2 PASS/BFS REDUNDANCY

THE BFS IS NOT CONSIDERED IN THE PASS DPS REDUNDANCY REQUIREMENTS.

The BFS software was not designed with the requirement to accomplish on-orbit operations. It was designed to assume control of the vehicle in the event the PASS can no longer control the vehicle during dynamic flight regimes. Unlike the PASS, the BFS cannot perform IMU alignments or MDM port moding; and it does not have any time management controls. The system management (SM) function is limited in the sense that all PASS SM capabilities are not available in the BFS. With this in mind, the BFS cannot be considered as being interchangeable or redundant to the PASS GPC's.

A7.1.1-3 GNC GPC REACTIVATION PRIORITY

THE ORDER OF PREFERENCE FOR REGAINING VEHICLE CONTROL FOR LOSS OF ALL OPERATING GNC GPC(S) ON ORBIT IS:

- A. FREEZE-DRY GNC 2.
- B. FREEZE-DRY GNC 3 (IF AVAILABLE).
- C. BFS.

Activation of the G2FD GPC would recover full vehicle control with minimal impact to nominal-orbit configuration. Activation of the G3FD GPC requires activation of special LRU's needed by the OPS 3 software. A G3FD GPC will only be available if G3 archive capability has been lost and a G3FD has been established. In addition, the crew procedures for recovering and/or reconfiguring the PASS are simplified if the BFS has not been engaged. Ref. Rule {A7.1.3-19}, GNC 3 ARCHIVE MANAGEMENT.

FLIGHT RULES

A7.1.1-4 GNC GPC REDUNDANCY REQUIREMENTS

REDUNDANT GNC GPC'S ARE REQUIRED FOR THE FOLLOWING ORBIT OPERATIONS :

- A. RNDZ/PROX OPS .
- B. PAYLOAD RETRIEVAL .
- C. EVA OPERATIONS WITH MANNED FREE FLYER OPS. ©[090894-1667]
- D. OMS/RCS BURNS WHICH ARE CRITICAL FOR CREW SAFETY AND/OR WHICH ARE CLASSIFIED AS FLIGHT SUCCESS DELTA V MANEUVERS .

Redundant GNC GPC's meet the fail-safe capability which is required for these operations. Rendezvous requires redundancy at the point in the profile where on-time execution of delta V maneuvers becomes critical to mission success and when a breakout capability is required. For crew safety, proximity operations and payload retrieval operations require +Z redundancy for translation separation maneuvers. For EVA operations involving an untethered crewmember, vehicle control is required in order to rescue a crewmember for certain free flyer apparatus (i.e., SAFER) failures. OMS burns require a downmode capability for delta V maneuvers which are critical for crew safety (such as some postdeployment separation burns) and flight success. RCS burns require +Z redundancy for translation separation maneuvers which are critical for crew safety (such as IPS, RMS, or KU jettison). With redundant GPC's, uninterrupted vehicle control would be provided even if one GNC GPC fails.

Rule {A7.1.3-5A}, GPC MAJOR FUNCTION CONFIGURATION, references this rule.

In general, reference rules {A2.1.3-15}, OMS/RCS MANEUVER CRITICALITY, and {A2.1.3-21}, RNDZ/PROX OPS DPS SYSTEMS MANAGEMENT, for related requirements. ©[090894-1667]

FLIGHT RULES

LOSS/FAILURE DEFINITIONS

A7.1.2-1 PASS DPS FAILURE

PASS DPS FAILURES ARE DECLARED BY THE FOLLOWING GUIDELINES USING ONBOARD AND GROUND MONITORING:

A. REDUNDANT SET (RS) FAILURE - DURING ASCENT OR ENTRY, AN RS FAILURE IS DEFINED AS FOLLOWS:

1. ALL PASS GPC'S QUIT OR HALT (POSSIBLE ANNUNCIATION OF THREE OR FOUR COMPUTER ANNUNCIATION MATRIX (CAM) DIAGONALS).

A QUIT or HALT state means that no software is being executed.

2. RS BREAKUP TO ALL SIMPLEX (THREE OR FOUR DIAGONALS).

An RS breakup can be induced by a GPC software or hardware problem. When an RS breakup occurs, each simplex GPC uses only the response data from its assigned string; it no longer incorporates response data from LRU's/BTU's controlled by the other GPC's. The PASS set is no longer operating on the same information and individual GPC's may send conflicting commands to subsystems.

B. AN RS SPLIT IS DEFINED AS FOLLOWS:

1. DURING ASCENT OR ENTRY, THE ORIGINAL SET OF FOUR PASS GPC'S SPLIT INTO TWO SETS OF TWO GPC'S (CALLED A TWO-ON-TWO) WITH EACH SET OF GPC'S VOTING AGAINST THE OTHER, OR TWO GPC'S EACH SPLIT FROM THE REMAINING SET OF TWO GPC'S, RESULTING IN A 2-1-1 SPLIT.

A GPC software or hardware failure can induce an RS split. With this type of failure, each set of two GPC's continues to process as if that set were the only one running. Although information is no longer exchanged between the two sets, both GPC's within each set maintain coordination. Unlike the redundant set breakup to all simplex, incorporation of flight-critical MDM response data is maintained within each set. In this configuration, the sets may send conflicting commands to subsystems. Additionally, it is possible for two GPC's to each split from the remaining redundant set of two GPC's. The result is three separate groups of GPC's that may each be issuing commands to subsystems that could be conflicting.

2. ON ORBIT, WHEN RS GNC GPC'S DO NOT MAINTAIN RS SYNC BUT DO MAINTAIN COMMON SET (CS) SYNC WITH EACH OTHER.

A GPC software or hardware problem can induce an RS split. With this type of failure, the GNC GPC uses only response data from its assigned strings; it no longer incorporates response data from LRU's/BTU's controlled by the other GNC GPC. The GNC GPC's do maintain common set coordination with each other and other GPC(s) in the common set. In this configuration, the sets may send conflicting commands to subsystems.

FLIGHT RULES

THIS RULE CONTINUED ON NEXT PAGE

FLIGHT RULES

A7.1.2-1 PASS DPS FAILURE (CONTINUED)

C. A GPC FAILURE IS DEFINED AS FOLLOWS:

1. A GPC FAILS OUT OF CS OPERATIONS OR ANNUNCIATES MULTIPLE "GPC BITE" FAULT MESSAGES.

GPC BITE fault messages indicate GPC software or hardware problems exist. A GPC BITE fault message annunciated multiple times by a single GPC implies that the GPC has ceased running a software module for multiple cycles. This cessation is considered an abnormal early termination of software capability and the GPC is considered failed. However, a GPC which only experiences a single GPC BITE and still maintains common set synchronization implies that no critical processes have been affected by the one-time early termination and that no immediate action is required.

2. A SINGLE GPC ANNUNCIATES A "SUMWORD ICC X" FAULT MESSAGE WHILE OPERATING IN THE CS WITH OTHER GPC'S IN MM 105, MM 106, OPS 2, MM 301, MM 302, OR MM 303.

A SUMWORD ICC X fault message notifies the crew of data mismatches between the CS GPC's on specific parameters being passed via ICC buses. To avoid possible use of incorrect GPC data which may cause subsequent OPS transition failures, this single GPC is treated as failed.

3. DURING ASCENT (MM 102 TO MM 104) OR ENTRY (MM 304, MM 305, MM 601 TO MM 603), A GPC ANNUNCIATING A "SUMWORD ICC X" FAULT MESSAGE AND NOT FAILED-TO-SYNC WILL BE ALLOWED TO CONTINUE OPERATING IN THE REDUNDANT SET AND DECLARED FAILED FOR THE NEXT OPS TRANSITION. MANAGEMENT OF THE GPC SHALL BE PER FIGHT RULE {A7.1.3-3A}, GPC FAILURE.

A SUMWORD ICC X message is not indicative of a GPC's ability to command a FC bus. If the GPC remains in the RS after the message is annunciated, it is expected that the set will remain intact until the next OPS transition when the GPC should be moded to HALT. If the GPC remains in the set, control redundancy is not affected and action to remove the GPC from the set is not warranted since the worst case result would be a forced FTS. The GPC is expected to FTS at the OPS transition and should be removed prior to attempting the transition.

The response to this condition is divided into two groupings because of the opportunities to respond to the condition. During ascent through MM 104, GPC MODE/POWER switches are considered to be inaccessible. Therefore, a non-FTS GPC cannot be taken to HALT. The dynamic part of entry starts with MM 304. Although GPC MODE switches are accessible, DPS system reconfiguration is not allowed except for certain failure conditions as stated in All Flights Rule {A2.1.5-4C}, ENTRY STRING REASSIGNMENT. Therefore, removing an annunciating GPC would reduce system redundancy. Prior to MM 304, an annunciating GPC still in the RS can be HALTED and the DPS system reconfigured to maintain redundancy (Rule {A2.1.5-4A}).

FLIGHT RULES

THIS RULE CONTINUED ON NEXT PAGE

FLIGHT RULES

A7.1.2-1 PASS DPS FAILURE (CONTINUED)

This rule is referenced by Rule {A7.1.3-3A}, GPC FAILURE.

- D. A DATA PATH FAILURE IS DEFINED AS THE LOSS OF CORRECT COMMUNICATION BETWEEN A GPC AND A BTU OR LRU (I.E., MDM, MMU, DEUCRT, IMU, HUD, ETC.). [@\[040899-2459B\]](#)

A data path failure is manifested when problems occur at the GPC, BTU, or LRU. Loss of information to/from a GPC may be indicated by an INPUT/OUTPUT (I/O) ERROR fault message, BCE STRING fault message, BCE BYPASS fault message, or MDM OUTPUT fault message. However, failures exist (i.e., GPC to BTU/LRU output failures) where no message is annunciated. Failures where no message is annunciated may be detected by the flight control community and/or crewmembers using subsystems performance or onboard indications.

Rules {A2.1.2-10}, BFS ENGAGE CRITERIA, {A2.1.5-8A}, BFS ENGAGE, and {A7.1.2-4}, TRANSIENT GPC, reference this rule.

A7.1.2-2 BFS DPS FAILURE

BFS DPS FAILURES ARE DECLARED BY THE FOLLOWING GUIDELINES:

- A. THE BFS WILL BE DECLARED FAILED IF NO FORWARD DEUCRT INTERFACE EXISTS (POSSIBLY CONCURRENT WITH "SELF FAIL" COMPUTER ANNUNCIATION MATRIX (CAM) LIGHT). [@\[ED \] @\[040899-2459B\]](#)

If no forward DEUCRT interface exists, the crew has no insight or interface with the BFS. The CAM light may blink for some BFS GPC hardware failures where the BFS is restarting on multiple major cycles. One point worth noting is that the CAM light will not illuminate for the total GPC power loss failure. Reference Rule {A7.1.4-1A}, ASCENT/ENTRY BFS MANAGEMENT GUIDELINES. [@\[040899-2459B\]](#)

- B. THE BFS WILL BE "NO-GO FOR ENGAGEMENT" FOR THE FOLLOWING:

BFS is no-go if it cannot be relied upon to back up the PASS because it either (1) cannot be engaged or (2) the hardware/software of the BFS GPC cannot control the vehicle subsequent to engage.

1. BFS HAS OPERATED IN STANDALONE MODE (WILL NOT TRACK PASS) IN:
 - a. MM 102, 103, AND 601 FOR 10 SECONDS.

THIS RULE CONTINUED ON NEXT PAGE

FLIGHT RULES**A7.1.2-2 BFS DPS FAILURE (CONTINUED)**

- b. MM 304, 305, 602, AND 603 FOR 45 SECONDS.

The BFS is NO-GO when sensor data are lost due to not listening to any PASS-initiated input transactions because the BFS has lost the ability to accurately update the vehicle's state vector. GNC degradation rate is not exactly known; however, 10 seconds in ascent powered flight and 45 seconds in entry dynamic flight were estimated pre-STIS-1. Reference Rule {A7.1.4-1B}, ASCENT/ENTRY BFS MANAGEMENT GUIDELINES.

2. CONTROL CA1 BUS FAILED.

If CNTL CA1 is lost and BFS resides in GPC's 3 or 5, the BFS will not receive engage discretetes. (For BFS in GPC's 1, 2, or 4, failure of CNTL AB3 bus will cause the loss of engage discretetes.) It is important to note, if the engage is attempted, BFS will not recognize the engage and part of the PASS set will go to software halt. Reference Rule {A7.1.4-1C}, ASCENT/ENTRY BFS MANAGEMENT GUIDELINES.

3. LOSS OF ESS 3AB.

For loss of ESS 3AB power, the BFS select capability is lost and no GPC's can be selected as the BFS. If an engage is attempted, BFS will not recognize the engage, and all of the PASS set will go to software halt. Reference Rule {A7.1.4-1C}, ASCENT/ENTRY BFS MANAGEMENT GUIDELINES.

4. IF THE BFS I/O TERM B FAILS HIGH.

If the BFS I/O TERM B is failed high, then the BFS cannot be engaged since this input must be low for the BFS to recognize an engage. If an engage is attempted with the BFS I/O TERM B failed high, the BFS will not recognize the engage and PASS will go to software halt. Since the I/O TERM B is normally high for the BFS pre-engage, this failure will probably not be recognized unless the BFS internal receiver 2 of hybrid receiver 4 failed. The "half-hybrid" failure will cause the BFS I/O TERM A to go high since the I/O TERM B and I/O TERM A are paired together on internal receiver 2 of hybrid 4 (ref. paragraph C7 and Rule {A7.1.4-1D}, ASCENT/ENTRY BFS MANAGEMENT GUIDELINES).

5. BOTH BFS BFC CRT SEL DISCRETES AND THE BFS I/O TERM B DISCRETE FAIL LOW SIMULTANEOUSLY.

The simultaneous failure of both the BFS BFC CRT SEL discretetes and the BFS I/O TERM B discrete is indicative of a 5 volt power supply failure in the BFS BFC module. The BFS BFC module will not respond to the engage with the 5 volt power supply failed, and the BFS will not engage. PASS will recognize the engage and go to software halt.

THIS RULE CONTINUED ON NEXT PAGE

FLIGHT RULES

A7.1.2-2 BFS DPS FAILURE (CONTINUED)

C. THE BFS WILL BE DECLARED "SUSPECT" FOR THE FOLLOWING:

An operating BFS (GNC and SM) is considered suspect when its ability to respond to an engage or to control the vehicle subsequent to engage is in doubt due to a hardware/software failure.

1. BFS HAS EVER ENTERED THE HALT STATE WITHOUT FIRST EXECUTING AN OPS 000 PRO AND HAS SUBSEQUENTLY BEEN RETURNED TO STANDBY OR RUN.

The BFS performs a cleanup when an OPS 000 PRO is performed. Without proper cleanup, the BFS may not be initialized correctly when placing the mode switch back to standby (User Note B04524C). This same situation can occur after the BFS experiences a transient halt state and subsequently returns to standby or run.

2. BFS HAS BEEN RE-IPL'D DURING ASCENT PER RULE {A7.1.4-1E}, ASCENT/ENTRY BFS MANAGEMENT GUIDELINES. A BFS RE-IPL'D DURING ASCENT WILL NOT BE USED FOR GNC PURPOSES. ©[071494-1641]

A BFS which failed and was re-IPL'd during ascent should not be used for GNC purposes. Since the GPC has failed once, the hardware and software integrity of the BFS cannot be assured. Therefore, a BFS so 'recovered' should only be used for systems monitoring and should not be engaged except as a last resort in the event of loss of vehicle control.

3. BFS HAS EXPERIENCED SOFT ERRORS AGAINST THE LOWER PAGE OF MEMORY AT A CONSTANT RATE OR EXPERIENCED AN INSTANTANEOUS SOFT ERROR COUNT OF 7F. ©[041896 1872]

Random single-memory hits are expected to occur at a rate of several per day or in single bursts of several errors. A constant incrementing of the error count is indicative of a hard-memory failure. Errors in the upper page of memory are not reflective of errors in the lower page of memory. Currently, the upper page of memory is not used for BFS and; therefore, soft errors in this portion of memory will have no impact to the operating ability of the BFS. ©[041196 1872]

4. UNEXPLAINED "GPC BITE" FAULT MESSAGE.

The BFS generates a GPC BITE fault message when it encounters a condition requiring a software restart for error recovery. This could also point to a software or hardware problem. The BFS may not function properly in the event that a BFS engage is required.

THIS RULE CONTINUED ON NEXT PAGE

FLIGHT RULES

A7.1.2-2 BFS DPS FAILURE (CONTINUED)

5. UNEXPLAINED "GPC PWR" FAULT MESSAGE.

A GPC PWR fault message is an indication that the BFS GPC has experienced a power transient. The BFS may not function properly in the event that a BFS engage is required. Rules {A7.1.4-2}, ON-ORBIT BFS MANAGEMENT GUIDELINES, and {A7.1.3-2}, REDUNDANT SET SPLIT, reference this rule.

6. IF THE BFS I/O TERM B FAILS LOW.

The I/O TERM B and the engage discrete inputs to the BFS are generated by logic contained within the BFC. The BFC depends on power to and the configuration of the GPC OUTPUT switches on panel 06. If the fuse leading to the output switches fails or if the BFC experiences an internal power failure, the I/O TERM B will go low at the BFS. While the lack of an I/O TERM B discrete input to the BFS will not prevent the BFS from recognizing an engage, it does cast doubt on the inputs to the BFC and/or its ability to properly process the engage discretets and I/O TERM B. If the problem is within the BFC module serving the BFS or the inputs to this module, then the PASS set will go to software halt upon engage and the BFS may not engage. Since the source of the problem cannot be determined, the BFS should be declared suspect.

7. IF THE BFS I/O TERM A FAILS HIGH.

The I/O TERM A and the I/O TERM B share a common internal receiver in GPC hybrid receiver 4. An I/O TERM A failure could be indicative of a single discrete failure on hybrid receiver 4 or could indicate the loss of both the I/O TERM A and I/O TERM B if the common internal receiver has failed. Since the pre-engage state of the BFS I/O TERM B is high, it is not possible to determine the health of the I/O TERM B discrete without moding the BFS OUTPUT switch to NORMAL. If the common receiver has failed high, then the BFS cannot be engaged since the I/O TERM B must be low for the BFS to recognize the engage. If an engage is attempted with the common receiver failed high, the BFS will not recognize the engage and PASS will go to software halt. The BFS should be declared suspect until the status of the I/O TERM B can be verified (ref. paragraph B,4).

FLIGHT RULES

A7.1.2-3 UNRECOVERABLE GPC

AN UNRECOVERABLE GPC IS DEFINED AS FOLLOWS:

An unrecoverable GPC will not be used for PASS redundant/common set operations, or as a BFS GPC.

A. THE GPC FAILS AND WILL NOT RESPOND TO AN IPL.

A GPC that does not respond to an IPL after experiencing a failure is indicative of a hardware problem. The GPC is considered failed and cannot be used.

B. THE GPC FAILS FOR UNKNOWN CAUSES MORE THAN ONCE EVEN THOUGH IT RESPONDS TO AN IPL.

A GPC which responds to an IPL even after it has failed more than once does not ensure the GPC is healthy. IPL'ing a computer more than once for unexplained failures points to an unreliable GPC.

C. THE GPC HAS ONE OR MORE FAILED INPUT/OUTPUT PROCESSOR (IOP) RECEIVER ON BUS CONTROL ELEMENT (BCE) FC 1, 2, 3, 4, 5, 6, 7, 8 OR ANY ICC BCE (EXCEPT AS NOTED IN RULE {A7.1.3-10}, PASS GPC BCE FAILURE MANAGEMENT).

A PASS GPC with an ICC receiver failure prevents that GPC from operating in a redundant or common set. A PASS GPC with a flight-critical receiver failure prevents that GPC from operating in a redundant set. Although a PASS GPC with a flight-critical receiver failure could operate in the common set, that GPC could not operate in the redundant set for entry. Hence, it is declared unrecoverable ~~and will be scheduled for an IFM when possible.~~ @[101096-45161](#)

The exception as noted in Rule {A7.1.3-10}, PASS GPC BCE FAILURE MANAGEMENT, is for BCE FC4 (primary ports) or FC8 (secondary ports) receiver failures where FF4 MDM is bypassed. For this case, turning off MDM FF4 allows the GPC with the receiver failure to be assigned any string and operated in the redundant set to allow us to retain GPC redundancy. ~~This exception may be invoked when there is not time to schedule an IFM.~~ @[101096-45161](#)

FLIGHT RULES

A7.1.2-4 TRANSIENT GPC

A TRANSIENT GPC IS DEFINED AS:

- A. A GPC WHICH HAS FAILED ONLY ONCE, BUT HAS SUCCESSFULLY RESPONDED TO AN IPL.

A GPC failure is generally thought to be caused by hardware failures more than software problems. Even if the failed GPC recovers by doing an IPL, there is concern that the GPC will fail again. If dump analysis can confirm a software-induced failure, the GPC will ~~not be changed out and will be considered recovered. If a spare GPC is manifested, a GPC changeout will be scheduled for late in the flight to allow time for the dump analysis to be completed. If subsequent analysis reveals no need for a changeout, then the procedure will be canceled.~~ [092195-1798] [101096-4516]

- B. A GPC (101S) WHICH EXPERIENCES SOFT ERRORS AGAINST THE LOWER PAGE FOR A PASS OR BFS, OR UPPER PAGE FOR A PASS GPC, OF MEMORY AT A CONSTANT RATE OR EXPERIENCES A SOFT ERROR COUNT OF 7F. [101096-4477]

Random single-memory hits are expected to occur at a rate of several per day or in single bursts of several errors. A constant incrementing of the error count is indicative of a hard-memory failure. Although a single hard bit error in a GPC memory location is corrected by the error detection and correction code, an additional error in this memory location cannot be corrected, and if accessed by the computer would cause the GPC to fail. Errors in the upper page of memory are not reflective of errors in the lower page of memory. [101096-4477]

The upper page of memory in PASS GPC's is used for G3 archive in OI20 and subsequent OI deliveries. Starting with OI-25, the upper page of PASS GPC's is also used to store certain software library routines. Therefore, a hard memory error in the upper memory of a PASS GPC becomes significant to normal operation in addition to the concern for the G3 archive software. G3 archive concerns with s-Soft errors against the upper page of memory are addressed in Rule {A7.1.3-19}, GNC 3 ARCHIVE MANAGEMENT. Upper memory in a BFS GPC is currently not utilized. [101096-4477]

- C. A GPC WHICH ANNUNCIATES A SINGLE "GPC BITE" FAULT MESSAGE.

A GPC BITE fault message indicates that a GPC software or hardware problem exists and the GPC has ceased running a software module for at least one cycle. This cessation is considered an abnormal early termination of software capability. If only a single BITE condition is annunciated, then the cause of the problem is considered transient and the GPC should be treated as such under Rule {A7.1.3-5C}, GPC MAJOR FUNCTION CONFIGURATION. If the GPC fails-to-sync, then the GPC is declared failed per Rule {A7.1.2-1C.1}, PASS DPS FAILURE.

FLIGHT RULES

A7.1.2-5

PAYLOAD MDM SERIAL I/O LINK LOSS/FAILURE
DEFINITION

SPACELAB

FAILED IF:

AFTER FAULT ISOLATION AND REPEATED ATTEMPTS TO REENABLE THE SUSPECT LINK, NO INPUTS OR OUTPUTS ARE SUPPORTED.

The annunciation of off-nominal performance between the serial I/O lines of either PL MDM and either SPACELAB CDMS I/O UNIT (IOU) is via two SM GPC fault messages. The "S212 SPACELAB LINK TERM" message indicates a hard break in communication, while the "S212 SPACELAB LINK ERROR (ERR)" message is indicative of a random "hit" on one of the serial interfaces. Several of these hits combined with associated anomalies in the SPACELAB CDMS (e.g., commanding problems) are also grounds to consider the link failed. PL MDM port moding and IOU coupler switching are among the techniques used to recover a payload MDM/IOU serial interface; however, reenabling the link often suffices. ©[ED 1

FLIGHT RULES

SYSTEMS MANAGEMENT

A7.1.3-1 REDUNDANT SET FAILURE

FOR AN RS FAILURE DURING ASCENT AND ENTRY DYNAMIC PHASES, ENGAGE BFS.

This rule calls for a BFS engage to regain vehicle control due to a redundant set failure.

A7.1.3-2 REDUNDANT SET SPLIT

A. ASCENT:

1. ASCENT, PRE-MECO, FOR MULTIPLE, NEAR SIMULTANEOUS GPC FAILURES WHERE AT LEAST ONE IS FAIL-TO-SYNC (INCLUDING 2-ON-2 SPLITS), ENGAGE BFS (REF. RULE {A2.1.2-10}, BFS ENGAGE CRITERIA). IF THE BFS IS TRACKING AND BOTH OF THE FOLLOWING ARE TRUE, THEN THE PASS SET WILL BE RECONFIGURED RATHER THAN BFS ENGAGE:
 - a. RECONFIGURATION CAN BE COMPLETED PRE-MECO (E.G., CREW CAN REACH THE AFFECTED GPC SWITCHES AND SUFFICIENT TIME IS AVAILABLE TO COMPLETE THE PROCEDURE).
 - b. NO ADDITIONAL COMPLICATING FAILURES ARE PRESENT.
2. IF PASS SET RECONFIGURATION IS TO BE PERFORMED, MCC WILL COORDINATE WITH THE CREW THE FOLLOWING STEPS PRE-MECO:
 - a. HALT SIMPLEX (OR NONPREFERRED PAIR) GPC'S.
 - b. MANUALLY SHUT DOWN THE ENGINE(S) WITH COMMAND PATH FAILURES PER RULE {A5.1.3-6}, MANUAL SHUTDOWN FOR COMMAND/DATA PATH FAILURES.

THIS RULE CONTINUED ON NEXT PAGE

FLIGHT RULES

A7.1.3-2 REDUNDANT SET SPLIT (CONTINUED)

- c. RESTRING ONLY IN ACCORDANCE WITH RULE {A2.1.2-14}, ASCENT STRING REASSIGNMENT.

If the BFS is standalone at the set split during powered flight, then its navigation state will quickly diverge, which eliminates the BFS engage option (ref. Rule {A7.1.2-2B.1}, BFS DPS FAILURE). In this case immediate engagement is the only acceptable action. Even if the BFS is tracking, BFS engagement is the quickest and simplest option to regain full vehicle control and LRU redundancy (except for GPC redundancy, of course). As long as the BFS continues to track the PASS following a set split, then reconfiguration of the PASS set is a viable option. However, adequate time must be available to complete the procedures before MECO; the crew must be physically capable of reaching the required switches under g-loads; and the overall crew/MCC work load due to additional complicating factors is not excessive.

Due to the extremely low probability of this failure case, no additional procedures will be documented nor valuable integrated simulation time expended. Any crew training will be limited and will emphasize the BFS engage procedure as this is the preferred option and will safely allow recovery from this failure scenario.

The PASS GPC fail procedure in the ascent cue cards is considered to be sufficient to specify those crew actions essential to immediately safing the vehicle in the event of a set split. Also, additional failures (at least two) in the communications system that preclude MCC instructions to the crew in this situation is not considered credible. Therefore, all remaining actions will be by MCC call.

In a two-on-two set split, the flight control team will identify the GPC's with the best remaining capability; the nonpreferred set will be moded to halt pre-MECO to avoid erroneous outputs from those GPC's.

The major reason for requiring pre-MECO crew action is to avoid a catastrophic SSME shutdown. For the 2-1-1 case, two or three engines could have command path failures at MECO with possible loss of crew and vehicle.

THIS RULE CONTINUED ON NEXT PAGE

FLIGHT RULES

A7.1.3-2 REDUNDANT SET SPLIT (CONTINUED)

A manual shutdown of all three engines will not work because of LO₂ NPSP problems caused by a zero-g shutdown. Manual shutdown for the case of two command path failures could result in loss of vehicle control because all GPC's may not see all engines that are shut down. This is required to mode the guidance software to single-engine roll control. To preclude these problems, the simplex GPC's must be prevented from commanding engines. This can be done by taking the simplex GPC's to HALT if the crew can reach the MODE switches. This may cause one engine to have a command path failure, but this is less severe than two or three engines with a command path failure. If only one GPC is halted, then two engines could still have command path failures. After the GPC(s) are moded to HALT, there will be one engine remaining with a command path failure that will need to be shut down manually. At this point the shuttle cannot handle an additional engine-out failure. With an additional engine-out failure, guidance will not mode to single-engine roll control on the remaining GPC's. This is an accepted risk. If the simplex GPC's cannot be halted, then engaging the BFS is the only other method to ensure a safe MECO. (Ref. A/E FTP #74 Minutes of 1/18/91)

B. DURING ASCENT OR ENTRY, FOR LOSS OF CONTROL, ENGAGE BFS.

This rule calls for a BFS engage to regain vehicle control for the case where a redundant set split causes a loss of control situation.

C. ON ORBIT, A SELECTION MAY BE PERFORMED BY IDENTIFYING THE GPC WHICH IS COMMANDING TWO OF THREE IMU'S. THE OTHER GPC WILL BE POWERED OFF AND A RESTRING WILL BE PERFORMED TO RECOVER ALL STRINGS.

An initial selection of the GPC commanding two of three IMU's will provide IMU redundancy. The remaining GPC will be powered off to cease software execution and allow for a restring to be performed. If the GPC is not powered off and a restring is performed, dual commands will result.

RULE {A2.1.2-10}, BFS ENGAGE CRITERIA, references this rule.

FLIGHT RULES

A7.1.3-3 GPC FAILURE

- A. DURING ASCENT (MM 102 TO 104) OR ENTRY (MM 304, 305, 601 TO 603), MODE A FAILED GPC TO "HALT" ASAP. POST-MM 104 OR PRE-MM 304, POWER OFF A FAILED GPC ASAP.

A GPC which experiences a fail-to-sync can send erroneous commands to the orbiter subsystems. To prevent a failed GPC from sending erroneous commands, the GPC is moded from RUN to STANDBY then HALT when the power switch is not accessible, otherwise GPC power is removed to preserve data for analysis.

In general, reach and visibility constraints do not allow the crew to reach the GPC mode switches until post-MECO. The exception to the MECO cutoff point is the SSME command path recovery restrung done post-SRB SEP when the g-forces have decreased and the crew can reach the switches. The failed GPC will have to be moded to HALT prior to the restrung to avoid dual commands. This rule is referenced by Rule {A7.1.2-1C}, PASS DPS FAILURE.

- B. ON ORBIT, POWER OFF FAILED GPC, CONFIGURE DPS PER RULES {A7.1.3-5}, GPC MAJOR FUNCTION CONFIGURATION, AND {A7.1.3-8}, PASS DATA BUS ASSIGNMENT CRITERIA, AND ATTEMPT TO RECOVER FAILED GPC.

A GPC failure will create a loss of GPC redundancy. Depending on the flight requirements, different GPC configurations may be required. Until GPC recovery can be performed, the referenced rules can be used as a guideline for reconfiguring the DPS system following GPC failures.

A7.1.3-4 DATA PATH FAILURE

- A. DURING ASCENT OR ENTRY, DPS RECONFIGURATION MAY BE PERFORMED PER RULES {A2.1.2-14}, ASCENT STRING REASSIGNMENT; {A2.1.5-4}, ENTRY STRING REASSIGNMENT; {A7.1.3-8C}, PASS DATA BUS ASSIGNMENT CRITERIA; OR {A7.1.3-10}, PASS GPC BCE FAILURE MANAGEMENT, TO RECOVER DATA PATHS LOST DUE TO GPC FAILURES.

Data path loss due to GPC failures results in a bypass of an entire or half-string. Although the string is downmoded, the attached peripheral devices are healthy. Communication may be reestablished with the string by reassigning the bypassed string(s) to a good GPC.

For failure of a PASS GPC BCE transmitter and/or receiver, communications may be reestablished by reassigning the entire string to another GPC with a good BCE, or port moding will regain the bypassed MDM at the expense of the alternate MDM on the same string.

THIS RULE CONTINUED ON NEXT PAGE

FLIGHT RULES

A7.1.3-4 DATA PATH FAILURE (CONTINUED)

For string reassignment criteria, refer to Rules {A2.1.2-14}, ASCENT STRING REASSIGNMENT; {A2.1.5-4}, ENTRY STRING REASSIGNMENT; and {A7.1.3-8C}, PASS DATA BUS ASSIGNMENT CRITERIA. For PASS GPC BCE failure management, refer to Rule {A7.1.3-10}, PASS GPC BCE FAILURE MANAGEMENT.

- B. ON ORBIT, RECONFIGURE PER RULES {A7.1.3-5}, GPC MAJOR FUNCTION CONFIGURATION; {A7.1.3-8}, PASS DATA BUS ASSIGNMENT CRITERIA; AND {A7.1.3-12}, MDM PORT MODING.
 [ED]

Data path lost because of GPC failures implies communication with the affected string is lost temporarily, but the attached LRU's are healthy. Communications may be reestablished by reassigning the affected string to a good GPC. This rule identifies the legal reassignment phases.

- C. ON ORBIT, A BTU OR LRU MAY BE DEACTIVATED TO PRECLUDE RECURRING NUISANCE FAULT MESSAGES.

A recurring fault message may become a nuisance to the crew. If the cause of the annunciation can be isolated to a BTU or LRU, consideration will be given to deactivating the erring unit. This will eliminate the repeat generations of the fault message. Deactivation may take the form of MCDS entered item entries which reconfigure the subsystem, or the unit may be powered off.

A7.1.3-5 GPC MAJOR FUNCTION CONFIGURATION

GPC MAJOR FUNCTION CONFIGURATION WILL BE PERFORMED PER THE FOLLOWING GUIDELINES:

- A. ORBIT CONFIGURATION [082593-1538]
1. NOMINAL ON-ORBIT GPC DISTRIBUTION BY MAJOR FUNCTION WILL BE AS FOLLOWS:
 - GPC 1 - GNC 2
 - GPC 2 - GNC 2 (FREEZE-DRY, IF REQUIRED FOR POWER SAVINGS)
 - GPC 3 - GNC 2 FREEZE-DRY (GNC 3 FREEZE-DRY)
 - GPC 4 - SM 2

THIS RULE CONTINUED ON NEXT PAGE

FLIGHT RULES**A7.1.3-5 GPC MAJOR FUNCTION CONFIGURATION (CONTINUED)**

GPC 5 - BFS

Two GNC GPC's are required to satisfy Rule {A7.1.1-4}, GNC GPC REDUNDANCY REQUIREMENTS. One GPC is required to accomplish the systems management functions. The BFS is always loaded in a GPC to gain vehicle control, if lost, from the PASS GPC's. The last GPC is loaded with G3 software to protect against mass memory failures if no G3 archive is resident in a nonfailed GNC major function GPC, otherwise G2 software will be loaded into this GPC. @[082593-1538]

2. DURING RENDEZVOUS/PROX OPS, A REDUNDANT SET (RS) OF THREE GPC'S MAY BE UTILIZED. @[082593-1538]

Three GNC GPC's are preferred for rendezvous/prox ops to simplify recovery procedures if a GNC GPC fails during the period when rendezvous nav is enabled. Only two GPC's are actually required (ref. Rule {A7.1.1-4}, GNC GPC REDUNDANCY REQUIREMENTS). If a GNC GPC fails, a restring to the remaining two GPC's recovers all LRU redundancy, still meets rendezvous GPC requirements and does not affect rendezvous nav functions as long as the target set is not changed. Since all PASS GPC's have G3 software stored in high memory, there is not a concern with giving up the G3 FD GPC prior to rendezvous to form a three GPC set. @[082593-1538]

- B. A REDUNDANT GNC GPC MAY BE CONFIGURED TO PL9 FOR THE FOLLOWING:

Using a redundant set GPC would not give up existing capability, only redundancy.

1. A PASS DEU IPL

A DEU can only be IPL'ed from PL9, SM OPS 2/4, a post-IPL OPS 0 GPC, or the BFS. If available, an SM 2/4 DEU IPL is preferred over a PL9 DEU IPL in order to preserve GNC GPC redundancy. A PL9, SM OPS 2/4, or post-IPL OPS 0 GPC provides full PASS DEU IPL capability. PASS critical formats will not be available after loading a DEU from the BFS, so it is preferable not to perform a BFS DEU IPL on a DEU which is to be driven by the PASS when one of the other viable alternatives exists.

2. A MASS MEMORY DUMP/PATCH

SM will normally be used for an MMU dump or patch as long as the MMU load block is less than or equal to 2,048 halfwords. PL9 has capability to accommodate an MMU dump or patch involving large MMU load blocks up to 16,384 halfwords.

THIS RULE CONTINUED ON NEXT PAGE

FLIGHT RULES**A7.1.3-5 GPC MAJOR FUNCTION CONFIGURATION (CONTINUED)**

- C. A TRANSIENT GPC WILL BE MADE THE REDUNDANT GNC GPC ON ORBIT, EXCEPT FOR SAFETY-CRITICAL OPERATIONS. A TRANSIENT GPC MAY BE MADE THE FREEZE-DRY GNC 2 IF REQUIRED FOR POWER SAVING ON ORBIT. IF USED FOR ENTRY, A TRANSIENT GPC WILL BE ASSIGNED STRING 4.

A transient GPC may fail again and, therefore, will not be used for orbit periods of safety-critical operations such as proximity operations where continuous and complete vehicle control is required to preclude collisions. For other periods, running the transient GPC in a redundant set may provide more data relating to the original failure. The use of a transient GPC for entry will generally be avoided, but if conditions cause a transient to be used for entry, then it will be assigned string 4 because string 4 interfaces with fewer LRU's and loss of this string is less significant than loss of any other string during the entry timeframe.

- D. FOR TWO PASS GPC'S FAILED DURING ASCENT, ATTEMPTS TO RECOVER THE GPC'S WILL BEGIN FOLLOWING THE FIRST DPS TRANSITION. THE CONFIGURATION DURING THIS PERIOD WILL BE ONE GNC 2 GPC, ONE SM GPC, AND THE BFS (EXCEPT AS NOTED IN PARAGRAPH E).

Recovery will be attempted as soon as possible after the data processing system is configured for orbit. One GNC GPC, one SM GPC, and one BFS provides the best configuration to continue with a minimum duration mission and accomplish mission objectives (i.e., one GNC GPC for vehicle control, one SM GPC for system management, and the BFS for backup in case a PASS failure occurs).

The exception reference refers to those operations that require redundant GNC GPC's. Orbit operations which require redundant GNC GPC's should be delayed, if possible, until GPC recovery is complete. The SM GPC would be given up to provide a redundant GNC GPC and the BFS should be activated to provide systems monitoring if a redundant GNC GPC is required for crew safety or total loss of major mission objectives. The BFS should not be given up to allow the SM GPC to support payload operations.

- E. FOR A GENERAL PURPOSE COMPUTER (GPC) FAILURE ON ORBIT:
@[011295-1746]

1. A BFS WILL BE MAINTAINED AS LONG AS AT LEAST TWO GPC'S ARE OPERABLE.

The BFS can perform limited systems management and it is preferred over the PASS SM when only two GPC's are available because of its entry capability.

THIS RULE CONTINUED ON NEXT PAGE

FLIGHT RULES

A7.1.3-5 GPC MAJOR FUNCTION CONFIGURATION (CONTINUED)

2. RECONFIGURATION WILL BE BASED ON GPC AVAILABILITY PER THE FOLLOWING PRIORITIES:
 - a. IF A G2FD (FREEZE DRY) IS AVAILABLE, THIS GPC MAY BE RECONFIGURED AS A GNC, SM, OR BFS GPC.
 - b. IF A G3FD IS CONFIGURED (DUE TO A LOSS OF G3 ARCHIVE):
 - (1) THE G3FD GPC MAY BE RECONFIGURED AS A GNC, SM, OR BFS GPC IF BOTH MASS MEMORY UNITS (MMU'S) ARE OPERATIONAL.
 - (2) IF AN MMU IS FAILED, THE G3FD WILL NOT BE SACRIFICED.
 - c. IF THE ORIGINAL CONFIGURATION WAS MULTIPLE G2, RECONFIGURATION WILL BE PERFORMED AS NEEDED TO MAINTAIN DUAL G2 IF REQUIRED PER THE FLIGHT RULE ANNEX (I.E., SACRIFICE THE SM IF NECESSARY). IF NO REQUIREMENT EXISTS FOR DUAL G2'S, THEN A SINGLE GNC GPC WILL BE MAINTAINED.

For normal DPS orbit operations, there will be either one or two G2FD GPC's since nominally three sources of entry software will exist onboard (two MMU's and G3 archive present in all PASS GPC's). A G2FD will be given up for any GPC failure. If G3 archive is lost in all GNC major function base GPC's, a G3FD will be established. The G3FD will only be given up as long as both MMU's are operational.

If dual G2 is required and only 3 GPC's are available, the SM GPC will be sacrificed as opposed to the BFS because of the rationale provided in paragraph 1 above.

Reference: {A7.1.1-1C} and D, DPS REDUNDANCY REQUIREMENTS; {A7.1.3-3B}, GPC FAILURE; and {A7.1.3-19A}, GNC 3 ARCHIVE MANAGEMENT ©[011295-1746]

THIS RULE CONTINUED ON NEXT PAGE

FLIGHT RULES**A7.1.3-5 GPC MAJOR FUNCTION CONFIGURATION (CONTINUED)**

- F. IF BOTH MMU'S HAVE FAILED PRIOR TO SUCCESSFUL COMPLETION OF THE GNC OPS 3 TRANSITION, THE SM GPC WILL BE RETAINED UNTIL TIG-50 MINUTES.

The SM software is only available from an MMU. In this case, where both MMU's are failed, once the SM function is given up to build another G3 GPC, it is not possible to reestablish an SM GPC if deorbit is waived off and a return to orbit ops is desired. An SM machine offers advantages over a BFS for use in systems monitoring and provides for the use of the Ku-band system, which the BFS GPC cannot provide. TIG-50 minutes is chosen as a convenient point to finally give up the SM machine and configure to a full up G3 set of GPC's before stowing all the orbit FDF and going to the Entry Checklist at TIG-50 minutes.

- G. IF PASS GPC'S INCUR HARD IP BCE FAILURES, DPS RECONFIGURATION, IF POSSIBLE, WILL BE PERFORMED TO REGAIN A MAJOR FUNCTION'S DOWNLIST.

Each GPC has a single IP bus to transmit data to the PCMMU for downlist. The redundant set designates a single GPC as the prime downlist GPC. Therefore, if a downlisting GPC can be recovered by simply redesignating the downlist GPC via item number on SPEC 0, it will be done. If the GPC with the IP bus failure is the SM GPC, the downlist can be recovered by placing SM in one of the redundant GNC GPC's and putting GNC back into the GPC previously loaded with SM.

Rules {A7.1.3-3B}, GPC FAILURE; and {A7.1.3-4B}, DATA PATH FAILURE, reference this rule.

A7.1.3-6 GPC MEMORY WRITE CRITERIA (CIL)

THE USE OF GPC MEMORY WRITE PROCEDURES ARE SUBJECT TO THE FOLLOWING GUIDELINES:

- A. ONLY THOSE WRITE PROCEDURES WHICH HAVE COMPLETED SOFTWARE DEVELOPMENT LEVEL VERIFICATION, CREW PROCEDURAL VERIFICATION, AND HAVE BEEN DOCUMENTED IN A CONTROLLED MANNER WILL BE CONSIDERED FOR USE.

Changing GPC memory contents in an uncontrolled manner can lead to catastrophic results. Therefore, this rule is designed to prevent real-time write procedures from being used before they have been evaluated and tested.

- B. GPC MEMORY PROCEDURES WHICH MODIFY PERFORMANCE RELATED PARAMETERS WILL BE VERIFIED AND APPROVED IN REAL TIME PRIOR TO THEIR EXECUTION.

This rule documents an agreement that Systems Division made with the Orbiter Project Office.

FLIGHT RULES

THIS RULE CONTINUED ON NEXT PAGE

FLIGHT RULES**A7.1.3-6 GPC MEMORY WRITE CRITERIA (CIL) (CONTINUED)**

- C. ONLY PREFLIGHT APPROVED AND VERIFIED (PREAUTHORIZED) GMEM WRITE PROCEDURES NEEDED IN TIME-CRITICAL SITUATIONS WILL BE USED WITHOUT FURTHER VERIFICATION. WHEN TIME PERMITS, THEY WILL BE REVERIFIED BEFORE USE. IF REVERIFICATION IS NOT COMPLETE BEFORE THE LAST IMPLEMENTATION OPPORTUNITY FOR A PREAUTHORIZED GMEM WRITE PROCEDURE, IT WILL BE IMPLEMENTED. ALL GMEM WRITE PROCEDURES THAT ARE NOT PREAUTHORIZED MUST UNDERGO FULL VERIFICATION BEFORE USE.

Certain GMEM's were approved with the understanding that they might be executed in time-critical situations. These GMEM's have been extensively verified by testing prior to release and can be used without further verification when required. An informational SPAN/MER chit should be initiated following such use. Good practice and NSTS policy require any countdown or in-flight GMEM to be verified to the greatest possible extent in real-time before being implemented. Therefore, when time permits, a SPAN/MER chit should be initiated requesting reverification of any preauthorized GMEM before its use. Waiting for that reverification to be completed, however, is not grounds to delay implementing a preauthorized GMEM beyond when it is needed. For GMEM's that have not been preauthorized, a chit requesting verification must be submitted, and the verification must be completed before the GMEM is authorized for use. The specific conditions, including major mode restrictions governing their use, are contained in the PASS Release Authorization Documents (RAD's) and the BFS Engineering Orders (EO's) that authorize their use. The authorizing document of the preflight approved GMEM's is the Release Authorization for Shuttle Software (RASS).

- D. UPLINK COMMAND LOADS WILL BE USED WHERE PRACTICAL FOR INCORPORATION OF GPC MEMORY WRITE PROCEDURES. PARAGRAPH G LISTS APPROVED AND DOCUMENTED GENERAL MEMORY WRITE PROCEDURES. WRITE PROCEDURES WHICH WILL NOT BE PERFORMED BY UPLINK ARE SO NOTED.

Uplink command loads from the ground offer more flexibility and assurance of the accuracy of the GPC memory procedure. This procedure also allows a change of a larger set of GPC memory addresses as opposed to only six at a time via the GPC memory SPEC. Additionally, it allows real-time review by the MCC personnel before its use (more eyes to detect errors).

- E. GPC MEMORY WRITE PROCEDURES WILL BE IMPLEMENTED AS PATCHES TO GPC RESIDENT SOFTWARE ONLY, AND WILL NOT BE IMPLEMENTED AS PATCHES TO THE MMU'S.

The MMU's are loaded prelaunch with all three areas the same or with approved and verified changes. The intent here is to not pollute the MMU contents in real time because of lack of appropriate time to permit verification and testing.

THIS RULE CONTINUED ON NEXT PAGE

FLIGHT RULES

A7.1.3-6 GPC MEMORY WRITE CRITERIA (CIL) (CONTINUED)

F. FOLLOWING THE IMPLEMENTATION OF THE FIRST IN-FLIGHT GPC MEMORY WRITE PROCEDURE, ADDITIONAL PREFLIGHT APPROVED GMEM WRITES WILL NOT BE USED UNTIL REVERIFICATION BY THE APPROPRIATE SOFTWARE DEVELOPER IS PERFORMED, UNLESS AUTHORIZED FOR CONCURRENT USE.

Once a GPC write procedure has been implemented, it is necessary to ensure that subsequent use of GMEM's do not induce failures in the system. Unless authorized for concurrent use while maintaining approved configuration, reverification is required to confirm that the next GMEM considered for use can be used in conjunction with at most one other GMEM in the system without any impact to the system. The appropriate PASS or BFS software developer is responsible for reverifying all subsequent GPC write procedures prior to their use. For GMEM write procedure(s) which can be used concurrently, refer to the authorizing document.

G. GPC MEMORY WRITE CRITERIA: PREFLIGHT APPROVED AND VERIFIED GENERAL MEMORY WRITE PROCEDURES. EXCEPT AS NOTED, THESE GMEM'S WILL NORMALLY BE IMPLEMENTED VIA UPLINK:

<u>TITLE</u>	<u>APPROVED IMPLEMENTATION</u>
OMS MIXED CROSSFEED (PASS) (CR 89577B) *	UL AND KYBD [1]
* PLANNED FOR EXECUTION IN A CRITICAL PHASE	

@[111094-1731]

NOTE: THE GMEM WRITE UPLINK OPERATION CODES ARE NOT LEGAL IN PASS OPS 1 AND 3. THE DEU EQUIVALENT UPLINK IS THE ONLY OPTION. DUE TO THE RELATIVELY LONG UPLINK TIME OF A DEU EQUIVALENT AND THE POSSIBILITY OF DATA DROPOUTS, THE CREW KEYBOARD IMPLEMENTATION IS PREFERRED OVER THE DEU EQUIVALENT UPLINK OPTION IF THIS GMEM WRITE IS IMPLEMENTED DURING TIME-CRITICAL ASCENT OR DEORBIT OPERATIONS. THIS GMEM WRITE WILL BE IMPLEMENTED VIA UPLINK IF REQUIRED FOR A NONTIME-CRITICAL DEORBIT. @[111094-1731]

Reapplication of a previously applied GMEM write is permitted and is not considered a second GMEM write application.

The list of GPC memory read/write procedures contained in paragraph G are considered critical enough to the crew and/or orbiter safety that preflight approval and verification for their use is obtained prior to the flight. Reverification is required unless specific authorization provides for procedures used in conjunction with another GPC memory altering procedure.

Rule {A2.1.3-12}, DPS COMMAND CRITERIA, references this rule.

THIS RULE CONTINUED ON NEXT PAGE

FLIGHT RULES

A7.1.3-6 GPC MEMORY WRITE CRITERIA (CIL) (CONTINUED)

H. GPC MEMORY WRITE CRITERIA: PREFLIGHT APPROVED, UNVERIFIED
GENERAL MEMORY WRITE PROCEDURES:

<u>TITLE</u>	<u>IMPLEMENTATION</u>
NONE CURRENTLY DEFINED	N/A

Rule {A2.1.3-12}, DPS COMMAND CRITERIA, references this rule.

I. FOR PASS REDUNDANT SET GMEM'S APPLIED TO PERMANENTLY
RESIDENT SYSTEM SOFTWARE, GMEM'S WILL BE APPLIED TO A RE-
IPL'ED GPC BEFORE THE GPC IS ADDED TO THE REDUNDANT SET.

The PASS software is required to be functionally identical in each GPC of the redundant set. A re-IPL'ed GPC would not have GMEM's installed, so reapplying active GMEM's would be necessary for the redundant system software to be identical. This rule is limited to the system software because GMEM's in the ops application software would be loaded from the PASS prime GPC during the ops transition. ©[030994-1611]

FLIGHT RULES

A7.1.3-7 GPC MEMORY DUMP CRITERIA

GPC MEMORY DUMPS, ASSOCIATED PROCESSING, AND ANALYSIS WILL BE ACCOMPLISHED USING THE FOLLOWING GUIDELINES:

- A. IF THE BFS IS RECALLED FROM MASS MEMORY, THE ENTIRE INVARIANT MEMORY CONTENTS OF THE RELOADED GPC WILL BE VERIFIED, TIME PERMITTING.

If a PASS RS GPC is re-IPL'ed, the verification of a good IPL is essentially provided by its ability to run in a redundant set. Since the BFS is used alone, the dump and compare is the only complete verification process available to ensure the validity of the reload software.

- B. IN GENERAL, FOR FAILED GPC'S, A HARDWARE-INITIATED DUMP WILL BE PERFORMED, TIME PERMITTING, TO SUPPORT GROUND ANALYSIS. WHEN POSSIBLE, A SOFTWARE DUMP OF A LIKE MEMORY CONFIGURATION GPC WILL BE OBTAINED.

A hardware dump of a failed GPC (PASS or BFS) is taken because it does not require a good software load to obtain the dump. A software dump of a nonfailed, like-configuration GPC is done because a software dump can be done without affecting the ability of a GPC to continue its operation after the dump. The two dumps can then be compared to help find where the problem which caused the GPC failure occurred. Although during entry there will probably not be enough time to complete the dump analysis prior to landing, collecting the data at the time of the failure and prior to any GPC reconfiguration allows the greatest probability of being able to determine the cause of the GPC failure. Also, in the event of a day(s) waveoff, the dumps can be analyzed to determine possible impacts to the subsequent entry attempt. These impacts may include, but are not limited to, GPC reconfigurations and/or GPC memory read/writes. If the dumps are not performed and the problem can not be recreated during postflight analysis, the failure would be treated as an unexplained anomaly. With TDRS coverage for entry, downlist interruption by a GPC dump is no longer a concern as it once was with STDN only coverage. (Ref. Rule {A2.1.4-3E}, DEORBIT DELAY GUIDELINES.) ©[121593-1585A]

- C. INABILITY TO OBTAIN, PROCESS, OR COMPLETE GROUND ANALYSIS OF MEMORY DUMP DATA IS NOT CAUSE TO DELAY RECOVERY OF A FAILED GPC.

Recovery procedures should not be dependent upon the results of ground-based memory dump processing since ground-based processing can be delayed by numerous external factors.

©[121593-1585A]

FLIGHT RULES

A7.1.3-8

PASS DATA BUS ASSIGNMENT CRITERIA

PASS GPC DATA BUSES WILL BE ASSIGNED USING THE FOLLOWING GUIDELINES:

A. DISPLAY/KEYBOARD (DK) BUSES:

1. FOR RS OPERATION, THE CDR'S (PLT'S) DEUCRT AND DDU WILL NOT BE ASSIGNED TO THE SAME GPC. DISTRIBUTION OF THE DEU'SCRT'S AND DDU'S PREVENTS LOSS OF CDR'S (PLT'S) INSTRUMENTATION AND DEUCRT DISPLAYED DATA FOR A SINGLE GPC FAILURE (N/A FOR MEDS VEHICLES). @040899-2459B1

Three DEU'sCRT's and two DDU's are available during RS operation. The DEU'sCRT's are nominally assigned to different GPC's (ref. paragraph A.2). The DDU's are driven from a flight-critical bus as selected by the data bus switches on panels F6 and F8. By proper data bus selection, the CDR's (PLT's) DEUCRT and flight instruments can be driven by different GPC's providing protection against total data loss for a single GPC failure.

2. FOR RS OPERATION IN A MEDS ENVIRONMENT, ALL OF THE CDR'S (PLT'S) DISPLAYS WILL NOT BE DRIVEN BY THE SAME GPC.

The DPS displays are driven via the DK buses which are nominally assigned to different GPC's. The flight instrument displays are driven from flight critical buses selected by the edge keys. By proper data bus selection, the CDR's (PLT's) DPS displays and flight instrument displays can be driven by different GPC's and IDP's providing protection against total data loss for a single GPC or IDP failure.

- ~~3~~2. ALL DEU'SCRT'S IN A PASS COMMON SET WILL NOT BE ASSIGNED VIA MAJOR FUNCTION SWITCH OR GPC/CRT KEY TO ANY ONE GPC.

If all DEU'sCRT's were assigned to a single GPC, and this GPC failed, the crew would lose insight into healthy GPC's and would be unable to communicate with the GPC's. @040899-2459B1

B. MMU BUSES WILL BE ASSIGNED TO DIFFERENT GPC'S FOR RS OPERATION.

The MMU buses will be distributed via NBAT assignment to different redundant set GPC's to provide different commanding GPC's on each MMU bus. This provides redundant GPC-to-MMU data paths.

C. FLIGHT CRITICAL (FC) BUSES:

FLIGHT RULES

1. ALL STRINGS WILL BE USED BY THE RS REGARDLESS OF THE NUMBER OF GPC'S IN THE SET.

All strings will be used by the redundant set to maintain full flight-critical systems redundancy except for cases of non-universal I/O errors (ref. Rule {A7.1.3-18}, NONUNIVERSAL I/O ERROR ACTION).

THIS RULE CONTINUED ON NEXT PAGE

FLIGHT RULES**A7.1.3-8 PASS DATA BUS ASSIGNMENT CRITERIA (CONTINUED)**

2. ORBIT STRINGING @[082593-1538]

- a. NORMAL STRINGING FOR ORBIT OPERATIONS WHEN THERE ARE TWO GNC GPC'S WILL BE STRINGS 1 AND 3 ASSIGNED TO ONE GPC AND STRINGS 2 AND 4 ASSIGNED TO THE OTHER.

This stringing provides optimal redundancy; it will provide continuous uninterrupted vehicle control (assuming no other failures) even if one GNC GPC fails. This string combination will provide jet redundancy for translation and LO Z rotation.

- b. NORMAL STRINGING FOR ORBIT OPERATIONS WHEN THERE ARE THREE GNC GPC'S WILL BE STRING 1 TO ONE GPC, STRING 2 TO ANOTHER GPC, AND STRINGS 3 AND 4 TO THE THIRD GPC.

For a rendezvous/prox ops with three GPC's, pairing strings 3 and 4 together provides the best jet authority protection against a GPC failure. If a GPC fails, there is no jet authority requirement that forces an immediate restrig. There is no other LRU failure that will force a restrig. This is true whether norm-Z or low-Z is being used. This stringing also keeps the three IMU's separated. @[082593-1538]

3. FOR HARD OR TRANSIENT FLIGHT-CRITICAL (FC) BCE TRANSMITTER-ONLY FAILURES IN GPC'S, STRING REASSIGNMENT MAY BE UTILIZED TO REGAIN THE DATA PATH.

A GPC BCE transmitter-only failure results in a data path loss; reassigning the bypassed BTU's/LRU's to a GPC with a healthy transmitter will restore communications with the bypassed BTU's/LRU's. Because the GPC with the BCE transmitter-only failure will continue to operate in the redundant set and is capable of commanding a different string, it will be assigned a different string and full flight-critical systems redundancy is maintained.

4. DURING ASCENT, STRING REASSIGNMENT WILL BE PERFORMED PER RULE {A2.1.2-14}, ASCENT STRING REASSIGNMENT.

Reference Rule {A2.1.2-14}, ASCENT STRING REASSIGNMENT.

THIS RULE CONTINUED ON NEXT PAGE

FLIGHT RULES

A7.1.3-8 PASS DATA BUS ASSIGNMENT CRITERIA (CONTINUED)

5. FOLLOWING GPC FAILURES, THE CRITERIA FOR ASCENT STRING ASSIGNMENTS IN ORDER OF PRIORITY ARE (ASSUMES NO LRU FAILURES) :

To maintain a fail-safe operational configuration, a set of priorities was established for string assignments.

- a. STRINGS 1, 2, AND 3 WILL NOT BE ASSIGNED TO THE SAME GPC TO PROTECT IMU REDUNDANCY.

Self-explanatory.

- b. STRINGS 1 AND 3 WILL NOT BE ASSIGNED TO THE SAME GPC TO PROTECT NSP REDUNDANCY.

Assigning strings 1 and 3 together causes a potential for loss of command and communication with the crew if the commanding GPC failed.

6. FOR A PASS SET OF FOUR GPC'S, A TRANSIENT ~~GPC OR THE INSTALLED SPARE~~ GPC WILL BE ASSIGNED STRING 4 DURING ENTRY. ~~IF THE INSTALLED SPARE GPC AND A TRANSIENT GPC ARE BOTH TO BE USED FOR ENTRY, THE TRANSIENT GPC WILL BE ASSIGNED STRING 4, AND OTHER STRINGS WILL BE ASSIGNED AS CLOSE AS POSSIBLE TO NORMAL ENTRY STRINGING.~~ @101096-45161

A transient GPC may fail again during entry. Because string 4 has fewer LRU's, loss of string 4 is of less significance than loss of other strings. ~~Installation of a spare GPC into a particular slot may not necessarily solve the problem causing the original GPC to fail if the failure was slot-related rather than GPC IOP or CPU induced. Therefore, the GPC in the slot which experienced the failure will be assigned string 4 for entry in a set of four PASS GPC's. If a transient GPC and a changed out GPC exist, then the changed out GPC slot is thought to be more reliable than the transient GPC, and string 4 will be assigned to the transient. If there are fewer than four PASS GPC's available for entry, then the necessity for double stringing along with restring priorities may result in string 4 not being assigned to the transient GPC.~~ @101096-45161

7. ENTRY STRINGING WILL BE ESTABLISHED PRE-TIG AND WILL NOT BE CHANGED POST-TIG UNLESS REQUIRED BY SUBSEQUENT FAILURES AS SPECIFIED IN RULE {A2.1.5-4}, ENTRY STRING REASSIGNMENT.

An NBAT assignment is agreed on prior to MM 302 to maximize flight-critical redundancy for entry control. A string assignment criteria has been established for a redundant set with less than four PASS GPC's. Reference paragraph C.8 for additional details.

FLIGHT RULES

THIS RULE CONTINUED ON NEXT PAGE

FLIGHT RULES

A7.1.3-8 PASS DATA BUS ASSIGNMENT CRITERIA (CONTINUED)

8. FOR DEORBIT BURN AND ENTRY, IF LESS THAN FOUR PASS GPC'S ARE AVAILABLE, THE STRINGS WILL BE DISTRIBUTED TO MINIMIZE THE LOSS OF CRITICAL FUNCTIONS FOR A SUBSEQUENT GPC FAILURE. THE PRIORITIZED LIST OF FUNCTIONS TO BE PROTECTED BY SELECTING THE STRING ASSIGNMENTS IS SHOWN BELOW, STARTING WITH THE HIGHEST PRIORITY. STRING ASSIGNMENTS WILL BE BASED ON DISTRIBUTION CONSIDERATIONS FIRST (DISTRIBUTING STRINGS AS EVENLY AS POSSIBLE OR AVOIDING CERTAIN STRING COMBINATIONS). AFTER DISTRIBUTION CONCERNS ARE MET, FINAL STRING ASSIGNMENT SELECTION WILL BE BASED ON AVOIDING ASSIGNMENT TO ANY TRANSIENT GPC'S, IF POSSIBLE.
 - a. ONE IMU (TRANSIENT GPC CONCERN ONLY)
 - b. TWO ASA'S
 - c. TWO RGA'S
 - d. TWO AA'S
 - e. TWO IMU'S
 - f. TWO YAW JETS
 - g. PITCH JETS (ONE FAULT TOLERANT)
 - h. RHC CONTACTS (ONE FAULT TOLERANT)
 - i. THREE ASA'S
 - j. VENT DOORS @[071494-1638]
 - k. NWS (FOR RTLS/TAL/AOA (KSC) OR ANY SITE WITH KNOWN DIRECTION CONTROL PROBLEMS) [1]
 - l. THREE RGA'S
 - m. THREE AA'S
 - n. FOUR ASA'S (FCS CRITERIA) (REF. RULE {A8.1.3-8}, FCS CHANNEL MANAGEMENT) AVOID ASSIGNING STRINGS 1 AND 2, 1 AND 3, OR 2 AND 3 TOGETHER

FLIGHT RULES

THIS RULE CONTINUED ON NEXT PAGE

FLIGHT RULES

A7.1.3-8 PASS DATA BUS ASSIGNMENT CRITERIA (CONTINUED)

- o. THREE YAW JETS
- p. THREE ADTA'S (ONE FAULT TOLERANT)
- q. RHC CONTACTS (TWO FAULT TOLERANT)
- r. THREE IMU'S
- s. L RHC CONTACTS
- t. NWS FOR EOM LANDING
- u. L OMS IGNITION (ONE FAULT TOLERANT) (DEORBIT BURN CONSIDERATION ONLY)
- v. R OMS IGNITION (ONE FAULT TOLERANT) (DEORBIT BURN CONSIDERATION ONLY)
- w. OMS TVC (DEORBIT BURN CONSIDERATION ONLY)
- x. FOUR AFT FIRING PRIMARY RCS JETS (DEORBIT BURN CONSIDERATION ONLY)
- y. ONE OR TWO NSP'S

NOTE:

- [1] CURRENT CHANNELIZATION FOR NWS IS THE SAME AS FOR VENT DOOR FUNCTION, I.E., PROTECTING ONE COVERS BOTH.

Rationale TBS.

9. IF THERE ARE MULTIPLE STRINGING COMBINATIONS WHICH SATISFY THE ABOVE CRITERIA, THE COMBINATION CLOSEST TO NOMINAL WILL BE SELECTED.

It is preferred to stay close to nominal because it reduces the risk of inducing errors when the crew responds to subsequent failures.

Rules {A7.1.3-3B}, GPC FAILURE; {A7.1.3-4B}, DATA PATH FAILURE; {A7.1.3-10A} and B, PASS GPC BCE FAILURE MANAGEMENT; and {A8.1.2-5}, ET SEPARATION RCS REQUIREMENTS, reference this rule.

FLIGHT RULES

A7.1.3-9 I/O RESET

I/O RESET KEY MAY BE USED ANYTIME IN PASS AND BFS TO ATTEMPT RESTORATION OF NOMINAL I/O, EXCEPT FOR CASES OF NONUNIVERSAL I/O ERROR. (REF. RULE {A7.1.3-18}, NONUNIVERSAL I/O ERROR ACTION.)

An I/O reset provides resetting of hardware electronics which reinitiates I/O and may clear transient I/O functions. Reinitiating I/O if a nonuniversal I/O error condition has occurred could cause a FTS or set split. Reference Rule {A7.1.3-18}, NONUNIVERSAL I/O ERROR ACTION (ref. FRCB meeting #49 held on January 23, 1991).

A7.1.3-10 PASS GPC BCE FAILURE MANAGEMENT

PASS GNC 3 GPC'S THAT INCUR BCE FAILURES WILL BE CONFIGURED ACCORDING TO THE FOLLOWING GUIDELINES:

- A. PRE-DEORBIT BURN: FOR BCE FAILURES AFFECTING STRINGS 1, 2, OR 3, RESTRINGING WILL BE PERFORMED WITH STRINGS ASSIGNED PER RULE {A7.1.3-8}, PASS DATA BUS ASSIGNMENT CRITERIA. FOR STRING 4 FAILURES, PORT MODING WILL BE DONE TO RECOVER FA4.
- B. POST-DEORBIT BURN: PORT MODING WILL BE DONE FOR BCE FAILURES IN ORDER TO RECOVER THE CAPABILITY OF FF1, 2, OR 3, AND FA4. FA1, 2, OR 3 WILL BE GIVEN UP IN FAVOR OF FF1, 2, OR 3, AND FF4 WILL BE GIVEN UP IN FAVOR OF FA4.

GPC's incurring FC BCE failures will be reconfigured by port moding or restringing to obtain the most optimum flight-critical capabilities depending on flight phase. Pre-deorbit burn restringing will be done to regain the full capability of strings 1, 2, and 3. Restringing will not be performed for string 4 BCE failures due to its lack of sensor authority with respect to strings 1 to 3. String 4 will be port moded to recover FA4 to obtain FCS channel capability. Post-deorbit burn, port moding will be done to recover the capability of FF1, 2, or 3 and FA 4. Post-deorbit burn restringing will not be performed for FC BCE failures due to concerns for the hazards of dynamic restringing. Port moding recovers nearly the same capability as restringing, while avoiding a restring.

- C. FOR HARD OR TRANSIENT PASS GPC BCE RECEIVER FAILURES THE GNC OPS 3 SET WILL BE CONFIGURED USING THE FOLLOWING CRITERIA FOR SYSTEM RECONFIGURATION:
 - 1. FOR BCE RECEIVER FAILURES AFFECTING STRINGS 1, 2, OR 3 THE GPC WILL BE GIVEN UP IN FAVOR OF THE MDM WITH STRINGS ASSIGNED PER RULE {A7.1.3-8}, PASS DATA BUS ASSIGNMENT CRITERIA.

FLIGHT RULES

THIS RULE CONTINUED ON NEXT PAGE

FLIGHT RULES

A7.1.3-10 PASS GPC BCE FAILURE MANAGEMENT (CONTINUED)

2. FOR FC4 (FF4) RECEIVER FAILURES, MDM FF4 MAY BE POWERED OFF TO RETAIN GPC REDUNDANCY.
3. FOR FC8 (FA4) RECEIVER FAILURES, STRING 4 MAY BE MODED TO SECONDARY PORTS AND MDM FF4 MAY BE POWERED OFF TO RETAIN GPC REDUNDANCY.

GPC's that experience flight-critical BCE receiver failures will force fail to sync due to nonuniversal I/O errors that result from RS GPC's disagreeing on the occurrence of the error. In the deorbit preparation timeframe, IFM's are not routinely done (ref. Rule {A2.1.3-4}, IN-FLIGHT MAINTENANCE (IFM)), so reconfiguration can be done to optimize GPC or LRU redundancy for entry. A GPC with a receiver failure affecting strings 1, 2, or 3 will be given up in favor of recovering full LRU redundancy. For string 4 failures, FF4 may be given up in order to maintain GPC redundancy, since FF4 is the "least critical" FC MDM. @[101096-4516]

If the failure is FC4 (FF4), MDM FF4 may be powered off prior to adding the previously failed GPC back into the GNC 3 set. This causes all GPC's to see I/O errors against FF4, therefore FF4 is bypassed and the recovered GPC does not fail to sync.

If the failure is FC8 (FA4), port moding string 4 will cause the failed BCE (FC8) to attempt to communicate with FF4's secondary port. FF4 can then be powered off and the failed GPC can be recovered.

- D. WHEN A CHOICE EXISTS BETWEEN LOSS OF A PASS GPC AND A DEUCRT, THE DEUCRT WILL NOT BE USED WITH PASS GPC'S AND WILL BE ASSIGNED TO THE BFS FOR ENTRY. FOR MEDS CONFIGURED VEHICLES, AN IDP MAY STILL BE USED IN A NON-DPS MODE ONCE IT HAS BEEN DEASSIGNED FROM ALL PASS GPC'S. @[040899-2459B]

Each GPC in a redundant set listens to all data to and from the DEU's CRT's assigned to the RS. Should a single RS GPC have a receiver failure on a DKCRT data bus, that GPC will fail to sync with the rest of the redundant set. The GPC can be recovered by assigning the DEUCRT that caused the problem to the BFS because the RS will stop listening to the data from that DEUCRT. IDP's which are not assigned to a PASS computer may still be used with a PASS GPC in a non-DPS mode since only the DPS mode requires the DK data bus interface. @[040899-2459B]

Rules {A2.1.1-5}, PORT MODING/RESTRINGING GUIDELINES; {A7.1.2-3}, UNRECOVERABLE GPC; and {A7.1.3-4}, DATA PATH FAILURE, reference this rule.

FLIGHT RULES

A7.1.3-11 POWER CYCLING/MANAGEMENT

A. FAILURES

GPC'S, MMU'S, DEU/DU'S CRT'S, AND MDM'S WILL BE POWERED OFF IF THEY INCUR HARD FAILURES. MDM'S WILL BE CYCLED "OFF" THEN "ON" TO RESET OUTPUTS FOLLOWING A DATA PATH FAILURE. MDM'S MAY BE CYCLED "OFF" THEN "ON" FOR GPC FAILURES. @J040899-2459B1

LRU's experiencing hard failures may be powered off to save power if they are nonfunctional.

B. POWER MANAGEMENT

MMU'S, DEU/DU'S CRT'S, AND MDM'S MAY BE POWERED OFF FOR POWER MANAGEMENT. GPC'S (101S) WILL NOT NORMALLY BE POWERED OFF FOR POWER MANAGEMENT. @J040899-2459B1

LRU's, except for the new GPC's (101S), may be powered off for power management. Mission extensions or unique flights such as Spacelab may require minimization of power consumption. The 101S GPC's power consumption in the sleep mode is 56 watts, less than one tenth of its operating power consumption. Since removing power from the 101S GPC causes loss of memory integrity, a 101S GPC will only be powered off under extreme powerdown conditions.

FLIGHT RULES

A7.1.3-12 MDM PORT MODING

MDM PORT MODING WILL BE PERFORMED ACCORDING TO THE FOLLOWING GUIDELINES:

- A. MM 102 - PORT MODING OF FLIGHT-CRITICAL OR PAYLOAD MDM'S WILL NOT BE ATTEMPTED UNLESS IT IS NECESSARY TO REGAIN CRITICAL SYSTEM CAPABILITY.

For port dependent MDM failures, port moding may be attempted to regain the required MDM redundancy by giving up port redundancy in the bypassed MDM. During MM 102, system reconfiguration is not routinely done due to the dynamic nature of this flight phase. For multiple failures that impact critical systems capability, port moding may be done.

- B. POST-MM 102 TO PRE-MECO - PORT MODING OF FLIGHT-CRITICAL AND PAYLOAD MDM'S MAY BE PERFORMED TO REGAIN CRITICAL SYSTEM CAPABILITY OR AFTER ANY SECOND FAILURE. NONCRITICAL RECOVERY WILL NOT BE ATTEMPTED FOR CASES OF NONUNIVERSAL I/O ERROR (REF. RULE {A7.1.3-18}, NONUNIVERSAL I/O ERROR ACTION).

For noncritical recovery, port moding is not performed until another failure has occurred. The other failure is any other failure and does not have to be avionics related, but a failure that sufficiently adds complexity to the overall vehicle system to warrant taking action.

- C. POST-MECO, FOR FLIGHT-CRITICAL OR PAYLOAD MDM FAILURES, RECOVERY ATTEMPTS BY PORT MODING MAY BE PERFORMED IN ANY MAJOR MODE OF ANY VALID OPS VIA DISPLAY ITEM ENTRIES ON THE DPS UTILITY DISPLAY EXCEPT FOR CASES OF NONUNIVERSAL I/O ERROR (REF. RULE {A7.1.3-18}, NONUNIVERSAL I/O ERROR ACTION).

FC or PL MDM's communicate on one of two redundant ports that are selectable via software. If an MDM is bypassed due to a port failure, communication on the redundant port may be attempted via an item entry to the available user SPEC to attempt recovery of the MDM.

- D. WHEN A CHOICE EXISTS BETWEEN THE LOSS OF AN FF OR FA MDM AND NO OTHER CRITICAL SYSTEM FAILURES EXIST, FA1, 2, OR 3 WILL BE GIVEN UP IN FAVOR OF FF1, 2, OR 3. FF4 WILL BE GIVEN UP IN FAVOR OF FA4.

FLIGHT RULES

For certain multiple MDM failure scenarios (i.e., FFX primary port failure and FAX secondary port failure) only one FC MDM per string can be selected at any given time. Using the port mode capability, system optimization can be achieved with respect to protecting for the next failure. FF1, 2, and 3 are selected for IMU capability. FA4 is desired for insight into OMS system/FCS channel capability, since giving up FF4 costs a minimum of capability. FA3 is given up even though it provides insight into the left OMS. It is believed that losing an IMU is more probable and critical than the loss of insight into an OMS system.

Rule {A2.1.1-5}, PORT MODING/RESTRINGING GUIDELINES, references this rule.

FLIGHT RULES

A7.1.3-13 MMU OPERATIONS

MMU OPERATIONS WILL BE ACCOMPLISHED USING THE FOLLOWING GUIDELINES:

- A. CREW TEXTS, WHEN UPLINKED, WILL BE MAINTAINED ON BOTH MMU'S.
- B. SM CHECKPOINTS WILL BE MAINTAINED ON BOTH MMU'S.
- C. IF ONE MMU HAS FAILED, OPERATIONS ON THE REMAINING MMU WILL PRECLUDE ROUTINE SM CHECKPOINTS. IN ADDITION, USE OF SM ROLL-IN DISPLAYS, CREW TEXT UPLINK AND TFL/DFL OPTIONS WILL BE MINIMIZED.

Both MMU's are initially loaded with exactly the same data, and procedurally this redundancy is maintained throughout the flight. Therefore, if one MMU fails or is inaccessible, the remaining MMU will still have a complete copy of all data. However, in the event one MMU has failed or is inaccessible, transactions on the remaining MMU are to be strictly limited to help protect against the subsequent loss of the remaining MMU. This means that SM checkpoints will not be performed for the remainder of the flight and other MMU transactions such as retrieval of SM Roll-in SPEC's and TFL/DFL loads will be minimized. (Crew text uplinks are rarely used anymore since the implementation of the teleprinter and TAGS.)

FLIGHT RULES

A7.1.3-14 TIME MANAGEMENT

ONBOARD TIME MANAGEMENT WILL BE ACCOMPLISHED USING THE FOLLOWING GUIDELINES:

- A. MTU/GPC GMT ERROR WILL BE MAINTAINED AT OR BELOW 100 MS WHEN SPEC 2 "TIME" IS AVAILABLE. A 15-MS UPDATE WILL BE PERFORMED ANYTIME THE ERROR EXCEEDS THAT THRESHOLD.

The MTU provides a stable frequency output which, over the course of a 7-day mission, should never be in error more than 100 milliseconds. However, due to an MTU failure, GMT may be in error. A greater variance in GMT may impact navigation, thus the GMT will be maintained within ± 100 milliseconds of true GMT. Since the onboard computers are processing in a redundant and/or common set, a software limitation of a maximum of 15 milliseconds per update precludes a GPC failure caused by a time change. A time update can only be performed using the SPEC 2 "time" display. SPEC 2 is not available in the BFS or during PASS GNC OPS 1/6/3.

- B. THE ONBOARD TIME MANAGEMENT SYSTEM (MTU/GPC) WILL NOT BE UPDATED IN-FLIGHT TO INCORPORATE ADJUSTMENTS TO THE WORLD WIDE TIME BASE REFLECTED BY WWV.

Because of variations in the Earth's orbit, leap seconds are incorporated into true GMT. Leap seconds are added or subtracted from GMT and are reflected in WWV GMT. Since the vehicle is not connected to WWV GMT, the crew would have to make multiple 15-millisecond updates to correct onboard time. (Note: It takes 1 to 2 minutes for one update.) Therefore, orbiter GMT will not be updated for leap seconds.

- C. FOR YEAR END ROLLOVER OF MTU GMT, THE MTU WILL BE REINITIALIZED WITH GPC GMT.

The onboard GPC's do not roll over (reset to GMT day 1) at year end; the MTU does. For the GPC's to accept the MTU time, they must be taken to STBY and reinitialized. This results in a period of no vehicle control, no navigation updates, and no payload support. Since this is unacceptable, the MTU is forced to accept GPC time. When this is done, the orbiter no longer reflects true GMT as reflected by WWV.

- D. A MANUAL MTU OSCILLATOR SWITCH WILL BE PERFORMED POST-MECO UP UNTIL HAC INTERCEPT FOR EITHER OF THE FOLLOWING CONDITIONS:

1. THE MTU BITE BIT 4 (OSCILLATOR 1/2 FREQ DIFFERENCE) IS SET AND THE MCC OBSERVES STEADILY INCREASING MTU DELTA TIMES.

THIS RULE CONTINUED ON NEXT PAGE

FLIGHT RULES

A7.1.3-14 TIME MANAGEMENT (CONTINUED)

2. IF THE BFS LOSES TRACK WITHIN 1 MINUTE OF THE MTU BITE BIT 4 BEING SET AND BFS I/O RESETS ARE UNSUCCESSFUL IN RECOVERING THE BFS.

If the MTU BITE bit 4 is set, this indicates a frequency difference between the two oscillators; this bit does not tell which oscillator is malfunctioning and is, therefore, not used by the auto switch logic. Therefore, the MCC must use the MTU 1 and MTU 2 delta times (the difference between the onboard MTU referenced GMT and the ground GMT) and/or the state of the BFS to determine if a manual oscillator switch needs to be made.

The BFS will lose track if the HFE listen command is late by more than 180 microseconds for 24 consecutive minor cycles. Because of perturbations in the HFE listen cycle, the engineering community feels the BFS may not lose track immediately. However, best engineering judgment dictates that the BFS will lose track within 1 minute. Therefore, if the BFS loses track of the PASS when the MTU BITE bit 4 is set, it is a good indication that the selected oscillator is drifting and is the cause of the BITE indication.

In the event of launch with the BITE bit indicator already set (either because of a false BITE indication due to a BITE circuitry failure or because of a failed oscillator), consideration should be given to performing a manual oscillator switch after BFS loses track before declaring the BFS failed and performing a BFS IPL.

If a manual oscillator switch is made to the bad oscillator, the worst outcome would be that the PASS would fault down to internal time (which testing has verified causes no serious degradation of performance). If this happened, the PASS could not be switched back to MTU time until SPEC 2 is available.

In general, reach and visibility constraints do not allow the crew to reach the MTU oscillator select switch until post-MECO. There is a time shortly after SRB SEP, however, when the G-forces have decreased enough for the crew to reach the switch. Therefore, a manual MTU oscillator switch post-SRB SEP could be attempted and will be a real-time call. Ref. Ascent/Entry Flight Techniques Panel #69 (7/20/90) minutes, and the 5/15/90 and 6/21/90 SARS minutes.

FLIGHT RULES

A7.1.3-15 IN-FLIGHT MAINTENANCE (IFM)

IN-FLIGHT REPLACEMENT OF LRU'S WILL BE PERFORMED FOR THE FOLLOWING EQUIPMENT FAILURE DEFINITIONS:

In-flight replacement (IFM) will be done to regain LRU redundancy and/or lost capabilities.

- A. IF A KEYBOARD FAILURE CAN BE ISOLATED TO A SPECIFIC KEY, THE KEY WILL BE REPLACED WITH THE AFT KEYBOARD "ACK" KEY; OTHERWISE, A FAILED FORWARD KEYBOARD WILL BE REPLACED BY THE AFT KEYBOARD.

Keyboard failures can occur on specific keys or the entire keyboard. IFM on such failures associated with the forward keyboard will be to replace it with the aft keyboard, since it is not used during entry.

- B. ANY FORWARD CRT MAY BE REPLACED BY CRT 4 IF THE SCREEN BLANKS OR IS UNREADABLE AND THE GROUND VERIFIES THE CRT IS THE FAILED ELEMENT VIA DISPLAY UNIT BITE (N/A FOR MEDS VEHICLES). ©[021397-4763] ©[040899-2459B]

CRT 4 has been selected as a replacement CRT for any forward CRT because it is not used during entry.

- C. ANY FAILED MDU MAY BE REPLACED BY ANOTHER MDU. AT LEAST ONE CDR MDU AND ONE PLT MDU MUST BE MAINTAINED FOR ENTRY.

An IFM to replace any forward MDU with an aft MDU allows for full redundancy for entry. AFD1 MDU is the preferred IFM unit since CRT4 MDU is used for entry. Because of the large number of MDU's (11) and the simple and low risk MDU IFM (45 minutes), an IFM to replace a failed aft MDU with a forward MDU could aid the crew in critical aft station operations (RNDZ, dock/undock) without losing any capability in the forward cockpit. In addition, the MDU can be reinstalled in the forward cockpit after the critical aft operations are complete. Maintaining at least one CDR and one PLT MDU allows for optimal viewing of the flight instrument displays for landing. ©[040899-2459B]

- ~~D.C.~~ DEU 1, 2, 3 MAY BE REPLACED WITH DEU 4 IF THE DEU FAILS TO FUNCTION FOLLOWING AN IPL AND THE GROUND VERIFIES THE DEU IS THE FAILED ELEMENT VIA DEU BITE (N/A FOR MEDS VEHICLES). ©[040899-2459B]

DEU's 1, 2, 3 will be replaced with DEU 4 because DEU 4 is not used during entry.

- E. IDP 1, 2, 3 MAY BE REPLACED WITH IDP 4 IF THE IDP FAILS TO FUNCTION.

FLIGHT RULES

IDP's 1, 2, 3 will be replaced with IDP 4 because sacrificing IDP4 to regain IDP1, 2, or 3 regains full capability for the forward flight stations. If an IDP only loses interface to the flight critical buses, an IFM is not required due to IDP redundancy. ©[040899-2459B]

THIS RULE CONTINUED ON NEXT PAGE

FLIGHT RULES

A7.1.3-15 IN-FLIGHT MAINTENANCE (IFM) (CONTINUED)

FD. A PL MDM WILL BE SWAPPED WITH THE OTHER PL MDM ONLY AFTER POWER CYCLING AND PORT MODING FAILS TO CLEAR A NON-GPC CAUSED "I/O ERROR PL" AND THERE HAS BEEN A FAILURE OF ANY PLBD MCA (EXCEPT MCA 2) CONTROLLED BY THE GOOD MDM. [@\[040899-2459B\]](#)

Payload MDM will be swapped to allow payload bay door closure. MCA 2 is an exception because swapping PL MDM will not recover all the necessary functions, and pin kit IFM procedures would still be required to close and latch the doors. For this case, Rule {A2.1.3-4C.16}, IN-FLIGHT MAINTENANCE (IFM), will be implemented.

FG. AN FF MDM 1, 2, OR 3 MAY BE REPLACED BY FF4 ONLY AFTER POWER CYCLING AND PORT MODING FAILS TO CLEAR A NON-GPC CAUSED "I/O ERROR FFX" OR TOTAL OUTPUT CARD FAILURE AND IT RESULTS IN THE LOSS OF:

1. A SECOND IMU
2. A SECOND AA (AA4 MUST BE FAILED)

Where previous LRU failures would cause a loss of at least fail-safe redundancy in an entry-critical system, it is considered viable to replace FF1, 2, or 3 with FF4. This operation would be accomplished to recover an IMU for redundancy in onboard navigation for entry. The same is true for an AA to regain redundancy for entry control.

GH. AN MMU CONTINGENCY POWERUP MAY BE PERFORMED TO RECOVER AN MMU THAT IS DOWN DUE TO POWER LOSS. [@\[101096-4516\]](#)

The IFM may be performed at a convenient time when it will not interfere with higher priority mission operations or crew activities. If the remaining MMU fails, this IFM will be performed ASAP. A successful IFM will return power to the MMU which in turn can be used for GNC/SM transitions, and GPC/DEU reload capabilities.

Rule {A7.1.3-5E.1.a}, GPC MAJOR FUNCTION CONFIGURATION, references this rule. [@\[040899-2459B\]](#)

FLIGHT RULES

A7.1.3-16 POWERED OFF GPC ACTION (101S)

A GPC (101S) THAT HAS HAD POWER REMOVED SHOULD BE RE-IPL'D BEFORE USE, TIME PERMITTING.

The GPC (101S) battery maintains memory during GPC poweroff but does not support memory error correction. This allows memory errors to accumulate. If this results in a double-bit error, the GPC will fail when the location is accessed. Re-IPL'ing the GPC will remove all soft errors and reestablish memory integrity.

Re-IPL'ing a GPC may not, however, be the best action in all cases because the GPC can require multiple uplinks before it can be used. Therefore, for time-critical cases where the IPL/uplink recovery sequence takes too much time, it may be desirable to accept the risk of a double-bit error. This risk is not constant and is directly related to the amount of time the GPC is powered off. As that time is reduced, the risk decreases.

A7.1.3-17 SM OPS 4 TRANSITION REQUIREMENTS

FOR FLIGHTS WHERE SM OPS 4 IS NOT SUPPORTED IN THE FLIGHT SOFTWARE TESTING CYCLE, A TRANSITION TO SM OPS 4 WILL NOT BE PERFORMED.

In order to reduce FEID and testing times for flight software loads, missions that require SM OPS 2 only will not have a requirement for SM OPS 4 S/W testing and verification. Therefore, for flights where SM OPS 4 S/W has not been tested, an SM OPS 4 transition will not be performed. Beginning with OI-20, a transition to SM OPS 4 will be prohibited by the flight S/W (by generating an ILLEGAL ENTRY message on the scratch pad line (SPL)) when SM OPS 4 S/W testing is not supported or required for the flight.

FLIGHT RULES

A7.1.3-18

NONUNIVERSAL I/O ERROR ACTION

RESTRINGING OR I/O RESETS WILL NOT BE PERFORMED FOR RECOVERY OF A BCE ELEMENT BYPASS NOR WILL AN OPS TRANSITION BE PERFORMED IF A NON-UNIVERSAL I/O ERROR CONDITION HAS OCCURRED ON ANY BUS UNLESS CRITICAL CAPABILITY RECOVERY IS BEING ATTEMPTED, OR UNTIL THE STRING ASSOCIATED WITH THE NON-UNIVERSAL CONDITION HAS BEEN SAFED. PORT MODING WILL NOT BE ATTEMPTED ON A STRING WITH A NON-UNIVERSAL I/O ERROR UNLESS THE BUS WITH THE ERROR HAS BEEN SAFED OR CRITICAL RECOVERY IS BEING ATTEMPTED. ~~DEASSIGNED FROM THE TARGET NBAT.~~ @121296-4564A]

When an element bypass occurs, if the I/O error condition is not logged equally in the I/O error logs by each GPC in the RS, then a nonuniversal I/O error has occurred. This could be caused by a GPC problem, an unterminated data bus, or a loquacious BTU. If only a single GPC in an RS logs an error associated with this condition, then that GPC will fail-to-sync. If more than one GPC, but not all GPC's log an error, then the condition is more properly called a nonuniversally detected error condition (as defined by the software developers). Upmoding of a bypassed element under conditions of nonuniversal I/O error by the use of port moding, restringing or I/O resets, can result in an FTS or in a redundant set split. Therefore, these actions should be avoided (user note 101757) until the string associated with the nonuniversal I/O error has been ~~safed~~ deassigned, unless critical capability recovery is being attempted. @121296-4564A]

Safing of a string associated with a non-universal I/O error condition is guaranteed by deassigning the string from the NBAT and performing an OPS mode recall or OPS transition. Also, a string may be safed by ensuring that all LRU's (except GPC's) capable of transmitting on the affected bus are powered off. If this can be done, then the nonuniversal I/O error condition becomes a universally detected error since there is no longer any LRU remaining which can respond to a request from the GPC for data. For the entry phase of flight, the only active LRU's on the flight critical buses are the FF and FA MDM's. The MEC's and EIU's are also connected to flight critical buses, but these LRU's are powered off during entry. If the MDM associated with the bus having the nonuniversal I/O error condition is powered off, the error is made universal, and the bus has been safed. During ascent, the MEC's and EIU's are powered on. Since the MEC's and EIU's cannot be powered off during OPS 1 or 6, the only viable method of safing flight critical buses ~~5-8~~ five through eight is to deassign the affected string. Flight critical buses ~~1-4~~ one through four (used by FF MDM's while on primary ports) only have the FF MDM's (or FA MDM if port moded to secondary ports) which can transmit on the bus. Therefore, for ascent, only buses ~~1-4~~ one through four could be safed by powering off the associated MDM. @121296-4564A]

THIS RULE CONTINUED ON NEXT PAGE

FLIGHT RULES

THIS PAGE INTENTIONALLY BLANK

FLIGHT RULES

A7.1.3-18 NONUNIVERSAL I/O ERROR ACTION (CONTINUED)

If fault messages indicate that not all GPC's are annunciating the error, then a nonuniversal I/O error has occurred and the crew will be aware of the condition. If the fault messages indicate universal annunciation of the error, there still may be a nonuniversal error condition, but the crew will not be able to detect it since the I/O error logs are the only absolute indicator of the condition.

Given no evidence of nonuniversal I/O errors or no advice from flight controllers, the crew will follow normal procedures which use I/O reset, port moding, and in some cases, restring, as part of the recovery attempts for bypasses.

Because the port moding operation only upmodes the string being port moded, a port mode can be done to recover a bypassed element under nonuniversal I/O error conditions if the nonuniversal error is associated with a different string than the one being port moded.

If recovery of critical capability is needed, then I/O reset, port mode and restringing may be attempted even if nonuniversal error conditions exist in an attempt to recover the bypassed element with the knowledge that a FTS or set split may occur.

For cases where a nonuniversal I/O error condition exists prior to execution of an OPS transition, the string with the nonuniversal I/O error condition should not be assigned in the NBAT for the OPS being entered unless the string has been safed. [@121296-4564A1](#)

Rules {A7.1.3-8C}.1, PASS DATA BUS ASSIGNMENT CRITERIA; {A7.1.3-9}, I/O RESET; and {A7.1.3-12}, MDM PORT MODING, reference this rule.

FLIGHT RULES

A7.1.3-19 GNC 3 ARCHIVE MANAGEMENT

- A. A GNC 3 FREEZE-DRIED GPC WILL NOT BE ESTABLISHED IF A COPY OF GNC 3 ARCHIVED SOFTWARE IS RESIDENT IN A NONFAILED GNC MAJOR FUNCTION GPC. IF NO GNC MAJOR FUNCTION GPC'S HAVE A COPY OF GNC 3 ARCHIVE RESIDENT IN UPPER MEMORY, A GNC 3 FREEZE-DRIED GPC WILL BE ESTABLISHED AS SOON AS PRACTICAL.

As long as a GNC major function GPC that has not failed or been re-IPL'ed on orbit has a copy of G3 archive software, it will be considered a redundant source of G3 software. If no such GPC exists, a G3FD GPC will be loaded to provide an additional onboard G3 software source.

Reference Rule {A7.1.3-5E}, GPC MAJOR FUNCTION CONFIGURATION. @[011295-1746]

- B. A GPC CONTAINING ARCHIVED GNC 3 SOFTWARE, WHICH EXPERIENCES AN UPPER MEMORY SOFT ERROR COUNT OF 7F, OR A CONSTANTLY INCREMENTING COUNT WILL NOT BE USED AS A SOURCE OF ENTRY SOFTWARE FOR NON-TAL OPS 3 TRANSITIONS. FOR TAL TRANSITIONS, THE GPC WILL BE USED.

A soft error counter increment is indicative of a single location memory error that was successfully corrected by the memory scrub circuitry. Random single-memory hits are expected to occur at a rate of several per day or in single bursts of several errors. A constant incrementing of the error count is indicative of a hard-memory failure.

All targeted G3 GPC's with G3 archive resident in upper memory will transfer the OPS 3 overlay to lower memory at initiation of OPS 3 when archive retrieve is enabled. Any targeted GPC's without G3 archive resident in upper memory will then receive the overlay from the lowest ID GPC that has the overlay in lower memory. If the archive retrieve is disabled, then the OPS 3 transition will utilize the mass memory units (MMU's) as the source for the G3 software. If one memory location in upper memory has two hard errors and the location is used to store the G3 software, then the GPC will fail-to-halt at the transition. If the location is not used to store G3 software, then the GPC will continue to operate without failing. If there exists only a single error in any upper memory location, then the error correction code will correct the data before it is moved into lower memory and the subsequent execution of G3 from lower memory is not impacted.

For non-TAL G3 transitions, there is no time criticality, and therefore certain actions can be taken to eliminate the chance of having a GPC fail because of upper memory errors. The easiest action for the crew is to simply disable the archive retrieve by entering a single item entry before execution of the OPS transition. The rest of their procedures can then be run without changes.

THIS RULE CONTINUED ON NEXT PAGE

FLIGHT RULES

A7.1.3-19 GNC 3 ARCHIVE MANAGEMENT (CONTINUED)

Due to the highly dynamic and time critical nature of TAL transitions, time delays in entering OPS 3 are critical. Therefore, disabling the archive retrieve and going to the MMU's introduces delays that should be avoided. The chance of having two errors in a single memory location is considered to be very slight, and therefore accepting the possibility of a single GPC fail versus delaying the entry into OPS 3 by using the MMU's is reasonable.

Errors in the upper page of memory are not reflective of problems with the lower page of memory. Rule {A7.1.1-3}, GNC GPC REACTIVATION PRIORITY, references this rule.

A7.1.3-20 SPACELAB ON-ORBIT GNC CONFIGURATION

THE NOMINAL ON-ORBIT GNC GPC CONFIGURATION WILL BE SIMPLEX.
(FLIGHT-SPECIFIC EXCEPTIONS ARE LISTED IN THE ANNEX.)

To sustain mission duration at payload power levels, a powerdown was deemed necessary. After systems review, it was decided to power down one of the redundant set (RS) GNC GPC's.

Ⓢ[ED]

A7.1.3-21 CONSTRAINTS ON PORT MODING OR I/O RESETS

THERE ARE NO SPACELAB/SPACEHAB-RELATED CONSTRAINTS ON PAYLOAD MDM PORT MODING OR SM I/O RESETS.

Both port moding and I/O resets are transparent to Spacelab/Spacehab. Ⓢ[ED]

FLIGHT RULES

A7.1.3-22 DEU EQUIVALENT CRITERIA

(REFERENCE RULE {A2.1.3-12}, DPS COMMAND CRITERIA.) @[072595-1775A]

- A. ALL DEU EQUIVALENT LOADS SHOULD BE COORDINATED WITH THE CREW. DEU EQUIVALENT LOADS DURING CREW SLEEP MUST BE COORDINATED WITH THE CREW PRIOR TO THE START OF THE SLEEP SHIFT UNLESS THE LOADS ARE REQUIRED TO AVOID POTENTIAL NUISANCE ALARMS.

In order for the crew to maintain situational awareness of all orbiter activities, they need to be informed of all planned DEU equivalent loads. As long as the crew has been informed of a general plan prior to going to sleep, it is acceptable to alter the specifics of the plan without notifying the crew of the changes. If the need arises for a DEU equivalent load after the crew has gone to sleep, it will not be uplinked unless it is required to prevent waking up the crew.

- B. OPS TRANSITIONS, MAJOR MODE TRANSITIONS, AND OPS MODE RECALLS WILL NOT BE PERFORMED VIA DEU EQUIVALENT LOADS. THE ONLY EXCEPTION TO THIS IS THE G1 TO G9 OPS TRANSITION REQUIRED BY THE MPS SAFING PROCEDURE DURING PAD ABORTS/HOLDS.

Although OPS transitions, major mode transitions, and OPS mode recalls can be performed via a DEU equivalent load, a program level decision was made to avoid such commands based on the high level of risk associated with them. Due to the complexity of performing these types of software operations, there exists the possibility of annunciating fault messages or, worse case, not successfully completing the transition. For pad aborts/holds within T-31 seconds, the MPS safing procedure allows the MCC to control the MPS propellant valves in the event KSC and the crew are both unable to perform the transition. The MPS safing procedure utilizes uplink single stage MDM commands. In G1, cyclic outputs would overwrite these commands within 40 ms. Therefore, the procedure must be accomplished in G9 where there are no cyclic outputs. The potential catastrophic damage to the vehicle and launch facility if the G1 to G9 OPS transition is not performed in a timely fashion far outweighs any inherent risk associated with using a DEU equivalent load for the transition. @[072795-1775A]

- C. DEU EQUIVALENT LOADS WILL NOT BE CHAINED. @[072595-1775A]

DEU equivalent loads will not be chained because the successful execution of one load cannot be verified before subsequent commands are executed. Although not necessarily recommended, it is acceptable to link multiple item entries on a specific page together via separator keys as long as a separate command is required to invoke the loaded data (i.e., arm and fire).

THIS RULE CONTINUED ON NEXT PAGE

FLIGHT RULES

A7.1.3-22 DEU EQUIVALENT CRITERIA (CONTINUED)

- D. IF A SPEC OTHER THAN THE OPS DISPLAY IS REQUIRED FOR DEU EQUIVALENT LOADS, IT WILL NOT BE CALLED UP UNTIL REQUIRED. THE SPEC WILL THEN BE RESUMED AS SOON AS PRACTICAL.

In order to avoid the possibility of accidentally trapping a SPEC due to certain GPC and CRT failures, it is best to always RESUME SPEC's when not in use. The crew is trained to place the CRT's in a specific configuration prior to sleep, and they expect them to be in this same configuration when they wake up. Therefore, leaving the OPS display up on all CRT's will coincide with what the crew expects.

- E. DUE TO GROUND LIMITATIONS, THE FOLLOWING KEYSTROKES CANNOT BE USED IN ANY DEU EQUIVALENT LOAD.

1. FAULT SUMM
2. SYS SUMM
3. GPC/CRT
4. MSG RESET
5. CLEAR
6. ACK @[072795-1775A]

Although the onboard software allows the above keystrokes, the ground command processing software prohibits DEU equivalent loads from containing them. Since the FAULT SUMM and SYS SUMM displays do not contain any ITEM entries, the MCC does not benefit from uplinking these keystrokes. The other four keystrokes can interfere with the crew's CRT configuration or fault message recognition. Therefore, it was decided prior to STS-1 to prohibit the ground from uplinking these specific keystrokes. @[072795-1775A]

FLIGHT RULES

BFS SYSTEMS MANAGEMENT

A7.1.4-1 ASCENT/ENTRY BFS MANAGEMENT GUIDELINES

DURING ASCENT (POST-MECO) AND ENTRY (POST-TIG), THE FOLLOWING GUIDELINES WILL BE FOLLOWED:

- A. FOR LOSS OF FORWARD DEUCRT INTERFACE, MODE THE BFS GPC TO "HALT" AND PLACE THE OUTPUT SWITCH IN "TERMINATE". [@\[040899-2459B\]](#)

If no forward DEUCRT interface exists after the crew performs BFS/DEUCRT recovery procedures, they will have no interface with the BFS; hence, the BFS is unusable. As a cleanup item, the BFS GPC will be moded to HALT to cease software execution, and the output switch will be placed in the TERMINATE position to protect the PASS from going to software halt in the event of an inadvertent engage. The TERMINATE position will be used instead of NORMAL for consistency with BFS standalone actions (ref. paragraph B). [@\[040899-2459B\]](#)

- B. FOR BFS STANDALONE MODE, MODE THE BFS GPC TO "STANDBY", AND PLACE THE BFS OUTPUT SWITCH IN "TERMINATE".

If the BFS continues in a standalone mode after the crew performs BFS recovery procedures, the BFS will be unable to perform SM antenna management. In addition, the ground will be unable to command via the payload buses. Moding the mode switch to STANDBY causes the BFS to relinquish the PL buses to the PASS. In the STANDBY position, the BFS can continue to perform FDA processing on orbiter OI subsystems. The output switch in the TERMINATE position will protect the PASS from going to software halt in the event of an inadvertent engage. The switch is placed in TERMINATE rather than NORMAL to keep the I/O TERM B discrete input high at the BFS, thus preventing a single-point BFS GPC failure (either full or half hybrid receiver 10 failing high) from causing the BFS to self-engage.

- C. FOR LOSS OF CONTROL CA1 (AB3) OR ESSENTIAL 3AB BUS, PLACE THE BFS OUTPUT SWITCH IN "TERMINATE".

The loss of control CA1 prevents the BFS from processing engage discretetes for GPC's 3 and 5. If the BFS is in one of these GPC's, then it cannot be engaged and it is necessary to protect the PASS from going to software halt in the event of an inadvertent engage. This is accomplished by placing the BFS output switch in TERMINATE. The switch is placed in TERMINATE rather than NORMAL to keep the I/O TERM B discrete input high at the BFS, thus preventing a single-point BFS GPC failure (either full or half hybrid receiver 10 failing high) from causing the BFS to self-engage. The same rationale can be applied to the loss of control AB3 if the BFS is in GPC 1, 2, or 4.

THIS RULE CONTINUED ON NEXT PAGE

FLIGHT RULES

A7.1.4-1 ASCENT/ENTRY BFS MANAGEMENT GUIDELINES (CONTINUED)

The loss of essential 3AB prevents any GPC from properly processing the engage discrettes as a BFS (ref. Rule {A7.1.2-2B.3}, BFS DPS FAILURE). This also places the BFS one failure away from self-engage by removing the I/O TERM B input to the BFS GPC. If the BFS is in GPC 1, 2, 4, or 5, the I/O TERM B can be reapplied by placing the BFS output switch in TERMINATE since this position is powered by a different bus. The I/O TERM B cannot be recovered if the BFS is in GPC 3 since the TERMINATE position is also powered by ESS3AB. However, placing the switch in TERMINATE for this case will maintain procedural consistency without placing the BFS or PASS in a worse configuration.

D. FOR BFS GPC I/O TERM B FAIL HIGH, PLACE THE BFS OUTPUT SWITCH IN "TERMINATE" .

If the BFS/I/O TERM B is failed high, then the BFS cannot recognize an engage and it is necessary to protect the PASS from going to software halt in the event of an inadvertent engage. This is accomplished by placing the BFS output switch in TERMINATE. The switch is placed in TERMINATE rather than NORMAL for consistency with other BFS NO-GO actions.

E. FOR BFS GPC FAIL DURING ASCENT, A BFS IPL MAY BE ATTEMPTED IN GPC 5 POST ET SEP.

BFS IPL during ascent is an MCC call to regain crew insight into critical systems.

BFS IPL will only be requested when there is adequate time to complete the procedure before the OMS-2 burn, and it would not interfere with other activities. A GPC 5 hardware dump will normally be performed before IPL'ing.

The BFS IPL is performed only on GPC 5 because we are unwilling to give up a good PASS GPC during ascent.

DPS will not recommend a BFS IPL in GPC 5 if GPC 5 has exhibited symptoms of erroneous output or degraded IOP functions.

Even if GPC 5 recovers via IPL, the BFS will be moved on orbit per Rule {A7.1.4-2}, ON-ORBIT BFS MANAGEMENT GUIDELINES.

F. IF DECLARED "SUSPECT", THE BFS WILL BE CONSIDERED "NOT AVAILABLE" FOR ASCENT/ENTRY RESTRING PURPOSES (RULE {A2.1.2-14}, ASCENT STRING REASSIGNMENT, AND RULE {A2.1.5-4}, ENTRY STRING REASSIGNMENT) AND WILL ONLY BE ENGAGED AS A LAST RESORT.

The difference between a "NO-GO for engagement" call and a "suspect" call is that in "NO-GO for engagement" the BFS will not fly the vehicle. In the "suspect" case, the BFS may fly the vehicle but it cannot be guaranteed.

FLIGHT RULES

Rule {A7.1.2-2}, BFS DPS FAILURE, references this rule.

FLIGHT RULES

A7.1.4-2

ON-ORBIT BFS MANAGEMENT GUIDELINES

ON ORBIT (POST-OPS 2 THROUGH PRE-TIG), FOR ANY BFS INDICATION DETERMINED TO BE A FAULT CONDITION INCLUDING THOSE LISTED BELOW, THE BFS WILL BE RELOADED INTO A GPC THAT HAS NOT EXPERIENCED ANY FAILURES. ~~THE BFS WILL NOT BE RELOADED INTO AN INSTALLED SPARE GPC.~~ @101096-4516]

A reload of the BFS (into a PASS GPC) regains the BFS function and provides a backup means during entry to assume control of the vehicle in the event the PASS set can no longer maintain vehicle control. Reassignment of the BFS should be performed as soon as practical to protect for contingency deorbit.

The BFS GPC is the last means of recovery for loss of the PASS set and is therefore critical to vehicle safety if it is engaged. The BFS will always be maintained in a GPC without any previous failures. ~~A GPC failure may not always be determined to be in the GPC itself, and may be slot related. Also, the ability of the replaced GPC to be engaged as a BFS cannot be verified on orbit as it is on the ground prelaunch. Therefore, a changed out GPC is not considered to be an acceptable GPC for the BFS.~~ @101096-4516]

- A. BFS GPC HAS BEEN DECLARED FAILED.
- B. BFS HAS BEEN DECLARED NO-GO FOR ENGAGEMENT DUE TO LOSS OF CONTROL CA1 BUS.

For loss of control CA1 bus, the BFS engage capability can be regained by reloading the BFS into another GPC except GPC 3 (or 5).

- C. THE BFS HAS BEEN DECLARED SUSPECT.

BFS "suspect" is defined in Rule {A7.1.2-2}, BFS DPS FAILURE.

- D. BFS GPC HAS AN INSTRUMENTATION PCMMU (IP) BUS CONTROL ELEMENT (BCE) FAILURE (LOSS OF DOWNLIST), TIME PERMITTING.

An IP BCE failure results in a loss of downlist and results in loss of OI data to the crew. With this type of failure, the MCC has no insight into orbiter systems performance. In addition, insight on two-stage command feedback is not available. It is highly desirable to have insight into the BFS; hence, the BFS will be reloaded time permitting. @101096-4516]

- E. BFS GPC HAS A PL1 OR PL2 BCE FAILURE, TIME PERMITTING.

A loss of a PL1 or PL2 BCE failure results in a loss of redundancy for antenna management. It is preferred to have redundancy for SM antenna management; hence, the BFS will be reloaded into another GPC.

FLIGHT RULES

THIS RULE CONTINUED ON NEXT PAGE

FLIGHT RULES

A7.1.4-2 ON-ORBIT BFS MANAGEMENT GUIDELINES (CONTINUED)

F. BFS GPC HAS ONE OR MORE FC BCE RECEIVER FAILURES, TIME PERMITTING.

Loss of one flight-critical BCE receiver results in loss of data from the associated MDM/BTU's to the BFS. Upon a BFS engage, the BFS would start without a full flight-critical redundancy. It is desirable to have the BFS track all PASS strings upon an engage; consequently, the BFS will be reloaded into another GPC time permitting.

Rules {A2.1.6-1} (NOTE 71), CONTINGENCY ACTION SUMMARY; and {A7.1.4-1}, ASCENT/ENTRY BFS MANAGEMENT GUIDELINES, reference this rule.

FLIGHT RULES**A7.1.5-1 DPS GO/NO-GO MATRIX (CONTINUED)**

NOTES:

- [1] ASSUMES G3 ARCHIVE OR G3 FREEZE-DRY CAPABILITY IS AVAILABLE.
- [2] LOSS OF MTU PRECLUDES BFS MET/GMT INITIALIZATION CAPABILITY.
- [3] SWAP OUT MAY BE USED TO SATISFY THE MINIMUM REQUIREMENTS.
- [4] ASSUMES TWO OPERATIONAL MMU'S OR ONE MMU AND GNC 3 ARCHIVE CAPABILITY IS AVAILABLE.
- [5] ASSUMES IFM CAPABILITY FOR PAYLOAD BAY DOOR CLOSURE.
- [6] BECAUSE OF THE LARGE NUMBER OF MDU'S AND SYSTEM FLEXIBILITY, THE MINIMUM DURATION REQUIREMENTS ARE COVERED IN RULE {A2.1.3-1}, MISSION DURATION REQUIREMENTS, WHICH ADDRESSES GENERIC FAILURES. @[040899-2459B]
- [7] IF TWO FORWARD CRT'S, PERFORM IFM ASAP.
- [8] IF TWO FORWARD IDP'S, PERFORM IFM ASAP. @[04082459A]
- [6] ~~RESERVED @[121296-4595C]@[101096-4516]~~

The DPS GO/NO-GO CRITERIA matrix reflects the MDF/PLS criteria (ref. Rules {A2.1.3-1B.2}, MISSION DURATION REQUIREMENTS, and {A2.1.7-1}, ORBITER SYSTEMS GO/NO-GO).

MDF - Multiple failures in an avionics system, even though it remains single-fault tolerant, may be indicative of a generic failure; consequently, an MDF is invoked for loss of two GPC's, ~~or~~ loss of two DEU/CRT's, or for MEDS flights, two IDP's. @[040899-2459B]

Although a nominal end of mission can be accomplished with no accessible mass memory units (MMU's), the loss of two MMU's would result in the inability to recover subsequent GPC and/or DEU failures, loss of TFL's and DFL's, and loss of system management (SM) roll-in displays. Loss of SM roll-in displays contributes to a loss of additional insight into systems status in the event of a significant failure. Therefore, because of the loss of the above capability, an MDF is invoked for failure of two MMU's.

Loss of flight-critical and payload MDM's is an exception to the single-fault tolerant rule because loss of a single MDM reduces redundancy in multiple systems increasing the risk that a single LRU failure in any one of several systems could put the orbiter at a zero-fault tolerant level.

A risk assessment presented at the AEFTP #131 concluded that the combination of LRU's lost with FF4 does not warrant early mission termination. There is no systems requirement for an MDF after the loss of FF4. In addition, mission length for the loss of FF1, 2, 3 and FA MDM's should correspond to the IMU and FCS mission length, respectively. Mission length for the first IMU and FCS failure was changed to NEOM. The probability of losing a second PL MDM, thereby requiring an IFM to close the PLBD's and latch gangs, is extremely low. Therefore, NEOM is acceptable after the loss of one PL MDM. @[121296-4595C]

THIS RULE CONTINUED ON NEXT PAGE

FLIGHT RULES

A7.1.5-1 DPS GO/NO-GO MATRIX (CONTINUED)

PLS - A next PLS deorbit will be executed at the earliest practical time for failures which place the orbiter system at the zero-fault tolerant level or results in a condition where one more failure causes a severe orbiter configuration management condition.

Loss of three GPC's may be indicative of a generic problem. If another GPC failure occurred, this would result in entry on a single PASS GPC. Therefore, a next PLS is invoked.

If two CRT's are lost in the forward station, for non-MEDS vehicles, a next PLS will be invoked because it will place the orbiter in a fail-critical situation for entry. The aft CRT may be used as a replacement CRT for the forward station. ©[121296-4595C] ©[040899-2459B]

One remaining keyboard (following an IFM) will place the orbiter in a zero-fault tolerant situation.

If two IDP's are lost in the forward station, a next PLS will be invoked because it will place the orbiter in a fail critical situation for entry. The aft IDP may be used as a replacement IDP for the forward station.

If two forward MDU's are failed, they can be replaced with the two aft MDU's. If additional MDU's fail, display flexibility allows the other MDU's to support DPS displays, Flight Instrument displays, and Subsystem Status displays. The loss of eight MDU's places the orbiter in a zero-fault tolerant entry configuration: one MDU for PASS software control, one for BFS insight, and one for ADI/AMI/AVVI capability. ©[040899-2459B]

FLIGHT RULES

SPACELAB COMMAND AND DATA MANAGEMENT SYSTEM (CDMS)
LOSS/FAILURE DEFINITIONS

A7.9.1-1 SUBSYSTEM COMPUTER (SSC)

FAILED IF:

IT WILL NOT RESPOND TO A MASS MEMORY UNIT (MMU) INITIAL PROGRAM LOAD (IPL) ON ANY SUBSYSTEM INPUT/OUTPUT (SSIO) POWER SUPPLY AFTER ANY OF THE FOLLOWING FAILURE INDICATIONS: @[071494-1642A]

- A. ORBITER MESSAGE "210 SUBSYSTEM COMPUTER (SSC) STOP."
- B. ORBITER MESSAGE "210 TEST FAIL."
- C. WILL NOT COMMUNICATE WITH THE SSIO AS INDICATED BY SIMULTANEOUS OCCURRENCE OF THE FOLLOWING:
 - 1. NO DATA DISPLAY SYSTEM (DDS) IS UPDATED FROM THE SSIO.
 - 2. THE ORBITER SM GPC TERMINATES THE PAYLOAD MDM LINK.
 - 3. SUBSYSTEM PCMMU DATA USED BY THE ORBITER SM GPC IS LOST.

Both specific annunciation and proven loss of function are used to identify a suspect device. Power supply failures can cause loss of an input/output unit (IOU). An MMU IPL is the most complete system reinitialization possible; it includes an elaborate self-test and partial self-diagnosis. The MMU IPL procedure also includes a power cycle of computer and IOU which resets all hardware logic contained therein. The Experiment Computer Operating System (ECOS) annunciates computer stops with only the TEST FAIL message, while SCOS annunciates stops with the TEST FAIL message hardware (H/W) or the SSC STOP message software (S/W). @[071494-1642A]

FLIGHT RULES

THIS PAGE INTENTIONALLY BLANK

FLIGHT RULES

A7.9.1-2 EXPERIMENT COMPUTER (EXC)

FAILED IF:

IT WILL NOT RESPOND TO AN MMU IPL ON ANY EXPERIMENT INPUT/OUTPUT (EXIO) POWER SUPPLY AFTER ANY OF THE FOLLOWING FAILURE INDICATIONS: @[071494-1642A]

- A. ORBITER MESSAGE "210 TEST FAIL."
- B. WILL NOT COMMUNICATE WITH THE EXIO AS INDICATED BY SIMULTANEOUS OCCURRENCE OF THE FOLLOWING:
 - 1. NO DDS IS UPDATED FROM THE EXIO.
 - 2. THE ORBITER SM GPC TERMINATES THE PAYLOAD MDM LINK.
 - 3. EXPERIMENT PCMMU DATA USED BY THE ORBITER SM GPC IS LOST.

Rationale is same as for Rule {A7.9.1-1}, SUBSYSTEM COMPUTER (SSC).

A7.9.1-3 DDS/REMOTE ACQUISITION UNIT (RAU)/MMU

FAILED IF:

AFTER FAILURE ISOLATION AND POWER CYCLING, NO DATA PATH IS SUPPORTED.

This definition reflects a general model for failure diagnosis of a nonfunctioning device. The malfunction procedures troubleshoot the data paths individually and if all data paths are failed, the device is failed. Power cycling is a general technique used to recover a device which is suspect because of some transient condition.

A7.9.1-4 DATA PATH

FAILED IF:

AFTER ATTEMPTING TO REESTABLISH THE NONFUNCTIONING PATH, NO INPUTS OR OUTPUTS ARE SUPPORTED.

FLIGHT RULES

This definition reflects a general model for failure diagnosis of a nonfunctioning device. The malfunction procedures troubleshoot the data paths individually and if all data paths are failed, the device is failed. Attempts to reestablish a path include OP'ing the data path, orbiter I/O reset to the pulse-code modulation master unit (PCMMU), and attempts to reenale the multiplexer/demultiplexer (MDM) link. Power cycling is a general technique used to recover a device which is suspect because of some transient condition.

FLIGHT RULES

SPACELAB CDMS SYSTEMS MANAGEMENT

A7.9.2-1 COMPUTER OR IOU FAULT ISOLATION SEQUENCE

SUSPECTED COMPUTER OR INPUT/OUTPUT UNIT (IOU) FAILURES CAUSING COMPLETE LOSS OF FUNCTION WILL BE MANAGED IN THE FOLLOWING SEQUENCE:

A. SUBSYSTEM COMPUTER (SSC)

1. IF THE SSC FAILS DUE TO A MEMORY PARITY ERROR, SSC RECOVERY WILL BE ATTEMPTED VIA MMU IPL. @[071494-1642A]

A memory parity error indicates a parity check failure on a location in computer memory; this signature does not indicate whether the failure occurred during a check of lower or upper memory. If the failure occurred in upper memory, an upper memory IPL (UMI) may be unsuccessful. Therefore, the best course of action for an SSC memory parity check failure is to proceed directly with an MMU IPL. @[120894-1738]

2. IF AN SSIO POWER SUPPLY FAILURE IS IDENTIFIED AS THE CAUSE, THE ALTERNATE POWER SUPPLY WILL BE SELECTED.

Swapping to the alternate power supply is the only course of action necessary for a power supply failure. No SSC reconfiguration or recovery steps need to be performed. Unlike power cycling the EXIO, power cycling the SSIO will not initiate a UMI.

3. THE SUSPECT SSC WILL BE RE-INITIALIZED VIA UPPER MEMORY IPL (UMI).

In order to reduce the reliance on the SL MMU, a new IPL capability was designed to take advantage of the computer's additional upper memory. Re-initialization via UMI does not require any interface with the SL MMU, and the UMI is faster and more efficient than an MMU IPL.

4. IF THE UMI FAILS, A SUBSYSTEM COMPUTER OPERATING SYSTEM (SCOS) MMU IPL WILL BE ATTEMPTED.

If the UMI fails, the next logical course of action is to proceed with an MMU IPL. This will ensure that the entire contents of computer memory will get reloaded.

5. IF THE SSC MMU IPL IS UNSUCCESSFUL, THE STORED SCOS IN THE BACKUP COMPUTER (BUC) WILL BE RE-INITIALIZED VIA UMI.

If the SSC MMU IPL is unsuccessful after using malfunction procedures, the BUC (which is preloaded with SCOS) will be used in place of the SSC. The UMI capability allows the preloaded SCOS to be executed without accessing the MMU. @[071494-1642A]

FLIGHT RULES

THIS RULE CONTINUED ON NEXT PAGE

FLIGHT RULES**A7.9.2-1 COMPUTER OR IOU FAULT ISOLATION SEQUENCE
(CONTINUED)**

6. IF TRAP ERROR DUMP DATA WERE WRITTEN TO THE MMU, THE CREW WILL DUMP SELECT FAILURE SIGNATURE DATA THROUGH SCOS, IF POSSIBLE. @[071494-1642A]

Dumping the error signature data to the ground as soon as an SCOS machine is available is important. A subsequent failure could cause another MMU dump, which would erase the first dump; the error signature data from the first failure would be lost. SCOS is used to initiate the ground dump because of its simpler command interface throughout the dump process. MMU dumps can be performed via ECOS; however, the procedure is more involved and may interrupt experiment activities/timelines.

B. EXPERIMENT COMPUTER (EXC)

1. IF THE EXC FAILS DUE TO A MEMORY PARITY ERROR, EXC RECOVERY WILL BE ATTEMPTED VIA MMU IPL. @[071494-1642A]

A memory parity error indicates a parity check failure on a location in computer memory; this signature does not indicate whether the failure occurred during a check of lower or upper memory. If the failure occurred in upper memory, an upper memory IPL (UMI) will be unsuccessful. Therefore, the best course of action for an EXC memory parity check failure is to proceed directly with an MMU IPL.

2. IF AN EXIO POWER SUPPLY FAILURE IS IDENTIFIED AS THE CAUSE, THE ALTERNATE POWER SUPPLY WILL BE SELECTED. THE EXC WILL AUTOMATICALLY BE RE-INITIALIZED VIA UPPER MEMORY IPL (UMI).

Swapping to the alternate power supply is the only course of action necessary for a power supply failure. Power cycling the EXIO will automatically initiate a UMI; power cycling the SSIO will not initiate a UMI.

3. IF THE UMI FAILS, AN EXPERIMENT COMPUTER OPERATING SYSTEM (ECOS) MMU IPL WILL BE ATTEMPTED.

If the UMI fails, the next logical course of action is to proceed with an MMU IPL. This will ensure that the entire contents of computer memory will get reloaded.

4. IF THE EXC MMU IPL IS UNSUCCESSFUL, THE BACKUP COMPUTER (BUC) WILL BE IPL'ED VIA THE MMU WITH ECOS.

If the EXC MMU IPL is unsuccessful after using malfunction procedures, the BUC will be used in place of the EXC. Because the BUC is preloaded with SCOS, an MMU IPL will be required to load ECOS. @[071494-1642A]

FLIGHT RULES

THIS RULE CONTINUED ON NEXT PAGE

FLIGHT RULES**A7.9.2-1 COMPUTER OR IOU FAULT ISOLATION SEQUENCE
(CONTINUED)**

5. IF TRAP ERROR DUMP DATA WERE WRITTEN TO THE MMU, THE CREW WILL DUMP SELECT FAILURE SIGNATURE DATA THROUGH SCOS, IF POSSIBLE. @[071494-1642A]

Dumping the error signature data to the ground as soon as an SCOS machine is available is important. A subsequent failure could cause another MMU dump, which would erase the first dump; the error signature data from the first failure would be lost. SCOS is used to initiate the ground dump because of its simpler command interface throughout the dump process. Also, if ECOS is deemed unavailable, the dump data can still be acquired through SCOS. MMU dumps can be performed via ECOS; however, the procedure is more involved and may interrupt experiment activities/timelines.

A7.9.2-2 OPERATIONS FOR TWO COMPUTERS LOST**MODULE**

- A. WITH THE SSC FAILED, THE FOLLOWING GUIDELINES WILL BE FOLLOWED IF AN ADDITIONAL SPACELAB COMPUTER FAILURE OCCURS:
 1. IF THE EXC FAILS, CONTINUE OPS WITH SCOS IN THE BUC. CONSIDERATION WILL BE GIVEN TO PERFORMING A PROCEDURE TO IPL ECOS IN THE BUC AND SUBSEQUENTLY USE THE BUC FOR SERIAL SCOS/ECOS OPERATIONS.

If the SSC fails, SCOS will be moved to the BUC. If the EXC also fails, serial use of the BUC as both an SCOS and ECOS machine via onboard procedures could be attempted. However, discussions with the HOSC must be held concerning the potential hardware damage which could occur when switching a Direct Memory Access (DMA) with an IOU powered. The outcome of such discussions could be different depending on the specific time of the failure in the flight, implications due to the loss of SS RAU data and commands (loss of subsystems insight and malfunction procedures), experiment operations considerations, other failures that have occurred, etc.

2. IF THE BUC FAILS, CONTINUE OPERATIONS WITH NO SCOS SUBSYSTEM SUPPORT. CONSIDERATION WILL BE GIVEN TO PERFORMING AN IFM (WHEN THE COMPUTER CABLES ARE AVAILABLE) TO CONFIGURE THE EXC AS A NEW BUC AND SUBSEQUENTLY USE THIS NEW BUC FOR SERIAL SCOS/ECOS OPS.

THIS RULE CONTINUED ON NEXT PAGE

FLIGHT RULES

A7.9.2-2 OPERATIONS FOR TWO COMPUTERS LOST (CONTINUED)

If the SSC fails, SCOS will be moved to the BUC. If the BUC also fails, there are no nominal procedures that exist to get back an SCOS machine. However, there is an IFM (available in MCC) which, through the use of two onboard cables, can be performed to configure the EXC as a new BUC. The computer cables used in the IFM are flown if required by the payload customers after negotiations with MSFC. If flown, it is documented in the PIP. Discussions with the HOSC and POCC would center around the fact that ECOS is running in the EXC and experiment ops are going on with no problems. Also, although no SS RAU data and high rate data assembly (HRDA) command capability exists, there are no safety concerns since all Spacelab Class 1 and 2 parameters are redundantly monitored in the SM GPC. Other discussions would concern the serial use of the new BUC, as noted in paragraph A.1. above, which could also be considered after the IFM was performed.

MODULE

B. WITH THE EXC FAILED, THE FOLLOWING GUIDELINES WILL BE FOLLOWED IF AN ADDITIONAL SPACELAB COMPUTER FAILURE OCCURS:

1. IF THE SSC FAILS, CONTINUE OPS WITH ECOS IN THE BUC. CONSIDERATION WILL BE GIVEN TO USING THE BUC FOR SERIAL SCOS/ECOS OPERATIONS.

If the EXC fails, ECOS will be moved to the BUC. If the SSC also fails, serial use of the BUC as both an SCOS and ECOS machine via onboard procedures could be attempted. However, discussions with the HOSC must be held concerning the potential hardware damage which could occur when switching a DMA with an IOU powered. The outcome of such discussions could be different depending on the specific time of the failure in the flight, implications due to the loss of SS RAU data and commands (loss of subsystems insight and malfunction procedures), experiment operations considerations, other failures that have occurred, etc.

2. IF THE BUC FAILS, CONTINUE OPERATIONS WITH NO ECOS EXPERIMENT SUPPORT. CONSIDERATION WILL BE GIVEN TO PERFORMING AN IFM (WHEN THE COMPUTER CABLES ARE AVAILABLE) TO CONFIGURE THE SSC AS A NEW BUC AND SUBSEQUENTLY USE THIS NEW BUC FOR SERIAL SCOS/ECOS OPS.

FLIGHT RULES

If the EXC fails, ECOS will be moved to the BUC. If the BUC also fails, there are no nominal procedures that exist to get back an ECOS machine. However, there is an IFM (available in MCC) which, through the use of two onboard cables, can be performed to configure the SSC as a new BUC. The computer cables used in the IFM are flown if required by the payload customers after negotiations with MSFC. If flown, it is documented in the PIP. Discussions with the HOSC and POCC would center around the fact that no ECOS is running and limited experiment ops can be performed without ECOS, although this is mission specific. Other discussions would concern the serial use of the new BUC, as noted in paragraph B.1. above, which could also be considered after the IFM was performed.

THIS RULE CONTINUED ON NEXT PAGE

FLIGHT RULES

A7.9.2-2 OPERATIONS FOR TWO COMPUTERS LOST (CONTINUED)

PALLET ONLY

C. EXPERIMENT OPERATIONS MAY BE CONTINUED WITHIN THE LIMITS OF THE PARTICULAR COMPUTER AVAILABLE AND IN AGREEMENT WITH THE INTENT OF ALL OTHER FLIGHT RULES.

There are no igloo IFM's available after two Spacelab computers have been lost, so in the event that the SSC and BUC or EXC and BUC have failed, serial ops are not a consideration. If the EXC is left, experiment ops are possible. All SS RAU data and all SS RAU commanding are lost. If the SSC is left, only experiment ops that can be performed without ECOS can be supported. @ED]

For the cases where both the SSC and EXC have failed, leaving the BUC as the only Spacelab computer, serial ops are a consideration based on mission elapsed time, loss of SS RAU data and commands without SCOS, loss of experiment ops without ECOS, previous failures, etc. @ED]

A7.9.2-3 COMPUTER RESTART MANAGEMENT

THE SPACELAB COMPUTER RESTART WILL BE ENABLED SUCH THAT AN INTERRUPTION OR CESSATION OF POWER TO THE ACTIVE COMPUTER WILL NOT PREVENT AN AUTOMATIC RECOVERY OF SCOS OR ECOS. THE RECOVERY WILL BE ACCOMPLISHED VIA AN UPPER MEMORY IPL. @[071494-1642A]

The automatic computer restart is invoked by utilizing the UMI. Performing a UMI transfers the Spacelab software stored in the Spacelab computer's upper memory to the active lower memory. The UMI provides a method of re-initializing SCOS or ECOS without having to access the MMU.

A7.9.2-4 IOU POWER SUPPLY/BUS MANAGEMENT

IOU POWER SUPPLIES WILL BE MANAGED AS FOLLOWS:

A. THE IOU POWER SUPPLY WILL NORMALLY BE SELECTED TO USE A DIFFERENT BUS THAN THE ACTIVE COMPUTER ON THE SAME DPA; I.E., THE "A" POWER SUPPLIES WILL BE UTILIZED.

Due to derating of all electrical wiring and fusing, electrical loads will be managed so they are kept as even as possible. The JSC safety specifications currently in use regarding fuse sizing and wire sizing require designs to limit current to 50 percent of the hardware nameplate size. Therefore, the CDMS bus fuseholders and fuses are derated to 15 amps. Reference MSFC memorandum, EB14 (24-90).

THIS RULE CONTINUED ON NEXT PAGE

FLIGHT RULES

A7.9.2-4 IOU POWER SUPPLY/BUS MANAGEMENT (CONTINUED)

B. CONTINGENCY CONFIGURATIONS ARE AS FOLLOWS:

1. FOR LOSS OF THE SSC OR EXC, THE BUC AND BOTH IOU "A" POWER SUPPLIES WILL BE UTILIZED. (NOTE THAT UTILIZING THE BUC ALWAYS IMPLIES AN SCOS UMI AND AN ECOS MMU IPL.)

@[071494-1642A]

2. FOR LOSS OF EITHER IOU "A" POWER SUPPLY, THE ASSOCIATED "B" POWER SUPPLY WILL BE UTILIZED.
3. FOR LOSS OF THE CDMS-1 BUS:
 - a. CDMS-2 WILL POWER THE EXC.
 - b. CDMS-3 WILL POWER THE BUC/SCOS.
 - c. COMMON PAYLOAD SUPPORT EQUIPMENT (CPSE) WILL POWER SSIO POWER SUPPLY "A" AND EXIO POWER SUPPLY "A."
4. FOR LOSS OF THE CDMS-2 BUS:
 - a. CDMS-1 WILL POWER THE SSC.
 - b. CDMS-3 WILL POWER THE BUC/ECOS.
 - c. COMMON PAYLOAD SUPPORT EQUIPMENT (CPSE) WILL POWER SSIO POWER SUPPLY "A" AND EXIO POWER SUPPLY "A".
5. FOR LOSS OF THE CDMS-3 BUS, BOTH IOU "A" POWER SUPPLIES WILL BE UTILIZED (IF AVAILABLE).
6. FOR LOSS OF THE CPSE BUS, BOTH IOU "B" POWER SUPPLIES WILL BE UTILIZED.

In each contingency case listed above, one or more of the CDMS buses may exceed the recommended JSC safety specification which derates the fuses and fuseholders to 50 percent. Note that the HRM is powered by CDMS-3. For all these cases, mission success outweighs any possible Subsystem Power Distribution Box (SPDB) damage that may occur. The intent is to also minimize impacts to subsystem or experiment operations due to IOU power supply reconfiguration.

FLIGHT RULES

A7.9.2-5 IOU COUPLER MANAGEMENT

IOU COUPLERS WILL BE MANAGED AS FOLLOWS:

- A. THE A COUPLERS WILL NORMALLY BE USED. B COUPLERS WILL BE INDIVIDUALLY SELECTED IN THE EVENT OF COUPLER OR DATA PATH FAILURES.

The CDMS hardware requirements offer the capability to select all A couplers or to select each B coupler individually. Starting with the B couplers, reconfigurations would require greater procedural complexity. (To get to an A coupler, one would need to select all A couplers and then select those specific couplers which were to be B, rather than just selecting a B coupler and leaving the rest in A). Also, this position follows the orbiter precedent of using PCMMU-1 (attached to coupler A) as the prime PCMMU. Finally, the selection of alternate couplers is the only way to access redundant data paths.

- B. COUPLERS WILL ONLY BE SWITCHED WITH THE IOU UNPOWERED, EXCEPT FOR BUC SERIAL OPS AND IOU FAILURE ISOLATION.

Documentation on the IOU states that if powered during coupler switches, internal IOU data bus noise could generate undesirable DMA access of interrupts toward the computer or peripheral. A power cycle causes reinitialization of the IOU coupler microcode programming. However, in utilizing the BUC for serial ops, after the loss of two computers, this rule is waived for the EXIO DMA. Also, this rule is waived for IOU failure troubleshooting where a single coupler has a short. In these cases, mission success outweighs the possible IOU damage that may occur.

Reference: IOU Electrical Design Report, TN. MA. 50.088, sections 2.4.8 and 3.4.7.

- C. EXIO COUPLER SWITCHING WILL BE PERFORMED WHEN EXPERIMENT ACTIVITY PERMITS THE EXIO POWER CYCLE, EXC OR BUC IPL, AND REESTABLISHMENT OF EXPERIMENT TIMELINE CONFIGURATION.

This rule embodies the idea that given a functioning EXP DPA, any reconfiguration is not a Spacelab subsystems issue and will be negotiated with the POCC for mission success criteria. Each experiment coupler failure results in a choice to the POCC; either we continue the experiment DPA activities with the loss of the data path or we interrupt experiment activities to recover the data path. In the case of remote acquisition unit (RAU), MDM, and MMU data path losses, it is probable that quick coupler switching will be requested by the POCC. Coupler switching may be done for peripheral failures such as RAU bus interface unit (BIU); however, this usually has less probability of impact at a given time.

THIS RULE CONTINUED ON NEXT PAGE

FLIGHT RULES

A7.9.2-5 IOU COUPLER MANAGEMENT (CONTINUED)

MODULE

- D. IF A COUPLER FAILURE IS SUSPECTED, THE SSIO POWER WILL BE CYCLED PRIOR TO SWITCHING COUPLERS. EXIO POWER WILL NOT BE CYCLED PRIOR TO COUPLER SWITCHING.

Since the SCOS has UMI capability, an SSIO power cycle (which has no effect on the SSC) is performed before switching from a possibly good coupler. In order to minimize experiment operation interruptions, an EXIO power cycle is not performed prior to swapping couplers. The EXIO will be power cycled as part of the coupler failure troubleshooting. An EXIO power cycle will automatically initiate an ECOS UMI. ©[071494-1642A]

FLIGHT RULES

A7.9.2-6

SSIO/EXIO/PCMMU INTERFACE MANAGEMENT

THE SSIO AND EXIO PCMMU INTERFACES WILL BE MANAGED TO COMMUNICATE WITH THE ACTIVE PCMMU ACCORDING TO THE FOLLOWING GUIDELINES:

- A. IF THE PCMMU IS SWITCHED FOR ORBITER FAILURES, SSIO AND EXIO COUPLER SWITCHES WILL NOT BE ATTEMPTED UNTIL ORBITER TROUBLESHOOTING IS COMPLETE.

The orbiter systems PCMMU data have higher priority than Spacelab subsystem or experiment PCMMU data. PCMMU troubleshooting sometimes involves multiple PCMMU switches. Because of the procedural complexity of switching couplers, the fact that in many cases the PCMMU ends up in formats that do not have Spacelab data, and the fact that the most complex malfunction procedure involving PCMMU switches takes about a half hour, it is more feasible to wait until the final PCMMU decision is made before the PCMMU couplers are switched.

- B. FOR SSIO TO PCMMU DATA PATH FAILURES, SSIO PCMMU COUPLERS MAY BE SWITCHED AS SOON AS POSSIBLE. THE EXIO PCMMU DATA WILL BE TEMPORARILY SUSPENDED TO RECOVER THE SSIO DATA. CONSIDERATION WILL BE GIVEN TO DELAYING THE EXIO PCMMU COUPLER SWITCHING TO MINIMIZE EXPERIMENT ACTIVITY IMPACT.

If the PCMMU must be switched to follow an SSIO coupler switch, it will be done immediately and the EXIO coupler must also be switched to recover its PCMMU link. SCOS PCMMU data are of higher priority than ECOS PCMMU data from a space shuttle viewpoint. The POCC does not require the ECOS PCMMU data because of their high rate data link via the HRM. The space shuttle does use ECOS PCMMU data for EXP DPA status and Video Analog Switch (VAS) configuration monitoring. Since the EXIO coupler switch will interrupt experiment ops, the time of the EXIO coupler switch will be negotiated with the POCC. @[071494-1642A]

- C. FOR EXIO DATA PATH TO PCMMU FAILURES, CONSIDERATION WILL BE GIVEN TO DELAYING EXIO PCMMU COUPLER, SSIO PCMMU COUPLER, AND PCMMU SWITCHING UNTIL EXPERIMENT ACTIVITY PERMITS.

The procedure for switching EXIO PCMMU couplers involves cycling power on the EXIO to ensure that the coupler microprogram is initialized properly. Since an EXIO power cycle and/or coupler swap interrupts experiment ops, the time of the EXIO coupler switch will be negotiated with the POCC. The SSIO PCMMU subsystems data link is not affected by the loss of the EXIO PCMMU data path. @[071494-1642A]

FLIGHT RULES

A7.9.2-7 PAYLOAD MDM SERIAL I/O DATA PATH MANAGEMENT

FOR PAYLOAD MDM SERIAL I/O DATA PATH FAILURES, MDM TROUBLESHOOTING WILL BE COMPLETED PRIOR TO SELECTING THE ALTERNATE COUPLER.

Orbiter troubleshooting may not impact experiment operations and may resolve an anomaly, preventing an unnecessary coupler switch, and ECOS UMI. @[071494-1642A]

A7.9.2-8 MASS MEMORY UNIT MANAGEMENT

THE MMU WILL BE MANAGED AS FOLLOWS:

- A. IF NEITHER THE EXIO NOR SSIO CAN COMMUNICATE WITH THE MMU, MMU POWER WILL BE CYCLED.

Malfunction procedures determine if the MMU is available to SS or EXP DPA. After troubleshooting, if it is determined that at least one DPA is supported, the data path problem cannot be in the MMU, and MMU power cycling which impacts experiment operations can be avoided. If no DPA is supported, the problem could be in the MMU and a power cycle will be performed as negotiated with the POCC.

MODULE

- B. IF ALL DATA PATHS THROUGH COUPLERS A AND B OF THE SSIO AND EXIO ARE FAILED AFTER MMU POWER CYCLING, THE MMU WILL BE REPLACED WITH THE SPARE (WHEN A SPARE MMU IS AVAILABLE).

The MMU may be required for experiment operations; therefore, a properly functioning MMU is highly desirable. After exhausting all other available troubleshooting, the in-flight maintenance procedure to change out the MMU with a spare will be executed (assuming a spare is carried). A spare MMU is flown if required by the payload customer after negotiations with MSFC. If flown, it is documented in the PIP. The MMU in-flight maintenance procedure could cost about 3 + hours in experiment activity. @[071494 1642A]

A7.9.2-9 REMOTE ACQUISITION UNIT (RAU) MANAGEMENT

RAU'S WILL BE MANAGED AS FOLLOWS:

- A. ALL SUBSYSTEM RAU'S WILL NORMALLY REMAIN POWERED.
- B. SUBSYSTEM OR EXPERIMENT RAU POWER WILL BE CYCLED IN AN ATTEMPT TO REESTABLISH THE DATA PATH. EXPERIMENT RAU POWER WILL BE CYCLED WHEN EXPERIMENT ACTIVITY PERMITS.

FLIGHT RULES

Power cycling of RAU's will normally be done only for attempting to recover a RAU-to-SSIO (EXIO) data path and not for power management. Each RAU only uses 14 to 35 watts. The power management of experiment RAU's could involve a great deal of replanning effort.

FLIGHT RULES

A7.9.2-10 DATA DISPLAY SYSTEM (DDS) MANAGEMENT

THE DDS'S WILL BE MANAGED AS FOLLOWS:

- A. WHEN NOT USED, THE DDS WILL BE POWERED OFF AT THE INTERFACE UNIT AND THE PGSC SCREEN WILL BE CLOSED. WHEN A SPACELAB PGSC IS NOT REQUIRED FOR DDS OPERATIONS, THE PGSC MAY BE RELEASED FOR OTHER PURPOSES PROVIDED THAT THE POWER PORT IS THE ONLY INTERFACE USED. WHEN USED FOR OTHER THAN DDS OPERATIONS, ORBITER POWER MUST BE USED FOR THE SPACELAB PGSC. THE INTERFACE UNIT (IU) WILL ONLY BE USED FOR DDS OPERATIONS.

Since there are usually two DDS's, both may not be required all the time. Spacelab requirements necessitate that an interface verification be performed prior to using any other device with Spacelab hardware. However, the possibility exists for a preflight agreement with Spacelab to interface Spacelab PGSC's with other devices after completion of interface verification and formal Program approval. Any such agreement will be documented in the flight specific rules and other appropriate flight specific requirements documents. The IU was designed for DDS operations and not intended to support non Spacelab operations. ©[030494-1607]

- B. A SPACELAB PGSC WHICH HAS FAILED WHILE PERFORMING IN THE DDS FUNCTION WILL BE REPLACED BY A SPARE SPACELAB PGSC.

Self-explanatory. However, the possibility exists for a preflight agreement with Spacelab to replace a failed Spacelab DDS PGSC with a SED33103332-713 or SED33103332-715 PGSC. After formal Program approval, any such agreement will be documented in the flight specific rules and other appropriate flight specific requirements documents. ©[071494-1666A]

- C. A DDS WILL NOT BE USED IF THE CREW CANNOT MONITOR THAT DDS'S SCRATCH PAD LINE.

Given the complexity of syntax, the use of the command (CMD) key without feedback is an unreliable procedure. Additionally, commanding in the blind is not operationally recommended.

- D. ALL DDS'S WILL BE POWERED OFF AT THE INTERFACE UNIT(S) UPON INITIAL CABIN PRESSURE REDUCTION FOR EVA ACTIVITIES.

The PGSC-DDS interface unit (DDS IU) is not qualified at pressures below 14.5 psia; therefore, the DDS will not be used at those pressures. The Spacelab PGSC has been qualified for 10.2 psia operation by similarity to the orbiter PGSC. The Spacelab PGSC, when released for other purposes, may be used for 10.2 psia operations and it is not necessary to power it off except as a power savings. ©[ED]

Reference: System Level Assessment of Spacelab Aft Flight Deck Equipment at 10.2 PSIA and 30 Percent Oxygen, MDTSCO TM No. 85005, May, 1985. Reference: Rule {A17.9.6-9}, 10.2 PSIA AFT FLIGHT DECK OPERATIONS, and Rule {A13.1.2-7}, EVA PREBREATHE PROTOCOL.

FLIGHT RULES

THIS RULE CONTINUED ON NEXT PAGE

FLIGHT RULES

A7.9.2-10 DATA DISPLAY SYSTEM (DDS) MANAGEMENT
(CONTINUED)

E. EXCEPTIONS TO THIS RULE ARE DOCUMENTED IN THE FLIGHT SPECIFIC ANNEX. @[072594-1666A]

A7.9.2-11 TEMPERATURE MANAGEMENT

A COMPUTER, IOU POWER SUPPLY, OR MMU WILL BE POWERED OFF FOR THE FOLLOWING DETECTED INTERNAL CONDITIONS:

	TEMPERATURE (DEGREES)
COMPUTER (AP101SL)	OVERTEMP EVENT
IOU POWER SUPPLY	> 124° F/51 C (111 F/44 C)
MMU	> 138° F/59 C (125 F/52 C)

FOR COMPUTER SHUTDOWN, THE BACKUP COMPUTER WILL BE ACTIVATED. FOR IOU POWER SUPPLY SHUTDOWN, THE ALTERNATE POWER SUPPLY WILL BE ACTIVATED. THE MCC WILL DIRECT REACTIVATION AS APPROPRIATE.

Devices which have internal temperature sensors will be turned off if the temperature exceeds the above associated qualification limit; this is the value to which a qualification unit was tested to verify performance. This temperature is greater than the acceptance value, thus the Spacelab program has accepted a loss of hardware lifetime during a mission in order to use the device. The use of corroborative cues (such as high currents, rise in coolant loop temperature, etc.) has proved to be infeasible.

The AP101SL computer has an overtemperature event sensor which is set to the computer's qualification limit. A ground call will be made to power off a computer after its overtemp sensor trips.

The values in parentheses are, for the analog temperature sensors, the qualification limits biased by sensor placement and instrumentation error. These values are the fault detection and annunciation (FDA) and crew action limits. The DDS auto shutdown may turn the DDS off for the overtemp before the crew has occasion to act. The IOU power supply value is the qualification baseplate temperature. The MMU value is the recording head temperature.

Reference: Telecon with MDSSC-HSV on March 18, 1992.

FLIGHT RULES

A7.9.2-12 TIME MANAGEMENT

IF A COMPUTER HAS FAULTED TO INTERNAL TIME AND CANNOT BE RESELECTED TO THE MTU, THE TIME WILL BE UPDATED AS NECESSARY TO MAINTAIN THE ERROR TO ≤ 1 SECOND RELATIVE TO ORBITER GREENWICH MEAN TIME (GMT).

If the Spacelab is on internal time, the only accuracy requirement is for crew display and data timetagging. Computer UMI or MMU IPL without an orbiter master timing unit (MTU) interface would be a case for correcting the initial GMT in a Spacelab computer. Time cannot be updated while the Spacelab computers are slaved to the MTU time. @[071494-1642A]

A7.9.2-13 MEMORY WRITE MANAGEMENT

COMPUTER MAIN MEMORY WRITES AND MASS MEMORY WRITES WILL BE PERFORMED WHEN REQUIRED USING THE FOLLOWING GUIDELINES:

- A. THE MCC DATA PROCESSING SYSTEM (DPS) OPERATOR WILL BE RESPONSIBLE FOR IMPLEMENTING SCOS, SUBSYSTEM COMPUTER APPLICATION SOFTWARE (SCAS), ECOS, AND EXPERIMENT COMPUTER APPLICATION SOFTWARE (ECAS) WRITES TO MAIN OR MASS MEMORY USING PHYSICAL ADDRESSES. THIS ENCOMPASSES COMMAND RECORD IDENTIFIER (RI) CODES 17 (WRITE CORE MEMORY CONTIGUOUS EXTENDED), 18 (WRITE CORE MEMORY SCATTER EXTENDED), 2C (WRITE CORE MEMORY CONTIGUOUS), 2D (WRITE CORE MEMORY SCATTER), AND 3F (WRITE MMU). @[ED]

Physical addressing, which can be done on the computers and the MMU's, has a high potential of adversely affecting software and data. CDMS is responsible for the Spacelab systems software during flight; however, the POCC will be allowed to alter certain specific software areas using symbolic (data set) addressing. The use of symbolic names implies that the onboard software must do a table look-up for the physical address, but does not perceptibly increase the length of the process (using a physical address is a more direct way of updating memory). @[111094-1706]
@[ED]

- B. THE POCC WILL REVISE SUBSYSTEM EXPERIMENT COMPUTER MAIN MEMORY OR MASS MEMORY USING ONLY SYMBOLIC ADDRESSING. THIS ENCOMPASSES USING DATA SET NAMES FOR SSC, EXC, OR MASS MEMORY UPDATES AND SIGNAL ID FOR PAYLOAD TABLE MAINTENANCE UPDATES. @[120894-1705A]

Rationale is same as for paragraph A.

THIS RULE CONTINUED ON NEXT PAGE

FLIGHT RULES

A7.9.2-13 MEMORY WRITE MANAGEMENT (CONTINUED)

- C. ALL MEMORY WRITES USING PHYSICAL ADDRESSING WILL BE VERIFIED IN THE SDF BY THE HOSC.

Software development level verification at Huntsville Operations Support Center (HOSC) is required because of the sensitivity to the CDMS of physical addressing. Normally, HOSC will verify a patch in the Software Development Facility (SDF).

Reference: Letter of Agreement for In-Flight Software Maintenance Support for Spacelab, DF/83-91, 9/27/83.

- D. MASS MEMORY WRITES WILL NORMALLY BE IMPLEMENTED TO BOTH PRIME AND REDUNDANT COPIES ON THE MMU.

Automatic logic selects the redundant copy on mass memory if there is some, possibly transient, error on the first attempt. If both copies are not updated, we will not be able to take advantage of this feature.

- E. MEMORY WRITES TO SCOS AND ECOS WILL NORMALLY BE IMPLEMENTED TO AVOID THE PROCEDURAL COMPLEXITY OF MASS MEMORY WRITES AND TO AVOID CHANGES TO THE MASS MEMORY UNIT WHICH MAY CAUSE THE SOFTWARE TO FAIL TO LOAD FROM THE MMU. CHANGES TO BOTH THE OPERATING SYSTEM AS WELL AS THE RESIDENT APPLICATIONS SOFTWARE WHICH IS CURRENTLY EXECUTING WILL BE ACCOMPLISHED BY MEMORY WRITES. CHANGES TO NON-RESIDENT APPLICATION SOFTWARE WILL BE DONE BY FIRST MODIFYING THE MMU CACHE VIA MEMORY WRITES. WHEN REQUIRED, THE UPDATED PORTION OF MMU CACHE WILL BE RELOADED INTO THE CURRENTLY EXECUTING SOFTWARE. @[071494-1642A]

It is preferred, because of the unnecessary additional complexity required with an MMU patch, that MMU patches be avoided if the same modification can be implemented in a memory patch**. Memory patches which are implemented to the active operating system as well as to the resident application software are not made to the memory image which is reloaded during a UMI. Thus, following a UMI, these patches must subsequently be reapplied. (Non-resident application software patches remain intact in the MMU cache). All memory patches must be reapplied if the computer is re-IPL'ed via the MMU instead of via a UMI. @[071494-1642A] @[111094-1707A]*

THIS RULE CONTINUED ON NEXT PAGE

FLIGHT RULES

A7.9.2-13 MEMORY WRITE MANAGEMENT (CONTINUED)

* MMU block patches are implemented as follows:

(Note: To ensure that changes to MMU cache and the UMI memory image are implemented properly, patches must be applied to the computer which is affected by the modification.) ©[071494-1642A]

- a. Dump MMU (prime copy) - verify correct MMU block.
- b. Write memory - patch in modification buffer.
- c. Dump memory - verify patch in computer memory.
- d. Write MMU (prime copy) - patch MMU.
- e. Dump MMU (prime copy) - verify patch in MMU block.
- f. Write MMU (redundant copy) - patch MMU.

[Redundant copy assumed correct by using standard MMU formula].

** Memory patches are implemented as follows: ©[071494-1642A]

- a. Dump memory - verify correct location.
- b. Write memory - implement the patch.
- c. Dump memory - verify the patch was implemented correctly. ©[111094-1707A]

FLIGHT RULES

SECTION 8 - GUIDANCE, NAVIGATION, AND CONTROL (GN&C)

GENERAL

A8.1.1-1 FCS DOWNMODE 8-1

A8.1.1-2 SSME THRUST VECTOR CONTROL (TVC) HARDOVER ... 8-3

A8.1.1-3 LOSS OF GNC SYSTEM 8-4

A8.1.1-4 FAULT TOLERANCE PHILOSOPHY 8-5

A8.1.1-5 ACCELEROMETER ASSEMBLIES (AA) FAULT TOLERANCE 8-7

A8.1.1-6 CONTROLLERS/FCS SWITCHING FAULT TOLERANCE ... 8-7

A8.1.1-7 ENTRY SYSTEMS SINGLE-FAULT TOLERANCE VERIFICATION 8-8

A8.1.1-8 ENTRY SYSTEMS RM DILEMMA 8-8

A8.1.1-9 AFT STATION GNC REDUNDANCY 8-9

A8.1.1-10 POWER/DATA PATH REDUNDANCY 8-9

A8.1.1-11 LOSS OF BFS 8-9

A8.1.1-12 HEAD UP DISPLAY (HUD) AND CREW OPTICAL ALIGNMENT SIGHT (COAS) ALIGNMENT 8-10

A8.1.1-13 RTLS ET SEPARATION 8-11

A8.1.1-14 POWER MANAGEMENT 8-12

A8.1.1-15 GNC PARAMETERS/LRU FAILURES 8-12

A8.1.1-16 GNC SYSTEMS FAILURES 8-12

A8.1.1-17 EQUIPMENT REQUIRED FOR EMERGENCY AUTOLAND .. 8-13

A8.1.1-18 LANDING SYSTEMS REQUIREMENTS 8-13

A8.1.1-19 YAW JET DOWNMODE 8-14a

A8.1.1-20 ENTRY ELEVON SCHEDULE SELECTION CRITERIA ... 8-15

A8.1.1-21 SSME REPOSITIONING FOR DRAG CHUTE 8-16

FAILURE DEFINITIONS

A8.1.2-1 PHILOSOPHY 8-17

FLIGHT RULES

A8.1.2-2 SENSOR FAILURES 8-17
 A8.1.2-3 OMS TVC LOSS 8-19
 A8.1.2-4 FIRST STAGE LOSS OF CONTROL DEFINITION 8-23
 A8.1.2-5 ET SEPARATION RCS REQUIREMENTS 8-23
 A8.1.2-6 BFS LRU REQUIREMENTS 8-24
 A8.1.2-7 PRELAUNCH IMU HOLD 8-26
 A8.1.2-8 ADI LOSS 8-33
 A8.1.2-9 IMU BITE FAILURE DEFINITION 8-32
 A8.1.2-10 LOSS OF VERNIER RCS DAP MODE 8-33
 A8.1.2-11 SSME SHUTDOWN DUE TO HYDRAULIC SYSTEM
 FAILURES 8-35

MANAGEMENT

A8.1.3-1 BEEP TRIM DEROTATION 8-41
 A8.1.3-2 SINGLE ENGINE ROLL CONTROL (SERC) FOR RTLS . 8-43
 A8.1.3-3 RGA SYSTEM MANAGEMENT (CIL) 8-44
 A8.1.3-4 PRIORITY RATE LIMITING (PRL) SYSTEMS
 MANAGEMENT 8-46
 A8.1.3-5 FCS CHECKOUT 8-46
 A8.1.3-6 CONTROLLERS 8-49
 A8.1.3-7 TVC-SSME STOW/ACTUATOR FLUID FILL
 (REPRESSURIZATION) 8-50
 A8.1.3-8 FCS CHANNEL MANAGEMENT 8-52
 A8.1.3-9 HUD/COAS SYSTEM MANAGEMENT 8-55
 A8.1.3-10 STAR TRACKER SYSTEM MANAGEMENT (CIL) 8-56
 A8.1.3-11 IMU SYSTEM MANAGEMENT 8-57
 A8.1.3-12 GNC AIR DATA SYSTEM MANAGEMENT (CIL) 8-64
 A8.1.3-13 AEROSURFACE ACTUATOR PROTECTION 8-67
 A8.1.3-14 OMS TVC SYSTEM MANAGEMENT 8-67
 A8.1.3-15 ENTRY BODY BENDING FILTER SELECTION 8-70

GNC GO/NO-GO CRITERIA

FLIGHT RULES

A8.1.6-1 GNC GO/NO-GO CRITERIA 8-71

FLIGHT RULES

SECTION 8 - GUIDANCE, NAVIGATION, AND CONTROL (GN&C)

GENERAL

A8.1.1-1 FCS DOWNMODE

- A. FOR CONTROL PROBLEMS, FCS DOWNMODE (CSS AND BFS ENGAGE) IS AN ONBOARD DECISION AND MAY RESULT FOR ANY OF THE FOLLOWING:
1. IMPENDING LOSS OF CONTROL (LOC).
 2. NO VEHICLE RESPONSE TO EXPECTED MANEUVERS.
 3. ANY UNEXPLAINED ATTITUDE/RATE EXCURSIONS OR UNDAMPED OSCILLATORY MOTIONS. WITH THIS IN MIND, THE FOLLOWING GUIDELINES ARE PROVIDED:
 - a. ASCENT - FIRST STAGE: ANY UNEXPLAINED VEHICLE RATE OR UNDAMPED OSCILLATION GREATER THAN 3 DEG/SEC.
 - b. ASCENT - SECOND STAGE: ATTITUDE ERRORS (3 DEGREES IN PITCH OR YAW; OR 10 DEGREES IN ROLL) WITHOUT CONVERGING RATES OR RATES GREATER THAN 3 DEG/SEC WITHOUT CORRESPONDING ATTITUDE ERRORS.
- B. CREW DOWNMODING PROCEDURE FOR LOSS OF CONTROL IN FIRST STAGE THROUGH LOAD RELIEF (90 SECONDS MET) SHOULD BE TO ENGAGE THE BFS. POST LOAD RELIEF AND THROUGHOUT SECOND STAGE, THE DOWNMODING SEQUENCE SHOULD BE, CONDITIONS PERMITTING, TO FLY CSS CONTROL FOLLOWED, IF NECESSARY, BY BFS ENGAGE.

FCS downmoding (CSS and BFS engagement) is an onboard decision. The crew is ultimately responsible for the safety of the vehicle and onboard personnel. The types of situations requiring downmode action include impending loss of control, lack of vehicle response to expected maneuvers or trajectory changes, or any unexplained vehicle attitude/rate excursions or undamped oscillations.

THIS RULE CONTINUED ON NEXT PAGE

FLIGHT RULES

A8.1.1-1 FCS DOWNMODE (CONTINUED)

Guideline limits are given which reflect our flight experience and simulation data base or, in the case of second stage, bound vehicle behavior such that an acceptable MECO target is achieved. The following sources were used to develop these criteria:

- a. *R&E ascent flight control system certification tests show vehicle rates no greater than 2 to 3 deg/sec.*
- b. *Flight Design and Dynamics Division range safety simulation cases of flight control disturbances (stuck SRB actuators, etc.) show, for survivable cases, that vehicle rates and oscillations typically did not exceed 3 deg/sec. In addition, these oscillations had periods on the order of 6 to 10 seconds and were fairly well damped.*
- c. *Rockwell simulations cases (refer to RI Internal Letter FSD&P/IGN&C87, November 25, 1987) with an attitude error bias in the digital autopilot concluded that proper MECO targets could be met and good flight control maintained when a 3-degree attitude error in any axis was applied and when a 10-degree attitude error in roll was applied. These runs included RTLS, TAL, and ATO abort scenarios.*

As a result, downmoding action is warranted when vehicle response is outside this flight envelope.

For violation of any of the criteria in paragraph A, the downmoding action is dependent upon the phase of flight. During first stage, loss of control may occur rapidly due to the control authority of the SRB's. In addition, the crew cannot adequately control the vehicle in CSS during load relief. Moding to the BFS in this timeframe changes the entire flight software which may recover control of the vehicle. (Note, auto flight control is the only mode available during powered flight in the BFS.) Post load relief, dynamic pressure is diminished (and in second stage control authority is decreased) which allows the crew to attempt CSS control for unusual vehicle behavior and then engage the BFS if necessary. Typically, CSS provides greater rate command authority than auto. In any phase of flight, however, conditions may be such (e.g., rapid LOC) to preclude the use of CSS prior to BFS engage. Note, for vehicle rate excursions or oscillations, CSS without RHC inputs will command attitude hold (zero rate command with attitude error command coming from integrated RGA data) and eliminate guidance, auto steering (and effectively IMU data) from the command loop. Vehicle displays, however, will reflect guidance parameters.

FLIGHT RULES

A8.1.1-2 SSME THRUST VECTOR CONTROL (TVC) HARDOVER

AN SSME WITH A CONFIRMED, UNCOMMANDED HARDOVER TVC ACTUATOR WILL BE MANUALLY SHUT DOWN IN ACCORDANCE WITH THE FOLLOWING TABLE :

ACTUATOR, DIRECTION	FAILURE OCCURS:	
	FIRST STAGE	SECOND STAGE
LEFT -YAW, RIGHT +YAW * CENTER + PITCH * CENTER ±YAW LEFT & RIGHT ±PITCH	PRIOR TO 1:40	N/A
LEFT +YAW, RIGHT -YAW	PRIOR TO 1:40	SINGLE ENG PRESS
CENTER -PITCH	PRIOR TO 7:00	PRIOR TO 7:00

* BELL COLLISION CONCERN

“Confirmed” hardovers imply that multiple independent sources of information indicate that an actuator is stuck hardover. These sources include OI position indications for all actuators, multiple FCS channel bypasses (same actuator), and vehicle control problems. Only the MCC can confirm that an actuator is hardover, and the MCC will inform the crew immediately upon recognition of the failure.

Failure of the lower engines hardover inboard in yaw (left -Y, right +Y) result in immediate bell collision in first or second stage. The MCC will attempt to recommend shutdown of the affected engine prior to MET 1:40 after which SRB thrust tailoff would further increase the amount of bell collision. In second stage, the MCC will not offer a recommended action (listed as N/A) because of the expected immediate bell collision.

Failure of the center engine hardover in positive pitch (toward lower engines) in first stage results in bell collision during SRB tailoff. Engine shutdown prior to MET 1:40 will prevent collision. In second stage, the case is listed as N/A because of the expected immediate bell collision.

Hardovers of the center engine ± yaw and lower engines ± pitch are controllable in first stage until SRB thrust tailoff. Shutdown of the affected engine prior to MET 1:40 will prevent LOC. These same failures in second stage cause vehicle control to be lost immediately. These cases are listed as N/A because of the expected immediate LOC.

THIS RULE CONTINUED ON NEXT PAGE

FLIGHT RULES

A8.1.1-2

SSME THRUST VECTOR CONTROL (TVC) HARDOVER (CONTINUED)

Failures of the lower engines outboard in yaw (left +Y, right -Y) during first stage result in vehicle sideslip (beta) angles of more than 25 degrees as SRB thrust tails off. This is well above the limits established to protect external tank (ET) heating constraints. Maximum ET heating occurs in the MET 100- to 120-second timeframe. The hardover engine should be shut down no later than MET 1:40 to allow control transients (specifically beta) to damp so as to not violate ET heating constraints. The same hardovers during second stage result in control transients (expected to be recoverable) at the time of the hardover. Depending on the time of the second stage failure, less than desirable MECO conditions can result if the affected engine is allowed to run until MECO. This occurs because control perturbations caused by failures later in second stage may not have sufficient time to damp out. Thus, the recommended action is to shut down the affected engine at single engine press to MECO.

Failure of the center engine hardover in negative pitch (bell up away from the lower engines) is controllable until late in ascent. As the vehicle center of gravity changes, the good actuators gimbal to maintain a trimmed vehicle. By approximately MET 7:00, the good actuators reach their software command limits and loss of control follows.

The actions presented in this rule summarize the results of SMS runs and an ascent thrust vector control hardover failure study using the Space Shuttle Functional Simulator. The study was performed using the STS-26 mission design. The recommended shutdown actions apply to all flights. (Ref. Lockheed Correspondence No. 46-88, 04/11/88, and Ascent Flight Techniques Panel Meeting #44, 05/17/88.)

Rule {A2.1.6-1}, CONTINGENCY ACTION SUMMARY, references this rule.

A8.1.1-3

LOSS OF GNC SYSTEM

REGARDLESS OF GNC SYSTEMS PROBLEMS DURING ASCENT, THE MOST DESIRABLE ACTION IS TO CONTINUE TO ORBIT. FOR CONFIRMED, PERMANENT LOSS OF ALL FAULT TOLERANCE IN ANY ENTRY-CRITICAL GNC SYSTEM, A FIRST DAY PLS RETURN WILL BE INVOKED.

Failures in an entry-critical GNC system will not cause aborts (RTLS, TAL, ATO, AOA) during the ascent phase. However, for the confirmed loss of all fault tolerance in an entry-critical system during ascent, a first day PLS should be performed to reduce the time available for any subsequent system failures which may affect deorbit/entry. Continuing the mission with no system redundancy constitutes unreasonable risk and deorbit should be performed.

Rule {A8.1.6-1}, GNC GO/NO-GO CRITERIA, references this rule.

FLIGHT RULES

A8.1.1-4 FAULT TOLERANCE PHILOSOPHY

- A. EARLY MISSION TERMINATION WILL BE SCHEDULED AT THE NEXT PLS OPPORTUNITY IF ANY ENTRY-CRITICAL GNC SYSTEM HAS LOST ALL FAULT TOLERANCE.

Continuing the mission with no fault tolerance in a critical system would result in unreasonable risk. By performing a next PLS deorbit, we reduce the exposure to a subsequent failure which would preclude a safe deorbit/entry (ref. Rule {A8.1.6-1}, GNC GO/NO-GO CRITERIA).

Several GNC systems have zero-fault tolerance during entry with two LRU's remaining. The system can still support entry if one of these LRU's fails on orbit. For these systems, remaining on orbit is acceptable, since the next on-orbit failure does not preclude a safe entry. Reference EFTP #45, 06/17/88.

- B. THE FLIGHT WILL CONTINUE TO NOMINAL END OF MISSION FOR THE FIRST FAILURE WHICH IMPACTS AN ENTRY-CRITICAL SYSTEM. IF THE ~~SYSTEM ORBITER REMAINS IS NO LONGER~~ SINGLE-FAULT TOLERANT (FAIL-SAFE), ~~IN THAT SYSTEM. EXCEPTIONS WHICH RESULT IN AN MDF FOR THE FIRST FAILURE ARE:~~ A REVIEW OF THE FAILURE MODE AND REMAINING SYSTEMS CAPABILITY WILL BE CONDUCTED TO DETERMINE WHETHER NEOM IS APPROPRIATE. @121296-4610]

REFERENCE RULES {A8.1.6-1}, GNC GO/NO-GO CRITERIA, ~~AND~~ {A2.1.3-1}, MISSION DURATION REQUIREMENTS.

In general, it is an acceptable configuration to continue to nominal EOM after a single failure in an avionics system which leaves that system with single-fault tolerance. The systems which fall into this category are the four-LRU systems (i.e., AA's, RGA's, and FCS channel position feedbacks). The risk of staying on orbit until nominal EOM is acceptable after one failure because these systems, after the second failure regardless of the cause for the failure (i.e., LRU, MDM, or GPC), are only vulnerable to the next LRU failure (third failure overall) while in MM 304 to 305. Prior to entry, a failure in the AA's, RGA's, or position feedbacks can be deselected via SPEC 53, ENTRY CONTROLS display.

FLIGHT RULES

The Flight Control System (FCS) command channels and the IMU system are single-fault tolerant (fail-safe) after the first failure, with the exception of certain “smart failures” during specific windows of deorbit and entry. Neither ~~the IMU’s system and Flight Control Systems (nor the FCS)~~ command channels ~~are exceptions because they cannot~~ sustain greater than two failures and still be able to fly entry. ~~Following a second IMU or FCS command channel failure, the system is zero-fault tolerant and is vulnerable to an LRU, MDM, or GPC failure. One of three IMU’s is required to perform entry. Two elevon, rudder, and speed brake FCS command channels (each of which have four command channels) are required since a single channel is uncertified (ref. SODB TBD). Only one of three body flap command channels is required to maintain acceptable drive capability during its normal trim function. However, with respect to the first failure in either of these systems,~~ a risk assessment completed by the AEFTP in 1996 (Ref. AEFTP #131 and 6/96 AEFTP Splinter Meeting) concluded that the relative risk of remaining on-orbit to NEOM rather than returning at the minimum duration flight (MDF) point after the first failure (in the FCS or IMU system) is an order of magnitude less than the launch risks and orbital debris risks. For an IMU or FCS command channel failure, the risk will be re-assessed in real time based on the latest run-time and failure history. @121296-4610]

In addition (per Rule {A2.1.3-1}, MISSION DURATION REQUIREMENTS), for multiple failures in an entry-critical system which results in loss of two-fault tolerance but still retains single-fault tolerance, an MDF will be declared. The MDF is performed due to the loss of confidence in the integrity of the system (ref. Rule {A2.1.3-1B.2}, MISSION DURATION REQUIREMENTS).

FLIGHT RULES

A8.1.1-5 ACCELEROMETER ASSEMBLIES (AA) FAULT TOLERANCE

IF FAIL-SAFE REDUNDANCY (THREE OF FOUR) DOES NOT EXIST IN NORMAL AA'S, THEN THE PITCH AXIS AUTO MODE WILL NOT BE USED IN MM 305, MM 602 (Nz HOLD PHASE), OR MM 603. MCC CALL MAY BE REQUIRED.

Fail-safe redundancy of normal accelerometers is required to engage the pitch axis auto mode in MM 305, MM 602, and MM 603. MCC call may be required since RM terminates after first failure.

The flight control auto pitch channel receives normal acceleration commands from guidance in MM 305, MM 602, and MM 603. If two normal accelerometers have failed, then the AA selection filter will be midvalue selecting bad Nz data if a third normal axis accelerometer fails. If the first two accelerometer failures are due to commfaults, the selection filter will average the remaining two.

The pitch channel uses Nz feedback to close the auto flight control loop and, if bad data concerning vehicle response is fed back, loss of control can occur. CSS removes Nz feedback from the flight control loop.

During the Nz hold phase of MM 602, the ADI pitch error needle displays Nz error, and the ACCEL tape on the AMI displays Nz in g's. If a third normal axis accelerometer failure occurs, it may be difficult to maintain the target Nz (approximately 2.1 g's) while flying manually, since these displays will be driven with bad feedback. The crewmember may have only the G-meter and the energy profile on the ENTRY TRAJ display as cues for maintaining target Nz. Although it may be difficult to maintain the precise Nz in the event of a third failure, pitch CSS is required after two failures to prevent a loss of control. Testing in the SMS has shown that if the pitch axis AUTO mode is used and the third failure occurs, a loss of control can result during MM602 Nz hold.

Rule {A2.1.4-11}, ENTRY DTO/AUTO MODE/CROSSWIND DTO GO/NO-GO, references this rule.

A8.1.1-6 CONTROLLERS/FCS SWITCHING FAULT TOLERANCE

EXCEPT FOR RHC'S, REQUIRED FAILURE TOLERANCE FOR ALL CONTROLLERS OR FCS SWITCHING FUNCTIONS CAN BE SATISFIED FROM EITHER SIDE OR BOTH SIDES OF THE COCKPIT. RECONFIGURATION IN GNC 8 IS ALLOWED TO MEET CONTROLLER AND SWITCH REDUNDANCY REQUIREMENTS.

Existence of station processing and system redundancy ensures availability of functions from either side of the cockpit. However, because of their use during entry (especially the CDR's RHC), RHC's require a higher priority for system reconfiguration which can be done in OPS 2 or 8.

Rule {A8.1.6-1}, GNC GO/NO-GO CRITERIA, references this rule.

FLIGHT RULES

A8.1.1-7 ENTRY SYSTEMS SINGLE-FAULT TOLERANCE VERIFICATION

- A. A FAILURE IN ANY ENTRY-CRITICAL SYSTEM THAT WILL PRECLUDE SINGLE-FAULT TOLERANCE DURING ENTRY WILL BE VERIFIED PRIOR TO DEORBIT BURN. IF THE FAILURE IS RECOVERABLE (TRANSIENT), ENTRY WILL BE DELAYED ONE ORBIT, IF AVAILABLE, TO ALLOW RECONFIGURATION.

A one-orbit deorbit delay will be called to allow system failure compensation/reconfiguration to be performed since most can be handled in one orbit. Delaying an entire extra day unnecessarily increases the exposure to further system failures.

- B. THE DEORBIT BURN WILL BE DELAYED UP TO 1 DAY TO ALLOW RECONFIGURATION TO RECOVER THE FUNCTION OF EITHER RHC.

Due to the RHC requirements during entry, a 1-day delay will be performed if multiple failures cause the loss of function of one RHC. The 1-day delay will allow the implementation of an RHC/DDU IFM (ref. Rule {A2.1.3-4C.7}, IN-FLIGHT MAINTENANCE (IFM)) in order to recover the RHC capability. The 1-day delay is needed due to the amount of time required to perform the RHC or DDU IFM. Both hardware changes take at least 3 hours to perform.

Rules {A2.1.6-1}, CONTINGENCY ACTION SUMMARY; and {A8.1.1-8}, ENTRY SYSTEMS RM DILEMMA, reference this rule.

A8.1.1-8 ENTRY SYSTEMS RM DILEMMA

FOR FAILURES RESULTING IN LOSS OF AN ENTRY-CRITICAL FUNCTION DUE TO RM DILEMMA, ENTRY WILL BE DELAYED TO ALLOW THE SINGLE REMAINING SYSTEM TO BE PRIME SELECTED.

If an entry-critical function has been lost due to an RM dilemma, delaying entry allows the crew to perform any recovery procedures necessary to recover the function by prime-selecting the single remaining system. The systems which could announce a dilemma prior to deorbit burn are the hand controllers and IMU's. However, of the hand controllers, only the RHC would cause a deorbit delay to recover the function of the RHC (ref. Rule {A8.1.1-7B} ENTRY SYSTEMS SINGLE-FAULT TOLERANCE VERIFICATION). For most of the systems, prime selection can be done in OPS 2 or 3.

Rule {A2.1.6-1}, CONTINGENCY ACTION SUMMARY, references this rule.

FLIGHT RULES

A8.1.1-9 **AFT STATION GNC REDUNDANCY**

LOSS OF AFT STATION GNC SYSTEMS SHALL NOT BE A CAUSE FOR EARLY FLIGHT TERMINATION. NO IFM WILL BE DONE TO REPLACE AN AFT GNC SYSTEM WITH A FORWARD SYSTEM.

Aft station systems are not required for safe entry. There are no on-orbit activities that would require risking the loss of an entry-critical forward system.

Rule {A8.1.6-1E}, GNC GO/NO-GO CRITERIA, references this rule.

A8.1.1-10 **POWER/DATA PATH REDUNDANCY**

LOSS OF POWER REDUNDANCY OR DATA PATH REDUNDANCY TO A GNC LRU IS NOT CONSIDERED LOSS OF THE LRU REDUNDANCY.

Loss of power or data path redundancy to an LRU does not indicate a generic systems failure. A single external failure should not imply impending LRU-related failures. The LRU should be considered operational as long as power and a communications path exist to the LRU.

A8.1.1-11 **LOSS OF BFS**

LOSS OF BFS BECAUSE OF LOSS OF GNC SYSTEMS WILL NOT BE CAUSE TO TERMINATE THE FLIGHT EARLY.

The role of the BFS GNC software is a protection against generic errors in the prime GNC software. The level of BFS GNC fault-tolerance is not considered a requirement for on-orbit stay time. Given the present early termination rules for GNC systems loss, only the loss of the BFS engage switches would invoke this rule. If the BFS GNC is lost by BFS hardware or software problems, then the generic protection is already lost and no extra risk is involved in staying on orbit until nominal end-of-flight.

Rule {A8.1.6-1}, GNC GO/NO-GO CRITERIA, references this rule.

FLIGHT RULES

A8.1.1-12 HEAD UP DISPLAY (HUD) AND CREW OPTICAL ALIGNMENT SIGHT (COAS) ALIGNMENT

A CALIBRATED HUD/-Z COAS IS AN ADEQUATE BACKUP TO THE STAR TRACKERS FOR ENTRY IMU ALIGNMENT. @[111094-1723A]

A 3-sigma COAS IMU alignment and a HAINS IMU drifting at 1 sigma in all axes result in a total platform misalignment of 0.25 degrees at EI which meets the navigation requirement of no more than 0.5 degrees (ref. Rule {A4.1.4-1}, IMU ALIGNMENT). The KT-70 IMU represents the worse case, since the HAINS IMU 1 sigma drift rate is significantly low. The 0.25 degree misalignment is based on SODB data (SODB para. 4.5.1.2.3.e.3.d) for a COAS calibrated immediately following a star tracker IMU alignment and an entry alignment that is done 2.5 hours prior to the deorbit burn with a time of approximately 30 minutes from burn to EI. Based on flight calibration data, it is assumed that a HUD IMU alignment will be as good as, if not better than, a COAS IMU alignment. As backups to the star trackers for IMU alignments, the CDR HUD is the primary station and the PLT HUD/-Z COAS is the secondary station. The +X COAS performance during flights has not been adequate to support an entry IMU alignment and should not be used as a backup to the star trackers (ref. On-Orbit FTP meeting #133, October 9, 1992, HUD/COAS CALIBRATION, and On-Orbit FTP meeting #148, September 9, 1994, HUD/COAS CALIBRATION STATUS). @[111094-1723A]

Rule {A8.1.3-9}, HUD/COAS SYSTEM MANAGEMENT, references this rule.

FLIGHT RULES

A8.1.1-13 RTLS ET SEPARATION

FOR RTLS ET SEPARATION, CREW ACTION SHALL BE AS FOLLOWS:

- A. DURING MATED COAST, COMMAND A FAST SEPARATION IF ALPHA $\neq -4 \pm 2$ DEGREES AND DIVERGING OR BETA $\neq 0 \pm 2$ DEGREES AND DIVERGING.

During RTLS mated coast, MM 601, G/C steer is commanding attitude hold in all axes in either CSS (while the RHC is in detent) or auto flight control mode. Due to the time limitations of performing RTLS ET separation, a fast separation should be commanded anytime the vehicle attitude is diverging from the RTLS ET separation structural release constraints. All of the RTLS ET separation design staging conditions are documented in JSC-07700, volume X, figure 3.2.1.1.10.4.

- B. DURING -Z TRANSLATION, SELECT CSS IF ALPHA DECREASING OR ANY RATE > 2 DEG/SEC WITH DIVERGING ATTITUDE ERRORS. THE CREW SHOULD DELAY 1 SECOND AFTER SEPARATION PRIOR TO DOWNMODING TO ENSURE ADEQUATE ORBITER/ET CLEARANCE.

During -Z translation, decreasing alpha may cause recontact with the ET. Rates greater than 2 deg/sec with a diverging attitude indicate a control problem in the auto mode which may lead to loss of control during recovery phase and entry. When performing an auto separation, the DAP will inhibit automatic rotational control for 1 second. CSS rotational commands are allowed anytime but should be avoided until adequate orbiter/ET clearance exists. One second was established as the optimum time to prevent propagation of initial disturbances resulting in loss of control but yet allow sufficient clearance from the ET (ref. Rockwell ET SEP Panel meeting, 12/2/82).

FLIGHT RULES

A8.1.1-14 POWER MANAGEMENT

- A. SYSTEMS REQUIRED FOR GNC 6 OR GNC 3 WILL BE ON FOR ASCENT AND LEFT ON UNTIL THE END OF AOA OPPORTUNITY.

Should an AOA be necessary, the crew will be busy preparing for the maneuver and should not be burdened with a requirement to power up equipment in this time-critical phase.

The MLS is the only GNC system not powered for the launch. However, the MLS will be powered for the abort (entry) per the FDF checklist.

- B. DURING ENTRY DAY, THE OPS 3 CRITICAL LRU'S (RGA'S, AA'S, AND ASA'S) WILL BE POWERED PRIOR TO MCC GO/NO-GO FOR OPS 3 TRANSITION. MCC TELEMETRY VERIFICATION IS HIGHLY DESIRABLE.

Additional time could be required for adequate MCC telemetry verification since it will not be obvious to the crew that all LRU's have been powered. The RGA's are powered prior to the OPS-3 transition in order to provide vehicle rate feedback to flight control (TRANS DAP). The ASA's are powered prior to the OPS-3 transition to preclude possible damage to the rudder/speed brake power drive unit (PDU) at APU start. The AA's are powered prior to the OPS-3 transition because of the proximity of these switches to the other LRU switches.

A8.1.1-15 GNC PARAMETERS/LRU FAILURES

GNC PARAMETERS/LRU'S THAT PERMANENTLY FAIL RM LIMITS OR GNC 8 SELF-TEST WILL BE INHIBITED FROM FURTHER USE.

Once an LRU has been identified as faulty by self-test or RM, it is no longer considered reliable.

A8.1.1-16 GNC SYSTEMS FAILURES

GNC SYSTEMS DECLARED FAILED BY RM WILL BE CONSIDERED FAILED UNLESS SUBSEQUENT VERIFICATION INDICATES THAT THE SYSTEM IS RECOVERABLE. WHEN TIME PERMITS, RECOVERY WILL BE ATTEMPTED FOR ANY GNC SYSTEMS TRANSIENT FAILURE.

FOR SOME SYSTEMS, THE CREW HAS VERY LITTLE VISIBILITY INTO THE REASON FOR RM DECLARED FAILURES. IN MOST CASES, THE FAILURES ARE CAUSED BY SYSTEM DEGRADATION WHICH CAN BE COMPENSATED BY THE MCC, THEREBY RECOVERING THE FUNCTION OF THAT LRU.

FLIGHT RULES

A8.1.1-17 EQUIPMENT REQUIRED FOR EMERGENCY AUTOLAND

THE FOLLOWING EQUIPMENT IS REQUIRED TO ALLOW USE OF AUTOLAND CAPABILITY TO TOUCHDOWN IN EMERGENCY SITUATIONS:

- A. ONE - NORMAL AA.
- B. ONE - MSBLS.
- C. ONE - ADTA.

Situations that may require emergency autoland include crew incapacitation, window contamination, or any contingency landing below weather minimums.

Normal axis accelerometer data is required for the Aerojet DAP auto mode in MM 305.

MLS is the only navigation LRU with sufficient accuracy to guide the orbiter to a precision runway landing in the auto mode. Autoland cannot be flown on default air data. The availability of these systems should not be considered as part of GO/NO-GO for deorbit.

Rule {A8.1.1.6-1}, GNC GO/NO-GO CRITERIA, references this rule.

A8.1.1-18 LANDING SYSTEMS REQUIREMENTS

- A. FOR THE GIVEN CONDITIONS AND LANDING SITES, THE FOLLOWING ARE THE NUMBER OF ONBOARD MSBLS REQUIRED:

	LAKEBED	CONCRETE RUNWAY
DAYLIGHT LANDING:		
CEILINGS > 10K FEET	0	0
CEILINGS < 10K FEET	1	2
NIGHT LANDING:		
CEILINGS > 15K FEET	1	2
CEILINGS < 15K FEET	2	2

For lower ceilings (8,000 to 10,000 feet) or night operations, redundant MSBLS (single-fault tolerance) is required for landing on a concrete runway. This is due to the fact that longitudinal and lateral concrete runway environments are limited and less forgiving of navigation errors when adequate visual cues are not available (i.e., lower ceilings or night landings). MSBLS provides accurate azimuth, elevation, and range information that allow a precise approach to the runway.

MSBLS is also mandatory for daylight landings on the lakebed with reduced ceilings but is not required to be redundant due to the increased margin for error on the lakebed.

THIS RULE CONTINUED ON NEXT PAGE

FLIGHT RULES

A8.1.1-18 LANDING SYSTEMS REQUIREMENTS (CONTINUED)

For a night landing and the loss of redundant MSBLS, a lakebed runway is required. In addition, ceilings must be greater than 15,000 feet for a night landing to a lakebed runway without redundant MSBLS to allow early acquisition of PAPI lights and aimpoint should a single point failure causing loss of MSBLS occur. This increased ceiling requirement allows more time for glide slope and runway centerline corrections. The 15,000 feet altitude is based on extensive analysis conducted in the Shuttle Mission Simulator (SMS) and Shuttle Training Aircraft (STA) by Flight Design and Dynamics personnel and crew representatives (ref. Rule {A2.1.1-6}, LANDING SITE WEATHER CRITERIA). ©[111094-1622B]

MSBLS redundancy is maintained with two onboard MSBLS remaining (one MSBLS failed) assuming the MCC is available to solve dilemmas. A dilemma occurs for an erroneous output failure of one of the remaining two units. The only information used to solve the dilemma (outside of MCC assistance) is built-in test equipment (BITE), which is limited in its ability to detect failures. The MCC requires ground radar along with telemetry data to isolate the bad MSBLS in the event of a dilemma.

Rule {A2.1.1-6}, LANDING SITE WEATHER CRITERIA, references this rule. ©[111094-1622B]

B. A DAYLIGHT LANDING WILL BE REQUIRED, IF AVAILABLE, FOR LOSS OF ANY OF THE FOLLOWING:

1. THREE MSBLS.
2. TWO FORWARD ADI'S (N/A FOR MEDS VEHICLES). ©[040899-2459B]

MSBLS is required at night to maintain an accurate approach path to a lower altitude before transitioning to visual cues (PAPI's, ball bar, and runway markings). For the loss of all three onboard MSBLS, enter to a daylight landing, if available.

One ADI is required to commit to a night landing in order to fly bank angle around the HAC in the event of guidance problems.

A requirement for the HSI was considered for night landings due to the need for accurate heading and course information; however, such a requirement was not levied since MSBLS and the HUD were required and should supply sufficient information during the approach phase.

C. FOR LOSS OF THE LEFT HUD, A DAYLIGHT LANDING IS HIGHLY DESIRABLE.

The left HUD is highly desirable for night landings in order to reduce approach and landing workload, monitor touchdown critical parameters, and offset the loss of outside visual references. Therefore, the left HUD is desired to commit to a night landing, situation permitting (e.g., weather, etc.). Reference Memorandum CB-89-265, and Rule {A2.1.3-4}, IN-FLIGHT MAINTENANCE (IFM). ©[072398-6646]

FLIGHT RULES

THIS RULE CONTINUED ON NEXT PAGE

FLIGHT RULES

A8.1.1-18 LANDING SYSTEMS REQUIREMENTS (CONTINUED)

D. RA ALTITUDE DATA IS HIGHLY DESIRABLE FOR NIGHT LANDINGS.

©[072398-6646]

Due to the lack of visual depth perception during night landings, the RA's and ball bar become the primary source for altitude and altitude rate information from approximately 50 feet until main gear touchdown. If RA data is not available, the ball bar is considered sufficient under normal circumstances to allow the pilot to achieve acceptable touchdown conditions. In the event of an RA failure(s), consideration should be given to landing site conditions (e.g., winds, turbulence, ceiling, lighting conditions, ~~visibility~~visibility, landing ground speed, vehicle mass properties, touchdown point, runway lighting, mission duration, etc.) as they relate to pilot workload and usefulness of the ball bar. Of particular concern are conditions, which if combined with no RA data, will increase the probability of exceeding landing gear/tire limits. Consideration should be given to selecting the landing site that offers the more benign landing conditions. This consideration should focus on which of the sites' landing conditions would result in minimum pilot workload and/or impact to the usefulness of the ball bar. ©[072398-6646]

Rules {A2.1.4-7}, LANDING SITE SELECTION; {A2.1.5-11}, ENTRY DTO/AUTO MODE/CROSSWIND DTO GO/NO-GO; {A8.1.2-8}, ADI LOSS; and {A8.1.6-1}, GNC GO/NO-GO CRITERIA, reference this rule.

FLIGHT RULES

A8.1.1-19 YAW JET DOWNMODE

- A. IF NO YAW JETS ARE AVAILABLE ON EITHER LEFT OR RIGHT SIDE, THE NO-YAW-JET DAP MODE WILL BE SELECTED IF ABOVE MACH = 1.

The no-yaw-jet mode for emergencies is a certified flight control mode from Q -bar = 20 psf through landing. This mode should be selected between Q -bar = 20 psf and Mach 1 (yaw jets inhibited) if no-yaw-jets are available on a side. In the low Q -bar regime (Q -bar < 20), vehicle response will be sluggish and pilot workload increased, but control will be better than with the baseline DAP. Once selected, it is not necessary to deselect the no-yaw-jet mode. Flight Rule {A6.1.5-5A.3,4}, AFT RCS REDLINES, defines when to engage no-yaw-jet based on aft RCS quantity. Reference DA8-88-20 (FT), Entry Flight Techniques Meeting #41.

- B. IN OPS 3, IF THE AEROJET DAP BASELINE MODE IS SELECTED AND ADDITIONAL LATERAL CONTROL MARGIN IS REQUIRED, THE WRAPAROUND DAP MODE WILL BE ENABLED IF ABOVE MACH 1. ©[021998-6485B]

The aerojet DAP wraparound mode is normally enabled for EOM, AOA/ATO, and contingency payload return entry but is not enabled for TAL abort entries, due to lack of certification for TAL aborts. The wraparound DAP is not available in OPS 6. If lateral control margin is reduced due to three yaw jets failed on one side or aileron trim saturation, a loss of control may occur. In addition, if LVAR 9 aerodynamic uncertainties are experienced (a low-probability potential below Mach 6), excessive jet firings and high RCS propellant usage may result. Enabling wraparound mode eliminates these problems by providing increased aileron authority. Reference DA8-88-20 (FT), Entry Flight Techniques Meeting #41, and Ascent/Entry Flight Techniques Panel meeting #141 minutes. ©[021998-6485B]

Rules {A6.1.2-16}, RCS LINE LEAK MANAGEMENT, and {A8.1.6-1}, GNC GO/NO-GO CRITERIA, reference this rule.

FLIGHT RULES

THIS PAGE INTENTIONALLY BLANK

FLIGHT RULES

A8.1.1-20 ENTRY ELEVON SCHEDULE SELECTION CRITERIA

THE AUTO ELEVON SCHEDULE WILL NOMINALLY BE SELECTED INDEPENDENT OF X-AXIS CENTER-OF-GRAVITY (X CG) LOCATION WITH THE FOLLOWING EXCEPTIONS:

- A. THE FIXED ELEVON SCHEDULE WILL BE SELECTED AS REQUIRED ON A FLIGHT-SPECIFIC BASIS IN ORDER TO SUPPORT AERODYNAMIC PTI'S. IF AERO PTI'S ARE SCHEDULED AND IT IS SUBSEQUENTLY DECIDED NOT TO EXECUTE THEM, THEN THE AUTO SCHEDULE WILL BE SELECTED.
- B. IF THE NO-YAW-JET MODE OF THE AEROJET DAP IS REQUIRED DURING ENTRY, THE FIXED SCHEDULE WILL BE SELECTED IF IT IS I-LOADED WITH THE AFT SCHEDULE. IF EITHER THE FORWARD OR MID SCHEDULE IS LOADED, THE AUTO SCHEDULE WILL BE SELECTED.

The smart body flap logic incorporated with OI-20 software eliminates the need for selecting elevon schedules based on the X CG for entry. The smart body flap is enabled anytime the auto schedule is selected and will maintain the elevons on a schedule that is similar to the previous mid-CG schedule but will allow the elevons to move off-schedule, within limits, in order to thermally protect the body flap and main engines.

The fixed elevon schedule maintains the body flap logic used prior to OI-20 and allows one of the three previously used schedules (fwd, mid or aft) to be loaded into this slot. It is planned to use this schedule to support aero PTI's as required on a flight-specific basis.

Low RCS propellant quantity or loss of yaw jets may require that the no-yaw-jet mode of the Aerojet DAP be selected during entry. Selecting a schedule with more positive elevon deflection (down) increases the control authority of the elevons by moving them into the airstream. For flights in which aero PTI's are not planned, the aft schedule will be loaded into the fixed slot and this schedule will be selected if the no-yaw-jet mode is required even though this may thermally impact the main engine nozzles (turnaround issue). The auto elevon schedule is certified for use with the no-yaw-jet mode; however, the aft schedule provides better control authority (ref. A/E FTP #76, held 3/15/91). The fwd schedule is not certified for use with the no-yaw-jet mode. The RCS critical entry cue card contains the procedural callout for selecting the correct schedule to be used with the no-yaw-jet mode.

FLIGHT RULES

A8.1.1-21 SSME REPOSITIONING FOR DRAG CHUTE

- A. SSME REPOSITIONING WILL BE INHIBITED IF THERE IS A SINGLE FAILURE THAT COULD CAUSE ENGINE BELL DAMAGE DURING THE REPOSITIONING SEQUENCE. IF THERE IS A KNOWN DIRECTIONAL CONTROL OR RUNWAY MARGIN PROBLEM, SINGLE FAULT TOLERANCE IS NOT REQUIRED.

It is highly desirable to manually inhibit SSME repositioning for drag chute if single-fault tolerance (SFT) is lost to prevent unnecessarily exposing the SSME bells to damage. However, in cases where drag chute deployment is mandatory (known directional control problems, aborts), single fault tolerance during the repositioning sequence is not required. Deploying a drag chute without first repositioning the SSME bells exposes the center main engine to riser cord abrasion damage. This known damage outweighs the risk of repositioning the main engines without single fault tolerance. Reference Ascent/Entry Flight Techniques Panel meeting #84, November 15, 1991, DRAG CHUTE IMPACTS.

- B. SSME REPOSITIONING IS NOT A CONSTRAINT TO DRAG CHUTE DEPLOY IF REQUIRED FOR VEHICLE CONTROL OR RUNWAY MARGIN.

The advantages of the drag chute in gaining lateral/directional stability or runway margin outweigh the risk of abrasive damage on the center SSME bell. Reference Ascent/Entry Flight Techniques Panel meeting #84, November 15, 1991, DRAG CHUTE IMPACTS.

FLIGHT RULES

FAILURE DEFINITIONS

A8.1.2-1 PHILOSOPHY

A GNC PARAMETER WILL BE CONSIDERED FAILED WHEN IT DIFFERS WITH COMMON REDUNDANT OUTPUTS BY A VALUE GREATER THAN THE I-LOADED RM TRACKING TEST LIMITS. IF AN LRU DOES NOT PROVIDE REDUNDANT OUTPUTS (IMU, TACAN, MSBLS, ETC.), PARAMETER LOSS WILL CONSTITUTE LRU LOSS. FOR THOSE LRU'S WITH REDUNDANT OUTPUTS, (RHC, RPTA, SBTC, SWITCHES, ETC.), THE LRU WILL NOT BE CONSIDERED FAILED UNTIL MULTIPLE FAILURES HAVE CAUSED THE SELECTION FILTER TO OUTPUT BAD DATA. REDUNDANT LRU'S MAY BE REGAINED BY RECONFIGURING RM TO "PRIME SELECT" A SINGLE OUTPUT PARAMETER. SUBSEQUENT FAILURE OF THE PRIME SELECT PARAMETER WILL CONSTITUTE LOSS OF THE LRU.

An LRU with redundant outputs may still be usable as long as the SF outputs good data. Deselection of failed parameters, allowing the SF to prime select the good parameter, regains use of that LRU. When this final good parameter fails, the LRU is, therefore, unusable.

A8.1.2-2 SENSOR FAILURES

SENSOR FAILURES DETECTED BY COMPARISON WITH GROUND RADAR DATA:

- A. IMU - AFTER ONBOARD RM HAS DECLARED A DILEMMA, THE FAULT IS ISOLATED TO THE LRU WITH THE MOST NON-ZERO SLOPE ON THE RADAR/IMU VELOCITY PLOTS.
- B. TACAN:
 1. AFTER ONBOARD RM HAS DECLARED A DILEMMA, THE FAULT IS ISOLATED TO THE LRU WHOSE RANGE OR BEARING EXHIBITS THE LARGEST DELTA FROM GROUND RADAR.
 2. IF THE GROUND RADAR/TACAN COMPARISON INDICATES A SIMILAR ERROR ON ALL LRU'S GREATER THAN 0.3 NM (RANGE) OR 1.0 DEGREE (BEARING), THEN THE ALTERNATE TACAN GROUND STATION WILL BE SELECTED (IF AVAILABLE).
 3. AT THE TACAN 2-LRU LEVEL, IF THE AVERAGE GROUND RADAR/TACAN DELTA IS GREATER THAN 0.3 NM (RANGE) OR 1.0 DEGREE (BEARING), THEN THE LRU WITH THE LARGER ERROR WILL BE DESELECTED.

THIS RULE CONTINUED ON NEXT PAGE

FLIGHT RULES

A8.1.2-2 SENSOR FAILURES (CONTINUED)

- C. ADTA - AFTER ONBOARD RM HAS DECLARED A DILEMMA, THE FAULT IS ISOLATED TO THE LRU WHOSE ALTITUDE IS FURTHEST FROM THE RADAR-COMPUTED ALTITUDE ON THE RADAR/ADTA PLOTS.
- D. MLS - AFTER ONBOARD RM HAS DECLARED A DILEMMA, THE FAULT IS ISOLATED TO THE LRU WHOSE RANGE/AZIMUTH/ELEVATION EXHIBITS THE LARGEST DELTA WITH RESPECT TO RADAR-COMPUTED VALUES ON THE MCC MLS PLOTS.

This rule applies to ascent/entry only.

A dilemma occurs at the two-level when a disagreement greater than the RM threshold occurs. Onboard RM may not be able to correctly isolate a dilemma. The ground can determine more readily and accurately which unit has failed by comparing the orbiter parameters to the ground radar. The crew has no insight into radar data.

- a. *For the IMU, the onboard state vector (PASS and BFS) may be compared to ground vector to resolve the dilemma. Onboard velocity data is a function of platform alignment as well as accelerometer accuracy. When accelerations are large (i.e., during powered flight or entry), the onboard velocity data is compared with radar data to determine which unit is providing the most accurate data, thus breaking the dilemma. During orbit operations, accelerometer output is read directly to reveal the IMU with incorrect velocity output.*
- b. *A TACAN dilemma will occur for a range disagreement of 3000 feet or for a bearing disagreement of 6 degrees. Analysis shows that selected TACAN errors greater than 0.3 nm in range or 1.0 degree in bearing can result in violation of position delta state limits. Rule {A4.1.5-6}, NAVIGATION FILTER MANAGEMENT AUTO/INHIBIT/FORCE (AIF), references this rule. (Ref. Rule {A4.1.5-4}, DELTA STATE POSITION UPDATES, and Ascent/Entry Flight Techniques #80.)*
- c. *At the four-level, a side-to-side dilemma can occur if there is a data miscompare between the two sides.*
- d. *For the MLS, the data good flag will be reset for a disagreement of 0.329 nm in range, 0.5 degree azimuth, or 0.4 degree elevation. In this case, navigation will default to IMU data. For an azimuth or range dilemma, MLS data should not be processed. For an elevation dilemma, do not process elevation data, but process azimuth or range data if good. Processing of bad MLS data can be inhibited by powering off the appropriate LRU, by changing the channel thumbwheel selection, or by forcing TACAN data.*

Rule {A4.1.5-6A}, NAVIGATION FILTER MANAGEMENT AUTO/INHIBIT/FORCE (AIF), references this rule.

FLIGHT RULES

A8.1.2-3 OMS TVC LOSS

- A. AN OMS ENGINE IS CONSIDERED FAILED IF TVC CAPABILITY (BOTH PRIMARY AND SECONDARY) IS LOST IN EITHER AXIS AND THE ENGINE DOES NOT MEET THE REQUIREMENT AS SPECIFIED IN PARAGRAPH D.

TVC capability is required in both axes of the OMS gimbal for proper vehicle control. It is possible to burn an engine with TVC power off if the position mistrim with respect to the vehicle CG is acceptable. RCS usage will increase in proportion to the magnitude of the mistrim. The maximum amount of mistrim acceptable (determined by RCS constraints) is documented in paragraph D.

- B. THE PRIMARY OR SECONDARY OMS TVC IS CONSIDERED FAILED IF THE GIMBAL DRIVE CHECK INDICATES A DRIVE RATE OF LESS THAN 2.9 DEG/SEC BETWEEN A GIMBAL POSITION OF ± 3 DEGREES.

The limit of 2.9 deg/sec is sufficient to provide adequate vehicle control, but this rate is well below average rate of all actuators in the field. The spec (Aerojet Rocket Company ALRC 42483-J) is 2.9 deg/sec and thus the lower limit for drive rate was established in accordance with the spec.

- C. ENGINE BELL MOVEMENT DURING ASCENT:

1. AN OMS ENGINE WILL NOT BE FIRED IF IT HAS BEEN CONFIRMED, BY BOTH THE PRIMARY AND SECONDARY POSITION TRANSDUCERS, THAT THE ENGINE BELL MOVED INBOARD OR UP MORE THAN 1.5 DEGREES IN EITHER AXIS FROM THE PRELAUNCH NORMAL ENGINE STOW POSITION (ENGINE BELL DOWN AND OUTBOARD) DURING THE TIME BETWEEN LIFTOFF +40 TO 70 SECONDS.

During the time between liftoff plus 40 to 70 seconds, the vehicle experiences maximum dynamic pressure. Movement of the OMS engine into the airstream during this region of ascent could expose the engine to windstream pressures great enough to cause damage to the nozzle/throat. Both the primary and secondary position transducers must confirm that the engine moved 1.5 degrees in either axis into the airstream. If such movement occurs, the nozzle may be deformed and/or the throat may be cracked. Firing an engine in this condition is potentially catastrophic. The constraints in this rule apply to both the thin- and thick-walled engine bells. (Ref. SODB, volume III, paragraph 4.3.3.6, CA8-82-05 (FT), EH12-81-99, and EH12-82-030.)

2. FOR SUSPECTED MOVEMENT (ONE OF TWO TRANSDUCERS) INBOARD OR UP MORE THAN 1.5 DEGREES IN EITHER AXIS, THE ENGINE WILL ONLY BE FIRED DURING ABORT DUMPS IN ACCORDANCE WITH RULE {A6.1.2-33}, OMS ENGINE BELL MOVEMENT DURING ASCENT.

FLIGHT RULES

Suspected movement is movement indicated by only one transducer. PROP Rule {A6.1.2-33}, OMS ENGINE BELL MOVEMENT DURING ASCENT, explains the risks incurred by not firing an engine during ascent abort dumps.

THIS RULE CONTINUED ON NEXT PAGE

FLIGHT RULES**A8.1.2-3 OMS TVC LOSS (CONTINUED)**

D. AN OMS ENGINE MAY BE USED FOR OMS BURNS WITH TVC POWER OFF IF THE NO-BACK DEVICE HELD POSITION, ± 0.2 DEGREES, FOR THE ASCENT PHASE OF FLIGHT AND ALL SUBSEQUENT OMS BURNS WITH THE TVC POWER OFF. THE PROPELLANT COST (ADDITIONAL POUNDS OF RCS PROPELLANT PER SECOND OF COMPUTED BURN TIME) FOR BURNING ENGINES WITH THE TVC POWER OFF (FIXED TVC) IS AS FOLLOWS:

1. FOR A TWO-ENGINE OMS BURN, ONE ENGINE FIXED TVC, A PROPELLANT COST OF 0.9 LB/SEC (100 PERCENT ARCS) WILL PROTECT FOR AN ENGINE TRIMMED THROUGH THE CG WITHIN 1.0 DEGREE IN PITCH AND WITHIN 0.5 DEGREES IN YAW.
2. FOR A SINGLE ENGINE OMS BURN WITH FIXED TVC, THE PROPELLANT COST WILL BE (72 PERCENT ARCS, 28 PERCENT FRCS):
 - a. 1.5 LB/SEC, FOR TOTAL MISTRIM ($|P| + |Y|$) ≤ 2.0 DEGREES
 - b. 0.75 LB/SEC PER DEGREE MISTRIM, FOR TOTAL MISTRIM > 2.0 DEGREES

SODB paragraph 4.3.3.4.6.1.2e specifies that the minimum operating life of a no-back device is unknown. It further specifies, however, that if the no-back device holds ± 0.2 degrees for the boost phase of flight, it will hold an engine in position for subsequent OMS burns for the remainder of that mission and is acceptable for a subsequent mission.

The propellant cost figures for fixed TVC burns are taken from studies in which data from Trans DAP OMS TVC burns was gathered/generated and analyzed from the following sources: SSFS (1983), SAIL (1984, 1985), and Draper SLS Simulator (1987, 1988). The data was analyzed separately for the two-engine burns (one fixed TVC) and for the single-engine fixed TVC burns.

For the two-engine cases, the pre-deorbit burn mass properties were used from STS 61-C; delta-V total = 227.7 ft/sec and vehicle weight = 216,520 lb (ref. SODB, volume II). These cases involved combinations of cg mistrims on the fixed TVC of pitch = -1.0, 0.0, +1.0 and yaw = -0.5, 0.0, +0.5. It should be noted that uncertainties in the cg estimate contribute to the expected total mistrim error (RSS of 3-sigma mistrim estimates) of approximately 0.6 degrees (ref. Charles Stark Draper Laboratory, Inc. memo no. SSV-88-50). The data indicated that a propellant cost of 0.9 lb/sec of computed burn time would protect for all combinations of P and Y mistrims as stated above.

THIS RULE CONTINUED ON NEXT PAGE

FLIGHT RULES

A8.1.2-3 OMS TVC LOSS (CONTINUED)

For the single-engine cases, the pre-deorbit burn mass properties were used from STS-6, STS 41-D, and STS 61-C. The delta-V total ranged from 227.7 to 284.7 ft/sec, and the vehicle weight ranged from 197,500 to 216,520 lb (ref. SODB, volume II.). Other pertinent assumptions include the trimming of residuals and data normalization. In all cases, if the X and Z residuals were more than 2.0 ft/sec, the propellant cost to trim them to less than 2.0 ft/sec [+X (25 lb/fps), -X (30 lb/fps), +Z (24 lb/fps), -Z (35 lb/fps)] was included in the total propellant cost figure. In order to account for the differences in mass properties and delta V of the burns, the data was normalized using computed burn time.

The propellant cost for total mistrims ($|P| + |Y|$) less than or equal to 2.0 degrees is 1.5 lb/sec of computed burn time. However, even in this range where the cost is a constant, one can expect that the lower the total mistrim, the lower the propellant cost, especially for single axis mistrims. Therefore, mistrim should still be minimized. The data is noisy in this regime and it was necessary to assume a cost of 1.5 lb/sec for all cases less than 2.0 degrees in order to safely blanket all data points.

The cost for a total mistrim of greater than 2.0 degrees was determined to be 0.75 lb/sec of computed burn time, per degree of total mistrim. This is the linear function that safely covers all data points for total mistrims greater than 2.0 degrees. The 0.75 lb/sec per degree of mistrim is conservative and the actual amount of mistrim in each axis (and the direction of the mistrim) determines the more exact propellant cost. Due to the general dependence on the given combination of pitch and yaw mistrims and the differences in mass properties and burn delta V, it is recommended that, time permitting, the actual case is simulated to supplement the results shown here. This data and all other data from the mentioned studies is documented (ref. Lockheed Engineering and Management Services Co. memo LEMSCO-19176; Charles Stark Draper Laboratory, Inc., memos SSV-87-10, SSV-87-18, and SSV-88-14; and G&C Systems Briefs 12.0, OMS TVC).

Rules {A6.1.2-33A}, OMS ENGINE BELL MOVEMENT DURING ASCENT; {A8.1.5-14A.4, A.5 and B}, OMS TVC SYSTEM MANAGEMENT; and {A8.1.6-1}, GNC GO/NO-GO CRITERIA, reference this rule.

FLIGHT RULES

A8.1.2-4 FIRST STAGE LOSS OF CONTROL DEFINITION

FOR THE PURPOSES OF RANGE SAFETY DECISIONS, LOSS OF VEHICLE CONTROL DURING FIRST STAGE POWERED FLIGHT IS DEFINED AS PITCH OR YAW RATES GREATER THAN 5 DEG/SEC SUSTAINED FOR MORE THAN 5 SECONDS.

This rule defines vehicle loss of control during first stage, for the purposes of range safety, as sustained rates in pitch or yaw of larger than 5 deg/sec. For large oscillations where the rates are returning to less than 5 deg/sec (within 5 seconds), the vehicle will not be defined as out of control in order to allow the flight control system the opportunity to arrest the perturbations.

Flight control system certification tests showed pitch and yaw rates no greater than 2 to 3 deg/sec. An additional limited set of simulation runs by FDDD of stuck SRB actuators showed that, for the cases where intact abort capability and vehicle structural integrity were maintained, the vehicle pitch and yaw rates did not exceed 3 deg/sec (ref. Range Safety Panel Minutes from August 27, 1987). Typical periods of these oscillations were on the order of 6 to 10 seconds. (In other words, the flight control system responded in only a few seconds.)

It is postulated that a disturbance resulting in vehicle rate oscillations of greater than 5 deg/sec may be arrested by the flight control system. Hence, the flight control system should be given the opportunity (up to 5 seconds) to arrest such a disturbance (ref. Rule {A4.1.6-3}, FLIGHT TERMINATION CRITERIA, in section 4 and Ascent Flight Techniques, 4/24/87).

A8.1.2-5 ET SEPARATION RCS REQUIREMENTS

JET GROUP	MINIMUM REQUIREMENTS	
	NOMINAL	RTL5
FWD DOWN	1	3
AFT LEFT	1	3
AFT RIGHT	1	3
AFT UP	1/SIDE	2/SIDE
AFT DN	1/SIDE	2/SIDE
FWD YAW	-	1/SIDE

These requirements represent the minimum jets required to maintain vehicle control during mated coast, prevent contact between the ET and the vehicle during ET separation, and to meet the required staging conditions post RTL5 ET separation. Nominal ET separation occurs at a lower dynamic pressure such that fewer jets are required to achieve satisfactory separation. These requirements were determined from JSC Engineering Directorate studies (ref. SODB, paragraph 4.5.1.1.6.1). (Ref. Rules {A2.1.2-14}, ASCENT STRING REASSIGNMENT; {A2.1.5-4}, ENTRY STRING REASSIGNMENT; and {A7.1.3-8C.4}, PASS DATA BUS ASSIGNMENT CRITERIA.)

Rules {A2.1.2-20} REGAIN RCS JETS FOR RTL5 ET SEPARATION; and {A6.1.2-11A.2}, RCS MANIFOLD/OMS CROSSFEED LINE REPRESSURIZATION (CIL), reference this rule.

FLIGHT RULES

A8.1.2-6 BFS LRU REQUIREMENTS

THE FOLLOWING DOUBLE LRU FAILURES (ERROR > PASS RM LIMIT) WHICH COULD RESULT IN LOSS OF CONTROL WILL CAUSE THE BFS TO BE NO-GO UNTIL THE LRU'S ARE DESELECTED BY THE CREW. DUAL NULL FAILURES ARE ACCEPTABLE FOR ALL LRU'S EXCEPT SRB RGA'S.

There is no FDI in the BFS. To determine if the LRU is failed in the BFS, the same criteria that is used by FDI in the PASS to declare an RM failure must be applied.

Interchangeable-mid-value-select (IMVS) is used for all AA's and RGA's, the same as in the PASS. The aerosurface feedback selection scheme utilizes IMVS that functions like quad-mid-value-select (QMVS) due to an I-load which is unique to the BFS. QMVS and IMVS protect against dual null failures, but neither protect against dual null failures greater than RM. In either case, the crew will deselect the failed LRU's in the BFS in order to maintain an engageable BFS. The BFS has the same manual deselect capability as the PASS for AA's, RGA's, and aerosurface feedbacks. There is no automatic downmoding for comm faults, so deselection is also needed for these cases. The SRB RGA selection filter uses a mid-value-select (MVS) scheme for LRU's 1, 2, and 3 only, with no deselect capability.

A. OPS 1:

1. ANY TWO LATERAL AA'S PRIOR TO THE END OF FIRST STAGE (LATERAL AA'S NOT USED IN OPS 1 POST-MM 102).
2. ANY TWO NORMAL AA'S PRIOR TO END OF LOAD RELIEF (90 SECONDS MET).

The lateral axis feedback is used in first stage from load relief through SRB tailoff, but the normal axis feedback is not used in OPS 1 after load relief is complete. The normal axis feedback is gained to zero at Vrel = 2628 fps, which correlates to approximately 90 seconds MET. Double failures of AA feedback in the same axis would cause the BFS selection filter to output bad data.

3. ANY TWO ORBITER RGA'S, SAME AXIS.
4. ANY TWO OF SRB RGA'S 1, 2, OR 3, SAME AXIS (MM 102 ONLY).

The RGA's are used all through ascent to provide vehicle rate data to guidance and flight control. Like the AA's, a double failure in RGA feedback in the same axis could cause the BFS selection filter to provide bad data to flight control. The SRB RGA selection filter uses a MVS scheme for LRU's 1, 2, and 3 only, with no deselect capability.

THIS RULE CONTINUED ON NEXT PAGE

FLIGHT RULES

A8.1.2-6 BFS LRU REQUIREMENTS (CONTINUED)

B. OPS 3 OR 6:

1. ANY TWO LATERAL AA'S.
2. ANY TWO ELEVON OR BODY FLAP POSITION FEEDBACKS, SAME SURFACE.
3. ANY TWO RGA'S, SAME AXIS.

In general, it is assumed that the crew will not engage the BFS unless absolutely required. The philosophy is that, if it is considered usable, the BFS is GO for engage after committing to entry, even though it may require off-nominal crew procedures.

Double failures of RGA, lateral AA, body flap, or elevon position feedbacks could cause the BFS selection filter to provide bad data to flight control. This may result in loss of vehicle control.

AA lateral (Ny) feedback was originally added to the flight control system to control beta (sideslip) dispersions as a result of alpha errors. A post-ST5-4 R&E study (which assumed no Ny feedback, LVAR 20 elliptical uncertainties, FAD 4 aero, and only two RCS yaw jets available per pod) concluded that alpha errors (as a result of IMU errors and winds) resulted in a beta buildup and subsequent reduction of stability margins.

Sensitivity to alpha errors was especially noted during bank maneuvers since these maneuvers are performed about the vehicle stability axis (alpha is used in flight control to determine the stability axis).

A reduction in both the aerodynamic variations and in the severity of wind environment since the ST5-1 development program increase the capability of the flight control system with Ny feedback failed to null. A quick look R&E study performed in 1987 using the ST5-26 conditions and nominal aero revealed that with Ny feedback failed to null, alpha errors up to 4 degrees were acceptable assuming all RCS yaw jets were available. As a result, the EFTP concluded that the BFS flight control system should be considered GO with null Ny feedback.

It is also important to note that the incorporation of air data into GNC essentially eliminates alpha error and reduces the requirement for Ny feedback. Reference EFTP #39, 12/11/87.

AA normal (Nz) feedback is not as critical in the BFS. It is removed from the command loop in CSS (BFS is CSS only). However, with bad Nz feedback, the crew displayed ADI pitch error will be erroneous. This presents an increased flying challenge since the crew is not well trained to fly in this configuration.

For body flap (BF) feedback failures, loss of control is a concern if the failures cause the BF to drive full DOWN and stay there. The elevons will be driven up to maintain pitch axis trim. This causes a degradation of aileron control authority which significantly impacts lateral/directional vehicle control. SES studies (September 4, 1990) showed that loss of control can occur with the BF stuck full DOWN. A full UP BF does not create flight control problems, but this may have significant thermal impacts.

FLIGHT RULES

Rule {A2.1.2-10B}, BFS ENGAGE CRITERIA, references this rule.

A8.1.2-7 PRELAUNCH IMU HOLD

PRELAUNCH IMU HOLD DOES NOT APPLY PRIOR TO T MINUS 4 MINUTES (EVENT 11 TIME) WHEN CONTINUOUS IMU ALIGNMENT IS COMPLETE AND THE IMU'S GO INERTIAL. AFTER T MINUS 4 MINUTES, THE FOLLOWING CRITERIA APPLY:

- A. THE JSC MISSION EVALUATION ROOM (MER) WILL PROVIDE THE IMU INERTIAL REFERENCE MISALIGNMENT LAUNCH GO/NO-GO RECOMMENDATION TO THE JSC FLIGHT CONTROL TEAM. KSC WILL SERVE AS A BACKUP TO THE MER.

The inertial reference alignment monitor system (IRAMS) is required to monitor individual IMU prelaunch misalignment. IRAMS is available at the JSC MER and at KSC. All MER calls relating to the IMU system will be coordinated with the GNC officer. The MER is responsible for coordination with all elements (KSC, RI, etc.) (ref. AFTP #40).

- B. THE LAUNCH WILL BE NO-GO FOR THE FOLLOWING:

1. THE INERTIAL REFERENCE MISALIGNMENT OF ANY IMU AXIS, AS MEASURED BY THE IRAMS, EXCEEDS THE APPLICABLE REDLINE AS SHOWN BELOW:

The redlines have been developed as limits on the IMU inertial reference misalignment as measured by IRAMS. Redlines are applicable for standard and direct insertion flights (ref. AFTP #40).

- a. FOR A 28.5-DEGREE INCLINATION (DUE EAST) LAUNCH, THE GENERIC REDLINES FOR A SAFE AOA TO EDWARDS ARE: @[011295-1752A]

$$-243 \text{ ARC SECONDS} \leq \theta_N \leq 330 \text{ ARC SECONDS}$$

$$| 0.43\theta_W + \theta_U | \leq 821 \text{ ARC SECONDS}$$

- b. FOR A 28.5-DEGREE INCLINATION (DUE EAST) LAUNCH, THE GENERIC REDLINES FOR A SAFE AOA TO NORTHRUP ARE: @[011295-1752A]

$$-203 \text{ ARC SECONDS} \leq \theta_N \leq 279 \text{ ARC SECONDS}$$

$$| 0.43\theta_W + \theta_U | \leq 841 \text{ ARC SECONDS}$$

THIS RULE CONTINUED ON NEXT PAGE

FLIGHT RULES

A8.1.2-7

PRELAUNCH IMU HOLD (CONTINUED)

- c. FOR A 39-DEGREE INCLINATION LAUNCH, THE GENERIC REDLINES FOR A SAFE AOA TO EDWARDS ARE:

$$-251 \text{ ARC SECONDS} \leq \theta_N + 0.513\theta_W + 0.102\theta_U \leq 334 \text{ ARC SECONDS}$$

$$828 \text{ ARC SECONDS} \geq | -0.206\theta_N + 0.348\theta_W + \theta_U |$$

- d. FOR A 39-DEGREE INCLINATION LAUNCH, THE GENERIC REDLINES FOR A SAFE AOA TO NORTHRUP ARE:

$$-232 \text{ ARC SECONDS} \leq \theta_N + 0.516\theta_W + 0.098\theta_U \leq 310 \text{ ARC SECONDS}$$

$$853 \text{ ARC SECONDS} \geq | -0.201\theta_N + 0.338\theta_W + \theta_U |$$

- e. FOR A 51.6-DEGREE INCLINATION (MIR RENDEZVOUS) LAUNCH, THE GENERIC REDLINES ARE:

$$-287 \text{ ARC SECONDS} \leq \theta_N + 0.992\theta_W - 0.184\theta_U$$

$$373 \text{ ARC SECONDS} \geq \theta_N + 0.992\theta_W - 0.184\theta_U$$

$$855 \text{ ARC SECONDS} \geq | -0.307\theta_N + 0.262\theta_W + \theta_U | \quad \text{@[011295-1752A]}$$

- f. FOR A 57-DEGREE INCLINATION LAUNCH, THE GENERIC REDLINES ARE:

$$-266 \text{ ARC SECONDS} \leq 0.82\theta_N + \theta_W - 0.18\theta_U$$

$$322 \text{ ARC SECONDS} \geq 0.73\theta_N + \theta_W - 0.04\theta_U$$

$$847 \text{ ARC SECONDS} \geq | -0.33\theta_N + 0.23\theta_W + \theta_U |$$

THIS RULE CONTINUED ON NEXT PAGE

FLIGHT RULES**A8.1.2-7 PRELAUNCH IMU HOLD (CONTINUED)**

- g. FOR RENDEZVOUS MISSIONS (EXCEPT FOR MIR RENDEZVOUS), REDLINES ARE SPECIFIED IN THE FLIGHT-SPECIFIC ANNEX WHEN REQUIRED: @[011295-1752A]

WHERE :

q_n = MISALIGNMENT ABOUT THE NORTH AXIS

q_w = MISALIGNMENT ABOUT THE WEST AXIS

q_u = MISALIGNMENT ABOUT THE UP AXIS

NOTE: REF. FLIGHT RULES ANNEX FOR FLIGHT-SPECIFIC MISALIGNMENT REDLINES.

The OI-22 software upgrades added the capability to continuously align IMU's in OPS 1, up to T-4 minutes. With this change, the probability of violating the above redlines is extremely low. The scenario to invoke this part of the rule would generally involve counting down past T-4 minutes, where the OPS 1 continuous align software is terminated, and then recycling back for a later launch attempt while remaining in OPS 1. (Note: at least 1 hour of holdtime is required for ET propellant conditioning and APU cooldown.) If the recycle requires returning to G9, then the IMU preflight alignment will have to be reaccomplished (time permitting, ref. paragraph E.1.a of this rule) and the likelihood of violating this part of the rule will be negligible. For 51.6-degree inclination missions (Mir and Station flights), the extremely small launch window makes the probability of violating the redlines (without failing an IMU) negligible. @[011295-1752A]

Historically, the redlines were written to protect for a safe launch and abort (RTLS, TAL, ATO, AOA) (ref. AFTP's #35, #37, #39, #40, and #44). The constraining case is the AOA. With the OPS 1 continuous IMU alignment, it is very unlikely that the redlines could be violated. Effectively, this rule now protects for an IMU failure occurring after T-4 minutes (no BITE or RM FL annunciated) and thus precludes launching into an early mission termination. @[011295-1752A]

THIS RULE CONTINUED ON NEXT PAGE

FLIGHT RULES

A8.1.2-7 PRELAUNCH IMU HOLD (CONTINUED)

The redlines protect for 99.74 percent (3 sigma) probability for a safe AOA based on the following assumptions and groundrules:

- a. A single IMU was assumed as the baseline configuration in redline determination.
- b. A 3-sigma IMU postlaunch performance based on previous flight experience is equal to 2/3 of the 3-sigma IMU specification.
- c. OPS 1/3 transition will be accomplished per procedure at least 10 minutes before OMS-2 ignition.
- d. An AOA requires EI-5 downtrack navigation to protect the following constraints:
 1. 375 psf Q -bar vehicle structural limit with worst case aerodynamics at TACAN update (constraint drives the negative north tilt misalignment redline for 28.5-degree inclination launch and contributes to the redlines for a 57-degree inclination launch).
 2. TACAN low energy stretch maneuver capability assuming TACAN is forced at 130k feet altitude (constraint drives the positive north tilt misalignment redline for a 28.5-degree inclination launch; not a driver for 57-degree inclination launch redlines).
 3. Leading edge temperature limit of 3100° F with no heat rate limit (constraint contributes to 57-degree inclination launch redlines; not a driver for 28.5-degree inclination launch redlines).
- e. A ground state vector uplink or GCA is not required.
- f. Launch is from KSC.
- g. AOA landing site is Edwards or Northrup for 28.5-degree or 39-degree inclination launch and Northrup for 57-degree inclination launch (ref. CSDL Memo Shuttle - 90-035). The AOA landing site is 51.6-degree inclination launch (ref. CSDL MEMO Shuttle-94-025). @[011295-1752A]
- h. KT-70 IMU.
- i. 245 fps maximum MECO underspeed.
- j. Prelaunch and postlaunch IMU performance are independent.
- k. Maximum EI minus 5 crosstrack dispersion 16.7 nm to protect trajectory control and autoland transition criteria (constraint drives the west and up misalignment redlines for a 28.5-degree inclination launch; not a driver for 57.0-degree inclination launch redlines). @[011295-1752A]

FLIGHT RULES

1. *The Onboard Navigation Systems Characteristics (ONSC) model was used in developing the redlines.*

THIS RULE CONTINUED ON NEXT PAGE

FLIGHT RULES

A8.1.2-7 PRELAUNCH IMU HOLD (CONTINUED)

- m. IRAMS 1-sigma azimuth measurement error is 40 arc seconds.
- n. Worst case vehicle AOA mass properties of heavyweight and forward CG (240k lb, 1080 inches).

2. IF THE IRAMS MISALIGNMENT COMPUTATION IS NOT AVAILABLE AT EITHER JSC OR KSC, THE LAUNCH GO/NO-GO CALL WILL BE MADE BASED ON THE FOLLOWING GUIDELINES:

LAUNCH WILL BE NO-GO IF MCC IMU RELATIVE DRIFT COMPUTATIONS INDICATE THAT ANY IMU CLUSTER AXIS IS DRIFTING AT A RATE > 0.05 DEG/HR. IMU PREFLIGHT CALIBRATION AND ALIGNMENT WILL BE REQUIRED BEFORE A SUBSEQUENT LAUNCH ATTEMPT. ©[011295-1752A]

Individual IMU misalignment cannot be observed if IRAMS is unavailable at both KSC and JSC. MCC relative drift computations (between IMU's) provide the only remaining method of monitoring IMU prelaunch drift. Since relative drift only indicates the rate at which IMU's are drifting apart and does not indicate individual IMU performance, it can only serve as a rough health check of the IMU's. An IMU axis drift rate greater than 0.05 deg/hr (HAINS) in the IMU cluster reference frame (ref. SODB 4.5.1.2.3.p.2) indicates an anomalous condition. Interpretation of relative drift data and implementation of this rule is dependent on engineering judgment. A preflight calibration is required before a subsequent launch attempt to calculate gyro drift compensation terms and correct excessive drift, or verify an IMU failure. This will require a minimum of approximately 3.6 hours and exceed the 3-hour crew hold-time limit (ref. Rule {A2.1.1-4A}, LAUNCH DAY CREW TIME CONSTRAINTS), causing the launch to be scrubbed. The limit serves only as a health check of the IMU (ref. AFTP #40). Derivation of the limit follows:

	<u>HAINS</u>
a. 1-Sigma Acceleration Sensitive Drift Specification At 1g	0.015 Deg/Hr
b. 1-Sigma Bias Drift Specification (Up To 17 Hours From Start Of Preflight Calibration)	0.006 Deg/Hr
c. 1-Sigma Total Prelaunch Drift (RSS Of Above)	0.016 Deg/Hr
d. 3-Sigma Total Prelaunch Drift	0.05 Deg/Hr

©[011295-1752A]

THIS RULE CONTINUED ON NEXT PAGE

FLIGHT RULES

A8.1.2-7 PRELAUNCH IMU HOLD (CONTINUED)

- C. A PERIOD OF 30 MINUTES AFTER THE IMU'S GO INERTIAL (T MINUS 4 MINUTES) IS REQUIRED PRIOR TO USING THE IRAMS LAUNCH HOLD PREDICTION CAPABILITY.

IRAMS requires 30 minutes to generate an accurate hold time. The time required for an accurate hold time prediction is dependent on actual IMU performance and may vary, but 30 minutes is used as a guideline. If a prediction is required before 30 minutes, it will be accompanied by an estimated accuracy of the prediction. In this case, the predicted hold time and the estimated accuracy of that prediction are heavily dependent on engineering judgment (ref. AFTP #40).

- D. THE IMU'S MAY BE REALIGNED IF EITHER OF THE FOLLOWING WILL OCCUR PRIOR TO T-0 (THE NEW T-0 FOR UNPLANNED HOLDS), OR PRIOR TO THE END OF THE LAUNCH WINDOW IF A NEW T-0 IS UNCERTAIN:
1. IMU RELATIVE DATA INDICATES THREE-SIGMA OR GREATER DRIFT RATES.
 2. IRAMS HOLD PREDICTION PROGRAM DETERMINES THAT A MISALIGNMENT REDLINE WILL BE VIOLATED.

NOTE: REFERENCE PARAGRAPHS B.1, B.2, AND E OF THIS RULE.

If it is predicted that the IMU relative drift will exceed three sigma or if the IRAMS prediction program indicates that a violation will occur, then the IMU's should be realigned, time permitting, to attempt a launch within the window. If the IMU's are not realigned and a redline violation occurs without sufficient time for realignment, then the launch may be scrubbed unnecessarily.

- E. PRELAUNCH IMU REALIGNMENT MAY BE ACCOMPLISHED BY THE FOLLOWING METHODS:
1. G9 IMU PREFLIGHT ALIGNMENT MAY BE USED SUBJECT TO THE FOLLOWING CONSTRAINTS:
 - a. THE LAUNCH WINDOW MUST SUPPORT THE 90 MINUTES REQUIRED TO RECYCLE TO G9 FOR IMU REALIGNMENT AND COUNTDOWN TO T-0.

After a recycle to G9, the IMU alignment and nominal G1 prelaunch timeline requires 90 minutes. Some additional time may be required in G1 prior to transition to G9.

THIS RULE CONTINUED ON NEXT PAGE

FLIGHT RULES

A8.1.2-7 PRELAUNCH IMU HOLD (CONTINUED)

2. G1 GYRO BIAS UPLINK MAY BE USED FOR IMU REALIGNMENT SUBJECT TO THE FOLLOWING CONSTRAINTS:
 - a. IRAMS IS REQUIRED TO CALCULATE GYRO BIAS UPLINK TERMS.

IRAMS is required to monitor individual IMU prelaunch misalignment and calculate gyro bias uplink values to correct the misalignment.

- b. THE LAUNCH WINDOW MUST SUPPORT THE 15 MINUTES REQUIRED TO GENERATE AND VERIFY THE GYRO BIAS UPLINK. THE GYRO BIAS TERMS (AS COMPUTED BY THE IMU PREFLIGHT CALIBRATION) WILL BE ON-BOARD, AND THE PERFORMANCE WILL BE VERIFIED PRIOR TO LIFT-OFF. IT IS HIGHLY DESIRABLE TO VERIFY THE PERFORMANCE PRIOR TO RESUMING THE COUNT AT T MINUS 5 MINUTES.

Five minutes is required for the uplink decision and implementation process. This process consists of the MER/MCC decision that an uplink is required; coordination of required compensation values between MER and MCC; uplink load generation; uplink load verification; coordination between MER, MCC and KSC prior to uplink execution; uplink execution; and 1 minute for torquing out IMU misalignment. An additional 10-minute monitoring/verification period is required after the realignment is complete prior to committing to launch.

A8.1.2-8 ADI LOSS

AN ADI IS CONSIDERED FAILED ONLY IF THE ATTITUDE BALL IS FAILED [\(N/A FOR MEDS VEHICLES\)](#). [@\[040899-2459B\]](#)

The entry-critical parameters required by the crew can be monitored using the attitude ball (or sphere). While rate and error needles are desirable (especially for monitoring vehicle control), the attitude ball is sufficient in providing the required information. As a result, an ADI will be considered failed only if the attitude sphere is not providing accurate or stable attitude reference. This rule is needed for making decisions regarding early flight termination, night landings, and IFM. (Ref. Rules {A8.1.6-1E}, GNC GO/NO-GO CRITERIA, for dedicated displays and {A8.1.1-18}, LANDING SYSTEMS REQUIREMENTS.) (Ref. Entry Flight Tech. Panel #34, 8/21/87.)

FLIGHT RULES

A8.1.2-9 IMU BITE FAILURE DEFINITION

FOR PURPOSES OF EARLY MISSION TERMINATION AND LANDING SITE DOWNMODING, AN IMU WITH A BITE SHOULD BE CONSIDERED FAILED WITH THE FOLLOWING EXCEPTIONS:

- A. TRANSMISSION WORD 2 BITE
- B. TRANSMISSION WORD 1 BITE
- C. TEMPERATURE SAFE BITE
- D. TEMPERATURE READY BITE @[011295-1752A]

IF REAL-TIME ASSESSMENT DETERMINES THE BITE TO BE FALSE OR NO IMPACT, THEN THE IMU WILL NO LONGER BE CONSIDERED FAILED.

At the three-level, redundancy management (RM) will not downmode an IMU with a BITE because there is no risk of incorporating bad data. At the two-level, RM will downmode the IMU with the BITE should the attitude or velocity disagree by more than the RM threshold.

A BITE is an indication that the IMU has experienced a failure and may be operating outside of spec. BITE will almost always indicate an actual problem with the IMU. In most cases, data can be used to determine whether or not the BITE is real. There is, however, the possibility of a failure in the BITE circuitry itself - termed false BITE. Also, it cannot necessarily be determined whether or not an IMU will continue to operate in a consistent manner while outside of spec. For several BITE's, performance will remain unknown until data is observed during entry. It is logical, therefore, to assume that the BITE logic has correctly identified a real failure and to consider the unit failed. Since RM provides for BITE's, there is no requirement for manual deselection of the affected IMU.

~~*Declaring an MDF a*~~After the first BITE, ~~*reduces the risk of losing another IMU, which could result in one IMU remaining for entry (should the IMU with the BITE operate outside the RM limits during entry).*~~ ~~*Downmoding to the Edwards complex should also be considered according to Rule {A2.1.4-7}, LANDING SITE SELECTION. @[121296-4610]*~~

A next PLS should be declared after the second BITE (or the first BITE at the two-level) to reduce the risk of losing the last IMU. Reference Rule {A2.1.4-7}, LANDING SITE SELECTION, for runway priorities.

The Transmission Word 2 Fail BITE (loss of slew) only impacts the IMU if an IMU/IMU alignment is required. Even if an IMU/IMU is required, other options exist to fully recover the IMU.

THIS RULE CONTINUED ON NEXT PAGE

FLIGHT RULES

A8.1.2-9 IMU BITE FAILURE DEFINITION (CONTINUED)

A Transmission Word 1 Fail BITE (loss of pulse torquing) indicates that the IMU has detected an error in the GPC transmitted pulse torquing commands. The IMU will not use these commands and will drift at its uncompensated rate. Since, the internal compensations of the HAINS are not updated on a flight-to-flight basis, the uncompensated drift rates can vary. For a real Transmission Word 1 BITE, real-time assessment will be required to determine if drifts are within acceptable limits to support entry. Matrix alignments can be performed to keep the IMU aligned and not appreciably alter the relative skew between the IMU platforms. ©[011295-1752A]

A false BITE has no impact to IMU performance except in the case of a false Transmission Word 1 BITE. If the Transmission Word 1 Fail BITE is false, the GPC will overtorque the IMU. The impact of this false BITE can be minimized by zeroing the uplinked gyro drift compensation command, moding the IMU to standby and back to operate, and then performing a matrix alignment. ©[011295-1752A]

The Temperature Safe and Temperature Ready BITE's do not indicate temperature problems, but rather power supply failures. These discrettes are driven directly by the +5 V dc isolated power supply on the input power conditioner (IPC) card and are used only to maintain transparency between the current HAINS and the previous KT-70 IMU's. If only one of these BITE's is annunciated, it is probably a false indication. If both BITE's are set together, then the +5 V dc isolated power supply is suspect. Failure of this power supply would also result in Platform Temperature Safe, Platform Temperature Ready, and Communication Good BITE's. The In-operate Mode and Operate command would also be set false, resulting in the IMU moding to standby. ©[011295-1752A]

A8.1.2-10 LOSS OF VERNIER RCS DAP MODE

THE VERNIER RCS DAP MODE IS CONSIDERED LOST IF:

- A. ANY SINGLE DOWN-FIRING VRCS JET (F5L, F5R, L5D, R5D) IS LOST.

For the loss of a down-firing VRCS jet, closed-loop (i.e., AUTO, INRTL-DISC, LVLH-DISC) DAP stability and controllability usually cannot be maintained, and the VRCS system will not be used in this mode. The DAP will downmode to free drift for such a failure, but the software will not prevent reselection of a VRCS closed-loop mode, even though this mode could result in an unstable DAP configuration. Open-loop VRCS control (INRTL-PULSE, FREE) will also be significantly degraded, and the use of this mode should be assessed on a case by case basis.

THIS RULE CONTINUED ON NEXT PAGE

FLIGHT RULES

A8.1.2-10 LOSS OF VERNIER RCS DAP MODE (CONTINUED)

B. EITHER SIDE-FIRING VRCS JET (R5R, L5L) IS LOST WHILE A PAYLOAD IS ATTACHED TO THE ORBITER IN ANY NON-ENTRY CONFIGURATION.

EXCEPTIONS IN WHICH DAP PERFORMANCE IS KNOWN TO BE ACCEPTABLE FOR THE LOSS OF EITHER SIDE-FIRING JET INCLUDE:

1. ALL SPACELAB MISSIONS IN WHICH LOADED RMS OPERATIONS ARE NOT BEING PERFORMED.
2. ALL CONFIGURATIONS FOR INERTIAL UPPER STAGE (IUS) DEPLOYS.
3. THE PORTIONS OF THE HUBBLE SPACE TELESCOPE (HST) REVISITS IN WHICH THE PAYLOAD IS ATTACHED DIRECTLY TO THE PAYLOAD BAY.
4. ALL FLIGHTS FOR WHICH MISSION-SPECIFIC DAP STABILITY ANALYSES HAVE FOUND DAP PERFORMANCE TO BE ACCEPTABLE FOR THIS CONFIGURATION.

Stable VRCS DAP performance has been verified for the loss of L5L or R5R with either an empty payload bay or payloads berthed in the bay. However, if payloads are attached to the orbiter in a non-entry configuration (e.g., on the remote manipulator system (RMS) or deployed on the stabilized payload deployment system (SPDS)), the stability and controllability of the orbiter/payload system must be uniquely verified for each payload position and each combination of operable VRCS jets. This type of study is necessitated by the influence on DAP performance of both payload CG offsets and the flexibility of the attached mechanisms.

A study has already been performed on several payloads which are commonly flown (Spacelab and all payloads deployed using an IUS), as well as the portions of the HST maintenance missions in which HST is attached directly to the payload bay. It was found during the study that DAP stability will be adequate with these payloads in these configurations (ref. Draper Memo SSV-90-027, Controllability of Orbiter With Vernier Jet Failures During Attached Payload Operations). For any other non-entry orbiter/payload configuration, the loss of a side-firing vernier should be cause to NO-GO the VRCS DAP mode unless an applicable study has been performed which indicates that the given configuration will result in adequate DAP performance. If such a study is performed, it will be documented in Section A3.12 of the mission-specific Flight Rules Annex (JSC-18308). Rule {A6.1.2-27}, RCS VERNIER OPERATION TERMINATION, references this rule.

FLIGHT RULES

A8.1.2-11 SSME SHUTDOWN DUE TO HYDRAULIC SYSTEM FAILURES

THE FAILURE OF TWO HYDRAULIC SYSTEMS DURING ASCENT WILL RESULT IN THE LOSS OF TVC ON ONE SSME AND THE LOSS OF THROTTLE CAPABILITY ON TWO SSME'S. IF TWO HYDRAULIC SYSTEMS FAIL, THE FOLLOWING ACTION WILL BE TAKEN:

- A. WITH TWO ENGINES RUNNING (NOM/ATO/TAL/RTLS), ONE OF THEM NONGIMBALLING, SINGLE ENGINE ROLL CONTROL (SERC) WILL BE INVOKED IMMEDIATELY BY THE CREW. THE NONGIMBALLING ENGINE WILL BE SHUT DOWN WHEN SINGLE-ENGINE PRESS CAPABILITY FOR THE CURRENT TRAJECTORY IS ACHIEVED, BASED ON THE THROTTLE LEVEL OF THE GIMBALLING ENGINE AND WITHOUT ABORT GAP CLOSURE TECHNIQUES APPLIED.

Simulator testing has verified that a loss of control is almost certain to occur, usually very quickly, when one of the two remaining engines has lost gimbal capability and SERC is not active. Even if SERC is invoked (TRAJ display, Item 6), a loss of vehicle control is still possible, especially during very dynamic vehicle maneuvers such as powered pitcharound (PPA) on an RTLS. However, if SERC is invoked within a few seconds of the failure that results in this configuration, it will often provide good vehicle control until SSME gimbal saturation occurs. Gimbal saturation generally does not occur prior to single-engine capability, but will usually occur prior to MECO, resulting in rapid degradation of vehicle control. Shutting down the nongimballing engine at single-engine press eliminates the possibility of gimbal saturation occurring after that point. Single-engine capability calls ("single-engine press," "single-engine TAL," etc. depending on current trajectory) should be based on the throttle level of the gimballing engine with no abort gap closure techniques applied (ref. Rule {A4.1.2-7H}, PERFORMANCE BOUNDARIES). The risk of a few more seconds of exposure to potential gimbal saturation is considered small compared to the risks of flying gap closure techniques. If single-engine capability has already been achieved when this failure scenario occurs, the nongimballing engine should be shut down immediately. ©[082593-1464C]

- B. THREE ENGINES RUNNING:

1. NOMINAL/ATO - THE NONGIMBALLING ENGINE WILL BE SHUT DOWN AT SINGLE-ENGINE PRESS TO MECO.

SES testing has verified that vehicle control is acceptable with three engines running and one nongimballing (two-engine control laws are utilized). To minimize the time to single-engine press, the nongimballing engine will be allowed to continue to run. The risk incurred in this period is that a gimballing engine will shut down and immediate action (invoking SERC, ref. Paragraph A above) will be required to maintain vehicle control. ©[082593-1464C]

After single-engine capability is achieved, the performance risk incurred due to a good engine failing following shutdown of the nongimballing engine is minimized. At the same time, the loss of control risk associated with allowing the nongimballing engine to continue to run remains. Therefore, the non-gimballing engine should be shut down at single-engine press to minimize the next failure impact.

FLIGHT RULES

THIS RULE CONTINUED ON NEXT PAGE

FLIGHT RULES

A8.1.2-11 SSME SHUTDOWN DUE TO HYDRAULIC SYSTEM FAILURES (CONTINUED)

If two engine throttles are stuck at a high power level, 3.5g may be exceeded near MECO. Shutting an engine down at an operationally convenient point such as single-engine press will eliminate this problem.

2. TAL - THE NONGIMBALLING ENGINE WILL BE SHUT DOWN AT SINGLE-ENGINE TAL. MANUAL THROTTLES WILL BE ENABLED PRIOR TO ABORT SELECTION IN ORDER TO MAINTAIN THE THROTTLES AT THE NOMINAL POWER LEVEL. ©[082593-1464C]

For a three-engine TAL, the same rationale as paragraph 1 above applies for engine shutdown. There are several reasons why it is undesirable to throttle down the good engine: It may result in guidance transients, flight control would not be as good during the roll to heads up (although it would still be acceptable), little time would be gained to perform the abort dump, and the time to single-engine press would be increased. Therefore, manual throttles will be selected to prevent an automatic throttle down when TAL is declared. This action is not required if TAL is declared early enough that automatic throttling will not occur at abort selection. However, since there is no disadvantage to selecting manual throttles for this short period of time, manual throttles will always be selected, for consistency. AUTO throttle will be reselected after TAL is declared. ©[082593-1464C]

3. RTLS:
 - a. IF ONE OR BOTH OF THE ENGINES WITH STUCK THROTTLES ARE AT 85 PERCENT OR LESS, THEN THE NONGIMBALLING ENGINE WILL BE ALLOWED TO RUN TO MECO.
 - b. IF BOTH ENGINES WITH STUCK THROTTLES ARE AT MORE THAN 85 PERCENT, THEN THE NONGIMBALLING ENGINE WILL BE SHUT DOWN 2 MINUTES PRIOR TO MECO.

NOTE: BEFORE SELECTING RTLS, MANUAL THROTTLES WILL BE ENABLED AND MINIMUM THROTTLES SELECTED. AT LEAST 10 SECONDS OF MINIMUM THROTTLE LEVEL IS DESIRED PRIOR TO RTLS SELECTION. AUTO THROTTLES WILL BE RESELECTED ANYTIME PRIOR TO PPA. ©[082593-1464C]

As with the NOM/ATO/TAL cases, it is preferable to leave the nongimballing engine running through single-engine press to MECO and accept the risk of the loss of a gimbaling engine to this point. Due to the possibility of SSME failures resulting from valve drift on the engines in hydraulic lockup, the time to single-engine press should be minimized, since engine failures prior to this point can result in loss of vehicle and crew bailout. Unfortunately, shutting an engine down at single-engine press on an RTLS with two stuck throttles can lead to undesirable results.

FLIGHT RULES

THIS RULE CONTINUED ON NEXT PAGE

FLIGHT RULES**A8.1.2-11****SSME SHUTDOWN DUE TO HYDRAULIC SYSTEM FAILURES
(CONTINUED)**

For the contingency case in which two hydraulic system failures, in addition to another independent failure, result in a three-engine RTLS with two SSME throttles stuck high, it is possible for g forces to get as high as 3.9g. Therefore, if both stuck throttles are above 85 percent, an engine must be shut down before MECO-20 seconds in order to avoid the possibility of exceeding 3.5g. However, analysis has shown that shutting down the nongimballer with 85 seconds of MECO in this scenario leaves more than 2 percent propellant remaining in the ET at MECO, resulting in orbiter/ET recontact after ET SEP. Therefore, MECO-2 minutes was selected as an operationally convenient shutdown cue that would eliminate both the recontact and the g-load concerns. One drawback to shutting down at this point (or any later point) is that guidance commands a large pitch-up. Although the vehicle adequately follows the guidance commands, this pitch transient causes the dedicated displays to pass through the singularity point, degrading the crew's capability to monitor vehicle control. The only way to avoid this pitch transient would be to shut the engine down just after powered pitcharound (PPA), which would extend the time to single-engine press by more than 1 minute, compared to shutting down at MECO-2 minutes. Since the pitch transient is due to a guidance command and not a control problem and since the risk of engine failure due to valve drift was considered to be a greater concern than the momentary loss of crew monitoring capability, it was decided that MECO-2 minutes is the optimal shutdown time. (Reference Ascent/Entry Flight Techniques Panel #105, 10/22/93.)

For the case in which at least one throttle is stuck at or below 85 percent, there is no threat of exceeding 3.5g. Depending on the throttle levels of the stuck engines, it also may not be acceptable, from a performance standpoint, to shut down the nongimballing engine before single-engine press. Since shutting down after single-engine press can result in an undesirable pitch transient and is not required to protect for excessive g-loads, it is preferable to leave all three engines running to MECO for this case. The only risk incurred with this philosophy is that the window of exposure to the failure of a gimballing engine remains open until MECO for this case.

The 85-percent throttle level provides an operationally convenient breakpoint which ensures that a shutdown will never be performed if the engine is needed to achieve the desired MECO targets, while also ensuring that an engine will always be shut down if any threat of exceeding 3.5g exists. For scenarios in which engines are stuck at intermediate throttle settings, acceptable results can sometimes be obtained regardless of whether or not an engine is shut down.

For all RTLS cases with two stuck throttles, minimum throttles will be selected prior to abort selection. Doing so will allow guidance to converge on the correct average thrust level and will reduce the probability of a early PPA. For guidance to have enough time to converge, minimum throttle levels must be achieved at least 10 seconds prior to RTLS selection. If not, an early PPA may occur, resulting in MECO conditions that are not optimized. AUTO throttles should be reselected at some point prior to PPA, but are not mandatory prior to RTLS selection. ©[082593-1464C]

THIS RULE CONTINUED ON NEXT PAGE

FLIGHT RULES

A8.1.2-11 SSME SHUTDOWN DUE TO HYDRAULIC SYSTEM FAILURES
(CONTINUED)

C. SHUTDOWN MATRIX:

FAILED HYDRAULIC SYSTEM	NONGIMBALLING ENGINE	ENGINES WITH STUCK THROTTLES
1 AND 3	CENTER	CENTER AND RIGHT
1 AND 2	LEFT	CENTER AND LEFT
2 AND 3	RIGHT	LEFT AND RIGHT

The failure of two hydraulic systems will cause two engines to lock up hydraulically and eliminate TVC capability on one of these two engines. The engine shutdown matrix identifies which engines have lost TVC and/or throttle capability.

Rules {A4.1.2-10}, MANUAL THROTTLE SELECTION; {A5.1.3-8}, MANUAL SHUTDOWN FOR TWO STUCK THROTTLES (NOT DUAL APU FAILURES); {A5.1.3-3}, LIMIT SHUTDOWN CONTROL; and {A2.1.6-1}, CONTINGENCY ACTION SUMMARY, reference this rule. ©[092195-1770A]

FLIGHT RULES

MANAGEMENT

A8.1.3-1 BEEP TRIM DEROTATION

- A. THE RHC BEEP TRIM SWITCH WILL NOMINALLY BE USED TO PERFORM ORBITER DEROTATION. THE RHC WILL BE USED AS A BACKUP IF THE BEEP TRIM IS INOPERABLE OR INHIBITED PER PART B. @[120894-1722A]

The RHC beep trim switch provides a smooth and predictable orbiter pitch derotation rate. Use of this switch eliminates the derotation rate dispersions introduced during the initiation of derotation when using the RHC. The improved derotation characteristics provided by the beep trim switch reduces tire and main landing gear peak loads. This in turn allows derotation to be performed at higher airspeeds than it can be performed using the RHC. Derotating at higher airspeeds reduces the time in the two point attitude where less lateral control authority is available.

- B. THE RHC/PNL TRIM INHIBIT/ENABLE SWITCH WILL BE PLACED IN INHIBIT AND BEEP TRIM DEROTATION WILL NOT BE PERFORMED IF THE FLIGHT CONTROL SYSTEM IS ZERO FAULT TOLERANT TO AN UNCOMMANDED RHC TRIM INPUT, EXCEPT UNDER THE FOLLOWING CIRCUMSTANCES, WHEN THE BEEP TRIM SWITCH WILL STILL BE USED WITHOUT FAULT TOLERANCE: @[020196-1811A].—@[120894-1722A]
1. A KNOWN CONDITION EXISTS (LEAKING/FLAT MG TIRE, SINGLE APU LANDING, OR HIGH CROSSWIND) WHICH COULD RESULT IN DEGRADED VEHICLE CONTROL DURING TOUCHDOWN AND DEROTATION, OR
 2. CDR DISCRETION BASED ON EXPECTED TOUCHDOWN/DEROTATION WORKLOAD. @[020196-1811A]

The RHC trim switches are two contact switches. If one contact has been either commfaulted or failed ON, the system becomes zero fault tolerant (ZFT). The next failure would result in rate commands being sent to the Flight Control System and could degrade the pilot's ability to fly the vehicle (trim switch inputs are only effective while in CSS). Therefore, if the system becomes ZFT, the trim inhibit switch will be placed in the INHIBIT position to protect against the inadvertent trim input. For this case, the beep trim derotation technique will not be performed. This condition will be evaluated on the left and right side separately; i.e., the Pilot's switches may be ZFT, but the Commander's may be usable and the beep trim derotation can be executed by the Commander. It would be possible to deactivate the RHC trim switches by turning off the flight controller power, but this would also result in the loss of all controllers on that side and Nose Wheel Steering (for the right flight controller power switch) and will therefore not be done. @[120894-1722A]

THIS RULE CONTINUED ON NEXT PAGE

FLIGHT RULES

A8.1.3-1

BEEP TRIM DEROTATION (CONTINUED)

The exceptions to this rule are for scenarios where it is likely that performing derotation manually with the RHC will exacerbate an already challenging set of circumstances for vehicle control during touchdown/derotation. In these scenarios, the risk of having control problems which could have been lessened by using the beep trim for derotation is considered greater than the risk of sustaining the next failure affecting the beep trim in this relatively small window during entry. It has been demonstrated that the beep trim derotation technique helps to minimize flight control system (FCS) inputs to the elevons and reduces the probability of surface rate saturation during derotation for single APU landings (Ames Research Center Vertical Motion Simulator (VMS), August 1995). Additionally, the beep trim derotation provides the best probability that the nose gear loads will not be violated for stressed cases such as a single APU landing with a Region III vehicle. For other scenarios (leaking/flat main gear tire, crosswind landings above the crosswind limit) where the lateral directional control task is made more complicated due to the yawing and rolling moments resulting from a blown main gear tire, or the lateral drift in the two-point attitude resulting from high crosswinds on the surface, performing derotation with the beep trim reduces the time/effort required for the pitch task, allowing the CDR/PLT to more effectively control the lateral axis, as required. (Ref. A/E FTP # 126, September 15, 1995). ©[020196-1811A]

- C. THE PANEL TRIM POWER SWITCH WILL BE TURNED OFF IF THE FLIGHT CONTROL SYSTEM IS ZERO FAULT TOLERANT TO AN UNCOMMANDED PANEL TRIM INPUT. BEEP TRIM DEROTATION MAY STILL BE PERFORMED.

The panel trim switches are two contact switches. If one contact has been either commfaulted or failed ON, the system becomes zero fault tolerant (ZFT). The next failure would result in trim commands being sent to the Flight Control System (FCS) and would degrade vehicle control. Therefore, if the system becomes ZFT, the panel trim switches will be deactivated by turning off the power switch. It is prudent to procedurally turn off the panel trim power switches prior to enabling the RHC trim switches. This action enhances the safety of the beep trim derotation by ensuring that panel trim switch failures do not affect flight control. The panel trim power will be turned off and the trim switches will be enabled during entry. The Pilot's RHC trim switches are not functional in the backup flight software (BFS). ©[120894-1722A]

FLIGHT RULES

A8.1.3-2 SINGLE ENGINE ROLL CONTROL (SERC) FOR RTLS

SINGLE ENGINE ROLL CONTROL (SERC) WILL BE TOGGLED (ON AND THEN OFF) PRIOR TO REENABLING SSME LIMITS (HDOT = 100 FPS) ON AN RTLS WHEN THE FOLLOWING CONDITIONS ARE SATISFIED:

- A. TWO ENGINES ARE RUNNING AND AT LEAST ONE OF THEM IS CONSIDERED A SUSPECT ENGINE, AND
- B. THE REMAINING GOOD SSME IS NOT THE CENTER ENGINE.

Engineering analysis and Shuttle Engineering Simulations (SES) test data indicates that an RTLS single-engine controllability problem was introduced with the OI-22 software implementation. The problem exists near the end of an RTLS trajectory, beginning where equivalent airspeed (EAS) is greater than 53 knots ($Q_{bar} = 10$ psf) and lasting until powered pitch down (PPD). If a second SSME failure occurs in this region (approx. 20-second window) leaving a single side (left or right) engine running, a severe flight control transient results from the unbalanced moments on the vehicle. The transient is generally a large yaw-out due to the asymmetry of the thrust vector, which in turn induces the severe roll-off due to the presence of sufficient aerodynamic forces in the regime on an RTLS. The severity of the transient is dependent on the engine out configuration. A center SSME failure followed by either side engine failing produces the largest transients, where yaw-out and roll-off can exceed 30 and 70 degrees, respectively. A side engine failure followed by the other side engine failing (center engine only remaining) does not cause a control problem since the thrust vector remains symmetric. In all cases investigated, adequate vehicle control is technically regained prior to MECO.

FLIGHT RULES

Toggling SERC on and then off (RTL5 TRAJ display, Item 6 execute, twice) prior to the second engine failure establishes the OMS/RCS propellant interconnect, where the interconnect remains after SERC is turned off. This action provides for the immediate availability of the RCS jets to SERC as soon as the second engine failure is recognized by the guidance software. This elimination of the time delay for the RCS jet availability for SERC allows the flight control system (FCS) some lead time for balancing the moments created by the aerodynamic forces in this region, and ultimately prevents (reduces for some cases) the yaw-out and subsequent roll-off transient. For these reasons, if at least one of the two remaining engines is a suspect engine (ref. Rule {A5.1.1-5}, SUSPECT ENGINE) that could fail in the region of concern leaving a single side engine running, SERC will be toggled on and then off. This action will be performed during the RTL5 flyback phase, some time after any required propellant dumps are completed and prior to re-enabling the SSME limits (nominally performed at Hdot = 100 fps). A procedurally convenient place to implement the SERC action will be chosen on a case-by-case basis using this basic criteria. The SERC toggle will be performed prior to Hdot = 100 fps even if re-enabling the SSME limits is not performed at that time (for example, limits hard-enabled for low LH2 NPSP). Note that the same results can be achieved by turning SERC on (no toggle) prior to enabling the SSME limits at Hdot = 100 fps. The risk incurred with this option is that the second engine failure may not occur, resulting in two engines running with the FCS using single-engine gains (uncertified flight control mode). Although no scenarios have been identified which cause vehicle performance or control problems in this region when two engines are running with single-engine FCS gains, the exact desired MECO target may not be achieved. For these reasons, the SERC toggle option is the preferred method for procedurally eliminating (or reducing) the control transient.

Ref. Abort Panel Splinter Meeting, 4/29/93); A/E FTP #102, 7/16/93; and A/E FTP #104, 9/17/93.

A8.1.3-3 **RGAS SYSTEM MANAGEMENT (CIL)**

IF FOUR ORBITER RGA'S ARE AVAILABLE AND A KNOWN FAILURE CONDITION EXISTS WHERE ONE ADDITIONAL FAILURE WOULD CAUSE TWO ORBITER RGA'S TO SIMULTANEOUSLY LOSE POWER, ONE OF THE AFFECTED RGA'S WILL BE DESELECTED IN THE BFS (CIL).

Test data indicates that when power is removed from an orbiter RGA or SRB RGA the RGA output electronics generate a false rate approximately equal to 18 deg/sec in roll and 10 deg/sec in pitch and yaw. This false rate signature decreases linearly to zero approximately 10 seconds after the power is removed from the RGA. Since interchangeable midvalue selection (IMVS) is used for the RGA selection filter in the BFS when four RGA's are available, a simultaneous power fail of two RGA's would feed the bad rate signature directly into BFS flight control. This is not a concern in the PASS, since PASS redundancy management automatically deselects power failed RGA's. The effect of this transient and subsequent bad rate feedback on flight control may be catastrophic during any dynamic flight phase. (Ref. Configuration Control Board, January 22, 1991, Power Loss Characteristics for FCS RGA's.)

FLIGHT RULES

If it is known that one electrical bus failure will remove power simultaneously from two RGA's (requires previous failure), one of those RGA's can be deselected in the BFS to protect for that bus failure. Deselecting an RGA will downmode the selection filter to a MVS scheme and thus regain full single-fault tolerance.

If less than four RGA's are available, deselecting an RGA to protect for the next bus failure would leave the system at risk to any RGA LRU or power failure (while averaging or prime selecting), so no action will be taken.

FLIGHT RULES

A8.1.3-4 **PRIORITY RATE LIMITING (PRL) SYSTEMS MANAGEMENT**

- A. MANUAL SYSTEMS MANAGEMENT WILL BE REQUIRED ANY TIME THE PRL SOFTWARE DOES NOT REFLECT THE CURRENT STATUS OF THE HYDRAULIC SYSTEMS.

Self-explanatory.

- B. DURING ENTRY, SINGLE APU PRL RATES ARE REQUIRED WHEN ONE HYDRAULIC SYSTEM IS DRIVING THREE OR MORE ELEVONS.

One hydraulic system cannot support the flow rate required to move three elevons at the maximum commanded rate of 30 degrees per second (ref. SODB 4.2.7.1.1). Short term pressure degradations (due to the high hydraulic fluid flow rate) would have an adverse effect on vehicle flight control due to sluggish or stalled elevon movement.

There are no concerns with the hydraulic flow required to support single APU rates with two hydraulic systems, regardless of how many elevons are being driven by one of the two systems.

The areas of concern for vehicle flight control are during the final flare maneuver and vehicle derotation, when actuator rates are at the highest. The risks associated with single APU drive rates during this timeframe are less than those associated with unequal elevon movement. Ascent load relief and entry prior to Mach 0.6 are not of concern for this case, since the nominal actuator rates are not high enough to cause significant pressure degradation. (Ref. A/E Flight Techniques Panel #69, July 20, 1990.)

A8.1.3-5 **FCS CHECKOUT**

THE FCS CHECKOUT PART 1 (SECONDARY ACTUATOR CHECK) WILL BE PERFORMED, IF POSSIBLE, PRIOR TO THE DEORBIT BURN (PREFERABLY IN OPS 8). IF THE ACTUATOR CHECK CANNOT BE PERFORMED PRIOR TO THE BURN, IT WILL BE PERFORMED, IF POSSIBLE, IN MM 303. THE ACTUATOR CHECK WILL BE DONE UTILIZING AN APU OR HYDRAULIC SYSTEM CIRCULATION PUMP ACCORDING TO THE FOLLOWING PRIORITY:

- A. AN APU PREBURN.
B. A CIRCULATION PUMP PREBURN.
C. AN APU POSTBURN.

FLIGHT RULES

The primary purpose of the secondary actuator check is to test the aerosurface servo amplifiers (ASA's) for null driver failures. Two undetected null failures on an elevon could cause loss of vehicle control because the two good channels could be bypassed during a request for high surface rate (CIL 05-1-FC60402-1). The secondary purpose of the check is to test the secondary pressure transducers and the fault-detection circuitry in the ASA that issues channel bypass commands. (This test requires hydraulic system pressure greater than 2025 psi to be completely accomplished.)

THIS RULE CONTINUED ON NEXT PAGE

FLIGHT RULES

A8.1.3-5 FCS CHECKOUT (CONTINUED)

It is preferable to perform the complete FCS checkout pre-deorbit burn to allow time to fully troubleshoot any flight control system failures. The first priority is to use an APU if possible. If one or more APU's have failed, MMACS will determine if it is safe to attempt starting a failed APU. If an APU cannot be used for the actuator check, then a hydraulic system circulation pump will be used, if possible, to do the check preburn.

When using an APU, the checkout procedure has the crew bypass any port that does not bypass when the stimulus is applied. A port may not bypass because of either a null driver failure (1R/2) or a fault detection circuit failure (1R/3). Without insight into secondary delta pressures, the crew must assume the worst case driver failure and manually bypass the port. Given time to review the data (i.e., for checks done preburn), the MCC can confirm which failure exists. For a fault-detection circuitry failure, the channel is considered to be good and the port will be reset.

When using a circulation pump, two things are given up because the hydraulic system pressure is not great enough. The rudder and speedbrake drivers cannot be checked because brakes will not allow these surfaces to move, and the fault-detection circuitry for all surfaces cannot be tested. These two things considered, it is still preferable to accomplish the check for null elevon drivers before committing to entry rather than to wait until after the deorbit burn to accomplish a more complete check.

If the situation does not permit the actuator check to be accomplished with either an APU or circulation pump prior to the burn, the check will be performed in MM 303 if it is possible to do so. An APU will be used with its hydraulic pump in normal pressure even if only one APU is available for entry.

One polarity stimulus is sufficient to test for null failures; both polarity stimuli are required to fully test the fault-detection circuitry. If the check is done using a circulation pump or if it is done postburn, it will be abbreviated in that only one stimulus will be used. The abbreviated check is appropriate postburn because it minimizes the time required to perform the check.

The priorities are the same for early mission termination scenarios (AOA, next PLS, MDF) with or without APU/hydraulic systems failures. Considerations of whether to perform the check when entering early include crew workload, other systems failures, and APU hot restart constraints.

Reference Rules {A10.1.2-1}, LOSS OF APU/HYDRAULIC SYSTEM(S) ACTIONS; {A10.1.2-9}, FCS CHECKOUT APU OPERATIONS; and Ascent/Entry Flight Techniques Panel Meeting #47, Continuation, August 29, 1988.

Rules {A10.1.2-1}, LOSS OF APU/HYDRAULIC SYSTEM(S) ACTIONS, and {A10.1.2-9}, FCS CHECKOUT APU OPERATIONS, reference this rule.

FLIGHT RULES

A8.1.3-6 CONTROLLERS

IF TWO CHANNEL FAILURES OCCUR ON AN RHC, THE REMAINING TRANSDUCER WILL BE PRIME SELECTED, IF POSSIBLE, TO REGAIN THE CONTROLLER FUNCTION AND THE RHC WILL THEN BE POWERED OFF. THE RHC MAY BE POWERED AT ANY TIME IF REQUIRED FOR VEHICLE CONTROL. IF THE FAILED RHC IS ON THE CDR'S SIDE, THE CDR WILL FLY THE VEHICLE DURING APPROACH AND LANDING AS LONG AS THERE HAS BEEN NO MORE THAN ONE TRANSDUCER FAILURE.

If two channels of an RHC fail, prime-selecting the one remaining transducer permits use of that RHC. The RHC is powered off to preclude a failure of the remaining good transducer which could cause inadvertent jet firings, incorrect aerosurface commands, or loss of vehicle control. This implies that if the left (CDR) RHC is failed, then the vehicle must be flown using the right (PLT) RHC, either by the PLT or by the CDR after changing seats. Since the CDR and PLT are most proficient in systems knowledge and operation on their respective sides of the cockpit and the CDR is more highly trained to fly the vehicle, it is strongly desired that the CDR fly the vehicle whenever possible and only from the left seat. The only danger in using the remaining channel (pitch and roll transducer) is if it should fail when the orbiter is extremely close to the ground. This would be a third failure and would have to be a smart failure as well, since it would have to occur in a very narrow bandwidth of time after having successfully functioned for most of the approach. Since each member of the crew is highly trained to perform specific functions during the approach and landing, there is a much greater risk involved with altering these functions just to protect for a highly unlikely smart, third failure. If there is no reason to suspect the reliability of the remaining channel (pitch and roll transducer), i.e., its outputs are normal and both previous failures were not due to transducer problems, then there is an acceptable risk in using that RHC (two transducer failures could indicate a possible generic problem). Therefore, as long as the last remaining channel (pitch and roll transducer) on the CDR's RHC has good outputs and is believed to be reliable, the CDR will fly the vehicle during approach and landing.

Rules {A2.1,5-11}, ENTRY DTO/AUTO MODE/CROSSWIND DTO GO/NO-GO, and {A8.1.6-1}, GNC GO/NO-GO CRITERIA, reference this rule.

FLIGHT RULES

A8.1.3-7

TVC-SSME STOW/ACTUATOR FLUID FILL (REPRESSURIZATION)

- A. IF SSME STOW PROBLEMS OCCUR AT THE END OF ASCENT, THE APU'S WILL BE SHUT DOWN ON TIME AND THE STOW OPERATION WILL BE COMPLETED ON ENTRY DAY.

It is possible, under certain conditions, to not achieve SSME stow during ascent. Because the last commands issued are carried across OPS transitions, if the stow commands are not sent before the stow sequence is halted in OPS 1, the SSME's will not be commanded to stow in OPS 3. Thus, a transition to OPS 8 is required since the stow commands are issued upon transition. If the stow commands are sent before the sequence is halted, the stow commands will carry over across the OPS 3 transition.

- B. SSME ACTUATOR FLUID FILL USING FULL HYDRAULIC PRESSURE WILL BE PERFORMED ON ENTRY DAY ON ALL ACTUATORS OF ALL THREE ENGINES EXCEPT FOR THE FOLLOWING CONDITIONS:
1. THE DIFFERENCE BETWEEN ANY COMMAND (AVERAGE OF THE ACTIVE ATVC DRIVER OUTPUTS) AND THE INDICATED POSITION IS GREATER THAN 2 DEGREES. FOR ACTUATORS THAT ARE SUSPECTED TO HAVE A BIASED POSITION TRANSDUCER (SINGLE STRING), DATA FROM PAST FLIGHTS OF THAT ACTUATOR WILL BE USED TO ASSESS THE LIKELIHOOD OF ACTUALLY MOVING THE ACTUATOR MORE THAN 2 DEGREES.
 2. MAIN ENGINE POSITION DATA IS NOT AVAILABLE AND DATA BEFORE THE LOSS INDICATES THAT A STEP OF 2 DEGREES OR MORE IS POSSIBLE.

EVERY ATTEMPT WILL BE MADE TO AVOID VIOLATING THE 2-DEGREE STEP CONSTRAINT, INCLUDING STARTING AN APU ON ORBIT TO PERFORM SSME FLUID FILL.

Fluid fill and engine repositioning is required due to hydraulic fluid shrinkage after cooling down which may result in engine movement of 2 to 3 degrees in each axis. A 2- to 3-degree movement from the stow position would result in exceeding the design nozzle temperature limits (aerodynamic heating) on engines 2 and 3 (left and right ME's). Two APU's will repressurize all three engines. One APU will repressurize two ME's (ref. Rule {A10 1.2-1B}, LOSS OF APU/HYDRAULIC SYSTEM (S) ACTIONS).

THIS RULE CONTINUED ON NEXT PAGE

FLIGHT RULES

A8.1.3-7

TVC-SSME STOW/ACTUATOR FLUID FILL (REPRESSURIZATION) (CONTINUED)

SSME steps greater than 2 degrees (indicated) under full hydraulic pressure risk damage (possible rupture) to the hydraulic lines and subsequent loss of that hydraulic system. The average of the active ATVC driver outputs are used in the differencing scheme (as opposed to the software command) to eliminate the uncertainties in the command path. The 2-degree constraint takes into account the transducer uncertainty (ref. SODB 3.4.5.1h.1). Since some SSME TVC actuator position transducers have shown biases and scale factors in the position output, a false indication of the command/position delta could lead to multiple APU starts and SSME represses. For a suspected bias in the transducer (single transducer through MDM OA1), data from the post-MECO stow position and past hydraulic represses of that actuator will be used to assess the likelihood of actually moving the actuator more than 2 degrees. The flight history data will be obtained from the SSME actuator and hydraulics subsystem managers through a SPAN-MER hit.

Main engine position data are used by the MCC to ensure the 2-degree constraint will not be violated. If position data is lost, an attempt will be made to determine if a 2-degree step is likely. The command/position delta at the time of loss of data, the drift rate at the time of loss of data, and previous flight history are factors that will be used to aid in this determination.

Wind tunnel testing indicates that movement of a main engine nozzle from its stow position during entry increases aerodynamic heating on that nozzle. Not performing SSME fluid fill increases the possibility that nozzle damage will occur during entry.

This rule is referenced by Rule {A8.1.3-8I}, FCS CHANNEL MANAGEMENT.

FLIGHT RULES

A8.1.3-8 FCS CHANNEL MANAGEMENT

A. FOR RESTRING CASES DUE TO GPC FAILURES, ASA AVAILABILITY (VIA FCS CHANNEL SWITCHES) WILL BE MANAGED SO THAT EACH GPC IN THE REDUNDANT SET WILL BE ASSIGNED AN EQUAL NUMBER OF ASA'S. WITH NO ADDITIONAL FAILURES, THE GPC/FCS CHANNEL ASSIGNMENTS WILL BE:

FOUR GPC'S - FOUR CHANNELS IN AUTO, ONE CHANNEL PER GPC.

THREE GPC'S - THREE CHANNELS IN AUTO, ONE CHANNEL PER GPC, ONE CHANNEL OFF.

TWO GPC'S - FOUR CHANNELS IN OVERRIDE, TWO CHANNELS PER GPC.

ONE GPC - FOUR CHANNELS IN AUTO.

If each GPC does not control an equal number of FCS channels, subsequent failure of the GPC that has the larger number of channels could cause good ports to be bypassed resulting in a loss of vehicle control. Ports are taken offline by taking the FCS channel power to OFF.

To equalize channels for the three GPC-four FCS channel case, one FCS channel must be turned off. It is desirable to turn off FCS channel 4 since both the bodyflap and the BFS use channels 1-3. On OV-102, this will result in the loss of high rate ACIP data, but low rate data is considered acceptable. For the two-GPC case, having all channels in override will prevent loss of good ports for the next GPC failure. In this case, rapid crew action will still be required to turn off the channels on the failed GPC, but this is the safest configuration of all of the options. With one GPC, the next GPC failure cannot be accepted, but the auto system will operate properly for FCS channel problems.

B. FOR AN FA MDM OR GPC FAILURE DURING ASCENT OR ENTRY, THE CORRESPONDING FCS CHANNEL WILL BE TURNED OFF.

When an FA MDM fails or a GPC fails to halt or sync, its actuator commands are no longer valid. The FCS channel, if left powered, would cause a force fight with the other good channels. It is appropriate to turn the FCS channel OFF, which will bypass that channel. It will also eliminate the possibility of a subsequent failure causing a two-on-two force fight.

THIS RULE CONTINUED ON NEXT PAGE

FLIGHT RULES**A8.1.3-8 FCS CHANNEL MANAGEMENT (CONTINUED)**

- C. DURING OPS 1, 3, OR 6 IF ANY OF THE FIRST THREE FCS CHANNELS ARE TURNED OFF, THE CORRESPONDING POSITION FEEDBACKS WILL BE DESELECTED. IF FCS CHANNEL 4 IS TURNED OFF, THE CORRESPONDING FEEDBACKS WILL NOT BE DESELECTED UNLESS THERE IS A POSITION FEEDBACK FAILURE ON ONE OF THE FIRST THREE FCS CHANNELS.

Deselection of feedbacks is performed on CONTROLS SPEC 53, which is available in OPS 1, 3, and 6. Crew item deselection removes all feedbacks on the associated FCS channel. For the first three FCS channels, feedbacks should be deselected any time the channel is turned off. This action allows FCS channel 4 feedbacks to be used and protects against failing the position feedbacks on the unpowered channel if the failure that caused the channel to be turned off is subsequently recovered. If there are no other FCS channel position feedback problems, position feedbacks should not be deselected on FCS channel 4 when it is turned off. This action will allow FDIR to isolate a problem on FCS channels 1, 2, or 3 without requiring the position feedbacks to be deselected on all aerosurfaces of the affected channel. It is not critical to protect the rudder or speedbrake position feedbacks. The rudder feedback is only used for crew display on the surface position indicator (SPI). The speedbrake position is used to set a pitch trim rate gain in the AEROJET DAP and for crew display on the SPI. Since the bodyflap uses a QMVS selection filter, no action is required for the bodyflap position feedbacks. Feedbacks are deselected in OPS 1 to ensure a good feedback configuration is available should an abort be required.

- D. IF A SINGLE CHANNEL IS FAILED BUT NOT BYPASSED, THE REMAINING CHANNELS WILL BE PLACED IN "OVERRIDE".

This action protects for the next GPC/MDM/LRU failure. If the channels are left in auto, the next failure could cause both good channels to be bypassed resulting in loss of vehicle control. By placing the remaining channels in override, we inhibit port popping of the good channels. The FCS system must now be managed manually, using ground calls. Reference RI-Downey Internal Letter 283-430-81-075.

- E. WHEN ONLY TWO GOOD FCS CHANNELS REMAIN ON A SINGLE ACTUATOR, BOTH WILL BE PLACED IN "OVERRIDE".

This action protects for the next GPC/MDM/LRU failure. If the channels are left in AUTO, the next failure could cause the good channel to be bypassed resulting in loss of vehicle control. In override, the next failure will result in a one-on-one force fight which is preferred because it may allow the crew time to secure the bad channel and engage BFS to recover good channels. One channel control is not certified. The FCS channels in override must be managed manually. Reference RI-Downey Internal Letter 283-430-81-075.

THIS RULE CONTINUED ON NEXT PAGE

FLIGHT RULES

A8.1.3-8 FCS CHANNEL MANAGEMENT (CONTINUED)

F. WHEN MOVING MULTIPLE FCS CHANNEL SWITCHES FROM "AUTO" TO "OVERRIDE" OR "OVERRIDE" TO "AUTO", A 2-SECOND DELAY BETWEEN INDIVIDUAL SWITCH ACTUATIONS WILL BE MAINTAINED.

The FCS switches are of the break-before-make type. When moved from one position to another, power to the FCS channel is temporarily interrupted. When power is interrupted, logic inside the ASA causes power to remain off for at least 510 msec and for as long as 1370 msec regardless of how fast the FCS switch is moved (ref. RI-Downey Internal Letter 283-220-86-009). The affected channel is bypassed during the time that the ASA power is off. If multiple channel switches are actuated at the same time, an aerosurface may have no active ports controlling it because all ports have been bypassed due to previous failures and/or switch actuations. This could cause the surface to go hardover which would cause a transient in the flight control system.

G. IN OPS 3 OR 6, AN AEROSURFACE PORT WILL BE MANUALLY BYPASSED IF IT IS FORCE FIGHTING OTHER CHANNELS WITH A SECONDARY DELTA PRESSURE OF 1400 PSI OR GREATER.

The ASA hardware has built-in fault detection that will bypass a port if its secondary delta pressure is greater than 2025 psi. This limit is a compromise; it is high enough to avoid transient failures of good channels yet low enough that a bad channel will likely be isolated. Also, the ASA has a redundant channel equalization function designed to compensate for variation of hardware tolerances. By design, equalization should prevent a port with no hardware failure from being bypassed. The effect of equalization is fully realized when the secondary delta pressure for the affected port has reached about 1400 psi (ref. SODB volume III, par. 4.5.1.1.1).

The intent of this rule is to allow for manual isolation of a port that has a failure below the hardware fault detection limit of 2025 psi, but above equalization (1400 psi). This action protects for the next worst failure which could result in a two-on-two force fight. A two-on-two is an uncertified FCS configuration and could cause bypass of the two good FCS channels resulting in loss of control during entry. No action is required in OPS 1 because aerosurfaces are not used for control. (The capability to manually bypass a port exists in OPS 1, 3, 6, and 8.)

H. DURING OPS 3, FCS CHANNEL MANAGEMENT TO REGAIN ATVC REDUNDANCY WILL NOT BE PERFORMED IF IT RESULTS IN A LOSS OF ASA SINGLE FAULT TOLERANCE.

FCS channel management to optimize ATVC's in OPS 3 would only be performed to provide fault tolerance for drag chute repositioning. Aerosurface control redundancy will not be jeopardized to reposition SSME bells for drag chute deployment since the drag chute can be deployed, if required, without SSME repositioning. Reference Ascent/Entry Flight Techniques Panel meeting #84, November 15, 1991, DRAG CHUTE IMPACTS.

@[041196 1883]

FLIGHT RULES

This rule references Rule {A8.1.3-7B}, TVC-SSME STOW/ACTUATOR FLUID FILL (REPRESSURIZATION).

A8.1.3-9 HUD/COAS SYSTEM MANAGEMENT

- A. IF EITHER STAR TRACKER IS SUSPECTED OF BEING FAILED, THE CALIBRATION PROCEDURE FOR THE CDR HUD WILL BE PERFORMED WITHIN 24 HOURS. IF AN UPDATE IS REQUIRED, THE PROCEDURE WILL BE RUN AGAIN WITHIN 24 HOURS TO VERIFY THE CALIBRATION. @[111094-1723A]

If a star tracker is lost and the CDR HUD is not calibrated, the capability to perform an entry alignment is zero-fault tolerant. The calibration procedure should be run for the CDR HUD to ensure the SODB specified COAS IMU alignment accuracy for entry is met. During the procedure, if the delta bias is large enough that an update is required, the procedure should be run again within 24 hours to verify the accuracy of the calibration. Although the HUD flight data has shown no significant in-flight line-of-sight (LOS) shifts, it is prudent to ensure it will provide the best possible IMU alignment capability if required. (Ref. Rule {A8.1.1-12}, HEAD UP DISPLAY (HUD) AND CREW OPTICAL ALIGNMENT SIGHT (COAS) ALIGNMENT). (Ref. On-Orbit FTP meeting #133, October 9, 1992, HUD/COAS CALIBRATION and On-Orbit FTP meeting #148, September 9, 1994, HUD/COAS CALIBRATION STATUS.)

- B. THE SECONDARY STATION CALIBRATION WILL BE PERFORMED AS SOON AS PRACTICAL UPON LOSS OF THE PRIMARY STATION IF A STAR TRACKER IS FAILED.

A calibrated device at one station is required. If it has been determined that the calibrated device has been lost (e.g., loss of power or an obstructed window), the other station will be calibrated to meet the requirements in paragraph A of this rule. As backups to the star trackers for IMU alignments, the CDR HUD is the primary station and the PLT HUD/-Z COAS is the secondary station. (Ref. On-Orbit FTP meeting #148, September 9, 1994, HUD/COAS CALIBRATION STATUS.)

- C. THE SECONDARY STATION WILL BE CALIBRATED IF THE CABIN IS AT A PRESSURE DIFFERENT FROM THE PRIMARY STATION CALIBRATION AND A STAR TRACKER IS FAILED.

There is insufficient data to state that a decrease in cabin pressure to 10.2 psi will or will not cause a HUD/COAS line-of-sight shift large enough to violate the 0.5 degree EI IMU alignment accuracy requirement for entry (ref. Rule {A4.1.4-1}, IMU ALIGNMENT). Therefore, if a star tracker is lost, a HUD/-Z COAS calibration is required for fail-safe redundancy to perform an entry IMU alignment. Using the CDR or PLT HUD and the alternate software location for the calibrated vector is acceptable to meet the intent of this rule which is to provide a calibrated device at both cabin pressures. @[111094-1723A]

THIS RULE CONTINUED ON NEXT PAGE

FLIGHT RULES

A8.1.3-9 HUD/COAS SYSTEM MANAGEMENT (CONTINUED)

- D. IT IS HIGHLY DESIRABLE THAT HUD/COAS CALIBRATIONS BE IMMEDIATELY PRECEDED BY A STAR TRACKER IMU ALIGNMENT. @[111094-1723A]

HUD/COAS calibration accuracy is directly dependent on IMU misalignment. This is a controllable error source and should be minimized.

- E. IF BOTH STAR TRACKERS ARE SUSPECTED OF BEING FAILED, THE SECONDARY STATION WILL BE CALIBRATED AS SOON AS POSSIBLE.

If both star trackers are failed, the CDR HUD will be the primary device for performing IMU alignments. Since the HUD is zero fault tolerant (e.g. power failure), a PLT HUD/-Z COAS calibration is required for fail-safe redundancy to perform an entry IMU alignment. The PLT HUD/-Z COAS calibration should be performed as soon as possible to minimize IMU misalignment error and improve the accuracy of the calibration. @[111094-1723A]

A8.1.3-10 STAR TRACKER SYSTEM MANAGEMENT (CIL)

- A. BOTH STAR TRACKERS WILL BE CONTINUOUSLY POWERED FOR THE ON-ORBIT PORTION OF THE FLIGHT TO OBTAIN STAR-OF-OPPORTUNITY DATA. TRACKERS MAY BE POWERED OFF IF A PARTICULAR LONG DURATION ATTITUDE PRECLUDES GATHERING STAR-OF-OPPORTUNITY DATA.
- B. ONE STAR TRACKER DOOR WILL BE CLOSED IF A KNOWN FAILURE CONDITION EXISTS WHERE ONE ADDITIONAL FAILURE WOULD CAUSE BOTH DOORS TO BE FAILED OPEN. (CIL)

Star-of-opportunity alignments can decrease or eliminate the need to repeatedly perform maneuvers for IMU alignment, saving crew effort, time, and propulsion consumables.

Rockwell thermal studies (ref. SAS-TA-TPS-87-238, IL 294-400-87-071, and IL SAS-TA-RCC-78-160) have shown that entry with one star tracker door open results only in minor local damage due to stagnation conditions in a single opening cavity. In the absence of further studies showing that a two-door-open entry is also safe, conservative engineering judgment must assume that a plasma flow between the two doors could cause potentially catastrophic damage to the airframe, crew cabin, and/or navigation base.

Therefore, if the next electrical failure results in the loss of the last motor function on both doors, one door will be closed immediately to eliminate the potential for a two-door-open entry. Additionally, if one door is already stuck open, the other door will be closed immediately (even if redundant motor capability is available) in order to protect for a mechanical failure (e.g., door jam) that could result in a two-door-open entry (ref. CIL 02-4F-032001-1).

FLIGHT RULES

A8.1.3-11 IMU SYSTEM MANAGEMENT

- A. A PRE-DEORBIT IMU-TO-IMU ALIGNMENT WILL BE PERFORMED AT DEORBIT TIG - 70 MINUTES TO RESET THE IMU RM THRESHOLDS.

The pre-deorbit IMU/IMU alignment is required to reset the IMU RM thresholds. If the thresholds are not reset, then the IMU RM two-level attitude failure coverage during entry is drastically reduced. For no pre-deorbit IMU/IMU alignment, the probability of isolation for XY plane IMU errors at the two-level is 64 percent to 46 percent (decreasing with time) between EI and touchdown. The probability of isolation for Z-axis IMU errors (corresponds to critical orbiter vertical and down-range position and velocity errors) is 0 percent between EI and touchdown. In contrast, having performed the pre-deorbit IMU/IMU alignment, the probability of isolation for XY plane IMU errors at the two level is approximately 68 percent (reaching a max of 70 percent) between EI and touchdown. The probability of isolation for Z-axis (critical) IMU errors is 100 percent between EI and touchdown.

For deorbit wave-off cases, the pre-deorbit IMU/IMU alignment can be waved and performed one time only at the TIG - 70-minute point of the actual deorbit. For a wave-off declared after the IMU/IMU alignment has been performed, the alignment will be performed again at the next TIG - 70-minute point.

- B. THE PRE-DEORBIT STAR ALIGNMENT ON ENTRY DAY IS DEFINED AS CRITICAL.

IMU accuracy needs to be determined during the entry alignment and verification to assure that the IMU's will be within 0.5 degrees of desired attitude (RSS at EI) in order to protect the vehicle and crew during the entry phase (ref. Rule {A4.1.4-1}, IMU ALIGNMENT). The pre-deorbit alignment is currently the only identified critical alignment.

- C. ONBOARD ALIGNMENT VERIFICATION IS REQUIRED FOLLOWING ANY CRITICAL ALIGNMENT. DEORBIT WILL BE DELAYED ONE ORBIT, IF AVAILABLE, TO ALLOW THE OPS 3 STAR ALIGNMENT VERIFICATION TO BE COMPLETED.

The time element here is crucial. Any noncritical alignment results can be observed over some extended time period and verified by the MCC. Any problems discovered can then be corrected. However, a critical alignment must be as accurate as possible at that point in time, as the future provides little or no opportunity for correction.

- D. ONBOARD VERIFICATION IS NOT REQUIRED FOLLOWING NONCRITICAL ALIGNMENTS. VERIFICATION WILL BE ACCOMPLISHED BY THE MCC USING TELEMETERED STAR-OF-OPPORTUNITY AND RELATIVE MISALIGNMENT DATA.

Rationale same as for paragraph C.

THIS RULE CONTINUED ON NEXT PAGE

FLIGHT RULES

A8.1.3-11 IMU SYSTEM MANAGEMENT (CONTINUED)

- E. IMU GYRO DRIFT TERMS WILL BE UPDATED WHEN THE DRIFT EXCEEDS 3 SIGMA IN ANY AXIS. COMPENSATIONS LESS THAN 3 SIGMA WILL BE DONE AS REQUIRED TO MINIMIZE LONG TERM, STABLE DRIFT.

Correcting large (3 sigma) gyro drift errors will maintain the IMU's in the best possible position to support contingency deorbit and orbiter and payload operations. An IMU drifting at 3 sigma (0.02 deg/hr) will not jeopardize the 0.5 degree entry misalignment constraint for over 25 hours but does indicate significant out-of-spec performance, which should be corrected. Gyro drifts of this magnitude need not be compensated immediately but should wait for reliable drift measurements. Gyro drifts of less than 3 sigma, but which are stable and of long duration (typically 8 hours or more), should be corrected to place the IMU's in the best possible configuration to support orbiter and payload activities, sleep periods, IMU align wave-offs, entry, and any contingencies. The 1-sigma drift value is 0.006 deg/hr (ref. SODB 4.5.1.2.3.q.2.a-2p.2.a-2). ©[011291752A] [@\[081497-4060A\]](#)

- F. IMU ACCELEROMETER BIAS TERMS WILL BE UPDATED WHEN THE ERROR EXCEEDS 3 SIGMA IN ANY AXIS. COMPENSATIONS LESS THAN 3 SIGMA WILL BE DONE AS REQUIRED TO MINIMIZE LONG TERM, STABLE ERRORS.

Correcting large (3 sigma) accelerometer errors will maintain the IMU's in the best possible position to support orbiter and payload activities and entry. A 3-sigma error indicates significant out-of-spec performance which should be corrected when a reliable error measurement is available. Accelerometer errors of less than 3 sigma, but which are stable and of long duration (typically 4 hours or more), should be corrected to place the IMU in the best possible position to support entry as well as to provide an extra margin of safety on orbit. The 1-sigma value is ~~4050-~~ μG 's (ref. SODB 4.5.1.2.3.q.1-bp-1). ©[011295-1752A] ~~f~~[@\[081497-4060A\]](#)

- G. THE IMU'S NEED NOT BE REALIGNED WITH STAR DATA TO SUPPORT A DEORBIT ON ORBITS 2 OR 3.

A worse case IMU (3 sigma in all axes) results in a total platform misalignment of 0.125 degrees (RSS) at EI for an orbit 3 deorbit which meets navigation's requirement of 0.5 degrees (RSS) (ref. Rule {A4.1.4-1}, IMU ALIGNMENT). An orbit 2 or 3 deorbit would be an emergency action, and an IMU alignment using stars would impact the crew timeline. This rule does not preclude the use of an IMU/IMU alignment to regain a failed IMU.

- H. IMU ALIGNMENTS WILL BE PERFORMED FOR LAUNCH DAY DEORBITS AFTER ORBIT 3 TO OPTIMIZE ENTRY NAVIGATION.

FLIGHT RULES

A 3-sigma HAINS IMU drift (in all axes) results in a total platform misalignment of 0.312 degrees (RSS) at EI for orbit 7 deorbit. This meets navigation's requirement of 0.5 degree (RSS) but is worse than the desired 0.25 deg at EI (ref. Rule {A4.1.4-1}, IMU ALIGNMENT). Using the scheduled alignment for these deorbit opportunities has no impact on the crew timeline workload and the align will be performed as required to optimize entry navigation. ®[011295-1752A]

THIS RULE CONTINUED ON NEXT PAGE

FLIGHT RULES

A8.1.3-11 IMU SYSTEM MANAGEMENT (CONTINUED)

- I. THE CRITICAL ENTRY IMU STAR ALIGNMENT WILL BE REACCOMPLISHED AS REQUIRED IN ORDER TO PROTECT THE 0.5 DEGREE (RSS) ATTITUDE ERROR LIMIT (REF. RULE {A4.1.4-1}, IMU ALIGNMENT). IF A "NO-GO" FOR DEORBIT IS GIVEN PRIOR TO THE IMU ALIGNMENT, THEN, TIMELINE PERMITTING, THE ALIGNMENT WILL SLIP TO THE SAME RELATIVE PLACE AS NOMINAL WITH RESPECT TO THE NEW BACKUP DEORBIT OPPORTUNITY.

From the time of critical alignment for entry to the one orbit late backup orbit deorbit time, the IMU drift is still within requirements to support an entry without a realignment. If a NO-GO for deorbit is called prior to the entry alignment, it is best to move the alignment to the nominal pre-entry time to maximize IMU accuracy for entry (ref. A/E Flight Techniques #5, Sept. 9, 1983). ©[011295-1752A]

- J. IMU STAR ALIGNMENTS WILL BE PERFORMED AS REQUIRED TO MAINTAIN THE ENTRY INTERFACE (EI) IMU ALIGNMENT CRITERIA. STAR ALIGNMENTS WILL BE SCHEDULED APPROXIMATELY ONCE PER FLIGHT DAY. ©[011295-1752A]

IMU star alignments will be performed periodically on orbit to ensure that the 0.5 degree (RSS) EI IMU alignment criteria is satisfied for contingency situations (ref. Rule {A4.1.4-1}, IMU ALIGNMENT). For nominal circumstances, the desired 0.25 degree alignment criteria will be maintained to ensure the best possible navigation performance during entry. IMU star alignments will be performed using either star-of-opportunity (SOO) data or star data acquired from dedicated orbiter maneuvers.

Scheduling star alignments once per flight day accounts for the expected IMU performance to ensure that the EI criteria is satisfied, while minimizing crew time and RCS propellant usage for alignments. ©[011295-1752A]

- K. IMU GYRO CALIBRATION WILL BE BASED ON A SET OF TORQUING ANGLES MEASURED AT LEAST 3 HOURS FROM THE TIME THE PREVIOUS SET OF TORQUING ANGLES WAS MEASURED.

For several hours postalignment, the misalignment uncertainty is as large as the actual platform misalignment. Therefore, reliable drift rates cannot be computed from torquing angles generated shortly after an alignment. As IMU misalignment grows with time, one can more accurately determine the true drift rate of the platform.

- L. CALIBRATION DATA WILL BE UPLINKED TO THE BFS, IF REQUIRED, AS SOON AS PRACTICAL ON ENTRY DAY. ©[011295-1752A]

As the BFS has not been running on orbit, the gyro drift and accelerometer changes have only been made in the PASS. Thus, the BFS machine needs to be brought up to date with the PASS machine bias alterations by uplink as soon as practical on entry day.

FLIGHT RULES

THIS RULE CONTINUED ON NEXT PAGE

FLIGHT RULES

A8.1.3-11 IMU SYSTEM MANAGEMENT (CONTINUED)

M. G-SENSITIVE TERMS WILL BE UPDATED IN-FLIGHT VIA UPLINK, BASED ON ANALYSES OF ASCENT PERFORMANCE AND PREDICTED CHANGES AS REQUIRED TO MAINTAIN 3 SIGMA LRU PERFORMANCE. ©[011295-1752A]

Analysis of ascent data may indicate a scale factor problem (G-sensitive term) in an IMU. An uplink will be done to maximize performance. Due to the granularity of MCC programs, it will not be possible to guarantee any level of LRU performance.

N. IN OPS 3, A ZERO DELTA STATE UPDATE WILL BE PERFORMED IN THE PASS PRIOR TO RESELECTING AN IMU THAT HAS BEEN COMMFAULTED WITH THE FOLLOWING EXCEPTIONS: ©[092195-1781]

1. IF MCC DETERMINES THAT THE NAV STATE ASSOCIATED WITH THE COMMFAULTED IMU IS NOT IN ERROR, THEN THE IMU MAY BE RESELECTED WITHOUT A NAV ZERO DELTA UPDATE.
2. ZERO DELTA STATE UPDATE AND SUBSEQUENT IMU RESELECTION WILL NOT BE PERFORMED IN THE PASS BETWEEN 200,000 FEET ALTITUDE AND INITIAL TACAN PROCESSING. ©[092195-1781]
3. FOR AOA, ZERO DELTA STATE UPDATE AND SUBSEQUENT IMU RESELECTION WILL NOT BE PERFORMED BETWEEN OPS 3 TRANSITION AND INITIAL TACAN PROCESSING WHEN RECOVERING A THIRD IMU. A SECOND IMU MAY BE RECOVERED IF PRIOR TO 200,000 FEET ALTITUDE. ©[092195-1781]

Because the PASS navigation software propagates independent state vectors for each IMU in OPS 3, a NAV zero delta state update is performed to force the three IMU state vectors to the RM selected state and thereby correct NAV state errors of the commfaulted IMU. ©[092195-1781]

If an IMU is commfaulted and subsequently recovered during a period of no acceleration, or if only commfaulted for a very short time when under acceleration, then its NAV state may not be in error and a NAV zero delta update is not necessary before IMU reselection. MCC will determine when a zero delta state update is not required since there is no onboard display of the individual IMU state vectors. ©[092195-1781]

THIS RULE CONTINUED ON NEXT PAGE

FLIGHT RULES

A8.1.3-11 IMU SYSTEM MANAGEMENT (CONTINUED)

A zero delta state update several minutes prior to TACAN processing changes the covariance matrix such that initial TACAN range velocity gains are dramatically increased. In the presence of nominal TACAN range residuals (2 nm), this causes undesirable downrange velocity transients at initial TACAN processing. For smaller NAV state errors, the resultant velocity transients are acceptable. For larger state errors (2 sigma), MCC delta state limits may be exceeded for a zero delta state update performed in this region. Since MCC knowledge of NAV state errors is questionable during this period of entry, it is assumed that they may be large enough to cause an undesirable transient. An altitude of 200,000 feet is a convenient reference point about 5 minutes before nominal TACAN processing. Five minutes is the minimum advisable time delay between a zero delta state and initial TACAN processing in order to allow the TACAN velocity gains to shrink sufficiently. If recovering an IMU in the PASS during this period, the zero delta state update and IMU reselection should be delayed until after initial TACAN processing in order to avoid the velocity transients.. Otherwise, the magnitude of the nav error may exceed delta state and guidance constraint limits. The navigation errors can violate limits for several minutes until TACAN alone is able to bring the errors under control, and guidance capability to recover from the errors is reduced during this timeframe. Therefore, the IMU will not be recovered in the PASS until TACAN processing has started. The IMU should be reselected in the BFS immediately (if previously deselected). Since no zero delta state update is required to recover the IMU in the BFS, TACAN processing should not introduce velocity transients into the BFS nav state. Should the last PASS IMU fail, the BFS nav state should remain good for engage or for manual flying using BFS attitude errors if the PASS remains in control, but with a degraded PASS nav state. The crew can take CSS when down to one IMU to protect against the next worst failure (loss of IMU resulting in loss of control while in AUTO) (ref. Rule - TBD and A/EFTP #122, March 10, 1995. ©[092195-1781]

On an AOA, the zero delta state is undesirable anytime in OPS 3 prior to TACAN processing as it would result in replacing the unique AOA covariance matrix. This covariance was developed for the larger navigation errors and different uncertainty distributions associated with an AOA (ref. A/EFTP #75, February 15, 1991). On an AOA, the zero delta state update and IMU reselection may be performed immediately when recovering a second IMU due to the increased risk of flying with no IMU redundancy. However, the window from 200,000 feet altitude to initial TACAN processing should still be protected from zero delta state updates per the above discussion.

©[092195-1781]

FLIGHT RULES

A8.1.3-12 GNC AIR DATA SYSTEM MANAGEMENT (CIL)

- A. AIR DATA WILL BE INCORPORATED INTO G&C BASED ON A REASONABLENESS ASSESSMENT OF h , M , AND ALPHA ONBOARD, AND A REASONABLENESS ASSESSMENT OF THE ALTITUDE (H-GROUND COMPUTED) AND RAW PRESSURES ON THE GROUND.

The crew is able to read h , M , and alpha onboard on their override SPEC. They can compare this to navigation data as we can on the ground. If the data agrees, within reason (reasonableness assessment), then the crew will pass the air data information into the flight control system. This assessment opportunity is used in solving dilemmas as well.

- B. IF ONLY ONE GOOD ADTA REMAINS, AIR DATA INPUT TO G&C WILL BE INHIBITED AND VEHICLE WILL BE FLOWN WITH "DEFAULT/NAVDAD" AIR DATA EXCEPT FOR THE FOLLOWING CONDITIONS WHEN A SINGLE GOOD ADTA WILL BE INCORPORATED INTO G&C:

1. BFS ENGAGE.
2. BAD NAV STATE.
3. HIGH WINDS ON THE HAC (≥ 80 KNOTS).
4. ANYTIME THE ADDITIONAL BURDEN OF FLYING THETA LIMITS PRESENTS AN UNSATISFACTORY RISK OF LOSING CONTROL OR THE ABILITY TO MAINTAIN A SATISFACTORY GROUNDTRACK (CDR'S DISCRETION).

Incorporating air data (AD) to G&C when only a single ADTA remains may result in loss of vehicle control if that last remaining ADTA should fail. Numerous AD parameters (dynamic press, TAS, EAS, M , and alpha) are being used by the flight control system. Should the last remaining ADTA fail, no fault detection exists to identify or isolate this bad ADTA and loss of vehicle control could result before the crew or MCC can react. While a high piloting task, use of default AD/NAVDAD (flying "theta limits") is considered an acceptable flight control mode and should be used when only a single good ADTA remains.

The BFS, however, does not have default AD and, thus, resorts to NAVDAD alone for no AD. Also, the BFS itself is only single string. Therefore, when the BFS is engaged, incorporating the last ADTA into G&C is preferred.

In the event of a bad navigational state, air data incorporation would be required to G&C. Since NAVDAD/default air data utilizes navigation parameters (V_{rel} , altitude, drag decel, alpha, and vehicle mass), a bad navigation state, and in particular a bad V_{rel} , would be reason to incorporate AD to G&C when only a single ADTA remains.

FLIGHT RULES

THIS RULE CONTINUED ON NEXT PAGE

FLIGHT RULES

A8.1.3-12 GNC AIR DATA SYSTEM MANAGEMENT (CIL) (CONTINUED)

High winds on the HAC would be another circumstance for which air data will be incorporated into G&C. For winds on the HAC ≥ 80 knots, the risk of LOC or excessive loss of energy due to the difficulty of the theta limits task exceeds the risk of utilizing the last remaining ADTA.

A single ADTA will be incorporated into G&C, at the CDR's discretion, in the event conditions arise which would significantly increase the possibility of loss of vehicle control or result in an unsatisfactory groundtrack if theta limits were flown. The crew task of flying "theta limits" should be avoided when circumstances arise such that the crew is not able to devote the attention required for this task. These circumstances include, but are not limited to, numerous other systems failures, health problems, etc. As a result, under these conditions, the risk associated with using a single ADTA will be accepted.

Reference Entry Flight Techniques Panel meetings #39 and #43.

- C. IF AIR DATA IS BEING INPUT TO G&C BELOW TAEM INTERFACE (< MACH 2.5), THE PITCH AXIS "CSS" MODE WILL BE SELECTED. "AUTO" MAY BE RESELECTED FOLLOWING INCORPORATION.

Dynamic pressure (Q -bar) and dynamic pressure rate (Q -bar dot) are currently not reinitialized for all ADTA SOP dynamic pressure source selection changes. Large, falsely derived Q -bar dot rates can occur during NAVDAD-to-air-data mode changes. In TAEM ($M < 2.5$), an increase in Q -bar of the order that can occur during the NAVDAD-to-air-data mode change will result in a step in the normal acceleration command (N_{zc}). Pitch axis CSS mode will prevent the step N_{zc} change.

- D. WHEN ALL AIR DATA IS LOST OR NOT INCORPORATED INTO FLIGHT CONTROL, THETA LIMITS WILL BE ENFORCED. (CIL) [@\[041196 1870A\]](#)

If air data is not incorporated into G&C, flight control defaults to use a fixed value of alpha (7.5 degrees). Q -bar is derived from an I-loaded table as a function of navigation ground relative velocity (V_{rel}). Since guidance no longer limits alpha by protecting the low Q -bar boundary, it is necessary for the crew to follow theta limits on the vertical situation display. In this situation, the displayed alpha is not reliable. Keeping theta between the NOSE HI and NOSE LO region will ensure that the vehicle alpha is within acceptable limits. Allowing theta to exceed NOSE HI increases the chances of stall while allowing theta to fall below NOSE LO could cause Q -bar to increase to unacceptable limits. Keeping theta within limits also reduces energy dispersions. Although the speedbrake setting during Approach and Landing is affected by the lack of air data to G & C, off-line simulations have shown that when the speedbrake is left in auto, performance is generally better than when it is set to a predetermined position (reference AEFTP #128, 12/8/95). Therefore, the speedbrake will be left in auto and the setting evaluated for reasonableness. If the speedbrake setting is unreasonable, the crew may select manual speedbrake and set it as necessary. [@\[041196 1870A\]](#)

Rules {A2.1.5-11}, ENTRY DTO/AUTO MODE/CROSSWIND DTO GO/NO-GO, and {A8.1.6-1}, GNC GO/NO-GO CRITERIA, reference this rule.

FLIGHT RULES

A8.1.3-13 AEROSURFACE ACTUATOR PROTECTION

TO PRECLUDE DAMAGE TO AEROSURFACE ACTUATORS, APU'S WILL NOT BE STARTED IN OPS 2. ALSO, ALL AVAILABLE AEROSURFACE AMPLIFIERS MUST BE "ON" PRIOR TO APU START (REF. RULE {A10.1.2-2G}, APU START/RESTART LIMITS).

By turning the APU's on while in OPS 2, we run the risk of damaging the aerosurface actuators by applying hydraulic pressure to the systems. Since OPS 1, the aerosurfaces may have drifted from their last commanded position such that, if the position delta is great enough at APU start, it could be possible to generate such a command force on the actuator that damage may occur. If the APU's have to be started on orbit, it is prudent to turn the ASA's on prior to transition to OPS 8 and APU start. The OPS 8 software for aerosurface control will be active so that at transition to OPS 8 the aerosurface commands will be made equal to their present position.

Rule {A10.1.2-2G}, APU START/RESTART LIMITS, references this rule.

A8.1.3-14 OMS TVC SYSTEM MANAGEMENT

A. FOR LOSS OF AN OMS TVC:

1. DURING PERIODS OF INACTIVITY, THAT OMS ENGINE WILL BE PARKED THOUGH THE NOMINAL EOM DEORBIT BURN CG AND THE TVC WILL BE POWERED OFF AS SOON AS PRACTICAL.

Parking the affected OMS engine through the cg and powering off the TVC protects against loss of that OMS engine for numerous single-point failures in the OMS TVC, failure of an FA MDM, or power failure. (Note: Loss of an FA MDM can result in loss of the remaining TVC on that engine, ignition redundancy on the other engine, and two +X RCS jets.) Given that the other OMS engine is usable, the procedure for parking that engine should be performed when practical.

2. OMS-1, OMS-2, AND THE DEORBIT BURN WILL BE PERFORMED TWO-ENGINE WITH TVC ACTIVE ON BOTH ENGINES.

As long as the other OMS engine is usable, sufficient redundancy exists to permit use of the remaining TVC for OMS burns. This is especially true for OMS-1, OMS-2, and the deorbit burn due to the criticality and time constraints of these burns.

3. IT IS PREFERABLE TO PERFORM ALL ON-ORBIT BURNS SINGLE ENGINE, USING THE OMS ENGINE WITH REDUNDANT TVC.

Given that OMS TVC redundancy is lost on one engine, it is preferable to perform all on-orbit burns single engine, using the OMS engine with redundant TVC. It is desired to leave the OMS engine with only a single TVC parked and powered off as much as possible to preserve it as a safe deorbit capability.

FLIGHT RULES

THIS RULE CONTINUED ON NEXT PAGE

FLIGHT RULES**A8.1.3-14 OMS TVC SYSTEM MANAGEMENT (CONTINUED)**

4. IF THE REMAINING TVC ON THE OMS ENGINE WITH THE FAILED TVC IS SUSPECT, POST-OMS-2 THAT OMS ENGINE WILL BE PARKED THROUGH THE NOMINAL EOM DEORBIT BURN CG ASAP AND POWERED OFF UNTIL AFTER THE DEORBIT BURN.

The purpose of this rule is to preserve the engine as a safe deorbit method. The engine should remain parked and powered off through the deorbit burn. The deorbit burn will be accomplished with that engine parked through the CG and TVC powered off. Post-deorbit burn, the engine should be powered on and driven to the entry stow position. (Ref. Rule {A8.1.2-3}, OMS TVC LOSS.)

5. IF THE AFFECTED OMS ENGINE IS THE LAST REMAINING OMS ENGINE:
- a. OMS-1 WILL BE PERFORMED SINGLE ENGINE WITH TVC ACTIVE.
 - b. POST-OMS-1 THE OMS ENGINE WILL BE PARKED THROUGH THE CG ASAP AND POWERED OFF. OMS-2 AND ALL SUBSEQUENT OMS BURNS WILL BE PERFORMED SINGLE ENGINE, TRIMMED THROUGH THE CG WITH TVC OFF.

If the last OMS engine has only one TVC remaining, that engine should be parked through the CG and powered off as soon as possible to preserve it as a safe deorbit method. The first opportunity to park the engine is post-OMS-1 due to the time constraints and criticality of that burn. Since that engine is the last remaining engine, all OMS burns post-OMS-1 should be performed with the engine parked through the CG and TVC powered off. Even if RCS deorbit capability exists, parking the engine protects against the requirement for a next PLS entry for failure of the TVC. (Ref. Rule {A8.1.2-3}, OMS TVC LOSS.)

- B. FOR TWO-ENGINE BURNS WHERE ONE ENGINE IS TO BE BURNED WITH THE TVC POWER OFF, THE BURN WILL BE PERFORMED USING CG TRIMS.

For two-engine burns where one engine is to be burned with TVC power off, CG trims are required to protect for the loss of the engine with TVC on. Using CG trims places the OMS engine without TVC through the CG and enables the use of that engine if the engine with active TVC fails during the burn. (Ref. Rule {A8.1.2-3}, OMS TVC LOSS.)

THIS RULE CONTINUED ON NEXT PAGE

FLIGHT RULES

A8.1.3-14 **OMS TVC SYSTEM MANAGEMENT (CONTINUED)**

C. OMS TVC GIMBAL CHECKS

1. THE NOMINAL OMS GIMBAL CHECK PLAN IN OPS 1 AND OPS 3 WILL CONSIST OF PERFORMING ONE GIMBAL CHECK OF BOTH PRIMARY AND SECONDARY SYSTEMS POST-OMS-2 AND IN MM 301 (PRE DEORBIT BURN).

IN OPS 2, POSTBURN GIMBAL CHECKS WILL BE PERFORMED ON THE GIMBALS THAT ARE PLANNED TO BE USED DURING THE NEXT BURN. ONLY GIMBALS THAT WILL BE USED FOR TWO-ENGINE CRITICAL BURNS OR ANY SINGLE-ENGINE BURN NEED BE CHECKED.

A full system gimbal check performed post-OMS-2 and prior to deorbit burn will always be performed in order to assess the status of the TVC system. The gimbals, nominally, will not be checked prior to OMS-2 due to the time constraints and ground coverage available.

It is desirable to minimize gimbal checks on orbit to increase the lifetime of the TVC's. Hence, for any single-engine or two-engine critical burn, only the system(s) that have not been checked since their last active use will be checked. During single-engine burns, the nonburning engine TVC is still active (unless powered off) and being driven and so must be checked before subsequent selection as an engine to be burned, per the criteria above (two-engine critical or single-engine burn). Checking the gimbals immediately after the previous burn provides the maximum amount of time to troubleshoot any problem uncovered during the check.

2. UNSCHEDULED GIMBAL CHECKS WILL BE PERFORMED AS REQUIRED BY MCC FOR SYSTEM ANALYSIS TO TROUBLESHOOT ANY INDICATED OMS SYSTEMS ANOMALIES.

Gimbal checks will be performed on a system anytime the MCC believes there may be a problem with a gimbal system.

A8.1.3-15 **ENTRY BODY BENDING FILTER SELECTION**

THE PAYLOAD BODY BENDING FILTER WILL BE SELECTED FOR RETURNING PAYLOADS GREATER THAN 10,000 LB.

Selection of the payload body bending filter for returning payloads greater than 10,000 lb precludes the flex body high frequency oscillations which creates greater elevon deflections and increased APU fuel consumption. The 10,000-lb weight is representative of the weight for primary payloads (i.e., PAM's, IUS, Syncom, etc.).

FLIGHT RULES

GNC GO/NO-GO CRITERIA

A8.1.6-1

GNC GO/NO-GO CRITERIA

SYSTEMS	INVOKE MDF IF:	ENTER NEXT PLS IF:	ENTER FIRST DAY PLS IF:
A. CONTROLLER AND SWITCHES:			
1. LH RHC (3).....	[2] 2 ↓ SAME SIDE	[16] [2] 5 ↓	
2. RH RHC (3).....	[5]	[5]	
3. AFT RHC (3).....			
4. LH THC (3).....		[3] 3 ↓ [2]	
5. AFT THC (3).....			
6. LH RPTA (3).....			
7. RH RPTA (3).....			
8. LH SBTC (3).....	3 ↓ SAME SIDE	5 ↓	
9. RH SBTC (3).....	1 ↓ OTHER SIDE	[18]	
10. LH BF UP & DN SW (2).....			
11. RH BF UP & DN SW (2).....			
12. LH & RH RHC TRIM SW (2).....			
13. LH PANEL TRIM SW (2).....			
14. RH PANEL TRIM SW (2).....			
15. LH & RH BFS ENG SW (3).....			
16. LH FCS MODE AUTO SW (3).....		[4]	
17. RH FCS MODE AUTO SW (3).....			
18. LH & RH FCS MODE CSS SW (3).....			
19. LH FCS MODE BF A/M SW (3).....	2 ↓	[4]	
20. RH FCS MODE BF A/M SW (3).....			
21. LH & RH FCS MODE SB A/M (3).....			
22. LH SBTC TAKEOVER SW (3).....	3 ↓ SAME SIDE	5 ↓	
23. RH SBTC TAKEOVER SW (3).....	1 ↓ OTHER SIDE	[18]	
24. ENTRY MODE (4).....			
25. ABORT MODE SW (3).....			
26. ORBIT DAP PBI'S (2).....	[6]	[6]	

THIS RULE CONTINUED ON NEXT PAGE

FLIGHT RULES

A8.1.6-1

GNC GO/NO-GO CRITERIA (CONTINUED)

<u>SYSTEMS</u>	INVOKE MDF IF:	ENTER NEXT PLS IF:	ENTER FIRST DAY PLS IF:
B. <u>TVC AND DRIVERS:</u>			
1. SSME ACT CHNL (4).....			
2. SSME SEC ΔP (4).....			
3. SRB ACT CHNL (4).....			
4. SRB SEC ΔP (4).....			
5. L OMS PITCH TVC (2).....		[7] [8]	[7] [8]
6. L OMS YAW TVC (2).....		[7] [8]	[7] [8]
7. R OMS PITCH TVC (2).....		[7] [8]	[7] [8]
8. R OMS YAW TVC (2).....		[7] [8]	[7] [8]
9. FORWARD RCS JETS (16).....			
10. LEFT RCS JETS LEFT (4).....		2 ↓ [11]	
11. RIGHT RCS JETS RIGHT (4).....		2 ↓ [11]	
12. L/R RCS JETS VERNIER (4).....			
13. LEFT RCS JETS UP (3).....		2 ↓	2 ↓
14. LEFT RCS JETS DOWN (3).....		2 ↓	2 ↓
15. RIGHT RCS JETS UP (3).....		2 ↓	2 ↓
16. RIGHT RCS JETS DOWN (3).....		2 ↓	2 ↓
17. LEFT RCS JETS AFT (2).....		[8]	[8]
18. RIGHT RCS JETS AFT (2).....		[8]	[8]

THIS RULE CONTINUED ON NEXT PAGE

FLIGHT RULES

A8.1.6-1

GNC GO/NO-GO CRITERIA (CONTINUED)

SYSTEMS	INVOKE MDF IF:	ENTER NEXT PLS IF:	ENTER FIRST DAY PLS IF:
C. AEROSURFACES:			
1. FCS CHNL (4)		[16] 2 ↓ [9]	[16] 2 ↓ [9]
2. BF ACT CHNL (3)		[16] 2 ↓	
3. ELEVON/BF POS FDBK (4).....	[12] 2 ↓ [9]	[12] 3 ↓ [9]	[12] 3 ↓ [9]
4. RUDDER POS FDBK (4).....		[12]	[12]
5. SPDBK POS FDBK (4).....		[12]	[12]
6. ELEVON PRI ΔP (4).....	2 ↓ [9]	3 ↓ [9]	
7. SEC ΔP (4).....			
D. SENSORS			
1. AA (LATERAL) (4).....	[16] 2 ↓	[16] 3 ↓	[16] 3 ↓
2. AA (NORMAL) (4).....			
3. RGA - ORB (4).....	[16] 2 ↓	[16] 3 ↓	[16] 3 ↓
4. RGA - SRB (4).....			
5. IMU (3).....		[16] 2 ↓	[16] 2 ↓
6. STAR TRACKER (2) & HUD (2)	[6] 42 ↓ [19]	[6] 34 ↓ [19]	
7. -Z COAS (1).....		AND 1 ↓	
6. STAR TRACKER (2)	[6] 2 ↓	[6] 1 ↓	
7. COAS (1).....		AND 1 ↓	
8. ATT REF PB (3).....	[10]	[10] 2 ↓	
9. TACAN (3).....	[14] 2 ↓	[15] 3 ↓	
10. TACAN MODE SW (3).....			
11. TACAN ANT SEL (3).....			
12. TACAN CHNL SEL (3).....			
13. ADTA (4).....	[16] 2 ↓	[16] 3 ↓	[16] 3 ↓
14. MSBLS (3).....			
15. RA (2).....			

@[121296-4610] @ED | @[111298-6750]

THIS RULE CONTINUED ON NEXT PAGE

FLIGHT RULES



A8.1.6-1

GNC GO/NO-GO CRITERIA (CONTINUED)

SYSTEMS	INVOKE MDF IF:	ENTER NEXT PLS IF:	ENTER FIRST DAY PLS IF:
E. DEDICATED DISPLAYS:			
1. LH & RH ADI (2).....	[20] 1 ↓ [2]		
2. AFT ADI (1).....	[20]		
3. HUD/AMI (4).....	[20] 2 ↓ [2]	[20] 3 ↓ [2]	
4. HUD/AVVI (4).....	[20] 2 ↓ [2]	[20] 3 ↓ [2]	
5. HUD/FWD ADI (4).....	[20] 2 ↓ [2]	[20] 3 ↓ [2]	
6. HUD (2).....			
7. HSI (2).....	[20]		
8. SPI (1).....	[20]		
9. G-METER (1).....	[20]		

[@J040899-2459B1](#)

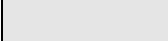
LEGEND:

NO REQUIREMENT	
REQUIRED	
QUANTITY	()
NOTE REFERENCE	[]

THIS RULE CONTINUED ON NEXT PAGE

FLIGHT RULES

A8.1.6-1 GNC GO/NO-GO CRITERIA (CONTINUED)

NOTES:

- [1] RESERVED
- [2] THE AVAILABILITY OF A GOOD REPLACEMENT UNIT MAY BE USED TO SATISFY THE MINIMUM REQUIREMENTS FOR NEXT PLS OPPORTUNITY. (REPLACEMENT MAY OCCUR SUBSEQUENT TO NEXT PLS DECISION POINT.)
- [3] + X ONLY. REQUIRED ONLY IF RCS DEORBIT REQUIRED.
- [4] EITHER TWO OF THREE PER SIDE OR THREE OF THREE ON EITHER SIDE IS REQUIRED.
- [5] FOR FOUR OR MORE CHANNELS DOWN, REQUIRE ALL SYSTEMS NEEDED FOR AN EMERGENCY AUTOLAND (ADTA, MLS, AA-N₂). REF. RULE {A8.1.1-17}, EQUIPMENT REQUIRED FOR EMERGENCY AUTOLAND.
- [6] ~~IF COAS REQUIRED, ROTATIONAL~~ PULSE OR DISC RATE DAP MODE IS REQUIRED IN APPROPRIATE AXES; FOR -Z COAS (PITCH, AND ROLL) FOR -Z COAS AND HUDS OR (PITCH AND YAW) FOR +X COAS. @111298-6750]
- [7] ENGINE IS NO-GO IF TVC CAPABILITY IS LOST AS DEFINED IN RULE {A8.1.2-3}, OMS TVC LOSS.
- [8] REF. RULE {A6.1.5-6}, OMS/RCS GO/NO-GO CRITERIA (CIL), FOR MDF AND NEXT PLS. REF. RULE {A2.1.6-1}, CONTINGENCY ACTION SUMMARY, FOR FIRST DAY PLS.
- [9] SAME SURFACE.
- [10] REQUIRED ONLY IF COAS AND/OR HUD IS REQUIRED. ANY LOCATION ACCEPTABLE.
- [11] ONE FAILED YAW JET AND ORBITER CG OUTSIDE NOMINAL EOM BOUNDARY (REF. RULE TBD) IS CAUSE FOR NEXT PLS ENTRY PROVIDED THAT THE CG CANNOT BE RESTORED BY RECONFIGURATION, PAYLOAD DEPLOYMENT, ETC.
- [12] DECLARE MDF IF POSITION FEEDBACK FAILURE(S) RESULTS IN ONE FCS CHNL FAILED, AND ENTER PLS IF POSITION FEEDBACK FAILURE(S) RESULTS IN TWO FCS CHNLS FAILED.
- [13] RESERVED
- [14] MDF IF SINGLE-FAULT TOLERANCE CAPABILITY EXISTS WITH THE REMAINING TACAN LRU AND COMMAND DELTA STATE CAPABILITY. IF ELS PROTECTION IS REQUIRED (REF. RULE {A2.1.4-5}, EMERGENCY DEORBIT CAPABILITY REQUIREMENTS), OR IF HIGH-SPEED C-BAND RADAR IS NOT SCHEDULED AND NOT AVAILABLE TO BE SCHEDULED FOR ENTRY (REF. RULE 3-1, GROUND REQUIREMENTS OVERVIEW), THEN DEORBIT NEXT PLS. @041196-1914]
- [15] ENTER NEXT PLS (NOT FIRST DAY PLS) IF THREE LRU'S ARE FAILED AND COMMAND DELTA STATE CAPABILITY EXISTS.
- [16] REFERENCE RULE {A2.1.4-7}, LANDING SITE SELECTION, FOR RUNWAY PRIORITIES.
- [17] RESERVED
- [18] NEXT PLS IF AD TO G&C NOT AVAILABLE. AD TO G&C IS REQUIRED PER RULE {A8.1.5-12}, GNC AIR DATA SYSTEM MANAGEMENT (CIL).
- [19] THIS ASSUMES MANUAL CALIBRATION INSTRUMENTS ARE CALIBRATED AND VERIFIED. ANY UNCALIBRATED/UNVERIFIED INSTRUMENT SHOULD BE CONSIDERED FAILED FOR MISSION DURATION DETERMINATION. @111298-6750]
- [20] NA FOR MEDS CONFIGURED VEHICLES. @040899-2459B]

Reference Rule {A2.1.3-1}, MISSION DURATION REQUIREMENTS.

Rules {A8.1.1-4}, FAULT TOLERANCE PHILOSOPHY; {A2.1.6-1}, CONTINGENCY ACTION SUMMARY; {A8.1.2-7}, PRELAUNCH IMU HOLD; and {A8.1.2-8}, ADI LOSS, reference this rule.

When failure(s) require a next PLS entry but do not require a first day PLS entry, the rationale is that the risks associated with performing a first day PLS entry are greater than those associated with remaining on orbit until the next PLS opportunity.

THIS RULE CONTINUED ON NEXT PAGE

FLIGHT RULES

A8.1.6-1 GNC GO/NO-GO CRITERIA (CONTINUED)

A. CONTROLLERS and SWITCHES

If necessary or desirable, most entry-critical controllers and switches can be reconfigured in OPS 8 and/or OPS 2 (ref. Rule {A8.1.1-6} CONTROLLERS/FCS SWITCHING FAULT TOLERANCE).

LH, RH RHC

For the loss of two RHC channels on the same controller, MDF is required. Subsequent failures can be tolerated on orbit, either by RM or by channel reconfiguration. For four or more RHC channels failed, the next failure results in the loss of at least one RHC, and possibly both. For five channels failed, a next PLS is required since the RHC's are zero-fault tolerant for manual flight of the vehicle. There are no first day PLS requirements for RHC channel failures, since an IFM will be done to recover the failed RHC.

LH THC

There are no first day PLS requirements for the left THC since an IFM will be performed to regain RCS deorbit capability, if required.

AFT RHC, THC

Loss of aft station capability does not require early mission termination since these systems are not available for entry (ref. Rule {A8.1.1-9}, AFT STATION GNC REDUNDANCY).

LH, RH RPTA

There are no mission duration impacts. Although manual control capability is desirable, RPTA control is not required for a safe entry.

LH, RH SBTC

For three SBTC channels failed on one side (loss of that SBTC) and one failed on the other side, MDF is required. The next failure, unless a commfault, will result in the loss of manual speedbrake operations. If five SBTC channels are failed and, in addition, AD to G&C is not available, a next PLS will be declared. Manual speedbrake is required without AD to G&C, and the next failure could result in the loss of manual speedbrake capability and possible loss of vehicle.

LH, RH BF UP and DN SW

There are no mission duration impacts since the body flap can be manually driven UP for any number of body flap UP/DOWN switch failures. Manual control is only required for off-nominal CG or aero conditions, to use the body flap as a trim device and allow better elevon control authority.

THIS RULE CONTINUED ON NEXT PAGE

FLIGHT RULES

A8.1.6-1 GNC GO/NO-GO CRITERIA (CONTINUED)

LH, RH PANEL and RHC TRIM SW

These switches are not considered critical for entry and do not impact mission duration.

LH, RH BFS ENGAGE SW

Failures associated with the BFS engage switches do not require early mission termination (ref. Rule {A8.1.1-11}, LOSS OF THE BFS).

LH, RH FCS MODE AUTO SWITCH

For three or more FCS MODE AUTO switch (PITCH and ROLL/YAW) contacts failed (at least two failed one side, one failed other side), a next PLS is required. The system is zero-fault tolerant since the next failure results in no capability to mode the flight control system to AUTO.

LH, RH FCS MODE CSS SW

Failures in these switches are not considered critical and do not require early mission termination. RHC hot stick (to manual control) is available any time in OPS 3.

LH, RH FCS MODE BF A/M SW

The body flap will be in AUTO under most flight conditions, but manual (MAN) may be required (off-nominal CG or aero conditions). For two BF AUTO/MAN (A/M) switch contacts failed, changing the body flap flight control mode is single-fault tolerant, and MDF is required. For three or more contacts failed (at least two failed one side, one failed other side), a next PLS is required. At least two contacts on each side, or all three contacts on one side, are required to maintain single-fault tolerance on these switches.

LH, RH FCS MODE SB A/M SW

The SB A/M switch is used to mode the speedbrake from MAN to AUTO only, since MAN is achieved with the SBTC takeover switch. If the crew is required to take over MAN speedbrake and subsequent failures result in the loss of capability to mode back to AUTO, the crew can remain in manual with no added workload.

LH, RH SBTC TAKEOVER SW

Reference rationale for LH, RH SBTC rationale.

THIS RULE CONTINUED ON NEXT PAGE

FLIGHT RULES

A8.1.6-1 GNC GO/NO-GO CRITERIA (CONTINUED)

ENTRY MODE

This switch is not considered critical for entry. For a failure of the switch during entry (LO GAIN or NO-YAW-JET), the AUTO position can be selected on SPEC 51, OVERRIDE, in MM 304/305.

ABORT MODE SW

This switch is used to select the bailout function and early mission termination is not required.

ORBIT DAP PBI's

If the COAS is required for entry IMU alignment, then MDF is required by definition of COAS/STAR TRACKER requirements. If any of the required switches is zero-fault tolerant (and the COAS is required for entry IMU alignment), then a next PLS will be declared.

B. TVC and DRIVERS

SSME ACT CHNL and SSME SEC DELTA P

These systems are not required for performing a safe entry (impacts to postlanding configuration and turnaround activities only).

SRB ACT CHNL and SRB SEC DELTA P

These systems are not used for entry, and mission duration impacts do not apply.

L, R OMS PITCH and YAW TVC

The two OMS engines and the four +X RCS jets constitute three means of deorbit capability. If failures of the left and/or right OMS TVC in combination with failures of the +X RCS jets result in the loss of two out of three deorbit methods, then a next PLS (or first day PLS) is required (ref. Rule {A6.1.5-8}, OMS/RCS GO/NO-GO CRITERIA (CIL), and Rule {A8.1.1-3}, LOSS OF GNC SYSTEM).

FORWARD RCS JETS

The forward RCS jets are not considered critical for entry. Reduction of mission duration is not required for failures of these jets.

THIS RULE CONTINUED ON NEXT PAGE

FLIGHT RULES

A8.1.6-1 GNC GO/NO-GO CRITERIA (CONTINUED)

L, R RCS JETS LEFT and RIGHT (YAW JETS)

For one yaw jet failed and the orbiter CG outside of the nominal EOM boundary (ref. Rule {A4.1.4-3}, CG PLANNING), a next PLS is required due to the potential for elevon saturation. A full complement of yaw jets is required to ensure vehicle control within the contingency CG envelope. The loss of three yaw jets on the same side results in significantly degraded flight control in the low Q-bar regime (Q-bar < 20 psf). Therefore, a next PLS is required after two yaw jet failures, without regard to vehicle CG. There are no first day PLS requirements for the loss of these jets because the no-yaw-jet mode is certified (Q-bar > 20 psf) for flight control (ref. Rule {A6.1.5-8}, OMS/RCS GO/NO-GO CRITERIA (CIL); Rule {A8.1.1-19}, YAW JET DOWNMODE; and EFTP, 1/15/88).

L, R RCS VERNIER JETS

The loss of these jets has no impact on mission duration.

L, R RCS JETS UP and DOWN

For the loss of any two jets on the same side that fire in the same direction (two LEFT UP firing, for example), a next PLS (or first day PLS) is required. These jets are critical for vehicle pitch and roll control during entry, and entering next PLS reduces the risk for the next failure which could impact vehicle control (ref. Rule {A6.1.5-8}, OMS/RCS GO/NO-GO CRITERIA (CIL)).

L, R RCS JETS AFT (+X JETS)

If failures of the left and/or right OMS TVC in combination with failures of +X RCS jets result in the loss of two out of three deorbit methods, then a next PLS (or first day PLS) is required. There are no mission duration requirements for loss of these jets alone (ref. Rule {A6.1.5-8}, OMS/RCS GO/NO-GO CRITERIA (CIL)).

THIS RULE CONTINUED ON NEXT PAGE

FLIGHT RULES

A8.1.6-1 GNC GO/NO-GO CRITERIA (CONTINUED)

C. AEROSURFACES

FCS CHANNELS

For one channel failed (any surface) the FCS is single-fault tolerant, with the exception of certain “smart failures” during specific windows of entry, and MDF is required there are no mission duration impacts (ref. Rule {A8.1.1-4}, FAULT TOLERANCE PHILOSOPHY). The risk of sustaining a second failure in the FCS affecting the same aerosurface (ASA, MDM, or actuator) while on-orbit for the remainder of the mission (NEOM) will be assessed in real time and presented to the Mission Management Team (MMT), as required per Rule {A2.1.3-1}, MISSION DURATION REQUIREMENTS. After the first failure, there are certain failures in the FCS command channels (ASA, servo valve, actuator) which could reduce flight control margins (2-on-1 force fight) for short periods during entry until the MCC and crew can isolate the bad channel. However, the risk of sustaining one of these failures at the three-level on the FCS command channels during entry is the same regardless of when entry occurs (i.e., the window-of-exposure is the same regardless of flight duration). For two channels failed on the same aerosurface, a next PLS (or first day PLS) will be declared and a lakebed complex is required. Loss of three command channels on any aerosurface is an uncertified flight mode. - @121296-4610 @121296-4610

BF ACT CHNL

For one of three bodyflap (BF) channels failed, on the body flap, MDF is required since BF control is single-fault tolerant, and there are no mission duration impacts (ref. Rule {A8.1.1-4}, FAULT TOLERANCE PHILOSOPHY). The risk of sustaining a second BF channel failure while on-orbit for the remainder of the mission (NEOM) will be assessed in real time and presented to the Mission Management Team (MMT), as required per Rule {A2.1.3-1}, MISSION DURATION REQUIREMENTS. For two channels failed, next PLS is required since BF control is zero-fault tolerant. It is required to maintain control of the BF in order to avoid off-nominal flying configurations and to prevent damage to the main engine bells and/or the body flap itself. There are no first day PLS requirements for BF channel failures. - @121296-4610 @121296-4610

ELEVON/BF POS FDBK

For two elevon or body flap position feedbacks failed on the same surface, MDF is required since the system is single-fault tolerant. For three feedbacks failed on the same surface, the system is fail critical and a next PLS (or first day PLS) is required. However, if the affected port is bypassed, then the FCS channel loss criteria will apply (ref. A/E FTP #45, 6/17/88).

RUDDER and SPDBK POS FDBK

The position feedbacks for these surfaces are not used in the aerofet DAP but are used for surface position indications on the SPI. Although desirable, these indications are not considered critical for entry and there are no mission duration impacts associated with them. However, if the affected port is bypassed, then the FCS channel loss criteria will apply (ref. A/E FTP #45, 6/17/88).

FLIGHT RULES

THIS RULE CONTINUED ON NEXT PAGE

FLIGHT RULES

A8.1.6-1 GNC GO/NO-GO CRITERIA (CONTINUED)

ELEVON PRI DELTA P

For two elevon primary delta pressure indications failed on the same surface, MDF is required since the system is single-fault tolerant. For three failed, a next PLS is required because the system is zero-fault tolerant. The effector system requires at least one primary pressure feedback loop in an actuator since the ASA relies on these pressure indications to provide command stability (ref. SODB, volume I, paragraph 3.4.5.1-4).

SECONDARY DELTA P

The aerosurface and SSME/SRB actuator secondary delta pressure transducers provide fault detection (RM) in the ASA's and ATVC's, respectively. If RM is lost, the system can still be managed (MCC required) and any failed channels can be manually bypassed if required. FCS channel loss criteria will apply for transducer failures that degrade the FCS performance/redundancy.

D. SENSORS

LATERAL AA

For two lateral axis AA's failed, MDF is required to a lakebed complex; and, for three failed, a next PLS (or first day PLS), is required. The lateral axis AA feedback is used in the aerojet DAP for turn coordination by preventing rolloff during bank maneuvers. The lateral feedback is also used for NWS control during rollout (ref. A/E FTP #45, 6/17/88).

NORMAL AA

The normal AA feedback is used for ADI pitch error and alpha error indications only prior to MM 305. In MM 305, the normal AA feedback is used by guidance to provide Nz commands to the flight control system. However, failures in these feedbacks do not require reduction in mission duration because the crew can fly CSS in the pitch axis in MM 305, thereby removing the normal feedback from the command loop.

ORBITER RGA

For two orbiter RGA's failed, MDF is required to a lakebed complex because the system is single-fault tolerant on orbit. For three failed, a next PLS (or first day PLS) is required because the system is zero-fault tolerant on orbit (ref. A/E FTP #45, 6/17/88).

SRB RGA

These systems are not used for entry, and mission duration impacts do not apply.

THIS RULE CONTINUED ON NEXT PAGE

FLIGHT RULES

A8.1.6-1 GNC GO/NO-GO CRITERIA (CONTINUED)

IMU

For the loss of one IMU, the system is single-fault tolerant, with the exception of certain “smart failures” during specific windows of deorbit and entry, and there are no mission duration impacts (ref. Rule {A8.1.1-4}, FAULT TOLERANCE PHILOSOPHY). The risk of sustaining a second IMU failure while on-orbit for the remainder of the mission (NEOM) will be assessed in real time as required per Rule {A2.1.3-1}, MISSION DURATION REQUIREMENTS. Also, high-speed C-band radar is mandatory for entry at the IMU two-level (ref. Rule {3.1.1-1}, GROUND REQUIREMENTS OVERVIEW). There are single-point failures that can result in either an unresolvable dilemma at the two-level, or bad selected data due to a transient output which is not present long enough for IMU RM to operate and declare a failure. For these cases, the onboard state vector and/or vehicle flight control could be significantly impacted during critical deorbit or entry phases. However, the risk of sustaining one of these failures at the two-level during entry is the same regardless of when entry occurs (i.e., the window-of-exposure is the same regardless of flight duration). Additionally, it is expected that the IMU entry two-level redundancy management (RM), including the use of BITE, will correctly isolate and reconfigure the system (prime selecting the good IMU) for at least 98 percent of all failures. For two IMU’s failed, a next PLS (or first day PLS) is required. The system is zero-fault tolerant because navigation and flight control require one IMU for entry.

@[041196-1914] @[121296-4610]

STAR TRACKER/COAS/HUD @[111298-6750]

If only one instrument for aligning the IMU’s remains, enter next PLS. It is important to note that in considering the availability of manual alignment instruments, an instrument can only be considered available if it has been calibrated and verified. An instrument that is not calibrated and verified should not be used to perform IMU alignments. Only the CDR HUD is considered calibrated at launch (except on OV-104). This calibration should be verified before using the HUD to perform IMU alignments. Refer to Flight Rule {A8.1.3-9}, HUD/COAS SYSTEM MANAGEMENT.

The only exception to the PLS rule is the case where the -Z COAS is the only instrument remaining for performing IMU alignments. Since the probability of a COAS failure is considered extremely remote (COAS is a simple mechanical apparatus), the mission can be extended beyond next PLS to MDF.

If a manual alignment instrument is required, it is necessary to have the appropriate digital auto pilot (DAP) modes available. The DAP modes are required to allow the crew to mark accurately on a star. @[111298-6750]

THIS RULE CONTINUED ON NEXT PAGE

FLIGHT RULES

A8.1.6-1 GNC GO/NO-GO CRITERIA (CONTINUED)

ATT REF PB

The ATT REF PB is required for IMU alignments using the COAS or HUD. If the COAS and/or HUD is required for the entry and only alignment, then by definition the mission is MDF (ref. STAR TRACKER/COAS rationale). ~~For a single ATT REF PB remaining, a next PLS is required.~~ It should be noted that only the forward station ATT REF PB's are supported in OPS 3; and, if only the aft PB remains, the alignment will have to be performed in OPS 2. [@\[111298-6750\]](#)

TACAN

For two TACAN's failed, the system is single-fault tolerant (assuming command delta state capability exists), and MDF is required. For two TACAN's failed, enter next PLS if there is a requirement to protect for an ELS landing as specified in Rule {A2.1.4-5}, EMERGENCY DEORBIT CAPABILITY REQUIREMENTS, or if high-speed C-band radar is not scheduled and not available to be scheduled for entry (ref. Rule {3.1.1-1}, GROUND REQUIREMENTS OVERVIEW). The ELS sites do not have the tracking stations required for the delta state uplink, and the last remaining TACAN is required to update the state vector. For three TACAN's failed, a next PLS is required to protect for the loss of CONUS site capability. Entry with no TACAN's could require a GCA and/or a command delta state uplink to correct navigation errors, and declaring next PLS minimizes exposure to landings that do not have these options (ref. EFTP #28, #29, #30). [@\[041196-1914\]](#)

TACAN MODE SW, ANT SEL, CHNL SEL

The TACAN mode switch, antenna select, and channel select are not critical for entry. If the switch failures render the TACAN(s) unusable, then the TACAN loss criteria will apply.

ADTA

For two ADTA's failed, the system is zero-fault tolerant and MDF is required to a lakebed complex. With the next failure (three ADTA's failed), air data (AD) will not be incorporated into G&C except for specific off-nominal circumstances, and a next PLS (or first day PLS) is required. The incorporation of AD to G&C is required for auto flight control and very desirable for manual. It is highly desirable to protect against the last ADTA failure so that it can be used if necessary. Without AD, the crew will fly theta limits for pitch control (ref. A/E FTP #45, 6/17/88, and ENTRY FTP #34, 8/21/87).

THIS RULE CONTINUED ON NEXT PAGE

FLIGHT RULES

THIS PAGE INTENTIONALLY BLANK

FLIGHT RULES

A8.1.6-1 GNC GO/NO-GO CRITERIA (CONTINUED)

MSBLS

There are no requirements for early mission termination for MLS failures, since in most cases a safe landing can be performed without the use of MLS (ref. Rule {A8.1.1-18}, LANDING SYSTEMS REQUIREMENTS). However, for one MLS failed and MLS redundancy required (ref. Rule {3.1.5-2}, MLS), high-speed C-band radar should be scheduled as required (ref. Rule {3.1.1-1}, GROUND REQUIREMENTS OVERVIEW). @[041196-1914]

RA

The radar altimeters are used for altitude source from 5k feet to the ground and are highly desirable for night landings and/or low ceilings. However, there are no mission duration impacts for RA failures. (Ref. Rule {A8.1.1-18}, LANDING SYSTEMS REQUIREMENTS.) @[072398-6646]-

E. DEDICATED DISPLAYS

LH & RH ADI

Declare MDF when only one forward ADI remains since only a single display source of bank angle (phi) and vehicle rates and errors remains. Bank angle is required during MM 304 for controlling drag and H-dot in the event of bad guidance. Similarly, vehicle rates and attitude errors are required in the event of guidance or flight control problems. Given the availability of replacement units for both the ADI and DDU (aft station), two failures are required in order to have only a single remaining ADI in the forward station.

AFT ADI

There is no requirement for this display during entry. (Ref. Rule {A8.1.1-9}, AFT STATION GNC REDUNDANCY.)

HUD/AMI

Equivalent air speed (EAS), displayed on the HUD and AMI, is a critical parameter from TAEM to touchdown. As a result, declare PLS for loss of three of the four sources for this parameter, and MDF for loss of two of the four sources for this parameter.

THIS RULE CONTINUED ON NEXT PAGE

FLIGHT RULES

A8.1.6-1 GNC GO/NO-GO CRITERIA (CONTINUED)

HUD/AVVI

Altitude (H), displayed only on the HUD and AVVI from TAEM to touchdown, is a critical parameter required by the pilot during the approach and landing phases of the entry. Thus, declare PLS for loss of three of the four sources for this parameter, and MDF for loss of two of the four sources for this parameter.

While H-dot, displayed only on the AVVI in MM 304, is an important parameter, early flight termination will not be declared for the loss of one AVVI. It is not reasonable to declare early flight termination to protect for the extremely remote scenarios (if they exist at all) where H-dot would be required to fly a manual MM 304 entry.

HUD/FWD ADI

Phi (bank angle) and one of gamma (flight path angle) or theta (pitch) are required from TAEM through the approach phase of entry. These parameters are only available to the pilot on the HUD and forward ADI. Thus, declare PLS for loss of three of the four sources for these parameters, and MDF for loss of two of the four sources for these parameters.

HUD

The HUD is highly desirable but not mandatory for night landings; therefore, an MDF is not required. ~~©111298-67501 Note, for planned night landings a spare HUD should be available. (Ref: Rule {A8.1.1-18}, LANDING SYSTEMS REQUIREMENTS.)~~

HSI

For low ceilings (<10k feet) or night landings, the HSI is desirable, but not required, for accurate heading and course information. Since MLS is required under both of these situations, accurate approach information is available. In addition, rough course alignment and heading is provided by the Horizontal Situation Display (HSD). As a result, early flight termination is not required for loss of HSI(s). (Ref. Rules {A8.1.1-18}, LANDING SYSTEMS REQUIREMENTS; {A3.1.5-2}, MLS; and {A2.1.1-6}, LANDING SITE WEATHER CRITERIA.)

SPI and G-METER

Though desirable, these displays are not required.

FLIGHT RULES

SECTION 9 - ELECTRICAL

LOSS/FAILURE DEFINITIONS

A9.1.1-1	FUEL CELL (FC) LOSS (CIL)	9-1
A9.1.1-2	FC ALTERNATE H2O SYSTEM LOSS	9-5
A9.1.1-3	ELECTRICAL POWER DISTRIBUTION AND CONTROL (EPDC) SYSTEM (CIL)	9-5
A9.1.1-4	CAUTION AND WARNING (C&W)	9-7

FUEL CELL SYSTEMS MANAGEMENT

A9.1.2-1	FC POWER LEVEL CONSTRAINTS	9-8
A9.1.2-2	FC PURGE	9-9
A9.1.2-3	FC H2O SYSTEM HEATERS	9-12
A9.1.2-4	FC STANDBY DEFINITION	9-13
A9.1.2-5	FC SHUTDOWN DEFINITION (CIL)	9-13
A9.1.2-6	FC SAFING	9-14
A9.1.2-7	REUSABLE FC	9-15
A9.1.2-8	FC SUSTAINER HEATER	9-15
A9.1.2-9	FC - CELL PERFORMANCE MONITOR (CIL)	9-16
A9.1.2-10	FC COOLANT PUMP FAILURE MANAGEMENT (CIL)	9-17
A9.1.2-11	ACTIONS FOR FUEL CELL PH INDICATIONS	9-18

DC POWER DISTRIBUTION AND CONTROL SYSTEMS MANAGEMENT

A9.1.3-1	DC BUS VOLTAGE LIMITS	9-18b
A9.1.3-2	ESSENTIAL BUS	9-18b
A9.1.3-3	POWER REDUCTION GUIDELINES	9-18b
A9.1.3-4	MAIN BUS SHORT	9-19
A9.1.3-5	CB/RPC RESET	9-20
A9.1.3-6	CONTROL BUS	9-22
A9.1.3-7	MAIN BUS TIE (CIL)	9-25

FLIGHT RULES

A9.1.3-8 CRITICAL PHASE BUS MANAGEMENT 9-26

FLIGHT RULES

A9.1.3-9 PRIMARY PAYLOAD BUS MANAGEMENT 9-27
 A9.1.3-10 PREFLIGHT TEST BUS MANAGEMENT 9-27

**AC POWER DISTRIBUTION AND CONTROL SYSTEMS
 MANAGEMENT**

A9.1.4-1 AC INVERTER MANAGEMENT 9-33
 A9.1.4-2 AC BUS SENSORS SWITCH MANAGEMENT 9-33
 A9.1.4-3 AC BUS LOADING 9-33
 A9.1.4-4 AC LOAD MANAGEMENT DURING ASCENT 9-34
 A9.1.4-5 AC INVERTER THERMAL LIFE 9-39
 A9.1.4-6 LOSS OF SINGLE-PHASE AC 9-42
 A9.1.4-7 LOSS OF TWO-PHASE AC 9-43
 A9.1.4-8 AC POWER TRANSFER CABLE 9-43
 A9.1.4-9 MOTOR CONTROL ASSEMBLY (MCA) 9-44
 A9.1.4-10 CAUTION AND WARNING (C&W) (CIL) 9-44
 A9.1.4-11 HYDRAULIC CIRCULATION PUMP OPERATION 9-45

CRYOGENIC LOSS/FAILURE DEFINITIONS

A9.1.5-1 O₂ (H₂) MANIFOLD 9-46
 A9.1.5-2 CRYO TANK 9-47
 A9.1.5-3 CRYO TANK ANNULUS VACUUM 9-48
 A9.1.5-4 CRYO HEATER 9-43
 A9.1.5-5 O₂ DELTA CURRENT SENSOR 9-44

CRYOGENIC SYSTEMS MANAGEMENT

A9.1.6-1 CRYO HEATER MANAGEMENT FOR ASCENT 9-45
 A9.1.6-2 CRYO HEATER MANAGEMENT FOR ORBIT (CIL) 9-45
 A9.1.6-3 CRYO TANK HEATER TEMPERATURE MANAGEMENT 9-49
 A9.1.6-4 CRYO HEATERS DEACTIVATION 9-49
 A9.1.6-5 O₂ DELTA CURRENT SENSOR 9-50
 A9.1.6-6 CRYO O₂/H₂ TANK QUANTITY BALANCING 9-51

NASA - JOHNSON SPACE CENTER

FLIGHT RULES

A9.1.6-7 POWER REACTANT STORAGE AND DISTRIBUTION
(PRSD) H2 AND O2 REDLINE DETERMINATION 9-53

A9.1.6-8 CRYO O2 AND H2 PRESSURE MANAGEMENT 9-53

A9.1.6-9 CRYO O2/H2 MANIFOLD VALVES 9-57

A9.1.6-10 CRYO SYSTEM LEAKS (CIL) 9-60

A9.1.6-11 IMPENDING LOSS OF ALL CRYO 9-60

A9.1.6-12 EDO PALLET MANAGEMENT 9-61

ELECTRICAL GO/NO-GO CRITERIA

A9.1.7-1 ELECTRICAL GO/NO-GO CRITERIA 9-62

SPACEHAB SUPPORT

A9.6.1-1 SPACEHAB MAIN BUS 9-71

A9.6.1-2 SPACEHAB EMERGENCY BUS 9-71

A9.6.1-3 SPACEHAB INVERTER 9-71

A9.6.1-4 SPACEHAB SUBSYSTEM BUSES 9-71

A9.6.1-5 SPACEHAB FIRE/SMOKE DETECTION LOSS 9-72

**SPACEHAB ELECTRICAL POWER SUBSYSTEM (EPS)
MANAGEMENT**

A9.6.2-1 SPACEHAB MAIN BUS MANAGEMENT 9-73

A9.6.2-2 SPACEHAB EMERGENCY BUS LOSS 9-74

A9.6.2-3 SPACEHAB AC MANAGEMENT 9-74

A9.6.2-4 SPACEHAB MAIN DC BUS POWER INTERRUPTION 9-75

A9.6.2-5 FUSE/CIRCUIT BREAKER MANAGEMENT 9-75

A9.6.2-6 FUEL CELL FAILURE MANAGEMENT 9-77

A9.6.2-7 SPACEHAB MINIMUM POWER CONFIGURATION 9-78

A9.6.2-8 CAUTION AND WARNING (C&W) 9-78

**ELECTRICAL POWER DISTRIBUTION SYSTEM (EPDS)
LOSS/FAILURE DEFINITIONS**

A9.9.1-1 SPACELAB MAIN BUS 9-79

A9.9.1-2 SPACELAB AUXILIARY BUSES 9-79

FLIGHT RULES

A9.9.1-3 SPACELAB EMERGENCY BOX BUSES 9-80
A9.9.1-4 SPACELAB SUBSYSTEM (SS) OR EXPERIMENT (EXP)
ALTERNATING CURRENT (AC) INVERTER 9-80
A9.9.1-5 SPACELAB SS (EXP) AC BUS 9-81
A9.9.1-6 SPACELAB FIRE/SMOKE PRIMARY DETECTION LOSS . 9-81
A9.9.1-7 SPACELAB AURAL ANNUNCIATOR LOSS 9-81

EPDS SYSTEM MANAGEMENT

A9.9.2-1 SPACELAB MAIN BUS MANAGEMENT 9-82
A9.9.2-2 SPACELAB EMERGENCY BOX BUSES 9-82
A9.9.2-3 SPACELAB SS (EXPERIMENT) AC INVERTER
MANAGEMENT 9-83
A9.9.2-4 SPACELAB SS EXP AC BUSES 9-85
A9.9.2-5 SPACELAB MAIN BUS POWER INTERRUPTION 9-86
A9.9.2-6 FUSE/CIRCUIT BREAKER MANAGEMENT 9-86
A9.9.2-7 FUEL CELL FAILURE MANAGEMENT 9-89
A9.9.2-8 SPACELAB MINIMUM POWER CONFIGURATION 9-90
A9.9.2-9 CAUTION AND WARNING (C&W) 9-91
A9.9.2-10 SPACELAB AURAL ANNUNCIATOR (SAA) 9-91

FLIGHT RULES

SECTION 9 - ELECTRICAL

LOSS/FAILURE DEFINITIONS

A9.1.1-1 FUEL CELL (FC) LOSS (CIL)

A FUEL CELL (FC) IS CONSIDERED LOST IF:

- A. AN ABNORMAL OR UNEXPLAINED VOLTAGE VERSUS CURRENT PERFORMANCE LOSS OF ≥ 0.5 VOLT FOR A SINGLE FC BASED ON PREDICTED PERFORMANCE DATA.

For a three substack FC, the loss of 1 of 96 cells will result in a performance drop of approximately 0.5 volt. This assumes the FC is thermally stable with no internal heaters on. For each flight, predicted nominal performance curves are provided for each FC by Rockwell International Corp. via R&E subsystem manager. In-flight nominal performance is defined by the cue card curve selected after the first purge (reference back of the FC cue card).

DOCUMENTATION: SODB 3.4.4.1.6.b.

- B. THE COOLANT PUMP OR H₂ PUMP/H₂O SEPARATOR IS LOST. (CIL)

Loss of coolant pump results in loss of FC cooling and cryogenic O₂/H₂ preheating capability. With ascent electrical loads, excessive heating of the FC power section can occur within 9 minutes of pump failure. Excessive heating of the FC results in loosening of the stack due to loss of tie-rod tension resulting in the uncontrolled mixing of O₂ and H₂ which is a catastrophic failure. Since the FC coolant loop is no longer circulating, the cryogenic preheaters are no longer warming the cold reactants. This results in excessive cooling of the dual-gas regulator and possible loss of pressure regulation. Loss of H₂ pump results in loss of water removal capability from the FC. An FC without water removal capability has a predicted lifetime of about 110 amp-hrs. (See paragraph E for 110 amp-hr explanation.)

DOCUMENTATION: SODB, 3.4.4.1.15.

Rule {A9.1.7-1}, ELECTRICAL GO/NO GO CRITERIA, references this rule.

Rule {A9.1.4-10}, CAUTION AND WARNING (C&W) (CIL), references this rule. ©ED 1

THIS RULE CONTINUED ON NEXT PAGE

FLIGHT RULES**A9.1.1-1 FUEL CELL (FC) LOSS (CIL) (CONTINUED)**

C. THE FC STACK COOLANT TEMPERATURE IS >250 DEG (242.5 DEG) F OR <175 DEG (182.5 DEG) F.

At a stack temp >250 deg F, FC tie-rods lose tension causing loosening of the FC stack and seat/seal softening occurs allowing direct O₂/H₂ reactant mixing, or possible FC failure due to reactant gas crossover through a dry electrolyte matrix resulting from excessive water removal. At a stack temp <175 deg F, water removal capability is degraded sufficiently to allow FC failure due to dilution of KOH electrolyte to the point where it will no longer support adequate reaction within the cell. This flooding is caused by the reduced vapor pressure of H₂O at lower temperatures. Normally the water is removed from the power section as a vapor. It cannot be removed as a liquid.

DOCUMENTATION: SODB, 3.4.4.1.11. [@ED](#)]

D. THE COOLANT PRESSURE IS >75 (71.4) PSIA AND INCREASING.

Normal coolant pressure range is 55 to 70 psia. All insight into coolant pressure is lost at 100 psia. No real constraint at up to 100 psia has been identified. The upper limit comes from O₂/H₂ dual-gas regulator relief valve crack pressures plus instrumentation error. Likely causes of increased coolant pressure are preheater leak which would probably be confirmed by coolant pump cavitation causing delta P to fluctuate and eventually remain low, O₂/H₂ dual-gas regulator shift high, regulator stage failed open, or thermal expansion of an overfilled coolant loop (STS 61-A).

DOCUMENTATION: SODB, 4.4.1.6.i.

E. THE FC IS UNABLE TO DISCHARGE WATER. (CIL)

Inability to relieve product water from an FC results in loss of the FC due to flooding within approximately 110 amp-hr. The 110 amp-hr figure assumes a healthy FC with a KOH concentration of 32 percent at the time water removal capability is lost. With a water production rate of 0.02371 lb H₂O/amp-hr, the KOH concentration falls to 26 percent (flooded condition) within approximately 110 amp-hrs. Actual FC lifetime after loss of water removal capability depends on KOH concentration at the time of the failure. Even temporary water line blockage can result in an H₂ pump/water separator motor stall due to water buildup. Once stalled, the motor may not restart even if the blockage is removed. In a flooded cell, water electrolysis and O₂ generation in the H₂ system can occur. Therefore, a flooded fuel cell must be shut down and safed.

DOCUMENTATION: SODB, 4.4.1.3.

THIS RULE CONTINUED ON NEXT PAGE

FLIGHT RULES**A9.1.1-1 FUEL CELL (FC) LOSS (CIL) (CONTINUED)**

F. LOCAL KOH CONCENTRATION IS >48 PERCENT (45 PERCENT) DRY OR <24 PERCENT (29 PERCENT) WET AS INDICATED BY FC STACK TEMPERATURE, CONDENSER EXIT TEMPERATURE, AND CURRENT RELATIONSHIP.

A KOH concentration >48 percent indicates that an FC is drying out. This condition can lead to uncontrolled mixing of O₂ and H₂ (crossover) through a dry electrolyte matrix, which is a hazardous situation. A KOH concentration <24 percent indicates a wet FC which leads to a flooded condition; i.e., fluid covering the O₂ and H₂ reaction sites to the point that it will no longer support adequate reaction within the FC. If the H₂/H₂O separator is running, flooding an FC can lead to the leaching of KOH from the FC matrix and expulsion into the FC manifold and the orbiter potable H₂O supply. This contaminated H₂O is unsuitable for crew consumption and FES usage. KOH in the FC manifold is a possibly catastrophic situation inside the FC since the disassociation of H₂O could occur, generating O₂ in the H₂ manifold.

DOCUMENTATION: SODB, 3.4.4.1.8.a.

G. AN FC REACTANT VALVE FAILS CLOSED.

FC is unable to produce electricity without reactants.

H. THE FC CANNOT BE CONNECTED TO A MAIN BUS. (CIL)

An FC capable of producing power cannot be utilized if it cannot be connected to main bus A, B, or C.

I. THE FC H₂O PH IS CONFIRMED HIGH.

KOH in the product water is a hazardous situation because KOH would also be in the FC H₂ manifold and can provide a conductive path, thereby providing the mechanism for generating H₂ and O₂ from H₂O. KOH in the crew drinking water is unacceptable for medical considerations and is unacceptable for FES usage. Purging an FC in which this leaching has occurred can deposit KOH into the common H₂ purge line causing possible clogging of the line. An FC should be safed for this failure. Methods of confirming KOH in the water include: an indication from the pH sensor in the common product H₂O line, chemstrip test of the product water, crew taste test, or by FC performance degradation. Although no data exists to verify conclusively, substack delta volts may be useful in confirming the failure due to this instrumentation's ability in detecting non-uniform cell flooding in a substack.

DOCUMENTATION: SODB, 3.4.4.1.13.

THIS RULE CONTINUED ON NEXT PAGE

FLIGHT RULES

A9.1.1-1 FUEL CELL (FC) LOSS (CIL) (CONTINUED)

J. THE FC SUBSTACK DELTA VOLTS IS >150 MV AND INCREASING.
(CIL)

The failure that the cell performance monitor (CPM) is designed to detect; i.e., reactant crossover, can be hazardous if allowed to progress uncontrolled. The actual limit of concern is a cell whose performance has shifted 300 millivolts. Since the CPM has an absolute voltage output, the 300-millivolt shift could occur from +150 to -150 millivolts. Therefore, a cell which causes the CPM to exceed 150 millivolts should be shut down.

DOCUMENTATION: SODB, 3.4.4.1.6.a.

K. ITS VOLTAGE CANNOT BE MAINTAINED ≥ 27.5 VOLTS.

This voltage is required to assure that orbiter equipment requiring dc power is maintained at a voltage no lower than 24 volts. Below 27.5 volts, the capability to maintain voltage at all equipment above 24 volts is not possible due to line losses.

DOCUMENTATION: SODB, 3.4.5.6.2.

L. A SUSPECTED PH THAT HAS NOT BEEN CONFIRMED IN 1 HOUR.

It is imperative that an FC indicating a high pH with no confirming cues be evaluated immediately. This may be accomplished by the crew when SM software is available by use of a common pH sensor or by MCC when BFS software is available. The 1-hour time limit was derived from an ascent scenario in which the crew, for whatever reason, was unable to determine if KOH had actually been expelled with the product water from the suspected FC. The time required to perform the test was also factored in. If the FC is shut down without verifying its condition, it will not be restarted due to the possible catastrophic failure mode of an FC with KOH in the H₂ manifold.

DOCUMENTATION: SODB, 3.4.4.1.1.

FLIGHT RULES

A9.1.1-2 FC ALTERNATE H₂O SYSTEM LOSS

THE FC ALTERNATE H₂O SYSTEM IS CONSIDERED LOST IF:

- A. BOTH SYSTEM A AND B HEATER SYSTEMS ON THE FC ALTERNATE H₂O SYSTEM ARE LOST.

Loss of both heater systems will allow the stagnant H₂O in the alternate H₂O lines to freeze, resulting in a disabled alternate system.

- B. TWO OR MORE FC'S RELIEVING OVERBOARD.

Any FC relieving H₂O overboard indicates either a possible alternate and primary H₂O system failure or an overboard relief valve failed open. More than one FC relieving H₂O overboard indicates a probable generic FC H₂O system problem.

- C. ALTERNATE H₂O SYSTEM PRESSURE NOT TRACKING THE EVCSS (EMU WATER SUPPLY PRESSURE) H₂O SUPPLY PRESSURE (WHILE TANK B INLET AND OUTLET VALVES ARE OPEN).

Normal on-orbit alternate H₂O pressure will track the EVCSS H₂O supply pressure. Alternate H₂O pressure not tracking indicates a probable alternate common path failure.

A9.1.1-3 ELECTRICAL POWER DISTRIBUTION AND CONTROL (EPDC) SYSTEM (CIL)

- A. MAIN BUS IS CONSIDERED LOST IF THE BUS VOLTAGE CANNOT BE MAINTAINED >27.0 (27.2) V DC AND <32.0 (31.8) V DC. (CIL).
- B. FORWARD PCA BUS IS CONSIDERED LOST IF THE BUS VOLTAGE CANNOT BE MAINTAINED >26.2 (26.4) V DC AND <32.0 (31.8) V DC.
- C. AFT PCA BUS IS CONSIDERED LOST IF THE BUS VOLTAGE CANNOT BE MAINTAINED >26.1 (26.3) V DC AND <32.0 (31.8) V DC.
- D. CONTROL BUS IS CONSIDERED LOST IF THE BUS VOLTAGE CANNOT BE MAINTAINED >24.8 (25.0) V DC AND <32.0 (31.8) V DC, OR THE CONTROL BUS IS DETERMINED TO HAVE A SHORT BY THE MCC.

THIS RULE CONTINUED ON NEXT PAGE

FLIGHT RULES

**A9.1.1-3 ELECTRICAL POWER DISTRIBUTION AND CONTROL (EPDC)
SYSTEM (CIL) (CONTINUED)**

E. ESSENTIAL BUS IS CONSIDERED LOST IF THE BUS VOLTAGE CANNOT BE MAINTAINED >25.5 (25.7) V DC AND <38.0 (37.8) V DC.

Orbiter equipment is qualified to operate at 23 V dc for intermittent loads and at 24 V dc for continuous loads. Considering line losses from the orbiter buses to the user equipment, the lower voltage limits for the buses listed above guarantee 24 V dc at the equipment interface. The upper voltage for most orbiter equipment is 32 V dc; however, the equipment on the essential buses is qualified to 38 V dc due to the requirement to operate at near FC open circuit voltage. If a control bus is shorted, it will be unpowered even though its voltage measurement may be >24.8 V dc.

Rule {A9.1.3-1}, DC BUS VOLTAGE LIMITS, references this rule.

See rule {A9.1.3-6}, CONTROL BUS, for additional control bus loss rationale.

DOCUMENTATION: SODB, 3.4.5.6.2; Lockheed memo #EP5-M10-215, Shuttle Control Bus Kapton Wire Arc Tracking Test Summary, 10-12-90; and LEMSCO-25658, Summary of the Control Bus Re-power Test, May 1988.

F. AN AC SINGLE-PHASE BUS IS CONSIDERED LOST IF:

1. THE BUS VOLTAGE IS <110 (110.7) V AC OR >120 (119.3) V AC.

Orbiter ac equipment was designed to operate between 110 and 120 V ac.

DOCUMENTATION: SODB, 3.4.5.6.3.a.

2. THE POWERED SINGLE-PHASE BUS CURRENT EXCEEDS:
 - a. 14.4 (13.4) AMPS - (GROUND CALL ONLY) LAUNCH THROUGH MPS POWERDOWN .
 - b. 7.7 (6.7) AMPS - CONTINUOUS LOAD FROM MPS POWERDOWN PROJECTED THROUGH ENTRY.

NOTE: AC BUS CURRENT VALUES BASED ON BUS LOAD POWER FACTOR OF 0.8 LAGGING.

These numbers represent the output power capability of the inverter under both a continuous normal 100 percent load, 7.7 amps, and at 200 percent rated load for 2 minutes, 14.4 amps with cooling. An inverter operated above these limits could fail due to overheating.

DOCUMENTATION: SODB, 4.5.6.3.1.8

THIS RULE CONTINUED ON NEXT PAGE

FLIGHT RULES

A9.1.1-3 **ELECTRICAL POWER DISTRIBUTION AND CONTROL (EPDC)**
SYSTEM (CIL) (CONTINUED)

G. AN AC THREE-PHASE BUS IS CONSIDERED FAILED IF THE BUS CANNOT SATISFY USER REQUIREMENTS.

Self-explanatory.

H. MCA THREE-PHASE AC BUS IS CONSIDERED LOST IF ANY TWO PHASES ARE FAILED, OR IF ANY SINGLE AC PHASE IS SHORTED.

MCA buses power three-phase motors that cannot operate with two phases lost. Also, the MCA three-phase buses use "ganged" circuit breakers, so all three phases are lost when the single cb is opened to isolate a short circuit.

Rule {A9.1.3-1}, DC BUS VOLTAGE LIMITS, references this rule.

A9.1.1-4 **CAUTION AND WARNING (C&W)**

A. ALL C&W LIGHTS AND TONES ARE CONSIDERED LOST (PRIMARY, BACKUP, AND SM) IF POWER SUPPLIES A AND B ARE LOST.

Without power, the hardwire C&W, C&W tones, and SM tones are inoperable.

B. PRIMARY C&W IS CONSIDERED LOST IF:

1. POWER SUPPLY A IS LOST.
2. FAILS SELF-TEST.
3. FALSE ALARMS ARE GENERATED TO EXTENT IT IS UNUSABLE.
4. NEITHER LIGHT NOR TONE WILL ANNUNCIATE.

For any of the above failure modes, the system is either totally inoperable or suspect to the point of being unreliable.

C. BACKUP C&W IS CONSIDERED LOST IF:

1. NEITHER LIGHT NOR TONE WILL ANNUNCIATE.
2. FALSE ALARMS ARE GENERATED TO EXTENT IT IS UNUSABLE.

For any of the above failure modes, the system is either totally inoperable or suspect to the point of being unreliable.

FLIGHT RULES

FUEL CELL SYSTEMS MANAGEMENT

A9.1.2-1 FC POWER LEVEL CONSTRAINTS

- A. THE FC'S CAN BE OPERATED AT ANY POWER LEVEL BETWEEN 2 AND 12 KW CONSISTENT WITH SATISFACTORY DC BUS VOLTAGE AND FC TEMPERATURE MAINTENANCE. TO SATISFY MISSION OBJECTIVES AND FC LIFETIME CONSTRAINTS, FC POWER LEVELS SHOULD BE MANAGED AS FOLLOWS:
1. 2-10 KW - CONTINUOUSLY
 2. 10-12 KW - NOT MORE THAN 15 MINUTES EVERY 3 HOURS
- B. IN THE EVENT OF AN FC FAILURE, FC LOADING IMBALANCE BECAUSE OF UNEVEN FC PERFORMANCE CHARACTERISTICS, OR OTHER SYSTEM FAILURE, THE REMAINING FC'S MAY BE OPERATED AT:
1. 2-12 KW - CONTINUOUSLY
 2. 12-13 KW - FOR LESS THAN 4 HOURS
 3. UP TO 16 KW FOR 10 MINUTES CONSISTENT WITH SATISFACTORY BUS VOLTAGE AND FC TEMPERATURES

At <2 kW the FC voltage may exceed 32 volts. Most orbiter equipment is only certified to 32 volts. At >12 kW, the FC thermal control system capability may become unable to maintain the FC at safe operating temperatures. Due to lifetime considerations, FC power should be limited to less than 8 kW for normal operations. However, continuous operation between 8 and 10 kW is allowable as long as accelerated lifetime decay is accepted.

DOCUMENTATION: SODB, VOL I 3.4.4.1.2 and VOL III 4.4.1.1.15. ©ED 1

FLIGHT RULES

A9.1.2-2

FC PURGE

- A. THE FC'S WILL BE PURGED SEQUENTIALLY WITH O₂ AND H₂ ON A SCHEDULED BASIS NOT TO EXCEED 96 HOURS BETWEEN PURGES. THE FREQUENCY OF PURGES WILL BE BASED UPON FC PERFORMANCE LOSS OF 0.2 VOLTS BETWEEN EACH PURGE. FC LOAD SHOULD NOT EXCEED 10 KW OR 350 AMPS DURING PURGES. HOWEVER, FOR CONTINGENCY CASES, A NORMAL 2-MINUTE PURGE CAN BE DONE AT 12 KW OR 430 AMPS. @[090894-1681]

Both the O₂ and H₂ paths through an FC must be purged to rid the FC of inerts which dilute reactant, thereby reducing FC performance. Fuel cell degradation of 0.2 volts is based on engineering judgment as the minimum performance change which can be accurately assessed in real time. The 96-hour duration is based upon flight experience of the average maximum time before fuel cell degradation reaches 0.2 volts. Should the onboard cryogenic O₂ and H₂ contain excessive inerts, faster than normal voltage degradation would occur necessitating more frequent purges. @[090894-1681]

During a purge, the preheater capability to warm the cryogenic reactants coming into the dual-gas regulator is marginal. Regulator freeze-up and subsequent lockup of the regulator is possible if purged too long at >350 amps (430 amps for contingency operations provided purge is continuous for only 2 minutes).

DOCUMENTATION: SODB, 3.4.4.1.4.c. @[080894-1681]

- B. FC'S WILL BE PURGED USING THE AUTOMATIC SEQUENCE (SM OPS 2). THE MANUAL SEQUENCE WILL BE USED AS A BACKUP. ONE MANUAL PURGE WILL BE PERFORMED PER FLIGHT TO DEMONSTRATE OPERATIONAL CAPABILITIES. ALL AUTO PURGES, EXCEPT FOR POST-INSERTION PURGE, WILL NORMALLY BE INITIATED BY MCC TMBU.

The automatic purge sequence requires only that the flightcrew initiate the sequence, or that the MCC initiate the sequence when OI-20 and subsequent software is available. Manual purge is a backup method, and checkout of the manual purge is highly desirable. MCC initiation of purges allows real-time detailed analysis of fuel cell purge data by the MCC while relieving the flightcrew from housekeeping duties. The post-insertion purge is performed by the flightcrew to provide them a point of reference for fuel cell performance but may be initiated by MCC TMBU, if the crew prefers.

THIS RULE CONTINUED ON NEXT PAGE

FLIGHT RULES

A9.1.2-2 FC PURGE (CONTINUED)

- C. AN FC THAT HAS LOST O₂ PURGE CAPABILITY AND ITS PREDICTED PERFORMANCE WILL NOT SUPPORT NOMINAL EOM PLUS 2 DAYS WILL BE BUS TIED TO A HEALTHY FC, AND THEN EITHER PLACED IN STANDBY OR SHUTDOWN IN ORDER TO SUPPORT NOMINAL EOM PLUS 2 DAYS. THE DECISION TO PLACE THE FC IN STANDBY OR SHUTDOWN WILL DEPEND ON LIFETIME PREDICTIONS BASED ON DEGRADATION TO THAT POINT AND THE RESULTING FC TERMINAL VOLTAGE. IF THE FC IS SHUT DOWN, RESTART CAPABILITY MUST BE DEMONSTRATED TO CONTINUE PAST MDF.

Except during purge operations the FC O₂ system is not a flowthrough design. O₂ gas flows directly to the reaction sites where it is consumed. Contained within the O₂ reactant gas are minute quantities of other gases which accumulate in the reaction chambers. With time, inerts begin to dilute the O₂ gas, effectively reducing the partial pressure of O₂ in the area of the electrolyte/catalyst reaction sites. As FC performance is a direct function of reactant partial pressure, FC output decays as inert content builds. The O₂ system is more sensitive to performance loss than the H₂ system since the H₂ system has a large volume circulating loop to distribute the inerts. Remaining lifetime depends upon gas purity, FC load, and initial FC performance.

DOCUMENTATION: SODB, 4.4.1.3r., 4.4.1.4.o, and flight data.

- D. FOR THE LOSS OF THE CAPABILITY TO PURGE EITHER THE O₂ OR H₂ REACTION CHAMBERS FOR ALL THREE FC'S, A NEXT PLS IS REQUIRED.

The single-point failure causing the loss of all O₂ or all H₂ purge capability from all FC's is a blockage in the common purge vent line. With the blockage in the common purge ventline, all FC's are no longer fail-safe (see paragraph E rationale). In addition, all FC's have no means to recover from performance degradation, so their useful lifetime remaining is limited; therefore, the prudent action is to prepare for a PLS at the next opportunity.

DOCUMENTATION: SODB, 4.4.1.3r, 4.4.1.4.o, and flight data.

- E. AN FC THAT HAS LOST EITHER O₂ OR H₂ PURGE CAPABILITY DUE TO A SUSPECTED BLOCKED VENT/PURGE LINE WILL NOT BE SHUTDOWN UNLESS DICTATED BY PERFORMANCE DEGRADATION (REF. PARAGRAPH C).

FLIGHT RULES

With a blocked vent/purge line the dual-gas regulator in the fuel cell can no longer vent overboard should a failure occur in the regulator. This can result in overpressurization of the fuel cell. The worst case scenario, undetected rapid pressure increase, could cause fuel cell rupture. For vent/purge line blockage, shutting down the fuel cell would appear to be the appropriate action. However, this would result in a two-FC entry which exposes the program to potentially greater risks; therefore, the rule is to leave the fuel cell running. These risk trades were made when arriving at this decision:

THIS RULE CONTINUED ON NEXT PAGE

FLIGHT RULES

A9.1.2-2 FC PURGE (CONTINUED)

- a. *Evaluation of regulator failure history for 18 units with a total of 30,000 hours of operation (through STS 51-L) have indicated that the only failures involving internal leakage/pressurization were seal or seat leakage at a rate well below normal flow (consumption).*
- b. *Seal leakage would not be significant during normal operation because the reactant being leaked is consumed as part of the normal flow.*
- c. *Shutting down the fuel cell for seal leakage could result in a pressure increase as the consumption goes to zero, assuming the upstream reactant valve also leaks when closed. For this case continued operation of the fuel cell would be the proper action.*
- d. *Postulating a significant decrease in fuel cell load (50 amps) with a regulator that sticks at the higher demand setting, a pressure increase of approximately 20 psi/min could result. For this case the crew would have greater than 5 minutes to respond to the COOP P alert and shut down the fuel cell.*
- e. *Shutting down a fuel cell for a blocked vent line and flying a two-fuel cell entry exposes the program to any number of failures during entry on either of the remaining fuel cells that could result in a single fuel cell operation.*

Rule {A9.1.7-1}, ELECTRICAL GO/NO-GO CRITERIA, references this rule.

A9.1.2-3 FC H₂O SYSTEM HEATERS

ONE SET OF FC H₂O RELIEF SYSTEM HEATERS AND WATER LINE HEATERS WILL BE ENABLED AT ALL TIMES.

Capability to dump FC product water overboard must be immediately available in the event the FC can no longer deliver product water into the potable water tanks. Without this backup H₂O removal capability, the FC's will be lost due to flooding. To preclude any blockage in the nonredundant dump line due to freezing, thermal control of this dump line and nozzle is required continuously. Similarly, the FC alternate water lines are normally nonflowing and require thermal control to preclude freezing and line blockage.

DOCUMENTATION: SODB, 3.4.4.1.9.a. Also see System Thermal Control Design and Analysis (RI), SD 77-SH-0284, Dec. 1977, and Electrical Power Generation Water Relief Nozzle Development Test Final Report (RI) EPST-03, 6 Oct. 1976.

Rule {A18.1.8-1}A, TCS HEATER CONFIGURATION, references this rule.

FLIGHT RULES

A9.1.2-4 FC STANDBY DEFINITION

FC IN STANDBY IS DEFINED AS DISCONNECTION FROM ITS MAIN AND ESSENTIAL BUSES. THE ELECTRONIC CONTROL UNIT (ECU) REMAINS POWERED AND THE REACTANT VALVES REMAIN OPEN.

With the FC in standby, the disconnection of the FC from the buses removes all external load from the FC. By leaving the ECU powered and the reactant valves open, the FC remains thermally controlled by the internal sustaining heater and the coolant loop, which maintains it for immediate use.

A9.1.2-5 FC SHUTDOWN DEFINITION (CIL)

A. FC SHUTDOWN IS DEFINED AS DISCONNECTION FROM BUSES, FC TO "STOP", AND REACTANT VALVES CLOSED. IF THE FC IS STILL CONSIDERED USABLE IN-FLIGHT, THE REACTANT VALVES NEED NOT BE CLOSED AFTER THE FC IS STOPPED.

In the shutdown procedure, disconnection of the FC from the buses removes all external electrical load from the FC. FC to STOP removes any normal load on the FC caused by the thermostatically-controlled FC heaters and unpowers the coolant and H₂ pumps. Closing the reactant valves precludes the possibility of providing the reactants in a possible crossover, internal short, or failed-on heater situation.

B. ANY FC THAT IS SHUT DOWN, BUT CONSIDERED AVAILABLE FOR REUSE, WILL BE MAINTAINED > 40 DEG F (48 DEG F). THE SHUTDOWN FC WILL BE CONSIDERED "GO" FOR GO/NO-GO PURPOSES PROVIDED RESTART CAPABILITY IS DEMONSTRATED WHEN THE FC HAS REACHED THERMAL EQUILIBRIUM WITH ITS ENVIRONMENT. (RESTART APPROXIMATELY 48 HOURS AFTER SHUTDOWN FOR -ZLV ATTITUDE.) ©[071494-1659]

On-orbit restart capability of the FC's was a design consideration; however, this capability has not been verified at thermal equilibrium. Therefore, in order to confirm this capability, it is necessary to attempt a restart during which the FC will be put through as realistic of a thermal transient as it will see when it is called upon later in the flight to support entry. For planning purposes, the FC will be considered GO until this restart capability can be verified. It is the intent of this rule, that should a FC at ambient temperature be successfully restarted on orbit, the requirement to verify restart capability for any future FC shutdowns will not be required and that this rule will be modified accordingly.

FLIGHT RULES

The thermal data in parentheses is based on FC shutdown data from STS-2, STS-54, and STS-51 (All -ZLV attitude). On STS-2, FC1 was shut down due to internal flooding and not restarted. The cooling characteristics of the STS-2 fuel cell was different than the existing 3-substack fuel cells because it had only 2 substacks and less thermal blanketing. On STS-54, FC2 was shut down for 9 hours and then successfully restarted (DTO). The thermal data is based on accessory section of the FC since no direct power section insight exists.

DOCUMENTATION: JSC-26545, FC ON-ORBIT SHUTDOWN/RESTART DTO. @[071494-1659]

A9.1.2-6 FC SAFING

FC SAFING WILL BE PERFORMED UNDER THE FOLLOWING CIRCUMSTANCES :

- A. CONFIRMED PH HIGH IN FC PRODUCT WATER
- B. CROSSOVER OF REACTANTS WITHIN THE FC
- C. A SHORT CIRCUIT WITHIN THE FC
- D. CONFIRMED COOLANT PRESSURE > 75 (71.4) PSIA

FC SAFING IS DEFINED AS EVACUATION OF THE FC REACTANT CHAMBERS BY OPERATING THE FC WHILE ITS REACTANT VALVES ARE CLOSED. IT IS DISCONNECTED FROM BUSES AND THEN OPERATED UNTIL THE FC COOLANT PRESSURE IS <15 PSI OR FOR 5 MINUTES AFTER STACK OUT TEMPERATURE DROPS BELOW 185 DEG F.

The FC safing procedure uses the FC startup and sustaining heaters to use up the reactants once the FC has cooled to 185 deg F. This shortens the time a crossover situation or an FC internal short could sustain itself. Also, for the case of KOH in the manifold (pH high), safing evacuates the manifold of reactants to prevent electrolysis due to thin films of KOH across two or more cells. With KOH and water in the reactant chamber, electrolysis can occur that would disassociate H₂O into H₂ and O₂, allowing for recombination and resultant heat. Once the FC cools to the point where its thermostatically-controlled heaters will come on, 5 minutes of operation should be sufficient to reduce its coolant pressure to <15 psi. At <15 psi, the density of the reactants is so small that a catastrophic event is unlikely. Getting much below 15 psi is very difficult due to the continuing outgassing of reactants and H₂O vapor pressure (STS-2 experience). Also, the dual-gas regulator is designed such that the O₂ side always remains 5 psi above the H₂ side. In case of high coolant pressure, FC safing will relieve the FC stack overpressure.

FLIGHT RULES

A9.1.2-7 REUSABLE FC

AN FC WILL BE SHUT DOWN AND WILL BE CONSIDERED REUSABLE FOR THE FOLLOWING CASES:

A. INABILITY TO MAINTAIN BUS VOLTAGE <32 VOLTS.

All orbiter equipment requiring dc power is qualified to a maximum of 32 volts. A main bus voltage is >32 only when the FC is lightly loaded (i.e., due to a powerdown). The FC is reusable when it is sufficiently loaded to drop its voltage below 32 V dc.

DOCUMENTATION: SODB, 3.4.5.6.2.b.

B. ANY FC WITH A COOLANT PRESSURE THAT IS NOT AT LEAST 10 PSIA ABOVE THE SUPPLY H2O TANK PRESSURE WILL BE SHUT DOWN IMMEDIATELY. THE FC MAY BE RESTARTED AFTER H2O TANK A HAS BEEN VENTED PROVIDED THE COOLANT PRESSURE IS AT LEAST 6 PSIA ABOVE THE SUPPLY H2O TANK PRESSURE IF ONLY TANK A VENTED, OR 10 PSIA ABOVE THE SUPPLY H2O TANK PRESSURE IF ALL TANKS VENTED, AND ULLAGE EXISTS IN THE VENTED TANK(S). @[090894-1680]

An FC with a low coolant pressure that is not at least 10 psia above the supply H2O tank pressure cannot be guaranteed to have its product H2O removed. Without the H2O removal capability, the FC H2 pump will be irrecoverably lost within a few minutes resulting in FC flooding. If the FC is shut down quickly, it may be used after supply water tank A has been vented to allow the FC coolant pressure to be at least 6 psia greater than supply H2O pressure if tank A is the only tank vented, or at least 10 psia greater than supply H2O pressure if all tanks are vented. The 10 psia differential pressure requirement is due to the measurement error of the pressure transducer (3.6 psia) plus worst case tolerances on three check values between the FC's and the ECLSS supply H2O tanks (2 psia each). With supply H2O tank A vented, all three FC's will be filling tank A since it has the lowest tank pressure. Therefore, tank A ullage must be managed. @[090894-1680]

C. UNABLE TO PURGE O₂ OR H₂ REACTANT SYSTEM AND PREDICTED FC PERFORMANCE WOULD NOT BE ABOVE THE LAUNCH COMMIT V-I CURVE AT NOMINAL EOM.

It is advisable to save the FC for critical mission phases such as entry.

THIS RULE CONTINUED ON NEXT PAGE

FLIGHT RULES

A9.1.2-7 REUSABLE FC (CONTINUED)

D. LOSS OF FC PUMP PACKAGE WHICH IS RECOVERABLE BY AN IFM REQUIRING CONTINUOUS POWER FROM AN ASSOCIATED PREFLIGHT TEST BUS. IN ADDITION TO THE PREFLIGHT TEST BUS CONSTRAINTS (REF. RULE {A9.1.3-10}, PREFLIGHT TEST BUS MANAGEMENT), THE FOLLOWING CONSTRAINTS WILL BE USED FOR THE IFM IMPLEMENTATION:

1. THIS IFM IS NOT CONSIDERED FEASIBLE FOR LOSS OF THE MAIN DISTRIBUTION BOX ESSENTIAL BUS.
2. ORBIT - USE TO RECOVER FC ON FIRST FAILURE. THE FC WILL BE CONSIDERED LOST FOR GO/NO-GO PURPOSES AND WILL BE POWERED DOWN FOR ENTRY UNLESS REQUIRED TO PROVIDE SFT. MISSION IMPACT - MDF.
3. IFM USED ONLY TO RESTORE ENTRY SFT (TWO FC ENTRY).

The IFM procedure to restore power to the FC pump package takes 21 hours to perform. The FC can be operated a maximum of 9 minutes without the coolant pump; therefore, the FC must be shut down while the IFM procedure is performed. Each essential bus has three power sources. The single failure that would cause loss of a main distribution box essential bus is a bus short. Since the preflight test bus powers the essential bus, the short would probably cause the pre-flight test bus fuse to open. On orbit, the IFM will be performed for the first FC failure, since single failures associated with powering the preflight test bus are recoverable without placing the crew/vehicle in a critical situation. To be consistent with the preflight test bus Flight Rule {A9.1.3-10}, PREFLIGHT TEST BUS MANAGEMENT, concerning entry operations, only SFT entry critical functions are recovered since use of the preflight test bus may expose the crew to problems not as easily recoverable as during orbit operations. The mission impact for first FC failure will be MDF since the FC will not be used for entry. @ED 1

See Rule {A9.1.3-10}, PREFLIGHT TEST BUS MANAGEMENT, for additional rationale.

A9.1.2-8 FC SUSTAINER HEATER

A SUSTAINER HEATER FAILED ON IS NOT CAUSE TO SHUT DOWN THE AFFECTED FC. HOWEVER, IF FC SHUTDOWN IS REQUIRED FOR OTHER REASONS, IT WILL BE SAFED BY CLOSING ITS REACTANT VALVES PRIOR TO UNPOWERING THE FC PUMPS.

FLIGHT RULES

Thermal analysis by International Fuel Cells (IFC) indicates that a failed-on sustainer heater does not overheat an FC and that the FC would be usable for the normal mission duration. If the FC is shut down, the failed-on sustainer heater will remain powered as long as there are reactants to power the FC. To prevent excessive localized heating, the reactants will be depleted prior to unpowering the coolant pump.

DOCUMENTATION: SODB, 4.4.1.1.1.

FLIGHT RULES

A9.1.2-9 FC - CELL PERFORMANCE MONITOR (CIL)

AN FC WITH LOSS OF ANY CELL PERFORMANCE MONITOR (CPM) TELEMETRY WILL BE BUS TIED TO ANOTHER FC. A PERFORMANCE SHIFT SUFFICIENT TO CAUSE A DELTA AMPS CHANGE OF >12 AMPS AND DIVERGING THAT IS NOT RELATED TO REACTANT PRESSURE CHANGE, THERMAL CONTROL, INERTS OR NORMAL V-I PERFORMANCE DIFFERENCES (DERIVED FROM BASELINE PERFORMANCE CURVES) COULD BE INDICATIVE OF AN INTERNAL CELL FAILURE. THE FC WILL BE SHUT DOWN AND ITS REACTANT VALVES CLOSED. IF FC PERFORMANCE HAS NOT VIOLATED THE ABOVE CRITERIA THE BUSES WILL BE UNTIED PRIOR TO THE DEORBIT BURN.

For loss of CPM, a viable procedure to regain insight into possible crossover in an FC is to tie the affected FC to an adequately instrumented healthy FC and note any change in the delta amps between the FC's once an equilibrium delta amp has been identified. A performance shift of 12 amps is equivalent to an approximate 300 mV degradation in one of the 96 cells of the FC. It is the engineering judgment of the FC vendor that this degree of performance change might indicate an internal cell problem and, if allowed to continue, could lead to a crossover condition. The time period between deorbit TIG and touchdown is considered short enough not to require the insight afforded by the bus tie. Also, it is advisable to isolate the three main buses whenever possible for EPDC redundancy.

Rule {A9.1.3-7}, MAIN BUS TIE (CIL), references this rule.

FLIGHT RULES

A9.1.2-10 FC COOLANT PUMP FAILURE MANAGEMENT (CIL)

- A. THE FC MUST BE SHUT DOWN WITHIN 9 MINUTES (AT 7 KW) FOR LOSS OF COOLING. FC SAFING IS NOT REQUIRED.

After the loss of cooling, the FC must be shut down to preclude catastrophic failure due to overheating. Overheating will result in expansion of the stack, leaking of reactants into the PBD, and uncontrolled mixing of O₂ and H₂ resulting in potential explosion. Testing and analysis indicate that the FC will reach the redline stack temperature of 250 deg F in approximately 9 minutes at 7 kW.

DOCUMENTATION: SODB, 3.4.4.1.15.

- B. FUEL CELL OPERATION WITHOUT COOLING MAY BE EXTENDED BEYOND 9 MINUTES IF THE MCC CALCULATED FC STACK TEMPERATURE IS PREDICTED TO BE LESS THAN 250 DEG F. FC OPERATIONS BEYOND 9 MINUTES WILL ONLY BE ALLOWED DURING CRITICAL MISSION PHASES TO:

1. MAINTAIN TWO FUEL CELLS, OR
2. MAINTAIN THREE MAIN BUSES (I.E., BUS TIE CAPABILITY LOST)

At the FC power load of 7 kW, a FC can be operated for 9 minutes before the FC stack temperature reaches 250 deg F. However, if the power level can be reduced quickly after the loss of FC cooling, FC operation may be extended beyond 9 minutes since a lower power level lowers the heating rate. FC operations would be extended when absolutely necessary to maintain two FC's or three main buses to allow critical equipment to remain powered, provide extra time to reconfigure safely, or to get past a critical event (i.e., ascent/entry). The 250 deg F limit of the FC stack temperature is required to maintain integrity of the FC power stack. Based upon analysis and testing conducted by IFC and JSC E&D, the predicted FC stack temperature can be calculated from the FC stack temperature at the time of the failure and the affected FC subsequent power levels (reliable FC stack temperature measurement is lost following the loss of coolant flow).

DOCUMENTATION: RI Internal Letter, 287-EPS-88-074, FC Operating Time Following Loss of Coolant, May 24, 1988.

JSC-23091, Internal Note for FC X708 Thermal System Off-Limits Test, November 25, 1988.

SODB, 3.4.4.1.15.

FLIGHT RULES**A9.1.2-11 ACTIONS FOR FUEL CELL PH INDICATIONS ©[121296-4737B]**

A FUEL CELL THAT HAS RECEIVED A "PH" INDICATION WILL BE HANDLED IN THE FOLLOWING MANNER:

- A. THE FUEL CELL'S ASSOCIATED MAIN BUS WILL BE BUS TIED TO A GOOD FUEL CELL'S MAIN BUS AND THE SUPPLY H₂O TANK A INLET VALVE WILL BE CLOSED.

Reception of a pH indication can be signs of fuel cell flooding, crossover, new stack build, or other mechanisms that cause the KOH to escape from a fuel cell. If KOH is escaping, fuel cell failure may occur. The bus tie is performed to protect the fuel cell's associated main bus should the fuel cell completely fail and to monitor the fuel cell's load sharing performance. Closing the tank A inlet will force the high pH water into tank B. This will protect the crew's potable water in tank A and avoid contamination of the water used by FES B in tanks C & D. Tank B will then be dumped overboard as necessary to eliminate the contaminated water. For Mir flights, water in tank B is used for transfer to the Mir station. High pH water in this case does not pose a problem since the Iodine Removal & Mineral Injection System (IRMIS) cartridge has been proven in testing to remove the KOH from the water.

Rationale: Engineering judgment.

- B. FOR RECEPTION OF BOTH THE FUEL CELL AND COMMON H₂O LINE PH INDICATIONS, A LITMUS TEST OF THE FUEL CELL PRODUCT WATER WILL BE PERFORMED WITHIN 1 HOUR TO VERIFY THE PRESENCE OF KOH. TO ALLOW ENOUGH TIME FOR THE CONTAMINATED H₂O TO MIGRATE TO THE GALLEY, THE LITMUS TEST SHOULD NOT BE PERFORMED PRIOR TO 20 MINUTES AFTER THE INITIAL FUEL CELL PH INDICATION OR APPROXIMATELY 12 MINUTES AFTER THE COMMON H₂O LINE PH INDICATION. IF THE LITMUS TEST CANNOT BE PERFORMED WITHIN 1 HOUR, THE FUEL CELL WILL BE SHUT DOWN, SAFED, AND CONSIDERED LOST.

The fuel cell pH and common H₂O line pH sensors measure conductivity of the fuel cell product water and are not measurements of KOH content. To confirm the presence of KOH, litmus testing of the water must be performed. As much as 20 minutes transport time from the affected fuel cell to the galley OD may be required (8-9 minutes between the affected fuel cell pH indication and the common H₂O line indication). Furthermore, continued operation of a fuel cell with an unconfirmed pH for greater than 1 hour is out of history for shuttle fuel cells. The 1 hour operational constraint is based upon engineering judgment and fuel cell historical flight data (STS-79 FC2 pH indication only lasted about 20 minutes; therefore, >1 hour is out of history for shuttle fuel cells by 300 percent).

Rationale: SODB Volume 1 Section 3.4.4.1 (13) and STS-79 flight experience. ©[121296-4737B]

THIS RULE CONTINUED ON NEXT PAGE

FLIGHT RULES

A9.1.2-11 ACTIONS FOR FUEL CELL PH INDICATIONS (CONTINUED)

C. IF CONFIRMING INDICATIONS OF FUEL CELL FLOODING OR CROSSOVER ARE RECEIVED AT ANY TIME, THE FUEL CELL WILL BE SHUT DOWN, SAFED, AND CONSIDERED LOST. ©[121296-4737B]

Fuel cell flooding is the most probable cause of KOH in the product water. Flooding may be the result of improper condenser temperature maintenance, coolant pressure imbalance, or degraded or failed water removal. Confirming indications of flooding can be thermal control shifts, performance decay and increased H₂ pump status and associated AC currents from the lugging or stalling H₂ pump. Continued fuel cell operation will only result in additional flooding until complete failure and loss of all electrical generation. Confirming indications of crossover may be increasing substack delta volts or unexplained performance degradation.

Rationale: SODB Volume 1 Section 3.4.4.1 (13) & Engineering judgment.

D. FUEL CELL OPERATION FOR CONFIRMED PH INDICATIONS (BY SENSORS AND LITMUS TEST) WITHOUT SIGNS OF FLOODING OR CROSSOVER IS ALLOWABLE FOR 1 HOUR. IF THE INDICATIONS ARE SUSTAINED FOR GREATER THAN 1 HOUR, THE FUEL CELL WILL BE SHUT DOWN, SAFED, AND CONSIDERED LOST.

For confirmed pH indications that are sustained for greater than 1 hour with no indications of fuel cell flooding or crossover, unknown mechanisms are at work expelling the KOH. The 1 hour time period was chosen to allow the high pH to clear, preventing premature fuel cell shutdown and safing. Because of the unknown nature of the failure, the risks associated with continued fuel cell operation are also unknown.

Rationale: SODB Volume 1 Section 3.4.4.1 (13), STS-79 Flight Experience and Engineering judgment.

E. FUEL CELL OPERATION MAY CONTINUE WITH BOTH SENSORS ON BUT PH < 9 (BASED UPON LITMUS TEST), AND NO INDICATIONS OF FLOODING OR CROSSOVER. THE BUS TIE WILL BE MAINTAINED TO MONITOR FUEL CELL PERFORMANCE UNTIL FUEL CELL HEALTH IS VERIFIED.

A fuel cell with continuously on pH sensors but whose product water is verified to have a pH level < 9 (i.e., no KOH escaping the fuel cell) and whose performance is nominal will be allowed to continue operation. The sensor indications are possibly due to increased electrical conductivity of the product water due to the presence of metallic ions or very minute amounts of KOH that the litmus test cannot verify (localized, single cell flooding). Because this is still an off-nominal situation, the bus tie will be maintained so that the ground can monitor fuel cell performance. If long term performance degradation or indications of flooding are received that indicate the presence of KOH, the fuel cell will be shut down and safed.

FLIGHT RULES

Rationale: SODB Volume 1 Section 3.4.4.1 (13), STS-79 flight experience, and engineering judgment. ©[121296-4737B]

FLIGHT RULES

DC POWER DISTRIBUTION AND CONTROL SYSTEMS MANAGEMENT

A9.1.3-1 DC BUS VOLTAGE LIMITS

DC BUS VOLTAGE WILL BE MAINTAINED AS FOLLOWS:

- A. MAIN BUS VOLTS > 27.0 (27.2) V DC AND < 32.0 (31.8) V DC.
- B. CONTROL BUS VOLTS > 24.8 (25.0) V DC AND < 32.0 (31.8) V DC.
- C. ESSENTIAL BUS VOLTS > 25.5 (25.7) V DC AND < 38.0 (37.8) V DC.
- D. FORWARD PCA VOLTS > 26.2 (26.4) V DC AND < 32.0 (31.8) V DC.
- E. AFT PCA VOLTS > 26.1 (26.3) V DC AND < 32.0 (31.8) V DC.

Rationale same as for Rules {A9.1.1-3}A through E, ELECTRICAL POWER DISTRIBUTION AND CONTROL (EPDC) SYSTEM (CIL).

A9.1.3-2 ESSENTIAL BUS

EACH ESSENTIAL BUS WILL BE CONNECTED TO ALL THREE OF ITS POWER SOURCES.

The highest level of power redundancy will be maintained to the essential buses. They power orbiter critical equipment such as GPC's.

A9.1.3-3 POWER REDUCTION GUIDELINES

IF AN ELECTRICAL POWER SYSTEM PROBLEM REQUIRES AN IMMEDIATE POWER REDUCTION, POWER TO MADS AND/OR PAYLOAD EQUIPMENT MAY BE TERMINATED.

Those electrical loads not required for orbiter systems operations while in a situation requiring immediate reduction in electrical load to prevent FC overloading and/or equipment undervoltage will be terminated.

FLIGHT RULES

A9.1.3-4 MAIN BUS SHORT

IF A CONFIRMED MAIN BUS SHORT RESULTS IN A TOTAL BUS CURRENT GREATER THAN 500 AMPS (OFF-SCALE HIGH) AND DOES NOT CLEAR AUTOMATICALLY:

- A. PRE-MECO, THE MAIN BUS WILL REMAIN POWERED AS LONG AS THE ASSOCIATED AC BUS VOLTAGE IS > 95 V AC OR UNTIL MCC CONFIRMS SSME CONTROLLER SWITCHOVER HAS OCCURRED.

The orbiter EPDC system is designed for self-isolation of shorted circuitry. In reality, a sustained short of this magnitude is highly unlikely. Should it occur, however, main engine controller power requirements will not be jeopardized. The crew has no insight into SSME controller switchover. Once the ground confirms switchover or MECO has occurred, the uncleared short will be isolated. As long as the ac voltage remains above 95 volts, controller switchover will not take place.

- B. DURING OMS MANEUVERS CRITICAL FOR CREW SAFETY, DEORBIT BURN, AND TAEM, THE MAIN BUS WILL REMAIN POWERED AS LONG AS BUS VOLTAGE DOES NOT DROP BELOW 26.4 (26.6) V DC.

During OMS maneuvers critical for crew safety (as defined in the Flight Rule Annex), deorbit burn, and TAEM, it is highly desirable that the maximum level of electrical power redundancy to orbiter equipment be maintained and that single power source equipment not be lost. The crew should take action at the C&W limit of 26.4 V dc.

FLIGHT RULES

A9.1.3-5

CB/RPC RESET

- A. A CB OR RPC WILL NOT BE RESET IMMEDIATELY UNLESS THE FUNCTION OR SYSTEM LOST IS CRITICAL TO MAINTAIN SAFE ORBITER OPERATIONS. THE MCC WILL REVIEW ASSOCIATED DATA FOR CAUSE OF THE OPEN CIRCUIT.
1. IF A SHORT OR OVERLOAD CAUSED THE TRIP, IT WILL NOT BE RESET UNLESS THE AFFECTED LRU(S) WOULD BE THE LAST METHOD TO PERFORM A CRITICAL FUNCTION. IT WILL NOT BE RESET TO REGAIN REDUNDANCY FOR A CRITICAL FUNCTION OR TO REGAIN MISSION SUCCESS ITEMS.
 2. IF THERE IS CONCLUSIVE EVIDENCE THAT NO SHORT/OVERLOAD EXISTS, IT CAN BE RESET (DURING MCC COVERAGE). RESET SHOULD ONLY BE PERFORMED IF THE LRU IS NEEDED. CONCLUSIVE EVIDENCE IS TELEMETRY INDICATING THE EXACT TIME OF POWER LOSS AND ADEQUATE RESOLUTION AND SAMPLE RATE FOR THE BUS CURRENTS AT THAT TIME. IF THE LRU IS REGAINED DURING A CB RESET AND NO SHORT IS SEEN, BUT THE CB FAILS TO HOLD, THE IFM CB RETENTION DEVICE CAN BE INSTALLED IMMEDIATELY FOR CREW SAFETY ISSUES ONLY. INSTALLATION OF THE RETENTION DEVICE FOR MISSION SUCCESS SHOULD BE AVOIDED, BUT INDIVIDUAL CASES WILL BE CONSIDERED BASED UPON IMPACT OF LRU LOSS, LENGTH OF TIME THAT RETENTION DEVICE IS NEEDED, MOST PROBABLE FAILURE MODE, ETC.
 3. IF DATA IS INCONCLUSIVE (E.G., INADEQUATE RESOLUTION OR TIME NOT KNOWN) CB/RPC RESET WILL BE BASED UPON IMPACT OF LRU LOSS, WIRE TYPE (KAPTON TWISTED PAIR IS HIGHEST RISK), DEGREE OF UNCERTAINTY IN DATA ANALYSIS, ETC.

Laboratory tests on Kapton wiring indicate that "arc tracking" can cause extensive damage to wire harnesses. Loss of a wire harness in itself could be catastrophic. Reset of the circuit protection in many cases caused more damage than the original occurrence. However, if it is known that the open circuit was not caused by a short, the cause is most likely mechanical failure or the control was inadvertently bumped. Installation of the cb retention device should be avoided since there have been instances where the cb is damaged in such a manner that it will not latch, nor would it be able to trip if held closed. Under some circumstances, it will be impossible to verify that no short occurred. Examples include: loss of data, circuit protection trip characteristics in noise level of bus currents, low data sample rates, unable to determine exact time of event, etc. Since these present varying degrees of uncertainty and since wire type plays an important role in the risk of reset, cases falling into this category will be addressed based on real-time conditions.

FLIGHT RULES

DOCUMENTATION: Testing performed at KSC Malfunction Analysis Laboratory and at the JSC EPDC Laboratory. Also CAR # AC1737-010.

THIS RULE CONTINUED ON NEXT PAGE

FLIGHT RULES

A9.1.3-5 CB/RPC RESET (CONTINUED)

- B. A CIRCUIT OR LRU WHICH IS PROTECTED BY A CB (NOT TRIPPED) AND WHICH HAS FAILED TO FUNCTION FOR AN UNDETERMINED REASON, MAY HAVE ITS CB CYCLED ONCE. IF NO SHORT IS SEEN, IT MAY BE CYCLED FIVE TIMES.

Corrosion can form on the contacts of cb's. Troubleshooting experience has shown that this corrosion can be removed by cycling the cb while under load. Five cycles have been sufficient. In case the cb has popped internally due to a short, MCC must review data after the first cycle.

DOCUMENTATION: CF NOI53 (STS-3 and subs), CF7/82-19, Orbiter Circuit Breaker Contact Oxidation.

A9.1.3-6 CONTROL BUS

- A. A CONTROL BUS THAT IS DETERMINED TO HAVE A SHORT BY THE MCC WILL BE UNPOWERED USING THE FOLLOWING GUIDELINES.
1. IF A SHORT CAUSES THE LOSS OF A CONTROL BUS RPC, THE CONTROL BUS CENTER POWER SOURCE CIRCUIT BREAKER (ON PANEL R15) WILL BE OPENED AND THE REMAINING RPC WILL BE DISABLED BY CONTINUOUSLY HOLDING THE CONTROL BUS RPC RESET SWITCH (ON PANEL R1) IN THE RESET POSITION WHILE AN IFM IS PERFORMED TO UNPOWER THE DESIRED RPC.
 2. IF A SHORT DOES NOT CAUSE LOSS OF ANY CONTROL BUS RPC'S, BOTH OF THE ASSOCIATED CONTROL BUS RPC RESET SWITCHES WILL BE ACTUATED CONTINUOUSLY TO DISABLE BOTH CONTROL BUS RPC'S UNTIL AN IFM IS PERFORMED TO UNPOWER THE DESIRED RPC'S. IF, AFTER DISABLING BOTH RPC'S, THE CREW REPORTS VISIBLE ARCING OR SMOKE, THE R15 CENTER SOURCE CB WILL BE PULLED. THIS WILL DISABLE THREE CONTROL BUSES (E.G., CNTL AB1/2/3) UNTIL THE IFM CAN BE PERFORMED.
- B. A CONTROL BUS WHICH HAS FAILED DUE TO A SHORT MAY HAVE ONE OF ITS RPC'S RESET (DURING GROUND COVERAGE ON MCC REQUEST) TO ATTEMPT POSITIONING OF VALVES OR RELAYS (POWERED BY THE CONTROL BUS THROUGH MOMENTARY SWITCHES) WHEN THE ATTEMPT IS CONSIDERED MANDATORY FOR FLIGHT SAFETY.

*Breadboard testing in May 1988 determined that a control bus short would not open all three circuit protection devices due to bus wire size and length. The result would be a partial control bus loss with the short still being supplied power. (The maximum power possible from a 5-amp RPC source is $7.5A * 30V = 225$ watts).*

FLIGHT RULES

THIS RULE CONTINUED ON NEXT PAGE

FLIGHT RULES

A9.1.3-6 CONTROL BUS (CONTINUED)

If a control bus is determined to have a short, it will be unpowered as soon as possible to prevent further damage due to localized heating and/or possible arc tracking. Kapton wire arc-tracking tests performed in 1990 indicate that initiation of arc tracking on a single conductor wire (as used for control buses) is unlikely. However, if it did occur, testing indicates that the entire bundle/harness could be damaged. Since control bus wires are routed in bundles and harnesses containing other control buses and critical functions, damage affecting multiple wires could be catastrophic.

If a control bus is shorted, one of the power sources will most likely be lost.

- a. If a control bus RPC is lost due to a short, the quickest way to remove the other two power sources is to use the RPC reset switch and open the center source circuit breaker. This action will cause four other control buses to lose one of three power sources, and two other control buses to lose two of three power sources. After the IFM is performed to unpower the "reset RPC," two RPC's will be regained by releasing the RPC reset switch. This will result in one control bus (the one with the short) with no power sources, four control buses with two of three power sources, and all others with all three power sources.*
- b. If a control bus short does not cause the loss of an RPC, the center source 5-amp fuse (downstream of the 10-amp cb) is probably open. The only quick method of removing the other two power sources is to use the two associated RPC reset switches. This action will cause six other control buses to lose one of three power sources, and two other control buses to lose two of three power sources. After the IFM is performed to unpower the associated "reset RPC's," four RPC's will be regained by releasing the RPC reset switches. This results in one control bus (the one with the short) with no power sources, two control buses with two of three power sources, and all others with all three power sources. Continued arcing and smoke may require the center feed cb to be pulled to ensure no power is available to the shorted bus.*

The IFM unpowers individual RPC's using the appropriate LF MDM cable pins. The IFM does not power the LF MDM or the preflight test bus.

With respect to resetting a control bus RPC to attempt positioning of valves or relays, depending on the location and magnitude of the short, tests have indicated that it may be possible to power momentary (2 to 3 seconds) loads by resetting one of the control bus RPC's.

DOCUMENTATION: SODB 3.4.5.6.2; Lockheed memo #EP5-M10-215, Shuttle Control Bus Kapton Wire Arc Tracking Test Summary, 10-12-90; and LEMSCO-25658, Summary of the Control Bus Repower Test, May 1988.

FLIGHT RULES

A9.1.3-7 MAIN BUS TIE (CIL)

A. NORMALLY THE MAIN BUSES WILL BE ISOLATED FROM EACH OTHER. TWO OR THREE MAIN BUSES WILL BE TIED:

1. TO REGAIN INSIGHT INTO AN FC PERFORMANCE DUE TO SUSPECT OR FAILED INSTRUMENTATION (I.E., CPM) AND WILL BE UNTIED PRIOR TO DEORBIT TIG. FOR PAYLOAD DEPLOYS OR PROX OPS, A MAXIMUM OF TWO MAIN BUSES WILL BE TIED. WHILE TIED, FC MANAGEMENT WILL BE PERFORMED PER RULE {A9.1.2-9}, FC - CELL PERFORMANCE MONITOR (CIL).

It has been determined that a viable alternative to adequate FC instrumentation is to tie the FC to a healthy, adequately instrumented FC. For critical flight phases during which the temporary loss of all GPC's would be unacceptable, only two buses will remain tied.

DOCUMENTATION: SODB, 4.4.1.1.1.

2. FOR CELL FAILURE OR DEGRADATION IN ORDER TO MAINTAIN THREE POWERED MAIN BUSES.

It is highly desirable to always maintain the highest level of power redundancy to all orbiter equipment.

3. IN PERFORMANCE OF MALFUNCTION PROCEDURES TO MINIMIZE LOAD TRANSIENTS ON THE FC'S.

It is highly desirable that no FC be stressed unnecessarily by excessive loading. Therefore, for total vehicle electrical loads of >18 kW, all three buses will be tied during periods of troubleshooting. The FC malfunction procedures reflect this philosophy.

DOCUMENTATION: SODB, 3.4.4.1.2.

4. FOR EXTENDED ON-ORBIT OPERATION OF PAYLOADS REQUIRING >4 KW.(TWO BUSES TIED.)

This is the standard configuration for Spacelab flights. It is used to preclude one FC from being overstressed by excessive electrical load caused from supporting a main bus and the high power requirement of the payload.

After a powerdown of orbiter equipment to accommodate the payload power requirements, the orbiter will still require approximately 4 kW power per FC. With the addition of a payload power demand of 4 kW on a single fuel cell, about 1 kW of the total load will shift to the other FC due to the dioded load sharing. The total load remaining on the fuel cell will be approximately 7 kW which is the SODB maximum limit for continuous power from a fuel cell. Therefore, payload power demands greater than 4 kW require two buses tied so that additional load can be shared between two FC's.

DOCUMENTATION: SODB, 3.4.4.1.2 and engineering judgment.

THIS RULE CONTINUED ON NEXT PAGE

FLIGHT RULES

A9.1.3-7 MAIN BUS TIE (CIL) (CONTINUED)

- B. BUS TIEING DURING ASCENT/ENTRY WILL ONLY BE PERFORMED IF THE TOTAL FC ELECTRICAL LOAD IS ≤ 27 KW OR 930 AMPS AND THE REMAINING FC PERFORMANCE (V-I) HAS BEEN NOMINAL.

A bus tie to a decaying FC during powered flight is acceptable provided the remaining FC's have adequate performance margins available to support two buses.

- C. BUS TIEING TO A DEAD BUS (I.E., BUS VOLTS < 20 V DC) PRIOR TO SRB SEPARATION WILL NOT BE PERFORMED.

The voltage transient on a good bus while tying to an unpowered bus may cause an undervoltage condition on the SRB buses resulting in the loss of two of three power sources to the SRB's. All critical equipment will remain powered with loss of one main bus (volts < 20). Therefore, only the switching absolutely necessary should be performed pre-SRB separation, and the bus tie steps when main volts are < 20 Vdc should not be performed.

A9.1.3-8 CRITICAL PHASE BUS MANAGEMENT

ELECTRICAL BUSES NOT REQUIRED FOR ASCENT AND/OR ENTRY (E.G., PAYLOAD BUSES NOT REQUIRED FOR THESE PHASES) WILL NORMALLY BE POWERED OFF PRIOR TO THE CRITICAL PHASE.

Unpowered circuitry cannot provide a site for a short. This affords more protection to the orbiter during critical mission phases.

This rule is referenced by Rule {A9.1.6-12}, EDO PALLET MANAGEMENT.

FLIGHT RULES

A9.1.3-9 PRIMARY PAYLOAD BUS MANAGEMENT

ELECTRICAL POWER TO MAJOR PAYLOADS IN THE ORBITER PLB IS PROVIDED VIA THE ORBITER PRIMARY PAYLOAD BUS. THE PRIMARY PAYLOAD POWER SOURCES TO THE ORBITER PLB WILL BE MANAGED AS FOLLOWS:

- A. PRIMARY PAYLOAD MNC - 8 KW CONTINUOUS, 12 KW PEAK FOR 15 MINUTES EVERY 3 HOURS.
- B. PRIMARY PAYLOAD FC3 - 8 KW CONTINUOUS, 12 KW PEAK FOR 15 MINUTES EVERY 3 HOURS.
- C. PRIMARY PAYLOAD MNB - 7 KW CONTINUOUS, AND PEAK @071494-1658A]

By design, the power level constraints noted above must be observed. The orbiter MNC bus feed is the normal source of power to the primary payload bus to maximize the amount of power delivered to a payload. Although the FC3 feed has the same power constraints as the orbiter MNC bus feed, it has always been the philosophy to feed the payloads from orbiter buses rather than directly from the FC, when possible. The MNC and FC3 feeder constraint is based upon FC power limitations. The existing fuel cells cannot supply the full power capabilities of the four feeders (each with 200 amp fuses) without violating the FC power constraints. The orbiter MNB feed does not have the power capabilities of the other feeds due to the fuse sizing between the orbiter MNB bus and the primary payload bus. The MNB feeder constraint was based on a detailed analysis completed by the subsystems managers. It was determined for a worst case of 26.8 volts and a 10 percent difference between the two feeders, that 7 kW continuous and peak was to be the highest level that the MNB bus should operate at and still maintain the integrity of the feeder and provide a slight margin of safety. Payload power includes all ac and dc power provided to the payload. Primary payload power is measured at the FC output terminals. @071494-1658A]

DOCUMENTATION: SODB 4.5.6.8.1.

A9.1.3-10 PREFLIGHT TEST BUS MANAGEMENT

IF NECESSARY TO REGAIN A CRITICAL FUNCTION, THE PREFLIGHT TEST BUS MAY BE POWERED MOMENTARILY OR CONTINUOUSLY FOR ORBIT OR ENTRY. THE PRELAUNCH MDM'S WILL NOT BE POWERED. SPECIFIC LRU'S OR SITUATIONS THAT USE THE PREFLIGHT TEST BUS WILL BE IDENTIFIED IN THE RULES SECTION FOR EACH DISCIPLINE.

- A. USAGE OF THE PREFLIGHT TEST BUS WILL BE CONSTRAINED AS FOLLOWS:
 - 1. ORBIT - RESTORE CRITICAL EQUIPMENT AFTER FIRST FAILURE.

FLIGHT RULES

2. ENTRY - RESTORE CRITICAL EQUIPMENT FOR ENTRY SINGLE-FAULT TOLERANCE (SFT).

FLIGHT RULES

A9.1.3-10 PREFLIGHT TEST BUS MANAGEMENT (CONTINUED)

- B. THE FOLLOWING CONSTRAINTS MUST BE FOLLOWED IF THE PREFLIGHT TEST BUS IS POWERED CONTINUOUSLY.
1. ORBIT - A MAIN BUS TIE WILL BE PERFORMED TO PROTECT AGAINST AN INADVERTENT MAIN BUS DISCONNECT PRIOR TO PREFLIGHT TEST BUS POWERUP:
 - a. FOR PREFLIGHT BUS 1 USAGE - BUS TIE MNA TO MNB.
 - b. FOR PREFLIGHT BUS 2 USAGE TO RECOVER FC3 - TO PRECLUDE POSSIBLE LOSS OF TWO MAIN BUSES, BUS TIE MNA TO MNC WHILE THE PREFLIGHT BUS IS POWERED AND FC3 IS NOT YET RECOVERED. ONCE FC3 IS RECOVERED, RECONFIGURE THE BUS TIE MNB TO MNC AND CONNECT FC3 AND MNC TO THE PRIMARY PAYLOAD BUS.
 - c. FOR PREFLIGHT BUS 2 USAGE IN ALL OTHER CASES - BUS TIE MNB TO MNC AND CONNECT FC3 AND MNC TO THE PRIMARY PAYLOAD BUS.
 2. ENTRY - FOR FUEL CELL (ECU) RECOVERY, THE PREFLIGHT TEST BUS WILL BE USED TO PROVIDE A TWO FC ENTRY (REF. RULE {A9.1.2-7}D, REUSABLE FC). TO PRECLUDE POSSIBLE LOSS OF TWO MAIN BUSES DUE TO A PREFLIGHT TEST BUS DRIVER FAILURE, THE FOLLOWING MAIN BUS TIE/PRIMARY PAYLOAD BUS CONFIGURATION SCHEDULE WILL BE IMPLEMENTED:
 - a. FC1 RECOVERED, FC2(3) FAILED: BUS TIE MNB TO MNC
 - b. FC2 RECOVERED, FC1 FAILED: BUS TIE MNC TO MNA
CONNECT FC3 TO PRI PL
BUS
CONNECT MNC TO PRI PL
BUS
 - c. FC2 RECOVERED, FC3 FAILED: BUS TIE MNC TO MNA
 - d. FC3 RECOVERED, FC1(2) FAILED: BUS TIE MNA TO MNC (MNB)
CONNECT FC3 TO PRI PL
BUS
CONNECT MNC TO PRI PL
BUS

FLIGHT RULES

FOR ALL OTHER USES, FOLLOW THE MAIN BUS TIE GUIDELINES
IN PARAGRAPH B.1.

NOTE: A CREWMEMBER MUST BE ABLE TO UNPOWER THE
PREFLIGHT TEST BUS WHILE SECURED IN SEAT.

THIS RULE CONTINUED ON NEXT PAGE

FLIGHT RULES

A9.1.3-10 PREFLIGHT TEST BUS MANAGEMENT (CONTINUED)

C. MOMENTARY USE OF THE PREFLIGHT TEST BUS CONSTRAINTS ARE AS FOLLOWS:

IF MOMENTARY USE IS POSSIBLE DURING ENTRY, ON-ORBIT PREFLIGHT TEST BUS POWERUP IS REQUIRED TO VERIFY NO DRIVER FAILURES. IF POSSIBLE, THE MOMENTARY FUNCTION WILL BE EXERCISED ON ORBIT.

Powering the preflight test bus enables circuits that use the single-string launch MDM's and data bus system to operate most orbiter systems equipment during ground turnaround. Due to the design, a single driver failure could cause equipment to be inadvertently commanded whenever the preflight test bus is powered. A study prepared by the Electrical Systems Section, Systems Division, Mission Operations Directorate, showed that the results of each driver failure is recoverable and would not place the orbiter or crew in a critical situation. Therefore, while on orbit, the preflight test bus may be used to restore critical redundancy beyond SFT. Due to entry being a critical phase of flight, use of the preflight test bus is limited to restore only single-fault tolerance to entry-critical systems. Note that at no time would the prelaunch MDM's be powered during a mission since a single card failure could send multiple, conflicting commands to orbiter systems and alter vehicle configuration severely (e.g., simultaneous FC/main bus disconnect/connect, etc.). The three most significant single driver failures that were noted were the FC/main bus disconnect, three-phase ac inverter and bus disconnect, and APU fuel valve closure.

During the orbit phase, if the preflight bus is to be powered continuously, a bus tie is performed to prevent loss of a main bus due to an inadvertent disconnect caused by a preflight test bus driver failure. For the recovery of FC3, total prevention of the loss of a main bus cannot be met. However, to avoid losing two main buses, the bus tie configuration is modified so MNC is tied to MNA during the relatively brief time when the preflight test bus is powered, but FC3 is not yet recovered. This configuration covers the case for the untied FC2/MNB bus system having a failed driver when the preflight test bus is first powered which results in the temporary loss of MNB. The prevention of the loss of a main bus can be met once FC3 is recovered and connected to its main bus by reconfiguring the bus tie between MNB and MNC. In addition, while FC3 is operating, the primary payload bus can be used to provide a redundant electrical path between FC3 and MNC which will prevent FC3 from inadvertently disconnecting from its main bus.

During entry, the bus tie configuration depends upon the reason the preflight test bus is being used. For the case where it is used to recover a FC, the bus tie configuration depends upon which FC is recovered and which FC has failed. The reason for this is to protect the electrical system from losing more than one main bus due to a driver failure. Again, the primary payload bus can be used to provide a redundant electrical path between FC3 and MNC which will prevent FC3 from inadvertently disconnecting from its main bus.

A disconnect of either ac inverter power or ac buses can be corrected during either orbit or entry phase of flight by unpowering the preflight bus and using the panel switches to restore the affected ac system. Unpowering the preflight test bus will result in the loss of the system it recovered.

FLIGHT RULES

A9.1.3-10 PREFLIGHT TEST BUS MANAGEMENT (CONTINUED)

Since avionics bay fire suppression can be inhibited by an undetectable DISCHARGE CMD driver failure (one driver per avionics bay), as well as other undesirable driver failures affecting vehicle configuration, the crew must be able to unpower the preflight test bus while seated for entry. If fire suppression is required for an avionics bay while on orbit, either the preflight test bus can be unpowered momentarily to recover the AV bay built-in system or a handheld bottle can be discharged. Preflight test bus 1 can affect avionics bay 3 fire suppression, and preflight test bus 2 can affect avionics bays 1 and 2 fire suppression.

Momentary use of the preflight test bus would require only a few seconds of operations (<5 seconds) to accomplish most switching or reconfiguration tasks, so exposure to driver failures is limited. The only constraint is that on-orbit verification of preflight test bus capability be performed which will ensure the integrity of the test bus and the IFM procedure prior to its use during entry.

DOCUMENTATION: On-Orbit/Entry Usages of Preflight Test Bus, Electrical Systems Section - Mission Operations Directorate. Presented to Orbit Flight Techniques on November 18, 1988.

Rule {A9.1.2-7}D, REUSABLE FC, references this rule.

FLIGHT RULES

AC POWER DISTRIBUTION AND CONTROL SYSTEMS MANAGEMENT

A9.1.4-1 AC INVERTER MANAGEMENT

NORMALLY, ALL AC INVERTERS AND BUSES WILL BE POWERED DURING FLIGHT. IF AN INVERTER FAILS, IT WILL BE DISCONNECTED FROM BOTH THE AC AND DC BUSES.

All nine ac inverters are utilized by orbiter equipment. The dc power to a failed inverter will be disconnected since the inverter could act as a load. Also, the output capacitor acts as a load of 2.95 amps on the other two phases of the ac bus supplying power to coupled three-phase loads (ac motors).

A9.1.4-2 AC BUS SENSORS SWITCH MANAGEMENT

TO PRECLUDE INADVERTENT AC BUS DISCONNECT, THE AC BUS SENSORS WILL BE PLACED IN THE "MONITOR" POSITION DURING ASCENT (UNTIL MM 105) AND DURING ENTRY (FROM MM 304 UNTIL WHEELS STOP). ALSO, DURING ASCENT PRIOR TO MECO, IF ANY AC PHASE BUS FAILS, OR IF A MAIN ENGINE SHUTS DOWN, OR IF AN SSME CONTROLLER LOSES REDUNDANCY, THEN ALL THREE AC BUS SENSOR SWITCHES WILL BE PLACED TO "OFF".

AC sensors are put to MONITOR during powered flight to prevent an inadvertent tripoff which would cause SSME controller auto switchover from the affected bus to a secondary SSME controller on another ac bus. During entry, the same precaution is taken to preclude a proximity sensor package problem that would set elevon control as if touchdown had already occurred. The ac sensor switches will be put to OFF so that no failure in the ac bus sensor could cause further complications.

Rule {A5.1.3-10}A, AC BUS SENSOR ELECTRONICS CONTROL (CIL) references this rule.

A9.1.4-3 AC BUS LOADING

WHEN POSSIBLE, AC BUS LOADING WILL BE SELECTED TO PROVIDE SEPARATE POWER SOURCES TO REDUNDANT EQUIPMENT AND TO BALANCE BUS LOADS.

The highest level of power redundancy should be maintained. It is advisable to maintain near equal loading on all buses in the event that, if a single FC powers two main buses, it will not be overstressed.

FLIGHT RULES

A9.1.4-4 AC LOAD MANAGEMENT DURING ASCENT

- A. ONLY THE FOLLOWING AC SWITCHABLE LOADS, WHOSE RECOVERY CANNOT BE DELAYED UNTIL POST-MECO, MAY BE RECONFIGURED PRE-MECO:
1. FREON PUMPS (IF ONLY ONE FREON LOOP AFFECTED, SWITCH WITHIN 6 MINUTES; IF BOTH FREON LOOPS AFFECTED, SWITCH ASAP)
 2. RAD BYPASS VALVES (ONLY FOR LOSS OF FES OR FREON LOOP(S) AFFECTED)
 3. RAD ISOLATION VALVES (FOR AN UNEXPLAINED LEAKING LOOP ATTEMPT ISOLATION ASAP; IF LEAK RATE CAN SUPPORT MECO AND AC CRITICAL, DELAY ACTION UNTIL POST-MECO) @J040899-2568A]
 - ~~34~~. AVIONICS BAY FANS (SWITCH WITHIN 3 MINUTES IF A POWERED GOULD TACAN IS LOCATED IN AFFECTED AV BAY)
 - ~~45~~. OMS/RCS VALVES
 - ~~56~~. APU/HYD WSB CONTROLLER (ONLY AFTER HIGH TEMP FDA ALERT)
 - ~~67~~. H₂O LOOP PUMPS (ONLY IN THE EVENT OF AVIONICS AIR TEMP FDA)
 - ~~78~~. CREW SEAT OPERATIONS (ONLY IF CONSIDERED MANDATORY BY THE CREW) @J040899-2568A]
- B. AC CIRCUIT BREAKERS WHICH HAVE OPENED WILL NOT BE RESET PRE-MECO UNLESS THE FUNCTION IS CRITICAL AND:
1. THE MCC HAS CONFIRMED THAT THE CB(S) DID NOT OPEN BECAUSE OF A SHORT, OR:
 2. THE MCC CONFIRMS THAT BOTH SSME CONTROLLERS ON THE AFFECTED BUS HAVE BEEN LOST, OR:
 3. LOSS OF THE FUNCTION IS CONSIDERED TO BE A GREATER RISK THAN LOSS OF THE TWO AFFECTED SSME CONTROLLERS.

FLIGHT RULES

- C. FOR A SHORTED OR STALLED AC LRU, WHEN RECONFIGURATION IS DELAYED UNTIL POST-MECO, THE POWER WILL BE REMOVED PRE-MECO.

THIS RULE CONTINUED ON NEXT PAGE

FLIGHT RULES

A9.1.4-4 AC LOAD MANAGEMENT DURING ASCENT (CONTINUED)

- D. AC EQUIPMENT WITH MULTIPLE POWER SOURCES WILL NOT BE RECONFIGURED TO AN ALTERNATE SOURCE PRE-MECO.
- E. IF PRE-MECO AND A SSME HAS LOST SSMEC REDUNDANCY, SWITCHING OF REDUNDANT HARDWARE ON TO A CRITICAL AC BUS WILL BE DELAYED AS LONG AS POSSIBLE.
- F. IF NEEDED, ANY UNSHORTED EQUIPMENT THAT HAS BECOME UNPOWERED MAY BE REPOWERED PRE-MECO.

Under normal circumstances, the startup transients of three-phase motors will not introduce a voltage transient on an ac bus that would affect a Space Shuttle main engine controller (SSMEC). However, switching such equipment increases the risk of causing severe voltage transients since an unknown short circuit may be present on the previously unpowered circuitry. By limiting the reconfiguration of ac loads to those absolutely required, this risk can be minimized.

Those loads that may be reconfigured prior to MECO include the Freon pumps since they provide vehicle cooling, radiator bypass valve motors to obtain radiator flow for cooling if total FES fails or to determine if there is blockage in the bypass leg of the Freon loop when Freon flow is low, avionics bay fans since they are required to provide cooling to the Gould TACAN's (an ac powered LRU that has been shown to short-circuit within 5 minutes following loss of cooling), OMS/RCS valves since they are required in malfunction cases, leak isolation or propellant dump operations, and the crew seat motors since they may be needed due to reach or visual problems. Reconfiguration of these items cannot wait until MECO.

With one Freon loop down and one good Freon loop, corrective actions can be delayed for 6 minutes (at ascent power loads) without any violation of any orbiter thermal limits (ref. RI Analysis SEH-ITA-80-055T).

However, if both Freon loops are affected, troubleshooting of the Freon loops will occur ASAP. The loss of both Freon loops is an RTLS/TAL abort. Switching of Freon pumps and moving the Rad bypass valves or RAD isolation valves may be required to determine the status of the Freon loops before an abort call can be made. Additionally, a Freon loop leak that is observable during ascent is a large leak and will require first day PLS if no action is taken. The radiator isolation valve may isolate the leak and allow mission extension to MDF. @[040899-2568A]-

THIS RULE CONTINUED ON NEXT PAGE

FLIGHT RULES

A9.1.4-4 AC LOAD MANAGEMENT DURING ASCENT (CONTINUED)

The SODB indicates the Gould TACAN's are the only avionics bay equipment that may be expected to fail because of the loss of an avionics bay fan during the powered flight time period. When the Gould TACAN fails due to the loss of cooling, the ac transient generated could cause loss of SSMEC redundancy on two SSME's. The TACAN's could be unpowered for ascent since ample time exists, even during an RTLS, for their activation before they are required. However, access to TACAN's would require an MS to unbuckle to reach the switches since they are located beyond the reach of the crew while seated. The redundant avionics bay fans are checked about 12 hours prior to launch. Therefore, switching to the redundant avionics bay fan appears to be of less risk than having a crewmember unrestrained in an attempt to turn on the TACAN's during an abort. The avionics fan will be switched within 3 minutes after loss of original fan (ref. SODB Table 34.32-1, note h).

The Enhanced Middeck Cooling modification will place cabin fans in Av Bay 3A vice the normal avionics fans. Because of the large startup AC transient associated with these type fans, the Av Bay 3A fans will not be switched, in powered flight, if the modification is in place. Vehicles with cabin fans installed in Av Bay 3A will also have Collins TACAN's which are free air cooled. Switching fans pre-MECO will not be necessary. ©[040899-2568A]

Following the loss of a water loop pump or APU/HYD WSB controller, reconfiguration can wait until post-MECO without great risk to the equipment. Should real-time data indicate that the temperatures are out of limits, then action will be taken in order to preserve the necessary equipment prior to MECO. Reconfiguring of affected ac equipment prior to MECO may be attempted since this action may reduce the risk of further problems. Temperature violations are not expected pre-MECO. Cabin fan, IMU fan, and humidity separator reconfiguration is not required until post-MECO.

If a circuit breaker has opened, it could very well be due to a short circuit. If both SSME controllers have been lost (due to the short), or if a short was not the problem, then the cb(s) may be reset if needed to regain a critical function. Resetting a cb which has opened due to a short would further expose SSME controllers (if not already lost) while the chance of a successful reset would be minimal.

AC LRU's with alternate power sources should not be reconfigured since an electrical short in the LRU will place the short on the affected ac bus; and, by switching the source power, the short will be transferred to another ac bus. During ascent, this could result in the loss of one SSME and total loss of redundancy for the two remaining SSME's.

If Pre-MECO and a SSME has lost controller redundancy, switching of redundant hardware on to a critical ac bus will be delayed as long as possible. By delaying switching to after "Press to MECO" or "Single Engine Press" (if possible), even in the unlikely event the alternate fan or pump is stalled and causes a transient on a critical bus, the orbiter could still make it to orbit with the loss of a SSME.

FLIGHT RULES

If an LRU is not shorted and was operating nominally, but somehow became deactivated, then it can be repowered pre-MECO, if it is required. Since the shutdown and startup of the LRU would be on the same ac bus, multiple SSMEC's could not be affected.

DOCUMENTATION: SODB 3.4.5.2-1.

FLIGHT RULES

A9.1.4-5 AC INVERTER THERMAL LIFE

- A. THE INVERTER/AC BUS WILL BE DISCONNECTED IMMEDIATELY IF:
1. THE AC VOLTAGE IS CONFIRMED >130, OR
 2. THE AC VOLTAGE IS <95 AS CAUSED BY A SHORT/OVERLOAD, OR
 3. BOTH MAIN ENGINE CONTROLLERS POWERED BY THAT BUS ARE NONFUNCTIONAL (POST-MECO OR MCC VERIFIED FAILED PRE-MECO) AND:
 - a. THE AC VOLTAGE IS CONFIRMED <108, OR
 - b. THE AC VOLTAGE IS CONFIRMED >123, OR
 - c. A SHORT/OVERLOAD CONDITION EXISTS.

AC equipment is only guaranteed to operate from 110 to 120 volts. If the voltage is > 123 (C&W high limit), the potential exists to damage LRU's on the bus. If the voltage is < 108 (C&W low limit), leaving the inverter connected to the bus can result in a load on the remaining two phases, or maintaining power to a short circuit if an overload exists. These risks will be accepted for a short duration of time (until MECO) providing that at least one of the affected main engine controllers is still functioning. Only the MCC can verify controller operation. If the voltage is > 130, then the main engine controllers should not be functional and damage could occur to other equipment on the bus. If the voltage is <95 and caused by a short/overload condition, then the engine controllers will probably not be functional, and leaving the inverter on line and feeding the short creates a fire hazard. This rule is consistent with the philosophy expressed in Rule {A9.1.3-4} A, MAIN BUS SHORT.

DOCUMENTATION: SODB 4.5.6.2.a, ICD-13M15000, engineering judgment.

- B. MECO THROUGH EOM LANDING WITH COOLING:
1. 7.7 (6.76) AMPS CONTINUOUS
 2. 9.6 (8.6) AMPS (130 PERCENT) 5 HOURS
 3. 11.1 (10.1) AMPS (150 PERCENT) 30 MINUTES

THIS RULE CONTINUED ON NEXT PAGE

FLIGHT RULES

A9.1.4-5 AC INVERTER THERMAL LIFE (CONTINUED)

4. 14.4 (13.4) AMPS (200 PERCENT) 2 MINUTES

POWERDOWN WILL BE PERFORMED AS REQUIRED TO MEET THE 7.7 (6.7) AMPS CONTINUOUS LOAD CRITERIA.

These values represent the output power capability of the inverters under various load conditions with nominal orbiter cooling.

DOCUMENTATION: SODB, 4.5.6.3.1.8.

C. WITHOUT COOLING:

1. 3.2 (2.3) AMPS (60 PERCENT) CONTINUOUS

2. 5.1 (4.2) AMPS (70 PERCENT) 5 HOURS

3. 6.4 (5.5) AMPS (85 PERCENT) 1.5 HOURS

4. 8.3 (7.4) AMPS (115 PERCENT) 30 MINUTES

These values represent the output power capability of the inverters under various load conditions without cooling (extrapolated from test data).

DOCUMENTATION: Westinghouse Elec. Corp., Aerospace Elec. Div., Lima, Ohio, Engineering Development Lab, Report No. LY21018, April, 1980, Test Report on 150 percent Overload and no Coolant Tests, Space Shuttle 750 VA Power Static Inverter.

NOTES: 1. AC BUS CURRENT VALUES ARE BASED ON BUS LOAD POWER FACTORS OF 0.8 LAGGING WITH COOLING AND 0.85 LAGGING WITHOUT COOLING.

The use of 0.8 power factor with cooling was to be able to give inverter output capability at a specific power factor so the values could be easily compared. The SODB gives the output capability at various loads at various power factors. The test data for inverter capability with no cooling used a power factor of 0.85.

THIS RULE CONTINUED ON NEXT PAGE

FLIGHT RULES

A9.1.4-5

AC INVERTER THERMAL LIFE (CONTINUED)

2. AC INVERTER PHASE CURRENTS WILL BE USED TO PREDICT INVERTER THERMAL LIFE. INVERTER CURRENT WILL BE CALCULATED BY VECTORIALLY SUMMING ITS AC BUS CURRENT WITH A 2.95 AMP CAPACITOR LOAD.

THE INVERTER CURRENTS WILL BE CALCULATED USING THE FOLLOWING EXPRESSION:

$$I_{INV}^2 = 8.7 + I_{BUS}^2 + 5.9 I_{BUS} \frac{PF}{|PF|} \sqrt{1 - (PF)^2}$$

WHERE: I_{INV} = INVERTER CURRENT

I_{BUS} = AC BUS CURRENT

PF = PREDICTED BUS POWER FACTOR (MINUS FOR LAGGING)

The ac current transducer is located downstream from the inverter output capacitor. Inverter thermal constraints are based on its output amperage upstream of the capacitor (no temperature readout is available). Due to the ac V-I phase shift with reactive loads, the measured amps must be vectorially summed with the output capacitor load to determine the actual inverter load. This calculation differentiates a theoretical inverter load which is covered by specifications from a bus load by a 10-microfarad capacitor located on the output of the inverter.

DOCUMENTATION: Information provided by Westinghouse Elect. Corp.

FLIGHT RULES

A9.1.4-6 LOSS OF SINGLE-PHASE AC

- A. IF ANY SINGLE-PHASE BUS IS SHORTED, IT WILL BE ISOLATED FROM BOTH THE INVERTER AND ITS THREE-PHASE AC LOADS. THE AFFECTED THREE-PHASE "GANGED" CB'S WILL BE OPENED TO ISOLATE THESE LOADS FROM THE SHORTED BUS. THE SUB-BUSES POWERED BY THESE CB'S WILL BE CONSIDERED LOST.

Single-phase shorts will be isolated from the three-phase loads so that the remaining two phases will not be loaded by the short by motor transformer coupling.

- B. IF ANY SINGLE-PHASE BUS IS LOST, BUT NOT SHORTED, ONLY THE AFFECTED SINGLE-PHASE LOADS WILL BE ISOLATED FROM THE BUS. ALL THREE-PHASE LOAD CB'S WILL REMAIN CLOSED.

Single-phase loads will be isolated from the lost ac bus so that the remaining two phases will not be loaded by motor transformer coupling.

- C. IF A SINGLE-PHASE BUS IS LOST FROM AC2 OR AC3 AND A DEACTIVATED CABIN FAN IS AFFECTED, THEN IT MUST BE DEMONSTRATED ON THE AFFECTED CABIN FAN THAT IT CAN SUCCESSFULLY START ON THE REMAINING TWO PHASES IN ORDER TO CONTINUE TO NOMINAL EOM. OTHERWISE, THE CABIN FAN IS CONSIDERED TO BE LOST.

Ground tests of the start capability of the cabin fan on two phases was marginal. Therefore, start capability on two phases should be demonstrated on orbit before continuing to nominal EOM.

- D. AFTER ALL REQUIRED BUS ISOLATION HAS BEEN PERFORMED, THREE-PHASE EQUIPMENT WILL BE ALLOWED TO OPERATE ON THE TWO REMAINING PHASES, WITH THE EXCEPTION OF THE H₂O AND FREON PUMPS WHICH WILL BE SWITCHED TO AN ALTERNATE POWER SOURCE OR PUMP.

The two-phase operation of the Freon and H₂O pumps results in loss of flow capability that is significant enough to warrant switching pumps or power sources. All other motors are capable of operating on two phases.

Rule {A9.1.7-1}, ELECTRICAL GO/NO-GO CRITERIA, references this rule.

FLIGHT RULES

A9.1.4-7 LOSS OF TWO-PHASE AC

IF TWO PHASES OF A THREE-PHASE ARRAY ARE LOST, MULTIPLE PHASE AC LOADS WILL BE DISCONNECTED SO THAT THE REMAINING SINGLE AC PHASE CAN REMAIN POWERED.

Attempted operation of three-phase equipment with only one good phase results in stall currents on the good remaining phase. The multiphase loads will be removed so that normal operation of single-phase loads can be resumed.

A9.1.4-8 AC POWER TRANSFER CABLE

A. THE AC POWER TRANSFER CABLE WILL BE USED TO REPOWER A THREE-PHASE BUS WHEN TWO OR MORE OF ITS INVERTERS ARE FAILED. ALL INVERTERS WILL BE DISCONNECTED FROM THE FAILED THREE-PHASE BUS BEFORE CONNECTING THE CABLE. CRITICAL EQUIPMENT WILL BE POWERED THROUGH THE CABLE; HOWEVER, AC CURRENT PER PHASE WILL BE LIMITED TO 3 AMPS. A THREE-PHASE AC BUS REGAINED BY USE OF THIS CABLE WILL BE CONSIDERED ACCEPTABLE FOR MDF PROVIDED CRITICAL LRU'S CAN BE POWERED.

The IFM procedure describes the concept of using an "extension cord" from a reliable ac bus utility outlet to power another ac bus through its utility outlet. A maximum of 3 amps per phase is due to the size of the utility outlet circuit breakers. This load will always include the FC pumps (coolant and H₂) and may include any other required equipment as long as the total continuous load does not exceed 3 amps. An MDF will be declared for this failure since the next worst failure (loss of the FPC bus powering the inverters used to recover the lost ac system) would result in the loss of two ac systems and the associated fuel cells. (The ac power transfer cable would be used to regain one ac system, if the second failure occurred on orbit.)

B. FOR LOSS OF TWO OF THREE PHASES ON AN AC BUS (UNSHORTED), A ONE ORBIT DELAY PRIOR TO A DEORBIT BURN WILL BE INVOKED, IF NECESSARY, TO INSTALL THE AC TRANSFER CABLE, REGAINING THE AC BUS. A 1-DAY DELAY IS ACCEPTABLE IF INSTALLATION OF THE AC TRANSFER CABLE IS REQUIRED TO MAINTAIN TWO-FC ENTRY CAPABILITY.

Loss of the ac bus causes loss of a fuel cell and some critical ac loads. It is preferable to delay to install the cable and regain the fuel cell and critical ac loads.

DOCUMENTATION: FDF, IFM Checklist, All Vehicle, AC Power Transfer Cable Installation, pg. A-3. Also, a list of possible loads to repower is in the FPC bus loss SSR's in the Orbiter Malfunction Procedures Book.

Rule {A9.1.7-1}, ELECTRICAL GO/NO-GO CRITERIA, references this rule.

FLIGHT RULES

A9.1.4-9 **MOTOR CONTROL ASSEMBLY (MCA)**

INDIVIDUAL MCA BUS POWER MAY BE CYCLED AS REQUIRED TO PROTECT A BUS FROM SHORTED MOTOR LOADS OR TO REMOVE A "FAILED ON" MOTOR LOAD FROM A BUS.

Shorts will always be isolated from the rest of the electrical power and distribution system. It also may be necessary to remove power to a failed-on motor to protect the motor for future use during the flight.

A9.1.4-10 **CAUTION AND WARNING (C&W) (CIL)**

A. PRIMARY C&W SYSTEM PARAMETERS WHICH ARE NOT OPERATIONALLY FUNCTIONING WILL BE INHIBITED TO EXTINGUISH ANNUNCIATION LIGHTS.

Primary C&W system parameters which are not operationally functioning will be inhibited to extinguish annunciation lights so that they will not mask other parameters using the same light for alarm annunciation or interfere with recognition of new malfunctions.

B. BACKUP C&W PARAMETERS WHICH GENERATE NUISANCE ALARMS WILL BE INHIBITED.

Backup C&W parameters which generate nuisance alarms will be inhibited because by definition the nuisance alarms provide no new information for system operations and distract the flight crew from other activities.

C. THE PRIMARY AND BACKUP C&W LIMIT VALUES WILL BE MAINTAINED THE SAME.

The primary C&W limits and backup C&W limits will be the same to ensure fail-safe operations in alerting the flight crew to perform necessary safing reconfiguration.

D. A FAILED PRIMARY C&W SYSTEM MAY REMAIN POWERED AND ENABLED TO RETAIN TONE CAPABILITY PROVIDED NO NUISANCE ALARMS ARE GENERATED.

A failed primary C&W system may remain powered and enabled to retain tone capability if no nuisance alarms are generated in order to provide redundancy in audio tones for the backup C&W system. Redundant alarm tones are not required when they are a nuisance and distract the flight crew from other activities.

THIS RULE CONTINUED ON NEXT PAGE

FLIGHT RULES**A9.1.4-10 CAUTION AND WARNING (C&W) (CIL) (CONTINUED)**

- E. FOLLOWING THE LOSS OF C&W POWER SUPPLY A OR B, ONE OF THE FOLLOWING ACTIONS WILL BE PERFORMED:
1. REDUNDANTLY POWER THE REMAINING C&W POWER SUPPLY SO THAT LOSS OF ANY ESSENTIAL BUS WILL TRIGGER AN AUDIBLE ALARM.
 2. DEDICATE A CREWMEMBER TO CONTINUOUSLY MONITOR CRT MESSAGES FOR LOSS OF ESS2CA DA2 AFTER LOSS OF C&W SYSTEM A OR ESS1BC DA1 AFTER LOSS OF C&W SYSTEM B (NO AUDIBLE ALARMS).
 3. PLACE AFFECTED FC IN STANDBY AFTER LOSS OF C&W SYSTEM A (FC 2) OR AFTER LOSS OF C&W SYSTEM B (FC 1).

Failure of ESS1BC DA1 (ESS2CA DA2) after loss of C&W power supply B(A) will not be aurally annunciated. The FC 1(2) coolant pump will stop, and the flight crew must, within a few minutes, shut down the fuel cell to prevent a catastrophic failure due to overheating. The flight crew must continuously monitor displays so that a failure will be detected and appropriate actions to save the orbiter can be taken. Restoration of power to a lost C&W power supply or establishment of redundant power to the remaining power supply may be accomplished by performing C&W ELECTRONICS UNIT CONTINGENCY POWER IFM procedure and will allow audible alarms if an essential bus is lost. Standby operation of the associated FC will preclude the time-critical ESS bus/coolant pump failure mode. (Ref. Rules {A9.1.1-1} B, FUEL CELL (FC) LOSS (CIL); {A2.1.3-3} A.5.b and {A2.1.3-3A.6}, SYSTEMS REDUNDANCY REQUIREMENTS.)

A9.1.4-11 HYDRAULIC CIRCULATION PUMP OPERATION

NORMALLY, A HYDRAULIC CIRC PUMP WILL NOT BE STARTED ON A MAIN BUS THAT POWERS THE PRIMARY PAYLOAD BUS WHILE SPACELAB/SPACEHAB IS ACTIVATED. AN EXCEPTION WOULD BE IF REACTION TO PREVENT LOSS OF A HYDRAULIC SYSTEM DID NOT PERMIT TIME FOR POWER RECONFIGURATION, IF REQUIRED.

The voltage ripple caused by the startup of a hydraulic circ pump is greater than the Spacelab/Spacehab interface control document (ICD) requirements. Critical orbiter systems take precedence over payload systems if those orbiter systems are in jeopardy.

Reference: Spacelab/Spacehab PIP. ©[ED]

FLIGHT RULES

CRYOGENIC LOSS/FAILURE DEFINITIONS

A9.1.5-1 O2 (H2) MANIFOLD

AN O₂ (H₂) MANIFOLD IS CONSIDERED LOST IF UNABLE TO ISOLATE A PRSD SYSTEM LEAK OF > 10 LB/HR (O₂) OR 1 LB/HR (H₂) TO THE MANIFOLD ASSOCIATED TANK(S), FUEL CELL, OR PCS SYSTEM.

The O₂ manifold leak rate at which the manifold would be considered failed was derived to cover the worst case in which a tank near residual quantities of approximately 10 percent could be required to supply the leak and two fuel cells at entry power levels. Entry power levels will require about 5 lb/hr per fuel cell or 10 lb/hr total. The flow capacity of an O₂ tank (with single heater) near 10 percent quantity is approximately 20 lb/hr. Therefore the maximum leak rate that can be tolerated on top of the required fuel cell flow is 10 lb/hr.

DOCUMENTATION: SODB figure 4.4.2-16 and engineering judgment.

The H₂ manifold leak rate at which the manifold would be considered failed was derived from a study which concluded that the isolation or reduction of an H₂ leak to less than 2 lb/hr before entry is mandatory to eliminate a possible hazardous concentration during entry/landing. Additionally, H₂ leaks less than 1 lb/hr result in nonflammable H₂ concentrations throughout entry. Therefore, 1 lb/hr leak rate was chosen to provide a margin of safety.

DOCUMENTATION: Engineering judgment.

FLIGHT RULES

A9.1.5-2 CRYO TANK

A CRYO TANK IS CONSIDERED LOST IF:

A. ALL CRYO HEATERS IN THE AFFECTED TANK ARE DEFINED AS LOST.

The addition of heat into the cryogenic reactant is the method used to extract fluid from the tank. With the loss of tank heaters, the only flow available from a tank is that corresponding to tank heat leak which is negligible compared to normal requirements. Therefore, the tank is considered lost for all practical purposes.

DOCUMENTATION: SODB, H₂ figure 4.4.1-6, 4.4.2-9 and O₂ figure 4.4.1-11, 4.4.2-17.

B. ELECTRICAL POWER DEMAND CANNOT BE SUPPORTED BY THE TANK.

If the cryo tank cannot be depended on to support normal electrical power levels, declaring it lost guards against the next tank failure for GO/NO-GO rule implementation purposes. The management philosophy that consumables will determine mission duration for a single tank loss still applies; therefore, the tank can be used to extend the mission as long as practical, but a subsequent tank failure would be considered two tanks lost for entering the GO/NO-GO matrix to determine the appropriate action. This rule is intended to cover the blocked filter and the failed closed check valve scenarios.

DOCUMENTATION: Engineering judgment.

C. CRYO TANK PRESSURE CANNOT BE MAINTAINED ABOVE THE TWO-PHASE SATURATION PRESSURE OF THE FLUID.

If the pressure goes significantly below the saturation pressure, there is a possibility that the fluid would go two-phase (under normal operating pressures the fluid is always single phase). The tank can be repressurized with the tank heaters; however, the danger is that, if the fluid is two-phase, some areas of the heater surface may be in the gaseous region and localized overtemperatures could occur that would not necessarily be indicated by the heater surface temperature. Overtemperature in the O₂ tank could result in ignition of Teflon in the tank. Overtemperature in the H₂ tank could result in damage to the tank structure.

DOCUMENTATION: SODB, paragraph 3.4.4.2, and EGIL Console Handbook, SCP 2.8.6.

Rule {A2.1.4-5}, EMERGENCY DEORBIT, references this rule.

FLIGHT RULES

A9.1.5-3 CRYO TANK ANNULUS VACUUM

A CRYO TANK ANNULUS VACUUM IS CONSIDERED LOST IF:

A. A TANK LEAK OF ANY SIZE HAS BEEN IDENTIFIED.

Leakage from the pressure vessel into the annulus vacuum will cause the burst disk to open on the girth ring of the tank assembly when the pressure difference exceeds 60 ± 25 psid. Very small leaks into the annulus resulting in total gas in the annulus of as little as 0.1 lbm H_2 or 0.7 lbm O_2 (at gas temperature of 70 deg F) will result in this pressure differential. Since the exact location of a pressure vessel leak cannot be identified, it must be assumed for worst-case purposes that the leak is from the pressure vessel into the annulus.

DOCUMENTATION: Engineering judgment.

B. EXCESSIVE HEAT LEAK INTO THE TANK HAS BEEN IDENTIFIED WHEN THE HEATERS ARE UNPOWERED.

In atmospheric flight, air entering the annulus will increase the heat transfer into the tank. In orbit, small pressure vessel leaks into the annulus, prior to the burst disk opening, will result in increased heat leak into the tank from the outer shell because of conduction through the gas in the annulus. This heat leak into the tanks may not always be readily detectable.

DOCUMENTATION: Orbiter Hazard Reassessment ORBI 281, Qualification Test Report for PRSD Vacuum Lost Test, Ball Aerospace Division (TM06,BR16425), and engineering judgment.

Rule {A9.1.6-2}G, CRYO HEATER MANAGEMENT FOR ORBIT (CIL), references this rule.

FLIGHT RULES

A9.1.5-4 CRYO HEATER

A CRYO HEATER IS CONSIDERED LOST IF:

- A. O₂/H₂ CRYO HEATER TEMPERATURE CANNOT BE MAINTAINED BELOW 350 DEG/200 DEG F (INSTRUMENTATION ERROR INCLUDED).

The O₂ heater temperature was set on the basis of the auto ignition temperature of Teflon (700 deg F) contained in the quantity probe. The 350 deg includes a 200 deg F margin and takes into account sensor lag (50 deg F), analytical and instrumentation error (50 deg F), and the delta T between the temperature sensor and the maximum point (550 deg F). The H₂ tank maximum heater temperature is 200 deg F to prevent potential damage to the tank structure. [@IED](#) 1

DOCUMENTATION: SODB, paragraph 3.4.4.2; and NASA memo, Oxygen tank heater temperature limit, 02/04/71.

Rule {A9.1.6-2F}, CRYO HEATER MANAGEMENT FOR ORBIT (CIL), references this rule.

- B. AN O₂ DELTA CURRENT SENSOR TRANSITIONS TO "TRIP" WHILE ITS HEATER IS RECEIVING POWER.

If a delta current sensor trips while a heater is receiving power, it is considered highly possible that a short had developed in the heater. The consequences of repowering a shorted heater element are so grave that it would not be considered for mission success.

DOCUMENTATION: Flight experience, Apollo 13, and engineering judgment.

- C. BOTH O₂ DELTA CURRENT SENSORS TO THE HEATER ARE LOST.

Without a delta current sensor, a heater short would be a single point catastrophic failure. This is not an acceptable risk to accomplish mission objectives.

DOCUMENTATION: Flight experience, Apollo 13, and engineering judgment.

FLIGHT RULES

A9.1.5-5 O₂ DELTA CURRENT SENSOR

AN O₂ DELTA CURRENT SENSOR IS CONSIDERED LOST IF:

- A. THE O₂ DELTA CURRENT SENSOR DOES NOT ~~INDICATE "TRIP"~~
INHIBIT THE A OR B HEATER WHEN TESTED.

If a sensor test does not ~~indicate "trip"~~ inhibit the heater when tested, it is assumed that the sensor would not function if an actual heater short were to occur. @061297-60051

DOCUMENTATION: Engineering judgment.

- B. THE O₂ DELTA CURRENT SENSOR TRANSITIONS TO "TRIP" WHEN NO POWER IS BEING APPLIED TO THE HEATER ELEMENT, AND A RESET DOES NOT REMOVE THE "TRIP" STATUS.

A "trip" due to an actual heater short cannot occur unless a heater is being powered. The inability to reset the "trip" status indicates a failed sensor.

DOCUMENTATION: Engineering judgment.

- C. THE O₂ DELTA CURRENT SENSOR LATCHING LOGIC WILL NOT REMAIN TRIPPED ONCE THE SENSOR HAS TRANSITIONED TO "TRIP".

The delta current sensor will automatically shut down the defective heater circuit in less than 5 milliseconds if a differential current of greater than 0.91 ampere is sensed, but once the sensor has tripped, the short has been removed and the sensor will allow heater reactivation. The function of the latching logic is to ensure that the heater remains disabled after it has been shut down or tripped offline. A heater element with a short that could not be automatically shut down would be a single point catastrophic failure. This is not an acceptable risk to accomplish mission objectives.

DOCUMENTATION: Engineering judgment.

FLIGHT RULES

CRYOGENIC SYSTEMS MANAGEMENT

A9.1.6-1 CRYO HEATER MANAGEMENT FOR ASCENT

- A. THE A HEATERS IN CRYO TANKS 1 AND 2 WILL BE ENABLED FOR LIFT-OFF. THE B HEATERS IN CRYO TANKS 1 AND 2 WILL BE ENABLED POST-OMS-1.

Tank heaters will be enabled for launch in an attempt to maintain system pressurization. Only one heater per tank is used to minimize power load transients. In the event of a fuel cell/main bus loss during ascent, electrical power usage is critical. Since cryo heaters are normally not required, it is desirable to lose as many cryo heaters as possible with loss of a fuel cell or main bus during ascent. Since the A heaters are more susceptible to bus failures (loss of either of two main buses causes loss of heater) than the B heaters (requires loss of particular main bus to lose heater), the A heaters will be used for launch.

DOCUMENTATION: Engineering judgment.

- B. SHOULD AN RTLS BE REQUIRED FOR A CABIN LEAK, BOTH HEATERS IN CRYO O₂ TANKS 1 AND 2 SHOULD BE ACTIVATED.

In an RTLS case, the O₂ tanks have to supply flow to both the LES and fuel cell demand. Since the LES's are used through touchdown, all heaters in O₂ tanks 1 and 2 are activated to assure adequate flow capability in this circumstance. (Refer to Rule {A17.1.5-1A}, CABIN PRESSURE INTEGRITY.)

A9.1.6-2 CRYO HEATER MANAGEMENT FOR ORBIT (CIL)

- A. CRYO HEATER AND CONTROLLER OPERATION, IN ALL TANKS, WILL BE VERIFIED AS SOON AS PRACTICAL, BASED UPON BALLAST/CG REQUIREMENTS AND STANDARD CRYOGENIC MANAGEMENT PLAN.
@[071494-1653A]

A system health check on all tanks is required to determine flight duration and to formulate any off-nominal cryo management plan. Should a cryo controller be discovered to be failed, and AUTO cryo heater control capability be lost in a tank, MANUAL heater operations would be required. This may place constraints on crew activities. Therefore, it is desirable to discover controller failures early in the mission when latitude is available for timeline replanning. There is no safety of flight requirement to check out cryo controllers. Normally, Orbiter Tank Sets 1 - 5 will be checked out during the first 24 hours of the flight. Heaters in the EDO Tank Sets will be enabled per the cryo management plan. @[071494-1653A]

DOCUMENTATION: Engineering judgment and flight data.

THIS RULE CONTINUED ON NEXT PAGE

FLIGHT RULES

A9.1.6-2 CRYO HEATER MANAGEMENT FOR ORBIT (CIL) (CONTINUED)

- B. A DELTA CURRENT SENSOR CHECK WILL BE PERFORMED ~~DAILY~~ONCE PER FLIGHT EXCEPT IN A TANK WHERE A REAL CURRENT SENSOR TRIP (HEATER SHORT) HAD OCCURRED. IF A SENSOR FAILS, A SENSOR CHECK WILL BE PERFORMED ON THE REDUNDANT SENSOR EACH DAY THAT THE AFFECTED HEATERS ARE USED. @J061297-6005]

The purpose of the delta current sensors is to protect against heater shorts internal to the tank. The delta current sensors are tested to ensure that a trip and heater inhibit will occur if a heater is shorted. If the sensors fail the test, the affected heater(s) will not be used. @J061297-6005]

Flight Rule {A9.1.6-5A}, O₂ DELTA CURRENT SENSOR, states that a delta current sensor that had transitioned to "trip" while its associated heater is receiving power will not be reset, ensuring that the heater will not be operated. If the remaining heater in that tank is required for use, it will not be possible to test and reset the delta current sensor in the operating heater without also resetting the tripped sensor (one switch tests and resets all delta current sensors in a tank). Therefore, no current sensor tests will be conducted in that tank.

DOCUMENTATION: Engineering judgment.

- C. IF AUTO CRYO HEATER CONTROL IS LOST, THE HEATERS IN THE AFFECTED TANK OR TANK SET WILL BE MANUALLY CYCLED DURING CREW AWAKE PERIODS. TANK QUANTITY BALANCING WILL BE MAINTAINED.

If auto heater control is lost, the crew must manually cycle the heaters in order to use the tank. The management plan is followed in order to balance quantities in the tanks and to minimize the impact of a single failure on consumables and mission duration.

DOCUMENTATION: Engineering judgment.

- D. A CRYO HEATER THAT IS DEFINED AS LOST WILL BE DEACTIVATED BY PLACING ITS CORRESPONDING SWITCH IN THE "OFF" POSITION. IF POSSIBLE, CRYO MANAGEMENT WILL BE MODIFIED TO EXPEDITE DEPLETION OF THE AFFECTED TANK. THE EXPEDITED TANK DEPLETION WILL BE TERMINATED WHEN THE NOMINAL MISSION DURATION PLUS TWO EXTENSION DAYS CAN BE ACCOMPLISHED IF THE REMAINING HEATER FAILS (LOSS OF TANK). IN ANY CASE, THE TANK WILL NOT BE DEPLETED PAST THE FOLLOWING POINTS:
1. FOR TANK 1 AND 2: MINIMUM QUANTITY TO GUARANTEE USAGE TO SUPPORT ITS ASSOCIATED FC/MN BUS FOR A NEXT PLS IN THE EVENT THAT ITS MANIFOLD BECOMES ISOLATED.

FLIGHT RULES

THIS RULE CONTINUED ON NEXT PAGE

FLIGHT RULES

A9.1.6-2 CRYO HEATER MANAGEMENT FOR ORBIT (CIL)
(CONTINUED)

2. MINIMUM QUANTITY WHICH WILL ALLOW CLOSURE OF ONE MANIFOLD VALVE FOR EACH SLEEP PERIOD FOR THE NOMINAL MISSION DURATION PLUS TWO EXTENSION DAYS, IF REQUIRED. IF TANK 1 OR 2 IS THE AFFECTED TANK, ITS ASSOCIATED MANIFOLD VALVE WILL NOT BE CLOSED FOR SLEEP PERIODS, IF POSSIBLE, TO PROTECT AGAINST A FAILED MANIFOLD VALVE.

The reference to the switch position is made so an O₂ delta current sensor "trip" will not be considered as a way of heater deactivation without further action. If the failure occurs in tank 1 or 2, the affected tank will be used until the total quantity remaining in the unaffected tanks will support the nominal mission duration plus two extension days. However, tank 1 or 2 will not be depleted because the next worst failure (center manifold leak) could result in loss of two fuel cells. If the failure occurs in any one of tanks 3 through 9, the same next failure would result in loss of one fuel cell. If the failure occurs in tanks 3 through 9, the affected tank will be immediately depleted. Also, sufficient quantity must remain in the tank so that a manifold valve may be closed during crew sleep. However, if other tanks can be used (e.g., modified cryo management), then the sufficient quantity requirement is met by the other tanks.

- E. AN O₂ CRYO HEATER WITH ONE OF TWO DELTA CURRENT SENSORS LOST WILL BE DEACTIVATED BY PLACING ITS CORRESPONDING SWITCH IN THE "OFF" POSITION, UNLESS DOING SO WOULD RESULT IN LOSS OF THE TANK.

If mission success can be performed without the use of the affected heater, then it is an unnecessary risk to continue to operate that heater with loss of the current sensor redundancy. With loss of a current sensor on each string in a tank (failure of the cb powering both current sensors), normal operation will continue since there is one current sensor left on each string and this sensor will be verified operational at least once a day (ref. paragraph B). The old ideology of depleting the tank is considered to be an unnecessary increase of risk, due to operation of the heaters more often than normal.

Rule {A9.1.6-5}, O₂ DELTA CURRENT SENSOR, references this rule.

THIS RULE CONTINUED ON NEXT PAGE

FLIGHT RULES

A9.1.6-2 **CRYO HEATER MANAGEMENT FOR ORBIT (CIL)**
(CONTINUED)

F. A CRYO HEATER THAT CONTINUES TO BE POWERED AFTER PLACING ITS CORRESPONDING SWITCH IN THE "OFF" POSITION WILL BE DEACTIVATED BY PERFORMING THE FOLLOWING: (CIL)

1. AN ATTEMPT WILL BE MADE TO DEACTIVATE AN O₂ HEATER BY PERFORMING A CURRENT LEVEL DETECTOR TEST. IF REQUIRED, THE HEATER CAN STILL BE USED MANUALLY BY OPERATION OF THE CURRENT LEVEL DETECTOR SWITCH (TEST/RESET FOR HEATER OFF/ON).

An O₂ heater that fails on for more than 9 hours after depletion of the tank to residual levels will risk exceeding the thermal limits of the tank. Prior to this though, the heater surface temperature will exceed the flight rule limit of 350 deg F for O₂ (ref. Rule {A9.1.5-4A}, CRYO HEATER).

DOCUMENTATION: FMEA/CIL No. M5-6MB-2029M1-2.

2. IF REQUIRED, AN H₂ HEATER OR AN O₂ HEATER WILL BE DEACTIVATED BY DROPPING THE MAIN BUS THAT POWERS THE HEATER. THE MAIN BUS MAY BE BROUGHT UP FOR ENTRY IF THE TANK QUANTITY ALLOWS CONTINUOUS HEATER OPERATION WITHOUT VIOLATING HEATER TEMPERATURE LIMITS.

If the use of the current level detector function for O₂ or any potential IFM for either O₂ or H₂ is not successful, dropping a main bus is the only option.

An H₂ heater that fails on for more than 35 hours after depletion of the tank to residual levels will risk exceeding the thermal limits of the tank. Prior to this, however, the heater surface temperature will exceed the flight rule limits of 350 deg/200 deg F for O₂/H₂ (ref. Rule {A9.1.5-4A}, CRYO HEATER). Based on quantity and fuel cell flowrate, the heater could pressurize the tank and manifold until relieved by the overboard relief valve. Cracking of the relief valve could cause ingestion of cryo into the midbody, which is a hazardous condition. However, the alternative is performing entry with two main buses which could put the orbiter/crew at greater risk.

DOCUMENTATION: Engineering judgment, FMEA/CIL No. M5-6MB-2027M1-2, and SODB paragraph 4.4.2.6.2/4.4.2.7.2.

THIS RULE CONTINUED ON NEXT PAGE

FLIGHT RULES

A9.1.6-2 CRYO HEATER MANAGEMENT FOR ORBIT (CIL) (CONTINUED)

G. AN O₂ (H₂) TANK THAT HAS LOST ITS ANNULUS VACUUM WILL BE DEPLETED PRIOR TO ENTRY.

Loss of annulus vacuum in a PRSD O₂ (H₂) (ref. Rule {A9.1.5-3}, CRYO TANK ANNULUS VACUUM) tank would result in overboard venting of O₂ (H₂) through the relief ports near compartment vent doors. In atmospheric flight, atmosphere will enter the annulus and increase the heat transfer to the tank. An uncontrollable pressure rise would result until the overboard relief opens. Ingestion of vented H₂ through open vent doors may result in the accumulation of a flammable/explosive environment in orbiter compartments during entry. The possible H₂ flowrates, as determined by testing, vary from 120 lb/hr (100 percent quantity) to 240 lb/hr (40 percent quantity) to 2.5 lb/hr (10 percent quantity). Depletion of the affected H₂ tank will reduce the H₂ available to be vented and minimize venting flowrates. If the relief valve is opened during entry due to an O₂ tank vacuum loss, verification of that valve will have to be performed during ground turnaround. Depletion of the affected O₂ tank prior to entry will reduce the chance of opening the relief valve.

DOCUMENTATION: Orbiter Hazard Reassessment ORBI 281, Qualification Test Report for PRSD Vacuum Lost Test, Ball Aerospace Systems Division (TM06, BR16425), FMEA/CIL No. 04-1B-TK010-2, 04-1B-TK0 30-2.

A9.1.6-3 CRYO TANK HEATER TEMPERATURE MANAGEMENT

O₂/H₂ CRYO HEATERS WILL BE MANAGED TO PRECLUDE HEATER TEMPERATURES EXCEEDING 350 DEG/200 DEG F (INSTRUMENTATION ERROR INCLUDED).

The O₂ heater temperature was set on the basis of the auto ignition temperature of Teflon (700 deg F) (in the quantity gauging probe). The 350 deg includes a 200 deg F margin and takes into account sensor lag (50 deg F), analytical and instrumentation error (50 deg F), and the delta T between the temperature sensor and the maximum point (50 deg F). The H₂ tank maximum heater temperature is 200 deg F to prevent potential damage to the tank structure.

DOCUMENTATION: SODB, paragraph 3.4.4.2, and NASA memo, Oxygen Tank Heater Temperature Limit, 02/04/71.

A9.1.6-4 CRYO HEATERS DEACTIVATION

AT APPROXIMATELY 50 (53) PERCENT QUANTITY, ONE SET OF O₂ CRYO HEATERS WILL BE DEACTIVATED IN THE AFFECTED TANK.

With both heater sets activated in an O₂ tank, the heater surface temperature will begin to increase exponentially at lower quantities and could exceed 350 deg F. Therefore, below about 50 percent quantity, one-half of the heaters in each tank are disabled to minimize heater temperature.

FLIGHT RULES

DOCUMENTATION: SODB, 3.1.4.2-7, and flight data.

A9.1.6-5 **O2 DELTA CURRENT SENSOR**

- A. IF AN O₂ DELTA CURRENT SENSOR TRANSITIONS TO "TRIP" WHILE ITS HEATER IS RECEIVING POWER, IT WILL NOT BE RESET AND THE HEATER WILL NOT BE USED UNLESS REQUIRED FOR PREVENTION OF LOSS OF CREW AND VEHICLE.

THE REDUNDANT HEATER IN THE TANK WILL BE UNPOWERED AND USED ONLY TO: COMPLETE THE NOMINAL MISSION DURATION, PROVIDE AUTO HEATER CONTROL WHEN THE MANIFOLD VALVE(S) CLOSES, OR ALLOW USE OF TANKS 1 AND 2 FOR ENTRY.

The purpose of the heater delta current sensors is to provide automatic protection against O₂ tank internal electrical shorts that could cause explosions. In the event of a sensor trip, a reset of the sensor will not be attempted and the heater will be deactivated for safety. A reset and heater use would be allowed if the vehicle encountered extreme circumstances.

The unaffected heater in the tank will be unpowered because, although it is not considered likely, a short on one of two heater elements in an O₂ heater assembly could potentially damage an adjacent heater. It is prudent to unpower all heaters which could be affected if loss of the tank does not impact the mission duration. The unaffected heater may also be used to allow manifold valves to be closed during crew sleep and for entry, if required.

DOCUMENTATION: Flight experience and Apollo 13.

- B. RESET OF A TRIPPED DELTA CURRENT SENSOR ON AN UNPOWERED CIRCUIT CAN BE PERFORMED. THE ASSOCIATED HEATER WILL BE LEFT OFF UNLESS REQUIRED TO PREVENT LOSS OF THE TANK. IF THE HEATER MUST BE POWERED, THE SUSPECT SENSOR WILL BE UNPOWERED.

Two reasons exist for the reset: to allow determination of failure status (hard fail or inadvertent trip); and performing the daily sensor test (no reset would lock out rest of tank). It is undesirable to use a heater string with a failed sensor (see Rule {A9.1.6-2E}, CRYO HEATER MANAGEMENT FOR ORBIT (CIL)). Loss of the tank is considered to be a greater impact than operation of a heater string with only one delta current sensor.

DOCUMENTATION: Engineering judgment.

FLIGHT RULES

A9.1.6-6

CRYO O2/H2 TANK QUANTITY BALANCING

TANK MANAGEMENT WILL BE PERFORMED IN A MANNER WHICH WOULD MINIMIZE THE IMPACT OF A TANK OR MANIFOLD LOSS.

- A. FOR THREE TANK SET MISSIONS, TANK HEATERS AND MANIFOLD VALVES WILL BE CONFIGURED DURING THE PRE/POSTSLEEP PERIODS TO MAINTAIN QUANTITY BALANCE AMONG ALL TANKS. @[082593-1532]
- B. FOR MISSIONS WITH FOUR OR MORE TANK SETS, ONE TANK IN THE CENTER MANIFOLD (PREFERABLY TANK 3) WILL BE HELD IN RESERVE, AND THE ADDITIONAL CENTER MANIFOLD TANKS (TANKS 4, 5, AND 6-9) WILL BE DEPLETED AS SOON AS PRACTICAL.
 - 1. FOR OV-102 WHERE TANK 5 IS PRESENT, TANKS 4 AND 5 WILL BE DEPLETED FIRST, FOLLOWED BY EQUAL DEPLETION OF ANY EDO TANKS (6-9).
 - 2. FOR OV-105, OR OV-102 WITHOUT TANK 5, THE ADDITIONAL CENTER MANIFOLD TANKS WILL BE MANAGED TO PROVIDE QUANTITY BALANCE AMONG THEMSELVES AS THEY ARE DEPLETED.
- C. FOR FORWARD CG PROBLEMS PREDICTED DURING NEOM OR EARLY ENTRY, CONSIDERATION WILL BE GIVEN TO THE FOLLOWING:
 - 1. FOR MISSIONS WITH ADDITIONAL MARGIN, CONSIDERATION WILL BE GIVEN TO LEAVING CRYO IN THE CENTER MANIFOLD TANKS (4-9) AS OPPOSED TO DEPLETING THE TANKS. THE AMOUNT AVAILABLE TO REMAIN IN THE TANKS (4-9) IS THE DIFFERENCE BETWEEN THE CURRENT TOTAL QUANTITY MINUS THE MISSION REQUIREMENTS AND REDLINE QUANTITIES. THIS DIFFERENCE SHOULD BE THE CURRENT MARGIN AVAILABLE.

THIS RULE CONTINUED ON NEXT PAGE

FLIGHT RULES

A9.1.6-6 CRYO O₂/H₂ TANK QUANTITY BALANCING (CONTINUED)

2. FOR MISSIONS WITHOUT MARGIN, TANKS 1, 2, AND 3 WILL BE USED AS NECESSARY, EARLIER THAN NORMALLY PLANNED, IN COMBINATION WITH THE CENTER MANIFOLD TANKS TO MAINTAIN THE REQUIRED CG. MINIMUM TANK QUANTITY AS DEFINED IN RULE A9.1.6-2D.1&2, CRYO HEATER MANAGEMENT FOR ORBIT (CIL), WILL NOT BE VIOLATED.

When flying with four or more tank sets, a manifold leak could cause loss of all tanks in the center manifold (as many as seven tanks). Depletion of these tanks first minimizes the time exposure where a large number of tanks could be lost. While depleting these tanks, their quantity will be balanced to minimize the impact of a single tank loss. The exception to this philosophy is OV-102, where a five-tank configuration leaves O₂ tanks 4/5 with single heaters, and H₂ tanks 4/5 with a common check valve. This makes it desirable to deplete these tanks, followed by equal depletion of any EDO tanks. Tank 3 is the preferred center manifold tank to hold in reserve since its switches are accessible during entry.

For the forward CG missions, the mission margin may be used to adjust the CG. This will be accomplished by leaving the margin in the center manifold tanks, which are normally depleted. Tanks 1 and 2 will be held in reserve for entry. For extension requirements, if the margin is required, the quantity reserved in the center tanks will be used and the tanks will be depleted. A cryo management plan which allows quantity balancing between the forward cryo tanks and the center manifold tanks will alleviate the necessity to carry additional ballast to control forward CG.

DOCUMENTATION: Engineering judgment.

Rule {A9.1.6-12}, EDO PALLET MANAGEMENT references this rule.

FLIGHT RULES

A9.1.6-7 POWER REACTANT STORAGE AND DISTRIBUTION (PRSD) H2 AND O2 REDLINE DETERMINATION

THE REDLINE (AMOUNT CONSIDERED UNAVAILABLE FOR NORMAL MISSION OPERATIONS) CONSISTS OF:

- A. TANK RESIDUALS ($H_2 = 4$ PERCENT IN EACH OF TWO TANKS, 2.5 PERCENT IN REMAINING H_2 TANKS, $O_2 = 6.5$ PERCENT IN ALL TANKS).
- B. MEASUREMENT ERROR RSS'ED FOR THE NUMBER OF TANKS. INDIVIDUAL TANK ERROR IS 2.6 PERCENT.
- C. A 2-DAY MISSION EXTENSION PAST THE PLANNED LANDING. THE ON-ORBIT POWER LEVEL DURING THESE 2 DAYS WILL BE BASED ON A PRIORITY POWERDOWN GROUP C CONFIGURATION (REF. RULE {A2.1.3-7}, CONSUMABLES MANAGEMENT), PLUS ANY PAYLOAD SURVIVAL POWER. ONE DEORBIT PREP (IN ADDITION TO THE NORMAL EOM DEORBIT) WILL BE BUDGETED DURING THESE 2 DAYS.

The 2.5 percent and 6.5 percent numbers are the minimum quantities guaranteed to be obtainable prior to reaching maximum tank heater temperature limits. The 4 percent requirement in two H_2 tanks protect for entry fuel cell flow demands. This assumes dual heaters in each of two tanks (400 watts total) which yields a flow capacity of $400 \times 3.41/750 = 1.8$ lb/hr, or approximately 20 kW. 750 is the approximate dQ/dM for the 4 percent density fluid at 200 psia.

DOCUMENTATION: Flight Design Level B Groundrules and Constraints (NSTS 21075); SODB 3.4.4.2, 4.4.2, Table 4.4.2-6; Rockwell Internal Letter #287-100-91-MMS-019; and NBS Technical Note 617.

A9.1.6-8 CRYO O2 AND H2 PRESSURE MANAGEMENT

CRYO O_2 AND H_2 PRESSURES WILL BE MANAGED ACCORDING TO THE FOLLOWING CONSTRAINTS:

- A. MANIFOLD PRESSURE UPPER LIMIT OF 950 (890) PSIA FOR O_2 AND 270 (250) PSIA FOR H_2 .

Maximum absolute pressure should be such that the manifold relief valves do not crack. If the manifold relief valves open in flight, a retest is required before the next flight. This is not normally a planned test. Crack pressures are 975 psig for oxygen and 290 psig for hydrogen. The recommended maximum operating pressures are chosen to allow some margin for pressure overshoot and transducer error.

DOCUMENTATION: Engineering judgment and SODB 4.4.2.

FLIGHT RULES

THIS RULE CONTINUED ON NEXT PAGE

FLIGHT RULES

A9.1.6-8 CRYO O2 AND H2 PRESSURE MANAGEMENT (CONTINUED)

- B. PEAK TO PEAK PRESSURE EXCURSIONS SHALL NOT EXCEED 375 PSI FOR OXYGEN AND 150 PSI FOR HYDROGEN.

Pressure excursions of greater than these values represent a structural pressure cycle on the tank. The tanks are designed to accommodate a lifetime total of 300 such pressure cycles. With a total lifetime requirement of 100 flights, only three structural cycles can be experienced per flight. One cycle is used during initial loading and pressurization. The other two cycles per flight are intended for any required ground testing or checkout.

DOCUMENTATION: SODB 3.4.4.2.9.

- C. OPERATION OF THE CRYO TANK HEATERS IN A TWO-PHASE FLUID WILL BE AVOIDED.
1. FOR MANUAL HEATER OPERATIONS, THE TANK PRESSURE WILL BE MAINTAINED ABOVE THE O₂/H₂ CRITICAL PRESSURES OF 731.4/187.5 PSIA.

Flight data from STS-51D shows that a two-phase condition existed in a tank during manual operation of the heaters. The expected condition of the fluid in the tank, based on quantity and pressure measurements, indicated a single-phase condition. This situation possibly existed because the heaters boiled the liquid around the elements faster than the pressure rise could keep the fluid liquefied. The danger of this is that some areas of the heater surface may be in the gaseous region and localized overtemperature could occur that would not necessarily be indicated by the heater temperature transducer. For this reason, operating heaters in this condition for long periods of time is unacceptable. Overtemperature in the O₂ tank could result in ignition of Teflon in the tank. Overtemperature in the H₂ tank could result in structural tank damage. Maintaining super-critical pressurization ensures that the fluid is single-phase at any temperature or density.

DOCUMENTATION: SODB, paragraph 3.4.4.2, and flight data.

2. FOR SITUATIONS IN WHICH THE TANK PRESSURE GOES BELOW THE CRITICAL PRESSURE BUT IS STILL ABOVE THE TWO-PHASE SATURATION PRESSURE, HEATERS MAY BE USED (DUAL HEATERS ARE PREFERRED) TO RAISE THE PRESSURE BACK ABOVE THE CRITICAL PRESSURE.

A two-phase condition may still exist depending on the degree of stratification in the tank. Dual heater operation will increase the pressure of the tank at a faster rate and lessen the possibility of creating a two-phase condition. This was evident from the flight data of STS-51D. Initially, when operating manual heaters, dual heaters were used and no phase change was observed. Later in the flight, single heaters were used and the pressure plateaued at the critical pressure of the fluid. Once the phase change was complete, the pressure continued to rise at a slower rate than before.

DOCUMENTATION: Engineering judgment and flight data.

FLIGHT RULES

THIS RULE CONTINUED ON NEXT PAGE

FLIGHT RULES

A9.1.6-8 CRYO O2 AND H2 PRESSURE MANAGEMENT (CONTINUED)

3. IF THE TANK PRESSURE FALLS BELOW THE TWO-PHASE SATURATION PRESSURE, THE HEATERS WILL BE DISABLED UNTIL NORMAL HEAT TRANSFER INTO THE TANK RAISES THE PRESSURE ABOVE THE TWO-PHASE SATURATION PRESSURE. THE HEATERS MAY BE OPERATED ONLY IN A CONTINGENCY SITUATION.

When the pressure falls below the two-phase saturation pressure, two-phase fluid is located throughout the tank. The amount could be considerably more than the situation created in paragraph 2. The reason for the deactivation is the same as paragraph 2, except that greater risk is thought to be involved.

DOCUMENTATION: Engineering judgment.

A9.1.6-9 CRYO O2/H2 MANIFOLD VALVES

MANIFOLD VALVE CONFIGURATION WILL BE MANAGED AS FOLLOWS:

- A. AT LEAST ONE MANIFOLD VALVE (PER SYSTEM) WILL REMAIN OPEN, EXCEPT DURING ISOLATION PROCEDURES FOR LEAKS EXCEEDING THE CURRENTLY CONFIGURED TANK HEATER FLOW CAPACITY. FOR THESE MAJOR LEAKS, BOTH MANIFOLD VALVES WILL BE CLOSED. IF NECESSARY, THE REACTANT VALVES ON THE AFFECTED FUEL CELL WILL BE CLOSED TO TROUBLESHOOT THE LEAK. A MANIFOLD VALVE WILL BE REOPENED AS SOON AS POSSIBLE ONCE MANIFOLD INTEGRITY IS RESTORED OR VERIFIED.

The PRSD system was designed without a relief valve in the crossover manifold. Closure of both manifold valves induces a potential hazard if reactant flow to fuel cell 3 is stopped (e.g., reactant valve fails closed). This is due to pressure buildup from environmental heat flow into a dense fluid contained within a fixed volume. An open manifold valve will provide relief through its associated hardware.

It is not considered acceptable to induce this potential hazard with a normal manifold valve configuration. However, in the event of a major system leak, it is desirable to isolate as many fuel cells from the leak as quickly as possible. If the leak is in manifold 1 or 2, no risk is induced by closure of the associated fuel cell reactant valves. If the leak is in the crossover manifold, then closure of the fuel cell 3 reactant valves for a short time period is considered to be a smaller risk than exposing a second fuel cell to the leak, or performing an unorthodox fuel cell shutdown procedure. Analytical and test data indicate that more than 1 minute could elapse before the pressure in the closed manifold reaches the advertised PRSD component burst pressure. Manifold valve testing at JSC indicated that the valves do relieve overpressures. However, relief pressure was in excess of the advertised manifold valve and check valve burst.

FLIGHT RULES

THIS RULE CONTINUED ON NEXT PAGE

FLIGHT RULES

A9.1.6-9 CRYO O2/H2 MANIFOLD VALVES (CONTINUED)

B. ASCENT/ENTRY: ALL MANIFOLD VALVES WILL NORMALLY BE OPEN.

The risk of pressure buildup is not considered to be an acceptable trade-off for protecting (by closing both manifold valves) against a major PRSD system leak. The crew response time to the leak is considered to be roughly the same as the response time required for the overpressure concern (30 to 60 seconds). Since closure of any manifold valve can result in loss of a fuel cell due to a tank leak, both valves open is considered to be the best configuration.

C. ORBIT: ONE MANIFOLD VALVE PER SYSTEM WILL NORMALLY BE CLOSED FOR CREW SLEEP PERIODS (SINGLE SHIFT OPS).

During sleep, a major PRSD system leak could cause loss of fuel cell pressurization before the crew could respond. Closure of one valve will protect at least one fuel cell, while not inducing a safety hazard. The vehicle can be safed and reconfigured on orbit starting with a single main bus.

DOCUMENTATION: Rockwell informal desktop analysis on tank pressure blowdown, SODB volume I, tables 4.4.1-2, 4.4.1-3, and 4.4.1-5; and engineering judgment.

FLIGHT RULES

A9.1.6-10 CRYO SYSTEM LEAKS (CIL)

THE PRSD SYSTEM WILL BE MANAGED AS FOLLOWS FOR SYSTEM LEAKS:

A. ASCENT (PRE-MECO) - ISOLATION PROCEDURES WILL BE INITIATED IF A LEAK CAUSES THE PRESSURE TO DECAY BELOW THE HEATER CONTROL RANGE. THE PRSD SYSTEM WILL BE CONFIGURED TO MAINTAIN FULL CELL POWER OUTPUT BY:

1. CLOSING BOTH MANIFOLD VALVES.
2. ACTIVATING ALL TANK HEATERS IN THE LEAKING LEG.
3. CLOSING THE AFFECTED PCS O₂ SUPPLY VALVE (IF AN O₂ LEAK).

By the time that leak isolation procedures could be accomplished, the vehicle is no longer in atmospheric flight. Therefore, feeding the leak only amounts to a loss of consumables and is not a flammability concern. The above actions are considered to be the best compromise to prevent loss of pressurization to two fuel cells, while still trying to maintain pressure to the fuel cell in the leaking leg.

B. ENTRY (POST-DEORBIT TIG) - ISOLATION PROCEDURES WILL BE INITIATED IF A LEAK CAUSES THE PRESSURE TO DECAY BELOW THE HEATER CONTROL RANGE. FOR H₂ LEAKS WHERE NO FUEL CELLS HAVE PREVIOUSLY FAILED, THE PRSD SYSTEM WILL BE CONFIGURED TO ISOLATE OR REDUCE THE LEAK RATE BY:

1. CLOSING BOTH MANIFOLD VALVES.
2. USING ONLY THE STANDARD HEATER CONFIGURATION IN THE LEAKING LEG TO MAINTAIN PRESSURE.
3. SHUTTING DOWN THE AFFECTED FUEL CELL.

FOR O₂ LEAKS OR FOR H₂ LEAKS WHERE ONE FUEL CELL HAS PREVIOUSLY FAILED, THE PRSD SYSTEM WILL BE CONFIGURED TO MAINTAIN FUEL CELL POWER OUTPUT IN ACCORDANCE WITH THE ASCENT GROUND RULES.

FLIGHT RULES

Since a hydrogen leak during entry can result in fire or explosion, it is considered less of a risk to shut down the first fuel cell than to attempt hydrogen leak isolation. Consequently, extra heat will not be used in the leaking leg (as done for ascent) to overpower the leak. However, after TIG, if isolation of the leak requires a fuel cell shutdown leaving the orbiter with only one fuel cell, then the leak will be allowed to continue and extra heaters activated. This is because the risk of recovering from the loss of one main bus and further powerdown (for loss of the second fuel cell) is considered greater than the chance of fire or explosion in the midbody.

THIS RULE CONTINUED ON NEXT PAGE

FLIGHT RULES

A9.1.6-10 CRYO SYSTEM LEAKS (CIL) (CONTINUED)

Increased oxygen concentrations from leaks are not considered a significant enough risk to warrant fuel cell shutdown to attempt leak isolation.

DOCUMENTATION: Engineering judgment and FMEA/CIL 04-1B-A01FSH-1/FSO-1.

C. ORBIT (MECO TO DEORBIT TIG):

1. TANK LEAKS - CONSUMPTION OUT OF THE LEAKING TANK WILL BE MAXIMIZED. THE CONFIGURATION OPTIONS ARE CONTINGENT ON HEATER FLOW CAPACITY (FUNCTION OF TANK QUANTITY) AND THE SIZE OF THE LEAK. IN ORDER OF PREFERENCE, THEY ARE:
 - a. DEACTIVATE ALL OTHER TANK HEATERS (LEAVE TANKS 1 AND 2 ACTIVE IF LEAK IS IN TANK 3/4/5) AND FEED ALL FUEL CELLS FROM THE LEAKING TANK. IF NECESSARY, DEORBIT WILL BE DELAYED IN ORDER TO DEplete A LEAKING H₂ TANK (FOR ANY SIZE LEAK). MANUAL HEATERS CAN BE USED TO CRACK THE TANK RELIEF VALVE IF NECESSARY TO EXPEDITE DEPLETION FOR A DEORBIT OPPORTUNITY.
 - b. FOR A TANK 1 OR 2 LEAK, IF SUPERCRITICAL PRESSURE CANNOT BE MAINTAINED WITH OPTION A, ISOLATE TANK TO ITS MANIFOLD AND FEED ITS ASSOCIATED FUEL CELL.
 - c. IF SUPERCRITICAL PRESSURE CANNOT BE MAINTAINED WITH OPTIONS A OR B, DEACTIVATE THE TANK HEATERS AND ALLOW THE PRESSURE TO BLEED DOWN. THIS MUST BE PERFORMED PRIOR TO ENTRY. IF INSUFFICIENT TIME EXISTS PRIOR TO DEORBIT TIG TO REDUCE AN H₂ LEAK TO < 1 LB/HR, THEN ENTRY WILL BE DELAYED IF ADEQUATE CONSUMABLES ARE AVAILABLE.

Maximizing consumption from the leaking tank will minimize the amount of consumables lost due to the leak. H₂ leaks > 1 lb/hr create flammable concentrations in the midbody during portions of entry and are considered to be of more risk than delaying entry. Depleting the tank and allowing its pressure to bleed down can aid in minimizing the leak rate and flammability concern during entry. If the leak rate/heater flow capacity will allow depletion, then deorbit can be waived off, if required, for any size leak. This is because the smallest of leaks can fill the vacuum annulus, pop the burst disk, and allow convective heat transfer during entry to cause extremely high venting overboard (200-300 lb). It is possible that the vented H₂ could be ingested into the midbody through the vents, creating a flammable condition.

FLIGHT RULES

THIS RULE CONTINUED ON NEXT PAGE

FLIGHT RULES

A9.1.6-10 CRYO SYSTEM LEAKS (CIL) (CONTINUED)

DOCUMENTATION: Engineering judgment, FMEA/CIL 04-1B-A01FSH-1/FSO-1, and JSC Structures and Mechanics Division informal analysis.

Rule {A2.1.6-1}, CONTINGENCY ACTION SUMMARY, references this rule.

2. MANIFOLD OR FUEL CELL LEAKS:

- a. ORBIT RECONFIGURATION - AT LEAST ONE GOOD MANIFOLD/ FUEL CELL WILL BE PROTECTED FROM THE LEAK BY CLOSURE OF A MANIFOLD VALVE OR THE LEAKING FUEL CELL REACTANT VALVES. FOR MANIFOLD LEAKS, THE ASSOCIATED TANK(S) WILL BE DEPLETED AS SOON AS PRACTICAL. IF ADEQUATE CONSUMABLES ARE NOT AVAILABLE TO FEED THE LEAK FOR AN MDF + 24 HOURS (PLS + 24 HOURS IF ONE FUEL CELL HAS PREVIOUSLY FAILED), OR IF SUPER-CRITICAL PRESSURIZATION CANNOT BE MAINTAINED, THEN THE LEAK WILL BE ISOLATED (REQUIRING FUEL CELL SHUTDOWN).

- b. ENTRY RECONFIGURATION - SEVERAL OPTIONS ARE AVAILABLE, BASED ON THE SIZE OF THE LEAK AND WHICH SYSTEM (O₂ OR H₂) IS AFFECTED:

FOR AN H₂ LEAK < 1 LB/HR OR O₂ LEAK OF ANY SIZE, ENTRY WILL BE PERFORMED WHILE FEEDING THE LEAK, PROVIDING THAT SUPER-CRITICAL PRESSURIZATION CAN BE MAINTAINED USING NORMAL HEATER MANAGEMENT. AT LEAST ONE GOOD MANIFOLD/FUEL CELL WILL BE PROTECTED FROM THE LEAK BY CLOSURE OF A MANIFOLD VALVE.

FOR AN H₂ LEAK > 1 LB/HR WHERE NO FUEL CELL HAS PREVIOUSLY FAILED, THE LEAK WILL BE ISOLATED (REQUIRING FUEL CELL SHUTDOWN) AND ENTRY PERFORMED ON TWO FUEL CELLS. IF INSUFFICIENT TIME EXISTS PRIOR TO DEORBIT TIG TO REDUCE THE LEAK RATE TO <1 LB/HR, THEN ENTRY WILL BE DELAYED IF ADEQUATE CONSUMABLES ARE AVAILABLE.

FLIGHT RULES

FOR AN H₂ LEAK > 1 LB/HR WHERE ONE FUEL CELL HAS PREVIOUSLY FAILED, THE LEAK WILL BE ISOLATED (AND FUEL CELL SHUT DOWN) ONLY IF SUPER-CRITICAL PRESSURIZATION CANNOT BE MAINTAINED. THE REMAINING FUEL CELL WILL BE PROTECTED FROM THE LEAK BY CLOSURE OF A MANIFOLD VALVE.

THIS RULE CONTINUED ON NEXT PAGE

FLIGHT RULES

A9.1.6-10 CRYO SYSTEM LEAKS (CIL) (CONTINUED)

Since the plumbing in the affected manifold or fuel cell is no longer reliable, it must be isolated from the other manifolds and fuel cells to protect against rapid loss of pressurization affecting all fuel cells. Since the tanks themselves do not have isolation valves, then the only method of stopping or minimizing a manifold leak is to isolate it by closing one or both manifold valves, and then depleting its associated tank(s). After this is done, the manifold can be repressurized/isolated by opening/closing a manifold valve.

Since shutdown of a fuel cell requires the mission to be shortened to an MDF (PLS for loss of the second fuel cell), and if consumables will support the abbreviated mission plus a 24-hour extension while feeding the leak, then no gain is achieved by shutting down the fuel cell while on orbit.

Hydrogen leaks of > 1 lb/hr create flammable concentrations during portions of entry and are considered to be a greater risk than loss of the first fuel cell, but not the second.

DOCUMENTATION: Engineering judgment, FMEA/CIL 04-1B-A01FSH-1/FS0-1, and JSC Structures and Mechanics Division informal analysis.

A9.1.6-11 IMPENDING LOSS OF ALL CRYO

IN THE EVENT THAT ALL RECONFIGURATION PROCEDURES HAVE BEEN PERFORMED FOR CRYOGENIC SYSTEMS FAILURES AND THAT A CONDITION STILL EXISTS WHERE ALL TANK AND MANIFOLD PRESSURES ARE DECREASING, THE EARLIEST ASCENT ABORT MODE AVAILABLE WILL BE SELECTED (REF. RULE {A2.1.2-4}, RTLS, TAL, AND AOA ABORTS FOR SYSTEMS FAILURES (CIL)).

If the pressure cannot be maintained in at least one cryo tank and manifold, the fuel cells will eventually stop producing electrical power, no matter what the quantity is in the cryo tanks. Since the amount of time available before "blowdown" of the tanks is dependent on a large number of variables, specific numbers cannot be defined for the purpose of selecting the most preferred abort mode. Therefore, this condition warrants the selection of the earliest abort opportunity.

DOCUMENTATION: Engineering judgment.

Rules {A2.1.2-4A.45}, RTLS, TAL, AND AOA ABORTS FOR SYSTEMS FAILURES (CIL); and {A2.1.4-5A.2.b}, EMERGENCY DEORBIT. [@ED 1](#)

FLIGHT RULES

A9.1.6-12 EDO PALLET MANAGEMENT

- A. ACTIVATION/DEACTIVATION - THE MAIN DC POWER TO THE PALLET WILL BE ACTIVATED SHORTLY AFTER POST INSERTION AND DEACTIVATED IN DEORBIT PREP. INSTRUMENTATION POWER WILL BE ACTIVE FOR LAUNCH AND ENTRY FOR THE PURPOSES OF TANK QUANTITY GAUGING AND LEAK DETECTION.

Since the pallet tanks are not required for ascent/entry, the main power will be removed to eliminate an unnecessary path for an electrical short. Reference rule {A9.1.3-8}, CRITICAL PHASE BUS MANAGEMENT. The pressure and quantity instrumentation was intentionally placed on a separate power source to allow quantity gauging and leak detection.

- B. TANK HEATER MANAGEMENT - TANK QUANTITY BALANCING WILL BE PERFORMED PER RULE {A9.1.6-6}, CRYO O₂/H₂ TANK QUANTITY BALANCING. IF THE SPARE MDCA-1 (100-AMP FUSE SIZE) IS USED, NORMALLY ONLY ONE SET OF HEATERS WILL BE ACTIVATED WHEN USING A TANK.

The original design modification to MDCA-1 included a 100-amp fuse to the EDO bus A power feed. A subsequent design change was performed which made it possible to exceed 100 amps if all the tank heaters were activated simultaneously. The second of two units built has a 200-amp fuse to correct this problem. The first unit (used as a spare) will retain the 100-amp fuse until the unit requires further modification. Single-string tank heaters will be used to provide a margin of safety if that box is ever flown.

FLIGHT RULES

ELECTRICAL GO/NO-GO CRITERIA

A9.1.7-1 **ELECTRICAL GO/NO-GO CRITERIA**

SYSTEM/COMPONENTS/FUNCTIONS	CONTINUE NOMINAL ASCENT IF:	INVOKE MDF IF:	ENTER NEXT PLS IF:
A. <u>CRYO:</u>			
1. O2 TANKS (3/4)	2/3 ↓	[2]	2/2 ↓
2. H2 TANKS (3/4)	2/3 ↓	[2]	2/2 ↓
3. O2, H2 MANIFOLDS (6)		1 ↓ [3]	2 ↓ [3]
B. <u>FUEL CELLS:</u>			
FUEL CELLS (3)	2 ↓	1 ↓ [4]	2 ↓ [5]
FC PRIMARY H2O FLOW TO ECLSS (3)		2 ↓ [6]	3 ↓ [6]
FC OVERBOARD RELIEF SYSTEM			
FC ALTERNATE H2O SYSTEM			
FC VENT LINE BLOCKAGE (O2 OR H2)			[7]
FC O2 PURGE		[8]	[8]
FC H2 PURGE			
C. <u>ELECTRICAL PWR DIST & CNTL:</u>			
1. MAIN DC BUSES			
a. <u>MNA</u>			
DA1			[9]
FPC1		[10] [11]	[10] [12]
FLC1			
FMC1			
MPC1		[13]	[12]
MMC1		[14]	[15]

THIS RULE CONTINUED ON NEXT PAGE

FLIGHT RULES

A9.1.7-1

ELECTRICAL GO/NO-GO CRITERIA (CONTINUED)

SYSTEM/COMPONENTS/FUNCTIONS	CONTINUE NOMINAL ASCENT IF:	INVOKE MDF IF:	ENTER NEXT PLS IF:
C. <u>ELECTRICAL PWR DIST & CNTL: (CONT)</u>			
1. MAIN DC BUSES			
a. <u>MNA (CONT)</u>			
MMC3		[14]	[16]
APC4			
APC1			
ALC1			
AMC1			
014			
R15			
014 & A8			
R1A1			
A6 & A14			
ML86B			
A11EDO			
A15EDO			
PPC1			
b. <u>MNB</u>			[18]
DA2			
FPC2		[10] [19]	[10] [15]
FLC2		[20]	
FMC2			
MPC2		[21]	[15]
MMC1			
MMC2		[14]	[22]

THIS RULE CONTINUED ON NEXT PAGE

FLIGHT RULES

A9.1.7-1

ELECTRICAL GO/NO-GO CRITERIA (CONTINUED)

SYSTEM/COMPONENTS/FUNCTIONS	CONTINUE NOMINAL ASCENT IF:	INVOKE MDF IF:	ENTER NEXT PLS IF:
C. <u>ELECTRICAL PWR DIST & CNTL: (CONT)</u>			
1. MAIN DC BUSES			
b. <u>MNB (CONT)</u>			
MMC3			
MMC4		[14]	[15]
APC5			
APC2			
ALC2			
AMC2			
R15			
015 & A8			
015			
R1A1			
A6 & A14			
ML86B			
A11EDO			
A15EDO			
PPC2			
c. <u>MNC</u>			
DA3			[23]
FPC3		[10] [24]	[10] [12]
FLC3		[25]	
FMC3			
MPC3		[26]	[12]
MMC2		[14]	[16]
MMC4		[14]	[16]

THIS RULE CONTINUED ON NEXT PAGE

FLIGHT RULES

A9.1.7-1

ELECTRICAL GO/NO-GO CRITERIA (CONTINUED)

SYSTEM/COMPONENTS/FUNCTIONS	CONTINUE NOMINAL ASCENT IF:	INVOKE MDF IF:	ENTER NEXT PLS IF:
C. <u>ELECTRICAL PWR DIST & CNTL</u> : (CONT)			
1. MAIN DC BUSES			
c. <u>MNC</u> (CONT)			
APC6			
APC3			
ALC3			
AMC3			
R15			
016RJD			
016		[27]	
R1A1			
A6 & A14			
ML86B			
2. CONTROL BUSES		[14]	[15]
a. <u>CNTL</u>			
CNTLAB1			
CNTLAB2			[16]
CNTLAB3		[14]	[12]
CNTLBC1		[14] [28]	[22]
CNTLBC2		[14] [25]	[15]
CNTLBC3		[14]	[15]
CNTLCA1			[16]
CNTLCA2		[14]	[16]
CNTLCA3		[14]	[12]

THIS RULE CONTINUED ON NEXT PAGE

FLIGHT RULES

A9.1.7-1 ELECTRICAL GO/NO-GO CRITERIA (CONTINUED)

SYSTEM/COMPONENTS/FUNCTIONS	CONTINUE NOMINAL ASCENT IF:	INVOKE MDF IF:	ENTER NEXT PLS IF:
C. <u>ELECTRICAL PWR DIST & CNTL: (CONT)</u>			
4. AC BUSES			
a. <u>AC INVERTERS</u>			
AC1 INVERTERS↓ (3)		2 ↓ [10] [11]	2 ↓ [10] [12]
AC2 INVERTERS↓ (3)		2 ↓ [10] [32]	2 ↓ [10] [5] [22]
AC3 INVERTERS↓ (3)		2 ↓ [10] [33]	2 ↓ [10] [12]
b. <u>AC1</u>			
AC1(3Φ)		[11]	[12]
AC1ΦA		[34]	[34]
AC1ΦB		[34]	[34]
AC1ΦC		[34]	[34]
AC1 FMC1			
AC1 MMC1		[14]	[15]
AC1 MMC3		[14]	[16]
AC1 AMC1			
c. <u>AC2</u>		[32]	[15] [22]
AC2(3Φ)			
AC2ΦA		[34] [35]	[34]
AC2ΦB		[34] [35]	[34]
AC2ΦC		[34] [35]	[34]
AC2 FMC2			
AC2 MMC1			
AC2 MMC2		[14]	[22]
AC2 MMC3			
AC2 MMC4		[14]	[15]
AC2 AMC2			

THIS RULE CONTINUED ON NEXT PAGE

FLIGHT RULES

A9.1.7-1 ELECTRICAL GO/NO-GO CRITERIA (CONTINUED)

SYSTEM/COMPONENTS/FUNCTIONS	CONTINUE NOMINAL ASCENT IF:	INVOKE MDF IF:	ENTER NEXT PLS IF:
C. <u>ELECTRICAL PWR DIST & CNTL: (CONT)</u>			
4. AC BUSES (CONT)			
d. <u>AC3</u>			
AC3(3Φ)		[33]	[12]
AC3ΦA		[34] [36]	[34]
AC3ΦB		[34] [36]	[34]
AC3ΦC		[34] [36]	[34]
AC3 FMC3			
AC3 MMC2		[14]	[16]
AMC MMC4		[14]	[16]
AC3 AMC3			
D. <u>CAUTION AND WARNING:</u>			
C&W - PRIMARY AND BACKUP (2).....			2 ↓ [37]

LEGEND: NO REQUIREMENT () QUANTITY

REQUIRED [] NOTE REFERENCE

THIS RULE CONTINUED ON NEXT PAGE

FLIGHT RULES**A9.1.7-1 ELECTRICAL GO/NO-GO CRITERIA (CONTINUED)**

- [1] IF A FIVE-TANK SET IS FLOWN, TANKS 4 AND 5 ARE CONSIDERED AS ONE TANK.
- [2] FOR SINGLE TANK FAILURES, CONSUMABLES DETERMINE FLIGHT DURATION.
- [3] MAY REQUIRE FUEL CELL SHUTDOWN PRIOR TO ENTRY.
- [4] SINGLE FAULT TOLERANT. REF. RULE {A2.1.3-1B-2}, MISSION DURATION REQUIREMENTS. @101796-4561A]
- [5] ZERO FAULT TOLERANT. REF. RULE {A2.1.3-1B-3C}, MISSION DURATION REQUIREMENTS.
- [6] LOSS OF PRIMARY SYSTEM FOR MULTIPLE FC'S MAY HAVE RESULTED FROM FREEZING OF H₂O RELIEF PANEL WHICH COULD ALSO CAUSE LOSS OF OVERBOARD RELIEF AND LEAVE ONLY THE ALTERNATE SYSTEM FOR H₂O REMOVAL. REF. RULE {A2.1.3-1CB-3}, MISSION DURATION REQUIREMENTS. @101796-4561A]
- [7] LOSS OF PURGE CAPABILITY ON ALL THREE FC'S. ALSO, ALL THREE FC'S UNABLE TO VENT O₂ (H₂) FOR A DUAL GAS REGULATOR FAILURE. ALL THREE FC'S NO LONGER FAIL-SAFE. REF. RULES {A9.1.1-1J}, FUEL CELL (FC) LOSS (CIL); AND {A9.1.2-2C}, D, AND E, FC PURGE.
- [8] FUEL CELL PREDICTED PERFORMANCE DETERMINES MISSION DURATION.
- [9] LOSE ALL MNA SUB-BUSES AND ASSOCIATED EQUIPMENT.
- [10] IF AC BUS NOT SHORTED, AN MDF MAY BE COMPLETED BY THE USE OF THE AC POWER TRANSFER CABLE TO REGAIN CRITICAL AC LRU'S. NEXT PLS REQUIRED IF AC BUS NOT REGAINED. REF. RULE {A9.1.4-8}, AC POWER TRANSFER CABLE. @ED]
- [11] LOSE PLBD CLOSE FUNCTION MOTOR REDUNDANCY, FUEL CELL 1 PUMPS. REF. RULES {A9.1.1-1B}, FUEL CELL (FC) LOSS (CIL), AND {A10.1.11-9H}, PLBD RULE REFERENCE MATRIX.
- [12] LOSE ONE MOTOR IN MULTIPLE PLBD CENTERLINE AND IN MULTIPLE PLBD BULKHEAD LATCH GANGS. REF. RULE {A10.1.11-9B}, PLBD RULE REFERENCE MATRIX.
- [13] LOSE PLBD CLOSE FUNCTION MOTOR REDUNDANCY, FUEL CELL 1 PURGE VALVES. REF. RULES {A9.1.2-2C} AND D, FC PURGE, AND {A10.1.11-9H}, PLBD RULE REFERENCE MATRIX.
- [14] LOSE PLBD CLOSE FUNCTION MOTOR REDUNDANCY. REF. RULE {A10.1.11-9H}, PLBD RULE REFERENCE MATRIX.
- [15] LOSE ONE MOTOR IN MULTIPLE PLBD BULKHEAD LATCH GANGS. REF. RULE {A10.1.11-9H}, PLBD RULE REFERENCE MATRIX.
- [16] LOSE ONE MOTOR IN MULTIPLE PLBD CENTERLINE LATCH GANGS. REF. RULE {A10.1.11-9H}, PLBD RULE REFERENCE MATRIX.
- [17] RESERVED @082593-1530]
- [18] LOSE ALL MNB SUB-BUSES AND ASSOCIATED EQUIPMENT.
- [19] LOSE FUEL CELL 2 PUMPS, PLBD CLOSE FUNCTION MOTOR REDUNDANCY, S-BAND SYSTEM 1 (INCLUDES NSP 1), CABIN FAN B. REF. RULES {A9.1.1-1B}, FUEL CELL (FC) LOSS (CIL); {A9.1.7-1}, ELECTRICAL GO/NO-GO CRITERIA; {A10.1.11-9H}, PLBD RULE REFERENCE MATRIX; AND {A11.1.2-28}, COMMUNICATIONS GO/NO-GO CRITERIA. @ED]
- [20] LOSE S-BAND SYSTEM 1 (INCLUDES NSP 1). REF. RULE {A11.1.2-28}, COMMUNICATIONS GO/NO-GO CRITERIA.
- [21] LOSE PLBD CLOSE FUNCTION MOTOR REDUNDANCY, FUEL CELL 2 PURGE VALVES. REF. RULES {A9.1.2-2C} AND D, FC PURGE, AND {A10.1.11-9H}, PLBD RULE REFERENCE MATRIX.
- [22] LOSE PLBD MOTOR REDUNDANCY ON ONE CENTERLINE LATCH GANG AND ONE BULKHEAD LATCH GANG. REF. RULE {A10.1.11-9B}, PLBD RULE REFERENCE MATRIX.
- [23] LOSE ALL MNC SUB-BUSES AND ASSOCIATED EQUIPMENT.
- [24] LOSE FUEL CELL 3 PUMPS, PLBD CLOSE FUNCTION MOTOR REDUNDANCY, S-BAND SYSTEM 2 (INCLUDES NSP 2), CABIN FAN A. REF. RULES {A9.1.1-1B}, FUEL CELL (FC) LOSS (CIL); {A9.1.7-1}, ELECTRICAL GO/NO-GO CRITERIA; {A10.1.11-9H}, PLBD RULE REFERENCE MATRIX; AND {A11.1.3-1}, COMMUNICATIONS GO/NO-GO CRITERIA.
- [25] LOSE S-BAND SYSTEM 2 (INCLUDES NSP 2). REF. RULE {A11.1.3-1}, COMMUNICATIONS GO/NO-GO CRITERIA. @ED]
- [26] LOSE PLBD CLOSE FUNCTION MOTOR REDUNDANCY, FUEL CELL 3 PURGE VALVES, RGA 3. REF. RULES {A8.1.6-1D}, GNC GO/NO-GO CRITERIA; {A9.1.2-2C} AND D, FC PURGE; AND A10.1.11-9H, PLBD RULE REFERENCE MATRIX.
- [27] LOSE ADTA 3 AND 4. REF. RULE {A8.1.6-1D}, GNC GO/NO-GO CRITERIA.

FLIGHT RULES

THIS RULE CONTINUED ON NEXT PAGE

FLIGHT RULES

A9.1.7-1 ELECTRICAL GO/NO-GO CRITERIA (CONTINUED)

- [28] LOSE S-BAND SYSTEM 1 (INCLUDES NSP 1). RGA 2. REF. RULES {A11.1.3-1}, COMMUNICATIONS GO/NO-GO CRITERIA; AND {A8.1.6-1D}, GNC GO/NO-GO CRITERIA. @ED]
- [29] LOSE FUEL CELL 1 ECU PUMP PRIMARY RELAYS. REF. RULE {A9.1.1-1B}, FUEL CELL (FC) LOSS (CIL).
- [30] LOSE FUEL CELL 2 ECU PUMP PRIMARY RELAYS. REF. RULE {A9.1.1-1B}, FUEL CELL (FC) LOSS (CIL).
- [31] LOSE FUEL CELL 3 ECU PUMP PRIMARY RELAYS. REF. RULE {A9.1.1-1B}, FUEL CELL (FC) LOSS (CIL).
- [32] LOSE PLBD CLOSE FUNCTION MOTOR REDUNDANCY, FUEL CELL 2 PUMPS, CABIN FAN B. REF. RULES {A9.1.1-1B}, FUEL CELL (FC) LOSS (CIL); SECTION B; AND {A10.1.11-9H}, PLBD RULE REFERENCE MATRIX.
- [33] LOSE PLBD CLOSE FUNCTION MOTOR REDUNDANCY, FUEL CELL 3 PUMPS, CABIN FAN A. REF. RULES {A9.1.1-1B}, FUEL CELL (FC) LOSS (CIL); SECTION B; AND 1 {A10.1.11-9H}, PLBD RULE REFERENCE MATRIX.
- [34] IF BUS SHORT-CIRCUITED, INVOKE CRITERIA FOR FMC, MMC, AMC SUB-BUSES, UNLESS SHORTED PHASE CAN BE ISOLATED FROM GANGED CB ASSEMBLY. REF. RULE {A9.1.4-6}, LOSS OF SINGLE-PHASE AC @ED]
- [35] LOSE 1 AC ϕ OF CABIN FAN B. CONTINUE IF DEMONSTRATED IN FLIGHT THAT CABIN FAN CAN BE STARTED ON TWO REMAINING AC ϕ 'S.
- [36] LOSE 1 AC ϕ OF CABIN FAN A. CONTINUE IF DEMONSTRATED IN FLIGHT THAT CABIN FAN CAN BE STARTED ON TWO REMAINING AC ϕ 'S.
- [37] LOSS OF ALL C&W ALARM TONES AND LIGHTS. FLIGHT CREW MUST MONITOR CRT MESSAGES FOR CRITICAL SYSTEM FAULT ANNUNCIATION. REF. RULES {A2.1.3-1CB-3}, MISSION DURATION REQUIREMENTS; AND {A2.1.3-3A.6A-6}, SYSTEMS REDUNDANCY REQUIREMENTS. @101796-4561A]

CRYO

a. Continue Nominal Ascent

If all but one of the cryo tanks fails during ascent, an abort is not required because the remaining tank will support a first day PLS entry.

b. Invoke Minimum Duration Flight

If a single tank fails, the amount of consumables will determine the length of the mission. After a single tank failure, at least two more failures are required before loss of crew/ vehicle.

c. Enter Next PLS

If two tanks fail, a PLS is called because the risk has increased that similar failures will occur in the remaining tanks. Loss of cryo is loss of crew/vehicle.

FLIGHT RULES

SPACEHAB SUPPORT

A9.6.1-1 SPACEHAB MAIN BUS

LOST IF:

VOLTAGE CANNOT BE MAINTAINED ≥ 24 OR ≤ 32 VOLTS DC.

Spacehab dc equipment was designed to operate within these values.

A9.6.1-2 SPACEHAB EMERGENCY BUS

LOST IF:

EMERGENCY BUS - BUS VOLTAGE CANNOT BE MAINTAINED ≥ 24 OR ≤ 32 VOLTS DC.

Spacehab dc equipment was designed to operate within these values.

A9.6.1-3 SPACEHAB INVERTER

LOST IF:

OUTPUT VOLTAGES CANNOT BE MAINTAINED > 105 OR < 125 VOLTS AC

Spacehab ac equipment was designed to operate within these values.

A9.6.1-4 SPACEHAB SUBSYSTEM BUSES

LOST IF:

A. DC SUBSYSTEM BUS - BUS VOLTAGE CANNOT BE MAINTAINED > 24
OR < 32 VOLTS DC

B. DC INVERTER BUS - BUS VOLTAGE CANNOT BE MAINTAINED > 24 OR
 < 32 VOLTS DC

Spacehab equipment was designed to operate within these values.

FLIGHT RULES

A9.6.1-5

SPACEHAB FIRE/SMOKE DETECTION LOSS

SPACEHAB SMOKE DETECTION SHALL BE CONSIDERED LOST FOR ANY ONE OF THE FOLLOWING REASONS:

- A. ONE SMOKE DETECTOR FAILS BOTH PORTIONS OF THE CIRCUIT TEST AND THE OTHER SMOKE DETECTOR FAILS EITHER PORTION OF THE CIRCUIT TEST.
- B. POWER TO THE DETECTORS CANNOT BE MAINTAINED.
- C. LOSS OF AIR CIRCULATION (BOTH FANS FAILED).

Each smoke detector outputs two smoke detection indications (an alarm indication and a concentration measurement), and these two measurements are independent of one another except for a smoke detector hardware failure. The only hardware failure that can be detected by the circuit test is an air pump failure which would force the detector to fail both portions of the circuit test. If the smoke detector passes either portion of the circuit test, the air pump is then verified as operative, and the concentration readout sent to the GPC for FDA limit sensing (Class 0 only, does not produce alarm) is considered a valid indication.

Power is required for the smoke detectors to operate. Loss of air circulation prevents particulates from reaching the smoke detector in a timely manner if the combustion is not close to the smoke detector. If only one indication is left in the Spacehab, the system is considered suspect to the point of being unreliable.

DOCUMENTATION: R.I. vendor drawings VS70-620109, V070-623420, and V70-960099.

FLIGHT RULES

SPACEHAB ELECTRICAL POWER SUBSYSTEM (EPS) MANAGEMENT

A9.6.2-1 SPACEHAB MAIN BUS MANAGEMENT

- A. ELECTRICAL POWER TO THE SPACEHAB MAIN BUS IS PROVIDED VIA THE PRIMARY PAYLOAD BUS. THE PRIMARY PAYLOAD BUS IS SUBJECT TO THE FOLLOWING CONSTRAINTS AS SPECIFIED IN THE SPACEHAB PIP:
1. THE NORMAL POWER SOURCE FOR THE PRIMARY PAYLOAD BUS IS THE ORBITER MNC BUS FOR ALL FLIGHT PHASES.
 2. IN THE EVENT OF AN ORBITER FAILURE OR OTHER PAYLOAD POWER REQUIREMENTS REQUIRING A CHANGE IN THE SOURCE OF POWER FOR THE PRIMARY PAYLOAD BUS, THE BUS MAY BE POWERED BY MNB (EXCEPT DURING ASCENT) OR DIRECTLY FROM FUEL CELL 3.
 3. FOR ALL THREE SOURCES, THE POWER IS LIMITED TO 3.5 KW CONTINUOUS, 6 KW PEAK FOR 15 MINUTES EVERY 3 HOURS IN A TWO STANDARD MIXED CARGO HARNESS (SMCH) CONFIGURATION.

Bus power limitations are due to the SMCH configuration. Each SMCH is capable of supporting 1.75 kW (3 kW peak). Actual MNB and MNC payload power limitations are higher. The orbiter MNC bus is the normal source of primary payload power in order to maximize the power delivered to a payload. Although FC3 also delivers the same power capability, this capability is only as a backup to the primary configuration using MNC. The orbiter MNC bus will be the normal source of primary payload power.

Reference: All Flights Rule {A9.1.3-9}, PRIMARY PAYLOAD BUS MANAGEMENT.

- B. THE ASCENT/ENTRY POWER ALLOCATION TO SPACEHAB IS: < 1.3 KW.

PIP requirement.

- C. FOR LOSS OF EITHER SMCH FEED CAPABILITY IN A TWO SMCH POWER CONFIGURATION, SPACEHAB OPERATIONS WILL CONTINUE.

Spacehab will adapt to the reduced power allocation via replanning of experiment activities.

FLIGHT RULES

A9.6.2-2 SPACEHAB EMERGENCY BUS LOSS

- A. IF EITHER ORBITER DC SOURCE, PL AUX A OR PL AFT B, SUPPLYING POWER TO THE SPACEHAB EMERGENCY BUS IS LOST, SPACEHAB ACTIVITIES WILL CONTINUE.

PL AUX A and PL AFT B provide redundant power to the Spacehab emergency bus. The emergency bus sources are cross strapped and the Spacehab emergency bus is still powered.

- B. IF THE SPACEHAB EMERGENCY BUS IS LOST, THE SPACEHAB WILL BE DEACTIVATED AND ALL POWER REMOVED.

All fire detection/suppression capability has been lost.

A9.6.2-3 SPACEHAB AC MANAGEMENT

- A. THE SPACEHAB INVERTER WILL BE THE MODULE'S AC POWER SOURCE DURING ASCENT AND ENTRY.

Orbiter ac power is not available to payloads during these mission phases.

- B. SUBSYSTEM AC EQUIPMENT (ARS FAN, CABIN FAN, AND WATER PUMP 2) WHICH CAN BE SWITCHED BETWEEN SPACEHAB INVERTER AND ORBITER AC POWER SOURCES WILL NORMALLY BE DEACTIVATED BEFORE SWITCHING SOURCES.

Hot switching equipment will lead, over time, to degraded relay contacts in the Power Distribution Unit (PDU); however, in an off-nominal condition, hot switching can be performed without significantly damaging Spacehab hardware.

- C. WHEN POWER IS INTERRUPTED TO SUBSYSTEM AC EQUIPMENT, THE EQUIPMENT WILL BE DEACTIVATED BEFORE POWER IS REAPPLIED.
- D. IN ORDER TO PREVENT EXCEEDANCE OF THE SPACEHAB INVERTER'S CAPABILITIES:
1. TURN ON FANS BEFORE THE WATER PUMP IF FANS ARE TO BE POWERED BY INVERTER AC.
 2. MCC APPROVAL MUST BE OBTAINED BEFORE USING THE VACUUM CLEANER.

Turning the fans on before the pump avoids potential in-rush problems, since the fans have a higher in-rush current.

FLIGHT RULES

The orbiter vacuum cleaner has a high in-rush current of 4.5 amps/phase. Due to the mission unique experiment configuration and other ac power concerns which are timeline dependent, the MCC must be contacted to perform an ac analysis to ensure inverter capability.

A9.6.2-4 SPACEHAB MAIN DC BUS POWER INTERRUPTION

- A. IF SPACEHAB MAIN BUS POWER IS INTERRUPTED, SPACEHAB INVERTER POWERED AC ROTATING EQUIPMENT WILL BE DEACTIVATED PRIOR TO REAPPLYING POWER.

If Spacehab ac systems are not deactivated, the inverter allocations and capabilities may be exceeded.

- B. IF THE SPACEHAB ORBITER AC BUS (PL AC3) POWER IS INTERRUPTED, SPACEHAB AC ROTATING EQUIPMENT POWERED BY ORBITER PL AC3 WILL BE DEACTIVATED PRIOR TO REAPPLYING POWER.

If Spacehab ac systems using orbiter ac power are not deactivated, the orbiter's inverter capabilities may be exceeded.

A9.6.2-5 FUSE/CIRCUIT BREAKER MANAGEMENT

- A. APPLICABLE EXPERIMENTS AND SUBSYSTEM EQUIPMENT WILL BE DEACTIVATED PRIOR TO REPLACING A FUSE OR RESETTING A CIRCUIT BREAKER.

This action is required to prevent in-rush current or the original cause of the failure from opening the fuse or tripping the breaker again during the reset/replacement activity.

- B. A CIRCUIT BREAKER SHALL ONLY BE RESET OR FUSE REPLACED AFTER MCC REVIEW OF THE ASSOCIATED DATA. IT IS MANDATORY TO HAVE MCC REAL-TIME COVERAGE WHEN A CIRCUIT BREAKER RESET ATTEMPT OR FUSE REPLACEMENT IS MADE. REPEATED CIRCUIT BREAKER RESETS OR FUSE REPLACEMENTS WILL NOT BE ALLOWED.

A known short will not be repowered due to safety concerns. Real-time coverage is required in order to provide systems experts the opportunity to monitor the action and the associated response. Repeated circuit breaker trips or fuse failures indicate a hardware problem and for safety reasons, the repeated actions will not be allowed.

- C. A CIRCUIT BREAKER MAY BE RESET TO REGAIN SUBSYSTEM OR EXPERIMENT EQUIPMENT FUNCTIONS AFTER REMOVING UNNECESSARY LOADS AND THE EQUIPMENT CAUSING THE FAILURES.

FLIGHT RULES

Circuit breakers often feed more than one piece of equipment; therefore, if unnecessary loads or troublesome equipment is removed, the circuit breaker may be successfully reset and the remaining loads used.

THIS RULE CONTINUED ON NEXT PAGE

FLIGHT RULES

A9.6.2-5 FUSE/CIRCUIT BREAKER MANAGEMENT (CONTINUED)

- D. NO CIRCUIT BREAKER RETENTION DEVICE SHALL BE USED IN THE SPACEHAB ELECTRICAL SUBSYSTEM.

The circuit breaker retention device is only used to recover emergency or crew safety related items. Mission success does not justify use of the retention device. Failure modes exist where the retention device can override circuit protection.

Reference: NASA/DF Note Of Interest, DF7/83-45, June 14, 1983.

A9.6.2-6 FUEL CELL FAILURE MANAGEMENT

- A. FOR THOSE MISSIONS REQUIRING A POWERED SPACEHAB MODULE DURING ASCENT/ENTRY, IF A FUEL CELL FAILS DURING ASCENT, THE SPACEHAB WILL NOT REMAIN POWERED DURING ASCENT.

There is not adequate power margin for Spacehab operations with only two orbiter fuel cells available during ascent. During orbit and entry, power margins may potentially allow payload power.

- B. FOR A FUEL CELL FAILURE ON ORBIT, THE SPACEHAB POWER THROUGH PRIMARY MNB FEEDER WILL BE LIMITED TO 3.5 KW CONTINUOUS, 6 KW PEAK FOR 15 MINUTES EVERY 3 HOURS.

In the event of a fuel cell failure, the 18 kW limit prevents overloading of the last remaining fuel cell. The Spacehab power limits (and rationale) for a single fuel cell failure are based on a two SMCH configuration.

FLIGHT RULES

A9.6.2-7 SPACEHAB MINIMUM POWER CONFIGURATION

THE MINIMUM POWER LEVEL ON ORBIT WILL BE THE LEVEL THAT IS REQUIRED TO MAINTAIN THE SPACEHAB IN A SURVIVAL CONFIGURATION MUCH LIKE AN ON-ORBIT WAIT AND PRESERVE SCIENCE RESULTS/SAMPLES ALREADY OBTAINED. BOTH THE SURVIVAL CONFIGURATION AND THE MINIMUM POWER LEVEL WILL BE COMPATIBLE WITH AND LEAD INTO THE SPACEHAB ENTRY REQUIREMENTS.

- A. SURVIVAL CONFIGURATION IS DEFINED AS THAT WHICH WOULD PROTECT SPACEHAB/EXPERIMENT HARDWARE.
- B. MINIMUM POWER IS DEFINED AS THAT LEVEL NECESSARY TO ALSO PRESERVE LIVE SAMPLES OR PERISHABLE EXPERIMENT RESULTS.

A known minimum power level is required to provide for a case in which the crew's full attention would have to be turned to an orbiter problem. The Spacehab/experiments would need to be placed in a condition which would draw the least amount of both crew time and orbiter resources. The minimum power/survival configuration for the Spacehab/experiments needs to be clearly defined premission so that this configuration can be achieved quickly and without ambiguity.

A9.6.2-8 CAUTION AND WARNING (C&W)

CAUTION AND WARNING SYSTEM AND SYSTEM MANAGEMENT PARAMETERS WHICH GENERATE FALSE OR NUISANCE ALARMS WILL BE INHIBITED.

Inhibiting the alarms prevents reaction/response to nuisance and/or erroneous failure indications.

FLIGHT RULES

ELECTRICAL POWER DISTRIBUTION SYSTEM (EPDS) LOSS/FAILURE DEFINITIONS

A9.9.1-1 SPACELAB MAIN BUS

LOST IF:

VOLTAGE CANNOT BE MAINTAINED ≥ 24 OR ≤ 32 VOLTS DIRECT CURRENT (V DC). [ED]

Spacelab dc equipment was designed to operate between 24 and 32 volts dc. Reference: Spacelab Operational Data Book (SLODB) 3.1.3, Table 4.1.2-V.

A9.9.1-2 SPACELAB AUXILIARY BUSES

LOST IF:

A. AUX A - BUS VOLTAGE CANNOT BE MAINTAINED ≥ 24 OR ≤ 32 V DC.

B. AUX B - BUS VOLTAGE CANNOT BE MAINTAINED ≥ 24 OR ≤ 32 V DC.

Spacelab emergency and essential dc equipment was designed to operate between 24 and 32 volts dc.

Reference: SLODB 3.1.2, Table 4.1.2-V.

FLIGHT RULES

A9.9.1-3 SPACELAB EMERGENCY BOX BUSES

LOST IF:

- A. EMERGENCY (EM) A BUS - BUS VOLTAGE CANNOT BE MAINTAINED ≥ 24 OR ≤ 32 V DC.
- B. ESSENTIAL (ESS) EXP BUS - BUS VOLTAGE CANNOT BE MAINTAINED ≥ 24 OR ≤ 32 V DC.
- C. ESS SS BUS - BUS VOLTAGE CANNOT BE MAINTAINED ≥ 24 OR ≤ 32 V DC.
- D. ESS RAAB BUS - BUS VOLTAGE CANNOT BE MAINTAINED ≥ 24 OR ≤ 32 V DC.

MODULE

- E. EM B1 BUS - BUS VOLTAGE CANNOT BE MAINTAINED ≥ 24 OR ≤ 32 V DC.
- F. EM B2 BUS - BUS VOLTAGE CANNOT BE MAINTAINED ≥ 24 OR ≤ 32 V DC.
- G. EM C BUS - BUS VOLTAGE CANNOT BE MAINTAINED ≥ 24 OR ≤ 32 V DC.

MODULE

- H. FLUID LOOP MONITOR AND CONTROL PANEL (FLMCP) ESS BUS - BUS VOLTAGE CANNOT BE MAINTAINED ≥ 24 OR ≤ 32 V DC. @[102793-1558]

A9.9.1-4 SPACELAB SUBSYSTEM (SS) OR EXPERIMENT (EXP) ALTERNATING CURRENT (AC) INVERTER

LOST IF - OUTPUT VOLTAGES CANNOT BE MAINTAINED ≥ 110 OR ≤ 124 V AC.

Spacelab ac equipment was designed to operate between 110 and 124 volts ac.

Reference: SPAH A, 3.1.3 and McDonnell Douglas Memorandum A90-A220-SLP-890475, July 13, 1989.

FLIGHT RULES

A9.9.1-5 SPACELAB SS (EXP) AC BUS

LOST IF - BUS VOLTAGE CANNOT BE MAINTAINED ≥ 110 OR ≤ 124 V AC OR PHASE AB, PHASE BC AND PHASE CA VOLTAGE CANNOT BE MAINTAINED ≥ 191 OR ≤ 215 V AC.

Rationale same as for Rule {A9.9.1-4}, SPACELAB SUBSYSTEM OR EXPERIMENT AC INVERTER.

Reference: SLODB, 3.1.4, 3.1.6, Table 4.1.2-V.

A9.9.1-6 SPACELAB FIRE/SMOKE PRIMARY DETECTION LOSS

MODULE

LOST IF BOTH A AND B DETECTORS IN THE SUBFLOOR, OR RIGHT RACK, OR LEFT RACK FAIL SELF-TEST.

Loss of both smoke detectors in a rack or in the subfloor results in loss of all primary smoke detection in the affected area until reconfiguration (see Rule {A9.9.2-11}, SPACELAB FIRE/SMOKE DETECTION, for reconfiguration explanation).

A9.9.1-7 SPACELAB AURAL ANNUNCIATOR LOSS

LOST IF TONE IS NOT ANNUNCIATED.

Self-explanatory.

FLIGHT RULES

EPDS SYSTEM MANAGEMENT

A9.9.2-1 SPACELAB MAIN BUS MANAGEMENT

- A. ELECTRICAL POWER TO THE SPACELAB MAIN BUS IS PROVIDED VIA THE PRIMARY PAYLOAD BUS.
1. THE PRIMARY PAYLOAD BUS IS NORMALLY POWERED FROM THE ORBITER MNC BUS FEEDER (PRIMARY PAYLOAD MNC), AND ITS POWER IS LIMITED TO 8 KW CONTINUOUS, 12 KW PEAK FOR 15 MINUTES EVERY 3 HOURS.
 2. IN THE EVENT OF A FAILURE REQUIRING A CHANGE IN THE SOURCE OF POWER FOR THE PRIMARY PAYLOAD BUS, THE BUS MAY BE POWERED DIRECTLY FROM FUEL CELL (FC)3 (PRIMARY PAYLOAD FC3) WITH THE SAME POWER CONSTRAINTS AS THE ORBITER MNC BUS FEEDER.
 3. THE CAPABILITY ALSO EXISTS TO POWER THE PRIMARY PAYLOAD BUS FROM THE ORBITER MNB BUS FEEDER (PRIMARY PAYLOAD MNB), BUT ITS POWER IS LIMITED TO 7 KW CONTINUOUS OR PEAK. @[111094-1703]
- B. IN ADDITION TO THE CONSTRAINTS LISTED IN PARAGRAPH A ABOVE, THE SUM TOTAL OF ALL PAYLOAD POWER (PRIMARY PAYLOAD + AUXILIARY PAYLOAD + CABIN PAYLOAD + AFT PAYLOAD + UTILITY OUTLET PAYLOAD) MUST NOT EXCEED 8 KW CONTINUOUS.

By design, the power level constraints noted above must be observed. The orbiter MNC bus feed is the normal source of power to the primary payload bus to maximize the amount of power delivered to a payload. Although the FC3 feed has the same power constraints as the orbiter MNC bus feed, it has always been the philosophy to feed the payloads from orbiter buses rather than directly from the fuel cell, when possible. The MNC and FC3 feeder constraint is based on FC power limitations. The existing fuel cells cannot supply the full power capabilities of the four feeders (each with 200 amp fuses) without violating the FC power constraints. The orbiter MNB feed does not have the power capabilities of the other feeds due to the fuse sizing between the orbiter MNB bus and the primary payload bus. The MNB feeder constraint was based on a detailed analysis completed by the subsystem managers. It was determined that for a worst case of 26.8 volts and a 10 percent difference between the two feeders, 7 kW continuous and peak was the highest level that the MNB bus should operate at and still maintain the integrity of the feeder and provide a small margin of safety. Payload power includes all ac and dc power provided to the payload. Primary payload power is measured at the FC output terminals.

Reference: SODB, 4.5.6.8.1.

THIS RULE CONTINUED ON NEXT PAGE

FLIGHT RULES

A9.9.2-1 SPACELAB MAIN BUS MANAGEMENT (CONTINUED)

C. THE POWER ALLOCATIONS TO THE SPACELAB ARE:

1. ASCENT/ENTRY ≤ 1.5 KW (IF REQUIRED) EXCEPT AS DOCUMENTED IN THE FLIGHT SPECIFIC ANNEX. @ED]

The maximum power level that can be allotted to Spacelab systems and experiments, and not impact orbiter power requirements for ascent/entry, is 1.5 kW, within the constraint of 2.6 kW maximum continuous or peak at this primary payload bus, at X₀ 645. The 2.6-kW constraint is based on electrical power considerations only and does not take into account the payload heat exchanger heat rejection constraint. A flight-specific thermal analysis must be performed in order to verify that the payload heat exchanger constraint is not violated when primary payload power exceeds 1.5 kW. The flight-specific results will be documented in the flight specific annex.

Reference: SLODB, Table 3.1.8-II; ICD-2-19001, Table 7.3.2.2-1; and SODB, Table 4.5.6.8.

2. ON ORBIT - POWER LEVELS WILL BE MAINTAINED WITHIN ACCEPTABLE CRYOGENIC CONSUMABLE PREDICTIONS, VOLTAGE MARGINS, AND HEAT REJECTION CAPACITY.

Spacelab is allotted a specific quantity of energy determined preflight and may use this energy as long as the Spacelab operations do not compromise the normal orbiter system operations.

3. EXCEPTIONS TO THIS RULE ARE DOCUMENTED IN THE FLIGHT SPECIFIC ANNEX.

A9.9.2-2 SPACELAB EMERGENCY BOX BUSES

MODULE

IF BOTH THE SPACELAB EM A AND EM B1 BUSES ARE LOST, THE SPACELAB WILL BE DEACTIVATED AND ALL POWER REMOVED SINCE ALL FIRE DETECTION/SUPPRESSION IS LOST.

Smoke detection/suppression is mandatory in any area that contains a source of ignition.

FLIGHT RULES**A9.9.2-3 SPACELAB SS (EXPERIMENT) AC INVERTER MANAGEMENT**

- A. SPACELAB MISSIONS REQUIRING MAXIMUM CONTINUOUS AC LOADS >2.7 KVA (7.75 AMPS PER PHASE AT 116 V AC) WILL HAVE THE SPACELAB SS INVERTER AND THE EXP INVERTER CONNECTED TO THE SS AC BUS AND THE EXP AC BUS, RESPECTIVELY. IN THE EVENT OF AN INVERTER FAILURE, BOTH BUSES WILL BE CONNECTED TO THE REMAINING INVERTER, AFTER APPROPRIATE SYSTEMS POWERDOWN.
- B. SPACELAB MISSIONS REQUIRING AC LOADS <2.7 KVA (7.75 AMPS PER PHASE AT 116 V AC) WILL HAVE THE SPACELAB SS INVERTER CONNECTED TO BOTH THE SS AC BUS AND THE EXP AC BUS. FOR A FAILURE OF THE SS INVERTER, THE EXP INVERTER WILL BE CONNECTED TO THE SS AC BUS AND THE EXP AC BUS.

The inverters are designed for a maximum total transient output of 3.5 kVA (10 amps per phase at 116 V ac). The actual limiting factor is that the inverter cannot exceed 2.7 kVA which is equivalent to 0.9 kVA per phase (7.75 amps at 116 V ac). Since inverter voltages may be different from inverter to inverter and to avoid possible confusion later, the rule should state the limit in terms of kVA, not just amps.

Reference: SLODB, 3.1.7 and 3.2.17.

MODULE

- C. IF THE ORBITER VACUUM CLEANER IS TO BE POWERED FROM THE INRUSH CURRENT LIMITED AC UTILITY OUTLET, SINGLE INVERTER OPERATION IS ACCEPTABLE GIVEN THE INVERTER LOAD IS LESS THAN 5.25 AMPS PRIOR TO VACUUM ACTIVATION. OTHERWISE, DUAL INVERTER OPERATION IS REQUIRED AND THE AC BUS WILL BE MANAGED PER FLIGHT RULE {A9.9.2-4}, SPACELAB SS EXP AC BUSES. DUAL INVERTER OPERATION AND AC BUS MANAGEMENT, PER FLIGHT RULE {A9.9.2-4}, SPACELAB SS EXP AC BUSES, ARE ALSO REQUIRED IF THE CB31 (32) AC OUTLET IS USED FOR VACUUM POWER. @[071494-1661]

For a typical Spacelab module mission with active subsystem and experiment ac loads when the vacuum cleaner is used, the total ac demand may exceed the single inverter capabilities. Reference paragraphs A and B and Rule {A9.9.2-4}, SPACELAB SS EXP AC BUSES.

THIS RULE CONTINUED ON NEXT PAGE

FLIGHT RULES

A9.9.2-3

SPACELAB SS (EXPERIMENT) AC INVERTER MANAGEMENT
(CONTINUED)

- D. THE SPACELAB FREON PUMP WILL BE POWERED OFF DURING STARTUP OF EITHER A CABIN FAN OR AN AVIONICS FAN (LOW (LO) TO HIGH (HI) SPEED) TO PREVENT EXCESSIVE STARTUP CURRENTS FROM OVERLOADING THE INVERTER.

Excessive currents associated with cabin fan or avionics fan (lo to hi speed) startup, when combined with the normal operating load of the remaining ac powered equipment, will require the inverter to exceed its design limit of 3.5K (10 amps per phase at 116 v ac). Above this limit, the inverter will current-limit by voltage degradation and/or failure. To compensate for these high start transients, the Freon pump will be powered off for cabin or avionics fan startup.

Reference: SLODB 3.1.7 and 3.2.17.

- E. AN INVERTER WILL BE POWERED OFF IF THE TEMPERATURE EXCEEDS 131 DEG F/55 DEG C (115 DEG F/46 DEG C).

The upper qualification temperature for the inverters is 131 deg F at the baseplate. Since the flight temperature instrumentation is not located directly on the baseplate, 115 deg F accounts for location inaccuracy as well as transducer inaccuracy. The qualification temperature is greater than the acceptance value of 113 deg F (97 deg F), thus the Spacelab program has accepted a loss of hardware lifetime during a mission, if necessary.

Reference: SLODB 3.1.7 and TR-AE-82-7101.

FLIGHT RULES

A9.9.2-4 SPACELAB SS EXP AC BUSES

- A. THE STEADY-STATE SS (EXP) AC LOAD DEMAND WILL BE MAINTAINED ≤ 2.7 KVA (7.75 AMPS PER PHASE AT 116 V AC); HOWEVER, DURING A LOAD TRANSIENT, THE TOTAL INVERTER DEMAND MUST BE ≤ 3.3 KVA (9.5 AMPS PER PHASE AT 116 V AC).
 ©[ED]

The inverters are designed for a maximum transient output of 3.5 kVA (10 amps per phase at 116 V ac). Above the 3.5 kVA (10 amps per phase at 116 V ac) output, the inverter will current limit by voltage degradation and/or failure. The 3.3 kVA limit in paragraph A will ensure the inverter does not enter its current limiting mode during transients. Due to the possibility of premature failure from overheating at such high power levels, the inverter steady-state loading is kept below 2.7 kVA (7.75 amps per phase at 116 V ac). Reference Rule {A9.9.2-3}, SPACELAB SS (EXPERIMENT) AC INVERTER MANAGEMENT.

Reference: SLODB, 3.1.7.

MODULE

- B. THE AVIONICS FAN AND FREON PUMP WILL BE POWERED FROM SEPARATE ENVIRONMENTAL CONTROL SYSTEM (ECS) AC BUSES TO AVOID BUS OVERLOADING.

Each of the ECS AC 2 and 3 buses in the subsystem power distribution box (SPDB) is protected by a remote controlled circuit breaker (RCCB) rated at 5.2 amps per phase which, when tripped, disconnects all three phases on its respective bus. For normal ops, ECS AC 2 and 3 support the avionics fan, Freon pump, and H₂O pump which require up to 2.4 amps per phase, 1.5 amps per phase, and 0.4 amp per phase, respectively, during steady-state operation. The separation of the avionics fan and the Freon pump loads on different buses significantly reduces the probability of tripping an RCCB due to limited load margin.

- C. IF AVAILABLE, THE INRUSH CURRENT LIMITED AC UTILITY OUTLET IS THE PREFERRED OUTLET FOR USE WITH INTERMITTENTLY POWERED EQUIPMENT. ©[071494-1654A]

Excessive currents associated with startup, or high currents associated with equipment failures, may cause the inverter to exceed its design limit of 3.5 kVA (10 amps per phase at 116 Vac). Above this limit, the inverter will current-limit by voltage degradation. Use of the inrush current limited ac utility outlet will allow no more than 6.0 amps per phase starting current from the outlet and will be protected by a 5-amp circuit breaker during steady state. This outlet, if available, should always be used for orbiter ac vacuum cleaner operations in the module. Reference Rule {A9.9.2-3}, SPACELAB SS (EXPERIMENT) AC INVERTER MANAGEMENT. ©[071494-1654A]

FLIGHT RULES

A9.9.2-5 SPACELAB MAIN BUS POWER INTERRUPTION

IF SPACELAB MAIN BUS POWER IS INTERRUPTED, AC ROTATING EQUIPMENT WILL BE DEACTIVATED PRIOR TO REAPPLYING POWER.

Deviation from a standard rotating machinery powerup will force the ac inverter into a current-limiting overload condition. Recovery from this condition will not be accomplished automatically by the inverter.

A9.9.2-6 FUSE/CIRCUIT BREAKER MANAGEMENT

A. APPLICABLE EXPERIMENTS WILL BE DEACTIVATED PRIOR TO REPLACING ANY FUSE OR RESETTING ANY CIRCUIT BREAKER WHICH MAY HAVE OPENED.

Applicable experiments are deactivated prior to fuse replacement or circuit breaker reset to prevent in-rush current or the original cause of the failure from opening the fuse or tripping the breaker again.

B. THE FOLLOWING CRITERIA WILL BE UTILIZED IN RESETTING CIRCUIT BREAKERS OR REPLACING FUSES TO REGAIN SPACELAB SYSTEMS OR EXPERIMENT FUNCTIONS AS REQUIRED TO CONTINUE PLANNED OPERATIONS.

A CIRCUIT BREAKER SHALL NOT BE RESET OR A FUSE REPLACED UNTIL COMPLETION OF A REVIEW OF APPROPRIATE DATA TO DETERMINE IF A SHORT EXISTS ON THE CIRCUIT. DATA REVIEW SHALL INCLUDE, BUT NOT BE LIMITED TO, MCC REVIEW OF FUEL CELL CURRENTS (HIGH DATA RATE) AND, FOR EXPERIMENT FUSES/CIRCUIT BREAKERS, POCC REVIEW OF EXPERIMENT HARDWARE DATA. NO CIRCUIT BREAKER WILL BE RESET OR FUSE REPLACED IF THERE IS EVIDENCE OF A SHORT. REAL-TIME GROUND TELEMETRY COVERAGE IS MANDATORY DURING CIRCUIT BREAKER RESET/FUSE REPLACEMENT. CIRCUIT BREAKERS/ FUSES WILL NOT BE REPEATEDLY RESET/REPLACED IF THEY CONTINUE TO TRIP. THE POCC WILL TAKE ACTION TO SAFE AND PROPERLY CONFIGURE THE EXPERIMENT(S) PRIOR TO POWER RESTORATION. @[110194-1704]

1. SPACELAB CIRCUIT BREAKERS/FUSES DOWN TO AND INCLUDING THE EXPERIMENT POWER SWITCHING PANELS (EPSP'S) (MODULE) AND DOWN TO THE EXPERIMENT POWER BRANCHING DISTRIBUTOR'S (EPBD'S) (PALLET) WILL BE MANAGED BY THE MCC. IF THE SYSTEM/FUNCTION IS REQUIRED, RESET WILL BE CONSIDERED AFTER MCC REVIEW, CONSULTATION WITH THE POCC, AND POCC RECONFIGURATION OF THE EXPERIMENTS AS REQUIRED.

FLIGHT RULES

THIS RULE CONTINUED ON NEXT PAGE

FLIGHT RULES

A9.9.2-6 FUSE/CIRCUIT BREAKER MANAGEMENT (CONTINUED)

2. EXPERIMENT MISSION-PECULIAR EQUIPMENT (MPE) CIRCUIT BREAKERS AND FUSES DOWNSTREAM OF THE EPSP (MODULE) AND DOWNSTREAM OF AND INCLUDING THE EPBD (PALLET) WILL BE MANAGED BY THE POCC. IF THE SYSTEM/FUNCTION IS REQUIRED, RESET WILL BE CONSIDERED AFTER POCC AND MCC REVIEW. ONCE IT HAS BEEN DETERMINED THAT NO EVIDENCE OF A SHORT EXISTS, THE POCC WILL INFORM MCC OF WHEN AN ATTEMPT TO RESET THE CIRCUIT BREAKER WILL BE MADE AND ALERT THE PAYLOAD CREW SO THE PROCESS CAN BE MONITORED ONBOARD AND AT THE MCC AND POCC.

A circuit breaker may be reset (or fuse replaced) after evaluation of data available in the POCC and MCC has determined that a short has not occurred. Any circuit breaker that continues to trip indicates a bus fault or faulty breaker and will be left open for safety considerations.

A known short will not be repowered because of the associated safety considerations (e.g., toxic smoke, fire, further hardware damage). These potential safety problems are particularly significant with Kapton wire and its known potential to do more damage on a reset than on the original short. Under some circumstances (e.g., loss of data, low data sample rates, unknown time of trip), it will be impossible to verify that no short occurred. High sample rate fuel cell data is required since shorts may not be evident at lower sample rates. Real-time coverage and crew attention are mandatory for a circuit breaker reset or fuse replacement so that the crew, MCC, and POCC are aware of the existence of any short circuit condition on the suspected circuit. If the short is proven to be inside equipment that can be isolated from the circuit, consideration will be given to repowering the circuit after isolating the faulty equipment from the circuit.

- C. NO CIRCUIT BREAKER RETENTION DEVICE SHALL BE USED IN THE SPACELAB ELECTRICAL SUBSYSTEM.

The circuit breaker retention device is only used to recover emergency or crew safety related items. Mission success does not dictate use of the retention device. Failure modes exist where the retention device can override circuit protection.

Reference: NASA/DF Note of Interest, DF7/83-45, June 14, 1983.

FLIGHT RULES

A9.9.2-7 FUEL CELL FAILURE MANAGEMENT

- A. FOR THOSE MISSIONS REQUIRING SPACELAB POWER DURING ASCENT/ENTRY, IF A FUEL CELL FAILS DURING ASCENT, THE SPACELAB WILL NOT REMAIN POWERED.

There is not adequate power margin for Spacelab operations with only two orbiter fuel cells available during ascent. During entry, power margins allow payload power. ©[041097-4898B]

- B. FOR A FUEL CELL FAILURE ON ORBIT, SPACELAB POWER WILL BE MANAGED TO MAINTAIN TOTAL ORBITER POWER LEVEL < 18 KW MAXIMUM. THE REMAINING TWO FUEL CELLS TOTAL POWER LEVEL WILL BE MAINTAINED ≤18 KW. IF FUEL CELL 3 HAS FAILED, THE SPACELAB WILL BE POWERED VIA PRIMARY PAYLOAD MNB. THE SPACELAB POWER THROUGH PRIMARY PAYLOAD MNB FEEDER WILL BE LIMITED TO 5 KW CONTINUOUS, 8 KW PEAK FOR 15 MINUTES EVERY 3 HOURS.

In the event of a second fuel cell failure, the 18 kW limit prevents overloading the last remaining fuel cell, in the event that a second fuel cell were to fail. Typically the loss of one fuel cell will powerdown the orbiter to approximately 12.5-13 kW. This allows approximately 5 kW for the Spacelab.

If the failed fuel cell is FC3, MNA and MNC will be tied with Spacelab powered by MNB to balance fuel cell loading. The 5 kW constraint on the MNB feed is due to the fuse sizing between the orbiter MNB bus and the primary payload bus. See Rule {A9.9.2-1}, SPACELAB MAIN BUS MANAGEMENT.

- C. IF FUEL CELL 3 HAS FAILED, THE SPACELAB WILL BE POWERED VIA PRIMARY PAYLOAD MNB. MNA AND MNC WILL BE TIED WITH SPACELAB POWERED BY MNB.

If the failed fuel cell is FC3, MNA and MNC will be tied with Spacelab powered by MNB to balance fuel cell loading. See Rule {A9.9.2-1}, SPACELAB MAIN BUS MANAGEMENT.

Reference: SODB Vol. I, Para. 3.4.4.1.2. Analysis and SLODB, 4.5.6.8.1.

Engineering analysis was performed based on the Powerdown Study done in 1988. ©[041097-4898B]
Analysis and SLODB, 4.5.6.8.1.

FLIGHT RULES

A9.9.2-8

SPACELAB MINIMUM POWER CONFIGURATION

THE MINIMUM POWER LEVEL ON ORBIT WILL BE THE LEVEL THAT IS REQUIRED TO MAINTAIN THE SPACELAB IN A SURVIVAL CONFIGURATION MUCH LIKE AN ON-ORBIT WAIT, AND PRESERVE SCIENCE RESULTS/SAMPLES ALREADY OBTAINED. BOTH THE SURVIVAL CONFIGURATION AND THE MINIMUM POWER LEVEL WILL BE COMPATIBLE WITH AND LEAD INTO THE SPACELAB ENTRY REQUIREMENTS.

- A. SURVIVAL CONFIGURATION IS DEFINED AS THAT WHICH WOULD PROTECT SPACELAB/EXPERIMENT HARDWARE.
- B. MINIMUM POWER IS DEFINED AS THAT LEVEL NECESSARY TO ALSO PRESERVE LIVE SAMPLES OR PERISHABLE EXPERIMENT RESULTS.

A known minimum power level is required to provide for a case in which the crew's full attention would have to be turned to an orbiter problem. The Spacelab/experiments would need to be placed in a condition which would draw the least amount of both crew time and orbiter resources. The minimum power/survival configuration for the Spacelab/experiments needs to be clearly defined permission so that this configuration can be achieved quickly and without ambiguity.

FLIGHT RULES

A9.9.2-9 CAUTION AND WARNING (C&W)

CAUTION AND WARNING SYSTEM PARAMETERS WHICH ARE NOT FUNCTIONING PROPERLY WILL BE INHIBITED TO EXTINGUISH PANEL F7 ANNUNCIATION LIGHTS. PARAMETERS MONITORED IN SYSTEMS MANAGEMENT (SM) OR SUBSYSTEM COMPUTER OPERATING SYSTEM (SCOS) WHICH GENERATE NUISANCE ALARMS AND LIGHTS, WHICH ARE NOT PRECONDITIONED, WILL BE INHIBITED.

This action prevents reaction/response to erroneous and/or nuisance failure indications.

A9.9.2-10 SPACELAB AURAL ANNUNCIATOR (SAA)

MODULE

- A. THE SPACELAB AURAL ANNUNCIATOR (SAA) ON THE ORBITER AFT FLIGHT DECK (AFD) WILL NORMALLY REMAIN UNPOWERED AND WILL BE ACTIVATED ONLY IF THE SPACELAB MODULE SAA FAILS OR WHEN THE CREW DESIRES THIS FUNCTION ON THE AFD. IF THE SPACELAB SAA FAILS, AN IFM PROCEDURE WILL BE CONSIDERED TO REPLACE IT WITH THE ORBITER SAA. LOSS OF BOTH SAA'S SHALL NOT BE CAUSE TO TERMINATE SPACELAB OPERATIONS.

The orbiter SAA is redundant to the Spacelab module SAA. Since the SAA will annunciate both nominal and off-nominal conditions for Spacelab subsystems and experiments, use of the AFD SAA may cause nuisance alarms for sleeping crewmembers. Furthermore, the Spacelab is provided annunciation via the C&W/FSS panel in the module for major Spacelab failures and loss of both SAA's is not considered cause to terminate Spacelab operations.

PALLET ONLY

- B. LOSS OF THE SAA ON THE ORBITER AFT FLIGHT DECK SHALL NOT BE CAUSE TO TERMINATE SPACELAB OPERATIONS.

Major Spacelab failures are annunciated via the orbiter C&W and SM.

FLIGHT RULES

THIS PAGE INTENTIONALLY BLANK

FLIGHT RULES

SECTION 10 - MECHANICAL

AUXILIARY POWER UNIT (APU) LOSS FAILURE/DEFINITION

A10.1.1-1 APU LOSS DEFINITIONS 10-1

APU SYSTEMS MANAGEMENT

A10.1.2-1 LOSS OF APU/HYDRAULIC SYSTEM(S) ACTIONS ... 10-6b

A10.1.2-2 APU START/RESTART LIMITS 10-8

A10.1.2-3 APU ENTRY START TIME 10-15

A10.1.2-4 APU OIL/GEARBOX TEMPERATURE/PRESSURE 10-17

A10.1.2-5 APU HIGH SPEED SELECTION/SHIFT 10-19

A10.1.2-6 APU AUTO SHUTDOWN INHIBIT MANAGEMENT 10-22

A10.1.2-7 APU FUEL LEAKS (CIL) 10-22

A10.1.2-8 AOA APU/HYDRAULIC SYSTEM OPERATIONS 10-25

A10.1.2-9 FCS CHECKOUT APU OPERATIONS 10-26

A10.1.2-10 LOSS OF APU HEATERS/INSTRUMENTATION (CIL) . 10-29

A10.1.2-11 APU FREEZE/THAW 10-31

A10.1.2-12 APU/HYD CONSUMABLES 10-33

A10.1.2-13 APU DEFINITIONS 10-36

HYDRAULIC SYSTEMS LOSS/FAILURE DEFINITIONS

A10.1.3-1 HYDRAULIC LOSS DEFINITIONS 10-34a

HYDRAULIC SYSTEMS

A10.1.4-1 HYDRAULIC SYSTEMS CONFIGURATION 10-37

A10.1.4-2 HYDRAULIC LEAKS 10-39

A10.1.4-3 HYDRAULIC SYSTEMS PRESSURE/TEMPERATURE
(CIL) 10-43

A10.1.4-4 HYDRAULIC CIRCULATION PUMP OPERATION (CIL) 10-47

FLIGHT RULES

WATER SPRAY BOILER (WSB) LOSS/FAILURE DEFINITIONS

A10.1.5-1 WSB LOSS DEFINITIONS 10-48

WSB SYSTEMS MANAGEMENT

A10.1.6-1 WSB CONFIGURATION 10-50

A10.1.6-2 LOSS OF WSB(S) ACTIONS 10-50

LANDING/DECEL SYSTEMS MANAGEMENT

A10.1.7-1 NOSE WHEEL STEERING (NWS) 10-52

LANDING GEAR SYSTEMS MANAGEMENT

A10.1.8-1 TIRE PRESSURE (CIL) 10-57

A10.1.8-2 DRAG CHUTE DEPLOY TECHNIQUES 10-70

A10.1.8-3 DRAG CHUTE DEPLOY CONSTRAINTS 10-73

A10.1.8-4 UNCOMMANDED BRAKE PRESSURE (CIL) 10-75

A10.1.8-5 BRAKING 10-76

MECHANICAL SYSTEMS LOSS/FAILURE DEFINITIONS

A10.1.9-1 DRIVE MECHANISMS LOSS DEFINITIONS 10-79

GENERAL MECHANISMS SYSTEMS MANAGEMENT

A10.1.10-1 DRIVE MECHANISMS 10-81

FLIGHT RULES

SECTION 10 - MECHANICAL

AUXILIARY POWER UNIT (APU) LOSS FAILURE/DEFINITION @ED]

A10.1.1-1 APU LOSS DEFINITIONS

A. AN APU IS CONSIDERED LOST IF:

1. THERE IS A CONFIRMED OR SUSPECTED HYDRAZINE LEAK. LEAKS MUST BE CONFIRMED BY THE GROUND. HYDRAZINE LEAKS CAN BE DETECTED BY ANY OF THE FOLLOWING:
 - a. UNEXPLAINED DECAY IN FUEL TANK OR FUEL FEED LINE PRESSURE. @040899-6824]
 - b. UNEXPLAINED COOLING OF HYDRAZINE TANKS, LINES, AND VALVES, OR ON-ORBIT HEATER DUTY CYCLES.
 - c. WHILE THE FUEL ISOLATION VALVES ARE OPEN, A PUMP SEAL CAVITY PRESSURE INCREASE TO ABOVE 40 PSIA FOLLOWED BY A DROP IN PRESSURE (INDICATING THAT THE BURST DISK HAS RUPTURED) AND EITHER: REPEATED PUMP SEAL CAVITY EXCURSIONS TO THE RELIEF VALVE CRACKING PRESSURE OF APPROXIMATELY 28 TO 34 PSIA OR SUSTAINED FUEL PUMP SEAL CAVITY PRESSURE ABOVE THE VALVE RESEAT PRESSURE OF 16.8 TO 20.4 PSIA WHICH CANNOT BE EXPLAINED BY AN EXISTING STATIC LEAK INTO THE SEAL CAVITY DRAIN LINE AND/OR HEATER CYCLING ON THE LINE.
 - (1) REPEATED PUMP SEAL CAVITY EXCURSIONS TO THE RELIEF VALVE CRACKING PRESSURE OF APPROXIMATELY 28 TO 42 PSIA, OR
 - (2) SUSTAINED FUEL PUMP SEAL CAVITY PRESSURE ABOVE THE VALVE RESEAT PRESSURE OF 16.8 TO 25.2 PSIA.
 - d. UNEXPLAINED DECAY IN SEAL CAVITY DRAIN LINE PRESSURE WHEN FUEL PUMP SEAL LEAKAGE HAS BEEN DETECTED.

A hydrazine leak into the aft compartment is a fire and corrosion hazard that could lead to loss of crew/vehicle.

FLIGHT RULES

~~There are may be cases where an actual hydrazine leak cannot be confirmed. For example, a decay in if the fuel tank pressure/quantity could be the result of a decreasing with no other abnormal indications, then a hydrazine leak is suspected. The problem could just as well be because the fuel tank is losing the GN₂ precharge pressure due to a gas leak. While there are many ways a hydrazine leak may be confirmed as described above, †There is only one way to distinguish between a fuel leak and confirm a GN₂ leak †(without other confirming cues) is to run the APU until the fuel is depleted. †If it is a hydrazine leak, †The fuel tank pressure will stabilize around 80 psia for a hydrazine leak (the GN₂ precharge pressure) and 0 psia; for a †GN₂ leak. the pressure will continue to decrease down to 0 psia. There are theoretical pressure history differences between liquid and gas leaks, but no method exists to distinguish accurately between them. APU fuel leak signatures fall into this category; therefore, †The flight rules assume the worst case scenario of a (fuel leak). @[040899-6824]~~

THIS RULE CONTINUED ON NEXT PAGE

FLIGHT RULES

A10.1.1-1 APU LOSS DEFINITIONS (CONTINUED)

Due to a combination of transducer placement and the large thermal mass of the tank and fuel, a ~~Many times~~ A fuel tank heater cycle causes the tank temperature to rise much faster than the corresponding rise in tank pressure. Before equilibrium is established, the onboard and ground fuel quantity computations show a decrease in quantity similar to a leak, followed by a rise in quantity to the original pre-heater cycle value. Since ~~Many times~~ the crew cannot always distinguish between an actual leak and a heater cycle or transducer failure, ~~Therefore, before the crew takes any dramatic action like shutting down an APU,~~ the ground ~~must will~~ confirm whether or not a leak exists. ~~For mission rule GO/NO GO purposes, an APU is considered lost if there is a confirmed or suspected hydrazine leak, even if there is plenty of fuel still left in the fuel tank. If the leak is not isolatable (upstream of the fuel tank valves), then the APU will be started and run until its fuel is depleted.~~

~~If the leak is isolatable, the fuel line downstream of the tank valves will be evacuated when the valves are closed. If the tank valves are then opened (in preparation for APU start), the fuel in the tank, which is still pressurized, will "slam" into the fuel pump creating a high pressure shock wave in the hydrazine. This high pressure shock could produce a high, localized temperature of short duration but sufficient to cause ignition of the hydrazine in the fuel line and/or line rupture. Also, when the tank valves are opened, hydrazine will again start leaking into the orbiter aft compartment. Because of these conditions, the APU is considered lost and will not be started unless absolutely necessary (one other APU failed). @I040899-6824]~~

A cooling effect may be seen if fuel is leaking near a temperature transducer. ~~If hydrazine is leaking externally, then any portion of the fuel tank, lines, or valves within the spray pattern of the leaking hydrazine could undergo a cooling effect which would be reflected by the closest temperature measurement. If hydrazine is leaking externally, then any portion of the fuel tank, lines, or valves within the spray pattern of the leaking hydrazine could undergo a cooling effect which would be reflected by the closest temperature measurement. During STS-9 entry, there was an APU injector stem leak was indicated by, which was seen on the ground as a 20 degree F drop in GGVM temperature which could not be explained. Care should be exercised, h~~ However, if a drop in GGVM temperature ~~is seen~~ shortly after liftoff can be the result of: ~~N~~normal H₂O condensation in the aft compartment ~~(could be causing the temperature drop. If so, the decreased GGVM temperature will be present for only about 1 minute; this signature was seen on STS 41-C).~~

Another indication of a hydrazine leak is ~~a~~ An increased heater duty cycle could result from the cooling effect of leaking fuel or the loss in fuel line thermal mass caused by the vacated fuel. ~~of the heaters in that portion of the fuel line. However, attitude effects and thermostat debonding can show a similar signature.~~

FLIGHT RULES

~~An internal hydrazine leak may occur when also. If the fuel pump/drain line seal degrades and hydrazine could leak into the fuel pump seal cavity drain line system. This is would be indicated by an increase in drain line pressure PMP DRN LIN P. With continuing leakage, if the fuel leak is significant enough, the pressure could will increase to the point that the burst disk ruptures (at 45 +5 psid) and the relief valve could opens (at 28 to 3442 psia), causing hydrazine to be spilled overboard onto the surface tiles. A leak of this type occurred on an ALT flight (without the burst disk; this modification first flew on STS-88). Note that the relief valve will remain stay open until down to the reseal pressure of 16.8 to 20.45.2 psia is reached (the relief valve will not reseal for high enough leak rates). Also note that, if a static leak (one that exists while the APU is not running) exists from the fuel line into the seal cavity drain line, the seal cavity drain pressure could rise to 20 psi or higher while on orbit, depending on the size of the leak and how warm the drain line heater is cycling. This type of static leak is usually evident prelaunch, as the fuel pump inlet pressure decreases noticeably following fuel tank servicing. A similar decrease will also be seen on orbit after heat soakback from the APU has ceased. For this type of leak, the APU should not be declared lost because it will not increase appreciably while the APU is running and thus will not relieve overboard.~~

Fuel pump seal leakage can be detected by an increase in drain line pressure (not due to heater cycles) while the APU is running (dynamic leak), or by a decrease in feed line pressure with a corresponding increase in drain line pressure while the APU is not running (static leak). However, fuel pump seal leakage by itself is not sufficient reason to declare an APU lost because the hydrazine is contained within the drain system. For the case of a decay in both feed line and drain line pressures, or a decay in drain line pressure following a dynamic leak, a small amount of hydrazine (up to 1.4 lbs, from between the fuel isolation valves and the shutoff valve, for the static leak case; reference SODB 4.4.3.2.d.3) has leaked into the aft compartment and the APU should be considered lost.

Hydrazine may also leak past multiple seals into the APU gearbox. ~~The indication of this would be detected as an increase in both gearbox pressure and an increasing seal cavity drain line pressures since, in order to leak in to the gearbox, the fuel had to first leak into the seal cavity drain line. No leakage of this type has been seen since the dual lip extra seals were incorporated as part of the IAPU design (first flight STS-45). Paragraph A.1.c is based on an ALT in flight fuel leak experience. @1040899-6824]~~

Reference Rule {A10.1.2-7B}, APU FUEL LEAKS, and SODB 4.4.3.6.

THIS RULE CONTINUED ON NEXT PAGE

FLIGHT RULES

A10.1.1-1 APU LOSS DEFINITIONS (CONTINUED)

2. UNABLE TO MAINTAIN TURBINE SPEED BETWEEN 95 (95) PERCENT AND 121 (121) PERCENT WHILE THE APU IS RUNNING.

The primary fuel valve controls turbine speed at 103 ± 8 percent (95 to 111 percent) and is the one normally in control. If HI SPEED is selected, the secondary valve will control turbine speed at 113 ± 8 percent (105 to 121 percent).

If turbine speed cannot be maintained > 95 percent, the capability of that APU to support high demand is questionable and is considered lost.

If turbine speed cannot be maintained < 121 percent, then the normal speed control circuit has failed and an automatic shutdown for overspeed is likely. Since the length of time the APU will run is unknown, the APU is considered lost for mission rule purposes.

3. THE LUBRICATION OIL OUTLET PRESSURE IS > 150 (140) PSIA WHILE THE APU IS RUNNING.

A high lubrication oil outlet pressure is indicative of severely restricted lube oil flow. The oil pump and associated plumbing are not qualified for pressures above 150 psia, so component rupture is a concern. Also, since oil flow is restricted, little or no cooling of the gearbox will take place, resulting in bearing overheat and possible failure. Reference SODB, vol. I, 3.4.4.3.9a.

Reference Rule {A10.1.2-4D}, APU OIL/GEARBOX TEMPERATURE/PRESSURE.

4. THE DELTA PRESSURE BETWEEN THE GEARBOX GN₂ PRESSURE AND THE LUBRICATION OIL OUTLET PRESSURE IS < 20 PSID WHILE THE APU IS RUNNING.

A low delta P across the gearbox is indicative of a severely degraded oil pump. If the delta P is less than 20 psid, then not enough oil is flowing to provide adequate lubrication/cooling to the gearbox. If allowed to continue, the gearbox will overheat, resulting in possible bearing failure. Reference SODB 3.4.4.3.9b.

Reference Rule {A10.1.2-4C}, APU OIL/GEARBOX TEMPERATURE/PRESSURE.

5. GEARBOX PRESSURE < 2.0 (3.5) PSIA PRIOR TO APU START.

FLIGHT RULES

If the gearbox pressure is less than 2 psia, the oil pump may cavitate at APU startup. The low pressure may be caused by a GN₂ leak or an oil leak in the gearbox, which are indistinguishable prior to APU start. If the low pressure is due to a GN₂ leak, starting the APU will repressurize the gearbox from the GN₂ bottle, thus preventing pump cavitation. Once the APU is running, this GN₂ will also begin to leak from the gearbox, and volumetric inefficiency with resulting degradation in lubrication can result. However, an APU start attempt is safe as long as the oil pressure is carefully monitored during startup so the unit can be shut down if there is no oil pressure. The APU should be considered lost in the meantime. Reference SODB 3.4.4.3.

THIS RULE CONTINUED ON NEXT PAGE

FLIGHT RULES

A10.1.1-1 APU LOSS DEFINITIONS (CONTINUED)

Reference Rules {A10.1.2-3B}.5, APU ENTRY START TIME, and {A10.1.2-4C}, APU OIL/GEARBOX TEMPERATURE/PRESSURE.

6. THE LUBRICATION OIL OUTLET TEMPERATURE > 425 DEG (405 DEG) F OR GEARBOX BEARING TEMPERATURE > 450 DEG (435 DEG) F WHILE APU IS RUNNING.

At high lube oil and bearing temperatures, the oil begins to break down (low viscosity) resulting in degraded lubrication/heat transfer capability, with high bearing and gear wear. Once all lubrication is lost, the bearings will seize and the APU will experience an underspeed shutdown. Although a start on an APU that has previously exceeded these limits may be attempted on entry, its condition is suspect and should be considered lost for planning purposes. Reference Ascent/Entry Flight Techniques #50, October 20, 1988.

Rule {A10.1.2-4A}, APU OIL/GEARBOX TEMPERATURE/PRESSURE, references this rule.

7. UNABLE TO MAINTAIN THE FOLLOWING APU TEMPERATURES WITHIN LIMITS:
- a. FUEL TANK > 35 DEG (38.7 DEG, TK SKIN 43 DEG) F
 - b. FUEL LINES > 35 DEG (40 DEG, GGVM SUPPLY LN 58 DEG) F
 - c. FUEL PUMP > 35 DEG (40 DEG) F
 - d. LUBRICATION OIL > 0 DEG (INLET TEMPERATURE 15 DEG, OUTLET TEMPERATURE 20 DEG) F - [011295-1736C] F. [ED] 1
 - e. GGVM > 35 DEG (48 DEG) F - [011295-1736C] F. [ED] 1

Hydrazine freezes at 35 deg F (ref. SODB, vol. I, tables 3.4.4.3-1 and 4.4.3a-4). If the fuel is frozen, then obviously the APU will not operate. If the fuel cannot be thawed, the APU will be considered lost. As hydrazine freezes, it contracts; when it thaws, it expands. Analysis has not been performed for APU components subjected to freeze/thaw cycles. Because of the possibility that a fuel system component could rupture, the APU is considered lost if any of the fuel system drops below 35 deg F. Below 0 deg F the lube oil will have such a high viscosity that it cannot adequately lubricate the gearbox. If the APU is started, gear bearing temperature will rise much faster than the oil temperature, and bearing or gear damage may occur before the oil can reach temperature for proper lubrication. Since the APU may be very limited in run time, it is considered lost for mission rule purposes. [011295-1736C]

Because the GGVM temperature and GGVM supply line temperature instrumentation errors are so large, the temperatures should be compared to other transducers in the area

FLIGHT RULES

Reference Rule {A10.1.2-11}, APU FREEZE/THAW.

THIS RULE CONTINUED ON NEXT PAGE

FLIGHT RULES**A10.1.1-1 APU LOSS DEFINITIONS (CONTINUED)**

8. AN APU FUEL LINE HAS SUSTAINED TWO OR MORE FREEZE/THAW CYCLES.

McDonnell Douglas and JSC have performed analysis that indicate that a fuel line may rupture if it sustains as few as 3 freeze/thaw cycles (McDonnell Douglas Report TM-950002-02, December 23, 1994). The theoretical analysis addressed a straight section of 1/2 inch diameter fuel line that has yielded as a result of the freeze/thaw cycle. The fuel line radius has permanently expanded due to the yield. The line freezes again, and during thaw the resulting pressures further yield the line. This process continues until the ultimate strain of the line has been exceeded resulting in rupture. RI/Downey performed an analysis on fuel line bends that coupled TTA test data with a theoretical analysis. The engineering community decided, after a review of the analysis, that the fuel line bends could withstand two freeze/thaw cycles. A qualitative review of the fuel line welds and T's found them to be less critical for freeze/thaw than the tube bend section. The pressures resulting from thaw are directly related to the density of the frozen hydrazine. As hydrazine freezes the density increases linearly as a function of temperature decrease. The analysis assumed a worst case temperature of the solid hydrazine at -45 Deg F which then warms up to 70 Deg F.

Reference rule {A10.1.2-11}, APU FREEZE/THAW.

9. FUEL TANK PRESSURE < 90 (97) PSIA PRIOR TO ON-ORBIT START. @[011295-1736C]

APU startup time is a function of tank pressure. In order for the turbine speed to reach 80 percent in 9.5 seconds (to avoid an underspeed shutdown), the fuel tank pressure must be at least 90 psia. If INHIBIT is used to defeat the 9.5-second timer, the APU may start at a lower tank pressure, and a start attempt may be made unless the pressure is < 70 psi. Below 70 psia, start attempts become dangerous. However, as far as the flight rules are concerned, the APU must be considered lost because it may not start if the pressure is less than 90 psia. Reference SODB, Vol. I, 3.4.4.3 and Figure 4.4.3.

Rules {A10.1.2-2D}, APU START/RESTART LIMITS; {A10.1.2-4C}, APU OIL/GEARBOX TEMPERATURE/PRESSURE; and {A10.1.2-10A}, LOSS OF APU HEATERS/INSTRUMENTATION, reference this rule.

THIS RULE CONTINUED ON NEXT PAGE

FLIGHT RULES

A10.1.1-1 APU LOSS DEFINITIONS (CONTINUED)

10. THE FUEL PUMP INLET PRESSURE IS < 15 (34) PSIA PRIOR TO OPENING THE FUEL ISOLATION VALVES. LOSS OF INSTRUMENTATION WILL NOT BE CAUSE FOR DECLARING AN APU LOST. [021998-6491A]

If a large delta pressure exists across the FIV's, a surge pressure could result when the valves are opened. Under normal conditions, residual hydrazine in the fuel lines provides a damping force which reduces this surge pressure. At low pressures, the rapid compression results in frothing which may significantly reduce this damping force. When the pressure in the fuel lines is less than 15 psia prior to opening the FIV's, surge pressures over 2500 psia could result (WSTF Report 96-30335, 11/14/96). White Sands straight tube and U-tube testing showed that hydrazine becomes unstable above 2500 psia and Adiabatic Bubble Compression Detonation (ABCD) could occur (RD-WSTF-0002, 2/20/90). Ref. SODB, Vol I, 3.4.4.3, and Rule {A.10.1.2-2}, APU START/RESTART LIMITS.

Loss of the FPIP transducer results in loss of pressure monitoring of the portion of fuel line between the FIV's and the SOV. Loss of instrumentation alone is insufficient cause to declare an APU lost, but other factors (rising drain line pressure, history of leakage, leakage trend prior to transducer loss, etc.) in conjunction with loss of instrumentation may be enough to declare loss of a system.

The 34 psia limit accounts for transducer inaccuracies. Actual transducer biases are given for each mission based on data from KSC and should be taken into account for each system. [021998-6491A]

B. GG INJECTOR COOLING CAPABILITY IS CONSIDERED LOST IF GG INJECTOR COOLING WATER TANK PRESSURE IS < 53 (63) PSIA AT 70 DEG F (GROUND DETECTION ONLY) OR TANK OR LINE TEMPERATURES ARE < 32 DEG (51 DEG) F. [ED]

As long as at least one restart capability remains, injector cooling is still usable. From the SODB curve, with one restart remaining (five used already) and using worst case temperature of 70 deg F, the minimum pressure is 53 psia. Below this pressure, no hot restarts remain and injector cooling is considered lost. Reference SODB, Vol. I, Figure 4.4.3.

FLIGHT RULES

THIS PAGE INTENTIONALLY BLANK

FLIGHT RULES

APU SYSTEMS MANAGEMENT

A10.1.2-1 LOSS OF APU/HYDRAULIC SYSTEM(S) ACTIONS

A. EARLY MISSION TERMINATION FOR APU/HYDRAULIC SYSTEM LOSS(ES) WILL BE AS FOLLOWS:

1. FOR LOSS OF A SINGLE APU/HYDRAULIC SYSTEM, FLIGHT WILL CONTINUE TO NOMINAL EOM UNLESS A REVIEW OF THE FAILURE MODE AND THE REMAINING APU/HYDRAULIC SYSTEMS' CAPABILITY DETERMINES EARLY MISSION TERMINATION IS APPROPRIATE. ©[041097-4611B]

The APU/hydraulic systems are essentially quiescent while on-orbit. Because a subsequent failure of another APU/hydraulic system will likely only occur when these systems are operated for entry, there are no significant risks to continuing the flight until nominal EOM. A review of the failure mode and the remaining APU/hydraulic systems capability is required to determine that there are no generic or other failure concerns.

Rules {A2.1.3-1B}, MISSION DURATION REQUIREMENTS; and {A2.1.6-1}, CONTINGENCY ACTION SUMMARY, reference this rule.

2. FOR LOSS OF REDUNDANCY IN THE APU/HYDRAULIC/WSB SYSTEMS WHERE THE NEXT FAILURE RESULTS IN SINGLE APU/HYDRAULIC SYSTEM OPERATION AT ANY POINT FROM EI TO WHEELSTOP, A NEXT PLS WILL BE PERFORMED.

It is prudent to shorten the mission to minimize the time of exposure to any additional on-orbit failure that would result in a single APU entry. Only detectable on-orbit failures, including electrical bus failures, which may be affected by increased time on orbit will be considered as basis for early mission termination. Examples of redundancy for APU/hydraulic/WSB systems include, but are not limited to, the following:

APU Controller RPC, MPU, fuel tank isolation valve, fuel line heaters

HYD Accumulator (leak), circ pump, main pump depress RPC

WSB Controller, steam vent heater

Each of the above components has experienced failure at least once during the history of the program.

This rule is referenced by Rule {A10.1.6-2B}, LOSS OF WSB(S) ACTIONS. ©[041097-4611B]

THIS RULE CONTINUED ON NEXT PAGE

FLIGHT RULES

A10.1.2-1 LOSS OF APU/HYDRAULIC SYSTEM(S) ACTIONS (CONTINUED)

3. FOR LOSS OF TWO APU/HYDRAULIC SYSTEMS, ENTRY WILL BE PERFORMED AT THE NEXT PLS OPPORTUNITY THAT ALLOWS FOR EXPEDITED PAYLOAD DEPLOY/JETTISON. FOR NONDEPLOY FLIGHTS, ENTRY WILL BE PERFORMED AT THE NEXT PLS OPPORTUNITY (FIRST DAY PLS IF APPLICABLE). @[041097-4611B]

The loss of two APU/hydraulic systems results in a situation where a single APU entry has to be made. It is desirable to stay on orbit in order to deploy payloads because this will improve the vehicle capability to maneuver and land safely. Jettison of deployable payloads that for some reason cannot be deployed should be considered and used as a means of last resort to improve the vehicle entry and landing capability. Once attempts have been made to deploy the payloads, the mission should not be extended beyond the next PLS opportunity. Staying on orbit increases the vehicle exposure time to the loss of the last APU. For flights where nondeployable payloads are onboard, the risk of staying on orbit outweighs the gain of continuing the flight; therefore, the mission should be terminated.

The PLS opportunity should be selected which provides the best possible conditions (i.e., trajectory, landing site, crew and vehicle health, weather conditions, etc.) for a single APU entry. Reference WX placards in Rule {A10.1.2-3A}, APU ENTRY START TIME.

4. FOR IMPENDING LOSS OF ALL TWO APU/HYDRAULIC SYSTEM CAPABILITIES AND THE REMAINING SYSTEM FAILING, AN ABORT AT THE EARLIEST OPPORTUNITY WILL BE PERFORMED. THE PREFERRED ABORT MODE PRIORITY IS RTLS, TAL, AOA, FIRST DAY PLS, PLS, AND ELS. @[041097-4611B] @[040899-6857]

Since at least one operating APU/hydraulic system is required for entry, a landing as soon as possible is required if ~~two~~ all APU/hydraulic systems capability is are lost and the third is failing. If this failure situation develops during ascent, an abort mode should be selected that minimizes entry time. This rule assumes that at least one APU/hydraulic system will be operating at any point throughout entry to wheelstop. @[040899-6857]

Rules {A2.1.2-4A.1}, RTLS, TAL, AND AOA ABORTS FOR SYSTEMS FAILURES (CIL), and {A2.1.4-5A}.2.c, EMERGENCY DEORBIT, reference this rule.

THIS RULE CONTINUED ON NEXT PAGE

FLIGHT RULES

A10.1.2-1 LOSS OF APU/HYDRAULIC SYSTEM(S) ACTIONS
(CONTINUED)

- B. DURING ENTRY, IF ONLY ONE GOOD APU/HYDRAULIC SYSTEM IS AVAILABLE THE APU WILL NOT BE SHUT DOWN IF RUNNING AND ITS HYDRAULIC PUMP WILL BE IN "LOW PRESS" UNTIL MM 304. IF NOT RUNNING, THE APU WILL BE STARTED AT TIG MINUS 5 MINUTES. AN ABBREVIATED ACTUATOR CHECK MAY BE PERFORMED IF REQUIRED. NO HYDRAULIC THERMAL CONDITIONING OR SSME REPRESSURIZATION WILL BE PERFORMED. IF THE APU/HYDRAULIC SYSTEM IS NOT NOMINAL, IT WILL BE SHUT DOWN AND RESTARTED, IF REQUIRED, TO MAINTAIN THE SYSTEM FROM MM 304 THROUGH WHEELSTOPTOUCHDOWN. @021199-68141

If an APU is shut down, there is always the risk that it may not restart. This risk, however small, is simply not warranted in light of the criticality of the single APU that remains. The hydraulic pump is depressurized not only to save fuel, but also to put minimum stress on the system until absolutely required (MM 304-EI). However, if an abbreviated secondary actuator check is to be performed, the system will be taken to normal pressure in MM 303 post-deorbit burn just prior to the start of the check. If the APU is not already running (other two APU's known to be failed prior to TIG minus 5 minutes), it will be started at TIG minus 5 minutes. This ensures the APU will be fully operational before committing to the deorbit burn.

Reference Rules {A8.1.3-5}, FCS CHECKOUT, and {A10.1.1-1}, APU LOSS DEFINITIONS.

FLIGHT RULES

THIS PAGE INTENTIONALLY BLANK

FLIGHT RULES

A10.1.2-2 APU START/RESTART LIMITS

- A. ~~WITH GG INJECTOR COOLING, AN APU START/RESTART MAY BE ATTEMPTED AT ANYTIME IF THE BRANCH PASSAGE TEMPERATURE IS WITHIN ACCEPTABLE LIMITS. BRANCH PASSAGE TEMPERATURE IS ENSURED TO BE WITHIN ACCEPTABLE LIMITS IF ANY OF THE FOLLOWING IS TRUE: @[072398-6685A] IF THE APU IS NOT RESTARTED AT THE CONCLUSION OF THE FIRST 3.5 MINUTES OF INJECTOR COOLING, CONTINUOUS INJECTOR COOLING WILL BE PERFORMED TO ENSURE ACCEPTABLE BRANCH PASSAGE TEMPERATURE FOR RESTART. WITHOUT GG INJECTOR COOLING, GG BED TEMPERATURE CONSTRAINTS FOR NORMAL APU START ARE AS FOLLOWS:~~
1. NO MORE THAN ONE SECOND HAS ELAPSED AFTER TERMINATION OF A MINIMUM OF 3.5 MINUTES OF CONTINUOUS ACTIVE GG INJECTOR COOLING.
 - ~~21.~~ GG BED TEMPERATURE < 444-DEG (430-DEG) DEG F -WITHOUT ACTIVE GG INJECTOR COOLING IF HIGH TEMPERATURE IS DUE TO BED HEATER CYCLING.
 - ~~32.~~ GG BED TEMPERATURE < 415-DEG (401-DEG) DEG F -WITHOUT ACTIVE GG INJECTOR COOLING IF HIGH TEMPERATURE IS DUE TO HEAT SOAKBACK FROM APU OPERATION.

Branch passage temperatures must be below 415 deg F for a safe restart. This temperature is not necessarily reflected by the GG injector instrumentation; therefore, the only reliable method to ensure a safe limit is to cool the injector for the 3.5-minute period or to verify the temperature, as measured by instrumentation at the injector, is below 415 deg F, which will ensure that the branch passages are also below the limit. Once cooling has been terminated the branch passage temperature will rise rapidly with the GG injector temperature, violating restart limits, and causing the APU to require additional cooling.

FLIGHT RULES

In the improved APU, The A and B GG bed heaters are located on opposite sides of the bed and wrap 160 degrees around the bed. The GG bed temperature transducer is located near the B heater. If the supplied heat comes from either heater, Sundstrand thermal analysis has shown that the temperature of the branch passages will remain well below that indicated by the bed temperature transducer. However, if the supplied heat is from soakback due to APU operation, there are parts of the bed that will be much hotter than the transducer and the measured temperature will not be the maximum. See the SODB, Vol. I, Figure 4.4.3 for test data. If the GG bed temperature is above specified limits and a start attempt is made, the hydrazine fuel will begin decomposing before reaching the bed. The result will be extreme GG pressure spikes and possibly an uncontained APU GG explosion. The danger of explosion increases with GG temperature at the time of restart. On a test stand at Sundstrand, an APU was successfully restarted with sea-level pressure and a hot bed 19 times. It exploded during the 20th try. Later, with near space pressure in a chamber at JSC (TTA), an APU exploded during the first hot restart attempt without GG cooling (hot restart). Despite this test information, it is not possible to make a correlation between altitude and the probability of an explosion for a hot restart attempt (ref. SODB 3.4.4.3).

Rule s {A10.1.2-3B}, APU ENTRY START TIME, and {A10.1.2-13}, APU DEFINITIONS, reference this rule. [@\[072398-6685A\]](#)

THIS RULE CONTINUED ON NEXT PAGE

FLIGHT RULES**A10.1.2-2 APU START/RESTART LIMITS (CONTINUED)**

- B. AN APU CAN BE RESTARTED PROVIDED THE FUEL PUMP TEMPERATURE IS < 210 DEG (205 DEG) F, AND THE VALVE MODULE TEMPERATURE IS < 200 DEG (180 DEG) F.

Large bubbles may form in the valve module or in the fuel pump due to decomposition. When the APU is started, the bubbles will collect in the filter downstream of the pump or in the valve, and the pump output pressure will increase as the pump comes up to speed when the APU is started. Adiabatic compression of the bubbles will increase their temperature and could cause the hydrazine to detonate. If allowed to cool, the bubbles that may have formed are much less likely to cause problems when the APU is started. During tests, an APU fuel system has detonated on a start attempt with fuel pump temperature above 240 deg F and GGVM temperature above 200 deg F. None have detonated during starts below 210 deg F on the pump and 200 deg on the valve, even if the temperature had been higher previous to the start attempt. While the high temperatures were not absolutely determined to have caused the APU detonations, they are still considered to be the most likely reason for the failures. Reference RI internal letter no. SSD-287-400-92-050, dated 1/6/92.

Rule {A10.1.2-3B}.4, APU ENTRY START TIME, references this rule.

- C. AN APU WILL NOT BE RESTARTED THAT HAS BEEN SHUT DOWN DUE TO CONFIRMED OVERSPEED.

An APU overspeed is an extremely hazardous situation as the turbine could disintegrate, producing shrapnel, and if uncontained, could damage other equipment in the aft fuselage. Once safed, either by manual or automatic shutdown, the affected APU should never be restarted.

- D. APU START WITH LOW FUEL TANK PRESSURE:

1. AUTO SHUTDOWN WILL BE INHIBITED FOR AN APU START WITH THE FUEL TANK PRESSURE < 90 (97) PSI.

Normal APU starts at fuel tank pressures > 70 psia are not considered dangerous but may result in an APU underspeed shutdown. Low tank pressures will cause a slower than normal turbine spinup (violating the 9.5-second startup criteria); hence, auto shutdown inhibit mode is recommended.

Reference SODB 3.4.4.3, and Rule {A10.1.1-1A}.8, APU LOSS DEFINITIONS.

2. RESTART WILL NOT BE PERFORMED ON AN APU WITH THE FUEL TANK PRESSURE < 100 (107) PSI.

Restarts at low fuel pressures can result in uncontrolled hydrazine decomposition in the APU bed, causing a detonation.

FLIGHT RULES

THIS RULE CONTINUED ON NEXT PAGE

FLIGHT RULES

A10.1.2-2 APU START/RESTART LIMITS (CONTINUED)

E. AN APU WILL NOT BE STARTED WITH THE GAS GENERATOR BED TEMPERATURE < 70 DEG (84 DEG) F, UNLESS REQUIRED. @J072398-6685A~~EXCEPT TO MAINTAIN TWO APU/HYDRAULIC SYSTEMS FOR ENTRY, TO PROVIDE NWS (IF REQUIRED), OR TO PROVIDE A REDUNDANT LANDING GEAR DEPLOY METHOD.~~

Should both GG bed heaters fail on orbit, this rule allows the affected APU to be restarted as long as the bed temperature remains above 70 deg (84 deg) F. Testing at the component GG level showed that peak chamber pressures and catalyst ignition time delays were affected more by bed temperature than catalyst poisoning and both began increasing below a temperature of 100 deg F. Below 70 deg F, the peak chamber pressures and ignition time delays increased exponentially, indicating a potential for detonation at APU start.

Operationally, the risk of APU detonation as a result of low GG bed temperatures is judged to be less than the risks associated with entry on only one APU. An APU with both GG bed heaters failed off will not be considered lost for mission planning purposes since it may be used when absolutely necessary.

Documentation: SODB, Sections 3.4.4.3 and 4.4.3.5.1.b., and ORBITER APU REVIEW, Sundstrand, June 28, 1990, p. 22-25.

Reference Rules {A17.1.19-1A}, ORBITER THERMAL CONSTRAINTS AND ATTITUDE MANAGEMENT (CIL); ~~and~~ {A10.1.2-10A}, LOSS OF APU HEATERS/INSTRUMENTATION; and {A10.1.2-13}, APU DEFINITIONS.

F. DURING ASCENT, IF AN APU LUBE OIL OUTLET TEMPERATURE EXCEEDS 375 DEG (355 DEG) F OR GEARBOX BEARING TEMPERATURE EXCEEDS 400 DEG (385 DEG) F, THE AFFECTED APU WILL NOT BE STARTED FOR ENTRY UNLESS REQUIRED~~EXCEPT TO MAINTAIN TWO APU/HYDRAULIC SYSTEMS DURING ENTRY, TO PROVIDE NWS (IF REQUIRED), OR TO PROVIDE A REDUNDANT LANDING GEAR DEPLOY METHOD.~~

Above these limits, lubrication is degraded, and gear/bearing/APU damage will eventually occur. Engineering tests have not been performed to determine APU life with temperatures above these limits. However, based on engineering judgment, the APU should be able to support entry, although seal and/or lube oil degradation and increased APU temperatures may result. In addition, consideration can be given to starting the APU at TAEM to provide three APU's if a real-time evaluation of the ascent temperature signature indicates that the oil/bearing heat up rate will be slow enough to prevent overheating from TAEM through wheel stop. Reference SODB, Section 3.4.4.3.

Rule {A10.1.2-3B}, APU ENTRY START TIME references this rule. Reference Rule {A10.1.2-13}, APU DEFINITIONS. @J072398-6685A

NASA - JOHNSON SPACE CENTER

FLIGHT RULES

THIS RULE CONTINUED ON NEXT PAGE

FLIGHT RULES

A10.1.2-2 APU START/RESTART LIMITS (CONTINUED)

- G. ON ORBIT, AN APU CAN ONLY BE STARTED IN OPS 8 OR OPS 3. ALL AEROSURFACE AMPLIFIERS MUST BE ON TO PRECLUDE DAMAGE TO THE AEROSURFACE ACTUATORS.

With the APU's and aerosurface amplifiers (ASA's) off (normal on-orbit conditions), the aerosurfaces, over a period of days, tend to "drift" from their original positions. This is due to a combination of gravity torques and circulation pump operations. If an APU is then started with the ASA's off and full hydraulic pressure applied, the actuator will try to drive the aerosurface to its hardstop, possibly causing damage. With the ASA's on and the software in OPS 3 or OPS 8, new commands are issued which cause little or no surface motion. Without OPS 3 or OPS 8, the surfaces will drive at high rate to the last commanded position. Once an APU has been started in OPS 3 or OPS 8, transition back to OPS 2 can be accomplished without fear of damage to an actuator.

Reference Rule {A8.1.5-13}, AEROSURFACE ACTUATOR PROTECTION.

- H. THE FUEL ISOLATION VALVES WILL NOT BE OPENED ON AN APU WITH A FUEL PUMP INLET PRESSURE < 15 (34) PSIA, UNLESS THE APU IS REQUIRED ~~TO MAINTAIN TWO APU/HYDRAULIC SYSTEMS DURING ENTRY OR TO PROVIDE NWS (IF REQUIRED), BRAKING REDUNDANCY, OR A REDUNDANT LANDING GEAR DEPLOY METHOD.~~ THE FUEL ISOLATION VALVES MAY BE CYCLED OPEN ONCE TO REPRESSURIZE THE FUEL LINE PRIOR TO REACHING THE LOWER LIMIT. @[021998-6491A] ~~@[072398-6685A]~~

Starting an APU with a low FPIP may result in high surge pressures and introduces the possibility of Adiabatic Bubble Compression Detonation (ABCD). ~~The risk of ABCD is judged to be less than the risks of entry with only one APU operating, no directional control, no braking redundancy, or zero fault tolerance for gear deploy. Braking redundancy is defined as fault tolerance for 50-percent braking~~ Ref. SODB, Vol I, 3.4.4.3, and rules {A-10.1.1-1}, APU LOSS DEFINITIONS, and {A10.1.2-13}, APU DEFINITIONS. ~~@[072398-6685A]~~

If a corresponding increase in drain line pressure is noted, , the fuel isolation valves may be opened to repressurize the fuel line to prevent reaching the loss limit. The pressure in the drain line and the fuel feed line should equalize to a value greater than 16.8 psia (the reseal pressure of the drain line overboard relief valve) if leakage continues. This should not be done more than once, since continued leakage below the limit indicates a possible external leak.

The 34 psia limit accounts for transducer inaccuracies. Actual transducer biases are given for each mission based on data from KSC and should be taken into account for each system. @[021998-6491A]

FLIGHT RULES

A10.1.2-3 APU ENTRY START TIME

A. AT LEAST ONE APU/HYDRAULIC SYSTEM MUST BE OPERATING PRIOR TO EXECUTING THE DEORBIT BURN.

1. PRIOR TO THE DEORBIT BURN, IF AN APU/HYDRAULIC SYSTEM FAILS OR ITS CAPABILITY TO SUPPORT TAEM THROUGH WHEELSTOP IS SUSPECT, ANOTHER APU WILL BE STARTED IF THE FOLLOWING WEATHER PLACARDS ARE MET FOR THE TARGETED LANDING SITE: @[021199-68141]

- a. CEILING \geq 10K FEET
- b. VISIBILITY \geq 7 STATUTE MILES
- c. CROSSWIND \leq 10 KNOTS (PEAK)
- d. NO GREATER THAN LIGHT TURBULENCE
- e. ACCEPTABLE ROLLOUT MARGIN/BRAKE ENERGY ON HALF BRAKES WITHOUT NWS (DIFFERENTIAL BRAKING)

OTHERWISE, THE DEORBIT BURN WILL NOT BE EXECUTED.

THIS RULE CONTINUED ON NEXT PAGE

FLIGHT RULES

THIS PAGE INTENTIONALLY BLANK

FLIGHT RULES**A10.1.2-3 APU ENTRY START TIME (CONTINUED)**

2. IF AN APU/HYDRAULIC SYSTEM IS NOT OPERATING NOMINALLY PRIOR TO THE DEORBIT BURN, BUT IS NOT CONSIDERED FAILED, AND ITS CAPABILITY TO SUPPORT TAEM THROUGH ~~WHEELSTOP TOUCHDOWN~~ IS NOT SUSPECT, THE DEORBIT BURN WILL BE EXECUTED. IF NECESSARY, ANOTHER APU WILL BE STARTED AND THE FIRST APU SHUT DOWN. [@\[021199-6814.1\]](#)

Starting an APU prior to the deorbit burn gives a measure of confidence that at least one APU will support entry. Nominally, more than one APU is not started prior to the deorbit burn in order to preserve consumables for dynamic flight where operating APU/hydraulic systems are required. The loss of a second APU can be sustained as long as the weather placards are observed. Actual runway priority depends on weight and C.G. (ref. Rule {A2.1.4-7}, LANDING SITE SELECTION). Once the deorbit burn begins, no action will be taken to terminate above safe Hp for APU/hydraulic system failures.

An APU that is not operating nominally, yet not considered failed (e.g., shift to high speed), can still be operated during the critical portions of entry, though it may be preferable to shut it down until it is needed. If there is a situation where it is prudent to shut down the off-nominal APU, the plan is to start another APU prior to the deorbit burn and shut down the off-nominal APU/hydraulic system. If there is not time to start a second APU, the deorbit burn will proceed, and appropriate action will be taken during deorbit coast. In this situation, starting a second APU is acceptable even though, in some cases, if the APU had actually been failed, a second APU would not have been started. However, if the failure mode is not understood, then that APU capability to support TAEM through ~~wheelstop touchdown~~ will be considered suspect. [@\[021199-6814.1\]](#)

Reference Rules {A4.1.3-8, BRAKING AND ROLLOUT REQUIREMENTS, and {A2.1.1-6, LANDING SITE WEATHER CRITERIA. @[111094-1622B]

Rules {A2.1.1-6}, LANDING SITE WEATHER CRITERIA; {A2.1.3-1B}, MISSION DURATION REQUIREMENTS; {A2.1.4-7}, LANDING SITE SELECTION; {A2.1.6-1}, CONTINGENCY ACTION SUMMARY; and, {A10.1.2-1}, LOSS OF APU/HYDRAULIC SYSTEM(S) ACTIONS, reference this rule. @[111094-1622B]

THIS RULE CONTINUED ON NEXT PAGE

FLIGHT RULES

A10.1.2-3 APU ENTRY START TIME (CONTINUED)

B. AN APU WILL HAVE ITS ENTRY START TIME DELAYED FOR THE FOLLOWING:

FAILURE/CONSTRAINT	START TIME
1. LOSS OF WSB COOLING CAPABILITY	TAEM
2. APU LUBE OIL OUTLET OR GEARBOX BEARING TEMPERATURES EXCEEDED LIMITS SPECIFIED IN RULE {A10.1.2-2F} DURING ASCENT	NO EARLIER THAN TAEM (IF NEEDED TO MAINTAIN TWO SYSTEMS)
3. APU WILL ONLY OPERATE WITH THE AUTO SHUTDOWN FUNCTION INHIBITED	TAEM (UNLESS NEEDED EARLIER TO MAINTAIN TWO SYSTEMS)
4. APU DOES NOT HAVE GG INJECTOR COOLING (IF APPLICABLE TO SINGLE APU ONLY)	EI-13
5. GEARBOX OR GN ₂ REPRESS BOTTLE HAS KNOWN EXTERNAL LEAK WHICH WILL NOT SUPPORT ENTIRE ENTRY OR GN ₂ REPRESS VALVE IS FAILED CLOSED	NO LATER THAN MACH 1.0
6. HYDRAULIC SYSTEM LEAK	NO EARLIER THAN TAEM BASED ON LEAK RATE
7. FREON LEAK INTO A HYDRAULIC SYSTEM	TAEM
8. HYDRAULIC SYSTEM RESERVOIR PRESSURE LOST	AFTER OTHER APU'S RUNNING AT NORMAL PRESSURE
9. HYDRAULIC SYSTEM RESERVOIR TEMPERATURE > 162° (154°) F PRIOR TO DEORBIT APU START.	TAEM

@[051194-1619B] @IED 1

1, 2. *The loss of lube oil cooling will limit APU run time to approximately 11 minutes, based on data from previous flights. The time period from TAEM through landing is more critical for APU/hydraulic system availability since the system will be needed for heavy aerosurface activity, landing gear deployment, and braking during that period.*

If WSB cooling was lost for the hydraulic fluid (due to a failure of the bypass valve), the impact to the system is not so much overheating of the hydraulic system, but rather possible premature depletion of the water supply for the water boiler, resulting in the loss of APU cooling. Bypass valve failures during entry on STS-7 and STS 61-C caused significant depletion in the water supply. The hydraulic fluid temperature sensors demanded spraying, but the bypass valve failure did not allow the fluid to receive any cooling and spraying continued. The APU start time should be delayed to move the time at which the hydraulic fluid temperatures will demand spraying to as close to TAEM as possible.

Reference Rule {A10.1.2-2F}, APU START/RESTART LIMITS.

3. *Since inhibiting the auto shutdown logic does remove one layer of protection, starting the APU at TAEM will reduce the amount of time this protection is not present. However, if another APU/ hydraulic system is failed or failing, this APU may be started earlier than TAEM to maintain two systems. In this case, it would not be necessary to start the APU any earlier than EI minus 13 minutes.*

FLIGHT RULES

THIS RULE CONTINUED ON NEXT PAGE

FLIGHT RULES**A10.1.2-3 APU ENTRY START TIME (CONTINUED)**

4. *If an APU is started at TIG minus 5 minutes and then a one-orbit waveoff is declared, the APU will have to be shut down. Without injector cooling, this APU could not be restarted to support entry as it would not have had time to cool (reference rule {A10.1.2-2A}, APU START/RESTART LIMITS). For this case, the APU should be started after the deorbit burn as a waveoff is no longer a possibility.*

5. *If gearbox GN₂ leakage occurs, the GN₂ repressurization bottle will repressurize the gearbox at APU start. GN₂ will leak, requiring further represses and eventually depleting the bottle. By delaying the start of the APU until Mach 1.0, atmospheric pressure would prevent further leakage from the gearbox while the APU is running and actually would tend to back pressurize the gearbox. It is not possible to distinguish between an oil leak and a GN₂ leak when the APU is not running. If the drop in pressure is due to oil leakage, low oil pressure will be seen at startup, bearing temperatures will rise rapidly, and the APU will have to be shut down.*

If the GN₂ bottle develops a leak or the repress valve fails closed, typical GN₂ leakage from the gearbox may not support the entire entry. In this case, delay the start of the APU until it will support ~~through wheelstop touchdown~~ or Mach 1.0, where atmospheric pressure will prevent GN₂ leakage from the gearbox. With an evacuated repress bottle, if a gearbox repress is required, the valve will come open and the oil/GN₂ from the gearbox will flow into the bottle. The pressure would equalize at a lower value, the valve will remain open, and the oil/GN₂ will continue to leak. Below Mach 1, the repress valve most likely will not be activated. If it is, there will be some atmospheric pressure in the bottle that will reduce the amount of flow from the gearbox. [@J021199-6814.1](#)

Reference Rules {A10.1.1-1A}.5, APU LOSS DEFINITIONS, and {A10.1.2-4C}, APU OIL/GEARBOX TEMPERATURE/PRESSURE.

6. *See Rule {A10.1.4-2}, HYDRAULIC LEAKS, for rationale.*

7. *Analysis by RI/Downey has determined that when Freon and hydraulic fluid are mixed, the bulk modulus of the hydraulic fluid is maintained within an acceptable range as long as fluid temperatures are limited to below 150 deg F. To prevent excessive temperature buildup in a hydraulic system with a Freon leak into it, the associated APU start should be delayed until no earlier than TAEM. The temperature rise from TAEM to ~~wheelstop touchdown~~ is not expected to exceed 100 deg F. [@J021199-6814.1](#)*

THIS RULE CONTINUED ON NEXT PAGE

FLIGHT RULES

A10.1.2-3 APU ENTRY START TIME (CONTINUED)

8. *Loss of bootstrap pressure may result in cavitation of the hydraulic pump when a start attempt is made. Rockwell/Downey studies have shown that start capability is questionable when reservoir pressure is below 15 psi. If bootstrap pressure is lost and cannot be maintained by the circulation pump, the start attempt should be delayed until the most favorable conditions exist. Intersystem leakage from two other hydraulic systems operating at full pressure will provide some head pressure. Additional head pressure may be obtained by starting the APU at a lower altitude, when atmospheric pressure and gravity will be acting on the hydraulic system. Once the APU has started, the main pump should be run in NORM pressure. Reference Rule {A10.1.3-1.A.5}, HYDRAULIC LOSS DEFINITIONS; RIC IL 288-503-81-055, November 10, 1981; and STS-7 SPAN/MER Action Request 041, June 21, 1983.*
9. *Hydraulic system temperatures greater than 162 deg F at APU start will lead to early water spray boiler spraying. The early spraying coupled with cool lube oil temperatures could lead to a water spray boiler freeze up and loss of the associated APU lube oil cooling. Loss of lube oil cooling would require an APU shutdown. The APU could not be restarted until Mach 1 to support ~~through wheelstop touchdown~~ (ref. rule {A10.1.2-4B}, APU OIL/GEARBOX TEMPERATURE/PRESSURE). To avoid this situation, starting an APU/hydraulic system with reservoir temperature greater than 162 (154) deg F should be delayed until TAEM. At reservoir temperatures below 162 (154) deg F the APU lube oil will require cooling prior to hydraulic spraying. The heat load from the APU will prevent a water spray boiler freezeup. [@\[021199-6814\]](#)*
- Rules {A10.1.2-4C}, APU OIL/GEARBOX TEMPERATURE/PRESSURE; {A10.1.6-2B}, LOSS OF WSB(s) ACTIONS, and {A10.1.4-3E}, HYDRAULIC SYSTEM PRESSURE/TEMPERATURE, reference this rule. @[051194-1619B]*

FLIGHT RULES

A10.1.2-4 APU OIL/GEARBOX TEMPERATURE/PRESSURE

- A. POST-MECO, AN APU WILL BE SHUT DOWN IF THE LUBE OIL OUTLET TEMPERATURE EXCEEDS 325 DEG (305 DEG) F OR IF THE GEARBOX BEARING TEMPERATURE EXCEEDS 350 DEG (335 DEG) F (MCC CALL).

The APU should be shut down after MECO is obtained, since the consequences are no longer severe. This is done to protect the APU for use during entry and landing. At or below these temperatures, APU reuse is guaranteed.

Reference Rule {A10.1.1-1A.6}, APU LOSS DEFINITIONS, and SODB 3.4.4.3.

- B. DURING ENTRY/ABORTS, FOR CONFIRMED LOSS OF APU LUBE OIL COOLING CAPABILITY, IF POST-MECO AND MACH > 1.0, THE AFFECTED APU WILL BE SHUT DOWN ASAP IF AT LEAST ONE OTHER GOOD APU/HYDRAULIC SYSTEM REMAINS. A RESTART WILL BE PERFORMED NO EARLIER THAN MACH 1.0, IF THE APU IS REQUIRED. FOR MACH < 1.0, AN APU WILL NOT BE SHUT DOWN FOR LOSS OF LUBE OIL COOLING UNTIL POST-WHEEL-STOP. ©[072398-6685A] @ED 1

If all lube oil cooling capability has been lost due to water spray boiler failure(s), the affected APU will have only a limited operational lifetime. APU lube oil and bearing temperature rise rates without sufficient cooling may be higher than during previous operation. This is due to a continuous breakdown of lube oil viscosity at elevated temperatures as well as the high workload of the APU in the latter portions of approach and landing.

If cooling capability is lost after the normal cooling control point is reached (250 deg F), the available APU run time is estimated to be no more than a few minutes before gearbox seals are lost and/or bearing seizure occurs. For this reason, the APU should be shut down and the remaining run time saved if needed to provide a second system operating during final approach and landing.

Once a velocity of Mach 1 (approximately 4 minutes to touchdown) is reached, an APU that loses its lube oil cooling capability should be left running through wheel-stop. This is because below Mach 1, there may not be sufficient time to perform shutdown, cooldown, and restart before touchdown. Though continued operation through ~~wheelstop~~~~touchdown~~ may be questionable, it is preferable to have the APU operating as long as possible. ©[021199-6814] @ED 1

Rules {A10.1.2-3B.9}, APU ENTRY START TIME, and {A10.1.2-13}, APU DEFINITIONS, reference this rule. ©[051194-1619B] ©[072398-6685A]

THIS RULE CONTINUED ON NEXT PAGE

FLIGHT RULES

A10.1.2-4 APU OIL/GEARBOX TEMPERATURE/PRESSURE (CONTINUED)

- C. AN APU WITH GEARBOX PRESSURE < 2.0 (3.5) PSIA WILL ONLY BE USED FOR ENTRY. FOLLOWING APU START, IF THE OIL OUTLET PRESSURE IS NOT > 20 (30) PSIA AFTER 30 SECONDS AND OIL OUTLET TEMPERATURE IS NOT INCREASING, THE APU WILL BE SHUT DOWN AND NOT RESTARTED.

If the APU gearbox pressure is < 2 psia, a leak is present in the gearbox or associated plumbing and some amount of lube oil/GN₂ has been lost. Starting the APU will repressurize the gearbox from the GN₂ bottle, but it may only be able to do this once (GN₂ bottle may be dumped into the gearbox) and this will also begin to leak from the gearbox. Because of this one-shot potential, the APU should only be started to support entry. Once the APU is started, if the oil pressure is greater than 20 psia, then the gearbox has been successfully repressurized and sufficient lube oil is still present to allow the APU to operate.

- D. DURING ENTRY/ABORTS, AN APU WILL BE SHUT DOWN POST-MECO IF THE OIL OUTLET PRESSURE IS > 150 (140) PSIA.

Structural damage could result if the APU is run with an oil pressure > 150 psia. Reference SODB, Vol. I, 3.4.4.3.9a. ©[072398-6685A]

Rules {A10.1.1-1A}.4, 5, and 8, APU LOSS DEFINITIONS, and {A10.1.2-3B}.5, APU ENTRY START TIME, reference this rule.

- E. POST-MECO AND MACH > 1.0, AN APU THAT IS RUNNING WITH A GEARBOX PRESSURE OF < 2.0 (3.5) PSIA WILL BE SHUT DOWN ASAP IF AT LEAST ONE OTHER GOOD APU/HYDRAULIC SYSTEM REMAINS. A RESTART WILL BE PERFORMED, NO EARLIER THAN MACH = 1.0, IF THE APU IS REQUIRED. FOR MACH < 1.0, AN APU WILL NOT BE SHUT DOWN FOR LOSS OF GEARBOX PRESSURE UNTIL POST-WHEEL-STOP. ⑥ED |

If an APU is running with its gearbox pressure < 2 psia, a leak is present in the gearbox or associated plumbing that can no longer be supported by repressurizations from the GN₂ bottle. It is not possible to distinguish between a lube oil or GN₂ leak. However, if the leak is mostly GN₂, shutting down the APU at this point will prevent it from seizing due to loss of lubrication. The APU can then be restarted, if required, at Mach 1.0 since the atmospheric pressure would prevent further leakage from the gearbox while the APU is running and actually would tend to back pressurize the gearbox. If a significant amount of oil is also being lost, the bearing temperatures will eventually begin to rise, indicating the loss of lubrication and imminent bearing seizure. In this case, the APU would be shut down based on temperature rise and would be nonrecoverable.

Rule {A10.1.2-13}, APU DEFINITIONS, references this rule. ©[072398-6685A]

FLIGHT RULES

A10.1.2-5 APU HIGH SPEED SELECTION/SHIFT

- A. THE REMAINING APU(S) WILL BE RUN AT HIGH SPEED IF ONE OR MORE APU/HYDRAULIC SYSTEMS ARE LOST DURING ASCENT OR RTLS.

In order to minimize the performance degradation resulting from APU/hydraulic system loss(es), the remaining APU(s) are taken to high speed as soon as a system is declared lost.

- B. DURING ENTRY/ABORTS (EXCEPT RTLS), HIGH SPEED WILL BE SELECTED:

1. AT MM 304 IF ONLY A SINGLE GOOD APU/HYDRAULIC SYSTEM IS OPERATING.

If two APU's have been lost, then there is degradation in aerosurface movement rate capability. The remaining APU must be in high speed in order to obtain maximum horsepower to minimize this degradation. Also, it is absolutely essential that the APU be operating at maximum rpm when the vehicle first enters the Earth's atmosphere (MM 304-EI) to provide the best chance of landing the orbiter on one APU.

2. AT TAEM, IF ONLY TWO GOOD APU/HYDRAULIC SYSTEMS ARE OPERATING.

If one APU is lost, the two remaining APU's can still meet all aerosurface rate demands with no loss of performance even if they are running at normal speed. They are taken to high speed at TAEM as a precautionary measure in the event one of the remaining APU's fails during the critical final landing maneuvers.

Rule {A10.1.4-2}, HYDRAULIC LEAKS, references this rule.

- C. AN APU WILL NOT BE SHUT DOWN PRIOR TO MECO, EXCEPT FOR CONFIRMED OVERSPEED > 129 (129) PERCENT.

Shutting down an APU in powered flight will result in the associated main engine going into hydraulic lockup. Test data on SSME valve drift is very limited while in the hydraulic lockup condition. Excessive SSME valve drift can severely impact ascent performance to the point of risking loss of orbit capability. For this reason, it is highly desirable to avoid hydraulic lockup even at the expense of possible loss of an APU.

In addition to valve drift concerns, the failure of an SSME bypass valve prior to STS-26 has also contributed to the desire to avoid the SSME hydraulic lockup condition. Failure of the bypass valve in combination with hydraulic lockup (i.e., APU shutdown) can result in loss of hydraulic and pneumatic engine shutdown capability. A catastrophic engine shutdown will result. Because the bypass valve failure is not detectable (transparent to crew and MCC), manual shutdown of an APU in response to any failure except a confirmed overspeed during powered flight is not allowed. Reference Ascent/Entry Flight Techniques #50, October 20, 1988.

NASA - JOHNSON SPACE CENTER

FLIGHT RULES

THIS RULE CONTINUED ON NEXT PAGE

FLIGHT RULES

A10.1.2-5 APU HIGH SPEED SELECTION/SHIFT (CONTINUED)

- D. DURING ASCENT, AN APU WHICH SHIFTS TO HIGH SPEED WITH NORMAL SPEED SELECTED WILL BE SHUT DOWN ASAP POST-MECO.

An APU that shifts to high speed (due to a failure of the pulse control valve to regulate speed) is a single failure (failed open secondary valve) from a possible uncontained overspeed. The risk of a second failure in that APU is accepted in powered flight in order to retain SSME throttling capability and SSME hydraulic valve control. (Shutting down one APU results in hydraulic lockup of one main engine.) Risk of operating the APU after MECO is not warranted, and the APU will be shut down.

Though it has experienced a shift to high speed, the APU will not be considered lost for planning purposes since it may be used when absolutely necessary.

- E. DURING ENTRY/ABORTS, IF AN APU SHIFTS TO HIGH SPEED WITH NORMAL SPEED SELECTED AND TWO GOOD APU/HYDRAULIC SYSTEMS REMAINING, THE APU WILL BE SHUT DOWN ASAP POST-MECO. A RESTART WILL BE PERFORMED IF THE APU IS ~~REQUIRED~~NEEDED TO MAINTAIN TWO APU/HYDRAULIC SYSTEMS, TO PROVIDE NWS (IF REQUIRED), OR TO PROVIDE A REDUNDANT LANDING GEAR DEPLOY METHOD (SHUTDOWN WILL NOT BE PERFORMED FOR THESE CASES IF INSUFFICIENT TIME IS AVAILABLE TO RESTART THE AFFECTED APU). [@I073498-6685A1](#)

If the other APU's are functioning properly, the affected APU will be shut down to protect against a possible uncontained overspeed. That APU may be considered available for restart after completion of injector cooling should a second APU be required.

If only one other APU is functioning properly, the affected APU will be left operating in order to provide dual APU flight control authority throughout entry.

APU operations after an uncommanded shift to high speed shall be performed with the APU SPEED SELECT switch in high in order to prevent nuisance alarms. This will also enable the 115 percent comparator, which will provide backup speed control in the case that the initial failure was in the 103 percent comparator. In addition, auto shutdown shall remain enabled as long as one other good APU remains.

Reference Rules {A2.1.5-4C}, ENTRY STRING REASSIGNMENT; ~~and~~ {A10.1.2-6}, APU AUTO SHUTDOWN INHIBIT MANAGEMENT; and {A10.1.2-13}, APU DEFINITIONS. [@I072398-6685A1](#)

FLIGHT RULES

A10.1.2-6 APU AUTO SHUTDOWN INHIBIT MANAGEMENT

- A. AN APU WILL HAVE ITS AUTO SHUTDOWN FUNCTION INHIBITED IF:
1. ONE OTHER APU/HYDRAULIC SYSTEM IS LOST OR FAILING SUCH THAT SUPPORT OF NOMINAL ASCENT THROUGH MECO IS SUSPECT (SEE PARAGRAPH B FOR EXCEPTIONS).
 2. THE OTHER TWO APU/HYDRAULIC SYSTEMS ARE LOST OR FAILING SUCH THAT SUPPORT OF ABORT/ENTRY THROUGH ~~WHEELSTOP TOUCHDOWN~~ IS SUSPECT. @[021199-6814]
 3. THE APU IS NEEDED TO PROVIDE A LAST METHOD OF GEAR DEPLOY OR DIRECTIONAL CONTROL. @[072398-6685A]

The purpose of the auto shutdown function is to quickly secure the APU in the event of a potentially hazardous situation (such as an overspeed condition). The auto shutdown logic secures the APU by disabling the shutoff valve commands and removing power from the fuel tank isolation valves (causing the valves to close). The auto shutdown function can be inhibited to protect against an erroneous shutdown of an APU, but this also removes all overspeed/underspeed protection.

With the redundancy inherent in the digital controller, an erroneous APU shutdown is highly unlikely. At least two controller component/magnetic pickup unit (MPU) failures are necessary to cause an inadvertent shutdown after the first 10.5 seconds of run time. Due to their design, location, and failure history, the probability of two MPU failures is considered much greater than that of two controller failures. And in INHIBIT, the loss of two MPU's would result in an uncontained overspeed. Therefore, inhibiting the auto shutdown function is not likely to prevent a spurious shutdown, and it does increase the risk of an uncontained overspeed.

However, there are some specific mechanical failure scenarios where the APU would only continue to run if the auto shutdown was inhibited. These single mechanical failures are more likely than the dual controller/MPU failures, but the ability of the affected APU/hydraulic system to provide useful support is highly questionable.

Even though the increased risk associated with running an APU in INHIBIT is relatively small, the potential consequences do not warrant accepting the risk except for the cases listed. In these cases, even the small gains associated with inhibiting auto shutdown are considered necessary to maintain critical functions. This applies to the loss of a single APU during power flight due to controllability concerns associated with the loss of a second APU.

THIS RULE CONTINUED ON NEXT PAGE

FLIGHT RULES

A10.1.2-6 APU AUTO SHUTDOWN INHIBIT MANAGEMENT (CONTINUED)

4. INHIBIT IS NECESSARY TO ALLOW THE APU TO OPERATE (SEE PARAGRAPHS B AND C FOR EXCEPTION).

There are several component failure scenarios in the digital controller (e.g., false overspeed), as well as several mechanical scenarios (e.g., low fuel tank pressure, valve contamination), that would result in an erroneous shutdown during APU startup. These situations would require inhibiting the auto shutdown function to get the APU running. For the controller failures, the auto shutdown must remain inhibited since the erroneous signal(s) in the controller would shut the APU down if the function were reenabled.

In these cases, the risk of running an APU with its auto shutdown inhibited is considered less dangerous than the risk of losing entry-critical APU/hydraulic systems. Therefore, the auto shutdown logic is inhibited to maintain a fail-safe configuration for entry even if two other good APU's remain.

- B. THE AUTO SHUTDOWN FUNCTION WILL BE (RE)ENABLED FOR AN APU WHICH HAS ONE OF THE FOLLOWING CONDITIONS WHEN AT LEAST ONE GOOD APU/HYDRAULIC SYSTEM REMAINS:
1. THE APU TURBINE SPEED HAS SHIFTED TO THE HIGH SPEED BAND, IS ERRATIC WITH HIGH SPEED SELECTED, OR IS LOST DUE TO A SUSPECTED MPU FAILURE.
 2. THE APU IS RUNNING WITH AN ISOLATABLE FUEL LEAK.

IF (RE)ENABLING THE AUTO SHUTDOWN FUNCTION WILL CAUSE THE APU TO SHUT DOWN, THE AUTO SHUTDOWN MAY REMAIN INHIBITED TO MAINTAIN TWO APU'S THROUGH MECO OR WHEELSTOP TOUCHDOWN. @021199-6814.1

Auto shutdown should be enabled in situations where there is a high potential for an uncontrolled shutdown which could cause damage to other equipment in the aft compartment. If the turbine speed is erratic and selecting high speed did not clear the problem or if turbine speed has shifted to the high speed band, the APU is one failure away from an overspeed condition. Similarly, the loss of a MPU (i.e., loss of turbine speed not explainable by an MDM/DSC or other failure), with the auto shutdown function inhibited, places the APU one failure away from an uncontained overspeed condition. In these cases, the risk of an uncontrolled shutdown is considered greater than an erroneous shutdown causing single APU operations. If the APU is in INHIBIT to allow it to operate, taking it back to ENABLE will cause the APU to shut down. Therefore, this should only be done if two good APU/hydraulic systems remain.

FLIGHT RULES

A fuel leak can lead to a fire and an explosive shutdown such as occurred on STS-9. The auto shutdown logic is beneficial in this case because it automatically closes the fuel tank isolation valves upon shutting down the APU. This may isolate the leak, thus minimizing the risk due to hydrazine in the aft compartment.

THIS RULE CONTINUED ON NEXT PAGE

FLIGHT RULES

A10.1.2-6 APU AUTO SHUTDOWN INHIBIT MANAGEMENT
(CONTINUED)

C. DURING ENTRY/ABORTS, FOR AN APU THAT HAS SHUTDOWN DUE TO AN UNEXPLAINED UNDERSPEED WITH AUTO SHUTDOWN ENABLED:
@[062797-4889]

1. THE APU WILL BE RESTARTED WITH AUTO SHUTDOWN ENABLED AND NORM SPEED SELECTED ONLY IF TIME IS AVAILABLE TO PERFORM TWO APU RESTARTS (T/D > APPROX 10 MIN) AND ANY OF THE FOLLOWING ARE TRUE:
 - a. ANOTHER APU/HYD SYSTEM IS FAILED OR SUSPECT.
 - b. THE APU IS REQUIRED. ~~@[072398-6685A] FOR L/G DEPLOY REDUNDANCY, BRAKING REDUNDANCY, OR NWS (IF REQUIRED).~~
 - c. SINGLE APU WX PLACARDS ARE EXCEEDED.
2. IF A RESTART IS ATTEMPTED AND THE APU:
 - a. STARTS AND RUNS, THE APU WILL CONTINUE TO OPERATE WITH AUTO SHUTDOWN ENABLED. THE APU WILL BE CONSIDERED SUSPECT.
 - b. DOES NOT START OR SUSTAINS AN UNDERSPEED SHUTDOWN WITHIN THE FIRST 10.5 SECONDS OF OPERATION, THE APU WILL BE RESTARTED AND OPERATED WITH AUTO SHUTDOWN INHIBITED IF REQUIRED. ~~@[072398-6685A] TO PROVIDE TWO APU/HYD SYSTEMS, L/G DEPLOY REDUNDANCY, BRAKING REDUNDANCY, OR NWS (IF REQUIRED).~~
 - c. SUSTAINS AN UNDERSPEED SHUTDOWN AFTER 10.5 SECONDS, ANOTHER RESTART OF THE APU MAY BE ATTEMPTED IF TIME PERMITS. THE APU WILL BE OPERATED WITH AUTO SHUTDOWN ENABLED.
 - d. SUSTAINS AN OVERSPEED SHUTDOWN, THE APU WILL BE SHUT DOWN AND NO FURTHER TROUBLESHOOTING WILL BE ATTEMPTED. @[061297-4889]

THIS RULE CONTINUED ON NEXT PAGE

FLIGHT RULES**A10.1.2-6 APU AUTO SHUTDOWN INHIBIT MANAGEMENT**
(CONTINUED)

3. IF TIME IS NOT AVAILABLE TO ATTEMPT TWO RESTARTS, AN APU COOLDOWN WILL BE PERFORMED AT MACH 7. THE APU WILL BE RESTARTED, WITH AUTO SHUTDOWN INHIBITED, ONLY TO PROVIDE A LAST APU/HYD SYSTEM, LANDING GEAR DEPLOY METHOD, OR BRAKING. @[061297-4889]

An APU has sustained an “unexplained” underspeed shutdown if a dual magnetic pickup unit (MPU) failure cannot be ruled out as the cause of the shutdown (other than by attempting a restart of the APU; examples of explainable underspeed shutdowns include failures within the underspeed slow latch circuit, overspeed slow latch circuit, and timer failures). Analysis performed by JSC SR&QA indicates that the most probable APU electrical failure is an MPU. The APU has three MPU’s which provide APU turbine speed data to the APU controller - dual MPU failures result in APU shutdown. The signature for a dual MPU failure case is closure of the fuel tank isolation valves (FIV), illumination of the F7 APU underspeed light, and closure of the shutoff valve (SOV) while the APU is running in NORM or HIGH speed. This occurs because three of the four speed control channels indicate zero speed due to the failed MPU’s which results in the logic on these three channels voting for underspeed. The same signature can result with two intermittent MPU’s. Another signature is also possible for the case of two intermittent MPU’s. The signature for this scenario is the APU spinning down from NORM or HIGH speed, and at a turbine speed of 80 percent, the FIV’s close and the F7 APU underspeed light is illuminated. The signature for two intermittent MPU’s is dependent on which of the three MPU’s have failed. Therefore, there is not a specific shutdown signature for all MPU failure cases.

During APU start, the controller locks out the underspeed shutdown logic for 10.5 seconds to allow the APU adequate time to spin up. The overspeed shutdown logic is not affected during this 10.5 second period. Since the dual MPU failure is interpreted as a zero turbine speed by the APU controller on three of the four speed control channels, the controller does not sense the APU spinning up. As a result, the APU continues to increase in RPM until the remaining MPU senses that the speed has reached 129 percent, which triggers the overspeed shutdown logic and shuts down the APU if auto shutdown is enabled. If auto shutdown was inhibited, the APU would experience an uncontained overspeed - the turbine could disintegrate, producing shrapnel that could damage other equipment in the aft fuselage.

To determine if the underspeed was due to a dual MPU failure, the APU is restarted with auto shutdown enabled. If the APU overspeeds and automatically shuts down, then the dual MPU failure case is confirmed - the APU will be safed and should never be restarted. If the APU does not start or experiences an underspeed shutdown within the first 10.5 seconds of operation, a dual MPU failure is not the cause of the shutdown (dual failures may be in the APU or the controller). If the APU restarts and operates but subsequently fails after 10.5 seconds, the failure is transient (e.g., a single failed MPU coupled with an intermittent MPU) - the APU would experience an uncontained overspeed if the transient MPU recurred with auto shutdown inhibited, so the APU will only be restarted and run with auto shutdown enabled. _ @[061297-4889]

FLIGHT RULES

THIS RULE CONTINUED ON NEXT PAGE

FLIGHT RULES

A10.1.2-6 APU AUTO SHUTDOWN INHIBIT MANAGEMENT (CONTINUED)

Touchdown minus 10 minutes is the minimum amount of time needed to accomplish two APU cooldowns in order to support APU operations no later than approach and landing. Since hardware damage to the affected APU may result if an overspeed condition occurs, troubleshooting for an unexplained underspeed should only be performed if critical redundancy is lost. If there is insufficient time to perform two cooldowns and the APU is needed to provide a critical landing capability, a start attempt will be made with auto shutdown inhibited to provide the best chance of regaining the APU. ©[061297-4889]

Braking redundancy is defined as fault tolerance for 50 percent braking. This rule is referenced by Rule {A10.1.2-5}, APU HIGH SPEED SELECTION/SHIFT. Reference Rule {A10.1.2-13}, APU DEFINITIONS. ©[061297-4889] ©[072398-6685A]

A10.1.2-7 APU FUEL LEAKS (CIL)

A. DURING ASCENT, IF AN APU DEVELOPS A FUEL LEAK, IT WILL BE SHUT DOWN ASAP POST-MECO.

If the leak is upstream of the tank valves, then the leak is not isolatable and fuel will continue to leak into the orbiter aft compartment even with the APU shut down. A significant amount of free hydrazine in the aft compartments presents a severe safety hazard during entry. To avoid this, the APU should be restarted and allowed to run until its fuel is depleted. This will ensure that most of the hydrazine is burned and exhausted overboard and will minimize the amount of hydrazine that leaks into the aft bay. The restart should only be performed if fuel tank pressure is > 100 (107) psi.

If the fuel leak is downstream of the tank valves, the leak will be isolated when the APU is shut down. The APU is still considered lost, however, and should not be started unless one of the two remaining APU's fails (not available for entry).

Reference Rule {A10.1.1-1.A.1.b}, APU LOSS DEFINITIONS.

B. ON ORBIT POST-MECO, AN APU WILL BE OPERATED FOR THE PURPOSE OF BURNING ITS FUEL IF THERE IS A SUSPECTED OR CONFIRMED NONISOLATABLE HYDRAZINE LEAK. (CIL)

1. WITH TWO OTHER GOOD APU/HYDRAULIC SYSTEMS, THIS TECHNIQUE WILL APPLY WITHOUT CONSIDERING LANDING OPPORTUNITIES.

THIS RULE CONTINUED ON NEXT PAGE

FLIGHT RULES

A10.1.2-7 APU FUEL LEAKS (CIL) (CONTINUED)

2. WITH ONLY ONE OTHER GOOD APU/HYDRAULIC SYSTEM REMAINING, THIS WILL APPLY IF THE LEAK RATE DOES NOT SUPPORT THE NEXT PLS ASSUMING THE AFFECTED APU IS STARTED AT TAEM.

If the leak is upstream of the fuel tank isolation valves, then the leak is not isolatable and fuel will continue to leak into the orbiter aft compartment even with the APU shut down. A significant amount of free hydrazine in the aft compartment presents a severe safety hazard during entry. If two fully operational APU's remain, the leaking APU will be started and its fuel burned off in order to minimize the amount of free hydrazine that is left to leak in the aft compartment. If one APU has already failed, however, the leak rate will be assessed to see if fuel will support a next PLS entry. If the leak rate is slow enough that the APU would be able to support a next PLS entry, then the APU will not be started to burn off its fuel. Performing a single APU entry is more hazardous than having free hydrazine in the aft bay. Start of the APU will be delayed until TAEM to reduce entry usage requirements and optimize the remaining capability to support the leak rate. If the leak rate will not support the next PLS, then the APU will be started and the fuel burned off since it would not be available for entry whether the APU was started or not.

- C. DURING ENTRY/ABORTS, FOR A FUEL LEAK, ACTION WILL BE TAKEN IN ORDER TO PROVIDE AT LEAST TWO APU/HYDRAULIC SYSTEMS FROM TAEM THROUGH WHEELSTOPTOUCHDOWN. @021199-68141

1. IF ONLY ONE OTHER GOOD APU/HYDRAULIC SYSTEM REMAINS AND THE LEAK SUPPORTS CONTINUED OPERATION THROUGH WHEELSTOPTOUCHDOWN, THE APU WILL BE ALLOWED TO RUN. IF THE LEAK WILL NOT SUPPORT CONTINUED OPERATION THROUGH WHEELSTOPTOUCHDOWN OR IF TWO OTHER GOOD APU/HYDRAULIC SYSTEMS REMAIN, THE AFFECTED APU WILL BE SHUT DOWN IF IT IS DETERMINED THAT THE FUEL TANK PRESSURE WILL NOT FALL BELOW 100 (107) PSIA BEFORE AN APU RESTART COULD BE PERFORMED. (CIL)

- a. IF THE LEAK IS ISOLATED, THE AFFECTED APU WILL BE RESTARTED IF NEEDED TO MAINTAIN TWO APU/HYDRAULIC SYSTEMS FROM TAEM THROUGH WHEELSTOPTOUCHDOWN, A LAST METHOD OF GEAR DEPLOY, OR DIRECTIONAL CONTROL (CIL). @[072398-6685A] @021199-68141

THIS RULE CONTINUED ON NEXT PAGE

FLIGHT RULES

A10.1.2-7 APU FUEL LEAKS (CIL) (CONTINUED)

- b. IF THE LEAK IS NOT ISOLATED AND THE LEAK RATE WILL NOT SUPPORT APU OPERATIONS FROM TAEM THROUGH WHEELSTOPTOUCHDOWN, THE AFFECTED APU WILL BE RESTARTED ASAP. OTHERWISE, THE AFFECTED APU WILL BE RESTARTED WHEN ABLE TO SUPPORT APU OPERATIONS THROUGH WHEELSTOPTOUCHDOWN (NO LATER THAN TAEM). (CIL) @[021199-6814]

There are two important goals to achieve when troubleshooting a leaking APU: maintaining two good APU's for flight control and minimizing fuel leakage into the aft compartment, which can lead to fire. This rule will minimize free hydrazine in the aft compartment and reduce the risk of a fire which could potentially cause the loss of a second APU. The risk of fire damaging remaining APU's is considered greater than APU detonation concerns as a result of APU shutdown and subsequent heat soakback. Restarting a leaking APU risks a large fuel leak and potential detonation of the GGVM, but this risk is considered acceptable when considering the inability of the vehicle to land on a single APU.

We are forced to accept the risk of an aft compartment fire in order to provide two APU's for flight control. If only two APU's are operating, we do not want to risk shutting one down to try and isolate the leak, since it may not restart when required at TAEM. If the leaking APU will not support ~~through wheelstoptouchdown~~ in its present condition, it is acceptable to shut it down and try to isolate the leak. If the leak is isolatable, this may allow a restart at TAEM to provide two APU's for landing.

If the leak rate is large enough that the fuel tank pressure would fall below 100 psia before an APU restart could be performed (in the event shutting the APU down does not isolate the leak), it should be assumed that the leak is nonisolatable; thus, the APU should be allowed to run to continue burning off fuel. Simulation experience shows that it takes approximately 5 minutes for the crew to shut down and then immediately restart an APU; this 5 minute time should be used when determining if the tank pressure will fall below 100 psia. ~~Including the amount of time to evaluate the situation post shutdown, make a call to the crew and restart the APU after using injector cooling; the elapsed time from shutdown to restart would be about 5 minutes.~~

Reference Rule {A10.1.2-2A}, APU START/RESTART LIMITS, and SODB 3.4.4.3.

2. PRIOR TO TAEM, AN APU WITH A SUSTAINED OVERBOARD FUEL PUMP SEAL CAVITY DRAIN SYSTEM LEAK WILL BE SHUT DOWN ASAP IF TWO OTHER GOOD APU/HYDRAULIC SYSTEMS REMAIN AND THE LEAKING APU FUEL TANK PRESSURE IS > 100 (107) PSIA. THE APU WILL BE RESTARTED IF NEEDED TO MAINTAIN TWO APU/HYDRAULIC SYSTEMS FROM TAEM THROUGH WHEELSTOPTOUCHDOWN, A LAST METHOD OF GEAR DEPLOY, OR DIRECTIONAL CONTROL. @[072398-6685A] @[040899-6824]

THIS RULE CONTINUED ON NEXT PAGE

FLIGHT RULES

A10.1.2-7 APU FUEL LEAKS (CIL) (CONTINUED)

This rule accepts the risk of aft compartment fire damage after TAEM caused by ingestion, through the aft vent doors, of the fuel leaking overboard. A fuel pump seal leak may be detected by repeated excursions in drain line pressure to the relief valve cracking pressure (28 to 42 psia) or sustained drain line pressure above the relief valve reseal pressure (16.8 to 25.2 psia). A fuel pump seal cavity drain-leak will, by nature, be small; combined with the low probability of ingestion~~therefore~~, chances of catastrophic damage from such a leak are small. There is insufficient time post-TAEM for a cooldown and restart of the affected APU, if required. Therefore, it is better to allow the APU to continue running so it will be available to support operations through ~~wheelstop to wheel down~~ in the event another APU is lost. If the fuel tank pressure has already fallen below 100 psia, the APU should not be restarted if it is shut down. [@\[021199-6814\]](#) [@\[040899-6824\]](#)

Reference Rule {A10.1.2-2A}, APU START/RESTART LIMITS, and SODB 3.4.4.3.

A10.1.2-8 AOA APU/HYDRAULIC SYSTEM OPERATIONS

- A. IF ORBIT CAPABILITY IS QUESTIONABLE, THE APU'S WILL REMAIN RUNNING UNTIL THE DECISION IS MADE TO CONTINUE TO ORBIT. THE HYDRAULIC MAIN PUMPS WILL BE TAKEN TO "LOW PRESS" FOLLOWING MPS DUMP COMPLETION.

If an AOA has been declared, or is even a strong possibility, the APU's should continue operating to preclude the need for a later restart of all three APU's in order to support the AOA. Performing a restart on an APU is not something to be done without good reason and should be avoided if at all possible. A single failure in the injector cool system could cause the loss of all restart capability. The hydraulic main pumps will be depressurized to minimize fuel usage as well as WSB H₂O usage.

Reference SODB, vol. I, 3.4.4.3.5a

Rule {A2.1.2-17}, APU SHUTDOWN DELAY CRITERIA, references this rule.

- B. DURING AN AOA, THE APU'S WILL REMAIN RUNNING WITH HYDRAULIC PUMPS IN "LOW PRESS" UNTIL MM 304. AN APU WILL BE SHUT DOWN, IF REQUIRED, TO MAINTAIN THE APU FOR ENTRY REGARDLESS OF OTHER APU/HYDRAULIC SYSTEMS STATUS.

APU consumables are loaded to account for continuous APU operation throughout an AOA. However, the margins are very small. Any off-nominal APU or WSB operation could result in exceeding these margins. Failure modes, such as a MPS/TVC ISOL valve failing to fully close (STS 51-J), result in additional loads and increased fuel and water usage on the APU which are not accounted for in the consumable analyses. When required, an APU should be shut down if this will allow it to be available throughout entry and landing.

FLIGHT RULES

A10.1.2-9 FCS CHECKOUT APU OPERATIONS

- A. APU SELECTION FOR FCS CHECKOUT WILL BE DONE REAL TIME BASED ON APU/HYDRAULIC SYSTEMS STATUS. CONSIDERATION WILL NOT BE GIVEN TO LANDING GEAR REDUNDANCY OR SWITCHING VALVE CYCLING.

The overriding consideration for APU system management decisions during the orbit/FCS checkout flight phase is the upcoming entry. The APU's must be in the best possible condition for entry. Therefore, the APU selected for FCS checkout must have had no potentially serious anomalies during ascent, consumables must be adequate to meet redline criteria, and there must be no major loss in performance monitoring instrumentation.

If APU 1 is selected for FCS checkout and should fail as a result of being selected, landing gear deploy redundancy would be lost. However, if APU 1 ran only long enough for FCS checkout, then it probably would not have supported the entire entry anyway. Thus, landing gear redundancy will not be considered when selecting an APU.

Certain hydraulic switching valves will change state during FCS checkout depending on which APU is selected. Should they fail in that state, hydraulic redundancy would be lost. But some switching valves must change state no matter which APU is selected; so switching valve cycling is not good criteria for selecting an APU.

- B. FCS CHECKOUT WITH AN APU WILL BE PERFORMED ONLY IF IT IS DETERMINED THAT TWO OF THREE APU/HYDRAULIC SYSTEMS WILL HAVE AT LEAST 192 LB APU FUEL AND 63 LB WSB H₂O FOLLOWING FCS CHECKOUT. ©[012694-1596]

The fuel and H₂O quantities above are based on the following:

	<u>APU</u>
FCS CHECKOUT	14.7
DEORBIT COAST	27.1
ENTRY	98.0
RESIDUALS	5.4
LOADING UNCERTAINTY	8.0
RESERVES AND ALLOWANCES	<u>53.4</u>
TOTALS	206.6 LB
TOTAL WITHOUT FCS CHECKOUT	191.9 LB

©[012694-1596]

FLIGHT RULES

THIS RULE CONTINUED ON NEXT PAGE

FLIGHT RULES

A10.1.2-9 FCS CHECKOUT APU OPERATIONS (CONTINUED)

- C. IF THE STATUS OF AN APU/HYDRAULIC SYSTEM IS QUESTIONABLE TO SUPPORT ENTRY, ATTEMPTS MAY BE MADE TO START AND OPERATE THAT SYSTEM FOR FCS CHECKOUT IN ORDER TO VERIFY ENTRY CAPABILITY PROVIDED THAT THE SYSTEM CAN BE OPERATED SAFELY (MCC CALL).

If only one or two APU's are nominally operable, it is unwise to activate either, except to support entry. If the orbit FCS checkout part 1 (secondary actuator check) were to be performed, one of the two remaining nominal APU's (or the last operational APU for the single remaining APU case) would have to be activated twice, increasing the risk of loss. Under these conditions, if an APU/hydraulic system has experienced suspect operation such that its capability to support entry is questionable, its entry status can be verified, if determined safe to operate, by attempting to use the system for FCS checkout.

- D. IF CONDITIONS PRECLUDE OPERATION OF ANY ONE OF THE THREE APU/HYDRAULIC SYSTEMS, THE HYDRAULIC CIRCULATION PUMP ON A FAILED SYSTEM MAY BE ACTIVATED IN ORDER TO PERFORM AN ABBREVIATED SECONDARY ACTUATOR CHECK. IF CONDITIONS ALSO PRECLUDE USE OF A CIRCULATION PUMP ON A FAILED SYSTEM, A CIRCULATION PUMP ON A NOMINAL HYDRAULIC SYSTEM MAY BE USED TO PERFORM THE CHECK.

If only one or two APU's are nominally operable or if it could be determined that operating an APU would be unsafe (isolated fuel leak, etc.), an abbreviated actuator check could be performed utilizing the system circulation pump. If it would also be unwise to activate the hydraulic system utilizing the circulation pump, a circulation pump on a nominal system could then be used to perform the abbreviated actuator check.

Reference Rule {A10.1.4-4E}, HYDRAULIC CIRCULATION PUMP OPERATION. ©[072398-6686B] ©[072398-6686A]

- E. IF MISSION CONSTRAINTS PRECLUDE ACCOMPLISHING EITHER THE FULL OR ABBREVIATED ACTUATOR CHECK ON ORBIT, THE NOMINAL APU/HYDRAULIC SYSTEM WHICH IS STARTED AT TIG MINUS 5 MINUTES MAY BE OPERATED WITH THE HYDRAULIC MAIN PUMP IN "NORM PRESS" IN ORDER TO SUPPORT AN ABBREVIATED ACTUATOR CHECK IN MM 303.

Self-explanatory.

Reference Rules {A8.1.3-5}, FCS CHECKOUT, and {A10.1.2-1B}, LOSS OF APU/HYDRAULIC SYSTEM(S) ACTIONS.

FLIGHT RULES

A10.1.2-10 LOSS OF APU HEATERS/INSTRUMENTATION (CIL)

- A. AN APU WILL BE STARTED PERIODICALLY OR THE ORBITER ATTITUDE ADJUSTED, IF REQUIRED TO MAINTAIN ACCEPTABLE APU SYSTEM TEMPERATURES. (CIL)

If there is a dual heater failure in an APU subsystem, orbiter attitude adjustment will be considered to prevent component freeze-up. If this is not practical, this rule allows an APU to be started to generate heat in the system and, using the heat soakback, to warm the surrounding components.

Reference Rules {A17.1.19-1}, ORBITER THERMAL CONSTRAINTS AND ATTITUDE MANAGEMENT, and {A10.1.1-1A.8}, APU LOSS DEFINITIONS.

Rules {A8.1.3-5}, FCS CHECKOUT; {A8.1.5-13}, AEROSURFACE ACTUATOR PROTECTION; {A10.1.1-1A.1}, APU LOSS DEFINITIONS; {A10.1.2-1B}, LOSS OF APU/HYDRAULIC SYSTEMS(S) ACTIONS; and {A10.1.2-2}, APU START/RESTART LIMIT, reference this rule.

- B. THE FOLLOWING ACTIONS WILL BE TAKEN FOR AN APU WITH BOTH FUEL LINE TEMPERATURE TRANSDUCERS T1 AND T2 LOST:
1. SIDE/TOP SUN SOLAR INERTIAL ATTITUDE WILL BE ESTABLISHED ASAP AND MAINTAINED SUBJECT TO HIGH PRIORITY PAYLOAD REQUIREMENTS (ØS90 ØS45 FOR APU 3; ØS90 ØS315 FOR APU 1, 2).
 2. WHEN NOT IN SIDE/TOP SUN ATTITUDE OR PRIOR TO THERMAL STABILIZATION AFTER SIDE/TOP SUN ATTITUDE HAS BEEN ESTABLISHED, MANUAL HEATER MANAGEMENT WILL BE PERFORMED BY CYCLING APU HEATERS TANK/FUEL/ LINE/H₂O SYSTEMS A AND B SIMULTANEOUSLY TO "AUTO" FOR 18 MINUTES THEN "OFF" FOR 42 MINUTES. THE HEATERS WILL BE TURNED "OFF" DURING ON-ORBIT OPERATIONS WHEN MANUAL HEATER MANAGEMENT IS NOT REQUIRED AND DURING ENTRY.
 - a. FOR SIDE/TOP SUN ATTITUDE ESTABLISHED BEFORE MET = 35 HOURS, MANUAL HEATER MANAGEMENT IS REQUIRED UNTIL MET = 40 HOURS.

THIS RULE CONTINUED ON NEXT PAGE

FLIGHT RULES**A10.1.2-10 LOSS OF APU HEATERS/INSTRUMENTATION (CIL)
(CONTINUED)**

- b. FOR SIDE/TOP SUN ATTITUDE ESTABLISHED AFTER MET = 35 HOURS, MANUAL HEATER MANAGEMENT IS REQUIRED FOR 5 HOURS AFTER SIDE/TOP SUN HAS BEEN ESTABLISHED.

Because APU fuel line heater operation cannot be verified, steps must be taken to ensure that a failed-on heater does not detonate the fuel line, while also ensuring the fuel line does not freeze. Going to a side/top Sun attitude will eventually provide a warm enough environment for the fuel line that the heaters can be turned off. After an MET of 40 hours, going to side/top Sun will provide a stable environment within about 5 hours, but before 40 hours, the MPS cryogenic chilldown in the aft compartment hinders the warming process. For the period prior to the establishment of side/top Sun and thermal stabilization, manual heater cycling must be conducted to try to prevent the fuel from freezing. Both heaters are cycled on simultaneously to preclude a failed-off heater from allowing fuel line freezing, and a manual off cycle is required to prevent a failed-on heater from detonating the line. Once the affected APU is started, heater management is no longer required and the heaters can be powered off for entry.

Analysis by Rockwell-Downey has determined that as long as the manual heater cycling is done when the aft compartment is not warm enough to keep the heater off, the affected APU can be considered good and usable for entry. The APU will be started prior to the deorbit burn to preclude heater management postburn.

Reference Rockwell IL SETO TCS-87-134, Heater Duty Cycles for Low/Intermediate Angle Top LV & GG Attitudes, and SODB submittal R1-1371, December 11, 1987.

3. IF THE INSTRUMENTATION IS LOST BEFORE DEORBIT TIG - 5 MINUTES, THE AFFECTED APU WILL BE STARTED AT TIG - 5 MINUTES.

Because a failed fuel line heater has little or no impact upon an APU that is running, it is best to start this APU at the "single APU start" time in order to protect against subsequent heater failures and to have this APU for entry operations.

4. IF THE INSTRUMENTATION IS LOST AFTER DEORBIT TIG - 5 MINUTES, THE AFFECTED APU WILL BE STARTED ASAP.

As stated above, fuel line heater failures are not a concern when the APU is running. Because there are sufficient consumables margins in all APU's to run for the entire entry, the affected APU can be immediately started.

FLIGHT RULES

A10.1.2-11 APU FREEZE/THAW

- A. FOR AN APU THAT HAS SUSTAINED ONE OR MORE FUEL LINE FREEZES THE FOLLOWING ACTIONS WILL BE TAKEN (UNLESS THE FREEZE IS SUSPECTED TO BE THE RESULT OF THE APU LEAKING FUEL) : @[011295-1736C]
1. POWER BOTH 'A' AND 'B' FUEL LINE HEATERS SIMULTANEOUSLY. @[011295-1736C]
 2. ESTABLISH A SIDE/TOP SUN SOLAR INERTIAL ATTITUDE AS LONG AS NECESSARY TO THAW THE FROZEN FUEL LINE SEGMENT (THETA S90 PHI S45 FOR APU 3; THETA S90 PHI S315 FOR APU 1,2).
- B. FOR AN APU THAT HAS SUSTAINED MULTIPLE FUEL LINE FREEZE/THAW CYCLES AND NO FUEL LEAKAGE IS SUSPECTED, THE APU WILL NOT BE STARTED UNLESS REQUIRED. ~~@[072398-6685A] TO MAINTAIN TWO APU/HYDRAULIC SYSTEMS, TO PROVIDE NWS (IF REQUIRED), OR TO PROVIDE A REDUNDANT LANDING GEAR DEPLOY METHOD.~~

APU data from STS-62, TTA , and McDonnell Douglas indicate that the APU fuel lines can sustain a single freeze/thaw cycle without rupture. The STS-62 fuel line freeze was a result of aft water intrusion that pooled between the fuel line insulation and the fuel line. The sublimation of the water provided enough heat transfer from the hydrazine to overcome the effect of the fuel line heater resulting in a line freeze during the post insertion time frame. The frozen fuel line segment was located near the fuel tank isolation valves downstream of where the test line attaches to the fuel line. This prevented pressure relief back into the APU fuel tank during soakback and resulted in fuel line pressures of around 800 psia. The location of the frozen segment was determined by the effect of the fuel line and test line heaters on the fuel pump inlet pressure trace.

Although difficult to determine, the time frame in which line freezing occurs may help to indicate what type of mechanism is causing the freeze. STS-62 data indicates that the water intrusion failure mode should occur relatively shortly after post insertion.

During STS-62 the engineering community (JSC engineering, RI/Downey, Sundstrand and SR&QA) concluded that there were no constraints with APU operation due to the single freeze/thaw cycle. The APU was started at TAEM due to the slight possibility the fuel line freeze may have been caused by an external fuel leak. Although inconclusive on the exact cause of the failure, post landing examination of the affected area did not reveal any fuel leaks or line bulges.

THIS RULE CONTINUED ON NEXT PAGE

FLIGHT RULES

A10.1.2-11 APU FREEZE/THAW (CONTINUED)

The published freezing point of N_2H_4 is 35 Deg F. As N_2H_4 freezes the density increases resulting in a decreased volume. Superpacking results when a line full of liquid transforms into a line full of solid. As N_2H_4 expands during the thaw process line yield may result if the pressures can not be relieved. For this to occur the thaw would have to occur in a trapped volume or from the middle outward in a frozen line segment.

TTA tests performed in 1988 (JSC-22912) used a 3/8 inch diameter APU fuel line to study the effects of frozen N_2H_4 in a superpacked state. The results indicate that line yield occurred in both tests, with a maximum line pressure of 6300 psia. ©[011295-1736C]

A separate theoretical analysis was performed by McDonnell Douglas and JSC which indicate that a fuel line may rupture if it sustains as few as 3 freeze/thaw cycles (McDonnell Douglas Report TM-950002-02, December 23, 1994). The analysis addressed a straight 1/2 inch diameter fuel line that has yielded as a result of the freeze/thaw cycle. The fuel line radius has permanently expanded due to the yield. The line freezes again, and during thaw the resulting pressures further yield the line. This process continues until the ultimate strain of the line has been exceeded which results in rupture. The engineering community feels that this analysis, due to the level of detail, is more representative of the freeze/thaw event as compared with analysis performed during STS-62. RI/Downey performed an analysis on fuel line bends that coupled TTA test data with a theoretical analysis. The engineering community decided, after a review of the analysis, that the fuel line bends could withstand two freeze/thaw cycles. A qualitative review of the fuel line welds and T's found them to be less critical for freeze/thaw than the tube bend section. The McDonnell Douglas analysis also concluded that a straight section of yielded fuel line has infinite fatigue life due to fuel pump pressure cycles and vibration.

Establishing a vehicle attitude will warm the affected APU fuel lines which will accelerate the sublimation of the frozen fluid that may be causing the line freeze.

Reference rules [{A10.1.1-1A}.8](#), [APU LOSS DEFINITIONS](#), and [{A10.1.2-13}](#), [APU DEFINITIONS](#). ©[011295-1736C] [©\[072398-6685A\]](#)

FLIGHT RULES

A10.1.2-12 APU/HYD CONSUMABLES

A. THE FOLLOWING MATRIX DEPICTS THE BASIS FOR DEFINING APU AND WSB CONSUMABLES REDLINES.

	APU N ₂ H ₄ (LBS)		WSB H ₂ O (LBS)	
<u>QUANTITY AVAILABLE PER SYSTEM (QA)</u>			TANK <u>118.3 LB</u>	CORE <u>3.5 LB</u>
QUANTITY (NORMAL LOAD)	332.0		121.8	
RESIDUALS	5.4		2.8	
LOADING UNCERTAINTY	8.0		1.0	
<u>USABLE QUANTITY</u>	318.6		118.0	
<u>MISSION REQUIREMENTS (MR)</u>				
	NOM FLT	AOA	NOM FLT	AOA
SYS 1	189.4	221.6	71.8	102.0
SYS 2	198.1	221.6	59.3	102.0
SYS 3	179.6	221.6	52.8	102.8
<u>MISSION MARGIN (MM)</u>				
	NOM FLT	AOA [1]	NOM FLT	AOA [1]
SYS 1	129.2 [2]	97.0	62.0 [2]	16.0
SYS 2	120.5 [3]	97.0	78.8 [3]	16.0
SYS 3	139.0	97.0	80.6	16.0
NOTE: MM=QA-MR				
<u>RESERVES AND ALLOWANCES (RA)</u>				
	NOM FLT	AOA	NOM FLT	AOA
[4] SYS 1	53.4	30.3	16.4	9.0
SYS 2	53.4	30.3	32.1	9.0
SYS 3	53.4	30.3	32.6	9.0
<u>KSC RESERVES PER SYSTEM (KR)</u>				
[5] SYS 1	NOM FLT 65.7	AOA 65.7	NOM FLT 5.0	AOA 7.0
<u>FLIGHT PLANNING MARGIN (FPM)</u>				
	NOM FLT	AOA	NOM FLT	AOA
FLIGHT SYS 1	10.1	1.0	40.6	0.0
PLANNING SYS 2	1.4	1.0	41.7	0.0
MARGIN (LB) SYS 3	19.9	1.0	43.0	0.0
NOTE: FPM=MM-RA-KR				
<u>ESTIMATED USAGE RATE ASC/ORBIT/ENTRY</u>	2.0 - 3.5 LB/MIN		0.8 - 1.8 LB/MIN	

THE CONSUMABLES REDLINE DATA INCLUDE ALLOWANCES FOR:

- [1] WHEEL-STOP, LANDING AT KSC. @ED]
- [2] DEORBIT COAST ON SYSTEM 1.
- [3] FCS CHECKOUT ON SYSTEM 2.
- [4] ONE APU FAILURE.
- [5] 19-MINUTE PRELAUNCH RUN TIME (5-MINUTE LAUNCH RECYCLE, TWO 7-MINUTE LAUNCH HOLDS).

Values are based upon consumables budgets developed by the generic STS redline analysis performed using composite APU and hydraulic data and generic trajectory tapes. A detailed explanation of all above data is located in the Level B Groundrules and Constraints document (NSTS-21075) and the Mechanical and Crew Systems Console Handbook, Vol II (JSC-26101). The SODB (Sec. 4.4) also documents the above data. The loading uncertainty is consistent with that of the KSC APU "1317" Fuel Loading Cart. ©[012694-1596]

FLIGHT RULES

THIS RULE CONTINUED ON NEXT PAGE

FLIGHT RULES

A10.1.2-12 APU/HYD CONSUMABLES (CONTINUED)

B. MINIMUM PRE-DEORBIT APU FUEL AND WSB H₂O QUANTITY REQUIREMENTS ARE AS FOLLOWS:

1. WITH TWO OR THREE APU/HYDRAULIC SYSTEMS OPERATIONAL, 192 LB APU FUEL AND 63 LB H₂O ARE REQUIRED. THIS ASSUMES SINGLE APU/HYDRAULIC SYSTEM STARTED PRIOR TO TIG AND APU SHUTDOWN AT WHEEL-STOP. ©[012694-1596] @ED 1

The fuel and H₂O quantities above are based on the following:

	<u>APU</u>	<u>WSB</u>
FCS CHECKOUT	14.7	0.0
DEORBIT COAST	27.1	8.9
ENTRY	98.0	33.9
RESIDUALS	5.4	2.8
LOADING UNCERTAINTY	8.0	1.0
RESERVES AND ALLOWANCES	<u>53.4</u>	<u>16.4</u>
TOTALS	206.6 LB	63.0 LB
TOTAL WITHOUT FCS CHECKOUT	191.9 LB	63.0 LB
©[012694-1596]		

2. WITH ONE APU/HYDRAULIC SYSTEM OPERATIONAL, 203 LB APU FUEL AND 67 LB H₂O ARE REQUIRED.

The fuel and H₂O quantities above are based on the following:

	<u>APU</u>	<u>WSB</u>
DEORBIT COAST	27.1	8.9
ENTRY	108.9	37.9
RESIDUALS	5.4	2.8
LOADING UNCERTAINTY	8.0	1.0
RESERVES AND ALLOWANCES	<u>53.4</u>	<u>16.4</u>
TOTALS	202.8 LB	67.0 LB
©[012694-1596]		

FLIGHT RULES

A10.1.2-13 APU DEFINITIONS

A. FOR ENTRY/ABORTS AND PLANNING PURPOSES, AN APU IS DEFINED AS "REQUIRED" IF IT IS NEEDED TO PROVIDE THE FOLLOWING:
@[072398-6685A]

1. TWO APU/HYD SYSTEMS FOR AEROSURFACE ACTUATOR OPERATION,
2. LANDING GEAR DEPLOY REDUNDANCY,
3. NWS (IF REQUIRED), OR
4. BRAKING REDUNDANCY FOR MAINTAINING HALF BRAKES CAPABILITY.

Single APU/HYD system landings are uncertified. The critical need for gear deploy necessitates having deploy redundancy when- possible. NWS requirements are defined in Rule {A10.1.7-1A}, NOSE WHEEL STEERING (NWS). Braking redundancy is satisfied if the next failure (following recovery of the "required" APU) results in at least single string, 50 percent braking.

This rule is referenced by {A10.1.2-2E}, F, H, APU START/RESTART LIMITS; {A10.1.2-4B}, D, E, APU OIL/GEARBOX TEMPERATURE/PRESSURE; {A10.1.2-5E}, APU HIGH SPEED SELECTION/SHIFT, {A10.1.2-1B}, APU FREEZE/THAW; and {A10.1.4-2E}, HYDRAULIC LEAKS.

- B. AN APU "START" IS DEFINED AS INITIATING APU OPERATION WHILE BRANCH PASSAGE TEMPERATURE IS WITHIN ACCEPTABLE LIMITS WITHOUT REQUIRING ACTIVE GG INJECTOR COOLING.
- C. AN APU "RESTART" IS DEFINED AS INITIATING APU OPERATION WHEN ACTIVE GG INJECTOR COOLING WAS REQUIRED TO ENSURE ACCEPTABLE BRANCH PASSAGE TEMPERATURE.
- D. AN APU "HOT RESTART" IS DEFINED AS INITIATING APU OPERATION WHILE BRANCH PASSAGE TEMPERATURE IS ABOVE ACCEPTABLE LIMITS.

These are the definitions for "START," "RESTART," and "HOT RESTART" used by other flight rules.

Reference rule {A10.1.2-2A}, APU START/RESTART LIMITS. @[072398-6685A]

FLIGHT RULES**HYDRAULIC SYSTEMS LOSS/FAILURE DEFINITIONS** ⑥ED]**A10.1.3-1** **HYDRAULIC LOSS DEFINITIONS**

A. A HYDRAULIC SYSTEM IS CONSIDERED LOST IF:

1. IT IS UNABLE TO PROVIDE HYDRAULIC PUMP PRESSURE OF 2760-3500 (2860-3400) PSIA AT DEMANDED FLOW WITH THE APU RUNNING AND THE MAIN PUMP PRESSURIZED.

Operation of the hydraulic actuators requires a minimum pressure of 2700 psi. A 60 psi safety margin is given. Maximum hydraulic pressure is 3500 psia (reference SODB 3.4.3.1-12, 4.2.4.8.1.).

2. FOR A CONFIRMED NONISOLATABLE HYDRAULIC LEAK:
 - a. DURING ASCENT/ORBIT, THE SYSTEM WILL BE CONSIDERED LOST FOR PLANNING PURPOSES.

For planning purposes, a system with a nonisolatable leak should be considered lost since its capability to support entry from EI through wheel-stop in NORM PRESS is suspect. ⑥ED]

- b. DURING ENTRY/ABORTS, THE SYSTEM WILL BE CONSIDERED FAILED IF THE ASSOCIATED RESERVOIR QUANTITY IS LESS THAN 15 (20) PERCENT FOR SYSTEM 1 OR 5 (10) PERCENT FOR SYSTEMS 2 AND 3.

NOTE: THE HYDRAULIC SYSTEM 1 MINIMUM RESERVOIR QUANTITY PROTECTS THE 10 TO 15 PERCENT RESERVOIR QUANTITY REQUIRED FOR LANDING GEAR DEPLOY.

A reservoir quantity of 15 percent is required for system 1 since a 10 to 15 percent quantity drop is typically seen at landing gear deploy. Failure to maintain 15 percent for landing gear deploy may lead to pump cavitation and the loss of that system. Because systems 2 and 3 are prime for elevon operation, a reservoir quantity of 5 percent is required to protect control system operations during approach and landing (reference SODB 3.4.2.4.4.).

3. HYDRAULIC FLUID TEMPERATURES CAN NOT BE MAINTAINED ABOVE -40 DEGREES F.

At -40 deg F, the hydraulic fluid viscosity will have increased to a point where it is no longer possible for the hydraulic main pump to push the fluid through the system. Other hydraulic system components may be damaged if their temperatures are less than -65 deg F (reference SODB, table 3.4.2.4-1.).

NASA - JOHNSON SPACE CENTER

FLIGHT RULES

THIS RULE CONTINUED ON NEXT PAGE

FLIGHT RULES

THIS PAGE INTENTIONALLY BLANK

FLIGHT RULES**A10.1.3-1 HYDRAULIC LOSS DEFINITIONS (CONTINUED)**

4. A SWITCHING VALVE WILL NOT SELECT A HYDRAULIC SYSTEM TO AN ACTUATOR (DUE TO A FAILURE IN THE SWITCHING VALVE). (FAILURE OF PRIMARY/STANDBY 1 VALVE TO STANDBY 1 POSITION IS LOSS OF ONE SYSTEM. FAILURE OF STANDBY 2 VALVE TO STANDBY 2 POSITION IS LOSS OF TWO SYSTEMS.)

Switching valves are two-position valves which compare pressure between two of the redundant hydraulic systems assigned to a control element to ensure that the actuator receives flow from a hydraulic system with adequate pressure. Redundant hydraulic systems are designated as primary, standby 1, and standby 2 systems.

An actuator having three redundant hydraulic systems assigned to it will have two switching valves, a primary/standby 1 valve and a standby 1/standby 2 valve. A switching valve failure to one position will only allow pressure from the hydraulic systems assigned to that position to operate the actuator. The hydraulic system assigned to the other position is essentially lost insofar as the actuator is concerned.

A failure in the primary/standby 1 valve to either position results in the loss of one of the hydraulic systems to the actuator. A failure in the standby 1/standby 2 valve to the standby 1 position results in the loss of one system, the standby 2 system. Both the primary and standby 1 systems may still operate the actuator through the standby 1 port.

A failure of the standby 1/standby 2 valve to the standby 2 position will allow only the standby 2 system to operate the control element, resulting in the loss of the primary and standby 1 systems.

5. UNABLE TO MAINTAIN RESERVOIR PRESSURE GREATER THAN 15 DEGREES (28) PSIA WITH THE APU NOT RUNNING. @ED 1

Hydraulic pumps may cavitate with insufficient head pressure at startup. Main pumps require a minimum 15 psia positive pressure to start. Reference SODB 3.4.2.4-7.

Rules, {A10.1.2-3}, APU ENTRY START TIME, and {A10.1.4-3E}, HYDRAULIC SYSTEM PRESSURE/ TEMPERATURE (CIL), reference this rule. @[051194-1619B]

THIS RULE CONTINUED ON NEXT PAGE

FLIGHT RULES**A10.1.3-1 HYDRAULIC LOSS DEFINITIONS (CONTINUED)**~~BB. HYDRAULIC CIRCULATION PUMPS LOST~~

1. A HYDRAULIC CIRCULATION PUMP WILL BE CONSIDERED LOST IF THE CIRCULATION PUMP BODY TEMPERATURE IS > 230 (222) DEG F, OR RESERVOIR TEMPERATURE > 230 (222) DEG F WHILE THE CIRCULATION PUMP IS RUNNING. [@\[091098-6554B\]](#)

Operating a circulation pump above 230 deg F exceeds the circulation pump electronics temperature limit. (ref SODB Vol. I, table 3.4.2.4-1). Testing has shown that operating a circulation pump above this limits significantly reduces the pump electronics lifetime. The loss of a circulation pump alone is not considered loss of a hydraulic system. If the circulation pump is running to maintain accumulator pressure fore a leaking accumulator, it is possible that the accumulator may lock up (as it did on STS-50). Therefore, the loss of a circulation pump does not require loss of a hydraulic system actions. @[051194-1619B]

- ~~2. A HYDRAULIC CIRCULATION PUMP WILL BE CONSIDERED LOST IF THE PUMP BODY TEMPERATURE FALLS BELOW 20 (28) DEG F. @[051194-1619B]~~

~~*Circulation pump starts at body temperatures below 20 degrees F will exceed the allowable circulation pump start up time of 60 seconds (ref. SODB 3.4.2.1.C).*~~

Rule {A10.1.4-3E}, HYDRAULIC SYSTEM PRESSURE/TEMPERATURE (CIL), references this rule. @[051194-1619B] [@\[091098-6554B\]](#)

FLIGHT RULES

HYDRAULIC SYSTEMS MANAGEMENT ©ED]

A10.1.4-1 HYDRAULIC SYSTEMS CONFIGURATION ©ED]

- A. THE LANDING GEAR EXTEND ISOLATION VALVE WILL REMAIN CLOSED EXCEPT WHEN OPENED DURING ENTRY/ABORTS.

Landing gear extend isolation valve remains closed to safeguard the hydraulic system from attempting to deploy the landing gear at any time other than landing. The landing gear cannot be retracted during flight once it has been deployed. Landing gear extend isolation valve is opened when the vehicle reaches Vrel of 800 fps to set up gear deployment.

- B. THE BRAKE ISOLATION VALVES WILL REMAIN CLOSED UNTIL OPENED DURING ENTRY/ABORTS UNLESS REQUIRED FOR ON ORBIT THERMAL CONDITIONING.

Brake isolation valves 1, 2, and 3 remain closed when the landing gear systems are not in use to protect the hydraulic systems in the event of a leak downstream of one of the isolation valves. All brake isolation valves open automatically at main gear touchdown.

- C. DURING ENTRY/ABORTS, IF AUTOMATIC CAPABILITY TO OPEN A BRAKE ISOLATION VALVE AT WOW IS LOST, THE VALVE WILL BE OPENED MANUALLY AFTER M=8 TO PROVIDE NWS (IF REQUIRED) OR FULL BRAKING. BRAKE ISOLATION VALVE 2 WILL BE OPENED BETWEEN M=8 AND LANDING GEAR DEPLOY IF REQUIRED TO PROVIDE REDUNDANT NLG DEPLOY.

To protect against uncommanded brake pressure, brake isolation valves will only be opened manually for the cases listed. It is desirable to open the valves during wings-level flight periods to reduce the risk of vertigo in the PLT. Manual valve opening will be delayed until after M=8 to reduce the opportunity for silting of the brake system (can lead to uncommanded brake pressure). Brake silting is a function of the time the isolation valve is open with the hydraulic system in NORM PRESS. Reference Ascent/Entry Flight Techniques Panel #45 minutes, June 23, 1988.

The risk of uncommanded brake pressure is acceptable to gain redundant nose landing gear deploy capability.

THIS RULE CONTINUED ON NEXT PAGE

FLIGHT RULES

A10.1.4-1 HYDRAULIC SYSTEMS CONFIGURATION (CONTINUED)

ⓂED 1

Opening brake isolation valves after WOW for braking and nosewheel steering retains protection against uncommanded brake pressure, which is no longer catastrophic after wheel spinup. However, manual valve opening prior to landing is acceptable, if automatic capability is lost, due to the high crew workload after touchdown and the risk of inducing vertigo. Allowing the isolation valves to open automatically is considered acceptable due to the inherent reliability of the redundant WOW cue. Brake energy and rollout margin calculations do not protect for the loss of half brakes (reference Rule {A4.1.3-8}, BRAKING AND ROLLOUT REQUIREMENTS). Half brakes are adequate for any directional control requirements between MGTD and NGTD. For uncommanded brake pressure actions, reference Rule {A10.1.8-4}, UNCOMMANDED BRAKE PRESSURE (CIL). For nosewheel steering requirements, reference Rule {A10.1.7-1A}, NOSE WHEEL STEERING (NWS).

- D. THE MPS/TVC ISOLATION VALVES WILL BE CLOSED ON ORBIT AND WILL REMAIN CLOSED EXCEPT FOR SSME HYDRAULIC REPRESSURIZATION AND SSME REPOSITIONING.

The TVC isolation valves are pressure-actuated valves requiring a minimum of 100 psid positive pressure to close. This pressure may be supplied by the APU or the hydraulic circulation pump.

Closing the MPS/TVC isolation valve during powered flight will cause the hydraulically actuated main engine valves to lock up, so the MPS/TVC isolation valve is left open past MECO.

The MPS/TVC isolation valves are normally closed after SSME stowage on orbit is complete.

Two isolation valves are normally opened for 10 seconds each prior to EI to repressurize the hydraulic fluid in the TVC actuators (SSME HYD REPRESS). This is done to eliminate any voids which may be formed in the actuators due to hydraulic fluid contraction as a result of orbit cooling. Eliminating the voids ensures that the actuators will hold the engine bells in place when subjected to aerodynamic loads during entry.

The isolation valves will be cycled in order to reposition the main engines to preclude contact with the drag chute during deploy and post-rollout for rain drain.

- E. THE HYDRAULIC MAIN PUMP WILL BE RUN IN "NORM PRESS" AFTER APU START ON A HYDRAULIC SYSTEM WITH AN ACCUMULATOR LEAK.

Accumulator pressure is used to charge the hydraulic reservoir and maintain the required inlet pressure for the main pump to operate without cavitation. The main pump must provide its own inlet pressure through a bootstrap system when the accumulator has lost its charge. Operating the main pump at low pressure (800 psi) may not provide sufficient head pressure at the pump inlet (reference RIC IL 288-503-81-055, November 10, 1981). The main pump is nominally run in low pressure after APU start on an APU started prior to the deorbit burn.

FLIGHT RULES

A10.1.4-2 HYDRAULIC LEAKS

FOR A HYDRAULIC FLUID LEAK, THE FOLLOWING ACTIONS WILL BE TAKEN:

- A. DURING ASCENT, NO ACTION WILL BE TAKEN UNTIL POST-MECO. IF THE APU/HYDRAULIC SYSTEM IS STILL OPERATING POST-MECO, THE APPROPRIATE MPS/TVC ISOLATION VALVE WILL BE CLOSED. IF THE LEAK IS NOT SUBSEQUENTLY ISOLATED, THE SYSTEM(S) WILL BE TAKEN TO "LOW PRESS" AND/OR SHUT DOWN AS REQUIRED IN ORDER TO EVALUATE AND MAINTAIN REMAINING CAPABILITY.
@[072398-6686B]

The MPS/TVC isolation valve is closed in an attempt to isolate the leak if the leak is downstream of the isolation valve. Closing the MPS/TVC isolation valve before MECO would cause the main engine hydraulically actuated valves to lock up, resulting in a loss of throttle control and TVC redundancy.

If the leak is not isolated by closing the MPS/TVC valve, the leaking hydraulic system should be taken to low pressure to reduce the stress on the system while allowing continued evaluation of the leak. Efforts within system limitations will be made to verify that the location of leakage does not exist downstream of an actuator switching valve where it could potentially cause imminent loss of all three hydraulic systems. Additionally, the leak could be due to intersystem leakage. It may become necessary to depressurize additional hydraulic systems to try to pinpoint the source of the leak. If the leak is determined to be downstream of an actuator switching valve, a mission abort will be required.

After all pertinent troubleshooting has been completed, the APU should be shut down as soon as practical to further reduce the pressure on the system thereby reducing the leak.

Rule {A2.1.2-4}, RTL, TAL, AND AOA ABORTS FOR SYSTEMS FAILURES (CIL), references this rule. @[072398-6686B]

- B. ON ORBIT, IF A LEAK IS DETECTED AND THE ASSOCIATED HYDRAULIC SYSTEM BRAKE ISOLATION VALVE IS OPEN, THE VALVE WILL BE CLOSED ASAP.

*Closing the brake isolation valve may isolate the leak. If the leak is isolated, then the valve will remain closed to protect the system and to limit the amount of hydraulic fluid leaked into the wheel well. This reduces the chance of a fire at wheel-stop due to hydraulic fluid on hot brakes. _
@ED ___|*

FLIGHT RULES

- C. DURING ENTRY/ABORTS, IF A LEAK IS DETECTED PRIOR TO TOUCHDOWN AND THE ASSOCIATED SYSTEM BRAKE ISOLATION VALVE IS OPEN AND THE LEAK WILL NOT SUPPORT OPERATIONS THROUGH WHEEL-STOP, THE VALVE WILL BE CLOSED ASAP. THE VALVE MAY BE OPENED AT TOUCHDOWN TO PROVIDE BRAKING AND WILL BE CLOSED ASAP POST-WHEEL-STOP. @ED 1

THIS RULE CONTINUED ON NEXT PAGE

FLIGHT RULES

A10.1.4-2 HYDRAULIC LEAKS (CONTINUED)

The brake isolation valve will be allowed to open automatically at main gear touchdown to provide braking capability but must be closed ASAP post-wheel-stop to reduce the amount of hydraulic fluid leaked into the fuselage or wheel well. This will reduce the chance of a tire fire due to hydraulic fluid on hot brakes if the leak is in the wheel well. [@ED 1](#)

- D. DURING ENTRY/ABORTS, IF A LEAK IS DETECTED AND THE LANDING GEAR EXTEND ISOLATION VALVE IS OPEN AND THE LEAK WILL NOT SUPPORT OPERATIONS THROUGH WHEEL-STOP, THE VALVE WILL BE CLOSED ASAP. THE VALVE WILL BE REOPENED ONLY TO GAIN NWS OR REDUNDANT LANDING GEAR DEPLOY. THE VALVE WILL BE CLOSED ASAP POST-WHEEL-STOP. [@ED 1](#)

Closing the landing gear extend isolation valve may isolate the leak, and hydraulics for NWS and two methods of gear deploy remain. If the leak is isolated, the valve will remain closed to preserve the system unless NWS or a redundant landing gear deploy method is required. In these cases, the valve will be opened near the ground and closed post-wheel-stop to minimize the amount of hydraulic fluid leaked. This reduces the chance of a fire due to hydraulic fluid on hot brakes if the leak is in the wheel well. [@ED 1](#)

- E. DURING ENTRY/ABORTS, A SYSTEM WITH A NONISOLATABLE HYDRAULIC LEAK WILL HAVE ITS MAIN PUMP TAKEN TO "LOW PRESS". IF THE LEAK RATE IS SUCH THAT, WITH "NORM PRESS" SELECTED AT HAC INTERCEPT, THE SYSTEM WILL: [@\[072398-6686B\]](#)

Taking the main hydraulic pump to "low press" will likely slow the leak by reducing pressure in the system. Even if the leak rate as detected in "norm press" will support to wheelstop, there is a possibility that the leak will become larger, so the system should be depressurized to improve its chances of supporting the later phase of entry. To protect for a subsequent failure of one of the good systems, the leaking system should be allowed to operate in "low press" to be ready to provide two APU/Hydraulic systems during entry should another APU/Hydraulic system fail.

1. SUPPORT TO WHEELSTOP, THE SYSTEM, IF REQUIRED, WILL BE TAKEN BACK TO "NORM PRESS" AS SOON AS THE CAPABILITY TO SUPPORT TO WHEELSTOP IS ACHIEVED (NO EARLIER THAN TAEM).
2. NOT SUPPORT TO WHEELSTOP, THE APU WILL BE SHUTDOWN. THE APU WILL BE RESTARTED (TIME PERMITTING), IF REQUIRED, WHEN THE LEAKING SYSTEM WILL SUPPORT TO WHEELSTOP.

If the leaking hydraulic system will not support entry at its present leak rate, then the APU should be shut down to minimize fluid leakage. It will be restarted later to support the final phase of entry if there is enough time to perform a cooldown and restart. [@\[072398-6686B\]](#)

FLIGHT RULES

THIS RULE CONTINUED ON NEXT PAGE

FLIGHT RULES

A10.1.4-2 HYDRAULIC LEAKS (CONTINUED)

During STS-76, when a known hydraulic leak existed, the APU was started at TAEM with the hydraulic system kept in "low press" for the remainder of the entry. Remaining in "low press" affords support in a standby mode while minimizing fluid leakage. Additionally, remaining in "low press" allows the other two good hydraulic systems to be in control of all the aerosurface actuators. In the event that the leaking system fails at a critical time while close to the ground, the aerosurface switching valves will already be set up to use the good system(s) and will not enter into a "chattering" mode whereby control could be jeopardized. @072398-6686B] @072398-6686A]

Reference Rule {A10.1.2-13}, APU DEFINITIONS. @072398-6686B] @072398-6686A]

A10.1.4-3 HYDRAULIC SYSTEMS PRESSURE/TEMPERATURE (CIL)

- A. A HYDRAULIC SYSTEM THAT CANNOT MAINTAIN > 200 (300) PSIA WILL HAVE ITS APU SHUT DOWN. DURING ASCENT, THE APU WILL BE SHUT DOWN POST-MECO.

Running the main pump at less than 200 psi does not support actuator performance and may result in cavitation and/or overheating of the main pump due to insufficient hydraulic fluid flow.

- B. A HYDRAULIC SYSTEM WILL BE TAKEN TO "LOW PRESS" OR ITS APU SHUT DOWN (DURING ASCENT, THE APU WILL BE SHUTDOWN POST-MECO), IF PUMP PRESSURE FLUCTUATIONS OCCUR SUCH THAT PUMP OUTLET PRESSURE REPEATEDLY FALLS BELOW 1500 (1600) PSI.
(CIL)

Pressure fluctuations below 1500 psi are indicative of a malfunction in the main pump compensator system. This type of failure will not allow the pump to maintain system pressure on demand.

The pump supply pressure will decrease in response to the demand from an actuator supplied by the pump. The actuator will not respond until the failed system pressure falls below the switching valve pressure (1500 psi). At that pressure, the standby hydraulic system cycles the switching valve and takes over control of the actuator. With the standby system controlling the actuator and the demand gone, the failed hydraulic pump pressure will recover and eventually the switching valve will cycle back to the failed system. The switching valve will cycle in this manner each time the actuator is commanded.

The switching valve cycling will cause the actuator response to be slower due to the time required for the switching valve to transfer. Additionally, continued operation of the actuator could cause switching valve cycling to occur at a rapid rate, which could cause damage to the valve or create undesirable vibration frequencies due to pressure fluctuations.

FLIGHT RULES

Depressurizing the failed pump will drop its output pressure to 800 to 1000 psi, which will allow the standby hydraulic systems to cycle the switching valves and take control of the actuators. If the main pump cannot be depressurized, the APU will have to be shut down.

THIS RULE CONTINUED ON NEXT PAGE

FLIGHT RULES**A10.1.4-3 HYDRAULIC SYSTEMS PRESSURE/TEMPERATURE (CIL)
(CONTINUED) @ED]**

- C. DURING ASCENT, NO ACTION WILL BE TAKEN FOR A HIGH HYDRAULIC RESERVOIR TEMPERATURE UNTIL AFTER MECO. DURING ENTRY/ABORTS, THE FOLLOWING ACTIONS WILL BE TAKEN:
1. THE HYDRAULIC MAIN PUMP WILL BE TAKEN TO "LOW PRESS" IF THE RESERVOIR TEMPERATURE EXCEEDS 250 DEG (TBD) F.
 2. THE APU WILL BE SHUT DOWN IF THE RESERVOIR TEMPERATURE EXCEED 275 DEG (268 DEG) F.

The hydraulic reservoir temperature increases based on the amount of APU run time and the load on the system. Flight data has shown that ascent conditions typically cause the hydraulic reservoir temperatures to increase to 150 deg to 175 deg F at APU shutdown (approximately 4 to 8 minutes after MECO). For this reason, the reservoir temperature is very unlikely to demand action prior to MECO, except in the case of a pump compensator failure. This failure results in high output pressure and flow through the relief valve and is considered unlikely. The hydraulic system design is, therefore, considered to be protection against exceeding the SSME interface temperature requirements (reference SODB 3.4.2.4-12.).

Hydraulic fluid temperatures in excess of 275 deg F can cause degradation of the hydraulic seals which could ultimately lead to leakage (ref. SODB 3.4.2.4.1.d). Depressurizing the main pump reduces the heat input into the hydraulic system and should allow the APU to continue operating. If depressurizing the main pump fails to maintain the reservoir temperature below 275 deg F, the APU will have to be shut down.

- D. DURING DEORBIT, HYDRAULIC THERMAL CONDITIONING WILL BE PERFORMED IF THE ACTIVE HYDRAULIC SYSTEM FLUID LINE TEMPERATURES ARE PREDICTED TO BE < 35 DEG F, OR THE FIRST STANDBY SYSTEM FLUID LINE TEMPERATURES ARE PREDICTED TO BE < 0 DEG F AT EI.

The active hydraulic system fluid line temperatures are required to be > 35 deg F since this is the minimum hydraulic fluid temperature where optimum system performance can be expected. Standby system temperatures need to be above 0 deg F (per Rockwell/Downey thermal analysis) by EI so they may be quickly warmed up to the full performance temperature if required. Preentry hydraulic thermal conditioning involves cycling the aerosurfaces with all three APU's running before EI (reference SODB table 3.4.2.4.1.).

THIS RULE CONTINUED ON NEXT PAGE

FLIGHT RULES**A10.1.4-3 HYDRAULIC SYSTEMS PRESSURE/TEMPERATURE (CIL)
(CONTINUED) [ED]**

E. ON ORBIT, ATTEMPTS WILL BE MADE TO MAINTAIN HYDRAULIC RESERVOIR TEMPERATURE < 162 (154) DEG F PRIOR TO APU START. THE FOLLOWING ARE ACCEPTABLE METHODS TO ATTEMPT TO MAINTAIN RESERVOIR TEMPERATURES < 162 (154) DEG F.

1. MINIMIZE CIRC PUMP RUN TIME WHILE MAINTAINING RSVR P > 15 (28) PSIA. [ED]
2. POWER DOWN ORBITER/SPACELAB EQUIPMENT OR RECONFIGURE THE ORBITER ACTIVE THERMAL COOLING SYSTEM (ATCS) TO LOWER FREON TEMPERATURES AT THE FREON/HYDRAULIC HEAT EXCHANGER TO < 95 DEG F AS INDICATED BY THE FREON COOLANT RAD IN TEMP (V63T1209A AND V63T1409A).

During STS-50, hydraulic system 2 circulation pump was run for extended periods due to an accumulator GN2 leak. The hydraulic system fluid temperature continued to increase during this time. Post flight data revealed the increase was due to high Freon temperatures (Freon temperatures greater than 95 deg F at the Freon/hydraulic heat exchanger). As the hydraulic fluid temperature increased, the Freon/hydraulic heat exchanger bypass valve cycled causing the hydraulic fluid to bypass the heat exchanger. Heat from the hydraulic circ pump caused the hydraulic fluid temperature to continue to increase until the circulation pump was taken off. Flight data indicates that maintaining Freon temperatures below 95 deg F allows the hydraulic fluid to reject heat to the Freon loops and prevents the bypass valve from bypassing the Freon/hydraulic heat exchanger (the bypass valve cycles when the hydraulic fluid reaches 115 deg F). Once the heat exchanger is bypassed, the hydraulic fluid will continue to heat up as long as the circulation pump continues to run.

Minimizing circulation pump run time will minimize the heat added to the hydraulic system. The reservoir pressure however should not be allowed to drop below 15 (24) psia (ref. rule {A10.1.3-1A.5}, HYDRAULIC LOSS DEFINITION)

Powering down orbiter and Spacelab equipment, deploying the radiators, or activating the FES can lower the Freon/hydraulic heat exchanger temperature. Radiator deployment will not affect the Freon/hydraulic heat exchanger temperature.

Excessively high hydraulic systems temperatures can lead to a delayed APU start for entry and loss of the hydraulic circulation pump (ref. rules {A10.1.2-3B}, APU ENTRY START TIME and {A10.1.3-1B}, HYDRAULIC LOSS DEFINITIONS). [051194-1619B]

FLIGHT RULES

A10.1.4-4 HYDRAULIC CIRCULATION PUMP OPERATION (CIL)

A. HYDRAULIC CIRCULATION PUMPS WILL BE USED AS REQUIRED:
(CIL)

1. TO MAINTAIN BOOTSTRAP ACCUMULATOR PRESSURE. (CIL)

The bootstrap accumulator provides positive pressure to the hydraulic reservoir to assure positive main pump inlet fluid pressure during on-orbit zero-gravity starts.

- a. BEFORE THE ACCUMULATOR PRESSURE HAS DECAYED TO PREFLIGHT CHARGE PRESSURE (APPROXIMATELY 1730 (1850) PSIA), THE CIRCULATION PUMP WILL BE RUN TO RECHARGE THE ACCUMULATOR. (CIL)

If accumulator pressure falls below the GN₂ precharge pressure, the piston will be at the fluid side of the cylinder. If the piston makes contact with the fluid end, GN₂ pressure will be pushing the piston against the cylinder wall rather than against the hydraulic fluid, and hydraulic pressure will be lost. The circulation pump is required to push the piston away from the fluid end of the cylinder (ref. SODB, 3.4.2.4.7).

- b. IF A CONFIRMED GN₂ LEAK CAUSES THE ACCUMULATOR PRESSURE TO BE < 2500 (2380) PSIA WITH THE CIRCULATION PUMP RUNNING, THE ACCUMULATOR WILL BE RECHARGED WHEN THE PUMP OFF PRESSURE DECAYS TO HALF THE PREVIOUS PUMP RUNNING PRESSURE PLUS 200 PSIA. IF THE ACCUMULATOR PRESSURE DECAYS TO 615 (735) PSIA, THE CIRCULATION PUMP WILL BE OPERATED CONTINUOUSLY UNTIL APU START.

An accumulator pressure of less than 2500 psia with the circulation pump running is a sign of a GN₂ leak. A GN₂ leak allows the circulation pump to push the accumulator piston all the way over to the GN₂ side of the cylinder. With the circulation pump off, the piston will begin traveling over to the fluid end of the cylinder. The GN₂ pressure will decay to half the previous pressure (indicated while the pump was running) when the piston reaches the fluid side of the cylinder. Since hydraulic pressure would be lost if the piston reached the fluid side of the cylinder, the circulation pump is turned on before the accumulator pressure indicates the piston has reached the fluid end.

Accumulator pressure is precharged to 1760 psi. A decay in pressure below 1760 psi would therefore be the result of a GN₂ leak (ref. SODB 3.4.2.4.5).

The hydraulic main pump requires a minimum positive pressure of 15 psia from the hydraulic reservoir to avoid cavitation during startup. The reservoir is charged by the accumulator at a 40 to 1 ratio (accumulator vs. reservoir). Accumulator pressure falling below 615 psia will result in reservoir pressure below 15 psia (ref. SODB 3.4.2.4.7).

FLIGHT RULES

THIS RULE CONTINUED ON NEXT PAGE

FLIGHT RULES

**A10.1.4-4 HYDRAULIC CIRCULATION PUMP OPERATION (CIL)
(CONTINUED)**

2. FOR SUPPLEMENTARY FREON LOOP COOLING FOR FES FAILURES.

The circulation pump can be used to circulate hydraulic fluid through the hydraulic heat exchanger to remove heat from the orbiter Freon loops.

3. TO PROVIDE WARMING FOR HYDRAULIC FLUID, IF REQUIRED, SHOULD APU START BE DELAYED PAST EI MINUS 13 MINUTES.

The hydraulic fluid is warmed before entry to the minimum fluid temperature for system full performance, which is 35 deg F. This is normally done by the APU at nominal startup time. If APU startup is delayed, the circulation pump may be used to warm the hydraulic fluid until APU start. This is done to assure that the hydraulic fluid will be warmed to 35 deg F in time for hydraulic system performance (reference SODB table 3.4.2.4-1.).

4. TO MAINTAIN HYDRAULIC SYSTEM COMPONENT AND LINE TEMPERATURES WITHIN THE FOLLOWING LIMITS: @[121296-4173B]

<u>COMPONENTS AND LINES</u>	<u>TEMPERATURE LIMIT</u>
DOWNSTREAM OF BRAKE ISOLATION VALVES	ABOVE -20 DEG F PRIOR TO LANDING
ELEVON, BODYFLAP, AND RUDDER/SPEEDBRAKE	- 40 DEG F
DOWNSTREAM OF LANDING GEAR EXTEND ISOLATION VALVE	NOT APPLICABLE
ALL OTHERS	ABOVE -4 DEG F

Hydraulic fluid viscosity increases at low temperatures. Maintaining the fluid above -4 degrees F where practical will keep fluid viscosity at a level where the hydraulic pumps will have no problem pumping the fluid. Reference: SODB 3.4.2.4-8. @[121296-4173B]

Starting the circulation pump at low fluid temperatures will result in a longer period of time for the pump to reach operating speed and may: ~~This "slow start" will cause a characteristic but undesirable current spike on a main bus, which, depending on when it occurs, may adversely affect other equipment on that bus. Additionally, slow starts adversely affect the lifetime of a pump.~~ _ @[091098-6554B]

The components and line temperatures downstream of all the brake isolation valves should be above -20 degrees F prior to landing due to brake system limitations. The -20 degrees F is the lower limit for the brakes for degraded performance and exceeding that may result in a delayed release from a brake lockup condition. Reference: SODB 3.4.2.4-8. @[121296-4173B]

THIS RULE CONTINUED ON NEXT PAGE

FLIGHT RULES

A10.1.4-4 HYDRAULIC CIRCULATION PUMP OPERATION (CIL) (CONTINUED)

The elevon bodyflap and rudder/speedbrake components typically get very cold on orbit due to the shading effects of the vertical tail. These components experience highly localized temperature excursions and recover immediately as soon as fluid is circulated. There are no adverse effects to the circulation pump start-up due to these particular cold temperatures so these components have lower allowable temperatures. @[121296-4173B]

Hydraulic system 1 landing gear extend isolation valve is closed during all flight phases (except entry) to protect against deploying the landing gear inadvertently. Therefore, system 1 hydraulic components downstream of the landing gear extend isolation valve cannot be warmed by the circulation pump on orbit and have lower allowable temperatures.

~~*Starting the circulation pump at low fluid temperatures will result in a longer period of time for the pump to reach operating speed. This "slow start" will cause a characteristic but undesirable current spike on a main bus, which, depending on when it occurs, may adversely affect other equipment on that bus. Additionally, slow starts adversely affect the lifetime of a pump. @[ED]*~~

5. TO CYCLE MPS/TVC ISOLATION VALVES OR BRAKE ISOLATION VALVES WHILE THE APU IS NOT RUNNING.

The valves are pressure-actuated, requiring a minimum of 100 psid positive pressure to operate. Therefore, the circulation pump is required to supply adequate hydraulic pressure to operate the valves when the APU's are not running.

6. TO MAINTAIN CIRCULATION PUMP BODY TEMPERATURE ABOVE 20 ~~DEG~~-(20~~DEG~~) DEG F (EXCEPT IN POWER-CRITICAL SITUATIONS) . @[091098-6554B]

Hydraulic circulation pump starts with the pump body temperature between 240 and -20 deg F were performed during testing. Longer than nominal starts (>1 second to attain stable operating speed) occurred at 20 deg F. Starting a circulation pump that has a body temperature below 20 deg F result in a longer startup time for the pump and an undesirable increase in the electrical power supplied to the pump motor/inverter. This in turn will produce high stress on the circulation pump inverter/motor transistors and possibly limit the lifetime of the pump (ref. SODB, vol I, 3.4.2.4.8b and table 3.4.2.4-1, JSC-14860 Internal. Note: Hydraulic Circulation Pump Test, July 1979).

The value used in this rule does not take into account transducer error. The circ pump body temperature transducer has proven reliable in accuracy, and the hydraulic community has signed up to not protecting for transducer error. @[091098-6554B]

7. TO GENERATE WATER FOR ACTIVE THERMAL CONTROL SYSTEM USE.

FLIGHT RULES

The circulation pumps may be used to generate water through consumption of fuel cell cryogenic fuel. This was done successfully during STS 61-C.

THIS RULE CONTINUED ON NEXT PAGE

FLIGHT RULES

A10.1.4-4 HYDRAULIC CIRCULATION PUMP OPERATION (CIL)
(CONTINUED)

- B. CIRCULATION PUMPS WILL NOT BE ALLOWED TO CYCLE DURING PAYLOAD DEPLOYMENT WHEN THE DEPLOYMENT MECHANISM INVOLVES PYROTECHNICS WHICH ARE POWERED BY THE ORBITER. FOR CONDITION REQUIRING CONTINUOUS CIRCULATION PUMP OPERATION, THE PUMPS WILL BE PLACED IN THE "ON" POSITION VICE "GPC" (REFERENCE THE FLIGHT RULES ANNEX FOR OPERATING CONSTRAINTS DURING PAYLOAD ACTIVITIES).

The startup transient of a circulation pump has a high inrush current, a bus voltage drop of 4 to 5 volts, and considerable EMI. This transient is only present for less than 1 second, but the concern is that the bus voltage spikes or EMI could trigger any armed pyrotechnics in the vicinity. There is no concern with a circulation pump that is already running at the start of these types of payload operations - only the startup transient causes problems. Since in GPC mode the pump could be commanded on at an inopportune time caused by the failure of control transducers or their respective MDM's or DSC's, the GPC position will not be allowed during these operations.

- C. A CIRCULATION PUMP WILL NOT BE STARTED ON A MAIN BUS THAT POWERS THE PRIMARY PAYLOAD BUS WHILE A PAYLOAD IS ACTIVATED AND SENSITIVE TO CIRCULATION PUMP ACTIVATION, EXCEPT TO PREVENT LOSS OF AN APU/HYDRAULIC SYSTEM IF REACTION TIME DID NOT PERMIT FOR POWER SOURCE RECONFIGURATION.

The voltage ripple caused by the startup of a hydraulic circulation pump may be greater than the payload ICD requirements. Critical orbiter systems take precedence over payload systems if those orbiter systems are in jeopardy.

DOCUMENTATION: ICD2-19001, NSTS 07700, Volume XIV, Attachment 1.

THIS RULE CONTINUED ON NEXT PAGE

FLIGHT RULES

THIS PAGE INTENTIONALLY BLANK

FLIGHT RULES

A10.1.4-4 HYDRAULIC CIRCULATION PUMP OPERATION (CIL) (CONTINUED)

D. HYDRAULIC THERMAL CONDITIONING SOFTWARE WILL NOT BE REQUIRED FOR CONTINUING ANY FLIGHT PHASE.

For loss of software control of the hydraulic circulation pumps, the ground controllers will be responsible for tracking the relevant temperatures. The crew will then control the circulation pumps per ground instruction. Since these actions can be performed manually, there will be no constraints to continuing any flight phase.

E. A CIRCULATION PUMP ON A HYDRAULIC SYSTEM WITH A NON-ISOLATABLE LEAK WILL ONLY BE USED FOR HYDRAULIC ACCUMULATOR/RESERVOIR PRESSURE MANAGEMENT AND TO MAINTAIN SYSTEM COMPONENTS AND LINES ABOVE THEIR MINIMUM OPERATING TEMPERATURES. THE CIRCULATION PUMP WILL NOT BE USED FOR FCS CHECKOUT. ©[072398-6686B] ©[072398-6686A]

Circulation pump cycles on a hydraulic system with a non-isolatable leak may potentially degrade that system or possibly decrease the available run time for entry. Therefore, the use of this circ pump should be minimized. It is acceptable to run circ pumps for accumulator/reservoir pressure management to preclude the loss of that hydraulic system. Additionally, thermally conditioning this particular system in order to protect for optimal hydraulic performance is not warranted. However, a better trade-off can be made by keeping the system only minimally conditioned so as to only protect for minimum performance.

(Reference SODB table 3.4.2.4-1)

Rule {A10.1.2-9}, FCS CHECKOUT APU OPERATIONS references this rule. ©[072398-6686B] ©[072398-6686A]

FLIGHT RULES

WATER SPRAY BOILER (WSB) LOSS/FAILURE DEFINITIONS

A10.1.5-1 WSB LOSS DEFINITIONS

A WSB IS CONSIDERED LOST IF:

- A. AN N₂ OR H₂O LEAK IS VIOLATING CONSUMABLES REDLINES OR N₂ REGULATOR PRESSURE < 19.0 (21.6) PSIG WITH THE N₂ SUPPLY VALVE OPEN.

If consumables (water or GN₂) are below the redline, there is insufficient water supply for the WSB to provide adequate cooling for the APU or hydraulic fluid. The water spray bar will not operate properly at pressures < 19 psig; thus, there will be inadequate cooling (reference SODB, 3.4.2.4.11b.).

- B. UNABLE TO MAINTAIN APU LUBRICATION OIL RETURN TEMPERATURE < 325 DEG (310 DEG) F OR HYDRAULIC RESERVOIR TEMPERATURE < 230 DEG (222 DEG) F WITH CONTROLLER A OR B.

These temperatures are the SODB (3.4.2.4.1d and table 3.4.4.3-1) limits on these fluids. At 325 deg F, lubrication oil breakdown occurs and its viscosity becomes unacceptable. At 275 deg F, the seals in the hydraulic system become degraded which could result in leaks. Since the WSB primary purpose is to maintain these temperatures within limits, its failure to do so using both controllers constitute its loss.

- C. UNABLE TO MAINTAIN H₂O TANK TEMPERATURES < 125 DEG (118 DEG) F OR > 32 DEG (39 DEG) F.

The WSB controllers are mounted on the water tank which serves as the heat sink for the controllers. Temperatures > 125 deg F may cause excessive controller temperatures which could cause controller failure (ref. SODB, table 3.4.2.4-1). Temperatures below 32 deg F will allow the water to freeze.

- D. BOTH STEAM VENT HEATERS ARE LOST.

A steam vent heater is required prior to deorbit APU start to ensure that ice does not plug or restrict the steam vent orifice. A restricted steam vent orifice causes excessive boiler core pressure and may result in a steam vent duct rupture. The rupture (large orifice) may lead to a boiler spray bar freeze up and loss of lube oil cooling. This would require the APU to be shut down prior to Mach 1. A TAEM start of the associated APU ensures that cooling is not required and the system is available from TAEM to wheelstoptouchdown. @021199-68141

Reference rules {A10.1.2-3}, APU ENTRY START TIME, and {A10.1.2-4}, APU OIL/GEARBOX TEMPERATURE/ PRESSURE.

FLIGHT RULES

NOTE: LOSS OF WSB RESULTS IN EVENTUAL LOSS OF ITS ASSOCIATED
APU/HYDRAULIC SYSTEM.

FLIGHT RULES

WSB SYSTEMS MANAGEMENT @ED 1

A10.1.6-1 WSB CONFIGURATION

THE WSB N₂ SUPPLY VALVE WILL BE CLOSED EXCEPT IN PREPARATION FOR AND DURING APU OPERATIONS.

The valve provides isolation of the GN₂ tank. If a leak develops downstream of the valve, keeping it closed will preserve the GN₂ until needed for WSB operation.

A10.1.6-2 LOSS OF WSB(S) ACTIONS

A. FOR THE LOSS OF A SINGLE WSB, FLIGHT WILL CONTINUE TO NOMINAL EOM. @[041097-4611B]

The WSB's are essentially quiescent while on orbit. Because a subsequent failure of another APU/hydraulic/WSB system will likely only occur when these systems are operated for entry, there are no significant risks to continuing the flight until nominal EOM.

The loss of a WSB system does not indicate the immediate loss of an APU/hydraulic system, though the APU can only run for about 11 minutes before reaching an overtemperature condition. The APU associated with the lost WSB will be started late during entry to support landing (ref. Rule {A10.1.2-3}, APU ENTRY START TIME). Assuming the other two APU/hydraulic/WSB systems are good, three APU/hydraulic systems will be available to support the latter part of entry and landing. @[041097-4611B]

B. FOR THE LOSS OF TWO WSB'S, A NEXT PLS ENTRY WILL BE PERFORMED. IF THE FAILURE OCCURS ON LAUNCH DAY:

1. FOR NONDEPLOYABLE PAYLOAD FLIGHTS, A FIRST DAY PLS ENTRY WILL BE PERFORMED.

THIS RULE CONTINUED ON NEXT PAGE

FLIGHT RULES

A10.1.6-2 LOSS OF WSB(S) ACTIONS (CONTINUED)

2. FOR DEPLOYABLE PAYLOAD FLIGHTS, PAYLOAD DEPLOY AND/OR JETTISON WILL BE SCHEDULED TO ALLOW FOR DEORBIT ON DAY 2.

The loss of a WSB system does not indicate the immediate loss of an APU/hydraulic system, though the APU can only run about 11 minutes before reaching temperature limits. The APU associated with the lost WSB will be started late during entry to support landing (ref. Rule {A10.1.2-3}, APU ENTRY START TIME). Assuming the other APU/hydraulic/WSB systems are good, three APU/hydraulic systems will be available to support the latter part of entry and landing.

For the loss of two WSB's, entry should be made at the next PLS opportunity after deployable payloads have been deployed. It is desirable to deploy the payloads since this will improve the vehicle capability to maneuver and land safely if an APU or hydraulic system fails during entry. Jettison of deployable payloads that, for some reason, cannot be deployed should be considered as a means of last resort to improve the vehicle entry and landing capability.

If the APU/hydraulic system not associated with the lost WSB's fails or if the remaining WSB fails, one of the APU/hydraulic systems with limited run time must be started. Starts and restarts of both limited lifetime APU/hydraulic systems must be managed to allow for at least one system running at all times. Accomplishing this may be an impossible task if the good APU/hydraulic system fails at the worst possible time, i.e., prior to the deorbit burn. A next PLS entry should be performed for the loss of two WSB's in order to minimize the amount of time the vehicle is exposed to the next failure that would result in the orbiter being down an APU/hydraulic system and two water spray boilers.

Rule {A2.1.6-1}, CONTINGENCY ACTION SUMMARY, references this rule.

FLIGHT RULES

LANDING/DECEL SYSTEMS MANAGEMENT

A10.1.7-1 NOSE WHEEL STEERING (NWS)

A. NWS IS REQUIRED TO MAINTAIN DIRECTIONAL CONTROL DURING ROLLOUT:

1. FOR RTLS/TAL/AOA (KSC) LANDINGS.
2. AT ANY LANDING SITE IF THERE ARE KNOWN DIRECTIONAL CONTROL PROBLEMS (MLG OR NLG TIRE PREDICTED TO BE BELOW THE MINIMUM ACCEPTABLE PRESSURE AT TOUCHDOWN, UNCOMMANDED BRAKE PRESSURE, OR PEAK CROSSWINDS ABOVE THE SURFACE WIND LIMITS).

EFFORTS WILL BE TAKEN TO REGAIN NWS AS SPECIFIED IN THE REFERENCED FLIGHT RULES.

NWS provides the most effective means of preventing runway departure at any site where lateral margins are very limited, especially if a subsequent directional control problem develops. Ames VMS testing (July/August 1988, May/June 1989) demonstrated that differential braking and rudder inputs may not always provide adequate directional control capability when directional control problems are known to exist, even for runways with wide lateral margins. The forward position of the nose wheel provides a long moment arm (relative to the vehicle CG) for very effective vehicle steering. Therefore, NWS can overcome high frictional forces that may develop between a flat tire and a soft lakebed surface and also overcome the high frictional forces caused by uncommanded brake pressure. Moreover, excessive energy dissipated through differential braking can lead to subsequent loss of tire pressure (overtemperature of fuse plugs). In all cases, NWS is much more effective for directional control than differential braking.

B. NWS IS REQUIRED TO TARGET KSC AS THE PRIMARY LANDING SITE (PLS).

For KSC landings (where lateral margins are limited), NWS can appreciably help maintain acceptable vehicle handling qualities, particularly if a subsequent directional control problem develops sometime prior to rollout and wheel-stop. Therefore, NWS is required before committing to a deorbit burn to KSC in order to protect for unknown failures or adverse conditions that may arise during entry, landing, and rollout. Deorbit would be delayed if NWS is failed in order to retarget an alternate landing site (Edwards/Northrup) so that potential directional control difficulties are minimized. [@IED](#) |

FLIGHT RULES

However, once the deorbit burn has been performed to KSC and there are no known directional control problems, the risk of attempting to regain NWS (i.e., restringing flight-critical data buses, restarting a leaking or anomalous APU/HYD system, etc.) during dynamic flight is not warranted simply to protect against landing with an unknown failure or unexpected weather condition. KSC is an acceptable backup site for landing without NWS because differential braking is adequate for performing the nominal rollout steering task and will not cause excessive tire wear with commercial tread tires (ref. Rules {A2.1.4-7}, LANDING SITE SELECTION, and {A2.1.6-1}, CONTINGENCY ACTION SUMMARY).

THIS RULE CONTINUED ON NEXT PAGE

FLIGHT RULES

A10.1.7-1 NOSE WHEEL STEERING (NWS) (CONTINUED)

- C. NWS WILL BE TURNED OFF FOR ENTRY IF, DURING THE OPS 8 CHECKOUT, TWO OF THREE STEERING POSITION TRANSDUCERS DO NOT INDICATE -0.42 ± 0.31 VOLTS (GROUND) OR 0.0 ± 0.75 DEGREES (ONBOARD).

The NWS system requires at least two good steering position transducers for reliable nose wheel position SOP operation. If none of the steering position transducers have been comm faulted (all three inputs available), the nose wheel position SOP will midvalue select from the three position transducer values, regardless of their failure status. If one transducer is failed or biased, one of the two good transducers will always yield the midvalue of the three. In this case, the SOP will always select a good value. If two transducers are failed or biased, one of these two may yield the midvalue, and the SOP would then select an erroneous value. However, Ames VMS data (July/August 1988) confirmed that, for this scenario, the selected value will exceed the nose wheel position comparison limits when compared against the DAP-commanded nose wheel position and rate. The nose wheel position SOP will then generate a nose wheel position error and downmode to castor.

- D. NWS1 WILL BE USED AS THE PRIMARY MEANS OF DIRECTIONAL CONTROL. IF NWS1 HAS FAILED:
1. BEFORE NGTD: NWS2 WILL BE SELECTED AND USED AS THE MEANS OF DIRECTIONAL CONTROL.
 2. POST-NGTD: NWS2 CAN BE SELECTED AND USED AS THE MEANS OF DIRECTIONAL CONTROL.

The NWS1 and NWS2 modes of improved NWS are comparable to the GPC mode of the baseline NWS system. Therefore, either mode can provide the best means of rollout directional control. Although both modes provide identical functions and capabilities, NWS1 provides more downlisted system status parameters; NWS1 is, therefore, selected over NWS2.

If NWS is determined to be failed during the OPS 8 checkout or anytime prior to nose gear touchdown (ground speed enable flag set true), selecting NWS2 will provide the best alternative for rollout directional control. Ames VMS testing (July/August 1988) demonstrated that switching NWS modes during rollout was an effective procedure, particularly for MDM hardover failure cases.

However, SAIL testing (April 1991) demonstrated that for certain scenarios where the NWS1 channel downmoded to free castor (post-NGTD), the NWS system did not recover after selecting NWS2. In these cases, the NWS2 channel was selected coincident with a large rudder pedal command (DR 100737 and 106206). The NWS system was never perceived to have recovered as it downmoded unnoticeably 240 milliseconds after selection. Although the NWS software may not recover if the alternate NWS channel is selected on rollout, NWS2 can still be safely selected post-NGTD and is likely to regain control if a large rudder pedal input is not present at selection.

FLIGHT RULES

THIS RULE CONTINUED ON NEXT PAGE

FLIGHT RULES**A10.1.7-1 NOSE WHEEL STEERING (NWS) (CONTINUED)**

E. NWS WILL BE TURNED OFF FOR LOSS OF TWO LATERAL AA'S, TWO LEFT OR TWO RIGHT RPTA CHANNELS, RIGHT DDU (TWO POWER SUPPLIES - A, B, OR C), OR TWO STEERING POSITION TRANSDUCERS, EXCEPT FOR:

1. RTLS/TAL/AOA (KSC) LANDINGS.
2. KNOWN DIRECTIONAL CONTROL PROBLEMS (MLG OR NLG TIRE PREDICTED TO BE BELOW THE MINIMUM ACCEPTABLE PRESSURE AT TOUCHDOWN, UNCOMMANDED BRAKE PRESSURE, OR PEAK CROSSWINDS ABOVE THE SURFACE WIND LIMITS).

Once two lateral AA's or RPTA's have failed, there are potential vehicle control risks if NWS is selected. A hardover or high bias of one of these remaining components could result in loss of vehicle control. For runways with wide lateral margins, where differential braking and rudder inputs can provide adequate vehicle control, the use of NWS is not warranted at the risk of a third AA or RPTA failure, provided there are no known directional control problems. However, for abort landing sites (without wide lateral margins), the risk of runway departure due to a subsequent directional control problem outweighs the potential for a third AA or RPTA failure during the small window of rollout, and NWS should be selected.

Results of a NWS test matrix performed using the NASA Ames VMS in May/June 1991 indicate that vehicle control can be difficult to nonrecoverable after a third AA or RPTA hardover failure has occurred (Cooper/Harper ratings from 5 to 10). The matrix also demonstrated that, although landing with a known directional control problem (failed tire) without NWS is unsatisfactory (Cooper/Harper ratings between 5 and 8), this condition is sometimes controllable. Again, the risk of runway departure due to a known directional control problem outweighs the potential for a third AA or RPTA failure during rollout, and NWS should be selected

Rules {A2.1.5-4C.1}, ENTRY STRING REASSIGNMENT; {A2.1.5-11}, ENTRY DTO/AUTO MODE/CROSSWIND DTO GO/NO GO; {A2.1.6-1}, CONTINGENCY ACTION SUMMARY; {A7.1.3-8C.8}, PASS DATA BUS ASSIGNMENT CRITERIA; {A10.1.2-2}E and F, APU START/RESTART LIMITS; {A10.1.2-4B}, APU OIL/GEARBOX TEMPERATURE/PRESSURE; {A10.1.2-5D}, APU HIGH SPEED SELECTION/SHIFT; {A10.1.4-1}, HYDRAULIC SYSTEM CONFIGURATION; {A10.1.4-2B}, HYDRAULIC LEAKS; {A10.1.8-1}, TIRE PRESSURE (CIL); and {A10.1.8-4}, UNCOMMANDED BRAKE PRESSURE, reference this rule. ©[111094-1622B]

FLIGHT RULES

LANDING GEAR SYSTEMS MANAGEMENT

A10.1.8-1 TIRE PRESSURE (CIL)

A. THERMAL EFFECTS:

THE ORBITER ATTITUDE WILL BE MANAGED TO THERMALLY CONDITION THE TIRES TO MAINTAIN ACCEPTABLE PRESSURES AND TEMPERATURES FOR LANDING. THE FOLLOWING CONSTRAINTS APPLY: @[041097-4009E]

1. FOR NEOM LANDING AND EXTENSION DAYS, MAIN LANDING GEAR TIRE PRESSURE WILL BE MAINTAINED ABOVE THE MINIMUM PRESSURE DERIVED FROM THE NEOM/EXTENSION DAY PLOTS (+2 PSI UNCERTAINTY).
2. DURING THE FLIGHT, WHEN PAYLOAD ACTIVITIES ALLOW, MAIN LANDING GEAR TIRE PRESSURE WILL BE MAINTAINED ABOVE THE MINIMUM TIRE PRESSURE DERIVED FROM THE NEOM/EXTENSION DAY PLOTS (+2 PSI UNCERTAINTY) (OR AS HIGH AS PRACTICAL IF THE LIMIT CANNOT BE MET).
3. AT ALL TIMES DURING THE FLIGHT, MAIN LANDING GEAR TIRE PRESSURE WILL BE MAINTAINED ABOVE THE MINIMUM PRESSURE DERIVED FROM THE ANYTIME DEORBIT CONCRETE (+2 PSI UNCERTAINTY) PLOTS. EXCEPTIONS TO THIS RULE WILL BE DOCUMENTED IN THE FLIGHT-SPECIFIC ANNEX.
4. FOR A DEORBIT PRIOR TO NEOM, ALL REASONABLE EFFORTS WILL BE MADE TO SATISFY THE EOM REQUIREMENT. IN THE EVENT THE NEOM MINIMUM TIRE PRESSURE CANNOT BE MET (I.E., EMERGENCY DEORBIT), THEN DRAG CHUTE DEPLOY MAY BE USED TO REDUCE TIRE LOADS. @[050495-1771B]
5. TIRE TEMPERATURE WILL BE MAINTAINED ABOVE THE MINIMUM OPERATIONAL TEMPERATURE OF ~~-3545 DEG F~~ (-33-43) DEG F). @[111298-6764A]

Depending on the orbiter attitude, main gear tire temperatures are typically between 0 to 30 deg F while on orbit. ~~However, (some flights have seen temperatures as low as -25 deg F).~~ Since the tires are very good insulators and require significant time to warm up, there is no significant change in tire pressure from TIG to landing. The nose gear tires have never required thermal conditioning. @[111298-6764A] ~~Tire rubber becomes brittle at -35 deg F resulting in tire nylon strength degradation.~~

FLIGHT RULES

Michelin Aircraft Tire Corporation completed a Delta Certification for the Space Shuttle Orbiter Main Landing Gear Tire on August 20, 1998 (reference CR # 26-194-0007-0005B), verifying that the tire is capable of operating at a temperature of -45 deg F (previous certification limit was -35 deg -F). The tire demonstrated the ability to maintain air retention after being subjected to four landing load tests at -45 deg F. @[111298-6764A]

THIS RULE CONTINUED ON NEXT PAGE

FLIGHT RULES

A10.1.8-1 TIRE PRESSURE (CIL) (CONTINUED)

Protecting the ~~-3545~~ deg_F thermal limit is required in order to ensure emergency deorbit capability, since there would be no time to thermally condition the tires in an emergency deorbit timeline. (Reference SODB, volume I, table 3.4.2.1-1.) ©[050495-1771B] ©[041097-4009E] [@\[111298-6764A\]](#)

Past flight experience and thermal analysis show that, after going to a bottom Sun attitude, it is typically 4 to 5 hours before any increase is seen in the wheel wells due to thermal inertia. Once this occurs, the temperature typically goes up 1 deg per hour which results in a pressure increase of approximately 0.77 psi per hour. (Reference AEFTP #91, July 17, 1992.) ©[041097-4009E]

In order to avoid significant payload impact, the limits for anytime deorbit which do not include the undispersed limit (nominal load for given mass properties without RSS'd performance dispersions added) will be used. This is acceptable due to the unlikely event of an anytime deorbit, the availability of drag chute deploy, and the additional capability of the tire/strut shown in off-nominal testing. In the event of deorbit earlier than NEOM, all reasonable attempts will be made to meet the dispersed limits (i.e., MDF or next PLS with deorbit the following day should allow sufficient time to condition the tires). ©[050495-1771B]

FLIGHT RULES

Tire load capability and thereby minimum tire pressure allowed depend greatly on the maximum load conditions that the tires may encounter. The maximum load is a function of several parameters primarily associated with the initiation of the derotation maneuver post-main gear touchdown. Orbiter mass properties (total weight and X center of gravity) are significant factors in the maximum tire loading. The other factors which significantly affect tire loading are controlled by crew procedures which affect the derotation maneuver, especially in the first second or two of the initiation of derotation. These procedures are documented in the Flight Procedures Handbook; Approach, Landing, and Rollout, JSC-23266, Section 5.3.6.7. Among these crew procedure controlled parameters are the indicated airspeed at which derotation is initiated. This is a significant factor in the maximum load that the tires will experience. Crew technique to initiate derotation is to wait for an indicated 185 KEAS and perform a beep trim derotation. Errors in display plus some allowance for human factors lead to a maximum dispersion on the high side of 195 KEAS actual for a dispersed initiation of derotation. Lower airspeeds lead to significantly lower main gear loads but increase the nose gear load at slapdown. Lakebed runways have significantly higher loads on the nose gear. The same 10-KEAS error applies to lakebed runway derotation as well as to concrete runway derotation. The second parameter affecting main gear maximum loads that is controlled by crew procedure is the derotation rate that is established by the crew in the initial part of the derotation for a manual derotation. This should not be confused with the overall or average derotation rate for the entire maneuver since quite high rates can be achieved after $\theta = 0$ degree. Nor should this rate be confused with the actual rate the vehicle achieves in the initial few seconds of derotation. Ames VMS sims (and flight data) have consistently shown that the average rate achieved in the initial derotation is on the order of 0.7 to 0.8 deg/sec. For simplicity, the analysis assumes the derotation rate of 1.0 deg/sec and includes dispersions to 1.5 deg/sec. In some few very dispersed cases, an early rate of nearly 2.0 deg/sec was accomplished but this took significantly longer than the 1.0-second time (next parameter) to achieve. The third important parameter affected by crew procedural control is the speed with which the derotation rate is achieved. A rapid or jerky rate can lead to tire "bounce" with greatly increased (though oscillating) loads. Crew procedures specifically call for the rate to be put in smoothly over a 1- to 2-second interval. Ames VMS studies (and flight data) show that the average time for rate buildup is 1 second with the most dispersed times being 0.5 second. When initial studies

THIS RULE CONTINUED ON NEXT PAGE

FLIGHT RULES

A10.1.8-1 TIRE PRESSURE (CIL) (CONTINUED)

were done with the maximum dispersions (185 KEAS derotation, 2.0 deg/sec, 0.5 second ramp input time), the loads exceed the tire capability at nominal (launch) pressures. Further examination of the Ames VMS data (and flight data) shows that the combination of high rate (over 1 deg/sec) and short input time (less than 1 second) never occurs. The 1 deg/sec with 0.5 second input time represents a worst case combination from the load standpoint. Therefore, this was chosen as the dispersed case (the other option, 2 deg/sec with 1 second ramp time yielded significantly lower loads). This is why the table in this rule shows the command initiation time to be 1.0 second with -0.5 second dispersion. Other combinations of dispersions may be postulated, but all real-world possible combinations result in lower main gear loads. ©[050495-1771B]

Interpolation for different orbiter weights on the tire plots is allowed between 185,000 pounds and 248,000 pounds. Extrapolation below 185,000 pounds on the tire plots is not allowed. If vehicle landing weight is less than 185,000 pounds, either mission-specific analysis is required or use the 185,000 pound line at the proper CG. If vehicle mass properties are otherwise off the chart (landing weight above 248,000 pounds, CG forward of 1076.7 or aft of 1111.0 - which is a contingency case), specific analysis is required. The forward CG limit of 1075.2 inches is for Mach 3.5 and not touchdown. Gear deploy causes the CG to shift AFT and therefore the carpet plots were only derived to 1076 inches. -Between 1078.5 and 1076.7, use the value for 1078.5. ©[050495-1771B] ©[091098-6713]

All plots use the following nominal and dispersed pitchover command parameters for main gear rollout assessments shown below and are taken from the SODB (ref. SODB Vol. V, Section 4.3 and Rule {A2.1.4-6}, DEROTATION SPEED.) Current derotation is at 185 KEAS using beep trim. The minimum loads and tire pressures for 185 KEAS beep trim and 175 KEAS manual derotation are protected by the 185 manual derotation plots. The 185 KEAS beep trim and 175 KEAS manual derotation plots are not shown here but are in SODB Vol V, Section 4.3.3. ©[050495-1771B]

Parameter	Value	
	Nominal	Dispersion
Derotation speed		
· Concrete	185 KEAS	+10 KEAS
· Lakebed	185 KEAS	+10 KEAS
Command initiation time	1.0 sec	-0.5 sec
Pitch command rate *	-1.0 deg/sec	-0.5 deg/sec
Crosswind	15 knots	+5 knots

©[050495-1771B]

* This is RHC commanded rate being fed into the system.

Since derotation rate increases during derotation, actual pitch rate at slapdown would be of a high magnitude.

THIS RULE CONTINUED ON NEXT PAGE

FLIGHT RULES

A10.1.8-1

TIRE PRESSURE (CIL) (CONTINUED)

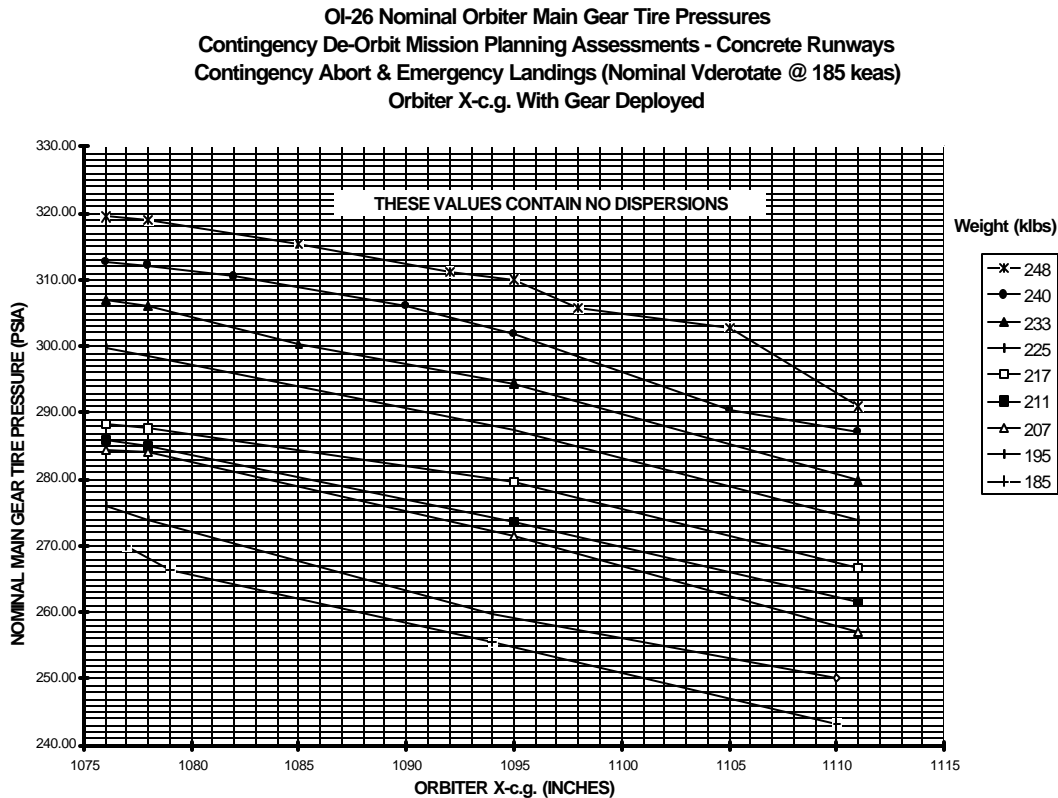

©[091098-6713]

**Contingency Minimum Orbiter Main Gear Tire Pressure - Concrete - Derotation
 Initiation at 185 KEAS**

FIGURE A10.1.8-1-I - ANYTIME DEORBIT (CONCRETE RUNWAY)

THIS RULE CONTINUED ON NEXT PAGE

FLIGHT RULES

A10.1.8-1 TIRE PRESSURE (CIL) (CONTINUED)

**OI-23 Nominal Orbiter Main Gear Tire Pressures
Contingency De-Orbit Mission Planning Assessments - Lakebed Runways
Contingency Abort & Emergency Landings (Nominal Vderotate @ 185 keas)**

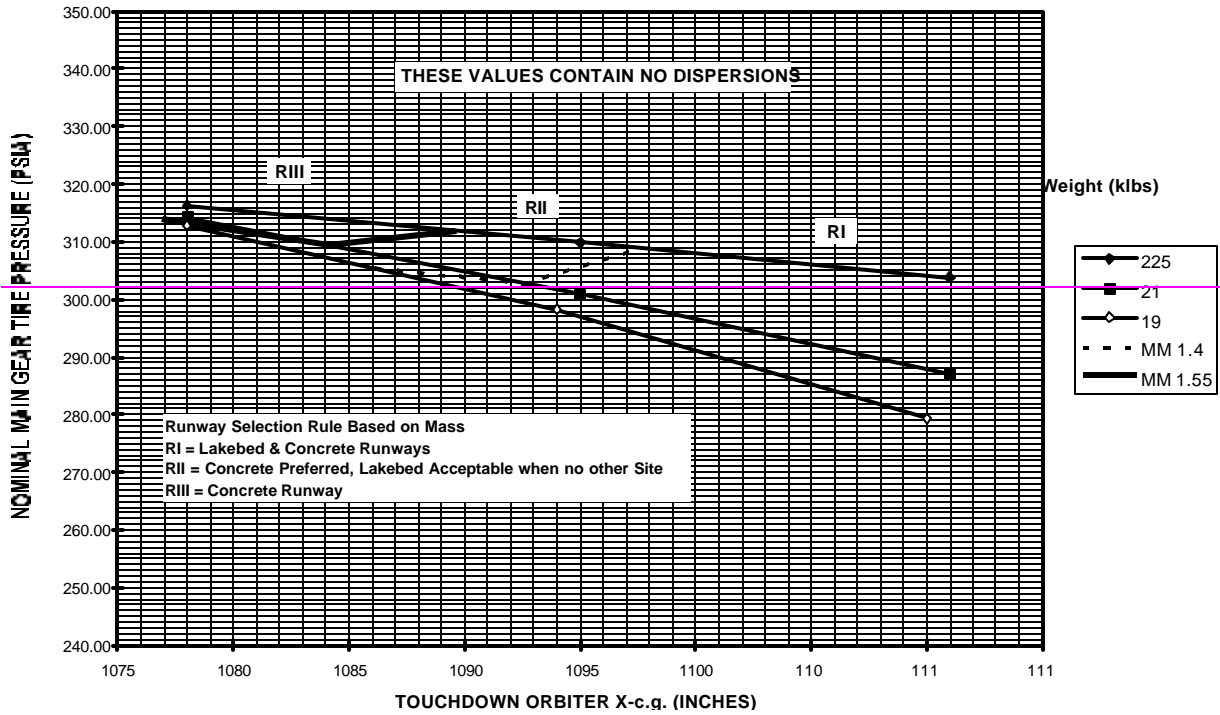

~~Contingency Minimum Orbiter Main Gear Tire Pressure - Lakebed - Derotation Initiation at 185 KEAS~~

~~Orbiter Landing Weights Greater Than 225 KLBS Require Separate Evaluation~~

~~FIGURE A10.1.8-1-II - ANYTIME DEORBIT (LAKEBED RUNWAY)~~

FLIGHT RULES

THIS RULE CONTINUED ON NEXT PAGE

OI-26 Nominal Orbiter Main Gear Tire Pressures
Contingency De-Orbit Mission Planning Assessments - Lakebed Runways
Contingency Abort & Emergency Landings (Nominal Vderotate @ 185 keas)
Orbiter X-cg With Gear Deployed

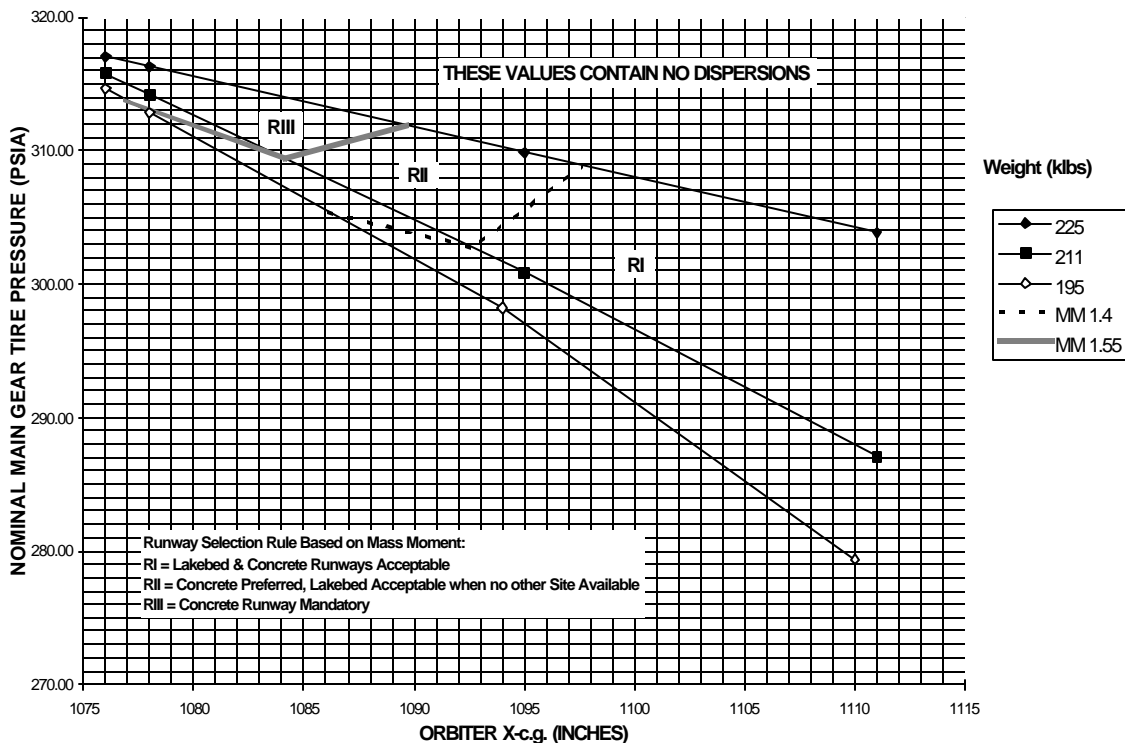

©[091098-6713]

Contingency Minimum Orbiter Main Gear Tire Pressure - Lakebed - Derotation Initiation at 185 KEAS

Orbiter Landing Weights Greater Than 225 KLBS Require Separate Evaluation

FIGURE A10.1.8-1-II - ANYTIME DEORBIT (LAKEBED RUNWAY)

THIS RULE CONTINUED ON NEXT PAGE

FLIGHT RULES

A10.1.8-1

TIRE PRESSURE (CIL) (CONTINUED)

OI-26 Minimum Orbiter Main Gear Tire Pressure
Mission Planning Assessments - Concrete Runways
All Normal & Intact Abort Landings (Nominal Vderotate @ 185 keas)
Orbiter X-c.g. With Gear Deployed

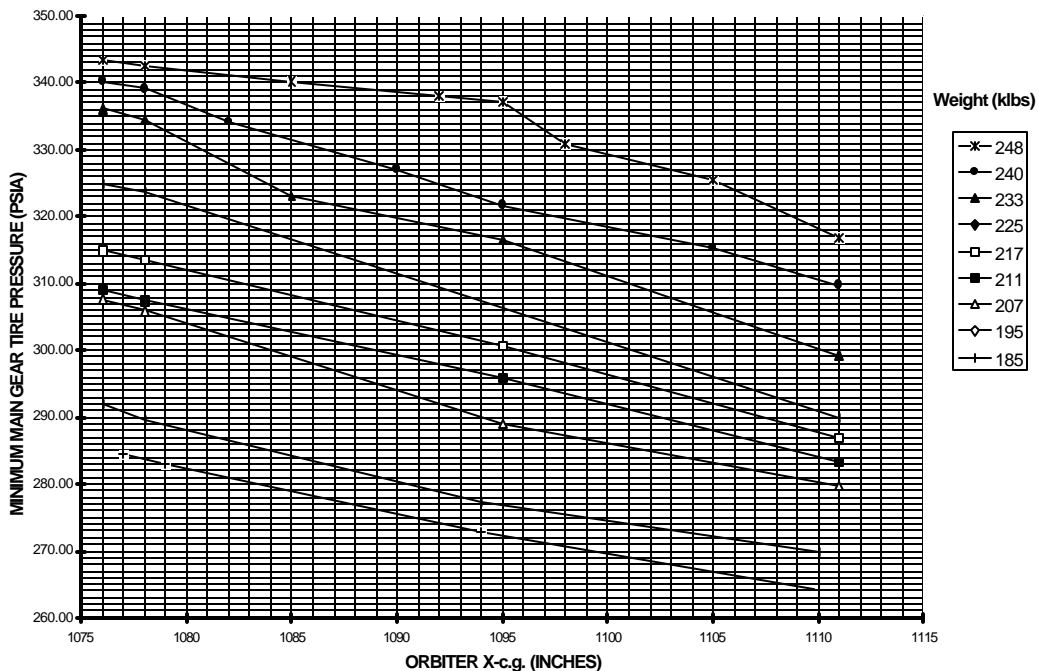

[\[091098-6713\]](#)

Minimum Orbiter Main Gear Tire Pressure - Concrete - Derotation Initiation at 185 KEAS

FIGURE A10.1.8-1-III - NOMINAL/EXTENSION DAY (CONCRETE RUNWAY)

THIS RULE CONTINUED ON NEXT PAGE

FLIGHT RULES

A10.1.8-1

TIRE PRESSURE (CIL) (CONTINUED)

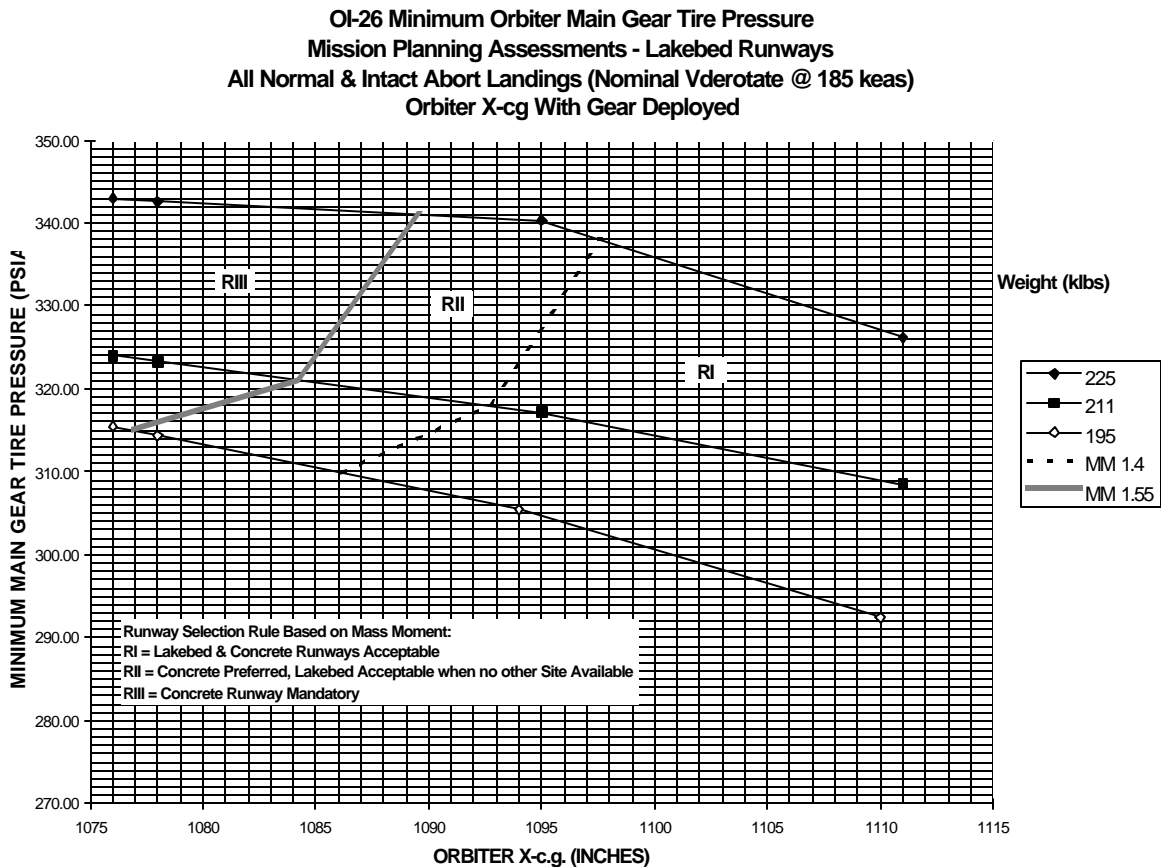

©[091098-6713]

Minimum Orbiter Main Gear Tire Pressure - Lakebed - Derotation Initiation at 185 KEAS

Orbiter Landing Weights Greater Than 225 KLBS Require Separate Evaluation

FIGURE A10.1.8-1-IV - NOMINAL/EXTENSION DAY (LAKEBED RUNWAY)

THIS RULE CONTINUED ON NEXT PAGE

FLIGHT RULES

A10.1.8-1 TIRE PRESSURE (CIL) (CONTINUED)

B. LEAKING/FLAT TIRE:

1. A TIRE LEAK IS DEFINED AS A DECREASE IN A TIRE'S PRESSURE MEASUREMENTS THAT IS INCONSISTENT WITH CHANGES IN PRESSURE OF THE OTHER TIRES AND CANNOT BE EXPLAINED BY INSTRUMENTATION INACCURACY/FAILURE OR VARIATIONS IN TEMPERATURE. @[041097-4009E]
2. LOSS OF TIRE PRESSURE INSTRUMENTATION WILL NOT BE CAUSE FOR EARLY MISSION TERMINATION.
3. FOR A LEAKING TIRE, IF THE AFFECTED TIRE PRESSURE CAN BE MAINTAINED > 260 (262) PSIG/275 (277-260 (262) PSIG/275 (277) PSIA AT THE LANDING TIME FOR THE NEXT PLS PLUS 2 EXTENSION DAYS, PLANNED ON-ORBIT ACTIVITIES MAY CONTINUE. OTHERWISE, DEORBIT WILL BE SCHEDULED AT THE NEXT PLS OPPORTUNITY. PAYLOADS MAY BE DEPLOYED/JETTISONED PRIOR TO ENTRY IN ORDER TO DECREASE TIRE LOADS. (CIL)
4. FOR A LEAKING MAIN GEAR TIRE ~~LEAK~~, A LANDING WITH A CROSSWIND FROM THE SIDE OF THE AFFECTED TIRE IS HIGHLY DESIRABLE.

Since tire pressure is greatly dependent upon temperature, a leak cannot be confirmed unless there is a sustained unexpected decay in both the actual and temperature-corrected pressure measurements on a tire. The loss of both pressure measurements will not be cause to declare a leaking/flat tire. The 2 psi transducer error is based on the ability to compare the TPDMS system to KSC mechanical gauge readings (0.1 percent accuracy) prelaunch and to eliminate the measurement scatter. The remaining 2 psi error includes the KSC mechanical gauge error and scatter seen prelaunch in the TPDMS pressure readings due to variations in temperature.

If a leaking condition is confirmed in a main or nose gear tire, the load-carrying capability of that tire is reduced. The main gear and nose gear values were derived from Convair 990 low pressure testing which simulated a 248K vehicle landing at 225 knots in a 15 knot crosswind for the mains (20 knot crosswind for the nose tires) and showed a low pressure tire could sustain a heavy load. Neither main or nose gear tire failed at the lowest pressures tested on Convair. The flat tire limit was derived from this lowest pressure tested (235 psig/250 psia) with 10 percent added for safety. The good main gear tire, 355 psia, received 62 percent of the strut load (162.5K peak vert. load) while the flat tire, 250 psia, received 48 percent (123.5K) of the load (Convair flight tests 121/122). The 161.5K peak load tested exceeds the tire

THIS RULE CONTINUED ON NEXT PAGE

FLIGHT RULES

A10.1.8-1 TIRE PRESSURE (CIL) (CONTINUED)

certification of 142.5 klbs. The CV-990 test demonstrated additional vertical load capability by reducing the crosswind to 15 knots. The good nose gear tire, 325 psia, received 61 percent of the strut load (55.0K peak vert. load) while the flat nose tire, 250 psia, received 49 percent (46.3 percent of the load. (Convair flight tests 145/150). (Ref. Dryden Test Report, August 1995: Landing System Research Aircraft Low Pressure Stress Test Flights.) Reference SODB 3.4.2.1. ©[041097-4009E]

The intent of a nominal drag chute deploy is to achieve disreef just prior to NGTD (reference Ascent/Entry Flight Techniques Panel #104). In the event of a leaking/flat tire, by minimizing MLG loads there is a possibility that the good tire on that strut will not fail. Ames (6/93) data indicates that main landing gear loads are minimized (decreased by up to 17 percent) by obtaining disreef just before NGTD. ~~Flight data and testing at Ames (1/96) show that to ensure disreef prior to NGTD, the chute should be deployed 10 knots prior to derotation. Ames (2/93) tests show that a chute deploy just prior to initiation of derotation results in disreef immediately before NGTD, assuming as high as a commanded 2 deg/sec average derotation rate.~~ Deploy will be performed regardless of the status of SSME repositioning (ref. Rule {A10.1.8-2}, DRAG CHUTE DEPLOY TECHNIQUES). ©[041097-4009E]

Rule {A10.1.8-2}, DRAG CHUTE DEPLOY TECHNIQUES references this rule. ©[111094-1690B]

~~*The 275 psig (290 psia) value was also substantiated with additional analysis which predicts main gear tire deflection to be less than 6.6 inches under a 115k lb tire load, 230k lb strut load, assuming 50-50 load sharing (i.e., lakebed landing), including a 5 percent uncertainty. Requiring the tire pressure to support 2 additional days maintains tire capability should a deorbit waveoff or bad weather occur to prevent landing on the desired PLS opportunity (protects for one additional PLS landing opportunity). Because load-carrying capability of the tire is reduced if tire pressure is degraded, deploy or jettison of the payload is desired, if accomplishable, so that orbiter landing weight and tire loading may be reduced, increasing the possibility of tire survival. The one additional PLS landing opportunity should not be sacrificed in order to avoid an early payload deploy or jettison, if applicable.*~~

~~*The 260 psig (275 psia) nose gear value was selected as an interim value until a formal analysis is performed to determine a precise lower limit. Though the actual limit may be lower, there is general agreement that protecting the 260 psig (275 psia) value will most likely prevent a nose gear tire failure due to loading.*~~

FLIGHT RULES

Landing with a crosswind from the side of the affected [main gear](#) tire is highly desirable because landing loads on the adjacent tire and strut will be less than those encountered on the leeward side of the vehicle, thereby decreasing the possibility of a second failed tire on the same strut. If such a tradeoff is necessary, a higher priority should be placed on choosing a landing with the crosswind from the side of the affected [main gear](#) tire over considerations due to head winds or tail winds. Minimizing the tailwind component is a secondary priority. Vehicle ground speed increases with increasing tail winds. A higher ground speed decreases vehicle controllability, especially in the presence of directional control problems such as a tire failure. Though a lower ground speed is desirable, a beneficial crosswind component is the highest priority in order to reduce the possibility of a second tire failure. [@\[041097-4009E\]](#)

Rule {A2.1.4-7}, LANDING SITE SELECTION, references this rule.

FLIGHT RULES

A10.1.8-2 DRAG CHUTE DEPLOY TECHNIQUES

- A. NOMINAL DEPLOY: DRAG CHUTE DEPLOY WILL **NOMINALLY** BE PERFORMED **POST MGTD AT 195 KNOTS, JUST PRIOR TO THE INITIATION OF DEROTATION.** THE FOLLOWING EXCEPTIONS APPLY:

The intent of a nominal drag chute deploy is to achieve disreef just prior to NGTD. Flight data and testing at Ames (1/96 and 7/96) show that, to ensure disreef prior to NGTD, the chute should be deployed 10 knots prior to derotation. ~~Ames (2/93) tests show that a chute deploy at the initiation of derotation results in disreef immediately before or at NGTD, assuming as high as a commanded 2°/sec average derotation rate.~~ Results from DTO 521 (Drag Chute System) show that a chute deploy after the derotation rate is established results in a disreef immediately after NGTD. Ames (2/93) data shows that the vehicle sensitivity to lateral excursions is a function of how long the orbiter's nose is in the air after chute disreef, due to the limited ability of the rudder to compensate for large yawing moments. STS-47 chute disreef occurred approximately 2 seconds prior to NGTD, which resulted in a 40 ft lateral excursion off the runway centerline and subsequent redesign of the drag chute (5 ribbons were removed to improve chute stability). Ames (~~2/93~~ 1/96, 7/96, and 1/97) data shows that deploying the chute 10 knots just prior to the initiation of derotation is a safe technique for all vehicle mass moment cases with regard to nose gear slapdown limits and lateral excursions. The delta between chute deploy speed and the speed at the initiation of derotation should be no greater than 10 knots to prevent lateral control position and rate saturation problems from occurring, particularly with crosswinds > 10 knots with a lightweight vehicle. - A nominal deploy alleviates the concern of objectionable vehicle performance which may occur if disreef occurs significantly prior to NGTD (ref. Ascent/Entry Flight Techniques Panel #97, #104). - Recent Flight experience (as of 8/94) supports these conclusions. @J041097-4890A1

1. EARLY DEPLOY: DRAG CHUTE DEPLOY MAY BE PERFORMED BETWEEN MGTD AND THE NOMINAL DEPLOY TIME ONLY FOR INSUFFICIENT ROLLOUT MARGIN ~~AND FOR A VEHICLE MASS MOMENT > 1.53 X 106 FT-LB.~~ @J041097-4890A1

Maximum deceleration benefits from the drag chute are obtained when the drag chute is deployed as early as possible. A chute deploy at MGTD provides approximately an additional 1000 ft of rollout margin over a nominal deploy (ref. Ames Pilot Report dated 4/93).

Adequate braking capability is determined based on brake energy predictions, rollout margin, and landing conditions of the day (ref. Rule {A4.1.3-8}, BRAKING AND ROLLOUT REQUIREMENTS). An analysis performed by Flight Design & Dynamics (10/92) indicated that for adequate control and stopping distance, ³ 37.5 percent brakes are required without NWS, and that ³ 25 percent brakes are required with NWS (for all landing sites). This analysis assumed 15 kt crosswinds and no drag chute, and looked at brake torque only. The rollout margin predictions made from real-time trajectory simulations must satisfy flight rule {A4.1.3-8} specified minimums to make a runway GO. These simulations do not include the effects of the drag chute. After committing to a landing site, if a braking/deceleration system partially or totally fails or TD energy is unexpectedly high, an early drag chute deploy is allowed to provide additional rollout margin protection.

FLIGHT RULES

~~The 5/90 Ames VMS testing indicated that early deploys with vehicle mass moments $< 1.53 \times 10^6$ ft-lb had problems with elevon saturation. Ames data from 2/94 indicated that early deploys with vehicle mass moments $> 1.80 \times 10^6$ ft-lb may violate NLG slatdown limits (6 percent of the VMS runs). Ames testing performed in 1993, and 1994, and 1997 has shown that strut loads and handling qualities are acceptable with all vehicle Mass Moments $< 1.80 \times 10^6$ ft-lb. Maintaining the 1.53×10^6 ft-lb lower limit protects for elevon rate and position limiting (this is needed particularly in the event of a delayed derotation).~~ @041097-4890A]

THIS RULE CONTINUED ON NEXT PAGE

FLIGHT RULES**A10.1.8-2 DRAG CHUTE DEPLOY TECHNIQUES (CONTINUED)**

2. LATE DEPLOY: DRAG CHUTE DEPLOY WILL BE PERFORMED AFTER NGTD FOR A LOW ENERGY LANDING. @[111094-1690B]

Ames data shows a late deploy is required because, after drag chute deployment during a low energy landing, deceleration happens so quickly that trailing edge "up" saturation occurs, and it is difficult to control derotation precisely. These factors cause high pitchdown rates and excessive NLG strut loads. Late deployment of the chute still allows some of the benefits of the chute to be retained.

- B. EMERGENCY DEPLOY: DRAG CHUTE DEPLOY WITH SSME REPOSITIONING INCOMPLETE WILL ONLY BE PERFORMED FOR A TAL/ELS, LEAKING/FLAT TIRE, INSUFFICIENT ROLLOUT MARGIN, LOSS OF BRAKING CAPABILITY, OR A SINGLE APU LANDING. @[111094-1690B]

If SSME repositioning is not complete, the drag chute will not be deployed unless one or more of the above conditions are present. If none of the above conditions are present, the call to the crew should be "Go for emergency chute deploy only", indicating to the crew to not deploy the drag chute unless they feel that the drag chute could provide some additional benefit. If SSME repositioning did not occur and one or more of the above conditions are present, the call to the crew will be the type of deploy to be performed (e.g. Go for nominal deploy, early deploy, or late deploy).

Deploying the drag chute without SSME repositioning risks damage to engine bells. Rockwell analysis (1/91) shows that the most likely contact point would be between the top edge of the center main engine bell and the risers, when the risers are at full line stretch (twang). For certain cases, the benefits of the drag chute outweigh the risk of potential damage to the SSME bells.

The drag chute minimizes MLG loads if disreef occurs prior to NGTD. The additional loads margin of a nominal chute deploy and the margin the chute provides for the uncertainties of a short, narrow runway outweigh the risk of engine bell damage in the event of a TAL or ELS landing. During an RTLS, the engine bells are moved to the RTLS stow position which is the same as the drag chute stow position. Due to the length and width of the KSC runway, RTLS is not a sufficient reason to deploy if failures prevent the center main engine from reaching the stow position.

In the event of a leaking/flat tire, by minimizing MLG loads there is a possibility that the good tire on that strut will not fail. Main landing gear loads are minimized (decreased by up to 17 percent) by obtaining disreef just before NGTD (ref. Rule {A10.1.8-1}, TIRE PRESSURE (CIL), and Ascent/Entry Flight Techniques Panel #104, September 17, 1993).

THIS RULE CONTINUED ON NEXT PAGE

FLIGHT RULES

A10.1.8-2 DRAG CHUTE DEPLOY TECHNIQUES (CONTINUED)

Adequate rollout margin is determined based on brake energy predictions and landing conditions of the day (ref. Rule {A4.1.3-8}, BRAKING AND ROLLOUT REQUIREMENTS). An analysis performed by Flight Design & Dynamics (10/92) indicated that for adequate control and stopping distance, ³ 37.5 percent brakes are required without NWS, and that³ 25 percent brakes are required with NWS (for all landing sites). This analysis assumed 15 kt crosswinds and no drag chute, and looked at brake torque only.

For a single APU landing, the drag chute provides rollout margin in the event the last APU fails during rollout. Ames '91 testing shows no noticeable changes in drag chute handling qualities due to a single APU landing.

*Rule {A2.1.5-12}, LANDING DTO's, and {A10.1.8-1}, TIRE PRESSURE (CIL) reference this rule.
 ©[111094-1690B]*

A10.1.8-3 DRAG CHUTE DEPLOY CONSTRAINTS

THE DRAG CHUTE WILL BE DEPLOYED FOR ALL LANDINGS SUBJECT TO THE FOLLOWING: ©[111094-1690B]

The drag chute adds margin to the landing and rollout capabilities of the shuttle by reducing main gear strut loads (possibly preventing a second blown tire at NGTD in the event of a leaking/flat tire), increasing directional stability (especially with directional control problems), and reducing rollout distance. Ames (6/93) data indicates that main gear load savings are maximized (loads decreased up to 17 percent) by obtaining disreef just before NGTD (ref. Ascent/Entry Flight Techniques Panel #104, September 17, 1993).

A. THE DRAG CHUTE WILL NOT BE DEPLOYED IF CROSSWIND > 15 KNOTS PEAK.

The crosswind limit is for peak winds, in accordance with All Flights Rule {A2.1.1-6}, LANDING SITE WEATHER CRITERIA. Ames 1991 data shows that deploying the chute in high crosswinds will increase the vertical loads on the downwind tires and may also cause reduced pilot handling qualities. Handling qualities ratings (HQR's) degrade as the crosswinds approach 15 kts, but are still typically within acceptable limits (level 1-2 Cooper Harper ratings). A few level 3 HQR's occurred during 6/93 VMS runs with crosswinds of 15 and 20 kts (ref Ascent/Entry Flight Techniques Panel #104, September 17, 1993).

B. THE DRAG CHUTE WILL NOT BE DEPLOYED PRIOR TO MGTD.

Before MGTD, the crew may not have time to jettison the chute nor will there be sufficient force to cause the pivot pin (105k - 125k lb shear pin) to disengage and release the chute (Ames 1990).

THIS RULE CONTINUED ON NEXT PAGE

FLIGHT RULES

A10.1.8-3 DRAG CHUTE DEPLOY CONSTRAINTS (CONTINUED)

C. THE DRAG CHUTE WILL NOT BE DEPLOYED AT SPEEDS > 230 KEAS OR < 80 KGS. @[111094-1690B]

The pivot pin in the attach/jettison mechanism is designed to disengage and release the chute for forces between 105k lbs and 125k lbs, preventing structural damage. Above 230 KEAS, the loads are expected to exceed the pivot pin disengage limits. If these limits are exceeded, the pivot pin will most likely release the chute during disreef, the period of maximum loading. If this occurs, the elevons may not have enough time to react to the sudden change in moment of the orbiter, and derotation could increase to a rate which would result in exceeding NLG slapdown loads. @[111094-1690B]

If the drag chute is deployed at speeds < 80 KGS, only the pilot chute will deploy (ref. Rockwell Downey 1992 Computer Simulations). Analytical data shows there should be no contact between the risers and the center main engine bell at speeds as low as 75 KGS. Flight data shows that 75 KGS may be conservative, as the chute is riding higher than anticipated.

D. THE DRAG CHUTE WILL BE ARMED AND DEPLOYED SIMULTANEOUSLY.

When the chute is armed, an inadvertent deploy can result from additional failures in a deploy switch and/or electrical components within the drag chute avionics. An inadvertent deploy of the chute can result in excessive sink rates, which can be catastrophic.

E. FOLLOWING DEPLOY, THE CHUTE WILL BE JETTISONED AT A SPEED OF 60 ± 20 KGS. THE CHUTE WILL NOT BE JETTISONED BELOW 40 KGS.

Ames (1/93) data has shown that jettison of the chute prior to NGTD can result in poor handling qualities, and can increase the nose gear slapdown loads above allowable structural limits.

If the chute is jettisoned below 20 KEAS, there is an increased probability that the drag chute risers will contact and possibly damage the engine bells (Rockwell engineering analysis). All crew procedures after nose gear touchdown that are cued to velocity must use ground speed because the HUD display changes from airspeed to ground speed at WONG. The 40 KGS minimum jettison cue is 20 kt faster than the 20 KEAS constraint to account for wind and atmospheric effects, instrumentation error, and system lag.

Rules {A2.1.5-12}, LANDING DTO's and {A2.1.1-6}, LANDING SITE WEATHER CRITERIA, reference this rule. @[111094-1690B]

FLIGHT RULES

A10.1.8-4 UNCOMMANDED BRAKE PRESSURE (CIL)

- A. BRAKE ISOLATION VALVE (S) WILL BE CLOSED IF NECESSARY TO PREVENT LANDING WITH UNCOMMANDED BRAKE PRESSURE > 180 (180) PSI IN ONE OR MORE BRAKE/SKID CONTROL VALVES. THE ASSOCIATED BRAKE ISOLATION VALVE (S) WILL BE OPENED AFTER NOSE GEAR TOUCHDOWN TO PROVIDE FULL BRAKING.

Brake application is possible at pressures ≥ 180 psi. If brake pressure increases above 180 psi at main gear touchdown, the tire(s) will "skid" until tire failure. The tire adjacent to the failed tire may fail at nose gear touchdown, resulting in severe lateral-directional control problems during rollout. The high friction forces of a locked wheel may also result in nose gear loads in excess of structural limits.

Closing the affected isolation valve(s) isolates the brakes from the high pressure flow, and the pressure should decrease to nominal levels through the return pressure lines. This covers the most credible failure modes (brake servovalve problems due to contamination and silting or an antiskid card failure).

- B. IF CLOSING THE BRAKE ISOLATION VALVE(S) FAILS TO RELIEVE THE BRAKE PRESSURE, AN APU WILL BE SHUT DOWN TO PREVENT LANDING WITH BRAKE PRESSURE > 180 (180) PSI IN A SINGLE BRAKE/SKID CONTROL VALVE IF TWO OTHER GOOD APU/HYDRAULIC SYSTEMS REMAIN. TWO APU'S WILL BE SHUT DOWN IF NECESSARY TO RELIEVE UNCOMMANDED BRAKE PRESSURE IN MULTIPLE BRAKE/SKID CONTROL VALVES. THE ASSOCIATED BRAKE ISOLATION VALVE(S) WILL BE OPENED PRIOR TO APU SHUTDOWN.

If uncommanded brake pressure is not relieved when the isolation valve(s) is closed, the selector valve is stuck such that it is blocking both the primary and secondary return lines. The primary system brake isolation valve(s) will be reopened to allow a return path for the hydraulic fluid, and the primary APU (1 or 2) will be shut down. If high brake pressure is detected in only one brake/skid control module, a second APU will NOT be shut down because of the possibility that the failure is a transducer failure.

The 180-psi value used in this rule does not take into account the ± 100 psi transducer error. If transducer error was considered, the value at which to take action would be well within the nominal system operating range. The transducers have proven to be reliable in their accuracy.

With OI-21 software and the major modification hydraulic changes, the brake isolation valves will remain closed until MGTD. Therefore, it would take at least two failures to implement this rule.

Reference SODB, Volume I, Section 3.4.2.1, and Mechanical Systems Console Handbook, Volume II, Section 2.5.9.

Rule {A10.1.4-1}, HYDRAULIC SYSTEM CONFIGURATION, references this rule.

FLIGHT RULES

A10.1.8-5 BRAKING

A. DEFINITIONS :

1. NOMINAL BRAKING PROFILE - THE NOMINAL BRAKING PROFILE CONSISTS OF APPLYING THE BRAKES WHEN THE VEHICLE HAS REACHED A SPEED OF 140 KNOTS GROUND SPEED (GS). ONCE BRAKES ARE APPLIED, A DECELERATION RATE OF 8 FPS² SHOULD BE MAINTAINED UNTIL A SPEED OF 40 KNOTS GS IS REACHED, WHEN THE DECELERATION RATE SHOULD BE REDUCED TO LESS THAN 6 FPS².

The 140 knots GS was chosen as the nominal brake-on speed because it is the maximum speed that can be used with this deceleration rate and not exceed the reuse energy limit of the brakes. This was determined by landing and rollout analysis programs discussed at Flight Techniques meetings and verified in the SMS and Ames VMS. Applications of brakes before 140 knots will lead to brake energies above the allowable limits before wheel-stop occurs. Applying brakes below this speed will lengthen rollout distances from the predicted values. An additional consideration with regards to brake-on speed is that the hydroplaning speed for the orbiter tire pressure is approximately 140 knots, and skidding could occur above this speed if brakes are applied. The deceleration rate was chosen to provide the most efficient stop versus total brake energy and takes into consideration the following design characteristic of the brakes: working best under moderately high torque values. (Because of heat buildup and transfer throughout the brake, it is desirable to stop quickly, before thermal damage can occur - yet not so quickly that total energy exceeds limits.) Finally, brake torque increases at lower speeds, and it is therefore desirable to let off on the deceleration rate below 40 knots GS to prevent brake structural failure and subsequent lockup of the wheel. @ED 1

2. MAXIMUM BRAKING PROFILE - THE MAXIMUM BRAKING PROFILE CONSISTS OF APPLYING MAXIMUM BRAKE PRESSURE TO ACHIEVE THE HIGHEST POSSIBLE DECELERATION RATE. MAXIMUM DECELERATION RATE SHOULD BE ACHIEVED IN NOT < 2 SECONDS FROM BRAKE APPLICATION. WHEN THE VEHICLE REACHES 40 KNOTS GS, IF SUFFICIENT RUNWAY REMAINS, THE DECELERATION RATE SHOULD BE DECREASED TO < 6 FPS² UNTIL WHEELS-STOP. @ED 1

Since the maximum braking profile is to be used only when there is a danger of the vehicle running off the end of the runway, no regard is given to using up the brake hardware by exceeding energy limits; therefore, the maximum amount of torque available should be used. A smooth rather than sudden application is preferred to prevent possible high-speed failure of the brake stack. Also, if sufficient runway remains after the high-speed part of the stop, it is desirable to release the brakes below 40 knots GS to prevent low-speed lockup of the wheel, since brake torque increases at lower speeds.

NASA - JOHNSON SPACE CENTER

FLIGHT RULES

THIS RULE CONTINUED ON NEXT PAGE

FLIGHT RULES

A10.1.8-5 BRAKING (CONTINUED)

B. BRAKING PROFILE SELECTION - THE FOLLOWING CRITERIA DETERMINE THE SELECTION OF THE BRAKING PROFILE TO BE USED:

1. NO BRAKING BEFORE MIDFIELD.

All shuttle runways are at least 11,000 feet long to ensure that midfield will always provide a minimum distance (5,500 feet) to the end of the runway. Landing analysis shows that stopping distance requirements can always be met in this distance; therefore, there is no requirement to apply the brakes before midfield, thus preserving the brakes and reducing the risk of failures.

2. AFTER MIDFIELD, BUT BEFORE THE 5,000-FOOT REMAINING POINT, THE NOMINAL BRAKING PROFILE WILL BE USED WHEN A SPEED OF 140 KNOTS GS IS REACHED. (BRAKES WILL NOT BE APPLIED IN THIS REGION UNTIL THE 140 KNOTS GS SPEED IS REACHED.)

Landing and deceleration analysis has shown that the nominal braking profile can stop the vehicle with sufficient margin when used before the 5,000-foot remaining point when brakes are applied at 140 knots GS. There is no requirement to apply the brakes before the 140 knots GS speed in this region thus preventing damage from high-energy stops.

3. WHEN THE VEHICLE PASSES THE 5,000-FOOT REMAINING POINT AND IF THE GROUND SPEED IS < 140 KNOTS, THE NOMINAL BRAKING PROFILE WILL BE OBSERVED. IF THE GROUND SPEED IS > 140 KNOTS, THE MAXIMUM BRAKING PROFILE WILL BE OBSERVED.

If the vehicle is still going faster than 140 knots GS when it passes the 5,000-foot remaining point, maximum braking will be required to stop before the end of the runway with adequate margins. Maximum braking effort is reserved for this extreme case, since it will lead to extensive brake damage, possibly before wheels-stop, and creates a potential for a post-stop brake fire. If the vehicle has already slowed to less than 140 knots GS at the 5,000-foot remaining point, the vehicle can be stopped using the nominal braking profile. [@ED 1](#)

FLIGHT RULES

MECHANICAL SYSTEMS LOSS/FAILURE DEFINITIONS

A10.1.9-1 DRIVE MECHANISMS LOSS DEFINITIONS

A. DRIVE MECHANISMS ASSOCIATED WITH VENT DOORS, PLBD'S, RADIATORS, LATCHES, ET UMBILICAL DOORS, PAYLOAD RETENTION LATCHES, ACTIVE KEEL LATCHES, AND THE KU-BAND MECHANISM ARE CONSIDERED FAILED IF:

1. THE DRIVE TIME EXCEEDS SINGLE MOTOR DRIVE TIME (EXCEPT IN THOSE CASES WHERE VISUAL INDICATIONS ARE AVAILABLE).

The drive mechanisms mentioned above each possess two motors for redundancy purposes. A single motor can drive the mechanism; however, dual motor drive will actuate the mechanism in half the time (dual motor drive is nominally used for the mechanisms above). Therefore, if the drive time (for open/close, latch/unlatch, etc.) associated with the mechanism exceeds that for single-motor drive (the maximum it would take if either motor drove), then it is assumed that the mechanism has failed to reach the desired position. If visual cues are available to ascertain the mechanism's position and it is determined that the desired position has been reached, the mechanism is not considered failed.

2. THE DRIVE MECHANISM CAN BE OBSERVED AND IS NOT MOVING IN RESPONSE TO THE COMMAND.

Assuming the proper switch and circuit breaker configuration and that the mechanism has not already attained the commanded position, movement should be seen; otherwise, the mechanism has failed.

3. THE DRIVE MECHANISM CANNOT BE OBSERVED AND THERE IS NEITHER OPEN NOR CLOSED POSITION INDICATIONS AND DRIVE TIME EXCEEDS SINGLE-MOTOR DRIVE TIME.

If sufficient time has elapsed for the mechanism to have reached the desired state for only one motor driving and no indications of it reaching the commanded position are seen, then the mechanism is considered to have failed in transit. This applies only to that mechanism's position. This is based on the low probability of transducer failures for the end-of-travel indications that would imply that the mechanism had failed coupled with the assumption that it is safer to consider the mechanism failed.

THIS RULE CONTINUED ON NEXT PAGE

FLIGHT RULES

A10.1.9-1 DRIVE MECHANISMS LOSS DEFINITIONS (CONTINUED)

APPROXIMATE SINGLE MOTOR DRIVE TIMES ARE:

PLBD CENTERLINE LATCHES (*OPEN ONLY).....	40	SECONDS
PLBD BULKHEAD LATCHES*.....	60	SECONDS
PLBD DRIVE*.....	126	SECONDS
RADIATOR LATCHES.....	60	SECONDS
RADIATOR STOW/DEPLOY DRIVE*.....	100	SECONDS
ET DOOR CENTERLINE LATCHES.....	12	SECONDS
ET DOOR DRIVE.....	48	SECONDS
ET DOOR UPLOCK LATCHES.....	12	SECONDS
VENT DOOR DRIVE.....	10	SECONDS
PAYLOAD RETENTION LATCHES.....	60	SECONDS
KU-BAND DRIVE*.....	46	SECONDS

*VISUAL CUE AVAILABLE

The table above gives the design specification time required for the indicated drive mechanism to reach the full open/close/etc. position. These times can vary somewhat and are usually less than that shown. The dual motor drive time can be determined by dividing the single-motor drive time by two.

Visual cues are provided by bulkhead camera views and/or by looking out the payload bay windows. For the centerline latches only, the open position can be observed. When partially or fully closed, the latch hook is hidden behind the extended guide roller and the latch hook roller brackets. It is not possible to visually determine if the latches are closed far enough.

FLIGHT RULES

GENERAL MECHANISMS SYSTEMS MANAGEMENT

A10.1.10-1 DRIVE MECHANISMS

- A. IF VISUAL CUES ARE NOT AVAILABLE, A DRIVE MECHANISM WILL BE CONSIDERED TO HAVE ATTAINED ITS COMMANDED POSITION, OPEN/CLOSED/STOWED/DEPLOYED/LATCHED/RELEASED, IF AT LEAST ONE INDICATION OF THAT STATE OCCURS WITHIN SINGLE-MOTOR OPERATING TIME.

Redundant indications are provided for the drive mechanisms for the open/closed/stowed/deployed/latched/released positions. If, during a drive sequence for any of the above mechanisms that does not have means of visual verification, any of the end-of-travel indications are present within the single-motor drive envelope, the mechanism will be considered to be in the desired position. This is based on the low probability of a transducer failing within the time that the indication was expected thereby giving a false verification of position.

- B. DRIVE MECHANISM COMMANDS WILL BE TERMINATED IF THE MECHANISM CAN BE OBSERVED AND IS NOT MOVING IN RESPONSE TO THE COMMAND.

To prevent damage to motors (burnout), drive mechanism commands will be terminated if no mechanism movement is observed for those mechanisms which can be visually verified.

- C. DRIVE MECHANISMS WHICH CANNOT BE OBSERVED WILL BE ALLOWED TO DRIVE TO THE SINGLE-MOTOR DRIVE TIME. COMMANDS WILL BE TERMINATED AFTER SINGLE-MOTOR TIME OR AFTER RECEIPT OF ONE TERMINAL POSITION INDICATION IN THE DIRECTION OF TRAVEL.

If one motor fails, the time required for the mechanism to change state will be twice the normal dual motor time. If the mechanism cannot be observed, it is safe to send drive commands for the single-motor drive time which will be adequate even if one motor has failed. Commands should be terminated after single-motor time even if no terminal indication is received because (the mechanism may have a more serious failure, possible jam) continuing the command could possibly damage the motor(s) or clutch(es).

- D. DRIVE MECHANISMS WHICH CAN BE OBSERVED WILL BE ALLOWED TO DRIVE IN EXCESS OF SINGLE-MOTOR DRIVE TIME WHEN DRIVING IN THE CLOSED/LATCHED DIRECTION WITH DETECTABLE MOTION.

Allowing a mechanism to drive beyond single-motor drive time, as long as the mechanism can be observed, can possibly place that mechanism in a fail-safe configuration (closed/latch direction is fail-safe and desirable).

FLIGHT RULES

PAYLOAD DOOR (PLBD) SYSTEMS MANAGEMENT

A10.1.11-1	PLBD GENERAL	10-73
A10.1.11-2	PLBD VISUAL CUES	10-76
A10.1.11-3	PLBD CRITICAL LATCHES	10-77
A10.1.11-4	FAILED PLBD GPC SEQUENCE	10-78
A10.1.11-5	PLBD CLEARANCE CONSTRAINTS	10-78
A10.1.11-6	PLBD CLOSE GO/NO-GO	10-79
A10.1.11-7	PLBD OVERLAP	10-85
A10.1.11-8	CONTINGENCY PLBD CLOSURE	10-86
A10.1.11-9	PLBD RULE REFERENCE MATRIX	10-87

RADIATOR SYSTEMS MANAGEMENT

A10.1.12-1	RADIATOR MECHANICAL	10-97
A10.1.12-2	RADIATOR VISUAL CUES	10-100

ET UMBILICAL DOORS SYSTEMS MANAGEMENT

A10.1.13- <u>1</u>	ET UMBILICAL DOOR KEYBOARD ENTRY	10-101
A10.1.13-2	ET UMBILICAL DOORS ON ORBIT	10-101
A10.1.13-3	ET UMBILICAL DOOR CLOSURE DELAY FOR DISCONNECT VALVE FAILURE (CIL)	10-102

VENT DOOR SYSTEMS MANAGEMENT

A10.1.14-1	VENT DOOR MANAGEMENT	10-103
------------	----------------------------	--------

PAYLOAD RETENTION LATCHES (PRLA) SYSTEMS MANAGEMENT

A10.1.15-1	PRLA'S/AKA'S	10-107
------------	--------------------	--------

FLIGHT RULES

KU-BAND ANTENNA DEPLOY MECHANISM SYSTEMS MANAGEMENT

A10.1.16-1	ANTENNA STOW REQUIREMENT (CIL)	10-113
A10.1.16-2	DAP CONFIGURATION FOR ANTENNA STOW	10-114
A10.1.16-3	ANTENNA CONTINGENCY PROCEDURES	10-114
A10.1.16-4	LOSS OF KU-BAND ANTENNA DEPLOYMENT ACTUATOR STOW MOTOR REDUNDANCY	10-116

STRUCTURAL MANAGEMENT

A10.1.17-1	THERMAL WINDOWPANE FAILURE (CIL)	10-117
A10.1.17-2	PRESSURE/REDUNDANT WINDOWPANE FAILURE	10-118
A10.1.17-3	BAILOUT/POSTLANDING EMERGENCY EGRESS PYROTECHNICS MANAGEMENT	10-119
<u>A10.1.17-4</u>	<u>MAXIMUM NUMBER OF FILLED CWC'S</u>	<u>10-120</u>
<u>A10.1.17-5</u>	<u>FILLED CWC STOWAGE MANAGEMENT</u>	<u>10-120</u>

ANDROGYNOUS PERIPHERAL DOCKING SYSTEM (APDS) SYSTEMS MANAGEMENT

<u>A10.1.18-1</u>	<u>APDS CONFIGURATION</u>	<u>10-124</u>
<u>A10.1.18-2</u>	<u>APDS PRESSURE/TEMPERATURE</u>	<u>10-126</u>
<u>A10.1.18-3</u>	<u>APDS MECHANISM END OF TRAVEL INDICATIONS</u>	<u>10-128</u>
<u>A10.1.18-4</u>	<u>APDS DOCKING SEQUENCE OPERATIONS</u>	<u>10-130</u>
<u>A10.1.18-5</u>	<u>APDS RECONFIGURATION AFTER FAILED DOCKING</u>	<u>10-134</u>
<u>A10.1.18-6</u>	<u>APDS REDUNDANCY REQUIREMENTS</u>	<u>10-135</u>

MMACS GO/NO-GO

A10.1. <u>19</u> -1	MMACS GO/NO-GO CRITERIA	10-136
---------------------	-----------------------------------	--------

FLIGHT RULES

VIEWPORT SYSTEMS MANAGEMENT

A10.6.1-1	VIEWPORT (VP)	10-139
A10.6.1-2	CRACKED VIEWPORT	10-142
A10.6.1-3	VIEWPORT CONFIGURATION FOR CLOSED SPACEHAB HATCH	10-142
A10.6.1-4	LOSS OF VP PRESSURE INTEGRITY	10-143
A10.6.1-5	EVA REQUIREMENTS FOR FAILED VP OUTER COVER	10-143

VIEWPORT SYSTEMS MANAGEMENT

A10.9.3-1	VIEWPORT (VP)	10-144
A10.9.3-2	CRACKED VIEWPORT (VP)	10-147
A10.9.3-3	LOSS OF VIEWPORT (VP) PRESSURE INTEGRITY .	10-148
A10.9.3-4	VIEWPORT (VP) EXPERIMENT ACCOMMODATIONS ..	10-148
A10.9.3-5	EVA REQUIREMENTS FOR FAILED VIEWPORT (VP) OUTER COVER	10-149
A10.9.3-6	VIEWPORT LOST DEFINITION	10-149

FLIGHT RULES

THIS PAGE INTENTIONALLY BLANK

FLIGHT RULES

PAYLOAD DOOR (PLBD) SYSTEMS MANAGEMENT

A10.1.11-1 PLBD GENERAL

A. LAUNCH DAY LANDING PLBD OPERATIONS:

1. IF A LANDING IS REQUIRED AND SUPPLY/WASTE WATER WILL SUPPORT FES OPERATIONS UNTIL ENTRY BY 7 HOURS MET, NO ATTEMPT WILL BE MADE TO OPEN ONE OR BOTH THE PLBD'S. @ [020196-1804A]

For launch day landings at the first available PLS, the supply and waste water tanks are loaded such that there is within 7 hours, there should be sufficient water for FES operations; therefore, there is no requirement to incur the risks associated with opening the PLBD's, thus eliminating an increase in the crew workload during this timeframe and since the orbiter would be entering with an adequate margin, the risks incurred by opening the PLBD's are not justified. Additionally, there is no desire to increase the crew workload during this timeframe when it is not necessary.

2. IF A LANDING IS REQUIRED AFTER PREDICTED EXHAUSTION OF SUPPLY AND WASTE WATER FOR THE FES 7 HOURS MET, THE PLBD'S MAY BE OPENED PROVIDED DUAL MOTOR CLOSE CAPABILITY EXISTS.

For launch day landings after the first PLS opportunity, insufficient supply/waste water may have been loaded to support FES operations to entry. If the first PLS opportunity is no-go or likely to be no-go, then PLBD opening will be required. This situation may result in having to open the PLBD without close redundancy. @ [020196-1804A] 7 hours, sufficient time is provided to open the PLBD's to cold soak the radiators. It is also desired to maintain PLBD close redundancy should the PLBD's be opened. If there is not PLBD close redundancy, then the PLBD's should remain closed for as long as water loading/FES operation will allow. Note: If landing is required on FD 2, PLBD's will be opened without regard to redundancy (see paragraph 3 below). @ [121593-1590]

3. FOR PROBLEMS PROHIBITING NECESSARY HEAT REJECTION, THE PLBD'S MAY BE OPENED (TIME PERMITTING) WITHOUT REGARD TO CLOSE-MOTOR REDUNDANCY, FES WATER SUPPLY AVAILABILITY, OR MET OF LANDING. @ [020196-1804A]

For cases where there are cooling problems and opening the PLBD's is required to alleviate heating of critical equipment needed for entry, the PLBD's should be opened to provide the increased cooling capability. This may be necessary even though redundant PLBD closure does not exist and the timeline/workload would be increased.

- B. IF A LATCH GANG FAILS TO FULLY OPEN BUT CAN BE VERIFIED TO CLEAR THE ROLLERS BY VISUAL OBSERVATION/TV, IT WILL NOT BE CYCLED CLOSED.

FLIGHT RULES

In order to provide a maximum chance to at least complete an MDF, a failed in-transit latch gang that can be observed to be open will not be cycled closed. Some risk is associated with cycling the latch gang closed. It may fail close or nearly closed prohibiting PLBD opening operations. There is no real advantage in cycling the latch gang closed when the problem is first discovered over closing it in preparation for entry.

THIS RULE CONTINUED ON NEXT PAGE

FLIGHT RULES

A10.1.11-1 PLBD GENERAL (CONTINUED)

C. PLBD LATCHES WILL NOT BE CYCLED CLOSED WHILE THE PLBD'S ARE OPEN.

To preclude system failures (mechanical, structural, software) that may occur while the latch gang is being closed or is closed, the most conservative thing to do is not close the latch gang while the PLBD's are opened. There is no EVA capability to open a failed closed latch gang. A failure where the latch gang remains closed would prohibit complete PLBD closure and latching for entry. Cycling of a latch gang while the PLBD's are open will not be done for troubleshooting purposes.

D. THE STARBOARD PLBD WILL NOT BE CLOSED WITH THE PORT PLBD OPEN.

Structural interference between the centerline latch hangers (port PLBD) and the bell-crank/hook bracket assembly (starboard PLBD) prevents complete PLBD closure and latching. Also, if the starboard PLBD drive mechanism fails (PLBD jams closed) while the port PLBD is open, the orbiter is in an unflyable system configuration.

E. PLBD WILL NOT BE REOPENED ONCE IT HAS BEEN CLOSED DURING AN EVA.

If an EVA had to be performed in order to put the vehicle in a fail-critical configuration, reopening a failed latch and/or PLBD in any case is not a prudent thing to do. Entry should be made at the next PLS opportunity after the EVA is completed.

FLIGHT RULES

A10.1.11-2 PLBD VISUAL CUES

A. THE PLBD'S AND PLBD LATCHES ARE CONSIDERED OPEN OR CLOSED IF THEY CAN BE VISUALLY VERIFIED VIA THE FOLLOWING CRITERIA:

1. PLBD'S OPEN - THE SIX PUSH RODS SHOULD HAVE 10 STRIPES IN THE FIELD OF VIEW ABOVE THE LONGERON SILL.

Opening and closing of the PLBD's is accomplished by actuators acting through pushrods and bell cranks and thus on the PLBD's themselves. The actuators are hidden beneath the payload bay liner. Each pushrod has 10 stripes; the first, eighth, and ninth (counting from the top) are gold with the other seven being silver. When the PLBD's are closed, the pushrods retract behind the liner and only the uppermost stripe may be visible on any of the six pushrods for that door. For the fully open position, the pushrods must extend far enough that all 10 stripes can be seen. The other stripes indicate intermediate door positions.

2. CENTERLINE LATCHES CLEAR OF ROLLERS (DESIGN OVERLAP CASE) - THE TIP OF THE LATCH SHOULD BE POINTING ABOUT 30 DEGREES DOWN FROM THE Y-AXIS WITH THE TIP APPROXIMATELY 1 INCH FROM THE ROLLER.

When the centerline latches are in the open position, the tip of the latch is pointing about 30 degrees down from the horizontal (see SSSH drawing 14.1,2). If this can be visually confirmed, then the latches are clear of the rollers. Due to the position of the latches when partially to fully closed, it is not possible to determine if the latches are closed far enough. Binoculars are available, but no markings are provided.

FLIGHT RULES

A10.1.11-3 PLBD CRITICAL LATCHES

- A. FOR FAILURE OF ANY TWO PLBD LATCH GANGS TO FULLY ENGAGE (CENTERLINE OR BULKHEAD), AN EVA WILL BE PERFORMED TO INSTALL MANUAL LATCH TOOLS ON AT LEAST ONE OF THE FAILED LATCH GANGS.
- B. FOR FAILURE OF ANY SINGLE OR MULTIPLE PLBD LATCH GANGS TO FULLY ENGAGE (CENTERLINE OR BULKHEAD), ENTRY LOADS WILL BE MINIMIZED PER THE FOLLOWING:
1. ENTRY TEST MANEUVERS WILL NOT BE PERFORMED, AND ANY PROGRAMMED TEST INPUTS (PTI'S) WILL BE INHIBITED.
 2. CONSIDERATION WILL BE GIVEN TO TARGETING A RUNWAY/HAC APPROACH AT THE PLS OR SLS TO MINIMIZE TAILWIND AT HAC INITIATION AND TURBULENCE/SURFACE WINDS.

There is no analysis which indicates that entry with multiple latch gang failures is an acceptable condition. Although the latch tools have not been proven to provide the same structural integrity as a nominal latch gang, performing an EVA to install these latch tools provides a workaround to recover at least some load-carrying capability. Two latch tools are required to secure a single failed latch gang; however, only two centerline and two bulkhead latch tools are flown. When two of the same type gangs have failed, only one gang can be secured, as both available tools are required to secure one of these latch gangs.

A 1991 Rockwell assessment (which refined analyses performed in 1981 and 1987/1988) for a PLBD single latch-out (centerline or bulkhead) certified a nominal entry trajectory in AUTO flight control by exhibiting structural, thermal, and aerodynamic margins above the required 1.4 safety factor. This analysis shows that steps and gaps may occur as a result of the payload bay-to-ambient delta pressure and latch disengagement. Temperature exceedances may occur at these steps and gaps, but the resulting thermal damage poses no flight safety concerns. The extent of the postflight repairs can be limited by minimizing side slip and steady pitch-up maneuvers, according to the 1991 analysis. (Reference Structural Assessment of Shuttle Payload Bay Doors for Entry with a Latch Gang Out, SSD91D0276, May 1991, and A/E FTP #96, 12/18/92.)

Although entry test maneuvers and PTI's should not expose the vehicle to conditions outside of its certification limits, flying a nominal entry trajectory minimizes adverse mechanical, thermal, and aerodynamic loads. Vehicle accelerations, heating, and compartment-to-ambient pressure differentials can be limited by avoiding these maneuvers. Selecting a runway/HAC that minimizes HAC winds (most importantly, tailwind at HAC initiation) will help to minimize normal loads, and selecting a landing site with benign turbulence and surface wind conditions reduces the need for any abrupt directional control maneuvers.

Rules {A2.1.5-10}, ENTRY LOAD MINIMIZATION, and {A10.1.11-9}, PLBD RULE REFERENCE, reference this rule.

FLIGHT RULES

A10.1.11-4 FAILED PLBD GPC SEQUENCE

IF THE GPC CONTROLLING THE PLBD SEQUENCE FAILS DURING PLBD OPERATIONS, THE PAYLOAD MDM'S WILL BE CYCLED OFF, THEN ON, TO TERMINATE EXISTING PLBD COMMANDS UNTIL THE SOFTWARE FUNCTION CAN BE REESTABLISHED.

Cycling the MDM's will clear the commands.

A10.1.11-5 PLBD CLEARANCE CONSTRAINTS

- A. THE KU-BAND ANTENNA CAN BE DEPLOYED ONLY IF THE STARBOARD PAYLOAD BAY DOOR IS FULLY OPEN.

The starboard PLBD must be fully open (ref. Rule {A10.1.11-2A.1}, PLBD VISUAL CUES) in order to allow the antenna to rotate freely without any interference with orbiter hardware. If the starboard PLBD is open to 160 degrees, interference will occur between the PLBD bellcrank/pushrod assembly and the Ku-band antenna deployed electronics assembly (DEA). Each pushrod has 10 stripes; nine visible stripes indicate that the door is only 140 degrees open and 10 visible stripes confirm a full-open position of 175 degrees. Intermediate PLBD positions (e.g., 160 degrees) between 140 degrees and 175 degrees cannot be accurately determined. Therefore, the open microswitch indications and/or the tenth pushrod stripe must be visible prior to performing any Ku-band deploy/stow operation. (Reference SODB paragraph 3.4.5.2-25.)

- B. THE MANIPULATOR POSITIONING MECHANISMS (MPM) CAN BE DEPLOYED ONLY IF THE PORT PLBD PUSHRODS HAVE AT LEAST SIX STRIPES VISIBLE. IF THE RMS IS INSTALLED, NINE STRIPES MUST BE VISIBLE.

The port PLBD must be open greater than 69 degrees in order to allow the MPM's to be deployed without any interference with the PLBD structure. If the port PLBD is open less than 69 degrees, the bottom of the RMS shoulder pedestal will interfere or drive against the bottom of the PLBD. Each PLBD pushrod has 10 stripes; six stripes indicate that the door is at a minimum angle of 84 degrees. A PLBD position of 69 degrees is indicated on the fifth silver stripe. Intermediate positions prior to the sixth stripe cannot be accurately measured for adequate clearance margins. Therefore, in order to provide acceptable clearance capability prior to performing any MPM deploy operations, six PLBD pushrod stripes must be visible.

The port PLBD must be open greater than 130 degrees in order to allow MPM's to deploy a cradled RMS. If the port PLBD is open less than 130 degrees, interference will occur between the RMS wrist yaw joint and the EVA slidewire mount. Each PLBD pushrod has 10 stripes; nine visible stripes indicate that the door is at a minimum angle of 137 degrees. Eight pushrod stripes correspond to a maximum PLBD angle of 125 degrees. Intermediate PLBD positions (e.g., 130) cannot be accurately determined; therefore, the ninth pushrod stripe must be visible prior to performing any MPM deploy operations.

FLIGHT RULES

A10.1.11-6 PLBD CLOSE GO/NO-GO

A. THERMAL CONSTRAINTS:

1. ON ORBIT, PLBD CLOSURES WILL NOT BE PERFORMED FOR THE FOLLOWING THERMAL CONDITIONS:
 - a. PORT DOOR - IF V34T1126A IS \leq -100 DEG (-87 DEG) F. FOR FAILURE OF V34T1126A, V34T1128A IS AN ALTERNATE.
 - b. STARBOARD - IF V34T1130A IS \leq -100 DEG (-87 DEG) F. FOR FAILURE OF V34T1130A, V34T1132A IS AN ALTERNATE.

The PORT RDY-TO-LATCH switch module failed on STS-3. The failure of this module to switch state after PLBD opening (during cold case testing) determined these low temperature operational limits (ref. paragraph B).

2. FOR NOMINAL END OF MISSION PLBD CLOSURE, THE BENDING EFFECT TEMPERATURE MUST BE LESS THAN 160 DEG F. THE BENDING EFFECT TEMPERATURE IS DEFINED AS THE DIFFERENCE BETWEEN AVERAGE LOWER BONDLINE AND AVERAGE SILL LONGERON TEMPERATURES ADDED TO THE DIFFERENCE BETWEEN 70 DEG F AND THE AVERAGE SILL LONGERON TEMPERATURES. (LOWER BONDLINE TEMPERATURES - V09T1016A, V34T1110A, V34T1112A; PORT LONGERON TEMPERATURES - V34T1114A, V34T1116A, V34T1118A; AND STBD LONGERON TEMPERATURES - V34T1120A, V34T1122A, V34T1124A USE THE AVERAGE OF THE COLDER SIDE LONGERON TEMPERATURES.)

Bending effect temperature (BET) = (lower bondline avg. T - sill longeron avg. T) + (70 deg F - sill longeron avg. T). This equation uses both the delta between top and bottom on the orbiter and a comparison between a standard ground temperature of 70 deg F and average sill longeron temperatures to predict door closure constraints caused by thermal deflections. The worst case thermal conditions for PLBD closure were seen on STS-3. During the first attempt to close the doors, door closure was prevented by structural interference between the port PLBD and the aft bulkhead. This occurred because of the extremely cold overall temperatures and the high thermal delta between the top and bottom, resulting in a "banana effect" which expanded the bottom and shrunk the top to make the gap between the door and the aft bulkhead too small to allow proper door closure. After thermal conditioning, the doors closed properly with a delta between lower bondline and sill longerons of approximately 52 deg F and an average sill longeron temperature of -41 deg F. For this case: $BET = 52 \text{ deg F} + (70 \text{ deg F} - 41 \text{ deg F}) = 163 \text{ deg F}$. From this, 160 deg F was selected as the limit. This constraint is for all planned PLBD operations.

FLIGHT RULES

THIS RULE CONTINUED ON NEXT PAGE

FLIGHT RULES**A10.1.11-6 PLBD CLOSE GO/NO-GO (CONTINUED)**

3. THERMAL ATTITUDE WILL BE MANAGED TO MAINTAIN THE BET BELOW 200 DEG F TO FACILITATE CONTINGENCY PLBD CLOSURE. THERMAL CONDITIONING WILL BE PERFORMED FOR AS LONG AS PRACTICAL TO ATTEMPT TO GET WITHIN THE CONSTRAINTS DEFINED IN PARAGRAPH B. FLIGHT SPECIFIC EXCEPTIONS FOR HIGH PRIORITY FLIGHT OPERATIONS WILL BE IDENTIFIED IN THE FLIGHT RULES ANNEX. FOR ANY MISSION NOMINALLY EXCEEDING THE CONTINGENCY LIMITS, THE EXCEPTION WILL BE TAKEN TO THE PRCB FOR INFORMATION.

After STS-3, the hardware was modified by shaving 0.39 inch off the aft lug to allow for additional door gap clearance between the doors and aft bulkhead. This additional clearance would have allowed the doors to close, even for the worst-case thermal conditions seen during the unsuccessful door closing attempt on STS-3. (BET = 74 deg F + (+7 deg minus -64 deg F) = 208 deg F. A limit of 200 deg F was selected to allow for uncertainties in the analysis. This constraint is for contingency deorbit/PLBD closure anytime during the mission.

Reference Rockwell Document, Effect of On-Orbit Temperature on Shuttle Payload Bay Door Closure, STS90D0172, March 1990, for temperature effect and bulkhead modification descriptions.

Rules {A2.1.3-5}, PBD OPERATIONS (CIL); {A2.1.3-30}, ORBITER ON-ORBIT HIGH DATA RATE REQUIREMENTS; and {A17.1.19-1}, ORBITER THERMAL CONSTRAINTS AND ATTITUDE MANAGEMENT (CIL), reference this rule.

B. PLBD CENTERLINE LATCH EXTENDED GUIDE ROLLER TRAJECTORY:

THE GO/NO-GO CRITERIA FOR PLBD CLOSE IS PER RULE {A10.1.11-5}, PLBD CLEARANCE CONSTRAINTS. THE PORT PLBD WILL BE CLOSED AND LATCHED, AND THE STARBOARD PLBD WILL BE CLOSED TO THE POINT THAT THE CLOSEST EXTENDED GUIDE ROLLER (STARBOARD DOOR) IS AS NEAR AS FEASIBLE TO ITS STRIKER PLATE (PORT PLBD) WITHOUT IMPACTING IT. THE VISUAL PROJECTION OF THE EXTENDED GUIDE ROLLER TRAJECTORY MUST NOT EXCEED THE BOUNDARIES IDENTIFIED IN THE PLBD CENTERLINE LATCH EXTENDED GUIDE ROLLER TRAJECTORY DIAGRAM BELOW.

The crew will utilize the PLBD CENTERLINE LATCH EXTENDED GUIDE ROLLER TRAJECTORY (diagram) as GO/NO-GO criteria to latch the centerline latches on entry day. In addition, this diagram is used to satisfy the "PLBD FIT TEST" DTO requirement to continue the mission on launch day for the first flight of a new vehicle.

THIS RULE CONTINUED ON NEXT PAGE

FLIGHT RULES

A10.1.11-6 PLBD CLOSE GO/NO-GO (CONTINUED)

PLBD CENTERLINE LATCH EXTENDED GUIDE ROLLER TRAJECTORY
(DIAGRAM)

THIS RULE CONTINUED ON NEXT PAGE

FLIGHT RULES

A10.1.11-6 PLBD CLOSE GO/NO-GO (CONTINUED)

C. PORT AFT BULKHEAD LATCH GO/NO-GO CRITERIA:

PLBD'S CLOSED SUFFICIENT FOR BULKHEAD LATCHING - THE PORT PLBD SCALLOP MUST BE ON OR BELOW THE TOP OF TARGET STRIPE (AFT BULKHEAD) OR THE PORT AFT PLBD CLOSE INDICATION MUST BE PRESENT AS SHOWN IN THE PORT AFT BULKHEAD LATCH GO/NO-GO DIAGRAM ON THE FOLLOWING PAGE.

The PORT AFT BULKHEAD LATCH GO/NO-GO CRITERIA was developed to aid in bulkhead latching subsequent to the jamming of the port PLBD edge of the aft bulkhead seal bracket on STS-4. If the port PLBD close indications are present, then the PLBD is sufficiently closed to permit bulkhead latching. Without these indications, visual verification can be made by observing if the port PLBD scallop (the leading edge of the PLBD/latch mechanism at the extreme aft portion of the PLBD) is on or below the top of the black stripe (1 inch wide) painted on the aft bulkhead. If so, the PLBD is closed far enough for the latches to engage.

THIS RULE CONTINUED ON NEXT PAGE

FLIGHT RULES

A10.1.11-6 PLBD CLOSE GO/NO-GO (CONTINUED)

PORT AFT BULKHEAD LATCH GO/NO-GO (DIAGRAM)

FLIGHT RULES

A10.1.11-7 PLBD OVERLAP

IF A PLBD OVERLAP CONDITION EXISTS AT EOM DOOR CLOSURE SUCH THAT THE PLBD'S CANNOT BE CLOSED, ENTRY WILL BE DELAYED 24 HOURS ALLOWING PLBD THERMAL CONDITIONING TO REGAIN NORMAL CLOSING CONDITIONS. IF ENTRY-CRITICAL SYSTEMS ARE NOT SINGLE-FAULT TOLERANT OR A 1-DAY WAVE-OFF CAPABILITY IS NOT AVAILABLE, THEN TOP SUN PLBD CONDITIONING WILL BE DONE FOR AS LONG AS PRACTICAL. IF ADVERSE OVERLAP CONDITIONS STILL EXIST AFTER TOP SUN, THE SIMULTANEOUS PLBD CLOSING PROCEDURE WILL BE USED.

Steps will be undertaken to thermal condition the PLBD's for entry when nominal preentry conditioning does not adequately allow for PLBD centerline latching. The simultaneous PLBD closing procedure is the last means by which the centerline can be latched and is used as a contingency means to latch the PLBD's.

Rules {A2.1.6-1}, CONTINGENCY ACTION SUMMARY, and {A17.1.19-1}, ORBITER THERMAL CONSTRAINTS AND ATTITUDE MANAGEMENT (CIL), reference this rule.

FLIGHT RULES

A10.1.11-8 CONTINGENCY PLBD CLOSURE

FOR PLBD JAM CASES, WHICH RESULT IN THE INABILITY TO NOMINALLY LATCH THE AFT BULKHEAD LATCHES, THE FOLLOWING CONTINGENCY PLBD CLOSE PROCEDURES WILL BE IMPLEMENTED IN LISTED ORDER UNTIL ONE METHOD IS SUCCESSFUL.

A. NOMINAL EOM PLBD CLOSE PROBLEMS:

1. CYCLE PLBD.
2. ONE ORBIT TOP SUN THERMAL CONDITIONING - REPEAT PLBD CYCLE.
3. DRIVE AFT LATCHES AND PLBD PART WAY.
4. WAVE OFF (THERMAL CONDITION IN TOP SUN - CHECK CLOSE BEFORE SLEEP).
5. PERFORM EVA.

B. EMERGENCY DEORBIT PLBD CLOSE PROBLEMS:

1. CYCLE PLBD.
2. TOP SUN THERMAL CONDITIONING (IF TIME PERMITS) - REPEAT PLBD CYCLE.
3. DRIVE AFT LATCHES AND PLBD PART WAY.
4. DRIVE AFT LATCHES AND PLBD TO STALL.
5. CLOSE BOTH PLBD'S AND FORWARD BULKHEAD LATCHES, THEN CLOSE CENTERLINE LATCHES IN FORWARD TO AFT ORDER, THEN CLOSE AFT BULKHEAD LATCHES.

PLBD contingency PLBD closure procedures were developed as a result of the PLBD closure problems experienced on STS-3 and STS-4 during thermal testing of the orbiter. Postmission investigations resulted in the conclusion that midfuselage structure thermal distortion caused by the extreme thermal attitudes had closed the gap between the PLBD and the X=1307 bulkhead. These attitudes were (1) at the end of tail Sun, top to space, orbital late roll attitude and (2) at the end of bottom solar inertial attitude. In response to these problems, PLBD and latch modifications were made to the orbiters. The solution basically allowed the PLBD lug to be moved forward to increase the gap. Flight verification of this fix has not been done; however, analysis has indicated that a positive gap will exist at more severe temperature gradients than was experienced on STS-3 and STS-4; i.e., PLBD closure should not be a problem after experiencing the same attitude profiles.

The procedures listed above start with the most benign steps and progress to the more severe action to be taken for each case.

FLIGHT RULES

A10.1.11-9 **PLBD RULE REFERENCE MATRIX**

FAILURE MODE	FLIGHT RULE	
	DAY 1/ON ORBIT	ENTRY DAY
	DOOR RULES	
A. LATCH GANG DOES NOT HAVE TWO MOTORS FOR CLOSE	<ul style="list-style-type: none"> CONTINUE FLIGHT AS PLANNED 	<ul style="list-style-type: none"> CONTINUE FLIGHT AS PLANNED
B. ONE MOTOR IN EACH OF TWO SEPARATE LATCH GANGS FAILED AND NEXT FAILURE WILL RESULT IN MULTIPLE LATCH GANGS OUT: 1. DUE TO A MECHANICAL OR ELECTRICAL FAILURE 2. DUE TO PL MDM FAILURE	<ul style="list-style-type: none"> ENTER FIRST DAY PLS/NEXT PLS CONTINUE FLIGHT AS PLANNED —MDF 	<ul style="list-style-type: none"> ENTER NEXT PLS CONTINUE FLIGHT AS PLANNED —MDF
C. C/L LATCH GANG FAILS CLOSED OR IN TRANSIT AND CANNOT BE VISUALLY VERIFIED TO BE CLEAR OF THE ROLLERS	<ul style="list-style-type: none"> DO NOT OPEN PLBD'S ENTER FIRST DAY PLS/NEXT PLS [1] [2] 	<ul style="list-style-type: none"> ENTER NEXT PLS [1] [2]
D. STARBOARD BULKHEAD LATCH GANG FAILS CLOSED OR IN TRANSIT AND CANNOT BE VISUALLY VERIFIED TO BE CLEAR OF THE ROLLERS	<ul style="list-style-type: none"> DO NOT OPEN PLBD'S ENTER FIRST DAY PLS/NEXT PLS [1] [2] 	<ul style="list-style-type: none"> ENTER NEXT PLS [1] [2]
E. PORT BULKHEAD LATCH GANG FAILS CLOSED OR IN TRANSIT AND CANNOT BE VISUALLY VERIFIED TO BE CLEAR OF THE ROLLERS	<ul style="list-style-type: none"> CANNOT OPEN PORT PLBD LEAVE STBD DOOR OPEN IF ADEQUATE COOLING EXISTS, INVOKE MDF (IF NOT, NEXT PLS) POWER DOWN, IF NEEDED [1] [2] 	<ul style="list-style-type: none"> CONTINUE FLIGHT AS PLANNED CANNOT OPEN PORT PLBD [1] [2]
F. C/L LATCH GANG FAILS OPEN OR IN TRANSIT AND CAN BE VERIFIED CLEAR OF THE ROLLERS	<ul style="list-style-type: none"> OPEN PLBD'S IN MANUAL MODE CONTINUE FLIGHT AS PLANNED [1] [2] 	<ul style="list-style-type: none"> CONTINUE FLIGHT AS PLANNED [1] [2]
G. BULKHEAD LATCH GANG FAILS OPEN OR IN TRANSIT AND CAN BE VERIFIED CLEAR OF ROLLERS	<ul style="list-style-type: none"> OPEN PLBD'S IN MANUAL MODE CONTINUE FLIGHT AS PLANNED [1] [2] 	<ul style="list-style-type: none"> CONTINUE FLIGHT AS PLANNED [1] [2]
H. <u>PLBD DOES NOT HAVE CLOSE REDUNDANCY</u> 1. <u>DUE TO A MECHANICAL OR ELECTRICAL FAILURE</u> 2. <u>DUE TO PL MDM FAILURE</u>	<ul style="list-style-type: none"> MDF CONTINUE FLIGHT AS PLANNED 	<ul style="list-style-type: none"> MDF CONTINUE FLIGHT AS PLANNED
I. STBD DOOR FAILED CLOSED	<ul style="list-style-type: none"> ENTER FIRST DAY PLS/NEXT PLS 	<ul style="list-style-type: none"> ENTER NEXT PLS

@121296-3194B]

[1] ACCEPTABLE TO ENTER WITH ONE LATCH GANG UNLATCHED.

[2] MINIMIZE ENTRY LOADS PER RULE (A10.1.11-3B), PLBD CRITICAL LATCHES.

FLIGHT RULES

THIS RULE CONTINUED ON NEXT PAGE

FLIGHT RULES

A10.1.11-9 PLBD RULE REFERENCE MATRIX (CONTINUED)

FAILURE MODE	FLIGHT RULE	
	DAY 1/ON ORBIT	ENTRY DAY
	DOOR RULES	
<p>J. STBD PLBD FAILED OPEN OR IN TRANSIT:</p> <p>1. READY -TO-LATCH INDICATIONS PRESENT</p> <ul style="list-style-type: none"> • LATCH STBD BULKHEAD/C/L LATCHES • ENTER FIRST DAY PLS/NEXT PLS <p>2. READY -TO-LATCH INDICATIONS NOT PRESENT:</p> <p>a. ADEQUATE CLEARANCE TO OPEN PORT DOOR</p> <ul style="list-style-type: none"> • OPEN PORT DOOR AND LEAVE OPEN UNTIL CLOSED FOR D/O • PREPARE FOR EVA [3] (POWER DOWN, IF NECESSARY) • INVOKE MDF IF COOLING ALLOWS (IF NOT, PLS) • IF ADEQUATE COOLING, PORT DOOR CLEARANCE, AND PAYLOAD CLEARANCE EXISTS, A 5-SEC DRIVE TEST CAN BE PERFORMED <p>b. NOT ENOUGH CLEARANCE TO OPEN PORT DOOR</p> <ul style="list-style-type: none"> • DO NOT OPEN PORT DOOR • IF FAILED OPEN, TRY TO CLOSE STBD DOOR • EVA TO CLOSE STBD DOOR [3] • ENTER FIRST DAY PLS/NEXT PLS 	<ul style="list-style-type: none"> • LATCH STBD BULKHEAD/C/L LATCHES • ENTER NEXT PLS • OPEN PORT PLBD • 24-HOUR DELAY (POWER DOWN, IF NECESSARY) • EVA TO CLOSE DOOR [3] • DO NOT OPEN PORT DOOR • EVA TO CLOSE STBD DOOR [3] 	
<p>K. PORT PLBD FAILED CLOSED</p> <ul style="list-style-type: none"> • STBD DOOR WILL REMAIN OPEN UNTIL D/O • POWER DOWN, IF NEEDED • INVOKE MDF IF COOLING ALLOWS (IF NOT, PLS) 	<ul style="list-style-type: none"> • STBD DOOR WILL REMAIN OPEN UNTIL D/O • POWER DOWN, IF NEEDED 	
<p>L. PORT PLBD FAILED OPEN OR IN TRANSIT</p> <ul style="list-style-type: none"> • STBD PLBD WILL REMAIN OPEN UNTIL D/O • PREPARE FOR EVA (POWER DOWN, IF NECESSARY) [3] • INVOKE MDF IF COOLING ALLOWS (IF NOT, PLS) • IF ADEQUATE COOLING AND PAYLOAD CLEARANCE IS AVAILABLE A 5-SEC DRIVE TEST CAN BE PERFORMED 	<ul style="list-style-type: none"> • STBD PLBD WILL BE OPENED OR REMAIN OPEN • 24-HOUR DELAY (POWERDOWN, IF NECESSARY) • EVA TO CLOSE PLBD [3] 	

[3] ENTRY IS REQUIRED AT NEXT PLS AFTER EVA IS COMPLETE. @ED]

NASA - JOHNSON SPACE CENTER

FLIGHT RULES

THIS RULE CONTINUED ON NEXT PAGE

FLIGHT RULES**A10.1.11-9 PLBD RULE REFERENCE MATRIX (CONTINUED)***(Latches)***A. LATCH GANG DOES NOT HAVE TWO MOTORS FOR CLOSE.**

The vehicle is in a fail-safe condition where the redundant motor remains to close the latch gang. Loss of the redundant motor will still allow safe entry. Rockwell's 1991 latch-out analysis has shown that an entry can be performed with a single bulkhead or centerline latch gang out. Adequate structural, thermal, and stability margins exist above the required 1.4 factor of safety for all tested flight conditions. (Ref. Structural Assessment of Shuttle Orbiter Payload Bay Door for Entry with a Latch Gang Out, SSD91D0276, May 1991; and SODB 3.4.2.3.)

B. ONE MOTOR IN EACH OF TWO SEPARATE LATCH GANGS FAILED AND NEXT FAILURE WILL RESULT IN MULTIPLE LATCH GANGS OUT.

1. *Entry should be made at the next PLS opportunity in order to minimize exposure time to the next failure which could result in multiple latch gangs out. There is no analysis to indicate that entry with multiple latch gangs out is an acceptable condition or that the manual latch tools provide the same structural integrity as a latch gang. (Reference Rule {A10.1.11-3}, PLBD CRITICAL LATCHES, and Structural Assessment of Shuttle Orbiter Payload Bay Door for Entry with a Latch Gang Out, SSD91D0276, May 1991.)* ©[121296-3194B]

Rule {A17.1.1322-1}, LIFE SUPPORT/TEECOM GO/NO-GO CRITERIA, references this rule. ©[121296-3194B] ©[ED]

2. *A PLBD IFM procedure exists that allows for closing a PLBD latch group(s) and/or the PLBD's if one or both payload MDM's (or associated cards) is lost. This IFM procedure is considered a level of redundancy for PLBD and latch gang closure. Therefore, after the loss of one PL MDM, single-fault tolerance to close the PLBD's and latch gangs exists. Since single-fault tolerance exists and since the probability of requiring the IFM is extremely low, NEOM is acceptable after the loss of one PL MDM. (Reference AEFTP #131 minutes and 6/96 MDF splinter AEFTP.)* ©[ED]

C. CENTERLINE (C/L) LATCH GANG FAILS CLOSED OR IN TRANSIT AND CANNOT BE VISUALLY VERIFIED TO BE CLEAR OF THE ROLLERS.

If the C/L latch gang fails closed or in transit without visual verification that it is clear of the rollers, the PLBD's should remain closed and entry should be done at the next PLS opportunity. For the C/L latch gang failed in transit where the latches cannot be verified clear of the rollers, opening the PLBD's with no positive cues that the C/L latch gangs are completely open could lead to structural damage to the PLBD and/or latches. (Reference {A10.1.11-2A.2} PLBD VISUAL CUES.) Additionally, full PLBD closure and/or C/L latching may be inhibited.

FLIGHT RULES

Entry should be performed as early as possible, and entry loads should be minimized (ref. Rule {A10.1.11-3B}, PLBD CRITICAL LATCHES).

THIS RULE CONTINUED ON NEXT PAGE

FLIGHT RULES**A10.1.11-9 PLBD RULE REFERENCE MATRIX (CONTINUED)****D. STARBOARD BULKHEAD LATCH GANG FAILS CLOSED OR IN TRANSIT AND CANNOT BE VISUALLY VERIFIED CLEAR OF THE ROLLERS.**

If a starboard bulkhead latch gang fails closed or in transit and cannot be visually verified to be clear of the rollers, the PLBD's cannot be opened and entry should be done at the next PLS opportunity. For a starboard bulkhead latch failed in transit where it cannot be visually verified clear of the rollers, opening the starboard PLBD without positive cues that the latches are clear of the rollers could also lead to structural damage of the PLBD and/or bulkhead latches. PLBD closing could be inhibited. Entry loads should be minimized (ref. Rule {A10.1.11-3B}, PLBD CRITICAL LATCHES).

E. PORT BULKHEAD LATCH GANG FAILS CLOSED OR IN TRANSIT AND CANNOT BE VISUALLY VERIFIED TO BE CLEAR OF THE ROLLERS.

For a port bulkhead latch failed closed or in transit with no visual verification that it is clear of the rollers, the starboard door should remain open to provide cooling. The port door cannot be opened, and a MDF should be invoked. If a port bulkhead latch gang is partially open, but not clear of the rollers, any attempt to open the door could cause structural damage to the door and/or latches, and PLBD closure could be inhibited. An MDF should be considered, if adequate cooling allows, otherwise, entry must be done next PLS. Entry loads should be minimized (ref. Rule {A10.1.11-3B}, PLBD CRITICAL LATCHES).

F./G. CENTERLINE/BULKHEAD LATCH GANG FAILS OPEN OR IN TRANSIT AND CAN BE VERIFIED CLEAR OF THE ROLLERS.

If a centerline or bulkhead latch gang fails open or in transit and can be verified clear of the rollers the flight can continue as planned since entry with a single bulkhead latch gang out has been deemed acceptable (SODB 3.4.2.3 and Rockwell Latch Out Analysis, 1991). Auto PLBD software will terminate PLBD operations if single motor drive time is exceeded and manual mode will have to be used. The only single-point failure that will result in multiple latch gang failure is a mechanical jam during PLBD closure. Since the doors are already open, the risk associated with another mechanical jam is incurred only when the doors are closed. Terminating the mission early does not reduce the risk of the next failure. Consequently, the mission can continue as planned. EVA is not required for a single latch gang out, but entry loads should be minimized if a gang is unlatched (ref. Rule {A10.1.11-3}, PLBD CRITICAL LATCHES).

THIS RULE CONTINUED ON NEXT PAGE

FLIGHT RULES**A10.1.11-9 PLBD RULE REFERENCE MATRIX (CONTINUED)***(PLBD's)***H. PLBD DOES NOT HAVE CLOSE REDUNDANCY.**

1. *For loss of door closure redundancy due to an electrical or mechanical failure, an MDF must be declared to minimize exposure to the next failure that would prevent the payload bay doors from closing without an EVA.*

2. *Reference B2 rationale. -@[121296-3194B | @ED]*

Reference Rules {A2.1.3-3A}.1.b, SYSTEM REDUNDANCY REQUIREMENTS, and {A17.1.13-1} LIFE SUPPORT GO/NO-GO CRITERIA. @ED]

I. STARBOARD DOOR FAILED CLOSED.

For the starboard door failed closed, entry must be done at the next PLS opportunity. The failed starboard door prevents either door from opening, and results in lack of radiator cooling.

J. STARBOARD PLBD FAILED OPEN OR IN TRANSIT.

If the ready-to-latch indications are present, the starboard door is within 4 degrees of being fully closed. The bulkhead latches can be used to help "pull" the PLBD closed, since this position is within the bulkhead latch reach capability. Entry should be made at the next PLS since the PLBD's cannot be opened and limited vehicle cooling exists.

If the ready-to-latch indications are not present, the starboard door is partially or fully opened. The starboard door is opened greater than two stripes on the pushrods, there is sufficient clearance for the port door to open without interference. The port door should be opened and remain open to allow some radiator cooling since an EVA will have to be performed to close the starboard door. An MDF will be done, if adequate cooling allows, to limit exposure to the next failure that might affect EVA capability or cooling. If the door is jammed while opening, a 5-second drive test can be done to troubleshoot the problem as long as closing the door will not threaten cooling margins, port door closure, or the payload deploy envelope.

If the failure occurs on entry day, a 24-hour waveoff will be required to prepare for and complete the EVA. A next PLS entry will be required after the EVA is complete. If the starboard door is not open far enough (two pushrod stripes) to allow the port door to open, an entry must be done at the next PLS opportunity, since neither door can be opened for radiator cooling. If the door will drive closed, close it; if jammed in the open direction, perform an EVA to close the door.

FLIGHT RULES

THIS RULE CONTINUED ON NEXT PAGE

FLIGHT RULES

A10.1.11-9 PLBD RULE REFERENCE MATRIX (CONTINUED)

K. *PORT PLBD FAILED CLOSED.*

If the port door fails closed, the starboard door should remain open to provide radiator cooling. An MDF should be considered if adequate cooling is available, otherwise enter next PLS.

L. *PORT PLBD FAILED OPEN OR IN TRANSIT.*

For a port door failed open or in transit, an MDF can be considered, but whether it can be accomplished depends on how far the failed PLBD is open for radiator cooling. Even if there is no cooling constraint, an MDF must be invoked to limit exposure to the next failure that will affect EVA capability. The starboard door should remain open. An EVA should be planned. If the door jammed while opening, a 5-second drive test may be performed to troubleshoot the problem as long as closing the door will not threaten cooling margins or the payload deploy envelope.

For a failure on entry day, a 24-hour waveoff should be done to prepare for and complete the EVA. Landing at the next PLS will be required upon completion of the EVA.

Rule {A17.1.2213-1}, LIFE SUPPORT ~~EFCOM~~ GO/NO-GO CRITERIA, references this rule. @ED 1

FLIGHT RULES

RADIATOR SYSTEMS MANAGEMENT

A10.1.12-1 RADIATOR MECHANICAL

- A. PORT OR STARBOARD RADIATOR PANELS WILL BE STOWED AND LATCHED WHEN ONLY SINGLE-MOTOR CAPABILITY REMAINS TO STOW OR LATCH THAT SIDE.

Failure of one radiator stow or latch motor places the vehicle one failure away from loss of stow/latch capability. Losing the stow function on a deployed radiator will require an EVA to stow that radiator prior to payload bay door closure. An unlatched radiator may cause the loss of the associated Freon loop due to entry loads and vibrations which would place the vehicle one failure away from possible loss of crew/vehicle (loss of remaining Freon loop). It is not known if the stowed, unlatched radiator could come into contact with items in the payload bay during entry. While EVA backup exists for stowing the radiators, it does not exist for latching them.

- B. THE FLIGHT WILL CONTINUE, WATER CONSUMABLES PERMITTING, WITH THE FOLLOWING FAILURES:
1. RADIATOR LATCHES FAILED CLOSED OR OPEN.
 2. RADIATOR PANELS FAILED STOWED OR DEPLOYED.

The radiators were designed to operate in either the deployed or stowed position. This rule was written to document to the community that, regardless of the radiator position or latch status, the mission may continue.

- C. AN EVA WILL BE REQUIRED TO STOW A FAILED DEPLOYED RADIATOR PANEL.

The PLBD's cannot be closed with a failed, deployed radiator due to possible interference with the opposite door, radiator, or payload. EVA is the only means available if the deploy/stow mechanism has failed. No EVA capability is available for a failed radiator latch.

- D. OPERATIONS WHILE THE RMS IS UNCRADLED:

1. RADIATOR DEPLOY OPERATIONS:

IF PRACTICAL, RADIATOR DEPLOY OPERATIONS WILL BE DELAYED UNTIL AFTER RMS OPERATIONS ARE COMPLETE OR THE RMS WILL BE CRADLED DURING DEPLOY OPERATIONS. IF IT IS NOT PRACTICAL TO CRADLE THE RMS, RADIATOR DEPLOY OPERATIONS WILL BE PERFORMED WITH THE CIRCUIT BREAKERS OPEN FOR MPM SYSTEM SAFING (SOME ACTUATORS WILL OPERATE SINGLE MOTOR).

FLIGHT RULES

THIS RULE CONTINUED ON NEXT PAGE

FLIGHT RULES

A10.1.12-1 RADIATOR MECHANICAL (CONTINUED)

2. RADIATOR STOW OPERATIONS MAY BE PERFORMED WHILE THE RMS IS UNCRADLED (SOME ACTUATORS WILL OPERATE SINGLE MOTOR).

In order to prevent the uncradled RMS from being one failure away from inadvertent MPM stow (possible loss of crew/vehicle), the following cb's are opened to remove power to the MPM system:

MA73C: C cb MCA PWR AC 2 3Ø MID 2
D cb MCA PWR AC 3 3Ø MID 4

These also affect radiator motors, but allow at least single-motor operations in all actuators. Stow operations may occur anytime since it is not necessary to verify dual-motor operations. During deploy operations, dual-motor operations must be verified so that the radiators and latches will not be one failure away from loss of latch/stow capability due to an undetected failure (i.e., it is not known if the powered-off motor is functional). Losing the latch or stow function on a radiator may cause the loss of the associated Freon loop due to entry loads and vibrations which would put the vehicle one failure away from the possible loss of crew/vehicle. It is not known if the unsecured radiator could come into contact with a returned payload; this should be considered, if applicable. Therefore, to ensure dual-motor radiator operations, deploy should wait until after RMS nominal operations are completed and the RMS can be safely cradled (payload berthed or released, etc.). If radiator deploy is time critical, the RMS will be cradled if present operations permit; otherwise, the radiators will be deployed single motor. It is highly desirable that dual-motor operations be verified ASAP after the RMS is cradled. This is especially critical for latching, because there is no known EVA backup to provide this function as there is for stowing.

Rule {A12.1.3-4}, INADVERTENT MPM CYCLING PROTECTION (CIL), references this rule.

FLIGHT RULES

A10.1.12-2 RADIATOR VISUAL CUES

- A. RADIATOR DEPLOYED - A SUSPECT RADIATOR IS CONSIDERED DEPLOYED IF IT APPEARS TO BE IN THE SAME RELATIVE POSITION AS THE OTHER RADIATOR WHEN IT IS DEPLOYED.
- B. RADIATOR STOWED - A SUSPECT RADIATOR CANNOT BE EVALUATED FOR THE STOWED POSITION (IF CLOSE TO IT) UNTIL THE PLBD IS PARTIALLY CLOSED (90 DEGREES). FOR SAFE LATCHING THE POSITIONS OF THE FIXED AND DEPLOYED PANELS ON THE SAME SIDE SHOULD BE ALIGNED WITH EACH OTHER.

If the radiator is thought to have not deployed fully (e.g., failure to receive the deploy indications), then the only visual means of determining if it reached the commanded position is to compare it to the other (fully deployed) radiator.

If a radiator is suspected to have not reached the stowed position (e.g., failure to receive the stow indications), then it can be checked in the following manner. The PLBD to which it is attached must be closed 90 degrees (about halfway) so that the radiator can be easily seen. On each PLBD, there are four radiator panels, two deployable (forward) and two fixed (aft). When the deployable panels are stowed, the seam between them and the fixed set should match up. If so, the radiator can be safely latched.

FLIGHT RULES

ET UMBILICAL DOORS SYSTEMS MANAGEMENT

A10.1.13-1 ET UMBILICAL DOOR KEYBOARD ENTRY

THE ET DOOR CLOSE SINGLE ITEM KEYBOARD ENTRY WILL ONLY BE USED AS A BACKUP FOR AN AOA.

With the exception of an RTL or a TAL, the software sequence is not nominally scheduled, and the doors must be closed manually. After separation, but while still in OPS 1, the software sequence may be initiated by an item entry on SPEC 51. This software issues commands based on nominal motor drive time and does not check or stop for anomalous operation. The potential exists to drive the doors against the centerline latches (if they do not stow nominally), damaging the drive mechanism and preventing proper ET door closure. Using the software sequence is an acceptable risk during an AOA. In all other situations, the MCC will be contacted to determine other methods of door closure.

A10.1.13-2 ET UMBILICAL DOORS ON ORBIT

THE ET DOORS WILL NORMALLY BE CLOSED AFTER THE H₂ PRESSURIZATION LINE VENTING IS COMPLETED. BOTH ET DOORS MUST BE CLOSED AND LATCHED BEFORE DEORBIT.

H₂ pressurization line venting should be completed before ET door closure to ensure that any residual H₂ in the line can dissipate into space. If the doors are closed, H₂ can be trapped in the ET door cavity and will take a much longer time to vent through the aft compartment. The doors should be closed and latched before entry to avoid structural damage because of protruding surfaces during reentry heating and to provide a smooth undersurface for stable aerodynamic control.

FLIGHT RULES

A10.1.13-3 ET UMBILICAL DOOR CLOSURE DELAY FOR DISCONNECT VALVE FAILURE (CIL)

A. NOMINAL/ATO

MANUAL CLOSURE OF THE ET UMBILICAL DOORS WILL BE DELAYED FOR THE FAILURE OF THE LO₂ AND/OR LH₂ 17-INCH DISCONNECT VALVE(S) TO CLOSE. DOOR CLOSURE WILL BE DELAYED TO ALLOW FOR VENTING RESIDUALS AND THERMAL CONDITIONING. A MINIMUM OF 40 CONTINUOUS MINUTES OF BOTTOM-SUN EXPOSURE IMMEDIATELY PRIOR TO ET DOOR CLOSURE WILL SATISFY THESE REQUIREMENTS.

B. AOA

MANUAL DOOR CLOSURE WILL BE DELAYED AS LONG AS POSSIBLE BUT WILL BE PERFORMED PRIOR TO TRANSITIONING FROM OPS 1.

C. TAL/RTLS

NO ACTION

For most orbits (160 nm., 28.5-degree inclination), a maximum of 55 minutes of Sun exposure can be obtained. For ATO orbits (106 nm altitude), only 40 minutes of Sun exposure can be obtained. Higher inclination orbits will give more Sun exposure. A minimum of 40 continuous minutes with the orbiter in a bottom-Sun attitude ensures thermal conditioning of the ET door pressure seal and thermal barrier and venting of residuals from the umbilical compartment. This will allow proper door closure/sealing and prevent pressurization of the ET umbilical compartment and residuals entering the aft compartment. Reference SODB submittal P1-1577 for thermal analysis. Redundancy for ET umbilical door closure will be maintained and the doors closed prior to entry. On an AOA mission, redundancy exists in OPS 1 only, via the ET umbilical door mode switch and SPEC 51 item entry. Therefore, the ET umbilical doors will be closed prior to transitioning out of OPS 1. For nominal/ATO missions, door closure can be delayed until OPS 2 since ground commands can be used to close the door in the event of ET umbilical door switch failure. Nominal TAL procedures will be followed to allow an expedited transition to OPS 3. Closure during an RTLS is automatic.

FLIGHT RULES

VENT DOOR SYSTEMS MANAGEMENT [ED]

A10.1.14-1 VENT DOOR MANAGEMENT

A. ORBIT - ALL VENT DOORS WILL NOMINALLY BE OPEN DURING ORBIT OPS EXCEPT FOR THE FOLLOWING:

1. IF REDUNDANT CLOSE CAPABILITY IS LOST FOR VENT DOORS 1 AND 2, THE AFFECTED DOOR WILL BE CLOSED PROVIDED OPEN REDUNDANCY EXISTS ON THE OPPOSITE DOOR. FOR THE REMAIN-ING DOORS, NO ACTION WILL BE TAKEN FOR THE LOSS OF REDUNDANT CLOSE CAPABILITY.

For loss of close redundancy, the affected door is closed to limit the exposure to the next failure that would leave the door failed open. It is predicted that the 1/2 vent box will melt if exposed, resulting in structural damage that, although not a flight-safety concern, is a significant impact to vehicle turnaround (upper and lower fuselage must be demated for repair - estimated > 1 year).

If open redundancy does not exist on the opposite door, the affected door will not be closed in order to protect against a subsequent failure that could fail the door in the closed position. With the loss of open redundancy, the flight rule is biased towards ensuring 1/2 compartment venting is guaranteed (i.e., door open) rather than closing the door to protect against the thermal impact during entry should subsequent failures occur.

The thermal impact with a door failed open is the most severe in the forward compartment. The midbody doors will experience 600 deg to 700 deg F heating while the aft compartment doors will experience less than 550 deg F heating. The structural impact associated with these temperatures is minimal. Consequently, no protective measures are implemented.

2. FOR A VENT DOOR FAILED OPEN, NO ACTION WILL BE TAKEN UNLESS CLOSE REDUNDANCY IS LOST ON THE OPPOSITE DOOR. LOSS OF CLOSE REDUNDANCY ON THE OPPOSITE DOOR WILL BE CAUSE TO CLOSE THE DOOR.

Discussions at the Entry Flight Techniques Panel (FTP) #43 determined that sufficient entry venting can be maintained with one side of a vent group closed. (Assumes nominal entry. If entry is dispersed and vent door fails closed, the factor of safety will be less than 1.4). Furthermore, entry with both sides open will result in structural damage due to hot plasma and possible flow-through of hazardous gas. Therefore, if a vent door fails open and close redundancy is lost on the opposite door, the opposite door will be closed to protect against the next failure that would leave the door failed open.

THIS RULE CONTINUED ON NEXT PAGE

FLIGHT RULES

A10.1.14-1 VENT DOOR MANAGEMENT (CONTINUED)

3. VENT DOORS MAY BE CLOSED IN ORDER TO MINIMIZE THE POTENTIAL FOR CONTAMINATION OF SPACECRAFT OR EVA OPERATIONS WHEN A KNOWN CONTAMINANT EXISTS IN AN ACTIVELY VENTED COMPARTMENT. ©[072398-6686B] @[072398-6686A]

On-orbit, the vent doors are nominally left open to permit molecular venting of the thermal insulation. The risk of closing the forward and/or aft compartments to preclude any potential off-gassing of a known contaminant from these compartments outweighs the risk of compartment overpressurization should a large OMS or RCS tank leak occur. ©[072398-6686B] @[072398-6686A]

B. ENTRY

1. IF OPEN CAPABILITY IS LOST ON ANY VENT DOOR DUE TO A MULTIPHASE AC LOSS (NO SHORT), DEORBIT WILL BE DELAYED TO INSTALL THE AC BUS TRANSFER CABLE AND REGAIN OPEN CAPABILITY.

Deorbit will be delayed if the ac bus transfer cable can be installed to regain open capability on any vent door. This will allow entering with the maximum available venting.

2. IF VENT DOORS 1 AND 2 OR 8 AND 9 ARE FAILED CLOSED ON ONE SIDE AND OPEN REDUNDANCY IS LOST ON THE OPPOSITE SIDE, DEORBIT WILL BE DELAYED IF INSTALLATION OF THE AC BUS TRANSFER CABLE WILL REGAIN OPEN REDUNDANCY.

Deorbit will be delayed if the ac bus transfer cable can be installed to regain open redundancy after the opposite door has failed closed in the forward or aft compartment. This will allow entering with the doors closed, precluding entry heating structural damage.

3. ALL VENT DOORS WILL NOMINALLY BE CLOSED FOR ENTRY EXCEPT AS FOLLOWS:
- a. FORWARD/AFT VENT DOORS:
- (1) IF OPEN REDUNDANCY IS LOST ON BOTH SIDES OF THE AFFECTED COMPARTMENT (1 AND 2 OR 8 AND 9) AND ONE FAILURE (AVIONICS/POWER) WILL RESULT IN LOSS OF OPEN CAPABILITY OF DOORS ON BOTH SIDES, ONE DOOR WILL REMAIN OPEN THROUGHOUT THE MISSION.

THIS RULE CONTINUED ON NEXT PAGE

FLIGHT RULES

A10.1.14-1 VENT DOOR MANAGEMENT (CONTINUED)

During nominal entry, it is required to maintain the capability to open at least one side of each vent door group in the forward and aft compartments for sufficient compartment venting. After the loss of redundancy on both sides of either the forward or aft compartments and one failure of avionics or power resulting in loss of open capability of doors on both sides, one door will remain open throughout the mission. This action will cause structural damage to the orbiter due to the hot plasma (1200 deg F for 1 and 2 and less than 550 deg F for 8 and 9), but will protect against the next failure preventing any venting to a compartment. Loss of venting in the forward or aft compartments is catastrophic.

- (2) IF VENT DOORS 1 AND 2 OR 8 AND 9 ARE FAILED CLOSED ON ONE SIDE AND OPEN REDUNDANCY IS LOST ON THE OPPOSITE SIDE, THE OPPOSITE VENT DOORS WILL REMAIN OPEN FOR ENTRY. IF THE AFFECTED DOOR IS MECHANICALLY FAILED CLOSED, THE OPPOSITE DOOR WILL REMAIN OPEN FOR ENTRY INDEPENDENT OF OPEN REDUNDANCY.

Entry FTP #43 determined that it is expected that sufficient venting can be maintained during nominal entry with one side of a vent door group in the forward or aft compartment closed. Entry with both sides of a vent group failed closed in the forward or aft compartment will result in structural failure and possible loss of crew/vehicle. If a vent door fails closed in the forward or aft compartment, as long as open redundancy exists on the opposite door, no action will be taken. The orbiter is still two failures away from a catastrophic condition (i.e., no compartment venting), assuming a structural failure, gearbox jam, or torque limiter slip does not occur.

Single-point structural failures exist but are not protected because of the extreme low probability of occurrence (no failures experienced in testing or flight). However, if a vent door fails closed during flight and is unexplained, a mechanical failure will be assumed. The opposite vent door will remain open, protecting against a subsequent mechanical failure that would be catastrophic.

SODB and CIL's assume that failure to open a single vent door below 70,000 feet will result in loss of the crew/vehicle.

- (3) LEFT VENT DOORS 1/2 AND 8/9 WILL REMAIN OPEN FOR ENTRY IN THE EVENT OF AN OMS OXIDIZER, RCS OXIDIZER, OR OMS He LEAK. IF THE LEAK IS SUBSEQUENTLY ISOLATED, THESE DOORS WILL BE CLOSED. FOR AN OMS FUEL, RCS FUEL, RCS He, OR APU FUEL LEAK DURING ENTRY, NO ACTION WILL BE TAKEN.

THIS RULE CONTINUED ON NEXT PAGE

FLIGHT RULES**A10.1.14-1 VENT DOOR MANAGEMENT (CONTINUED)**

It has been determined that gas leaks which exceed structural limits occur so rapidly that the crew cannot respond. For example, assuming an initial tank pressure of 2000 psia and a hole diameter of 0.11 inch, transient leak analysis for the OMS pod large helium tank indicated that the peak differential pressure would occur 20.7 seconds after the leak started. In addition, if the OMS pod to ambient differential pressure exceeds 0.65 psid, the aft vent doors may not open when commanded (see JSC memorandum ES42-110M-85). As a result, a GPC item entry is used during MM 301 to command left doors 1/2 and 8/9 open independent of the other vent doors. This capability protects the orbiter from possible compartment overpressurization in the event of a massive OMS oxidizer, RCS oxidizer, or OMS He leak during MM 301, 302, and 303.

Nominally, the doors are closed at MM 304 transition to avoid structural damage and hazardous gas ingestion due to the plasma phase of entry. However, if a leak cannot be isolated, left vent doors 1/2 and 8/9 will remain open throughout entry in order to remain within structural limits.

If there is a question between an RCS helium or RCS oxidizer leak, an oxidizer leak will be assumed (ref. A/E FTP #13).

b. MIDBODY VENT DOORS:

- (1) NO ACTION WILL BE TAKEN FOR MIDBODY VENT DOORS FAILED CLOSED AND/OR LOSS OF REDUNDANCY.

Discussions at the Entry FTP #43 determined that with a nominal entry, sufficient venting can be maintained in the midbody after two opposite doors have failed closed.

- (2) FOR ENTRY WITH A MIDBODY H₂ LEAK > 1.0 LB/HR, MAXIMIZE VENTING BY LEAVING VENT DOORS OPEN UNTIL AUTO CLOSURE MM 304 TRANSITION (EI-5).

Leaks of H₂ greater than 1 lb/hr can lead to H₂ concentrations in the midfuselage that exceed the H₂ flammability limit during entry (ref. informal note, DF7/84-126, dated 6/20/84). Delaying the closure of the vent doors until the MM 304 transition will reduce the amount of time that is available for H₂ to build up within the midfuselage while providing the maximum amount of time prior to the high heating phase of entry that H₂ has the opportunity to escape.

The current vent door software will automatically close any vent doors at the MM 304 transition that might have been left open prior to that time. Additionally, the capability does not exist in the current software to open any midbody vent door prior to the MM 305 transition which occurs well below the 100,000 foot altitude. Therefore, the latest the midbody vent doors can be left open for H₂ venting is MM 304, and the earliest the doors can be opened is MM 305 (Mach 2.4).

FLIGHT RULES

PAYLOAD RETENTION LATCHES (PRLA) SYSTEMS MANAGEMENT

A10.1.15-1 PRLA'S/AKA'S

A. PRLA/AKA MANAGEMENT :

1. FOR A DEPLOYABLE PAYLOAD (WITH RETURN CAPABILITY), THE ASSOCIATED PRLA'S/AKA'S WILL NOT BE CLOSED UNTIL PAYLOAD RETURN CAPABILITY IS NO LONGER AN OPTION.
③ED]
2. FOR A PAYLOAD RETRIEVAL MISSION, THE ASSOCIATED PRLA'S/AKA'S WILL NOT BE CLOSED ON ORBIT UNTIL THE PAYLOAD IS BERTHED.

Because of inherent single-point failures in the payload retention system, the PRLA's and AKA's will remain open to avoid a failure that could preclude returning a payload.

3. AN EVA WILL BE CONSIDERED TO OPEN OR CLOSE ANY TYPE PRLA THAT HAS FAILED TO RELEASE OR LATCH. AKA'S AND STANDARD WEIGHT PRLA'S ARE EXCLUDED FROM CONSIDERATION.

The super middleweight longeron latch (SMWLL), middleweight longeron latch (MWLL), modified middleweight longeron latch (MMWLL), and lightweight longeron latch (LWLL) types have EVA release/latch drive mechanisms incorporated into their designs. EVA should be considered in lieu of discontinuing payload operations or payload jettison in order to preserve mission success. The standard weight PRLA (also called heavyweight PRLA) has no provisions for EVA manipulation; the standard weight and lightweight AKA types have neither EVA drive capability nor physical access.

B. PRLA/AKA REQUIREMENTS FOR NOMINAL PAYLOAD BERTHING OPERATIONS :

1. CONFIRMING VISUAL CLUES AND/OR AT LEAST ONE OF TWO RELEASE INDICATIONS ON ALL PRLA'S/AKA'S MUST BE PRESENT BEFORE MANEUVERING THE PAYLOAD INTO THE PRLA V-GUIDES.

During berthing operations, PRLA's/AKA's must be verified released in order to preclude possible structural damage to the payload and orbiter.

2. CONFIRMING VISUAL CLUES AND/OR AT LEAST ONE OF TWO READY-FOR-LATCH MICROSWITCH INDICATIONS MUST BE PRESENT ON ALL PRLA'S BEFORE CONTINUING NOMINAL PRLA/AKA CLOSE PROCEDURES.

FLIGHT RULES

The absence of both PRLA R-F-L indications represents a condition where a payload trunnion may be outside the 2-inch PRLA latch envelope. Continuation of PRLA ops without further evaluation could allow the payload operator to drive this latch against the trunnion, causing the PRLA motors to stall.

THIS RULE CONTINUED ON NEXT PAGE

FLIGHT RULES

A10.1.15-1 PRLA'S/AKA'S (CONTINUED)

For contingency IUS reberthing operations, R-F-L indications are not required, since the IUS keel kick-off spring will nominally prevent the IUS trunnions from contacting the R-F-L microswitch lever arms. The AFTA, however, will maintain the trunnions within the PRLA latch envelope once the IUS is returned to the PRLA release position.

When latching an AKA, the R-F-L indication is not expected until the latch is almost completely closed. The indication actually serves as a trunnion-in-place indication instead of a R-F-L cue.

3. WHEN NOMINALLY BERTHING A PAYLOAD WITH MULTIPLE PRLA'S AND ONE OR MORE AKA'S, THE AKA(S) MUST BE LATCHED FIRST BEFORE CLOSING THE PRLA'S. (REFER TO SPACE SHUTTLE OPERATIONAL FLIGHT RULES ANNEX FOR EXCEPTIONS.)

During berthing operations, the AKA(s) provides the necessary force required to center the payload within the payload bay. The AKA has a limited capability in the Y-direction (2,500 lb with less than a 0.25-inch payload offset, 1,000 lb with a greater than 0.25-inch offset), which may be insufficient to overcome the longeron latch resistance once the PRLA's are latched. Therefore, the AKA(s) must be closed prior to the PRLA's to preclude an AKA from stalling. Reference RI STS84-0190A, Payload Retention System Latches Safety Assessment Report, July 1984; and Shuttle Flight Operations Manual (SFOM), Volume 16, Payload Deployment and Retrieval System, Final, June 1, 1981.

C. PRLA/AKA REQUIREMENTS FOR PAYLOAD DEPLOY

CONFIRMING VISUAL CUES AND/OR AT LEAST ONE OF TWO RELEASE INDICATIONS ON ALL PRLA'S/AKA'S MUST BE PRESENT BEFORE CONTINUING NOMINAL PAYLOAD DEPLOY OPERATIONS.

During deploy operations, PRLA's/AKA's must be verified released in order to preclude possible structural damage to the payload and orbiter.

D. PRLA/AKA LATCHED DEFINITION

FOR PAYLOAD RETURN OR ON-ORBIT MANEUVERS AND TRANSLATIONS, A PRLA/AKA WILL NOT BE CONSIDERED LATCHED WITHOUT THE COMBINATION OF AT LEAST ONE OF TWO LATCH MICROSWITCH INDICATIONS, AND AT LEAST ONE OF TWO RFL MICROSWITCH INDICATIONS (VISUAL CUES ACCEPTABLE FOR R-F-L INDICATIONS).

FLIGHT RULES

PRLA's/AKA's must be verified latched in order to preclude possible structural damage to the payload and orbiter. Failure of any PRLA/AKA to indicate a latched configuration will be evaluated on a flight-specific basis regarding subsequent on-orbit maneuvers, orbiter attitude control, and return to Earth capabilities.

THIS RULE CONTINUED ON NEXT PAGE

FLIGHT RULES

A10.1.15-1 PRLA'S/AKA'S (CONTINUED)

E. PAYLOAD RETENTION PAYLOAD SELECT ROTARY SWITCH OPERATIONS:

1. FOR MISSIONS WHERE NOMINALLY ONLY A SINGLE PAYLOAD SELECT POSITION WILL BE UTILIZED, THE PAYLOAD RETENTION PAYLOAD SELECT ROTARY SWITCH WILL BE CONFIGURED TO THAT POSITION FOR LAUNCH AND WILL REMAIN IN THAT POSITION FOR THE DURATION OF THE FLIGHT.
2. FOR ALL OTHER MISSIONS, THE ROTARY SWITCH WILL BE LAUNCHED IN THE MONITOR POSITION AND WILL BE OPERATED AS REQUIRED TO BEST SUPPORT THE MISSION.

Operation of the rotary switch for single payload select missions is not necessary; and because of inherent single-point failures within the payload select rotary switch, use of this switch for this type mission is avoided to preclude the potential of mission failure. The payload retention system maintains fail op/fail safe redundancy against inadvertent operation when launched and flown in any position.

For missions using multiple payload select positions, use of the rotary switch is usually required. The monitor position allows a complete systems status verification for launch commit criteria purposes and for orbit operations.

F. PRLA/AKA CONFIGURATION FOR ASCENT/ENTRY (WITH NO PAYLOAD) ~~©[072398-6687] ALL PRLA'S SHOULD BE CONFIGURED TO THEIR LATCHED POSITIONS FOR ASCENT AND ENTRY TO PRECLUDE POSSIBLE PRLA DAMAGE. AKA'S MAY BE FLOWN IN ANY POSITION TO BEST ACCOMMODATE FLIGHT REQUIREMENTS.~~

1. PRLA'S: LATCHED
2. FLOATING AKA'S: RELEASED
3. FIXED AKA'S: LATCHED OR RELEASED

(REFER TO SPACE SHUTTLE OPERATIONAL FLIGHT RULES ANNEX FOR EXCEPTIONS.)

FLIGHT RULES

All PRLA certification testing for dynamic flight was done using hardware in the latched configuration. Because of the inherent latch mechanism free-play when not latched overcenter, the loads and vibration levels associated with dynamic flight may cause internal PRLA damage and accelerate mechanism wear. ~~The AKA employs a different type mechanism that is stable in any position.~~ Without a payload trunnion present, a floating AKA in its latched position is free to move along its bridge fitting approximately 9 inches in the x-axis. Therefore, the AKA can impact its end stops, resulting in AKA and/or orbiter payload bay hardware damage. In addition, extensive ground turnaround testing/repair would be required. When released, however, a floating AKA opens up to completely fill the gap between its end stops, and movement along its bridge fitting cannot occur. A fixed AKA is installed with a center stop which prevents the AKA from sliding when fully latched. The bridge fitting end stops prevent movement when the AKA is released.

Reference SODB, Vol. I, 3.4.2.5-14 and Table 3.4.2.5-5 (Active Keel Latch Ascent and Entry Constraints). [@I072398-66871](#)

FLIGHT RULES

KU-BAND ANTENNA DEPLOY MECHANISM SYSTEMS MANAGEMENT

A10.1.16-1 ANTENNA STOW REQUIREMENT (CIL)

- A. REDUNDANT KU-BAND ANTENNA STOW CAPABILITY IS REQUIRED FOR CONTINUATION OF KU-BAND ANTENNA OPERATIONS EXCEPT FOR THOSE CASES STATED IN THE FLIGHT SPECIFIC ANNEX. (CIL)

Without redundant stow capability, the antenna could not be stowed normally if a single additional failure occurred. If stow capability could not be regained by one of the methods given in Rule {A10.1.16-3}, ANTENNA CONTINGENCY PROCEDURES, the antenna would have to be jettisoned in order to close the payload bay doors. Unless stowing the antenna would be costly in terms of mission success (cases stated in the annex), the antenna will be stowed when redundancy is lost.

Rule {A2.1.3-2C}, EXTENSION DAY REQUIREMENTS, references this rule. ©[090894-1670B]

- B. FOR LOSS OF TEMPERATURE CONTROL OR TEMPERATURE MONITORING CAPABILITY, THE KU-BAND ANTENNA WILL BE STOWED. (CIL)

Precise antenna positioning capability is required to lock the gimbals and properly stow the Ku-band antenna. When the temperature of the antenna gyro mechanism, signal feed, or the alpha or beta gimbal angle cannot be maintained within SODB limits, the capability to obtain correct stow angles may be lost. The Ku-band antenna deployed assembly (gimbals) must be locked for entry, or jettison is inevitable. Therefore, when the Ku-band antenna temperature control or monitoring capability is lost, the Ku-band system should be deactivated and the antenna stowed as a precaution. The Ku-band will be jettisoned if the gimbals cannot be locked for entry. (Reference Rules {A11.1.2-27}, LOSS OF ANY OI DSC; {A11.1.2-6}, LOSS OF KU-BAND TEMPERATURE CONTROL (CIL); and {A10.1.16-3C}, ANTENNA CONTINGENCY PROCEDURES.) ©[ED]

- C. FOLLOWING UNSUCCESSFUL ATTEMPTS TO FULLY DEPLOY THE KU-BAND ANTENNA, THE ANTENNA WILL BE DRIVEN BACK TO THE STOWED POSITION.

If the antenna cannot be successfully deployed, there is a good possibility of a mechanism problem that could also affect the stow capability. It is important to stow the antenna early in the flight so IFM or EVA contingency procedures can be planned per Rule {A10.1.16-3}, ANTENNA CONTINGENCY PROCEDURES, if required. Also, the antenna is of little or no use if not fully deployed and there is a potential for an additional failure to make antenna stowage less likely as the flight progresses.

FLIGHT RULES

A10.1.16-2 DAP CONFIGURATION FOR ANTENNA STOW

THE DAP WILL BE CONFIGURED TO "VERN" OR "FREE DRIFT" DURING KU-BAND DEPLOY ASSEMBLY STOWING.

Reference SODB, Volume I, 3.4.5.2.10. In order to ensure proper gimbal locking during the antenna automatic stow sequence, the primary RCS jets cannot be selected. Damage to the gimbal locking mechanism may be caused by orbiter accelerations greater than 0.5 deg/sec² and orbiter rates greater than 5 deg/sec during the stow sequence. Either "vern" or "free drift" is acceptable.

A10.1.16-3 ANTENNA CONTINGENCY PROCEDURES

A. IF THE KU-BAND ANTENNA GIMBALS CANNOT BE LOCKED FOR KU-BAND STOW, CONSIDERATION WILL BE GIVEN TO PERFORMING AN EVA TO LOCK THE GIMBALS IF A DEORBIT DAY PLUS 1-DAY WAVEOFF IS AVAILABLE AFTER EVA DAY.

For this case, an EVA is considered an option if it can be performed and consumables will support a deorbit day plus 1 day waveoff after EVA day.

B. IF THE KU-BAND ANTENNA CANNOT BE STOWED OR THE GIMBALS CANNOT BE LOCKED BUT THE FAILURE OCCURS SUCH THAT AN EVA CANNOT BE PERFORMED, CONSIDERATION WILL BE GIVEN TO A 1-ORBIT WAVEOFF OR A 1-DAY EXTENSION IN ORDER TO PERFORM ANY OF THE FOLLOWING CONTINGENCY PROCEDURES IF A DEORBIT DAY PLUS 1-DAY WAVEOFF DAY IS MAINTAINED:

1. KU-BAND ANTENNA - FAILED DEPLOY/STOW SWITCH (IFM).
2. KU-BAND ANTENNA - GIMBALS CAN BE LOCKED (IFM).
3. USE OF THE KU-BAND ANTENNA DIRECT STOW SWITCH.
4. KU-BAND ANTENNA JETTISON (IF FAILURE PREVENTS PLBD CLOSURE).

The rule assumes that, for whatever reason, performing an EVA has not been an option. It also assumes that on entry day we are unable to stow the antenna or lock the gimbals.

There are a few contingency procedures that do not involve an EVA, but might require a one-orbit waveoff or a 1-day extension to perform. Depending on the failure, they could result in saving the antenna and still enter with at least a 1-day backup.

The contingency procedure required to be used is dependent on the actual failure condition; however, if the failure can be corrected via IFM, the IFM procedure should have priority over the others. The IFM procedures allow for normal antenna stow procedures to be used once the gimbals are locked.

FLIGHT RULES

Rule {A10.1.16-1B and C}, ANTENNA STOW REQUIREMENT (CIL), references this rule.

THIS RULE CONTINUED ON NEXT PAGE

FLIGHT RULES

A10.1.16-3 ANTENNA CONTINGENCY PROCEDURES (CONTINUED)

C. THE KU-BAND WILL BE JETTISONED IF THE GIMBALS CANNOT BE LOCKED FOR ENTRY.

With the Ku-band mechanism stowed and the antenna gimbals unlocked, the antenna disk is free to move about its gimbal axes and cause radiator damage when subjected to entry and landing loads. Loss of the ability to lock the antenna gimbals and secure the disk for entry is considered a criticality I failure.

Reference JSC VNS-87-26, Ku-Band Comm/Radar FMEA/CIL, Level III CCB minutes (12/10/86).

A10.1.16-4 LOSS OF KU-BAND ANTENNA DEPLOYMENT ACTUATOR STOW MOTOR REDUNDANCY

SPACELAB

THE KU-BAND DEPLOYED ASSEMBLY WILL BE DEPLOYED AND REMAIN DEPLOYED TO SUPPORT SPACELAB OPERATIONS EVEN IF ONLY SINGLE-MOTOR DEPLOYMENT ACTUATOR STOW CAPABILITY EXISTS. FOR THIS FAILURE CASE, THE DEPLOYED ASSEMBLY WILL BE STOWED 1 DAY PRIOR TO ENTRY AND WILL NOT BE REDEPLOYED FOR MISSION EXTENSION DAYS.

The Ku-band subsystem is essential for relaying Spacelab experiment data to the ground. Therefore, stowing the deployed assembly (consisting of the antenna dish, gimbal motors, and deployed electronics) immediately after deployment actuator stow redundancy has been lost would be costly in terms of mission success. However, in order to minimize the potential of a second failure that would require a deployed assembly jettison and in order to allow sufficient time to respond to any contingency that may arise during the stow operation (including the need for an EVA to tie down the jettisoned deployed assembly), the deployed assembly shall be stowed at least 1 day prior to deorbit. The antenna dish can be positioned manually during an EVA if a gimbal motor or gimbal motor drive fails, in order to permit locking the gimbals for entry. However, the deployed assembly cannot be manually repositioned to within the GO FOR PLBD CLOSURE envelope in the event of a dual motor deployment actuator failure.

FLIGHT RULES

STRUCTURAL MANAGEMENT

A10.1.17-1 THERMAL WINDOWPANE FAILURE (CIL)

A THERMAL WINDOWPANE IS CONSIDERED FAILED IF PIECES OF THE PANE ARE MISSING. A CRACKED THERMAL WINDOWPANE IS NOT CONSIDERED FAILED WHILE THE PANE REMAINS INTACT.

NOTE: THE PROBABILITY OF A CRACKED PANE FAILING IS HIGHEST DURING THE MAXIMUM DYNAMIC PRESSURE PHASE (MAX Q) (T=40 TO T=60).

FOR A FAILED FORWARD WINDSHIELD OR SIDE HATCH THERMAL WINDOWPANE PRIOR TO THE RTLS BOUNDARY, ABORT RTLS, OTHERWISE CONTINUE EOM. FOR A FAILED OVERHEAD THERMAL WINDOWPANE, CONTINUE EOM.

A thermal windowpane could fail due to flaws caused by ice or other debris impacting it during ascent. A cracked thermal windowpane is more likely to fail during MAX Q phase. An RTLS abort should be performed if possible to minimize thermal effects on the remaining windowpanes and structure, as the RTLS abort has the most benign reentry thermal environment of all entry modes. The nominal and the thermally similar AOA impose the most heating on the panes.

TAL aborts have a slightly more benign thermal environment with respect to the windowpanes and surrounding structure than the nominal EOM. However, the risk of a TAL abort outweighs the benefit of slightly less heating on the windows. Therefore, post-RTLS, no other abort should be initiated. The overhead windows are not considered for an RTLS abort since the thermal environment for these windows during a nominal EOM entry is relatively benign (ref. A/E FTP #68, June 29, 1990).

A side hatch thermal pane failure may be undetectable during ascent because of crew visibility. For a failed side hatch thermal pane or forward windshield past the RTLS boundary, thermal conditioning of the affected window may be required prior to deorbit, based on real-time thermal analysis.

[Rule {A2.1.2-4A.2}, RTLS, TAL. AND AOA ABORTS FOR SYSTEMS FAILURES \(CIL\), references this rule. ©\[021998-6493\]](#)

FLIGHT RULES

A10.1.17-2 PRESSURE/REDUNDANT WINDOWPANE FAILURE

FOR A FAILURE OF EITHER A PRESSURE PANE (I.E., UNIFORM SHATTERING OF AN INNER PANEL INTO SMALL PIECES) OR A REDUNDANT PANE (I.E., CRACKED OR SHATTERED PANE WITH FRAGMENTS AROUND RETAINER FRAME), CABIN PRESSURE WILL BE REDUCED TO 10.2 PSI. CABIN DEPRESSURIZATION WILL NOT BE ATTEMPTED PRIOR TO THE POST INSERTION TIMEFRAME OR AFTER SEAT INGRESS FOR ENTRY:

- A. ON ASCENT, AN ORBIT 3 ENTRY WILL BE PERFORMED.
- B. ON ORBIT, ENTER NEXT PLS.

A severe impact may break the pressure pane. Neither the pressure pane (other than severe impact) nor the redundant panel should fail. If a failure of one of these panes has occurred for an unknown reason, the remaining windows may be threatened. Pressure redundancy is required in the orbiter window system (the thermal panel does not provide cabin pressure redundancy). The pressure redundancy requirement is violated with a failure of any one of the pressure panes or redundant panes (windshields, overhead windows, rear viewing windows, or side hatch window). Loss of both the pressure pane and the redundant pane in a window would result in loss of crew and orbiter.

Flight techniques discussions have resulted in the choice of an orbit 3 deorbit as the best choice to minimize exposure time to a single string windowpane situation without the risks entailed in more rapid abort situations. A reduced cabin pressure is desired due to the time-at-stress nature of windowpane failures.

Flight Techniques have indicated that wearing the LES helmet for the 4.6 hours of orbit 3 is acceptable. The reason for wearing the LES helmet after a pressure pane failure is to reduce the possibility of crewmember exposure to shattered pane particles. The LES helmet must be worn for all entries; therefore, using anticontamination goggles and masks until donning the LES helmet is not desired for the orbit 3 case due to the possibility of contamination during the donning process.

Reference Ascent Flight Techniques Panel Meetings #33 and #36, August 28 and October 15, 1987.

FLIGHT RULES

A10.1.17-3 BAILOUT/POSTLANDING EMERGENCY EGRESS PYROTECHNICS MANAGEMENT

- A. THE SAFING PIN FOR THE T-HANDLE BOX COVER WILL BE REMOVED AND STOWED PRELAUNCH, REINSTALLED DURING POST INSERTION, REMOVED AND STOWED DURING DEORBIT PREP, AND REINSTALLED POSTLANDING.

This procedure improves access to the pyro vent valve and side hatch jettison T-handles during an ascent, entry, or postlanding emergency, and ensures that the handles are less accessible at other times.

- B. THE SAFING PINS FOR THE PYRO VENT VALVE AND SIDE HATCH JETTISON T-HANDLES WILL NOT BE REMOVED UNLESS REQUIRED FOR ORBITER BAILOUT OF EMERGENCY GROUND EGRESS.

The purpose of this rule is to prevent accidental activation of the handles. Removal of the safing pins requires less than 1 second for each handle; therefore, an insignificant time delay is imposed during an emergency.

- C. THE PYRO VENT VALVE WILL ONLY BE ACTIVATED:
1. DURING AN IN-FLIGHT BAILOUT, PRIOR TO JETTISONING THE SIDE HATCH.
 2. DURING A POSTLANDING EMERGENCY EGRESS, IF NECESSARY.

The purpose of the pyro vent valve is to equalize the difference in pressure between the crew compartment and the outside atmosphere. If the side hatch is jettisoned during an in-flight bailout before the pressure is equalized, the large delta P will probably cause the floor of the middeck to buckle, leading to extensive damage within the vehicle. The postlanding delta P is much smaller and will not buckle the middeck floor. Because the pyro vent valve is an ignition source in the payload bay, it should not be activated postlanding unless a side hatch emergency egress is impossible and the overhead escape panel (W8) will not open due to the delta P.

- D. THE SIDE HATCH WILL ONLY BE JETTISONED:
1. DURING AN IN-FLIGHT BAILOUT.
 2. DURING A POSTLANDING EMERGENCY WHERE THE SIDE HATCH CANNOT BE OPENED NORMALLY AND RAPID EGRESS OF THE CREW IS NECESSARY IN ORDER TO PREVENT LOSS OF LIFE. IN THIS CASE, THE CREW SHALL MAKE EVERY EFFORT TO VERIFY THAT ALL FIRE/RESCUE PERSONNEL ARE CLEAR OF THE SIDE HATCH BEFORE IT IS JETTISONED.

This rule prevents unnecessary damage to the orbiter and minimizes the risk that side hatch jettison poses to fire/rescue personnel.

FLIGHT RULES

A10.1.17-4 **MAXIMUM NUMBER OF FILLED CWC'S**

THE NUMBER OF FILLED CONTINGENCY WATER CONTAINERS (CWC'S) WILL NOT EXCEED THE NUMBER OF AVAILABLE CERTIFIED STOWAGE LOCATIONS, AS DETAILED IN THE FLIGHT SPECIFIC RULES ANNEX. ©[100997-6345A]

This assures that, in the event of an unplanned deorbit (PLS), all CWC's can be stowed in locations that will not cause structural damage or endanger the crew in the event of a hard landing.

Determination of the number and placement of CWC's is performed by DF54/Crew Systems.

Reference OFTP #161, February 14, 1997. ©[072398-6621] ~~Analysis of the number and placement of CWCs is performed by DF54/Crew Systems. Reference OFTP #161, February 14, 1997.~~

A10.1.17-5 **FILLED CWC STOWAGE MANAGEMENT**

FILLED CONTINGENCY WATER CONTAINERS (CWC'S) THAT MUST BE RETURNED IN THE ORBITER WILL BE DISPOSED OF WITH THE FOLLOWING PRIORITY, TIME AND AVAILABILITY PERMITTING: ©[100997-6345A]

A. OVERBOARD NOZZLE DUMP

A filled CWC represents a considerable mass that must be properly restrained to insure structural loads will not be violated in an emergency landing. CWC's can be used to transfer water from the orbiter to Mir or ISS. Stowage of filled CWC's will be required if water transfer cannot be accomplished. For Mir water transfer, CWC's are normally filled to approximately 100 lbs. This weight is assumed below, unless otherwise stated. Reference SODB, Volume I, paragraph 3.4.1. To avoid the stowage and structural limits concern, it is most desirable to dump the water from the CWC's overboard and then stow the empty CWC's. Filled CWC's can also represent considerable mass stowed far forward of the orbiter CG. An overboard CWC dump prior to deorbit may relax propellant margins if ballasting would otherwise be increased. However, there must be adequate time to dump water from filled CWC's overboard prior to deorbit prep. Flight data from STS-60 shows that it takes approximately 1 hour to dump a single CWC (the rate is 1.56 lbm/min). Certain stowage locations can accept loads imposed by a filled CWC during landing and will be utilized if dump capability is not available. In cases where propellant margins are tight, stowage locations minimizing ballast requirements are preferred. ©[100997-6345A]

THIS RULE CONTINUED ON NEXT PAGE

FLIGHT RULES

A10.1.17-5 FILLED CWC STOWAGE MANAGEMENT (CONTINUED)

B. STOWAGE IN THE FOLLOWING STRUCTURALLY CERTIFIED LOCATIONS
(SEE FLIGHT SPECIFIC RULES ANNEX FOR ADDITIONS): @[100997-6345A]

LOCATION	MAXIMUM WEIGHT (LBS)	ORBITER COORDINATES			MAX. VOL. (CU. FT.)	MAX. # CWC'S
		X _o	Y _o	Z _o		
SLEEP STATION LOWER BUNK.	350 [1]	461	31	325	N/A	3
EXTERNAL AIRLOCK STOWAGE BAG [2]	206	649 (BAY2) 731 (BAY3)	0	333	9.7	2
MIDDECK STOWAGE BAG [3]	206	545	±24 (STBD/PORT)	333 (FLOOR LOWER) 382 (CEILING UPPER)	9.7	2
INTERNAL AIRLOCK CEILING BAG	212	545	0	385	7	2
INTERNAL AIRLOCK KIT FLOOR BAG	190	545	0	333	7.33	2 [4]
VOLUME F	240	491	33	315	8	2
LiOH BOX WET TRASH [7]	250	492	0	311	6.7	2
VOLUME H	95	525	-42	317	3.33	1
VOLUME G [8]	95	525	42	317	3.33	1
MIDDECK RETENTION NET (ON THE FLOOR)	[5]	438	48	325	N/A	1
SEAT 6 STOWAGE BAG	204	492	-12	325	N/A	2 [6]
SEAT 7 STOWAGE BAG	204	492	12	325	N/A	2 [6]

@[100997-6345A] [@\[072398-66211\]](#)

Reference SODB, Volume I, paragraph 3.4.1. These locations would be available (provided soft stowage can be removed and stowed in alternate locations).

- [1] STOWAGE MAY BE PLACED ON BOTTOM BUNK (FLOOR LEVEL) ONLY, EVENLY DISTRIBUTED ALONG THE FLOOR INSIDE THE BUNK, STARTING AT THE FORWARD WIRE TRAY CLOSE-OUT PANEL. A SLEEPING BAG OR GRAY TAPE WILL BE PLACED OVER THE CWC FOR RESTRAINT.
- [2] 206 LBS IS MAX WEIGHT OF EXTERNAL AIRLOCK BAG. EXT A/L IS LIMITED TO 990 LBS MINUS THE WEIGHT OF EMU'S (TWO @ 330 LBS EACH). 649 IN. IS X-CG FOR BAY 2 EXTERNAL AIRLOCK LOCATION. 731 IS X-CG FOR BAY 3 EXTERNAL AIRLOCK LOCATION (FORWARD TUNNEL ADAPTER).
- [3] THE LIMITS ARE VALID FOR THE SMALL AND LARGE VERSIONS OF THE MIDDECK ~~STOWAGE BAG~~. [@\[072398-66211\]](#)
- [4] 95 LBS EACH.
- [5] ACTUAL STOWAGE IS A FUNCTION OF AV BAY 2 STOWAGE AND LOCKER WEIGHT. REFERENCE PARAGRAPH 3.4.1.1.10 OF THE SODB FOR THE APPROPRIATE COMPUTATION OF ALLOWABLE WEIGHT.
- [6] CWC'S STANDING ON END, SIDE-BY-SIDE
- [7] AVAILABLE ONLY ON OV-102 WITH RCRS
- [8] LOCKER REMOVAL REQUIRED TO ALLOW ACCESS TO VOLUME G. @[100997-6345A]

NASA - JOHNSON SPACE CENTER

FLIGHT RULES

THIS RULE CONTINUED ON NEXT PAGE

FLIGHT RULES

A10.1.17-5 FILLED CWC STOWAGE MANAGEMENT (CONTINUED)

C. DUMP INTO WCS.

This option would only apply if the nozzle dump were unavailable, no certified stowage was available, and adequate time existed. There is only limited ullage in the waste tank, and it is time consuming for the crew to do this. @[100997-6345A]

D. STOWED AND RESTRAINED IN THE FOLLOWING UNCERTIFIED LOCATIONS:

<u>LOCATION</u>	<u>MAXIMUM WEIGHT (LBS.)</u>	<u>ORBITER COORDINATES</u>			<u>MAX. # CWC'S</u>
		<u>X₀</u>	<u>Y₀</u>	<u>Z₀</u>	
<u>EXTERNAL AIRLOCK FLOOR</u>	<u>300 (MINUS WEIGHT OF OTHER FLOOR STOWAGE)</u>	<u>649 (BAY 2)</u> <u>731 (BAY 3)</u>	<u>0</u>	<u>333</u>	<u>2</u>
<u>FORWARD TUNNEL ADAPTER FLOOR</u>	<u>TBD</u>	<u>582</u>	<u>0</u>	<u>333</u>	<u>2</u>
<u>INTERNAL AIRLOCK FLOOR</u>	<u>225 WITH 4 EMU'S INSTALLED</u>	<u>545</u>	<u>0</u>	<u>333</u>	<u>2</u>

@[100997-6345A]

These locations have not been certified, due to possible inability to fully restrain CWC's. These locations should only be used when necessitated by lack of certified stowage and the time criticality of entry. The priority reflects the desire to remove the CWC's as far as possible from the cabin, due to the possibility of hatch penetration by the CWC as a projectile during hard landing. Leakage or failure of a CWC carries the risk of damaging electronic equipment stowed in these locations. All stowage in these locations should be restrained on the floor in such a manner that it does not interfere with, or damage existing, certified equipment stowed nearby during landing settling. Gray tape and bungies are suggested (although uncertified) methods of restraint. _

@[100997-6345A]

FLIGHT RULES

ANDROGYNOUS PERIPHERAL DOCKING SYSTEM (APDS) SYSTEMS MANAGEMENT

A10.1.18-1 APDS CONFIGURATION

A. THE DOCKING RING MUST BE AT THE INITIAL POSITION AND THE RING ALIGNED BEFORE ATTEMPTING TO DOCK. @021199-6816]

With the ring aligned at the initial position, each ballscrew/nut assembly has its maximum stroke available to react to and attenuate the docking loads. If the ring is not aligned, or if it is extended beyond or below the initial position, the available stroke decreases, thus decreasing attenuation capability. This would also increase the probability of bottoming out the mechanism, which could result in excessive loads and damage to the mechanism or the vehicles. In addition, if the ring is not aligned, the probability of achieving capture is reduced, since the mechanism must then overcome misalignments in the ring as well as piloting misalignments in order to engage all three capture latches.

B. THE INNER HATCH WILL BE CLOSED AND LATCHED PRIOR TO ANY ATTEMPT TO DOCK WITH ISS. IF AN IFM IS REQUIRED TO COMPLETE DOCKING, THE IFM WILL BE SET UP PRIOR TO THE DOCKING ATTEMPT. THE INNER HATCH WILL BE OPENED AFTER CAPTURE IS OBTAINED TO DRIVE THE APPROPRIATE APDS MOTOR TO COMPLETE THE SEQUENCE.

Closing the inner hatch isolates the crew cabin from the ODS volume should the APDS hatch or ODS structure be breached during a docking attempt.

C. THE DOCKING RING WILL NOMINALLY BE RETRACTED TO ITS FINAL POSITION PRIOR TO CLOSING THE PLBD'S. IF THE RING CANNOT BE RETRACTED, THE SYSTEM IS STILL IN A SAFE CONFIGURATION FOR ENTRY.

The active docking ring will nominally be retracted during the docking sequence and will not be re-extended. If the docking sequence is not completed, the ring should be retracted before attempting to close the payload bay doors. Analysis has not been done to show that damage to the ring or ballscrew mechanism will not occur if the ring is extended during entry. However, the ring does not interfere with the payload bay door envelope even at its fully extended position. If the capability does not exist to retract the ring, there are no safety concerns with the ring being extended during entry. Reference Rockwell-Downey Internal Letter ODS-36.11-94-142. @021199-6816]

FLIGHT RULES

FLIGHT RULES**A10.1.18-2 APDS PRESSURE/TEMPERATURE**

A. THE DMCU, DSCU, LACU, PACU, AND PSU AVIONICS BOXES WILL NOT BE OPERATED IF THE EXTERNAL AIRLOCK PRESSURE IS LESS THAN 8.0 PSIA. @021199-6816]

To ensure adequate heat dissipation, the atmospheric pressure within the DMCU, DSCU, LACU, and PACU avionics boxes (which is represented by the external airlock pressure) must be greater than 8.0 psia. If the airlock pressure falls below 8.0 psia and is subsequently repressurized to > 8.0 psia, operation of these boxes is acceptable (assuming paragraph D of this rule has not been violated). Reference APDS Multi-Mir Critical Design Review, February 1995.

B. THE PFCU IS DESIGNED AS A ONE-TIME USE BOX AND MAY BE OPERATED IN A VACUUM IF REQUIRED.

There are no relays within the PFCU that are continuously energized as in the other boxes. Since it takes less than a second to activate the necessary relays to fire the hook 6, there is no issue with overheating and premature failure of the components due to lack of atmosphere in the box. In addition, the PFCU is designed to be used only once. This is due to the degradation of the fusistors as they are heated by the current flow and the probability of the KQ relay contacts welding closed. Reference APDS Multi-Mir Critical Design Review Protocol, February 23, 1995.

C. THE DCU'S ARE SEALED BOXES AND MAY BE OPERATED AS REQUIRED IN A VACUUM.

There are no heat rejection concerns with the DCU's because the DCU's do not use the same heat-generation relays that the other boxes have. Since these boxes are also hermetically sealed, there is no constraint to operation in a vacuum.

D. THE DMCU, DSCU, LACU, PACU, AND PFCU AVIONICS BOXES HAVE A MAXIMUM CUMULATIVE NON-OPERATING VACUUM EXPOSURE LIMIT OF 200 HOURS.

The DMCU, DSCU, LACU, PACU and PFCU avionics boxes are not sealed; therefore, exposing these boxes to a vacuum will expose the internal electronics to a vacuum. Due to concerns about the effect of vacuum exposure on the electronics, these boxes have a maximum cumulative nonoperation vacuum exposure limit of 200 hours. Reference: Procurement Specification for the Androgynous Peripheral Docking System for the ISS Missions (JSC-26938, Rev C). @021199-6816]

THIS RULE CONTINUED ON NEXT PAGE

FLIGHT RULES

A10.1.18-2 APDS PRESSURE/TEMPERATURE (CONTINUED)

E. DOCKING SYSTEM TEMPERATURES, AS INDICATED BY THE DOCKING BASE, CAPTURE LATCH, BALL DRIVE, RING DRIVE, AND HOOK DRIVE TEMPERATURES, MUST BE MAINTAINED WITHIN THE LIMITS LISTED BELOW. ORBITER ATTITUDE WILL BE MANAGED, OR THE DOCKING RING EXTENDED OR RETRACTED, TO MAINTAIN THESE LIMITS. @J021199-6816]

<u>MISSION PHASE</u>	<u>LIMITS</u>
<u>DOCKING</u>	<u>-22°F/-30°C (-13°F/-25°C) < T < 122°F/50°C (113°F/45°C)</u>
<u>RING EXTENSION RING RETRACTION UNDOCKING</u>	<u>-58°F/-50°C (-49°F/-45°C) < T < 122°F/50°C (113°F/45°C)</u>
<u>NON-OPERATING</u>	<u>-85°F/-65°C (-76°F/-60°C) < T < 185°F/85°C (176°F/80°C)</u>

A 9-degree F margin was used to protect worst case component temperatures. Reference: Procurement Specification for the Androgynous Peripheral Docking System for the ISS Missions (JSC-26938, Rev C).

F. THE DMCU, DSCU, LACU, PACU, AND PSU AVIONICS BOXES WILL NOT REMAIN POWERED ON FOR LONGER THAN 2 HOURS. THE AVIONICS MUST THEN BE POWERED OFF FOR A MINIMUM OF 30 MINUTES PRIOR TO THE NEXT POWERUP.

To avoid excessive heat buildup, the docking system avionics boxes have a maximum power on time constraint of 2 hours. Following powerup, the boxes must be powered down for a minimum of 30 minutes to allow for adequate heat dissipation.

G. THE DCU BOXES DO NOT HAVE A POWERON TIME CONSTRAINT.

The electronics within the data collection units have negligible heat buildup characteristics even though the box is sealed. Therefore, the DCU's are capable of remaining powered indefinitely. Reference APDS Multi-Mir Critical Design Review, February 23, 1995.

H. THE DAMPERS WILL NOT REMAIN POWERED ON FOR MORE THAN 5 MINUTES OF CONTINUOUS OPERATION.

RSC-Energia has constrained damper operation to a maximum of 5 minutes in order to preclude excessive heat buildup and potential hardware degradation. Note that once the dampers are powered off, they cannot be re-enabled during the same docking attempt. Reference Technical Interface Meeting, June 1998. @J021199-6816]

FLIGHT RULES

A10.1.18-3 APDS MECHANISM END OF TRAVEL INDICATIONS

A. THE ACTIVE DOCKING RING WILL BE CONSIDERED TO HAVE ATTAINED ITS COMMANDED POSITION, FINAL/INITIAL/FORWARD, IF AT LEAST ONE OF THE FOLLOWING INDICATIONS OCCURS WITHIN SINGLE-MOTOR DRIVE TIME: @[021199-6816]

1. THE ASSOCIATED APDS CONTROL PANEL STATUS LIGHT OR THE ASSOCIATED DISCRETE TELEMETRY DATA INDICATES FINAL/INITIAL/FORWARD.
2. THE ASSOCIATED ANALOG POTENTIOMETER MEASUREMENT IS AT 5 PERCENT (± 3 PERCENT) FOR FINAL POSITION, 76 PERCENT (± 3 PERCENT) FOR INITIAL POSITION, OR 98 PERCENT (± 2 PERCENT) FOR FORWARD POSITION.

Redundant indications are provided for the ring drive mechanisms for the final/initial/forward and analog position indications. During ring operations, if any of the proper end-of-travel indications are obtained within the single-motor drive envelope, the ring will be considered to be in the desired position. This is based on the low probability of a sensor failing within the time that the indication was expected, thereby giving a false verification of position. Reference January 1998, APDS ISS Brassboard Functional Testing.

B. THE ACTIVE DOCKING RING WILL BE CONSIDERED PROPERLY ALIGNED IF AT LEAST ONE OF THE FOLLOWING INDICATIONS IS OBTAINED:

1. THE ASSOCIATED APDS CONTROL PANEL STATUS LIGHT OR DISCRETE TELEMETRY DATA INDICATES RING ALIGNED.
2. THE ASSOCIATED ANALOG POTENTIOMETER MEASUREMENTS ON THE RING ARE AT 50 PERCENT (± 1 PERCENT) AND THOSE ON THE BASE ARE WITHIN 1 PERCENT OF EACH OTHER.

The docking ring is aligned when all six ballscrews are extended the same length. For the ring to be aligned in pitch, roll, and z, the base potentiometer measurements should be within 1 percent of each other. Alignment in the yaw, x, and y axes is confirmed by the ring potentiometer measurements being centered at 50 percent ± 1 percent.

C. THE CAPTURE LATCHES WILL BE CONSIDERED OPEN IF AT LEAST ONE OF THE FOLLOWING INDICATIONS CAN BE VERIFIED:

1. THE ASSOCIATED APDS CONTROL PANEL STATUS LIGHT OR THE ASSOCIATED DISCRETE TELEMETRY DATA INDICATES OPEN WITHIN THE MOTOR DRIVE TIME. @[021199-6816]

FLIGHT RULES

THIS RULE CONTINUED ON NEXT PAGE

10.1.18-3 APDS MECHANISM END OF TRAVEL INDICATIONS
(CONTINUED)

2. THE LATCHES CAN BE VERIFIED OPEN AS INDICATED BY A FULLY RETRACTED RING POST-HARD-DOCK. @J021199-6816I

The capture latches indicate open when all three latches are open (i.e., the redundant contacts of each sensor are wired in series). During latch operations, if the open indications are obtained within the expected drive time of 3-4 seconds, the latches will be considered to be in the desired position. This is based on the low probability of a sensor failing within the time that the indication was expected, thereby giving a false verification of position. Also, if the ring can be retracted to the final position as indicated by ring position or verified visually, all three latches are known to be open.

- D. THE CAPTURE LATCHES WILL BE CONSIDERED CLOSED IF THE ASSOCIATED APDS CONTROL PANEL STATUS LIGHT OR THE ASSOCIATED DISCRETE TELEMETRY DATA INDICATES CLOSED WITHIN THE MOTOR DRIVE TIME.

The capture latches indicate closed when all three latches are closed (i.e., the redundant contacts of each sensor are wired in series). During latch operations, if the closed indications are obtained within the expected drive time of 3-4 seconds, the latches will be considered to be in the desired position. This is based on the low probability of a sensor failing within the time that the indication was expected, thereby giving a false verification of position. Also, if the ring cannot be retracted to the final position post-hard-dock, at least one capture latch should be considered closed.

- E. EACH GANG OF APDS HOOKS WILL BE CONSIDERED OPEN/CLOSED IF AT LEAST ONE OF THE FOLLOWING INDICATIONS OCCURS WITHIN SINGLE-MOTOR DRIVE TIME:

1. THE ASSOCIATED APDS CONTROL PANEL STATUS LIGHT OR THE ASSOCIATED DISCRETE TELEMETRY DATA INDICATES OPEN/CLOSED.
2. THE ASSOCIATED ANALOG POTENTIOMETER MEASUREMENT IS AT 5 PERCENT (± 3 PERCENT) FOR HOOKS OPEN OR 92 PERCENT (± 3 PERCENT) FOR HOOKS CLOSED.

FLIGHT RULES

Redundant indications are provided for the hook drive mechanisms for the open/close and analog position indications. During hook operations, if any of the end-of-travel indications are obtained within the single-motor drive envelope, the hooks will be considered to be in the desired position. This is based on the low probability of a sensor failing within the time that the indication was expected, thereby giving a false verification of position. In addition to the indications above, the APDS hooks have close microswitches on each of the individual hooks (except for hooks 6 and 7, which are driven directly by the hook power drive units). These sensors indicate the individual hooks are closed when the hook potentiometer indicates approximately 80 percent. The PMA 2/3 hooks have close microswitches similar to the PMA-1 hooks; however, the PMA 2/3 sensors are wired in series, in groups of three. @J021199-6816.]

THIS RULE CONTINUED ON NEXT PAGE

A10.1.18-4 APDS DOCKING SEQUENCE OPERATIONS

A. IF ANY APDS CONTROL PANEL STATUS LIGHT INADVERTENTLY ACTIVATES OR FAILS TO ACTIVATE: @J021199-6816.]

- 1. PRIOR TO DOCKING, IF THE FAILURE IS DETERMINED TO BE IN A SINGLE SENSOR CONTACT, DOCKING MAY PROCEED AS PLANNED. IF MULTIPLE FAILURES EXIST, DOCKING WILL BE DELAYED AS REQUIRED TO ALLOW TROUBLESHOOTING.**
- 2. DURING DOCKING, THE APDS DOCKING SEQUENCE WILL BE STOPPED VIA A POWER CYCLE. IF THE FAILURE IS DETERMINED TO BE IN A SINGLE SENSOR CONTACT, DOCKING MAY BE COMPLETED. IF MULTIPLE FAILURES EXIST, COMPLETION OF THE DOCKING SEQUENCE WILL BE DELAYED AS REQUIRED TO ALLOW TROUBLESHOOTING.**

The design philosophy within the APDS avionics utilizes three separate electrical paths; two of the three are required to activate any particular function. For feedback from sensors external to the avionics boxes, the three paths are typically combined into two paths to the sensors, with the APDS A logic bus feeding both paths (i.e., A and B paths completed through one sensor contact, A and C through the other). In this way, with any two busses powered, the system can complete its function. Conversely, however, if any one contact or associated wiring shorts to ground or fails closed, two of the three paths associated with that sensor will be activated, possibly disrupting the system operation. This is the basis for all of the avionics single-point failures.

FLIGHT RULES

Due to the avionics design, workarounds are available to bypass any single contact failure (e.g., by removing one source of power to the contact). Removing one power source also provides a means of determining if a single-point failure exists, or if multiple failures have caused the erroneous indication. Since the single failure scenarios are already accounted for in the docking sequence cue cards, if there is a contact short, the docking may proceed using the appropriate workarounds. If multiple failures exist, further troubleshooting must be done to determine the source of the failures and any possible workarounds. ©[021199-6816]

THIS RULE CONTINUED ON NEXT PAGE

FLIGHT RULES

A10.1.18-4 APDS DOCKING SEQUENCE OPERATIONS (CONTINUED)

B. POST-CONTACT, ALL RELATIVE MOTION BETWEEN THE ORBITER AND ISS MATED STACK WILL BE ALLOWED TO DAMP OUT PRIOR TO DRIVING THE ACTIVE DOCKING RING. WHEN THE RELATIVE MOTION HAS STOPPED, THE DOCKING SEQUENCE WILL BE RESTARTED. @021199-6816]

1. IF THE RING IS NOT ALIGNED AFTER ALL RELATIVE MOTION HAS STOPPED, THE APDS SEQUENCE WILL BE RESTARTED BY EXTENDING THE RING TO THE FORWARD POSITION IN ORDER TO FORCE ALIGNMENT.
2. IF THE RING IS ALIGNED, THE APDS SEQUENCE CAN BE RESTARTED BY EITHER EXTENDING THE RING TO THE FORWARD POSITION OR BY RETRACTING THE RING.

The APDS high and low energy dampers are automatically energized 5 seconds after contact. Preflight analysis has shown that the docking system dynamics will be over-damped, and therefore, the ring will likely not align itself after all relative motion has stopped. Consequently, before the ring can be retracted with fixers engaged, it must first be driven to the Forward position (against its hard stops) to force alignment. The dampers remain energized during this extension operation, in order to prevent excessive motion of the ring (caused by perturbations of the system induced during the ring extension). However, if the ring is aligned at the Initial position after motion is damped, the docking sequence can be restarted with a Ring In command. The ring can also be extended to Forward, and then retracted, in order to keep crew procedures consistent with nominal operations. However, ring extension is not required if ring alignment is achieved at the ring Initial position. MCC-H is usually prime for determining when relative motion has damped completely, and when the ring has been aligned sufficiently to allow ring extension/retraction. However, in a loss of communications scenario, the crew has sufficient indications/verifications in order to continue the docking sequence without ground concurrence.

C. THE DOCKING SEQUENCE CAN BE PAUSED OR STOPPED AT ANY TIME AFTER CAPTURE, IN ORDER TO TROUBLESHOOT ERRONEOUS APDS OPERATION OR TO PERFORM A BACKAWAY.

Five seconds after capture, the high energy and low energy electromagnetic dampers are activated to null the relative motion between the vehicles. These dampers remain active until the crew performs a PWR ON reset or a power cycle of the avionics. If a backaway needs to be performed, the successful completion of damping becomes irrelevant, and the sequence may be stopped as required. @021199-6816]

FLIGHT RULES

THIS RULE CONTINUED ON NEXT PAGE

FLIGHT RULES

A10.1.18-4 APDS DOCKING SEQUENCE OPERATIONS (CONTINUED)

D. IF RING EXTENSION TO THE FORWARD POSITION IS REQUIRED IN ORDER TO FORCE ALIGNMENT AND THE DAMPERS ARE DE-ENERGIZED, THE RING WILL BE PAUSED JUST PRIOR TO REACHING THE FORWARD POSITION. WHEN THE RELATIVE MOTION HAS STOPPED, THE RING DRIVE TO FORWARD WILL BE RESTARTED. @[021199-6816]

Nominally, the dampers remain energized during ring extension to the Forward position in order to prevent excessive motion of the ring (caused by perturbations of the system induced during the ring extension). By stopping the ring drive just prior to the Forward position and allowing all relative motion to damp out, excessive loads against the mechanism hard stops can be avoided. Loads against the hard stops will be minimized when the ring drive is restarted.

A10.1.18-5 APDS RECONFIGURATION AFTER FAILED DOCKING

A. IN THE EVENT OF A FAILED CAPTURE, THE DOCKING RING WILL BE EXTENDED TO THE FORWARD POSITION (IF REQUIRED TO REALIGN THE RING), FULLY RETRACTED, AND THEN RE-EXTENDED TO THE INITIAL POSITION PRIOR TO A SECOND DOCKING ATTEMPT. THE AVIONICS WILL ALSO BE REINITIALIZED BY MEANS OF A POWER CYCLE.

To ensure the APDS mechanism did not experience excessive loads during a failed capture that could damage mechanism components and to ensure all active dampers have disengaged, the ring will be extended with the fixers off to the forward position (in order to force alignment), then retracted and re-extended. This allows a review of the drive system characteristics (drive time, currents) as an indicator of system health. The ring also needs to be realigned to be in the proper position for the next docking attempt. The avionics will also be reinitialized to ensure that its logic is in the proper state for another docking attempt.

B. AFTER AN UNSUCCESSFUL DOCKING ATTEMPT DURING WHICH THE APDS ACTIVE DAMPING WAS COMMANDED ON, A SECOND DOCKING ATTEMPT WILL NOT BE ATTEMPTED UNTIL THE DAMPING MECHANISM IS CONFIRMED TO BE DISENGAGED.

During 6 degree-of-freedom docking loads testing in Moscow, an instance occurred during which the damping mechanism did not disengage after the damping commands were removed. During the next test, loads in excess of the acceptable docking loads were noted. Upon investigation of the high loads, it was determined that the damping mechanisms clutch had not disengaged. Therefore, to ensure that a similar problem does not occur during the Shuttle/ISS docking missions, a second docking attempt, following an attempt that failed after the dampers were commanded ON, should not be performed until the dampers can positively be verified disengaged. @[021199-6816]

FLIGHT RULES

A10.1.18-6 APDS REDUNDANCY REQUIREMENTS

IN SUPPORT OF ALL FLIGHTS RULE {A2.1.3-3}, SYSTEMS REDUNDANCY REQUIREMENTS, EXTRAVEHICULAR ACTIVITY (EVA) WILL BE CONSIDERED AS A LEVEL OF REDUNDANCY IN ORDER TO ACCOMPLISH SHUTTLE/ISS UNDOCKING. EVA WILL BE USED AS THE THIRD METHOD TO ACHIEVE SEPARATION. @[021199-6816]

The shuttle docking system has two sets of six hooks; each set is opened and closed by dual-motor electro-mechanical actuators and a pulley/cable drive system. Additionally, there are independent pyro systems that can remotely release the active and/or passive hooks. The active hooks pyro system releases all 12 shuttle hooks, and the passive hooks system releases all 12 passive hooks. In the event that either hooks drive system fails, and discharging either or both pyro systems is unsuccessful, the 96-Bolt EVA will be executed in order to separate the shuttle. @[021199-6816]

FLIGHT RULES

MMACS GO/NO-GO

A10.1.198-1 MMACS GO/NO-GO CRITERIA @ [021199-6816]

SYSTEMS/COMPONENTS/FUNCTIONS	CONTINUE NOMINAL ASCENT IF:	INVOKE MDF IF:	ENTER NEXT PLS IF:
A. APU/HYD:	2↓ [2]		1↓ [10] [11]
B. WSB:.....[1]			1↓ [10] [11]
C. LANDING GEAR:.....			
1. HYD OR PYRO DEPLOYMENT SYSTEMS.....[3]			2↓
2. DIRECTIONAL CONTROL (BRAKES, NWS).....			ZERO FAULT TOLERANT
3. TIRES (LEAKING/FLAT)			[13]
D. MECHANICAL SYSTEMS:.....			
1. PLBD DRIVE MOTORS (2/DOOR).....		1 CLS ↓	2↓ [8]
2. PLBD LCH DRIVE MOTORS (2/GANG).....			2↓ [6]
3. RAD DEPLOYMENT SYSTEMS[5]			
4. VENT DOOR DRIVE SYSTEMS			
5. ET UMB DOOR CLOSURE[4]	[14]		
6. KU-BAND ANT STOW MECHANISM.....[9]			
7. WINDOWS.....			
PRESSURE (OR REDUNDANT) PANE.....			1↓
THERMAL PANE (FORWARD OR SIDE HATCH)	[12]		
THERMAL PANE (OVERHEAD)			

@ [041097-4611B]

LEGEND:

 NO REQUIREMENT

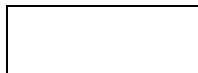
 REQUIRED

[] NOTE REFERENCE

The table above gives the action taken for specific MMACS hardware losses. The decision to invoke MDF or to enter next PLS is based on redundancy and safety requirements. Refer to the MMACS systems loss/failure definitions for what constitutes a “down” system.

FLIGHT RULES

THIS RULE CONTINUED ON NEXT PAGE

FLIGHT RULES

A10.1.198-1 MMACS GO/NO-GO CRITERIA (CONTINUED)

NOTES:

- [1] LOSS OF A WSB COULD RESULT IN EVENTUAL LOSS OF ITS ASSOCIATED APU AND HYDRAULIC SYSTEM.
- [2] IF TWO APU'S ARE SHUT DOWN DURING ASCENT, AND THE THIRD APU/HYDRAULIC/WSB SYSTEM PERFORMANCE IS NOMINAL, THE THIRD ONE WILL BE SHUT DOWN AND LATER RESTARTED TO SUPPORT A DAY 1 PLS. THE THIRD APU/HYDRAULIC/WSB WILL NOT BE SHUT DOWN FOR AN AOA, TAL, OR RTLS ABORT. IF THE THIRD APU/HYDRAULIC/WSB SYSTEMS ARE NOT NOMINAL, IT WILL BE SHUT DOWN AND RESTARTED AS REQUIRED TO SUPPORT ANY ABORT OR ENTRY.
- [3] HYDRAULIC SYSTEM 1 PLUS 2 PYROS.
- [4] MUST BE CLOSED PRIOR TO ENTRY.
- [5] FAILURE TO DEPLOY ONE RADIATOR PANEL WILL RESULT IN A 20 TO 30 PERCENT LOSS OF HEAT REJECTION IN THAT FCL/RAD. ORBIT LIFETIME WILL BE DEPENDENT ON ORBITER THERMAL HEAT REJECTION REQUIREMENTS.
- [6] NEXT PLS IF IN SEPARATE LATCH GANGS AND NEXT FAILURE RESULTS IN MULTIPLE LATCH GANG FAILURES, OR IN SAME LATCH GANG AND CANNOT BE VISUALLY VERIFIED CLEAR OF ROLLERS. NOMINAL EOM IF IN SAME LATCH GANG AND CAN BE VISUALLY VERIFIED CLEAR OF ROLLERS.
- [7] RESERVED.
- [8] SAME DOOR. IF DOOR OPEN AND OPEN CAPABILITY LOST, INVOKE MDF. ENTRY IS REQUIRED AT NEXT PLS AFTER EVA TO CLOSE DOORS IS COMPLETED.
- [9] KU-BAND ANTENNA WILL BE STOWED FOR LOSS OF REDUNDANT STOW CAPABILITY.
- [10] ENTER NEXT PLS IF ONE APU/HYD/WSB FAILED AND THE NEXT FAILURE RESULTS IN A SINGLE APU ENTRY.
- [11] ENTER NEXT PLS AFTER EXPEDITED PAYLOAD DEPLOY, IF APPLICABLE.
- [12] IF PIECES ARE NOTED MISSING PRIOR TO THE RTLS BOUNDARY, AN RTLS ABORT WILL BE PERFORMED. OTHERWISE, CONTINUE NEOM.
- [13] ENTER NEXT PLS IF TIRE PRESSURE WILL BE \leq 260 PSIG (275 PSIA) AT NEXT PLS LANDING OPPORTUNITY PLUS 2 DAYS.
- [14] IF CAPABILITY TO CLOSE ET DOORS IS LOST PRIOR TO RTLS BOUNDARY, PERFORM AN RTLS. @[041097-4611B]

FLIGHT RULES

VIEWPORT SYSTEMS MANAGEMENT

A10.6.1-1 VIEWPORT (VP)

- A. WHEN THE VP IS NOT IN USE, THE OUTER COVER WILL REMAIN CLOSED. @[051194-1637]

Limiting VP use to experiment operations and earth/space observations minimizes the risk of mechanism damage (from landing loads) should the outer cover fail in the OPEN position. The outer cover provides mechanical and thermal protection when it is closed; however, it does not provide a redundant pressure seal.

- B. THE VP OUTER COVER MUST BE CLOSED WITHIN 35 MINUTES OF VP WINDOW EXPOSURE TO THE SUN IN FIELD OF VIEW (FOV) OR 2 HOURS OF VP WINDOW EXPOSURE TO DEEP SPACE (VP HEATER ACTIVATED AND FUNCTIONAL).

The sun exposure constraint precludes the VP internal surfaces from exceeding the maximum allowable touch temperature of 45 deg C (113 deg F). The deep space constraint precludes the formation of condensation on the actuator mechanism and VP glass (a free fluid, ice formation, and hardware degradation concern), and ensures VP seal integrity. The VP lower thermal qualification limit is -10 deg C (1 deg F).

The sun is in FOV of the VP whenever it is within a 60 deg half-cone angle about the VP normal vector. The VP is exposed to deep space whenever the sun and the entire earth are outside an 80 deg half-cone angle about the VP normal vector. (The VP normal vector is in the orbiter -Z body axis.)

Reference: JSC-16744, Spacelab Operational Data Book (SLODB) 3.5.1, Constraints/Contingency Operations; TR-OK-0008, Thermal Vacuum Test Results: Viewport; TN-ER-36-061-77, VP/Viewport Adapter Assembly (VAA) Thermal Analysis, 5/30/78; and MDC-93-W-5652, 5/93. @[051194-1637]

THIS RULE CONTINUED ON NEXT PAGE

FLIGHT RULES

A10.6.1-1 VIEWPORT (VP) (CONTINUED)

- C. THE INNER SAFETY COVER SHOULD REMAIN INSTALLED ON THE VP AT ALL TIMES, UNLESS ITS REMOVAL IS REQUIRED FOR PAYLOAD ACCOMMODATIONS. THE INNER SAFETY COVER MUST BE INSTALLED PRIOR TO MODULE EGRESS. (INSTALLATION IS REQUIRED WHEN EGRESSING FOR MODULE DEACTIVATION OR EVA PREPARATIONS; INSTALLATION IS NOT REQUIRED WHEN EGRESSING FOR EMERGENCY DEACTIVATION.) AN INNER SCREEN OTHER THAN THE INNER SAFETY COVER WILL NOT BE INSTALLED ON THE VP. ©[051194-1637]

The VP glass assembly contains three laminated panes of Triplex "10-20" glass (26mm total thickness). Because these panes are laminated, the assembly cannot be considered fail-safe. However, the inner safety cover (a safety pane of polycarbonate plastic) provides a structural seal over the VP aperture that allows sufficient time to complete a contingency Spacehab deactivation/evacuation of the module in the event of a total glass failure. (A small port in the inner safety cover allows for venting/air circulation/pressure equalization between both sides of the cover.) The inner safety cover also protects the VP glass against impact from inside the module. However, safe return of the crew is not compromised if the inner safety cover is not installed for a Spacehab emergency deactivation. To preclude the scenario where an EVA is required during the mission, and subsequent module ingress is not possible, the inner safety cover must be installed to properly restrain it for entry. An installed inner screen (other than the inner safety cover) can cause a potential "greenhouse" effect from solar radiation whenever the outer cover is open, or from a failed on VP heater whenever the outer cover is closed. Either case can cause VP glass degradation. The inner safety cover provides similar optical qualities (transmissivity) as the VP glass assembly.

Reference: TN-ER-36-061-77, VP/Viewport Adapter Assembly (VAA) Thermal Analysis, 5/30/78.

- D. THE VP HEATER MUST BE ACTIVATED WHENEVER THE VP WINDOW IS EXPOSED TO DEEP SPACE, OR AT ANY TIME CONDENSATION FORMS ON THE VP GLASS OR ACTUATOR MECHANISM. THE VP HEATER MAY REMAIN POWERED FOR NO LONGER THAN 20 MINUTES WHEN THE SUN IS IN FOV OF THE VP GLASS.

The VP heater is only required when the VP window is exposed to deep space to prevent condensation from forming on the VP glass and/or to extend the time until condensation forms on the VP actuator. The seals will remain above the lower thermal qualification limit of -10 deg C (14 deg F) if the deep space exposure time limits are not exceeded, and/or the heater is active. The VP inner surface may exceed the maximum allowable touch temperature of 45 deg C (113 deg F) if the heater is activated with the outer cover closed, if the VP glass is not exposed to deep space, or if the VP heater is powered for more than 20 minutes with the sun in FOV of the VP glass.

Reference: TR-OK-0008, Thermal Vacuum Test Results: Viewport; and MDC-93-W-5652, 5/93.
©[051194-1637]

NASA - JOHNSON SPACE CENTER

FLIGHT RULES

THIS RULE CONTINUED ON NEXT PAGE

FLIGHT RULES

A10.6.1-1 VIEWPORT (VP) (CONTINUED)

E. ORBITER ATTITUDE ADJUSTMENTS MAY BE MADE TO MAINTAIN THE VP TEMPERATURE WITHIN OPERATIONAL LIMITS IF HIGH PRIORITY MISSION OBJECTIVES ARE NOT JEOPARDIZED. @[051194-1637]

If required to work around an outer cover and/or heater failure, adjusting the attitude timeline is an acceptable option for maintaining the VP temperature within operational limits as long as high priority mission objectives are not significantly affected. The VP lower thermal qualification limit is -10 deg C (14 deg F); the upper limit is 60 deg C (140 deg F).

F. ON-ORBIT VP ATTITUDE TIMELINE MANAGEMENT TO ENSURE COMPLIANCE WITH VP OPERATIONAL FLIGHT RULES/TEMPERATURE LIMITS IS THE RESPONSIBILITY OF MISSION CONTROL CENTER-HOUSTON (MCC-H).

Due to the dynamic nature of orbiter flight attitude timeline changes, MCC-H management of on-orbit VP operations will be required to ensure VP FOV constraints and operational temperature limits are not exceeded.

A10.6.1-2 CRACKED VIEWPORT

FOR A CRACKED VP WINDOW, THE INNER SAFETY COVER WILL BE INSTALLED, AND THE OUTER COVER WILL BE CLOSED AND REMAIN CLOSED. SPACEHAB OPS WILL BE ALLOWED TO CONTINUE IF THE VP WINDOW CAN MAINTAIN PRESSURE INTEGRITY.

The VP glass assembly contains three laminated panes of Triplex "10-20" glass (26 mm total thickness), each of which is capable of maintaining pressure. However, the VP inner safety cover (a safety pane of polycarbonate plastic) provides a structural seal over the VP aperture that allows sufficient time to complete a contingency Spacehab deactivation/evacuation of the module in the event of a total glass failure (A small port in the inner safety cover allows for venting/air circulation/pressure equalization between both sides of the cover.) VP operations should be terminated in order to minimize thermal stresses on a cracked VP window. Installing the inner safety cover and closing the outer cover ensures containment of any loose glass debris. Installing the VP inner safety cover also ensures safe continuation of Spacehab operations by providing cabin pressure redundancy (as long as the VP window is maintaining pressure). @[051194-1637]

A10.6.1-3 VIEWPORT CONFIGURATION FOR CLOSED SPACEHAB HATCH

FOR SPACEHAB OPERATIONS WITH THE SPACEHAB HATCH (X = 660) CLOSED, THE VP OUTER COVER WILL BE CLOSED AND THE INNER SAFETY COVER WILL BE INSTALLED. @[051194-1637]

FLIGHT RULES

Failure conditions exist which would prevent re-entry into the module (e.g., after an EVA) to secure the viewport. If orbiter entry is performed with the external cover open, damage to the cover/viewport is likely to occur.

A10.6.1-4 LOSS OF VP PRESSURE INTEGRITY

FOR LOSS OF VP PRESSURE INTEGRITY, THE INNER SAFETY COVER WILL BE INSTALLED, AND THE OUTER COVER WILL BE CLOSED AND REMAIN CLOSED. SPACEHAB OPERATIONS WILL BE TERMINATED.

The VP inner safety cover provides a structural seal over the VP aperture that allows sufficient time to complete a contingency Spacehab deactivation/evacuation of the module when VP pressure integrity has been lost. (A small port in the inner safety cover allows for venting/air circulation/pressure equalization between both sides of the cover.)

A10.6.1-5 EVA REQUIREMENTS FOR FAILED VP OUTER COVER

AN EVA IS NOT REQUIRED TO STOW OR SECURE A FAILED OPEN VP OUTER COVER.

When open, the VP outer cover does not infringe upon the PLBD dynamic envelope. Although there is a potential for VP mechanism damage from landing loads, the risk of an EVA to stow the outer cover is not warranted. ©[051194-1637]

©[021998-6492]

FLIGHT RULES

VIEWPORT SYSTEMS MANAGEMENT

A10.9.3-1 VIEWPORT (VP)

MODULE

- A. WHEN THE VP IS NOT IN USE, THE OUTER COVER WILL REMAIN CLOSED. @[121593-1578A]

Limiting VP use to experiment operations and Earth/space observations minimizes the risk of mechanism damage (from landing loads) should the outer cover fail in the OPEN position. The outer cover provides mechanical and thermal protection when it is closed; however, it does not provide a redundant pressure seal.

- B. THE VP OUTER COVER MUST BE CLOSED WITHIN 35 MINUTES OF VP WINDOW EXPOSURE TO THE SUN IN FIELD OF VIEW (FOV) OR 2 HOURS OF VP WINDOW EXPOSURE TO DEEP SPACE (VP HEATER ACTIVATED AND FUNCTIONAL). THE VP OUTER COVER MUST BE CLOSED AT ALL TIMES WHEN THE VP IS EXPOSED TO DEEP SPACE IF THE VP HEATER IS DEACTIVATED/FAILED OFF.

The Sun exposure constraint precludes the VP internal surfaces from exceeding the maximum allowable touch temperature of 45 deg C (113 deg F). The deep space constraint (with and without a functional heater) precludes the formation of condensation on the actuator mechanism (a free fluid, ice formation, and hardware degradation concern) and ensures VP seal integrity. The VP lower thermal qualification limit is -10 deg C (14 deg F).

The Sun is in FOV of the VP whenever it is within a 60 deg half-cone angle about the VP normal vector. The VP is exposed to deep space whenever the Sun and the entire Earth are outside an 80 deg half-cone angle about the VP normal vector. (The aft-end cone VP normal vector is in the orbiter X-Z plane, located 60 degrees from the orbiter -Z-axis, and 30 degrees from the orbiter -X-axis. The top VP or viewport adapter assembly (VAA) normal vector is along the orbiter -Z-axis.)

Reference: JSC-16744, SLODB 3.5.1, Constraints/Contingency Operations; TR-OK-0008, Thermal Vacuum Test Results: Viewport; TN-ER-36-061-77, VP/Viewport Adapter Assembly (VAA) Thermal Analysis, 5/30/78; and MDC-93-W-5652, 5/93. @[121593-1578A]

THIS RULE CONTINUED ON NEXT PAGE

FLIGHT RULES**A10.9.3-1 VIEWPORT (VP) (CONTINUED)**

- C. THE INNER SAFETY COVER SHOULD REMAIN INSTALLED ON THE VP AT ALL TIMES, UNLESS ITS REMOVAL IS REQUIRED FOR PAYLOAD ACCOMMODATIONS. THE INNER SAFETY COVER MUST BE INSTALLED PRIOR TO MODULE EGRESS. (INSTALLATION IS REQUIRED WHEN EGRESSING FOR MODULE DEACTIVATION OR EVA PREPARATIONS; INSTALLATION IS NOT REQUIRED WHEN EGRESSING FOR EMERGENCY DEACTIVATION.) AN INNER SCREEN OTHER THAN THE INNER SAFETY COVER WILL NOT BE INSTALLED ON THE VP. @[121593-1578A]

The VP glass assembly contains three laminated panes of Triplex "10-20" glass (26 mm total thickness). Because these panes are laminated, the assembly cannot be considered fail-safe. However, the inner safety cover (a safety pane of polycarbonate plastic) provides a structural seal over the VP aperture that allows sufficient time to complete a contingency Spacelab deactivation/evacuation of the module in the event of a total glass failure. (A small port in the inner safety cover allows for venting/air circulation/pressure equalization between both sides of the cover.) The inner safety cover also protects the VP glass against impact from inside the module. However, safe return of the crew is not compromised if the inner safety cover is not installed for a Spacelab emergency deactivation. To preclude the scenario where an EVA is required during the mission, and subsequent module ingress is not possible, the inner safety cover must be installed to properly restrain it for entry. An installed inner screen (other than the inner safety cover) can cause a potential "greenhouse" effect from solar radiation whenever the outer cover is open or from a failed ON VP heater whenever the outer cover is closed. Either case can cause VP glass degradation. The inner safety cover provides similar optical qualities (transmissivity) as the VP glass assembly.

Reference: TN-ER-36-061-77, VP/Viewport Adapter Assembly (VAA) Thermal Analysis, 5/30/78.

- D. THE VP HEATER MUST BE ACTIVATED WHENEVER THE VP WINDOW IS EXPOSED TO DEEP SPACE, OR AT ANY TIME CONDENSATION FORMS ON THE VP GLASS OR ACTUATOR MECHANISM. THE VP HEATER MAY REMAIN POWERED FOR NO LONGER THAN 20 MINUTES WHEN THE SUN IS IN FOV OF THE VP GLASS.

The VP heater is only required when the VP window is exposed to deep space to prevent condensation from forming on the VP glass, and/or to extend the time until condensation forms on the VP actuator. The seals will remain above the lower thermal qualification limit of -10 deg C (14 deg F) if the deep space exposure time limits are not exceeded, and/or the heater is active. The VP inner surface may exceed the maximum allowable touch temperature of 45 deg C (113 deg F) if the heater is activated with the outer cover closed, if the VP glass is not exposed to deep space, or if the VP heater is powered for more than 20 minutes with the Sun in FOV of the VP glass.

Reference: TR-OK-0008, Thermal Vacuum Test Results: Viewport; and MDC-93-W-5652, 5/93.
@[121593-1578A]

FLIGHT RULES

THIS RULE CONTINUED ON NEXT PAGE

FLIGHT RULES

A10.9.3-1 VIEWPORT (VP) (CONTINUED)

E. ORBITER ATTITUDE ADJUSTMENTS MAY BE MADE TO MAINTAIN THE VP TEMPERATURE WITHIN OPERATIONAL LIMITS IF HIGH PRIORITY MISSION OBJECTIVES ARE NOT JEOPARDIZED. @[121593-1578A]

If required to work around an outer cover and/or heater failure, adjusting the attitude timeline is an acceptable option for maintaining the VP temperature within operational limits, as long as high priority mission objectives are not significantly affected. The VP lower thermal qualification limit is -10 deg C (14 deg F); the upper limit is 6 deg C (140 deg F). @[ED]

Reference: TN-ER-36-061-77, VP/Viewport Adapter Assembly (VAA) Thermal Analysis, 5/30/78.

F. ON-ORBIT VP ATTITUDE TIMELINE MANAGEMENT TO ENSURE COMPLIANCE WITH VP OPERATIONAL FLIGHT RULES/TEMPERATURE LIMITS IS THE RESPONSIBILITY OF MCC-H.

Due to the dynamic nature of orbiter flight attitude timeline changes, MCC-H management of on-orbit VP operations will be required to ensure that VP FOV constraints and operational temperature limits are not exceeded.

A10.9.3-2 CRACKED VIEWPORT (VP)

MODULE

FOR A CRACKED VP WINDOW, THE INNER SAFETY COVER WILL BE INSTALLED, AND THE OUTER COVER WILL BE CLOSED AND REMAIN CLOSED. SPACELAB OPS WILL BE ALLOWED TO CONTINUE IF THE VP WINDOW CAN MAINTAIN PRESSURE INTEGRITY. @[121593-1578A]

The VP glass assembly contains three laminated panes of Triplex "10-20" glass (26 mm total thickness), each of which is capable of maintaining pressure. However, the VP inner safety cover (a safety pane of polycarbonate plastic) provides a structural seal over the VP aperture that allows sufficient time to complete a contingency Spacelab deactivation/evacuation of the module in the event of a total glass failure. (A small port in the inner safety cover allows for venting/air circulation/pressure equalization between both sides of the cover.) VP operations should be terminated in order to minimize thermal stresses on a cracked VP window. Installing the VP inner safety cover, and closing the outer cover, ensures containment of any loose glass debris. Installing the VP inner safety cover also ensures safe continuation of Spacelab operations by providing cabin pressure redundancy (as long as the VP window is maintaining pressure integrity). @[121593-1578A]

FLIGHT RULES

A10.9.3-3 LOSS OF VIEWPORT (VP) PRESSURE INTEGRITY

MODULE

FOR LOSS OF VP PRESSURE INTEGRITY, THE INNER SAFETY COVER WILL BE INSTALLED, AND THE OUTER COVER WILL BE CLOSED AND REMAIN CLOSED. SPACELAB OPS WILL BE TERMINATED. @[121593-1578A]

The VP inner safety cover provides a structural seal over the VP aperture that allows sufficient time to complete a contingency Spacelab deactivation/evacuation of the module when VP pressure integrity has been lost. (A small port in the inner safety cover allows for venting/air circulation/pressure equalization between both sides of the cover.)

A10.9.3-4 VIEWPORT (VP) EXPERIMENT ACCOMMODATIONS

MODULE

A. EXPERIMENTS MOUNTED ON THE VP OR VAA WILL BE REMOVED AND STOWED PRIOR TO DEORBIT.

Experiments will be removed and stowed prior to deorbit to avoid exceeding the structural limitations of the VP/VAA. The VP flange can sustain entry/landing loads if an emergency deorbit is required.

Reference: Spacelab Payload Accommodations Handbook, SLP/2104-2, section 4.7.3.3.

B. EXPERIMENTS MOUNTED ON THE VP OR VAA SHOULD NOT EXCEED THE FOLLOWING MASSES:

1. VP/VAA - 25 KG (55 LB) (ATTACHED TO THE VP FLANGE)
2. VAA - 50 KG (110 LB) (ATTACHED TO THE VP ADAPTER PLATE)

The referenced masses ensure that the structural limitations of the VP are not exceeded when attached to the inner safety cover attach points (25 Kg) or VP adapter plate (50 Kg). The VP flange can sustain entry/landing loads if an emergency deorbit is required.

Reference: Spacelab Payload Accommodations Handbook, SLP/2104-2, section 4.7.3.3 and JSC-16744, SLODB 3.5.1, Constraints/Contingency Operations.

C. FOR EMERGENCY LANDING CONDITIONS, EXPERIMENTS MAY REMAIN INSTALLED ON THE VP UNLESS THERE IS TIME TO PERMIT A NOMINAL STOW.

Orbiter damage is not a concern if time does not permit experiment removal and stowage prior to deorbit.

FLIGHT RULES

D. EXCEPTIONS TO THIS RULE ARE DOCUMENTED IN THE FLIGHT SPECIFIC ANNEX. @[121593-1578A]

A10.9.3-5 EVA REQUIREMENTS FOR FAILED VIEWPORT (VP) OUTER COVER

MODULE

AN EVA IS NOT REQUIRED TO STOW OR SECURE A FAILED OPEN VP OUTER COVER.

The VP outer cover when open does not infringe upon the payload bay door dynamic envelope. Although there is a potential for VP mechanism damage from landing loads, the risk of an EVA to stow the outer cover is not warranted. @[121593-1578A]

A10.9.3-6 VIEWPORT LOST DEFINITION

MODULE @[021998-6492]

VIEWPORT WILL BE CONSIDERED LOST FOR EXPERIMENT OPS IF THE VIEWPORT OUTER COVER FAILS CLOSED.

Viewport outer cover failed closed condition constitutes inability to use system for experiment operations or Earth viewing purposes; therefore, the system is considered lost.

Reference: MSFC, Spacelab High Quality Window, November 16, 1983, memorandum. @[021998-6492]

FLIGHT RULES

THIS PAGE INTENTIONALLY BLANK

FLIGHT RULES

A10.1.8-1 TIRE PRESSURE (CIL) (CONTINUED)

**OI-23 Nominal Orbiter Main Gear Tire Pressures
Contingency De-Orbit Mission Planning Assessments - Concrete Runways
Contingency Abort & Emergency Landings (Nominal Vderotate @ 185 keas)**

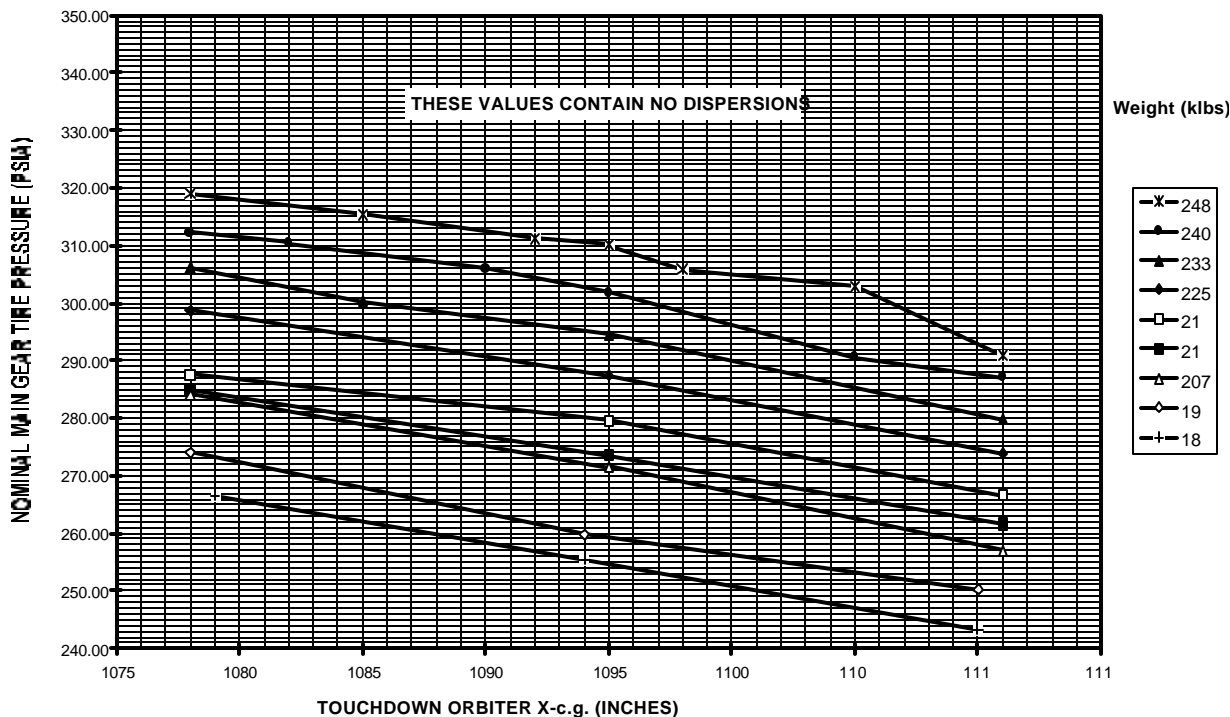

Contingency Minimum Orbiter Main Gear Tire Pressure - Concrete - Derotation Initiation at 185 KEAS

FIGURE A10.1.8-1-I - ANYTIME DEORBIT (CONCRETE RUNWAY)

THIS RULE CONTINUED ON NEXT PAGE

FLIGHT RULES

A10.1.8-1 TIRE PRESSURE (CIL) (CONTINUED)

**OI-23 Nominal Orbiter Main Gear Tire Pressures
Contingency De-Orbit Mission Planning Assessments - Lakebed Runways
Contingency Abort & Emergency Landings (Nominal Vderotate @ 185 keas)**

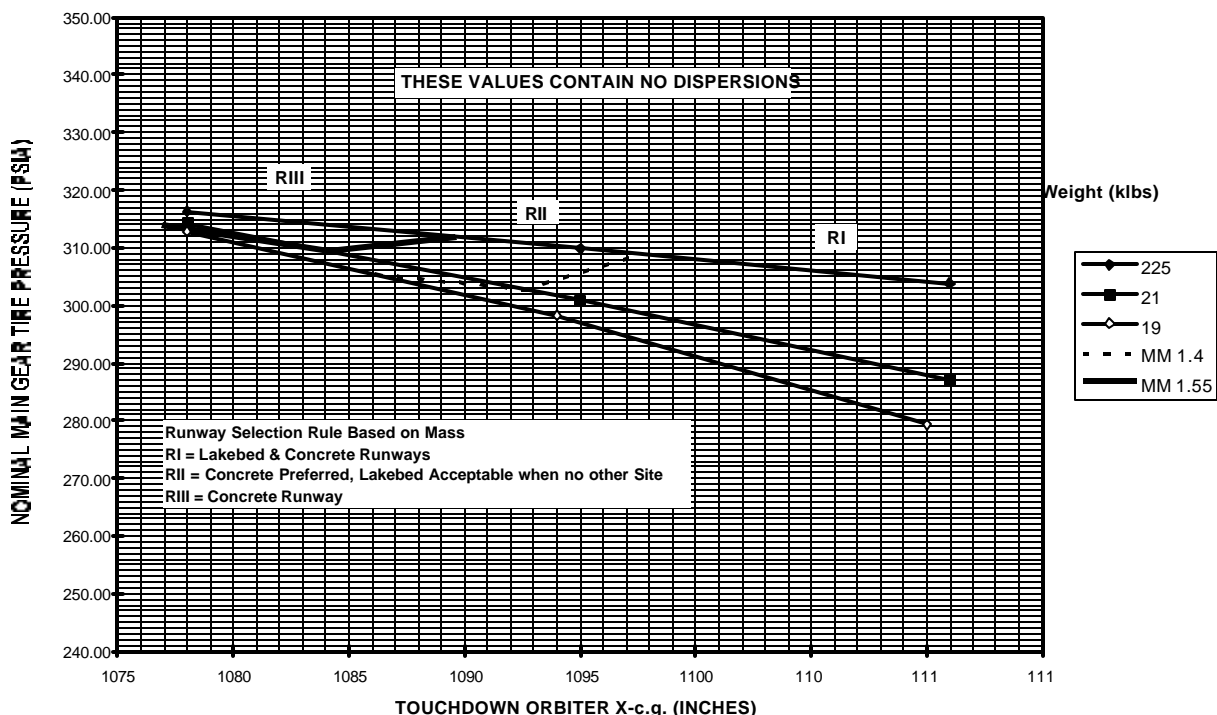

**Contingency Minimum Orbiter Main Gear Tire Pressure - Lakebed - Derotation Initiation at 185 KEAS
Orbiter Landing Weights Greater Than 225 KLBS Require Separate Evaluation**

FIGURE A10.1.8-1-II - ANYTIME DEORBIT (LAKEBED RUNWAY)

NASA - JOHNSON SPACE CENTER

FLIGHT RULES

THIS RULE CONTINUED ON NEXT PAGE

FLIGHT RULES

A10.1.8-1

TIRE PRESSURE (CIL) (CONTINUED)

OI-23 Minimum Orbiter Main Gear Tire Pressure
 Mission Planning Assessments - Concrete Runways
 All Normal & Intact Abort Landings (Nominal Vderotate @ 185 keas)

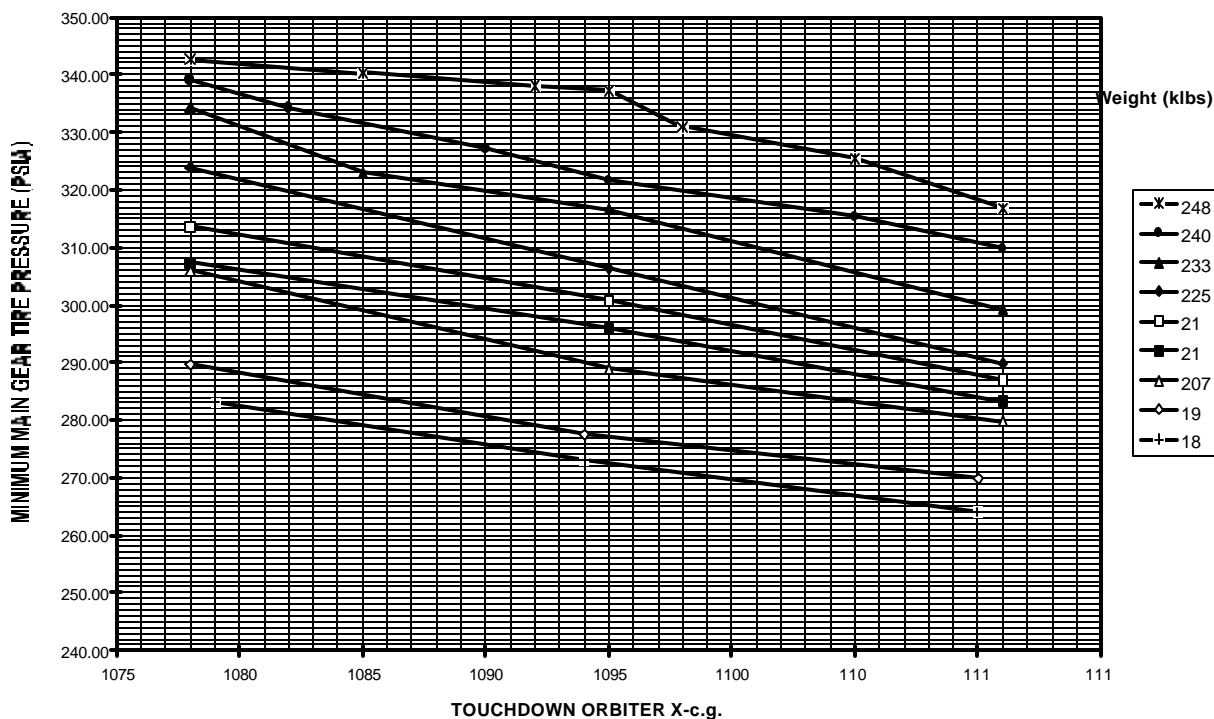

Minimum Orbiter Main Gear Tire Pressure - Concrete - Derotation Initiation at 185 KEAS

FIGURE A10.1.8-1-III - NOMINAL/EXTENSION DAY (CONCRETE RUNWAY)

THIS RULE CONTINUED ON NEXT PAGE

FLIGHT RULES

A10.1.8-1 TIRE PRESSURE (CIL) (CONTINUED)

**OI-23 Minimum Orbiter Main Gear Tire Pressure
Mission Planning Assessments - Lakebed Runways
All Normal & Intact Abort Landings (Nominal Vderotate @ 185 keas)**

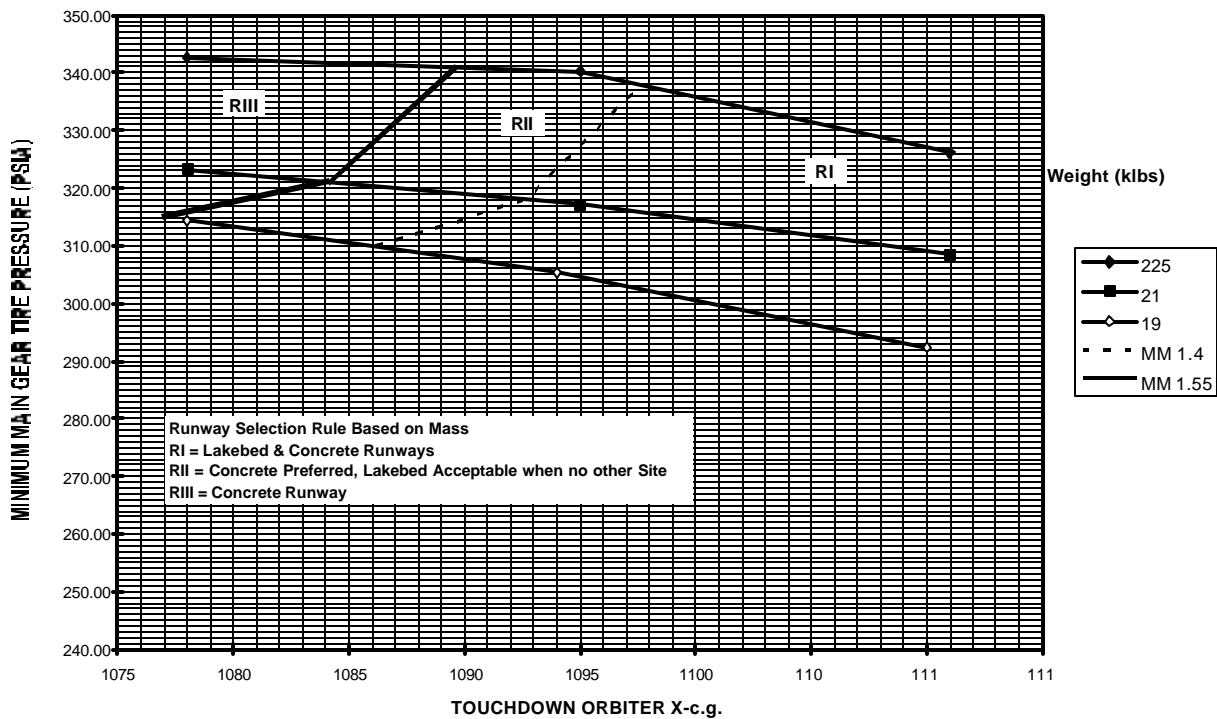

**Minimum Orbiter Main Gear Tire Pressure - Lakebed - Derotation Initiation at 185 KEAS
Orbiter Landing Weights Greater Than 225 KLBS Require Separate Evaluation**

FIGURE A10.1.8-1-IV - NOMINAL/EXTENSION DAY (LAKEBED RUNWAY)

THIS RULE CONTINUED ON NEXT PAGE

FLIGHT RULES

A10.1.11-6 PLBD CLOSE GO/NO-GO (CONTINUED)

PLBD CENTERLINE LATCH EXTENDED GUIDE ROLLER TRAJECTORY (DIAGRAM):

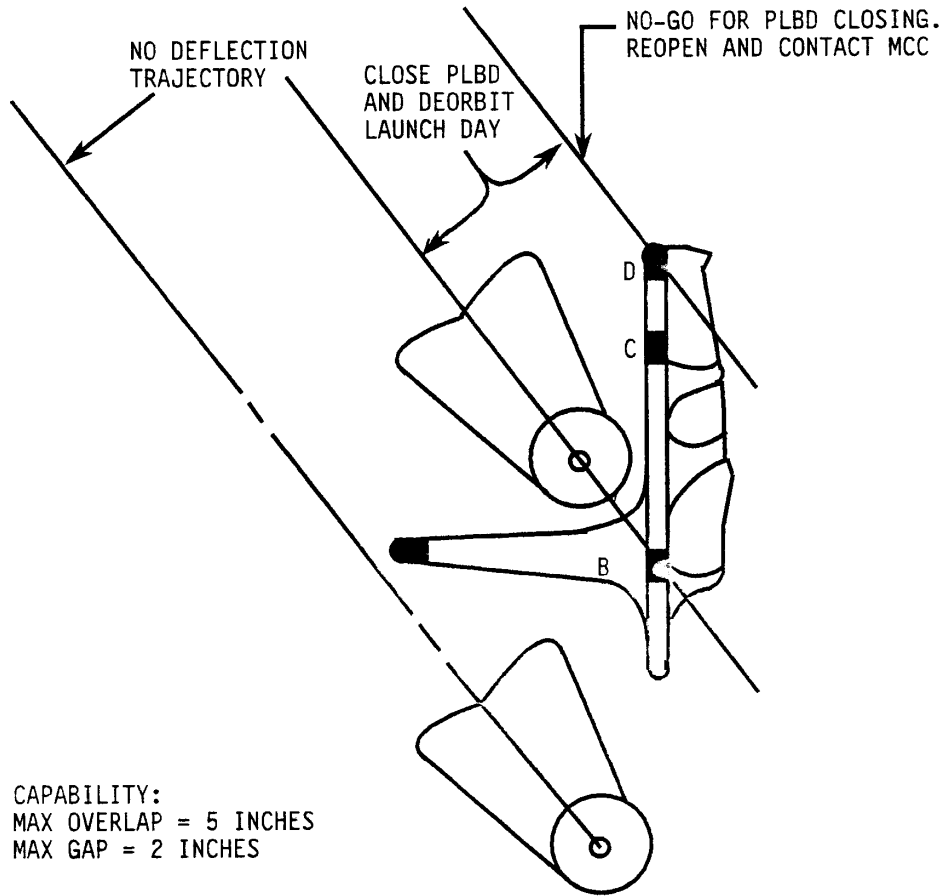

THIS RULE CONTINUED ON NEXT PAGE

FLIGHT RULES

A10.1.11-6 PLBD CLOSE GO/NO-GO

PORT AFT BULKHEAD LATCH GO/NO-GO (DIAGRAM)

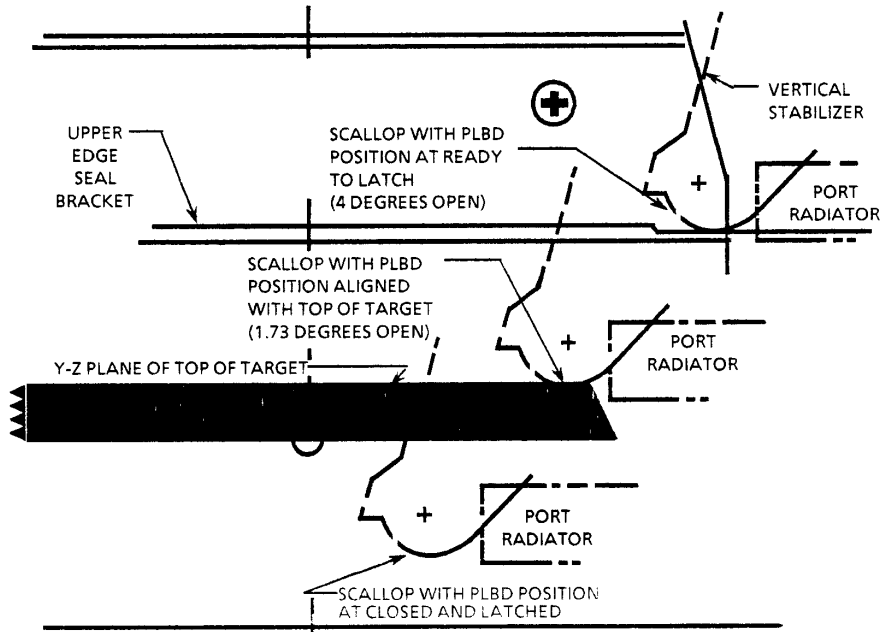

**PORT AFT LATCH
GO/NO-GO CRITERIA**

- GO - IF SCALLOP IS ON OR BELOW TOP OF TARGET PLANE OR IF PORT AFT PLBD CLOSE INDICATION IS PRESENT.
- NO-GO - IF SCALLOP IS ABOVE TOP OF TARGET PLANE AND PORT AFT PLBD CLOSE INDICATION IS NOT PRESENT.

THIS RULE CONTINUED ON NEXT PAGE

FLIGHT RULES

SECTION 11 - COMMUNICATIONS

SYSTEM MANAGEMENT RULES

A11.1.1-1	COMMUNICATIONS DURING ASCENT	11-1
A11.1.1-2	S-BAND/UHF LAUNCH REQUIREMENT	11-1
A11.1.1-3	UPLINK HANDOVER DURING ASCENT FROM KSC	11-1
A11.1.1-4	ORBITER DATA PRIORITY DURING ASCENT/ENTRY	11-3
A11.1.1-5	POSTLANDING S-BAND ANTENNA SELECTION	11-3
A11.1.1-6	MINIMUM COMMUNICATIONS REQUIREMENTS FOR SCHEDULED EVA	11-4
A11.1.1-7	KU-BAND OPERATIONS DURING EVA	11-4
A11.1.1-8	ORBITER S-BAND OPERATIONS DURING EVA	11-8
A11.1.1-9	RECORDER USAGE	11-9
A11.1.1-10	UHF USAGE	11-10
A11.1.1-11	S-BAND FM USAGE	11-11
A11.1.1-12	S-BAND PM USAGE	11-11
A11.1.1-13	S-BAND PAYLOAD USAGE	11-12
A11.1.1-14	CREW ALERT SPC'S	11-13
A11.1.1-15	ELBOW CAMERA/PAYLOAD INTERFERENCE (CIL)	11-13
A11.1.1-16	KU-BAND MANAGEMENT	11-14
A11.1.1-17	PI CHANNELS AND S-BD FREQUENCIES COMPATIBILITIES	11-14
A11.1.1-18	COMSEC USAGE	11-16
A11.1.1-19	UPLINK BLOCK	11-16
A11.1.1-20	UPLINK COMMANDING DURING OPS TRANSITIONS	11-16
A11.1.1-21	CRITICAL UPLINK COMMAND POLICY	11-18
A11.1.1-22	TWO-STAGE COMMAND BUFFER TLM REJECT	11-18
A11.1.1-23	TDRS-Z USE	11-19

FLIGHT RULES

SYSTEM FAILURE RULES

A11.1.2-1	LOSS OF TWO-WAY VOICE	11-14 <u>b</u>
A11.1.2-2	LOSS OF BOTH VOICE AND COMMAND	11-15
A11.1.2-3	LOSS OF COMMAND	11-16
A11.1.2-4	LOSS OF TELEMETRY	11-16
A11.1.2-5	LOSS OF KU-BAND	11-18
A11.1.2-6	LOSS OF KU-BAND TEMPERATURE CONTROL (CIL) .	11-18
A11.1.2-7	LOSS OF KU-BAND TEMPERATURE MONITORING CAPABILITY (CIL)	11-19
A11.1.2-8	LOSS OF TRANSPONDERS	11-20
A11.1.2-9	FM SYSTEM IFM GROUND RULE	11-21
A11.1.2-10	LOSS OF TDRS TRACKING CAPABILITY	11-21
A11.1.2-11	LOSS OF S-BAND PREAMPS AND POWER AMPS	11-21
A11.1.2-12	LOSS OF ANTENNA ELECTRONICS	11-22
A11.1.2-13	LOSS OF NSP'S	11-22
A11.1.2-14	LOSS OF COMMUNICATIONS SECURITY (COMSEC) ..	11-24
A11.1.2-15	AUDIO CENTRAL CONTROL UNIT (ACCU)	11-25
A11.1.2-16	LOSS OF ACCU'S	11-25
A11.1.2-17	LOSS OF THE PLT AND MS ATU'S	11-27
A11.1.2-18	LOSS OF INTERCOM	11-27
A11.1.2-19	LOSS OF UHF	11-28
A11.1.2-20	LOSS OF GCIL	11-28
A11.1.2-21	LOSS OF RECORDERS	11-28
A11.1.2-22	LOSS OF TV	11-31
A11.1.2-23	LOSS OF TIPS	11-31
A11.1.2-24	PCM MASTER UNIT (PCMMU)	11-31
A11.1.2-25	LOSS OF PCMMU'S	11-32
A11.1.2-26	LOSS OF OI MDM	11-32
A11.1.2-27	LOSS OF ANY OI DSC	11-32

FLIGHT RULES

GO/NO-GO CRITERIA

A11.1.3-1 COMMUNICATIONS GO/NO-GO CRITERIA 11-33

COMMUNICATIONS AND INSTRUMENTATION LOSS/FAILURE DEFINITIONS

A11.9.1-1 HIGH DATA RATE RECORDER (HDRR) 11-36

COMMUNICATIONS AND INSTRUMENTATION SYSTEMS MANAGEMENT

A11.9.2-1 OPERATIONS (OPS) RECORDER MANAGEMENT 11-37

A11.9.2-2 HIGH RATE MULTIPLEXER (HRM) VOICE
MANAGEMENT 11-37

A11.9.2-3 HDRR MANAGEMENT 11-38

A11.9.2-4 HRM/HDRR OPERATION RESPONSIBILITY 11-38

A11.9.2-5 HDRR TO PAYLOAD RECORDER DOWNMODE 11-39

A11.9.2-6 HRM FAILURE CASE 11-40

A11.9.2-7 MCC/CREW PRIME OPS OF VIDEO ANALOG SWITCH
(VAS)/VIDEO CASSETTE RECORDER SYSTEM (VCRS) 11-40

A11.9.2-8 ORBITER VIDEO CONTROL UNIT (VCU) FAILURE .. 11-41

A11.9.2-9 COMM TEMPERATURE LIMITS TO POWER OFF 11-42

FLIGHT RULES

THIS PAGE INTENTIONALLY BLANK

FLIGHT RULES

SECTION 11 - COMMUNICATIONS

SYSTEM MANAGEMENT RULES

A11.1.1-1 COMMUNICATIONS DURING ASCENT

THERE ARE NO COMMUNICATIONS FAILURES FOR WHICH THE ASCENT PHASE WILL BE TERMINATED.

Termination of the ascent phase implies an immediate return; i.e., an RTL, AOA, or TAL/TPL. Continuing to orbit is the most benign environment for the orbiter and crew. In addition, there is a high probability of restoring at least one communications link once on orbit; and, if communication is not restored, the orbiter is capable of a safe day 1 return without any further contact with the MCC.

A11.1.1-2 S-BAND/UHF LAUNCH REQUIREMENT

S-BAND PM VOICE WILL BE PRIME FOR LAUNCH. THE UHF SYSTEM WILL BE CONFIGURED IN TRANSMIT/RECEIVE MODE AS BACKUP TO THE S-BAND PM SYSTEM.

The S-band PM system is the only system available for launch that can provide redundant real-time telemetry, command, ranging, and duplex voice required for ascent phase support. SSME engine interface unit (EIU) data uses the S-band FM system and is redundantly recorded on Ops recorder 1. C-band skin tracking provides a redundant tracking source, and the UHF system provides an additional simplex voice source.

A11.1.1-3 UPLINK HANDOVER DURING ASCENT FROM KSC

UPLINK HANDOVER FROM MIL TO PDL WILL OCCUR BEFORE THE LINE-OF-SIGHT FROM THE ORBITER TO MIL INTERSECTS THE SRB PLUME. THE CARRIER WILL REMAIN ON PDL UNTIL POST-SRB STAGING. AT THAT TIME IT WILL BE HANDED BACK TO MIL TO REGAIN S-BAND TRACKING.

FLIGHT RULES

During ascent it is highly desirable to provide S-band ranging data to the MCC as an additional tracking source for trajectory evaluation. S-band ranging is available from MIL/MILX and BDA, but not PDL. Ascents from KSC necessarily result in the line-of-site from the orbiter to MIL/MILX intersecting the SRB plume. The SRB plume characteristics are such that severe S-band attenuation (approaching 60 dB) and erratic phase shifts will adversely affect the S-band PM link, resulting in poor uplink lock conditions and intermittent downlink data. To avoid the plume, the orbiter antennas are optimized for PDL from lift-off and the uplink is handed to PDL just before plume intersection until after SRB staging. This loss of S-band ranging and somewhat weaker signal margin during this time period is considered preferable to intermittent S-band uplink and downlink lock conditions, since downlink vectors and C-band tracking are still available for trajectory monitoring.

FLIGHT RULES

A11.1.1-4 ORBITER DATA PRIORITY DURING ASCENT/ENTRY

ORBITER DATA WILL TAKE PRIORITY OVER PAYLOAD DATA DURING ASCENT/ENTRY. PCMMU SWITCHES FOR THE PURPOSE OF RECOVERING ORBITER DATA WILL BE PERFORMED AT THE EXPENSE OF PDI PAYLOAD DATA.

OI MDM port failures and internal PCMMU failures affecting downlink or crew display of orbiter data can be recovered by power cycling the active PCMMU or by switching to the alternate PCMMU. During ascent/entry phases, when the SM major function for PCMMU reloading is unavailable, the PDI data downlinked to the MCC would be lost as the PCMMU defaults to Format 129 upon powerup and this format allocates no bandwidth to PDI data. The intent of this rule is to document that monitoring of orbiter data during ascent/entry takes precedence over remoting payload data to remote POCC's. PDI data displayed to the crew will not be affected.

A11.1.1-5 POSTLANDING S-BAND ANTENNA SELECTION

MCC WILL INSURE THAT THE UPPER ANTENNAS ARE SELECTED FOR POSTLANDING COMMUNICATIONS SUPPORT.

- A. MCC WILL NOMINALLY INHIBIT BFS ANTENNA POINTING AND SELECT UPPER ANTENNAS VIA COMMAND POST WHEELSTOP.
- B. FOR LOSS OF MCC COMMAND THE CREW WILL BE INSTRUCTED TO MANUALLY SELECT THE PROPER UPPER ANTENNAS AFTER WHEELSTOP.

Upper antennas are required to protect the convoy personnel from RF radiation. BFS automatic antenna pointing is required to be inhibited due to nominal postlanding nav state "drift". This drift in orbiter position could cause an inadvertent antenna selection which could result in a loss of comm or a hazard to the convoy personnel. If command is not available the crew will be instructed to manually select the proper upper antennas which overrides the BFS automatic pointing capability. This task will be performed for both GSTDN and TDRS landings.

FLIGHT RULES

A11.1.1-6 MINIMUM COMMUNICATIONS REQUIREMENTS FOR SCHEDULED EVA

IN ORDER TO COMMIT TO OR CONTINUE A SCHEDULED EVA, EACH EVA CREWMEMBER MUST HAVE TWO-WAY COMMUNICATIONS WITH THE ORBITER, EITHER DIRECTLY OR VIA THE OTHER EVA CREWMEMBER.

All scheduled EVA's are planned for two crewmembers who are trained to coordinate their activities and accomplish their task within a limited time. EVA activities often result in encountering unforeseen problems which must be solved by the EVA crewmember on the scene as the orbiter and MCC are in a poor position for offering assistance. Additionally, the EVA crewmembers must always be prepared to assist each other in case of emergency. As long as the EVA is scheduled and not required for contingency reasons (e.g., failure of the payload bay doors to close), it is not prudent to attempt an EVA without adequate means of crew coordination, even if some mission objectives cannot be accomplished.

Rule {A15.1.1-7}, MINIMUM RF COMMUNICATIONS DEFINITION, references this rule.

A11.1.1-7 KU-BAND OPERATIONS DURING EVA

A. FOR EVA ACTIVITIES CONDUCTED WITHIN THE AREAS PROTECTED BY THE KU-BAND BETA MASK OR ORBITER STRUCTURAL BLOCKAGE, THE KU-BAND MAY BE OPERATED WITHOUT POINTING CONSTRAINTS DURING AOS AND WILL BE PLACED IN STANDBY DURING LOS.

When EVA activities are conducted within the areas protected by the microprocessor mask (including the Beta function in the communication mode) or orbiter structural blockage, the Ku-band transmitter is automatically turned off protecting the crew. The radiation exposure levels will remain below 20 volts meter which is the limit exposed by the EMU specification. Although a single-point failure which could allow the transmitter to radiate into the normally protected region exists, the risk is considered acceptable because the MCC will monitor the automatic cutoff function during AOS and because a redundant cutoff function (standby mode) will be commanded by MCC to be effective during LOS periods. No permanent damage is expected at levels exceeding 20 volts/meter although this has not been confirmed by tests. Human exposure limits have been defined as 137 volts/meter.

④ED]

1. A BETA MASK OF 0 DEGREES BETA ONLY WILL BE USED TO PROTECT EVA CREWMEMBERS OPERATING WITHIN THE GENERIC PAYLOAD BAY ENVELOPE. REFERENCE RULE {A15.1.1-24}, EVA OPERATIONS IN THE GENERIC PAYLOAD BAY ENVELOPE. ④ED]
2. A BETA MASK OF 21 DEGREES BETA + MASK WILL BE USED TO PROTECT EVA CREWMEMBERS OPERATING ENTIRELY WITHIN THE CONFINES OF THE PAYLOAD BAY MOLDLINE.

FLIGHT RULES

THIS RULE CONTINUED ON NEXT PAGE

FLIGHT RULES

A11.1.1-7 KU-BAND OPERATIONS DURING EVA (CONTINUED)

Analysis presented at EVA Flight Techniques #16 in January 1992 revealed that a Beta Mask of 0 degrees Beta Only will protect any EVA crewmember confined to operating within the limits of the generic payload bay envelope as defined in Rule {A15.1.1-24}, EVA OPERATIONS IN THE GENERIC PAYLOAD BAY ENVELOPE. The SM default value of 21 degrees Beta + Mask is known to protect the Orbiter payload bay moldline boundary. @ED]

- B. FOR EVA ACTIVITIES WHICH MAY BE CONDUCTED EXTERNAL TO THE KU-BAND PROTECTIVE BETA MASK OR ORBITER STRUCTURAL BLOCKAGE, THE KU-BAND SYSTEM/ORBITER ATTITUDE WILL BE MANAGED TO PRECLUDE RADIATING THE EVA CREWMEMBER WITH AN EXPOSURE OF > 20 VOLT/METER OR EXPOSURE IN THE MAIN BEAM AT A RANGE < 125 METERS FROM THE ANTENNA FACE. DURING AOS PERIODS, THE CREW AND THE MCC WILL BOTH BE PREPARED TO TAKE THE KU-BAND SYSTEM TO STANDBY IN THE EVENT THAT THE LINE OF SIGHT CROSSES INTO THE PROTECTED HEMISPHERE. DURING PREDICTED LOS PERIODS, THE MCC WILL COMMAND THE KU-BAND SYSTEM TO STANDBY. @[021998-6515A]

When EVA activities are conducted outside the areas protected by the microprocessor mask or orbiter structural blockage, the Ku-band transmitter is not automatically turned off to protect the crew. In this case it is acceptable to manage the orbiter attitude so that Ku-band pointing will be restricted to the + Z hemisphere (below the X-Y plane) while EVA activities will be conducted in the opposite hemisphere. The crew and the MCC will both be prepared to take the Ku-band to STANDBY ~~shut off the transmitter~~ in the event that the line of sight crosses into the protected hemisphere. This will be based upon predicted times and will be backed up with real-time monitoring of antenna position. During predicted LOS periods, the MCC will command the Ku-band to STANDBY ~~transmitter off~~ to positively preclude any possibility of radiation. The maximum exposure levels are defined in the rule for reference. @[021998-6515A]

- C. IF THE MMU IS FLOWN OUTSIDE THE PAYLOAD BAY AND SIMULTANEOUS KU-BAND TRANSMISSION IS REQUIRED, THEN MMU FLIGHT WILL BE RESTRICTED TO THE ORBITER - Z HEMISPHERE AND THE KU-BAND ANTENNA POINTING WILL BE RESTRICTED TO THE + Z HEMISPHERE.

The rationale for this rule applying to MMU operations is same as rationale for paragraph B.

- D. USE OF THE KU-BAND IN THE LOW POWER RADAR MODE DURING EVA OPERATIONS IS UNRESTRICTED.

When the Ku-band system is in the radar mode with low power selected, analysis has shown that the crewmember radiation limits will not be exceeded at any range or look angle. Therefore, EVA operations may be freely conducted without any special monitoring or procedure for the purposes of avoiding excessive radiation levels of exposure.

FLIGHT RULES

Rule {A15.1.1-24}, EVA OPERATIONS IN THE GENERIC PAYLOAD BAY ENVELOPE, references this rule.

FLIGHT RULES

A11.1.1-8 ORBITER S-BAND OPERATIONS DURING EVA

- A. ALL ORBITER S-BAND SYSTEMS MAY BE OPERATED WITHOUT RESTRICTION DURING EVA OPERATIONS CONDUCTED WITHIN THE GENERIC PAYLOAD BAY ENVELOPE.

The generic payload bay EVA envelope was developed assuming the use of simple avoidance to control S-band radiation to less than 120 V/M (ref. Rule {A15.1.1-24}, EVA OPERATIONS IN THE GENERIC PAYLOAD BAY ENVELOPE).

- B. ALL ORBITER S-BAND SYSTEMS MAY BE OPERATED WITHOUT RESTRICTION DURING EVA OPERATIONS OUTSIDE THE GENERIC PAYLOAD BAY ENVELOPE AS LONG AS THE EVA CREWMEMBER REMAINS AT LEAST 1 METER AWAY FROM ANY RADIATING OR POTENTIALLY RADIATING ANTENNA.

An S-band dipole antenna "near field" is generally considered to extend approximately 1 meter from the antenna in all directions. Within this near field region, exact field intensities cannot be computed, and as such, could exceed the acceptable level for the EMU (120 V/M). If an antenna is totally inhibited (e.g., PI turned OFF or S-band FM forced to the lower antenna by crew switch) then the EVA crewmember is not at risk in approaching these antennas. Since an S-band PM antenna under GPC control could begin radiating without warning, the crewmember must stay 1 meter away to ensure his/her safety.

- C. FOR EVA OPERATIONS WHICH MUST BE CONDUCTED LESS THAN 1 METER AWAY FROM AN ORBITER S-BAND ANTENNA, STEPS MUST BE TAKEN TO ENSURE THAT THE ANTENNA WILL NOT RADIATE WHILE THE CREWMEMBER IS WITHIN 1 METER.

An S-band dipole antenna's "near field" is generally considered to extend approximately 1 meter from the antenna in all directions. Within this near field region, exact field intensities cannot be computed, and as such, could exceed the certification level for the EMU (120 V/M). If an antenna is totally inhibited (e.g., PI turned OFF or S-band FM forced to the lower antenna by crew switch) then the EVA crewmember is not at risk in approaching these antennas. Since an S-band PM antenna under GPC control could begin radiating without warning, the crewmember must stay 1 meter away to ensure his/her safety.

Reference Documentation: United Technology/Hamilton Standard Engineering Memorandum EMUM-604, April 30, 1992.

Rule {A15.1.1-24}, EVA OPERATIONS IN THE GENERIC PAYLOAD BAY ENVELOPE, references this rule.

FLIGHT RULES

A11.1.1-9 RECORDER USAGE

- A. THE OPS RECORDERS WILL BE MANAGED FROM THE GROUND SUCH THAT ONE RECORDER WILL BE RECORDING DURING EACH LOS PERIOD.

In order to maximize mission data recovery and retrieve data for analysis concerning events or anomalies that occur during LOS periods, the Ops recorders will be managed accordingly. Since this is a continuous and repetitive function and since data playback involves coordination with ground stations or TDRS, it is best accomplished by the MCC rather than the crew. Flight Data File procedures cover those cases when a crew interface with the recorders is required.

- B. OPS DATA AND VOICE (192 KBPS) WILL BE RECORDED DURING HIGH ACTIVITY PERIODS OR WHEN REQUIRED FOR CREW VOICE LOGS. DURING OTHER PERIODS, ONLY DATA (128 KBPS) WILL BE RECORDED. FOR DOD ENCRYPTED FLIGHTS, THE OPTION OF RECORDING 128 KBPS IS NOT AVAILABLE.

Crew voice will be recorded only during high activity mission phases (ascent, entry, EVA's, etc.) and upon crew request. At other times data will be recorded without voice. This technique allows quicker data retrieval as the recorders can be operated at a slower speed and dumped at an 8:1 vs. 5:1 rate with voice disabled.

- C. IF THE REQUIREMENT TO RECORD DATA AND VOICE CAUSES RECORDER CAPACITY TO BE EXCEEDED, THEN ONLY DATA WILL BE RECORDED.

If the recorders are expected to overflow for whatever reason (recorder failure, site or Ku-band problems, etc.) and data and voice recording is expected to be lost, only data will be recorded (no voice). This is the quickest and easiest way to avoid the overflow as the dump/record ratio is then 8:1 as opposed to 5:1. The loss of crew recorded voice during high activity periods when recorded voice is scheduled can be compensated for by crew logs, more detailed real-time voice reports, or other hand-held recorders. The loss of recorded data is irretrievable, however, and should be avoided if possible.

FLIGHT RULES

A11.1.1-10 UHF USAGE

- A. THE UHF TRANSCEIVER WILL BE NOMINALLY CONFIGURED IN SIMPLEX 259.7 MHZ.

The UHF system provides a completely independent source of air/ground voice to the S-band system. The UHF system is simplex for air/ground use (one direction at a time) and can be configured to any one of three frequencies: 296.8, 259.7 and 243.0 MHz. The 243.0 MHz frequency is reserved as a guard channel (for contingency communications with air traffic control facilities only) and is not normally used on orbit. Either 296.8 MHz or 259.7 MHz can be used on orbit (not TDRS). The 259.7 MHz channel is preferred as it has the better circuit margins. Should ground interference disturb the crew, the UHF system is often turned off. It is generally turned off during DOD flights on orbit as UHF voice is not encrypted.

- B. IN THE EVENT OF A ONE-PERSON EVA, THE ORBITER WILL BE CONFIGURED FOR EVA DUPLEX, TRANSMIT ON 296.8, AND THE EVA CREWMEMBER WILL BE CONFIGURED FOR MODE "B". THERE WILL BE NO UHF COMMUNICATIONS WITH THE GSTDN. FOR A TWO-PERSON EVA, THE OTHER EVA CREWMEMBER WILL BE CONFIGURED FOR MODE "A".

During a two-person EVA it is desirable for each crewmember to transmit on his own frequency thus enabling full conferencing capability between the IVA crewmember in the orbiter and both EVA crewmembers. All three parties can have simultaneous communication, but only when the orbiter is configured for 296.8 MHz transmit; one crewmember is in EVA mode A and the other in mode B. Any other configuration results in less than full conferencing capability. In the case where there is only one EVA crewmember, it is arbitrary, from an onboard standpoint, whether or not the EMU is configured for mode A or B as either mode permits duplex communications. Mode B is preferred, however, since it uses a transmit frequency of 279.0 MHz which is not used at the GSDTN sites, thus allowing the ground an interference-free interrupt capability if required on the GSDTN prime frequency. When Mode A is used, the transmit frequency is 259.7 MHz, which coincides with the prime GSDTN UHF requiring the ground to interrupt on the GSDTN alternate frequency, 296.8 MHz. The orbiter UHF mode (the simplex power amp is bypassed) circuit margins do not permit UHF communications with the GSDTN during EVA's, but the ground will be configured to monitor the prime frequency (259.7 MHz) should the crew need to call.

FLIGHT RULES

A11.1.1-11 **S-BAND FM USAGE**

- A. THE S-BAND SYSTEM SHALL BE REQUIRED TO TRANSMIT MAIN ENGINE DATA DURING ASCENT PHASE.

The S-band FM system provides the only real-time source of main engine interface unit (EIU) high rate data. It is sufficiently important enough to require downlinking in real time as well as being redundantly recorded onboard.

- B. FOR THE REMAINDER OF THE FLIGHT, THE S-BAND FM SYSTEM WILL BE USED FOR TV, OPS RECORDER DUMPS, REAL-TIME PAYLOAD DATA, AND PAYLOAD RECORDER DUMPS.

The S-band FM system provides a wideband downlink to GSDTN sites (not for TDRS) which can be configured for any one of several inputs (e.g., Ops or Payload recorder dumps, TV, and real-time analog, or digital payload data). Individual mission requirements will dictate when these inputs will be required to use the FM system for a particular flight and what the time-sharing plan will be.

A11.1.1-12 **S-BAND PM USAGE**

- A. THE S-BAND PM SYSTEM 2 LRU'S WILL NOMINALLY BE SELECTED VIA COMMAND FOR THE ENTIRE FLIGHT. ONBOARD SWITCHES WILL BE IN THE SYSTEM 1 LRU CONFIGURATION.

Since the S-band system is the prime orbiter communications system, it is desirable that switchover capability to the redundant system be reachable from the CDR or PLT seats during ascent/entry and other high activity phases. The design of panel and command hybrid driver logic within the GCIL allows the entire S-band PM system (NSP, XPNDR, antenna electronics, Power Amp, Pre Amp) to be switched to the redundant string with a single switch on panel C3. The redundant string is selectable via the panel C3 switch (nominally string 1). The choice of system 1 or 2 is arbitrary; however, the Flight Data File has long been written assuming this configuration.

- B. THE GROUND WILL BE PRIME FOR OPERATION OF THE S-BAND PM SYSTEM.

The orbiter S-band PM system must be configured differently for TDRS, GSTDN or SGLS modes continuously as required during the flight. This is a routine, repetitive task necessary during both crew awake and crew sleep periods in order to maximize data retrieval and is best done by MCC to free the flightcrew for more mission-unique tasks. Additionally, through telemetry indications from the orbiter and using voice reports and other indications from TDRS, GSTDN, and SGLS sites, the MCC has better overall visibility into the total air/ground communications network and is better suited for operating the total system, especially during non-nominal conditions.

THIS RULE CONTINUED ON NEXT PAGE

FLIGHT RULES

A11.1.1-12 S-BAND PM USAGE (CONTINUED)

- C. S-BAND PM ANTENNA MANAGEMENT WILL BE VIA GPC AUTOMATIC ANTENNA SELECTION.

S-band PM antenna management can be done either manually by the crew or ground or via GPC automatic selection. As long as the GPC's knowledge of attitude and position is accurate, it is less error prone to enable automatic selection. This has the added benefit of greatly reducing crew or ground workload for what is largely a routine function.

A11.1.1-13 S-BAND PAYLOAD USAGE

- A. THE S-BAND PAYLOAD SYSTEM 1 LRU'S WILL NORMALLY BE USED TO SUPPORT PAYLOAD OPERATIONS. ONBOARD SWITCHES WILL MATCH THE DESIRED CONFIGURATION.

The S-band payload system consists of redundant PI/PSP strings. Although there are exceptions on some flights, the flightcrew is typically much more involved with the usage of this system than in the S-band PM system, the management of which is primarily a ground function. The switch setup for S-band PM is unmatched from that commanded so that the crew need throw a minimum number of switches to restore communications in the event of onboard failure. In the case of the S-band payload system, it is preferable to have the switches match the commanded configuration so that the crew can easily track the current status since they are the prime system operators.

- B. THE S-BAND PAYLOAD INTERROGATOR (PI) CHANNEL SELECT THUMBWHEELS WILL BE CONFIGURED SO THAT INADVERTENT PI ACTIVATION WILL NOT INTERFERE WITH THE S-BAND PM SYSTEM. THE STANDARD SETTING FOR ASCENT/ENTRY SHALL BE CHANNEL 000.

Although the PI may be unpowered, a single-point failure exists that can inadvertently result in PI activation. Should this occur when the selected channel is one that interferes with the S-band PM uplink or downlink, a loss of uplink or downlink PM lock may occur disrupting the prime mode of communications. The cause of this unexpected disruption would be difficult to detect, result in confusion, and the workaround would not be obvious even if the alternate UHF link were available. Therefore, it should be avoided. Channel 000 is safe for ascent/entry since it cannot cause any interference.

FLIGHT RULES

A11.1.1-14 CREW ALERT SPC'S

DURING TIME PERIODS WHEN ALL CREWMEMBERS SLEEP SIMULTANEOUSLY, A CREW ALERT SPC WILL BE ROUTINELY USED TO ALERT THE CREW TO COMMUNICATIONS SYSTEMS PROBLEMS. THE SPC WILL TIME OUT APPROXIMATELY HALFWAY THROUGH THE SLEEP PERIOD IN THE EVENT OF A LOSS OF UPLINK COMMAND.

The crew alert commands result in an onboard class 3 alarm. When loaded into the SM SPC buffer during time periods when all crewmembers are sleeping, it can be used to alert the crew that uplink S-band command and probably voice capability has been lost. The crew alert commands are uplinked at the beginning of a sleep period and timetagged to execute midway through the sleep period. Should no loss of command occur, these commands are cleared from the SPC buffer before execution. If uplink command is lost, it is possible that uplink voice or even downlink voice and telemetry may be lost as well since common components are used. Single-point failures in the S-band PM system exist making this possible. UHF provides a redundant voice source but is often deactivated during crew sleep periods due to ground interference. Therefore, the crew alert commands are used to warn the crew of a possible loss of all monitoring capability and all communications capability. This is considered serious enough to wake the crew.

A11.1.1-15 ELBOW CAMERA/PAYLOAD INTERFERENCE (CIL)

FOR THOSE MISSIONS WHERE AN ELBOW CAMERA/PAYLOAD INTERFERENCE PROBLEM EXISTS, THE ELBOW CAMERA WILL NOT BE ACTIVATED UNLESS THE INTERFERENCE PROBLEM IS ELIMINATED. THIS APPLIES EVEN IF THE RMS IS DEPLOYED.

FLIGHT-SPECIFIC EXCEPTIONS FOR HIGH PRIORITY OPERATIONS WILL BE IDENTIFIED IN THE FLIGHT RULES ANNEX.

Due to the geometry of the elbow camera 25-degree mounting wedge when the MPM is stowed, the maneuvering envelope of the camera intrudes upon the maximum payload envelope. A potential interference problem exists with a payload manifested at the same X location as the elbow camera. The interference could prevent stowing the MPM's and require an RMS jettison or EVA to close PLBD's.

FLIGHT RULES

A11.1.1-16 KU-BAND MANAGEMENT

THE ORBITER KU-BAND SYSTEM WILL BE OPERATED IN THE "BETA PLUS MASK" MODE WITH A LIMIT OF 21 DEGREES UNLESS PAYLOAD OR IPS IS FLOWN WHICH EXTENDS BEYOND THE PAYLOAD BAY DOOR ENVELOPE. IN THIS CASE, FLIGHT-SPECIFIC KU MASKING IS DEFINED IN RULES {A2.6.1-14} AND {A2.9.1-14}, COMMUNICATIONS (COMM) CONSTRAINTS. [ED]

The Ku-band masking is used to protect a payload or the IPS in the payload bay from the Ku main beam RF radiation. A limit of 21 degrees in the "Beta Plus Mask" mode will protect the entire bay up to the payload bay door moldline and prevent any part of the bay being exposed to a level greater than 10 volts per meter (the ICD limit). This masking mode also provides the maximum comm coverage while still providing the required protection.

If a payload instrument or the IPS is present which extends beyond the payload bay door moldline, then this masking may not protect the payload or IPS from levels higher than the ICD level or the 70 volts per meter (V/M) to which the IPS has been qualified. The required mode and beta limit is then dependent on the location of the payload or IPS in the bay and on the dimensions of the payload or the IPS mounted instruments. Thus, the limit must be calculated for the specific mission case.

Note that the beta mask function does not apply to Ku radar operation. The radar mode uses the old microprocessor mask which is equivalent to beta plus mask with a limit of -90 degrees. This is more restrictive (i.e., more protection) than 21 degrees. [ED]

Rule {A2.1.3-19}, RNDZ/PROX OPS COMMUNICATION SYSTEMS MANAGEMENT, references this rule. [061396-1961]

A11.1.1-17 PI CHANNELS AND S-BD FREQUENCIES COMPATIBILITIES

IN ORDER TO PREVENT MUTUAL INTERFERENCE BETWEEN THE PAYLOAD INTERROGATOR (PI) AND THE S-BAND PM SYSTEM, THE FOLLOWING PI CHANNELS AND S-BAND PM FREQUENCIES COMPATIBILITY TABLE WILL BE FOLLOWED FOR ALL PI OPERATIONS: [090894-1648B]

COMPATIBLE PI CHANNELS AND S-BAND PM FREQUENCIES	
WHEN USING PI CHANNEL	USE S-BAND PM FREQUENCY
001-407	HIGH
408-433	NOT COMPATIBLE WITH LOW OR HIGH *
434-883	LOW
899-909	HIGH
910-920	LOW

* PI INTERFERENCE WITH SSA FORWARD LINK TEST SHOWS THAT THERE IS A POTENTIAL FOR DEGRADED SSA FORWARD LINK ACQUISITION AND; THEREFORE, THIS PI/S-BD PM COMBINATION (408-420/421-433) WILL NOT BE USED. EXCEPTIONS MAY BE MADE ON A FLIGHT SPECIFIC BASIS BY DETAILED ANALYSIS.

FLIGHT RULES

The S-Band PM system and Payload Interrogator selectable frequencies overlap and if not properly selected could interfere with each other. The consequence of selecting channels other than those noted in the table above are unknown and potentially compromise S-Band PM communications and/or communications with a detached payload. Reference ESTL report EE7-93-214. ©[090894-1648B]

FLIGHT RULES

A11.1.1-18 COMSEC USAGE

IN ORDER TO PROTECT THE ORBITER FROM UNAUTHORIZED COMMANDS, THE S-BAND SYSTEM UPLINK WILL NORMALLY BE ENCRYPTED FOR ALL FLIGHTS.

Configuring the S-band uplink for encryption protects against unauthorized commands being received via both the S-band and Ku-band systems as the COMSEC equipment interfaces with the NSP which is common to both systems. Uplinks bypassing the NSP can still be received via the alternate (216 kbps) Ku-band channel, but this channel (intended for TIPSTAGS and high rate payload data) does not interface with the GPC's or other critical orbiter systems. [@\[111298-6778.1\]](#) ~~TAGS can also be configured to interface with separate COMSEC equipment if required.~~

A11.1.1-19 UPLINK BLOCK

- A. WHEN SM IS UNAVAILABLE AND THE UPLINK IS NOT ENCRYPTED, COMMANDS WILL BE BLOCKED VIA "UPLINK" SWITCH WHEN COMMAND ACTIVITY IS NOT REQUIRED. LOSS OF THE BLOCK FUNCTION, HOWEVER, IS NOT A CONSTRAINT TO CONTINUING TO NOMINAL EOM.

National Security Decision Directive 145 (NSDD 145) and NASA policy dictates that the uplink command path be blocked or encrypted to prohibit unauthorized command sources from reaching the orbiter. This is necessary to preclude any possibility of unwanted GMEM's, DEU equivalents, etc., from disrupting or endangering flight operations. When SM and encryption are both unavailable, the crew is required to manually enable or block the uplink using the UPLINK switch in panel C3 since no automatic function exists.

- B. WHEN SM IS AVAILABLE, UPLINK COMMANDS WILL BE AUTOMATICALLY BLOCKED BY THE SM SOFTWARE WHENEVER THE SITE-IN-VIEW FLAG IS NOT PRESENT AND THE UPLINK WILL NORMALLY BE ENCRYPTED. REFERENCE RULE {A11.1.2-14}, LOSS OF COMMUNICATION SECURITY (COMSEC).

SM software and the use of encryption provide uplink protection during on-orbit periods. Rule {A11.1.2-14}, LOSS OF COMMUNICATION SECURITY (COMSEC), addresses cases when COMSEC is failed.

A11.1.1-20 UPLINK COMMANDING DURING OPS TRANSITIONS

NORMALLY, UPLINK COMMANDING TO THE ORBITER WILL BE PROHIBITED DURING OPS MODE TRANSITIONS.

FLIGHT RULES

Because of software cleanup operations during an OPS transition, there is a short (1 second) window of vulnerability where a redundant set split, fail-to-sync, or erroneous command may occur if an uplink command is received. This could be hazardous during time-critical operations or could cause serious delays to mission completion operations.

FLIGHT RULES

A11.1.1-21 CRITICAL UPLINK COMMAND POLICY

CRITICAL COMMANDS SHALL NOT BE UPLINKED WITHIN 10 MINUTES OF LOS OR DURING PERIODS OF PREDICTED POOR COMMUNICATIONS UNLESS THOSE COMMANDS ARE TIME CRITICAL TO OPERATIONS.

During periods of marginal communications, error rates increase and uplinks have a higher probability of dropouts. Commands which are critical, such as GMEM's, state vectors, etc., but not time critical, should only be uplinked when sufficient time remains to assess the success of those commands on the onboard systems.

A11.1.1-22 TWO-STAGE COMMAND BUFFER TLM REJECT

NO TWO-STAGE COMMANDS SHALL BE EXECUTED WHEN THE TWO-STAGE COMMAND BUFFER IS NOT AVAILABLE VIA TELEMETRY TO VERIFY SUCCESSFUL UPLINK, WITHOUT THE APPROVAL OF THE FLIGHT DIRECTOR.

Without telemetry, the ground cannot verify that the uplinked command has correctly been received onboard. However, for cases where not executing a command may have worse consequences than the possible consequences of an erroneous command, the Flight Director may elect to approve execution of the command.

FLIGHT RULES

A11.1.1-23 TDRS-Z USE

A. ASCENT/ENTRY (BFS) OPERATIONS @121197-4007B]

TDRS-Z WILL BE USED TO SUPPORT OMS-2 AND THE DEORBIT BURN.

B. ON-ORBIT (SM) OPERATIONS

ROUTINE SUPPORT OF ORBITER OR PAYLOAD OPERATIONS (COMMAND AND TELEMETRY) WILL NOT BE SCHEDULED TO OCCUR DURING THE ZOE IF THAT SUPPORT REQUIRES EITHER AN UPLINK OR DOWNLINK TO MCC-H OR A REMOTE POCC.

1. TDRS-Z USE FOR ORBITER ACTIVITIES WILL BE RESTRICTED TO THOSE TIMES DURING WHICH CRITICAL OPERATIONS SUCH AS PROX OPS, DOCKING, AND UNDOCKING ARE OCCURRING.
2. TDRS-Z USE IN SUPPORT OF NON-ROUTINE PAYLOAD OPERATIONS WILL BE CONSIDERED ON A CASE-BY-CASE BASIS ONLY AFTER ALL OTHER REASONABLE MEANS OF SUPPORT HAVE BEEN ELIMINATED.

TDRS-Z, while operationally available for routine use through the network, is not supported in PASS or BFS flight software, nor is it routinely supported in the MCC trajectory software. Use of TDRS-Z prior to OI-28 is a time and personnel-intensive task that carries with it a risk of loss of communications through TDRS-W. The vector method of handover will not be used in the BFS to preclude loss of TDRS-W. Because of the intense nature of the required operations, the use of TDRS-Z must be limited to those periods that present a risk to crew or vehicle safety or can cause a loss of mission success. With this level of concern for the use of TDRS-Z, it is reasonable to require that routine operations, including payload command windows and significant payload reconfigurations, not be scheduled to occur during the ZOE unless these activities can be accomplished without the use of ground resources. _

@121198-4007B]

FLIGHT RULES

THIS PAGE INTENTIONALLY LEFT BLANK

FLIGHT RULES

SYSTEM FAILURE RULES

A11.1.2-1 LOSS OF TWO-WAY VOICE

IF ONLY A SINGLE SOURCE OF ENTRY TWO-WAY VOICE COMMUNICATIONS REMAINS (COMMAND OK), THE FLIGHT WILL BE TERMINATED AT THE NEXT PLS. IF THIS OCCURS ON FD 1 HOWEVER, DELAY ENTRY UNTIL FD 2. THIS COULD RESULT FROM THE FOLLOWING FAILURES:

- A. TWO NSP'S (UPLINK OR DOWNLINK).
- B. TWO XPNDRS (UPLINK OR DOWNLINK WITH UNSUCCESSFUL IFM).
- C. UHF AND ONE NSP OR XPNDR.

Voice communications is the most valuable communications mode of all due to its flexibility. In contingency cases when command or telemetry is lost, voice can be used as a substitute although it is a slower means of conveying this type of information. It is the only satisfactory means of crew/MCC coordination during high activity phases. The only available voice sources during entry are the two S-band channels (A/G 1 and 2) and UHF. A/G 1 and 2 are redundant and UHF is partially redundant. Should a combination of failures result in being a single failure away from loss of all entry two-way voice, it is best to be prudent and terminate the mission while overall systems and landing site status are known and understood. This is more prudent than risking future occurrences which could result in a crew or vehicle safety hazard due to the absence of a satisfactory means of crew/MCC coordination. In the event these multiple voice failures occur on FD 1, it is better to stay on orbit until the next day and deliberately plan on the possibility of a no-voice entry rather than rush through deorbit activities while adapting to the zero g environment.

Rules {A11.1.2-13A}, C, and D, LOSS OF NSP's; {A11.1.2-8B}, LOSS OF TRANSPONDERS; and {A11.1.3-1}, COMMUNICATIONS GO/NO-GO CRITERIA, reference this rule.

FLIGHT RULES

A11.1.2-2 LOSS OF BOTH VOICE AND COMMAND

A. DURING ASCENT - CONTINUE TO ORBIT; DEORBIT ON ORBIT 2.

Continuing to orbit is the most benign action. Deorbit on orbit 2 is recommended since this allows sufficient time to perform the loss of command and voice procedures while minimizing the degradation of the state vector. Deorbit on orbit 3 would probably not be useful from a systems recovery standpoint and only causes further degradation of the state vector.

B. ON-ORBIT - DEORBIT TO THE PLS AT THE TIG OF THE SLEEP VECTOR TARGET SET. IF THIS TIG IS IN THE PAST OR A SLEEP VECTOR IS NOT ONBOARD, THEN DEORBIT WITHIN THE NEXT 13 HOURS IF PERIGEE IS GREATER THAN 120 NM; OR THE NEXT 9 HOURS IF PERIGEE IS GREATER THAN 105 NM; OR FROM LOSS OF VOICE AND COMMAND ACCORDING TO THE FOLLOWING PRIORITIES:

1. THE NEXT LIGHTED CONUS OPPORTUNITY.
2. THE NEXT CONUS OPPORTUNITY.
3. THE NEXT LIGHTED ELS OPPORTUNITY.

A study was presented to Orbit Flight Techniques Panel #86 (6/10/88) which shows, for a general case, an onboard state vector will remain within tolerances per Rule {A4.1.4-4}, DOWNTRACK ERROR, for 13 hours if perigee is greater than 120 nm. A subsequent study showed that the vector will remain within tolerances for 9 hours if perigee is greater than 105 nm. This assumes a 1-sigma case with a semi-major axis error of 1000 feet and a downtrack error of 20,000 feet at loss of communication (the crew will be informed if the ground is unable to maintain the vector to this accuracy.) This was approximately the average quality of the onboard state vector before a new one was uplinked based on previous flight data. This was selected to reduce the chance of committing to an ELS landing. It is therefore best to deorbit within the specified time limits unless the state vector is confirmed for a future landing opportunity. The confirmation can come as a sleep vector (zero delta-V command load with the TIG of the deorbit burn to the PLS) or by voice at the time the state vector was uplinked.

If the onboard state vector has been confirmed for a deorbit to the next PLS, it is best to plan for that.

The case where the confirmation has not been received is more difficult. It is clearly more desirable to land at a CONUS landing site containing a full complement of landing aids. It is also more desirable to land during the day. Therefore, the next two priorities are a lighted CONUS landing, then a dark one.

If no CONUS opportunity exists within the specified times, it is best to deorbit as soon as possible to the next lighted ELS. There will always be a lighted ELS opportunity within the next 9 hours at any time during the mission, so a dark ELS landing is not addressed.

FLIGHT RULES

If the Ku-band and Thermal Impulse Printer System (TIPS)TAGS system are operational and a source of telemetry is available, a delta state vector can be uplinked to the crew via the TIPSTAGS system. The crew can then manually enter the delta state into the GPC in GNC OPS 3. The telemetry, which is required to allow the ground to compute the delta state, could be the normal GNC downlist available via S-band or Ku-band. [@021998-65161](#)

A11.1.2-3 LOSS OF COMMAND

IF ALL COMMAND CAPABILITY IS LOST BUT AT LEAST TWO SOURCES OF ENTRY VOICE ARE STILL AVAILABLE, AN MDF WILL BE PERFORMED.

Loss of all command capability implies redundant failures and would impose a significant increase in workload to the crew as state vectors, gyro biases, target loads, etc., would have to be relayed to the crew by voice, ~~teleprinter~~ or TIPSTAGS and entered into the computers manually, in many cases, by GMEM Read/Write. Recorder dumps and communications configurations would also have to be done manually and, for some flights, payload operations would be adversely affected as control is only from the POCC. Therefore, the potential for introducing errors into computer updates is increased. [@021998-65161](#)

Rules {A11.1.2-8B}, LOSS OF TRANSPONDERS; {A11.1.2-13A}, LOSS OF NSP's; and {A11.1.3-1}, COMMUNICATIONS GO/NO-GO CRITERIA, reference this rule.

A11.1.2-4 LOSS OF TELEMETRY

IF ALL SOURCES OF TELEMETRY TO MCC ARE LOST THE FLIGHT WILL TERMINATE AT THE NEXT PLS. THIS COULD RESULT FROM:

- A. LOSS OF DOWNLINK FROM BOTH NSP'S.
- B. LOSS OF BOTH PCMMU'S.
- C. LOSS OF BOTH TRANSPONDERS FOLLOWED BY AN UNSUCCESSFUL IFM. (REF. RULE {A11.1.2-8C}, LOSS OF TRANSPONDERS.)

The MCC has a much greater systems monitoring capability than available onboard and most crew procedures and training are based on the availability of having telemetry data in the MCC or POCC monitored by systems experts. Without telemetry, computer loads could not be verified before execution. Some future system failures could remain undetected (such as those requiring trend monitoring) or the extent of the failure unappreciated (e.g., bus transients). Also, for many missions, payload data is only retrievable via telemetry. If telemetry during the entry phase is known to be unavailable (even though onboard data may be unaffected), then it is safest to terminate the mission while overall systems status is known and understood by all rather than risk adverse future occurrences which could result in a crew or vehicle safety hazard due to the loss of insight normally provided by the MCC.

FLIGHT RULES

Rules {A11.1.2-13}, LOSS OF NSP's; and {A11.1.3-1}, COMMUNICATIONS GO/NO-GO CRITERIA, reference this rule.

FLIGHT RULES

A11.1.2-5 LOSS OF KU-BAND

LOSS OF KU-BAND WILL RESULT IN THE FLIGHT CONTINUING TO NOMINAL EOM. IF THE MISSION-SPECIFIC CAPABILITY JUSTIFIES THE REQUIREMENT FOR THE KU-BAND, PERFORM AN MDF.

Refer also to mission-specific rules that may be documented in Flight Rules Annexes.

Ku-band communication is provided primarily to support payloads. It is used to provide supplemental capabilities unavailable via the prime S-band communications system such as TDRS television, TDRS recorder dumps, [TIPSTAGS](#), and high rate payload data. Generally speaking, other useful mission objectives can be accomplished even with the loss of these capabilities and, therefore, early mission termination is not justified. The Ku-band system also provides the only source of rendezvous radar capability, but alternate onboard and ground capabilities allow rendezvous to continue in the event of radar failure. Specific mission objectives that cannot be accomplished with a loss of Ku-band are identified in the Flight Rules Annex. [\[021998-6516\]](#)

Rule {A11.1.3-1}, COMMUNICATIONS GO/NO-GO CRITERIA, references this rule.

A11.1.2-6 LOSS OF KU-BAND TEMPERATURE CONTROL (CIL)

INABILITY TO MAINTAIN KU-BAND TEMPERATURES WITHIN THEIR SODB LIMITS (DEFINED AS ABOVE MINIMUM TURN-ON AND BELOW MAXIMUM SURVIVAL) WILL RESULT IN KU-BAND DEACTIVATION AND STOWAGE.

If temperature control of the Ku-band gyro or either alpha or beta gimbal cannot be maintained within SODB limits, the subsequent potential of degradation could result in inability to properly stow the deployed assembly since fairly precise positioning is required for the antenna to lock. Stowing the deployed assembly with an unlocked antenna could result in damage to the antenna or the adjacent radiator panel during entry. Temperature control of the antenna feed, the transmitter, and the receiver is also required to prohibit damage to these components. For any of these cases the system should be deactivated and stowed as a precaution.

Rule {A10.1.16-1B}; ANTENNA STOW REQUIREMENT (CIL), and {A11.1.2-7}, LOSS OF KU-BAND TEMPERATURE MONITORING CAPABILITY (CIL), reference this rule.

FLIGHT RULES

A11.1.2-7 **LOSS OF KU-BAND TEMPERATURE MONITORING
CAPABILITY (CIL)**

LOSS OF THE CAPABILITY TO MONITOR THE KU-BAND GYRO, ALPHA GIMBAL, OR BETA GIMBAL TEMPERATURES WILL RESULT IN DEACTIVATION AND STOWAGE EXCEPT FOR THOSE CASES DOCUMENTED IN THE FLIGHT RULES ANNEX.

FLIGHT-SPECIFIC EXCEPTIONS FOR HIGH PRIORITY OPERATIONS WILL BE IDENTIFIED IN THE FLIGHT RULE ANNEX.

Ku-band temperature control is necessary to ensure that component damage will not occur and to ensure that the antenna can be properly locked and stowed for entry (ref. Rule {A11.1.2-6}, LOSS OF KU-BAND TEMPERATURE CONTROL (CIL)). A failed transducer would result in the inability to detect a heater that is failed ON or failed OFF. Since heater monitoring locations are relatively insulated, attempting to extrapolate remaining measurements to determine an out-of-limits condition for the gyro or either gimbal is unreliable.

FLIGHT RULES

A11.1.2-8 LOSS OF TRANSPONDERS

- A. LOSS OF ONE TRANSPONDER (UPLINK OR DOWNLINK) WILL RESULT IN CONTINUING TO NOMINAL EOM.

Loss of one transponder is still one failure away from any condition resulting in either a minimum duration flight or a next PLS landing.

- B. LOSS OF UPLINK CAPABILITY FROM BOTH TRANSPONDERS WILL RESULT IN A NEXT PLS LANDING.

Refer to Rule {A11.1.2-1}, LOSS OF TWO-WAY VOICE; and Rule {A11.1.2-3}, LOSS OF COMMAND. This failure results in the loss of all S-band voice and command.

- C. IF ALL S-BAND PM DOWNLINK TO MCC IS LOST RESULTING FROM A FAILURE OF BOTH TRANSPONDERS AND THE IFM TO USE THE S-BAND FM IS SUCCESSFUL, AN MDF WILL BE COMPLETED. IF THE IFM IS UNSUCCESSFUL THEN THE FLIGHT WILL TERMINATE AT THE NEXT PLS.

Loss of telemetry and downlink voice from two transponders leaves only Ku-band as a telemetry source and UHF and Ku-band for voice. An IFM is available to restore real-time S-band telemetry and downlink S-band voice in the event of a dual transponder failure using the S-band FM transmitters. This coverage is unavailable via TDRS and would result in limited ground coverage from DOD and NASA stations which would have to be called up for support. However, it still would provide a source for entry telemetry. This failure leaves recorded telemetry still available. Therefore, sufficient systems insight remains to complete a minimum duration flight. An unsuccessful IFM would result in no telemetry and only UHF voice following Ku-band stowage. To avoid the possibility of a no-telemetry entry with an orbiter degraded by a subsequent systems failure, a next PLS landing is justified as being the conservative approach.

Rules {A11.1.2-4}, LOSS OF TELEMETRY; and {A11.1.3-1}, COMMUNICATIONS GO/NO-GO CRITERIA, reference this rule.

FLIGHT RULES

A11.1.2-9 **FM SYSTEM IFM GROUND RULE**

FOLLOWING A CONFIRMED LOSS OF DOWNLINK IN ONE S-BAND TRANSPONDER, CONSIDERATION WILL BE GIVEN TO IMPLEMENTING AN IFM PROCEDURE TO ALLOW THE USE OF THE FM SYSTEM AS A REDUNDANT TELEMETRY SOURCE FOR ENTRY.

Following a transponder loss, no redundancy remains for downlink telemetry. The IFM regains this redundancy using the FM system, and implementation of the IFM should be considered prior to entry. The IFM procedure to allow the use of the S-band FM system for downlink voice and telemetry results in disconnecting flight cables and terminating the use of one of the Ops recorders. The NSP's must be switched when real-time and dump data share the FM downlink. This is compatible only with ground stations, not TDRS. For these reasons it is desirable to troubleshoot the transponders to determine alternate capabilities before considering the IFM which nominally requires about 2-1/2 hours of crew time. As transponder troubleshooting necessarily requires a ground station or TDRS to confirm status, the ground should direct the procedure rather than the crew if the remaining capability makes this feasible. The ground is required because compatible configurations are necessary onboard and at the STDN to ensure valid checks.

A11.1.2-10 **LOSS OF TDRS TRACKING CAPABILITY**

LOSS OF TDRS TRACKING CAPABILITY WILL RESULT IN CONTINUING TO NOMINAL EOM.

Loss of TDRS tracking would require call up of contingency use S-band tracking stations that are obligated to provide support in the event of such an orbiter or ground system failure. These stations, supplemented as required by C-band radars, can provide satisfactory support to continue nominal orbital operations and entry preparations.

Rule {A11.1.3-1}, COMMUNICATIONS GO/NO-GO CRITERIA, references this rule.

A11.1.2-11 **LOSS OF S-BAND PREAMPS AND POWER AMPS**

LOSS OF BOTH S-BAND PREAMPLIFIERS AND/OR BOTH POWER AMPLIFIERS WILL RESULT IN CONTINUING TO NOMINAL EOM.

Loss of either both preamps or both power amps results in loss of all TDRS S-band capability. Ku-band still remains but does not provide a tracking source and is unavailable following antenna stowage during deorbit prep. A total loss of TDRS S-band would require call up of the contingency ground stations that are obligated to provide support in the event of such an orbiter failure. These stations would be a combination of deep space network (DSN), DOD remote tracking stations (RTS), and C-band radars. These stations can provide satisfactory support to continue nominal orbital operations and nominal entry preparations.

Rule {A11.1.3-1}, COMMUNICATIONS GO/NO-GO CRITERIA, references this rule.

FLIGHT RULES

A11.1.2-12 LOSS OF ANTENNA ELECTRONICS

THE FLIGHT WILL BE CONTINUED FOR LOSS OF THE S-BAND ANTENNA ELECTRONICS.

Loss of both S-band antenna electronics results in the inability to select S-band antennas (i.e., only one antenna could be used). All communications functions would remain, but severe attitude constraints would have to be imposed to maintain TDRS S-band. TDRS Ku-band would be unaffected, and ground station (GSTDN) S-band would be slightly degraded due to reduced (but still acceptable) circuit margins. Since the attitude timeline would be affected, it is reasonable to assume that mission activities would be impacted. As long as productive mission objectives can still be accomplished, the mission need not be shortened. Rule {A11.1.3-1}, COMMUNICATIONS GO/NO-GO CRITERIA, references this rule.

A11.1.2-13 LOSS OF NSP'S

A. LOSS OF UPLINK CAPABILITY FROM ONE NSP WILL RESULT IN CONTINUING TO NOMINAL EOM.

Loss of uplink from one NSP is still one failure away from any condition resulting in either a minimum duration flight or a next PLS landing. Refer to Rules {A11.1.2-1}, LOSS OF TWO-WAY VOICE; and {A11.1.2-3}, LOSS OF COMMAND.

B. LOSS OF ALL DOWNLINK REAL TIME AND ALL RECORDED DATA OUTPUTS FROM ONE NSP WILL RESULT IN AN MDF.

The NSP's are required to provide all telemetry, recorded telemetry and voice, all command and all S-band voice. UHF voice may still remain, but the limited ground coverage (essentially Continental U.S.) is insufficient to satisfy orbital requirements. Ku-band [TIPSTAGS](#) and downlink TV capabilities may also remain during the period that the Ku-band is deployed, but these relatively slow, one-way communications paths are of little value in the event of a subsequent systems problem. Considering the impact of losing all NSP capability in the event of a second failure versus the small gain in mission achievement that may be possible, redundant NSP's should be required to extend the flight beyond minimum duration. [@021998-65161](#)

C. LOSS OF UPLINK CAPABILITY FROM BOTH NSP'S WILL RESULT IN A NEXT PLS LANDING.

Refer to the rationale for Rule {A11.1.2-1}, LOSS OF TWO-WAY VOICE. Loss of both NSP uplinks would result in only UHF availability for two-way voice.

D. LOSS OF ALL DOWNLINK REAL TIME AND ALL RECORDED DATA OUTPUTS FROM BOTH NSP'S WILL RESULT IN A NEXT PLS LANDING.

FLIGHT RULES

Refer to the rationale for Rules {A11.1.2-1}, LOSS OF TWO-WAY VOICE; and {A11.1.2-4}, LOSS OF TELEMETRY. Loss of all downlink capability from both NSP's would result in only UHF availability for two-way voice and no telemetry to MCC.

Rule {A11.1.3-1}, COMMUNICATIONS GO/NO-GO CRITERIA, references this rule.

FLIGHT RULES

A11.1.2-14 LOSS OF COMMUNICATIONS SECURITY (COMSEC)

A. LOSS OF COMSEC WILL RESULT IN THE FLIGHT CONTINUING TO NOMINAL EOM.

Refer also to mission-specific rules that may be documented in Flight Rules Annexes.

Current agency policy with a fully operational TDRSS is to encrypt command/control uplinks or data as appropriate to protect sensitive government data and provide protection from unauthorized commands. When all data is unclassified, as it is for NASA flights, this policy would be waived (as it has been in the past) in order to complete the mission. In the event of total COMSEC failure, uplink protection will be provided by use of the uplink block protection. When data is classified, as for DOD flights, COMSEC rules will be defined in the Flight Rules Annex.

B. FOR LOSS OF A SINGLE COMSEC (UPLINK AND/OR DOWNLINK), ORBIT OPERATIONS WILL CONTINUE TO BE ENCRYPTED. FOR ASCENT AND ENTRY, REDUNDANCY WILL BE PROVIDED BY GOING TO CLEAR. IF UPLINK ENCRYPTION IS DESELECTED, THE UPLINK BLOCK SWITCH WILL BE USED BY THE CREW TO PROTECT COMMAND UPLINK WHEN COMMAND ACTIVITY IS NOT REQUIRED.

ENCRYPTION LOST	CONFIGURATION FOR ASCENT/ENTRY
BOTH UPLINK AND DOWNLINK	CLEAR UPLINK AND DOWNLINK (CREW USES BLOCK SWITCH)
UPLINK ONLY	CLEAR UPLINK AND DOWNLINK (CREW USES BLOCK SWITCH)
DOWNLINK ONLY	ENCRYPTED UPLINK, CLEAR DOWNLINK

Loss of a single COMSEC (uplink and/or downlink) does not prevent protection of that link with the remaining COMSEC system. Subsequent COMSEC failures can be resolved by deselecting encryption. For ascent and entry, the encryption will be deselected (uplink and/or downlink) to recover redundancy for command and S-band voice (the encryption switches are not accessible from the crew seats). When data are classified, as for DOD flights, COMSEC rules will be defined in the Flight Rules Annex.

Rule {A11.1.3-1}, COMMUNICATIONS GO/NO-GO CRITERIA, references this rule.

FLIGHT RULES

A11.1.2-15 **AUDIO CENTRAL CONTROL UNIT (ACCU)**

THE ACCU IS CONSIDERED LOST IF TWO-WAY VOICE ON THE FOLLOWING LOOPS IS INOPERABLE:

- A. AIR/GROUND 1.
- B. AIR/GROUND 2.
- C. AIR/AIR.

These are the only loops that interface with the communications equipment (both air/ground and EVA). Only Intercom and Page loops remain. Therefore, a subsequent failure in the alternate ACCU would result in the loss of all orbiter communications. One-half of the ACCU BYPASS IFM (J4) should be performed as described in Rule {A11.1.2-16}, LOSS OF ACCU's.

Rule {A11.1.2-16}, LOSS OF ACCU's, references this rule.

A11.1.2-16 **LOSS OF ACCU'S**

- A. FOR THE LOSS OF ONE ACCU, ONE-HALF OF THE ACCU BYPASS IFM (J4) WILL BE PERFORMED AS SOON AS PRACTICAL AND THE NOMINAL FLIGHT COMPLETED. IF UNSUCCESSFUL A NEXT PLS LANDING WILL BE PERFORMED.

Refer to Rule {A11.1.2-15}, AUDIO CENTRAL CONTROL UNIT (ACCU).

- B. FOR THE LOSS OF BOTH ACCU'S, THE IFM WILL BE COMPLETED AND AN MDF WILL BE PERFORMED.

The primary difference between A and B above is that loss of an ACCU is only loss of one source of redundancy while loss of total IFM is loss of two sources.

Loss of one ACCU is one failure away from loss of all air/ground voice. The IFM, when installed, provides two sources of air/ground voice. Implementing the J4 half of the IFM allows normal use of the remaining ACCU but with the following lost capabilities:

1. PS, OS, and AIRLOCK ATU's.
2. TACAN 3 tones.
3. C&W B tones via ACCU (MD SMU tones remain).
4. NSP 2 voice record channel 1.
5. NSP 1 voice record channel 2.

FLIGHT RULES

THIS RULE CONTINUED ON NEXT PAGE

FLIGHT RULES

A11.1.2-16 LOSS OF ACCU'S (CONTINUED)

6. *NSP 1 Air/Ground 2 loop.*
7. *PLT ATU is limited to only the Air/Ground 1 loop in NSP 2 and only in hot mike mode.*

The extent of these lost capabilities is of minor mission impact and does not constitute grounds for shortening the mission. For vehicles 103 and 104 only one crewmember in the airlock will have hardline communications which has a minor procedural impact. Should the remaining ACCU fail after the J4 IFM, the CDR and PLT ATU's (only) will still retain an S-band communications capability although it will be nonredundant. The IFM should then be completed restoring dual S-band communications redundancy. Since redundancy is available, an immediate (next PLS) landing is not necessary, but the dwindling communication capabilities justify that the flight be continued only until MDF.

Rule {A11.1.2-15}, AUDIO CENTRAL CONTROL UNIT (ACCU), references this rule.

A11.1.2-17 LOSS OF THE PLT AND MS ATU'S

LOSS OF BOTH THE PLT AND MS ATU'S WILL RESULT IN THE FLIGHT CONTINUING TO NOMINAL EOM.

These two ATU's are necessary to process audio system configuration data for external interfaces such as the NSP's, recorders, UHF, Spacelab, etc. In the event of a subsequent ACCU switch failure, these external configurations would come up in a random state. However, testing and analysis have shown that the probability of regaining a working Air/Ground loop on each switch attempt (A/G 1, 2, or UHF) exceeds 90 percent. Therefore, shortening the mission for these failures is not justified.

Rule {A11.1.3-1}, COMMUNICATIONS GO/NO-GO CRITERIA, references this rule.

A11.1.2-18 LOSS OF INTERCOM

THE FLIGHT WILL BE CONTINUED FOR THE LOSS OF ALL INTERCOM.

Intercom is desirable but not mandatory for crew coordination. When seated for entry, the CDR and PLT can easily communicate without the intercom. Communications with MS1 and MS2 can be done using the Air/Ground or Air/Air loops if necessary, although simultaneous transmissions to the STDN in these cases would occur. It would also be necessary to use the Air/Ground or Air/Air loops to record voice on the Ops recorders. These conditions may be undesirable but not considered serious enough to shorten the mission

Rule {A11.1.3-1}, COMMUNICATIONS GO/NO-GO CRITERIA, references this rule.

FLIGHT RULES

A11.1.2-19 LOSS OF UHF

LOSS OF UHF WILL RESULT IN THE FLIGHT CONTINUING TO NOMINAL EOM.

UHF voice is used as the sole source of EVA communications, as the source of communication on the universal guard channel (243.0 MHz), and as an alternate source of communication during ascents and entries. Failures of UHF affecting air/ground communications should not result in an early mission termination as long as S-band redundancy exists for entry.

Rule {A11.1.3-1}, COMMUNICATIONS GO/NO-GO CRITERIA, references this rule.

A11.1.2-20 LOSS OF GCIL

LOSS OF GCIL WILL RESULT IN THE FLIGHT CONTINUING TO NOMINAL EOM.

Loss of GCIL capability implies loss of command capability to most of the communications systems, loss of a quick way to switch S-band strings (the "Panel/Command" capability) and loss of some unique functions that require a GCIL; e.g., frequency selection. Workarounds exist in all cases although the crew would have to assume some additional workload. The resulting loss of efficiency does not justify shortening the mission.

Rule {A11.1.3-1}, COMMUNICATIONS GO/NO-GO CRITERIA, references this rule.

A11.1.2-21 LOSS OF RECORDERS

A. THE FLIGHT WILL BE CONTINUED FOR A LOSS OF ALL OPS, MADS/OEX AND PAYLOAD RECORDERS.

In order to justify a mission termination, either an actual or potential crew safety hazard must exist, all planned mission objectives must have been achieved, or no further useful mission objectives can be achieved on this flight for whatever reason. It is extremely unlikely that failure of any or all of these recorders would result in one of these three conditions. Recorders are generally used to document a complete mission history and to backup or supplement analog or digital data that is acquired by other means, e.g., real time. When this is not the case, the data is rarely critical to total mission success as a backup was apparently not justifiable. The MADS/OEX recorder is a sole source of orbiter supplemental data; but, since this data is usually for entry performance evaluation, a MADS/OEX recorder failure does not justify an early reentry as the data is lost regardless. Recorder criticality, if any, would be defined in the Flight Rules Annex.

THIS RULE CONTINUED ON NEXT PAGE

FLIGHT RULES

A11.1.2-21 LOSS OF RECORDERS (CONTINUED)

- B. IN THE EVENT BOTH OPS RECORDERS FAIL, THE OPS 2 RECORDER WILL BE REPLACED WITH THE PAYLOAD RECORDER.

The payload recorder is not used for recording orbiter systems data and, therefore, its loss can only impact the degree of mission success. Since real-time orbiter systems data is not continuous, but is limited by station coverage or entry blackout, it is probable that the Ops recorders could prove the sole source of orbiter data and recorded voice at the time a systems anomaly occurs. Since this data is much more extensive than that available to the crew, it is potentially critical for allowing complete systems anomaly troubleshooting. It is also the only source of crew intercom voice. Therefore, giving up the payload recorder for these dual failure conditions is prudent. Ops 2 is preferred as it is much more accessible than Ops 1.

- C. NO RECORDER CHANGEOUTS WILL BE ACCOMPLISHED FOR LOSS OF A SINGLE OPS RECORDER.

The availability of TDRS and the reduction of the need for voice recording to only high activity mission phases results in only one Ops recorder for a given flight being required to satisfy requirements. The other Ops recorder is considered a backup. Since the payload recorder is used on some flights to acquire data unavailable elsewhere and since approximately 2 hours of crew time is necessary to change out recorders, the replacement of the backup Ops recorder with the payload recorder is not justified.

- D. IF THE OPS 2 RECORDER FAILS DURING ASCENT, THE OPS 1 RECORDER WILL BE RECONFIGURED TO RECORD BOTH MAIN ENGINE DATA AND OI DATA. THE SPEED WILL BE THE OPTIMUM (24 IPS) FOR OI DATA RATE. A RECORDER IS CONSIDERED FAILED WHEN ANY OF THE FOLLOWING OCCUR:

1. RECORDER BITE INDICATION PRESENT.
2. RECORDER TEMPERATURE > 120 DEG F.
3. UNABLE TO DETECT TAPE MOTION.

The Ops 1 recorder can be configured to record orbiter OI telemetry and voice, but provides the only means of recording SSME EIU data during ascent. The Ops 2 recorder can only be used to record OI data and voice which is its nominal ascent configuration. Should the Ops 2 recorder fail during ascent, both EIU and orbiter data can be recorded on Ops 1 during powered flight in a slightly degraded but recoverable mode. After powered flight, Ops 1 can be reconfigured to record only OI data and voice.

Recent test data shows both EIU and OI data and voice may be recorded and recovered, on the same recorder, with minimum degradation.

FLIGHT RULES

Rule {A11.1.3-1}, COMMUNICATIONS GO/NO-GO CRITERIA, references this rule.

FLIGHT RULES

A11.1.2-22 LOSS OF TV

THE FLIGHT WILL BE CONTINUED FOR LOSS OF ALL OR PART OF THE TV SYSTEM.

The TV system has never been identified as being essential for crew safety purposes. It is usually used for real-time or near real-time public information purposes and for mission documentation of payload bay activities. It has also proven useful as a close-in ranging aid, as an RMS grapple aid, for monitoring PAM PKM burns, and miscellaneous, often unforeseen, mission activities such as water dump nozzle survey. None of these uses are considered a realistic justification for an early flight termination. It is conceivable however, that some mission objectives may not be satisfied for a total TV system loss. These will be identified in the Flight Rule Annex.

Rule {A11.1.3-1}, COMMUNICATIONS GO/NO-GO CRITERIA, references this rule.

A11.1.2-23 LOSS OF TIPSTAGS

LOSS OF TIPSTAGS WILL RESULT IN THE FLIGHT CONTINUING TO NOMINAL EOM.

TIPSTAGS is a major convenience for passing information to the crew. If TIPSTAGS capability were lost, the same information would be passed via voice ~~or teleprinter (if available)~~. [@021998-65161](#)

A11.1.2-24 PCM MASTER UNIT (PCMMU)

THE PCMMU IS CONSIDERED LOST IF ANY ONE OR MORE OF THE FOLLOWING IS TRUE:

- A. IT CANNOT SUPPLY DATA TO AT LEAST ONE GPC.
- B. IT CANNOT SUPPLY HIGH DATA RATE AND LOW DATA RATE TELEMETRY TO THE GROUND.
- C. IT CANNOT SUPPLY DOWNLIST DATA FROM AT LEAST ONE GPC TO THE GROUND.

The PCMMU is required for three major purposes. It supplies all orbiter real-time and recorded telemetry (OI MDM and PDI data). It supplies OI and PDI data to the SM and BFS GPC's for onboard display and fault detection (class 3 alarms). It supplies all GPC downlist data to real-time and recorded telemetry. The loss of either of these three functions is a serious impact upon systems monitoring visibility for either the crew or MCC. The extent of the visibility loss is significant enough to consider the PCMMU as unusable and essentially failed.

FLIGHT RULES

A11.1.2-25 LOSS OF PCMMU'S

A. LOSS OF ONE PCMMU WILL RESULT IN AN MDF.

The PCMMU's are required to provide all real-time and recorded telemetry to MCC and much onboard systems data to the SM or BFS GPC's for crew display and class 3 alerts. There are no available workarounds for a PCMMU failure. Considering the impact of losing such extensive insight into the onboard systems in the event of a second failure versus the small gain in mission achievement that may be possible, redundant PCMMU's should be required to extend the flight beyond minimum duration.

B. LOSS OF TWO PCMMU'S WILL RESULT IN A NEXT PLS LANDING.

This failure results in a significant loss of telemetry or onboard monitoring capability.

Rule {A11.1.3-1}, COMMUNICATIONS GO/NO-GO CRITERIA, references this rule.

A11.1.2-26 LOSS OF OI MDM

LOSS OF ANY OI MDM WILL RESULT IN THE FLIGHT CONTINUING TO NOMINAL EOM.

The impacts of losing any single OI multiplexer/demultiplexer have been analyzed with the results documented in JSC-16983, OI MDM/DSC Failure Impacts. The analysis reveals that adequate instrumentation remains for making mission-critical decisions using other sources. Flight Data File procedures exist that reference any configurations that are necessary following the loss of the LRU.

A11.1.2-27 LOSS OF ANY OI DSC

LOSS OF ANY OI DSC WILL RESULT IN THE FLIGHT CONTINUING TO NOMINAL EOM.

The impacts of losing any single OI Dedicated Signal Conditioner have been analyzed with the results documented in JSC-16983, OI MDM/DSC Failure Impacts. The analysis reveals that adequate instrumentation remains for making mission critical decisions using other sources. Flight Data File procedures exist that reference any reconfigurations that are necessary following the loss of the LRU.

FLIGHT RULES

GO/NO-GO CRITERIA

A11.1.3-1 COMMUNICATIONS GO/NO-GO CRITERIA

FAILURE	INVOKE MDF IF:	ENTER NEXT PLS IF:	RULE REF.
A. COMMUNICATIONS			
(1) 2-WAY VOICE (3) (A/G, 1, 2, UHF)		2 ↓	{A11.1.2-1}
(2) COMMAND (S-BD 1, 2)	2 ↓		{A11.1.2-3}
(3) 2-WAY VOICE + COMMAND		ALL ↓ [4]	{A11.1.2-2}
(4) TELEMETRY		ALL ↓	{A11.1.2-4}
(5) TDRS TRACKING			{A11.1.2-10}
(6) NSP UPLINK (2)		2 ↓ [8]	{A11.1.2-13A},C
(7) NSP DOWNLINK (2)	1 ↓	2 ↓ [9]	{A11.1.2-13B},D
(8) XPNDR UPLINK (2)		2 ↓ [8]	{A11.1.2-8A},B
(9) XPNDR DOWNLINK (2) (I)	2 ↓	2 ↓ I ↓ [7]	{A11.1.2-8A},C
(10) ACCU (2) (I)	2 ↓ [5] I ↑	1 ↓ I ↓ [6]	{A11.1.2-15}
(11) COMSEC (2) [1]			{A11.1.2-14}
(12) KU-BAND [1]			{A11.1.2-5}
(13) UHF			{A11.1.2-19}
(14) ATU (PLT & MS)			{A11.1.2-17}
(15) TV			{A11.1.2-22}
(16) TIPSTAGS			{A11.1.2-23}
(17) INTERCOM			{A11.1.2-18}
(18) PI (2) [1]			ANNEX
(19) PSP (2) [1]			ANNEX
(20) S-BD PREAMP (2) [10]			{A11.1.2-11}
(21) S-BD PWR AMP (2) [10]			{A11.1.2-11}
(22) GCIL			{A11.1.2-20}
(23) ANTENNA ELECTRONICS			{A11.1.2-12}
B. INSTRUMENTATION			
(1) PCMMU (2)	1 ↓	2 ↓	{A11.1.2-25}
(2) OI MDM'S (7)			{A11.1.2-26}
(3) OI DSC'S (14) [11]			{A11.1.2-27}
(4) PDI [1]			ANNEX
(5) MADS/OEX			{A11.1.2-21A}
(6) OPS RCDR (2)			{A11.1.2-21A}
(7) PL RCDR [1]			{A11.1.2-21A} OR ANNEX

©[111298-6778]

LEGEND:

	NO REQUIREMENT
	REQUIRED

- () QUANTITY
- [] NOTE REFERENCE
- I ↑ IFM SUCCESSFUL

FLIGHT RULES

Rule {A17.1.13-1}, LIFE SUPPORT GO/NO-GO CRITERIA, references this rule.

THIS RULE CONTINUED ON NEXT PAGE

FLIGHT RULES

A11.1.3-1 COMMUNICATIONS GO/NO-GO CRITERIA (CONTINUED)

NOTES:

- [1] REFER ALSO TO ANY MISSION-SPECIFIC RULES DOCUMENTED IN FLIGHT RULES ANNEXES.
- [2] RESERVED
- [3] RESERVED
- [4] IF NO VOICE AND NO COMMAND AND PAST LAST PLS OPPORTUNITY AND NO MCC CONFIRMATION OF STATE VECTOR STABILITY THEN DEORBIT NEXT SLS.
- [5] IFM REMAINS WHICH BYPASSES THE ACCU'S AND RESTORES DUAL AIR/GROUND VOICE SOURCES.
- [6] LOSS OF ONE ACCU AND AN UNSUCCESSFUL IFM RESULTS IN BEING ONE FAILURE AWAY FROM LOSS OF ALL VOICE. LOSS OF BOTH ACCU'S AND AN UNSUCCESSFUL IFM RESULTS IN LOSS OF ALL VOICE.
- [7] IFM ALLOWS REGAIN OF DOWNLINK (NOT TO TDRS) TO GROUND STATIONS. RULE IS BASED UPON LOSS OF ALL ENTRY TELEMETRY AND ONLY A SINGLE VOICE SOURCE (UHF) REMAINING FOR ENTRY.
- [8] RULE IS BASED ON ONLY A SINGLE VOICE SOURCE (UHF) REMAINING FOR ENTRY.
- [9] RULE IS BASED UPON LOSS OF TELEMETRY AND ONLY A SINGLE VOICE SOURCE (UHF) REMAINING FOR ENTRY.
- [10] IMPLIES LOSS OF TDRS TELEMETRY.
- [11] ADDITIONAL DCS'S ARE INSTALLED FOR EDO PALLET FLIGHTS.

FLIGHT RULES

COMMUNICATIONS AND INSTRUMENTATION LOSS/FAILURE DEFINITIONS

A11.9.1-1 HIGH DATA RATE RECORDER (HDRR)

FAILED IF:

- A. DUMP DATA IS OF UNACCEPTABLE QUALITY ACCOMPANIED BY CONSISTENT FAILURE OF HDRR SELF-TEST.

The purpose of the HDRR is to record and play back payload data. If it cannot perform this function, then it is considered failed. The HDRR self-test records a test pattern on the tape and plays it back to test the recorder function. If the self-test consistently fails, it indicates the problem is in the HDRR and not in some other part of the data system. If the self-test passes but the payload data recorded on the HDRR is of unacceptable quality, the problem is most likely in some other part of the data system and not the HDRR.

- B. THE HDRR MECHANICALLY JAMS.

If the HDRR mechanically jams and cannot be freed, then it is incapable of recording or playing back payload data and is failed.

FLIGHT RULES

COMMUNICATIONS AND INSTRUMENTATION SYSTEMS MANAGEMENT

A11.9.2-1 OPERATIONS (OPS) RECORDER MANAGEMENT

THE OPS RECORDERS SHALL BE OPERATED IN THE DATA-ONLY RECORD MODE (128 KBPS) WHENEVER THE HRM VOICE CHANNELS ARE ENABLED. FOR ANY LOSS OF SIGNAL (LOS) THAT THE HRDA IS CONSTRAINED OR THE HRM VOICE CHANNELS ARE INHIBITED, THE OPS RECORDERS WILL BE OPERATED IN THE DATA/VOICE MODE (192 KBPS). AN AVERAGE OF 10 MINUTES OF KU-BAND CHANNEL 2 DUMP TIME IS REQUIRED FOR EACH HOUR OF LOS IN THE DATA-ONLY RECORD MODE. FOR THE DATA/VOICE RECORD MODE, AN AVERAGE OF 15 MINUTES PER HOUR OF LOS IS REQUIRED.

The ops recorders will be operated to ensure all orbiter data is recovered for postflight analysis and in-flight monitoring or troubleshooting. This requires all data not relayed to the MCC (high data rate) in real time be recorded.

No voice will be recorded because the high rate multiplexer (HRM) and HDRR are recording necessary crew voice so it is not necessary to record it on the ops recorders. This also reduces the amount of time required to dump the ops recorders since the record data rate is reduced (from 192 kbps to 128 kbps) allowing an 8 to 1 rather than a 5 to 1 dump.

The nominal way to dump the ops recorders is via the Ku-band. The number of 10 minutes for every hour recorded gives time for the 8 to 1 dump with sufficient overhead for set up and link dropouts.

Mission constraints or HRM format usage requirements may necessitate that the HRM voice channels are inhibited for all or part of a given mission. In this event, the ops recorders will be used to record both data and voice.

A11.9.2-2 HIGH RATE MULTIPLEXER (HRM) VOICE MANAGEMENT

THE VOICE CHANNELS TO THE HRM WILL NORMALLY BE ENABLED.

The HRM and HDRR need to record the crew voice for post mission data purposes. The voice is used by the POCC to reconstruct the crew activities and as a direct log of crew observations. The recording of crew voice on the HRM/HDRR also relieves the orbiter ops recorders from having to do so and reduces the amount of Ku-band time which must be used by the orbiter. This leaves more Ku-band time available to the payload.

Mission constraints or HRM format usage requirements may necessitate that the HRM voice channels are inhibited for all or part of a given mission. In this event, the ops recorders will be used to record both data and voice.

FLIGHT RULES

A11.9.2-3 **HDRR MANAGEMENT**

THE HDRR WILL NORMALLY BE OPERATED SO AS TO RECORD ALL HRM DATA WHEN KU-BAND IS NOT AVAILABLE BUT WILL NOT NORMALLY RECORD DURING TRACKING AND DATA RELAY SATELLITE SYSTEM (TDRSS) RECONFIGURATIONS AND/OR HANDOVER. SPECIFIC RECORDING REQUIREMENTS WILL BE IDENTIFIED BY THE POCC IN THE DATA MANAGEMENT CHECKLIST.

The purpose of the HDRR is to capture data when the Ku-band is not available to relay it to the ground in real time. TDRSS reconfigurations consist of data rate changes required by the POD data flow plan and handovers from one satellite to the other. In both cases, the data outage is small (less than 1 minute).

For many cases, the HDRR cannot be simply put in record because of the HRM format loaded. The HRM would have to be reconfigured to a record format and then configured back to a real-time format after the TDRSS reconfiguration was complete. There would be data outage caused by the HRM format reconfigurations. This makes the recording of data during TDRS reconfigurations for the most part not worth the trouble. If the POCC data team identifies a need to record during the reconfiguration of TDRSS and the data flow timeline is planned accordingly, then the HDRR can be used to cover for the data outage.

A11.9.2-4 **HRM/HDRR OPERATION RESPONSIBILITY**

THE MCC IS PRIME FOR THE OPERATION OF THE HRM AND THE HDRR.

The HRM and the HDRR can only be operated effectively by someone who has knowledge of the TDRS system status and the orbiter Ku-band system configuration. Without such knowledge, it is not possible to know when to dump the HDRR or change to a real-time HRM format since it is not known if the Ku-band is configured to relay the data or if TDRS is configured to receive and relay the data to the POCC. The orbiter Ku-band system is operated by the MCC and the TDRS network is configured and monitored by the MCC. Thus, the MCC should be the prime operator of the HRM and HDRR.

The MCC will coordinate HRM and HDRR operations with the POCC data team in the execution of the data management checklist as defined in the appropriate Joint Operations Interface Procedure (JOIP).

FLIGHT RULES

A11.9.2-5

HDRR TO PAYLOAD RECORDER DOWNMODE

- A. IN THE EVENT OF AN HDRR FAILURE, THE PAYLOAD RECORDER WILL BE USED FOR LOS RECORDING. RECORD RATES WILL BE LIMITED TO 1 MEGABIT PER SECOND (MBPS) OR LESS, AND THE DUMP RATE WILL BE 1 MBPS.

The payload recorder is the only recorder available to record HRM data if the HDRR fails. The maximum record rate that the payload recorder hardware will support is 1.024 mbps. The highest HRM rate that is less than this is 1 mbps. Thus the record rates must be limited to 1 mbps. The highest dump speed available is 120 inches per second (ips) which will yield a 1 mbps dump. This is the most efficient use of the payload recorder.

MODULE

- B. IF THE HDRR CONSISTENTLY FAILS SELF-TEST AND DUMP DATA IS UNUSABLE BUT ALL OTHER INDICATIONS ARE NORMAL, A TAPE CHANGE WILL BE PERFORMED IF SPARE TAPE IS AVAILABLE.

If the HDRR consistently fails the self-test, then a problem with the HDRR and not with the rest of the comm system is indicated. If all other indications are normal (i.e., the tape transport seems OK and all telemetry shows normal), then a problem with the tape or the record/playback heads is indicated. The appropriate action is to replace the tape with the spare and inspect the heads as part of the tape change procedure. This action is more likely to recover operation of the HDRR than more detailed inspections or troubleshooting and should be performed first.

- C. IN THE EVENT THAT BOTH THE HDRR AND PAYLOAD RECORDERS FAIL AND BOTH OPERATIONAL RECORDERS (OPS 1 AND 2) ARE OPERATING NOMINALLY, A CABLE IN-FLIGHT MAINTENANCE (IFM) WILL BE PERFORMED TO CONNECT THE INPUT AND OUTPUT CABLES OF THE PAYLOAD RECORDER TO THE OPS 2 RECORDER. THE IFM WILL ENSURE THAT THE RECORD AND DUMP RATES FOR THE OPS 2 RECORDER WILL BE THE SAME AS THOSE OF THE PAYLOAD RECORDER. PRIOR TO DEORBIT, THE OPS 2 RECORDER WILL BE PUT BACK INTO ITS NOMINAL CONFIGURATION.

Given the possibility of failure of the Spacelab HDRR, a backup to the orbiter payload recorder has been requested. In the event that both the HDRR and payload recorder fail, jumper cables could be unstowed and installed to connect the OPS 2 recorder to the input/output cables that go to the payload recorder. The IFM will also swap the payload recorder program plug with the OPS 2 recorder program plug. Thus, the OPS 2 recorder will have the same record and playback rates. The decision to use the OPS 2 recorder to record payload data will depend on the operating condition of the orbiter systems and will require that both OPS 1 and 2 recorders be operational.

- D. EXCEPTIONS TO THIS RULE ARE DOCUMENTED IN THE FLIGHT SPECIFIC ANNEX.

FLIGHT RULES

A11.9.2-6 HRM FAILURE CASE

MODULE

FOR FAILURE OF A SINGLE HRM INPUT CHANNEL (AS VERIFIED BY HRM SELF-TEST), CONSIDERATION WILL BE GIVEN TO PERFORMING AN IFM TO SWITCH THE AFFECTED EXPERIMENT TO A SPARE HRM CHANNEL AND MODIFYING THE HRM FORMATS.

If a single input channel to the HRM fails, an IFM is available to connect the experiment to a spare channel. The HRM formats would have to be modified (an MCC or HOSC function) to sample the data from the spare channel instead of the normal one. The high rate demultiplexer (HRDM) formats (on the ground) would not have to be modified.

The HRM self-test should be run to ensure the failure is in the HRM. If the HRM passes the self-test, then the failure is most likely in the experiment or the wiring harness and the IFM would do no good. In any event, the importance of the affected data should be weighed against the risks of performing an IFM on the heart of the SL high rate data system. It may be preferable to do without the data than risk damage to the HRM or wiring and lose even more.

A11.9.2-7 MCC/CREW PRIME OPS OF VIDEO ANALOG SWITCH (VAS)/VIDEO CASSETTEINSTRUMENTATION TAPE RECORDER SYSTEM (VCITRS)

MODULE

A. THE MCC IS PRIME FOR VIDEO ANALOG SWITCH (VAS) AND VIDEO CASSETTEINSTRUMENTATION TAPE RECORDER SYSTEM (VCITRS) OPERATIONS FOR VIDEO DUMPS AND FOR THE INITIAL SETUP OF THE VAS FOR NON-DUMP FUNCTIONS. [@J021998-6517.1](#)

The dumping of the VCITRS's can only be done effectively by someone who has knowledge of the status of the Ku-band comm system and the TDRS network. Without such knowledge, it is not possible to know when to start a dump since one would not know if the TDRS network, for example, was ready to receive it. The MCC normally operates the Ku-band and configures and monitors the TDRS network. Neither the crew nor the POCC has this visibility and knowledge. Thus the MCC should operate the VAS and VCITRS for video dumps. [@J021998-6517.1](#)

THIS RULE CONTINUED ON NEXT PAGE

FLIGHT RULES

A11.9.2-7 MCC/CREW PRIME OPS OF VIDEO ANALOG SWITCH
(VAS)/VIDEO CASSETTE RECORDER SYSTEM (VCRS) —
INSTRUMENTATION TAPE RECORDER (VTR) —
(CONTINUED)

- B. THE CREW IS PRIME FOR ALL CREW-ATTENDED VIDEO OPERATIONS WHICH REQUIRE THE VAS, ~~VIDEO TAPE RECORDER (VTR)~~, OR VCRSVTR. THE MCC IS PRIME FOR INITIAL VAS SETUP AND FOR ALL UNATTENDED VIDEO OPERATIONS WHICH REQUIRE THE VAS, ~~VTR~~, OR VCRSVTR. [@J021998-65171](#)

The initial setup of the VAS for nondump functions can be done by the MCC since the TV operations are timelined in the data management checklist and the MCC has knowledge of this timeline. This relieves the crew of this task.

Subsequent crew-attended video operations which require the VAS, ~~VTR~~, or VCRSVTR may not be done effectively by the MCC since often only the crew knows exactly where they are in the timeline. These operations should be done by the crew. [@J021998-65171](#)

Many timelined video operations using experiment supplied science cameras, however, are unattended and crew-independent such as the periodic recording or downlink of crystals, plant growth, or cell cultures. These operations should be performed by the MCC since the MCC has knowledge of the timeline and can relieve the crew of this task.

- C. EXCEPTIONS TO THIS RULE ARE DOCUMENTED IN THE FLIGHT SPECIFIC ANNEX.

A11.9.2-8 ORBITER VIDEO CONTROL UNIT (VCU) FAILURE

MODULE

FOR FAILURE OF THE ORBITER VIDEO CONTROL UNIT (VCU), VAS OPERATIONS WILL CONTINUE WITH ALL TV SOURCES ASYNCHRONOUS, ASYNCHRONOUS GMT INSERTION IN VIDEO DATA, NO AUDIO INSERTION, AND NO REMOTE SPACELAB CAMERA CONTROL.

The orbiter VCU furnishes the master sync signal to the VAS and to all Spacelab cabin cameras. The failure of the VCU would result in all cameras running asynchronously and make it impossible for the VAS to properly insert GMT timetags or audio in the Spacelab video. This results in some picture degradation. The VCU provides the camera commands for remote control for the Spacelab cameras; thus no remote control would be possible in the event of a VCU failure; but crew control using the local pushbuttons and switches on the camera would be available. Camera overtemp sensing would not be available but the camera temps could be monitored by downlinking the Spacelab cameras and letting the MCC read the temperature out of the video. TV operations could continue in the module as long as the above restrictions are not an impact.

FLIGHT RULES

A11.9.2-9 COMM TEMPERATURE LIMITS TO POWER OFF

THE FOLLOWING COMM EQUIPMENT WILL BE POWERED OFF IF ITS ASSOCIATED TEMPERATURE REACHES THE FOLLOWING LIMIT:

EQUIPMENT	TEMP LIMIT
HRM	126° F/52° C (142° F/61° C)
HDRR	104° F/40° C (106° F/41° C)
VAS	176° F/80° C (158° F/70° C)
VITR	140° F/60° C (126° F/52° C)

HRM limits derived from baseplate qualification temperature in conjunction with Spacelab Module Mission Flight Data from SL-1, SL-3, D-1, SLS-1, IML-1, and USML-1, from Spacelab Pallet Mission Flight Data for SL-2, ASTRO-1, and ATLAS-1, and HRM 20-RP-ME-0019. HDRR limits are from the 9116013 Odetics Report and TM-SEAD-84131. VAS and VITR limits are from the Spacelab Operational Data Book (SODB). Limits represent the highest temperature to which the equipment has been qualified. Exceeding these limits may result in permanent damage to the equipment. The component lifetime limits may be exceeded before these limits are reached. The numbers in () are biased for instrumentation accuracy and location and are the values where action will be taken.

FLIGHT RULES

THIS PAGE INTENTIONALLY BLANK

FLIGHT RULES

SECTION 12 - ROBOTICS

GENERAL

A12.1.1-1	EVA FOR RMS OPERATIONS	12-1
A12.1.1-2	UNATTENDED RMS CONSTRAINTS	12-2
A12.1.1-3	TEMPERATURE CONSTRAINTS (CIL)	12-4
A12.1.1-4	RMS ACTIVITY TERMINATION	12-5
A12.1.1-5	ORBITER AVOIDANCE MANEUVERS CONSTRAINT (CIL)	12-7
A12.1.1-6	OMS/RCS CONSTRAINTS	12-7
A12.1.1-7	RMS IFM D&C KIT	12-16
A12.1.1-8	RMS OPCODE UPLINKS	12-18
A12.1.1-9	RMS MCIU BITE OVERRIDES (CIL)	12-21

MPM/MRL LOSS/FAILURE DEFINITIONS

A12.1.2-1	MPM/MRL POSITIONING	12-22
A12.1.2-2	MPM FAILED IN TRANSIT	12-22
A12.1.2-3	MRL FAILED IN TRANSIT	12-22

MPM/MRL SYSTEMS MANAGEMENT

A12.1.3-1	MPM/MRL CYCLING	12-23
A12.1.3-2	MPM DEPLOY/STOW CONSTRAINTS	12-23
A12.1.3-3	MRL CONSTRAINTS	12-25
A12.1.3-4	INADVERTENT MPM CYCLING PROTECTION (CIL) . .	12-25

RMS PREOPERATION SYSTEM MANAGEMENT

A12.1.4-1	SHOULDER BRACE OPERATION	12-26
A12.1.4-2	RMS CHECKOUT	12-26

FLIGHT RULES

RMS DRIVE SYSTEM MANAGEMENT

A12.1.5-1	MODE AVAILABILITY DRIVE CONSTRAINT	12-28
A12.1.5-2	FIELD OF VIEW CONSTRAINT (CIL)	12-28
A12.1.5-3	AUTO MODE ENTRY CONSTRAINT (CIL)	12-29
A12.1.5-4	ORBITER PROXIMITY CONSTRAINTS (CIL)	12-30
A12.1.5-5	INOPERATIVE BRAKE CONSTRAINT (CIL)	12-34
A12.1.5-6	AUTO BRAKES CONSTRAINT (CIL)	12-35
A12.1.5-7	CONTINGENCY STOP (CIL)	12-35
A12.1.5-8	POHS AND LEFT-HANDED COORDINATE SYSTEMS . . .	12-35
<u>A12.1.5-9</u>	<u>RMS MODES FOR CBM CAPTURE OPERATIONS</u>	<u>12-28a</u>

END EFFECTOR (EE) LOSS/FAILURE DEFINITIONS

A12.1.6-1	EE BACKUP RELEASE	12-29
A12.1.6-2	EE CAPTURE/RIGIDIZE	12-29
A12.1.6-3	EE RELEASE/DERIGIDIZE	12-29

END EFFECTOR SYSTEM MANAGEMENT

A12.1.7-1	PAYLOAD GRAPPLE CONSTRAINTS	12-30
A12.1.7-2	EE MODE SWITCH CONSTRAINTS (CIL)	12-31
A12.1.7-3	CAPTURE AND RELEASE PROXIMITY CONSTRAINT (CIL)	12-32
A12.1.7-4	PAYLOAD RELEASE DURING BERTHING	12-32

RMS JETTISON SYSTEM MANAGEMENT

A12.1.8-1	JETTISON SYSTEM CONSTRAINT	12-33
A12.1.8-2	RMS/PAYLOAD JETTISON	12-33

GO/NO-GO CRITERIA

A12.1.9-1	RMS GO/NO-GO CRITERIA	12-34
-----------	---------------------------------	-------

FLIGHT RULES

SECTION 12 - ROBOTICS

GENERAL

A12.1.1-1 **EVA FOR RMS OPERATIONS**

- A. FOR RMS FAILURES THAT ARE KNOWN PRIOR TO THE START OF RMS OPERATIONS:

AN UNSCHEDULED EVA TO CONFIGURE THE RMS FOR OPERATIONS (E.G., SHOULDER BRACE RELEASE, MPM DEPLOY) MAY BE CONSIDERED ONLY IF A SECOND EVA WILL NOT BE REQUIRED TO MAKE THE ORBITER SAFE FOR ENTRY.

FLIGHT-SPECIFIC EXCEPTIONS FOR HIGH PRIORITY OPERATIONS WILL BE IDENTIFIED IN THE FLIGHT-SPECIFIC ANNEX.

EVA techniques are available to release the shoulder brace and to deploy the arm which will place the RMS into an operational configuration. Subsequent to MPM deploy, there could be occasions where the EVA crewmember would wait for the accomplishment of the mission objective and stow the MPM within the same EVA. But it is not safe to require another EVA to stow the MPM because the orbiter must retain the capability to perform a contingency payload bay door EVA.

The shoulder brace is only required for ascent loads; so, once it is released, an additional EVA will not be required to reattach it. However, if the arm is deployed EVA, it is very likely a second EVA would be required to stow it. If a second EVA is not available, the arm would have to be jettisoned to make the payload bay safe for entry.

- B. FOR RMS FAILURES THAT OCCUR OR ARE DISCOVERED AFTER RMS OPERATIONS HAVE COMMENCED:

IF CONDITIONS PERMIT, AND AFTER ALL OTHER METHODS HAVE FAILED, AN UNSCHEDULED EVA MAY BE CONSIDERED FOR THE FOLLOWING TASKS TO PRECLUDE HAVING TO JETTISON THE RMS, PAYLOAD, AND/OR MPM:

1. END EFFECTOR (EE) RELEASE.
2. RMS JOINT ALIGN.
3. RMS TIEDOWN.
4. MPM STOW.

THIS RULE CONTINUED ON NEXT PAGE

FLIGHT RULES

A12.1.1-1 EVA FOR RMS OPERATIONS (CONTINUED)

5. PAYLOAD BERTHING.

Once RMS operations have commenced, there are additional EVA techniques available for various failures in the end effector, joint motors, MRL, and MPM which will make the RMS safe for entry and preclude jettison of the arm, payload, and/or MPM. For certain payloads, the crew may also be trained to berth the payload manually using EVA techniques.

Rule {A2.1.3-13A}, PDRS, references this rule. @ED]

A12.1.1-2 UNATTENDED RMS CONSTRAINTS

A. DURING CREW AWAKE PERIODS, THE UNCRADLED RMS (LOADED OR UNLOADED) MAY BE LEFT UNATTENDED IF ALL OF THE FOLLOWING CONDITIONS ARE MET:

1. THE ARM IS SELECTED.
2. THE BRAKES ARE ON.
3. THE MODE SWITCH IS NOT IN DIRECT.
4. THE JOINT SWITCH IS IN THE CRITICAL TEMPERATURE POSITION.
5. THE MCIU MAINTAINS I/O WITH THE GPC.
6. THE FLIGHT-SPECIFIC ANNEX RULES ARE MET.
7. RMS/PAYLOAD CLEARANCE OF AT LEAST 1.5 METERS (5 FEET) FROM STRUCTURE IS MAINTAINED.

With the arm selected, I/O established with the MCIU, and the brakes on, the RMS software is in the idle mode with all six joints held by the mechanical brakes. Idle mode is required to determine the health of the arm. The RMS mode switch should be left in any position except DIRECT so that the joint slip algorithm will operate. The joint switch should be in the CRIT TEMP position so that a failure of the SINGLE/DIRECT DR switch will not lead to a single-joint runaway. Meeting the flight-specific annex rules is required to ensure that specific DAP configuration and RMS position/clearance constraints are met to prevent orbiter/RMS/payload contact (PDRS Working Panel 16-4 baselined this criteria).

THIS RULE CONTINUED ON NEXT PAGE

FLIGHT RULES

A12.1.1-2 UNATTENDED RMS CONSTRAINTS (CONTINUED)

- B. NOMINALLY, DURING CREW SLEEP PERIODS AND DURING EXTENDED PERIODS OF NON-RMS OPERATIONS, THE RMS SHALL BE CRADLED, LATCHED, AND THE SYSTEM LEFT IN THE TEMPERATURE MONITOR MODE. HOWEVER, PREFLIGHT PLANNED OVERNIGHT PARKING IS ACCEPTABLE IF THE RMS IS UNGRAPPLD AND THE CONDITIONS IN PARAGRAPH A ARE SATISFIED. FLIGHT-SPECIFIC EXCEPTIONS FOR HIGH PRIORITY PAYLOADS ARE IDENTIFIED IN THE FLIGHT RULES ANNEX. THE RMS CONFIGURATION FOR THE EXCEPTIONS IS DEFINED IN PARAGRAPH A.

The cradled and latched configuration of the RMS protects against RMS and MRL failures causing a delay should an emergency deorbit be required. Preflight planned parking of the ungrappled RMS is acceptable to accommodate specific customer requirements such as witness plates and other data gathering that cannot be accomplished in 1 crew day. No flight-specific analysis needs be done for the ungrappled RMS.

- C. FOR A CONTINGENCY REQUIRING OVERNIGHT PARK, THE UNCRADLED RMS (LOADED OR UNLOADED) MAY BE LEFT UNATTENDED PROVIDED ALL CONDITIONS IN PARAGRAPH A ARE SATISFIED.

The crew response time to an RMS alert is longer when the crew is asleep. The additional risk imposed by a longer response time is considered small and preferable to RMS/payload jettison. The arm shall be left configured per paragraph A for the same reasons as above. On-Orbit Flight Techniques Panel #130 baselined acceptability of this RMS configuration for contingency overnight parking.

- D. FOR RMS/ORBITER CONTINGENCIES WHERE THE CONDITIONS OF PARAGRAPH A CANNOT BE MET, UNLOADED, UNATTENDED OVERNIGHT PARK IS ACCEPTABLE WITH THE ARM UNPOWERED.

FLIGHT-SPECIFIC EXCEPTIONS FOR LOADED CASES WILL BE IDENTIFIED IN THE FLIGHT RULES ANNEX.

Certain RMS anomalies (e.g., loss of health monitoring insight or loss of one electrical inhibit) combined with mission situations may require the RMS to be deselected and/or power removed. An unpowered arm prevents subsequent electrical failures from causing a possible unannounced or unprotected hazard. Deselecting the arm is the preferred method of removing power to allow temperature, MCIU, and D&C health monitoring. RMS power may also be removed via the RMS power switch. RMS temperature control and/or monitoring should be considered prior to removing RMS power. Real-time insight and annunciation as to the status of the RMS will be affected when removing RMS power.

FLIGHT RULES

A12.1.1-3 TEMPERATURE CONSTRAINTS (CIL)

- A. BOTH RMS HEATERS SHALL BE ACTIVATED AT LEAST 1 HOUR PRIOR TO RMS OPERATIONS. IF EVENTS REQUIRE THE RMS TO BE USED BEFORE THE 1 HOUR REQUIREMENT HAS BEEN MET, BOTH HEATER SYSTEMS SHOULD BE ACTIVATED AND THE LIGHT EMITTING DIODE (LED) AND THE ARM BASED ELECTRONICS (ABE) TEMPERATURES MUST BE AT LEAST 10 DEG (21 DEG) F.

SPAR Aerospace recommended, during the FMEA/CIL activities, that both RMS heater buses be turned on at least 1 hour before arm operations to guarantee that thermal gradients across the joints do not cause joint problems in the event of a heater failure. SPAR also confirmed that RMS operations may proceed immediately without any risk of uncommanded motion if the temperatures as reported by the thermistors are within the nominal range (at least 21 deg F). (SPAR Aerospace Response to NASA-VP-87-020.)

- B. RMS OPERATIONS WILL BE TERMINATED AND THE ARM CRADLED AND LATCHED WITHIN 25 MINUTES IF THE LOW TEMPERATURE ALARM LIMIT (LED -20 DEG (0 DEG) F, ABE -20 DEG (0 DEG) F) IS REACHED, AND TROUBLE-SHOOTING DOES NOT ALLEVIATE THE PROBLEM. IF THE LOW TEMPERATURE QUALIFICATION LIMIT (LED -42 DEG (-10 DEG) F, ABE -33 DEG (-10 DEG) F) IS REACHED, FURTHER RMS OPERATIONS WILL NOT BE PERFORMED UNTIL THE TEMPERATURES RETURN WITHIN THE ALARM LIMITS. A JOINT DRIVE TEST IN DIRECT WILL BE PERFORMED TO VERIFY HEALTH PRIOR TO ANY FURTHER OPERATIONS.

There is an SODB requirement that heater power must be restored within 25 minutes of receipt of the low temperature alarm. If troubleshooting does not alleviate the low temperature problem, the arm must be placed in a safe configuration (meaning cradled and latched) within 25 minutes to prevent any degraded performance due to the low temperature. If the low temperature qualification limits are reached, arm performance may be unreliable; so, further RMS operations will not be performed until temperatures return within the alarm limits. Once within limits, a joint drive test in direct will be performed to ascertain joint health. Numbers in parentheses assume a 1-3/4 count potential error in the thermistor readings.

THIS RULE CONTINUED ON NEXT PAGE

FLIGHT RULES

A12.1.1-3 TEMPERATURE CONSTRAINTS (CIL) (CONTINUED)

C. RMS OPERATIONS WILL BE TERMINATED AND THE ARM CRADLED AND LATCHED WITHIN 15 MINUTES IF THE HIGH TEMPERATURE ALARM LIMIT (LED 176 DEG (172 DEG) F, ABE (EE) 147 DEG (144 DEG) F, ABE (SPA) 110 DEG (106 DEG) F) IS REACHED, AND TROUBLESHOOTING DOES NOT ALLEVIATE THE PROBLEM. THE ARM MUST BE CRADLED AND LATCHED BEFORE THE TEMPERATURE REACHES THE ACCEPTANCE TEMPERATURE LIMIT (LED 186 DEG (181 DEG) F, ABE (EE) 157 DEG (154 DEG) F, ABE (SPA) 120 DEG (117 DEG) F). IF THE ARM REACHES THE ACCEPTANCE TEMPERATURE LIMIT, POWER WILL BE REMOVED. IF THE HIGH TEMPERATURE QUALIFICATION LIMIT (LED 205 DEG (202 DEG) F, ABE (EE) 178 DEG (176 DEG) F, ABE (SPA) 140 DEG (136 DEG) F) IS REACHED, FURTHER RMS OPERATIONS WILL NOT BE PERFORMED UNTIL THE TEMPERATURES RETURN WITHIN THE ALARM LIMITS. A JOINT DRIVE TEST IN DIRECT WILL BE PERFORMED TO VERIFY HEALTH PRIOR TO ANY FURTHER OPERATIONS. @ED]_ [@\[111298-6744\]](#)

There is an SODB requirement that continued operation of the RMS is limited to 15 minutes if the high temperature alarm limit has been reached. In addition, all power will be removed from the arm if the high temperature acceptance test limits are reached. If troubleshooting does not alleviate the problem, the arm must be placed in a safe configuration (meaning cradled and latched) as soon as possible to prevent any degraded performance due to the high temperature. If the high temperature qualification limits are reached, arm performance may be unreliable so the arm should not be uncradled again until temperatures return within the alarm limits. Once within limits, a joint drive test in direct will be performed to ascertain joint health prior to any further arm operations. Numbers in parentheses assume a 1-3/4 count potential error in the thermistor readings. Spar Aerospace Memo PMO/97-017, dated June 25, 1997, updated the upper limit ABE numbers based on the redesigned SPA lower acceptance and qualification limits. [@\[111298-6744\]](#)

Rules {A18.1.10-1}, ORBITER THERMAL CONSTRAINTS AND ATTITUDE MANAGEMENT (CIL), and {A12.1.9-IV}, RMS GO/NO-GO CRITERIA, reference this rule. @ED]

A12.1.1-4 RMS ACTIVITY TERMINATION

- A. FOR MPM AND MRL EOM CONSTRAINTS, REFERENCE RULE {A2.1.3-2C} AND D, EXTENSION DAY REQUIREMENTS. @090894-1670B] @[113095-1809A]
- B. DECLARATION OF A NEXT PLS DEORBIT IS CAUSE TO TERMINATE RMS ACTIVITIES IMMEDIATELY. FLIGHT-SPECIFIC EXCEPTIONS FOR HIGH-PRIORITY OPERATIONS WILL BE IDENTIFIED IN THE FLIGHT-SPECIFIC ANNEX.

FLIGHT RULES

In the event of a next PLS situation, the orbiter must be in a safe configuration as soon as possible. This requires that the RMS be cradled, latched, and stowed prior to payload bay door closure. If important arm operations are being performed, such as berthing a payload, the situation may allow for those operations to be completed depending on the time left before deorbit.

FLIGHT RULES

A12.1.1-5 ORBITER AVOIDANCE MANEUVERS CONSTRAINT (CIL)

A PILOT SHALL ALWAYS BE AVAILABLE TO PERFORM A COLLISION AVOIDANCE MANEUVER DURING ALL LOADED RMS OPERATIONS IN THE EVENT OF A PAYLOAD UNCOMMANDED RELEASE.

Since there are failure modes that result in an uncommanded release of a payload that is attached to the arm, it may be necessary to maneuver the orbiter in a short period of time to avoid collision with the free-flying payload.

A12.1.1-6 OMS/RCS CONSTRAINTS

A. VRCS @[113095-1809A]

1. VRCS CONTROL IS NOT PERMITTED WHEN THE RMS IS:
 - a. IN TEST MODE AND GRAPPLED TO A NON-CONSTRAINED PAYLOAD.
 - b. PERFORMING FREE-FLYING PAYLOAD END EFFECTOR OPERATIONS.
 - c. IN MOTION WITH A PAYLOAD OVER 3640 KG (8000 LBS). (NOTE: THIS CONSTRAINT APPLIES TO DAP AUTO CONTROL ONLY; DAP MANUAL MODE IS ALLOWED.)
2. FOR OTHER VRCS CONSTRAINTS DURING LOADED RMS OPERATIONS (DUE TO DAP STABILITY PROBLEMS, PAYLOAD CLEARANCE CONCERNS, PAYLOAD LOADS SENSITIVITY CONCERNS, OR OTHER PAYLOAD CONSTRAINTS), REFERENCE THE FLIGHT RULES ANNEX.

When in test mode, unexpected arm motion due to payload inertia may result from VRCS firings since all joints are at maximum current attenuation and are essentially free to rotate when external forces are applied (except for internal gearbox friction). No free-flying EE operations should be performed with VRCS because jet firings may cause unexpected motion of the EE when the arm is limped for capture or rigidize sequences or tipoff rates may occur at release. Volume XIV, Appendix 8 states that prior to the grapple sequence, the orbiter RCS will be configured to free drift. It also specifies an orbiter DAP free drift period prior to release between 15 and 120 seconds to allow RMS oscillation damping.

FLIGHT RULES

Both SPAR and MPAD have performed analyses which show there is no chance of exceeding RMS or longeron loads for any combination of VRCS firings with a loaded RMS. However, there can be stability problems associated with manipulation of high mass payloads due to the change in the composite cg of the orbiter/payload. Volume XIV, Appendix 8 states that for payloads weighing over 8000 pounds, DAP free drift is required while the RMS is maneuvering the payload. ©[113095-1809A]

THIS RULE CONTINUED ON NEXT PAGE

FLIGHT RULES

A12.1.1-6 OMS/RCS CONSTRAINTS (CONTINUED)**B. PRCS ATTITUDE CONTROL @[113095-1809A]**

1. PRCS PRI DAP ATTITUDE CONTROL IS NOT PERMITTED WHEN THE RMS IS:
 - a. IN A SINGULARITY.
 - b. AT A REACH LIMIT.
 - c. IN TEST MODE UNLESS GRAPPLED TO A CONSTRAINED PAYLOAD.
 - d. PERFORMING END EFFECTOR OPERATIONS.
 - e. MANEUVERING A PAYLOAD OVER APPROXIMATELY 450 KG (1000 LBS).
 - f. CLOSER THAN APPROXIMATELY 1.5M (5 FT) FROM ORBITER STRUCTURE, OTHER PAYLOADS, OR EVA CREWMEMBER.
2. FOR ADDITIONAL LOADED RMS PRCS CONSTRAINTS, REFERENCE THE FLIGHT RULES ANNEX.

Both SPAR and MPAD have performed analyses that show there is no constraint to an unloaded arm for PRCS firing as long as the arm is not positioned near a reach limit or singularity. At these positions, a degree of freedom is lost and the arm cannot relieve loads through backdriving. When in test mode, unexpected arm motion may result from PRCS firings since all joints are at maximum current attenuation and are essentially free to rotate when external forces are applied (except for internal gearbox friction). No EE operations should be performed with PRCS because jet firings may cause unexpected motion of the EE when the arm is limped for capture or rigidize sequences or tipoff rates may occur at release. Volume XIV, Appendix 8 states that prior to the grapple sequence, the orbiter RCS will be configured to free drift. It also specifies an orbiter DAP free drift period prior to release between 15 and 120 seconds to allow RMS oscillation damping.

The ICD specifically prohibits RMS from maneuvering a payload greater than 450 kg (1000 lbs) unless PRCS is inhibited.

Level B Groundrules and Constraints defines minimum clearance of 1.5 M (5 ft) to protect for induced motion resulting from PRCS auto hold and PRCS auto maneuver. @[113095-1809A]

THIS RULE CONTINUED ON NEXT PAGE

FLIGHT RULES

A12.1.1-6 OMS/RCS CONSTRAINTS (CONTINUED)

C. PRCS TRANSLATIONS @[113095-1809A]

1. PRCS TRANSLATIONS ARE NOT PERMITTED EXCEPT WHEN THE RMS IS:
 - a. UNLOADED PROVIDED CLEARANCE OF APPROXIMATELY 1.5M (5 FT) OR GREATER IS MAINTAINED BETWEEN THE RMS AND OTHER ORBITER STRUCTURE.
 - b. GRAPPLED TO A SIX-DOF CONSTRAINED PAYLOAD IN CONTINGENCY SITUATIONS THAT REQUIRE TRANSLATIONS.
2. REFERENCE THE FLIGHT RULES ANNEX FOR EXCEPTIONS FOR PAYLOADS REQUIRING TRANSLATIONS.

The loaded RMS has not been certified to withstand the motion or loads associated with PRCS translations, and a flight-specific analysis will need to be done for each specific case.

D. OMS USAGE: @[113095-1809A]

1. OMS BURNS WILL NOT BE PERFORMED WITH AN UNCONSTRAINED LOADED RMS.
2. PLANNED OMS BURNS (DUAL OR SINGLE ENGINE) ARE PERMITTED PROVIDED THE RMS IS CRADLED WITH AT LEAST TWO OF THREE MRL'S LATCHED OR THE UNLOADED RMS IS IN THE PRECRADLE POSITION (SY = 0, SP = 25, EP = -25, WP = 5, WY = 0, WR = 0).

THIS RULE CONTINUED ON NEXT PAGE

FLIGHT RULES

A12.1.1-6 OMS/RCS CONSTRAINTS (CONTINUED)

3. IN CONTINGENCY SITUATIONS THAT REQUIRE OMS BURNS (I.E., OMS LEAK), OMS USAGE IS PERMITTED WITH THE UNLOADED RMS UNCRADLED AND NOT IN THE PRECRADLE POSITION (ASSUMES BEST EFFORT TO POSITION THE RMS AS CLOSE TO THE PRECRADLE POSITION AS POSSIBLE). OMS BURNS ARE ALSO PERMITTED IF THE RMS IS GRAPPELED TO A SIX-DOF CONSTRAINED PAYLOAD.

Rockwell Space Operations Company (RSOC) analysis has determined that loads from OMS burns are well below the flight planning load limits, and no joint slippage occurs when the RMS is in the precradle position during an OMS burn. The analysis investigated single, double, and worst case failure conditions as well and determined all loads and motion were acceptable. Other positions analyzed showed several inches to several feet of motion for worst case OMS failures. OMS burns with a loaded RMS showed unacceptable motion and loads and could result in payload-to-orbiter contact. If a contingency OMS burn is required and the RMS cannot be maneuvered to the precradle position, a best effort to maneuver to the precradle is required to minimize the potential motion. Refer to STSOC transmittal Form, RSOC-635/250-91-066, October 4, 1991.

- E. EXCEPT FOR TRANSITORY MOTION, NO PART OF THE RMS SHALL BE MANEUVERED OR PARKED WITHIN THE FOLLOWING DISTANCES OF AN RCS JET CONTINUOUS FIRING RATE STAY-OUT ZONE, AS DEFINED BELOW, UNLESS THE JET IS DESELECTED. ©[113095-1809A]
- F. FLIGHT-SPECIFIC EXCEPTIONS FOR THE LOWER RATE STAYOUT ZONES MAY BE IDENTIFIED IN THE FLIGHT-SPECIFIC ANNEX. ©[113095-1809A]

1. PRCS:

FIRING RATE	STAY-OUT ZONES*							
CONTINUOUS	X=0	R=200	X=425	R=150	X=500	R=100	X=600	R=0
6 SECONDS	X=0	R=200	X=200	R=100	X=340	R=0		
80 MSEC	X=0	R=40	X=130	R=40	X=160	R=30	X=180	R=0

2. VRCS:

FIRING RATE	STAY-OUT ZONES*							
CONTINUOUS	X=0	R=18	X=50	R=18	X=70	R=10	X=80	R=0
80 MSEC	X=0	R=5	X=30	R=0				

FLIGHT RULES

*X = DISTANCE IN INCHES FROM THRUSTER IN DIRECTION OF THRUSTER
PLUME

R = LATERAL DISTANCE IN INCHES FROM CENTER OF THRUSTER

THIS RULE CONTINUED ON NEXT PAGE

FLIGHT RULES

A12.1.1-6 OMS/RCS CONSTRAINTS (CONTINUED)

Based on data presented by SPAR at the STS-2 Orbit Flight Techniques Meeting #19 on August 28, 1981, the above clearances are required to prevent damage to the RMS thermal protection system. This is the minimum required separation in direct line with the center axis of the thruster. Based on Orbit Flight Techniques Meeting #149 on December 16, 1994, the decision was made to deselect the affected jets for long-term parking of the RMS in a jet stay-out zone to preclude the inadvertent pluming of the RMS. Additionally, PDRS Ops Checklist Unloaded Survey procedures have been updated to deselect jets for those surveys that violate RCS stay-out zones. @[113095-1809A]

G. IN UNPLANNED CONTINGENCY SITUATIONS, WHEN THE STATIONARY RMS IS LOADED, CLOSED-LOOP VRCS ATTITUDE CONTROL (I.E., DAP AUTO, INRTL-DISC, LVLH-DISC) IS PERMITTED FOR ARM CONFIGURATIONS THAT HAVE NOT BEEN ANALYZED FOR DAP STABILITY PREFLIGHT IF THE FOLLOWING CRITERIA ARE MET:
@[113095-1809A]

1. THE PAYLOAD WEIGHT IS LESS THAN 35K LB.
2. THE RMS IS NOT IN A REACH LIMIT OR SINGULARITY.
3. CLEARANCE BETWEEN THE PAYLOAD AND ORBITER IS AT LEAST 10 FEET.
4. THE PAYLOAD IS NOT LOAD SENSITIVE.
5. THE CREW MONITORS THE RMS AND ORBITER FOR SIGNS OF DAP INSTABILITY.
6. THE FLIGHT CONTROL TEAM MONITORS FOR SIGNS OF DAP INSTABILITY.
7. TIGHT RATE AND ATTITUDE DEADBANDS, SUCH AS THOSE USED FOR PAYLOAD RELEASE, ARE NOT USED.
8. CLOSED-LOOP ATTITUDE HOLD WILL NOT BE INITIATED DURING LOS.
9. CLOSED-LOOP ATTITUDE MANEUVERS WILL NOT BE INITIATED OR TERMINATED DURING LOS.
10. THE BEST AVAILABLE DAP I-LOAD SET (CNTL ACCEL) FOR THE RMS/PL CONFIGURATION IS USED.

IF AN INSTABILITY IS DETECTED, THE ORBITER DAP SHOULD BE DOWNMODED TO FREE DRIFT AND MANUAL CONTROL USED FOR ATTITUDE HOLD AND MANEUVERS.

FLIGHT RULES

THIS RULE CONTINUED ON NEXT PAGE

FLIGHT RULES

A12.1.1-6 OMS/RCS CONSTRAINTS (CONTINUED)

IN ORDER TO REGAIN CLOSED-LOOP DAP CAPABILITY AFTER AN INSTABILITY HAS OCCURRED, THE RMS AND/OR DAP SHOULD BE RECONFIGURED BEFORE REINITIATING AUTO CONTROL.

A limited analysis of the effects of an unstable VRCS DAP on the loaded RMS (22k PL) has shown loads to be below the flight planning load limit and motion of the payload at a rate less than 2 in/min with the RMS brakes on and insignificant when the RMS was in position hold (Orbit Flight Techniques Panel Meeting #101). Discussion at Orbit Flight Techniques Panel meeting #105 concluded that the magnitude of the uncommanded motion of the RMS/PL is more than an order of magnitude below any unacceptable limit and that the RMS joints will backdrive to relieve loads as long as the RMS is not in a singularity or reach limit. Additionally, flight controllers can monitor phase plane activity and jet firing patterns to determine whether or not the DAP is unstable if the crew cannot detect the instability (ref. Draper memo SSV-88-49, Identification of RMS/FCS Instability During Payload Extended Operations, 10/21/88). Tight deadbands should not be used at nonanalyzed configurations because they have a high probability of causing an instability. Draper Lab recommends widening the deadbands to a rate limit of 0.1 deg/sec and an attitude deadband of 2.0 degrees. Instability during attitude maneuvers is less likely to occur by using a maneuver rate less than or equal to the rate limit. The most likely time for an instability to occur is when closed-loop control is first initiated or when an auto maneuver is started or terminated. Because the crew cannot easily detect an instability, it is preferable to initiate closed-loop control during a period of AOS to allow the flight control team to assess the DAP's performance. Auto maneuvers should be scheduled to begin and end during an AOS period, also. Before initiating closed-loop attitude control, the DAP I-load set (CNTL ACCEL on SPEC 20) that best matches the RMS/PL configuration should be selected. In determining the best CNTL ACCEL, the payload Z position is the most important parameter. An improper CNTL ACCEL can lead to inefficient jet selection and possible loss of attitude control.

If an instability occurs, the crew should downmode to free drift and use manual control. Reconfiguring the RMS and/or DAP before reinitiating auto control may result in a stable DAP.

FLIGHT RULES

A12.1.1-7 RMS IFM D&C KIT

- A. FOR RMS A8 D&C PANEL FAILURES, IF THE MISSION TIMELINE CAN ACCOMMODATE THE INSTALLATION AND REMOVAL TIME OF THE RMS D&C KIT, FOR GO/NO-GO DECISIONS, ITS PRESENCE CAN BE ASSUMED WHETHER IT IS CURRENTLY INSTALLED OR NOT. CONVERSELY, WHEN THE KIT IS INSTALLED, PANEL A8 CONTROLLED FUNCTIONS WHICH ARE DISABLED BY KIT INSTALLATION (AUTO/MAN EE DRIVE AND DIRECT DRIVE) WILL NOT BE CONSIDERED PERMANENTLY LOST FOR GO/NO-GO DECISIONS.

Approximately 1 hour is required to install the RMS D&C kit and an additional hour is required for removal. If sufficient time exists for installation and removal, the system configuration (and capabilities) will be modified by the kit; hence, its functions should be used in the decision-making process.

Since the kit will only be installed if sufficient time exists for its removal, the system configuration will be returned to nominal, and those functions disabled by kit presence should not be considered permanently lost in the decision-making process.

- B. WHEN THE RMS D&C KIT IS INSTALLED, THE APPLICABLE AC/DC SWITCH POWERING THE KIT WILL REMAIN OFF UNTIL IMMEDIATELY PRIOR TO THE REQUIRED OPERATION AND WILL BE RETURNED TO OFF IMMEDIATELY AFTER THE OPERATION IS COMPLETED. THE KIT WILL BE REMOVED AS SOON AS PRACTICAL AFTER THE REQUIRED FUNCTION IS COMPLETED.

The RMS D&C kit utilizes separate cabling for ac and dc controlled functions. Since the kit design does not include an enable switch for the joint drive or end effector ~~or safing~~ functions, failures of these switches with the kit installed will potentially produce CRIT 1 situations. For this reason, the switch powering the kit will be used as an enable/inhibit switch, and power will only be applied during the actual operation which caused installation of the kit. @111298-67441

- C. USE OF ANY APPROVED DC POWER KIT FUNCTIONS EXCEPT EE OPERATIONS IN SUPPORT OF PAYLOAD RELEASE MUST BE PRECEDED BY A KIT VERIFICATION. PRIOR TO APPLICATION OF DC POWER TO THE KIT, THE FOLLOWING CONDITIONS MUST BE MET:
1. THE RMS/PL MUST BE POSITIONED WELL CLEAR OF (> APPROXIMATELY 5 FEET) STRUCTURE.
 2. THE KIT JOINT SELECT SWITCH MUST BE POSITIONED TO A JOINT WHICH WILL PRODUCE BENIGN MOTION IF UNCOMMANDED DIRECT DRIVE OCCURS.

THIS RULE CONTINUED ON NEXT PAGE

FLIGHT RULES

A12.1.1-7 RMS IFM D&C KIT (CONTINUED)

3. IF LOADED, THE RMS MUST BE POSITIONED SUCH THAT PAYLOAD ROTATIONS DUE TO UNCOMMANDED DERIGID WILL NOT CAUSE CONTACT, AN ORBITER PILOT MUST BE AVAILABLE TO PERFORM AN IMMEDIATE SEPARATION SHOULD AN UNCOMMANDED RELEASE OCCUR, AND DOWNLINK MUST BE AVAILABLE TO CONFIRM LACK OF EE STALL CURRENTS.

When dc power is applied to the kit, the direct drive, and EE drive, ~~and safing inhibit~~ switches are all enabled and failures within these switches could command those functions. Failures within the kit direct drive switch will override all commands (even if brakes on and RMS stationary) and result in uncommanded drive of the joint selected on the kit. The best method to halt this motion is to remove primary power from the RMS (application of brakes will be ineffective). Also, when dc power is applied to the kit, EE functions are enabled, and subsequent failure of those switches could result in uncommanded payload derigid, release, or EE burnout. @111298-6744] ~~Failure of the safing inhibit switch with dc power applied to the kit would disable auto detection of six joint RMS runaways and require crew intervention to halt the RMS should such a situation occur.~~

It should be determined that the selected joint does not drive in the presence of no command and that multiple joints do not drive when a command is issued. The kit joint select switch should be prepositioned to the joint which would produce the most benign motion should uncommanded joint drive occur when power is applied to the kit. ~~It is not possible to verify the health of the safing inhibit switch; however, it is not mandatory that this function be verified since the only viable "long term" application of dc power to the kit is to regain direct drive mode and runaway failures requiring safing would not result in uncommanded motion when driving in direct.~~ Application of dc power to support EE functions is short term and hence an acceptable risk. ~~If using the kit to intentionally inhibit safing, failures within the switch would be transparent.~~

D. USE OF THE RMS D&C KIT IS APPROVED FOR THE FOLLOWING FUNCTIONS:

1. RMS SHOULDER BRACE RELEASE
2. EE OPERATIONS
3. DIRECT DRIVE (LOADED OR UNLOADED) @111298-6744]
- ~~4. SAFING INHIBIT~~

RMS shoulder brace release utilizes ac power. There are no other ac kit functions hence no risk associated with use of this function.

THIS RULE CONTINUED ON NEXT PAGE

FLIGHT RULES

A12.1.1-7 RMS IFM D&C KIT (CONTINUED)

When dc power is applied to the kit, the direct drive, *and EE drive*, ~~and safing inhibit~~ switches are all enabled and failures within these switches could command those functions. However, health status of the kit is verified prior to its operational use (except for PL release) and; hence, the period of vulnerability to subsequent failure is limited to the timeframe that dc power is actually applied to the kit. Other flight rules constrain power application times to the minimum required to perform the desired function with the kit. [@\[111298-6744\]](#)

EE operations utilize dc power. EE drive times are procedurally limited to under 30 seconds; hence, this is deemed to be an acceptable risk (to failures within the direct drive ~~or safing inhibit~~ switches).

Direct drive operations utilize dc power. Direct drive may require extensive time periods for maneuvering; however, the potential benefits to loaded RMS mission success outweigh the risk of uncommanded EE operations if a successful kit verification has been completed as required.

~~Use of safing inhibit is approved. The -5 MCIU does not use auto safing to safe the RMS. If the auto safing circuit were to fail on, the IFM D&C kit can be used to regain computer supported modes. The redesign of the Servo Power Amplifiers has obviated the need for a safing inhibit function.~~ [@\[111298-6744\]](#):-

A12.1.1-8 RMS OPCODE UPLINKS

A. RMS OPCODE UPLINKS ARE NOT PERFORMED ON A NOMINAL BASIS. UPLINKS MAY BE PERFORMED FOR THE FOLLOWING CASES.

RMS level C data is nominally defined during the flight cycle of the flight software (FSW) build.

1. IDENTIFICATION OF LEVEL C REQUIREMENTS LATE IN THE PROGRAM FLOW.

FLIGHT-SPECIFIC REQUIREMENTS WILL BE IDENTIFIED IN THE FLIGHT-SPECIFIC ANNEX.

Previously, payload or program requirements identified after the nominal flight cycle deadlines could only be accommodated by a costly software patch. The uplink capability provides a cost-efficient alternative to meeting these requirements.

2. PAYLOAD OR PROGRAM REQUIRES MORE LEVEL C DATA THAN FSW LIMITATIONS CAN SUPPORT.

FLIGHT-SPECIFIC REQUIREMENTS WILL BE IDENTIFIED IN THE FLIGHT-SPECIFIC ANNEX.

FLIGHT RULES

Current manifest projections and increased payload complexities may require more EEID's, PLID's, or autosequences than FSW can support. The opcode uplink enables RMS to have the capability to support these situations without requiring a GMEM read/write.

THIS RULE CONTINUED ON NEXT PAGE

FLIGHT RULES

A12.1.1-8 RMS OPCODE UPLINKS (CONTINUED)

3. CONTINGENCY RMS OPCODE UPLINKS DESIGNED AND SUBMITTED DURING A MISSION.

Situations unanticipated preflight could arise where the opcode unlink capability is useful to successfully meet mission objectives.

- B. CONTINGENCY OPCODE UPLINK DATA WILL BE DEVELOPED AND TESTED WITH THE RMS PLANNING SYSTEM (RPS) TOOL AND VALIDATION WILL CONSIST OF THE FOLLOWING:

RPS is a configuration controlled (MOD Software Management Plan for Workstation Applications) RMS tool used to design, develop, and test nominal level C data and RMS procedures. An application exists on RPS to build and test data files for uplink applications.

1. RPS TESTING FOR LEVEL C GENERATION, RANGE LIMIT CHECKING, AND RMS FUNCTIONAL TESTS. ANY RANGE LIMIT EXCEEDANCES WILL BE DOCUMENTED IN A MER CHIT, RESOLVED WITH THE MER, AND BROUGHT TO THE FD'S ATTENTION PRIOR TO UPLINK.

Data range limits defined in STS-97-0017 (RMS Level C Functional Subsystem Software Requirements document) are based on formulas developed to ensure RMS integrity given payload-specific mass property data. Level C data must be within these specified ranges else it will be rejected by the SM preprocessor and the opcode program. Situations arise where these limits can safely be exceeded. Range limit exceedances annunciated to the RPS or workstation user will be evaluated on a case-by-case basis to determine if the uplink should be performed.

RPS and the opcode uplink program software are designed to perform testing and procedure verification comparable to the Shuttle Avionics Integration Laboratory (SAIL), RSOC Level 8, IBM Software Development Facility (SDF), and SM preprocessor. Therefore, no additional testing is required.

2. MER CONCURRENCE ON THE UPLINK AND RPS VALIDATION VIA MER CHIT.

The MER chit ensures the RMS community concurs the data is valid and will not compromise the RMS.

- C. THE RMS MUST HAVE THE BRAKES ON WHEN THE OPCODE UPLINK IS PERFORMED.

This ensures a runaway due to the uplinked data will not occur. Additionally, the FSW will reject the uplink if the RMS is not in the suspend, idle, or temperature monitor mode.

FLIGHT RULES

A12.1.1-9 RMS MCIU BITE OVERRIDES (CIL)

MCIU OVERRIDES (SM 95, ITEMS 36, 37, OR 38) WILL NOT BE PERFORMED WITHOUT MCC CONCURRENCE. @[071494-1644]

With BITE overrides enabled, the failed joint is one failure away from a crit 1 situation for which the autobrakes are designed to catch. With a joint BITE failure overridden, autobrakes and fault annunciation are disabled for a subsequent failure of that same joint. Requiring the MCC to concur with performing BITE overrides ensures that the risks are assessed and precautions taken to mitigate the effects of subsequent failures. @[071494-1644]

FLIGHT RULES

MPM/MRL LOSS/FAILURE DEFINITIONS

A12.1.2-1 MPM/MRL POSITIONING

AN MPM OR MRL MECHANISM SHALL BE CONSIDERED TO HAVE ATTAINED ITS COMMANDED POSITION IF AT LEAST ONE INDICATION OF THAT STATE OCCURS WITHIN THE SINGLE MOTOR DRIVE TIME.

If a microswitch changes to reflect what is believed to be the true state of the hardware at the exact time the hardware is supposed to achieve that state, it is extremely probable that the hardware is indeed at the indicated state even if the redundant microswitch does not verify the condition.

While operating the MPM or MRL, flight experience has demonstrated that there are normal drive times associated with failure free conditions. Anything other than those times achieved during operation would be grounds to suspect an anomalous condition. However, if the drive time is within the single motor specification time and other cues (visual and/or duration of current signatures) corroborate the single microswitch indication, it is assumed that the mechanism is actually at the indicated state.

A12.1.2-2 MPM FAILED IN TRANSIT

WHEN COMMANDING THE MPM, IF NEITHER THE SHOULDER DEPLOYED (ONE OF TWO) NOR STOWED (ONE OF TWO) POSITIONS ARE INDICATED AFTER THE SINGLE MOTOR DRIVE TIME HAS ELAPSED, IT SHALL BE ASSUMED THAT THE MPM HAS FAILED IN TRANSIT.

Without a deploy or stow indication of the MPM, the system is considered in transit and unlocked. The rule is only applicable when the MPM is being driven. Once the MPM has reached the stowed or deployed position, it is assumed that it remains there, even if the microswitches change state, unless there is a drive command present.

In fact, this has occurred during flight on several occasions. While the arm was being driven, the MPM deploy microswitches cycled to the "not deploy" state. The community has concluded that this phenomenon is associated with arm operational stresses applied to the base of the MPM and the relatively sensitive nature of the microswitch rigging calibration.

A12.1.2-3 MRL FAILED IN TRANSIT

WHEN COMMANDING THE MRL'S, IF AN MRL DOES NOT INDICATE THE LATCHED (ONE OF TWO) OR RELEASED (ONE OF TWO) POSITION AFTER THE SINGLE MOTOR DRIVE TIME HAS ELAPSED, IT SHALL BE ASSUMED THAT THE MRL HAS FAILED IN TRANSIT.

Without the proper latched or released indications, the latch position is indeterminate.

FLIGHT RULES

MPM/MRL SYSTEMS MANAGEMENT

A12.1.3-1 MPM/MRL CYCLING

CYCLING OF THE MPM OR MRL SHALL ONLY BE PERFORMED WHILE THE ARM IS CRADLED.

There are two intentions for this rule. The first is to prevent MPM motion with the arm uncradled since the system was not designed for that capability. The other is to prevent the latches from failing closed when the RMS is uncradled. If this occurred, the RMS could not be cradled. Therefore, adequate clearance would not exist between the arm and radiators with the doors shut, and the arm would have to be jettisoned.

A12.1.3-2 MPM DEPLOY/STOW CONSTRAINTS

A. THE MPM'S SHALL BE STOWED AS SOON AS PRACTICAL IF ONLY SINGLE MOTOR DRIVE IS AVAILABLE.

FLIGHT-SPECIFIC EXCEPTIONS FOR HIGH PRIORITY OPERATIONS WILL BE IDENTIFIED IN THE FLIGHT-SPECIFIC ANNEX.

The MPM's are all driven by a single torque tube from two separate motors. The MPM shall be stowed if a single motor is lost since a subsequent failure of the other motor would require an EVA or jettison of the arm and MPM's. During normal operations of the arm, it is unacceptable to continue if the system is one failure from having to jettison or perform an EVA. EVA tools and procedures are available to deploy or stow the MPM that has stopped because of an electrical failure but not for a mechanical jam.

Rule {A2.1.3-2E}, EXTENSION DAY REQUIREMENTS, references this rule. @[090894-1670B]

B. THE MPM MUST BE POSITIONED AS FOLLOWS DURING RMS OPS:

1. UNLOADED RMS - THE MPM MUST BE EITHER FULLY DEPLOYED OR FULLY STOWED. IF STOWED, DAP FREE DRIFT, VRCS, OR ALT MODE ATTITUDE CONTROL IS REQUIRED. IF ALT MODE IS USED, TWO JET CONTROL WITH JET ON TIME OF 0.08 SECONDS MUST BE USED. DELAY TIMES OF 5 SECONDS OR LESS ARE ACCEPTABLE. @[071494-1662A]

THIS RULE CONTINUED ON NEXT PAGE

FLIGHT RULES

A12.1.3-2 MPM DEPLOY/STOW CONSTRAINTS (CONTINUED) @ED]

2. LOADED RMS - THE MPM MUST BE FULLY DEPLOYED.

FLIGHT-SPECIFIC EXCEPTIONS FOR HIGH PRIORITY OPERATIONS WILL BE IDENTIFIED IN THE FLIGHT-SPECIFIC ANNEX.

Without deployed or stowed indications, the MPM's are considered in transit and unlocked with only the stiffness of the torque tube present to maintain a firm shoulder position. This is not a sufficient load path to support any arm operations without possible structural failure. In the fully deployed or stowed positions, loads are distributed to the sill longeron by overcenter locked structural links plus, if fully deployed, a load-bearing J-hook. Supplemental Rockwell-Downey analyses (280-STSD-106-89-027) have shown that for an unloaded RMS, positive MPM structural margins exist during nominal RMS maneuvering or RMS runaway failures at various worst case (bounding) RMS orientations with the shoulder MPM in the stowed position. Previous analyses have concluded that runaway loads bound VRCS induced loads but do not always bound Pri DAP induced loads. RSOC Analysis (RSOC-635/250-94-009) also shows that longeron loads induced by reasonable worst case PRCS alt mode jet firings are bounded by the previous runaway loads, hence, the free drift, VRCS, or alt mode constraint. @[071494-1662A] @[113095-1809A]

C. ONCE THE MPM'S ARE DEPLOYED, THEY MAY REMAIN DEPLOYED UNTIL RMS MISSION OPERATIONS ARE COMPLETED. REFERENCE PARAGRAPH A FOR THE LOSS OF DUAL-MOTOR STOW CAPABILITY.

With two-motor stow capability, there is no problem with leaving the MPM's deployed. Paragraph A of this rule addresses the loss of dual-motor stow capability. The intent of this rule is to not require stowing the MPM's at the end of each day if RMS operations are planned on subsequent days.

Rule {A12.1.9-1C}, E, and F, RMS GO/NO-GO CRITERIA, references this rule.

FLIGHT RULES

A12.1.3-3 MRL CONSTRAINTS

- A. THE RMS SHALL BE CRADLED AND LATCHED AS SOON AS PRACTICAL IF THE MRL'S ARE ONE FAILURE AWAY FROM BEING UNABLE TO LATCH AT LEAST TWO OF THREE PEDESTALS.

FLIGHT-SPECIFIC EXCEPTIONS FOR HIGH PRIORITY OPERATIONS WILL BE IDENTIFIED IN THE FLIGHT-SPECIFIC ANNEX.

There are failures that result in the loss of two or three MRL latch motors. If the configuration of the MRL is such that the next failure can result in the inability to latch at least two MRL's, the arm shall be cradled ASAP since there is no analysis that indicates that it is safe to return the orbiter with the RMS unlatched (ref. paragraph B).

Rule {A2.1.3-2E}, EXTENSION DAY REQUIREMENTS, references this rule. ©[090894-1670B]

- B. THE RMS MUST HAVE TWO OF THREE MRL'S SECURED FOR ENTRY.

Each of the three MRL's have two independent drive motors, and either a mechanical jam would have to occur or both drive systems would have to fail to cause loss of latch capability for an MRL pedestal. Flight Techniques analysis has indicated that two of three MRL's must be secured for entry (via MRL latch or EVA technique) to prevent RMS/radiator contact. This capability is protected by staying at least two failures away from not being able to latch two of three MRL's.

Rules {A12.1.9-1D} and G, RMS GO/NO-GO CRITERIA, and {A2.1.3-2E}, EXTENSION DAY REQUIREMENTS, reference this rule. ©[090894-1670B]

A12.1.3-4 INADVERTENT MPM CYCLING PROTECTION (CIL)

WHILE THE RMS IS UNCRADLED, THE FOLLOWING CIRCUIT BREAKERS WILL BE OPENED TO PREVENT INADVERTENT CYCLING OF THE MPM SYSTEM:

MA73C:C cb MCA PWR AC2 3Ø MID 2
MA73C:D cb MCA PWR AC3 3Ø MID 4

FMEA'S exist for MPM DPLY/STOW switch or hybrid relay failures that result in uncommanded motion of the MPM. The orbiter/RMS/payload may be damaged if the MPM stows during RMS operations. Opening these circuit breakers removes ac power from both MPM motors. This provides protection while the payload bay mechanical power switches are on. These cb's must be closed for vent and payload bay door operations; neither of which are normally done during RMS operations. For radiator stow/deploy, see Rule {A10.1.12-1D}, RADIATOR MECHANICAL.

FLIGHT RULES

RMS PREOPERATION SYSTEM MANAGEMENT

A12.1.4-1 SHOULDER BRACE OPERATION

THE SHOULDER BRACE SHOULD BE RELEASED AS EARLY AS PRACTICAL AFTER PLBD OPENING.

There are failure modes which may prohibit the operation of the shoulder brace release mechanism. Orbit thermal effects could also prevent release. Therefore, it is prudent to release the brace as soon as practical since its only function is to support ascent loads.

Rule {A12.1.9-1A}, RMS GO/NO-GO CRITERIA, references this rule.

A12.1.4-2 RMS CHECKOUT

- A. THE RMS FLIGHT DATA FILE CHECKOUT PROCEDURES SHALL BE PERFORMED ONCE PER MISSION, AS EARLY AS PRACTICAL, PRIOR TO ANY NOMINAL RMS OPERATIONS.

There are several failure modes that can be detected during the RMS checkout. Early detection of a failure may provide adequate time to troubleshoot the problem and develop workaround procedures.

- B. FOR OFF-NOMINAL SITUATIONS WHERE A RAPID RMS RESPONSE IS DESIRED, COMPLETION OF THE CHECKOUT PROCEDURES FOR BACKUP AND DIRECT DRIVE MODE SHALL BE ACCOMPLISHED AS A MINIMUM.

This will ensure that the arm is not a single failure away from having to be jettisoned or stowed EVA. One of these modes is required to cradle the arm. Approximately 5 to 10 minutes are required to complete these tests. A test of direct drive gives valuable insight into any possible joint degradation while testing single may not indicate the problem. The PDRS checklist has been modified to give the crew a success criteria for direct drive.

- C. THE EE CHECKOUT WILL BE PERFORMED ONCE PER MISSION PRIOR TO ANY EE OPERATIONS.

It is important to understand if there are any failures resident in the EE prior to operations to prohibit unsafe use of the system. This rule also implies that the EE does not have to be checked if there are no EE operations for the flight.

- D. RESERVED

THIS RULE CONTINUED ON NEXT PAGE

FLIGHT RULES

A12.1.4-2 RMS CHECKOUT ~~A12.1.4-1 SHOULDER BRACE OPERATION~~
(CONTINUED) ©ED]

E. THE DIRECT DRIVE TEST SHALL BE PERFORMED ON EACH JOINT WITH A MINIMUM CONTINUOUS DRIVE IN EACH DIRECTION FOR 12 SECONDS.

RMS checkout operations on orbit are the only tests of the RMS in which the results are not affected by gravity and the inadequacies of the test equipment. Parametric studies by SPAR Aerospace Limited have concluded that the direct drive mode tests, if properly run, will supply the necessary data for trend analysis of the individual RMS joints. To make this data meaningful, each joint must be driven continually in each direction for 12 seconds to guarantee that the motor has stabilized at the maximum rate.

FLIGHT RULES

RMS DRIVE SYSTEM MANAGEMENT

A12.1.5-1 **MODE AVAILABILITY DRIVE CONSTRAINT**

RMS OPERATIONS SHALL CEASE AND THE RMS SHALL BE CRADLED AND LATCHED IF BACKUP PLUS ONE OTHER PRIMARY SINGLE JOINT MODE IS NOT AVAILABLE TO DRIVE EACH JOINT.

FLIGHT-SPECIFIC EXCEPTIONS FOR HIGH PRIORITY OPERATIONS WILL BE IDENTIFIED IN THE FLIGHT-SPECIFIC ANNEX.

Backup mode is electrically independent from all other modes; therefore, requiring this mode in addition to one other single joint mode to begin or continue normal RMS operations ensures that, after a single point failure, the arm can still be cradled. It has not been demonstrated that the arm can be cradled in any mode other than one utilizing a single joint drive method. In addition, the only way that loss of backup can be determined is during the RMS checkout or by the loss of main bus B.

Rules {A12.1.9-1M} and N, RMS GO/NO-GO CRITERIA, reference this rule.

A12.1.5-2 **FIELD OF VIEW CONSTRAINT (CIL)**

THE RMS SHALL NOT BE DRIVEN UNLESS THE CREW IS OBSERVING THE EXPECTED MOTION OF THE RMS/PAYLOAD STRUCTURE VIA WINDOW AND/OR CCTV VIEWS.

There are a considerable number of failure modes identified in the FMEA which can result in unannunciated, uncommanded motion (e.g., two joints drive, wrong joint drives, hand controller fails at 56 percent of max command, etc.). If the operator is driving the arm in a configuration where the occurrence of one of these failure modes could not be observed, then the operator may not react to the failure by stopping the arm with the brakes (or whatever means are available) to avoid a collision with the orbiter/payload/EVA crewmember.

FLIGHT RULES

A12.1.5-3 AUTO MODE ENTRY CONSTRAINT (CIL)

AUTO MODES SHALL NOT BE ENTERED UNLESS THE PAYLOAD BAY AND PAYLOAD STRUCTURES ARE IN A CONFIGURATION FOR WHICH THE SEQUENCES HAVE BEEN VERIFIED. THE OPERATOR SHALL ONLY ENTER AN AUTO MODE IMMEDIATELY PRIOR TO SELECTION OF "PROCEED" .

The first part of the rule requires that the payload bay be configured the way it was when the sequence was validated. This is simply to ensure that no appendages or other objects have been placed in the path of the sequence. Validation of the preflight designed auto sequences is accomplished by performing them on several of the available simulators and during crew training. Most of the operator-commanded auto sequences (OCAS) are also verified preflight in this way. However, in some cases, the crew may opt to develop a new OCAS real time. This OCAS can be verified by the ground flight controllers on their simulator or by the crew if the geometry is simple enough that they are confident that the procedure will run safely.

There are failure modes which can cause an auto sequence to begin prematurely (once the mode is entered), not stop at pause points, or not stop when "stop" is selected. By following this procedural rule, these failures will not place the crew in a hazardous condition. For operator-commanded auto sequences, care should be exercised in entering the desired position and attitude parameters because the sequence could begin with no operator command.

Rule {A12.1.5-4}, ORBITER PROXIMITY CONSTRAINTS (CIL), references this rule.

FLIGHT RULES

A12.1.5-4 ORBITER PROXIMITY CONSTRAINTS (CIL)

- A. IF THE MANIPULATOR CONTROLLER INTERFACE UNIT (MCIU) SAFING FUNCTION IS LOST, COMPUTER-SUPPORTED MODES SHALL NOT BE USED CLOSE TO (WITHIN APPROXIMATELY 5 FEET) STRUCTURE/PAYLOAD/EVA CREWMEMBER. WHILE BERTHING A PAYLOAD, ALL MODES CAN BE USED ONCE THE TRUNNIONS HAVE ENTERED THE V-GUIDES.

With this class of failure mode, MCIU safing will not automatically stop the arm if I/O with the GPC is erratic or interrupted while the arm is operating in a computer-supported mode. It is prudent to use only direct when close to any obstacles when MCIU safing is lost since direct is unaffected by these failure modes. Approximately 5 feet is considered sufficient since the runaway will be at the last commanded rate unlike other runaways which can result in maximum torque and joint rates. Once within the V-guides, any uncommanded motion is constrained by the physical guide. When the arm is not close to obstacles, all modes can be used since there is sufficient time for the operator to detect any uncommanded motion and apply the brakes.

- B. OPERATE AT/OR LESS THAN VERNIER RATES WHEN THE ARM/PAYLOAD IS CLOSE TO (WITHIN APPROXIMATELY 10 FEET) STRUCTURE/PAYLOAD/EVA CREWMEMBER. THE OPERATOR MUST CYCLE THE APPROPRIATE PANEL SWITCH WHEN DRIVING IN DIRECT OR BACKUP TO APPROXIMATELY MAINTAIN RATES AT OR LESS THAN VERNIER RATES.

There are many failure modes which result in uncommanded, unannounced motion (e.g., hand controller fails, wrong joint drives, wrong joint direction, two joints drive, sluggish, or stalled joint, etc.) which the operator must detect and stop by applying the brakes. Many of these failure modes will run away at the last commanded rate or are joint rate limited so operating in vernier will limit the ultimate rates the failure can produce. The rest of the failure modes result in unexpected motion, uncommanded release, or derigidize. The detection and arresting of this motion or maneuvering the orbiter clear of a released payload will be less hazardous (i.e., give the crew more time to react) if the arm is operating at a slow rate.

- C. RATE HOLD SHALL NOT BE USED WHEN THE RMS/PAYLOAD IS CLOSE TO (WITHIN APPROXIMATELY 10 FEET) AND IS MOVING TOWARDS STRUCTURE/PAYLOAD/EVA CREWMEMBER EXCEPT WHEN CAPTURING A FREE FLYING PAYLOAD.

There are failure modes which result in the inability to cancel rate hold. If this occurs close to an obstacle, a collision could occur before the operator has enough time to detect and apply the brakes. Therefore, it is prudent not to use rate hold close to any obstacles. Rate hold may be used when capturing a free-flying payload since the payload/arm combination will be far from the orbiter.

FLIGHT RULES

THIS RULE CONTINUED ON NEXT PAGE

FLIGHT RULES

A12.1.5-4 ORBITER PROXIMITY CONSTRAINTS (CIL) (CONTINUED)

D. ~~RESERVED TEST MODE SHALL NOT BE ENTERED WHEN THE RMS/PAYLOAD IS CLOSE TO (WITHIN APPROXIMATELY 10 FEET) STRUCTURE/PAYLOAD/EVA CREWMEMBER. WHEN GRAPPLED TO A BERTHED PAYLOAD WHICH MOVES DURING THE LATCH OR RELEASE PROCESS, TEST MODE MAY BE ENTERED TO REMOVE RMS STRAINS.~~

~~THERE ARE FAILURE MODES IN THE CURRENT LIMITER WHICH RESULT IN JOINT RUNAWAYS IN TEST MODE AND DURING EE CAPTURE ONLY (WHEN THE ARM IS LIMP). THESE RUNAWAYS MAY BE UNANNUNCIATED AND MAY NOT BE STOPPED BY AUTO BRAKES. THEREFORE, IT IS PRUDENT TO NOT USE TEST MODE UNLESS THE ARM IS FAR FROM STRUCTURE TO ALLOW THE OPERATOR TIME TO DETECT THE FAILURE AND APPLY BRAKES. IT IS ALLOWABLE TO USE TEST MODE WHEN GRAPPLED TO A BERTHED PAYLOAD SINCE IT IS ATTACHED TO ITS LATCHES OR IS IN THE GUIDES. BECAUSE THE PAYLOAD IS CONSTRAINED, IT CANNOT RUN AWAY WITH THE FAILURE MODE.~~

E. AUTO TRAJECTORIES SHALL BE DESIGNED SUCH THAT THE ARM/PAYLOAD DOES NOT PASS CLOSE TO (WITHIN APPROXIMATELY 5 FEET) STRUCTURE/PAYLOAD/EVA CREWMEMBER. [@111298-6744](#)

There are failure modes (e.g., sluggish and stalled joints) which result in undetected deviations from the intended auto trajectory. This requirement will allow the operator time to detect the failure and apply brakes. There is another rule (Rule {A12.1.5-3}, AUTO MODE ENTRY CONSTRAINT (CIL)) which governs use of auto mode (vice design). That rule prohibits using auto for unverified trajectories.

EF. THE RMS/PAYLOAD SHALL NOT BE MANEUVERED OR PARKED IN REGIONS WHERE IT CANNOT BE MANEUVERED TO A SAFE JETTISON POSITION WITH THE LOSS OF ANY SINGLE JOINT. [@111298-6744](#)

There are single point failure modes which result in the inability to drive an arm joint in either primary or backup modes. If any of these failures occurs and an EVA cannot be performed, the arm must be jettisoned prior to closing the PLBD. Therefore, since a joint failure may restrict arm mobility, the arm shall never be in a position where it cannot be maneuvered to a safe jettison position using only five of six joints.

The only single point failure modes which can result in the inability to drive all joints are in the power and arm select switches. These failure modes can be worked around by using an IFM pin kit. Final approval requires CIL change.

FLIGHT RULES

THIS RULE CONTINUED ON NEXT PAGE

FLIGHT RULES

A12.1.5-4 ORBITER PROXIMITY CONSTRAINTS (CIL) (CONTINUED)

G. EXCEPT FOR TRANSITORY MOTION (I.E., BERTHING/UNBERTHING, CRADLING/UNCRADLING, PAYLOAD DOCKING/UNDOCKING, OR PAYLOAD CAPTURE/RELEASE), THE RMS/PAYLOAD SHALL NOT BE MANEUVERED OR PARKED (CREW AWAKE) CLOSER THAN 60 CM (2 FT) FROM ORBITER STRUCTURE OR OTHER PAYLOADS. FOR APPLICATION OF THIS RULE, EVA CREWMAN IS NOT CONSIDERED ORBITER STRUCTURE OR PAYLOAD.

FLIGHT SPECIFIC EXCEPTIONS FOR HIGH PRIORITY OPERATIONS WILL BE IDENTIFIED IN THE FLIGHT SPECIFIC ANNEX.

Crew comfort, RMS and payload visibility, VRCS and ALT mode induced motion, RMS failures, and lack of task specific crew training become overriding concerns when maneuvering payloads in close proximity to orbiter structure. In cases where missions cannot be completed without violating this rule, the program incurs greater risk. As such, task specific assessment is required to document the risk and proposed methods, if any, to control it.

A12.1.5-5 INOPERATIVE BRAKE CONSTRAINT (CIL)

IF A BRAKE IS INOPERATIVE DUE TO A MECHANICAL FAILURE, THE RMS SHALL BE CRADLED IN SINGLE MODE AND LATCHED AS SOON AS POSSIBLE. IF THE WRIST ROLL BRAKE IS INOPERATIVE, UNLOADED RMS OPERATIONS MAY CONTINUE. PAYLOAD OPERATIONS WILL NOT CONTINUE WITH THE EXCEPTION OF COMPLETION OF BERTHING OPERATIONS IF THE PAYLOAD IS ALREADY WITHIN THE BERTHING GUIDES.

A failure mode exists which results in a brake pad mechanically not engaging. The motor drive amplifier (MDA) will still be inhibited when the brakes are electrically commanded on, so the failed joint will be free in both primary and backup modes. Single mode must be used to cradle the arm since it is the only remaining single joint mode that is still operative (uses position hold instead of brakes to maintain arm position). During unloaded operations, operations may continue with a known wrist roll brake problem since runaways on the wrist roll cannot result in any uncommanded translations of the arm.

Rules {A12.1.9-10} and P, RMS GO/NO-GO CRITERIA, reference this rule.

FLIGHT RULES

A12.1.5-6 **AUTO BRAKES CONSTRAINT (CIL)**

COMPUTER-SUPPORTED MODES SHALL NOT BE USED IF THE AUTO BRAKES FUNCTION HAS FAILED.

There are many failure modes which result in runaways (six or single joint) which are detected and automatically stopped by the auto brakes function. SPAR SIMFAC simulations have demonstrated that without these automatic checks a runaway in a computer-supported mode could travel as far as 18 feet before a crewmember could stop it by applying the brakes. Therefore, computer-supported modes should not be used after loss of this function.

Rule {A12.1.9-1Q}, RMS GO/NO-GO CRITERIA, references this rule.

A12.1.5-7 **CONTINGENCY STOP (CIL)**

THE BRAKES SHALL ALWAYS BE THE METHOD USED TO STOP THE RMS IF UNCOMMANDED MOTION OR UNUSUAL RMS BEHAVIOR OCCURS (INSTEAD OF SAFING, AUTO STOP SWITCH, OR RELEASING THE COMMAND). IF THE BRAKES ARE INOPERATIVE VIA THE PANEL SWITCH, THEY SHALL BE APPLIED BY TERMINATING PRIMARY POWER.

Use of the brakes is the most positive method of stopping the arm in emergency situations. It is preferred over safing since it inhibits the MDA at the joints which will stop a runaway joint caused by the servo or MDA (safing would not in many cases). It is also preferred over the stop switch during auto sequences since there are D&C failures which could prohibit the stop switch from operating.

A12.1.5-8 **POHS AND LEFT-HANDED COORDINATE SYSTEMS**

RMS POSITION AND ORIENTATION HOLD SELECT (POHS) MUST BE DISABLED FOR USE OF RMS PAYLOAD ID'S THAT ARE DEFINED USING A LEFT-HANDED PAYLOAD OPERATING COORDINATE FRAME. @[071494-1644]

POHS is a right-handed algorithm. It generates arm drive commands that are normal to the desired path which attempt to reduce off-axis deviations. Attempts to use it with left-handed defined payload operating systems results in unexpected motion by generating commands which are in a direction away from the desired trajectory. @[071494-1644]

FLIGHT RULES

A12.1.5-9 RMS MODES FOR CBM CAPTURE OPERATIONS

THE RMS WILL REMAIN IN POSITION HOLD UNTIL THE FUNCTIONING CBM LATCHES HAVE SUCCESSFULLY COMPLETED CBM FIRST STAGE CAPTURE. AFTER THE SUCCESSFUL COMPLETION OF CBM FIRST STAGE CAPTURE, RMS TEST MODE WILL BE ENTERED FOR THE REMAINDER OF THE CAPTURE SEQUENCE. @[021998-6503]

IF POSITION HOLD IS NOT AVAILABLE, THE RMS BRAKES WILL BE ON THROUGHOUT THE LATCHING SEQUENCE.

Test mode is the preferred RMS mode for CBM latching to avoid having RMS loads cause backdriving of the CBM latches during mating. However, transition from position hold to test mode or brakes-on in the presence of an external load (RTL spring forces) has been observed to cause payload motion and loss of RTL indications (PFTA, LDEF, RMS). Once the CBM latches successfully completed CBM first stage capture, the fittings cannot escape the latches and the RTL indications cannot be turned off. @[021998-6503]

FLIGHT RULES

THIS PAGE INTENTIONALLY BLANK

FLIGHT RULES

END EFFECTOR (EE) LOSS/FAILURE DEFINITIONS

A12.1.6-1 **EE BACKUP RELEASE**

EE BACKUP RELEASE IS CONSIDERED LOST IF SNARES DO NOT OPERATE SMOOTHLY TO THE FULLY OPEN POSITION.

Data from SPAR indicates that temperature has a significant effect on the time for the snares to open during the backup release check. Times on the order of minutes were seen at the lowest qualification test temperatures. With no grapple pin in the EE, the snares open quickly for the first 70-80 percent of travel then slow down at the end of travel. At the coldest flight conditions, during the on-orbit backup release check, the snares should fully open within 2 minutes, although 20-25 seconds has been typical. If the snares do not open smoothly and completely, there is a mechanical problem and backup release would be considered lost.

A12.1.6-2 **EE CAPTURE/RIGIDIZE**

EE CAPTURE OR RIGIDIZE FUNCTIONS ARE CONSIDERED LOST FOR AUTO AND/OR MANUAL IF THE CAPTURE TIME EXCEEDS 3 SECONDS OR THE RIGIDIZE TIME EXCEEDS 25 SECONDS.

The maximum capture specification time is 3 seconds and the maximum rigidize specification time is 25 seconds. Failure to meet these time constraints is indicative of binding in the drive mechanism or loss of one mode due to an electrical failure.

Rule {A2.1.3-13}, PDRS, references this rule.

A12.1.6-3 **EE RELEASE/DERIGIDIZE**

EE RELEASE OR DERIGIDIZE FUNCTIONS ARE CONSIDERED LOST FOR AUTO AND/OR MANUAL IF THE RELEASE TIME EXCEEDS 3 SECONDS OR THE DERIGIDIZE TIME EXCEEDS 25 SECONDS.

The maximum release specification is 3 seconds and the maximum derigidize specification time is 25 seconds. Failure to meet these constraints is indicative of binding in the drive mechanism or loss of one mode due to an electrical failure.

FLIGHT RULES

END EFFECTOR SYSTEM MANAGEMENT

A12.1.7-1 PAYLOAD GRAPPLE CONSTRAINTS

- A. PAYLOADS SHALL NOT BE GRAPPLED AND UNBERTHED UNLESS BACKUP RELEASE AND ONE OF TWO METHODS TO CAPTURE AND RIGIDIZE (AUTO OR MANUAL) AND ONE OF TWO METHODS TO DERIGIDIZE AND RELEASE (AUTO OR MANUAL) ARE AVAILABLE.

FLIGHT-SPECIFIC EXCEPTIONS FOR HIGH PRIORITY OPERATIONS WILL BE IDENTIFIED IN THE FLIGHT-SPECIFIC ANNEX.

The EE system is designed such that a single failure can result in the loss of both the auto and manual release capability. The backup release capability can also be lost with a single failure, but it is electrically isolated from auto and manual. As a rule, backup as well as one other release mode is required so that more than one failure has to occur before the arm must be jettisoned or the payload released via EVA.

- B. LOADED OPERATIONS WILL CEASE AS SOON AS PRACTICAL IF BACKUP AND ONE OF TWO METHODS TO RELEASE (AUTO OR MANUAL) ARE NOT AVAILABLE.

FLIGHT-SPECIFIC EXCEPTIONS FOR HIGH PRIORITY OPERATIONS WILL BE IDENTIFIED IN THE FLIGHT-SPECIFIC ANNEX.

If backup or both primary methods of releasing a payload are lost, then the RMS is one failure from being unable to release the payload. In a worst case situation this would lead to arm/payload jettison. It is unacceptable to continue operations when the system is one failure away from jettison.

Mission activities such as final release or berth may be completed under certain conditions with this failure.

- C. A CAPTURE SHALL NOT BE ATTEMPTED WHILE IN A REACH LIMIT OR SINGULARITY.

The RMS does not respond normally to commands while in a reach limit or singularity. Also, excessive arm loads may result when a capture is attempted in a reach limit or singularity since one or more degrees of freedom are lost. With this loss the arm may not be able to conform to the payload if there are any EE/payload grapple fixture misalignments. If the arm cannot conform, significant forces may be applied to the EE/RMS structure.

Rules {A12.1.9-1S}, T and U, RMS GO/NO-GO CRITERIA, reference this rule.

FLIGHT RULES

A12.1.7-2 EE MODE SWITCH CONSTRAINTS (CIL)

- A. THE EE MODE SWITCH SHALL ONLY BE TAKEN OUT OF THE "OFF" POSITION:
1. FOR FREE-FLYING PAYLOADS (I.E., PAYLOADS NOT ATTACHED TO THE RMS OR ANY ORBITER STRUCTURE) WHEN THE EE IS IN THE:
 - a. PRECAPTURE POSITION (I.E., THE POSITION THE RMS MAINTAINS ABOVE THE PLB DURING THE RENDEZVOUS PROCESS) JUST PRIOR TO CAPTURE,
 - OR
 - b. RELEASE POSITION.
 2. FOR BERTHED PAYLOADS WHEN THE EE IS IN THE:
 - a. CAPTURE ENVELOPE,
 - OR
 - b. RELEASE POSITION.
 3. DURING RMS CHECKOUT.

There are many failure modes that can cause the arm to limp unexpectedly or produce an uncommanded release or derigidize when the EE mode switch is in the manual or auto position. Therefore, the EE mode switch should only be taken out of the OFF position when it is safe to do so (i.e., when the arm is not moving and is far from obstacles or is in the process of moving the last few feet during the capture process of a free-flying payload).

- B. THE EE MODE SWITCH SHALL ALWAYS BE PLACED BACK IN THE "OFF" POSITION IMMEDIATELY AFTER THE NOMINAL CAPTURE/RIGIDIZE AND RELEASE/DERIGIDIZE TIMES HAVE ELAPSED.

There are many failure modes which can result in a continuously limped arm (e.g., incomplete rigidize sequence) or stalled EE drive motor (e.g., motor reversals, rigid microswitch fails low, etc., which lead to motor burnout in approximately 2 minutes) so that the microswitches never attain the proper state to complete an automatic EE capture or release. The effect of these failure modes can be nullified simply by turning the EE mode switch to off.

FLIGHT RULES

A12.1.7-3 CAPTURE AND RELEASE PROXIMITY CONSTRAINT (CIL)

DURING A CAPTURE OR RELEASE OF A FREE-FLYING PAYLOAD, THE EE SHALL BE FAR ENOUGH AWAY FROM ORBITER STRUCTURE/OTHER PAYLOADS/EVA CREWMEMBER THAT NO CONTACT COULD OCCUR REGARDLESS OF PAYLOAD ROTATIONS.

FLIGHT-SPECIFIC EXCEPTIONS FOR LARGE PAYLOADS OR TO MEET DAP STABILITY CONSTRAINTS WILL BE IDENTIFIED IN THE FLIGHT-SPECIFIC ANNEX.

There are many failure modes which result in a payload being snared but only partially rigidized. When capturing a rotating payload, the payload could continue to rotate around the EE. If this occurs during release, gravity gradient and LVLH effects could result in payload rotation. This rule would procedurally prohibit any contact (other than the arm) for these failure scenarios. For payloads that cannot be positioned far enough from orbiter structure due to size or DAP constraints, an exception shall be identified in the flight-specific annex.

A12.1.7-4 PAYLOAD RELEASE DURING BERTHING

DURING BERTHING, A NOMINAL RELEASE OF A PAYLOAD WILL NOT BE PERFORMED UNTIL THE PAYLOAD IS VERIFIED BERTHED AND LATCHED.

If the payload was released without being latched, orbiter recontact could occur. The payload would have to be jettisoned per procedure unless EVA straps are available to strap a payload down for entry. Minimum payload latch configuration must be examined from a structural standpoint and may be different for on-orbit and entry/landing requirements. Reference flight-specific annex rules for the definition of the minimum payload latch configuration.

FLIGHT RULES

RMS JETTISON SYSTEM MANAGEMENT

A12.1.8-1 JETTISON SYSTEM CONSTRAINT

- A. RMS OPERATIONS SHALL BE ALLOWED TO CONTINUE IF EITHER OF THE JETTISON SYSTEM BUSES MNB ML86B OR MNC ML86B IS LOST PROVIDED RMS DRIVE MODE REDUNDANCY, END EFFECTOR RELEASE MODE REDUNDANCY, AND MPM AND MRL STOW AND LATCH REDUNDANCY EXISTS. ©[113095-1809A]
- B. IF FLIGHT SPECIFIC ANNEX RULES ALLOW OPERATIONS TO CONTINUE FOR RMS SYSTEMS REDUNDANCY FAILURES, AN IFM WILL BE PERFORMED TO REGAIN A LOST JETTISON SYSTEM BUS WHEN CONVENIENT. THE IFM ONLY NEEDS TO BE PERFORMED UP TO THE POINT OF BEING INVASIVE TO THE ORBITER PANELS AND OTHER ORBITER SYSTEMS (I.E., RCS HEATERS).
- C. FLIGHT-SPECIFIC EXCEPTIONS FOR HIGH PRIORITY OPERATIONS WILL BE IDENTIFIED IN THE FLIGHT-SPECIFIC ANNEX.

With an RMS system redundancy failure and loss of a jettison system, the system is two failures away from a catastrophic situation in the event of an emergency deorbit. However, there is no means of verifying the current health of the alternate pyro system even though load and resistance tests were performed on turnaround. Therefore, if the Flight Specific Annex allows operations to continue in this posture, as much of the IFM should be performed as possible without impacting RCS heaters and by removing all but two of the panel A14 fasteners. With loss of RCS heaters, hotfiring of the affected RCS jets is the primary method to maintain thermal conditioning. A PRCS hotfire, if required, would be at odds with RMS operations. An additional 5 minutes will be required to complete the IFM should jettison subsequently be required. ©[113095-1809A]

Rule {A12.1.9-1B}, RMS GO/NO-GO CRITERIA, references this rule.

A12.1.8-2 RMS/PAYLOAD JETTISON

IF AN RMS/PAYLOAD COMBINATION MUST BE JETTISONED, THE RMS AND PAYLOAD SHALL BE JETTISONED AS A SINGLE UNIT, IF AT ALL POSSIBLE.

It is desirable to limit the number of free objects in space to avoid recontact problems by jettisoning the arm and payload as one unit.

FLIGHT RULES

GO/NO-GO CRITERIA

A12.1.9-1

RMS GO/NO-GO CRITERIA

CONTINUE OPERATIONS IF:							
	MPM DEPLOY	RMS UNCRADLE	CONTINUE UNLOADED	GRAPPLE UNBERTH	CONTINUE LOADED	ENTRY	FLIGHT RULES REF.
A. SHOULDER BRACE REL (1)		0 ↓					{A12.1.4-1}
B. JETTISON SYSTEM (2)	1 ↓ [4]	1 ↓ [4]	1 ↓ [4]	1 ↓ [4]	1 ↓ [4]		{A12.1.8-1}
C. MPM STOW MOTORS (2)	0 ↓	0 ↓	0 ↓	0 ↓	0 ↓		{A12.1.3-2}
D. MRL LAT CAP (3)		[1]	[1]	[1]	[1]		{A12.1.3-3}
E. MPM (4) STOWED INDICATIONS (8)						[2]	{A12.1.3-2}
F. MPM (4) DEP INDICATIONS (8)		SHOULDER 1 ↓	SHOULDER 1 ↓	SHOULDER 1 ↓	SHOULDER 1 ↓		{A12.1.3-2}
G. MRL'S LATCHED (3)						1 ↓	{A12.1.3-3}
H. THC AXIS (1)							
I. RHC AXIS (1)							
J. AUTO MODE (1)							
K. OPR CMDED MODE (1)							
L. MANUAL AUG MODE (1)							
M. DIRECT MODE (1)		1 ↓	1 ↓	1 ↓	1 ↓		{A12.1.5-1}
N. SINGLE MODE (1)							
O. BACKUP MODE (1)		0 ↓	0 ↓	0 ↓	0 ↓		{A12.1.5-1}
P. BRAKES (6)		WRIST ROLL ↓	WRIST ROLL ↓	0 ↓	0 ↓		{A12.1.5-5}
Q. AUTO BRAKES (1)		0 ↓ [3]	0 ↓ [3]	0 ↓ [3]	0 ↓ [3]		{A12.1.5-6}
R. CAPTURE & RIGIDIZE (2)				1 ↓			{A12.1.7-1A}
S. RELEASE & DERIGIDIZE (2)				1 ↓	1 ↓		{A12.1.7-1A},B
T. BACKUP, RELEASE (1)				0 ↓	0 ↓		{A12.1.7-1A},B
U. CCTV (6)							
THERMAL -20 (0)° F < LED < 176° (172°) F -20 (0)° F < ABE (EE) < 147° (144°) F <u>-20 (0)° F < ABE (SPA)</u> <u>≤ 110° (106°) F</u>		REQUIRED	REQUIRED	REQUIRED	REQUIRED		{A12.1.1-3}

@[113095-1809A] _@[111298-6744]

NOTES

- [1] CONTINUE OPERATIONS IF ONE FAILURE WILL NOT RESULT IN THE INABILITY TO LATCH AT LEAST TWO MRL'S.
- [2] ONE AT THE SHOULDER AND ONE AT EITHER THE MID OR AFT PEDESTAL IS REQUIRED.

FLIGHT RULES

- [3] OPERATIONS IN DIRECT AND BACKUP CAN CONTINUE WITH THE LOSS OF AUTOBRAKES.
- [4] RMS SYSTEM REDUNDANCY OR JETT REDUNDANCY IFM REQUIRED. @[113095-1809A]

FLIGHT RULES

SECTION 13 - AEROMEDICAL

ASCENT

A13.1.1-1	ASCENT ABORT	13-1
-----------	------------------------	------

ON-ORBIT

A13.1.2-1	EARLY FLIGHT TERMINATION	13-2
A13.1.2-2	ONBOARD MEDICAL KIT	13-2
A13.1.2-3	CABIN PRESSURE	13-3
A13.1.2-4	PACO ₂ CONSTRAINT	13-5
A13.1.2-5	MINIMUM PPO ₂ CONSTRAINTS	13-6
A13.1.2-6	100 PERCENT OXYGEN USE CONSTRAINT	13-9
A13.1.2-7	EVA PREBREATHE PROTOCOL	13-10
A13.1.2-8	SCHEDULED AND UNSCHEDULED EVA CONSTRAINTS .	13-16
A13.1.2-9	PRIVATE MEDICAL COMMUNICATION (PMC)	13-16
A13.1.2-10	IRB PROTOCOLS	13-18
A13.1.2-11	CREW AWAKE TIME CONSTRAINT	13-19
A13.1.2-12	HOT CABIN ATMOSPHERE	13-19
A13.1.2-13	CABIN ATMOSPHERE CONTAMINATION	13-20
A13.1.2-14	BROKEN GLASS/HAZARDOUS SUBSTANCE CONSTRAINT	13-32
A13.1.2-15	ORBITER HAZARDOUS SUBSTANCE SPILL RESPONSE	13-33
A13.1.2-16	SPACEHAB/SPACELAB HAZARDOUS SUBSTANCE SPILL RESPONSE	13-37
A13.1.2-17	HAZARDOUS SPILL LEVEL DEFINITIONS	13-53
A13.1.2-18	MISSION DURATION BUILD-UP CONSTRAINTS	13-55
A13.1.2-19	ACCELERATION RESTRICTIONS ON MEDICAL PROCEDURES	13-56

FLIGHT RULES

A13.1.2-20	LOWER BODY NEGATIVE PRESSURE (LBNP)	13-57
A13.1.2-21	LBNP TEST TERMINATION CRITERIA	13-58
A13.1.2-22	INTENSE CYCLE EXERCISE	13-60
A13.1.2-23	SPACELAB CONTINGENCY EGRESS	13-62
A13.1.2-24	ATMOSPHERE PURGING	13-64
A13.1.2-25	NOISE LEVEL CONSTRAINTS	13-65
<u>A13.1.2-26</u>	<u>DECOMPRESSION SICKNESS SYMPTOMS AND CREW</u> <u>DISPOSITION</u>	<u>13-54</u>
<u>A13.1.2-27</u>	<u>DECOMPRESSION SICKNESS RESPONSE AND</u> <u>TREATMENT</u>	<u>13-57</u>

ENTRY

A13.1.3-1	ANTI G-SUIT PROTOCOL	13-75
A13.1.3-2	FLUID LOADING	13-75
A13.1.3-3	TANK B WATER CONTINGENCY USE	13-76

FLIGHT RULES

SECTION 13 - AEROMEDICAL

ASCENT

A13.1.1-1 **ASCENT ABORT**

THERE ARE NO MEDICAL REASONS FOR ABORTING DURING THE ASCENT PHASE .

The powered flight phase is too short to allow an adequate evaluation of any medical problem that may develop and to call an abort would impose unacceptable risks on the remainder of the crew.

FLIGHT RULES

ON-ORBIT

A13.1.2-1 EARLY FLIGHT TERMINATION

ANY FLIGHT TERMINATION DECISION RELATED TO CREW HEALTH WILL BE A REAL-TIME CALL AND WILL ONLY BE CONSIDERED IF ACCEPTABLE ON-ORBIT TREATMENT IS NOT AVAILABLE.

Early flight termination may be required for the onset of any condition which adversely affects crew safety or health and performance. Rule {A17.1.13-1}, LIFE SUPPORT GO/NO-GO CRITERIA, references this rule.

A13.1.2-2 ONBOARD MEDICAL KIT

THOSE ITEMS IN THE SHUTTLE ORBITER MEDICAL SYSTEM (SOMS) MEDICAL KIT LABELED "PHYSICIAN APPROVAL REQUIRED FOR USE" WILL BE USED BY NON-PHYSICIAN CREWMEMBERS ONLY AS DIRECTED BY THE FCR SURGEON OR AN ONBOARD ASTRONAUT PHYSICIAN. A COMPLETE LISTING OF ALL ONBOARD MEDICATIONS AND THEIR SIDE EFFECTS CAN BE FOUND IN THE MEDICAL CHECKLIST APPENDIX. ALL ITEMS USED FROM THE MEDICAL KIT WILL BE LOGGED IN FLIGHT ON INDIVIDUAL CARDS LOCATED IN THE SOMS KIT AND REPORTED TO THE SURGEON DURING THE POSTFLIGHT DEBRIEF.

Prescription drugs must be controlled by a physician during flight in the same manner that they are controlled on the ground. Drug control protects the crew by preventing inappropriate use of medications and unexpected side effects which could affect performance. Records of usage are required for reconstructing medical history and to assist in the refurbishment of the SOMS kits for subsequent flights.

FLIGHT RULES

A13.1.2-3 CABIN PRESSURE

A. MINIMUM CABIN PRESSURE:

1. IF THE PCS IS UNABLE TO MAINTAIN THE CABIN PRESSURE AT OR ABOVE 8.0 PSIA, THE FLIGHT WILL BE TERMINATED AT THE NEXT PLS.

The minimum cabin pressure of 8 psia is specified to provide adequate protection from decompression sickness (bends) for continued on-orbit operations. A decompression from 14.7 to 8 psia would produce an R value of 1.50. (The R value is a measure of risk for developing decompression sickness and is the ratio of tissue nitrogen pressure prior to decompression to the final ambient pressure.) The risk of simple limb bends is estimated to be less than 10 percent and the risk of incapacitating bends less than 2 percent at this level. This level is more conservative than the EVA rule (ref. Rule {A13.1.2-7A}, EVA PREBREATHE PROTOCOL) because the crew could be exposed for many hours, and the cabin could not be repressurized above 8 psia should symptoms of bends develop.

Rule {A17.1.6-8}, LOSS OF CABIN INTEGRITY TMAX DEFINITION AND TIG SELECTION, references this rule. @[042594-ED]

2. MINIMUM PRESSURES BELOW 8 PSI - FOR CONTINGENCY PLANNING, IF POSSIBLE, PRESSURE REDUCTIONS BELOW 8 PSI WILL NOT EXCEED THE SPECIFIED LIMITS SHOWN BELOW.
 - a. 6.5 PSI FOR NO MORE THAN 90 MINUTES.
 - b. 3.5 PSI FOR NO MORE THAN 30 MINUTES.

The contingency limits on cabin pressure specified provide adequate protection from decompression sickness to allow safe return of crew to preferred recovery sites. Risk of decompression sickness is a complex function of many factors, including amount of pressure reduction, exposure time, and activity of the crewmembers. Based on available data, exceeding the specified limits in the shuttle environment would result in a risk of incapacitating bends of more than 5 to 10 percent and a risk of "pain only" bends of approximately 40 percent.

THIS RULE CONTINUED ON NEXT PAGE

FLIGHT RULES

A13.1.2-3 CABIN PRESSURE (CONTINUED)

B. UNPLANNED REDUCTION IN CABIN PRESSURE:

1. ANY UNPLANNED REDUCTION OR PROJECTION OF CABIN PRESSURE BELOW 12.5 PSIA WILL REQUIRE THE CREW TO DON THE QUICK DON MASK (QDM) IMMEDIATELY. THE FINAL, STABILIZED CABIN PRESSURE WILL DETERMINE THE NEED FOR CONTINUED USE OF THE QDM. THE FCR SURGEON SHOULD BE CONSULTED FOR PLANNING OF ALL SUBSEQUENT CREW ACTIVITIES.

Reduction in cabin pressure and the resulting decrease in PPO₂ may result in hypoxia and increase the risk of decompression sickness in crewmembers. If the QDM is donned above a pressure of 12.5 psia, formation of microemboli in the blood may still be prevented. With a rapid loss of pressure, an understanding of the resulting cabin environment and the restrictions it may impose must be evaluated by the surgeon.

2. CREWMEMBERS MAY DISCONTINUE USE OF THE QDM WHEN THE FINAL, STABILIZED CABIN PRESSURE AND PPO₂ LEVELS ARE AT OR ABOVE THE FOLLOWING MINIMUM VALUES:

FOR TEMPERATURES WITHIN 70 DEG TO 85 DEG F, USE THE IN-RANGE VALUE. THE OUT-OF-RANGE VALUE IS USED FOR TEMPERATURES LESS THAN 70 DEG F OR GREATER THAN 85 DEG F.

CABIN PRESSURE (PSIA)	PPO ₂ (PSIA)			OXYGEN CONCENTRATION (PERCENT)		
		IN	OUT		IN	OUT
14.7	2.29	2.37	2.44	15.6	16.1	16.6
10.2	2.35	2.43	2.50	23.0	23.8	24.5
8.0	2.38	2.46	2.53	30.1	30.8	31.6

All of the cabin pressure-PPO₂ combinations provide the equivalent of an 8000-foot pressure altitude breathing air. The rationale of Rule {A13.1.2-5BA}, MINIMUM PPO₂ CONSTRAINTS, applies. ©[ED]

FLIGHT RULES

A13.1.2-4 PPCO₂ CONSTRAINT

A. TWO-GAS ENVIRONMENT (CABIN) :

1. IF THE ATMOSPHERIC REVITALIZATION SYSTEM (ARS) IS UNABLE TO MAINTAIN THE PPCO₂ IN THE ORBITER CREW COMPARTMENT BELOW 15 MMHG, THE CREW WILL DON THE QDM. THE MISSION WILL BE TERMINATED AT THE NEXT PLS.

Deleterious physiological changes can be expected at PPCO₂ levels of 15 mmHg and above. These symptoms will be alleviated by using the QDM and breathing 100 percent O₂. If the ARS is unable to maintain PPCO₂ levels below 15 mmHg, the mission must be terminated as the cabin atmosphere is unsafe for routine crew activities without supplementary oxygen. Oxygen toxicity must be avoided with the prolonged exposure to 100 percent O₂ while using the QDM (ref. Rule {A13.1.2-6}, 100 PERCENT OXYGEN USE CONSTRAINT).

2. FOR PPCO₂ LEVELS BETWEEN 7.6 MMHG AND 15 MMHG, PLANNING FOR ALL CREW ACTIVITIES WILL REQUIRE EVALUATION BY THE FCR SURGEON.

A PPCO₂ of 7.6 mmHg is the maximum level that can be tolerated by the crew for long periods. Above 7.6 mmHg, physiological changes may occur that are unacceptable for crew safety, health, and performance. The length of exposure to levels above 7.6 mmHg and the planned crew activities will need to be reviewed by the FCR surgeon for consideration of physiological and performance effects.

B. ONE-GAS ENVIRONMENT (EMU) :

1. FOR PPCO₂ LEVELS BETWEEN 3 AND 8 MMHG WITH —SYMPTOMS INDICATIVE OF CO₂ EXPOSURE, THE CREWMEMBER WILL TERMINATE THE EVA, PROCEED TO THE AIRLOCK, AND CONNECT TO THE SERVICE AND COOLING UMBILICAL (SCU). @ED 1
2. FOR PPCO₂ LEVELS GREATER THAN 8 MMHG DURING EVA, IF IT CANNOT BE CONFIRMED THAT THE ELEVATED LEVELS ARE DUE TO A SENSOR ERROR, THE EVA CREWMEMBER WILL TERMINATE THE EVA, PROCEED TO THE AIRLOCK, AND CONNECT TO THE SCU. @121197-6456A1

THIS RULE CONTINUED ON NEXT PAGE

FLIGHT RULES

A13.1.2-4 PPCO₂ CONSTRAINT (CONTINUED)

3. FOR LOSS OF PPCO₂ SENSOR, THE FLIGHT SURGEON MAY REQUEST PHYSIOLOGICAL STATUS CHECKS TO EVALUATE THE CREWMEMBER FOR SYMPTOMS OF HYPERCAPNIA. IF SYMPTOMS ARE DETECTED, THE EVA WILL BE TERMINATED. ©[121197-6456A]

For a PPCO₂ indication of 8 mmHg, the actual level in the helmet can be 15 mmHg and may be as high as 23 mmHg, depending on the metabolic rate. For a PPCO₂ indication of 3 to 8 mmHg, the actual level in the helmet can be 11 to 15 mmHg and may be as high as 19 to 23 mmHg, depending on the metabolic rate. If symptoms are associated with indicated values of 3 to 8 mmHg, this indicates a high level of CO₂ in the helmet, and the EVA should be terminated.

In order to avoid unnecessary termination of an EVA due to faulty high PPCO₂ readings, an evaluation of the PPCO₂ sensor should be performed if the indicated level is greater than 8 mmHg. The EVA cuff checklist outlines the procedure to be followed by the crewmember. Additional evaluation can be performed by ground personnel to determine the status of the sensor. If the indicated PPCO₂ level is greater than 8 mmHg, due to a confirmed and a sensor error is confirmed, the crewmember may continue the EVA; but crewmember symptoms should be evaluated periodically. If symptoms are noted the EVA should be terminated, and the crewmember should proceed to the airlock and connect to the SCU. When the crewmember is connected to the SCU with the helmet purge valve open, the resultant O₂ flow alleviates danger of high PPCO₂ levels.

For CO₂ transducer loss, the ability to detect a high CO₂ level relies primarily on the crewmember's ability to detect physiological symptoms. Since one of the symptoms of hypercapnia is impaired judgment, the unaffected EVA crewmember, IV crewmember, and Flight Surgeon will assist in periodically monitoring the affected crewmember's physiological condition. The most common sign of CO₂ exposure is an increased breathing rate which will occur at 1 to 2 percent (7.6 to 15 mmHg). The pulse rate will increase at 3 to 5 percent (22 to 38 mmHg). Nonspecific symptoms experienced by the crewmember can be headache, dizziness, drowsiness, muscular weakness, etc. Note that the OSHA standard for an 8-hour workplace exposure is 0.5 percent (3.8 mmHg). The Flight Surgeon will continually monitor the downlinked ECG and metabolic data as well as the voice communications and breathing rate and may request physiological status checks be performed with the crewmember as necessary. The other EVA crewmember and the IV crewmember will monitor the affected crewmember's task performance and voice communications and should perform status checks every 30-60 minutes or as requested by the Flight Surgeon. If symptoms persist are detected, the EVA should be terminated. Thirty minutes was determined to be the minimum time it would take for the PPCO₂ levels to increase from 3 mmHg to 8 mmHg due to a LiOH breakthrough. ©[121197-6456A]

Rules {A17.1.7-1}, CABIN ATMOSPHERE MANAGEMENT; {17.1.3-6}, REGENERATIVE CO₂ REMOVAL SYSTEM (RCRS) LOSS DEFINITION; {A13.1.2-6}, 100 PERCENT OXYGEN USE CONSTRAINT; and {A15.1.2-2H}, EMU GO/NO-GO CRITERIA, reference this rule. ©[ED]

FLIGHT RULES

A13.1.2-5 MINIMUM PPO2 CONSTRAINTS

A. TWO-GAS ENVIRONMENT (CABIN):

1. THE PCS SHOULD MAINTAIN THE PPO₂ AT OR ABOVE THE FOLLOWING SPECIFIED CABIN PRESSURES:

a. FOR TEMPERATURES WITHIN 70 DEG TO 85 DEG F, USE THE IN-RANGE VALUE. THE OUT-OF-RANGE VALUE IS USED FOR TEMPERATURES LESS THAN 70 DEG F OR GREATER THAN 85 DEG F.

CABIN PRESSURE (PSIA)	PPO ₂ (PSIA)			OXYGEN CONCENTRATION (PERCENT)		
		IN	OUT		IN	OUT
14.7	2.29	2.37	2.44	15.6	16.1	16.6
10.2	2.35	2.43	2.50	23.0	23.8	24.5
8.0	2.38	2.46	2.53	30.1	30.8	31.6

THIS RULE CONTINUED ON NEXT PAGE

FLIGHT RULES

THIS PAGE INTENTIONALLY BLANK

FLIGHT RULES

A13.1.2-5 MINIMUM PPO2 CONSTRAINTS (CONTINUED)

- b. IF THE LEVEL OF PPO2 CANNOT BE MAINTAINED AT THE ABOVE LEVELS, THE MISSION WILL BE TERMINATED AT THE NEXT PLS.

The PPO₂ minimum acceptable limits defined in the table are established to ensure adequate delivery of oxygen to the pulmonary alveoli. These limits represent the minimum PPO₂ required to maintain the alveolar pressure of oxygen equivalent to that of breathing air at an 8000-foot pressure altitude. Due to the saturation of breathing gases with water, PPO₂ limits must increase as cabin pressure decreases to maintain the same alveolar partial pressure of oxygen. For temperatures of 70 deg to 85 deg F, the maximum PPO₂ sensor error is ± 0.08 psia. This error is added to the minimum acceptable true PPO₂ (8,000 feet altitude equivalent) to arrive at the minimum acceptable PPO₂ sensor reading (e.g., $2.29 + 0.08 = 2.37$). For temperatures outside this range, the PPO₂ error is ± 0.15 psia, and this error must be adjusted accordingly per OMRSD V61AJ0.141. Above a pressure altitude of 8,000 feet, deleterious changes in crew performance can occur from hypoxia and altitude sickness. Symptoms of altitude sickness can develop over several hours consisting of headache, lethargy, and reduced appetite in 15 to 20 percent of crewmembers. More serious symptoms of confusion, loss of coordination, and difficulty in breathing may occur. These more serious symptoms must be treated with oxygen and an immediate increase in ambient pressure. (Ref. Rule {A13.1.2-6}, 100 PERCENT OXYGEN USE CONSTRAINT). ⑥ED 1

Rules {A17.1.5-3}, PPO₂ CONTROL, and {A17.1.13-1}, LIFE SUPPORT GO/NO-GO CRITERIA, reference this rule.

- 2. FOR NEXT PLS LANDING, THE PPO₂ MAY BE ALLOWED TO DECREASE TO THE FOLLOWING LEVELS FOR NO MORE THAN 24 HOURS. THE LAUNCH/ENTRY SUIT (LES) SHALL BE DONNED 1 HOUR PRIOR TO LANDING WITH VISORS DOWN.

FOR TEMPERATURES WITHIN 70 DEG TO 85 DEG F, USE THE IN-RANGE VALUE. THE OUT-OF-RANGE VALUE IS USED FOR TEMPERATURES LESS THAN 70 DEG F OR GREATER THAN 85 DEG F.

CABIN PRESSURE (PSIA)	PPO ₂ (PSIA)			OXYGEN CONCENTRATION (PERCENT)		
		IN	OUT		IN	OUT
14.7	2.09	2.17	2.24	14.2	14.8	15.2
10.2	2.14	2.22	2.29	20.1	21.8	22.5
8.0	2.20	2.28	2.35	27.5	28.5	29.4

FLIGHT RULES

THIS RULE CONTINUED ON NEXT PAGE

FLIGHT RULES

A13.1.2-5 MINIMUM PPO₂ CONSTRAINTS (CONTINUED)

These PPO₂ levels represent a pressure altitude, breathing air of 10,000 feet. Rapid ascents to 10,000 feet cause a mild altitude sickness incidence of 20 to 40 percent. The risk of altitude sickness is increased principally from the reduced alveolar oxygen tension and to a lesser degree from the decrease in the ambient air pressure. High altitude pulmonary edema has been noted in the 15 to 25 percent of those exposed to a 14,000-foot pressure altitude for 24 hours and has occurred as low as 9,000 feet. Death from high altitude cerebral edema has been reported at 10,000 feet. The risk of altitude sickness at certain cabin pressures and PPO₂ levels must be balanced against system anomalies and difficulties generated from landing at a non-PLS site. Wearing the LES and breathing 100 percent oxygen 1 hour prior to landing will eliminate the subtle performance decrements that occur with hypoxia (ref. Rule {A13.1.2-6}, 100 PERCENT OXYGEN USE CONSTRAINT).

Rules {A17.1.5-3}, PPO₂ CONTROL; {A17.1.6-4}, CABIN O₂ CONCENTRATION; and {A17.1.13-1}, LIFE SUPPORT GO/NO-GO CRITERIA, reference this rule. [@ED 1](#)

3. FOR CONTINGENCY LANDING PURPOSES, IN A SITUATION WHERE THE PPO₂ CANNOT BE MAINTAINED AT THE LEVELS IN PARAGRAPH A.2, THE QDM SHALL BE DONNED. THE FINAL DETERMINATION OF QDM USE AND LES DONNING WILL DEPEND ON FINAL STABLE CABIN PRESSURE, PPO₂, AND TIG.

If the cabin cannot be maintained at the PPO₂ levels delineated in paragraph A.2, use of the QDM is necessary to prevent hypoxia and altitude sickness. Providing supplementary oxygen with the QDM or LES can prevent deleterious changes in crew performance from both hypoxia and altitude sickness.

4. CONSULT THE FCR SURGEON FOR THE TOTAL LENGTH OF TIME THAT THE CREW MAY WEAR THE QDM OR LES.

The next PLS opportunity may not occur for several hours. Some crewmembers may be able to remove their QDM or LES for brief periods of time during low activity and/or sleep periods. This removal will provide for greater crew comfort, increased mobility, and will prevent possible oxygen toxicity from breathing 100 percent oxygen (ref. Rule {A13.1.2-6}, 100 PERCENT OXYGEN USE CONSTRAINT). The FCR surgeon can estimate the pressure altitude, breathing air from the known cabin pressure and PPO₂, and can estimate the length of time that the crew may safely remove their QDM or LES.

- B. ONE-GAS ENVIRONMENT (EMU) - IF THE PRESSURE IN THE SUIT FALLS BELOW 3.25 PSI, THE EVA CREWMEMBER WILL TERMINATE THE EVA, PROCEED TO THE AIRLOCK, AND CONNECT TO THE SCU.

At 92 percent O₂, 3.25 psia corresponds to a pressure altitude of 8000 feet and the rationale of paragraph A.1 applies. Exhaled nitrogen from the crewmember dilutes the oxygen atmosphere in the suit to 92 percent.

FLIGHT RULES

Rule {A13.1.2-3B.2}, CABIN PRESSURE, references this rule.

FLIGHT RULES

A13.1.2-6 100 PERCENT OXYGEN USE CONSTRAINT

A. THE MAXIMUM AMOUNT OF TIME A CREWMEMBER MAY BREATHE 100 PERCENT OXYGEN BY WEARING THE QDM OR LES AT VARIOUS CABIN PRESSURES IS:

CABIN PRESSURE	MAXIMUM QDM OR LES HELMET TIME
12-14.7 PSI	6 HOURS
10.2-12 PSI	12 HOURS
<10.2 PSI	INDEFINITELY

Breathing 100 percent oxygen at sea level pressure will result in physiologic changes due to oxygen toxicity after 6 hours minimum. Since oxygen toxicity is proportional to the oxygen partial pressure and not the percent gas, longer exposures of 100 percent oxygen can be tolerated at lower pressures. For 100 percent oxygen at sea level, physiologic changes begin as mild (2 to 5 percent) asymptomatic decreases in vital capacity (the largest volume of air which can be exhaled voluntarily) beginning with fully inflated lungs. After 12 hours, coughing, sore throat, and substernal soreness are usually seen, and after 24 hours, atelectasis, pulmonary edema, broncho-pneumonia, and further decrements in vital capacity may develop. Intermittent air breaks or lowering pressure may avoid such effects.

B. CONTINGENCIES, SUCH AS FIRE OR SMOKE IN THE CABIN, HALON 1301 OR OTHER TOXIC COMPOUNDS SPILLED IN THE CABIN, MAY REQUIRE EXTENDED USE OF THE QDM OR LES BEYOND THE LIMITS STATED IN PARAGRAPH A. THE FCR SURGEON SHOULD BE CONSULTED FOR THE MAXIMUM LENGTH OF TIME THE QDM OR LES MUST BE WORN (REF. RULE {A13.1.2-4}, P_{PCO₂} CONSTRAINT).

After exposure of the shuttle cabin atmosphere to a toxic substance and subsequent cleanup, the atmosphere may need to be purged of residual toxic contamination based on the type of substance, amount released, relative toxic potential, and the ability of ARS to remove the substance.

The atmosphere is considered purged of residual toxic material that can be removed by the ARS after a six-fold cycle through the ARS.

Oxygen toxicity changes are usually mild at onset and may be considered less limiting than other considerations, including PLS availability and deorbit time requirements. Individual determination by the crew surgeon is required to balance cost/benefits for specific cases.

Rules {A13.1.2-4A.1}, P_{PCO₂} CONSTRAINT; and {A13.1.2-5A.2}, MINIMUM P_{PO₂} CONSTRAINTS, reference this rule.

FLIGHT RULES

A13.1.2-7 EVA PREBREATHE PROTOCOL

A. FOR SCHEDULED AND UNSCHEDULED EVA'S, PREBREATHING WILL BE ACCOMPLISHED USING THE PROTOCOL DEFINED IN PARAGRAPH A.1 (10.2 PSI CABIN) UNLESS THE PROTOCOL DEFINED IN PARAGRAPH A.2 (IN-SUIT) IS REQUIRED FOR A SPECIFIC FLIGHT.

1. 10.2 PSI CABIN OPTIONS:

a. EVA SCHEDULED WITHIN 36 HOURS OF CABIN DEPRESS TO 10.2 PSI:

INITIAL PREBREATHE	TIME AT 10.2 PSI	FINAL PREBREATHE
60 MINUTES	24 HOURS	40 MINUTES
60 MINUTES	20 HOURS	50 MINUTES
60 MINUTES	16 HOURS	60 MINUTES
60 MINUTES	12 HOURS	75 MINUTES

(1) THE INITIAL PREBREATHE MUST BE AN UNBROKEN PREBREATHE WITH > 95 PERCENT O₂, AT LEAST 45 MINUTES OF WHICH MUST BE ACCOMPLISHED PRIOR TO DEPRESSURIZATION BELOW 12.5 PSI. THE PREBREATHE WILL NOT BE TERMINATED UNTIL THE CABIN PRESSURE REACHES 10.2 PSI.

(2) THE FINAL PREBREATHE MUST BE AN UNBROKEN PREBREATHE IN THE SUIT OF 40 MINUTES (24-HOUR PROTOCOL) OR 75 MINUTES (12-HOUR PROTOCOL) IMMEDIATELY PRIOR TO EVA. THE FINAL PREBREATHE MAY BE GRADUALLY REDUCED FOR 10.2 PSI EXPOSURES LONGER THAN 12 HOURS BUT LESS THAN 24 HOURS. CONSULT THE FCR SURGEON FOR THE TOTAL TIME REQUIRED FOR THE FINAL PREBREATHE.

b. EVA SCHEDULED FOR LATER THAN 36 HOURS AT 10.2 PSI:

(1) IF THE EVA IS SCHEDULED FOR LATER THAN 36 HOURS AFTER CABIN DEPRESS TO 10.2, THE INITIAL PREBREATHE MAY BE ELIMINATED. THE FINAL PREBREATHE WILL BE 40 MINUTES.

FLIGHT RULES

- (2) IF THE INITIAL PREBREATHE IS ELIMINATED, BUT THE EVA OCCURS PRIOR TO 36 HOURS AT 10.2 PSI, THEN 60 MINUTES WILL BE ADDED TO THE PREBREATHE.

THIS RULE CONTINUED ON NEXT PAGE

FLIGHT RULES

A13.1.2-7 EVA PREBREATHE PROTOCOL (CONTINUED)

2. IN-SUIT OPTION:

A MINIMUM OF 4 HOURS UNBROKEN PREBREATHE WITH > 95 PERCENT O₂ IS REQUIRED AT A CABIN PRESSURE ABOVE 12.5 PSI PRIOR TO ANY CABIN OR AIRLOCK DEPRESSURIZATION BELOW 8 PSI.

All prebreathe options in paragraphs A.1 and A.2 produce the same denitrogenation for all crewmembers (R=1.65-1.68) and these protocols or less conservative protocols have been verified in ground-based testing. The R value is the ratio of tissue N₂ prior to decompression to the final ambient pressure. The R value is a measure of risk for decompression sickness. The O₂ prebreathe displaces nitrogen from the tissues and blood thus lowering the risk for decompression sickness at low ambient pressure. The nitrogen displaced from the tissues will dilute the suit oxygen slightly (down to 92 percent), but supply oxygen > 95 percent will still provide adequate denitrogenation. The 10.2 cabin option is always preferred and will be used unless a specific flight carries equipment that cannot be exposed to a 10.2 psi cabin atmosphere and must continue to operate throughout the EVA. For off-nominal prebreathe situations, a calculated prebreathe time based on an R-value of 1.65 is highly desirable. Lack of ground-based support data for off-nominal prebreathe scenarios dictates a conservative approach in the prevention of DCS symptoms. @032395-1761]

Prebreathe protocols for 12 and 24 hours at 10.2 psi have been tested in ground-based studies and are the preferred operational protocols. Prebreathe exposures between 12 and 24 hours may be considered as necessary, but no ground-based test data has been obtained at intermediate exposures.

When an EVA is scheduled after 36 hours at 10.2, it is unlikely that any dispersed gas bubbles formed by the depressurization to 10.2 would remain beyond 36 hours. If the initial prebreathe was not performed, but an EVA becomes necessary prior to 36 hours, then the calculated final prebreathe will be extended by 60 minutes. It is estimated that the extra 60 minutes of final prebreathe would offset the reduced nitrogen washout capability that small persistent bubbles would cause.

B. FOR ANY CONTINGENCY EVA, PREBREATHING WILL BE ACCOMPLISHED AS FOLLOWS:

1. IF SUFFICIENT CREW TIME IS AVAILABLE DURING PREPARATION FOR A CONTINGENCY EVA, THE PREBREATHE PROTOCOLS OF PARAGRAPHS A.1 OR A.2 SHALL APPLY.

THIS RULE CONTINUED ON NEXT PAGE

FLIGHT RULES

A13.1.2-7 EVA PREBREATHE PROTOCOL (CONTINUED)

2. IF EVA PREPARATION TIME IS CRITICAL TO CREW SAFETY, A MINIMUM OF 2.5 HOURS UNBROKEN PREBREATHE WITH > 95 PERCENT O₂ IS RECOMMENDED AT A CABIN PRESSURE ABOVE 12.5 PSI PRIOR TO ANY CABIN OR AIRLOCK PRESSURE BELOW 8 PSI. THE FCR SURGEON SHALL BE CONSULTED FOR A RECOMMENDED PREBREATHE PROTOCOL FOR ANY CONTINGENCY EVA.

A minimum prebreathe of 2.5 hours will reduce the estimated risk of incapacitating bends to < 50 percent for an EVA up to 6 hours in duration. This recommended time is very approximate and should be extended if possible. A prebreathe < 2.5 hours would exceed a 50 percent risk of incapacitating bends, and the risk would increase as the prebreathe was progressively shortened. The FCR surgeon should be consulted on each contingency EVA situation for an estimate of the risk based on the proposed length of prebreathe time.

C. INTERRUPTION OF THE PREBREATHE PROTOCOL:

1. 10.2 CABIN OPTION:
 - a. NO MODIFICATION OF THE 10.2 PSI PREBREATHE PROTOCOL IS REQUIRED IF THE CABIN PRESSURE IS MAINTAINED BELOW THE MAXIMUM LIMIT OF 10.84 (10.6) PSI.
 - b. IF THE CABIN PRESSURE EXCEEDS 10.6 PSI INDICATED, THE EVA CREWMEMBERS WILL DON THE QDM IMMEDIATELY. CONSULT THE FCR SURGEON FOR THE REQUIRED MODIFICATION TO THE PREBREATHE PROTOCOL.

An increase in the cabin pressure above 10.6 psi indicated will cause the tissues and blood to reabsorb nitrogen. At an indicated cabin pressure of 10.6 psi, the true cabin pressure may be 10.84 psi. The indicated PPO₂ caution and warning limit of 2.55, 2.40 psi true, produces a worst case PPN₂ of 8.44 (10.84 - 2.40) psi. This maximum PPN₂ of 8.44 psi is acceptable for continued prebreathe without modification. For pressures above 10.6 psi indicated, wearing the QDM and breathing 100 percent oxygen can prevent renitrogenation and preserve the prebreathe protocol. (Ref. Rule {A17.1.7-1}, CABIN ATMOSPHERE MANAGEMENT.)

THIS RULE CONTINUED ON NEXT PAGE

FLIGHT RULES

A13.1.2-7 EVA PREBREATHE PROTOCOL (CONTINUED)

2. QDM/EMU OPERATIONS (100 PERCENT O₂ PREBREATHE)

- a. ANY INTERRUPTION OF THE PREBREATHE PROTOCOL WHICH OCCURS WHILE THE CREW IS WEARING THE QDM OR IS IN THE EMU WILL REQUIRE AN INCREASE IN THE TIME ON 100 PERCENT O₂ AT A RATIO OF 2 ADDITIONAL MINUTES FOR EACH 1 MINUTE INTERRUPTION OF PREBREATHE. ~~@[021199-6806A] CONSULT THE FCR SURGEON FOR THE REQUIRED INCREASE IN LENGTH OF THE PREBREATHE PERIOD.~~
- b. IF THE EMU IN-SUIT PREBREATHE IS INTERRUPTED AFTER COMPLETION OF THE SUIT PURGE, THE INTERRUPTION DURATION IS DEFINED AS THE TIME BREATHING CABIN ATMOSPHERE PLUS THE TIME BREATHING SUIT ATMOSPHERE PRIOR TO REINITIATION OF A SUBSEQUENT SUIT PURGE. THE SUBSEQUENT SUIT PURGE DURATION DOES NOT COUNT AS EITHER THE INTERRUPTION TIME OR THE ADDITIONAL PREBREATHE TIME.
- c. THE RESULTING PREBREATHE TIME (ADDITIONAL PREBREATHE PLUS REMAINDER OF ORIGINAL PREBREATHE) WILL NOT EXCEED THE ORIGINAL PREBREATHE TIME PER PARAGRAPHS A.1 OR A.2. CONSULT THE FCR SURGEON FOR THE REQUIRED INCREASE IN LENGTH OF THE PREBREATHE PERIOD. @[021199-6806A]

Breathing nitrogen after the prebreathe has begun allows the tissues and blood to reabsorb nitrogen. Renitrogenation occurs at a more rapid rate than denitrogenation, and a break in the prebreathe will require extra prebreathe time to be added to the protocol.

D. FOR MULTIPLE EVA'S:

1. IF THE PROTOCOLS OUTLINED IN PARAGRAPH A.1 ARE USED, THE CABIN PRESSURE WILL BE MAINTAINED AT 10.2 PSI UNTIL COMPLETION OF THE FINAL EVA. EACH SUBSEQUENT EVA MUST HAVE AN UNBROKEN PREBREATHE OF AT LEAST 40 MINUTES IN THE SUIT IMMEDIATELY PRIOR TO EVA.
2. IF THE IN-SUIT PREBREATHE OPTION IS USED, EACH EVA WILL FOLLOW THE PROTOCOL OUTLINED IN PARAGRAPH A.2.

*Rules {A2.1.3-6C}, EVA GUIDELINES; {A17.1.7-9}, CABIN PRESSURE TIME AT 10.2 PSIA; {A13.1.2-3}, CABIN PRESSURE; and {A15.1.3-1}, DENITROGENATION, reference this rule.
@[012694-1600]*

FLIGHT RULES

FLIGHT RULES

A13.1.2-8 SCHEDULED AND UNSCHEDULED EVA CONSTRAINTS

- A. NO SCHEDULED OR UNSCHEDULED EVA SHALL OCCUR PRIOR TO APPROXIMATELY 24 HOURS MET OF FLIGHT.
- B. NO SCHEDULED EVA SHALL OCCUR PRIOR TO APPROXIMATELY 72 HOURS MET UNLESS AN ASSESSMENT OF CREW HEALTH HAS BEEN ACCOMPLISHED BY THE FCR SURGEON DURING A PMC.

Symptoms of motion sickness are experienced by 73 percent of crewmembers on their first shuttle flight. Thirteen percent of them will have a severe case characterized by drowsiness, inability to concentrate, severe nausea and vomiting, and little or no food or water intake over 24 to 48 hours. The majority of susceptible crewmembers develop symptoms in the first 6 hours of flight, and all crewmembers graded as moderate or severe had symptom onset in the first 6 hours. Symptoms peak over 24 to 48 hours MET and resolve over 48 to 72 hours MET. During adaption to zero-g, movement (especially head movement) may provoke nausea and vomiting in susceptible crewmembers and potentially endanger the safety of the crewmember by decreased concentration, lethargy, or vomitus in the helmet.

- C. NO UNSCHEDULED EVA SHALL OCCUR PRIOR TO APPROXIMATELY 48 HOURS MET UNLESS AN ASSESSMENT OF CREW HEALTH HAS BEEN ACCOMPLISHED BY THE FCR SURGEON DURING A PMC.

An unscheduled EVA for mission success is a high priority EVA and may be performed after approximately 48 hours MET as many crewmembers will have resolving symptoms of motion sickness and will be less susceptible to provocative motion stimuli after 48 hours MET. The reduced risk of motion sickness is balanced against the prospective gain of a successful mission. The limitations elaborated in the Crew Scheduling document, Appendix K, recognize that the EVA may not be performed due to crew health concerns.

Rules {A13.1.2-9}, PRIVATE MEDICAL COMMUNICATION (PMC); and {A15.1.1-14}, SCHEDULED AND UNSCHEDULED EVA CONSTRAINTS, reference this rule.

A13.1.2-9 PRIVATE MEDICAL COMMUNICATION (PMC)

- A. A PMC MAY BE REQUESTED AS NEEDED BY THE CREW CDR, FCR SURGEON, OR FLIGHT DIRECTOR.

This rule reflects NASA Policy and Privacy Act of 1974 considerations regarding the privileged nature of doctor-patient communications.

- B. MEDICAL TREATMENT IN RESPONSE TO CREW REQUESTS MAY BE PRESCRIBED DURING NONPRIVATE COMMUNICATION PERIODS AT THE DISCRETION OF THE CDR AND THE FCR SURGEON.

FLIGHT RULES

The crew may discuss medical concerns and treatment over nonprivate air-to-ground loops if they choose to waive the privacy accorded them by the Privacy Act of 1974.

THIS RULE CONTINUED ON NEXT PAGE

FLIGHT RULES

A13.1.2-9 PRIVATE MEDICAL COMMUNICATION (PMC) (CONTINUED)

C. A PMC WILL BE SCHEDULED PRIOR TO ANY EVA OR LANDING EARLIER THAN MET 72 HOURS EXCEPT WHEN LANDING ON LAUNCH DAY.

Early deorbit/landing or scheduled and unscheduled EVA's may be considered during flight. A PMC is necessary to accurately assess crew health during the first 72 hours MET when symptoms of motion sickness are greatest. (Reference Rule {A13.1.2-8B} and C, SCHEDULED AND UNSCHEDULED EVA CONSTRAINTS, and rationale.)

D. A PMC WILL BE SCHEDULED ON ALL FLIGHT DAYS. IT WILL USUALLY BE SCHEDULED DURING THE PRESLEEP PERIOD EXCEPT ON LANDING DAY WHEN IT WILL BE SCHEDULED PRIOR TO DEORBIT PREP, PREFERABLY IN THE POST SLEEP PERIOD.

FOR DUAL-SHIFT MISSIONS, PMC'S WILL BE SCHEDULED WHEN BOTH TEAMS ARE AWAKE, IF POSSIBLE.

This rule provides the opportunity for the surgeon to discuss health-related concerns with the crew and assist in the treatment of medical problems.

A13.1.2-10 IRB PROTOCOLS

ALL LIFE SCIENCES EXPERIMENTS USING THE CREW AS TEST SUBJECTS WILL BE CONDUCTED ACCORDING TO PROTOCOLS APPROVED BY THE JSC INSTITUTIONAL REVIEW BOARD (IRB) AND OTHER PARTICIPATING MEDICAL BOARDS. DEVIATIONS IN FLIGHT TO THESE PROTOCOLS REQUIRE THE CONCURRENCE OF THE FCR SURGEON. ANY SAFETY RELATED ISSUES OR PROCEDURES ARE THE FINAL RESPONSIBILITY OF FCR SURGEON. @[092195-1797]

Life sciences experiments often involve hardware which requires detailed procedures, safety devices, and restraints to minimize the risk of injury to the participating crewmember(s). Data collection is not allowed until the JSC Institutional Review Board (IRB) is satisfied that the experiment has been designed to minimize the risk of injury or illness for the crewmember. Therefore, deviation from approved protocols and procedures may compromise the safety of an experiment and expose the crewmember to an unacceptable level of risk for injury. @[092195-1797]

FLIGHT RULES

A13.1.2-11 **CREW AWAKE TIME CONSTRAINT**

- A. ON ORBIT - THE MAXIMUM ON-ORBIT CREW AWAKE TIME IS 18 HOURS.
- B. LANDING DAY - THE MAXIMUM CREW AWAKE TIME ON LANDING DAY IS 18 HOURS FROM CREW WAKE-UP ON ORBIT TO THE SLEEP PERIOD AFTER LANDING, INCLUSIVE OF ALL POSTLANDING ACTIVITIES.

Fatigue represents a blend of factors resulting in a state of decreased ability. It has been shown to negatively impact both mental and physical performance, and fatigue-induced changes increase after 18 hours awake time. The strong relationship between sleep loss and the development of fatigue is well known.

For landing day, the post landing activities are described in the Crew Scheduling Constraints Document, Appendix K, Section 3.5 (JSC-22354). Post landing activities may be scheduled up to a maximum crew awake time of 18 hours inclusive of the presleep period.

A13.1.2-12 **HOT CABIN ATMOSPHERE**

IN THE EVENT OF LOSS OF CABIN COOLING CAPABILITY AND TIG IS GREATER THAN 2.5 HOURS, THE FOLLOWING MEASURES SHOULD BE TAKEN:

- A. MONITOR AND RECORD CREW AND CABIN TEMPERATURE AND HUMIDITY CHANGES USING AVAILABLE SENSORS INCLUDING MEDICAL KIT THERMOMETERS.
- B. BEGIN IMMEDIATE FLUID LOADING, WITH 8 OUNCES OF WATER EVERY 15 MINUTES AND ONE SALT TABLET EVERY 30 MINUTES.
- C. DON QDM FOR CREWMEMBER DISCOMFORT (I.E., ESTIMATED CABIN TEMPERATURE GREATER THAN 90 DEG F AND HUMIDITY GREATER THAN 90 PERCENT) WITH CONTINUED WEAR UNTIL RESOLUTION OF THE COOLING PROBLEM. DEORBIT TO AN EMERGENCY LANDING SITE MAY BE REQUIRED PRIOR TO PLS AS DETERMINED REAL TIME BY CREW, FLIGHT DIRECTOR, AND CREW SURGEON.

THIS RULE CONTINUED ON NEXT PAGE

FLIGHT RULES

A13.1.2-12 HOT CABIN ATMOSPHERE (CONTINUED)

- D. WEAR LES DURING ENTRY. INFLATION OF G-SUIT PORTION OF THE LES TO 1.5 PSI REQUIRED AT EI.

A hot cabin may quickly reach crew tolerance limits and impair crew performance/health prior to PLS opportunities, and monitoring of the cabin and crew may be very limited due to the powerdown. Crew tolerances may be near limits when their skin temperature increases greater than 2.5 deg F (1 deg F core) or if pulse is greater than 140, but precise prediction of crew tolerances and time constraints for entry is not possible. Stepwise preventive measures, including water and salt intake, QDM use (for respiratory cooling with low humidity oxygen), and LES wear with G-suit use (to increase effective blood volume by preventing blood pooling in lower extremities) are necessary to provide maximum protection from the environment. Cabin purges may also be used for cooling. An emergency landing may be required to prevent crew incapacitation during certain situations, and preparations for such landings must begin well in advance. Such a determination will be a real-time call depending on the situation due to the numerous factors involved.

A13.1.2-13 CABIN ATMOSPHERE CONTAMINATION

- A. PLANNED OR ACCIDENTAL DISCHARGE OF EITHER A FIXED AVIONICS BAY FIRE EXTINGUISHER OR A PORTABLE FIRE EXTINGUISHER INTO AN AVIONICS BAY WITH NO SMOKE/FIRE DETECTED: @[090894-1682A]
1. THE CREW MAY BE EXPOSED TO THE CABIN ATMOSPHERE FOR 72-100 HOURS FROM THE TIME OF DISCHARGE WITHOUT IMPACT.
 2. THE CREW WILL CONTACT MCC TO DETERMINE THE MAXIMUM ALLOWABLE EXPOSURE TIME ON-ORBIT. THE SURGEON WILL MAKE A DECISION AS TO WHEN THE CREW MAY DON THE QDM'S OR LES'S AND BREATHE 100 PERCENT OXYGEN TO INCREASE MISSION DURATION.
 3. THE CDR, PLT, AND FLIGHT ENGINEER WILL CLOSE VISORS ON THE LES'S AND BREATHE 100 PERCENT OXYGEN FOR 60 MINUTES PRIOR TO LANDING AND THROUGH LANDING ROLLOUT.

REAL-TIME DISCUSSION OF MISSION DURATION OR EXTENSION WILL BE DEPENDENT UPON SUCH FACTORS AS CREW SYMPTOMS, PERFORMANCE, AND/OR INITIATION OF A DEDICATED AVIONICS BAY PURGE.

THIS RULE CONTINUED ON NEXT PAGE

FLIGHT RULES

A13.1.2-13 CABIN ATMOSPHERE CONTAMINATION (CONTINUED)

The above criterion was established based upon information from NASA's Halon 1301 Human Inhalation Study (reference JSC-23845, August 1989), the National Research Council (NRC), and JSC Toxicology Group. The human study involved exposing 8 volunteers to Halon 1301 for a period of 24 hours at a concentration of 1.0 percent (10,000 ppm). The effects on both physiology and performance were studied using a computerized battery of tests on reaction time, decision-making, etc. No significant changes in any physiological parameters were noted. There were no alterations of any blood counts or chemistries, no pulmonary function changes, no cardiac dysrhythmias, and no mental status changes. There were no significant decrements in performance recorded from the pre-exposure baselines. Based on this study, exposure of crewmembers to Halon concentration levels above 1.0 percent is not permitted.

As a result of research done in the "Documentation of the Spacecraft Maximal Allowable Concentration Values on Bromotrifluoromethane" (White Paper), the NRC approved revised SMAC levels for Halon 1301 on November 18, 1993. These guidelines state that for 24-hour exposure, the SMAC level is 0.35 percent (3500 parts per million), and for 7-day exposure, the SMAC level is 0.18 percent (1800 ppm). The JSC Toxicology Group sponsored the mentioned study and proposed SMAC levels to the NRC.

Approximately 50 percent of Halon 1301 discharged from a fire extinguisher into the avionics bay will diffuse into the cabin atmosphere within 50 hours, and 100% of it will diffuse in 100 hours. Halon 1301 is poorly absorbed by the charcoal in the LiOH canisters as well as the Ambient Temperature Catalytic Oxidizer (ATCO) canister. Thus, it cannot be effectively removed from the cabin atmosphere. @[090894-1682A]

Discharge of one portable fire extinguisher into an avionics bay would produce a Halon 1301 concentration of approximately 0.3 percent (3000 ppm). Discharge of one fixed avionics bay fire extinguisher would produce a concentration of approximately 0.4 percent (4000 ppm). These concentrations were calculated on the assumption that complete equilibration of Halon 1301 with the cabin atmosphere occurs after 100 hours. @[090894-1682A]

Provided sufficient consumables are available, the mission duration may be extended by having the crew don the QDM's or LES's and breathe 100 percent oxygen for up to 6 hours at 12.0-14.7 psia without risk of oxygen toxicity (reference rule {A13.1.2-6}; 100 PERCENT OXYGEN USE CONSTRAINT). The Surgeon and EECOM shall coordinate their efforts to derive a plan that can increase mission duration after the crew has been exposed to Halon 1301.

Data shows that the half-life of Halon 1301 in non-fatty tissues (primarily blood) is 5 minutes; whereas, the half-life of Halon 1301 is approximately 200 minutes in fat (Halon is lipid soluble). Breathing 100 percent oxygen for 60 minutes prior to landing should significantly reduce the blood and brain levels of Halon 1301 and further protect crew performance during critical performance periods (i.e., de-orbit preparation, landing, landing rollout). Due to O2 concentration limits, three crewmembers can breathe 100 percent O2 for 1 hour, or seven crewmembers can breathe 100 percent O2 for 30 minutes.

FLIGHT RULES

THIS RULE CONTINUED ON NEXT PAGE

FLIGHT RULES**A13.1.2-13 CABIN ATMOSPHERE CONTAMINATION (CONTINUED)**

A real-time decision is to be made by the Flight Director, Surgeon, EECOM, IFM, and any other disciplines involved with the decision-making process to perform a landing after the crew has been exposed to Halon 1301. The range of 72-100 hours is to be used as a guideline. The actual mission duration or extension is dependent upon such factors as crew symptoms, performance, and/or initiation of a dedicated avionics bay purge.

B. PLANNED OR ACCIDENTAL DISCHARGE OF A PORTABLE FIRE EXTINGUISHER INTO A PANEL OR INTO THE OPEN CABIN ATMOSPHERE, OR DETECTION OF A LEAKING PORTABLE FIRE EXTINGUISHER, WITH NO SMOKE/FIRE DETECTED:

1. THE CREW MAY BE EXPOSED TO THE CABIN ATMOSPHERE FOR 24-48 HOURS FROM THE TIME OF DISCHARGE OR DETECTION OF A LEAKING BOTTLE WITHOUT IMPACT.
2. THE CREW WILL CONTACT MCC TO DETERMINE THE MAXIMUM ALLOWABLE EXPOSURE TIME ON-ORBIT. THE SURGEON WILL MAKE A DECISION AS TO WHEN THE CREW MAY DON THE QDM'S OR LES'S AND BREATHE 100 PERCENT OXYGEN TO INCREASE MISSION DURATION. @[090894-1682A]
3. THE CDR, PLT, AND FLIGHT ENGINEER WILL CLOSE VISORS ON THE LES'S AND BREATHE 100 PERCENT OXYGEN FOR 60 MINUTES PRIOR TO LANDING AND THROUGH LANDING ROLLOUT. @[090894-1682A]

REAL-TIME DISCUSSION OF MISSION DURATION OR EXTENSION WILL BE DEPENDENT UPON SUCH FACTORS AS CREW SYMPTOMS, PERFORMANCE, AND/OR DETERMINATION OF THE AMOUNT OF HALON LEAKED/DISCHARGED INTO THE CABIN.

Discharge of a fire extinguisher into a panel or into the open cabin will produce a rapid equilibration with the cabin atmosphere. A Halon 1301 level of approximately 0.3 percent (3000 ppm) will be rapidly achieved, and the maximum allowable crewmember exposure time at this level is in the range of 24-48 hours based on the SMAC levels for Halon 1301 in paragraph A's rationale.

Provided sufficient consumables are available, the mission duration may be extended by having the crew don the QDM's or LES's and breathe 100 percent oxygen for up to 6 hours at 12.0-14.7 psia without risk of oxygen toxicity (reference Rule {A13.1.2-6}; 100 PERCENT OXYGEN USE CONSTRAINT). The Surgeon and EECOM shall coordinate their efforts to derive a plan that can increase mission duration after the crew has been exposed to Halon 1301.

THIS RULE CONTINUED ON NEXT PAGE

FLIGHT RULES**A13.1.2-13 CABIN ATMOSPHERE CONTAMINATION (CONTINUED)**

Breathing 100 percent oxygen for 60 minutes prior to landing should significantly reduce the blood and brain levels of Halon 1301 and further protect crew performance during critical performance periods (i.e., de-orbit preparation, landing, landing rollout). Due to O2 concentration limits, three crewmembers can breathe 100 percent O2 for 1 hour, or seven crewmembers can breathe 100 percent O2 for 30 minutes.

A real-time decision is to be made by the Flight Director, Surgeon, EECOM, and any other disciplines involved with the decision-making process to perform a landing after the crew has been exposed to Halon 1301. The range of 24-48 hours is to be used as a guideline. The actual mission duration or extension is dependent upon such factors as crew symptoms, performance, and/or determination of the amount of Halon leaked/discharged into the cabin. Reference Flight Rule {17.1.2-4}, MANAGEMENT FOLLOWING HALON DISCHARGE WITHOUT FIRE CONFIRMATION. [090894-1682A] [ED]

- C. SMOKE OR FIRE DETECTED AND CONFIRMED VIA VISUAL OBSERVATION, TWO SMOKE DETECTORS, OR CREW SYMPTOMS.
1. IMMEDIATELY DON THE QDM'S AND INITIATE O2 FLOW. [090894-1673A]
 2. INSTALL TWO FRESH LIOH CANISTERS IN THE ARS, OR ONE FRESH LIOH CANISTER AND THE FRESHEST CHARCOAL CANISTER IF THE RCRS IS FLOWN. [090894-1673A]
 3. TURN CABIN TEMPERATURE CONTROLLER TO FULL COOL. [090894-1673A]
 4. ACTIVATE THE WASTE MANAGEMENT SYSTEM (WMS) AIR SCRUBBER.
 5. UNSTOW CPA AND TAKE READINGS IN VICINITY OF THE FIRE.
 6. WHEN HCL < 5 PPM OR TIG < 3 HOURS, REPLACE ONE LIOH CANISTER WITH THE ATCO CANISTER.

To protect crewmembers from toxicological injury, noncontaminated breathing gases must be provided immediately following a fire since even small concentrations of some combustion products can be lethal. Combustion products of Halon, polyvinyl chloride, Teflon, and Kapton include hydrogen fluoride (HF), hydrogen chloride (HCl), hydrogen cyanide (HCN), hydrogen bromide (HBr), fluorine and bromine gases, carbonyl fluoride (COF2), and carbon monoxide (CO).

HF, HCl, and HBr act instantaneously on the mucous membrane of the eye and respiratory tract causing temporary blindness, coughing, and wheezing. Bronchitis and pneumonia can develop hours later. High levels of HCN and CO may become an immediate danger to life and health.

FLIGHT RULES

THIS RULE CONTINUED ON NEXT PAGE

FLIGHT RULES

A13.1.2-13 CABIN ATMOSPHERE CONTAMINATION (CONTINUED)

Protection of the eyes and respiratory tract is achieved by donning the QDM. The QDM is recommended over the LES since the QDM can be donned more quickly. Donning the full LES will be considered later. Continuous use of the QDM or LES will rapidly use the gaseous N₂ reserves to maintain the cabin O₂ concentration within limits (the QDM or LES put O₂ into the cabin and diluting it with N₂ is the only way to prevent the O₂ concentration from rising above the maximum allowable limit; reference Rule {A17.1.6-4}; CABIN O₂ CONCENTRATION). The total N₂ available will be insufficient to last more than 10.5 hours with seven crewmembers on the QDM or LES (assuming an average O₂ concentration of 40 percent, 216 lb usable N₂, 3 lb O₂/hr/crewmember introduced into the cabin due to QDM or LES use). For the worst case redline value of 80 lb usable N₂, the time decreases to approximately 4 hours.

HF, HBr, HCl, fluorine, and bromine are absorbed by the LiOH canisters. The CO is removed only by the ATCO canister. HCN is only effectively removed by the activated charcoal in the LiOH canister, the charcoal canister (flown on RCRS flights), the WMS Odor Bacteria Filter, or the ATCO canister

One LiOH canister should be changed out every 15 minutes for HCN scrubbing. Since there is only 1/4 lb of charcoal in the LiOH canisters, its capability to scrub HCN is limited to approx. 15 min. The charcoal canisters contain 5 lbs of activated charcoal and by comparison should last for up to 2 hours. LiOH canister changeout should continue until the HCN concentration reaches acceptable levels or stabilizes, at which time the preflight changeout schedule can be reimplemented. ©[090894-1673A]

Two fresh LiOH canisters are immediately installed to remove the acid gases (primarily HCL) which can degrade the platinum catalyst in the ATCO canister and therefore inhibit the effect of CO removal. When HCL concentration drops below 5 ppm, the ATCO canister can be installed without significant risk of degradation. 5 ppm is based upon engineering judgment. At tested HCL levels of 500 ppm, the ATCO canister was completely degraded, and conversely HCL levels of 1 ppm resulted in no measurable degradation. In the interest of beginning CO scrubbing as quickly as possible, a level of 5 ppm was determined to pose no significant risk of degradation and allowed the ATCO to be installed earlier by several hours as compared to 1 ppm HCL. If TIG < 3 hrs, the ATCO should be installed regardless of the detected HCL levels. By analysis, the worst case CO levels will be scrubbed out of the cabin atmosphere in approx. 4 hrs; therefore, the ATCO is installed to provide the maximum CO scrubbing capability prior to touch down. ©[090894-1673A]

Turning the cabin temperature controller to the full-cool mode will maximize the air flow rate through the cabin heat exchanger and therefore increase the amount of contaminants removed by the humidity separator and the removal efficiency of HF and CO₂.

The WMS air scrubber contains activated charcoal and can assist in the removal of acid gases due to its high flow rate and large capacity.

FLIGHT RULES

The Combustion Products Analyzer (CPA) is currently manifested as developmental flight hardware. However, the CPA readings may be used qualitatively to follow trends in contaminant concentrations in the cabin post-fire.

THIS RULE CONTINUED ON NEXT PAGE

FLIGHT RULES

A13.1.2-13 CABIN ATMOSPHERE CONTAMINATION (CONTINUED)

Documentation: Combustion Product Removal From Cabin Air (OFTP #109 minutes, dated 8/90) Phase I Combustion Products Test Results (OFTP # 113 minutes, dated 1/09/91), Phase II Combustion Products Test Results (OFTP #120 minutes, dated 8/21/91), LESC memo 053-52-BR1, Suggested Flight Procedures in Response to an Accidental Burning of Wire in the Orbiter, dated 9/12/90. @[090894-1673A]

7. THE MCC WILL ASSIST IN EVALUATING THE CABIN CONCENTRATION OF THE COMBUSTION PRODUCTS. THE CREW WILL REMOVE QDM'S ONLY ON MCC CALL. THIS DECISION WILL BE BASED UPON THE FOLLOWING: @[090894-1682A]
 - a. CREW SYMPTOMS
 - b. SMOKE DETECTORS RESPONSE
 - c. CPA RESPONSE
 - d. MATHEMATICAL MODEL OF ARS REMOVAL @[090894-1682A]
 - e. CREW INPUT ON AMOUNT & TYPE OF MATERIAL BURNED @[090894-1682A]

Collectively, these will provide only an estimate of the total toxicity hazard in the cabin. If crew symptoms like temporary blindness, coughing, and wheezing are noted, QDM's should remain donned. Crew will remove QDM's based on coordinated communication with the Flight Director, Surgeon, and EECOM. QDM's will be donned if any symptoms are incurred. QDM's can stay doffed if all crewmembers remain symptom-free for greater than 10 minutes.

Medical Operations cannot recommend that crewmembers discontinue breathing noncontaminated gases unless there is satisfactory evidence that the cabin concentration of combustion products are within safe limits. However, the risk of breathing contaminated gases must be weighed against the risks of an ELS, or exceeding cabin O2 limits. These risks were assessed by the community and have been considered in sections 8, 9, and 10 of this flight rule.

Smoke detector readings will be evaluated by EECOM for safe levels. QDM's should remain donned if visible indication of smoke remains in the cabin.

THIS RULE CONTINUED ON NEXT PAGE

FLIGHT RULES

A13.1.2-13 CABIN ATMOSPHERE CONTAMINATION (CONTINUED)

A real-time decision-making process, using the CPA, will be based upon daily on-orbit baseline readings compared with the decreasing trend in contaminant concentrations measured by the CPA. The Surgeon, EECOM, and Toxicology Group will be consulted in these decisions. These baseline readings will be compared with the following contaminant levels (SMAC is Spacecraft Maximum Allowable Concentrations): CO < 55 ppm (1-hour SMAC); HCN < 0.7 ppm (1-hour SMAC); HCl < 5 ppm (1-hour SMAC); HF < 2 ppm (1-hour SMAC). Depending on the profile of changing contaminant concentrations, the following 24-hour SMAC may be used as guidelines: CO < 20 ppm; HCN < 0.7 ppm; HCl < 2 ppm; HF < 1 ppm. The fact that irritant gases (HCl and HF) act additively will be considered. The criteria for determining a safe cabin or removing QDM's will not be based solely on CPA readings.

The mathematical models of ARS removal of toxic compounds will be utilized to predict the rate of decrease in cabin concentrations. These predictions will be correlated with real-time CPA data.

Crew input on the amount and type of materials burned will determine the potential thermal degradation and/or toxic byproducts.

8. IF EVALUATION SHOWS THE CABIN ATMOSPHERE PRESENTS A DEFINITE SHORT-TERM HAZARD:
 - a. ALL CREWMEMBERS WILL REMAIN ON QDM'S.
 - b. LES'S WILL BE USED WITH VISORS DOWN FOR ENTRY AND ORBITER EGRESS. @[090894-1682A]
 - c. AN ELS OR NEXT PLS LANDING WILL BE PERFORMED BASED ON N2 CONSUMABLES AND THE TIME TO THE NEXT PLS. @[090894-1682A]

If the cabin atmosphere is clearly hazardous, there is no choice but to protect the crew by wearing the QDM's and LES's. An ELS may be required.

9. IF EVALUATION OF THE CABIN ATMOSPHERE SHOWS A LOW PROBABILITY OF BEING HAZARDOUS:
 - a. A NEXT PLS/CONUS LANDING WILL BE PERFORMED.
 - b. THE QDM'S MAY BE REMOVED, IF REQUIRED, TO PREVENT EXHAUSTING ALL N2 PRIOR TO THE NEXT PLS LANDING.
 - c. IF POSSIBLE, CDR AND PLT WILL REMAIN ON QDM'S.

IF, AFTER DOFFING QDM'S, THE CABIN ATMOSPHERE IS CONFIRMED TO BE HAZARDOUS:

FLIGHT RULES

THIS RULE CONTINUED ON NEXT PAGE

FLIGHT RULES

A13.1.2-13 CABIN ATMOSPHERE CONTAMINATION (CONTINUED)

- d. QDM'S WILL BE RE-DONNED BY ALL CREWMEMBERS.
- e. AN ELS OR NEXT PLS LANDING WILL BE PERFORMED BASED ON N2 CONSUMABLES AND THE TIME TO THE NEXT PLS.
- f. LES'S WILL BE USED WITH VISORS DOWN FOR ENTRY AND ORBITER EGRESS.

If the assessment of the inhalation hazard of combustion products is inconclusive or the range of uncertainty in the assessment is such that some risk still exists that the atmosphere may be hazardous, the risk to the crew is real and a next PLS or CONUS landing is justified. Although the potential risk to crew health with the QDM's removed is recognized, in the assessment of the overall community, there is a greater risk associated with an ELS landing or exceeding cabin O2 concentration limits (fire risk). If it becomes necessary to remove the QDM's to minimize N2 consumption, ensuring a PLS or CONUS landing, the CDR and PLT should remain on noncontaminated breathing gases to assure their peak performance throughout entry and landing. @[090894-1682A]

- 10. IF EVALUATION SHOWS THE CABIN ATMOSPHERE IS CLEARLY SAFE, THE SOURCE OF THE FIRE CAN BE LOCATED AND SAFED (I.E., A SHORT THAT CAN BE UNPOWERED), AND A HALON BOTTLE HAS NOT BEEN DISCHARGED: @[090894-1682A]

- a. QDM'S WILL BE REMOVED.
- b. A NOMINAL DURATION MISSION MAY BE PERFORMED.

IF A HALON BOTTLE HAS BEEN DISCHARGED, PARAGRAPHS A OR B OF THIS RULE WILL APPLY.

If the cabin atmosphere can be shown to be safe, there is no reason to shorten the flight

- D. IF A FREON-TO-WATER-LOOP LEAK OCCURS IN THE HEAT EXCHANGER AND, SUBSEQUENTLY, A WATER LOOP LEAK INTO THE CABIN DEVELOPS:
 - 1. QDM'S WILL BE DONNED BY ALL CREWMEMBERS.
 - 2. CABIN ATMOSPHERE CONTAMINATION BY FREON 21 MAY REQUIRE MISSION TERMINATION AT THE NEXT PLS.

THIS RULE CONTINUED ON NEXT PAGE

FLIGHT RULES

A13.1.2-13 CABIN ATMOSPHERE CONTAMINATION (CONTINUED)

3. LES'S WILL BE USED WITH VISORS DOWN FOR ENTRY AND ORBITER EGRESS.

Freon 21 detection, concentration determination, and toxic effects will be difficult to determine in orbit and require conservative management. Although concentration and SMAC limits at various time intervals have been established for Freon 21, accurate in-flight determination is not possible at present. In chronic exposures and low concentrations (0.02 percent or 200 ppm for 7 days), Freon 21 may cause liver damage, with mental impairment expected at 0.05 percent (500 ppm) and cardiac arrhythmias at 0.5 percent (5000 ppm) during acute exposures. Cardiac arrhythmias and pulmonary effects are progressively worsened at higher levels and are potentiated by increased epinephrine levels. The potential cabin concentration upon release of 3.0 gm. is 11.0 ppm; there is nearly 272 kg. of Freon 21 onboard the orbiter. For each 0.45 kg. of charcoal in the ARS LiOH canisters, Freon 21 concentration will only be lowered approximately 12.5 ppm. Given the larger number of toxic compounds carried on the orbiter and in experiments, early recognition and response in atmosphere contamination contingencies are essential for crew safety.

Rule {A17.1.2-1}, MANAGEMENT FOLLOWING LOSS OF SMOKE DETECTION, references this rule. @[090894-1682A]

A13.1.2-14 BROKEN GLASS/HAZARDOUS SUBSTANCE CONSTRAINT

- A. IF BROKEN GLASS OR A HAZARDOUS SUBSTANCE SPILLS INTO A CLOSED VOLUME AREA, THAT VOLUME AREA WILL NOT BE OPENED TO THE HABITABLE ENVIRONMENT. FLIGHT-SPECIFIC EXCEPTIONS WILL BE LISTED IN THE FLIGHT-SPECIFIC ANNEX.

This will prevent the introduction of the hazardous substance into the crew's environment.

- B. RELEASE OF BROKEN GLASS IN THE CABIN ENVIRONMENT IS A LEVEL 2 HAZARDOUS SPILL. REFERENCE RULE {A13.1.2-15C}, ORBITER HAZARDOUS SUBSTANCE SPILL RESPONSE, FOR CREW ACTIONS.

Free-floating glass particles represent a hazard to the eyes and respiratory tract. Cleanup may be attempted with the crew wearing protective equipment as noted for a level 2 hazardous spill.

FLIGHT RULES

A13.1.2-15 ORBITER HAZARDOUS SUBSTANCE SPILL RESPONSE

THE FLIGHT-SPECIFIC ANNEX WILL LIST ALL LEVEL 4 THROUGH LEVEL 1 PAYLOAD HAZARDOUS SUBSTANCES. REFERENCE RULE {A13.1.2-17}, HAZARDOUS SPILL LEVEL DEFINITIONS. THE FOLLOWING ACTIONS WILL BE TAKEN IN THE EVENT THAT A HAZARDOUS SUBSTANCE IS RELEASED INTO THE ORBITER ATMOSPHERE.

A. LEVEL 4

1. ALL CREWMEMBERS WILL DON AND ACTIVATE QUICK DON MASKS. THE CLEANUP CREW WILL TAKE THE FOLLOWING ACTIONS:
 - a. SET CABIN TEMPERATURE CONTROLLER TO FULL COOL.
 - b. TURN ON THE WASTE COLLECTION SYSTEM.
 - c. TURN OFF THE REGENERATIVE CO₂ REMOVAL SYSTEM (RCRS) (IF APPLICABLE).
2. THE CREW SHALL PERFORM A CABIN DEPRESS TO 8 PSI AND A CONTINUOUS CABIN PURGE AT 8 PSI IF REQUIRED TO CONTROL PPO₂. (REFERENCE RULE {A17.1.6-4}, CABIN O₂ CONCENTRATION). @[090894-1673A]
3. THE FLIGHT CONTROL ROOM SURGEON SHOULD BE CONSULTED FOR THE MAXIMUM LENGTH OF TIME THE QUICK DON MASKS CAN BE WORN. (REFERENCE RULE {A13.1.2-6}, 100 PERCENT OXYGEN CONSTRAINT.)

A level 4 hazardous substance is defined as either a gas, a volatile liquid, or fumes that are not containable by the crew. Crew exposure could result in systemic toxicity, severe irritation, and/or tissue damage. The driving factor that distinguishes a level 4 substance from a level 3 substance is noncontainability.

The immediate priorities for a level 4 spill are to prevent crew exposure to the substance and to configure the ARS to scrub the environment. All crewmembers will don and activate QDM's to avoid any debilitating effects.

THIS RULE CONTINUED ON NEXT PAGE

FLIGHT RULES

A13.1.2-15 ORBITER HAZARDOUS SUBSTANCE SPILL RESPONSE (CONTINUED)

The ARS configuration steps were determined to provide maximum decontamination. Setting the cabin temperature to full cool will provide maximum removal of water soluble or particulate hazardous substances through the humidity separator as condensate. Other atmospheric scrubbing can be accomplished with the use of the odor/bacterial filter of the WCS and the LiOH and/or charcoal canisters that are already installed. The most recently installed LiOH canisters may have exhausted CO₂ removal capability; however, the LiOH/CO₂ product, Li₂CO₃, and existing charcoal still have scrubbing potential. For flights that use the RCRS, the RCRS must be unpowered to prevent contamination of the solid amine.

A cabin depress to 8 psi and continuous purge at 8 psi will manage O₂ concentrations below maximum levels as well as decrease the concentration of the level 4 substance. This action could extend the time on orbit so as to avoid an ELS entry. ©[090894-1673A]

B. LEVEL 3

1. ALL CREWMEMBERS WILL DON AND ACTIVATE QUICK DON MASKS AND SILVER SHIELD GLOVES. THE FLIGHT DECK CREW WILL TURN OFF THE CABIN AND IMU FANS ONE CREWMEMBER WILL CONTINUOUSLY MONITOR THE SPILL. THE CLEANUP CREW WILL TAKE THE FOLLOWING ACTIONS:
 - a. ATTEMPT TO CLEAN UP THE SPILL.
 - b. BAG, LABEL AND STOW IN WET TRASH.
2. IF CLEANUP ATTEMPT FAILS, THE HAZARDOUS SPILL WILL BE UPGRADED TO A LEVEL 4.

A level 3 hazardous substance is defined as a solid or nonvolatile liquid that is containable by the cleanup crew. It is this containability that separates a level 3 substance from a level 4.

Crew exposure to a level 3 substance could result in systemic toxicity, severe irritation, and/or tissue damage. It is this severity of effects on exposure that separates a level 3 substance from the levels 2, 1, and 0 substances. All crewmembers must wear QDM's to protect themselves during the cleanup.

During the cleanup, all airflow is halted by deactivating the cabin and IMU fans to prevent dispersion of the spilled substance. The maximum time that a cabin fan can be deactivated in an off-nominal situation is 20 minutes (ref. SODB, Volume 3, Rev. A, Table 4.5.0-1, Display Driver Unit). The maximum time that an IMU fan can be deactivated in an off-nominal situation is 45 minutes, (ref. SODB, Volume 3, Rev. A, Table 4.5.0-1, Inertial Measuring Unit).

FLIGHT RULES

By definition, a level 3 hazardous spill is catastrophic and containable. If the level 3 cleanup fails, this spill will be upgraded to a level 4, and level 4 cleanup actions shall be implemented.

THIS RULE CONTINUED ON NEXT PAGE

FLIGHT RULES

A13.1.2-15 ORBITER HAZARDOUS SUBSTANCE SPILL RESPONSE
(CONTINUED)

C. LEVEL 2

1. ALL CREWMEMBERS WILL DON GOGGLES, SURGICAL MASKS, AND SILVER SHIELD GLOVES. THE FLIGHT DECK CREW WILL TURN OFF THE CABIN AND IMU FANS. THE CLEANUP CREW WILL TAKE ACTIONS 1.a AND 1.b LISTED IN PARAGRAPH B ABOVE.
2. IF CLEANUP ATTEMPT FAILS, THE HAZARDOUS SPILL WILL BE UPGRADED TO A LEVEL 4.

A level 2 substance is either a solid or a nonvolatile liquid that is containable by the cleanup crew. Crew exposure could result in moderate to severe irritation that has the potential for long-term crew performance decrement. All crewmembers will be adequately protected by the 5-micron surgical masks, goggles, and silver shield gloves.

See paragraph B, level 3 rationale, for the reason for stopping the airflow in the spill area.

Even though a level 2 substance causes less severe effects than a level 3 substance, a level 2 spill is defined as catastrophic and containable. If the level 2 cleanup fails, this spill will be upgraded to a level 4, and level 4 cleanup actions shall be implemented.

D. LEVEL 1

ALL CREWMEMBERS WILL DON GOGGLES AND SURGICAL MASKS. THE FLIGHT DECK CREW WILL TURN OFF THE CABIN AND IMU FANS. THE CLEANUP CREW WILL DON SURGICAL GLOVES AND TAKE ACTIONS a AND b LISTED IN PARAGRAPH B.

A level 1 hazardous substance may or may not be containable by the crew. Crew exposure will result only in slight to moderate irritation. All crewmembers will be protected by surgical masks and goggles.

See paragraph B, level 3 rationale, for the reason for stopping the airflow in the spill area.

If the spill is not containable by the crew, the MCC will determine other procedures for containment or for a workaround.

THIS RULE CONTINUED ON NEXT PAGE

FLIGHT RULES

A13.1.2-15 ORBITER HAZARDOUS SUBSTANCE SPILL RESPONSE
(CONTINUED)

E. LEVEL 0

THE FLIGHT DECK CREW WILL TURN OFF THE CABIN AND IMU FANS. THE CLEANUP CREW WILL TAKE ACTIONS a AND b LISTED IN PARAGRAPH B.

A level 0 substance may or may not be containable by the crew. Crew exposure would result in only slight transient (less than 30 minutes) irritation.

No protective gear is required.

See paragraph B, level 3 rationale, for the reason for stopping the airflow in the spill area.

If the spill is not containable by the crew, the MCC will determine other procedures for containment or for a workaround.

All payload substances are reviewed by the Payload Safety Review Panel; those not listed as level 4 through 1 are considered nonhazardous (level 0).

A13.1.2-16 SPACEHAB/SPACELAB HAZARDOUS SUBSTANCE SPILL
RESPONSE

SPACELAB MODULE

THE FOLLOWING ACTIONS WILL BE TAKEN IN THE EVENT THAT A HAZARDOUS SUBSTANCE IS RELEASED INTO THE SPACELAB/ORBITER ATMOSPHERE. REFERENCE RULE {A13.1.2-17}, HAZARDOUS SPILL LEVEL DEFINITIONS.

A. LEVEL 4

1. ORBITER

IF SPILL OCCURS IN THE ORBITER, EVACUATE ALL CREWMEMBERS (WITH QUICK DON MASKS IN HAND) TO THE MODULE EXCEPT THE SAFING CREW. THE EVACUATING CREW WILL CLOSE THE MANUAL PAYLOAD ISOLATION VALVE (MAN PL ISO VLV) AND DEACTIVATE THE TUNNEL FAN. THE SAFING CREW WILL PERFORM THE FOLLOWING ACTIONS:

- a. DON/ACTIVATE THE QUICK DON MASKS
- b. SET CABIN TEMPERATURE (TEMP) CONTROLLER TO FULL COOL

FLIGHT RULES

c. TURN ON THE WASTE COLLECTION SYSTEM (WCS)

THIS RULE CONTINUED ON NEXT PAGE

FLIGHT RULES

A13.1.2-16 SPACEHAB/SPACELAB HAZARDOUS SUBSTANCE SPILL RESPONSE (CONTINUED)

- d. TURN OFF THE REGENERATIVE CO₂ REMOVAL SYSTEM (RCRS) (IF APPLICABLE)
- e. EVACUATE TO THE MODULE WITH QUICK DON MASKS

NOTE: ALL EXPERIMENTS/SAMPLES CONTAINING LEVEL 4 PAYLOAD HAZARDOUS SUBSTANCES ARE LISTED IN THE FLIGHT RULES ANNEX.

A level 4 hazardous substance is defined as either a gas, a volatile liquid, or fumes that are not containable by the crew. Crew exposure could result in systemic toxicity, severe irritation, and/or tissue damage. The driving factor that distinguishes a level 4 substance from a level 3 substance is noncontainability.

The immediate priorities for a level 4 spill in the orbiter are crew evacuation to the module and configuration of the atmospheric revitalization system (ARS) for environmental scrubbing. Non-essential crew will evacuate to the module to limit crew exposure to the hazardous substance. Quick Don Masks are removed to the module to eliminate the possibility of their contamination. The MAN PL ISO VLV is closed and the tunnel fan is deactivated to preserve the module environment as a temporary safe haven. The safing crew will don and activate Quick Don Masks to avoid any decremental effects while they configure the ARS.

The ARS configuration steps were determined to provide maximum decontamination with minimum crew involvement. Setting the cabin temperature to full cool will provide maximum removal of water soluble or particulate toxic substances through the humidity separator as condensate. Other atmospheric scrubbing can be accomplished with the use of the odor/bacterial filter of the WCS and the LiOH and charcoal canisters that are already installed. For flights that use the RCRS, the RCRS must be unpowered to prevent contamination of the solid amine.

The cleanup crew will not install fresh LiOH canisters before evacuation to the module because of the priority of immediate crew safety. The most recently installed LiOH canisters may have exhausted CO₂ removal capability; however, the LiOH/CO₂ product, LiCO₃, and the existing charcoal still have scrubbing potential. The crew could reenter to install fresh LiOH cans after the ARS has had time to remove some of the hazardous substance. Evacuation of all crewmembers to the module while the ARS scrubs the environment is essential. An MCC assessment will determine when it is safe to reenter the orbiter.

THIS RULE CONTINUED ON NEXT PAGE

FLIGHT RULES

A13.1.2-16 **SPACEHAB/SPACELAB HAZARDOUS SUBSTANCE SPILL**
RESPONSE (CONTINUED)

2. SPACELAB MODULE

IF HAZARDOUS SPILL OCCURS IN THE SPACELAB MODULE, EVACUATE ALL CREWMEMBERS TO THE ORBITER EXCEPT THE SAFING CREW. EVACUATING CREW WILL TURN THE TUNNEL FAN OFF AND CLOSE THE MAN PL ISO VLV. THE SAFING CREW WILL PERFORM THE FOLLOWING ACTIONS:

- a. DON/ACTIVATE SEBS
- b. SET SPACELAB MODULE TEMP CONTROLLER TO FULL COOL
- c. SAFE THE MODULE FOR ENTRY
- d. TURN THE TUNNEL FAN ON @[033193-1489]
- e. EVACUATE THE MODULE
- f. CLOSE THE D HATCH

NOTE: ALL EXPERIMENTS/SAMPLES CONTAINING LEVEL-4 PAYLOAD HAZARDOUS SUBSTANCES ARE LISTED IN THE FLIGHT RULES ANNEX.

Reference the rationale for paragraph 1 for a definition of level 4 hazardous substances. The immediate priorities for a level 4 spill in the module are crew evacuation to the orbiter, configuration of the Spacelab ARS for environmental scrubbing, and safing the Spacelab penetrable items for entry. Nonessential crew will evacuate to the orbiter to limit crew exposure to the hazardous substance. The MAN PL ISO VLV is closed to stop air exchange between the Spacelab and the orbiter through the transfer tunnel ducting. The tunnel fan is temporarily deactivated by the exiting crew to halt air exchange within the transfer tunnel while the D hatch is still open.

The safing crew will don and activate SEBS to avoid any systemic effects while they configure the Spacelab ARS and secure the module. Setting the Spacelab cabin temperature controller to full cool will provide maximum removal of water soluble or particulate toxic substances through the humidity separator as condensate.

The module is safed for entry by securing the penetrable items in case the Spacelab ARS cannot sufficiently scrub the module environment for the crew to reenter. This step assumes that the time required to safe the penetrable items in the module does not jeopardize the safety of the safing crew. The tunnel fan is turned back on by the exiting safing crew to provide use of the tunnel scrubber and to provide additional air circulation within the module for scrubbing.

An MCC assessment will determine when it is safe to reenter the module.

FLIGHT RULES

THIS RULE CONTINUED ON NEXT PAGE

FLIGHT RULES**A13.1.2-16 SPACEHAB/SPACELAB HAZARDOUS SUBSTANCE SPILL
RESPONSE (CONTINUED)****B. LEVEL 3**

ORBITER OR SPACELAB MODULE:

ALL CREWMEMBERS EXCEPT THE CLEANUP CREW WILL EVACUATE THE ORBITER OR MODULE. THE EVACUATING CREW WILL CLOSE THE MAN PL ISO VLV. FOR A MODULE SPILL, THE EVACUATING CREW WILL ALSO DEACTIVATE THE TUNNEL FAN AND THE FLIGHT DECK CREW WILL DEACTIVATE THE SPACELAB CABIN FAN. THE CLEANUP CREW WILL TAKE THE FOLLOWING ACTIONS:

1. DON/ACTIVATE SEBS OR QUICK DON MASKS AND SILVER SHIELD GLOVES @[033193-1489]
2. IF ORBITER SPILL, TURN OFF CABIN AND IMU FANS R
3. ATTEMPT TO CLEAN UP THE SPILL
4. BAG, LABEL, AND STOW IN WET TRASH

NOTE: IF CLEANUP FAILS, THIS SPILL WILL BE UPGRADED TO A LEVEL 4. ALL EXPERIMENTS/SAMPLES CONTAINING LEVEL 3 PAYLOAD TOXIC MATERIALS ARE LISTED IN RULE {X13.1.1-1}, PAYLOAD HAZARDOUS MATERIALS. @[072893-1525A]

A level 3 hazardous substance is defined as a solid or nonvolatile liquid that is containable by the cleanup crew. It is this containability that separates a level 3 substance from a level 4.

Crew exposure to a level 3 substance could result in systemic toxicity, severe irritation, and/or tissue damage. It is this severity of effects on exposure that separates a level 3 substance from the level 2, 1, and 0 substances. Evacuation of nonessential crew to the orbiter for a module spill and to the module for an orbiter spill is required to limit crew exposure. The cleanup crew must use SEBS or Quick Don Masks along with gloves to protect themselves while they perform the cleanup.

During the cleanup, all airflow in the spill area is halted to prevent dispersion of the spilled substance. For an orbiter spill, this requires deactivating the cabin and IMU fans and closing the MAN PL ISO VLV. The maximum time that a cabin fan can be deactivated in an off-nominal situation is 20 minutes (reference SODB Volume 3, Rev. A, Table 4.5.0-1, for the display driver unit). The maximum time that an IMU fan can be deactivated in an off-nominal situation is 45 minutes (reference SODB Volume 3, Rev. A, Table 4.5.0-1, for the inertial measuring unit). For a module spill, this involves deactivating the Spacelab cabin and tunnel fans and closing the MAN PL ISO VLV.

By definition, a level 3 hazardous spill is catastrophic and containable. If the level 3 cleanup fails, this spill will be upgraded to a level 4, and level 4 cleanup actions will be implemented.

FLIGHT RULES

THIS RULE CONTINUED ON NEXT PAGE

FLIGHT RULES

A13.1.2-16 **SPACEHAB/SPACELAB HAZARDOUS SUBSTANCE SPILL
RESPONSE (CONTINUED)**

C. LEVEL 2

ORBITER OR SPACELAB MODULE:

ALL CREWMEMBERS IN THE MODULE OR ORBITER (WHEREVER THE SPILL OCCURS) WILL DON GOGGLES, SURGICAL MASKS, AND SILVER SHIELD GLOVES. CREWMEMBERS NOT PARTICIPATING IN OR DIRECTLY INTERACTING IN EXPERIMENT OPERATIONS SHOULD EVACUATE THE SPILL AREA. ONE MEMBER OF THE CLEANUP CREW WILL CONTINUOUSLY MONITOR THE SPILL. THE CLEANUP CREW WILL TAKE THE FOLLOWING ACTIONS: @[033193-1489]

1. CLOSE MAN PL ISO VLV
2. IF ORBITER SPILL, TURN OFF CABIN AND IMU FANS
3. IF MODULE SPILL, TURN OFF SPACELAB CABIN AND TUNNEL FANS
4. ATTEMPT TO CLEAN UP THE SPILL
5. BAG, LABEL, AND STOW IN WET TRASH

NOTE: IF CLEANUP FAILS, THIS SPILL WILL BE UPGRADED TO A LEVEL 4. ALL EXPERIMENTS CONTAINING LEVEL 2 PAYLOAD TOXIC MATERIALS ARE LISTED IN RULE {X13.1.1-1}, PAYLOAD HAZARDOUS MATERIALS. @[072893-1525A]

A level 2 hazardous substance is either a solid or a nonvolatile liquid that is containable by the cleanup crew. Crew exposure could result in moderate-to-severe irritation that has the potential for long-term crew performance decrement. All crewmembers will be adequately protected by the 5-micron surgical masks, goggles, and silver shield gloves. @[033193-1489]

Reference paragraph B, level 3 rationale, for the reason for stopping airflow in the spill area.

Even though a level 2 substance causes less severe effects than a level 3 substance, a level 2 hazardous spill is defined as catastrophic and containable. If the level 2 cleanup fails, this spill will be upgraded to a level 4, and level 4 cleanup actions shall be implemented.

THIS RULE CONTINUED ON NEXT PAGE

FLIGHT RULES

A13.1.2-16 SPACEHAB/SPACELAB HAZARDOUS SUBSTANCE SPILL
RESPONSE (CONTINUED)

D. LEVEL 1

ORBITER OR SPACELAB MODULE:

ALL CREWMEMBERS IN THE MODULE OR ORBITER (WHEREVER THE SPILL OCCURS) WILL DON GOGGLES AND SURGICAL MASKS. CREWMEMBERS NOT PARTICIPATING IN OR DIRECTLY INTERACTING WITH EXPERIMENT OPERATIONS SHOULD EVACUATE THE SPILL AREA. ONE MEMBER OF THE CLEANUP CREW WILL CONTINUOUSLY MONITOR THE SPILL. THE REMAINING MEMBER WILL DON SURGICAL GLOVES AND TAKE ACTIONS 1 THROUGH 5 LISTED IN PARAGRAPH C. IF THE CLEANUP FAILS, THE MCC WILL DETERMINE ALTERNATE CLEANUP PROCEDURES AND WILL ADVISE THE CREW ON WHEN IT IS SAFE TO REMOVE THE PROTECTIVE GEAR. @[033193-1489] @[072893-1525A]

A level 1 hazardous substance may or may not be containable by the crew. Crew exposure could result only in slight-to-moderate irritation. All crewmembers will be protected by surgical masks and goggles. Also, the cleanup crew will need to use surgical gloves. @[033193-1489]

Reference paragraph B, level 3 rationale, for the reason for stopping the airflow in the vicinity of the spill. If the spill is not containable by the crew, the MCC will determine other procedures for containment or for a workaround.

E. LEVEL 0

ORBITER OR SPACELAB MODULE:

ONE MEMBER OF THE CLEANUP CREW WILL CONTINUOUSLY MONITOR THE SPILL. THE REMAINING CREWMEMBER WILL TAKE ACTIONS 1 THROUGH 5 LISTED IN PARAGRAPH C.

A level 0 substance is assumed to be containable by the crew. Crew exposure would result in only slight transient (less than 30 minutes) irritation. No protective gear is required. Reference paragraph B, level 3 rationale, for the reason for stopping the airflow in the vicinity of the spill.

If the spill is not containable by the crew, the MCC will determine other procedures for containment or for a workaround.

All payload substances are reviewed by the Payload Safety Review Panel; those not listed as level 4 through 1 are considered nonhazardous (level 0).

THIS RULE CONTINUED ON NEXT PAGE

FLIGHT RULES

A13.1.2-16 **SPACEHAB/SPACELAB HAZARDOUS SUBSTANCE SPILL
RESPONSE (CONTINUED)**

SPACEHAB

THE FOLLOWING ACTIONS WILL BE TAKEN IN THE EVENT THAT A HAZARDOUS SUBSTANCE IS RELEASED INTO THE SPACEHAB/ORBITER ATMOSPHERE. REFERENCE RULE {A13.1.2-17}, HAZARDOUS SPILL LEVEL DEFINITIONS.

A. LEVEL 4

1. ORBITER

IF SPILL OCCURS IN THE ORBITER, ALL CREWMEMBERS DON AND ACTIVATE QUICK DON MASKS. THE CLEANUP CREW WILL TAKE THE FOLLOWING ACTIONS:

- a. DON/ACTIVATE THE QUICK DON MASKS.
- b. SET CABIN TEMPERATURE (TEMP) CONTROLLER TO FULL COOL.
- c. TURN ON THE WASTE COLLECTION SYSTEM (WCS).
- d. TURN OFF THE REGENERATIVE CO₂ REMOVAL SYSTEM (RCRS) (IF APPLICABLE).

THE CREW SHALL ISOLATE AND SAFE THE SPACEHAB MODULE FOR ENTRY AND PERFORM AN ORBITER CABIN DEPRESS AND REPRESS IF REQUIRED TO CONTROL PPO₂. (REFERENCE ALL FLIGHTS RULE {A17.1.6-4}, CABIN O₂ CONCENTRATION.)

THE MCC WILL DETERMINE THE MAXIMUM LENGTH OF TIME THE QUICK DON MASKS CAN BE WORN. (REFERENCE ALL FLIGHTS RULE {A13.1.2-6}, 100 PERCENT OXYGEN USE CONSTRAINT.)

NOTE: ALL EXPERIMENT/SAMPLES CONTAINING LEVEL 4 PAYLOAD HAZARDOUS SUBSTANCES ARE LISTED IN THE FLIGHT SPECIFIC ANNEX.

A level 4 hazardous substance is defined as either a gas, a volatile liquid, or fumes that are not containable by the crew. Crew exposure could result in a systemic toxicity, severe irritation, and/or tissue damage. The driving factor that distinguishes a level 4 substance from a level 3 substance is noncontainability.

THIS RULE CONTINUED ON NEXT PAGE

FLIGHT RULES

A13.1.2-16 SPACEHAB/SPACELAB HAZARDOUS SUBSTANCE SPILL RESPONSE (CONTINUED)

The immediate priorities for a level 4 spill in the orbiter are prevention of crew exposure to the substance and configuration of the atmospheric revitalization system (ARS) for environmental scrubbing. All crewmembers will don and activate Quick Don Masks to avoid any detrimental effects.

The ARS configuration steps were determined to provide maximum decontamination with minimum crew involvement. Setting the cabin temperature to full cool will provide maximum removal of water soluble or particulate toxic substances through the humidity separator as condensate. Other atmospheric scrubbing can be accomplished with the use of the odor/bacterial filter of the WCS and the LiOH and charcoal canisters that are already installed. Flights that use the RCRS must be unpowered to prevent contamination of the solid amine.

The module cannot be used as a safe haven for the crew because the module ARS is incapable of controlling humidity, O₂, N₂, and CO₂ concentrations.

A depress and repress of the cabin will lower the O₂ concentration levels as well as the concentration of the level 4 substance. This action could extend the time on orbit so as to avoid an Emergency Landing Site (ELS) entry.

2. SPACEHAB MODULE

IF HAZARDOUS SPILL OCCURS IN THE SPACEHAB MODULE, EVACUATE ALL CREWMEMBERS TO THE ORBITER EXCEPT THE SAFING CREW. CREW WILL CLOSE THE MAN PL ISOL VLV. THE FLIGHTCREW WILL TURN OFF THE SPACEHAB CABIN FAN AND ARS FAN. THE SAFING CREW WILL PERFORM THE FOLLOWING ACTIONS:

- a. DON/ACTIVATE SEBS
- b. PERFORM SPACEHAB RAPID SAFING CONTINGENCY DEACT
- c. EVACUATE THE MODULE
- d. CLOSE THE D-HATCH

NOTE: MODULE DEACTIVATION IS NECESSARY BECAUSE THE MODULE ARS DOES NOT HAVE THE CAPABILITY TO SCRUB THE CONTAMINATED AIR. ALL EXPERIMENT/SAMPLES CONTAINING LEVEL 4 PAYLOAD HAZARDOUS SUBSTANCES ARE LISTED IN THE FLIGHT SPECIFIC ANNEX.

Reference the rationale for paragraph 1 for a definition of level 4 hazardous substances.

THIS RULE CONTINUED ON NEXT PAGE

FLIGHT RULES

A13.1.2-16 SPACEHAB/SPACELAB HAZARDOUS SUBSTANCE SPILL RESPONSE (CONTINUED)

The immediate priorities for a level 4 spill in the module are crew evacuation to the orbiter and deactivating Spacehab for entry. Nonessential crew will evacuate to the orbiter to limit crew exposure to the hazardous substance. The ARS and cabin fans are temporarily deactivated by the flightdeck crew to halt air exchange within the transfer tunnel while the D hatch is still open. The MAN PL ISOL VLV is closed to stop air exchange between Spacehab and the orbiter through the transfer tunnel ducting.

The safing crew will don and activate SEBS to avoid systemic effects while they secure the module.

B. LEVEL 3

1. ORBITER:

ALL CREWMEMBERS WILL DON QUICK DON MASKS AND SILVER SHIELD GLOVES. THE FLIGHTDECK CREW WILL DEACTIVATE THE CABIN AND IMU FANS. THE CLEANUP CREW WILL TAKE THE FOLLOWING ACTIONS: @[033193-1489]

- a. ATTEMPT TO CLEAN UP THE SPILL.
- b. BAG, LABEL, AND STOW IN WET TRASH.

NOTE: IF CLEANUP FAILS, THIS SPILL WILL BE UPGRADED TO A LEVEL 4. ALL EXPERIMENTS/SAMPLES CONTAINING LEVEL 3 PAYLOAD TOXIC MATERIALS ARE LISTED IN THE FLIGHT SPECIFIC ANNEX.

A level 3 hazardous substance is defined as a solid or nonvolatile liquid that is containable by the cleanup crew. It is this containability that separates a level 3 substance from a level 4.

Crew exposure to a level 3 substance could result in systemic toxicity, severe irritation, and/or tissue damage. It is this severity of effects on exposure that separates a level 3 substance from the level 2, 1, and 0 substances. Since O₂/N₂, CO₂, and humidity control are not available in the module for an orbiter spill, all crewmembers must don and activate Quick Don Masks and don chemically resistant silver shield gloves.

FLIGHT RULES

During the cleanup, all airflow in the spill area is halted to prevent dispersion of the spilled substance. For an orbiter spill, this requires deactivating the cabin and IMU fans, closing the MAN PL ISOL VLV, and turning off the ARS fan. The maximum time that a cabin fan can be deactivated in an off-nominal situation is 20 minutes (reference SODB Volume 3, Rev. A, Table 4.5.0-1, for the display driver unit). The maximum time that an IMU fan can be deactivated in an off-nominal situation is 45 minutes. (Reference SODB Volume 3, Rev. A, Table 4.5.0-1, for the inertial measuring unit). By definition, a level 3 hazardous spill is catastrophic and containable. If the level 3 cleanup fails, this spill will be upgraded to a level 4, and level 4 cleanup actions will be implemented.

THIS RULE CONTINUED ON NEXT PAGE

FLIGHT RULES

A13.1.2-16 **SPACEHAB/SPACELAB HAZARDOUS SUBSTANCE SPILL**
RESPONSE (CONTINUED)

2. SPACEHAB MODULE:

ALL CREWMEMBERS EXCEPT THE CLEANUP CREW WILL EVACUATE THE MODULE. THE FLIGHTDECK CREW WILL DEACTIVATE THE SPACEHAB ARS AND CABIN FANS. THE EVACUATING CREW WILL CLOSE THE MAN PL ISOL VLV. THE CLEANUP CREW WILL TAKE THE FOLLOWING ACTIONS:

- a. DON/ACTIVATE SEBS AND SILVER SHIELD GLOVES
- b. ATTEMPT TO CLEAN UP THE SPILL
- c. BAG LABEL AND STOW IN WET TRASH

NOTE: IF CLEANUP FAILS, THIS SPILL WILL BE UPGRADED TO A LEVEL 4. ALL EXPERIMENTS/SAMPLES CONTAINING LEVEL 3 PAYLOAD TOXIC MATERIALS ARE LISTED IN THE FLIGHT SPECIFIC ANNEX.

See rationale from part 1 for a definition of a level 3 hazardous spill.

The cleanup crew must use SEBS along with chemically resistant silver shield gloves to protect themselves while they perform the cleanup.

During the cleanup, all airflow in the spill area is halted by closing the MAN PL ISOL VLV and by deactivating the SH cabin and ARS fans. If the initial module PPCO₂ level is 7.15 mmHg at the time the SH ARS fan is deactivated, it will take 23.7 minutes to reach a level of 7.6 mmHg and 378 minutes to reach 15 mmHg (reference TM-SPACEHAB-91003, April 1991).

By definition, a level 3 hazardous spill is catastrophic and containable. If the level 3 cleanup fails, this spill will be upgraded to a level 4, and level 4 cleanup actions will be implemented.

C. LEVEL 2

ORBITER OR SPACEHAB MODULE:

ALL CREWMEMBERS IN THE MODULE OR ORBITER (WHEREVER THE SPILL OCCURS) WILL DON GOGGLES, SURGICAL MASKS, AND SILVER SHIELD GLOVES. CREWMEMBERS NOT PARTICIPATING IN OR DIRECTLY INTERACTING IN EXPERIMENT OPERATIONS SHOULD EVACUATE THE SPILL AREA. ONE MEMBER OF THE CLEANUP CREW WILL CONTINUOUSLY MONITOR THE SPILL. THE CLEANUP CREW WILL TAKE THE FOLLOWING ACTIONS: @[033193-1489]

THIS RULE CONTINUED ON NEXT PAGE

FLIGHT RULES

A13.1.2-16 **SPACEHAB/SPACELAB HAZARDOUS SUBSTANCE SPILL
RESPONSE (CONTINUED)**

1. IF MODULE SPILL, TURN OFF SPACEHAB CABIN AND ARS FANS.
2. IF ORBITER SPILL, TURN OFF CABIN AND IMU FANS, AND SH ARS FAN.
3. CLOSE MAN PL ISO VLV.
4. ATTEMPT TO CLEAN UP THE SPILL.
5. BAG, LABEL, AND STOW IN WET TRASH.

NOTE: IF CLEANUP FAILS, THIS SPILL WILL BE UPGRADED TO A LEVEL 4. ALL EXPERIMENTS CONTAINING LEVEL 2 PAYLOAD TOXIC MATERIALS ARE LISTED IN THE FLIGHT SPECIFIC ANNEX.

A level 2 hazardous substance is either a solid or a nonvolatile liquid that is containable by the cleanup crew. Crew exposure could result in moderate-to-severe irritation that has the potential for long-term crew performance decrement. All crewmembers will be adequately protected by the 5-micron surgical masks, goggles, and silver shield gloves.

Reference paragraph B, level 3 rationale for the reason for stopping airflow in the spill area.

Even though a level 2 substance causes less severe effects than a level 3 substance, a level 2 hazardous spill is defined as catastrophic and containable. If the level 2 cleanup fails, this spill will be upgraded to a level 4, and level 4 cleanup actions shall be implemented.

THIS RULE CONTINUED ON NEXT PAGE

FLIGHT RULES

A13.1.2-16 **SPACEHAB/SPACELAB HAZARDOUS SUBSTANCE SPILL**
RESPONSE (CONTINUED)

D. LEVEL 1

ORBITER OR SPACEHAB MODULE:

ALL CREWMEMBERS IN THE MODULE OR ORBITER (WHEREVER THE SPILL OCCURS) WILL DON GOGGLES AND SURGICAL MASKS. CREWMEMBERS NOT PARTICIPATING IN OR DIRECTLY INTERACTING WITH EXPERIMENT OPERATIONS SHOULD EVACUATE THE SPILL AREA. ONE MEMBER OF THE CLEANUP CREW WILL CONTINUOUSLY MONITOR THE SPILL. THE REMAINING MEMBER WILL DON SURGICAL GLOVES AND TAKE ACTIONS 1 THROUGH 5 LISTED IN PARAGRAPH C. IF THE CLEANUP FAILS, THE MCC WILL DETERMINE ALTERNATE CLEANUP PROCEDURES AND WILL ADVISE THE CREW ON WHEN IT IS SAFE TO REMOVE THE PROTECTIVE GEAR. ©[033193-1489]

A level 1 hazardous substance may or may not be containable by the crew. Crew exposure could result only in slight-to-moderate irritation. All crewmembers will be protected by surgical masks and goggles. Also, the cleanup crew will need to use surgical gloves.

Reference paragraph B, level 3 rationale for the reason for stopping the airflow in the vicinity of the spill. Reference Rule {13.1.2-17}, HAZARDOUS SPILL LEVEL DEFINITIONS.

If the spill is not containable by the crew, the MCC will determine other procedures for containment or for a workaround. ©[033193-1489]

E. LEVEL 0

ORBITER OR SPACEHAB MODULE:

ONE MEMBER OF THE CLEANUP CREW WILL CONTINUOUSLY MONITOR THE SPILL. THE REMAINING CREWMEMBER WILL TAKE ACTIONS 1 THROUGH 5 LISTED IN PARAGRAPH C.

A level 0 substance is assumed to be containable by the crew. Crew exposure would result in only slight transient (less than 30 minutes) irritation. No protective gear is required. Reference paragraph B, level 3 rationale for the reason for stopping the airflow in the vicinity of the spill.

If the spill is not containable by the crew, the MCC will determine other procedures for containment for a workaround.

All payload substances are reviewed by the Payload Safety Review Panel; those not listed as level 4 through 1 are considered nonhazardous (level 0).

FLIGHT RULES

A13.1.2-17 HAZARDOUS SPILL LEVEL DEFINITIONS

HAZARDOUS SPILL LEVELS ARE DEFINED BY THE FOLLOWING HAZARDOUS SPILL LEVEL DEFINITION TABLE.

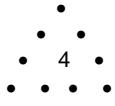
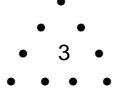
COLOR/ LEVEL	STATE	FLAMMABILITY	SYSTEMIC/ INTERNAL DAMAGE	IRRITANCY	CRIT	SUMMARY OF HAZARD LEVEL
<p>RED</p> 	<p>GAS, VOLATILE LIQUID, OR FUMES THAT ARE NOT CONTAINABLE BY A CLEANUP CREW. THE ARS WILL BE USED TO DECONTAMINATE. THE 5-MICRON SURGICAL MASKS WILL NOT PROTECT THE CREW. EITHER THE QUICK DON MASKS OR THE SEBS ARE REQUIRED.</p>	<p>MAY BE CAPABLE OF PRODUCING FLAMMABLE VAPORS OR FINE MIST IN SUFFICIENT QUANTITY TO PRODUCE A HAZARD.</p>	<p>APPRECIABLE EFFECTS ON COORDINATION, PERCEPTION, MEMORY, ETC., OR POTENTIAL FOR LONG TERM (DELAYED) SERIOUS INJURY (E.G., CANCER) OR MAY RESULT IN INTERNAL TISSUE DAMAGE.</p>	<p>MODERATE TO SEVERE IRRITATION THAT HAS THE POTENTIAL FOR LONG-TERM CREW PERFORMANCE DECREMENT (FOR EYE ONLY HAZARDS, THERE MUST BE A RISK OF PERMANENT EYE DAMAGE).</p> <p>NOTE: WILL REQUIRE THERAPY IF CREW IS EXPOSED.</p>	[1]	<p>IT IS A CATASTROPHIC HAZARD (CAPABLE OF CAUSING DISABLING INJURY) THAT IS NOT CONTAINABLE BY A CLEANUP CREW AND HAS THE POTENTIAL FOR SYSTEMIC TOXICITY, MODERATE-TO-SEVERE IRRITANT, TISSUE DAMAGE, OR CAN PRODUCE FLAMMABLE VAPORS. THE SURGICAL MASKS WILL NOT, COMBINED WITH GOGGLES AND GLOVES, PROTECT THE CREW. EITHER QUICK DON MASKS OR SEBS ARE REQUIRED TO BE WORN WHILE THE ARS DECONTAMINATES. NO PROVISION HAS BEEN MADE FOR SEVERE SKIN IRRITATION OR ABSORPTION.</p> <p>EXAMPLE: METAL VAPOR LIKE MERCURIC IODIDE.</p>
<p>ORANGE</p> 	<p>EITHER A SOLID OR NONVOLATILE LIQUID. CAN BE CONTAINED BY A CLEANUP CREW AND DISPOSED OF. SURGICAL MASKS AND GLOVES WILL NOT PROTECT THE CREW. EITHER QUICK DON MASKS OR SEBS AND SILVER SHIELD GLOVES ARE REQUIRED.</p>	<p>MAY BE CAPABLE OF PRODUCING FLAMMABLE VAPORS OR FINE MIST IN SUFFICIENT QUANTITY TO PRODUCE A HAZARD.</p>	<p>APPRECIABLE EFFECTS ON COORDINATION, PERCEPTION, MEMORY, ETC., OR THE POTENTIAL FOR LONG-TERM (DELAYED) SERIOUS INJURY (E.G., CANCER) OR MAY RESULT IN INTERNAL TISSUE DAMAGE.</p>	<p>THERE MAY BE IRRITATION THAT ACCOMPANIES THE SYSTEMIC TOXICITY CONCERNS; HOWEVER, IRRITANCY ALONE WOULD NOT DRIVE YOU TO A LEVEL 3.</p> <p>NOTE: WILL REQUIRE THERAPY IF CREW IS EXPOSED.</p>	[1]	<p>IT IS A CATASTROPHIC HAZARD (CAPABLE OF CAUSING DISABLING INJURY) THAT IS CONTAINABLE BY A CLEANUP CREW AND HAS THE POTENTIAL FOR SYSTEMIC TOXICITY, OR IS CAPABLE OF PRODUCING FLAMMABLE VAPORS, OR COULD CAUSE INTERNAL TISSUE DAMAGE. THE 5-MICRON SURGICAL MASKS, GLOVES, AND GOGGLES ARE NOT SUFFICIENT TO PROTECT THE CREW. THEREFORE, EITHER QUICK DON MASKS OR SEBS ARE REQUIRED TO BE WORN BY ALL CREWMEMBERS. ONLY THE CLEANUP CREW WILL BE REQUIRED TO WEAR SILVER SHIELD GLOVES.</p> <p>EXAMPLE: ACETONITRILE.</p>

KEY:

[1] - CATASTROPHIC

[2] - CRITICAL

[3] - NONE

THIS RULE CONTINUED ON NEXT PAGE

FLIGHT RULES

A13.1.2-17 HAZARDOUS SPILL LEVEL DEFINITIONS (CONTINUED)

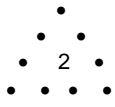
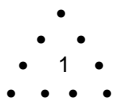
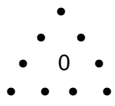
COLOR/ LEVEL	STATE	FLAMMABILITY	SYSTEMIC/ INTERNAL DAMAGE	IRRITANCY	CRIT	SUMMARY OF HAZARD LEVEL
<p>YELLOW</p> 	<p>EITHER A SOLID OR NONVOLATILE LIQUID. CAN BE CONTAINED BY A CLEANUP CREW AND DISPOSED OF. THE CREW WILL BE PROTECTED BY 5-MICRON SURGICAL MASKS, SILVER SHIELD GLOVES, AND GOGGLES.</p>	<p>MAY BE CAPABLE OF PRODUCING FLAMMABLE SOLIDS OR LIQUIDS BUT NOT VAPORS IN SUFFICIENT QUANTITY TO PRODUCE A HAZARD.</p>	<p>NONE.</p>	<p>MODERATE-TO-SEVERE IRRITATION THAT HAS THE POTENTIAL FOR LONG-TERM CREW PERFORMANCE DECREMENT (FOR EYE-ONLY HAZARDS, THERE MUST BE A RISK OF PERMANENT EYE DAMAGE).</p> <p>NOTE: WILL REQUIRE THERAPY IF CREW IS EXPOSED.</p>	<p>[1]</p>	<p>IT IS A CATASTROPHIC HAZARD (CAPABLE OF CAUSING DISABLING INJURY) THAT IS CONTAINABLE BY A CLEANUP CREW. SINCE THERE ARE NO SYSTEMIC TOXICITY CONCERNS OR TISSUE DAMAGE (OTHER THAN EYE), 5-MICRON SURGICAL MASKS, GOGGLES, AND SILVER SHIELD GLOVES WILL PROTECT THE CREW. NEITHER QUICK DON MASKS NOR SEBS ARE REQUIRED. SINCE THE SUBSTANCE IS A SEVERE IRRITANT OR COULD CAUSE EYE DAMAGE, THE CREW MUST WEAR SURGICAL MASKS, GOGGLES, AND GLOVES. NO PROVISION HAS BEEN MADE FOR SEVERE SKIN IRRITATION OR ABSORPTION.</p> <p>EXAMPLE: SODIUM HYDROXIDE WITH VERY HIGH PH (>12)</p>
<p>BLUE</p> 	<p>GAS, SOLID, OR LIQUID MAY OR MAY NOT BE CONTAINABLE. HOWEVER, THE CREW WILL BE PROTECTED BY SURGICAL MASKS AND GOGGLES. CLEANUP CREW SHOULD ALSO USE SURGICAL GLOVES.</p>	<p>VERY LOW FLAMMABILITY POTENTIAL. THE SUBSTANCE HAS A HIGH FLASH POINT AND A LOW VAPOR PRESSURE.</p>	<p>MINIMAL EFFECTS. NO POTENTIAL FOR LASTING INTERNAL TISSUE DAMAGE.</p>	<p>SLIGHT-TO-MODERATE IRRITATION THAT LASTS > 30 MINUTES. IF AN EYE-ONLY HAZARD, CAN AFFECT VISUAL ACUITY > 30 MINUTES.</p> <p>NOTE: WILL REQUIRE THERAPY IF CREW IS EXPOSED.</p>	<p>[2]</p>	<p>IT IS A CRITICAL HAZARD (CAPABLE OF CAUSING NONDISABLING INJURY) AND MAY OR MAY NOT BE CONTAINABLE BY A CLEANUP CREW. IF NOT CONTAINABLE, THE CREW MUST BE PROTECTED BY THE SURGICAL MASKS AND GOGGLES. WITH LEVEL 1 HAZARDS, IT IS ASSUMED THAT THE CREW NEEDS THERAPY IF EXPOSED. THEREFORE, ALL CREWMEMBERS IN THE AREA MUST WEAR PROTECTIVE GEAR SO AS TO AVOID CONTACT. CLEANUP CREW MUST ALSO USE SURGICAL GLOVES.</p> <p>EXAMPLE: SOLUTIONS LIKE 15% SODIUM CHLORIDE.</p>
<p>GREEN</p> 	<p>GAS, SOLID, OR LIQUID MAY OR MAY NOT BE CONTAINABLE.</p>	<p>NONE.</p>	<p>NONE.</p>	<p>SLIGHT IRRITATION THAT LASTS < 30 MINUTES AND WILL NOT REQUIRE THERAPY. ALL EFFECTS WILL BE RESOLVED WITHIN 30 MINUTES WITHOUT THERAPY.</p>	<p>[3]</p>	<p>IT IS NOT A HEALTH OR FIRE HAZARD. MAY OR MAY NOT BE CONTAINABLE. IF NOT, REPORT TO MCC.</p> <p>EXAMPLE: SILICON OIL OR WEAK HYPERTONIC SOLUTIONS.</p>

KEY:

[1] - CATASTROPHIC

[2] - CRITICAL

[3] - NONE

FLIGHT RULES

A13.1.2-18 MISSION DURATION BUILD-UP CONSTRAINTS

THESE RULES ARE APPLICABLE TO FLIGHTS OF GREATER THAN 11 DAYS PLANNED MISSION LENGTH AS FOLLOWS: @[012694-1603A]

A. FOR FLIGHTS GREATER THAN 11 DAYS (COMMANDER FLIGHT DAYS) OF PLANNED MISSION LENGTH:

1. ANTI-G SUITS MUST BE INFLATED TO 0.5 PSI AFTER ENTRY INTERFACE AND TO AT LEAST 1.0 PSI AT 1 G. THE ANTI-G SUITS MUST REMAIN INFLATED UNTIL AT LEAST WHEEL-STOP.

Anti-G suit inflation needs to occur prior to occurrence of symptoms. This will be especially important to help prevent orthostatic problems after longer duration flights.

2. CREW EXERCISE

- a. PRESCRIBED EXERCISE SHALL BE PERFORMED BY THE CDR, PLT, AND MS2 AT LEAST EVERY OTHER DAY FROM FD 4 TO NOMINAL EOM-1. EXERCISE SHALL BE PERFORMED BY THE REST OF THE CREW (MS'S AND PS'S) AT LEAST EVERY 3 DAYS (ONCE EVERY 2 DAYS IS HIGHLY DESIRABLE). EXERCISE ON FD 3 IS HIGHLY DESIRABLE AND SHALL BE PERFORMED IF CREW SPACE MOTION SICKNESS (SMS) SYMPTOMS SHALL PERMIT (CREW CALL).

Exercise may improve the crew's condition on return to a 1-G environment. Exercise will be prescribed by the Crew Surgeon and Medical Sciences Division. All crewmembers need to be capable of emergency egress should it be required; the CDR, PLT, and MS2 must be capable of performing the necessary piloting tasks of a nominal landing and, therefore, have priority in scheduling exercise. Schedule constraints may not allow scheduling the payload crew every other day. If exercise cannot be scheduled that often, 1 day out of 3 is acceptable. This rule does not reduce the Appendix K constraints on scheduling exercise. Exercise will not be required for waveoff days due to time constraints involved in setting up the exercise equipment.

- b. FAILURE OF THE EXERCISE EQUIPMENT WILL NOT BE CAUSE TO SHORTEN THE FLIGHT.

Alternate exercise protocols will be determined real time and are believed to be sufficient such that shortening the flight is not warranted.

THIS RULE CONTINUED ON NEXT PAGE

FLIGHT RULES

A13.1.2-18 MISSION DURATION BUILD-UP CONSTRAINTS (CONTINUED)

- c. THE LOWER BODY NEGATIVE PRESSURE (LBNP) COUNTERMEASURE SOAK PROTOCOL MAY BE SUBSTITUTED FOR AN EXERCISE SESSION FOR THE PURPOSE OF THIS RULE.

The LBNP soak provides a stress to the cardiovascular system. If the LBNP session is not performed for some reason, then exercise must be scheduled and performed per paragraph a of this rule. @[032395-1762]

- B. ADDITIONALLY, FOR FLIGHT DURATIONS GREATER THAN 13 DAYS (COMMANDER FLIGHT DAYS) OF PLANNED MISSION LENGTH:

THE NOMINAL DURATION OF THE MISSION WILL NOT EXCEED THE PREFLIGHT PLANNED LENGTH, EVEN IF CONSUMABLES ALLOW.

Until the Space Shuttle Program management determines, based in part by input by the Extended Duration Orbiter Medical Project (EDOMP), that further lengthening of mission duration can be accomplished, each mission will be incrementally lengthened. @[012694-1603A]

A13.1.2-19 ACCELERATION RESTRICTIONS ON MEDICAL PROCEDURES

- A. THE FOLLOWING TYPES OF MEDICAL EXPERIMENTS WILL NOT BE PERFORMED DURING PRCS ATTITUDE HOLD, TRANSLATIONS, OR OMS FIRINGS: @[111094-1714A]

1. INVASIVE EXPERIMENTS WHICH REQUIRE A DEVICE TO PENETRATE THE SKIN OF THE SUBJECT CREWMEMBER.
2. APPLICATION OF ANY DEVICE TO THE SURFACE OF THE EYE.
3. EXPERIMENTS WHICH REQUIRE THE INSERTION OF ANY DEVICE INTO THE EAR, NOSE, OR MOUTH.
4. EXPERIMENTS WHICH REQUIRE THE USE OF A SYRINGE OR ANY SHARP-EDGED DEVICE.

Relative motion between an operator and subject will occur during OMS or RCS firings. This motion could lead to injury.

- B. THE CREW WILL INFORM THE ORBITER COMMANDER OR PILOT PRIOR TO PERFORMING DELICATE/INVASIVE MEDICAL OPERATIONS.

FLIGHT RULES

Delicate or invasive operations require that acceleration levels do not exceed those produced by the VRCS. In the case of the loss of VRCS, the crew needs to coordinate with the CDR or PLT to ensure that the orbiter is in free drift until the operation has been completed. This will prevent injury to the crew. @[111094-1714A] @[ED]

A13.1.2-20 LOWER BODY NEGATIVE PRESSURE (LBNP)

A. A/G VOICE REQUIREMENTS

ELECTROCARDIOGRAM (ECG) TELEMETRY AND CONTINUOUS A/G VOICE COMMUNICATIONS ARE REQUIRED DURING PORTIONS OF THE LBNP RAMP TEST > 30 MMHG DECOMPRESSION.

- B. A SECOND CREWMEMBER IS REQUIRED TO BE IN CLOSE PROXIMITY DURING ALL LBNP OPERATIONS WHILE A SUBJECT IS IN THE LBND. THE SECOND CREWMEMBER MAY PERFORM OTHER EXPERIMENTS.

The second crewmember acts as an operator to assist the subject to egress the LBNP during rapid egress and in the event the subject becomes incapacitated (ref. SL-J Phase III Payload Flight Safety Review minutes). The second crewmember may operate other experiments but cannot be restrained or leave the immediate vicinity. The second crewmember must be physically in attendance (in close proximity) during ramp sessions.

C. LOSS OF CONSCIOUSNESS

FOR LOSS OF CONSCIOUSNESS BY SUBJECT DURING RAMP OR SOAK PROTOCOL, IMMEDIATELY RECOMPRESS LBNP BY BREAKING WAIST SEAL, OPENING THE MANUAL RELIEF VALVE, OR SEPARATING A QUICK DISCONNECT, AND CONTACT FLIGHT SURGEON. @[ED]

FLIGHT RULES

A13.1.2-21 LBNP TEST TERMINATION CRITERIA

A. LBNP RAMP OPERATIONS ON A SUBJECT WILL BE TERMINATED FOR ANY ONE OF THE CRITERIA BELOW:

G - GROUND PERSONNEL CAN MAKE CALL

S - CREWMEMBER IN-FLIGHT CAN MAKE CALL

G	S	(1) DROP IN HEART RATE > 15 BEATS PER MINUTE IN 1 MINUTE
G	S	(2) DROP IN BLOOD PRESSURE (EITHER A SYSTOLIC DROP > 25 MMHG OR A DIASTOLIC DROP > 15 MMHG IN 1 MINUTE
G	S	(3) SYSTOLIC BLOOD PRESSURE ≤ 70 MMHG
G		(4) SIGNIFICANT CARDIAC ARRHYTHMIAS <ul style="list-style-type: none"> • HEART RATE < 40 BPM FOR PERSONS WHOSE RESTING HEART IS > 50 BPM • THREE OR MORE BEATS IN A ROW OF SUPRAVENTRICULAR OR VENTRICULAR TACHYCARDIA • EVIDENCE OF HEART BLOCK OTHER THAN FIRST DEGREE • PREMATURE VENTRICULAR COMPLEXES (PVC) WHICH MEET ANY OF THE FOLLOWING CRITERIA: <ul style="list-style-type: none"> - ≥ 6 PVC'S IN 1 MINUTE - PVC'S THAT ARE CLOSELY COUPLED (QR/QT < 0.85) - PVC'S THAT FALL ON THE T-WAVE OF THE PRECEDING BEAT (R ON T PHENOMENA) - PVC'S THAT OCCUR IN PAIRS OR IN RUNS - PVC'S THAT ARE MULTIFORMED
	S	(5) SEVERE NAUSEA, CLAMMY SKIN, PROFUSE SWEATING, LIGHTHEADEDNESS, TINGLING, DIZZINESS
	S	(6) SUBJECT REQUEST AT ANY TIME
G	S	(7) LOSS OF ECG AT THE SURGEON'S CONSOLE OR VOICE DOWNLINK DURING PORTIONS OF RAMP PROTOCOLS BELOW 30 MMHG OF DECOMPRESSION (- 40 MMHG AND - 50 MMHG)
G	S	(8) RESTING HEART RATE GREATER THAN THE MAXIMUM HEART RATE OBSERVED DURING PREFLIGHT PRE-SYNCO PAL LBNP TESTING

@[ED]

NOTE: FOLLOWING LBNP OPERATIONS TERMINATION, A PRIVATE MEDICAL CONFERENCE (PMC) WILL BE CONDUCTED IF NECESSARY. IF THE SITUATION IS TIME CRITICAL, THE SURGEON WILL INSTRUCT THE CREW DIRECTLY FROM THE CAPCOM CONSOLE. IF THE RAMP MUST BE TERMINATED DUE TO REACHING TERMINATION CRITERIA, THE LBNP WILL BE RECOMPRESSED TO AMBIENT PRESSURE. FOLLOWING A 5-MINUTE RECOVERY WITH ECG DOWNLINK AND A GO FROM MCC/POCC, THE SOAK TO - 30 MMHG MAY BE RESUMED.

THIS RULE CONTINUED ON NEXT PAGE

FLIGHT RULES

A13.1.2-21 LBNP TEST TERMINATION CRITERIA (CONTINUED)

B. LBNP SOAK OPERATIONS ON A SUBJECT WILL BE TERMINATED FOR ANY ONE OF THE CRITERIA BELOW:

G	S	(1) SYSTOLIC BLOOD PRESSURE \leq 70 MMHG
G		(2) SIGNIFICANT CARDIAC ARRHYTHMIAS <ul style="list-style-type: none"> • HEART RATE < 40 BPM FOR PERSONS WHOSE RESTING HEART IS > 50 BPM • THREE OR MORE BEATS IN A ROW OF SUPRAVENTRICULAR OR VENTRICULAR TACHYCARDIA • EVIDENCE OF HEART BLOCK OTHER THAN FIRST DEGREE • PREMATURE VENTRICULAR COMPLEXES (PVC) WHICH MEET ANY OF THE FOLLOWING CRITERIA: <ul style="list-style-type: none"> - \geq 6 PVC'S IN 1 MINUTE - PVC'S THAT ARE CLOSELY COUPLED (QR/QT < 0.85) - PVC'S THAT FALL ON THE T-WAVE OF THE PRECEDING BEAT (R ON T PHENOMENA) - PVC'S THAT OCCUR IN PAIRS OR IN RUNS - PVC'S THAT ARE MULTIFORMED
	S	(3) SEVERE NAUSEA, CLAMMY SKIN, PROFUSE SWEATING, LIGHTHEADEDNESS, TINGLING, DIZZINESS
	S	(4) SUBJECT REQUEST AT ANY TIME
G	S	(5) RESTING HEART RATE GREATER THAN THE MAXIMUM HEART RATE OBSERVED DURING PREFLIGHT PRE-SYNCO PAL LB NP TESTING

NOTE: FOLLOWING LBNP OPERATIONS TERMINATION, A PRIVATE MEDICAL CONFERENCE (PMC) WILL BE CONDUCTED IF NECESSARY. IF THE SITUATION IS TIME CRITICAL, THE SURGEON WILL INSTRUCT THE CREW DIRECTLY FROM THE CAPCOM CONSOLE. IF THE RAMP MUST BE TERMINATED DUE TO REACHING TERMINATION CRITERIA, THE LBNP WILL BE RECOMPRESSED TO AMBIENT PRESSURE. FOLLOWING A 5-MINUTE RECOVERY WITH ECG DOWNLINK AND A GO FROM MCC/POCC, THE SOAK TO - 30 MMHG MAY BE RESUMED.

⑥ED]

FLIGHT RULES

A13.1.2-22 INTENSE CYCLE EXERCISE

THIS RULE APPLIES TO EXPERIMENTAL/DSO EXERCISE PROTOCOLS, WHEN REQUIRED BY THE HRPPC, AND DOES NOT APPLY TO CREW OPTIONAL EXERCISE.

A. A/G VOICE REQUIREMENTS

WHEN FLOWN, INTENSE CYCLE EXERCISE REQUIRES ELECTROCARDIOGRAM (ECG) TELEMETRY AND CONTINUOUS A/G VOICE COMMUNICATIONS DURING PORTIONS OF THE CYCLE TEST (I.E., AT LEVELS > 80 PERCENT PREFLIGHT MAXIMUM HEART RATE) AND CONTINUING THROUGH THE RECOVERY PERIOD. THE RECOVERY PERIOD SHALL LAST A MINIMUM OF 5 MINUTES AND MAY BE EXTENDED AT THE FLIGHT SURGEON'S DISCRETION. THE SUBJECT SHALL CONTACT FLIGHT SURGEON IMMEDIATELY PRIOR TO BEGINNING THE EXERCISE PROTOCOL AND AGAIN IMMEDIATELY BEFORE PERFORMING EACH WORKLOAD INCREASE THAT EXCEEDS 80 PERCENT IN ORDER TO CONFIRM NO ORBITER LOSS OF SIGNAL (LOS).

B. ON FLIGHTS WITHOUT A TRAINED PHYSICIAN ASTRONAUT OR ONBOARD ECG MONITORING CAPABILITY, LOSS OF ECG/COMM WILL NECESSITATE LIMITING EXERCISE TO 80 PERCENT WORKLOAD OR REDUCING EXERCISE TO 80 PERCENT IF ALREADY ABOVE IT. ©[072893-1517A]

C. IF ECG CAN BE MONITORED ONBOARD AND A TRAINED PHYSICIAN ASTRONAUT IS AVAILABLE, THE A/G VOICE REQUIREMENTS IN PARAGRAPHS A AND B ABOVE DO NOT APPLY. THE PHYSICIAN ASTRONAUT MUST CONTINUOUSLY MONITOR THE ECG DURING EXERCISE ABOVE THE 80 PERCENT WORKLOAD. THE PHYSICIAN ASTRONAUT MAY NOT PERFORM OTHER EXPERIMENTS AT THIS TIME AND MUST BE ABLE TO SEE THE ECG DATA.

The physician astronaut will be able to detect significant dysrhythmias since ECG is available onboard. The physician astronaut should be certified in advanced cardiac life support to assure capability in dysrhythmia recognition and intervention. Prior to exceeding the 80 percent workload, ECG downlink/comm should be confirmed. If downlink is available, the flight surgeon in the MCC will monitor the ECG data.

THIS RULE CONTINUED ON NEXT PAGE

FLIGHT RULES

A13.1.2-22 INTENSE CYCLE EXERCISE (CONTINUED)

D. TEST TERMINATION CRITERIA @072893-1517A]

INTENSE CYCLE EXERCISE OPERATIONS ON A SUBJECT WILL BE TERMINATED FOR ANY ONE OF THE CRITERIA LISTED BELOW:

G - GROUND PERSONNEL CAN MAKE CALL

S - CREWMEMBER IN SPACE CAN MAKE CALL

G 1. THE CARDIAC RHYTHM DISTURBANCES, LISTED BELOW, OCCUR: SUSTAINED ABNORMAL SUPRAVENTRICULAR TACHYCARDIA (I.E., PAROXYSMAL ATRIAL TACHYCARDIA, ATRIAL FIBRILLATION, ATRIAL FLUTTER, OR OTHER SUPRAVENTRICULAR TACHYCARDIA OF UNIDENTIFIED ETIOLOGY LASTING MORE THAN 10 SECONDS)

a. VENTRICULAR TACHYCARDIA

b. EXERCISE INDUCED BUNDLE BRANCH BLOCK

c. R-ON-T PVC'S

d. UNEXPLAINED INAPPROPRIATE BRADYCARDIA

e. MULTIFOCAL PVC'S

f. ONSET OF SECOND OR THIRD DEGREE HEART BLOCK

g. INCREASING VENTRICULAR ECTOPY (>30 PERCENT OF TOTAL BEATS UNIFOCAL PVC'S DEFINED AS ABNORMAL)

G S 2. A MAXIMUM HEART RATE VALUE GREATER THAN THAT EXPLAINABLE BY THE EXERCISE STIMULUS AND NORMAL PHYSIOLOGICAL VARIABILITY OCCURS. (IF THIS OCCURS AT LOW LEVELS, WITH NO SIGNS OF INTOLERANCE, CREWMEMBER SHOULD CHECK HEART WATCH AND CONFIRM HEART RATE WITH GROUND).

S 3. SUBJECT EXPERIENCES CHEST PAIN, DIZZINESS, OR OTHER INAPPROPRIATE SYMPTOMS OF EXCEPTIONAL INTOLERANCE.

S 4. SUBJECT REQUESTS TO STOP. @ED]

FLIGHT RULES

A13.1.2-23 SPACELAB CONTINGENCY EGRESS

SPACELAB MODULE

- A. SPACELAB EGRESS MAY BE REQUIRED FOR THE ONSET OF ANY CONDITION WHICH ADVERSELY AFFECTS CREW SAFETY OR HEALTH AND PERFORMANCE.

Self-explanatory.

- B. THE CREW WILL NORMALLY EGRESS THE SPACELAB MODULE IF THE PARTIAL PRESSURE OF CARBON DIOXIDE (PPCO₂) IN THE MODULE CANNOT BE MAINTAINED BELOW 7.6 MILLIMETERS OF MERCURY (MMHG). IF ADEQUATE AIR MIXING IS CONFIRMED VIA THE TUNNEL FAN, MODULE CONTINGENCY EGRESS MAY BE DELAYED UNTIL THE ORBITER PPCO₂ SENSOR REACHES 7.6 MMHG.

PPCO₂ control is considered lost when the CO₂ cannot be maintained below 7.6 mmHG. This is the maximum level that is considered acceptable for long-term exposure without seriously compromising crew performance. The tunnel fan moves air at 48 cubic feet per minute (cfm) and may provide additional capability for use of the Spacelab until the orbiter PPCO₂ sensor reaches 7.6 mmHG. At this point, the CO₂ can be expected to reach 15 mmHG in 2 to 3 hours, and egress should be started to allow enough time to secure experiments and equipment in the Spacelab.

- C. BELOW PPO₂ LEVELS INDICATED IN THE FOLLOWING TABLE, THE CREW WILL REQUIRE SUPPLEMENTAL OXYGEN BREATHING AND THE SPACELAB MODULE WILL BE EGRESSSED. FOR TEMPERATURES WITHIN 70 DEG TO 85 DEG F, USE THE IN-RANGE VALUE. THE OUT-OF-RANGE VALUE IS USED FOR TEMPERATURES LESS THAN 70 DEG F OR GREATER THAN 85 DEG F.

CABIN PRESS (PSIA)	PPO ₂ (PSIA)		OXYGEN CONCENTRATION (%)	
	IN	OUT	IN	OUT
14.7	2.29 (2.44)	(2.54)	15.6 (16.60)	(17.3)

@[080994-1650]

FLIGHT RULES

The PPO2 minimum acceptable limits defined in the table are established to ensure adequate delivery of oxygen to the pulmonary alveoli. These limits represent the minimum PPO2 required to maintain the alveolar pressure of oxygen equivalent to that of breathing air at an 8000-ft pressure altitude. Due to the saturation of breathing gases with water, PPO2 limits must increase as cabin pressure decreases to maintain the same alveolar partial pressure of oxygen. For temperatures of 70 deg to 85 deg F, the maximum PPO2 sensor error is ± 0.15 psia. This error is added to the minimum acceptable true PPO2 (8,000 feet altitude equivalent) to arrive at the minimum acceptable PPO2 sensor reading (e.g., $2.29 + 0.15 = 2.44$). This error is based on a 3 percent accuracy with a 90-day drift requirement

THIS RULE CONTINUED ON NEXT PAGE

FLIGHT RULES**A13.1.2-23 SPACELAB CONTINGENCY EGRESS (CONTINUED)**

For temperatures outside this range, the PPO₂ error is ±0.15 psia and this error must be adjusted accordingly per OMRSD V61AJ0.141. This error is based on a 5 percent accuracy with a 90-day drift requirements. Above a pressure altitude of 8,000 feet, deleterious changes in crew performance can occur from hypoxia and altitude sickness. Symptoms of altitude sickness can develop over several hours consisting of headache, lethargy, and reduced appetite in 15 to 20 percent of crewmembers. More serious symptoms of confusion, loss of coordination, and difficulty in breathing may occur. These more serious symptoms must be treated with oxygen and an immediate increase in ambient pressure. (Reference All Flights Rule {A13.1.2-6}, 100 PERCENT OXYGEN USE CONSTRAINT.) ©[090894-1650]

- D. SPACELAB EGRESS MAY BE REQUIRED FOR EXPERIMENT FAILURES OR CONDITIONS THAT RESULT IN THE RELEASE OF A HAZARDOUS SUBSTANCE INTO THE ENVIRONMENT PER RULE {A13.1.2-16}, SPACEHAB/SPACELAB HAZARDOUS SUBSTANCE SPILL RESPONSE.

Compromise of experiment containers may allow toxic liquids, gases, or solids to disperse throughout the module atmosphere. Many experimental compounds that have flown would have exceeded SMAC limits by several orders of magnitude had the entire sample been dispersed. Significant health hazards could result from skin or eye contact, inhalation, or swallowing a toxic substance. Thus, contingency egress and subsequent cleanup are required. Rule {A13.1.2-16}, SPACEHAB/SPACELAB HAZARDOUS SUBSTANCE SPILL RESPONSE, defines the procedure.
 ©[ED]

A13.1.2-24 ATMOSPHERE PURGING**SPACELAB MODULE**

AFTER EXPOSURE OF THE SPACELAB ATMOSPHERE TO A TOXIC OR IRRITANT SUBSTANCE AND SUBSEQUENT SPACELAB CONTINGENCY EGRESS AND CLEANUP, THE ATMOSPHERE MAY NEED TO BE PURGED OF RESIDUAL TOXIC CONTAMINATION BASED ON THE TYPE OF SUBSTANCE, AMOUNT RELEASED, RELATIVE TOXIC POTENTIAL, AND THE ABILITY OF THE ATMOSPHERIC SCRUBBERS TO REMOVE THE SUBSTANCE. THE FOLLOWING GENERAL GUIDELINES MAY BE USED:

- A. IF AT LEAST ONE LITHIUM HYDROXIDE (LIOH) SCRUBBER AND THE TUNNEL SCRUBBER ARE AVAILABLE, THE ATMOSPHERE MUST CYCLE FOR 10 HOURS.
- B. IF ONLY THE TUNNEL SCRUBBERS ARE AVAILABLE, THE ATMOSPHERE MUST CYCLE FOR 186 HOURS.

FLIGHT RULES

Some substances may diffuse slowly through the atmosphere, adhere to or react with material in the module, or be slowly removed from the available LiOH beds. Other substances are not removed by the LiOH beds at all. Adequate cleansing of the atmosphere is considered to be a six-fold cycling of the atmosphere through the scrubbers. [ED]

A13.1.2-25 NOISE LEVEL CONSTRAINTS

- A. IF THE 24-HOUR AVERAGE NOISE LEVEL (LEQ) IN ANY HABITABLE VOLUME (INCLUDING ORBITER FLIGHT DECK, MIDDECK, SPACELAB, SPACEHAB) IS GREATER THAN OR EQUAL TO 74 DBA AS MEASURED BY THE AUDIO DOSIMETER, ONE OR MORE OF THE FOLLOWING ACTIONS WILL BE TAKEN: [072795-1785A]
1. POWER OFF THE GREATEST NOISE PRODUCER(S). THE POCC/MCC MAY DECIDE ANY PRIORITIES IN THE POWERDOWN IF THERE IS MORE THAN ONE LOUD NOISE SOURCE. [ED]
 2. RESCHEDULE THE TIMELINE SO THAT ESPECIALLY NOISY EXPERIMENTS DO NOT OCCUR ON THE SAME DAY.
 3. WEAR HEARING PROTECTION DURING SLEEP TO ALLOW A RECOVERY PERIOD FROM THE NOISE.
 4. IN CONTINGENCY SITUATIONS ONLY, WEAR HEARING PROTECTION DURING THE DAY. [072795-1785A]

Exposure to noise levels of 74-76 dB for 10 days has been seen to cause fatigue, headaches, ringing in the ears and temporary threshold shifts of up to 20-25 dB. Exposure to these levels for even 24 hours led to complaints of the irritating effect of the noise. Each payload has been required to meet certain noise constraints. A number of payloads have not met those constraints and have been granted waivers. Any individual payload is not likely to cause difficulty but, in combination, may produce unacceptable noise levels. Powering off the loudest noise producers or rescheduling the time so that several loud experiments do not occur on the same day should lower the 24-hour noise exposure to an acceptable level. [072795-1785A]

Wearing hearing protection (e.g., foam ear plugs) during sleep provides a period of time to recover from the temporary threshold shift in hearing. The noise level during the day may still be irritating and fatiguing and may cause difficulty with communication. Wearing hearing protection during the day should eliminate the irritation and fatigue from the noise; however, communication among the crew, with the ground, and the ability to hear alert tones may be impacted.

THIS RULE CONTINUED ON NEXT PAGE

FLIGHT RULES

A13.1.2-25 NOISE LEVEL CONSTRAINTS (CONTINUED)

B. IF THE NOISE LEVEL, USING THE AUDIO DOSIMETER IN THE SOUND LEVEL METER MODE, EXCEEDS THE FOLLOWING LIMITS, STATEMENTS 1, 2, OR 4 OF PARAGRAPH A ABOVE MAY BE IMPLEMENTED. ©[072795-1785A]

76-80 DBA	5 MINUTES
81-85 DBA	1 MINUTE
≥ 86 DBA	NOT ALLOWED

At noise levels greater than 85 dBA, adequate communication with the ground would be extremely difficult, if not impossible, representing a potentially unsafe situation if urgent calls to the crew cannot be heard. Noise levels in the range from 76-85 dBA will make communication difficult both among the crew and between the crew and the ground. These time limits have been recommended by the Spacelab Payloads Acoustic Working Group and were approved by the Shuttle Program as a maximum time that this level of communication interference by an individual payload should be allowed.

C. IF, AT ANY TIME, THE NOISE LEVELS ARE SUCH THAT THE CREW BECOMES UNCOMFORTABLE OR IS UNABLE TO COMMUNICATE WITH EACH OTHER OR THE GROUND ADEQUATELY, THE CREW MAY INSTITUTE CORRECTIVE ACTIONS PER PARAGRAPH A.

IF THE AUDIO DOSIMETER IS INOPERATIVE OR NOT AVAILABLE, THE SAME CORRECTIVE ACTIONS MAY BE IMPLEMENTED. NOISE LEVEL READINGS CAN BE TAKEN AT ANY TIME BY THE CREW, OR MAY BE REQUESTED BY THE FLIGHT DIRECTOR OR FCR SURGEON IF PREFLIGHT OR INFLIGHT CONCERN OVER NOISE LEVEL EXISTS.

Noise levels in paragraphs A & B are established as mandatory levels; however, the crew may experience fatigue, headaches, or other symptoms at lower noise levels or may encounter problems in communication with each other or the ground. The crew has the authority to make such judgment calls and use the above guidelines and priorities to achieve a workable environment to complete the mission safely and successfully. ©[012694-1601] ©[ED]

FLIGHT RULES

A13.1.2-26 DECOMPRESSION SICKNESS SYMPTOMS AND CREW DISPOSITION

A. CUFF CLASS 1: @[040899-6836A]

1. SYMPTOMS: MILD PAIN AT SINGLE OR MULTIPLE SITES
AND/OR SINGLE EXTREMITY PARASTHESIA. SYMPTOMS
WHICH ARE DIFFICULT TO DISTINGUISH FROM SUIT
PRESSURE POINTS. SYMPTOMS DO NOT INTERFERE WITH
PERFORMANCE.
2. RESPONSE: CONTINUE EVA AND REPORT IN POST-EVA PMC.
3. NO IMPACT ON FUTURE EVA PLANS FOR THE AFFECTED
CREWMEMBER OR ON MISSION DURATION.

The EMU can cause pressure points and pains which could be confused with DCS symptoms. However, the risk of mild pain of this nature progressing to a serious symptom is low. Because there is low concern with injury and the symptoms are expected to resolve during repress if they are DCS related, it is acceptable to continue the EVA and report the symptoms later in a PMC. It is specifically mentioned in the rule that there is no impact to future EVA to encourage cuff class 1 symptom reporting. This reporting is required to verify total DCS risk over time.

B. CUFF CLASS 2:

1. SYMPTOMS: MODERATE CUFF CLASS 1 SYMPTOMS THAT
INTERFERE WITH PERFORMANCE.
2. RESPONSE: TERMINATE EVA FOR AFFECTED CREWMEMBER.
UNAFFECTED CREWMEMBER TERMINATES EVA AFTER COMPLETING
WORK SITE CLEAN-UP AND PAYLOAD BAY SAFING. REPRESS
AIRLOCK AS SOON AS PAYLOAD BAY SAFING IS COMPLETE.
CONDUCT PMC AFTER REPRESS.
3. NO IMPACT ON MISSION DURATION IF SYMPTOMS RESOLVE.
SURGEON WILL DETERMINE CONSTRAINTS ON FUTURE EVA FOR
AFFECTED CREWMEMBER CONSISTENT WITH NASA JSC
DECOMPRESSION SICKNESS PROCEDURES AND GUIDELINES JPG
1800.3. @[040899-6836A]

THIS RULE CONTINUED ON NEXT PAGE

FLIGHT RULES**A13.1.2-26 DECOMPRESSION SICKNESS SYMPTOMS AND CREW
DISPOSITION (CONTINUED)**

This level of symptoms is distinguishable from EMU pressure points by a trained EVA astronaut. Because it represents confirmed DCS symptoms and pressure is one of the most effective treatments, the affected crewmember should be repressed as soon as practical. The overall risk is low enough to warrant work site clean-up and payload bay safing before repressing but not additional mission success tasks. The affected crewmember's activity should be minimized because continued joint loads can aggravate the symptoms. During the post-repress PMC, the Surgeon will determine specific treatment required. NASA JSC Decompression Sickness Procedures and Guidelines JPG 1800.3 documents the approved limits for return-to-duty and return-to-delta pressure operations. The responses in these flight rules are consistent with this document. @[040899-6836A]

C. CUFF CLASS 3:

1. SYMPTOMS: SEVERE CUFF CLASS 1 SYMPTOMS OR MIGRATORY, TRUNKAL OR MULTIPLE SITE PARESTHESIA, OR SEVERE OR UNUSUAL HEADACHE.
2. RESPONSE: TERMINATE EVA FOR BOTH CREWMEMBERS. UNAFFECTED CREWMEMBER WILL ASSIST AFFECTED CREWMEMBER TO AIRLOCK THEN PERFORM PAYLOAD BAY SAFING. REPRESS AIRLOCK AS SOON AS PAYLOAD BAY SAFING IS COMPLETE. CONDUCT PMC AFTER REPRESS.
3. NO IMPACT ON MISSION DURATION IF SYMPTOMS RESOLVE. SURGEON WILL DETERMINE CONSTRAINTS ON FUTURE EVA FOR AFFECTED CREWMEMBER CONSISTENT WITH NASA JSC DECOMPRESSION SICKNESS PROCEDURES AND GUIDELINES JPG 1800.3.

These symptoms are more severe than cuff class 2 because they are a more generalized level of DCS and there is a higher risk of symptom progression. Because continued joint loads can aggravate the symptoms, the affected crewmember's activity should be restricted to airlock ingress and should be assisted as much as possible. Further, work site and payload bay clean-up should be limited to only those required to safe the payload bay for an expedited deorbit. The overall risk is low enough to warrant delaying repress until both crewmembers are in the airlock. During the post-repress PMC, the Surgeon will determine specific treatment required. NASA JSC Decompression Sickness Procedures and Guidelines JPG 1800.3 documents the approved limits for return-to-duty and return-to-delta pressure operations. The responses in these flight rules are consistent with this document. @[040899-6836A]

THIS RULE CONTINUED ON NEXT PAGE

FLIGHT RULES

A13.1.2-26 DECOMPRESSION SICKNESS SYMPTOMS AND CREW DISPOSITION (CONTINUED)

D. CUFF CLASS 4: @[040899-6836A]

1. SYMPTOMS: CENTRAL NEUROLOGICAL OR CARDIOPULMONARY.
2. RESPONSE: ABORT EVA. UNAFFECTED CREWMEMBER WILL ASSIST AFFECTED CREWMEMBER TO AIRLOCK. AFFECTED CREWMEMBER WILL BE RERESSED IMMEDIATELY, WITH THE UNAFFECTED CREWMEMBER PERFORMING PAYLOAD BAY SAFING AND REPRESSING SEPARATELY IF REQUIRED. CONDUCT PMC AFTER REPRESSING THE AFFECTED CREWMEMBER.
3. SURGEON WILL DETERMINE CONSTRAINTS ON FUTURE EVA FOR AFFECTED CREWMEMBER CONSISTENT WITH NASA JSC DECOMPRESSION SICKNESS PROCEDURES AND GUIDELINES JPG 1800.3.

The absolute minimum time to repress the affected crewmember is essential because these symptoms pose a serious health risk and increase the probability of an emergency deorbit. Therefore, it is acceptable to repress the affected crewmember separately while the other crewmember safes the payload bay for an expedited deorbit. At this level, it is likely the affected crewmember will require assistance due to impairment, and continued joint loads can aggravate the symptoms. During the post-repress PMC, the Surgeon will determine specific treatment required. NASA JSC Decompression Sickness Procedures and Guidelines JPG 1800.3 documents the approved limits for return-to-duty and return-to-delta pressure operations. The responses in these flight rules are consistent with this document.

DOCUMENTATION: DCS Risk Definition and Contingency Plan Review, April 1998; NASA JSC Decompression Sickness Procedures and Guidelines JPG 1800.3.

Reference Rule {A13.1.2-27}, DCS RESPONSE AND TREATMENT. @[040899-6836A]

FLIGHT RULES

A13.1.2-27 DECOMPRESSION SICKNESS RESPONSE AND TREATMENT

A. DEORBIT REQUIREMENTS: @[040899-6835B]

1. ANY EARLY MISSION TERMINATION AND DEORBIT FOR DCS PURPOSES WILL ONLY BE CONSIDERED TO A SITE DESIGNATED AS A PRIMARY HYPERBARIC CARE SITE.

Deorbit timeframe will be based on deorbit opportunities and Surgeon's evaluation of the severity of the specific symptoms. The additional risk of landing at an ELS will only be considered if the site has hyperbaric treatment capability since the most important treatment for DCS is increased pressure. The landing site list maintained by Flight Surgeon is annotated to show sites that medical operations has classified as primary hyperbaric care sites. This designation reflects the time to transport the injured crewmember to the chamber and the level of support available at the chamber.

2. FOR ALL LEVELS OF DCS WHICH RESOLVE WITH TREATMENT, THERE IS NO REQUIREMENT FOR EMERGENCY DEORBIT.

If symptoms resolve with treatment, there is a low risk of recurring symptoms and injury to the crewmember. Therefore, the risk of an emergency deorbit is not warranted. However, based on specific symptoms and response to treatment, Surgeon may request the affected crewmember be returned to Earth before the normal end of mission.

3. FOR ALL CUFF CLASS 1 SYMPTOMS, OR CUFF CLASS 2 AND 3 SYMPTOMS WHICH RESOLVE WITH TREATMENT, THERE IS NO REQUIREMENT FOR ANY EARLY MISSION TERMINATION.

4. EARLY DEORBIT WILL GENERALLY NOT BE CONSIDERED FOR UNRESOLVED NON-CUFF CLASS 4 SYMPTOMS UNLESS MEDICAL JUDGEMENT DEEMS THE SYMPTOMS ARE PROGRESSING AND/OR ENDANGER CREW HEALTH AND SAFETY.

98.6 percent or more of non-Cuff Class 4 symptoms resolve with ground level O₂, so we would expect them to resolve with our on-orbit treatments. Additionally, we have data and experience that clearly suggests the suit creates residual symptoms, pain and paresthesia, that are consistent with non-Cuff Class 4 DCS. Also, data indicates there is no long term injury associated with unresolved non-Cuff Class 4 symptoms.

5. FOR UNRESOLVED CUFF CLASS 4 SYMPTOMS, DEORBIT TO THE NEXT PRIMARY LANDING SITE OR WITHIN THE SCOPE OF NORMAL NPLS DEORBIT TIMING TO A LANDING SITE DESIGNATED AS A PRIMARY HYPERBARIC CARE SITE. BASED ON THE SPECIFIC MEDICAL SITUATION, DEORBIT WILL BE CONSIDERED TO THESE SITES AS EARLY AS 10 HOURS AFTER THE ONSET OF CUFF 4 SYMPTOMS. @[040899-6835B]

FLIGHT RULES

THIS RULE CONTINUED ON NEXT PAGE

FLIGHT RULES

A13.1.2-27 DECOMPRESSION SICKNESS RESPONSE AND TREATMENT (CONTINUED)

After the full treatment flow, persistent Cuff Class 4 symptoms are life threatening. Even in this case, the additional risk of landing at an ELS will only be considered if the site has hyperbaric treatment capability since the most important treatment for DCS is increased pressure. Long term risk to an affected crewmember is reduced if treatment is initiated within approximately 12 hours. Depending on the severity of the specific Cuff 4 symptoms, Surgeon may request an expedited deorbit. Considering the treatment available simply from cabin pressure and when the risk to the affected crewmember is weighed against the risk to the full crew and spacecraft, it was concluded that landing in less than 10 hours is not justified. @[040899-6835B]

B. THE CAPABILITY OF THE AFFECTED CREWMEMBER TO RETURN TO DUTY AND TO EVA AFTER TREATMENT WILL BE DETERMINED BY THE SURGEON CONSISTENT WITH NASA JSC DECOMPRESSION SICKNESS PROCEDURES AND GUIDELINES JPG 1800.3.

C. THE SUIT WILL REMAIN IN THE PRESS MODE AS SUPPORTED BY SUIT CONSUMABLES. THE BTA WILL NOT BE INSTALLED FOR INITIAL DCS TREATMENT.

Keeping the suit in PRESS mode will pressurize the affected crewmember to 4.3 psi above ambient after the airlock repress. For initial treatment, this combination of cabin and suit pressures is expected to provide significant therapeutic benefit and can be done quickly. However, installing the BTA requires opening the suit at cabin pressure for some period of time, delaying the additional pressure increase. The benefit of the additional pressure provided by the BTA is outweighed by the benefit of increasing the pressure as soon as possible. Also, the small increase in treatment efficacy does not justify installing a BTA and rendering a suit unusable for subsequent EVA, except as a later response for symptoms which do not resolve.

D. CABIN PRESSURE WILL BE MANAGED AS FOLLOWS:

1. FOR CUFF CLASS 2 OR 3 SYMPTOMS WHICH DO NOT RESOLVE WITHIN 20 MINUTES OF AIRLOCK REPRESS, THE CABIN WILL BE REPRESSURIZED TO 14.7 PSI. FOR CASES THAT DO NOT RESOLVE WITH 14.7 TREATMENT, THE CABIN WILL BE FURTHER PRESSURIZED TO THE HIGHEST PRESSURE SUPPORTABLE BY CONSUMABLES AND OXYGEN CONSTRAINTS UP TO 15.56 PSI.
2. FOR CUFF CLASS 4 SYMPTOMS, THE CABIN WILL BE REPRESSURIZED TO 14.7 PSI BEFORE OR DURING AIRLOCK REPRESS. FOLLOWING CABIN/AIRLOCK REPRESS, THE CABIN WILL BE FURTHER PRESSURIZED TO THE HIGHEST PRESSURE SUPPORTABLE BY CONSUMABLES AND OXYGEN CONSTRAINTS UP TO 15.56 PSI. @[040899-6835B]

FLIGHT RULES

THIS RULE CONTINUED ON NEXT PAGE

FLIGHT RULES

A13.1.2-27 DECOMPRESSION SICKNESS RESPONSE AND TREATMENT (CONTINUED)

3. FOR CUFF CLASS 2, 3 AND 4 SYMPTOMS, THE AFFECTED CREWMEMBER WILL NOT BE EXPOSED TO A REDUCED CABIN PRESSURE FOR AT LEAST 72 HOURS AFTER DCS TREATMENT UNLESS REQUIRED FOR DEORBIT, CONSUMABLES MANAGEMENT, OR OXYGEN CONSTRAINTS. FOR CASES WITH THE CABIN PRESSURE RAISED ABOVE 14.7 PSIA, THE CABIN PRESSURE WILL BE ALLOWED TO BLEED DOWN TO 14.7 PSIA. @[040899-6835B]

In all cases, the most effective immediate treatment is repressurization. The total pressure reached at cabin pressure with the suit in PRESS mode suffices for cuff class 2 and 3 symptoms. If the symptoms resolve, there is no need to increase the cabin pressure above the pressure at ingress. However, if Cuff Class 2 and 3 symptoms do not resolve with the initial treatment in a 10.2 psi cabin, the additional 4.5 psi is the most effective next step and the cabin will be repressed to 14.7 psi.

Due to the severity of cuff class 4 symptoms, the cabin will immediately be repressed to at least 14.7 psi to maximize the initial treatment pressure. Total pressure will be raised as high as 15.56 psi if supported by consumables and oxygen constraints. This pressure provides 0.24 psi margin (cabin pressure sensor measurement error) below the positive pressure relief valve (PPRV) cracking pressure based on a relief pressure of 15.8 psi for OV-105. 15.8 psia is the lowest PPRV cracking pressure of the fleet. The other vehicle's PPRV cracking pressures are as follows: OV-102 and OV-103 - 15.9 psia, OV-104 - 15.95 psia.

To prevent recurring symptoms, the affected crewmember will not be exposed to cabin pressure reductions for at least 72 hours. Surgeon may require a longer period based on specific symptoms and response to treatment.

The cabin pressure may be raised to 15.56 psia while treating severe symptoms. However, at the end of the treatment, the crewmember will be removed from the EMU which is providing the majority of the additional pressure during the treatment. Therefore, it is acceptable to allow the cabin pressure to bleed down over time to 14.7 psia in order to return to automatic atmosphere maintenance using the O₂/N₂ cabin regulators.

DOCUMENTATION: NSTS 16007 LCC Rev G (ECL-05), DCS Risk Definition and Contingency Plan Review, April 1998; NASA JSC Decompression Sickness Procedures and Guidelines JPG 1800.3, OMI V1217 Test Data.

Reference Rules {A13.1.2-26}, DECOMPRESSION SICKNESS SYMPTOMS AND CREW DISPOSITION, and {A17.1.6-4}, CABIN O₂ CONCENTRATION. @[040899-6835B]

FLIGHT RULES

ENTRY

A13.1.3-1 ANTI G-SUIT PROTOCOL

WHEN PREPARING FOR ENTRY, EACH CREWMEMBER WILL DON THE LES. IF THE CREWMEMBER ELECTS TO INFLATE THE ANTI-G BLADDERS, THE BLADDERS WILL REMAIN INFLATED UNTIL LANDING. IF THE CREWMEMBER ELECTS TO DEFLATE THE ANTI-G BLADDERS PRIOR TO EGRESS, DEFLATION WILL BE ACCOMPLISHED PROGRESSIVELY OVER AT LEAST A 10-MINUTE PERIOD.

Normal adaptation to zero-g results in a condition equivalent to a 10-percent loss of blood volume. During entry (re-exposure to gravity), blood tends to pool in the lower extremities and a "light headedness" or visual symptoms may result. Inflation of the anti-g bladders prevents blood pooling and increases blood return to the heart. Gradual deflation of the bladders after landing minimizes symptoms by reducing blood pooling.

A13.1.3-2 FLUID LOADING

A. FLUID LOADING IS REQUIRED BY ALL CREWMEMBERS PRIOR TO DEORBIT. CREWMEMBERS WILL INITIATE FLUID LOADING NO EARLIER THAN 1.5 HOURS BEFORE DEORBIT TIG AND NO LATER THAN DEORBIT TIG. EACH CREWMEMBER WILL CONSUME 8 OUNCES OF WATER AND TWO SALT TABLETS OR 8 OUNCES OF OTHER APPROVED SOLUTION EVERY 15 MINUTES, ACCORDING TO THE FOLLOWING TABLE. FLUID LOADING SHOULD BE COMPLETED BY EI. [030994-1608]

FLUID LOADING AMOUNTS FOR ENTRY BASED ON BODY MASS:

PREFLIGHT CREWMEMBER MASS	NUMBER OF 8 OZ DRINK CONTAINERS	AND	NUMBER OF SALT TABLETS	OR	APPROVED SOLN (OZ)
<120 LBS	3		6		24
120-155	4		8		32
155-190	5		10		40
>190 LBS	6		12		48

THE CREWMEMBERS WILL BE INSTRUCTED ON THE PROPER AMOUNTS PRIOR TO LAUNCH. REMINDERS CAN BE GIVEN DURING THE ENTRY DAY PMC IF NECESSARY.

THIS RULE CONTINUED ON NEXT PAGE

FLIGHT RULES

A13.1.3-2 FLUID LOADING ~~**A13.1.3-1 ANTI G-SUIT PROTOCOL**~~
(CONTINUED) @ED]

- B. IF THERE IS A ONE ORBIT WAVE-OFF AND THE FLUID-LOADING PROTOCOL DESCRIBED IN PARAGRAPH A WAS COMPLETED, THE PROTOCOL SHOULD BE REPEATED TO A TOTAL OF ONE-HALF OF THE PRESCRIBED AMOUNT DETERMINED IN PARAGRAPH A, TO BE COMPLETED BY EI. IF THERE IS A GREATER THAN ONE ORBIT WAVEOFF, THE ENTIRE PROTOCOL DESCRIBED IN PARAGRAPH A SHOULD BE REPEATED.
- C. IF A CREWMEMBER IS PARTICIPATING IN A FLUID-LOADING DSO, THE PROTOCOL AND ITS METHOD OF IMPLEMENTATION WILL BE DETAILED PREFLIGHT BY THE INVESTIGATOR AND THE CREW SURGEON. THE PROTOCOL WILL ALSO BE DOCUMENTED IN THE MISSION-SPECIFIC FLIGHT RULES ANNEX.

Oral fluid loading with a salt/water mixture similar to body fluids has been shown to significantly reduce detrimental heart rate and blood pressure changes during orthostatic stress post flight. Basing the amount of salt and water (in a proper ratio) or other approved solution on the crewmember's body mass helps to assure the fluid loading is adequate for larger crewmembers and possibly not too much for smaller crewmembers. ASTROADE® and other tested isotonic solutions provide plasma volume expansion similar to salt tablets/water and may be easier for some crewmembers to ingest. Flight Surgeons must approve these alternate solutions for individual use prior to flight. @030994-1608] @ED]

A13.1.3-3 TANK B WATER CONTINGENCY USE

TANK B WATER SHOULD ONLY BE USED AS A POTABLE WATER SOURCE IN A CONTINGENCY. IF IT BECOMES NECESSARY FOR CREWMEMBERS TO CONSUME TANK B WATER, DIRECT FLOW OF TANK B WATER THROUGH THE AUXILIARY WATER PORT MICROBIAL CHECK VALVE (MCV) AND WAIT 10 MINUTES TO ALLOW THE IODINE SUFFICIENT TIME TO KILL THE BACTERIA. TANK B WATER MUST NOT BE MIXED WITH ANY FLAVORING ADDITIVES DURING THE 10-MINUTE PERIOD.

FLIGHT RULES

Tank B water is unsafe for crew consumption without additional preparation. Although it is iodinated prior to launch, it is nominally utilized for FES operations soon after orbital insertion. Tank B subsequently receives water directly from the fuel cell without being iodinated by an MCV. Therefore, while on orbit, tank B water is subject to bacterial growth and should be considered contaminated. In order to ensure the crew does not drink contaminated water, tank B water should be iodinated for an appropriate period of time prior to consumption. An IFM procedure will be utilized to divert flow of tank B water through the auxiliary water port MCV. The water must not be consumed for 10 minutes after passing through the MCV, allowing the iodine sufficient time to kill bacteria. In addition, water flavoring additives (lemonade, tea, etc.) should not be added to the recently iodinated tank B water. These additives will bind with iodine and prevent its antibacterial activity. @ED]

FLIGHT RULES

THIS PAGE INTENTIONALLY BLANK

FLIGHT RULES

SECTION 14 - SPACE ENVIRONMENT

DEFINITIONS

A14.1.1-1	UNCONFIRMED ARTIFICIAL EVENT DEFINITION	14-1
A14.1.1-2	CONFIRMED ARTIFICIAL EVENT DEFINITION	14-1
A14.1.1-3	MAJOR SOLAR FLARE DEFINITION	14-1
A14.1.1-4	SOLAR PARTICLE EVENT DEFINITION	14-2
A14.1.1-5	OTHER RADIATION EVENT DEFINITION	14-2
A14.1.1-6	PROJECTED OPERATIONAL DOSE LIMIT VIOLATION DEFINITION	14-2

MANAGEMENT

A14.1.2-1	CREW RADIATION EXPOSURE LIMITS	14-3
A14.1.2-2	UNCONFIRMED ARTIFICIAL EVENT	14-3
A14.1.2-3	CONFIRMED ARTIFICIAL EVENT	14-4
A14.1.2-4	MAJOR SOLAR FLARE	14-5
A14.1.2-5	SOLAR PARTICLE EVENT	14-5
A14.1.2-6	OTHER RADIATION EVENT	14-5
A14.1.2-7	PROJECTED OPERATIONAL DOSE LIMIT VIOLATION .	14-6

SPACE ENVIRONMENT GO/NO-GO CRITERIA

A14.1.3-1	SPACE ENVIRONMENT GO/NO-GO CRITERIA	14-9
-----------	---	------

FLIGHT RULES

THIS PAGE INTENTIONALLY BLANK

FLIGHT RULES

SECTION 14 - SPACE ENVIRONMENT

The Flight Rules of the Space Environment Section deal specifically with ionizing radiation and are intended to provide assurance that crew radiation exposure during space shuttle operations will be maintained as low as reasonably achievable (ALARA), as required by the Code of Federal Regulations for Safety and Health. In this context, space shuttle operations includes crew activities for EVA and IVA for the orbiter and any habitable payload (Spacelab, Spacehab, etc.). JSC Space and Life Sciences personnel (Flight Surgeon, Radiological Health Officer, and the Space Radiation Analysis Group) are responsible for prelaunch, orbit, and postflight assessment of all shuttle mission crew radiation hazard/health issues.

DEFINITIONS

A14.1.1-1 UNCONFIRMED ARTIFICIAL EVENT DEFINITION

AN UNCONFIRMED ARTIFICIAL EVENT IS DEFINED AS AN ARTIFICIAL EVENT NOT CONFIRMED BY THE PROPER SUPPORT DATA SOURCE.

This definition is self-explanatory. It is included to minimize the influence on space shuttle operations of rumor or speculation from unofficial sources.

A14.1.1-2 CONFIRMED ARTIFICIAL EVENT DEFINITION

A CONFIRMED ARTIFICIAL EVENT IS DEFINED AS AN ARTIFICIAL EVENT THAT IS REPORTED BY THE PROPER SUPPORT DATA SOURCE AND THAT MEETS THE PREDETERMINED CRITERIA FOR DETONATION MAGNITUDE, ALTITUDE, AND GEOGRAPHIC POSITION.

This definition is self-explanatory.

A14.1.1-3 MAJOR SOLAR FLARE DEFINITION

A MAJOR SOLAR FLARE IS DEFINED AS A SOLAR FLARE THAT PRODUCES AN M5 OR LARGER X-RAY EVENT (5.0×10^{-5} WATTS/SQUARE METER).

This definition is self-explanatory. It is included to identify the minimum flare size which could produce a particle event large enough to cause concern for crew safety. (All solar flares do not produce solar particles at the Earth.)

FLIGHT RULES

A14.1.1-4 SOLAR PARTICLE EVENT DEFINITION

A SOLAR PARTICLE EVENT IS DEFINED AS AN INCREASE IN THE NEAR-EARTH RADIATION ENVIRONMENT RESULTING FROM SOLAR FLARE ACTIVITY. (THRESHOLD LEVEL IS 10 PROTONS/CM²/SEC > 30 MeV ABOVE BACKGROUND AT GEOSYNCHRONOUS ALTITUDE.)

This definition is self-explanatory.

A14.1.1-5 OTHER RADIATION EVENT DEFINITION

OTHER RADIATION EVENT IS DEFINED AS INCREASED RADIATION RATES PRODUCED BY ANY SOURCE OTHER THAN SOLAR OR ARTIFICIAL EVENT ACTIVITY. (THRESHOLD LEVEL IS ANY INCREASE ABOVE THE NOMINAL MISSION RATE PROJECTIONS.)

This definition is included to cover any natural or manmade exposure enhancement from radiation sources not listed in the definitions above.

A14.1.1-6 PROJECTED OPERATIONAL DOSE LIMIT VIOLATION DEFINITION

PROJECTED OPERATIONAL DOSE LIMIT VIOLATION IS DEFINED AS A DOSE EXTRAPOLATION THAT VIOLATES AN OPERATIONAL LIMIT (RULE {A14.1.2-1}, CREW RADIATION EXPOSURE LIMITS) BASED UPON ANALYTICAL PROJECTIONS WITH ACCUMULATION RATES CONFIRMED BY ONBOARD DOSIMETRY READOUT.

This definition is self-explanatory.

FLIGHT RULES

MANAGEMENT

A14.1.2-1 CREW RADIATION EXPOSURE LIMITS

THE FOLLOWING OPERATIONAL CREW IONIZING RADIATION EXPOSURE LIMITS WILL BE ADHERED TO:

EXPOSURE LIMITS (REM)

	DEPTH	EYE	SKIN
CONSTRAINT	(5 CM)	(0.3 CM)	(0.01 CM)
30 DAY	25	100	150
ANNUAL	50	200	300
CAREER	100 - 400 *	400	600
MALE - * 200 + 7.5 (AGE - 30) REM, UP TO 400 REM MAXIMUM			
FEMALE - * 200 + 7.5 (AGE - 38) REM, UP TO 400 REM MAXIMUM			

Space shuttle crew radiation exposure limits recommended to NASA by the National Council on Radiation Protection and Measurements, "Guidance on Radiation Received in Space Activities" - NCRP Report No. 98, July 31, 1989, have been legally adopted as the Agency's Supplementary Standard in accordance with 29 CFR 1960.18. Space shuttle flights are nominally constrained to the 30-day exposure limits, which are conservatively set to minimize mission impact. Rule {A14.1.1-6}, PROJECTED OPERATIONAL DOSE LIMIT VIOLATION DEFINITION, references this rule.

A14.1.2-2 UNCONFIRMED ARTIFICIAL EVENT

FOR ALL FLIGHT PHASES AND PRELAUNCH, IF AN ARTIFICIAL EVENT IS UNCONFIRMED, THE FLIGHT DIRECTOR WILL BE NOTIFIED AND CONFIRMATION WILL BE PURSUED FROM ALL DATA SOURCES.

No action is required other than notification of the flight director since the predicted or reported event may not be real.

FLIGHT RULES

A14.1.2-3 CONFIRMED ARTIFICIAL EVENT

FOR A CONFIRMED ARTIFICIAL EVENT:

A. PRELAUNCH:

1. THE FLIGHT DIRECTOR WILL REQUEST A LAUNCH HOLD IF PRIOR TO L-31 SECONDS.

If prior to L-31 seconds, it is better to hold/terminate than to risk exposing the flightcrew to a potentially hazardous radiation environment.

2. IF THE LAUNCH COUNTDOWN IS LESS THAN L-31 SECONDS, FURTHER ACTION WILL BE GOVERNED BY PARAGRAPH B BELOW.

After L-31 seconds, it is safer to continue a nominal ascent and order deorbit if required. After achieving orbit, further action will be governed by orbit flight phase rules.

B. ORBIT (FOR EXTREME CASES DURING ORBIT FLIGHT PHASE, CONFIRMATION OF PROJECTED DOSE LIMIT VIOLATION FROM ONBOARD DOSIMETRY MAY BE WAIVED):

1. THE FLIGHT DIRECTOR WILL NOTIFY THE FLIGHTCREW AND REQUEST THE CREW TO TAKE AND REPORT DOSIMETER READINGS AT SPECIFIED INTERVALS.

Dosimeter readings are needed to confirm exposure and rate of exposure so that valid projections can be determined.

2. BASED ON PROJECTED RADIATION EXPOSURE LEVELS, FURTHER ACTION WILL BE UNDERTAKEN IF/WHEN RULE {A14.1.2-7}, PROJECTED OPERATIONAL DOSE LIMIT VIOLATION, BECOMES APPLICABLE.

This rule is included to minimize unnecessary mission impacts.

C. EVA:

1. THE EVA CREWMEMBER WILL RETURN TO THE AIRLOCK ASAP.

This rule will minimize crew exposure from the potentially very high dose rates that can be produced before stabilization of the enhanced trapped electron belts.

2. GO/NO-GO FOR CONTINUATION OF EVA WILL BE BASED ON PROJECTED RADIATION EXPOSURE LEVELS.

FLIGHT RULES

Depending on projected exposure levels, EVA may continue as planned or as modified by Rule {A14.1.2-7}, PROJECTED OPERATIONAL DOSE LIMIT VIOLATION.

A14.1.2-4 MAJOR SOLAR FLARE

FOR ALL FLIGHT PHASES AND PRELAUNCH, IF A MAJOR SOLAR FLARE OCCURS, THE FLIGHT DIRECTOR WILL BE NOTIFIED AND CONFIRMATION WILL BE PURSUED FROM ALL DATA SOURCES.

No action is required other than notification of the flight director since most solar flares do not produce particles at the Earth. Rule {A14.1.2-5}, SOLAR PARTICLE EVENT, covers solar flare particles.

A14.1.2-5 SOLAR PARTICLE EVENT

A. FOR ALL FLIGHT PHASES AND PRELAUNCH, IF A SOLAR PARTICLE EVENT HAS BEEN CONFIRMED, THE FLIGHT DIRECTOR WILL NOTIFY THE FLIGHTCREW AND MAXIMUM DATA RECOVERY FROM STS RADIATION SUPPORT DATA SOURCES WILL BE PURSUED.

No action is required until dose projections reach levels of concern for crew safety. Hazard is specifically dependent on mission inclination and particle intensities. (Minimum hazard for low inclination, maximum for polar orbit.)

B. FOR ORBIT AND EVA FLIGHT PHASES, IF PROJECTED RADIATION EXPOSURES REACH A LEVEL OF CONCERN FOR CREW SAFETY, THE FLIGHT DIRECTOR WILL REQUEST THE FLIGHTCREW TO TAKE AND REPORT DOSIMETER READINGS AT SPECIFIED INTERVALS. FURTHER ACTION WILL BE UNDERTAKEN IF/WHEN RULE {A14.1.2-7}, PROJECTED OPERATIONAL DOSE LIMIT VIOLATION, BECOMES APPLICABLE.

Dosimeter readings are needed to verify exposure projections.

Rule {A14.1.2-4}, MAJOR SOLAR FLARE, references this rule.

A14.1.2-6 OTHER RADIATION EVENT

IF ANOTHER RADIATION EVENT OCCURS, THE FLIGHT DIRECTOR WILL BE NOTIFIED. THE FLIGHT DIRECTOR WILL NOTIFY THE FLIGHTCREW AND REQUEST THE CREW TO TAKE AND REPORT DOSIMETER READINGS. FURTHER ACTION WILL BE UNDERTAKEN IF/WHEN PROJECTIONS/MEASUREMENTS INDICATE THAT RULE {A14.1.2-7}, PROJECTED OPERATIONAL DOSE LIMIT VIOLATION, IS APPLICABLE.

FLIGHT RULES

This rule is included to cover any unexpected or unusual enhancement to the internal/external radiation environment of the orbiter.

A14.1.2-7 PROJECTED OPERATIONAL DOSE LIMIT VIOLATION

FOR ALL FLIGHT PHASES AND PRELAUNCH, IF AN OPERATIONAL DOSE LIMIT VIOLATION HAS BEEN PROJECTED, THE FLIGHT DIRECTOR WILL BE NOTIFIED. NOTIFICATION WILL INCLUDE EXPOSURE MAGNITUDE AND TIME CONSTRAINTS.

Exposure magnitude and time to reach dose limit are important factors for risk versus gain assessment.

A. PRELAUNCH:

1. THE FLIGHT DIRECTOR WILL REQUEST A LAUNCH HOLD IF PRIOR TO L-31 SECONDS.

This rule is included to preclude launching into a hazardous enhanced radiation environment. (Large solar particle event or artificial event environments.)

2. IF THE LAUNCH COUNTDOWN IS LESS THAN L-31 SECONDS, THE LAUNCH WILL BE CONTINUED.

After L-31 seconds, it is safer to continue a nominal ascent and orderly deorbit.

3. FURTHER ACTION WILL BE GOVERNED BY PARAGRAPH B BELOW.

Once safe orbit is achieved, rules for orbit flight phase are applicable.

B. ORBIT - THE FLIGHT DIRECTOR WILL NOTIFY THE FLIGHTCREW OF THE PROJECTED DOSE LIMIT VIOLATION. BASED ON THE PROJECTED RADIATION EXPOSURE LEVELS AND TIME REMAINING TO REACH THE DOSE LIMIT, CONSIDERATIONS WILL BE GIVEN TO:

1. LOWERING ALTITUDE.
2. CHANGE ORBITER ATTITUDE.
3. RESTRICT CREW LOCATION WITHIN THE ORBITER.
4. DEORBIT NEXT PLS.
5. DEORBIT NEXT DAY PLS.

Based on the projected radiation exposure levels, time to reach limit, and source, different actions are taken to minimize exposure and allow risk versus gain assessment on selected action.

FLIGHT RULES

THIS RULE CONTINUED ON NEXT PAGE

FLIGHT RULES

A14.1.2-7 PROJECTED OPERATIONAL DOSE LIMIT VIOLATION
(CONTINUED)

C. EVA - BASED ON THE PROJECTED RADIATION EXPOSURE LEVELS AND TIME TO REACH THE DOSE LIMIT, THE EVA CREWMEMBER WILL:

1. MODIFY EVA TIMELINE, OR
2. ORDERLY TERMINATE EVA, OR
3. RETURN TO THE AIRLOCK AND TERMINATE EVA IMMEDIATELY.

FURTHER ACTION WILL BE GOVERNED BY PARAGRAPH B ABOVE.

Based on the time of projected dose limit violation and magnitude of current exposure levels, it may be possible to complete critical EVA tasks and the stow/cleanup operations prior to returning to the increased safety of the orbiter cabin.

Rules {A14.1.2-3}, CONFIRMED ARTIFICIAL EVENT; {A14.1.2-5}, SOLAR PARTICLE EVENT; and {A14.1.2-6}, OTHER RADIATION EVENT, reference this rule.

FLIGHT RULES

SPACE ENVIRONMENT GO/NO-GO CRITERIA

A14.1.3-1

SPACE ENVIRONMENT GO/NO-GO CRITERIA

RADIATION CONDITION	FLIGHT PHASE		
	PRELAUNCH	ORBITAL	EVA
UNCONFIRMED ARTIFICIAL EVENT	[1]	[1]	[1]
CONFIRMED ARTIFICIAL EVENT	[2] [4] [5]	[4] [5]	[3] [4] [5]
MAJOR SOLAR FLARE	[1]	[1]	[1]
SOLAR PARTICLE EVENT	[4]	[4]	[4]
OTHER RADIATION EVENT	[4]	[4]	[4]
PROJECTED OPERATIONAL DOSE LIMIT VIOLATION	[2] [4] [5]	[5]	[3] [5]

- NOTES:
- [1] PURSUE CONFIRMATION FROM ALL DATA SOURCES.
 - [2] HOLD LAUNCH IF PRIOR TO L-31 SECONDS.
 - [3] EVA CREW TO AIRLOCK (MAY REQUIRE RISK VERSUS GAIN ASSESSMENT). (TEMPORARY ACTION. GO/NO-GO FOR CONTINUATION OF EVA DETERMINED THROUGH IMPLEMENTATION OF NOTES 4 AND 5, IF NECESSARY.)
 - [4] PURSUE MAXIMUM DATA RECOVERY FROM STS RADIATION SUPPORT DATA SOURCES AND/OR SPACECRAFT DOSIMETRY FOR RISK ASSESSMENT. (ONBOARD DOSIMETRY READOUT WILL BE REQUESTED IF PROJECTED EXPOSURES REACH LEVELS OF CONCERN OR IF DATA ASSESSMENT INDICATES HIGH EXPOSURES HAVE BEEN RECEIVED. RESULTS OF DATA ASSESSMENT WILL DETERMINE THE NECESSITY FOR NOTE 5 IMPLEMENTATION.)
 - [5] CONSIDER MISSION CHANGE TO LOWER DOSE WITHOUT INCREASING TOTAL RISK TO CREW. NASA MANAGEMENT RISK VERSUS GAIN DECISION REQUIRED. (CONSIDERATIONS ARE RADIATION SOURCE AND EXPOSURE LEVEL DEPENDENT, AND INCLUDE; LOWERING ALTITUDE, CHANGING ORBITER ATTITUDE, RESTRICTING CREW LOCATION, EVA CREW TO AIRLOCK AT SPECIFIED TIMES, TERMINATE EVA, DEORBIT AT A SPECIFIED PLS, DEORBIT NEXT PLS, DEORBIT NEXT DAY PLS, ETC.

The criteria table provides a logical sequence for operational decisions to maximize crew safety: (1) identifies the radiation source, (2) confirms the enhanced radiation condition, (3) projects the anticipated exposure level, and (4) provides information pertinent to risk versus gain assessment.

FLIGHT RULES

SECTION 15 - EXTRAVEHICULAR ACTIVITY (EVA)

GENERAL

A15.1.1-1	EVA TIME DEFINITION	15-1
A15.1.1-2	TERMINATE EVA DEFINITION	15-1
A15.1.1-3	ABORT EVA DEFINITION	15-1
A15.1.1-4	SCHEDULED EVA DEFINITION	15-2
A15.1.1-5	UNSCHEDULED EVA DEFINITION	15-2
A15.1.1-6	CONTINGENCY EVA DEFINITION	15-2
A15.1.1-7	MINIMUM RF COMMUNICATIONS DEFINITION	15-2
A15.1.1-8	OPERATIONAL CAUTION AND WARNING SYSTEM (CWS) DEFINITION	15-2
A15.1.1-9	TWO/ONE-CREWMEMBER EVA GUIDELINES	15-4
A15.1.1-10	EVA CREWMEMBER(S) SUPPORT	15-4
A15.1.1-11	SAFETY TETHER REQUIREMENTS	15-4
A15.1.1-12	HAZARDOUS EQUIPMENT SAFING	15-4
A15.1.1-13	AIRLOCK CONFIGURATION	15-5
A15.1.1-14	SCHEDULED AND UNSCHEDULED EVA CONSTRAINTS ..	15-5
A15.1.1-15	CONTINGENCY EVA PROTECTION	15-6
A15.1.1-16	EVA TERMINATION FOR CABIN LEAK	15-6
A15.1.1-17	PAYLOAD BAY CONFIGURATION POST-EVA	15-7
A15.1.1-18	PAYLOAD OPERATION/DEPLOY GUIDELINE	15-7
A15.1.1-19	UNSCHEDULED EVA PREPARATION	15-7
A15.1.1-20	ECG TELEMETRY CHECKOUT	15-7
A15.1.1-21	LEAKING RCS THRUSTER/APU AVOIDANCE	15-7
A15.1.1-22	RCS/APU THRUSTER PLUME AVOIDANCE	15-8
A15.1.1-23	EV CREW IN VICINITY OF ACTIVE PAYLOAD RETENTION LATCH ASSEMBLIES	15-8
A15.1.1-24	EVA OPERATIONS IN THE GENERIC PAYLOAD BAY ENVELOPE	15-9
A15.1.1-25	ORBITER EVA OPERATIONS NEAR S-BAND ANTENNAS	15-10

FLIGHT RULES

<u>A15.1.1-26</u>	<u>KEEPOUT ZONE FOR EVA OPERATIONS NEAR THE ORBITER UHF PAYLOAD BAY ANTENNA</u>	15-10a
-------------------	---	--------

FLIGHT RULES

LOSS/FAILURE DEFINITIONS

A15.1.1.2-1	EVA CAPABILITY	15-11
A15.1.1.2-2	EMU GO/NO-GO CRITERIA	15-11
A15.1.1.2-3	<u>RESERVED</u>	15-22

SYSTEMS MANAGEMENT

A15.1.1.3-1	DENITROGENATION	15-23
A15.1.1.3-2	EMU CONSUMABLES	15-23
A15.1.1.3-3	VACUUM TRANSFERS	15-23
<u>A15.1.1.3-4</u>	<u>RESERVED</u>	<u>15-23</u>
<u>A15.1.1.3-5</u>	<u>RESERVED</u>	<u>15-24</u>
<u>A15.1.1.3-6</u>	<u>RESERVED</u>	<u>15-24</u>
<u>A15.1.1.3-7</u>	<u>RESERVED</u>	<u>15-24</u>
<u>A15.1.1.3-8</u>	<u>RESERVED</u>	<u>15-26</u>
<u>A15.1.1.3-9</u>	<u>RESERVED</u>	<u>15-26</u>
A15.1.1.3-10	EMU CONSUMABLES PRE-EVA	15-26
A15.1.1.3-11	EMU CONSUMABLES REDLINES	15-25
A15.1.1.3-12	MANIPULATOR FOOT RESTRAINT (MFR) AND PFR ATTACHMENT DEVICE (PAD) GUIDELINES	15-26

EXTERNAL AIRLOCK

A15.1.1.4-1	EXTERNAL AIRLOCK HATCH THERMAL COVER	15-27
A15.1.1.4-2	EXTERNAL AIRLOCK LCG PRESSURE AND TEMPERATURE MANAGEMENT USING THE EMU	15-28
<u>A15.1.1.4-3</u>	<u>CABIN ATMOSPHERE DECONTAMINATION FOLLOWING EVA</u>	<u>15-31</u>

FLIGHT RULES

SECTION 15 - EXTRAVEHICULAR ACTIVITY (EVA)

GENERAL

A15.1.1-1 EVA TIME DEFINITION

A. EMU TIME

EMU TIME STARTS WHEN THE EMU IS SWITCHED TO INTERNAL POWER, ENDS WHEN THE EMU IS SWITCHED TO ORBITER POWER.

EMU time represents the time that the EMU is operating on internal power. The EMU primary life support subsystem (PLSS) provides consumables for a duration of 7 hours. In order to provide a 30-minute reserve of primary consumables, EVA operations should be scheduled to be completed within a phase elapse time (PET) of 6 hours 30 minutes. This time includes all overhead activities (such as airlock egress/ingress and payload bay setup/cleanup) in addition to the EVA task itself.

B. EVA PHASE ELAPSE TIME

EVA PET STARTS WHEN THE EMU IS SWITCHED TO INTERNAL POWER, ENDS WHEN AIRLOCK REPRESSURIZATION IS INITIATED.

EVA PET represents the time that the EMU is exposed to vacuum. Some EVA scenarios require the EVA crew to return to the airlock and wait for some other operation to be completed (e.g., a payload deployment) before resuming EVA tasks or before initiating airlock repressurization. Since the EMU is operating on orbiter power during this time, EVA PET may be significantly longer than EMU time. EVA PET will be used when tabulating historical mission data.

A15.1.1-2 TERMINATE EVA DEFINITION

TERMINATE EVA MEANS TO CEASE EVA ACTIVITIES, CLOSE OUT PAYLOAD BAY, TRANSFER TO ORBITER AIRLOCK, INGRESS, AND REPRESSURIZE AIRLOCK.

NOTE: IF EMU PROBLEM CAN BE STABILIZED/CORRECTED BY USING SERVICE AND COOLING UMBILICAL (SCU), CREWMEMBER WITH PROBLEM MAY REMAIN ON SCU AT VACUUM FOR POSSIBLE RESCUE/ASSIST, WHILE OTHER CREWMEMBER COMPLETES EVA.

A15.1.1-3 ABORT EVA DEFINITION

ABORT EVA MEANS TO IMMEDIATELY TRANSFER TO ORBITER AIRLOCK, INGRESS, AND REPRESSURIZE AIRLOCK.

FLIGHT RULES

A15.1.1-4 **SCHEDULED EVA DEFINITION**

A SCHEDULED EVA IS DEFINED AS ANY EVA INCORPORATED INTO THE NOMINAL FLIGHT PLAN. @[041896-1868]

A15.1.1-5 **UNSCHEDULED EVA DEFINITION**

AN UNSCHEDULED EVA IS USED TO ACHIEVE/ENHANCE THE MISSION OBJECTIVES OF THE ORBITER OR ITS PAYLOADS. IT IS NOT PART OF THE FLIGHT PLAN. @[041896-1869]

A15.1.1-6 **CONTINGENCY EVA DEFINITION**

A CONTINGENCY EVA IS DEFINED AS AN EVA REQUIRED TO EFFECT THE SAFE RETURN OF THE CREW AND THE ORBITER.

A15.1.1-7 **MINIMUM RF COMMUNICATIONS DEFINITION**

IN ORDER TO COMMIT TO OR CONTINUE A SCHEDULED OR UNSCHEDULED EVA, EACH EVA CREWMEMBER MUST HAVE TWO-WAY COMMUNICATIONS WITH THE ORBITER, EITHER DIRECTLY OR VIA THE OTHER EVA CREWMEMBER (REF. RULE {A11.1.1-6}, MINIMUM COMMUNICATIONS REQUIREMENTS FOR SCHEDULED EVA). @[ED]

| Rules {A15.1.2-2EA-7}, EMU GO/NO-GO CRITERIA; and {A15.1.3-12}, MANIPULATOR FOOT RESTRAINT (MFR) AND PFR ATTACHMENT DEVICE (PAD) GUIDELINES, reference this rule. @[090894-1669A] @[ED]

A15.1.1-8 **OPERATIONAL CAUTION AND WARNING SYSTEM (CWS) DEFINITION**

THE EMU CWS IS DETERMINED TO BE OPERATIONAL IF EITHER OF THE FOLLOWING TWO CONDITIONS ARE SATISFIED: @[090894-1668]

- A. THE ABILITY TO MONITOR THE OPERATIONAL INTEGRITY OF THE EMU (AT LEAST STATUS LIST) BY THE EVA CREW.
- B. THE ABILITY FOR MCC TO MONITOR THE EMU STATUS WITH THE EVA CREW MONITORING CWS ALERT TONES AND THE DISPLAYS AND CONTROL MODULE (DCM) SUIT PRESSURE GAUGE.

The EMU CWS is operational if the EVA crew can monitor at least the DCM status list to determine EMU failures. If the crew cannot monitor the DCM status list, then MCC will have to monitor EMU status while the EVA crew monitors the CWS alert tones and the DCM suit pressure gauge. If a CWS alert tone was to occur with a non-functional DCM display, the EVA crew would check the suit pressure gauge and check with MCC to determine the type of failure and action.

FLIGHT RULES

Reference Rule {A15.1.2-2[K.2](#)}, EMU GO/NO-GO CRITERIA. ©[090894-1668] ©[ED]

FLIGHT RULES

A15.1.1-9 TWO/ONE-CREWMEMBER EVA GUIDELINES

REFERENCE RULE {A2.1.3-6}, EVA GUIDELINES.

A15.1.1-10 EVA CREWMEMBER(S) SUPPORT

AT ALL TIMES DURING EVA, AT LEAST ONE INTRAVEHICULAR (IV) CREWMEMBER WILL BE DEDICATED TO SUPPORTING THE EVA CREWMEMBERS. ~~@[021199-6747B] DURING MMU FREE FLIGHT, ONE (IV OR EV) CREWMEMBER WILL TRACK THE MMU AT ALL TIMES.~~

IV crewmember is responsible for recording EMU status, monitoring the timeline, and providing orbiter support. ~~The orbiter must always track the MMU crewmember for possible rescue scenarios and/or collision avoidance.~~

A15.1.1-11 SAFETY TETHER REQUIREMENTS

A. AT ALL TIMES DURING EVA, EXCEPT WHEN INSIDE A CLOSED AIRLOCK ~~OR ATTACHED TO AN MMU~~, EACH EVA CREWMEMBER WILL BE ATTACHED TO THE ORBITER VIA A SAFETY TETHER. FLIGHT-SPECIFIC EXCEPTIONS TO TETHERING TO THE ORBITER WILL BE IDENTIFIED IN THE FLIGHT-SPECIFIC ANNEX. ~~@[021199-6747B]~~

Prevent loss of crewmember and resulting rescue scenarios. For some missions, it may be desirable for the crewmember to be attached (to a certified tether point) to the payload secured in the payload bay rather than the orbiter.

B. EVA TOOLS WILL BE TETHERED TO THE CREWMEMBER AT ALL TIMES DURING THEIR USE.

Prevents loss of tools. Free-floating tools could impact orbiter causing orbiter damage.

A15.1.1-12 HAZARDOUS EQUIPMENT SAFING

POTENTIALLY HAZARDOUS EQUIPMENT WILL BE VERIFIED SAFE IN THE EVENT OF EVA.

Potentially hazardous equipment will be verified safe in the event of an EVA to minimize chances for injury to the EV crewmember.

FLIGHT RULES

A15.1.1-13 AIRLOCK CONFIGURATION

AN EVA CREWMEMBER SHALL NOT BE LOCKED OUT OF A PRESSURIZED AIRLOCK EXCEPT IN THE CASE OF AN "ABORT EVA" WHERE THE EV CREWMEMBERS ARE SIGNIFICANTLY SEPARATED AND REPRESSURIZATION TIME IS CRITICAL ~~(E.G., DURING MMU FREE FLIGHT)~~. @[021199-6747B]

In the case of a serious EMU failure (i.e., loss of suit pressure), the EV crewmember must have immediate access to the airlock. This includes an abort scenario where the other EV crewmember is significantly separated from the airlock ~~flying the MMU~~. In this case, the separated ~~MMU~~ crewmember still has the capability to depressurize the airlock for ingress via the outer hatch equalization valves. @[021199-6747B]

A15.1.1-14 SCHEDULED AND UNSCHEDULED EVA CONSTRAINTS

A. NO SCHEDULED EVA WILL BE PERFORMED PRIOR TO MET 72 HOURS.

During adaptation to zero-g conditions, moving about may provoke symptoms of illness. The activity associated with putting on a suit would increase the chance of an EVA crewmember being ill and potentially endanger the crewmember with vomitus in the suit.

B. UNSCHEDULED EVA'S:

1. NO UNSCHEDULED EVA SHALL OCCUR DURING THE FIRST 24 HOURS OF FLIGHT.
2. AN UNSCHEDULED EVA MAY BE PERFORMED PRIOR TO MET 72 HOURS ONLY IF AN ASSESSMENT OF CREW HEALTH HAS BEEN ACCOMPLISHED BY THE FCR SURGEON AND APPROVED BY THE FLIGHT DIRECTOR.

Asymptomatic crewmembers may be able to safely perform an unscheduled EVA before MET 72 hours. An accurate assessment of the health status of the EVA crew can be made by the FCR surgeon during a private medical conference.

THIS RULE CONTINUED ON NEXT PAGE

FLIGHT RULES

A15.1.1-14 SCHEDULED AND UNSCHEDULED EVA CONSTRAINTS (CONTINUED)

C. NO SCHEDULED OR UNSCHEDULED EVA SHALL BE PERFORMED ON ENTRY DAY.

1. FOR A FLIGHT USING A SINGLE CREW SHIFT, A SCHEDULED OR UNSCHEDULED EVA MAY BE PERFORMED ON THE DAY BEFORE ENTRY ONLY IF AIRLOCK INGRESS IS COMPLETED NOT LATER THAN CREW SLEEP MINUS 7 HOURS.
2. FOR A FLIGHT USING DUAL SHIFT OPERATIONS, A SCHEDULED OR UNSCHEDULED EVA MAY BE PERFORMED ON THE DAY BEFORE ENTRY ONLY IF AIRLOCK INGRESS IS COMPLETED NOT LATER THAN CREW SLEEP (NONENTRY TEAM) MINUS 4.5 HOURS.

An EVA may be done on the day before entry if there is adequate time post-EVA to perform required activities. These activities include airlock repress, post-EVA, EMU maintenance recharge, post-EVA entry prep, cabin stow, and presleep. Seven hours is considered the minimum amount of time to accomplish these activities for a single shift flight. FCS C/O, RCS hot fire, and cabin repress activities must also be performed but can be overlapped with post-EVA and cabin stow activities. For an unscheduled EVA on the day before entry, it will be necessary to perform this EVA as a "quick response" EVA (i.e., the EMU C/O and cabin depress will need to be done on the day prior to the EVA). For a dual shift flight, 4.5 hours is considered the minimum due to cabin stow occurring on entry day for the nonentry team.

A15.1.1-15 CONTINGENCY EVA PROTECTION

A SCHEDULED OR UNSCHEDULED EVA WILL NOT BE CONDUCTED IF IT JEOPARDIZES FUTURE CONTINGENCY EVA CAPABILITY (E.G., INSUFFICIENT CONSUMABLES FOR RECHARGE).

Must always preserve the capability to perform a contingency EVA to bring the orbiter home safely. Reference Rule {A2.1.3-6A}, EVA GUIDELINES.

A15.1.1-16 EVA TERMINATION FOR CABIN LEAK

A SCHEDULED OR UNSCHEDULED EVA WILL BE TERMINATED FOR A CABIN LEAK WHICH CAUSES LOSS OF HIGHER PRIORITY FLIGHT OBJECTIVES OR COMPROMISES SAFE ENTRY.

This rule assumes that the leak is in the inner hatch and became evident after the start of the EVA.

FLIGHT RULES

A15.1.1-17 PAYLOAD BAY CONFIGURATION POST-EVA

AT THE END OF AN EVA, THE PAYLOAD BAY WILL BE LEFT IN A CONFIGURATION WHICH DOES NOT REQUIRE A SUBSEQUENT EVA FOR DEORBIT. EXCEPTIONS:

- A. ABORT THE EVA.
- B. A SPECIFIC PAYLOAD HAS THE CAPABILITY TO BE JETTISONED OR STOWED BY REMOTE ACTION.

It can never be assumed that there will be the time or consumables available for a subsequent EVA to clean up the payload bay:

- a. The first exception is the case when an EVA must be aborted because an EV crewmember's life might be in jeopardy. In that case, repressurization of the airlock is the immediate priority.*
- b. The second exception is allowed since the payload in question has the capability to be jettisoned or stowed remotely (e.g., cabin switch or ground command) if a subsequent orbiter condition would preclude a second EVA for entry safing.*

A15.1.1-18 PAYLOAD OPERATION/DEPLOY GUIDELINE

PAYLOADS OPERATIONS THAT REQUIRE AN UNSCHEDULED EVA AS A THIRD LEVEL OF REDUNDANCY MAY OPERATE PRIOR TO 48 HOURS ASSUMING THE UNSCHEDULED EVA CAN BE DELAYED UNTIL AFTER 48 HOURS.

PREFLIGHT-IDENTIFIED EXCEPTIONS WILL BE DOCUMENTED IN THE FLIGHT SPECIFIC FLIGHT RULES, SECTION 2.

Due to the possibility that the crew may be disabled by SAS, payload operations which would require a quick mandatory response EVA should not be started prior to 48 hours. Unscheduled EVA's will be defined preflight as to the nature of the response time required. Certain payloads may require an unscheduled EVA earlier than 48 hours. These payloads will have processed exemptions to the generic EVA rules and each will have a rule in the Flight Specific Annex to govern the conduct of unscheduled EVA.

FLIGHT RULES

A15.1.1-19 **UNSCHEDULED EVA PREPARATION**

IF A FAILURE HAS OCCURRED IN A PAYLOAD THAT WOULD PLACE CONTINUED OPERATION/DEPLOYMENT ONE FAILURE AWAY FROM AN UNSCHEDULED EVA, THE FLIGHT DIRECTOR MAY DELAY PAYLOAD OPERATIONS UNTIL EMU CHECKOUT AND THE 10.2 EVA PREBREATHE PROTOCOL ARE COMPLETED TO SET UP FOR THE POTENTIAL UNSCHEDULED EVA. CASES IDENTIFIED PREFLIGHT WILL BE DOCUMENTED IN THE FLIGHT SPECIFIC FLIGHT RULES, SECTION 2.

Based on the nature of the payload failure and the current condition of orbiter systems, it may be appropriate to delay payload operations or a deployment until preparations can be completed to accomplish an unscheduled EVA. Certain payload operations are allowed to continue even though we may be one failure away from an EVA. This is due to: (1) confidence in the remaining system, (2) the payload may be jettisonable, (3) there is already a scheduled EVA available, or (4) continuing to deploy is safer than waiting (e.g., TDRS).

A15.1.1-20 **ECG TELEMETRY CHECKOUT**

IF POSSIBLE, ECG TELEMETRY SIGNAL QUALITY WILL BE CHECKED PRIOR TO EVA.

The rule allows for troubleshooting of hardware or adjusting of sensors prior to EVA if no signal is received. Biomed is not a requirement for any EVA.

Rule {A15.1.2-2-N}, EMU GO/NO-GO CRITERIA, references this rule. ©[090894-1669A] ©[ED]

A15.1.1-21 **LEAKING RCS THRUSTER/APU AVOIDANCE**

AN EVA CAN BE PERFORMED DURING A KNOWN RCS JET OR APU LEAK. THE EVA CREWMEMBER WILL AVOID THE IMMEDIATE VICINITY OF THE LEAKING JET OR APU.

For RCS or APU leaks, the propellant tends to sublime very quickly and is not considered to be a threat to the crewmember as long as he stays out of the vicinity. The propellant has no effect on the EMU in small quantities.

FLIGHT RULES

A15.1.1-22 RCS/APU THRUSTER PLUME AVOIDANCE

AN ~~EVA~~EMU/MMU CREWMEMBER SHALL NOT BE POSITIONED WITHIN THE FOLLOWING DISTANCES OF AN RCS THRUSTER WITH DRIVER POWER ON OR THE EXHAUST PORT OF AN OPERATING APU (ALONG PRIMARY AXIS).
@[021199-6747B]

PRCS - 27 FEET

VRCS - 3 FEET

APU - 3 FEET

These distances are conservative estimates based on the thermal effects of the jets on the EMU, particularly the visor, which is most sensitive to thermal extremes. These numbers were generated from analytical tests which modeled the heat flux from the respective jets and the thermal characteristics of the visor. Crew injury/EMU damage may result from hydrazine brought into the cabin after being picked up from an operating APU. Flight Rule {A6.1.2-22A}, RCS JET DRIVER MANAGEMENT (CIL), requires primary RJD's to be powered off while the crew is outside the payload bay envelope. The EVA checklist "CONTINGENCY DAP/JET CONFIG" directs the crew as to which jets to inhibit or power off based on EVA crew location.

A15.1.1-23 EV CREW IN VICINITY OF ACTIVE PAYLOAD RETENTION LATCH ASSEMBLIES

WHEN PAYLOAD RETENTION LATCH ASSEMBLIES MUST BE OPERATED AND EV CREWMEMBERS MAY BE WITHIN REACH, THEN THE EV CREW SHALL STAY CLEAR OF THE LATCHES AT THE TIME OF ACTUATION AND THE EV CREWMEMBERS SHALL GIVE THE GO FOR LATCH OPERATION.

Latch actuation without regard for EVA crewmembers constitutes a potential pinch hazard. The path traced by the motion of a latch is sufficiently localized for EV crewmembers to avoid when they are warned and properly positioned during the actuation.

FLIGHT RULES

A15.1.1-24 EVA OPERATIONS IN THE GENERIC PAYLOAD BAY ENVELOPE

EVA OPERATIONS MAY BE CONDUCTED IN ANY REGION OF THE GENERIC PAYLOAD BAY ENVELOPE. THE GENERIC PAYLOAD BAY ENVELOPE IS DEFINED AS THOSE REGIONS OF THE PAYLOAD BAY ACCESSIBLE TO THE UNAIDED EVA CREWMEMBER (E.G., NOT ATTACHED TO THE RMS, ~~USING AN MMU,~~ ETC.) WITH THE FOLLOWING EXCEPTIONS: @J021199-6747B1

- A. FOR $X_0 = 576$ TO $X_0 = 596$, THE CREWMEMBER MUST REMAIN BELOW THE LEVEL OF THE PAYLOAD BAY DOOR MOLD LINE.
- B. FOR $X_0 = 576$ TO $X_0 = 815$, THE CREWMEMBER MUST REMAIN ON THE INBOARD SIDE OF THE STARBOARD EVA SLIDEWIRE.

THIS AREA WILL BE PROTECTED FROM S-BAND PER RULE {A11.1.1-8}, ORBITER S-BAND OPERATIONS DURING EVA, AND KU-BAND PER RULE {A11.1.1-7}, KU-BAND OPERATIONS DURING EVA. @ED]

EVA operations for the unaided crewmember in the payload bay are constrained by potential RF radiation exposure from only two sources. Those sources are represented by the restrictions in paragraphs A and B.

S-band radiation from the orbiter S-band PM antennas creates the restriction in paragraph A. This limit means that the crewmember must stay below the mold line for the first 20 inches aft of the 576 bulkhead. This requirement is based upon the need to remain 1 meter away from all S-band antennas.

Paragraph B is created by the need to maintain a reasonable level of Ku-band communications while not overly restricting EVA mobility. This limit implies that the crewmember must stay on the inboard side of the starboard slidewire for the first 20 feet of its length. This limitation will allow the use of a 0-degree Beta mask and a Beta-only operating mode for the Ku-band system. It should be understood that this rule does not require the use of any specific Beta mask, only that the volume was designed with Beta = 0 degree as an acceptable value. This requirement is based on the need to prevent Ku-band exposures for the EVA crewmember from exceeding the 20 V/M certification limit for the EMU at Ku-band. If there are no planned EVA operations outboard of the starboard slidewire, then the normal Ku-band operating mode of Beta + mask with Beta = 21 degrees may be used. @ED]

FLIGHT RULES

A15.1.1-25 ORBITER EVA OPERATIONS NEAR S-BAND ANTENNAS

EVA OPERATIONS MAY NOT BE CONDUCTED WITHIN 1 METER OF ANY ORBITER S-BAND ANTENNA UNLESS STEPS HAVE BEEN TAKEN TO PREVENT THAT ANTENNA FROM RADIATING.

An S-band dipole antenna's "near field" is generally considered to extend approximately 1 meter from the antenna in all directions. Within this near field, exact field intensities cannot be computed and as such could exceed the acceptable level for the EMU (120 V/M). If an antenna is totally inhibited (e.g., PI turned OFF or S-band FM forced to the lower antenna by crew switch), then the EVA crewmember is not at risk in approaching these antennas. Since an S-band PM antenna could begin radiating without warning, the crewmember must stay 1 meter away to ensure his/her safety

Reference Documentation: United Technology/Hamilton Standard Engineering Memorandum EMUM-604, April 30, 1992.

FLIGHT RULES**A15.1.1-26 KEEPOUT ZONE FOR EVA OPERATIONS NEAR THE ORBITER UHF PAYLOAD BAY ANTENNA**

- A. WHEN THE SPACE-TO-SPACE ORBITER RADIO (SSOR) IS IN HIGH POWER MODE, THE EVA KEEPOUT ZONE IS 0.7 METER (2.3 FEET) OVERHEAD AND 0.4 METER (1.3 FEET) FROM THE SIDE OF THE UHF PLB ANTENNA RADOME SURFACE. @[040899-6873A]
- B. WHEN THE SSOR IS IN LOW POWER MODE, THE EVA KEEPOUT ZONE IS 0.14 METER (0.5 FEET) OVERHEAD AND FROM SIDE OF THE UHF PLB ANTENNA RADOME SURFACE.

~~ALSO SEE INCO FLIGHT RULE COMPLIMENT, A11.1.1-8.1.~~

The SSOR and UHF PLB antenna are required for EVA communications with the crew, and the EV crew will nominally translate in close proximity to the UHF PLB antenna. During EVA, the SSOR nominally operates in low power mode (UHF PWR AMP off) and a 0.14 meter (6 inch) keepout zone precludes exposure of the EMU to excessive RF radiation (30 V/m). If the SSOR operates in high power mode (UHF PWR AMP on), the keepout zone increases to 0.7 meter (2.3 feet) overhead and 0.4 meter (1.3 feet) from the side. If the EV crew violates the keepout zone in low power mode, a potential exists to temporarily bias the EMU SOP transducer high and cause RF interference to the SSER (momentary ratty or broken comm). If the KOZ is violated in high power, potential exists to cause the EMU CWS to malfunction, trip EMU current limiters, damage the SSER, and exceed the physiological limit (102 V/m).

The SSOR operating frequency also effects the EMU. If the SSOR is in 414.2 MHz (nominal frequency) and inadvertently switches from low to high power mode while the crew maintains the low power keepout zone (0.14 meter, or 6 inches), sufficient margin still remains to protect the crewmember and EMU from harm. In 417.1 MHz, the EMU margin is still sufficient but is reduced, resulting in greater susceptibility to CWS and EMU current limiter malfunctions.

Provided that the crew maintains the specified keepout zones, the physiological limit (102 V/m) will not be exceeded. The analysis showed that no physiological impacts would be incurred when at the physiological limit (102 V/m) for an 8 hour duration. In low power mode, the physiological limits are reached at the radome top surface and 0.05 meter (2 inches) from the side. In high power, the limits are reached at 0.06 meter (2.5 inches) from the radome top surface and 0.12 meter (5 inches) from the side.

Reference Rule {A11.1.1-X}, SSOR OPERATIONS DURING EVA.

DOCUMENTATION: Orbit Flight Techniques Panel #171, EVA Space-to-Space Communications UHF PLB Antenna Keep-Out Zones, NASA Extravehicular Mobility Unit (EMU) with ISS EMU Umbilical Electromagnetic Compatibility Certification Test Report for the International Space Station/Orbiter Requirements (Hamilton-Standard EMU 1-13-025), and IEEE Standards for Safety Levels with respect to Human Exposure to Radio Frequency Electromagnetic Fields, 3 kHz to 300 GHz (IEEE C95.1-1991). @[040899-6873A]

FLIGHT RULES

FLIGHT RULES

THIS PAGE INTENTIONALLY BLANK

FLIGHT RULES

LOSS/FAILURE DEFINITIONS

A15.1.2-1 EVA CAPABILITY

EVA CAPABILITY IS CONSIDERED LOST IF UNABLE TO DEPRESSURIZE/REPRESSURIZE THE AIRLOCK WHILE MAINTAINING CABIN INTEGRITY.

The inability to depressurize/repressurize the airlock while maintaining cabin integrity resolves to a leaking airlock hatch. If either hatch leaks at greater than 0.2 psi/min airlock pressure decay rate, the EVA capability is lost.

A15.1.2-2 EMU GO/NO-GO CRITERIA

THE EMU CAPABILITIES LISTED IN THE EMU GO/NO-GO MATRIX ARE CONSIDERED LOST IF ONE OF THE FOLLOWING CONDITIONS ARE MET:
@[090894-1669A]

- A. SUIT PRESSURE INTEGRITY - EMU PRESSURE DECAY > 0.3 PSI/MIN DURING INTEGRITY CHECK. @[090894-1669A]

A leak > 0.3 psi/min can no longer be considered a worst case for EMU specification leakage (i.e., seal leaks and metabolic use). At greater than 0.3 psi/min, there is some other leak that could possibly propagate. @[090894-1669A]

The automated leak check will report failure when the pressure drop is 0.3 psi or greater for 1 minute. A 2-minute, manual leak check is performed during EMU checkout where failure is determined by a pressure drop of 0.3 psi or greater.

For loss of suit pressure integrity, if the failure occurs prior to EVA, the EMU is considered to be non-fail-safe and is therefore NO-GO for EVA. If the failure occurs during EVA, the SCU may provide a safe configuration if the leak (minor leak) does not allow the suit pressure to drop below the caution and warning SUIT P LOW limit (4.05 psid). If this is the case, then a TERMINATE EVA (i.e., enter airlock, connect SCU) is required for the affected crewmember. If the suit leak allows the suit pressure to drop below the CWS limit (major leak), an ABORT EVA (i.e., both crewmembers enter airlock and perform emergency repress) is required. @[090894-1669A]

THIS RULE CONTINUED ON NEXT PAGE

FLIGHT RULES

A15.1.2-2 EMU GO/NO-GO CRITERIA (CONTINUED)

- B. PRIMARY O₂ TANK PRESSURE INTEGRITY - PRIMARY O₂ PRESSURE DECAYS AT A RATE > 110 PSI/24 HRS FROM A FULLY CHARGED STATE, AND LEAK RATE IS SUCH THAT IT WILL PRECLUDE SAFE COMPLETION OF THE INTENDED EVA TASK. ©[090894-1669A]

The primary O₂ tanks are considered fully charged when they are pressurized > 850 psi. Leak rates > 110 psi/24 hrs are indicative of a significant primary tank leak. An excessive external leak of the primary O₂ tanks will cause the primary O₂ supply to be depleted at a higher than normal rate. However, in the case where an excessive external leak is detected, real-time analysis may indicate that the leak will not preclude an EVA for the intended tasks. Further testing may determine that the leak is internal to the suit volume, which may not impact the O₂ use rate during EVA.

The EMU is considered NO-GO for EVA for a major leak. A major leak is a leak rate that is too high to support on the SCU (i.e., requires more O₂ than can be provided by the orbiter, case specific). If a major leak happens during EVA, then an ABORT EVA is required, since the EMU is no longer capable of remaining at vacuum. A minor leak is a leak rate that can be supported on the SCU. The EMU is considered GO for EVA if the leak is minor and if periodic recharges do not interfere with completing the EVA tasks. The EMU is considered GO to remain on the SCU if the leak is a minor leak and if frequent recharges interfere with completing the EVA tasks. If this happens during EVA, then a TERMINATE EVA is required for the affected crewmember. Leak propagation is not a concern with primary O₂ tank leaks because the seals in this system are hard/static seals.

- C. PRESSURE REGULATION - SUIT PRESSURE CANNOT BE MAINTAINED IN A RANGE ABOVE THE SOP REGULATION PRESSURE AND BELOW THE POSITIVE PRESSURE RELIEF VALVE (PPRV) CRACKING PRESSURE.

If the primary suit regulator cannot maintain suit pressure above SOP regulation pressure, the SOP will flow during the EVA and the emergency oxygen supply will be consumed, eventually making the SOP incapable of supporting 30 minutes of DCM purge flow. If the primary suit regulator cannot regulate below the positive pressure relief valve (PPRV) cracking pressure, the PPRV will open during the EVA and primary oxygen will be depleted more rapidly than normal.

The operational specification for the primary regulator with the O₂ actuator in PRESS or EVA is 4.2 to 4.4 psid. Checkout values outside of this range warrant further investigation to ensure that the requirements of this rule will be met. If the primary regulator is determined to be stable between 4.05 - 4.55 psid, then SOP flow and PPRV cracking should not be a concern since the specifications of the SOP regulator and PPRV will not overlap this range. If the primary regulation pressure is outside of the 4.05 to 4.55 psid range, real-time analysis considering the preflight performance of the specific EMU will be required. ©[090894-1669A]

THIS RULE CONTINUED ON NEXT PAGE

FLIGHT RULES

A15.1.2-2 EMU GO/NO-GO CRITERIA (CONTINUED)

The specification for SOP regulation is 3.33 to 3.9 psid (dependent on flow rate). The specification for the minimum cracking pressure for the PPRV is 4.7 psid. A "SUIT P LOW" message occurs when sensed suit pressure is less than 4.05 psid. A "SUIT P EMERG" message occurs when sensed suit pressure is less than 3.10. A "SUIT P HIGH" message will occur when sensed suit pressure is 4.55 psid or greater. ©[090894-1669A]

For scheduled or unscheduled EVA's, the EMU is considered to be non-fail-safe and is therefore NO-GO. For contingency EVA's, the EMU is considered GO for SCU ops to be available for rescue/assist scenarios. For either types of EVA's, if a pressure regulation failure happens during EVA, a TERMINATE EVA is required for the affected crewmember.

D. OPERATIONAL SECONDARY OXYGEN PACK (SOP) :

1. SOP BOTTLE PRESSURE (AT IV AMBIENT TEMPERATURES)
< PRESSURE NEEDED TO PROVIDE A MINIMUM OF 30 MINUTES
SECONDARY O₂.

The SOP must be capable of supporting (with DCM purge valve open) a minimum of 30 minutes. The design specification for the EMU SOP bottle pressure is ³ 5800 psig (at ambient IV temperatures) which guarantees a minimum of 30 minutes secondary O₂. However, engineering analysis has shown that the performance characteristics of a specific EMU may permit a minimum of 30 minutes secondary O₂ for bottle pressures < 5800 psig. If the bottle pressure is < 5800 psig, calculations must be performed based on the performance of the specific EMU to determine the actual minimum (30-minute) bottle pressure.

For scheduled or unscheduled EVA's, the EMU is considered to be non-fail-safe and is therefore NO-GO. For contingency EVA's, the EMU is considered GO for SCU ops to be available for rescue/assist scenarios.

2. SOP REGULATOR IS NOT CAPABLE OF MAINTAINING SUIT
PRESSURE ABOVE 3.33 PSI AND BELOW PRIMARY O₂
REGULATION PRESSURE FOR 30 MINUTES DURING EMERGENCY
DCM PURGE.

The operational specification for the SOP regulator is 3.33 to 3.9 (dependent on flow rate). SOP checkout values outside of this range warrant further investigation to ensure that the requirements of this rule will be met. Emergency DCM purge is representative of the worst case oxygen demand that could occur during an EVA. The SOP must be capable of maintaining suit pressure at a safe level (> 3.33 psi) during an emergency purge configuration (DCM purge valve open). An SOP that is regulating above the specification limit of 3.9 is satisfactory as long as it is regulating below the regulation pressure of the primary regulator. If the SOP regulates above the primary regulator pressure, the SOP oxygen will be consumed instead of primary oxygen. If this occurs during EVA, a TERMINATE EVA is required for the affected crewmember. ©[090894-1669A]

FLIGHT RULES

THIS RULE CONTINUED ON NEXT PAGE

FLIGHT RULES**A15.1.2-2 EMU GO/NO-GO CRITERIA (CONTINUED)**

For scheduled or unscheduled EVA's, the EMU is considered to be non-fail-safe and is therefore NO-GO. For contingency EVA's, the EMU is considered GO for SCU ops to be available for rescue/assist scenarios.

3. SOP FIRST STAGE REGULATION PRESSURE CANNOT BE MAINTAINED BELOW 600 PSIG AS MEASURED BY THE INTERSTAGE GAUGE DURING SOP CHECKOUT. @[090894-1669A]

The primary intent of the interstage gauge (located between the first- and second-stage pressure regulators) is to detect excessive leakage or failed open conditions related to the SOP first-stage regulator. Preflight processing also uses this gauge as a reference point for first-stage regulation. The 600 psig value is based on nominal first-stage regulation of 200 psig added to the +400 psig gauge tolerance. Due to the inaccuracy of the gauge at the low end (+400/-200 psig), detection of regulator shifts is difficult. However, gauge readings are worthwhile for comparison with pre-flight data. A failed SOP first-stage regulator followed by a failed SOP second-stage regulator will result on rapid suit overpressurization and rupture.

For scheduled or unscheduled EVA's, the EMU is considered to be non-fail-safe and is therefore NO-GO. For contingency EVA's, the EMU is considered GO for SCU ops to be available for rescue/assist scenarios.

- E. MINIMUM RF COMMUNICATIONS (REF. RULE {A15.1.1-7}, MINIMUM RF COMMUNICATIONS DEFINITION)

For crew safety, two-way voice (including relay) communication must be available. Crewmembers must preserve the availability to vocally communicate in case assistance or aid is necessary in areas where the crewmember might not be able to maintain visual contact.

For scheduled or unscheduled EVA's, the EMU is considered to be non-fail-safe and is therefore NO-GO. For contingency EVA's, the EMU is considered GO for SCU ops to be available for rescue scenarios. For either types of EVA's, if the failure happens during EVA, a TERMINATE EVA is required for the affected crewmember.

- F. POSITIVE PRESSURE RELIEF VALVE - FAILS CLOSED DURING DEPRESS

This failure is only detected during depressurization. The EMU is considered NO-GO for EVA if the valve cannot be opened, because the EMU is not fail-safe for overpressurization. @[090894-1669A]

THIS RULE CONTINUED ON NEXT PAGE

FLIGHT RULES

A15.1.2-2 EMU GO/NO-GO CRITERIA (CONTINUED)

- G. VENTILATION FLOW - INSUFFICIENT FLOW (< 4.0 ACFM) TO PROVIDE CO₂ REMOVAL FROM THE HELMET OR DEFOGGING CAPABILITY. ©[090894-1669 A]

The vent flow sensor detects low flow at less than 4.0 acfm, and the CWS message (NO VENT FLOW) is triggered when vent flow drops below this level. This is the minimum flow required to adequately remove CO₂ from the helmet. CO₂ buildup in the helmet will lead to hypercapnia (excess CO₂ in the blood stream) which increases heart and respiration rate and can impair a crewmember's judgment and ability to perform the EVA task. Hypercapnia will eventually lead to an unconscious crewmember. Normal ventilation flow is 6 to 8 acfm. Helmet purge valve may be used to provide alternate vent flow if EMU consumables can be managed to support this.

Insufficient ventilation flow will also increase the fogging of the visor. This will hinder the crewmember's vision and will impair their ability to perform the EVA task. Under this condition while EVA, the crewmember is in a safe configuration while attached to the SCU. The EMU is somewhat degraded, but operational, for a possible crewmember assist/rescue scenario.

- H. CO₂ CONTROL - PPCO₂ LEVEL CANNOT BE MAINTAINED BELOW 8.0 MMHG.

For PPCO₂ indication of 8 mmHg by the CWS, the actual level in the helmet may be 15 mmHg or higher depending on metabolic rate. Problems arise if the crewmember's symptoms coincide with this PPCO₂ level and the contaminant control cartridge cannot be replaced. This PPCO₂ level will cause physiological changes (hypercapnia) that can impair the crewmember's judgment and ability to perform the EVA task. Reference Rule {A13.1.2-4-B}, PPCO₂ CONSTRAINT. ©[ED]

Under this condition, the crewmember is in a safe condition while attached to the SCU with the helmet purge valve open. The EMU is somewhat degraded, but operational, for a possible crewmember assist/rescue scenario.

- I. BATTERY POWER - EMU BATTERY IS NOT CAPABLE OF PROVIDING POWER.

The EMU battery provides power for all EMU systems once off of the SCU. At cabin pressure, the battery may be replaced by a spare and the EMU is GO-For-EVA. If a spare is unavailable, the EMU will be able to remain on the SCU for a possible crewmember assist/rescue scenario.
©[090894-1669A]

THIS RULE CONTINUED ON NEXT PAGE

FLIGHT RULES

A15.1.2-2 EMU GO/NO-GO CRITERIA (CONTINUED)

- J. THERMAL CONTROL - THERMAL CONTROL CANNOT BE MAINTAINED IN A TOLERABLE RANGE THROUGHOUT ALL SUITED OPERATIONS WHILE STILL PROVIDING AN ADEQUATE LEVEL OF WATER VAPOR REMOVAL. ©[090894-1669 A]

Thermal control must be maintained throughout all EMU suited operations. If water vapor produced by the crewmember and as a byproduct of the chemical reaction of CO₂ with LiOH is not removed, excessive water vapor levels in the EMU will cause fogging of the visor, degrading crewmember visibility. If cooling control is lost, it may be possible, if the crewmember is too cold, for the crewmember to manage cooling by periodically opening and closing the feedwater shutoff valve. Another option, if the crewmember is too hot, involves opening one of the two available purge valves on the suit. The feasibility of utilizing these options is case dependent.

If thermal control is lost via the SCU, the EMU is considered GO for EVA, since cooling will be restored once at vacuum when the sublimator is activated. If this is the case, when not on the sublimator, cooling must be provided through the DCM purge valve, assuming that the SCU can support the purge flow for the required time or by swapping SCU's if possible. If the failure happens during EVA, the EMU is considered GO to continue EVA. If thermal control is lost via the EMU (i.e., failure in either sublimator or LCVG), the EMU is considered GO to remain on the SCU, since cooling will be provided via the SCU (for sublimator failure) or will be provided with the DCM purge valve (for LCVG failure), assuming the SCU can support the purge flow for the required time. If the failure happens during EVA, a TERMINATE EVA is required for the affected crewmember.

- K. CRITICAL INSTRUMENTATION:

1. LOSS OF EVA CREW'S CAPABILITY TO MONITOR BOTH SUIT PRESSURE SENSOR AND DISPLAY AND CONTROL MODULE (DCM) SUIT PRESSURE GAUGE.

The capability must exist to monitor suit pressure via either the pneumatic gauge or the pressure transducer at all times during the EVA

With the loss of both suit pressure transducer and gauge, there is no indication to the crewmember of suit pressure. For a scheduled or unscheduled EVA, the EMU is considered NO-GO. Since a third failure has to occur before the crewmember's life is in danger, the EMU is considered GO for SCU ops for a contingency EVA so that the crewmember is available for rescue ops. ©[090894-1669A]

THIS RULE CONTINUED ON NEXT PAGE

FLIGHT RULES

A15.1.2-2 EMU GO/NO-GO CRITERIA (CONTINUED)

2. LOSS OF OPERATIONAL CWS: @[090894-1669A]

Reference Rule {A15.1.1-8}, OPERATIONAL CAUTION AND WARNING SYSTEM (CWS) DEFINITION.

- a. BITE LIGHT ILLUMINATED UNLESS "LIMITS BAD" MESSAGE PRESENT.

The built-in test equipment (BITE) light is illuminated when the BITE circuitry has detected either a hardware or software problem within the CWS. If, upon inspection, the status list can be verified to be functioning properly, the CWS is considered operational. If the status list cannot be verified to be operating normally, the CWS is not considered to be operational. If the BITE is illuminated and LIMITS BAD message is present, the CWS is considered to be operational because the BITE circuitry has already verified that the status list is good and the problem resides in PROMS which contains only CWS limits.

- b. CREWMEMBER OR MCC DETERMINES INSUFFICIENT RELIABLE DATA AVAILABLE.

For the loss of operational CWS, the crewmember is in a safe condition while attached to the SCU. The EMU is somewhat degraded, but operational, for a possible crewmember assist/rescue scenario.

3. DCM DISPLAY - CREWMEMBER IS UNABLE TO READ DCM DISPLAY AND MCC CANNOT MONITOR EMU DATA VIA REAL-TIME DATA SYSTEM.

EMU is considered GO (fail-ops) if MCC is capable of monitoring EMU status via the EMU Real-Time Data System (RTDS). EMU is considered GO to remain on the SCU if MCC monitoring capability is not available. If the failure happens during EVA, EMU is considered GO to continue EVA, unless MCC monitoring capability of EMU data is lost. If MCC monitoring capability is lost, then a TERMINATE EVA is required by the affected crewmember. @[090894-1669A]

THIS RULE CONTINUED ON NEXT PAGE

FLIGHT RULES**A15.1.2-2 EMU GO/NO-GO CRITERIA (CONTINUED)**

L. SINGLE COMPONENT INSTRUMENTATION - LOSS OF ONE OF THE FOLLOWING SENSORS: @[090894-1669A]

SUIT PRESSURE XDUCER	SUBLIMATOR PRESSURE XDUCER
XDUCER	SOP PRESSURE XDUCER
VENT FLOW SENSOR	SOP INTERSTAGE GAUGE
CO ₂ XDUCER	H ₂ O GAS PRESSURE XDUCER
BATTERY VDC XDUCER	H ₂ O WATER PRESSURE XDUCER
BATTERY AMP XDUCER	H ₂ O TEMPERATURE XDUCER
O ₂ PRESSURE XDUCER	

EMU is considered GO (fail-ops). For the loss of any one sensor or transducer, the integrity of the system monitored by the failed sensor can be monitored via other sensors. A failure in that system will be manifested by a warning message from another sensor or by some other noticeable indication. For CO₂ transducer loss, the ability to detect a high CO₂ level relies entirely on the crewmember's ability to detect physiological symptoms and take appropriate action as required, such as purge valve activation (Rule {A13.1.2-4B}, PPCO₂ CONSTRAINT, rationale indicates symptoms of CO₂ exposure). For SOP interstage gauge loss, there is no other instrumentation device available in flight to verify SOP first-stage regulation. For any single sensor loss, consider using EMU 3 (if available) to regain full operational capability, depending on the extent of resizing necessary to accommodate the affected crewmember.

M. SCU POWER - NO POWER PROVIDED TO EMU THROUGH SERVICE AND COOLING UMBILICAL.

The EMU is considered fully operational on battery power. Battery may need to be changed out prior to depressurization to preserve full EVA time capability. EMU is considered GO-for-EVA under this condition.

THIS RULE CONTINUED ON NEXT PAGE

FLIGHT RULES

A15.1.1.2-2 EMU GO/NO-GO CRITERIA (CONTINUED)

N. ECG TELEMETRY - NO ECG TELEMETRY IS PROVIDED TO MCC.

The EMU is considered fully operational. Reference Rule {A15.1.1-20}, ECG TELEMETRY CHECKOUT. @090894-1669A]

O. LOSS OF OPERATIONAL EMU HEATED GLOVE(S) IS NOT A CONSTRAINT TO PERFORMING AN EVA. -@[111298-6755A]

1. FOR A FAILURE OF HEATED GLOVES PRE-EVA AND THERMAL ANALYSIS INDICATING SKIN TEMPERATURE VIOLATIONS WITHOUT USE OF HEATED GLOVES BY THE CREW, ACTION WILL BE TAKEN TO RESTORE HEATED GLOVE POTENTIAL OR ESTABLISH CREW LIMITS WITHIN MISSION CAPABILITIES.

The actions for a failure are: EVA flights fly backup heated gloves for EV crewmembers which should be used for a heater element failure; replacement of batteries; identify to the crew potential keep-out areas or limit handling of items for durations as specified in the EMU Glove Palm Certification Curves if capability is not restored (i.e. scheduled use of items listed in paragraph 2 of rule); swapping to backup EMU components (i.e. PLSS/HUT or arm segments) for a harness failure. The last action may place an EV crewmember in a non-optimum sized EMU and is the least preferred action and will be decided real time.

The EMU is considered GO for a failure of EMU heated glove(s) before the EVA. Reasonable-Every effort will be made to restore the capability so that heated gloves will be available to the EV crewmember if preflight thermal analysis deems likely the use of heated gloves. Need for heated gloves depends on mission attitude, timelines, locations of EVA tasks, and initial hand temperatures. The heated glove system for the EMU is a simple wire harness connecting a battery to the heater elements in the glove fingertips through connectors and toggle switches routed along the outside of the PLSS and arms. For the 3-volt system, a single failure will result in the loss of only one heated glove because each has a separate wire harness and battery.

Reference Documentation: JSC-39116 (CTSD-SS-1621) EMU Phase VI Glove Thermal Vacuum Test and Analysis Final Report, "Glove Palm Certification Limits" graphs, August 20, 1998.

2. FOR LOSS OF OPERATIONAL HEATED GLOVE DURING THE EVA, THE FOLLOWING OPTIONS, LISTED IN PRIORITY, ARE AVAILABLE TO THE EV CREW:
- a. NOTIFICATION TO CREW OF POTENTIAL COLD AREAS TO AVOID, IF POSSIBLE, BASED ON THERMAL ANALYSIS.
- b. FOR SINGLE GLOVE FAILURE, USE OF NON-AFFECTED HAND FOR GRASPING AND HANDLING COLD OBJECTS. @[111298-6755A]

FLIGHT RULES

THIS RULE CONTINUED ON NEXT PAGE

FLIGHT RULES

A15.1.2-2 EMU GO/NO-GO CRITERIA (CONTINUED)

- c. USE OF BRT (OR OTHER RESTRAINT DEVICE) TO ALLOW HANDS-FREE OPERATION. @[111298-6755A]
- d. USE OF ADJUSTABLE THERMAL MITTENS.
- e. USE OF OTHER EV CREWMEMBER FOR OPERATIONS THAT ARE DEEMED TOO COLD BY THE AFFECTED EV CREW OR LIMIT HAND CONTACT DURATION.
- f. USE OF EMU LCVG BYPASS.
- g. CREW WOULD NOT WORK DURING NIGHT PASSES.
- h. EV CREW MAY MOVE TO SUN SIDE TO WARM HANDS AFTER TASK.

For a failure of the EMU heated gloves during the EVA, the EMU is GO to continue. The loss may require the affected EV crewmember to modify his/her operations as deemed necessary by that crewmember. For the 3-volt system, a single failure will result in the loss of only one heated glove because each has a separate wire harness and battery.

Restraint devices can be used to hold ORU's or restrain crewmembers to handrails. Thermal mittens may be used as an added layer to the EMU gloves but will reduce dexterity of the hands. The other EV crewmember may be used for cold tasks. Least preferred options include; EMU LCVG bypass may be used in an attempt to warm the crewmember's core temperature in an effort to warm the arms and hands, not working during night passes, or having the affected crewmember warm hands on the sun side as required.

The crewmember shall be reminded to preclude affected hand(s) from becoming too cold in the first place. Once the hands are cold, it will invalidate the crewmember's sense of temperature and lower their "threshold" of comfort. The affect is that the crewmember's hand does not need to warm as much to give the sensation of being comfortable; therefore, the hand will start at a colder initial temperature the next time it is exposed. Iterations of this process over the EVA duration could lead to tissue damage without the crewmember being aware.

Reference Documentation: JSC-39116 (CTSD-SS-1621), EMU Phase VI Glove Thermal Vacuum Test and Analysis Final Report, "Glove Palm Certification Limits" graphs, August 20, 1998. @[111298-6755A]

THIS RULE CONTINUED ON NEXT PAGE

NASA - JOHNSON SPACE CENTER

FLIGHT RULES

A15.1.2-2

EMU GO/NO-GO CRITERIA (CONTINUED)

LOSS OF:		PRE EVA			EVA			COMMENTS (FOR EVA CASE)
		NO GO	GO FOR SCU	GO FOR EVA	ABORT	TERMINATE	CONTINUE	
A	SUIT PRESSURE INTEGRITY MAJOR LEAK MINOR LEAK	X X			X	X		SUIT P LOW & O ₂ USE HIGH MSGS DISPLAYED ONLY O ₂ USE HIGH MSG DISPLAYED
B	PRIMARY O ₂ TANK P INTEGRITY MAJOR LEAK MINOR LEAK PERIODIC RECHARGE ACCEPTABLE PERIODIC RECHARGE <u>NOT</u> ACCEPTABLE	X		X	X	X		LEAK RATE TOO HIGH TO SUPPORT ON SCU RECHARGE ON SCU AS REQUIRED REMAIN ON SCU IF RECHARGE FREQUENCY TOO HIGH TO SUPPORT EVA TASKS
C	PRESSURE REGULATION HIGH LOW	X X	C C		X X			ASSUMES SCU CAN SUPPORT PPRV FLOW ASSUMES SOP OPERATIONAL
D	OPERATIONAL SOP	X	C		X			
E	MINIMUM RF COMMUNICATIONS	X	C		X			
F	POS PRESS RELIEF VALVE FAILS CLOSED	X						ONLY DETERMINED DURING DEPRESS
G	VENTILATION FLOW		X		X			ASSUMES SCU CAN SUPPORT PURGE FLOW
H	CO ₂ CONTROL		X		X			ASSUMES SCU CAN SUPPORT PURGE FLOW
I	BATTERY POWER		X		X			EMU WILL NOT HAVE POWER WHEN OFF SCU
J	THERMAL CONTROL SCU EMU		X	X	X			ASSUMES SCU CAN SUPPORT PURGE FLOW ASSUMES SCU CAN SUPPORT PURGE FLOW
K	CRITICAL INSTRUMENTATION:							
	SUIT P XDUCER & GAUGE	X	C		X			
	CWS		X		X			
	DCM DISPLAY WITH MCC MONITOR WITHOUT MCC MONITOR		X	X	X			TERMINATE EVA IF MCC MONITORING LOST
L	SINGLE COMPONENT INSTRUMENTATION:							
	SUIT P XDUCER			X		X		
	GAUGE			X		X		
	VENT FLOW SENSOR			X		X		
	CO ₂ XDUCER			X		X		
	BATTERY VDC XDUCER			X		X		
	BATTERY AMPS XDUCER			X		X		
	O ₂ P XDUCER			X		X		
	SUBLIMATOR XDUCER			X		X		
	SOP P XDUCER			X		X		
	SOP INTERSTAGE GAUGE			X		X		
	H ₂ O GAS P XDUCER			X		X		
	H ₂ O WATER P XDUCER			X		X		
	H ₂ O TEMP XDUCER			X		X		
M	SCU POWER			X		X		MAY REQUIRE BATTERY CHANGEOUT
N	ECG TELEMETRY			X		X		
O	<u>HEATED GLOVE(S)</u>			X		X		<u>WORKAROUNDS NOTED IN FLIGHT RULE</u>

FLIGHT RULES

NOTE: C = CONTINGENCY EVA ONLY @[090894-1669A] [@\[111298-6755A\]](#)

FLIGHT RULES

A15.1.2-3 RESERVED ©[021199-6747B] MMU

~~THE MMU IS CONSIDERED LOST IF:~~

~~A. EITHER CONTROL SYSTEM (A OR B) IS LOST.~~

~~*Loss of flight system redundancy due to failure of a single MMU control system is not acceptable (ref. Rule {A15.1.3 7C}, MMU STOW).*~~

~~B. EITHER HAND CONTROLLER FAILS (RHC OR THC).~~

~~*Loss of control authority of MMU due to loss of control over a single translation or rotation axis is not acceptable (ref. Rule {A15.1.3 7C}, MMU STOW).*~~

~~C. LOSS OF PROPELLANT PRESSURE INTEGRITY (A OR B).~~

~~*Loss of control system redundancy due to a propellant system leak or violation of flight specific redlines is not acceptable (ref. Rule {A15.1.3 7C}, MMU STOW).*~~

~~D. LOSS OF REDUNDANT PRIMARY LIFE SUPPORT SYSTEM (PLSS)/MMU ATTACHMENT:~~

~~1. FAILURE OF EITHER MMU/PLSS LATCH~~

~~2. FAILURE OF EITHER LAP BELT~~

~~*EMU secured to MMU without redundancy.*~~

~~E. BOTH CROSSFEED VALVES OPEN.~~

~~*This means that the MMU pilot does not have redundant system isolation capability. A single propellant leak will bring both systems down. The pilot may have initiated this condition because of a problem. Rule {A15.1.3 4}, MMU CROSSFEED VALVES, references this rule*~~

FLIGHT RULES

SYSTEMS MANAGEMENT

A15.1.3-1 DENITROGENATION

DENITROGENATION OF THE EVA CREWMEMBER WILL BE ACCOMPLISHED IN ACCORDANCE WITH AEROMED RULE {A13.1.2-7}, EVA PREBREATHE PROTOCOL.

Proper denitrogenation is required to prevent bends in the EV crewmember.

A15.1.3-2 EMU CONSUMABLES

EVA CREWMEMBER WILL INITIATE EVA TERMINATION ACTIVITIES WHEN 30 MINUTES REMAIN OF ANY EMU CONSUMABLE.

Thirty minutes is considered the redline for primary consumables, and the EVA should be terminated to prevent bringing the non-replenishable redundant system (SOP) on-line. This is considered an operational constraint.

A15.1.3-3 VACUUM TRANSFERS

VACUUM DISCONNECT/CONNECT OF THE SCU CAN BE PERFORMED TO EXTEND EVA TIME OR WHEN RETURNING TO THE AIRLOCK WITH AN EMU MALFUNCTION OR CONSUMABLES PROBLEM.

It is possible to replenish O₂ and water, to conserve power, and to provide cooling via the SCU. If a crewmember experiences difficulty with ventilation flow and/or CO₂ scrubbing, the purge operation via the helmet purge valve can be initiated while on the SCU. There is no problem with vacuum connections and this has been demonstrated numerous times. (The current flight procedures include vacuum connect/disconnect of the SCU.)

A15.1.3-4 RESERVED ©[021199-6747B] ~~MMU CROSSFEED VALVES~~

~~DURING NOMINAL MMU FLIGHT, BOTH PROPELLANT CROSSFEED VALVES WILL BE CLOSED.~~

~~*Ensures isolation capability (ref. Rule {A15.1.2-3E}, MMU).*~~

FLIGHT RULES

A15.1.3-5 RESERVED ©[021199-6747B] MMU TEMPERATURE CONSTRAINTS

~~MMU OPERATIONS WILL NOT BE INITIATED WHEN COMPONENT TEMPERATURES ARE OUTSIDE THE LIMITS LISTED BELOW. ONCE TEMPERATURES ARE BROUGHT BACK INTO NORMAL RANGE, THE MMU IS GO FOR NORMAL OPERATIONS:~~

Results of thermal qualification testing and analysis.

A15.1.3-6 RESERVED ©[021199-6747B] MMU CHECKOUT

~~PRIOR TO EVERY MMU FREE FLIGHT, A STANDARD MMU CHECKOUT PROCEDURE WILL BE PERFORMED ON THE SELECTED MMU BEFORE EGRESSING THE FLIGHT SUPPORT STATION (FSS) FOOT RESTRAINTS.~~

The standard checkout is performed to verify proper thruster and control operation prior to free flight. Checkout of the second MMU (if available) is not performed because of the orbiter rescue capability. Prior to an MMU pilot's first free flight, a familiarization free flight within the payload bay envelope may be performed for crew and system confidence. This flight is optional based on EVA time and MMU propellant constraints.

A15.1.3-7 RESERVED ©[021199-6747B] MMU STOW

~~A. FOR EMU FAILURES REQUIRING "EVA TERMINATION", THE MMU WILL BE FLOWN BACK TO THE FSS AND STOWED PRIOR TO AIRLOCK REPRESSURIZATION.~~

"EVA termination" implies that the EMU failure is such that the EVA can be concluded in an orderly but expeditious manner. The EV crewmember will have time to save the MMU for the "terminate EVA" case.

~~B. FOR EMU FAILURES REQUIRING "EVA ABORT", THE MMU WILL BE FLOWN BACK TO THE PAYLOAD BAY AND THE CREWMEMBERS WILL SELECT THE MOST EXPEDIENT METHOD OF AIRLOCK INGRESS AND PRESSURIZATION. THIS COULD REQUIRE MMU JETTISON.~~

For more serious EMU failures (i.e., loss of suit pressure), the crewmember's immediate priority is pressurization of the airlock. This may not allow time for stowage of the MMU.

FLIGHT RULES

~~C. FOR FAILURES RESULTING IN LOSS OF MMU OPERATIONAL CAPABILITY, THE MMU WILL BE RETURNED TO THE FSS AT THE NEXT OPPORTUNITY EXCEPT WHEN CAPTURING/BERTHING A FREE-FLYING SPACECRAFT AND AFTER MMU BRAKING INITIATION. THEN ONLY ONE OF TWO MMU CONTROL SYSTEMS (A OR B) IS REQUIRED FOR DOCKING AND STABILIZATION.~~

Operational capability is defined as a preservation of redundancy in the MMU flight control systems. Loss of this redundancy means the MMU is not necessarily fail safe and must be returned to the FSS. The exception is allowed to enhance MMU pilot rescue by the orbiter. A three body orbital rescue scenario is not desirable. Rules (A15.1.2-3A), B and C, MMU, reference this rule.

~~D. THE MINIMUM MMU RESTRAINT CONFIGURATION FOR ENTRY IS AS FOLLOWS:~~

NOTES:

~~[1] BOTH BOTTOM BOLTS IN ADDITION TO TOP BOLT(S) WILL MINIMIZE POTENTIAL DAMAGE TO MMU.~~

~~[2] PRD STRAP AT LEVEL OF TOP BOLTS AND PRELOADED.~~

Per structures analysis.

FLIGHT RULES

A15.1.3-8

RESERVED ©[021199-6747B] MMU APPROACH/SEPARATION

~~NORMAL FINAL APPROACH TO OR SEPARATION FROM THE ORBITER BY THE MMU WILL BE ALONG THE Z CENTERLINE OF THE PAYLOAD BAY.~~

~~Sighting of the MMU crewmember for monitoring and possible rescue is best along the Z centerline of the payload bay. This also minimizes possible plume impingement from the RCS.~~

A15.1.3-9

RESERVED ©[021199-6747B] MMU OPERATIONAL RANGE

~~A. DURING PERIODS OF ORBITAL DAYLIGHT, THE RANGE OF THE MMU FROM THE ORBITER WILL NOT EXCEED 400 FEET.~~

~~A range of 400 feet is based on simulations which show that at 500 feet the effects of orbital mechanics between the orbiter and the MMU become very pronounced. The extent of these effects at > 400 feet are such that too much propellant is used making corrections to the flight path.~~

~~B. DURING PERIODS OF ORBITAL DARKNESS, THE MMU WILL REMAIN IN THE NEAR VICINITY OF THE PAYLOAD BAY (< 200 FEET WITH OPERATIONAL LOCATOR LIGHTS AND < 50 FEET WITHOUT LOCATOR LIGHTS).~~

~~Allows the IV or EV crew to adequately monitor the MMU crewmember.~~

~~C. FOR CAPTURE/BERTHING OF A FREE FLYING SPACECRAFT DURING PERIODS OF ORBITAL DARKNESS, THE MMU WILL REMAIN IN THE PAYLOAD BAY EXCEPT WHEN ATTACHED TO A FREE FLYING SPACECRAFT.~~

~~Enhances MMU pilot and IV crew visual tracking of the spacecraft. Also minimizes risk of MMU rescue operations.~~

A15.1.3-10

EMU CONSUMABLES PRE-EVA

SUFFICIENT CONSUMABLES MUST BE AVAILABLE TO SUPPORT THE COMPLETE EVA TIMELINE PLUS 15 MINUTES OF EVA PREPARATION ACTIVITY, 15 MINUTES OF POST-EVA ACTIVITY, AND A 30-MINUTE RESERVE.

This rule is provided as an operational guide in planning EVA timelines based on consumable constraints. For purposes of EMU certification, this rule assumes 6 hours of scheduled/unscheduled EVA operations, with 15 minutes for egress, 15 minutes for ingress, and 30 minutes of primary oxygen reserve to make a total of 7 hours EVA time. In addition, a 30-minute emergency oxygen supply is provided.

FLIGHT RULES

A15.1.3-11 EMU CONSUMABLES REDLINES

THE FOLLOWING CONSUMABLES MATRIX DEPICTS THE BASIS FOR DEFINING CONSUMABLES REDLINES:

	PRIMARY O ₂ (PSIA)	SECONDARY O ₂ (PSIA)	WATER (LBM)	POWER (AMP-HR)	LiOH (BTU)
QUANTITY LOADED (NOMINAL)	850	6000	8.8	26.6	9000
RESIDUAL	75	300	0	N/A	0
RESERVES (30 MIN)	129 [1]	N/A	[1]	[1]	[1]
MEASUREMENT ERROR	±27.5	±259 (TANK SENSOR) ±400 (TANK GAUGE) +400/-200 @200 PSIA (INTERSTAGE GAUGE)	N/A	N/A	N/A
EST USE RATE					
PREBREATHE:	0	0	0	0	500 BTU/HR
EVA	1.8 PSI/MIN	0	1.2 LB/HR	3.7 A	1000 BTU/HR
HELMET PURGE	[2]	[2]	1.2 LB/HR	3.7 A	0
DCM PURGE	[2]	[2]	0	1.0 A (NO FAN)	0

NOTES:

[1] THE EMU C&W SYSTEM PROVIDES 30-MINUTE LIMITING CONSUMABLE MESSAGES FOR:

- a. OXYGEN: WHEN O₂ TIME LEFT = $\frac{O_2 P - 75}{O_2 \text{ USE RATE}} = 30 \text{ MINUTES.}$
- b. WATER: WHEN H₂O GAS PRESS - H₂O WATER PRESS > 2.1 PSID.
- c. POWER: WHEN PWR TIME LEFT = $\frac{26.6 - \text{AMP HR USED}}{\text{PWR USE RATE}} = 30 \text{ MINUTES.}$
- d. LiOH: WHEN PPCO₂ > 3 mmHg, THE CREWMEMBER IS ALERTED TO IMPENDING LiOH BREAKTHROUGH.

THE PERCENTAGE OF O₂ AND POWER REMAINING IS DISPLAYED TO THE CREWMEMBER. THE LIMITING CONSUMABLE AND THE TIME LEFT IN THE EVA IS ALSO DISPLAYED.

[2] TOTAL PURGE TIME AVAILABLE (SOP = 5800 PSI):

	O ₂ PRESS AT PURGE INITIATION	
	850 PSI	75 PSI
HELMET PURGE	67 MIN	44 MIN
DCM PURGE	47 MIN	30 MIN

FLIGHT RULES

A15.1.3-12 MANIPULATOR FOOT RESTRAINT (MFR) AND PFR ATTACHMENT DEVICE (PAD) GUIDELINES

- A. ONLY MINIMUM COMMUNICATIONS FOR EVA BETWEEN THE RMS OPERATOR AND THE MFR/PAD OPERATOR ARE REQUIRED. (REF. RULE {A15.1.1-7}, MINIMUM RF COMMUNICATIONS DEFINITION.)

The EVA crewmember on the MFR/PAD has the best vantage point from which to direct the operator of the RMS to and about the worksite. Communications between the RMS operator and the MFR/PAD operator will maximize safety. Minimum communication is two-way communication with the orbiter even if relayed through the other EVA person.

- B. VISUAL VERIFICATION OF MFR/PAD POSITION/CLEARANCE IS REQUIRED.

This is to preclude contact and possible damage to payloads and structures in the payload bay imparted by the RMS and MFR/PAD.

- C. MFR/PAD WILL BE OPERATED ONLY IN THOSE AREAS WHERE THE RMS CANNOT IMPART EXCESSIVE LOADS TO THE EMU.

In certain configurations, the arm can impart excessive loads to the EMU and the EVA crewmember. The PLSS (the part of the EMU least tolerant to impact forces) is certified for a maximum 400-lb impact force on a 2-inch diameter sphere at a 2 ft/sec velocity before impact. The RMS will be kept out of regimes where impact loads of this type are possible to minimize the possibility of damage to the EMU.

FLIGHT RULES

EXTERNAL AIRLOCK

A15.1.4-1 EXTERNAL AIRLOCK HATCH THERMAL COVER

DURING EVA, THE EXTERNAL AIRLOCK HATCH THERMAL COVERS FOR THE UPPER AND AFT HATCHES SHOULD REMAIN CLOSED. IF EITHER COVER OPENS DURING EVA, AN EVA CREWMEMBER WILL RETURN TO THE AIRLOCK TO CLOSE IT AT THE NEXT CONVENIENT OPPORTUNITY. @I061297-4904]

This rule is constrained by the orbiter cold case attitude (+XSI, PLB to space, beta = 90, or -XLV, PLB north, beta = -75). Design analysis that considered a closed hatch and thermal cover indicated that the water lines will approach freezing temperatures during the EVA period, even with the heaters enabled (for the analysis, the EVA period was defined as 10 hours with the airlock depressurized).

The airlock internal water lines are thermally insulated from the airlock structure by fiberglass standoffs. The segments of the internal water lines that have a direct view of deep space when both hatch and thermal cover are opened, will decrease more rapidly than the airlock structure. Therefore, there is a potential of the internal water lines freezing if the hatch thermal cover remains open during the EVA period.

Analysis indicates that when the airlock is pressurized, there is no concern for water line freezing regardless of the position of the hatch thermal cover.

DOCUMENTATION: Rockwell OER Presentation Charts September 18, 1996, and November 6, 1996, Rockwell IL 270-200-97-007, engineering judgment. @I061297-4904]

FLIGHT RULES

A15.1.4-2 EXTERNAL AIRLOCK LCG PRESSURE AND TEMPERATURE MANAGEMENT USING THE EMU

THE SERVICE AND COOLING UMBILICAL (SCU) WILL NOMINALLY BE
DISCONNECTED FROM AN UNPOWERED EMU. IN THE EVENT THE EXTERNAL
AIRLOCK LIQUID COOLING GARMENT (LCG) FLUID LINES EXPERIENCE AN
UNEXPECTED PRESSURE OR TEMPERATURE INCREASE (REF RULE {A18.1.2-
12}, EXTERNAL AIRLOCK WATER LINE OVERPRESSURE/TEMPERATURE
MANAGEMENT), THE FOLLOWING CONSTRAINTS AND ACTIONS APPLY: @061297-
4904]

A. IF THE SERVICE AND COOLING UMBILICAL (SCU) IS DISCONNECTED
FROM THE EMU:

THE SCU CAN BE CONNECTED TO THE EMU AND THE EMU FAN/PUMP
TURNED ON FOR A MAXIMUM OF 2 MINUTES, IF THE EMU WATER
TANKS CONTAIN THE NOMINAL ULLAGE.

*The external airlock EMU Liquid Cooling Garment (LCG) lines are routed externally to the
airlock/orbiter and are susceptible to pressure and temperature increases due to a "hot" orbiter
attitude or failed on line heaters. There are no accumulators, shut-off valves, or regulators in
the LCG loop. In the EMU, the LCG loop is connected to the water tanks through the bypass of
the EMU Coolant Isolation Valve. The EMU water tanks, with nominal 1 lb ullage, will act as an
accumulator for the LCG lines through the bypass of the EMU Coolant Isolation Valve.*

*Although not certified for this purpose, the EMU can be used as a contingency device for
lowering the pressure (and temperature) in the LCG lines by using the EMU fan/pump to
circulate the LCG water to the orbiter LCG HX for cooling. The EMU fan/pump should not be on
for longer than two minutes without O₂ pressurization of the EMU water tanks due to potential
cavitation and damage of the pump.*

*It is preferable to change orbiter attitude if possible to lower the pressure (temperature) of the
LCG fluid lines.*

DOCUMENTATION: Engineering judgment. @061297-4904]

THIS RULE CONTINUED ON NEXT PAGE

FLIGHT RULES

A15.1.4-2 EXTERNAL AIRLOCK LCG PRESSURE AND TEMPERATURE MANAGEMENT USING THE EMU (CONTINUED)

B. IF THE SERVICE AND COOLING UMBILICAL (SCU) IS CONNECTED TO
THE EMU: @061297-4904]

1. THE EMU FAN/PUMP WILL BE TURNED ON FOR A MAXIMUM OF 2
MINUTES BEFORE THE LCG LINE PRESSURE REACHES 18 (16.6)
PSIG FOR UNEXPECTED AND INCREASING PRESSURE.
2. A NOMINAL EMU WATER TANK ULLAGE DUMP MUST BE PERFORMED
AFTER AN UNEXPECTED PRESSURE INCREASE OR IF THE LCG
PRESSURE DID NOT DECREASE AFTER SCU CONNECTION.

*A steady pressure increase in either of the LCG lines (MSID V64P0170A or V64P0171A) with
the SCU connected, EMU fan/pump and O₂ actuator off, indicates the EMU water tanks no
longer contain any nominal ullage and are no longer acting as an accumulator for the LCG
lines. In the EMU, the LCG loop is connected to the water tanks through the bypass of the EMU
Coolant Isolation Valve. At 19.0 ± 1.0 psig, the EMU Feedwater Relief Valve will open and vent
water from the EMU water tanks into the airlock (ref Rule {A18.2-11}, EXTERNAL AIRLOCK
LCG FLUID LINE LOSS DEFINITION).*

*Although not certified for this purpose, the EMU can be used as a contingency device for lowering
the pressure (and temperature) in the LCG lines by using the EMU fan/pump to circulate the LCG
water to the orbiter LCG HX for cooling. Therefore, the EMU pump will be turned on prior to
reaching 18 psig (16.6 psig indicated) which will prevent the LCG loop pressure from reaching the
Feedwater Relief Valve lower regulation of 18 psig. The EMU fan/pump should not be on for
longer than two minutes without O₂ pressurization of the EMU water tanks due to potential
cavitation and damage of the pump.*

*If the LCG line water has been cooled using the EMU fan/pump to stop a pressure increase, or if
the pressure did not decrease after SCU connection, approximately 1 pound of water must be
dumped from the EMU water tanks before reaching the Feedwater Relief Valve lower regulation of
18 psig to restore the capability for the EMU to act as an accumulator for the LCG lines through
the bypass of the EMU Coolant Isolation Valve. In place of using the EMU, it is preferable to
change orbiter attitude if possible.*

*DOCUMENTATION: Reference Hamilton Standard, EMUM-1337, and engineering judgment.
@061297-4904]*

THIS RULE CONTINUED ON NEXT PAGE

FLIGHT RULES**A15.1.4-2 EXTERNAL AIRLOCK LCG PRESSURE AND TEMPERATURE
MANAGEMENT USING THE EMU (CONTINUED)**

C. THE LCG WATER MUST BE CIRCULATED BY THE EMU FAN/PUMP FOR A
MAXIMUM OF 2 MINUTES BEFORE EV CREWMEMBER EXPOSURE VIA THE
LCVG IF THE LCG LINE TEMPERATURE IS \geq 100 (92) AND $<$ 160
DEGREES F. @061297-4904]

DURING AN EVA, THE EMU TEMPERATURE CONTROL VALVE WILL BE
PLACED IN MAX C WITH WATER ON BEFORE CONNECTING TO THE
SCU.

The external airlock EMU Liquid Cooling Garment (LCG) lines are routed externally to the airlock/orbiter and are susceptible to pressure and temperature increases due to a “hot” orbiter attitude or failed on line heaters. To eliminate the potential of “hot” water being supplied to the EV crewmember’s Liquid Cooling and Ventilation Garment (LCVG) during initial donning of the EMU or EVA, the water in the orbiter supply LCG line must be circulated past the EMU to the orbiter LCG HX when either LCG supply temperature (MSID V64T0182A and V64T0185A) is greater than 100 degrees F (92 degrees F indicated). Calculations show the LCG supply “hot” water flows through the LCVG in 45 seconds. Two minutes will ensure that the water can pass through the LCG HX at least twice for cooling. During an EVA, the EMU Temperature Control Valve will be placed in MAX C with WATER ON before SCU connection. Thus, for the first 2 minutes of SCU flow, the EMU sublimator will provide cooling of the LCG water. The 100 degrees was chosen for conservatism below the 113 degree crewmember touch limit. The LCG temperature transducers (MSID V64T0182A and V64T0185A) are off-scale high at 160 degrees F which is used as the EMU upper limit (ref. Rule {A15.1.4-2D}, EXTERNAL AIRLOCK LCG PRESSURE AND TEMPERATURE MANAGEMENT USING THE EMU).

D. THE EMU FAN/PUMP WILL NOT BE TURNED ON AND THE SCU WILL BE
DISCONNECTED OR NOT CONNECTED TO THE EMU IF THE LCG SUPPLY
TEMPERATURE IS $>$ 160 DEGREES F.

The external airlock EMU Liquid Cooling Garment (LCG) lines are routed externally to the airlock/orbiter and are susceptible to pressure and temperature increases due to a “hot” orbiter attitude or failed on line heaters. EMU LCG water flow will not be initiated (FAN-ON) with the LCG temperature above 200 degrees F due to the potential of damaging the tubing in the EMU Liquid Cooling and Ventilation Garment (LCVG) or LCVG jumper. The LCG temperature transducers (MSID V64T0182A and V64T0185A) are off-scale high at 160 degrees F which is used as the EMU upper limit. A change in orbiter attitude would be required to cool the LCG lines.
@061297-4904]

FLIGHT RULES

A15.1.4-3 CABIN ATMOSPHERE DECONTAMINATION FOLLOWING EVA

@[021199-6821A]

A. FOLLOWING A NEGATIVE DRAGER TUBE READING, THE CABIN AIR WILL BE TREATED UNDER THE ASSUMPTION THAT THE AIRLOCK VOLUME IS CONTAMINATED TO THE MINIMUM SENSITIVITY LEVEL FOR THE SPECIFIC DRAGER TUBE (250 PPB FOR HYDRAZINES AND AMMONIA, AND 500 PPB FOR NO₂). @[021199-6821A]

This rule assumes that contamination of the EMU was either suspected or confirmed and action was taken to eliminate the contaminants from the affected EVA crewmember (such as bakeout) prior to performing airlock repress. Under these conditions, a Drager tube reading is required.

Because the Drager tubes are not sensitive enough to detect acceptable SMAC levels, lack of a reading does not verify that the contamination level is below the 7-day SMAC. The assumed contamination level is the minimum sensitivity of the specific Drager tube. The minimum sensitivities of the hydrazine/ammonia and nitrogen dioxide tubes are 250 ppb and 500 ppb, respectively.

DOCUMENTATION: Drager-Tube Handbook, 1994.

B. THE FOLLOWING ACTIONS WILL BE TAKEN IN AN ATTEMPT TO REDUCE THE ASSUMED CONTAMINANT CONCENTRATION BELOW THE DESIGNATED 7-DAY SMAC LEVELS AND TO PROTECT THE CREW DURING ATMOSPHERE SCRUBBING:

1. IMMEDIATELY PRIOR TO AIRLOCK HATCH OPENING, THE IV CREW WILL DON QDM'S AND BREATHE O₂. THE IV CREW WILL REMAIN ON THE QDM'S FOR 20 MINUTES FOLLOWING HATCH OPENING.
2. PRIOR TO AIRLOCK HATCH OPENING, PERFORM THE FOLLOWING ACTIONS AND CONTINUE FOR 3 HOURS AFTER AIRLOCK HATCH OPENING:
 - a. INSTALL TWO ATCO CANISTERS TO SCRUB HYDRAZINES AND AMMONIA FROM THE CABIN ATMOSPHERE.
 - b. PLACE CABIN TEMP CONTROLLER IN THE "FULL COOL" POSITION.
 - c. INITIATE AIR FLOW THROUGH WCS ODOR/BACTERIA FILTER.
 - d. IV CREW WILL DON LONG SLEEVES, LONG PANTS, AND GLOVES AS PRACTICAL. @[021199-6821A]

FLIGHT RULES

THIS RULE CONTINUED ON NEXT PAGE

FLIGHT RULES**A15.1.4-3 CABIN ATMOSPHERE DECONTAMINATION FOLLOWING EVA
(CONTINUED)**

3. FOLLOWING AIRLOCK HATCH OPENING: @[021199-6821A]
- a. EV CREW WILL REMAIN IN EMU'S FOR 20 MINUTES FOLLOWING AIRLOCK HATCH OPENING.
 - b. WIPE EMU'S AND AIRLOCK WALLS WITH WET TOWELS.
 - c. INSTALL/ACTIVATE BOOSTER FAN AND ASSOCIATED DUCTWORK AS SOON AS POSSIBLE.
- C. FOLLOWING A NEGATIVE READING AND COMPLETION OF THE ATMOSPHERE SCRUBBING ACTIVITIES (REF PARAGRAPH B), THERE ARE NO MISSION DURATION CONSTRAINTS.

Following EVA, the Drager test is performed with the airlock pressure at 5 psia. Repressurizing the airlock to 10.2 psia will reduce the contaminant concentration by a factor of 2 in the airlock (2.9 by repressurizing to 14.7 psia). This will bring the concentration below the 24-hour SMAC for all cases except MMH.

After airlock hatch opening and the atmospheres have mixed, the concentration will be further reduced by a factor of 7 (tunnel adapter) and 12 (airlock only) depending upon the specific volume configuration. This will bring the concentration below the 7-day SMAC for all cases except MMH.

The expected contamination level following dilution by volume equalization, assuming good atmospheric mixing, will be approximately 11 ppb (approximately 18 ppb with a tunnel adapter) for a 10.2 psia cabin. For a 14.7 psia cabin following equalization, the expected contamination level will be approximately 7 ppb (approx 12 ppb with a tunnel adapter).

The IV crew must remain on the QDM's and the EV crew must remain in the EMU for at least 20 minutes following hatch opening to allow time for the two atmospheres to mix and to allow any localized pockets of contaminants to dissipate. Twenty minutes was chosen as a time to allow effective mixing without requiring further action to control the O₂ concentration in the cabin. Donning long sleeves, long pants and gloves will minimize the amount of exposed skin and further protect the IV crewmembers from exposure to the toxic products following airlock hatch opening. This is listed as "as practical" because there is currently no requirement for crewmembers to select long pants and long-sleeved shirts as part of their in-flight wardrobe. @[021199-6821A]

THIS RULE CONTINUED ON NEXT PAGE

FLIGHT RULES**A15.1.4-3 CABIN ATMOSPHERE DECONTAMINATION FOLLOWING EVA
(CONTINUED)**

Two ambient temperature catalytic oxidizer (ATCO) canisters are installed to remove additional hydrazine, MMH, UDMH, and ammonia from the cabin atmosphere. In 2 to 3, hours it is expected that the cabin PPCO₂ levels will increase enough to require replacement of one of the ATCO canisters with a fresh LiOH canister. The other ATCO canister should remain in place as long as practical. The ATCO canister is 100 percent effective at neutralizing the contaminants from the air that passes through it. Based upon nominal cabin fan airflow, each ATCO canister will scrub the volume equivalent of the cabin atmosphere every 90 minutes. It is assumed that for each volume equivalent cycle through an ATCO can, approximately 63 percent of the remaining contaminants have been neutralized. Therefore, in 3 hours, assuming one ATCO is replaced with a LiOH after 2 hours, the entire cabin atmosphere will have passed through an ATCO canister at least three times and the concentration will be reduced to < 10 percent of the initial concentration. The 63 percent contamination reduction number is based upon analysis that shows for each complete volume equivalent cycle through a LiOH canister slot, because the atmospheric mixing is not ideal, only 63 percent vs 100 percent of the molecules of air in the cabin will actually flow across the catalyst bed in the ATCO canister. For all of the contamination compounds, including MMH, final concentration will be below the 7-day SMAC within 3 hours of airlock hatch opening and initial ATCO scrubbing. @[021199-6821A]

Because hydrazines are water soluble, wiping the EMU's with wet towels will dilute the contaminant and transfer the contaminant to the towels and prevent additional off-gassing from the EMU. The contaminated towels can be placed in Ziplock bags. Also, due to the solubility of hydrazines, contaminants can be condensed out of the atmosphere and sent in solution to the waste water system. Therefore, the IV crew will place the cabin temp controller to the "FULL COOL" position thus maximizing airflow across the ARS condensing heat exchanger.

The WCS odor/bacteria filter is designed to remove ammonia (NH₃) from the airflow through the WCS. Activation of the WCS commode will initiate the maximum airflow through the odor/bacteria filter and aid in scrubbing ammonia from the cabin atmosphere. The volume equivalent of the cabin atmosphere will flow through the WCS odor/bacteria filter approximately every 60 minutes.

The booster fan is reinstalled and activated, with associated ductwork connected, as soon as possible to circulate the contaminated atmosphere from the airlock to the cabin in an attempt to dilute the overall concentration through mixing of the atmospheres and to send the contaminated atmosphere through the ARS as quickly as possible. @[021199-6821A]

THIS RULE CONTINUED ON NEXT PAGE

FLIGHT RULES

**A15.1.4-3 CABIN ATMOSPHERE DECONTAMINATION FOLLOWING EVA
(CONTINUED)**

In all cases, the procedure governed by this rule meets the criteria listed in the following table with the exception of the 24-hour SMAC for MMH. Orbit Flight Techniques (November 12, 1998) deemed this acceptable based upon the ability to meet the 24-hour and the 7-day SMAC within 3 hours of cabin contamination. Additionally, White Sands personnel have been previously exposed to MMH at levels several orders of magnitude higher than the 24-hour SMAC with no deleterious effects. @021199-6821A]

The table below lists the SMAC levels informally proposed by the JSC Toxicology group.

TABLE A15.1.4-3-I - SMAC LEVELS (PPB)

<u>CHEMICAL</u>	<u>DRAGER DETECTION LEVEL</u>	<u>1-HOUR</u>	<u>24-HOURS</u>	<u>7-DAYS</u>
<u>N₂H₄</u>	<u>250</u>	<u>4,000</u>	<u>300</u>	<u>40</u>
<u>MMH</u>	<u>250</u>	<u>2</u>	<u>2</u>	<u>2</u>
<u>UDMH</u>	<u>250</u>	<u>NOT SET</u>	<u>NOT SET</u>	<u>100</u>
<u>N₂O₄ (NO₂)</u>	<u>500</u>	<u>NOT SET</u>	<u>NOT SET</u>	<u>500</u>
<u>NH₃</u>	<u>250</u>	<u>30,000 (30 PPM)</u>	<u>20,000 (20 PPM)</u>	<u>10,000 (10 PPM)</u>

DOCUMENTATION: EVA Console Handbook, Sec. 6.5 N2H4 Contamination (EVA/JSC-20597), engineering judgment. @021199-6821A]

FLIGHT RULES

SECTION 16 - POSTLANDING

GENERAL

A16.1.1-1	CONVOY POSITIONING	16-1
A16.1.1-2	VEHICLE SYSTEM RECONFIGURATION CONSTRAINT ..	16-1
A16.1.1-3	PRECREW EGRESS TROUBLESHOOTING CONSTRAINT ..	16-1
A16.1.1-4	VEHICLE SYSTEM MODING CONSTRAINT	16-1
A16.1.1-5	MEMORY RECONFIGURATION CONSTRAINT	16-1
A16.1.1-6	RECORDER DUMP	16-2
A16.1.1-7	GOM HANDOVER	16-2
A16.1.1-8	CREW EGRESS METHOD DETERMINATION (FOR MODE V EGRESS)	16-3
A16.1.1-9	SSME REPOSITIONING CONSTRAINT	16-4
A16.1.1-10	NORMAL POSTLANDING OPERATIONS	16-7
A16.1.1-11	EXPEDITED POWERDOWN	16-7
A16.1.1-12	EMERGENCY POWERDOWN	16-8
A16.1.1-13	SIDE HATCH OPENING CONSTRAINT	16-11

COOLING

A16.1.2-1	NO GROUND COOLING/EARLY VEHICLE POWER TERMINATION	16-12
A16.1.2-2	EXTENDED COOLING	16-14
A16.1.2-3	FREON LOOP CONFIGURATION	16-15
A16.1.2-4	AMMONIA BOILER MANAGEMENT	16-15

ET UMBILICAL DOOR

A16.1.3-1	ET UMBILICAL DOOR POSITIONING	16-16
-----------	-------------------------------------	-------

VENT DOORS

A16.1.4-1	VENT DOOR POSITIONING	16-17
-----------	-----------------------------	-------

FLIGHT RULES

APU/HYDRAULIC

A16.1.5-1	HYDRAULIC CIRCULATION PUMP OPERATION	16-18
A16.1.5-2	APU REQUIREMENTS	16-19
A16.1.5-3	APU/HYDRAULIC LOAD TEST TERMINATION	16-19
A16.1.5-4	WINDWARD APU OPERATION CONSTRAINT	16-20
A16.1.5-5	EARLY APU SHUTDOWN	16-21

FUEL CELLS

A16.1.6-1	FUEL CELL LIFETIME	16-21
-----------	------------------------------	-------

CONTAMINATION/FLAMMABILITY

A16.1.7-1	CONTAMINATION/FLAMMABILITY/TOXICITY	16-22
A16.1.7-2	EMERGENCY OXYGEN SYSTEM REQUIREMENTS	16-22

FLIGHT RULES

SECTION 16 - POSTLANDING

GENERAL

A16.1.1-1 **CONVOY POSITIONING**

CONVOY POSITIONING WILL NOT BE CAUSE TO CONSTRAIN RUNWAY SELECTION.

A16.1.1-2 **VEHICLE SYSTEM RECONFIGURATION CONSTRAINT**

SYSTEM RECONFIGURATION WHICH WOULD RESULT IN DESTROYING VEHICLE TURNAROUND PROBLEM ANALYSIS WILL BE AVOIDED WHERE POSSIBLE.

A16.1.1-3 **PRECREW EGRESS TROUBLESHOOTING CONSTRAINT**

PRECREW EGRESS TROUBLESHOOTING WILL BE LIMITED TO REGAINING A CAPABILITY REQUIRED FOR POSTLANDING ACTIVITIES.

Emphasis will be on configuring the Orbiter in a safe configuration for crew egress. Activities that can be accomplished by the exchange crew will be delayed until crew egress in order to expedite the crew egress timeline.

A16.1.1-4 **VEHICLE SYSTEM MODING CONSTRAINT**

IF AN EMERGENCY POWERDOWN IS REQUIRED, NO VEHICLE SYSTEM MODING WILL BE ACCOMPLISHED TO PROTECT VEHICLE SYSTEMS DATA.

Emergency powerdown and crew safety have priority over vehicle systems data.

A16.1.1-5 **MEMORY RECONFIGURATION CONSTRAINT**

IF THE BFS IS ENGAGED PRIOR TO THE POSTLANDING G3 TO G9 TRANSITION, GNC RECONFIGURATION TO A SIMPLEX PASS GNC 9 MEMORY CONFIGURATION WILL NOT BE ATTEMPTED.

Cause for the BFS engage is most likely a combination of LRU failures and GPC failures. No attempt at establishing a PASS computer will be performed in order to preserve data for failure reconstruction purposes. SSME repositioning will not be attempted since the capability is not supported in the BFS. Rule {A16.1.1-9}, SSME REPOSITIONING CONSTRAINT, references this rule.

FLIGHT RULES

A16.1.1-6 RECORDER DUMP

POSTLANDING RECORDER DUMPS WILL BE ACCOMPLISHED BY MCC SO AS NOT TO CONSTRAIN THE CREW EGRESS TIMELINE.

This rule clarifies that MCC is prime for recorder dumps and crew participation will be minimal. Should there be an unexpected need for onboard assistance, the dump will be delayed until the astronaut support crew is available.

A16.1.1-7 GOM HANDOVER

- A. NOMINAL HANDOVER TO THE GOM WILL OCCUR AT CREW EGRESS OR GSE COOLING ACTIVATION, WHICHEVER OCCURS LATER.
- B. FOR LOSS OF MCC VOICE AND TELEMETRY, OR IF A MODE V OR VI EMERGENCY CONDITION IS DECLARED, HANDOVER TO THE GOM WILL BE ACCOMPLISHED ASAP; IF TOTAL LCC CAPABILITY IS LOST, NO CHANGE TO POSTLANDING ACTIVITIES WILL OCCUR, BUT HANDOVER TO THE GOM WILL BE DELAYED UNTIL THE CAPABILITY IS REGAINED OR THE ORBITER IS POWERED DOWN.
- C. HANDOVER TO THE GOM WILL OCCUR AT WHEELS STOP FOR LOSS OF MCC COMMUNICATIONS WITH THE VEHICLE.

LCC data monitoring is available to the Ground Operations Manager if loss of MCC systems insight and communication capability occurs. Handover will occur ASAP in order for normal postlanding operations to continue. If LCC monitoring capability is lost, systems monitoring will continue to be supported by the MCC until no longer needed (vehicle powerdown or restoration of LCC capability).

FLIGHT RULES

A16.1.1-8 CREW EGRESS METHOD DETERMINATION (FOR MODE V EGRESS)

THE CREW WILL DETERMINE WHICH OF THE FOLLOWING MODE V EGRESS METHODS WILL BE USED: @041196-1881A

- A. OPEN HATCH ON MODE V - CREW MANUALLY OPENS SIDE HATCH. WHENEVER POSSIBLE, THE CREW WILL USE THIS TECHNIQUE.
- B. HATCH JETTISON MODE V - CREW PYROTECHNICALLY JETTISONS THE SIDE HATCH. A CREW WILL USE THIS TECHNIQUE ONLY UNDER THE FOLLOWING CONDITIONS:
 - 1. INTOLERABLE CABIN CONDITIONS DUE TO FIRE, SMOKE, TOXIC GASSES, OR HIGH TEMPERATURES PRESENT IN THE CREW CABIN AND NOT READILY ELIMINATED BY OTHER ACTIONS.
 - 2. IMMINENT THREAT TO LIFE AND SAFETY OF THE CREW AS DETERMINED BY THE CDR.
- C. ESCAPE PANEL MODE V - CREW PYROTECHNICALLY JETTISONS THE WINDOW 8 ESCAPE PANEL. THIS TECHNIQUE WILL BE USED ONLY UNDER THE CIRCUMSTANCES LISTED FOR HATCH JETTISON IN PARAGRAPH B ABOVE, AND THEN HATCH JETTISON IS PREFERRED. ESCAPE PANEL MODE V WILL BE PERFORMED ONLY IF SITUATIONS REQUIRING IMMEDIATE EGRESS WHEN THE SIDE HATCH IS (1) BLOCKED, (2) JAMMED, (3) STRUCTURALLY DEFORMED, (4) OTHERWISE SUSPECTED OF BEING UNABLE TO BE JETTISONED, OR (5) WHEN GROUND PERSONNEL ARE IN THE HAZARD ZONE AROUND THE SIDE HATCH.

PYROTECHNIC JETTISON WILL NOT BE UTILIZED WHEN AN EXPLOSIVE/ FLAMMABLE ATMOSPHERE IS PRESENT. THE CREW SHOULD MAKE EVERY POSSIBLE ATTEMPT TO COORDINATE WITH GROUND PERSONNEL BEFORE PYROTECHNIC JETTISON.

SIDE HATCH NORMALLY

B. BLOW SIDE HATCH

FLIGHT RULES

The crew is in the best position to determine the safest egress mode. If time allows, it is preferable to reposition the egress slide on the side hatch and then open the hatch normally and inflate the slide. This prevents further damage to the vehicle. If the crew is in immediate danger, the side hatch may be jettisoned. In the case of a slide failure, the crew can still egress out the side hatch using the sky genie descent devices.~~blown~~. An egress through the overhead escape panel (window W8) is slower and more inherently dangerous and, therefore, should not be performed unless egress through the side hatch is impossible.

The crew should attempt to notify the crash/rescue crew of their intentions either by orbiter A/G, PRC-112 survival radio (Channel A), or light signals per the Entry Checklist. ©[041196-1881A]

A16.1.1-9 SSME REPOSITIONING CONSTRAINT

SSME REPOSITIONING WILL NOT BE ATTEMPTED FOR THE FOLLOWING CONDITIONS :

- A. FA MDM'S 1, 2, 3, OR 4 I/O FAILURE OR FA MDM 1 OR 4 BCE STRING "D" FAILURE.

The GPC's depend on SSME, OMS, and aerosurface actuator feedback information transmitted through the flight-critical FA and OI OA1 MDM's and the PCMMU's to properly reposition the SSME's. The FA MDM I/O type failure or FA 1 or 4 BCE string D type failure will result in an error code 104 being generated and displayed on SPEC 105 which in turn will prevent any repositioning of the SSME's. This rule was verified by IBM desk analysis with informal testing in December 1987. Reference document KSC launch operations 80K00086 titled, TCS-S User's Guide (VFBF3 rev 11) dated 7/5/84, revised 11/12/84 applies to this rule and subsequent parts B, C, D, E, F, and H.

- B. OI MDM OA1/DSC OA1 FAILED.

Rationale is the same as for paragraph A above.

- C. BOTH OI PCMMU'S FAILED.

Rationale is the same as for paragraph A above.

- D. TWO APU'S/HYDRAULICS SYSTEMS FAILED OFF.

The loss of two APU's/hydraulic systems will keep one of the SSME's from being repositioned since each engine only has two hydraulic systems available as shown below:

Center engine - Hydraulic systems 1 and 3.

Right engine - Hydraulic systems 2 and 3.

FLIGHT RULES

Left engine - Hydraulic systems 1 and 2.

The inability to reposition one engine may cause contact between that engine and the other two when the repositioning sequence is activated.

E. BODY FLAP RM ("HOLD, CYCLE, FAIL").

The failure of the body flap to move as commanded during entry, which causes the messages of HOLD, CYCLE, or FAIL to occur, signifies a problem in the body flap drive system. In cases where the body flap happens to be in the up position, a recontact of the body flap with the SSME may occur when the repositioning sequence is activated. The call to NO-GO SSME repositioning due to the body flap messages is an MCC call.

THIS RULE CONTINUED ON NEXT PAGE

FLIGHT RULES

A16.1.1-9 SSME REPOSITIONING CONSTRAINT (CONTINUED)

F. THE DIFFERENCE BETWEEN ANY COMMAND (AVERAGE OF THE ACTIVE ATVC DRIVER OUTPUTS) AND THE INDICATED POSITION IS GREATER THAN 2.0 DEGREES.

SSME steps greater than 2.0 degrees (indicated) under full hydraulic pressure risk damage (possible rupture) to the hydraulic lines and subsequent loss of that hydraulic system. The average of the active ATVC driver outputs are used in the differencing scheme (as opposed to the software command) to eliminate the uncertainties in the command path. The 2.0-degree constraint takes into account the transducer uncertainty (ref. SODB 3.4.5.1.h.1).

The SSME TVC position transducers are required by the GPC's to determine if the actuators are within tolerance. Should the position data be in error, a step in position will occur during repositioning. Should this step exceed 2.0 degrees, the possibility of rupturing hydraulic lines exists. Even if the hydraulic lines are not ruptured, the command/position delta may result in an error code 103 being generated and displayed on SPEC 105 which in turn will prevent any further repositioning of the SSME's.

G. BFS ENGAGED.

The BFS cannot perform SSME repositioning (ref. Rule {A16.1.1-5}, MEMORY RECONFIGURATION CONSTRAINT).

H. THE PRIMARY OR SECONDARY OMS ENGINE FEEDBACK INDICATIONS ARE NOT EXPECTED TO BE WITHIN THE FOLLOWING LIMITS:

PITCH	-7.3 TO +7.3 DEGREES.
LEFT YAW	-0.8 TO +8.1 DEGREES.
RIGHT YAW	+0.8 TO -8.1 DEGREES.

FOR CERTAIN FAILURES, FF MDM POWER MANAGEMENT WILL PROVIDE A WORKAROUND.

Repositioning the SSME's while the OMS engines are not in the stow position may cause an OMS engine to center engine contact.

FLIGHT RULES

A16.1.1-10 **NORMAL POSTLANDING OPERATIONS**

NORMAL POSTLANDING OPERATIONS WILL BE CONTINUED EXCEPT FOR THE FOLLOWING CONDITIONS:

A. LIGHTNING WITHIN 5 MILES.

The KSC Ground Operations Safety Plan (GP-1098E) requires that all operations be terminated for lightning within 5 miles. However, if orbiter tow operations are underway, towing may continue if all personnel on foot enter a covered vehicle.

B. LIQUID LEAKS, HYPERGOLIC VENTING, OR HAZARDOUS MATERIALS TOXICITY ABOVE ALLOWABLE LIMITS (REF. RULE {A16.1.7-1}, CONTAMINATION/FLAMMABILITY/ TOXICITY).

C. MMH, N₂O₄, OR HYDRAZINE CONCENTRATIONS WITHIN THE POD/AFT COMPARTMENT. (FOR MMH OR HYDRAZINE, REF. RULE {A16.1.1-11C}, EXPEDITED POWERDOWN.) (FOR N₂O₄, REF. RULE {A16.1.5-4}, APU SHUTDOWN FOR FUEL/OXIDIZER LEAKS.)

D. LOSS OF COMMUNICATION/SYSTEMS MONITORING CAPABILITY (REF. RULE {A16.1.1-11}, EXPEDITED POWERDOWN).

E. ORBITER CONDITIONS REQUIRING EXPEDITED/EMERGENCY POWERDOWN (REF. RULE {A16.1.1-12}, EMERGENCY POWERDOWN).

A16.1.1-11 **EXPEDITED POWERDOWN**

AN EXPEDITED POWERDOWN IS DEFINED TO ALLOW ACCOMPLISHMENT OF ET DOOR OPENING (RTL5 ONLY), OMS/RCS SAFING, NOMINAL GPC POWERDOWN FOLLOWED IMMEDIATELY BY AN EMERGENCY POWERDOWN.

AN EXPEDITED POWERDOWN AND MODE V CREW EGRESS WILL BE ACCOMPLISHED FOR:

A. LOSS OF ALL COMMUNICATIONS (INCLUDING VISUAL SIGNALS AND MCC RELAY) BETWEEN CREW AND CONVOY ELEMENTS.

NOTE: RULE {A16.1.1-8}, CREW EGRESS METHOD DETERMINATION (FOR MODE V EGRESS) GOVERNS THE MODE V EGRESS METHOD THE CREW WILL USE. @041196-1881A]

Crew safety could be compromised with the loss of communication between the crew and convoy personnel. Possible orbiter problems that occur during landing and rollout not reflected in orbiter systems would not be available to the crew (i.e., tire fire, explosive/flammable conditions, etc.).

NASA - JOHNSON SPACE CENTER

FLIGHT RULES

THIS RULE CONTINUED ON NEXT PAGE

FLIGHT RULES

A16.1.1-11 EXPEDITED POWERDOWN (CONTINUED)

- B. LOSS OF ALL TELEMETRY (MCC AND LCC) AND ONBOARD SYSTEMS MONITORING (BFS, C&W PANEL, AND FDA) VISIBILITY. IF COMM IS AVAILABLE TO CREW, MCC WILL DETERMINE IF MODE V IS REQUIRED.

As long as insight into critical vehicle systems and communication with the crew are maintained, normal postlanding operations can continue. Critical systems information is available at KSC (LCC) which allows the LCC to be an acceptable source for orbiter systems monitoring.

- C. A NONISOLATABLE OMS, RCS, OR APU FUEL LEAK OR FOR AN ISOLATED LEAK WHEN THERE HAS BEEN INSUFFICIENT TIME FOR FUEL SUBLIMATION (RTLS, TAL, AOA, OR POST-DEORBIT IGNITION). FOR THESE CASES, A MODE V CREW EGRESS WILL BE IMPLEMENTED. RCS JET LEAKS AND APU SEAL CAVITY DRAIN LEAKS ARE EXEMPTED FROM THIS CATEGORY.

Leaking OMS, RCS, or APU fuel poses a toxicity and fire hazard. An expedited powerdown should be performed in order to minimize the danger to the flightcrew and ground operations personnel. If a fuel leak occurs and is isolated during an RTLS, TAL, AOA, or post-deorbit ignition, there is insufficient time for the fuel to sublime, and an expedited powerdown is prudent.

An isolated RCS jet leak does not pose a risk to the orbiter/crew with continued postlanding operations. In the event of an APU fuel pump seal failure, the APU seal cavity drain dumps hydrazine overboard. Once the APU is shut down, the leak is isolated.

Rules {A16.1.1-10C} and D, NORMAL POSTLANDING OPERATIONS, and {A6.1.2-16}, RCS LINE LEAK MANAGEMENT, reference this rule.

- D. A CONFIRMED OR SUSPECTED FIRE FOR WHICH A FIRE SUPPRESSION BOTTLE HAS BEEN DISCHARGED DURING ENTRY.

Vehicle damage can pose hazards to crew safety after a fire is extinguished, especially if its location is unknown. Wires melted together could cause any number of hazards (e.g., inadvertent GPC commanding causing fuel valves to open, etc.). In addition, if the fire occurred in an avionics bay several hours (minutes for a cabin fire) before landing, the crew should exit the vehicle to avoid breathing Halon and toxic combustion byproducts which slowly leak out of the avionics bay and panels.

- E. A NON-ISOLATABLE H₂ LEAK GREATER THAN 6.5 LB/HR (5.5 LB/HR FOR SPACELAB/PAYLOAD RETURN).

Leaking H₂ poses a possible fire hazard in the midbody. An H₂ concentration of 4 percent represents the lower ignitable limit of H₂ (deflagrates or burns rapidly).

NASA - JOHNSON SPACE CENTER

FLIGHT RULES

THIS RULE CONTINUED ON NEXT PAGE

FLIGHT RULES

A16.1.1-11 EXPEDITED POWERDOWN (CONTINUED)

Rule {A16.1.5-5F}, EARLY APU SHUTDOWN, references this rule. ©[072398-6577.1]

Normally, KSC is prime for recommending an expedited powerdown/crew egress based on detected H₂ concentrations. For known H₂ leaks prior to touchdown, this rule identifies the H₂ leak rate criteria to be used by MCC in determining whether an expedited powerdown/crew egress should be performed prior to KSC assessment (i.e., for large leaks). These leak rates are based on a 4 percent concentration 35 minutes after wheels stop.

For leak rates below 6.5 (5.5) lb/hr, KSC is prime for determining whether or not an expedited powerdown is required, based on actual detection of H₂. The MCC H₂ leak rate prediction is based on the initial size of the leak once detected, a homogenous mixing in the midbody, and no consideration for venting or leakage of H₂ from the midbody at wheel stop.

DOCUMENTATION: ECLS Console Handbook, SCP 4.6.2, and KSC OMI S0026, Revision L.

F. AN INCOMPLETE MPS LH₂ DUMP.

The failure of the LH₂ outboard fill/drain valve will result in an incomplete LH₂ dump on RTLS aborts. Analysis (reference Rockwell Internal Letter no. 287-100-94-164) has shown that approximately 40.8 pounds of LH₂ residuals will remain in the MPS LH₂ manifold if the only LH₂ dump path is through the backup LH₂ valves. Venting LH₂ residuals will preclude normal convoy operations. Sufficient time exists to dump LH₂ residuals through the backup LH₂ valves for nominal ATO, AOA, or TAL. ©[090894-1730A]

Rules {A5.1.5-10}, ENTRY MPS PROPELLANT DUMP FAILURES, and {A5.1.5-11}, MPS DUMP INHIBIT, reference this rule. ©[030994-1604B] ©[030994-1617] ©[090894-1730A]

A16.1.1-12 EMERGENCY POWERDOWN

AN EMERGENCY POWERDOWN WILL BE IMPLEMENTED POST-ROLLOUT FOR THE FOLLOWING CONDITIONS OR AS REQUESTED BY THE FLIGHT DIRECTOR OR CONVOY COMMANDER:

An emergency powerdown will be performed if Orbiter systems cannot support continued operations or if orbiter conditions compromise crew safety. The normal egress mode is preferred if allowed by system conditions. Loss of cooling will allow an orderly egress to continue.

If conditions exist that compromise crew safety (fire, smoke, explosive conditions, etc.), a MODE V egress is warranted. Based on knowledge of Orbiter conditions and systems indications, the Flight Director and Convoy Commander are able to recognize problems and recommend the appropriate action/egress mode.

THIS RULE CONTINUED ON NEXT PAGE

FLIGHT RULES

A16.1.1-12 EMERGENCY POWERDOWN (CONTINUED)

A. NORMAL EGRESS (SIDE HATCH, CONVOY CREW ASSIST):

1. LOSS OF BOTH FREON COOLANT LOOPS.

If both loops are lost, the emergency powerdown is required because there is absolutely no cooling of the vehicle. The fuel cell stack temperature will reach the specification limit of 250 degrees F within approximately 50 minutes. In addition, the electrolyte concentration will reach the 25 percent operational limit in approximately 75 minutes. At this point, continued operation of the fuel cells is questionable. This assumes a simultaneous purge of all three fuel cells and a 12.54 kWh (4.18 kWh/fuel cell) power level. If the failure occurred on orbit, the situation would be time-critical postlanding. Purging H₂ into the atmosphere should be avoided if at all possible (ref. Rule {A16.1.7-1}, CONTAMINATION/ FLAMMABILITY/TOXICITY). Without the purge, the fuel cells will flood in approximately 18 minutes based on an 8.0 kWh (2.67 kWh/fuel cell) power level (ref. Rules {A2.1.2-4}, RTLS, TAL, AND AOA ABORTS FOR SYSTEMS FAILURES; and {A2.1.4-5}, EMERGENCY DEORBIT CAPABILITY REQUIREMENTS). Upon completion of the emergency powerdown, a normal crew egress can be performed.

DOCUMENTATION: Dual Freon Loop Failure Entry Analysis, Rockwell International IL 388-301-79-018, and SODB table 3.4.4.1-1.

2. LOSS OF BOTH H₂O COOLANT LOOPS.

If both loops are lost, the emergency powerdown is required because there is no cooling to water and air cooled equipment in the cabin. If the failure occurred on orbit, avionics equipment and GPC's would be cycled to their thermal limits in order to maintain as much redundancy as possible during critical mission phases. Since this failure scenario does not contain any hazard to the crew, an orderly, normal egress can be accomplished.

DOCUMENTATION: MDTSCO analysis 1.1-ECLSS-09, Dual Water Coolant Loop Failed Entry Contingency.

3. LOSS OF BOTH NH₃ SYSTEMS WHEN CRITICAL TEMPERATURES ARE (RULE {A16.1.2-1}, NO GROUND COOLING/EARLY VEHICLE POWER TERMINATION) EXCEEDED.

Postlanding, orbiter cooling is provided by the heat sink capacity remaining from the on-orbit radiator coldsoak, the NH₃ system, and the ground cooling cart. In the event that the ground cooling cart is not available, NH₃ must supply the cooling once the radiator coldsoak has been used. Therefore, subsequent loss of both NH₃ systems will eventually lead to loss of all vehicle cooling, and loss of all vehicle cooling has the same result as described in the loss of both Freon loops in paragraph A.1.

DOCUMENTATION: Engineering judgment.

NASA - JOHNSON SPACE CENTER

FLIGHT RULES

THIS RULE CONTINUED ON NEXT PAGE

FLIGHT RULES

A16.1.1-12 EMERGENCY POWERDOWN (CONTINUED)

B. MODE V EGRESS:

1. WHEEL WELL FIRE OR BRAKE FIRE THAT POTENTIALLY WILL PROPAGATE TO THE WHEEL WELL. EGRESS WILL BE BASED ON CONVOY COMMANDER RECOMMENDATION.
2. EXPLOSIVE/FLAMMABLE CONDITIONS (REF. RULE {A16.1.7-1}, CONTAMINATION/FLAMMABILITY/TOXICITY).
3. SMOKE, FIRE, OR OBVIOUS STRUCTURAL DAMAGE.
4. INTOLERABLE CABIN CONDITIONS.

NOTE: RULE {A16.1.1-8}, CREW EGRESS METHOD DETERMINATION (FOR MODE V EGRESS) GOVERNS THE MODE V EGRESS METHOD THE CREW WILL USE. @[041196-1881A]

It is preferable to perform a normal egress. However, if cabin conditions warrant, a MODE V egress may be performed. An emergency powerdown should be implemented for the conditions listed in paragraph B1, 2, 3 above in order to eliminate electrical ignition/isolate volatile propellant sources that could make the vehicle anomalous condition worse. A confirmed MPS LH₂ leak is considered to be an explosive/flammable condition (ref. rule {A5.1.5-11}, MPS DUMP INHIBIT). @[030994-1604B]

DOCUMENTATION: Engineering judgment.

Rule {A16.1.1-10E}, NORMAL POSTLANDING OPERATIONS, references this rule.

A16.1.1-13 SIDE HATCH OPENING CONSTRAINT

IF CABIN PRESSURE EXCEEDS LANDING SITE ATMOSPHERIC PRESSURE BY MORE THAN 3.2 PSID, THEN THE CABIN VENT VALVES WILL BE USED TO DEPRESSURIZE THE CABIN TO BRING THE PRESSURE DIFFERENTIAL BELOW 3.2 PSID BEFORE ATTEMPTING TO OPEN THE SIDE HATCH.

An unisolatable leak into the cabin could result in cabin pressure being as much as 16 psid greater than landing site atmosphere pressure (the cabin relief valves relieve at 16 psid). Rockwell International has verified side hatch structural capability to vent excess cabin pressure postlanding only as high as 3.2 psid. The 3.2 psid pressure differential was selected for verification because it is the maximum expected to be encountered at the highest altitude landing site (White Sands) under normal cabin pressure conditions.

DOCUMENTATION: Side Hatch Structural Capability to Release Cabin Pressure Following Rollout, Rockwell International Internal Letter No. 280-106-82-016, May 7, 1983.

FLIGHT RULES

COOLING

A16.1.2-1 NO GROUND COOLING/EARLY VEHICLE POWER TERMINATION

POSTLANDING LOSS OF COOLING WILL BE DEFINED AS FOLLOWS: @[012694-1599]

A. IF MCC VOICE AND TELEMETRY ARE AVAILABLE, COOLING WILL BE DECLARED LOST AND AN EMERGENCY POWERDOWN PERFORMED WHEN ANY OF THE FOLLOWING CONDITIONS OCCUR:

1. FUEL CELL COOLANT RETURN TEMP > 140 DEGREES (135 DEGREES) F OR LOCAL FUEL CELL KOH < 24 PERCENT (29 PERCENT)
2. AVIONICS BAY AIR OUTLET TEMP EXCEEDS THE FOLLOWING LIMITS PRIOR TO ENT C/L "LRU DEACT":
 - a. AVIONICS BAY 1 OR 2 AIR OUTLET TEMP > 133 DEGREES (128 DEGREES) F
 - b. AVIONICS BAY 3 AIR OUTLET TEMP > 117 DEGREES (112 DEGREES) F
3. AVIONICS BAY AIR OUTLET TEMP EXCEEDS THE FOLLOWING LIMITS POST ENT C/L "LRU DEACT":
 - a. AVIONICS BAY 1 OR 2 AIR OUTLET TEMP > 113 DEGREES (108 DEGREES) F
 - b. AVIONICS BAY 3 AIR OUTLET TEMP > 107 DEGREES (102 DEGREES) F
4. CABIN TEMPERATURE > 95 DEGREES (90 DEGREES) F
5. MIDBODY COLDPLATE OUTLET TEMP > 115 DEGREES (110 DEGREES) F
6. AFT COLDPLATE OUTLET TEMP > 112 DEGREES (107 DEGREES) F

The FCP coolant return temp is a direct indication of the status of the FCP cooling capability. Inadequate cooling of the fuel cell may result in fuel cell KOH concentrations < 24 percent, which indicate a wet fuel cell and impending fuel cell flooding.

FLIGHT RULES

Avionics bay temperatures above the listed limits indicate LRU outlet temperature > 130 degrees F limit. Cabin temperatures above 95 degrees F will cause overtemp conditions for flight deck avionics. The limits listed above will not result in hardware damage or certification violation if an emergency powerdown is executed when the limit is reached. ©[012694-1599]

THIS RULE CONTINUED ON NEXT PAGE

FLIGHT RULES

A16.1.2-1 **NO GROUND COOLING/EARLY VEHICLE POWER
TERMINATION (CONTINUED)**

- B. FOR LOSS OF MCC VOICE OR TELEMETRY, AN EMERGENCY POWERDOWN PERFORMED WHEN ANY OF THE FOLLOWING CONDITIONS OCCUR: @[012694-1599]
1. FUEL CELL CONDENSER EXIT TEMP > 164 DEGREES F
 2. AVIONICS BAY AIR OUTLET TEMP EXCEEDS THE FOLLOWING LIMITS PRIOR TO ENT C/L "LRU DEACT":
 - a. AVIONICS BAY 1 OR 2 AIR OUTLET TEMP > 133 DEGREES (128 DEGREES) F
 - b. AVIONICS BAY 3 AIR OUTLET TEMP > 117 DEGREES (112 DEGREES) F
 3. AVIONICS BAY AIR OUTLET TEMP EXCEEDS THE FOLLOWING LIMITS POST ENT C/L "LRU DEACT":
 - a. AVIONICS BAY 1 OR 2 AIR OUTLET TEMP > 113 DEGREES (108 DEGREES) F
 - b. AVIONICS BAY 3 AIR OUTLET TEMP > 107 DEGREES (102 DEGREES) F

Postlanding cooling tests performed after STS-58 indicate that loss of the 508 GSE cooling cart will not result in violations of the above limits if the radiators are flowing, and PLB purge air is available. The purge air for this test was controlled to approximately 45 degrees F. If PLB purge is not available, or is insufficient, an emergency powerdown should be implemented when the appropriate thermal limit is violated.

DOCUMENTATION: MACDAC 1.1 ECLSS 122 and SODB 3.4.4.1.11, page 3.4.4.1-3, engineering judgment, and STS-58 Post Mission report.

Rule {A16.1.1-12A.3}, EMERGENCY POWERDOWN, references this rule. @[012694-1599]

A16.1.2-2 **EXTENDED COOLING**

ORBITER COOLING MAY BE EXTENDED AS FOLLOWS:

- A. MAINTAIN RADIATOR FLOW.
- B. POWERDOWN AS QUICKLY AS POSSIBLE PER THE NORMAL POST-ROLLOUT PROCEDURES (DEPENDING ON LANDING SITE AND OTHER FAILURE SITUATIONS).

FLIGHT RULES

It is highly desirable to hand over the vehicle in a powered condition in order to expedite turnaround operations. Crew requirements or vehicle systems management may dictate a need to operate the vehicle for a greater than normal amount of time without ground cooling.

DOCUMENTATION: Engineering judgment.

A16.1.2-3 **FREON LOOP CONFIGURATION**

THE FPV IN BOTH FREON LOOPS WILL BE PLACED TO THE "ICH" POSITION IF BOTH THE EVAPORATOR OUTLET TEMPERATURES ARE LESS THAN 32 DEGREES (34.4 DEGREES) F. IF THE PAYLOAD LOOP DOES NOT CONTAIN WATER, A REAL-TIME CALL WILL BE MADE TO PLACE BOTH FPV'S TO THE "P/L" POSITION.

Provided that both orbiter water loops and a payload water loop (if installed) are flowing, the ICH position provides orbiter water loop freeze protection for Freon temperatures as low as 6 degrees F and payload water loop protection for Freon temperatures as low as -30 degrees F (extrapolated). If left in the P/L position, the payload water loop would freeze at a Freon temperature of 32 degrees F and the orbiter water loops at -30 degrees F (extrapolated) Freon temperature. For payload flow rates < 150 lb/hr, the P/L water loop will freeze eventually, but is delayed if the FPV is placed in the ICH position.

DOCUMENTATION: Lockheed analysis, LEMSCO 19630.

A16.1.2-4 **AMMONIA BOILER MANAGEMENT**

THE AMMONIA BOILER WILL BE ACTIVATED WHEN THE FLASH EVAPORATOR OUTLET TEMPERATURE > 55 DEGREES F.

The standard orbiter entry cooling configuration is to utilize radiator heat sink capacity (cold soak) from 160k feet altitude until depletion. Normally this occurs post-rollout. At that time the ammonia boiler is activated to maintain thermal control. Upon ammonia activation, specification leakage past the primary control valves will result in ammonia boiler outlet temperatures dropping 17 degrees F. Delaying ammonia activation until flash evaporator outlet temperatures are greater than 55 degrees F protects downstream H₂O loop components from freezing.

DOCUMENTATION: Engineering judgment. SODB, volume 1, 4.6.3.11.2.b.6 and c.3

FLIGHT RULES

ET UMBILICAL DOOR

A16.1.3-1 ET UMBILICAL DOOR POSITIONING

- A. FAILURE TO OPEN THE ET UMBILICAL DOOR WILL REQUIRE NO CHANGE TO NORMAL POSTLANDING PROCEDURES.

For normal postlanding, the ET doors are opened by the flightcrew to facilitate ground handling at KSC, EAFB, and NOR. If the doors cannot be opened by the crew, ground turnaround time of the vehicle will be extended somewhat. There are no safety concerns if this cannot be done.

- B. THE ET DOORS MUST BE OPENED ASAP POSTLANDING FOR TAL OR RTLS. FOR NORMAL EOM, AOA, OR CLS, THEY MUST BE OPENED ASAP IF THERE IS EVIDENCE OF POTENTIAL FOR H₂ BUILDUP.

Hydrogen poses an explosion hazard. Opening the ET doors as soon as possible after wheel stop will help to vent the trapped hydrogen into the atmosphere.

- C. WHEN OPENING IS REQUIRED, THE ET DOORS WILL BE DRIVEN TO THE POSTLANDING POSITION OF 110 + 30 DEGREES. THERE IS NO CONSTRAINT ON OPENING THE ET DOORS POSTLANDING FOR BLOWING DUST OR SAND.

The postlanding ET door position of 110 ± 30 degrees takes into consideration allowable tolerances for wind loads on door mechanism (stationary vehicle or while being towed) and tolerances on clearance for mounting the GSE jacks when used to prepare the vehicle for transport on the Shuttle carrier aircraft. It has been established that the doors can be opened regardless of blowing sand or dust (ref. Ascent/Entry Flight Techniques #5, 7/27/83).

FLIGHT RULES

VENT DOORS

A16.1.4-1 VENT DOOR POSITIONING

- A. VENT DOOR POSITIONING IS NOT A CONSTRAINT TO NORMAL POSTLANDING OPERATIONS (REGARDLESS OF BLOWING SAND OR DUST).

KSC prefers to have the vent doors configured to the purge position (midbody vents closed; forward and aft vents in purge) in order to expedite vehicle turnaround time. However, if this cannot be accomplished, having the doors open, as is the case when the vehicle lands, all doors open is considered to be a safe configuration (hazardous gas buildup prevention). Hazardous gas protection is of higher priority than blowing sand or dust protection. Other normal crew-initiated postlanding procedures can continue since the procedures are unaffected by the position of the vent doors.

- B. IF PURGING CAN BE ACCOMPLISHED, THE VENT DOORS WILL BE CONFIGURED AS FOLLOWS:
1. ALL MIDBODY VENT DOORS CLOSED.
 2. ALL FORWARD AND AFT VENT DOORS IN THE PURGE POSITION.

These are the desired positions of the vent doors for vehicle purging.

- C. IF PURGING CANNOT BE ACCOMPLISHED OR IS LOST AFTER INITIATION, THE PREFERRED VENT DOOR POSITION IS OPEN (REGARDLESS OF BLOWING SAND OR DUST).

Reference rule rationale for paragraph A.

FLIGHT RULES

APU/HYDRAULIC

A16.1.5-1 HYDRAULIC CIRCULATION PUMP OPERATION

A. FOLLOWING APU SHUTDOWN, HYDRAULIC CIRCULATION PUMPS WILL BE OPERATED IF ANY OF THE FOLLOWING BONDLINE TEMPERATURES EXCEED 245 DEGREES F UNTIL THE HYDRAULIC RETURN LINE TEMPERATURES HAVE PEAKED AND BEGUN TO DECREASE. LOSS OF ONE OR MORE OF THESE PUMPS WILL NOT CONSTRAIN NORMAL POSTLANDING OPERATIONS. SHOULD POWER PROBLEMS DICTATE, CIRCULATION PUMPS MAY BE OPERATED ONE AT A TIME IN 5-MINUTE INTERVALS; OTHERWISE, ALL THREE WILL BE OPERATED SIMULTANEOUSLY (MCC CALL):

V09T1006A	LIB ELVN LWR BL Y-235 T (OV-102 ONLY).
V09T1026A	BODY FLAP LWR CL BL T (OV-102 ONLY).
V09T1002A	LWR L WING BL X 1278, Y-240 T.
V09T1702A	AFT FUS LWR CL BL T.
V09T1004A	TOP R WING BL X 1278, Y 240 T.
V09T1624A	CAB CL BL LWR X 560 T.

When vehicle bondline temperatures have exceeded 245 degrees F, heat soakback would cause temperatures to rise in the hydraulic fluid to the point where seals would degrade resulting in fluid leakage. Turning on the circulation pumps will help transport hotter fluid to cooler areas, thus reducing the chances of seal degradation.

If bus power problems arise such that it is desirable not to run all three circulation pumps at once, then each pump can be run at 5-minute intervals.

B. MPS HELIUM WILL BE PROVIDED TO AN ENGINE PRIOR TO HYDRAULIC CIRCULATION PUMP OPERATION POSTLANDING IF THE ASSOCIATED MPS/TVC ISOLATION VALVE IS OPEN.

Maintaining helium pressure on the closed side of the engine valves will insure that the valves do not drift open when hydraulic circulation pump pressure is applied to the TVC actuators. Keeping the engine valves closed prevents engine contamination and reduces the number of helium regulator cycles. ©[072795-1786]

FLIGHT RULES

A16.1.5-2 **APU REQUIREMENTS**

POSTLANDING ACTIVITIES WITH APU'S OPERATING, IN ORDER OF PRIORITY, ARE:

- A. SSME REPOSITIONING.
- B. HYDRAULIC LOAD TEST.

SSME repositioning is required every flight to position the engines for ferry operations (Edwards/Northrup) or to prevent rain from entering into the nozzle, possibly damaging engine components. The hydraulic load test is performed to test the capability of the APU's after the fifth flight of a particular orbiter. The load test can be rescheduled to another flight and is not critical to postlanding operations.

A16.1.5-3 **APU/HYDRAULIC LOAD TEST TERMINATION**

AN APU/HYDRAULIC LOAD TEST WILL BE TERMINATED FOR ANY OF THE FOLLOWING:

- A. ANY PROBLEM REQUIRING AN EXPEDITED OR EMERGENCY POWERDOWN.
- B. INSUFFICIENT CONSUMABLES.
- C. INABILITY TO OBTAIN DATA (REAL TIME OR RECORDED).
- D. LESS THAN TWO GOOD APU/HYDRAULIC SYSTEMS.

The APU/hydraulic load test is conducted to gather data on APU catalyst bed roughness; i.e., the efficiency of fuel decomposition and hydraulic system main pump performance degradation. The test entails manually cycling the elevons, rudder, and body flap with hydraulic system 1 depressed and then system 2 depressed. The duration of motion is about 80 seconds. For the cases listed above, the load test should be terminated since the data being obtained is not critical and can be obtained during postlanding of a later flight.

FLIGHT RULES

A16.1.5-4 WINDWARD APU OPERATION CONSTRAINT

TO AVOID EXCEEDING VERTICAL TAIL STRUCTURAL TEMPERATURE LIMITS, THE WINDWARD APU(S) WILL NOT BE OPERATED LONGER THAN THE ALLOWABLE POSTLANDING APU RUN TIME, OBTAINED FROM THE POSTLANDING OPERATIONS PLOT.

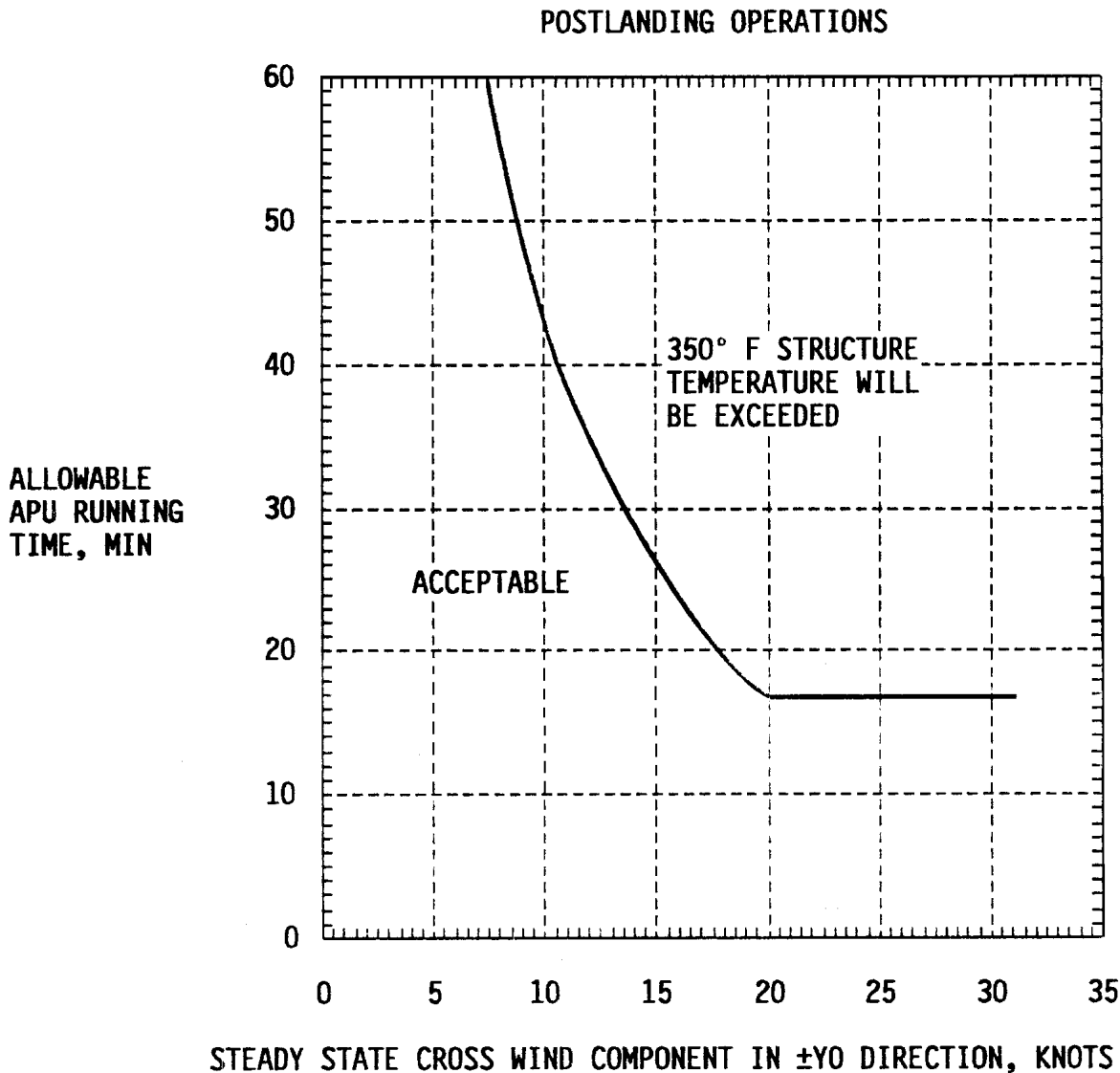

If the postlanding run time exceeds the allowable run time, vertical tail overtemperature and subsequent structural damage can occur if the APU plume has ignited. There are no constraints to run time if the APU plume has not ignited; however, due to the difficulty in visually determining whether the plume is burning or not, the worst case is assumed.

Reference SPDB 3.2.1.1.

FLIGHT RULES

A16.1.5-5 **EARLY APU SHUTDOWN**

AN APU (OR APU'S) WILL BE SHUTDOWN ASAP POST-WHEEL STOP:

- A. IF A FUEL OR OXIDIZER LEAK IS SUSPECTED OR DETECTED IN THE MPS, OMS, RCS, OR ANY APU, EVEN IF THE LEAKS HAVE BEEN ISOLATED (DOES NOT APPLY FOR RCS JET LEAKS). ©[030994-1604B]

The requirements for APU operations postlanding, SSME repositioning, and hydraulic load test are not considered mandatory. In cases where fuel or oxidizer leaks are suspected or detected, the APU's should be shut down ASAP to reduce chances of the leak developing into a greater flammability hazard, brought on by the operation of hot, rotating machinery. Note that an APU fuel tank N₂ leak is considered a fuel leak.

APU's will not be shut down early for RCS jet leaks since these types of leaks are isolated and external to the orbiter. No flammability hazard exists for continued APU operations with known RCS jet leaks.

Rules {A5.1.5-11}, MPS DUMP INHIBIT, and {A6.1.2-16}, RCS LINE LEAK MANAGEMENT, reference this rule. ©[030994-1604B]

- B. IF A FIRE IS OBSERVED IN A WHEEL WELL OR TIRE/BRAKE AREA. THE HYDRAULIC LANDING GEAR EXTEND AND BRAKE ISOLATION VALVES WILL BE CLOSED PRIOR TO SHUTTING DOWN THE APU'S.

A fire in the wheel well or landing gear area could involve hydraulic fluid. Closing the landing gear isolation valves will isolate the fluid from the gear area, thus preventing any further feeding of the fire. The APU's should be shut down in an effort to reduce high pressure flow of hydraulic fluid to the gear area should an isolation valve fail to close.

- C. IF THERE IS A NON-ISOLATABLE LEAK IN ITS ASSOCIATED HYDRAULIC SYSTEM.

The APU should be shut down postlanding to minimize hydraulic leakage into the aft compartment. Postlanding operations requiring hydraulic power are not mandatory and can be performed if there are two remaining good systems.

- D. IF THE APU SHIFTS TO HIGH SPEED WITH NORMAL SPEED SELECTED.

The APU should be shut down postlanding to protect against a possible uncontained overspeed. Postlanding operations requiring the APU's are not mandatory and can be performed if there are two remaining good systems.

- E. FOR INSUFFICIENT LUBE OIL OR HYDRAULIC COOLING.

The APU should be shut down postlanding to minimize bearing and gear wear due to degraded lubrication capability. Postlanding operations requiring the APU's are not mandatory and can be performed if there are two remaining good systems.

NASA - JOHNSON SPACE CENTER

FLIGHT RULES

THIS RULE CONTINUED ON NEXT PAGE

FLIGHT RULES

A16.1.5-5 EARLY APU SHUTDOWN (CONTINUED)

F. FOR A NON-ISOLATABLE H₂ LEAK GREATER THAN 6.5 LB/HR (5.5 LB/HR FOR SPACELAB/PAYLOAD RETURN). @[072398-6577]

Leaking H₂ poses a possible fire hazard in the orbiter midbody. The leaking H₂ is lighter than air and may escape from the payload bay at the payload bay door (PLBD) aft bulkhead interface and from ~~the~~ where payload bay doors interface along the centerline. Pressure seals are located at the PLBD/bulkhead interface as well as along the PLBD centerline. However, the integrity of the pressure seals to contain H₂ is unknown. The APU exhaust ducts are located at the base of the vertical tail and are in close proximity to the aft bulkhead/PLBD interface. The APU exhaust plume is assumed to be ignited, which could provide an ignition source for the H₂ in the payload bay.

Reference rule {A16.1.1-11E}, EXPEDITED POWERDOWN. @[072398-6577]

FLIGHT RULES

FUEL CELLS

A16.1.6-1 FUEL CELL LIFETIME

FUEL CELL LIFETIME CONSIDERATION WILL NOT BE A CONSTRAINT DURING POSTLANDING OPERATIONS THROUGH CREW EGRESS.

Fuel cell lifetime concerns will not preclude normal postlanding operations through crew egress because of the desire to perform nominal postlanding procedures. The additional time impact to fuel cell lifetime from touchdown through crew egress is insignificant.

FLIGHT RULES

CONTAMINATION/FLAMMABILITY

A16.1.7-1 **CONTAMINATION/FLAMMABILITY/TOXICITY**

- A. THE CONVOY COMMANDER WILL NOTIFY THE FLIGHT DIRECTOR OF ANY EXPLOSIVE, FLAMMABLE, AND/OR TOXIC CONDITIONS THAT EXIST THAT PRECLUDE/DELAY NORMAL CREW EGRESS OPERATIONS.
- B. FOR EXTERNAL LEAKS OR HYPERGOLIC VENTING WHERE CONTAMINATION IS SUSPECT BUT BELOW MAXIMUM ALLOWABLE LIMITS, NORMAL POSTLANDING/CREW EGRESS OPERATIONS WILL BE CONTINUED.

Reference the postlanding Operational Maintenance Instructions (OMI) for contamination/flammability/toxicity limits. Convoy personnel are primarily responsible for the detection of hazardous substances that may preclude normal crew egress operations. Notification of explosive/toxic limit violation is consistent with the Flight Director's responsibility to ensure adequate vehicle safing and allow normal crew egress. Postlanding operations will continue as long as hazardous substance concentrations are within acceptable limits (i.e., below established explosive/toxic limit criteria).

Contamination, flammability, and toxic limits have been identified in the KSC Ground Operations Safety Plan and are consistent with the most stringent OSHA/NIOSH standards.

Rules {A16.1.1-10B}, NORMAL POSTLANDING OPERATIONS; and {A16.1.1-12A.1} and B.2, EMERGENCY POWERDOWN, reference this rule.

A16.1.7-2 **EMERGENCY OXYGEN SYSTEM REQUIREMENTS**

- A. THE CREW WILL ACTIVATE THE EMERGENCY OXYGEN SYSTEM FOR ANY UNAIDED EMERGENCY EGRESS.

For an unaided egress, the KSC Safety Assessment Team will not be available to test for the hazardous materials toxicity limits so the emergency oxygen system will be activated to protect against unknown contamination.

DOCUMENTATION: Engineering judgment.

- B. THE CREW WILL ACTIVATE EMERGENCY OXYGEN SYSTEM FOR ANY NONEMERGENCY EGRESS WHERE THE CABIN OR EXTERNAL ATMOSPHERE IS EITHER CONTAMINATED OR UNKNOWN.

This rule protects the crew from the hazards of toxic materials.

DOCUMENTATION: Engineering judgment.

FLIGHT RULES

SECTION 17 - LIFE SUPPORT

SMOKE DETECTION/FIRE SUPPRESSION LOSS DEFINITIONS

A17.1.1-1	FIRE/POST-FIRE DEFINITIONS	17-1
A17.1.1-2	SMOKE DETECTION LOSS DEFINITION	17-3
A17.1.1-3	FORWARD AVIONICS BAY FIRE SUPPRESSION	17-5

SMOKE DETECTION/FIRE SUPPRESSION MANAGEMENT

A17.1.2-1	MANAGEMENT FOLLOWING LOSS OF SMOKE DETECTION	17-7
A17.1.2-2	MANAGEMENT FOLLOWING LOSS OF FIRE SUPPRESSION IN AN AVIONICS BAY	17-11
A17.1.2-3	FIRE AND POST-FIRE ACTIONS	17-11
A17.1.2-4	MANAGEMENT FOLLOWING HALON DISCHARGE WITHOUT FIRE CONFIRMATION	17-17

ATMOSPHERE REVITALIZATION SYSTEM (ARS) AIR LOSS DEFINITIONS

A17.1.3-1	CABIN FAN	17-18
A17.1.3-2	CABIN ATMOSPHERIC CONTROL	17-18
A17.1.3-3	LOSS OF AVIONICS BAY FAN	17-14
A17.1.3-4	IMU FAN	17-14
A17.1.3-5	AVIONICS BAY COOLING	17-15
A17.1.3-6	REGENERATIVE CO2 REMOVAL SYSTEM (RCRS) LOSS DEFINITION	17-20

FLIGHT RULES

ARS AIR SYSTEM MANAGEMENT

A17.1.4-1 CABIN ATMOSPHERE CONTROL 17-21

A17.1.4-2 CABIN TEMPERATURE CONTROL 17-22

A17.1.4-3 CABIN/AVIONICS BAY FAN MANAGEMENT 17-24

A17.1.4-4 MANAGEMENT OF DEGRADED ROTATING EQUIPMENT . 17-22

A17.1.4-5 REGENERATIVE CO2 REMOVAL SYSTEM (RCRS)
MANAGEMENT 17-22

A17.1.4-6 RCRS MANUAL SHUTDOWN CRITERIA 17-24

A17.1.4-7 LIOH REDLINE DETERMINATION 17-25

A17.1.4-8 MANAGEMENT OF LIOH CANS FOR ADDITIONAL DAYS 17-25

**PRESSURE CONTROL SYSTEMS (PCS) LOSS
DEFINITIONS**

A17.1.5-1 CABIN PRESSURE INTEGRITY 17-28

A17.1.5-2 8 PSIA CABIN CONTINGENCY 165-MINUTE RETURN
CAPABILITY 17-31

A17.1.5-3 PPO2 CONTROL 17-33

A17.1.5-4 N2 SUPPLY 17-34

A17.1.5-5 PPO2 SENSOR LOSS DEFINITION 17-34

A17.1.5-6 LES O2 SUPPLY SYSTEM LOSS DEFINITION 17-35

PCS SYSTEMS MANAGEMENT

A17.1.6-1 NORMAL PCS CONFIGURATION 17-36

A17.1.6-2 CABIN PRESSURE RELIEF VALVES 17-38

A17.1.6-3 CABIN VENT VALVES 17-38

A17.1.6-4 CABIN O2 CONCENTRATION 17-39

A17.1.6-5 8 PSIA EMERGENCY CABIN CONFIGURATION 17-41

A17.1.6-6 O2 BLEED ORIFICE MANAGEMENT 17-42

A17.1.6-7 N2 SYSTEM MANAGEMENT 17-42

A17.1.6-8 LOSS OF CABIN INTEGRITY T_{MAX} DEFINITION AND
TIG SELECTION 17-43

A17.1.6-9 N2 REDLINE DETERMINATION 17-45

FLIGHT RULES

A17.1.6-10 LES O2 SUPPLY SYSTEM LOSS MANAGEMENT 17-46

10.2 PSIA CABIN ATMOSPHERE OPERATION

A17.1.7-1 CABIN ATMOSPHERE MANAGEMENT 17-47

A17.1.7-2 10.2 PSIA CABIN DEPRESSURIZATION
CONSTRAINTS 17-47

A17.1.7-3 CABIN REPRESSURIZATION PRIOR TO DEORBIT ... 17-50

A17.1.7-4 10.2 PSIA CABIN PRESSURE MANAGEMENT FOR
MULTIPLE EVA'S 17-50

A17.1.7-5 14.7 PSIA CABIN REPRESSURIZATION LIMITATION 17-51

A17.1.7-6 10.2 PSIA CABIN TEMPERATURE CONSTRAINT 17-51

A17.1.7-7 PAYLOAD 10.2 PSIA CABIN OPERATIONS 17-51

A17.1.7-8 ATCS (10.2 PSIA CABIN) CONFIGURATION 17-52

A17.1.7-9 CABIN PRESSURE TIME AT 10.2 PSIA 17-52

**WASTE COLLECTION SYSTEM (WCS)/VACUUM VENT
LOSS DEFINITIONS**

A17.1.8-1 WCS SEPARATOR 17-53

A17.1.8-2 WCS URINE COLLECTION 17-53

A17.1.8-3 WCS COMMODE 17-53

A17.1.8-4 VACUUM VENT LOSS DEFINITION 17-55

WCS/VACUUM VENT MANAGEMENT

A17.1.9-1 WCS USAGE CONSTRAINT 17-56

A17.1.9-2 LEAKING WCS WATER LINES 17-56

A17.1.9-3 ALTERNATE FECAL COLLECTION 17-56

A17.1.9-4 ALTERNATE URINE COLLECTION 17-57

A17.1.9-5 VACUUM VENT SYSTEMS MANAGEMENT (CIL) 17-57

WASTE WATER LOSS DEFINITIONS

A17.1.10-1 WASTE WATER TANK 17-59

A17.1.10-2 WASTE WATER DUMP CAPABILITY 17-59

FLIGHT RULES

SECTION 17 - LIFE SUPPORT

SMOKE DETECTION/FIRE SUPPRESSION LOSS DEFINITIONS

A17.1.1-1 FIRE/POST-FIRE DEFINITIONS

A. FIRE SHALL BE DEFINED AS ONE OR MORE OF THE FOLLOWING:

1. CREW OBSERVANCE OF FLAME OR SMOKE.
2. FOR AN AVIONICS BAY, ANY ONE OF THE FOLLOWING: @[090894-1674]
 - a. TWO SMOKE DETECTOR CONCENTRATION LEVELS OVER 2000 UG/M**3 IN THE SAME COMPARTMENT.
 - b. ONE CONCENTRATION LEVEL 2000 UG/M**3 AND INCREASING, AND THE ALTERNATE DETECTOR HAS FAILED SELF TEST.
 - c. ONE CONCENTRATION LEVEL 2000 UG/M**3 AND INCREASING, AND CONFIRMATION BY ELECTRICAL DATA OF A SUSTAINED SHORT.

*A confirmation is required to accurately detect a fire condition; this confirmation can be via a separate smoke detector indicating a concentration level over 2000 ug/m**3, or crew observations. In the event the alternate smoke detector fails a self test in an avionics bay, a fire condition will be assumed. Any indications of a sustained short in the affected avionics bay will also be considered as confirmation of a fire.*

In the event of a cabin fire, the crew will most likely react to olfactory sensing prior to the annunciation of a smoke detector(s), since the human nose is significantly more sensitive. Also, visual cues will most likely be used as confirmation of a fire condition rather than relying solely upon two smoke detector indications. For a cabin fire, the crew must locate the fire and therefore confirm its existence prior to discharging a Halon bottle. Without confirmation of the fire there can be no guarantee that the Halon was discharged in the appropriate place or had any affect on the fire. @[090894-1674]

B. POST-FIRE SHALL BE DEFINED AS THE FOLLOWING:

1. CREW OBSERVANCE THAT FIRE HAS BEEN SUPPRESSED.
2. SMOKE DETECTOR CONCENTRATIONS INDICATE STABLE OR DECREASING.

FLIGHT RULES

THIS RULE CONTINUED ON NEXT PAGE

FLIGHT RULES

A17.1.1-1 FIRE/POST-FIRE DEFINITIONS (CONTINUED)

3. FOR AN AV BAY FIRE, A HALON BOTTLE HAS BEEN DISCHARGED AND THE AFFECTED LRU UNPOWERED. @[090894-1674]

If the crew continues to observe a fire or increasing smoke, the fire condition still exists. If a fire has been suppressed by either Halon discharge or removal of power, the smoke detector concentration indications should stabilize or decrease. An avionics bay fire is considered suppressed, when the avionics bay fans have been deactivated, Halon has been discharged into the bay, and the affected LRU's have been unpowered. @[090894-1674]

DOCUMENTATION: SODB 4.6.5.1.e; engineering judgment; and materials branch discussions.

A17.1.1-2 SMOKE DETECTION LOSS DEFINITION

- A. AVIONICS BAY SMOKE DETECTION SHALL BE CONSIDERED LOST FOR ANY ONE OF THE FOLLOWING REASONS:
 1. ONE SMOKE DETECTOR FAILS BOTH PORTIONS OF THE CIRCUIT TEST AND THE OTHER SMOKE DETECTOR FAILS EITHER PORTION OF THE CIRCUIT TEST.
 2. POWER TO BOTH THE DETECTORS IN THAT AVIONICS BAY CANNOT BE MAINTAINED.
 3. LOSS OF AIR CIRCULATION (BOTH AVIONICS BAY FANS FAILED) IN THE BAY.
- B. CREW CABIN SMOKE DETECTION SHALL BE CONSIDERED LOST FOR ANY ONE OF THE FOLLOWING REASONS:
 1. ALL THREE DETECTORS FAIL BOTH PORTIONS OF THE CIRCUIT TEST.
 2. POWER TO ALL THREE CABIN DETECTORS CANNOT BE MAINTAINED.
 3. LOSS OF AIR CIRCULATION (BOTH CABIN FANS FAILED) IN THE CREW CABIN.

FLIGHT RULES

Each smoke detector outputs two smoke detection indications (an alarm indication and a concentration measurement), and these two measurements are independent of one another except for a smoke detector hardware failure. The only hardware failure that can be detected by the circuit test is an air pump failure which would force the detector to fail both portions of the circuit test. If the smoke detector passes either portion of the circuit test, the air pump is then verified as operative, and the concentration readout sent to the GPC for FDA limit sensing is considered a valid indication.

THIS RULE CONTINUED ON NEXT PAGE

FLIGHT RULES

A17.1.1-2 SMOKE DETECTION LOSS DEFINITION (CONTINUED)

Power is required for the smoke detectors to operate. Loss of air circulation prevents particulates from reaching the smoke detector in a timely manner if the combustion is not close to the smoke detector. If only one indication is left in an avionics bay, the system is considered suspect to the point of being unreliable.

DOCUMENTATION: R. I. Vendor drawings VS70-620109, V070-623420, and V70-960099. Rule {A17.1.13-1}, LIFE SUPPORT GO/NO-GO CRITERIA, references this rule.

A17.1.1-3 FORWARD AVIONICS BAY FIRE SUPPRESSION

FORWARD AVIONICS BAY FIRE SUPPRESSION IS CONSIDERED LOST IF:

- A. THE "AGENT DISCHARGE" PBI IS ILLUMINATED WITH NO CONCURRENT AURAL CUE.

The system is suspect to the point of being unreliable. An AGENT DISCHARGE light indicates an "empty" bottle. Without an aural cue, it would not be known when or how fast the agent discharged.

- B. 50 HOURS HAS ELAPSED AFTER THE "AGENT DISCHARGE" PBI IS ILLUMINATED AND WITH A CONCURRENT AURAL CUE.

The avionics bays are not airtight and will allow the Halon 1301 fire suppressant to dissipate into the cabin over a period of time. However, the resultant concentration of Halon 1301 in an avionics bay from a fully charged bottle will stay above the required 4 percent needed to extinguish a fire for 50 hours.

DOCUMENTATION: SODB 4.6.5.2.A.2.R.

- C. FOR AV BAY 3A WITH ENHANCED MIDDECK COOLING AND ACTIVELY COOLED PAYLOADS: 28 HOURS HAS ELAPSED AFTER THE "AGENT DISCHARGE" PBI IS ILLUMINATED WITH A CONCURRENT AURAL CUE. @J040899-2497.]

Avionics bays that have been modified for enhanced middeck cooling, and have actively cooled payloads stowed in the bay, have a higher leakage rate than avionics bays that have not been modified. As such, Halon 1301 fire suppressant will dissipate into the cabin faster from the enhanced avionics bays. The resultant concentration of Halon 1301 in an enhanced avionics bay from a fully charged bottle will stay above the required 4 percent needed to extinguish a fire for 28 hours. If the av bay has enhanced cooling capability; however, no actively cooled payloads have been manifested, then paragraph B applies because the payload ducts have been capped.

DOCUMENTATION: BNA 287-200-098-017, Middeck Bay 3A Leakage Analysis. @J040899-2497.]

FLIGHT RULES

Rule {A17.1.13-1}, LIFE SUPPORT GO/NO-GO CRITERIA, references this rule.

FLIGHT RULES

SMOKE DETECTION/FIRE SUPPRESSION MANAGEMENT

A17.1.2-1 MANAGEMENT FOLLOWING LOSS OF SMOKE DETECTION

A. AVIONICS BAY:

1. HALON DISCHARGE CRITERIA

DURING ANY PHASE OF FLIGHT, A HALON BOTTLE WILL BE DISCHARGED IF THERE IS EQUIPMENT FAILURE IN THAT AVIONICS BAY AND THE FAILURE IS ATTRIBUTED TO A SUSTAINED SHORT. IF THE MCC IS NOT AVAILABLE TO DETERMINE IF A SHORT WAS PRESENT, THE REMAINING EQUIPMENT IN THE BAY WILL BE POWERED DOWN UNTIL THE ASSESSMENT CAN BE MADE. A HALON BOTTLE WILL BE DISCHARGED IF SECONDARY CUES ARE PRESENT. @[090894-1674]

An equipment failure due to a sustained short could provide an ignition source for a fire and should be considered a fire condition. A short that has cleared has effectively eliminated the ignition source and should not be considered a fire condition. If the MCC is not available when a piece of equipment fails, powerdown of the bay is considered the best compromise to safe the bay while not prematurely discharging Halon. If the crew confirms a fire condition with secondary cues such as simultaneous or subsequent equipment failure or crew observance of smoke, a Halon bottle will be discharged.

2. POWERDOWN MANAGEMENT FOR AVIONICS BAYS 1 AND 2

- a. FOR AVIONICS BAYS 1 AND 2, A POST-OMS-2 POWERDOWN OF ALL AIR-COOLED EQUIPMENT AND THE AVIONICS BAY FAN IN THE AFFECTED AVIONICS BAY SHALL BE ACCOMPLISHED. ALL THIS EQUIPMENT MAY BE POWERED UP FOR ENTRY

Air-cooled equipment and avionics bay fan will be powered down to (1) prevent the propagation of any fire by removing the convection currents that would feed O2 to the fire and (2) eliminate friction generated by the fan as a potential ignition source. This action safes the avionics bay from any combustion except for arc tracking during the critical time of powering up equipment required for entry.

- b. PRIOR TO POWERUP OF EQUIPMENT IN THE AFFECTED AVIONICS BAY FOR ENTRY, A HANDHELD HALON BOTTLE WILL BE DISCHARGED IN THAT BAY.

FLIGHT RULES

The affected avionics bay will be safed by Halon discharge because the possibility exists that a fire condition could occur without proper and timely fire suppression since smoke detection is lost.

Firing of a handheld bottle is preferred since it allows the crew the option of firing the remotely controlled Halon bottle during entry, if it becomes necessary and the remote bottle is still available.

®[090894-1674]

THIS RULE CONTINUED ON NEXT PAGE

FLIGHT RULES

A17.1.2-1 MANAGEMENT FOLLOWING LOSS OF SMOKE DETECTION
(CONTINUED)

3. AVIONICS BAY 3 MANAGEMENT:

- a. FOR AVIONICS BAY 3, A POST-OMS-2 POWERDOWN OF ALL AIR-COOLED EQUIPMENT (EXCEPT COMMUNICATIONS EQUIPMENT, CAUTION AND WARNING EQUIPMENT, AND THE AVIONICS BAY FAN) SHALL BE ACCOMPLISHED. ALL OF THIS EQUIPMENT MAY BE POWERED UP FOR ENTRY. A LOCKER IN FRONT OF AVIONICS BAY 3 WILL BE REMOVED TO EXPOSE THE BAY TO THE CABIN ENVIRONMENT FOR SMOKE DETECTION. @[090894-1674]

The communication and caution and warning equipment (air-cooled equipment) in avionics bay 3 is required for flight and cannot be unpowered. This precludes fire suppression by lack of convection currents because the fan is still running. Removal of a locker in front of avionics bay 3 will expose the bay to the cabin environment, thus allowing the cabin smoke detectors and the crew to monitor the powered equipment for evidence of a fire. The alternative would be to leave the locker in place and discharge a handheld Halon bottle to safe the bay since air-cooled equipment remains powered up. This action would cause possible early mission termination due to Halon discharge constraints (ref. Rule {A13.1.2-13A}, CABIN ATMOSPHERE CONTAMINATION).

- b. PRIOR TO POWERUP OF EQUIPMENT IN AVIONICS BAY 3 FOR ENTRY, ANY PREVIOUSLY REMOVED LOCKERS WILL BE REINSTALLED AND A HANDHELD HALON BOTTLE WILL BE DISCHARGED IN THE BAY.

The avionics bay 3 will be safed by Halon discharge prior to entry because the possibility exists that a fire condition could occur without proper and timely fire suppression since smoke detection is lost. Firing of a handheld bottle is preferred since it allows the crew the option of firing the remotely controlled Halon bottle during entry, if it becomes necessary, and the remote bottle is still available. @[090894-1674]

B. CREW CABIN

A CREWMEMBER MUST REMAIN AWAKE AT ALL TIMES FOLLOWING LOSS OF SMOKE DETECTION IN THE CREW CABIN TO MONITOR FOR SMOKE/FIRE.

A crewmember must be available for monitoring the cabin since a sleeping crew may not be awakened by a smoke/fire condition.

THIS RULE CONTINUED ON NEXT PAGE

FLIGHT RULES

A17.1.2-1 MANAGEMENT FOLLOWING LOSS OF SMOKE DETECTION
(CONTINUED)

C. MINIMAL SMOKE DETECTION MANAGEMENT

IF ONLY TWO SMOKE DETECTION INDICATIONS REMAIN IN THE CABIN OR AVIONICS BAY, THE CIRCUIT TEST SHALL BE PERFORMED EVERY DAY UNTIL EOM.

Each smoke detector has two separate indications (hardware alarm and GPC concentration readout). Thus, nominally, the cabin has six indications, and each avionics bay has four indications. If only two of these indications are available in an area, the circuit test should be performed every day to verify that the minimum requirement is still met.

Note: The risk of an avionics bay fire is extremely low due to the design of the vehicle. The design limits ignition sources and provides little fuel for a fire. Any ignition that did occur would most likely be due to wire bundle arc tracking on which Halon has no effect.

Note: The powerdown of the air-cooled equipment causes little procedural impact on orbit but is a severe impact during dynamic flight phases (ascent through OMS-2, deorbit prep through landings).

Note: The discharge of a handheld Halon bottle in the avionics bay has little postlanding turnaround impact.

DOCUMENTATION: Engineering judgment; Flammability Requirements, NHB 8060.1b, p. 1-1; and Halon 1301 Fire Extinguishment in Avionics Bays, M. Pedley.

Rule {A17.1.13-1}, LIFE SUPPORT GO/NO-GO CRITERIA, references this rule.

FLIGHT RULES

A17.1.2-2 MANAGEMENT FOLLOWING LOSS OF FIRE SUPPRESSION IN AN AVIONICS BAY

FOR LOSS OF FIRE SUPPRESSION IN AN AVIONICS BAY, NO ACTION WILL BE TAKEN UNLESS THE SMOKE DETECTORS IN THE AFFECTED AVIONICS BAY INDICATE A FIRE CONDITION. AT THAT TIME A HANDHELD HALON BOTTLE WILL BE DISCHARGED INTO THE AVIONICS BAY.

A HANDHELD HALON BOTTLE WILL BE DISCHARGED INTO THE AFFECTED AVIONICS BAY PRIOR TO SEAT INGRESS IF ONE HAS NOT BEEN PREVIOUSLY DISCHARGED INTO THE AVIONICS BAY.

If a fire condition exists in an avionics bay, then the handheld Halon bottles will be used to suppress the fire. During deorbit, however, the crew may not be able to reach the affected bay to discharge a handheld Halon bottle to suppress a fire; therefore, it is prudent to discharge a handheld Halon bottle in the avionics bay prior to seat ingress to prevent the ignition and/or propagation of a fire. This action has no adverse turnaround impacts.

DOCUMENTATION: Engineering judgment.

Rule {A17.1.13-1}, LIFE SUPPORT GO/NO-GO CRITERIA, references this rule.

A17.1.2-3 FIRE AND POST-FIRE ACTIONS

A. AVIONICS BAY FIRE ACTIONS

IF A FIRE CONDITION IS DETECTED IN THE AVIONICS BAY DURING ANY PHASE OF FLIGHT, THE FOLLOWING ACTIONS WILL BE ACCOMPLISHED AS SOON AS POSSIBLE:

1. AN AVIONICS BAY HALON BOTTLE WILL BE DISCHARGED IN THAT AVIONICS BAY.
2. THE AVIONICS BAY FAN WILL BE TURNED OFF.
3. THE CREW WILL DON THE HRA/LES HELMETS WITH VISORS DOWN.

B. CREW CABIN FIRE ACTIONS

IF A FIRE CONDITION IS DETECTED IN THE CABIN DURING ANY PHASE OF FLIGHT, THE FOLLOWING ACTIONS SHALL BE ACCOMPLISHED AS SOON AS POSSIBLE:

1. THE CABIN FAN SHALL BE TURNED OFF.

FLIGHT RULES

2. THE CREW SHALL DON HRA/LES HELMETS WITH VISORS DOWN.

THIS RULE CONTINUED ON NEXT PAGE

FLIGHT RULES

A17.1.2-3 FIRE AND POST-FIRE ACTIONS (CONTINUED)

3. THE CREW SHALL DISCHARGE THE HANDHELD HALON BOTTLE IN THE APPROPRIATE FIRE PORT.

A Halon discharge should safe the avionics bay from any further combustion except for arc tracking upon which Halon has no effect. In the case of a cabin fire, the HRA/LES helmets protect the crew from breathing potentially toxic gases; donning of the LES will be considered later if appropriate. The discharged Halon should suppress the fire in most conditions. Also the cabin fan and avionics fan produces convection air currents that will feed oxidizer to a fire. Without convection currents a fire should extinguish itself due to a lack of oxidizer and also localize toxins in the vicinity of combustion until the crew has donned protective gear.

DOCUMENTATION: Materials Processing in Space: Early Experiments, NASA SP-443.

C. AVIONICS BAY POST-FIRE ACTIONS

FOLLOWING A FIRE CONDITION FOR WHICH A HALON BOTTLE HAS BEEN DISCHARGED INTO AN AVIONICS BAY:

1. IN ORDER TO MINIMIZE ELECTRICAL AND FRICTIONAL IGNITION SOURCES, A POWERDOWN OF ALL EQUIPMENT IN THAT AVIONICS BAY SHALL BE ACCOMPLISHED WITH THE EXCEPTION OF THE IMU FANS, INSTRUMENTATION REQUIRED FOR THE CREW AND MCC TO ASSESS POST-FIRE SAFETY STATUS, AND COMMUNICATIONS EQUIPMENT WHICH WILL BE POWERED DOWN ONLY IF INDICATIONS SHOW IT HAS FAILED. @[090894-1673A]
 - a. THE POWERED DOWN EQUIPMENT IN THE AFFECTED AVIONICS BAY WILL BE DECLARED LOST UNTIL PROVEN GO FOR GO/NO-GO CRITERIA.
 - b. THE ONLY EQUIPMENT TO BE CONSIDERED FOR REACTIVATION WILL BE EQUIPMENT REQUIRED TO RESTORE SINGLE-FAULT TOLERANCE FOR ENTRY @[090894-1673A]

THIS RULE CONTINUED ON NEXT PAGE

FLIGHT RULES

A17.1.2-3 FIRE AND POST-FIRE ACTIONS (CONTINUED)

Without direct insight into the affected bay, the damage to the equipment is unknown. Some of the equipment may not have been in use during the fire or may have suffered failures not immediately detectable; therefore, the equipment must be considered NO-GO for all GO/NO-GO purposes. For avionics bay 1, IMU fans (located in the avionics bay) must remain operating since the IMU's (not located in avionics bays) cannot operate for more than 30 minutes without cooling. If a fan has failed, a redundant fan will be activated immediately. For avionics bay 3, communication is considered too important during the entry phase of flight to allow it to become unpowered without a confirmed failure. For all three avionics bays, in order to maintain insight into the health of the remaining systems and to implement the post-fire cabin depress and purge at 8 psi, the instrumentation equipment is required. Instrumentation is required in order to properly limit the rate of the cabin depress such that a positive delta pressure is maintained on the avionics bay while a dedicated avionics bay purge is in place. The positive delta pressure on the avionics bay will ensure that the toxic combustion products from the fire are not forced into the cabin.

Repowered equipment in the affected avionics bay should be restricted to that required to achieve single-fault tolerance to entry systems so exposure to the source of the fire can be minimized. The health of the systems and/or crew cannot be guaranteed following a fire; therefore, entry may be necessary following cabin evaluation.

2. AFTER THE DISCHARGE OF A HALON BOTTLE IN AN AVIONICS BAY, AN OVERBOARD PURGE OF THAT BAY WILL BE INITIATED. IF COMBUSTION PRODUCTS ARE DETECTED IN THE CABIN, THE CREW WILL REMAIN ON THE QDM'S AND A CABIN DEPRESS TO 8 PSI FOLLOWED BY A CONTINUOUS CABIN PURGE AT 8 PSI WILL BE PERFORMED. THE PURGE WILL BE TERMINATED AND THE CREW ALLOWED TO BREATHE CABIN AIR ACCORDING TO THE CRITERIA OUTLINED IN RULE {A13.1.2-13C.7}, CABIN ATMOSPHERE CONTAMINATION.

Post-fire, a cabin depress to 8 psia and continuous purge at 8 psia will manage O₂ concentrations below maximum levels as well as decrease the concentration of discharged Halon and any toxic gases that were produced by a fire. This action will extend the time on orbit so as to potentially avoid an ELS entry by effectively reducing the amount of N₂ needed to control O₂ concentrations. Since in an 8 psi cabin condition, the O₂ concentration is allowed to reach 40 percent which increases the flammability potential, the crew should make sure that the fire has been fully extinguished before initiating the depress to prevent flares. If sufficient N₂ is available to reach a PLS, it is not necessary to go to 8 psi. ©[090894-1673A]

THIS RULE CONTINUED ON NEXT PAGE

FLIGHT RULES**A17.1.2-3 FIRE AND POST-FIRE ACTIONS (CONTINUED)**

A cabin depress without first purging the affected avionics bay directly overboard, would create a negative pressure differential between the cabin and avionics bay that would draw any Halon and/or toxic combustion products from the avionics bay into the cabin. Therefore, the 50-hour period between the Halon discharge in an avionics bay and the diffusion of a potentially hazardous level of Halon into the cabin (ref. Rule {A13.1.2-13A}, CABIN ATMOSPHERE CONTAMINATION) could not be guaranteed following a cabin depress without first initiating an avionics bay purge. A dedicated avionics bay purge of at least 3 lb/hr directly overboard will maintain a positive delta pressure on the avionics bay with respect to the cabin during a controlled cabin depress to 8 psi, thus ensuring that any Halon and/or combustion products would not be drawn into the cabin. In order to maintain the positive delta pressure on the affected avionics bay, the cabin EQ dP/dT must be controlled to below a maximum of -0.1 psi/min during the transition from the current cabin pressure to 8 psi.

In the case of a fire following the depletion of all available Halon, lowering of the O₂ concentrations to 15 percent could be used as an alternative means of fire suppression.

Note: A safe level of toxicity in the cabin cannot be guaranteed following a fire condition, but a cabin depress without initiating a dedicated avionics bay purge would quicken the diffusion rate of toxins into the cabin. @[090894-1673A]

3. THE RCRS WILL BE MANUALLY SHUT DOWN FOLLOWING AN ORBITER AVIONICS BAY FIRE.

See Rule {A17.1.4-6}, RCRS MANUAL SHUTDOWN CRITERIA, for rationale.

DOCUMENTATION: Engineering judgment

D. CREW CABIN POST-FIRE ACTIONS

POST-FIRE THE FOLLOWING ACTIONS SHALL BE ACCOMPLISHED:

1. THE CREW WILL POWER DOWN SUSPECT EQUIPMENT.

The crew should power down suspect equipment because the equipment health cannot be guaranteed and is a potential ignition source.

2. THE CREW SHALL PERFORM A FLIGHT DECK AVIONICS CHECKOUT FOR SUSPECT EQUIPMENT AND/OR EQUIPMENT REQUIRED FOR ENTRY.

If required for entry, the equipment should be checked out before use.

THIS RULE CONTINUED ON NEXT PAGE

FLIGHT RULES

A17.1.2-3 FIRE AND POST-FIRE ACTIONS (CONTINUED)

3. FOLLOWING A FIRE/HALON BOTTLE DISCHARGE, IF COMBUSTION PRODUCTS ARE DETECTED IN THE CABIN, THE CREW WILL REMAIN ON THE QDM'S. THE CREW SHALL PERFORM A CABIN DEPRESS TO 8 PSI AND A CONTINUOUS PURGE AT 8 PSI WILL BE PERFORMED. THE PURGE MAY BE TERMINATED AND THE CREW ALLOWED TO BREATHE CABIN AIR ACCORDING TO THE CRITERIA OUTLINED IN RULE {A13.1.2-13C.7}, CABIN ATMOSPHERE CONTAMINATION. ©[090894-1673A]

Post-fire, a cabin depress to 8 psi and continuous purge at 8 psi will manage O₂ concentrations below maximum levels as well as decrease the concentration of discharged Halon and any toxic gases that were produced by a fire. This action will extend the time on orbit so as to potentially avoid an ELS entry by effectively reducing the amount of N₂ needed to control O₂ concentrations.

Following a fire condition, the health of the systems and/or crew cannot be guaranteed; therefore, following a cabin atmosphere evaluation, entry may be necessary. Since in an 8 psi cabin condition, the O₂ concentration is allowed to reach 40 percent which increases the flammability potential, the crew should make sure that the fire has been fully extinguished before initiating the depress to prevent flares. If sufficient N₂ is available to reach a PLS, it is not necessary to go to 8 psi.

In the case of a fire following the depletion of all available Halon, lowering of the O₂ concentrations to 15 percent could be used as an alternative means of fire suppression. ©[090894-1673A]

DOCUMENTATION: SODB 4.6.5.2.a.2.r; engineering judgment; and Halon 1301 Fire Extinguishment in Avionics Bays, M. Pedley.

4. THE RCRS WILL BE MANUALLY SHUT DOWN FOLLOWING AN ORBITER CABIN FIRE.

See Rule {A17.1.4-6}, RCRS MANUAL SHUTDOWN CRITERIA for rationale.

DOCUMENTATION: Engineering judgment

Rule {A17.1.13-1}, LIFE SUPPORT, EECOM GO/NO-GO CRITERIA, references this rule.

FLIGHT RULES

A17.1.2-4 MANAGEMENT FOLLOWING HALON DISCHARGE WITHOUT FIRE CONFIRMATION

A. AVIONICS BAY: @[090894-1673A]

FOLLOWING A BOTTLE EMPTY INDICATION, AN AVIONICS BAY PURGE WILL BE PERFORMED. IF THE TIME OF DISCHARGE CAN BE ACCURATELY DETERMINED, EARLY MISSION TERMINATION CRITERIA AS SPECIFIED IN RULE {A13.1.2-13A}, CABIN ATMOSPHERE CONTAMINATION, MAY BE WAIVED ON MCC CALL. IF THE TIME OF DISCHARGE OF THE HALON BOTTLE CANNOT BE DETERMINED, A WORSE CASE TIME OF DISCHARGE AT LIFT-OFF WILL BE APPLIED.

A dedicated overboard purge of the affected avionics bay will begin to decrease the concentration of Halon in the bay and ensure that it does not migrate into the cabin. The purge should be initiated as soon as possible in order to avoid potential mission termination due to toxic concentrations of Halon in the cabin.. If the time of discharge cannot be accurately determined, it must be assumed that the bottle began leaking at the worst case time of lift-off. The MCC indication of an empty bottle provides no insight into the start of a potential leak or the time of discharge. A 140 db audible cue and a rapid rise in smoke concentrations are the only indications to determine time of discharge and this only applies to a bottle discharging all of its contents within a matter of seconds. Reference Rule {A13.1.2-13}, CABIN ATMOSPHERE CONTAMINATION, for EOM determination due to Halon concentrations from an avionics bay Halon bottle.

B. CABIN:

IF THE START OF A LEAK FROM A HANDHELD BOTTLE CAN BE ACCURATELY DETERMINED, THE REMAINING CONTENTS OF THE BOTTLE WILL BE DISCHARGED OVERBOARD THROUGH THE AIRLOCK DEPRESS VALVE.

Discharge of the remaining contents of a handheld Halon bottle directly overboard will reduce the concentration of Halon in the cabin and potentially minimize the EOM impacts. The time of the start of the leak is critical because, coupled with the discharge duration through the depress valve, there is no other way to effectively determine how much Halon has leaked into the cabin. The nominal discharge time for a handheld Halon bottle is 15 - 19 seconds. Neither the crew nor the MCC have insight into an empty or leaking handheld bottle unless the crew can audibly detect a leak. Reference rule {A13.1.2-13B}. CABIN ATMOSPHERE CONTAMINATION for EOM determination due to Halon concentrations from a handheld Halon bottle.

Another option for disposal of a leaking handheld bottle is to place it in the airlock and expose it to vacuum. However, since there is no effective way to determine the leak rate of the bottle, it is not possible to determine how much Halon has leaked into the cabin or how long the bottle must be exposed to vacuum before it is completely empty. @[090894-1673A]

FLIGHT RULES

ATMOSPHERE REVITALIZATION SYSTEM (ARS) AIR LOSS DEFINITIONS

A17.1.3-1 CABIN FAN

A CABIN FAN IS CONSIDERED LOST IF THE FAN DELTA PRESSURE IS <4.20 (4.49) INCHES H₂O OR >6.80 (6.51) INCHES H₂O AND CREW DETECTS LOSS OF AIR FLOW.

With a delta P of 4.2 inches H₂O (low on the portion of performance band) the flow is approximately 1575 lb/hr. This is considered to be the maximum flow available with low delta P with intact systems (no leakage; therefore, proper cooling to all areas).

The minimum required flowrate for proper cooling is 1400 lb/hr (at the high portion of the performance band); the delta P required to maintain the flow is 6.8 inches H₂O. A delta P higher than this will not meet the required minimum cooling.

Measurement accuracy is ± 3.6 percent of full scale (0.036 x 8 inches H₂O = 0.288).

A17.1.3-2 CABIN ATMOSPHERIC CONTROL

CABIN ATMOSPHERIC CONTROL IS CONSIDERED LOST IF:

- A. UNABLE TO MAINTAIN CABIN TEMPERATURE CONTROL AT <95 DEG (90 DEG) F.

Temperatures above 95 deg F would cause an overtemperature condition in the avionics on the flight deck. The lower limit for the flight deck avionics is 40 deg F which cannot be achieved if the vehicle is in the full, on-orbit avionics configuration. From analysis and flight experience, the water pump outlet temperature will run 8 deg to 10 deg F below cabin temperature; therefore, a 39 deg F cabin temperature would result in a water pump outlet temperature below the freezing point of water.

DOCUMENTATION: SODB 4.6.1.3.4-1.1, 1.1-ECLSS-122

- B. UNABLE TO SATISFY BIOMED CONSTRAINTS ON PPCO₂ (REF. RULE {A13.1.2-4}, PPCO₂ CONSTRAINT).

See Rule {A13.1.2-4}, PPCO₂ CONSTRAINT, rationale.

DOCUMENTATION: SODB 3.4.6.1 and SODB 4.6.1.3.1-C.

THIS RULE CONTINUED ON NEXT PAGE

FLIGHT RULES

A17.1.3-2 CABIN ATMOSPHERIC CONTROL (CONTINUED)

C. HUMIDITY CONTROL

1. UNEXPLAINED DECREASE IN THE WASTE WATER TANK FILL RATE (NORMALLY 6 ± 1 LB/DAY-CREWMEMBER).

The increase in waste tank quantity is used in determining status of humidity control instead of change in the humidity level. On STS-5 when fan separator B became degraded due to blockage at the separator inlet, the humidity level did not change. The failure was detected by the flight controllers when the waste quantity increase became a slower rate. From past flights, the combined waste water quantity fill rate from metabolic production and the LiOH-CO₂ reaction has been about 0.25 lb/hr-crewmember (6 lb/day-crewmember). If the waste quantity is increasing only from the crew's use of the WCS (3.49 lb/day-crewmember), the crew will inspect the crew module for condensation.

DOCUMENTATION: SODB 4.6.2.2.4, 1.3-TM-DF86T50-54.

2. VISUAL CONDENSATION ON THE STRUCTURE OR THE EQUIPMENT.

If humidity control fails, moisture in the air will condense on equipment and/or parts of the vehicle structure with a corresponding temperature below the dewpoint.

DOCUMENTATION: Flight experience and SEH-SETO-87-014.

FLIGHT RULES

A17.1.3-3 LOSS OF AVIONICS BAY FAN

A. AV BAY COOLING @[040899-2498A]

AVIONICS BAY FAN SHALL BE CONSIDERED LOST IF THE FAN DELTA PRESSURE IS < 2.5 INCHES OF H₂O OR > 4.3 INCHES OF H₂O.

A delta pressure of 2.5 inches of H₂O is considered the minimum value which provides adequate airflow required for avionics bay cooling. This minimum value corresponds to the estimated fan delta pressure of two-phase fan operation. This delta pressure should also provide adequate cooling flow in the case of duct leakage or degraded fan performance.

The maximum delta pressure which provides minimum airflow for required cooling is 4.3 inches of H₂O. This maximum delta pressure/minimum airflow is based on a temperature violation of the GPC's. A delta pressure > 4.3 inches of H₂O will not meet the required minimum flowrate for adequate cooling. A delta pressure exceeding this value would be indicative of possible duct blockage or filter blockage.

The minimum and maximum delta pressure values are in general agreement with current LCC and OMRSD limits which are based on analytical predictions of flowrates as described in reference documentation.

Fan delta pressure is a coarse representation of avionics bay cooling performance. Other indicators to determine the effectiveness of the cooling are avionics bay air outlet, active water coolant loop heat exchanger inlet and outlet temperatures, and H₂O flowrate. Therefore, measurement error for delta pressure will not be used to determine the loss of an avionics bay fan.

DOCUMENTATION: RI-D IL-287-203-91-003, IL-287-203-90-86, and engineering judgment. (SODB request submitted.)

B. UPGRADED AV BAY FANS FOR ENHANCED MIDDECK COOLING: @[040899-2498A]

AN UPGRADED AV BAY FAN SHALL BE CONSIDERED LOST IF THE FAN DELTA PRESSURE IS < 4.5 INCHES OF H₂O OR > 7.8 INCHES OF H₂O.

The new upgraded av bay fans are identical to the current cabin fans, with the exception of the housing. As of January 1999, the new av bay fans are currently installed in Av Bay 3A of OV-104. OV-103 and OV-105 will receive the upgraded fans sometime in the future; however, the Shuttle Program has not determined when that will be. OV-102 is not scheduled to receive the upgraded fans.

A delta pressure of 4.5 inches of H₂O is considered the minimum value which provides adequate airflow required for avionics cooling. This minimum value corresponds to the estimated fan delta pressure of two phase fan operation. This delta pressure should also provide adequate cooling flow in the case of duct leakage or degraded fan performance.

FLIGHT RULES

THIS RULE CONTINUED ON NEXT PAGE

FLIGHT RULES

A17.1.3-3 LOSS OF AVIONICS BAY FAN (CONTINUED)

The maximum delta pressure which provides minimum airflow for required cooling is 7.8 inches of H₂O. The maximum delta pressure/minimum airflow is based on temperature violation of the GPC's. A delta pressure of 7.8 inches of H₂O will not meet the required minimum flow rate for adequate cooling. A delta pressure exceeding this value would be indicative of duct blockage or filter blockage.

Fan delta pressure is a coarse representation of avionics cooling performance. Other indicators to determine the effectiveness of the cooling are avionics bay outlet, active water coolant loop heat exchanger inlet and outlet temperatures, and H₂O flowrate. Therefore, measurement error for delta pressure will not be used to determine the loss of an avionics bay fan.

DOCUMENTATION: BNA Memo No. 287-200-098-019, Bay 3A Enhanced Avionics Fan Delta Pressure Limit. @[040899-2498A]

FLIGHT RULES

A17.1.3-4 IMU FAN

AN IMU FAN IS CONSIDERED LOST IF:

- A. FAN DELTA PRESSURE IS < 3.70 (3.94) OR > 4.95 (4.71) INCHES H₂O.

The minimum required flowrate for proper cooling is 144 lb/hr which is supplied by a maximum delta P of 4.95 inches H₂O (temperature dependent value). A delta P any higher than this would not be able to supply the air flowrate required for proper cooling.

A delta P of 3.7 inches H₂O produces a flow of approximately 185 lb/hr. This is considered to be the maximum fan flow available for an intact system. Therefore, any lower delta P would have to be produced by a system with questionable integrity (leakage). Measurement accuracy is ±3.4 percent of full scale (0.034 x 7 inches H₂O = 0.238).

- B. IMU FAN SPEED INDICATES ABNORMAL WHEN FAN IS SELECTED.

IMU fan speed range for normal speed indication is 10,000 ± 240 to 12,720 ± 700 rpm. Fan speeds outside this range indicate degraded fan operations not producing the necessary flow for cooling or a breach of system integrity.

DOCUMENTATION: Hamilton Standard Component Data Handbook SP01T80, Specification Number SVHS 6416.

A17.1.3-5 AVIONICS BAY COOLING

AVIONICS BAY COOLING IS LOST IF:

- A. ASCENT/ENTRY:

UNABLE TO MAINTAIN AVIONICS BAY AIR OUTLET TEMPERATURE < 130 DEG (125 DEG) F.

For a fully powered avionics bay, air outlet temperatures above 130 deg F would result in an overtemperature condition of the avionics in that avionics bay. @[030994-1609]

DOCUMENTATION: SODB 3.4.6.1.1.

- B. ON-ORBIT:

1. FOR A 14.7 PSI CABIN, UNABLE TO MAINTAIN AVIONICS BAY AIR OUTLET TEMPERATURE BELOW: @[090894-1673A]
 - a. 120 DEG (115 DEG) F, IF TWO GPC'S IN RUN.

FLIGHT RULES

THIS RULE CONTINUED ON NEXT PAGE

FLIGHT RULES

A17.1.3-5 AVIONICS BAY COOLING (CONTINUED)

- b. 108 DEG (103 DEG) F, IF ONLY ONE GPC IN RUN.
- c. 100 DEG (95 DEG) F, IF NO GPC'S IN RUN.
- 2. FOR A 10.2 PSI CABIN, UNABLE TO MAINTAIN AVIONICS BAY AIR OUTLET TEMPERATURE BELOW:
 - a. 117 DEG (112 DEG) F, IF TWO GPC'S IN RUN.
 - b. 101 DEG (96 DEG) F, IF ONLY ONE GPC IN RUN.
 - c. 89 DEG (84 DEG) F, IF NO GPC'S IN RUN.
- 3. FOR AN 8 PSI CABIN, UNABLE TO MAINTAIN AVIONICS BAY AIR OUTLET TEMPERATURE BELOW:
 - a. 127 DEG (122 DEG) F, IF TWO GPC'S IN RUN (AV BAY 1, WITH COLLINS TACAN, ONLY).

122 DEG (117 DEG) F, IF TWO GPC'S IN RUN (AV BAY 1, WITH GOULD TACAN, ONLY).

119 DEG (114 DEG) F, IF TWO GPC'S IN RUN (AV BAY 2 ONLY).
 - b. 109 DEG (104 DEG) F, IF ONLY ONE GPC IN RUN (AV BAY 1, WITH COLLINS TACAN, ONLY).

105 DEG (100 DEG) F, IF ONLY ONE GPC IN RUN (AV BAY 1, WITH GOULD TACAN, ONLY).

101 DEG (96 DEG) F, IF ONLY ONE GPC IN RUN (AV BAYS 2 & 3). @[090894-1673A]
 - c. 87 DEG (82 DEG) F, IF NO GPC'S IN RUN (AV BAY 1 ONLY). @[090894-1673A]

83 DEG (78 DEG) F, IF NO GPC'S IN RUN (AV BAYS 2 & 3).

THIS RULE CONTINUED ON NEXT PAGE

FLIGHT RULES

A17.1.3-5 AVIONICS BAY COOLING (CONTINUED)

The airflow in each of the avionics bays is distributed such that each LRU has enough airflow to remain under its maximum operational temperature limit based upon a design requirement of 95 degrees F maximum avionics bay inlet temperature. Since the inlet temperature is not a measured parameter, the air outlet temperature sensor must be used to determine if adequate cooling is available to the individual LRU's. The measured avionics bay air outlet temperature is a mixed air temperature for all LRU's (active & inactive) in the respective bay and is therefore an indication of the average heat load. When an LRU is powered off, its relatively cooler airflow will mix with the warmer air from the active LRU's, resulting in a mixed air temperature, in most cases, lower than that of an active LRU. For example, with a single active GPC, a mixed air outlet temperature of 130 degrees F would result in a GPC operating above its maximum operational limit of 130 degrees F. Consequently, a measured avionics bay air outlet temperature which corresponds to a maximum inlet temperature of 95 degrees F will be LRU configuration dependent. When set up for on-orbit operations (assuming nominal on-orbit configuration: TACAN, MLS, etc., are unpowered), the GPC is the largest heat load and each GPC affects approximately one-third of the airflow in that bay. Therefore, the configuration dependent air outlet temperature limit for on-orbit is driven primarily by the individual avionics bay's GPC configuration. The derived outlet temperature limits assume no airflow blockage within the avionics bay/LRU ducting.

Three different analyses were performed for cabin pressures of 14.7, 10.2, and 8.0 psia. The 14.7 psia case protects against the design requirement of 95 degrees F maximum avionics bay inlet temperature. Based upon the airflow distribution unique to each avionics bay, the individual GPC operating temperatures were derived to be 122 and 126 degrees F for avionics bays #1 and #2 respectively. The resulting mixed air temperatures (avionics bay air outlet temperature) is listed in section 1 of the rule since it is the monitored parameter. Consequently, there is between 4 and 8 degrees F margin depending on the specifics of the avionics bay.

Since there are no design requirements for the 10.2 and 8.0 psia cases, the analyses were performed as follows:

In order to be consistent between the two nominal cases (10.2 and 14.7 psia), the 10.2 analysis protected the same individual GPC box outlet temperatures as the 14.7 psia case, and backed out an air inlet temperature of ~ 80 degrees F. From these two parameters, the mixed air outlet temperature was calculated and listed in section 2 of the rule. The analysis was performed taking into account the decrease in air flow due to the lower cabin pressure. The expected decrease in airflow at 10.2 psia is based upon a linear function of the airflow at 14.7 psia and the lower cabin pressure. ©[090894-1673A]

FLIGHT RULES

Since the 8.0 psia case is a contingency scenario, the analysis protected against the maximum GPC operating temperature of 130 degrees as opposed to the derived design limit used for the 14.7 and the 10.2 psia cases. Therefore based upon a GPC operating temperature of 130 degrees F, the analysis calculated the mixed air outlet temperatures listed in section 3 of the rule. The 8.0 psi case has limits which are specific to the avionics bays as compared to the 10.2 and 14.7 psi cases. This is due to the fact that the lower pressure of 8.0 psi magnifies the impacts of the different avionics bay airflow configurations (including whether Gould or Collins TACAN's are installed in the avionics bay). For the higher pressure cases, the airflow differences did not cause a divergence in results significant enough to be considered separately. ®[090894-1673A]

THIS RULE CONTINUED ON NEXT PAGE

FLIGHT RULES

A17.1.3-5 AVIONICS BAY COOLING (CONTINUED)

Avionics bay airflow reconfigurations due to the installation of the new Collins TACAN's has no impact on the avionics bay air outlet temperature limits at either 8, 10.2 or 14.7 psi cabin pressures. @[030994-1609]

DOCUMENTATION: Memo DF7-93-46, Avionics Bay Temperature Limits Analyses for On-Orbit and Post-Landing; Memo DF7-94-36, , Avionics Bay Temperature Limits Analyses for On-Orbit and Post-Landing Addendum, SODB 3.4.5.3, 3.4.5.4, 4.6.1.4.2, and 4.6.1-41; IBM 855440-010, Flight GPC Thermal Analysis Report; and RI Memo 287-203-90-086, "Update To Avionics Bay Changes For Installation of New GPC's and New TACAN's. @[090894-1673A] "

C. BOTH FANS ARE LOST. @[030994-1609]

If unable to get the required air flow, the avionics bay is considered lost.

DOCUMENTATION: Engineering Judgment.

A17.1.3-6 REGENERATIVE CO2 REMOVAL SYSTEM (RCRS) LOSS DEFINITION

THE RCRS IS CONSIDERED LOST IF:

A. UNABLE TO MAINTAIN PPCO₂ BELOW 7.6 MM HG.

RCRS CO₂ removal capability will not be effective if the vacuum vent line isol valve closes the vacuum vent duct blocks, or for ARS duct leakage occurs.

RCRS operations are not possible if both controller A and B have failed since the RCRS requires an automatic controller (no manual RCRS override capability).

RCRS auto shutdown logic will shut down the RCRS if bed pressures, bed delta pressures, or compressor RPM and valve position indications are not acceptable.

Reference Rule {A13.1.2-4A.2}, PPCO₂ CONSTRAINT, rationale.

DOCUMENTATION: RCRS Critical Design Review, March 15-17, 1990.

B. UNABLE TO MAINTAIN PPCO₂ INSIGHT.

See Rule {A17.1.4-5B.4}, REGENERATION CO₂ REMOVAL SYSTEM (RCRS) MANAGEMENT for rationale.

DOCUMENTATION: Engineering judgment.

FLIGHT RULES

ARS AIR SYSTEM MANAGEMENT

A17.1.4-1 CABIN ATMOSPHERE CONTROL

- A. THE CABIN TEMPERATURE CONTROL BYPASS VALVE WILL BE AUTOMATICALLY DRIVEN TO THE "FULL COOL" POSITION FOR ASCENT AND ENTRY.

The heat load in the cabin is large enough to require full cool during these phases. Having the valve in full cool is SOP. This is done to protect against the high heat loads in the cabin during an 8 psi ascent or entry situation.

DOCUMENTATION: SEH-ITA-80-245.

- B. WHEN TIME PERMITS THE LIOH CANISTERS WILL BE REMOVED FOR AN 8 PSI ENTRY.

The canister removal increases the fan efficiency for cooling which is critical at a reduced pressure. One fan increases in flow from 820 lb/hr (with LiOH in) to 870 lb/hr (with LiOH out). This rule also assumes the crew is wearing launch/entry suit (LES) helmets or that the PPCO₂ level is under control before removing the canisters.

DOCUMENTATION: 1.2-TM-B1709-24.

- C. LIOH CANISTER(S) WILL NORMALLY BE REPLACED PRESLEEP AND POSTSLEEP OR WHEN PPCO₂ IS VERIFIED TO BE ≥ 7.6 (6.1) MMHG.

Changeouts are scheduled so normal housekeeping activities will not interfere with mission or payload operations. Single or dual canister changeouts are based on an analysis to maximize LiOH utilization as a function of crew size. Additionally, the rule specifies that a changeout will occur when PPCO₂ increases above 7.6 mmHG which is the level we will manage PPCO₂ to prevent possible physiological changes to the crew.

DOCUMENTATION: SEH-ITA-85-145, SODB 3.4.6.1, SODB 4.6.1.3.1-C.

- D. WINDOW SHADES MAY BE USED TO MINIMIZE LOCAL CABIN TEMPERATURE GRADIENTS.

The effects of solar heat loads transmitted through the windows to the cabin and flight deck can essentially be negated by installing the shades.

DOCUMENTATION: SEH-ITA-82-028T.

THIS RULE CONTINUED ON NEXT PAGE

FLIGHT RULES

A17.1.4-1 CABIN ATMOSPHERE CONTROL (CONTINUED)

E. CABIN FANS WILL NOT BE CYCLED ~~PRE-MECO DURING FIRST STAGE~~
~~(SRB UNDERVOLT CONSTRAINT)~~. @J040899-25701

The cabin fan large ac loads during the first stage are nearly at their maximum level. Cycling fans (8.0 amps startup) could create a voltage transient to the main engine controllers jeopardizing engine performance.

F. UPGRADED AVIONICS BAY FANS WILL NOT BE CYCLED PRE-MECO.

Upgraded avionics fans have been installed in OV-104 and will later be installed in OV-103 and OV-105 to provide additional cooling to middeck payloads. The startup transient currents associated with these fans are significantly larger than the older avionics fans (7.4 amps/phase vs 2.0 amps/phase). Cycling fans could create a voltage transient to the main engine controllers, jeopardizing engine performance. @J040899-25701

A17.1.4-2 CABIN TEMPERATURE CONTROL

A. IF THE CABIN TEMPERATURE IS TOO COLD, CREW COMFORT WILL BE MAINTAINED BY MANUALLY PINNING THE CABIN HEAT EXCHANGER AIR BYPASS VALVE IN THE REQUIRED POSITION. IF FURTHER ACTION SHOULD BE REQUIRED, THE FOLLOWING WILL BE PERFORMED IN ORDER OF PRIORITY:

1. POWERUP PANEL AND FLOOD LIGHTS.
2. POWERUP AIR COOLED EQUIPMENT.
3. OPERATE BOTH WATER LOOPS WITH FULL INTERCHANGER FLOW.
4. DEACTIVATE THE FES.
5. OPERATE THE RADIATOR CONTROLLER OUTLET TEMPERATURE IN "HI" (57 DEG ± 2 DEG F).

Each action will decrease the amount of heat rejected from the cabin or increase the cabin heat load, thus allowing an incremental temperature increase. New analysis indicates that operating the water loop in full interchanger flow will not warm the cabin and may, in fact, cool the cabin.

DOCUMENTATION: RI IL 287-203-91-025, SODB RI-1344.

B. CABIN TEMPERATURE WILL NORMALLY BE MANAGED >65 DEG (69.5 DEG) F AND <84 DEG (79.5 DEG) F.

This is the cabin temperature control range for crew comfort.

FLIGHT RULES

DOCUMENTATION: SODB 4.6.1.3.4-C.

FLIGHT RULES

A17.1.4-3 CABIN/AVIONICS BAY FAN MANAGEMENT

- A. FOR LOSS OF AN AVIONICS BAY FAN DELTA PRESSURE TRANSDUCER, THE SECOND FAN WILL BE TURNED ON AND LEFT ON UNTIL EOM.

Since the crew and the ground operator have lost insight into fan performance with the loss of a fan delta pressure transducer, two fans will be turned on to protect against a fan failing undetected. This rule still applies for upgraded avionics fans (cabin fans) installed in av bay 3A. Even though the fans are larger than regular avionics fans, the crew may not be able to detect a fan loss by sound as mentioned in paragraph B of this rule. Mission duration may be impacted due to a higher consumables usage with an additional fan powered on. ©[040899-2499B]-

DOCUMENTATION: Engineering judgment.

- B. FOR LOSS OF A CABIN FAN DELTA PRESSURE TRANSDUCER, BOTH CABIN FANS WILL BE TURNED ON DURING SLEEP PERIODS.

Since the crew and the ground operator have lost insight into fan performance with the loss of a fan delta pressure transducer, two fans will be turned on during sleep periods to protect against a fan failing undetected while the crew is asleep. The crew can detect cabin fan loss (sound) during awake periods. Mission duration may be impacted due to a higher consumables usage with an additional fan powered on. ©[040899-2499B]-

DOCUMENTATION: Engineering judgment.

FLIGHT RULES

A17.1.4-4 MANAGEMENT OF DEGRADED ROTATING EQUIPMENT

- A. ANY ROTATING EQUIPMENT (EXCEPT THE CABIN FAN) THAT LOSES A SINGLE PHASE WILL BE SWITCHED TO THE ALTERNATE EQUIPMENT. ©[032395-1752A]

All equipment with the exception of the cabin fan and the upgraded avionics fan can be restarted on two phases. ©[040899-2500]

Since the lifetime of two-phase operations is confirmed to 168 hours (for new equipment) and the two-phase equipment operates below normal performance, it is prudent to switch from the two-phase equipment.

The JSC test and OV-101 fan test at Rockwell-Downey showed that when a cabin fan was started on two phases that it popped the 3 AMP cb's powering the fans.

If a cabin fan loses a phase, it is prudent to continue operating the two phase cabin fan since it may not be possible to restart that fan if it is turned off and loss of one cabin fan results in an MDF (reference Rule {A17.1.13-1}, LIFE SUPPORT GO/NO-GO CRITERIA). In the case of an upgraded avionics fan, which is the same as a cabin fan, it is not necessary to continue operating an upgraded av bay fan on two phases since the loss of one av fan has no mission duration impacts. Further, it is not recommended to continue operating the fan on two phases since two phase operation is below nominal performance and could cause damage to the fan. Should a second failure occur which causes loss of the remaining fan, there is an IFM to swap power supplies assuming the second failure is not a power supply failure. ©[040899-2500]

- B. FOR ROTATING EQUIPMENT THAT IS DEGRADED FROM NORMAL OPERATING LEVELS, BUT ABOVE LOSS DEFINITIONS FOR REASONS OTHER THAN LOSS OF A PHASE, THE FOLLOWING MANAGEMENT WILL BE APPLIED:
1. FOR EQUIPMENT THAT WOULD CAUSE EARLY MISSION TERMINATION IF THE EQUIPMENT COULD NOT BE RESTARTED, THE DEGRADED EQUIPMENT WILL CONTINUE TO BE OPERATED, PROVIDED NO SAFETY HAZARD EXISTS.

If equipment is degrading for reasons other than loss of a phase (bearing seizure, material failure, etc.) then restarting that piece of equipment could not be guaranteed (static friction being greater than dynamic friction). If the equipment is required GO for GO/NO-GO purposes, then it would have to be shown that it would restart once it was deactivated. This could cause early mission termination. Therefore, it would be prudent to remain on the degraded equipment until the performance violates its loss definition, provided no safety hazard exists. ©[032894-1751A]

THIS RULE CONTINUED ON NEXT PAGE

FLIGHT RULES

A17.1.4-4

MANAGEMENT OF DEGRADED ROTATING EQUIPMENT
(CONTINUED)

2. FOR EQUIPMENT THAT WOULD NOT CAUSE EARLY MISSION TERMINATION IF IT COULD NOT BE RESTARTED, THE DEGRADED EQUIPMENT WILL BE SWITCHED TO THE ALTERNATE EQUIPMENT. ©[032894-1751A]

Since the equipment is not required GO for GO-NO/GO purposes, it would be prudent to switch from the degraded equipment. This would eliminate the risk/probability of a safety hazard while having no EOM impacts.

Documentation: SODB Vol. IV 4.1.6.3, 4.1.6.4, Hamilton Standard, SP 01TB0 [Item SV 6405 (Avionics Fans), SV 6470 (Humidity Separator), SV 6416 (IMU fans)], MCR 6159 (Rockwell's pitch to the CCB on 10/12/79 about starting fans on two phases). Engineering judgment. ©[032395-1751A]

FLIGHT RULES

A17.1.4-5 REGENERATIVE CO₂ REMOVAL SYSTEM (RCRS) MANAGEMENT

A. ASCENT/ENTRY OPERATIONS

THE RCRS WILL BE DEACTIVATED FOR ASCENT AND ENTRY.

The RCRS requires a vacuum source to operate properly. Since a vacuum source is not available during ascent and entry, the unit is deactivated. LiOH canisters provide PPCO₂ control during these periods. If the RCRS remains activated through entry, the loss of vacuum source will cause the RCRS to shut down and will not damage the RCRS.

DOCUMENTATION: Engineering judgment.

B. ORBIT OPERATIONS

1. ACTIVATION/DEACTIVATION

THE RCRS WILL BE ACTIVATED AS SOON AS PRACTICAL ONCE ON ORBIT POST-OMS 2 AND DEACTIVATED AS LATE AS PRACTICAL PRE-DEORBIT BURN.

The RCRS serves a highly critical PPCO₂ removal function. Without a successful RCRS activation, mission duration is limited by the number of LiOH canisters flown. Early on-orbit RCRS activation allows immediate determination of whether the unit is operating properly allowing the crew maximum utility of the remaining LiOH canisters for entry planning. Troubleshooting and failure impact can then begin as soon as this information is known.

Deactivating the RCRS late in the deorbit timeframe minimizes usage of the manifested LiOH canisters in the event the mission is waved off for weather or system failures. When the RCRS is deactivated, a fresh LiOH canister will have been installed to control CO₂ levels through the remainder of deorbit prep and through entry.

THIS RULE CONTINUED ON NEXT PAGE

FLIGHT RULES

A17.1.4-5 **REGENERATIVE CO2 REMOVAL SYSTEM (RCRS)**
MANAGEMENT (CONTINUED)

DOCUMENTATION: Engineering judgment.

2. REACTIVATION

IF THE RCRS HAS BEEN DEACTIVATED FOR DEORBIT PREP, THE RCRS WILL NOT BE REACTIVATED FOR WAVE-OFF ORBITS, BUT WILL BE REACTIVATED FOR A WAVE-OFF DAY IF CONSUMABLES PERMIT.

For wave-off orbits, the RCRS is not reactivated since RCRS activation coupled with LiOH canister removal during the busy deorbit prep period creates an unacceptably high crew workload.

For wave-off days, the RCRS is reactivated to save LiOH but only if cryogenic consumables permit the additional power consumption. Generally, sufficient stowed LiOH cans will permit at least two days of mission extension. The LiOH canister installed for RCRS deactivation will be removed for later use.

DOCUMENTATION: Engineering judgment.

3. CABIN AND AIRLOCK DEPRESS

THE RCRS WILL BE DEACTIVATED DURING A CABIN DEPRESS OR AN AIRLOCK DEPRESS.

The RCRS controller logic will shut down during cabin depresses or during an airlock depress since the failure logic criteria will be satisfied due to vacuum vent line or cabin pressure inputs. When the unit shuts down, a fault summary message (S66 CO₂ RL SYS MALF) will be generated and a fault light (panel M051F) lit. Once shutdown has occurred, the unit must be powered down and repowered in an orderly fashion to regain RCRS operations. Due to the high probability of this shutdown occurring during a critical time period, it is preferred to manually shut down the unit during these events. After these time periods, the RCRS will be reactivated.

CO₂ removal during this period is of little concern since the deactivation duration is short (~20 minutes) and since the partial pressure of CO₂ will decrease simply from the reduction of cabin or airlock pressure.

THIS RULE CONTINUED ON NEXT PAGE

FLIGHT RULES

A17.1.4-5 REGENERATIVE CO₂ REMOVAL SYSTEM (RCRS) MANAGEMENT (CONTINUED)

4. FOR LOSS OF THE RCRS, LIOH CANS WILL BE INSTALLED AND WILL DETERMINE EOM.

When the RCRS is lost (loss of PPCO₂ insight or total functional loss (ref. Rule {A17.1.3-6}, REGENERATIVE CO₂ REMOVAL SYSTEM (RCRS) LOSS DEFINITION)), either proper evaluation of the RCRS CO₂ removal capability is not possible or CO₂ control is lost. Without PPCO₂ insight, the proper action is to install and remove LiOH cans on a regular basis to ensure adequate CO₂ control.

Similarly, installation of LiOH cans subsequent to a total RCRS functional loss is required to regain proper CO₂ control.

Due to the limited number of cans stowed, their number will determine EOM.

A17.1.4-6 RCRS MANUAL SHUTDOWN CRITERIA

THE RCRS WILL BE MANUALLY SHUT DOWN FOLLOWING EITHER A CABIN OR AN AVIONICS BAY FIRE.

In the event of either an orbiter cabin or avionics bay fire, preserving the RCRS CO₂ removal capability is of primary importance due to the limited number of LiOH canisters flown. Fire/smoke contaminants will be removed from the orbiter atmosphere with either fresh or used LiOH/charcoal and ATCO canisters. Exposure of the RCRS solid amine beds to fire contaminants causes irreversible damage to the RCRS CO₂ removal capability. Of the most probable orbiter fire combustion products (CO₂, CO, COF₂, HF, HCL, HCN, SO₂, NO_x, CF₃Br), the HCL, HF, and HCN react irreversibly with solid amine. Once absorbed, these gases will not be removed on exposure to vacuum through normal operation but will remain on the surface adsorption sites, degrading RCRS CO₂ removal capability. Additionally, RCRS post-fire contaminant removal is inefficient due to the limited RCRS airflow. After the contaminants have been removed from the air environment via LiOH/ATCO canisters, the RCRS will be reactivated to continue CO₂ removal operations. Reference Flight Rule {A17.1.2-3 C.3} and D.4, FIRE AND POST-FIRE ACTIONS.

DOCUMENTATION: Engineering judgment.

FLIGHT RULES

A17.1.4-7 LIOH REDLINE DETERMINATION

A MINIMUM OF 2 DAYS OF UNUSED LIOH CANS MUST BE HELD IN RESERVE FOR CONTINGENCY USE THROUGH PLANNED NOMINAL END OF MISSION. A MAXIMUM PPCO₂ OF 7.6 MMHG WILL BE PROTECTED, UNLESS MISSION-SPECIFIC PAYLOAD CONSTRAINTS (REFERENCE PAYLOAD ANNEX FOR THAT MISSION) DICTATE MORE RESTRICTIVE LIMITS. @[032395-1749]

Since the capability of a used (bagged) can is assessed only through analysis and cannot be guaranteed, only unused LiOH cans will be counted towards the redline. Enough unused standard LiOH canisters should be held in reserve to allow a minimum of 2 days of CONUS landing site opportunities in the event the prime form of CO₂ removal is lost (i.e., CO₂ removal system, LiOH cans in excess of redline, ISS CO₂ removal system while docked). If a repair cannot be completed before using LiOH from the 2-day reserve, a next PLS should be declared. The only form of CO₂ removal after all LiOH is depleted would be to perform cabin air overboard purges which will support as little as 2 hours of CO₂ control (assumes seven crewmembers, start and maintain 7.6 mmHg CO₂, N₂ consumables at redline). As a guideline, the number of LiOH canisters required for 2 days at 7.6 mmHg equals the number of crewmembers on board (a LiOH canister provides CO₂ removal for approximately 50 man-hours). Real-time or mission-specific assessments may override this guideline. @[032395-1749]

A17.1.4-8 MANAGEMENT OF LIOH CANS FOR ADDITIONAL DAYS

- A. WHEN ADDITIONAL MISSION DAYS ARE DESIRED, A CHANGEOUT PLAN UTILIZING A PPCO₂ LEVEL OF 7.6 MMHG MAY BE USED IF NEEDED TO CREATE LIOH MARGIN. IN ORDER TO ACHIEVE MAXIMUM MISSION DURATION AND TO MINIMIZE BAGGING AND REUSE OF CANS, 7.6 CHANGEOUT SCHEDULES SHOULD BE IMPLEMENTED AS SOON AS POSSIBLE. MISSION-SPECIFIC PAYLOAD CONSTRAINTS MAY DICTATE WHETHER THIS MAXIMUM PPCO₂ LEVEL (AND THEREFORE THE MISSION EXTENSION) CAN BE SUPPORTED. FLIGHT SPECIFIC EXCEPTIONS WILL BE DOCUMENTED IN THE ANNEX. @[032395-1748A]
- B. WHEN EXTENSION OF MISSION DURATION REQUIRES USED (BAGGED) LIOH CANS, THE FOLLOWING GUIDELINES WILL APPLY:
1. NO BAGGED CAN WITH LESS THAN 1 LBM OF LIOH REMAINING WILL BE CONSIDERED.
 2. BAGGED CANS WILL BE USED AS EARLY AS POSSIBLE.
 3. ONE USED CAN WILL BE UTILIZED IN COMBINATION WITH ONE FRESH CAN.

FLIGHT RULES

THIS RULE CONTINUED ON NEXT PAGE

FLIGHT RULES

A17.1.4-8 MANAGEMENT OF LIOH CANS FOR ADDITIONAL DAYS
(CONTINUED)

4. THE PPCO₂ WILL BE NORMALLY MANAGED BELOW 7.6 MMHG. ADDITIONAL PAYLOAD CONSTRAINTS MAY REQUIRE LOWER PPCO₂ LEVELS; HOWEVER, THESE LOWER LEVELS WILL MAKE RE-USE OF CANS LESS EFFECTIVE.

When mission days are added to a flight after pre-flight planning has already dictated the use of a "standard" LiOH changeout schedule (cue card), a "7.6 Changeout Schedule" is the preferred way to ensure desired mission extension. Utilizing fresh LiOH until a PPCO₂ level of 7.6 mmHg is reached maximizes the efficiency of each can. Analysis and implementation of such a plan is straightforward, since the amount of LiOH in each fresh (unused) can is always known. The amount of LiOH in previously used cans is not known. This amount is arrived at by analysis only and is subject to variables such as actual crew metabolic rates, exactly when a can has been changed out, and how well it has been sealed.

Whenever a 7.6 plan is being considered, it should always be implemented as soon as possible. The longer a decision is delayed about the use of a 7.6 plan, the greater the uncertainty (amount of LiOH in bagged cans). ©[032395-1748A]

Circumstances may be such that mission duration extension can only be achieved through the use of previously used LiOH cans. However, cans with less than 1 lbm of usable LiOH remaining do not have sufficient CO₂ removal capability to be of practical use. ©[032395-1748A]

Since the amount of LiOH in used cans is estimated, they should be used as much as possible before the end of the mission. Further, since CO₂ removal rate degrades substantially as the quantity of LiOH remaining decreases, it is not always possible to maintain acceptable CO₂ rates, even though LiOH is being consumed out of the can. Installing a used can with a fresh can allows the used can to completely deplete while the fresh can maintains control over CO₂ levels.

DOCUMENTATION: Engineering judgment. ©[032395-1748A]

FLIGHT RULES

PRESSURE CONTROL SYSTEMS (PCS) LOSS DEFINITIONS

A17.1.5-1 CABIN PRESSURE INTEGRITY

CABIN PRESSURE INTEGRITY IS CONSIDERED LOST IF:

A. ASCENT:

1. A NONISOLATABLE LEAK > 0.15 PSIA/MIN WILL RESULT IN THE INTACT ABORT THAT WILL PROVIDE THE EARLIEST AVAILABLE RETURN AND LANDING TIME.
2. A NONISOLATABLE LEAK > 0.02 PSIA/MIN, AND ≤ 0.15 PSIA/MIN, WILL RESULT IN AN AOA ABORT (GROUND CALL).
3. FOR A NONISOLATABLE LEAK \leq TO 0.02 PSIA/MIN, OR ANY LEAK WHICH OCCURS AFTER THE CLOSE OF THE AOA WINDOW, PARAGRAPH B WILL DETERMINE EOM.

NOTE: ALL DP/DT VALUES REFERENCED IN THIS RULE ARE ASSUMED TO BE AN EQUIVALENT DP/DT AT 14.7 PSI CABIN PRESSURE AND NEGATIVE IN SIGN.

The rationale for selecting one dp/dt on which to call an immediate abort comes from the assumption that any penetration through the cabin wall always has the possibility of propagating, thereby increasing the leak rate. The numbers contained in this rule and rationale are leak rates which confirm a cabin leak during the different phases of ascent. Additionally, the numbers include a margin to protect for an increase in the leak rate. The leak rate of 0.15 psia/min is the dp/dt limit for an orbit 3 deorbit opportunity which protects for an 8 psi cabin to the ground. In order to provide margin against an increase in the leak rate, the intact abort that results in the quickest return and landing will be selected for any cabin leak rate that remains above 0.15 psia/min (both on-orbit and ground call). @[120894-1740]

The highest probability of the leak occurring is during the first few minutes of flight when the drop in atmospheric pressure creates a large delta in pressure across the cabin wall. However, during the first 2 minutes of flight, cabin stretch (by $\gg -0.07$ psia/min) and LES flow (by $\gg +0.02$ psia/min) will bias any dp/dt that is associated with a true leak. By selecting a leak rate of 0.15 psia/min as the immediate abort call, a dp/dt of this size will provide positive indication of a cabin leak at any point during ascent. @[120894-1740]

A leak rate in the range $0.02 < dp/dt \leq 0.15$ will allow continuing to orbit and then performing leak isolation procedures to determine whether the leak can be stopped. A leak rate of -0.02 would allow a landing at the next PLS. However, an AOA will be performed to provide additional margin should the leak rate increase. This leak rate is small enough to allow conservatism, but also large enough to not be masked by the post-MECO transient ($\gg -0.02$) so that a NO-GO call for APU shutdown can be made for a real leak. @[120894-1740] @[ED]

FLIGHT RULES

THIS RULE CONTINUED ON NEXT PAGE

FLIGHT RULES

A17.1.5-1 CABIN PRESSURE INTEGRITY (CONTINUED)

The onboard AOA call will be 0.08 psia/min which will be used for crew loss of communication procedures. This leak rate trips the class 1 Klaxon alarm and, therefore, cues the crew to a possible cabin leak and to cross check with a cabin pressure decrease. The C&W dp/dt limit is set at 0.08 psia/min to prevent nuisance alarms during the period from lift off to MECO when cabin pressure is transient due to LES helmet flow, thermal and external pressure drop effects.

DOCUMENTATION: Engineering judgment. @[120894-1740] @[ED]

B. ON-ORBIT:

A NONISOLATABLE LEAK SUCH THAT O₂/N₂ CONSUMABLES CAPABILITY WILL NOT ALLOW A NEXT PLS ENTRY AT 14.7 (10.2 IF ALREADY IN 10.2 PSIA OPS) PSIA PLUS THE GREATER CONSUMABLE REQUIREMENT OF THE FOLLOWING:

1. A 48-HOUR FLIGHT EXTENSION AT 14.7 (10.2 IF ALREADY IN 10.2 PSIA OPS) PSIA BEYOND THE NEXT PLS OPPORTUNITY, OR
2. THE PLANNED CONSUMABLES FOR THE 165-MINUTE, 8 PSIA CONTINGENCY RETURN REQUIREMENT

Cabin pressure integrity for on-orbit operations is defined to be lost at the point where normal operations can no longer take place (i.e., 14.7 (10.2 if already in 10.2 psia ops) psia cabin plus all reserves remaining intact). The two reserves which must be included to define loss of cabin pressure integrity are: (1) The required consumables to maintain 14.7 (10.2 if already in 10.2 psia ops) psia for two mission extension days, or (2) Loss of the 165-minute, 8 psia contingency reserve which would not allow an emergency deorbit should one become necessary. Allowing for all three of the above named consumable requirements does not leave sufficient margin between loaded quantities and what is required for contingency. Therefore, only the greater of the two reserves is required in addition to the 14.7 (10.2 if already in 10.2 psia ops) psia cabin maintenance to the next PLS.

Rules {A2.1.6-1}, CONTINGENCY ACTION SUMMARY; and {A17.1.7-5}, 14.7 PSIA CABIN REPRESSURIZATION LIMITATION, {A9.1.6-1}, CRYO HEATER MANAGEMENT FOR ASCENT; and {A17.1.13-1}, LIFE SUPPORT GO/NO-GO CRITERIA, reference this rule.

FLIGHT RULES

A17.1.5-2 8 PSIA CABIN CONTINGENCY 165-MINUTE RETURN CAPABILITY

THE 8 PSIA CABIN CONTINGENCY (165 MINUTES) RETURN CAPABILITY IS CONSIDERED LOST IF:

- A. AT LEAST 2.5 LB O₂/HR/CREWMEMBER CANNOT BE SUPPLIED TO THE LES HELMETS.

The 8 psia cabin may present an unacceptable atmosphere for normal breathing (PPO₂ can drop below 2.5 psia), in which case the LES helmets must be worn. A 20 lb/hr flowrate to the LES helmet manifold is necessary to provide eight LES helmets with 2.5 lb/hr O₂ (11.0 liters/minute). This means sufficient upstream pressure must be supplied from the cryo tanks to accommodate LES helmet flowrates during LES helmet operations. The 2.5 lb/hr can supply enough O₂ to allow regular breathing both at rest and during a state of excitement in a resting position.

DOCUMENTATION: (Two-way memo received from J. Waligora/SD5 dated 2/2/87).

B. TOTAL N ₂ QUANTITY IS LESS THAN:	93.0	(98.7)	LBM	2 TANK SET
	99.5	(106.5)	LBM	3 TANK SET
	106.0	(114.1)	LBM	4 TANK SET
	112.5	(121.6)	LBM	5 TANK SET
	119.0	(128.9)	LBM	6 TANK SET

@[121593-1597]

IF OPERATING AT 10.2 PSIA, ADD 34.0 LBS TO TOTAL TO GET REDLINE.

The total N₂ quantity required is the 80 lbm contingency return plus residuals and the relevant measurement error (MER) for either a single N₂ system or both N₂ systems. Nominal management of the N₂ systems (per Rule {A17.1.6-7}, N₂ SYSTEM MANAGEMENT) has both N₂ systems being used as one system. Therefore, the two-system MER and residuals must be used if the integrity of either N₂ system has not been violated. The contingency return requirement (80.0) plus residuals (13.0, 19.5, 26.0, 32.5, 39.0, depending on number of tanks) plus the MER (5.7, 7.1, 8.1 9.1, 9.9, depending on number of tanks) for any configuration gives a minimum value of N₂ (as stated in rule) as the contingency return amount. @[121593-1597]

EDO flights will carry as many as six tanks with four tanks on a single system.

FLIGHT RULES

The 80.0 lbm contingency return amount assumes an intermittent flow of 17 lbm/hr O₂ from the direct O₂ and an intermittent flow of 23 lbm/hr O₂ from the cabin regulator to manage O₂ levels in the cabin environment. ©[121593-1597]

The extra 34.0 lbs of N₂ is the amount required to give the same 165 min return capability for a cabin leak at 10.2 as there is at 14.7 psia.

THIS RULE CONTINUED ON NEXT PAGE

FLIGHT RULES

A17.1.5-2 **8 PSIA CABIN CONTINGENCY 165-MINUTE RETURN CAPABILITY (CONTINUED)**

DOCUMENTATION: DF7/93-39, Cabin Leak Analysis (0.45 in Hole in Cabin, 165 Minute Return Capability), 11/16/93, and Level B Groundrules and Constraints. ©[121593-1597]

Rules {A17.1.7-2}, 10.2 PSIA CABIN DEPRESSURIZATION CONSTRAINTS; {A17.1.13-1D}, LIFE SUPPORT GO/NO-GO CRITERIA; and {A2.1.2-4 D.6}, RTLS, TAL, AND AOA ABORTS FOR SYSTEMS FAILURES (CIL), reference this rule.

A17.1.5-3 **PPO₂ CONTROL**

PPO₂ CONTROL IS CONSIDERED LOST WHEN BOTH AUTOMATIC AND MANUAL METHODS OF CONTROLLING PCS OXYGEN SUPPLY CAN NO LONGER CONTROL THE AMOUNT OF OXYGEN FLOWING INTO THE CABIN.

The ability to control PPO₂ inside the crew module is dependent on the integrity of the oxygen supply lines, valves, sensors, and automatic controllers. Control is considered lost on the low side when oxygen can no longer be fed to the cabin. This will eventually result in the PPO₂ level inside the cabin dropping to unsafe limits due to crew metabolic consumption of oxygen and cabin leakage.

PPO₂ control is considered lost on the high side when an unisolatable oxygen leak occurs or the crew is required to wear their launch/entry suit helmets for a period of time which causes the percent oxygen level in the cabin to exceed the GO/NO-GO criteria for a PLS (ref. Rule {A17.1.13-1D.3}, LIFE SUPPORT GO/NO-GO CRITERIA). Depending on the leak rate, early termination will probably be necessary due to high oxygen concentration within the cabin.

DOCUMENTATION: Engineering judgment.

Rules {A17.1.7-1}, CABIN ATMOSPHERE MANAGEMENT; and {A17.1.13-1D}, LIFE SUPPORT GO/NO-GO CRITERIA, reference this rule.

FLIGHT RULES

A17.1.5-4 N2 SUPPLY

- A. THE PCS N2 SUPPLY IS CONSIDERED LOST IF THE N2 TANK PRESSURE IS < 200 (375) PSIA. [ED]

The N₂ regulators control the N₂ pressure to the cabin regulators to 200 ± 15 psig. If the N₂ tank pressure is < 200 psia, the N₂ regulator loses control and regulator flow may not be adequate to meet the demand of the 14.7 psi cabin regulator. Below 200 psia, the N₂ supply is, for all practical purposes, lost.

DOCUMENTATION: SODB 4.6.1.1.4.A.3.

MODULE

- B. LOST IF N2 TANK PRESSURE IS < 300 PSIA / 20.7 BARS.

The operating range of the N₂ tank is 300 to 3306 psi. The N₂ tank residual is 7 pounds mass (lbm) at a tank pressure of 300 psia.

Reference: SLODB 3.2.4 and MSFC Memorandum for Record, EP 45 (83-103), August 31, 1983, Subject: Updated SL-1 O₂/N₂ Consumables Analysis Results. [ED]

A17.1.5-5 PPO2 SENSOR LOSS DEFINITION

A SINGLE PPO₂ SENSOR WILL BE CONSIDERED LOST IF IT DEVIATES MORE THAN 0.15 PSI FROM THE NEAREST READING OF THE TWO SENSORS THAT ARE WITHIN 0.15 PSI OF EACH OTHER.

A SUBSEQUENT SENSOR FAILURE WILL BE DETERMINED BY ANALYSIS USING PREVIOUS SIGNATURES AND O₂ FLOWRATES.

The initial failure of a PPO₂ sensor will be determined by comparison with the readings of the other two sensors. The sensors that are reading within 0.15 psi (±3.0 percent full scale) of each other are assumed to be nominal and the deviant sensor (>0.15 psi from the nearest PPO₂ reading) will be considered failed based on this assumption.

Because there are only two remaining sensors, no “voting out” capability exists; so, subsequent PPO₂ sensor failures will have to be determined through the analysis of previous PPO₂ signatures from both the current and past flight data, by the frequency of O₂/N₂ controller cycles, and by O₂ flow rates.

Note that the PPO₂ sensors have different accuracy specifications based on ambient temperature. Between 70 deg and 85 deg F, the sensor accuracy is ±1.5 percent of full scale; outside this band the accuracy drops to ±3.0 percent of full scale. The greater error is assumed for this rule.

DOCUMENTATION: Engineering judgment and MCR 16202.

FLIGHT RULES

A17.1.5-6 LES O₂ SUPPLY SYSTEM LOSS DEFINITION

ONE (OF TWO) LES O₂ SUPPLY SYSTEMS IS LOST IF THE ASSOCIATED O₂ CROSSOVER VALVE OR ECLSS O₂ SUPPLY VALVE CANNOT BE OPENED, OR FOR ANY OTHER BLOCKAGE IN THAT LEG OF THE SYSTEM (E.G., CHECK VALVE FAILED CLOSED). ©[050495-1756B]

The LES manifold is required to support procedures for a fire or toxic spill case. For these cases, the crew immediately dons the LESH/QDM. At 14.7 (10.2) psia, the maximum crew breathing rate is 5.5 (3.8) lbm/hr/crewman. If this rate cannot be met then on the LESH, the anti-suffocation device will open allowing ambient air to be ingested, possibly subjecting the crew to harmful gases/combustion products. When the crew is on the QDM's, they may be starved of O₂, possibly forcing them to remove the masks. For a 5 to 8 man crew at 14.7 psia, this rate cannot be met by a single O₂ supply system (24 lbm/hr). For a 5 or 6 man crew at 10.2 psia, the safety tolerance is marginal.

For the cabin leak case, the crew dons the LESH/QDM's at a pressure below 10.2 psia; therefore, the breathing requirement is lowered (2.7 lb/hr/crewman) and one O₂ system can supply enough O₂ for this contingency. Also, it would be acceptable for the anti-suffocation valves to periodically open since there is not a contamination concern. ©[050495-1756B]

The 8 psia cabin may present an unacceptable atmosphere for normal breathing (PPO₂ can drop below 2.7 psia), in which case the LESH/QDM's must be worn. A 21.6 lb/hr flowrate to the LES helmet manifold is necessary to provide eight LESH/QDM's with 2.7 lb/hr O₂ (11.8 liters/minute). This means sufficient upstream pressure must be supplied from the cryo tanks to accommodate LESH/QDM flowrates during LESH/QDM operations. The 2.7 lb/hr can supply enough O₂ to allow regular breathing both at rest and during a state of excitement in a resting position. ©[050495-1756B]

The O₂ supply system can be obstructed by the O₂ XOVR valve, ECLSS O₂ SUPPLY valve, or CHECK valve failing closed, as well as a blockage.

DOCUMENTATION: Two-way memo received from J. Waligora/SD5, dated 2/2/87. ©[050495-1756B]

FLIGHT RULES

PCS SYSTEMS MANAGEMENT

A17.1.6-1 NORMAL PCS CONFIGURATION

NORMAL PCS COMPONENT CONFIGURATION WILL BE AS FOLLOWS:

- A. PCS 1 WILL BE OPERATED FROM LIFT-OFF TO MISSION MIDPOINT.
PCS 2 WILL BE OPERATED FROM MISSION MIDPOINT TO EOM.

As part of the redundant component checkout that is normally performed midway through the mission, the PCS system will be reconfigured to the alternate PCS system to verify system health and maximize total operating lifetime. Additionally, PCS 2 will be selected since it is impractical for KSC to perform a redundant component checkout during ground turnaround.

DOCUMENTATION: Engineering judgment.

B. NORMAL PCS VALVE CONFIGURATION:

1. ASCENT/ENTRY:

- a. BOTH PCS 1 AND 2 14.7 PSIA CABIN REGULATOR INLET VALVES - CLOSED.
- b. PCS 1 O₂/N₂ CONTROL VALVE - OPEN.
- c. PCS 2 O₂/N₂ CONTROL VALVE - CLOSED.
- d. O₂ REGULATOR INLET VALVES - CLOSED.

(NOTE: 8.0 PSIA EMERGENCY REGULATORS CANNOT BE DISABLED.)

2. ORBIT:

- a. PCS 1(2) 14.7 PSIA CABIN REGULATOR INLET VALVES - OP;
PCS 2(1) 14.7 CABIN REGULATOR INLET VALVES - CLOSED.
- b. PCS 1(2) O₂/N₂ CONTROL VALVE - AUTO;
PCS 2(1) O₂/N₂ CONTROL VALVE - CLOSED.
- c. O₂ REGULATOR INLET VALVE 1(2) - OPEN;
O₂ REGULATOR INLET VALVE 2(1) - CLOSED.

FLIGHT RULES

The above ascent/entry configuration is the desirable switch setup in the event of a cabin leak during these flight phases. This configuration and associated rationale is different from the orbit configuration for a cabin leak, since the crew, on orbit, has more time to react to the leak and they are able to move about and reach the necessary switches.

THIS RULE CONTINUED ON NEXT PAGE

FLIGHT RULES

A17.1.6-1 NORMAL PCS CONFIGURATION (CONTINUED)

For ascent/entry, the cabin regulator inlet valves must be configured prior to entering these flight phases due to the crew not being able to reach these switches once in their seats. The configuration of the O₂/N₂ control valves allows for one PCS system to be active to respond to a cabin leak once cabin pressure reaches 8.0 psia. For large leaks (meaning a leak where the stabilization pressure is below 6.5 psia with only one system active), the crew will procedurally activate PCS system 2 upon reaching 6.5 psia cabin pressure, to gain a minimum of 75 lb/hr additional N₂ flow. For the smaller leaks (<75 lb/hr), only one PCS system active is the preferred configuration. The O₂ regulator inlet valves are closed to supply all O₂ flow to the crew and any extra O₂ will flow to the cabin, during a cabin leak, via the direct O₂ valve.

For orbit operations, part A to this rule defines PCS system configuration for the mission. This determines which cabin regulator inlet valves and O₂/N₂ control valves apply in the orbit portion of this rule. Normally, while on orbit, only one PCS system is used to automatically control cabin atmosphere. Therefore, the active PCS system will have the 14.7 psia cabin regulator open to maintain a 14.7 psia cabin, the O₂/N₂ control valve in auto to automatically regulate oxygen/nitrogen partial pressure, and the O₂ regulator inlet valve open to allow O₂ flow during O₂ cycles.

DOCUMENTATION: Engineering judgment.

A17.1.6-2 CABIN PRESSURE RELIEF VALVES

BOTH CABIN POSITIVE PRESSURE RELIEF VALVES WILL BE ENABLED DURING ALL FLIGHT PHASES.

The failure of a pressure relief valve to open will not be detected until an overpressure condition exists. Because of the potential for an overpressure condition with possible catastrophic results, the redundant pressure relief function is enabled at all times.

DOCUMENTATION: Engineering judgment.

A17.1.6-3 CABIN VENT VALVES

THE CABIN VENT VALVES WILL BE CLOSED PRELAUNCH AND THE CB'S OPENED AFTER ASCENT. THE CB'S WILL REMAIN OPEN FOR THE REMAINDER OF THE FLIGHT THROUGH POSTLANDING HANDOVER.

The cabin vent valves are opened to vent the cabin after the prelaunch cabin leak check at T minus 30 minutes and closed at T minus 20 minutes. After ascent the circuit breakers are opened to prevent accidental opening of the valves. Circuit breaker opening is postponed until after ascent because they cannot be reached by the crew prior to lift-off or during powered flight.

DOCUMENTATION: Engineering judgment.

FLIGHT RULES

A17.1.6-4 CABIN O₂ CONCENTRATION

CABIN O₂ CONCENTRATION WILL BE MAINTAINED WITHIN THE SPECIFIED LIMITS FOR THE FOLLOWING CABIN PRESSURES:

- A. FOR 14.7 PSIA OPERATIONS, THE CABIN O₂ CONCENTRATION LEVEL WILL BE MAINTAINED BELOW 25.9 PERCENT.

Orbiter cabin materials and all middeck payload/experiments are required to be compatible (non-fire-propagating) with 25.9 percent O₂ concentration and have been qualified by test. Any materials or payloads flown which do not meet O₂ concentration requirements as stated in the Shuttle/Payload Middeck Accommodations document must have a waiver from the program office prior to flight. Instrumentation error for percent O₂ is derived by dividing worst case (high) PPO₂ plus instrumentation error (0.075) by worst case (low) cabin pressure minus instrumentation error (0.24) and equating this value to 25.9 percent. Then the indicated values, without the instrumentation error, are divided to arrive at the percent O₂ error.

DOCUMENTATION: NHB 8060.1B and NSTS 21000-IDD-MDK.

- B. FOR 10.2 PSIA OPERATIONS, THE CABIN O₂ CONCENTRATION LEVEL WILL BE MAINTAINED BELOW 30.0 PERCENT.

Testing on orbiter cabin materials has demonstrated that orbiter materials are non-fire-propagating at O₂ concentrations up to 30 percent. Middeck payloads/experiments are required to be compatible with a 30 percent O₂ atmosphere at a cabin pressure of 10.2 psi. Currently, all planned scheduled/unscheduled and contingency EVA's will be performed at 10.2 psi, if possible. However, until the vehicle is certified for 10.2 psi operations, a waiver is required to allow O₂ concentrations up to 30 percent.

DOCUMENTATION: MCR 11891 and NSTS 21000-IDD-MDK.

- C. FOR 8.0 PSIA OPERATIONS, THE CABIN O₂ CONCENTRATION LEVEL WILL BE MAINTAINED BELOW 40 PERCENT IF REMAINING CONSUMABLES ALLOW LESS THAN 36 HOURS TO ACCOMPLISH A LANDING. IF GREATER THAN 36 HOURS EXISTS, 35 PERCENT WILL BE THE UPPER LIMIT WHILE AT 8.0 PSIA. @[090894-1673A]

1. FOR CABIN LEAK SCENARIOS, OR SITUATIONS WHERE IT IS POSSIBLE, AN UPPER LIMIT OF 30 PERCENT WILL APPLY TO THE TRANSITION FROM 14.7 PSIA OPERATIONS TO 8.0 PSIA OPERATIONS.

THIS RULE CONTINUED ON NEXT PAGE

FLIGHT RULES

A17.1.6-4 CABIN O₂ CONCENTRATION (CONTINUED)

2. WHEN A DEPRESS TO 8 PSI IS USED AS A METHOD TO CONTROL RISING O₂ CONCENTRATIONS, AN UPPER LIMIT OF 40 PERCENT WILL APPLY TO THE TRANSITION FROM 14.7 PSIA OPERATIONS TO 8.0 PSIA OPERATIONS.

The 8.0 psia cabin operations is a contingency situation only requiring a landing no further than the next PLS. The 30 percent limit during the transition represents an O₂ concentration which is considered acceptable at all operating cabin pressures (14.7, 10.2, 8.0) for contingency situations. However, for scenarios where the depress to 8 psi is required as a method for controlling rising O₂ concentrations below the maximum limits (such as when the crew is required to remain on the QDM. LES's for extended periods of time or during an unisolatable O₂ leak into the cabin), it is not possible or practical to maintain the O₂ concentration below 30 percent. Therefore, in these cases, the 8.0 psia upper limit of 40 percent will apply. For example, in an avionics bay fire case, a depress rate great enough to maintain 30 percent maximum O₂ concentrations will also result in a negative differential pressure on the avionics bay, with respect to the cabin, causing the Halon and toxic combustion products to be drawn into the cabin (reference the rationale for Rule{A17.1.2-3C.2}, FIRE AND POST-FIRE ACTIONS). For these cases, it is considered less risk to manage the O₂ concentration between 30 and 40 percent in order to extend on-orbit time and avoid exposing the crew to toxic gasses. The decision to manage oxygen concentration up to 40 percent while at 8.0 psia is based on several factors. First, Flight Rule {A13.1.2-5A.2}, MINIMUM PPO₂ CONSTRAINTS, requires the minimum acceptable PPO₂ level for 8.0 psia operations to be 2.35 psi in order for the crew to remain off the launch/entry suit helmets (LESH)/Quick Don Masks (QDM's) in a contingency situation. This is equivalent to a 30 percent O₂ level which is equivalent to the limit to which cabin materials have been tested. If the crew were to don the LESH once PPO₂ dropped below 2.35 psi, the resulting excess flow of oxygen would not allow maintaining the O₂ concentration below 30 percent. Therefore, it is not possible to both maintain percent O₂ under acceptable limits (30 percent) and maintain an acceptable breathing atmosphere for the crew, without helmets, at 8.0 psia. Secondly, Halon 1301 effectively is degraded at O₂ percentages higher than 40 percent; however, test data shows it can extinguish a fire in 8.0 psia/40 percent O₂ concentration. Finally, 40 percent allows the crew more on-orbit stay time and less crew involvement with the direct O₂ valve than an upper limit less than 40 percent. ©[090894-1673A]

The 36-hour decision point for which upper limit to apply to oxygen concentration at 8.0 psi is arbitrary. A reason for having two upper limits while at 8.0 psi is to avoid extended operations at high O₂ concentration levels. Leak rates which allow less than 36 hours will be large enough to keep the oxygen concentration from remaining above 35 percent for long periods of time. (Ref. Rule {A13.1.2-5A.2}, MINIMUM PPO₂ CONSTRAINTS.). ©[090894-1673A]

Documentation: PRCB PCIN 41004, NASA TR-255-001.

Rules {A17.1.2-3}, FIRE AND POST-FIRE ACTIONS; and {A13.1.2-13C}, CABIN ATMOSPHERE CONTAMINATION, reference this rule.

FLIGHT RULES

A17.1.6-5

8 PSIA EMERGENCY CABIN CONFIGURATION

THE 14.7 PSIA CABIN REGULATOR INLET VALVES WILL BE CLOSED AND THE CABIN WILL BE ALLOWED TO BLEED TO 8 PSIA ONLY IF: @[090894-1673A]

- A. CABIN LEAK: O₂/N₂ CONSUMABLES ARE INSUFFICIENT TO ALLOW THE ORBITER TO EFFECT A NEXT PLS ENTRY AT 14.7 (10.2 IF ALREADY IN 10.2 PSIA OPS) PSIA CABIN PRESSURE PLUS A 24-HOUR FLIGHT EXTENSION AT 8 PSIA.

Operation at 14.7 psia is preferred because, at 8 psia, a powerdown is required and the crew must wear the LES helmet. However, if inadequate consumables exist to allow both a 14.7 (10.2 if already in 10.2 PSIA ops) psia cabin pressure to the next PLS opportunity and 1 extension day at 8 psia, the cabin will be immediately reconfigured to the 8 psia emergency configuration (i.e., 14.7 cabin regulators closed and associated powerdowns performed).

If it is determined that enough consumables exist to allow the 14.7 (10.2 if already in 10.2 PSIA ops) psia cabin pressure to the next PLS plus the 24-hour extension day at 8 psia, then the 14.7 (10.2 if already in 10.2 PSIA ops) psia cabin will be maintained to the next PLS opportunity to attempt a normal entry. If entry cannot be performed at the PLS opportunity, then the cabin must be reconfigured to the 8 psia emergency configuration for the remainder of the mission and an entry performed prior to consumables depletion @[090894-1673A]

DOCUMENTATION: Engineering judgment.

Rule {A17.1.6-4}, CABIN O₂ CONCENTRATION, references this rule.

- B. CABIN/AV BAY FIRE OR LEVEL 4 HAZARDOUS SPILL: THE CREW IS REQUIRED TO WEAR THE LES/QD, FOR AN EXTENDED PERIOD OF TIME TO PROTECT THEMSELVES AGAINST A CONTAMINATED CABIN ATMOSPHERE. @[090894-1673A]

A cabin depress to 8 psi and continuous purge at 8 psi will manage O₂ concentration below maximum levels as well as decrease the concentration of discharged Halon and any potentially toxic gases that were produced by a fire or hazardous elements that were spilled into the cabin atmosphere. This action could extend the time on orbit so as to avoid an ELS entry (ref. Rule {A17.1.2-3}, FIRE AND POST-FIRE ACTIONS, and {A13.1.2-15}, ORBITER HAZARDOUS SPILL RESPONSE, LEVEL 4).

DOCUMENTATION: Engineering judgment @[090894-1673A]

Rule {A17.1.6-4}, CABIN O₂ CONCENTRATION, references this rule

FLIGHT RULES

A17.1.6-6 O2 BLEED ORIFICE MANAGEMENT

THE O₂ BLEED ORIFICE WILL BE INSTALLED IN AN LEH VALVE QUICK DISCONNECT (QD), PRESLEEP ON FLIGHT DAY 1, IF PPO₂ LEVELS ARE BELOW 3.20 PSIA AND REMOVED DURING DEORBIT PREPARATION ACTIVITIES ON ENTRY DAY.

The O₂ bleed orifice, sized specifically for metabolic consumption of O₂ based on crew size, is installed to keep the 14.7 cabin regulator inlets in the low flow region of the regulator. This eliminates nuisance O₂/N₂ FLOW HIGH alarms caused by WCS cycles and O₂/N₂ flow switchovers. Normally, the bleed orifice is installed presleep on flight day 1, if PPO₂ levels permit. Due to oxygen introduced into the cabin via LES flow during ascent, however, the PPO₂ may be elevated to such a degree that bleed orifice installation is not necessary until postsleep on flight day 2. Delaying the installation will allow metabolic consumption to lower PPO₂ to nominal levels.

The bleed orifice is not used during ascent/entry since the PCS system is deactivated and there is no concern of generating nuisance flow alarms.

DOCUMENTATION: Flight data.

A17.1.6-7 N2 SYSTEM MANAGEMENT

BOTH N₂ SYSTEMS WILL NORMALLY BE OPERATED AS ONE SYSTEM.

Nominal operations for N₂ systems 1 and 2 has both systems fully open (i.e., supply valves, regulator inlet valves, etc.) so N₂ will be depleted simultaneously from all tanks. One of the drawbacks of operating both nitrogen systems as a single system is the possibility of losing more than one system's nitrogen quantity in the event of a massive tank leak. However, by operating both systems fully open, the risk is removed of a supply valve failing closed and cutting off one N₂ system for the remainder of the mission. The likelihood of a supply valve failing closed is considered greater than the possibility of a massive tank leak, and therefore the system is operated to protect against failure of one, or both, of the N₂ supply valves failing closed. Also, by depleting nitrogen equally from both systems, the quantity of N₂ remaining in a good system is maximized.

DOCUMENTATION: Engineering judgment.

Rule {A17.1.5-2B}, 8 PSIA CABIN CONTINGENCY 165-MINUTE RETURN CAPABILITY, references this rule.

FLIGHT RULES

A17.1.6-8 LOSS OF CABIN INTEGRITY T_{MAX} DEFINITION AND TIG SELECTION

- A. T_{MAX} IS DEFINED AS THE LATEST DEORBIT TIG THAT WILL ALLOW A LANDING BEFORE THE DEPLETION OF N₂ CONSUMABLES. IF CONSUMABLES WILL BE DEPLETED BEFORE A PLS LANDING, AN ELS LANDING WILL BE EFFECTED.
- B. THE MINIMUM ACCEPTABLE CABIN PRESSURE PRIOR TO ATMOSPHERIC REPRESSURIZATION IS 8 PSIA. THE PCS SHALL BE CONFIGURED TO MAINTAIN 8 PSIA. NOTE: EXTENDED TIME ON ORBIT AT A LOWER CABIN PRESSURE WILL BE SACRIFICED TO MAINTAIN A CABIN PRESSURE OF 8 PSIA.
- C. A DEORBIT TIG FOR LOSS OF CABIN PRESSURE INTEGRITY SHALL OCCUR AT OR BEFORE T_{MAX}.

T_{max} is defined as the deorbit TIG that synchronizes touchdown with the depletion of N₂ consumables. Note that T_{max} is independent of landing site availability and does not account for cooling certification violations due to loss of cabin pressure.

The T_{max} prediction is based on an assumed 8-psia emergency regulator maximum flowrate of 125 lb/hr of N₂ each (while the spec max flow is 75 lb/hr, OMRS testing shows that the actual average max flow is about 125 lb/hr). It also assumes that the time from TIG to touchdown is 60 minutes and that O₂ is managed between 2.2 and 3.0 psia (ref. Rules {A17.1.6-4}, CABIN O₂ CONCENTRATION, and {A13.1.2-5}, MINIMUM PPO₂ CONSTRAINTS). N₂ depletion is defined in Rule {A17.1.5-4}, N₂ SUPPLY, as tank pressure below 200 (375) psia.

The vehicle avionics are not certified to withstand cabin pressures below 8 psia due to cooling requirements. Also, a cabin pressure of 8 psia is the minimum pressure which will allow the crew to function normally for any length of time without a prebreathe. Reference Flight Rule {A13.1.2-3A}, CABIN PRESSURE. For these reasons, maintaining 8 psia (if possible) is mandatory.

In maintaining 8 psia, N₂ supplies will be exhausted as necessary. No N₂ conservation steps that involve lowering the cabin stabilization pressure below 8 psia will be attempted. Therefore, the time on orbit that could be achieved if the cabin was allowed to stabilize at a lower pressure will be sacrificed to maintain 8 psia.

Actual TIG determination will be based on T_{max} and not the cabin stabilization pressure. Obviously, TIG must occur at or before T_{max} so that N₂ consumables do not deplete before touchdown, thereby allowing the cabin to drop to near zero pressure.

If a PLS site is available at 8 psia, it would be the most desirable landing site. Landing site options at cabin pressures lower than 8 psia will be very limited (probably one, if any) due to the rapid depletion of N₂ (a leak would have to be over 250 lb/hr for cabin pressure to stabilize below 8 psia). Therefore, landing site selection at cabin stabilization pressures lower than 8 psia need not be addressed.

FLIGHT RULES

THIS RULE CONTINUED ON NEXT PAGE

FLIGHT RULES

A17.1.6-8 **LOSS OF CABIN INTEGRITY T_{MAX} DEFINITION AND TIG SELECTION (CONTINUED)**

All other rules regarding acceptable PPO₂ levels for breathing and O₂ concentration levels in the cabin must be upheld during a cabin leak in order to effect a safe entry.

DOCUMENTATION: NASA memo from James M. Waligora/SD5 - 7/14/86, EVA Prebreathe N₂ vs. Decompression Sickness Risk Table, engineering judgment, and KSC 8-psia reg OMRSD ground checkout testing.

A17.1.6-9 **N₂ REDLINE DETERMINATION**

REDLINE IS DETERMINED BY THE SUMMATION OF RESIDUALS (6.5 LB/TANK), MEASUREMENT ERROR RSS'ED FOR THE NUMBER OF TANKS FLOWN (4.05 LB/TANK), NOMINAL FLIGHT REQUIREMENT, AND AN 8 PSI, 165-MINUTE CONTINGENCY RETURN CAPABILITY (80.0 LB FOR 14.7 OPS, 114.0 FOR 10.2 OPS). @[121593-1597]

Consumable redline quantities are based on normal mission requirements plus the single worst case contingency. When the cabin is depressed to 10.2, the contingency requirement is greater because of the minimal bleeddown time to 8 psia. The extra 34 lbs at N₂ is the amount required to give the same 165 min return capability for a cabin leak at 10.2 as there is at 14.7 psia. This redline is further adjusted based on possible instrumentation inaccuracy.

Rule {A17.1.7-2}, 10.2 PSIA CABIN DEPRESSURIZATION CONSTRAINTS, references this rule.

FLIGHT RULES

A17.1.6-10 LES O2 SUPPLY SYSTEM LOSS MANAGEMENT

- A. IF AN O₂ SYSTEM IS LOST DUE TO AN O₂ XOVR VALVE FAILURE, CHECK VALVE FAILURE, OR BLOCKAGE, AN IFM TO RESTORE FLOW WILL BE PERFORMED. @[050495-1756B]

If an O₂ XOVR valve or check valve is failed closed, the ability to protect the crew from a contaminated cabin is probably lost. For the blockage case, the IFM will be performed if the blockage is in such a place that allows the IFM to be viable. The IFM will restore full functionality to the LES MANIFOLD.

- B. UNTIL THE IFM IS COMPLETE, MIDDECK EXPERIMENTS INVOLVING LEVEL 3 OR 4 TOXIC MATERIALS THAT HAVE FEWER THAN THE SAFETY PANEL APPROVED NUMBER OF LEVELS OF CONTAINMENT SHOULD NOT BE PERFORMED, UNLESS DOING SO CLEARLY DOES NOT INCREASE THE RISK FOR A SPILL.

Experiments involving Level 3 or 4 toxic materials that have fewer than the Safety Panel approved number of levels of containment have lost a level of containment. Performing these experiments while an LES O₂ SUPPLY SYSTEM is lost may subject the crew to unnecessary risk. Experiments in isolatable volumes (Spacelab, Spacehab, etc.) are not affected by this rule. @[050495-1756B]

- C. CONSIDERATION WILL BE GIVEN TO PERFORMING A REAL-TIME TEST OF THE LES MANIFOLD CAPABILITIES. IF THE SINGLE O₂ SYSTEM SUPPLIES ENOUGH O₂ TO PREVENT THE ANTI-SUFFOCATION VALVES FROM OPENING WHILE ALL CREWMEMBERS ARE BREATHING RAPIDLY, THEN THE LES O₂ SUPPLY SYSTEM MAY BE CONSIDERED GO. @[050495-1756B]

It is generally believed that each crewmember consumes approximately 5.5 lb/hr of O₂ while breathing on the LES or QDM's, which exceeds the capacity of a single O₂ supply system. However, usage varies with each crew, so it is possible that a single system could support.

Documentation: STS-26 flight data, engineering judgment.

Reference Rule {A17.1.5-6}, LES O₂ SUPPLY SYSTEM LOSS DEFINITION. @[050495-1756B]

FLIGHT RULES

10.2 PSIA CABIN ATMOSPHERE OPERATION

A17.1.7-1 CABIN ATMOSPHERE MANAGEMENT

THE CABIN ATMOSPHERE WILL BE MANUALLY MANAGED TO MAINTAIN THE CABIN PRESSURE BETWEEN 10.0 AND 10.4 PSIA AND THE CABIN PPO₂ BETWEEN 2.55 AND 2.80 PSIA, INDICATED.

Operation at these conditions satisfies the 10.2 EVA protocol for bends prevention, provides adequate PPO₂, and maintains an acceptable O₂ concentration below 30 percent. The 10.0 psia cabin pressure minimum avoids a powerdown due to cooling requirements. The 10.4 psia cabin pressure avoids C&W alarms from being tripped. The C&W upper limit is set at 10.6 to avoid breaking the 8.44 PPN₂ limit for EVA prebreathe. A PPO₂ of 2.55 psia prevents the crew from having to don LES helmets for 2.50 psia minimum metabolic PPO₂ at a 10.2 psia cabin pressure. 2.80 psia PPO₂ is within the 30 percent O₂ concentration flammability limit during 10.2 psia operations (ref. Rule {A13.1.2-5A.1}, MINIMUM PPO₂ CONSTRAINTS).

Rule {A13.1.2-7 C.1}, EVA PREBREATHE PROTOCOL, references this rule.

A17.1.7-2 10.2 PSIA CABIN DEPRESSURIZATION CONSTRAINTS

CABIN DEPRESSURIZATION WILL NOT BE PERFORMED IF ANY OF THE FOLLOWING CONDITIONS EXIST:

- A. CABIN PRESSURE TRANSDUCER HAS FAILED, OR THE CABIN PRESSURE TRANSDUCER HAS DRIFTED BEYOND ± 1.2 PERCENT FULL-SCALE AND NEITHER OF THE FOLLOWING IS AVAILABLE:
 1. UPLINK OF A PASS SM CABIN PRESSURE CALIBRATION COEFFICIENT REAL-TIME COMMANDER OR,
 2. AN EMU FEEDWATER PRESSURE SENSOR THAT CAN BE VERIFIED AS ACCURATE TO WITHIN ± 0.24 PSIA FOR USE AS AN ALTERNATE CABIN PRESSURE TRANSDUCER. @[111094-1687]

The available OI backup measurements to determine cabin pressure, airlock/overboard delta P, and the delta P between supply H₂O inlet P and H₂O regulator P are not accurate enough to keep the cabin within specified pressure and PPO₂ limits. The airlock/overboard delta P transducer can give as much as ± 2.0 psi inaccuracy on the true cabin pressure. Using the H₂O regulator inlet pressure transducers and the H₂O supply inlet pressure can give as much as ± 2.8 psi inaccuracy. Therefore, the depressurization should not be performed using only these since these transducers do not provide accurate means of determining cabin pressure and O₂ concentration. @[111094-1687]

THIS RULE CONTINUED ON NEXT PAGE

FLIGHT RULES

A17.1.7-2

10.2 PSIA CABIN DEPRESSURIZATION CONSTRAINTS
(CONTINUED)

One of the requirements for the 10.2 psi certification (PCIN 60154) was to ensure the cabin pressure transducer would be within ± 1.2 percent full-scale (± 0.24 psi) accuracy prior to launch. The OMRSD requires the transducer to be within ± 1.0 percent prior to the vehicle leaving the OPF. This allows for some drift to occur between OPF processing and launch. A single point check is then performed during PPO₂ sensor calibration approximately 2 weeks prior to launch. If the transducer is determined to have drifted beyond ± 1.2 percent during the single point check, then a SCALING COEFFICIENT SET UPDATE (OI-21 and subs) will be required for any 10.2 psi operations using the last seven-point calibration verification for that vehicle. @[111094-1687]

The EMU feedwater pressure sensor is certified as Crit 1 flight instrumentation. The spec accuracy of the EMU feedwater pressure sensor is ± 0.4 psia (± 2.5 percent full-scale); however, actual performance of the sensor far exceeds the specifications during vacuum chamber testing. The actual sensor performance varies with each EMU and is calibrated prior to each mission. If the orbiter cabin pressure sensor were to fail, an EMU would be unstowed, powered up, and a reading made of the feedwater pressure (AIRLK P XX.X on the EMU DCM) with the feedwater shutoff valve closed (WATER - OFF). The downlinked value of feedwater pressure sensor is given to two decimal place; however, it requires that the EMU UHF comm be active. The reading should be taken as soon as possible (within 1/2 hour is preferred) after the failure of the cabin pressure sensor is detected. The reported EMU reading would be compared to the last valid reading of the orbiter cabin pressure sensor and the vacuum chamber feedwater pressure sensor calibration data to verify that ± 0.24 psia accuracy (the 10.2 certification requirement) can be met.

Use of the EMU for monitoring cabin pressure will only be required during the depress to 10.2 psi and the 10.2 psi maintenance activities. It is not necessary for the MMU to remain powered continuously. This will not pose a constraint to missions where only two EMU's are manifested since the cabin atmosphere will not be managed to preclude the need for a 10.2 psi maintenance during the EVA when no EMU's are available in the orbiter. If there are no other EVA's scheduled, the cabin can be repressed to 14.7 psi during the EVA.

Additional methods are available to perform coarse checks of the EMU feedwater pressure reading without the orbiter cabin pressure sensor. These methods include comparisons of the airlock/overboard (cabin/airlock) delta pressures and the delta pressure between the supply H₂O inlet pressure and H₂O regulator pressure, and Fluke MultiCal Pressure Sensor. The Fluke MultiCal Pressure Sensor is currently not certified as Crit 1 hardware and is therefore not available for use as an alternate means of monitoring for 10.2 psi operations.

THIS RULE CONTINUED ON NEXT PAGE

FLIGHT RULES

A17.1.7-2 10.2 PSIA CABIN DEPRESSURIZATION CONSTRAINTS
(CONTINUED)

If 10.2 EVA protocol cannot be utilized, the EVA crew will be required to prebreathe for 4 hours (14.7 EVA protocol) prior to each EVA. The 10.2 EVA protocol requires only a 40-minute prebreathe. @[111094-1687]

- DOCUMENTATION: PCN 60154 - 10.2 psi certification waiver/QSA.*
- MCR 11891 - Establishment and certification of orbiter for EVA operational environments.*
- SS-P-0002-1400 - CPDS SS DOWNLIST/UPLINK software requirements.*
- SCR 90173A - Add cabin P to SCALING COEFF U/L CMD.*
- SV799100/S - PLSS S/A D (Portable Life Support System Specifications and Drawings)*
- Boeing FEPC EMU Flight Data Book*
- JSC EMU Chamber testing, and engineering judgment*

@[111094-1687]

B. TWO OF THE THREE PPO2 SENSORS ARE FAILED. @[090894-1455]

During the depress to 10.2 psia and while at 10.2 psia, the cabin atmosphere is maintained manually, using PPO2 as one of the determining parameters. Because the PPO2 transducers have a history of drifting and PPO2 must be maintained within tight limits, one parameter is not sufficient to guarantee that PPO2 will be maintained within limits; therefore, there needs to be at least one confirming sensor to insure an accurate PPO2 and O2 concentration reading.

If C&W/FDA limits cannot be annunciated for PPO2, the crew will have to closely monitor it to maintain the proper atmosphere. @[090894-1455]

DOCUMENTATION: Engineering judgment.

C. TOTAL N₂ QUANTITY IS LESS THAN THE NOMINAL MISSION REQUIREMENT PLUS:

INSUFFICIENT QTY'S	2 TANK SET
144.5 (151.5) LBM	3 TANK SET
151.0 (159.1) LBM	4 TANK SET
157.5 (166.6) LBM	5 TANK SET
164.0 (173.9) LBM	6 TANK SET

THIS RULE CONTINUED ON NEXT PAGE

FLIGHT RULES

A17.1.7-2 10.2 PSIA CABIN DEPRESSURIZATION CONSTRAINTS (CONTINUED)

This value comprises the mission completion redline (ref. Rule {A17.1.5-2B}, 8 PSIA CABIN CONTINGENCY 165-MINUTE RETURN CAPABILITY) plus the quantity required to repressurize the cabin (≈ 45 lb) for entry. All attempts should be made to protect mission completion redlines. By violating this consumable redline, the 165-minute hole-in-the-cabin contingency reserve cannot be preserved. A cabin repressurization requires approximately 45 lb of N_2 and 11 lb of O_2 (ref. Rules {A17.1.5-2}, 8 PSIA CABIN CONTINGENCY 165-MINUTE RETURN CAPABILITY; and {A17.1.6-9}, N_2 REDLINE DETERMINATION). ©[121593-1597]

DOCUMENTATION: Engineering judgment.

A17.1.7-3 CABIN REPRESSURIZATION PRIOR TO DEORBIT

PRIOR TO DEORBIT, THE CABIN WILL BE REPRESSURIZED BACK TO 14.7 PSIA.

An entry at a cabin pressure less than 14.7 psia would require a powerdown (loss of cabin pressure, 8 psi powerdown) which is undesirable during entry. A concern also exists about the structural integrity of some components exposed to cabin pressures less than 14.7 psi during entry. These components would require a postflight structural analysis to determine if they should be replaced prior to next flight, resulting in extended turnaround time and unnecessary cost to the program.

DOCUMENTATION: Minutes of Initial 10.2 psia Certification meeting, 8/18/86.

A17.1.7-4 10.2 PSIA CABIN PRESSURE MANAGEMENT FOR MULTIPLE EVA'S

FOR MULTIPLE EVA'S, THE CABIN WILL REMAIN AT 10.2 PSIA UNTIL THE LAST SCHEDULED EVA HAS BEEN COMPLETED.

Cabin repressurization from 10.2 to 14.7 psia requires 45 lb of N_2 and 11 lb of O_2 . Repressurizing the cabin, knowing that another EVA is pending, would cause an unnecessary use of consumables.

DOCUMENTATION: Engineering judgment.

FLIGHT RULES

A17.1.7-5 **14.7 PSIA CABIN REPRESSURIZATION LIMITATION**

CABIN REPRESSURIZATION WILL NOT BE PERFORMED IF A CABIN LEAK OF UNKNOWN ORIGIN OCCURS WHILE THE CABIN PRESSURE IS BEING MANAGED AT 10.2 PSIA.

By repressing the cabin with a declared unknown leak in the pressurized module, a structural pressure cycle will be imparted on the cabin which could cause the leak to enlarge. If the leak is of known origin and the source of the leak ensures the hole will not become larger by repressing the cabin to 14.7 psia, then a cabin repressurization may be performed if it can be done within the consumables guidelines of Rule {A17.1.5-1B}, CABIN PRESSURE INTEGRITY.

DOCUMENTATION: Engineering judgment.

A17.1.7-6 **10.2 PSIA CABIN TEMPERATURE CONSTRAINT**

CABIN REPRESSURIZATION TO 14.7 PSIA WILL BE PERFORMED IF THE CABIN TEMPERATURE CANNOT BE MAINTAINED < 80 DEG F.

The maximum air outlet temperature for all flight deck avionics is 130° F. At a 10.2 psia cabin pressure, the avionics have a 50 deg F delta temperature across the LRU. Therefore, the flight deck avionics must have an air inlet of less than or equal to 80 deg F so that the avionics will not overtemp. This rule is designed to protect the IMU's which cannot be powered down and are flight-critical avionics.

DOCUMENTATION: SEH-ITA-83-179T.

Rule {A17.1.7-8}, ATCS (10.2 PSIA CABIN) CONFIGURATION, references this rule.

A17.1.7-7 **PAYLOAD 10.2 PSIA CABIN OPERATIONS**

PAYLOADS WITHIN THE CREW MODULE THAT HAVE NOT BEEN CERTIFIED TO OPERATE IN A 30 PERCENT O₂ ENVIRONMENT WILL BE POWERED OFF DURING 10.2 PSIA CABIN OPERATIONS.

The Orbiter Middeck/Payload Standard Interface Control Document (ICD) gives a requirement that payloads must be compatible with a 31 percent O₂ environment at 10.2 psia cabin pressure. This avoids creating an ignition source in a high oxygen concentrated environment. This rule applies to payloads which may have a waiver or some other reason for being manifested on a flight with a scheduled cabin depress.

DOCUMENTATION: Orbiter Middeck/Payload Standard ICD, ICD 2-1 M001, March 1984.

FLIGHT RULES

A17.1.7-8 ATCS (10.2 PSIA CABIN) CONFIGURATION

ATCS CONFIGURATION WILL BE AS FOLLOWS:

- A. WITH ONLY ONE FLOW PROPORTIONING VALVE (FPV) IN THE INTERCHANGER (ICH) POSITION, A FES PRIMARY CONTROLLER MUST BE ACTIVATED. @ED 1

With only one FPVM in the ICH position, the FES is required to maintain cabin temperature < 80 deg F and the avionics bay air outlet temperatures < 130 deg F (per Rule {A17.1.7-6}, 10.2 PSIA CABIN TEMPERATURE CONSTRAINT). @ED 1

- B. WITH BOTH FPVM'S IN THE ICH POSITION, THE FES MAY BE DEACTIVATED IF ORBITER ATTITUDES ALLOW THE RADIATORS TO CONTROL THE EVAP OUT T < 52 DEG F. @ED 1

This should maintain cabin temperature < 80 deg F and the avionics bay air outlet temperatures < 130 deg F (per Rule {A17.1.7-6}, 10.2 PSIA CABIN TEMPERATURE CONSTRAINT). However, the FES is normally activated during 10.2 psia operations to minimize fluctuations in cabin temperature and cabin pressure.

During periods when the orbiter attitude allows sunlight into the orbiter windows, the cabin temperature may experience fluctuations that exceed 80 deg F. For those cases, the window sunshades should be installed on the affected windows to minimize the thermal impact.

DOCUMENTATION: SEH-ITA-83-179T; flight data (STS-7, STS-41D, STS-31).

A17.1.7-9 CABIN PRESSURE TIME AT 10.2 PSIA

TIME AT 10.2 PSIA WILL BE MINIMIZED AS MUCH AS PRACTICAL.

Operations at 10.2 psia run closer to the flammability and cooling limits (than at 14.7 psia) as well as putting the orbiter in an off-nominal configuration for emergency deorbit. For these reasons, time at 10.2 psia should be minimized. However, the prebreathe protocol that requires the crew to be at 10.2 psia for 36 hours prior to an EVA should have priority over these concerns. The 36-hour period is required to avoid the initial 1-hour prebreathe prior to/during cabin depress.

Documentation: SEH-ITA-83-179T, Minutes of Initial 10.2 psia Certification meeting, 8/18/86.

Reference Rule {A13.1.2-7}, EVA PREBREATHE PROTOCOL. @[012694-1600]

FLIGHT RULES

WASTE COLLECTION SYSTEM (WCS) / VACUUM VENT LOSS DEFINITIONS

A17.1.8-1 WCS SEPARATOR

THE WCS SEPARATOR IS CONSIDERED LOST IF:

- A. UNABLE TO ESTABLISH DC OR AC POWER TO THE WCS SEPARATOR.
- B. THE SEPARATOR IS FLOODED AND CANNOT BE CLEARED.

The primary function of the WCS separator is to separate waste water from the cabin atmosphere. If the separator is flooded and cannot be cleared, or it will not start because it is unpowered, it is considered lost.

DOCUMENTATION: Engineering judgment.

A17.1.8-2 WCS URINE COLLECTION

WCS URINE COLLECTION CAPABILITY IS CONSIDERED LOST IF UNABLE TO TRANSPORT URINE TO THE WASTE WATER SYSTEM THROUGH EITHER PATH IN THE WCS.

The primary function of the WCS urine collection system is to transport liquid waste water to the waste water tank. If the line is blocked, leaking, or both separators are lost or any combination of failures which prevents the WCS from transporting urine to the waste water system, the urine collection mode is considered lost.

DOCUMENTATION: Engineering judgment and schematic.

A17.1.8-3 WCS COMMODE

THE WCS COMMODE IS CONSIDERED LOST AND SHOULD NO LONGER BE OPERATED IF:

- A. UNABLE TO OPEN THE SLIDE VALVE.
- B. THE COMMODE IS FULL AND CANNOT BE EMPTIED.
- C. UNABLE TO ESTABLISH SUFFICIENT AIRFLOW THROUGH COMMODE OUTLET TO CONTAIN FECAL MATTER WHEN THE SLIDE VALVE IS OPEN.
- D. VACUUM VENT CANNOT BE REMOVED FROM COMMODE FOR WCS USAGE.

FLIGHT RULES

THIS RULE CONTINUED ON NEXT PAGE

FLIGHT RULES

A17.1.8-3 WCS COMMODE (CONTINUED)

E. THE FECAL STORAGE TANK IS RUPTURED.

The commode must be able to collect and retain fecal matter. Operation of the WCS with any of the above conditions (except paragraph D) results in potential fecal matter in the cabin environment, which is unacceptable for reason of crew health.

For conditions A, B, C, and E, lengthy IFM procedures may have to be executed. If the WCS cannot be repaired, the mission may be terminated early because only a finite number of bags are carried on the orbiter.

If the vacuum vent (ref. paragraph D) cannot be removed from the commode during WCS usage, the WCS is at least partially open to vacuum. Furthermore, operation of the WCS under this condition could damage the slide valve and/or its seals. Several EECOM/IFM methods exist to remove the vacuum vent from the commode (e.g., STS-33 in-flight anomaly), but the intent of this rule is to cease WCS operations while the WCS is being evaluated and repaired.

DOCUMENTATION: Engineering judgment and schematic.

A17.1.8-4 VACUUM VENT LOSS DEFINITION

VACUUM VENT CAPABILITY IS LOST IF THE VACUUM VENT ISOLATION VALVE FAILS CLOSED AND THE WCS WASTE COLLECTOR PRESSURE EXCEEDS 1.0 PSIA WITH THE COMMODE NOT IN USE.

The primary functions of the vacuum vent are to vent gaseous waste, particularly H₂ gas extracted from fuel cell product water (approximately 9.75 × E-5 lb/hr), overboard and to provide a means for evacuation and depressurization of the airlock for EVA. The vacuum vent isolation valve is constructed such that an orifice in the valve plate allows a flow of approximately 3 lb/hr even with the valve fully closed. Assuming the commode is not in use, an increasing WCS waste collector pressure would indicate an obstruction somewhere in the vacuum vent line, the line pressure is increasing from the buildup of hydrogen from the hydrogen separators, and cabin air from the WCS wet trash vents as the line attempts to equalize to cabin pressure. The choice of 1.0 psia as a failure definition is not precise; however, since the time required to reach 1.0 psia after the failure occurs is short (approximately 10 minutes), it is used to eliminate transducer inaccuracy as the cause and to ensure time to identify a real problem.

This mixture of hydrogen and oxygen (from the air) could produce localized pockets of potentially flammable/detonable mixture, and an alternate means to vent this mixture overboard is required. While this is no longer possible to vent gaseous waste overboard through the vacuum vent line, the capability to depressurize the airlock for EVA can still be accomplished through use of the hatch "B" equalization valves, or in the case of a Spacelab module, through the use of the hatch "C" equalization valves.

DOCUMENTATION: Engineering judgment and schematic.

Rule {A17.1.9-5}, VACUUM VENT SYSTEMS MANAGEMENT (CIL), references this rule.

FLIGHT RULES

WCS/VACUUM VENT MANAGEMENT

A17.1.9-1 WCS USAGE CONSTRAINT

THE WCS WILL NOT BE USED IF:

A. THE CABIN IS BEING REPRESSURIZED.

Possible low O₂ concentrations resulting from high N₂ flow during cabin repressurization could cause possible acute hypoxia of the crewmember using the WCS. Due to the small area that the WCS is in and due to the location of the WCS in relation to the PCS panel, M010W, exposure to the WCS area should be minimized.

DOCUMENTATION: CSD-SH-194.

B. AN EMU IS BEING DRAINED.

The WCS fan separator maximum waste water flowrate is 0.09 lbm/sec. With a crewmember using the WCS at a flowrate of 0.088 lbm/sec, the separator will flood when the EMU waste water is also drained through the WCS.

DOCUMENTATION: SODB 4.6.2.2.1.a.1.a and 4.6.2.2.3.b.2.b.

A17.1.9-2 LEAKING WCS WATER LINES

FOR AN UNREPARABLE LEAK IN THE WCS URINE LINE FROM THE INLINE FILTER TO THE WCS/WASTE WATER INTERFACE QUICK DISCONNECT, NO LIQUIDS WILL BE TRANSPORTED THROUGH THE WCS.

This is to prevent water from flowing into the cabin. Free water in the cabin could cause crew exposure to bacteria and toxins contained in waste water or the possibility of an electrical circuit malfunction.

DOCUMENTATION: Engineering judgment and schematic.

A17.1.9-3 ALTERNATE FECAL COLLECTION

IF THE WCS COMMODE IS LOST, THE CREW WILL USE THE APOLLO FECAL BAG TO COLLECT FECAL MATTER.

Waste bags are the alternate method of collecting waste. The standard manifest provides 40 bags to accommodate at least a PLS plus 2 days (3 days).

DOCUMENTATION: Engineering judgment and Crew Compartment Configuration Drawings, drawing SED-32101800-306.

FLIGHT RULES

A17.1.9-4 ALTERNATE URINE COLLECTION

IF THE WCS URINE COLLECTION CAPABILITY IS LOST, THE CREW WILL USE THE APPROPRIATE CONTINGENCY DEVICE: THE MALE URINE COLLECTION DEVICE (UCD) OR THE FEMALE URINE ABSORPTION SYSTEM (UAS).

UCD's and UAS's are alternate measures for collecting urine. The standard manifest provides 58 UCD's (4 are dedicated to the EMU's) and 36 UAS's to accommodate at least a PLS plus 2 days (3 days).

DOCUMENTATION: Engineering judgment and Crew Compartment Configuration Drawings, drawing SED-32101800-306.

A17.1.9-5 VACUUM VENT SYSTEMS MANAGEMENT (CIL)

- A. SHOULD THE VACUUM VENT ISOLATION VALVE FAIL CLOSED, WCS WASTE COLLECTOR PRESSURE WILL BE UTILIZED TO MONITOR PROPER VENTING OF GASEOUS WASTE OVERBOARD THROUGH THE VACUUM VENT ORIFICE.
- B. IF VACUUM VENT CAPABILITY IS LOST, THE WCS VACUUM VALVE MUST REMAIN OPEN FOR THE DURATION OF THE MISSION, INCLUDING ENTRY.
- C. IF VACUUM VENT CAPABILITY IS LOST, THE FOLLOWING STEPS WILL BE ACCOMPLISHED:
 - 1. THE "CONTINGENCY VACUUM VENT OPERATION" IFM WILL BE ACCOMPLISHED TO RESTORE VACUUM VENT CAPABILITY.
 - 2. WCS COMMODE OPS WILL BE TERMINATED UNTIL VACUUM VENT CAPABILITY IS RESTORED.
 - 3. THE IFM HOSE WILL BE DISCONNECTED AT THE CONTINGENCY WATER CROSSTIE WASTE QD DURING WASTE WATER DUMPS.
 - 4. THE "CONTINGENCY VACUUM VENT OPERATION" IFM WILL REMAIN INSTALLED THROUGH ENTRY.

THIS RULE CONTINUED ON NEXT PAGE

FLIGHT RULES

A17.1.9-5 VACUUM VENT SYSTEMS MANAGEMENT (CIL) (CONTINUED)

Failure of the vacuum vent isolation valve in the closed position will not adversely impact nominal WCS operations; however, WCS waste collector pressure will be closely monitored to ensure proper operation of the vacuum vent system. If vacuum vent capability is considered lost (ref. Flight Rule {A17.1.8-4}, VACUUM VENT LOSS DEFINITION), WCS commode ops will be terminated until vacuum vent capability is restored through use of the CONTINGENCY VACUUM VENT OPERATION IFM to minimize hydrogen release into the cabin and to stop the rapid (within minutes) formation of a flammable/detonable gas mixture with the WCS/vacuum vent ducting. Upon indications of vacuum vent failure, preliminary analysis calls for implementation of the IFM within 1 to 2 hours to preclude formation of localized pockets of a potentially flammable/detonable mixture. At no time should the WCS vacuum valve be closed as this would result in a potentially flammable/detonable gas mixture forming in the vacuum vent duct in a matter of minutes. Once the IFM is accomplished, it will remain in place for the duration of the mission through entry to ensure safe, overboard venting of hydrogen gas. To prevent possible waste water backup into the cabin, the IFM hose will be disconnected at the contingency water cross-tie waste QD during waste water dumps.

DOCUMENTATION: Engineering judgment and schematic. Informal letter from Michael D. Pedley to John Wong; Subject: Compatibility of Nyloseal tubing with a hydrogen/air mixture, dated 9-6-90.

FLIGHT RULES

WASTE WATER LOSS DEFINITIONS

A17.1.10-1 WASTE WATER TANK

THE WASTE WATER TANK IS CONSIDERED LOST IF:

- A. UNABLE TO FILL THE TANK.
- B. THE TANK OR INLET MANIFOLD HAS AN IRREPARABLE LEAK.
- C. THE WASTE TANK QUANTITY IS AT 98 (93) PERCENT AND WASTE DUMP CAPABILITY IS LOST.
- D. THE WASTE TANK HAS A BELLOWS LEAK AND THE WASTE LIQUID PRESSURE IS ≥ 5 PSID ABOVE THE H₂O N₂ REGULATOR INLET PRESSURE. [ED]

The primary purpose of the waste tank is to collect and store waste water. If the line to the waste tank is blocked or has an irreparable leak, or if the waste water tank is full and cannot be dumped, the waste tank is considered lost. For an irreparable leak, the waste tank will be unable to store waste water. For a bellows leak, there is no way to determine the quantity in the waste water tank. The waste liquid pressure normally reads approximately the same as H₂O N₂ regulator inlet pressure. If the waste liquid pressure is ≥ 5 psid, then the waste water tank is full and will not be allowed to store any more water, because then water will transfer into the N₂ system by passing through the hydrophobic filter.

DOCUMENTATION: Engineering judgment and SODB, 4.6.2.2.4.c.2.

A17.1.10-2 WASTE WATER DUMP CAPABILITY

THE WASTE WATER DUMP CAPABILITY IS CONSIDERED LOST IF:

- A. THE WASTE WATER DUMPLINE TEMPERATURE CANNOT BE MAINTAINED > 32 DEG (37 DEG) F.

This is the minimum temperature at which a successful dump may be accomplished to prevent any ice from forming on the nozzle and to prevent the water in the dumpline from freezing.

The contingency crosstie will not be used because it is downstream of the dump isolation valve. This is to prevent the stagnant water in the waste water dumpline from forming into ice, while the waste water is being dumped through the supply water nozzle.

DOCUMENTATION: SEH-TCH-85-036.

THIS RULE CONTINUED ON NEXT PAGE

FLIGHT RULES

A17.1.10-2 WASTE WATER DUMP CAPABILITY (CONTINUED)

- B. THE WASTE WATER DUMPLINE IS BLOCKED AND THE CREW IS UNABLE TO USE THE CONTINGENCY CROSSTIE.

If the dumpline is blocked, the primary path to dump waste water is unusable. If the crew cannot use the contingency crosstie to dump waste water through the supply water nozzle (see Rule {A18.1.2-2}, SUPPLY/WASTE WATER CROSSCONNECT), the only other method to dump waste water has been lost.

DOCUMENTATION: Engineering judgment.

- C. AN IRREPARABLE LEAK IN THE LINE EXISTS PAST THE WASTE DUMP ISOLATION VALVE.

This is to prevent free water in the cabin if the leak is inside the crew module. If the leak is outside the 576 bulkhead, it is to prevent ice from forming under the payload bay liner causing damage to the equipment that is located under the liner.

DOCUMENTATION: Engineering judgment and schematic.

- D. BOTH WASTE NOZZLE TEMPERATURE TRANSDUCERS ARE FAILED, THE RMS IS UNAVAILABLE TO OBSERVE A WASTE WATER DUMP, AND THE CREW IS UNABLE TO USE THE CONTINGENCY CROSSTIE.

With no insight into the nozzle temperatures, waste water dumps will not be permitted (without the RMS observing) to prevent forming an icicle on the nozzle due to an undetectable heater failure. If available, the RMS must be used to observe all subsequent dumps. Once ice growth outward from the nozzle is visually observed, the dump shall be terminated (see Rule {A17.1.11-5C}, WASTE WATER DUMP NOZZLE TEMPERATURE CONSTRAINTS). If the crew cannot use the contingency crosstie to dump waste water through the supply water nozzle (see Rule {A18.1.2-2}, SUPPLY/WASTE WATER CROSSCONNECT), the only remaining method to dump waste water has been lost.

DOCUMENTATION: Engineering judgment.

- E. THE NOZZLE TEMPERATURE CRITERIA FOR DUMPING WASTE WATER CANNOT BE MET AND THE CREW IS UNABLE TO USE THE CONTINGENCY CROSSTIE.

If the nozzle temperature criteria cannot be met, the primary path to dump waste water is unusable (ref. Rule {A17.1.11-5}, WASTE WATER DUMP NOZZLE TEMPERATURE CONSTRAINTS). If the crew cannot use the contingency crosstie to dump waste water through the supply water nozzle (ref. Rule {A18.1.2-2}, SUPPLY/WASTE WATER CROSSCONNECT), the only other method to dump waste water has been lost.

DOCUMENTATION: Engineering judgment.

FLIGHT RULES

WASTE WATER MANAGEMENT

A17.1.11-1	ALTERNATE PRESSURE VALVE MANAGEMENT	17-55
A17.1.11-2	WASTE DUMP NOZZLE ICE FORMATION	17-55
A17.1.11-3	WASTE WATER STORAGE	17-56
A17.1.11-4	MINIMUM WASTE TANK QUANTITY AFTER DUMPING .	17-57
A17.1.11-5	WASTE WATER DUMP NOZZLE TEMPERATURE CONSTRAINTS	17-57
A17.1.11-6	WASTE WATER SYSTEM LEAK MANAGEMENT	17-59
A17.1.11-7	OMS & PRCS BURNS WITH FREE H2O IN THE CABIN	17-61

SPACELAB/SPACEHAB

A17.1.12-1	SPACELAB NITROGEN MANAGEMENT MODULE	17-62
------------	---	-------

LIFE SUPPORT GO/NO-GO CRITERIA

A17.1.13-1	LIFE SUPPORT GO/NO-GO CRITERIA	17-63
------------	--	-------

SPACEHAB FIRE/SMOKE DETECTION LOSS DEFINITION

A17.6.1-1	SPACEHAB FIRE/SMOKE DETECTION LOSS	17-70
-----------	--	-------

FIRE/SMOKE MANAGEMENT

A17.6.2-1	SPACEHAB FIRE/SMOKE DETECTION	17-71
-----------	---	-------

SPACEHAB ECS MANAGEMENT

A17.6.3-1	SPACEHAB CABIN FAN/AIR LOOP	17-75
A17.6.3-2	CABIN ATMOSPHERIC CONTROL	17-75

FLIGHT RULES

MODULE ATMOSPHERE MANAGEMENT

A17.6.4-1	MODULE ATMOSPHERIC CONTROL	17-76
A17.6.4-2	CABIN FAN	17-77
A17.6.4-3	ATMOSPHERE RECIRCULATION SYSTEM (ARS) FAN .	17-78
A17.6.4-4	WATER FLOW CONTROL ELECTRONICS UNIT (WFCEU)	17-79
A17.6.4-5	PARTIAL PRESSURE OF OXYGEN (PPO2) SENSORS .	17-80
A17.6.4-6	PARTIAL PRESSURE OF CARBON DIOXIDE (PPCO2) SENSORS	17-80

ATMOSPHERE INTEGRITY

A17.6.5-1	MODULE PRESSURE INTEGRITY LOSS DEFINITION .	17-81
A17.6.5-2	MODULE PRESSURE CONTROL LOSS DEFINITION . .	17-81
A17.6.5-3	PPCO2 CONTROL LOSS DEFINITION	17-81
A17.6.5-4	MODULE PRESSURE INTEGRITY	17-82
A17.6.5-5	NEGATIVE PRESSURE RELIEF VALVE COVERS	17-82
A17.6.5-6	CABIN DEPRESS VALVE (CDV)	17-83
A17.6.5-7	ASCENT/DESCENT INLET STUB	17-83
A17.6.5-8	EXPERIMENT VENT VALVE	17-83

SPACELAB FIRE/SMOKE DETECTION LOSS DEFINITION

A17.9.1-1	SPACELAB FIRE/SMOKE PRIMARY DETECTION LOSS	17-84
A17.9.2-1	SPACELAB FIRE/SMOKE DETECTION	17-85

ATMOSPHERE REVITALIZATION SYSTEM (ARS) LOSS/FAILURE DEFINITIONS

A17.9.3-1	CABIN FAN/AIR LOOP	17-87
A17.9.3-2	CABIN ATMOSPHERIC CONTROL	17-88
A17.9.3-3	AVIONICS FAN/AIR LOOP	17-89

FLIGHT RULES

ARS SYSTEM MANAGEMENT

A17.9.4-1	CABIN ATMOSPHERE CONTROL (ARS AIR CIRCULATION)	17-91
A17.9.4-2	CONDENSATE SEPARATOR/TANK	17-93
A17.9.4-3	AVIONICS FAN	17-94
A17.9.4-4	RACK COOLING ASSEMBLY	17-98
A17.9.4-5	TUNNEL FAN	17-99

ATMOSPHERE STORAGE AND CONTROL SYSTEM (ASCS) LOSS/FAILURE DEFINITIONS

A17.9.5-1	CABIN PRESSURE INTEGRITY	17-100
A17.9.5-2	CABIN PRESSURE CONTROL	17-101
A17.9.5-3	PPO2 CONTROL	17-101

ATMOSPHERE STORAGE AND CONTROL SYSTEM (ASCS) MANAGEMENT

A17.9.6-1	CABIN PRESSURE INTEGRITY	17-102
A17.9.6-2	CABIN PRESSURE CONTROL	17-102
A17.9.6-3	RELIEF VALVE COVERS	17-103
A17.9.6-4	CABIN DEPRESS VALVE	17-103
A17.9.6-5	O2 ENRICHMENT CONTROL	17-104
A17.9.6-6	LOSS OF O2 PARTIAL PRESSURE CONTROL	17-104
A17.9.6-7	SPACELAB N2 SUPPLY MANAGEMENT	17-105
A17.9.6-8	SPACELAB POWER TERMINATION	17-105
A17.9.6-9	10.2 PSI AFT FLIGHT DECK OPERATIONS	17-106
A17.9.6-10	EXPERIMENT VENT VALVE POSITION	17-107

FLIGHT RULES

WASTE WATER MANAGEMENT

A17.1.11-1 ALTERNATE PRESSURE VALVE MANAGEMENT

THE ALTERNATE PRESSURE VALVE WILL NORMALLY BE CLOSED THROUGHOUT THE FLIGHT.

The alternate pressure valve is a backup means of supplying pressure (cabin pressure) to the water system. Normal water system pressurization utilizes the gaseous nitrogen system. Activation of this valve only lowers available water system pressure to cabin pressure and should be used in a contingency mode only.

DOCUMENTATION: Engineering judgment, SODB 4.6.1.1.1 r, SODB figures 4.6.1-3 and 4.6.1-4.

A17.1.11-2 WASTE DUMP NOZZLE ICE FORMATION

- A. IF ICE IS DETECTED ON THE WASTE DUMP NOZZLE, ALL FURTHER DUMPS FROM EITHER NOZZLE WILL BE DISCONTINUED UNTIL SUCH TIME AS THE ABSENCE OF THE ICE CAN BE VERIFIED. [@\[061396-1878C\]](#)
- B. ONCE THE ABSENCE OF ICE CAN BE VERIFIED VISUALLY OR BY THE OBSERVATION OF NOMINAL NOZZLE HEATER CYCLES, DUMPS FROM THE SUPPLY NOZZLE MAY BE PERFORMED.
- C. SUBSEQUENT WASTE DUMPS MAY BE CONSIDERED ~~ATTEMPTED~~ IF SUFFICIENT ULLAGE (WASTE TANK + CWCS) IS NOT AVAILABLE TO MAKE NOMINAL EOM, AND A METHOD TO VISUALLY OBSERVE THE NOZZLE IS AVAILABLE. [@\[061396-1878C\]](#) ~~ONCE THE ICE HAS BEEN VISUALLY VERIFIED TO BE GONE, DUMPS FROM THE SUPPLY NOZZLE MAY BE PERFORMED.~~

Detectable ice buildup on the waste dump nozzle has been known to compound the ice formation on the supply nozzle due to the close proximity of the nozzles to each other (approximately 6.5 to 7.0 inches). Frost has not been a problem. If the ice can be procedurally removed, supply dumping can be resumed because the mechanism aiding in the supply nozzle ice growth no longer exists. The original problem causing the waste nozzle to ice is probably still present so the risk of creating more ice is reduced by not allowing any more waste dumps. When a method is available to visually observe the nozzle for ice formation, the dump can be stopped when it is observed that the ice is starting to grow outward from the nozzle and before the ice becomes a problem. [@\[061396-1878C\]](#)

~~*The original problem causing the waste nozzle to ice is probably still present so the risk of creating more ice is reduced by not allowing any more waste dumps.*~~

FLIGHT RULES

DOCUMENTATION: Engineering judgment; CSD-SH-291; flight data STS-8, STS 41-B, STS 41-D, and STS-65. ©[061396-1878C]

Rule {A17.1.11-5}, WASTE WATER DUMP NOZZLE TEMPERATURE CONSTRAINTS, references this rule. ©[061396-1878C]

FLIGHT RULES

A17.1.11-3 WASTE WATER STORAGE

THE FOLLOWING TECHNIQUES WILL BE USED, IN ORDER OF PRIORITY, TO MANAGE WASTE WATER.

The priorities for management of liquid waste are necessary to provide for protection of the crew's health while maintaining ability to complete certain mission objectives.

- A. PLAN TO DUMP THE WASTE WATER THROUGH THE WASTE WATER DUMP NOZZLE WHEN THE WASTE QUANTITY REACHES 80 PERCENT.

The waste tank will be dumped when the waste tank quantity reaches 80 percent in order to minimize the number of dumps that need to be performed during a mission.

- B. FILL THE WASTE TANK TO 98 (93) PERCENT IF IT CAN SUPPORT EOM.

- C. UTILIZE THE CONTINGENCY WATER COLLECTION BAG (CWC).

Steps A, B and C are the most acceptable way to manage the waste water system because it provides for protection of the crew's health by isolating the waste water from the supply water system.

- D. USE THE CONTINGENCY WATER CROSSTIE TO DUMP WASTE WATER THROUGH THE SUPPLY WATER DUMP NOZZLE.

The contingency water crosstie limits the amount of line that has to be replaced during ground turnaround (potable water is protected from contamination by the dump isolation and tank A outlet valves).

- E. TERMINATE THE FLIGHT EARLY.

- F. CONFIGURE SUPPLY WATER TANK B AS A SPARE WASTE TANK AFTER THE LAST EMU RECHARGE FOR ALL PLANNED EVA'S.

Waste water will contaminate FES feedline A and the EMU supply line. In addition, vehicle turnaround at KSC is impacted when the potable water system is contaminated by waste water.

DOCUMENTATION: Engineering judgment, schematic, and 1.3-TM-DF86050-014.

FLIGHT RULES

A17.1.11-4 MINIMUM WASTE TANK QUANTITY AFTER DUMPING

WASTE TANK WILL NOT BE DUMPED TO 0 PERCENT (5 PERCENT) .

This is to prevent the metal bellows from being subjected to stress while hard on the stops. If the waste tank is at 0 percent, a vacuum will exist on the waste dumpline and the waste tank bellows. If there is a vacuum on the water side of the bellows, a cabin leak will occur when the WCS and the humidity separator liquid check valve cracks. If the pressure on the water side decreases sufficiently, the bellows will exceed their maximum operational pressure of 28 psid or its burst pressure of 32 psid.

DOCUMENTATION: Engineering judgment, schematic, and MC-262-0067.

A17.1.11-5 WASTE WATER DUMP NOZZLE TEMPERATURE CONSTRAINTS

- A. THE WASTE DUMP NOZZLE TEMPERATURE SHOULD NOT EXCEED 350 DEG F WHILE THE NOZZLE HEATERS ARE ACTIVATED.

The maximum design operating temperature of the waste water dump nozzle is 350 deg F. External tiles surrounding the nozzle are likely to debond if this temperature is exceeded.

- B. NORMALLY, WASTE WATER DUMPS WILL BE INITIATED WHEN THE NOZZLE TEMPERATURES ARE GREATER THAN 150 DEG F.

This is the minimum temperature (on STS-35) at which waste water dumps have been accomplished).

DOCUMENTATION: STS-35 flight data and STS-35 SPAN-MER CHIT 037.

- C. IF THE RMS IS USED TO OBSERVE A WASTE H₂O DUMP , THE DUMP WILL BE TERMINATED IF EITHER:

1. THE WASTE WATER DUMP NOZZLE TEMPERATURE IS <45 DEG F. THE NOZZLE MAY BE REHEATED FOR ANOTHER DUMP ATTEMPT;

OR

2. ICE GROWTH OUTWARD FROM THE NOZZLE IS VISUALLY OBSERVED. ANOTHER DUMP WILL NOT BE ATTEMPTED UNTIL THE ICE FORMATION IS MELTED. NOZZLE GLAZING OR FROSTING IS NOT CAUSE TO TERMINATE THE DUMP.

The minimum temperature limit prevents ice from forming on the nozzle. Instrumentation error is not considered when the RMS is available to monitor for ice formation. The dump can be stopped when it is observed that the ice is starting to grow outward from the nozzle and before it becomes a problem.

FLIGHT RULES

DOCUMENTATION: SODB 3.4.6.2, table 3.4.6.2.1, and flight data.

THIS RULE CONTINUED ON NEXT PAGE

FLIGHT RULES

A17.1.11-5 WASTE WATER DUMP NOZZLE TEMPERATURE CONSTRAINTS **(CONTINUED)**

- D. IF THE RMS IS NOT OBSERVING THE WASTE WATER DUMP, THE DUMP WILL BE TERMINATED IF THE WASTE DUMP NOZZLE TEMPERATURE IS <50 DEG F. THE NOZZLE MAY BE REHEATED FOR ANOTHER DUMP ATTEMPT.

This is the minimum temperature used in past missions at which successful waste water dumps have been accomplished. Another dump attempt will be done only if the slope of the dump nozzle temperature indicates a normal profile (to prevent the formation of ice on the nozzle).

DOCUMENTATION: STS-49 and STS-46 flight data.

- E. IF PLATEAUIING IS OBSERVED ANYTIME IN THE NOZZLE TEMPERATURE WARM-UP PROFILE, NO FURTHER WASTE H₂O DUMPS WILL BE PERFORMED.

The plateauing effect, indicating that ice has formed on the nozzle, has been observed on past flights. To prevent more ice from forming on the nozzle, no dumps will be performed until Flight Rule {A17.1.11-2}, WASTE DUMP NOZZLE ICE FORMATION, is satisfied.

DOCUMENTATION: SEH-ITA-84-134 and flight data.

Rule {A17.1.10-2}, WASTE WATER DUMP CAPABILITY, references this rule.

A17.1.11-6 WASTE WATER SYSTEM LEAK MANAGEMENT

FOR WASTE WATER SYSTEM LEAKS, THE FOLLOWING GUIDELINES WILL PERTAIN:

- A. IF FREE WASTE WATER IS IN THE CABIN, THE "FREE FLUID DISPOSAL" IFM PROCEDURE WILL BE PERFORMED IMMEDIATELY. IF PRACTICAL, THE WASTE WATER TANK WILL BE DUMPED TO 5 PERCENT PRIOR TO INITIALLY PERFORMING THE "FREE FLUID DISPOSAL" IFM PROCEDURE.

Immediate removal of free waste water is necessary to protect the crew from the bacteria and toxins in the waste water. Free fluid in the cabin is an unacceptable condition because of LRU exposure to the free liquid causing an electric circuit malfunction and possible subsequent LRU failures.

THIS RULE CONTINUED ON NEXT PAGE

FLIGHT RULES

A17.1.11-6 WASTE WATER SYSTEM LEAK MANAGEMENT (CONTINUED)

Dumping the waste water tank creates additional ullage so that, if the IFM procedure causes a blockage in the waste water dump line, waste water will continue to collect to maximize the on-orbit stay period. STS-32 experienced free water in the lower equipment bay due to degraded humidity separator collection. The FREE FLUID DISPOSAL IFM was employed to dump the water overboard via the waste water dump nozzle. However, while employing the IFM procedure on the third occasion during the mission on FD 10, the waste water dump line became blocked by matter collected using the free fluid nozzle (wand). The mission was then limited by the remaining ullage in the waste water tank and the CWC volume.

For the STS-36 humidity separator failure, the waste water tank was dumped prior to using the FREE FLUID DISPOSAL IFM. Even though no blockage occurred in the waste water dump line, the mission on-orbit stay was maximized by having additional ullage created by the dump.

DOCUMENTATION: Ref. STS-32 MER Anomaly #21, January 19, 1990; STS-32 CAR No. 32RF21; STS-36 MER Anomaly #11, April 3, 1990; STS-36 CAR No. 36RF13; and engineering judgment.

- B. IF THE WASTE TANK HAS AN IRREPARABLE EXTERNAL LEAK, THE TANK WILL BE VENTED TO CABIN PRESSURE AND DUMPED OVERBOARD (IF POSSIBLE). PROVISIONS WILL BE MADE FOR COLLECTION OF LIQUID WASTE USING CWC. IF POSSIBLE, NO FURTHER WASTE WATER WILL BE ALLOWED TO ACCUMULATE IN THE WASTE TANK.
 @[090894-1665A]

Venting a leaking waste tank equalizes the pressure to that of the cabin, which serves to reduce the outflow of waste water into the cabin. Dumping the waste tank is necessary to further prevent waste water flow into the cabin and should be done unless otherwise prevented from doing so. Since the orbiter has only one waste tank, the CWC is used to collect liquid waste from the Humidity and WCS Fan Separators. The CWC is then dumped periodically, based on the actual flight waste production rate. Each flight typically carries two CWC's, rated at 95 lbm H₂O. For a typical 7-person crew, this is about 4545 hours capability per CWC based on 0.3 lb/hr per crewmember. @[090894-1665A] @[041196-1874A]

- C. IF AN UNISOLABLE N₂ LEAK INVOLVING THE WASTE TANK IS PRESENT, THE N₂ SUPPLY TO THE WATER PRESSURIZATION SYSTEM WILL BE SHUT OFF. LEAK LOCATION PERMITTING, AN IFM TO ISOLATE THE WASTE TANK FROM THE REST OF THE WATER PRESSURIZATION SYSTEM WILL BE PERFORMED. THE REMAINING PARTS OF THE WATER SYSTEM WILL BE RETURNED TO NORMAL PRESSURE ONCE THAT IFM IS COMPLETE (LEAK LOCATION PERMITTING).

FLIGHT RULES

For an unisolable N₂ leak, the N₂ pressurant supply to the water pressurization manifold is temporarily shut off to prevent continuous N₂ flow into the cabin. Returning to normal water system pressurization is highly desirable, since the FES is sometimes adversely affected by lower system pressures (depending on orbiter power level and cooling needs).

DOCUMENTATION: STS-55 flight experience and engineering judgment.

A17.1.11-7 OMS & PRCS BURNS WITH FREE H₂O IN THE CABIN

CONSIDERATION WILL BE GIVEN TO DELAYING NON-CRITICAL OMS AND PRCS BURNS WHEN THE PRESENCE OF FREE H₂O IN THE CREW CABIN IS CONFIRMED. ©[051195-1755]

In microgravity, the surface tension of water tends to force free water to collect in globules. OMS and PRCS burns have the potential to disperse free H₂O throughout the Cabin/LEB, possibly being dislodged to the surfaces of electrically powered LRU's/wire bundles, thus providing the potential for an electrical short.

Several flights have had instances where large amounts of H₂O was present in the LEB. During STS-27 and STS-32, approximately 2 gallons of free H₂O was found present in the lower equipment bay. This water was found to be dispersed and present on the surfaces of several pieces of equipment in the LEB. On STS-27, some of this water seeped through two middeck panels.

The amount of H₂O present, its location and adherence to equipment or structure, and the criticality of the burn will determine if delaying of the burn will be necessary.

DOCUMENTATION: Engineering judgment. ©[051195-1755]

FLIGHT RULES

SPACELAB/SPACEHAB

A17.1.12-1 SPACELAB NITROGEN MANAGEMENT MODULE

SPACELAB NITROGEN WILL BE DEPLETED BEFORE ORBITER NITROGEN SUPPLY.

In the event of an orbiter cabin pressure leak, it is desirable to have the maximum amount of nitrogen available to the orbiter pressure control system (PCS) in order to maximize orbiter on-orbit lifetime. Therefore, it is prudent to use the Spacelab nitrogen supply first, since the Spacelab nitrogen is not accessible from the orbiter once both the Spacelab hatch and manual payload isolation valve are closed.

Reference: Engineering judgment. [ED]

FLIGHT RULES

LIFE SUPPORT GO/NO-GO CRITERIA

A17.1.13-1 LIFE SUPPORT GO/NO-GO CRITERIA

SYSTEM/COMPONENTS/FUNCTIONS	ASCENT ABORT IF:	INVOKE MDF IF:	ENTER NEXT PLS IF:
A. <u>FIRE PROTECTION:</u>	04/28/94 FINAL, PCN-20		
1. AV BAY SMOKE DETECTION SYS (2 PER BAY) [1]			
2. CABIN, SMOKE DETECTION SYS			3 ↓ [3]
3. FIRE SUPPRESSION SYS (1 BOTTLE PER BAY)			
4. FIRE DETECTED/SUPPRESSED [16]			[2]
5. HALON DISCHARGE, CABIN OR AV BAY (W/O FIRE CONFIRMATION) [16]			
B. <u>ARS AIR:</u>			
1. CABIN FANS (2)		1 ↓	2 ↓ [230]
2. AV BAY COOLING			
a. AV BAY 1 [4]		[6]	[7]
b. AV BAY 2 [4]		[6]	[7]
c. AV BAY 3 [4]		[8]	[9] [7]
3. IMU FANS (3) [5]			2 ↓
C. <u>CABIN ATMOSPHERE:</u>			[10]
1. CO2 CONTROL			
2. CABIN TEMP CONTROL			
3. HUMIDITY CONTROL			[10]
4. RCRS		[11]	[11]
D. <u>PCS:</u>	[129]		
1. CABIN PRESS INTEGRITY			
2. 165-MIN 8-PSI CONTINGENCY RETURN			
3. PPO2			[12]
4. LES O2 SUPPLY SYSTEM (2)		1 ↓ [17]	2 ↓ [18]

@[050495-1756B] @[020196-1810A] @[ED]

THIS RULE CONTINUED ON NEXT PAGE

FLIGHT RULES**A17.1.13-1 LIFE SUPPORT GO/NO-GO CRITERIA (CONTINUED)**

NOTES:

- [1] ALL AIR-COOLED EQUIPMENT INCLUDING THE FAN WILL BE UNPOWERED (EXCEPT FOR THE COMMUNICATIONS EQUIPMENT, CAUTION & WARNING EQUIPMENT, AND FAN IN AV BAY 3A). ALL EQUIPMENT MAY BE REPOWERED FOR ENTRY IF SAFED WITH A HALON BOTTLE. REFERENCE RULES {A17.1.2-1A.2 & 3}, MANAGEMENT FOLLOWING LOSS OF SMOKE DETECTION, MANAGEMENT FOLLOWING LOSS OF SMOKE DETECTION. @[090894-1675]
- [2] IF TOXIC COMBUSTION PRODUCTS CANNOT BE SATISFACTORILY REMOVED FROM THE CABIN ATMOSPHERE, THE CREW WILL REMAIN ON THE QDM/LES BREATHING 100 PERCENT O₂ UNTIL ORBITER EGRESS. AN ELS OR PLS LANDING IS REQUIRED BASED UPON AVAILABLE N₂ CONSUMABLES FOR MAINTAINING THE O₂ CONCENTRATION WITHIN ACCEPTABLE LIMITS. REFERENCE RULE {A13.1.2-13C}, CABIN ATMOSPHERE CONTAMINATION. WITHOUT DIRECT INSIGHT INTO THE AFFECTED AVIONICS BAY, THE EXTENT OF THE DAMAGE TO THE EQUIPMENT IS UNKNOWN. A PLS LANDING WILL BE PERFORMED TO MINIMIZE THE RISK OF THE OCCURRENCE OF AN ADDITIONAL FIRE OR ARC TRACKING. @[090894-1675]
- [3] UNLESS CREW PERSON REMAINS AWAKE DURING SLEEP PERIODS TO MONITOR FOR SMOKE CONDITIONS. REF. RULE {A17.1.1-2}, SMOKE DETECTION LOSS DEFINITION
- [4] LOSS OF BOTH FANS IN ANY ONE BAY IS A GO-TO-ORBIT CASE. THE AVIONICS BAY WILL BE RECONFIGURED POST-MECO (TACAN'S AND MLS ONLY) AND POST-OMS-1 (ALL AIR-COOLED EQUIPMENT).
- [5] LOSS OF THREE IMU FANS IS A GO-TO-ORBIT CASE WITH IMU CYCLING. VACUUM CLEANER FAN WILL BE INSTALLED ON ORBIT. ENTER FIRST DAY PLS. @[020196-1810A]
- [6] MDF FOR LOSS OF COOLING TO TWO GPC'S (DUE TO UNACCEPTABLE TEMPERATURE).
- [7] ENTER NEXT PLS IF A SINGLE ELECTRICAL FAILURE (AC BUS) COULD CAUSE THE LOSS OF AIR COOLING TO TWO AV BAYS.
- [8] MDF FOR LOSS OF SMOKE DETECTION (LOSS OF AIR FLOW ONLY).
- [9] PLS FOR LOSS OF COOLING TO THE C&W.
- [10] AN ALTERNATE MODE OF CO₂/HUMIDITY CONTROL WOULD BE TO PERFORM CABIN PURGES (OR PARTIAL DUMPS) VIA THE AIRLOCK DEPRESSURIZATION VALVE.
- [11] QUANTITY OF LIOH CANSTERS AND CREW SIZE WILL DETERMINE EOM.
- [12] PLS REQUIRED IF AUTOMANUAL PPO₂ CONTROL CANNOT MAINTAIN AEROMED MINIMUM (REF. RULE {A13.1.2-5A.1}, MINIMUM PPO₂ CONSTRAINTS) AND LESS THAN 30 PERCENT O₂ AT TOUCHDOWN. ELS REQUIRED IF 40 PERCENT O₂ IS EXPECTED TO BE EXCEEDED PRIOR TO NEXT PLS TOUCHDOWN.
- [13] WITHOUT THE WCS, THE CREW REQUIRES SUFFICIENT BAGS FOR AT LEAST A PLS PLUS 2 DAYS (3 DAYS). EOM IS DEPENDENT ON DEFECATION/URINATION RATE, NUMBER/GENDER OF CREW, AND NUMBER OF ALTERNATE COLLECTION DEVICES.
- [14] CWC AND UCD ULLAGE WILL DETERMINE EOM. @[121593-1589]
- [15] ULLAGE WILL DETERMINE EOM.
- [16] FOR CONFIRMED DISCHARGE INTO AN AVIONICS BAY, AN OVERBOARD PURGE OF THE AFFECTED BAY WILL BE INITIATED AS A MEANS OF REDUCING HALON CONCENTRATIONS AND EXTENDING AVAILABLE ON-ORBIT TIME. FOR A LEAKING HANDHELD HALON BOTTLE IN THE CABIN, THE BOTTLE WILL BE DISCHARGED OVERBOARD THROUGH THE AIRLOCK DEPRESS VALVE. REFERENCE THE AEROMED FLIGHT RULE {A13.1.2-13}, CABIN ATMOSPHERE CONTAMINATION FOR EOM DETERMINATION DUE TO HALON TOXICITY CONCERNS. REFERENCE AEROMED FLIGHT RULE {A13.1.2-6}, 100 PERCENT OXYGEN USE CONSTRAINT, FOR MAXIMUM TIME CREW CAN REMAIN ON 100 PERCENT O₂. @[090894-1675]
- [17] MDF DUE TO INABILITY TO SUPPORT LES/QDM FLOW TO ENTIRE CREW IN THE EVENT OF A CONTAMINATED CABIN (E.G., FIRE OR TOXIC SPILL). IF REAL-TIME TEST INDICATES THAT ENTIRE CREW CAN BE SUPPORTED OR AN IFM ALLEVIATES THE PROBLEM, AN MDF IS NOT REQUIRED (REF. RULE {A17.1.6-10C}, LES O₂ SUPPLY SYSTEM LOSS MANAGEMENT).
- [18] INABILITY TO SUPPORT 8 PSIA CABIN (REF. RULE {A17.1.5-3A}, PPO₂ CONTROL). @[050494-1756B]
- [19] ABORT RTLS/TAL FOR ORBITER -DP/DT > 0.15; AOA FOR ORBITER -DP/DT > 0.02.
- [20] ELS WILL PROBABLY BE REQUIRED IF THE NEXT PLS OR SLS IS GREATER THAN 8 HOURS. AS LONG AS CABIN ENVIRONMENT IS ACCEPTABLE A PLS WILL BE TARGETED. @[020196-1810A]

FLIGHT RULES

THIS RULE CONTINUED ON NEXT PAGE

FLIGHT RULES

A17.1.13-1 LIFE SUPPORT GO/NO-GO CRITERIA (CONTINUED)

D. PCS

The requirement for cabin pressure integrity is dependent on the leak rate. Ascent aborts are summarized in Rule {A17.1.5-1A}, CABIN PRESSURE INTEGRITY. No requirement exists for an MDF due to the philosophy that the flight will be terminated once the integrity of the cabin has been declared lost. (Ref. Rule {A17.1.5-1}, CABIN PRESSURE INTEGRITY, for rationale defining cabin pressure integrity.)

The 165-minute, 8-psia contingency return is defined by two requirements; the first being the N₂ required to perform the contingency return and the second being a functional launch/entry suit (LES) helmet for each crewmember which will supply enough oxygen to allow the crewmember to breathe normally.

The N₂ consumable is budgeted to provide enough N₂ for nominal mission requirements and remain above the N₂ redline (contingency return capability + measurement error + residuals) at EOM. If an N₂ leak develops or nominal flight activities (i.e., MMU recharges, cabin represses, etc.) cause us to break the N₂ redline prior to EOM, a next day PLS will be declared. The PLS is required due to insufficient consumables to maintain an 8-psia cabin for 165-minute contingency return in the event of a hole in the cabin equivalent to 0.45 inch.

An LEH is defined to be lost when it can no longer supply 2.5 lb/hr O₂ to the crewmember. This implies either a hardware failure or a failure in cryogenic oxygen supply which will not provide the necessary amount of O₂ to the crewmember. Since the 165-minute, 8 psia contingency return will cause cabin pressure and PPO₂ to drop below safe metabolic limits for breathing cabin atmosphere, the LES helmet will have to be used prior to touchdown to supply enough oxygen to each crewmember. Therefore, one lost helmet is loss of the contingency return requirement. (Ref. Rule {A17.1.5-2}, 8 PSIA CABIN CONTINGENCY 165-MINUTE RETURN CAPABILITY, for loss of 165-minute, 8-psia contingency return definition.)

If PPO₂ cannot be maintained within the specified control band (Ref. Rule {A17.1.5-3}, PPO₂ CONTROL) using either auto or manual control, a next day PLS will be declared to avoid operations with a 30 percent or greater O₂ concentration (Ref. Rule {A17.1.6-4A}, CABIN O₂ CONCENTRATION), or an oxygen deficient cabin which cannot support crew metabolic needs (Ref. Rule {A13.1.2-5 A.1}, MINIMUM PPO₂ CONSTRAINTS).

THIS RULE CONTINUED ON NEXT PAGE

FLIGHT RULES**A17.1.13-1 LIFE SUPPORT GO/NO-GO CRITERIA (CONTINUED)**Memos/Documents

JSC-07700 Vol. 10, Rev D, 9/30/83.

Contract NAS9-14000 Orbiter Vehicle End Item Specification for the Space Shuttle System, Part 1, Performance and Design Requirements, 1/3/83.

NHB 8060.1B, Flammability, Odor, and Offgassing Requirements and Test Procedures for Materials in Environments that Support Combustion, 9/81.

On-Orbit Flight Techniques #28 minutes, 9/26/78.

Master Measurement List, 2/15/85.

NASA/JSC Memo from James Waligora, EVA Prebreathe vs. Decompression Sickness Risk Table, 7/14/86.

JSC-18504, STS Operational Flight Design - Standard Groundrules and Constraints, Level B, 9/84.

Minutes of Initial 10.2 psia Certification Meeting - 8/18/86.

JSC- 22276, STS Medical Console Handbook.

Orbiter Middeck/Payload Standard Interfaces Control Document - ICD 2-1 M001, March 1984.

Rockwell International Documents

Certification Approval Request - Attachment #2, 5/22/80.

Shuttle Operational Data Book - volume 1, revision D, section 4.6.1, 10/84.

SEH-ITA-83-179T - ECLSS Analysis of 10.2 psia Cabin Pressure Control Demonstration, 1983.

SEH-ITA-83-349T - Relative Effect of Interchanger Water Flowrates on ARS Temperatures: 10/14/83.

F. WASTE H₂O

1. The waste tank is the primary means of storing waste water. Without a place to store waste water, the crew would lose humidity control, urine collection capability, and EMU drain capability. The CWC serves as a spare waste water storage container. Waste water can be drained into it from the waste tank via the Contingency Cross-tie Waste QD. Alternatively, the CWC can function as a spare waste tank, where waste water is fed directly into it (again via the Contingency Cross-tie Waste QD). In either case, the CWC would last about 47 hours (assuming seven crew members). This would require dumping the CWC when it is full or using a second one to hold more waste water. ©[121593- 1589]
2. If waste dump capability is lost, the ullage in the waste tank and the CWC will determine the end of mission. When the tank is full, the crew would lose humidity control, WCS urine collection capability, and EMU drain capability.

FLIGHT RULES

©[121593- 1589]

FLIGHT RULES

SPACEHAB FIRE/SMOKE DETECTION LOSS DEFINITION

A17.6.1-1 SPACEHAB FIRE/SMOKE DETECTION LOSS

SPACEHAB SMOKE DETECTION SHALL BE CONSIDERED LOST FOR ANY ONE OF THE FOLLOWING REASONS:

- A. ONE SMOKE DETECTOR FAILS BOTH PORTIONS OF THE CIRCUIT TEST AND THE OTHER SMOKE DETECTOR FAILS EITHER PORTION OF THE CIRCUIT TEST.
- B. POWER TO THE DETECTORS CANNOT BE MAINTAINED.
- C. LOSS OF AIR CIRCULATION (BOTH FANS FAILED).

Each smoke detector outputs two smoke detection indications (an alarm indication and a concentration measurement), and these two measurements are independent of one another except for a smoke detector hardware failure. The only hardware failure that can be detected by the circuit test is an air pump failure which would force the detector to fail both portions of the circuit test. If the smoke detector passes either portion of the circuit test, the air pump is then verified as operative, and the concentration readout sent to the GPC for FDA limit sensing (Class 0 only, does not produce alarm) is considered a valid indication.

Power is required for the smoke detectors to operate. Loss of air circulation prevents particulates from reaching the smoke detector in a timely manner if the combustion is not close to the smoke detector. If only one indication is left in the Spacehab, the system is considered suspect to the point of being unreliable.

DOCUMENTATION: R.I. vendor drawings VS70-620109, V070-623420, and V70-960099.

FLIGHT RULES

FIRE/SMOKE MANAGEMENT

A17.6.2-1 SPACEHAB FIRE/SMOKE DETECTION

A. LOSS OF SMOKE DETECTION

1. FOR LOSS OF TWO OF THE FOUR SMOKE INDICATIONS, SPACEHAB OPERATIONS MAY CONTINUE; HOWEVER, A SENSOR TEST IS REQUIRED EVERY 24 HOURS.

A second smoke detector provides redundant monitoring.

2. FOR LOSS OF SMOKE DETECTION, NOMINAL SPACEHAB OPERATIONS MAY CONTINUE IF A CREWMEMBER IS AWAKE IN THE MODULE AT ALL TIMES TO MONITOR FOR SMOKE/FIRE.
3. IF AN ON-DUTY CREWMEMBER WILL NOT BE IN THE MODULE, THE MODULE WILL BE DEACTIVATED (EXCEPT FOR THE AFT PAYLOAD BAY) AND CONFIGURED FOR SAFE ENTRY AND THE HATCH CLOSED UNTIL THE CREW RETURNS.

An on-duty crewmember must be available for monitoring the module for smoke/fire. If an on-duty crewmember is not inside the module, the Spacehab must be configured for a safe entry. This configuration will force the deactivation of certain experiments.

B. ASCENT/ENTRY

FOR A CONFIRMED SPACEHAB FIRE (SEE PARAGRAPH D FOR CONFIRMATION CUES), THE FSS WILL BE ARMED AND DISCHARGED.
@[051194-1633]

The Payload Safety Review Panel approved SH HR F-1, which states that the module material selection and design practices should prevent initiation and/or propagation of a fire. Based on this, the most likely cause of smoke in the module would be from a transient electrical short.

THIS RULE CONTINUED ON NEXT PAGE

FLIGHT RULES**A17.6.2-1 SPACEHAB FIRE/SMOKE DETECTION (CONTINUED)**

The STS-60 Flight Techniques Panel concluded on November 23, 1993, that, for a confirmed fire during ascent, the FSS should be discharged. This panel consisted of representatives of Crew Safety, Emergency, Environmental and Consumables Management (EECOM), STS-60 CDR, Safety, Flight Surgeon, and Spacehab. Flight experiences (STS-6, STS-28, and STS-35) indicate that short-term electrical transients do not typically produce enough smoke to exceed smoke sensor noise levels, which is far below alarm thresholds. Since the fire confirmation criteria outlined in paragraph D requires that smoke concentrations continue to increase for 20 seconds after an alarm has occurred, it can be inferred that the cause of smoke in this case would not be self-safing and that crew action must be taken. Based on proper material selection and stowage, removal of power from the module should be adequate to safe the situation. However, if removal of main power to the module was required, it would not be advisable to subsequently repower the module (removal of power was the only corrective action taken to safe the situation). Additionally, the sustained burning described could have released highly toxic combustion products into the module atmosphere, and it should remain isolated from the orbiter. Since module ingress after an event of this magnitude is unlikely, and since removal of power removes insight into fire propagation (smoke concentration readings), it is considered prudent to maximize protection by discharging Halon from the FSS.

Documentation: SH HR F-1, STS-60 OFTP Minutes (11/23/93), STS-6, STS-28, STS-35 flight experience, and engineering judgment. @[051194-1633]

C. ON-ORBIT

1. FOR A CONFIRMED SPACEHAB FIRE, THE SEBS WILL BE ACTIVATED, AIRFLOW TO THE MODULE WILL BE ISOLATED, AND THE FOLLOWING ACTIONS WILL BE USED IN PRIORITY AS REQUIRED TO SUPPRESS THE FIRE: @[051194-1633]
 - a. REMOVE INDIVIDUAL LINE REPLACEABLE UNIT (LRU) POWER (IF CREW CAN DETERMINE SOURCE OF SMOKE), FOLLOWED BY CREW EVALUATION.
 - b. PERFORM MAIN POWER KILL, FOLLOWED BY CREW EVALUATION.
 - c. OPEN MANUAL CABIN DEPRESS VALVE (CDV), EGRESS MODULE, CLOSE HATCH, AND, DISCHARGE THE FSS.

For case a or b, if the crew feels as though a significant amount of smoke has been released into the module, cleanup procedures will be initiated, the module evacuated, and hatch closed pending further evaluation.

THIS RULE CONTINUED ON NEXT PAGE

FLIGHT RULES**A17.6.2-1 SPACEHAB FIRE/SMOKE DETECTION (CONTINUED)**

The crew will attempt to remove power from the fire source (if the source can be determined). If the individual LRU cannot be identified or individual LRU powerdown does not stop the fire, then the crew will perform a MAIN POWER KILL to remove all power. The crew will then monitor conditions to determine if the fire has been safed. If the fire has been extinguished, but the module atmosphere contaminated, cleanup procedures must be initiated and the module isolated from the orbiter, until the cleanup is complete.

If the fire is not safed, the module must be prepared for Halon discharge. Isolating the module will provide protection of the crew from the fire, smoke, and impending Halon release. This isolation will also increase the effectiveness of the fire suppression system by constraining the volume.

©[051194-1633]

Arming the FSS issues the main bus power kill command which eliminates the most likely source of the ignition and/or fire and stops the circulation of air/oxygen to the fire. Since the fire has been confirmed, there is no need to continue to force air flow over the smoke detectors.

2. IF THE MODULE FSS IS DISCHARGED AND/OR THE MODULE IS TO BE DEPRESSURIZED, THE SPACEHAB HATCH WILL BE CLOSED AND THE MODULE WILL NOT BE ENTERED.

If the FSS is used, the Spacehab environment has been compromised. If the module has been depressed, it will not be repressurized.

Reference: Rule {A2.6.1-8G.4}, FIRE/SMOKE IN SPACEHAB.

D. CONFIRMATION OF A FIRE WILL BE ANY ONE OF THE FOLLOWING (SUBSEQUENT TO SENSOR RESET, WHEN POSSIBLE):

1. BOTH SMOKE SENSOR ALARMS WITH INCREASING CONCENTRATION(S) FOR ≥ 20 SECONDS
2. ONE SENSOR ALARM AND THE OTHER SMOKE SENSOR CONCENTRATION INCREASING FOR ≥ 20 SECONDS
3. BOTH CONCENTRATIONS INCREASING FOR ≥ 20 SECONDS
4. VISIBLE SMOKE OR FIRE

Most sensor failures can be cleared with a sensor reset. When possible, a sensor reset should be accomplished.

THIS RULE CONTINUED ON NEXT PAGE

FLIGHT RULES

A17.6.2-1 **SPACEHAB FIRE/SMOKE DETECTION (CONTINUED)**

E. LOSS OF BOTH THE SPACEHAB FSS BOTTLE DISCHARGE CAPABILITIES; MONITOR AND CONTROL PANEL (MCP) AND FIRE SUPPRESSION CONTROL UNIT (FSCU); AND LOSS OF SPACEHAB DEPRESSURIZATION CAPABILITY WILL REQUIRE THE MODULE TO BE DEACTIVATED AND UNPOWERED.

Loss of both fire suppression methods and loss of depressurization capability in Spacehab would make the module zero fault tolerant to a fire.

FLIGHT RULES

SPACEHAB ECS MANAGEMENT

A17.6.3-1 SPACEHAB CABIN FAN/AIR LOOP

LOST IF FAN DELTA PRESSURE ≤ 0.1 INCHES H₂O.

The accuracy of the delta pressure sensor measurement is ± 0.1 in. H₂O. Therefore, if the fan is lost, the delta pressure measurement may read as low as 0.1 in. H₂O. No high delta pressure is specified, since this must be a real-time call and is dependent upon other sensor values.

A17.6.3-2 CABIN ATMOSPHERIC CONTROL

- A. CO₂ CONTROL - LOST IF UNABLE TO SATISFY AEROMED PARTIAL PRESSURE OF CARBON DIOXIDE (PPCO₂) CONSTRAINTS. REFERENCE ALL FLIGHTS RULE {A13.1.2-4A}, PPCO₂ CONSTRAINT.

Spacehab provides no CO₂ control other than an air exchange with the orbiter. The most likely causes of a high PPCO₂ in the Spacehab module are:

- a. *Orbiter malfunction*
- b. *Insufficient orbiter to module air exchange*

- B. PPO₂ CONTROL - LOST IF UNABLE TO MAINTAIN PPO₂ ABOVE 2.7 PSIA.

The orbiter ECLSS system is designed to maintain these levels. The most likely causes of a low PPO₂ in the Spacehab module would be:

- a. *Orbiter malfunction*
- b. *Insufficient orbiter to module air exchange*

The PPO₂ minimum acceptable limits defined are established to ensure adequate delivery of oxygen to the pulmonary alveoli. These limits represent the minimum PPO₂ required to maintain the alveolar pressure of oxygen equivalent to that of breathing air at an 8000-foot pressure altitude. Due to the saturation of breathing gases with water, PPO₂ limits must increase as cabin pressure decreases to maintain the same alveolar PPO₂.

- C. HUMIDITY CONTROL - LOST IF THE ORBITER CANNOT CONTROL THE HUMIDITY IN BOTH THE SPACEHAB AND THE ORBITER.

FLIGHT RULES

MODULE ATMOSPHERE MANAGEMENT

A17.6.4-1 MODULE ATMOSPHERIC CONTROL

THE ORBITER ENVIRONMENT WILL BE MANAGED TO ALLOW THE MODULE TO OPERATE WITHIN THE FOLLOWING GUIDELINES:

- A. MODULE PRESSURE BETWEEN 10.0 AND 15.95
- B. MODULE PPO₂ BETWEEN 2.7 AND 3.6
- C. MODULE PPCO₂ < 7.6 MM HG
- D. MODULE TEMPERATURE BETWEEN 65 AND 80
- E. MODULE DEWPOINT < FAN HX INLET H₂O TEMP

IF ANY OF THE ABOVE CONDITIONS CANNOT BE MAINTAINED, CONSIDERATION WILL BE GIVEN TO DEACTIVATION AND CLOSEOUT OF THE MODULE.

The module environment is controlled by mixing of orbiter/module airflow. The orbiter and module systems must be operated to yield an environment as described in order to provide crew habitability and stay within certification limits. Since the module has no provision for condensate removal, the module humidity (dewpoint) must be maintained below the water loop temperature to avoid uncontained condensation.

FLIGHT RULES

A17.6.4-2 CABIN FAN

A. THE CABIN FAN MAY BE OPERATED USING ONLY TWO-PHASE POWER.

The cabin fan was operated during preflight testing on two phases. There is an IFM procedure for replacing the cabin fan with a spare carried aboard. The cabin fan may be operated but not started on only two phases.

B. THE CABIN FAN WILL BE ACTIVATED (IF NOT POWERED DURING ASCENT) AS SOON AS POSSIBLE DURING NOMINAL SPACEHAB ACTIVATION.

The cabin fan will establish the air flow required by the air-cooled subsystems and provides circulation of air over the fire/smoke detector assemblies.

C. THE CABIN FAN WILL NORMALLY BE POWERED BY THE SPACEHAB INVERTER IF USED DURING ASCENT/ENTRY AND BY THE ORBITER AC BUS WHILE ON ORBIT.

Orbiter ac power is not available during ascent/entry. Once on orbit, the fan is moved to the orbiter (PLAC3) supply in order to balance the Spacehab ac loads (cabin fan, ARS fan, water loop pump, etc.) within the orbiter ac allotments and Spacehab inverter capabilities.

D. THE CABIN FAN WILL NORMALLY BE DEACTIVATED PRIOR TO SWITCHING BETWEEN THE ORBITER AND INVERTER AC BUSES.

Hot switching equipment will lead, over time, to degraded relay contacts in the PDU. However, in an off-nominal condition, hot switching can be performed without significantly damaging Spacehab hardware.

E. WHEN POWER IS INTERRUPTED TO THE CABIN FAN, THE FAN WILL BE DEACTIVATED BEFORE POWER IS REAPPLIED.

Prevents in-rush current concerns.

F. FOR LOSS OF THE CABIN FAN, AN IFM WILL BE CONSIDERED AS SOON AS PRACTICAL TO CHANGE OUT THE FAN.

Without the cabin fan, Spacehab has determined that the ARS fan can supply enough air flow to the fire/smoke detectors. However, the temperature in the module may not be maintained. Based on temperature and other environmental parameters, it is possible that the IFM could be postponed or the mission continued using only the ARS fan.

FLIGHT RULES

A17.6.4-3 ATMOSPHERE RECIRCULATION SYSTEM (ARS) FAN

A. THE ARS FAN MAY BE OPERATED ONLY USING TWO-PHASE POWER.

The ARS fan was operated on two phases during preflight testing. The ARS fan may operate but not be started on only two phases. There is an IFM procedure for replacing the ARS fan with a spare carried aboard.

B. THE ARS FAN WILL NORMALLY BE POWERED BY THE SPACEHAB INVERTER IF USED DURING ASCENT/ENTRY AND BY THE ORBITER AC BUS WHILE ON-ORBIT.

The ARS fan is powered by the orbiter supply in order to balance the Spacehab ac (PL AC3) loads (cabin fan, ARS fan, water loop pump, etc.) within the orbiter ac allotments and Spacehab inverter capabilities.

C. THE ARS FAN WILL NORMALLY BE DEACTIVATED PRIOR TO SWITCHING BETWEEN THE ORBITER AND INVERTER AC BUSES.

Hot switching equipment will lead, over time, to degraded relay contacts in the PDU. However, in an off-nominal condition, hot switching can be performed without significantly damaging Spacehab hardware.

D. WHEN POWER IS INTERRUPTED TO THE ARS FAN, THE FAN WILL BE DEACTIVATED BEFORE POWER IS REAPPLIED.

Prevents in-rush current concerns.

E. FOR LOSS OF THE ARS FAN, AN IFM WILL BE PERFORMED (BASED ON PPCO₂, ETC.) TO CHANGE OUT THE FAN. UNTIL THE IFM IS PERFORMED, ALLOWABLE CREW TIME IN THE MODULE IS LIMITED BY DEWPOINT AND PPCO₂ RESTRICTIONS PER RULE {A17.6.4-1}, MODULE ATMOSHPERIC CÖNTROL. @[101096-4494]

Without the ARS fan, air exchange with the orbiter is degraded.

F. THE ARS FAN SHALL NOT BE OPERATED WITH THE PL ISO VALVE CLOSED UNLESS THE ASCENT/DESCENT INLET STUB IS OPEN.

Operation of the ARS fan with the PL ISO valve and inlet stub closed will cause failure of the ARS fan.

FLIGHT RULES

A17.6.4-4 WATER FLOW CONTROL ELECTRONICS UNIT (WFCEU)

- A. DURING MODE 1 OPS, IF ANY ONE OF THE SEVEN SENSOR INPUTS TO THE WFCEU FAIL OR GIVE ERRONEOUS DATA, A COMMAND WILL BE ISSUED FROM THE MCDS WHICH ALLOWS THE WFCEU TO OVERRIDE THAT INPUT.

The seven inputs to the WFCEU are: dew point temperature, cabin temperature, cabin temperature setpoint, water pump inlet temperature, fan/HX inlet temperature, WFCV cold inlet temperature, and WFCV position. Any of the seven can be compensated for by the WFCEU upon commanding from the MCDS. The MCC will inform the crew which flag command should be issued.

- B. IF THE WFCEU FAILS TO OPERATE SATISFACTORILY IN MODE 1 (AUTOMATIC CONTROL OF CABIN TEMPERATURE), MODE 2 (AUTOMATIC CONTROL OF FAN/HX INLET TEMPERATURE) WILL BE INITIATED. IF MODE 2 FAILS TO OPERATE SATISFACTORILY, THEN MODE 3 (CONTROL OF VALVE POSITION BY CABIN TEMPERATURE SET POINT KNOB) WILL BE USED BY ISSUING COMMANDS FROM THE MCDS.

The WFCEU software has multiple modes to allow for multiple sensor failures. Mode 2 requires an operational fan/HX inlet temperature sensor, while mode 3 does not require any operational temperature sensors, only the cabin temperature set point. The MCC will inform the crew when these operational modes are necessary and which specific commands are required.

- C. IF MODE 3 FAILS TO OPERATE SATISFACTORILY, MODULE TEMPERATURE WILL BE CONTROLLED BY MANUALLY ADJUSTING TWO WATER BYPASS VALVES. BEFORE ATTEMPTING MANUAL CONTROL, THE WATER LINE HEATERS WILL BE TURNED ON.

An IFM will be necessary to reconfigure the water loop. Direction on WFCV bypass valve adjustment will be provided by the POCC. Crew adjustment of water metering valves could cause a flow rate to the PLHX less than 50 lbm/hour. Reference ICD 21095, Interface Review Notice 37. ©[121593-1594]

- D. IF THE WFCEU AUTOMATICALLY JUMPS TO MODE 2 OR 3, A CLASS 3 ALARM WILL BE ISSUED AND CREW ADJUSTMENT OF THE CABIN TEMPERATURE SETPOINT SELECTOR WILL BE REQUIRED.

The WFCEU is programmed to switch modes automatically in the event of specific multiple sensor failures. The POCC will inform the crew of the required cabin temperature setpoint selector setting.

FLIGHT RULES

A17.6.4-5 PARTIAL PRESSURE OF OXYGEN (PPO2) SENSORS

NOMINAL SPACEHAB OPERATIONS MAY CONTINUE FOR LOSS OF BOTH SENSORS IF THE SPACEHAB ARS FAN IS OPERATIONAL. @[030994-1606A]

As long as air flow is satisfactory, these parameters should be very close to orbiter readings.

A17.6.4-6 PARTIAL PRESSURE OF CARBON DIOXIDE (PPCO2) SENSORS

NOMINAL SPACEHAB OPERATIONS MAY CONTINUE FOR LOSS OF BOTH SENSORS IF THE SPACEHAB ARS FAN IS OPERATIONAL. @[030994-1606A]

As long as air flow is satisfactory, these parameters should be very close to orbiter readings.

FLIGHT RULES

ATMOSPHERE INTEGRITY

A17.6.5-1 **MODULE PRESSURE INTEGRITY LOSS DEFINITION**

MODULE CABIN PRESSURE INTEGRITY IS DECLARED LOST IF:

A LEAK WHICH CANNOT BE ISOLATED EXISTS SUCH THAT ORBITER O₂ AND N₂ CONSUMABLES CAPABILITY WILL NOT ALLOW A NEXT PLS ENTRY AT 14.7 PSIA PLUS THE GREATER CONSUMABLE REQUIREMENT OF THE FOLLOWING:

- A. A 48-HOUR FLIGHT EXTENSION AT 14.7 PSIA BEYOND THE NEXT PLS OPPORTUNITY, OR
- B. THE PLANNED CONSUMABLES FOR THE 165-MINUTE, 8 PSIA CONTINGENCY RETURN REQUIREMENT.

The Spacehab module does not have its own O₂ and N₂ supplies and it is dependent on the orbiter to maintain the atmosphere. The integrity is considered lost if normal operations (i.e., 14.7 psi ops plus standard reserves) cannot take place. The standard reserves are defined as (1) the ability to maintain 14.7 psi for 2 mission extension days and (2) the emergency deorbit capability.

Reference: All Flights Rule {A17.1.5-1B}, CABIN PRESSURE INTEGRITY. ©[ED]

A17.6.5-2 **MODULE PRESSURE CONTROL LOSS DEFINITION**

LOST IF UNABLE TO CONTROL CABIN PRESSURE BETWEEN 10 PSIA AND 15.95 PSIA.

The positive pressure relief valves are designed to maintain Spacehab pressure below 15.95 psia. The orbiter's O₂/N₂ controller is designed to maintain 10.0 psia minimum.

A17.6.5-3 **PPCO₂ CONTROL LOSS DEFINITION**

LOST IF UNABLE TO MAINTAIN PPCO₂ BELOW 7.6 MILLIMETERS OF MERCURY (MMHG).

The orbiter ECLSS is designed to maintain these levels. The most likely case of a high PPCO₂ in the Spacehab module would be:

- a. *Inadequate air exchange with the orbiter*
- b. *Orbiter malfunction*

FLIGHT RULES

A17.6.5-4 MODULE PRESSURE INTEGRITY

FOR A NON-ISOLATABLE MODULE PRESSURE LEAK, THE MODULE WILL BE MANAGED AS FOLLOWS:

- A. IF PRIOR TO THE MISSION MDF, THE MODULE WILL BE ISOLATED FROM THE ORBITER AS REQUIRED TO PRESERVE AN MDF + 2 DAYS WITHOUT VIOLATION OF ORBITER N₂ REDLINES.
- B. IF AFTER THE MISSION MDF, THE MODULE WILL BE ISOLATED FROM THE ORBITER AS REQUIRED TO PRESERVE LANDING AT THE NEXT PLS + 2 DAYS WITHOUT VIOLATION OF ORBITER N₂ REDLINES.
- C. FOR CASES WHERE ORBITER REDLINES FOR THE PLANNED EOM + 2-DAY DURATION CANNOT BE PROTECTED WHILE FEEDING A MODULE LEAK, THE DECISION TO SHORTEN THE MISSION OR ISOLATE THE MODULE WILL BE BASED ON MISSION PRIORITIES AND LANDING SITE AVAILABILITY.
- D. ALL POWER WILL BE REMOVED FROM THE MODULE IF THE PRESSURE DROPS BELOW 10.0 PSIA.

Mission success items such as module operations cannot be allowed to impact the ability of the orbiter to reach an MDF or PLS. Adequate protection (+ 2 days) must always be available in the event of unforeseen circumstances such as weather or systems problems preventing deorbit. For cases where orbiter and crew safety are not in jeopardy, mission priorities (balanced with other factors) will be used to determine proper tradeoffs. Also, Spacehab equipment is not certified for operations below 10.0 psia.

A17.6.5-5 NEGATIVE PRESSURE RELIEF VALVE COVERS

THE MODULE'S NEGATIVE PRESSURE RELIEF VALVE COVERS WILL BE OUT AND LOCKED OPEN DURING ASCENT. THE COVERS WILL BE CLOSED ON ORBIT AND REMAIN CLOSED DURING ENTRY.

This action prevents chatter damage to valve seats during periods of ascent vibration.

FLIGHT RULES

A17.6.5-6 **CABIN DEPRESS VALVE (CDV)**

- A. THE MANUAL CABIN DEPRESS VALVE LOCATED IN THE SPACEHAB MODULE WILL BE LEFT CLOSED AT ALL TIMES UNLESS OPENED BY THE CREW DURING A FIRE/SMOKE ALARM INITIATED MODULE EGRESS.

Leaving the CDV nominally closed eliminates a potential leak source. The CDV assembly consists of a 28 volt dc motor driven butterfly valve in series with a manually operated butterfly valve.

- B. IN THE EVENT THE FIRE SUPPRESSION SYSTEM (FSS) FAILS, THE MODULE WILL BE DEPRESSURIZED USING THE REMOTELY ACCESSED MOTORIZED CABIN DEPRESS VALVE.

Depressurization is the final method to eliminate a fire. Redundant methods exist to fire the FSS.

A17.6.5-7 **ASCENT/DESCENT INLET STUB**

THE ASCENT/DESCENT INLET STUB WILL BE CLOSED UPON ENTERING THE MODULE DURING ACTIVATION AND OPENED BEFORE EGRESSING THE MODULE IF THE SPACEHAB HATCH IS TO BE CLOSED.

The inlet stub allows the ARS fan to serve as a backup to the cabin fan during powered ascent/descent, prelaunch, and postlanding. During these powered, closed Spacehab hatch stages, a fan is required to provide air flow for the smoke detectors. The air flow also provides some cooling. The stub must be closed upon module entry to ensure air exchange with the orbiter. Opening the stub prior to module egress and Spacehab hatch closure allows additional air circulation for module component cooling.

A17.6.5-8 **EXPERIMENT VENT VALVE**

- A. IF THE EXPERIMENT VENT VALVE IS NOT IN USE, THE VALVE WILL BE CLOSED.
- B. THE EXPERIMENT VENT VALVE WILL ALWAYS BE CLOSED WHEN ALL THE CREW IS ASLEEP UNLESS REQUIRED FOR EXPERIMENT OPERATION.

Closing the valve will significantly reduce the likelihood of a slow leak or of an inadvertent opening of the vent. For certain experiment complements, a vent line is attached and flown on the experiment vent valve. When this is the case, only the vent valve is closed.

FLIGHT RULES

SPACELAB FIRE/SMOKE DETECTION LOSS DEFINITION

A17.9.1-1 **SPACELAB FIRE/SMOKE PRIMARY DETECTION LOSS**

MODULE

LOST IF BOTH A AND B DETECTORS IN THE SUBFLOOR, OR RIGHT RACK, OR LEFT RACK FAIL SELF-TEST.

Loss of both smoke detectors in a rack or in the subfloor results in loss of all primary smoke detection in the affected area until reconfiguration (see Rule {A17.9.2-1}, SPACELAB FIRE/SMOKE DETECTION, for reconfiguration explanation).

FLIGHT RULES

A17.9.2-1 SPACELAB FIRE/SMOKE DETECTION

MODULE

A. LOSS OF SMOKE DETECTORS:

1. FOR LOSS OF SMOKE DETECTION IN THE PORT OR STARBOARD RACKS, SPACELAB OPERATIONS MAY CONTINUE.

The left and right avionics racks share a common manifold in the air coolant loop, so smoke in one side may be detected by detectors in the other side. Smoke detection annunciation could be delayed up to 1 minute 40 seconds for high speed fan operations and 3 minutes 30 seconds for low speed operations. The annunciation delay is due to additional time required for the air to complete a full cycle through the avionics air loop.

2. FOR LOSS OF BOTH SUBFLOOR DETECTORS, NOMINAL SPACELAB OPERATIONS MAY CONTINUE IF A CREWMEMBER IS AWAKE IN THE MODULE AT ALL TIMES TO MONITOR FOR SMOKE/FIRE. NOTE THAT AN IFM TO REPLACE A SUBFLOOR SMOKE DETECTOR WITH AN AVIONICS RACK DETECTOR WILL BE ATTEMPTED.

IF AN ON-DUTY CREWMEMBER WILL NOT BE IN THE MODULE, THE AVIONICS AIR LOOP WILL BE CONFIGURED TO THE CREW INGRESS/EGRESS CONFIGURATION. EXPERIMENT RACK EQUIPMENT OPERATION WILL BE LIMITED TO RACKS THAT RECEIVE SUFFICIENT COOLING AND SMOKE DETECTION PRIOR TO CREW INGRESS OR EGRESS (ASCENT/ENTRY CONFIGURATION).

An on-duty crewmember must be available for monitoring the module for smoke/fire. If an on-duty crewmember is not inside the module, the Spacelab avionics loop will be configured to provide smoke detection in the module. However, this configuration will force the deactivation of experiments that do not receive cooling or proper smoke detection with the avionics loop in the crew ingress/egress configuration.

Configuring the avionics air loop to the crew ingress or egress configuration (whichever is appropriate) will allow the avionics smoke detectors to receive airflow from both the subfloor and avionics racks, thereby providing complete smoke detection for the module. This configuration also lowers the cooling capability of the avionics loop however, necessitating limited experiment rack operations.

An IFM exists to replace a single subfloor detector with an avionics rack detector. This IFM will be performed, if possible, in the event of the above scenario. During the IFM the crew will serve as smoke detection.

Documentation: Engineering judgment.

FLIGHT RULES

THIS RULE CONTINUED ON NEXT PAGE

FLIGHT RULES

A17.9.2-1 SPACELAB FIRE/SMOKE DETECTION (CONTINUED)

3. LOSS OF ALL SIX SPACELAB SMOKE DETECTORS WILL REQUIRE THE MODULE TO BE DEACTIVATED AND UNPOWERED.

Insight into monitoring a critical safety hazard has been lost.

B. ASCENT/ENTRY:

FOR A CONFIRMED SPACELAB FIRE CONDITION, THE SPACELAB MAIN POWER WILL BE TERMINATED, AND THE FIRE SUPPRESSION SYSTEM BOTTLES WILL BE DISCHARGED. @[072795-1780B]

Main power is disconnected to eliminate the most likely source of fire and the FSS is discharged to eliminate any continuation of the fire. Module depress is not available for ascent. @[072795-1780B]

C. ON-ORBIT:

1. THE RACK COOLING SHUTOFF VALVE(S) WILL BE MAINTAINED IN A FULLY OPEN CONDITION FOR RACKS CONTAINING ANY ACTIVE ELECTRICAL EQUIPMENT.

Smoke detection is mandatory in any area that contains a source of ignition and the rack shutoff valves must be open to allow routing of air to the smoke detectors.

2. FOR A CONFIRMED SPACELAB FIRE CONDITION, THE FOLLOWING ACTIONS WILL BE TAKEN:
 - a. TERMINATE SPACELAB MAIN BUS POWER, AND ALL NON-ESSENTIAL MODULE PERSONNEL WILL EGRESS.
 - b. ACTIVATE SEBS AND EVALUATE UPON EGRESS.
 - c. OPEN MANUAL CABIN DEPRESS VALVE. @[051194-1635A]
 - d. ISOLATE SPACELAB FROM THE ORBITER. @[072795-1780B]
 - e. THE FIRE SUPPRESSION BOTTLES WILL BE DISCHARGED. @[072795-1780B]
 - f. THE MCC WILL BE CONSULTED FOR FURTHER ACTIONS. MODULE DEPRESSURIZATION WILL BE CONSIDERED IF THERE IS CONCERN THAT THE FIRE MAY NOT BE EXTINGUISHED.

THIS RULE CONTINUED ON NEXT PAGE

FLIGHT RULES

A17.9.2-1 SPACELAB FIRE/SMOKE DETECTION (CONTINUED)

- g. TERMINATE EMERGENCY BUS POWER.

The crew in the module dons the SEBS due to the toxic byproducts of combustion and Halon 1301 as it is exposed to high temperatures. The crew may then evaluate the fire condition, and if they are able to isolate the fire to one location, they have the option to use the handheld fire extinguisher. If the fire cannot be isolated, or at any time at crew discretion, the crew will egress the module and continue with the performance of the rest of this rule.

©[072595-1780B]

Main power is disconnected to eliminate the most likely source of fire. This removes all forced air circulation in the Spacelab module, thus starving the fire of O₂. This also removes any electrical ignition sources from most of the module. The manual depress valve is opened to allow for remote depressurization of the module. The smoke detectors should not be relied upon after forced air circulation has been removed, since continuous airflow past the sensor is required to determine an accurate smoke concentration.

Emergency power will remain ON to power the remote cabin depress valve, if required. If there is continued concern that the fire may not be extinguished, module depressurization through the remotely powered depress valve will be considered as a last attempt at fire suppression. After this action, the emergency bus can be unpowered since no further actions can be taken. ©[072795-1780B]

Reference: Sax, N. Irving; Dangerous Properties of Industrial Material, fourth edition, section 12, Reinhold Publishing Corp, New York, New York, 1975.

3. AFTER A FIRE CONDITION HAS OCCURRED AND THE FSS BOTTLES HAVE BEEN DISCHARGED, THE SPACELAB WILL NOT BE REPOWERED OR INHABITED.

The toxic byproducts of Halon 1301 when exposed to high temperatures preclude ingress of the Spacelab module for any reason.

Reference: Sax, N. Irving; Dangerous Properties of Industrial Material; fourth edition; section 12; Reinhold Publishing Corp; New York, New York; 1975.

4. CONFIRMATION OF FIRE WILL BE ANY ONE OF THE FOLLOWING:
- a. TWO SENSOR ALARMS
 - b. TWO DETECTOR CONCENTRATIONS INCREASING
 - c. ONE SENSOR ALARM AND ONE OTHER DETECTOR CONCENTRATION INCREASING
 - d. VISIBLE SMOKE OR FIRE

NASA - JOHNSON SPACE CENTER

FLIGHT RULES

THIS RULE CONTINUED ON NEXT PAGE

FLIGHT RULES

A17.9.2-1 SPACELAB FIRE/SMOKE DETECTION (CONTINUED)

5. THERE IS NO REQUIREMENT FOR CREW SUPERVISION ON ANY SPACELAB EXPERIMENT EQUIPMENT (INCLUDING EQUIPMENT DETAILED IN PARAGRAPH 6 BELOW) EXCEPT AS DEFINED IN PARAGRAPH 7 BELOW. ©[012694-1526A]
6. THE EQUIPMENT THAT IS MOUNTED EXTERNAL TO NORMAL AVIONICS AIR FLOW AND HAS NO AUTOMATIC FIRE DETECTION/SUPPRESSION CAPABILITY WILL BE DEFINED IN THE FLIGHT SPECIFIC ANNEX.

The equipment identified in this paragraph has been reviewed by the mission manager's risk assessment and preflight payload safety assessment and found acceptable to operate without crew supervision.

7. IN THE EVENT OF AN ANOMALY OF ANY SYSTEMS/EXPERIMENT DURING A MISSION, A REEVALUATION OF THE EXPERIMENT/SYSTEM FLAMMABILITY SAFETY ASSESSMENT AND THE MISSION MANAGER'S RISK ASSESSMENT WILL BE CONDUCTED. CONSIDERATION WILL BE GIVEN TO CONTINUED OPERATION OF THE SYSTEM/EXPERIMENT IF CREW SUPERVISION IS PROVIDED AND THE SAFETY/RISK ASSESSMENT IS DETERMINED TO STILL BE VALID.

It is prudent that all powered equipment have smoke detection and fire suppression capability; however, the Space Shuttle Payload Safety Review Panel only requires the experiment/system to be designed to not present a fire hazard (i.e., through material selection/usage and reduction of potential ignition sources). In the event that a failure has occurred which causes the experiment/system flammability safety assessment to no longer be valid (examples of this are loss of containment exposing ignition or heat sources, loss of fault tolerance against runaway heater conditions, loss of circuit protection exposing an electrical wire to potential shorts and possible ignition, etc.), then crew supervision is required to manually monitor its condition and be immediately available to apply fire suppression, if necessary. If crew supervision is necessitated, then the experiment/system can only be powered while the crew is physically present in the module, e.g., not during crew sleep (for single shift flights), crew handovers, or meals. ©[012694-1526A]

- D. LOSS OF BOTH THE SPACELAB FSS BOTTLE DISCHARGE CAPABILITY AND THE SPACELAB CABIN DEPRESSURIZATION CAPABILITY WILL REQUIRE THE MODULE TO BE DEACTIVATED AND UNPOWERED.

Spacelab is different from the orbiter fire/smoke responses in that the module can be depressurized to halt progress or terminate the combustion. In addition, the standard capability to suppress a fire situation is provided by a Halon system.

FLIGHT RULES

Loss of both fire suppression methods available in Spacelab results in a zero-fault tolerant configuration. Fire suppression capability is an emergency system that must work when required. The loss of an emergency system assumes loss of crew and vehicle. Therefore, when both capabilities (primary and backup) are lost, the module will be deactivated to prevent exposing the crew to the critical hazard.

FLIGHT RULES

A17.9.2-1 SPACELAB FIRE/SMOKE DETECTION (CONTINUED)

E. IF THE FIRE SUPPRESSION SYSTEM IS IN AN IRREVERSIBLY ARMED STATE, THERE ARE TWO MEANS AVAILABLE TO REGAIN THE USE OF THE CABIN FAN: @061396-3199]

1. OPENING THE PYRO CONTROL BOX BREAKERS. THIS OPTION WILL RESTORE USE OF THE CABIN FAN, BUT WILL CAUSE THE LOSS OF HALON BOTTLE DISCHARGE CAPABILITY DUE TO A PROCEDURAL LOSS OF POWER TO THE PYRO CONTROL BOX. IN THIS CASE, A CREWMEMBER MUST REMAIN IN THE MODULE AT ALL TIMES OR, IF THE CREW MUST DEPART THE SPACELAB, THE PYRO CONTROL BOX CIRCUIT BREAKERS MUST BE CLOSED AND THE ARS MUST BE CONFIGURED FOR ASCENT/ENTRY PER RULE {A17.9.4-1}, CABIN ATMOSPHERE CONTROL (ARS AIR CIRCULATION).

If the pyro control box circuit breakers are opened to reenable the Spacelab cabin fan, in order for the fire suppression system to be considered operative, a crewmember must be available in the module at all times to close the circuit breakers for a fire condition. It is not necessary that the crewmember remain awake since the smoke detectors would wake him in case of a fire. If the crew must depart the module after opening the pyro control box circuit breakers, the following actions should take place: (1) the hatch and payload isolation valve will be closed to isolate the Spacelab cabin from the orbiter cabin, (2) the pyro control box circuit breakers are closed which restores remote fire suppression capability from the orbiter, and (3) the ARS is placed in the ascent/entry configuration per the loss of Spacelab Cabin Fan rule, which allows the avionics rack smoke detectors to receive air flow from the subfloor to provide the necessary smoke detection.

2. PERFORMANCE OF THE "BYPASSING THE CABIN FAN INTERLOCK" IFM. THIS OPTION ONLY BYPASSES THE CABIN FAN INTERLOCK AND DOES NOT REMOVE POWER TO THE FIRE SUPPRESSION SYSTEM. IN THIS CONFIGURATION, THE CABIN FAN MUST BE DEACTIVATED MANUALLY PRIOR TO FSS DISCHARGE.

If the IFM has been performed to reenable the Spacelab cabin fan, the crew is not required to stay in the module. Performance of the IFM only bypasses the cabin fan interlock and does not remove power to the fire suppression system, but instead leaves the fire suppression irreversibly armed. In this configuration, in the event discharge of the fire suppression system is required, the cabin fan would need to be manually deactivated prior to discharge. It is an acceptable risk for the fire suppression system to be armed in this situation. @061396-3199]

FLIGHT RULES

ATMOSPHERE REVITALIZATION SYSTEM (ARS) LOSS/FAILURE DEFINITIONS

A17.9.3-1 CABIN FAN/AIR LOOP

MODULE

- A. THE LOSS OF THE CABIN FAN/AIR LOOP IS DETECTED BY A COMBINATION OF CREW DETECTION OF LOSS OF AIR FLOW AND BY MONITORING THE CABIN FAN DELTA P. @[082593-1535]

A CD CABIN FAN IS CONSIDERED LOST IF THE CD FAN DELTA P <7.60 MILLIBAR(S) (MBAR)/0.1102 POUNDS PER SQUARE INCH DIFFERENTIAL (PSID) OR >14.83 MBAR/0.2150 PSID (13.83 MBAR/0.20 PSID)

OR,

AN FOP CABIN FAN IS CONSIDERED LOST IF THE FOP FAN DELTA P <7.60 MBAR/0.1102 PSID OR >13.30 MBAR/0.1928 PSID (12.30 MBAR/0.1784 PSID)

Limits derived for this flight rule are based on measured performance points within the stable operational range of both fans within the CD and FOP fan packages, respectively. Declaration of loss of cabin fan defines operations beyond the known tested operational capabilities of a Spacelab cabin fan. All module flow/cooling requirements can be fulfilled within the full range of the nominal individual cabin fan curves generated and validated in ADP-DS-0087 for CD cabin fans and ADP-DS-5081 for FOP cabin fans. Rationale for the high delta P limit (low flow) is based on the lowest flow tested during the post vibration acceptance test for a single cabin fan (curves were adjusted for pressure drop within the cabin fan package). The cabin fan will enter the stall region to the left of this point causing the fan to overheat and damage hardware within minutes. (Reference SLODB, section 3.2.11, pg. 3-158). Rationale for the low delta P limit is based on a cabin fan failure causing the fan curve to shift downward below the long module system curve at the lowest tested flow rate for a Spacelab cabin fan. This represents the lowest delta P where adequate air flow is achievable. The long module system curve was derived via test and documented in the Domier Cabin Loop Delta P Summary, TN-DS-50-089-77.

The numbers in parentheses are biased to include sensor accuracy (± 2.5 percent of the sensor measurement range) and offset (maximum allowable as defined by the OMRS) and are the values where action will be taken.

- B. EXCEPTIONS TO THIS RULE ARE DOCUMENTED IN THE FLIGHT SPECIFIC ANNEX.

FLIGHT RULES

A17.9.3-2 CABIN ATMOSPHERIC CONTROL

MODULE

- A. CO₂ CONTROL - LOST IF UNABLE TO SATISFY AEROMED PPCO₂ CONSTRAINTS. [ED]

Reference All Flights Rule {A13.1.2-4A}, PPCO₂ CONSTRAINT, for rationale.

- B. HUMIDITY CONTROL - LOST IF THE CONDENSATE SEPARATOR IS NO LONGER ABLE TO SEPARATE AND TRANSFER CONDENSATE TO THE STORAGE TANK AND THE ORBITER SYSTEM CANNOT CONTROL THE HUMIDITY IN BOTH SPACELAB AND THE ORBITER.

Humidity control is not lost if the orbiter humidity control system can control Spacelab's humidity level. No insight exists into the relative humidity level in the Spacelab module since no sensor exists in the module. Additionally, the condensate tank does not have a quantity gauge to tell whether or not the condensate separator is functional. Therefore, orbiter cues are the only reliable insight into Spacelab humidity levels.

Reference: Engineering judgment.

- C. CONDENSATE TANK AND DUMP - LOST IF UNABLE TO FILL TANK OR DUMP TANK WHEN FULL.

The condensate tank is no longer usable if it cannot be filled or if it cannot be dumped when full. If you cannot dump the tank, dump capability is lost. If the condensate tank is not usable, then humidity control is lost because the condensate separator will no longer be able to transfer condensate to the storage tank.

Reference: Engineering judgment.

- D. TUNNEL FAN/AIR LOOP - LOST IF FAN DELTA P <0.4 IN H₂O/0.75 MMHG OR >0.9 IN H₂O/1.7 MMHG.

Rationale for low delta P (high flow) limit of 0.4 in. H₂O is undetermined -- MSFC is researching. At a delta P above 0.9 in. H₂O, the tunnel fan is entering the stall region. The determination that the fan is entering the stall region is an engineering judgment based upon an interpretation of the delta P versus flow rate plot. Minimum flow requirement is undetermined and perhaps not applicable since Spacelab operations can continue with loss of the tunnel fan; MSFC is researching.

FLIGHT RULES

A17.9.3-3 AVIONICS FAN/AIR LOOP

MODULE

A. LOW SPEED LOST IF FOP FAN DELTA P <0.044 PSID/3.0 MILLIBARS (MBARS) OR >0.071 PSID/4.9 MBARS.

OR

LOW SPEED LOST IF CD FAN DELTA P <0.044 PSID/3.0 MBARS OR >0.085 PSID/5.8 MBARS.

Upper and lower limits for the avionics fans are dependent on whether the FOP fan or the CD fan is used on a specific module configuration. Periodic refurbishment of the fans may lead to changes in limits when fans are retested. Rationale for low delta P (high flow) limit of 0.044 psid is undetermined - MSFC is researching. At a delta P above the upper limit during low speed operations, the avionics fan is entering the stall region. The determination that the fan is entering the stall region is an engineering judgment based upon interpretation of the delta P versus flow rate plot. The avionics fan must not be operated under stall conditions because it will overheat in minutes (SODB, p. 3-213). The minimum acceptable flow rate is undetermined - MSFC is researching.

Reference: Engineering judgment, documentation pending.

B. HIGH SPEED LOST IF FOP FAN DELTA P <0.17 PSID/11.6 MBARS OR >0.27 PSID/31.4 MBARS.

OR

HIGH SPEED LOST IF CD FAN DELTA P <0.17 PSID/11.6 MBARS OR >0.28 PSID/19.0 MBARS.

Upper and lower limits for the avionics fans are dependent on whether the FOP fan or the CD fan is used on a specific module configuration. Periodic refurbishment of the fans may lead to changes in limits when fans are retested. Rationale for low delta P (high flow) limit of 0.17 psid is undetermined - MSFC is researching. At a delta P above the upper limit during high speed operations, the avionics fan is entering the stall region. The determination that the fan is entering the stall region is an engineering judgment based upon interpretation of the delta P versus flow rate plot. The avionics fan must not be operated under stall conditions because it will overheat in minutes (SODB, p. 3-213). The minimum acceptable flow rate determined by analysis is 1742 lb/hr (790 kg/hr) (Spacelab Data Request SL 83-030). The avionics fan delta P versus volumetric flow rate graphs on SODB pgs. 3-217 and 3-218 support the delta P upper limit. However, the avionics fan delta P versus mass flow rate graphs in SL DCR Vol III, Book 12, Part 2, pgs. 390, 391, 504, and 505 indicate that a delta P of 0.280 psid/19 mbars would not provide the minimum required flow rate of 1742 lb/hr (790 kg/hr).

FLIGHT RULES

Reference: Engineering judgment, documentation pending.

FLIGHT RULES

ARS SYSTEM MANAGEMENT

A17.9.4-1 CABIN ATMOSPHERE CONTROL (ARS AIR CIRCULATION)

MODULE

- A. MODULE CABIN TEMPERATURE WILL NORMALLY BE MAINTAINED BETWEEN 64 DEG AND 81 DEG F TO PROVIDE FOR CREW COMFORT. IF ACCEPTABLE TEMPERATURES CANNOT BE MAINTAINED, THE CREW MAY EGRESS THE MODULE.

The automatic cabin temperature controller design range is 64.4 deg to 80.6 deg F (± 2 deg F) and should provide for normal crew comfort. Crew comfort should be maintained using any available procedures, including reconfiguration of the cabin temperature controller, module water loop, orbiter Freon loops, or any other means considered acceptable including manual control. If temperatures cannot be maintained to support crew habitability, an egress can be performed until the MCC can evaluate a solution.

- B. CABIN FAN:

1. ONLY ONE CABIN FAN WILL BE OPERATED AT A TIME.

Both cabin fans are powered through the SS inverter. With one cabin fan, an avionics fan, a water pump, CDMS loads and possibly a Freon pump operating (all on the SS inverter), the startup transient of the second cabin fan may overload and trip off the inverter.

Reference: SLODB 3.2.11.

2. THE FREON PUMP WILL BE DEACTIVATED PRIOR TO ACTIVATING THE CABIN FAN TO PREVENT EXCESSIVE STARTUP CURRENTS FROM OVERLOADING THE INVERTER.

This rule applies only if a Freon loop is onboard. The Freon pump, avionics fan, water pump, CDMS loads and cabin fan are normally powered through the SS inverter. To avoid overloading and tripping off the inverter with the cabin fan startup transient, the Freon pump must be turned off.

Reference: SLODB 3.2.11.

THIS RULE CONTINUED ON NEXT PAGE

FLIGHT RULES

A17.9.4-1 **CABIN ATMOSPHERE CONTROL (ARS AIR CIRCULATION)**
(CONTINUED)

3. FOR LOSS OF BOTH SPACELAB CABIN FANS, THE AVIONICS AIR LOOP WILL BE CONFIGURED TO THE CREW INGRESS CONFIGURATION. RACK LOCATED EXPERIMENTS WILL BE LIMITED TO RACKS OPEN DURING ASCENT. THE ATMOSPHERE STORAGE AND CONTROL SYSTEM (ASCS) WILL BE DEACTIVATED AND THE ORBITER PRESSURE CONTROL SYSTEM (PCS) ACTIVATED.

Procedure restores Spacelab to a stable thermal configuration and provides subfloor smoke detection capability. It is assumed that no cabin fan was required for ascent.

Reference: Engineering judgment.

4. THE CABIN FAN WILL BE OPERATED USING THREE-PHASE POWER ONLY.

Continued operation of the cabin fan on only two phases will result in an overcurrent condition which will trip the environmental control and life support (ECLS) power switching unit circuit breaker.

Reference: SLODB 3.2.11.

FLIGHT RULES

A17.9.4-2 CONDENSATE SEPARATOR/TANK

MODULE

- A. THE SEPARATOR SHOULD BE ACTIVATED PRIOR TO CABIN FAN ACTIVATION. BOTH SEPARATORS SHOULD BE ACTIVATED FOR AT LEAST 15 MINUTES AFTER CABIN FAN DEACTIVATION TO PREVENT FLOODING OF EITHER SEPARATOR.

The separator is activated prior to cabin fan activation to prevent flooding the separator. Both separators are run for 15 minutes after the cabin fan is turned off to avoid separator flooding and to avoid failure due to grease being washed out of the bearings.

Reference: SLODB 3.2.14.

- B. FOR LOSS OF SPACELAB CONDENSATE SEPARATOR, THE ORBITER'S SYSTEM WILL BE USED FOR HUMIDITY CONTROL. ONE FREON COOLANT LOOP FLOW PROPORTIONING VALVE WILL BE RETURNED TO THE INTERCHANGER POSITION. NORMAL SPACELAB OPERATIONS WILL CONTINUE UNTIL HUMIDITY REACHES AN UNACCEPTABLE LEVEL AS DETERMINED BY CREW JUDGMENT.

To complete as much of the mission as possible, a Freon loop flow proportioning valve is returned to the interchanger position in an attempt to increase the water loop temperature provided to the Spacelab cabin heat exchanger to above that at the orbiter cabin heat exchanger. This will minimize condensation buildup in the lab ducting and aid in allowing the orbiter humidity separators to perform humidity control. Reassessment of Spacelab experiment cooling capabilities will be necessary in this configuration.

Reference: Engineering judgment.

- C. THE OVERBOARD DUMPING NOZZLE TEMPERATURE MUST BE ≥ 135 DEG F/ 57 DEG C BEFORE STARTING CONDENSATE DUMP. THE OVERBOARD DUMP NOZZLE TEMPERATURE MUST BE ≥ 135 DEG F/57 DEG C BEFORE POWER IS REMOVED FROM THE CONDENSATE DUMP HEATER CONTROL AT THE COMPLETION OF THE DUMP. [ED]

To prevent water from freezing inside and on the surface of the dump nozzle.

Reference: SLODB 3.2.16.

FLIGHT RULES

A17.9.4-3 AVIONICS FAN

MODULE

A. ONLY ONE AVIONICS FAN WILL BE OPERATED AT A TIME.

Both avionics fans are powered through the SS inverter. With one avionics fan, a cabin fan, a water pump, CDMS loads, and possibly a Freon pump operating (all on the SS inverter), the startup transient of the second avionics fan will overload the SS inverter.

Reference: Engineering judgment.

B. THE FREON PUMP WILL BE DEACTIVATED BEFORE SWITCHING TO AN ALTERNATE AVIONICS FAN AND BEFORE SWITCHING FROM LOW TO HIGH SPEED.

This rule applies only if a Freon loop is on board. The Freon pump, avionics fan, water pump, CDMS loads, and cabin fan are normally powered through the SS inverter. To avoid overloading and tripping off the inverter with the excessive avionics fan startup transient, the Freon pump must be turned off.

Reference: SLODB 3.2.17.

C. THE AVIONICS FAN AND THE FREON PUMP WILL BE POWERED FROM DIFFERENT AC ECS BUSES TO AVOID OVERLOADING (I.E., DO NOT USE AVIONICS FAN 1 (2) WITH FREON PUMP 1 (2)). NORMAL CONFIGURATION IS AVIONICS FAN 1 ON.

This rule applies only if a Freon loop is on board. Avionics fan 1 and Freon pump 1 are both powered by AC ECS 2. Avionics fan 2 and Freon pump 2 are both powered by AC ECS 3. Neither AC ECS bus can handle the startup transient of the avionics fan (Freon pump) if the Freon pump (avionics fan) on the same bus is operating.

Reference: Engineering judgment.

D. THE AVIONICS FAN WILL BE IN OPERATION BEFORE ANY AV FAN AIR-COOLED SPACELAB AVIONICS OR PAYLOAD EQUIPMENT IS POWERED ON.

To prevent overheating of the air-cooled equipment and for smoke detection.

Reference: SLODB 3.2.17.

THIS RULE CONTINUED ON NEXT PAGE

FLIGHT RULES

A17.9.4-3 AVIONICS FAN (CONTINUED)

- E. TWO CONSECUTIVE ACTIVATIONS (HIGH SPEED ONLY) OF THE SAME AVIONICS FAN ARE NOT PERMITTED WITHIN A 5-MINUTE TIME SPAN.

Avoids overheating resistors in the power factor corrector/in-rush current limiter (PFC/ICL).

Reference: SLODB 3.2.17.

DOCUMENTATION: SPAH Main Volume 4.6.3.2.3.

F. FOR NORMAL OPERATIONS

1. THE AVIONICS FAN WILL BE OPERATED IN HIGH SPEED ON ORBIT.
2. THE AVIONICS FAN WILL BE OPERATED IN LOW SPEED DURING ASCENT/ENTRY AND EXTENSION DAYS, IF SPACELAB IS POWERED.

These constraints are to provide the required cooling while on orbit and to provide fire/smoke detection capability in the subfloor and rack areas whenever the Spacelab is powered.

- G. THE AVIONICS FAN MAY BE OPERATED IN HIGH SPEED DURING ASCENT/ENTRY IF AIR FLOW/COOLING REQUIREMENTS CANNOT BE SATISFIED BY THE AVIONICS FAN LOW SPEED OPERATION. THE USE OF THE AVIONICS FAN IN HIGH SPEED DURING ASCENT/ENTRY MUST BE ANALYZED AND COORDINATED WITH MSFC ON A FLIGHT-BY-FLIGHT BASIS.

High speed operation of the avionics fan is allowed during ascent/entry only when the air flow/cooling requirements cannot be satisfied by the low speed operation. MSFC has the tools necessary to perform the analysis.

DOCUMENTATION: SPAH Main Volume 4.6.3.2.3.

- H. THE AVIONICS FAN MAY BE OPERATED IN LOW SPEED ON ORBIT, BUT ONLY A LIMITED NUMBER OF RACKS MAY BE OPERATED. THE OPERATIONAL CONFIGURATION MUST BE COORDINATED WITH MSFC PRIOR TO OPERATING IN THE LOW SPEED MODE ON ORBIT.

Operation of the avionics fan in low speed cannot satisfy the cooling requirements of the avionics equipment in all the racks simultaneously.

DOCUMENTATION: SPAH Main Volume 4.6.3.2.3.

FLIGHT RULES

THIS RULE CONTINUED ON NEXT PAGE

FLIGHT RULES

A17.9.4-3 AVIONICS FAN (CONTINUED)

I. LOSS OF AVIONICS FANS:

ASCENT/ENTRY:

1. FOR LOSS OF BOTH AVIONICS FANS, THE PRIMARY PAYLOAD BUS WILL BE UNPOWERED AND THE AUXILIARY BUS WILL REMAIN POWERED.

Loss of the avionics fans constitutes loss of cooling to some equipment and a complete loss of smoke detection annunciation; so, the primary bus is unpowered to remove ignition and heat sources. The auxiliary bus will remain powered to provide fire suppression capability.

2. IF ONLY LOW-SPEED AVIONICS FAN OPERATION IS AVAILABLE, NORMAL OPERATIONS WILL CONTINUE.

Prior to SCOS activation, only low speed is selectable if the fan that is in high speed is lost. As soon as SCOS is available, the avionics fan will be configured to high speed if high speed is needed for a flight-specific rack configuration. If only low-speed operation is available, the smoke detection/annunciation may be delayed. This is acceptable because the module is unoccupied.

ORBIT:

3. FOR LOSS OF BOTH AVIONICS FANS, THE MODULE WILL BE POWERED DOWN AND EGRESSED, EXCEPT FOR FLIGHT-SPECIFIC RESTRICTIONS/EXCEPTIONS TO THIS RULE DOCUMENTED IN THE FLIGHT SPECIFIC ANNEX.

Loss of both avionics fans leaves only the cabin fan to circulate air in the module. The cabin fan is not ducted to provide sufficient cooling or smoke detection in the avionics loops. (Safety Hazard, refer to Spacelab Critical Item Control Summary No. 408.01).

FLIGHT RULES

A17.9.4-4 RACK COOLING ASSEMBLY

MODULE

- A. THE CONTROL CENTER RACK (CCR) SHUTOFF VALVE (SOV) WILL BE SET TO THE "INTERMEDIATE" POSITION VIA THE "CLOSE" POSITION.

Eliminates CCR SOV hysteresis to ensure proper positioning of the valve. Improper positioning of the CCR SOV may result in CCR overheating. Whenever repositioning of the valve is required, it should be done by taking the valve to the closed position first, then to intermediate to avoid improper positioning.

Reference: SLODB 3.2.9.

- B. WHEN RECONFIGURATION OF SOV'S IS REQUIRED, OPENING THE SET TO BE OPENED WILL ALWAYS PRECEDE CLOSING THE SET TO BE CLOSED.

Avoids an abrupt decrease in flow (increase in delta P) that might stall the avionics fan.

Reference: SLODB 3.2.9.

- C. NO ATTEMPT WILL BE MADE TO CHANGE SOV POSITIONS FROM PREDETERMINED STOP SETTINGS.

The shutoff valve stop settings are finely tuned preflight to balance flows with heat loads and cannot be deviated from without causing serious cooling problems.

Reference: Engineering judgment.

- D. EXPERIMENT RACKS WILL NOT BE POWERED WITHOUT AIR FLOW BEING SUPPLIED TO THE RACK.

To prevent experiment rack overheating and possible fire.

Reference: SLODB 3.2.9.

- E. RACK AIR MANAGEMENT CHANGES WILL BE COORDINATED WITH THE POD.

Many Spacelab experiments require cooling provided through the Spacelab racks. If the air flow in these racks must be disturbed, the POD needs to be notified in order to secure cooling sensitive experiments and prevent their damage.

FLIGHT RULES

A17.9.4-5 TUNNEL FAN

MODULE

FOR LOSS OF TUNNEL FAN OPERATIONS, THE SPACELAB AND ORBITER ATMOSPHERE CONTROL SYSTEMS WILL BE MANAGED, ALTERNATING BETWEEN SYSTEMS AS REQUIRED. IF THE REGENERABLE CARBON DIOXIDE REMOVAL SYSTEM (RCRS) IS FLOWN, SPACELAB CO₂ LEVELS WILL BE CONTROLLED BY INSTALLING LIOH CANISTERS IN THE SPACELAB LOCATIONS. IF NO RCRS IS FLOWN, PPCO₂ LEVELS WILL BE CONTROLLED BY USING ALL FOUR LIOH INSTALLATION LOCATIONS (TWO ORBITER/TWO SPACELAB). THE NUMBER OF CANISTERS AVAILABLE WILL DETERMINE THE LENGTH OF SPACELAB OPERATIONS.

The Spacelab module and orbiter both have pressure control systems, either of which can maintain proper cabin pressure, PPO₂ and PPCO₂ levels for the combined Spacelab module and orbiter volume, if the tunnel fan is operating properly. If the tunnel fan fails, it will be necessary to alternate between use of the Spacelab module ASCS and the orbiter PCS to keep PPO₂ levels within limits in both sections. To control the PPCO₂ level with no tunnel fan, independent and parallel PPCO₂ control in both volumes is necessary. Since the number of LiOH cans manifested for RCRS flights is usually based upon orbiter safe return criteria, Spacelab operations following loss of a tunnel fan will probably be severely limited.

Reference: Engineering judgment.

FLIGHT RULES

ATMOSPHERE STORAGE AND CONTROL SYSTEM (ASCS)
LOSS/FAILURE DEFINITIONS

A17.9.5-1 **CABIN PRESSURE INTEGRITY**

MODULE

IF AN UNISOLATABLE LEAK EXISTS SUCH THAT O₂/N₂ CONSUMABLES CAPABILITY WILL NOT ALLOW A NEXT PLS ENTRY AT 14.7 PSIA PLUS THE GREATER CONSUMABLE REQUIREMENT OF THE FOLLOWING:

- A. A 48-HOUR FLIGHT EXTENSION AT 14.7 PSIA BEYOND THE NEXT PLS OPPORTUNITY

OR

- B. THE PLANNED CONSUMABLES FOR THE 165-MIN, 8 PSIA CONTINGENCY RETURN REQUIREMENT,

THEN CABIN PRESSURE INTEGRITY IS DECLARED LOST.

Cabin pressure integrity for on-orbit operations is defined to be lost at the point where normal operations can no longer take place (i.e., 14.7 psia cabin plus all reserves remaining intact). The two reserves which must be included to define loss of cabin pressure integrity are: 1) the required consumables to maintain 14.7 psi for 2 mission extension days, or 2) loss of the 165-min, 8 psia contingency reserve which would not allow an emergency deorbit should one become necessary. Allowing for all three of the above named consumables requirements does not leave sufficient margin between loaded quantities and what is required for a contingency. Therefore, only the greater of the two reserves is required in addition to the 14.7 psia cabin maintenance to the next PLS. (Reference All Flights Rule {A17.1.5-1B}, CABIN PRESSURE INTEGRITY). ©[ED]

DOCUMENTATION: Engineering judgment.

FLIGHT RULES

A17.9.5-2 CABIN PRESSURE CONTROL

MODULE

LOST IF UNABLE TO CONTROL CABIN PRESSURE >14.5 PSIA/ 1.0 BAR (14.1 PSIA/ 0.97 BAR) AND <14.9 PSIA/ 1.03 BARS (15.3 PSIA/ 1.06 BARS).

The cabin pressure regulators are designed to maintain cabin pressure at 14.7 ± 0.2 psia.

Reference: SLODB 3.2.4.

A17.9.5-3 PPO₂ CONTROL

MODULE

LOST IF UNABLE TO MAINTAIN PPO₂ >2.95 PSIA/ 0.20 BAR (2.8 PSIA/ 0.19 BAR) OR <3.48 PSIA/ 0.24 BAR (3.60 PSIA/ 0.25 BAR).

The O₂/N₂ controller is designed to maintain PPO₂ at 3.20 ± 0.25 psia.

Reference: SLODB 3.2.4.

FLIGHT RULES

ATMOSPHERE STORAGE AND CONTROL SYSTEM (ASCS) MANAGEMENT

A17.9.6-1 CABIN PRESSURE INTEGRITY

MODULE

IN THE EVENT THE CABIN PRESSURE INTEGRITY OF THE MODULE IS DECLARED LOST, THEN SPACELAB MODULE OPERATIONS WILL BE TERMINATED, THE MODULE CONFIGURED FOR ENTRY, AND THE CREW WILL EGRESS THE MODULE AND ISOLATE SPACELAB BY EXECUTING THE ADAPTER/ TUNNEL HATCH CLOSED PROCEDURE. POWER WILL BE TERMINATED TO SPACELAB IF THE SPACELAB MODULE PRESSURE IS LESS THAN 13.8 PSIA/0.95 BAR.

If the module does not demonstrate cabin pressure integrity as defined in Rule {A17.9.5-1}, CABIN PRESSURE INTEGRITY, it is prudent for the crew to terminate all experiments as soon as possible and egress the module in an orderly manner. Other non-module operations may continue as long as their power source is not derived via the module. The module will be sealed in order to prevent the module leak from affecting orbiter safety.

Power is removed from the module to prevent avionics from overheating as air cooling performance is reduced at these low cabin pressures. Additionally, Spacelab equipment is not certified to operate at low cabin pressures.

Documentation: Engineering judgment, MSFC NA5i (85-190), MDTSCO TM 100A-85005, SODB 4.1.3.1, and SLP/ 2104-3 4.1.2.

A17.9.6-2 CABIN PRESSURE CONTROL

MODULE

IF UNABLE TO CONTROL CABIN PRESSURE >14.5 PSIA/1.0 BAR (14.1 PSIA/ 0.97 BAR) AND <14.9 PSIA/1.03 BARS (15.3 PSIA/1.06 BARS), ASCS WILL BE DEACTIVATED AND ORBITER PCS ACTIVATED.

Cabin pressure control by the ASCS is lost by definition.

Reference: Rule {A17.9.5-2}, CABIN PRESSURE CONTROL.

FLIGHT RULES

A17.9.6-3 RELIEF VALVE COVERS

MODULE

CABIN AND SPACELAB TRANSFER TUNNEL (STT) NEGATIVE PRESSURE RELIEF VALVE COVERS WILL BE OUT AND LOCKED OPEN DURING ASCENT. THE COVERS WILL BE CLOSED ON ORBIT AND REMAIN CLOSED DURING ENTRY.

To prevent chatter damage to valve seat during periods of ascent vibration (launch and maximum dynamic pressure (MAX Q)).

Reference: SODB 3.2.21.

A17.9.6-4 CABIN DEPRESS VALVE

MODULE

A. IN THE EVENT OF AN UNCONTROLLABLE FIRE, THE MODULE WILL BE DEPRESSURIZED (IF POSSIBLE) UTILIZING THE REMOTELY ACCESSED MOTORIZED CABIN DEPRESS VALVE. @[092293-1546A]

An uncontrollable fire is defined as one in which the FSS has failed to extinguish the fire. Thus, in order to suppress the fire, the module atmosphere is evacuated, thereby depriving the combustion process of all oxidizer.

B. THE MANUAL CABIN DEPRESS VALVE LOCATED IN THE SPACELAB MODULE WILL BE LEFT CLOSED FOR ASCENT, ORBIT, AND ENTRY OPERATIONS. @[051194-1635A] @[072795-1780B]

C. THE MOTORIZED CABIN DEPRESS VALVE (R7 PANEL SWITCHES) WILL BE IN THE SAFE AND OPEN POSITION WITH THE VALVE DRIVEN CLOSED FOR ALL PHASES OF FLIGHT.

D. IF THERE IS A FIRE OR A TOXIC SPILL WHEN THE CREW EGRESSES THE MODULE, THE MANUAL VALVE WILL BE OPENED.

FLIGHT RULES

This action will not allow depressurization of the module in the event that a module fire or toxic spill (level 4) occurs while the crew is not present in the module. It is an unacceptable risk for a crewmember to re-enter the module to extinguish a fire or clean up a toxic spill (level 4). The manual valve is closed for ascent, orbit, and entry to prevent loss of Spacelab atmosphere from single-point failures which can inadvertently drive the series motor valve open. The motorized valve configuration (R7 panel) prevents motor damage due to an inadvertent not-closed status indication on the motor valve. An erroneous not-closed indication can cause the valve logic to continuously drive the valve closed, resulting in valve motor damage within 4 to 10 minutes if the R-7 panel switch is left in the closed position.
 ©[072795-1780B]

Reference: OFTP #141 minutes and engineering judgment. ©[051194-1635A]

A17.9.6-5 O2 ENRICHMENT CONTROL

MODULE

- A. DURING SYSTEM ACTIVATION THE O₂/N₂ CONTROLLER SHOULD BE ACTIVATED BEFORE O₂ SUPPLY VALVE ACTIVATION.

The O₂/N₂ controller valve is closed when not powered (i.e., O₂/N₂ controller not activated and O₂ feeds cabin regulator manifold). If the O₂ supply valve is opened before the O₂/N₂ controller is activated and cabin pressure is below the cabin pressure regulator opening point, then O₂ will flow into the cabin. If PPO₂ levels are high, then the PPO₂ high limit could be exceeded before the cabin pressure regulator closes.

Reference: SODB 3.2.4.

- B. DURING SYSTEM DEACTIVATION, THE O₂ SUPPLY VALVE SHOULD BE CLOSED BEFORE CLOSING THE N₂ SUPPLY VALVE AND DISABLING THE O₂/N₂ CONTROLLER.

Rationale and reference same as for paragraph A.

A17.9.6-6 LOSS OF O2 PARTIAL PRESSURE CONTROL

MODULE

IF UNABLE TO CONTROL PPO₂ >2.95 PSIA/0.20 BAR (2.80 PSIA/0.19 BAR) AND <3.48 PSIA/0.24 BAR (3.60 PSIA/0.25 BAR) ASCS WILL BE DEACTIVATED AND ORBITER PCS ACTIVATED.

PPO₂ control by the ASCS is lost.

Reference: Rule {A17.9.5-3}, PPO₂ CONTROL.

FLIGHT RULES

A17.9.6-7 SPACELAB N2 SUPPLY MANAGEMENT

THE SPACELAB ASCS WILL NORMALLY BE ACTIVE UNTIL THE SPACELAB N₂ TANK PRESSURE REACHES 300 PSI. AT THAT TIME, THE ASCS SHOULD BE DEACTIVATED AND ORBITER PCS ACTIVATED. HOWEVER, THE N₂ TANK CAN BE DEPLETED TO NEARLY CABIN PRESSURE IF ADDITIONAL N₂ MARGIN IS NEEDED. ©[012694-1602]

The Spacelab N₂ regulators control the downstream N₂ supply to 215 ± 15 psi. Maintaining the upstream pressure at 300 psi or above will insure that the regulators will have spec flow capability while still nearly maximizing N₂ use (no testing has been performed below 300 psi). There will be about 7 lbm remaining in the tank at 300 psi.

If necessary, the N₂ tank can be depleted to 120 psi (the minimum N₂ pressure required by the function of the O₂/N₂ controller) while still maintaining auto ASCS capability. It can also be depleted to nearly cabin pressure by shutting off the O₂ into the Spacelab. In doing either of these, however, there is no guarantee that the regulators will maintain spec flow capability.

The tank will not be depleted below 300 psi unless necessary to avoid reconfiguration of ASCS hardware and fault detection limits.

Documentation: SLSH, Engineering Judgment, SODB 3.2.4.2 ©[012694-1602]

A17.9.6-8 SPACELAB POWER TERMINATION

MODULE

SPACELAB POWER WILL BE TERMINATED IF THE SPACELAB PPO₂ CANNOT BE MAINTAINED AT <24.5 PERCENT.

Spacelab cabin materials have been qualified as non-fire-propagating with a maximum O₂ concentration of 24.5 percent.

Reference: PPO₂ Control and Requirement for Spacelab Mission, letter from John W. Thomas/MSFC to Glynn S. Lunney/JSC, Space Shuttle Manager, June 21, 1983.

FLIGHT RULES

A17.9.6-9

10.2 PSI AFT FLIGHT DECK OPERATIONS

- A. FOR THE DURATION OF 10.2 PSIA CABIN PRESSURE OPERATIONS, AFT FLIGHT DECK (AFD) SPACELAB HARDWARE SHALL BE POWERED OFF. FLIGHT SPECIFIC EXCEPTIONS TO THIS RULE ARE DOCUMENTED IN THE FLIGHT SPECIFIC ANNEX. ©[022493-1479] ©[ED]

The following Spacelab hardware is not qualified to operate in the 10.2 psia, 30 percent O₂ environment which is required to support a 10.2 EVA prebreathe protocol: DDS interface unit; AFD power distribution box; and all AFD Remote Acquisition Units (RAU's). Therefore, power shall not be applied to this unqualified hardware when flown in the orbiter in order to preclude an AFD Spacelab equipment originated fire from occurring while at a 10.2 psia cabin pressure. The R7 panel, or Integrated Monitoring and Control Panel (IMCP), is certified for partial operations, i.e., with the F1 fuse removed, in a 10.2 psia environment. This allows experiment operations to continue via POCC commanding and monitoring during the 10.2 psia prebreathe protocol. Flight specific cases for continued experiment operations during a 10.2 psia prebreathe protocol are identified in the flight specific annex.

Reference: MSFC NA51 (85-190), SL AFD Equipment at Low Pressure; TM-SLMDH-0208, IMCP Low Pressure Operations; Rule {A7.9.2-10F}, DATA DISPLAY SYSTEM (DDS) MANAGEMENT; Rule {A2.9.1-18}, EVA; and JSC-48090, Spacelab Pallet Operations.

- B. SPACELAB EXPERIMENT OPERATIONS WILL BE TERMINATED AND THE EXPERIMENTS SAFED AND POWERED OFF EXCEPT AS DEFINED FOR THE FLIGHT SPECIFIC CASES IDENTIFIED IN THE FLIGHT SPECIFIC ANNEX.

In general, Spacelab experiments cannot continue due to monitoring requirements for their health and safety. Based on the experiment complement, on some flights it may be possible to operate the system by ground command if there is no health or safety issue with the experiment hardware.

©[ED]

FLIGHT RULES

A17.9.6-10 EXPERIMENT VENT VALVE POSITION

WHEN NOT REQUIRED ON A DAILY, ROUTINE BASIS, THE F5D AND A6D EXPERIMENT VENT VALVES SHALL BE CLOSED. THE "1" POSITION OF THE VALVE SHALL BE SELECTED FOR EXPERIMENT USE UNLESS SCIENCE RETURN WOULD BE COMPROMISED BY NOT USING THE "2" OR "OPEN" POSITION. @[012793-1436]

Each experiment vent valve is a potential cabin leak source. The vacuum line leading from the experiment to the valve is several feet long and connects directly to an experiment chamber and to bleed valves that are or could be opened to the cabin. A failure of the chamber, bleed valves, a line rupture, or crew error could cause a severe cabin leak. To protect against these potential failures, the minimum flow setting should be selected whenever possible. When vacuum is not required for extended periods, i.e., for several hours, the valve should be closed.

The following flow rates are possible in each vent valve position:

VENT VALVE POSITION	FLOW RATE
1	7.80 lbs/min (3.60 kg/min) <i>Equates to a dp/dt of 0.29 psi/min.*</i>
2	15.60 lbs/min (7.20 kg/min) <i>Equates to a dp/dt of 0.57 psi/min.*</i>
OPEN	21.18 lbs/min (9.60 kg/min) <i>Equates to a dp/dt of 0.78 psi/min.*</i>

* Calculated based on combined Spacelab/orbiter volume

DOCUMENTATION: Spacelab SODB, Section 3.2.8.

FLIGHT RULES

THIS PAGE INTENTIONALLY BLANK

FLIGHT RULES

SECTION 18 - THERMAL

SUPPLY WATER LOSS DEFINITIONS

A18.1.1-1	SUPPLY WATER TANK	18-1
A18.1.1-2	SUPPLY WATER DUMPLINE	18-1
A18.1.1-3	SUPPLY WATER DUMP CAPABILITY	18-2

SUPPLY WATER MANAGEMENT - THERMAL

A18.1.2-1	SUPPLY H ₂ O TANK A MANAGEMENT	18-3
A18.1.2-2	SUPPLY/WASTE WATER CROSSCONNECT	18-3
A18.1.2-3	SUPPLY WATER TANK A OUTLET VALVE MANAGEMENT	18-4
A18.1.2-4	SUPPLY WATER TANK A PRESSURE CONTROL MANAGEMENT	18-5
A18.1.2-5	SUPPLY WATER DUMP	18-5
A18.1.2-6	SUPPLY WATER DUMP NOZZLE TEMPERATURE CONSTRAINT	18-7
A18.1.2-7	SUPPLY WATER TANKS C AND D REFILL MANAGEMENT	18-8
A18.1.2-8	SUPPLY WATER SYSTEM LEAK MANAGEMENT	18-9
A18.1.2-9	SUPPLY WATER REDLINE	18-10
<u>A18.1.2-10</u>	<u>EXTERNAL AIRLOCK WATER LINES</u>	<u>18-10a</u>
<u>A18.1.2-11</u>	<u>EXTERNAL AIRLOCK LCG FLUID LINE LOSS DEFINITION</u>	<u>18-10b</u>
<u>A18.1.2-12</u>	<u>EXTERNAL AIRLOCK WATER LINE OVERPRESSURE/TEMPERATURE MANAGEMENT</u>	<u>18-10c</u>

ARS H2O LOOP LOSS DEFINITIONS

A18.1.3-1	ARS WATER LOOP	18-11
-----------	----------------------	-------

ARS H2O LOOP LOSS MANAGEMENT

A18.1.4-1	ARS WATER LOOP	18-13
-----------	----------------------	-------

FLIGHT RULES

ACTIVE THERMAL CONTROL SYSTEM (ATCS) LOSS DEFINITIONS

A18.1.5-1 FREON COOLANT LOOPS (FCL) 18-16

A18.1.5-2 TOPPING EVAPORATOR 18-20

A18.1.5-3 HIGH-LOAD EVAPORATOR 18-21

A18.1.5-4 FES PRIMARY A (B) CONTROLLER 18-22

A18.1.5-5 FES SECONDARY CONTROLLER 18-23

A18.1.5-6 FES H2O FEEDLINE 18-24

A18.1.5-7 AMMONIA BOILER SUBSYSTEM (ABS) 18-25

A18.1.5-8 RADIATOR FLOW CONTROL ASSEMBLY (RFCA) 18-26

ATCS MANAGEMENT

A18.1.6-1 FREON COOLANT LOOPS (FCL) 18-27

A18.1.6-2 FLASH EVAPORATOR SYSTEM (FES) 18-32

A18.1.6-3 AMMONIA BOILER SUBSYSTEM (ABS) 18-37

A18.1.6-4 ABS AMMONIA REDLINE 18-40

A18.1.6-5 RADIATOR FLOW CONTROL ASSEMBLY (RFCA) 18-40

EECOM HEATER MANAGEMENT

A18.1.7-1 TCS HEATER CONFIGURATION 18-46

A18.1.7-2 TCS HEATER REDUNDANCY 18-48

A18.1.7-3 REDUNDANT TCS HEATER VERIFICATION 18-48

A18.1.7-4 TCS HEATER OPERATIONS FOR LOSS OF INSTRUMENTATION 18-50

A18.1.7-5 LOSS OF HEATER SM CAPABILITY 18-50

A18.1.7-6 EXTERNAL AIRLOCK HEATER LOSS MANAGEMENT ... 18-51

EECOM SOFTWARE REQUIREMENT

A18.1.8-1 EECOM SOFTWARE REQUIREMENT 18-42a

TPS BONDLINE TEMPERATURES MANAGEMENT

FLIGHT RULES

A18.1.9-1 THERMAL PROTECTION SYSTEM (TPS) BONDLINE
TEMPERATURES 18-43

FLIGHT RULES

SECTION 18 - THERMAL

SUPPLY WATER LOSS DEFINITIONS

A18.1.1-1 SUPPLY WATER TANK

THE SUPPLY WATER TANK IS CONSIDERED LOST IF:

- A. UNABLE TO EXTRACT WATER FROM OR REFILL THE TANK.
- B. THE TANK HAS AN IRREPARABLE LEAK.
- C. THE TANK HAS A BELLOWS LEAK.

The primary purpose of the supply water tanks is to store excess fuel cell water for crew consumption, EMU recharges, and for ATCS FES usage. A water tank cannot be used if unable to perform these functions. A bellows leak is loss of a tank because N₂ gas is ingested into the supply water, and it has been shown that gas adversely affects the performance of the FES by causing shutdowns.

DOCUMENTATION: Engineering judgment and flight data.

A18.1.1-2 SUPPLY WATER DUMPLINE

THE SUPPLY WATER DUMPLINE IS CONSIDERED LOST IF:

- A. THE DUMPLINE TEMPERATURE CANNOT BE MAINTAINED TO > 32 DEG (37 DEG) F.
- B. THE DUMPLINE IS BLOCKED.
- C. THE DUMPLINE IS RUPTURED.
- D. BOTH SUPPLY WATER NOZZLE TEMPERATURE MEASUREMENTS ARE FAILED.
- E. THE NOZZLE TEMPERATURE CRITERIA OUTLINED IN RULE {A18.1.2-6}, SUPPLY WATER DUMP NOZZLE TEMPERATURE CONSTRAINT, CANNOT BE MET. @ED]

The primary purpose of the dumpline is to provide a transport path for the supply water to the dump nozzle. If the dumpline is blocked, ruptured, frozen, or temperatures are not within an acceptable range, the transport path cannot be utilized to effectively perform this function. For the above failures, the flash evaporator is used to dump supply water before consideration is given to using the potable contingency crosstie.

FLIGHT RULES

DOCUMENTATION: Engineering judgment, flight data, STS-8, STS-41B, and SEH-TCS-85-036.

A18.1.1-3 SUPPLY WATER DUMP CAPABILITY

THE SUPPLY WATER DUMP CAPABILITY IS CONSIDERED LOST IF:

- A. THE SUPPLY WATER DUMPLINE IS LOST AND THE CREW IS UNABLE TO USE THE CONTINGENCY CROSSTIE TO DUMP SUPPLY WATER THROUGH THE WASTE WATER NOZZLE, OR INTO A CWC AND [071494-1647A]
- B. UNABLE TO DUMP SUPPLY WATER THROUGH THE FES.

If the dumpline is lost, the primary path to dump supply water is lost. If the crew cannot use the contingency crosstie or the FES, for any reason, the alternate methods to dump supply water have also been lost.

DOCUMENTATION: Engineering judgment.

FLIGHT RULES

SUPPLY WATER MANAGEMENT - THERMAL

A18.1.2-1 **SUPPLY H₂O TANK A MANAGEMENT**

SUPPLY H₂O DUMPS AND FES OPERATIONS WHICH REQUIRE TANK A H₂O WILL BE MINIMIZED. TANK A H₂O CAN BE UTILIZED TO ACHIEVE LANDING OPPORTUNITIES. @[111094-1689A]

Iodine has been found to be a cause of corrosion in the FES cores. This corrosion has caused several FES cores to develop Freon leaks. All four supply H₂O tanks are iodinated prelaunch but tank A remains iodinated throughout a flight. Minimizing FES and nozzle dumps which utilize tank A H₂O will minimize the overall quantity of iodinated H₂O which will pass through the FES core. If supply H₂O management can not be accomplished with tank B only then the crossover valve will be opened and H₂O will be managed out of tanks B and D. Supply H₂O from tank A will be used for crew consumption, contingencies and to make entry opportunities if required.

DOCUMENTATION: STS-65 MER-SPAN CHIT 012. @[111094-1689A]

A18.1.2-2 **SUPPLY/WASTE WATER CROSSCONNECT**

THE CONTINGENCY WATER CROSSTIE CAPABILITY WILL BE USED TO:

- A. PROVIDE SUPPLY OR WASTE WATER DUMP CAPABILITY THROUGH THE ALTERNATE DUMP NOZZLE.

Provides for dumpline redundancy in the event of a dumpline failure for either system.

DOCUMENTATION: Engineering judgment.

- B. PROVIDE CONTINGENCY COOLING WATER FROM THE WASTE WATER TANK TO THE FES.

Certain launch day PLS opportunities cannot be met without increasing available supply water consumables. This is done by filling the waste tank with supply water. In the event that the PLBD's do not open, the additional supply water that was loaded in the waste tank must be used. The contingency crosstie capability allows the connection of the waste water system to the supply water system so that the supply water loaded in the waste tank is available to the FES.

DOCUMENTATION: Engineering judgment.

THIS RULE CONTINUED ON NEXT PAGE

FLIGHT RULES

A18.1.2-2 SUPPLY/WASTE WATER CROSSCONNECT (CONTINUED)

C. PROVIDE CONTINGENCY WATER COLLECTION (CWC) BAG WITH FILL CAPABILITY.

A single waste tank with a maximum liquid capacity of 168 lb exists for each orbiter. Under various crew sizes and flight timelines, the amount of waste liquid generated exceeds the 168-lb storage capacity. The waste tank must be dumped under these conditions. If the waste tank cannot be dumped, additional ullage for the expected generated waste liquids must be made available. The CWC provides the additional ullage. In order for this ullage to be useful to the crew, the fill capability for the CWC must be provided via the contingency crosstie.

DOCUMENTATION: Engineering judgment.

Rule {A17.1.10-2}, WASTE WATER DUMP CAPABILITY, references this rule.

A18.1.2-3 SUPPLY WATER TANK A OUTLET VALVE MANAGEMENT

TANK A OUTLET VALVE WILL NORMALLY REMAIN CLOSED THROUGHOUT THE FLIGHT. IT WILL BE OPENED AS REQUIRED TO ENSURE SUPPLY WATER COLLECTION CAPABILITY.

Under normal water system management and configuration, tank A outlet valve is closed to preserve the sterility of water used for crew consumption. In the event that immediate supply water ullage is required in the supply water system (i.e., ECLSS water line blockage), water tank A outlet valve is opened to provide the necessary ullage for fuel cell water collection. Tank A outlet valve is opened because the risk of flooding three fuel cells outweighs microbial concerns affecting potable water for the crew. IFM procedures exist to guarantee potable water for crew consumption once the requirement for supply water collection capability is satisfied.

DOCUMENTATION: Engineering judgment.

FLIGHT RULES

A18.1.2-4 SUPPLY WATER TANK A PRESSURE CONTROL MANAGEMENT

FOR LAUNCH, THE SUPPLY WATER GN₂ TANK A SUPPLY AND SUPPLY WATER GN₂ TANK VENT VALVES WILL BE IN THE "CLOSED" AND "VENT" CONFIGURATION, RESPECTIVELY. THE VALVES WILL BE PLACED IN THE "OPEN" AND "PRESS" POSITIONS BEFORE WATER TANK A REACHES 98 (93) PERCENT AND PRIOR TO DEPLETION OF TANK B.

The orientation of the orbiter and the acceleration during launch both work against the flow of fuel cell product water into the supply water tanks. Without reducing the pressurization of water tank A to cabin pressure, the fuel cells will vent product water through the fuel cell relief line instead of transporting the water to the water tanks. The supply water GN₂ tank A supply and supply water GN₂ tank vent valves must be placed in the CLOSED and VENT position in order to depressurize water tank A.

The valves must be placed in the OPEN and PRESS position in order to pressurize water tank A. If tank A is not pressurized prior to quantity reaching 100 percent, delta pressure across the tank bellows can exceed 15 psid resulting in serious damage to the bellows. Tank A must also be pressurized prior to the depletion of tank B to prevent the FES from shutting down.

DOCUMENTATION: Engineering judgment; flight data, 1.3 - TM - DF86050 - 013; and SODB 4.6.1.1.11.

A18.1.2-5 SUPPLY WATER DUMP

THE METHOD OF DUMPING SUPPLY WATER WILL BE AS FOLLOWS IN ORDER OF PRIORITY:

- A. IF PAYLOAD AND CREW TIMELINE CONSTRAINTS ALLOW, UTILIZE THE SUPPLY WATER DUMPLINE.
- B. UTILIZE THE FES.
- C. UTILIZE THE POTABLE H₂O CONTINGENCY CROSSTIE AND DUMP INTO A CWC.
- D. UTILIZE THE WASTE WATER DUMPLINE VIA THE WASTE WATER CONTINGENCY CROSSTIE. @[071494-1647A]

FLIGHT RULES

This rule outlines the desired medical and environmental systems operation priority of dumping excess supply water. Payload constraints will be considered when applicable. Utilization of the FES to dump excess supply water will be considered to minimize crew work load and propellant usage. The dumpline will remain higher priority than the FES, to minimize nozzle pulses on the FES. This priority is consistent with ensuring crew health by maintaining supply water system sterility. Dumping supply water through the supply dumpline, FES or into a CWC guarantees water system sterility. Dumping into the two CWC's onboard will create an additional 14-18 hours of ullage (depending on KW level). Connection of the supply water system to the waste dumpline increases the risk of contamination to the supply water system. ©[071494-1647A]

DOCUMENTATION: Engineering judgment.

FLIGHT RULES

A18.1.2-6 SUPPLY WATER DUMP NOZZLE TEMPERATURE CONSTRAINT

A SUPPLY WATER DUMP WILL BE TERMINATED IF BOTH OF THE SUPPLY WATER NOZZLE TEMPERATURES ARE LESS THAN 90 DEG F. NO FURTHER DUMPS WILL BE ATTEMPTED THROUGH THE SUPPLY DUMP NOZZLE. MINIMUM NOZZLE TEMPERATURE FOR SUPPLY DUMP INITIATION WILL BE 100 DEG F.

Utilizing the normal supply dump procedures, the supply water nozzle temperatures should rise and not decrease when the dump is initiated at a nozzle temperature of 100 deg F. If, instead of continuing to increase, the nozzle temperature decreases, then some problem exists with the dump nozzle which could lead to ice formation if the nozzle temperature drops below 45 deg F. The 90 deg F limit was established simply as an indication that the nozzle temperature is indeed decreasing from its original 100 deg F starting temperature and a cue that termination of the supply dump can be effected in a timely manner to prevent ice formation.

MCC GO/NO-GO requirement and visual references to frosting or glazing is not required due to the fact that ice formation, glazing, or frosting on the new supply dump nozzle does not occur until nozzle temperatures are well below 45 deg F.

The procedural act of dumping supply water calls for termination of the supply water dump if the nozzle temperatures drop below 90 deg F for no more than 4 seconds. The 90 deg F lower limit is well above the temperature at which ice, glazing, or frosting of the nozzle would occur. @ED |

Rule {A18.1.1-2E}, SUPPLY WATER DUMPLINE, references this rule.

FLIGHT RULES

A18.1.2-7 SUPPLY WATER TANKS C AND D REFILL MANAGEMENT

- A. WATER TANKS C AND D WILL BE MAINTAINED AS FULL AS POSSIBLE THROUGHOUT THE FLIGHT. FOR REFILL, WATER TANKS C AND D WILL NOT BE ALLOWED TO EXCEED 98 (93) PERCENT. IF GASEOUS HYDROGEN IS NOTED IN THE SUPPLY WATER SYSTEM, FUEL CELL WATER WILL NOT BE INTRODUCED IN SUPPLY WATER TANK(S) C AND/OR D UNTIL SUCH TIME AS ALL PLANNED EVA AND REQUIRED EMU RECHARGES ARE COMPLETED. @[111094-1689A]

Water management can normally be accomplished through water tanks B. When it is not necessary to create ullage or use water from tanks C and D, they are maintained as full as possible for contingency purposes such as PLBD anomalies, wave-offs, or anytime deorbits. If additional ullage or water is necessary for water management, tank C can normally be isolated and water managed through tanks B and D. The tanks are fill-restricted to 98 percent to prevent hardfilling the tanks which could result in venting FC water overboard. Ingestion of hydrogen laden fuel cell H₂O into the EMU in sufficient quantities has the potential for creating a flammable condition. However, current hardware configuration (i.e., two hydrogen separators, new EMU water bladders) and analysis by Hamilton Standard/Windsor Locks indicates that it is no longer necessary to nominally protect the EMU's from ingestion of fuel cell product water. There have been no anomalies reported to date on the orbiter's H₂ separators, and there is no known failure that would cause degraded operations. @[111094-1689A]

DOCUMENTATION: Engineering judgment, flight data, H84-22-HS Hamilton Standard, and 1.2-TM-DF86050-028.

- B. TO REFILL SUPPLY WATER TANKS C AND/OR D, THE SUPPLY H₂O CROSSOVER VALVE WILL BE OPENED TO FILL TANKS B, C, AND/OR D TOGETHER. @[111094-1189A]

Refilling of tanks C and D should be handled by opening the crossover valve and not by closing the tank B inlet valve. Closing tank B inlet results in a configuration that is one failure away (i.e., B/C check valve failed closed) from forcing the fuel cell water to relieve overboard. By opening the crossover valve instead, the fuel cell water will retain its path redundancy. @[111094-1689A]

DOCUMENTATION: Engineering judgment.

FLIGHT RULES

A18.1.2-8 SUPPLY WATER SYSTEM LEAK MANAGEMENT

FOR SUPPLY WATER SYSTEM LEAKS, THE FOLLOWING GUIDELINES WILL PERTAIN:

- A. IF FREE SUPPLY WATER IS IN THE CABIN, THE "FREE FLUID DISPOSAL" IFM PROCEDURE WILL BE PERFORMED IMMEDIATELY. IF PRACTICAL, THE WASTE WATER TANK WILL BE DUMPED TO 5 PERCENT PRIOR TO INITIALLY PERFORMING THE "FREE FLUID DISPOSAL" IFM PROCEDURE.

Free fluid in the cabin is an unacceptable condition because of LRU exposure to the free liquid causing an electric circuit malfunction and possible subsequent LRU failures.

Dumping the waste water tank creates additional ullage so that, if the IFM procedure causes a blockage in the waste water dump line, waste water will continue to collect to maximize the on-orbit stay period. STS-32 experienced free water in the lower equipment bay due to degraded humidity separator collection. The FREE FLUID DISPOSAL IFM was employed to dump the water overboard via the waste water dump nozzle. However, while employing the IFM procedure on the third occasion during the mission on FD 10, the waste water dump line became blocked by matter collected using the free fluid nozzle (wand). The mission was then limited by the remaining ullage in the waste water tank and the CWC volume.

For the STS-36 humidity separator failure, the waste water tank was dumped prior to using the FREE FLUID DISPOSAL IFM. Even though no blockage occurred in the waste water dump line, the mission on-orbit stay was maximized by having additional ullage created by the dump.

DOCUMENTATION: Ref. STS-32 MER Anomaly #21, January 19, 1990; STS-32 CAR No. 32RF21; STS-36 MER Anomaly #11, April 3, 1990; STS-36 CAR No. 36RF13; and Engineering judgment.

- B. ANY SUPPLY WATER TANK WITH AN IRREPARABLE OR NONISOLATABLE LEAK WILL BE VENTED, DUMPED, ISOLATED, AND NOT USED FOR THE REMAINDER OF THE MISSION. THE TANK WILL REMAIN DEPRESSURIZED UNTIL DUMPED.

A leaking supply water tank cannot be pressurized without forcing water out of the tank. If the tank is dumped and isolated from further fuel cell water collection, then the remaining water tanks can be repressurized and normal operations can continue until end of mission. A tank that is depressurized is not likely to leak in a zero gravity field as no pressure differential exists to force the water out of the tank.

DOCUMENTATION: Engineering judgment.

THIS RULE CONTINUED ON NEXT PAGE

FLIGHT RULES

A18.1.2-8 SUPPLY WATER SYSTEM LEAK MANAGEMENT (CONTINUED)

- C. FOR A SUPPLY WATER TANK OUTLET MANIFOLD LEAK, TWO TANKS NOT SUPPLYING THE LEAK WILL BE SELECTED ALONG WITH THE PROPER FLASH EVAPORATOR SUBSYSTEM (IF REQUIRED). THE LEAKING MANIFOLD WILL BE ISOLATED FOR THE REMAINDER OF THE MISSION.

Any water system manifold leak has the potential of reducing the ability of two water tanks to supply water under demand conditions. By isolating the leaking manifold, the amount of free water introduced into the cabin is minimized while maintaining water system support integrity.

DOCUMENTATION: Engineering judgment.

- D. FOR A SUPPLY WATER TANK INLET MANIFOLD LEAK, THE WATER TANKS WILL REMAIN DEPRESSURIZED.

When water tanks are depressurized for an inlet manifold leak, the available water supply to the leak has been reduced such that the rate at which water is expelled into the cabin cannot exceed FC generation rate. DOCUMENTATION: Engineering judgment.

A18.1.2-9 SUPPLY WATER REDLINE

- A. THE MINIMUM SUPPLY WATER QUANTITY ACCEPTABLE TO ALLOW FOR ANYTIME ENTRY REQUIREMENTS IS 175 LBM.

Analysis results conclude that 175 lbm of water is sufficient to supply orbiter cooling requirements for an anytime 165-minute emergency deorbit.

DOCUMENTATION: Anytime Contingency Deorbit Water Redline, STSOC Transmittal Form No. FDD-SA-88-220-082, 5/25/88.

- B. FOR A NORMAL ORBITER CONFIGURATION, SUPPLY WATER SHOULD BE MANAGED SO THAT 281 LBM IS AVAILABLE 4 HOURS PRIOR TO EVERY PLS TIG TIME (THIS SHOULD BE MAINTAINED UNTIL THE PLS TIG IS PASSED).

THIS RULE CONTINUED ON NEXT PAGE

FLIGHT RULES

A18.1.2-9 SUPPLY WATER REDLINE (CONTINUED)

C. RETURN PAYLOAD COOLING WATER REQUIREMENTS ARE SPECIFIED IN THE APPROPRIATE FLIGHT-SPECIFIC ANNEX.

Normal orbiter configuration assumes no active payload cooling (both FCL flow proportioning valves in ICH position) and normal orbiter power levels. For active payload cooling cases, additional water is required, depending on flight-specific cooling requirements. This redline is derived as a minimum water quantity required to support a nominal deorbit timeline. Contingency return cases require less water (175 lbm) due to a shorter deorbit time. Failures requiring EVA (PLBD fail to close) would require a 1-day waveoff to accumulate extra water required to support the new deorbit and EVA timeline. The study used to define this redline uses the following major assumptions:

- a. RAD coldsoak (RADS HI, Topping FES-ON) starts at TIG minus 3:56.*
- b. RAD bypass at TIG minus 2:50.*
- c. PLBD's closed at TIG minus 2:35.*
- d. FES deactivated at TD minus 12 minutes.*
- e. Entry power level of 19 kw.*

Measurement error, crew consumption and 10 percent dispersion are included in the analysis.

DOCUMENTATION: Anytime Contingency Deorbit Water Redline, STSOC Transmittal Form No. FDD-SA-88-220-082, 5/25/88.

FLIGHT RULES

A18.1.2-10 EXTERNAL AIRLOCK WATER LINES

THE EXTERNAL AIRLOCK WATER LINES ARE CONSIDERED LOST IF: @061297-4904]

A. THE EXTERNAL AIRLOCK WATER LINE TEMPERATURES IN EITHER ZONE 1 OR ZONE 2 CANNOT BE MAINTAINED TO > 32 DEG (40 DEG) F.

The external airlock water lines consist of six different water lines broken up into two zones, routed between the Xo=576 bulkhead and the external airlock. They are:

One EMU/ISS transfer supply water line

One EMU waste water return line

Two EMU liquid cooling garment supply lines (one for each EMU)

Two EMU liquid cooling garment return lines (one for each EMU)

Each line is wrapped with triply redundant heater strings in each of the two zones. Redundant temperature transducers are available for each zone (two each for zones 1 and 2) and they are located to be representative of the temperature in all six of the lines when water is not flowing. A third transducer (V64T0185A) is available on zone 2, but because of its location and subsequent sluggish response, it is not used for fault detection. It is mainly used to detect a short between heater segments.

Due to the location of each of the sensors, they do not indicate the exact temperature of the coldest segment of the six water lines. Per analysis, the following indicated temperatures reflect when the coldest segment of the lines has reached 32 deg. These values do not include the measurement error of the transducer:

H2O SPLY T ZN1 (V64T0181A) - 34 deg F

LCG2 SPLY T ZN1 (V64T0182A) - 47 deg F

QD PNL T ZN2 (V64T0183A) - 42 deg F

H2O SPLY T ZN2 (V64T0184A) - 36 deg F

B. THE EXTERNAL AIRLOCK STRUCTURAL TEMPERATURES CANNOT BE MAINTAINED TO > 32 DEG (40 DEG) F.

Preliminary analysis indicates that with the airlock depressed and the hatch and thermal cover open, the internal water line temperatures decrease faster than the indicated structural temperatures (reference Rule {A15.1.4-1}, EXTERNAL AIRLOCK HATCH THERMAL COVER). During EVA and while the ductwork is disconnected, the only active thermal control for the interior of the airlock is provided by the structural heaters. Based upon attitude, there is a concern for water line freezing if an active heater zone fails.

DOCUMENTATION: Engineering judgment and Rockwell I.L. 270-200-95-152, Rev 1. @061297-4904]

NASA - JOHNSON SPACE CENTER

FLIGHT RULES

FLIGHT RULES

A18.1.2-11 EXTERNAL AIRLOCK LCG FLUID LINE LOSS DEFINITION

THE LCG FLUID LINES SHALL BE CONSIDERED LOST IF: @[061297-4904]

A. WITH THE SCU DISCONNECTED FROM THE EMU, THE LCG PRESSURE CANNOT BE MAINTAINED ≤ 28.1 (26.4) PSIG.

B. WITH THE SCU CONNECTED TO THE EMU AND THE EMU UNPOWERED, THE LCG PRESSURE CANNOT BE MAINTAINED ≤ 18 (16.6) PSIG.

The pressure in either of the LCG lines (MSID V64P0170A or V64P0171A) shall be maintained below the SCU certified maximum operating pressure of 28.1 psig, in order to protect the SCU from exposure to proof pressure cycles (SCU proof pressure is 42.2 psig, burst pressure is 56.2 psig). The SCU can be connected to the EMU to relieve the pressure in the LCG lines.

A steady pressure increase in either of the LCG lines with the SCU connected, EMU fan/pump and O₂ actuator off, indicates the EMU water tanks no longer contain any nominal ullage and are no longer acting as an accumulator for the LCG lines. In the EMU, the LCG loop is connected to the water tanks through the bypass of the EMU coolant isolation valve. At 19.0 \pm 1.0 psig, the EMU feedwater relief valve will open and vent water from the EMU water tanks into the airlock.

DOCUMENTATION: Hamilton Standard EMUM-1337, S/AD SV767730/2 (Service & Cooling Umbilical Drawing), and engineering judgment. @[061297-4904]

FLIGHT RULES

A18.1.2-12 EXTERNAL AIRLOCK WATER LINE OVERPRESSURE/TEMPERATURE MANAGEMENT

UNEXPECTED PRESSURE AND/OR TEMPERATURE INCREASES IN THE EXTERNAL AIRLOCK LIQUID COOLING GARMENT (LCG) FLUID LINES WILL BE MANAGED AS FOLLOWS IN ORDER OF PRIORITY: @[061297-4904]

- A. DEACTIVATION OF WATER LINE HEATERS
- B. CHANGE ORBITER ATTITUDE, IF OPERATIONAL AND PAYLOAD CONSTRAINTS ALLOW
- C. CIRCULATE THE WATER IN THE LCG LINES VIA THE EMU FAN/PUMP (REF RULE {A15.1.4-2}, EXTERNAL AIRLOCK LCG PRESSURE AND TEMPERATURE MANAGEMENT USING THE EMU).

There is no accumulator located on the LCG fluid lines, and they are configured in a closed loop system. The only room for thermal expansion in these fluid lines is via the flexible portion of the SCU lines, when disconnected from the EMU, or the available ullage in the EMU water tanks when the SCU is connected to the EMU. It is possible, in "hot" thermal attitudes, that the available expansion in the LCG lines may not be sufficient to prevent a hydraulic lockup condition, without taking action to lower the pressure/temperature of the fluid lines.

DOCUMENTATION: Engineering judgment. @[061297-4904]

FLIGHT RULES

THIS PAGE INTENTIONALLY LEFT BLANK

FLIGHT RULES

ARS H2O LOOP LOSS DEFINITIONS

A18.1.3-1 ARS WATER LOOP

AN ARS WATER LOOP IS CONSIDERED LOST IF:

- A. ACCUMULATOR QUANTITY EQUALS 0 (≤ 5) PERCENT.

When the accumulator is empty, voids are created in the water loop causing pump cavitation.

DOCUMENTATION: Engineering judgment.

- B. INTERCHANGER FLOWRATE CANNOT BE MAINTAINED ≥ 600 (649) LB/HR IN THE "MIN BYP" POSITION.

At flowrate < 600 lb/hr, avionics bay 2 coldplates cannot be maintained below their 130 deg F upper limit in a normal entry (five GPC's).

DOCUMENTATION: SEH-ECS-86-106.

- C. ACTIVE LOOP PUMP OUTLET TEMPERATURE CANNOT BE MAINTAINED TO < 85 DEG (82.75 DEG) F AT A 14.7 PSIA CABIN PRESSURE.

The maximum air supply temperature to the avionics bays is 95 deg F at 14.7 psia cabin pressure by design specification. The air temperature leaving the avionics heat exchanger is about 10 deg F hotter than the water coolant loop pump outlet temperature. Avionics equipment may overheat if pump outlet temperature cannot be maintained to less than 85 deg F.

DOCUMENTATION: MF0004-009, REV A; Flight data (E.G. SEH-ITA-82-333).

- D. THERE IS CONFIRMED INTERLOOP LEAKAGE (WATER-TO-WATER OR FREON-TO-WATER).

For a water-to-water loop leak, the loops are now operating as one loop. (Ref. {A18.1.4-1D}, ARS WATER LOOP.) The next failure, an external leak, could result in loss of both loops. For a Freon-to-water loop leak, high pressures and material incompatibilities between Freon 21 and water loop components increase the probability of an external leak in the water loop and exposing the crew to the toxic Freon 21. To reduce such probability, the affected water loop is not to be operated unless required. (Ref. Rule {A18.1.3-1E}, ARS WATER LOOP.)

DOCUMENTATION: Engineering judgment; JSC-08934, vol. 3, 4.6.1.2.1.2.

THIS RULE CONTINUED ON NEXT PAGE

FLIGHT RULES

A18.1.3-1 ARS WATER LOOP (CONTINUED)

E. THERE IS CONFIRMED ACCUMULATOR BELLOWS FAILURE CAUSING GN₂ AND WATER COOLANT TO MIX.

For an accumulator bellows failure causing GN₂ to mix with water coolant, nitrogen bubbles will pass through the pump if the affected loop is activated. The pump would operate erratically as would be demonstrated by the pump delta P and interchanger flowrate. Since a reliable continuous pump operation cannot be expected, the loop should be considered lost.

DOCUMENTATION: Engineering judgment.

FLIGHT RULES

ARS H2O LOOP LOSS MANAGEMENT

A18.1.4-1 ARS WATER LOOP

A. NORMAL CONFIGURATION FOR ASCENT/ENTRY:

BYPASS VALVE CONTROL IN THE "MAN" MODE AND THE INTERCHANGER FLOW PRESET TO 950 ± 50 LB/HR ON BOTH LOOPS.

1. LOOP 1 -PUMP B WITH CONTROL "OFF".
2. LOOP 2 -PUMP CONTROL "ON".

The heat load mismatch between Freon and water loops at the interchanger causes the bypass valve controller to operate improperly at high heat loads when in the AUTO mode. Reference the Environmental Systems Console Handbook for a complete description of this mismatch. The optimum water loop flowrate for both the cabin temperatures and the avionics temperatures is determined by analysis to be 950 lb/hr for when the Freon loop FPM's are in either ICH or P/L positions. For these reasons, it is desirable to operate at this constant 950 lb/hr flowrate with the bypass valve in the MAN mode, during Ascent/Entry.

Water loop 2 is used as the active loop because of the "undetected failure" concern. Water loop 2 has one pump and water loop 1 has two pumps. If water loop 1 were to be the prime active loop, the pump in water loop 2 could fail and remain undetected until loop 1 failed and loop 2 was needed.

Water loop 1 is preset to a 950 lb/hr flowrate so that, when needed, it can be brought on line with optimum performance.

DOCUMENTATION: 1.2-TM-B1109-27; SEH-ITA-82-029.

B. CONFIGURATION FOR ON ORBIT:

1. AUTO MODE

BYPASS VALVE CONTROL IN THE AUTO MODE: LOOP 2 - PUMP CONTROL "ON", AND LOOP 1 - PUMP B WITH "GPC" CONTROL AND BYPASS VALVE IN MAN MODE.

THIS RULE CONTINUED ON NEXT PAGE

FLIGHT RULES**A18.1.4-1 ARS WATER LOOP (CONTINUED)**

2. MANUAL MODE

BYPASS VALVE CONTROL IN THE MAN MODE AND THE INTERCHANGER FLOW PRESET TO 950 ± 50 LB/HR ON BOTH LOOPS: LOOP 1 - PUMP B WITH "GPC" CONTROL, AND LOOP 2 - PUMP CONTROL "ON."

Flight data has indicated that the heat load mismatch at the Freon/H₂O interchanger is not as severe as previously predicted by analysis. Water loop control temperature (PUMP OUT TEMP) is not significantly affected by the FREON/H₂O ICH heat load mismatch. During STS-44, H₂O LOOP 2 performed nominally in the AUTO mode. Postflight crew comments about cabin temperature indicate AUTO mode is also beneficial to the persistent cabin temperature problem. Reference OFTP 8-14-91, 12-13-91.

H₂O loop 1, pump B, is in the GPC position for periodic cycling to satisfy thermal conditioning requirements. Pump A is normally operated on the ground. [@J041196-1882](#)

DOCUMENTATION: SEH-ITA-83-151

- C. BOTH WATER LOOPS WILL BE TURNED ON IF THE EVAPORATOR OUTLET TEMPERATURES IN BOTH FREON LOOPS ARE <32 DEG (34.6 DEG) F. (REF. {A18.1.6-1E}, FREON COOLANT LOOPS.)

Turning both water loops on allows more heat to be transferred to the water loops at their coldplates and heat exchangers, which at the same time reduces the interchanger heat transfer effectiveness from water-to-Freon loops. Analysis has shown that with both water loops operating and both Freon FPM's at the ICH positions, freezing of water is prevented until the Freon inlet temperature to the interchanger drops below 6 deg F.

DOCUMENTATION: LEMSCO 19630.

- D. FOR A WATER-TO-WATER LOOP LEAK, BOTH WATER LOOPS WILL BE ACTIVATED.

Depending on the loading of the water loops, it is possible to empty the accumulator of the operating loop into the nonoperating loop in the case of an interloop leak. Operating both loops eliminates this problem.

DOCUMENTATION: Engineering judgment.

THIS RULE CONTINUED ON NEXT PAGE

FLIGHT RULES

A18.1.4-1 ARS WATER LOOP (CONTINUED)

E. FOR A FREON-TO-WATER LOOP LEAK, THE AFFECTED WATER LOOP WILL NOT BE OPERATED UNLESS REQUIRED.

For a Freon-to-water loop leak, pressures in the water loop can get up to 135 psig (proof pressure) and higher if the affected water loop is operated. In addition, several components in the water loop are incompatible with Freon 21 and may fail to seal or function. Operating the affected water loop will circulate Freon 21 in the loop and accelerate seal degradation. The high pressures and material incompatibilities together increase the probability of an external leak in the water loop and exposing the crew to the toxic Freon 21.

@[082593-1527]

F. FOR A WATER LOOP LEAK, THE AFFECTED LOOP WILL BE DEACTIVATED.

When there is a coolant leak into the cabin from the water loop, it becomes zero-fault tolerant to crew safety because the next failure, a Freon-to-water leak at the interchanger, will introduce toxic Freon 21 into the crew habitable area. Deactivating the leaking loop may slow the leak rate (depending on the location of the leak on the loop) and minimize the risk of transferring Freon into the cabin should an interchanger leak occur. This would allow this loop to be used in the contingency event the other water loop should fail.

DOCUMENTATION: Engineering judgment; JSC-08934, volume 3, section 4.6.1.2.1.2.

Rule {A18.1.3-1D}, ARS WATER LOOP, references this rule.

FLIGHT RULES

ACTIVE THERMAL CONTROL SYSTEM (ATCS) LOSS DEFINITIONS

A18.1.5-1 FREON COOLANT LOOPS (FCL)

AN FCL IS CONSIDERED LOST IF:

A. CALCULATED FREON FLOWS, WHICH ASSUME THE RADIATORS ARE BYPASSED AND THE FLOW PROPORTIONING MODULE (FPM) IN "ICH," CANNOT BE MAINTAINED GREATER THAN:

1. INTERCHANGER FLOW EQUALS 1800 (1925) LB/HR.

The minimum interchanger flowrate required to support a one Freon loop entry (with three GPC's) is 1800 lb/hr. This flowrate is required to ensure that the fuel cell coolant return temperature is maintained below its 140 deg F limit until just before touchdown. (The exceedance is of short enough duration that no fuel cell damage will occur.)

DOCUMENTATION: G189A analysis dated 8/4/89.

A Freon loop with a flow proportioning valve failed in the PL position is considered lost because, with loss of the other loop, it will not provide enough cooling to the interchanger (av bays and cabin) during a one Freon loop entry. Assuming one FCL powerdown and an additional two GPC's powered down (one GPC/avionics bay powered up), avionics bays 1, 2, and 3 violate mixed air outlet temperature limits. -The PL position provides only 51 percent (1500 lb/hr/lp) of the total Freon flow to the interchanger, while the ICH position provides 81 percent (2400 lb/hr/lp). Freon loop total flow is not greatly affected by the FPM position and thus, FC cooling is not a concern for this failure. @J041097-3104B]

DOCUMENTATION: SE-TSAT-95-010. Reference SODB Volume III, par. 4.5.4.1.2, memo ED5-90-48, and IBM report 90-544-004 for GPC cooling requirements. @J041097-3104B]

2. AFT COLDPLATE FLOW EQUALS 211 (236) LB/HR.

The minimum aft coldplate flow required for a one Freon loop entry is 211 lb/hr. This flowrate is required to maintain the aft avionics bay 4 coldplate temperature below the 112 deg F limit and the aft avionics RGA outlet temperature below the 120 deg F limit. This assumes that the aft coldplate equipment is powered up for a nominal deorbit prep and entry (no powerdown), and no waveoffs are performed.

225 (250) lb/hr aft coldplate flow is required to support a nominal entry, with two weather waveoff revs (3- hour extended deorbit prep) with no powerdown or cycling of the aft coldplate equipment.

If PLS is declared for low aft coldplate Freon flow, then all landing sites should be made available to maximize a single opportunity if a good FCL should fail. If the good FCL should fail and deorbit cannot be accomplished, backout, powerdown, and another single deorbit attempt the next day will not violate orbiter cooling requirements (as long as flow is greater than 211 lbs/hr total).

FLIGHT RULES

DOCUMENTATION: SE-TSAT-93-068, SEH-ITA-84-249T, and Engineering judgment. ©[012694-1542A]

THIS RULE CONTINUED ON NEXT PAGE

FLIGHT RULES

A18.1.5-1 FREON COOLANT LOOPS (FCL) (CONTINUED)

B. PUMP INLET PRESSURE < 33.5 (48.5) PSIA

Pump cavitation will occur for a pressure at the pump inlet below Freon vaporization point. Since there is not a measurement of pump inlet temperature, the maximum pump inlet temperature vaporization pressure is used. The FCL's were designed for a 90 deg F inlet to the midbody coldplates for one FCL operation (90 deg F pump outlet temperature). Therefore, based on design, the maximum pump inlet temperature without exceeding the midbody coldplate outlet temperature is 88 deg F. This corresponds to a vaporization pressure of 32 psia for Freon.

However, the location of the pressure transducer is at the upstream of the pump inlet filter, and the pressure loss through the filter must be accounted for to make sure the pump inlet pressure is above vaporization point. The maximum pressure drop of the filter is 1.5 psid; therefore, the pressure shall be no less than 33.5 psid to ensure proper pump performance. The pump cavitation will cause erratic discharge pressure and pumping flowrate.

DOCUMENTATION: SODB figure 4.6.3-8; SODB TBD.

C. THERE IS A CONFIRMED INTERLOOP LEAKAGE (FREON-TO-FREON).

The FCL, as related to fluid volume, would now be acting as one FCL. One additional failure (external fluid leak) would result in loss of both FCL's. For GO/NO-GO purposes, one FCL would be considered lost in the event of interloop leakage.

DOCUMENTATION: N/A, engineering judgment.

D. ACCUMULATOR QUANTITY EQUALS 0 (3) PERCENT.

When there is no Freon left in the accumulator, voids are created in the FCL, causing pump cavitation.

DOCUMENTATION: N/A, engineering judgment.

E. FOR THE PURPOSES OF MAKING ASCENT ABORT CALLS, A FREON LEAK IS CONFIRMED BY AN OTHERWISE UNEXPLAINED 1.6 PERCENT DECREASE IN ACCUMULATOR QUANTITY AND A CORRESPONDING 2 PSI DROP IN PUMP IN PRESSURE FROM LIFT-OFF VALUES.

FLIGHT RULES

An earliest possible abort is required for loss of two Freon loops. A 1.6 percent quantity drop and 2 psi drop in PUMP IN PRESSURE is the minimum amount needed to confirm a loop leaking during ascent. Quantity and pressure always increase slightly during ascent due to the heat loads; therefore, any drop in quantity and pressure is always indicative of a leak. If, for any reason, the ascent heat loads should decrease (i.e., H₂O loop failure), this could cause a drop in pressure and quantity, and the loop would not be called lost on this criteria. Once a loop is leaking, the FCL loss is imminent and is considered failed for abort calls. Pressing to orbit with leaking loops is not desirable, since the loss of two Freon loops during entry could result in loss of crew/vehicle.

DOCUMENTATION: Flight history and engineering judgment.

FLIGHT RULES

A18.1.5-2 TOPPING EVAPORATOR

THE TOPPING EVAPORATOR IS CONSIDERED LOST IF:

- A. BOTH PRIMARY CONTROLLERS AND THE SECONDARY CONTROLLER CANNOT MAINTAIN PROPER CONTROL, AS DEFINED IN THE CONTROLLER LOSS DEFINITION.

The topping evaporator cannot function without a controller. Reference controller loss definitions, Rules {A18.1.5-4}, FES PRIMARY A (B) CONTROLLER, and {A18.1.5-5}, FES SECONDARY CONTROLLER.

DOCUMENTATION: Hamilton Std, SEM 62408.

- B. FORWARD OR AFT TOPPING DUCTS CANNOT BE MAINTAINED ≥ 100 DEG (120 DEG) F.

This temperature ensures that, as the topping evaporator boils water, the H₂O vapor does not condense and freeze in the ducts. If freezing occurs, the back pressure in the Flash Evaporator System (FES) core increases, which raises the boiling point. This may result in an overtemp shutdown.

DOCUMENTATION: Hamilton Std, SEM 62449.

- C. BOTH A AND B FEEDLINES ARE LOST.

If both feedlines are lost, H₂O cannot be supplied to the topping evaporator. Reference Rule {A18.1.5-6}, FES H₂O FEEDLINE, loss definition.

DOCUMENTATION: N/A, system schematic analysis.

FLIGHT RULES

A18.1.5-3 HIGH-LOAD EVAPORATOR

THE HIGH-LOAD EVAPORATOR IS CONSIDERED LOST IF:

- A. BOTH PRIMARY CONTROLLERS AND THE SECONDARY CONTROLLER CANNOT MAINTAIN PROPER CONTROL, AS DEFINED IN THE CONTROLLER LOSS DEFINITION.

The high-load evaporator cannot function without a controller. Ref. Rules {A18.1.5-4}, FES PRIMARY A (B) CONTROLLER; and {A18.1.5-5}, FES SECONDARY CONTROLLER.

DOCUMENTATION: Hamilton Std, SEM 62408.

- B. INBOARD OR OUTBOARD HIGH-LOAD DUCT SECTIONS CANNOT BE MAINTAINED ≥ 150 DEG (170 DEG) F. @ED]

This temperature ensures that, as the high-load evaporator boils water, the H₂O vapor does not condense and freeze in the duct. If freezing occurs, the back pressure in the FES core increases, which raises the boiling point. This may result in an overtemp shutdown.

- C. BOTH A AND B FEEDLINES ARE LOST.

If both feedlines are lost, H₂O cannot be supplied to the high-load evaporator. Reference Rule {A18.1.5-6}, FES H₂O FEEDLINE, loss definition.

DOCUMENTATION: N/A, system schematic analysis.

FLIGHT RULES

A18.1.5-4 FES PRIMARY A (B) CONTROLLER

THE FES PRIMARY A (B) CONTROLLER IS CONSIDERED LOST IF:

- A. UNABLE TO MAINTAIN EVAPORATOR OUTLET TEMPERATURE BETWEEN 36 DEG F AND 42 DEG F WHEN THE EVAPORATOR IS ENABLED.
 @ED 1

If the controller is controlling at temperatures outside this range, three failures have occurred in the PRI A controller (one control sensor and two shutdown sensors) and two failures have occurred in the PRI B controller (one control sensor and one shutdown sensor). Based on the number of failures, the controllers are not considered reliable and, therefore, must be considered failed. The primary controller controls between 38 deg and 40 deg F and is enabled at an inlet temperature of 41 deg F. The 36 deg F lower limit is based on the fact that the undertemperature shutdown logic on each controller will shut down the controller if the evaporator-outlet temperature remains below 37 ± 0.25 deg F for 20 seconds. The 42 deg F upper limit is based on the fact that the overtemperature shutdown logic will shut down the controller if the evaporator-outlet temperature does not decrease to less than 41.5 ± 0.25 deg F when the FES is enabled.

DOCUMENTATION: Hamilton Std, SEM 62408.

- B. AUTO SHUTDOWN CIRCUITRY WILL NOT ALLOW FES TO REMAIN ONLINE.

Auto shutdown logic will shut down the FES if temperatures and temperature decrease rates are not satisfied.

DOCUMENTATION: Hamilton Std, SEM 62408.

- C. A(B) FEEDLINE IS LOST.

If the A(B) feedline is lost, the primary A(B) controller will not operate (no H₂O).

Reference Rule {A18.15-6}, FES H₂O FEEDLINE, loss definition.

DOCUMENTATION: N/A, system schematic analysis.

Rules {A18.1.5-2A}, TOPPING EVAPORATOR; and {A18.1.5-3A}, HIGH-LOAD EVAPORATOR, reference this rule.

FLIGHT RULES

A18.1.5-5 FES SECONDARY CONTROLLER

THE FES SECONDARY CONTROLLER IS CONSIDERED LOST IF IT IS UNABLE TO MAINTAIN EVAPORATOR OUTLET TEMPERATURE BETWEEN > 60 DEG F AND < 65 DEG F.

The control band for the secondary controller is 62 deg ± 2 deg F. If the secondary controller is controlling below 60 deg F, a failure in the controller has occurred and it cannot be considered reliable.

The FES secondary controller does not have shutdown logic. In the event the orbiter heat load exceeds the FES capability, the evaporator outlet temperature will be maintained greater than its normal control band without shutdown.

The SODB requires the maximum temperature of air entering the avionics boxes to be less than 95 deg F and less than 130 deg F at the outlet of the boxes. At a 65 deg F evaporator outlet temperature with flow proportioning valves of both Freon loops configured to the ICH position and H₂O loop flowrate adjusted to full interchanger flow, analyses indicate that these limits will not be violated for a normal on-orbit ARS heat load (seven crewmembers, one GPC per avionics bay, etc.) in a 14.7 psia cabin environment. Powering up an additional GPC in the avionics bay will raise the measured outlet air temperature by approximately 10 deg to 15 deg F. This will cause frequent temperature excursions over the 130 deg F limit at the box outlet, leaving little or no margin for the operation of additional equipment in the same avionics bay. Since adequate thermal control cannot be maintained for a fully powered ARS when evaporator outlet temperatures are greater than 65 deg F, the FES is considered lost.

Rules {A18.1.5-2A}, TOPPING EVAPORATOR; and {A18.1.5-3A}, HIGH-LOAD EVAPORATOR, reference this rule.

DOCUMENTATION: Hamilton Std, SEM 62408; 283-440-84-005; STS85-0246; JSC 08934, 4.6.1.

FLIGHT RULES

A18.1.5-6 FES H₂O FEEDLINE

THE FES H₂O FEEDLINE IS CONSIDERED LOST IF:

A. TEMPERATURES IN ANY SECTION ARE <32 DEG (40 DEG) F.

At 32 deg F, the H₂O in the lines will freeze.

DOCUMENTATION: N/A, engineering judgment.

B. FEEDLINE ACCUMULATOR N₂ CHARGE IS LOST ("NOK" INDICATION PRESENT).

The N₂ charge is required to prevent water hammer effect which could cause erratic FES operations.

DOCUMENTATION: N/A, engineering judgment.

C. THERE IS A CONFIRMED LEAK IN THE FEEDLINE SUCH THAT H₂O USAGE RATE WILL NOT SUPPORT NOMINAL ENTRY.

If the leak is large enough that H₂O requirements for entry cannot be met, the feedline cannot be used.

DOCUMENTATION: N/A, engineering judgment.

D. SUPPLY ISOLATION VALVE IS FAILED CLOSED (B FEEDLINE ONLY).

If the valve is failed closed, the feedline cannot supply H₂O to the FES.

DOCUMENTATION: N/A, System schematic analysis.

Rules {A18.1.5-2C}, TOPPING EVAPORATOR; {A18.1.5-3C}, HIGH-LOAD EVAPORATOR; and {A18.1.5-4C}, FES PRIMARY A (B) CONTROLLER, reference this rule.

FLIGHT RULES

A18.1.5-7 AMMONIA BOILER SUBSYSTEM (ABS)

THE ABS SUBSYSTEM IS CONSIDERED LOST IF:

- A. UNABLE TO MAINTAIN EVAPORATOR OUTLET TEMPERATURE AT ≥ 31 DEG F AND ≤ 65 DEG F.

The control point for the ammonia boiler is 34 deg \pm 3 deg F. Less than 31 deg F is unacceptable due to the potential for freezing the orbiter water loops or a payload water loop, if installed. If the EVAP OUT TEMP reaches 32 deg F, a C&W will be annunciated and the EVAP OUT TEMP LOW procedure will be worked. This will provide freeze protection for temperatures down to 6 deg F.

If the NH3 boiler is controlling above 65 deg F, adequate thermal control of the vehicle cannot be maintained.

DOCUMENTATION: Lockheed analysis, LEMSCO 19630; 283-440-84-005; STS85-0245; JSC 08934, 4.6.1.

- B. NH3 QUANTITY EQUALS 0 (3) LB AS DETERMINED BY P-V-T RELATIONSHIPS (GROUND ONLY).

When there is no NH3 left, the ABS cannot cool. The NH3 system does not have a quantity reading and, therefore, quantity must be determined by tank pressure and tank temperature. Temperature does not remain constant on orbit, and, therefore, P-V-T curves must be used to determine quantity.

DOCUMENTATION: N/A, engineering judgment.

FLIGHT RULES

A18.1.5-8 RADIATOR FLOW CONTROL ASSEMBLY (RFCA)

THE RFCA IS CONSIDERED LOST IF:

A. FAILED IN RADIATOR BYPASS POSITION.

The radiator, as a heat rejection source, is unusable. Therefore, the RFCA is considered lost.

DOCUMENTATION: N/A, engineering judgment.

B. UNABLE TO MAINTAIN CONTROLLER OUTLET TEMPERATURE > 32 DEG (35 DEG) F.

The potential exists for freezing the FES water spray valves, the ARS water coolant loops, and the payload water loop (if installed) if the RFCA cannot maintain > 32 deg F control.

DOCUMENTATION: N/A, engineering judgment.

C. CANNOT MAINTAIN EVAPORATOR OUTLET TEMPERATURE < 65 DEG F WITH THE FES DISABLED.

The SODB requires the maximum temperature of air entering the avionics boxes to be less than 95 deg F and less than 130 deg F at the outlet of the boxes. At a 65 deg F evaporator outlet temperature with flow proportioning valves of both Freon loops configured to the ICH position and H₂O loop flowrate adjusted to full interchanger flow, analyses indicate that these limits will not be violated for a normal on-orbit ARS heat load (seven crewmembers, one GPC per avionics bay, etc.) in a 14.7 psia cabin environment. Powering up an additional GPC in the avionics bay will raise the measured outlet air temperature by approximately 10 deg to 15 deg F. This will cause frequent temperature excursions over the 130 deg F limit at the box outlet, leaving little or no margin for the operation of additional equipment in the same avionics bay. Since adequate thermal control cannot be maintained for a fully powered ARS when evaporator outlet temperatures are greater than 65 deg F, the RFCA is considered lost.

DOCUMENTATION: 283-440-84-005; STS85-0245; JSC-08934, 4.6.1.

Rule {A18.1.6-5B}, RADIATOR FLOW CONTROL ASSEMBLY (RFCA), references this rule.

FLIGHT RULES

ATCS MANAGEMENT

A18.1.6-1 FREON COOLANT LOOPS (FCL)

- A. BOTH FCL'S, WITH ONE PUMP OPERATING IN EACH FCL, ARE REQUIRED FOR NORMAL OPERATIONS.

To operate with only one FCL on orbit could require a minor powerdown (to 15 kW) and would require the use of the FES or flying in a cold attitude. If -ZLV (the most common attitude) is flown, a negative net H₂O storage rate would exist. To eliminate these types of constraints and issues, both FCL's are operated.

DOCUMENTATION: SEH-ITA-80-054T.

- B. THE FOLLOWING TEMPERATURES SHALL NOT BE EXCEEDED:
1. FOR ASCENT/ENTRY (RADIATORS BYPASSED): 140 DEG (132 DEG) F AT RADIATOR INLET.
 2. ON-ORBIT (RADIATORS IN FLOW):
 - a. 65 DEG (60 DEG) F AT EVAPORATOR OUTLET FOR NO FES OPERATIONS (BOTH LOOPS IN ICH POSITION).
 - b. 68 DEG (63 DEG) F AT RADIATOR OUTLET FOR FES OPERATIONS.

In all cases (pre-lift-off, while on orbit, and pre-deorbit) orbiter power levels are planned to ensure that these limits are not exceeded.

The maximum capability of the FES (full up mode) is 148,000 Btu/hr (test data). This is equivalent to a 140 deg F radiator inlet temperature.

The SODB requires the maximum temperature of air entering the avionics boxes to be less than 95 deg F and less than 130 deg F at the outlet of the boxes. At a 65 deg F evaporator outlet temperature with flow proportioning valves of both Freon loops configured to the ICH position and H₂O loop flowrate adjusted to full interchanger flow, analyses indicate that these limits will not be violated for a normal on-orbit ARS heat load (seven crewmembers, one GPC per avionics bay, etc.) in a 14.7 psia cabin environment. Powering up an additional GPC in the avionics bay will raise the measured outlet air temperature by approximately 10 deg to 15 deg F. This will cause frequent temperature excursions over the 130 deg F limit at the box outlet, leaving little or no margin for the operation of additional equipment in the same avionics bay.

The maximum capability for the topping evaporator is 39,000 Btu/hr (SODB, based on test data). This is equivalent to a 68 deg F radiator outlet temperature.

DOCUMENTATION: SEH-ITA-81-107; 283-440-84-005; STS85-0245; JSC 08934, 4.6.1.

FLIGHT RULES

THIS RULE CONTINUED ON NEXT PAGE

FLIGHT RULES

A18.1.6-1 FREON COOLANT LOOPS (FCL) (CONTINUED)

C. IF IT IS REQUIRED TO DEACTIVATE AN OPERATING FCL OR BYPASS A RADIATOR:

1. THE ASSOCIATED RADIATOR WILL BE STOWED.

Stowing the radiators prevents Freon freezing (except in total deep space attitudes).

DOCUMENTATION: SODB **TBD** (request submitted).

2. ATTITUDES THAT EXCLUDE EARTH OR SUN VIEWING (DEEP SPACE) WILL BE LIMITED TO NO MORE THAN 1 HOUR.

For an initial Freon temperature of -40 deg F, it will take approximately 1.5 hours for Freon to freeze. Since there is no insight into the actual temperature of the Freon in the radiators, a conservative limit of 1 hour was chosen.

DOCUMENTATION: SODB **TBD** (request submitted).

3. ORBITER ATTITUDES WILL BE MANAGED TO MAINTAIN THE ACCUMULATOR QUANTITY \geq 5 PERCENT INDICATED.

For a good FCL (not leaking), the minimum acceptable accumulator quantity is 5 percent indicated. Taking instrumentation accuracy into account, the actual quantity could be 2 percent. At 2 percent quantity, the loop can still be activated if needed in an emergency. At 0 percent quantity, thermal conditioning would be required prior to activating the FCL.

DOCUMENTATION: N/A, engineering judgment.

4. CLOSING THE AFFECTED RADIATOR'S PLBD WILL BE CONSIDERED IF ATTITUDE CONSTRAINTS CANNOT BE MET.

Closing the PLBD increases the temperature of the FCL.

DOCUMENTATION: Flight data.

THIS RULE CONTINUED ON NEXT PAGE

FLIGHT RULES**A18.1.6-1 FREON COOLANT LOOPS (FCL) (CONTINUED)**

- D. THE FLOW PROPORTIONING VALVE (FPV) IN BOTH FCL'S WILL NORMALLY BE PLACED IN THE "ICH" POSITION FOR ALL PHASES OF FLIGHT. EITHER OR BOTH FPV'S MAY BE PLACED IN "P/L" IF A PAYLOAD REQUIREMENT EXISTS.

Placing the FPV's in the ICH position maximizes the Freon flowrate to the H₂O Freon interchanger: approximately 4800 lb/hr in the ICH position vs. approximately 3000 lb/hr in the P/L HX position. This maximizes cooling to the cabin and avionics bays via the water loop. However, placing both loops in the P/L position does not increase the temperatures a significant amount (5 deg to 7 deg F).

DOCUMENTATION: Flight data.

- E. THE FPV IN BOTH FCL'S WILL BE PLACED TO THE "ICH" POSITION IF BOTH THE EVAPORATOR OUTLET TEMPERATURES ARE < 32 DEG (34.4 DEG) F. IF THE PAYLOAD LOOP DOES NOT CONTAIN WATER, A REAL-TIME CALL WILL BE MADE TO PLACE BOTH FPV'S TO THE "P/L" POSITION.

This will prevent or delay the freezing of the payload and orbiter water loops. Provided that both orbiter water loops and a 500 lb/hr flowrate payload water loop (if installed) are flowing, the ICH position provides orbiter water loop freeze protection for Freon temperatures as low as 6 deg F, and payload water loop protection for Freon temperatures as low as -30 deg F (extrapolated). If left in the P/L position, the payload water loop would freeze at Freon temps of 32 deg F and the orbiter water loops at -30 deg F (extrapolated) Freon temperatures. For payload flowrates <150 lb/hr, the payload water loop will freeze eventually, but is delayed if the FPV is placed in the ICH position.

DOCUMENTATION: Lockheed analysis, LEMSCO 19630.

- F. IF AN FCL IS DEACTIVATED, THE ASSOCIATED PRESSURE CONTROL O₂ SYSTEM (PCS) SUPPLY VALVE WILL BE CLOSED.

If the FCL is deactivated, Freon in the stagnant loop will freeze if O₂ is flowing (cryogenic O₂ temperature is -254 deg F). Since the O₂ is no longer being warmed by the Freon, the O₂ restrictor seal will leak when exposed to the cryogenic temperatures. Normal flow of O₂ is 0.5 lb/hr for crew metabolic usage. For 0.1 lb/hr O₂ flow, the stagnant FCL will freeze in 10 minutes. For a 10 lb/hr flowrate the FCL will freeze in 100 seconds. Lab test results indicate that the O₂ restrictor seal will leak when exposed to -100 deg to -240 deg F temperatures. The leak will stop when the temperature gets above -47 deg F.

DOCUMENTATION: SEH-ITA-80-236T; LTR 4309-3101.

THIS RULE CONTINUED ON NEXT PAGE

FLIGHT RULES

A18.1.6-1 FREON COOLANT LOOPS (FCL) (CONTINUED)

- G. FOR A FREON-TO-WATER LOOP LEAK, THE RADIATORS WILL NOT BE COLDSOAKED FOR ENTRY AND ATTITUDES THAT EXCLUDE EARTH OR SUN VIEWING (DEEP SPACE) WILL BE AVOIDED.

For a Freon-to-water loop leak, it is possible to get water into the Freon. Coldsoaking the Freon increases the chances of freezing this water, which may affect the performance of the Freon loop. This risk outweighs the gain of a coldsoak. It is not likely that water will be introduced into the Freon loop until the pressures in the two loops equalize; therefore if coldsoak starts before the leak occurs, it should be stopped anytime before the affected water loop's accumulator quantity reaches 100 (97) percent. The radiator controllers should be returned to the norm set point, and to avoid decreasing the Freon temperature in the radiators, deep space attitudes should be avoided.

DOCUMENTATION: N/A, engineering judgment.

- H. IF AN FCL'S RFCA IS FAILED IN BYPASS (MINIMUM RADIATOR FLOW), THE AFFECTED FCL WILL BE DEACTIVATED, AND A POWERDOWN TO AT LEAST 15 KW WILL BE PERFORMED. THE FCL WILL BE REACTIVATED FOR DEORBIT PREPARATION.

An RFCA, failed in bypass or minimum radiator flow, will result in negative H₂O production if the FES is activated, or temperature violations if the FES is deactivated. Deactivating the FCL will alleviate these problems and only requires a powerdown to 15 kW. (Also reference paragraphs C and F.)

DOCUMENTATION: SEH-ITA-80-054T; SEH-ECS-86-102T.

- I. FOR AN EXTERNAL FREON LEAK (INCLUDING FREON TO HYDRAULIC), WHICH WILL NOT SUPPORT NEXT PLS, THE AFFECTED LOOP WILL BE DEACTIVATED IN AN ATTEMPT TO SLOW THE LEAK RATE FOR USE DURING ENTRY.

Deactivating the pump decreases pressure around the loop, slowing most leaks. This is done to save the loop for deorbit/entry. Reactivating the affected Freon loop for entry would allow a full powerup and opening of the associated O₂ supply valve required to provide an adequate O₂ source for greater than four crewmembers on LES.

DOCUMENTATION: Engineering judgment.

Rule {A18.1.4-1C}, ARS WATER LOOP, references this rule.

FLIGHT RULES

A18.1.6-2 FLASH EVAPORATOR SYSTEM (FES)

- A. NO MORE THAN ONE FES CONTROLLER SHALL BE ACTIVATED AT ANY TIME.

If two controllers are activated, both may pulse water when required thereby providing an increased rate of cooling. This will most likely result in an FES undertemperature shutdown or a freezeup of the FES core.

DOCUMENTATION: Flight data STS-51-B.

- B. FOR INITIAL TROUBLESHOOTING OF ON-ORBIT FES SHUTDOWNS, ONLY ONE RESTART ON EACH PRIMARY CONTROLLER WILL BE ATTEMPTED. DURING ASCENT OR ENTRY, THE SECONDARY CONTROLLER WILL BE ACTIVATED IF RESTARTS ON THE PRIMARY CONTROLLERS WERE UNSUCCESSFUL.

Repeated FES restarts after an unexplainable FES shutdown may add ice in the core if icing was the initial cause of the shutdown. Minimizing the number of restarts to one per controller minimizes de-icing time on orbit. During high heat load periods such as ascent or entry, every effort should be made to avoid vehicle overtemperature. Therefore, it is worth the risk to make another attempt using the secondary controller. The alternative is to open the PLBD post-OMS-1 or to establish radiator flow during entry.

DOCUMENTATION: Flight data; engineering judgment.

- C. THE HIGH-LOAD EVAPORATOR CONTROL SWITCH WILL BE PLACED IN THE "OFF" POSITION DURING ORBITAL OPERATIONS WHEN RADIATOR COOLING IS VERIFIED (CONTROLLER OUTLET TEMPERATURE < 68 DEG (62.8 DEG) F).

The high-load evaporator is unstable at low heat loads and will cause an FES shutdown under these conditions. This has been seen on several flights. The topping evaporator can maintain < 40 deg F evaporator outlet temperature for a maximum FES inlet temperature of 68 deg F (39,000 Btu/hr). Also, in disabling the high-load evaporator, the orbiter can maintain attitude control with the vernier RCS jets instead of the primary jets (minimizes propellant usage). Jet duty cycle is also a concern if VRCS is used for attitude control while in high load operations.

DOCUMENTATION: Flight data.

THIS RULE CONTINUED ON NEXT PAGE

FLIGHT RULES**A18.1.6-2 FLASH EVAPORATOR SYSTEM (FES) (CONTINUED)**

- D. THE TOPPING EVAPORATOR WILL BE USED WITH A PRIMARY CONTROLLER TO SUPPLEMENT RADIATOR COOLING AND MAY BE USED FOR DUMPING EXCESS FC WATER ON ORBIT.

The topping evaporator will maintain a stable evaporator outlet temperature when the radiators cannot control to < 41 deg F. The topping evaporator is used particularly when the orbiter is in a "warm" radiator attitude and the payload requires low temperatures or steady temperatures. Flight Rule {A18.1.2-5}, SUPPLY WATER DUMP, covers dumping of FC water. The secondary controller which controls the evaporator outlet temperature of 62 deg F cannot normally be used since the radiator outlet temperatures are normally less than 62 deg F. The FES is normally on for either a payload need or for 10.2 psi cabin operations, both of which require considerably less than a 62 deg F Freon temperature.

DOCUMENTATION: N/A, engineering judgment.

- E. FES DUCT TEMPERATURES MUST BE GREATER THAN THE MINIMUM VALUES LISTED BELOW PRIOR TO FES STARTUP, EXCEPT FOR TIME-CRITICAL DEORBITS:

	<u>DUCT (DEG F)</u>
1. HIGH-LOAD - INBOARD, OUTBOARD	150 (170)
2. TOPPING - FORWARD, AFT	100 (120)

These temperatures ensure that, as the FES boils water, the duct is sufficiently warm so that the water vapor does not condense and begin to freeze in any portion of the FES outlet ducting.

DOCUMENTATION: Hamilton Standard SEM #62449.

- F. FES ICING @[082593-1528]
1. THE FES SHOULD NOT BE OPERATED WITH THE SUPPLY WATER TANKS VENTED UNLESS ABSOLUTELY NECESSARY TO STAY WITHIN ORBITER OR PAYLOAD CONSTRAINTS.

THIS RULE CONTINUED ON NEXT PAGE

FLIGHT RULES

A18.1.6-2 FLASH EVAPORATOR SYSTEM (FES) (CONTINUED)

2. A FES CORE FLUSH CAN BE ATTEMPTED AFTER SUSPECTED ICING. THE PREFERRED METHOD IS TO BYPASS THE RADIATORS USING THE FLOW CONTROL VALVES AND THEN USE THE SECONDARY FES CONTROLLER TO FLUSH ICE FROM THE CORE.

Vendor test results show that even at a pressure of 20 psia, ice can build up in the topping core. This was especially evident at heat loads between 23 and 32 kBtu/hr; however, even at lower heat loads, icing is possible. When the tanks are vented to cabin pressure (15.0 psia or less), there is increased risk of building ice in the topping core. During STS-55, the FES operated with the radiator set point in HI, water dump mode (24.3 kBtu/hr), successfully for 10.1 hours while the tanks were vented to 14.7 psia. It continued to operate normally in and out of standby with the radiator set point in NORM and heat loads between 0 and 17.5 Btu/hr. When a second dump was attempted, the FES overtemp shut down after 2.3 hours due to icing. Even after repressurizing the water tanks, the FES could not be restarted. It was suspected that the ice build up was gradual, interfering with the FES's capability to function and finally resulting in the shutdown.

The ice was later removed using a topping core flush procedure proven during SESL testing which had the Freon loop radiators bypassed, inducing a high heat load, and cycling the secondary FES controller. If the FES is used with the tanks vented for any reason and icing causes a FES shutdown, this flush procedure could be used at the earliest available time to flush the core and resume normal FES operations as required. If possible, the radiator set point should be left in HI to help thaw the core; however, this is not required prior to performing the flush procedure. User of the flow control valves is preferred to minimize the risk encountered during radiator bypass.

DOCUMENTATION: STS-55 mission data; Hamilton Standard SESL Test Data documented in Internal Correspondence Letter: SPACE SHUTTLE ORBITER Flash Evaporator Program, Justification for Increased Feedwater Pressure and Addition of an Accumulator to the Vehicle Feedwater System, February 15, 1978 (analysis 78-37, File 2.16.2).

- G. IF ICING IS SUSPECTED IN AN EVAPORATOR CORE DURING ASCENT, THE SECONDARY CONTROLLER WILL BE SELECTED ON BOTH CORES (AND ALTERNATE FEEDLINE, IF REQUIRED, ON THE SECONDARY HI LOAD) PRIOR TO RADIATOR ACTIVATION IN AN ATTEMPT TO FLUSH THE CORES AND PROVIDE DIAGNOSTIC INFORMATION.

FLIGHT RULES

During STS-26, FES shutdowns occurred during 38 to 55 minutes MET. Both primary controllers were selected and repeatedly shut down. The secondary topper was selected and appeared to operate nominally. A postlanding inspection indicated corrosion in the topping core surface which degraded the evaporation process and gave ice a foothold. Use of the secondary controller cleared the ice out of the topping core (secondary topper uses both A and B H₂O spray nozzles alternately, has no shutdown feature, and operates at a higher control temperature), but the high load core, which was considered suspect, was not tested until the radiator bypass FES checkout toward the end of the flight. An earlier indication of system status is preferred.

THIS RULE CONTINUED ON NEXT PAGE

FLIGHT RULES

A18.1.6-2 FLASH EVAPORATOR SYSTEM (FES) (CONTINUED)

After radiator activation, the secondary controller will not operate, since radiator output temperature will be below the secondary control temperature. Flushing the core with secondary controller would require bypassing the radiators on orbit.

DOCUMENTATION: STS-26 Flight Data, engineering judgment.

H. THE FES FEEDLINE A(B) HEATERS WILL BE DEACTIVATED IF THE HIGH-LOAD LINE TEMPERATURE EXCEEDS 250 DEG F (OSH) FOR 1 HOUR AND THE ACCUMULATOR LINE TEMPERATURE FOR FEEDLINE A(B) IS NOT CYCLING. THE ALTERNATE HEATERS MAY BE SELECTED. IF THE ACCUMULATOR LINE TEMPERATURE INDICATES THAT THE THERMOSTAT IS DITHERING, HEATER OPERATION CAN CONTINUE SO LONG AS THE ACCUMULATOR LINE TEMPERATURE IS WITHIN THE NORMAL CONTROL BAND. @[092195-1790A]

FES feedline A and B high-load line temperatures (V63T1895A and V63T1896A) have exceeded the upper limit of 250 deg F during several missions with no adverse effects. If the 250 deg F limit is exceeded for extended periods (> 1 hour), however, the water in the feedline may boil to such an extent that damage could result. This could cause a vapor barrier in the line and possible heater burnout or FES shutdown when the high-load evaporator is used for entry. Heater failure will occur at a line temperature of 400 deg F. This will be reached approximately 1 hour after exceeding 250 deg F with a failed-on heater. The accumulator line heater and the high-load line heater are controlled by the same thermostat. The accumulator line temperatures A (V63T1892A) and B (V63T1894A) indicate that the associated thermostat is operating properly. If the accumulator line temperature indicates that the thermostat is dithering, operation of the heaters can continue. Flight experience from STS-68 with a dithering thermostat showed no overheating damage after 8 hours of operation. The dithering thermostat is acceptable, provided that the thermostat is not constantly on at a temperature near the upper limit of the normal control band. @[092195-1790A]

DOCUMENTATION: Flight data and MER-SPAN Mission Action Requests 26 for STS 41-D and 13 for STS 61-A. document the acceptability of exceeding the 250 deg F limit for 1 hour. STS-68 PR #PV6-275540 (IFA #5, EICN ECL-5-08-0398) indicates that no damage or evidence of overheating were found during postflight inspection and replacement of dithering thermostat. @[092195-1790A]

THIS RULE CONTINUED ON NEXT PAGE

FLIGHT RULES

A18.1.6-2 FLASH EVAPORATOR SYSTEM (FES) (CONTINUED)

- I. IF A 1-DAY WAVE-OFF IS DECLARED AFTER RADIATOR BYPASS, THE TOPPING EVAPORATOR WILL BE DEACTIVATED, AS REQUIRED, DURING THE EXTENSION DAY. DISABLING THE FES WILL TAKE PRECEDENCE OVER ANY FES REQUIREMENT FOR PAYLOAD OPERATIONS BEING CONSIDERED FOR THE EXTENSION DAY. CONSIDERATION WILL BE GIVEN TO ENABLING THE FES WHEN/IF SUPPLY H₂O QUANTITIES ARE SUFFICIENT TO SUPPORT FUTURE DEORBIT OPPORTUNITIES.

After the radiators have been bypassed, the FES is the sole means of vehicle cooling. During this time, the net H₂O rate is approximately -55 lb/hr. If a wave-off is called after the radiator panels have been bypassed, supply H₂O quantities may not support multiple deorbit opportunities at a later time. Disabling the FES and allowing the radiators to maintain vehicle cooling during extension days will allow supply H₂O quantities to increase so that future deorbit opportunities may be supported. Maximizing deorbit opportunities is a high priority than conducting unplanned payload operations on extension day.

DOCUMENTATION: Engineering judgment.

A18.1.6-3 AMMONIA BOILER SUBSYSTEM (ABS)

- A. IF RADIATORS HAVE BEEN COLD SOAKED, BOTH NH₃ CONTROLLERS WILL REMAIN OFF, EXCEPT WHEN REQUIRED FOR ENTRY COOLING BELOW 120K FEET. WHEN RADIATOR HEAT SINK CAPACITY IS DEPLETED, ONE NH₃ CONTROLLER WILL BE ACTIVATED. THE ALTERNATE CONTROLLER WILL BE ACTIVATED WHEN THE FIRST SYSTEM IS DEPLETED.

If the radiators are coldsoaked in deorbit preparation, the radiators can provide adequate cooling from FES deactivation to touchdown. Also, since NH₃ is a consumable which can be depleted, leaving the NH₃ system off until the radiator heat sink capacity is depleted will maximize orbiter cooling capability postlanding (length of time) until GSE cooling carts can be connected to the orbiter.

- B. THE ABS MAY BE ACTIVATED POST-EI IF ADDITIONAL COOLING IS REQUIRED.

For the ABS to operate, enough gravitational force is required in the relative direction of the tank outlet to keep the NH₃ at the outlet and not allow the helium pressurant to escape first (NH₃ tanks do not have a bladder system). The vehicle orientation combined with the gravitational force is correct for ABS activation for altitudes of 400k feet (EI) or less. Therefore, if cooling is required (no radiator coldsoak, no FES, etc.), the ABS is operable post-EI and may be used.

DOCUMENTATION: SODB 3.4.6.3-2B.

FLIGHT RULES

THIS RULE CONTINUED ON NEXT PAGE

FLIGHT RULES

A18.1.6-3 AMMONIA BOILER SUBSYSTEM (ABS) (CONTINUED)

C. FOR A LOST/DEGRADED FCL:

1. IF AN FCL IS TOTALLY LOST (E.G., NO FLOW), ITS ASSOCIATED ABS CONTROLLER WILL BE DEACTIVATED AND NOT REACTIVATED. IN THE EVENT NO OTHER COOLING IS AVAILABLE DURING ENTRY, THE ABS WILL BE REACTIVATED AND MANUAL CYCLING MAY BE REQUIRED TO PREVENT WATER LOOP FREEZING.

NH3 system A controller uses three temperature sensors on the FCL 1 outlet line while NH3 system B controller uses three sensors on the FCL 2 outlet. If FCL 1(2) is lost and NH3 A(B) controller is selected, the temperature at the control sensors of the lost loop will not provide proper control of the cooling. This will result in the ABS flowing NH3 at whatever rate the inoperative sensors demand, which may result in too much cooling, thus undertemping the active loop, or too little cooling, causing an overtemperature condition. Some manual cycling of the NH3 controller while observing the evaporator outlet temperature may be possible, but should be used only if no other cooling options exist.

DOCUMENTATION: N/A, system schematic analysis.

2. FOR A DEGRADED FCL IF THE DIFFERENCE IN TOTAL FLOW BETWEEN THE TWO FCL'S IS > 450 LB/HR, THE DEGRADED FCL'S NH3 SYSTEM WILL BE SELECTED IF COOLING IS REQUIRED.

For a difference in total flow between the two FCL's of greater than 450 lb/hr, activating the good loop NH3 system will result in NH3 system outlet temperatures < 32° F. This can cause freezing of low flowrate payload water loops and rupture of the payload heat exchanger.

DOCUMENTATION: SEH-ECS-85-052T.

- #### D. NH3 CONTROLLERS WILL BE ALTERNATED FLIGHT TO FLIGHT FOR POSTLANDING COOLING, WHEN PRACTICAL, SO THAT EACH OF THE FOUR IS USED AT LEAST ONCE EVERY FOUR FLIGHTS (TO SATISFY STEP). ABS SECONDARY MODE OPERATION WILL BE SELECTED ONLY WHEN DATA TO THE GROUND AND VOICE COMMUNICATION ARE AVAILABLE.

FLIGHT RULES

NH3 controller alternation is implemented to accomplish periodic checkout of the secondary controllers, which is a program requirement but results in an unacceptable impact to vehicle turnaround if done postflight (KSC checkout). Secondary mode operation on the ABS is attended by slightly higher risk due to the design of the undertemperature protection, such that an ABS failure causing undertemperature results in an automatic switchover from the primary to the secondary, but not from secondary to primary. For this reason, the secondary controller should be selected only when data and communication are available so that ground controllers have visibility into and can react quickly to any ABS problem that might develop.

DOCUMENTATION: MD3/84-20; DF/83-178.

A18.1.6-4 ABS AMMONIA REDLINE

ABS AMMONIA - THERE IS NO REQUIREMENT FOR NH3 AFTER ORBIT INSERTION.

There is no requirement for NH3 after nominal orbit insertion. The FES and radiators are used for orbit and entry cooling. The NH3 boiler is not required until post-rollout and an emergency powerdown can be performed if NH3 is not available. The ammonia boiler is required for launch aborts since the radiators cannot be coldsoaked in these cases. Therefore, after nominal ascent and insertion have been completed, there is no requirement for the NH3 boiler.

DOCUMENTATION: Flight data.

A18.1.6-5 RADIATOR FLOW CONTROL ASSEMBLY (RFCA)

A. ASCENT OPERATIONS:

1. THE RADIATORS WILL BE BYPASSED FOR ASCENT, EXCEPT IN CASE OF LOSS OF FES OPERATION.

The radiators are used as a backup heat sink in case of loss of topping, high-load, or total FES during ascent. If the radiators are not bypassed for launch, this heat sink would not be available. There are also some ground problems with launching in radiator flow. Should radiator flow be initiated with the GSE cooling system still connected (anytime the vehicle is on the pad, pre-lift-off, or during a launch hold), the GSE cannot react quickly enough to the decreased heat load. This could result in very low orbiter Freon temperatures. For these reasons radiator flow prior to lift-off is not attempted.

DOCUMENTATION: SEH-ITA-83-OI7T.

2. IF THE TOTAL FES FAILS, RADIATOR FLOW WILL BE INITIATED.

FLIGHT RULES

During ascent, the FES is the only means of cooling the vehicle. If the total FES is lost, radiator flow is initiated for cooling. This takes advantage of any coldsoak that exists in the radiators. If only one evaporator is lost, the secondary controller can be used with the good evaporator core. Flight data from STS-26 showed that the secondary topper can handle nominal ascent loads and control to 62 deg F.

DOCUMENTATION: SEH-ITA-81-107, SEH-ITA-80-047T, and STS-26 flight data.

THIS RULE CONTINUED ON NEXT PAGE

FLIGHT RULES

A18.1.6-5 RADIATOR FLOW CONTROL ASSEMBLY (RFCA)
(CONTINUED) @ED]

3. IF THE RADIATOR BYPASS VALVE FAILS IN BYPASS (NOT IN TRANSIT) DURING RADIATOR FLOW INITIATION, THE ALTERNATE CONTROLLER WILL BE SELECTED. IF THE ALTERNATE CONTROL-LER IS INOPERATIVE OR THE VALVE WAS FAILED IN TRANSIT, ATTEMPTS WILL BE MADE TO MANUALLY POSITION IT TO FULL RADIATOR FLOW. IF THE VALVE REMAINS IN AN INTERMEDIATE POSITION OR WAS MANUALLY POSITIONED TO FULL RADIATOR FLOW, THE CONTROLLER AC CB'S WILL BE OPENED AND CONSIDERATION GIVEN TO ATTITUDE CONSTRAINTS FOR UNDER TEMPERATURE PROTECTION MEASURES ON ORBIT.

If the bypass valve fails in-transit during flow initiation, the alternate controller will not be selected since the possibility exists that the valve could be driven back to bypass (initialization sequence) and stick there. If it is already stuck in bypass, changing controllers does not increase the risk. For either case, attempts should be made to drive the valve manually to radiator flow so that proper cooling from both FCL's is available. Opening the controller ac circuit breaker ensures that the valve will not be inadvertently driven to bypass where it might stick (possibly permanently) causing early mission termination.

B. ON-ORBIT OPERATIONS:

1. NORMALLY, THE RADIATORS WILL BE LEFT IN THE STOWED POSITION BUT MAY BE DEPLOYED IF ANY OF THE FOLLOWING CONDITIONS EXIST:
 - a. IF THE AVERAGE NET WATER STORAGE RATE IS ≤ 0 AND/OR THE SUPPLY WATER QUANTITY REDLINE WILL BE VIOLATED BASED ON EXPECTED WATER STORAGE RATES.
 - b. IF MINIMIZING FES OPERATION, FROM A PAYLOAD STANDPOINT, IS DESIRED.

THIS RULE CONTINUED ON NEXT PAGE

FLIGHT RULES**A18.1.6-5 RADIATOR FLOW CONTROL ASSEMBLY (RFCA)****(CONTINUED) @ED]**

- c. IF AN EVAPORATOR OUTLET TEMPERATURE WILL RESULT IN VIOLATION OF AN ORBITER OR PAYLOAD LIMIT WHEN THE FES CANNOT BE OPERATED.

The radiators normally remain stowed. If deployed, and a failure occurs such that the radiators cannot be stowed, an EVA would be required to cut the radiator deploy/stow linkage to allow the EVA crewmember to manually stow the radiator. The PLBD will not close if the radiator is deployed. Deploying the radiators, in most attitudes, increases cooling capacity by utilizing additional surface area. Therefore, if present cooling capabilities are not adequate or if FES usage is great enough to jeopardize mission success/completion, any available cooling capacity should be used. See also the rationale for Rule {A18.1.5-8C}, RADIATOR FLOW CONTROL ASSEMBLY (RFCA).

DOCUMENTATION: N/A, engineering judgment.

2. THE RADIATOR PANEL OUT TEMPERATURES SHOULD NOT BE ALLOWED TO DECREASE BELOW -90 DEG F (-85 DEG F) TO PROTECT AGAINST WATER CONTENT COMING OUT OF SOLUTION AND FREEZING. IF THIS VIOLATION OCCURS, ACTION WILL BE TAKEN TO INCREASE THE TEMPERATURES IN THE RADIATORS.

The SODB (volume 1, table 3.4.6.3-1) lists the minimum operating temperature for the RFCA at -85 deg F. This limit protects up to 20 ppm of water content in Freon and allows for cold spots in the radiators. The maximum allowable H₂O content in the Freon loops is 15 ppm. Data indicates that, at approximately -93 deg F, 15 ppm moisture precipitates as ice crystals. If this temperature is exceeded, ice crystals can form and damage the temperature sensor and cause flow loss by collecting on RFCA filters. The -90 deg F limit was added to protect against the maximum allowable limit of H₂O in Freon 21 (15 ppm) and to give the operations team some margin in mission planning. The -90 deg F temperature has only been exceeded once in flight (STS-35). It is believed that, since the -90 deg F protects the allowable content of H₂O from freezing and would rarely be reached, the -90 deg F limit would protect the RFCA and not impact the mission timeline. Since the radiator panel out temperatures are the inlet temperatures to the RFCA, this limit must be protected. Actions may include stowing radiators, positioning radiators to normal, and an attitude change. The -85 deg F is the limit without transducer error included. Due to the large range of the RAD PNL out temperature transducer (-250 deg to 400 deg F) a 5 percent error would make the lower limit (-53 deg F) unreasonable. Flight experience has shown that the transducer has performed better than the 5 percent error allowed.

DOCUMENTATION: JSC-08934, 3.4.6.3-1, RI IL No. 287-203-90-090.

THIS RULE CONTINUED ON NEXT PAGE

FLIGHT RULES

A18.1.6-5 RADIATOR FLOW CONTROL ASSEMBLY (RFCA)

(CONTINUED) @ED]

C. ENTRY OPERATIONS:

1. IF VEHICLE STATUS PERMITS, THE RADIATORS WILL NORMALLY BE COLD SOAKED 1 HOUR PRIOR TO PLBD CLOSURE BY PLACING THE RADIATOR CONTROLLER IN THE HIGH TEMPERATURE CONTROL MODE, AND THEN BY BYPASSING THE RADIATORS AT PLBD CLOSURE.

This coldsoak provides heat sink capacity which may be used in a nominal entry to delay ABS activation until post-rollout, or which may be used in the event of a FES failure to provide some cooling prior to the availability of the ABS at entry interface. The radiator controller is placed in the high temperature control mode instead of bypassing the radiators in order to conserve both supply water and propellant. Greater than 1 hour is acceptable in the normal cold soak attitude and configuration.

DOCUMENTATION: SEH-ITA-85-001T.

2. IF, DUE TO AUTO CONTROLLER PROBLEMS, THE BYPASS VALVE HAS BEEN MANUALLY POSITIONED IN "RAD FLOW" PRIOR TO DEORBIT, OR IF THE BYPASS VALVE IS STUCK IN TRANSIT, ATTEMPTS WILL NOT BE MADE TO POSITION IT TO "BYPASS" AT PLBD CLOSURE.

If positioned to "bypass," the valve could permanently stick and radiator flow could not be initiated. For loss of FES or partial loss of FES, radiator flow is required.

DOCUMENTATION: N/A, engineering judgment.

3. RADIATOR FLOW WILL NORMALLY BE INITIATED AT V = 12K FPS (APPROXIMATELY 75K FEET) AND NO LATER THAN 130K FEET. RADIATOR FLOW MAY BE INITIATED EARLIER IF REQUIRED.

Once radiator flow is initialized, 90 seconds must pass before the valves go to the flow position. If radiator flow is initiated at 175k feet, flow will begin around 154k feet. This is prior to FES shutdown (approximately 100k to 110k feet) and eliminates thermal transients. If initiated at 130k feet, radiator flow will begin around 110k feet, or right at FES shutdown. Radiator flow can be initiated earlier in contingency situations.

DOCUMENTATION: Flight data.

4. IF EITHER RFCA AUTOMATICALLY BYPASSES WHEN RADIATOR FLOW IS INITIATED, THAT CONTROLLER WILL BE CYCLED ONCE.

FLIGHT RULES

This situation occurred on past flights where certain conditions (a warm slug of fluid immediately followed by a cold slug of fluid) caused the controller logic to bypass the radiators. Procedures were changed to alleviate this condition; however, should it exist, cycling the controller one time remedies this situation.

DOCUMENTATION: Flight experience.

FLIGHT RULES

EECOM HEATER MANAGEMENT

A18.1.7-1 TCS HEATER CONFIGURATION

A. THE FOLLOWING HEATERS WILL BE ENABLED FOR LIFT-OFF:

1. FES TOP NOZZLE (LEFT AND RIGHT) @[ED]
2. FUEL CELL RELIEF LINE
3. FES TOPPING AND HIGH-LOAD DUCT
4. FUEL CELL WATER LINE

NOTE: IN ALL CASES, UNLESS THERMAL CONDITIONS REQUIRE OTHERWISE, ONLY A SINGLE HEATER SYSTEM WILL NORMALLY BE ENABLED.

FES heaters are activated prior to lift-off and remain on through lift-off to ensure that duct temperatures are high enough to prevent freezing of the water vapor in the ducts upon FES activation. Nozzle heaters are not required for nominal situations, but are desired in case of high FES carryover.

For the fuel cell relief line heater and water line heater, see Rule {A9.1.2-3}, FC H₂O SYSTEM HEATERS.

DOCUMENTATION: HAMILTON STD. SEM 62449.

B. THE FES FEEDLINE HEATERS WILL BE ENABLED POST-OMS-1:

The feedline heaters are enabled at this time to prevent freezing of the water in these lines. With PLBD's open it is estimated that in a cold attitude these lines will freeze in approximately 45 minutes and in a warm attitude in approximately 1.5 hours.

DOCUMENTATION: ES2-81-256M.

C. THE FOLLOWING HEATERS WILL BE ENABLED AFTER SEAT EGRESS:

1. VACUUM VENT NOZZLE
2. SUPPLY/WASTE/VACUUM VENT LINE
3. EXTERNAL AIRLOCK STRUCTURAL AND WATER LINE @[061297-4904]

Prelaunch PLB thermal conditioning maintains proper temperatures; therefore, the associated heaters are not required. As a general guideline, power not required for ascent is inhibited from use. The heaters should be enabled as soon as practical once on orbit so possible freezing water will not become a concern when the PLBD's are opened and so the WCS can be used normally, if required.

FLIGHT RULES

DOCUMENTATION: *Rockwell I.L. 270-200-95-152, Rev 1, and engineering judgment.* ©[061297-4904]

THIS RULE CONTINUED ON NEXT PAGE

FLIGHT RULES

A18.1.7-1 TCS HEATER CONFIGURATION (CONTINUED)

D. THE FOLLOWING HEATERS WILL BE ENABLED WHEN REQUIRED:

1. SUPPLY DUMP NOZZLE
2. WASTE DUMP NOZZLE
3. FUEL CELL PURGE
4. HIGH-LOAD DUCT

The high-load evaporator and high-load duct heaters are disabled on orbit. Prior to re-enabling the high-load evaporator, the duct heaters must be reactivated to prevent freezing of the water vapor in the ducts upon high-load activation.

FC purging and water dumping are normally performed only during the presleep and post sleep periods, and thus, not continuously required. Using the heaters during the overboard venting prevents the possibility of water freezing and rendering the nozzles worthless for future mandatory dumps and purges.

DOCUMENTATION: HAMILTON STD. SEM 62449 and engineering judgment.

A18.1.7-2 TCS HEATER REDUNDANCY

ALL REDUNDANT HEATERS WILL NORMALLY HAVE ONLY ONE CIRCUIT ENABLED AT A TIME.

The heaters are designed so that only one circuit is necessary.

DOCUMENTATION: Engineering judgment and flight data.

A18.1.7-3 REDUNDANT TCS HEATER VERIFICATION

AT APPROXIMATELY THE MIDPOINT IN THE FLIGHT, ALL REDUNDANT HEATERS WILL BE RECONFIGURED TO THE ALTERNATE CIRCUITS TO VERIFY SYSTEM HEALTH AND MAXIMIZE TOTAL SYSTEM OPERATING LIFETIME.

The heaters will be switched to verify that the redundant heater works. This is necessary because KSC has difficulty verifying the operation of most heaters, since ambient temperatures at the Cape will prevent automatic heater operation. The heaters are designed such that both heater circuits are encased in a common insulator. For this reason, if the "a" circuit is used exclusively and fails, then both circuits, including the circuit that has never been used, would have to be replaced. By alternating their use, total system lifetime is maximized.

FLIGHT RULES

DOCUMENTATION: N/A; system schematic analysis.

FLIGHT RULES

A18.1.7-4 **TCS HEATER OPERATIONS FOR LOSS OF INSTRUMENTATION**

IF INSTRUMENTATION IS LOST ON REDUNDANT HEATER SYSTEMS OF THE FOLLOWING COMPONENTS, BOTH SYSTEMS WILL BE OPERATED SIMULTANEOUSLY FOR THE REMAINDER OF THE FLIGHT:

- A. HIGH-LOAD FES DUCT/NOZZLE (WHILE OPERATING)
- B. TOPPING FES DUCT (FORWARD OR AFT)
- C. SUPPLY AND WASTE WATER DUMP LINES

D. EXTERNAL AIRLOCK STRUCTURAL AND WATER LINES @[061297-4904]

This is done to protect against an undetected heater failure which could cause freezing of water vapor in the duct upon FES activation and loss of FES, freezing of water in the dump lines resulting in the loss of mandatory dump capability, or freezing of water in the external airlock water lines.

The water line heaters protect against freezing of water in the externally routed airlock water lines resulting in a loss of EMU servicing and ISS water transfer. They are triply redundant; therefore, only two of the three strings are required in this scenario. Each of the two zones for the water lines have two transducers for monitoring heater performance.

The external airlock structural heaters protect against the freezing of the internally routed airlock water lines during periods when the airlock is at vacuum resulting in a loss of EMU servicing and ISS water transfer and against condensation build-up in the external airlock avionics bay where the docking avionics are installed. Each of the three structural heater zones have only one temperature transducer for the monitoring of heater performance.

DOCUMENTATION: Hamilton Standard SEM 62449; Rockwell I.L. 270-200-95-152, Rev 1, and 270-200-97-007; and engineering judgment. @[061297-4904]

A18.1.7-5 **LOSS OF HEATER SM CAPABILITY**

IF SM CAPABILITY IS LOST, BOTH SYSTEMS OF THE TOPPING FES DUCT HEATER SYSTEMS WILL BE ENABLED FOR THE REMAINDER OF THE FLIGHT.

If SM capability is lost, so is onboard alert capability for these temperatures. If a heater failed, the crew would not be alerted, causing possible loss of a critical function. Both heaters are enabled so that an undetected failure of one will not present a problem. A failed-on heater here cannot produce a high enough temperature to present a problem.

DOCUMENTATION: JSC-18549.

FLIGHT RULES

A18.1.7-6 EXTERNAL AIRLOCK HEATER LOSS MANAGEMENT

FOR LOSS OF EITHER THE EXTERNAL AIRLOCK WATER LINE HEATERS OR STRUCTURAL HEATERS, ATTITUDE MANAGEMENT WILL BE USED TO PRECLUDE FREEZING OF THE EXTERNAL AIRLOCK INTERNAL AND EXTERNAL WATER LINES. ©[061297-4904]

Loss of the external airlock water lines will result in the loss of EMU servicing and ISS water transfer capabilities.

DOCUMENTATION: Engineering judgment and Rockwell I.L. 270-200-95-152, Rev 1, and 270-200-97-007. ©[061297-4904]

FLIGHT RULES

EECOM SOFTWARE REQUIREMENT

A18.1.8-1 EECOM SOFTWARE REQUIREMENT

THE WATER LOOP GPC CYCLING MODE, FES/ABS ON-OFF COMMANDS OR ANY ECLSS COMPUTATIONS WILL NOT BE REQUIRED FOR CONTINUING ANY FLIGHT PHASE AS LONG AS MANUAL BACKUP METHODS ARE INTACT.

The GPC modes for the FES and the NH3 boiler are used only during ascent and entry to reduce the number of switch throws required by the crew during critical phases. The inactive H₂O loop is cycled periodically on orbit via the GPC mode for thermal conditioning purposes only. If the manual modes for these systems are working, the GPC modes are not required. @[\[041196-1882\]](#)

DOCUMENTATION: SEH-ITA-83-151T.

FLIGHT RULES

THIS PAGE INTENTIONALLY BLANK

FLIGHT RULES

TPS BONDLINE TEMPERATURES MANAGEMENT

A18.1.9-1 THERMAL PROTECTION SYSTEM (TPS) BONDLINE TEMPERATURES

- A. ORBITER ATTITUDE WILL BE MANAGED TO MAINTAIN BONDLINE TEMPERATURES AT GREATER THAN -170 DEG (-137.5 DEG) F AND LESS THAN THE MAXIMUM ENTRY INTERFACE TEMPERATURES, DEFINED IN PARAGRAPH B.

The minimum temperature of -170 deg F corresponds to the temperature at which glassy transition occurs on the RTV (becomes brittle). Maximum allowable entry and postlanding bondline temperatures are dependent on the type of structure underlying the TPS, and on structural thermal stress limits, as follows:

a. *Underlying Material Limits:*

- (1) ALUMINUM 350 deg F. (400 deg F or greater) is a lifetime constraint.
- (2) GRAPHITE EPOXY SKIN
 - (a) OMS POD 250 deg F (presumes water ingestion into the laminated skin)
 - (b) PLBD 350 deg F

DOCUMENTATION: SODB, Table 3.4.1.3; Shuttle Vehicle Systems Temperature Limits and STS Operational Flight Rules Review Meeting; RI IL SAS-TA-P/C/TCS-87-031; and RI IL SETO-TCS-87-066-RI, On-Orbit Thermal Constraints Summary, Revision 1.

b. *Structural Stress Limits:*

Midbody structural stress is generated by temperature gradients present in the vehicle. Bondline temperatures are used to determine the magnitude of the gradients and therefore the amount of structural stress. Limits have been established for the bondline temperatures, and exceeding these limit could result in less than 1.4 factor of safety for design entry loads. ©[030994-1598A]

THIS RULE CONTINUED ON NEXT PAGE

FLIGHT RULES**A18.1.9-1 THERMAL PROTECTION SYSTEM (TPS) BONDLINE
TEMPERATURES (CONTINUED)**

Predicted values for bondline temperatures are calculated by the Simplified Thermal Evaluation Program (STEP) analyses based on actual and predicted vehicle attitudes during the mission. Accuracy of STEP has been determined by comparing calculated temperatures to past flight data. Resulting delta-temperature biases needed to correct each bondline MSID have been tabulated. To complete a STEP analysis, the appropriate biases are added to STEP outputs to obtain the corrected prediction values. These predictions are compared to flight-specific limits similar to those shown in the table of paragraph B to verify that bondline temperatures will be acceptable at EI. The correction biases are, strictly, only applicable to attitudes, durations, sequences, and beta-angle. which duplicate flight data used to generate the biases (ref. Rule {X18.1.1-1}, THERMAL PROTECTION SYSTEM (TPS) BONDLINE TEMPERATURES, and Rule {A18.1.10-1C}, ORBITER THERMAL CONSTRAINTS AND ATTITUDE MANAGEMENT (CIL).

Documentation: STEP Accuracy Definition Document, RI IL SE-TCS-93-042, May 14, 1993, and NASA JSC Memo ES2-93-096.

Rules {A2.1.3-9}, STRUCTURES THERMAL CONDITIONING; {A2.1.3-30}, ORBITER ON-ORBIT HIGH DATA RATE REQUIREMENTS; and {A18.1.10-1B}, ORBITER THERMAL CONSTRAINTS AND ATTITUDE MANAGEMENT (CIL), reference this rule.

- B. MAXIMUM ALLOWABLE BONDLINE ENTRY INTERFACE (EI) TEMPERATURES ARE BASED ON STRUCTURAL CONSTRAINTS AND FLIGHT-SPECIFIC PARAMETERS FOR ENTRY AND VEHICLE LOADING. THE MAXIMUM GENERICALLY-ACCEPTABLE BONDLINE TEMPERATURE MEASUREMENTS ARE SHOWN BELOW. SPECIFIC MAXIMUM VALUES (RELAXED FROM THE GENERIC LIMITS) FOR EACH FLIGHT WILL BE PROVIDED IN THE FLIGHT-SPECIFIC FLIGHT RULES ANNEX. EACH FLIGHT-SPECIFIC BONDLINE LIMIT WILL REPRESENT THE WORST-CASE LIMIT FROM ANALYSIS OF ALL POSSIBLE DEORBIT OPPORTUNITIES FOR THAT FLIGHT. @[030994-1598A]

THIS RULE CONTINUED ON NEXT PAGE

FLIGHT RULES

A18.1.9-1 THERMAL PROTECTION SYSTEM (TPS) BONDLINE
TEMPERATURES (CONTINUED)

DESCRIPTION	TEMPERATURE MEASUREMENT NOS.	OV-103/104/105 MAX LIMIT, DEG F	OV-102 MAX LIMIT, DEG F
PORT	V09T1012	75	52
	V09T1030 [1]	58	58
	V09T1724	29	46
	V34T1102	96	71
	V34T1106	75	120
	V43T4722	250 (237) [3]	250 (237) [3]
STBD	V09T1014	75	52
	V09T1028 [1]	58	58
	V09T1720	29	46
	V34T1104	96	71
	V34T1108	75	120
	V43T5722	250 (237) [3]	250 (237) [3]
TOP	V09T1004	81	81
	V09T1024	81	81
	V09T1524	60	61
	V09T1510	215 (198) [3]	215 (198) [3]
	V09T1514	215 (198) [3]	215 (198) [3]
	V09T1020	250 (235) [3]	250 (238) [3]
PLBD [2]	V37T1000 [1]	63	69
	V37T1002 [1]	84	88
	V37T1004 [1]	84	88
	V37T1006 [1]	63	69
BOTTOM	V09T1000	28	30
	V09T1002	28	30
	V09T1016	99	103
	V09T1022	81	91
	V09T1624	78	44
	V09T1702	47	37
	V34T1110	32	42
	V34T1112	29	38
	V09T1006		190 (177) [3]
	V09T1026		190 (177) [3]

NOTES:

- [1] GRAPHITE EPOXY SKIN.
- [2] CLOSED PLBD TEMPERATURES ARE NOT PREDICTED BY STEP.
- [3] THESE LIMITS ARE BASED MATERIAL LIMITS AS OPPOSED TO THE OTHER LOWER LIMITS BASED ON STRUCTURAL THERMAL STRESS LIMITS. THIS TPS MATERIAL IS HRSI. TEMPERATURES HIGHER THAN THOSE LISTED WOULD CAUSE VIOLATION OF THE MAXIMUM POST-ROLLOUT STRUCTURAL MATERIAL TEMPERATURES OF 250 DEGREES F FOR GRAPHITE EPOXY (OMS POD) OR 350 DEGREES F FOR ALUMINUM. THESE PREENTRY LIMITS ARE DEFINED FROM THE WORST-CASE ENTRY TRAJECTORY AVAILABLE.

DOCUMENTATION: SODB Tables 3.4.1.3-2 and 3.4.1.3-3, and SODB Vol V, Table 4.1.2-1; STEP Accuracy Definition Document, RI IL SE-TCS-93-042, May 14, 1993; and NASA, JSC Memo ES2-93-096. @[030994-1598A]

FLIGHT RULES

ATTITUDE MANAGEMENT FOR THERMAL CONTROL

A18.1.10-1 ORBITER THERMAL CONSTRAINTS AND ATTITUDE
MANAGEMENT (CIL).....18-46

COOLING EQUIPMENT CONSTRAINTS

A18.1.11-1 MAXIMUM OFF TIME FOR COOLING EQUIPMENT.....18-74

THERMAL GO/NO-GO CRITERIA

A18.1.12-1 THERMAL GO/NO-GO CRITERIA.....18-70

WATER LOOP

A18.6.1-1 SPACEHAB WATER LOOP.....18-85

A18.6.1-2 WATER LINE HEATERS.....18-85

A18.6.1-3 WATER LINE HEATER MANAGEMENT.....18-86

A18.6.1-4 SPACEHAB CONTINGENCY COMMANDING.....18-89

SPACEHAB ENVIRONMENTAL CONTROL SYSTEM (ECS) MANAGEMENT

A18.6.2-1 SPACEHAB ENVIRONMENTAL CONTROL AND LIFE
SUPPORT (ECLS) REQUIREMENTS.....18-90

A18.6.2-2 SPACEHAB WATER LOOP MANAGEMENT.....18-91

A18.6.2-3 ORBITER/SPACEHAB INTEGRATED RULES.....18-91

SPACELAB ACTIVE THERMAL CONTROL SYSTEM (ATCS) LOSS/FAILURE DEFINITIONS

A18.9.1-1 SPACELAB H2O LOOP.....18-92

A18.9.1-2 SPACELAB FREON LOOP.....18-93

FLIGHT RULES

SPACELAB ATCS SYSTEMS MANAGEMENT

A18.9.2-1	SPACELAB ECLS REQUIREMENTS.....	18-96
A18.9.2-2	H2O LOOP MANAGEMENT.....	18-97
A18.9.2-3	FREON LOOP MANAGEMENT.....	18-99
A18.9.2-4	IGLOO MANAGEMENT PALLET ONLY.....	18-104
A18.9.2-5	ORBITER/SPACELAB INTEGRATED RULES.....	18-104

FLIGHT RULES

ATTITUDE MANAGEMENT FOR THERMAL CONTROL

A18.1.10-1 ORBITER THERMAL CONSTRAINTS AND ATTITUDE MANAGEMENT (CIL)

A. ORBITER ATTITUDE WILL BE MANAGED TO MAINTAIN ORBITER SYSTEMS WITHIN LIMITS LISTED IN THE FOLLOWING MATRIX: (CIL)

SYSTEM	CONCERN	LIMIT	CORRECTIVE ACTION	MISSION IMPACT IF PROBLEM NOT FIXED
PAYLOAD BAY DOOR	• EXCESSIVE OVERLAP	UL = 5 INCHES	• TOP SUN	• REF. RULES {A10.1.11-7}, PLBD OVERLAP, AND {A10.1.11-6}, PLBD CLOSE GO/NO-GO
	• EXCESSIVE GAP	UL = 2 INCHES	• TAIL SUN	
	• DOORS DO NOT FULLY CLOSE	<ul style="list-style-type: none"> • FOR CONT PLBD OPS, BET <200° F [6] • FOR NOM PLBD OPS, BET <160° F 	<ul style="list-style-type: none"> • TOP SUN OR <ul style="list-style-type: none"> • PTC (IF TIME PERMITS) 	<ul style="list-style-type: none"> • DOORS MAY NOT CLOSE DUE TO OBSTRUCTION • REF. RULE {A10.1.11-6}, PLBD CLOSE GO/NO-GO
PROP - FRCS	PROP LINES [1] PROP BULK	LL = + 40° F LL = + 40° F	<ul style="list-style-type: none"> • NOSE SUN (FWD HTR-NOT NEEDED FOR ENTRY) • TAIL SUN 	<ul style="list-style-type: none"> • FROZEN OR HOT LINES COULD CAUSE LOSS OF COMPONENT
	BULK	UL = +100° F [2] UL = +100° F		
ARCS	PROP BULK	LL = + 50° F [3] LL = + 70° F	<ul style="list-style-type: none"> • ATTITUDE CONSTRAINTS ARE NOT NORMALLY REQUIRED IF ARCS PROP "B" HEATERS ARE OPERATIONAL • IF ONLY "A" HEATERS ARE AVAILABLE, THE FOLLOWING ACTIONS APPLY <ul style="list-style-type: none"> - IF "A" HTRS OPER-ATING, TOP SUN, PITCH DWN 30 DEG, ROLL ±20 DEG - IF "A" HTRS NOT OPERATING, NOSE SUN, PITCH UP 10 DEG 	<ul style="list-style-type: none"> • SEE OMS/RCS FLIGHT RULES FOR SPECIFIC LOSS • REF. RULE {A6.1.3-7}, ARCS BULK PROPELLANT TEMPERATURE MANAGEMENT
	PROP BULK	UL = +100° F [2]		

FLIGHT RULES

THIS RULE CONTINUED ON NEXT PAGE

FLIGHT RULES

A18.1.10-1 ORBITER THERMAL CONSTRAINTS AND ATTITUDE MANAGEMENT (CIL) (CONTINUED)

A. ORBITER ATTITUDE VERSUS SYSTEMS LIMITS (ALL PHASES) - CONTINUED

SYSTEM	CONCERN	LIMIT	CORRECTIVE ACTION	MISSION IMPACT IF PROBLEM NOT FIXED
OMS	PROP BULK	LL = +30° F [4] LL = +40° F	<ul style="list-style-type: none"> • LINES: TAIL SUN • TANKS - IF HTRS OPERATING, TOP SUN, PITCH DWN 30 DEG, ROLL ±20 DEG - IF HTRS NOT OPERATING, NOSE SUN, PITCH UP 10 DEG 	
	PROP BULK	UL = +125° F [5] UL = +100° F	<ul style="list-style-type: none"> • NOSE, SUN, PITCH UP 10 DEG 	
CRSFD LNS	PROP BULK	LL = +40° F LL = N/A	<ul style="list-style-type: none"> • TOP SUN, PITCH DOWN 30 DEG 	<ul style="list-style-type: none"> • FROZEN OR HOT LINES COULD CAUSE LOSS OF COMPONENT • SEE OMS/RCS FLIGHT RULES FOR SPECIFIC LOSS
	PROP BULK	UL = +125° F [5] UL = N/A	<ul style="list-style-type: none"> • NOSE SUN, PITCH UP 10 DEG 	
RMS	QUALIFICATION LIMITS IF HEATERS ARE FAILED	LL = - 33° F (ABE) LL = - 42° F (LED) UL = +178° F (ABE) UL = +205° F (LED)	<ul style="list-style-type: none"> • TOP SUN • NOSE SUN OR TAIL SUN 	<ul style="list-style-type: none"> • NO RMS OPERATIONS • REF. RULE {A12.1.1-3}, TEMPERATURE CONSTRAINTS (CIL)
APU (CIL)	2 HTR FAIL, FUEL FREEZE	LL = +35° F	<p>IF PROBLEM ON:</p> <ul style="list-style-type: none"> • SERVICE LINES • FUEL FEEDLINES • TANK • SEAL CAVITY DRAIN LINES <p>APU 1, 2: PORT SIDE SUN</p> <p>APU 3: STARBOARD SIDE SUN</p> <p>IF PROBLEM ON COMPONENT ON BULKHEAD:</p> <p>APU 1, 2, 3: TOP SUN OR TAIL SUN (TOP SUN QUICKEST WARMUP)</p> <p>NOTE: DEPENDING ON PROBLEM AND PREVIOUS ATTITUDES. ATTITUDE CHANGE MAY NOT PREVENT FREEZING</p>	<ul style="list-style-type: none"> • EARLY MISSION TERMINATION (MDF)

THIS RULE CONTINUED ON NEXT PAGE

FLIGHT RULES

A18.1.10-1 ORBITER THERMAL CONSTRAINTS AND ATTITUDE MANAGEMENT (CIL) (CONTINUED)

A. ORBITER ATTITUDE VERSUS SYSTEMS LIMITS (ALL PHASES) - CONCLUDED

SYSTEM	CONCERN	LIMIT	CORRECTIVE ACTION	MISSION IMPACT IF PROBLEM NOT FIXED
BONDLINES	GLASSY TRANSITION	LL = -170° F	PTC IF TIME CRITICAL: • TOP SUN FOR UPPER SURFACE • BOTTOM SUN FOR LOWER SURFACE	• POSSIBLE TILE LOSS
	MIDBODY THERMAL STRESS DURING ENTRY	• REF. RULES {A2.1.3-9}, STRUCTURES THERMAL CONDITIONING AND {A18.1.9-1B}, TPS BONDLINE TEMPS	• REF. RULES {A2.1.3-9}, STRUCTURES THERMAL CONDITIONING AND {A18.1.9-1B}, TPS BONDLINE TEMPERATURES	• REF. RULES {A2.1.3-9}, STRUCTURES THERMAL CONDITIONING AND {A18.1.9-1B}, TPS BONDLINE TEMPERATURES
FES	2 HTR STRINGS FAIL, FEEDLINES FREEZE	LL = +32° F	• FES OPS AND/OR ATTITUDE MGMT WILL BE USED TO AVOID FREEZING	• EARLY MISSION TERMINATION
HYDRAULICS	• AFT COMPARTMENT: MAIN PUMP, RESERVOIR, SUPPLY/ RETURN LINES	LL = -40° F	• TAIL SUN	• MAIN HYD PUMP LOSS
	• BODY FLAP, PDU, RETURN LINES	LL = -40° F	• TAIL SUN	• LOSS OF BODY FLAP CONTROL
	• ELEVON RETURN LINES	LL = -40° F	• TOP SUN	• LOSS OF ELEVON CONTROL
	• MAIN LANDING GEAR	LL = -35° F	• BOTTOM SUN	• LANDING GEAR WILL NOT DEPLOY IN 10 SECONDS
	• NOSE LANDING GEAR	LL = -20° F	• BOTTOM SUN	• LANDING GEAR WILL NOT DEPLOY IN 10 SECONDS
	• NOSE LANDING GEAR STEERING	LL = -10° F	• BOTTOM SUN	• IMPACTS NWS
	• MIDBODY LINES	LL = -50° F	• BOTTOM SUN	• LOSS OF HYD CONTROL OF LG DEPLOY AND NWS
	• RSB, TVC, ISOL VLVS, COMPONENTS/LINES	LL = -40° F	• TAIL SUN	• LOSS OF RSB AND ISOL VLV CONTROL

@[030994-1598A]

THIS RULE CONTINUED ON NEXT PAGE

FLIGHT RULES

A18.1.10-1 **ORBITER THERMAL CONSTRAINTS AND ATTITUDE
MANAGEMENT (CIL) (CONTINUED)**

NOTES:

- [1] STAGNANT LINES FOR BOTH THE OMS AND RCS:
 - OXID LL = +20° F
 - UL = +150° F
 - FU LL = -30° F
 - UL = +150° F
- [2] +100° F UPPER LIMIT FOR BULK PROPELLANT, BASED ON EXPULSION EFFICIENCY. TEMPERATURE SENSOR IS LOCATED ON TANK SKIN WHICH HAS UPPER LIMIT OF +150° F FOR LOCALIZED REGIONS.
- [3] +70° F FOR ENTRY FOR ZOT PREVENTION. ON-ORBIT (TANK CERTIFICATION) LIMIT = +50° F. REFERENCE RULES {A6.1.3-5}, OMS/RCS HEATER MANAGEMENT; AND {A6.1.3-7}, ARCS BULK PROPELLANT TEMPERATURE MANAGEMENT.
- [4] +30° F COLD SLUG START TRANSIENT.
- [5] +125° F HOT SLUG START TRANSIENT.
- [6] BENDING EFFECT TEMPERATURE (BET) = (LOWER BONDLINE AVG. T - SILL LONGERON AVG. T) + (70° F - SILL LONGERON AVG. T)

THIS RULE CONTINUED ON NEXT PAGE

FLIGHT RULES

A18.1.10-1 ORBITER THERMAL CONSTRAINTS AND ATTITUDE MANAGEMENT (CIL) (CONTINUED)

B. ORBITER SYSTEMS CONSTRAINTS VERSUS BETA ANGLE AND ORBITER ATTITUDE ARE LISTED IN THE FOLLOWING MATRIX. THE MATRIX SERVES AS A GUIDELINE FOR ASSESSMENT OF THERMAL ATTITUDE RESTRICTIONS WHEN A MORE DETAILED (E.G., STEP) ANALYSIS HAS NOT BEEN COMPLETED. THE TABLE DOES NOT INCLUDE POTENTIAL CONSTRAINTS FOR BET, TIRES, DRAG CHUTE, EDO PALLET, OR BONDLINES. ONLY THE MOST CONSTRAINING FACTOR IS LISTED FOR A GIVEN ATTITUDE. REFERENCE SODB, VOLUME V IF ADDITIONAL INFORMATION IS NEEDED. @[030994-1598A]

0° TO <20° β

ORBITER ATTITUDE [1]		LIMIT [2]	CONCERN [3]	RECOVERY [4]
LVLH (EARTH INERTIAL)		NONE	NONE	NONE
SOLAR INERTIAL (THREE AXES INERTIAL)	(-X SI) TAIL TO SUN	71 HR	NLG HYDRAULIC LINES IN MID FUSELAGE LL = -50 F [5] (V58T0127,1134A)	5 HR OF PTC OR TOP SUN [7]
		72 HR	MLG HYDRAULIC COMP LL = -355 F [5] [10]	7 HR OF PTC [7]
	(±Y SI) SIDE TO SUN	110 HR	ARCS PROPELLANT [11] LL = +50° F LL = +70° F [12] (REF. RULES {A6.1.3-5}, OMS/RCS HTR MGT; AND {A6.1.3-7}, ARCS BULK PROP TEMP MGT)	PREFERENCE: 20 HR NOSE SI PITCHED UP 10 DEGREES [8]
(-Z SI) TOP TO SUN	160 HR	ARCS PROPELLANT [11] LL = +50° F LL = +70° F [12] (REF. RULES {A6.1.3-5}, OMS/RCS HTR MGT; AND {A6.1.3-7}, ARCS BULK PROP TEMP MGT)	PREFERENCE: 20 HR NOSE SI PITCHED UP 10 DEGREES [8]	

THIS RULE CONTINUED ON NEXT PAGE

FLIGHT RULES

A18.1.10-1 ORBITER THERMAL CONSTRAINTS AND ATTITUDE MANAGEMENT (CIL) (CONTINUED)

B. ORBITER SYSTEMS CONSTRAINTS VERSUS BETA ANGLE - CONTINUED

20° TO <60° β

ORBITER ATTITUDE [1]		LIMIT [2]	CONCERN [3]	RECOVERY [4]	
LVLH	(-ZLV) TOP TO EARTH	(+Y VV) STBD ON V (+BETA)	13 HR	OME PROPELLANT LINE UL = +125° F (REF. RULE {A6.1.3-5}, OMS/RCS HTR MGT)	30 HR PTC OR NOSE SUN
		(-Y VV) PORT ON V (-BETA)			
		(±X, VV) NOSE OR TAIL ON V FOR BETA >30 DEG	100 HR	ARCS PROPELLANT [11] LL = +50° F LL = +70° F [12] (REF. RULES {A6.1.3-5}, OMS/RCS HTR MGT; AND {A6.1.3-7}, ARCS BULK PROP TEMP MGT)	PREFERENCE: 20 HR NOSE SI PITCHED UP 10 DEGREES [8]
		(+ZLV) BOTTOM TO EARTH	(-Y VV) PORT ON V (+BETA)	13 HR	OME PROPELLANT LINE UL = +125° F (REF. RULE {A6.1.3-5}, OMS/RCS HTR MGT)
	(+YVV) STBD ON V (-BETA)				
	(-XLV) TAIL TO EARTH	(+Y VV) STBD ON V (-BETA)	100 HR	ARCS PROPELLANT [11] LL = +50° F LL = +70° F [12] (REF. RULES {A6.1.3-5}, OMS/RCS HTR MGT; AND {A6.1.3-7}, ARCS BULK PROP TEMP MGT)	PREFERENCE: 20 HR NOSE SI PITCHED UP 10 DEGREES [8]
		(-Y VV) PORT ON V (+BETA)			
		(±Z VV) BOTTOM OR TOP ON V FOR BETA > 30 DEG			
(+XLV) NOSE TO EARTH	(+Y VV) STBD ON V (+BETA)	100 HR	ARCS PROPELLANT [11] LL = +50° F LL = +70° F [12] (REF. RULES {A6.1.3-5}, OMS/RCS HTR MGT; AND {A6.1.3-7}, ARCS BULK PROP TEMP MGT)	PREFERENCE: 20 HR NOSE SI PITCHED UP 10 DEGREES [8]	
	(-Y VV) PORT ON V (-BETA)				

@[030994-1598A]

THIS RULE CONTINUED ON NEXT PAGE

FLIGHT RULES

A18.1.10-1 ORBITER THERMAL CONSTRAINTS AND ATTITUDE MANAGEMENT (CIL) (CONTINUED)

B. ORBITER SYSTEMS CONSTRAINTS VERSUS BETA ANGLE - CONTINUED

20° TO <60° β

ORBITER ATTITUDE [1]		LIMIT [2]	CONCERN [3]	RECOVERY [4]
SOLAR INERTIAL (THREE AXES INERTIAL)	(-X SI) TAIL TO SUN	(ANY OMICRON)	6 HR OMS OXIDIZER HI PT BLEED LINE QD LL = +20°F (ANALYSIS)	6 HR OF PTC
		ALL ROLL ANGLES	13 HR OME PROPELLANT LINE UL = +125°F (REF RULE {A6.1.3-5}, OMS/RCS HTR MGT)	30 HR OF PTC OR NOSE SUN
	(±Y SI) SIDE TO SUN	(ANY OMICRON) ALL PITCH ANGLES	90 HR ARCS PROPELLANT [11] LL = +50° F LL = +70° [12] (REF. RULES {A6.1.3-5}, OMS/RCS HTR MGT; AND {A6.1.3-7}, ARCS BULK PROP TEMP MGT)	PREFERENCE: 20 HR NOSE SI PITCHED UP 10 DEGREES [8]
(-Z SI) TOP TO SUN	(ANY OMICRON) ALL YAW ANGLES	160 HR ARCS PROPELLANT [11] LL = +50° F LL = +70° F [12] (REF. RULES {A6.1.3-5}, OMS/RCS HTR MGT; AND {A6.1.3-7}, ARCS BULK PROP TEMP MGT)	PREFERENCE: 20 HR NOSE SI PITCHED UP 10 DEGREES [8]	

@[030994-1598A]

THIS RULE CONTINUED ON NEXT PAGE

FLIGHT RULES

A18.1.10-1 ORBITER THERMAL CONSTRAINTS AND ATTITUDE MANAGEMENT (CIL) (CONTINUED)

B. ORBITER SYSTEMS CONSTRAINTS VERSUS BETA ANGLE - CONTINUED

60° TO <90° β

ORBITER ATTITUDE [1]		LIMIT [2]	CONCERN [3]	RECOVERY [4]	
LVLH	(-ZLV) TOP TO EARTH	(+Y VV) STBD ON V (+BETA)	6 HR	OME PROPELLANT LINE UL = +125° F (REF. RULE {A6.1.3-5}, OMS/RCS HTR MGT)	14 HR NOSE SUN
		(-Y VV) PORT ON V (-BETA)			
		(+Y VV) STBD ON V (-BETA)	38 HR	NLG HYDRAULIC LINES IN MID FUSELAGE LL = -50 F [5] (V58T0127,1134A)	6 HR OF PTC OR TOP SUN [7]
		(-Y VV) PORT ON V (+BETA)			
		(±X VV) NOSE OR TAIL ON V	90 HR	ARCS PROPELLANT [11] LL = +50° F LL = +70° F [12] (REF. RULES {A6.1.3-5}, OMS/RCS HTR MGT; AND {A6.1.3-7}, ARCS BULK PROP TEMP MGT)	PREFERENCE: 20 HR NOSE SI PITCHED UP 10 DEGREES [8]
	(+ZLV) BOTTOM TO EARTH	(±X VV) NOSE OR TAIL ON V	98 HR	MLG HYDRAULIC LL = -35° F [5] [10]	6 HR PTC [7]
		(+Y VV) STBD ON V (-BETA)	6 HR	OME PROPELLANT LINE UL = +125° F (REF. RULE {A6.1.3-5}, OMS/RCS HTR MGT)	NOSE SUN <u>TBD</u>
			6 HR	OMS OXIDIZER HI PT BLEED LINE QD LL = +20° F	6 HR OF PTC
	(-XLV) TAIL TO EARTH	(±Z VV) BOTTOM OR TOP ON V	90 HR	ARCS PROPELLANT [11] LL = +50° F LL = +70° F [12] (REF. RULES {A6.1.3-5}, OMS/RCS HTR MGT; AND {A6.1.3-7}, ARCS BULK PROP TEMP MGT)	PREFERENCE: 20 HR NOSE SI PITCHED UP 10 DEGREES [8]
(-Y VV) PORT ON V (+BETA)					
(+Y VV) STBD ON V (-BETA)					

@[030994-1598A]

FLIGHT RULES

THIS RULE CONTINUED ON NEXT PAGE

FLIGHT RULES

A18.1.10-1 ORBITER THERMAL CONSTRAINTS AND ATTITUDE MANAGEMENT (CIL) (CONTINUED)

B. ORBITER SYSTEMS CONSTRAINTS VERSUS BETA ANGLE - CONTINUED

60° TO <90° β

ORBITER ATTITUDE [1]		LIMIT [2]	CONCERN [3]	RECOVERY [4]	
LVLH (CONCLUDED)	(+XLV) NOSE TO EARTH	(±Z VV) BOTTOM OR TOP ON V	90 HR	ARCS PROPELLANT [11] LL = +50° F LL = +70° F [12] (REF. RULES {A6.1.3-5}, OMS/RCS HTR MGT; AND {A6.1.3-7}, ARCS BULK PROP TEMP MGT)	PREFERENCE: 20 HR NOSE SI PITCHED UP 10 DEGREES [8]
		(-Y VV) PORT ON V (-BETA)			
		(+Y VV) STBD ON VA (+BETA)			
	(-YLV) PORT SIDE TO EARTH	(-Z VV) TOP ON V (-BETA)	38 HR	NLG HYDRAULIC LINES IN MID FUSELAGE LL = -50° F (V58T0127,1134A) [5]	6 HR OF PTC OR TOP SUN [7]
		(+Z VV) BOTTOM ON V (+BETA)			
		(-Z VV) TOP ON V (+BETA)	6 HR	OMS OXIDIZER HI PT BLEED LINE QD LL = +20° F (BETA >80 DEG, ANALYSIS)	6 HR OF PTC
		(+Z VV) BOTTOM ON V (-BETA)			
	(+YLV) STBD SIDE TO EARTH	(-Z VV) TOP ON V (-BETA)	6 HR	OME PROPELLANT LINE UL = + 125° F (REF. RULE {A6.1.3-5}, OMS/RCS HTR MGT)	14 HR NOSE SUN
		(+Z VV) BOTTOM ON V (+BETA)			
	(-Z VV) TOP ON V (+BETA)	(±Z VV) BOTTOM ON V (-BETA)	38 HR	NLG HYDRAULIC LINES IN MID FUSELAGE LL = -50° F [5] (V58T0127,1134A)	6 HR OF PTC OR TOP SUN [7]

©[030994-1598A]

FLIGHT RULES

THIS RULE CONTINUED ON NEXT PAGE

FLIGHT RULES

A18.1.10-1 ORBITER THERMAL CONSTRAINTS AND ATTITUDE MANAGEMENT (CIL) (CONTINUED)

B. ORBITER SYSTEMS CONSTRAINTS VERSUS BETA ANGLE - CONTINUED

60° TO <90° β

ORBITER ATTITUDE [1]		LIMIT [2]	CONCERN [3]	RECOVERY [4]
SOLAR INERTIAL (THREE AXIS INERTIAL)	(-X SI) TAIL TO SUN	(ANY OMICRON) ALL ROLL ANGLES	6 HR OME PROPELLANT LINE UL = +125° F (REF. RULE {A6.1.3-5}, OMS/RCS HTR MGT)	14 HR NOSE SUN
			6 HR OMS OXIDIZER HI PT BLEED LINE QD LL = +20° F (ANALYSIS)	6 HR OF PTC
	(+X SI) NOSE TO SUN	(ANY OMICRON) ALL ROLL ANGLES	110 HR NLG HYDRAULIC LINES IN MID FUSELAGE LL = -50° F [5] (V58T0127,1134A)	3 HR OF PTC OR TOP SUN [7]
	(±Y SI) SIDE TO SUN	(ANY OMICRON) ALL PITCH ANGLES	90 HR ARCS PROPELLANT [11] LL = +50° F LL = +70° F [12] (REF. RULES {A6.1.3-5}, OMS/RCS HTR MGT; AND {A6.1.3-7}, ARCS BULK PROP TEMP MGT)	PREFERENCE: 20 HR NOSE SI PITCHED UP TO 10 DEGREES [8]
	(-Z SI) TOP TO SUN	(ANY OMICRON) ALL YAW ANGLES	160 HR ARCS PROPELLANT [11] LL = +50° F LL = +70° F [12] (REF. RULES {A6.1.3-5}, OMS/RCS HTR MGT; AND {A6.1.3-7}, ARCS BULK PROP TEMP MGT)	PREFERENCE: 20 HR NOSE SI PITCHED UP 10 DEGREES [8]
	(+Z SI) BOTTOM TO SUN			

@[030994-1598A]

THIS RULE CONTINUED ON NEXT PAGE

FLIGHT RULES

A18.1.10-1 ORBITER THERMAL CONSTRAINTS AND ATTITUDE MANAGEMENT (CIL) (CONTINUED)

NOTES:

- [1] DEVIATIONS FROM THE SPECIFIED ATTITUDES MAY NEED TO BE FURTHER ANALYZED.
- [2] THE ATTITUDE HOLD CONSTRAINED DURATION IS FROM PTC EQUILIBRIUM TEMPERATURES TO THE LIMIT TEMPERATURE.
- [3] ALL CONCERNS ARE SAFETY ISSUES UNLESS OTHERWISE NOTED.
- [4] UNLESS OTHERWISE NOTED, FLYING THE RECOVERY ATTITUDE ALLOWS REPETITION OF THE CONSTRAINED ATTITUDE FOR THE CONSTRAINED DURATION. ALL RECOVERY IS TO PTC EQUILIBRIUM TEMPERATURE UNLESS OTHERWISE NOTED.
- [5] SYSTEMS PERFORMANCE IS AFFECTED.
- [6] RESERVED @[030994-1598A]
- [7] RECOVERY IS TO THE MINIMUM OPERATIONAL LIMIT TEMPERATURE FROM THE MINIMUM NON-OPERATIONAL LIMIT TEMPERATURE OR ATTITUDE THERMAL EQUILIBRIUM TEMPERATURE (WHICHEVER IS WARMER).
- [8] THIS ATTITUDE RESULTS IN ONLY A MINIMAL RATE OF INCREASE ($< 2^{\circ}$ F/DAY) OF ARCS BULK PROPELLANT TEMPERATURE. THE CONSTRAINED DURATION CANNOT BE REPEATED.
- [9] RESERVED @[030994-1598A]
- [10] TCS DESIGN DATA BOOK SECTION L REFERENCE.
- [11] ATTITUDE CONSTRAINTS ARE NOT NORMALLY REQUIRED IF ARCS PROP "B" HEATERS ARE OPERATIONAL. THE ARCS CONCERN IS VALID IF ONLY THE "A" HEATERS ARE AVAILABLE.
- [12] ARCS PROP + 70° F FOR ENTRY FOR ZOT PREVENTION. ON-ORBIT (TANK CERTIFICATION) LIMIT = + 50° F.

There are six areas of concern where orbiter structure and/or systems thermal constraints can be exceeded if an unfavorable orbiter vehicle attitude is maintained for an excessive period of time. The maximum/minimum temperature, the time in the constraining attitude, and the attitude/time used to recover from a violation of the constraints are all dependent on the structure or orbiter system involved, the vehicle (OVI02,103,104) used, Sun beta angle, and the three basic attitude control modes used; i.e., LVLH, ORB RATE (single axis), and inertial (three axis) hold. The six areas of concern, their limits (temperature or time), and the impact (lifetime (L), system performance (P), and safety of flight (S)) of violating the limits are identified below: @[030994-1598A]

THIS RULE CONTINUED ON NEXT PAGE

FLIGHT RULES

A18.1.10-1

ORBITER THERMAL CONSTRAINTS AND ATTITUDE MANAGEMENT (CIL) (CONTINUED)

<u>Concern</u>	<u>Attitude/limit</u>	<u>Impact</u>
<i>OMS oxidizer hi-point bleed line, QD minimum temperature</i>	<i>6 hours, tail Sun port side or bottom to Earth/+20° F</i>	<i>Oxidizer line freeze/rupture, QD leakage (S)</i>
<i>NLG hydraulic line in mid fuselage minimum temperature</i>	<i>30-44/53-92 hours, tail or nose Sun, bottom to space/-50°/-65° F (OP/non-OP)</i>	<i>NLG deploy time > 10 seconds (P)</i>
<i>MLG hydraulic component minimum temperature</i>	<i>61-72/98-160 hours, tail or nose Sun, bottom to space/-35°/-60° F (OP/non-OP)</i>	<i>MLG deploy time > 10 seconds (P)</i>
<i>ARCS bulk propellant, minimum temperature</i>	<i>90-160 hours, top or side Sun/70° F (if ARCS "B" heaters are inoperative)</i>	<i>Thruster (ZOT) problem (L). Two yaw jets per side (S)</i>
<i>Bondline maximum temperature</i>	<p><i>(1) Material Strength Limit: 1-5 hours bottom Sun/Ref. Rule {A18.1.9-1B}, THERMAL PROTECTION SYSTEM (TPS) BONDLINE TEMPERATURE</i></p> <p><i>(2) Midbody Structural Thermal Stress: Limit is a function of Beta-angle and attitude prior to entry. (Ref. Rules {A2.1.3-9}, STRUCTURES THERMAL CONDITIONING, and {A18.1.9-1B}, TPS BONDLINE TEMPERATURES)</i></p>	<p><i>(1) Bondline temperature may exceed maximum structural limit during entry and/or after landing. Aluminum 350° F (> 400° F) (L) graphite epoxy skin (S):</i></p> <ul style="list-style-type: none"> <i>- OMS POD 250° F</i> <i>- PLBD 350° F</i> <p><i>(2) Excessive temperature gradients can result in stresses which exceed certification limits.</i></p>
<i>OME propellant line maximum temperature</i>	<i>6-13 hours, tail Sun/125° F</i>	<i>Violates engine certification limits (S), possible engine cooling problem</i>

@[030994-1598A]

THIS RULE CONTINUED ON NEXT PAGE

FLIGHT RULES**A18.1.10-1 ORBITER THERMAL CONSTRAINTS AND ATTITUDE
MANAGEMENT (CIL) (CONTINUED)**

B. ORBITER SYSTEMS CONSTRAINTS VERSUS BETA ANGLE - CONCLUDED

Matrix Limitations:

This table is intended as a first iteration for attitude planning. The orbiter attitudes listed represent "pure" orientations. Flight-specific STEP analysis will confirm the acceptability of the integrated attitude timeline. The table limits, which represent the constrained attitude durations in hours, were derived from analyses initialized to PTC equilibrium temperatures. These durations define the time it takes to go from PTC equilibrium temperature to the system limit. The concern column lists the vehicle structural/system limit that constrains the attitude duration. In most cases, flying the recovery attitude provides the capability to repeat the constrained attitude for the constrained duration. Exceptions to this recovery attitude definition exist for hydraulic systems, the TPS bondline, and the ARCS propellant temperature limits. For hydraulics, the recovery attitude allows the system temperature to recover to its temperature limit (presumes that the limit can be exceeded). For the TPS bondlines, preentry thermal conditioning (in addition to the normal end of mission timeline) may be required. In the case of the ARCS propellant minimum temperatures, the recovery attitude will "maintain" the bulk propellant temperature above its limit. In all three cases, the recovery to the limiting temperatures must be accomplished prior to entry. ©[030994-1598A]

DOCUMENTATION: Space Shuttle Thermodynamics Design Data Book, TCS, SD73-SH0226, Volume 1E, Book V, 9/85; Shuttle Vehicle Systems Temperature Limits and STS Operational Flight Rules Review, RI-IL SAS-TA-P/C/TCS-87-031; On-Orbit Thermal Constraints Summary, Revision 1, RI-IL SETO-TCS-87-066-R1; and Shuttle Operational Data Book, JSC-08934, Volume V, Table 3.1-1, April 1993. ©[030994-1598A]

Rules {A10.1.2-2}, APU START/RESTART LIMITS, and {A10.1.210}, LOSS OF APU HEATERS/INSTRUMENTATION (CIL), reference this rule.

THIS RULE CONTINUED ON NEXT PAGE

FLIGHT RULES

**A18.1.10-1 ORBITER THERMAL CONSTRAINTS AND ATTITUDE
MANAGEMENT (CIL) (CONTINUED)**

- C. ORBITER SYSTEMS CONSTRAINTS WHICH ARE APPLIED BY THE USE OF THE SIMPLIFIED THERMAL EVALUATION PROGRAM (STEP) ARE LISTED IN THE FOLLOWING TABLES. THESE CONSTRAINTS INCORPORATE STEP ACCURACY EVALUATION DATA AND REPRESENT THE WAY IN WHICH VEHICLE CONSTRAINTS ARE ANALYZED BY APPLICATION OF A BIAS AS GIVEN IN TABLE {A18.1.10-1-I} OR AS REFERENCED. THE LISTED BIASES ARE CONSERVATIVE ONLY FOR ATTITUDES AND TPS CONFIGURATIONS WHICH HAVE BEEN PREVIOUSLY FLOWN. IT IS UNDERSTOOD THAT IF ACTUAL ATTITUDES, DURATIONS, SEQUENCES, AND BETA-ANGLES ARE BEING FLOWN FOR THE FIRST TIME, A LARGER ERROR CAN RESULT WHICH SHOULD CAUSE LIMIT VIOLATIONS AND REQUIRE REAL-TIME CORRECTIVE ACTION.

FOR THE OMS OXIDIZER HIGH-POINT BLEED QUICK DISCONNECT (QD), IF THE ENVIRONMENT CONSTRAINT CANNOT BE MET DIRECTLY, THE HEATER DUTY CYCLE WILL BE VERIFIED TO BE ACCEPTABLE USING FIGURE {A18.1.10-1-II}.

DETERMINATION OF WHETHER AN RCS THRUSTER CONSTRAINT MAY EXIST WILL BE DONE USING FIGURE {A18.1.10-1-III} AND {A18.1.10-1-IV}. IF A LIMIT VIOLATION IS POSSIBLE, PREFLIGHT COORDINATION WITH ENGINEERING DIRECTORATE WILL DETERMINE ACCEPTABLE ATTITUDES.

THE DRAG CHUTE WILL BE ANALYZED BY ASSUMING THAT IT IS THE SAME TEMP AS THE ENVIRONMENT OF HYDRAULIC SYSTEM 2 RSB RETURN TEMP (V58T0298) AND RSB SEAL DRAIN LINE TEMP AT LOWER AFT OF VERTICAL STABILIZER (V58T1600).

EDO CRYO PALLET CONSTRAINT ASSESSMENT WILL BE COORDINATED WITH ENGINEERING DIRECTORATE PREFLIGHT. ©[030994-1598A]

THIS RULE CONTINUED ON NEXT PAGE

FLIGHT RULES

A18.1.10-1 ORBITER THERMAL CONSTRAINTS AND ATTITUDE MANAGEMENT (CIL) (CONTINUED)

TABLE A18.1.10-1-I - DELTA TEMPERATURE BIAS TO BE APPLIED TO STEP PREDICTIONS TO CHECK THERMAL CONSTRAINT LIMITS

GENERAL CONSTRAINTS	LIMIT -° F	DELTA TEMP [A] TO BE ADDED TO STEP	
	L LOWER		
	U UPPER	OV-103/104/105	OV-102
MLG TIRE (BRAKE LINE)	L VARIABLE	CURVE 1	CURVE 2
V58T1700/1750			
BET (PLBD CLOSURE)	U 160/200	+36° F	+36° F
OMS ENGINE OX/FUEL LINE	U 125/150	0° F	0° F
V43T4216/4642/5216/5642			
NLG HYD LINE IN MID			
V58T0127 (X=853)	L -50/-65	-13° F	-17° F
V58T1143 (X=1020)	L -50/-65	-15° F	-15° F
ZOT: V42T2200/2300/3200/3300	L 70	-7° F	-7° F
OMS OX HI POINT BLEED			
LINE QD			
ENV V34T1108	L 20	-23° F [B]	-23° F [B]
T/S V43T6235		DATA UNAVAILABLE	
RCS THRUSTERS	U 150/175	DATA UNAVAILABLE	
DRAG CHUTE	L -60	DATA UNAVAILABLE	
EDO CRYO PALLET TANKS	U 110	DATA UNAVAILABLE	

[A] CURVE NUMBERS REFER TO FIGURE {A18.1.10-I}.

[B] THESE DELTA TEMPERATURES ARE FOR OMS OX HPBL QD ENVIRONMENT ONLY, NOT FOR EI LIMIT. @[030994-1598A]

NASA - JOHNSON SPACE CENTER

FLIGHT RULES

THIS RULE CONTINUED ON NEXT PAGE

FLIGHT RULES

A18.1.10-1 ORBITER THERMAL CONSTRAINTS AND ATTITUDE MANAGEMENT (CIL) (CONTINUED)

TABLE A18.1.10-1-I - DELTA TEMPERATURE BIAS TO BE APPLIED TO STEP PREDICTIONS TO CHECK THERMAL CONSTRAINT LIMITS (CONTINUED)

BONDLINE EI TEMPERATURES										
SENSOR			OV-103/104/105				OV-102			
			LIMIT -°F		DELTA TEMP (°F) [A]		LIMIT -°F		DELTA TEMP (°F) [A]	
MIN	MAX	MIN	MAX							
P	S	V09T1012	75	90	+ 12° F	52	67	+ 24° F		
O	I	V09T1030	58	67	CURVE 3	58	67	CURVE 3		
R	D	V09T1724	29	83	CURVE 4	46	100	CURVE 5		
T	E	V34T1102	96	114	+ 29° F	71	89	+ 43° F		
		V34T1106	75	93	+ 26° F	120	138	+ 20° F		
S	S	V09T1014	75	90	+ 10° F	52	67	+ 22° F		
T	I	V09T1028	58	67	CURVE 3	58	67	CURVE 3		
B	D	V09T1720	29	83	CURVE 4	46	100	CURVE 5		
D	E	V34T1104	96	114	+ 29° F	71	89	+ 43° F		
		V34T1108	75	93	+ 26° F [B]	120	138	+ 20° F [B]		
T		V09T1004	81	100	CURVE 6	81	100	CURVE 6		
O		V09T1024	81	100	CURVE 6	81	100	CURVE 6		
P		V09T1524	60	60	+ 11° F	61	61	+ 19° F		
P		V37T1000	63	63	CLOSED PLBD	69	69	CLOSED PLBD		
L		V37T1002	84	84	TEMPS NOT	88	88	TEMPS NOT		
B		V37T1004	84	84	PREDICTED	88	88	PREDICTED		
D		V37T1006	63	63	BY STEP	69	69	BY STEP		
		V09T1000	28	100	CURVE 7	30	102	CURVE 8		
B		V09T1002	28	100	CURVE 7	30	102	CURVE 8		
O		V09T1016	99	158	+ 4° F	103	162	+ 4° F		
T		V09T1022	81	140	CURVE 9	91	150	CURVE 9		
T		V09T1624	78	137	CURVE 10	44	103	+ 21° F		
O		V09T1702	47	72	CURVE 11	37	62	CURVE 11		
M		V34T1110	32	91	CURVE 12	42	101	CURVE 13		
		V34T1112	29	88	CURVE 14	38	97	CURVE 15		

[A] CURVE NUMBERS REFER TO FIGURE {A18.1.10-1} - I.

[B] THESE DELTA TEMPERATURES ARE FOR IE LIMIT ONLY, NOT FOR OMS OX HPBL. @[030994-1598A]

NASA - JOHNSON SPACE CENTER

FLIGHT RULES

THIS RULE CONTINUED ON NEXT PAGE

FLIGHT RULES

A18.1.10-1 ORBITER THERMAL CONSTRAINTS AND ATTITUDE
MANAGEMENT (CIL) (CONTINUED)

FIGURE A18.1.10-1-I - DELTA TEMPERATURE BIAS TO BE APPLIED TO
STEP PREDICTIONS TO CHECK THERMAL CONSTRAINT LIMITS

THIS RULE CONTINUED ON NEXT PAGE

FLIGHT RULES

A18.1.10-1 ORBITER THERMAL CONSTRAINTS AND ATTITUDE
MANAGEMENT (CIL) (CONTINUED)

FIGURE A18.1.10-1-I - DELTA TEMPERATURE BIAS TO BE APPLIED TO
STEP PREDICTIONS TO CHECK THERMAL CONSTRAINT LIMITS
(CONTINUED)

THIS RULE CONTINUED ON NEXT PAGE

FLIGHT RULES

A18.1.10-1 ORBITER THERMAL CONSTRAINTS AND ATTITUDE
MANAGEMENT (CIL) (CONTINUED)

FIGURE A18.1.10-1-I - DELTA TEMPERATURE BIAS TO BE APPLIED TO
STEP PREDICTIONS TO CHECK THERMAL CONSTRAINT LIMITS
(CONTINUED)

THIS RULE CONTINUED ON NEXT PAGE

FLIGHT RULES

A18.1.10-1 ORBITER THERMAL CONSTRAINTS AND ATTITUDE
MANAGEMENT (CIL) (CONTINUED)

A18.1.10-1-II - OMS OXIDIZER MID HPBL HEATER
SYSTEM PERFORMANCE ESTIMATE

THIS RULE CONTINUED ON NEXT PAGE

FLIGHT RULES

A18.1.10-1 ORBITER THERMAL CONSTRAINTS AND ATTITUDE
MANAGEMENT (CIL) (CONTINUED)

FIGURE A18.1.10-1-III - ORBITAL PERCENT SUNLIGHT
AS FUNCTION OF BETA ANGLE AND ALTITUDE

THIS RULE CONTINUED ON NEXT PAGE

FLIGHT RULES

A18.1.10-1 ORBITER THERMAL CONSTRAINTS AND ATTITUDE
MANAGEMENT (CIL) (CONTINUED)

FIGURE A18.1.10-1-IV - PRIMARY RCS THRUSTER
CONSTRAINT SCREENING GRAPH

THIS RULE CONTINUED ON NEXT PAGE

FLIGHT RULES

**A18.1.10-1 ORBITER THERMAL CONSTRAINTS AND ATTITUDE
MANAGEMENT (CIL) (CONTINUED)**

STEP accuracy biases were generated by evaluation of attitudes normally flown. Application to other attitudes may result in predicted temperatures which differ from actual values by additional bias uncertainty.

Documentation: STEP Accuracy Definition Document, RI IL SE-TCS-93-042, May 14, 1993; and OV-103 Orbiter On-Orbit Thermal Constraints, RI IL SE-TCS-94-004, January 17, 1994.

Rule {A18.1.9-1}, THERMAL PROTECTION SYSTEM (TPS) BONDLINE TEMPERATURES, references this rule.

FLIGHT RULES

COOLING EQUIPMENT CONSTRAINTS

A18.1.11-1 MAXIMUM OFF TIME FOR COOLING EQUIPMENT

ORBIT @[051194-1610A]

THE FOLLOWING IS A LISTING OF THE MAXIMUM TIME THAT COOLING EQUIPMENT CAN BE OFF BEFORE POWERDOWN ACTION IS REQUIRED:

- A. CABIN FANS - 20 MIN
- B. AVIONICS FAN - 26 MIN
- C. IMU FANS - 45 MIN
- D. H₂O LOOPS - 10 MIN
- E. BOTH FREON LOOPS - 10 MIN

Cooling equipment off time is constrained by the requirements of the LRU's that they cool. If cooling equipment remains off for a time exceeding the LRU specific cooling limits, then a powerdown may be required due to a potential overtemp condition.

- a. *The CABIN fans can only be off for 20 minutes due to the cooling constraints of the Flight Controller electronics (specifically the Display Driver Unit).*
- b. *The AVIONICS bay fans can only be off for 26 minutes due to the cooling constraints of the GPC's.*
- c. *The IMU fans can only be off for 45 minutes due to the cooling constraints of the IMU's.*
- d. *The H₂O loops can only be off for 10 minutes due to the cooling constraints of the S-band power amplifier.*
- e. *Both FREON loops can only be off for 10 minutes due to the cooling constraints of the S-band power amplifier. Note that the catastrophic failure may occur as early as 50 minutes due to loss of cooling to the fuel cells.*

Documentation: SODB Vol. III, Table 4.5.0-1, Dual Freon Loop Failure Entry Analysis, Rockwell International, IL #388-301-79-018, 7/21/81. @[051194-1610A]

FLIGHT RULES

THERMAL GO/NO-GO CRITERIA

A18.1.12-1 THERMAL GO/NO-GO CRITERIA

SYSTEM/COMPONENTS/FUNCTIONS	ASCENT ABORT IF:	INVOKE MDF IF:	ENTER NEXT PLS IF
A. <u>SUPPLY H2O:</u>			2 ↓ [1]
1. SUPPLY H ₂ O TANKS (4)			
2. DUMP CAPABILITY			
B. <u>ARS H2O:</u>			1 ↓ [3]
1. H ₂ O LOOPS (2)	1 ↓ [2]		
2. H ₂ O LOOP LEAK			
C. <u>ATCS:</u>			1 ↓
1. FCL (2)	2 ↓		[11]
2. FCL LEAK			[4]
3. FCL PMPS (4)	4 ↓		
4. FES (2)	[5]	1 ↓ (TOPPING) [6] [7]	1 ↓ (HI-LOAD) [6] [7]
5. FES CONTRS (PRI A, PRI B, SEC) (3)	[5]	2 ↓ (PRIMARY)	3 ↓ [7]
6. FES FEEDLINE (2)	[5]		2 ↓ [7]
7. ABS (2)			
8. RFCA (2)		1 ↓ [8]	2 ↓
9. HEAT EXCHANGER LEAK		[9]	[10]

[@\[121593-1589\]](#) [@\[020196-1810A\]](#) [@\[061396-3104A\]](#) [@\[ED\]](#)

LEGEND: NO REQUIREMENT () QUANTITY
 REQUIRED [] NOTE REFERENCE

THIS RULE CONTINUED ON NEXT PAGE

FLIGHT RULES

A18.1.12-1 THERMAL GO/NO-GO CRITERIA (CONTINUED)

NOTES:

- [1] A MINIMUM OF 300 LB OF H₂O REQUIRED TO SUPPORT CONTINGENCY EVA AND DEORBIT PREPARATION FOR A PLBD FAIL TO CLOSE CASE.
- [2] LOSS OF TWO H₂O LOOPS REQUIRES AN AOA.
- [3] IF TWO WATER LOOPS ARE LOST, A LANDING WILL BE REQUIRED WITHIN 4 HOURS OF THE FAILURE.
- [4] ENTER NEXT PLS IF FCL 1 PUMP B AND FCL 2 PUMP A FAILED.
- [5] FOR LOSS OF ALL FES COOLING, MUST PRESS TO ORBIT AND OPEN PLBD'S ASAP POST-OMS-1.
- [6] CONSIDERATION WILL BE GIVEN TO REMAINING ON ORBIT TO ATTEMPT TO THAW OUT EITHER EVAPORATOR.
- [7] REQUIRES POWERDOWN FOR ENTRY.
- [8] MDF IF RFCA FAILED IN BYPASS OR MINIMUM RADIATOR FLOW. SUPPLY WATER WILL BE MANAGED SO THAT, IF THE NEXT WORST FAILURE (LOSS OF GOOD FREON LOOP) OCCURS, THE AVAILABLE SUPPLY WATER WILL SUPPORT A NEXT PLS (CIL). ELS REQUIRED IF THIS NEXT FAILURE OCCURS BEFORE SUPPLY WATER QUANTITIES CAN SUPPORT A NEXT PLS.
- [9] MDF IF LEAK IN HEAT EXCHANGER BETWEEN DISSIMILAR FLUIDS OTHER THAN FREON TO ORBITER H₂O.
- [10] ENTER NEXT PLS IF LEAK BETWEEN FREON AND CABIN H₂O LOOP @[020196-1810A]
- [11] FOR A LEAKING FREON LOOP WHICH WILL SUPPORT NEXT PLS BUT NOT THE FOLLOWING PLS, A PLS WILL BE DECLARED IN ORDER TO ACHIEVE A NOMINAL D/O PREP AND ENTRY. A LOSS OF ONE FREON LOOP ENTRY REQUIRES A POWERDOWN TO 14 KW. @[061396-3104A]

A. SUPPLY H₂O

1. *Supply Water - two supply water tanks are required to maintain redundancy for FC water removal capability. If only one supply water tank was maintained, one additional failure (the remaining tank) could result in loss of all three FC's.*
2. *Dump Capability - Loss of dump capability requires FC relief system activation when all water tanks are full. The FC relief system is zero fault tolerant under these conditions and failure of this relief system would cause losses of vehicle and crew.*

B. ARS H₂O

1. H₂O LOOPS

Loss of one water loop has no impact to the orbiter cooling since only one loop is normally activated. However, the failure places the orbiter in a zero-fault tolerant level. The next failure, loss of the other loop, would leave the orbiter with no control for humidity and no cooling available to the avionics inside the crew module. Effective PPCO₂ concentration control would also be lost due to restricted operations of cabin fans to avoid overheating ac inverters which are actively cooled by water loops. For loss of one water loop during ascent, nominal ascent should therefore be continued and first day PLS be executed.

FLIGHT RULES

An AOA, rather than an earlier ascent abort mode, is preferred for loss of both water loops during ascent because the avionics, with proper management, will not overtemp in an AOA timeframe (~110 minutes). Avionics, due to the hot thermal environment encountered in the ascent phase, cannot be managed properly for the extended time required for a first day PLS to ensure a safe entry.

FLIGHT RULES

A18.1.12-1 THERMAL GO/NO-GO CRITERIA (CONTINUED)

Thermal analysis indicates that, if two water loops are lost, cabin conditions will become intolerable within 2 hours of the failure. Cabin temperatures approach 90 deg F and relative humidity reaches 100 percent. Avionics temperatures exceed their loss of cooling operate periods and must be powered down. The cabin conditions can be relieved by performing cabin depress/repress (DEP/REP) cycles. The 4-hour time to landing is based on a crew of seven with an N₂ quantity of 262 lb. Crew exposure to the extreme cabin conditions is the primary driver for terminating the flight. The DEP/REP cycles provide relief from the high heat and humidity by dumping the excessive heat and humidity overboard and replacing the air with cool, dry N₂ and O₂.

DOCUMENTATION: Lockheed Technical Memorandum, G189A ECLSS ANALYSIS OF THE LOSS OF TWO WATER LOOPS AFO (TIG > 2.5), to be published. Document no. LESC-24843; engineering judgment; 1.1-ECLSS-09.

2. H₂O LOOP LEAK

When there is a coolant leak into the cabin from the water loop, it becomes zero-fault tolerant to crew safety because the next failure, a Freon-to-water leak at the interchanger, will introduce toxic Freon 21 into the crew habitable area. However, based upon the confidence in the interchanger hardware integrity (stainless steel construction; no leak experience) and the desire to provide on-orbit time for crew adaption (SAS concerns), an MDF will be performed.

DOCUMENTATION: Engineering judgment; JSC-08934, volume 3, section 4.6.1.2.1.2.

C. ATCS

1. FCL:

Loss of one Freon loop requires a PLS because the next failure (loss of other Freon loop) could result in loss of crew/vehicle.

Nominal ascent is continued so that more time is available to reconfigure for a one Freon loop entry and also because loss of one Freon loop is not an emergency. If both loops are lost, an emergency entry (ascent abort) is required because all cooling to the vehicle is lost.

If both Freon loops are lost, an emergency entry is required because the FC stack temperatures will reach the specification operational limit of 250 deg F within approximately 50 minutes. In addition, the electrolyte will reach the 25 percent operational limit in approximately 75 minutes. At this point, continued operation of the FC's is questionable. This assumes a simultaneous purge of all three FC's and 12.54 kWh (4.18 kWh/FCP).

FLIGHT RULES

DOCUMENTATION: Dual Freon Loop Failure Entry Analysis, Rockwell International, IL #388-301-79-018, 7/21/81.

FLIGHT RULES

A18.1.12-1 THERMAL GO/NO-GO CRITERIA (CONTINUED)

2. FCL PUMPS:

Loss of FCL 1 pump B and FCL 2 pump A requires a PLS because both remaining pumps are powered by AC1. Loss of AC1 would cause the loss of both FCLS and could result in loss of crew/vehicle.

If both Freon loops are lost, an emergency entry is required because the FC stack temperatures will reach the specification operational limit of 250 deg F within approximately 50 minutes. In addition, the electrolyte will reach the 25 percent operational limit in approximately 75 minutes. At this point, continued operation of the FC's is questionable. This assumes a simultaneous purge of all three FC's and 12.54 kWh (4.18 kWh/FCP).

DOCUMENTATION: Dual Freon Loop Failure Entry Analysis, Rockwell International, IL #388-301-79-018, 7/21/81.

3. FES

Total FES

Loss of total FES requires a next PLS because the next failure (loss of one Freon loop) could result in loss of the crew/vehicle.

If the failure occurs on ascent, entry is not accomplished at the first day PLS because:

The thermal condition of the vehicle would be extremely hot. Whether or not an entry could be accomplished without a massive powerdown has not been established. It is desirable to remain on orbit until the next day PLS in order to "coldsoak" the vehicle. No analysis for an orbit 3/5 loss of FES case has been run. An AOA case was run with the following assumptions and results:

- a. PLBD open at 15 minutes.*
- b. PLBD closed at EI-7 minutes (total time PLBD open \approx 50 minutes).*
- c. Touchdown occurred \approx 38 minutes after doors closed.*
- d. Av bays 1 and 2 were 11 deg F above the air inlet for 27 minutes.*
- e. Av bays 1 and 2 were 6 deg F above the air outlet for 13 minutes.*

THIS RULE CONTINUED ON NEXT PAGE

FLIGHT RULES**A18.1.12-1 THERMAL GO/NO-GO CRITERIA (CONTINUED)**

f. *Only two crewmembers were used.*

If the FES fails prior to TIG -45 minutes, there is sufficient time for reopening the PLBD, coldsoaking the radiators, performing the required powerdown, and reclosing the PLBD prior to TIG. No thermal violations are expected during entry. ©[020196-1810A]

If the FES fails between 45 and 15 minutes before TIG and a one rev late deorbit is available, a one rev wave off will be performed to allow time to reopen the doors, coldsoak the radiator, and perform the powerdown. No thermal violations are expected during entry if a one rev wave off is performed.

If the FES fails with the radiator coldsoaked between 45 and 15 minutes before TIG and a one rev deorbit is not available, the coldsoak will be utilized to continue with the planned TIG. Assuming the failure occurs at TIG -45 minutes, cabin temperature is expected to exceed 92 degrees F. Avionics bay supply air temperatures are expected to peak at 105 degrees (96 degrees being a violation) prior to NH3 activation. These thermal violations are limited to approximately 10 minutes, peaking at EI and returning with limits shortly after NH3 activation at EI, and will not affect crew performance. A one day wave off is not preferred since the next worst failure, loss of one Freon Loop, could cause the loss of the crew and vehicle.

If the FES fails without a radiator coldsoak between 45 and 15 minutes before TIG and a one rev deorbit is not available, a day wave off is required. There is insufficient time to reopen the PLBD and coldsoak the radiators prior to TIG. And there is not adequate thermal capacitance in the radiators to support the orbiter for up to 1.25 hours without active cooling.

If the FES fails after TIG -15 minutes, powerdown will be performed and planned TIG will be executed. Without a coldsoak, avionics bay supply air temperatures are expected to peak at 105 degrees (96 degrees being a violation) prior to NH3 activation. These thermal violations are limited to approximately 20 minutes, peaking at EI and returning with limits shortly after NH3 activation at EI, and will not affect crew performance. A one day wave off is not preferred since the next worst failure, loss of one Freon Loop, could cause the loss of the crew and vehicle. However, with a coldsoak, no thermal violations are expected. ©[020196-1810A]

DOCUMENTATION: SEH-ITA-85-001T; SEH-ITA-80-206T.

THIS RULE CONTINUED ON NEXT PAGE

FLIGHT RULES

A18.1.12-1 THERMAL GO/NO-GO CRITERIA (CONTINUED)

4. FES CONTRS

Partial loss of FES/controllers

Loss of high-load evaporator is a PLS (including first day PLS) because the next failure (loss of one Freon loop) could result in loss of crew or vehicle. The capability of the topping evaporator on Freon loop one (worst case) is $\approx 24,600$ Btu/hr or 5.5 kW. The 24,600 Btu/hr is based on test data on one topping evaporator core. No specification data exists for the topping evaporator on one Freon loop. Freon loop 1 is worst case because loop 2 runs closer to the topping evaporator core and has better heat transfer than loop 1.

Loss of topping evaporator or the loss of both primary controllers requires an MDF because the next failure (loss of one Freon loop) would cause an extensive powerdown to be completed before entry; however, it is believed an entry can be performed at this power level. The capability of the high-load evaporator/secondary controller on Freon loop 2 (worst case) is $\approx 44,200$ Btu/hr or 10 kW. The 44,200 Btu/hr is based on test data on one high-load evaporator core. No specification data exists for the high-load evaporator on one Freon loop. Freon loop 2 is worst case because Freon loop 1 runs closer to the high-load evaporator core and has better heat transfer than loop 2.

For loss of either the topping or high-load evaporator, due to a suspected freeze-up, consideration will be given to staying on orbit in order to attempt to thaw out the affected evaporator. It must be noted, however, that the symptoms of freeze-up are ambiguous with the instrumentation available. Further, simply flushing out the ice does not necessarily address the root cause of the problem as our flight history (below) has demonstrated. Flushing the core with the secondary controller on orbit will require elevated Freon temperatures to the FES. This can be accomplished by bypassing the radiators or closing the doors.

Flight and Ground History. During Space Environment Simulation Laboratory (SESL) testing of the FES pre-ST5-1, there were several episodes of core freezing, all of which were successfully flushed within very short periods (hours). SESL testing was done under one g conditions, however, and the effects of that are not well known. During ST5 41-G, when the topping evaporator froze, the ice was successfully removed from the core after 28 hours with the radiators in the high set point. During ST5-26, FES shutdowns occurred between 38 and 55 minutes MET. Corrosion in the topping core surface degraded the evaporation process and gave the ice a foothold. Use of the secondary controller cleared the ice out of the topping core (secondary topper uses both A and B H₂O nozzles alternately, has no shutdown feature, and operates at a higher control temperature). On orbit, the radiator controllers were operated in the high set point to thaw out any ice that remained in the high load or topping cores.

FLIGHT RULES

THIS RULE CONTINUED ON NEXT PAGE

FLIGHT RULES

A18.1.12-1 THERMAL GO/NO-GO CRITERIA (CONTINUED)

There is a high probability that the FES core can be thawed and/or flushed while the next worst failure, loss of a Freon loop, is severe but it is a low probability. It has been decided that the risk of staying on orbit to thaw the FES is warranted.

DOCUMENTATION: SEH-ITA-081-107; SEH-ITA-83-011T; STS 41-G and STS-26 flight data; and engineering judgment.

5. FES FEEDLINES

Loss of two feedlines is equivalent to the loss of total FES which requires a next PLS. This is because the next failure (loss of one Freon loop) could result in loss of crew or vehicle.

With the loss of one feedline, full operational capability is maintained. Although this results in a single fault tolerant situation, an MDF is not called because the Freon loops and flash evaporator system are single-fault tolerant systems from launch.

DOCUMENTATION: SEH-ITA-83-011T; SEH-ITA-81-107.

6. ABS

There is no requirement for the NH₃ after nominal orbit insertion. The FES and radiators are used for orbit and entry cooling. The NH₃ boiler is not required until post-rollout and an emergency powerdown can be performed if NH₃ is not available. The ammonia boiler is required for launch aborts since the radiators cannot be coldsoaked in these cases. Therefore, after nominal ascent and insertion have been completed, there is no requirement for the NH₃ boiler.

DOCUMENTATION: Flight data.

THIS RULE CONTINUED ON NEXT PAGE

FLIGHT RULES

A18.1.12-1 THERMAL GO/NO-GO CRITERIA (CONTINUED)

7. RFCA

An RFCA failed in bypass or minimum flow is accepted to be an MDF by the Flight Techniques Panel with the following considerations:

After the orbit 3 opportunity is passed, there exists a “gap” in which there is not enough water for continuous FES operations to sustain the orbiter cooling to the next prime deorbit opportunity in the event the flowing Freon loop fails (ELS required). Flight experience has shown, with few exceptions so far, supply water quantities to be between 360 and 450 lb at PLBD opening (≈ 1.5 hr MET). The exact value depends on the initial water load at lift-off and to a lesser degree on the ascent power loads. Using 350 lb as the quantity, the “gap” is 5 to 8 hours depending upon whether KSC or EDW is selected to be the prime landing site based on the following assumptions/procedures:

- a. Upon radiator failure, deactivate affected Freon loop and flash evaporator, maneuver to a cold radiator attitude (e.g., GG, nose Sun), and powerdown to 15 kW.*
- b. Powerdown to 7 kW immediately after the flowing loop fails.*
- c. Powerup to 11 kW for entry at TIG-2 hours.*

Weighing the risk of the flowing loop failing during the “gap” versus the crew adaptation concerns (SAS), in conducting a next PLS (same day) entry, the Flight Techniques panel decided an MDF should be performed. A next day PLS is not necessary because sufficient fuel cell generated water can be accumulated and maintained through proper management to protect against the next failure. Although the ascent day “gap” was used in the above, the same consideration should still apply as long as SAS remains a concern. It should be noted that, for a radiator failed in bypass, no active cooling of payloads will be available. In addition, it is mandatory to turn the FES off and to maneuver to a cold radiator attitude in order to provide proper thermal control and to accumulate water generated by the fuel cells.

Loss of both RFCA’s is a PLS because the next failure (loss of FES) could result in loss of crew/vehicle.

THIS RULE CONTINUED ON NEXT PAGE

FLIGHT RULES

A18.1.12-1 THERMAL GO/NO-GO CRITERIA (CONTINUED)

If an RFCA is failed in the "full open" position, several measures can be taken to ensure the evaporator outlet temperature remains above 32 deg F. This is required to prevent freezing of the H2O loops at the interchanger. These measures include:

- a. Bypassing the good loop's radiator.*
- b. Going to high control set point (57 deg F) on the good loop.*
- c. Attitude constraints (-ZLV).*
- d. Closing the PLBD of the failed loop.*
- e. Raise ATCS heat load.*
- f. Disable flow control valve on good loop in a hotter position.*

When deciding which measure to use, it should be taken into account that, if the good loop should suddenly fail, the evaporator outlet temperature on the failed loop should be warm enough so as not to freeze the water loops.

Since several measures can be taken to ensure the evaporator outlet temperature remains above 32 deg F, it is not necessary to shorten the mission for this failure.

If both Freon loop RFCA's are failed in the full open position, the following steps can be taken to ensure the evaporator outlet temperature remains above 32 deg F:

- a. Attitude constraints (-ZLV; bay to Earth).*
- b. Closing the PLBD of either loop.*
- c. Raise ATCS heat load.*

If one loop suddenly stops running, the evaporator outlet temperature will be above 32 deg F.

Since these measures can be taken to ensure the evaporator outlet temperature remains above 32 deg F, it is not necessary to shorten the mission for these failures.

It should be noted that, if a loop with an RFCA failed full open cannot be bypassed, either manually or automatically, it should not be deactivated if at all possible. A stagnant loop will coldsoak to temperatures below zero degrees. If the loop is deactivated, depending on the length of time deactivated, attitude, and temperature of the loop when deactivated, the loop may not be usable without freezing the interchanger.

FLIGHT RULES

DOCUMENTATION: SEH-ITA-81-416T

THIS RULE CONTINUED ON NEXT PAGE

FLIGHT RULES**A18.1.12-1 THERMAL GO/NO-GO CRITERIA (CONTINUED)**8. HEAT EXCHANGER LEAK

An MDF is required for a heat exchanger leak between dissimilar fluids (other than Freon and cabin water) because the possibility exists that a generic problem, such as corrosion, exists in the heat exchanger. This type of problem could eventually result in a total loss of the heat exchanger and the vehicle. It is considered that the risk of losing the heat exchanger does not warrant a PLS, but does warrant an MDF.

If the leak is between Freon and a cabin water loop, PLS is required because the next failure (external leak in the water loop) could result in the crew being exposed to Freon 21, which is very toxic. In addition, the water loop is considered lost because several components in the water loop are incompatible with Freon 21 and may fail to seal or function. These material incompatibilities, in addition to high pressures in the water loop (caused by the Freon loop leaking into the water loop), increase the chances of the water loop developing an external leak into the cabin and exposing the crew to Freon 21. In November of 1985, the following statement was published in the SODB, volume III concerning a Freon to water loop leak: "In the case of leakage occurring during a mission, it is mandatory to abort the mission at the earliest practical time in order to minimize the possibility for a second failure which could result in Freon leak into the cabin air."

DOCUMENTATION: Engineering judgment; SODB, volume II, section 4.6.1.2.1.2.

DOCUMENTATION for ATCS (12/08/86)Hamilton Standard Memos/Analyses

SEM 62408 *Flash Evaporator Controller Operation Description, 1/25/82.*
SEM 62449 *FES Duct Heaters Launch Criteria, 7/20/84.*

JSC Memos/Documents

CSD-SH-143 *Crew Systems Division Integrated Active Thermal
(JSC-14182) Control Subsystem Test Final Report, 8/24/79.*
DF/83-178 *Orbiter Systems Redundancy Checkout, 11/28/83.*
ES2-81-256M *TCS Design & STS-1 On-Orbit Failed Heater
Summary Matrix, 3/3/81.*
JSC -08934 *Shuttle Operational Data Book.*
JSC-11174 *Space Shuttle Systems Handbook.*
JSC-18549 *Operational Space Shuttle Orbiter Heater Systems, 10/15/82.*
MD3/84-20 *Orbiter Systems Redundancy Checkout, 05/15/84.*

Lockheed Engineering & Management Services Co., Inc. Memos/Analyses

LEMSCO 19630 *Orbiter & P/L H₂O Coolant Loop Freezeup, 8/11/83.*

FLIGHT RULES

THIS RULE CONTINUED ON NEXT PAGE

FLIGHT RULES**A18.1.12-1 THERMAL GO/NO-GO CRITERIA (CONTINUED)**McDonnell Douglas Memos/Analyses

1.1-ECLSS-09 *Dual Water Coolant Loop Failed Entry Contingency, 2/7/83.*
 1.1-ECLSS-57 *One Freon Loop Failure On Orbit/Entry, 12/20/83.*
 1.1-ECLSS-122 *Cabin Air Temperature Response Study, 9/30/85.*
 1.2-TM-B1109-27 *Optimum Interchanger Water Flow for STS-1, 10/15/79.*

Rockwell International Analyses/Tests

SEH-ITA-80-047T *STS-1 Ascent With and Evaporator Failure, 3/06/80.*
 SEH-ITA-80-054T *STS-1 On-orbit with a FCL Failure, 3/11/80.*
 SEH-ITA-80-206T *STS-11 Failed FES Abort Once Around 12/09/80.*
 SEH-ITA-80-263T *O₂ Restrictor Analysis, 12/09/80.*
 SEH-ITA-81-107 *OV102 ATCS Heat Sink Characteristics, 4/8/81.*
 SEH-ITA-81-416T *FCA Malfunction Analysis, 12/8/81.*
 SEH-ITA-82-028 *Air Cooling Perf, EVA Prep Cabin Press Study, 2/1/82.*
 SEH-ITA-82-029 *Optimum Interchanger Water Flow for STS-1, 2/1/82.*
 SEH-ITA-82-333 *STS-4 Flight Data Evaluation.*
 SEH-ITA-83-011T *Entry Continuation with Loss of FES, 1/24/83.*
 SEH-ITA-83-017T *Ascent With RAD Flow in One FCL, 2/10/83.*
 SEH-ITA-83-151T *OV099 Dormant Water Loop Cycle Requirements, 6/9/83.*
 SEH-ITA-83-349 *Relative Effect of Interchanger Water Flowrate on ARS
 Temperatures, 10/14/83.*

Rockwell International Analyses/Tests (Continued)

SEH-ITA-84-249T *Minimum Freon Flowrate for Aft Avionics Cooling, 7/11/84.*
 SEH-ITA-85-001T *Revised Deorbit Preparation Timeline Analysis, 1/10/85.*
 SEH-ECS-85-052T *Ammonia Boiler Operations With Degraded Flow, 4/26/85.*
 SEH-ECS-86-102T *One Freon Coolant Loop Failed in Bypass, 7/2/86.*
 SEH-ECS-86-106 *Degraded Cabin WCL Flowrate Analysis, 12/86.*
 LTR 4309-3101 *Lab Test Report - O₂ Restrictor Evaluation Test, 11/84.*
 MF0004-009, *Equip Cooling Requirements, Electrical/Electronic, Rev A 8/2/78.*
 288-503-84-010 *Internal Letter - Freon 21 Contamination of Hydraulic Systems,
 2/27/85.*
 388-301-79-018 *Internal Letter - FCP Operation During Dual Freon/Water
 Coolant
 Loop Loss Abort and Entry, 3/30/79*

FLIGHT RULES

WATER LOOP

A18.6.1-1 SPACEHAB WATER LOOP

LOST IF:

- A. PUMP ACCUMULATOR QUANTITY IS < 3.4 PERCENT AND SYMPTOMS OF PUMP CAVITATION ARE PRESENT.

Spacehab has identified this percentage as an indication of accumulator failure; 3.4 percent is the range of uncertainty of the quantity sensor.

- B. FLOW CANNOT BE MAINTAINED GREATER THAN:

1. ASCENT/ENTRY: 130 POUNDS PER HOUR (LB/HR)

Analysis indicates this minimum flow is required to reject powered Spacehab ascent/entry heat loads.

2. ON-ORBIT: 140 POUNDS PER HOUR

For a Spacehab continuous heat load of 2 kW, this is the minimum flow which will avoid violating the maximum coolant return temperature of 104 degrees F.

- C. THERE ARE SYMPTOMS OF PUMP CAVITATION AND THE PUMP INLET PRESSURE IS LESS THAN 20 PSIA.

Pump will operate erratically and may cavitate at pressures less than specified value.

- D. USE OF THE MANUAL BYPASS VALVE PROCEDURES RESULTS IN FLOW TO THE PLHX OF LESS THAN 50 POUND MASS (LBM)/HR.

Manual bypass of the Water Flow Control Valve (WFCV) is an IFM procedure performed by the crew. Before this IFM procedure is performed, the water line heaters are activated to preclude water freezing in case crew adjustment of the valves decreases the flow through the PLHX below 50 lbm/hr. In the event of water line heater failure, attitude adjustment would be necessary to prevent water freezing. Reference ICD 21095, Interface Review Notice 37. @[121593-1594]

A18.6.1-2 WATER LINE HEATERS

LOST IF WATER LINE STATUS IS 0 INSTEAD OF 1.

FLIGHT RULES

A18.6.1-3 WATER LINE HEATER MANAGEMENT

A. THE WATER LINE HEATERS WILL BE ACTIVATED FOR ANY OF THE FOLLOWING CONDITIONS (WHEN THE PLBD'S ARE OPEN):

1. LOSS OR DEACTIVATION OF SPACEHAB WATER LOOP.

Loss of water loop results in loss of flow through the PLHX.

2. PRIOR TO PERFORMING AN IFM TO ADJUST THE MANUAL BYPASS VALVES.

Crew adjustment of the bypass valves may result in water flow rates to the PLHX below 50 lbm/hr, leaving the water lines susceptible to freezing. Reference ICD 21095, Interface Review Notice 37. ©[121593-1594]

3. WHEN MAIN DC AND AC POWER HAVE BEEN REMOVED FROM THE SPACEHAB.

If PLBD's remain open after emergency deactivation, water line heaters must be active since the pumps are no longer operational. Note that emergency power must be supplied to the Spacehab for the water line heaters to receive power.

4. LOSS OF THE DMU DATA STREAM TO THE PDI WHILE CONTINUING SPACEHAB OPERATIONS.

Heaters are turned on since the status of the water pumps is no longer available.

5. WHEN CONTINUING SPACEHAB OPERATIONS WITH A DEGRADED WATER LOOP, CONSIDERATION WILL BE GIVEN TO DEACTIVATING THE HEATERS IF IT CAN BE SHOWN THAT FLOW TO THE PLHX IS ≥ 50 LB/HR. ©[051194-1632A]

A degraded water loop could result in reduced flow to the PLHX, while providing sufficient heat rejection to continue the mission. After the heaters are activated, if power savings are required, the heaters may be deactivated if the flow through the PLHX is high enough that there is not a potential for freezing the water loop.

Reference All Flights Rule {A18.6.1-1}, SPACEHAB WATER LOOP. ©[051194-1632A]

B. THERMAL CONDITIONING BY ADJUSTING THE ORBITER ATTITUDE WILL BE USED TO PREVENT WATER LINE FREEZING IF THE WATER LINE HEATERS CANNOT BE VERIFIED ACTIVE AND THE WATER LOOP IS OFF.

In the event of a water line heater failure, no other means exists to prevent the water lines from freezing.

FLIGHT RULES

THIS RULE CONTINUED ON NEXT PAGE

FLIGHT RULES

A18.6.1-3 WATER LINE HEATER MANAGEMENT (CONTINUED)

C. IF THE SPACEHAB WATER LINE HEATERS ARE LOST AND WATER LOOP FLOW TO THE PLHX IS LESS THAN 50 LBM/HR, A TOP SUN ATTITUDE IS REQUIRED IMMEDIATELY. (CAN BE DELAYED UP TO 30 MINUTES ONLY IF STARTING FROM A -ZLV ATTITUDE). @[011295-1750A]

ALTERNATIVE ATTITUDES OTHER THAN THE TOP SUN CAN BE ACCOMMODATED ONLY PER THE FOLLOWING TABLE. OTHER ALTERNATIVE ATTITUDES WILL ONLY BE PERFORMED AFTER THERMAL ANALYSIS CAN BE ACCOMPLISHED.

NUMBER OF ORBITS IN ALTERNATIVE ATTITUDE ALLOWED AFTER:			» b ANGLE (DEG)	ALTERNATIVE ATTITUDE FROM -ZSI
4 ORBITS OF -ZSI	8 ORBITS OF -ZSI	12 ORBITS OF -ZSI		
5	8	NOT ANALYZED	-60< β <+60	ANY -ZLV
1	1	1	-60< β <+60	WORST CASE COLD α
2	4	6	-60< β <+60	\pm XLV \pm ZVV
1	1	2	+ β	-XLV +YVV OR +XLV -YVV
1	1	2	- β	-XLV -YVV OR +XLV +YVV

α - EXCLUDING TOP EARTH OR SUN VIEWING
@[011295-1750A]

Freezing of the water lines may result in orbiter Freon loop payload heat exchanger damage which puts both Freon loops at risk of leaking. Analysis results indicate that the onset of freezing of the water lines may occur as early as 10 minutes after this failure in an attitude which excludes Earth or Sun viewing; 12 minutes for typical \pm XLV rendezvous attitudes; and 30 minutes for a -ZLV attitude. To protect against the worst case, a maneuver to a top Sun attitude should be initiated immediately. @[011295-1750A]

A nominal rendezvous lasting no more than 9 hours can be flown only if preceded by 12 or more orbits of top Sun (analyzed for Beta angles between -60 deg and +60 deg. This applies only if the rendezvous attitude is predominantly \pm XLV \pm ZVV.

Top Sun/alternative attitude times in table cannot be ratioed to longer durations. For example, the 4/5 -ZSI/-ZLV ratio cannot be flown as an 8/10 attitude sequence.

For Beta angles $> \gg |60 \text{ deg}|$, the -ZSI attitudes can be biased in pitch or roll only as required to avoid upfiring RCS jet or orbiter maneuvering engine (OME) line thermal violations. However, in the event of conflicting constraints, the water loop must be considered a high priority to be protected from freezing.

Documentation: Rockwell International Internal Letter #SE-PSE-94-087, November 17, 1994, Flight Rule Revision to Payload Active Cooling Kit (PACK) Thermal Constraints.

FLIGHT RULES

Rule {A18.6.2-2B.3}, SPACEHAB WATER LOOP MANAGEMENT, references this rule. ©[011295-1750A]

A18.6.1-4 SPACEHAB CONTINGENCY COMMANDING

- A. FOR A DECLARED FAILURE OF THE FAN IN USE (EITHER ARS OR SPACEHAB CABIN FAN) DURING NON-POWERED FLIGHT PORTIONS OF ASCENT/ENTRY, AN MCC CONTINGENCY COMMAND WILL BE CONSIDERED TO SWITCH THE FAILED FAN OFF AND TO SWITCH THE REMAINING FAN ON.

Air circulation by either the ARS or Spacehab cabin fan is required to maintain module air flow over the Spacehab fire/smoke detectors. Nominal ascent/entry configuration is ARS fan ON and cabin fan OFF. Without switching fans, all fire/smoke detection capability is lost, and powerdown of the module will be required with the potential of a significant mission success impact. (An IFM is available on orbit to install a spare fan to replace either the Spacehab cabin fan or the ARS fan. No on-board command capability exists in OPS 1 or OPS 3).

- B. FOR A DECLARED FAILURE OF A SPACEHAB WATER COOLING LOOP PUMP DURING NON-POWERED FLIGHT PORTIONS OF ASCENT/ENTRY, AN MCC CONTINGENCY COMMAND WILL BE CONSIDERED TO SWITCH WATER PUMPS.

The Spacehab water cooling loop is required for achieving thermal control of the module environment. Without switching pumps, all module cooling is lost and module powerdown will be required. This results in the potential for significant mission success impact (no on-board command capability exists in OPS 1 or OPS 3). The H₂O line heaters must be ON, or commanded ON, to prevent freezing of the PLHX, if the PLBD's are open.

FLIGHT RULES

SPACEHAB ENVIRONMENTAL CONTROL SYSTEM (ECS) MANAGEMENT

A18.6.2-1 SPACEHAB ENVIRONMENTAL CONTROL AND LIFE SUPPORT (ECLS) REQUIREMENTS

SPACEHAB EXPERIMENTS WHICH REQUIRE SPECIFIC ENVIRONMENTAL CONTROLS IN EXCESS OF NORMAL SUBSYSTEM REQUIREMENTS ARE DOCUMENTED IN THE FLIGHT SPECIFIC ANNEX.

A. THE ANNEX WILL USE THE FOLLOWING FORMAT TO INSURE ORBITER COMPATIBILITY

DURING OPERATIONS OF SPACEHAB ACTIVELY COOLED EXPERIMENTS, THE ORBITER CABIN ATMOSPHERE MUST BE MAINTAINED WITHIN THESE SPECIFIED LIMITS:

1. (PAYLOAD 1)	OPERATING RANGE
PPCO2	<u>TBD</u> < MMHG < <u>TBD</u>
TEMPERATURE	<u>TBD</u> < T < <u>TBD</u>
TOTAL PRESS, PPO2, ETC	<u>TBD</u>

B. PAYLOADS WHICH REQUIRE SPECIFIC ENVIRONMENTAL CONTROLS IN EXCESS OF NORMAL SUBSYSTEM REQUIREMENTS ARE DOCUMENTED IN THE FLIGHT SPECIFIC ANNEX.

Documenting payload cooling limits in this rule in the annex ensures that the proper orbiter cooling configuration will be established for the flight. The operating range indicates absolute minimum and maximum acceptable temperatures of the payload coolant as it exits the payload heat exchanger. Analysis of heat exchanger performance will use payload heat load data as supplied in PIP ANNEX 2 PART 1. The stability requirement dictates special payload limits to minimize oscillations within the operating range. The stability values reflected here are those introduced by changes in the orbiter Freon inlet temperature and do not account for perturbations due to changes in payload heat load.

Certain middeck and/or Spacehab payloads may require unique atmosphere conditions that are outside of the normal range of operations of the ARS. Documentation of the payload constraints in this rule ensures that the atmosphere is managed within the specified limits.

C. EXPERIMENTS THAT WILL NORMALLY RELEASE GASES INTO THE CABIN ARE DOCUMENTED IN THE FLIGHT SPECIFIC ANNEX.

FLIGHT RULES

A18.6.2-2 SPACEHAB WATER LOOP MANAGEMENT

- A. THE SPACEHAB WATER LOOP SHOULD BE OPERATING AT ALL TIMES WHEN THE MODULE IS POWERED; ONLY ONE PUMP WILL BE RUNNING AT ANY TIME. NORMAL CONFIGURATION IS PUMP 1 ON.

Pump 1 is operated nominally in order to divide the ac load between orbiter power and Spacehab inverter power on orbit.

- B. FOR A DECLARED FAILURE OF THE SPACEHAB WATER LOOP AS DEFINED IN RULE {A18.6.1-1}, SPACEHAB WATER LOOP: @[121593-1587]
1. LIMITED SPACEHAB EXPERIMENT OPERATIONS MAY CONTINUE.
 2. WATER LINE HEATERS WILL BE ACTIVATED.
 3. IF THE WATER LINE HEATERS ARE LOST OR INEFFECTIVE, CONTROL THE ORBITER ATTITUDE TO PRECLUDE WATER LINE FREEZING OR PAYLOAD HEAT EXCHANGER OVER PRESSURIZATION. (REFERENCE RULE {A18.6.1-3C}, WATER LINE HEATER MANAGEMENT, FOR ACCEPTABLE ATTITUDES.) @[011295-1750A]

Although heat rejection via water cooling has been lost, approximately 800 watts can be rejected via air exchange with the orbiter. This would require some subsystem and experiment equipment to be powered off. This configuration is also more beneficial than total module deactivation since module temperatures are more easily controlled. The water line heaters must be activated so that the lines between the module and the orbiter's payload heat exchanger interface do not freeze. Attitude changes are the least desirable option to control water line temperatures. @[121593-1587]

- C. WHEN THE SPACEHAB MODULE IS UNPOWERED ON ASCENT/ENTRY, THE WATER LOOP MUST BE ACTIVE PRIOR TO PAYLOAD BAY DOOR OPENING AND MUST REMAIN ACTIVE UNTIL AFTER PAYLOAD BAY DOOR CLOSURE.

A18.6.2-3 ORBITER/SPACEHAB INTEGRATED RULES

FOR AN ORBITER FREON LOOP TO SPACEHAB WATER LOOP LEAK, THE SPACEHAB MODULE WILL BE EGRESSED, ISOLATED, AND A MINIMUM DURATION FLIGHT (MDF) WILL BE INSTITUTED.

An MDF is called for a heat exchanger leak between dissimilar fluids because the problem could eventually result in a total loss of the heat exchanger and the orbiter due to subsequent loss of two Freon loops. The risk of losing the heat exchanger does not warrant a next primary landing site (PLS) but does warrant an MDF. Reference Rule {A2.6.1-4}, SPACEHAB MINIMUM DURATION FLIGHT CRITERIA.

FLIGHT RULES

Egress of the Spacehab module is performed to avoid the possibility of the crew being exposed to toxic Freon. Although the water loop is compatible with Freon 21, a relatively high pressure in the water loop (caused by Freon leaking into the water loop) increases the chances of the water loop developing a leak into the module and exposing the crew to Freon.

SPACELAB ACTIVE THERMAL CONTROL SYSTEM (ATCS) LOSS/FAILURE DEFINITIONS

A18.9.1-1 SPACELAB H2O LOOP

MODULE

LOST IF:

- A. PUMP ACCUMULATOR QUANTITY IS < 6 PERCENT OR SYMPTOMS OF PUMP CAVITATION ARE PRESENT.

Pump accumulator may be empty when its measurement indicates 6 percent which is the range of measurement uncertainty. Pump will behave erratically and cavitate when there is not enough fluid to meet the pump inlet requirement.

- B. FLOW CANNOT BE MAINTAINED GREATER THAN:

1. 70 POUNDS PER HOUR (LB/HR) - ASCENT/ENTRY OPERATIONS.

Analysis indicates the minimum flow without overheating the pump motor is 51 lb/hr. It was estimated that the required flow rate to reject an activated Spacelab module ascent/entry configuration heat load (approximately 1.3 kW total assumed) should be no less than 70 lb/hr.

Reference: SLODB data request SL 83-031 and engineering judgment.

2. 360 POUNDS PER HOUR (LB/HR) - ON-ORBIT OPERATIONS.

Estimated minimum flow rate to avoid violating the maximum coolant return temperature (104 deg Fahrenheit (F)) requirement for a continuous Spacelab operations heat load (7 kW, STS-9) is 360 lb/hr. Nominal flow rate is 500 lb/hr.

Reference: SLODB data request SL 83-031 and engineering judgment.

- C. PUMP CAVITATION - PUMP INLET PRESSURE IS LESS THAN:

1. 23 PSI AT 104 DEG F PUMP INLET TEMPERATURE.
2. 21 PSI AT 86 DEG F PUMP INLET TEMPERATURE.

FLIGHT RULES

3. 19 PSI AT 68 DEG F PUMP INLET TEMPERATURE.

4. 17 PSI AT 50 DEG F PUMP INLET TEMPERATURE.

Pump will operate erratically and may cavitate at pressures less than specified values for water with 1.6 percent N₂ content.

Reference: EP45 (83-107), MSFC.

A18.9.1-2 SPACELAB FREON LOOP

LOST IF:

A. PUMP ACCUMULATOR QUANTITY IS < 6 PERCENT AND SYMPTOMS OF PUMP CAVITATION ARE PRESENT.

Pump accumulator may be empty when its measurement indicates 6 percent, which is the range of measurement uncertainty. Pump will behave erratically and cavitate when there is not enough fluid to meet the pump inlet requirement.

B. PUMP FLOW CONSTRAINTS

1. FLIGHT SPECIFIC DIFFERENCES WILL BE DEFINED IN THE FLIGHT SPECIFIC FLIGHT RULES ANNEX. @ED]

MODULE

2. FLOW CANNOT BE MAINTAINED > 365 LB/HR.

ICD 2-19001, Table 6.2.2.2-1 states that the maximum coolant return temperature to the orbiter heat exchanger shall be 104 deg F. Considering that approximately 210 lb/hr is required to prevent the Freon pump from overheating and allowing for a minimum operational load of 150 watts for experimental and environmental heat loads, the Freon flow must be maintained above 365 lb/hr to prevent a violation of the ICD requirement. Nominal Freon loop flow rate is 3016 lb/hr.

Reference: Engineering judgment.

PALLET ONLY

3. FLOW CANNOT BE MAINTAINED > 1000 LB/HR.

ICD 2-19001, Table 6.2.2.2-1 states that the maximum coolant return temperature to the orbiter heat exchanger shall be 104 deg F. Considering that approximately 600 lb/hr is required to support the Spacelab pallet-only configuration and allowing for minimum operational load of 2 kW for experimental and environmental heat loads, the Freon flow must be maintained above 1000 lb/hr to prevent a violation of this ICD requirement. Nominal Freon loop flow rate is 2100 lb/hr.

FLIGHT RULES

Reference: Engineering judgment.

THIS RULE CONTINUED ON NEXT PAGE

FLIGHT RULES

A18.9.1-2 SPACELAB FREON LOOP (CONTINUED)

C. PUMP CAVITATION - PUMP INLET PRESS LESS THAN:

1. 80 PSI AT 104 DEG F PUMP INLET TEMPERATURE.
2. 63 PSI AT 86 DEG F PUMP INLET TEMPERATURE.
3. 50 PSI AT 68 DEG F PUMP INLET TEMPERATURE. [ED]
4. 39 PSI AT 50 DEG F PUMP INLET TEMPERATURE.

Pump will operate erratically and may cavitate at pressures less than specified values for Freon 114 with 1.1 percent dissolved N₂ content.

Reference: EP45 (83-107), MSFC.

D. AN ORBITER FREON LOOP TO PALLET FREON LOOP LEAK

An orbiter Freon loop to pallet Freon loop leak is defined as the equalization of loop pressures accompanied by a simultaneous decrease in pallet accumulator quantity.

A leak between two loops results in an equalization of the pressure in those loops. Additionally, fluid transfer will occur from the loop with the higher pressure to that with the lower pressure. It is expected that the pallet Freon loop will leak into the orbiter Freon loop.

FLIGHT RULES

SPACELAB ATCS SYSTEMS MANAGEMENT

A18.9.2-1 SPACELAB ECLS REQUIREMENTS

SPACELAB EXPERIMENTS WHICH REQUIRE SPECIFIC ENVIRONMENTAL CONTROLS IN EXCESS OF NORMAL SUBSYSTEM REQUIREMENTS ARE DOCUMENTED IN THE FLIGHT SPECIFIC ANNEX.

A. THE ANNEX WILL USE THE FOLLOWING FORMAT TO INSURE ORBITER COMPATIBILITY

DURING OPERATIONS OF SPACELAB ACTIVELY COOLED EXPERIMENTS, THE ORBITER CABIN ATMOSPHERE MUST BE MAINTAINED WITHIN THESE SPECIFIED LIMITS:

1. (PAYLOAD 1)	OPERATING RANGE
PPCO2	<u>TBD</u> < MMHG < <u>TBD</u>
TEMPERATURE	<u>TBD</u> < T < <u>TBD</u>
TOTAL PRESS, PPO2, ETC	<u>TBD</u>

B. PAYLOADS WHICH REQUIRE SPECIFIC ENVIRONMENTAL CONTROLS IN EXCESS OF NORMAL SUBSYSTEM REQUIREMENTS ARE DOCUMENTED IN THE FLIGHT SPECIFIC ANNEX. [ED]

Documenting payload cooling limits in this rule in the annex ensures that the proper orbiter cooling configuration will be established for the flight. The operating range indicates absolute minimum and maximum acceptable temperatures of the payload coolant as it exits the payload heat exchanger. Analysis of heat exchanger performance will use payload heat load data as supplied in PIP ANNEX 2 PART 1. The stability requirement dictates special payload limits to minimize oscillations within the operating range. The stability values reflected here are those introduced by changes in the orbiter Freon inlet temperature, and do not account for perturbations due to changes in payload heat load.

Certain middeck and/or Spacelab payloads may require unique atmosphere conditions that are outside of the normal range of operations of the ARS. Documentation of the payload constraints in the flight specific rules ensures that the atmosphere is managed within the specified limits. [ED]

C. EXPERIMENTS THAT WILL NORMALLY RELEASE GASES INTO THE CABIN ARE DOCUMENTED IN THE FLIGHT SPECIFIC ANNEX.

FLIGHT RULES

A18.9.2-2 H2O LOOP MANAGEMENT

MODULE

- A. SPACELAB H₂O LOOP SHOULD BE OPERATING AT ALL TIMES WITH ONLY ONE PUMP BEING ACTIVATED. NORMAL CONFIGURATION IS H₂O PUMP 1 ON.

Spacelab water loop is the primary heat rejecting coolant loop in a module configuration. Operating both water pumps simultaneously does not provide any performance improvement and will eventually cause damage to the pumps. To properly distribute ac power loads on AC ECS 2 and AC ECS 3 and maintain each ac bus load to within the 5.2 amps remote control circuit breaker (RCCB) limit, water pump 1 was chosen as the normal configuration.

- B. THE LOOP SHALL NORMALLY BE DEACTIVATED ONLY AFTER THE PAYLOAD BAY DOORS ARE CLOSED.
- C. DURING EXTENSION DAYS WHILE THE PAYLOAD BAY DOORS ARE OPEN, THE WATER LOOP WILL BE MANAGED IN ONE OF THE FOLLOWING WAYS:
1. THE WATER LOOP WILL BE ACTIVATED PRIOR TO PAYLOAD BAY DOOR OPENING AND RUN CONTINUOUSLY UNTIL PAYLOAD BAY DOOR CLOSURE.
 2. IF CONSUMABLES DO NOT PERMIT CONTINUOUS WATER LOOP OPERATION, MANEUVER TO ONE OF THE FOLLOWING ATTITUDES AND ACTIVATE THE LOOP FOR ANY ATTITUDE EXCURSIONS.

BETA ANGLE	LOOP-OFF ATTITUDE
(0 TO ± 60 DEGREES)	TOP SUN
- 60 TO - 90	± XLV BAY SOUTH *
60 TO 90	± XLV BAY NORTH *

* WITH A 22 - DEGREE AERO TRIM ROLL

THIS RULE CONTINUED ON NEXT PAGE

FLIGHT RULES

A18.9.2-2 H2O LOOP MANAGEMENT (CONTINUED)

D. IF THE SPACELAB H₂O LOOP IS LOST:

1. IF THE LOOP INTEGRITY REMAINS INTACT WHILE THE PAYLOAD BAY DOORS ARE OPEN, MANEUVER TO ONE OF THE ATTITUDES LISTED IN PARAGRAPH C.2 ABOVE. EXCURSIONS OUT OF THESE ATTITUDES WILL BE MINIMIZED.

Analysis indicates that the stagnant water lines outside the module and the payload bay liner may freeze when the payload bay doors are open if in -ZLV, PTC, tail Sun attitude unless one of the above procedures is used. Freezing both the inlet and outlet water lines to the payload heat exchanger will hydraulically lock up the line and could result in damage to the heat exchanger the potential of losing both Freon loops. The top Sun attitude as well as the -XLV attitude provides solar environmental temperatures above the freezing point of water. Reference RI ANALYSIS SE-TSAT-90-008.

2. TERMINATE SPACELAB OPERATIONS AND INITIATE H₂O LOOP LOSS POWERDOWN TO AVOID THERMAL DAMAGE OF SPACELAB AVIONICS AND INVERTERS AND TO ALLOW FOR AN ORDERLY DEACTIVATION OF SPACELAB.

Loss of the water coolant loop means loss of Spacelab active heat rejection in the module configuration. Powerdown should be initiated immediately to protect the Spacelab avionics and inverters and allow for an orderly deactivation of Spacelab.

E. CONSIDERATION WILL BE GIVEN TO ALLOW H₂O LOOP TO REMAIN ACTIVATED UNTIL SYMPTOMS OF CAVITATION OCCUR OR UNTIL MINIMUM THERMAL CONTROL CANNOT BE PROVIDED.

Depending on the time and mode of the water loop degradation, it may be desirable to allow water loop pump operation for as long as possible to maximize the experiment data collection. Termination of water coolant loop operations should be instituted when symptoms of pump cavitation occur or loop is unable to maintain thermal control to avoid component damages. Spacelab water loop is not mandatory for orbiter reentry heat rejection.

THIS RULE CONTINUED ON NEXT PAGE

FLIGHT RULES**A18.9.2-2 H2O LOOP MANAGEMENT (CONTINUED)****F. REGENERATIVE HEAT EXCHANGER:**

1. TO AVOID CONDENSATION IN THE AVIONICS LOOP, THE DIVERTER VALVE WILL BE SET TO COLD CASE POSITION TO MAINTAIN AVIONICS (AV) HEAT EXCHANGER (HX) H₂O IN T > 50 DEG F (10 DEG C), UNLESS OTHERWISE REQUIRED.

Portions of the warm coolant downstream of the avionics HX and subsystems coldplates are diverted back and through the regenerative HX when the diverter valve is set at COLD CASE position. This recycled heat helps maintain the avionics bay surface temperature above the dew point and avoid the formation of condensation.

2. TO MAINTAIN SUFFICIENT COOLING TO THE COLDPLATED SYSTEMS, SET THE DIVERTER VALVE TO NORMAL POSITION IF:
 - a. AV HX H₂O OUT T > 93 DEG F (34 DEG C), OR
 - b. AV HX AIR OUT T > 95 DEG F (35 DEG C).

To avoid overheating the subsystem equipment, the water supply temperature to the first subsystem coldplate during steady state on-orbit operation is required to be less than 93 deg F (34 deg C). Normal air inlet temperature to the avionics racks is to be between 50 deg F (10 deg C) and 95 deg F (35 deg C).

Reference: Spacelab Payload Accommodation Handbook (SPAH), Appendix C (ERNO) Spacelab Program (SLP)/2104-3) 5.2.

A18.9.2-3 FREON LOOP MANAGEMENT

- A. SPACELAB FREON LOOP WILL NOT BE OPERATED DURING ASCENT AND ENTRY. ONLY ONE FREON PUMP WILL BE OPERATED AT A TIME.

Spacelab Freon pump package is not qualified to be operated during ascent and entry. Operating both Freon pumps does not improve the system performance and will eventually cause damage to the pumps.

- B. IF SPACELAB FREON LOOP IS DEGRADED, THERMAL LOADS ON THE FREON SYSTEM WILL BE REDUCED ACCORDINGLY. THE FREON LOOP WILL REMAIN ACTIVATED UNTIL SYMPTOMS OF CAVITATION OCCUR OR UNTIL MINIMUM THERMAL CONTROL CANNOT BE PROVIDED.

FLIGHT RULES

A reduced Spacelab operation may still be feasible if thermal loads are managed properly. Depending on the time and mode of the Freon loop degradation, Freon pump will be allowed to operate in the degraded mode to provide cooling and maximize the experiment data collection without incurring damage to the pump package.

THIS RULE CONTINUED ON NEXT PAGE

FLIGHT RULES

A18.9.2-3 FREON LOOP MANAGEMENT (CONTINUED)

C. IF SPACELAB FREON LOOP IS LOST:

THE FLIGHT MAY BE CONTINUED WITH ORBITER/SPACELAB REORIENTED TO A BENIGN ATTITUDE TO AVOID FREEZING OR VAPORIZATION OF FREON. FLIGHT-SPECIFIC EXCEPTIONS ARE DOCUMENTED IN THE FLIGHT SPECIFIC ANNEX.

Self-explanatory.

D. SPACELAB FREON LOOP WILL NOT BE DEACTIVATED FOR LONGER THAN 15 MINUTES IN A HOT ATTITUDE (TOP SUN, -X NADIR, +YVV AT BETA 60 DEGREES).

Analysis shows that Freon 114 in a stagnant Freon loop will exhibit localized boiling in 15 minutes in a hot attitude.

Reference: TM No. IPM-90031, Stagnant Freon Loop Thermal Assessment, July 1990.

E. SPACELAB FREON LOOP PRESSURE

SPACELAB FREON LOOP WILL NOT BE ACTIVATED IF THE PUMP INLET PRESSURE EXCEEDS 141.5 PSIA. FLIGHT-SPECIFIC EXCEPTIONS TO THIS RULE ARE DOCUMENTED IN THE FLIGHT SPECIFIC ANNEX.

Activating the loop with pump inlet pressure exceeding 141.5 psia (qualified maximum outlet pressure of 200 psia - pump delta pressure 58.5 psia) will overpressurize the loop components.

Reference: Spacelab Pallet System Igloo Pallet Thermal Control Analysis, MDSCC Document, MDC H0841 R2, October 1985.

F. SPACELAB FREON LOOP DEACTIVATION

TO PREVENT FREON LOOP FROM FREEZING, SPACELAB FREON LOOP WILL NOT BE DEACTIVATED FOR LONGER THAN 4 HOURS WHILE IN A COLD ATTITUDE (PAYLOAD BAY TO SPACE). FLIGHT-SPECIFIC EXCEPTIONS TO THIS RULE ARE DOCUMENTED IN THE FLIGHT SPECIFIC ANNEX.

Analysis shows that Freon 114 in a stagnant Freon loop will freeze in 4 to 6 hours in a payload bay- to-deep-space attitude. Exposure of Spacelab hardware to 4 hours in a cold attitude with the Freon loop deactivated will cause exceedance of Spacelab subsystem hardware qualification limits and subsequent hardware damage; however, this poses no hazard to crew or orbiter. Each Spacelab mission will be assessed on a mission-by-mission basis to further define times allowed in a cold attitude and affected hardware.

FLIGHT RULES

THIS RULE CONTINUED ON NEXT PAGE

FLIGHT RULES

A18.9.2-3 FREON LOOP MANAGEMENT (CONTINUED)

Reference: TM No. IFM-90031, Stagnant Freon Loop Thermal Assessment, July 1990.

MODULE

- G. THE ACTIVATED FREON PUMP WILL RECEIVE POWER FROM A DIFFERENT AC ECS BUS THAN THE AVIONICS FAN. NORMAL ON-ORBIT CONFIGURATION IS FREON PUMP 2 ON.

Avionics fan and Freon pump are both high current use equipment, especially during their startup. When both are on the same AC ECS bus, maximum RCCB current limit of 5.2 amps may be exceeded during start up transient. Freon pump 2 is on AC ECS 3, avionics fan 1 is on AC ECS 2.

MODULE

- H. SPACELAB FREON PUMP WILL BE DEACTIVATED PRIOR TO THE FOLLOWING OPERATIONS:
1. ACTIVATION OF SPACELAB CABIN FAN. SPACELAB FREON PUMP MAY BE REACTIVATED 1.5 SECONDS AFTER CABIN FAN ACTIVATION.
 2. SELECTION OF SPACELAB AVIONICS FAN TO HIGH SPEED. SPACELAB FREON PUMP MAY BE REACTIVATED 10 SECONDS AFTER AVIONICS FAN HIGH SPEED SELECTION.

To avoid exceeding the Spacelab inverter maximum output current limit (10 amps) during the startup transients, Freon pump should not be operating during the activations of Spacelab cabin fan and/or avionics fan (high speed). The Freon pump has a relatively smaller startup transient current rise compared to those of cabin fan and avionics fan. Transient for cabin fan lasts approximately 1.5 seconds, transient for avionics fan (high speed) lasts approximately 10 seconds.

MODULE

- I. BEFORE REACTIVATION OF THE SPACELAB FREON LOOP, ORBITER/ SPACELAB SHOULD BE MANEUVERED TO A WARM ATTITUDE TO AVOID FREEZING THE INTERLOOP HEAT EXCHANGER. @ED]

Maneuvering to a warm attitude is necessary to warm Freon 114 to above 32 deg F to prevent freezing the Spacelab interloop HX.

FLIGHT RULES

A18.9.2-4 IGLOO MANAGEMENT PALLET ONLY

LOSS OF IGLOO PRESSURE WILL NOT CAUSE SPACELAB PALLET OPERATIONS TO BE TERMINATED.

There is no existing igloo repressurization capability. Analysis and testing show there is no safety issue in reentry with a depressurized igloo.

A18.9.2-5 ORBITER/SPACELAB INTEGRATED RULES

A. ACTIVATED SPACELAB - ORBITER SHALL PROVIDE ADDITIONAL HEAT REJECTION BY PERFORMING, IN ORDER OF PRIORITY, THE FOLLOWING:

1. FREON FLOW PROPORTIONAL VALVES PLACED TO PAYLOAD HEAT EXCHANGER (PLHX)
2. RADIATORS DEPLOYED
3. FLASH EVAPORATOR ACTIVATED
4. ATTITUDE CHANGE

Activated Spacelab is allocated by orbiter/Spacelab ICD a maximum steady state heat load of 8.5 kW. This high heat rejection to orbiter requires additional orbiter cooling support. The priorities are based on the least effort involved, least impact to experiments, and consumables management.

Reference: ICD-2-05201.

MODULE

B. DEACTIVATED SPACELAB - ORBITER FREON FLOW PROPORTIONAL VALVES WILL BE POSITIONED TO INTERCHANGER (ICH) TO AVOID CONDENSATION IN THE SPACELAB AVIONICS LOOPS.

Analysis shows with orbiter Freon flow proportional valves positioned to PL HX position, condensation in the Spacelab avionics racks may occur in a deactivated Spacelab (avionics fan in low speed and water loop operating with minimum Spacelab power load).

THIS RULE CONTINUED ON NEXT PAGE

FLIGHT RULES

A18.9.2-5 ORBITER/SPACELAB INTEGRATED RULES (CONTINUED)

MODULE

- C. FOR AN ORBITER FREON LOOP TO SPACELAB H₂O LOOP LEAK, THE SPACELAB MODULE WILL BE EGRESSED AND A MINIMUM DURATION FLIGHT (MDF) WILL BE DECLARED. (REFERENCE ALL FLIGHTS RULE {A18.1.4-1E}, ARS WATER LOOP.)

An MDF is called for a heat exchanger leak between dissimilar fluids because the possibility exists that a generic problem, such as corrosion, exists in the heat exchanger. This problem could eventually result in a total loss of the heat exchanger and orbiter due to the subsequent loss of two Freon loops. The risk of losing the heat exchanger does not warrant a next PLS but does warrant an MDF.

Egress of the Spacelab module is performed to avoid the crew being exposed to toxic Freon 21. Several components in the water loop are incompatible with Freon 21 and may fail to seal or function. These material incompatibilities, in addition to relatively high pressures in the water loop (caused by the Freon loop leaking into the water loop), increase the chances of the water loop developing an external leak into the cabin and exposing the crew to Freon 21.

Reference: SODB, Volume III, Section 4.6.1.2.1.2.

PALLET ONLY

- D. FOR A SPACELAB FREON AND ORBITER FREON LOOP TO LOOP LEAK, A MINIMUM DURATION FLIGHT WILL BE DECLARED.

An MDF is called for a heat exchanger leak between dissimilar fluids because the possibility exists that a generic problem, such as corrosion, exists in the heat exchanger. This problem could eventually result in a total loss of the heat exchanger and orbiter due to the subsequent loss of two Freon loops. The risk of losing the heat exchanger does not warrant a next PLS but does warrant an MDF.

FLIGHT RULES

THIS PAGE INTENTIONALLY BLANK

FLIGHT RULES

A18.1.10-1 **ORBITER THERMAL CONSTRAINTS AND ATTITUDE MANAGEMENT (CIL) (CONTINUED)**

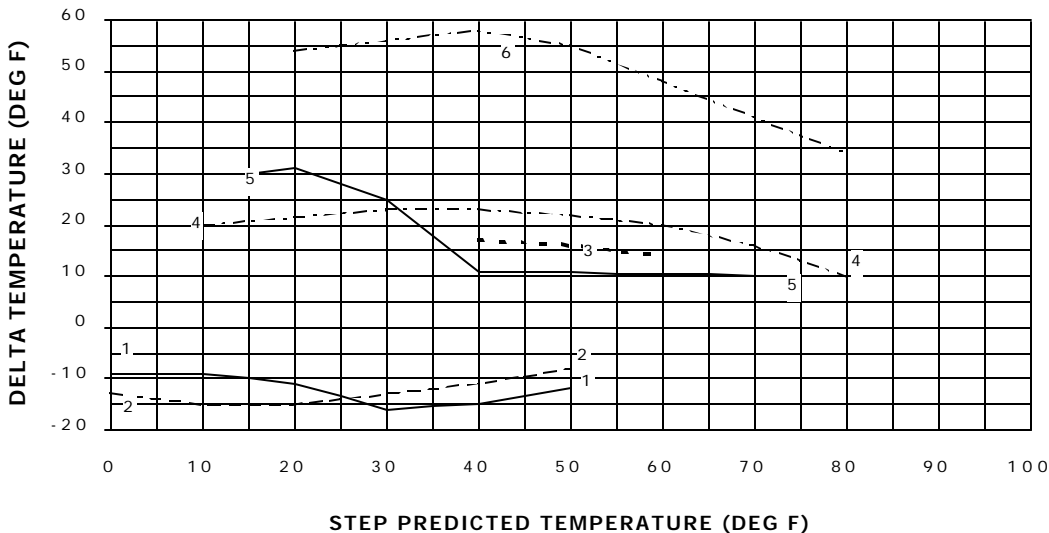

OV-103 MSID	CURVE	OV-102 MSID	CURVE
V09T1000	7	V09T1000	8
V09T1002	7	V09T1002	8
V09T1004	6	V09T1004	6
V09T1022	9	V09T1022	9
V09T1024	6	V09T1024	6
V09T1028	3	V09T1028	3
V09T1030	3	V09T1030	3
V09T1624	10	V09T1624	11
V09T1702	11	V09T1702	5
V09T1720	4	V09T1720	5
V09T1724	4	V09T1724	13
V34T1110	12	V34T1110	15
V34T1112	14	V34T1112	2
V58T1700	1	V58T1700	2
V58T1750	1	V58T1750	2

FIGURE A18.1.10-1-I - DELTA TEMPERATURE BIAS TO BE APPLIED TO STEP PREDICTIONS TO CHECK THERMAL CONSTRAINT LIMITS

THIS RULE CONTINUED ON NEXT PAGE

FLIGHT RULES

A18.1.10-1

ORBITER THERMAL CONSTRAINTS AND ATTITUDE
MANAGEMENT (CIL) (CONTINUED)

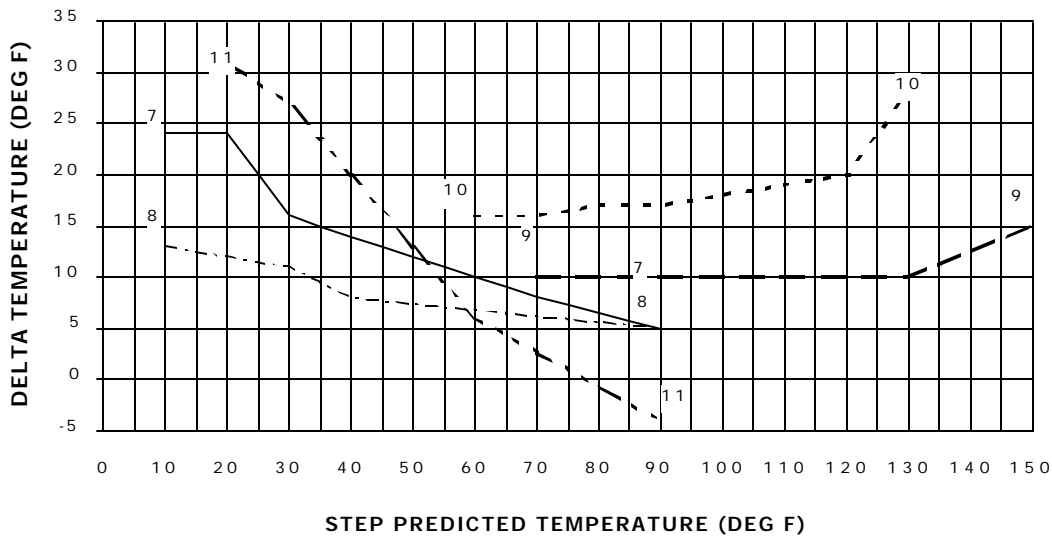

OV-103 MSID	CURVE	OV-102 MSID	CURVE
V09T1000	7	V09T1000	8
V09T1002	7	V09T1002	8
V09T1004	6	V09T1004	6
V09T1022	9	V09T1022	9
V09T1024	6	V09T1024	6
V09T1028	3	V09T1028	3
V09T1030	3	V09T1030	3
V09T1624	10	V09T1624	11
V09T1702	11	V09T1702	5
V09T1720	4	V09T1720	5
V09T1724	4	V09T1724	13
V34T1110	12	V34T1110	15
V34T1112	14	V34T1112	2
V58T1700	1	V58T1700	2
V58T1750	1	V58T1750	2

FIGURE A18.1.10-1-I - DELTA TEMPERATURE BIAS TO BE APPLIED TO
STEP PREDICTIONS TO CHECK THERMAL CONSTRAINT LIMITS
(CONTINUED)

NASA - JOHNSON SPACE CENTER

FLIGHT RULES

THIS RULE CONTINUED ON NEXT PAGE

FLIGHT RULES

A18.1.10-1

ORBITER THERMAL CONSTRAINTS AND ATTITUDE MANAGEMENT (CIL) (CONTINUED)

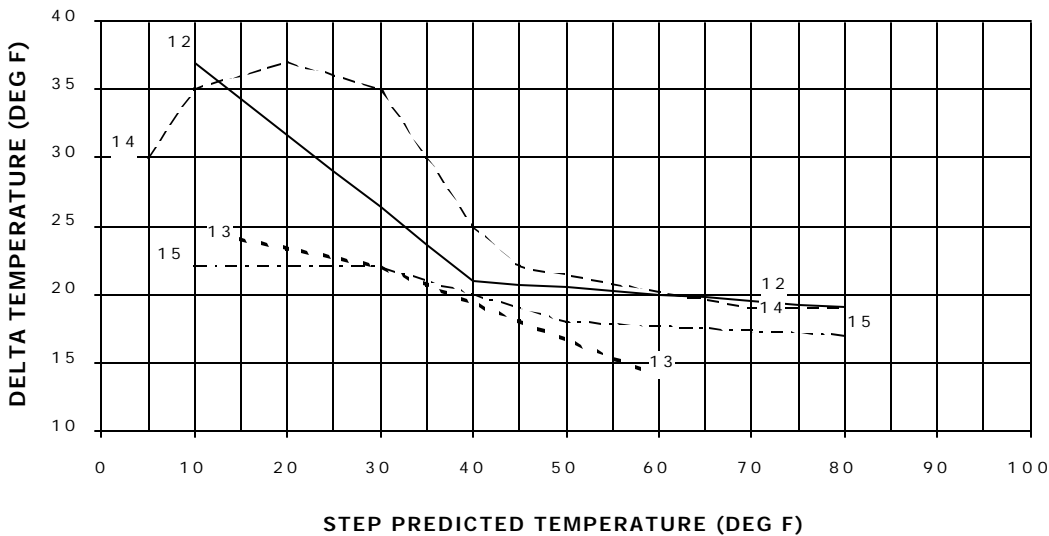

OV-103 MSID	CURVE	OV-102 MSID	CURVE
V09T1000	7	V09T1000	8
V09T1002	7	V09T1002	8
V09T1004	6	V09T1004	6
V09T1022	9	V09T1022	9
V09T1024	6	V09T1024	6
V09T1028	3	V09T1028	3
V09T1030	3	V09T1030	3
V09T1624	10	V09T1624	11
V09T1702	11	V09T1702	5
V09T1720	4	V09T1720	5
V09T1724	4	V09T1724	13
V34T1110	12	V34T1110	15
V34T1112	14	V34T1112	2
V58T1700	1	V58T1700	2
V58T1750	1	V58T1750	2

FIGURE A18.1.10-1-I - DELTA TEMPERATURE BIAS TO BE APPLIED TO STEP PREDICTIONS TO CHECK THERMAL CONSTRAINT LIMITS (CONTINUED)

FLIGHT RULES

THIS RULE CONTINUED ON NEXT PAGE

FLIGHT RULES

A18.1.10-1

ORBITER THERMAL CONSTRAINTS ATTITUDES MANAGEMENT
(CIL) (CONTINUED)

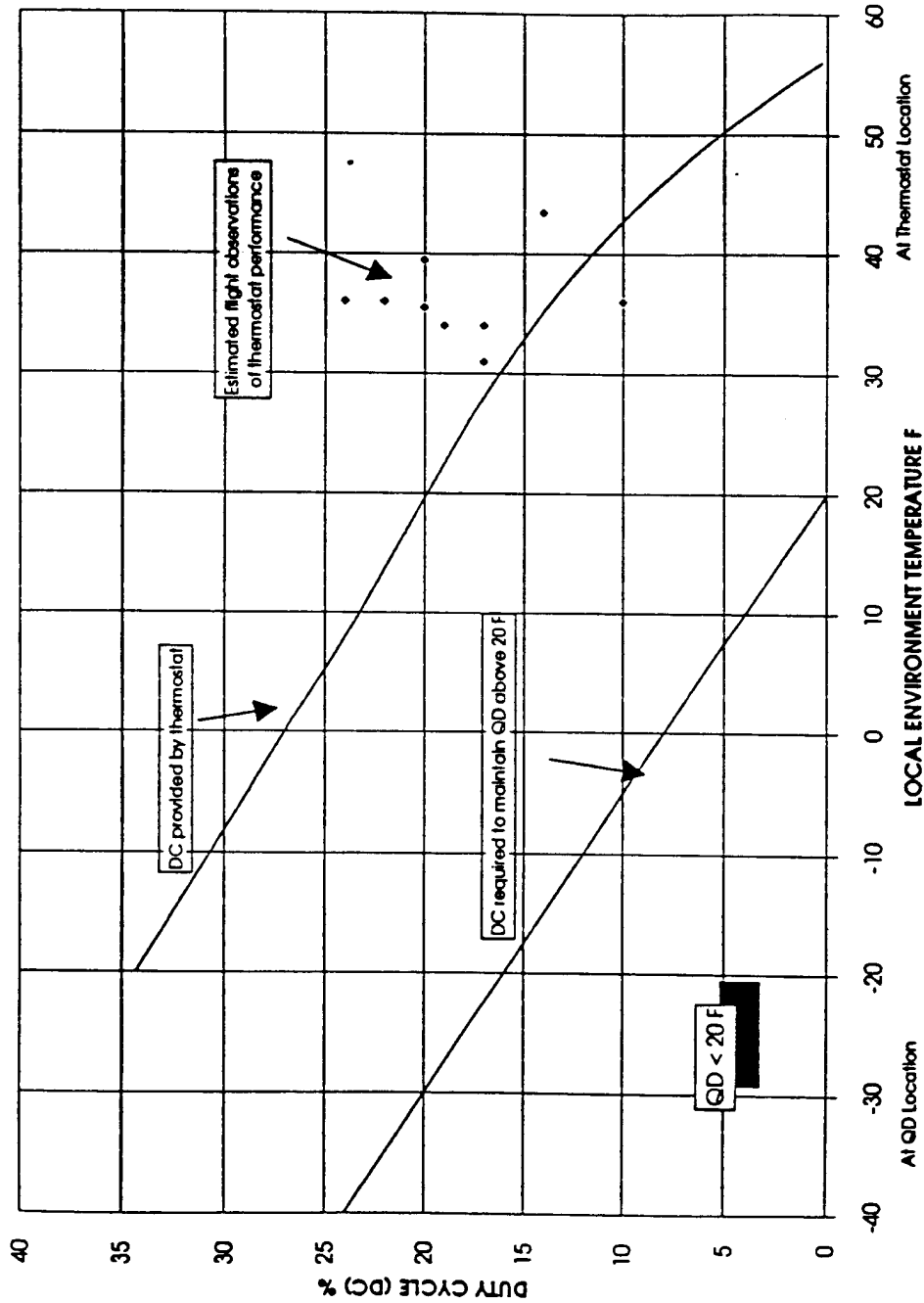

OxMS Oxidizer Mid HPBL Heater System Performance Estimate

FIGURE A18.1.10-1-II - OMS OXIDIZER MID HPBL HEATER SYSTEM PERFORMANCE ESTIMATE

THIS RULE CONTINUED ON NEXT PAGE

FLIGHT RULES

A18.1.10-1

ORBITER THERMAL CONSTRAINTS AND ATTITUDE MANAGEMENT (CIL) (CONTINUED)

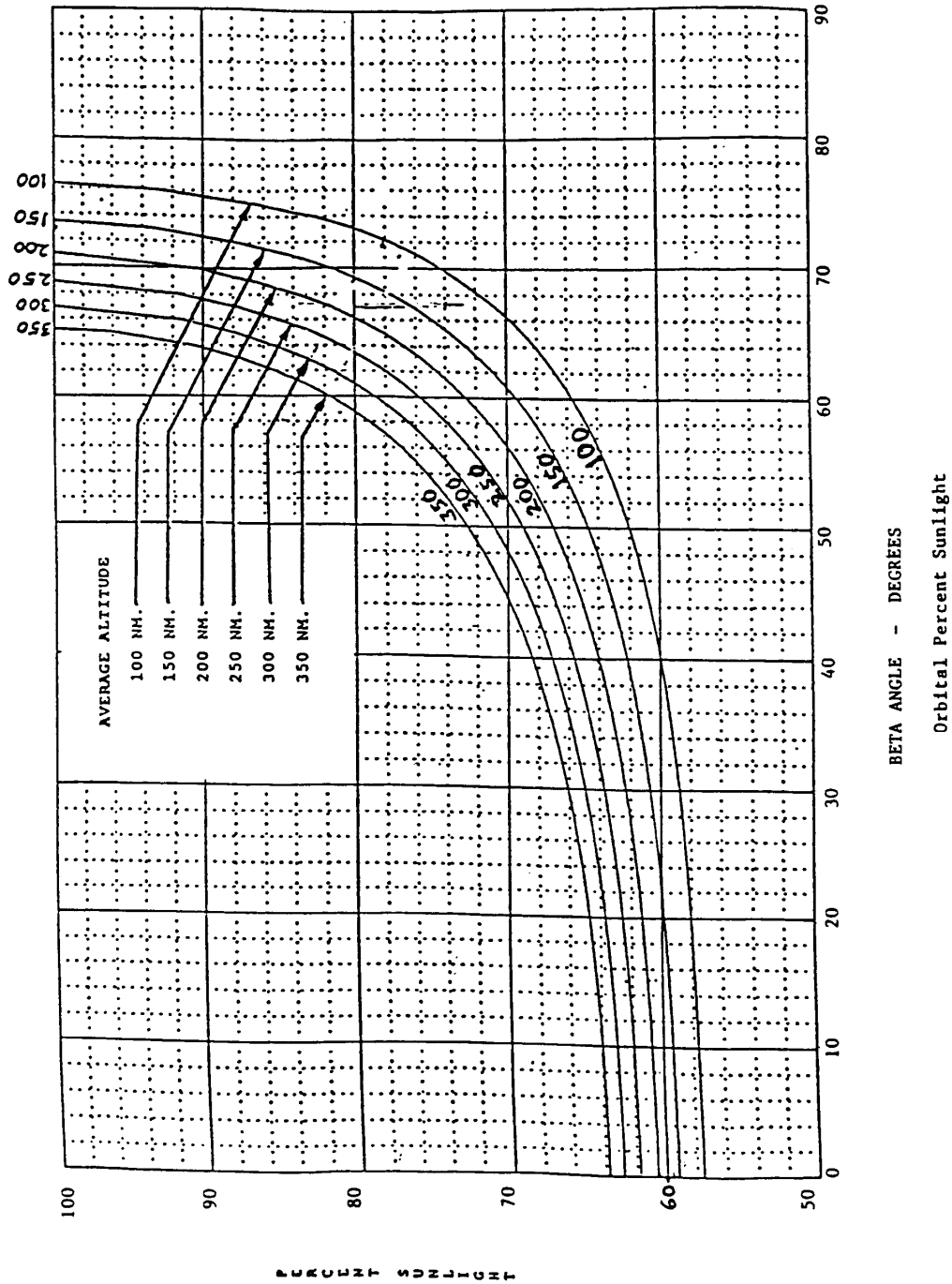

FIGURE A18.1.10-1-III - ORBITAL PERCENT SUNLIGHT AS FUNCTION OF BETA ANGLE AND ALTITUDE

THIS RULE CONTINUED ON NEXT PAGE

FLIGHT RULES

A18.1.10-1

ORBITER THERMAL CONSTRAINTS AND ATTITUDE MANAGEMENT (CIL) (CONTINUED)

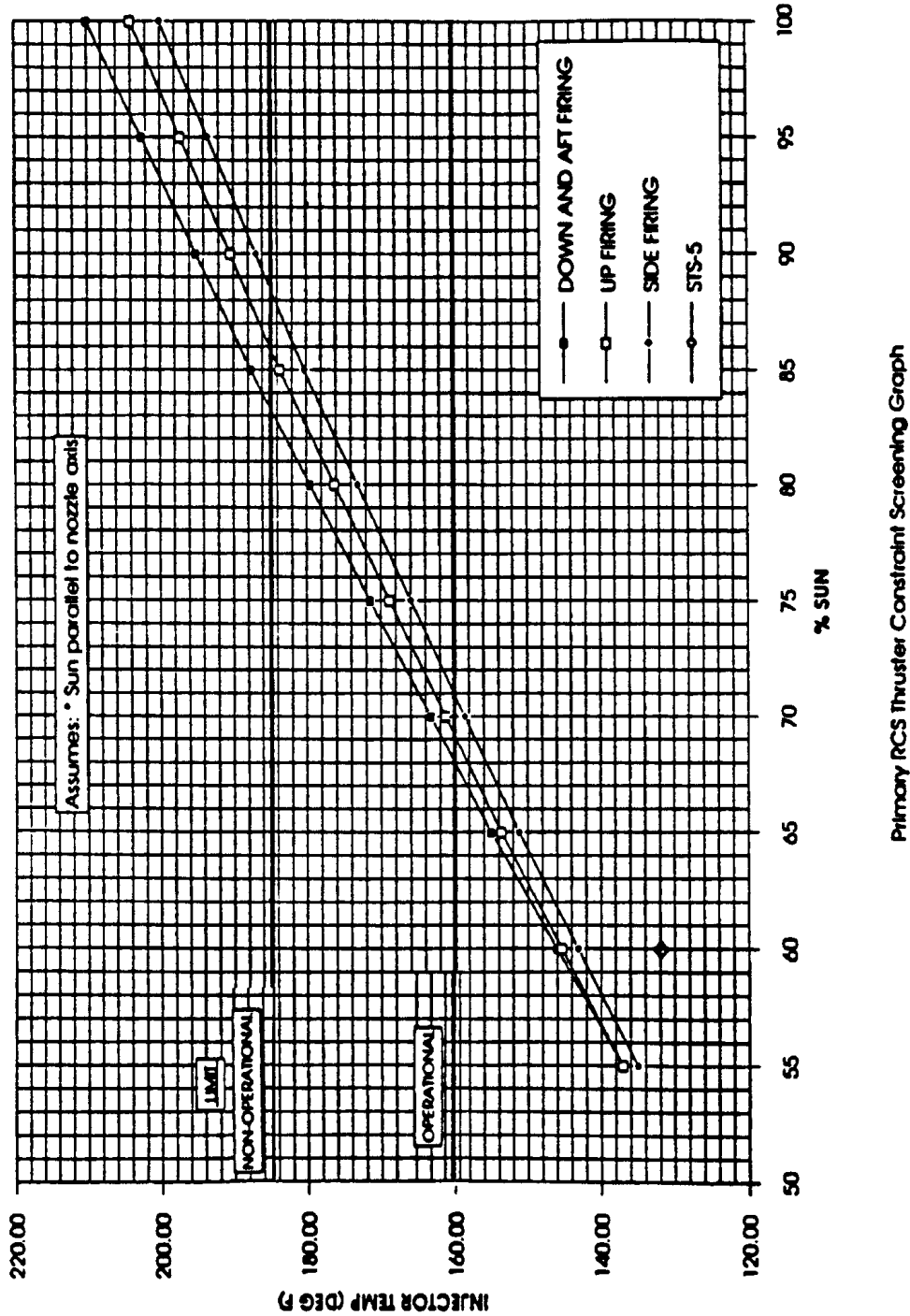

FIGURE A18.1.10-1-IV - PRIMARY RCS THRUSTER CONSTRAINT SCREENING GRAPH

FLIGHT RULES

THIS RULE CONTINUED ON NEXT PAGE

FLIGHT RULES

APPENDIX B - CHANGE CONTROL

CONTENTS

1.0	<u>INTRODUCTION</u>	B-1
1.1	PURPOSE	B-1
1.2	GENERAL	B-1
1.3	EFFECTIVITY	B-1
2.0	<u>CHANGE PROCEDURES</u>	B-2
2.1	SUBMISSION OF CHANGES	B-2
2.1.1	<u>Format</u>	B-3
2.1.2	<u>CR Input Nonconformance</u>	B-3
	FLIGHT RULES EZ CR	B-4
2.2	CR APPROVAL	B-6
2.2.1	<u>Coordination</u>	B-6
2.2.2	<u>Approved/Disapproved/Deferred Rules</u>	B-7
2.2.2.1	Generic CR's	B-7
2.2.2.2	Annex CR's	B-7
3.0	<u>DOCUMENT REVISIONS/DEVELOPMENT</u>	B-7
3.1	DEVELOPMENT	B-7
3.2	DOCUMENT APPROVAL	B-8
3.2.1	<u>Generic Rules Documents</u>	B-8
3.2.2	<u>Annex Documents</u>	B-8
3.3	PUBLICATION	B-9
3.3.1	<u>Schedule</u>	B-9
3.3.1.1	Generic Rules	B-9
3.3.1.2	Annex/Increment Rules	B-9
3.3.1.3	Flight Rules Document Review (NSTS-12820 or NSTS-18308)	B.9
3.3.2	<u>Distribution</u>	B-9
	FLIGHT RULES CHANGE FORM	B-10
	INSTRUCTIONS	B-11

FLIGHT RULES

THIS PAGE INTENTIONALLY BLANK

FLIGHT RULES

APPENDIX B

CHANGE CONTROL

1.0 INTRODUCTION

1.1 PURPOSE

The purpose of this appendix is to delineate change control procedures for Volumes A, B, C and flight-specific/increment-specific Flight Rules Annexes. This will ensure the proper coordination of changes and provide a record of the proposed changes including the rule rationale and the reason for making the change. The change request (CR) form on page B-10 is designed to assist this change control process. An electronic form designed for Microsoft Word is available on the JSCOPS WEB at URL: <http://flight.jsc.nasa.gov/rulesindex.html>.

1.2 GENERAL

All Flights CIL-related rules and generic rules with a recurring potential for mission-specific options or exceptions will be flagged so that they are readily identifiable in the All Flights generic documents. Hazard control related rules are monitored by NS5/Safety Division, and impact to a hazard control rule requiring PRCB/SSCB is reported to the FRCB. When a change to a CIL-related specific flight rule is approved and CIL retention rationale is affected by the change, the change will not be incorporated until a corresponding change to the retention rationale is approved. The same general philosophy applies to the changes that modify existing payload or orbiter hazard controls. These flight rule changes will not be incorporated until the appropriate safety organization approves a corresponding change to the related hazard control documentation. Examples of All Flights rules that have the recurring potential for flight-specific options or exceptions are some of the remote manipulator system rules. For those type flight rules, the options or exceptions can be exercised as part of the flight-specific Flight Rules Annex development process. Flight-specific exceptions to any other All Flights generic rules must be approved by the appropriate Flight Rules Control Board (FRCB), Shuttle or Station.

It is suggested that those organizations with flight rules which affect critical items list (CIL) retention rationale or hazard controls implement an independent internal CR handling procedure that identifies CIL flight rules and protects against inappropriate changes to these types of rules.

The FRCB is responsible for review and approval of CR's written against the Volume A, B, and C generic rules documents. The FRCB is chaired by the Mission Operations Director or his designee.

1.3 EFFECTIVITY

[May 5, 1999.](#)

FLIGHT RULES

2.0 CHANGE PROCEDURES

2.1 SUBMISSION OF CHANGES

The flight rule change control process starts when someone in the technical community identifies a valid need to delete or modify an existing flight rule or to add a new rule. That individual fills out a CR form using the Flight Rule Template. If access to the electronic CR form is not available to the user, a paper form is provided on page B-10. In developing the electronic change, the CR author should cut and paste appropriate pages to the bottom of the CR template and SAVE AS a user file in the user's directory. Changes may be made to the appropriate rules of the author's file. When working this file, please accept any revisions on the copied page then turn the REVISION MODE on so the change inputs are highlighted. Extracted rule pages or blank pages free of the graphics frame are encouraged.

All Flight Rules are available on the internet. The URL is: <http://flight.jsc.nasa.gov/rulesindex.html>. The user ID is **fltguest** and the password may be obtained from any one of the following sources: JSC users may call x30031 and the phone mail will include the password. Off-site users may call J. M. Bryant (281-483-5558), W. P. Dill (281-483-5418), B. A. Levy (281-483-8586), or B. R. Bentinck (281-483-3684). You will be asked for a point of contact who knows you by voice at JSC. That person will be given the password and can then call you and supply the password to you.

The completed CR is then submitted to a division FRCB representative for approval. That representative should ensure that all CR's are coordinated within the originating division before submitting them to the DA8/Flight Director Office, Lyndon B. Johnson Space Center, Houston, Texas 77058. Each division should establish its own process to handle this internal coordination. DF/System Division is an exception to this protocol. CR's from DF are not processed through the DF FRCB representative, but submitted to the Flight Director Office by DF Branch Offices. When internal coordination has been completed, the division FRCB representative signs the form and forwards it to the Flight Director Office. For electronic CR's, facsimile signature is recognized by the DA8/Flight Director office when the CR is mailed electronically from the appropriate Branch Manager or the Division FRCB representative within MOD to DA8/J. M. Bryant (to the appropriate DA8/Book Manager for Annexes) for generic rule CR's and cc to DA8/W. P. Dill for Space Shuttle Operational Flight Rules, Volume A; ~~DA8/B. A. Levy for~~ ISS Generic Operational Flight Rules, Volume B; or ~~DA8/B. R. Bentinck for~~ Joint Shuttle/ISS Generic Operational Flight Rules, Volume C. **Examples of the electronic addresses are: SMPT: william.p.dill1@jsc.nasa.gov or [smt: wdill@ems.jsc.nasa.gov](mailto:wdill@ems.jsc.nasa.gov).** Organizations outside MOD may submit CR's through the appropriate MOD division to facilitate presubmittal review and coordination or may submit completed CR's directly to the Flight Director Office. If submitted through a division, the division should review, coordinate, and approve the CR in the established manner before forwarding it to the Flight Director Office. When practicable, coordination should include the Flight Director. Electronic CR's are encouraged from outside MOD.

FLIGHT RULES

2.1.1 Format

Individuals desiring to submit a flight rule change will complete the CR form shown on page B-10. For new flight rule submittals, the rule and its associated rationale should be phrased as it is intended to appear in the flight rules document. Supporting data for the rationale may be attached. This form must be typed or neatly printed. Additional pages may be used if the space provided is not adequate. For changes to existing rules, the proposed changes must be made obvious by either providing a copy of the latest flight rule with marked up changes or, if retyped, by utilizing bold type, underlines, etc.

Changes submitted on obsolete/nonstandard forms will be returned to the originator unprocessed.

2.1.2 CR Input Nonconformance

If an error is discovered while reviewing an incorporated Flight Rule CR, please notify the Book Manager of the nonconformance using the EZ CR form provided on the next page of this appendix. (Be aware that this is not the Flight Rule CR form and should only be used to report nonconformances.) Verification of the nonconformance initiates a metric input, correction, possible corrective action, nonconformance disposition/approval, and closure. Closure of "Control of Nonconforming Product" nonconformance EZ CR's are approved by the Flight Director Office USA supervisor or his designee. Closure of "Corrective and Preventive Action" nonconformance EZ CR's are approved by the Chief of the Flight Director Office or his designee.

FLIGHT RULES

INSTRUCTIONS

1. DATE - Enter FLIGHT RULES EZ CR initiation date.
2. INITIATED BY: ORG/NAME/PHONE - Enter the originator's organization, name, and phone number (including area code if other than JSC).
3. RULE NUMBER - Enter the nonconformance rule number.
4. CONTROL NUMBER - Leave blank; will be assigned and entered by the document manager.
5. FLIGHT EFFECTIVITY - Enter whether Generic or Flight Specific Number.
6. OTHER AFFECTED RULES - Enter other rules affected.
7. DOCUMENT DATE w/Date/ REV Date - Enter the "affective document" document date and the PCN/Rev (if applicable) that contains the rule to be modified.
8. Enter All Flights Volume A, B, or C, or check the appropriate box for the annex
9. RULE ELEMENT - Enter the rule element number.
10. RULE SECTION - Enter the rule section number
11. SHORT DESCRIPTIVE TITLE OF CHANGE - Enter a short descriptive title of the change.
12. RULE, RATIONALE - Check appropriate box for whether the nonconformance is in rule and/or rationale.
13. NONCONFORMANCE DESCRIPTION - Enter a description of the nonconformance.
14. SPECIAL INSTRUCTIONS (IF REQUIRED) - Enter any special instruction here.
15. NONCONFORMANCE - Leave blank; will be assigned and entered by the document manager.

FLIGHT RULES

2.2 CR APPROVAL

2.2.1 Coordination

Pre-coordination between the author and affected disciplines is assumed. When the Flight Director Office receives a generic flight rule CR for disposition, a control number and coordinating flight director will be assigned to it. The coordinating flight director works with the initiator on any desired changes to the wording for the rule or rationale. The coordinating flight director conducts the Flight Director Office review and assists in the identification of any additional data or coordination that may be required. When this initial coordination has been completed and external coordination is required, a mandatory review sheet is distributed for formal review and comment with an appropriate suspense date provided. When required, all FRCB members plus others identified by the coordinating flight director will receive review copies or be directed to electronic review copies. To allow adequate review time, the suspense date is established to support the next scheduled FRCB (or specific launch date). CR's are required to be delivered to the Flight Director Office for review 3 weeks prior to the FRCB.

This review includes an assessment of impact to retention rationale for CIL-related rules and a review of related orbiter or payload hazard reports. All proposed changes to CIL-related flight rules or rules related to orbiter hazard reports are sent to the DF/Systems Division FRCB representative. For CIL-related flight rules, the appropriate DF/Systems Division discipline then coordinates with the affected subsystem manager to determine if the CR will change the CIL retention rationale. For orbiter hazard report related flight rules, the appropriate DF/Systems Division discipline coordinates with the NS5/SRQA Safety Division to determine if documented hazard controls are affected. Those flight rule changes that could impact payload hazard reports are sent to the DO/Operations Division FRCB representative, who then works with the DO/Operations Division Assistant for Safety to determine if the proposed change invalidates or modifies documented payload hazard controls. When the Systems Division or the Operations Division completes this assessment, the division FRCB representative forwards an impact statement along with recommended disposition to the Flight Director Office. The impact statement is then used by the FRCB when it disposes the proposed flight rule CR.

FLIGHT RULES

2.2.2 Approved/Disapproved/Deferred CR's

2.2.2.1 Generic CR's

For minor changes to generic rules/rationale, format only changes to flight rules, and when no mandatory review assignments have been made by the reviewing Flight Director, the FRCB Chairman may approve the CR out of board provided no changes were recommended by the board members. All other CR's will be considered by the appropriate FRCB. The FRCB considers each CR based on the impact on operations, the impact on documented hazard controls or CIL retention rationale, and the technical justification. Each CR will then be approved, disapproved, or deferred. Approved changes will be incorporated into the next page change notice (PCN) or revision to the generic document unless related hazard controls or CIL retention rationale must also be changed. For these cases, CR incorporation is delayed until corresponding changes to the related retention rationale or documented hazard controls are approved by the PRCB or SSCB or appropriate safety panel. Disapproved CR changes will be returned to the initiator along with the reason for disapproval. Disapprovals may be appealed to the Level II Program Office, if desired. The last possible FRCB action is deferral. CR's will be deferred for only two reasons: all mandatory concurrences have not been received, or additional data or analysis is needed. CR deferrals will be rescheduled for a subsequent FRCB meeting.

[FRCB minutes document the status of each CR dispositioned \(approved, deferred, approved with modification, etc.\). Electronic databased CR's may be processed by the book manager acting for the FRCB Chair in accordance with the FRCB CR status documented in the minutes.](#)

2.2.2.2 Annex CR's

The Lead Flight Director has approval authority of CR's for Flight Specific Increment Annexes or for Flight Specific Annexes.

3.0 DOCUMENT REVISIONS/DEVELOPMENT

3.1 DEVELOPMENT

The Flight Director Office will compile for the generic documents the effective changes and corrections of minor typographical errors into complete Revisions or PCN's to the basic document.

The Flight Director Office prepares annexes on a per flight basis according to schedule template at approximately launch minus 7 months in most cases.

Editorial changes may be used to correct typographical errors if there are no other changes on the page concerned.

FLIGHT RULES

3.2 DOCUMENT APPROVAL

3.2.1 Generic Rules Documents

Revisions/PCN's to the Volume A document will be approved by the Chief, Flight Director Office; Director; Mission Operations; and Manager, Space Shuttle Program. Pen and Ink (P&I) changes will be approved by the Chief, Flight Director Office under DA8 memorandum with concurrence by the Director, Mission Operations. Real-time CR's are approved by the Flight Director and the Mission Operations Director and are stasured to the Mission Management Team.

Revisions/PCN's to the Volume B document will be approved by the Chief, Flight Director Office; Director, Mission Operations; and Manager, Space Station Program. P&I changes will be approved by the Chief, Flight Director Office under DA8 memorandum with concurrence by the Director, Mission Operations. Real-time CR's are approved by the Flight Director and the Mission Operations Director and are stasured to the Mission Management Team.

Revisions/PCN's to the Volume C document will be approved by the Chief, Flight Director Office; Director, Mission Operations; Manager, Space Shuttle Program; and Manager, Space Station Program. P&I changes will be approved by the Chief, Flight Director Office under DA8 memorandum with concurrence by the Director, Mission Operations. Real-time CR's are approved by the Flight Director and the Mission Operations Director and are stasured to the Mission Management Team.

[Documents are updated with approved CR's and stasured at program review boards. If all signatures are not obtained in time to meet publication schedules, signatures pages will be posted by eratta when they are received.](#)

3.2.2 Annex Documents

A "Headsup" review copy of the "Final" document is provided for program review 5 working days prior to "Final" presentation to the affected Program Requirements Control Board (PRCB) or SSCB or Joint Board. After the 5-day review, the Flight Director is scheduled on the appropriate board agenda via a Control Board CR to brief any flight specific issues potentially affecting Program policies. Also, any additional significant changes received during the 5-day review period will be briefed.

Pre-Final documents are approved by the Lead Flight Director or his designee.

The Annex Final and Revisions/PCN's to the Final document will be approved by the Chief, Flight Director Office; Director, Mission Operations; and Manager, Space Shuttle Program. Pen and Ink (P&I) changes will be approved by the Lead Flight Director under DA8 memorandum with concurrence by the Chief, Flight Director Office and Director, Mission Operations. Real-time CR's are approved by the Flight Director and the Mission Operations Director and are stasured to the Mission Management Team.

The Increment Annex Final and Revisions/PCN's to the Final will be approved by the Chief, Flight Director Office; Director, Mission Operations; Manager, Space Shuttle Program; and Manager, Space Station Program. Pen and Ink changes will be approved by the Lead Flight Director under DA8 memorandum with concurrence from the Chief, Flight Director Office and the Director, Mission Operations. Real-time CR's are approved by the Flight Director and the Mission Operations Director and are stasured to the Mission Management Team.

FLIGHT RULES

3.3 PUBLICATION

3.3.1 Schedule

3.3.1.1 Generic Rules

All Flights books (Volumes A, B, and C) originating as initial documents would approximately follow the schedule described for annexes except the FRCB would exercise individual rules approval prior to obtaining respective PRCB's approvals. After initial release of Volumes A, B, C, etc., in "Final" form, subsequent revisions will be in the form of PCN's or Pen and Inks (P&I's), depending on CR traffic and mission requirements.

3.3.1.2 Annex/Increment Rules

Initial publication of annexes will be in "Basic" form and provided for the Flight Operations Review (FOR) data pack distribution at approximately launch minus 4 months (schedule provided by Payload FOR memorandum.) Post-FOR, the flight rules will be published in "Basic, Revision" form and distributed in time to support the flight simulation schedule. The "Final" approval process takes place at approximately liftoff minus 1 month. The logistics required for the formal approval process precludes initiating a PCN within 2 weeks of launch. Within 2 weeks of the launch, the Pen and Ink (P&I) process is invoked with P&I changes processed "on console" at launch minus 1 days, and produced on an "as required" basis. After liftoff, changes will be processed real time per the Flight Control Operations Handbook (FCOH), SOP 1.2.1., Real-Time Flight Rule Changes

3.3.1.3 Flight Rules Documents Review (NSTS-12820 or NSTS-18308)

These documents will be reviewed in accordance with the change traffic, but not less than once annually. This review will be performed by the Chief, Flight Director Office and noted as "Annual Review" on the revisions page with initials and date.

3.3.2 Distribution

Hard copy publications will be printed and distributed through normal administrative channels. Use of electronic copy off the web is encouraged.

NASA - JOHNSON SPACE CENTER
FLIGHT RULES

SUBMIT CR TO: Annex Book Manager or
DA8/W. P. DILL, NASA/JSC, PHONE 713-483-5418
E-MAIL: william.p.dill1@jsc.nasa.gov

RECEIVED:
INCORPORATED:
CR STATUS:

(DA8 Use Only)

JSCDA8 Ver 10.0 (Rev July 97) Electronic Media CR Form for Use with Word Ver 6.0 and later releases

FLIGHT RULES

INSTRUCTIONS

1. DATE - Enter CR initiation date.
2. INITIATED BY: ORG/NAME/PHONE - Enter the originator's organization, name, and phone number (including area code if other than JSC).
3. CONTROL NUMBER - Leave blank; will be assigned and entered by the document manager.
4. RULE NUMBER - Enter the existing rule number to be modified. If this is a new rule, enter the section number, the document manager will assign a rule number.
5. FLIGHT EFFECTIVITY & Term and Terminate after: - Enter the first flight for which the rule is required. If generic, enter "ALL". For Annex or Increment Annex STS-XX or INC X/STS-XX. If there is a mission that requires termination thereafter, make that entry here using similar annotation STS-XX, etc.
6. OTHER AFFECTED RULES - Enter other rules which either reference this rule or which this rule references.
7. DOCUMENT DATE w/Date/ REV Date - Enter the "affective document" document date and the PCN/Rev (if applicable) that contains the rule to be modified.
8. ALL FLIGHTS VOL, ANNEX - Enter All Flights Volume A, B, or C, or check the appropriate box for the annex document for which the CR is intended.
9. RULE ELEMENT - Enter the rule element number.
10. RULE SECTION - Enter the rule section number
11. SHORT DESCRIPTIVE TITLE OF CHANGE - Enter a short descriptive title of the change.
12. RULE, RATIONALE - Check appropriate box for rule and/or rationale.
13. RULE CHANGE- ATTACHED - Enter the rule and rationale exactly as it will appear in the document to be changed. It is preferred that the page(s) being changed be copied and pasted below the page break of the CR form ("Instructions" page to be deleted). The rule/rationale should be modified with revision mode ON. For a new rule, enter rule below the page break using format shown below:
14. TITLE - In capital letters and underlined.
 RULE - In capital letters exactly as it will appear in the document.
 RATIONALE - Enter the word "Rationale" followed by the rule rationale in lower case letters.
15. SPECIAL INSTRUCTIONS (IF REQUIRED) - Enter any special instruction here.
16. REASON FOR CHANGE - Enter the technical or philosophical reason for changing the existing rule or why a new rule is required.
17. PRE-COORD: (ORG/NAME) - Enter any pre-coordination information obtained here.
18. APPROVED: SUBMITTING ORGANIZATION FRCB MEMBER/DATE - This block is to be signed/dated by the Flight Rules Control Board (FRCB) member of the organization submitting the rule. Concurrences, if required, may be initialed in this block. Changes originating from organizations which have no FRCB membership may submit their proposed changes directly to the Flight Director Office, DA8, Lyndon B. Johnson Space Center, Houston, Texas 77058.
19. CIL HAZARD CONSTRAINTS TO OPERATIONS: YES NO - Optional, the originator may attempt to answer this question; however, the responsibility lies with DF to determine if the CR affects JSC 23227, "CIL/Hazard Constraints to Operations." This is the MOD ops retention rationale document.
20. DOES THIS CHANGE MODIFY EXISTING CIL RETENTION RATIONALE: YES NO - Optional, the originator may attempt to answer this question; however, the responsibility lies with DF to make this assertion.
21. DOES THIS CHANGE AFFECT CREW PROCEDURES? YES NO - The originator should attempt to answer this question and make reference to changes in the crew procedures document in item 11.
22. DOES THIS CHANGE MODIFY RATIONALE FOR A CONTROLLED HAZARD? YES NO - Optional, the originator may attempt to answer this question; however, the responsibility lies with the Systems or Operations Divisions to make this assessment.
23. APPROVED: FRCB CHAIRMAN - This block is to be signed by the FRCB Chairman, Operations Director, or his alternate signifying approval by the FRCB.
24. APPROVED: LEAD FLIGHT DIRECTOR - This block is to be used only for Lead Flight Director concurrence for changes to the flight-specific annexes.
25. CHANGE IS RESULT OF - Check appropriate box.
26. EVALUATION SUMMARY - Leave blank; used by DA8 to identify/request mandatory CR review.
27. RECEIVED/INCORPORATED/CR STATUS: - Leave blank; this block is used for internal document control by the document manager.

FLIGHT RULES

THIS PAGE INTENTIONALLY BLANK

FLIGHT RULES**APPENDIX A****ACRONYMS AND ABBREVIATIONS**

a	SEMI-MAJOR AXIS
A/D	ANALOG TO DIGITAL
A/E FTP	ASCENT/ENTRY FLIGHT TECHNIQUES PANEL
A/G	AIR-TO-GROUND (COMM)
A/L	AUTOLAND
	ASCENDING LEFT
A/M	AUTO/MANUAL
AA	ACCELEROMETER ASSEMBLY
ABE	ARM BASED ELECTRONICS
ABS	AMMONIA BOILER SUBSYSTEM
	ABSOLUTE
AC	ALTERNATING CURRENT
ACCEL	ACCELEROMETER
ACCU	AUDIO CENTRAL CONTROL UNIT
ACCUM	ACCUMULATOR
ACFM	ACTUAL CUBIC FEET PER MINUTE
ACIP	AERODYNAMIC COEFFICIENT IDENTIFICATION PACKAGE
ACK	ACKNOWLEDGE
ACLS	AUGMENTED CONTINGENCY LANDING SITE
ACQ	ACQUISITION
ACS	AUDIO CONTROL SYSTEM
ACT	ACTUATOR
	ACTIVATION
AD	AIR DATA
ADATA	AIR DATA TRANSDUCER ASSEMBLY
ADCOM	AEROSPACE DEFENSE COMMAND
ADI	ATTITUDE DIRECTION INDICATOR
ADS	AIR DATA SYSTEM
ADTA	AIR DATA TRANSDUCER ASSEMBLY
AED	ANALOG EVENT DRIVER
AEFTP	ASCENT/ENTRY FLIGHT TECHNIQUES
AERO	AERODYNAMICS
AF	AIR FORCE
AFB	AIR FORCE BASE
AFD	AFT FLIGHT DECK
AFD CONF	ASSISTANT FLIGHT DIRECTOR CONFERENCE LOOP
AFO	ABORT FOR ORBIT
AFFTC	AIR FORCE FLIGHT TEST CENTER
AFRCC	AIR FORCE RESCUE COORDINATION CENTER
AFSCF	AIR FORCE SATELLITE CONTROL FACILITY
AFTP	ASCENT FLIGHT TECHNIQUES PANEL

FLIGHT RULES

AGL	ABOVE GROUND LEVEL
AGS	ANTI G-SUIT
AIF	AUTO/INHIBIT/FORCE
AIL	AILERONS
AKA	ACTIVE KEEL ASSEMBLY
ALARA	AS LOW AS REASONABLY ACHIEVABLE
ALC(A)	AFT LOAD CONTROL (ASSEMBLY)
ALIGNS	ALIGNMENT(S)
ALP	APPROACH AND LANDING PLAN
ALS	AUGMENTED LANDING SITE
ALT	ALTITUDE
	APPROACH AND LANDING TESTS
AM	ACTUAL MODE
AME	ABORT MANEUVER EVALUATOR
AMI	ALPHA MACH INDICATOR
AMP	AMPERE
ANT	ANTENNA
AOA	ABORT-ONCE-AROUND
AOS	ACQUISITION OF SIGNAL
APC(A)	AFT POWER CONTROLLER (ASSEMBLY)
APU	AUXILIARY POWER UNIT
ARC	AMES RESEARCH CENTER
ARCS	AFT REACTION CONTROL SYSTEM
ARD	ABORT REGION DETERMINATION
ARPCS	ATMOSPHERIC REVITALIZATION PRESSURE CONTROL SYSTEM
ARS	ATMOSPHERIC REVITALIZATION SYSTEM
AS	AIRSPEED
ASA	AEROSURFACE SERVO AMPLIFIER
ASAP	AS SOON AS PRACTICAL
	AS SOON AS POSSIBLE
ASC	ASCENT
ASCS	ATMOSPHERE STORAGE AND CONTROL SYSTEM
ASI	AEROSURFACE STICK INPUT
ASSY	ASSEMBLY
ATCO	AMBIENT TEMPERATURE CATALYTIC OXIDIZER
ATCS	ACTIVE THERMAL CONTROL SYSTEM
ATO	ABORT TO ORBIT
ATT	ATTITUDE
ATU	AUDIO TERMINAL UNIT
ATVC	ASCENT THRUST VECTOR CONTROL
AUTO	AUTOMATIC
AUX	AUXILIARY
AV	AVIONICS
AVAIL	AVAILABLE

FLIGHT RULES

AVE	AVERAGE
AVG	AVERAGE
AVVI	ALTITUDE/VERTICAL VELOCITY INDICATOR
AZ	AZIMUTH
B/C	ELECTRICAL BUS DESIGNATORS
B/H	BULKHEAD
B/U	BACKUP
BARO	BAROMETER
BCE	BUS CONTROL ELEMENT
BD	BOARD
BD FLAP, B/F	BODY FLAP
BDA	BERMUDA ISLAND (STDN STATION)
BEN	BEN GUERIR (PRIME TAL SITE)
BET	BENDING EFFECT TEMPERATURE
	BEST ESTIMATE TRAJECTORY
BETA	VEHICLE SIDESLIP ANGLE
BF	BODY FLAP
BFS	BACKUP FLIGHT SYSTEM
BITE	BUILT-IN TEST EQUIPMENT
BIU	BUS INTERFACE UNIT
BLKHD	BULKHEAD
BRTS	BOOSTER REAL TIME SOFTWARE
BSR	BITE STATUS REGISTER
BSE	BOOSTER SYSTEMS ENGINEER
BT	BURN TIME
BTU	BUS TERMINAL UNIT
BUC	BACKUP COMPUTER
	BUCKHORN (STDN STATION)
BYD	BANJUL (PRIME TAL SITE)
BYP	BYPASS(ED)
C	CENTER
	CELSIUS
C&W	CAUTION AND WARNING
C/A	ELECTRICAL BUS DESIGNATORS
C/L	CENTER LINE
C/O	CUTOFF
	CHECKOUT
CA	CONTINGENCY ABORT
CAB	CABIN
CAL	CALIBRATION
	CALIFORNIA

FLIGHT RULES

CAM	COMPUTER ANNUNCIATION MATRIX
CAP	CAPABILITY
CAR	CORRECTIVE ACTION REPORT
CAU	CHANNEL ATTACH UNIT
CB, cb	CIRCUIT BREAKER
CC	CONVOY COMMANDER
CCAFS	CAPE CANAVERAL AIR FORCE STATION
CCB	CHANGE CONTROL BOARD
	CODED CONTROL SYSTEM COMMAND BUFFER
CCC	CENTRALIZED COMPUTATION COMPLEX
CCR	CONTROL CENTER RACK
CCS	COMMAND CONTROL SYSTEM
CCTV	CLOSED CIRCUIT TELEVISION
CDDS	COMMAND DATA AND DATA SUBSYSTEM
CDE	CONSOLIDATED DEVELOPMENT ENVIRONMENT
CDMS	COMMAND AND DATA MANAGEMENT SYSTEM
CDR	COMMANDER
CDS	COMMAND DATA SYSTEM (SUBSYSTEM)
	CURRENT DATA SYSTEM
CDSS	CONSOLIDATED DATA SELECT SWITCH
CEI	CERTIFIED END ITEM
CG, c.g.	CENTER OF GRAVITY
CHIT	SHORT NOTE OR LETTER (NOT AN ACRONYM)
CHNL, CH	CHANNEL
CI	CONE INDEX
CIC	CREW INTERFACE COORDINATOR
CIE	COMPUTER INTERFACE ELECTRONICS
CIL	CRITICAL ITEMS LIST
CIR, CIRC	CIRCULAR
	CIRCULATION
CIU	COMMUNICATIONS INTERFACE UNIT
CK	CHECK
CKT	CIRCUIT
CL, CLS	CLOSE(D)
CM	CENTIMETER
	CONFIGURATION MANAGEMENT
CMD, CMND	COMMAND
CMDR	COMMANDER
CME/V	COMMAND MESSAGE ENCODER/VERIFIER
CM/SEC	CENTIMETERS PER SECOND
CNTL	CONTROL
CNTRLR	CONTROLLER
CO	CARBON MONOXIDE
C/O	CHECKOUT
CO ₂	CARBON DIOXIDE

NASA - JOHNSON SPACE CENTER

FLIGHT RULES

COAS	CREW OPTICAL ALIGNMENT SIGHT
COF	PATRICK AIR FORCE BASE (TACAN)
COFR	CERTIFICATE OF FLIGHT READINESS
COF ₂	CARBONYL FLUORIDE
COLA	COLLISION AVOIDANCE
COMBO	COMPUTATION OF MISSES BETWEEN ORBITS
COMM	COMMUNICATIONS
COMP	COMPUTER
COMSEC	COMMUNICATIONS SECURITY
CONF	CONFERENCE
CONFIG	CONFIGURATION
CONT	CONTINGENCY
	CONTINUED
CONTRS	CONTROLLERS
CONUS	CONTINENTAL UNITED STATES
CPA	COMBUSTION PRODUCTS ANALYZER
	CLOSEST POINT OF APPROACH
CPDS	COMPUTER PROGRAM DESIGN SPECIFICATION
CPM	CELL PERFORMANCE MONITOR
CPSE	COMMON PAYLOAD SUPPORT EQUIPMENT
CR	CHANGE REQUEST
CRIT	CRITICAL
CRSFD	CROSSFEED
CRT	CATHODE RAY TUBE
CRU	CONVERTER REGULATOR UNIT
CRYO	CRYOGENIC
CS	COMMON SET
CSC	COMMAND SYSTEM CONTROLLER
	CONTINGENCY SUPPORT CENTER
CSDL	CHARLES STARK DRAPER LABORATORY
CSM	COMPUTER STATUS MATRIX
CSS	CONTROL STICK STEERING
CTU	COMMAND AND TELEMETRY UNIT
CU	CONTROL UNIT
CWC	CONTINGENCY WATER COLLECTION
CWEA	CAUTION AND WARNING ELECTRONIC ASSEMBLY
CWS	CAUTION AND WARNING SYSTEM
D	DAY
	DEPLOY
	DRAG
D&C	DISPLAY AND CONTROL
D/L	DOWN LINK
D/O	DEORBIT

FLIGHT RULES

D/Q	DISQUALIFICATION
DA	DISTRIBUTION ASSEMBLY
DAC	DIGITAL-TO-ANALOG CONVERTER
DACS	DATA ACQUISITION AND CONTROL SYSTEM
DAE	DOWNRANGE ABORT EVALUATOR
DAK	DAKAR (STDN SITE)
DAP	DIGITAL AUTO PILOT
DB	DEADBAND
	DECIBEL
DBZ	DECIBELS OF Z
DC, dc	DIRECT CURRENT
DCC	DATA COMPUTATION COMPLEX
DCM	DISPLAYS AND CONTROLS MODULE
DCU	DIGITAL COMPUTER UNIT
DDF	DATA DISTRIBUTION FUNCTION
DDH	DUMP DATA HANDLER
DDS	DESCENT DESIGN SYSTEM
	DATA DISPLAY SYSTEM
DDU	DISPLAY DRIVER UNIT
DEA	DEPLOYED ELECTRONICS ASSEMBLY
DEACT	DEACTIVATION
DEC	DECLINATION
DECEL	DECELERATION
DECOM(S)	DECOMMUTATION(S)
DED	DEDICATED
DEG	DEGREE
DEG/SEC	DEGREES PER SECOND
DEL	DEORBIT/ENTRY/LANDING
DELTA T	DELTA TRACKING
DELTA V	DELTA VELOCITY (CHANGE IN VELOCITY)
DEORB	DEORBIT
DEP/REP	DEPRESS/REPRESS
DES	DESCENDING
DETECT	DETECTION
DEU	DISPLAY ELECTRONICS UNIT
DEV	DEVIATION
DFI	DEVELOPMENT FLIGHT INSTRUMENTATION
DFL	DECOM FORMAT LOAD
DFRC	DRYDEN FLIGHT RESEARCH CENTER
DFRF	DRYDEN FLIGHT RESEARCH FACILITY
DIFF	DIFFERENT
DIR	DIRECTION
DISC	DISCONNECT
DISCH	DISCHARGE
DIST	DISTRIBUTION

FLIGHT RULES

DK	DISPLAY/KEYBOARD
DKR	DAKAR (STDN SITE)
DMA	DIRECT MEMORY ACCESS
DMP	DUMP
DMU	DATA MANAGEMENT UNIT
DN	DISCREPANCY NOTICE
DNS	DOMAIN NAME SERVER
DOD	DEPARTMENT OF DEFENSE
DOF	DEGREE-OF-FREEDOM
	DIRECTION OF FLIGHT
DOL	DAY OF LAUNCH
DOLILU	DAY OF LAUNCH I-LOAD UPLINK
DPA	DATA PROCESSING ASSEMBLY
DP/DT	PRESSURE CHANGE RATE
DPLY	DEPLOY
DPS	DATA PROCESSING SYSTEM (ALSO AN MCC-H FLIGHT CONTROL POSITION)
DR	DISCREPANCY REPORT
DRK	DISPLAY REQUIREMENTS KEYBOARD
DRN	DRAIN
DRSCS	DIGITAL RANGE SAFETY COMMAND SYSTEM
DS	DUAL STRING
DSC	DEDICATED SIGNAL CONDITIONER
	DYNAMIC STANDBY COMPUTER
DSN	DEEP SPACE NETWORK
DSO	DETAILED SUPPLEMENTARY OBJECTIVE
DT	DISCHARGE TEMPERATURE
DTE	DIGITAL TELEVISION EQUIPMENT
DTO	DETAILED TEST OBJECTIVE
DU	DISPLAY UNIT
DVIS	DIGITAL VOICE INTERCOMMUNICATIONS SYSTEM
DYN	DYNAMIC
e.g.	FOR EXAMPLE
E&D	ENGINEERING AND DEVELOPMENT
EAFB	EDWARDS AIR FORCE BASE
EAS	EQUIVALENT AIR SPEED
ECAL	EAST COAST ABORT LANDING
ECAS	EXPERIMENT COMPUTER APPLICATION SOFTWARE
ECG	ELECTROCARDIOGRAM
ECIO	EXPERIMENT COMPUTER INPUT/OUTPUT
ECLS	ENVIRONMENTAL CONTROL AND LIFE SUPPORT
ECLSS	ENVIRONMENTAL CONTROL AND LIFE SUPPORT SYSTEM
ECOS	EXPERIMENT COMPUTER OPERATING SYSTEM

FLIGHT RULES

ECS	ENVIRONMENTAL CONTROL SYSTEM
ECU	ENVIRONMENTAL CONTROL UNIT
ED	EDITORIAL
EDO	EXTENDED DURATION ORBITER
EDOMP	EXTENDED DURATION ORBITER MEDICAL PROJECT
EDTE	EMULATED DTE
EDW	EDWARDS AIR FORCE BASE
EE	END EFFECTOR
EECOM	EMERGENCY, ENVIRONMENTAL, AND CONSUMABLES MANAGEMENT SYSTEMS - MCC-H FLIGHT CONTROL POSITION
EFTP	ENTRY FLIGHT TECHNIQUES PANEL
EGIL	ELECTRICAL, GENERATION, AND INTEGRATED LOADING SYSTEMS - MCC-H FLIGHT CONTROL POSITION
EGT	EXHAUST GAS TEMPERATURE
EI	ENTRY INTERFACE
EIU	ENGINE INTERFACE UNIT
ELEV	ELEVON
ELS	EMERGENCY LANDING SITE
EMCC	EMERGENCY MISSION CONTROL CENTER
EM	EMERGENCY
EMER	EMERGENCY
EMI	ELECTROMAGNETIC INTERFERENCE
EMU	EXTRAVEHICULAR MOBILITY UNIT
EMUM	UNITED TECHNOLOGY/HAMILTON STANDARD ENGINEERING MEMORANDUM
ENA, ENBL	ENABLE(D)
ENG	ENGINE ENGAGE
ENT	ENTRY
EO	ENGINEERING ORDER
EOM	END OF MISSION
EPBD	ELECTRICAL POWER BRANCHING DISTRIBUTOR
EPIC(S)	ELECTRICAL POWER DISTRIBUTION AND CONTROL (SYSTEM)
EPODES	ELECTRICAL POWER DISTRIBUTION SYSTEM
EPA	ELECTRICAL POWER SUBSYSTEM
EPSOM	ELECTRICAL POWER SWITCHING PANEL
PEST	ELECTRICAL POWER SYSTEM TEST
ESL	EQUIPMENT SUPPORT SECTION ESSENTIAL BUS
ER	EASTERN RANGE
ESSMC	EASTERN SPACE AND MISSILE CENTER
ESCON	ENTERPRISE SYSTEM CONNECTION MANAGER
EST	ESTIMATED

FLIGHT RULES

ET	EXTERNAL TANK
ET	ET CETERA
METRO	EXPECTED TIME TO RETURN TO OPERATION
EVE	EXTRAVEHICULAR
EVA	EXTRAVEHICULAR ACTIVITY
EVAN	EVACUATED
EVAN	EVAPORATOR
EVES	EXTRAVEHICULAR LIFE SUPPORT SYSTEM
EXEC	EXECUTE
EX	EXPERIMENT COMPUTER
EXCEPT	EXPERIMENT CONTROL PANEL
EX	EXPERIMENT INPUT/OUTPUT
EX	EXPERIMENT
ET	EXTENSION
F	FAHRENHEIT
F/C	FLIGHT CONTROL
FAA	FLIGHT AFT
FAA	FEDERAL AVIATION AGENCY
FAD	FLIGHT ASSESSMENT AERO DATA
FC	FLIGHT CRITICAL
	FUEL CELL
FCL	FREON COOLANT LOOP
FCO	FLIGHT CONTROL OFFICER (RANGE/KSC)
FCP	FUEL CELL PANEL
FCR	FLIGHT CONTROL ROOM
FCS	FLIGHT CONTROL SYSTEM
FCT	FLIGHT CONTROL TEAM
FD	FLIGHT DAY
	FLIGHT DECK
	FLIGHT DIRECTOR
	FREEZE DRY
FDA	FAULT DETECTION AND ANNUNCIATION
FDBK	FEEDBACK
FDDD	FLIGHT DESIGN AND DYNAMICS DIVISION
FDF	FLIGHT DATA FILE
	FLIGHT DYNAMICS FACILITY
FDI	FAILURE DETECTOR INDICATOR
	FAULT DETECTION AND IDENTIFICATION
	FAULT DETECTION AND ISOLATION
FDIR	FAULT DETECTION, IDENTIFICATION, RECONFIGURATION
FDM	FREQUENCY DIVISION MULTIPLEXER
FDO	FLIGHT DYNAMICS OFFICER
FEID	FUNCTIONAL EQUIPMENT INTERFACE DEVICE

FLIGHT RULES

	FUNCTIONAL ENGINEERING INTERFACE DEVICE
FEP	FRONT END PROCESSOR
FES	FLASH EVAPORATOR SYSTEM
FF	FLIGHT FORWARD
FFM	FUEL FLOWMETER
FI	ADVANCED FELT REUSABLE SURFACE INSULATION
FID	FAILURE IDENTIFIER
FL	FLOW
FL'D	FAILED
FLC(A)	FORWARD LOAD CONTROL (ASSEMBLY)
FLEX	FLEXIBLE
FLMCP	FLUID LOOP MONITOR AND CONTROL PANEL
FLT	FLIGHT
FM	FREQUENCY MODULATION
FMC	FORWARD MOTOR CONTROLLER
FMEA	FAILURE MODES AND EFFECTS ANALYSIS
FO/FS	FAIL OPERATIONAL/FAIL SAFE
FOD	FLIGHT OPERATIONS DIRECTORATE
FOIO	FLIGHT OPERATIONS INTEGRATION OFFICE
FOR	FLIGHT OPERATIONS REVIEW
FOS	FACTOR OF SAFETY
FOSA	FLIGHT OPERATIONS SUPPORT ANNEX
FOV	FIELD OF VIEW
FPC(A)	FORWARD POWER CONTROL (ASSEMBLY)
FPM	FEET PER MINUTE
	FLOW PROPORTIONING MODULE
FPOV	FUEL PREBURNER OXIDIZER VALVE
FPR	FLIGHT PROPELLANT RESERVES
FPS	FEET PER SECOND
FPV	FLOW PROPORTIONING VALVE
FRCB	FLIGHT RULES CONTROL BOARD
FRD	FLIGHT REQUIREMENTS DOCUMENT
FRCS	FORWARD REACTION CONTROL SYSTEM
FRSI	FELT REUSABLE SURFACE INSULATION
FS	FLIGHT SURGEON
FSCEU	FIRE SUPPRESSION CONTROL ELECTRONICS UNIT
FSS	FIRE SUPPRESSION SYSTEM
FSW	FLIGHT SOFTWARE
FT	FEET
	FLIGHT TECHNIQUES
	FOOT
FT/SEC	FEET PER SECOND
FTO	FLIGHT TEXT OBJECTIVE
FTP	FLIGHT TECHNIQUES PANEL
FTR	FLIGHT TEST REQUIREMENTS

FLIGHT RULES

FTS	FAIL TO SYNCHRONIZE
	FLIGHT TERMINATION SYSTEM
FU	FUEL
FWD	FORWARD
g or G	FORCE OF GRAVITY AT SEA LEVEL
G&C	GUIDANCE AND CONTROL (ALSO AN MCC-H FLIGHT CONTROL POSITION)
G/S	GLIDE SLOPE
GAX	GN&C/ANNUNCIATION INTERFACE
GBI	GRAND BAHAMAN ISLANDS
GCA	GROUND CONTROLLED APPROACH
GCIL	GROUND INTERFACE COMMAND LOGIC CONTROLLER
GDR	GENERALIZED DATA RETRIEVAL
GDS	GOLDSTONE (STDN STATION)
GFE	GOVERNMENT FURNISHED EQUIPMENT
GG	GAS GENERATOR
	GRAVITY GRADIENT
GGVM	GAS GENERATOR VALVE MODULE
GH ₂	GASEOUS HYDROGEN
GLS	GROUND LAUNCH SEQUENCER
GMEM	GENERAL MEMORY UPDATE
GMT	GREENWICH MEAN TIME
GN ₂	GASEOUS NITROGEN
GNC	GUIDANCE, NAVIGATION, AND CONTROL - MCC-H FLIGHT CONTROL POSITION
GND	GROUND
GO ₂	GASEOUS OXYGEN
GOM	GROUND OPERATIONS MANAGER
GOSR	GROUND OPERATION SUPPORT ROOM
GPC	GENERAL PURPOSE COMPUTER
GPM	GALLONS PER MINUTE
GPS	GLOBAL POSITIONING SYSTEM
GRTL	GLIDE RETURN TO LANDING SITE
GS	GROUND SPEED
GSE	GROUND SUPPORT EQUIPMENT
GSFC	GODDARD SPACE FLIGHT CENTER
GSTDN	GROUND ELEMENTS OF SPACEFLIGHT TRACKING AND DATA NETWORK (EXCLUDES TDRSS)
GUID	GUIDANCE
GWM	GUAM (STDN STATION)
GYRO	GYROSCOPE

FLIGHT RULES

H	ALTITUDE
H-DOT	RATE OF CHANGE OF ALTITUDE
H ₂	HYDROGEN
H ₂ O	WATER
H ₂ O GP	WATER GAS PRESSURE
H ₂ O WP	WATER PRESSURE
H _A	HEIGHT OF APOGEE
HAC	HEADING ALIGNMENT CIRCLE
HBr	HYDROBROMIC ACID
HCl	HYDROGEN CHLORIDE
HCN	HYDROGEN CYANIDE
HD	HIGHLY DESIRABLE
HDOT	RATE OF CHANGE OF ALTITUDE
HDR	HIGH DATA RATE
HDRR	HIGH DATA RATE RECORDER
HDWE	HARDWARE
He	HELIUM
HF	HYDROFLUORIC ACID
HFE	HIGH FREQUENCY EXECUTIVE
Hg	MERCURY
HI	HIGH
HM	HINGE MOMENT
HOSC	HUNTSVILLE OPERATIONS SUPPORT CENTER
H _p	HEIGHT OF PERIGEE
HP	HIGH POWER
HPFT	HIGH PRESSURE FUEL TURBOPUMP
HPFTP	HIGH PRESSURE FUEL TURBOPUMP PRESSURE
HPG	HIGH PRESSURE GAS
HPMDE	HIGH PRIORITY MISSION OBJECTIVE EXCEPTION
HPOP	HIGH PRESSURE OXIDIZER PUMP
HPOT	HIGH PRESSURE OXIDIZER TURBOPUMP
HPOTP	HIGH PRESSURE OXIDIZER TURBOPUMP PRESSURE
HPU	HYDRAULIC POWER UNIT
HQR	HANDLING QUALITY RATING
HR	HOUR
HRA	HELMET RETENTION ASSEMBLY
HRDA	HIGH RATE DATA ASSEMBLY
HRDM	HIGH RATE DEMULTIPLEXER
HRM	HIGH RATE MULTIPLEXER
HRSI	HIGH TEMPERATURE REUSABLE SURFACE INSULATION
HR(S)	HOUR(S)
HSD	HORIZONTAL SITUATION DISPLAY
HSI	HORIZONTAL SITUATION INDICATOR
HST	HUBBLE SPACE TELESCOPE
HSTD	HIGH SPEED TRACKING DATA

FLIGHT RULES

HTR	HEATER
HUD	HEADS UP DISPLAY
H/W	HARDWARE
HX	HEAT EXCHANGER
HYD	HYDRAULIC
I	CURRENT
i.e.	THAT IS
I/C, ICH	INTERCHANGER
I/C	INTERCONNECT
I/F	INTERFACE
I/O	INPUT/OUTPUT
IAW	IN ACCORDANCE WITH
IBM	INTERNATIONAL BUSINESS MACHINES
ICB	INTEGRATION CONTROL BOARD
ICC	INTERCOMPUTER COMMUNICATION
ICD	INTERFACE CONTROL DOCUMENT
ICH	INTERCHANGER
ICV	INTERCENTER VECTOR
ID	IDENTIFICATION
IE	INPUT ELECTRONICS
IECM	INDUCED ENVIRONMENT CONTAMINATION MONITOR
IFA	IN-FLIGHT ANOMALY
IFM	IN-FLIGHT MAINTENANCE
IGN	IGNITION
IGOR	INTERCEPT GROUND OPTICAL RECORDER
IIP	INSTANTANEOUS IMPACT PREDICTION (POINT)
ILL	IMPACT LIMIT LINE
IMCP	INTEGRATED MONITORING AND CONTROL PANEL
IMSL	INTERMEDIATE SEAL
IMU	INERTIAL MEASUREMENT UNIT
IMVS	INTERCHANGEABLE-MID-VALUE-SELECT
IN	INCHES
IN/MIN	INCHES PER MINUTE
INBD	INBOARD
INCO	INTEGRATED COMMUNICATIONS OFFICER
INCRP	INCORPORATED
INH	INHIBIT
IN/HR	INCHES PER HOUR
INIT	INITIATION
INSTR	INSTRUMENTATION
INTRL	INERTIAL
INV	INVERTER
INWS	IMPROVED NOSEWHEEL STEERING

NASA - JOHNSON SPACE CENTER

FLIGHT RULES

IOM INPUT/OUTPUT MODULE
IOP INPUT/OUTPUT PROCESSOR
IOS INDIAN OCEAN STATION (SGLS STATION)
IOU INPUT/OUTPUT UNIT
IP INSTRUMENTATION PCMMU
IMPACT POINT
IPL INITIAL PROGRAM LOAD
IPS INCHES PER SECOND
IRAMS INERTIAL REFERENCE ALIGNMENT MONITOR SYSTEM
IRB INSTITUTIONAL REVIEW BOARD
IRD INTEGRATED RECEIVER DECODER
ISO ISOLATION
ISOL ISOLATION
ISP INTERMEDIATE SEAL PURGE
SPECIFIC IMPULSE
IU INTERFACE UNIT
IUS INERTIAL UPPER STAGE
IV INTRAVEHICULAR
IVA INTRAVEHICULAR ACTIVITY

JDI JONATHAN DICKINSON (STDN STATION)
JOIP JOINT OPERATIONS INTERFACE PROCEDURE
JSC JOHNSON SPACE CENTER

K THOUSAND(S)
KB KEYBOARD
KILOBITS
KBPS KILOBITS PER SECOND
KEAS KNOTS EQUIVALENT AIR SPEED
KFT/SM 1000 FEET PER STATUTE MILE
KG KILOGRAMS
KOH POTASSIUM HYDROXIDE
KSC KENNEDY SPACE CENTER
KTS KNOTS
KVA KILOVOLT AMPERES
KW or kW KILOWATTS
KWH KILOWATTS PER HOUR
KYBD KEYBOARD

L LEFT
L/D LIFT-TO-DRAG RATIO
L/L LAUNCH/LANDING

FLIGHT RULES

L/O	LIFT-OFF
LAN'S	LOCAL AREA NETWORKS
LAS	LAUNCH AREA STEEP
LB	POUND(S)
LB/HR	POUNDS PER HOUR
LBM	POUNDS MASS
LBMP	LOWER BODY NEGATIVE PRESSURE
LCA	LOAD CONTROL ASSEMBLY
LCC	LAUNCH COMMIT CRITERIA (DOCUMENT NSTS 16007)
	LAUNCH CONTROL CENTER
LCU	LAUNCH CORRELATION UNIT
LCVG	LIQUID COOLING VENTING GARMENT
LD	LOAD
LDB	LAUNCH DATA BUS
LDG GR, LG	LANDING GEAR
LDR	LOW DATA RATE
LED	LIGHT EMITTING DIODE

FLIGHT RULES

LEMSCO	LOCKHEED ENGINEERING AND MANAGEMENT SERVICES COMPANY
LEQ	AVERAGE NOISE LEVEL
LES	LAUNCH/ENTRY SUIT
LF	LAUNCH FACILITY
	LAUNCH FORWARD
	LEFT FORWARD
	LOAD FACTOR
LPFP	LOW PRESSURE FUEL PUMP
LFT	LEFT
LG	LANDING GEAR
LH	LEFT HAND
LH ₂	LIQUID HYDROGEN
LIB	LEFT INBOARD
LIN	LINE
LiOH (LIOH)	LITHIUM HYDROXIDE
LK	LEAK
LL	LOW LEVEL
	LOWER LIMIT
LMT	LIMIT
LNG	LANDING
LO ₂	LIQUID OXYGEN
LOB	LEFT OUTBOARD
LOC	LOSS OF CONTROL
LOS	LOSS OF SIGNAL
LOX	LIQUID OXYGEN
LP	LOW POWER
LPFT	LOW PRESSURE FUEL TURBOPUMP
LRD	LANDING AND RECOVERY DIRECTOR
LRSI	LOW TEMPERATURE REUSABLE SURFACE INSULATOR
LRU	LINE REPLACEABLE UNIT
LSEAT	LAUNCH SYSTEMS EVALUATION ADVISORY TEAM
LSO	LANDING SUPPORT OFFICER
LT	LIGHT
LTCH	LATCH
LUBE	LUBRICATION
LVAR	LATERAL VARIATIONS
LVL	LEVEL
LVLH	LOCAL VERTICAL LOCAL HORIZONTAL
LWKL	LIGHTWEIGHT KEEL LATCH
LWLL	LIGHTWEIGHT LONGERON LATCH
M	MANDATORY
	MACH NUMBER

FLIGHT RULES

MINUTE

FLIGHT RULES

MAD	MADRID (STDN STATION)
MADS	MODULAR AUXILIARY DATA SYSTEM
MAL	MALFUNCTION
MALF	MALFUNCTION
MAN	MANUAL
MANF	MANIFOLD
MAX Q	MAXIMUM DYNAMIC PRESSURE
MAX	MAXIMUM
MB	MEGABITS
MBARS	MILLIBARS
MBL	MOBILE UNIT (TACAN STATION)
MBPS	MEGABITS PER SECOND
MC	MISSION COMPLETION
MCA	MOTOR CONTROL ASSEMBLY
MCC	MISSION CONTROL CENTER
MCC-H	MISSION CONTROL CENTER-HOUSTON
MCDS	MULTIFUNCTION CRT DISPLAY SYSTEM
MCIU	MANIPULATOR CONTROLLER INTERFACE UNIT
MCP	MONITOR AND CONTROL PANEL
MCV	MICROBIAL CHECK VALVE
MD	MIDDECK
MDA	MOTOR DRIVE AMPLIFIER
MDF	MINIMUM DURATION FLIGHT
MDK	MIDDECK
MDSSC	SPACELAB/MCDONNELL DOUGLAS
MDTSCO	MCDONNELL DOUGLAS TECHNICAL SERVICES COMPANY
MDM	MULTIPLEXER/DEMULTIPLEXER
MEC	MASTER EVENT CONTROLLER
MECO	MAIN ENGINE CUTOFF
MED	MANUAL ENTRY DEVICE
	MEDICAL
<u>MEDS</u>	<u>MULTIFUNCTION ELECTRONIC DISPLAY SUBSYSTEM</u>
MEM	MEMORY
MEP	MINIMUM ENERGY POINT
	MAIN ENGINE PROPELLANT
MER	JSC MCC-H MISSION EVALUATION ROOM
	MEASUREMENT ERROR
MET	MISSION ELAPSED TIME
MEV	MILLION ELECTRON VOLTS
MF	MAJOR FUNCTION
MFR	MANIPULATOR FOOT RESTRAINT
MGMT	MANAGEMENT
MGTD	MAIN GEAR TOUCHDOWN
MHI	MCC HOST INTERFACE

NASA - JOHNSON SPACE CENTER

FLIGHT RULES

MHz	MEGAHERTZ
	MID-COURSE CORRECTION
MICB	MISSION INTEGRATION CONTROL BOARD
MIL, MILA	MERRITT ISLAND LAUNCH AREA (STDN STATION)
	MILLISECONDS
MILX	MERRITT ISLAND LAUNCH AREA (STDN STATION)
MIN	MINUTE
	MINIMUM
MKS	MARKS
MLG	MAIN LANDING GEAR
MLS	MICROWAVE LANDING SYSTEM
MM	MAJOR MODE, MASS MOMENT
MMACS	MECHANICAL, MAINTENANCE, ARM, AND CREW SYSTEMS (MCC-H FLIGHT CONTROL POSITION)
MMC(A)	MID MOTOR CONTROL (ASSEMBLY)
MMH	MONOMETHYL HYDRAZINE
mmHG	MILLIMETERS OF MERCURY
mm/HR	MILLIMETERS/HOUR
MMT	MISSION MANAGEMENT TEAM
MMU	MANNED MANEUVERING UNIT
	MASS MEMORY UNIT
MMWL	MODIFIED MIDDLEWEIGHT LATCH
MMWLL	MODIFIED MIDDLEWEIGHT LONGERON LATCH
MN	MAIN
MNA, B, C	MAIN BUS A, B, OR C
MNVR	MANEUVER
MOA	MEMORANDUM OF UNDERSTANDING
MOC	MISSION OPERATIONS COMPUTER
MOCR	MISSION OPERATIONS CONTROL ROOM
MODCOMP	MISSION OPERATIONS DIRECTORATE COMPUTER
MOV	MAIN OXIDIZER VALVE
MPAD	MISSION PLANNING AND ANALYSIS DIVISION
MPCC	MULTIPURPOSE CONTROL CENTER
MPE	MISSION PECULIAR EQUIPMENT
MPL	MINIMUM POWER LEVEL
MPM	MANIPULATOR POSITIONING MECHANISM
MPS	MAIN PROPULSION SYSTEM
MPSR	MULTIPURPOSE SUPPORT ROOM
MPU	MAGNETIC PICKUP UNIT
MR	MIXTURE RATIO
MRL	MANIPULATOR RETENTION LATCH
MRN	MORON, SPAIN (PRIME TAL SITE)
MS	MISSION SPECIALIST
MSBLS	MICROWAVE SCANNING BEAM LANDING SYSTEM
MSFC	MARSHALL SPACE FLIGHT CENTER

NASA - JOHNSON SPACE CENTER

FLIGHT RULES

MSG	MESSAGE
MSID	MEASUREMENT STIMULATION IDENTIFICATION
MSK	MASK
	MANUAL SELECT KEYBOARD
MSL	MEAN SEA LEVEL
MSPC	MULTIPLE STORED PROGRAM COMMAND
MTL	MT. LEMON (USAEPG C-BAND STATION)
MTM	MOC TELEMETRY MESSAGE
MTRS	MOTORS
MTU	MASTER TIMING UNIT
MUX	MULTIPLEXER
MV	MILLIVOLT
MVS	MID-VALUE-SELECT
MW	MILLIWATT
MWLL	MIDDLEWEIGHT LONGERON LATCH
N/A	NOT APPLICABLE
N ₂	NITROGEN
N ₂ H ₄	HYDRAZINE
N ₂ O ₄	NITROGEN TETROXIDE
NASA	NATIONAL AERONAUTICS AND SPACE ADMINISTRATION
NAVE	NAVIGATION
NERVED	NAVIGATION AID
NERVED	NAVIGATIONAL DERIVED AIR DATA
NBAT	NOMINAL BUS ASSIGNMENT TABLE
NC ₁	NOMINAL CORRECTION 1 MANEUVER
NCC	NOMINAL CORRECTION COMBINATION MANEUVER
	NETWORK CONTROL CENTER
NCRP	NATIONAL COUNCIL ON RADIATION PROTECTION
NEOM	NOMINAL END OF MISSION
NEP	NORMAL ENTRY POINT
NGTD	NOSE GEAR TOUCHDOWN
NH ₃	AMMONIA
NIS	NETWORK INFORMATION SYSTEM
NLE	NO LONGER ENDANGER
NLG	NOSE LANDING GEAR
NM, nm	NAUTICAL MILES
NOK	NO OK
NOM	NOMINAL
	NETWORK OUTPUT MULTIPLEXER
NOR	NORTHROP LAKEBED LANDING SITE
NORAD	NORTH AMERICAN AIR DEFENSE COMMAND
NORM	NORMAL
NOTAM	NOTICE TO AIRMEN

FLIGHT RULES

NOTMAR	NOTICE TO MARINERS
NPC	NOMINAL PLANE CHANGE
NR	NOT REQUIRED
NRC	NATIONAL RESEARCH COUNCIL
NRS	NETWORK REGIOTRATION SERVICE
NRT	NEAR REAL TIME
NPSP	NET POSITIVE SUCTION PRESSURE
NSDD	NATIONAL SECURITY DECISION DIRECTIVE
NSP	NASA SUPPORT PLAN
	NETWORK SIGNAL PROCESSOR
NSR	COELIPTIC MANEUVER
NSTS	NATIONAL SPACE TRANSPORTATION SYSTEM
NTD	NASA TEST DIRECTOR
NWS	NOSE WHEEL STEERING
NWTD	NOSE WHEEL TOUCHDOWN
N _y	LATERAL ACCELERATION
NYJ	NO YAW JET
N _z	NORMAL ACCELERATION
N _{zc}	NORMAL ACCELERATION COMMAND
O/B	ONBOARD
O ₂	OXYGEN
OA	OPERATIONAL AFT
OASCB	ORBITER AVIONICS SOFTWARE CONTROL BOARD
OBS	OBSERVATION
OCAS	OPERATOR-COMMANDED AUTO SEQUENCES
OE	OUTPUT ELECTRONICS
OEX	ORBITER EXPERIMENTS
OF	OPERATIONAL FORWARD
OFT	ORBITAL FLIGHT TEST
OFTP	ORBITER FLIGHT TECHNIQUES PANEL
OI	OPERATIONAL INSTRUMENTATION
OIS	OPERATIONAL INSTRUMENTATION SYSTEM
OME	ORBITER MANEUVERING ENGINE
OMI	OPERATIONAL MAINTENANCE INSTRUCTIONS
OMRS	OPERATIONAL MAINTENANCE REQUIREMENTS AND SPECIFICATION
OMRSD	OPERATIONAL MAINTENANCE REQUIREMENTS AND SPECIFICATION DOCUMENT
OMS	ORBITAL MANEUVERING SYSTEM
ONSC	ONBOARD NAVIGATION SYSTEMS CHARACTERISTICS
OOP	OUT-OF-PLANE
OPF	ORBITER PROCESSING FACILITY
OPOV	OXIDIZER PREBURNER OXIDIZER VALVE

FLIGHT RULES

OPS OPERATIONAL SEQUENCES
 OPERATIONS
 ORB ORBIT(AL)
 ORIDE OVERRIDE
 ORR ORRORAL VALLEY (STDN STATION)
 OS ORBIT STATION
 OSH OFF SCALE HIGH
 OSHA OCCUPATIONAL SAFETY AND HEALTH ADMINISTRATION
 OST OPERATIONS SUPPORT TEAM
 OTBD OUTBOARD
 OTC ORBITER TEST CONDUCTOR
 OVHD OVERHEAD
 OX OXIDIZER

P PRESSURE, POINTING VECTOR
 P-V-T PRESSURE-VOLUME-TEMPERATURE
 P/L, PL PAYLOAD
 PA PAYLOAD AFT
 PACK PAYLOAD ACTIVE COOLING KIT
 PAD PFR ATTACHMENT DEVICE
 PADM PORTABLE AUDIO DATA MONITOR
 PAM PAYLOAD ASSIST MODULE
 PAO PUBLIC AFFAIRS OFFICE
 PAPI PRECISION APPROACH PATH INDICATOR
 PARAM PARAMETER
 PASS PRIMARY AVIONICS SOFTWARE SYSTEM
 PATC PATRICK
 PBD PAYLOAD BAY DOOR
 PB(I) PUSHBUTTON (INDICATOR)
 Pc CHAMBER PRESSURE
 PCA POWER CONTROL ASSEMBLY
 PCM PULSE CODE MODULATION
 PCMMU PCM MASTER UNIT
 PCN PAGE CHANGE NOTICE
 PCS PRESSURE CONTROL SYSTEM
 PDI PAYLOAD DATA INTERLEAVER
 PDL(S) PONCE DE LEON (STDN STATION)
 PDRS PAYLOAD DEPLOYMENT AND RETRIEVAL SYSTEM
 PDU POWER DRIVE UNIT
 POWER DISTRIBUTION UNIT
 PEAP PERSONAL EMERGENCY AIR PACK
 PEG POWERED EXPLICIT GUIDANCE
 PF PAYLOAD FORWARD
 PREDICTED POWER FACTOR

FLIGHT RULES

	PAYLOAD FLEX
PFC/ICL	POWER FACTOR CORRECTOR/INRUSH CURRENT LIMITER
PGA	PRESSURE GARMENT ASSEMBLY
PGSC	PAYLOAD GENERAL SUPPORT COMPUTER
pH	HYDROGEN-ION CONCENTRATION
PI	PAYLOAD INTERROGATOR
PIC	PYROTECHNIC INITIATION CONTROLLER
PIP	PAYLOAD INTEGRATION PLAN
PIREP	PILOT REPORT
PKG	PACKAGE
PKM	PERIGEE KICK MOTOR
PL	PAYLOAD
PLB	PAYLOAD BAY
PLBD	PAYLOAD BAY DOOR(S)
PL HX	PAYLOAD HEAT EXCHANGER
PLS	PRIMARY LANDING SITE
PLSS	PRIMARY LIFE SUPPORT SYSTEM
PLOAD	PROPELLANT LOAD
PLT	PILOT
PM	PHASE MODULATION
PMC	PRIVATE MEDICAL COMMUNICATION
PMD	PALMDALE
PMP	PUMP
PNL	PANEL
PNEU	PNEUMATICS
POCC	PAYLOAD OPERATIONS CONTROL CENTER
POD	PAYLOAD OPERATIONS DIRECTOR
POHS	POSITION AND ORIENTATION HOLD SELECT
POPU	PUSH OVER PULL UP
POR	POINT OF RESOLUTION
POS	PORTABLE OXYGEN SYSTEM
	POSITION
POSN	POSITION
PP	PARTIAL PRESSURE
	POWERED PITCHDOWN
	PRESENT POSITION
PPA	POWERED PITCHAROUND
PPCO ₂	PARTIAL PRESSURE CARBON DIOXIDE
PPD	POWERED PITCHDOWN
PPM	PARTS PER MILLION
PPO ₂	PARTIAL PRESSURE OF OXYGEN
PPRV	POSITIVE PRESSURE RELIEF VALVE
PRB	PROCEDURES AND REQUIREMENTS BRANCH
PRCB	PROGRAM REQUIREMENTS CONTROL BOARD
PRCS	PRIMARY REACTION CONTROL SYSTEM

FLIGHT RULES

PRD	PAYLOAD RETENTION DEVICE
PRECIP	PRECIPITATION
PREP	PREPARATION
PRESS	PRESSURE
PRI	PRIMARY
	PRIORITY
PRL	PRIORITY RATE LIMITING
PRLA	PAYLOAD RETENTION LATCHES
PRO	"PROCEED" - A GPC COMMAND ENTRY
PROMS	PROGRAMMABLE READ ONLY MEMORY
PROP	PROPELLANT
PROX	PROXIMITY
PROX OPS	PROXIMITY OPERATIONS (RENDEZVOUS)
PRPLT	PROPELLANT
PRSD	POWER REACTANT STORAGE AND DISTRIBUTION SYSTEM
PRTLs	POWERED RETURN TO LANDING SITE
PS	POWER SUPPLY, PAYLOAD STATION, PAYLOAD SPECIALIST
PSF	POUNDS PER SQUARE FOOT
PSI	POUNDS PER SQUARE INCH
PSIA	POUNDS PER SQUARE INCH ABSOLUTE
PSID	POUNDS PER SQUARE INCH DIFFERENTIAL
PSIG	POUNDS PER SQUARE INCH GAUGE
PSP	PAYLOAD SIGNAL PROCESSOR
PSS	PLATFORM SYSTEM SERVICES SOFTWARE
PTB	PAYLOAD TIMING BUFFER
PTC	PASSIVE THERMAL CONTROL
PTI	PROGRAM TEST INPUT
PUPO	PULL UP PUSH OVER
PVT	PRIVATE
PWR	POWER
PYRO	PYROTECHNIC
q	DYNAMIC PRESSURE
Q-BAR	AVERAGE DYNAMIC PRESSURE
Q-BAR DOT	RATE OF CHANGE OF DYNAMIC PRESSURE
QD	QUICK DISCONNECT
QDM	QUICK DON MASK
QMVS	QUAD-MID-VALUE-SELECT
QSA	QUALIFICATION SITE APPROVAL
QTY	QUANTITY
R	RIGHT

FLIGHT RULES

R&E	RESEARCH AND ENGINEERING
R-BAR	ALONG THE RADIUS VECTOR
R-F-L	READY-FOR-LATCH
R-V	RANGE-VELOCITY
R/W	RUNWAY
RA	RADAR ALTIMETER
RAAB	REMOTE APPLICATION AND ADVISORY BOX
RAD(S)	RADIATOR(S)
	RELEASE AUTHORIZATION DOCUMENT
RASS	RELEASE AUTHORIZATION FOR SHUTTLE SOFTWARE
RAU	REMOTE ACQUISITION UNIT
RCC	RANGE CONTROL CENTER
RCCB	REMOTE CONTROL CIRCUIT BREAKER
RCDR	RECORDER
RCN	REQUIREMENTS CHANGE NOTICE
RCRS	REGENERABLE CARBON DIOXIDE REMOVAL SYSTEM
RCS	REACTION CONTROL SYSTEM
RCVR	RECEIVER
RDY	READY
REAS	REASONABLENESS
RECAL	RECALIBRATE
REDESIG	REDESIGNATION
REDUN	REDUNDANT
REF	REFERENCE
REG(S)	REGULATOR(S)
REL	RELATIVE
RELMAT	RELATIVE MATRIX
REM	ROENTGEN-EQUIVALENT MAN
REP	REPRESS
REQ	REQUIRE
RESVR	RESERVOIR
REV	REVOLUTION
RF	RADIO FREQUENCY
RFCA	RADIATOR FLOW CONTROL ASSEMBLY
R-F-L	READY FOR LATCH
RG	RATE GYRO ASSEMBLY
RGO	RANGE TO GO
RH	RIGHT HAND
RHC	ROTATIONAL HAND CONTROLLER
RI	ROCKWELL INTERNATIONAL
	RECORD IDENTIFIER
RIB	RIGHT INBOARD
RIC	ROCKWELL INTERNATIONAL CORPORATION
RJD	REACTION JET DRIVER
RLF	RELIEF

FLIGHT RULES

RM	REDUNDANCY MANAGEMENT
RMS	REMOTE MANIPULATOR SYSTEM
RMU	RMS/MECHANICAL/UPPERSTAGE
RNDZ	RENDEZVOUS
ROB	RIGHT OUTBOARD
ROCC	RETRIEVAL OPERATIONS COMMUNICATIONS CENTER
	RANGE OPERATIONS CONTROL CENTER
ROLREF	ROLL REFERENCE
ROM	RETRIEVAL OPERATIONS MANAGER
ROTA	NAVAL STATION ROTA, SPAIN
RPC	REMOTE POWER CONTROLLER
RPL	RATED POWER LEVEL
RPM	REVOLUTIONS PER MINUTE
RPS	RMS PLANNING SYSTEM
RPTA	RUDDER PEDAL TRANSDUCER ASSEMBLY
RQMT	REQUIREMENT
RR	RENDEZVOUS RADAR
RRM	RUNWAY REMAINING MARKER
RS	REDUNDANT SET
RSB	RUDDER SPEEDBRAKE
RSDS	RANGE SAFETY DISPLAY SYSTEM
RSLs	REDUNDANT SET LAUNCH SEQUENCER
RSO	RANGE SAFETY OFFICER
RSOC	ROCKWELL SPACE OPERATIONS COMPANY
RSOR	RANGE SAFETY OPERATING REQUIREMENT
RSR	RANGE SAFETY REPRESENTATIVE
RSS	ROOT, SUM, SQUARE(D)
	RANGE SAFETY SYSTEM
RST	RESTRING
RSTDS	RANGE SAFETY TELEMETRY DISPLAY SYSTEM
RSTNG	RESTRING
RT	REAL TIME
	RIGHT
RTC	REAL-TIME COMMAND
	REAL-TIME CLOCK
RTD	RESISTIVE THERMAL DEVICE
RTDS	RANGE SAFETY TELEMETRY DISPLAY SYSTEM
RTLS	RETURN TO LANDING SITE
RTN	RETURN
RTS	REMOTE TRACKING STATION
RTV	PLIABLE SEALANT
RUD	RUDDER
RVLC	REDLINE VOTING LOGIC CIRCUIT

FLIGHT RULES

S TRK	STAR TRACKER
S-BD	SIDE-BAND
S/B	STANDBY
S/C	STABILITY AND CONTROL
S/D, SHTDN	SHUTDOWN
S/W	SOFTWARE
SAA	SPACELAB AURAL ANNUNCIATOR
SAGI	SPACEHAB AUDIO GROUND ISOLATOR
SAIL	SHUTTLE AVIONICS INTEGRATION LABORATORY
SAL	NORTHROP STRIP
SAR	SEARCH AND RESCUE
SAS	SPACE ADAPTATION SYNDROME
SB	SPEEDBRAKE
SPDBK	SPEEDBRAKE
SBTA	SPEEDBRAKE TRANSDUCER ASSEMBLY
SBTC	SPEEDBRAKE/THRUST CONTROLLER
SCA	SHUTTLE CARRIER AIRCRAFT
SCAS	SUBSYSTEM COMPUTER APPLICATION SOFTWARE
SCO	SURVEILLANCE CONTROL OFFICER
SCOS	SUBSYSTEM COMPUTER OPERATING SYSTEM
SCR	STRIP CHART RECORDER
SCU	SECONDARY CONTROL UNIT
	SERVICE AND COOLING UMBILICAL
SDF	SOFTWARE DEVELOPMENT FACILITY
SDL	SOFTWARE DEVELOPMENT LAB
SDP	SHUTTLE DATA PROCESSOR
SEBS	SPACELAB EMERGENCY BREATHING SYSTEM
SEC	SECOND
	SECONDARY
SEGP	SINGLE ENGINE GOOD POD
SEII	SERVOACTUATOR ERROR INDICATION INTERRUPT
SEL	SELECT
SELP	SINGLE ENGINE LEAKING POD
SENS	SENSOR
SEP	SEPARATION
SEPTM	SINGLE ENGINE PRESS TO MECO
SERC	SINGLE-ENGINE ROLL CONTROL
SES	SHUTTLE ENGINE SIMULATOR
SESL	SPACE ENVIRONMENTAL SIMULATION LABORATORY
SESP	SINGLE ENGINE SINGLE POD
SETP	SINGLE ENGINE TWO PODS
SFCO	SENIOR FLIGHT CONTROL OFFICER (KSC)
SFT	SINGLE FAULT TOLERANT
SGLS	SPACE/GROUND LINK SYSTEM
SHOD	SPACEHAB OPERATIONS DIRECTOR

FLIGHT RULES

SIG COND	SIGNAL CONDITIONER
SIMO	SIMULTANEOUS
SL	SPACELAB
SLF	SHUTTLE LANDING FACILITY
SLODB	SPACELAB OPERATIONAL DATA BOOK
SLS	SECONDARY LANDING SITE
SM	SYSTEMS MANAGEMENT
	STATUTE MILE
SMAC	SPACECRAFT MAXIMUM ALLOWABLE CONCENTRATION
SMCH	STANDARD MIXED CARGO HARNESS

NASA - JOHNSON SPACE CENTER

FLIGHT RULES

SMG	SHUTTLE METEOROLOGICAL GROUP
SMIDEX	SPACELAB MIDDECK EXPERIMENTS
SMS	SHUTTLE MISSION SIMULATOR
	SPACE MOTION SICKNESS
SMU	SPEAKER MICROPHONE UNIT
SMWLL	SUPER MIDDLEWEIGHT LONGERON LATCH
SN	SPACE NETWORK
SNSR	SENSOR
SODB	SHUTTLE OPERATIONAL DATA BOOK
SOMS	SHUTTLE OPERATIONS MEDICAL SYSTEM
SOO	STAR OF OPPORTUNITY
SOP	SECONDARY OXYGEN PACK
	SUBSYSTEM OPERATING PROGRAM
SOV	SHUTOFF VALVE
SPAH	SPACELAB PAYLOAD ACCOMMODATION HANDBOOK
SPAN	JSC MCC-H SPACECRAFT ANALYSIS ROOM
SPAR	SPAR AEROSPACE
SPARTAN	SHUTTLE POINTED AUTONOMOUS RESEARCH TOOL FOR ASTRONOMY
SPC	STORED PROGRAM COMMAND
SPDB	SUBSYSTEM POWER DISTRIBUTION BOX
SPDS	STABILIZED PAYLOAD DEPLOYMENT SYSTEM
SPEC	SPECIALIST FUNCTION SPECIFICATION
SPI	SURFACE POSITION INDICATOR
SPK	SCOTT PEAK (USAEPG C-BAND STATION)
SPL	SCRATCH PAD LINE
SPLY	SUPPLY
SPW	SUPPORT WING
SRB	SOLID ROCKET BOOSTER
SRBTS	SRB RADAR BEACON TRACKING SYSTEM
SRM	SOLID ROCKET MOTOR
SRO	SUPERINTENDENT OF RANGE OPERATIONS
SS	SINGLE STRING SUBSYSTEM
SSC	SUBSYSTEM COMPUTER
SSD	SPACECRAFT SOFTWARE DIVISION
SSFS	SPACE SHUTTLE FUNCTIONAL SIMULATOR
SSIO	SUBSYSTEM INPUT/OUTPUT
SSME	SPACE SHUTTLE MAIN ENGINE
SSMEC	SPACE SHUTTLE MAIN ENGINE CONTROLLER
<u>SSOR</u>	<u>SPACE-TO-SPACE ORBITER RADIO</u>
SSP	STANDARD SWITCH PANEL SPACE SHUTTLE PROGRAM
SSR	STAFF SUPPORT ROOM

NASA - JOHNSON SPACE CENTER

FLIGHT RULES

SSV SPACE SHUTTLE VEHICLE
ST STAR TRACKER
STA SHUTTLE TRAINING AIRCRAFT
STANDARD
STANDARD OPERATING PROCEDURE
STBD STARBOARD
STBY STANDBY
STC SATELLITE TEST CENTER (SUNNYVALE, CA)
STD STS TEST DIRECTOR
STDN SPACECRAFT TRACKING AND DATA NETWORK
STEP SHUTTLE TURNAROUND ENHANCEMENT PROGRAM
SIMPLIFIED THERMAL EVALUATION PROGRAM
STG STAGE
STIN STRAIGHT-IN
STS SPACE TRANSPORTATION SYSTEM
STSOC SPACE TRANSPORTATION SYSTEM OPERATIONS COMPANY
STT SPACELAB TRANSFER TUNNEL
SUBS SUBSEQUENT
SV STATE VECTOR
SVO SPECIAL VEHICLE OPERATIONS
S/W SOFTWARE
SW SPACE WING
SW(S) SWITCH(ES)
SW VLV SWITCHING VALVE
SYNC SYNCHRONIZE
SYNCOM SYNCHRONOUS COMMUNICATION SATELLITE (HUGHES)
SYS SYSTEM

T TEMPERATURE
TRACKING
T/O TAKE OVER
T/R TRANSMIT AND RECEIVE
TACAN, TAC TACTICAL AIR NAVIGATION
TAEM TERMINAL AREA ENERGY MANAGEMENT
TAG TEXT AND GRAPHICS
TAGS TEXT AND GRAPHICS SYSTEM
TAL TRANSOCEANIC ABORT LANDING
TAS TRUE AIR SPEED
tb, TB INSTRUMENT PANEL TALKBACK
TBD TO BE DETERMINED
TBS TO BE SUPPLIED
TC THERMOCOUPLE
TCS THERMAL CONTROL SYSTEM
TCSS OAKHANGER (STDN)
TD TOUCHDOWN

FLIGHT RULES

TDRS

TRACKING DATA AND RELAY SATELLITE

TDRSS

TRACKING DATA AND RELAY SATELLITE SYSTEM

NASA - JOHNSON SPACE CENTER

FLIGHT RULES

TDT	TURBINE DISCHARGE TEMPERATURE
TELP	TWO ENGINES LEAKING POD
TEMP	TEMPERATURE
TETP	TWO ENGINES TWO PODS
TFL	TELEMETRY FORMAT LOAD
TGO	TIME TO GO TO MECO
TGT	TARGET
THC	TRANSLATIONAL HAND CONTROLLER
TI	TERMINAL PHASE INITIATION
TIC	TICK
TIG	TIME OF IGNITION
TIPS	<u>THERMAL IMPULSE PRINTER SYSTEM</u>
TK, TNK	TANK
TLM, TM	TELEMETRY, TECHNICAL MEMO
TMBU	TABLE MAINTENANCE BLOCK UPDATE
TMCC	TEMPORARY MISSION CONTROL CENTER
TP	TANGENT PLANE
TPC	TELEMETRY PREPROCESSING COMPUTER
TPF	TERMINAL PHASE FINALIZATION (BRAKING)
TPG	TOPPING
TPI	TERMINAL PHASE INITIATION
TPL	TRANSPACIFIC LANDING
TPS	THERMAL PROTECTION SYSTEM
TRAJ	TRAJECTORY
TREF	TIME REFERENCE WORD
TRK	TRACK
TTA	THERMAL TEST AREA
TTS	TITUSVILLE (TACAN STATION)
TURB	TURBINE, TURBULENCE
TV	TELEVISION
TVC	THRUST VECTOR CONTROL
U/L	UPLINK
UAS	URINE ABSORPTION SYSTEM
UCD	URINE COLLECTION DEVICE
UHF	ULTRA HIGH FREQUENCY
UL	UPPER LIMIT
UMB	UMBILICAL
UMI	UPPER MEMORY INITIAL PROGRAM LOAD
UPP	USER PARAMETER PROCESSING
UPS	UNINTERRUPTED POWER SUPPLY
US	UNITED STATES
USAEPG	U.S. ARMY ELECTRONIC PROVING GROUND
USAF	UNITED STATES AIR FORCE

FLIGHT RULES

USPD

UNDERSPEED

FLIGHT RULES

UTIL	UTILITIES
V	VOLTS
V, VEL	VELOCITY
V-BAR	ALONG THE VELOCITY VECTOR
VAA	VIEWPORT ADAPTER ASSEMBLY
VAB	VEHICLE ASSEMBLY BUILDING
VAC	VACUUM
	VOLTS, ALTERNATING CURRENT
VAFB	VANDENBERG AIR FORCE BASE
VAS	VIDEO ANALOG SWITCH
VCU	VIDEO CONTROL UNIT
VDC	VOLTS, DIRECT CURRENT
VERN	VERNIER
VGO	VELOCITY TO GO
VI, V-I	VOLTAGE - CURRENT
V_I	INERTIAL VELOCITY
VITR	VIDEO INSTRUMENTATION TAPE RECORDER
VLV(S)	VALVE(S)
VMS	VERTICAL MOTION SIMULATOR (AT NASA AMES)
VP	VERTICAL PLANE
	VIEWPORT
VRCS	VERNIER REACTION CONTROL SYSTEM
VREL	RELATIVE VELOCITY
V_{rel}	RELATIVE VELOCITY
VS	VERSUS
VTR	VIDEO TAPE RECORDER
VWSS	VERTICAL WIRE SKY SCREEN
W/	WITH
W/O	WITHOUT
W	WATTS
WB	WIDE BAND
WCCU	WIRELESS CREW COMM UNIT
WCS	WASTE COLLECTION SYSTEM
WFCEU	WATER FLOW CONTROL ELECTRONICS UNIT
WFCV	WATER FLOW CONTROL VALVE
WLPS	WALLOPS
WMS	WASTE MANAGEMENT SYSTEM
WNDW	WINDOW
WONG	WEIGHT ON NOSE GEAR
WOW	WEIGHT ON WHEELS
WPA	WINDOW PROTECTION ATTITUDE

FLIGHT RULES

WSB	WATER SPRAY BOILER
WSGT	WHITE SANDS GROUND TERMINAL
WSMR	WHITE SANDS MISSILE RANGE
WSSH	WHITE SANDS SPACE HARBOR
WSTF	WHITE SANDS TEST FACILITY
WST	WASTE
WWV	WORLD WIDE TIME BASE
WX	WEATHER
X CG	X-AXIS CENTER OF GRAVITY
XDCR	TRANSDUCER
XDUCER	TRANSDUCER
XFEED, XFD	CROSSFEED
XFER	TRANSFER
XLV	X-AXIS LOCAL VERTICAL
XVV	X-AXIS POINTED ALONG VELOCITY VECTOR
XPNDRS	TRANSPONDERS
XPONDER	TRANSPONDER
XRANGE	CROSSRANGE
XWIND	CROSSWIND
YLV	Y-AXIS LOCAL VERTICAL
YVV	Y-AXIS POINTED ALONG VELOCITY VECTOR
ZLV	Z LOCAL VERTICAL
ZOT	THE SPONTANEOUS COMBUSTION OF A SMALL AMOUNT OF FUEL IN THE THROAT OF A THRUSTER NOZZLE
ZSI	Z-AXIS SOLAR INERTIAL
ZVV	Z-AXIS POINTED ALONG VELOCITY VECTOR
ZZA	ZARAGOZA (PRIME TAL SITE)
α	ALPHA - ANGLE OF ATTACK
β	BETA - SIDESLIP ANGLE
δ	DELTA - AEROSURFACE DEFLECTION ANGLE
ϕ	PHI - ROLL (BANK) ANGLE, PHASE (AC)
σ	SIGMA - STANDARD DEVIATION
θ	THETA - PITCH ANGLE
$^{\circ}\text{F}$	DEGREES FAHRENHEIT
<	LESS THAN
>	GREATER THAN
ΔP	DELTA (DIFFERENCE IN) PRESSURE

FLIGHT RULES

μG	MICROGRAVITY
%	PERCENT
~	APPROXIMATELY
θ_n	MISALIGNMENT ABOUT THE NORTH AXIS
θ_w	MISALIGNMENT ABOUT THE WEST AXIS
θ_u	MISALIGNMENT ABOUT THE UP AXIS
γ	GAMMA - FLIGHT PATH ANGLE

FLIGHT RULES

THIS PAGE INTENTIONALLY BLANK

FLIGHT RULES

INDEX OF WAIVERS

1.0	INTRODUCTION	C-1
1.1	PURPOSE	C-1
1.2	SCOPE	C-1
	LIST OF WAIVERS	C-2

FLIGHT RULES

THIS PAGE INTENTIONALLY BLANK

FLIGHT RULES

INDEX OF WAIVERS

1.0 INTRODUCTION

1.1 PURPOSE

APPENDIX C CONTAINS THE LIST OF WAIVERS TO THE NSTS 12820, SPACE SHUTTLE OPERATIONAL FLIGHT RULES ALL FLIGHTS DOCUMENT, VOLUME A.

1.2 SCOPE

EACH WAIVER IS APPROVED BY THE SPACE SHUTTLE PROGRAM REQUIREMENTS CONTROL BOARD FOR THE FLIGHT EFFECTIVITY AS SPECIFIED. WAIVERS THAT HAVE BEEN APPROVED FOR MULTIPLE FLIGHTS ARE CURRENT AND IN EFFECT UNLESS THEY ARE IDENTIFIED AS HAVING BEEN RESCINDED BY THE PROGRAM OFFICE BOARD.

THE FLIGHT OPERATIONS TEAM IS RESPONSIBLE FOR IMPLEMENTATION OF THE WAIVERS TO THE OPERATIONS FLIGHT RULES THAT HAVE BEEN APPROVED BY THE SPACE SHUTTLE REQUIREMENTS CONTROL BOARD AS SPECIFIED BY THE PRCB DIRECTIVE SIGNED BY THE CHAIR.

FLIGHT RULES

LIST OF WAIVERS

NUMBER	TITLE	FLIGHT EFFECTIVITY	PRCB DIRECTIVE
1	WAIVER TO SPACE SHUTTLE OPERATIONAL FLIGHT RULES, ALL FLIGHTS DOCUMENT FOR STS-52	STS-52	S063689Q
2	WAIVER TO SPACE SHUTTLE OPERATIONAL FLIGHT RULES, ALL FLIGHTS DOCUMENT FOR STS-66	STS-66	S063689BQ
3	WAIVER TO SPACE SHUTTLE OPERATIONAL FLIGHT RULES, ALL FLIGHTS DOCUMENT FOR STS-71	STS-71	S063689CH
4	WAIVER TO SPACE SHUTTLE OPERATIONAL FLIGHT RULES, ALL FLIGHTS DOCUMENT FOR STS-75	STS-75	S063689CT
5	WAIVER TO SPACE SHUTTLE OPERATIONAL FLIGHT RULES, ALL FLIGHTS DOCUMENT FOR STS-76	STS-76	S063689CU
6	WAIVER TO SPACE SHUTTLE OPERATIONAL FLIGHT RULES, ALL FLIGHTS DOCUMENT FOR STS-94	STS-94	S063689DW
7	WAIVER TO SPACE SHUTTLE OPERATIONAL FLIGHT RULES, ALL FLIGHTS DOCUMENT FOR STS-95	STS-95	S063689EL

[@ED](#) 1

Mission Operations Directorate
NASA Lyndon B. Johnson Space Center
Houston, TX 77058

NASA JSC
AC5/J. W. Young
BT53/STI (3)
CA/D. C. Leestma
CB/Astronaut Office (10)
DA/B. R. Stone
DA83/Library/MOD SS LIB
DA8/Book Manager (40)
DA8/Consultant Group Library
DA8/J. M. Bryant
DA82/Action Center (8)
DF/R. Fitts
DF/G. B. Evans
DF/C. Wood (8)
DF22/R. H. Hudson (8)
DF24/S. L. Murray (6)
DF52/R. C. Doremus (6)
DF55/J. T. Sims (9)
DF62/K. J. Dwyer (7)
DF63/C. A. Larson (10)
DF7/R. E. Armstrong (8)
DF82/P. Hasbrook (12)
DF84/J. L. Spivey
DM21/P. C. Halvorson (2)
DM32/Group Lead (8)
DM32/F. B. Lowes
DM43/G. E. Pogue (4)
DM43/M. Trump (2)
DM44/B. A. Picka
DM46/J. S. Stich (5)
DO12/Safety Office
DO13/Library (6)
DO14/R. A. Galpin
DO4/R. H. Nute (3)
DO4/FDF Library (3)
DO5/Library (9)
DT22/CDH Library (2)
DT34/Library (5)
DT35/Section Library (4)
DT36/Systems (8)
DT37/Communications
DT32/Sim Sups
DT32/Team Lead
DX32/R. S. McDaniel (5)
DX2/Group Lead (3)
EC3/H. A. Rotter
EC5/S. L. Anderson
EP2/PPD Library
ES/G. F. Galbreath

EV111/Library
EV132/J. C. Lamoreux
EV2/R. I. Macias
MA2/G. H. Gerstenmaier
MA3/J. D. Holt
MT3/A. E. Sweet
MV/R. D. Dittermore
MV3/A. L. Magill
NC62/M. A. Martinez (2)
NQ/D. B. Cook
NQ/N. J. Davis
NQ/B. K. Kelly
OA/J. H. Greene
OA/F. L. Culbertson
OA/Program Mgmt Center
OE/L. Gana
OM2/E. Nandin
SA/W. Stephenson
SD2/R. D. Billica
SD24/M. Volpe (6)
SD2/P. Stepaniak
SD26/D. L. Baisden (2)
SN3/M. J. Golightly
ZR1/AF Tech Library
ZS8/F. C. Brody
MER Library
NASA HEADQUARTERS
QP/W. C. Hill
QP/R. Mielec
NASA GSFC
450.3/G. A. Morse
450.3/ATSC/E. Keith
453.2/W. Mitchell
S30.3/J. Burley
NASA KSC
LIBRARY -D
NASA MICHOU
MS-4240/P. Lewis
NASA MSFC
AT01D/Repository
EE31/J. Lusk
EJ41/H. H. Hight
EO02/C. M. Owen (10)
JA41/S. L. Walls
SA21/D. Wilson
NASA/WHITE SANDS

VOLUME A - "ALL FLIGHTS" FLIGHT RULES (NSTS 12820)

Distribution List
Effective Date: 5/5/99

RC/R. E. Mitchell
MARTIN MARIETTA
MIC Library
GB TECHNOLOGY
J. McLaughlin
INTERMETRICS-HOUSTON
S. H. Library
KRUG
HMF-P2/Library
MO-P2/J. D. Wolfer (2)

LOCKHEED
CO7A/R. L. Burns
C42/J. G. Greer
Lockheed Martin-Houston (OBS)
F9110/T. Garza (2)
NASA KSC
IM-NAO/Patrick AFB
Attn: W. Haase
PATRICK AFB
45SPW/SEO
Attn: D. Pawlowski
45RANS/DSO
Boeing North America-Downey
Space Transportation System
12214 Lakewood Blvd.
Downey, CA 90241
AC15/P. J. Ung
AD60/B. J. McMillan
AD75/Data Management
AC85/J. T. Hughes
AE70/J. Gallardo
AE85/M. Weiser
FA25/F. R. Kastelitz
FA99/J. J. Larson
FB13/G. A. Frank
FC94/M. H. Goossens
FA43/S. Copenhaver
Boeing North America-Houston
ZC01/C. C. Beatty
ZC01/J. E. Mechelay
USA
H30B/SOC Library
USH-423C/FD&D Library
USH-423E/Prox Ops Library
USH-423F/Descent Library (2)
USH-423H/Trak & Dyn (3)
USH-423H/Navigation Library
USH-442X/M&O Doc. Ctrl.
USH-454L/M. Prange
ALLIED SIGNAL TECH SERVICE
Goddard Corporate Park
7515 Mission Drive
Lanham, MD 20706
Attn: A2C36/C. Alston
Network/Div./MMU/R. Beadling

DLR
Dept. WT-RB-MP (KP)
Attn: Dr. K. D. Schmidt
Linder Hohe
D-51147 Koln
Germany
HAMILTON STANDARD
1 Hamilton Rd.
Windsor Locks, CT 06096
Attn: 1A-2-X65/J. Auman
INTERMETRICS
100 University Dr.
Fairmont, WV 26554
Attn: F.O. Library
MARTIN MARIETTA AEROSPACE
P. O. Box 29304
New Orleans, LA 70189
Attn: Technical Library
McDonnell-Douglas
Huntington Beach, CA
H017D709/R. Rose
BOEING
499 Boeing Blvd.
P.O. Box 24002
Huntsville, AL 35824-6402
Attn: JC32/C. M. Jaskolka
JC73
JC64/Spacelab DCC
OMITRON
Suite 600
6411 Ivy Lane
Greenbelt, MD 20770
Attn: A. J. Alfonso
ROCKWELL ROCKETDYNE
6633 Canoga Ave.
Canoga Park, CA 91303
Attn: 055-AC58/P. Seitz
SCITOR CORP
Attn: E. I. Fendell
17225 El Camino Real
Suite 420
Houston, TX 77058
SPAR AEROSPACE
Attn: C. Woodland
9445 Airport Rd.

Deletions/additions to this distribution should be directed to Sandra Lewis, NASA JSC DA8, 281-483-5426, E-mail - sandra.k.lewis1@jsc.nasa.gov.

Verify that this is the correct version before use

Mission Operations Directorate
NASA Lyndon B. Johnson Space Center
Houston, TX 77058
Brampton, Ontario
Canada L6S4J3

VOLUME A - "ALL FLIGHTS" FLIGHT RULES (NSTS 12820)
Distribution List
Effective Date: 5/5/99

CSOC

Attn: D1G/Doc Control (6)
555 Forge River Rd.
Houston, TX 77058

TELEDYNE BROWN ENGINEERING

Attn: MS172/M. Gilchrist
Cummings Research Park
300 Sparkman Drive
Huntsville, AL 35807-7007

THIOKOL INC.

Attn: E61A/C. Snyder
P. O. Box 707
Brigham City, UT 84302-0707

Goddard Corporate Park

Attn: MMS/J. Curley
7515 Mission Drive
Lanham, MD 20706

30th RANS/DOR

Attn: Capt. Slauenwhite
Suite C
816 13th Street
Vandenberg AFB, CA 93437-5233

5 SOPS

Attn: R. Tagalog
Onizuka Air Station
1080 Lockheed Way, Box 061
Sunnyvale, CA 94088-1237

Total - 341