

Orbit Operations Checklist

STS-120 Flight Supplement

**Mission Operations Directorate
Operations Division**

**Final
October 4, 2007**

National Aeronautics and
Space Administration

Lyndon B. Johnson Space Center
Houston, Texas

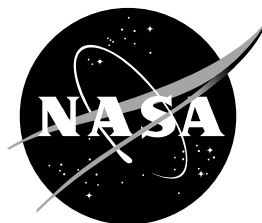

United Space Alliance

ORBIT OPERATIONS, STS-120 Flt Suppl**FINAL (October 4, 2007)****PCN-1 (Oct 9, 2007) Sheet 1 of 1**

List of Implemented Change Requests (482s):

ORB OPS_FS-0041

Incorporate the following:

1. Replace FS iii and FS iv
2. Replace FS 8-1 and FS 8-2

Prepared by:

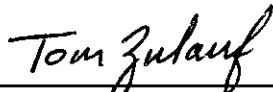

Publication Manager

Approved by:

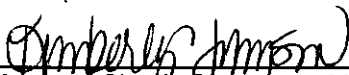

Manager, Shuttle Procedures Management

Accepted by:



FDF Manager

Encl: 4 pages

File this PCN immediately behind the front cover as a permanent record

MISSION OPERATIONS DIRECTORATE

**ORBIT OPERATIONS CHECKLIST
STS-120 FLIGHT SUPPLEMENT**

FINAL
October 4, 2007

PREPARED BY:



Thomas R. Zulauf
Publication Manager

APPROVED BY:

ACCEPTED BY:

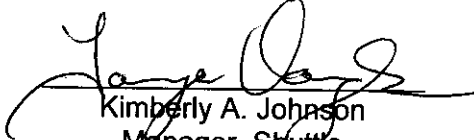
Kimberly A. Johnson
Manager, Shuttle
Procedures Management

Michael T. Hurt
FDF Manager

This document is under the configuration control of the Crew Procedures Control Board (CPCB). All proposed changes must be submitted via FDF Workflow Crew Procedure Change Request (CR) to DO3/FDF Manager.

Additional distribution of this book, for official use only, may be requested in writing to DO3/PMO Administrator. The request must include justification and requester's name, organization, position, and phone number. Contractor requests are made through the NASA or DOD organization supported. Deletions, reduction in quantity, or change of address may be submitted to DO3/FDF Management Office, 281-244-1184.

Incorporates the following:			
482#:	ORB OPS_FS-0031	ORB OPS_FS-0035	ORB OPS_FS-0039
	ORB OPS_FS-0032	ORB OPS_FS-0036	ORB OPS_FS-0040
	ORB OPS_FS-0033	ORB OPS_FS-0037	
	ORB OPS_FS-0034	ORB OPS_FS-0038	

AREAS OF TECHNICAL RESPONSIBILITY

Publication Manager	DO3/T. Zulauf	281-244-0922
Alternate Publication Manager	DO3/A. Jones	281-483-1861
COMM/INST	DS2/D. Branham	281-483-1187
PTG	DO4/M. Stocco	281-244-1023
DAP TABLES	DS6/D. Weiler	281-483-2666
REBOOST/DAP	DS6/D. Weiler	281-483-2666
OIU	DS2/D. Branham	281-483-1187
PRLA	DS4/K. Smith	281-483-9032
SDBI	SK/S. Irwin	281-483-5089
WLES	DO5/R. Carroll	281-244-0914
FRED	DX3/R. Behrendsen	281-483-0745
MAUI	DS6/D. Weiler	281-483-2666

CUE CARDS:

FLIGHT DAY 3 DOCKING ORBITER WITH ISS CO2 ABSORBER REPLACEMENT	DS4/B. Jarvis	281-483-6808
ORBIT BURN MONITOR	DS6/S. Stewart	281-483-5377
DAP TABLES	DS6/D. Weiler	281-483-2666
MAUI – RCS FIRING SEQUENCE	DS6/D. Weiler	281-483-2666
CDM CUE CARD	DS4/B. Jarvis	281-483-6808
MIDODRINE PILL INGESTION	Lockheed Martin/C. Hughes catherine.a.hughes@lmco.com	281-218-3313

ORBIT OPERATIONS CHECKLIST
 STS-120 FLIGHT SUPPLEMENT

LIST OF EFFECTIVE PAGES

FINAL 10/04/07
 PCN-1 10/09/07

Sign Off	*	120/FIN	FS 3-5.....	120/FIN
FS ii	*	120/FIN	FS 3-6.....	120/FIN
FS iii	*	120/FIN 1	FS 3-7.....	120/FIN
FS iv	*	120/FIN 1	FS 3-8.....	120/FIN
FS v.....	*	120/FIN	FS 4-1.....	120/FIN
FS vi.....	*	120/FIN	FS 4-2.....	120/FIN
FS vii		120/FIN	FS 4-3.....	120/FIN
FS viii		120/FIN	FS 4-4.....	120/FIN
FS ix.....		120/FIN	FS 4-5.....	120/FIN
FS x.....		120/FIN	FS 4-6.....	120/FIN
FS 1-1		120/FIN	FS 5-1.....	120/FIN
FS 1-2		120/FIN	FS 5-2.....	120/FIN
FS 1-3		120/FIN	FS 6-1.....	120/FIN
FS 1-4		120/FIN	FS 6-2.....	120/FIN
FS 1-5		120/FIN	FS 7-1.....	120/FIN
FS 1-6		120/FIN	FS 7-2.....	120/FIN
FS 1-7		120/FIN	FS 7-3.....	120/FIN
FS 1-8		120/FIN	FS 7-4.....	120/FIN
FS 2-1		120/FIN	FS 7-5.....	120/FIN
FS 2-2		120/FIN	FS 7-6.....	120/FIN
FS 2-3		120/FIN	FS 7-7.....	120/FIN
FS 2-4		120/FIN	FS 7-8.....	120/FIN
FS 2-5		120/FIN	FS 7-9.....	120/FIN
FS 2-6		120/FIN	FS 7-10.....	120/FIN
FS 2-7		120/FIN	FS 7-11.....	120/FIN
FS 2-8		120/FIN	FS 7-12.....	120/FIN
FS 3-1		120/FIN	FS 7-13.....	120/FIN
FS 3-2		120/FIN	FS 7-14.....	120/FIN
FS 3-3		120/FIN	FS 7-15.....	120/FIN
FS 3-4		120/FIN	FS 7-16.....	120/FIN

* – Omit from flight book

FS 8-1	120/FIN	FS CC 12-5..... *	120/FIN
FS 8-2	120/FIN 1	FS CC 12-6..... *	120/FIN
FS 8-3	120/FIN	FS CC 12-7..... *	120/FIN
FS 8-4	120/FIN	FS CC 12-8..... *	120/FIN
FS 8-5	120/FIN	FS CC 12-9..... *	120/FIN
FS 8-6	120/FIN	FS CC 12-10.... *	120/FIN
FS 8-7	120/FIN	FS CC 12-11.... *	120/FIN
FS 8-8	120/FIN	FS CC 12-12.... *	120/FIN
FS 8-9	120/FIN	FS CC 12-13.... *	120/FIN
FS 8-10	120/FIN	FS CC 12-14.... *	120/FIN
FS 8-11	120/FIN	FS CC 12-15.... *	120/FIN
FS 8-12	120/FIN	FS 12-16..... *	120/FIN
FS 8-13	120/FIN		
FS 8-14	120/FIN		
FS 8-15	120/FIN		
FS 8-16	120/FIN		
FS 8-17	120/FIN		
FS 8-18	120/FIN		
FS 9-1	120/FIN		
FS 9-2	120/FIN		
FS 10-1	120/FIN		
FS 10-2	120/FIN		
FS 10-3	120/FIN		
FS 10-4	120/FIN		
FS 10-5	120/FIN		
FS 10-6	120/FIN		
FS 11-1	120/FIN		
FS 11-2	120/FIN		
FS 11-3	120/FIN		
FS 11-4	120/FIN		
FS 11-5	120/FIN		
FS 11-6	120/FIN		
FS 11-7	120/FIN		
FS 11-8	120/FIN		
FS 12-1	* 120/FIN		
FS 12-2	* 120/FIN		
FS CC 12-3	* 120/FIN		
FS CC 12-4	* 120/FIN		

* – Omit from flight book

ORBIT OPS CUE CARDS

<u>Title</u>	<u>Ref. Page</u>	<u>Card No.</u>
FLIGHT DAY 3 DOCKING ORBITER WITH ISS CO2 ABSORBER REPLACEMENT (Front)	FS CC 12-3	ORB OPS-29a/ nonRCRS/120/O/B
LiOH CANISTER STOWAGE LOCATIONS (Back)	FS CC 12-4	ORB OPS-29b/ nonRCRS/120/O/B
ORBIT BURN MONITOR (Front).....	FS CC 12-5	ORB OPS-31a/120/O/B
OMS FAILURES (Back).....	FS CC 12-6	ORB OPS-31b/120/O/A
STS-120 DAP CONFIGURATIONS (Front/Top).....	FS CC 12-7	ORB OPS-41a/120/O/B
(Front/Bottom)	FS CC 12-8	ORB OPS-41aa/120/O/A
(Back/Top)	FS CC 12-9	ORB OPS-41b/120/O/C
(Back/Bottom).....	FS CC 12-10	ORB OPS-41bb/120/O/C
MAUI – RCS FIRING SEQUENCE (Front).....	FS CC 12-11	ORB OPS-42a/120/O/A
(Back).....	FS CC 12-12	ORB OPS-42b/120/O/A
CDM CUE CARD (Front).....	FS CC 12-13	ORB OPS-46a/120/O/A
(Back).....	FS CC 12-14	ORB OPS-46b/120/O/A
MIDODRINE PILL INGESTION (Front).....	FS CC 12-15	ORB OPS-45a/E/B



This Page Intentionally Blank



<u>CONTENTS</u>	<u>PAGE</u>
<u>COMM/INST</u>	FS 1-1
LOAD PCMMU FORMAT.....	FS 1-2
PDI DECOM FORMAT.....	FS 1-4
OIU FORMAT/CONFIG.....	FS 1-7
<u>PTG</u>	FS 2-1
STAR PAIRS SET A (APPLICABLE: FD01 – FD06)	
STAR PAIRS PAD.....	FS 2-2
PAIRS.....	FS 2-3
STAR PAIRS SET B (APPLICABLE: FD07 – FD11)	
STAR PAIRS PAD.....	FS 2-4
PAIRS.....	FS 2-5
STAR PAIRS SET C (APPLICABLE: FD12 – FD15)	
STAR PAIRS PAD.....	FS 2-6
PAIRS.....	FS 2-7
<u>DAP TABLES</u>	FS 3-1
DAP OVERVIEW.....	FS 3-2
UNIV PTG.....	FS 3-3
STS-120 DAP A CONFIGURATIONS.....	FS 3-4
B CONFIGURATIONS.....	FS 3-6
<u>REBOOST/DAP</u>	FS 4-1
AUTO REBOOST.....	FS 4-2
ATTITUDE REFERENCE.....	FS 4-4
DOCKED DAP REFERENCE.....	FS 4-5
<u>OIU PROCEDURES</u>	FS 5-1
OIU ACTIVATION.....	FS 5-2
DEACTIVATION.....	FS 5-2
<u>PRLA</u>	FS 6-1
PRLA CLOSE.....	FS 6-2

Cont next page

<u>SHORT DURATION BIOASTRONAUTICS</u>	
<u>INVESTIGATION (SDBI)</u>	FS 7-1
SDBI 1490 (PROTOCOL B), BIOAVAILABILITY & PERFORMANCE EFFECTS OF PROMETHAZINE (PMZ) DURING SPACE FLIGHT; SDBI 1634, SLEEP-WAKE ACTIGRAPHY	FS 7-2
SDBI 1900, INTEGRATED IMMUNE BLOOD COLLECTION.....	FS 7-6
SDBI 1900, SALIVA COLLECTION FOR INTEGRATED IMMUNE.....	FS 7-12
<u>WING LEADING EDGE SENSORS (WLES)</u>	
<u>PROCEDURES</u>	FS 8-1
WLES ACTIVATION AND CHECKOUT	FS 8-2
DEACTIVATION AND TEARDOWN	FS 8-9
LAPTOP RECEIVER UNIT (LRU) R&R	FS 8-11
CONFIGURE WLES DATA FILE BACKUP PATH ...	FS 8-14
DECONFIGURE WLES DATA FILE BACKUP PATH	FS 8-14
PREP WLES LAPTOPS FOR TRANSFER.....	FS 8-15
FOR RNDZ TOOLS CHECKOUT.....	FS 8-17
WLES RECONFIG POST DOCK/UNDOCK	FS 8-17
DISABLE WLES FILE BACKUP	FS 8-18
ENABLE WLES FILE BACKUP	FS 8-18
<u>FRED</u>	FS 9-1
FRED SETUP.....	FS 9-2
STOWAGE	FS 9-2
<u>MAUI ANALYSIS OF UPPER-ATMOSPHERIC</u>	
<u>INJECTIONS (MAUI)</u>	FS 10-1
MAUI PROCEDURE	FS 10-2
<u>CARBON DIOXIDE MONITORING (CDM)</u>	
<u>DEVELOPMENT TEST OBJECTIVE (DTO)</u>	
<u>PROCEDURES</u>	FS 11-1
CDM SETUP AND BATTERY CHANGEOUT	FS 11-2
ACTIVATION.....	FS 11-7
DEACTIVATION.....	FS 11-7
DTO COMPLETION	FS 11-8

Cont next page

<u>CUE CARD CONFIGURATION</u>	FS 12-1
FLIGHT DAY 3 DOCKING ORBITER WITH ISS	
CO2 ABSORBER REPLACEMENT (Front)	FS CC 12-3
LiOH CANISTER STOWAGE LOCATIONS	
(Back)	FS CC 12-4
ORBIT BURN MONITOR (Front)	FS CC 12-5
OMS FAILURES (Back)	FS CC 12-6
STS-120 DAP CONFIGURATIONS	
(Front/Top).....	FS CC 12-7
(Front/Bottom)	FS CC 12-8
(Back/Top).....	FS CC 12-9
(Back/Bottom).....	FS CC 12-10
MAUI – RCS FIRING SEQUENCE (Front).....	FS CC 12-11
(Back)	FS CC 12-12
CDM CUE CARD (Front).....	FS CC 12-13
(Back)	FS CC 12-14
MIDODRINE PILL INGESTION (Front).....	FS CC 12-15



This Page Intentionally Blank



FS x

ORB OPS/120/FIN



COMM/INST

LOAD PCMMU FORMAT.....	FS 1-2
PDI DECOM FORMAT.....	FS 1-4
OIU FORMAT/CONFIG.....	FS 1-7

**COMM/
INST**

COMM/
INST

LOAD PCMMU FORMAT

- C3 1. √OI PCMMU FORMAT – GPC
SM 62 PCMMU/PL COMM
- CRT 2. FORMAT:
SEL FXD – ITEM 1 EXEC (*)
SEL ID – ITEM 3 +X X X EXEC
3. √SM COMM BUF – RDY
LOAD – ITEM 4 EXEC
√LOAD, ITEM 4 – RUN,CPLT
- If LOAD – CPLT:
Repeat steps 2 and 3 for second ID
- * If LOAD – FAIL and ERR MSG – 'I/O ERR MMU 1(2)': *
 - * Go to 5.2a, 'I/O ERR MMU 1(2)' (MAL, *
DPS) >> *
 - * If LOAD – FAIL and a first load attempt: *
 - * Repeat steps 1 and 2 for failed ID *
 - * If LOAD – FAIL and a subsequent load *
 - * attempt: *
 - * √MCC *
 - * OI PCMMU PWR – 2(1) *
 - * √ERR MSG – 'I/O ERR PCM' *
 - CRT * I/O RESET PCM – ITEM 5 EXEC (*) *
 - * Repeat steps 2 and 3 *
4. When final LOAD – CPLT:
SEL PGM – ITEM 2 EXEC (*)

DNLIST COMPATIBILITY	PHASE	FORMAT ID 64/128	CONFIG NO.
G1,G3,BFS	(ASCENT)	102/FXD	–
G3,BFS	(ENTRY)	102/164	–
G2,G8,S2	ORBIT/ORBIT BURN/FCS C/O	103/161	–
G2,S2,OPS 0	OPS 0	– /163	–
G2,S2,P9	MMU C/O	– /163	–
G9	Prelaunch PL C/O	103/180	758
G2,G8,S2	RNDZ w/UHF FMT CCSU (SSOR/SSV/TCS) (PRIME)	103/192	763
G2,G8,S2	RNDZ w/UHF FMT CCSU (SSOR/SSV/TCS) (B/U)	103/211	770
G2,G8,S2	DOCKED ISS FMT CCSH (OIU/SSV) (PRIME)	103/184	760
G2,G8,S2	DOCKED ISS FMT CCSH (OIU/SSV) (B/U)	103/205	767
G2,G8,S2	DOCKED ISS FMT CCSH-A (OIU/SSV) (PRIME)	103/199	780
G2,G8,S2	DOCKED ISS FMT CCSH-A (OIU/SSV) (B/U)	103/212	781
G2,G8,S2	OIU C/O AND SSV RATE 4 (PRIME)	103/188	762
G2,G8,S2	OIU C/O AND SSV RATE 5 (B/U)	103/203	765

NOTE

LDR TFL may affect PCMMU BITE. If PCMMU or SM 2 GPC switched since last TFL, ID 64 and 128 will not reflect current state

LOAD PDI DECOM FORMAT

SM 62 PCMMU/PL COMM

1. PDI:

CRT √I/O RESET – ITEM 8 (*)
 SEL DECOM – ITEM 9 +X EXEC
 SEL FMT – ITEM 10 +X X X EXEC
 LOAD – ITEM 11 EXEC

If LOAD – CPLT:
 SEL INPUT – ITEM 12 +X EXEC
 LOAD – ITEM 13 EXEC
 Repeat step 1 for additional DECOMs/FPM

* If LOAD – FAIL and ERR MSG – 'I/O ERR *
* MMU 1(2)': *
* Go to 5.2a, 'I/O ERR MMU 1(2)' (MAL, *
* DPS) >> *
* *
* If LOAD – FAIL and a first load attempt: *
* Repeat step 1 *
* *
* If LOAD – FAIL and a subsequent load *
* attempt: *
* *
* NOTE *
* Power cycling PDI will cause PDI *
* to lose DFLs previously loaded *
* *
* √MCC *
A1L * S-BD PL CNTL – PNL *
* PL DATA INTLVR PWR – OFF,ON *
* √ERR MSG – 'S62 BCE BYP PL' *
* √'S62 BCE BYP PDI' *
* S-BD PL CNTL – CMD *
* *
* PCM: *
CRT * I/O RESET PCM – ITEM 5 EXEC (*) *
* PDI: *
* I/O RESET – ITEM 8 EXEC (*) *
* Repeat step 1 for all of config (XXX) *

CONFIG	DECOM	FMT	INPUT	USE
763 RNDZ w/UHF FMT CCSU (PRIME) TFL 192	1 2 3 4 5-FPM	30 - 9 4 503	1,2 - 5 4	OIU7 (CCSU) ** - TCS SSV (3) *** H-H-H *
770 RNDZ w/UHF FMT CCSU (BACKUP) TFL 211	1 2 3 4 5-FPM	14 31 - 19 502	4 1,2 - 5	SSV (3) *** OIU7 (CCSU) ** - TCS H-H-H *
760 DOCKED FMT CCSH (PRIME) TFL 184	1 2 3 4 5-FPM	7 - - 27 501	1,2 - - 4	OIU9 (CCSH) ** - - SSV (2) *** H-H-H *
767 DOCKED FMT CCSH (BACKUP) TFL 205	1 2 3 4 5-FPM	- 17 29 - 506	- 1,2 4 -	- OIU9 (CCSH) ** SSV (2) *** - H-H-H *
780 DOCKED FMT CCSH-A (PRIME) TFL 199	1 2 3 4 5-FPM	6 - - 27 501	1,2 - - 4	OIU9 (CCSH-A) ** - - SSV (2) *** H-H-H *
781 DOCKED FMT CCSH-A (BACKUP) TFL 212	1 2 3 4 5-FPM	- 16 29 - 506	- 1,2 4 -	- OIU9 (CCSH-A) ** SSV (2) *** - H-H-H *

* OI-GNC-SM, Orbiter Downlist Data Rates (High or Low)
** # in OIU# represents the OIU format;
(XXX) represents data type
*** # in SSV (#) represents the SSV Out Rate sw selection

Cont next page

FS 1-5

ORB OPS/120/FIN

CONFIG	DECOM	FMT	INPUT	USE
762 SSV RATE 4	1 2 3 4	5 - - 1	1,2 - - 4	OIU255 ** - - SSV (4) ***
(PRIME) TFL 188	5-FPM	505		H-H-H *
765 SSV RATE 5	1 2 3 4	- 15 11 -	- 1,2 4 -	- OIU255 ** SSV (5) *** -
(BACKUP) TFL 203	5-FPM	507		L-H-H *
758 Pre-Launch PL C/O	1 2 3 4	28 15 9 -	1,2 1,2 5 -	OIU253 ** OIU255 ** TCS -
(PRIME) TFL 180	5-FPM	504		H-H-H *

- * OI-GNC-SM, Orbiter Downlist Data Rates (High or Low)
- ** # in OIU# represents the OIU format;
(XXX) represents data type
- *** # in SSV (#) represents the SSV Out Rate sw selection

LOAD OIU FORMAT/CONFIG

Determine which step is needed and complete all actions to obtain desired OIU configuration

NOTE

A corresponding TFL/DFL CONFIG is reqd for MCC to receive telemetry. Reference S62 PCMMU/PL COMM for the last loaded HDR TFL and perform LOAD PCMMU FORMAT/LOAD PDI DECOM FORMAT for the associated CONFIG

S212 OIU

1. GNC-1 PRIMARY ON LB-ORB N2-1 (OIU BUS 3)

LOAD FORMAT	ITEM 1 + <u>9</u> EXEC
GNC TO GNC 1	ITEM 18 + <u>1</u> <u>4</u> EXEC
GNC 1 TO BUS 3	ITEM 18 + <u>1</u> <u>6</u> EXEC
BUS 4 BC	ITEM 15 EXEC (*)
BUS 3 RT	ITEM 10 EXEC (*)
LOAD FORMAT	ITEM 1 + <u>9</u> EXEC >>

2. GNC-1 PRIMARY ON LB-ORB N2-2 (OIU BUS 4)

LOAD FORMAT	ITEM 1 + <u>9</u> EXEC
GNC TO GNC 1	ITEM 18 + <u>1</u> <u>4</u> EXEC
GNC 1 TO BUS 4	ITEM 18 + <u>1</u> <u>5</u> EXEC
BUS 3 BC	ITEM 11 EXEC (*)
BUS 4 RT	ITEM 14 EXEC (*)
LOAD FORMAT	ITEM 1 + <u>9</u> EXEC >>

3. GNC-2 PRIMARY ON LB-ORB N2-1 (OIU BUS 3)

LOAD FORMAT	ITEM 1 + <u>9</u> EXEC
GNC TO GNC 2	ITEM 18 + <u>1</u> <u>3</u> EXEC
GNC 2 TO BUS 3	ITEM 18 + <u>1</u> <u>8</u> EXEC
BUS 4 BC	ITEM 15 EXEC (*)
BUS 3 RT	ITEM 10 EXEC (*)
LOAD FORMAT	ITEM 1 + <u>9</u> EXEC >>

4. GNC-2 PRIMARY ON LB-ORB N2-2 (OIU BUS 4)

LOAD FORMAT	ITEM 1 + <u>9</u> EXEC
GNC TO GNC 2	ITEM 18 + <u>1</u> <u>3</u> EXEC
GNC 2 TO BUS 4	ITEM 18 + <u>1</u> <u>7</u> EXEC
BUS 3 BC	ITEM 11 EXEC (*)
BUS 4 RT	ITEM 14 EXEC (*)
LOAD FORMAT	ITEM 1 + <u>9</u> EXEC >>

Cont next page

5. MPLM (if flown)
LOAD FORMAT ITEM 1 +5 EXEC
BUS 2 BC ITEM 7 EXEC (*)
LOAD FORMAT ITEM 1 +5 EXEC >>
6. SSOR
LOAD FORMAT ITEM 1 +7 EXEC
BUS 1 BC ITEM 3 EXEC (*)
LOAD FORMAT ITEM 1 +7 EXEC >>

PTG

STAR PAIRS SET A (APPLICABLE: FD01 – FD06)	
STAR PAIRS PAD.....	FS 2-2
PAIRS.....	FS 2-3
STAR PAIRS SET B (APPLICABLE: FD07 – FD11)	
STAR PAIRS PAD.....	FS 2-4
PAIRS.....	FS 2-5
STAR PAIRS SET C (APPLICABLE: FD12 – FD15)	
STAR PAIRS PAD.....	FS 2-6
PAIRS.....	FS 2-7

PTG

PTG

STAR PAIRS PAD											
STAR PAIR	SEP ANGLE	ATTITUDE SET 1					ATTITUDE SET 2				
		DUAL S TRK		SINGLE S TRK			DUAL S TRK		SINGLE S TRK		
				-Z	-Y				-Z	-Y	
A	93.2	-Y:35 R+ 2 -Z:37 P+ 245 Y+ 320	-Z:35 R+ 264 P+ 230 Y+ 329	-Y:37 R+ 97 P+ 254 Y+ 333	-Y:37 R+ 277 -Z:35 P+ 50 Y+ 27	-Z:37 R+ 182 P+ 59 Y+ 40	-Y:35 R+ 1 P+ 64 Y+ 19				
B	85.2	-Y:34 R+ 103 -Z:24 P+ 27 Y+ 357	-Z:34 R+ 17 P+ 22 Y+ 343	-Y:24 R+ 189 P+ 14 Y+ 3	-Y:24 R+ 170 -Z:34 P+ 197 Y+ 18	-Z:24 R+ 82 P+ 208 Y+ 8	-Y:34 R+ 258 P+ 186 Y+ 8				
C	87.4	-Y:41 R+ 89 -Z:73 P+ 115 Y+ 24	-Z:41 R+ 5 P+ 107 Y+ 12	-Y:73 R+ 182 P+ 101 Y+ 33	-Y:73 R+ 178 -Z:41 P+ 282 Y+ 349	-Z:73 R+ 95 P+ 295 Y+ 340	-Y:41 R+ 262 P+ 272 Y+ 337				
D	89.4	-Y:82 R+ 354 -Z:65 P+ 150 Y+ 8	-Z:82 R+ 269 P+ 138 Y+ 18	-Y:65 R+ 78 P+ 161 Y+ 19	-Y:65 R+ 274 -Z:82 P+ 318 Y+ 338	-Z:65 R+ 189 P+ 326 Y+ 351	-Y:82 R+ 8 P+ 333 Y+ 331				

STAR PAIRS PAD

FS 2-2

ORB OPS/120/FIN

PAIR		COAS ALIGN ATTITUDE 1	ANG SEP	COAS ALIGN ATTITUDE 2
COAS	+X HUD	35 R+ 102 P+ 66 Y+ 304	NOSE UP 93.6	57 R+ 99 P+ 51 Y+ 37
	-Z COAS	35 R+ 277 P+ 50 Y+ 28	TAIL UP	57 R+ 78 P+ 244 Y+ 57

SINGLE S TRK MIN MNVR OPT
TGT ID = 11-110 NAV STAR #

	-Z S TRK	-Y S TRK
BV	5	4
P	87.7	✓ 0
Y	358	✓ 280.57

SET A
FD01 - FD06

MET Applicable Post OMS2 to 5/12:00:00
Liftoff Date: 10/23/07
Liftoff GMT: 296/15:36:03.000

STAR PAIRS

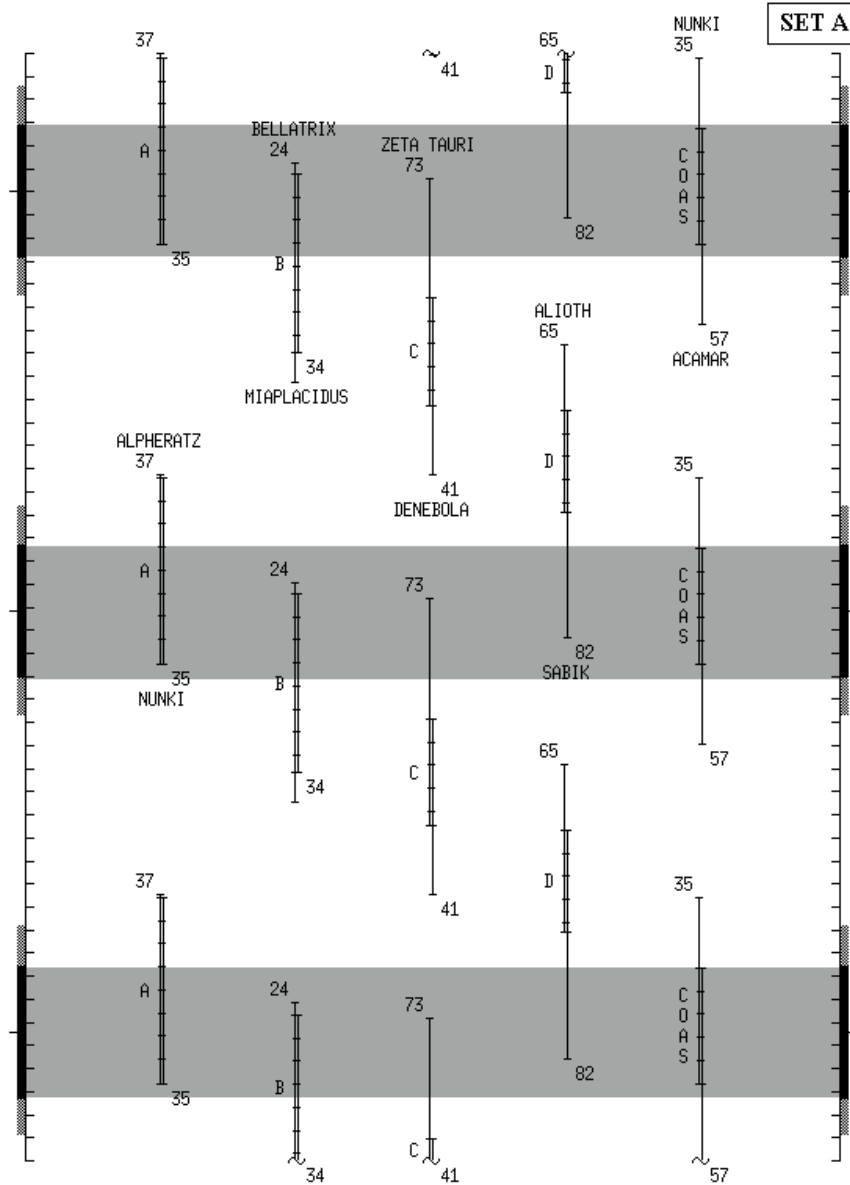

SET A

MET Applicable; Post OMS2 to 5/12:00:00
 Liftoff Date: 10/23/07
 Liftoff GMT: 296/15:36:03.000

FD01 - FD06

FS 2-4

ORB OPS/120/FIN

STAR PAIRS PAD										
STAR PAIR	SEP ANGLE	ATTITUDE SET 1					ATTITUDE SET 2			
		DUAL S TRK		SINGLE S TRK			DUAL S TRK		SINGLE S TRK	
				-Z	-Y				-Z	-Y
A	85.2	-Y:34 R+ 103 -Z:24 P+ 27 Y+ 357	-Z:34 R+ 17 P+ 22 Y+ 343	-Y:24 R+ 189 P+ 14 Y+ 3	-Y:24 R+ 170 -Z:34 P+ 197 Y+ 18	-Z:24 R+ 82 P+ 208 Y+ 8	-Y:34 R+ 258 P+ 186 Y+ 8			
B	85.1	-Y:41 R+ 82 -Z:18 P+ 117 Y+ 49	-Z:41 R+ 4 P+ 105 Y+ 37	-Y:18 R+ 182 P+ 98 Y+ 58	-Y:18 R+ 177 -Z:41 P+ 279 Y+ 324	R+ 103 P+ 296 Y+ 316	R+ 253 P+ 266 Y+ 313			
C	86.9	-Y:42 R+ 9 -Z:38 P+ 207 Y+ 33	-Z:42 R+ 292 P+ 190 Y+ 38	-Y:38 R+ 89 P+ 217 Y+ 46	-Y:38 R+ 251 -Z:42 P+ 8 Y+ 318	R+ 173 P+ 22 Y+ 328	R+ 347 P+ 22 Y+ 306			
D	82.3	-Y:66 R+ 324 -Z:60 P+ 235 Y+ 326	-Z:66 R+ 238 P+ 229 Y+ 339	-Y:60 R+ 57 P+ 251 Y+ 331	-Y:60 R+ 308 -Z:66 P+ 52 Y+ 17	R+ 225 P+ 51 Y+ 31	R+ 28 P+ 68 Y+ 16			

STAR PAIRS PAD

PAIR		COAS ALIGN ATTITUDE 1	ANG SEP	COAS ALIGN ATTITUDE 2
COAS	+X HUD	R+ 103 P+ 117 Y+ 2	90.6	R+ 192 P+ 16 Y+ 77
	-Z COAS	R+ 349 P+ 38 Y+ 75		R+ 76 P+ 297 Y+ 2

SINGLE S TRK MIN MNVR OPT
TGT ID = 11-110 NAV STAR #

	-Z S TRK	-Y S TRK
BV	5	4
P	87.7	✓ 0
Y	358	✓ 280.57

SET B
FD07 - FD11

MET Applicable 05/12:00:00 to 10/12:00:00
Liftoff Date: 10/23/07
Liftoff GMT: 296/15:36:03.000

STAR PAIRS

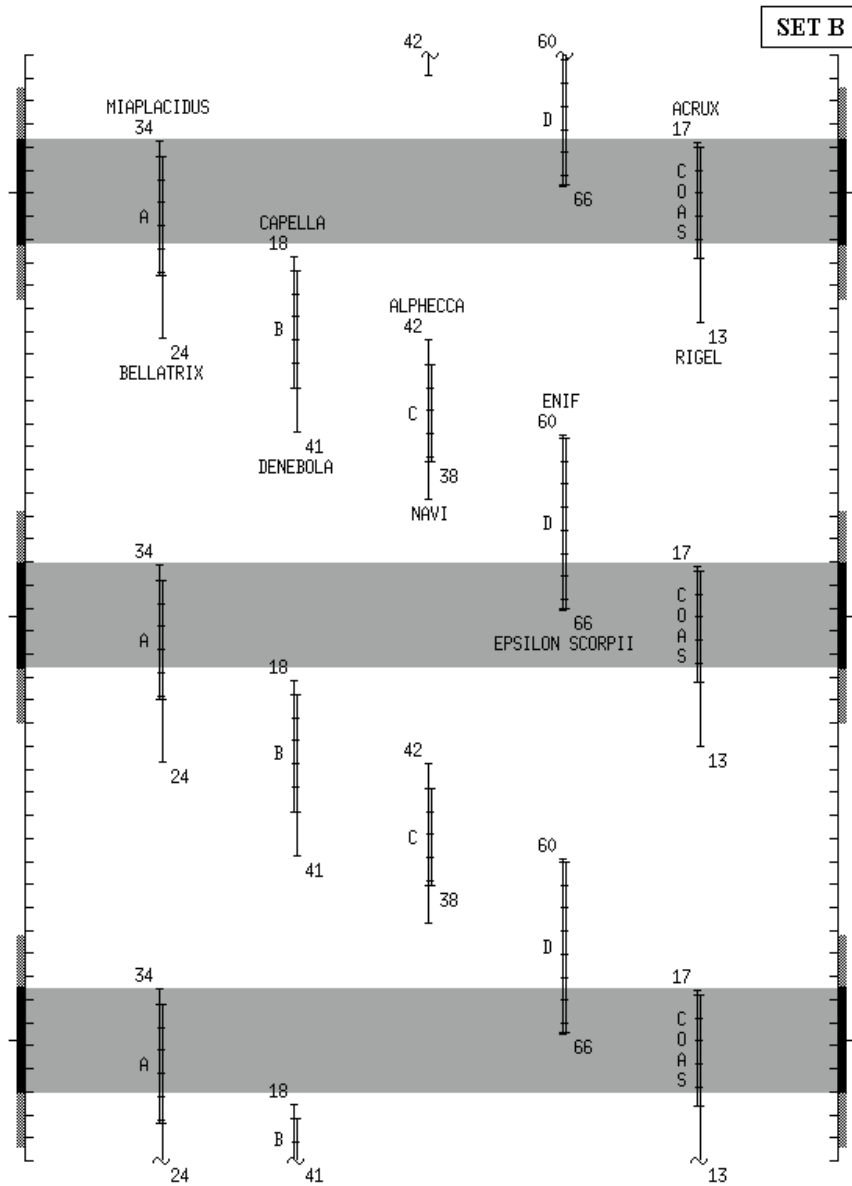

SET B

MET Applicable: 05/12:00:00 to 10/12:00:00
 Liftoff Date: 10/23/07
 Liftoff GMT: 296/15:36:03.000

FD07 - FD11

FS 2-6

ORB OPS/120/FIN

STAR PAIRS PAD											
STAR PAIR	SEP ANGLE	ATTITUDE SET 1						ATTITUDE SET 2			
		DUAL S TRK		SINGLE S TRK				DUAL S TRK		SINGLE S TRK	
				-Z	-Y		-Z			-Y	
A	89.0	-Y:88 R+ 152 -Z:40 P+ 27 Y+ 1	-Z:88 R+ 65 P+ 34 Y+ 348	-Y:40 R+ 238 P+ 13 Y+ 355	-Y:40 R+ 119 -Z:88 P+ 212 Y+ 16	-Z:40 R+ 32 P+ 211 Y+ 1	-Y:88 R+ 211 P+ 196 Y+ 17				
B	86.9	-Y:42 R+ 9 -Z:38 P+ 207 Y+ 33	-Z:42 R+ 292 P+ 190 Y+ 38	-Y:38 R+ 89 P+ 217 Y+ 46	-Y:38 R+ 251 -Z:42 P+ 8 Y+ 318	-Z:38 R+ 173 P+ 22 Y+ 328	-Y:42 R+ 347 P+ 22 Y+ 306				
C	85.5	-Y:36 R+ 327 -Z:27 P+ 196 Y+ 332	-Z:36 R+ 239 P+ 190 Y+ 346	-Y:27 R+ 59 P+ 211 Y+ 338	-Y:27 R+ 305 -Z:36 P+ 13 Y+ 11	-Z:27 R+ 220 P+ 12 Y+ 25	-Y:36 R+ 28 P+ 27 Y+ 10				
D	82.2	-Y:16 R+ 235 -Z:60 P+ 118 Y+ 313	-Z:16 R+ 163 P+ 136 Y+ 320	-Y:60 R+ 326 P+ 127 Y+ 299	-Y:60 R+ 19 -Z:16 P+ 322 Y+ 42	-Z:60 R+ 308 P+ 303 Y+ 43	-Y:16 R+ 97 P+ 330 Y+ 55				

STAR PAIRS PAD

PAIR		COAS ALIGN ATTITUDE 1	ANG SEP	COAS ALIGN ATTITUDE 2
COAS	+X HUD	50 R+ 103 P+ 109 Y+ 29	NOSE UP 88.7	32 R+ 248 P+ 315 Y+ 59
	-Z COAS	50 R+ 62 P+ 320 Y+ 62	TAIL UP	32 R+ 76 P+ 289 Y+ 337

SINGLE S TRK MIN MNVR OPT
TGT ID = 11-110 NAV STAR #

	-Z S TRK	-Y S TRK
BV	5	4
P	87.7	✓ 0
Y	358	✓ 280.57

SET C
FD12 - FD15

MET Applicable 10/12:00:00 to 15/00:00:00
Liftoff Date: 10/23/07
Liftoff GMT: 296/15:36:03.000

STAR PAIRS

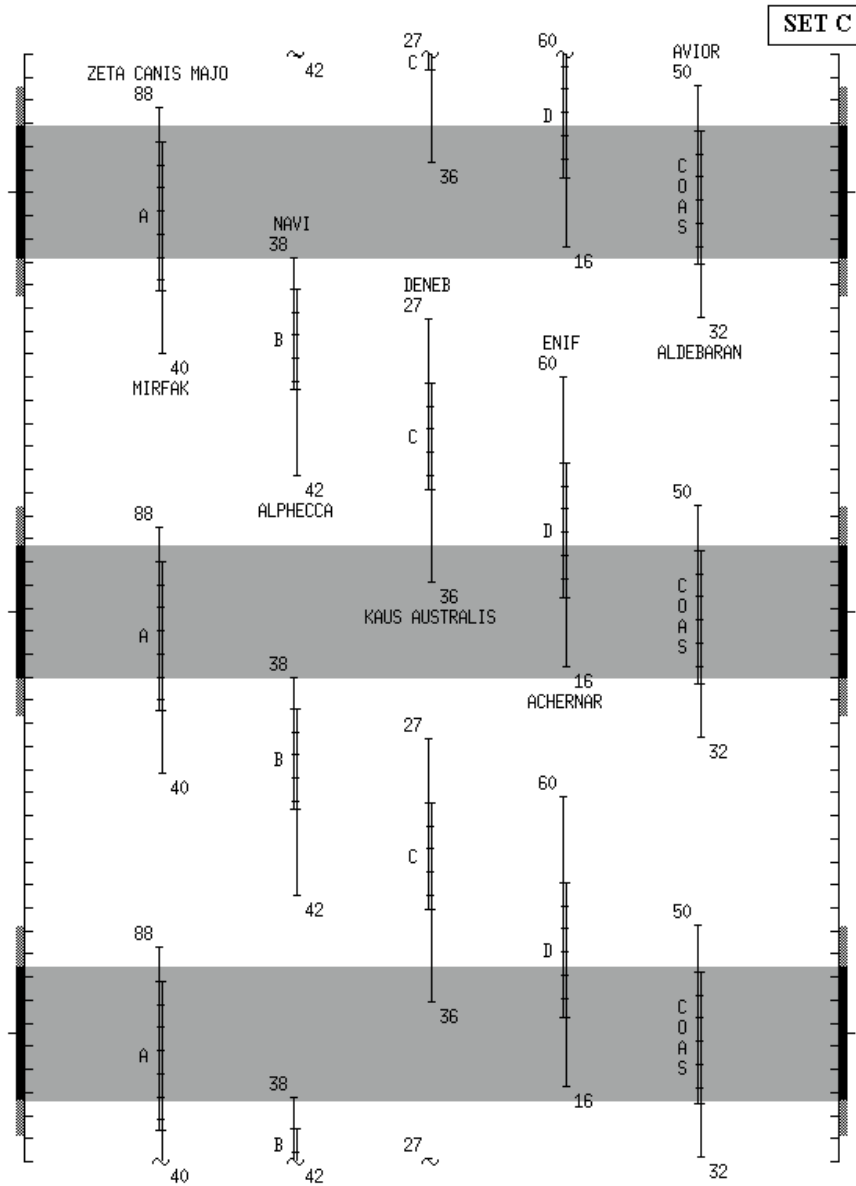

MET Applicable: 10/12:00:00 to 15/00:00:00
 Liftoff Date: 10/23/07
 Liftoff GMT: 296/15:36:03.000

FD12 - FD15



This Page Intentionally Blank



DAP TABLES

DAP OVERVIEW	FS 3-2
UNIV PTG	FS 3-3
STS-120 DAP A CONFIGURATIONS.....	FS 3-4
B CONFIGURATIONS.....	FS 3-6

**DAP
TABLES**

DAP TABLES

DAP Overview

DAP – Purpose	DAP – Purpose
A1 – Nominal	B1 – OMS & RCS Burns (ORB OPS)
A2 – PTC	B2 – Loss of VERN (Tail Only)
A3 – GG	B3 – Loss of VERN (All)
A4 –	B4 –
A5 – Loss of VERN (All)	B5 – COAS/HUD CAL
A6 – Loss of VERN (Tail Only)	B6 –
A7 – Rendezvous	B7 – Rendezvous
A8 – Terminal Phase	B8 – Terminal Phase
A9 – PROX OPS/Flyaround	B9 – PROX OPS/Flyaround
A10 – Docking	B10 – Docking
A11 – Auto Reboost	B11 –
A12 – Mated Stack (VRCS/ALT)	B12 – Mated Stack Backup (VRCS/ALT)
A13 –	B13 –
A14 – Orbiter alone SRMS/OBSS Ops	B14 –
A15 – Mated Stack RMS Ops (VRCS)	B15 –

- CNTL ACC = 0 Orbiter alone with unloaded RMS
 = 1 Orbiter alone SRMS/OBSS Ops
 = 2 Mated - VRCS/ALT, Shuttle Airlock Pressurized, Docked through Node 2 at Port Hover
 = 3 Mated - VRCS/ALT, Shuttle Airlock Pressurized with Node 2 at Intermediate through Pre-P6 Demate
 = 4 Mated - VRCS/ALT, Shuttle Airlock Pressurized with P6 at Demate
 = 5 Mated - VRCS/ALT, Shuttle Airlock Pressurized with P6 at Demate Intermediate
 = 6 Mated - VRCS/ALT, Shuttle Airlock Pressurized with P6 at Handoff
 = 7 Mated - VRCS/ALT, Shuttle Airlock Pressurized with P6 at Pre-Install Intermediate 1
 = 8 Mated - VRCS/ALT, Shuttle Airlock Pressurized with P6 at Pre-Install Intermediate 2
 = 9 Mated - VRCS/ALT, Shuttle Airlock Pressurized with P6 at Pre-Install Setup & Pre-Install through Undock

DAPs for mated operations are based on analysis from GNC, PDRS, and C. S. Draper Labs

FS 3-2

ORB OPS/120/FIN

UNIV PTG

TGT ID = 1 Orbiting Vehicle = 2 Earth Center = 3 Earth Target Input LAT (± 90) LON (± 180 , + = East) ALT (-3444.0 to 20000.0 nm) = 4 Sun Center = 5 Celestial Target Input RA (0-359.99) DEC (± 90) = 11-110 Nav Stars
BODY VECTOR = 1 +X* = 2 -X* = 3 -Z* = 4 -Y Star Tracker* = 5 Selectable Input P (0-359.99) Y (270-359.99, 0-90) *Input OM \rightarrow OM (0-359.99)
MON AXIS = 1 +X = 2 -X

STS-120 DAP A1 -- A8 CONFIGURATIONS

	ITEM #	A1	A2	A3	A4	A5	A6	A7	A8
PRI									
ROT RATE	10 (50)	0.2000	0.4000	0.2000	0.5000	0.2000	0.2000	0.2000	0.0500
ATT DB	11 (51)	5.00	1.00	0.30	3.00	5.00	5.00	2.00	2.00
RATE DB	12 (52)	0.20	0.20	0.20	0.20	0.20	0.20	0.20	0.20
ROT PLS	13 (53)	0.100	0.100	0.100	0.100	0.100	0.100	0.100	0.100
COMP	14 (54)	.000	.000	.000	.000	.000	.000	.000	.000
P OPTION	15 (55)	ALL	ALL	ALL	ALL	ALL	TAIL	ALL	ALL
Y OPTION	16 (56)	ALL	ALL	TAIL	ALL	ALL	TAIL	ALL	ALL
TRAN PLS	17 (57)	0.100	0.100	0.100	0.100	0.100	0.100	0.100	0.100
ALT									
RATE DB	18 (58)	0.200	0.200	0.070	0.200	0.070	0.070	0.100	0.100
JET OPT	19 (59)	ALL	ALL	ALL	ALL	ALL	TAIL	ALL	ALL
# JETS	20 (60)	2	2	1	2	1	1	2	2
ON TIME	21 (61)	0.08	0.08	0.08	0.08	0.08	0.08	0.08	0.08
DELAY	22 (62)	0.00	0.00	0.00	0.00	0.00	0.00	0.00	0.00
VERN									
ROT RATE	23 (63)	0.2000	0.4000	0.0080	0.2000	0.0500	0.0500	0.0160	0.0500
ATT DB	24 (64)	1.000	1.000	0.070	1.000	1.000	1.000	1.000	1.000
RATE DB	25 (65)	.020	.020	.010	.020	.020	.020	.020	.020
ROT PLS	26 (66)	0.010	0.010	0.010	0.010	0.010	0.010	0.010	0.050
COMP	27 (67)	.000	.000	.000	.000	.000	.000	.000	.000
CNTL ACC	28 (68)	0	0	0	0	0	0	0	0
PURPOSE		NOMINAL	PTC	GG		LOSS OF VERN (ALL)	LOSS OF VERN (TAIL ONLY)	RNDZ	TERMINAL PHASE

BOLD/ITALIC indicates change from I-Load.

FS 3-4

ORB OPS/120/FIN

STS-120 DAP A9 -- A15 CONFIGURATIONS

	ITEM #	A9	A10	A11	A12	A14	A15
PRI							
ROT RATE	10 (50)	0.1300	0.0500	0.0500	0.0500	0.2000	0.0500
ATT DB	11 (51)	2.00	0.60	10.00	5.00	5.00	5.00
RATE DB	12 (52)	0.10	0.10	0.20	0.20	0.20	0.20
ROT PLS	13 (53)	0.100	0.100	0.100	0.040	0.100	0.040
COMP	14 (54)	.000	.000	.000	.000	.000	.000
P OPTION	15 (55)	TAIL	TAIL	TAIL	TAIL	TAIL	TAIL
Y OPTION	16 (56)	TAIL	TAIL	TAIL	TAIL	TAIL	TAIL
TRAN PLS	17 (57)	0.050	0.050	0.100	0.010	0.100	0.010
ALT							
RATE DB	18 (58)	0.100	0.100	0.035 ¹	0.035 ¹	0.200	0.035 ¹
JET OPT	19 (59)	TAIL	TAIL	TAIL	TAIL	TAIL	TAIL
# JETS	20 (60)	2	2	1	3, 1 ²	1	3
ON TIME	21 (61)	0.08	0.08	0.16	0.08	0.08	0.08
DELAY	22 (62)	0.00	0.00	6.00	11.04, 6 ²	6.00	11.04
VERN							
ROT RATE	23 (63)	0.1300	0.0500	0.1000	0.1000	0.2000	0.1000
ATT DB	24 (64)	1.000	0.500	5.000	3.000	3.000	3.000
RATE DB	25 (65)	.020	.020	.050	.050	.200	.050
ROT PLS	26 (66)	0.050	0.050	0.010	0.002	0.010	0.002
COMP	27 (67)	.000	.000	.000	.000	.000	.000
CNTL ACC	28 (68)	0	0	9 ³	2 ⁴	1	3 ⁴
PURPOSE		PROX/OPS FLYAROUND	DOCKING	AUTO REBOOST	MATED STACK (VERN/ALT)	ORBITER ALONE SRMS/OBSS	MATED STACK RMS OPS (VERN/ALT)

BOLD/ITALIC indicates change from I-Load.

¹ I-Loaded below keyboard limit; do not change

² Post P6 install, ALT DAP requires 1 jet and 11.04 sec delay for attitude hold or 6 sec delay for mnvr

³ Config 2 only for post P6 install (CA 9); Config 3 for any non-loaded RMS mated ops (CA 2, 3, 9)

⁴ See DAP Overview for summary of CNTL ACCs

FS 3-5

ORB OPS/120/FIN

STS-120 DAP B1 -- B8 CONFIGURATIONS

	ITEM #	B1	B2	B3	B4	B5	B6	B7	B8
PRI									
ROT RATE	30 (50)	0.5000	0.2000	0.2000	0.2000	0.2000	0.5000	0.5000	0.0500
ATT DB	31 (51)	3.00	3.00	3.00	0.30	3.00	3.00	2.00	2.00
RATE DB	32 (52)	0.20	0.20	0.20	0.20	0.20	0.20	0.20	0.20
ROT PLS	33 (53)	0.040	0.040	0.040	0.040	0.040	0.040	0.040	0.040
COMP	34 (54)	.000	.000	.000	.000	.000	.000	.000	.000
P OPTION	35 (55)	ALL	TAIL	ALL	TAIL	TAIL	ALL	ALL	ALL
Y OPTION	36 (56)	ALL	TAIL	ALL	TAIL	TAIL	ALL	ALL	ALL
TRAN PLS	37 (57)	0.100	0.020	0.020	0.020	0.020	0.020	0.050	0.050
ALT									
RATE DB	38 (58)	0.200	0.070	0.070	0.100	0.200	0.200	0.100	0.100
JET OPT	39 (59)	ALL	TAIL	ALL	ALL	ALL	ALL	ALL	ALL
# JETS	40 (60)	2	1	1	2	2	2	2	2
ON TIME	41 (61)	0.08	0.08	0.08	0.08	0.08	0.08	0.08	0.08
DELAY	42 (62)	0.00	0.00	0.00	0.00	0.00	0.00	0.00	0.00
VERN									
ROT RATE	43 (63)	0.2000	0.2000	0.2000	0.0080	0.0160	0.2000	0.2000	0.0500
ATT DB	44 (64)	1.000	1.000	1.000	0.100	0.033	1.000	1.000	1.000
RATE DB	45 (65)	.020	.020	.020	.010	.020	.020	.020	.020
ROT PLS	46 (66)	0.002	0.002	0.002	0.002	0.002	0.002	0.002	0.020
COMP	47 (67)	.000	.000	.000	.000	.000	.000	.000	.000
CNTL ACC	48 (68)	0	0	0	0	0	0	0	0
PURPOSE		OMS & RCS Burns (ORB OPS)	Loss of VERN (Tail Only)	Loss of VERN (All)		COAS/HUD CAL		RNDZ	TERMINAL PHASE

BOLD/ITALIC indicates change from I-Load.

FS 3-6

ORB OPS/120/FIN

STS-120 DAP B9 -- B12 CONFIGURATIONS

	ITEM #	B9	B10	B12
PRI				
ROT RATE	30 (50)	0.1300	0.0500	0.0500
ATT DB	31 (51)	2.00	0.60	5.00
RATE DB	32 (52)	0.10	0.10	0.20
ROT PLS	33 (53)	0.040	0.040	0.040
COMP	34 (54)	.000	.000	.000
P OPTION	35 (55)	TAIL	TAIL	TAIL
Y OPTION	36 (56)	TAIL	TAIL	TAIL
TRAN PLS	37 (57)	0.010	0.010	0.010
ALT				
RATE DB	38 (58)	0.100	0.100	0.035 ¹
JET OPT	39 (59)	TAIL	TAIL	TAIL
# JETS	40 (60)	2	2	3, 1 ²
ON TIME	41 (61)	0.08	0.08	0.08
DELAY	42 (62)	10.00	0.00	11.04, 6 ²
VERN				
ROT RATE	43 (63)	0.1300	0.0500	0.1000
ATT DB	44 (64)	1.000	0.500	3.000
RATE DB	45 (65)	.020	.020	.050
ROT PLS	46 (66)	0.020	0.020	0.002
COMP	47 (67)	.000	.000	.000
CNTL ACC	48 (68)	0	0	2 ³
PURPOSE		PROX OPS/ FLYAROUND	DOCKING	MATED STACK BACKUP (VRCS/ALT)

BOLD/ITALIC indicates change from I-Load.

¹ I-Loaded below keyboard input limit; do not change

² Post P6 install, ALT DAP requires 1 jet and 11.04 sec delay for attitude hold or 6 sec delay for mnvr

³ See DAP Overview for summary of CNTL ACCs

FS 3-7

ORB OPS/120/FIN



This Page Intentionally Blank



REBOOST/DAP

AUTO REBOOST.....	FS 4-2
ATTITUDE REFERENCE.....	FS 4-4
DOCKED DAP REFERENCE	FS 4-5

**REBOOST/
DAP**

AUTO REBOOST

NOTE

Allow 5 min between establishing reboost attitude and reboost start time for DAP accelerations to converge

1. If PRCS required:

O14:F, RJDA 1A L2/R2 DRIVER – OFF
O15:F, RJD MANF L5/F5/R5 DRIVER – OFF
O16:F, Pri RJD LOGIC (eight) – ON

√MCC for GO to power up Pri Drivers
RJD MANF L5/F5/R5 DRIVER – ON
Pri RJD DRIVER (eight) – ON

2. Select Reboost Configuration

GNC 20 DAP CONFIG
REBOOST CFG – ITEM 8 + _ EXEC
INTVL – ITEM 9 + _ _ _ _ _ EXEC

3. Set up Future Reboost

GNC UNIV PTG
DURATION – ITEM 27 + _ _ + _ _ + _ _ _ _ _ EXEC
START TIME – ITEM 1 + _ _ _ _ + _ _ + _ _ _ _ _ EXEC

RBST – ITEM 25 EXEC (FUT-*)

4. Select appropriate Reboost Rotation DAP
When in attitude and prior to START TIME,
DAP: A11/AUTO/VERN(ALT)

C3

REBOOST/
DAP

Cont next page

FS 4-2

ORB OPS/120/FIN

If using Config 2:

GNC 20 DAP CONFIG

√X JETS ROT ENA – ITEM 7 EXEC (*)

Deselect Forward Firing Jets:

GNC 23 RCS

√RCS FWD – ITEM 1 EXEC (*)

√JET DES F1F – ITEM 31 (*)

√F2F – ITEM 35 (*)

F3F – ITEM 33 EXEC (*)

NOTE

Reboost can be aborted with an
ITEM 26 on UNIV PTG or by
selecting FREE on the DAP

5. Post Reboost Configuration

If using Config 2:

GNC 23 RCS

√RCS FWD – ITEM 1 EXEC (*)

JET DES F3F – ITEM 33 EXEC (no *)

Return to FLIGHT PLAN Attitude

DAP: as reqd

Pri RJD LOGIC, DRIVER (sixteen) – as reqd

C3
O14,
O15,
O16

AUTO REBOOST ATTITUDE REFERENCE

VRCS ATTITUDE HOLD CONFIGURATIONS:

Nose Up, Config 3 (VRCS)

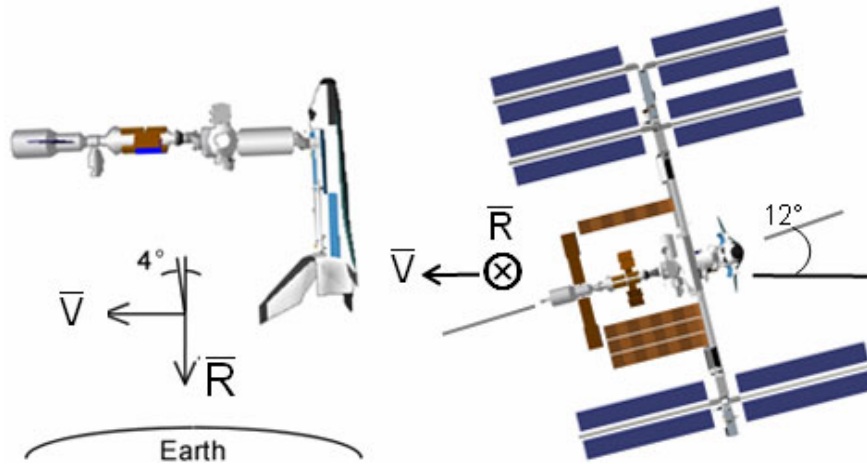

ALT ATTITUDE HOLD CONFIGURATIONS:

Nose up, Config 2 (+X)

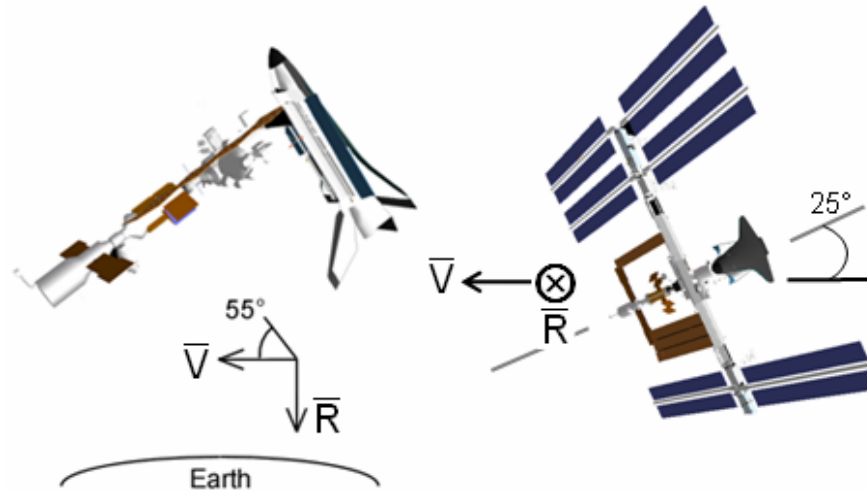

DOCKED DAP REFERENCE

To assume mated Shuttle attitude control, reconfigure DAP per NON-RMS DAPs or RMS DAPs, then perform RATE DAMPING

For mated OBSS operations, refer to NON-RMS DAPs for proper configuration

NON-RMS DAPs

	SHUTTLE EXTERNAL AIRLOCK		
	PRESS (≥ 3.45 psia)	DEPRESS (< 3.45 psia)	
	VERN/ALT	VERN	ALT
Post Dock - Pre Node 2 Install	A12 CA: 2	Not Certified	Not Certified
Post Node 2 Install - Pre P6 Demate	A15 CA: 3		
Post P6 Install - Undock	A12 CA: 9		

For mated control after P6 install on ALT PRCS, the following DAP changes are required:

ALT DAP Post P6 Install	GNC 20 DAP CONFIG	
	# JETS (ITEM 20)	DELAY (ITEM 22)
Attitude Hold	1	11.04
Maneuvers	1	6

RMS DAPs (Pressurized Airlock & Loaded SRMS/SSRMS)

Node 2	Payload Position	GNC 20 DAP CONFIG
SSRMS OPS	At Low Hover	DAP: A12/VERN CA: 2
	At Port Hover	DAP: A12/VERN CA: 2
	At Intermediate Position	DAP: A15/VERN CA: 3
	At Pre-Install	DAP: A15/VERN CA: 3

Cont next page

For Shuttle mated attitude control during P6 install,
 SPEC 20 DAP CONFIG changes must be made as
 noted in the table below

All changes will be made to DAP A15

NOTE

“----“ indicates no change from I-load required

		A15/VERN			
		GNC 20 DAP CONFIG			
P6	Payload Postion	ROT RATE (ITEM 23)	ATT DB (ITEM 24)	RATE DB (ITEM 25)	CNTL ACC (ITEM 28)
SSRMS OPS	Demate	----	----	0.08	4
	Demate Intermediate	----	----	0.08	5
	Handoff (SSRMS at WS4)	----	----	0.08	6
SRMS OPS	P6 Handoff	----	----	0.05	6
SSRMS OPS	Handoff (SSRMS at WS8)	----	----	0.05	6
	Pre-install Intermediate 1	0.05	10	0.32	7
	Pre-install Intermediate 2	0.05	10	0.32	8
	Pre-install Setup	0.05	10	0.32	9
	Pre-install	0.05	10	0.32	9

RATE DAMPING

RATE DAMPING	LVLH(INRTL), when rates are below rate deadband and jet activity stopped, FREE > 2 sec, AUTO
RATE > 0.20	LVLH(INRTL) 6 min max FREE, LVLH(INRTL)

OIU PROCEDURES

OIU ACTIVATION	FS 5-2
DEACTIVATION	FS 5-2

OIU

OIU ACTIVATION

NOTE

√MCC that steps 1 and 2 may not be reqd

- 1. Load PCMMU/PDI (config 760) for OIU
- 2. Power on PSP 1(2)

A1L √S-BD PL CNTL – CMD
 PWR SYS – 1(2)
 √SEL – PSP
 √PSP CMD OUTPUT – PL UMB
 CNTL – PNL,CMD

SM 62 PCMMU/PL COMM

I/O RESET PSP 1(2) – ITEM 6(7) EXEC (*)

- 3. Power on OIU 1(2)

SSP1 OIU PWR – OIU 1(2) ON
 √tb – UP(DN)

OIU DEACTIVATION

NOTE

√MCC for OIU ops complete

- 1. Possible 'S62 PDI DECOM FAIL' msg

SSP1 OIU PWR – OFF
 √tb – bp

- 2. MCC will config PCMMU and PDI as reqd

OIU

PRLA

PRLA CLOSE..... FS 6-2

PRLA

FS 6-1

ORB OPS/120/FIN

SHORT DURATION BIOASTRONAUTICS
INVESTIGATION (SDBI)

SDBI 1490 (PROTOCOL B), BIOAVAILABILITY & PERFORMANCE EFFECTS OF PROMETHAZINE (PMZ) DURING SPACE FLIGHT; SDBI 1634, SLEEP-WAKE ACTIGRAPHY	FS 7-2
SDBI 1900, INTEGRATED IMMUNE BLOOD COLLECTION	FS 7-6
SDBI 1900, SALIVA COLLECTION FOR INTEGRATED IMMUNE	FS 7-12

SDBI

SDBI 1490 (PROTOCOL B), BIOAVAILABILITY & PERFORMANCE EFFECTS OF PROMETHAZINE (PMZ) DURING SPACE FLIGHT; SDBI 1634, SLEEP-WAKE ACTIGRAPHY

ASAP after entry into orbit:

A. DON ACTIWATCH

MF57K

1. Unstow: Actiwatch
FLIGHT SLEEP LOG

NOTE

If necessary to remove Actiwatch, record doff/don time on FLIGHT SLEEP LOG

2. Don Actiwatch on non-dominant arm and wear continuously throughout mission
3. Deploy FLIGHT SLEEP LOG and record required information daily (within 15 min after waking)

NOTE

Perform B. PMZ PROTOCOL if SMS is experienced. If unable to collect saliva sample before taking PMZ dose, collect saliva sample at some other drug-free time during mission

B. PMZ PROTOCOL

MF57G

1. Unstow: Saliva Sample Kit
SALIVA/KSS LOG
2. Temp stow SALIVA/KSS LOG w/Saliva Sample Kit

SDBI

Cont next page

FS 7-2

ORB OPS/120/FIN

3. Collect Baseline saliva sample:
 - a. Unstow appropriate saliva tube

NOTE

Do not touch cotton w/fingers.
Do not bite/chew cotton

- b. Place small cotton roll in mouth and lightly roll w/tongue ~2 min
 - c. Replace saturated cotton roll into tube
 - d. Tighten cap
 - e. Record MET on tube and on SALIVA/KSS LOG
 - f. Record additional information required on SALIVA/KSS LOG
 - g. Stow tube in Saliva Sample Kit
 - h. Temp stow Saliva Sample Kit
4. Take PMZ

If PMZ dose taken less than 8 hrs prior to sleep but before pre-sleep:

5. Collect saliva samples per SALIVA/KSS LOG until sleep time, then pick up with next sample (24 hrs) following wakeup
6. Collect remaining saliva samples per SALIVA/KSS LOG following steps 3a-h

If PMZ dose is taken during pre-sleep:

7. Collect saliva samples pre-dose (Baseline sample) just before sleep, immediately upon wakeup, 1 hr after wakeup, and at 24,36, and 48 hrs post-dose

If second PMZ dose is taken within 48 hrs:

8. Begin PMZ protocol again; record MET in second column of SALIVA/KSS LOG

MF57G

9. If last saliva sample, stow Saliva Sample Kit |

Cont next page

FS 7-3

ORB OPS/120/FIN

C. DOFFING ACTIWATCH

On final day of orbit:

MF57K

1. Remove Actiwatch, stow

NOTE

If mission length extended, continue to wear Actiwatch and complete FLIGHT SLEEP LOG as timeline permits

FLIGHT SLEEP LOG (example below) is used with both SDBI 1490B and SDBI 1634:

FLIGHT SLEEP LOG

Crew ID: _____ Actiwatch Dot Color: _____

Current Time: _____ [ddd:hh:mm (MET)]

Lights Out: _____ [ddd:hh:mm (MET)]

Lights On: _____ [ddd:hh:mm (MET)]

1. How long did you take to fall asleep last night? _____ (hrs) _____ (mins)
2. How long did you sleep last night? _____ (hrs) _____ (mins)
3. How many times did you awaken during the night? _____
4. After the end of your sleep period, how long did you remain in bed before getting up?
_____ (hrs) _____ (mins)
5. Where did you sleep last night? [Flight deck / Middeck / Spacehab / Sleepstation]
6. Was your sleep disturbed: [Yes / No] (If Yes, check all that apply)
 shuttle noise mission duties voids, # of voids: _____ other crew
 physical discomfort too hot too cold other _____
7. How did you sleep last night?
poorly _____ great
8. How do you feel right now?
sleepy _____ alert
9. Did you have any caffeine yesterday? [Yes / No] (If Yes, indicate how much)
coffee _____ (cups) caffeine pills _____ (100mg) _____ (200mg)
tea _____ (cups) caffeinated soft drinks _____ (glasses)
Indicate how long before bed your last caffeine intake was: _____ (hrs) _____ (mins)
10. Did you take any medications yesterday? [Yes / No / Decline] (If Yes, list all)

Comments:

SALIVA/KSS LOG (example below) is used with SDBI 1490B:

Crew Member _____	Circle dosage form: 25mg Tablet 50mg Injectable 25mg Suppository	SALIVA / KSS LOG Note: To be used only if PMZ is taken.						
	PMZ Dose One		PMZ Dose Two					
Activity Time (hr) Post-PMZ Dose	KSS	Saliva Sample MET	KSS	Saliva Sample MET				
Baseline								
1								
2								
4								
8								
24								
36								
48								
(1) Rate sleepiness during last 5 mins using key (2) Record saliva collection MET KSS KEY								
1	2	3	4	5	6	7	8	9
very alert SDD46108178-601	alert normal level	neutral neither alert/sleepy	sleepy, no effort to stay awake			very sleepy, great effort to stay awake		

SDBI 1900, INTEGRATED IMMUNE BLOOD COLLECTION

OBJECTIVE:

Integrated Immune Assessment (Integrated Immune). The purpose of this procedure is to effectively and safely perform a blood draw, process blood samples, and properly stow them to achieve Integrated Immune Experiment objectives

PARTS:

Integrated Immune Blood Collection Kit:

- Band-Aid
- Fine Point Sharpie
- Gauze
- Tourniquet
- X-Large Gloves
- Butterfly Needle (1)
- Tube Holder
- Blood Sample Sleeve:
 - Blood 8.5ml ACD (yellow top tube)
 - Blood 10ml EDTA (purple top tube)
- Biocide Wipes
- Biohazard Bag
- Surgical Paper Tape, 1-in
- Sharps Container

Gray Tape

WARNING

All consumable items that come in contact with blood must be discarded in Biohazard Bag (provided in kit)

All sharp items (i.e., needles) must be discarded into Sharps Container

NOTE

Any spilled blood should be cleaned up with Gauze and followed with a Biocide Wipe

Cont next page

FS 7-6

ORB OPS/120/FIN

A. SETUP FOR BLOOD SAMPLE COLLECTION

NOTE

The lid of the Integrated Immune Blood Collection Kit, when opened, can be used as a workstation on which to temporarily store items via Velcro. Gray Tape can also be used

- MF28K
1. If desired for temporary storage of supplies during blood draw, deploy about 12-inch piece of Gray Tape near location of blood draw
 2. Deploy hardware near area where activity will be performed:
- MF57G
- Integrated Immune Blood Collection Kit:
 - Band-Aid
 - Fine Point Sharpie
 - Gauze (1 package)
 - Tourniquet
 - Butterfly Needle (1)
 - Tube Holder
 - Blood Sample Sleeve (open sleeve and loosen tubes)
 - Biocide Wipes
 - Surgical Paper Tape, 1-in
 - Sharps Container
 - Biohazard Bag
 - X-Large Gloves
 - 3. Place Biohazard Bag in convenient location for trash disposal

B. PERFORM BLOOD SAMPLE COLLECTION

1. Retrieve Butterfly Needle (1) and remove from package. Place package in the Biohazard Bag and temporarily store

Cont next page

FS 7-7

ORB OPS/120/FIN

2. Retrieve Tube Holder
Screw Tube Holder onto threaded end of
Butterfly Needle
Temp stow Butterfly Needle/Tube Holder
3. Retrieve Gauze, open package but do not
remove Gauze, temp stow Gauze package
4. Retrieve Tourniquet from Integrated Immune
Blood Collection Kit
Apply Tourniquet to subject's arm
Using fingers find vein and select puncture site

<p><u>WARNING</u> Operator must don X-Large Gloves prior to needle insertion and observe Universal Precautions for Handling Biohazardous Materials</p>

5. Retrieve and don X-Large Gloves
Retrieve and open Biocide Wipe, placing empty
package in Biohazard Bag
Cleanse area with Biocide Wipe
Place used Biocide Wipe in Biohazard Bag
6. Retrieve Butterfly Needle/Tube Holder from temp
stow
Remove protective cover from Butterfly
Needle/Tube Holder. Place cover in Biohazard
Bag

<p><u>CAUTION</u> Blood tubes must be inspected for cracks. If cracked, tubes should be discarded in the Biohazard Bag</p>

7. Retrieve:
Blood Sample Sleeve
Surgical Paper Tape, 1-in

WARNING

Insert needle at 30 degree angle to vein to ensure proper blood flow and avoid injury

Avoid shifting needle from side to side after entering vein

NOTE

Taping of central portion of needle tubing to subject's arm is to prevent excessive movement during blood draw. Only tape tubing after needle is properly inserted in vein

8. Insert Butterfly Needle in subject's arm with bevel up. When the needle is properly inserted in the vein a flash of blood will be observed in butterfly tubing

Using strips of 1-in Surgical Paper Tape as necessary, tape central portion of Butterfly Needle tubing to subject's arm

Blood
Sample
Sleeve

9. Retrieve subject's empty Blood 8.5ml ACD (yellow top blood tube)

NOTE

Allow 10 sec to ensure the tube vacuum draws the appropriate volume of blood

10. Verify a flash of blood in butterfly tubing
11. Firmly push the blood tube into the Tube Holder to puncture tube cap and initiate blood flow
12. When filled, detach blood tube from Tube Holder
13. Gently agitate tube for blood to mix with reagent for ~5 sec

Cont next page

FS 7-9

ORB OPS/120/FIN

- ┌ | | | ┌
- Blood Sample Sleeve
14. Temp stow filled blood tube in Blood Sample Sleeve
 15. Retrieve Blood 10.5ml EDTA tube (purple top) and repeat steps 11 thru 14 for the second tube

16. Loosen Tourniquet

17. Retrieve Gauze from temp stow

18. Hold Gauze to venipuncture site while simultaneously grasping wings of Butterfly Needle and removing it at same angle of insertion, applying gentle pressure to Gauze

Have subject hold Gauze on venipuncture site for 2-5 min

If taped, remove tape from arm and dispose

Slide safety shield over Butterfly Needle by holding yellow sheath and pulling wings backward

NOTE

Do not discard tube holder

19. Carefully unscrew Tube Holder from Butterfly Needle; temp stow

20. Discard used Butterfly Needle (with sharp edges facing down) in Sharps Container

21. Remove Tourniquet and stow in Integrated Immune Blood Collection Kit

Cont next page

FS 7-10

ORB OPS/120/FIN

└ | | | └

22. Keep Gauze on venipuncture site for pressure bandage
Place Band-Aid over folded Gauze
Discard any excess Gauze and Band-Aid wrapper in Biohazard Bag
 23. Retrieve filled blood tubes from Blood Sample Sleeve and label both tubes with crewmember name and GMT (e.g, Smith: GMT 168:19:48)
 24. Stow blood tubes back in Blood Sample Sleeve and temp stow
 25. Discard X-Large Gloves in Biohazard Bag
- Dispose of any remaining Biocide Wipes, Gauze, Gray Tape, or empty packaging used in the activity

C. STOW HARDWARE

1. Remove full Biohazard Bag, close with Gray Tape
Discard full Biohazard Bag in appropriate disposal location
2. Stow in Integrated Immune Blood Collection Kit:
Blood Sample Sleeve with blood samples
Sharps Container (bottom first into pouch)
Biocide Wipes (if any)
Gauze (if any)
Surgical Paper Tape, 1-in
Fine Point Sharpie
Tube Holder
Remaining Band-Aid packages (if any)
3. Stow:
Integrated Immune Blood Collection Kit
Put away Gray Tape per crew preference

MF57G

SDBI 1900, SALIVA COLLECTION FOR INTEGRATED IMMUNE

OBJECTIVE:

Integrated Immune Assessment (Integrated Immune). The purpose of this procedure is to effectively perform saliva collection to achieve Integrated Immune Experiment objectives

PARTS:

Integrated Immune Saliva Collection Kit:

Salivette Bag (package with cotton swabs)

Saliva Sample Preservative Bag

Label

Saliva Collection Dry Booklet

Saliva Sample Return Pouch

Fine Point Sharpie

A. SETUP FOR SALIVA SAMPLE COLLECTION

NOTE

Any Saliva Sample Return Pouch (labeled USED and does not have crewmember data filled in) located in the Integrated Immune Saliva Collection Kit will suffice for this step

- MF57G
1. Unstow:
Integrated Immune Saliva Collection Kit:
Fine Point Sharpie
Label from plastic window of Saliva Sample Return Pouch
 2. Write crewmember name on label using Fine Point Sharpie
Return label to plastic window it was taken from
Temp stow Fine Point Sharpie

Cont next page

FS 7-12

ORB OPS/120/FIN

B. PERFORM LIQUID SALIVA SAMPLE COLLECTION

NOTE

Liquid saliva should be collected immediately post-sleep (before brushing teeth, before breakfast, and before any liquid intake)

1. Retrieve from Integrated Immune Saliva Collection Kit:
 - Salivette Bag
 - Saliva Sample Preservative Bag
2. Temp stow Saliva Sample Preservative Bag

NOTE

Touching the Cotton Swab with fingers at any point of the data collection will contaminate the sample

3. Open Salivette Bag and by kneading and manipulating the outside of package, separate one Cotton Swab from the others and move it towards the opening of the package
4. Place Salivette Bag with Cotton Swab near mouth and then transfer Cotton Swab from package into mouth. Lightly roll Cotton Swab around mouth with tongue until saturated (2 min max). Do not bite down or chew on Cotton Swab
5. Stow Salivette Bag with remaining Cotton Swab in Integrated Immune Saliva Collection Kit
6. Retrieve Saliva Sample Preservative Bag from temp stow
7. Using mouth, place Cotton Swab in Saliva Sample Preservative Bag

Cont next page

8. Close seal on Saliva Sample Preservative Bag

NOTE

Ensure bag is sealed prior
to mixing preservative

9. Remove clamp, mix preservative with Cotton Swab
10. Reclamp across top of Saliva Sample Preservative Bag
11. Using Fine Point Sharpie, write crewmember name and GMT on Saliva Sample Preservative Bag (e.g., Smith: GMT 168:19:48)
12. Stow sample in Saliva Sample Return Pouch (labeled with crewmember name in part A step 2) inside Integrated Immune Saliva Collection Kit

C. PERFORM DRY SALIVA COLLECTION

NOTE

First sample should be taken as
soon after waking as is convenient

1. Retrieve from Integrated Immune Saliva Collection Kit:
Dry Saliva Collection Book
2. Write crewmember name in name section on cover of Dry Saliva Collection Book
3. Open cover
Select (but do not remove from book) the corresponding sheet of filter paper to the time period sample is being taken (WAKE, WAKE + 30 MINUTES, WAKE + SIX HOURS, WAKE + TEN HOURS, RETIRE) as illustrated on the cover

Label GMT on corresponding color and time period on cover

Cont next page

NOTE

Take care not to touch other collection time's filter papers when using Dry Saliva Collection Book

4. Place filter paper in mouth and saturate filter paper with saliva

NOTE

Do not touch saturated part of filter paper while drying. Filter paper does not have to be 100% dry before stowing/temp stowing. Use crew discretion

5. Remove filter paper from mouth. Wipe excess liquid saliva from filter paper with lips
Allow to air dry
6. Temp stow Dry Saliva Collection Book or maintain on person if desired
7. For subsequent collections, retrieve Dry Saliva Collection Book from temp stow and repeat steps 3 thru 6 four times throughout the day that correspond to the remaining four time intervals from wake period
8. After collecting last dry saliva sample, open Saliva Sample Return Pouch (labeled with crew ID) inside Integrated Immune Collection Kit and stow Dry Saliva Collection Book inside Saliva Sample Return Pouch

D. STOW HARDWARE

MF57G

1. Stow: Integrated Immune Saliva Collection Kit



This Page Intentionally Blank



WING LEADING EDGE SENSORS (WLES) PROCEDURES

WLES ACTIVATION AND CHECKOUT.....	FS 8-2
DEACTIVATION AND TEARDOWN.....	FS 8-9
LAPTOP RECEIVER UNIT (LRU) R&R.....	FS 8-11
CONFIGURE WLES DATA FILE BACKUP PATH.....	FS 8-14
DECONFIGURE WLES DATA FILE BACKUP PATH....	FS 8-14
PREP WLES LAPTOPS FOR TRANSFER.....	FS 8-15
FOR RNDZ TOOLS CHECKOUT	FS 8-17
WLES RECONFIG POST DOCK/UNDOCK	FS 8-17
DISABLE WLES FILE BACKUP	FS 8-18
ENABLE WLES FILE BACKUP	FS 8-18

WLE
SENSORS

WLES ACTIVATION AND CHECKOUT

1. UNSTOW EQUIPMENT

NOTE

A31p laptops may already be unstowed as part of orbiter laptop network setup

MA16D,F Unstow:
 Laptop Receiver Units (2)
 Cabin Relay Units (2) (S/N 1664, 1728)

ML60E Unstow:
 STS-6 A31p laptop (WLES)
 STS-5 A31p laptop (RPOP2)

2. SETUP WLES RELAY UNITS

A13 Retrieve WLES SYSTEM CABLE coiled on panel A6
 Connect to MICRO WIS SYSTEM A – J7 (see
 fig 8-1)

W7 Connect to J1 on Cabin Relay Unit S/N 1664 and
 secure to STBD side of aft cabin with Velcro (see
 fig 8-2)
 Verify terminator connected to J2

A13 Retrieve WLES SYSTEM CABLE coiled on panel A9
 Connect to MICRO WIS SYSTEM B – J8 (see
 fig 8-1)

A4 Connect to J1 on Cabin Relay Unit S/N 1728 and
 secure to PORT side of aft cabin with Velcro (see
 fig 8-3)
 Verify terminator connected to J2

NOTE

Green patch on Cabin Relay Unit is antenna and must face into cabin.
Software is configured to communicate with specific Relay Units on specific buses

Cont next page

FS 8-2

ORB OPS/120/FIN 1

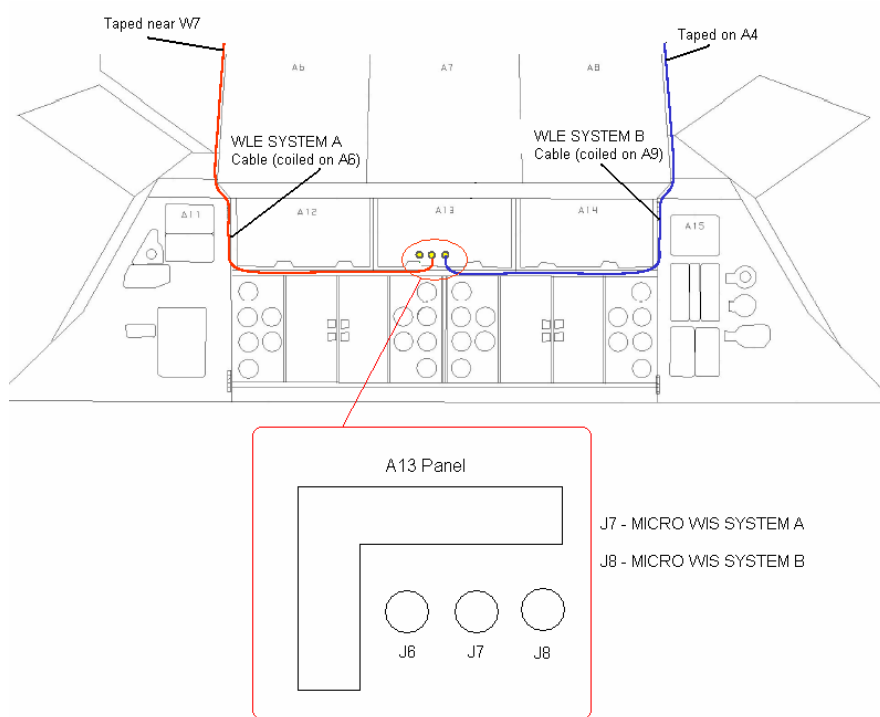

Figure 8-1.- A13 panel.

Cont next page

FS 8-3

ORB OPS/120/FIN

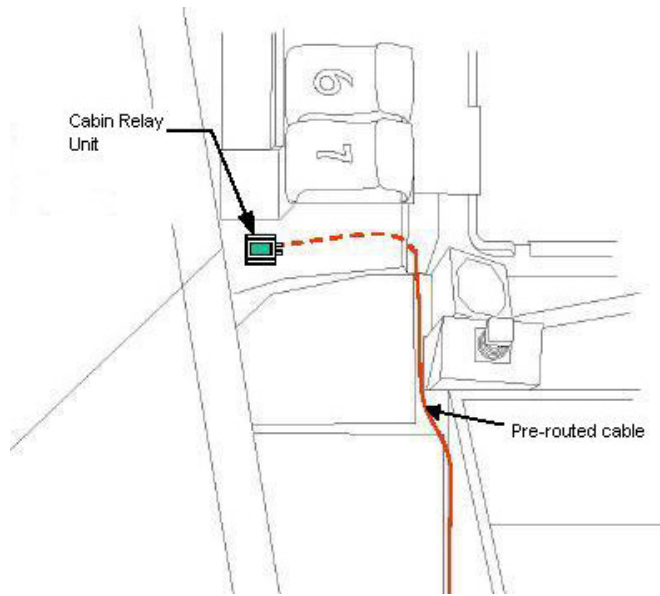

Figure 8-2.- Aft STBD location.

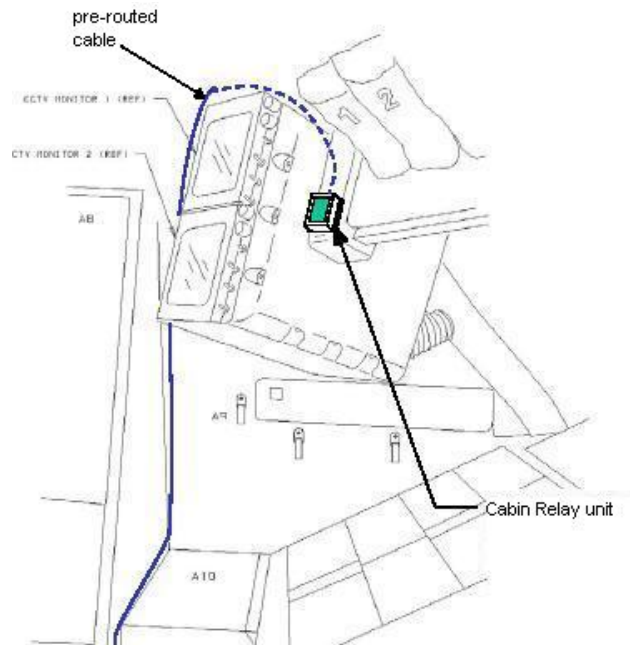

Figure 8-3.- Aft PORT location.

Cont next page

3. SETUP PRIME WLES LAPTOP

Verify laptop physically connected to network before proceeding with setup

A31p

If necessary, close all applications, exit Windows:

Click 'Start'>'Turn Off Computer...'>'Turn Off Secure Laptop Receiver Unit to A31p with Velcro (see fig 8-4)

Connect Laptop Receiver Unit to A31p Serial port using thumbscrews (see fig 8-5)

4. SETUP BACKUP WLES LAPTOP

Verify laptop physically connected to network before proceeding with setup

A31p

If necessary, close all applications, exit Windows:

Click 'Start'>'Turn Off Computer...'>'Turn Off Secure Laptop Receiver Unit to A31p with Velcro (see fig 8-4)

Connect Laptop Receiver Unit to A31p Serial port (see fig 8-5)

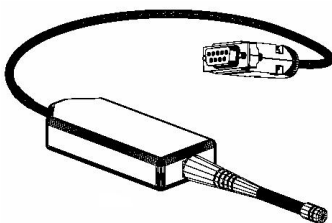

Figure 8-4.- Laptop Receiver Unit.



Figure 8-5.- A31p ports.

Cont next page

FS 8-5

ORB OPS/120/FIN

5. LAUNCH WLES SOFTWARE

Perform for both laptops:

A31p pwr – On

Select clock from system tray

Verify time is set to GMT (Casablanca,
Monrovia), adjust if necessary

Click 'OK'

Double click 'Shuttle Apps'>'WLES'

'Backup Mode Selection'

If setting up one A31p, select 'Standard'

|

If setting up two A31p laptops:

For prime laptop, select 'Primary'

For backup laptop, select 'Secondary'

If necessary, restart all applications closed in
steps 3 and 4 to return to nominal config

NOTE

The secondary laptop lid may be closed at this
time, if no longer needed for other applications.
The laptops are configured so that they do not
enter 'standby' or 'hibernate' mode when the lids
are closed. However, due to cooling concerns,
fully closing the lid is not recommended

Cont next page

FS 8-6

ORB OPS/120/FIN

6. VERIFY COMM WITH RELAY UNITS

Use prime WLES laptop

'Main'

Click 'Unit List' (left side of display)

NOTE

Each Cabin Relay Unit is identified with a unique serial number; this number appears as 'Unit ID' in the software

√Cabin Relay Units Unit ID 1664 and 1728 (2) present on display in first column; scroll down as necessary

For each Cabin Relay Unit:

√Unit ID present

√Type: 'Relay-GL'

√Last Update: time is updating

√Via: 'RF'

√Mode: 'Idle'

NOTE

'Last Update' times nominally update every 5 to 15 sec

If no time updates after 2 min, contact MCC-H

7. ENABLE DATA FILE BACKUP

Use prime WLES laptop

'Main'

Click 'System Settings' (left side of display)

'Directories'

At the line 'Backup Directory' click 'Browse...'

Navigate to the mapped drive for the backup WLES laptop (C on RPOP2 (S:))

Navigate to 'Program Files'>'Invocon'>'EWBMTAU-WLEFlight'

Click 'OK'

Cont next page

FS 8-7

ORB OPS/120/FIN

'Backup Interval'
Using drop-down list, select 30 minutes
Click 'Status' (left side of display)

8. INITIATE COMMANDING

NOTE

The first time a user navigates to 'Program Files' folder, display may show information saying the program files are hidden. To view the contents of the folder, select 'display files' in the left-hand portion of the Windows Explorer window

Using Windows Explorer, navigate to
'My Computer'>'C:'>'Program Files'>
'Invocon'>'EWBMTAU-WLEFlight'>'Command'

NOTE

Deleting 'BLOCK.xml' file initiates command execution. Command files disappear from this folder as they are executed

Delete file labeled 'BLOCK.xml'
At prompt "Are you sure you want to send
'Block.xml' to the Recycle Bin?", click 'Yes'

NOTE

Files appearing in the 'Data' folder verifies two-way communication with the Sensor Units in the orbiter wing. You may view this by using Windows Explorer to navigate to: 'My Computer'>'C:'>'Program Files'>'Invocon'>'EWBMTAU-WLEFlight'>'Data'

Notify MCC-H: "WLES setup complete"

NOTE

The laptop lid may be closed at this time, if no longer needed for other applications. The laptops are configured so that they do not enter 'standby' or 'hibernate' mode when the lids are closed. However, due to cooling concerns, fully closing the lid is not recommended

WLES DEACTIVATION AND TEARDOWN

1. DEACTIVATE WLES LAPTOP
A31p 'Enhanced Wideband MicroTAU – WLEFlight 2.2'

For each WLES A31p:

Click 'Exit'

At prompt 'Are you sure you want to exit?'

click 'Yes'

Click 'Start' > 'Turn Off Computer...' > 'Turn Off'

Disconnect Laptop Receiver Unit from A31p

Serial port

Remove Laptop Receiver Unit from Velcro on
A31p

2. REMOVE WLES RELAY UNITS

Remove Cabin Relay Units (2) from aft cabin (see
fig 8-6 and fig 8-7)

Disconnect Cabin Relay Units from pre-routed
cables

Disconnect and coil cables, stow in launch location

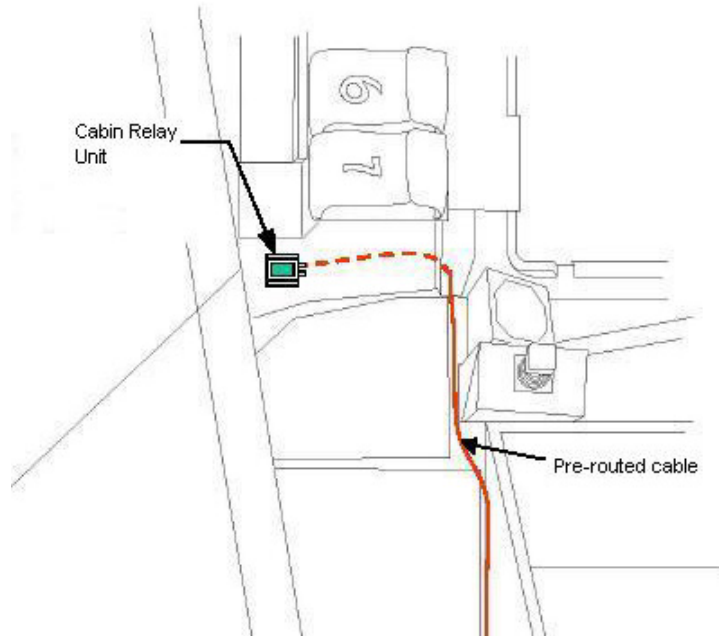

Figure 8-6.- Aft STBD location.

Cont next page

FS 8-9

ORB OPS/120/FIN

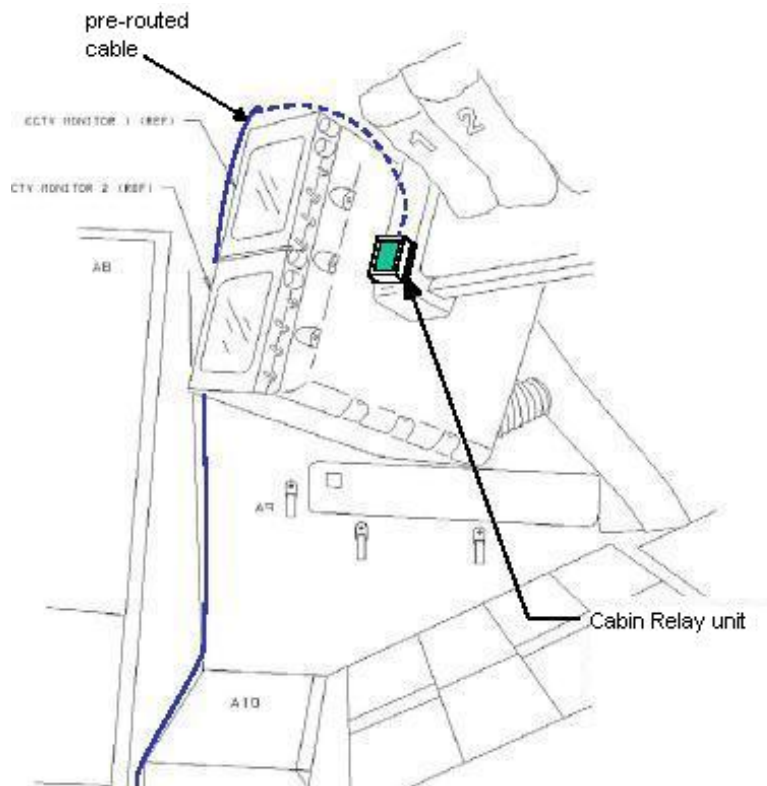

Figure 8-7.- Aft PORT location.

3. STOW EQUIPMENT

MA16D,F

Stow:

Laptop Receiver Units (2)

Cabin Relay Units (2)

Notify MCC-H: "WLES Teardown Complete"

WLES LAPTOP RECEIVER UNIT (LRU) R&R

- A31p 1. DISCONNECT BACKUP LRU FROM LAPTOP
'Enhanced Wideband MicroTAU – WLEFlight 2.2'

Click 'Exit'
At prompt 'Are you sure you want to exit?'
click 'Yes'
Close other software applications
Click 'Start'>'Turn Off Computer...'>'Turn Off'

Disconnect Backup LRU from Backup A31p Serial
port (see fig 8-8)
Remove Backup LRU from Velcro on Backup A31p
(see fig 8-9)

NOTE

Laptop can now be restarted for use.
Other applications will need to be
restarted to return to nominal config



Figure 8-8.- A31p ports.

- A31p 2. DISCONNECT PRIME LRU FROM LAPTOP
'Enhanced Wideband MicroTAU – WLEFlight 2.2'

Click 'Exit'
At prompt 'Are you sure you want to exit?',
click 'Yes'
Close other software applications
Click 'Start'>'Turn Off Computer...'>'Turn Off'

Cont next page

Disconnect Prime LRU from Prime A31p Serial port
(see fig 8-8)
Remove LRU from Velcro on A31p

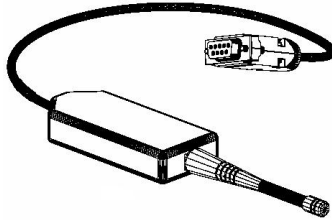

Figure 8-9.- Laptop Receiver Unit.

3. CONNECT BACKUP LRU
Connect Backup LRU to Prime WLES A31p Serial port
Secure LRU to A31p with Velcro

A31p

4. LAUNCH WLES SOFTWARE
Pwr – On
Double click ‘Shuttle Apps’>‘WLES’

‘Backup Mode Selection’
Select ‘Standard’

5. VERIFY COMM WITH RELAY UNITS
‘Main’

Click ‘Unit List’ (left side of display)

√Cabin Relay Units Unit ID 1664 and 1278 (2) present
on display in first column; scroll down as necessary

For each Cabin Relay Unit:

- √Unit ID present
- √Type: ‘Relay-GL’
- √Last Update: time is updating
- √Via: ‘RF’
- √Mode: ‘Idle’

Cont next page

FS 8-12

ORB OPS/120/FIN

NOTE

'Last Update' times nominally
update every 5 to 15 sec

If no time updates after 2 min, contact MCC-H

Click 'Status' (left side of display)

Notify MCC-H: "WLES LRU R&R complete", mark
failed LRU as 'failed'

MA16D,F 6. STOW EQUIPMENT

Stow:
Prime (failed) LRU

7. RETURN LAPTOP TO NOMINAL CONFIG

Restart applications closed in steps 1 and 2

CONFIGURE WLES DATA FILE BACKUP PATH

A31p Use prime WLES laptop

 'Main'
 Click 'System Settings' (left side of display)

 'Directories'
 At the line 'Backup Directory' click 'Browse...'

 Navigate to the mapped drive for the backup WLES
 laptop (C on RPOP2 (S:))

 Navigate to 'Program Files'>'Invocon'>'EWBMTAU-
 WLEFlight'

 Click 'OK'

 'Backup Interval'
 Verify interval is set for 30 minutes

 Click 'Status' (left side of display)

DECONFIGURE WLES DATA FILE BACKUP PATH

A31p Use prime WLES laptop

 'Main'
 Click 'System Settings' (left side of display)

 'Directories'
 At the line 'Backup Directory' click 'Browse...'

 Navigate to the 'C' drive of the Prime WLES laptop

 Navigate to 'Program Files'>'Invocon'

 Click 'OK'

 'Backup Interval'
 Verify interval is set for 30 minutes

 Click 'Status' (left side of display)

PREP WLES LAPTOPS FOR TRANSFER

- A31p
1. DEACTIVATE WLES LAPTOP(S)
'Enhanced Wideband MicroTAU – WLEFlight 2.2'
For each WLES A31p in use:
Click 'Exit'
At prompt 'Are you sure you want to exit?'
click 'Yes'
Click 'Start'>'Turn Off Computer... '>'Turn Off'
Disconnect Laptop Receiver Unit from A31p
Serial port
Remove Laptop Receiver Unit from Velcro on
A31p
 2. CONNECT LRU TO 'NEW' PRIME WLES LAPTOP
√MCC-H for which laptop to use
Close software applications
Click 'Start'>'Turn Off Computer... '>'Turn Off'
Connect LRU to A31p Serial port
Secure LRU to A31p with Velcro
 3. CONNECT LRU TO 'NEW' BACKUP WLES LAPTOP
√MCC-H for which laptop to use
Close software applications
Click 'Start'>'Turn Off Computer... '>'Turn Off'
Connect LRU to A31p Serial port
Secure LRU to A31p with Velcro
 4. LAUNCH WLES SOFTWARE
Perform for both laptops:
A31p pwr – On
Select clock from system tray
Verify time is set to GMT (Casablanca,
Monrovia), adjust if necessary
Click 'OK'
Double click 'Shuttle Apps'>'WLES'

'Backup Mode Selection'
For prime laptop, select 'Primary'
For backup laptop, select 'Secondary'

Cont next page

5. VERIFY COMM WITH RELAY UNITS

'Main'

Click 'Unit List' (left side of display)

√Cabin Relay Units Unit ID 1664 and 1728 (2) present on display in first column; scroll down as necessary

For each Cabin Relay Unit:

√Unit ID present

√Type: 'Relay-GL'

√Last Update: time is updating

√Via: 'RF'

√Mode: 'Idle'

NOTE

'Last Update' times nominally update every 5 to 15 sec

If no time updates after 2 min, contact MCC-H

Click 'Status' (left side of display)

6. ENABLE DATA FILE BACKUP

Use prime WLES laptop

'Main'

Click 'System Settings' (left side of display)

'Directories'

At the line 'Backup Directory' click 'Browse...'

Navigate to the mapped drive for the backup WLES laptop (recorded in step 3 above)

Navigate to 'Program Files'>'Invocon'>'EWBMTAU-WLEFlight'

Click 'OK'

7. RETURN LAPTOPS TO NOMINAL CONFIG

Restart applications closed in steps 2 and 3

Notify MCC-H: "WLES laptop prep for transfer complete"

PREP WLES FOR RNDZ TOOLS CHECKOUT

- A31p
1. DEACTIVATE BACKUP WLES LAPTOP
On backup WLES laptop:

 'Enhanced Wideband MicroTAU – WLEFlight 2.2'
 Click 'Exit'
 At prompt 'Are you sure you want to exit?'
 click 'Yes'
 Disconnect Laptop Receiver Unit from A31p
 Serial port
 Leave attached to laptop with Velcro on A31p
 2. DEACTIVATE WLES FILE BACKUP
On prime WLES laptop:

 'Main'
 Click 'System Settings' (left side of display)

 'Backup Mode'
 Click 'Standard'
 Click 'Status' (left side of display)

WLES RECONFIG POST DOCK/UNDOCK

- A31p
1. RECOVER BACKUP WLES LAPTOP
On backup WLES laptop:

 If necessary, close all applications, exit Windows:
 Click 'Start'>'Turn Off Computer... '>'Turn Off'
 Connect Laptop Receiver Unit to A31p Serial port

 A31p pwr – On
 Double click 'Shuttle Apps'>'WLES'

 'Backup Mode Selection'
 Click 'Secondary'

 Restart any applications closed above to return
 to nominal config

Cont next page

FS 8-17

ORB OPS/120/FIN

2. REACTIVATE WLES FILE BACKUP

On prime WLES laptop:

'Main'

Click 'System Settings' (left side of display)

'Backup Mode'

Click 'Primary'

Click 'Status' (left side of display)

DISABLE WLES FILE BACKUP

1. DISABLE WLES FILE BACKUP

A31p

On prime WLES laptop:

'Main'

Click 'System Settings' (left side of display)

'Backup Mode'

Click 'Standard'

Click 'Status' (left side of display)

ENABLE WLES FILE BACKUP

1. ENABLE WLES FILE BACKUP

A31p

On prime WLES laptop:

'Main'

Click 'System Settings' (left side of display)

'Backup Mode'

Click 'Primary'

Click 'Status' (left side of display)

FRED

FRED SETUP	FS 9-2
STOWAGE	FS 9-2

FRED

FS 9-1

ORB OPS/120/FIN

FRED

FRED SETUP

1. Unstow FRED tray and FRED leg brace
- A8L 2. Attach clutch bracket mount assy below aft panel A8 with captive fasteners (four)
3. Assemble FRED as shown and adjust to desired position. Note positions

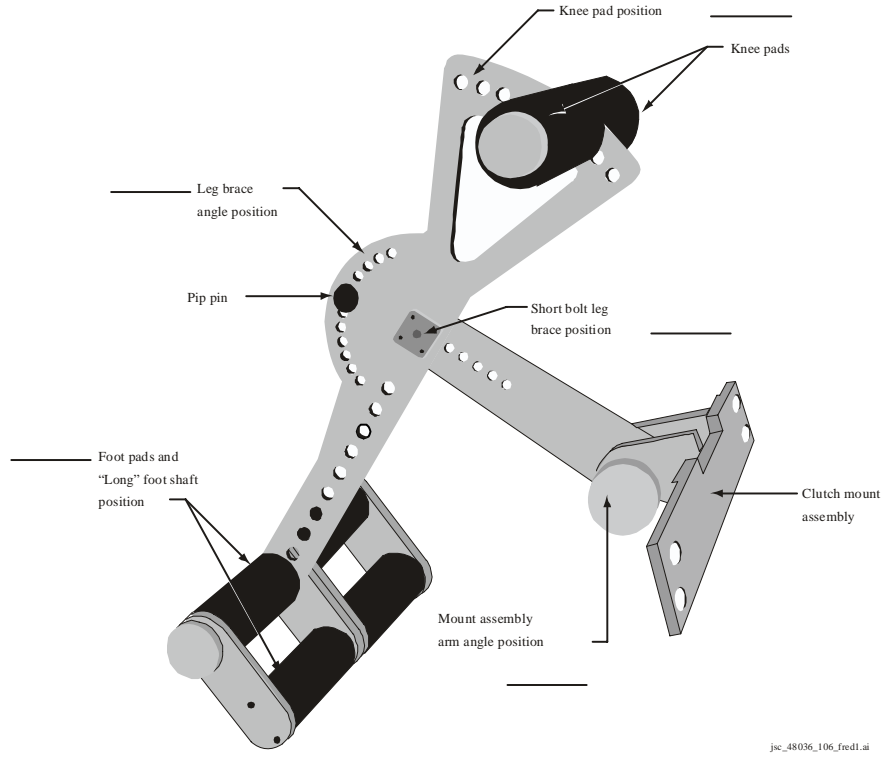

FRED STOWAGE

1. Disassemble FRED and set clutch bracket mount assy to #8 angle position
2. Stow FRED in locker tray cushion. Re-adjust clutch bracket mount assy as required
3. Stow leg brace

MAUI ANALYSIS OF UPPER-ATMOSPHERIC
INJECTIONS (MAUI)

MAUI PROCEDURE FS 10-2

MAUI

FS 10-1

ORB OPS/120/FIN

MAUI PROCEDURE

- 15:00 or earlier 1. MANEUVER TO START ATTITUDE
(BIASED +ZLV +YVV)

Deploy MAUI – RCS FIRING SEQUENCE
(Cue Card)

GNC 20 DAP CONFIG

√DAP A1, B1 loaded

UNIV PTG

TGT ID – ITEM 8 +2 EXEC
BODY VECT – ITEM 14 +5 EXEC
P – ITEM 15 +2 7 0 EXEC
Y – ITEM 16 +3 5 0 EXEC
OM – ITEM 17 +2 7 0 EXEC

TRK – ITEM 19 EXEC (CUR - *)

2. INITIATE TIMER

√MCC for start time

GNC 2 TIME

Set count down/count up timer per MCC

√MET – ITEM 2 EXEC (*)

CRT TIMER COUNT TO – ITEM 17 + + +
EXEC

3. SETUP

O14:E, cb DDU L (two) – cl
O15:E

O14:F, Pri RJD LOGIC, DRIVER (sixteen) – ON
O15:F,
O16:F

GNC 20 DAP CONFIG

DAP A PRI P OPTION – ITEM 15 EXEC (NOSE)

TRAN PLS – ITEM 17 +0.7 3 EXEC

VERN ROT PLS – ITEM 26 +0.1 5 3 EXEC

Cont next page

FS 10-2

ORB OPS/120/FIN

MAUI

GNC 23 RCS

Deselect Jets:

Forward RCS page – ITEM 1 EXEC

JET DES F1D – ITEM 23 EXEC (*)

F2D – ITEM 27 EXEC (*)

C3 √DAP: A/AUTO/VERN
 √DAP TRANS: PULSE/PULSE/PULSE
 DAP ROT: PULSE/PULSE/PULSE

-05:00 4. VERIFY ATTITUDE
 Verify in attitude

NOTE

For the following RCS firing sequence
(step 5):

- A. Expect total orbiter body rates
(RSS) to exceed 1 deg/sec
- B. Possible loss of comm due to orbiter
body rates and attitude excursions
- C. For any jet fail OFF, continue with
firing sequence
- D. Requirement is for a particular jet
group, not a specific jet
- E. The table in step 5 is also provided
as a cue card

Cont next page

FS 10-3

ORB OPS/120/FIN

5. RCS FIRING SEQUENCE

NOTE

Use the table below or the cue card

MAUI – RCS FIRING SEQUENCE

<u>Timer</u>	<u>Jets Fired</u>	<u>CDR</u>	<u>PLT</u>
-03:00		Body rates: $+0.047 \leq \text{roll} \leq +0.087$ $-0.020 \leq \text{pitch} \leq +0.020$ $-0.020 \leq \text{yaw} \leq +0.020$ DAP: FREE DAP: A/PRI Inform PLT "GO" for jet deselects	Configure initial setup GNC 23 RCS Left RCS page – ITEM 2 EXEC On CDR "GO", proceed <u>NOTE</u> Expect DAP RECONF msgs in following actions Deselect jets: JET DES L5L – ITEM 37 EXEC (*) Right RCS page – ITEM 3 EXEC JET DES R5D – ITEM 39 EXEC (*) Forward RCS page – ITEM 1 EXEC JET DES F5L – ITEM 37 EXEC (*) <u>NOTE</u> Queue the following ITEM entry on the scratch pad. Do not perform the EXEC until specified at 35 sec JET DES F3D – ITEM 25
-00:30		FLT CNTRL PWR – ON	
00:00	RXA, LXA	THC +X (in) (3 sec firing)	
00:15	FXL, LXL	THC +Y (right) (3 sec firing)	
00:30	FXR, RXR	THC -Y (left) (3 sec firing)	
00:35			When jets stop firing: GNC 23 RCS EXEC [JET DES F3D – ITEM 25 (*)]
00:45	F4D	RHC +pitch (hard stop, hold 3 sec)	
00:48		RHC release	
00:50			DAP: VERN
01:00	R5R	RHC +yaw (10 sec firing)	
01:20	L5D	RHC -pitch (12 sec firing)	
01:40	F5R	RHC +pitch (12 sec firing)	
		FLT CNTRL PWR – OFF	Return to MAUI PROCEDURE, step 6, (ORB OPS FS, MAUI)

Cont next page

FS 10-4

ORB OPS/120/FIN

6. CLEANUP
F6 √FLT CNTRL PWR – OFF

GNC 23 RCS

√Forward RCS page – ITEM 1 EXEC

Reselect Jets:

JET DES F1D – ITEM 23 EXEC (no *)
F3D – ITEM 25 EXEC (no *)
F2D – ITEM 27 EXEC (no *)
F5L – ITEM 37 EXEC (no *)

Left RCS page – ITEM 2 EXEC
JET DES L5L – ITEM 37 EXEC (no *)

Right RCS page – ITEM 3 EXEC
JET DES R5D – ITEM 39 EXEC (no *)

GNC 20 DAP CONFIG

DAP A1 – ITEM 1 + 1 EXEC

7. SNAP LVLH ATTITUDE AND NULL RATES

When time \geq +03:30:

DAP: A/PRI
DAP: LVLH

When rates stable:

DAP: VERN

Return to FLT PLN attitude

8. RECONFIGURE TO GROUP B POWERDOWN

√MCC

O14:E, cb DDU L (two) – op
O15:E

O14:F, Pri RJD LOGIC,DRIVER (sixteen) – OFF
O15:F, RJDA 1A L2/R2 MANF DRIVER – ON
O16:F



This Page Intentionally Blank



CARBON DIOXIDE MONITORING (CDM) DEVELOPMENT
TEST OBJECTIVE (DTO) PROCEDURES

CDM SETUP AND BATTERY CHANGEOUT	FS 11-2
ACTIVATION	FS 11-7
DEACTIVATION	FS 11-7
DTO COMPLETION	FS 11-8

CDM
DTO

CDM SETUP AND BATTERY CHANGEOUT

NOTE

CDM will emit a short beep once every 15 sec to indicate a low battery condition. Kapton tape over the alarm outlet will muffle the sound

Due to battery life concerns, limit CDM use to specified DTO periods only

Stored data is maintained for a max of 30 min without battery installed. All data will be lost if battery installation delayed more than 30 min

CDM
DTO

1. Unstow:
 - MF57G CDM (for initial setup only)
Clean Filter Assy (for initial setup only)
New Batt Pack
 - MF43C CDM Cue Card in Middeck Cue Card Kit (for initial setup only)
Sharpie
2. If initial use of CDM:
 - Verify speaker outlet on bottom of CDM is covered with Kapton tape as shown
 - Attach Velcro tether
 - Mate Filter Assy to CDM QD
 - Attach cue card to CDM



MODE pb

Alarm speaker outlet w/ Kapton tape

Cont next page

FS 11-2

ORB OPS/120/FIN

3. If CDM activated, deactivate:
Press, hold MODE pb until 'RELEASE' displayed
4. √CDM – OFF
5. Turn fasteners (two) on back panel ¼ turn ccw
6. Remove, temp stow back panel
7. Grasp Batt Pack pull tab, remove pack
8. For initial battery changeout, mark old Batt Pack as "SPARE". Mark all Batt Packs on subsequent changeouts as "DISCHARGED"
9. Install replacement Batt Pack, press firmly to seat electrodes
10. Replace back panel, press firmly, turn fasteners (two) ¼ turn cw to lock
11. Press, hold MODE pb until 'RELEASE' displayed
12. Wait ~1 min while unit runs self-check routine, verify display shows CO2 reading ("x ppm" or "x.xx CO2")
13. Press MODE pb once, until battery status displayed
14. Verify battery status indicates 'OK'
15. Press, hold MODE pb until 'RELEASE' displayed
16. √CDM – OFF

Cont next page

FS 11-3

ORB OPS/120/FIN

17. Attach CDM to a surface near Attachment Location specified in Flight Plan and check complete. Do not place unit directly in front of air diffusers

Middeck Attachment Location		CK CMPLT
Location 1	Forward Starboard (see fig 11-1)	
Location 2	Aft Starboard (see fig 11-2)	
Location 3	Aft Hatch "ditch" area (see fig 11-3)	
Location 4	Forward Port (see fig 11-4)	
Location 5	Aft Port (see fig 11-4)	

NOTE

When taking photo, back away as far as possible so the camera's field of view includes CDM and other equipment in vicinity

18. Record CDM monitoring location using DCS 760 digital camera:
 Lens – 17-35 mm, zoom to 17 mm
 Set camera to nominal in-cabin setup
 If required, perform SETUP, 760 Program w/Flash (PHOTO/TV, DCS 760), then:
 Record one photo showing location of CDM in relation to surroundings

- MF57G 19. Stow:
 Used Batt Pack
 Sharpie

Cont next page

FS 11-4

ORB OPS/120/FIN

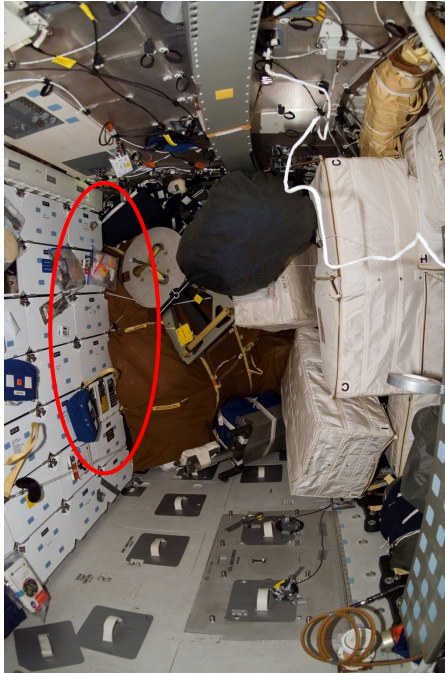

Figure 11-1.- Location 1 – Middeck Forward Starboard.



Figure 11-2.- Location 2 – Middeck Aft Starboard.

Cont next page

FS 11-5

ORB OPS/120/FIN

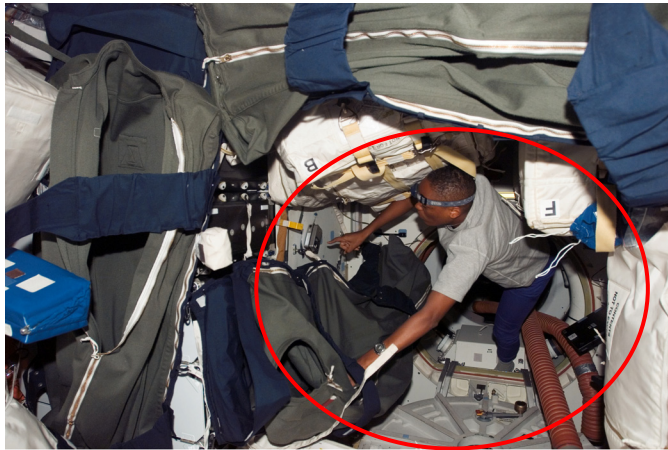

Figure 11-3.- Location 3 – Middeck Aft Hatch “Ditch”.

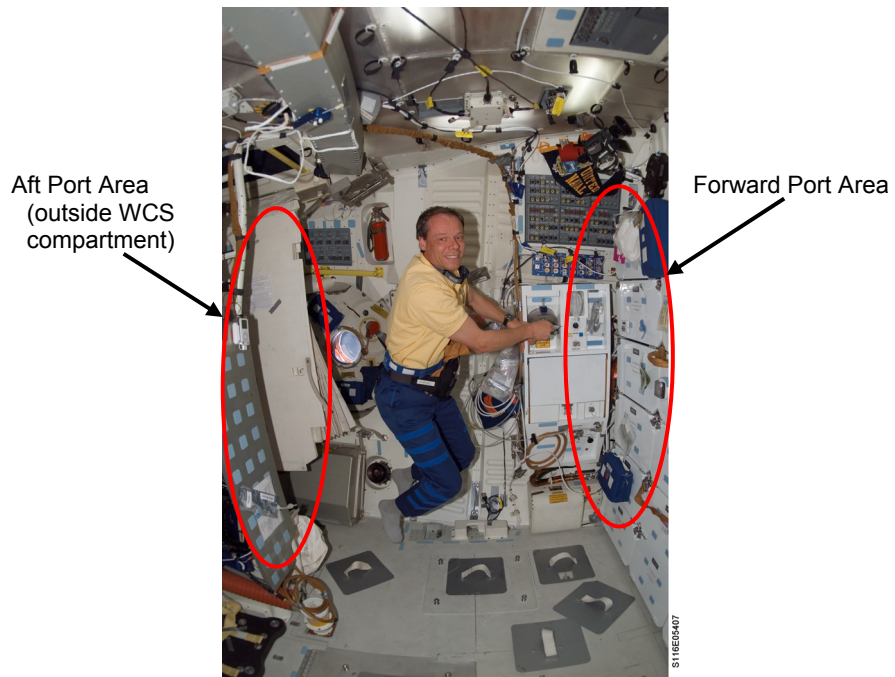

Figure 11-4.- Locations 4 and 5 – Middeck Forward Port and Middeck Aft Port.

CDM ACTIVATION

NOTE

Due to battery life concerns, limit CDM use to specified DTO periods only

1. Press and hold MODE pb until 'RELEASE' displayed
2. Wait ~1 min while unit runs self-check routine, verify display shows CO2 reading ("x ppm" or "x.xx CO2")
3. From CO2 concentration display, press MODE pb six times (once per sec), until alarm status displayed
4. Press E pb once to switch alarm off
5. Verify display indicates 'ALM OFF'
6. Record GMT Start

Middeck Attachment Location	GMT Start	GMT Stop
Location 1	Forward Starboard	
Location 2	Aft Starboard	
Location 3	Aft Hatch "ditch"	
Location 4	Forward Port	
Location 5	Aft Port	

CDM DEACTIVATION

* If 'BATTERY FAIL' message displayed, replace *
* battery immediately to maintain logged data: *
* Perform CDM SETUP AND BATTERY *
* CHANGEOUT (ORB OPS, CDM DTO) *
* Notify MCC-H *

1. Press and hold MODE pb until 'RELEASE' displayed
2. √CDM – OFF
3. Record GMT Stop, report completion to MCC-H

DTO COMPLETION

NOTE

Stored data is maintained for a max of 30 min without battery installed. All data will be lost if battery installation delayed more than 30 min

1. Unstow:
MF57G Batt Pack
Sharpie
2. Turn fasteners (two) on back panel ¼ turn ccw
3. Remove, temp stow back panel
4. Grasp Batt Pack pull tab, remove pack
5. Mark old Batt Pack as “DISCHARGED”
6. Install last unused Batt Pack, press firmly to seat electrodes. If all Batt Packs are marked “DISCHARGED”, install Batt Pack marked “SPARE” from initial changeout
7. Replace back panel, press firmly, turn fasteners (two) ¼ turn cw to lock
8. MF43C Remove CDM Cue Card, stow in Middeck Cue Card Kit
9. Demate filter assembly from CDM QD
10. √CDM – OFF
11. MF57G Stow CDM, used Batt Pack, and filter assembly

CUE CARD CONFIGURATION

FLIGHT DAY 3 DOCKING ORBITER WITH ISS
CO2 ABSORBER REPLACEMENT (Front) FS CC 12-3
LiOH CANISTER STOWAGE LOCATIONS
(Back)..... FS CC 12-4
ORBIT BURN MONITOR (Front) FS CC 12-5
OMS FAILURES (Back)..... FS CC 12-6
STS-120 DAP CONFIGURATIONS
(Front/Top) FS CC 12-7
(Front/Bottom) FS CC 12-8
(Back/Top)..... FS CC 12-9
(Back/Bottom) FS CC 12-10
MAUI – RCS FIRING SEQUENCE (Front) FS CC 12-11
(Back)..... FS CC 12-12
CDM CUE CARD (Front) FS CC 12-13
(Back)..... FS CC 12-14
MIDODRINE PILL INGESTION (Front)..... FS CC 12-15

**CUE
CARDS**

NOT FLOWN

FS 12-1

ORB OPS/120/FIN



This Page Intentionally Blank

**CUE
CARDS**



NOT FLOWN

FS 12-2

ORB OPS/120/FIN



TOP

HOOK
VELCRO

**FLIGHT DAY 3 DOCKING
ORBITER WITH ISS
CO2 ABSORBER REPLACEMENT**
(7 Crewmembers/Single Shift/FD 1-18)

FLIGHT DAY	POS A	POS B	CK CMPLT
LAUNCH	1	2	
PRE FD1	"	"	
POST FD2	3	4	
PRE FD2	"	5	
POST FD3	6	7	DOCKING
PRE FD3	8	"	
POST FD4	"	"	EVA 1
PRE FD4	"	9	
POST FD5	"	"	
PRE FD5	10	"	
POST FD6	"	"	EVA 2
PRE FD6	"	11	
POST FD7	"	"	
PRE FD7	12	"	
POST FD8	"	"	EVA 3
PRE FD8	"	13	
POST FD9	"	"	
PRE FD9	14	"	
POST FD10	"	"	EVA 4
PRE FD10	"	STS-121 32	
POST FD11	"	"	EVA 5
PRE FD11	STS-121 33	"	
POST FD12	"	"	
MID FD12	STS-121 35	STS-121 36*	HATCH CLOSURE
PRE FD12	"	STS-121 37*	
POST FD13	STS-121 38	STS-121 39	UNDOCK
PRE FD13	STS-121 40*	STS-121 41*	
POST FD14	15	16	
PRE FD14	17 *	18 *	
POST FD15	19	20	EOM
PRE FD15	21 *	22 *	
POST FD16	23	24	EOM+1
PRE FD16	25 *	26 *	
POST FD17	27	28	EOM+2
PRE FD17	29	"	
POST FD18	30	31	EOM+3

*Re-bag and seal LiOH cans w/Gray Tape and stow
(Locations of canisters on back)

ORB OPS-29a/nonRCRS/120/O/B

NOTE

This card is specifically used for the STS-120 mission with the orbiter conducting single shift operations with a crew size of 7. Changeout scheme reflects FD3 docking with ISS, Vozdukh and CDRA (activated in dual-bed mode) during docked ops, and undocking on FD13. ODS hatch closure will be worked the day before undocking

(reduced copy)

FAB USE ONLY

FS CC 12-3

ORB OPS/120/FIN

TOP
BACK OF 'FLIGHT DAY 3 DOCKING
ORBITER WITH ISS
CO2 ABSORBER REPLACEMENT'

HOOK
VELCRO

LiOH CANISTER STOWAGE LOCATIONS

ASCENT STOWAGE LOCATIONS

Orbiter:

MD52M (LiOH Box): Cans 3-31 *

* 2 LiOH cans installed in LiOH slots A and B

ENTRY (EOM) STOWAGE LOCATIONS

Orbiter:

MD52M (LiOH Box):

Cans 10-31, STS-121 cans 32, 33, 35-41

ORB OPS-29b/nonRCRS/120/O/B

(reduced copy)

FAB USE ONLY

FS CC 12-4

ORB OPS/120/FIN

TOP

HOOK
VELCRO

HOOK
VELCRO

ORBIT BURN MONITOR

OMS TEMP*	L R	
FU IN P ≥	225	220
≤	205	204
or No FU IN P		
		OMS ENG FAIL ----- OMS PRPLT FAIL
OMS PC* & OMS ↓		
ENG VLV 1 or 2 < 70		OMS ENG FAIL
or OX IN P > 227		
OX IN P ≤ 227		OMS PRPLT FAIL
or No OX IN P		
OMS OX/FU TK P (√ENG IN P)		
OX/FU LOW		He PRESS/VAP ISOL (two) – OP If aff TK P not incr: OMS PRPLT FAIL
OX & FU HIGH		He PRESS/VAP ISOL (two) – CL Cycle He A(B) to maintain TK P 234-284
OMS N2 REG P HIGH or LOW		OMS ENG – ARM
OMS N2 TK P LOW		At N2 TK P < 470: OMS ENG – ARM
(√[OMS/MPS])		
OMS GMBL	PRI fail	L(R) OMS GMBL – SEC (twice)
SEC fail		If high RCS usage: OMS ENG FAIL
GPC	<input type="checkbox"/> (<input type="checkbox"/>) & Burning OMS aff	aff GPC PWR – OFF If SEC GMBL avail: aff MDM FF 1(4) – OFF, ON L(R) OMS GMBL – SEC (twice)
SEC GMBL lost		If high RCS usage: OMS ENG FAIL
2 FAs lost		√MAN SHUTDN
I/O ERROR FA	1(4)	L(R) OMS GMBL – SEC I/O RESET If high RCS usage: OMS ENG FAIL
2 FAs lost		√MAN SHUTDN
BCE STRG D		I/O RESET (if recov: >>)
1(4)		If high RCS usage: L(R) OMS GMBL – SEC (twice)
GPC SET SPLIT	Non-crit burn	STOP BURN: OMS ENG(s) – OFF
Crit burn		Go to "GPC" above
I/O ERROR PCM		O1 PCMMU PWR – 2(1)
BCE BYP OA		SM I/O RESET

*If XFD, BLDN, or sensor fail, monitor ENG IN P for off-nominal performance

ORB OPS-31a/120/O/B

(reduced copy)

FAB USE ONLY

FS CC 12-5

ORB OPS/120/FIN

TOP
BACK OF 'ORBIT BURN MONITOR'



LEFT OMS

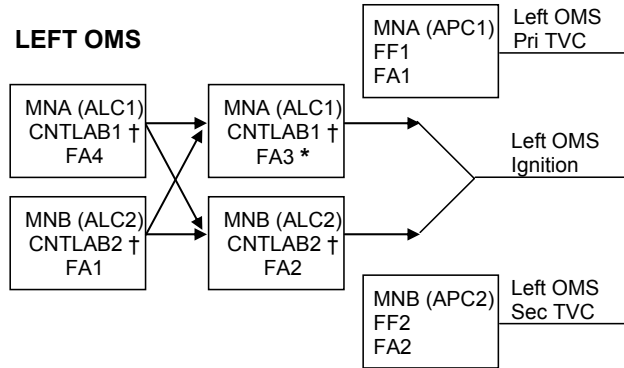

- † If CNTL AB1 or AB2 (CA1 or CA2) failed and ign path still exists at OMS fail, assume L(R) OMS ↓ is PRPLT FAIL
- * If L(R) Pc failed high during burn or FA3(4) failed, at L(R) OMS fail, no guidance downmode after L(R) OMS ENG switch OFF (TGO slow, ADI needles in error, 6 ft/s underburn)

RIGHT OMS

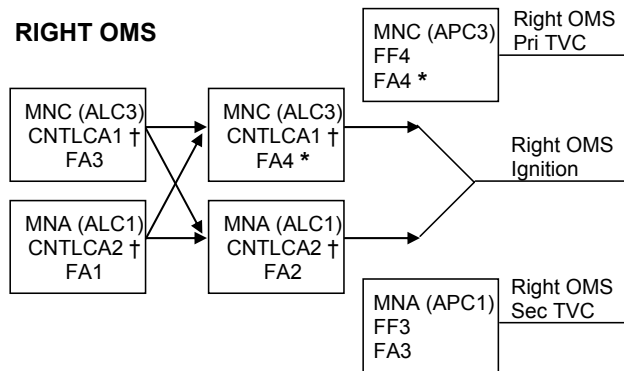

If two FA MDMs lost		
MDMs	Preburn: ENG – OFF	During burn: MAN SHUTDN
1,2	LEFT (TVC)	BOTH
1,3	RIGHT (IGN)	LEFT
1,4	LEFT (IGN)	RIGHT
2,3	LEFT (IGN)	RIGHT
2,4	RIGHT (IGN)	LEFT
3,4	RIGHT (TVC)	BOTH

ORB OPS-31b/120/O/A

(reduced copy)

FAB USE ONLY

FS CC 12-6

ORB OPS/120/FIN

FAB USE ONLY

FS CC 12-7

ORB OPS/120/FIN

(reduced copy)

TOP

PILE
VELCRO

ORB OPS-41a/120/O/B

PILE
VELCRO

STS-120 DAP A1 – DAP A8 CONFIGURATIONS

	ITEM #	A1	A2	A3	A4	A5	A6	A7	A8
PRI									
ROT RATE	10 (50)	0.2000	0.4000	0.2000	0.5000	0.2000	0.2000	0.2000	0.0500
ATT DB	11 (51)	5.00	1.00	0.30	3.00	5.00	5.00	2.00	2.00
RATE DB	12 (52)	0.20	0.20	0.20	0.20	0.20	0.20	0.20	0.20
ROT PLS	13 (53)	0.100	0.100	0.100	0.100	0.100	0.100	0.100	0.100
COMP	14 (54)	.000	.000	.000	.000	.000	.000	.000	.000
P OPTION	15 (55)	ALL	ALL	ALL	ALL	ALL	TAIL	ALL	ALL
Y OPTION	16 (56)	ALL	ALL	TAIL	ALL	ALL	TAIL	ALL	ALL
TRAN PLS	17 (57)	0.100	0.100	0.100	0.100	0.100	0.100	0.100	0.100
ALT									
RATE DB	18 (58)	0.200	0.200	0.070	0.200	0.070	0.070	0.100	0.100
JET OPT	19 (59)	ALL	ALL	ALL	ALL	ALL	TAIL	ALL	ALL
# JETS	20 (60)	2	2	1	2	1	1	2	2
ON TIME	21 (61)	0.08	0.08	0.08	0.08	0.08	0.08	0.08	0.08
DELAY	22 (62)	0.00	0.00	0.00	0.00	0.00	0.00	0.00	0.00
VERN									
ROT RATE	23 (63)	0.2000	0.4000	0.0080	0.2000	0.0500	0.0500	0.0160	0.0500
ATT DB	24 (64)	1.000	1.000	0.070	1.000	1.000	1.000	1.000	1.000
RATE DB	25 (65)	.020	.020	.010	.020	.020	.020	.020	.020
ROT PLS	26 (66)	0.010	0.010	0.010	0.010	0.010	0.010	0.010	0.050
COMP	27 (67)	.000	.000	.000	.000	.000	.000	.000	.000
CNTL ACC	28 (68)	0	0	0	0	0	0	0	0
PURPOSE		NOMINAL	PTC	GG		LOSS OF VERN (ALL)	LOSS OF VERN (TAIL ONLY)	RNDZ	TERMINAL PHASE

BOLD/ITALIC indicates change from I-Load.

HINGE

FAB USE ONLY

FS CC 12-8

ORB OPS/120/FIN

(reduced copy)

TOP
HINGED AT BOTTOM OF
'STS-120 DAP A1 – A8 CONFIGURATIONS'
HINGE

STS-120 DAP B1 – DAP B8 CONFIGURATIONS

	ITEM #	B1	B2	B3	B4	B5	B6	B7	B8
PRI									
ROT RATE	30 (50)	0.5000	0.2000	0.2000	0.2000	0.2000	0.5000	0.5000	0.0500
ATT DB	31 (51)	3.00	3.00	3.00	0.30	3.00	3.00	2.00	2.00
RATE DB	32 (52)	0.20	0.20	0.20	0.20	0.20	0.20	0.20	0.20
ROT PLS	33 (53)	0.040	0.040	0.040	0.040	0.040	0.040	0.040	0.040
COMP	34 (54)	.000	.000	.000	.000	.000	.000	.000	.000
P OPTION	35 (55)	ALL	TAIL	ALL	TAIL	TAIL	ALL	ALL	ALL
Y OPTION	36 (56)	ALL	TAIL	ALL	TAIL	TAIL	ALL	ALL	ALL
TRAN PLS	37 (57)	0.100	0.020	0.020	0.020	0.020	0.020	0.050	0.050
ALT									
RATE DB	38 (58)	0.200	0.070	0.070	0.100	0.200	0.200	0.100	0.100
JET OPT	39 (59)	ALL	TAIL	ALL	ALL	ALL	ALL	ALL	ALL
# JETS	40 (60)	2	1	1	2	2	2	2	2
ON TIME	41 (61)	0.08	0.08	0.08	0.08	0.08	0.08	0.08	0.08
DELAY	42 (62)	0.00	0.00	0.00	0.00	0.00	0.00	0.00	0.00
VERN									
ROT RATE	43 (63)	0.2000	0.2000	0.2000	0.0080	0.0160	0.2000	0.2000	0.0500
ATT DB	44 (64)	1.000	1.000	1.000	0.100	0.033	1.000	1.000	1.000
RATE DB	45 (65)	.020	.020	.020	.010	.020	.020	.020	.020
ROT PLS	46 (66)	0.002	0.002	0.002	0.002	0.002	0.002	0.002	0.020
COMP	47 (67)	.000	.000	.000	.000	.000	.000	.000	.000
CNTL ACC	48 (68)	0	0	0	0	0	0	0	0
PURPOSE		OMS & RCS Burns (ORB OPS)	Loss of VERN (Tail Only)	Loss of VERN (All)		COASHUD CAL		RNDZ	TERMINAL PHASE

BOLD/ITALIC indicates change from I-Load.

HOOK
VELCRO

ORB OPS-41aa/120/O/A

HOOK
VELCRO

FAB USE ONLY

FS CC 12-9

ORB OPS/120/FIN

(reduced copy)

TOP
BACK OF 'STS-120 DAP A1 – A8 CONFIGURATIONS'

PILE
VELCRO

ORB OPS-41b/120/O/C

PILE
VELCRO

STS-120 DAP A9 – DAP A15 CONFIGURATIONS

	ITEM #	A9	A10	A11	A12	A14	A15
PRI							
ROT RATE	10 (50)	0.1300	0.0500	0.0500	0.0500	0.2000	0.0500
ATT DB	11 (51)	2.00	0.60	10.00	5.00	5.00	5.00
RATE DB	12 (52)	0.10	0.10	0.20	0.20	0.20	0.20
ROT PLS	13 (53)	0.100	0.100	0.100	0.040	0.100	0.040
COMP	14 (54)	.000	.000	.000	.000	.000	.000
P OPTION	15 (55)	TAIL	TAIL	TAIL	TAIL	TAIL	TAIL
Y OPTION	16 (56)	TAIL	TAIL	TAIL	TAIL	TAIL	TAIL
TRAN PLS	17 (57)	0.050	0.050	0.100	0.010	0.100	0.010
ALT							
RATE DB	18 (58)	0.100	0.100	0.035 ¹	0.035 ¹	0.200	0.035 ¹
JET OPT	19 (59)	TAIL	TAIL	TAIL	TAIL	TAIL	TAIL
# JETS	20 (60)	2	2	1	3, 1 ²	1	3
ON TIME	21 (61)	0.08	0.08	0.16	0.08	0.08	0.08
DELAY	22 (62)	0.00	0.00	6.00	11.04, 6 ²	6.00	11.04
VERN							
ROT RATE	23 (63)	0.1300	0.0500	0.1000	0.1000	0.2000	0.1000
ATT DB	24 (64)	1.000	0.500	5.000	3.000	3.000	3.000
RATE DB	25 (65)	.020	.020	.050	.050	.200	.050
ROT PLS	26 (66)	0.050	0.050	0.010	0.002	0.010	0.002
COMP	27 (67)	.000	.000	.000	.000	.000	.000
CNTL ACC	28 (68)	0	0	9 ³	2 ⁴	1	3 ⁴
PURPOSE		PROX/OPS FLYAROUND	DOCKING	AUTO REBOOST	MATED STACK (VERN/ALT)	ORBITER ALONE SRMS/OBSS	MATED STACK RMS OPS (VERN/ALT)

BOLD/ITALIC indicates change from I-Load.

¹ I-Loaded below keyboard limit; do not change

² Post P6 install, ALT DAP requires 1 jet and 11.04 sec delay for attitude hold or 6 sec delay for mnvr

³ Config 2 only for post P6 install (CA 9); Config 3 for any non-loaded RMS mated ops (CA 2, 3, 9)

⁴ See DAP Overview for summary of CNTL ACCs

HINGE

FAB USE ONLY

FS CC 12-10

ORB OPS/120/FIN

(reduced copy)

TOP
 BACK OF 'STS-120 DAP B1 – B8 CONFIGURATIONS'
 HINGED AT BOTTOM OF 'STS-120 DAP A9 – A15 CONFIGURATIONS'
 HINGE

STS-120 DAP B9 – DAP B12 CONFIGURATIONS

	ITEM #	B9	B10	B12
PRI				
ROT RATE	30 (50)	0.1300	0.0500	0.0500
ATT DB	31 (51)	2.00	0.60	5.00
RATE DB	32 (52)	0.10	0.10	0.20
ROT PLS	33 (53)	0.040	0.040	0.040
COMP	34 (54)	.000	.000	.000
P OPTION	35 (55)	TAIL	TAIL	TAIL
Y OPTION	36 (56)	TAIL	TAIL	TAIL
TRAN PLS	37 (57)	0.010	0.010	0.010
ALT				
RATE DB	38 (58)	0.100	0.100	0.035 ¹
JET OPT	39 (59)	TAIL	TAIL	TAIL
# JETS	40 (60)	2	2	3, 1 ²
ON TIME	41 (61)	0.08	0.08	0.08
DELAY	42 (62)	10.00	0.00	11.04, 6 ²
VERN				
ROT RATE	43 (63)	0.1300	0.0500	0.1000
ATT DB	44 (64)	1.000	0.500	3.000
RATE DB	45 (65)	.020	.020	.050
ROT PLS	46 (66)	0.020	0.020	0.002
COMP	47 (67)	.000	.000	.000
CNTL ACC	48 (68)	0	0	2 ³
PURPOSE		PROX OPS/ FLYAROUND	DOCKING	MATED STACK BACKUP (VRGS/ALT)

BOLD/ITALIC indicates change from I-Load.

¹ I-Loaded below keyboard input limit; do not change

² Post P6 install, ALT DAP requires 1 jet and 11.04 sec delay for attitude hold or 6 sec delay for mnvr

³ See DAP Overview for summary of CNTL ACCs

HOOK
VELCRO

ORB OPS-41bb/120/O/C

HOOK
VELCRO

TOP

MAUI – RCS FIRING SEQUENCE

Timer	Jets Fired	CDR	PLT
-03:00		Body rates: $+0.047 \leq \text{roll} \leq +0.087$ $-0.020 \leq \text{pitch} \leq +0.020$ $-0.020 \leq \text{yaw} \leq +0.020$ DAP: FREE DAP: A/PRI Inform PLT "GO" for jet deselection	Configure initial setup GNC 23 RCS Left RCS page – ITEM 2 EXEC On CDR "GO", proceed <u>NOTE</u> Expect DAP RECONF msgs in following actions Deselect jets: JET DES L5L – ITEM 37 EXEC (*) Right RCS page – ITEM 3 EXEC JET DES R5D – ITEM 39 EXEC (*) Forward RCS page – ITEM 1 EXEC JET DES F5L – ITEM 37 EXEC (*) <u>NOTE</u> Queue the following ITEM entry on the scratch pad. Do not perform the EXEC until specified at 35 sec JET DES F3D – ITEM 25
-00:30		FLT CNTRL PWR – ON	
00:00	RXA, LXA	THC +X (in) (3 sec firing)	
00:15	FXL, LXL	THC +Y (right) (3 sec firing)	
00:30	FXR, RXR	THC -Y (left) (3 sec firing)	
00:35			When jets stop firing: GNC 23 RCS EXEC [JET DES F3D – ITEM 25 (*)]
00:45	F4D	RHC +pitch (hard stop, hold 3 sec)	
00:48		RHC release	
00:50			DAP: VERN
01:00	R5R	RHC +yaw (10 sec firing)	
01:20	L5D	RHC -pitch (12 sec firing)	
01:40	F5R	RHC +pitch (12 sec firing)	
		FLT CNTRL PWR – OFF	Return to MAUI PROCEDURE, step 6, (ORB OPS FS, MAUI)

ORB OPS-42a/120/O/A

(reduced copy)

FAB USE ONLY

FS CC 12-11

ORB OPS/120/FIN



TOP
BACK OF 'MAUI - RCS FIRING SEQUENCE'

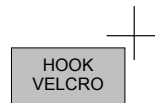
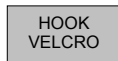
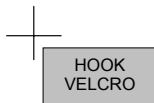

ORB OPS-42b/120/O/A



FAB USE ONLY

(reduced copy)
FS CC 12-12

ORB OPS/120/FIN

TOP

CDM ACTIVATION

NOTE

Due to battery life concerns, limit CDM use to specified DTO periods only

1. Press and hold MODE pb until 'RELEASE' displayed
2. Wait ~1 min while unit runs self-check routine, verify display shows CO2 reading ("x ppm" or "x.xx CO2")
3. From CO2 concentration display, press MODE pb six times (once per sec), until alarm status is displayed
4. Press E pb once to switch alarm off
5. Verify display indicates 'ALM OFF'
6. Record GMT Start

Middeck Attachment Location	GMT Start	GMT Stop
Location 1	Forward Starboard	
Location 2	Aft Starboard	
Location 3	Aft Hatch "ditch"	
Location 4	Forward Port	
Location 5	Aft Port	

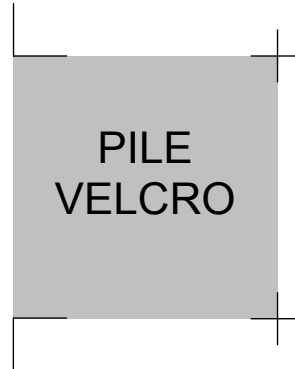

CDM DEACTIVATION

- * If 'BATTERY FAIL' message displayed, replace *
- * battery immediately to maintain logged data: *
- * Perform CDM SETUP AND BATTERY *
- * CHANGEOUT (ORB OPS, CDM.DTO) *
- * Notify MCC-H *

1. Press and hold MODE pb until 'RELEASE' displayed
2. CDM – OFF
3. Record GMT Stop, report completion to MCC-H

ORB OPS-46a/O/A

(reduced copy)

FAB USE ONLY

FS CC 12-13

ORB OPS/120/FIN

TOP
BACK OF, 'CDM CUE CARD'

HOOK
VELCRO

ORB OPS-46b/O/A

FAB USE ONLY

(reduced copy)
FS CC 12-14

ORB OPS/120/FIN

TOP

MIDODRINE PILL INGESTION

NO GO

If ANY of the conditions below are true, then you are NO GO for pill ingestion:

1. Midodrine PI/Crew Surgeon has given a "NO GO"
2. Taken promethazine/Phenergan or phenDex in the last 70 hrs.
3. Taken any medication that effects the autonomic nervous system within 24 hrs.
4. Performed maximum exercise in the last 24 hrs.
5. Taken nicotine, caffeine, or alcohol in the last 12 hrs.

GO

LOCATION	STEP
Midodrine Pill Kit	Ingest 10 mg dose (1 tablet) of midodrine with liquid NOTE In the event the midodrine pill is lost, a backup dose is located beneath the first pill
	Record time of ingestion: <input type="checkbox"/> GMT <input type="checkbox"/> MET
ACES right leg pocket	Stow kit.

ORB OPS-45a/E/B

(reduced copy)

FAB USE ONLY

FS CC 12-15

ORB OPS/120/FIN



This Page Intentionally Blank



Space Shuttle Program
FLIGHT DATA FILE

JSC-48036-120
FINAL



ORBIT OPS CHECKLIST

STS 120

Flight Cover (trim bottom to expose tabs)