

# Orbit Operations Checklist

## STS-123 Flight Supplement

---

**Mission Operations Directorate  
Operations Division**

**Final, Rev A  
February 19, 2008**

National Aeronautics and  
Space Administration

**Lyndon B. Johnson Space Center**  
Houston, Texas



***United Space Alliance***



MISSION OPERATIONS DIRECTORATE

**ORBIT OPERATIONS CHECKLIST  
STS-123 FLIGHT SUPPLEMENT**

FINAL, REV A  
February 19, 2008

PREPARED BY:

  
\_\_\_\_\_  
Thomas R. Zulauf  
Publication Manager

APPROVED BY:

ACCEPTED BY:

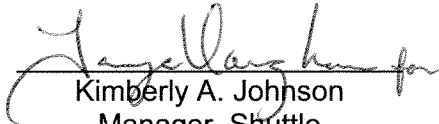
  
\_\_\_\_\_  
Kimberly A. Johnson  
Manager, Shuttle  
Procedures Management

  
\_\_\_\_\_  
Michael T. Hurt  
FDF Manager

This document is under the configuration control of the Crew Procedures Control Board (CPCB). All proposed changes must be submitted via FDF Workflow Crew Procedure Change Request (CR) to DO3/FDF Manager.

Additional distribution of this book, for official use only, may be requested in writing to DO3/PMO Administrator. The request must include justification and requester's name, organization, position, and phone number. Contractor requests are made through the NASA or DOD organization supported. Deletions, reduction in quantity, or change of address may be submitted to DO3/FDF Management Office, 281-244-1184.

Incorporates the following:			
482#:	ORB OPS FS-0059	ORB OPS FS-0063	ORB OPS FS-0066
	ORB OPS FS-0060	ORB OPS FS-0064	ORB OPS FS-0067
	ORB OPS FS-0062	ORB OPS FS-0065	ORB OPS FS-0068

AREAS OF TECHNICAL RESPONSIBILITY

Publication Manager	DO3/T. Zulauf	281-244-0922
Alternate Publication Manager	DO3/L. Giles	281-244-9068
COMM/INST	DS6/D. Brown	281-244-9058
PTG	DO4/A. Lalich	284-483-7065
DAP TABLES	DS6/K. Dunn	284-483-2413
REBOOST/DAP	DS6/K. Dunn	281-483-2413
OIU	DS2/D. Brown	281-244-9058
PRLA	DS5/J. Dake	281-438-6538
SDBI	SK/L. Kirschner	281-218-3038
WLES	DO5/L. Gonzales	281-244-0256
	DO5/R. Carroll	281-244-0914
MAUI	DS6/K. Dunn	281-483-2413
<u>CUE CARDS:</u>		
FLIGHT DAY 3 DOCKING ORBITER WITH ISS CO2 ABSORBER REPLACEMENT	DS4/R. Hinterlang	281-483-9398
ORBIT BURN MONITOR	DS6/L. Schmitt	281-483-0649
DAP TABLES	DS6/K. Dunn	281-483-2413
MAUI – RCS FIRING SEQUENCE	DS6/K. Dunn	281-483-2413
CDM CUE CARD	DS4/R. Hinterlang	281-483-9398

ORBIT OPERATIONS CHECKLIST  
STS-123 FLIGHT SUPPLEMENT

**LIST OF EFFECTIVE PAGES**

FINAL 11/16/07  
REV A 02/19/08

Sign Off .....	*	123/FIN A	FS 4-1 .....	123/FIN A
FS ii .....	*	123/FIN A	FS 4-2 .....	123/FIN A
FS iii .....	*	123/FIN A	FS 4-3 .....	123/FIN A
FS iv .....	*	123/FIN A	FS 4-4 .....	123/FIN A
FS v .....	*	123/FIN A	FS 4-5 .....	123/FIN A
FS vi .....	*	123/FIN A	FS 4-6 .....	123/FIN A
FS vii .....		123/FIN A	FS 5-1 .....	123/FIN A
FS viii .....		123/FIN A	FS 5-2 .....	123/FIN A
FS 1-1 .....		123/FIN A	FS 6-1 .....	123/FIN A
FS 1-2 .....		123/FIN A	FS 6-2 .....	123/FIN A
FS 1-3 .....		123/FIN A	FS 7-1 .....	123/FIN A
FS 1-4 .....		123/FIN A	FS 7-2 .....	123/FIN A
FS 1-5 .....		123/FIN A	FS 7-3 .....	123/FIN A
FS 1-6 .....		123/FIN A	FS 7-4 .....	123/FIN A
FS 1-7 .....		123/FIN A	FS 7-5 .....	123/FIN A
FS 1-8 .....		123/FIN A	FS 7-6 .....	123/FIN A
FS 2-1 .....		123/FIN A	FS 7-7 .....	123/FIN A
FS 2-2 .....		123/FIN A	FS 7-8 .....	123/FIN A
FS 2-3 .....		123/FIN A	FS 7-9 .....	123/FIN A
FS 2-4 .....		123/FIN A	FS 7-10 .....	123/FIN A
FS 2-5 .....		123/FIN A	FS 7-11 .....	123/FIN A
FS 2-6 .....		123/FIN A	FS 7-12 .....	123/FIN A
FS 3-1 .....		123/FIN A	FS 8-1 .....	123/FIN A
FS 3-2 .....		123/FIN A	FS 8-2 .....	123/FIN A
FS 3-3 .....		123/FIN A	FS 8-3 .....	123/FIN A
FS 3-4 .....		123/FIN A	FS 8-4 .....	123/FIN A
FS 3-5 .....		123/FIN A	FS 8-5 .....	123/FIN A
FS 3-6 .....		123/FIN A	FS 8-6 .....	123/FIN A
FS 3-7 .....		123/FIN A	FS 8-7 .....	123/FIN A
FS 3-8 .....		123/FIN A	FS 8-8 .....	123/FIN A

\* – Omit from flight book

FS 8-9 .....	123/FIN A
FS 8-10 .....	123/FIN A
FS 8-11 .....	123/FIN A
FS 8-12 .....	123/FIN A
FS 8-13 .....	123/FIN A
FS 8-14 .....	123/FIN A
FS 8-15 .....	123/FIN A
FS 8-16 .....	123/FIN A
FS 8-17 .....	123/FIN A
FS 8-18 .....	123/FIN A
FS 9-1 .....	123/FIN A
FS 9-2 .....	123/FIN A
FS 9-3 .....	123/FIN A
FS 9-4 .....	123/FIN A
FS 9-5 .....	123/FIN A
FS 9-6 .....	123/FIN A
FS 10-1 .....	123/FIN A
FS 10-2 .....	123/FIN A
FS 10-3 .....	123/FIN A
FS 10-4 .....	123/FIN A
FS 10-5 .....	123/FIN A
FS 10-6 .....	123/FIN A
FS 10-7 .....	123/FIN A
FS 10-8 .....	123/FIN A
FS 11-1 .....	123/FIN A
FS 11-2 .....	123/FIN A
FS CC 11-3 .....	123/FIN A
FS CC 11-4 .....	123/FIN A
FS CC 11-5 .....	123/FIN A
FS CC 11-6 .....	123/FIN A
FS CC 11-7 .....	123/FIN A
FS CC 11-8 .....	123/FIN A
FS CC 11-9 .....	123/FIN A
FS CC 11-10 ...	123/FIN A
FS CC 11-11 ...	123/FIN A
FS CC 11-12 ...	123/FIN A
FS CC 11-13 ...	123/FIN A
FS CC 11-14 ...	123/FIN A

\* – Omit from flight book

ORBIT OPS CUE CARDS

<u>Title</u>	<u>Ref. Page</u>	<u>Card No.</u>
FLIGHT DAY 3 DOCKING ORBITER WITH ISS CO2 ABSORBER REPLACEMENT (Front) .....	FS CC 11-3	ORB OPS-29a/ nonRCRS/123/O/A
LiOH CANISTER STOWAGE LOCATIONS (Back) .....	FS CC 11-4	ORB OPS-29b/ nonRCRS/123/O/A
ORBIT BURN MONITOR (Front).....	FS CC 11-5	ORB OPS-31a/123/O/A
OMS FAILURES (Back).....	FS CC 11-6	ORB OPS-31b/123/O/A
STS-123 DAP CONFIGURATIONS (Front/Top).....	FS CC 11-7	ORB OPS-41a/123/O/A
(Front/Bottom) .....	FS CC 11-8	ORB OPS-41aa/123/O/A
(Back/Top) .....	FS CC 11-9	ORB OPS-41b/123/O/C
(Back/Bottom).....	FS CC 11-10	ORB OPS-41bb/123/O/C
MAUI – RCS FIRING SEQUENCE (Front).....	FS CC 11-11	ORB OPS-42a/123/O/B
(Back).....	FS CC 11-12	ORB OPS-42b/123/O/A
CDM CUE CARD (Front).....	FS CC 11-13	ORB OPS-46a/O/A
(Back).....	FS CC 11-14	ORB OPS-46b/O/A



This Page Intentionally Blank





<u>CONTENTS</u>	<u>PAGE</u>
<u>COMM/INST</u> .....	FS 1-1
LOAD PCMMU FORMAT.....	FS 1-2
PDI DECOM FORMAT.....	FS 1-4
OIU FORMAT/CONFIG.....	FS 1-6
<u>PTG</u> .....	FS 2-1
STAR PAIRS PAD	
(MET APPLICABLE: POST OMS-2 – 008/00:00:00)	FS 2-2
STAR PAIRS	
(MET APPLICABLE: POST OMS-2 – 008/00:00:00)	FS 2-3
STAR PAIRS PAD	
(MET APPLICABLE: 008/00:00:00 – 016/00:00:00)	FS 2-4
STAR PAIRS	
(MET APPLICABLE: 008/00:00:00 – 016/00:00:00)	FS 2-5
<u>DAP TABLES</u> .....	FS 3-1
DAP OVERVIEW.....	FS 3-2
UNIV PTG.....	FS 3-3
STS-123 DAP A CONFIGURATIONS.....	FS 3-4
B CONFIGURATIONS.....	FS 3-6
<u>REBOOST/DAP</u> .....	FS 4-1
AUTO REBOOST.....	FS 4-2
ATTITUDE REFERENCE.....	FS 4-4
DOCKED DAP REFERENCE.....	FS 4-5
<u>OIU PROCEDURES</u> .....	FS 5-1
OIU ACTIVATION.....	FS 5-2
DEACTIVATION.....	FS 5-2
<u>PRLA</u> .....	FS 6-1
PRLA CLOSE.....	FS 6-2
<u>SHORT DURATION BIOASTRONAUTICS</u>	
<u>INVESTIGATION (SDBI)</u> .....	FS 7-1
SDBI 1634, SLEEP-WAKE ACTIGRAPHY.....	FS 7-2
SDBI 1900, INTEGRATED IMMUNE BLOOD	
COLLECTION.....	FS 7-3
SDBI 1900, SALIVA COLLECTION FOR	
INTEGRATED IMMUNE.....	FS 7-9

Cont next page

<u>WING LEADING EDGE SENSORS (WLES)</u>	
<u>PROCEDURES</u> .....	FS 8-1
WLES ACTIVATION AND CHECKOUT .....	FS 8-2
DEACTIVATION AND TEARDOWN .....	FS 8-10
LAPTOP RECEIVER UNIT (LRU) R&R .....	FS 8-12
CONFIGURE WLES DATA FILE BACKUP PATH ....	FS 8-14
PREP WLES LAPTOPS FOR TRANSFER .....	FS 8-15
WLES RNDZ TOOLS CHECKOUT PREP .....	FS 8-16
DOCK/UNDOCK RECOVERY .....	FS 8-16
DISABLE WLES FILE BACKUP .....	FS 8-17
ENABLE WLES FILE BACKUP .....	FS 8-17
<u>MAUI ANALYSIS OF UPPER-ATMOSPHERIC</u>	
<u>INJECTIONS (MAUI)</u> .....	FS 9-1
MAUI PROCEDURE .....	FS 9-2
<u>CARBON DIOXIDE MONITORING (CDM)</u>	
<u>DEVELOPMENT TEST OBJECTIVE (DTO)</u>	
<u>PROCEDURES</u> .....	FS 10-1
CDM SETUP AND BATTERY CHANGEOUT .....	FS 10-2
ACTIVATION .....	FS 10-7
DEACTIVATION .....	FS 10-7
DTO COMPLETION .....	FS 10-8
<u>CUE CARD CONFIGURATION</u> .....	FS 11-1
FLIGHT DAY 3 DOCKING ORBITER WITH ISS	
CO2 ABSORBER REPLACEMENT (Front) .....	FS CC 11-3
LiOH CANISTER STOWAGE LOCATIONS	
(Back) .....	FS CC 11-4
ORBIT BURN MONITOR (Front) .....	FS CC 11-5
OMS FAILURES (Back) .....	FS CC 11-6
STS-123 DAP CONFIGURATIONS	
(Front/Top) .....	FS CC 11-7
(Front/Bottom) .....	FS CC 11-8
(Back/Top) .....	FS CC 11-9
(Back/Bottom) .....	FS CC 11-10
MAUI – RCS FIRING SEQUENCE (Front) .....	FS CC 11-11
(Back) .....	FS CC 11-12
CDM CUE CARD (Front) .....	FS CC 11-13
(BACK) .....	FS CC 11-14

COMM/INST

LOAD PCMMU FORMAT.....	FS 1-2
PDI DECOM FORMAT.....	FS 1-4
OIU FORMAT/CONFIG.....	FS 1-6

**COMM/  
INST**

COMM/  
INST

## LOAD PCMMU FORMAT

- C3 1. √OI PCMMU FORMAT – GPC  
SM 62 PCMMU/PL COMM
- CRT 2. FORMAT:  
SEL FXD – ITEM 1 EXEC (\*)  
SEL ID – ITEM 3 +X X X EXEC
3. √SM COMM BUF – RDY  
LOAD – ITEM 4 EXEC  
√LOAD, ITEM 4 – RUN,CPLT
- If LOAD – CPLT:  
Repeat steps 2 and 3 for second ID
- \* If LOAD – FAIL and ERR MSG – 'I/O ERR MMU 1(2)':  
\* Go to 5.2a, 'I/O ERR MMU 1(2)' (MAL, DPS) >>  
\*  
\* If LOAD – FAIL and a first load attempt:  
\* Repeat steps 1 and 2 for failed ID  
\*  
\* If LOAD – FAIL and a subsequent load attempt:  
\* √MCC  
\* OI PCMMU PWR – 2(1)  
\* √ERR MSG – 'I/O ERR PCM'  
C3 \* I/O RESET PCM – ITEM 5 EXEC (\*)  
CRT \* Repeat steps 2 and 3  
\*
4. When final LOAD – CPLT:  
SEL PGM – ITEM 2 EXEC (\*)

DNLIST COMPATIBILITY	PHASE	FORMAT ID 64/128	CONFIG NO.
G1,G3,BFS	(ASCENT)	102/FXD	-
G3,BFS	(ENTRY)	102/164	-
G2,G8,S2	ORBIT/ORBIT BURN/FCS C/O	103/161	-
G2,S2,OPS 0	OPS 0	- /163	-
G2,S2,P9	MMU C/O	- /163	-
G9	Prelaunch PL C/O	103/180	758
G2,G8,S2	RNDZ w/UHF FMT CCSU (SSOR/SSV/TCS) (PRIME)	103/192	763
G2,G8,S2	RNDZ w/UHF FMT CCSU (SSOR/SSV/TCS) (B/U)	103/211	770
G2,G8,S2	DOCKED ISS FMT CCSH (OIU/SSV) (PRIME)	103/184	760
G2,G8,S2	DOCKED ISS FMT CCSH (OIU/SSV) (B/U)	103/205	767
G2,G8,S2	OIU C/O AND SSV RATE 4 (PRIME)	103/188	762
G2,G8,S2	OIU C/O AND SSV RATE 5 (B/U)	103/203	765

**NOTE**

LDR TFL may affect PCMMU BITE. If PCMMU or SM 2 GPC switched since last TFL, ID 64 and 128 will not reflect current state

## LOAD PDI DECOM FORMAT

### SM 62 PCMMU/PL COMM

1. PDI:

CRT      √I/O RESET – ITEM 8 (\*)  
          SEL DECOM – ITEM 9 +X EXEC  
          SEL FMT – ITEM 10 +X X X EXEC  
          LOAD – ITEM 11 EXEC

If LOAD – CPLT:  
          SEL INPUT – ITEM 12 +X EXEC  
          LOAD – ITEM 13 EXEC  
          Repeat step 1 for additional DECOMs/FPM

\* If LOAD – FAIL and ERR MSG – 'I/O ERR \*  
\* MMU 1(2)': \*  
\* Go to 5.2a, 'I/O ERR MMU 1(2)' (MAL, \*  
\* DPS) >> \*  
\* \*  
\* If LOAD – FAIL and a first load attempt: \*  
\* Repeat step 1 \*  
\* \*  
\* If LOAD – FAIL and a subsequent load \*  
\* attempt: \*  
\* \*  
\* NOTE \*  
\* Power cycling PDI will cause PDI \*  
\* to lose DFLs previously loaded \*  
\* \*  
\* √MCC \*  
A1L \* S-BD PL CNTL – PNL \*  
\* PL DATA INTLVR PWR – OFF,ON \*  
\* √ERR MSG – 'S62 BCE BYP PL' \*  
\* √'S62 BCE BYP PDI' \*  
\* S-BD PL CNTL – CMD \*  
\* \*  
\* PCM: \*  
CRT \* I/O RESET PCM – ITEM 5 EXEC (\*) \*  
\* PDI: \*  
\* I/O RESET – ITEM 8 EXEC (\*) \*  
\* Repeat step 1 for all of config (XXX) \*

CONFIG	DECOM	FMT	INPUT	USE
763 RNDZ w/UHF FMT CCSU  (PRIME) TFL 192	1 2 3 4 5-FPM	30 - 9 4 503	1,2 - 5 4	OIU7 (CCSU) ** - TCS SSV (3) *** H-H-H *
770 RNDZ w/UHF FMT CCSU  (BACKUP) TFL 211	1 2 3 4 5-FPM	14 31 - 19 502	4 1,2 - 5	SSV (3) *** OIU7 (CCSU) ** - TCS H-H-H *
760 DOCKED FMT CCSH  (PRIME) TFL 184	1 2 3 4 5-FPM	7 - - 27 501	1,2 - - 4	OIU9 (CCSH) ** - - SSV (2) *** H-H-H *
767 DOCKED FMT CCSH  (BACKUP) TFL 205	1 2 3 4 5-FPM	- 17 29 - 506	- 1,2 4 -	- OIU9 (CCSH) ** SSV (2) *** - H-H-H *
762 SSV RATE 4  (PRIME) TFL 188	1 2 3 4 5-FPM	5 - - 1 505	1,2 - - 4	OIU255 ** - - SSV (4) *** H-H-H *
765 SSV RATE 5  (BACKUP) TFL 203	1 2 3 4 5-FPM	- 15 11 - 507	- 1,2 4 -	- OIU255 ** SSV (5) *** - L-H-H *
758 Pre-Launch PL C/O  (PRIME) TFL 180	1 2 3 4 5-FPM	28 15 9 - 504	1,2 1,2 5 -	OIU253 ** OIU255 ** TCS - H-H-H *

\* OI-GNC-SM, Orbiter Downlist Data Rates (High or Low)  
\*\* # in OIU# represents the OIU format; (XXX) represents data type  
\*\*\* # in SSV (#) represents the SSV Out Rate sw selection

## LOAD OIU FORMAT/CONFIG

Determine which step is needed and complete all actions to obtain desired OIU configuration

### NOTE

A corresponding TFL/DFL CONFIG is reqd for MCC to receive telemetry. Reference S62 PCMMU/PL COMM for the last loaded HDR TFL and perform LOAD PCMMU FORMAT/LOAD PDI DECOM FORMAT for the associated CONFIG

#### S212 OIU

1. GNC-1 PRIMARY ON LB-ORB N2-1 (OIU BUS 3)

LOAD FORMAT	ITEM 1 + <u>9</u> EXEC
GNC TO GNC 1	ITEM 18 + <u>1</u> <u>4</u> EXEC
GNC 1 TO BUS 3	ITEM 18 + <u>1</u> <u>6</u> EXEC
BUS 4 BC	ITEM 15 EXEC (*)
BUS 3 RT	ITEM 10 EXEC (*)
LOAD FORMAT	ITEM 1 + <u>9</u> EXEC >>
  
2. GNC-1 PRIMARY ON LB-ORB N2-2 (OIU BUS 4)

LOAD FORMAT	ITEM 1 + <u>9</u> EXEC
GNC TO GNC 1	ITEM 18 + <u>1</u> <u>4</u> EXEC
GNC 1 TO BUS 4	ITEM 18 + <u>1</u> <u>5</u> EXEC
BUS 3 BC	ITEM 11 EXEC (*)
BUS 4 RT	ITEM 14 EXEC (*)
LOAD FORMAT	ITEM 1 + <u>9</u> EXEC >>
  
3. GNC-2 PRIMARY ON LB-ORB N2-1 (OIU BUS 3)

LOAD FORMAT	ITEM 1 + <u>9</u> EXEC
GNC TO GNC 2	ITEM 18 + <u>1</u> <u>3</u> EXEC
GNC 2 TO BUS 3	ITEM 18 + <u>1</u> <u>8</u> EXEC
BUS 4 BC	ITEM 15 EXEC (*)
BUS 3 RT	ITEM 10 EXEC (*)
LOAD FORMAT	ITEM 1 + <u>9</u> EXEC >>
  
4. GNC-2 PRIMARY ON LB-ORB N2-2 (OIU BUS 4)

LOAD FORMAT	ITEM 1 + <u>9</u> EXEC
GNC TO GNC 2	ITEM 18 + <u>1</u> <u>3</u> EXEC
GNC 2 TO BUS 4	ITEM 18 + <u>1</u> <u>7</u> EXEC
BUS 3 BC	ITEM 11 EXEC (*)
BUS 4 RT	ITEM 14 EXEC (*)
LOAD FORMAT	ITEM 1 + <u>9</u> EXEC >>

Cont next page



5. MPLM (if flown)  
LOAD FORMAT ITEM 1 +5 EXEC  
BUS 2 BC ITEM 7 EXEC (\*)  
LOAD FORMAT ITEM 1 +5 EXEC >>
6. SSOR  
LOAD FORMAT ITEM 1 +7 EXEC  
BUS 1 BC ITEM 3 EXEC (\*)  
LOAD FORMAT ITEM 1 +7 EXEC >>



This Page Intentionally Blank



PTG

STAR PAIRS PAD	
(MET APPLICABLE: POST OMS-2 – 008/00:00:00) ..	FS 2-2
STAR PAIRS	
(MET APPLICABLE: POST OMS-2 – 008/00:00:00) ..	FS 2-3
STAR PAIRS PAD	
(MET APPLICABLE: 008/00:00:00 – 016/00:00:00) ...	FS 2-4
STAR PAIRS	
(MET APPLICABLE: 008/00:00:00 – 016/00:00:00) ...	FS 2-5

**PTG**

FS 2-1

ORB OPS/123/FIN A

PTG

STAR PAIRS PAD											
STAR PAIR	SEP ANGLE	ATTITUDE SET 1						ATTITUDE SET 2			
		DUAL S TRK		SINGLE S TRK				DUAL S TRK		SINGLE S TRK	
				-Z	-Y		-Z			-Y	
A	82.7	-Y:71 R+ 40 -Z:70 P+ 85 Y+ 50	-Z:71 R+ 332 P+ 64 Y+ 46	-Y:70 R+ 125 P+ 84 Y+ 65	-Y:70 R+ 210 -Z:71 P+ 238 Y+ 311	-Z:70 R+ 142 P+ 259 Y+ 313	-Y:71 R+ 291 P+ 233 Y+ 297				
B	92.7	-Y:59 R+ 297 -Z:65 P+ 85 Y+ 276	-Z:59 R+ 213 P+ 90 Y+ 291	-Y:65 R+ 101 P+ 161 Y+ 285	-Y:65 R+ 320 -Z:59 P+ 279 Y+ 66	-Z:65 R+ 255 P+ 254 Y+ 80	-Y:59 R+ 15 P+ 317 Y+ 66				
C	90.9	-Y:36 R+ 345 -Z:59 P+ 232 Y+ 318	-Z:36 R+ 250 P+ 221 Y+ 330	-Y:59 R+ 81 P+ 246 Y+ 328	-Y:59 R+ 292 -Z:36 P+ 43 Y+ 26	-Z:59 R+ 201 P+ 47 Y+ 41	-Y:36 R+ 14 P+ 58 Y+ 21				
D	82.1	-Y:106 R+ 97 -Z:32 P+ 326 Y+ 336	-Z:106 R+ 9 P+ 319 Y+ 323	-Y:32 R+ 176 P+ 314 Y+ 344	-Y:32 R+ 181 -Z:106 P+ 133 Y+ 37	-Z:32 R+ 90 P+ 147 Y+ 29	-Y:106 R+ 270 P+ 123 Y+ 25				

STAR PAIRS PAD

FS 2-2

ORB OPS/123/FIN A

PAIR	COAS ALIGN ATTITUDE 1	ANG SEP	COAS ALIGN ATTITUDE 2
COAS	+X HUD 18 R+ 225 P+ 275 Y+ 41	NOSE UP 74.4	R+ 235 P+ 229 Y+ 340
	-Z COAS 18 R+ 51 P+ 223 Y+ 331		TAIL UP 29 R+ 332 P+ 120 Y+ 308

	SINGLE S TRK MIN MNVR OPT TGT ID = 11-110 NAV STAR #	
	-Z S TRK	-Y S TRK
BV	5	4
P	87.7	✓ 0
Y	358	✓ 280.57

MET Applicable Post OMS-2 to 008/00:00:00  
 Liftoff Date: 03/11/08  
 Liftoff GMT: 071/06:28:05.000

# STAR PAIRS

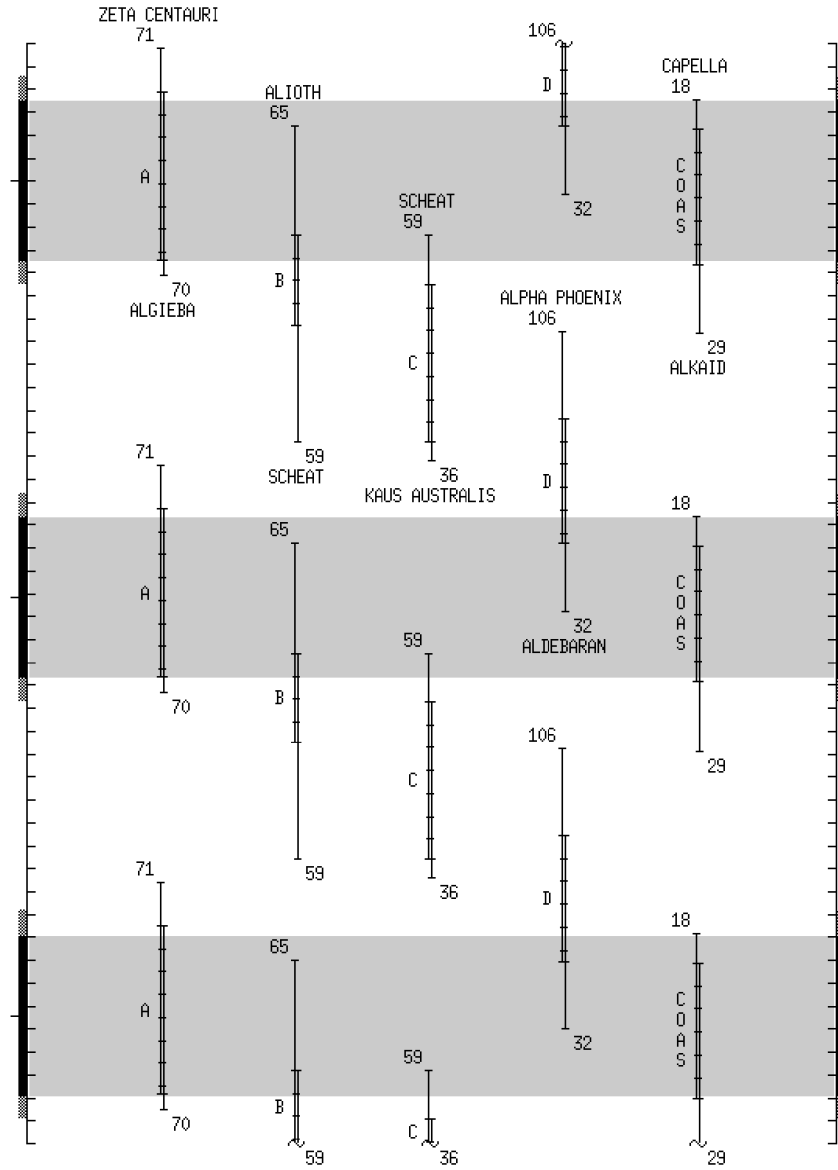

MET Applicable: Post OMS-2 to 008/00:00:00  
 Liftoff Date: 03/11/08  
 Liftoff GMT: 071/06:28:05.000

FS 2-4

ORB OPS/123/FIN A

STAR PAIRS PAD

STAR PAIR	SEP ANGLE	ATTITUDE SET 1				ATTITUDE SET 2			
		DUAL S TRK	SINGLE S TRK		DUAL S TRK	SINGLE S TRK			
			-Z	-Y		-Z	-Y		
A	87.1	-Y:87 R+ 265 -Z:91 P+ 293 Y+ 76	R+ 106 P+ 7 Y+ 81	-Y:91 P+ 318 Y+ 63	R+ 328 P+ 318 Y+ 63	-Y:91 R+ 83 -Z:87 P+ 191 Y+ 284	R+ 292 P+ 116 Y+ 280	-Y:87 P+ 167 Y+ 296	
B	85.5	-Y:36 R+ 327 -Z:27 P+ 196 Y+ 332	R+ 239 P+ 190 Y+ 346	-Y:27 P+ 211 Y+ 338	R+ 59 P+ 211 Y+ 338	-Y:27 R+ 305 -Z:36 P+ 13 Y+ 11	R+ 220 P+ 12 Y+ 25	-Y:36 R+ 28 P+ 27 Y+ 10	
C	91.9	-Y:67 R+ 304 -Z:58 P+ 241 Y+ 308	R+ 215 P+ 241 Y+ 323	-Y:58 P+ 265 Y+ 310	R+ 51 P+ 265 Y+ 310	-Y:58 R+ 324 -Z:67 P+ 65 Y+ 35	R+ 241 P+ 57 Y+ 49	-Y:67 R+ 42 P+ 83 Y+ 38	
D	85.6	-Y:17 R+ 237 -Z:26 P+ 173 Y+ 284	R+ 184 P+ 208 Y+ 294	-Y:26 P+ 256 Y+ 275	R+ 45 P+ 256 Y+ 275	-Y:26 R+ 351 -Z:17 P+ 39 Y+ 65	R+ 300 P+ 2 Y+ 71	-Y:17 R+ 43 P+ 75 Y+ 72	
E	91.0	-Y:105 R+ 155 -Z:108 P+ 50 Y+ 2	R+ 67 P+ 57 Y+ 349	-Y:108 P+ 36 Y+ 355	R+ 243 P+ 36 Y+ 355	-Y:108 R+ 116 -Z:105 P+ 236 Y+ 15	R+ 28 P+ 233 Y+ 0	-Y:105 R+ 208 P+ 220 Y+ 17	

STAR PAIRS PAD

PAIR	COAS ALIGN ATTITUDE 1	ANG SEP	COAS ALIGN ATTITUDE 2
COAS	+X HUD 29 R+ 331 P+ 236 Y+ 340	NOSE UP 64.4	R+ 8 P+ 308 Y+ 326
	-Z COAS 29 R+ 199 P+ 332 Y+ 332		R+ 213 P+ 30 Y+ 3

SINGLE S TRK MIN MNVR OPT  
TGT ID = 11-110 NAV STAR #

	-Z S TRK	-Y S TRK
BV	5	4
P	87.7	✓ 0
Y	358	✓ 280.57

MET Applicable 008/00:00:00 to 016/00:00:00  
Liftoff Date: 03/11/08  
Liftoff GMT: 071/06:28:05.000

# STAR PAIRS

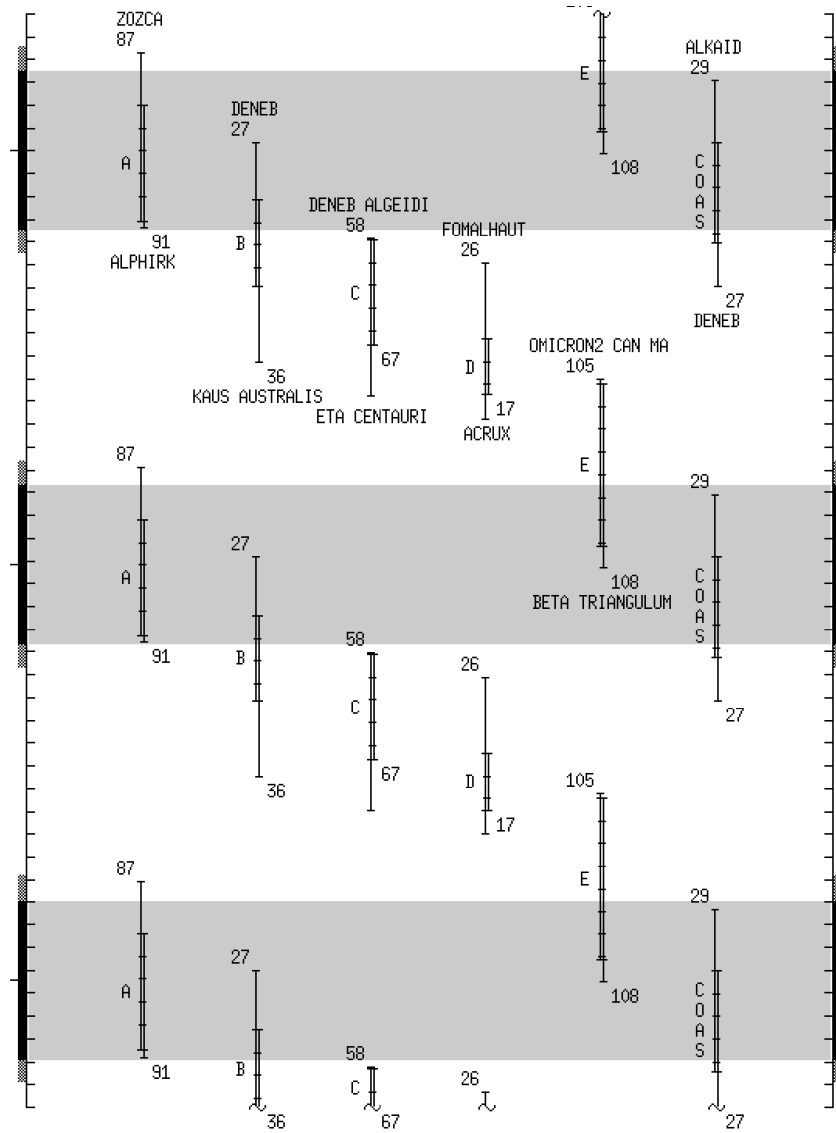

MET Applicable: 008/00:00:00 to 016/00:00:00  
 Liftoff Date: 03/11/08  
 Liftoff GMT: 071/06:28:05.000



This Page Intentionally Blank





DAP TABLES

DAP OVERVIEW .....	FS 3-2
UNIV PTG .....	FS 3-3
STS-123 DAP A CONFIGURATIONS.....	FS 3-4
B CONFIGURATIONS.....	FS 3-6

**DAP  
TABLES**

## DAP TABLES

### DAP Overview

DAP – Purpose	DAP – Purpose
A1 – Nominal	B1 – OMS & RCS Burns (ORB OPS)
A2 – PTC	B2 – Loss of VERN (Tail Only)
A3 – GG	B3 – Loss of VERN (All)
A4 – Pre/Post Deploy	B4 –
A5 – Loss of VERN (All)	B5 – COAS/HUD CAL
A6 – Loss of VERN (Tail Only)	B6 –
A7 – Rendezvous	B7 – Rendezvous
A8 – Terminal Phase	B8 – Terminal Phase
A9 – PROX OPS/Flyaround	B9 – PROX OPS/Flyaround
A10 – Docking	B10 – Docking
A11 – Auto Reboost	B11 –
A12 – Mated Stack (VRCS all & ALT maneuver)	B12 – Mated Stack (VRCS all & ALT attitude hold)
A13 –	B13 –
A14 – Orbiter alone SRMS/OBSS Ops	B14 –
A15 –	B15 –

- CNTL ACC = 0 Orbiter alone with unloaded RMS  
 = 1 Orbiter alone SRMS/OBSS Ops  
 = 2 Mated - VRCS and ALT with no vehicle docked to SM aft  
 = 3 Mated - VRCS and ALT with Progress/Soyuz docked to SM aft  
 = 4 Mated - VRCS and ALT with ATV docked to SM aft  
 = 5 Not used  
 = 6 Not used  
 = 7 Not used  
 = 8 Not used  
 = 9 Not used

DAPs for mated operations are based on analysis from GNC, PDRS, C. S. Draper Labs, and ISS Structures

FS 3-2

ORB OPS/123/FIN A

UNIV PTG

TGT ID = 1 Orbiting Vehicle = 2 Earth Center = 3 Earth Target Input LAT ( $\pm 90$ ) LON ( $\pm 180$ , + = East) ALT (-3444.0 to 20000.0 nm) = 4 Sun Center = 5 Celestial Target Input RA (0-359.99) DEC ( $\pm 90$ ) = 11-110 Nav Stars
BODY VECTOR = 1 +X* = 2 -X* = 3 -Z* = 4 -Y Star Tracker* = 5 Selectable Input P (0-359.99) Y (270-359.99, 0-90) *Input OM $\rightarrow$ OM (0-359.99)
MON AXIS = 1 +X = 2 -X

**STS-123 DAP A1 -- A8 CONFIGURATIONS**

	ITEM #	A1	A2	A3	A4	A5	A6	A7	A8
<b>PRI</b>									
ROT RATE	10 (50)	0.2000	0.4000	0.2000	0.5000	0.2000	0.2000	0.2000	0.0500
ATT DB	11 (51)	5.00	1.00	0.30	3.00	5.00	5.00	2.00	2.00
RATE DB	12 (52)	0.20	0.20	0.20	0.20	0.20	0.20	0.20	0.20
ROT PLS	13 (53)	0.100	0.100	0.100	0.100	0.100	0.100	0.100	0.100
COMP	14 (54)	.000	.000	.000	.000	.000	.000	.000	.000
P OPTION	15 (55)	ALL	ALL	ALL	ALL	ALL	TAIL	ALL	ALL
Y OPTION	16 (56)	ALL	ALL	TAIL	ALL	ALL	TAIL	ALL	ALL
TRAN PLS	17 (57)	0.100	0.100	0.100	0.100	0.100	0.100	0.100	0.100
<b>ALT</b>									
RATE DB	18 (58)	0.200	0.200	0.070	0.200	0.070	0.070	0.100	0.100
JET OPT	19 (59)	ALL	ALL	ALL	ALL	ALL	TAIL	ALL	ALL
# JETS	20 (60)	2	2	1	2	1	1	2	2
ON TIME	21 (61)	0.08	0.08	0.08	0.08	0.08	0.08	0.08	0.08
DELAY	22 (62)	0.00	0.00	0.00	0.00	0.00	0.00	0.00	0.00
<b>VERN</b>									
ROT RATE	23 (63)	0.2000	0.4000	0.0080	0.2000	0.0500	0.0500	0.0160	0.0500
ATT DB	24 (64)	1.000	1.000	0.070	1.000	1.000	1.000	1.000	1.000
RATE DB	25 (65)	.020	.020	.010	.020	.020	.020	.020	.020
ROT PLS	26 (66)	0.010	0.010	0.010	0.010	0.010	0.010	0.010	0.050
COMP	27 (67)	.000	.000	.000	.000	.000	.000	.000	.000
CNTL ACC	28 (68)	0	0	0	0	0	0	0	0
PURPOSE		NOMINAL	PTC	GG	PRE/POST DEPLOY	LOSS OF VERN (ALL)	LOSS OF VERN (TAIL ONLY)	RNDZ	TERMINAL PHASE

**BOLD/ITALIC** indicates change from I-Load.

FS 3-4

ORB OPS/123/FIN A

**STS-123 DAP A9 -- A14 CONFIGURATIONS**

	ITEM #	A9	A10	A11	A12	A14
<b>PRI</b>						
ROT RATE	10 (50)	0.1300	0.0500	0.0500	0.0500	0.2000
ATT DB	11 (51)	2.00	0.60	10.00	5.00	5.00
RATE DB	12 (52)	0.10	0.10	0.20	0.20	0.20
ROT PLS	13 (53)	0.100	0.100	0.100	0.040	0.100
COMP	14 (54)	.000	.000	.000	.000	.000
P OPTION	15 (55)	TAIL	TAIL	TAIL	TAIL	TAIL
Y OPTION	16 (56)	TAIL	TAIL	TAIL	TAIL	TAIL
TRAN PLS	17 (57)	0.050	0.050	0.100	0.010	0.100
<b>ALT</b>						
RATE DB	18 (58)	0.100	0.100	0.035 <sup>1</sup>	0.035 <sup>1</sup>	0.200
JET OPT	19 (59)	TAIL	TAIL	TAIL	TAIL	TAIL
# JETS	20 (60)	2	2	<b>1</b>	<b>1</b>	1
ON TIME	21 (61)	0.08	0.08	0.08	0.08	0.08
DELAY	22 (62)	0.00	0.00	<b>6.00</b>	<b>6.00</b>	6.00
<b>VERN</b>						
ROT RATE	23 (63)	0.1300	0.0500	0.1000	0.1000	0.2000
ATT DB	24 (64)	1.000	0.500	5.000	3.000	3.000
RATE DB	25 (65)	.020	.020	.050	.050	.200
ROT PLS	26 (66)	0.050	0.050	0.010	0.002	0.010
COMP	27 (67)	.000	.000	.000	.000	.000
CNTL ACC	28 (68)	0	0	<b>2(3)(4)</b> <sup>2</sup>	<b>2(3)(4)</b> <sup>2</sup>	1
PURPOSE		PROX/OPS FLYAROUND	DOCKING	AUTO REBOOST	MATED STACK (VRCS & ALT) <sup>3</sup>	ORBITER ALONE SRMS/OBSS

**BOLD/ITALIC** indicates change from I-Load.

<sup>1</sup> I-loaded below keyboard limit; do not change

<sup>2</sup> CA2 for no vehicle docked at SM aft  
CA3 for Progress/Soyuz docked at SM aft  
CA4 for ATV docked at SM aft

<sup>3</sup> VRCS for maneuvers and attitude hold

ALT for maneuvers and a maximum 15 min of attitude hold

FS 3-5

ORB OPS/123/FIN A

**STS-123 DAP B1 -- B8 CONFIGURATIONS**

	ITEM #	B1	B2	B3	B4	B5	B6	B7	B8
<b>PRI</b>									
ROT RATE	30 (50)	0.5000	0.2000	0.2000	0.2000	0.2000	0.5000	0.5000	0.0500
ATT DB	31 (51)	3.00	3.00	3.00	0.30	3.00	3.00	2.00	2.00
RATE DB	32 (52)	0.20	0.20	0.20	0.20	0.20	0.20	0.20	0.20
ROT PLS	33 (53)	0.040	0.040	0.040	0.040	0.040	0.040	0.040	0.040
COMP	34 (54)	.000	.000	.000	.000	.000	.000	.000	.000
P OPTION	35 (55)	ALL	TAIL	ALL	TAIL	TAIL	ALL	ALL	ALL
Y OPTION	36 (56)	ALL	TAIL	ALL	TAIL	TAIL	ALL	ALL	ALL
TRAN PLS	37 (57)	0.100	0.020	0.020	0.020	0.020	0.020	0.050	0.050
<b>ALT</b>									
RATE DB	38 (58)	0.200	0.070	0.070	0.100	0.200	0.200	0.100	0.100
JET OPT	39 (59)	ALL	TAIL	ALL	ALL	ALL	ALL	ALL	ALL
# JETS	40 (60)	2	1	1	2	2	2	2	2
ON TIME	41 (61)	0.08	0.08	0.08	0.08	0.08	0.08	0.08	0.08
DELAY	42 (62)	0.00	0.00	0.00	0.00	0.00	0.00	0.00	0.00
<b>VERN</b>									
ROT RATE	43 (63)	0.2000	0.2000	0.2000	0.0080	0.0160	0.2000	0.2000	0.0500
ATT DB	44 (64)	1.000	1.000	1.000	0.100	0.033	1.000	1.000	1.000
RATE DB	45 (65)	.020	.020	.020	.010	.020	.020	.020	.020
ROT PLS	46 (66)	0.002	0.002	0.002	0.002	0.002	0.002	0.002	0.020
COMP	47 (67)	.000	.000	.000	.000	.000	.000	.000	.000
CNTL ACC	48 (68)	0	0	0	0	0	0	0	0
PURPOSE		OMS & RCS Burns (ORB OPS)	Loss of VERN (Tail Only)	Loss of VERN (All)		COAS/HUD CAL		RNDZ	TERMINAL PHASE

**BOLD/ITALIC** indicates change from I-Load.

FS 3-6

ORB OPS/123/FIN A

**STS-123 DAP B9 -- B12 CONFIGURATIONS**

	ITEM #	B9	B10	B12
<b>PRI</b>				
ROT RATE	30 (50)	0.1300	0.0500	0.0500
ATT DB	31 (51)	2.00	0.60	5.00
RATE DB	32 (52)	0.10	0.10	0.20
ROT PLS	33 (53)	0.040	0.040	0.040
COMP	34 (54)	.000	.000	.000
P OPTION	35 (55)	TAIL	TAIL	TAIL
Y OPTION	36 (56)	TAIL	TAIL	TAIL
TRAN PLS	37 (57)	0.010	0.010	0.010
<b>ALT</b>				
RATE DB	38 (58)	0.100	0.100	0.035 <sup>1</sup>
JET OPT	39 (59)	TAIL	TAIL	TAIL
# JETS	40 (60)	2	2	<b>1</b>
ON TIME	41 (61)	0.08	0.08	0.08
DELAY	42 (62)	10.00	0.00	11.04
<b>VERN</b>				
ROT RATE	43 (63)	0.1300	0.0500	0.1000
ATT DB	44 (64)	1.000	0.500	3.000
RATE DB	45 (65)	.020	.020	.050
ROT PLS	46 (66)	0.020	0.020	0.002
COMP	47 (67)	.000	.000	.000
CNTL ACC	48 (68)	0	0	<b>2(3)(4) <sup>2</sup></b>
PURPOSE		PROX OPS/ FLYAROUND	DOCKING	MATED STACK (VRCS & ALT) <sup>3</sup>

**BOLD/ITALIC** indicates change from I-Load.

<sup>1</sup> I-loaded below keyboard limit; do not change

<sup>2</sup> CA2 for no vehicle docked at SM aft  
CA3 for Progress/Soyuz docked at SM aft  
CA4 for ATV docked at SM aft

<sup>3</sup> VRCS for maneuvers and attitude hold  
ALT for attitude hold only

FS 3-7

ORB OPS/123/FIN A



This Page Intentionally Blank





REBOOST/DAP

AUTO REBOOST.....	FS 4-2
ATTITUDE REFERENCE.....	FS 4-4
DOCKED DAP REFERENCE .....	FS 4-5

**REBOOST/  
DAP**

## AUTO REBOOST

### NOTE

Allow 5 min between establishing reboost attitude and reboost start time for DAP accelerations to converge

1. If PRCS required:

O14:F, RJDA 1A L2/R2 DRIVER – OFF  
O15:F, RJD MANF L5/F5/R5 DRIVER – OFF  
O16:F, Pri RJD LOGIC (eight) – ON

√MCC for GO to power up Pri Drivers  
RJD MANF L5/F5/R5 DRIVER – ON  
Pri RJD DRIVER (eight) – ON

2. Select Reboost Configuration

**GNC 20 DAP CONFIG**  
REBOOST CFG – ITEM 8 +\_ EXEC  
INTVL – ITEM 9 +\_ . . . . EXEC

3. Set up Future Reboost

**GNC UNIV PTG**  
DURATION – ITEM 27 +\_ +\_ +\_ . . . . EXEC  
START TIME – ITEM 1 +\_ . . . +\_ . . . +\_ . . . EXEC  
RBST – ITEM 25 EXEC (FUT-\*)

4. Select appropriate Reboost Rotation DAP  
When in attitude and prior to START TIME,  
DAP: A11/AUTO/VERN(ALT)

C3

If using Config 1(2):

**GNC 20 DAP CONFIG**  
Disable X JETS ROT – ITEM 7 EXEC (no \*)

Cont next page

FS 4-2

ORB OPS/123/FIN A

REBOOST/  
DAP

NOTE

Reboost can be aborted with an item 26 on UNIV PTG or by selecting FREE on the DAP

5. Post Reboost Configuration

If using Config 1(2):

**GNC 20 DAP CONFIG**

Enable X JETS ROT – ITEM 7 EXEC (\*)

Return to FLIGHT PLAN Attitude

DAP: as reqd

Pri RJD LOGIC,DRIVER (sixteen) – as reqd

C3  
O14,  
O15,  
O16

# AUTO REBOOST ATTITUDE REFERENCE

## ALT & VRCS ATTITUDE HOLD CONFIGURATIONS:

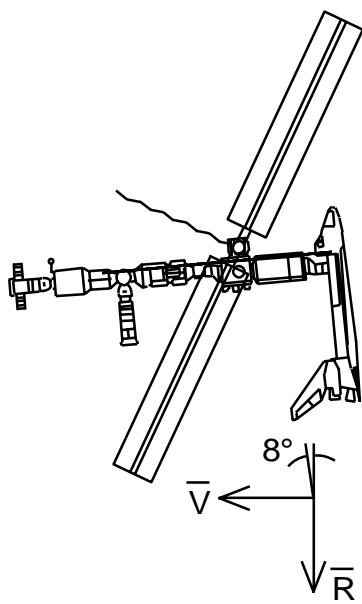

Earth  
Nose up, Configs 1-2 (ALT)

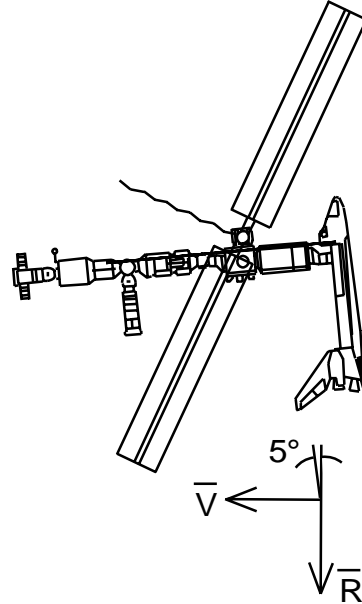

Earth  
Nose up, Configs 3-4 (VRCS)

## DOCKED DAP REFERENCE

The following DAP configurations cover both non-RMS operations and loaded RMS operations

	SHUTTLE AIRLOCK			VERN or ALT
	PRESS ( $\geq 3.45$ psia)			
	VERN	ALT maneuver and short term attitude hold ( $< 15$ minutes)	ALT attitude hold only	
No vehicle docked to SM aft	A12 (or B12) CA: 2	A12 CA: 2 Not certified for loaded RMS ops	B12 CA: 2 Not certified for loaded RMS ops	Not Certified
Progress/ Soyuz docked to SM aft	A12 (or B12) CA: 3	A12 CA: 3 Not certified for loaded RMS ops	B12 CA: 3 Not certified for loaded RMS ops	
ATV docked to SM aft	A12 (or B12) CA: 4	A12 CA: 4 Not certified for loaded RMS ops	B12 CA: 4 Not certified for loaded RMS ops	

CA = CNTL ACC on **GNC 20 DAP CONFIG**

Loaded RMS ops = SLP, JLP, or SPDM

### RATE DAMPING

RATE DAMPING	LVLH(INRTL), when rates are below rate deadband and jet activity stopped, FREE > 2 sec, AUTO
RATE > 0.20	LVLH(INRTL) 6 min max FREE, LVLH(INRTL)

### REBOOST

Configurations 1 & 2 are identical and ALT PRCS only

Configurations 3 & 4 are identical and VRCS only



This Page Intentionally Blank



OIU PROCEDURES

OIU ACTIVATION .....	FS 5-2
DEACTIVATION .....	FS 5-2

OIU





PRLA

PRLA CLOSE..... FS 6-2

**PRLA**

FS 6-1

ORB OPS/123/FIN A



SHORT DURATION BIOASTRONAUTICS  
INVESTIGATION (SDBI)

SDBI 1634, SLEEP-WAKE ACTIGRAPHY .....	FS 7-2
DON ACTIWATCH .....	FS 7-2
DOFF ACTIWATCH .....	FS 7-2
SDBI 1900, INTEGRATED IMMUNE BLOOD COLLECTION .....	FS 7-3
SDBI 1900, SALIVA COLLECTION FOR INTEGRATED IMMUNE .....	FS 7-9

SDBI

**SDBI 1634, SLEEP-WAKE ACTIGRAPHY**

- MA9L A. DON ACTIWATCH (ASAP after entry into orbit)
1. Unstow: Actiwatch  
SLEEP LOGBOOK

NOTE

Actiwatch should be worn on top of non-dominant wrist outside of clothing. Face of Actiwatch should remain uncovered at all times.

If necessary to remove Actiwatch, record doff/don time in SLEEP LOGBOOK

2. Don Actiwatch on non-dominant arm and wear continuously throughout mission
3. Deploy SLEEP LOGBOOK and record required information daily (within 15 min after waking)

B. DOFF ACTIWATCH

NOTE

If mission length extended, continue to wear Actiwatch and complete SLEEP LOGBOOK as timeline permits

- MA9L On final day of orbit:
1. Remove Actiwatch, stow in locker
  2. Recover SLEEP LOGBOOK, stow in locker

SDBI

## **SDBI 1900, INTEGRATED IMMUNE BLOOD COLLECTION**

### OBJECTIVE:

Integrated Immune Assessment (Integrated Immune). The purpose of this procedure is to effectively and safely perform a blood draw, process blood samples, and properly stow them to achieve Integrated Immune Experiment objectives

### PARTS:

Integrated Immune Blood Collection Kit:

- Band-Aid
- Fine Point Sharpie
- Gauze
- Tourniquet
- X-Large Gloves
- Butterfly Needle
- Tube Holder
- Blood Sample Sleeve:
  - Blood 8.5ml ACD (yellow top tube)
  - Blood 10ml EDTA (purple top tube)
- Biocide Wipes
- Biohazard Bag
- Surgical Paper Tape, 1-in
- Sharps Container
- Gray Tape

### WARNING

All consumable items that come in contact with blood must be discarded in Biohazard Bag (provided in kit)

All sharp items (i.e., needles) must be discarded into Sharps Container

### NOTE

Any spilled blood should be cleaned up with Gauze and followed with a Biocide Wipe

Cont next page

FS 7-3

ORB OPS/123/FIN A

A. SETUP FOR BLOOD SAMPLE COLLECTION

NOTE

The lid of the Integrated Immune Blood Collection Kit, when opened, can be used as a workstation on which to temporarily store items via Velcro. Gray Tape can also be used

- PI Locker
1. If desired for temporary stowage of supplies during blood draw, deploy about 12-inch piece of Gray Tape near location of blood draw
  2. Deploy hardware near area where activity will be performed:  
Integrated Immune Blood Collection Kit:  
Band-Aid  
Fine Point Sharpie  
Gauze (1 package)  
Tourniquet  
Butterfly Needle (1)  
Tube Holder  
Blood Sample Sleeve (open sleeve and loosen tubes)  
Biocide Wipes  
Surgical Paper Tape, 1-in  
Sharps Container  
Biohazard Bag  
X-Large Gloves
- MD Floor  
STBD 2 –  
Bag D
3. Place Biohazard Bag in convenient location for trash disposal

B. PERFORM BLOOD SAMPLE COLLECTION

1. Retrieve Butterfly Needle (1) and remove from package. Place package in the Biohazard Bag and temporarily store

Cont next page

FS 7-4

ORB OPS/123/FIN A

2. Retrieve Tube Holder  
Screw Tube Holder onto threaded end of  
Butterfly Needle  
Temp stow Butterfly Needle/Tube Holder
3. Retrieve Gauze, open package but do not  
remove Gauze, temp stow Gauze package
4. Retrieve Tourniquet from Integrated Immune  
Blood Collection Kit  
Apply Tourniquet to subject's arm  
Using fingers find vein and select puncture site

<p><b><u>WARNING</u></b> Operator must don X-Large Gloves prior to needle insertion and observe Universal Precautions for Handling Biohazardous Materials</p>
---

5. Retrieve and don X-Large Gloves  
Retrieve and open Biocide Wipe, placing empty  
package in Biohazard Bag  
Cleanse area with Biocide Wipe  
Place used Biocide Wipe in Biohazard Bag
6. Retrieve Butterfly Needle/Tube Holder from temp  
stow  
Remove protective cover from Butterfly  
Needle/Tube Holder. Place cover in Biohazard  
Bag

<p><b><u>CAUTION</u></b> Blood tubes must be inspected for cracks. If cracked, tubes should be discarded in the Biohazard Bag</p>
---

7. Retrieve:  
Blood Sample Sleeve  
Surgical Paper Tape, 1-in

Cont next page

WARNING

Insert needle at 30 degree angle to vein to ensure proper blood flow and avoid injury

Avoid shifting needle from side to side after entering vein

NOTE

Taping of central portion of needle tubing to subject's arm is to prevent excessive movement during blood draw. Only tape tubing after needle is properly inserted in vein

8. Insert Butterfly Needle in subject's arm with bevel up. When the needle is properly inserted in the vein a flash of blood will be observed in butterfly tubing

Using strips of 1-in Surgical Paper Tape as necessary, tape central portion of Butterfly Needle tubing to subject's arm

Blood  
Sample  
Sleeve

9. Retrieve subject's empty Blood 8.5ml ACD (yellow top blood tube)

NOTE

Allow 10 sec to ensure the tube vacuum draws the appropriate volume of blood

10. Verify a flash of blood in butterfly tubing
11. Firmly push the blood tube into Tube Holder to puncture tube cap and initiate blood flow
12. When filled, detach blood tube from Tube Holder
13. Gently agitate tube for blood to mix with reagent for ~5 sec

Cont next page

FS 7-6

ORB OPS/123/FIN A



- ┌ | | | ┌
- Blood Sample Sleeve
14. Temp stow filled blood tube in Blood Sample Sleeve
  15. Retrieve Blood 10.5ml EDTA tube (purple top) and repeat steps 11 thru 14 for the second tube
  16. Loosen Tourniquet
  17. Retrieve Gauze from temp stow
  18. Hold Gauze to venipuncture site while simultaneously grasping wings of Butterfly Needle and removing it at same angle of insertion, applying gentle pressure to Gauze
- Have subject hold Gauze on venipuncture site for 2-5 min
- If taped, remove tape from arm and dispose
- Slide safety shield over Butterfly Needle by holding yellow sheath and pulling wings backward

NOTE

Do not discard tube holder

19. Carefully unscrew Tube Holder from Butterfly Needle; temp stow
20. Discard used Butterfly Needle (with sharp edges facing down) in Sharps Container
21. Remove Tourniquet and stow in Integrated Immune Blood Collection Kit

Cont next page

FS 7-7

ORB OPS/123/FIN A

└ | | | └

22. Keep Gauze on venipuncture site for pressure bandage  
Place Band-Aid over folded Gauze  
Discard any excess Gauze and Band-Aid wrapper in Biohazard Bag
  23. Retrieve filled blood tubes from Blood Sample Sleeve and label both tubes with crewmember name and GMT (e.g., Smith: GMT 168:19:48)
  24. Stow blood tubes back in Blood Sample Sleeve and temp stow
  25. Discard X-Large Gloves in Biohazard Bag
- Dispose of any remaining Biocide Wipes, Gauze, Gray Tape, or empty packaging used in the activity

C. STOW HARDWARE

1. Remove full Biohazard Bag, close with Gray Tape  
Discard full Biohazard Bag in appropriate disposal location
2. Stow in Integrated Immune Blood Collection Kit:  
Blood Sample Sleeve with blood samples  
Sharps Container (bottom first into pouch)  
Biocide Wipes (if any)  
Gauze (if any)  
Surgical Paper Tape, 1-in  
Fine Point Sharpie  
Tube Holder  
Remaining Band-Aid packages (if any)
3. Stow:  
Integrated Immune Blood Collection Kit  
Put away Gray Tape per crew preference

MD Floor  
STBD 2 –  
Bag D

**SDBI 1900, SALIVA COLLECTION FOR INTEGRATED IMMUNE**

OBJECTIVE:

Integrated Immune Assessment (Integrated Immune). The purpose of this procedure is to effectively perform saliva collection to achieve Integrated Immune Experiment objectives

PARTS:

- Integrated Immune Saliva Collection Kit:  
Salivette Bag (package with cotton swabs)  
Saliva Sample Preservative Bag  
Label  
Saliva Collection Dry Booklet  
Saliva Sample Return Pouch  
Fine Point Sharpie

A. SETUP FOR SALIVA SAMPLE COLLECTION

NOTE

Any Saliva Sample Return Pouch (labeled USED and does not have crewmember data filled in) located in the Integrated Immune Saliva Collection Kit will suffice for this step

- MD Floor  
STBD 2 –  
Bag D
1. Unstow:  
Integrated Immune Saliva Collection Kit:  
Fine Point Sharpie  
Label from plastic window of Saliva Sample Return Pouch
  2. Write crewmember name on label using Fine Point Sharpie  
Return label to plastic window it was taken from  
Temp stow Fine Point Sharpie

Cont next page

FS 7-9

ORB OPS/123/FIN A

B. PERFORM LIQUID SALIVA SAMPLE COLLECTION

NOTE

Liquid saliva should be collected immediately post-sleep (before brushing teeth, before breakfast, and before any liquid intake)

1. Retrieve from Integrated Immune Saliva Collection Kit:  
Salivette Bag  
Saliva Sample Preservative Bag
2. Temp stow Saliva Sample Preservative Bag

NOTE

Touching the Cotton Swab with fingers at any point of the data collection will contaminate the sample

3. Open Salivette Bag and by kneading and manipulating the outside of package, separate one Cotton Swab from the others and move it towards the opening of the package
4. Place Salivette Bag with Cotton Swab near mouth and then transfer Cotton Swab from package into mouth. Lightly roll Cotton Swab around mouth with tongue until saturated (2 min max). Do not bite down or chew on Cotton Swab
5. Stow Salivette Bag with remaining Cotton Swab in Integrated Immune Saliva Collection Kit
6. Retrieve Saliva Sample Preservative Bag from temp stow
7. Using mouth, place Cotton Swab in Saliva Sample Preservative Bag

Cont next page

8. Close seal on Saliva Sample Preservative Bag

NOTE

Ensure bag is sealed prior  
to mixing preservative

9. Remove clamp, mix preservative with Cotton Swab
10. Reclamp across top of Saliva Sample Preservative Bag
11. Using Fine Point Sharpie, write crewmember name and GMT on Saliva Sample Preservative Bag (e.g., Smith: GMT 168:19:48)
12. Stow sample in Saliva Sample Return Pouch (labeled with crewmember name in part A step 2) inside Integrated Immune Saliva Collection Kit

C. PERFORM DRY SALIVA COLLECTION

NOTE

First sample should be taken as  
soon after waking as is convenient

1. Retrieve from Integrated Immune Saliva Collection Kit:  
Dry Saliva Collection Book
2. Write crewmember name in name section on cover of Dry Saliva Collection Book
3. Open cover  
Select (but do not remove from book) the corresponding sheet of filter paper to the time period sample is being taken (WAKE, WAKE + 30 MINUTES, WAKE + SIX HOURS, WAKE + TEN HOURS, RETIRE) as illustrated on the cover

Label GMT on corresponding color and time period on cover

Cont next page

NOTE

Take care not to touch other collection time's filter papers when using Dry Saliva Collection Book

4. Place filter paper in mouth and saturate filter paper with saliva

NOTE

Do not touch saturated part of filter paper while drying. Filter paper does not have to be 100% dry before stowing/temp stowing. Use crew discretion

5. Remove filter paper from mouth. Wipe excess liquid saliva from filter paper with lips  
Allow to air dry
6. Temp stow Dry Saliva Collection Book or maintain on person if desired
7. For subsequent collections, retrieve Dry Saliva Collection Book from temp stow and repeat steps 3 thru 6 four times throughout the day that correspond to the remaining four time intervals from wake period
8. After collecting last dry saliva sample, open Saliva Sample Return Pouch (labeled with crew ID) inside Integrated Immune Collection Kit and stow Dry Saliva Collection Book inside Saliva Sample Return Pouch

D. STOW HARDWARE

MD Floor  
STBD 2 –  
Bag D

1. Stow: Integrated Immune Saliva Collection Kit

WING LEADING EDGE SENSORS (WLES) PROCEDURES

WLES ACTIVATION AND CHECKOUT.....	FS 8-2
DEACTIVATION AND TEARDOWN.....	FS 8-10
LAPTOP RECEIVER UNIT (LRU) R&R.....	FS 8-12
CONFIGURE WLES DATA FILE BACKUP PATH.....	FS 8-14
PREP WLES LAPTOPS FOR TRANSFER.....	FS 8-15
WLES RNDZ TOOLS CHECKOUT PREP.....	FS 8-16
DOCK/UNDOCK RECOVERY.....	FS 8-16
DISABLE WLES FILE BACKUP .....	FS 8-17
ENABLE WLES FILE BACKUP .....	FS 8-17

**WLE  
SENSORS**

## WLES ACTIVATION AND CHECKOUT

### 1. UNSTOW EQUIPMENT

#### NOTE

A31p laptops may already be unstowed as part of orbiter laptop network setup

LW MAR

Unstow:

Laptop Receiver Units (2)

Cabin Relay Units (2):

CRU A (S/N 1920)

CRU B (S/N 1984)

STS-7 A31p laptop (WLES)

STS-6 A31p laptop (RPOP2)

### 2. SETUP WLES RELAY UNITS

#### CAUTION

Cross-connecting CRU A to MICRO WIS SYSTEM B (and vice versa) will prevent WLES ops, though step 8 would still show good comm

#### NOTE

Green patch on Cabin Relay Unit is antenna and must face into cabin

- |              |   |
|--------------|---|
| A6           | Unstow coiled WLE SYSTEM A cable  |
| A13          | Connect plug PNL A13 SYSTEM A to jack MICRO WIS SYSTEM A J7 (see fig 8-1) |
| CRU A        | Connect plug CABIN RELAY UNIT to J1 on CRU S/N 1920                       |
| STBD<br>OVHD | Secure CRU A to STBD side of aft cabin with Velcro (see fig 8-2)          |
| A9           | Unstow coiled WLE SYSTEM B cable  |
| A13          | Connect plug PNL A13 SYSTEM B to jack MICRO WIS SYSTEM B J8 (see fig 8-1) |
| CRU B        | Connect plug CABIN RELAY UNIT to J1 on CRU S/N 1984                       |
| PORT<br>OVHD | Secure CRU B to PORT side of aft cabin with Velcro (see fig 8-3)          |

Cont next page



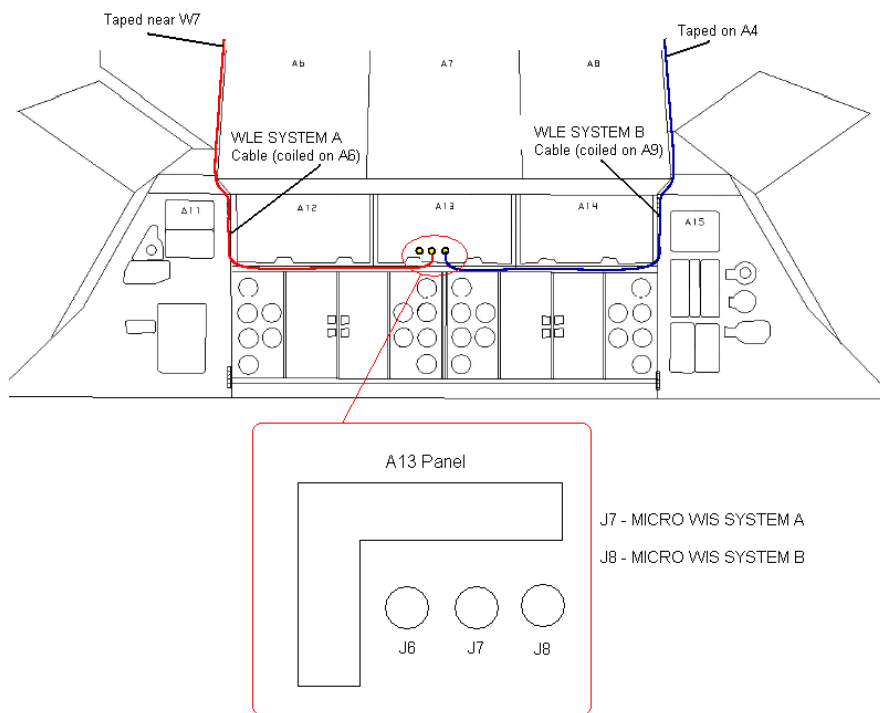

Figure 8-1.- A13 panel.

Cont next page

FS 8-3

ORB OPS/123/FIN A

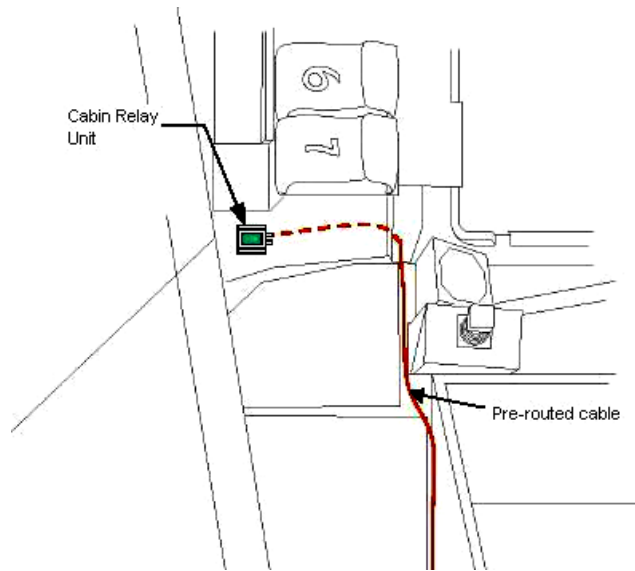

Figure 8-2.- Aft STBD location.

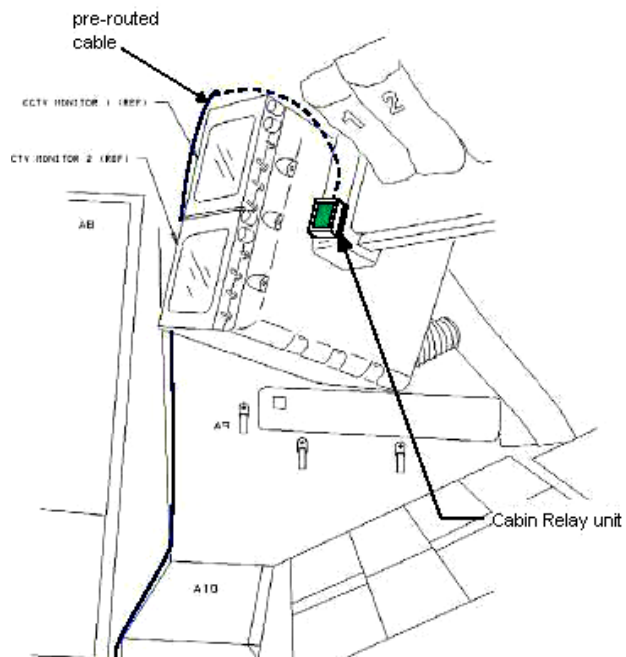

Figure 8-3.- Aft PORT location.

Cont next page

NOTE

Laptops may be powered or unpowered.  
Laptops may be connected to network or standalone

- A31p
3. SETUP PRIME WLES LAPTOP  
Secure Laptop Receiver Unit to A31p with Velcro (see fig 8-4)  
Connect Laptop Receiver Unit to A31p Serial port using thumbscrews (see fig 8-5)  
Verify line of sight between Laptop Receiver Unit and both CRUs  
Verify 5-in minimum distance between Laptop Receiver Unit and both CRUs
  4. SETUP BACKUP WLES LAPTOP

NOTE

Single laptop ops are preferred over delays in activation. If problems with Backup Laptop occur, skip step 4

Secure Laptop Receiver Unit to A31p with Velcro (see fig 8-4)  
Connect Laptop Receiver Unit to A31p Serial port using thumbscrews (see fig 8-5)  
Verify line of sight between Laptop Receiver Unit and both CRUs  
Verify 5-in minimum distance between Laptop Receiver Unit and both CRUs

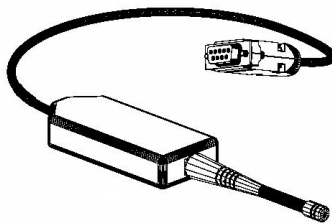

Figure 8-4.- Laptop Receiver Unit.

Cont next page

FS 8-5

ORB OPS/123/FIN A



Figure 8-5.- A31p ports.

5. LAUNCH WLES SOFTWARE

Perform for both laptops:

If laptops are off, A31p pwr – On

Double click the time in system tray (lower-right corner)

'Date and Time Properties'

'Time Zone'

Time zone – (GMT) Greenwich Mean Time

Click 'OK'

Double click 'Shuttle Apps'>'WLES'

'Backup Mode Selection'

If setting up one A31p, select 'Standard'

|

If setting up two A31p laptops:

For prime laptop, select 'Primary'

For backup laptop, select 'Secondary'

NOTE

The secondary laptop lid may be closed at this time, if no longer needed for other applications. The laptops are configured so that they do not enter 'standby' or 'hibernate' mode when the lids are closed. However, due to cooling concerns, fully closing the lid is not recommended

Cont next page

FS 8-6

ORB OPS/123/FIN A

A31p

6. VERIFY LRU INSTALLATION

Use prime WLES laptop

'Enhanced Wideband MicroTAU – WLEFlight 2.2'

Click 'System Settings' (left side of display)

'Communications Settings'

√RF Receiver Port: 'COM 1'

Click 'Query Receiver'

Verify 'Receiver found on COM1' message appears

7. ENABLE DATA FILE BACKUP

Use prime WLES laptop

'System Settings'

'Directories'

At the line 'Backup Directory:' click 'Browse...' (right side of display)

'Browse for Folder'

Navigate to WLES folder on RPOP2:

'My Computer'>'C on RPOP2 (S:)'>'Program Files'>'Invocon'>'EWBMTAU-WLEFlight'

Click 'OK'

Verify 'Backup Directory:' set to:

'S:\Program Files\Invocon\EWBMTAU-WLEFlight'

'Backup Interval'

Using drop-down list, select '30 minutes'

Cont next page

FS 8-7

ORB OPS/123/FIN A

8. VERIFY COMM WITH RELAY UNITS

Use prime WLES laptop

'Main'

Click 'Unit List' (left side of display)

NOTE

Each Cabin Relay Unit is identified with a unique serial number; this number appears as 'Unit ID' in the software

√Cabin Relay Units Unit ID 1920 and 1984 (2) present on display in first column; scroll down as necessary

For each Cabin Relay Unit:

√Unit ID present

√Type: 'Relay-GL'

√Last Update: time is updating (every 5 to 15 sec)

- \* If one CRU time updates: \*
- \* | Continue procedure \*
- \* | Report off-nominal CRU status in step 10 \*
- \* | \*
- \* If neither CRU time updates after 2 min, \*
- \* contact MCC-H \*

√Via: 'RF'

√Mode: 'Idle'

9. INITIATE COMMANDING

NOTE

The first time a user navigates to 'Program Files' folder, display may show information saying the program files are hidden. To view the contents of the folder, select 'display files' in the left-hand portion of the Windows Explorer window

Using Windows Explorer, navigate to  
'My Computer'>'C:'>'Program Files'>  
'Invocon'>'EWBMTAU-WLEFlight'>'Data'

Cont next page

In a second Windows Explorer window, navigate to  
'My Computer'>'C:'>'Program Files'>  
'Invocon'>'EWBMTAU-WLEFlight'>'Command'

NOTE

Deleting 'BLOCK.xml' file initiates command execution. Command files disappear from this folder as they are executed.

Files appearing in the 'Data' folder verifies two-way communication with the Sensor Units in the orbiter wing

'Command'

Delete file labeled 'BLOCK.xml'

At prompt "Are you sure you want to send 'Block.xml' to the Recycle Bin?", click 'Yes'

Wait 1 minute

Verify the first data file appears in the 'Data' folder

Close 'Command' and 'Data' folders

10. REPORT WLES STATUS

Notify MCC-H: "WLES setup complete"

If reporting off-nominal CRU status, include:

Unit ID

Type

Last Update (updating or static)

Via

Mode

NOTE

The laptop lid may be closed at this time, if no longer needed for other applications. The laptops are configured so that they do not enter 'standby' or 'hibernate' mode when the lids are closed. However, due to cooling concerns, fully closing the lid is not recommended

## WLES DEACTIVATION AND TEARDOWN

- A31p 1. DEACTIVATE WLES SENSORS LAPTOP  
'Enhanced Wideband MicroTAU – WLEFlight 2.2'

For each WLES A31p:

Click 'Exit'

At prompt 'Are you sure you want to exit?'

click 'Yes'

Click 'Start' > 'Turn Off Computer...' > 'Turn Off'

Disconnect Laptop Receiver Unit from A31p

Serial port

Remove Laptop Receiver Unit from Velcro on  
A31p

2. REMOVE WLES RELAY UNITS  
Remove Cabin Relay Units (2) from aft cabin (see  
figs 8-6 and 8-7)  
Disconnect Cabin Relay Units from pre-routed  
cables  
Disconnect and coil cables, stow in launch location

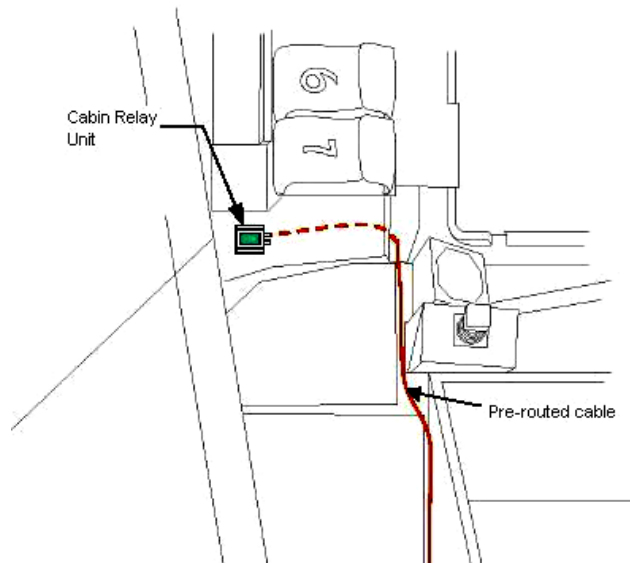

Figure 8-6.- Aft STBD location.

Cont next page

FS 8-10

ORB OPS/123/FIN A



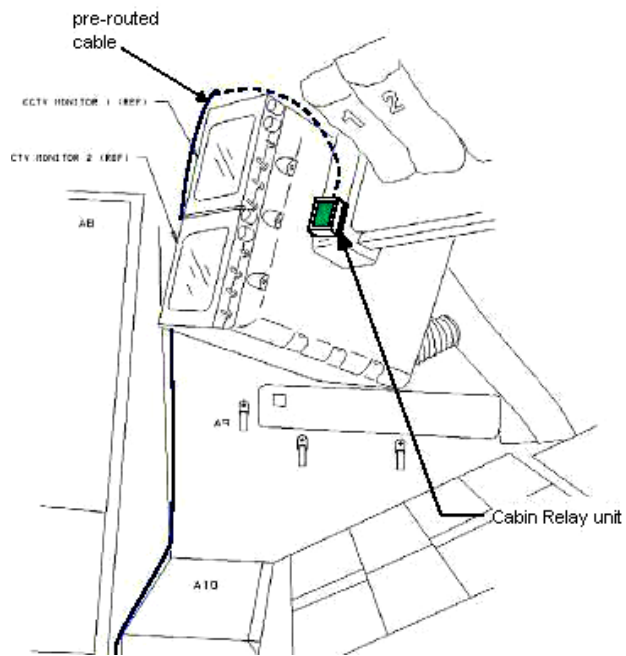

Figure 8-7.- Aft PORT location.

- LW MAR
3. STOW EQUIPMENT  
 Stow:  
     Laptop Receiver Units (2)  
     Cabin Relay Units (2)  
 Notify MCC-H: "WLES Teardown Complete"

## WLES LAPTOP RECEIVER UNIT (LRU) R&R

- A31p 1. DISCONNECT BACKUP LRU FROM LAPTOP  
'Enhanced Wideband MicroTAU – WLEFlight 2.2'

Click 'Exit'  
At prompt 'Are you sure you want to exit?'  
click 'Yes'

Disconnect Backup LRU from Backup A31p Serial  
port (see fig 8-8)  
Remove Backup LRU from Velcro on Backup A31p  
(see fig 8-9)



Figure 8-8.- A31p ports.

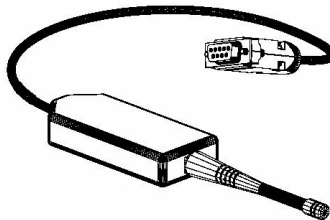

Figure 8-9.- Laptop Receiver Unit.

2. DISCONNECT PRIME LRU FROM LAPTOP  
Disconnect Prime LRU from Prime A31p Serial port  
(see fig 8-8)  
Remove LRU from Velcro on A31p

Cont next page

FS 8-12

ORB OPS/123/FIN A

3. CONNECT BACKUP LRU  
Connect Backup LRU to Prime WLES A31p Serial port  
Secure LRU to A31p with Velcro
- A31p
4. VERIFY LRU INSTALLATION  
Use prime WLES laptop
- ‘Enhanced Wideband MicroTAU – WLEFlight 2.2’  
Click ‘System Settings’ (left side of display)
- ‘Communications Settings’  
√RF Receiver Port: ‘COM 1’
- Click ‘Query Receiver’  
Verify ‘Receiver found on COM1’ message appears
5. VERIFY COMM WITH RELAY UNITS  
Click ‘Unit List’ (left side of display)  
√Cabin Relay Units Unit ID 1920 and 1984 (2) present on display in first column; scroll down as necessary  
For each Cabin Relay Unit:  
√Unit ID present  
√Type: ‘Relay-GL’  
√Last Update: time is updating (every 5 to 15 sec)  
√Via: ‘RF’  
√Mode: ‘Idle’
- If no time updates after 2 min, contact MCC-H
- Click ‘Unit List’ (left side of display)  
Notify MCC-H: “WLES LRU R&R complete”, mark failed LRU as ‘failed’
- LW MAR
6. STOW EQUIPMENT  
Stow:  
Prime (failed) LRU

## CONFIGURE WLES DATA FILE BACKUP PATH

### NOTE

MCC will identify new backup WLES laptop to be used in place of RPOP2 (S:)

A31p

Use prime WLES laptop

'Enhanced Wideband MicroTAU – WLEFlight 2.2'  
Click 'System Settings' (left side of display)

'Directories'  
At the line 'Backup Directory:' click 'Browse...' (right side of display)

'Browse for Folder'  
Navigate to WLES folder on RPOP2:  
'My Computer'>'C on RPOP2 (S:)'>'Program Files'>'Invocon'>'EWBMTAU-WLEFlight'

Click 'OK'

Verify 'Backup Directory:' set to:  
'S:\Program Files\Invocon\EWBMTAU-WLEFlight'

'Backup Interval'  
Verify interval is set for 30 minutes

Click 'Unit List' (left side of display)

## PREP WLES LAPTOPS FOR TRANSFER

- A31p 1. DEACTIVATE WLES LAPTOP(S)  
'Enhanced Wideband MicroTAU – WLEFlight 2.2'

For each WLES A31p to be transferred:

Click 'Exit'

At prompt 'Are you sure you want to exit?'

click 'Yes'

Click 'Start'>'Turn Off Computer... '>'Turn Off'

Disconnect Laptop Receiver Unit from A31p

Serial port

Remove Laptop Receiver Unit from Velcro on  
A31p

2. SET UP NEW WLES LAPTOPS

√MCC-H for which laptop to use

Perform WLES ACTIVATION AND CHECKOUT,  
steps 3 thru 8, then:

Notify MCC-H: "PREP WLES LAPTOPS FOR  
TRANSFER complete"

## WLES RNDZ TOOLS CHECKOUT PREP

- A31p
1. DEACTIVATE BACKUP WLES LAPTOP  
On backup WLES laptop:  
    'Enhanced Wideband MicroTAU – WLEFlight 2.2'  
    Click 'Exit'  
    At prompt 'Are you sure you want to exit?'  
    click 'Yes'  
    Disconnect Laptop Receiver Unit from A31p  
    Serial port  
    Leave attached to laptop with Velcro on A31p
  2. DEACTIVATE WLES FILE BACKUP  
On prime WLES laptop:  
    'Enhanced Wideband MicroTAU – WLEFlight 2.2'  
    Click 'System Settings' (left side of display)  
  
    'Backup Mode'  
    Click 'Standard'  
    Click 'Unit List' (left side of display)

## WLES DOCK/UNDOCK RECOVERY

- A31p
1. RECOVER BACKUP WLES LAPTOP  
On backup WLES laptop:  
    Connect Laptop Receiver Unit to A31p Serial port  
    If laptop is off, A31p pwr – On  
    Double click 'Shuttle Apps'>'WLES'  
  
    'Backup Mode Selection'  
    Click 'Secondary'  
  
    Click 'System Settings' (left side of display)  
  
    'Communications Settings'  
    √RF Receiver Port: 'COM 1'  
  
    Click 'Query Receiver'  
    Verify 'Receiver found on COM1' message  
    appears  
    Click 'Unit List' (left side of display)

Cont next page

2. REACTIVATE WLES FILE BACKUP

On prime WLES laptop:

'Enhanced Wideband MicroTAU – WLEFlight 2.2'  
Click 'System Settings' (left side of display)

'Backup Mode'  
Click 'Primary'  
Click 'Unit List' (left side of display)

**DISABLE WLES FILE BACKUP**

A31p On prime WLES laptop:

'Enhanced Wideband MicroTAU – WLEFlight 2.2'  
Click 'System Settings' (left side of display)

'Backup Mode'  
Click 'Standard'  
Click 'Unit List' (left side of display)

**ENABLE WLES FILE BACKUP**

A31p On prime WLES laptop:

'Enhanced Wideband MicroTAU – WLEFlight 2.2'  
Click 'System Settings' (left side of display)

'Backup Mode'  
Click 'Primary'  
Click 'Unit List' (left side of display)



This Page Intentionally Blank

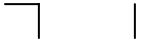



MAUI ANALYSIS OF UPPER-ATMOSPHERIC  
INJECTIONS (MAUI)

MAUI PROCEDURE ..... FS 9-2

**MAUI**

FS 9-1

ORB OPS/123/FIN A

MAUI

## MAUI PROCEDURE

- 15:00 or earlier 1. MANEUVER TO START ATTITUDE  
(BIASED +ZLV +YVV)

Deploy MAUI – RCS FIRING SEQUENCE  
(Cue Card)

GNC 20 DAP CONFIG

√DAP A1, B1 loaded

UNIV PTG

TGT ID – ITEM 8 +2 EXEC  
BODY VECT – ITEM 14 +5 EXEC  
P – ITEM 15 +2 7 0 EXEC  
Y – ITEM 16 +3 5 0 EXEC  
OM – ITEM 17 +2 7 0 EXEC

TRK – ITEM 19 EXEC (CUR - \*)

2. INITIATE TIMER

√MCC for start time

GNC 2 TIME

Set count down/count up timer per MCC

√MET – ITEM 2 EXEC (\*)

CRT TIMER COUNT TO – ITEM 17 +    +    +    EXEC

3. SETUP

O14:E, cb DDU L (two) – cl  
O15:E

O14:F, Pri RJD LOGIC, DRIVER (sixteen) – ON  
O15:F,  
O16:F

GNC 20 DAP CONFIG

DAP A PRI P OPTION – ITEM 15 EXEC (NOSE)  
ROT PLS – ITEM 13 +1.0 0 0 EXEC  
TRAN PLS – ITEM 17 +0.7 3 EXEC  
VERN ROT PLS – ITEM 26 +0.1 5 3 EXEC

Cont next page

**GNC 23 RCS**

Deselect Jets:

Forward RCS page – ITEM 1 EXEC

JET DES F1D – ITEM 23 EXEC (\*)

F2D – ITEM 27 EXEC (\*)

C3     √DAP: A/AUTO/VERN  
          √DAP TRANS: PULSE/PULSE/PULSE  
          DAP ROT: PULSE/PULSE/PULSE

-05:00   4. VERIFY ATTITUDE  
          Verify in attitude

NOTE

For the following RCS firing sequence  
(step 5):

- A. Expect total orbiter body rates  
(RSS) to exceed 1 deg/sec
- B. Possible loss of comm due to orbiter  
body rates and attitude excursions
- C. For any jet fail OFF, continue with  
firing sequence
- D. Requirement is for a particular jet  
group, not a specific jet
- E. The table in step 5 is also provided  
as a cue card

Cont next page

FS 9-3

ORB OPS/123/FIN A

## 5. RCS FIRING SEQUENCE

### NOTE

Use the table below or the cue card

#### MAUI – RCS FIRING SEQUENCE

Timer	Jets Fired	CDR	PLT
-03:00		Body rates: $+0.047 \leq \text{roll} \leq +0.087$ $-0.020 \leq \text{pitch} \leq +0.020$ $-0.020 \leq \text{yaw} \leq +0.020$ DAP: FREE DAP: A/PRI  Inform PLT "GO" for jet deselection	Configure initial setup GNC 23 RCS Left RCS page – ITEM 2 EXEC  On CDR "GO", proceed  <u>NOTE</u> Expect DAP RECONF msgs in following actions  Deselect jets: JET DES L5L – ITEM 37 EXEC (*) Right RCS page – ITEM 3 EXEC JET DES R5D – ITEM 39 EXEC (*) Forward RCS page – ITEM 1 EXEC JET DES F5L – ITEM 37 EXEC (*)  <u>NOTE</u> Queue the following ITEM entry on the scratch pad. Do not perform the EXEC until specified at 35 sec  JET DES F3D – ITEM 25
-00:30		FLT CNTRL PWR – ON	
00:00	RXA, LXA	THC +X (in) (3 sec firing)	
00:15	FXL, LXL	THC +Y (right) (3 sec firing)	
00:30	FXR, RXR	THC -Y (left) (3 sec firing)	
00:35			When jets stop firing: GNC 23 RCS EXEC [JET DES F3D – ITEM 25 (*)]
00:45	F4D	RHC +pitch (Past Soft Stop, hold 3 sec)	
00:48		RHC release	
00:50			DAP: VERN
01:00	R5R	RHC +yaw (10 sec firing)	
01:20	L5D	RHC -pitch (12 sec firing)	
01:40	F5R	RHC +pitch (12 sec firing)	
		FLT CNTRL PWR – OFF	Return to MAUI PROCEDURE, step 6, (ORB OPS FS, MAUI)

Cont next page

FS 9-4

ORB OPS/123/FIN A

6. CLEANUP  
F6 √FLT CNTRL PWR – OFF

GNC 23 RCS

√Forward RCS page – ITEM 1 EXEC

Reselect Jets:

JET DES F1D – ITEM 23 EXEC (no \*)  
F3D – ITEM 25 EXEC (no \*)  
F2D – ITEM 27 EXEC (no \*)  
F5L – ITEM 37 EXEC (no \*)

Left RCS page – ITEM 2 EXEC  
JET DES L5L – ITEM 37 EXEC (no \*)

Right RCS page – ITEM 3 EXEC  
JET DES R5D – ITEM 39 EXEC (no \*)

GNC 20 DAP CONFIG

DAP A1 – ITEM 1 + 1 EXEC

7. SNAP LVLH ATTITUDE AND NULL RATES

When time  $\geq$  +03:30:

DAP: A/PRI  
DAP: LVLH

When rates stable:

DAP: VERN

Return to FLT PLN attitude

8. RECONFIGURE TO GROUP B POWERDOWN

√MCC

O14:E,   cb DDU L (two) – op  
O15:E

O14:F,   Pri RJD LOGIC,DRIVER (sixteen) – OFF  
O15:F,   RJDA 1A L2/R2 MANF DRIVER – ON  
O16:F



This Page Intentionally Blank



CARBON DIOXIDE MONITORING (CDM) DEVELOPMENT  
TEST OBJECTIVE (DTO) PROCEDURES

CDM SETUP AND BATTERY CHANGEOUT .....	FS 10-2
ACTIVATION .....	FS 10-7
DEACTIVATION .....	FS 10-7
DTO COMPLETION.....	FS 10-8

**CDM**  
**DTO**

## CDM SETUP AND BATTERY CHANGEOUT

### NOTE

CDM will emit a short beep once every 15 sec to indicate a low battery condition. Kapton tape over the alarm outlet will muffle the sound

Due to battery life concerns, limit CDM use to specified DTO periods only

Stored data is maintained for a max of 30 min without battery installed. All data will be lost if battery installation delayed more than 30 min

CDM  
DTO

- |       |   |
|-------|---|
| MA9L  | 1. Unstow:<br>CDM (for initial setup only)<br>Clean Filter Assy (for initial setup only)<br>New Batt Pack |
| MF57G | CDM Cue Card in Middeck Cue Card Kit (for initial setup only)<br>Sharpie                                  |
2. If initial use of CDM:  
Verify speaker outlet on bottom of CDM is covered with Kapton tape as shown  
Attach Velcro tether  
Mate Filter Assy to CDM QD  
Attach cue card to CDM



MODE pb

Alarm speaker outlet w/ Kapton tape

Cont next page

FS 10-2

ORB OPS/123/FIN A



3. If CDM activated, deactivate:  
Press, hold MODE pb until 'RELEASE' displayed
4. √CDM – OFF
5. Turn fasteners (two) on back panel ¼ turn ccw
6. Remove, temp stow back panel
7. Grasp Batt Pack pull tab, remove pack
8. For initial battery changeout, mark old Batt Pack as "SPARE". Mark all Batt Packs on subsequent changeouts as "DISCHARGED"
9. Install replacement Batt Pack, press firmly to seat electrodes
10. Replace back panel, press firmly, turn fasteners (two) ¼ turn cw to lock
11. Press, hold MODE pb until 'RELEASE' displayed
12. Wait ~1 min while unit runs self-check routine, verify display shows CO2 reading ("x ppm" or "x.xx CO2")
13. Press MODE pb once, until battery status displayed
14. Verify battery status indicates 'OK'
15. Press, hold MODE pb until 'RELEASE' displayed
16. √CDM – OFF

Cont next page

FS 10-3

ORB OPS/123/FIN A

17. Attach CDM to a surface near Attachment Location specified in Flight Plan and check complete. Do not place unit directly in front of air diffusers

Middeck Attachment Location		CK CMPLT
Location 1	Forward Starboard (see fig 10-1)	
Location 2	Aft Starboard (see fig 10-2)	
Location 3	Aft Hatch "ditch" area (see fig 10-3)	
Location 4	Forward Port (see fig 10-4)	
Location 5	Aft Port (see fig 10-4)	

**NOTE**

When taking photo, back away as far as possible so the camera's field of view includes CDM and other equipment in vicinity

18. Record CDM monitoring location using DCS 760 digital camera:  
 Lens – 17-35 mm, zoom to 17 mm  
 Set camera to nominal in-cabin setup  
 If required, perform SETUP, 760 Program w/Flash (PHOTO/TV, DCS 760), then:  
 Record one photo showing location of CDM in relation to surroundings

19. Stow:  
 MA9L Used Batt Pack  
 Sharpie

Cont next page

FS 10-4

ORB OPS/123/FIN A

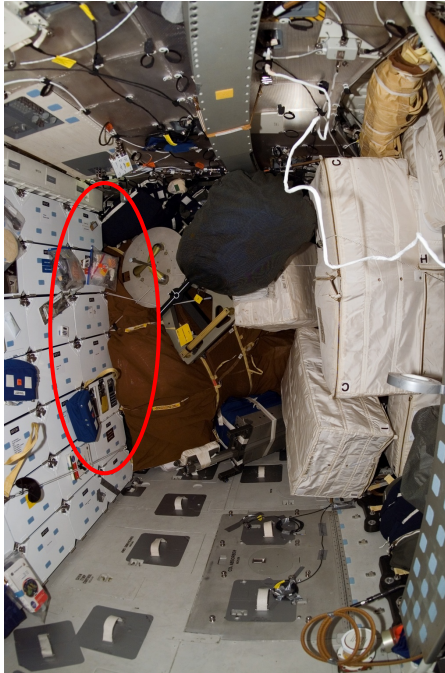

Figure 10-1.- Location 1 – Middeck Forward Starboard.



Figure 10-2.- Location 2 – Middeck Aft Starboard.

Cont next page

FS 10-5

ORB OPS/123/FIN A

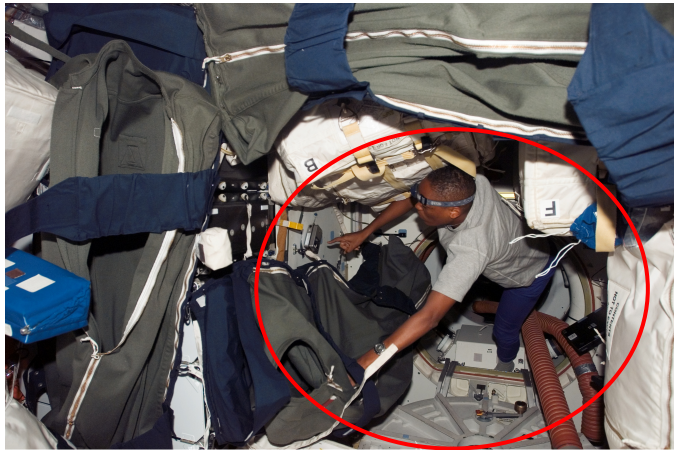

Figure 10-3.- Location 3 – Middeck Aft Hatch “Ditch”.

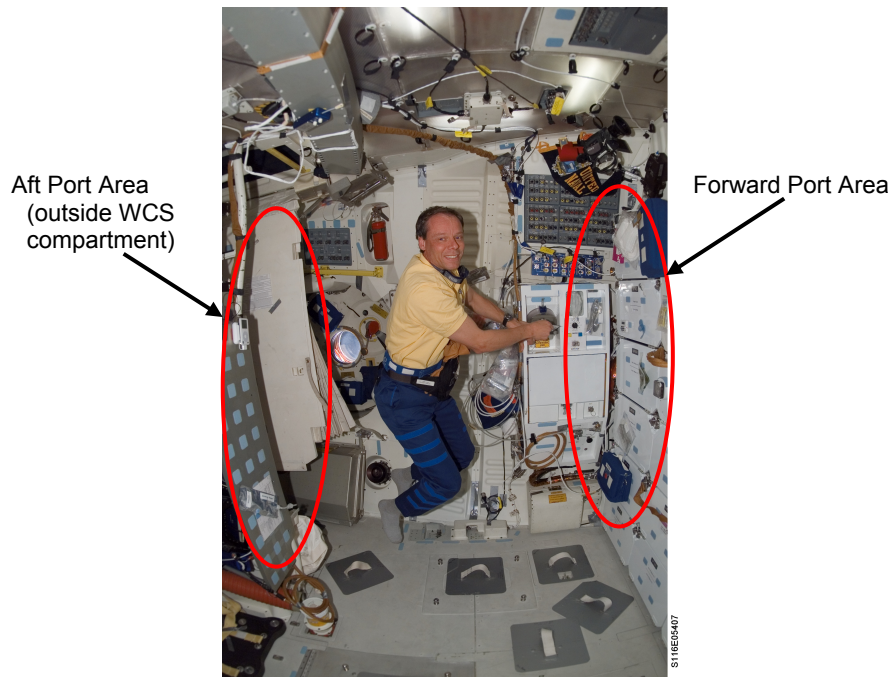

Figure 10-4.- Locations 4 and 5 – Middeck Forward Port and Middeck Aft Port.

## CDM ACTIVATION

### NOTE

Due to battery life concerns, limit CDM use to specified DTO periods only

1. Press and hold MODE pb until 'RELEASE' displayed
2. Wait ~1 min while unit runs self-check routine, verify display shows CO2 reading ("x ppm" or "x.xx CO2")
3. From CO2 concentration display, press MODE pb six times (once per sec), until alarm status displayed
4. Press E pb once to switch alarm off
5. Verify display indicates 'ALM OFF'
6. Record GMT Start

	<b>Middeck Attachment Location</b>	<b>GMT Start</b>	<b>GMT Stop</b>
Location 1	Forward Starboard		
Location 2	Aft Starboard		
Location 3	Aft Hatch "ditch"		
Location 4	Forward Port		
Location 5	Aft Port		

## CDM DEACTIVATION

\* If 'BATTERY FAIL' message displayed, replace \*  
\* battery immediately to maintain logged data: \*  
\* Perform CDM SETUP AND BATTERY \*  
\* CHANGEOUT (ORB OPS, CDM DTO) \*  
\* Notify MCC-H \*

1. Press and hold MODE pb until 'RELEASE' displayed
2. √CDM – OFF
3. Record GMT Stop, report completion to MCC-H

## DTO COMPLETION

### NOTE

Stored data is maintained for a max of 30 min without battery installed. All data will be lost if battery installation delayed more than 30 min

- |       |  |
|-------|--|
| MA9L  | <ol style="list-style-type: none"><li>1. Unstow:<br/>Batt Pack<br/>Sharpie</li><li>2. Turn fasteners (two) on back panel ¼ turn ccw</li><li>3. Remove, temp stow back panel</li><li>4. Grasp Batt Pack pull tab, remove pack</li><li>5. Mark old Batt Pack as “DISCHARGED”</li><li>6. Install last unused Batt Pack, press firmly to seat electrodes. If all Batt Packs are marked “DISCHARGED”, install Batt Pack marked “SPARE” from initial changeout</li><li>7. Replace back panel, press firmly, turn fasteners (two) ¼ turn cw to lock</li></ol> |
| MF57G | <ol style="list-style-type: none"><li>8. Remove CDM Cue Card, stow in Middeck Cue Card Kit</li><li>9. Demate filter assembly from CDM QD</li><li>10. √CDM – OFF</li></ol>  |
| MA9L  | <ol style="list-style-type: none"><li>11. Stow CDM, used Batt Pack, and filter assembly</li></ol>  |

CUE CARD CONFIGURATION

FLIGHT DAY 3 DOCKING ORBITER WITH ISS  
CO2 ABSORBER REPLACEMENT (Front) ..... FS CC 11-3  
LiOH CANISTER STOWAGE LOCATIONS (Back) ... FS CC 11-4 |  
ORBIT BURN MONITOR (Front) ..... FS CC 11-5  
OMS FAILURES (Back) ..... FS CC 11-6  
STS-123 DAP CONFIGURATIONS  
(Front/Top) ..... FS CC 11-7  
(Front/Bottom) ..... FS CC 11-8  
(Back/Top)..... FS CC 11-9  
(Back/Bottom) ..... FS CC 11-10  
MAUI – RCS FIRING SEQUENCE (Front) ..... FS CC 11-11  
(Back)..... FS CC 11-12  
CDM CUE CARD (Front) ..... FS CC 11-13  
(Back)..... FS CC 11-14 |

CUE  
CARDS

NOT FLOWN

FS 11-1

ORB OPS/123/FIN A



**CUE  
CARDS**

This Page Intentionally Blank



NOT FLOWN

FS 11-2

ORB OPS/123/FIN A



TOP

HOOK  
VELCRO

**FLIGHT DAY 3 DOCKING ORBITER WITH ISS  
CO2 ABSORBER REPLACEMENT**

(7 crewmembers/Single Shift/FD 1-15)

FLIGHT DAY	POS A	POS B	CK CMLPT
LAUNCH	1	2	
PRE FD01	"	"	
POST FD02	3	4	
PRE FD02	5	"	
POST FD03	6	7	DOCKING
PRE FD03	"	8	
POST FD04	"	"	EVA 1
PRE FD04	9	"	
POST FD05	"	"	
PRE FD05	"	10	
POST FD06	"	"	EVA 2
PRE FD06	11	"	
POST FD07	"	"	
PRE FD07	"	12	
POST FD08	"	"	EVA 3
PRE FD08	13	"	
POST FD09	"	"	
PRE FD09	"	14	
POST FD10	"	"	EVA 4
PRE FD10	15	"	
POST FD11	"	"	
PRE FD11	"	STS-118 - X	
POST FD12	"	"	EVA 5
PRE FD12	STS-118 - X	"	
POST FD13	"	"	
PRE FD13	"	STS-118 - X	
POST FD14	"	"	
PRE FD14	STS-118 - X	"	
POST FD15	"	"	
MID FD15	STS-118 - X	STS-118 - X*	HATCH CLOSE
PRE FD15	"	STS-118 - X*	

\*Re-bag and seal LiOH cans w/Gray Tape and stow.  
(Locations of canisters on back)

ORB OPS-29a/nonRCRS/123/O/A

NOTE

This card is specifically used for the STS-123 mission with the orbiter conducting single shift ops with a crew size of 7. Changeout scheme reflects FD3 docking with ISS, Vozdukh and CDRA (activated in dual-bed mode) during docked ops, and undocking on FD15

(reduced copy)

FAB USE ONLY

FS CC 11-3

ORB OPS/123/FIN A

TOP  
 BACK OF 'FLIGHT DAY 3 DOCKING  
 ORBITER WITH ISS  
 CO2 ABSORBER REPLACEMENT'

HOOK  
 VELCRO

**FLIGHT DAY 3 DOCKING ORBITER WITH ISS  
 CO2 ABSORBER REPLACEMENT**

(7 crewmembers/Single Shift/FD 16-20)

FLIGHT DAY	POS A	POS B	CK CMLPT
POST FD16	STS-118 - X	STS-118 - X	
PRE FD16	STS-118 - X	"	
POST FD17	STS-118 - X	STS-118 - X	EOM
PRE FD17	STS-118 - X*	STS-118 - X*	
POST FD18	STS-118 - X	STS-118 - X	EOM+1
PRE FD18	16	"	
POST FD19	17	18	EOM+2
PRE FD19	"	19	
POST FD20	20	21	EOM+3

\*Re-bag and seal LiOH cans w/Gray Tape and stow

**LiOH CANISTER STOWAGE LOCATIONS**

**Ascent Stowage Locations**

Orbiter:

MD52M (LiOH Box): cans 1-31 \*

**Entry (EOM) Stowage Locations**

Orbiter:

MD52M (LiOH Box): cans 4-21, 13 STS-118 cans \*

TBD: 3 STS-118 cans

\* 2 LiOH cans installed in LiOH slots A and B

ORB OPS-29b/nonRCRS/123/O/A

(reduced copy)

FAB USE ONLY

FS CC 11-4

ORB OPS/123/FIN A

TOP

HOOK  
VELCRO

HOOK  
VELCRO

**ORBIT BURN MONITOR**

<b>OMS TEMP*</b>	<table border="1"> <tr> <td></td> <td>L</td> <td>R</td> </tr> <tr> <td>FU IN P ≥</td> <td>219</td> <td>220</td> </tr> <tr> <td>≤</td> <td>201</td> <td>208</td> </tr> </table>		L	R	FU IN P ≥	219	220	≤	201	208	OMS ENG FAIL ----- OMS PRPLT FAIL
	L	R									
FU IN P ≥	219	220									
≤	201	208									
or No FU IN P											
<b>OMS PC* &amp; OMS ↓</b>	ENG VLV 1 or 2 < 70 ----- or OX IN P > 227 ----- OX IN P ≤ 227 ----- or No OX IN P	OMS ENG FAIL ----- OMS PRPLT FAIL									
<b>OMS OX/FU TK P (√ENG IN P)</b>	OX/FU LOW ----- OX & FU HIGH	He PRESS/VAP ISOL (two) – OP If aff TK P not incr: ----- OMS PRPLT FAIL He PRESS/VAP ISOL (two) – CL Cycle He A(B) to maintain TK P 234-284									
<b>OMS N2 REG P HIGH or LOW</b>		OMS ENG – ARM									
<b>OMS N2 TK P LOW (√OMS/MPS)</b>		At N2 TK P < 470: OMS ENG – ARM									
<b>OMS GMBL</b>	PRI fail ----- SEC fail	L(R) OMS GMBL – SEC (twice) If high RCS usage: OMS ENG FAIL									
<b>GPC</b>	<input type="checkbox"/> ( <input type="checkbox"/> ) & Burning OMS aff ----- SEC GMBL lost ----- 2 FAs lost	aff GPC PWR – OFF If SEC GMBL avail: aff MDM FF 1(4) – OFF,ON L(R) OMS GMBL – SEC (twice) ----- If high RCS usage: OMS ENG FAIL √MAN SHUTDN									
<b>I/O ERROR FA</b>	1(4) ----- 2 FAs lost	L(R) OMS GMBL – SEC I/O RESET If high RCS usage: OMS ENG FAIL √MAN SHUTDN									
<b>BCE STRG D</b>	1(4)	I/O RESET (if recov: >>) If high RCS usage: L(R) OMS GMBL – SEC (twice)									
<b>GPC SET SPLIT</b>	Non-crit burn ----- Crit burn	STOP BURN: OMS ENG(s) – OFF Go to "GPC" above									
<b>I/O ERROR PCM</b>		OI PCMMU PWR – 2(1)									
<b>BCE BYP OA</b>		SM I/O RESET									

\*If XFD, BLDN, or sensor fail, monitor ENG IN P for off-nominal performance

ORB OPS-31a/123/O/A

(reduced copy)

FAB USE ONLY

FS CC 11-5

ORB OPS/123/FIN A

TOP  
BACK OF 'ORBIT BURN MONITOR'

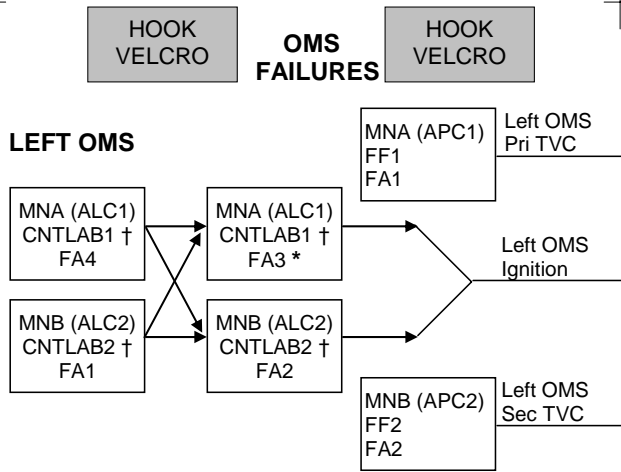

† If CNTL AB1 or AB2 (CA1 or CA2) failed and ign path still exists at OMS fail, assume L(R) OMS ↓ is PRPLT FAIL  
\* If L(R) Pc failed high during burn or FA3(4) failed, at L(R) OMS fail, no guidance downmode after L(R) OMS ENG switch OFF (TGO slow, ADI needles in error, 6 ft/s underburn)

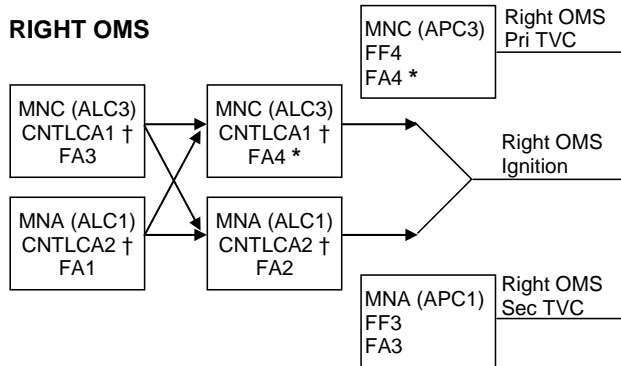

If two FA MDMs lost		
MDMs	Preburn: ENG – OFF	During burn: MAN SHUTDN
1,2	LEFT (TVC)	BOTH
1,3	RIGHT (IGN)	LEFT
1,4	LEFT (IGN)	RIGHT
2,3	LEFT (IGN)	RIGHT
2,4	RIGHT (IGN)	LEFT
3,4	RIGHT (TVC)	BOTH

ORB OPS-31b/123/O/A

(reduced copy)

FAB USE ONLY

FS CC 11-6

ORB OPS/123/FIN A

FAB USE ONLY

FS CC 11-7

ORB OPS/123/FIN A

(reduced copy)

TOP

PILE  
VELCRO

ORB OPS-41a/123/O/A

PILE  
VELCRO

**STS-123 DAP A1 – DAP A8 CONFIGURATIONS**

	ITEM #	A1	A2	A3	A4	A5	A6	A7	A8
<b>PRI</b>									
ROT RATE	10 (50)	0.2000	0.4000	0.2000	0.5000	0.2000	0.2000	0.2000	0.0500
ATT DB	11 (51)	5.00	1.00	0.30	3.00	5.00	5.00	2.00	2.00
RATE DB	12 (52)	0.20	0.20	0.20	0.20	0.20	0.20	0.20	0.20
ROT PLS	13 (53)	0.100	0.100	0.100	0.100	0.100	0.100	0.100	0.100
COMP	14 (54)	.000	.000	.000	.000	.000	.000	.000	.000
P OPTION	15 (55)	ALL	ALL	ALL	ALL	ALL	TAIL	ALL	ALL
Y OPTION	16 (56)	ALL	ALL	TAIL	ALL	ALL	TAIL	ALL	ALL
TRAN PLS	17 (57)	0.100	0.100	0.100	0.100	0.100	0.100	0.100	0.100
<b>ALT</b>									
RATE DB	18 (58)	0.200	0.200	0.070	0.200	0.070	0.070	0.100	0.100
JET OPT	19 (59)	ALL	ALL	ALL	ALL	ALL	TAIL	ALL	ALL
# JETS	20 (60)	2	2	1	2	1	1	2	2
ON TIME	21 (61)	0.08	0.08	0.08	0.08	0.08	0.08	0.08	0.08
DELAY	22 (62)	0.00	0.00	0.00	0.00	0.00	0.00	0.00	0.00
<b>VERN</b>									
ROT RATE	23 (63)	0.2000	0.4000	0.0080	0.2000	0.0500	0.0500	0.0160	0.0500
ATT DB	24 (64)	1.000	1.000	0.070	1.000	1.000	1.000	1.000	1.000
RATE DB	25 (65)	.020	.020	.010	.020	.020	.020	.020	.020
ROT PLS	26 (66)	0.010	0.010	0.010	0.010	0.010	0.010	0.010	0.050
COMP	27 (67)	.000	.000	.000	.000	.000	.000	.000	.000
CNTL ACC	28 (68)	0	0	0	0	0	0	0	0
PURPOSE		NOMINAL	PTC	GG	PREPOST DEPLOY	LOSS OF VERN (ALL)	LOSS OF VERN (TAIL ONLY)	RNDZ	TERMINAL PHASE

**BOLD/ITALIC** indicates change from I-Load.

HINGE

FAB USE ONLY

FS CC 11-8

ORB OPS/123/FIN A

(reduced copy)

TOP  
HINGED AT BOTTOM OF  
'STS-123 DAP A1 – A8 CONFIGURATIONS'  
HINGE

STS-123 DAP B1 – DAP B8 CONFIGURATIONS

	ITEM #	B1	B2	B3	B4	B5	B6	B7	B8
<b>PRI</b>									
ROT RATE	30 (50)	0.5000	0.2000	0.2000	0.2000	0.2000	0.5000	0.5000	0.0500
ATT DB	31 (51)	3.00	3.00	3.00	0.30	3.00	3.00	2.00	2.00
RATE DB	32 (52)	0.20	0.20	0.20	0.20	0.20	0.20	0.20	0.20
ROT PLS	33 (53)	0.040	0.040	0.040	0.040	0.040	0.040	0.040	0.040
COMP	34 (54)	.000	.000	.000	.000	.000	.000	.000	.000
P OPTION	35 (55)	ALL	TAIL	ALL	TAIL	TAIL	ALL	ALL	ALL
Y OPTION	36 (56)	ALL	TAIL	ALL	TAIL	TAIL	ALL	ALL	ALL
TRAN PLS	37 (57)	0.100	0.020	0.020	0.020	0.020	0.020	0.050	0.050
<b>ALT</b>									
RATE DB	38 (58)	0.200	0.070	0.070	0.100	0.200	0.200	0.100	0.100
JET OPT	39 (59)	ALL	TAIL	ALL	ALL	ALL	ALL	ALL	ALL
# JETS	40 (60)	2	1	1	2	2	2	2	2
ON TIME	41 (61)	0.08	0.08	0.08	0.08	0.08	0.08	0.08	0.08
DELAY	42 (62)	0.00	0.00	0.00	0.00	0.00	0.00	0.00	0.00
<b>VERN</b>									
ROT RATE	43 (63)	0.2000	0.2000	0.2000	0.0080	0.0160	0.2000	0.2000	0.0500
ATT DB	44 (64)	1.000	1.000	1.000	0.100	0.033	1.000	1.000	1.000
RATE DB	45 (65)	.020	.020	.020	.010	.020	.020	.020	.020
ROT PLS	46 (66)	0.002	0.002	0.002	0.002	0.002	0.002	0.002	0.020
COMP	47 (67)	.000	.000	.000	.000	.000	.000	.000	.000
CNTL ACC	48 (68)	0	0	0	0	0	0	0	0
PURPOSE		OMS & RCS Burns (ORB OPS)	Loss of VERN (Tail Only)	Loss of VERN (All)		COASHUD CAL		RNDZ	TERMINAL PHASE

**BOLD/ITALIC** indicates change from I-Load.

HOOK  
VELCRO

ORB OPS-41aa/123/O/A

HOOK  
VELCRO

FAB USE ONLY

FS CC 11-9

ORB OPS/123/FIN A

(reduced copy)

TOP  
BACK OF 'STS-123 DAP A1 – A8 CONFIGURATIONS'

PILE  
VELCRO

ORB OPS-41b/123/O/C

PILE  
VELCRO

**STS-123 DAP A9 – DAP A14 CONFIGURATIONS**

	ITEM #	A9	A10	A11	A12	A14
<b>PRI</b>						
ROT RATE	10 (50)	0.1300	0.0500	0.0500	0.0500	0.2000
ATT DB	11 (51)	2.00	0.60	10.00	5.00	5.00
RATE DB	12 (52)	0.10	0.10	0.20	0.20	0.20
ROT PLS	13 (53)	0.100	0.100	0.100	0.040	0.100
COMP	14 (54)	.000	.000	.000	.000	.000
P OPTION	15 (55)	TAIL	TAIL	TAIL	TAIL	TAIL
Y OPTION	16 (56)	TAIL	TAIL	TAIL	TAIL	TAIL
TRAN PLS	17 (57)	0.050	0.050	0.100	0.010	0.100
<b>ALT</b>						
RATE DB	18 (58)	0.100	0.100	0.035 <sup>1</sup>	0.035 <sup>1</sup>	0.200
JET OPT	19 (59)	TAIL	TAIL	TAIL	TAIL	TAIL
# JETS	20 (60)	2	2	<b>1</b>	<b>1</b>	1
ON TIME	21 (61)	0.08	0.08	0.08	0.08	0.08
DELAY	22 (62)	0.00	0.00	<b>6.00</b>	<b>6.00</b>	6.00
<b>VERN</b>						
ROT RATE	23 (63)	0.1300	0.0500	0.1000	0.1000	0.2000
ATT DB	24 (64)	1.000	0.500	5.000	3.000	3.000
RATE DB	25 (65)	.020	.020	.050	.050	.200
ROT PLS	26 (66)	0.050	0.050	0.010	0.002	0.010
COMP	27 (67)	.000	.000	.000	.000	.000
CNTL ACC	28 (68)	0	0	<b>2(3)(4) <sup>2</sup></b>	<b>2(3)(4) <sup>2</sup></b>	1
PURPOSE		PROX/OPS FLYAROUND	DOCKING	AUTO REBOOST	MATED STACK (VRCS & ALT) <sup>3</sup>	ORBITER ALONE SRMS/OBSS

**BOLD/ITALIC** indicates change from I-Load.

<sup>1</sup> I-loaded below keyboard limit; do not change

<sup>2</sup> CA2 for no vehicle docked at SM aft

CA3 for Progress/Soyuz docked at SM aft

CA4 for ATV docked at SM aft

<sup>3</sup> VRCS for maneuvers and attitude hold

ALT for maneuvers and a maximum 15 min of attitude hold

-----  
HINGE

FAB USE ONLY

FS CC 11-10

ORB OPS/123/FIN A

(reduced copy)

TOP  
 BACK OF 'STS-123 DAP B1 – B8 CONFIGURATIONS'  
 HINGED AT BOTTOM OF 'STS-123 DAP A9 – A14 CONFIGURATIONS'  
 HINGE

**STS-123 DAP B9 – DAP B12 CONFIGURATIONS**

	ITEM #	B9	B10	B12
<b>PRI</b>				
ROT RATE	30 (50)	0.1300	0.0500	0.0500
ATT DB	31 (51)	2.00	0.60	5.00
RATE DB	32 (52)	0.10	0.10	0.20
ROT PLS	33 (53)	0.040	0.040	0.040
COMP	34 (54)	.000	.000	.000
P OPTION	35 (55)	TAIL	TAIL	TAIL
Y OPTION	36 (56)	TAIL	TAIL	TAIL
TRAN PLS	37 (57)	0.010	0.010	0.010
<b>ALT</b>				
RATE DB	38 (58)	0.100	0.100	0.035 <sup>1</sup>
JET OPT	39 (59)	TAIL	TAIL	TAIL
# JETS	40 (60)	2	2	<b>1</b>
ON TIME	41 (61)	0.08	0.08	0.08
DELAY	42 (62)	10.00	0.00	11.04
<b>VERN</b>				
ROT RATE	43 (63)	0.1300	0.0500	0.1000
ATT DB	44 (64)	1.000	0.500	3.000
RATE DB	45 (65)	.020	.020	.050
ROT PLS	46 (66)	0.020	0.020	0.002
COMP	47 (67)	.000	.000	.000
CNTL ACC	48 (68)	0	0	<b>2(3)(4)</b> <sup>2</sup>
PURPOSE		PROX OPS/ FLYAROUND	DOCKING	MATED STACK (VRCS & ALT) <sup>3</sup>

**BOLD/ITALIC** indicates change from I-Load.

<sup>1</sup> I-loaded below keyboard limit; do not change

<sup>2</sup> CA2 for no vehicle docked at SM aft

CA3 for Progress/Soyuz docked at SM aft

CA4 for ATV docked at SM aft

<sup>3</sup> VRCS for maneuvers and attitude hold

ALT for attitude hold only

HOOK  
VELCRO

ORB OPS-41bb/123/O/C

HOOK  
VELCRO



TOP

**MAUI – RCS FIRING SEQUENCE**

Timer	Jets Fired	CDR	PLT
-03:00		Body rates: $+0.047 \leq \text{roll} \leq +0.087$ $-0.020 \leq \text{pitch} \leq +0.020$ $-0.020 \leq \text{yaw} \leq +0.020$ DAP: FREE DAP: A/PRI  Inform PLT "GO" for jet deselects	Configure initial setup [GNC 23 RCS] Left RCS page – ITEM 2 EXEC  On CDR "GO", proceed  NOTE Expect DAP RECONF msgs in following actions  Deselect jets: JET DES L5L – ITEM 37 EXEC (*) Right RCS page – ITEM 3 EXEC JET DES R5D – ITEM 39 EXEC (*) Forward RCS page – ITEM 1 EXEC JET DES F5L – ITEM 37 EXEC (*)  NOTE Queue the following ITEM entry on the scratch pad. Do not perform the EXEC until specified at 35 sec  JET DES F3D – ITEM 25
-00:30		FLT CNTRL PWR – ON	
00:00	RXA, LXA	THC +X (in) (3 sec firing)	
00:15	FXL, LXL	THC +Y (right) (3 sec firing)	
00:30	FXR, RXR	THC -Y (left) (3 sec firing)	
00:35			When jets stop firing: [GNC 23 RCS] EXEC [JET DES F3D – ITEM 25 (*)]
00:45	F4D	RHC +pitch (Past Soft Stop, hold 3 sec)	
00:48		RHC release	
00:50			DAP: VERN
01:00	R5R	RHC +yaw (10 sec firing)	
01:20	L5D	RHC -pitch (12 sec firing)	
01:40	F5R	RHC +pitch (12 sec firing)	
		FLT CNTRL PWR – OFF	Return to MAUI PROCEDURE, step 6, (ORB OPS FS, MAUI)

ORB OPS-42a/123/O/B

(reduced copy)

FAB USE ONLY

FS CC 11-11

ORB OPS/123/FIN A



TOP  
BACK OF 'MAUI - RCS FIRING SEQUENCE'

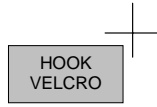
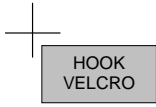

ORB OPS-42b/123/O/A



FAB USE ONLY

(reduced copy)  
FS CC 11-12

ORB OPS/123/FIN A

TOP

### CDM ACTIVATION

#### NOTE

Due to battery life concerns, limit CDM use to specified DTO periods only

1. Press and hold MODE pb until 'RELEASE' displayed
2. Wait ~1 min while unit runs self-check routine, verify display shows CO2 reading ("x ppm" or "x.xx CO2")
3. From CO2 concentration display, press MODE pb six times (once per sec), until alarm status is displayed
4. Press E pb once to switch alarm off
5. Verify display indicates 'ALM OFF'
6. Record GMT Start

Middeck Attachment Location	GMT Start	GMT Stop
Location 1	Forward Starboard	
Location 2	Aft Starboard	
Location 3	Aft Hatch "ditch"	
Location 4	Forward Port	
Location 5	Aft Port	

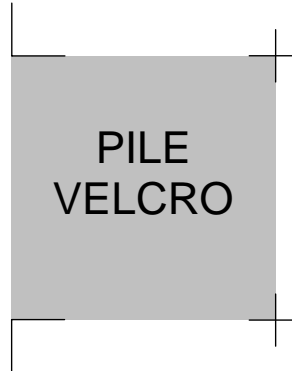

### CDM DEACTIVATION

- \* If 'BATTERY FAIL' message displayed, replace \*
- battery immediately to maintain logged data: \*
- \* Perform CDM SETUP AND BATTERY \*
- \* CHANGEOUT (ORB OPS, CDM DTO) \*
- \* Notify MCC-H \*

1. Press and hold MODE pb until 'RELEASE' displayed
2. √CDM – OFF
3. Record GMT Stop, report completion to MCC-H

ORB OPS-46a/O/A

(reduced copy)

FAB USE ONLY

FS CC 11-13

ORB OPS/123/FIN A

TOP  
BACK OF 'CDM CUE CARD'

HOOK  
VELCRO

ORB OPS-46b/O/A

FAB USE ONLY

(reduced copy)  
FS CC 11-14

ORB OPS/123/FIN A

Space Shuttle Program  
FLIGHT DATA FILE

JSC-48036-123  
FINAL, REV A

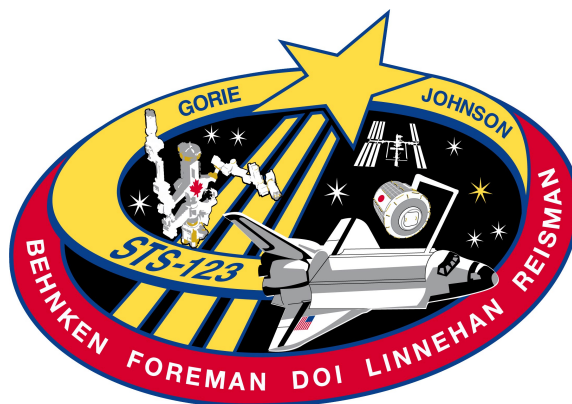

# ORBIT OPS CHECKLIST

STS  
123

Flight Cover (trim bottom to expose tabs)