

Orbit Operations Checklist

STS-128 Flight Supplement

**Mission Operations Directorate
Operations Division**

**Final
August 5, 2009**

National Aeronautics and
Space Administration

Lyndon B. Johnson Space Center
Houston, Texas



Verify this is the correct version for the pending operation (training, simulation or flight).
Electronic copies of FDF books are available. URL: <http://mod.jsc.nasa.gov/do3/FDF/index.html>

JSC-48036-128

MISSION OPERATIONS DIRECTORATE

**ORBIT OPERATIONS CHECKLIST
STS-128 FLIGHT SUPPLEMENT**

FINAL
August 5, 2009

PREPARED BY:

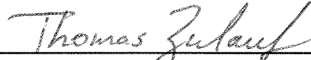

Thomas R. Zulauf
Publication Manager

APPROVED BY:

Manager, Flight Procedures

ACCEPTED BY:

Michael T. Hurt
FDF Manager

This document is under the configuration control of the Crew Procedures Control Board (CPCB). All proposed changes must be submitted via Change Request Workflow (CRW) to DO3/FDF Manager.

Additional distribution of this book, for official use only, may be requested in writing to DO3/PMO Administrator. The request must include justification and requester's name, organization, position, and phone number. Contractor requests are made through the NASA or DOD organization supported. Deletions, reduction in quantity, or change of address may be submitted to DO3/FDF Management Office, 281-244-1184.

ORB OPS/128/FIN

Incorporates the following:		
482#:	ORB OPS FS-00148	ORB OPS FS-00154
	ORB OPS FS-00149	ORB OPS FS-00156
	ORB OPS FS-00151	ORB OPS FS-00158

AREAS OF TECHNICAL RESPONSIBILITY

Publication Manager	DO3/T. Zulauf	281-244-0922
Alternate Publication Manager	DO3/L. Giles	281-244-9068
COMM/INST	DS2/D. Brown	281-244-9058
PTG	DO4/R. Molina	281-244-5718
DAP TABLES	DS6/D. Shafer	281-244-0143
REBOOST/DAP	DS6/D. Shafer	281-244-0143
OIU	DS2/D. Brown	281-244-9058
SDBI	SK/S. Rodgers	281-483-6357
WLES	DO5/D. Keiser	281-244-1688
MAUI	DS6/D. Shafer	281-244-0143
CWC-I FILL	DS4/R. Hinterlang	281-483-9398

CUE CARDS:

LIOH CHANGEOUT	DS4/R. Hinterlang	281-483-9398
ORBIT BURN MONITOR	DS6/S. Stewart	281-483-5377
DAP TABLES	DS6/D. Shafer	281-244-0143
MAUI – RCS FIRING SEQUENCE	DS6/D. Shafer	281-244-0143
WLES CONFIG AFTER PGSC REBOOT	DO5/D. Keiser	281-244-1688
SDBI 1904 PLACARD	SK/S. Rodgers	281-483-6357
SDBI 1904 QUESTIONNAIRE	SK/S. Rodgers	281-483-6357

ORBIT OPERATIONS CHECKLIST
STS-128 FLIGHT SUPPLEMENT

LIST OF EFFECTIVE PAGES

FINAL 08/05/09

Sign Off	*	128/FIN	FS 4-3	128/FIN
FS ii	*	128/FIN	FS 4-4	128/FIN
FS iii	*	128/FIN	FS 4-5	128/FIN
FS iv	*	128/FIN	FS 4-6	128/FIN
FS v	*	128/FIN	FS 5-1	128/FIN
FS vi	*	128/FIN	FS 5-2	128/FIN
FS vii		128/FIN	FS 6-1	128/FIN
FS viii		128/FIN	FS 6-2	128/FIN
FS 1-1		128/FIN	FS 6-3	128/FIN
FS 1-2		128/FIN	FS 6-4	128/FIN
FS 1-3		128/FIN	FS 6-5	128/FIN
FS 1-4		128/FIN	FS 6-6	128/FIN
FS 1-5		128/FIN	FS 6-7	128/FIN
FS 1-6		128/FIN	FS 6-8	128/FIN
FS 1-7		128/FIN	FS 6-9	128/FIN
FS 1-8		128/FIN	FS 6-10	128/FIN
FS 2-1		128/FIN	FS 6-11	128/FIN
FS 2-2		128/FIN	FS 6-12	128/FIN
FS 2-3		128/FIN	FS 7-1	128/FIN
FS 2-4		128/FIN	FS 7-2	128/FIN
FS 3-1		128/FIN	FS 7-3	128/FIN
FS 3-2		128/FIN	FS 7-4	128/FIN
FS 3-3		128/FIN	FS 7-5	128/FIN
FS 3-4		128/FIN	FS 7-6	128/FIN
FS 3-5		128/FIN	FS 7-7	128/FIN
FS 3-6		128/FIN	FS 7-8	128/FIN
FS 3-7		128/FIN	FS 7-9	128/FIN
FS 3-8		128/FIN	FS 7-10	128/FIN
FS 4-1		128/FIN	FS 7-11	128/FIN
FS 4-2		128/FIN	FS 7-12	128/FIN

* – Omit from flight book

FS 7-13	128/FIN	FS CC 10-15.... *	128/FIN
FS 7-14	128/FIN	FS CC 10-16.... *	128/FIN
FS 7-15	128/FIN	FS CC 10-17.... *	128/FIN
FS 7-16	128/FIN	FS CC 10-18.... *	128/FIN
FS 7-17	128/FIN	FS CC 10-19.... *	128/FIN
FS 7-18	128/FIN	FS CC 10-20.... *	128/FIN
FS 7-19	128/FIN	FS CC 10-21.... *	128/FIN
FS 7-20	128/FIN	FS CC 10-22.... *	128/FIN
FS 8-1	128/FIN	FS CC 10-23.... *	128/FIN
FS 8-2	128/FIN	FS CC 10-24.... *	128/FIN
FS 8-3	128/FIN	FS CC 10-25.... *	128/FIN
FS 8-4	128/FIN	FS CC 10-26.... *	128/FIN
FS 8-5	128/FIN		
FS 8-6	128/FIN		
FS 9-1	128/FIN		
FS 9-2	128/FIN		
FS 9-3	128/FIN		
FS 9-4	128/FIN		
FS 9-5	128/FIN		
FS 9-6	128/FIN		
FS 9-7	128/FIN		
FS 9-8	128/FIN		
FS 10-1	128/FIN		
FS 10-2	128/FIN		
FS CC 10-3	128/FIN		
FS CC 10-4	128/FIN		
FS CC 10-5	128/FIN		
FS CC 10-6	128/FIN		
FS CC 10-7	128/FIN		
FS CC 10-8	128/FIN		
FS CC 10-9	128/FIN		
FS CC 10-10 ...	128/FIN		
FS CC 10-11 ...	128/FIN		
FS CC 10-12 ...	128/FIN		
FS CC 10-13 ...	128/FIN		
FS 10-14	128/FIN		

* – Omit from flight book

ORBIT OPS CUE CARDS

<u>Title</u>	<u>Ref. Page</u>	<u>Card No.</u>
LIOH CHANGEOUT (Front) ..	FS CC 10-3	ORB OPS-29a/ nonRCRS/128/O/B
LIOH CANISTER STOWAGE LOCATIONS (Back)	FS CC 10-4	ORB OPS-29b/ nonRCRS/128/O/B
ORBIT BURN MONITOR (Front).....	FS CC 10-5	ORB OPS-31a/128/O/A
OMS FAILURES (Back).....	FS CC 10-6	ORB OPS-31b/128/O/A
STS-128 DAP CONFIGURATIONS (Front/Top).....	FS CC 10-7	ORB OPS-41a/128/O/A
(Front/Bottom)	FS CC 10-8	ORB OPS-41aa/128/O/A
(Back/Top).....	FS CC 10-9	ORB OPS-41b/128/O/C
(Back/Bottom).....	FS CC 10-10	ORB OPS-41bb/128/O/C
MAUI – RCS FIRING SEQUENCE (Front).....	FS CC 10-11	ORB OPS-42a/128/O/A
(Back).....	FS CC 10-12	ORB OPS-42b/128/O/A
WLES CONFIG AFTER PGSC REBOOT (Front).....	FS CC 10-13	ORB OPS-47a/128/O/A
SDBI 1904 PLACARD (MS 3) (Front/Left)	FS CC 10-15	ORB OPS-48a/128/A/B
(Front/Right).....	FS CC 10-15	ORB OPS-48aa/128/A/B
(Back/Right).....	FS CC 10-16	ORB OPS-48b/128/A/B
(Back/Left).....	FS CC 10-16	ORB OPS-48bb/128/A/B
SDBI 1904 PLACARD (MS 4) (Front/Left)	FS CC 10-17	ORB OPS-52a/128/A/A
(Front/Right).....	FS CC 10-17	ORB OPS-52aa/128/A/A
(Back/Right).....	FS CC 10-18	ORB OPS-52b/128/A/A
(Back/Left).....	FS CC 10-18	ORB OPS-52bb/128/A/A

SDBI 1904 PLACARD (MS 5)

(Front/Left)	FS CC 10-19	ORB OPS-53a/128/A/A
(Front/Right).....	FS CC 10-19	ORB OPS-53aa/128/A/A
(Back/Right).....	FS CC 10-20	ORB OPS-53b/128/A/A
(Back/Left).....	FS CC 10-20	ORB OPS-53bb/128/A/A

SDBI 1904 QUESTIONNAIRE (MS 3)

(Front).....	FS CC 10-21	ORB OPS-49a/128/A/B
(Back).....	FS CC 10-22	ORB OPS-49b/128/A/B

SDBI 1904 QUESTIONNAIRE (MS 4)

(Front).....	FS CC 10-23	ORB OPS-50a/128/A/B
(Back).....	FS CC 10-24	ORB OPS-50b/128/A/B

SDBI 1904 QUESTIONNAIRE (MS 5)

(Front).....	FS CC 10-25	ORB OPS-51a/128/A/A
(Back).....	FS CC 10-26	ORB OPS-51b/128/A/A

<u>CONTENTS</u>	<u>PAGE</u>
<u>COMM/INST</u>	FS 1-1
LOAD PCMMU FORMAT.....	FS 1-2
PDI DECOM FORMAT.....	FS 1-4
OIU FORMAT/CONFIG.....	FS 1-7
<u>PTG</u>	FS 2-1
STAR PAIRS PAD.....	FS 2-2
PAIRS.....	FS 2-3
<u>DAP TABLES</u>	FS 3-1
DAP OVERVIEW.....	FS 3-2
UNIV PTG.....	FS 3-3
STS-128 DAP A CONFIGURATIONS.....	FS 3-4
B CONFIGURATIONS.....	FS 3-6
<u>REBOOST/DAP</u>	FS 4-1
AUTO REBOOST.....	FS 4-2
ATTITUDE REFERENCE.....	FS 4-4
DOCKED DAP REFERENCE.....	FS 4-5
RATE DAMPING.....	FS 4-5
<u>OIU PROCEDURES</u>	FS 5-1
OIU ACTIVATION.....	FS 5-2
DEACTIVATION.....	FS 5-2
<u>SHORT DURATION BIOASTRONAUTICS</u>	
<u>INVESTIGATION (SDBI)</u>	FS 6-1
SDBI 1634, SLEEP-WAKE ACTIGRAPHY.....	FS 6-2
SDBI 1900, INTEGRATED IMMUNE BLOOD	
COLLECTION.....	FS 6-3
SDBI 1900, SALIVA COLLECTION FOR	
INTEGRATED IMMUNE.....	FS 6-9

Cont next page

<u>WING LEADING EDGE SENSORS (WLES)</u>	
<u>PROCEDURES</u>	FS 7-1
WLES ACTIVATION AND CHECKOUT	FS 7-2
DEACTIVATION AND TEARDOWN	FS 7-10
LAPTOP RECEIVER UNIT (LRU) R&R	FS 7-12
CABIN RELAY UNIT R&R	FS 7-14
CONFIGURE WLES DATA FILE BACKUP PATH	FS 7-16
PREP WLES LAPTOPS FOR TRANSFER	FS 7-17
WLES RNDZ TOOLS CHECKOUT PREP	FS 7-18
DOCK/UNDOCK RECOVERY	FS 7-18
DISABLE WLES FILE BACKUP	FS 7-19
ENABLE WLES FILE BACKUP	FS 7-19
 <u>MAUI ANALYSIS OF UPPER-ATMOSPHERIC</u>	
<u>INJECTIONS (MAUI)</u>	FS 8-1
MAUI PROCEDURE	FS 8-2
 <u>CWC-I FILL</u>	
CWC-I FILL	FS 9-1
CWC-I FILL	FS 9-2
 <u>CUE CARD CONFIGURATION</u>	
	FS 10-1

COMM/INST

LOAD PCMMU FORMAT.....	FS 1-2
PDI DECOM FORMAT.....	FS 1-4
OIU FORMAT/CONFIG.....	FS 1-7

**COMM/
INST**

FS 1-1

ORB OPS/128/FIN

COMM/
INST

LOAD PCMMU FORMAT

- C3 1. √OI PCMMU FORMAT – GPC
SM 62 PCMMU/PL COMM
- CRT 2. FORMAT:
SEL FXD – ITEM 1 EXEC (*)
SEL ID – ITEM 3 +X X X EXEC
3. √SM COMM BUF – RDY
LOAD – ITEM 4 EXEC
√LOAD, ITEM 4 – RUN,CPLT
- If LOAD – CPLT:
Repeat steps 2 and 3 for second ID
- * If LOAD – FAIL and ERR MSG – 'I/O ERR MMU 1(2)': *
 - * Go to 5.2a, 'I/O ERR MMU 1(2)' (MAL, *
DPS) >> *
 - * If LOAD – FAIL and a first load attempt: *
 - * Repeat steps 1 and 2 for failed ID *
 - * If LOAD – FAIL and a subsequent load *
 - * attempt: *
 - * √MCC *
 - * OI PCMMU PWR – 2(1) *
 - * √ERR MSG – 'I/O ERR PCM' *
 - CRT * I/O RESET PCM – ITEM 5 EXEC (*) *
 - * Repeat steps 2 and 3 *
4. When final LOAD – CPLT:
SEL PGM – ITEM 2 EXEC (*)

DNLIST COMPATIBILITY	PHASE	FORMAT ID 64/128	CONFIG NO.
G1,G3,BFS	(ASCENT)	102/FXD	–
G3,BFS	(ENTRY)	102/164	–
G2,G8,S2	ORBIT/ FCS C/O	103/161	–
G2,S2,OPS 0	OPS 0	– /163	–
G2,S2,P9	MMU C/O	– /163	–
G2,G8,S2	RNDZ w/UHF FMT CCSU (SSOR/SSV/TCS) (PRIME)	103/192	763
G2,G8,S2	RNDZ w/UHF FMT CCSU (SSOR/SSV/TCS) (B/U)	103/211	770
G2,G8,S2	DOCKED ISS FMT CCSH (OIU/SSV) (PRIME)	103/184	760
G2,G8,S2	DOCKED ISS FMT CCSH (OIU/SSV) (B/U)	103/205	767
G2,G8,S2	OIU C/O AND SSV RATE 4 (PRIME)	103/188	762
G2,G8,S2	OIU C/O AND SSV RATE 5 (B/U)	103/203	765
G2,G8,S2	MPLM FMT (OIU/SSV) (PRIME)	103/199	780
G2,G8,S2	MPLM FMT (OIU/SSV) (B/U)	103/212	781

NOTE

LDR TFL may affect PCMMU BITE. If PCMMU or SM 2 GPC switched since last TFL, ID 64 and 128 will not reflect current state

LOAD PDI DECOM FORMAT

SM 62 PCMMU/PL COMM

1. PDI:

CRT √I/O RESET – ITEM 8 (*)
 SEL DECOM – ITEM 9 +X EXEC
 SEL FMT – ITEM 10 +X X X EXEC
 LOAD – ITEM 11 EXEC

If LOAD – CPLT:
 SEL INPUT – ITEM 12 +X EXEC
 LOAD – ITEM 13 EXEC
 Repeat step 1 for additional DECOMs/FPM

* If LOAD – FAIL and ERR MSG – 'I/O ERR *
* MMU 1(2)': *
* Go to 5.2a, 'I/O ERR MMU 1(2)' (MAL, *
* DPS) >> *
* *
* If LOAD – FAIL and a first load attempt: *
* Repeat step 1 *
* *
* If LOAD – FAIL and a subsequent load *
* attempt: *
* *
* NOTE *
* Power cycling PDI will cause PDI *
* to lose DFLs previously loaded *
* *
* √MCC *
A1L * S-BD PL CNTL – PNL *
* PL DATA INTLVR PWR – OFF,ON *
* √ERR MSG – 'S62 BCE BYP PL' *
* √'S62 BCE BYP PDI' *
* S-BD PL CNTL – CMD *
* *
* PCM: *
CRT * I/O RESET PCM – ITEM 5 EXEC (*) *
* PDI: *
* I/O RESET – ITEM 8 EXEC (*) *
* Repeat step 1 for all of config (XXX) *

CONFIG	DECOM	FMT	INPUT	USE
763 RNDZ w/UHF FMT CCSU (PRIME) TFL 192	1 2 3 4 5-FPM	30 - 9 4 505	1,2 - 5 4	OIU7 (CCSU) ** - TCS SSV (3) *** H-H-H *
770 RNDZ w/UHF FMT CCSU (BACKUP) TFL 211	1 2 3 4 5-FPM	14 31 - 19 503	4 1,2 - 5	SSV (3) *** OIU7 (CCSU) ** - TCS H-H-H *
760 DOCKED FMT CCSH (PRIME) TFL 184	1 2 3 4 5-FPM	7 - - 27 501	1,2 - - 4	OIU9 (CCSH) ** - - SSV (2) *** H-H-H *
767 DOCKED FMT CCSH (BACKUP) TFL 205	1 2 3 4 5-FPM	- 17 29 - 508	- 1,2 4 -	- OIU9 (CCSH) ** SSV (2) *** - H-H-H *
762 SSV RATE 4 (PRIME) TFL 188	1 2 3 4 5-FPM	5 - - 1 507	1,2 - - 4	OIU255 ** - - SSV (4) *** H-H-H *
765 SSV RATE 5 (BACKUP) TFL 203	1 2 3 4 5-FPM	- 15 11 - 509	- 1,2 4 -	- OIU255 ** SSV (5) *** - L-H-H *

* OI-GNC-SM, Orbiter Downlist Data Rates (High or Low)
** # in OIU# represents the OIU format; (XXX) represents data type
*** # in SSV (#) represents the SSV Out Rate sw selection

Cont next page

FS 1-5

ORB OPS/128/FIN

780 MPLM FMT (PRIME) TFL 199	1 2 3 4 5-FPM	2 - - 4 504	1,2 - - 4	OIU5 (1M) ** - - SSV (3) *** H-H-H *
781 MPLM FMT (BACKUP) TFL 212	1 2 3 4 5-FPM	14 3 - - 502	4 1,2 - -	SSV (3) *** OIU5 (1M) ** - - H-H-H *

* OI-GNC-SM, Orbiter Downlist Data Rates (High or Low)
 ** # in OIU# represents the OIU format; (XXX) represents data type
 *** # in SSV (#) represents the SSV Out Rate sw selection

LOAD OIU FORMAT/CONFIG

Determine which step is needed and complete all actions to obtain desired OIU configuration

NOTE

A corresponding TFL/DFL CONFIG is reqd for MCC to receive telemetry. Reference S62 PCMMU/PL COMM for the last loaded HDR TFL and perform LOAD PCMMU FORMAT/LOAD PDI DECOM FORMAT for the associated CONFIG

S212 OIU

1. GNC-1 PRIMARY ON LB-ORB N2-1 (OIU BUS 3)

LOAD FORMAT	ITEM 1 + <u>9</u> EXEC
GNC TO GNC 1	ITEM 18 + <u>1</u> <u>4</u> EXEC
GNC 1 TO BUS 3	ITEM 18 + <u>1</u> <u>6</u> EXEC
BUS 4 BC	ITEM 15 EXEC (*)
BUS 3 RT	ITEM 10 EXEC (*)
LOAD FORMAT	ITEM 1 + <u>9</u> EXEC >>

2. GNC-1 PRIMARY ON LB-ORB N2-2 (OIU BUS 4)

LOAD FORMAT	ITEM 1 + <u>9</u> EXEC
GNC TO GNC 1	ITEM 18 + <u>1</u> <u>4</u> EXEC
GNC 1 TO BUS 4	ITEM 18 + <u>1</u> <u>5</u> EXEC
BUS 3 BC	ITEM 11 EXEC (*)
BUS 4 RT	ITEM 14 EXEC (*)
LOAD FORMAT	ITEM 1 + <u>9</u> EXEC >>

3. GNC-2 PRIMARY ON LB-ORB N2-1 (OIU BUS 3)

LOAD FORMAT	ITEM 1 + <u>9</u> EXEC
GNC TO GNC 2	ITEM 18 + <u>1</u> <u>3</u> EXEC
GNC 2 TO BUS 3	ITEM 18 + <u>1</u> <u>8</u> EXEC
BUS 4 BC	ITEM 15 EXEC (*)
BUS 3 RT	ITEM 10 EXEC (*)
LOAD FORMAT	ITEM 1 + <u>9</u> EXEC >>

4. GNC-2 PRIMARY ON LB-ORB N2-2 (OIU BUS 4)

LOAD FORMAT	ITEM 1 + <u>9</u> EXEC
GNC TO GNC 2	ITEM 18 + <u>1</u> <u>3</u> EXEC
GNC 2 TO BUS 4	ITEM 18 + <u>1</u> <u>7</u> EXEC
BUS 3 BC	ITEM 11 EXEC (*)
BUS 4 RT	ITEM 14 EXEC (*)
LOAD FORMAT	ITEM 1 + <u>9</u> EXEC >>

Cont next page

5. MPLM (if flown)
LOAD FORMAT ITEM 1 +5 EXEC
BUS 2 BC ITEM 7 EXEC (*)
LOAD FORMAT ITEM 1 +5 EXEC >>
6. SSOR
LOAD FORMAT ITEM 1 +7 EXEC
BUS 1 BC ITEM 3 EXEC (*)
LOAD FORMAT ITEM 1 +7 EXEC >>

PTG

STAR PAIRS PAD FS 2-2
PAIRS..... FS 2-3

PTG

FS 2-1

ORB OPS/128/FIN

PTG

STAR PAIRS PAD										
STAR PAIR	SEP ANGLE	ATTITUDE SET 1					ATTITUDE SET 2			
		DUAL S TRK		SINGLE S TRK			DUAL S TRK		SINGLE S TRK	
				-Z	-Y				-Z	-Y
A	83.7	-Y:27 R+ 15 -Z:54 P+ 283 Y+ 44	-Z:27 R+ 305 P+ 262 Y+ 47	-Y:54 R+ 92 P+ 293 Y+ 58	-Y:54 R+ 238 -Z:27 P+ 78 Y+ 309	-Z:54 R+ 166 P+ 96 Y+ 317	-Y:27 R+ 332 P+ 89 Y+ 296			
B	81.9	-Y:21 R+ 161 -Z:97 P+ 54 Y+ 30	-Z:21 R+ 73 P+ 63 Y+ 19	-Y:97 R+ 250 P+ 41 Y+ 22	-Y:97 R+ 113 -Z:21 P+ 242 Y+ 346	-Z:97 R+ 28 P+ 239 Y+ 332	-Y:21 R+ 194 P+ 227 Y+ 350			
C	89.9	-Y:39 R+ 184 -Z:47 P+ 251 Y+ 352	-Z:39 R+ 99 P+ 264 Y+ 345	-Y:47 R+ 269 P+ 243 Y+ 340	-Y:47 R+ 84 -Z:39 P+ 85 Y+ 19	-Z:47 R+ 358 P+ 75 Y+ 8	-Y:39 R+ 177 P+ 72 Y+ 29			
D	88.6	-Y:20 R+ 327 -Z:100 P+ 344 Y+ 295	-Z:20 R+ 232 P+ 335 Y+ 309	-Y:100 R+ 77 P+ 10 Y+ 304	-Y:100 R+ 308 -Z:20 P+ 159 Y+ 47	R+ 223 -Z:100 P+ 156 Y+ 62	R+ 20 -Y:20 P+ 180 Y+ 45			

STAR PAIRS PAD

PAIR		COAS ALIGN ATTITUDE 1	ANG SEP	COAS ALIGN ATTITUDE 2
COAS	+X HUD	R+ 237 P+ 327 Y+ 358	NOSE UP 67.1	R+ 209 P+ 273 Y+ 308
	-Z COAS	R+ 2 P+ 243 Y+ 302		TAIL UP 14

SINGLE S TRK MIN MNVR OPT
TGT ID = 11-110 NAV STAR #

	-Z S TRK	-Y S TRK
BV	5	4
P	87.7	✓ 0
Y	358	✓ 280.57

MET Applicable Post OMS-2 to Nominal EOM
Liftoff Date: 08/18/09
Liftoff GMT: 230/08:23:12.000

FS-2-2

ORB OPS/128/FIN

STAR PAIRS

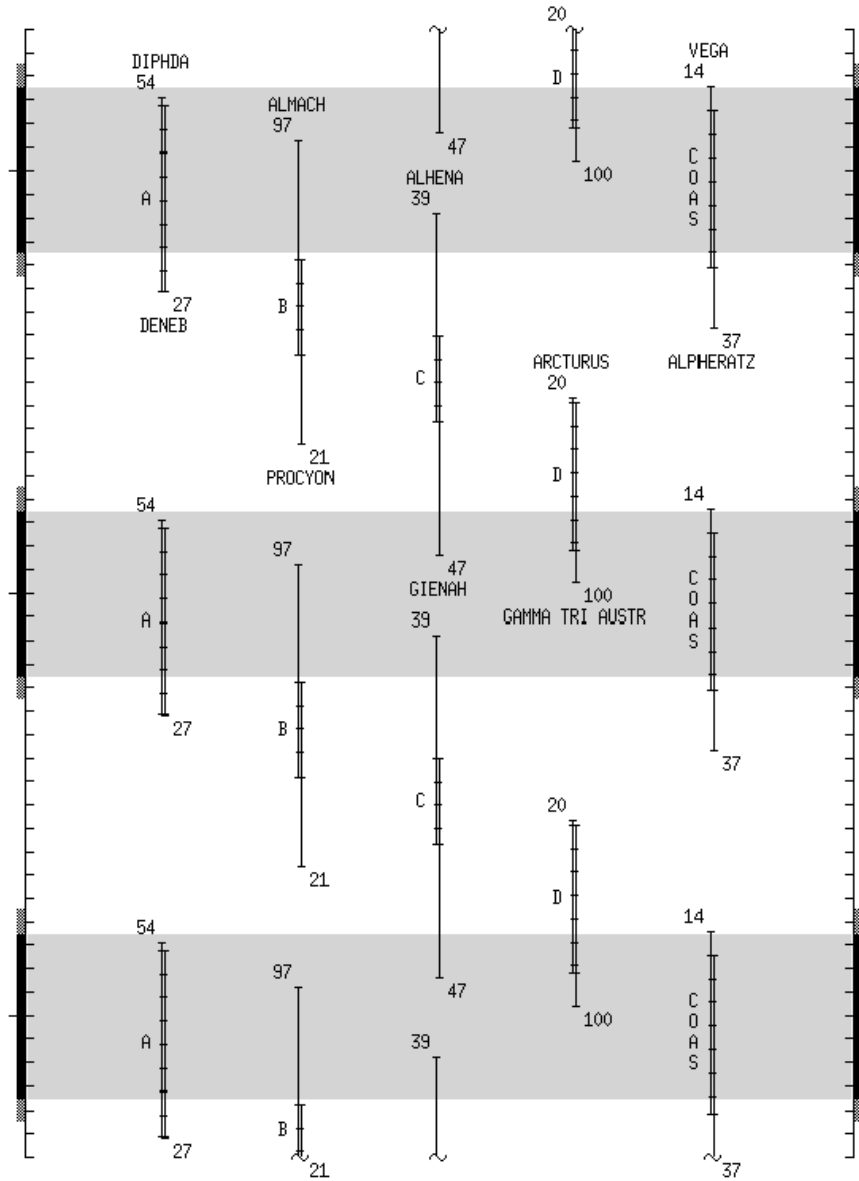

MET Applicable: Post OMS-2 to Nominal EOM
 Liftoff Date: 08/18/09
 Liftoff GMT: 230/08:23:12,000



This Page Intentionally Blank



DAP TABLES

DAP OVERVIEW	FS 3-2
UNIV PTG	FS 3-3
STS-128 DAP A CONFIGURATIONS.....	FS 3-4
B CONFIGURATIONS.....	FS 3-6

**DAP
TABLES**

DAP TABLES

DAP OVERVIEW

DAP	Purpose	DAP	Purpose
A1	Nominal	B1	OMS & RCS Burns (ORB OPS)
A2	PTC	B2	Loss of VERN (Tail Only)
A3	GG	B3	Loss of VERN (All)
A4		B4	
A5	Loss of VERN (All)	B5	COAS/HUD CAL
A6	Loss of VERN (Tail Only)	B6	
A7	Rendezvous	B7	Rendezvous
A8	Terminal Phase	B8	Terminal Phase
A9	PROX OPS/Flyaround	B9	Flyaround
A10	Docking	B10	Docking
A11	Auto Reboost	B11	
A12	Mated VRCS (Maneuvers, Robo)	B12	Mated VRCS & ALT (Attitude Hold)
A13		B13	
A14	Orbiter alone SRMS/OBSS Ops	B14	
A15		B15	

CNTL ACC	Purpose
0	Orbiter alone with unloaded RMS
1	Orbiter alone SRMS/OBSS Ops
2	Mated - VRCS and ALT with no vehicle docked to SM aft
3	Not used
4	Mated - VRCS and ALT with Progress/Soyuz docked to SM aft
5	Not used
6	Not used
7	Not used
8	Not used
9	Not used

DAPs for mated operations are based on analysis from GNC, PDRS, C. S. Draper Labs, and ISS Structures

FS 3-2

ORB OPS/128/FIN

UNIV PTG

TGT ID = 1 Orbiting Vehicle = 2 Earth Center = 3 Earth Target Input LAT (± 90) LON (± 180 , + = East) ALT (-3444.0 to 20000.0 nm) = 4 Sun Center = 5 Celestial Target Input RA (0-359.99) DEC (± 90) = 11-110 Nav Stars
BODY VECTOR = 1 +X* = 2 -X* = 3 -Z* = 4 -Y Star Tracker* = 5 Selectable Input P (0-359.99) Y (270-359.99, 0-90) *Input OM \rightarrow OM (0-359.99)
MON AXIS = 1 +X = 2 -X

FS 3-3

ORB OPS/128/FIN

STS-128 DAP A CONFIGURATIONS

STS-128 DAP A1 – DAP A8 CONFIGURATIONS

	ITEM #	A1	A2	A3	A4	A5	A6	A7	A8
PRI									
ROT RATE	10 (50)	0.2000	0.4000	0.2000	0.5000	0.2000	0.2000	0.2000	0.0500
ATT DB	11 (51)	5.00	1.00	0.30	3.00	5.00	5.00	2.00	2.00
RATE DB	12 (52)	0.20	0.20	0.20	0.20	0.20	0.20	0.20	0.20
ROT PLS	13 (53)	0.100	0.100	0.100	0.100	0.100	0.100	0.100	0.100
COMP	14 (54)	.000	.000	.000	.000	.000	.000	.000	.000
P OPTION	15 (55)	ALL	ALL	ALL	ALL	ALL	TAIL	ALL	ALL
Y OPTION	16 (56)	ALL	ALL	TAIL	ALL	ALL	TAIL	ALL	ALL
TRAN PLS	17 (57)	0.100	0.100	0.100	0.100	0.100	0.100	0.100	0.100
ALT									
RATE DB	18 (58)	0.200	0.200	0.070	0.200	0.070	0.070	0.100	0.100
JET OPT	19 (59)	ALL	ALL	ALL	ALL	ALL	TAIL	ALL	ALL
# JETS	20 (60)	2	2	1	2	1	1	2	2
ON TIME	21 (61)	0.08	0.08	0.08	0.08	0.08	0.08	0.08	0.08
DELAY	22 (62)	0.00	0.00	0.00	0.00	0.00	0.00	0.00	0.00
VERN									
ROT RATE	23 (63)	0.2000	0.4000	0.0080	0.2000	0.0500	0.0500	0.0160	0.0500
ATT DB	24 (64)	1.000	1.000	0.070	1.000	1.000	1.000	1.000	1.000
RATE DB	25 (65)	.020	.020	.010	.020	.020	.020	.020	.020
ROT PLS	26 (66)	0.010	0.010	0.010	0.010	0.010	0.010	0.010	0.050
COMP	27 (67)	.000	.000	.000	.000	.000	.000	.000	.000
CNTL ACC	28 (68)	0	0	0	0	0	0	0	0
PURPOSE		NOMINAL	PTC	GG		LOSS OF VERN (ALL)	LOSS OF VERN (TAIL ONLY)	RNDZ	TERMINAL PHASE

BOLD/ITALIC indicates change from I-Load.

FS 3-4

ORB OPS/128/FIN

STS-128 DAP A9 – DAP A14 CONFIGURATIONS

	ITEM #	A9	A10	A11	A12	A14
PRI						
ROT RATE	10 (50)	0.1300	0.0500	0.0500	0.0500	0.2000
ATT DB	11 (51)	2.00	0.60	10.00	5.00	5.00
RATE DB	12 (52)	0.10	0.10	0.20	0.20	0.20
ROT PLS	13 (53)	0.100	0.100	0.100	0.040	0.100
COMP	14 (54)	.000	.000	.000	.000	.000
P OPTION	15 (55)	TAIL	TAIL	TAIL	TAIL	TAIL
Y OPTION	16 (56)	TAIL	TAIL	TAIL	TAIL	TAIL
TRAN PLS	17 (57)	0.050	0.050	0.100	0.010	0.100
ALT						
RATE DB	18 (58)	0.100	0.100	0.020 ¹	0.020 ¹	0.200
JET OPT	19 (59)	TAIL	TAIL	TAIL	TAIL	TAIL
# JETS	20 (60)	2	2	1	1	1(2) ³
ON TIME	21 (61)	0.08	0.08	0.08	0.08	0.08
DELAY	22 (62)	0.00	0.00	7.04	7.04	6.00
VERN						
ROT RATE	23 (63)	0.1300	0.0500	0.1000	0.1000	0.2000
ATT DB	24 (64)	1.000	0.500	5.000	3.000	3.000
RATE DB	25 (65)	.020	.020	.050	.020	.200
ROT PLS	26 (66)	0.050	0.050	0.010	0.002	0.010
COMP	27 (67)	.000	.000	.000	.000	.000
CNTL ACC	28 (68)	0	0	4 ²	4 ²	1
PURPOSE		PROX/OPS FLYAROUND	DOCKING	AUTO REBOOST	MATED VRCS (MVNRS,ROBO)	ORBITER ALONE SRMS/OBSS

BOLD/ITALIC indicates change from I-Load.

¹ I-loaded below keyboard limit; do not change

² CA2 for no vehicle docked at SM aft
CA4 for Progress/Soyuz docked at SM aft

³ Use 1 for OBSS scan and 2 for Orbiter attitude maneuvers

FS 3-5

ORB OPS/128/FIN

STS-128 DAP B CONFIGURATIONS

STS-128 DAP B1 – DAP B8 CONFIGURATIONS

	ITEM #	B1	B2	B3	B4	B5	B6	B7	B8
PRI									
ROT RATE	30 (50)	0.5000	0.2000	0.2000	0.2000	0.2000	0.5000	0.5000	0.0500
ATT DB	31 (51)	3.00	3.00	3.00	0.30	3.00	3.00	2.00	2.00
RATE DB	32 (52)	0.20	0.20	0.20	0.20	0.20	0.20	0.20	0.20
ROT PLS	33 (53)	0.040	0.040	0.040	0.040	0.040	0.040	0.040	0.040
COMP	34 (54)	.000	.000	.000	.000	.000	.000	.000	.000
P OPTION	35 (55)	ALL	TAIL	ALL	TAIL	TAIL	ALL	ALL	ALL
Y OPTION	36 (56)	ALL	TAIL	ALL	TAIL	TAIL	ALL	ALL	ALL
TRAN PLS	37 (57)	0.100	0.020	0.020	0.020	0.020	0.020	0.050	0.050
ALT									
RATE DB	38 (58)	0.200	0.070	0.070	0.100	0.200	0.200	0.100	0.100
JET OPT	39 (59)	ALL	TAIL	ALL	ALL	ALL	ALL	ALL	ALL
# JETS	40 (60)	2	1	1	2	2	2	2	2
ON TIME	41 (61)	0.08	0.08	0.08	0.08	0.08	0.08	0.08	0.08
DELAY	42 (62)	0.00	0.00	0.00	0.00	0.00	0.00	0.00	0.00
VERN									
ROT RATE	43 (63)	0.2000	0.2000	0.2000	0.0080	0.0160	0.2000	0.2000	0.0500
ATT DB	44 (64)	1.000	1.000	1.000	0.100	0.033	1.000	1.000	1.000
RATE DB	45 (65)	.020	.020	.020	.010	.020	.020	.020	.020
ROT PLS	46 (66)	0.002	0.002	0.002	0.002	0.002	0.002	0.002	0.020
COMP	47 (67)	.000	.000	.000	.000	.000	.000	.000	.000
CNTL ACC	48 (68)	0	0	0	0	0	0	0	0
PURPOSE		OMS & RCS BURNS (ORB OPS)	LOSS OF VERN (TAIL ONLY)	LOSS OF VERN (ALL)		COAS/HUD CAL		RNDZ	TERMINAL PHASE

BOLD/ITALIC indicates change from I-Load.

FS 3-6

ORB OPS/128/FIN

STS-128 DAP B9 – DAP B12 CONFIGURATIONS

	ITEM #	B9	B10	B12
PRI				
ROT RATE	30 (50)	0.1300	0.0500	0.0100 ¹
ATT DB	31 (51)	2.00	0.60	1.00
RATE DB	32 (52)	0.10	0.10	0.20
ROT PLS	33 (53)	0.040	0.040	0.040
COMP	34 (54)	.000	.000	.000
P OPTION	35 (55)	TAIL	TAIL	TAIL
Y OPTION	36 (56)	TAIL	TAIL	TAIL
TRAN PLS	37 (57)	0.010	0.010	0.010
ALT				
RATE DB	38 (58)	0.100	0.100	0.020 ¹
JET OPT	39 (59)	TAIL	TAIL	TAIL
# JETS	40 (60)	2	2	1
ON TIME	41 (61)	0.08	0.08	0.08
DELAY	42 (62)	10.00	0.00	7.04
VERN				
ROT RATE	43 (63)	0.1300	0.0500	0.0100
ATT DB	44 (64)	1.000	0.500	1.000
RATE DB	45 (65)	.020	.020	.020
ROT PLS	46 (66)	0.020	0.020	0.002
COMP	47 (67)	.000	.000	.000
CNTL ACC	48 (68)	0	0	4 ²
PURPOSE		PROXOPS/ FLYAROUND	DOCKING	MATED VRCS & ALT (ATT HOLD)

BOLD/ITALIC indicates change from I-Load.

¹ I-loaded below keyboard limit; do not change

² CA2 for no vehicle docked at SM aft
CA4 for Progress/Soyuz docked at SM aft

FS 3-7

ORB OPS/128/FIN



This Page Intentionally Blank



REBOOST/DAP

AUTO REBOOST.....	FS 4-2
ATTITUDE REFERENCE.....	FS 4-4
DOCKED DAP REFERENCE	FS 4-5
RATE DAMPING.....	FS 4-5

**REBOOST/
DAP**

AUTO REBOOST

NOTE

Allow 5 min between establishing reboost attitude and reboost start time for DAP accelerations to converge

1. If PRCS required:

O14:F, RJDA 1A L2/R2 DRIVER – OFF
O15:F, RJD MANF L5/F5/R5 DRIVER – OFF
O16:F, Pri RJD LOGIC (eight) – ON

√MCC for GO to power up Pri Drivers
RJD MANF L5/F5/R5 DRIVER – ON
Pri RJD DRIVER (eight) – ON

2. Select Reboost Configuration

GNC 20 DAP CONFIG
REBOOST CFG – ITEM 8 +_ EXEC
INTVL – ITEM 9 +_ EXEC

3. Set up Future Reboost

GNC UNIV PTG
DURATION – ITEM 27 +_ +_ +_ EXEC
START TIME – ITEM 1 +_ . . . +_ . . . +_ EXEC
RBST – ITEM 25 EXEC (FUT-*)

4. Select appropriate Reboost Rotation DAP
When in attitude and prior to START TIME,
DAP: A11/AUTO/VERN(ALT)

C3

If using Config 1(2):

GNC 20 DAP CONFIG
Disable X JETS ROT – ITEM 7 EXEC (no *)

REBOOST/
DAP

Cont next page

FS 4-2

ORB OPS/128/FIN

NOTE

Reboost can be aborted with an item 26 on UNIV PTG or by selecting FREE on the DAP

5. Post Reboost Configuration

If using Config 1(2):

GNC 20 DAP CONFIG

Enable X JETS ROT – ITEM 7 EXEC (*)

Return to FLIGHT PLAN Attitude

DAP: as reqd

Pri RJD LOGIC,DRIVER (sixteen) – as reqd

C3
O14,
O15,
O16

AUTO REBOOST ATTITUDE REFERENCE

ALT & VRCS ATTITUDE HOLD CONFIGURATIONS:

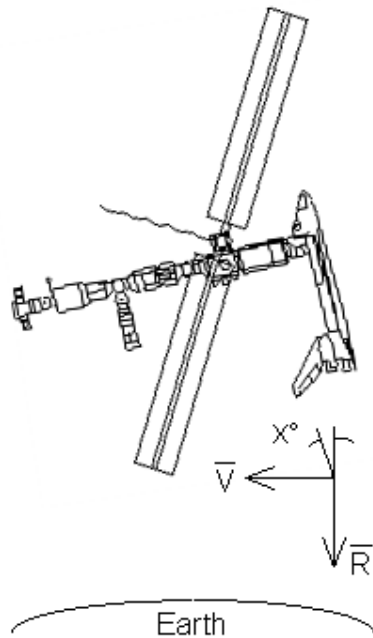

REBOOST

Configuration 1 is ALT PRCS only (Pitch, $X \approx 20^\circ$)

Configuration 2 is for SHUTTLE ONLY - Do Not Use While Docked

Configurations 3 & 4 are identical and VRCS only (Pitch, $X \approx 5^\circ$)

DOCKED DAP REFERENCE

NOTE

Shuttle mated attitude control is not certified when the Shuttle Airlock is depressurized (<3.45 psia)

Mated Maneuvers and MPLM (VERN ONLY)	Mated Attitude Hold (VERN or ALT)
A12	B12

ALT not certified for loaded RMS operations

ALT not certified for maneuvers. May be used in contingency with unloaded RMS. Expect long maneuver times and sloppy control

CNTL ACC configurations for VERN and ALT:

CNTL ACC 2: No vehicle docked at SM aft

4: Progress/Soyuz docked at SM aft

RATE DAMPING

DAP: LVLH(INRTL) - Dependent on desired attitude hold

Monitor Jet Activity Light:

If jet activity stopped for > 5 sec for VERN (15 sec for ALT)

DAP: FREE > 2 sec

DAP: AUTO >>

For continuous jet activity > 6 min:

DAP: FREE then restart RATE DAMPING



This Page Intentionally Blank

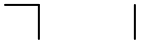

OIU PROCEDURES

OIU ACTIVATION	FS 5-2
DEACTIVATION	FS 5-2

OIU

OIU ACTIVATION

NOTE

√MCC that steps 1 and 2 may not be reqd

1. Load PCMMU/PDI (config 760) for OIU
2. Power on PSP 1(2)

A1L	√S-BD PL CNTL	– CMD
	PWR SYS	– 1(2)
	√SEL	– PSP
	√PSP CMD OUTPUT	– PL UMB
	CNTL	– PNL,CMD

SM 62 PCMMU/PL COMM

I/O RESET PSP 1(2) – ITEM 6(7) EXEC (*)

3. Power on OIU 1(2)

SSP1	OIU PWR – OIU 1(2) ON
	√tb – UP(DN)

OIU DEACTIVATION

NOTE

√MCC for OIU ops complete

1. Possible 'S62 PDI DECOM FAIL' msg

SSP1	OIU PWR – OFF
	√tb – bp

2. MCC will config PCMMU and PDI as reqd

OIU

SHORT DURATION BIOASTRONAUTICS
INVESTIGATION (SDBI)

SDBI 1634, SLEEP-WAKE ACTIGRAPHY	FS 6-2
DON ACTIWATCH	FS 6-2
DOFF ACTIWATCH	FS 6-2
SDBI 1900, INTEGRATED IMMUNE BLOOD COLLECTION	FS 6-3
SDBI 1900, SALIVA COLLECTION FOR INTEGRATED IMMUNE	FS 6-9

SDBI

SDBI 1634, SLEEP-WAKE ACTIGRAPHY

- MF14K A. DON ACTIWATCH (ASAP after entry into orbit)
1. Unstow: Actiwatch
SLEEP LOGBOOK

NOTE

Actiwatch should be worn on top of non-dominant wrist outside of clothing. Face of Actiwatch should remain uncovered at all times.

If necessary to remove Actiwatch, record doff/don time in SLEEP LOGBOOK

2. Don Actiwatch on non-dominant arm and wear continuously throughout mission
3. Deploy SLEEP LOGBOOK and record required information daily (within 15 min after waking)

B. DOFF ACTIWATCH

NOTE

If mission length extended, continue to wear Actiwatch and complete SLEEP LOGBOOK as timeline permits

- MF14K On final day of orbit:
1. Remove Actiwatch, stow in locker
 2. Recover SLEEP LOGBOOK, stow in locker

SDBI

SDBI 1900, INTEGRATED IMMUNE BLOOD COLLECTION

OBJECTIVE:

Integrated Immune Assessment (Integrated Immune). The purpose of this procedure is to effectively and safely perform a blood draw, process blood samples, and properly stow them to achieve Integrated Immune Experiment objectives

PARTS:

Integrated Immune Blood Collection Kit:

- Band-Aid
- Fine Point Sharpie
- Gauze
- Tourniquet
- X-Large Gloves
- Butterfly Needle
- Tube Holder
- Blood Sample Sleeve:
 - Blood 8.5ml ACD (yellow top tube)
 - Blood 10ml EDTA (purple top tube)
- Biocide Wipes
- Biohazard Bag
- Surgical Paper Tape, 1-in
- Sharps Container
- Gray Tape

WARNING

All consumable items that come in contact with blood must be discarded in Biohazard Bag (provided in kit)

All sharp items (i.e., needles) must be discarded into Sharps Container

NOTE

Any spilled blood should be cleaned up with Gauze and followed with a Biocide Wipe

Cont next page

FS 6-3

ORB OPS/128/FIN

A. SETUP FOR BLOOD SAMPLE COLLECTION

NOTE

The lid of the Integrated Immune Blood Collection Kit, when opened, can be used as a workstation on which to temporarily store items via Velcro. Gray Tape can also be used

PI Locker 1. If desired for temporary stowage of supplies during blood draw, deploy about 12-inch piece of Gray Tape near location of blood draw

2. Deploy hardware near area where activity will be performed:

MA16N Integrated Immune Blood Collection Kit: |
Band-Aid
Fine Point Sharpie
Gauze (1 package)
Tourniquet
Butterfly Needle (1)
Tube Holder
Blood Sample Sleeve (open sleeve and loosen tubes)
Biocide Wipes
Surgical Paper Tape, 1-in
Sharps Container
Biohazard Bag
X-Large Gloves

3. Place Biohazard Bag in convenient location for trash disposal

B. PERFORM BLOOD SAMPLE COLLECTION

1. Retrieve Butterfly Needle (1) and remove from package. Place package in the Biohazard Bag and temporarily store

Cont next page

FS 6-4

ORB OPS/128/FIN

2. Retrieve Tube Holder
Screw Tube Holder onto threaded end of
Butterfly Needle
Temp stow Butterfly Needle/Tube Holder
3. Retrieve Gauze, open package but do not
remove Gauze, temp stow Gauze package
4. Retrieve Tourniquet from Integrated Immune
Blood Collection Kit
Apply Tourniquet to subject's arm
Using fingers find vein and select puncture site

<p><u>WARNING</u> Operator must don X-Large Gloves prior to needle insertion and observe Universal Precautions for Handling Biohazardous Materials</p>

5. Retrieve and don X-Large Gloves
Retrieve and open Biocide Wipe, placing empty
package in Biohazard Bag
Cleanse area with Biocide Wipe
Place used Biocide Wipe in Biohazard Bag
6. Retrieve Butterfly Needle/Tube Holder from temp
stow
Remove protective cover from Butterfly
Needle/Tube Holder. Place cover in Biohazard
Bag

<p><u>CAUTION</u> Blood tubes must be inspected for cracks. If cracked, tubes should be discarded in the Biohazard Bag</p>

7. Retrieve:
Blood Sample Sleeve
Surgical Paper Tape, 1-in

Cont next page

WARNING

Insert needle at 30 degree angle to vein to ensure proper blood flow and avoid injury

Avoid shifting needle from side to side after entering vein

NOTE

Taping of central portion of needle tubing to subject's arm is to prevent excessive movement during blood draw. Only tape tubing after needle is properly inserted in vein

8. Insert Butterfly Needle in subject's arm with bevel up. When the needle is properly inserted in the vein a flash of blood will be observed in butterfly tubing

Using strips of 1-in Surgical Paper Tape as necessary, tape central portion of Butterfly Needle tubing to subject's arm

Blood
Sample
Sleeve

9. Retrieve subject's empty Blood 8.5ml ACD (yellow top blood tube)

NOTE

Allow 10 sec to ensure the tube vacuum draws the appropriate volume of blood

10. Verify a flash of blood in butterfly tubing
11. Firmly push the blood tube into Tube Holder to puncture tube cap and initiate blood flow
12. When filled, detach blood tube from Tube Holder
13. Gently agitate tube for blood to mix with reagent for ~5 sec

Cont next page

FS 6-6

ORB OPS/128/FIN

- ┌ | | | ┌
- Blood Sample Sleeve
14. Temp stow filled blood tube in Blood Sample Sleeve
 15. Retrieve Blood 10.5ml EDTA tube (purple top) and repeat steps 11 thru 14 for the second tube
 16. Loosen Tourniquet
 17. Retrieve Gauze from temp stow
 18. Hold Gauze to venipuncture site while simultaneously grasping wings of Butterfly Needle and removing it at same angle of insertion, applying gentle pressure to Gauze
- Have subject hold Gauze on venipuncture site for 2-5 min
- If taped, remove tape from arm and dispose
- Slide safety shield over Butterfly Needle by holding yellow sheath and pulling wings backward

NOTE

Do not discard tube holder

19. Carefully unscrew Tube Holder from Butterfly Needle; temp stow
20. Discard used Butterfly Needle (with sharp edges facing down) in Sharps Container
21. Remove Tourniquet and stow in Integrated Immune Blood Collection Kit

Cont next page

FS 6-7

ORB OPS/128/FIN

└ | | | └

22. Keep Gauze on venipuncture site for pressure bandage
Place Band-Aid over folded Gauze
Discard any excess Gauze and Band-Aid wrapper in Biohazard Bag

23. Retrieve filled blood tubes from Blood Sample Sleeve and label both tubes with crewmember name and GMT (e.g., Smith: GMT 168:19:48)

24. Stow blood tubes back in Blood Sample Sleeve and temp stow

25. Discard X-Large Gloves in Biohazard Bag

Dispose of any remaining Biocide Wipes, Gauze, Gray Tape, or empty packaging used in the activity

C. STOW HARDWARE

1. Remove full Biohazard Bag, close with Gray Tape

Discard full Biohazard Bag in appropriate disposal location

2. Stow in Integrated Immune Blood Collection Kit:

Blood Sample Sleeve with blood samples

Sharps Container (bottom first into pouch)

Biocide Wipes (if any)

Gauze (if any)

Surgical Paper Tape, 1-in

Fine Point Sharpie

Tube Holder

Remaining Band-Aid packages (if any)

3. Stow:

MA16N

Integrated Immune Blood Collection Kit

Put away Gray Tape per crew preference

SDBI 1900, SALIVA COLLECTION FOR INTEGRATED IMMUNE

OBJECTIVE:

Integrated Immune Assessment (Integrated Immune). The purpose of this procedure is to effectively perform saliva collection to achieve Integrated Immune Experiment objectives

PARTS:

- Integrated Immune Saliva Collection Kit:
 - Salivette Bag (package with cotton swabs)
 - Saliva Sample Preservative Bag
 - Label
 - Saliva Collection Dry Booklet
 - Saliva Sample Return Pouch
- Fine Point Sharpie

A. SETUP FOR SALIVA SAMPLE COLLECTION

NOTE

Any Saliva Sample Return Pouch (labeled USED and does not have crewmember data filled in) located in the Integrated Immune Saliva Collection Kit will suffice for this step

- 1. Unstow:
 - MA16N Integrated Immune Saliva Collection Kit: |
 - Fine Point Sharpie
 - Label from plastic window of Saliva Sample Return Pouch
- 2. Write crewmember name on label using Fine Point Sharpie
Return label to plastic window it was taken from
Temp stow Fine Point Sharpie

Cont next page

FS 6-9

ORB OPS/128/FIN

B. PERFORM LIQUID SALIVA SAMPLE COLLECTION

NOTE

Liquid saliva should be collected immediately post-sleep (before brushing teeth, before breakfast, and before any liquid intake)

1. Retrieve from Integrated Immune Saliva Collection Kit:
Salivette Bag
Saliva Sample Preservative Bag
2. Temp stow Saliva Sample Preservative Bag

NOTE

Touching the Cotton Swab with fingers at any point of the data collection will contaminate the sample

3. Open Salivette Bag and by kneading and manipulating the outside of package, separate one Cotton Swab from the others and move it towards the opening of the package
4. Place Salivette Bag with Cotton Swab near mouth and then transfer Cotton Swab from package into mouth. Lightly roll Cotton Swab around mouth with tongue until saturated (2 min max). Do not bite down or chew on Cotton Swab
5. Stow Salivette Bag with remaining Cotton Swab in Integrated Immune Saliva Collection Kit
6. Retrieve Saliva Sample Preservative Bag from temp stow
7. Using mouth, place Cotton Swab in Saliva Sample Preservative Bag

Cont next page

8. Close seal on Saliva Sample Preservative Bag

NOTE

Ensure bag is sealed prior
to mixing preservative

9. Remove clamp, mix preservative with Cotton Swab
10. Reclamp across top of Saliva Sample Preservative Bag
11. Using Fine Point Sharpie, write crewmember name and GMT on Saliva Sample Preservative Bag (e.g., Smith: GMT 168:19:48)
12. Stow sample in Saliva Sample Return Pouch (labeled with crewmember name in part A step 2) inside Integrated Immune Saliva Collection Kit

C. PERFORM DRY SALIVA COLLECTION

NOTE

First sample should be taken as
soon after waking as is convenient

1. Retrieve from Integrated Immune Saliva Collection Kit:
Dry Saliva Collection Book
2. Write crewmember name in name section on cover of Dry Saliva Collection Book
3. Open cover
Select (but do not remove from book) the corresponding sheet of filter paper to the time period sample is being taken (WAKE, WAKE + 30 MINUTES, WAKE + SIX HOURS, WAKE + TEN HOURS, RETIRE) as illustrated on the cover

Label GMT on corresponding color and time period on cover

Cont next page

NOTE

Take care not to touch other collection time's filter papers when using Dry Saliva Collection Book

4. Place filter paper in mouth and saturate filter paper with saliva

NOTE

Do not touch saturated part of filter paper while drying. Filter paper does not have to be 100% dry before stowing/temp stowing. Use crew discretion

5. Remove filter paper from mouth. Wipe excess liquid saliva from filter paper with lips
Allow to air dry
6. Temp stow Dry Saliva Collection Book or maintain on person if desired
7. For subsequent collections, retrieve Dry Saliva Collection Book from temp stow and repeat steps 3 thru 6 four times throughout the day that correspond to the remaining four time intervals from wake period
8. After collecting last dry saliva sample, open Saliva Sample Return Pouch (labeled with crew ID) inside Integrated Immune Collection Kit and stow Dry Saliva Collection Book inside Saliva Sample Return Pouch

D. STOW HARDWARE

MA16N

1. Stow: Integrated Immune Saliva Collection Kit |

WING LEADING EDGE SENSORS (WLES) PROCEDURES

WLES ACTIVATION AND CHECKOUT.....	FS 7-2
DEACTIVATION AND TEARDOWN.....	FS 7-10
LAPTOP RECEIVER UNIT (LRU) R&R.....	FS 7-12
CABIN RELAY UNIT R&R	FS 7-14
CONFIGURE WLES DATA FILE BACKUP PATH.....	FS 7-16
PREP WLES LAPTOPS FOR TRANSFER.....	FS 7-17
WLES RNDZ TOOLS CHECKOUT PREP.....	FS 7-18
DOCK/UNDOCK RECOVERY	FS 7-18
DISABLE WLES FILE BACKUP	FS 7-19
ENABLE WLES FILE BACKUP	FS 7-19

**WLE
SENSORS**

WLES ACTIVATION AND CHECKOUT

1. UNSTOW EQUIPMENT

NOTE

A31p laptops may already be unstowed as part of orbiter laptop network setup

ML60E

Unstow:

Laptop Receiver Units (2)

Cabin Relay Units (2):

CRU A (S/N 1664)

CRU B (S/N 1728)

STS6 A31p laptop (WLES)

STS5 A31p laptop (RPOP2)

2. SETUP WLES RELAY UNITS

CAUTION

Cross-connecting CRU A to MICRO WIS SYSTEM B (and vice versa) will prevent WLES ops, though step 8 would still show good comm

NOTE

Green patch on Cabin Relay Unit is antenna and must face into cabin

A6	Unstow coiled WLE SYSTEM A cable
A13	Connect plug PNL A13 SYSTEM A to jack MICRO WIS SYSTEM A J7 (see fig 7-1)
CRU A	Connect plug CABIN RELAY UNIT to J1 on CRU S/N 1664
STBD OVHD	Secure CRU A to STBD side of aft cabin with Velcro (see fig 7-2)
A9	Unstow coiled WLE SYSTEM B cable
A13	Connect plug PNL A13 SYSTEM B to jack MICRO WIS SYSTEM B J8 (see fig 7-1)
CRU B	Connect plug CABIN RELAY UNIT to J1 on CRU S/N 1728
PORT OVHD	Secure CRU B to PORT side of aft cabin with Velcro (see fig 7-3)

WLE
SENSORS

Cont next page

FS 7-2

ORB OPS/128/FIN

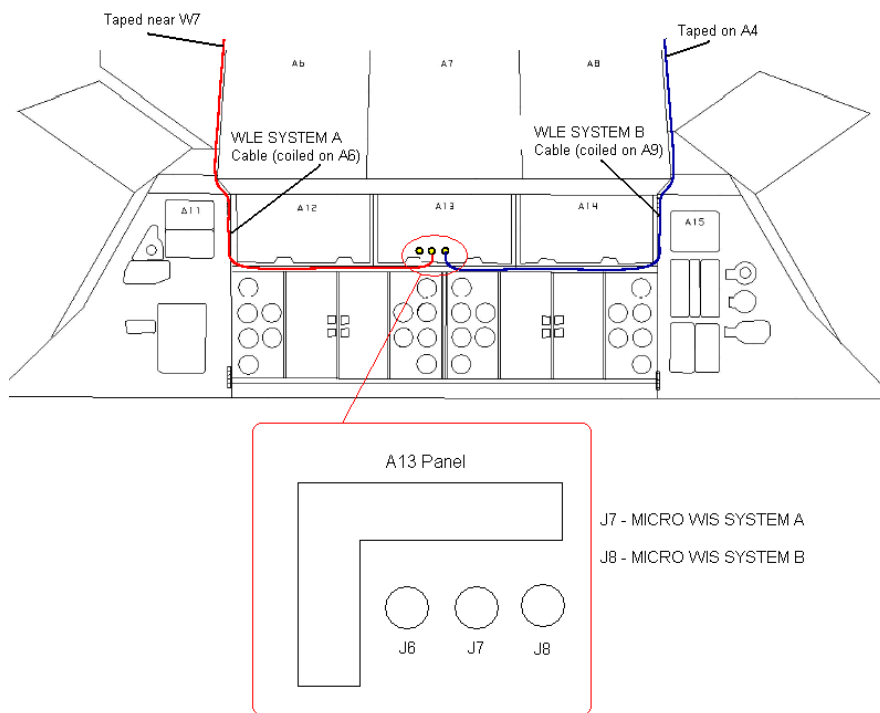

Figure 7-1.- A13 panel.

Cont next page

FS 7-3

ORB OPS/128/FIN

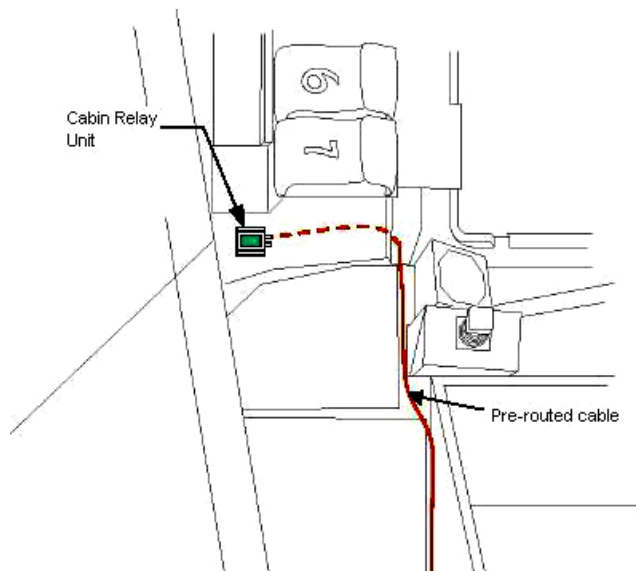

Figure 7-2.- Aft STBD location.

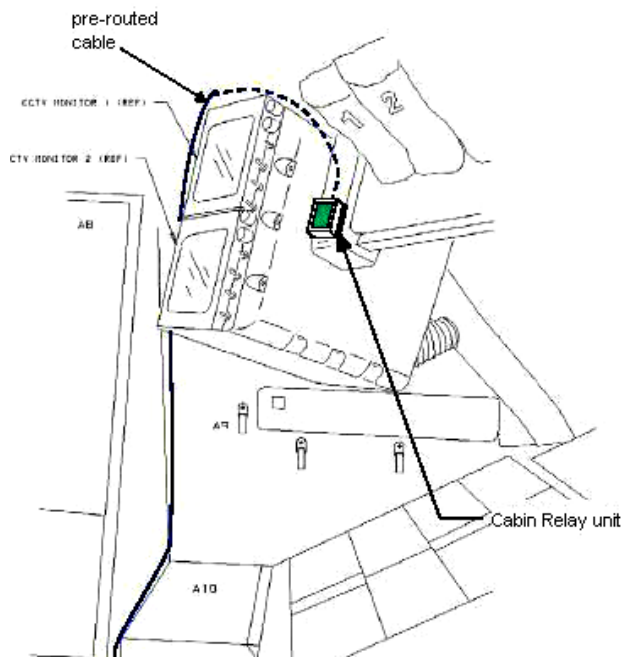

Figure 7-3.- Aft PORT location.

Cont next page

FS 7-4

ORB OPS/128/FIN

NOTE

Laptops may be powered or unpowered.
Laptops may be connected to network or standalone

- A31p
3. SETUP PRIME WLES LAPTOP
Secure Laptop Receiver Unit to A31p with Velcro (see fig 7-4)
Connect Laptop Receiver Unit to A31p Serial port using thumbscrews (see fig 7-5)
Verify line of sight between Laptop Receiver Unit and both CRUs
Verify 5-in minimum distance between Laptop Receiver Unit and both CRUs
 4. SETUP BACKUP WLES LAPTOP

NOTE

Single laptop ops are preferred over delays in activation. If problems with Backup Laptop occur, skip step 4

Secure Laptop Receiver Unit to A31p with Velcro (see fig 7-4)
Connect Laptop Receiver Unit to A31p Serial port using thumbscrews (see fig 7-5)
Verify line of sight between Laptop Receiver Unit and both CRUs
Verify 5-in minimum distance between Laptop Receiver Unit and both CRUs

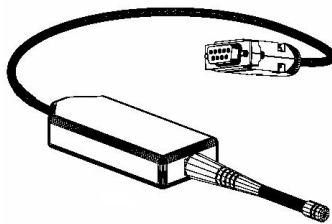

Figure 7-4.- Laptop Receiver Unit.

Cont next page

FS 7-5

ORB OPS/128/FIN



Figure 7-5.- A31p ports.

5. LAUNCH WLES SOFTWARE

Perform for both laptops:

If laptops are off, A31p pwr – On

Double click the time in system tray (lower-right corner)

'Date and Time Properties'

'Time Zone'

Time zone – (GMT) Greenwich Mean Time

Click 'OK'

Double click 'Shuttle Apps'>'WLES'>'WLES'

'Backup Mode Selection'

If setting up one A31p, select 'Standard'

If setting up two A31p laptops:

For prime laptop, select 'Primary'

For backup laptop, select 'Secondary'

If 'EWBMTAU-WLEFlight' appears with message 'Run the current command:

XXXX_AA_BB_SNYYYYY.xml?':

Click 'Yes'

NOTE

The secondary laptop lid may be closed at this time, if no longer needed for other applications. The laptops are configured so that they do not enter 'standby' or 'hibernate' mode when the lids are closed. However, due to cooling concerns, fully closing the lid is not recommended

Cont next page

A31p

6. VERIFY LRU INSTALLATION

Use prime WLES laptop

'Enhanced Wideband MicroTAU – WLEFlight 3.0'

Click 'System Settings' (left side of display)

'Communications Settings'

√RF Receiver Port: 'COM 1'

Click 'Query Receiver'

Verify 'Receiver found on COM1' message appears

- * If 'Query Receiver' fails: *
- * Reseat LRU *
- * Reboot prime WLES laptop *
- * Double click 'Shuttle Apps'>'WLES'> *
- * 'WLES' *
- * Select 'Primary' *
- * Repeat step 6 *
- * If no Joy, perform WLES LRU R&R, steps *
- * 1-4, 6, then: *

7. VERIFY DATA FILE BACKUP

Use prime WLES laptop

Verify 'Backup Directory:' set to:

'S:\Program Files\Invocon\EWBMTAU-WLEFlight'

- * If 'Backup Directory' not set as above: *
- * 'System Settings' *
- * 'Directories' *
- * At the line 'Backup Directory:' click *
- * 'Browse...' (right side of display) *
- * *
- * 'Browse for Folder' *
- * Navigate to WLES folder on RPOP2: *
- * 'My Computer'>'C on RPOP2 (S:)'> *
- * 'Program Files'>'Invocon'> *
- * 'EWBMTAU-WLEFlight' *
- * *
- * Click 'OK' *

Verify 'Backup Interval' set to '30 minutes'

Cont next page

FS 7-7

ORB OPS/128/FIN

8. VERIFY COMM WITH RELAY UNITS

Use prime WLES laptop

'Main'

Click 'Unit List' (left side of display)

NOTE

Each Cabin Relay Unit is identified with a unique serial number; this number appears as 'Unit ID' in the software

√Cabin Relay Units Unit ID 1664 and 1728 present on display in first column; scroll down as necessary

For each Cabin Relay Unit:

√Unit ID present

√Type: 'Relay-GL'

√Last Update: time is updating (every 5 to 15 sec)

- * If one CRU time does not update: *
- * | Perform WLES CABIN RELAY UNIT R&R, *
- * | steps 1 thru 3, then: *
- * | Go to step 9 *
- * If neither CRU time updates after 2 min, *
- * contact MCC-H *

√Via: 'RF'

√Mode: 'Idle'

9. INITIATE COMMANDING

Double click 'Shuttle Apps'>'WLES'>'WLES Data Folder'

Double click 'Shuttle Apps'>'WLES'>'WLES Cmd Folder'

Cont next page

FS 7-8

ORB OPS/128/FIN

NOTE

Deleting 'BLOCK.xml' file initiates command execution. Command files disappear from this folder as they are executed.

Files appearing in the 'Data' folder verifies two-way communication with the Sensor Units in the orbiter wing

'Command'

Delete file labeled 'BLOCK.xml'

At prompt "Are you sure you want to send 'Block.xml' to the Recycle Bin?", click 'Yes'

Wait 1 minute

Verify the first data file appears in the 'Data' folder

Close 'Command' and 'Data' folders

10. REPORT WLES STATUS

Notify MCC-H: "WLES setup complete"

If reporting a failed and replaced CRU, include:

Failed CRU S/N

NOTE

The laptop lid may be closed at this time, if no longer needed for other applications. The laptops are configured so that they do not enter 'standby' or 'hibernate' mode when the lids are closed. However, due to cooling concerns, fully closing the lid is not recommended

WLES DEACTIVATION AND TEARDOWN

1. DEACTIVATE WLES LAPTOP

NOTE

MCC will configure WLES for entry by setting all sensor units to idle mode

On MCC GO:

A31p 'Enhanced Wideband MicroTAU – WLEFlight 3.0'

For each WLES A31p:

Click 'Exit'

At prompt 'Are you sure you want to exit?'

click 'Yes'

Click 'Start' > 'Turn Off Computer...' > 'Turn Off'

Disconnect Laptop Receiver Unit from A31p

Serial port

Remove Laptop Receiver Unit from Velcro on A31p

2. REMOVE WLES RELAY UNITS

Remove Cabin Relay Units (2) from aft cabin (see figs 7-6 and 7-7)

Disconnect Cabin Relay Units from pre-routed cables

Disconnect and coil cables, stow in launch location

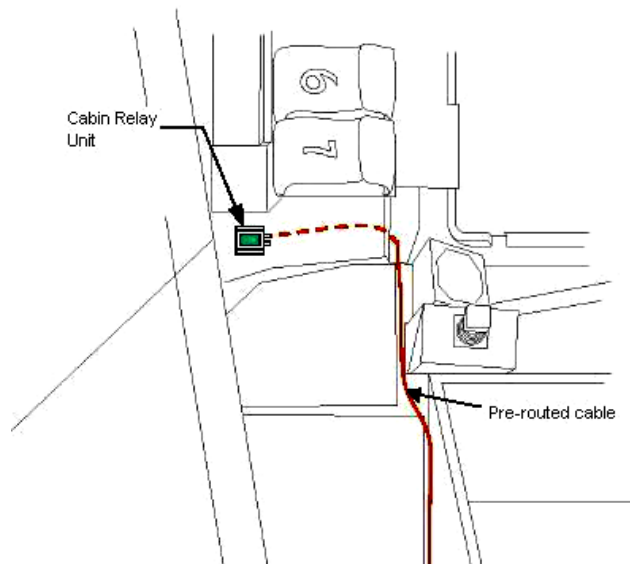

Figure 7-6.- Aft STBD location.

Cont next page

FS 7-10

ORB OPS/128/FIN

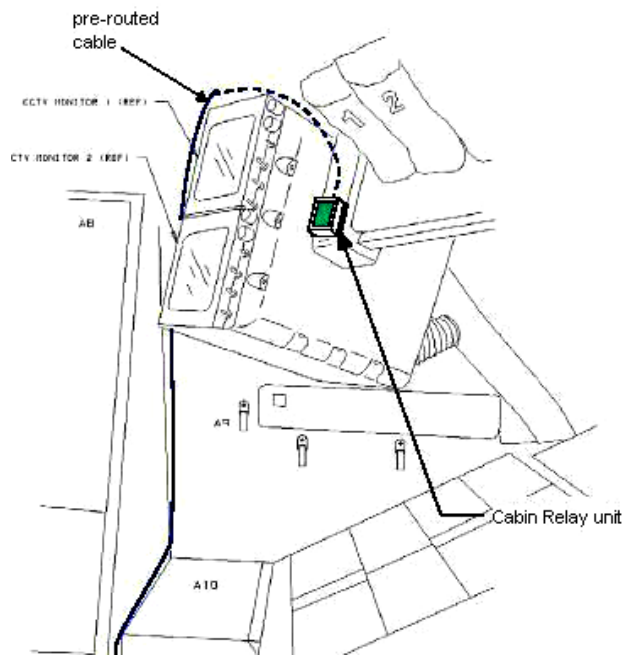

Figure 7-7.- Aft PORT location.

- ML60E
3. STOW EQUIPMENT
 Stow:
 Laptop Receiver Units (2)
 Cabin Relay Units (2)
 Notify MCC-H: "WLES Teardown Complete"

WLES LAPTOP RECEIVER UNIT (LRU) R&R

- A31p 1. DISCONNECT BACKUP LRU FROM LAPTOP
'Enhanced Wideband MicroTAU – WLEFlight 3.0'

Click 'Exit'
At prompt 'Are you sure you want to exit?'
click 'Yes'

Disconnect Backup LRU from Backup A31p Serial
port (see fig 7-8)
Remove Backup LRU from Velcro on Backup A31p
(see fig 7-9)



Figure 7-8.- A31p ports.

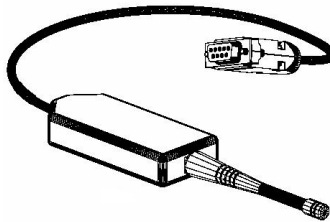

Figure 7-9.- Laptop Receiver Unit.

2. DISCONNECT PRIME LRU FROM LAPTOP
Disconnect Prime LRU from Prime A31p Serial port
(see fig 7-8)
Remove LRU from Velcro on A31p

Cont next page

FS 7-12

ORB OPS/128/FIN

3. CONNECT BACKUP LRU

Connect Backup LRU to Prime WLES A31p Serial port
Secure LRU to A31p with Velcro

A31p

4. VERIFY LRU INSTALLATION

Use prime WLES laptop

'Enhanced Wideband MicroTAU – WLEFlight 3.0'
Click 'System Settings' (left side of display)

'Communications Settings'
√RF Receiver Port: 'COM 1'

Click 'Query Receiver'
Verify 'Receiver found on COM1' message appears

5. VERIFY COMM WITH RELAY UNITS

Click 'Unit List' (left side of display)

√Cabin Relay Units Unit ID 1664 and 1728 present on display in first column; scroll down as necessary

For each Cabin Relay Unit:

- √Unit ID present
- √Type: 'Relay-GL'
- √Last Update: time is updating (every 5 to 15 sec)
- √Via: 'RF'
- √Mode: 'Idle'

If no time updates after 2 min, contact MCC-H

6. STOW EQUIPMENT

Notify MCC-H: "WLES LRU R&R complete", mark failed LRU as 'failed'

ML60E

Stow:
Prime (failed) LRU

WLES CABIN RELAY UNIT R&R

- OVHD 1. DISCONNECT FAILED CRU AND STOW
Disconnect WLE SYSTEM cable from J1 connector on failed CRU
Mark failed CRU as 'failed' and stow in ML60E
- ML60E 2. SETUP SPARE WLES RELAY UNIT
Unstow CRU SPARE (S/N 1792)

WLE SYSTEM cable
Connect plug CABIN RELAY UNIT A or B to J1 on CRU S/N 1792
- OVHD Secure CRU SPARE to the aft cabin with Velcro
- A31p 3. VERIFY COMM WITH SPARE RELAY UNIT
Use prime WLES laptop

'Main'
Click 'Unit List' (left side of display)

NOTE

Each Cabin Relay Unit is identified with a unique serial number; this number appears as 'Unit ID' in the software

√Cabin Relay Unit Unit ID 1792 present on display in first column; scroll down as necessary

Cabin Relay Unit:

- √Unit ID present
- √Type: 'Relay-GL'
- √Last Update: time is updating (every 5 to 15 sec)
- √Via: 'RF'
- √Mode: 'Idle'

NOTE

Loss of redundant relay path until the config file is updated by the ground

Cont next page

FS 7-14

ORB OPS/128/FIN

4. EXIT WLES SOFTWARE ON BOTH LAPTOPS

On MCC GO:

A31p

On both Prime and Backup WLES laptops:

'Enhanced Wideband MicroTAU – WLEFlight 3.0'
Click 'Exit' (upper right side of display)

'EWBMTAU – WLEFlight'
'Are you sure you want to exit?', click 'Yes'

Notify MCC-H when complete

NOTE

OCA will replace the config files on both laptops

5. LAUNCH WLES SOFTWARE

On MCC GO:

A31p

On both Prime and Backup WLES laptops:

Double click 'Shuttle Apps'>'WLES'>'WLES'

'Backup Mode Selection'
If setting up one A31p, select 'Standard'

If setting up two A31p laptops:
For prime laptop, select 'Primary'
For backup laptop, select 'Secondary'

If 'EWBMTAU-WLEFlight' window appears with
message 'Run the current command:
XXXX_AA_BB_SNYYYY.xml?':
Click 'Yes'

6. REVERIFY COMM WITH SPARE RELAY UNIT

Repeat step 3

7. REPORT WLES STATUS

Notify MCC-H: "WLES CRU R&R complete"

CONFIGURE WLES DATA FILE BACKUP PATH

NOTE

MCC will identify new backup WLES laptop to be used in place of RPOP2 (S:)

- A31p Use prime WLES laptop
- 'Enhanced Wideband MicroTAU – WLEFlight 3.0'
Click 'System Settings' (left side of display)
- 'Directories'
At the line 'Backup Directory:' click 'Browse...' (right side of display)
- 'Browse for Folder'
Navigate to WLES folder on RPOP2:
 'My Computer'>'C on RPOP2 (S:)'>'Program Files'>'Invocon'>'EWBMTAU-WLEFlight'
- Click 'OK'
- Verify 'Backup Directory:' set to:
 'S:\Program Files\Invocon\EWBMTAU-WLEFlight'
- Verify 'Backup Interval' set to '30 minutes'
- Click 'Unit List' (left side of display)

PREP WLES LAPTOPS FOR TRANSFER

- A31p 1. DEACTIVATE WLES LAPTOP(S)
'Enhanced Wideband MicroTAU – WLEFlight 3.0'

For each WLES A31p to be transferred:

Click 'Exit'

At prompt 'Are you sure you want to exit?'

click 'Yes'

Click 'Start' > 'Turn Off Computer...' > 'Turn Off'

Disconnect Laptop Receiver Unit from A31p

Serial port

Remove Laptop Receiver Unit from Velcro on
A31p

2. SET UP NEW WLES LAPTOPS

√MCC-H for which laptop to use

If Prime Laptop being transferred:

Perform WLES ACTIVATION AND CHECKOUT,
steps 3, 5 thru 8, then:

If Backup Laptop being transferred:

Perform WLES ACTIVATION AND CHECKOUT,
steps 4 and 5, then:

Notify MCC-H: "PREP WLES LAPTOPS FOR
TRANSFER complete"

WLES RNDZ TOOLS CHECKOUT PREP

- A31p
1. DEACTIVATE BACKUP WLES LAPTOP
On backup WLES laptop:
 'Enhanced Wideband MicroTAU – WLEFlight 3.0'
 Click 'Exit'
 At prompt 'Are you sure you want to exit?'
 click 'Yes'
 Disconnect Laptop Receiver Unit from A31p
 Serial port
 Leave attached to laptop with Velcro on A31p
 2. DEACTIVATE WLES FILE BACKUP
On prime WLES laptop:
 'Enhanced Wideband MicroTAU – WLEFlight 3.0'
 Click 'System Settings' (left side of display)

 'Backup Mode Selection'
 Click 'Standard'
 Click 'Unit List' (left side of display)

WLES DOCK/UNDOCK RECOVERY

- A31p
1. RECOVER BACKUP WLES LAPTOP
On backup WLES laptop:
 Connect Laptop Receiver Unit to A31p Serial port
 If laptop is off:
 | A31p pwr – On
 | At prompt select option 1 to start WLES
 If laptop is on:
 Double click 'Shuttle Apps'>'WLES'>'WLES'
 'Backup Mode Selection'
 Click 'Secondary'
 2. REACTIVATE WLES FILE BACKUP
On prime WLES laptop:
 'Enhanced Wideband MicroTAU – WLEFlight 3.0'
 Click 'System Settings' (left side of display)

 'Backup Mode Selection'
 Click 'Primary'
 Click 'Unit List' (left side of display)

┌ | | | ┌

DISABLE WLES FILE BACKUP

(SWITCH TO STANDARD MODE)

A31p On prime WLES laptop:
 'Enhanced Wideband MicroTAU – WLEFlight 3.0'
 Click 'System Settings' (left side of display)

 'Backup Mode Selection'
 Click 'Standard'
 Click 'Unit List' (left side of display)

ENABLE WLES FILE BACKUP

(SWITCH TO PRIMARY MODE)

A31p On prime WLES laptop:
 'Enhanced Wideband MicroTAU – WLEFlight 3.0'
 Click 'System Settings' (left side of display)

 'Backup Mode Selection'
 Click 'Primary'
 Click 'Unit List' (left side of display)



This Page Intentionally Blank



MAUI ANALYSIS OF UPPER-ATMOSPHERIC
INJECTIONS (MAUI)

MAUI PROCEDURE FS 8-2

MAUI

FS 8-1

ORB OPS/128/FIN

MAUI

MAUI PROCEDURE

- 15:00 or earlier 1. MANEUVER TO START ATTITUDE
(BIASED +ZLV +YVV)

Deploy MAUI – RCS FIRING SEQUENCE
(Cue Card)

GNC 20 DAP CONFIG

√DAP A1, B1 loaded

UNIV PTG

TGT ID – ITEM 8 +2 EXEC
BODY VECT – ITEM 14 +5 EXEC
P – ITEM 15 +2 7 0 EXEC
Y – ITEM 16 +3 5 0 EXEC
OM – ITEM 17 +2 7 0 EXEC

TRK – ITEM 19 EXEC (CUR - *)

2. INITIATE TIMER

√MCC for start time

GNC 2 TIME

Set count down/count up timer per MCC

√MET – ITEM 2 EXEC (*)

CRT TIMER COUNT TO – ITEM 17 + + +
EXEC

3. SETUP

O14:E, cb DDU L (two) – cl
O15:E

O14:F, Pri RJD LOGIC, DRIVER (sixteen) – ON
O15:F,
O16:F

GNC 20 DAP CONFIG

DAP A PRI P OPTION – ITEM 15 EXEC (NOSE)
ROT PLS – ITEM 13 +1.0 0 0 EXEC
TRAN PLS – ITEM 17 +0.7 3 EXEC
VERN ROT PLS – ITEM 26 +0.1 5 3 EXEC

Cont next page

GNC 23 RCS

Deselect Jets:

Forward RCS page – ITEM 1 EXEC

JET DES F1D – ITEM 23 EXEC (*)

F2D – ITEM 27 EXEC (*)

C3 √DAP: A/AUTO/VERN
 √DAP TRANS: PULSE/PULSE/PULSE
 DAP ROT: PULSE/PULSE/PULSE

-05:00 4. VERIFY ATTITUDE
 Verify in attitude

NOTE

For the following RCS firing sequence
(step 5):

- A. Expect total orbiter body rates
(RSS) to exceed 1 deg/sec
- B. Possible loss of comm due to orbiter
body rates and attitude excursions
- C. For any jet fail OFF, continue with
firing sequence
- D. Requirement is for a particular jet
group, not a specific jet
- E. The table in step 5 is also provided
as a cue card

Cont next page

FS 8-3

ORB OPS/128/FIN

5. RCS FIRING SEQUENCE

NOTE

Use the table below or the cue card

MAUI – RCS FIRING SEQUENCE

Timer	Jets Fired	CDR	PLT
-03:00		✓Body rates: $+0.047 \leq \text{roll} \leq +0.087$ $-0.020 \leq \text{pitch} \leq +0.020$ $-0.020 \leq \text{yaw} \leq +0.020$ DAP: FREE DAP: A/PRI Inform PLT "GO" for jet deselection	Configure initial setup GNC 23 RCS Left RCS page – ITEM 2 EXEC On CDR "GO", proceed <u>NOTE</u> Expect DAP RECONF msgs in following actions Deselect jets: JET DES L5L – ITEM 37 EXEC (*) Right RCS page – ITEM 3 EXEC JET DES R5D – ITEM 39 EXEC (*) Forward RCS page – ITEM 1 EXEC JET DES F5L – ITEM 37 EXEC (*) <u>NOTE</u> Queue the following ITEM entry on the scratch pad. Do not perform the EXEC until specified at 35 sec JET DES F3D – ITEM 25
-00:30		FLT CNTLR PWR – ON	
00:00	RXA, LXA	THC +X (in) (3 sec firing)	
00:15	FXL, LXL	THC +Y (right) (3 sec firing)	
00:30	FXR, RXR	THC -Y (left) (3 sec firing)	
00:35			When jets stop firing: GNC 23 RCS EXEC [JET DES F3D – ITEM 25 (*)]
00:45	F4D	RHC +pitch (Past Soft Stop, hold 3 sec)	
00:48		RHC release	
00:50			DAP: VERN
01:00	R5R	RHC +yaw (10 sec firing)	
01:20	L5D	RHC -pitch (12 sec firing)	
01:40	F5R	RHC +pitch (12 sec firing)	
		FLT CNTLR PWR – OFF	Return to MAUI PROCEDURE, step 6, (ORB OPS FS, MAUI)

Cont next page

FS 8-4

ORB OPS/128/FIN

6. CLEANUP
F6 √FLT CNTLR PWR – OFF

GNC 23 RCS

√Forward RCS page – ITEM 1 EXEC

Reselect Jets:

JET DES F1D – ITEM 23 EXEC (no *)
F3D – ITEM 25 EXEC (no *)
F2D – ITEM 27 EXEC (no *)
F5L – ITEM 37 EXEC (no *)

Left RCS page – ITEM 2 EXEC
JET DES L5L – ITEM 37 EXEC (no *)

Right RCS page – ITEM 3 EXEC
JET DES R5D – ITEM 39 EXEC (no *)

GNC 20 DAP CONFIG

DAP A1 – ITEM 1 + 1 EXEC

7. SNAP LVLH ATTITUDE AND NULL RATES

When time \geq +03:30:

DAP: A/PRI
DAP: LVLH

When rates stable:

DAP: VERN

Return to FLT PLN attitude

8. RECONFIGURE TO GROUP B POWERDOWN

√MCC

O14:E, cb DDU L (two) – op
O15:E

O14:F, Pri RJD LOGIC,DRIVER (sixteen) – OFF
O15:F, RJDA 1A L2/R2 MANF DRIVER – ON
O16:F



This Page Intentionally Blank





CWC-I FILL



CWC-I FILL FS 9-2

**CWC-I
FILL**

FS 9-1

ORB OPS/128/FIN



CWC-I FILL

CWC-I
FILL

NOTE

This procedure is to be used when filling a CWC-I containing a purple card (for iodinated water). Assumes Galley Morning Config and Overnight Config performed daily. To minimize contamination possibility, avoid touching any internal parts of QDs or connections

EQUIPMENT PREPARATION

Unstow from designated stowage when needed:

- Towel(s)
- CWC-I Fill Assembly
- 3/8" Male Hose Adapter ("-2" Adapter)
- Sample/Purge Kit
- CWC-I Bags
- Timer

A. CWC-I FILL ASSEMBLY SET UP

NOTE

Have towels ready to absorb any liquid released when mating or demating QDs

1. Retrieve CWC-I Fill Assembly
2. Connect R/Y QD Adapter of CWC-I Fill Assembly to free end of Tee attached to Chilled QD (#5) at QD bracket (see fig 9-1)

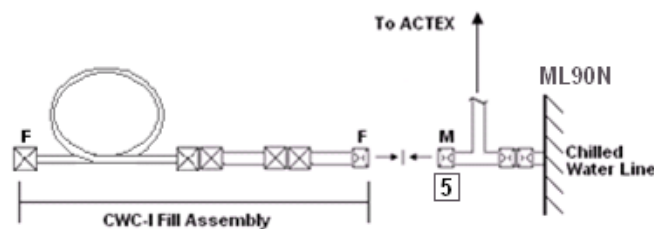

Figure 9-1.- CWC-I Fill Assembly connection at ML90N.

Cont next page

FS 9-2

ORB OPS/128/FIN

B. CWC-I FILL ASSEMBLY PURGE

NOTE

CWC-I FILL ASSEMBLY PURGE required only prior to first fill of mission

1. Retrieve 3/8" Male Hose Adapter ("-2" Adapter) and Sample/Purge Kit

CAUTION

Ensure Sample Adapter valve is not open prior to mating

NOTE

Use ONLY sampling adapter labeled for potable water sampling

2. Assemble Purge hardware as shown in fig 9-2

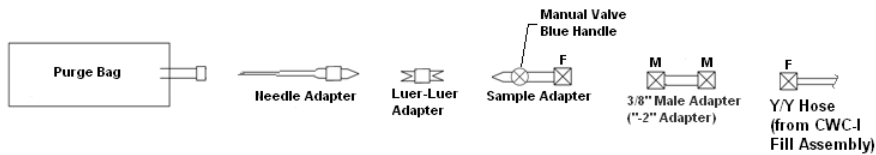

Figure 9-2.- CWC-I Fill Assembly purge hardware.

3. Remove cap on Needle Adapter and attach Purge Bag

CAUTION

Assembly provides high flow.
Throttle Sample Adapter Valve

4. Open valve on Sample Adapter and fill bag to capacity (about 12 ounces). Close valve when capacity reached
5. Disconnect Purge Bag from Needle Adapter
Stow Purge Bag in Ziplock Bag and place in crew designated location (Fresh Food Locker)
Replace cap on Needle Adapter

Cont next page

C. PURGE ASSEMBLY TEARDOWN

1. De-mate all connections shown in fig 9-2
2. Stow Purge Assembly hardware (place equipment in Ziplock Bags) in Sample/Purge Kit except “-2” Adapter. Return “-2” Adapter to Window Shade Bag

R11L D. CWC-I FILL INITIATION
If SPLY H2O XOVR VLV – CL (tb-bp) (water transfer config):

1. SPLY H2O TKA OUTLET – CL (tb-CL)

If reqd, unstow CWC-I Fill Assembly:

ML90N 2. CWC-I Fill Assembly →|← Chilled Water Line Tee QD (#5) (see fig 9-3)

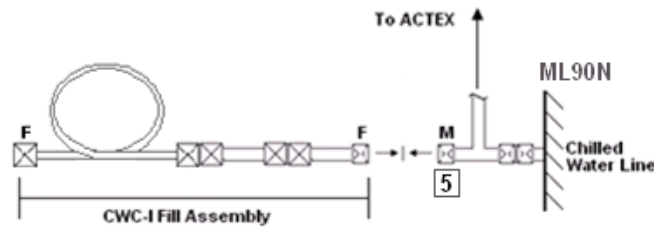

Figure 9-3.- CWC-I Fill Assembly connection at ML90N.

3. Report bag barcode and serial number (located on CWC-I label) to MCC-H

CAUTION
Do not overfill CWC-I as damage to bag may occur
Do not detach CWC-I QD restraint during fill

NOTE
CWC-I will begin filling as soon as free end of CWC-I Fill Assembly connected to CWC-I

Cont next page

FS 9-4

ORB OPS/128/FIN

4. Set timer for 10 min
Attach timer to Velcro square on CWC-I
5. CWC-I →|← CWC-I Fill Assembly (see fig 9-4)

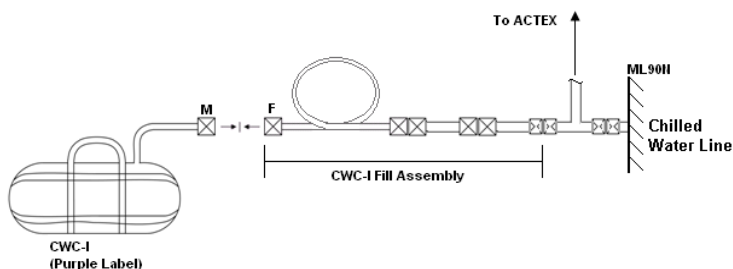

Figure 9-4.- CWC-I fill setup.

6. Start 10 min time

E. FILL TERMINATION

After 10 min or MCC call:

ML90N

1. CWC-I ←|→ CWC-I Fill Assembly
(see fig 9-5)

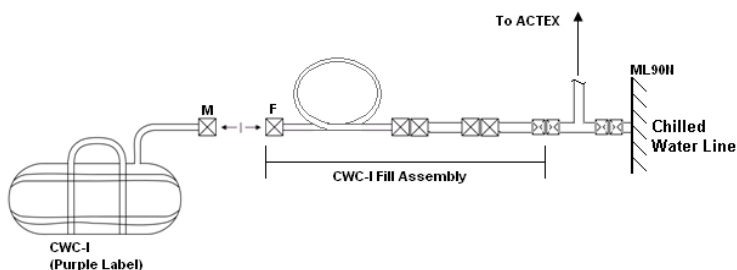

Figure 9-5.- CWC-I fill termination.

2. Verify purple card (for iodinated water) is visible in all three windows:
If samples reqd, perform CWC-I SAMPLING PROCEDURE, then proceed to step E3
If no samples reqd, temp stow CWC-I until transfer to ISS

Cont next page

3. If filling multiple CWC-Is, repeat steps D3 thru E2 for sequential fill(s)

R11L If SPLY H2O XOVR VLV – CL (tb-bp) (water transfer config):

4. SPLY H2O TKA OUTLET – OP (tb-OP)
5. Transfer CWC-I(s) to ISS

F. CWC-I FILL TEARDOWN

NOTE

Have towels ready to absorb any liquid released when demating QDs

- ML90N 1. CWC-I Fill Assembly ←|→ Chilled Water Line Tee QD (#5) (see fig 9-6)

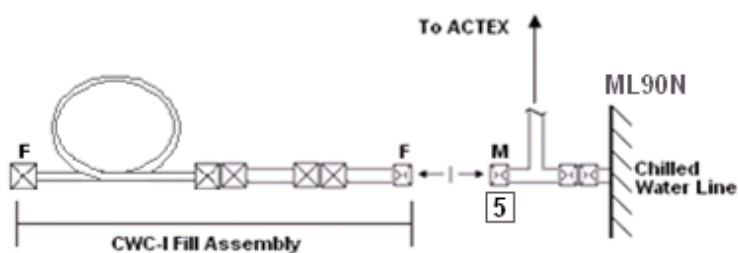

Figure 9-6.- CWC-I Fill Assembly removal.

2. Temp stow CWC-I Fill Assembly

After last CWC-I fill of day:

3. Stow CWC-I Fill Assembly in Window Shade Bag

CWC-I SAMPLING PROCEDURE (if reqd)

NOTE

Use ONLY sampling adapter labeled for potable water sampling

1. Retrieve Sample/Purge Kit and obtain Potable (blue handle) Sampling Adapter
2. Connect Sample Adapter to Sample Bag
3. Connect QD end of Sampling Adapter to CWC-I. Ensure manual valve set to open position
4. Fill sample bag full (estimate visually) by squeezing CWC-I. When complete, close manual valve and remove Sample Bag. Fill out Sample Bag label, stow in Ziplock Bag, and place in crew-designated sample stowage location
5. Disconnect Sampling Adapter from CWC-I and stow in Sample/Purge Kit. Temp stow CWC-I until transferred to ISS

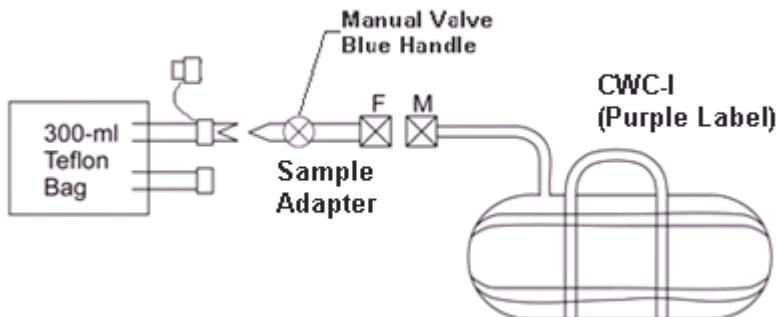
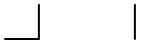

Figure 9-7.- CWC-I sample setup.



This Page Intentionally Blank





CUE
CARDS

CUE CARD CONFIGURATION



NOT FLOWN

FS 10-1

ORB OPS/128/FIN



CUE
CARDS

This Page Intentionally Blank

NOT FLOWN

FS 10-2

ORB OPS/128/FIN

TOP

HOOK
VELCRO

LiOH CHANGEOUT

(7 crewmembers/Single Shift/FD 1-15)

FLIGHT DAY	POS A	POS B	CK CMPLT
LAUNCH	1	2	
PRE FD01	"	"	
POST FD02	3	4	
PRE FD02	5	6 *	
POST FD03	"	7	DOCKING
PRE FD03	8	"	
POST FD04	"	9	
PRE FD04	10	"	
POST FD05	"	11	EVA 1
PRE FD05	12	"	
POST FD06	"	13	
PRE FD06	14	"	
POST FD07	"	15	EVA 2
PRE FD07	16	"	
POST FD08	"	17	
PRE FD08	18	"	
POST FD09	"	19	EVA 3
PRE FD09	20	"	
POST FD10	"	21	
PRE FD10	22	"	
POST FD11	"	23	
PRE FD11	24	"	
POST FD12	"	25	
MID FD12	26	27	HATCH CLOSE
PRE FD12	"	"	
POST FD13	28	29	
PRE FD13	30 *	31 *	
POST FD14	32	33	
PRE FD14	"	34	
POST FD15	35	36	EOM
PRE FD15	37 *	38 *	

*Re-bag and seal LiOH cans w/ Gray Tape and stow
(Location of canisters on back)

ORB OPS-29a/nonRCRS/128/O/B

NOTE

This card is specifically used for the STS-128 mission with the orbiter conducting single shift ops with a crew size of 7. This changeout scheme reflects FD3 docking with ISS, Vozdukh, and dual-bed CDRA operation

(reduced copy)

NOT FLOWN

FS CC 10-3

ORB OPS/128/FIN

TOP
BACK OF 'LIOH CHANGEOUT'

HOOK
VELCRO

LIOH CHANGEOUT (cont)
(7 crewmembers/Single Shift/FD 16-18)

FLIGHT DAY	POS A	POS B	CK CMPLT
POST FD16	39	40	EOM+1
PRE FD16	"	41	
POST FD17	42	43	EOM+2
PRE FD17	44 *	45 *	
POST FD18	46	47	EOM+3

*Re-bag and seal LiOH cans w/ Gray Tape and stow

LIOH CANISTER STOWAGE LOCATIONS

Ascent Stowage Locations

Orbiter:

MD52M (LiOH Box): cans 1-31 *

MPLM: cans 32-55

Entry (EOM) Stowage Locations

Orbiter:

MD52M (LiOH Box): cans 17-47 *

MPLM: cans 1-16

ISS:

Cans 48-55

* 2 LiOH cans installed in LiOH slots A and B

ORB OPS-29b/nonRCRS/128/O/B

(reduced copy)

NOT FLOWN

FS CC 10-4

ORB OPS/128/FIN

TOP

HOOK
VELCRO

HOOK
VELCRO

ORBIT BURN MONITOR

OMS TEMP*		
	L R	
FU IN P ≥	225 220	OMS ENG FAIL
≤	205 204	OMS PRPLT FAIL
or No FU IN P		
OMS PC* & OMS ↓		
ENG VLV 1 or 2 < 70		OMS ENG FAIL
or OX IN P > 227		OMS PRPLT FAIL
or OX IN P ≤ 227		OMS PRPLT FAIL
or No OX IN P		
OMS OX/FU TK P (√ENG IN P)		
OX/FU LOW		He PRESS/VAP ISOL (two) – OP If aff TK P not incr: OMS PRPLT FAIL
OX & FU HIGH		He PRESS/VAP ISOL (two) – CL Cycle He A(B) to maintain TK P 234-284
OMS N2 REG P HIGH or LOW		OMS ENG – ARM
OMS N2 TK P LOW (√[OMS/MPS])		At N2 TK P < 470: OMS ENG – ARM
OMS GMBL	PRI fail	L(R) OMS GMBL – SEC
	SEC fail	If high RCS usage: OMS ENG FAIL
GPC	<input type="checkbox"/> (<input type="checkbox"/>) & Burning OMS aff	aff GPC PWR – OFF If SEC GMBL avail: aff MDM FF 1(4) – OFF,ON L(R) OMS GMBL – SEC
	SEC GMBL lost	If high RCS usage: OMS ENG FAIL
	2 FAs lost	√MAN SHUTDN
I/O ERROR FA	1(4)	L(R) OMS GMBL – SEC ♦ I/O RESET If high RCS usage: OMS ENG FAIL
	2 FAs lost	√MAN SHUTDN
BCE STRG D	1(4)	I/O RESET (if recov: >>) If high RCS usage: L(R) OMS GMBL – SEC
GPC SET SPLIT	Non-crit burn	STOP BURN: OMS ENG(s) – OFF
	Crit burn	Go to “GPC” above
I/O ERROR PCM		OI PCMMU PWR – 2(1)
BCE BYP OA		SM I/O RESET

*If XFD, BLDN, or sensor fail, monitor ENG IN P for off-nominal performance

ORB OPS-31a/128/O/A

(reduced copy)

NOT FLOWN

FS CC 10-5

ORB OPS/128/FIN

TOP
BACK OF 'ORBIT BURN MONITOR'



LEFT OMS

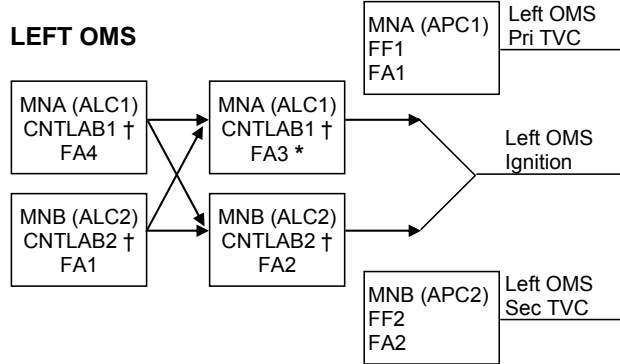

- † If CNTL AB1 or AB2 (CA1 or CA2) failed and ign path still exists at OMS fail, assume L(R) OMS ↓ is PRPLT FAIL
- * If L(R) Pc failed high during burn or FA3(4) failed, at L(R) OMS fail, no guidance downmode after L(R) OMS ENG switch OFF (TGO slow, ADI needles in error, 6 ft/s underburn)

RIGHT OMS

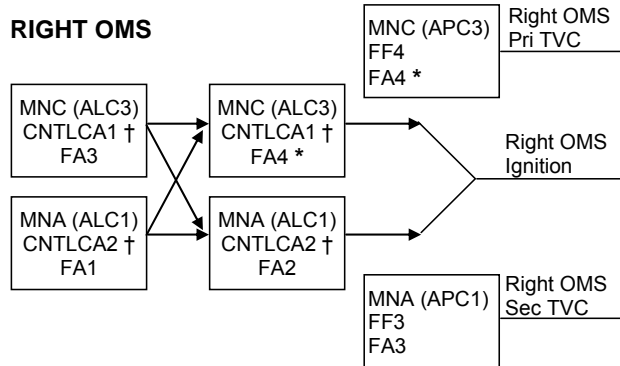

If two FA MDMs lost		
MDMs	Preburn: ENG – OFF	During burn: MAN SHUTDN
1,2	LEFT (TVC)	BOTH
1,3	RIGHT (IGN)	LEFT
1,4	LEFT (IGN)	RIGHT
2,3	LEFT (IGN)	RIGHT
2,4	RIGHT (IGN)	LEFT
3,4	RIGHT (TVC)	BOTH

ORB OPS-31b/128/O/A

(reduced copy)

NOT FLOWN

FS CC 10-6

ORB OPS/128/FIN

NOT FLOWN

FS CC 10-7

ORB OPS/128/FIN

(reduced copy)

TOP

PILE
VELCRO

ORB OPS-41a/128/O/A

PILE
VELCRO

STS-128 DAP A1 – DAP A8 CONFIGURATIONS

	ITEM#	A1	A2	A3	A4	A5	A6	A7	A8
PRI									
ROT RATE	10 (50)	0.2000	0.4000	0.2000	0.5000	0.2000	0.2000	0.2000	0.0500
ATT DB	11 (51)	5.00	1.00	0.30	3.00	5.00	5.00	2.00	2.00
RATE DB	12 (52)	0.20	0.20	0.20	0.20	0.20	0.20	0.20	0.20
ROT PLS	13 (53)	0.100	0.100	0.100	0.100	0.100	0.100	0.100	0.100
COMP	14 (54)	.000	.000	.000	.000	.000	.000	.000	.000
P OPTION	15 (55)	ALL	ALL	ALL	ALL	ALL	TAIL	ALL	ALL
Y OPTION	16 (56)	ALL	ALL	TAIL	ALL	ALL	TAIL	ALL	ALL
TRAN PLS	17 (57)	0.100	0.100	0.100	0.100	0.100	0.100	0.100	0.100
ALT									
RATE DB	18 (58)	0.200	0.200	0.070	0.200	0.070	0.070	0.100	0.100
JET OPT	19 (59)	ALL	ALL	ALL	ALL	ALL	TAIL	ALL	ALL
#JETS	20 (60)	2	2	1	2	1	1	2	2
ON TIME	21 (61)	0.08	0.08	0.08	0.08	0.08	0.08	0.08	0.08
DELAY	22 (62)	0.00	0.00	0.00	0.00	0.00	0.00	0.00	0.00
VERN									
ROT RATE	23 (63)	0.2000	0.4000	0.0080	0.2000	0.0500	0.0500	0.0160	0.0500
ATT DB	24 (64)	1.000	1.000	0.070	1.000	1.000	1.000	1.000	1.000
RATE DB	25 (65)	.020	.020	.010	.020	.020	.020	.020	.020
ROT PLS	26 (66)	0.010	0.010	0.010	0.010	0.010	0.010	0.010	0.050
COMP	27 (67)	.000	.000	.000	.000	.000	.000	.000	.000
CNTL ACC	28 (68)	0	0	0	0	0	0	0	0
PURPOSE		NOMINAL	PTC	GG		LOSS OF VERN (ALL)	LOSS OF VERN (TAIL ONLY)	RNDZ	TERMINAL PHASE

BOLD ITALIC indicates change from I-Load.

HINGE

NOT FLOWN

FS CC 10-8

ORB OPS/128/FIN

(reduced copy)

TOP
HINGED AT BOTTOM OF
'STS-128 DAP A1 – DAP A8 CONFIGURATIONS'
HINGE

STS-128 DAP B1 – DAP B8 CONFIGURATIONS

	ITEM #	B1	B2	B3	B4	B5	B6	B7	B8
PRI									
ROT RATE	30 (50)	0.5000	0.2000	0.2000	0.2000	0.2000	0.5000	0.5000	0.0500
ATT DB	31 (51)	3.00	3.00	3.00	0.30	3.00	3.00	2.00	2.00
RATE DB	32 (52)	0.20	0.20	0.20	0.20	0.20	0.20	0.20	0.20
ROT PLS	33 (53)	0.040	0.040	0.040	0.040	0.040	0.040	0.040	0.040
COMP	34 (54)	.000	.000	.000	.000	.000	.000	.000	.000
P OPTION	35 (55)	ALL	TAIL	ALL	TAIL	TAIL	ALL	ALL	ALL
Y OPTION	36 (56)	ALL	TAIL	ALL	TAIL	TAIL	ALL	ALL	ALL
TRAN PLS	37 (57)	0.100	0.020	0.020	0.020	0.020	0.020	0.050	0.050
ALT									
RATE DB	38 (58)	0.200	0.070	0.070	0.100	0.200	0.200	0.100	0.100
JET OPT	39 (59)	ALL	TAIL	ALL	ALL	ALL	ALL	ALL	ALL
# JETS	40 (60)	2	1	1	2	2	2	2	2
ON TIME	41 (61)	0.08	0.08	0.08	0.08	0.08	0.08	0.08	0.08
DELAY	42 (62)	0.00	0.00	0.00	0.00	0.00	0.00	0.00	0.00
VERN									
ROT RATE	43 (63)	0.2000	0.2000	0.2000	0.0080	0.0160	0.2000	0.2000	0.0500
ATT DB	44 (64)	1.000	1.000	1.000	0.100	0.033	1.000	1.000	1.000
RATE DB	45 (65)	.020	.020	.020	.010	.020	.020	.020	.020
ROT PLS	46 (66)	0.002	0.002	0.002	0.002	0.002	0.002	0.002	0.020
COMP	47 (67)	.000	.000	.000	.000	.000	.000	.000	.000
CNTL ACC	48 (68)	0	0	0	0	0	0	0	0
PURPOSE		OMS & RCS BURNS (ORB OPS)	LOSS OF VERN (TAIL ONLY)	LOSS OF VERN (ALL)		COAS/SHUD CAL		RNDZ	TERMINAL PHASE

BOLD/ITALIC indicates change from I-Load.

HOOK
VELCRO

ORB OPS-41aa/128/O/A

HOOK
VELCRO

NOT FLOWN

FS CC 10-9

ORB OPS/128/FIN

(reduced copy)

TOP
BACK OF 'STS-128 DAP A1 – DAP A8 CONFIGURATIONS'

PILE
VELCRO

ORB OPS-41b/128/O/C

PILE
VELCRO

STS-128 DAP A9 – DAP A14 CONFIGURATIONS

	ITEM #	A9	A10	A11	A12	A14
PRI						
ROT RATE	10 (50)	0.1300	0.0500	0.0500	0.0500	0.2000
ATT DB	11 (51)	2.00	0.60	10.00	5.00	5.00
RATE DB	12 (52)	0.10	0.10	0.20	0.20	0.20
ROT PLS	13 (53)	0.100	0.100	0.100	0.040	0.100
COMP	14 (54)	.000	.000	.000	.000	.000
P OPTION	15 (55)	TAIL	TAIL	TAIL	TAIL	TAIL
Y OPTION	16 (56)	TAIL	TAIL	TAIL	TAIL	TAIL
TRAN PLS	17 (57)	0.050	0.050	0.100	0.010	0.100
ALT						
RATE DB	18 (58)	0.100	0.100	0.020 ¹	0.020 ¹	0.200
JET OPT	19 (59)	TAIL	TAIL	TAIL	TAIL	TAIL
# JETS	20 (60)	2	2	1	1	1(2) ³
ON TIME	21 (61)	0.08	0.08	0.08	0.08	0.08
DELAY	22 (62)	0.00	0.00	7.04	7.04	6.00
VERN						
ROT RATE	23 (63)	0.1300	0.0500	0.1000	0.1000	0.2000
ATT DB	24 (64)	1.000	0.500	5.000	3.000	3.000
RATE DB	25 (65)	.020	.020	.050	.020	.200
ROT PLS	26 (66)	0.050	0.050	0.010	0.002	0.010
COMP	27 (67)	.000	.000	.000	.000	.000
CNTL ACC	28 (68)	0	0	4 ²	4 ²	1
PURPOSE		PROX/OPS FLY AROUND	DOCKING	AUTO REBOOST	MATED VRCS (M/NRS, ROBO)	ORBITER ALONE SRMS/OBSS

BOLD/ITALIC indicates change from I-Load.

¹ I-loaded below keyboard limit; do not change

² CA2 for no vehicle docked at SM aft

³ CA4 for Progress/Soyuz docked at SM aft

³ Use 1 for OBSS scan and 2 for Orbiter attitude maneuvers

HINGE

NOT FLOWN

FS CC 10-10

ORB OPS/128/FIN

(reduced copy)

TOP
 BACK OF 'STS-128 DAP B1 – DAP B8 CONFIGURATIONS'
 HINGED AT BOTTOM OF 'STS-128 DAP A9 – DAP A14 CONFIGURATIONS'
 HINGE

STS-128 DAP B9 – DAP B12 CONFIGURATIONS

	ITEM #	B9	B10	B12
PRI				
ROT RATE	30 (50)	0.1300	0.0500	0.0100 ¹
ATT DB	31 (51)	2.00	0.60	1.00
RATE DB	32 (52)	0.10	0.10	0.20
ROT PLS	33 (53)	0.040	0.040	0.040
COMP	34 (54)	.000	.000	.000
P OPTION	35 (55)	TAIL	TAIL	TAIL
Y OPTION	36 (56)	TAIL	TAIL	TAIL
TRAN PLS	37 (57)	0.010	0.010	0.010
ALT				
RATE DB	38 (58)	0.100	0.100	0.020 ¹
JET OPT	39 (59)	TAIL	TAIL	TAIL
# JETS	40 (60)	2	2	1
ON TIME	41 (61)	0.08	0.08	0.08
DELAY	42 (62)	10.00	0.00	7.04
VERN				
ROT RATE	43 (63)	0.1300	0.0500	0.0100
ATT DB	44 (64)	1.000	0.500	1.000
RATE DB	45 (65)	.020	.020	.020
ROT PLS	46 (66)	0.020	0.020	0.002
COMP	47 (67)	.000	.000	.000
CNTL ACC	48 (68)	0	0	4 ²
PURPOSE		PROXOPS/ FLYAROUND	DOCKING	MATED VRCS & ALT (ATT HOLD)

BOLD/ITALIC indicates change from I-Load.

¹ I-loaded below keyboard limit; do not change

² CA2 for no vehicle docked at SM aft

CA4 for Progress/Soyuz docked at SM aft

HOOK
VELCRO

ORB OPS-41bb/128/O/C

HOOK
VELCRO

TOP

MAUI – RCS FIRING SEQUENCE

Timer	Jets Fired	CDR	PLT
-03:00		Body rates: $+0.047 \leq \text{roll} \leq +0.087$ $-0.020 \leq \text{pitch} \leq +0.020$ $-0.020 \leq \text{yaw} \leq +0.020$ DAP: FREE DAP: A/PRI Inform PLT "GO" for jet deselects	Configure initial setup [GNC 23 RCS] Left RCS page – ITEM 2 EXEC On CDR "GO", proceed NOTE Expect DAP RECONF msgs in following actions Deselect jets: JET DES L5L – ITEM 37 EXEC (*) Right RCS page – ITEM 3 EXEC JET DES R5D – ITEM 39 EXEC (*) Forward RCS page – ITEM 1 EXEC JET DES F5L – ITEM 37 EXEC (*) NOTE Queue the following ITEM entry on the scratch pad. Do not perform the EXEC until specified at 35 sec JET DES F3D – ITEM 25
-00:30		FLT CNTLR PWR – ON	
00:00	RXA, LXA	THC +X (in) (3 sec firing)	
00:15	FXL, LXL	THC +Y (right) (3 sec firing)	
00:30	FXR, RXR	THC -Y (left) (3 sec firing)	
00:35			When jets stop firing: [GNC 23 RCS] EXEC [JET DES F3D – ITEM 25 (*)]
00:45	F4D	RHC +pitch (Past Soft Stop, hold 3 sec)	
00:48		RHC release	
00:50			DAP: VERN
01:00	R5R	RHC +yaw (10 sec firing)	
01:20	L5D	RHC -pitch (12 sec firing)	
01:40	F5R	RHC +pitch (12 sec firing)	
		FLT CNTLR PWR – OFF	Return to MAUI PROCEDURE, step 6, (ORB OPS FS, MAUI)

ORB OPS-42a/128/O/A

(reduced copy)

NOT FLOWN

FS CC 10-11

ORB OPS/128/FIN



TOP
BACK OF 'MAUI - RCS FIRING SEQUENCE'

HOOK
VELCRO

HOOK
VELCRO

HOOK
VELCRO



ORB OPS-42b/128/O/A



NOT FLOWN

(reduced copy)
FS CC 10-12

ORB OPS/128/FIN

TOP

WLES CONFIG AFTER PGSC REBOOT

1. If window appears asking to launch WLES software:
 - Click '1' to launch WLES software
 - Else:
 - Double click 'Shuttle Apps'>'WLES'>'WLES'
2. ✓MCC for 'Backup Mode Selection'
3. If 'EWBMTAU-WLEFlight' appears with message 'Run the current command: XXXX_AA_BB_SNYYYY.xml?':
 - Click 'Yes'

ORB OPS-47a/128/O/A

FABRICATION NOTES

Fabricate on flight approved yellow Post-it

NOT FLOWN

(reduced copy)

FS CC 10-13

ORB OPS/128/FIN



This Page Intentionally Blank



NOT FLOWN

FS 10-14

ORB OPS/128/FIN



NOT FLOWN

FS CC 10-15

ORB OPS/128/FIN

(reduced copy)

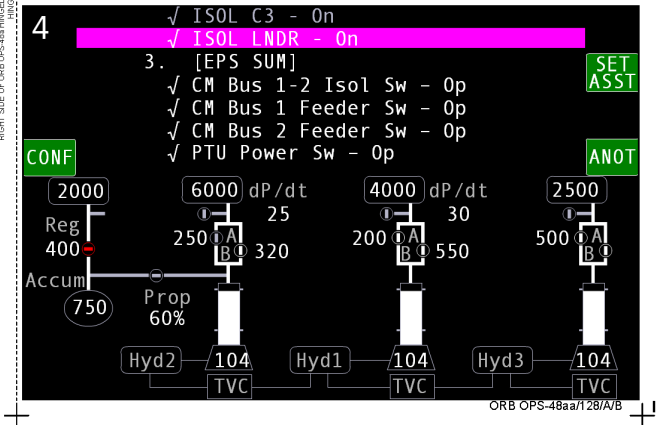
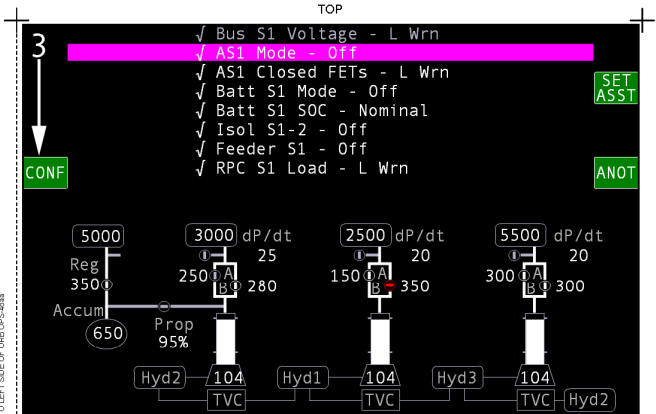
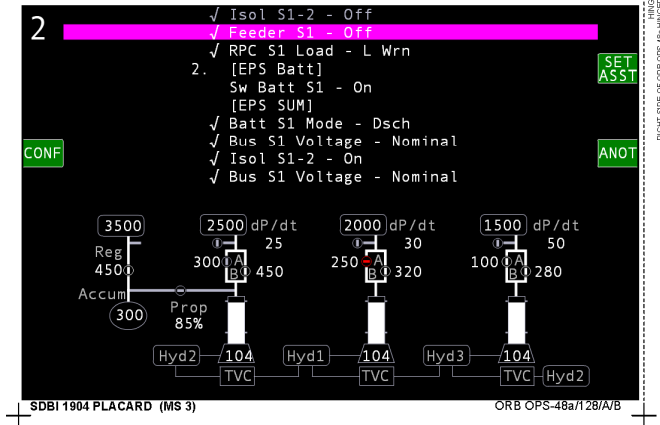
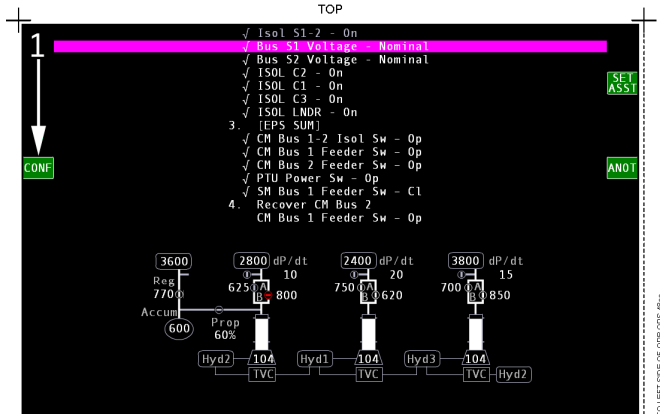

NOT FLOWN

(reduced copy)
FS CC 10-16

ORB OPS/128/FIN

TOP, BACK OF 'SDBI 1904 PLACARD (MS 3)' (side "aa")

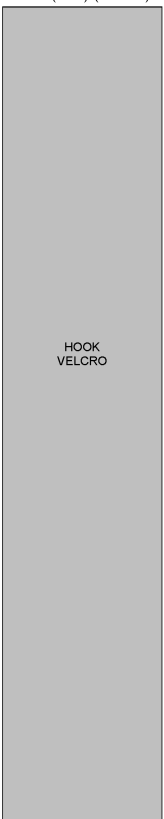

ORB OPS-48bb/128/A/B



HINGE
HINGE TO LEFT SIDE OF ORB OPS-48b
HINGE
HINGE TO RIGHT SIDE OF ORB OPS-48b

TOP, BACK OF 'SDBI 1904 PLACARD (MS 3)' (side "a")

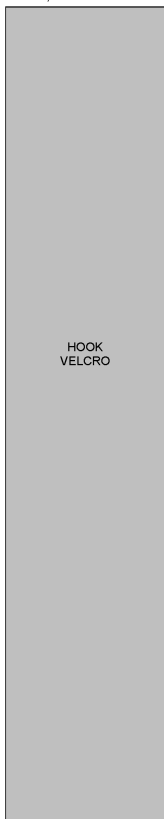

ORB OPS-48b/128/A/B

NOT FLOWN

FS CC 10-17

ORB OPS/128/FIN

(reduced copy)

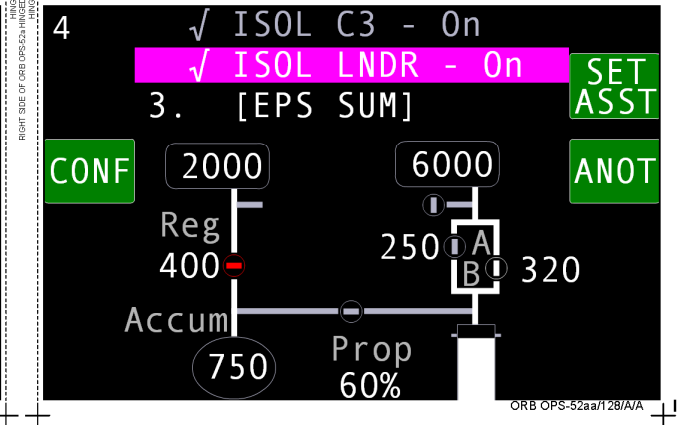
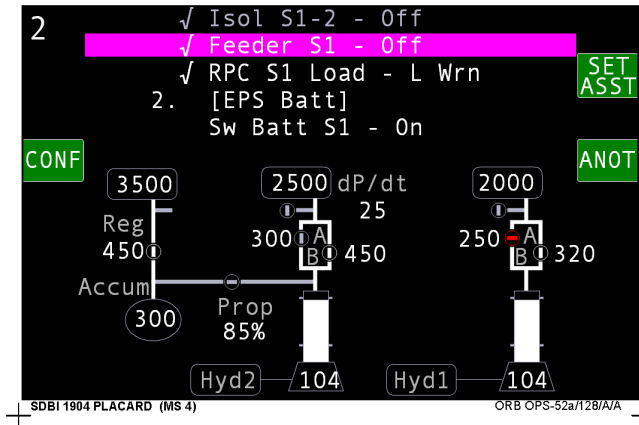
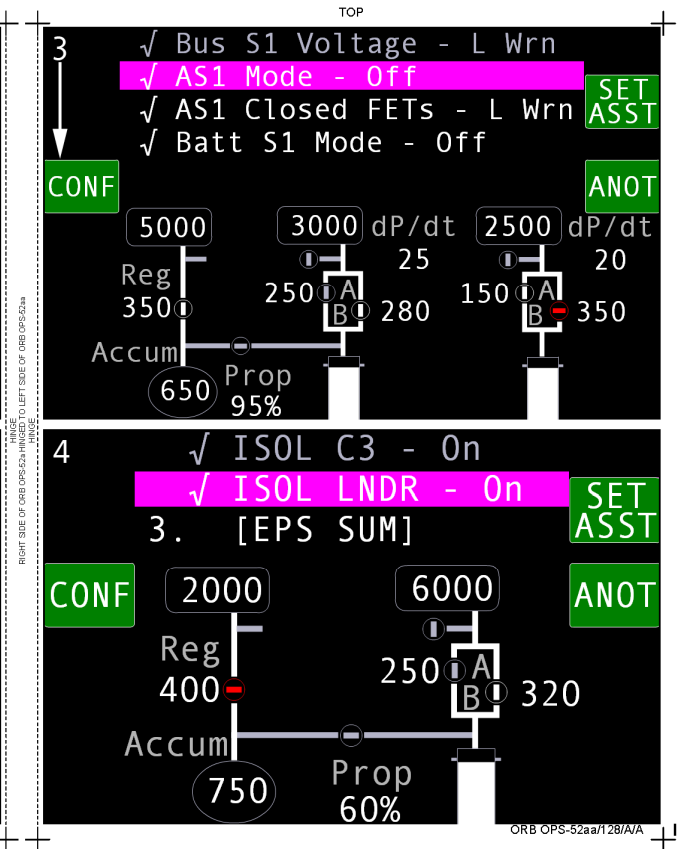
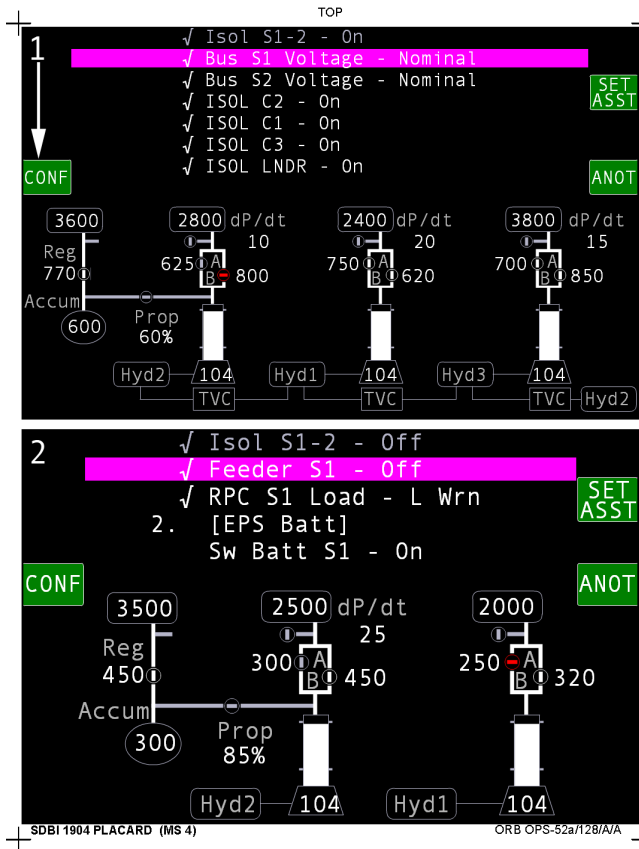

NOT FLOWN

(reduced copy)
FS CC 10-18

ORB OPS/128/FIN

TOP, BACK OF 'SDBI 1904 PLACARD (MS 4)' (side "aa")

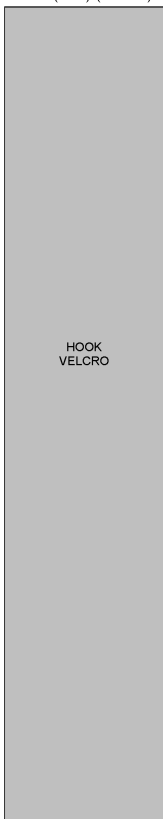

ORB OPS-52bb/128/A/A



TOP, BACK OF 'SDBI 1904 PLACARD (MS 4)' (side "a")

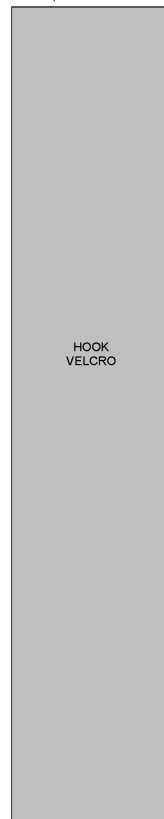

ORB OPS-52bb/128/A/A

HINGE TO LEFT SIDE OF ORB OPS-52bb/128/A/A
HINGE TO RIGHT SIDE OF ORB OPS-52bb/128/A/A

NOT FLOWN

FS CC 10-19

ORB OPS/128/FIN

(reduced copy)

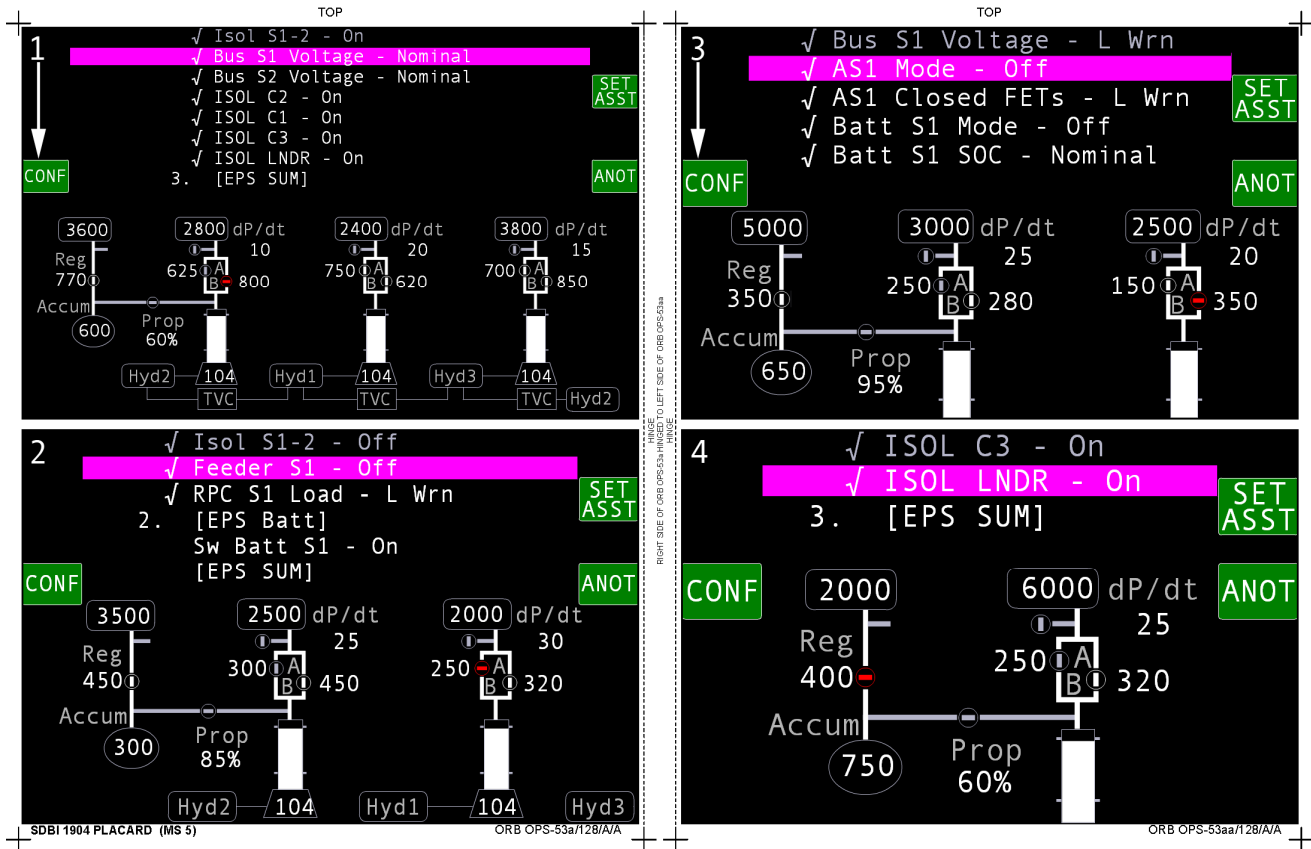

NOT FLOWN

(reduced copy)
FS CC 10-20

ORB OPS/128/FIN

TOP, BACK OF 'SDBI 1904 PLACARD (MS 5)' (side "aa")

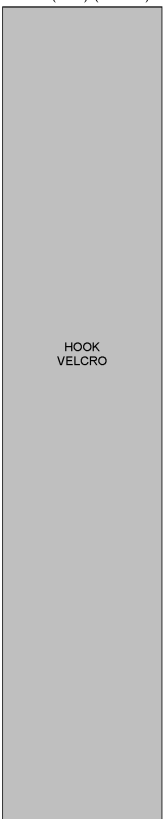

ORB OPS-53bb/128/A/A



HINGE
HINGE TO LEFT SIDE OF ORB OPS-53b
HINGE
HINGE TO RIGHT SIDE OF ORB OPS-53b



TOP, BACK OF 'SDBI 1904 PLACARD (MS 5)' (side "a")

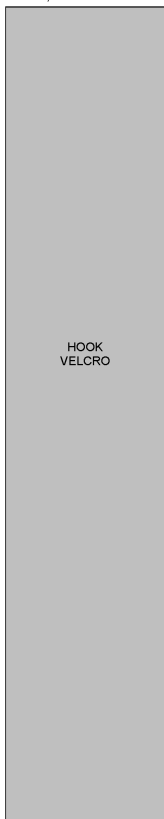

ORB OPS-53b/128/A/A

TOP

Scan procedure line and graphic in each quadrant.
Mark smallest readable quadrant.

MS 3

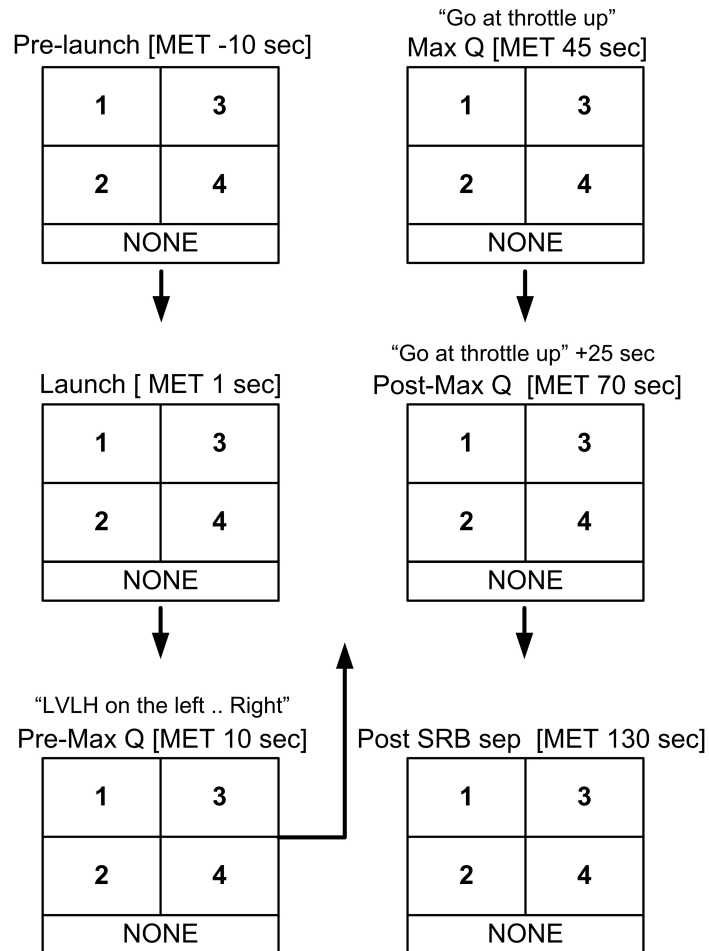

Please place in RETURN TO HOUSTON bag once completed.

ORB OPS-49a/128/A/B

FABRICATION NOTES

Fabricate as a keyboard card having corresponding 'a' and 'b' sides

(reduced copy)

NOT FLOWN

FS CC 10-21

ORB OPS/128/FIN

TOP
BACK OF 'SDBI 1904 QUESTIONNAIRE (MS 3)'

Complete after SRB Sep			
Consider your selected quadrant during vibe. Circle options.			
Confidence in use of info for <u>monitoring</u>	Low	Med	High
Confidence in use of info for <u>decision making</u>	Low	Med	High
When you excluded a quadrant, it was due to	Blurring	Discomfort	Lack of Confidence
Perceived direction of display movement	Up/Down	Right/Left	In/Out
	Circular	Diagonal	Random
Ease of reading/interpreting:			
Mixed case text	Difficult	Neutral	Easy
Upper case text	Difficult	Neutral	Easy
Numbers	Difficult	Neutral	Easy
Valve positions	Difficult	Neutral	Easy
Magenta fill bar	Difficult	Neutral	Easy
Green edge keys	Difficult	Neutral	Easy
White flow lines	Difficult	Neutral	Easy
Gray flow lines	Difficult	Neutral	Easy
Red Valves	Difficult	Neutral	Easy
Comments:			
<div style="border: 1px solid black; border-radius: 50%; width: 30px; height: 30px; display: flex; align-items: center; justify-content: center;">MS 3</div>			

ORB OPS-49b/128/A/B

FABRICATION NOTES

Fabricate as a kneeboard card having corresponding 'a' and 'b' sides

(reduced copy)

NOT FLOWN

FS CC 10-22

ORB OPS/128/FIN

TOP

Scan procedure line and graphic in each quadrant.
Mark smallest readable quadrant.

MS 4

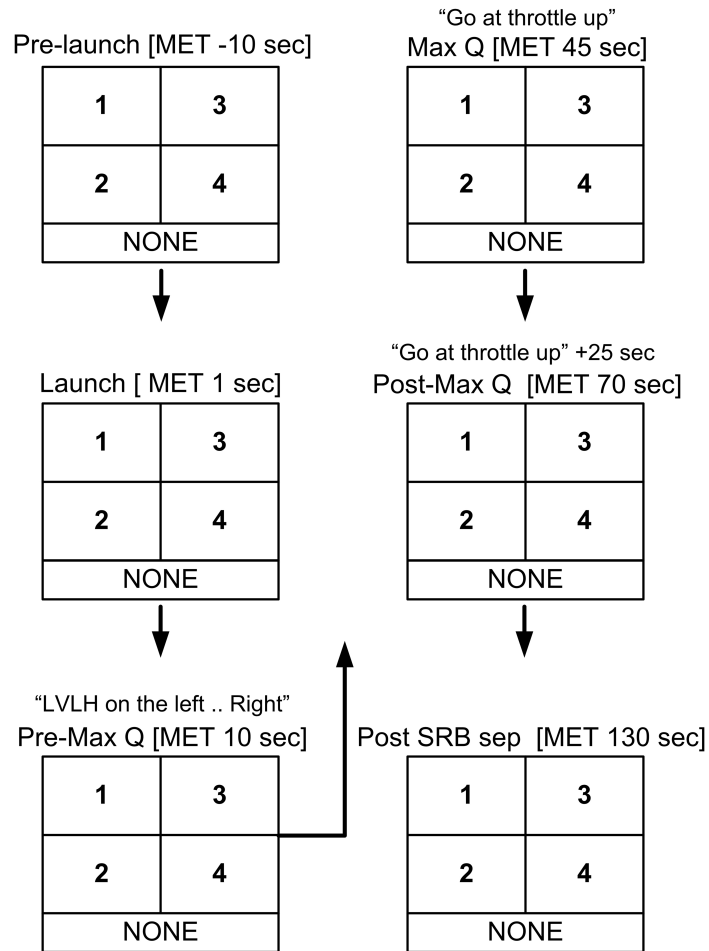

Please place in RETURN TO HOUSTON bag once completed.

ORB OPS-50a/128/A/B

FABRICATION NOTES

Fabricate as a kneeboard card having corresponding 'a' and 'b' sides

(reduced copy)

NOT FLOWN

FS CC 10-23

ORB OPS/128/FIN

TOP
BACK OF 'SDBI 1904 QUESTIONNAIRE (MS 4)'

Complete after SRB Sep			
Consider your selected quadrant during vibe. Circle options.			
Confidence in use of info for <u>monitoring</u>	Low	Med	High
Confidence in use of info for <u>decision making</u>	Low	Med	High
When you excluded a quadrant, it was due to	Blurring	Discomfort	Lack of Confidence
Perceived direction of display movement	Up/Down	Right/Left	In/Out
	Circular	Diagonal	Random
Ease of reading/interpreting:			
Mixed case text	Difficult	Neutral	Easy
Upper case text	Difficult	Neutral	Easy
Numbers	Difficult	Neutral	Easy
Valve positions	Difficult	Neutral	Easy
Magenta fill bar	Difficult	Neutral	Easy
Green edge keys	Difficult	Neutral	Easy
White flow lines	Difficult	Neutral	Easy
Gray flow lines	Difficult	Neutral	Easy
Red Valves	Difficult	Neutral	Easy
Comments:			
<div style="border: 1px solid black; border-radius: 50%; width: 30px; height: 30px; display: flex; align-items: center; justify-content: center; margin: 0 auto;">MS 4</div>			

ORB OPS-50b/128/A/B

FABRICATION NOTES

Fabricate as a kneeboard card having corresponding 'a' and 'b' sides

NOT FLOWN

FS CC 10-24

ORB OPS/128/FIN

TOP

Scan procedure line and graphic in each quadrant.
Mark smallest readable quadrant.

MS 5

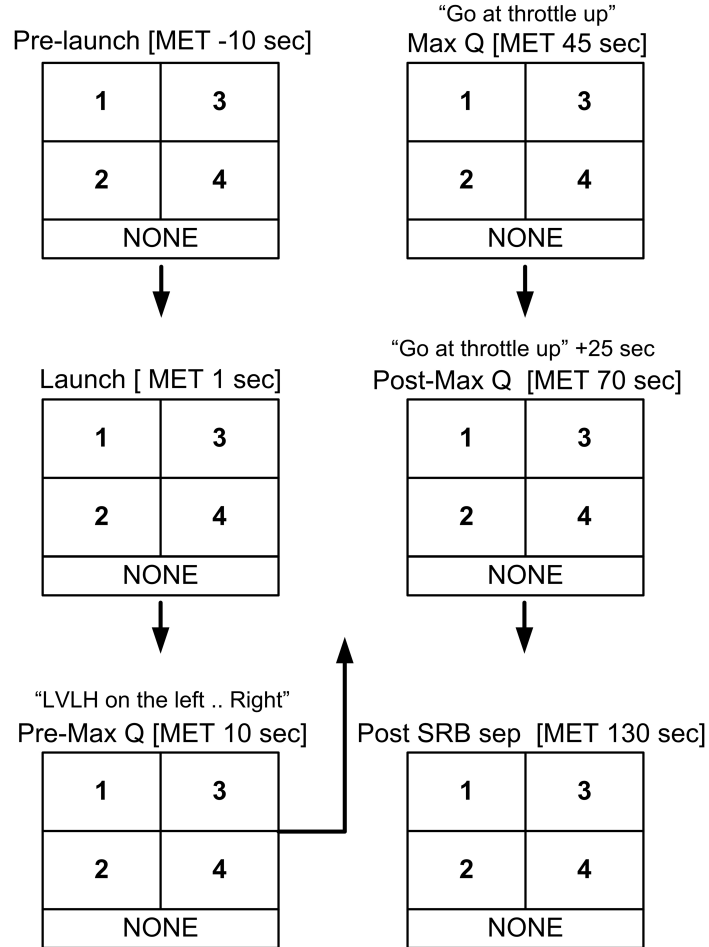

Please place in RETURN TO HOUSTON bag once completed.

ORB OPS-51a/128/A/A

FABRICATION NOTES

Fabricate as a kneeboard card having corresponding 'a' and 'b' sides

NOT FLOWN

FS CC 10-25

ORB OPS/128/FIN

TOP
BACK OF 'SDBI 1904 QUESTIONNAIRE (MS 5)'

Complete after SRB Sep			
Consider your selected quadrant during vibe. Circle options.			
Confidence in use of info for <u>monitoring</u>	Low	Med	High
Confidence in use of info for <u>decision making</u>	Low	Med	High
When you excluded a quadrant, it was due to	Blurring	Discomfort	Lack of Confidence
Perceived direction of display movement	Up/Down	Right/Left	In/Out
	Circular	Diagonal	Random
Ease of reading/interpreting:			
Mixed case text	Difficult	Neutral	Easy
Upper case text	Difficult	Neutral	Easy
Numbers	Difficult	Neutral	Easy
Valve positions	Difficult	Neutral	Easy
Magenta fill bar	Difficult	Neutral	Easy
Green edge keys	Difficult	Neutral	Easy
White flow lines	Difficult	Neutral	Easy
Gray flow lines	Difficult	Neutral	Easy
Red Valves	Difficult	Neutral	Easy
Comments:			
<div style="border: 1px solid black; border-radius: 50%; width: 30px; height: 30px; display: flex; align-items: center; justify-content: center;">MS 5</div>			

ORB OPS-51b/128/A/A

FABRICATION NOTES

Fabricate as a kneeboard card having corresponding 'a' and 'b' sides

(reduced copy)

NOT FLOWN

FS CC 10-26

ORB OPS/128/FIN

Space Shuttle Program
FLIGHT DATA FILE

JSC-48036-128
FINAL



ORBIT OPS CHECKLIST

STS
128

Flight Cover (trim bottom to expose tabs)