

# Orbit Operations Checklist

## STS-130 Flight Supplement

---

**Mission Operations Directorate  
Operations Division**

**Final  
January 15, 2010**

National Aeronautics and  
Space Administration

**Lyndon B. Johnson Space Center**  
Houston, Texas





JSC-48036-130

MISSION OPERATIONS DIRECTORATE

**ORBIT OPERATIONS CHECKLIST  
STS-130 FLIGHT SUPPLEMENT**

FINAL

January 15, 2010

PREPARED BY:



Thomas R. Zulaw  
Publication Manager

APPROVED BY:

ACCEPTED BY:

  
Manager, Flight Procedures  
Michael T. Hurt  
FDF Manager

This document is under the configuration control of the Crew Procedures Control Board (CPCB). All proposed changes must be submitted via Change Request Workflow (CRW) to DO3/FDF Manager.

Additional distribution of this book, for official use only, may be requested in writing to DO3/PMO Administrator. The request must include justification and requester's name, organization, position, and phone number. Contractor requests are made through the NASA or DOD organization supported. Deletions, reduction in quantity, or change of address may be submitted to DO3/FDF Management Office, 281-244-1184.

ORB OPS/130/FIN

Incorporates the following:		
482#:	ORB OPS FS-00172A	ORB OPS FS-00179
	ORB OPS FS-00173	ORB OPS FS-00180A
	ORB OPS FS-00174	ORB OPS FS-00181
	ORB OPS FS-00175	ORB OPS FS-00183
	ORB OPS FS-00176	ORB OPS FS-00184
	ORB OPS FS-00177	ORB OPS FS-00185
	ORB OPS FS-00178	ORB OPS FS-00186

AREAS OF TECHNICAL RESPONSIBILITY

Publication Manager	DO3/T. Zulauf	281-244-0922
Alternate Publication Manager	DO3/L. Giles	281-244-9068
COMM/INST	DS2/R. Deleon	281-483-5331
PTG	DO4/A. Rigas	281-483-2596
DAP TABLES	DS6/M. Jones	281-244-0066
REBOOST/DAP	DS6/M. Jones	281-244-0066
OIU	DS2/R. Deleon	281-483-5331
PRLA	DS4/A. Foxworth	281-483-0616
SDBI	SK/S. Rodgers	281-483-6357
WLES	DO5/R. Besser	281-244-5627
P/L OF OPP	DS6/M. Jones	281-244-0066
CWC OPS	DS4/B. Bailey	281-244-2563
FRED	DX2/A. Flagan	281-244-7322

CUE CARDS:

LIOH CHANGEOUT	DS4/M. FitzPatrick	281-483-0758
ORBIT BURN MONITOR	DS6/A. Marasia	281-483-0257
DAP TABLES	DS6/M. Jones	281-244-0066
MAUI – RCS FIRING SEQUENCE	DS6/M. Jones	281-244-0066
WLES CONFIG AFTER PGSC REBOOT	DO5/R. Besser	281-244-5627

ORBIT OPERATIONS CHECKLIST  
STS-130 FLIGHT SUPPLEMENT

**LIST OF EFFECTIVE PAGES**

FINAL 01/15/10

Sign Off .....	*	130/FIN	FS 4-3.....	130/FIN
FS ii .....	*	130/FIN	FS 4-4.....	130/FIN
FS iii .....	*	130/FIN	FS 4-5.....	130/FIN
FS iv .....	*	130/FIN	FS 4-6.....	130/FIN
FS v.....	*	130/FIN	FS 5-1.....	130/FIN
FS vi.....	*	130/FIN	FS 5-2.....	130/FIN
FS vii .....		130/FIN	FS 6-1.....	130/FIN
FS viii .....		130/FIN	FS 6-2.....	130/FIN
FS 1-1 .....		130/FIN	FS 7-1.....	130/FIN
FS 1-2 .....		130/FIN	FS 7-2.....	130/FIN
FS 1-3 .....		130/FIN	FS 8-1.....	130/FIN
FS 1-4 .....		130/FIN	FS 8-2.....	130/FIN
FS 1-5 .....		130/FIN	FS 8-3.....	130/FIN
FS 1-6 .....		130/FIN	FS 8-4.....	130/FIN
FS 1-7 .....		130/FIN	FS 8-5.....	130/FIN
FS 1-8 .....		130/FIN	FS 8-6.....	130/FIN
FS 2-1 .....		130/FIN	FS 8-7.....	130/FIN
FS 2-2 .....		130/FIN	FS 8-8.....	130/FIN
FS 2-3 .....		130/FIN	FS 8-9.....	130/FIN
FS 2-4 .....		130/FIN	FS 8-10.....	130/FIN
FS 3-1 .....		130/FIN	FS 8-11.....	130/FIN
FS 3-2 .....		130/FIN	FS 8-12.....	130/FIN
FS 3-3 .....		130/FIN	FS 8-13.....	130/FIN
FS 3-4 .....		130/FIN	FS 8-14.....	130/FIN
FS 3-5 .....		130/FIN	FS 8-15.....	130/FIN
FS 3-6 .....		130/FIN	FS 8-16.....	130/FIN
FS 3-7 .....		130/FIN	FS 8-17.....	130/FIN
FS 3-8 .....		130/FIN	FS 8-18.....	130/FIN
FS 4-1 .....		130/FIN	FS 8-19.....	130/FIN
FS 4-2 .....		130/FIN	FS 8-20.....	130/FIN

\* – Omit from flight book

FS 9-1 .....	130/FIN	FS CC 12-11.... *	130/FIN
FS 9-2 .....	130/FIN	FS CC 12-12.... *	130/FIN
FS 9-3 .....	130/FIN	FS CC 12-13.... *	130/FIN
FS 9-4 .....	130/FIN	FS 12-14..... *	130/FIN
FS 9-5 .....	130/FIN		
FS 9-6 .....	130/FIN		
FS 9-7 .....	130/FIN		
FS 9-8 .....	130/FIN		
FS 9-9 .....	130/FIN		
FS 9-10 .....	130/FIN		
FS 10-1 .....	130/FIN		
FS 10-2 .....	130/FIN		
FS 10-3 .....	130/FIN		
FS 10-4 .....	130/FIN		
FS 10-5 .....	130/FIN		
FS 10-6 .....	130/FIN		
FS 10-7 .....	130/FIN		
FS 10-8 .....	130/FIN		
FS 10-9 .....	130/FIN		
FS 10-10 .....	130/FIN		
FS 10-11 .....	130/FIN		
FS 10-12 .....	130/FIN		
FS 10-13 .....	130/FIN		
FS 10-14 .....	130/FIN		
FS 10-15 .....	130/FIN		
FS 10-16 .....	130/FIN		
FS 11-1 .....	130/FIN		
FS 11-2 .....	130/FIN		
FS 12-1 .....	130/FIN		
FS 12-2 .....	* 130/FIN		
FS CC 12-3 .....	* 130/FIN		
FS CC 12-4 .....	* 130/FIN		
FS CC 12-5 .....	* 130/FIN		
FS CC 12-6 .....	* 130/FIN		
FS CC 12-7 .....	* 130/FIN		
FS CC 12-8 .....	* 130/FIN		
FS CC 12-9 .....	* 130/FIN		
FS CC 12-10 ...	* 130/FIN		

\* – Omit from flight book

ORBIT OPS CUE CARDS

<u>Title</u>	<u>Ref. Page</u>	<u>Card No.</u>
LIOH CHANGEOUT (Front) ..	FS CC 12-3	ORB OPS-29a/ nonRCRS/130/O/B
LIOH CANISTER STOWAGE LOCATIONS (Back) .....	FS CC 12-4	ORB OPS-29b/ nonRCRS/130/O/B
ORBIT BURN MONITOR (Front).....	FS CC 12-5	ORB OPS-31a/130/O/A
OMS FAILURES (Back).....	FS CC 12-6	ORB OPS-31b/130/O/A
STS-130 DAP CONFIGURATIONS (Front/Top).....	FS CC 12-7	ORB OPS-41a/130/O/B
(Front/Bottom) .....	FS CC 12-8	ORB OPS-41aa/130/O/A
(Back/Top) .....	FS CC 12-9	ORB OPS-41b/130/O/B
(Back/Bottom).....	FS CC 12-10	ORB OPS-41bb/130/O/B
MAUI – RCS FIRING SEQUENCE (Front).....	FS CC 12-11	ORB OPS-42a/130/O/B
(Back).....	FS CC 12-12	ORB OPS-42b/130/O/A
WLES CONFIG AFTER PGSC REBOOT (Front).....	FS CC 12-13	ORB OPS-47a/130/O/A



This Page Intentionally Blank





<u>CONTENTS</u>	<u>PAGE</u>
<u>COMM/INST</u> .....	FS 1-1
LOAD PCMMU FORMAT.....	FS 1-2
PDI DECOM FORMAT.....	FS 1-4
OIU FORMAT/CONFIG.....	FS 1-6
<u>PTG</u> .....	FS 2-1
STAR PAIRS PAD.....	FS 2-2
PAIRS.....	FS 2-3
<u>DAP TABLES</u> .....	FS 3-1
DAP OVERVIEW.....	FS 3-2
UNIV PTG.....	FS 3-3
STS-130 DAP A CONFIGURATIONS.....	FS 3-4
B CONFIGURATIONS.....	FS 3-6
<u>REBOOST/DAP</u> .....	FS 4-1
AUTO REBOOST.....	FS 4-2
ATTITUDE REFERENCE.....	FS 4-4
DOCKED DAP REFERENCE.....	FS 4-5
RATE DAMPING.....	FS 4-5
<u>OIU PROCEDURES</u> .....	FS 5-1
OIU ACTIVATION.....	FS 5-2
DEACTIVATION.....	FS 5-2
<u>PRLA</u> .....	FS 6-1
PRLA CLOSE.....	FS 6-2
<u>SHORT DURATION BIOASTRONAUTICS</u>	
<u>INVESTIGATION (SDBI)</u> .....	FS 7-1
SDBI 1634, SLEEP-WAKE ACTIGRAPHY.....	FS 7-2

Cont next page

<u>WING LEADING EDGE SENSORS (WLES)</u>	
<u>PROCEDURES</u> .....	FS 8-1
WLES ACTIVATION AND CHECKOUT .....	FS 8-2
DEACTIVATION AND TEARDOWN .....	FS 8-10
LAPTOP RECEIVER UNIT (LRU) R&R .....	FS 8-12
CABIN RELAY UNIT R&R .....	FS 8-14
CONFIGURE WLES DATA FILE BACKUP PATH ....	FS 8-16
PREP WLES LAPTOPS FOR TRANSFER .....	FS 8-17
WLES RNDZ TOOLS CHECKOUT PREP .....	FS 8-18
DOCK/UNDOCK RECOVERY .....	FS 8-18
DISABLE WLES FILE BACKUP .....	FS 8-19
ENABLE WLES FILE BACKUP .....	FS 8-19
<u>PAYLOADS OF OPPORTUNITY</u> .....	FS 9-1
MAUI PROCEDURE .....	FS 9-2
RAMBO-2 PROCEDURE .....	FS 9-6
<u>CWC OPS</u> .....	FS 10-1
CWC FILL .....	FS 10-2
CWC-I FILL .....	FS 10-7
WASTE TANK OFFLOAD TO CWC .....	FS 10-13
<u>FRED</u> .....	FS 11-1
FRED SETUP .....	FS 11-2
FRED STOWAGE .....	FS 11-2
<u>CUE CARD CONFIGURATION</u> .....	FS 12-1

COMM/INST

LOAD PCMMU FORMAT.....	FS 1-2
PDI DECOM FORMAT .....	FS 1-4
OIU FORMAT/CONFIG.....	FS 1-6

**COMM/  
INST**

COMM/  
INST

## LOAD PCMMU FORMAT

- C3 1. √OI PCMMU FORMAT – GPC  
SM 62 PCMMU/PL COMM
- CRT 2. FORMAT:  
SEL FXD – ITEM 1 EXEC (\*)  
SEL ID – ITEM 3 +X X X EXEC
3. √SM COMM BUF – RDY  
LOAD – ITEM 4 EXEC  
√LOAD, ITEM 4 – RUN,CPLT
- If LOAD – CPLT:  
Repeat steps 2 and 3 for second ID
- \* If LOAD – FAIL and ERR MSG – 'I/O ERR MMU 1(2)':  
\* Go to 5.2a, 'I/O ERR MMU 1(2)' (MAL, DPS) >>  
\* If LOAD – FAIL and a first load attempt:  
\* Repeat steps 2 and 3 for failed ID  
\* If LOAD – FAIL and a subsequent load attempt:  
\* √MCC  
\* OI PCMMU PWR – 2(1)  
\* √ERR MSG – 'I/O ERR PCM'  
C3 \* I/O RESET PCM – ITEM 5 EXEC (\*)  
CRT \* Repeat steps 2 and 3
4. When final LOAD – CPLT:  
SEL PGM – ITEM 2 EXEC (\*)

DNLIST COMPATIBILITY	PHASE	FORMAT ID 64/128	CONFIG NO.
G1,G3,BFS	(ASCENT)	102/FXD	–
G3,BFS	(ENTRY)	102/164	–
G2,G8,S2	ORBIT/ORBIT BURN/FCS C/O	103/161	–
G2,S2,OPS 0	OPS 0	– /163	–
G2,S2,P9	MMU C/O	– /163	–
G9	Prelaunch PL C/O	103/180	758
G2,G8,S2	RNDZ w/UHF FMT CCSU (SSOR/SSV/TCS) (PRIME)	103/192	763
G2,G8,S2	RNDZ w/UHF FMT CCSU (SSOR/SSV/TCS) (B/U)	103/211	770
G2,G8,S2	DOCKED ISS FMT CCSH (OIU/SSV) (PRIME)	103/184	760
G2,G8,S2	DOCKED ISS FMT CCSH (OIU/SSV) (B/U)	103/205	767
G2,G8,S2	OIU C/O AND SSV RATE 4 (PRIME)	103/188	762
G2,G8,S2	OIU C/O AND SSV RATE 5 (B/U)	103/203	765

**NOTE**

LDR TFL may affect PCMMU BITE. If PCMMU or SM 2 GPC switched since last TFL, ID 64 and 128 will not reflect current state

## LOAD PDI DECOM FORMAT

### SM 62 PCMMU/PL COMM

1. PDI:

CRT      √I/O RESET – ITEM 8 (\*)  
          SEL DECOM – ITEM 9 +X EXEC  
          SEL FMT – ITEM 10 +X X X EXEC  
          LOAD – ITEM 11 EXEC

If LOAD – CPLT:  
          SEL INPUT – ITEM 12 +X EXEC  
          LOAD – ITEM 13 EXEC  
          Repeat step 1 for additional DECOMs/FPM

\* If LOAD – FAIL and ERR MSG – 'I/O ERR \*  
\* MMU 1(2)': \*  
\* Go to 5.2a, 'I/O ERR MMU 1(2)' (MAL, \*  
\* DPS) >> \*  
\* \*  
\* If LOAD – FAIL and a first load attempt: \*  
\* Repeat step 1 \*  
\* \*  
\* If LOAD – FAIL and a subsequent load \*  
\* attempt: \*  
\* \*  
\* NOTE \*  
\* Power cycling PDI will cause PDI \*  
\* to lose DFLs previously loaded \*  
\* \*  
\* √MCC \*  
A1L \* S-BD PL CNTL – PNL \*  
\* PL DATA INTLVR PWR – OFF,ON \*  
\* √ERR MSG – 'S62 BCE BYP PL' \*  
\* √'S62 BCE BYP PDI' \*  
\* S-BD PL CNTL – CMD \*  
\* \*  
\* PCM: \*  
CRT \* I/O RESET PCM – ITEM 5 EXEC (\*) \*  
\* PDI: \*  
\* I/O RESET – ITEM 8 EXEC (\*) \*  
\* Repeat step 1 for all of config (XXX) \*

CONFIG	DECOM	FMT	INPUT	USE
763 RNDZ w/UHF FMT CCSU  (PRIME) TFL 192	1 2 3 4 5-FPM	30 - 9 4 503	1,2 - 5 4	OIU7 (CCSU) ** - TCS SSV (3) *** H-H-H *
770 RNDZ w/UHF FMT CCSU  (BACKUP) TFL 211	1 2 3 4 5-FPM	14 31 - 19 502	4 1,2 - 5	SSV (3) *** OIU7 (CCSU) ** - TCS H-H-H *
760 DOCKED FMT CCSH  (PRIME) TFL 184	1 2 3 4 5-FPM	7 - - 27 501	1,2 - - 4	OIU9 (CCSH) ** - - SSV (2) *** H-H-H *
767 DOCKED FMT CCSH  (BACKUP) TFL 205	1 2 3 4 5-FPM	- 17 29 - 506	- 1,2 4 -	- OIU9 (CCSH) ** SSV (2) *** - H-H-H *
762 SSV RATE 4  (PRIME) TFL 188	1 2 3 4 5-FPM	5 - - 1 505	1,2 - - 4	OIU255 ** - - SSV (4) *** H-H-H *
765 SSV RATE 5  (BACKUP) TFL 203	1 2 3 4 5-FPM	- 15 11 - 507	- 1,2 4 -	- OIU255 ** SSV (5) *** - L-H-H *
758 Pre-Launch PL C/O  (PRIME) TFL 180	1 2 3 4 5-FPM	28 15 9 - 504	1,2 1,2 5 -	OIU253 ** OIU255 ** TCS - H-H-H *

\* OI-GNC-SM, Orbiter Downlist Data Rates (High or Low)  
\*\* # in OIU# represents the OIU format; (XXX) represents data type  
\*\*\* # in SSV (#) represents the SSV Out Rate sw selection

## LOAD OIU FORMAT/CONFIG

Determine which step is needed and complete all actions to obtain desired OIU configuration

### NOTE

A corresponding TFL/DFL CONFIG is reqd for MCC to receive telemetry. Reference S62 PCMMU/PL COMM for the last loaded HDR TFL and perform LOAD PCMMU FORMAT/LOAD PDI DECOM FORMAT for the associated CONFIG

#### S212 OIU

1. GNC-1 PRIMARY ON LB-ORB N2-1 (OIU BUS 3)

LOAD FORMAT	ITEM 1 + <u>9</u> EXEC
GNC TO GNC 1	ITEM 18 + <u>1</u> <u>4</u> EXEC
GNC 1 TO BUS 3	ITEM 18 + <u>1</u> <u>6</u> EXEC
BUS 4 BC	ITEM 15 EXEC (*)
BUS 3 RT	ITEM 10 EXEC (*)
LOAD FORMAT	ITEM 1 + <u>9</u> EXEC >>
  
2. GNC-1 PRIMARY ON LB-ORB N2-2 (OIU BUS 4)

LOAD FORMAT	ITEM 1 + <u>9</u> EXEC
GNC TO GNC 1	ITEM 18 + <u>1</u> <u>4</u> EXEC
GNC 1 TO BUS 4	ITEM 18 + <u>1</u> <u>5</u> EXEC
BUS 3 BC	ITEM 11 EXEC (*)
BUS 4 RT	ITEM 14 EXEC (*)
LOAD FORMAT	ITEM 1 + <u>9</u> EXEC >>
  
3. GNC-2 PRIMARY ON LB-ORB N2-1 (OIU BUS 3)

LOAD FORMAT	ITEM 1 + <u>9</u> EXEC
GNC TO GNC 2	ITEM 18 + <u>1</u> <u>3</u> EXEC
GNC 2 TO BUS 3	ITEM 18 + <u>1</u> <u>8</u> EXEC
BUS 4 BC	ITEM 15 EXEC (*)
BUS 3 RT	ITEM 10 EXEC (*)
LOAD FORMAT	ITEM 1 + <u>9</u> EXEC >>
  
4. GNC-2 PRIMARY ON LB-ORB N2-2 (OIU BUS 4)

LOAD FORMAT	ITEM 1 + <u>9</u> EXEC
GNC TO GNC 2	ITEM 18 + <u>1</u> <u>3</u> EXEC
GNC 2 TO BUS 4	ITEM 18 + <u>1</u> <u>7</u> EXEC
BUS 3 BC	ITEM 11 EXEC (*)
BUS 4 RT	ITEM 14 EXEC (*)
LOAD FORMAT	ITEM 1 + <u>9</u> EXEC >>

Cont next page



5. MPLM (if flown)  
LOAD FORMAT ITEM 1 +5 EXEC  
BUS 2 BC ITEM 7 EXEC (\*)  
LOAD FORMAT ITEM 1 +5 EXEC >>
6. SSOR  
LOAD FORMAT ITEM 1 +7 EXEC  
BUS 1 BC ITEM 3 EXEC (\*)  
LOAD FORMAT ITEM 1 +7 EXEC >>



This Page Intentionally Blank



PTG

STAR PAIRS PAD ..... FS 2-2  
PAIRS..... FS 2-3

**PTG**

FS 2-1

ORB OPS/130/FIN

PTG

STAR PAIRS PAD										
STAR PAIR	SEP ANGLE	ATTITUDE SET 1					ATTITUDE SET 2			
		DUAL S TRK		SINGLE S TRK			DUAL S TRK		SINGLE S TRK	
				-Z	-Y				-Z	-Y
A	83.5	-Y:47 R+ 76 -Z:31 P+ 89 Y+ 37	R+ 357 P+ 77 Y+ 27	-Y:31 R+ 169 P+ 75 Y+ 48	-Y:31 R+ 186 -Z:47 P+ 251 Y+ 333	-Z:31 R+ 109 P+ 267 Y+ 327	-Y:47 R+ 265 P+ 242 Y+ 321			
B	90.6	-Y:75 R+ 343 -Z:86 P+ 205 Y+ 4	R+ 256 P+ 195 Y+ 16	-Y:86 R+ 69 P+ 217 Y+ 13	-Y:86 R+ 287 -Z:75 P+ 17 Y+ 340	-Z:86 R+ 199 P+ 21 Y+ 355	-Y:75 R+ 21 P+ 32 Y+ 336			
C	91.1	-Y:43 R+ 1 -Z:37 P+ 243 Y+ 4	R+ 275 P+ 230 Y+ 12	-Y:37 R+ 88 P+ 252 Y+ 16	-Y:37 R+ 267 -Z:43 P+ 50 Y+ 344	-Z:37 R+ 181 P+ 59 Y+ 356	R+ 0 P+ 63 Y+ 335			
D	91.2	-Y:33 R+ 326 -Z:59 P+ 210 Y+ 290	R+ 229 P+ 200 Y+ 304	-Y:59 R+ 82 P+ 240 Y+ 299	-Y:59 R+ 310 -Z:33 P+ 24 Y+ 52	-Z:59 R+ 224 P+ 21 Y+ 67	-Y:33 R+ 19 P+ 48 Y+ 51			
E	90.5	-Y:68 R+ 165 -Z:54 P+ 97 Y+ 318	R+ 89 P+ 113 Y+ 307	-Y:54 R+ 240 P+ 78 Y+ 309	-Y:54 R+ 93 -Z:68 P+ 293 Y+ 57	-Z:54 R+ 13 P+ 282 Y+ 43	-Y:68 R+ 205 P+ 265 Y+ 62			

STAR PAIRS PAD

FS-2-2

ORB OPS/130/FIN

PAIR		COAS ALIGN ATTITUDE 1	ANG SEP	COAS ALIGN ATTITUDE 2
COAS	+X HUD	21 R+ 252 P+ 186 Y+ 62	NOSE UP 87.6	19 R+ 261 P+ 166 Y+ 335
	-Z COAS	21 R+ 80 P+ 168 Y+ 337	TAIL UP	19 R+ 295 P+ 15 Y+ 292

SINGLE S TRK MIN MNVR OPT  
TGT ID = 11-110 NAV STAR #

	-Z S TRK	-Y S TRK
BV	5	4
P	87.7	✓ 0
Y	358	✓ 280.57

MET Applicable Post OMS2 to 16/00:00:00  
Liftoff Date: 02/07/10  
Liftoff GMT: 038/09:39:39.000

# STAR PAIRS

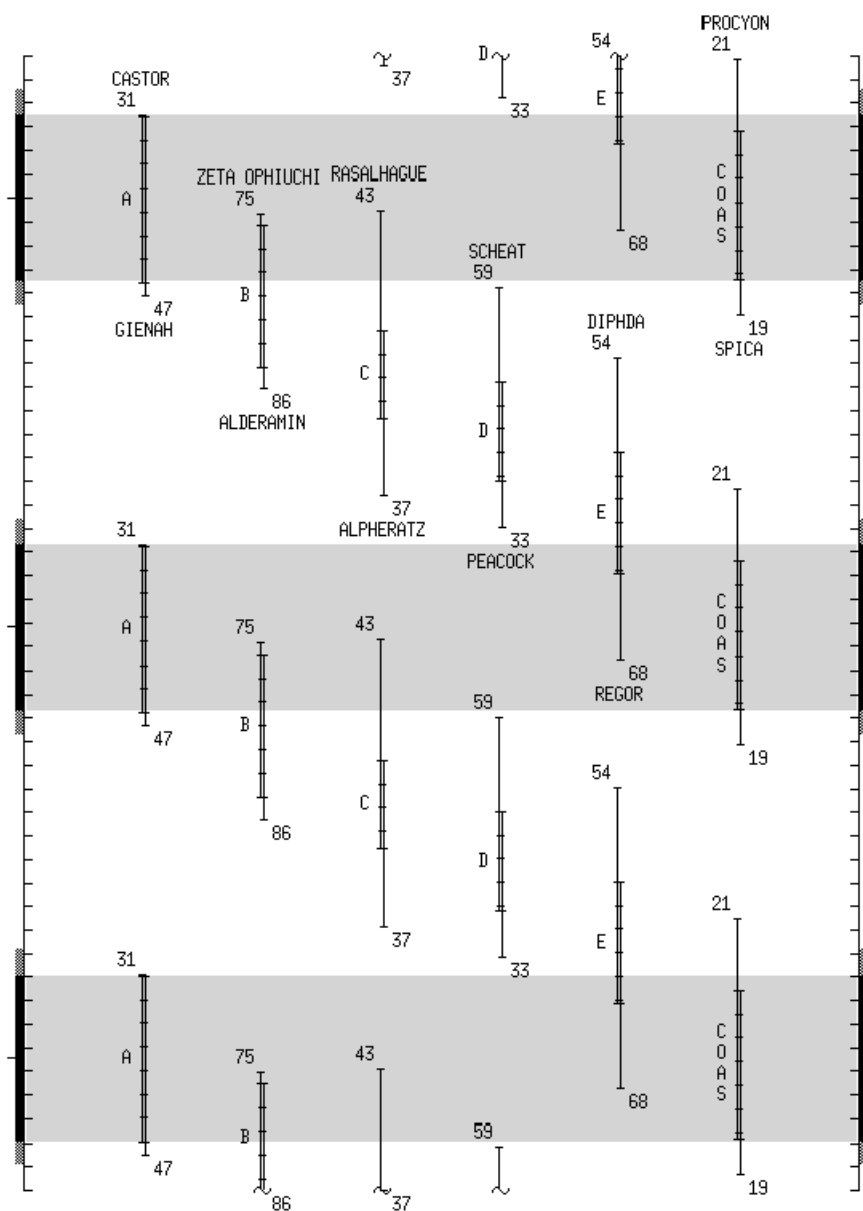

MET Applicable: Post OMS2 to 16/00:00:00  
 Liftoff Date: 02/07/10  
 Liftoff GMT: 038/09:39:39,000



This Page Intentionally Blank



DAP TABLES

DAP OVERVIEW .....	FS 3-2
UNIV PTG .....	FS 3-3
STS-130 DAP A CONFIGURATIONS.....	FS 3-4
B CONFIGURATIONS.....	FS 3-6

**DAP  
TABLES**

## DAP TABLES

### DAP OVERVIEW

DAP	Purpose	DAP	Purpose
A1	Nominal	B1	OMS & RCS Burns (ORB OPS)
A2	PTC	B2	Loss of VERN (Tail Only)
A3	GG	B3	Loss of VERN (All)
A4		B4	
A5	Loss of VERN (All)	B5	COAS/HUD CAL
A6	Loss of VERN (Tail Only)	B6	
A7	Rendezvous	B7	Rendezvous
A8	Terminal Phase	B8	Terminal Phase
A9	PROX OPS/Flyaround	B9	Flyaround
A10	Docking	B10	Docking
A11	Auto Reboost	B11	
A12	Mated Stack (Mnvr, Robotics & Att Hold)	B12	Mated Stack (Undocking and Att Hold)
A13		B13	Mated Stack (VRCS Deadband Collapse)
A14	Orbiter alone SRMS/OBSS Ops	B14	
A15		B15	

CNTL ACC	Purpose
0	Orbiter alone with unloaded RMS
1	Orbiter alone SRMS/OBSS Ops
2	Mated - Light Russian Segment, prior to Node 3 at SSRMS Radiator Hold position
3	Mated - Light Russian Segment, beginning with Node 3 at SSRMS Radiator Hold position
4	Mated - Medium Russian Segment, prior to Node 3 at SSRMS Radiator Hold position
5	Mated - Medium Russian Segment, beginning with Node 3 at SSRMS Radiator Hold position
6	Mated - Heavy Russian Segment, prior to Node 3 at SSRMS Radiator Hold position
7	Mated - Heavy Russian Segment, beginning with Node 3 at SSRMS Radiator Hold position
8	Not used
9	Not used

DAPs for mated operations are based on analysis from GNC, PDRS, C. S. Draper Labs, and ISS Structures

FS 3-2

ORB OPS/130/FIN



## UNIV PTG

TGT ID = 1 Orbiting Vehicle = 2 Earth Center = 3 Earth Target Input LAT ( $\pm 90$ ) LON ( $\pm 180$ , + = East) ALT (-3444.0 to 20000.0 nm) = 4 Sun Center = 5 Celestial Target Input RA (0-359.99) DEC ( $\pm 90$ ) = 11-110 Nav Stars
BODY VECTOR = 1 +X* = 2 -X* = 3 -Z* = 4 -Y Star Tracker* = 5 Selectable Input P (0-359.99) Y (270-359.99, 0-90) *Input OM $\rightarrow$ OM (0-359.99)
MON AXIS = 1 +X = 2 -X

FS 3-3

ORB OPS/130/FIN

## STS-130 DAP A CONFIGURATIONS

### STS-130 DAP A1 – DAP A8 CONFIGURATIONS

	ITEM #	A1	A2	A3	A4	A5	A6	A7	A8
<b>PRI</b>									
ROT RATE	10 (50)	0.2000	0.4000	0.2000	0.5000	0.2000	0.2000	0.2000	0.0500
ATT DB	11 (51)	5.00	1.00	0.30	3.00	5.00	5.00	2.00	2.00
RATE DB	12 (52)	0.20	0.20	0.20	0.20	0.20	0.20	0.20	0.20
ROT PLS	13 (53)	0.100	0.100	0.100	0.100	0.100	0.100	0.100	0.100
COMP	14 (54)	.000	.000	.000	.000	.000	.000	.000	.000
P OPTION	15 (55)	ALL	ALL	ALL	ALL	ALL	TAIL	ALL	ALL
Y OPTION	16 (56)	ALL	ALL	TAIL	ALL	ALL	TAIL	ALL	ALL
TRAN PLS	17 (57)	0.100	0.100	0.100	0.100	0.100	0.100	0.100	0.100
<b>ALT</b>									
RATE DB	18 (58)	0.200	0.200	0.070	0.200	0.070	0.070	0.100	0.100
JET OPT	19 (59)	ALL	ALL	ALL	ALL	ALL	TAIL	ALL	ALL
# JETS	20 (60)	2	2	1	2	1	1	2	2
ON TIME	21 (61)	0.08	0.08	0.08	0.08	0.08	0.08	0.08	0.08
DELAY	22 (62)	0.00	0.00	0.00	0.00	0.00	0.00	0.00	0.00
<b>VERN</b>									
ROT RATE	23 (63)	0.2000	0.4000	0.0080	0.2000	0.0500	0.0500	0.0160	0.0500
ATT DB	24 (64)	1.000	1.000	0.070	1.000	1.000	1.000	1.000	1.000
RATE DB	25 (65)	.020	.020	.010	.020	.020	.020	.020	.020
ROT PLS	26 (66)	0.010	0.010	0.010	0.010	0.010	0.010	0.010	0.050
COMP	27 (67)	.000	.000	.000	.000	.000	.000	.000	.000
CNTL ACC	28 (68)	0	0	0	0	0	0	0	0
PURPOSE		NOMINAL	PTC	GG		LOSS OF VERN (ALL)	LOSS OF VERN (TAIL ONLY)	RNDZ	TERMINAL PHASE

**BOLD/ITALIC** indicates change from I-Load.

FS 3-4

ORB OPS/130/FIN

**STS-130 DAP A9 – DAP A14 CONFIGURATIONS**

	ITEM #	A9	A10	A11	A12	A13	A14
<b>PRI</b>							
ROT RATE	10 (50)	0.1300	0.0500	0.0500	0.0500	0.0500	0.2000
ATT DB	11 (51)	2.00	0.60	10.00	5.00	5.00	5.00
RATE DB	12 (52)	0.10	0.10	0.20	0.20	0.20	0.20
ROT PLS	13 (53)	0.100	0.100	0.100	0.040	0.040	0.100
COMP	14 (54)	.000	.000	.000	.000	.000	.000
P OPTION	15 (55)	TAIL	TAIL	TAIL	TAIL	TAIL	TAIL
Y OPTION	16 (56)	TAIL	TAIL	TAIL	TAIL	TAIL	TAIL
TRAN PLS	17 (57)	0.050	0.050	0.100	0.010	0.010	0.100
<b>ALT</b>							
RATE DB	18 (58)	0.100	0.100	0.020 <sup>1</sup>	0.020 <sup>1</sup>	0.020 <sup>1</sup>	0.200
JET OPT	19 (59)	TAIL	TAIL	TAIL	TAIL	TAIL	TAIL
# JETS	20 (60)	2	2	2	2	2	1(2) <sup>3</sup>
ON TIME	21 (61)	0.08	0.08	0.08	0.08	0.08	0.08
DELAY	22 (62)	0.00	0.00	7.52	7.52	7.52	6.00
<b>VERN</b>							
ROT RATE	23 (63)	0.1300	0.0500	0.1000	0.1000	0.1000	0.2000
ATT DB	24 (64)	1.000	0.500	5.000	3.000	3.000	3.000
RATE DB	25 (65)	.020	.020	.050	.020	.020	.200
ROT PLS	26 (66)	0.050	0.050	0.010	0.002	0.002	0.010
COMP	27 (67)	.000	.000	.000	.000	.000	.000
CNTL ACC	28 (68)	0	0	<b>6(7)</b> <sup>2</sup>	<b>6(7)</b> <sup>2</sup>	2 <sup>2</sup>	1
PURPOSE		PROX/OPS FLYAROUND	DOCKING	AUTO REBOOST	MATED STACK (MNVRS, ROBO, ATT HOLD)		ORBITER ALONE SRMS/OBSS

***BOLD/ITALIC*** indicates change from I-Load.

<sup>1</sup> I-loaded below keyboard limit; do not change

<sup>2</sup> CA6 – Heavy Russian Segment, prior to Node 3 at SSRMS Radiator Hold position

CA7 – Heavy Russian Segment, beginning with Node 3 at SSRMS Radiator Hold position

<sup>3</sup> Use 1 for OBSS scan and 2 for Orbiter attitude maneuvers

FS 3-5

ORB OPS/130/FIN

## STS-130 DAP B CONFIGURATIONS

### STS-130 DAP B1 – DAP B8 CONFIGURATIONS

	ITEM #	B1	B2	B3	B4	B5	B6	B7	B8
<b>PRI</b>									
ROT RATE	30 (50)	0.5000	0.2000	0.2000	0.2000	0.2000	0.5000	0.5000	0.0500
ATT DB	31 (51)	3.00	3.00	3.00	0.30	3.00	3.00	2.00	2.00
RATE DB	32 (52)	0.20	0.20	0.20	0.20	0.20	0.20	0.20	0.20
ROT PLS	33 (53)	0.040	0.040	0.040	0.040	0.040	0.040	0.040	0.040
COMP	34 (54)	.000	.000	.000	.000	.000	.000	.000	.000
P OPTION	35 (55)	ALL	TAIL	ALL	TAIL	TAIL	ALL	ALL	ALL
Y OPTION	36 (56)	ALL	TAIL	ALL	TAIL	TAIL	ALL	ALL	ALL
TRAN PLS	37 (57)	0.100	0.020	0.020	0.020	0.020	0.020	0.050	0.050
<b>ALT</b>									
RATE DB	38 (58)	0.200	0.070	0.070	0.100	0.200	0.200	0.100	0.100
JET OPT	39 (59)	ALL	TAIL	ALL	ALL	ALL	ALL	ALL	ALL
# JETS	40 (60)	2	1	1	2	2	2	2	2
ON TIME	41 (61)	0.08	0.08	0.08	0.08	0.08	0.08	0.08	0.08
DELAY	42 (62)	0.00	0.00	0.00	0.00	0.00	0.00	0.00	0.00
<b>VERN</b>									
ROT RATE	43 (63)	0.2000	0.2000	0.2000	0.0080	0.0160	0.2000	0.2000	0.0500
ATT DB	44 (64)	1.000	1.000	1.000	0.100	0.033	1.000	1.000	1.000
RATE DB	45 (65)	.020	.020	.020	.010	.020	.020	.020	.020
ROT PLS	46 (66)	0.002	0.002	0.002	0.002	0.002	0.002	0.002	0.020
COMP	47 (67)	.000	.000	.000	.000	.000	.000	.000	.000
CNTL ACC	48 (68)	0	0	0	0	0	0	0	0
PURPOSE		OMS & RCS BURNS (ORB OPS)	LOSS OF VERN (TAIL ONLY)	LOSS OF VERN (ALL)		COAS/HUD CAL		RNDZ	TERMINAL PHASE

**BOLD/ITALIC** indicates change from I-Load.

FS 3-6

ORB OPS/130/FIN

**STS-130 DAP B9 – DAP B13 CONFIGURATIONS**

	ITEM #	B9	B10	B12	B13
<b>PRI</b>					
ROT RATE	30 (50)	0.1300	0.0500	0.0100 <sup>1</sup>	0.0100 <sup>1</sup>
ATT DB	31 (51)	2.00	0.60	1.00	1.00
RATE DB	32 (52)	0.10	0.10	0.20	0.20
ROT PLS	33 (53)	0.040	0.040	0.040	0.040
COMP	34 (54)	.000	.000	.000	.000
P OPTION	35 (55)	TAIL	TAIL	TAIL	TAIL
Y OPTION	36 (56)	TAIL	TAIL	TAIL	TAIL
TRAN PLS	37 (57)	0.010	0.010	0.010	0.010
<b>ALT</b>					
RATE DB	38 (58)	0.100	0.100	0.020 <sup>1</sup>	0.020 <sup>1</sup>
JET OPT	39 (59)	TAIL	TAIL	TAIL	TAIL
# JETS	40 (60)	2	2	2	2
ON TIME	41 (61)	0.08	0.08	0.08	0.08
DELAY	42 (62)	10.00	0.00	7.52	7.52
<b>VERN</b>					
ROT RATE	43 (63)	0.1300	0.0500	0.0100	0.0100
ATT DB	44 (64)	1.000	0.500	1.000	<b>0.100</b>
RATE DB	45 (65)	.020	.020	.020	.020
ROT PLS	46 (66)	0.020	0.020	0.002	0.002
COMP	47 (67)	.000	.000	.000	.000
CNTL ACC	48 (68)	0	0	<b>6(7)</b> <sup>2</sup>	<b>6(7)</b> <sup>2</sup>
PURPOSE		PROXOPS/ FLYAROUND	DOCKING	MATED ATT HOLD (VRCS & ALT)	MATED VRCS DB COLLAPSE

**BOLD/ITALIC** indicates change from I-Load.

<sup>1</sup> I-loaded below keyboard limit; do not change

<sup>2</sup> CA6 – Heavy Russian Segment, prior to Node 3 at SSRMS Radiator Hold position

CA7 – Heavy Russian Segment, beginning with Node 3 at SSRMS Radiator Hold position

FS 3-7

ORB OPS/130/FIN



This Page Intentionally Blank



REBOOST/DAP

AUTO REBOOST.....	FS 4-2
ATTITUDE REFERENCE.....	FS 4-4
DOCKED DAP REFERENCE .....	FS 4-5
RATE DAMPING.....	FS 4-5

**REBOOST/  
DAP**

## AUTO REBOOST

### NOTE

Allow 5 min between establishing reboost attitude and reboost start time for DAP accelerations to converge

1. If PRCS required:

O14:F, RJDA 1A L2/R2 DRIVER – OFF  
O15:F, RJD MANF L5/F5/R5 DRIVER – OFF  
O16:F, Pri RJD LOGIC (eight) – ON

√MCC for GO to power up Pri Drivers  
RJD MANF L5/F5/R5 DRIVER – ON  
Pri RJD DRIVER (eight) – ON

2. Select Reboost Configuration

**GNC 20 DAP CONFIG**  
REBOOST CFG – ITEM 8 +\_ EXEC  
INTVL – ITEM 9 +\_ . . . . EXEC

3. Set up Future Reboost

**GNC UNIV PTG**  
DURATION – ITEM 27 +\_ +\_ +\_ . . . . EXEC  
START TIME – ITEM 1 +\_ . . . +\_ . . . +\_ . . . . EXEC  
RBST – ITEM 25 EXEC (FUT-\*)

4. Select appropriate Reboost Rotation DAP  
When in attitude and prior to START TIME,  
DAP: A11/AUTO/VERN(ALT)

C3

If using Config 1 or 4:

**GNC 20 DAP CONFIG**  
Disable X JETS ROT – ITEM 7 EXEC (no \*)

Cont next page

FS 4-2

ORB OPS/130/FIN

REBOOST/  
DAP



NOTE

Reboost can be aborted with an item 26 on UNIV PTG or by selecting FREE on the DAP

5. Post Reboost Configuration

If using Config 1 or 4:

**GNC 20 DAP CONFIG**

Enable X JETS ROT – ITEM 7 EXEC (\*)

Return to FLIGHT PLAN Attitude

DAP: as reqd

Pri RJD LOGIC, DRIVER (sixteen) – as reqd

C3  
O14,  
O15,  
O16

## AUTO REBOOST ATTITUDE REFERENCE

### ALT & VRCS ATTITUDE HOLD CONFIGURATIONS:

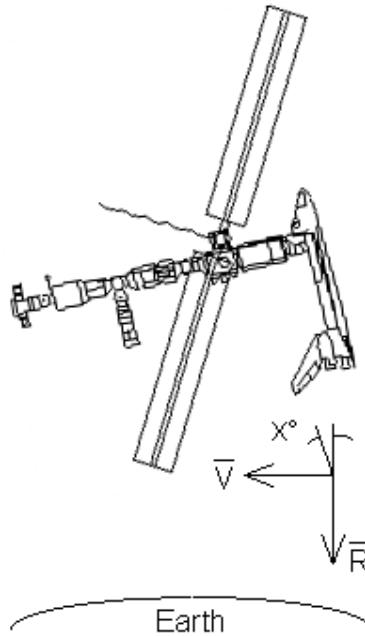

Configurations 1 and 4 use ALT PRCS (Pitch,  $X=4^\circ$ )  
Configuration 2 is for Shuttle only - Do Not Use While Docked  
Configuration 3 uses VRCS (Pitch,  $X=4^\circ$ )

## DOCKED DAP REFERENCE

### NOTE

Shuttle mated attitude control is not certified when the Shuttle Airlock is depressurized (<3.45 psia)

Mated Attitude Hold and Maneuvers (VERN or ALT)	Mated Attitude Hold (VERN or ALT)
A12	B12

ALT not certified for loaded RMS operations

CNTL ACC selection depends on the weight of the Russian Segment due to visiting vehicle configurations and status of Node 3 installation as described below:

Case	Docking Port				Russian Segment Weight Classification
	FGB	DC1	SM Aft	MRM2	
1	Occupied	Occupied	Occupied	Occupied	Heavy Use CA 6 <sup>1</sup> , 7 <sup>2</sup>
2	Occupied	Empty	Occupied	Occupied	
3	Occupied	Occupied	Empty	Occupied	Light Use CA 2 <sup>1</sup> , 3 <sup>2</sup>
4	Occupied	Occupied	Occupied	Empty	Medium Use CA 4 <sup>1</sup> , 5 <sup>2</sup>

<sup>1</sup> CNTL ACC 2, 4, or 6 - Prior to Node 3 at SSRMS Radiator Hold Position

<sup>2</sup> CNTL ACC 3, 5, or 7 - Beginning with Node 3 at SSRMS Radiator Hold Position

## RATE DAMPING

DAP: LVLH(INRTL) - Dependent on desired attitude hold

Monitor Jet Activity Light:

For continuous Jet Activity > 6 min:

DAP: FREE then restart this procedure

If Jet Activity Stopped for > 5 sec for VERN (15 sec for ALT)

DAP: FREE > 2 sec

DAP: AUTO >>



This Page Intentionally Blank



OIU PROCEDURES

OIU ACTIVATION .....	FS 5-2
DEACTIVATION .....	FS 5-2

OIU



PRLA

PRLA CLOSE..... FS 6-2

**PRLA**

FS 6-1

ORB OPS/130/FIN





SHORT DURATION BIOASTRONAUTICS  
INVESTIGATION (SDBI)

SDBI 1634, SLEEP-WAKE ACTIGRAPHY .....	FS 7-2
DON ACTIWATCH .....	FS 7-2
DOFF ACTIWATCH .....	FS 7-2

SDBI

FS 7-1

ORB OPS/130/FIN



WING LEADING EDGE SENSORS (WLES) PROCEDURES

WLES ACTIVATION AND CHECKOUT.....	FS 8-2
DEACTIVATION AND TEARDOWN.....	FS 8-10
LAPTOP RECEIVER UNIT (LRU) R&R.....	FS 8-12
CABIN RELAY UNIT R&R .....	FS 8-14
CONFIGURE WLES DATA FILE BACKUP PATH.....	FS 8-16
PREP WLES LAPTOPS FOR TRANSFER.....	FS 8-17
WLES RNDZ TOOLS CHECKOUT PREP.....	FS 8-18
DOCK/UNDOCK RECOVERY .....	FS 8-18
DISABLE WLES FILE BACKUP .....	FS 8-19
ENABLE WLES FILE BACKUP .....	FS 8-19

**WLE  
SENSORS**

## WLES ACTIVATION AND CHECKOUT

### 1. UNSTOW EQUIPMENT

#### NOTE

A31p laptops may already be unstowed as part of orbiter laptop network setup

ML60E

Unstow:

Laptop Receiver Units (2)

Cabin Relay Units (2):

CRU A (S/N 1920)

CRU B (S/N 1984)

STS6 A31p laptop (WLES)

STS5 A31p laptop (RPOP2)

### 2. SETUP WLES RELAY UNITS

#### CAUTION

Cross-connecting CRU A to MICRO WIS SYSTEM B (and vice versa) will prevent WLES ops, though step 8 would still show good comm

#### NOTE

Green patch on Cabin Relay Unit is antenna and must face into cabin

A6	Unstow coiled WLE SYSTEM A cable
A13	Connect plug PNL A13 SYSTEM A to jack MICRO WIS SYSTEM A J7 (see fig 8-1)
CRU A	Connect plug CABIN RELAY UNIT to J1 on CRU S/N 1920
STBD OVHD	Secure CRU A to STBD side of aft cabin with Velcro (see fig 8-2)
A9	Unstow coiled WLE SYSTEM B cable
A13	Connect plug PNL A13 SYSTEM B to jack MICRO WIS SYSTEM B J8 (see fig 8-1)
CRU B	Connect plug CABIN RELAY UNIT to J1 on CRU S/N 1984
PORT OVHD	Secure CRU B to PORT side of aft cabin with Velcro (see fig 8-3)

Cont next page

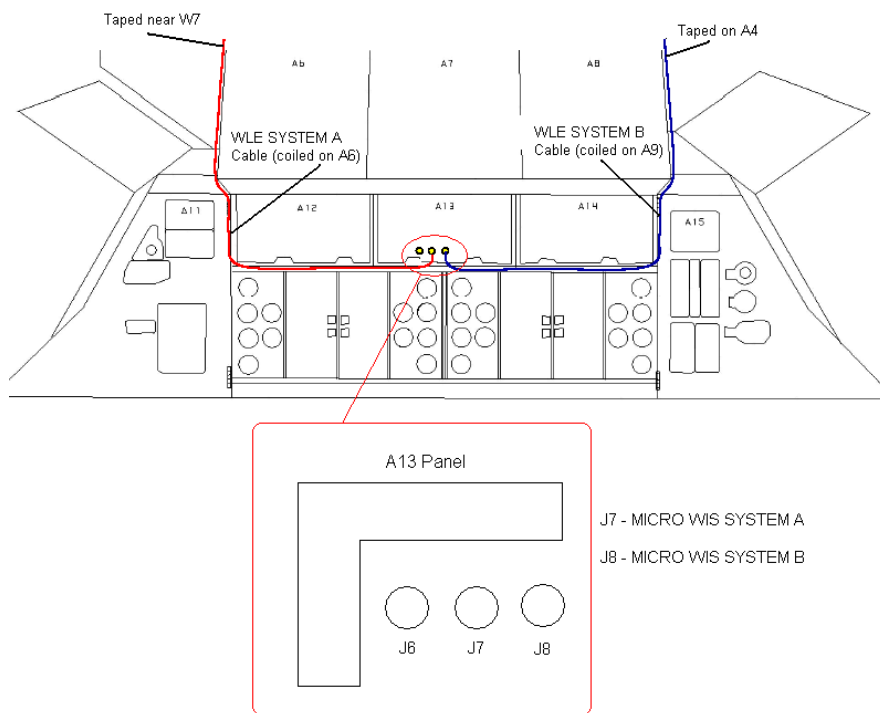

Figure 8-1.- A13 panel.

Cont next page

FS 8-3

ORB OPS/130/FIN

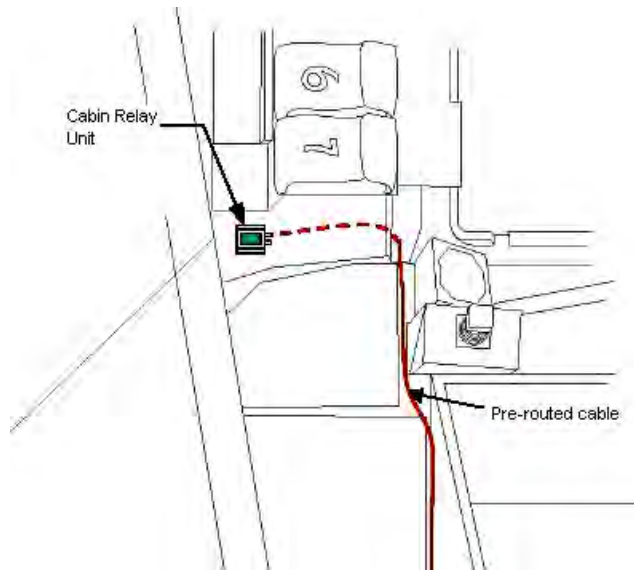

Figure 8-2.- Aft STBD location.

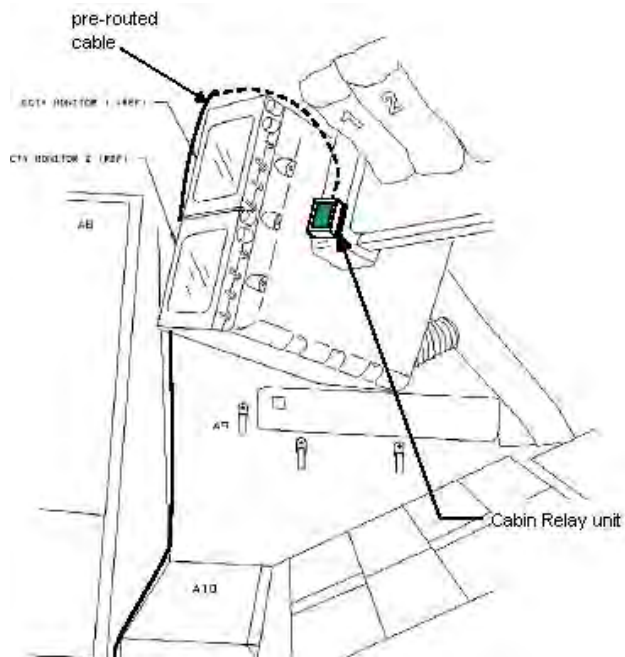

Figure 8-3.- Aft PORT location.

Cont next page

FS 8-4

ORB OPS/130/FIN

NOTE

Laptops may be powered or unpowered.  
Laptops may be connected to network or standalone

A31p

3. SETUP PRIME WLES LAPTOP

Secure Laptop Receiver Unit to A31p with Velcro  
(see fig 8-4)

Connect Laptop Receiver Unit to A31p Serial port  
using thumbscrews (see fig 8-5)

Verify line of sight between Laptop Receiver Unit  
and both CRUs

Verify 5-in minimum distance between Laptop  
Receiver Unit and both CRUs

4. SETUP BACKUP WLES LAPTOP

NOTE

Single laptop ops are preferred over  
delays in activation. If problems with  
Backup Laptop occur, skip step 4

Secure Laptop Receiver Unit to A31p with Velcro  
(see fig 8-4)

Connect Laptop Receiver Unit to A31p Serial port  
using thumbscrews (see fig 8-5)

Verify line of sight between Laptop Receiver Unit  
and both CRUs

Verify 5-in minimum distance between Laptop  
Receiver Unit and both CRUs

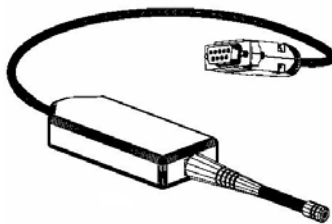

Figure 8-4.- Laptop Receiver Unit.

Cont next page

FS 8-5

ORB OPS/130/FIN



Figure 8-5.- A31p ports.

5. LAUNCH WLES SOFTWARE

Perform for both laptops:

If laptops are off, A31p pwr – On

Double click the time in system tray (lower-right corner)

'Date and Time Properties'

'Time Zone'

Time zone – (GMT) Greenwich Mean Time

Click 'OK'

Double click 'Shuttle Apps'>'WLES'>'WLES'

'Backup Mode Selection'

If setting up one A31p, select 'Standard'

If setting up two A31p laptops:

For prime laptop, select 'Primary'

For backup laptop, select 'Secondary'

If 'EWBMTAU-WLEFlight' appears with message 'Run the current command:

XXXX\_AA\_BB\_SNYYYY.xml?':

Click 'Yes'

NOTE

The secondary laptop lid may be closed at this time, if no longer needed for other applications.

The laptops are configured so that they do not enter 'standby' or 'hibernate' mode when the lids are closed. However, due to cooling concerns, fully closing the lid is not recommended

Cont next page



A31p

6. VERIFY LRU INSTALLATION

Use prime WLES laptop

'Enhanced Wideband MicroTAU – WLEFlight 3.0'

Click 'System Settings' (left side of display)

'Communications Settings'

√RF Receiver Port: 'COM 1'

Click 'Query Receiver'

Verify 'Receiver found on COM1' message appears

- \* If 'Query Receiver' fails: \*
- \*     Reseat LRU \*
- \*     Reboot prime WLES laptop \*
- \*     Double click 'Shuttle Apps'>'WLES'> \*
- \*     'WLES' \*
- \*     Select 'Primary' \*
- \*     Repeat step 6 \*
- \* If no Joy, perform WLES LRU R&R, steps \*
- \*     1-4, 6, then: \*

7. VERIFY DATA FILE BACKUP

Use prime WLES laptop

Verify 'Backup Directory:' set to:

'S:\Program Files\Invocon\EWBMTAU-WLEFlight'

- \* If 'Backup Directory' not set as above: \*
- \*     'System Settings' \*
- \*     'Directories' \*
- \*     At the line 'Backup Directory:' click \*
- \*     'Browse...' (right side of display) \*
- \*     \*
- \*     'Browse for Folder' \*
- \*     Navigate to WLES folder on RPOP2: \*
- \*     'My Computer'>'C on RPOP2 (S:)'> \*
- \*     'Program Files'>'Invocon'> \*
- \*     'EWBMTAU-WLEFlight' \*
- \*     \*
- \*     Click 'OK' \*

Verify 'Backup Interval' set to '30 minutes'

Cont next page

FS 8-7

ORB OPS/130/FIN

8. VERIFY COMM WITH RELAY UNITS

Use prime WLES laptop

'Main'

Click 'Unit List' (left side of display)

NOTE

Each Cabin Relay Unit is identified with a unique serial number; this number appears as 'Unit ID' in the software

√Cabin Relay Units Unit ID 1920 and 1984 present on display in first column; scroll down as necessary

For each Cabin Relay Unit:

√Unit ID present

√Type: 'Relay-GL'

√Last Update: time is updating (every 5 to 15 sec)

- \* If one CRU time does not update: \*
- \* | Perform WLES CABIN RELAY UNIT R&R, \*
- \* | steps 1 thru 3, then: \*
- \* | Go to step 9 \*
- \* If neither CRU time updates after 2 min, \*
- \* contact MCC-H \*

√Via: 'RF'

√Mode: 'Idle'

9. INITIATE COMMANDING

Double click 'Shuttle Apps'>'WLES'>'WLES Data Folder'

Double click 'Shuttle Apps'>'WLES'>'WLES Cmd Folder'

Cont next page

FS 8-8

ORB OPS/130/FIN

NOTE

Deleting 'BLOCK.xml' file initiates command execution. Command files disappear from this folder as they are executed.

Files appearing in the 'Data' folder verifies two-way communication with the Sensor Units in the orbiter wing

'Command'

Delete file labeled 'BLOCK.xml'

At prompt "Are you sure you want to send 'Block.xml' to the Recycle Bin?", click 'Yes'

Wait 1 minute

Verify the first data file appears in the 'Data' folder

Close 'Command' and 'Data' folders

10. REPORT WLES STATUS

Notify MCC-H: "WLES setup complete"

If reporting a failed and replaced CRU, include:

Failed CRU S/N

NOTE

The laptop lid may be closed at this time, if no longer needed for other applications. The laptops are configured so that they do not enter 'standby' or 'hibernate' mode when the lids are closed. However, due to cooling concerns, fully closing the lid is not recommended

## WLES DEACTIVATION AND TEARDOWN

### 1. DEACTIVATE WLES LAPTOP

#### NOTE

MCC will configure WLES for entry by setting all sensor units to idle mode

#### **On MCC GO:**

A31p 'Enhanced Wideband MicroTAU – WLEFlight 3.0'

For each WLES A31p:

Click 'Exit'

At prompt 'Are you sure you want to exit?'

click 'Yes'

Click 'Start' > 'Turn Off Computer...' > 'Turn Off'

Disconnect Laptop Receiver Unit from A31p

Serial port

Remove Laptop Receiver Unit from Velcro on A31p

### 2. REMOVE WLES RELAY UNITS

Remove Cabin Relay Units (2) from aft cabin (see figs 8-6 and 8-7)

Disconnect Cabin Relay Units from pre-routed cables

Disconnect and coil cables, stow in launch location

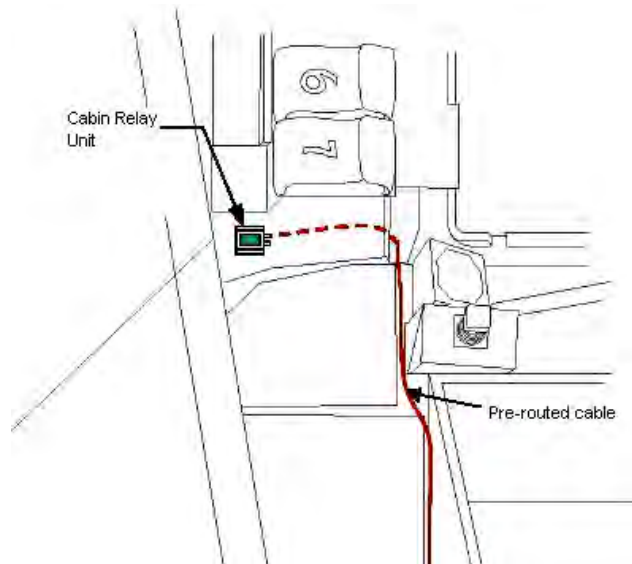

Figure 8-6.- Aft STBD location.

Cont next page

FS 8-10

ORB OPS/130/FIN

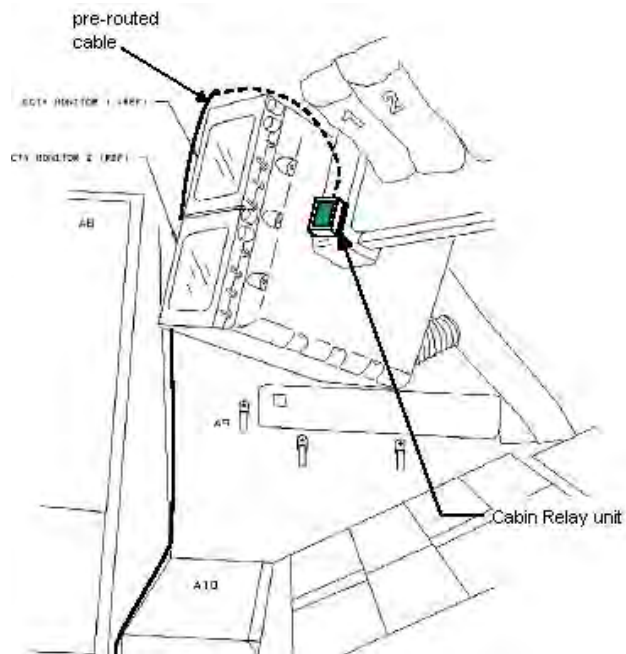

Figure 8-7.- Aft PORT location.

- ML60E
3. STOW EQUIPMENT  
Stow:
    - Laptop Receiver Units (2)
    - Cabin Relay Units (2)Notify MCC-H: "WLES Teardown Complete"

## WLES LAPTOP RECEIVER UNIT (LRU) R&R

- A31p 1. DISCONNECT BACKUP LRU FROM LAPTOP  
'Enhanced Wideband MicroTAU – WLEFlight 3.0'

Click 'Exit'  
At prompt 'Are you sure you want to exit?'  
click 'Yes'

Disconnect Backup LRU from Backup A31p Serial  
port (see fig 8-8)  
Remove Backup LRU from Velcro on Backup A31p  
(see fig 8-9)



Figure 8-8.- A31p ports.

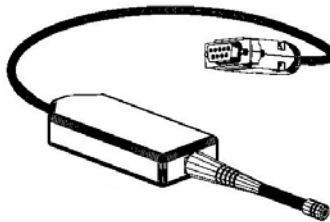

Figure 8-9.- Laptop Receiver Unit.

2. DISCONNECT PRIME LRU FROM LAPTOP  
Disconnect Prime LRU from Prime A31p Serial port  
(see fig 8-8)  
Remove LRU from Velcro on A31p

Cont next page

FS 8-12

ORB OPS/130/FIN

3. CONNECT BACKUP LRU

Connect Backup LRU to Prime WLES A31p Serial port  
Secure LRU to A31p with Velcro

A31p

4. VERIFY LRU INSTALLATION

Use prime WLES laptop

'Enhanced Wideband MicroTAU – WLEFlight 3.0'  
Click 'System Settings' (left side of display)

'Communications Settings'  
√RF Receiver Port: 'COM 1'

Click 'Query Receiver'  
Verify 'Receiver found on COM1' message appears

5. VERIFY COMM WITH RELAY UNITS

Click 'Unit List' (left side of display)

√Cabin Relay Units Unit ID 1920 and 1984 present on display in first column; scroll down as necessary

For each Cabin Relay Unit:

- √Unit ID present
- √Type: 'Relay-GL'
- √Last Update: time is updating (every 5 to 15 sec)
- √Via: 'RF'
- √Mode: 'Idle'

If no time updates after 2 min, contact MCC-H

6. STOW EQUIPMENT

Notify MCC-H: "WLES LRU R&R complete", mark failed LRU as 'failed'

ML60E

Stow:  
Prime (failed) LRU

## WLES CABIN RELAY UNIT R&R

- OVHD 1. DISCONNECT FAILED CRU AND STOW  
Disconnect WLE SYSTEM cable from J1 connector  
on failed CRU  
Mark failed CRU as 'failed' and stow in ML60E
- ML60E 2. SETUP SPARE WLES RELAY UNIT  
Unstow CRU SPARE (S/N 1856)
- WLE SYSTEM cable  
Connect plug CABIN RELAY UNIT A or B to J1 on  
CRU S/N 1856
- OVHD Secure CRU SPARE to the aft cabin with Velcro
- A31p 3. VERIFY COMM WITH SPARE RELAY UNIT  
Use prime WLES laptop
- 'Main'  
Click 'Unit List' (left side of display)

### NOTE

Each Cabin Relay Unit is identified with a unique serial number; this number appears as 'Unit ID' in the software

√Cabin Relay Unit Unit ID 1856 present on display in first column; scroll down as necessary

Cabin Relay Unit:

- √Unit ID present
- √Type: 'Relay-GL'
- √Last Update: time is updating (every 5 to 15 sec)
- √Via: 'RF'
- √Mode: 'Idle'

### NOTE

Loss of redundant relay path until the config file is updated by the ground

Cont next page

FS 8-14

ORB OPS/130/FIN



4. EXIT WLES SOFTWARE ON BOTH LAPTOPS

**On MCC GO:**

A31p

On both Prime and Backup WLES laptops:

'Enhanced Wideband MicroTAU – WLEFlight 3.0'  
Click 'Exit' (upper right side of display)

'EWBMTAU – WLEFlight'  
'Are you sure you want to exit?', click 'Yes'

Notify MCC-H when complete

NOTE

OCA will replace the config files on both laptops

5. LAUNCH WLES SOFTWARE

**On MCC GO:**

A31p

On both Prime and Backup WLES laptops:

Double click 'Shuttle Apps'>'WLES'>'WLES'

'Backup Mode Selection'  
If setting up one A31p, select 'Standard'

If setting up two A31p laptops:  
For prime laptop, select 'Primary'  
For backup laptop, select 'Secondary'

If 'EWBMTAU-WLEFlight' window appears with  
message 'Run the current command:  
XXXX\_AA\_BB\_SNYYYY.xml?':  
Click 'Yes'

6. REVERIFY COMM WITH SPARE RELAY UNIT

Repeat step 3

7. REPORT WLES STATUS

Notify MCC-H: "WLES CRU R&R complete"

## CONFIGURE WLES DATA FILE BACKUP PATH

### NOTE

MCC will identify new backup WLES laptop to be used in place of RPOP2 (S:)

- A31p      Use prime WLES laptop
- 'Enhanced Wideband MicroTAU – WLEFlight 3.0'  
Click 'System Settings' (left side of display)
- 'Directories'  
At the line 'Backup Directory:' click 'Browse...' (right side of display)
- 'Browse for Folder'  
Navigate to WLES folder on RPOP2:  
    'My Computer'>'C on RPOP2 (S:)'>'Program Files'>'Invocon'>'EWBMTAU-WLEFlight'
- Click 'OK'
- Verify 'Backup Directory:' set to:  
    'S:\Program Files\Invocon\EWBMTAU-WLEFlight'
- Verify 'Backup Interval' set to '30 minutes'
- Click 'Unit List' (left side of display)

## PREP WLES LAPTOPS FOR TRANSFER

- A31p 1. DEACTIVATE WLES LAPTOP(S)  
'Enhanced Wideband MicroTAU – WLEFlight 3.0'

For each WLES A31p to be transferred:

Click 'Exit'

At prompt 'Are you sure you want to exit?'

click 'Yes'

Click 'Start'>'Turn Off Computer... '>'Turn Off'

Disconnect Laptop Receiver Unit from A31p

Serial port

Remove Laptop Receiver Unit from Velcro on  
A31p

2. SET UP NEW WLES LAPTOPS

√MCC-H for which laptop to use

If Prime Laptop being transferred:

Perform WLES ACTIVATION AND CHECKOUT,  
steps 3, 5 thru 8, then:

If Backup Laptop being transferred:

Perform WLES ACTIVATION AND CHECKOUT,  
steps 4 and 5, then:

Notify MCC-H: "PREP WLES LAPTOPS FOR  
TRANSFER complete"

## WLES RNDZ TOOLS CHECKOUT PREP

- A31p
1. DEACTIVATE BACKUP WLES LAPTOP  
On backup WLES laptop:  
‘Enhanced Wideband MicroTAU – WLEFlight 3.0’  
Click ‘Exit’  
At prompt ‘Are you sure you want to exit?’  
click ‘Yes’  
Disconnect Laptop Receiver Unit from A31p  
Serial port  
Leave attached to laptop with Velcro on A31p
  2. DEACTIVATE WLES FILE BACKUP  
On prime WLES laptop:  
‘Enhanced Wideband MicroTAU – WLEFlight 3.0’  
Click ‘System Settings’ (left side of display)  
  
‘Backup Mode Selection’  
Click ‘Standard’  
Click ‘Unit List’ (left side of display)

## WLES DOCK/UNDOCK RECOVERY

- A31p
1. RECOVER BACKUP WLES LAPTOP  
On backup WLES laptop:  
Connect Laptop Receiver Unit to A31p Serial port  
If laptop is off:  
| A31p pwr – On  
| At prompt select option 1 to start WLES  
If laptop is on:  
Double click ‘Shuttle Apps’>‘WLES’>‘WLES’  
‘Backup Mode Selection’  
Click ‘Secondary’
  2. REACTIVATE WLES FILE BACKUP  
On prime WLES laptop:  
‘Enhanced Wideband MicroTAU – WLEFlight 3.0’  
Click ‘System Settings’ (left side of display)  
  
‘Backup Mode Selection’  
Click ‘Primary’  
Click ‘Unit List’ (left side of display)

┌ | | | ┌

## **DISABLE WLES FILE BACKUP**

(SWITCH TO STANDARD MODE)

A31p            On prime WLES laptop:  
                  'Enhanced Wideband MicroTAU – WLEFlight 3.0'  
                  Click 'System Settings' (left side of display)  
  
                  'Backup Mode Selection'  
                  Click 'Standard'  
                  Click 'Unit List' (left side of display)

## **ENABLE WLES FILE BACKUP**

(SWITCH TO PRIMARY MODE)

A31p            On prime WLES laptop:  
                  'Enhanced Wideband MicroTAU – WLEFlight 3.0'  
                  Click 'System Settings' (left side of display)  
  
                  'Backup Mode Selection'  
                  Click 'Primary'  
                  Click 'Unit List' (left side of display)



This Page Intentionally Blank



PAYLOADS OF OPPORTUNITY

MAUI PROCEDURE ..... FS 9-2  
RAMBO-2 PROCEDURE ..... FS 9-6

**P/L OF  
OPP**

FS 9-1

ORB OPS/130/FIN

## MAUI PROCEDURE

P/L OF  
OPP

- 15:00 or earlier 1. MANEUVER TO START ATTITUDE  
(BIASED +ZLV +YVV)

Deploy MAUI – RCS FIRING SEQUENCE  
(Cue Card)

GNC 20 DAP CONFIG

√DAP A1, B1 loaded

UNIV PTG

TGT ID – ITEM 8 +2 EXEC  
BODY VECT – ITEM 14 +5 EXEC  
P – ITEM 15 +2 7 0 EXEC  
Y – ITEM 16 +3 5 0 EXEC  
OM – ITEM 17 +2 7 0 EXEC

TRK – ITEM 19 EXEC (CUR - \*)

2. INITIATE TIMER

√MCC for start time

GNC 2 TIME

Set count down/count up timer per MCC

√MET – ITEM 2 EXEC (\*)

CRT TIMER COUNT TO – ITEM 17 +    +    +     
EXEC

3. SETUP

O14:E, cb DDU L (two) – cl  
O15:E

O14:F, Pri RJD LOGIC, DRIVER (sixteen) – ON  
O15:F,  
O16:F

GNC 20 DAP CONFIG

DAP A PRI P OPTION – ITEM 15 EXEC (NOSE)  
ROT PLS – ITEM 13 +1.0 0 0 EXEC  
TRAN PLS – ITEM 17 +0.7 3 EXEC  
VERN ROT PLS – ITEM 26 +0.1 5 3 EXEC

Cont next page



**GNC 23 RCS**

Deselect Jets:

Forward RCS page – ITEM 1 EXEC

JET DES F1D – ITEM 23 EXEC (\*)

F2D – ITEM 27 EXEC (\*)

C3     √DAP: A/AUTO/VERN  
          √DAP TRANS: PULSE/PULSE/PULSE  
          DAP ROT: PULSE/PULSE/PULSE

-05:00   4. VERIFY ATTITUDE  
          Verify in attitude

NOTE

For the following RCS firing sequence  
(step 5):

- A. Expect total orbiter body rates  
(RSS) to exceed 1 deg/sec
- B. Possible loss of comm due to orbiter  
body rates and attitude excursions
- C. For any jet fail OFF, continue with  
firing sequence
- D. Requirement is for a particular jet  
group, not a specific jet
- E. The table in step 5 is also provided  
as a cue card

Cont next page

FS 9-3

ORB OPS/130/FIN

## 5. RCS FIRING SEQUENCE

### NOTE

Use the table below or the cue card

Reminder: All inputs are momentary except RHC +pitch at 00:45

### MAUI – RCS FIRING SEQUENCE

Timer	Jets Fired	CDR	PLT
-03:00		Body rates: $+0.047 \leq \text{roll} \leq +0.087$ $-0.020 \leq \text{pitch} \leq +0.020$ $-0.020 \leq \text{yaw} \leq +0.020$ DAP: FREE DAP: A/PRI  Inform PLT "GO" for jet deselection	Configure initial setup GNC 23 RCS Left RCS page – ITEM 2 EXEC  On CDR "GO", proceed  <u>NOTE</u> Expect DAP RECONF msgs in following actions  Deselect jets: JET DES L5L – ITEM 37 EXEC (*) Right RCS page – ITEM 3 EXEC JET DES R5D – ITEM 39 EXEC (*) Forward RCS page – ITEM 1 EXEC JET DES F5L – ITEM 37 EXEC (*)  <u>NOTE</u> Queue the following ITEM entry on the scratch pad. Do not perform the EXEC until specified at 35 sec  JET DES F3D – ITEM 25
-00:30		FLT CNTLR PWR – ON	
00:00	RXA, LXA	THC +X (in) (3 sec firing)	
00:15	FXL, LXL	THC +Y (right) (3 sec firing)	
00:30	FXR, RXR	THC -Y (left) (3 sec firing)	
00:35			When jets stop firing: GNC 23 RCS EXEC [JET DES F3D – ITEM 25 (*)]
00:45	F4D	RHC +pitch Past Soft Stop, hold 3 sec	
00:48		RHC release	
00:50			DAP: VERN
01:00	R5R	RHC +yaw (10 sec firing)	
01:20	L5D	RHC -pitch (12 sec firing)	
01:40	F5R	RHC +pitch (12 sec firing)	
		FLT CNTLR PWR – OFF	Return to MAUI PROCEDURE, step 6, (ORB OPS FS, P/L OF OPP)

Cont next page

FS 9-4

ORB OPS/130/FIN

6. CLEANUP  
F6 √FLT CNTLR PWR – OFF

GNC 23 RCS

√Forward RCS page – ITEM 1 EXEC

Reselect Jets:

JET DES F1D – ITEM 23 EXEC (no \*)  
F3D – ITEM 25 EXEC (no \*)  
F2D – ITEM 27 EXEC (no \*)  
F5L – ITEM 37 EXEC (no \*)

Left RCS page – ITEM 2 EXEC  
JET DES L5L – ITEM 37 EXEC (no \*)

Right RCS page – ITEM 3 EXEC  
JET DES R5D – ITEM 39 EXEC (no \*)

GNC 20 DAP CONFIG

DAP A1 – ITEM 1 + 1 EXEC

7. SNAP LVLH ATTITUDE AND NULL RATES

When time  $\geq$  +03:30:

DAP: A/PRI  
DAP: LVLH

When rates stable:

DAP: VERN

Return to FLT PLN attitude

8. RECONFIGURE TO GROUP B POWERDOWN

√MCC

O14:E,   cb DDU L (two) – op  
O15:E

O14:F,   Pri RJD LOGIC,DRIVER (sixteen) – OFF  
O15:F,   RJDA 1A L2/R2 MANF DRIVER – ON  
O16:F

## RAMBO-2 PROCEDURE

### NOTE

This procedure completes a WAKE, RAM and Out-of-Plane burn. The direction of the Out-of-Plane burn is dependent upon satellite geometry and will be provided by MCC for the specific burn opportunity

- 15:00 or earlier 1. MANEUVER TO WAKE BURN ATTITUDE  
(BIASED +ZLV+XVV)

GNC 20 DAP CONFIG

√DAP A1, B1 loaded

UNIV PTG

TGT ID – ITEM 8 +2 EXEC  
BODY VECT – ITEM 14 +5 EXEC

P – ITEM 15 +2 2 0 EXEC

Y – ITEM 16 +0 EXEC

OM – ITEM 17 +0 EXEC

TRK – ITEM 19 EXEC (CUR - \*)

DAP: A/AUTO/VERN(ALT)

2. INITIATE TIMER

√MCC for burn sequence start time

GNC 2 TIME

Set count down/count up timer per MCC

√MET – ITEM 2 EXEC (\*)

CRT TIMER COUNT TO – ITEM 17 +    +    +     
EXEC

3. SETUP

O14:E, cb DDU L (two) – cl  
O15:E

O14:F, Pri RJD LOGIC,DRIVER (sixteen) – ON  
O15:F,  
O16:F

Cont next page

FS 9-6

ORB OPS/130/FIN

GNC 20 DAP CONFIG

DAP A PRI P OPTION – ITEM 15 EXEC (NOSE)  
Y OPTION – ITEM 16 EXEC (NOSE)

DAP TRANS: NORM/PULSE/PULSE

-01:00 4. VERIFY ATTITUDE  
Verify in attitude

F6 FLT CNTLR PWR – ON

0:00 5. WAKE BURN  
DAP: PRI

Wait 20 seconds

THC +X (in) for 10 seconds

Wait 20 seconds before executing next maneuver

F6 6. MANEUVER TO RAM BURN ATTITUDE  
(BIASED -ZLV-XVV)

F6 FLT CNTLR PWR – OFF

UNIV PTG

TGT ID – ITEM 8 +2 EXEC

BODY VECT – ITEM 14 +5 EXEC

P – ITEM 15 +1 2 0 EXEC

Y – ITEM 16 +0 EXEC

OM – ITEM 17 +0 EXEC

TRK – ITEM 19 EXEC (CUR - \*)

DAP: B/AUTO/ALT

When in attitude and if VRCS available:

DAP: VERN

When rates stable:

DAP: PRI

F6 FLT CNTLR PWR – ON

Wait 20 seconds

Cont next page

FS 9-7

ORB OPS/130/FIN

7. RAM BURN

THC +X (in) for 10 seconds

Wait 20 seconds before executing next maneuver

F6 8. MANEUVER TO OUT-OF-PLANE BURN ATTITUDE  
FLT CNTLR PWR – OFF

UNIV PTG

TGT ID – ITEM 8 +2 EXEC

BODY VECT – ITEM 14 +5 EXEC

P – ITEM 15 +9 0 EXEC

Y – ITEM 16 +0 EXEC

√MCC for burn omicron

If stbd wing to velocity vector:

| OM – ITEM 17 +2 7 0 EXEC

If port wing to velocity vector:

OM – ITEM 17 +9 0 EXEC

TRK – ITEM 19 EXEC (CUR - \*)

DAP: B/AUTO/ALT

When in attitude and if VRCS available:

DAP: VERN

When rate stable:

DAP: PRI

F6 FLT CNTLR PWR – ON

Wait 20 seconds

9. OUT-OF-PLANE BURN

THC +X (in) for 10 seconds

Wait 20 seconds before returning to VERN(ALT)  
below

Cont next page

FS 9-8

ORB OPS/130/FIN

10. CLEANUP  
F6 FLT CNTLR PWR – OFF

GNC 20 DAP CONFIG  
DAP A1 – ITEM 1 +1 EXEC

DAP: VERN(ALT)

Return to FLT PLN attitude

11. RECONFIGURE TO GROUP B POWERDOWN  
√MCC  
O14:E, cb DDU L (two) – op  
O15:E

O14:F, Pri RJD LOGIC, DRIVER (sixteen) – OFF  
O15:F, RJDA 1A L2/R2 MANF DRIVER – ON  
O16:F



This Page Intentionally Blank





CWC OPS

CWC FILL .....	FS 10-2
CWC-I FILL .....	FS 10-7
WASTE TANK OFFLOAD TO CWC .....	FS 10-13

**CWC OPS**

**CWC FILL**

NOTE

Assumes galley iodine removal hardware (GIRA) already installed. To minimize contamination possibility, avoid touching any internal parts of QDs or connections

EQUIPMENT PREPARATION

Unstow from designated stowage when needed:

- Towel(s)
- Disinfectant Wipes
- CWCs
- Mineral Syringe Kit
- Silver Biocide Kit
- Sample/Purge Kit

CWC OPS

WATER TRANSFER HOSE PURGE (see fig 10-1)

NOTE

WATER TRANSFER HOSE PURGE reqd only if prior to first fill or three or more days since last fill

- ML90N
1. Retrieve Needle Adapter from Sample/Purge Kit. Attach to injection port on tee at end of Water Transfer Hose coming from tee of previously installed ACTEX
  2. Remove cap on Needle Adapter and attach Purge Bag. Open valve on injection port and fill bag to capacity (about 12 ounces). Close valve when capacity reached
  3. Stow Purge Bag in Ziploc Bag and place in crew-designated location. Replace cap on Needle Adapter and temp stow adapter until further use

Cont next page

FS 10-2

ORB OPS/130/FIN

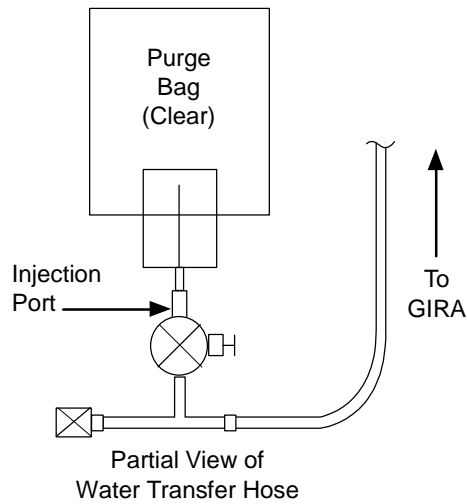

jsc48035\_004.cnv

Figure 10-1.- Initial purge setup; Water Transfer Hose coming from GIRA.

CWC FILL INITIATION (see fig 10-2)

NOTE

Potable water has both silver biocide and minerals added. Technical water has only silver biocide added

CAUTION

Do not squeeze CWC while filling. This may cause water backflow into connecting equipment and galley. Do not detach or move quantity measurement strap (if flown)

1. Retrieve desired number of CWCs. Report condition to MCC

NOTE

For Potable CWCs, ALWAYS add minerals first.

CWC will begin filling as soon as connected to Water Transfer Hose

Cont next page

2. Disinfect CWC QD and Water Transfer Hose QD
3. Attach CWC to Water Transfer Hose
4. If Potable CWC (Blue Label):  
Remove cap from Mineral Syringe. At injection port nearest to CWC, remove cap and install syringe. Open valve on injection port and inject Mineral solution. Slowly withdraw syringe plunger fully, filling syringe with water, then reinject. Close valve on injection port when final injection complete. Remove syringe and stow in empty syringe location
5. For all CWCs:  
Remove cap from Silver Biocide Syringe. At injection port nearest to CWC, remove cap and install syringe. Open valve on injection port and inject Silver Biocide solution. Slowly withdraw syringe plunger fully, filling syringe with water, then reinject. Close valve on injection port when final injection complete. Remove syringe and stow in empty syringe location

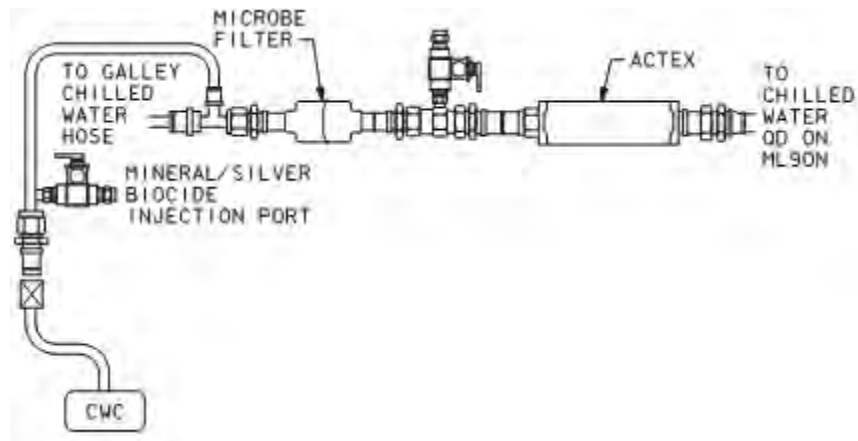

Figure 10-2.- CWC fill setup.

Cont next page

FS 10-4

ORB OPS/130/FIN

CWC FILL TERMINATION

1. If comm, terminate fill on MCC call  
If no comm, terminate fill after 52 minutes
2. To terminate fill, disconnect CWC from Water Transfer Hose. Flow to CWC will stop when this action performed
3. If no samples reqd, fill out CWC label and temp stow CWC until transferred to ISS. If sample reqd, fill out CWC label, then go to CWC SAMPLING PROCEDURE
4. Report barcode and serial number (located on CWC label) to MCC

Cont next page

FS 10-5

ORB OPS/130/FIN

CWC SAMPLING PROCEDURE (if reqd) (see fig 10-3)

NOTE

If sampling Potable CWCs, use ONLY sampling hardware with blue valve handle. Sampling hardware with green handle is for Technical CWCs only

1. Retrieve Sample/Purge Kit and obtain Sampling Adapter. Connect Luer-lock end to Sample Bag. Connect QD end of Sampling Adapter to CWC. Ensure manual valve set to open posn. Fill bag (estimate visually) by squeezing CWC. When complete, close manual valve and remove Sample Bag. Fill out Sample Bag label, stow in Ziploc Bag, and place in crew-designated sample stowage location
2. Disconnect Sampling Adapter from CWC and stow in Sample/Purge Kit. Temp stow CWC until transferred to ISS

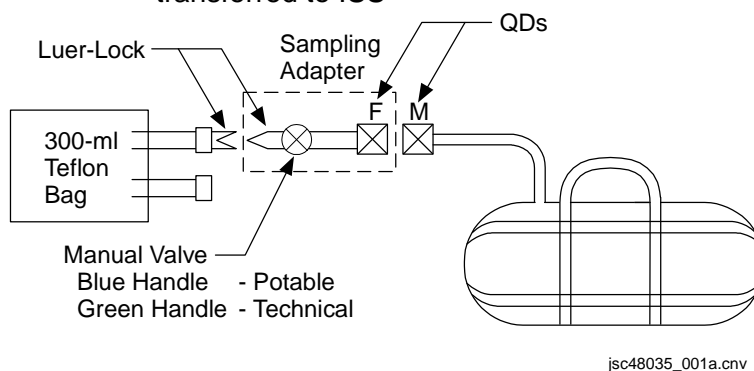

Figure 10-3.- CWC sample setup.

## CWC-I FILL

### NOTE

This procedure is to be used when filling a CWC-I containing a purple card (for iodinated water). Assumes Galley Morning Config and Overnight Config performed daily. To minimize contamination possibility, avoid touching any internal parts of QDs or connections

### EQUIPMENT PREPARATION

Unstow from designated stowage when needed:

- Towel(s)
- Disinfectant Wipes
- R-Y Hose
- 3/8" Male Hose Adapter ("2" Adapter)
- Sample/Purge Kit
- CWC-I Bags
- Timer

### A. CWC-I FILL SET UP

#### NOTE

Have towels ready to absorb any liquid released when mating or demating QDs

1. Retrieve R-Y Hose
2. Connect red end of R-Y Hose to free end of tee attached to Chilled Water Line QD (#5) at QD bracket (see fig 10-4)

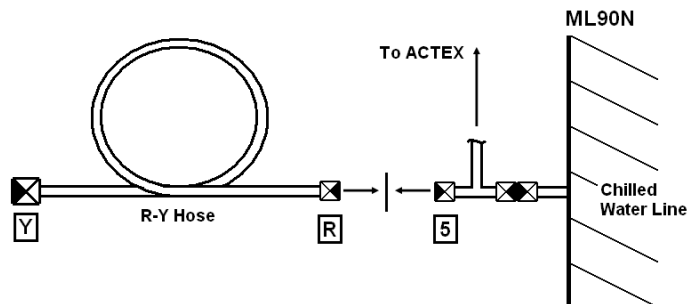

Figure 10-4.- R-Y Hose connection at ML90N.

Cont next page

B. CWC-I FILL HOSE PURGE

NOTE

CWC-I FILL HOSE PURGE required only prior to first fill of mission

1. Retrieve 3/8" Male Hose Adapter ("-2" Adapter) and Sample/Purge Kit

CAUTION

Ensure Sample Adapter valve is not open prior to mating

NOTE

Use ONLY sampling adapter labeled for iodinated water sampling

2. Assemble Purge hardware as shown in fig 10-5

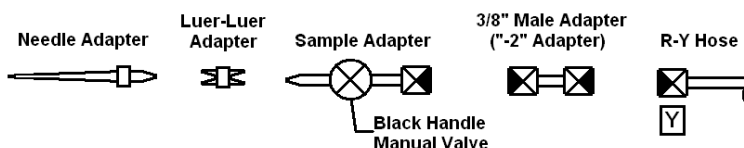

Figure 10-5.- CWC-I Fill Hose purge hardware.

3. Remove cap on Needle Adapter and attach Purge Bag

CAUTION

Assembly provides high flow.  
Throttle Sample Adapter Valve

4. Open valve on Sample Adapter and fill bag to capacity (about 12 ounces). Close valve when capacity reached
5. Disconnect Purge Bag from Needle Adapter  
Stow Purge Bag in Ziploc Bag and place in crew designated location  
Replace cap on Needle Adapter

Cont next page



C. PURGE ASSEMBLY TEARDOWN

1. De-mate all connections shown in fig 10-5  
Cap Yellow QD of R-Y Hose
2. Stow Purge Assembly hardware (place equipment in Ziploc Bags) in designated stowage location

R11L D. CWC-I FILL INITIATION  
If SPLY H2O XOVR VLV – CL (tb-bp) (Water Transfer Config):

1. SPLY H2O TKA OUTLET – CL (tb-CL)

ML90N If reqd, unstow R-Y Hose:  
2. Connect red end of R-Y Hose to free end of tee attached to Chilled Water Line QD (#5) at QD bracket (see fig 10-6)

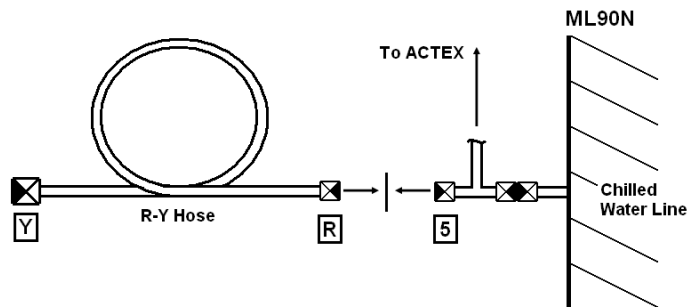

Figure 10-6.- R-Y Hose connection at ML90N.

3. Report bag barcode and serial number (located on CWC-I label) to MCC-H
4. Disinfect CWC-I QD and Yellow QD of R-Y Hose

**CAUTION**  
Do not overfill CWC-I as damage to bag may occur

**NOTE**  
CWC-I will begin filling as soon as free end of R-Y Hose connected to CWC-I

Cont next page

5. Set timer for 10 min  
Attach timer to Velcro square on CWC-I
6. Connect CWC-I to R-Y Hose (see fig 10-7)

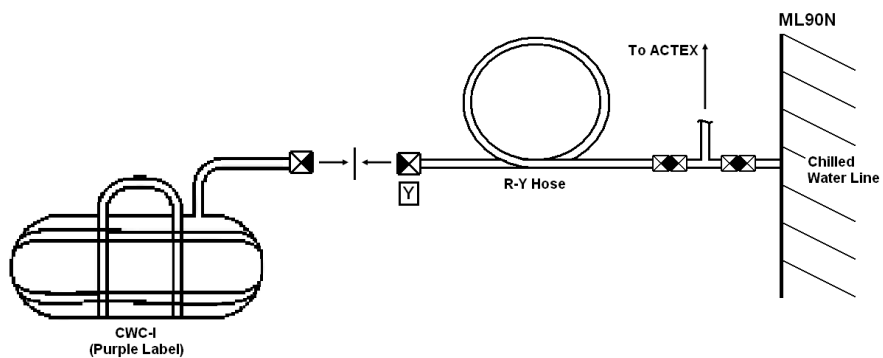

Figure 10-7.- CWC-I fill initiation.

7. Start 10 min timer

**E. CWC-I FILL TERMINATION**

After 10 min or MCC call:

ML90N

1. Disconnect CWC-I from R-Y Hose  
(see fig 10-8) and cap Yellow QD of R-Y  
Hose

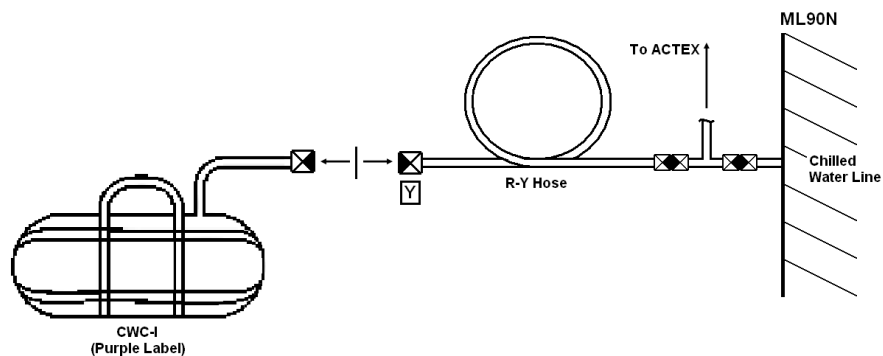

Figure 10-8.- CWC-I fill termination.

Cont next page

FS 10-10

ORB OPS/130/FIN

2. Verify purple card (for iodinated water) is visible in all three windows:

If sample reqd, perform CWC-I SAMPLING PROCEDURE, then proceed to step E3

If no sample reqd, temp stow CWC-I until transfer to ISS

3. If filling multiple CWC-I's, repeat steps D3 thru E2 for sequential fill(s)

R11L If SPLY H2O XOVR VLV – CL (tb-bp) (water transfer config):

4. SPLY H2O TKA OUTLET – OP (tb-OP)

5. Transfer CWC-I(s) to ISS

#### F. CWC-I FILL TEARDOWN

##### NOTE

Have towels ready to absorb any liquid released when demating QDs

- ML90N
1. Disconnect R-Y Hose from Chilled Water Line Tee QD (#5) (see fig 10-9) and cap both Red and Yellow QDs of R-Y Hose

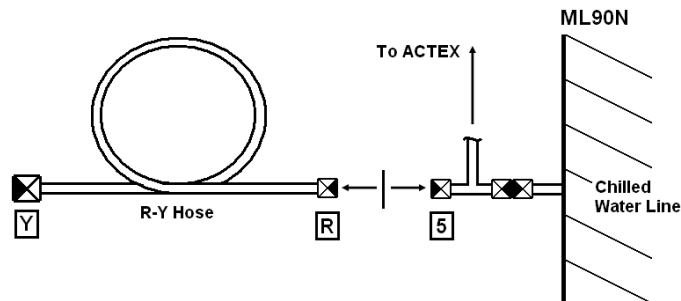

Figure 10-9.- R-Y Hose removal.

2. Temp stow R-Y Hose

After last CWC-I fill:

3. Stow R-Y Hose in designated location

CWC-I SAMPLING PROCEDURE (if reqd)

NOTE

Use ONLY sampling adapter labeled for iodinated water sampling

1. Retrieve Sample/Purge Kit and obtain Iodinated (black handle) Sampling Adapter
2. Connect Sample Adapter to Sample Bag
3. Connect QD end of Sampling Adapter to CWC-I. Ensure manual valve set to open position
4. Fill Sample Bag full (estimate visually) by squeezing CWC-I. When complete, close manual valve and remove Sample Bag. Fill out Sample Bag label, stow in Ziploc Bag, and place in crew-designated sample stowage location
5. Disconnect Sampling Adapter from CWC-I and stow in Sample/Purge Kit. Temp stow CWC-I until transferred to ISS

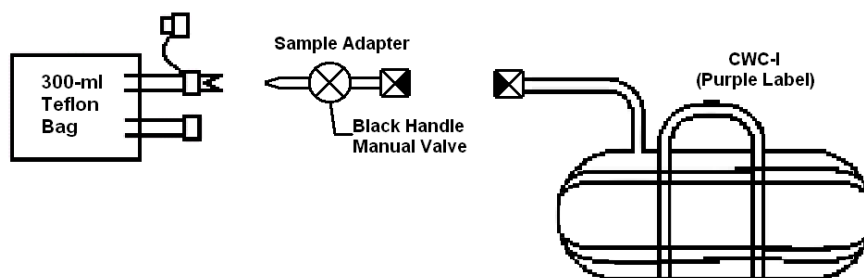

Figure 10-10.- CWC-I sample setup.

## WASTE TANK OFFLOAD TO CWC

**OBJECTIVE:** Use CWC to temp store waste water in the event the waste tank is full and cannot be dumped. CWC will be dumped at a later time

### NOTE

Requires Ops 2 config and two crewmembers

**LOCATION:** CONT H2O X-TIE WASTE QD located on outboard WCS wall (inside WCS compartment), Volume H (MD23R); see LOWER EQUIPMENT BAY (IFM, COMPONENT LOCATIONS)

### TOOLS REQD:

TOOL	Gray Tape
CHCK	8 ft Y-Y Hose
CWC	Dry Wipes (2-3)
MISC	PPE (gloves and goggles)
	36 x 36 Ziploc Bag (two)
Middeck	Contingency Water Container (CWC) (S/N TBD)

1. Remove contents of Vol H (MD23R), temp stow
2. Connect Y-Y Hose to CWC
3. Place CWC in one Ziploc

ML31C 4. WASTE H2O DUMP ISOL VLV – CL (tb-CL)

### NOTE

Discontinue WCS ops until procedure complete.

Use Dry Wipes to absorb any fluid released during QD mate/demate

5. Don PPE

WCS 6. Connect Y-Y Hose to CONT H2O X-TIE WASTE QD (upper QD with yellow Velcro and "WASTE" label)

### NOTE

MCC will TMBU limits if desired

Cont next page

FS 10-13

ORB OPS/130/FIN

7. FDA limit for Waste TK to CWC transfer \_\_\_\_\_%

8. **SM 60 TABLE MAINT**

PARAMETER NAME	PARA ID	SM ALERT	
		LOW	HIGH
WASTE H2O QTY 1	0620540	<input type="checkbox"/>	-

ML31C 9. WASTE H2O DUMP ISOL VLV – OP (tb-OP)

10. Monitor CWC fill rate continuously

**SM 66 ENVIRONMENT**

11. When 'S66 WASTE H2O QTY ↓', continue

ML31C 12. WASTE H2O DUMP ISOL VLV – CL (tb-CL)

WCS 13. Leave Y-Y Hose connected to CWC, disconnect Y-Y Hose from CONT H2O X-TIE WASTE QD, cap QD

ML31C 14. WASTE H2O DUMP ISOL VLV – OP (tb-OP)

15. Leaving Y-Y Hose protruding from corner of bag, lightly press air out of Ziploc, seal bag

16. Use Gray Tape to seal area around location where Y-Y Hose exits Ziploc (see photo below)



Cont next page

FS 10-14

ORB OPS/130/FIN

17. Fold any extra portion of Ziploc flat, coil Y-Y Hose on top
18. Place bagged CWC/Y-Y Hose assembly into second Ziploc , lightly press air out of bag, seal Ziploc
19. Temp stow entire assembly in Vol H (MD23R), ensuring minimal pressure is applied to CWC
20. Stow tools



This Page Intentionally Blank





FRED

FRED SETUP .....	FS 11-2
STOWAGE .....	FS 11-2

**FRED**

FS 11-1

ORB OPS/130/FIN

## FRED SETUP

1. Unstow FRED tray and FRED leg brace
- A8L 2. Attach clutch bracket mount assy below aft panel A8 with captive fasteners (four)
3. Assemble FRED as shown and adjust to desired position. Note positions

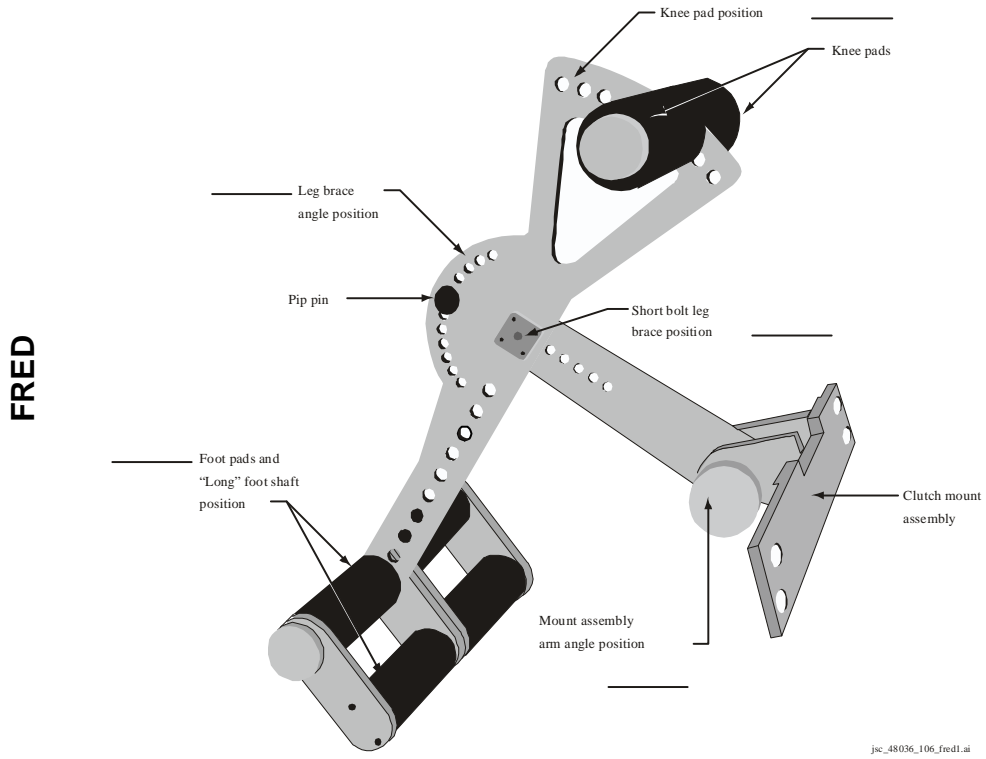

## FRED STOWAGE

1. Disassemble FRED and set clutch bracket mount assy to #8 angle position
2. Stow FRED in locker tray cushion. Re-adjust clutch bracket mount assy as required
3. Stow leg brace



CUE CARD CONFIGURATION

CUE  
CARDS

NOT FLOWN

FS 12-1

ORB OPS/130/FIN



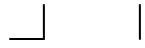

This Page Intentionally Blank

**CUE  
CARDS**



NOT FLOWN

FS 12-2

ORB OPS/130/FIN



TOP

HOOK  
VELCRO

**LiOH CHANGEOUT**

(6 crewmembers/Single Shift/FD 1-15)

FLIGHT DAY	POS A	POS B	CK CMPLT
LAUNCH	1	2	
PRE FD01	"	"	
POST FD02	3	4	
PRE FD02	5	"	
POST FD03	6	7	DOCKING
PRE FD03	"	8	
POST FD04	"	"	
PRE FD04	9	"	
POST FD05	"	10	EVA 1
PRE FD05	11	"	
POST FD06	"	12	
PRE FD06	13	14	
POST FD07	15	16	EVA 2
PRE FD07	17	"	
POST FD08	"	"	
PRE FD08	"	18	
POST FD09	19	"	EVA 3
PRE FD09	"	20	
POST FD10	"	"	
PRE FD10	21	"	
POST FD11	"	"	
MID FD11	22	23	ODS HATCH CL
PRE FD11	"	"	
POST FD12	24	"	UNDOCK
PRE FD12	26	"	
POST FD13	27	28	
PRE FD13	"	29	
POST FD14	30	31	EOM
PRE FD14	32	"	
POST FD15	33	34	EOM+1

\*Re-bag and seal LiOH cans w/Gray Tape and stow  
(Locations of canisters on back)

ORB OPS-29a/nonRCRS/130/O/B

**NOTE**

This card is specifically used for the STS-130 mission with the orbiter conducting single shift operations with a shuttle crew size of 6 and ISS crew size of 5. Changeout scheme reflects FD3 docking with ISS, Vozdukh, and CDRA (activated in dual-bed mode) during docked ops, and undocking on FD12. ODF hatch closure will be worked the night before undocking

(reduced copy)

NOT FLOWN

FS CC 12-3

ORB OPS/130/FIN

TOP  
BACK OF 'LIOH CHANGEOUT'

HOOK  
VELCRO

**LIOH CHANGEOUT (cont)**

FLIGHT DAY	POS A	POS B	CK CMLPT
PRE FD15	"	35	
POST FD16	36	37	EOM+2
PRE FD16	38	"	
POST FD17	39	40	EOM+3

\*Re-bag and seal LiOH cans w/Gray Tape and stow

**LIOH CANISTER STOWAGE LOCATIONS**

**Ascent Stowage Locations**

Orbiter:

MD52M (LiOH Box): Cans 1-31 \*

Cans 32-40 Node 3

**Entry (EOM) Stowage Locations**

Orbiter:

MD52M (LiOH Box): Cans 1-31 \*

Cans 32-40 \_\_\_\_\_

\* 2 LiOH cans installed in LiOH slots A and B

ORB OPS-29b/nonRCRS/130/O/B

(reduced copy)

NOT FLOWN

FS CC 12-4

ORB OPS/130/FIN

TOP

HOOK  
VELCRO

HOOK  
VELCRO

**ORBIT BURN MONITOR**

<b>OMS TEMP*</b>	L R	
FU IN P ≥	219	220
≤	201	208
or No FU IN P		
		OMS ENG FAIL
		OMS PRPLT FAIL
<b>OMS PC* &amp; OMS ↓</b>		
ENG VLV 1 or 2 < 70		
or OX IN P > 227		
OX IN P ≤ 227		
or No OX IN P		
		OMS ENG FAIL
		OMS PRPLT FAIL
<b>OMS OX/FU TK P (√ENG IN P)</b>		
OX/FU LOW		
He PRESS/VAP ISOL (two) – OP		
If aff TK P not incr:		
OMS PRPLT FAIL		
OX & FU HIGH		
He PRESS/VAP ISOL (two) – CL		
Cycle He A(B) to maintain TK P 234-284		
<b>OMS N2 REG P HIGH or LOW</b>	OMS ENG – ARM	
<b>OMS N2 TK P LOW</b> (√[OMS/MPS])	At N2 TK P < 470: OMS ENG – ARM	
<b>OMS GMBL</b>	PRI fail	L(R) OMS GMBL – SEC
	SEC fail	If high RCS usage: OMS ENG FAIL
<b>GPC</b>	<input type="checkbox"/> ( <input type="checkbox"/> ) & Burning OMS aff	aff GPC PWR – OFF If SEC GMBL avail: aff MDM FF 1(4) – OFF,ON L(R) OMS GMBL – SEC
	SEC GMBL lost	If high RCS usage: OMS ENG FAIL
	2 FAs lost	√MAN SHUTDN
<b>I/O ERROR FA</b>	1(4)	L(R) OMS GMBL – SEC
		♦ I/O RESET
		If high RCS usage: OMS ENG FAIL
	2 FAs lost	√MAN SHUTDN
<b>BCE STRG D</b>	1(4)	I/O RESET (if recov: >>)
		If high RCS usage: L(R) OMS GMBL – SEC
<b>GPC SET SPLIT</b>	Non-crit burn	STOP BURN: OMS ENG(s) – OFF
	Crit burn	Go to “GPC” above
<b>I/O ERROR PCM</b>	OI PCMMU PWR – 2(1)	
<b>BCE BYP OA</b>	SM I/O RESET	

\*If XFD, BLDN, or sensor fail, monitor ENG IN P for off-nominal performance

ORB OPS-31a/130/O/A

(reduced copy)

NOT FLOWN

FS CC 12-5

ORB OPS/130/FIN

TOP  
BACK OF 'ORBIT BURN MONITOR'



**LEFT OMS**

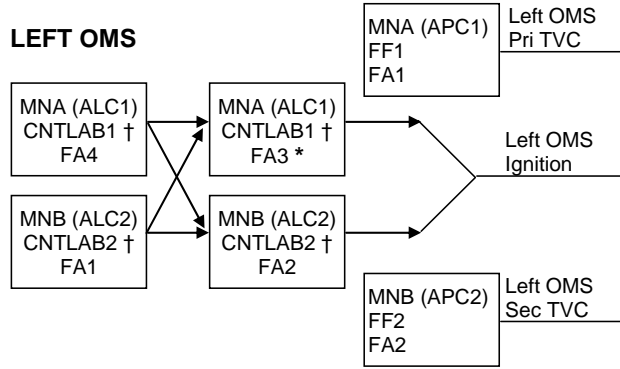

- † If CNTL AB1 or AB2 (CA1 or CA2) failed and ign path still exists at OMS fail, assume L(R) OMS ↓ is PRPLT FAIL
- \* If L(R) Pc failed high during burn or FA3(4) failed, at L(R) OMS fail, no guidance downmode after L(R) OMS ENG switch OFF (TGO slow, ADI needles in error, 6 ft/s underburn)

**RIGHT OMS**

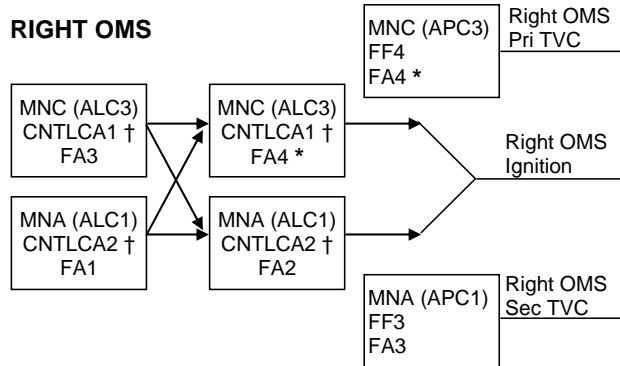

If two FA MDMs lost		
MDMs	Preburn: ENG – OFF	During burn: MAN SHUTDN
1,2	LEFT (TVC)	BOTH
1,3	RIGHT (IGN)	LEFT
1,4	LEFT (IGN)	RIGHT
2,3	LEFT (IGN)	RIGHT
2,4	RIGHT (IGN)	LEFT
3,4	RIGHT (TVC)	BOTH

ORB OPS-31b/130/O/A

(reduced copy)

NOT FLOWN

FS CC 12-6

ORB OPS/130/FIN



NOT FLOWN

FS CC 12-7

ORB OPS/130/FIN

(reduced copy)

TOP

PILE  
VELCRO

ORB OPS-41a/130/O/B

PILE  
VELCRO

**STS-130 DAP A1 – DAP A8 CONFIGURATIONS**

	ITEM#	A1	A2	A3	A4	A5	A6	A7	A8
<b>PRI</b>									
ROT RATE	10 (50)	0.2000	0.4000	0.2000	0.5000	0.2000	0.2000	0.2000	0.0500
ATT DB	11 (51)	5.00	1.00	0.30	3.00	5.00	5.00	2.00	2.00
RATE DB	12 (52)	0.20	0.20	0.20	0.20	0.20	0.20	0.20	0.20
ROT PLS	13 (53)	0.100	0.100	0.100	0.100	0.100	0.100	0.100	0.100
COMP	14 (54)	.000	.000	.000	.000	.000	.000	.000	.000
P OPTION	15 (55)	ALL	ALL	ALL	ALL	ALL	TAIL	ALL	ALL
Y OPTION	16 (56)	ALL	ALL	TAIL	ALL	ALL	TAIL	ALL	ALL
TRAN PLS	17 (57)	0.100	0.100	0.100	0.100	0.100	0.100	0.100	0.100
<b>ALT</b>									
RATE DB	18 (58)	0.200	0.200	0.070	0.200	0.070	0.070	0.100	0.100
JET OPT	19 (59)	ALL	ALL	ALL	ALL	ALL	TAIL	ALL	ALL
#JETS	20 (60)	2	2	1	2	1	1	2	2
ON TIME	21 (61)	0.08	0.08	0.08	0.08	0.08	0.08	0.08	0.08
DELAY	22 (62)	0.00	0.00	0.00	0.00	0.00	0.00	0.00	0.00
<b>VERN</b>									
ROT RATE	23 (63)	0.2000	0.4000	0.0080	0.2000	0.0500	0.0500	0.0160	0.0500
ATT DB	24 (64)	1.000	1.000	0.070	1.000	1.000	1.000	1.000	1.000
RATE DB	25 (65)	.020	.020	.010	.020	.020	.020	.020	.020
ROT PLS	26 (66)	0.010	0.010	0.010	0.010	0.010	0.010	0.010	0.050
COMP	27 (67)	.000	.000	.000	.000	.000	.000	.000	.000
CNTL ACC	28 (68)	0	0	0	0	0	0	0	0
PURPOSE		NOMINAL	PTC	GG		LOSS OF VERN (ALL)	LOSS OF VERN (TAIL ONLY)	RNDZ	TERMINAL PHASE

*BOLD ITALIC* indicates change from I-Load.

-----  
HINGE

NOT FLOWN

FS CC 12-8

ORB OPS/130/FIN

(reduced copy)

TOP  
HINGED AT BOTTOM OF  
'STS-130 DAP A1 – DAP A8 CONFIGURATIONS'  
HINGE

**STS-130 DAP B1 – DAP B8 CONFIGURATIONS**

	ITEM #	B1	B2	B3	B4	B5	B6	B7	B8
<b>PRI</b>									
ROT RATE	30 (50)	0.5000	0.2000	0.2000	0.2000	0.2000	0.5000	0.5000	0.0500
ATT DB	31 (51)	3.00	3.00	3.00	0.30	3.00	3.00	2.00	2.00
RATE DB	32 (52)	0.20	0.20	0.20	0.20	0.20	0.20	0.20	0.20
ROT PLS	33 (53)	0.040	0.040	0.040	0.040	0.040	0.040	0.040	0.040
COMP	34 (54)	.000	.000	.000	.000	.000	.000	.000	.000
P OPTION	35 (55)	ALL	TAIL	ALL	TAIL	TAIL	ALL	ALL	ALL
Y OPTION	36 (56)	ALL	TAIL	ALL	TAIL	TAIL	ALL	ALL	ALL
TRAN PLS	37 (57)	0.100	0.020	0.020	0.020	0.020	0.020	0.050	0.050
<b>ALT</b>									
RATE DB	38 (58)	0.200	0.070	0.070	0.100	0.200	0.200	0.100	0.100
JET OPT	39 (59)	ALL	TAIL	ALL	ALL	ALL	ALL	ALL	ALL
# JETS	40 (60)	2	1	1	2	2	2	2	2
ON TIME	41 (61)	0.08	0.08	0.08	0.08	0.08	0.08	0.08	0.08
DELAY	42 (62)	0.00	0.00	0.00	0.00	0.00	0.00	0.00	0.00
<b>VERN</b>									
ROT RATE	43 (63)	0.2000	0.2000	0.2000	0.0080	0.0160	0.2000	0.2000	0.0500
ATT DB	44 (64)	1.000	1.000	1.000	0.100	0.033	1.000	1.000	1.000
RATE DB	45 (65)	.020	.020	.020	.010	.020	.020	.020	.020
ROT PLS	46 (66)	0.002	0.002	0.002	0.002	0.002	0.002	0.002	0.020
COMP	47 (67)	.000	.000	.000	.000	.000	.000	.000	.000
CNTL ACC	48 (68)	0	0	0	0	0	0	0	0
PURPOSE		OMS & RCS BURNS (ORB OPS)	LOSS OF VERN (TAIL ONLY)	LOSS OF VERN (ALL)		COAS/SHUD CAL		RNDZ	TERMINAL PHASE

**BOLD/ITALIC** indicates change from I-Load.

HOOK  
VELCRO

ORB OPS-41aa/130/O/A

HOOK  
VELCRO

NOT FLOWN

FS CC 12-9

ORB OPS/130/FIN

(reduced copy)

TOP  
BACK OF 'STS-130 DAP A1 – DAP A8 CONFIGURATIONS'

PILE  
VELCRO

ORB OPS-41b/130/O/B

PILE  
VELCRO

STS-130 DAP A9 – DAP A14 CONFIGURATIONS

	ITEM #	A9	A10	A11	A12	A13	A14
<b>PRI</b>							
ROT RATE	10 (50)	0.1300	0.0500	0.0500	0.0500	0.0500	0.2000
ATT DB	11 (51)	2.00	0.60	10.00	5.00	5.00	5.00
RATE DB	12 (52)	0.10	0.10	0.20	0.20	0.20	0.20
ROT PLS	13 (53)	0.100	0.100	0.100	0.040	0.040	0.100
COMP	14 (54)	.000	.000	.000	.000	.000	.000
P OPTION	15 (55)	TAIL	TAIL	TAIL	TAIL	TAIL	TAIL
Y OPTION	16 (56)	TAIL	TAIL	TAIL	TAIL	TAIL	TAIL
TRAN PLS	17 (57)	0.050	0.050	0.100	0.010	0.010	0.100
<b>ALT</b>							
RATE DB	18 (58)	0.100	0.100	0.020 <sup>1</sup>	0.020 <sup>1</sup>	0.020 <sup>1</sup>	0.200
JET OPT	19 (59)	TAIL	TAIL	TAIL	TAIL	TAIL	TAIL
# JETS	20 (60)	2	2	2	2	2	1(2) <sup>3</sup>
ON TIME	21 (61)	0.08	0.08	0.08	0.08	0.08	0.08
DELAY	22 (62)	0.00	0.00	7.52	7.52	7.52	6.00
<b>VERN</b>							
ROT RATE	23 (63)	0.1300	0.0500	0.1000	0.1000	0.1000	0.2000
ATT DB	24 (64)	1.000	0.500	5.000	3.000	3.000	3.000
RATE DB	25 (65)	.020	.020	.050	.020	.020	.200
ROT PLS	26 (66)	0.050	0.050	0.010	0.002	0.002	0.010
COMP	27 (67)	.000	.000	.000	.000	.000	.000
CNTL ACC	28 (68)	0	0	<b>6(7)</b> <sup>2</sup>	<b>6(7)</b> <sup>2</sup>	2 <sup>2</sup>	1
PURPOSE		PROX/OPS FLYAROUND	DOCKING	AUTO REBOOST	MATED STACK (MNVRS, ROBO, ATT HOLD)		ORBITER ALONE SRMSOBSS

**BOLD/ITALIC** indicates change from I-Load.

<sup>1</sup> I-loaded below keyboard limit; do not change

<sup>2</sup> CA6 – Heavy Russian Segment, prior to Node 3 at SSRMS Radiator Hold position

CA7 – Heavy Russian Segment, beginning with Node 3 at SSRMS Radiator Hold position

<sup>3</sup> Use 1 for OBSS scan and 2 for Orbiter attitude maneuvers

-----  
HINGE

NOT FLOWN

FS CC 12-10

ORB OPS/130/FIN

(reduced copy)

TOP  
 BACK OF 'STS-130 DAP B1 – DAP B8 CONFIGURATIONS'  
 HINGED AT BOTTOM OF 'STS-130 DAP A9 – DAP A14 CONFIGURATIONS'  
 HINGE

**STS-130 DAP B9 – DAP B13 CONFIGURATIONS**

	ITEM #	B9	B10	B12	B13
<b>PRI</b>					
ROT RATE	30 (50)	0.1300	0.0500	0.0100 <sup>1</sup>	0.0100 <sup>1</sup>
ATT DB	31 (51)	2.00	0.60	1.00	1.00
RATE DB	32 (52)	0.10	0.10	0.20	0.20
ROT PLS	33 (53)	0.040	0.040	0.040	0.040
COMP	34 (54)	.000	.000	.000	.000
P OPTION	35 (55)	TAIL	TAIL	TAIL	TAIL
Y OPTION	36 (56)	TAIL	TAIL	TAIL	TAIL
TRAN PLS	37 (57)	0.010	0.010	0.010	0.010
<b>ALT</b>					
RATE DB	38 (58)	0.100	0.100	0.020 <sup>1</sup>	0.020 <sup>1</sup>
JET OPT	39 (59)	TAIL	TAIL	TAIL	TAIL
# JETS	40 (60)	2	2	2	2
ON TIME	41 (61)	0.08	0.08	0.08	0.08
DELAY	42 (62)	10.00	0.00	7.52	7.52
<b>VERN</b>					
ROT RATE	43 (63)	0.1300	0.0500	0.0100	0.0100
ATT DB	44 (64)	1.000	0.500	1.000	<b>0.100</b>
RATE DB	45 (65)	.020	.020	.020	.020
ROT PLS	46 (66)	0.020	0.020	0.002	0.002
COMP	47 (67)	.000	.000	.000	.000
CNTL ACC	48 (68)	0	0	<b>6(7)</b> <sup>2</sup>	<b>6(7)</b> <sup>2</sup>
PURPOSE		PROXOPS/ FLYAROUND	DOCKING	MATED ATT HOLD (VRCS & ALT)	MATED VRCS DB COLLAPSE

**BOLD/ITALIC** indicates change from I-Load.

<sup>1</sup> I-loaded below keyboard limit; do not change

<sup>2</sup> CA6 – Heavy Russian Segment, prior to Node 3 at SSRMS Radiator Hold position

CA7 – Heavy Russian Segment, beginning with Node 3 at SSRMS Radiator Hold position

HOOK  
VELCRO

ORB OPS-41bb/130/O/B

HOOK  
VELCRO

TOP

MAUI – RCS FIRING SEQUENCE

Timer	Jets Fired	CDR	PLT
-03:00		Body rates: $+0.047 \leq \text{roll} \leq +0.087$ $-0.020 \leq \text{pitch} \leq +0.020$ $-0.020 \leq \text{yaw} \leq +0.020$ DAP: FREE DAP: A/PRI  Inform PLT "GO" for jet deselects	Configure initial setup GNC 23 RCS Left RCS page – ITEM 2 EXEC  On CDR "GO", proceed  NOTE Expect DAP RECONF msgs in following actions  Deselect jets: JET DES L5L – ITEM 37 EXEC (*) Right RCS page – ITEM 3 EXEC JET DES R5D – ITEM 39 EXEC (*) Forward RCS page – ITEM 1 EXEC JET DES F5L – ITEM 37 EXEC (*)  NOTE Queue the following ITEM entry on the scratch pad. Do not perform the EXEC until specified at 35 sec  JET DES F3D – ITEM 25
-00:30		FLT CNTLR PWR – ON	
00:00	RXA, LXA	THC +X (in) (3 sec firing)	
00:15	FXL, LXL	THC +Y (right) (3 sec firing)	
00:30	FXR, RXR	THC -Y (left) (3 sec firing)	
00:35			When jets stop firing: GNC 23 RCS EXEC [JET DES F3D – ITEM 25 (*)]
00:45	F4D	RHC +pitch Past Soft Stop, hold 3 sec	
00:48		RHC release	
00:50			DAP: VERN
01:00	R5R	RHC +yaw (10 sec firing)	
01:20	L5D	RHC -pitch (12 sec firing)	
01:40	F5R	RHC +pitch (12 sec firing)	
		FLT CNTLR PWR – OFF	Return to MAUI PROCEDURE, step 6, (ORB OPS FS, P/L OF OPP)

ORB OPS-42a/130/O/B

(reduced copy)

NOT FLOWN

FS CC 12-11

ORB OPS/130/FIN



TOP  
BACK OF 'MAUI - RCS FIRING SEQUENCE'

HOOK  
VELCRO

HOOK  
VELCRO

HOOK  
VELCRO



ORB OPS-42b/130/O/A

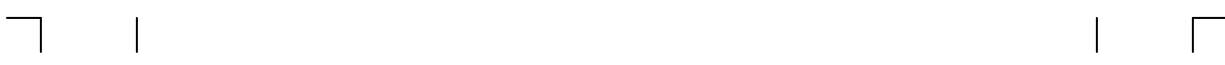

NOT FLOWN

(reduced copy)  
FS CC 12-12

ORB OPS/130/FIN

TOP

**WLES CONFIG AFTER PGSC REBOOT**

1. If window appears asking to launch WLES software:
  - Click '1' to launch WLES software
- Else:
  - Double click 'Shuttle Apps'>'WLES'>'WLES'
2. ✓MCC for 'Backup Mode Selection'
3. If 'EWBMTAU-WLEFlight' appears with message 'Run the current command: XXXX\_AA\_BB\_SNYYYY.xml?':
  - Click 'Yes'

ORB OPS-47a/130/O/A

FABRICATION NOTES

Fabricate on flight approved yellow Post-it

NOT FLOWN

(reduced copy)

FS CC 12-13

ORB OPS/130/FIN



This Page Intentionally Blank



NOT FLOWN

FS 12-14

ORB OPS/130/FIN





Space Shuttle Program  
FLIGHT DATA FILE

JSC-48036-130  
FINAL



# ORBIT OPS CHECKLIST

STS  
**130**

Flight Cover (trim bottom to expose tabs)