

# Orbit Operations Checklist

## STS-131 Flight Supplement

---

**Mission Operations Directorate  
Operations Division**

**Final  
November 4, 2009**

National Aeronautics and  
Space Administration

**Lyndon B. Johnson Space Center**  
Houston, Texas

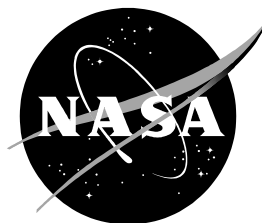



<b>ORBIT OPERATIONS, STS-131 Flt Suppl</b>
--

<b>FINAL (November 4, 2009)</b>
---------------------------------

**PCN-3 (March 15, 2010) Sheet 1 of 1**

List of Implemented Change Requests (482s):

ORB OPS FS-00201    ORB OPS FS-00203  
ORB OPS FS-00202    ORB OPS FS-00204

Incorporate the following:

1. Replace FS iii thru FS viii
2. Replace section 2 (FS 2-1 thru FS 2-4)
3. Replace FS 4-5 & FS 4-6
4. Replace FS 10-1 & FS 10-2
5. Replace FS CC 11-3 & FS CC 11-4

Prepared by:

  
\_\_\_\_\_  
Publication Manager

Approved by:

  
\_\_\_\_\_  
Manager, Flight Procedures

Accepted by:

  
\_\_\_\_\_  
FDF Manager

Encl: 16 pages

<b>File this PCN immediately behind the front cover as a permanent record</b>
---



<b>ORBIT OPERATIONS, STS-131 Flt Suppl</b>
--

<b>FINAL (November 4, 2009)</b>
---------------------------------

**PCN-2 (February 18, 2010) Sheet 1 of 1**

List of Implemented Change Requests (482s):

ORB OPS FS-00191	ORB OPS FS-00193	ORB OPS FS-00195
ORB OPS FS-00192	ORB OPS FS-00194	ORB OPS FS-00196

Incorporate the following:

1. Replace FS iii thru FS viii
2. Replace section 2 (FS 2-1 thru FS 2-6)
3. Replace FS 3-5 thru FS 3-8
4. Replace section 6 (FS 6-1 & FS 6-2)
5. Replace FS 7-1 & FS 7-2, FS 7-11 thru FS 7-14
6. Replace FS 8-3 thru FS 8-8
7. Replace section 10 (FS 10-1 thru FS 10-4)
8. Replace FS CC 11-9 thru FS CC 11-12

Prepared by:

  
\_\_\_\_\_  
Publication Manager

Approved by:

  
\_\_\_\_\_  
Manager, Flight Procedures

Accepted by:

  
\_\_\_\_\_  
FDF Manager

Encl: 38 pages

<b>File this PCN immediately behind the front cover as a permanent record</b>
---



**ORBIT OPERATIONS, STS-131 Flt Suppl****FINAL (November 4, 2009)****PCN-1 (February 4, 2010) Sheet 1 of 1**

List of Implemented Change Requests (482s):

ORB OPS FS-00179    ORB OPS FS-00187A    ORB OPS FS-00189  
ORB OPS FS-00183    ORB OPS FS-00188A    ORB OPS FS-00190

Incorporate the following:

1. Replace FS iii thru FS viii
2. Replace FS 1-1 & FS 1-2
3. Replace FS 3-5 thru FS 3-8
4. Replace FS 4-5 & FS 4-6
5. Replace FS 10-1 & FS 10-2  
After FS 10-8, add FS 10-9 thru FS 10-12
6. Replace FS 11-1 thru FS CC 11-4, FS CC 11-9 & FS CC 11-10

**Prepared by:** \_\_\_\_\_  
Publication Manager

**Approved by:** \_\_\_\_\_  
Manager, Flight Procedures

**Accepted by:** \_\_\_\_\_  
FDF Manager

Encl: 26 pages

***File this PCN immediately behind the front cover as a permanent record***





MISSION OPERATIONS DIRECTORATE

**ORBIT OPERATIONS CHECKLIST  
STS-131 FLIGHT SUPPLEMENT**

FINAL  
November 4, 2009

PREPARED BY:

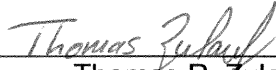

Thomas R. Zulauf  
Publication Manager

APPROVED BY:

ACCEPTED BY:

  
Manager, Flight Procedures  
Michael T. Hurt  
FDF Manager

This document is under the configuration control of the Crew Procedures Control Board (CPCB). All proposed changes must be submitted via Change Request Workflow (CRW) to DO3/FDF Manager.

Additional distribution of this book, for official use only, may be requested in writing to DO3/PMO Administrator. The request must include justification and requester's name, organization, position, and phone number. Contractor requests are made through the NASA or DOD organization supported. Deletions, reduction in quantity, or change of address may be submitted to DO3/FDF Management Office, 281-244-1184.

Incorporates the following:
482#: ORB OPS FS-00162A ORB OPS FS-00170 ORB OPS FS-00171

AREAS OF TECHNICAL RESPONSIBILITY

Publication Manager	DO3/T. Zulauf	281-244-0922
Alternate Publication Manager	DO3/L. Giles	281-244-9068
COMM/INST	DS2/D. Brown	281-244-9058
PTG	DO4/P. Renaud	281-244-6203
DAP TABLES	DS6/M. Chavez	281-483-3285
REBOOST/DAP	DS6/M. Chavez	281-483-3285
OIU	DS2/D. Brown	281-244-9058
SDBI	SK/S. Irwin	281-483-5089
WLES	DO5/R. Besser	281-244-5627
P/L OF OPP	DS6/M. Chavez	281-483-3285
FRED	DX4/R. Tomaro	281-483-3810
CWC-I FILL	DS4/K. Wollard	281-483-3815
<u>CUE CARDS:</u>		
LIOH CHANGEOUT	DS4/K. Wollard	281-483-3815
ORBIT BURN MONITOR	DS6/S. Stewart	281-483-5377
DAP TABLES	DS6/M. Chavez	281-483-3285
MAUI – RCS FIRING SEQUENCE	DS6/M. Chavez	281-483-3285
WLES CONFIG AFTER PGSC REBOOT	DO5/R. Besser	281-244-5627

ORBIT OPERATIONS CHECKLIST  
 STS-131 FLIGHT SUPPLEMENT

**LIST OF EFFECTIVE PAGES**

FINAL 11/04/09  
 PCN-1 02/04/10  
 PCN-2 02/18/10  
 PCN-3 03/15/10

Sign Off .....	* 131/FIN	FS 4-1 .....	131/FIN
FS ii .....	* 131/FIN	FS 4-2 .....	131/FIN
FS iii .....	* 131/FIN 3	FS 4-3 .....	131/FIN
FS iv .....	* 131/FIN 3	FS 4-4 .....	131/FIN
FS v .....	* 131/FIN 3	FS 4-5 .....	131/FIN 3
FS vi .....	* 131/FIN	FS 4-6 .....	131/FIN 1
FS vii .....	131/FIN 3	FS 5-1 .....	131/FIN
FS viii .....	131/FIN 2	FS 5-2 .....	131/FIN
FS 1-1 .....	131/FIN	FS 6-1 .....	131/FIN
FS 1-2 .....	131/FIN 1	FS 6-2 .....	131/FIN 2
FS 1-3 .....	131/FIN	FS 7-1 .....	131/FIN
FS 1-4 .....	131/FIN	FS 7-2 .....	131/FIN 2
FS 1-5 .....	131/FIN	FS 7-3 .....	131/FIN
FS 1-6 .....	131/FIN	FS 7-4 .....	131/FIN
FS 1-7 .....	131/FIN	FS 7-5 .....	131/FIN
FS 1-8 .....	131/FIN	FS 7-6 .....	131/FIN
FS 2-1 .....	131/FIN 3	FS 7-7 .....	131/FIN
FS 2-2 .....	131/FIN 3	FS 7-8 .....	131/FIN
FS 2-3 .....	131/FIN 3	FS 7-9 .....	131/FIN
FS 2-4 .....	131/FIN 3	FS 7-10 .....	131/FIN
FS 2-5 .....	deleted	FS 7-11 .....	131/FIN 2
FS 2-6 .....	deleted	FS 7-12 .....	131/FIN
FS 3-1 .....	131/FIN	FS 7-13 .....	131/FIN 2
FS 3-2 .....	131/FIN	FS 7-14 .....	131/FIN 2
FS 3-3 .....	131/FIN	FS 7-15 .....	131/FIN
FS 3-4 .....	131/FIN	FS 7-16 .....	131/FIN
FS 3-5 .....	131/FIN 2	FS 7-17 .....	131/FIN
FS 3-6 .....	131/FIN	FS 7-18 .....	131/FIN
FS 3-7 .....	131/FIN 2	FS 7-19 .....	131/FIN
FS 3-8 .....	131/FIN	FS 7-20 .....	131/FIN

\* – Omit from flight book

FS 8-1 .....	131/FIN
FS 8-2 .....	131/FIN
FS 8-3 .....	131/FIN
FS 8-4 .....	131/FIN 2
FS 8-5 .....	131/FIN
FS 8-6 .....	131/FIN 2
FS 8-7 .....	131/FIN 2
FS 8-8 .....	131/FIN 2
FS 8-9 .....	131/FIN
FS 8-10 .....	131/FIN
FS 9-1 .....	131/FIN
FS 9-2 .....	131/FIN
FS 10-1 .....	131/FIN 2
FS 10-2 .....	131/FIN 3
FS 10-3 .....	131/FIN 2
FS 10-4 .....	131/FIN 2
FS 11-1 .....	* 131/FIN 1
FS 11-2 .....	* 131/FIN 1
FS CC 11-3 .....	* 131/FIN 3
FS CC 11-4 .....	* 131/FIN 1
FS CC 11-5 .....	* 131/FIN
FS CC 11-6 .....	* 131/FIN
FS CC 11-7 .....	* 131/FIN
FS CC 11-8 .....	* 131/FIN
FS CC 11-9 .....	* 131/FIN 2
FS CC 11-10 .....	* 131/FIN 2
FS CC 11-11 .....	* 131/FIN 2
FS CC 11-12 .....	* 131/FIN 2
FS CC 11-13 .....	* 131/FIN
FS 11-14 .....	* 131/FIN

\* – Omit from flight book

ORBIT OPS CUE CARDS

<u>Title</u>	<u>Ref. Page</u>	<u>Card No.</u>
LIOH CHANGEOUT (Front) ..	FS CC 11-3	ORB OPS-29a/ nonRCRS/131/O/C
LIOH CANISTER STOWAGE LOCATIONS (Back) .....	FS CC 11-4	ORB OPS-29b/ nonRCRS/131/O/B
ORBIT BURN MONITOR (Front).....	FS CC 11-5	ORB OPS-31a/131/O/A
OMS FAILURES (Back).....	FS CC 11-6	ORB OPS-31b/131/O/A
STS-131 DAP CONFIGURATIONS (Front/Top).....	FS CC 11-7	ORB OPS-41a/131/O/A
(Front/Bottom) .....	FS CC 11-8	ORB OPS-41aa/131/O/A
(Back/Top) .....	FS CC 11-9	ORB OPS-41b/131/O/D
(Back/Bottom).....	FS CC 11-10	ORB OPS-41bb/131/O/D
MAUI – RCS FIRING SEQUENCE (Front).....	FS CC 11-11	ORB OPS-42a/131/O/B
(Back).....	FS CC 11-12	ORB OPS-42b/131/O/B
WLES CONFIG AFTER PGSC REBOOT (Front).....	FS CC 11-13	ORB OPS-47a/131/O/A



This Page Intentionally Blank



<u>CONTENTS</u>	<u>PAGE</u>
<u>COMM/INST</u> .....	FS 1-1
LOAD PCMMU FORMAT.....	FS 1-2
PDI DECOM FORMAT.....	FS 1-4
OIU FORMAT/CONFIG.....	FS 1-7
<u>PTG</u> .....	FS 2-1
STAR PAIRS PAD.....	FS 2-2
PAIRS.....	FS 2-3
<u>DAP TABLES</u> .....	FS 3-1
DAP OVERVIEW.....	FS 3-2
UNIV PTG.....	FS 3-3
STS-131 DAP A CONFIGURATIONS.....	FS 3-4
B CONFIGURATIONS.....	FS 3-6
<u>REBOOST/DAP</u> .....	FS 4-1
AUTO REBOOST.....	FS 4-2
ATTITUDE REFERENCE.....	FS 4-4
DOCKED DAP REFERENCE.....	FS 4-5
RATE DAMPING.....	FS 4-6
<u>OIU PROCEDURES</u> .....	FS 5-1
OIU ACTIVATION.....	FS 5-2
DEACTIVATION.....	FS 5-2
<u>SHORT DURATION BIOASTRONAUTICS</u>	
<u>INVESTIGATION (SDBI)</u> .....	FS 6-1
SDBI 1634, SLEEP-WAKE ACTIGRAPHY.....	FS 6-2

Cont next page

<u>WING LEADING EDGE SENSORS (WLES)</u>	
<u>PROCEDURES</u> .....	FS 7-1
WLES ACTIVATION AND CHECKOUT .....	FS 7-2
DEACTIVATION AND TEARDOWN .....	FS 7-10
LAPTOP RECEIVER UNIT (LRU) R&R .....	FS 7-12
CABIN RELAY UNIT R&R .....	FS 7-14
CONFIGURE WLES DATA FILE BACKUP PATH ....	FS 7-16
PREP WLES LAPTOPS FOR TRANSFER .....	FS 7-17
WLES RNDZ TOOLS CHECKOUT PREP .....	FS 7-18
DOCK/UNDOCK RECOVERY .....	FS 7-18
DISABLE WLES FILE BACKUP .....	FS 7-19
ENABLE WLES FILE BACKUP .....	FS 7-19
<u>PAYLOADS OF OPPORTUNITY</u> .....	FS 8-1
MAUI PROCEDURE .....	FS 8-2
RAMBO-2 PROCEDURE .....	FS 8-6
<u>FRED</u> .....	FS 9-1
FRED SETUP .....	FS 9-2
STOWAGE .....	FS 9-2
<u>CWC OPS</u> .....	FS 10-1
WASTE TANK OFFLOAD TO CWC .....	FS 10-2
<u>CUE CARD CONFIGURATION</u> .....	FS 11-1



COMM/INST

LOAD PCMMU FORMAT.....	FS 1-2
PDI DECOM FORMAT.....	FS 1-4
OIU FORMAT/CONFIG.....	FS 1-7

**COMM/  
INST**

COMM/  
INST

## LOAD PCMMU FORMAT

- C3 1. √OI PCMMU FORMAT – GPC  
SM 62 PCMMU/PL COMM
- CRT 2. FORMAT:  
SEL FXD – ITEM 1 EXEC (\*)  
SEL ID – ITEM 3 +X X X EXEC
3. √SM COMM BUF – RDY  
LOAD – ITEM 4 EXEC  
√LOAD, ITEM 4 – RUN,CPLT
- If LOAD – CPLT:  
Repeat steps 2 and 3 for second ID
- \* If LOAD – FAIL and ERR MSG – 'I/O ERR MMU 1(2)':  
\* Go to 5.2a, 'I/O ERR MMU 1(2)' (MAL, DPS) >>  
\* If LOAD – FAIL and a first load attempt:  
\* Repeat steps 2 and 3 for failed ID  
\* If LOAD – FAIL and a subsequent load attempt:  
\* √MCC  
\* OI PCMMU PWR – 2(1)  
\* √ERR MSG – 'I/O ERR PCM'  
C3 \* I/O RESET PCM – ITEM 5 EXEC (\*)  
CRT \* Repeat steps 2 and 3
4. When final LOAD – CPLT:  
SEL PGM – ITEM 2 EXEC (\*)

DNLIST COMPATIBILITY	PHASE	FORMAT ID 64/128	CONFIG NO.
G1,G3,BFS	(ASCENT)	102/FXD	–
G3,BFS	(ENTRY)	102/164	–
G2,G8,S2	ORBIT/ FCS C/O	103/161	–
G2,S2,OPS 0	OPS 0	– /163	–
G2,S2,P9	MMU C/O	– /163	–
G2,G8,S2	RNDZ w/UHF FMT CCSU (SSOR/SSV/TCS) (PRIME)	103/192	763
G2,G8,S2	RNDZ w/UHF FMT CCSU (SSOR/SSV/TCS) (B/U)	103/211	770
G2,G8,S2	DOCKED ISS FMT CCSH (OIU/SSV) (PRIME)	103/184	760
G2,G8,S2	DOCKED ISS FMT CCSH (OIU/SSV) (B/U)	103/205	767
G2,G8,S2	OIU C/O AND SSV RATE 4 (PRIME)	103/188	762
G2,G8,S2	OIU C/O AND SSV RATE 5 (B/U)	103/203	765
G2,G8,S2	MPLM FMT (OIU/SSV) (PRIME)	103/199	780
G2,G8,S2	MPLM FMT (OIU/SSV) (B/U)	103/212	781

**NOTE**

LDR TFL may affect PCMMU BITE. If PCMMU or SM 2 GPC switched since last TFL, ID 64 and 128 will not reflect current state

## LOAD PDI DECOM FORMAT

### SM 62 PCMMU/PL COMM

```
1. PDI:
CRT  √I/O RESET – ITEM 8 (*)
      SEL DECOM – ITEM 9 +X EXEC
      SEL FMT – ITEM 10 +X X X EXEC
      LOAD – ITEM 11 EXEC

If LOAD – CPLT:
      SEL INPUT – ITEM 12 +X EXEC
      LOAD – ITEM 13 EXEC
      Repeat step 1 for additional DECOMs/FPM

* If LOAD – FAIL and ERR MSG – 'I/O ERR *
* MMU 1(2)': *
* Go to 5.2a, 'I/O ERR MMU 1(2)' (MAL, *
* DPS) >> *
* *
* If LOAD – FAIL and a first load attempt: *
* Repeat step 1 *
* *
* If LOAD – FAIL and a subsequent load *
* attempt: *
* *
* NOTE *
* Power cycling PDI will cause PDI *
* to lose DFLs previously loaded *
* *
* √MCC *
A1L * S-BD PL CNTL – PNL *
* PL DATA INTLVR PWR – OFF,ON *
* √ERR MSG – 'S62 BCE BYP PL' *
* √'S62 BCE BYP PDI' *
* S-BD PL CNTL – CMD *
* *
* PCM: *
CRT * I/O RESET PCM – ITEM 5 EXEC (*) *
* PDI: *
* I/O RESET – ITEM 8 EXEC (*) *
* Repeat step 1 for all of config (XXX) *
```

CONFIG	DECOM	FMT	INPUT	USE
763 RNDZ w/UHF FMT CCSU  (PRIME) TFL 192	1 2 3 4 5-FPM	30 - 9 4 505	1,2 - 5 4	OIU7 (CCSU) ** - TCS SSV (3) *** H-H-H *
770 RNDZ w/UHF FMT CCSU  (BACKUP) TFL 211	1 2 3 4 5-FPM	14 31 - 19 503	4 1,2 - 5	SSV (3) *** OIU7 (CCSU) ** - TCS H-H-H *
760 DOCKED FMT CCSH  (PRIME) TFL 184	1 2 3 4 5-FPM	7 - - 27 501	1,2 - - 4	OIU9 (CCSH) ** - - SSV (2) *** H-H-H *
767 DOCKED FMT CCSH  (BACKUP) TFL 205	1 2 3 4 5-FPM	- 17 29 - 508	- 1,2 4 -	- OIU9 (CCSH) ** SSV (2) *** - H-H-H *
762 SSV RATE 4  (PRIME) TFL 188	1 2 3 4 5-FPM	5 - - 1 507	1,2 - - 4	OIU255 ** - - SSV (4) *** H-H-H *
765 SSV RATE 5  (BACKUP) TFL 203	1 2 3 4 5-FPM	- 15 11 - 509	- 1,2 4 -	- OIU255 ** SSV (5) *** - L-H-H *

\* OI-GNC-SM, Orbiter Downlist Data Rates (High or Low)  
\*\* # in OIU# represents the OIU format; (XXX) represents data type  
\*\*\* # in SSV (#) represents the SSV Out Rate sw selection

Cont next page

FS 1-5

ORB OPS/131/FIN

780 MPLM FMT  (PRIME) TFL 199	1 2 3 4 5-FPM	2 - - 4 504	1,2 - - 4	OIU5 (1M) ** - - SSV (3) *** H-H-H *
781 MPLM FMT  (BACKUP) TFL 212	1 2 3 4 5-FPM	14 3 - - 502	4 1,2 - -	SSV (3) *** OIU5 (1M) ** - - H-H-H *

\* OI-GNC-SM, Orbiter Downlist Data Rates (High or Low)  
 \*\* # in OIU# represents the OIU format; (XXX) represents data type  
 \*\*\* # in SSV (#) represents the SSV Out Rate sw selection

## LOAD OIU FORMAT/CONFIG

Determine which step is needed and complete all actions to obtain desired OIU configuration

### NOTE

A corresponding TFL/DFL CONFIG is reqd for MCC to receive telemetry. Reference S62 PCMMU/PL COMM for the last loaded HDR TFL and perform LOAD PCMMU FORMAT/LOAD PDI DECOM FORMAT for the associated CONFIG

#### S212 OIU

1. GNC-1 PRIMARY ON LB-ORB N2-1 (OIU BUS 3)  
LOAD FORMAT      ITEM 1 +9 EXEC  
GNC TO GNC 1      ITEM 18 +1 4 EXEC  
GNC 1 TO BUS 3    ITEM 18 +1 6 EXEC  
BUS 4 BC            ITEM 15 EXEC (\*)  
BUS 3 RT            ITEM 10 EXEC (\*)  
LOAD FORMAT      ITEM 1 +9 EXEC >>
2. GNC-1 PRIMARY ON LB-ORB N2-2 (OIU BUS 4)  
LOAD FORMAT      ITEM 1 +9 EXEC  
GNC TO GNC 1      ITEM 18 +1 4 EXEC  
GNC 1 TO BUS 4    ITEM 18 +1 5 EXEC  
BUS 3 BC            ITEM 11 EXEC (\*)  
BUS 4 RT            ITEM 14 EXEC (\*)  
LOAD FORMAT      ITEM 1 +9 EXEC >>
3. GNC-2 PRIMARY ON LB-ORB N2-1 (OIU BUS 3)  
LOAD FORMAT      ITEM 1 +9 EXEC  
GNC TO GNC 2      ITEM 18 +1 3 EXEC  
GNC 2 TO BUS 3    ITEM 18 +1 8 EXEC  
BUS 4 BC            ITEM 15 EXEC (\*)  
BUS 3 RT            ITEM 10 EXEC (\*)  
LOAD FORMAT      ITEM 1 +9 EXEC >>
4. GNC-2 PRIMARY ON LB-ORB N2-2 (OIU BUS 4)  
LOAD FORMAT      ITEM 1 +9 EXEC  
GNC TO GNC 2      ITEM 18 +1 3 EXEC  
GNC 2 TO BUS 4    ITEM 18 +1 7 EXEC  
BUS 3 BC            ITEM 11 EXEC (\*)  
BUS 4 RT            ITEM 14 EXEC (\*)  
LOAD FORMAT      ITEM 1 +9 EXEC >>

Cont next page

5. MPLM (if flown)  
LOAD FORMAT ITEM 1 +5 EXEC  
BUS 2 BC ITEM 7 EXEC (\*)  
LOAD FORMAT ITEM 1 +5 EXEC >>
6. SSOR  
LOAD FORMAT ITEM 1 +7 EXEC  
BUS 1 BC ITEM 3 EXEC (\*)  
LOAD FORMAT ITEM 1 +7 EXEC >>



PTG

STAR PAIRS PAD .....	FS 2-2
PAIRS.....	FS 2-3

**PTG**

FS 2-1

ORB OPS/131/FIN 3

PTG

STAR PAIRS PAD											
STAR PAIR	SEP ANGLE	ATTITUDE SET 1					ATTITUDE SET 2				
		DUAL S TRK		SINGLE S TRK			DUAL S TRK		SINGLE S TRK		
				-Z	-Y				-Z	-Y	
A	86.0	-Y:15 R+ 48 -Z:25 P+ 67 Y+ 52	R+ 338 P+ 46 Y+ 46	-Y:25 R+ 140 P+ 59 Y+ 67	-Y:25 R+ 202 -Z:15 P+ 219 Y+ 312	-Z:25 R+ 133 P+ 242 Y+ 311	-Y:15 R+ 281 P+ 211 Y+ 298				
B	90.5	-Y:22 R+ 353 -Z:65 P+ 144 Y+ 322	R+ 258 P+ 131 Y+ 333	-Y:65 R+ 87 P+ 155 Y+ 334	-Y:65 R+ 284 -Z:22 P+ 312 Y+ 23	-Z:65 R+ 193 P+ 319 Y+ 37	-Y:22 R+ 7 P+ 327 Y+ 17				
C	86.3	-Y:60 R+ 56 -Z:80 P+ 249 Y+ 328	R+ 320 P+ 232 Y+ 324	-Y:80 R+ 140 P+ 244 Y+ 342	-Y:80 R+ 227 -Z:60 P+ 48 Y+ 33	-Z:80 R+ 131 P+ 66 Y+ 36	-Y:60 R+ 312 P+ 51 Y+ 19				
D	82.9	-Y:16 R+ 101 -Z:23 P+ 341 Y+ 359	R+ 16 P+ 336 Y+ 345	-Y:23 R+ 185 P+ 328 Y+ 5	-Y:23 R+ 172 -Z:16 P+ 151 Y+ 16	-Z:23 R+ 86 P+ 162 Y+ 6	-Y:16 R+ 258 P+ 140 Y+ 6				

STAR PAIRS PAD

FS 2-2

ORB OPS/131/FIN 3

PAIR		COAS ALIGN ATTITUDE 1	ANG SEP	COAS ALIGN ATTITUDE 2
COAS	+X HUD	20 R+ 99 P+ 204 Y+ 334	59.7	25 R+ 99 P+ 195 Y+ 33
	-Z COAS	20 R+ 285 P+ 185 Y+ 58		25 R+ 74 P+ 32 Y+ 61

SINGLE S TRK MIN MNVR OPT TGT ID = 11-110 NAV STAR #		
	-Z S TRK	-Y S TRK
BV	5	4
P	87.7	✓ 0
Y	358	✓ 280.57

MET Applicable Post OMS-2 to 015/12:00:00  
 Liftoff Date: 04/05/10  
 Liftoff GMT: 095/10:21:16.000

# STAR PAIRS

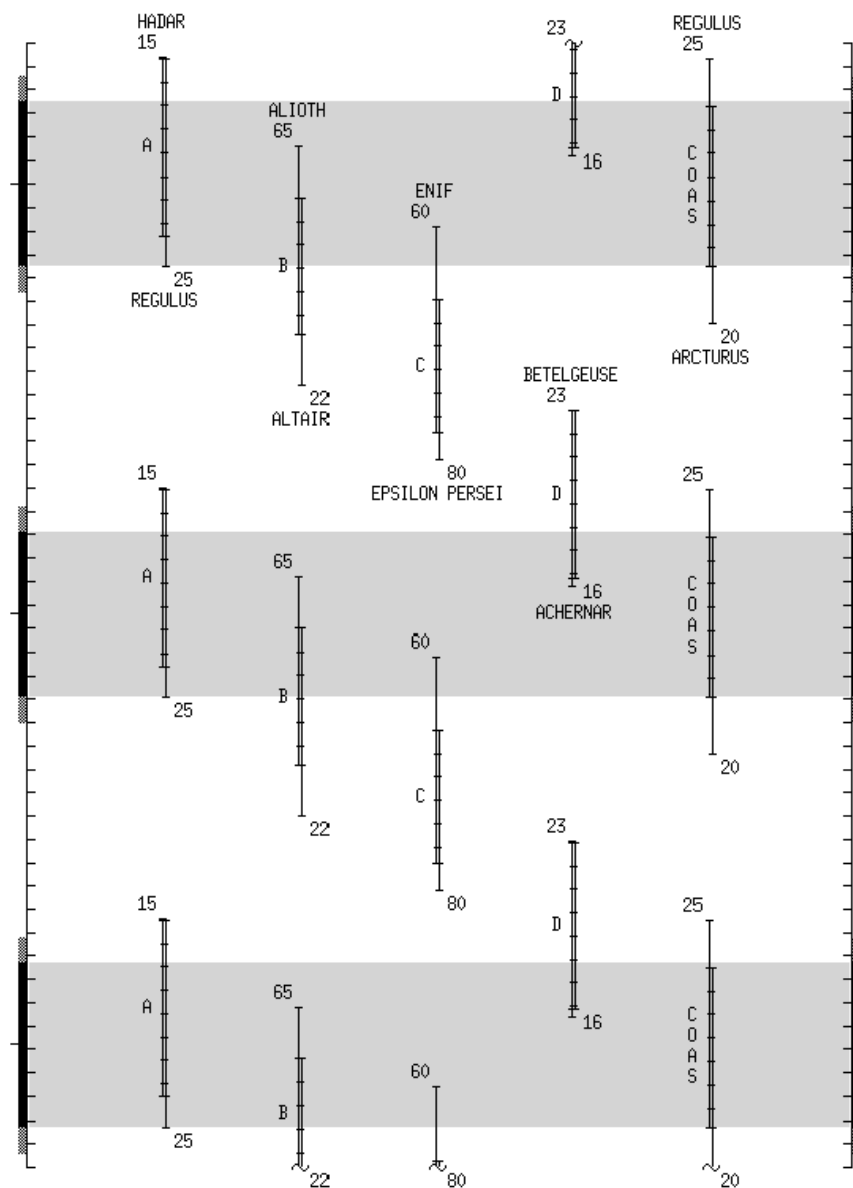

MET Applicable: Post OMS-2 to 015/12:00:00  
 Liftoff Date: 04/05/10  
 Liftoff GMT: 095/10:21:16.000



This Page Intentionally Blank



## DAP TABLES

DAP OVERVIEW .....	FS 3-2
UNIV PTG .....	FS 3-3
STS-131 DAP A CONFIGURATIONS.....	FS 3-4
B CONFIGURATIONS.....	FS 3-6

**DAP  
TABLES**

## DAP TABLES

### DAP OVERVIEW

DAP	Purpose	DAP	Purpose
A1	Nominal	B1	OMS & RCS Burns (ORB OPS)
A2	PTC	B2	Loss of VERN (Tail Only)
A3	GG	B3	Loss of VERN (All)
A4		B4	
A5	Loss of VERN (All)	B5	COAS/HUD CAL
A6	Loss of VERN (Tail Only)	B6	
A7	Rendezvous	B7	Rendezvous
A8	Terminal Phase	B8	Terminal Phase
A9	PROX OPS/Flyaround	B9	Flyaround
A10	Docking	B10	Docking
A11	Auto Reboost	B11	
A12	Mated VRCS (Maneuvers, Robo)	B12	Mated VRCS & ALT (Attitude Hold)
A13		B13	Mated VRCS DB COLLAPSE
A14	Orbiter alone SRMS/OBSS Ops	B14	
A15		B15	

CNTL ACC	Purpose
0	Orbiter alone with unloaded RMS
1	Orbiter alone SRMS/OBSS Ops
2	Mated - VRCS and ALT with Light Weight Russian Segment (SM AFT=EMPTY)
3	Not used
4	Mated - VRCS and ALT with Medium Weight Russian Segment (SM AFT=OCCUPIED AND MRM2=EMPTY)
5	Not used
6	Mated - VRCS and ALT with Heavy Weight Russian Segment (SM AFT=OCCUPIED AND MRM2=OCCUPIED)
7	Not used
8	Not used
9	Not used

DAPs for mated operations are based on analysis from GNC, PDRS, C. S. Draper Labs, and ISS Structures

FS 3-2

ORB OPS/131/FIN

## UNIV PTG

TGT ID = 1 Orbiting Vehicle = 2 Earth Center = 3 Earth Target Input LAT ( $\pm 90$ ) LON ( $\pm 180$ , + = East) ALT (-3444.0 to 20000.0 nm) = 4 Sun Center = 5 Celestial Target Input RA (0-359.99) DEC ( $\pm 90$ ) = 11-110 Nav Stars
BODY VECTOR = 1 +X* = 2 -X* = 3 -Z* = 4 -Y Star Tracker* = 5 Selectable Input P (0-359.99) Y (270-359.99, 0-90) *Input OM $\rightarrow$ OM (0-359.99)
MON AXIS = 1 +X = 2 -X

FS 3-3

ORB OPS/131/FIN

## STS-131 DAP A CONFIGURATIONS

### STS-131 DAP A1 – DAP A8 CONFIGURATIONS

	ITEM #	A1	A2	A3	A4	A5	A6	A7	A8
<b>PRI</b>									
ROT RATE	10 (50)	0.2000	0.4000	0.2000	0.5000	0.2000	0.2000	0.2000	0.0500
ATT DB	11 (51)	5.00	1.00	0.30	3.00	5.00	5.00	2.00	2.00
RATE DB	12 (52)	0.20	0.20	0.20	0.20	0.20	0.20	0.20	0.20
ROT PLS	13 (53)	0.100	0.100	0.100	0.100	0.100	0.100	0.100	0.100
COMP	14 (54)	.000	.000	.000	.000	.000	.000	.000	.000
P OPTION	15 (55)	ALL	ALL	ALL	ALL	ALL	TAIL	ALL	ALL
Y OPTION	16 (56)	ALL	ALL	TAIL	ALL	ALL	TAIL	ALL	ALL
TRAN PLS	17 (57)	0.100	0.100	0.100	0.100	0.100	0.100	0.100	0.100
<b>ALT</b>									
RATE DB	18 (58)	0.200	0.200	0.070	0.200	0.070	0.070	0.100	0.100
JET OPT	19 (59)	ALL	ALL	ALL	ALL	ALL	TAIL	ALL	ALL
# JETS	20 (60)	2	2	1	2	1	1	2	2
ON TIME	21 (61)	0.08	0.08	0.08	0.08	0.08	0.08	0.08	0.08
DELAY	22 (62)	0.00	0.00	0.00	0.00	0.00	0.00	0.00	0.00
<b>VERN</b>									
ROT RATE	23 (63)	0.2000	0.4000	0.0080	0.2000	0.0500	0.0500	0.0160	0.0500
ATT DB	24 (64)	1.000	1.000	0.070	1.000	1.000	1.000	1.000	1.000
RATE DB	25 (65)	.020	.020	.010	.020	.020	.020	.020	.020
ROT PLS	26 (66)	0.010	0.010	0.010	0.010	0.010	0.010	0.010	0.050
COMP	27 (67)	.000	.000	.000	.000	.000	.000	.000	.000
CNTL ACC	28 (68)	0	0	0	0	0	0	0	0
PURPOSE		NOMINAL	PTC	GG		LOSS OF VERN (ALL)	LOSS OF VERN (TAIL ONLY)	RNDZ	TERMINAL PHASE

**BOLD/ITALIC** indicates change from I-Load.

FS 3-4

ORB OPS/131/FIN



**STS-131 DAP A9 – DAP A14 CONFIGURATIONS**

	ITEM #	A9	A10	A11	A12	A13	A14
<b>PRI</b>							
ROT RATE	10 (50)	0.1300	0.0500	0.0500	0.0500	0.0500	0.2000
ATT DB	11 (51)	2.00	0.60	10.00	5.00	5.00	5.00
RATE DB	12 (52)	0.10	0.10	0.20	0.20	0.20	0.20
ROT PLS	13 (53)	0.100	0.100	0.100	0.040	0.040	0.100
COMP	14 (54)	.000	.000	.000	.000	.000	.000
P OPTION	15 (55)	TAIL	TAIL	TAIL	TAIL	TAIL	TAIL
Y OPTION	16 (56)	TAIL	TAIL	TAIL	TAIL	TAIL	TAIL
TRAN PLS	17 (57)	0.050	0.050	0.100	0.010	0.010	0.100
<b>ALT</b>							
RATE DB	18 (58)	0.100	0.100	0.020 <sup>1</sup>	0.020 <sup>1</sup>	0.020 <sup>1</sup>	0.200
JET OPT	19 (59)	TAIL	TAIL	TAIL	TAIL	TAIL	TAIL
# JETS	20 (60)	2	2	<b>1</b>	<b>1</b>	<b>1</b>	1(2) <sup>3</sup>
ON TIME	21 (61)	0.08	0.08	0.08	0.08	0.08	0.08
DELAY	22 (62)	0.00	0.00	<b>5.00</b>	<b>5.00</b>	<b>5.00</b>	6.00
<b>VERN</b>							
ROT RATE	23 (63)	0.1300	0.0500	0.1000	0.1000	0.1000	0.2000
ATT DB	24 (64)	1.000	0.500	5.000	3.000	3.000	3.000
RATE DB	25 (65)	.020	.020	.050	.020	.020	.200
ROT PLS	26 (66)	0.050	0.050	0.010	0.002	0.002	0.010
COMP	27 (67)	.000	.000	.000	.000	.000	.000
CNTL ACC	28 (68)	0	0	<b>6(2,4) <sup>2</sup></b>	<b>6(2,4) <sup>2</sup></b>	<b>6(2,4) <sup>2</sup></b>	1
PURPOSE		PROX/OPS FLYAROUND	DOCKING	AUTO REBOOST	MATED STACK (MVNRS,ROBO, ATT HOLD)		ORBITER ALONE SRMS/OBSS

**BOLD/ITALIC** indicates change from I-Load.

<sup>1</sup> I-loaded below keyboard limit; do not change

<sup>2</sup> CA2: Light Weight Russian Segment (SM AFT = EMPTY)

CA4: Medium Weight Russian Segment (SM AFT = OCCUPIED AND MRM2 = EMPTY)

CA6: Heavy Weight Russian Segment (SM AFT = OCCUPIED AND MRM2 = OCCUPIED)

<sup>3</sup> Use 1 for OBSS scan and 2 for Orbiter attitude maneuvers

FS-3-5

ORB OPS/131/FIN 2

**STS-131 DAP B CONFIGURATIONS**

**STS-131 DAP B1 – DAP B8 CONFIGURATIONS**

	ITEM #	B1	B2	B3	B4	B5	B6	B7	B8
<b>PRI</b>									
ROT RATE	30 (50)	0.5000	0.2000	0.2000	0.2000	0.2000	0.5000	0.5000	0.0500
ATT DB	31 (51)	3.00	3.00	3.00	0.30	3.00	3.00	2.00	2.00
RATE DB	32 (52)	0.20	0.20	0.20	0.20	0.20	0.20	0.20	0.20
ROT PLS	33 (53)	0.040	0.040	0.040	0.040	0.040	0.040	0.040	0.040
COMP	34 (54)	.000	.000	.000	.000	.000	.000	.000	.000
P OPTION	35 (55)	ALL	TAIL	ALL	TAIL	TAIL	ALL	ALL	ALL
Y OPTION	36 (56)	ALL	TAIL	ALL	TAIL	TAIL	ALL	ALL	ALL
TRAN PLS	37 (57)	0.100	0.020	0.020	0.020	0.020	0.020	0.050	0.050
<b>ALT</b>									
RATE DB	38 (58)	0.200	0.070	0.070	0.100	0.200	0.200	0.100	0.100
JET OPT	39 (59)	ALL	TAIL	ALL	ALL	ALL	ALL	ALL	ALL
# JETS	40 (60)	2	1	1	2	2	2	2	2
ON TIME	41 (61)	0.08	0.08	0.08	0.08	0.08	0.08	0.08	0.08
DELAY	42 (62)	0.00	0.00	0.00	0.00	0.00	0.00	0.00	0.00
<b>VERN</b>									
ROT RATE	43 (63)	0.2000	0.2000	0.2000	0.0080	0.0160	0.2000	0.2000	0.0500
ATT DB	44 (64)	1.000	1.000	1.000	0.100	0.033	1.000	1.000	1.000
RATE DB	45 (65)	.020	.020	.020	.010	.020	.020	.020	.020
ROT PLS	46 (66)	0.002	0.002	0.002	0.002	0.002	0.002	0.002	0.020
COMP	47 (67)	.000	.000	.000	.000	.000	.000	.000	.000
CNTL ACC	48 (68)	0	0	0	0	0	0	0	0
PURPOSE		OMS & RCS BURNS (ORB OPS)	LOSS OF VERN (TAIL ONLY)	LOSS OF VERN (ALL)		COAS/HUD CAL		RNDZ	TERMINAL PHASE

**BOLD/ITALIC** indicates change from I-Load.

FS 3-6

ORB OPS/131/FIN

**STS-131 DAP B9 – DAP B13 CONFIGURATIONS**

	ITEM #	B9	B10	B12	B13
<b>PRI</b>					
ROT RATE	30 (50)	0.1300	0.0500	0.0100 <sup>1</sup>	0.0100 <sup>1</sup>
ATT DB	31 (51)	2.00	0.60	1.00	1.00
RATE DB	32 (52)	0.10	0.10	0.20	0.20
ROT PLS	33 (53)	0.040	0.040	0.040	0.040
COMP	34 (54)	.000	.000	.000	.000
P OPTION	35 (55)	TAIL	TAIL	TAIL	TAIL
Y OPTION	36 (56)	TAIL	TAIL	TAIL	TAIL
TRAN PLS	37 (57)	0.010	0.010	0.010	0.010
<b>ALT</b>					
RATE DB	38 (58)	0.100	0.100	0.020 <sup>1</sup>	0.020 <sup>1</sup>
JET OPT	39 (59)	TAIL	TAIL	TAIL	TAIL
# JETS	40 (60)	2	2	<b>1</b>	<b>1</b>
ON TIME	41 (61)	0.08	0.08	0.08	0.08
DELAY	42 (62)	10.00	0.00	<b>5.00</b>	<b>5.00</b>
<b>VERN</b>					
ROT RATE	43 (63)	0.1300	0.0500	0.0100	0.0100
ATT DB	44 (64)	1.000	0.500	1.000	<b>0.100</b>
RATE DB	45 (65)	.020	.020	.020	.020
ROT PLS	46 (66)	0.020	0.020	0.002	0.002
COMP	47 (67)	.000	.000	.000	.000
CNTL ACC	48 (68)	0	0	<b>6(2,4)</b> <sup>2</sup>	<b>6(2,4)</b> <sup>2</sup>
PURPOSE		PROXOPS/ FLYAROUND	DOCKING	MATED ATT HOLD (VRCS & ALT)	MATED VRCS DB COLLAPSE

**BOLD/ITALIC** indicates change from I-Load.

<sup>1</sup> I-loaded below keyboard limit; do not change

<sup>2</sup> CA2: Light Weight Russian Segment (SM AFT = EMPTY)

CA4: Medium Weight Russian Segment (SM AFT = OCCUPIED AND MRM2 = EMPTY)

CA6: Heavy Weight Russian Segment (SM AFT = OCCUPIED AND MRM2 = OCCUPIED)

FS 3-7

ORB OPS/131/FIN 2



This Page Intentionally Blank



REBOOST/DAP

AUTO REBOOST.....	FS 4-2
ATTITUDE REFERENCE.....	FS 4-4
DOCKED DAP REFERENCE .....	FS 4-5
RATE DAMPING.....	FS 4-6

**REBOOST/  
DAP**

## AUTO REBOOST

### NOTE

Allow 5 min between establishing reboost attitude and reboost start time for DAP accelerations to converge

1. If PRCS required:

O14:F, RJDA 1A L2/R2 DRIVER – OFF  
O15:F, RJD MANF L5/F5/R5 DRIVER – OFF  
O16:F, Pri RJD LOGIC (eight) – ON

√MCC for GO to power up Pri Drivers  
RJD MANF L5/F5/R5 DRIVER – ON  
Pri RJD DRIVER (eight) – ON

2. Select Reboost Configuration

**GNC 20 DAP CONFIG**  
REBOOST CFG – ITEM 8 +\_ EXEC  
INTVL – ITEM 9 +\_ . . . . EXEC

3. Set up Future Reboost

**GNC UNIV PTG**  
DURATION – ITEM 27 +\_ +\_ +\_ . . . . EXEC  
START TIME – ITEM 1 +\_ . . . +\_ . . . +\_ . . . . EXEC  
RBST – ITEM 25 EXEC (FUT-\*)

4. Select appropriate Reboost Rotation DAP  
When in attitude and prior to START TIME,  
DAP: A11/AUTO/VERN(ALT)

C3

If using Config 4(1):

**GNC 20 DAP CONFIG**  
Disable X JETS ROT – ITEM 7 EXEC (no \*)

Cont next page

FS 4-2

ORB OPS/131/FIN

REBOOST/  
DAP

NOTE

Reboost can be aborted with an item 26 on UNIV PTG or by selecting FREE on the DAP

5. Post Reboost Configuration

If using Config 4(1):

**GNC 20 DAP CONFIG**

Enable X JETS ROT – ITEM 7 EXEC (\*)

Return to FLIGHT PLAN Attitude

DAP: as reqd

Pri RJD LOGIC,DRIVER (sixteen) – as reqd

C3  
O14,  
O15,  
O16

## **AUTO REBOOST ATTITUDE REFERENCE**

### **ALT & VRCS ATTITUDE HOLD CONFIGURATIONS:**

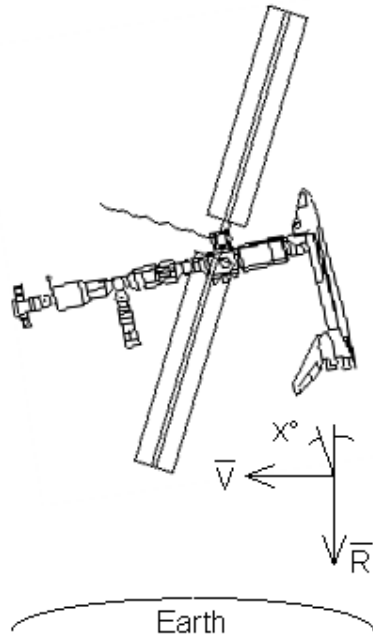

### **REBOOST**

Configurations 1 & 4 are ALT PRCS only (Pitch,  $X=4^\circ$ )

Configuration 2 is for SHUTTLE ONLY - Do Not Use While Docked

Configuration 3 is VRCS only (Pitch,  $X=4^\circ$ )



## DOCKED DAP REFERENCE

### NOTE

Shuttle mated attitude control is not certified when the Shuttle Airlock is depressurized (<3.45 psia)

Mated Attitude Hold, Maneuvers and MPLM (VERN or ALT)	Mated Attitude Hold (VERN or ALT)
A12	B12

ALT not certified for loaded RMS operations

CNTL ACC selection depends on weight of Russian Segment due to visiting vehicle configurations as described below:

Case	Docking Port				Russian Segment Weight Classification
	FGB	DC1	SM AFT	MRM2	
1	Occupied or Empty	Occupied or Empty	Occupied	Occupied	Heavy Use CA 6
2	Occupied or Empty	Occupied or Empty	Occupied	Empty	Medium Use CA 4
3	Occupied or Empty	Occupied or Empty	Empty	Occupied or Empty	Light Use CA 2

## RATE DAMPING

DAP: LVLH(INRTL) - Dependent on desired attitude hold  
Monitor Jet Activity Light:

If jet activity stopped for > 5 sec for VERN (15 sec for ALT)

DAP: FREE > 2 sec

DAP: AUTO >>

For continuous jet activity > 6 min:

DAP: FREE then restart RATE DAMPING



This Page Intentionally Blank



OIU PROCEDURES

OIU ACTIVATION .....	FS 5-2
DEACTIVATION .....	FS 5-2

OIU

## OIU ACTIVATION

### NOTE

√MCC that steps 1 and 2 may not be reqd

1. Load PCMMU/PDI (config 760) for OIU
2. Power on PSP 1(2)

A1L	√S-BD PL CNTL	- CMD
	PWR SYS	- 1(2)
	√SEL	- PSP
	√PSP CMD OUTPUT	- PL UMB
	CNTL	- PNL,CMD

### SM 62 PCMMU/PL COMM

I/O RESET PSP 1(2) – ITEM 6(7) EXEC (\*)

3. Power on OIU 1(2)

SSP1	OIU PWR – OIU 1(2) ON
	√tb – UP(DN)

## OIU DEACTIVATION

### NOTE

√MCC for OIU ops complete

1. Possible 'S62 PDI DECOM FAIL' msg

SSP1	OIU PWR – OFF
	√tb – bp

2. MCC will config PCMMU and PDI as reqd

OIU

SHORT DURATION BIOASTRONAUTICS  
INVESTIGATION (SDBI)

SDBI 1634, SLEEP-WAKE ACTIGRAPHY .....	FS 6-2
DON ACTIWATCH .....	FS 6-2
DOFF ACTIWATCH .....	FS 6-2

**SDBI**

FS 6-1

ORB OPS/131/FIN

**SDBI 1634, SLEEP-WAKE ACTIGRAPHY**

- MF71C    A. DON ACTIWATCH (ASAP after entry into orbit)  
1. Unstow: Actiwatch  
            SLEEP LOGBOOK

NOTE

Actiwatch should be worn on top of non-dominant wrist outside of clothing. Face of Actiwatch should remain uncovered at all times.

If necessary to remove Actiwatch, record doff/don time in SLEEP LOGBOOK

2. Don Actiwatch on non-dominant arm and wear continuously throughout mission
3. Deploy SLEEP LOGBOOK and record required information daily (within 15 min after waking)

B. DOFF ACTIWATCH

NOTE

If mission length extended, continue to wear Actiwatch and complete SLEEP LOGBOOK as timeline permits

- MF71C    On final day of orbit:  
1. Remove Actiwatch, stow in locker  
2. Recover SLEEP LOGBOOK, stow in locker

**SDBI**

WING LEADING EDGE SENSORS (WLES) PROCEDURES

WLES ACTIVATION AND CHECKOUT.....	FS 7-2
DEACTIVATION AND TEARDOWN.....	FS 7-10
LAPTOP RECEIVER UNIT (LRU) R&R.....	FS 7-12
CABIN RELAY UNIT R&R .....	FS 7-14
CONFIGURE WLES DATA FILE BACKUP PATH.....	FS 7-16
PREP WLES LAPTOPS FOR TRANSFER.....	FS 7-17
WLES RNDZ TOOLS CHECKOUT PREP.....	FS 7-18
DOCK/UNDOCK RECOVERY .....	FS 7-18
DISABLE WLES FILE BACKUP .....	FS 7-19
ENABLE WLES FILE BACKUP .....	FS 7-19

**WLE  
SENSORS**

## WLES ACTIVATION AND CHECKOUT

### 1. UNSTOW EQUIPMENT

#### NOTE

A31p laptops may already be unstowed as part of orbiter laptop network setup

MA16L	Unstow: Laptop Receiver Units (2) Cabin Relay Units (2): CRU A (S/N 1664) CRU B (S/N 1728)
ML60E	STS6 A31p laptop (WLES) STS5 A31p laptop (RPOP2)

### 2. SETUP WLES RELAY UNITS

#### CAUTION

Cross-connecting CRU A to MICRO WIS SYSTEM B (and vice versa) will prevent WLES ops, though step 8 would still show good comm

#### NOTE

Green patch on Cabin Relay Unit is antenna and must face into cabin

A6	Unstow coiled WLE SYSTEM A cable
A13	Connect plug PNL A13 SYSTEM A to jack MICRO WIS SYSTEM A J7 (see fig 7-1)
CRU A	Connect plug CABIN RELAY UNIT to J1 on CRU S/N 1664
STBD OVHD	Secure CRU A to STBD side of aft cabin with Velcro (see fig 7-2)
A9	Unstow coiled WLE SYSTEM B cable
A13	Connect plug PNL A13 SYSTEM B to jack MICRO WIS SYSTEM B J8 (see fig 7-1)
CRU B	Connect plug CABIN RELAY UNIT to J1 on CRU S/N 1728
PORT OVHD	Secure CRU B to PORT side of aft cabin with Velcro (see fig 7-3)

WLE  
SENSORS

Cont next page

FS 7-2

ORB OPS/131/FIN 2



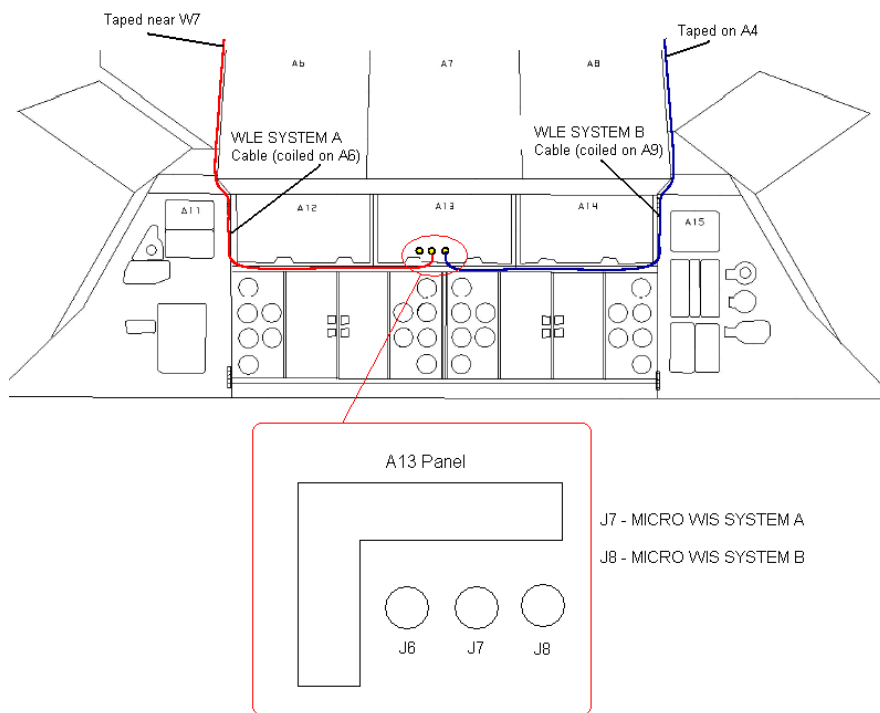

Figure 7-1.- A13 panel.

Cont next page

FS 7-3

ORB OPS/131/FIN

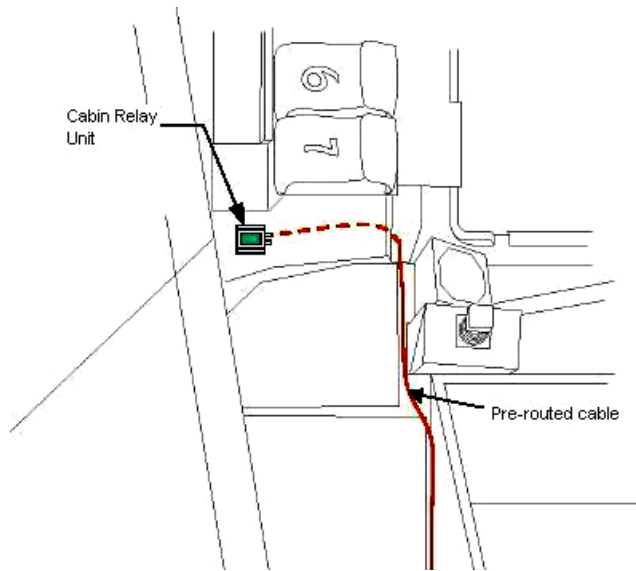

Figure 7-2.- Aft STBD location.

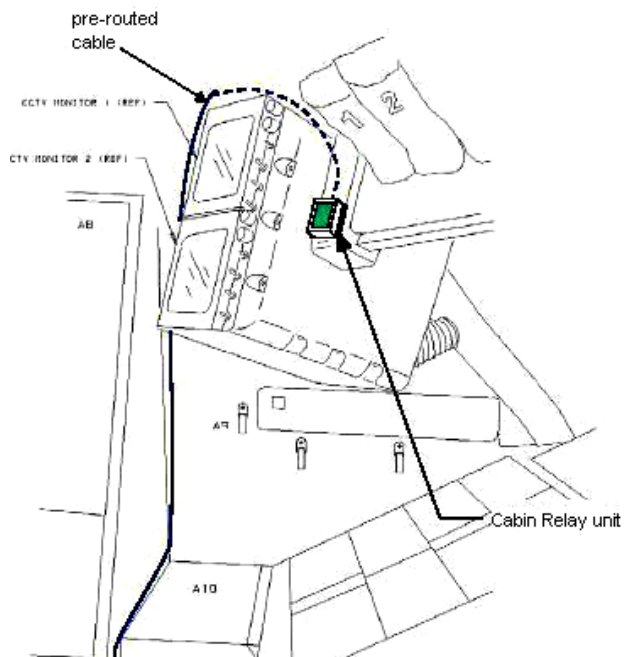

Figure 7-3.- Aft PORT location.

Cont next page

FS 7-4

ORB OPS/131/FIN

NOTE

Laptops may be powered or unpowered.  
Laptops may be connected to network or standalone

- A31p
3. SETUP PRIME WLES LAPTOP  
Secure Laptop Receiver Unit to A31p with Velcro (see fig 7-4)  
Connect Laptop Receiver Unit to A31p Serial port using thumbscrews (see fig 7-5)  
Verify line of sight between Laptop Receiver Unit and both CRUs  
Verify 5-in minimum distance between Laptop Receiver Unit and both CRUs
  4. SETUP BACKUP WLES LAPTOP

NOTE

Single laptop ops are preferred over delays in activation. If problems with Backup Laptop occur, skip step 4

Secure Laptop Receiver Unit to A31p with Velcro (see fig 7-4)  
Connect Laptop Receiver Unit to A31p Serial port using thumbscrews (see fig 7-5)  
Verify line of sight between Laptop Receiver Unit and both CRUs  
Verify 5-in minimum distance between Laptop Receiver Unit and both CRUs

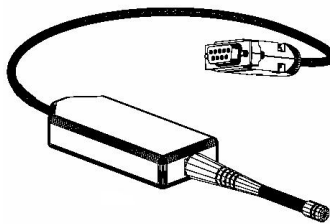

Figure 7-4.- Laptop Receiver Unit.

Cont next page

FS 7-5

ORB OPS/131/FIN



Figure 7-5.- A31p ports.

5. LAUNCH WLES SOFTWARE

Perform for both laptops:

If laptops are off, A31p pwr – On

Double click the time in system tray (lower-right corner)

'Date and Time Properties'

'Time Zone'

Time zone – (GMT) Greenwich Mean Time

Click 'OK'

Double click 'Shuttle Apps'>'WLES'>'WLES'

'Backup Mode Selection'

If setting up one A31p, select 'Standard'

|

If setting up two A31p laptops:

For prime laptop, select 'Primary'

For backup laptop, select 'Secondary'

If 'EWBMTAU-WLEFlight' appears with message 'Run the current command:

XXXX\_AA\_BB\_SNYYYY.xml?':

Click 'Yes'

NOTE

The secondary laptop lid may be closed at this time, if no longer needed for other applications.

The laptops are configured so that they do not enter 'standby' or 'hibernate' mode when the lids are closed. However, due to cooling concerns, fully closing the lid is not recommended

Cont next page

A31p

6. VERIFY LRU INSTALLATION

Use prime WLES laptop

'Enhanced Wideband MicroTAU – WLEFlight 3.0'

Click 'System Settings' (left side of display)

'Communications Settings'

√RF Receiver Port: 'COM 1'

Click 'Query Receiver'

Verify 'Receiver found on COM1' message appears

- \* If 'Query Receiver' fails: \*
- \*     Reseat LRU \*
- \*     Reboot prime WLES laptop \*
- \*     Double click 'Shuttle Apps'>'WLES'> \*
- \*     'WLES' \*
- \*     Select 'Primary' \*
- \*     Repeat step 6 \*
- \* If no Joy, perform WLES LRU R&R, steps \*
- \*     1-4, 6, then: \*

7. VERIFY DATA FILE BACKUP

Use prime WLES laptop

Verify 'Backup Directory:' set to:

'S:\Program Files\Invocon\EWBMTAU-WLEFlight'

- \* If 'Backup Directory' not set as above: \*
- \*     'System Settings' \*
- \*     'Directories' \*
- \*     At the line 'Backup Directory:' click \*
- \*     'Browse...' (right side of display) \*
- \*     \*
- \*     'Browse for Folder' \*
- \*     Navigate to WLES folder on RPOP2: \*
- \*     'My Computer'>'C on RPOP2 (S:)'> \*
- \*     'Program Files'>'Invocon'> \*
- \*     'EWBMTAU-WLEFlight' \*
- \*     \*
- \*     Click 'OK' \*

Verify 'Backup Interval' set to '30 minutes'

Cont next page

FS 7-7

ORB OPS/131/FIN

8. VERIFY COMM WITH RELAY UNITS

Use prime WLES laptop

'Main'

Click 'Unit List' (left side of display)

NOTE

Each Cabin Relay Unit is identified with a unique serial number; this number appears as 'Unit ID' in the software

√Cabin Relay Units Unit ID 1664 and 1728 present on display in first column; scroll down as necessary

For each Cabin Relay Unit:

√Unit ID present

√Type: 'Relay-GL'

√Last Update: time is updating (every 5 to 15 sec)

*	If one CRU time does not update:	*
*	Perform WLES CABIN RELAY UNIT R&R,	*
*	steps 1 thru 3, then:	*
*	Go to step 9	*
*	If neither CRU time updates after 2 min,	*
*	contact MCC-H	*

√Via: 'RF'

√Mode: 'Idle'

9. INITIATE COMMANDING

Double click 'Shuttle Apps'>'WLES'>'WLES Data Folder'

Double click 'Shuttle Apps'>'WLES'>'WLES Cmd Folder'

Cont next page

FS 7-8

ORB OPS/131/FIN

NOTE

Deleting 'BLOCK.xml' file initiates command execution. Command files disappear from this folder as they are executed.

Files appearing in the 'Data' folder verifies two-way communication with the Sensor Units in the orbiter wing

'Command'

Delete file labeled 'BLOCK.xml'

At prompt "Are you sure you want to send 'Block.xml' to the Recycle Bin?", click 'Yes'

Wait 1 minute

Verify the first data file appears in the 'Data' folder

Close 'Command' and 'Data' folders

10. REPORT WLES STATUS

Notify MCC-H: "WLES setup complete"

If reporting a failed and replaced CRU, include:

Failed CRU S/N

NOTE

The laptop lid may be closed at this time, if no longer needed for other applications. The laptops are configured so that they do not enter 'standby' or 'hibernate' mode when the lids are closed. However, due to cooling concerns, fully closing the lid is not recommended

## WLES DEACTIVATION AND TEARDOWN

### 1. DEACTIVATE WLES LAPTOP

#### NOTE

MCC will configure WLES for entry by setting all sensor units to idle mode

#### **On MCC GO:**

A31p 'Enhanced Wideband MicroTAU – WLEFlight 3.0'

For each WLES A31p:

Click 'Exit'

At prompt 'Are you sure you want to exit?'

click 'Yes'

Click 'Start' > 'Turn Off Computer...' > 'Turn Off'

Disconnect Laptop Receiver Unit from A31p

Serial port

Remove Laptop Receiver Unit from Velcro on A31p

### 2. REMOVE WLES RELAY UNITS

Remove Cabin Relay Units (2) from aft cabin (see figs 7-6 and 7-7)

Disconnect Cabin Relay Units from pre-routed cables

Disconnect and coil cables, stow in launch location

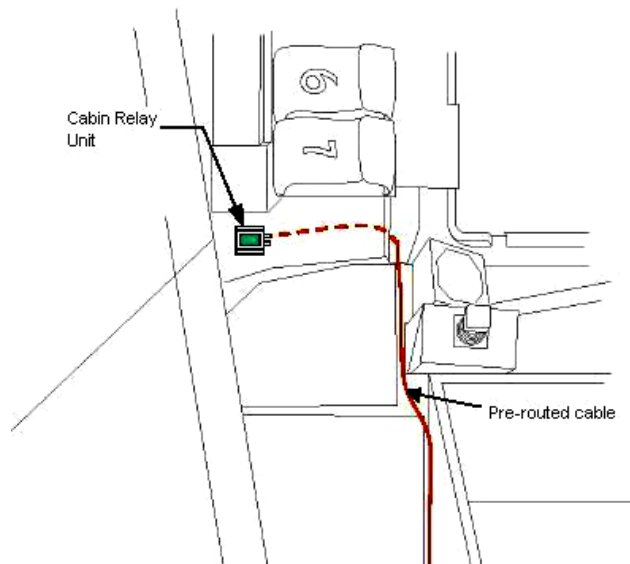

Figure 7-6.- Aft STBD location.

Cont next page

FS 7-10

ORB OPS/131/FIN



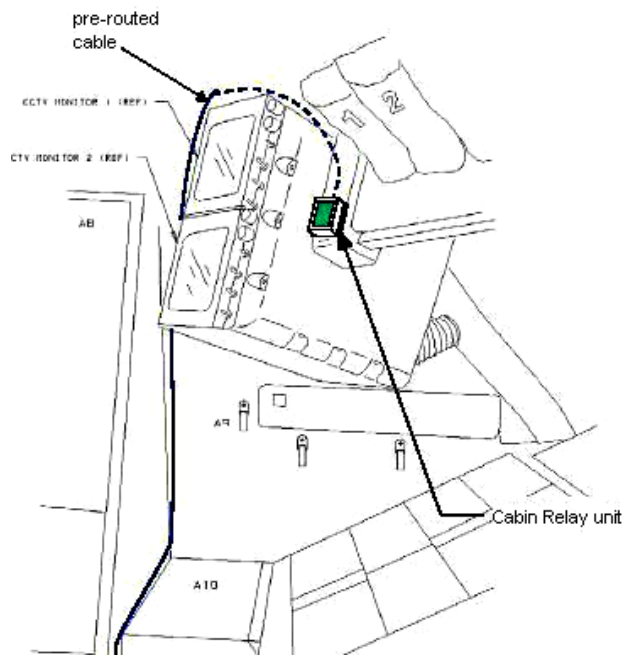

Figure 7-7.- Aft PORT location.

MA16L

3. STOW EQUIPMENT

Stow:

Laptop Receiver Units (2)

Cabin Relay Units (2)

Notify MCC-H: "WLES Teardown Complete"

## WLES LAPTOP RECEIVER UNIT (LRU) R&R

- A31p 1. DISCONNECT BACKUP LRU FROM LAPTOP  
'Enhanced Wideband MicroTAU – WLEFlight 3.0'

Click 'Exit'  
At prompt 'Are you sure you want to exit?'  
click 'Yes'

Disconnect Backup LRU from Backup A31p Serial  
port (see fig 7-8)  
Remove Backup LRU from Velcro on Backup A31p  
(see fig 7-9)



Figure 7-8.- A31p ports.

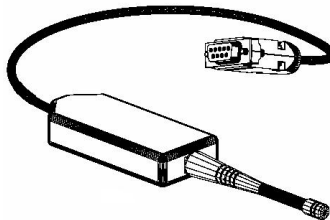

Figure 7-9.- Laptop Receiver Unit.

2. DISCONNECT PRIME LRU FROM LAPTOP  
Disconnect Prime LRU from Prime A31p Serial port  
(see fig 7-8)  
Remove LRU from Velcro on A31p

Cont next page

FS 7-12

ORB OPS/131/FIN

3. CONNECT BACKUP LRU

Connect Backup LRU to Prime WLES A31p Serial port  
Secure LRU to A31p with Velcro

A31p

4. VERIFY LRU INSTALLATION

Use prime WLES laptop

'Enhanced Wideband MicroTAU – WLEFlight 3.0'  
Click 'System Settings' (left side of display)

'Communications Settings'

√RF Receiver Port: 'COM 1'

Click 'Query Receiver'

Verify 'Receiver found on COM1' message appears

5. VERIFY COMM WITH RELAY UNITS

Click 'Unit List' (left side of display)

√Cabin Relay Units Unit ID 1664 and 1728 present on display in first column; scroll down as necessary

For each Cabin Relay Unit:

√Unit ID present

√Type: 'Relay-GL'

√Last Update: time is updating (every 5 to 15 sec)

√Via: 'RF'

√Mode: 'Idle'

If no time updates after 2 min, contact MCC-H

6. STOW EQUIPMENT

Notify MCC-H: "WLES LRU R&R complete", mark failed LRU as 'failed'

MA16L

Stow:

Prime (failed) LRU

## WLES CABIN RELAY UNIT R&R

- OVHD 1. DISCONNECT FAILED CRU AND STOW  
Disconnect WLE SYSTEM cable from J1 connector  
on failed CRU  
Mark failed CRU as 'failed' and stow in MA16L
- MA16L 2. SETUP SPARE WLES RELAY UNIT  
Unstow CRU SPARE (S/N 1792)  
  
WLE SYSTEM cable  
Connect plug CABIN RELAY UNIT A or B to J1 on  
CRU S/N 1792
- OVHD Secure CRU SPARE to the aft cabin with Velcro
- A31p 3. VERIFY COMM WITH SPARE RELAY UNIT  
Use prime WLES laptop  
  
'Main'  
Click 'Unit List' (left side of display)

### NOTE

Each Cabin Relay Unit is identified with a unique serial number; this number appears as 'Unit ID' in the software

√Cabin Relay Unit Unit ID 1792 present on display in first column; scroll down as necessary

Cabin Relay Unit:

- √Unit ID present
- √Type: 'Relay-GL'
- √Last Update: time is updating (every 5 to 15 sec)
- √Via: 'RF'
- √Mode: 'Idle'

### NOTE

Loss of redundant relay path until the config file is updated by the ground

Cont next page

FS 7-14

ORB OPS/131/FIN 2

4. EXIT WLES SOFTWARE ON BOTH LAPTOPS

**On MCC GO:**

A31p

On both Prime and Backup WLES laptops:

'Enhanced Wideband MicroTAU – WLEFlight 3.0'  
Click 'Exit' (upper right side of display)

'EWBMTAU – WLEFlight'  
'Are you sure you want to exit?', click 'Yes'

Notify MCC-H when complete

NOTE

OCA will replace the config files on both laptops

5. LAUNCH WLES SOFTWARE

**On MCC GO:**

A31p

On both Prime and Backup WLES laptops:

Double click 'Shuttle Apps'>'WLES'>'WLES'

'Backup Mode Selection'  
If setting up one A31p, select 'Standard'

If setting up two A31p laptops:  
For prime laptop, select 'Primary'  
For backup laptop, select 'Secondary'

If 'EWBMTAU-WLEFlight' window appears with  
message 'Run the current command:  
XXXX\_AA\_BB\_SNYYYY.xml?':  
Click 'Yes'

6. REVERIFY COMM WITH SPARE RELAY UNIT

Repeat step 3

7. REPORT WLES STATUS

Notify MCC-H: "WLES CRU R&R complete"

## CONFIGURE WLES DATA FILE BACKUP PATH

### NOTE

MCC will identify new backup WLES laptop to be used in place of RPOP2 (S:)

- A31p      Use prime WLES laptop
- 'Enhanced Wideband MicroTAU – WLEFlight 3.0'  
Click 'System Settings' (left side of display)
- 'Directories'  
At the line 'Backup Directory:' click 'Browse...' (right side of display)
- 'Browse for Folder'  
Navigate to WLES folder on RPOP2:  
    'My Computer'>'C on RPOP2 (S:)'>'Program Files'>'Invocon'>'EWBMTAU-WLEFlight'
- Click 'OK'
- Verify 'Backup Directory:' set to:  
    'S:\Program Files\Invocon\EWBMTAU-WLEFlight'
- Verify 'Backup Interval' set to '30 minutes'
- Click 'Unit List' (left side of display)

## PREP WLES LAPTOPS FOR TRANSFER

- A31p 1. DEACTIVATE WLES LAPTOP(S)  
'Enhanced Wideband MicroTAU – WLEFlight 3.0'

For each WLES A31p to be transferred:

Click 'Exit'

At prompt 'Are you sure you want to exit?'

click 'Yes'

Click 'Start'>'Turn Off Computer... '>'Turn Off'

Disconnect Laptop Receiver Unit from A31p

Serial port

Remove Laptop Receiver Unit from Velcro on  
A31p

2. SET UP NEW WLES LAPTOPS

√MCC-H for which laptop to use

If Prime Laptop being transferred:

Perform WLES ACTIVATION AND CHECKOUT,  
steps 3, 5 thru 8, then:

If Backup Laptop being transferred:

Perform WLES ACTIVATION AND CHECKOUT,  
steps 4 and 5, then:

Notify MCC-H: "PREP WLES LAPTOPS FOR  
TRANSFER complete"

## WLES RNDZ TOOLS CHECKOUT PREP

- A31p
1. DEACTIVATE BACKUP WLES LAPTOP  
On backup WLES laptop:  
    'Enhanced Wideband MicroTAU – WLEFlight 3.0'  
    Click 'Exit'  
    At prompt 'Are you sure you want to exit?'  
    click 'Yes'  
    Disconnect Laptop Receiver Unit from A31p  
    Serial port  
    Leave attached to laptop with Velcro on A31p
  2. DEACTIVATE WLES FILE BACKUP  
On prime WLES laptop:  
    'Enhanced Wideband MicroTAU – WLEFlight 3.0'  
    Click 'System Settings' (left side of display)  
  
    'Backup Mode Selection'  
    Click 'Standard'  
    Click 'Unit List' (left side of display)

## WLES DOCK/UNDOCK RECOVERY

- A31p
1. RECOVER BACKUP WLES LAPTOP  
On backup WLES laptop:  
    Connect Laptop Receiver Unit to A31p Serial port  
    If laptop is off:  
        | A31p pwr – On  
        | At prompt select option 1 to start WLES  
    If laptop is on:  
        Double click 'Shuttle Apps'>'WLES'>'WLES'  
        'Backup Mode Selection'  
        Click 'Secondary'
  2. REACTIVATE WLES FILE BACKUP  
On prime WLES laptop:  
    'Enhanced Wideband MicroTAU – WLEFlight 3.0'  
    Click 'System Settings' (left side of display)  
  
    'Backup Mode Selection'  
    Click 'Primary'  
    Click 'Unit List' (left side of display)



┌ | | | ┌

## **DISABLE WLES FILE BACKUP**

(SWITCH TO STANDARD MODE)

A31p            On prime WLES laptop:  
                  'Enhanced Wideband MicroTAU – WLEFlight 3.0'  
                  Click 'System Settings' (left side of display)  
  
                  'Backup Mode Selection'  
                  Click 'Standard'  
                  Click 'Unit List' (left side of display)

## **ENABLE WLES FILE BACKUP**

(SWITCH TO PRIMARY MODE)

A31p            On prime WLES laptop:  
                  'Enhanced Wideband MicroTAU – WLEFlight 3.0'  
                  Click 'System Settings' (left side of display)  
  
                  'Backup Mode Selection'  
                  Click 'Primary'  
                  Click 'Unit List' (left side of display)



This Page Intentionally Blank



PAYLOADS OF OPPORTUNITY

MAUI PROCEDURE .....	FS 8-2
RAMBO-2 PROCEDURE.....	FS 8-6

**P/L OF  
OPP**

FS 8-1

ORB OPS/131/FIN

P/L OF  
OPP

## MAUI PROCEDURE

- 15:00 or earlier 1. MANEUVER TO START ATTITUDE  
(BIASED +ZLV +YVV)

Deploy MAUI – RCS FIRING SEQUENCE  
(Cue Card)

GNC 20 DAP CONFIG

√DAP A1, B1 loaded

UNIV PTG

TGT ID – ITEM 8 +2 EXEC  
BODY VECT – ITEM 14 +5 EXEC  
P – ITEM 15 +2 7 0 EXEC  
Y – ITEM 16 +3 5 0 EXEC  
OM – ITEM 17 +2 7 0 EXEC

TRK – ITEM 19 EXEC (CUR - \*)

2. INITIATE TIMER

√MCC for start time

GNC 2 TIME

Set count down/count up timer per MCC

√MET – ITEM 2 EXEC (\*)

CRT TIMER COUNT TO – ITEM 17 +    +    +     
EXEC

3. SETUP

O14:E, cb DDU L (two) – cl  
O15:E

O14:F, Pri RJD LOGIC, DRIVER (sixteen) – ON  
O15:F,  
O16:F

GNC 20 DAP CONFIG

DAP A PRI P OPTION – ITEM 15 EXEC (NOSE)  
ROT PLS – ITEM 13 +1.0 0 0 EXEC  
TRAN PLS – ITEM 17 +0.7 3 EXEC  
VERN ROT PLS – ITEM 26 +0.1 5 3 EXEC

Cont next page

**GNC 23 RCS**

Deselect Jets:

Forward RCS page – ITEM 1 EXEC

JET DES F1D – ITEM 23 EXEC (\*)

F2D – ITEM 27 EXEC (\*)

C3     √DAP: A/AUTO/VERN  
          √DAP TRANS: PULSE/PULSE/PULSE  
          DAP ROT: PULSE/PULSE/PULSE

-05:00   4. VERIFY ATTITUDE  
          Verify in attitude

NOTE

For the following RCS firing sequence  
(step 5):

- A. Expect total orbiter body rates (RSS) to exceed 1 deg/sec
- B. Possible loss of comm due to orbiter body rates and attitude excursions
- C. For any jet fail OFF, continue with firing sequence
- D. Requirement is for a particular jet group, not a specific jet
- E. The table in step 5 is also provided as a cue card

Cont next page

FS 8-3

ORB OPS/131/FIN

## 5. RCS FIRING SEQUENCE

### NOTE

Use the table below or the cue card

Reminder: All inputs are momentary except RHC +pitch at 00:45

### MAUI – RCS FIRING SEQUENCE

Timer	Jets Fired	CDR	PLT
-03:00		Body rates: $+0.047 \leq \text{roll} \leq +0.087$ $-0.020 \leq \text{pitch} \leq +0.020$ $-0.020 \leq \text{yaw} \leq +0.020$ DAP: FREE DAP: A/PRI  Inform PLT "GO" for jet deselection	Configure initial setup [GNC 23 RCS] Left RCS page – ITEM 2 EXEC  On CDR "GO", proceed  <u>NOTE</u> Expect DAP RECONF msgs in following actions  Deselect jets: JET DES L5L – ITEM 37 EXEC (*) Right RCS page – ITEM 3 EXEC JET DES R5D – ITEM 39 EXEC (*) Forward RCS page – ITEM 1 EXEC JET DES F5L – ITEM 37 EXEC (*)  <u>NOTE</u> Queue the following ITEM entry on the scratch pad. Do not perform the EXEC until specified at 35 sec  JET DES F3D – ITEM 25
-00:30		FLT CNTLR PWR – ON	
00:00	RXA, LXA	THC +X (in) (3 sec firing)	
00:15	FXL, LXL	THC +Y (right) (3 sec firing)	
00:30	FXR, RXR	THC -Y (left) (3 sec firing)	
00:35			When jets stop firing: [GNC 23 RCS] EXEC [JET DES F3D – ITEM 25 (*)]
00:45	F4D	RHC +pitch (Past Soft Stop, hold 3 sec)	
00:48		RHC release	
00:50			DAP: VERN
01:00	R5R	RHC +yaw (10 sec firing)	
01:20	L5D	RHC -pitch (12 sec firing)	
01:40	F5R	RHC +pitch (12 sec firing)	
		FLT CNTLR PWR – OFF	Return to MAUI PROCEDURE, step 6, (ORB OPS FS, P/L OF OPP)

Cont next page

FS 8-4

ORB OPS/131/FIN 2

6. CLEANUP  
F6 √FLT CNTLR PWR – OFF

GNC 23 RCS

√Forward RCS page – ITEM 1 EXEC

Reselect Jets:

JET DES F1D – ITEM 23 EXEC (no \*)  
F3D – ITEM 25 EXEC (no \*)  
F2D – ITEM 27 EXEC (no \*)  
F5L – ITEM 37 EXEC (no \*)

Left RCS page – ITEM 2 EXEC  
JET DES L5L – ITEM 37 EXEC (no \*)

Right RCS page – ITEM 3 EXEC  
JET DES R5D – ITEM 39 EXEC (no \*)

GNC 20 DAP CONFIG

DAP A1 – ITEM 1 + 1 EXEC

7. SNAP LVLH ATTITUDE AND NULL RATES

When time  $\geq$  +03:30:

DAP: A/PRI  
DAP: LVLH

When rates stable:

DAP: VERN

Return to FLT PLN attitude

8. RECONFIGURE TO GROUP B POWERDOWN

√MCC

O14:E,   cb DDU L (two) – op  
O15:E

O14:F,   Pri RJD LOGIC,DRIVER (sixteen) – OFF  
O15:F,   RJDA 1A L2/R2 MANF DRIVER – ON  
O16:F

## RAMBO-2 PROCEDURE

### NOTE

This procedure completes a WAKE, RAM and Out-of-Plane burn. The direction of the Out-of-Plane burn is dependent upon satellite geometry and will be provided by MCC for the specific burn opportunity

- 15:00 or earlier 1. MANEUVER TO WAKE BURN ATTITUDE  
(BIASED +ZLV+XVV)

GNC 20 DAP CONFIG

√DAP A1, B1 loaded

UNIV PTG

TGT ID – ITEM 8 +2 EXEC  
BODY VECT – ITEM 14 +5 EXEC

P – ITEM 15 +2 2 0 EXEC

Y – ITEM 16 +0 EXEC

OM – ITEM 17 +0 EXEC

DAP: A/AUTO/VERN(ALT)

TRK – ITEM 19 EXEC (CUR - \*)

2. INITIATE TIMER

√MCC for burn sequence start time

GNC 2 TIME

Set count down/count up timer per MCC

√MET – ITEM 2 EXEC (\*)

CRT TIMER COUNT TO – ITEM 17 +   +   +   EXEC

3. SETUP

O14:E, cb DDU L (two) – cl  
O15:E

O14:F, Pri RJD LOGIC,DRIVER (sixteen) – ON  
O15:F,  
O16:F

Cont next page

FS 8-6

ORB OPS/131/FIN 2



GNC 20 DAP CONFIG

DAP A PRI P OPTION – ITEM 15 EXEC (NOSE)  
Y OPTION – ITEM 16 EXEC (NOSE)

DAP TRANS: NORM/PULSE/PULSE

-01:00 4. VERIFY ATTITUDE  
Verify in attitude

F6 FLT CNTLR PWR – ON

0:00 5. WAKE BURN  
DAP: PRI

Wait 20 seconds

THC +X (in) for 10 seconds

Wait 20 seconds before executing next maneuver

F6 6. MANEUVER TO RAM BURN ATTITUDE  
(BIASED -ZLV-XVV)

F6 FLT CNTLR PWR – OFF

UNIV PTG

TGT ID – ITEM 8 +2 EXEC

BODY VECT – ITEM 14 +5 EXEC

P – ITEM 15 +1 2 0 EXEC

Y – ITEM 16 +0 EXEC

OM – ITEM 17 +0 EXEC

DAP: B/AUTO/ALT

TRK – ITEM 19 EXEC (CUR - \*)

When in attitude and if VRCS available:

DAP: A/VERN

When rates stable:

DAP: A/PRI

F6 FLT CNTLR PWR – ON

Wait 20 seconds

Cont next page

FS 8-7

ORB OPS/131/FIN 2

7. RAM BURN  
THC +X (in) for 10 seconds

Wait 20 seconds before executing next maneuver

F6 8. MANEUVER TO OUT-OF-PLANE BURN ATTITUDE  
FLT CNTLR PWR – OFF

UNIV PTG

TGT ID – ITEM 8 +2 EXEC

BODY VECT – ITEM 14 +5 EXEC

P – ITEM 15 +9 0 EXEC

Y – ITEM 16 +0 EXEC

√MCC for burn omicron

If stbd wing to velocity vector:

| OM – ITEM 17 +2 7 0 EXEC

If port wing to velocity vector:

OM – ITEM 17 +9 0 EXEC

DAP: B/AUTO/ALT

TRK – ITEM 19 EXEC (CUR - \*)

When in attitude and if VRCS available:

DAP: A/VERN

When rate stable:

DAP: A/PRI

F6 FLT CNTLR PWR – ON

Wait 20 seconds

9. OUT-OF-PLANE BURN  
THC +X (in) for 10 seconds

Wait 20 seconds before returning to VERN(ALT)  
below

Cont next page

FS 8-8

ORB OPS/131/FIN 2

10. CLEANUP  
F6 FLT CNTLR PWR – OFF

GNC 20 DAP CONFIG  
DAP A1 – ITEM 1 +1 EXEC

DAP: VERN(ALT)

Return to FLT PLN attitude

11. RECONFIGURE TO GROUP B POWERDOWN  
√MCC  
O14:E, cb DDU L (two) – op  
O15:E

O14:F, Pri RJD LOGIC,DRIVER (sixteen) – OFF  
O15:F, RJDA 1A L2/R2 MANF DRIVER – ON  
O16:F



This Page Intentionally Blank



FRED

FRED SETUP .....	FS 9-2
STOWAGE .....	FS 9-2

**FRED**

FS 9-1

ORB OPS/131/FIN

FRED

## FRED SETUP

1. Unstow FRED tray and FRED leg brace
- A8L 2. Attach clutch bracket mount assy below aft panel A8 with captive fasteners (four)
3. Assemble FRED as shown and adjust to desired position. Note positions

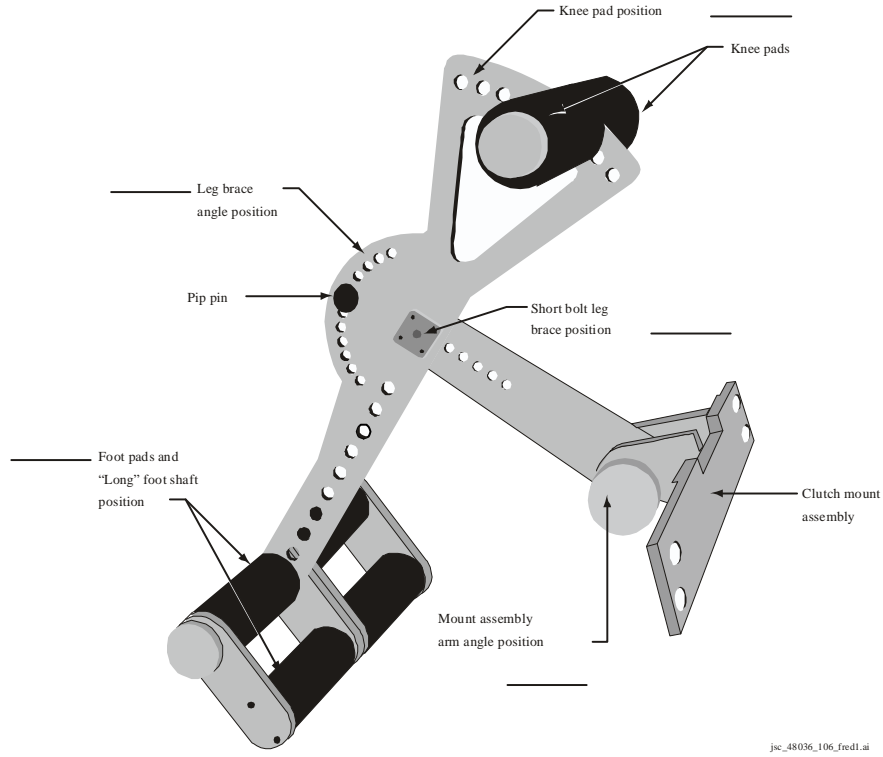

## FRED STOWAGE

1. Disassemble FRED and set clutch bracket mount assy to #8 angle position
2. Stow FRED in locker tray cushion. Re-adjust clutch bracket mount assy as required
3. Stow leg brace

CWC OPS

WASTE TANK OFFLOAD TO CWC ..... FS 10-2

CWC OPS

FS 10-1

ORB OPS/131/FIN 2

## WASTE TANK OFFLOAD TO CWC

OBJECTIVE: Use CWC to temp store waste water in the event the waste tank is full and cannot be dumped. CWC will be dumped at a later time

### NOTE

Requires Ops 2 config and two crewmembers

LOCATION: CONT H2O X-TIE WASTE QD located on outboard WCS wall (inside WCS compartment), Volume H (MD23R); see LOWER EQUIPMENT BAY (IFM, COMPONENT LOCATIONS)

CWC OPS

### TOOLS REQD:

TOOL	Gray Tape
CHCK	8 ft Y-Y Hose
WCS	Dry Wipes (2-3)
MISC	PPE (gloves and goggles)
	36 x 36 Ziploc Bag (two)
Middeck	Contingency Water Container (CWC) (Check MCC for CWC S/N)

1. Remove contents of Vol H (MD23R), temp stow
2. Connect Y-Y Hose to CWC
3. Place CWC in one Ziploc

ML31C 4. WASTE H2O DUMP ISOL VLV – CL (tb-CL)

### NOTE

Discontinue WCS ops until procedure complete.

Use Dry Wipes to absorb any fluid released during QD mate/demate

5. Don PPE

WCS 6. Connect Y-Y Hose to CONT H2O X-TIE WASTE QD (upper QD with yellow Velcro and "WASTE" label)

### NOTE

MCC will TMBU limits if desired

Cont next page



7. FDA limit for Waste TK to CWC transfer \_\_\_\_\_%

8. **SM 60 TABLE MAINT**

PARAMETER NAME	PARA ID	SM ALERT	
		LOW	HIGH
WASTE H2O QTY 1	0620540	<input type="checkbox"/>	-

ML31C 9. WASTE H2O DUMP ISOL VLV – OP (tb-OP)

10. Monitor CWC fill rate continuously

**SM 66 ENVIRONMENT**

11. When 'S66 WASTE H2O QTY ↓', continue

ML31C 12. WASTE H2O DUMP ISOL VLV – CL (tb-CL)

WCS 13. Leave Y-Y Hose connected to CWC, disconnect Y-Y Hose from CONT H2O X-TIE WASTE QD, cap QD

ML31C 14. WASTE H2O DUMP ISOL VLV – OP (tb-OP)

15. Leaving Y-Y Hose protruding from corner of bag, lightly press air out of Ziploc, seal bag

16. Use Gray Tape to seal area around location where Y-Y Hose exits Ziploc (see photo below)



Cont next page

17. Fold any extra portion of Ziploc flat, coil Y-Y Hose on top
18. Place bagged CWC/Y-Y Hose assembly into second Ziploc , lightly press air out of bag, seal Ziploc
19. Temp stow entire assembly in Vol H (MD23R), ensuring minimal pressure is applied to CWC
20. Stow tools



CUE CARD CONFIGURATION

CUE  
CARDS

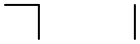

NOT FLOWN

FS 11-1

ORB OPS/131/FIN 1

**CUE  
CARDS**

This Page Intentionally Blank

NOT FLOWN

FS 11-2

ORB OPS/131/FIN 1

TOP

HOOK  
VELCRO

**LIQH CHANGEOUT**

(7 crewmembers/Single Shift/FD 1-17)

FLIGHT DAY	POS A	POS B	CK CMPLT
LAUNCH	1	2	
PRE FD01	"	"	
POST FD02	3	4	
PRE FD02	5	6 *	
POST FD03	"	7	DOCKING
PRE FD03	8	"	
POST FD04	"	9	
PRE FD04	10	"	
POST FD05	"	11	
PRE FD05	12	"	
POST FD06	"	13	
PRE FD06	14	"	
POST FD07	"	15	
PRE FD07	16	"	
POST FD08	"	17	
PRE FD08	18	"	
POST FD09	"	19	
PRE FD09	20	"	
POST FD10	"	21	
PRE FD10	22	"	
POST FD11	"	23	
MID FD11	24 *	25 *	HATCH CLOSE
PRE FD11	"	"	
POST FD12	26	27	
PRE FD12	28	"	
POST FD13	29	30	
PRE FD13	31 *	32 *	
POST FD14	33	34	EOM
PRE FD14	35	"	
POST FD15	36	37	EOM+1
PRE FD15	38 *	39 *	
POST FD16	40	41	EOM+2
PRE FD16	42	"	
POST FD17	43	44	EOM+3

\*Reseal LiOH cans with Gray Tape and stow  
(Location of canisters on back)

ORB OPS-29a/nonRCRS/131/O/C

**NOTE**

This card is specifically used for the STS-131 mission with the orbiter conducting single shift ops with a Shuttle crew size of 7 and ISS crew size of 6. This changeout scheme reflects FD3 docking with ISS, Vozdukh, and dual-bed CDRA operation

(reduced copy)

NOT FLOWN

FS CC 11-3

ORB OPS/131/FIN 3

TOP  
BACK OF 'LIOH CHANGEOUT'



HOOK  
VELCRO



**LIOH CANISTER STOWAGE LOCATIONS**

**Ascent Stowage Locations**

Orbiter:

MD52M (LiOH Box): cans 1-31 \*  
MPLM: cans 32-46

\* 2 LiOH cans installed in LiOH slots A and B



ORB OPS-29b/nonRCRS/131/O/B

(reduced copy)

NOT FLOWN

FS CC 11-4

ORB OPS/131/FIN 1

TOP

HOOK  
VELCRO

HOOK  
VELCRO

**ORBIT BURN MONITOR**

<b>OMS TEMP*</b>		
FU IN P ≥	L 225   R 220	OMS ENG FAIL
≤	L 205   R 204	OMS PRPLT FAIL
or No FU IN P		
<b>OMS PC* &amp; OMS ↓</b>		
ENG VLV 1 or 2 < 70		OMS ENG FAIL
or OX IN P > 227		OMS PRPLT FAIL
or OX IN P ≤ 227		
or No OX IN P		
<b>OMS OX/FU TK P (√ENG IN P)</b>		
OX/FU LOW		He PRESS/VAP ISOL (two) – OP If aff TK P not incr: OMS PRPLT FAIL
OX & FU HIGH		He PRESS/VAP ISOL (two) – CL Cycle He A(B) to maintain TK P 234-284
<b>OMS N2 REG P HIGH or LOW</b>		OMS ENG – ARM
<b>OMS N2 TK P LOW</b> (√[OMS/MPS])		At N2 TK P < 470: OMS ENG – ARM
<b>OMS GMBL</b>	PRI fail	L(R) OMS GMBL – SEC
	SEC fail	If high RCS usage: OMS ENG FAIL
<b>GPC</b>	<input type="checkbox"/> ( <input type="checkbox"/> ) & Burning OMS aff	aff GPC PWR – OFF If SEC GMBL avail: aff MDM FF 1(4) – OFF,ON L(R) OMS GMBL – SEC
	SEC GMBL lost	If high RCS usage: OMS ENG FAIL
	2 FAs lost	√MAN SHUTDN
<b>I/O ERROR FA</b>	1(4)	L(R) OMS GMBL – SEC ♦ I/O RESET If high RCS usage: OMS ENG FAIL
	2 FAs lost	√MAN SHUTDN
<b>BCE STRG D</b>	1(4)	I/O RESET (if recov: >>) If high RCS usage: L(R) OMS GMBL – SEC
<b>GPC SET SPLIT</b>	Non-crit burn	STOP BURN: OMS ENG(s) – OFF
	Crit burn	Go to “GPC” above
<b>I/O ERROR PCM</b>		OI PCMMU PWR – 2(1)
<b>BCE BYP OA</b>		SM I/O RESET

\*If XFD, BLDN, or sensor fail, monitor ENG IN P for off-nominal performance

ORB OPS-31a/131/O/A

(reduced copy)

NOT FLOWN

FS CC 11-5

ORB OPS/131/FIN

TOP  
BACK OF 'ORBIT BURN MONITOR'

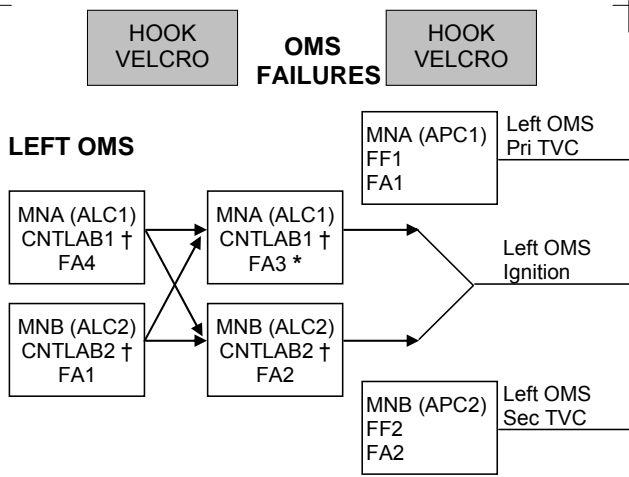

† If CNTL AB1 or AB2 (CA1 or CA2) failed and ign path still exists at OMS fail, assume L(R) OMS ↓ is PRPLT FAIL  
 \* If L(R) Pc failed high during burn or FA3(4) failed, at L(R) OMS fail, no guidance downmode after L(R) OMS ENG switch OFF (TGO slow, ADI needles in error, 6 ft/s underburn)

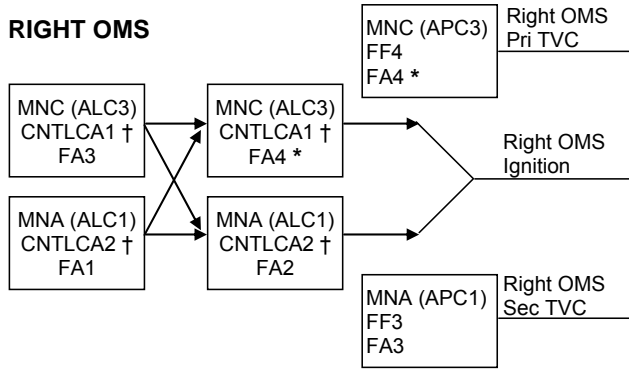

If two FA MDMs lost		
MDMs	Preburn: ENG – OFF	During burn: MAN SHUTDN
1,2	LEFT (TVC)	BOTH
1,3	RIGHT (IGN)	LEFT
1,4	LEFT (IGN)	RIGHT
2,3	LEFT (IGN)	RIGHT
2,4	RIGHT (IGN)	LEFT
3,4	RIGHT (TVC)	BOTH

ORB OPS-31b/131/O/A

(reduced copy)

NOT FLOWN

FS CC 11-6

ORB OPS/131/FIN



NOT FLOWN

FS CC 11-7

ORB OPS/131/FIN

(reduced copy)

TOP

PILE  
VELCRO

ORB OPS-41a/131/O/A

PILE  
VELCRO

**STS-131 DAP A1 – DAP A8 CONFIGURATIONS**

	ITEM#	A1	A2	A3	A4	A5	A6	A7	A8
<b>PRI</b>									
ROT RATE	10 (50)	0.2000	0.4000	0.2000	0.5000	0.2000	0.2000	0.2000	0.0500
ATT DB	11 (51)	5.00	1.00	0.30	3.00	5.00	5.00	2.00	2.00
RATE DB	12 (52)	0.20	0.20	0.20	0.20	0.20	0.20	0.20	0.20
ROT PLS	13 (53)	0.100	0.100	0.100	0.100	0.100	0.100	0.100	0.100
COMP	14 (54)	.000	.000	.000	.000	.000	.000	.000	.000
P OPTION	15 (55)	ALL	ALL	ALL	ALL	ALL	TAIL	ALL	ALL
Y OPTION	16 (56)	ALL	ALL	TAIL	ALL	ALL	TAIL	ALL	ALL
TRAN PLS	17 (57)	0.100	0.100	0.100	0.100	0.100	0.100	0.100	0.100
<b>ALT</b>									
RATE DB	18 (58)	0.200	0.200	0.070	0.200	0.070	0.070	0.100	0.100
JET OPT	19 (59)	ALL	ALL	ALL	ALL	ALL	TAIL	ALL	ALL
# JETS	20 (60)	2	2	1	2	1	1	2	2
ONTIME	21 (61)	0.08	0.08	0.08	0.08	0.08	0.08	0.08	0.08
DELAY	22 (62)	0.00	0.00	0.00	0.00	0.00	0.00	0.00	0.00
<b>VERN</b>									
ROT RATE	23 (63)	0.2000	0.4000	0.0080	0.2000	0.0500	0.0500	0.0160	0.0500
ATT DB	24 (64)	1.000	1.000	0.070	1.000	1.000	1.000	1.000	1.000
RATE DB	25 (65)	.020	.020	.010	.020	.020	.020	.020	.020
ROT PLS	26 (66)	0.010	0.010	0.010	0.010	0.010	0.010	0.010	0.050
COMP	27 (67)	.000	.000	.000	.000	.000	.000	.000	.000
CNTL ACC	28 (68)	0	0	0	0	0	0	0	0
PURPOSE		NOMINAL	PTC	GG		LOSS OF VERN(ALL)	LOSS OF VERN (TAIL ONLY)	RNDZ	TERMINAL PHASE

*BOLDITALIC* indicates change from I-Load.

HINGE

NOT FLOWN

FS CC 11-8

ORB OPS/131/FIN

(reduced copy)

TOP  
HINGED AT BOTTOM OF  
'STS-131 DAP A1 – DAP A8 CONFIGURATIONS'  
HINGE

**STS-131 DAP B1 – DAP B8 CONFIGURATIONS**

	ITEM #	B1	B2	B3	B4	B5	B6	B7	B8
<b>PRI</b>									
ROT RATE	30 (50)	0.5000	0.2000	0.2000	0.2000	0.2000	0.5000	0.5000	0.0500
ATT DB	31 (51)	3.00	3.00	3.00	0.30	3.00	3.00	2.00	2.00
RATE DB	32 (52)	0.20	0.20	0.20	0.20	0.20	0.20	0.20	0.20
ROT PLS	33 (53)	0.040	0.040	0.040	0.040	0.040	0.040	0.040	0.040
COMP	34 (54)	.000	.000	.000	.000	.000	.000	.000	.000
P OPTION	35 (55)	ALL	TAIL	ALL	TAIL	TAIL	ALL	ALL	ALL
Y OPTION	36 (56)	ALL	TAIL	ALL	TAIL	TAIL	ALL	ALL	ALL
TRAN PLS	37 (57)	0.100	0.020	0.020	0.020	0.020	0.020	0.050	0.050
<b>ALT</b>									
RATE DB	38 (58)	0.200	0.070	0.070	0.100	0.200	0.200	0.100	0.100
JET OPT	39 (59)	ALL	TAIL	ALL	ALL	ALL	ALL	ALL	ALL
# JETS	40 (60)	2	1	1	2	2	2	2	2
ON TIME	41 (61)	0.08	0.08	0.08	0.08	0.08	0.08	0.08	0.08
DELAY	42 (62)	0.00	0.00	0.00	0.00	0.00	0.00	0.00	0.00
<b>VERN</b>									
ROT RATE	43 (63)	0.2000	0.2000	0.2000	0.0080	0.0160	0.2000	0.2000	0.0500
ATT DB	44 (64)	1.000	1.000	1.000	0.100	0.033	1.000	1.000	1.000
RATE DB	45 (65)	.020	.020	.020	.010	.020	.020	.020	.020
ROT PLS	46 (66)	0.002	0.002	0.002	0.002	0.002	0.002	0.002	0.020
COMP	47 (67)	.000	.000	.000	.000	.000	.000	.000	.000
CNTL ACC	48 (68)	0	0	0	0	0	0	0	0
PURPOSE		OMS & RCS BURNS (ORB OPS)	LOSS OF VERN (TAIL ONLY)	LOSS OF VERN (ALL)		COAS/UID CAL		RNDZ	TERMINAL PHASE

**BOLD/ITALIC** indicates change from I-Load.

HOOK  
VELCRO

ORB OPS-41aa/131/O/A

HOOK  
VELCRO

NOT FLOWN

FS CC 11-9

ORB OPS/131/FIN 2

(reduced copy)

TOP  
BACK OF 'STS-131 DAP A1 – DAP A8 CONFIGURATIONS'

PILE  
VELCRO

ORB OPS-41b/131/O/D

PILE  
VELCRO

STS-131 DAP A9 – DAP A14 CONFIGURATIONS

	ITEM #	A9	A10	A11	A12	A13	A14
<b>PRI</b>							
ROT RATE	10 (50)	0.1300	0.0500	0.0500	0.0500	0.0500	0.2000
ATT DB	11 (51)	2.00	0.60	10.00	5.00	5.00	5.00
RATE DB	12 (52)	0.10	0.10	0.20	0.20	0.20	0.20
ROT PLS	13 (53)	0.100	0.100	0.100	0.040	0.040	0.100
COMP	14 (54)	.000	.000	.000	.000	.000	.000
P OPTION	15 (55)	TAIL	TAIL	TAIL	TAIL	TAIL	TAIL
Y OPTION	16 (56)	TAIL	TAIL	TAIL	TAIL	TAIL	TAIL
TRAN PLS	17 (57)	0.050	0.050	0.100	0.010	0.010	0.100
<b>ALT</b>							
RATE DB	18 (58)	0.100	0.100	0.020 <sup>1</sup>	0.020 <sup>1</sup>	0.020 <sup>1</sup>	0.200
JET OPT	19 (59)	TAIL	TAIL	TAIL	TAIL	TAIL	TAIL
# JETS	20 (60)	2	2	1	1	1	1(2) <sup>3</sup>
ON TIME	21 (61)	0.08	0.08	0.08	0.08	0.08	0.08
DELAY	22 (62)	0.00	0.00	<b>5.00</b>	<b>5.00</b>	<b>5.00</b>	6.00
<b>VERN</b>							
ROT RATE	23 (63)	0.1300	0.0500	0.1000	0.1000	0.1000	0.2000
ATT DB	24 (64)	1.000	0.500	5.000	3.000	3.000	3.000
RATE DB	25 (65)	.020	.020	.050	.020	.020	.200
ROT PLS	26 (66)	0.050	0.050	0.010	0.002	0.002	0.010
COMP	27 (67)	.000	.000	.000	.000	.000	.000
CNTL ACC	28 (68)	0	0	<b>6(2,4)<sup>2</sup></b>	<b>6(2,4)<sup>2</sup></b>	<b>6(2,4)<sup>2</sup></b>	1
PURPOSE		PROX/OPS FLYAROUND	DOCKING	AUTO REBOOST	MATED STACK (MVNRS, ROBO, ATT HOLD)		ORBITER ALONE SRMS/OBSS

**BOLDITALIC** indicates change from I-Load.

<sup>1</sup> I-loaded below keyboard limit; do not change

<sup>2</sup> CA2: Light Weight Russian Segment (SM AFT = EMPTY)

CA4: Medium Weight Russian Segment (SM AFT = OCCUPIED AND MRM2 = EMPTY)

CA6: Heavy Weight Russian Segment (SM AFT = OCCUPIED AND MRM2 = OCCUPIED)

<sup>3</sup> Use 1 for OBSS scan and 2 for Orbiter attitude maneuvers

-----  
HINGE

NOT FLOWN

FS CC 11-10

ORB OPS/131/FIN 2

(reduced copy)

TOP  
 BACK OF 'STS-131 DAP B1 – DAP B8 CONFIGURATIONS'  
 HINGED AT BOTTOM OF 'STS-131 DAP A9 – DAP A14 CONFIGURATIONS'  
 HINGE

**STS-131 DAP B9 – DAP B13 CONFIGURATIONS**

	ITEM #	B9	B10	B12	B13
<b>PRI</b>					
ROT RATE	30 (50)	0.1300	0.0500	0.0100 <sup>1</sup>	0.0100 <sup>1</sup>
ATT DB	31 (51)	2.00	0.60	1.00	1.00
RATE DB	32 (52)	0.10	0.10	0.20	0.20
ROT PLS	33 (53)	0.040	0.040	0.040	0.040
COMP	34 (54)	.000	.000	.000	.000
P OPTION	35 (55)	TAIL	TAIL	TAIL	TAIL
Y OPTION	36 (56)	TAIL	TAIL	TAIL	TAIL
TRAN PLS	37 (57)	0.010	0.010	0.010	0.010
<b>ALT</b>					
RATE DB	38 (58)	0.100	0.100	0.020 <sup>1</sup>	0.020 <sup>1</sup>
JET OPT	39 (59)	TAIL	TAIL	TAIL	TAIL
# JETS	40 (60)	2	2	<b>1</b>	<b>1</b>
ON TIME	41 (61)	0.08	0.08	0.08	0.08
DELAY	42 (62)	10.00	0.00	<b>5.00</b>	<b>5.00</b>
<b>VERN</b>					
ROT RATE	43 (63)	0.1300	0.0500	0.0100	0.0100
ATT DB	44 (64)	1.000	0.500	1.000	<b>0.100</b>
RATE DB	45 (65)	.020	.020	.020	.020
ROT PLS	46 (66)	0.020	0.020	0.002	0.002
COMP	47 (67)	.000	.000	.000	.000
CNTL ACC	48 (68)	0	0	<b>6(2.4)</b> <sup>2</sup>	<b>6(2.4)</b> <sup>2</sup>
PURPOSE		PROXOPS/ FLYAROUND	DOCKING	MATED ATT HOLD (VRCS & ALT)	MATED VRCS DB COLLAPSE

**BOLD/ITALIC** indicates change from I-Load.

<sup>1</sup> I-loaded below keyboard limit; do not change

<sup>2</sup> CA2: Light Weight Russian Segment (SM AFT = EMPTY)

CA4: Medium Weight Russian Segment (SM AFT = OCCUPIED AND MRM2 = EMPTY)

CA6: Heavy Weight Russian Segment (SM AFT = OCCUPIED AND MRM2 = OCCUPIED)

HOOK  
VELCRO

ORB OPS-41bb/131/O/D

HOOK  
VELCRO

**MAUI – RCS FIRING SEQUENCE**

Reminder: All inputs are momentary except RHC +pitch at 00:45

Timer	Jets Fired	CDR	PLT
-03:00		√Body rates: +0.047 ≤ roll ≤ +0.087 -0.020 ≤ pitch ≤ +0.020 -0.020 ≤ yaw ≤ +0.020 DAP: FREE DAP: A/PRI  Inform PLT "GO" for jet deselects	Configure initial setup GNC 23 RCS Left RCS page – ITEM 2 EXEC  On CDR "GO", proceed  NOTE Expect DAP RECONF msgs in following actions  Deselect jets: JET DES L5L – ITEM 37 EXEC (*) Right RCS page – ITEM 3 EXEC JET DES R5D – ITEM 39 EXEC (*) Forward RCS page – ITEM 1 EXEC JET DES F5L – ITEM 37 EXEC (*)  NOTE Queue the following ITEM entry on the scratch pad. Do not perform the EXEC until specified at 35 sec  JET DES F3D – ITEM 25
-00:30		FLT CNTLR PWR – ON	
00:00	RXA, LXA	THC +X (in) (3 sec firing)	
00:15	FXL, LXL	THC +Y (right) (3 sec firing)	
00:30	FXR, RXR	THC -Y (left) (3 sec firing)	
00:35			When jets stop firing: GNC 23 RCS EXEC [JET DES F3D – ITEM 25 (*)]
00:45	F4D	RHC +pitch (Past Soft Stop, hold 3 sec)	
00:48		RHC release	
00:50			DAP: VERN
01:00	R5R	RHC +yaw (10 sec firing)	
01:20	L5D	RHC -pitch (12 sec firing)	
01:40	F5R	RHC +pitch (12 sec firing)	
		FLT CNTLR PWR – OFF	Return to MAUI PROCEDURE, step 6, (ORB OPS FS, P/L OF OPP)

ORB OPS-42a/131/O/B

(reduced copy)

NOT FLOWN

FS CC 11-11

ORB OPS/131/FIN 2



TOP  
BACK OF 'MAUI - RCS FIRING SEQUENCE'

HOOK  
VELCRO

HOOK  
VELCRO

HOOK  
VELCRO



ORB OPS-42b/131/O/B

NOT FLOWN

(reduced copy)  
FS CC 11-12

ORB OPS/131/FIN 2



TOP

**WLES CONFIG AFTER PGSC REBOOT**

1. If window appears asking to launch WLES software:
  - Click '1' to launch WLES software
  - Else:
    - Double click 'Shuttle Apps'>'WLES'>'WLES'
2. ✓MCC for 'Backup Mode Selection'
3. If 'EWBMTAU-WLEFlight' appears with message 'Run the current command: XXXX\_AA\_BB\_SNYYYY.xml?':
  - Click 'Yes'

ORB OPS-47a/131/O/A

FABRICATION NOTES

Fabricate on flight approved yellow Post-it

NOT FLOWN

(reduced copy)

FS CC 11-13

ORB OPS/131/FIN



This Page Intentionally Blank



NOT FLOWN

FS 11-14

ORB OPS/131/FIN





Space Shuttle Program  
FLIGHT DATA FILE

JSC-48036-131  
FINAL



# ORBIT OPS CHECKLIST

STS  
131

Flight Cover (trim bottom to expose tabs)