

Orbit Operations Checklist

STS-134 Flight Supplement

**Mission Operations Directorate
Operations Division**

**Final, Rev A
October 6, 2010**

National Aeronautics and
Space Administration

Lyndon B. Johnson Space Center
Houston, Texas



ORBIT OPERATIONS, STS-134 Flt Suppl

FINAL, REV A (October 6, 2010)

PCN-1 (March 28, 2011) Sheet 1 of 1

List of Implemented Change Requests (482s):

ORB OPS FS-00232
ORB OPS FS-00239
ORB OPS FS-00240
ORB OPS FS-00241
ORB OPS FS-00242
ORB OPS FS-00243

Incorporate the following:

1. Replace FS iii thru FS viii
2. Replace section 2 (FS 2-1 thru FS 2-4)
3. Replace section 7 (FS 7-1 & FS 7-2)
4. Replace FS 9-3 & FS 9-4, FS 9-7 & FS 9-8, FS 9-13 thru FS 9-18
5. Replace FS CC 12-3 & FS CC 12-4, FS CC 12-11 thru FS 12-16

Prepared by: Thomas Zulauf
Publication Manager

Approved by: Kimberly Johnson
Manager, Flight Procedures

Accepted by: STEP
PDF Manager

Encl: 30 pages

File this PCN immediately behind the front cover as a permanent record

MISSION OPERATIONS DIRECTORATE

**ORBIT OPERATIONS CHECKLIST
STS-134 FLIGHT SUPPLEMENT**

FINAL, REV A
October 6, 2010

PREPARED BY:

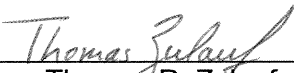

Thomas R. Zulauf
Publication Manager

APPROVED BY:

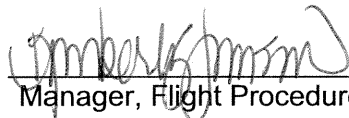

Amber Johnson
Manager, Flight Procedures

ACCEPTED BY:



Michael T. Hurt
FDF Manager

This document is under the configuration control of the Crew Procedures Control Board (CPCB). All proposed changes must be submitted via Change Request Workflow (CRW) to DO3/FDF Manager.

Additional distribution of this book, for official use only, may be requested in writing to DO3/PMO Administrator. The request must include justification and requester's name, organization, position, and phone number. Contractor requests are made through the NASA or DOD organization supported. Deletions, reduction in quantity, or change of address may be submitted to DO3/FDF Management Office, 281-244-1184.

Incorporates the following:		
482#:	ORB OPS FS-00212	ORB OPS FS-00219
	ORB OPS FS-00214	ORB OPS FS-00220
	ORB OPS FS-00215	ORB OPS FS-00222
	ORB OPS FS-00218	ORB OPS FS-00223

AREAS OF TECHNICAL RESPONSIBILITY

Publication Manager	DO3/T. Zulauf	281-244-0922
Alternate Publication Manager	DO3/L. Giles	281-244-9068
COMM/INST	DS2/C. Maranto	281-244-2261
PTG	DO4/R. Garcia	281-244-0955
DAP TABLES	DS6/D. Shafer	281-244-0143
REBOOST/DAP	DS6/D. Shafer	281-244-0143
OIU	DS2/C. Maranto	281-244-2261
PRLA	DS4/L. Slovey	281-483-1685
SDBI	SK/S. Rodgers	281-218-3068
WLES	DO5/R. Besser	281-244-5627
P/L OF OPP	DS6/D. Shafer	281-244-0143
PGSC FS	DO4/T. Melroy	281-244-1132
<u>CUE CARDS:</u>		
LIOH CHANGEOUT	DS4/C. Ledet	281-483-5344
ORBIT BURN MONITOR	DS6/I. Young	281-483-2918
DAP TABLES	DS6/D. Shafer	281-244-0143
MAUI FIRING SEQUENCES	DS6/D. Shafer	281-244-0143
WLES CONFIG AFTER PGSC REBOOT	DO5/R. Besser	281-244-5627

ORBIT OPERATIONS CHECKLIST
 STS-134 FLIGHT SUPPLEMENT

LIST OF EFFECTIVE PAGES

FINAL	04/12/10
REV A	10/06/10
PCN-1	03/28/11

Sign Off	*	134/FIN A	FS 3-7	134/FIN A
FS ii	*	134/FIN A	FS 3-8	134/FIN A
FS iii	*	134/FIN A,1	FS 4-1	134/FIN A
FS iv	*	134/FIN A,1	FS 4-2	134/FIN A
FS v	*	134/FIN A,1	FS 4-3	134/FIN A
FS vi	*	134/FIN A	FS 4-4	134/FIN A
FS vii		134/FIN A	FS 4-5	134/FIN A
FS viii		134/FIN A,1	FS 4-6	134/FIN A
FS 1-1		134/FIN A	FS 5-1	134/FIN A
FS 1-2		134/FIN A	FS 5-2	134/FIN A
FS 1-3		134/FIN A	FS 6-1	134/FIN A
FS 1-4		134/FIN A	FS 6-2	134/FIN A
FS 1-5		134/FIN A	FS 6-3	134/FIN A
FS 1-6		134/FIN A	FS 6-4	134/FIN A
FS 1-7		134/FIN A	FS 7-1	134/FIN A
FS 1-8		134/FIN A	FS 7-2	134/FIN A,1
FS 1-9		134/FIN A	FS 8-1	134/FIN A
FS 1-10		134/FIN A	FS 8-2	134/FIN A
FS 1-11		134/FIN A	FS 8-3	134/FIN A
FS 1-12		134/FIN A	FS 8-4	134/FIN A
FS 2-1		134/FIN A	FS 8-5	134/FIN A
FS 2-2		134/FIN A,1	FS 8-6	134/FIN A
FS 2-3		134/FIN A,1	FS 8-7	134/FIN A
FS 2-4		134/FIN A	FS 8-8	134/FIN A
FS 3-1		134/FIN A	FS 8-9	134/FIN A
FS 3-2		134/FIN A	FS 8-10	134/FIN A
FS 3-3		134/FIN A	FS 8-11	134/FIN A
FS 3-4		134/FIN A	FS 8-12	134/FIN A
FS 3-5		134/FIN A	FS 8-13	134/FIN A
FS 3-6		134/FIN A	FS 8-14	134/FIN A

* – Omit from flight book

FS 8-15	134/FIN A	FS CC 12-3..... *	134/FIN A,1
FS 8-16	134/FIN A	FS CC 12-4..... *	134/FIN A,1
FS 8-17	134/FIN A	FS CC 12-5..... *	134/FIN A
FS 8-18	134/FIN A	FS CC 12-6..... *	134/FIN A
FS 8-19	134/FIN A	FS CC 12-7..... *	134/FIN A
FS 8-20	134/FIN A	FS CC 12-8..... *	134/FIN A
FS 8-21	134/FIN A	FS CC 12-9..... *	134/FIN A
FS 8-22	134/FIN A	FS CC 12-10.... *	134/FIN A
FS 8-23	134/FIN A	FS CC 12-11.... *	134/FIN A,1
FS 8-24	134/FIN A	FS CC 12-12.... *	134/FIN A,1
FS 9-1	134/FIN A	FS CC 12-13.... *	134/FIN A,1
FS 9-2	134/FIN A	FS CC 12-14.... *	134/FIN A,1
FS 9-3	134/FIN A	FS CC 12-15.... *	134/FIN A,1
FS 9-4	134/FIN A,1	FS 12-16..... *	134/FIN A
FS 9-5	134/FIN A		
FS 9-6	134/FIN A		
FS 9-7	134/FIN A,1		
FS 9-8	134/FIN A		
FS 9-9	134/FIN A		
FS 9-10	134/FIN A		
FS 9-11	134/FIN A		
FS 9-12	134/FIN A		
FS 9-13	134/FIN A		
FS 9-14	134/FIN A,1		
FS 9-15	134/FIN A,1		
FS 9-16	134/FIN A,1		
FS 9-17	134/FIN A,1		
FS 9-18	134/FIN A		
FS 10-1	134/FIN A		
FS 10-2	134/FIN A		
FS 10-3	134/FIN A		
FS 10-4	134/FIN A		
FS 11-1	134/FIN A		
FS 11-2	134/FIN A		
FS 11-3	134/FIN A		
FS 11-4	134/FIN A		
FS 12-1	* 134/FIN A		
FS 12-2	* 134/FIN A		

* – Omit from flight book

ORBIT OPS CUE CARDS

<u>Title</u>	<u>Ref. Page</u>	<u>Card No.</u>
LIOH CHANGEOUT (Front) ..	FS CC 12-3	ORB OPS-29a/ nonRCRS/134/O/B
LIOH CANISTER STOWAGE LOCATIONS (Back)	FS CC 12-4	ORB OPS-29b/ nonRCRS/134/O/B
ORBIT BURN MONITOR (Front).....	FS CC 12-5	ORB OPS-31a/134/O/A
OMS FAILURES (Back).....	FS CC 12-6	ORB OPS-31b/134/O/A
STS-134 DAP CONFIGURATIONS (Front/Top).....	FS CC 12-7	ORB OPS-41a/134/O/A
(Front/Bottom)	FS CC 12-8	ORB OPS-41aa/134/O/A
(Back/Top).....	FS CC 12-9	ORB OPS-41b/134/O/B
(Back/Bottom).....	FS CC 12-10	ORB OPS-41bb/134/O/B
MAUI PRCS AND VRCS – RCS FIRING SEQUENCE (Front).....	FS CC 12-11	ORB OPS-42a/134/O/C
MAUI PRCS ONLY FIRING SEQUENCE (Back of MAUI PRCS AND VRCS – RCS FIRING SEQUENCE).....	FS CC 12-12	ORB OPS-42aa/134/O/B
MAUI VRCS ONLY FIRING SEQUENCE (Front).....	FS CC 12-13	ORB OPS-42b/134/O/C
(Back).....	FS CC 12-14	ORB OPS-42bb/134/O/B
WLES CONFIG AFTER PGSC REBOOT (Front).....	FS CC 12-15	ORB OPS-47a/134/O/A



This Page Intentionally Blank



<u>CONTENTS</u>	<u>PAGE</u>
<u>COMM/INST</u>	FS 1-1
LOAD PCMMU FORMAT.....	FS 1-2
PDI DECOM FORMAT.....	FS 1-4
OIU FORMAT/CONFIG.....	FS 1-7
DOWNLINK OCA DATA VIA WIDE BAND ANALOG FM.....	FS 1-9
<u>PTG</u>	FS 2-1
STAR PAIRS PAD.....	FS 2-2
PAIRS.....	FS 2-3
<u>DAP TABLES</u>	FS 3-1
DAP OVERVIEW.....	FS 3-2
UNIV PTG.....	FS 3-3
STS-134 DAP A CONFIGURATIONS.....	FS 3-4
B CONFIGURATIONS.....	FS 3-6
<u>REBOOST/DAP</u>	FS 4-1
AUTO REBOOST.....	FS 4-2
ATTITUDE REFERENCE.....	FS 4-4
DOCKED DAP REFERENCE.....	FS 4-5
RATE DAMPING.....	FS 4-5
<u>OIU PROCEDURES</u>	FS 5-1
OIU ACTIVATION.....	FS 5-2
DEACTIVATION.....	FS 5-2
<u>PRLA</u>	FS 6-1
PRLA CLOSE.....	FS 6-2
<u>SHORT DURATION BIOASTRONAUTICS</u>	
<u>INVESTIGATION (SDBI)</u>	FS 7-1
SDBI 1634, SLEEP-WAKE ACTIGRAPHY.....	FS 7-2

Cont next page

<u>WING LEADING EDGE SENSORS (WLES)</u>	
<u>PROCEDURES</u>	FS 8-1
WLES ACTIVATION AND CHECKOUT	FS 8-2
DEACTIVATION AND TEARDOWN	FS 8-10
LAPTOP RECEIVER UNIT (LRU) R&R	FS 8-12
CABIN RELAY UNIT R&R	FS 8-14
CONFIGURE WLES DATA FILE BACKUP PATH	FS 8-16
PREP WLES LAPTOPS FOR TRANSFER	FS 8-17
WLES RNDZ TOOLS CHECKOUT PREP	FS 8-18
DOCK/UNDOCK RECOVERY	FS 8-18
DISABLE WLES FILE BACKUP	FS 8-19
ENABLE WLES FILE BACKUP	FS 8-19
LRU TROUBLESHOOTING	FS 8-20
<u>PAYLOADS OF OPPORTUNITY</u>	FS 9-1
MAUI PRCS AND VRCS PROCEDURE	FS 9-2
VRCS ONLY PROCEDURE	FS 9-6
PRCS ONLY PROCEDURE	FS 9-10
RAMBO-2 PROCEDURE	FS 9-14
<u>CWC OPS</u>	FS 10-1
WASTE TANK OFFLOAD TO CWC	FS 10-2
<u>PGSC FS</u>	FS 11-1
KFX DOWNLINK IN THE BLIND	FS 11-2
<u>CUE CARD CONFIGURATION</u>	FS 12-1

COMM/INST

LOAD PCMMU FORMAT.....	FS 1-2
PDI DECOM FORMAT	FS 1-4
OIU FORMAT/CONFIG.....	FS 1-7
DOWNLINK OCA DATA VIA WIDE BAND ANALOG FM..	FS 1-9

**COMM/
INST**

FS 1-1

ORB OPS/134/FIN A

COMM/
INST

LOAD PCMMU FORMAT

- C3 1. √OI PCMMU FORMAT – GPC
SM 62 PCMMU/PL COMM
- CRT 2. FORMAT:
SEL FXD – ITEM 1 EXEC (*)
SEL ID – ITEM 3 +X X X EXEC
3. √SM COMM BUF – RDY
LOAD – ITEM 4 EXEC
√LOAD, ITEM 4 – RUN,CPLT
- If LOAD – CPLT:
Repeat steps 2 and 3 for second ID
- * If LOAD – FAIL and ERR MSG – 'I/O ERR MMU 1(2)': *
 - * Go to 5.2a, 'I/O ERR MMU 1(2)' (MAL, *
* DPS) >> *
 - * If LOAD – FAIL and a first load attempt: *
 - * Repeat steps 2 and 3 for failed ID *
 - * If LOAD – FAIL and a subsequent load *
 - * attempt: *
 - * √MCC *
 - * OI PCMMU PWR – 2(1) *
 - * √ERR MSG – 'I/O ERR PCM' *
 - CRT * I/O RESET PCM – ITEM 5 EXEC (*) *
 - * Repeat steps 2 and 3 *
4. When final LOAD – CPLT:
SEL PGM – ITEM 2 EXEC (*)

DNLIST COMPATIBILITY	PHASE	FORMAT ID 64/128	CONFIG NO.
G1,G3,BFS	(ASCENT)	102/FXD	–
G3,BFS	(ENTRY)	102/164	–
G2,G8,S2	ORBIT/ORBIT BURN/FCS C/O	103/161	–
G2,S2,OPS 0	OPS 0	– /163	–
G2,S2,P9	MMU C/O	– /163	–
G9	Prelaunch PL C/O	103/180	758
G2, G8, S2	OIU C/O AND SSV RATE 4	103/179	757
G2, G8, S2	PRE AMS02 DEPLOY (AMS02/SSV) (PRIME)	103/199	780
G2, G8, S2	PRE AMS02 DEPLOY (AMS02/SSV) (B/U)	103/212	781
G2, G8, S2	STORM (SSV/TCS) (PRIME)	103/206	768
G2, G8, S2	STORM (SSV/TCS) (B/U)	103/185	761
G2,G8,S2	DOCKED ISS FMT CCSH (OIU/SSV) (PRIME)	103/184	760
G2,G8,S2	DOCKED ISS FMT CCSH (OIU/SSV) (B/U)	103/205	767
G2,G8,S2	RNDZ w/AMS02 FMT (PRIME)	103/188	762
G2,G8,S2	RNDZ w/AMS02 FMT (B/U)	103/208	769
G2,G8,S2	UNDOCK w/UHF FMT CCSU (SSOR/SSV/TCS) (PRIME)	103/192	763
G2,G8,S2	UNDOCK w/UHF FMT CCSU (SSOR/SSV/TCS) (B/U)	103/211	770

NOTE

LDR TFL may affect PCMMU BITE. If PCMMU or SM 2 GPC switched since last TFL, ID 64 and 128 will not reflect current state

LOAD PDI DECOM FORMAT

SM 62 PCMMU/PL COMM

1. PDI:

CRT √I/O RESET – ITEM 8 (*)
 SEL DECOM – ITEM 9 +X EXEC
 SEL FMT – ITEM 10 +X X X EXEC
 LOAD – ITEM 11 EXEC

If LOAD – CPLT:
 SEL INPUT – ITEM 12 +X EXEC
 LOAD – ITEM 13 EXEC
 Repeat step 1 for additional DECOMs/FPM

* If LOAD – FAIL and ERR MSG – 'I/O ERR *
* MMU 1(2)': *
* Go to 5.2a, 'I/O ERR MMU 1(2)' (MAL, *
* DPS) >> *
* *
* If LOAD – FAIL and a first load attempt: *
* Repeat step 1 *
* *
* If LOAD – FAIL and a subsequent load *
* attempt: *
* *
* NOTE *
* Power cycling PDI will cause PDI *
* to lose DFLs previously loaded *
* *
* √MCC *
A1L * S-BD PL CNTL – PNL *
* PL DATA INTLVR PWR – OFF,ON *
* √ERR MSG – 'S62 BCE BYP PL' *
* √'S62 BCE BYP PDI' *
* S-BD PL CNTL – CMD *
* *
* PCM: *
CRT * I/O RESET PCM – ITEM 5 EXEC (*) *
* PDI: *
* I/O RESET – ITEM 8 EXEC (*) *
* Repeat step 1 for all of config (XXX) *

CONFIG	DECOM	FMT	INPUT	USE
780 PRE AMS02 DEPLOY (PRIME) TFL 199	1 2 3 4 5-FPM	2 4 - - 504	1,2 4 - - -	OIU4 (AMS02) ** SSV (3) *** - - - H-H-H *
781 PRE AMS02 DEPLOY (BACKUP) TFL 212	1 2 3 4 5-FPM	- 3 14 - 510	- 1,2 4 - -	- OIU4 (AMS02) ** SSV (3) *** - - H-H-H *
760 DOCKED FMT CCSH (PRIME) TFL 184	1 2 3 4 5-FPM	7 - - 27 503	1,2 - - 4 -	OIU9 (CCSH) ** - - SSV (2) *** - H-H-H *
767 DOCKED FMT CCSH (BACKUP) TFL 205	1 2 3 4 5-FPM	- 17 29 - 509	- 1,2 4 - -	- OIU9 (CCSH) ** SSV (2) *** - - H-H-H *
763 UNDOCK w/UHF FMT CCSU (PRIME) TFL 192	1 2 3 4 5-FPM	30 4 9 - 506	1,2 4 5 - -	OIU7 (CCSU) ** SSV (3) *** TCS - - H-H-H *
770 UNDOCK w/UHF FMT CCSU (BACKUP) TFL 211	1 2 3 4 5-FPM	- 31 14 19 512	- 1,2 4 5 -	- OIU7 (CCSU) ** SSV (3) *** TCS - H-H-H *

* OI-GNC-SM, Orbiter Downlist Data Rates (High or Low)
** # in OIU# represents the OIU format; (XXX) represents data type
*** # in SSV (#) represents the SSV Out Rate sw selection

Cont next page

FS 1-5

ORB OPS/134/FIN A

CONFIG	DECOM	FMT	INPUT	USE
762 RNDZ w/AMS02 FMT (PRIME) TFL 188	1 2 3 4 5-FPM	2 - 9 27 505	1,2 - 5 4	OIU4 (AMS02) ** - TCS SSV (2) *** H-H-H *
769 RNDZ w/AMS02 FMT (BACKUP) TFL 208	1 2 3 4 5-FPM	- 3 29 19 511	- 1,2 4 5	- OIU4 (AMS02) ** SSV (2) *** TCS H-H-H *
768 STORRM (PRIME) TFL 206	1 2 3 4 5-FPM	- 11 - 19 508	- 4 - 5	- SSV (5) *** - TCS L-H-H *
761 STORRM (BACKUP) TFL 185	1 2 3 4 5-FPM	1 - 9 - 502	4 - 5 -	SSV (4) *** - TCS - L-H-H *
757 SSV RATE 4 (PRIME) TFL 179	1 2 3 4 5-FPM	1 5 15 - 501	4 1,2 1,2 -	SSV (4) *** OIU255 ** OIU255 ** - L-H-H *
758 Pre-Launch PL C/O (PRIME) TFL 180	1 2 3 4 5-FPM	28 5 9 - 507	1,2 1,2 5 -	OIU253 ** OIU255 ** TCS - H-H-H *

* OI-GNC-SM, Orbiter Downlist Data Rates (High or Low)
** # in OIU# represents the OIU format; (XXX) represents data type
*** # in SSV (#) represents the SSV Out Rate sw selection

LOAD OIU FORMAT/CONFIG

Determine which step is needed and complete all actions to obtain desired OIU configuration

NOTE

A corresponding TFL/DFL CONFIG is reqd for MCC to receive telemetry. Reference S62 PCMMU/PL COMM for the last loaded HDR TFL and perform LOAD PCMMU FORMAT/LOAD PDI DECOM FORMAT for the associated CONFIG

S212 OIU

1. GNC-1 PRIMARY ON LB-ORB N2-1 (OIU BUS 3)

LOAD FORMAT	ITEM 1 + <u>9</u> EXEC
GNC TO GNC 1	ITEM 18 + <u>1</u> <u>4</u> EXEC
GNC 1 TO BUS 3	ITEM 18 + <u>1</u> <u>6</u> EXEC
BUS 4 BC	ITEM 15 EXEC (*)
BUS 3 RT	ITEM 10 EXEC (*)
LOAD FORMAT	ITEM 1 + <u>9</u> EXEC >>

2. GNC-1 PRIMARY ON LB-ORB N2-2 (OIU BUS 4)

LOAD FORMAT	ITEM 1 + <u>9</u> EXEC
GNC TO GNC 1	ITEM 18 + <u>1</u> <u>4</u> EXEC
GNC 1 TO BUS 4	ITEM 18 + <u>1</u> <u>5</u> EXEC
BUS 3 BC	ITEM 11 EXEC (*)
BUS 4 RT	ITEM 14 EXEC (*)
LOAD FORMAT	ITEM 1 + <u>9</u> EXEC >>

3. GNC-2 PRIMARY ON LB-ORB N2-1 (OIU BUS 3)

LOAD FORMAT	ITEM 1 + <u>9</u> EXEC
GNC TO GNC 2	ITEM 18 + <u>1</u> <u>3</u> EXEC
GNC 2 TO BUS 3	ITEM 18 + <u>1</u> <u>8</u> EXEC
BUS 4 BC	ITEM 15 EXEC (*)
BUS 3 RT	ITEM 10 EXEC (*)
LOAD FORMAT	ITEM 1 + <u>9</u> EXEC >>

4. GNC-2 PRIMARY ON LB-ORB N2-2 (OIU BUS 4)

LOAD FORMAT	ITEM 1 + <u>9</u> EXEC
GNC TO GNC 2	ITEM 18 + <u>1</u> <u>3</u> EXEC
GNC 2 TO BUS 4	ITEM 18 + <u>1</u> <u>7</u> EXEC
BUS 3 BC	ITEM 11 EXEC (*)
BUS 4 RT	ITEM 14 EXEC (*)
LOAD FORMAT	ITEM 1 + <u>9</u> EXEC >>

Cont next page

5. AMS02 (OIU BUS 2)

LOAD FORMAT	ITEM 1 + <u>4</u> EXEC
BUS 2 BC	ITEM 7 EXEC (*)
LOAD FORMAT	ITEM 1 + <u>4</u> EXEC >>

6. SSOR (OIU BUS 1)

LOAD FORMAT	ITEM 1 + <u>7</u> EXEC
BUS 1 BC	ITEM 3 EXEC (*)
LOAD FORMAT	ITEM 1 + <u>7</u> EXEC >>

DOWNLINK OCA DATA VIA WIDE BAND ANALOG FM

(35 min)

OBJECTIVE: Downlink OCA data via S-band system

LOCATION: Payload Station on aft Flight Deck (L10:A1), PDIP1 (L12)

TOOLS REQD:

TOOL Gray Tape
 Kapton Tape
 Pin Kit (Test Jumper Leads)
MISC Sharpie

1. Obtain two, 5-in 22-ga Pin/Socket Test Jumper Leads from the Pin Kit
- L10:A1 2. Open locker door, locate "Bottom of Locker Cable" (see diagram below)
3. Demate Dnlk Y Cable (SED39127625-301) from Bottom of Locker Cable P2 (see diagram below)

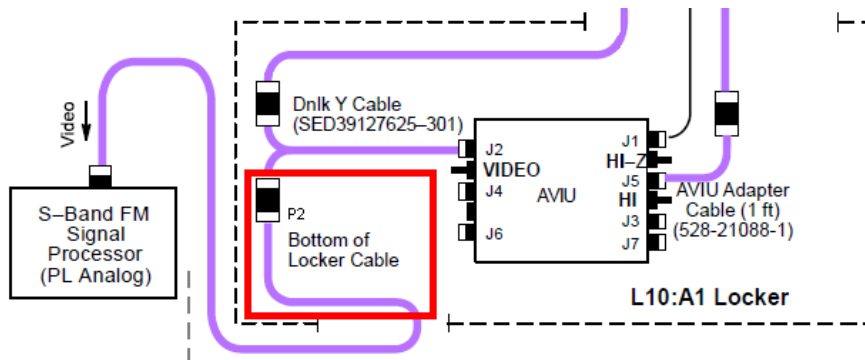

- Middeck 4. Power down the OCA Router
- L12 5. Locate OCA INTF Cable (SED16103948-301) plug P2 mated to J4 on PDIP1
6. Demate OCA INTF Cable plug P2 from J4
Re-route OCA INTF Cable plug P2 near L10A1 to allow jumper installation in following steps (remove pre-route ties as necessary)

Cont next page

FS 1-9

ORB OPS/134/FIN A

- L10:A1
7. Obtain Test Jumper Leads, mark both ends of one Lead using Sharpie
 8. Twist Test Jumper Leads together to form a twisted pair (see diagram below)
 9. Per the drawing below, install Test Jumper Lead twisted pair between the Bottom of Locker Cable plug P2 and the OCA INTF Cable plug P2 (ensure Sharpie marked Test Jumper Lead is connected between socket 1 and pin 15)

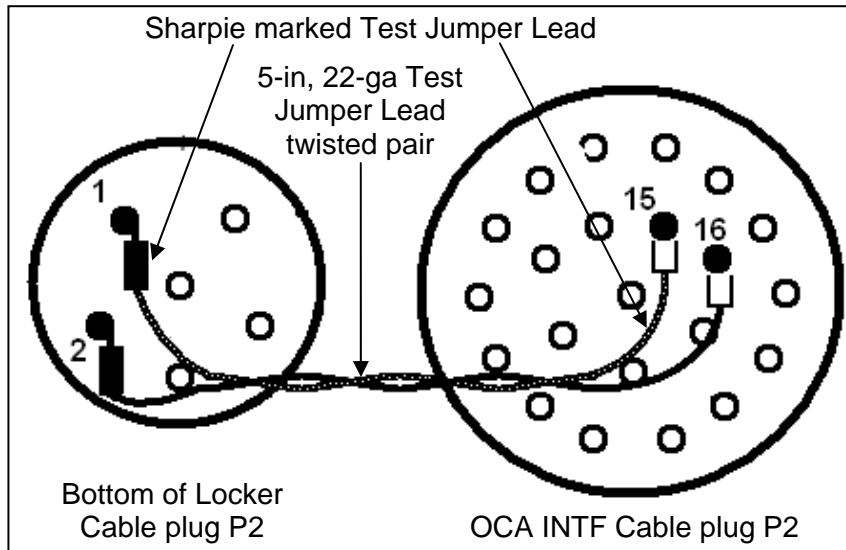

10. Using Kapton Tape, secure Test Jumper Lead/plug connections, cover unused pins/sockets on plugs
 11. Ensure connector shells are in contact for chassis ground
 12. Using Gray Tape, secure cables, plugs, jumpers
Secure locker door as required (use caution not to pinch wiring)
- Middeck
13. Power on the OCA Router
 14. Stow tools

Cont next page

- When OCA downlink no longer required:
- Middeck 15. Power down the OCA Router
 - L10:A1 16. Remove Gray Tape, Kapton Tape as required
 - 17. Remove Test Jumper Leads from Bottom of Locker Cable and OCA INTF Cable plugs
 - 18. Mate Dnlk Y Cable (SED39127625-301) to Bottom of Locker Cable plug P2
 - L12 19. Re-route OCA INTF Cable plug P2 to PDIP1
 - 20. Mate OCA INTF Cable plug P2 to J4 on PDIP1
 - 21. Stow tools

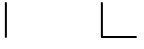
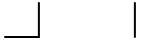

This Page Intentionally Blank

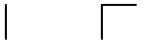

PTG

STAR PAIRS PAD FS 2-2
PAIRS..... FS 2-3

PTG

FS 2-1

ORB OPS/134/FIN A

PTG

STAR PAIRS PAD											
STAR PAIR	SEP ANGLE	ATTITUDE SET 1					ATTITUDE SET 2				
		DUAL S TRK			SINGLE S TRK		DUAL S TRK			SINGLE S TRK	
					-Z	-Y				-Z	-Y
A	85.8	-Y:29 R+ 287 -Z:53 P+ 335 Y+ 293	R+ 207 P+ 342 Y+ 307	-Y:53 R+ 49 P+ 14 Y+ 292	-Y:53 R+ 332 -Z:29 P+ 169 Y+ 51	-Z:53 R+ 260 P+ 153 Y+ 63	-Y:29 R+ 39 P+ 192 Y+ 55				
B	93.6	-Y:60 R+ 332 -Z:51 P+ 26 Y+ 38	R+ 250 P+ 15 Y+ 51	-Y:51 R+ 50 P+ 44 Y+ 43	-Y:51 R+ 293 -Z:60 P+ 197 Y+ 306	-Z:51 R+ 206 P+ 201 Y+ 321	-Y:60 R+ 44 P+ 223 Y+ 305				
C	88.6	-Y:89 R+ 196 -Z:26 P+ 119 Y+ 358	R+ 109 P+ 133 Y+ 354	-Y:26 R+ 282 P+ 114 Y+ 345	-Y:26 R+ 74 -Z:89 P+ 315 Y+ 10	-Z:26 R+ 348 P+ 303 Y+ 0	-Y:89 R+ 164 P+ 305 Y+ 22				
D	91.7	-Y:18 R+ 140 -Z:57 P+ 166 Y+ 38	R+ 49 P+ 171 Y+ 24	-Y:57 R+ 239 P+ 149 Y+ 33	-Y:57 R+ 132 -Z:18 P+ 348 Y+ 339	-Z:57 R+ 45 P+ 350 Y+ 324	-Y:18 R+ 215 P+ 331 Y+ 338				
E	87.8	-Y:40 R+ 143 -Z:25 P+ 255 Y+ 321	R+ 62 P+ 263 Y+ 308	-Y:25 R+ 217 P+ 236 Y+ 319	-Y:25 R+ 125 -Z:40 P+ 79 Y+ 56	-Z:25 R+ 38 P+ 80 Y+ 41	-Y:40 R+ 233 P+ 54 Y+ 54				

STAR PAIRS PAD

FS 2-2

ORB OPS/134/FIN A,1

PAIR		COAS ALIGN ATTITUDE 1	ANG SEP	COAS ALIGN ATTITUDE 2
COAS	+X HUD	29 R+ 296 P+ 233 Y+ 338	NOSE UP 83.8	22 R+ 34 P+ 351 Y+ 299
	-Z COAS	29 R+ 214 P+ 352 Y+ 301	TAIL UP	22 R+ 244 P+ 50 Y+ 11

SINGLE S TRK MIN MNVR OPT
TGT ID = 11-110 NAV STAR #

	-Z S TRK	-Y S TRK
BV	5	4
P	87.7	✓ 0
Y	358	✓ 280.57

MET Applicable Post OMS-2 to EOM
Liftoff Date: 04/19/11
Liftoff GMT: 109/23:48:53.000

STAR PAIRS

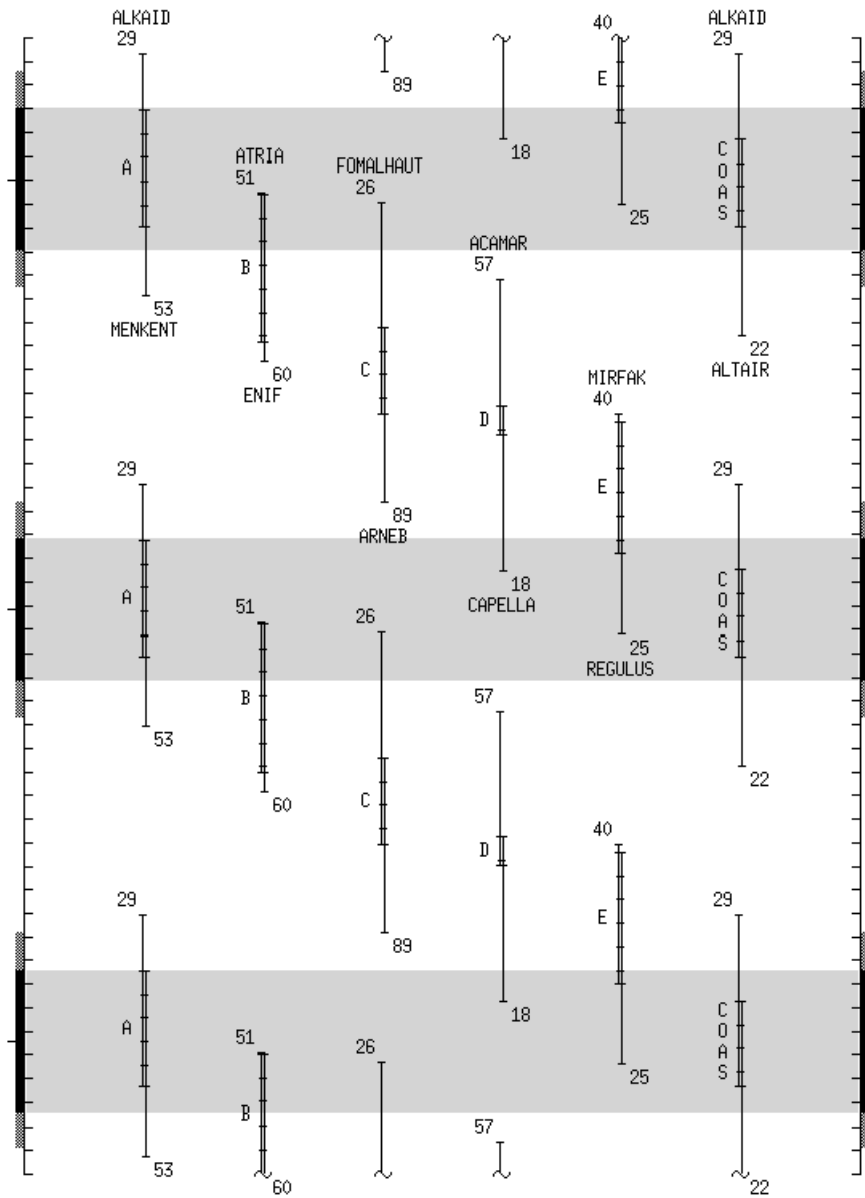

MET Applicable: Post OMS-2 to EOM
 Liftoff Date: 04/19/11
 Liftoff GMT: 109/23:48:53.000

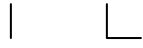

This Page Intentionally Blank



DAP TABLES

DAP OVERVIEW	FS 3-2
UNIV PTG	FS 3-3
STS-134 DAP A CONFIGURATIONS.....	FS 3-4
B CONFIGURATIONS.....	FS 3-6

**DAP
TABLES**

DAP TABLES

DAP OVERVIEW

DAP	Purpose	DAP	Purpose
A1	Nominal	B1	OMS & RCS Burns (ORB OPS)
A2	PTC	B2	Loss of VERN (Tail Only)
A3	GG	B3	Loss of VERN (All)
A4		B4	
A5	Loss of VERN (All)	B5	COAS/HUD CAL
A6	Loss of VERN (Tail Only)	B6	
A7	Rendezvous	B7	Rendezvous
A8	Terminal Phase	B8	Terminal Phase
A9	PROX OPS/Flyaround	B9	Flyaround
A10	Docking	B10	Docking
A11	Auto Reboost	B11	
A12	Mated Stack (Mnvr, Robotics & Att Hold)	B12	Mated Stack (Undocking and Att Hold)
A13		B13	Mated Stack (VRCS Deadband Collapse)
A14	Orbiter alone SRMS/OBSS Ops	B14	
A15		B15	

CNTL ACC	Purpose
0	Orbiter alone with unloaded RMS
1	Orbiter alone SRMS/OBSS Ops
2	Mated - Light Russian Segment, docking through AMS grappled by SSRMS
3	Mated - Light Russian Segment, AMS on SSRMS in Intermediate position through undock
4	Mated - Medium Russian Segment, docking through AMS grappled by SSRMS
5	Mated - Medium Russian Segment, AMS on SSRMS in Intermediate position through undock
6	Mated - Heavy Russian Segment, docking through AMS grappled by SSRMS
7	Mated - Heavy Russian Segment, AMS on SSRMS in Intermediate position through undock
8	Mated - ATV2 Docked to SM Aft, docking through AMS grappled by SSRMS
9	Mated - ATV2 Docked to SM Aft, AMS on SSRMS in Intermediate position through undock

DAPs for mated operations are based on analysis from GNC, PDRS, C. S. Draper Labs, and ISS Structures

FS 3-2

ORB OPS/134/FIN A

UNIV PTG

TGT ID = 1 Orbiting Vehicle = 2 Earth Center = 3 Earth Target Input LAT (± 90) LON (± 180 , + = East) ALT (-3444.0 to 20000.0 nm) = 4 Sun Center = 5 Celestial Target Input RA (0-359.99) DEC (± 90) = 11-110 Nav Stars
BODY VECTOR = 1 +X* = 2 -X* = 3 -Z* = 4 -Y Star Tracker* = 5 Selectable Input P (0-359.99) Y (270-359.99, 0-90) *Input OM \rightarrow OM (0-359.99)
MON AXIS = 1 +X = 2 -X

FS 3-3

ORB OPS/134/FIN A

STS-134 DAP A CONFIGURATIONS

STS-134 DAP A1 – DAP A8 CONFIGURATIONS

	ITEM #	A1	A2	A3	A4	A5	A6	A7	A8
PRI									
ROT RATE	10 (50)	0.2000	0.4000	0.2000	0.5000	0.2000	0.2000	0.2000	0.0500
ATT DB	11 (51)	5.00	1.00	0.30	3.00	5.00	5.00	2.00	2.00
RATE DB	12 (52)	0.20	0.20	0.20	0.20	0.20	0.20	0.20	0.20
ROT PLS	13 (53)	0.100	0.100	0.100	0.100	0.100	0.100	0.100	0.100
COMP	14 (54)	.000	.000	.000	.000	.000	.000	.000	.000
P OPTION	15 (55)	ALL	ALL	ALL	ALL	ALL	TAIL	ALL	ALL
Y OPTION	16 (56)	ALL	ALL	TAIL	ALL	ALL	TAIL	ALL	ALL
TRAN PLS	17 (57)	0.100	0.100	0.100	0.100	0.100	0.100	0.100	0.100
ALT									
RATE DB	18 (58)	0.200	0.200	0.070	0.200	0.070	0.070	0.100	0.100
JET OPT	19 (59)	ALL	ALL	ALL	ALL	ALL	TAIL	ALL	ALL
# JETS	20 (60)	2	2	1	2	1	1	2	2
ON TIME	21 (61)	0.08	0.08	0.08	0.08	0.08	0.08	0.08	0.08
DELAY	22 (62)	0.00	0.00	0.00	0.00	0.00	0.00	0.00	0.00
VERN									
ROT RATE	23 (63)	0.2000	0.4000	0.0080	0.2000	0.0500	0.0500	0.0160	0.0500
ATT DB	24 (64)	1.000	1.000	0.070	1.000	1.000	1.000	1.000	1.000
RATE DB	25 (65)	.020	.020	.010	.020	.020	.020	.020	.020
ROT PLS	26 (66)	0.010	0.010	0.010	0.010	0.010	0.010	0.010	0.050
COMP	27 (67)	.000	.000	.000	.000	.000	.000	.000	.000
CNTL ACC	28 (68)	0	0	0	0	0	0	0	0
PURPOSE		NOMINAL	PTC	GG		LOSS OF VERN (ALL)	LOSS OF VERN (TAIL ONLY)	RNDZ	TERMINAL PHASE

BOLD/ITALIC indicates change from I-Load.

FS 3-4

ORB OPS/134/FIN A

STS-134 DAP A9 – DAP A14 CONFIGURATIONS

	ITEM #	A9	A10	A11	A12	A13	A14
PRI							
ROT RATE	10 (50)	0.1300	0.0500	0.0500	0.0500	0.0500	0.2000
ATT DB	11 (51)	2.00	0.60	10.00	5.00	5.00	5.00
RATE DB	12 (52)	0.10	0.10	0.20	0.20	0.20	0.20
ROT PLS	13 (53)	0.100	0.100	0.100	0.040	0.040	0.100
COMP	14 (54)	.000	.000	.000	.000	.000	.000
P OPTION	15 (55)	TAIL	TAIL	TAIL	TAIL	TAIL	TAIL
Y OPTION	16 (56)	TAIL	TAIL	TAIL	TAIL	TAIL	TAIL
TRAN PLS	17 (57)	0.050	0.050	0.100	0.010	0.010	0.100
ALT							
RATE DB	18 (58)	0.100	0.100	0.020 ¹	0.020 ¹	0.020 ¹	0.200
JET OPT	19 (59)	TAIL	TAIL	TAIL	TAIL	TAIL	TAIL
# JETS	20 (60)	2	2	1	1	1	1(2) ³
ON TIME	21 (61)	0.08	0.08	0.08	0.08	0.08	0.08
DELAY	22 (62)	0.00	0.00	5.00	5.00	5.00	6.00
VERN							
ROT RATE	23 (63)	0.1300	0.0500	0.1000	0.1000	0.1000	0.2000
ATT DB	24 (64)	1.000	0.500	5.000	3.000	3.000	3.000
RATE DB	25 (65)	.020	.020	.050	.020	.020	.200
ROT PLS	26 (66)	0.050	0.050	0.010	0.002	0.002	0.010
COMP	27 (67)	.000	.000	.000	.000	.000	.000
CNTL ACC	28 (68)	0	0	8(9) ²	8(9) ²	2 ²	1
PURPOSE		PROX/OPS FLYAROUND	DOCKING	AUTO REBOOST	MATED STACK (MNVRS, ROBO, ATT HOLD)		ORBITER ALONE SRMS/OBSS

BOLD/ITALIC indicates change from I-Load.

¹ I-loaded below keyboard limit; do not change

² CA8 – ATV2 Docked to SM Aft, docking through AMS grappled by SSRMS

CA9 – ATV2 Docked to SM Aft, AMS on SSRMS in Intermediate position through undock

³ Use 1 for OBSS scan and 2 for Orbiter attitude maneuvers

FS 3-5

ORB OPS/134/FIN A

STS-134 DAP B CONFIGURATIONS

STS-134 DAP B1 – DAP B8 CONFIGURATIONS

	ITEM #	B1	B2	B3	B4	B5	B6	B7	B8
PRI									
ROT RATE	30 (50)	0.5000	0.2000	0.2000	0.2000	0.2000	0.5000	0.5000	0.0500
ATT DB	31 (51)	3.00	3.00	3.00	0.30	3.00	3.00	2.00	2.00
RATE DB	32 (52)	0.20	0.20	0.20	0.20	0.20	0.20	0.20	0.20
ROT PLS	33 (53)	0.040	0.040	0.040	0.040	0.040	0.040	0.040	0.040
COMP	34 (54)	.000	.000	.000	.000	.000	.000	.000	.000
P OPTION	35 (55)	ALL	TAIL	ALL	TAIL	TAIL	ALL	ALL	ALL
Y OPTION	36 (56)	ALL	TAIL	ALL	TAIL	TAIL	ALL	ALL	ALL
TRAN PLS	37 (57)	0.100	0.020	0.020	0.020	0.020	0.020	0.050	0.050
ALT									
RATE DB	38 (58)	0.200	0.070	0.070	0.100	0.200	0.200	0.100	0.100
JET OPT	39 (59)	ALL	TAIL	ALL	ALL	ALL	ALL	ALL	ALL
# JETS	40 (60)	2	1	1	2	2	2	2	2
ON TIME	41 (61)	0.08	0.08	0.08	0.08	0.08	0.08	0.08	0.08
DELAY	42 (62)	0.00	0.00	0.00	0.00	0.00	0.00	0.00	0.00
VERN									
ROT RATE	43 (63)	0.2000	0.2000	0.2000	0.0080	0.0160	0.2000	0.2000	0.0500
ATT DB	44 (64)	1.000	1.000	1.000	0.100	0.033	1.000	1.000	1.000
RATE DB	45 (65)	.020	.020	.020	.010	.020	.020	.020	.020
ROT PLS	46 (66)	0.002	0.002	0.002	0.002	0.002	0.002	0.002	0.020
COMP	47 (67)	.000	.000	.000	.000	.000	.000	.000	.000
CNTL ACC	48 (68)	0	0	0	0	0	0	0	0
PURPOSE		OMS & RCS BURNS (ORB OPS)	LOSS OF VERN (TAIL ONLY)	LOSS OF VERN (ALL)		COAS/HUD CAL		RNDZ	TERMINAL PHASE

BOLD/ITALIC indicates change from I-Load.

FS 3-6

ORB OPS/134/FIN A

STS-134 DAP B9 – DAP B13 CONFIGURATIONS

	ITEM #	B9	B10	B12	B13
PRI					
ROT RATE	30 (50)	0.1300	0.0500	0.0100 ¹	0.0100 ¹
ATT DB	31 (51)	2.00	0.60	1.00	1.00
RATE DB	32 (52)	0.10	0.10	0.20	0.20
ROT PLS	33 (53)	0.040	0.040	0.040	0.040
COMP	34 (54)	.000	.000	.000	.000
P OPTION	35 (55)	TAIL	TAIL	TAIL	TAIL
Y OPTION	36 (56)	TAIL	TAIL	TAIL	TAIL
TRAN PLS	37 (57)	0.010	0.010	0.010	0.010
ALT					
RATE DB	38 (58)	0.100	0.100	0.020 ¹	0.020 ¹
JET OPT	39 (59)	TAIL	TAIL	TAIL	TAIL
# JETS	40 (60)	2	2	1	1
ON TIME	41 (61)	0.08	0.08	0.08	0.08
DELAY	42 (62)	10.00	0.00	5.00	5.00
VERN					
ROT RATE	43 (63)	0.1300	0.0500	0.0100	0.0100
ATT DB	44 (64)	1.000	0.500	1.000	0.100
RATE DB	45 (65)	.020	.020	.020	.020
ROT PLS	46 (66)	0.020	0.020	0.002	0.002
COMP	47 (67)	.000	.000	.000	.000
CNTL ACC	48 (68)	0	0	8(9) ²	8(9) ²
PURPOSE		PROXOPS/ FLYAROUND	DOCKING	MATED ATT HOLD (VRCS & ALT)	MATED VRCS DB COLLAPSE

BOLD/ITALIC indicates change from I-Load.

¹ I-loaded below keyboard limit; do not change

² CA8 – ATV2 Docked to SM Aft, docking through AMS grappled by SSRMS

CA9 – ATV2 Docked to SM Aft, AMS on SSRMS in Intermediate position through undock

FS 3-7

ORB OPS/134/FIN A

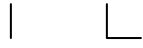

This Page Intentionally Blank



REBOOST/DAP

AUTO REBOOST.....	FS 4-2
ATTITUDE REFERENCE.....	FS 4-4
DOCKED DAP REFERENCE	FS 4-5
RATE DAMPING.....	FS 4-5

**REBOOST/
DAP**

AUTO REBOOST

NOTE

Allow 5 min between establishing reboost attitude and reboost start time for DAP accelerations to converge

- O14:F,
O15:F,
O16:F
1. If PRCS required:
RJDA 1A L2/R2 DRIVER – OFF
RJD MANF L5/F5/R5 DRIVER – OFF
Pri RJD LOGIC (eight) – ON

√MCC for GO to power up Pri Drivers
RJD MANF L5/F5/R5 DRIVER – ON
Pri RJD DRIVER (eight) – ON

2. Select Reboost Configuration

GNC 20 DAP CONFIG
REBOOST CFG – ITEM 8 +_ EXEC
INTVL – ITEM 9 +_ EXEC

3. Set up Future Reboost

GNC UNIV PTG
DURATION – ITEM 27 +_ +_ +_ EXEC
START TIME – ITEM 1 +_ . . . +_ . . . +_ . . . EXEC
RBST – ITEM 25 EXEC (FUT-*)

4. Select appropriate Reboost Rotation DAP
When in attitude and prior to START TIME,
DAP: A11/AUTO/VERN(ALT)

C3

If using Config 1 or 4:

GNC 20 DAP CONFIG
Disable X JETS ROT – ITEM 7 EXEC (no *)

Cont next page

FS 4-2

ORB OPS/134/FIN A

REBOOST/
DAP

NOTE

Reboost can be aborted with an item 26 on UNIV PTG or by selecting FREE on the DAP

5. Post Reboost Configuration

If using Config 1 or 4:

GNC 20 DAP CONFIG

Enable X JETS ROT – ITEM 7 EXEC (*)

Return to FLIGHT PLAN Attitude

DAP: as reqd

Pri RJD LOGIC,DRIVER (sixteen) – as reqd

C3
O14,
O15,
O16

AUTO REBOOST ATTITUDE REFERENCE

ALT & VRCS ATTITUDE HOLD CONFIGURATIONS:

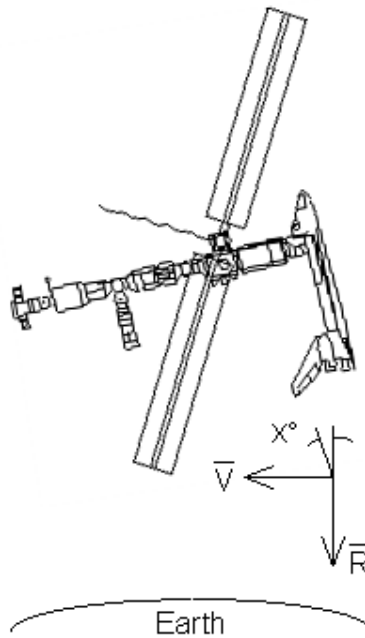

Configurations 1 and 4 use ALT PRCS (Pitch, $X=4^\circ$)
Configuration 2 is for Shuttle only - Do Not Use While Docked
Configuration 3 uses VRCS (Pitch, $X=4^\circ$)

DOCKED DAP REFERENCE

NOTE

Shuttle mated attitude control is not certified when the Shuttle Airlock is depressurized (<3.45 psia)

Mated Attitude Hold and Maneuvers (VERN or ALT)	Mated Attitude Hold (VERN or ALT)
A12	B12

ALT not certified for loaded RMS operations

CNTL ACC selection depends on the weight of the Russian Segment due to visiting vehicle configurations and status of AMS installation as described below:

Refer to notes [1], [2]	SM AFT PORT Empty	SM AFT PORT PROG/SOYUZ	SM AFT PORT ATV2
DC1 and/or MRM2 Empty	LIGHT (CNTL ACC 2/3)	MEDIUM (CNTL ACC 4/5)	ATV (CNTL ACC 8/9)
DC1 and MRM2 Occupied	LIGHT (CNTL ACC 2/3)	HEAVY (CNTL ACC 6/7)	ATV (CNTL ACC 8/9)

[1] CNTL ACC 2, 4, 6 or 8 - docking through AMS grappled by SSRMS

[2] CNTL ACC 3, 5, 7 or 9 - AMS on SSRMS in Intermediate position through undock

RATE DAMPING

DAP: LVLH(INRTL) - Dependent on desired attitude hold
Monitor Jet Activity Light:

For continuous Jet Activity > 6 min:

DAP: FREE then restart this procedure

If Jet Activity Stopped for > 5 sec for VERN (15 sec for ALT)

DAP: FREE > 2 sec

DAP: AUTO >>



This Page Intentionally Blank



OIU PROCEDURES

OIU ACTIVATION	FS 5-2
DEACTIVATION	FS 5-2

OIU

PRLA

PRLA CLOSE..... FS 6-2

PRLA

FS 6-1

ORB OPS/134/FIN A

NOTE: Single motor times (> 30 sec)

- A6U 6. PL RETEN LAT 1,2 (two) – LAT (tb-LAT, 60 sec max)
– OFF
3,4 (two) – LAT (tb-LAT, 60 sec max)
– OFF
- R13L 7. PL RETEN LOGIC PWR SYS 1,2 (two) – OFF
BAY MECH PWR SYS 1,2 (two) – OFF
- A6U 8. PL RETEN PL SEL – MON
- MA73C:A 9. If MCA LOGIC switches taken OFF in step 1:
:B MCA LOGIC MNC MID 2 – ON
MNB MID 4 – ON

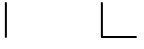
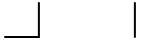

This Page Intentionally Blank

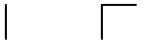

SHORT DURATION BIOASTRONAUTICS
INVESTIGATION (SDBI)

SDBI 1634, SLEEP-WAKE ACTIGRAPHY	FS 7-2
DON ACTIWATCH	FS 7-2
DOFF ACTIWATCH	FS 7-2

SDBI

FS 7-1

ORB OPS/134/FIN A

WING LEADING EDGE SENSORS (WLES) PROCEDURES

WLES ACTIVATION AND CHECKOUT.....	FS 8-2
DEACTIVATION AND TEARDOWN.....	FS 8-10
LAPTOP RECEIVER UNIT (LRU) R&R.....	FS 8-12
CABIN RELAY UNIT R&R	FS 8-14
CONFIGURE WLES DATA FILE BACKUP PATH.....	FS 8-16
PREP WLES LAPTOPS FOR TRANSFER.....	FS 8-17
WLES RNDZ TOOLS CHECKOUT PREP.....	FS 8-18
DOCK/UNDOCK RECOVERY	FS 8-18
DISABLE WLES FILE BACKUP	FS 8-19
ENABLE WLES FILE BACKUP	FS 8-19
LRU TROUBLESHOOTING	FS 8-20

**WLE
SENSORS**

WLES ACTIVATION AND CHECKOUT

1. UNSTOW EQUIPMENT

NOTE

A31p laptops may already be unstowed as part of orbiter laptop network setup

ML60E

Unstow:

Laptop Receiver Units (2)

Cabin Relay Units (2):

CRU A (S/N 1920)

CRU B (S/N 1984)

STS6 A31p laptop (WLES)

STS5 A31p laptop (RPOP2)

2. SETUP WLES RELAY UNITS

CAUTION

Cross-connecting CRU A to MICRO WIS SYSTEM B (and vice versa) will prevent WLES ops, though step 8 would still show good comm

NOTE

Green patch on Cabin Relay Unit is antenna and must face into cabin

A6	Unstow coiled WLE SYSTEM A cable
A13	Connect plug PNL A13 SYSTEM A to jack MICRO WIS SYSTEM A J7 (see fig 8-1)
CRU A	Connect plug CABIN RELAY UNIT to J1 on CRU S/N 1920
STBD OVHD	Secure CRU A to STBD side of aft cabin with Velcro (see fig 8-2)
A9	Unstow coiled WLE SYSTEM B cable
A13	Connect plug PNL A13 SYSTEM B to jack MICRO WIS SYSTEM B J8 (see fig 8-1)
CRU B	Connect plug CABIN RELAY UNIT to J1 on CRU S/N 1984
PORT OVHD	Secure CRU B to PORT side of aft cabin with Velcro (see fig 8-3)

Cont next page

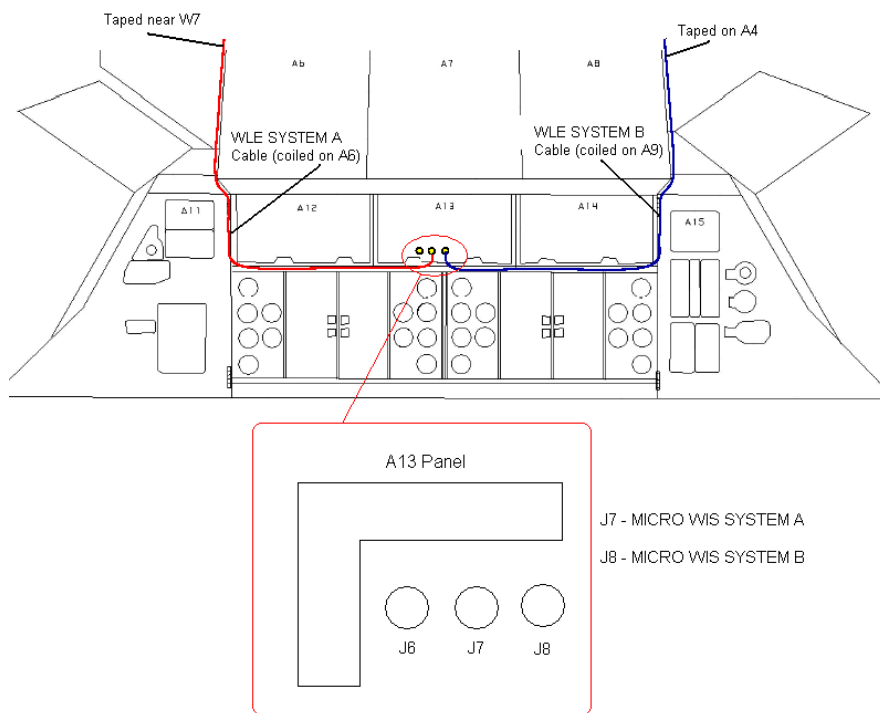

Figure 8-1.- A13 panel.

Cont next page

FS 8-3

ORB OPS/134/FIN A

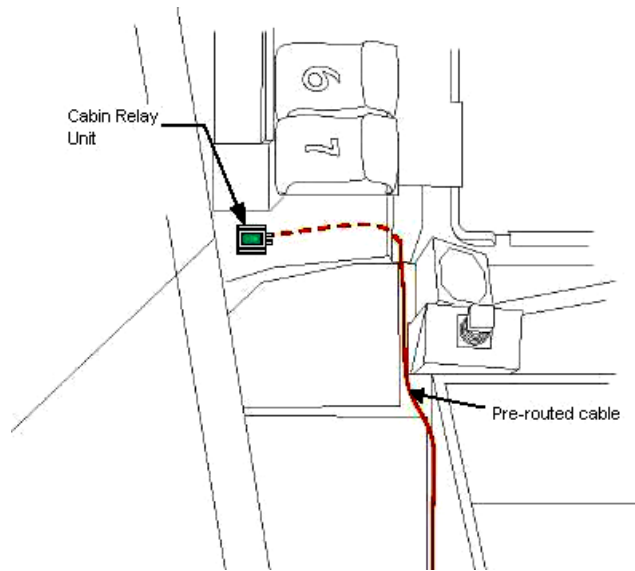

Figure 8-2.- Aft STBD location.

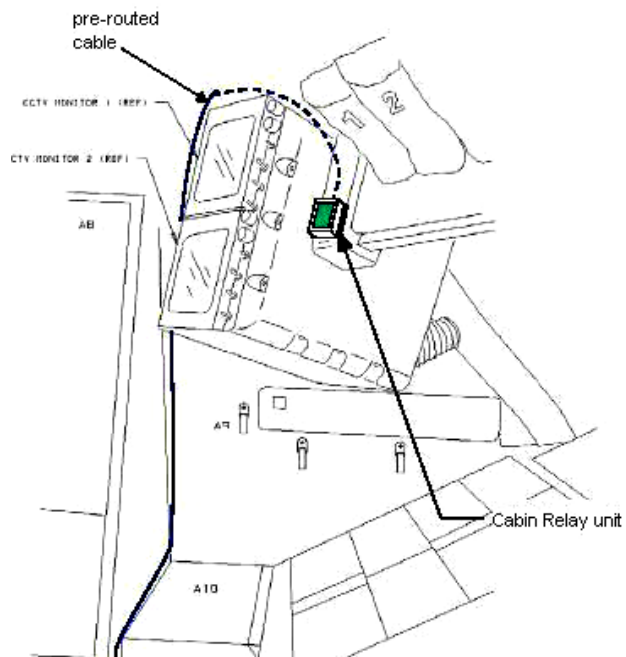

Figure 8-3.- Aft PORT location.

Cont next page

NOTE

Laptops may be powered or unpowered.
Laptops may be connected to network or
standalone

A31p

3. SETUP PRIME WLES LAPTOP

Secure Laptop Receiver Unit to A31p with Velcro
(see fig 8-4)

Connect Laptop Receiver Unit to A31p Serial port
using thumbscrews (see fig 8-5)

Verify line of sight between Laptop Receiver Unit
and both CRUs

Verify 5-in minimum distance between Laptop
Receiver Unit and both CRUs

4. SETUP BACKUP WLES LAPTOP

NOTE

Single laptop ops are preferred over
delays in activation. If problems with
Backup Laptop occur, skip step 4

Secure Laptop Receiver Unit to A31p with Velcro
(see fig 8-4)

Connect Laptop Receiver Unit to A31p Serial port
using thumbscrews (see fig 8-5)

Verify line of sight between Laptop Receiver Unit
and both CRUs

Verify 5-in minimum distance between Laptop
Receiver Unit and both CRUs

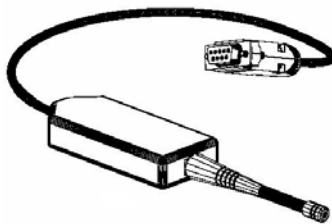

Figure 8-4.- Laptop Receiver Unit.

Cont next page

FS 8-5

ORB OPS/134/FIN A



Figure 8-5.- A31p ports.

5. LAUNCH WLES SOFTWARE

Perform for both laptops:

If laptops are off, A31p pwr – On

Double click the time in system tray (lower-right corner)

'Date and Time Properties'

'Time Zone'

Time zone – (GMT) Greenwich Mean Time

Click 'OK'

Double click 'Shuttle Apps'>'WLES'>'WLES'

'Backup Mode Selection'

If setting up one A31p, select 'Standard'

|

If setting up two A31p laptops:

For prime laptop, select 'Primary'

For backup laptop, select 'Secondary'

If 'EWBMTAU-WLEFlight' appears with message 'Run the current command:

XXXX_AA_BB_SNYYYY.xml?':

Click 'Yes'

NOTE

The secondary laptop lid may be closed at this time, if no longer needed for other applications.

The laptops are configured so that they do not enter 'standby' or 'hibernate' mode when the lids are closed. However, due to cooling concerns, fully closing the lid is not recommended

Cont next page

A31p

6. VERIFY LRU INSTALLATION

Use prime WLES laptop

'Enhanced Wideband MicroTAU – WLEFlight 3.0'

Click 'System Settings' (left side of display)

'Communications Settings'

√RF Receiver Port: 'COM 1'

Click 'Query Receiver'

Verify 'Receiver found on COM1' message appears

- * If 'Query Receiver' fails: *
- * Reseat LRU *
- * Reboot prime WLES laptop *
- * Double click 'Shuttle Apps'>'WLES'> *
- * 'WLES' *
- * Select 'Primary' *
- * Repeat step 6 *
- * If no Joy, perform WLES LRU R&R, steps *
- * 1-4, 6, then: *

7. VERIFY DATA FILE BACKUP

Use prime WLES laptop

Verify 'Backup Directory:' set to:

'S:\Program Files\Invocon\EWBMTAU-WLEFlight'

- * If 'Backup Directory' not set as above: *
- * 'System Settings' *
- * 'Directories' *
- * At the line 'Backup Directory:' click *
- * 'Browse...' (right side of display) *
- * *
- * 'Browse for Folder' *
- * Navigate to WLES folder on RPOP2: *
- * 'My Computer'>'C on RPOP2 (S:)'> *
- * 'Program Files'>'Invocon'> *
- * 'EWBMTAU-WLEFlight' *
- * *
- * Click 'OK' *

Verify 'Backup Interval' set to '30 minutes'

Cont next page

FS 8-7

ORB OPS/134/FIN A

8. VERIFY COMM WITH RELAY UNITS

Use prime WLES laptop

'Main'

Click 'Unit List' (left side of display)

NOTE

Each Cabin Relay Unit is identified with a unique serial number; this number appears as 'Unit ID' in the software

√Cabin Relay Units Unit ID 1920 and 1984 present on display in first column; scroll down as necessary

For each Cabin Relay Unit:

√Unit ID present

√Type: 'Relay-GL'

√Last Update: time is updating (every 5 to 15 sec)

- * If one CRU time does not update: *
- * | Perform WLES CABIN RELAY UNIT R&R, *
- * | steps 1 thru 3, then: *
- * | Go to step 9 *
- * If neither CRU time updates after 2 min, *
- * contact MCC-H *

√Via: 'RF'

√Mode: 'Idle'

9. INITIATE COMMANDING

Double click 'Shuttle Apps'>'WLES'>'WLES Data Folder'

Double click 'Shuttle Apps'>'WLES'>'WLES Cmd Folder'

Cont next page

FS 8-8

ORB OPS/134/FIN A

NOTE

Deleting 'BLOCK.xml' file initiates command execution. Command files disappear from this folder as they are executed.

Files appearing in the 'Data' folder verifies two-way communication with the Sensor Units in the orbiter wing

'Command'

Delete file labeled 'BLOCK.xml'

At prompt "Are you sure you want to send 'Block.xml' to the Recycle Bin?", click 'Yes'

Wait 1 minute

Verify the first data file appears in the 'Data' folder

Close 'Command' and 'Data' folders

10. REPORT WLES STATUS

Notify MCC-H: "WLES setup complete"

If reporting a failed and replaced CRU, include:

Failed CRU S/N

NOTE

The laptop lid may be closed at this time, if no longer needed for other applications. The laptops are configured so that they do not enter 'standby' or 'hibernate' mode when the lids are closed. However, due to cooling concerns, fully closing the lid is not recommended

WLES DEACTIVATION AND TEARDOWN

1. DEACTIVATE WLES LAPTOP

NOTE

MCC will configure WLES for entry by setting all sensor units to idle mode

On MCC GO:

A31p 'Enhanced Wideband MicroTAU – WLEFlight 3.0'

For each WLES A31p:

Click 'Exit'

At prompt 'Are you sure you want to exit?'

click 'Yes'

Click 'Start' > 'Turn Off Computer...' > 'Turn Off'

Disconnect Laptop Receiver Unit from A31p

Serial port

Remove Laptop Receiver Unit from Velcro on A31p

2. REMOVE WLES RELAY UNITS

Remove Cabin Relay Units (2) from aft cabin (see figs 8-6 and 8-7)

Disconnect Cabin Relay Units from pre-routed cables

Disconnect and coil cables, stow in launch location

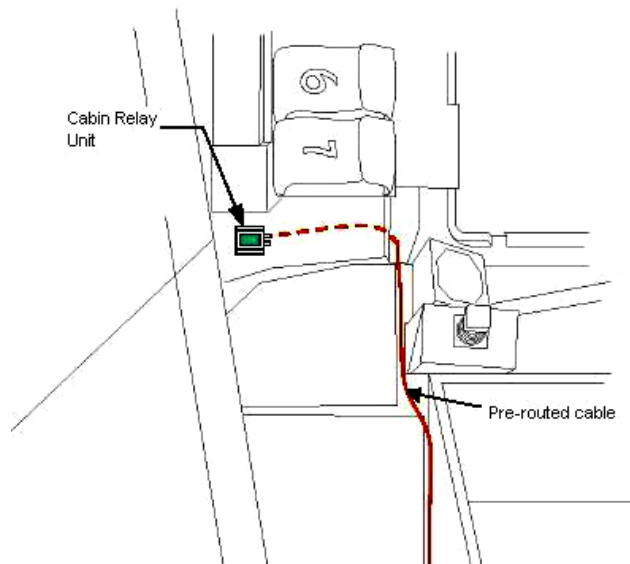

Figure 8-6.- Aft STBD location.

Cont next page

FS 8-10

ORB OPS/134/FIN A

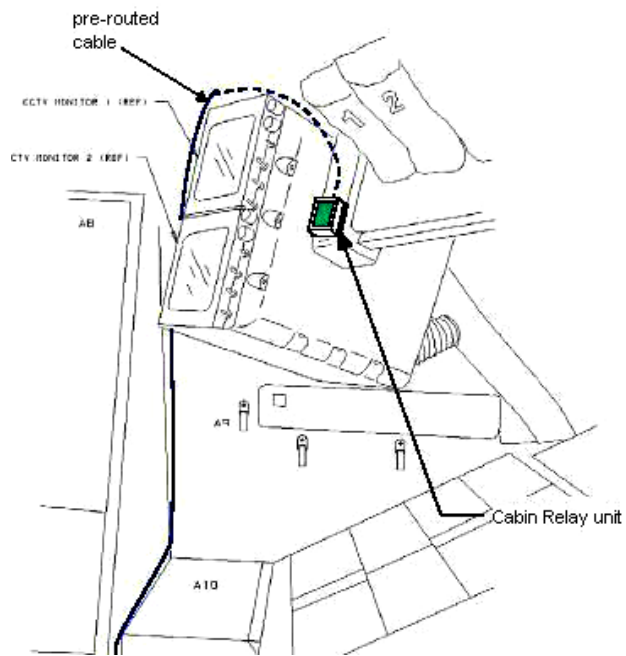

Figure 8-7.- Aft PORT location.

- ML60E
3. STOW EQUIPMENT
 Stow:
 Laptop Receiver Units (2)
 Cabin Relay Units (2)
 Notify MCC-H: "WLES Teardown Complete"

WLES LAPTOP RECEIVER UNIT (LRU) R&R

- A31p 1. DISCONNECT BACKUP LRU FROM LAPTOP
'Enhanced Wideband MicroTAU – WLEFlight 3.0'

Click 'Exit'
At prompt 'Are you sure you want to exit?'
click 'Yes'

Disconnect Backup LRU from Backup A31p Serial
port (see fig 8-8)
Remove Backup LRU from Velcro on Backup A31p
(see fig 8-9)



Figure 8-8.- A31p ports.

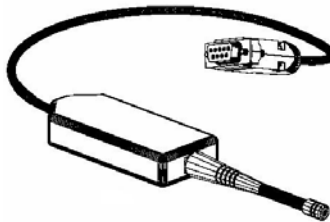

Figure 8-9.- Laptop Receiver Unit.

2. DISCONNECT PRIME LRU FROM LAPTOP
Disconnect Prime LRU from Prime A31p Serial port
(see fig 8-8)
Remove LRU from Velcro on A31p

Cont next page

FS 8-12

ORB OPS/134/FIN A

3. CONNECT BACKUP LRU

Connect Backup LRU to Prime WLES A31p Serial port
Secure LRU to A31p with Velcro

A31p

4. VERIFY LRU INSTALLATION

Use prime WLES laptop

'Enhanced Wideband MicroTAU – WLEFlight 3.0'
Click 'System Settings' (left side of display)

'Communications Settings'

√RF Receiver Port: 'COM 1'

Click 'Query Receiver'

Verify 'Receiver found on COM1' message appears

5. VERIFY COMM WITH RELAY UNITS

Click 'Unit List' (left side of display)

√Cabin Relay Units Unit ID 1920 and 1984 present on display in first column; scroll down as necessary

For each Cabin Relay Unit:

√Unit ID present

√Type: 'Relay-GL'

√Last Update: time is updating (every 5 to 15 sec)

√Via: 'RF'

√Mode: 'Idle'

If no time updates after 2 min, contact MCC-H

6. STOW EQUIPMENT

Notify MCC-H: "WLES LRU R&R complete", mark failed LRU as 'failed'

ML60E

Stow:

Prime (failed) LRU

WLES CABIN RELAY UNIT R&R

- OVHD 1. DISCONNECT FAILED CRU AND STOW
Disconnect WLE SYSTEM cable from J1 connector on failed CRU
Mark failed CRU as 'failed' and stow in ML60E
- ML60E 2. SETUP SPARE WLES RELAY UNIT
Unstow CRU SPARE (S/N 1856)
- WLE SYSTEM cable
Connect plug CABIN RELAY UNIT A or B to J1 on CRU S/N 1856
- OVHD Secure CRU SPARE to the aft cabin with Velcro
- A31p 3. VERIFY COMM WITH SPARE RELAY UNIT
Use prime WLES laptop
- 'Main'
Click 'Unit List' (left side of display)

NOTE

Each Cabin Relay Unit is identified with a unique serial number; this number appears as 'Unit ID' in the software

√Cabin Relay Unit Unit ID 1856 present on display in first column; scroll down as necessary

Cabin Relay Unit:

- √Unit ID present
- √Type: 'Relay-GL'
- √Last Update: time is updating (every 5 to 15 sec)
- √Via: 'RF'
- √Mode: 'Idle'

NOTE

Loss of redundant relay path until the config file is updated by the ground

Cont next page

FS 8-14

ORB OPS/134/FIN A

4. EXIT WLES SOFTWARE ON BOTH LAPTOPS

On MCC GO:

A31p

On both Prime and Backup WLES laptops:

'Enhanced Wideband MicroTAU – WLEFlight 3.0'
Click 'Exit' (upper right side of display)

'EWBMTAU – WLEFlight'
'Are you sure you want to exit?', click 'Yes'

Notify MCC-H when complete

NOTE

OCA will replace the config files on both laptops

5. LAUNCH WLES SOFTWARE

On MCC GO:

A31p

On both Prime and Backup WLES laptops:

Double click 'Shuttle Apps'>'WLES'>'WLES'

'Backup Mode Selection'
If setting up one A31p, select 'Standard'

If setting up two A31p laptops:
For prime laptop, select 'Primary'
For backup laptop, select 'Secondary'

If 'EWBMTAU-WLEFlight' window appears with
message 'Run the current command:
XXXX_AA_BB_SNYYYY.xml?':
Click 'Yes'

6. REVERIFY COMM WITH SPARE RELAY UNIT

Repeat step 3

7. REPORT WLES STATUS

Notify MCC-H: "WLES CRU R&R complete"

CONFIGURE WLES DATA FILE BACKUP PATH

NOTE

MCC will identify new backup WLES laptop to be used in place of RPOP2 (S:)

- A31p Use prime WLES laptop
- 'Enhanced Wideband MicroTAU – WLEFlight 3.0'
Click 'System Settings' (left side of display)
- 'Directories'
At the line 'Backup Directory:' click 'Browse...' (right side of display)
- 'Browse for Folder'
Navigate to WLES folder on RPOP2:
 'My Computer'>'C on RPOP2 (S:)'>'Program Files'>'Invocon'>'EWBMTAU-WLEFlight'
- Click 'OK'
- Verify 'Backup Directory:' set to:
 'S:\Program Files\Invocon\EWBMTAU-WLEFlight'
- Verify 'Backup Interval' set to '30 minutes'
- Click 'Unit List' (left side of display)

PREP WLES LAPTOPS FOR TRANSFER

- A31p 1. DEACTIVATE WLES LAPTOP(S)
'Enhanced Wideband MicroTAU – WLEFlight 3.0'

For each WLES A31p to be transferred:

Click 'Exit'

At prompt 'Are you sure you want to exit?'

click 'Yes'

Click 'Start'>'Turn Off Computer... '>'Turn Off'

Disconnect Laptop Receiver Unit from A31p

Serial port

Remove Laptop Receiver Unit from Velcro on
A31p

2. SET UP NEW WLES LAPTOPS

√MCC-H for which laptop to use

If Prime Laptop being transferred:

Perform WLES ACTIVATION AND CHECKOUT,
steps 3, 5 thru 8, then:

If Backup Laptop being transferred:

Perform WLES ACTIVATION AND CHECKOUT,
steps 4 and 5, then:

Notify MCC-H: "PREP WLES LAPTOPS FOR
TRANSFER complete"

WLES RNDZ TOOLS CHECKOUT PREP

- A31p
1. DEACTIVATE BACKUP WLES LAPTOP
On backup WLES laptop:
 'Enhanced Wideband MicroTAU – WLEFlight 3.0'
 Click 'Exit'
 At prompt 'Are you sure you want to exit?'
 click 'Yes'
 Disconnect Laptop Receiver Unit from A31p
 Serial port
 Leave attached to laptop with Velcro on A31p
 2. DEACTIVATE WLES FILE BACKUP
On prime WLES laptop:
 'Enhanced Wideband MicroTAU – WLEFlight 3.0'
 Click 'System Settings' (left side of display)

 'Backup Mode Selection'
 Click 'Standard'
 Click 'Unit List' (left side of display)

WLES DOCK/UNDOCK RECOVERY

- A31p
1. RECOVER BACKUP WLES LAPTOP
On backup WLES laptop:
 Connect Laptop Receiver Unit to A31p Serial port
 If laptop is off:
 | A31p pwr – On
 | At prompt select option 1 to start WLES
 If laptop is on:
 Double click 'Shuttle Apps'>'WLES'>'WLES'
 'Backup Mode Selection'
 Click 'Secondary'
 2. REACTIVATE WLES FILE BACKUP
On prime WLES laptop:
 'Enhanced Wideband MicroTAU – WLEFlight 3.0'
 Click 'System Settings' (left side of display)

 'Backup Mode Selection'
 Click 'Primary'
 Click 'Unit List' (left side of display)

┌ | | | ┌

DISABLE WLES FILE BACKUP

(SWITCH TO STANDARD MODE)

A31p On prime WLES laptop:
 'Enhanced Wideband MicroTAU – WLEFlight 3.0'
 Click 'System Settings' (left side of display)

 'Backup Mode Selection'
 Click 'Standard'
 Click 'Unit List' (left side of display)

ENABLE WLES FILE BACKUP

(SWITCH TO PRIMARY MODE)

A31p On prime WLES laptop:
 'Enhanced Wideband MicroTAU – WLEFlight 3.0'
 Click 'System Settings' (left side of display)

 'Backup Mode Selection'
 Click 'Primary'
 Click 'Unit List' (left side of display)

LRU TROUBLESHOOTING

NOTE

This procedure requires 30 min crew time or
15 min if the ground can verify good COM 1

1. VERIFY LINE OF SIGHT

Verify unobstructed line of sight between LRU and
both CRUs

Verify 5-in minimum distance between LRU and both
CRUs

A31p

2. VERIFY COMM WITH RELAY UNITS

Use prime WLES laptop

'Enhanced Wideband MicroTAU – WLEFlight 3.0'

'Main'

Click 'Unit List' (left side of display)

√Cabin Relay Units Unit ID 1920 and 1984 present on
display in first column; scroll down as necessary

For each Cabin Relay Unit:

√Unit ID present

√Type: 'Relay-GL'

√Last Update: time is updating (every 5 to 15 sec)

√Via: 'RF'

√Mode: 'Idle'

If both times updating:

Notify MCC: "Line of sight problem" >>

If both times not updating:

Notify MCC and proceed to step 3

3. RESEAT LRU AND RESTART LAPTOP

Completely disconnect and then reconnect LRU
from serial port on prime WLES laptop

If other applications are running on prime WLES
laptop, √MCC

Cont next page

FS 8-20

ORB OPS/134/FIN A

‘Enhanced Wideband MicroTAU – WLEFlight 3.0’
Click ‘Exit’ (upper right side of display)

‘EWBMTAU - WLEFlight’
‘Are you sure you want to exit?’, click ‘Yes’

Reboot prime WLES laptop

Click ‘1’ to launch WLES Software

‘Backup Mode Selection’
Select ‘Primary’

4. VERIFY COMM WITH RELAY UNITS

‘Enhanced Wideband MicroTAU – WLEFlight 3.0’
Click ‘System Settings’ (left side of display)

‘Communications Settings’
√RF Receiver Port: ‘COM 1’

Click ‘Query Receiver’
Verify ‘Receiver found on COM1’ message appears

If ‘Timeout exceeded...’ message appears:
Notify MCC and proceed to step 5

‘Main’
Click ‘Unit List’ (left side of display)

√Cabin Relay Units Unit ID 1920 and 1984 present on
display in first column; scroll down as necessary

For each Cabin Relay Unit:

- √Unit ID present
- √Type: ‘Relay-GL’
- √Last Update: time is updating (every 5 to 15 sec)
- √Via: ‘RF’
- √Mode: ‘Idle’

Cont next page

If both times updating:

Notify MCC: "Computer problem/bad LRU connection" >>

If both times not updating:

Notify MCC and proceed to step 5

5. REPLACE FAILED LRU

Perform WLES LAPTOP RECEIVER UNIT (LRU) R&R, then:

If both times updating in LRU R&R step 5:

Notify MCC: "LRU Failure" >>

If both times not updating in LRU R&R step 5:

Notify MCC and proceed to step 6

6. EXIT SOFTWARE ON PRIME WLES LAPTOP

Use prime WLES laptop

'Enhanced Wideband MicroTAU – WLEFlight 3.0'

Click 'Exit' (upper right side of display)

'EWBMTAU – WLEFlight'

'Are you sure you want to exit?', click 'Yes'

7. RETURN BACKUP LRU TO BACKUP WLES LAPTOP

Disconnect Backup LRU from Prime A31p Serial port

Remove Backup LRU from Velcro on Prime A31p

Connect Backup LRU to Backup A31p Serial port

Secure Backup LRU to Backup A31P with Velcro

Verify unobstructed line of sight between LRU and both CRUs

Verify 5-in minimum distance between LRU and both CRUs

Cont next page

FS 8-22

ORB OPS/134/FIN A

8. CONFIGURE BACKUP WLES LAPTOP AS NEW PRIME LAPTOP

Use backup WLES laptop

Double click 'Shuttle Apps'>'WLES'>'WLES'
'Backup Mode Selection'
Click 'Primary'

9. VERIFY COMM WITH RELAY UNITS

Use backup WLES laptop

'Enhanced Wideband MicroTAU – WLEFlight 3.0'
Click 'System Settings' (left side of display)

'Communications Settings'
√RF Receiver Port: 'COM 1'

Click 'Query Receiver'
Verify 'Receiver found on COM1' message appears

'Main'
Click 'Unit List' (left side of display)

√Cabin Relay Units Unit ID 1920 and 1984 present on display in first column; scroll down as necessary

For each Cabin Relay Unit:

- √Unit ID present
- √Type: 'Relay-GL'
- √Last Update: time is updating (every 5 to 15 sec)
- √Via: 'RF'
- √Mode: 'Idle'

If both times updating:

Notify MCC: "Serial port hardware failure on prime WLES laptop"
Go to step 10

If both times not updating:

√MCC >>

Cont next page

FS 8-23

ORB OPS/134/FIN A

10. CONFIGURE NEW BACKUP PATH

Use backup WLES laptop

'Enhanced Wideband MicroTAU – WLEFlight 3.0'

'System Settings'

'Directories'

At the line 'Backup Directory:' click 'Browse...' (right side of display)

'Browse for Folder'

Navigate to WLES folder on WLES:

'My Computer'>'C on WLES (V:)'>'Program Files'>'Invocon'>'EWBMTAU-WLEFlight'

Click 'OK'

Verify 'Backup Directory:' set to:

'V:\Program Files\Invocon\EWBMTAU-WLEFlight'

Verify 'Backup Interval' set to '30 minutes'

Click 'Unit List' (left side of display)

Notify MCC: "LRU Troubleshooting Complete"

ML60E

Stow:

Prime LRU

PAYLOADS OF OPPORTUNITY

MAUI PRCS AND VRCS PROCEDURE.....	FS 9-2
VRCS ONLY PROCEDURE	FS 9-6
PRCS ONLY PROCEDURE	FS 9-10
RAMBO-2 PROCEDURE.....	FS 9-14

**P/L OF
OPP**

MAUI PRCS AND VRCS PROCEDURE

- 15:00 or earlier 1. MANEUVER TO START ATTITUDE
(BIASED +ZLV +YVV)

NOTE

External lights should remain OFF from 15 minutes before, until 5 minutes after the MAUI burn

P/L OF
OPP

- A7U √PL BAY FLOOD (all) – OFF
 √ILLUMINATORS (all)– OFF

Deploy MAUI PRCS AND VRCS – RCS FIRING SEQUENCE (Cue Card)

GNC 20 DAP CONFIG

- √DAP A1, B1 loaded

UNIV PTG

- TGT ID – ITEM 8 +2 EXEC
BODY VECT – ITEM 14 +5 EXEC
P – ITEM 15 +2 7 0 EXEC
Y – ITEM 16 +3 5 0 EXEC
OM – ITEM 17 +2 7 0 EXEC
TRK – ITEM 19 EXEC (CUR - *)

2. INITIATE TIMER

- √MCC for start time

GNC 2 TIME

Set count down/count up timer per MCC

- √MET – ITEM 2 EXEC (*)

CRT TIMER COUNT TO – ITEM 17 + + + EXEC

3. SETUP

O14:E, cb DDU L (two) – cl
O15:E

O14:F, Pri RJD LOGIC,DRIVER (sixteen) – ON
O15:F,
O16:F

Cont next page

GNC 20 DAP CONFIG

DAP A PRI P OPTION – ITEM 15 EXEC (NOSE)
TRAN PLS – ITEM 17 +0.7 3 EXEC
VERN ROT PLS – ITEM 26 +0.1 5 3 EXEC

C3 √DAP: A/AUTO/VERN
 √DAP TRANS: PULSE/PULSE/PULSE

-05:00 4. VERIFY ATTITUDE
 Verify in attitude

DAP ROT: PULSE/PULSE/PULSE

NOTE

For the following RCS firing sequence
(step 5):

- A. Expect total orbiter body rates
(RSS) to exceed 1 deg/sec
- B. Possible loss of comm due to orbiter
body rates and attitude excursions
- C. For any jet fail OFF, continue with
firing sequence
- D. Requirement is for a particular jet
group, not a specific jet
- E. The table in step 5 is also provided
as a cue card

Cont next page

FS 9-3

ORB OPS/134/FIN A

5. MAUI PRCS AND VRCS - RCS FIRING SEQUENCE

NOTE

Use the table below or the cue card

Reminder: All inputs are momentary

<u>Timer</u>	<u>Jets Fired</u>	<u>CDR</u>	<u>PLT</u>
-03:00		√Body rates: $+0.047 \leq \text{roll} \leq +0.087$ $-0.020 \leq \text{pitch} \leq +0.020$ $-0.020 \leq \text{yaw} \leq +0.020$ DAP: FREE DAP: A/PRI Inform PLT "GO" for jet deselects	Configure initial setup <u>GNC 23 RCS</u> Left RCS page – ITEM 2 EXEC On CDR "GO", proceed <u>NOTE</u> Expect DAP RECONF msgs in following actions Deselect jets: JET DES L5L – ITEM 37 EXEC (*) Right RCS page – ITEM 3 EXEC JET DES R5D – ITEM 39 EXEC (*) Forward RCS page – ITEM 1 EXEC JET DES F5L – ITEM 37 EXEC (*)
-00:30		FLT CNTLR PWR – ON	
00:00	RXA, LXA	THC +X (in) (3 sec firing)	
00:15	FXL, LXL	THC +Y (right) (3 sec firing)	
00:30	FXR, RXR	THC -Y (left) (3 sec firing)	
00:35			DAP: VERN
00:45	R5R	RHC +yaw (10 sec firing) Do not exceed soft stop	
01:05	L5D	RHC -pitch (12 sec firing) Do not exceed soft stop	
01:25	F5R	RHC +pitch (12 sec firing) Do not exceed soft stop	
		FLT CNTLR PWR – OFF	Return to MAUI PRCS AND VRCS PROCEDURE, step 6, (ORB OPS FS, <u>P/L OF OPP</u>)

Cont next page

FS 9-4

ORB OPS/134/FIN A,1

6. CLEANUP
F6 √FLT CNTLR PWR – OFF

GNC 23 RCS

√Forward RCS page – ITEM 1 EXEC

Reselect Jets:

JET DES F5L – ITEM 37 EXEC (no *)

Left RCS page – ITEM 2 EXEC

JET DES L5L – ITEM 37 EXEC (no *)

Right RCS page – ITEM 3 EXEC

JET DES R5D – ITEM 39 EXEC (no *)

GNC 20 DAP CONFIG

DAP A1 – ITEM 1 +1 EXEC

7. SNAP LVLH ATTITUDE AND NULL RATES

When time \geq +03:30:

DAP: A/PRI

DAP: LVLH

When rates stable:

DAP: VERN

Return to FLT PLN attitude

8. RECONFIGURE TO GROUP B POWERDOWN

√MCC

O14:E, cb DDU L (two) – op
O15:E

O14:F, Pri RJD LOGIC,DRIVER (sixteen) – OFF
O15:F, RJDA 1A L2/R2 MANF DRIVER – ON
O16:F

MAUI VRCS ONLY PROCEDURE

- 15:00 or earlier 1. MANEUVER TO START ATTITUDE
(BIASED -XLV +ZVV)

NOTE

External lights should remain OFF from 15 minutes before, until 5 minutes after the MAUI burn

- A7U √PL BAY FLOOD (all) – OFF
√ILLUMINATORS (all)– OFF

Deploy MAUI VRCS ONLY FIRING SEQUENCE
(Cue Card)

GNC 20 DAP CONFIG

- √DAP A1, B1 loaded

UNIV PTG

- TGT ID – ITEM 8 +2 EXEC
BODY VECT – ITEM 14 +5 EXEC
P – ITEM 15 +1 8 0 EXEC
Y – ITEM 16 +0 EXEC
OM – ITEM 17 +0 EXEC
TRK – ITEM 19 EXEC (CUR - *)

2. INITIATE TIMER

- √MCC for start time

GNC 2 TIME

Set count down/count up timer per MCC

- √MET – ITEM 2 EXEC (*)

CRT TIMER COUNT TO – ITEM 17 +__ +__ +__ EXEC

3. SETUP

- O14:E, cb DDU L (two) – cl
O15:E

GNC 20 DAP CONFIG

DAP A VERN ROT PLS – ITEM 26 +0.1 5 3 EXEC

- C3 √DAP: A/AUTO/VERN

Cont next page

-05:00 4. VERIFY ATTITUDE

Verify in attitude

DAP ROT: PULSE/PULSE/PULSE

NOTE

For the following VRCS firing sequence (step 5):

- A. Possible loss of comm due to orbiter body rates and attitude excursions
- B. For any jet fail OFF, continue with firing sequence
- C. The table in step 5 is also provided as a cue card

5. VRCS ONLY FIRING SEQUENCE

NOTE

Use the table below or the cue card

Reminder: All inputs are momentary

Timer	Jets Fired	CDR	PLT
-02:00		√Body rates: $-0.020 \leq \text{roll} \leq +0.020$ $-0.087 \leq \text{pitch} \leq -0.047$ $-0.020 \leq \text{yaw} \leq +0.020$ DAP: FREE √DAP: VERN Inform PLT "GO" for jet deselection	Configure initial setup GNC 23 RCS Left RCS page – ITEM 2 EXEC (*) On CDR "GO", proceed <u>NOTE</u> Expect DAP RECONF msgs in following actions Deselect jets: JET DES L5L – ITEM 37 EXEC (*) Right RCS page – ITEM 3 EXEC (*) JET DES R5D – ITEM 39 EXEC (*) Forward RCS page – ITEM 1 EXEC (*) JET DES F5L – ITEM 37 EXEC (*)
-00:30		FLT CNTLR PWR – ON	
00:00	R5R	RHC +yaw (10 sec firing) Do not exceed soft stop	
00:20	L5D	RHC -pitch (12 sec firing) Do not exceed soft stop	
00:40	F5R	RHC +pitch (12 sec firing) Do not exceed soft stop	
		FLT CNTLR PWR – OFF	Return to MAUI VRCS ONLY PROCEDURE, step 6, (ORB OPS FS, P/L OF OPP)

Cont next page

6. CLEANUP
F6 √FLT CNTLR PWR – OFF

GNC 23 RCS

√Forward RCS page – ITEM 1 EXEC

Reselect Jets:

JET DES F5L – ITEM 37 EXEC (no *)

Left RCS page – ITEM 2 EXEC

JET DES L5L – ITEM 37 EXEC (no *)

Right RCS page – ITEM 3 EXEC

JET DES R5D – ITEM 39 EXEC (no *)

GNC 20 DAP CONFIG

DAP A1 – ITEM 1 +1 EXEC

7. SNAP LVLH ATTITUDE AND NULL RATES

When time \geq +02:00:

DAP: LVLH

Return to FLT PLN attitude

8. RECONFIGURE TO GROUP B POWERDOWN

√MCC

O14:E, cb DDU L (two) – op
O15:E



This Page Intentionally Blank



MAUI PRCS ONLY PROCEDURE

- 15:00 or earlier 1. MANEUVER TO START ATTITUDE
(BIASED +ZLV +YVV)

NOTE

External lights should remain OFF from 15 minutes before, until 5 minutes after the MAUI burn

- A7U √PL BAY FLOOD (all) – OFF
√ILLUMINATORS (all)– OFF

Deploy MAUI PRCS ONLY FIRING SEQUENCE
(Cue Card)

GNC 20 DAP CONFIG

- √DAP A1, B1 loaded

UNIV PTG

- TGT ID – ITEM 8 +2 EXEC
BODY VECT – ITEM 14 +5 EXEC
P – ITEM 15 +2 7 0 EXEC
Y – ITEM 16 +3 5 0 EXEC
OM – ITEM 17 +2 7 0 EXEC
TRK – ITEM 19 EXEC (CUR - *)

2. INITIATE TIMER

- √MCC for start time

GNC 2 TIME

Set count down/count up timer per MCC

- √MET – ITEM 2 EXEC (*)

CRT TIMER COUNT TO – ITEM 17 + + + EXEC

3. SETUP

O14:E, cb DDU L (two) – cl
O15:E

O14:F, Pri RJD LOGIC, DRIVER (sixteen) – ON
O15:F,
O16:F

Cont next page

FS 9-10

ORB OPS/134/FIN A

GNC 20 DAP CONFIG

DAP A PRI P OPTION – ITEM 15 EXEC (NOSE)
ROT PLS – ITEM 13 +1.0 0 0 EXEC
TRAN PLS – ITEM 17 +0.7 8 EXEC

GNC 23 RCS

Deselect Jets:

Forward RCS page – ITEM 1 EXEC
JET DES F1D – ITEM 23 EXEC (*)
F2D – ITEM 27 EXEC (*)

C3 √DAP: A/AUTO/VERN
 √DAP TRANS: PULSE/PULSE/PULSE

-05:00 4. VERIFY ATTITUDE
 Verify in attitude

NOTE

For the following PRCS firing sequence
(step 5):

- A. Expect total orbiter body rates (RSS) to exceed 1 deg/sec
- B. Possible loss of comm due to orbiter body rates and attitude excursions
- C. For any jet fail OFF, continue with firing sequence
- D. Requirement is for a particular jet group, not a specific jet
- E. The table in step 5 is also provided as a cue card

Cont next page

FS 9-11

ORB OPS/134/FIN A

5. PRCS FIRING SEQUENCE

NOTE

Use the table below or the cue card

Reminder: all inputs are momentary except
RHC +pitch at 00:45

<u>Timer</u>	<u>Jets Fired</u>	<u>CDR</u>	<u>PLT</u>
-01:00		√Body rates: +0.047 ≤ roll ≤ +0.087 -0.020 ≤ pitch ≤ +0.020 -0.020 ≤ yaw ≤ +0.020 DAP: FREE DAP: A/PRI	Configure initial setup [GNC 23 RCS] √Forward RCS page – ITEM 1 EXEC (*) <u>NOTE</u> Queue the following ITEM entry on the scratch pad. Do not perform the EXEC until specified at +00:35 sec Queue JET DES F3D – ITEM 25
-00:30		FLT CNTLR PWR – ON	
00:00	RXA, LXA	THC +X (in) (3 sec firing)	
00:15	FXL, LXL	THC +Y (right) (3 sec firing)	
00:30	FXR, RXR	THC -Y (left) (3 sec firing)	
00:35			When jets stop firing: [GNC 23 RCS] EXEC [JET DES F3D – ITEM 25 (*)]
00:45	F4D	RHC +pitch to hardstop, hold 3 sec	
00:48		RHC release	
		FLT CNTLR PWR – OFF	Return to MAUI PRCS ONLY PROCEDURE, step 6, (ORB OPS FS, P/L OF OPP)

Cont next page

FS 9-12

ORB OPS/134/FIN A

6. CLEANUP
F6 √FLT CNTLR PWR – OFF

GNC 23 RCS

√Forward RCS page – ITEM 1 EXEC

Reselect Jets:

 JET DES F1D – ITEM 23 EXEC (no *)

 F3D – ITEM 25 EXEC (no *)

 F2D – ITEM 27 EXEC (no *)

GNC 20 DAP CONFIG

DAP A1 – ITEM 1 +1 EXEC

7. SNAP LVLH ATTITUDE AND NULL RATES

When time \geq +02:00:

 √DAP: A/PRI

 DAP: LVLH

When rates stable:

 DAP: VERN

Return to FLT PLN attitude

8. RECONFIGURE TO GROUP B POWERDOWN

√MCC

O14:E, cb DDU L (two) – op
O15:E

O14:F, Pri RJD LOGIC,DRIVER (sixteen) – OFF
O15:F, RJDA 1A L2/R2 MANF DRIVER – ON
O16:F

RAMBO-2 PROCEDURE

NOTE

This procedure completes a Out-of-Plane, RAM, and WAKE burn in the following window:

MET WINDOW OPEN: _____

MET WINDOW CLOSE: _____

WINDOW DURATION: _____

Count-up pacing times from window open, prefaced with a "~", are provided to enhance time awareness as the crew works through the procedure and will ensure completion of all burns within the window. Count-up pacing times from window open, prefaced with a "+", are provided to indicate preferred burn TIGs for the second and third burns in the sequence (RAM and WAKE). If the vehicle arrives in attitude prior to the preferred burn time, do not deflect THC until the preferred burn time is reached on the counter; if the vehicle arrives in attitude after the preferred burn time, begin THC inputs immediately when the THC +X step is reached

-15:00 or earlier 1. MANEUVER TO OOP BURN ATTITUDE

GNC 20 DAP CONFIG

√DAP A1, B1 loaded

UNIV PTG

TGT ID - ITEM 8 +2 EXEC
BODY VECT - ITEM 14 +5 EXEC
P - ITEM 15 +8 0 EXEC
Y - ITEM 16 +0 EXEC
OM - ITEM 17 +9 0 EXEC

DAP: A/AUTO/VERN(ALT)

TRK - ITEM 19 EXEC (CUR - *)

Cont next page

FS 9-14

ORB OPS/134/FIN A,1

2. INITIATE TIMER

GNC 2 TIME

Set count down/count up timer for the WINDOW
OPEN time

√MET – ITEM 2 EXEC (*)

CRT TIMER COUNT TO – ITEM 17 +__+__+__
EXEC

3. SETUP

O14:E, cb DDU L (two) – cl
O15:E

O14:F, Pri RJD LOGIC,DRIVER (sixteen) – ON
O15:F,
O16:F

GNC 20 DAP CONFIG

DAP B PRI ROT RATE – ITEM 30 +___.___.___. EXEC
ATT DB – ITEM 31 +5 EXEC
P OPTION – ITEM 35 EXEC (NOSE)
Y OPTION – ITEM 36 EXEC (NOSE)

DAP TRANS: NORM/PULSE/PULSE

4. VERIFY OOP BURN ATTITUDE

-01:00 Verify in attitude

F6 FLT CNTLR PWR – ON

-00:20 DAP: B/AUTO/PRI

5. OOP BURN

0:00 THC +X (in) for 10 seconds

F6 FLT CNTLR PWR – OFF

Wait 20 seconds before executing the next
maneuver or changing the DAP configuration

Cont next page

FS 9-15

ORB OPS/134/FIN A,1

6. RAM BURN MANEUVER

UNIV PTG

P – ITEM 15 +1 2 0 EXEC

Y – ITEM 16 +0 EXEC

OM – ITEM 17 +0 EXEC

~00:35

DAP: B/AUTO/ALT

TRK – ITEM 19 EXEC (CUR - *)

When in attitude with rates <0.2 deg/sec:

DAP: B/VERN

Wait 5 seconds:

DAP: B/PRI

Wait 20 seconds before THC inputs

7. RAM BURN

F6 FLT CNTLR PWR – ON

+__:__ THC +X (in) for 10 seconds

F6 FLT CNTLR PWR – OFF

Wait 20 seconds before executing the next maneuver or changing the DAP configuration

8. WAKE BURN MANEUVER

UNIV PTG

P – ITEM 15 +2 2 0 EXEC

Y – ITEM 16 +0 EXEC

OM – ITEM 17 +0 EXEC

~__:__

DAP: B/AUTO/ALT

TRK – ITEM 19 EXEC (CUR - *)

When in attitude with rates <0.2 deg/sec:

DAP: B/VERN

Cont next page

Wait 5 seconds:
DAP: B/PRI

Wait at least 20 seconds before THC inputs

9. WAKE BURN
F6 FLT CNTLR PWR – ON
+__:__ THC +X (in) for 10 seconds
F6 FLT CNTLR PWR – OFF

10. CLEAN UP

Wait 20 seconds before returning to VERN(ALT)
below or executing a maneuver

GNC 20 DAP CONFIG
DAP B1 – ITEM 2 +1 EXEC

DAP TRANS: PULSE/PULSE/PULSE
DAP: A/VERN(ALT)

Return to FLT PLN attitude

11. RECONFIGURE TO GROUP B POWERDOWN

- √MCC
O14:E, cb DDU L (two) – op
O15:E

O14:F, Pri RJD LOGIC, DRIVER (sixteen) – OFF
O15:F, RJDA 1A L2/R2 MANF DRIVER – ON
O16:F

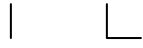

This Page Intentionally Blank



CWC OPS

WASTE TANK OFFLOAD TO CWC FS 10-2

CWC OPS

FS 10-1

ORB OPS/134/FIN A

WASTE TANK OFFLOAD TO CWC

OBJECTIVE: Use CWC to temp store waste water in the event the waste tank is full and cannot be dumped. CWC will be dumped at a later time

NOTE

Requires Ops 2 config and two crewmembers

LOCATION: CONT H2O X-TIE WASTE QD located on outboard WCS wall (inside WCS compartment), Volume H (MD23R); see LOWER EQUIPMENT BAY (IFM, COMPONENT LOCATIONS)

CWC OPS

TOOLS REQD:

TOOL	Gray Tape
CHCK	8 ft Y-Y Hose
WCS	Dry Wipes (2-3)
MISC	PPE (gloves and goggles)
	36 x 36 Ziploc Bag (two)
Middeck	Contingency Water Container (CWC) (Check MCC for CWC S/N)

1. Remove contents of Vol H (MD23R), temp stow
2. Connect Y-Y Hose to CWC
3. Place CWC in one Ziploc

ML31C 4. WASTE H2O DUMP ISOL VLV – CL (tb-CL)

NOTE

Discontinue WCS ops until procedure complete.

Use Dry Wipes to absorb any fluid released during QD mate/demate

5. Don PPE

WCS 6. Connect Y-Y Hose to CONT H2O X-TIE WASTE QD (upper QD with yellow Velcro and "WASTE" label)

NOTE

MCC will TMBU limits if desired

Cont next page

FS 10-2

ORB OPS/134/FIN A

7. FDA limit for Waste TK to CWC transfer _____%

8. **SM 60 TABLE MAINT**

PARAMETER NAME	PARA ID	SM ALERT	
		LOW	HIGH
WASTE H2O QTY 1	0620540	<input type="checkbox"/>	-

ML31C 9. WASTE H2O DUMP ISOL VLV – OP (tb-OP)

10. Monitor CWC fill rate continuously

SM 66 ENVIRONMENT

11. When 'S66 WASTE H2O QTY ↓', continue

ML31C 12. WASTE H2O DUMP ISOL VLV – CL (tb-CL)

WCS 13. Leave Y-Y Hose connected to CWC, disconnect Y-Y Hose from CONT H2O X-TIE WASTE QD, cap QD

ML31C 14. WASTE H2O DUMP ISOL VLV – OP (tb-OP)

15. Leaving Y-Y Hose protruding from corner of bag, lightly press air out of Ziploc, seal bag

16. Use Gray Tape to seal area around location where Y-Y Hose exits Ziploc (see photo below)



Cont next page

17. Fold any extra portion of Ziploc flat, coil Y-Y Hose on top
18. Place bagged CWC/Y-Y Hose assembly into second Ziploc , lightly press air out of bag, seal Ziploc
19. Temp stow entire assembly in Vol H (MD23R), ensuring minimal pressure is applied to CWC
20. Stow tools

PGSC FS

KFX DOWNLINK IN THE BLIND FS 11-2

PGSC FS

FS 11-1

ORB OPS/134/FIN A

KFX DOWNLINK IN THE BLIND

- PGSC
1. Verify with MCC that the KFX application is running on the OCA PLAN A client and that the MCC is configured for an OCA Downlink
 2. CONFIGURE KFX APPLICATION
If reqd, enlarge KFX window

On KFX menu bar select 'View'>'Options'
In 'Options' window click 'Network' tab
In 'Network' tab change 'Maximum Xmit Rate' to '1500' Kbits/sec
Click 'OK'
Click 'Yes' when prompted for KFX S/W restart

After KFX S/W restart, on 'KFX' window:

- √REMOTE KFX – yellow
- √Uplink arrow ('↑' next to send rate) – yellow
- √Dnlink arrow ('↓' next to send rate) – yellow

3. SELECT FILE(S) TO DOWNLINK
Use WINDOWS EXPLORER to sel files/directories to transfer
Drag files over KFX window
Rel mouse button

The following dialog will be displayed when the files for downlink are dragged over the KFX window:

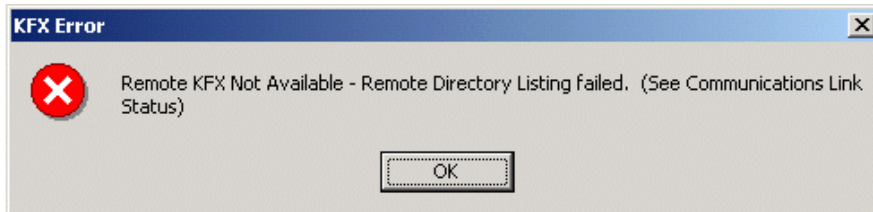

Click 'OK'

√'KFX File Transfer Preview' display appears with selected file(s) listed

Cont next page

4. ADD ADDITIONAL FILE FOR DOWNLINK (if reqd)

- √'KFX File Transfer Preview' display active
- Sel 'add to list' button (button with documents, '+' symbols)
- √'Select Files from Transfer' display appears
- Sel desired file from file listbox
- Sel 'Select' button
- Repeat for each additional file as reqd
- Sel 'Done' button

5. REMOVE FILE FROM DOWNLINK (if reqd)

- √'KFX File Transfer Preview' display active
- Sel desired file(s) in listbox
- Sel 'delete' button (button with 'X')

6. START FILE DOWNLINK

NOTE

User may halt transfer while in progress by sel 'Abort' button

- √'KFX File Transfer Preview' display active

Sel 'downlink' button (button with '↓')

The following two warning dialogs will be displayed:

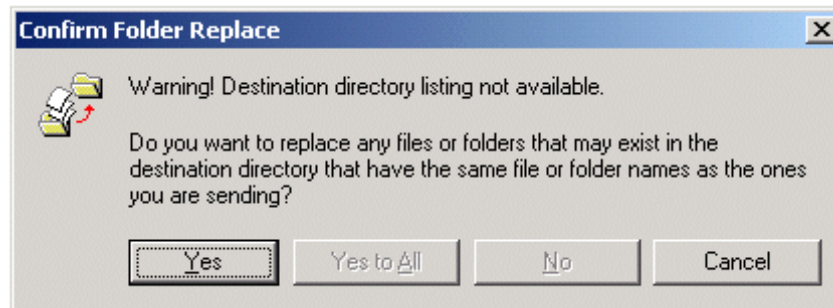

Click 'Yes'

Cont next page

FS 11-3

ORB OPS/134/FIN A



On MCC Go, click 'Ignore'
√'File Transfer Status' display appears
√Displaying xfer status

* If error displayed, repeat step 6 *



CUE CARD CONFIGURATION

CUE
CARDS

NOT FLOWN

FS 12-1

ORB OPS/134/FIN A



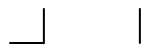

This Page Intentionally Blank

**CUE
CARDS**



NOT FLOWN

FS 12-2

ORB OPS/134/FIN A



TOP

HOOK
VELCRO

LIOH CHANGEOUT

(6 crewmembers/Single Shift/FD 1-18)

FLIGHT DAY	POS A	POS B	CK CMLPT
LAUNCH	1	2	
PRE FD01	"	"	
POST FD02	3 *	4	
PRE FD02	5 *	"	
POST FD03	6	7	DOCKING
PRE FD03	"	8	
POST FD04	9	"	
PRE FD04	"	10	
POST FD05	"	"	EVA 1
PRE FD05	11	"	
POST FD06	"	STS-130	
PRE FD06	STS-130	"	
POST FD07	"	"	EVA 2
PRE FD07	"	STS-130	
POST FD08	STS-130	"	
PRE FD08	"	STS-130	
POST FD09	"	"	EVA 3
PRE FD09	STS-130	"	
POST FD10	"	STS-130	
PRE FD10	STS-132	"	
POST FD11	"	"	EVA 4
PRE FD11	"	STS-132	
POST FD12	"	"	
MID FD12	STS-132 *	STS-132 *	Hatch Close
PRE FD12	"	"	
POST FD13	STS-132	STS-132	Undocking
PRE FD13	STS-132 *	"	
POST FD14	STS-132	STS-132	EOM-1
PRE FD14	"	STS-132 *	
POST FD15	STS-132	STS-132	EOM
PRE FD15	23	"	
POST FD16	24	25	EOM+1
PRE FD16	"	26	
POST FD17	27	28	EOM+2
PRE FD17	29 *	"	
POST FD18	30	31	EOM+3

*Re-bag and seal LiOH cans w/Gray Tape and stow
(Locations of canisters on back)

ORB OPS-29a/nonRCRS/134/O/B

NOTE

This card is specifically used for the STS-134 mission with the orbiter conducting single shift operations with a orbiter crew size of 6 and ISS crew size of 6. Changeout scheme reflects FD3 docking with ISS, Vozdukh, and dual bed CDRA operation

(reduced copy)

NOT FLOWN

FS CC 12-3

ORB OPS/134/FIN A,1

TOP
BACK OF 'LIOH CHANGEOUT'

HOOK
VELCRO

LIOH CANISTER STOWAGE LOCATIONS

Ascent Stowage Locations

Orbiter: *

MD52M (LiOH Box): STS-134 Cans 1-31

ISS:

STS-130 Cans 25-31 (7)

STS-132 Cans 32-43 (12)

Entry (EOM) Stowage Locations

Orbiter: *

MD52M (LiOH Box): STS-134 Cans 9-11, 23-31 (10)

STS-130 Cans 25-31 (7)

STS-132 Cans 32-43 (12)

ISS:

STS-134 Cans 12-22 (11)

USED STS-134 Cans 1-8 (8)

* 2 LiOH cans installed in LiOH slots A and B

ORB OPS-29b/nonRCRS/134/O/B

(reduced copy)

NOT FLOWN

FS CC 12-4

ORB OPS/134/FIN A,1

TOP

HOOK
VELCRO

HOOK
VELCRO

ORBIT BURN MONITOR

OMS TEMP*	L R	
FU IN P \geq	219	220
\leq	201	208
or No FU IN P		
		OMS ENG FAIL
		OMS PRPLT FAIL
OMS PC* & OMS ↓		
ENG VLV 1 or 2 < 70		
or OX IN P > 227		
or OX IN P \leq 227		
or No OX IN P		
		OMS ENG FAIL
		OMS PRPLT FAIL
OMS OX/FU TK P ($\sqrt{\text{ENG IN P}}$)		
OX/FU LOW		
He PRESS/VAP ISOL (two) – OP		
If aff TK P not incr:		
OMS PRPLT FAIL		
OX & FU HIGH		
He PRESS/VAP ISOL (two) – CL		
Cycle He A(B) to maintain TK P 234-284		
OMS N2 REG P HIGH or LOW	OMS ENG – ARM	
OMS N2 TK P LOW	At N2 TK P < 470:	
($\sqrt{\text{OMS/MPS}}$)	OMS ENG – ARM	
OMS GMBL	PRI fail	L(R) OMS GMBL – SEC
	SEC fail	If high RCS usage: OMS ENG FAIL
GPC	<input type="checkbox"/> (<input type="checkbox"/>) & Burning OMS aff	aff GPC PWR – OFF
		If SEC GMBL avail:
		aff MDM FF 1(4) – OFF, ON
		L(R) OMS GMBL – SEC
	SEC GMBL lost	If high RCS usage: OMS ENG FAIL
	2 FAs lost	$\sqrt{\text{MAN SHUTDN}}$
I/O ERROR FA	1(4)	L(R) OMS GMBL – SEC
		♦ I/O RESET
		If high RCS usage: OMS ENG FAIL
	2 FAs lost	$\sqrt{\text{MAN SHUTDN}}$
BCE STRG D		I/O RESET (if recov: >>)
	1(4)	If high RCS usage:
		L(R) OMS GMBL – SEC
GPC SET SPLIT	Non-crit burn	STOP BURN: OMS ENG(s) – OFF
	Crit burn	Go to "GPC" above
I/O ERROR PCM		OI PCMMU PWR – 2(1)
BCE BYP OA		SM I/O RESET

*If XFD, BLDN, or sensor fail, monitor ENG IN P for off-nominal performance

ORB OPS-31a/134/O/A

(reduced copy)

NOT FLOWN

FS CC 12-5

ORB OPS/134/FIN A

TOP
BACK OF 'ORBIT BURN MONITOR'



LEFT OMS

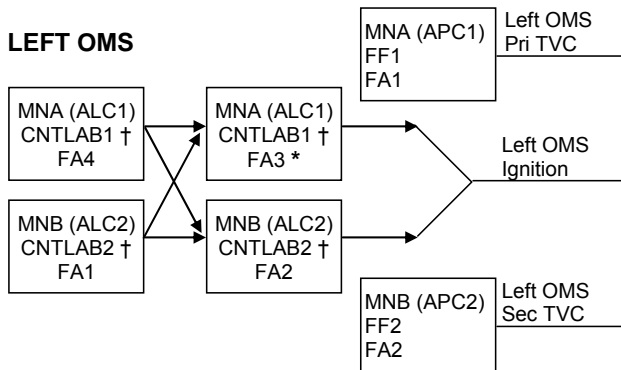

- † If CNTL AB1 or AB2 (CA1 or CA2) failed and ign path still exists at OMS fail, assume L(R) OMS ↓ is PRPLT FAIL
- * If L(R) Pc failed high during burn or FA3(4) failed, at L(R) OMS fail, no guidance downmode after L(R) OMS ENG switch OFF (TGO slow, ADI needles in error, 6 ft/s underburn)

RIGHT OMS

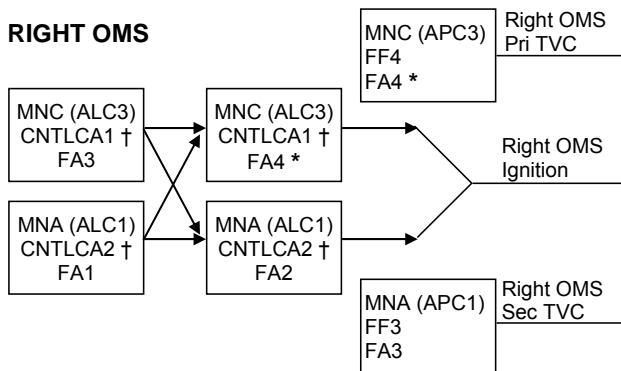

If two FA MDMs lost		
MDMs	Preburn: ENG – OFF	During burn: MAN SHUTDN
1,2	LEFT (TVC)	BOTH
1,3	RIGHT (IGN)	LEFT
1,4	LEFT (IGN)	RIGHT
2,3	LEFT (IGN)	RIGHT
2,4	RIGHT (IGN)	LEFT
3,4	RIGHT (TVC)	BOTH

ORB OPS-31b/134/O/A

(reduced copy)

NOT FLOWN

FS CC 12-6

ORB OPS/134/FIN A

NOT FLOWN

(reduced copy)
FS CC 12-7

ORB OPS/134/FIN A

TOP

PILE
VELCRO

ORB OPS-41a/134/O/A

PILE
VELCRO

STS-134 DAP A1 – DAP A8 CONFIGURATIONS

	ITEM #	A1	A2	A3	A4	A5	A6	A7	A8
PRI									
ROT RATE	10 (50)	0.2000	0.4000	0.2000	0.5000	0.2000	0.2000	0.2000	0.0500
ATT DB	11 (51)	5.00	1.00	0.30	3.00	5.00	5.00	2.00	2.00
RATE DB	12 (52)	0.20	0.20	0.20	0.20	0.20	0.20	0.20	0.20
ROT PLS	13 (53)	0.100	0.100	0.100	0.100	0.100	0.100	0.100	0.100
COMP	14 (54)	.000	.000	.000	.000	.000	.000	.000	.000
P OPTION	15 (55)	ALL	ALL	ALL	ALL	ALL	TAIL	ALL	ALL
Y OPTION	16 (56)	ALL	ALL	TAIL	ALL	ALL	TAIL	ALL	ALL
TRAN PLS	17 (57)	0.100	0.100	0.100	0.100	0.100	0.100	0.100	0.100
ALT									
RATE DB	18 (58)	0.200	0.200	0.070	0.200	0.070	0.070	0.100	0.100
JET OPT	19 (59)	ALL	ALL	ALL	ALL	ALL	TAIL	ALL	ALL
# JETS	20 (60)	2	2	1	2	1	1	2	2
ON TIME	21 (61)	0.08	0.08	0.08	0.08	0.08	0.08	0.08	0.08
DELAY	22 (62)	0.00	0.00	0.00	0.00	0.00	0.00	0.00	0.00
VERN									
ROT RATE	23 (63)	0.2000	0.4000	0.0080	0.2000	0.0500	0.0500	0.0160	0.0500
ATT DB	24 (64)	1.000	1.000	0.070	1.000	1.000	1.000	1.000	1.000
RATE DB	25 (65)	.020	.020	.010	.020	.020	.020	.020	.020
ROT PLS	26 (66)	0.010	0.010	0.010	0.010	0.010	0.010	0.010	0.050
COMP	27 (67)	.000	.000	.000	.000	.000	.000	.000	.000
CNTL ACC	28 (68)	0	0	0	0	0	0	0	0
PURPOSE		NOMINAL	PTC	GG		LOSS OF VERN (ALL)	LOSS OF VERN (TAIL ONLY)	RNDZ	TERMINAL PHASE

BOLDITALIC indicates change from I-Load.

HINGE

NOT FLOWN

FS CC 12-8

ORB OPS/134/FIN A

(reduced copy)

TOP
HINGED AT BOTTOM OF
'STS-134 DAP A1 – DAP A8 CONFIGURATIONS'
HINGE

STS-134 DAP B1 – DAP B8 CONFIGURATIONS

	ITEM #	B1	B2	B3	B4	B5	B6	B7	B8
PRI									
ROT RATE	30 (50)	0.5000	0.2000	0.2000	0.2000	0.2000	0.5000	0.5000	0.0500
ATT DB	31 (51)	3.00	3.00	3.00	0.30	3.00	3.00	2.00	2.00
RATE DB	32 (52)	0.20	0.20	0.20	0.20	0.20	0.20	0.20	0.20
ROT PLS	33 (53)	0.040	0.040	0.040	0.040	0.040	0.040	0.040	0.040
COMP	34 (54)	.000	.000	.000	.000	.000	.000	.000	.000
P OPTION	35 (55)	ALL	TAIL	ALL	TAIL	TAIL	ALL	ALL	ALL
Y OPTION	36 (56)	ALL	TAIL	ALL	TAIL	TAIL	ALL	ALL	ALL
TRAN PLS	37 (57)	0.100	0.020	0.020	0.020	0.020	0.020	0.050	0.050
ALT									
RATE DB	38 (58)	0.200	0.070	0.070	0.100	0.200	0.200	0.100	0.100
JET OPT	39 (59)	ALL	TAIL	ALL	ALL	ALL	ALL	ALL	ALL
# JETS	40 (60)	2	1	1	2	2	2	2	2
ON TIME	41 (61)	0.08	0.08	0.08	0.08	0.08	0.08	0.08	0.08
DELAY	42 (62)	0.00	0.00	0.00	0.00	0.00	0.00	0.00	0.00
VERN									
ROT RATE	43 (63)	0.2000	0.2000	0.2000	0.0080	0.0160	0.2000	0.2000	0.0500
ATT DB	44 (64)	1.000	1.000	1.000	0.100	0.033	1.000	1.000	1.000
RATE DB	45 (65)	.020	.020	.020	.010	.020	.020	.020	.020
ROT PLS	46 (66)	0.002	0.002	0.002	0.002	0.002	0.002	0.002	0.020
COMP	47 (67)	.000	.000	.000	.000	.000	.000	.000	.000
CNTL ACC	48 (68)	0	0	0	0	0	0	0	0
PURPOSE		OMS & RCS BURNS (ORB OPS)	LOSS OF VERN (TAIL ONLY)	LOSS OF VERN (ALL)		COAS/HUD CAL		RNDZ	TERMINAL PHASE

BOLD/ITALIC indicates change from I-Load.

HOOK
VELCRO

ORB OPS-41aa/134/O/A

HOOK
VELCRO

NOT FLOWN

FS CC 12-9

ORB OPS/134/FIN A

(reduced copy)

TOP
BACK OF 'STS-134 DAP A1 – DAP A8 CONFIGURATIONS'

PILE
VELCRO

ORB OPS-41b/134/O/B

PILE
VELCRO

STS-134 DAP A9 – DAP A14 CONFIGURATIONS

	ITEM #	A9	A10	A11	A12	A13	A14
PRI							
ROT RATE	10 (50)	0.1300	0.0500	0.0500	0.0500	0.0500	0.2000
ATT DB	11 (51)	2.00	0.60	10.00	5.00	5.00	5.00
RATE DB	12 (52)	0.10	0.10	0.20	0.20	0.20	0.20
ROT PLS	13 (53)	0.100	0.100	0.100	0.040	0.040	0.100
COMP	14 (54)	.000	.000	.000	.000	.000	.000
P OPTION	15 (55)	TAIL	TAIL	TAIL	TAIL	TAIL	TAIL
Y OPTION	16 (56)	TAIL	TAIL	TAIL	TAIL	TAIL	TAIL
TRAN PLS	17 (57)	0.050	0.050	0.100	0.010	0.010	0.100
ALT							
RATE DB	18 (58)	0.100	0.100	0.020 ¹	0.020 ¹	0.020 ¹	0.200
JET OPT	19 (59)	TAIL	TAIL	TAIL	TAIL	TAIL	TAIL
# JETS	20 (60)	2	2	1	1	1	1(2) ³
ON TIME	21 (61)	0.08	0.08	0.08	0.08	0.08	0.08
DELAY	22 (62)	0.00	0.00	5.00	5.00	5.00	6.00
VERN							
ROT RATE	23 (63)	0.1300	0.0500	0.1000	0.1000	0.1000	0.2000
ATT DB	24 (64)	1.000	0.500	5.000	3.000	3.000	3.000
RATE DB	25 (65)	.020	.020	.050	.020	.020	.200
ROT PLS	26 (66)	0.050	0.050	0.010	0.002	0.002	0.010
COMP	27 (67)	.000	.000	.000	.000	.000	.000
CNTL ACC	28 (68)	0	0	8(9) ²	8(9) ²	2 ²	1
PURPOSE		PROX OPS FLYAROUND	DOCKING	AUTO REBOOST	MATED STACK (MNVRS, ROBO, ATT HOLD)		ORBITER ALONE SRMS/OBSS

BOLD/ITALIC indicates change from I-Load.

¹ I-loaded below keyboard limit; do not change

² CA8 – ATV2 Docked to SM Aft, docking through AMS grappled by SSRMS

³ CA9 – ATV2 Docked to SM Aft, AMS on SSRMS in Intermediate position through undock

³ Use 1 for OBSS scan and 2 for Orbiter attitude maneuvers

HINGE

NOT FLOWN

FS CC 12-10

ORB OPS/134/FIN A

(reduced copy)

TOP
 BACK OF 'STS-134 DAP B1 – DAP B8 CONFIGURATIONS'
 HINGED AT BOTTOM OF 'STS-134 DAP A9 – DAP A14 CONFIGURATIONS'
 HINGE

STS-134 DAP B9 – DAP B13 CONFIGURATIONS

	ITEM #	B9	B10	B12	B13
PRI					
ROT RATE	30 (50)	0.1300	0.0500	0.0100 ¹	0.0100 ¹
ATT DB	31 (51)	2.00	0.60	1.00	1.00
RATE DB	32 (52)	0.10	0.10	0.20	0.20
ROT PLS	33 (53)	0.040	0.040	0.040	0.040
COMP	34 (54)	.000	.000	.000	.000
P OPTION	35 (55)	TAIL	TAIL	TAIL	TAIL
Y OPTION	36 (56)	TAIL	TAIL	TAIL	TAIL
TRAN PLS	37 (57)	0.010	0.010	0.010	0.010
ALT					
RATE DB	38 (58)	0.100	0.100	0.020 ¹	0.020 ¹
JET OPT	39 (59)	TAIL	TAIL	TAIL	TAIL
# JETS	40 (60)	2	2	1	1
ON TIME	41 (61)	0.08	0.08	0.08	0.08
DELAY	42 (62)	10.00	0.00	5.00	5.00
VERN					
ROT RATE	43 (63)	0.1300	0.0500	0.0100	0.0100
ATT DB	44 (64)	1.000	0.500	1.000	0.100
RATE DB	45 (65)	.020	.020	.020	.020
ROT PLS	46 (66)	0.020	0.020	0.002	0.002
COMP	47 (67)	.000	.000	.000	.000
CNTL ACC	48 (68)	0	0	8(9) ²	8(9) ²
PURPOSE		PROXOPS/ FLYAROUND	DOCKING	MATED ATT HOLD (VRCS & ALT)	MATED VRCS DB COLLAPSE

BOLD/ITALIC indicates change from I-Load.

¹ I-loaded below keyboard limit; do not change

² CA8 – ATV2 Docked to SM Aft, docking through AMS grappled by SSRMS

CA9 – ATV2 Docked to SM Aft, AMS on SSRMS in Intermediate position through undock

HOOK
VELCRO

ORB OPS-41bb/134/O/B

HOOK
VELCRO

TOP

MAUI PRCS AND VRCS – RCS FIRING SEQUENCE

Reminder: All inputs are momentary

PILE
VELCRO

HINGE

Timer	Jets Fired	CDR	PLT
-03:00		Body rates: $+0.047 \leq \text{roll} \leq +0.087$ $-0.020 \leq \text{pitch} \leq +0.020$ $-0.020 \leq \text{yaw} \leq +0.020$ DAP: FREE DAP: A/PRI Inform PLT "GO" for jet deselects	Configure initial setup GNC 23 RCS Left RCS page – ITEM 2 EXEC On CDR "GO", proceed NOTE Expect DAP RECONF msgs in following actions Deselect jets: JET DES L5L – ITEM 37 EXEC (*) Right RCS page – ITEM 3 EXEC JET DES R5D – ITEM 39 EXEC (*) Forward RCS page – ITEM 1 EXEC JET DES F5L – ITEM 37 EXEC (*)
-00:30		FLT CNTLR PWR – ON	
00:00	RXA, LXA	THC +X (in) (3 sec firing)	
00:15	FXL, LXL	THC +Y (right) (3 sec firing)	
00:30	FXR, RXR	THC -Y (left) (3 sec firing)	
00:35			DAP: VERN
00:45	R5R	RHC +yaw (10 sec firing) Do not exceed soft stop	
01:05	L5D	RHC -pitch (12 sec firing) Do not exceed soft stop	
01:25	F5R	RHC +pitch (12 sec firing) Do not exceed soft stop	
		FLT CNTLR PWR – OFF	Return to MAUI PRCS AND VRCS PROCEDURE, step 6, (ORB OPS FS, P/L OF OPP)

ORB OPS-42a/134/O/C

PILE
VELCRO

(reduced copy)

NOT FLOWN

FS CC 12-11

ORB OPS/134/FIN A,1

TOP
BACK OF MAUI PRCS AND VRCS - RCS FIRING SEQUENCE

HOOK
VELCRO

HOOK
VELCRO

HOOK
VELCRO

MAUI PRCS ONLY FIRING SEQUENCE

Reminder: All inputs are momentary except RHC +pitch at 00:45

Timer	Jets Fired	CDR	PLT
-01:00		Body rates: $+0.047 \leq \text{roll} \leq +0.087$ $-0.020 \leq \text{pitch} \leq +0.020$ $-0.020 \leq \text{yaw} \leq +0.020$ DAP: FREE DAP: A/PRI	Configure initial setup [GNC 23 RCS] Forward RCS page – ITEM 1 EXEC (*) NOTE Queue the following ITEM entry on the scratch pad. Do not perform the EXEC until specified at +00:35 sec Queue JET DES F3D – ITEM 25
-00:30		FLT CNTLR PWR – ON	
00:00	RXA, LXA	THC +X (in) (3 sec firing)	
00:15	FXL, LXL	THC +Y (right) (3 sec firing)	
00:30	FXR, RXR	THC -Y (left) (3 sec firing)	
00:35			When jets stop firing: [GNC 23 RCS] EXEC [JET DES F3D – ITEM 25 (*)]
00:45	F4D	RHC +pitch to hardstop, hold 3 sec	
00:48		RHC release	
		FLT CNTLR PWR – OFF	Return to MAUI PRCS ONLY PROCEDURE, step 6, (ORB OPS FS, P/L OF OPP)

HINGE

PILE
VELCRO

ORB OPS-42aa/134/O/B

(reduced copy)

NOT FLOWN

FS CC 12-12 ORB OPS/134/FIN A,1

TOP

HOOK
VELCRO

HOOK
VELCRO

HOOK
VELCRO

MAUI VRCS ONLY FIRING SEQUENCE

Reminder: All inputs are momentary

HINGED TO RIGHT SIDE OF MAUI VRCS ONLY FIRING SEQUENCE.
HINGE

Timer	Jets Fired	CDR	PLT
-02:00		√Body rates: -0.020 ≤ roll ≤ +0.020 -0.087 ≤ pitch ≤ -0.047 -0.020 ≤ yaw ≤ +0.020 DAP: FREE √DAP: VERN Inform PLT "GO" for jet deselection	Configure initial setup [GNC 23 RCS] Left RCS page – ITEM 2 EXEC (*) On CDR "GO", proceed NOTE Expect DAP RECONF msgs in following actions Deselect jets: JET DES L5L – ITEM 37 EXEC (*) Right RCS page – ITEM 3 EXEC (*) JET DES R5D – ITEM 39 EXEC (*) Forward RCS page – ITEM 1 EXEC (*) JET DES F5L – ITEM 37 EXEC (*)
-00:30		FLT CNTLR PWR – ON	
00:00	R5R	RHC +yaw (10 sec firing) Do not exceed soft stop	
00:20	L5D	RHC -pitch (12 sec firing) Do not exceed soft stop	
00:40	F5R	RHC +pitch (12 sec firing) Do not exceed soft stop	
		FLT CNTLR PWR – OFF	Return to MAUI VRCS ONLY PROCEDURE, step 6, (ORB OPS FS, P/L OF OPP)

ORB OPS-42b/134/O/C

HOOK
VELCRO

(reduced copy)

NOT FLOWN

FS CC 12-13

ORB OPS/134/FIN A,1

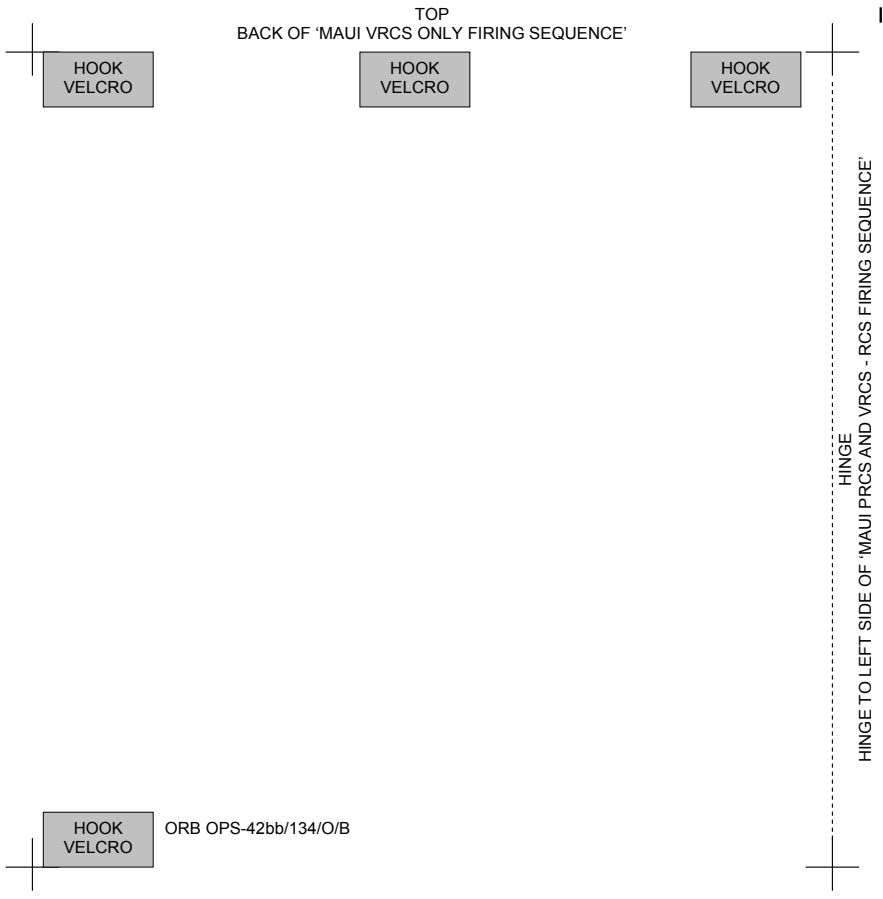

(reduced copy)

NOT FLOWN

FS CC 12-14 ORB OPS/134/FIN A,1



TOP

WLES CONFIG AFTER PGSC REBOOT

1. If window appears asking to launch WLES software:
 - Click '1' to launch WLES software
- Else:
 - Double click 'Shuttle Apps'>'WLES'>'WLES'
2. ✓MCC for 'Backup Mode Selection'
3. If 'EWBMTAU-WLEFlight' appears with message 'Run the current command: XXXX_AA_BB_SNYYYY.xml?':
 - Click 'Yes'

ORB OPS-47a/134/O/A

FABRICATION NOTES

Fabricated as a decal (SED33112142)

NOT FLOWN

(reduced copy)

FS CC 12-15 ORB OPS/134/FIN A,1



This Page Intentionally Blank



NOT FLOWN

FS 12-16

ORB OPS/134/FIN A



Space Shuttle Program
FLIGHT DATA FILE

JSC-48036-134
FINAL, REV A

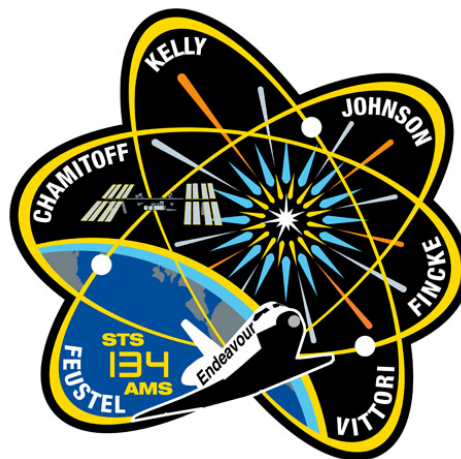

ORBIT OPS CHECKLIST

STS
134

Flight Cover (trim bottom to expose tabs)