

Space Flight Operations Contract

Space Shuttle Flight Data File Standards and Specifications

Annex C of the Space Shuttle Crew Procedures Management Plan

June 28, 2006

Contract NAS9-20000



Space Shuttle Flight Data File Standards and Specifications

Annex C of the Space Shuttle Crew Procedures Management Plan

Prepared by



Book Manager
USA/Shuttle Procedures Management

Approved by

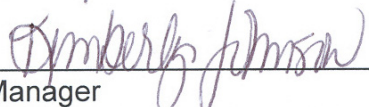

Manager
USA/Shuttle Procedures Management



FDF Manager
USA/Flight Procedures Management

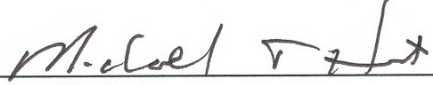

CPCB Chairman
USA/Flight Procedures and International Liaison

REVISION LOG

Rev. letter	Change no.	Description	Date
Basic A		Supersedes JSC-08969 Annex C Appendixes A and B were changed to Appendixes B and C, respectively. A new Appendix A was added. The following CRs were incorporated: CMCP_Annex_CU2 CMCP_Annex_CU3 CMCP_Annex_CU5 CMCP_Annex_CU6	09/09/2002 03/21/2003
B		The following CRs were incorporated: CMCP_Annex_CU8A (Electronic Documentation) CMCP_Annex_CU9A (JSC Numbers in Flight Documents) CMCP_Annex_CU10A (Time Critical Events) CMCP_Annex_CU11A (Solid Diamonds) CMCP_Annex_CU12A (Pushbuttons and Lights) CMCP_Annex_CU13 (Standardize Workflow References) CMCP_Annex_CU14A (AESP Minor Tabs) CMCP_Annex_CU16 (EZ: PNOM References) CMCP_Annex_CU17 (EZ: Annex E Reference) CMCP_Annex_CU18 (EZ: Annual Review – No Chgs)	06/30/2004
C		The following CRs were incorporated: CPMP_Annex_CU15A (Cleanup change for Annex C) CPMP_Annex_CU20 (Paragraph Email Update) CPMP_Annex_CU21 (OpNom Reference) CPMP_Annex_CU25 (EZ: Editorial and Clarifications)	03/11/2005

REVISION LOG

Rev. letter	Change no.	Description	Date
C	CPN-1	The following CRs were incorporated: CPMP_Annex_CU21 (OpNom Reference) (R) CPMP_Annex_CU22A (Dash and Hyphen) (P) CPMP_Annex_CU23 (Change Tracking Standards) CPMP_Annex_CU24 (Leading Designators) CPMP_Annex_CU26 (Toggle Circuit Breakers) CPMP_Annex_CU27 (Yellow Highlight change on 11-26) CPMP_Annex_CU28 (Signature Page: via) CPMP_Annex_CU29 (Change in Distribution Process) CPMP_Annex_CU30 (EZ LOEP CueCard Change Bars) CPMP_Annex_CU32 (Procedure Title Format) CPMP_Annex_CU34A (CPN-1 Edits)	06/28/2006

LIST OF EFFECTIVE PAGES

The current status of all pages in this document is as shown below:

<u>Page No.</u>	<u>Change No.</u>
Preface	CPN-1
Annex Docmts	Rev. C
i	CPN-1
ii - iv	Rev. C
v	CPN-1
vi - viii	Rev. C
1-1 – 1-3	Rev. C
2-1	Rev. C
3-1 – 3-6	Rev. C
4-1 – 4-6	Rev. C
4-7 – 4-8	CPN-1
5-1 – 5-2	Rev. C
5-3	CPN-1
5-4 – 5-14	Rev. C
6-1 – 6-16	Rev. C
7-1 – 7-6	Rev. C
8-1 – 8-4	Rev. C
8-5 – 8-7	CPN-1
9-1 – 9-3	Rev. C
10-1 – 10-11	Rev. C
11-1 – 11-13	Rev. C
11-14 – 11-28	CPN-1
12-1 – 12-2	Rev. C
13-1 – 13-4	Rev. C
14-1 – 14-4	Rev. C
15-1	CPN-1
16-1 – 16-5	Rev. C
17-1 – 17-4	Rev. C
18-1 – 18-3	Rev. C
19-1 – 19-3	Rev. C
20-1 – 20-12	Rev. C
20-13	CPN-1

<u>Page No.</u>	<u>Change No.</u>
20-14 – 20-21	Rev. C
20-22 – 20-23	CPN-1
20-24 – 20-43	Rev. C
21-1 – 21-10	CPN-1
22-1 – 22-4	Rev. C
23-1 – 23-3	Rev. C
24-1 – 24-2	Rev. C
25-1 – 25-6	Rev. C
26-1	Rev. C
27-1 – 27-2	Rev. C
28-1 – 28-7	Rev. C
29-1 – 29-2	Rev. C
30-1	Rev. C
31-1	Rev. C
A-1	Rev. C
A-2	CPN-1
B-1	Rev. C
C-1 – C-6	Rev. C

PREFACE

The Space Shuttle Flight Data File Standards and Specifications, Annex C of the Space Shuttle Crew Procedures Management Plan, was prepared by the United Space Alliance (USA), Flight Operations.

The primary responsibility is with USA, Shuttle Procedures Management, D/4231.

Questions concerning the technical content of this document should be directed to Joseph Brezovic, 281-244-8325, USH-423N, D/4231.

ANNEX DOCUMENTS

Listed below are the Annex documents of the Crew Procedures Management Plan (CPMP) that expand the guidelines and policies of the CPMP into system requirements, working agreements, and work techniques. The annexes are separately published documents that will be coordinated through the Flight Data File (FDF) Manager prior to submission for approval by the chairman of the Crew Procedures Control Board (CPCB). Listed with the document titles are the JSC document numbers. The Space Shuttle Mission Operations Procedures Branch, Operations Division, is the Office of Primary Responsibility (OPR) for the CPMP and annexes.

Annex A – FDF Definition Document	USA005466, Annex A
Annex B – FDF Configuration Management Plan	USA005466, Annex B
Annex C – FDF Standards and Specifications	USA005466, Annex C
Annex D – FDF Management Support	USA005466, Annex D
Annex E – FDF Materials Handbook	USA005466, Annex E

CONTENTS

Section	Page
1.0 DESCRIPTION OF DOCUMENT	1-1
1.1 PURPOSE	1-1
1.2 SCOPE	1-1
1.3 AUTHORITY	1-2
1.4 PUBLICATION AND REVISION OF THIS DOCUMENT	1-2
1.5 PERSONAL, PROPRIETARY, AND SENSITIVE INFORMATION	1-2
1.6 EXCEPTIONS FOR ISS PROCEDURES	1-3
2.0 REFERENCE DOCUMENTS	2-1
3.0 INTRODUCTION	3-1
3.1 STANDARDS USE	3-1
3.2 WAIVERS	3-2
3.3 STANDARDS CHANGES	3-3
3.4 DEFINITIONS	3-3
4.0 CONVENTIONS OF USAGE	4-1
4.1 LANGUAGE	4-1
4.2 FONT	4-1
4.3 CAPITALIZATION, SPELLING, AND NOMENCLATURE	4-2
4.4 INDENTATION	4-3
4.4.1 Carryover Text Lines	4-4
4.4.2 Alternate Format for Switch Callouts	4-4
4.4.3 Subentries Following Introductory Lines	4-5
4.4.4 Step Number Alignment	4-5
4.4.5 Conditional Step Alignment	4-5
4.4.6 Initial Words Omission	4-7
4.4.7 Leading Designators	4-7
5.0 CHECKLIST PROCEDURE ELEMENTS	5-1
5.1 PROCEDURE IDENTIFIER CODE	5-2
5.2 TITLES AND SUBTITLES FORMATS AND LOCATION	5-2
5.2.1 Levels of Procedure Titles	5-3
5.2.2 Subprocedure Titles	5-4
5.2.3 Step Titles	5-6
5.3 TIMETAG LOCATIONS	5-6
5.4 CREWMEMBER DESIGNATIONS	5-7
5.5 LOCATION DESIGNATION	5-8
5.6 STEP NUMBERS AND SUBPROCEDURE IDENTIFIERS	5-11
5.7 ACTION LOCATION	5-14

Section	Page
6.0 LOGIC FLOW DIAGRAM (MALFUNCTION PROCEDURES) ELEMENTS	6-1
6.1 THE CONDITION COLUMN	6-2
6.2 THE RESOLUTION COLUMN	6-4
6.2.1 The Instruction Block.....	6-5
6.2.2 The Results Block	6-9
6.2.3 Clarifying Information Blocks – Notes, Cautions, and Warnings.....	6-10
6.2.4 Reference Symbols.....	6-12
6.2.5 Transfer Block.....	6-12
6.2.6 Remote Event Indicator (Cross-Reference to Another Mal Procedure)	6-13
6.3 THE REFERENCE COLUMN (NOTES).....	6-15
7.0 ACTIONS	7-1
7.1 ACTION FORMATS	7-1
7.2 COMBINING AND SIMPLIFYING ACTIONS	7-2
7.3 CLEAR TEXT INSTRUCTIONS	7-5
8.0 PHYSICAL CONTROL DEVICES	8-1
8.1 SWITCHES	8-1
8.2 CIRCUIT BREAKERS	8-5
8.3 VALVES	8-6
8.4 HAND CONTROLLER DEVICES.....	8-6
8.5 PEDALS, LATCHES, HANDLES, AND KNOBS	8-7
9.0 METERS, INDICATORS, AND ANNUNCIATORS	9-1
9.1 METERS AND INDICATORS	9-1
9.1.1 Talkbacks.....	9-2
9.2 ANNUNCIATORS	9-3
10.0 SHUTTLE GENERAL PURPOSE COMPUTER INTERFACES – SWITCHES, CRTS, AND KEYPADS	10-1
10.1 GPC SWITCHES	10-1
10.2 CRT BOXES	10-2
10.2.1 CRT Box Organization	10-2
10.2.2 CRT Box Content.....	10-3
10.2.3 CRT Box Placement.....	10-4
10.2.4 CRT Display Item Callouts	10-5
10.3 DAP CALLOUTS.....	10-9
11.0 SYMBOLS: PUNCTUATION, MATH, OPERATIONS, LOGICAL EXPRESSION, LEGEND, AND OTHER SPECIAL SYMBOLS	11-1
11.1 PUNCTUATION AND FORMATTING SYMBOLS.....	11-2
11.1.1 Comma [,]	11-2

Section	Page
11.1.2 Colon [:].....	11-3
11.1.3 Period [.].....	11-5
11.1.4 Slash [/].....	11-6
11.1.5 Single Quotation Marks [' '].....	11-6
11.1.6 Double Quotation Marks [" "].....	11-7
11.1.7 Parentheses [()]	11-8
11.1.8 Underline [_].....	11-9
11.1.9 Braces { }	11-10
11.1.10 Ellipsis [...].....	11-10
11.2 MATHEMATICAL SYMBOLS.....	11-11
11.2.1 Operator and Relationship Symbols	11-11
11.2.2 Qualifier Symbols.....	11-12
11.2.3 Unit Symbols.....	11-12
11.3 OPERATIONS SYMBOLS	11-13
11.3.1 Dash [–] and Hyphen [-].....	11-14
11.3.2 Double Arrowhead [>>] – exit symbol.....	11-16
11.3.3 “To” – data range	11-16
11.3.4 Triangle [►] and Pennants – Time-Critical Activities.....	11-17
11.3.5 Adjust Symbols [↻] [↺] [↻] [↺] [↻].....	11-17
11.3.6 Connect Symbol [→ ←]	11-18
11.3.7 Disconnect Symbol [← →]	11-18
11.3.8 Double Arrows [⇒ ↑ ↓]	11-18
11.3.9 Diamond [◆] – MCC Communication	11-19
11.3.10 Repetitive Command Loop Symbol.....	11-19
11.3.11 Synchronization Line for Concurrent Activities.....	11-20
11.3.12 Joint Vehicle Operations	11-21
11.3.13 Real-Time Bars	11-21
11.3.14 Start Timer Symbol [⊕]	11-24
11.4 LOGICAL EXPRESSIONS SYMBOLS.....	11-24
11.4.1 Braces.....	11-24
11.4.2 Parentheses [()]	11-25
11.5 LEGEND SYMBOLS	11-25
11.5.1 LOEP Symbols.....	11-25
11.5.2 LICR Symbols	11-26
11.6 SYMBOLIC REPRESENTATION OF WORDS	11-26
11.7 LINES AND BOXES.....	11-27
11.8 OTHER SPECIAL SYMBOLS.....	11-28
12.0 VERIFICATION	12-1
13.0 TIME REFERENCES	13-1
13.1 RELATIVE TIME	13-2
13.2 TIME-CRITICAL EVENTS.....	13-3

Section	Page
14.0 NOTES, CAUTIONS, AND WARNINGS	14-1
14.1 NOTES.....	14-2
14.2 CAUTIONS	14-2
14.3 WARNINGS	14-3
15.0 COMMUNICATION (CONTROL CENTERS AND VEHICLES).....	15-1
16.0 REFERENCING OTHER PROCEDURES AND DOCUMENTS	16-1
16.1 PERFORM ..., THEN.....	16-4
16.2 GO TO	16-5
17.0 CONDITIONAL, ALTERNATE, AND CONTINGENCY BRANCHES.....	17-1
17.1 CONDITIONAL STATEMENTS	17-1
17.2 ALTERNATE NOMINAL PROCEDURES (DASHED BOX).....	17-3
17.3 CONTINGENCY PROCEDURES (ASTERISKS).....	17-3
18.0 HANDLING LOOSE EQUIPMENT	18-1
18.1 STOWAGE LISTS.....	18-1
18.2 EQUIPMENT LISTS.....	18-2
18.3 LOOSE EQUIPMENT CALLOUTS	18-3
19.0 REFERENCE INFORMATION	19-1
19.1 TABLES	19-1
19.2 GRAPHS, DIAGRAMS AND FIGURES	19-1
19.3 PADS	19-2
19.4 CHECKLISTS	19-2
20.0 FDF BOOK STRUCTURE.....	20-1
20.1 FDF BOOK PUBLICATIONS	20-1
20.2 REQUIRED CONTENT FOR FDF BOOKS.....	20-2
20.3 FRONT MATTER.....	20-3
20.3.1 Covers.....	20-3
20.3.2 Signature Page	20-11
20.3.3 List of Implemented Change Requests	20-13
20.3.4 Areas of Technical Responsibility	20-14
20.3.5 User Notes	20-15
20.3.6 List of Effective Pages.....	20-16
20.3.7 List of Fabricated Items (Cue Cards)	20-22
20.3.8 Table of Contents.....	20-23
20.4 BODY OF FDF BOOKS	20-24
20.5 PAPER SIZE AND MARGINS.....	20-25
20.6 TABS.....	20-26
20.6.1 Tab Use	20-28
20.6.2 Tab Titles	20-31
20.6.3 Tabbed Page Format/Layout (Non-Ladder Tabs)	20-32

Section	Page
20.6.4 Cut Tabs Location	20-33
20.7 PAGINATION.....	20-35
20.8 PAGE CODES	20-40
20.9 PAGE NOTES.....	20-41
20.10 DISTRIBUTION LIST	20-42
21.0 CHANGE MARKING AND PUBLICATION STANDARDS	21-1
21.1 PAGE CHANGE NOTICE VS. REVISION	21-2
21.2 GENERAL PCN INFORMATION	21-4
21.3 PCN COVER SHEET	21-4
21.4 PCN INSTRUCTIONS.....	21-5
21.5 PEN-AND-INK INSTRUCTIONS	21-6
21.6 PCN REPLACEMENT PAGES	21-10
22.0 FLIGHT ERRATA PACKAGE (ERRATA PACK)	22-1
23.0 SIMULATION PACKAGES (SIM PACKS).....	23-1
24.0 EVA PROCEDURE STANDARDS	24-1
25.0 ELECTRONIC DOCUMENTATION STANDARDS	25-1
25.1 CD-ROMS.....	25-1
25.1.1 FDF CD Content	25-1
25.1.2 FDF CD-ROM Labels.....	25-2
25.1.3 FDF CD Binder Cover	25-4
26.0 TIMELINE FORMATS	26-1
27.0 REFERENCE DOCUMENTS	27-1
27.1 C/W AND FDA LIMITS TABLES	27-1
27.2 DPS/CDMS DISPLAY DIAGRAMS	27-1
28.0 CUE CARDS	28-1
28.1 CUE CARD PAGINATION, PAGE CODE, AND CARD CODE	28-1
28.2 CUE CARD/VEHICLE COORDINATION	28-2
28.3 CUE CARD LOGISTICS	28-3
28.4 CUE CARD CONFIGURATION	28-3

Section	Page
29.0 FLIP BOOK FORMATS	29-1
30.0 CCTV OVERLAYS	30-1
31.0 WAIVERS.....	31-1

Appendix

A ACRONYMS AND ABBREVIATIONS	A-1
B PROOF MARKS.....	B-1
C ABBREVIATIONS USED IN PROCEDURAL NOMENCLATURE	C-1

TABLES

Table		Page
20-1	FDF margin specifications	20-28
20-2	Flight book fabrication specifications	20-30

FIGURES

Figure

5-1	Flight panels where location callouts are not mandatory	5-9
20-1	Standard JSC cover.....	20-6
20-2	Flight cover as published	20-8
20-3	Typical LOEP.....	20-19
20-4	LOEP for a generic book with an integrated flight supplement	20-20
20-5	LOEP for an integrated supplement.....	20-21
20-6	List of Fabricated Items (Cue Cards)	20-22
20-7	Typical ladder tab series.....	20-30
20-8	Tab titles for Quick Access	20-31
20-9	Tab titles	20-32
20-10	Tab locations – 5-tab series with same level, different color minor tabs.....	20-34
20-11	Tab locations – 5-tab series with 2 nd level, minor tabs (same or different color).....	20-34
20-12	Examples of the position of page notes, page numbers, and page codes (at bottom of pages from selected small checklists).....	20-39
20-13	Typical FDF book distribution list.....	20-43
21-1	Sample single-page PCN cover sheet (not to scale)	21-7
21-2	Sample PCN cover sheet with pen and ink instructions (not to scale).....	21-8
22-1	Typical cover of errata package.....	22-4
23-1	Sample sim pack instructions	23-3
24-1	IVA procedures showing integrated EVA (Cuff Checklist)/IVA procedure	24-2
25-1	Blank FDF CD.....	25-5
25-2	CD Binder Cover.....	25-5
25-3	CD Set Index Image Area.....	25-6
27-1	Color indications in CRT display diagram	27-2

Figure		Page
28-1	Example of a cue card master prepared for specific location	28-4
28-2	Example of a reduced cue card configuration page.....	28-5
29-1	Example of a flip book page master	29-2
30-1	CCTV overlay template	30-1

1.0 DESCRIPTION OF DOCUMENT

1.1 PURPOSE

The Flight Data File (FDF) standards and specifications document defines the formats and conventions used in producing crew procedures. This document contains standards that apply to all crew procedures in the FDF.

Crew procedures are formatted to provide clear and concise instructions for the flight crew. The presentation of data shall remain consistent as the crew moves from one FDF article to the next in order to maximize crew efficiency and safety and minimize the impact of the media on the mission (e.g., quantity of paper flown).

1.2 SCOPE

All shuttle FDF procedures developers will abide by the standards and specifications documented herein. To ensure uniformity, payload agencies should also use these standards and specifications to develop their Payload Flight Data File (PFDF) articles.

When a situation occurs that precludes the use of approved FDF standards and specifications in the development of procedures, a waiver form should be completed and submitted to the FDF Manager for approval. See Section 31.0 for specifics on the use of the waiver forms.

The implementation of “new” standards into the FDF books take time and cannot be incorporated into all FDF products simultaneously. Therefore, the “old” and “new” standards will be documented in Annex C until all the FDF products have been updated with the “new” standards. When all the FDF products have been updated, the “old” standards will be removed from Annex C. This insures that Annex C will accurately reflect the standards being used in all FDF products at any given time. All “new” standards incorporated into Annex C will also include the associated Management Document Workflow Change Request (CR) number. The CR will contain the expected book implementation completion date for all FDF flight documents.

Although the FDF contains decals, photos, and other specialized articles, these standards and specifications pertain primarily to the paper documents that form the major portion of the FDF and the computer software (electronic documents) that emulate the paper documents. This includes procedural Checklists (C/Ls), timelines, anomaly evaluation and response instructions, and reference data. This document does not address standards for preparing unique FDF articles such as Earth maps, special photos, or star charts. However, source and material specifications for these items are provided.

In case of conflict, the International Space Station Program (ISSP) Operations Data File (ODF) Standards (SSP 50253) shall take precedence over the standards in this document for the following:

- a. FDF procedures related to shuttle payloads that are also operated or planned to be operated aboard the International Space Station (ISS).
- b. Lists and procedures related to transfer of items between the shuttle and the ISS.
- c. Procedures extracted from an ODF document. Such procedures will be used verbatim in the FDF, with the possible exception of language translation, if required.

1.3 AUTHORITY

This document is Annex C of the Crew Procedures Management Plan (CPMP). The CPMP is written under the authority vested in Johnson Space Center (JSC) Mission Operations Directorate (MOD) for the definition, development, validation, and control of all crew procedures for National Aeronautics and Space Administration (NASA) manned missions.

1.4 PUBLICATION AND REVISION OF THIS DOCUMENT

This edition of this document represents the current baseline for the mature operations phase of the Shuttle Program. All proposed changes to any CPMP document must be submitted via Management Document Workflow CR (see CPMP, Annex B).

The document will be updated and distributed on paper periodically. The most up-to-date version of the document, as well as a list of all approved CRs, will be available on line.

1.5 PERSONAL, PROPRIETARY, AND SENSITIVE INFORMATION

Occasionally, it is necessary to include data in a crewmember's flight copy of the FDF that cannot be released to the general user. Examples are an individual crewmember's medical information, proprietary systems drawings, proprietary toxicity information, and sensitive radio frequencies. The quantity of such data is generally small and will be published as a Page Change Notice (PCN) subsequent to publication of the affected addition or revision. The PCN containing the actual data is given limited distribution as determined by the Payload Officer, Book Manager, and FDF Coordinator. The PCN cover sheet, List of Effective Pages (LOEP) and, if required, an updated Table of Contents (TOC) are given the standard distribution to ensure that the entire community has the correct version of the book. A note should be placed on the PCN cover sheet to indicate that the actual data for the PCN is proprietary and has been given limited distribution. The enclosures listed at the bottom of the PCN cover sheet (Encl:) should indicate the number of pages for both those receiving the data (limited distribution) and those not receiving the data. Also, a special symbol should be used on the LOEP to indicate which pages have limited distribution (see Section 21.0).

It is possible for a PCN to contain both regular data and proprietary data. In this case, special attention should be given to the enclosures at the bottom of the PCN cover sheet, the LOEP, and the note supplying additional information.

1.6 EXCEPTIONS FOR ISS PROCEDURES

Procedures for payloads currently flying on shuttle that will also fly on ISS in the future, or those that are being transported by the shuttle to the ISS will use ODF standards.

All transfer procedures will follow the ODF standards except for SPACEHAB procedures.

2.0 REFERENCE DOCUMENTS

This section lists the documents applicable to the development of the FDF Standards document or used as reference material.

If there is a conflict between this document and another program document, except as noted in Scope, it should be brought to the attention of the CPCB and resolved there.

The following documents are applicable to the extent specified within this document.

JSC-09958	Space Shuttle Flight Data File Preparation Standards (partially superceded by this document, USA005466 Annex C)
JSC-19203	FDF Design & Materials Handbook (to be superceded by pending changes to this document, USA005466 Annex E)
JSC-19409	All Vehicle Display and Control (D&C) Procedural Nomenclature (PNOM), and Flight Supplements
NASA RP 1059	Space Transportation System and Associated Payloads: Glossary, Acronyms, and Abbreviations (NASA Reference Publication 1050, Revised)
JSC-48017	DPS Dictionary
JSC-10506	Drafting Standards for Systems Handbook Drawings
SL-T-0003	General Requirements for the Preparation of Space Shuttle Technical Manuals (for guidance only; CPMP, including this Annex C, takes precedence)
SSP 50254	ISS Operations Nomenclature (OpNom)

Webster's Ninth New Collegiate Dictionary

Government Printing Office (GPO) Style Manual

JSC Publication Manual

For ISS Procedures:

SSP 50254 ISS Operations Nomenclature (OpNom)

SSP 50253 Operations Data File Standards

3.0 INTRODUCTION

The FDF is the total onboard complement of FDF procedures and reference information. The terms “procedure” or “crew procedure,” as used in this document, refer to an FDF procedure throughout this document unless specified otherwise (as in the ODF procedure in the ISSP).

An FDF procedure is a set of instructions used by the onboard crew to fulfill certain tasks needed to operate and maintain shuttle systems and payloads under both nominal and off-nominal conditions. Procedures are organized and presented in a consistent manner to maximize efficiency and safety, but may be presented in various ways (C/Ls, logic flow diagrams, cue cards, decals, etc.). Standardization also facilitates training.

The standards for developing FDF procedures that all authors must conform to are described in this document. Any standards deviations must be approved via waiver.

3.1 STANDARDS USE

This FDF Standards and Specifications document contains both standards and guidelines. Three levels of significance are established, and the applicable level is conveyed through the use of the specific verb in the directive.

Standards are rules that must be followed in developing procedures. They are either critical to operations or crew/vehicle safety or are essential to provide clarity, consistency, and/or usability of the procedures.

- a. Hard standards use the verb “shall” and are critical to flight operations or crew/orbiter (ORB) safety. A written waiver from the FDF Manager or his representative is required to deviate from a hard standard. The production of an FDF publication in which a deviation from a hard standard does not have an approved waiver in writing will be halted at signoff.
- b. Soft standards use the verb “will” and must be followed for clarity, consistency, printability, readability, and/or usability. The production of an FDF publication in which a deviation from a soft standard does not have an approved waiver (verbal or in writing) will be halted prior to print request preparation.

Guidelines are recommendations for a preferred method of use in developing procedures. They may be modified if there is a compelling reason to do so. A deviation from a guideline would not halt the processing of an FDF document; however, the book manager will verify to the FDF Manager the reason the guideline deviation occurred.

- a. Guidelines use the verb “should.”

Statements of fact that are related to the standards but are not part of the standard use common verbs such as “are” and “is.”

Standards and guidelines shall be interpreted and implemented consistently within a procedure and document.

These standards and guidelines apply for paper and electronic FDF procedures. Differences due to the media are noted as appropriate within this document.

The accepted authority for spelling and word usage in procedures is Webster's Ninth New Collegiate Dictionary.

The FDF Standards are illustrated with numerous examples and figures, which are considered accurate for the standard that applies. However, these examples and figures should not be taken out of context from the appropriate text. Efforts are made to ensure that these examples are in accord with the FDF standards, but as the standards are refined or modified, a specific example may appear to be in conflict. A figure, for example, that is used to illustrate the placement of change bars should not be used as a guide for text placement which is illustrated elsewhere. Always refer to the proper text and example (if one is given) for a specific standard.

3.2 WAIVERS

All standards deviations must be approved by the FDF Manager or his representative in writing (required for hard standards) or verbally. Deviations from guidelines do not require a written waiver; however, one may be requested to avoid having to justify repeated deviation for specific circumstances. See Section 31.0 regarding the waiver form.

Normally, a waiver is limited to a given document or to a specific print package (e.g., Basic milestone, PCN, etc.), but a written waiver from the FDF Manager may also provide a general waiver that may affect multiple or all FDF documents. Likewise, a waiver issued for a specific situation is a specific document and should not be construed as permission for a standard deviation in a different document or a different situation. Each approved waiver is standalone adjudication.

The approval on a FDF Workflow Crew Procedure CR does not necessarily convey approval for an FDF standards deviation. Changes to FDF documents submitted on FDF Workflow Crew Procedure CRs should conform to FDF standards and specifications. CRs that are not in conformance will be edited and appropriately documented by the responsible book manager to comply with the Annex C FDF Standards and Specifications; otherwise, a specific waiver will be required to incorporate nonconforming data.

3.3 STANDARDS CHANGES

Suggested changes to the standards provided in this document may be submitted to the FDF Manager for consideration or via Management Document Workflow CR (see CPMP Annex B). The FDF Manager will present proposed changes affecting crew interface to the Astronaut Office to obtain a crew consensus prior to disposition. CRs go into effect immediately upon approval; however, implementation of changed standards will normally be done on a noninterference basis in a regularly scheduled publication.

3.4 DEFINITIONS

Action – An element of a step that instructs the crew to change or verify the state of an object, (e.g., move a switch to a different position). See Section 7.0.

Note: The words “operation,” “operational callout,” “instruction,” and “step” are often used to refer to an action.

Activation and Checkout (A&C) procedures – Procedures used to activate, power up, and check out systems or individual subsystem components. For the individual systems files (Electrical Power System (EPS), Environmental Control and Life Support System (ECLSS), etc.), this encompasses the initial activation and checkout of the individual systems and subsystems, as well as activation and checkout of components after a powerdown.

Alternate nominal procedures – Procedures that accomplish a reconfiguration or objective using a sequence of steps that is different from the nominal sequence.

Automated procedures – Procedure scripts that are automatically sequentially executed on a computer when initiated by a crewmember or by timer.

Callout – See “Action.”

Caution – The caution block provides information or instructions necessary to prevent hardware damage or malfunction. This block appears before the action or condition it describes. The intelligence in the caution block is sometimes referred to as a “Caution Note.”

C/L procedures – Step-by-step instructions that allow the crew to accomplish an objective.

Clear text – Information or instructions in sentence format.

Electronic procedures – The electronic display of crew procedures.

Electronic FDF – All FDF information (procedures, reference information, etc.) displayed electronically on the Payload and General Support Computer (PGSC). Electronic FDF can include manual procedures (i.e., viewed using Manual Procedures Viewer, (MPV)) and procedural displays, which may include the ability to send commands and receive telemetry.

FDF Workflow Crew Procedure Change Request (CR) – A formal request for a change to the FDF/crew procedures submitted, processed and dispositioned electronically. (Note: The obsolete paper system used the JSC Form 482.) The workflow system can be accessed through the internet from the [FDF Homepage](#).

Hyphen – The hyphen symbol (-) may be considered a short dash. The hyphen appears on the keyboard on the lower half of the key located on the top row between the number zero "0" and the equal mark "=".

Logic flow procedures – Procedures in which flow between steps is represented graphically to facilitate crew decision-making when several alternatives are present. Logic flow diagrams allow the user to visualize flow between steps and determine what results can be expected upon the completion of branches before the procedures are executed.

Dash – The dash (–) is also known as an "en dash." The dash is slightly longer than the hyphen. The width of the dash is relative to the size of the font. The width of the dash is equal to the width of the letter "N." The "en dash" can be found under symbols (special characters tab).

Malfunction procedures – A special type of logic flow diagram procedure designed to resolve system or equipment failure. The use of the logic flow diagram provides a diagnostic process to determine the nature of the failure and possible corrective action. Malfunction procedures also allow the crew to assess the extent of degradation and the effects on subsequent operations if normal conditions cannot be restored. These procedures are not normally considered time-critical; however, they generally should be performed as soon as possible.

Management Document Workflow Change Request (CR) – A formal request for a change to the FDF management documentation (i.e. FDF Standards) submitted, processed, and dispositioned electronically. (Note: The obsolete paper system used the JSC Form 1209.) The workflow system can be accessed through the internet from the [FDF Homepage](#).

Manual procedures – Paper or electronic procedures that do not have command and telemetry or automation capability embedded in them.

Nominal character space – A space that is equal to one space bar spacing (for carry over lines and indentations, this is defined in FDF Templates as a .08 inch space).

Nominal operations procedures – Procedures used to carry out day-to-day operations of shuttle systems and payloads. These include preventative and periodic maintenance procedures, as well as those that involve transfer of cargo and crew between the shuttle and the ISS.

Notes – Information that describes a status or condition the crew should be aware of prior to the execution of that step. A note does not involve crew safety. (The intelligence in Caution blocks and Warning blocks are sometimes referred to as “Caution notes” and “Warning notes.” In this case, this information does involve orbiter damage and crew safety.) Notes typically precede a procedural step; however, if a note is less than one line of text, it may be placed in parentheses.

Off-nominal situations – A situation in which a failure or other event occurs that prevents the normal flow through a procedure. Contingency actions may be required to correct for failures.

Procedure – A logical grouping of steps to accomplish a given objective. A procedure may contain steps, clarifying information, and reference information.

Quick-response procedures – Procedures used to quickly safe the system or payload in the event of a failure or anomaly in the nominal operation of the system or subsystem components. These procedures must be accomplished within a limited amount of time (approximately 5 minutes) in order to prevent propagation of failures to other systems or components and to prevent danger to the crew and/or the orbiter. Usually, execution of a malfunction procedure will follow, providing troubleshooting and corrective action steps. Examples of conditions that would require the execution of these procedures include, but are not limited to: Class 1 Alarms, which include fire, cabin depressurization, and toxic atmosphere; and Class 2 Alarms, which may include chemical spills and loss of vehicle control.

Reference information – Nonexecutable support data used by the crew as reference for the successful execution of a procedure. Reference information may be part of a procedure or may be contained separately in a reference book or section of a book and can be found in various formats throughout the FDF. Examples of reference information include lists of equipment lost when a bus is lost, caution and warning message definitions, inventory and stowage lists, Earth observation maps, and the definitions of information found on shuttle computer Cathode Ray Tube (CRT) displays, as well as diagrams and drawings used for system familiarization and diagnostic troubleshooting.

Step – A step is (1) a group of elements in the syntax given in Section 5.0, (2) a single discrete action (see definition for “Action”), or (3) a group of actions within a procedure.

Subprocedure – A titled set of steps normally in logical subgroups within a procedure normally beginning with a sequential letter (e.g., A., B., etc.) and normally starting a new step-numbering sequence.

Warnings – The warning block provides information or instructions necessary to ensure crew safety. This block appears before the action or condition it describes.

4.0 CONVENTIONS OF USAGE

In the preparation of FDF procedures, specialized conventions have evolved. The use of parentheses, special symbols, capitalization, and structured vertical text alignment and spacing techniques are well defined and have unique meanings in procedural statements. FDF documents, with limited exceptions, use the “hanging indentation” style in C/L format. The accepted authority for spelling and word usage will be Webster’s Ninth New Collegiate Dictionary. The United States Government Printing Office (GPO) Style Manual (March 1984) will remain the basis for all conventions of usage. However, deviations from the GPO Style Manual are necessary for the special requirements in FDF procedures. The specialized conventions and deviations from the GPO Style Manual are addressed in the following conventions of usage. The presentation of data will remain consistent within the same document and from FDF document to FDF document.

4.1 LANGUAGE

Standard

- a. All FDF procedures shall be in English.

Guideline

Procedures in a language other than English may be included in the FDF when required for operational or safety reasons. Both English and non-English versions will be included.

4.2 FONT

Standards

- a. The font used for hardcopy timelines, logic flow diagram procedures, tables, drawings, schematics, and pictorials shall not be less than 8 point.
- b. The font used in hardcopy C/L procedures and other information not otherwise specified shall not be less than 11 point.
- c. A typeface similar in appearance to Arial shall be used. (This text is written in Arial 12-point font.)
- d. No other special features (e.g., bold, italics) are acceptable for making text stand out, except those listed in this document. Boldface text often does not show up as such when photocopied.
- e. When boldface text is used, the font size will be slightly but noticeably larger than the surrounding text.

- f. The font size in electronic versions of both C/L and logic flow procedures shall appear equal to the paper size at 100 percent scale viewing.
- g. The Orbit Pocket C/L, Entry Pocket C/L, Ascent Pocket C/L (APCL), Ascent/Entry Systems Procedures (AESPs), Photo/TV C/L, and Data Processing System (DPS) will use 10-point or smaller type (see document-unique standards, TBS) due to special spacing needs.

4.3 CAPITALIZATION, SPELLING, AND NOMENCLATURE

The United States GPO Style Manual will form the basis for capitalization, spelling, and nomenclature in FDF documents, with departures from that basis as necessary and as documented in the standards below.

Standards

- a. Appendix B of this document, Abbreviations Used in Procedural Nomenclature (PNOM), shall have priority over other references should a conflict of capitalization usage (e.g., tb, pb, cb) or spelling occur.
- b. Any unconventional abbreviations or acronyms not listed in Appendix C or in documents listed in Section 2.0 will be defined within the FDF book.
- c. The ISS Operations Nomenclature (OpNom) document shall be the authority for nomenclature of ISS items. The OpNom document shall have priority over the references should a conflict in capitalization usage or spelling occur.
- d. Each procedural statement will begin with the first word capitalized unless affected by another capitalization rule or condition.
- e. All display and control words shall be written in all capital letters.
- f. Nomenclature placarded on hardware will be written in all capital letters. The PNOM document shall remain as the authority for capitalization of switch callouts.

Example:

O14:A BRAKES MNA – ON

- g. Words that are not placarded on hardware will be written in lowercase letters when used in switch callouts and switch positions.

Example:

cb MNA WCS CNTLR – op

Vacuum Cleaner pwr – OFF

- h. The first word following a checkmark that begins a statement will be capitalized, unless the prior rule applies.

Examples:

√cb MNA WCS CNTLR – op

√Latches, handles turned upward

- i. Trade names must always be capitalized in accordance with trademark rules and regulations (e.g., Calfax, Velcro, Arriflex).
- j. All orbiter-flown loose equipment names and descriptions will be capitalized (e.g., Foot Tray, Gray Tape, Headset, Wet Wipes).
- k. Unless a unique spelling rule applies, the plural of an acronym or an abbreviation will be formed by adding an “s” (lower case) without an apostrophe (examples: cbs, FCs, msgs). The apostrophe is reserved for possessive word usage and approved contractions. The apostrophe will also be omitted from the coined plurals of letters, figures, and symbols (e.g., 1990s, ABCs, OKs, *s, ↓s).
- l. Proper names will be capitalized (Houston, Moscow, Earth, Spacehab), as well as the names of the celestial bodies (Sun, Moon, Mars). Use lowercase in the word “moon” in expressions such as “the moons of Jupiter.” Also, use lowercase in the words sunset, moonrise, and similar derivations. Orbiter is now considered a generic term and is not capitalized.

Guidelines

- a. Trade names should be used only when necessary to uniquely identify an object.
- b. Acronyms and abbreviations will generally be capitalized unless specifically listed as lower-case terms in Appendix B, or in the NASA Reference Publication 1059 Revised, Space Transportation System and Associated Payloads: Glossary, Acronyms, and Abbreviations.

4.4 INDENTATION

FDF documents use a “hanging indentation” style and omit a closing period for instructions. Therefore, the proper use of indentation is deemed critical for clarity, communication, and readability. Specific indentation standards are provided for carryover text lines, special switch callout, TOC, substeps or subentries following introductory lines, conditional substeps, repeated procedure text, step number alignment, and conditional step number alignment.

4.4.1 Carryover Text Lines

A “carryover text line” refers to a line of text that is wrapped from one line to the next.

Standards

- a. One nominal character space indentation (defined in FDF Templates as .08 inch space) will be used for carryover lines.

Example:

Remove Otoscope head; remove light source;
attach Ophthalmoscope head

- b. Checkmarks (√) are treated as any other word or character in carryover lines. A checkmark after the line break will be placed at the normal indentation.

Example:

If sequence will not complete:
√MCC (ITEM 5 EXEC will terminate)

4.4.2 Alternate Format for Switch Callouts

Standard

Two nominal character spaces prior to the first letter will be used to indicate omitted words in switch names that are continued on another line.

Example:

AFT L,R RCS
HE PRESS (four) – OP
TK ISOL (six) – GPC
XFEED (four) – GPC

The nomenclature on all three switches begins with “AFT L,R RCS.” Repeated text at the beginning of successive callouts is omitted (see Section 4.4.6). The above format could be used to conserve horizontal space.

4.4.3 Subentries Following Introductory Lines

Standards

- a. Three nominal character spaces will be used for substeps or subentries following introductory lines.

Example:

For ENG BURN:
TRIM LOAD per MNVR PAD
L,R – ITEM 6 +0.0 EXEC

- b. For numbered steps, the spacing will count to the unit's position of a step number.

For ENG BURN:
1. TRIM LOAD per MNVR PAD
2. L,R – ITEM 6 +0.0 EXEC

4.4.4 Step Number Alignment

Refer to Section 5.6 for the purpose, use, and location of step numbers within procedures and procedural callouts. Step number indentation is dependent upon which procedure elements are utilized within a procedural callout.

Standards

- a. The instruction is indented at least two nominal character spaces (which is approximately equivalent to three keyboard spaces) after a step number and its period. One of the two nominal character spaces is reserved for the checkmark, when required.
- b. Successive step numbers will be aligned on the period in a single column.
- c. An exception to this rule occurs when steps will be indented to show conditional use as described in the following Section 4.4.5.

4.4.5 Conditional Step Alignment

Conditional steps refer to steps that are dependent on a previous statement, such as a condition. More information on conditional statements can be found in Section 17.0.

The vertical alignment is critical to prevent a crewmember or others from misinterpreting the sequence of the steps to be performed. The vertical alignment of procedure steps determines which actions are to be skipped or followed when subentries or conditional phrases are used.

Standards

- a. The first character of unnumbered conditional statements will be aligned with the first digit of the appropriate preceding step number.

Example:

3. H2O PUMP LOOP 1 (two) – ON,B
If no PL H2O Loop present:
 4. FLOW PROP VLV LOOP 1,2 (two) PL HX (tb-PL)

- b. The connecting line between the “conditional statements” will be aligned with the first letter as shown below.
- c. Conditional subsets shall be indented three nominal character spaces from the connecting line.

Example:

- If verified by F9 voltmeter:
3. (Aff) ESS BUS SOURCE MN – OFF,ON
If bus regained:
 4. (Aff) FC – START (10 sec or P tb-gray)
 5. Go to aff BUS LOSS ACTION
- If bus regained:

4.4.6 Initial Words Omission

When characters and words are the same on successive lines, those initial characters or words are omitted in order to improve readability (except for checkmarks).

Standards

- a. When the leading words of successive actions are the same, the repeated words will be omitted.
- b. When lines are indented for this purpose, the checkmark will move to remain to the left of the first printed word. (Note: A slight vertical misalignment may occur, which is acceptable.)

Example:

1. S-BD PL CNTL – CMD
2. MOD – OFF
3. CNTL – PNL
4. √PWR SEL – BOTH

Guideline

Leading words may be repeated to avoid ambiguity.

4.4.7 *Leading Designators*

A leading designator is a clarifying word at the beginning of a callout. Common leading designators used in the FDF include:

- *Affected (aff)*
- *Good*
- *Bad*
- *Both*

Standards

- a. *A leading designator will have initial caps if it is the first word of a sentence or callout; otherwise, it is lowercased.*
- b. *A leading designator used in an action or verification callout (for switches on panels or items on displays) will be in parentheses because it is not part of the nomenclature (on the panel or display).*
- c. *Leading designators used in clear text sentences (when generalizing) will not be in parentheses.*

- d. *Leading designators will be spelled out if room is available (otherwise, use approved abbreviations).*

Examples:

(Good) OMS ENG – ARM/PRESS

(Aff) OMS TK ISOL (four) – OP

When aff OMS Pc < 72%:

(Both) OMS ENG (two) – OFF

If (aff) MANF tb – OP or sw not thrown:

Go to aff BUS LOSS and if AC1(AC2) aff >>

Isolate aff Φ B:

5.0 CHECKLIST PROCEDURE ELEMENTS

Procedures written in C/L format are primarily textual and provide step-by-step instructions.

Standards

- a. A procedure defining crew operations will be composed of a unique procedure identifier code, a unique title, and an action.
- b. In addition to the action, a step may consist of a timetag, a crew designation, the location identification, and a step number. The action element is the only mandatory part of the step. The other elements (timetag, crew designation, location identification, and step number) are optional and used as required.

<u>TIMETAG</u>	<u>CREWMEMBER</u>	<u>LOCATION</u>	<u>STEP NO.</u>	<u>ACTION</u>	<u>(feedback)</u>	<u>(clarifying comments)</u>
TIG-2	PLT	R2	1.	HYD PUMP PRESS 1 – NORM		

- c. The C/L procedure elements, when required, are always presented in the order above, with the first required element positioned flush to the left margin.

Example:

TIG-2	PLT	L10	1.	PRLA RELEASE		
				When in attitude,		
				~		
	PLT			√DAP: A9/AUTO/VERN(ALT)		
				~		
	MS3			VTR – RCD		
	MS1	L10		TILT TBL DR ENA PRI(ALT) – INTERM		

- d. At least one nominal character space must be left between elements (timetag, crew designator, location, step number, and action) in a step.
- e. Each element used in a given procedure shall be vertically aligned (per page) with the first occurrence of that element (exceptions are noted in the sections below).
- f. An element must not be repeated in consecutive steps if performed at the same location. *Rationale: It is implied that the preceding entry for that element applies.*

Guideline

When a required element is used infrequently within a procedure and there is a need to conserve horizontal space, that element may be positioned in vertical alignment with another element as long as both elements are not required on the same line, assuming that there is no ambiguity.

5.1 PROCEDURE IDENTIFIER CODE

Note: Implementation of this standard is deferred until further notice.

Standards

- a. Each procedure shall have a unique Procedure Identifier Code (PIC).
- b. Each PIC will contain the last three digits of the JSC document number, the section number within the book, and the initial sequential placement within the section, separated by hyphens (e.g., 035-6-6). Subsequent new procedures will be assigned the next available number, regardless of location within the section (to avoid having to renumber and/or relink existing procedures).
- c. Each PIC will be located at a To Be Determined (TBD) location.

Rationale: A PIC allows each procedure to be uniquely identified and, therefore, tracked more easily in electronic systems (e.g., Flight Planning System).

5.2 TITLES AND SUBTITLES FORMATS AND LOCATION

Standards

- a. Each procedure shall have a main procedure title that is unique to the book.
- b. The title will be the first line in a procedure.
- c. Titles will not be repeated on successive pages unless intervening data requires this duplication for clarity.
- d. All procedure titles will be left justified, all caps, bolded, and sized at least one point greater than the accompanying text. See Section 5.2.1 for successive levels.
- e. A title will generally contain an object and an action, with the action in noun form.

Note: Sometimes the object or the action is understood and not printed.

OBJECT/SUBSYSTEM ACTION (Clarifying Comments - optional)

Examples:

FCS C/O

CABIN TEMP CONTROL

- f. The title format for anomaly response procedures (e.g., Medical, Malfunction, etc.) will use the symptom.

SYMPTOM (Clarifying Comments - optional)

Examples:

BREATHING DIFFICULTY

ESS BUS V LOW

I/O ERROR MMU 1(2)

- g. In the case of a procedure title being the same as the message on an electronic display, the use of uppercase and lowercase letters in the procedure title is permitted to be consistent with the display title. See Section 11.0 concerning the use of quotation marks in referencing items on displays.

Example:

'I/O ERROR MMU 1(2)'

Note: Checkmarks will not be used in titles.

Guidelines

- a. Titles should be concise (25 characters or less) and descriptive.
- b. Acronyms and abbreviations such as prep (preparation), ops (operations), config (configuration) etc., should be used to simplify titles.
- c. *Titles should be identical to the associated fault message if such a message is to be displayed to the crew.*

5.2.1 Levels of Procedure Titles

Standards

- a. The main procedure title (1st level) shall be left justified, bold, all capitals, at least one point larger than the type used for the procedure text, and not underlined.

Example:

INITIATE LATCH PROCEDURE

- b. The 2nd-level procedure title will be unbolded, all capitals, and underlined.

Example:

CLOSE LATCH PWRDN

- c. The 3rd-level procedure title will be unbolded, initial capitals, and underlined.

Example:

Close Latch Activity

- d. The 4th-level procedure title will be unbolded, initial capitals, and not underlined.

Example:

Activate Repair Activity

- e. These formats apply whether a letter, as in subprocedure titles, or a number, as in step titles, precedes the title.
- f. A blank line will be left between the main title (including any carryover clarifying information) and the first line of the procedure body. The exception is the Entry C/L where spacing maybe a problem.
- g. A blank line will be left between subprocedure titles and preceding procedure text.

5.2.2 Subprocedure Titles

Standards

- a. When used, subprocedure titles will use a 2nd-level title format.
- b. Subprocedure titles are vertically aligned with the step that follows, with the optional letter placed in front of it.

Example:

PILOT WITHOUT RHC

PCS A. PILOT OPERATION WITHOUT RHC
 1. Double-click 'Shuttle Apps'> 'PILOT w/out RHC'

- c. Two nominal character spaces will be placed between the period following the letter and the beginning of the title when letters identify subprocedures.
- d. The first steps of a subprocedure will begin beneath the title, with no additional blank lines.
- e. Titles of subprocedures will be lettered if there is a potential that the subprocedure will be performed separately from the rest of the procedure in which it is contained.

Guideline

A procedure may be divided into subprocedures with titles or major steps with lettered or numbered titles (see examples 1 and 2). If the procedure is very large (several pages long) or made up of several smaller procedures, then the procedure should be divided into subprocedures for ease of readability.

A procedure may also be divided by step groupings with numbered step titles (see example 3). For added clarity, a step consisting of multiple actions may be titled with a step title. (See Section 5.2.3 on step titles)

Example 1 – Lettered subprocedure titles:

IMU ALIGNMENT – S TRK

- PNL A. COLLECT STAR DATA
 1. *(procedure step)*
 2. *(procedure step)*
- B. VERIFY STAR DATA
 1. *(procedure step)*
 2. *(procedure step)*

Example 2 – Unlettered subprocedure titles:

IMU ALIGNMENT – S TRK

- PNL COLLECT STAR DATA
 1. *(procedure step)*
 2. *(procedure step)*
- VERIFY STAR DATA
 1. *(procedure step)*
 2. *(procedure step)*

Example 3 – Numbered step titles:

IMU ALIGNMENT – S TRK

- PNL 1. COLLECT STAR DATA
 (procedure steps)
2. VERIFY STAR DATA
 (procedure steps)

5.2.3 Step Titles

Standards

- a. Single-line steps will not be titled.
- b. Step titles will use a 2nd-level title format when subprocedure titles are not used. When subprocedure titles are used, step titles will use 3rd-level or 4th-level title formats, as appropriate.
- c. The line containing the step title will be numbered.
- d. The first action of a step will begin beneath the title, with no additional blank lines.
- e. Step titles are vertically aligned with the steps (the action or the step number of the action if used) that follow, with the step number placed in front of the title.

Example:

3. EXECUTE MULTI-AXIS BURN
DAP: B1/AUTO/VERN(PRI)

- f. Two nominal character spaces will be placed between the period following the step identifier (number or letter) and the beginning of the title.

Guidelines

- a. A step consisting of multiple actions may be titled.
- b. Substeps may have titles.
- c. Substep titles may be lettered.

5.3 TIMETAG LOCATIONS

Standards

- a. Timetags will be used when it is necessary to specify when an action is to be taken. The time may be an absolute time or relative to an event.
- b. Timetags will be positioned flush to the left margin when required.
- c. When there are multiple vertical timetags, the colons must remain aligned.

Example:

+45:00 Initiate TRK
+6:15 When MNVR complete

- d. When a time is used only a few times in a procedure, the time will be at the beginning of the action following the step number (if used).

Example:

- 6. Hatch – Close
- 7. 04:15:00 Vlv2 – Open

Note: Reference Section 13.0 for timetag format standards. Events (such as altitude, velocity, Mach number, etc.) that are used to denote when to initiate or terminate an action may be referenced in the timetag location.

Example:

V = 6 PLT L10 1. P – AUTO

5.4 CREWMEMBER DESIGNATIONS

Crew designation is optional in a procedure but is intended to show which crewmember is to perform an action. This determination is normally related to crew training and can be either general or specific.

Standards

- a. Crewmember designations will be used when necessary to ensure crew efficiency or to satisfy task requirements.

- b. The following designations will be used to indicate a particular crewmember:

- CM - Any crewmember (used only if specific crewmembers were previously designated)
- A - All crewmembers
- CDR - Commander (preferred)
- C - Commander
- PLT - Pilot (preferred)
- P - Pilot
- B - Both Commander and Pilot
- EV - Any Extravehicular Activity (EVA) crewmember
- EV1 - EVA crewmember 1 (also EV2, etc.)
- IV - Any Intravehicular Activity (IVA) crewmember
- IV1 - IVA crewmember 1 (also IV2, etc.)
- MS - Any Mission Specialist
- MS1 - Mission Specialist 1 (also MS2, etc.)
- PS - Any Payload Specialist
- PS1 - Payload Specialist 1 (also PS2, etc.)

- c. Crew designations will not be placed within the action.

5.5 LOCATION DESIGNATION

Location designation is used to specify where an action will occur. Location designation may be specific, such as a panel, stowage locker number, loose equipment, display, etc. Likewise, the location identification may be general, such as flight deck, middeck, or airlock.

Standards

- a. The current applicable Procedural Nomenclature (PNOM) document (JSC-19409) shall be used for the appropriate panel location callouts. Other orbiter structural elements (windows, stowage volumes, etc.) are identified in the Shuttle Crew Operations Manual.
- b. Displays will be called out as “CRT,” “IDP,” “PGSC,” “MDU,” etc.
- c. Loose equipment is identified by an accepted abbreviation.
- d. When ISS locations are designated within the FDF, the locations will be identified per the ISS Operations Nomenclature book.
- e. Panel numbers will always be shown in switch verification lists, bus loss actions, and powerdowns.
- f. When panels have placarded row identification for circuit breakers, the row will be used as part of the location callout. For example: ML86B:A, where “ML86B” is the panel number and “A” is the row.
- g. A location designation must be specified for each step when there is a requirement to perform the operation in a specific location, unless one of the following exceptions applies (except when the omission would result in ambiguity or is in conflict with one of the above standards).
 1. The operation is continuing at a previously identified location.
 2. The title of the procedure includes the location where the procedure is to be accomplished.
 3. The location is obviously at any CRT, such as ops mode changes, item entries, or SPEC configuration changes.
 4. The location is obviously a Digital Autopilot (DAP) keyboard (panels C3 and A6).
 5. The location is obviously a hand controller, as in the Rotational Hand Controller (RHC), Translation Hand Controller (THC), and Speedbrake/Thrust Control (SBTC).

6. The location is obviously panel A8, as in performing deploy/recovery operations with the Remote Manipulator System (RMS).
7. The panels are obviously circuit breaker panels being called out from the Ascent C/L, Flip Books (FBs), and Pocket C/Ls. *Rationale: Due to size limitations of these books and the nature of the procedure, circuit breaker panel callouts will normally not be used.*
8. The panels are identified in Figure 5-1. *Rationale: These panels are used extensively during training, and the crew is intimately familiar with the displays and controls on these panels.*

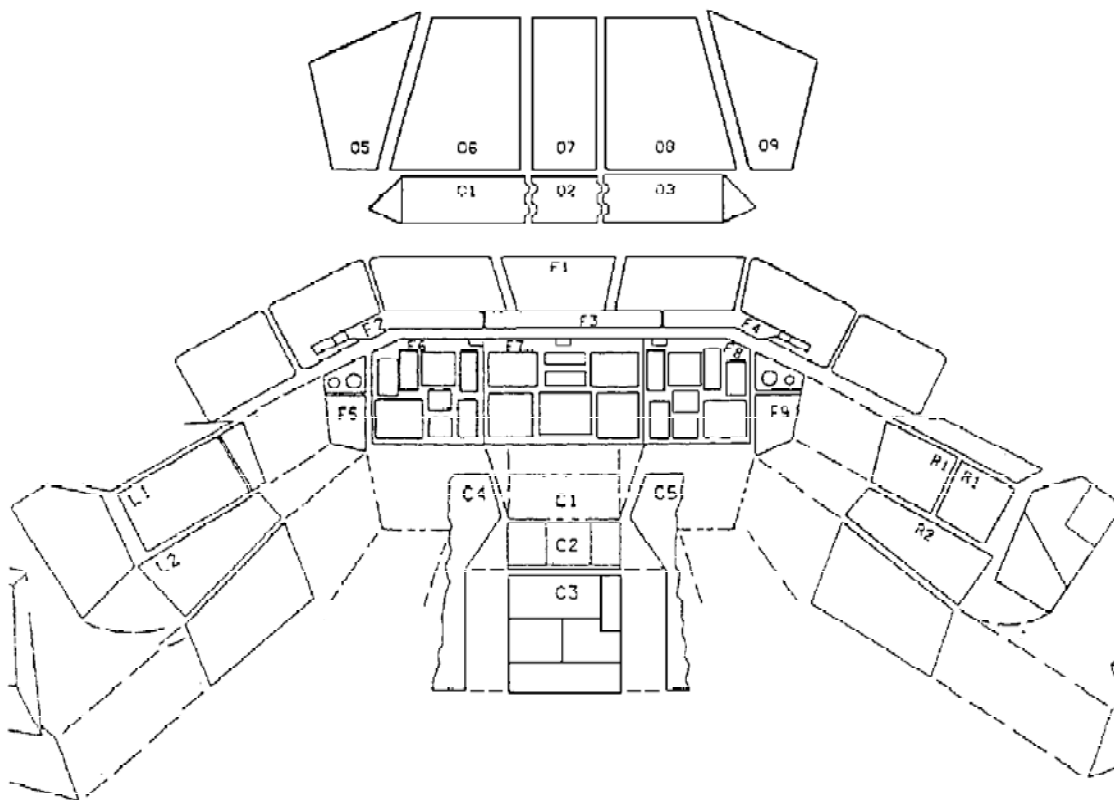

JSC-29031_021.cnv

Figure 5-1. Flight panels (those with numbers) where location callouts may be optional

- h. Multiple panel locations will be combined to save space and to consolidate operations into single steps whenever possible.
1. A comma indicates that the operation will be performed at all given locations (“and”).

Examples:

F7,A6U FLT CNTLR PWR (two) – ON

To conserve horizontal space, use (preferred):

O14:F, RJD DRIVER (eight) – ON
O15:F,
O16:F

To conserve vertical space, use:

O14,O15,O16:F RJD DRIVER (eight) – ON

2. Parentheses indicate that the step is performed at either one location or the other.

Example:

F7(A6U) FLT CNTLR PWR – ON

3. A slash indicates that the step is performed at one location and/or the other.

Example:

F7/A6U FLT CNTLR PWR – ON

- i. In cases where the panel number is different in different vehicles, boxes will be used to indicate the various choices. An exception is in switch lists, where other standards may be used to conserve space (see section on book-specific standards).

103,104	F8	FLT CNTLR PWR – ON
105	F7	FLT CNTLR PWR – ON

- j. In cases where the stowage location is unknown at the time of publication, an underscore will be placed in the location designator area for manual entry later.

5.6 STEP NUMBERS AND SUBPROCEDURE IDENTIFIERS

Standards

- a. Step numbers will be provided for each titled step consisting of multiple, logically related actions.
- b. A group of closely related actions will be given a single number.

Example:

```
ML31C    5. WASTE H2O TK1 VLV – CL (tb-CL)
          DUMP ISOL VLV      – OP (tb-OP)
          VLV                 – OP (tb-OP)
MF57M    6. Unstow Gray Tape
```

- c. Step numbers will be provided for individual actions when one of the following applies.
 - 1. There is a probability they will be called out individually. *Rationale: The individual step may be changed, omitted, or used as a reference point.*
 - 2. Execution spans a long time period.
 - 3. Breaks are expected during execution.
 - 4. Communication with MCC or other crewmembers regarding execution of procedures is expected.
- d. Each numbered step will begin on a new line.
- e. Steps, including indented steps, will be numbered sequentially within a procedure or subprocedure.
- f. Step numbers will be followed by a period.
- g. A step number will be placed to the left of its action with at least two nominal character spaces between the period and the action. One of the spaces is reserved for the checkmark, when required.
- h. Step numbers will be aligned on the period within logical groupings of steps (see Sections 4.4.5 on Conditional Step Alignment and 17.1 on Conditional Statements).
- i. If there is a need to identify individual substeps, they will be sequentially lettered with lowercase letters (a., b., etc.).
- j. Note/Caution/Warning blocks (see Section 14.0) will not be numbered.

- k. A conditional statement will not be numbered unless a single action is included, in which case the condition and action are considered one step.

Example:

- If (aff) MANF tb – OP or sw not thrown:
1. If FRCS: √MCC
 2. If ARCS: RCS RM MANF CL OVRD – ITEM 41 EXEC
 3. If (aff) MANF tb–bp: (Aff) MANF – GPC

Guidelines

- a. Step numbers may be provided for steps consisting of a single action.

Note: To enhance readability, it is preferable not to have every line of a procedure numbered. In numbering steps, consideration should be given to readability and communication/coordination with the ground.

- b. Procedure lines containing physical locations (as in equipment lists) or display locations (as in CRT header boxes) generally are not numbered unless they are the first action in an untitled grouping.
- c. If vertical space is constrained, a single step may consist of a two-part action.

Examples:

1. Install A on B, B on C

is the same as:

1. Install A on B
2. Install B on C

- d. Individual procedures, subprocedures, or steps should consist of groupings of no more than 20 actions. The following example illustrates the use of step letters to create breaks or subprocedures.

Example:

MPS VACUUM INERT

A. ACTIVATION

- LO2 Inert
- R4
1. MPS FILL/DRAIN LO2 OUTBD – CL
 2. INBD – CL
- Wait 15 sec, then:
3. MPS FILL/DRAIN LO2 OUTBD – OP
 4. INBD – OP
- LH2 Inert
5. MPS FILL/DRAIN LH2 OUTBD – CL
 6. INBD – CL
- Wait 15 sec, then:
7. MPS FILL/DRAIN LH2 OUTBD – OP
 8. INBD – OP

B. TERMINATION

- LO2 Inert
- R4
1. MPS FILL/DRAIN LO2 OUTBD – CL
- Wait 15 sec, then:
2. MPS FILL/DRAIN LO2 OUTBD – GND
 3. INBD – GND
- LH2 Inert
4. MPS FILL/DRAIN LH2 OUTBD – CL
- Wait 15 sec, then:
5. MPS FILL/DRAIN LH2 OUTBD – GND
 6. INBD – GND

- e. A group of actions performed by one crewmember on one panel should be given a single step number.

Example:

- PS R1
8. (Aff) cb AC CONTR (three) – cl
- INV/AC BUS – OFF (tb-OFF)
- INV/PWR – OFF (tb-OFF)
- cb AC CONTR (three) – op

5.7 ACTION LOCATION

Reference Section 7.0 for information on formatting actions.

6.0 LOGIC FLOW DIAGRAM (MALFUNCTION PROCEDURES) ELEMENTS

The logic flow format is primarily used for resolution of off-nominal conditions. This format is useful in diagnosing the cause of the off-nominal condition, determining the extent of degradation, and assessing the effect of continued operation.

Standards

- a. Information in a logic flow diagram procedure will include
 1. The affected system
 2. The off-nominal condition (symptom)
 3. The nominal configuration
 4. The instructions and decisions required to assess and resolve the condition
 5. Reference information
- b. A logic flow diagram will be formatted in three columns: Condition, Resolution, and Reference. The columns are presented in the order given.
- c. All three columns will be used on the first page of the procedure. Fewer columns may be used on following pages.
- d. Information presented in logic flow diagram procedures is read from left to right and top to bottom, starting at the top of the Condition column.
- e. All numbered information blocks and circles are numbered left to right, top to bottom within their respective columns. The lowest numbered block will always be the highest positioned block on the page in the left-most position. Other numbered blocks will follow in sequence.
- f. Each logic flow diagram procedure will have a unique title that is numbered, left justified in the Resolution column, bolded, at least one font larger than the text in the procedure, and all capitals. See Section 5.2 for additional information on titles.
- g. Each logic flow diagram title will be in single quotes if same as an error message.
- h. Logic flow diagram procedures will not address multiple unrelated conditions. This stipulation prevents the procedures from becoming complex.
- i. Logic flow diagram procedures entered from a C/L procedure will not repeat the C/L steps.

- j. Panel location designators or other location identification (e.g., O7) will be placed in parentheses before the actions. Panel locations will be flush left, in parentheses, and on the first available line (after a block number and title) within a particular box.
- k. Display names will appear in a display box (see Section 10.0).
- l. Other than the title and the affected system, all text will use 8-point font.

6.1 THE CONDITION COLUMN

Standards

- a. The Condition column (also known as the symptom column) will contain the symptoms, or cues, that alert the flight crew to an off-nominal condition.
- b. On continuation pages, this column will be deleted and more room is made available for the resolution and reference columns.
- c. The Condition column will contain
 - 1. The affected system, which may be the same as the section name, left-justified at the top of the column, in 12-point font, all capitals and bolded (e.g., **COMM**).
 - 2. Indicator of an off-nominal situation, which may be in the form of an alarm, Systems Management (SM) ALERT light, Caution and Warning (C/W) light, fault summary message, a meter reading, or an observed condition (intercom lost, shutter nonoperation, etc.).
 - 3. A list of all independent points of entry into the procedure; a list of conditions that might cause the indication.
 - 4. The nominal configuration includes a list of switches, circuit breakers, and other related configuration data. These serve as a memory aid in confirming nominal configuration. The nominal configuration list will be directly beneath the symptom designation and will be limited to only those switches and items that have a direct relationship to the specific failure.
- d. Each indication will be enclosed in a box as shown below.
- e. Different types of condition blocks are used for initial entry into the procedure. These blocks, along with supporting information under each block, explain and qualify the situation so the user fully understands the existing symptom or condition.

1. C/W or Systems Status Light Block (class 2): This condition block has the appearance of a C/W panel or system status panel light with the name of the light listed within the block. Any additional explanatory notes (e.g., C/W or systems parameters which trigger the light), should also appear under the block. This symbol will normally represent a major symptom. Any block representing an F7 panel light (primary or backup C/W) or an A8U (Payload Deployment Retrieval System (PDRS) C/W) panel light will be shaded and appears with "(F7)" or "(A8U)" centered below it. If a light is Backup Flight System (BFS)-generated, the letters "BFS" should appear on the top of the box.

AV BAY/
CABIN AIR
(F7)

2. SM Alert Light Block (class 3) – This condition (symptom) has the appearance of the status panel light. In most cases, this symbol will represent a major symptom. If the alert is BFS-generated, the letters "BFS" will appear flush left on the top of the box.

SM
ALERT

3. Fault Summary Message (class 4) – This condition (symptom) has the appearance of a GPC-generated CRT fault message. Usually, this symbol will represent a major system. If BFS-generated, the letters "BFS" will be flush left at the top of the condition box.

BFS
SM2 AV BAY
TEMP

4. Other symptom blocks – The other condition blocks cover any malfunction symptoms not already covered. These blocks will include such items as abnormal system reading (CRT or meters), intercom lost, TV not transmitting, film not advancing, etc. Since these blocks will normally have only one exit branch and describe only a single condition for a particular symptom (e.g., O2 PRESS HI rather than O2 PRESS HI or LOW), this type of block will serve as a major malfunction symptom or as a secondary entry point for subsymptoms that are directly related to a major symptom. Directly below the block, explanatory information may be listed, such as: low- or high-pressure limits (depending on the particular symptom), normal pressure range, etc.

S66 HUMID
SEP A(B)

HUMIDITY SEP
A(B) underspeed

- f. The condition blocks are arranged in order of criticality, with the most critical first.
- g. Condition blocks must describe a single condition.

- h. Condition blocks must have a single exit branch, entering into the procedure at block 1. Class 2 and class 3 alarm will not have exit branches.

Example:

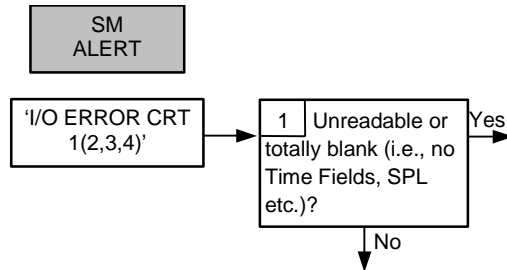

- i. The nominal configuration list will be below the associated condition block.

6.2 THE RESOLUTION COLUMN

Standards

- a. The resolution column will contain the procedural steps necessary to assess and resolve the condition, including direction to other procedures or information if needed. The resolution column will contain information to help the crew gain control of the situation by stopping divergent rates, out-of-tolerance leaks, etc.; locating and isolating the failure; and establishing alternative modes of operation.
- b. The resolution section may contain any number of the following:
1. Instruction blocks – Contain the decisions and actions required to analyze and respond to the event that caused the logic flow procedure to be used. There are three types of instruction blocks:
 - (a) Action blocks
 - (b) Decision blocks
 - (c) Combined action/decision blocks
 2. Result blocks.
 3. Notes, caution and warning blocks – Alert the crew to situations which, if not corrected, may degrade the operational integrity of orbiter or spacecraft systems or experiment components or which may have critical crew safety consequences.
 4. Reference symbols – Used to reference items in the Reference Column.
 5. Transfer information – Used to refer to other procedural steps.
 6. Remote Event Indicator

- c. All instructions, results, and clarifying information will be contained within their respective blocks.
- d. Procedure flow will be from top to bottom and left to right, as required.
- e. All instructions, results, and clarifying information blocks will be numbered in the upper left-hand corner within its own box.
- f. Blocks containing crew actions will use an abbreviated C/L-style format rather than clear text to conserve space.
- g. Each procedural step, except a CRT display action, will be identified by a bullet.

6.2.1 The Instruction Block

Standards

- a. Logic flow diagram procedures will use three types of instruction blocks:
 - 1. Action blocks
 - 2. Decision blocks
 - 3. Combined action/decision blocks
- b. If the instruction block has a title, the title will appear next to the block number and be separated from the rest of the procedures with a line.

Example:

2	Try to reestablish I/O
• I/O ON – ITEM 5	

- c. If the instruction must be performed in a particular location, the instruction block will contain a location in parentheses left justified on the line after the block number and/or title.

Example:

5	
(A8U)	
• SAFING – CANCEL (tb-gray)	
• Continue ops	

- d. The left to right block positioning should be aligned along the top edge of the row of blocks whenever possible.

Example:

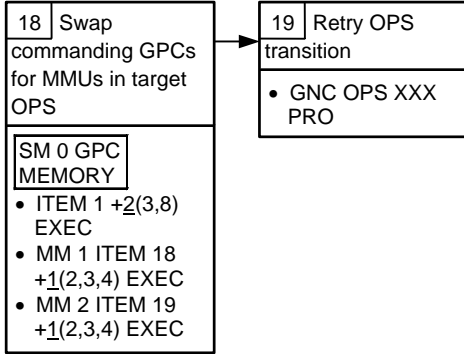

6.2.1.1 The Action Block

Standards

- An action block will be used only to identify crew actions.
- An action block contains a block number, an optional descriptive title followed by a location, and the action.
- Each procedural step within an action block will be identified with a bullet [•] instead of a step number.
- An action block will be used to group actions to which a note or reference information may be applicable.
- With each change of location (physical or on a display) within the action block, a separator line will be drawn to indicate the change of location.

Example:

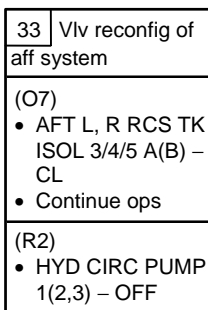

Guidelines

- a. If further divisions within an action block are needed, they may be added using a dotted line.

Example:

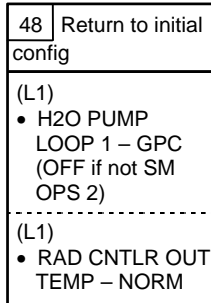

- b. An action may be the terminal steps of a procedural sequence.

Note: Reference Section 7.0 for formatting of actions.

6.2.1.2 The Decision Block

Standards

- a. A decision block is used to ask a question and provide multiple paths in assessing a condition.

Example:

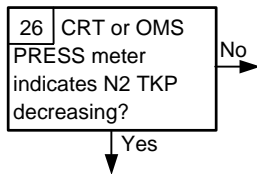

- b. The Decision block will contain a block number followed by a question that requires a decision.
- c. Whenever possible, a Decision block will be connected to the prior action block unless the prior block in the sequence is another decision block or a combined action/decision block.

Example:

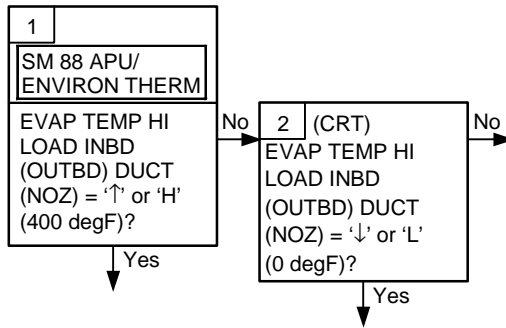

- d. Action blocks and Decision blocks will be combined into combined/decision blocks to conserve space and improve logic diagram flow.
- e. The block to the right of a decision block, connected by a line, will be aligned with the top edge of the original decision block.
- f. If a decision block contains exits for multiple decisions, a solid line will separate each decision question.

Example:

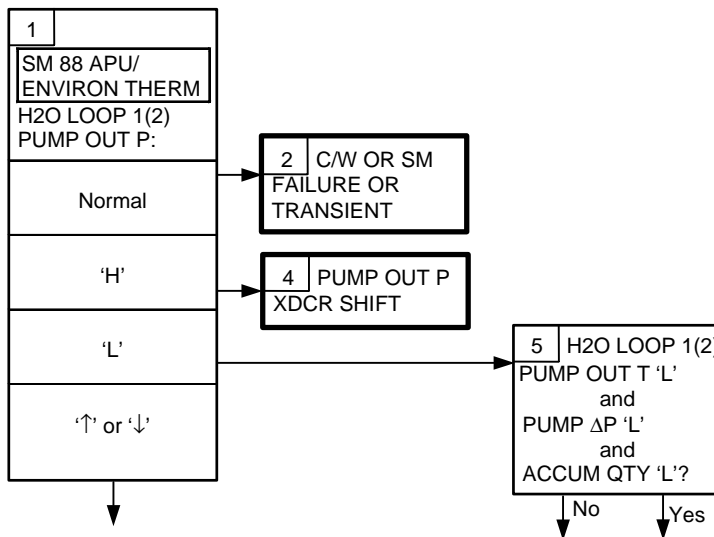

- g. The words explaining each decision must be spelled out whenever possible (or use the PNOM abbreviation).

Guidelines

Blocks to the right of a decision block, not line connected, may be higher or lower than the decision block since they have no relationship to the flow of information from the decision block.

6.2.1.3 The Combined Action/Decision Block

Standards:

- a. A combined action/decision block (also known as the procedural block) combines a related action and decision into one block.

Example:

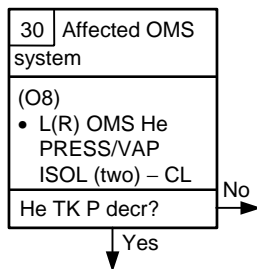

- b. The action/decision block will always list the action first.
- c. A single line will separate the action from the decision.
- d. If a line connects an action/decision block to another block to the right, the right-hand block must be aligned with the line separating the action and decision in the action/decision block.
- e. Whenever possible, a decision block will be connected to the prior action block unless the prior block in the sequence is another decision block or a combined action/decision block.
- f. Action blocks and decision blocks will be combined into combined action/decision blocks to conserve space and improve logic diagram flow.

6.2.2 The Results Block

Standards

- a. The results block will contain a block number and a description of the results of the logic flow diagram procedure, usually an error condition or failure description (diagnosis).
- b. To easily identify the results, the results block will be outlined with a thicker border than any other block in the logic flow procedure. The text will be all caps, unless special rules of grammar apply.

Example:

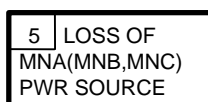

- c. If Special Subroutines (SSRs) or reconfiguration procedures are required, a special format is used to reference the SSR, noting the involved system and the SSR number.

Example:

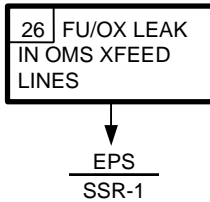

For space constraints, the title of the SSR is omitted. However, if the title is essential to be noted along with the SSR number, the SSR number is placed in an action block using the “Perform” or “Go to” format per example below.

Examples:

41	Reduce CABIN P
<ul style="list-style-type: none"> • Perform RECONFIG TO ALT PCS SYS, (14.7 PSI OPS) ECLS SSR-3 [3] (10.2 PSI OPS) ECLS SSR-3 [6] • Go to ECLS COMPUTATION INHIBIT, ECLS SSR-14, Table B and Table C 	

2	If FC purge reqd
<ul style="list-style-type: none"> • Go to EPS SSR-8 or PRIORITY PWRDN (ORB PKT) to reduce FC AMPS to < 350 (< 430 for contingency ops) during purge 	

6.2.3 Clarifying Information Blocks – Notes, Cautions, and Warnings

Standards

- a. Special Notes will be used to follow actions in instruction blocks to describe a status or condition the crew should be aware of prior to the next step. The notes do not involve crew safety.

Example:

1	Select IMU
<ul style="list-style-type: none"> • ITEM XX EXEC 	
<p>NOTE</p> <p>During reconfig, maintain one IMU</p>	

- b. Caution blocks appear before the action or condition the block describes and will be similar in appearance to C/L-procedure style Caution blocks as described in Section 14.0. The Caution block will provide information/instructions necessary to prevent hardware damage or malfunction. Caution blocks will not have a step number. Procedural steps will not be placed inside a caution block.

Example:

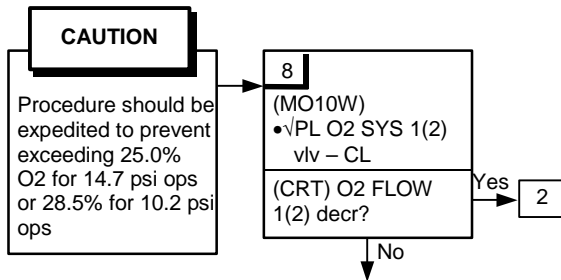

- c. Warning blocks appear before the action or condition they describe and will be similar in appearance to C/L-procedure style Warning blocks as described in Section 14.0. The Warning block will provide information/instructions necessary to ensure crew safety. Warning blocks will not have a step number. Procedural steps will not be placed inside a warning block.

Example:

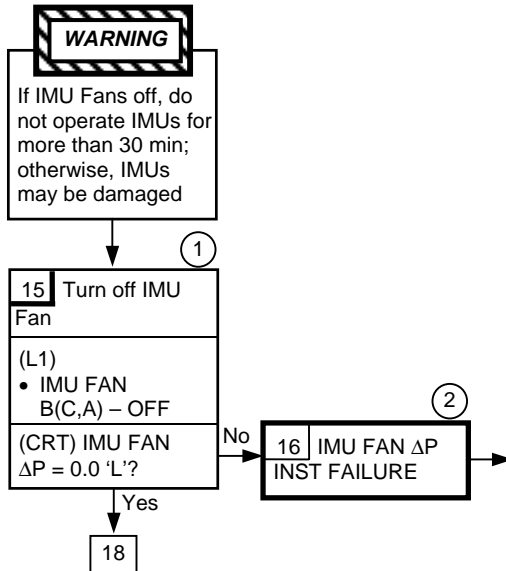

- d. When an instruction block is preceded by a caution or warning block, the number box of that block will have wide borders to alert the crew to the possibility that the information in that block may identify a problem.

6.2.4 Reference Symbols

Standards

- a. Reference symbols are used to refer to additional information in the reference column.
- b. The reference information (in the reference column) will be visible from (on the same page as) the associated instruction box that uses a reference symbol to refer to it. In the reference column, the circled number, denoting a particular piece of information, precedes that information. The reference information identifies a failure or action in more detail, describes the status of the system or subsystem, or explains the urgency with which the failure must be treated. The notes will be numbered in sequence, left to right, then top to bottom on the page as they appear in the resolution column. Inserting a new note into the procedural flow will require succeeding notes to be renumbered.
- c. The reference symbol, consisting of a number enclosed in a circle, will be located above the right-hand corner of an instruction block.

Example:

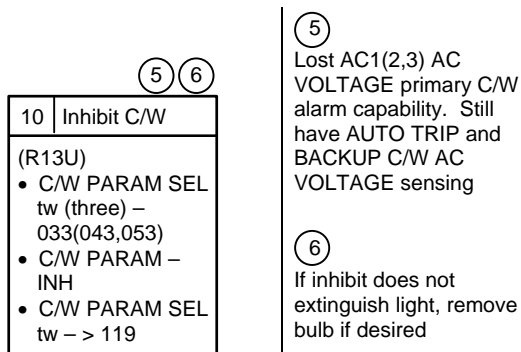

6.2.5 Transfer Block

Standards

- a. The transfer block will be used as a link between two instruction blocks within the same logic flow diagram procedure.
- b. The transfer block symbol is a block number within a box. The block number indicates the next instruction block to be entered.

Example:

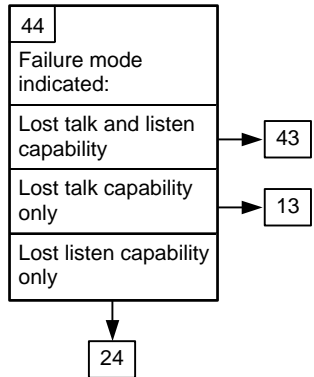

- c. The transfer block is used to reference the procedure flow on a continued page or on the same page when it is impractical to directly link two instruction blocks.

6.2.6 Remote Event Indicator (Cross-Reference to Another Mal Procedure)

Standards

- The remote event indicator will be used as a link between two instruction blocks within different logic flow diagram procedures.
- The remote event indicator will usually follow an instruction block and may refer to a Failure Recovery Procedure (FRP), SSR, or another malfunction procedure.
- If the remote event indicator instructs the user to leave the book, the name of the new book and the underlined major tab will be indicated, as well as the new logic flow diagram procedure number and the appropriate block number at the bottom of or to the right of the arrow.

Examples:

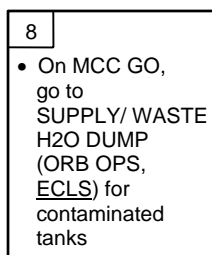
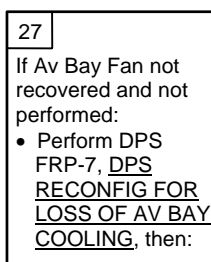

- d. If the remote event indicator instructs the user to leave the procedure but stay within the same book, only the new logic flow diagram procedure number and block number are indicated at the bottom or to the right of the arrow.

Example:

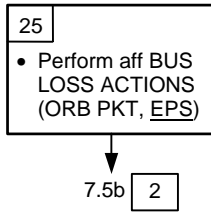

- e. If a logic flow diagram procedure is to be entered other than at the start of the procedure, Block 1, the information required to uniquely identify the procedure that was entered from it is placed above the arrow.

Examples:

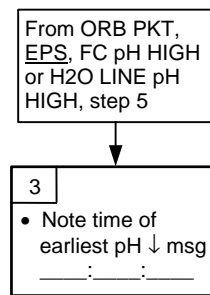
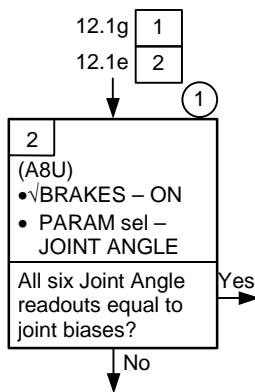

6.3 THE REFERENCE COLUMN (NOTES)

Standards

- a. Reference information can be presented either concurrently with the procedure steps (in the resolution column) or in a separate column on the right-hand side (in the reference column).

Example:

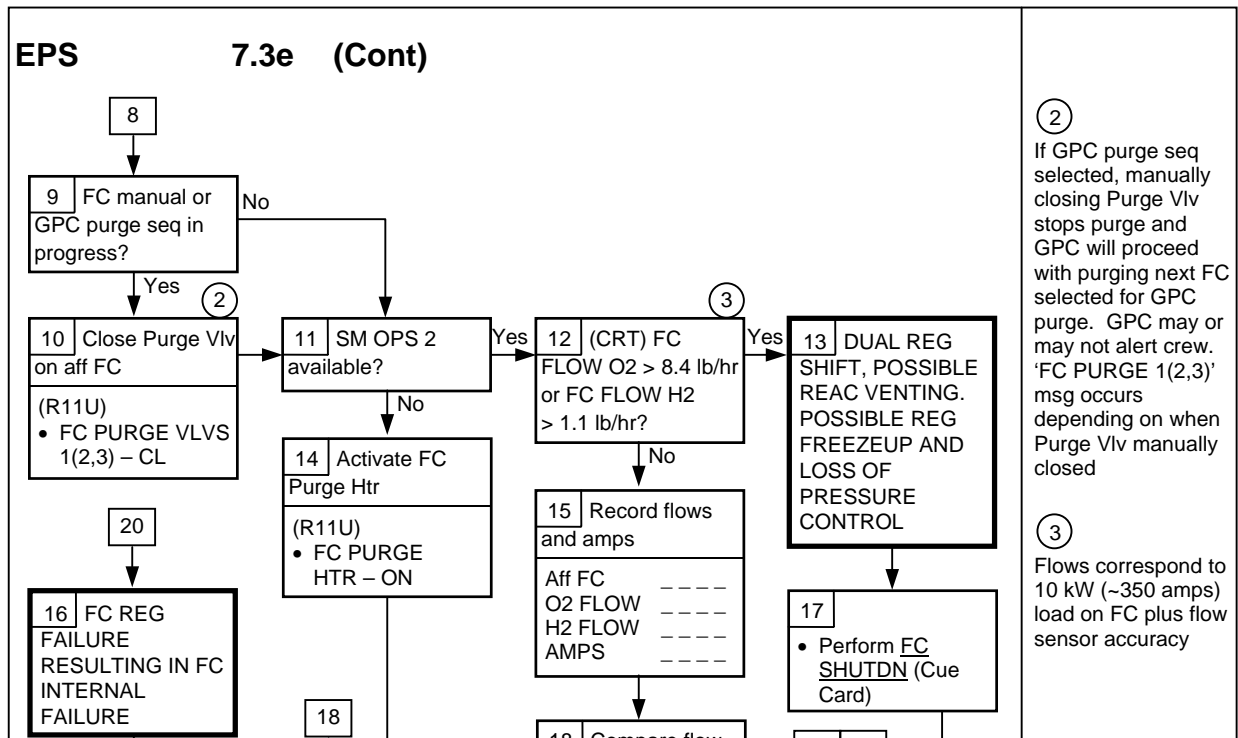

- b. The reference column will contain numbered notes that explain and qualify situations described in the other columns.
- c. The reference column will not contain actions.
- d. The reference information will be numbered in sequence, with each number contained within a circle (“reference symbol”).
- e. Initial numbering of the reference information will reflect the left to right and top to bottom flow of the procedure.
- f. Inserting a new note into the reference information, other than at the end, will require successive notes and the associated reference symbols within the resolution section to be renumbered.

- g. Information presented in the reference column will be of sufficient detail to enable the user to evaluate and understand the relative importance of the condition/symptom and the urgency with which it must be treated. The reference column is used to
 - 1. Qualify threshold values that trigger C/W lights or the SM ALERT light
 - 2. Indicate limits for meter reading parameters and the effects of exceeding these limits
 - 3. Specify, at the point where a condition is determined, the resultant operational capability and conditions of subsequent usage
- h. The procedure shall be complete and safe without the reference column. Directions included in the reference column, as required, may refer the user to backup procedures or other procedures and steps.

7.0 ACTIONS

7.1 ACTION FORMATS

Standards

- a. Each action will begin on a new line.
- b. The articles “a,” “an,” and “the” will be omitted for brevity in actions, unless the article affects the meaning of the action.
- c. The conjunction “and” will be replaced by a comma unless the omission of the conjunction affects the meaning. See Section 11.1.1.
- d. Actions will be expressed in either of two main forms:
 1. Operational callouts (preferred) are typically used for instructions involving physical devices and computer displays.
 2. “Clear text” (see Section 7.3) is used primarily for operations not associated with computer displays and physical controls and may be of two types: a “simple” command or a “conditional” command.
- e. Operational callouts identify which object(s) are to be operated upon or observed followed by the action(s) to be performed or the state of the object.
 1. For commands, the object will be separated by a dash [–] from the desired state. A colon will be used if the state is a numerical value.

OBJECT – STATE

Example:

R AUD PWR – OFF

This callout instructs the crew to set the RIGHT AUD POWER switch to the OFF position.

2. For verifications, the object(s) and the state(s) will be separated by a dash [–] unless a relationship symbol such as “<” applies or a numerical value is inserted. A colon will be used if the state is a numerical value.

√OBJECT – STATE

Example:

√R AUD PWR – OFF

The above callout instructs the crew to verify that the RIGHT AUDIO POWER switch is in the OFF position.

Examples:

√DAP: A/AUTO/ALT(PRI)
√TGT ID: 2
√EXEC, ITEM 16 – (no *)
√ΔBIAS < .12

- f. For a series of more than two consecutive actions, the dashes [-] will be vertically aligned to the right of the object callouts, except when prevented by space constraints.

Example:

GPC MODE – HALT
GPC MODE – HALT
FREON PUMP – B
cb AC CONTR (three) – cl

- g. The dash may end a line break, but will not begin a line that requires a carryover of text to two or more lines.

Example:

H2O PUMP LOOP 2 BYP MODE –
MAN

- h. A “simple” command will use phrase structure beginning with a verb and ending with the object.

Example:

Insert film into camera

- i. A “conditional” command will be preceded by a conjunction such as “if” or “when” introducing the conditional phrase.

7.2 COMBINING AND SIMPLIFYING ACTIONS

Refer to Section 8.0, Physical Control Devices, Section 9.0, Meters, Indicators, and Annunciators and Section 10.0, GPC/CRT Interfaces, for information on formatting the object portion of actions.

Standards

- a. Multiple actions will be combined to save space and to consolidate operations into a single step whenever possible.

OBJECT (quantity) – STATE

1. Clarifying information (quantity) in parentheses indicates that the same action applies to multiple physical devices with similar device names.

Example:

use... APU CNTLR PWR (three) – ON (if all switches operated)

instead of... APU CNTLR PWR 1 – ON
 APU CNTLR PWR 2 – ON
 APU CNTLR PWR 3 – ON

2. A comma (meaning “and”; see Section 11.1.1) indicates action on specified systems:

Example:

use... APU CNTLR PWR 1,3 (two) – ON (not all switches operated)

instead of... APU CNTLR PWR 1 – ON
 APU CNTLR PWR 3 – ON

3. Parentheses (meaning “or”; see Section 11.1.7, standard no. 2) indicate that the operator has a choice of alternate systems, with the preferred system given first:

Examples:

use... APU CNTLR PWR 1(2) – ON (“or” switch operation)

instead of... APU CNTLR PWR 1 or 2 – ON

use... GPC MODE 1(2,4,5) – HALT

instead of... GPC MODE 1 or 2 or 4 or 5 – HALT

Note: In a series of related switch callouts, the operator should use the same system (either system 1 or system 2, etc.) consistently throughout the procedure.

- b. Two control devices with a common title will be called out as follows:
OBJECT (quantity) – STATE (of 1st device), STATE (of 2nd device)

Example:

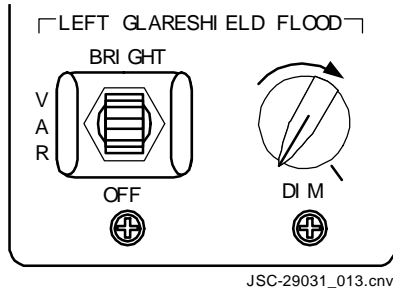

LTG L GLRSHLD FLOOD (two) – VAR, DIM

If the light is powered off or set to BRIGHT, the rotary adjustment switch need not be listed:

LTG L GLRSHLD FLOOD – BRT

Example:

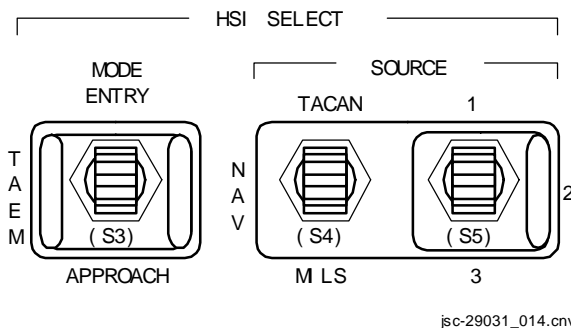

HSI SEL SOURCE (two) – NAV, 2

In such cases, both switches will always be listed together, even if only one is reconfigured.

- c. The designator “X” will be used to indicate action to be taken on a particular object not identifiable prior to the mission. The specific object is dependent upon the affected system.

Example:

GPC MODE X – HALT

- d. If the “X” designator is not specified or more than one object will be acted upon, clarifying information will be given in parentheses prior to the object.

Examples:

(Aff) GPC MODE – HALT
(SM) GPC MODE – HALT
(Aff) FREON PUMP – B
(Aff) cb AC CONTR (three) – cl

Note: The leading designators are in parentheses because they are not part of the switch nomenclature.

Note: “Aff” (affected) is capitalized only as the first word of a sentence or callout; otherwise, “aff” is lowercase. “SM” refers to the GPC assigned to Systems Management functions.

7.3 CLEAR TEXT INSTRUCTIONS

Clear text conveys information or instructions in “sentence” format.

Standards

- a. Clear text will be used for operations not associated with displays and controls. Each action will be placed on a separate line without a period.

Examples:

Unstow EV Gloves
Replace LiOH Cart
Stow EV Gloves

- b. Clear text will be used to convey clarifying information as required. The text will be enclosed in parentheses.

Example:

TEST LOW – ITEM 10 EXEC (*) (after 10 sec, no *)

Guidelines:

- a. In extended clear text, punctuation is generally in accordance with the rules of grammar, except for omission of periods (see Section 11.1.3).
- b. All actions should be expressed as simply as possible. Complex commands may be broken into multiple simple commands to improve clarity and readability. Avoid using several words or sentences to describe a simple operation.

Example:

Instead of: Unlock and open stowage container lid
 Remove hardware from stowage container

Use: Unstow hardware

Example:

Instead of: Push knob in and rotate it counterclockwise 10 times

Use: Loosen Calfax

- c. Minimize the use of repeated descriptive references to a given item. For example, the crewmember may be instructed to obtain a 5-foot cable. The first time the cable is identified, it is called out as a “5-ft cable, part no. XED 123456-301.” Later in the procedure, if the identification is obvious and easily understood (i.e., only one cable was obtained), the action should simply specify “cable.”
- d. To improve clarity, abbreviate lengthy or wordy names of hardware assemblies or subassemblies items not covered by standard nomenclature documents:
 1. The preferred technique is to use accepted abbreviations.
 2. An alternate technique is to use the most descriptive part in the name.

Example:

Consider an experiment hardware subassembly that is referred to as the “rear backplate/shelf assembly.”

- (a) “Assembly” should be abbreviated to “assy.”
- (b) If there is only one backplate assembly, the word “rear” should be deleted.
- (c) If, for some particular reason, “backplate” has more meaning than “shelf,” it may be appropriate to delete “shelf.”
- (d) Consequently, the “rear backplate/shelf assembly” could be referred to as the “backplate assy.”
- (e) Finally, if the crew cannot disassemble the “backplate assy,” the item should be further shortened to “backplate.”

8.0 PHYSICAL CONTROL DEVICES

Physical control devices allow the crew to configure and reconfigure shuttle systems and payloads. The types of physical control devices on the shuttle are

- a. Switches (sw)
- b. Toggle switches
- c. Momentary switches (mom)
- d. Display select switches (sel)
- e. Pushbuttons (pb)
- f. Thumbwheels (tw)
- g. Circuit breakers (cb)
- h. Valves (vlv)
- i. Hand controller devices
- j. Pedals, latches, handles, and knobs

8.1 SWITCHES

The new standards incorporated into this section (8.1(a) and (f)) will be implemented in the STS-114 flight books. (CR# CPMP_Annex_CU12A)

Standards

- a. Switch operations will use the following format:

SWITCH TITLE type (quantity) – POSITION/ACTION (feedback) (optional comments)

Examples:

FLT CNTLR PWR (two) – ON
L,R OMS XFEED (four) – CL (tb-CL)
VID IN A pb – push (lt off)
– push (A lt on)

- b. The type of control device will be identified by using lowercase letters after the name for the following:

Pushbutton – pb
Thumbwheel – tw
Display select switch – sel

- c. The singular form will always be used regardless of the number of switches or control devices called out in the statement. Exception: The Procedural Nomenclature (PNOM) document designates certain switches in the plural form, which shall be followed in those instances. Therefore, if more than one switch is involved, the quantity will be shown in lowercase letters (never numerals) within parentheses. (See Section 7.0 for simplifying multiple switch actions.)

Example:

HYD CIRC PUMP (three) – ON *all pumps will be turned on*

- d. When a switch is to be cycled or moved to multiple positions successively, the positions will be called out, separated by commas with nonplacarded positions or instructions also separated by commas.

Example:

GPC MODE 1 – STBY, HALT, pause, STBY, RUN

- e. The switch position or action shall be the placarded switch position (i.e., ON, OFF, A, PRI, etc.) given in the Procedural Nomenclature (PNOM) document. See Appendix B for selected abbreviations used in procedural nomenclature.
- f. Pushbutton actions should be described simply as “push.” However, care should be used in describing pushbuttons since it is difficult to explain exactly what switch state is desired. If the feedback is a light that turns on or off, the light title should reflect the exact wording found on the light. (see PNOM book)

TITLE type (quantity) – action (feedback) (optional comments)

Examples:

LDG GEAR ARM pb – push (ARM lt on)
– push (lt off)

√LDG GEAR ARM pb – ARM lt on
√pb – lt off

- g. Momentary (spring-loaded) switches may require an action of “push and hold,” and the hold duration will be specified in parentheses.

Example:

MOTION PRI – LOWER (hold 5 sec)

- h. If a toggle switch has no placarded position, the words “up,” “dn,” “left,” “right,” or “ctr” will be used to denote the desired switch action. Direction will be relative to the placarded panel nomenclature and will be followed by a parenthetical statement of the function selected. As an example, “up (enable)” denotes that an up position enables the function.
- i. Clarifying comments, if needed, will be added in parentheses as a catchall, but will serve only to clarify the action and will not provide data found elsewhere in the procedure or notes.

Example:

A7U PL BAY FLOOD FWD, AFT (four) – ON (~3 min to full bright)

- j. When it is desirable to combine control device callouts into a single statement, specific rules shall be followed. The tier bracket titles, as they appear on the panel, shall be sequentially used until the control device is uniquely and properly identified.

Example:

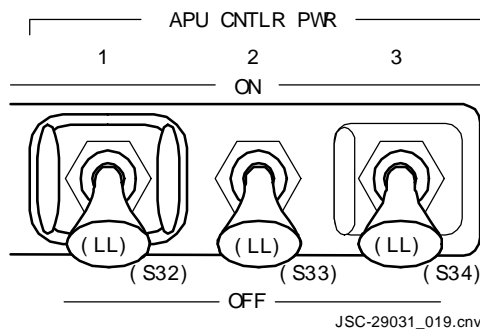

In the example above, to identify a single switch, use

APU CNTLR PWR 1 – ON

To identify two of the three switches, use

APU CNTLR PWR 1,3 (two) – ON

To configure all three switches, only the top tier of the panel with the quantity will be necessary.

APU CNTLR PWR (three) – OFF

- k. Placarded titles/names will be called out and abbreviated per the D&C Procedural Nomenclature document.
- l. When combining control devices located on different panels that have the same title, the quantities will indicate the number of actions (e.g., switch throws) required.

Example:

Only one of the two Flight Controller Power Switches (CDR or PLT) located on panels F7 and F8 is required. However, both could be turned on (Reference Section 5.5, standards no. h). Since only one switch needs to be thrown, the callout will appear as follows:

F7/F8 FLT CNTLR PWR – ON

Note that, in this case, even though both switches can be thrown, the switch quantity “(two)” will not be used.

If both had to be turned on, the following format would be used:

F7,F8 FLT CNTLR PWR (two) – ON

m. Two control devices given the same title on the panel will be called out as follows:

Examples:

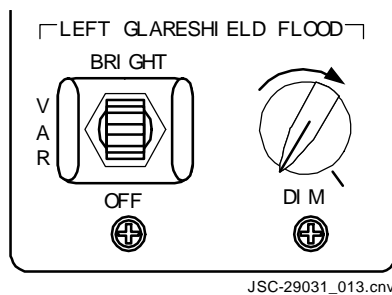

LTG L GLRSHLD FLOOD (two) – VAR, DIM

If the light is powered off or set to BRIGHT, the rotary adjustment switch need not be listed.

LTG L GLRSHLD FLOOD – BRT

The Horizontal Situation Indicator (HSI) source select switches are another example.

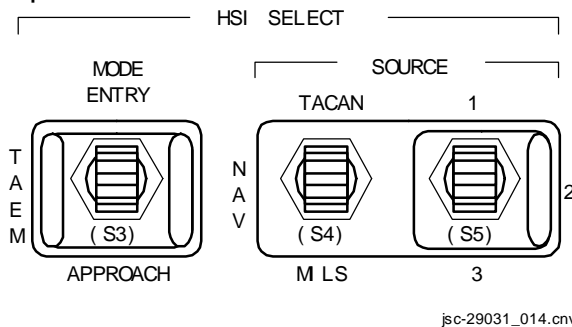

HSI SEL SOURCE (two) – NAV, 2

In such cases, both switches will always be listed together, even if only one is reconfigured.

8.2 CIRCUIT BREAKERS

Two types of circuit breakers are used in a spacecraft: toggle and push/pull.

Standards

- a. *Push/pull* circuit breaker (cb) operations will use the following format:

cb TITLE (quantity) – POSITION/ACTION (optional comment)

Example:

```
O14:E      cb ADTA 1 (two) – op
O13:D,B    ESS 1BC CRYO QTY O2 TK2 (two) – op
L4:R      AC1 ΦA INST R – cl
```

- b. The lowercase letters “cb” shall always precede a circuit breaker operation callout. The panel and row (*if row is given on panel*) will be identified (see Section 5.5, standard no. 6). The action *for push/pull breakers* will be open (op) or closed (cl) and will be written in lowercase letters. *The action for toggle-type breakers may vary dependent on placarded legend, if any.* In plain text, the circuit breaker will be either “cb” for singular or “cbs” for plural in lowercase letters. However, in panel callouts, the word “cb” will be used for both singular and plural usage.
- c. *Toggle circuit breakers are operated like normal switches. Therefore, toggle breakers will be treated like switches in the FDF. The toggle breaker operations will use the switch format (see Section 8.1).*

Examples:

```
A7L      cb CNTL PNL PWR A – ON
A7L      HTR3/DCU PWR H3 – OFF
```

- d. Toggle breakers without placarded position will require an additional clarifying comment *as done with normal switches.*

Examples:

```
– cl (up)
– op (dn)
```

8.3 VALVES

Standards

- a. Valve operations will use the following format:

VALVE TITLE vlv (quantity) – POSITION/ACTION (optional comments)

Example:

CAB TEMP CNTLR vlv (two) – FULL COOL

- b. The lowercase “vlv” denotes that these are manually operated valves rather than switches. For valves that are operated by switches, “vlv” is not used. The same rules for showing the quantity of switches operated will apply to valves.

8.4 HAND CONTROLLER DEVICES

Hand controllers are used by the crew with such a high degree of frequency that references to these devices are not stated, but are implied. Typical hand controller devices are

RHCs – Rotational Hand Controllers

THCs – Translational Hand Controllers

SBTC – Speed Brake Thrust Controller

The following examples show how operations with these devices will be stated:

RHC

Mnvr to attach point “C”

THC

THC – +X (10 sec)

SBTC

SPD BK: 98%

8.5 PEDALS, LATCHES, HANDLES, AND KNOBS

Rudder pedals, latches, handles, and knobs are also frequently used on the shuttle. The following examples show how operations with these devices will be stated:

Latches

Release latches (two), stow tripod

Handles

Hatch handle – CL

Knobs

CRT 1 BRT – MAX

9.0 METERS, INDICATORS, AND ANNUNCIATORS

Meters and indicators provide the crew with insight into the status of shuttle systems and payloads and are one of the following types:

- a. Meter indications – ind (tape, bar, digital, rotational)
- b. Lights – lt
- c. Flags – flag
- d. Talkbacks – tb

Annunciators also provide the crew with insight into the status of shuttle systems. Various orbiter systems annunciate C/W signals in one of two main ways, lights and tones, and are one of the following types:

- a. MA – Master Alarm light and tone
- b. C/W – Caution and Warning message and tone
- c. SM ALERT – SM alert light and tone
- d. Klaxon – Cabin depress
- e. Siren – Fire/smoke

9.1 METERS AND INDICATORS

The new standards incorporated into this section (9.1(a) and (e)) will be implemented in the STS-114 flight books. (CR# CPMP_Annex_CU12A)

Standards

- a. Verifications of meters and indicators will use the following format:

√TITLE type (quantity) – READING (optional comment)

Note: A colon will be used if the reading is a numerical value.

Examples:

√HYD PRESS ind (three) – HI green
√FREON EVAP OUT TEMP ind: 62 ± 2
√RCS CMD R lt – L lt on
√RCS CND R lt – lt off

- b. The reading of a meter will be shown without the units (i.e., psi, °F, etc.) unless necessary to avoid confusion.

- c. Colored tape is sometimes used on the meter to make a range clear to the crewmember. In this case, the reading will be given as “HI green,” or any other appropriate description.
- d. Light titles should always reflect the exact wording found on the light unless directed otherwise by the PNOM book.

Guideline

If an acceptable operating range has been determined, an approximate (~) reading may be used.

9.1.1 Talkbacks

Standards

- a. In procedural format, talkback will always be written as “tb” in lowercase letters for both singular and plural usage.
- b. A talkback (tb) status will normally be given following a switch action.

Examples:

L OMS XFEED B – OP (tb-OP)
FWD RCS MANF ISOL 1,2,3,4 (four) – OP (tb-OP)
√EE tb (six) – bp
XYZ PWR (four) – OFF (four tb-bp)

- c. The numerical quantity of talkbacks to be checked will be spelled out in lowercase (i.e., four, six, eighteen), as with switch quantities. The numerical quantities are just needed for clarity.
- d. Talkbacks may be barberpole (bp), gray, or any status shown on the talkback (e.g., OP, CL, STO, etc.). The verification of a talkback without a switch action will be written similar to other verifications (see Section 12.0).

Examples:

√KU ANT tb – STO
√XYZ tb (four) – ON

- e. When using “clear text,” the plural of talkbacks may be used as “tbs” without an apostrophe.

Example:

Monitor four XYZ tbs for possible change in status.

- f. When confusion may result from talkbacks having different titles from each other or from the associated switch title, each talkback should be listed in a separate callout as follows:

FWD PWR – OFF
√ABC tb – bp
√DEF tb – bp
√GHB tb – bp

9.2 ANNUNCIATORS

Annunciating tones emanate from alert systems (C/W, SM, etc.), navigation aids (Tactical Air Command and Navigation (TACAN)), and the intercom/communications system. Annunciating tones always result from some event that is crew, ground, or vehicle initiated.

Standard:

- a. If a tone occurs concurrently with other indicators (meter, light), the tone will be announced first in the series.
- b. Tones will be specified as clarifying comments after the operation that causes the annunciation.

Example:

L1 3. AV BAY 1(2,3) FAN A(B) – OFF (SM ALERT)

10.0 SHUTTLE GENERAL PURPOSE COMPUTER INTERFACES – SWITCHES, CRTS, AND KEYPADS

Each orbiter originally carried four CRTs (three forward, one aft) to interface with the GPCs that provide command and control and monitoring capabilities. Some vehicles have been upgraded with the Multifunction Electronic Display Subsystem (MEDS) capability and use computer terminal screens. Some of the MEDS terminals are used in an identical way as the old CRTs in that they are assigned to GPCs in the same way, and they run the same displays. Therefore, the term “CRT” in the FDF is used to refer to either the old CRTs or the new MEDS displays performing the CRT functions.

This section applies only to the orbiter GPC interfaces and not to portable onboard computers (e.g., PGSCs, etc.).

10.1 GPC SWITCHES

Standards

- a. In procedures where a particular control device to be operated depends on GPC assignment, failures, etc., there are special standards to follow. As an example, a possible switch command will be as follows:

GPC MODE 1(2,3,4) – HALT

- b. If a single switch to be thrown depends on conditions of only one of several similar switches, the following nomenclature will be used, as long as it is obvious which switch the “X” designates.

GPC MODE X – HALT

- c. If the previous identification nomenclature (X) is not specified, more information will be given.

Example:

(Aff) GPC MODE – HALT
(SM) GPC MODE – HALT

The leading designators in the two previous examples are in parentheses because they are not part of the switch nomenclature.

Note: “Aff,” which stands for affected, is capitalized only as the first word of a sentence or callout; otherwise, “aff” is lowercase.

10.2 CRT BOXES

Standards

- a. Reference to information displayed on CRTs shall precisely duplicate the letters, symbols, and spacing displayed on the CRT, if possible, even if this conflicts with nomenclature standards normally used in the FDF. Abbreviations shall be used only if mandatory to fit available space. Refer to the Data Processing System (DPS) Dictionary for orbiter CRT display formats.
- b. The use of the CRT box will identify CRT displays in procedures.
- c. The CRT box serves as a procedural step instructing the crewmember to call up the display.

10.2.1 CRT Box Organization

Standards

- a. The contents of the CRT box shall consist of the CRT Number (if required) followed by a colon, the BFS designation (if required), the Major Function, the Spec. Number, and the Display Title as shown below.

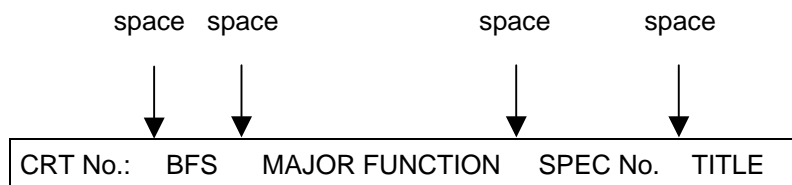

- b. All elements in the CRT box will be separated by one nominal character space (exaggerated above). Do not use random dashes, commas, etc.
- c. The CRT Number is specified only when it is necessary to manage the use of the available CRTs.
- d. The "BFS" designation shall be used only if the display comes from the backup flight system. A comma after the BFS is optional.
- e. The Major Function identified shall be consistent with the "known" condition of the MAJ FUNC switch and shall be "GNC," "SM," or "PL." The designation shall be used in all cases except
 1. When calling a SYS SUMM display and "GNC" and "SM" are part of that display title
 2. When calling the FAULT SUMM display

- f. The Spec. Number shall always be used in all CRT Title Boxes except when calling
 - 1. OPS or MM
 - 2. SYS SUMM
 - 3. FAULT
- g. The CRT Display Title will always be used in all CRT Title Boxes and will be identical to the title on the display. Abbreviations are acceptable if space does not allow use of the full title.

10.2.2 CRT Box Content

Standards

- a. For displays with unique keypad buttons, such as FAULT SUMM and SYS SUMM, it is assumed that the crew will access the displays with those buttons. A box containing the display title shall be used to instruct the crew to “call up” that display.
- b. The FAULT SUMM display will be referenced as follows:

FAULT

- c. The SYS SUMM display will be referenced as follows:

GNC SYS SUMM 1

SM SYS SUMM 2

3: BFS, GNC SYS SUMM 1

- d. For displays common to multiple major functions, the specification of the major function is not technically necessary. However, for clarity and to avoid confusion of SPEC numbers with CRT numbers, “GNC” or “SM” will precede the SPEC numbers in the CRT box as appropriate.

Example:

1: GNC 1 DPS UTILITY

- e. The CRT callouts for all other displays will be written as follows:

Examples:

GNC 33 REL NAV

means GNC, SPEC 33 PRO

SM 60 SM TABLE MAINT

means GNC, SPEC 33 PRO

10.2.3 CRT Box Placement

10.2.3.1 CRT Header Boxes

CRT Header Boxes refers to the use of three boxes in which to define which displays should be called up on each of the forward three CRTs.

Large Checklist (8-1/2 x 11) Format Pages

1:	3:	2:
----	----	----

Small Checklist (6 x 8) Format Pages

1:	2:
3:	

Standards

- When it is desired to manage the use of CRTs, such as for the Ascent or Entry C/L, header boxes shall appear at the top of each page to define the display configuration for all three CRTs.
- CRT header boxes that appear later in the procedure (not at the top of the page) shall line up with the appropriate box at the top of the procedure.
- Once a CRT display has been identified in a procedure using the CRT header box, subsequent references to the display will be made simply by using "CRT" in the left margin (location column), as long as no other CRT displays have been called in the interim.

10.2.3.2 CRT Title Boxes

Standards

- If the display is required at the very beginning of a procedure, the CRT box will be placed to the right of the procedure title.

Example:

APU OIL OVERTEMP

BFS, SM SYS SUMM 2

If APU OIL OUT T > 305:

- CRT Title boxes will be the same length as the display title.

10.2.3.3 CRT Title Boxes Within Procedures

Standards

- a. CRT boxes embedded within procedures will be the same length as the display title.
- b. The “frame” of the CRT box will be left justified in the actions column when used within a procedure.

Examples:

```

          [GNC 23 RCS]
1. Ovrđ FWD MANFs STAT – CL
2. DAP: FREE
          [GNC UNIV PTG]
3. CNCL – ITEM 21 EXEC
          [SM 66 ENVIRONMENT]
L1      HUM SEP B – OFF
          A – ON
```

- c. CRT boxes will not be numbered as steps in procedures.

10.2.3.4 CRT Boxes as Part of Actions

Standards

- a. Display callouts will sometimes be made part of a procedural callout (embedded within actions).

```
[GNC 21 IMU ALIGN] – resel IMU
```

- b. CRT boxes embedded within actions will be the same length as the display title.
- c. The “frame” of the CRT box will be left justified in the actions column when embedded within actions.

10.2.4 CRT Display Item Callouts

This section discusses the standards associated with how information contained on orbiter displays is written within FDF procedures.

10.2.4.1 Execution

The crew uses the keypad to enter data into the GPCs via the CRT.

Note: An item entry is “executed” (EXEC) on orbiter displays, rather than “entered.”

Standards

- a. If it is desired to reinitialize a CRT screen, the following procedural step should be used:

SM, SPEC 99 PRO

- b. CRT display item number execution will be shown as follows:

CRT NOMENCLATURE – ITEM NO. EXEC

Example:

RESTART – ITEM 21 EXEC (*)

- c. Alternate item numbers will be shown in parentheses.

Example:

IMU DES 1(2,3) – ITEM 7(8,9)

- d. Data entries will use the following format:

CRT NOMENCLATURE – ITEM NO. D A T A E N T R Y EXEC

Examples:

TRK – ITEM 8 +2 0 8 EXEC

ALTM – ITEM 1 +2 9.8 5 EXEC

- e. Alphanumeric entries will be underlined except for plus signs, minus signs, and decimal points. The plus or minus sign will be closed up on the first digit being entered. The decimal period, if used, will be closed up on the digits before and after. If listing alternate data entries, DO NOT underline the numbers contained within the parentheses.

Example:

CONFIG – ITEM 1 +1(2,3,4,6,8) EXEC

- f. All noncritical leading zeros for CRT input will be deleted.
- g. For multiple data entries where one title is displayed on the CRT, the data entries will string together.

Example:

CRT TIMER SET – ITEM 9 +1 3 +5 +3 2 EXEC

- h. If each entry has a separate item number, separate lines will be used.

Example:

```
ITEM 30 +1 2 3 7 6 EXEC  
ITEM 31 -.7 6 2 8 EXEC
```

- i. Feedback that indicates an item or data entry has taken effect will be shown in parentheses following the EXEC or ENTER, if required for clarity. Quote marks will not be used to enclose asterisks within parentheses.

Example:

```
START MNVR – ITEM 18 EXEC (FUT - *)  
JET DES R1R – ITEM 9 EXEC (no *)
```

10.2.4.2 Verification

Standards

- a. Verification of the status of a field will be shown as follows:

```
√CRT NOMENCLATURE – FIELD STATUS
```

Examples:

```
√SOURCE – ASE  
√RF CONFIG CMD MOD – *  
√S TABLE CLR, ITEM 20 – (no unwanted data)
```

- b. The item number of executable fields is given when verifying the status of the field (see last example above).
- c. Field statuses that actually appear on the CRT will be written in all caps just as they appear on the CRT. Otherwise, the status condition will appear in lower case within the parentheses.
- d. When referring to a special CRT symbol or character (such as an asterisk or the up and down arrows) in the text of a procedure, the character will be enclosed in single quotes (so long as parentheses are not used).

Examples:

```
Wait for '*' to appear
```

```
√No '↑' or '↓'
```

- e. Verification of a value (that this numerical) or a range of values for a particular parameter will be shown as follows:

√CRT/DDU NOMENCLATURE: VALUE

or

√CRT/DDU NOMENCLATURE: RANGE OF VALUES

Note: The dash will be used for non-numeric values.

Examples:

√MSN PHASE: 3

√BUS VOLTS: 26.0-28.0

√RF CONFIG RF POWER: 25.0 ± 5.0

√TEMP: -10.0 to -5.0 degF

Note: The use of the word “to” for ranges is optional, but mandatory when addressing the range of negative values. (See Section 11.3.3)

- f. Some orbiter GPC displays (e.g., SM 200 IUS) contain data fields that toggle back and forth between two data sources. Toggling fields and values will be shown as follows:

√CRT NOMENCLATURE: FIELD STATUS 1/FIELD STATUS 2

or

√CRT NOMENCLATURE: DATA VALUE 1/DATA VALUE 2

or

√CRT NOMENCLATURE: DATA RANGE 1/DATA RANGE 2

Note: The dash will be used when the field status or data value is non-numeric.

Examples:

(Field Status) √RF CONFIG CMD MOD – */(blank)

(Data Values) √COUNTER – ODD/EVEN

(Data Range) √AMPS: 15.1 to 23.1/10.0 to 18.0

- g. In all data ranges, the word “to” is used to avoid confusion with a minus sign. (See Section 11.3.3)

Examples:

√AMPS: -15.1 to 23.1/10.0 to 18.0
15.1 to -23.1/10.0 to 18.0
15.1 to 23.1/-10.0 to 18.0

- h. Sometimes the word EXEC flashes on the CRT to prompt the crew prior to a burn or other event. This will be shown as

`EXEC` (when dashed box capability exists)
or "EXEC (flashing)" otherwise.

- i. When the crew is to perform an I/O RESET EXEC on the keyboard, this action will be called out without the "EXEC," which is understood.

Example:

I/O RESET

10.3 DAP CALLOUTS

Common DAP configurations are given in the DAP book, which is published in the FLIGHT PLAN for each flight. Each configuration (rates, deadbands, etc.) is identified with a letter ("A" or "B") and a number.

In the standards below

"X" means "A" or "B" for DAP configurations

"n" refers to the DAP configuration number from the DAP book

"mode" means AUTO, INRTL, LVLH, or FREE configuration

"jets" means PRI, ALT, or VERN

In using the Translational DAP, "X mode" and "Y mode" are either NORM or PULSE, and Z mode is one of the following:

NORM
NORM, HI Z
NORM, LO Z
NORM, no LO Z (when leaving LO Z mode)
PULSE
PULSE, LO Z
PULSE, no LO Z (when leaving LO Z mode)

Standards

- a. CRT Display SPEC 20 DAP will not be called out in a procedure as is normally done when entering data on a CRT.
- b. The DAP panel number will not be called out.
- c. DAP parameters: To load DAP parameters on SPEC 20:

Change DAP X to Xn

Examples:

Change DAP A to A4

Change DAP A,B to A3,B4

- d. To verify DAP parameters on SPEC 20:

√DAP X set to Xn

Examples:

√DAP A set to A4

√DAP A,B set A3, B3

- e. DAP configuration: To configure a loaded DAP:

DAP: Xn/mode/jets

Examples:

DAP: A4/INRTL/PRI

DAP: B2/AUTO/ALT

- f. In situations where neither Vernier (VERN) nor Primary (PRI) is required, VERN will be called out, as this is what the crews are trained to select. This is applicable to procedures that utilize the “hot stick” capability, which downmodes to PRI when the hand controllers are deflected.

- g. Translation DAP: To use the translation DAP submodes:

DAP TRANS: X mode/Y mode/Z mode

Example:

DAP TRANS: NORM/NORM/NORM, LO Z

- h. ROT DAP: To use the rotation DAP submodes:

DAP ROT: Roll mode/Pitch mode/Yaw mode

- i. When the modes are either Discrete (DISC) or PULSE:

DAP ROT: DISC/DISC/PULSE

- j. When no specific DAP is required or when returning to the FLIGHT PLAN, use the following:

DAP: as reqd

- k. Free drift mode will be called out as shown in the following:

DAP: FREE

- l. Use “DAP: FREE” in OPS 2 if specific DAP number and jet selections are not required; otherwise, use “DAP: Xn/FREE/jets,” as shown in the following example:

DAP: A4/FREE/VERN

- m. DAP A/B selection, jet selection, and the “FREE” pushbutton are not available in OPS 1 or 3. Free drift, in OPS 1 and 3, shall be called out with the following two lines:

DAP: INRTL
DAP ROT: PULSE/PULSE/PULSE

- n. The use of the parentheses to indicate alternate options will be applicable as shown below:

DAP: A4/FREE/PRI(VERN)

11.0 SYMBOLS: PUNCTUATION, MATH, OPERATIONS, LOGICAL EXPRESSION, LEGEND, AND OTHER SPECIAL SYMBOLS

Symbols are used in procedures to clarify and abbreviate. The following criteria should be used in considering FDF symbol usage.

Standards

- a. Two different symbols shall not have the same meaning.
- b. One symbol shall not have two meanings within context. Exception: See Section 15.0 for the use of double arrows for communication between spacecraft and control centers and for navigation between specific FDF books.
- c. One symbol must be easily discriminated from another.
- d. Symbols not defined in this section will be defined within the FDF document.

Guidelines

- a. Symbol meanings should be intuitive and logical.
- b. Symbols should comply with commonly recognized usage.
- c. Symbols should not conflict with other recognized standards.
- d. Symbols should be available in a standard font set.
- e. Symbols should be used only in place of common verbs or simple activities.
- f. Symbols should have specific advantages (space savings; clarity; etc.).
- g. In some cases, the use of symbols is optional and can be replaced by words to indicate the necessary operation. The standards and guidelines below discuss when the use of words instead of symbols is appropriate.

Types of symbols

Several types of symbols are currently used in FDF procedures.

- a. Punctuation and formatting symbols – Punctuation in FDF procedures differs slightly from traditional usage presented in the GPO Style Manual. Eight particular punctuation marks will be used in special ways. See Section 11.1. Other punctuation marks will be used in the manner described in the GPO Style Manual. Likewise, the GPO Style Manual will govern the usage of the eight referenced marks for usages not described in this section or otherwise in this document. Formatting refers to the use of underlining for specific purposes.

- b. Mathematical symbols – Symbols used for mathematical expressions, including operators, relationship symbols, qualifiers and units, are defined in Section 11.2.
- c. Operations symbols – Symbols used for operations instructions are defined in Section 11.3.
- d. Logical expression symbols – Symbols used for logical expressions are defined in Section 11.4.
- e. Legend symbols – Symbols used for legends are defined in Section 11.5.
- f. Symbols used to represent words are defined in Section 11.6.
- g. The use of various types of lines and boxes in the FDF are discussed in Section 11.7.
- h. Other special symbols – Other special symbols are defined in Section 11.8.

11.1 PUNCTUATION AND FORMATTING SYMBOLS

The accepted symbols for use as punctuation are

- Comma [,]
- Double quotation mark [“]
- Colon [:]
- Parentheses [()]
- Period [.]
- Underline [_]
- Slash [/]
- Braces { }
- Single quotation mark [‘]
- Ellipsis [...]

11.1.1 Comma [,]

Standards

- a. The comma will be used to imply the word “and” in FDF procedural statements and callouts.

Example:

APU CNTL 1,2 – OFF

Reads as: Switch both Auxiliary Power Unit (APU) Control (CNTL) 1 and APU CNTL 2 to the off positions.

- b. When the comma is used to imply “and,” the unit will be written without spaces after the comma; however, spaces may be used for clarity.

Examples:

CAB RELIEF A – CL (tb–CL),pause

or: CAB RELIEF A – CL (tb–CL), pause

GPC MODE – STBY,HALT,pause,STBY,HALT

or: GPC MODE – STBY, HALT, pause, STBY, HALT

- c. A comma is used to imply “and” when separating items in a sequence.

Example:

Stow: Couplers, treadmill, ramp

Reads as: Stow couplers and treadmill and ramp.

Rationale: The lack of commas would lead to confusion if there were a sequence of numbers.

- d. A comma is used within a reference to another FDF article. See Section 16.0.

Guideline:

When it is necessary to more tightly compress the material on the display or page, it is permissible to not use spaces when listing designations with the same name that differ only by number.

Example:

Stow: Cables 1,2,4,6

11.1.2 Colon [:]

Standards

- a. Lists - The colon will be used when subentries follow introductory lines in lists, tables, and leader work.

Examples:

Stow:

Equipment Assy Cab (EAC)
Transceiver

Unstow: Experiment Assy

- b. Time - The colon will be used in referencing time in the format DDD/HH:MM:SS.S (see Section 13.0).
- c. Conditional statements - The colon will be used after conditional phrases when subentries follow on separate lines.

Example:

If no comm:

Go to EMER PWRDN (Cue Card)

- 1. A colon or a comma will be used when a single subentry conditional phrase runs in on the same line.

Example:

If no comm, go to EMER PWRDN (Cue Card)

or

If no comm: go to EMER PWRDN (Cue Card)

- 2. Within FDF documents, the first word on the next line immediately after a colon will be initial cap, except when standard no. (f) under capitalization applies (see Section 4.3). A word following a comma either on the same line or on the next line will be written with lowercase letters. Likewise, if the text continues on the same line following a colon, the first word following the colon will be lowercase unless normal grammar rules (refer to GPO Style Manual) dictate otherwise (such as quoted speech).

Examples:

Prior to deorb TIG:

- 1. Return to RCS straight feed
- 2. (Aff) RCS He PRESS A,B – CL (tb-CL)
- 3. Cycle He PRESS A(B) to maintain PRPLT TK P 220-245

If pressure > 150, continue

Inform CDR, "Procedure complete"

Report to MCC: "Initiate GSE cooling. Activate Freon pump"

Note: The colon is used in the last example because more than one sentence is placed in quotes.

- 3. The second line of a conditional statement is indented. See Section 17.0.
- d. CRT displays – The colon is used in CRT Header boxes. See Section 10.0.

11.1.3 Period [.]

Standards

- a. Abbreviations and symbols will not use periods except for the terms “e.g.,” “i.e.,” and similar terms.
- b. A period will not be used for abbreviated measurement terms such as ft, lb, in, deg, and similar terms. Do not use a period with degrees; “degF” or “degC” will be used for temperature, and the degree symbol “°” for angle. See Section 11.2 for more information on math symbols.
- c. Avoid the use of a period for inch measurements, because these generally read as hard stops in the text and may result in an unclear message. However, if confusion would result from “in” as a measurement being mistaken for “in” as a word, then spell out “inch” or create a unit modifier with the preceding number. The inch symbol “ ” should not be used for FDF procedures unless the symbol is the only clear way to identify the measurement, such as in degrees of latitude/longitude.

Examples:

Stow 5-in wrench

Slide target 2 in in from fixture. (*Note: Some clarity lost by using “in” for inches.*)

Place target 2 inches from fixture. (*Note: Clarity improved by spelling “inches.”*)

Remove bolts (length: 3 in)

- d. A period must be used after the step number or letter in C/L format procedures.
Rationale: Prevents interpretation of the step number as a part of the step.
- e. The period is used as a separator of numerals or letters.

Example:

Paragraph 17.2

- f. The period is used as a separator between the whole number and the fraction in a decimal number, including in the time format.

Examples:

10.567

Ten and five hundred sixty seven one-thousandths

03:14:17.24

Three hours, fourteen minutes, seventeen seconds, and twenty-four hundredths of a second

Guideline

Sentences - The period is typically not used as a sentence-ending mark in a procedure unless one sentence is completed and followed immediately by another sentence in the same operational step or note. The last word (or text unit) of a note or procedural step usually does not end with a period.

Example:

Do not set APU PWR to OFF. APU overspeed may result

11.1.4 Slash [/]

Standards

- a. The slash will be used to indicate “and/or” in FDF procedures.

Example:

F8/A6U FLT CNTLR PWR – ON

√UP/DOWN arrows appear on CRT

- b. For device (e.g., switch) callouts, the slash will be used as listed in the All Vehicle D&C Procedural Nomenclature document. The slash may or may not indicate the “and/or” situation.
- c. The slash is used for division in mathematical operations. See Section 11.2.
- d. A slash is used for separating the date from the time in the time format. See Section 13.0.

11.1.5 Single Quotation Marks [‘ ’]

Standards

- a. Single quotation marks will be used to quote information from CRT displays or fault messages.
 1. The CRT display items and the fault messages, enclosed in single quotes, will be word for word in all capital letters unless the display uses specific lowercase elements as the text appears on the screen.

Example:

Does ‘I/O ERROR PL 1(2)’ msg occur?

Note: The actual message enclosed in single quotes is written in all capital letters.

2. If punctuation (not part of the actual message) is needed after a display or fault message, the punctuation should come outside the single quotes, not inside.

Example:

Expect fault msgs: 'I/O ERROR', 'MS ALERT', or 'DPY MNVR'

Note: Contrary to normal grammar rules, the commas are outside the quotes.

- b. Special characters (asterisk, up/down arrows) will be enclosed in single quotes when used in clear text (see Section 7.3).

Examples:

Enter data in fields marked with an '*'

√All values reset and no '↓'

11.1.6 Double Quotation Marks [“ ”]

Standards

- a. Double quotation marks (quotes) will be used in conventional ways for coined words, oral comments, and other purposes as defined in the GPO Style Manual.
 1. For double quotes, FDF documents will use standard (normally inside the quote) punctuation style as defined in the GPO Style Manual.

Examples:

On egress, report to the convoy which “VFBs,” phases, and panels were available for “A and (B or C)”

Inform CDR, “GO/NO-GO to doff suits,” then activate RCS SAFING

- b. Double quotation marks must be used for indicating oral communication.

Example:

“Go for EVA”

Rationale: Distinguishes oral communication from an instruction.

11.1.7 Parentheses [()]

Standards:

- a. The parentheses are used to clarify or explain.
 1. When parentheses are used as a clarifying tool, the parenthetical text material will be added to the end of the switch callout.

Example:

COMMODE CNTL – OFF (dn)

This reads: The Commode Control is switched to off, and the switch is then in the down position. The information in parentheses explains the position of the switch.

2. When parentheses are used to clarify switch quantities, the parenthetical quantity must be spelled out and will be inserted immediately prior to the dash in switch callouts.

Example:

HYD CIRC PUMP 1,3 (two) – OFF

This reads: The Hydraulic Circulation (Circ) Pumps 1 and 3 are the only two out of an unnamed series to be switched to off positions. The information in parentheses will clarify the number of switches involved.

3. When used to provide additional information, “clarifying comments” in parentheses will not provide data found elsewhere in the procedure or notes.
- b. The parentheses are used to imply the word “or.” The text will be written as one unit without spacing.

Examples:

APU CNTL 1(2) – OFF

This reads: Either APU Control 1 or APU Control 2 is switched off, depending on prior instructions or selection. Often this format is used to identify an alternate selection (e.g., APU Control 2) based on previous text lines or prior switch callouts.

O2(H2) CNTL P 1(2,3,4,5)

This reads: Either Oxygen (O2) or Hydrogen (H2) is selected, along with either Control Pressure 1 or 2, or 3, or 4, or 5. The alternate choices total 10 selections.

- c. See Section 11.4.2 for the use of parentheses in logical expressions.
- d. The parentheses are used as a “start time” option to the timetag column when only a few timetags are required for procedures. When “start times” are placed in parentheses, this time indicator shall lead the statement or procedure rather than follow at the end. When only a few time callouts are used in a document, this is an option to using the timetag column and conserves space by doing away with a separate timetag column. The time will begin in the “operation” column following the step number (if used).

Example:

INITIATE LATCH PROCEDURE

- O14 1. Close latches
- 2. (04:14) Initiate mnvr
- 3. GPC PWR – 3

11.1.8 Underline [_]

Standards:

Note: Previously, the underline was used in FDF Standards to indicate the predominant conjunction(s) when two or more are given. Now, braces will be used for conjunctions and are similar to parentheses in mathematical equations. See Section 11.4.1.

- a. Reference Section 5.2 for the underlining of procedure titles. In general, the underline is used for second- (all caps) and third-level (initial caps) procedure titles.

Examples:

- INITIATE LATCH PROCEDURE** (first-level title)
- O14 CLOSE LATCH PWRDN (second-level title)
- 1. GPC PWR – 3
- Close Latch Activity (third-level title)
- 2. Initiate RMS activity
- Activate Repair Activity (fourth-level title)
- 3. Unstow tools

Note: The second- and third-level titles may be part of the numbered step sequence; however, a fourth-level title will not be numbered, because a fourth-level title, if numbered, would be confused with an activity.

- b. Reference Section 16.0 for the use of the underline in referencing other documents. The underline will be used to identify the tab callouts in a cross-reference and to indicate a cue card title.

Examples:

16. Perform LEAKING OMS BURN (Cue Card)

17. Perform SINGLE G2 BPC OPS (ORB OPS, DPS), 4-2

Note the Cue Card title in step 16 and the tab title in step 17.

- c. Reference Section 19.3 for the use of the underline for manual data entry. The underline will be used to indicate data to be entered within the procedure (prelaunch or on orbit).

Example:

Record AIRLOCK-Vest ΔP : _____ psid

- d. Reference Section 10.2.4.1 for the use of the underline for on-orbit computer data entry. The underline shall be used to indicate data to be input via CRT item entry.

Example:

OIU LOAD – ITEM 1 +2 EXEC

11.1.9 Braces { }

Standard

- a. Reference Section 11.4.1 for the use of braces in logical expressions.

11.1.10 Ellipsis [...]

Standards

- a. An ellipsis [...] will be used to indicate omitted letters or words in clear text.
- b. An ellipsis will not be used in omitted text (see Section 4.4.6).

11.2 MATHEMATICAL SYMBOLS

Standards

- a. Numerical values will be expressed using a period “.” as the decimal point. There will be no separator except for the decimal place (such as a comma indicating thousands).

Example:

1876.5

one thousand eight hundred and seventy six and five tenths

- b. Within an equation, no space will be left between a variable and its qualifier.

Example:

$50Y + 10X = 60$

Guideline

For lines that must be continued on the following line, break before the mathematical symbol.

Example:

√MBSU 5 SCA RBI 08 Volts
> 131.0 V

11.2.1 Operator and Relationship Symbols

The mathematical operator and relationship symbols are as follows:

Operators:

+ addition - subtraction
X multiplication / division

Relationship:

= equal ≠ not equal to
< less than > greater than
≤ less than or equal to ≥ greater than or equal to

Standard

All mathematical operator and relationship symbols must have one nominal character space before and after the symbol.

Examples:

Temp < 15 degC

Press = 15 psi

X = Z + 40

Y = X - 18

11.2.2 Qualifier Symbols

The mathematical qualifiers are as follows:

+ positive	- negative
± plus or minus	~ approximate

Standards

- A space must not be left between a qualifier symbol and the numerical value.

Examples:

Temp: -52 degC
When temp ~50 degC, go to step 4

- The use of the approximate symbol is optional. The approximate symbol [~] can be used when a readout must be close to the stated value, but does not have to match it exactly.
- When the approximate symbol is used with a negative number, the number and its negative sign will be enclosed within parentheses. When approximate is spelled out, the number and negative sign will not be enclosed within parentheses.

Example:

When Temp ~(-50 degC), go to step 4
When Temp approximately -50 degC, go to step 4

11.2.3 Unit Symbols

Symbols used to represent units are as follows:

% percent
° degrees (angle)

Note: Reference Section 4.3 for information on the use of abbreviations as units (e.g., “in” for inches, “deg” for degrees, etc.).

Standards

- a. A unit symbol will be used only with numbers. If numbers are not used, the word will be written out (percent, degrees).

Example:

A pressure increase of several percent was noticed

- b. To designate several numbers or a range of numbers, do not duplicate or repeat the unit symbol.

Example:

Expect velocity change of 10 to 15%

- c. The percent symbol is used to indicate a percentage value. There will be no space left between the number and the symbol.

Example:

Decrease lighting by 10%

- d. When using the degree symbol [°], do not leave a blank space between the number and the symbol.
- e. Avoid the use of the degree symbol [°] when referring to temperature. Instead, use the terms “degF” or “degC.” However, “°F” may appear for a labeled gauge on a panel that will be used according to the Procedural Nomenclature (PNOM) document, but avoid using “°F” or “°C” in other procedures.
 1. Do not use a period with “deg” to indicate degrees temperature.

Example:

√Temp: 98.6 degC

- f. Use the degree symbol [°] for angles.

Example:

Increase pitch by 5°

11.3 OPERATIONS SYMBOLS

- a. Long and short dash [–]
- b. Double arrowhead [>>] – exit symbol

- c. “to” – data range
- d. Triangle [▶] and pennants – time-critical activities
- e. Adjust symbols [↷] [↶] [↻] [↺] [↻]
- f. Connect symbol [→|←]
- g. Disconnect symbol [←|→]
- h. Double arrows [⇒ ↑ ↓]
- i. Diamond [◆] – MCC communication
- j. Repetitive Command Loop symbol
- k. Synchronization lines for concurrent activities
- l. Joint Vehicle Operations
- m. Real-time bars
- n. Start timer symbol [⊕]

11.3.1 **Dash [–] and Hyphen [-]**

Standard

- a. The dash (–) will be used in operational callouts to separate the object from the action or state. *There will be one nominal character space before and after the dash.*

Example:

AC BUS SNSR (three) – OFF

- b. *A procedural line may end with a dash (–). A carryover line shall not start with a dash (or a hyphen). The carryover line will be indented one nominal character space, except in notes, cautions, warnings, and other block formats approved for FDF documents. There will be one nominal character space before the dash.*

Examples:

*APU HTR TK/FU LN /H2O SYS 2A,3B (two) –
AUTO*

- c. *The hyphen (-) will be used to indicate a range of (positive) values (see Section 11.3.3). There will be no spaces before and after the hyphen.*

Examples:

Temp 10-30 degC

Repeat steps 5-12, then:

- d. *The hyphen will be used to indicate negative values (see Section 11.2.2). There will be no space between the hyphen and the number.*

Examples:

-0.3G

-2:30

TIG-1:30

TGT PEG 7 ΔVX – ITEM -3 EXEC

- e. *The hyphen will be used in hyphenated words. There will be no spaces between the hyphen and the words. A hyphenated word shall not break across lines. A "nonbreaking" hyphen should be used if a hyphenated word is likely to end a line of text.*

Example:

fail-safe

- f. *The hyphen will be used in subtraction (mathematical symbol/equations) (see Section 11.2.1). There will be one nominal character space before and after the hyphen.*

Example:

Y = X - 18

- g. *The hyphen will be used in clarifying information such as talkbacks (see Section 9.1.1). There will be no spaces before and after the hyphen.*

Example:

(tb-CL)

- h. *The hyphen will be used in page numbers (see Section 20.7). There will be no spaces before and after the hyphen.*

Example:

6-13

- i. *The dash will be used to separate figure legend numbers from the respective figure titles, whenever numbered figures are used. There is no space between the period after the figure legend number and the dash. There will be one nominal character space between the dash and the figure title. The hyphen will be used within figure and table numbers, whenever numbered tables or figures are used. (See Sections 19.1 and 19.2 for table titles and figure titles).*

Examples:

Figure 8-6.— Laptop Receiver Unit

Table 3-2. A31p Serial Ports

Guidelines

Dashes may be used in titles (in instances other than hyphenated words). There will be one nominal character space before and after the dash.

Example:

LOSS OF 2 FREON LOOPS – LOOPS FAILED

11.3.2 Double Arrowhead [>>] – exit symbol

Standards

- a. The double arrowhead [>>] shall be used to indicate an intermediate point within a procedure where the crewmember is to exit, never to return to this procedure. The double arrowhead will be preceded by two nominal character spaces.

Example:

If O2 Pressure < 16 psi, >>

- b. The exit symbol [>>] will not be used in the last step of the procedure.

11.3.3 “To” – data range

Standard

The use of the word “to” should be used to indicate a data range and implies inclusive, as in “through.” The word “to” will be used when the range includes negative numbers. The hyphen [-] may be used to indicate data range of positive numbers. There will be no spaces before and after the hyphen.

Example:

Temp -10 to 20 degC

Temp 10-20 degC

Temp -20 to -10 degC

11.3.4 Triangle [▶] and Pennants – Time-Critical Activities

Reference Section 13.2 for information on time-critical activities.

11.3.5 Adjust Symbols [↻] [↻] [↻] [↻] [↻]

Standards

- a. The use of the adjust symbols is optional.
- b. The clockwise symbol [↻] will be used to indicate that a control device is to be turned clockwise.
- c. The clockwise to stop symbol [↻] will be used to indicate that a control device is to be turned clockwise until the stop is reached.
- d. The counterclockwise symbol [↻] will be used to indicate that a control device is to be turned counterclockwise.
- e. The counterclockwise to stop symbol [↻] will be used to indicate that a control device is to be turned counterclockwise until the stop is reached.
- f. The adjust as required symbol [↻] will be used to indicate adjustment of controls that rotate (knobs, thumbwheels, etc.) as desired by the crew.
- g. Use of the symbol shall follow an object – action format. The symbol shall be placed immediately following the object to be rotated.

Example:

Knob Brightness ↻

- h. The symbol shall be used as a verb or as an adverb.
 1. Except in clear text statements, the symbol shall replace verbs such as “turn, rotate, and twist.”

Clear text example

Rotate the Brightness knob clockwise until the digits are visible

Symbol example

Knob Brightness ↻ until digits are visible

2. Except in clear text statements, the symbol shall replace adverbs such as “clockwise” or abbreviations such as “cw” or “ccw.”

Clear text example:

Rotate Brightness knob clockwise until digits are visible

Symbol example:

Rotate Brightness knob ↻ until digits are visible

11.3.6 Connect Symbol [→|←]

Standards

- a. The use of the connect symbol is optional (or the word “connect” can be spelled out). The connect symbol will be used to indicate that two (or more) devices are to be connected.
- b. When used, the connect symbol will be placed between the devices to be connected.
- c. The connect symbol is not to be used for install or stow.

Example:

Cable A →|← Cable B

11.3.7 Disconnect Symbol [←|→]

Standards

- a. The use of the disconnect symbol is optional (or the word “disconnect” can be spelled out). The disconnect symbol will be used to indicate that two (or more) devices are to be disconnected.
- b. When used, the disconnect symbol will be placed between the devices to be disconnected.
- c. The disconnect symbol will not be used for remove or unstow.

Example:

Cable A ←|→ Cable B

11.3.8 Double Arrows [⇒ ↑ ↓]

See Section 15.0 on the use of these symbols in communications.

Standard

The following special symbols will be used in the ASC/ENT SYS, ASC PKT C/L, and ENT PKT C/L procedures to allow quick cross-referencing during powered and glided flight.

- a. ⇒ At the end of a procedure line directs the crew to continue to either the Glided Flight division of the ASC/ENT SYS and/or to the ASC PKT C/L as dictated by the procedure
 - ⇒G At the end of a procedure line indicates one should continue to the Glided Flight division of the ASC/ENT SYS
 - ⇒A At the end of a procedure indicates one should continue to the ASC PKT C/L
- b. ⇒ Preceding a line indicates the starting point of the procedure if coming from a procedure with the (⇒) icon

11.3.9 Diamond [◆] – MCC Communication

See Section 15.0 on the use of this symbol in communications. (Symbol means “Wait for MCC GO unless LOS.”)

11.3.10 Repetitive Command Loop Symbol

Standard

The use of the repetitive command loop symbol is optional. To avoid excessive repetition within a procedure, the following “loop” approach may be used for repetitive commands:

- a. “X” will be used to denote that the procedure (bracketed by the double lines to the left) will be accomplished on all the items identified by substituting the boxed values into the preceding text field.
- b. The double-line bracket delineates the “loop” itself, and extends between the first appropriate line and the subsequent “Repeat” line. All the text lines within these brackets will be indented. (*This is an ISS example.*)

Example:

```
13. Inhibiting PMA1 heaters  
  
sel PMA1 Htr [X] where [X] = 

|   |   |   |   |   |
|---|---|---|---|---|
| 1 | 2 | 3 | 4 | 5 |
|---|---|---|---|---|

  
    sel Htr Commands  
    cmd Inh Execute  
    √Availability: Inh  
Repeat
```

Guideline

If at all possible, nested repetitive command loops should be avoided.

11.3.11 Synchronization Line for Concurrent Activities

Concurrent activities involve a set of procedures performed by two or more crewmembers simultaneously. These activities require that certain steps in each set be completed or initiated at the same point in time, or performed in a specific sequence relative to steps in the other procedure.

Standards

- The use of the following standards for synchronization line for concurrent activities is optional.
- When used, procedures for concurrent activities will be on facing pages or in adjacent columns.
- A solid line will be used to indicate synchronization points between procedures in which steps in procedures are dependent upon the status of steps performed in the other procedure.
- A dashed line will be used to indicate synchronization points between procedures when steps must be performed relative to a specified event or time.

Example:

These are two facing pages in the Ascent checklist.

<p>ABORT RTLS</p> <ul style="list-style-type: none"> * No joy: * * OPS 601 PRO * <p>✓ GUIDANCE STATUS on RTLS TRAJ Expect PPA when GUID % to go = 0</p> <table style="width: 100%; border-collapse: collapse;"> <tr> <td style="width: 80%;"></td> <td style="text-align: center; border-bottom: 1px solid black;">WINDS</td> </tr> <tr> <td style="border-right: 1px solid black;">50K</td> <td style="border-right: 1px solid black; text-align: center;">/</td> </tr> <tr> <td style="border-right: 1px solid black;">* If GUID 'INHB': *</td> <td style="border-right: 1px solid black; text-align: center;">38 /</td> </tr> <tr> <td style="border-right: 1px solid black;">* ✓ UNCONVERGED GUID TABLE *</td> <td style="border-right: 1px solid black; text-align: center;">28 /</td> </tr> <tr> <td style="border-right: 1px solid black;">* MAN PPA per PRPLT *</td> <td style="border-right: 1px solid black; text-align: center;">20 /</td> </tr> <tr> <td style="border-right: 1px solid black;">* REMAINING *</td> <td style="border-right: 1px solid black; text-align: center;">12 /</td> </tr> <tr> <td style="border-right: 1px solid black;">* After GUID CONVERGE:</td> <td style="border-right: 1px solid black; text-align: center;">7 /</td> </tr> <tr> <td style="border-right: 1px solid black;">* P,R/Y AUTO/AUTO THROTTLE *</td> <td style="border-right: 1px solid black; text-align: center;">3 /</td> </tr> <tr> <td style="border-right: 1px solid black;">After PPA: ✓ BFS ITEM 1 (*)</td> <td style="border-right: 1px solid black; text-align: center;">1 /</td> </tr> <tr> <td style="border-right: 1px solid black;">[TRAJ] ✓ Bugs, [HSI] ✓ </td> <td style="border-right: 1px solid black; text-align: center;">SURF /</td> </tr> <tr> <td style="border-right: 1px solid black;">Pitchdn ($\beta = 0^\circ, \alpha = -2^\circ$)</td> <td style="border-right: 1px solid black; text-align: center;">SPDBK @ 3000 FT</td> </tr> </table> <hr style="border-top: 1px dashed black;"/> <p style="text-align: center;">MECO ----- MECO</p> <p>ET SEP (MECO + 16 sec) ✓ MM602 ($\alpha > 10^\circ$ and SEP + 10 sec) ✓ P,R/Y, SPDBK, BDY FLP - AUTO $\alpha = 50^\circ$ until -1.8g, maintain 2.2g</p> <p>Adjust seat</p> <p>$\dot{H} = -320 \uparrow$ [VERT SIT] ✓ α vs Mach V = 5K AIR DATA PROBES (two) - Deploy (✓ Heat) ✓ RUD, AIL TRIM M = 3.2 ✓ SPDBK → 65% M = 2.7 L HUD PWR - ON</p> <p style="text-align: center;">* If M < 2.5, P CSS for ADTA to G&C incorp *</p> <p>M = 2.0 Ensure ADTA to G&C else THETA limits M < 1.0 P,R/Y - CSS, ✓ SPDBK CMD vs POS ✓ NWS - 1</p>		WINDS	50K	/	* If GUID 'INHB': *	38 /	* ✓ UNCONVERGED GUID TABLE *	28 /	* MAN PPA per PRPLT *	20 /	* REMAINING *	12 /	* After GUID CONVERGE:	7 /	* P,R/Y AUTO/AUTO THROTTLE *	3 /	After PPA: ✓ BFS ITEM 1 (*)	1 /	[TRAJ] ✓ Bugs, [HSI] ✓	SURF /	Pitchdn ($\beta = 0^\circ, \alpha = -2^\circ$)	SPDBK @ 3000 FT	<p style="text-align: center;">UNCONVERGED GUIDANCE TABLE</p> <table border="1" style="width: 100%; border-collapse: collapse; text-align: center;"> <thead> <tr> <th>ENG OUT</th> <th>OUTBOUND INITIAL θ</th> <th>PITCHAROUND at % (8°/sec)</th> <th>FLYBACK INITIAL θ</th> </tr> </thead> <tbody> <tr> <td>Liftoff</td> <td>60°</td> <td>44%</td> <td>64°</td> </tr> <tr> <td>:30</td> <td>56°</td> <td>47%</td> <td>63°</td> </tr> <tr> <td>1:00</td> <td>57°</td> <td>47%</td> <td>63°</td> </tr> <tr> <td>:30</td> <td>56°</td> <td>48%</td> <td>62°</td> </tr> <tr> <td>2:00</td> <td>49°</td> <td>51%</td> <td>61°</td> </tr> <tr> <td>:30</td> <td>42°</td> <td>51%</td> <td>52°</td> </tr> <tr> <td>3:00</td> <td>38°</td> <td>52%</td> <td>50°</td> </tr> <tr> <td>:30</td> <td>34°</td> <td>53%</td> <td>48°</td> </tr> <tr> <td>4:00</td> <td>Last RTLS</td> <td>52%</td> <td>46°</td> </tr> </tbody> </table> <p>✓ P_c at PPA + 20 sec</p> <ul style="list-style-type: none"> * If $P_c = 104\%$ (2 eng): * * [G51] MAX THROT - ITEM 4 (*) * <p>Pitchdn: ✓ $P_c \rightarrow 67\%$</p> <hr style="border-top: 1px dashed black;"/> <p style="text-align: center;">MECO ----- MECO</p> <p>KEAS = 77 ✓ SPDBK → 81% ✓ ET DOORS - Closed and latched (MECO +1:30) ✓ ET SEP, SRB SEP - AUTO Adjust seat ✓ TACANS, INCORPORATE</p> <ul style="list-style-type: none"> * If KSC TACAN Fail: * * TACAN Ch 073X (OMN), ITEM 5 EXEC * <p>[G51] ✓ AIR DATA, INCORPORATE</p> <p>MM603 HYD MPS/TVC ISOL VLV (three) - CL (hold 5 sec) ✓ tb - CL H = 85K MLS (three) - ON If Rwy 33(15): MLS CH (three) - 6(8) I/O RESET</p> <p>M = 2.7 R HUD PWR - ON M < 1.0 ✓ R FLT CNTLR PWR - ON Lock Inertia Reels</p> <p>M = 0.7 ✓ LG EXTEND ISOL VLV - OP H = 10K ✓ BDY FLP - TRAIL LES Visors - Down</p> <p>POST LANDING: ENT, POST LDG</p>	ENG OUT	OUTBOUND INITIAL θ	PITCHAROUND at % (8°/sec)	FLYBACK INITIAL θ	Liftoff	60°	44%	64°	:30	56°	47%	63°	1:00	57°	47%	63°	:30	56°	48%	62°	2:00	49°	51%	61°	:30	42°	51%	52°	3:00	38°	52%	50°	:30	34°	53%	48°	4:00	Last RTLS	52%	46°
	WINDS																																																														
50K	/																																																														
* If GUID 'INHB': *	38 /																																																														
* ✓ UNCONVERGED GUID TABLE *	28 /																																																														
* MAN PPA per PRPLT *	20 /																																																														
* REMAINING *	12 /																																																														
* After GUID CONVERGE:	7 /																																																														
* P,R/Y AUTO/AUTO THROTTLE *	3 /																																																														
After PPA: ✓ BFS ITEM 1 (*)	1 /																																																														
[TRAJ] ✓ Bugs, [HSI] ✓	SURF /																																																														
Pitchdn ($\beta = 0^\circ, \alpha = -2^\circ$)	SPDBK @ 3000 FT																																																														
ENG OUT	OUTBOUND INITIAL θ	PITCHAROUND at % (8°/sec)	FLYBACK INITIAL θ																																																												
Liftoff	60°	44%	64°																																																												
:30	56°	47%	63°																																																												
1:00	57°	47%	63°																																																												
:30	56°	48%	62°																																																												
2:00	49°	51%	61°																																																												
:30	42°	51%	52°																																																												
3:00	38°	52%	50°																																																												
:30	34°	53%	48°																																																												
4:00	Last RTLS	52%	46°																																																												

11.3.12 Joint Vehicle Operations

Joint vehicle operations involve concurrent procedures performed on the orbiter and the space station.

Standards

- a. The use of the joint vehicle operation format is optional.
- b. When used, procedures involving operation of the vehicle on which the procedure resides will contain all procedural steps for operation of that vehicle.
- c. Procedures involving operation of the vehicle, on which the procedure does not reside, may be summarized.
- d. Those portions of the procedure that involve operation of the vehicle on which the procedure does not reside will be shaded.
- e. Procedures to be performed in parallel will be indicated by a dashed arrow on the left-hand side of the procedure running from the first to the last step.
- f. When the parallel procedural steps are shaded, the dashed arrow on the left-hand side must be outside the shaded area.
- g. The middle of both dashed arrows on one side must be joined by a square bracket.

Example (taken from an ISS ODF procedure):

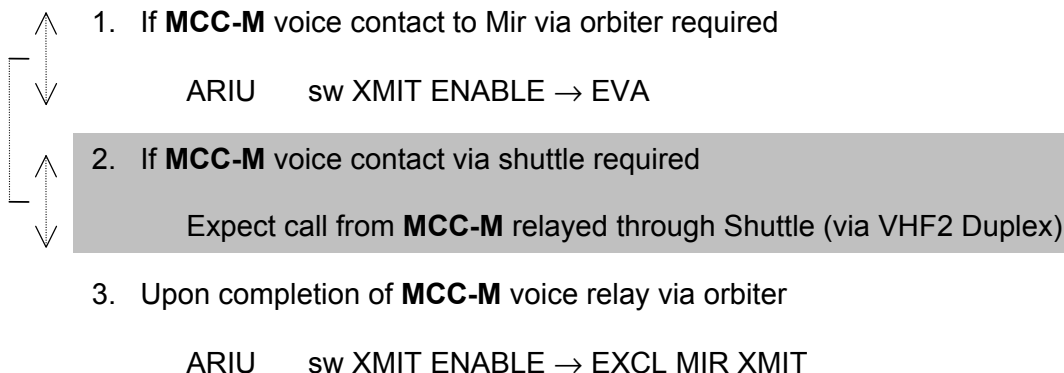

11.3.13 Real-Time Bars

Procedures requiring real-time video operations, real-time voice, real-time ground commanding, or real-time data downlink must incorporate a set of horizontal bars with appropriate text to designate the beginning and end of the activity. If the bars are used, the following apply:

Standards

- a. The use of the real-time bars is optional.
- b. When used, the start bars will be inserted in the procedure at the point where video data, voice, or ground commanding activity will be started.
- c. The end bars will be placed in the procedure at the point where video, data, voice, or ground commanding activity will be stopped.
- d. The note boxes will be placed prior to the first step of the associated activity. If notes are required, they will be formatted and positioned according to Section 14.1.
- e. A blank line will be placed before and after the bars.
- f. The bars will be 1.8 inches (45.72 cm) in length and 6 points in width, separated by a 2-inch space for text.

Note: The bars can be constructed using the drawing tool and contained inside a table with no borders. The text table cell is 2 inches in width.

Examples:

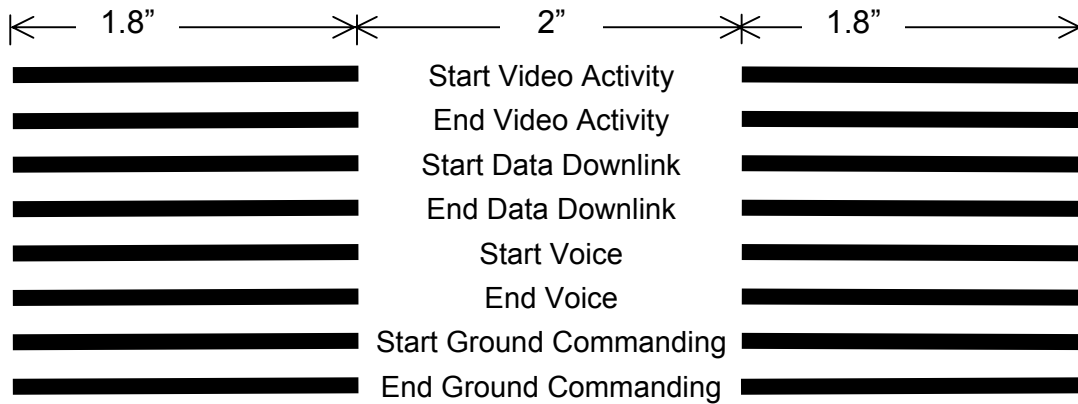

Examples of Real-time data downlink notes:

NOTE

1. This procedure contains real-time data downlink requirements
2. Ku-band AOS required for real-time data downlink requirement

Real-time video downlink notes:

NOTE

1. This procedure contains real-time downlink video requirements
2. Ku-band AOS required for real-time video downlink requirement

NOTE

1. This procedure contains near real-time video downlink or LAB VTR recording requirements
2. AOS required for POIC to configure onboard system for downlink or LAB VTR recording

Real-time voice notes:

NOTE

1. This procedure contains real-time voice requirements
2. S-band AOS required for real-time voice requirement

Real-time ground commanding notes:

NOTE

1. This procedure contains near real-time commanding requirements
2. S-Band and Ku-Band AOS required for real-time commanding

Note for any activity requiring ground commanding to configure data, video, power, thermal, or other systems:

NOTE

Prior to and following execution of this procedure, POIC must ground command to configure onboard systems

11.3.14 Start Timer Symbol [⌚]

Standards

- a. The use of the start timer symbol is optional.
- b. When used, the start timer symbol will be used to notify the crew to start a timer.
- c. The start timer symbol will be placed after the step number (if any) and prior to the first character of the action.
- d. The “3 o’clock timeface” will be used for the symbol.

11.4 LOGICAL EXPRESSIONS SYMBOLS

The logical expressions symbols are Braces [{ }] and Parentheses [()].

11.4.1 Braces

Standards

- a. For logical expressions, writing out “and” and “or” is optional.
- b. Use of braces [{ }] for groupings is optional. Use of parentheses for groupings is also optional.
- c. Perform left to right for precedence.

Examples below are for clarification.

1. If the FDF procedure states: SwA or {SwB and SwC} – On; the flow looks like:

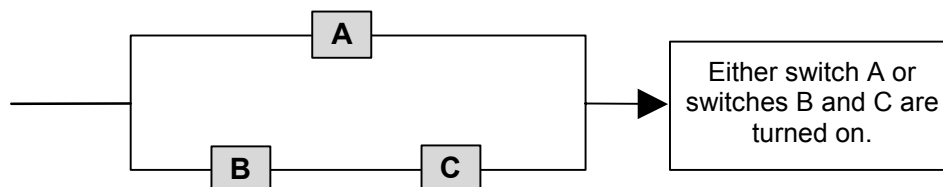

2. If the FDF procedure states: SwA and {SwB or SwC} – On; the flow looks like:

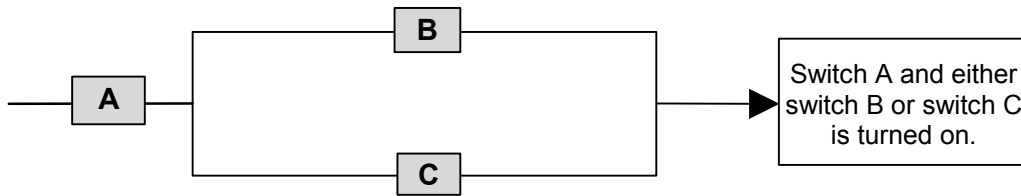

3. If the FDF procedure states: {SwA or SwB} and SwC – On ; the flow looks like:

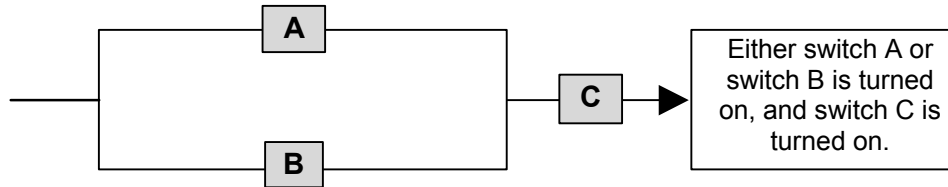

11.4.2 Parentheses [()]

Standard

- a. Parentheses will be used to indicate the order of operation in mathematical expressions.

Example:

$$3(1+5)$$

First add 1 and 5, then multiply by 3

- b. Use of parentheses for groupings is also optional.

11.5 LEGEND SYMBOLS

Several other symbols are used in the FDF for legends or footnotes located in the List of Implemented Change Requests (LICR), LOEP, and other places.

11.5.1 LOEP Symbols

The following symbols are used as footnotes in the FDF LOEP:

- * asterisk – The page is not flown in the flight copies
- Δ delta – The page is to be changed out (replaced) with appropriate flight-specific page or pages
- ☒ boxed “x” – The page contains a pad for data that must be entered in the flight copies prior to flight
- ⊗ circled “x” – The page contains information that is to be highlighted in flight copies prior to flight

Additional LOEP symbols can be found in Section 20.3.6.

11.5.2 LICR Symbols

The following symbols are used in the legend in the FDF LICRs:

- * asterisk
- § “paragraph” symbol
- # number symbol
- Δ delta
- † “dagger”
- ‡ “double dagger”

Additional LICR symbols can be found in Section 20.3.3.

11.6 SYMBOLIC REPRESENTATION OF WORDS

The following are special symbols commonly used when referring to numbers and math expressions.

- " inch symbol
- ' foot symbol
- Δ delta symbol (indicating “change” or “difference”)
- Φ Phase symbol

Standards

- a. Whenever possible, inch and foot will be spelled out. In the case of space limitations, the appropriate abbreviations or symbols will be used. Use the inch symbol ["] to represent measurement in inches and the foot symbol ['] to represent measurement in feet only when there will be no ambiguity in meaning. See Section 4.3 on abbreviations.
- b. When using abbreviations, use “in” for inch, and “ft” for foot.

11.7 LINES AND BOXES

The FDF uses several different types of lines and boxes that have very specific meanings. They are as follows:

- | Vertical line (“pipe”) – See Section 17.0 on conditional statements
- : Vertical dotted line – See Section 17.0 on conditional statements
- L Capital letter “L” – used at the lower end of the dotted vertical line above to indicate the last step associated with the preceding condition
- l Change bar – See Section 21.0 on the vertical bar in page margin used to indicate change in procedure since last publication
- ⋯ Dashed box – See Section 17.0 on alternate nominal procedures
- Box – See Sections 10.0 (for CRT boxes), 19.3 (for pad entries), and 14.0 for text/note/caution/warning boxes
- n Numbered box – Encloses identification number referring to a set of procedural steps enclosed in a box; read “block n.”

() □ . □ □ □ Boxes will be used for handwritten data, either preflight or real time

() — — □ . — — Underlines will be provided where the crew is to enter data. The added data is then available for later use or postflight analysis

□105
□103,104 Boxes will contain vehicle numbers for information pertaining only to specific vehicles. The boxes will be placed in the column used for location/panel callouts. NOTE: In switch lists, other formats will be used to conserve space

⋯EXEC⋯ Dashed boxes will be used to denote CRT fields that are flashing. An alternative representation will be “EXEC (flashing)”

□ □ ———
□ □ ——— In deorbit burn procedures, the dashed and solid lines will be used along with the boxes. Depending on the value written in the boxes and flight conditions (e.g., above or below HP), the procedures written above or below the lines are to be followed

11.8 OTHER SPECIAL SYMBOLS

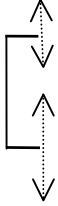
- √ Checkmark [√] – See Section 12.0 on the use of the checkmark.
- ~ “Squiggle” – Indicates a temporary break in a graphical line (e.g., vertical “if” line) or is used to represent “approximate” (see Section 11.2.2).
- ③ Circled numbers – See Section 6.2.4 for the use of circled numbers for references in logic flow diagram procedures.
-  Bracketed arrows – See Section 11.3.12 on Joint Vehicle Procedures.
- Bullet – Identifies each procedural step within a logic flow procedure only. *Rationale: indicates the beginning of a new step and replaces step numbers. See Section 6.2.1.1.*
- .. Double dot or “highlighting mark” – Indicates that the preceding text is highlighted (*yellow*) in *the crews* flight books. The symbol will be placed at the right end of the line or word(s) to be highlighted.

Example:

Cutoff release THC”

12.0 VERIFICATION

Note: See Section 15 for information on: “On MCC GO,” “√MCC,” “Notify MCC,” and the communication symbols [⇒ ↑ ↓ ♦].

Standards

- a. The checkmark will be used to inform the crew that the condition of an item needs to be checked (verified) to see if it reflects the desired state. A procedural line that uses a checkmark is called a “verification.”
- b. Verifications use the following form. A dash will be used to separate the object from its state in a verification.

√OBJECT – STATE

Note: A colon will be used for numerical values.

Example:

√MPEV – Closed

√Equal vlv (two) – OFF, capped

√S TABLE CLR, ITEM 20 – (no unwanted data)

- c. If the condition of the item does not reflect the desired state and there is a crew-controllable interface (i.e., a switch that can be moved into the correct position or rotary knob that can adjust a value), the crew will
 1. Take action to position the item in the desired state.
 2. Contact MCC if there is no known reason the item is not in the expected state. There is no requirement to first contact MCC, although it is still necessary to inform the ground at a convenient opportunity if the reason for the out-of-configuration state was unknown.
- d. If there is no crew-controllable interface (i.e., a voltage on a display), or the crew’s action is not successful in achieving the desired state, the crew must stop in the procedure at this point to contact MCC unless
 1. An “if” statement is provided (in a starred block, for instance), with direction for the out-of-configuration case, or
 2. The reason for the out-of-configuration state is known and considered completely acceptable and safe by the crew

Example:

√Spd, rpm: 3877 rpm ± 100

√RPC 5 Position – cl

- e. The checkmark will be placed immediately to the left of the action to which it applies (after the step number, if any). The checkmark symbol will be closed up on the character or word following the checkmark (e.g., √BRAKES – ON). See Section 4.4.1 for use of checkmarks in carryover lines.
- f. When using clear text, the first word following the checkmark will be initial capital or all capitals.
- g. The checkmark will be placed on each line to which it applies; i.e., the checkmark will not be assumed from previous lines.
- h. When the first part of a callout is omitted because it repeats the line above, the checkmark will move to remain immediately to the left of the printed text. When using proportional fonts, the addition of the checkmark may make forcing a perfect alignment of the indented operational callout very difficult; therefore, a slight misalignment of an indented verification line is acceptable.

See the second and third lines in the following example. A slight vertical misalignment between the “P” and the “1” would be acceptable.

Example:

FREON PUMP LOOP 1,2 (two) – A
√H2O PUMP LOOP 1 (two) – ON, A
 √1 ICH FLOW > 900
√MCC

- i. Checkmarks will not be used in titles.

13.0 TIME REFERENCES

Standards

- a. The “absolute time” reference for the Shuttle Program is GMT (Greenwich Mean Time).
- b. Time will be expressed as DDD/hh:mm:ss, where DDD represents sequential day of the year; hh represents hours; mm represents minutes; and ss represents seconds.
 1. GMT days are represented by the sequential number of the day of the year.

Example:

240/23:12:12

means: August 28 (in the year 2001), 23 hours, 12 minutes, 12 seconds

2. Mission Elapsed Time (MET) days are incremented by adding “1” each 24 hours after the time of launch.

Example:

001/23:12:12

means: MET day 1 (which is 24 hours after launch) plus 23 hours, 12 minutes, 12 seconds

Note: To avoid ambiguity when referencing date/time, follow with the annotation “GMT,” “MET,” “CDT,” etc., wherever possible.

- c. Where required, the seconds format can be extended to include tenths of a second, as in: hh:mm:ss.s
- d. A field (sequential day, ss, etc.) may be omitted if it is not essential to convey the desired day or time and is not ambiguous (in the context of the procedure).
 1. Two numbers separated by a colon will usually refer to minutes and seconds.

Example:

12:12

means: 12 minutes, 12 seconds

2. Single numbers will typically refer to minutes, but also may be used to refer to seconds. Use units (s for seconds, etc.) when required to ensure clarity.

Examples:

TIG-4	means “time to ignition” minus 4 minutes
EI-10	means “entry interface” minus 10 minutes
TIG-:15	means “time to ignition” minus 15 seconds
MECO+35 s	means “main engine cutoff” minus 35 seconds

13.1 RELATIVE TIME

Relative time (i.e., PET - Phase Elapsed Time) is the difference in time between an event and an action. Base time is the event time from which to count up or down.

Events typically referred to include

- a. Ignition (TIG – Time of Ignition)
- b. Deploy (Dpy)
- c. Cutoff (as in MECO – Main Engine Cutoff)
- d. External Tank Separation (ET SEP)
- e. Entry Interface (EI)

Standards

- a. An equal sign [=] will be used to indicate that the action will be initiated or terminated at the specified time or event. One nominal character space before and after the equal sign.

Examples:

MET = 02/05:00 means: at MET = 2 days, 5 hours, perform the following action

M = 3.5 means: at Mach = 3.5, perform the following action

- b. A minus sign [-] will be used to indicate that the action will be initiated or terminated at a specified time prior to the referenced event.

Examples:

TIG-6 means: at 6 minutes prior to TIG, perform the following action

Dpy-20:00 means: at 20 minutes prior to deploy, perform the following action

- c. A plus sign [+] will be used to indicate that the action will be initiated or terminated at a specified time after the referenced event.

Examples:

TIG+8 means: at 8 minutes after TIG, perform the following action

Dpy+15:00 means: at 15 minutes after deploy, perform the following action

13.2 TIME-CRITICAL EVENTS

The time-critical event symbol is a new standard and will be implemented into the flight books for the STS-114 flight. (CR# CPMP_Annex_CU10A)

Standards

- a. A filled-in right-facing arrow [▶] will be used to mark the timetags of actions to indicate that the action or activity must be performed precisely on time.
- b. The triangle will be placed to the left of the timetag.
- c. No “extra” space will be left between the symbol and the timetag; (there may be a small space between the symbol and the timetag if the triangle character does not fill the space of the font).

Example:

▶TIG-5 P R2 HYD CIRC PUMP 1 – OFF

- d. A filled-in right-facing arrow with a vertical line extending upward [▶] will be used to mark the timetags of actions to indicate a “start no later than” time.
- e. A filled-in right-facing arrow with a vertical line extending downward [▶] will be used to mark the timetags of actions to indicate a “start no earlier than” time.
- f. A time bracket [▶] will be used to bracket the times between which an activity should be completed.

14.0 NOTES, CAUTIONS, AND WARNINGS

There are occasions when additional information or clarification is required to support procedure execution.

There are three types of clarifying information used in the FDF. The type used depends upon the impact of not providing this information. They are as follows:

- a. Notes
- b. Cautions
- c. Warnings

Standards

- a. Notes, cautions, and warnings will be placed immediately before the operation they are clarifying.
- b. A blank line (before and after) will separate notes, cautions, or warnings from the surrounding procedure information in C/L format procedures.
- c. Notes will have no visible box lines. Each caution will be placed in a single-line box. Each warning will be placed in a double-line box. See the following sections for specific box format.
- d. The notes, cautions, and warnings will be sufficiently indented over the body of the procedure in C/L format procedures.
- e. Procedural steps will not be placed within notes, cautions, or warnings.
- f. If actions are required to correct or avoid a hazard, the actions will immediately follow the boxed information.
- g. Information contained in notes, cautions, and warnings shall be concise. Do not attempt to tell the crew more than they need to know. If the crew cannot affect the situation, do not address it.
- h. Cautions and warnings will not be used to tell the crew what will happen if they do not follow procedures. Assume that the crew will follow given procedures unless there is a very good reason to believe otherwise.
- i. Information contained in notes, cautions, and warnings shall be precise. Ensure that the crew is able to grasp the entire context of a note, caution, or warning quickly.

14.1 NOTES

Standards

- a. Notes will provide amplifying information of a general nature.
- b. The note is identified by the word NOTE, underlined, capitalized, and centered above the associated text.
- c. Omit the ending period on a one-sentence note. Use periods to end sentences when multiple sentences are used, except omit the period at the end of the last sentence.

Examples:

NOTE
System warmup takes ~4 min

NOTE
MCC will call for BFS to be taken from RUN to
STBY for Recorder dumping. Ground support
personnel establish comm at PS station.
RCS/OMS VALVE TEST completed by PLT

- d. If multiple notes are grouped, they will be separated by a blank line.
- e. References within notes to procedure steps are permitted.

Guideline

Only when space is limited will the note be given on one line.

Example:

NOTE: System warmup takes ~4 min

14.2 CAUTIONS

Standards

- a. Cautions will provide information or instructions necessary to prevent hardware damage or malfunction.

- b. Cautions will be identified by the word CAUTION, underlined, capitalized, centered within the top of the single-line box.

Example:

<u>CAUTION</u> MN Pump may be damaged if APU started with HYD ACCUM P zero

- c. If multiple cautions are grouped, a divider line will be used between them. This allows for the separation of independent trains of thought. A thought can consist of more than one sentence.

Example:

<u>CAUTION</u> MN Pump may be damaged if APU started with HYD ACCUM P zero
Do not reactivate affected heater sys

- d. References within caution boxes to procedure steps are permitted.

14.3 WARNINGS

Standards

- a. Warnings will provide information or instructions necessary to ensure crew safety.
- b. Warnings shall be identified by the word WARNING, underlined, capitalized, centered within the top of the double-line box.

Example:

<u>WARNING</u> Side hatch should not be operated until ground confirms external atmosphere is clear of contamination

- c. It is preferred that multiple warnings be kept to a minimum. However, if multiple warnings are grouped, a divider line will be used between them. This allows for the separation of independent trains of thought. A thought can consist of more than one sentence.

Example:

<u>WARNING</u>
If $-dP/dT$ is 0.55 psi/min, loss of vehicle atmosphere is imminent
When $PPO_2 < 2.2$, emergency breathing apparatus is required ($dP/dT \times 0.2 = PPO_2$ decay rate)
If, after alarm, $O_2(N_2)$ flow > 1.0 , assume flow rate exceeds 5.0 lb/hr (OSH)

- d. References within Warning blocks to procedure steps are permitted.

15.0 COMMUNICATION (CONTROL CENTERS AND VEHICLES)

Standards

- a. When the MCC is required to give the crew a “GO” before the subsequent procedure is executed, the following format will be used (most critical case):

On MCC GO, ...

- b. When the crew should check with MCC before proceeding and wait for Acquisition of Signal (AOS) if LOS, use the checkmark [√] in the following format:

√MCC

- c. When the crew should check with MCC if AOS but can proceed without MCC approval if LOS, use the diamond [◆] preceding the action.

◆ 1. (Aff) He ISOL (two) – CL

- d. There will be no space between the checkmark and MCC.

- e. When the crew is requested to notify the ground of condition/status at their earliest convenience (as in providing data at the end of an experiment or that a procedure is complete), but response from ground is not necessary, the following clear text format will be used:

Notify MCC

- f. The following symbols will be used to indicate communication between control centers and spacecraft. The use of these symbols is optional (or it can be written out):

1. The ⇒ symbol will be used for communication between control centers or spacecraft.
2. The ↑ symbol will be used for communication from the ground to a spacecraft.
3. The ↓ symbol will be used for communication from a spacecraft to the ground.

Examples:

Orbiter ⇒ ISS, “Orbiter is in Free Drift”

Orbiter ↓ MCC-H, “Orbiter is in Free Drift”

MCC-H ⇒ MCC-M, “Orbiter is in Free Drift”

MCC-H ↑ orbiter, “Go for Free Drift”

16.0 REFERENCING OTHER PROCEDURES AND DOCUMENTS

Standards

- a. The book abbreviations found in CPMP Annex A, Appendix C, Flight Data File Book Titles and Abbreviations, will be used when referencing other FDF documents.
- b. Referencing will be used to the maximum extent feasible. Referencing conserves space by preventing repetition or duplicating of procedures. Duplicate procedures are difficult to keep in sync.
- c. The designation of a destination procedure must be detailed enough to uniquely identify that procedure.
- d. References will use the following format and will provide only the information necessary to completely identify the procedure and its location:

PROCEDURE TITLE, additional information (BOOK, SECTION/MAJOR TAB), page number

References to procedures in the same book will not use the book title. References to procedures in other books will not use page numbers, since the book manager usually has limited control over the referenced book's page numbering.

"Additional information" may refer to step numbers, specified parts of a procedure, block number, omission of steps, substitution of data within the procedure, etc. Omission of additional information indicates that the entire procedure should be performed.

Examples:

TEPC, step 6 (ORB OPS, CREW SYS)

Referenced in Flight Plan to a procedure in another book therefore no page number needed

Perform KU-BD MANUAL ACQUISITION (COMM), 2-7, then:...

Reference to another procedure in the same book therefore no book identification needed and the entire procedure should be performed

Go to RNDZ NAV RECOVERY (RNDZ, CONTINGENCY OPS)

Reference to a procedure in another book therefore no page number needed

Perform SINGLE G2 GPC OPS, steps 3 to 9 (ORB OPS, DPS), then:

Referenced to a procedure in another book therefore no page number needed

- e. References to malfunction procedures will be formatted as follows. Use the block number only when necessary to indicate a starting point other than the beginning of the procedure.

MAL, MAJOR TAB, procedure or section number Block No.

Examples:

Perform MAL, MECH, 9.2a

Perform MAL, RCS, 10.1 1.2

- f. When referencing cue card procedures, the phrase “Cue Card” will be used for the book title, and the title of the card, if any, will be substituted for the major tab. Use the page number only when referring to a cue card that is included as a printed version in the flight books.

PROCEDURE TITLE (Cue Card, CARD TITLE)

PROCEDURE TITLE (Cue Card, CARD TITLE), CC x-x

Examples:

Go to TACAN DLMA (Cue Card; GNC)

Go to AFT RCS (Cue Card; OPS 1 RCS BURN), CC 10-10

- g. References to a procedure that has the same title as the major tab or the cue card title will use the following format.

SECTION/MAJOR TAB (BOOK)

CARD/PROCEDURE TITLE (Cue Card)

Examples:

Perform RMS PWRDN (PDRS OPS), then: ...

Perform LEAKING OMS BURN (Cue Card)

Go to FAILED LEAK CHECK (14.7/10.2 PSI) (Cue Card), CC 6-4

- h. Page numbers will be used without prefixes (such as p. or pg.) unless to avoid ambiguity, in which case “pg” will be used.

- i. Minor tabs will not be called out in references unless they are required to uniquely locate a procedure. In other words, minor tabs will be called out only when there are two versions of a procedure with the same title under the same major tab but different minor tabs. In this case, the callout is

PROCEDURE TITLE, additional information (BOOK, MAJOR TAB; MINOR TAB)

Examples:

PASS GPC (1st FAIL) (EPCL, DPS; Pre-TIG)

PASS GPC (1st FAIL) (EPCL, DPS; Post Burn)

- j. When referencing a cue card or other physical document (book) rather than the content, use the clear text format that best conveys the intent as in the following format.

CARD TITLE Cue Card

Examples:

Remove SAFER and SAFER CHECKOUT RESULTS Cue Card from
Stowage Bag/FDF Locker

Return to DEPRESS/REPRESS Cue Card, DEPRESS, step 5 (suit
pressure sensor unreliable)

Make the following P&I changes to the ENT C/L

- k. Similarly, a flight supplement is considered the same book as its generic counterpart when they are ringed together for flight; therefore, a reference to a flight supplement procedure will use the “FS” page designator, but not the book title.
- l. The “FS” in a “Book” title will be called out when referencing a procedure in a flight supplement that has a major tab with the same title as the procedure in the generic book.

Example:

Go to LOAD PCMMU FORMAT (ORB OPS FS, COMM/INST)

- m. When navigating between procedures, the following expressions will be used:
 1. Perform ... , then: (the current procedure will be resumed) (see section 16.1)
 2. Go to ... (the current procedure is exited) (see section 16.2)

Note: Reference Section 11.3.8 for the use of the navigation arrow [⇒].

Note: Reference Section 11.3.2 for the use of the exit symbol [>>] when exiting a procedure prior to the last step without instructions for entering another procedure.

Guideline

When using references, take care to ensure that the crew is not forced to refer to so many documents or procedures that the task becomes cumbersome. This is especially true of quick response procedures. Likewise, the process of maintaining procedures containing references should not be exhaustive.

16.1 PERFORM ..., THEN

Standards

- a. The expression “Perform ..., then:” will be used when calling another procedure if the current procedure will be continued after the referenced procedure is completed.
- b. The procedural step following the “Perform ..., then:” statement is normally an independent step and will not be indented.
- c. The format for “Perform... , then:” is

Perform [reference per above standards], then:

Example:

Perform SINGLE G2 GPC OPS (DPS), 4-2, then:

- d. Procedures referenced in timelines will be formatted as follows:

PROCEDURE TITLE (BOOK, SECTION/MAJOR TAB)

Example:

POST-SLEEP ACTIVITY (ORB OPS, CREW SYS)

“Perform ..., then:” is understood and not written in timelines such as the Flight Plan, Post Insertion, etc.

Guideline

Within malfunction procedures (logic flow diagram format), the word “then” may be omitted in “Perform ..., then:” statements only when needed to conserve space.

MAL, MAJOR TAB, procedure, or section number

Block No.

Examples:

Perform MAL, MECH, 9.2a

Perform MAL, RCS, 10.1 1.2

16.2 GO TO ...

Standards

- a. The expression “Go to...” is used
 - (1) when directing to another procedure and the current procedure is to be exited (and not returned to).
 - (2) when directing to another step within the current procedure.

- b. The format for “Go to...” is:

Go to [reference per above standards]

Go to [reference per above standards] >>

Examples:

Go to BUS LOSS ACTION >> *intermediate step to exit the procedure*

Go to SINGLE G2 GPC OPS, steps 3 to 9 (ORB OPS, DPS) *last step*

Go to step 9 *directed to step within the procedure*

Guideline

Exit symbols [>>] are needed in “Go to...” expressions except when the step is the last step in the current procedure or when directing to another step within the current procedure.

17.0 CONDITIONAL, ALTERNATE, AND CONTINGENCY BRANCHES

Various situations may arise where it is necessary to allow for contingencies, alternate nominal operations, and other conditional factors.

17.1 CONDITIONAL STATEMENTS

Where two or more clear branches develop in a procedure, conditional statements may be used to denote the various paths through the procedure.

Standards

- a. A conditional statement is a conditional clause introduced by a conjunction such as “if,” “when,” “for,” “at” (as in “At T = 100 degF”), and “on” (as in “On MCC GO”).
- b. Any conditional statement must always be given before the action(s) to which it applies.

Example – One-line conditionals:

1. When condition A, ...
2. If condition B, ...
3. ...

Example of incorrect format:

1. PGSC pwr – on (while holding [F1] key down)

Avoid parenthetical conditions following an action.

- c. Steps on lines following a conditional statement must be indented at least two nominal character spaces.
- d. A solid connecting line will be used only between two conditional statements that are mutually exclusive. The connecting line will be aligned vertically between the “I’s” of the two “If” statements (not indented).

- e. If conditional statements become difficult to read due to nesting or length (three or more lines), a vertical line of dots should be used to clarify when the steps under a conditional are complete. A dotted line will be used to indicate the steps associated with the preceding condition when a solid line is not applicable (unless there is only one action following the conditional). A capital “L” will form a “foot” on the final line of actions.

Example – Multiple-line conditionals:

- 1. If condition A:
 - | action
 - | action
 - | action
- If condition B:
 - : action
 - : action
 - L action >>
- 2. Next do this action....

Note: The “>>” indicates that the procedure will be exited if the second condition in step 1 was met and the actions performed. If the symbol is not present, the crew will continue to step 2 – just as he/she would do following performance of actions associated with the first conditional statement.

- f. To avoid long vertical lines connecting the “If” statements, the conditional phrase with the fewest substeps should come first unless there is a chronological sequence required.

Example:

- 11. FLOW PROP VLV LOOP tb (two) – ICH
- If FES not ena:
 - : If EVAP OUT T 41 to 47 degF:
 - : | 12. RAD CNTLR OUT TEMP – HI
 - : | When EVAP OUT T > 50 degF:
 - : | : 13. FLASH EVAP CNTLR PRI A(B) – ON
 - : | : Wait 3 sec, then:
 - : | L 14. RAD CNTLR OUT TEMP – NORM
 - : If EVAP OUT T < 41 or > 47 degF:
 - L 15. FLASH EVAP CNTLR PRI A(B) – ON
- 16. ANTISKID – OFF

- g. Statements like “If recovered,” “If successful,” or “if no joy” will be used to avoid repeating long conditional statements.

Guideline

A conditional statement does not necessarily require a step number.

17.2 ALTERNATE NOMINAL PROCEDURES (DASHED BOX)

Alternate nominal procedures are steps within a procedure that attain an objective in a manner that is different from the nominal sequence to accommodate different anticipated scenarios.

Standards

- a. Alternate nominal procedures will be contained within dashed boxes.
- b. Alternate nominal procedure titles are left justified, all capitals, and bolded on the first line inside the box.
- c. Alternate nominal procedures will be less than 10 steps in length. Longer alternate nominal procedures will be managed as a separate procedure.

Example:

IF 24-HR EXTENSION		
P	O7	AFT L,R RCS He PRESS A (two) – GPC (tb-OP) B (two) – CL (tb-CL) TK ISOL (six) – OP (tb-CL) XFEED (four) – CL (tb-CL)
	O8	FWD RCS He PRESS A – GPC (tb-OP) B – CL (tb-CL)

Guidelines

- a. The condition in which alternate nominal procedures will be used is typically reflected in its title.
- b. Where practical, alternate nominal procedure steps should be placed after the corresponding nominal procedure steps.
- c. The dashed box should be indented within the margins of the main procedure.

17.3 CONTINGENCY PROCEDURES (ASTERISKS)

Contingency procedures are steps within a procedure that respond to failures or other anomalies.

Standards

- a. Contingency procedures will be contained between two columns of asterisks.

Example:

```
* If no start:                *
*   APU OPER – OFF           *
*   Start another APU        *
*                             *
* If second APU starts, shut *
* down unstarted APU        *
* (Cue Card) >>            *
```

- b. Contingency procedure titles reflect the condition under which the procedure is used.
- c. Contingency procedure titles are left justified on the first line between the asterisk columns.
- d. Contingency procedures will be less than 10 steps in length. *Longer contingency procedures will be managed as a separate procedure.*
- e. Contingency procedures will be inserted where the anomaly would likely occur or at points where particular action is required due to an anomaly.

Guideline

The asterisk columns will be indented within the margins of the main procedure when practical.

18.0 HANDLING LOOSE EQUIPMENT

Loose equipment is defined as any item not attached to the orbiter. Examples include hand tools, medical equipment, window covers, food and other crew support and personal items, payload equipment and instruments, etc.

Standards

- a. FDF procedures associated with crew interfaces with loose equipment will follow applicable standards detailed throughout this document.
- b. All orbiter-flown loose equipment names (and any descriptors) will begin with a capital letter except when used in clear text.

18.1 STOWAGE LISTS

Stowage lists are usually complete lists of loose equipment as stowed in the orbiter and/or Spacehab. The list may be alphabetical by item or may list items according to where they are located.

Standards

- a. Stowage lists by item (kit) will be alphabetized and will include the location of the item.
- b. Stowage lists by location will be organized logically to reflect where loose equipment is stored. Only the detail needed to specify the location (e.g., major element, minor element, locker, pouch, etc.) will be given.
 1. Vehicle: Orbiter, Spacehab, ISS, etc.
 2. Major element: Flt Deck, middeck, Multipurpose Logistics Module (MPLM), etc.
 3. Minor element: Forward lockers, aft lockers, compartment, volume, or racks in the middeck, etc.
 4. Locker number
 5. First tray, second tray, third tray, top tray, bottom tray, etc.
 6. Bag, pallet, packet, and pouch name
- c. Horizontal lines will be used to divide items in different trays within a locker.
- d. The quantity (in numerical form) or any other clarifying information will be enclosed in parentheses and will follow the item name.

- e. Some stowage items are located in specialized bags, pallets, packets, and pouches. When referencing these items, the kit, the pallet, and the item location will be identified in that order.

Example:

Afrin nasal spray (MBK G1-1,2)
Sudafed (MBK E2-14)

18.2 EQUIPMENT LISTS

Equipment lists identify items required to perform a procedure.

Standards

- a. Required support equipment will be identified early in a procedure. Identifying all needed equipment up front allows the crew to properly prepare to efficiently execute a procedure.
- b. The list of required equipment implies an instruction to obtain all identified equipment.
- c. Items will be listed vertically unless it is necessary to list them horizontally to conserve space.
- d. Loose equipment items lists will be grouped logically by stowage location (vehicle unit, major element, minor element, etc.) so the crewmember follows a logical path to all equipment stowage areas.

Example:

	<u>TOOLS REQD:</u>	ORBITER
		Orbiter Vacuum Cleaner (Vacuum Cleaner ops only, as reqd)
		Vacuum Cleaner Suction Hose (Vacuum Cleaner ops only, as reqd)
		Crevice Tool (Vacuum Cleaner Ops only, as reqd)
		SPACEHAB
SS Stow 4		Flat Tip Screwdriver (long)
		Needlenose Pliers (large)
SS Stow 1		Tape

- e. The quantity (in numerical form) or any other clarifying information will be enclosed in parentheses and will follow the item name.

Examples:

Gray Tape (3 strips, ~10 in each)

12-gauge sockets (3)

Guideline

The first item of the list may be an instruction to “Obtain:” or “Unstow:.”

18.3 LOOSE EQUIPMENT CALLOUTS

Use the following standard when loose equipment is being referenced within an action.

Standard

Spell out the quantity within a clear text action. Follow the quantity with the numeral in parentheses unless adding the parenthetical information would cause confusion.

Examples:

Remove five (5) screws

Remove two 5/8-in hex bolts

19.0 REFERENCE INFORMATION

This section defines standards for data and graphics.

19.1 TABLES

Standards

- a. Unless the content of a table is obvious, each table will have a title centered above the table.

Example:

Table 3-2. A31p Serial Ports

- b. When a table is continued on the next page of a paper document, the Table Title followed by the abbreviation “(Cont)” will be centered above the table.
- c. When necessary, a table will contain thematic subheadings that are separated from the preceding text and centered.

Example:

ALPHABETICAL STOWAGE

ITEM	LOCATION	QTY	NOTES
------	----------	-----	-------

- d. The information in each cell of the table is called an entry. Separate the entries using horizontal and vertical blank or solid lines to clearly demark different entries.

Guidelines

- a. It is permissible to omit a table title.
- b. The heading “Table ...,” followed by the number that corresponds to the section and a title indicating the content of the table may be centered above each table.

19.2 GRAPHS, DIAGRAMS AND FIGURES

Standards

- a. Unless the content of a graph is obvious, each graph will have a title centered above or below the graph.

Example:

Figure 8-6.– Laptop Receiver Unit

- b. Unless displaying the magnitude of parameters is not necessary, units will be displayed on the graph.

- c. Print explanations to the graphs, monographs, drawings and diagrams in the working field, replacing them with position numbers only when there is not sufficient space.

Guidelines

- a. It is permissible to omit a title of a graph or diagram.
- b. When utilizing paper, it is permissible to position graphs and diagrams horizontally (landscape) on a page.
- c. The heading “Figure ...” or “Diagram ...” with the number that corresponds to the section and the title indicating the content of the figure or diagram may be centered above or below each figure or diagram.

19.3 PADS

Various C/L procedures contain several types of pads, such as burn pads, state vector pads, etc. Pads are used for manual data entry onto the C/L for later use. Pad data may be required for display item entries or for noting system limits, etc.

Standards

- a. Unless the content of a pad is obvious, each pad will have a title centered above it.
- b. Boxes will be provided for each manual entry character.
- c. Decimals, colons, slashes, or other delimiters necessary for use in the data entry area will be typed in and not left blank for manual entry.
- d. Any units that must be shown on the pad will be typed in and not left blank for manual entry.

19.4 CHECKLISTS

Various C/L procedures contain several types of C/Ls – Go/No Go C/Ls, Switch Lists, Activity Lists, etc.

Standards

- a. Unless the content of a C/L is obvious, each will have a title centered above it.
- b. A table will be used with a blank column to allow the crew to manually check off completed items.

Example:

**DUAL SHIFT ORBITER
CO2 ABSORBER REPLACEMENT**
(7 Crewmembers/RED sleeps 1st/FD 1-16)

FLIGHT DAY	POS A	POS B	CK CMPLT
LAUNCH	1 *	2	
PRE BLUE FD1	3 *	"	
POST BLUE FD2	4	5	
PRE BLUE FD2	6	"	

20.0 FDF BOOK STRUCTURE

FDF documents come in multiple types, the most basic of which is the book form. Derivative documents consist of C/Ls, individual cue cards, ringed cards, FBs, transparent overlays, and other formats as required to facilitate crew use. The content of each directive document, as well as information regarding its form, fit and function, is contained within a book for configuration management purposes.

Printed FDF books are in two forms: flight quality and bond. Flight quality books are fabricated in two formats: small (6 x 8 inch) and large (8½ x 11 inch). Bond books contain duplicates of the flight-quality documents and are printed on standard 8½ by 11-inch paper. See Section TBD.

Electronic procedures are presented as images of the published hard copy (bond) documents, normally as Portable Document Format (PDF) files. These files are made available for flight use on removable computer media such as CD-ROM. They are made available for ground use on a JSC Local Area Network (LAN) server, which is accessible to non-JSC personnel through the Internet. In addition, copies of the crew's CD-ROMs are provided to key MCC positions in case of a network/server failure or activation of a contingency MCC.

This section contains standards specific to the hard copy production of FDF documents, including editions and revisions, front matter required, and FDF standards for size, image area, composition sequence, page codes, pagination, and overall document layout. These standards address both flight quality and bond books and also apply to documents presented electronically.

Information specific to PCNs, simulation (sim) pack, and errata pack formats is given in Sections 21, 22, and 23. Standards for other printed media, such as cue cards, are given in Sections 28, 29, and 30.

20.1 FDF BOOK PUBLICATIONS

Standards

- a. FDF documents will be published as major editions, with subsequent revisions (Rev) and PCNs generated as required. See CPMP Annex A, Section 2.0 for definition of these publications.
- b. Specific versions of FDF publications will be identified as follows:

Major Edition	Rev	PCN
Preliminary (PRE)	Sequential English letter	Sequential Arabic number 1, 2, 3, ...
Basic (BAS)	A, B, C, ...	
Final (FIN)		
Generic (GEN)		

Examples: BAS; FIN 2; PRE B; GEN D,2

- c. A Flight Supplement to a generic book, if required, will be published as a separate document. A supplement is normally flown at the back of the book that it supplements; however, with special permission, it may be placed at the front or have its pages integrated into the baseline book.
- d. Reprints will use the latest published masters (major edition or latest revision with all applicable PCNs incorporated). Corrections will not be made in a reprint.

20.2 REQUIRED CONTENT FOR FDF BOOKS

Standards

- a. All FDF books will have the following components.
 - 1. Front matter
 - (a) Front cover (Flight format differs from non-flight)
 - (b) Signature page (not flown)
 - (c) LICR (not flown)*
 - (d) Areas of Technical Responsibility (not flown)*
 - (e) Not flown user notes, if required
 - (f) LOEP (not flown)*
 - (g) List of Fabricated Items, if applicable (not flown)*
 - (h) TOC (including Hazard Control (HC) and Critical Item List (CIL) Designation) (flown)
 - (i) Notes for in-flight use, if required (not flown)
 - *May be omitted from Preliminary editions.
 - 2. Body of text (procedures) (flown)
 - (a) Sections, subsections if required, procedures
 - (b) Section for in-flight notes, if required
 - (c) Section for configuration of fabricated items, if required
 - 3. Distribution list (not flown)
 - 4. Back cover (flight format differs from non-flight)

- b. All pages, except the front covers and signature page, will have the following information:
 - 1. Page code
 - 2. Page number
 - 3. Page note (if required)

20.3 FRONT MATTER

Front matter consists of those items that identify the book, give its applicability (i.e., flight, vehicle, etc.), provide authority for use, contain change implementation information, and allow for ease of use.

20.3.1 Covers

New covers (JSC standard and flight) shall be prepared in accordance with the standards outlined in this section for each major edition or revision of FDF books. Formal covers shall not be provided for PCNs, but a cover sheet will be prepared according to Section 21.0.

The cover for ground users (standard cover) meets the requirements of the JSC Management Instruction 1512.1D, Standards of Publication Covers. The crew uses a different cover on the actual flight books to allow quick identification (“flight-quality” cover).

Covers will not be replaced via PCN, except to correct an error or as given in Section 20.3.1.3 when using the book on a different flight.

20.3.1.1 Elements of Standard Cover

Standards

The standard front cover of an FDF document will contain the following (see Figure 20-1):

- a. Unique JSC document number (48000 to 48499 block series). The Procedures Management Office will obtain the document number from the JSC Technical Library.
 - 1. The JSC document number corresponds to the title of the book. In the event of a change of format, the book will maintain the JSC document number that matches the title.

Example of generic book becoming a flight specific book:

generic JSC-12345 becomes flight specific JSC-12345-xxx

Example of generic book with a supplement that is being retired:

generic JSC-12345 with supplement JSC-67890-xxx
becomes stand alone flight specific JSC-12345-xxx

Example of new number assigned (or reinstated if previously retired):

stand alone flight specific JSC-12345-xxx becomes generic
JSC-12345 plus supplement JSC-67890-xxx

2. A flight supplement will have a number that is independent of its baseline documents number.
3. Flight supplement numbers will be made unique by the addition of the applicable flight number as a suffix.

Example of generic book:

Orb Ops JSC-48035

Example of flight specific book:

Orb Ops FS for STS-112 JSC-48036-112

4. A specific volume of a book will use the baseline document's number plus the volume identifier as a suffix.

- b. Series identification logo.



- c. Book title from CPMP Annex A (includes applicability if book is not generic or other identifying information, if required).
- d. Parent organization of the Office of Primary Responsibility (OPR) for book management (i.e., applicable directorate and division).

If book management is an SFOC contractor-accountable function, the parent organization will be the NASA unit responsible for oversight of its content.

- e. Major edition name (i.e., Preliminary, Basic, Final, or Generic).
- f. Revision identification if applicable (e.g., Rev A, Rev B; etc.).
- g. Publication date (within ± 10 days of the "to print" date).

- h. NASA/JSC address element and logo.

If book management is an SFOC contractor-accountable function, the contractor logo may be added.

- i. The following note:

<p>Verify this is the correct version for the pending operation (training, simulation or flight). Electronic copies of FDF books are available. URL: http://mod.jsc.nasa.gov/do3/FDF/index.html</p>

- j. Note(s) or Special Information boxes will be on the front cover if needed to ensure that the reader is aware of certain applicability or other information

Guidelines

- a. When coordinated with the FDF Manager beforehand, the cover may also contain mission-specific information regarding specific program, payloads, launch date, special use considerations, etc.
- b. To facilitate printing copies from PDF files, a print master set will contain a blank page for the back of the front cover.

Space Shuttle Program ① JSC-48027

FLIGHT DATA FILE ②

Malfunction Procedures ③

Mission Operations Directorate ⑤
Operations Division

Generic, Rev G ⑥
January 12, 2005 ⑦

NOTE
For STS-114 and subsequent flights

⑨

National Aeronautics and
Space Administration

Lyndon B. Johnson Space Center
Houston, Texas





⑩ Verify this is the correct version for the pending operation (training, simulation or flight).
Electronic copies of FDF books are available. URL: <http://mod.jsc.nasa.gov/do3/FDF/index.html>

Space Shuttle Program JSC-48040-114

FLIGHT DATA FILE

**PDRS Operations
Checklist**

STS-114 Flight Supplement ④

Mission Operations Directorate
EVA, Robotics, & Crew Systems
Operations Division

Basic, Rev A
August 27, 2004

NOTE
For STS-114 and subsequent flights

National Aeronautics and
Space Administration

Lyndon B. Johnson Space Center
Houston, Texas



Verify this is the correct version for the pending operation (training, simulation or flight).
Electronic copies of FDF books are available. URL: <http://mod.jsc.nasa.gov/do3/FDF/index.html>

Legend

- ① JSC Document Number (12 pt)
- ② Series Identifier (FDF Logo)
- ③ Book Title (36 pt)
- ④ Additional Book Identifier, if required (30 pt)
- ⑤ Responsible NASA Organization (24 pt)
- ⑥ Publication/Version Identifier (24 pt)
- ⑦ Publication Date (24 pt)
- ⑧ Note(s), Special Information
- ⑨ NASA/JSC Address/Logo and,
if applicable, Contractor Logo
- ⑩ Verification/Electronic Copy Note

Figure 20-1. Standard JSC cover

20.3.1.2 Elements of Flight Cover

Standards

The flight front cover of an FDF document will contain the following (see Figure 20-2):

- a. The JSC document number.
- b. Major edition identifier (i.e., Preliminary, Basic, Final, or Generic) and the revision identifier if applicable (e.g.; REV A, REV B, etc.).
- c. Series identifier (i.e., Flight Data File logo).
- d. Space Shuttle Program (SSP) patch or flight patch.
 1. SSP patch will be used for generic books.
 2. Crew's flight patch will be used for flight-specific books, if available, when the book is scheduled to be published; otherwise, the SSP patch will be used.
- e. Book title.
- f. Applicable flight or vehicle.
 1. Flight numbers will be preceded by "STS"
 2. Vehicle numbers will be preceded by "OV"
 3. "ALL" will be used for generic books that are neither flight nor vehicle specific
- g. Flight identification, vehicle identification, or "All," as applicable.
- h. For Pocket C/Ls and AESP only, a "phase usage table" will be provided. This table will show the five books and associated flight phases. The phase(s) for which a given book is applicable will be highlighted by shading the remainder.

Note: For flight, Ascent/Entry AESP and APCL are flown as a combined book.)

AESP: MM101
APCL: MM104
OPCL: MM106
EPCL: MM301
AESP: MM304

Guideline

Information beyond what is given above should not be added to flight document covers unless mandatory for operational use.

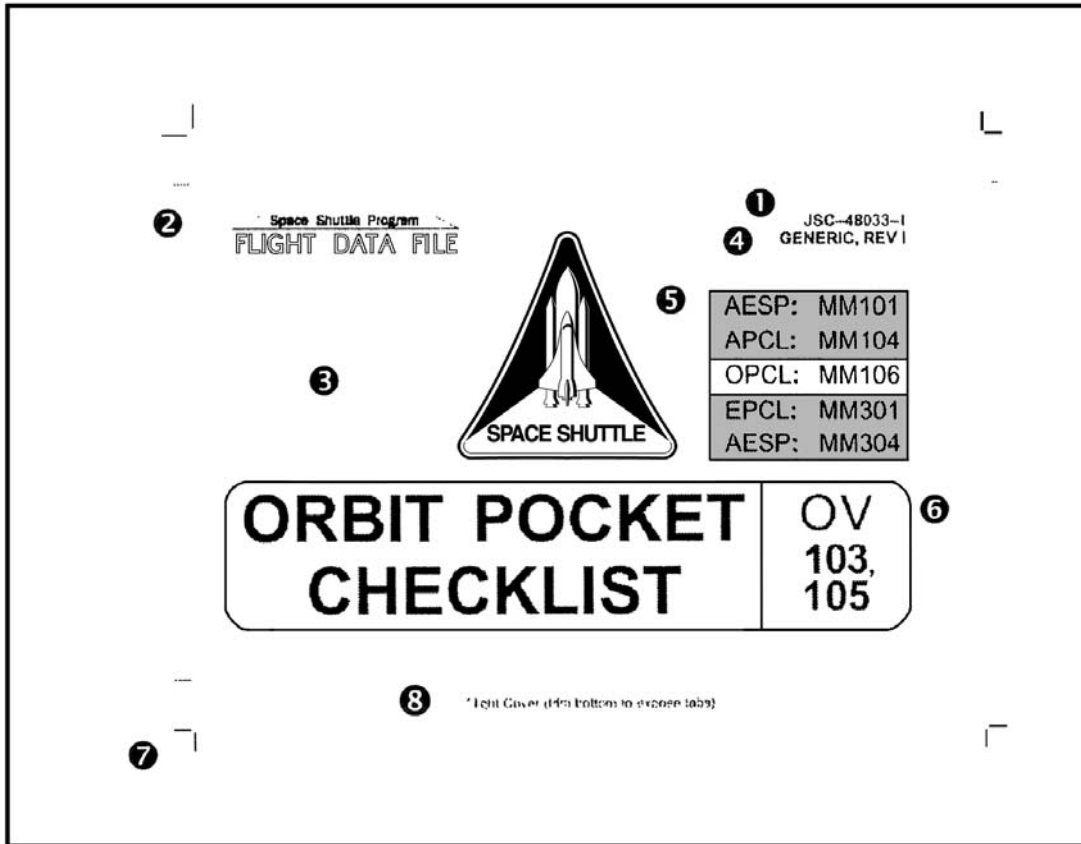

Legend

- ❶ JSC Document Number (12 pt)
- ❷ Series Identifier (FDF Logo)
- ❸ Book Title or Abbreviation (36 to 60 pt)
- ❹ Publication/Version Identifier (24 pt / 12 pt)
- ❺ Note(s), Special Information
- ❻ Applicable flight, vehicle or ALL (24 to 90 pt)
- ❼ Crop Marks (4 places; small format books only)
- ❽ Note to fabricator

usa005466c_002.tif

Figure 20-2. Flight cover as published

20.3.1.3 Multiple Flights/Reflight Covers

Missions with the same or similar objectives allow normally flight-specific FDF documents to be recycled rather than require a complete new FDF development/production/verification cycle. Referred to as a reflight of an earlier flight, the changes to

the books from the first flight are limited to those required to support the second flight; i.e., reflight of STS-83 as STS-94.

Note: If there is a need for a complete revision to a particular book between flights, the publication will be treated as a new book (normally a Final edition) for the second flight with no mention of the first flight.

20.3.1.3.1 Cover for Multiple Flights

If it is known (planned) that a book will be used for more than one flight at the time of its publication, the following standards apply:

Standards

- a. The color of the initial cover will be that for the first flight.
- b. The JSC document number will identify both flights.
Example: JSC 48020-83/94
- c. The title on the initial cover for bond books will identify the book as being for the first flight, with the second flight listed as a subtitle. The subtitle will be in smaller, 24-point lettering in parentheses under the horizontal line.
- d. The title on the initial cover for flight books will identify the first flight only.

20.3.1.3.2 Cover for Follow-On Flight

If it is either planned or determined after a book is published that the book will be used for a follow-on flight, the following standards apply.

Standards

- a. A new cover will be provided for the second flight.
- b. The color of the new cover will be that for the second flight.
- c. The JSC document number will identify both flights.
Example: JSC 48020-83/94
- d. The title on the new cover for bond books will identify the book as being for the second flight, with the first flight listed as a subtitle. The subtitle will be smaller, 24-point lettering in parentheses under the horizontal line.
- e. A note will be placed on the bond reflight cover with information stating that the cover is replaced by PCN-X.

- f. The title on the new cover for flight books will identify the second flight only.
- g. A PCN will be published with instructions to replace the book covers.

Note: The PCN numbering sequence will continue from the first flight, if one is established.

20.3.1.4 Reprint Covers

Standards

- a. A reprint uses the latest published cover with an added note stating that the print package is a reprint, the date of the reprint, and, if applicable, which PCNs are included.

Example:

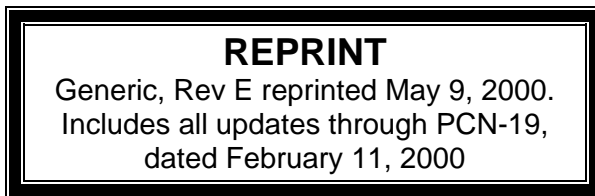

- b. If a user note already exists on the cover, the reprint note will be placed below and parallel to the existing note.

20.3.1.5 Cover Paper Stock

Standards

- a. Flight-quality covers will be printed on K-10 paper, and bond covers will be printed on index stock.
- b. All covers will be white unless the document is flight or vehicle specific.
- c. Covers for flight-specific books, both flight-quality and bond copies, will have an assigned color based on the flight number.
 - 1. The colors blue, salmon, and buff will be used in rotation.
 - 2. The specific color for a given flight will be determined as follows:

Divide the assigned flight number by 3 to obtain an integer value and a remainder. (Ignore the integer value.)

If the remainder is zero, the color is blue; if one, the color is salmon; and if two, the color is buff.

Example:

For flight number STS-150: $150/3 = 50$ and the remainder is zero, thus the color is blue.

More examples:

<u>Flight number</u>	<u>Color</u>
STS-111, 114, 117, 120 . . . LON-3, 6 . . .	Blue
STS-112, 115, 118, 121 . . . LON-4, 7 . . .	Salmon
STS-113, 116, 119, 122 . . . LON-5, 8 . . .	Buff

- d. Colors for covers of vehicle-specific books currently identified (as a result of major modifications incorporated) follow:

OV-104 - Tan
OV-103 and OV-105 (combined) - Green

Guideline

The FDF Manager may designate specific colors for the covers of special FDF documents.

20.3.2 Signature Page

Standards

- a. The signature page will be the first (right-hand) page in a major edition or revision.
- b. The signature page of FDF books will contain the following information:
 1. JSC document number (same as on front cover)
 2. "Mission Operations Directorate"
 3. Full (formal; not abbreviated) book title from CPMP Annex A
 4. Edition and date
 5. Signature element of individual primarily responsible for preparing the document; book manager
 6. Signature element of approving authorities (normally section head and branch chief - or contractor equivalent; refer to CPMP Annex A)
 7. Signature element of accepting authority (if approving authority does not represent the organization responsible for the overall FDF subsystem)

8. Statement regarding CPCB control
9. Statement regarding requested change in distribution
10. Page code

Guidelines

Signature elements other than those given above may be included if required. Excessive signature elements are discouraged due to the time required to obtain the signatures and the apparent dilution of authority/responsibility.

- a. Each signature element will consist of an individual's name, title or position, and organization beneath a line on which the signature is to be placed.
- b. The statement of CPCB control will be one of the four listed below as appropriate.
 1. The statement for preliminary books that are not yet under control of the CPCB (i.e., do not require FDF Workflow Crew Procedure CRs to change procedures) will read as follows:

“This document is not currently under the configuration control of the Crew Procedures Control Board (CPCB). During the interim, changes may be submitted directly to the book manager.”

2. The statement for books under partial control will read as given below. An example of a book under partial control would be a preliminary deploy C/L containing upper stage procedures that have flown before, but with new spacecraft procedures. In this case, the upper stage procedures would remain under control, but the spacecraft procedures would not be under control.

“Parts of this document are under control of the Crew Procedures Control Board (CPCB). Consult the book manager for information on which procedures are under control. All proposed changes to controlled portions must be submitted on FDF Workflow Crew Procedure Change Request (CR) to DO3/FDF Manager. Changes to non-controlled portions may be submitted directly to the book manager.”

3. The statement for books that are under control and are part of the Flight Operations Review (FOR) data pack will read as given below. This statement recognizes that the book may be changed by Discrepancy Notices (DNs) prior to and at the FOR, as well as by FDF Workflow Crew Procedure CRs.

“This document is under the configuration control of the Crew Procedures Control Board (CPCB). Except for Discrepancy Notices (DN) approved at the flight operations review (FOR), all proposed changes must be submitted via FDF Workflow Crew Procedure Change Request (CR) to DO3/FDF Manager.”

4. The statement for books that are under complete control (i.e., require an approved FDF Workflow Crew Procedure CR for all changes) will read as follows:

“This document is under the configuration control of the Crew Procedures Control Board (CPCB). All proposed changes must be submitted *via* FDF Workflow Crew Procedure Change Request (CR) to DO3/FDF Manager.”

- c. The statement regarding change in distribution will read as follows:

“Additional distribution of this book, for official use only, may be requested in writing to *DO3/PMO Administrator*. The request must include justification and requester’s name, organization, position, and phone number. Contractor requests are made through the NASA or DOD organization supported. Deletions, reduction in quantity, or change of address may be submitted to DO3/FDF Management Office, 281-244-1184.”

- d. The signature page will be unnumbered, but is regarded as page i in the front matter
- e. Once published, the signature page will not be updated or revised until a revision to the document is published. If the principals have changed, a complete signature element; i.e., typed name as well as title, may be used on a PCN (refer to Section 21.0).

20.3.3 List of Implemented Change Requests

Standards

- a. An LICR table that lists all FDF Workflow Crew Procedure CR control numbers incorporated in the publication will begin on the back of the signature page.
- b. Where applicable, the following implementation note designators follow the FDF Workflow Crew Procedure CR number (in parentheses), and there will be a legend at the bottom of the table:

D - Deleted	<i>The change was previously implemented with interim approval, but it was subsequently disapproved and is removed by the publication.</i>
P - Partial	<i>The change is partially implemented in the publication.</i>
R - Remainder	<i>The rest of a previous partial implementation is in the publication.</i>
S - Superseded	<i>The change was superseded by another approved change request prior to implementation.</i>

- c. If needed to explain other off-nominal situations, a symbol will be placed next to the FDF Workflow Crew Procedure CR number and a footnote will be inserted at the bottom of the table. The following symbols will be used as needed in the order given: *, †, ‡, Δ, §

Examples:

- * Previously implemented in an earlier publication. (The control number was inadvertently omitted from the LICR in the other publication.)
- † Previously implemented for another flight also. (The change was included in the prior publication of another book because it affected multiple flights.)

- d. The LICR table will be formatted as follows.

Incorporates the following:			
482#:	MAL-1468 (S)	MAL-1488	MULTI-1663
	MAL-1479 (P)	MAL-1489 (D)	MULTI-1664
	MAL-1480A	MAL-1490A	MULTI-1671 (R)
	MAL-1481	MAL-1491	
	MAL-1482	MAL-1497	
	MAL-1483	MAL-1510	
	MAL-1484A	MAL-1533	
	MAL-1486A*		

S - Superseded P - Partial D - Deleted R - Remainder

*Previously implemented in an earlier publication.

- e. If there are no change requests incorporated, the following statement will be used in lieu of actual FDF Workflow Crew Procedure CR control numbers in the LICR table:

NONE – Establishes baseline

20.3.4 Areas of Technical Responsibility

Standards

- a. A list of personnel and organizations responsible for specific portions of the technical content of a book will be provided beneath the LICR on the back of the signature page.
- b. The list will include the book manager (first entry) and those people who, working directly with the book manager, lend technical expertise on major areas such as orbiter systems, specific payloads, etc.
- c. The list will not include casual contributors; i.e., it is not for general acknowledgements.
- d. For uniform presentation, only the first initial and last name of each individual will be used.

- e. An e-mail address will be given only for those individuals who do not have a JSC e-mail account.
- f. Once published, the Areas of Technical Responsibility list will not be updated until a revision is issued for the book. (New personnel responsible for specific technical areas may be given as a note on a PCN instruction page; see Section 21.0.)

Example:

AREAS OF TECHNICAL RESPONSIBILITY

Book Manager	DO3/H. Scott	281-483-0670
ACME P/L	Ace Corp./J. Dough jbdough@ace.com	555-123-4567
APU/HYD	DF5/J. Jason	281-483-7575
COMM	DF2/J. McKinnie	281-483-0792
C/W	DF7/M. Welch	281-483-6602

20.3.5 User Notes

In general, user notes are discouraged in published FDF documents because the procedures are written primarily for a trained crew to use. However, a note or a series of notes is sometimes required to define the applicability of a book, the time references used, book-unique standards, or other specific information needed to use a book.

Standards

- a. A user note will be provided to explain new or unique symbols, abbreviations, or acronyms used in the book.
- b. If the notes occupy less than two pages and are not required for in-flight use, they will begin on a new page that follows the Areas of Technical Responsibility list, immediately before the LOEP in the front matter.
- c. If the notes occupy more than two pages and are not required for in-flight use, they will appear in a separate section at the end of the book. If there is more than one section of these not-flown notes (such as in the Flight Plan), the notes sections will be separated from the remainder of the book by a divider page (see Section 20.6.1.2, full tabs).
- d. If the notes occupy less than two pages, are required for in-flight use, and generally apply to the entire book, they will be placed on a new page that follows the TOC in the front matter.
- e. If the notes occupy more than two pages, are required for in-flight use, and generally apply to the entire book, they will appear in a separate section located at the appropriate place, as determined by the book manager and flight crew.

- f. Notes pages will conform to the rules for text image area, page numbers (front matter if applicable), page notes, page codes, etc., as given in this section.

Guidelines

- a. If user notes are required for in-flight operations and apply to only one section, they may be placed within that section, regardless of size.
- b. Extensive notes should not be placed in FDF books as a substitute for console documentation or training material.

20.3.6 List of Effective Pages

The LOEP serves as a guide for updating the book and verifying the correct configuration, as well as providing a record of the revisions and page changes for the latest major edition.

The LOEP contains information for fabrication of flight crew copies (e.g., pages requiring manually entered data or highlighting prior to flight, pages to be omitted from flight copies, pages added from other books, etc.).

Standards

- a. The LOEP will begin on a new right-hand page.
- b. A version history will be provided at the top of the first page of the LOEP.
 - 1. The history will include the identification and publication date for:
 - (a) Current major edition
 - (b) Current revision, if any
 - (c) All published page change notices, if any, since the last major edition or major revision was published
 - 2. Listed publications that are no longer needed to make a complete current book (i.e., all published pages that were subsequently deleted or replaced) will be shaded.
- c. The body of the LOEP will contain the following:
 - 1. The page number references for all pages, in the sequence they are published
 - (a) "Sign Off" will be used in lieu of page i
 - (b) Pages to be obtained from other sources will be included in the sequence in which they are to be inserted into the flight book

- (c) Pages deleted (not replaced) by the current update will be included
 - (d) Pages deleted in previous updates will not be included unless a sequence is interrupted
 - (e) Listed pages that do not have an assigned version identifier, such as pages that were deleted, will be grouped together in the LOEP (e.g., "2-9 thru 2-14 . . . deleted")
2. The current page code, minus the book identifier part of the code, for each published page
- (a) Pages to be obtained from other FDF books will identify the source, not the page code. If the source is a companion to an integrated book, "generic" or "flt suppl" will be used.
 - (b) Pages to be obtained from non-FDF documents will contain the page version identifier used in that document. The identifier may be a date in some cases.
 - (c) Pages that are deleted will use "deleted" in place of the code.
3. Symbols or comments regarding fabrication of flight books
- (a) Symbols will be identified in the lower left corner of the page by footnote legends in 10-point type. The standard fabrication symbols follow:
 - * – Omit from flight book
 - ** – Omit entire section from flight book (symbol placed next to first page in section)
 - ⊗ – Highlights required
 - Δ – See note on affected page. *Flight books are to be treated differently per page footnote. Commonly used for replacing a page in a generic book with a page from the flight supplement*
 - ☒ – Pre-liftoff information required
 - † – Extra pages in crew copy only
 - (b) Other symbols (e.g., ‡, §, etc.) may be used with appropriate footnotes to provide additional fabrication instructions.
- d. Redundant copies of a specific page (same page number) will not be listed in the page column of the LOEP nor be published as part of the bond books.
- 1. If multiple copies of information on a page (normally fill-in forms) are required in the crew's book(s) but not the ground copies, a notation for the number of copies (e.g., "4 pgs") will be placed after the page number in the LOEP. One

copy will be printed in the published book and extra copies will be prepared separately for insertion in the crew's book(s).

2. If ground users and the crew need multiple copies of information on a page, each copy will be treated as a different page with different page numbers.
- e. Books consisting of a generic baseline with an integrated flight supplement document (separate publications) will have a complete LOEP in each document. Each document will provide the page codes for pages published in the document but will identify the companion document as the source for pages to be inserted.
 - f. Whenever the complete LOEP is republished, a minimum of four blank lines will be reserved at the bottom of each column. The blank lines may be used in a future PCN to accommodate data for added pages in order to avoid having to republish the entire LOEP again. The blank lines can also be used for Pen-and-Ink (P&I) fabrication notes, if needed.
 - g. In integrated flight supplements, the code for generic cue cards will be replaced with the legend "generic." Likewise, the integrated generic book will use "flt suppl" for the code applicable to flight-specific cue cards.
 - h. The drawing number that identifies the schematics will appear on the LOEP, with additional reference data and/or source page codes, if required.

Examples: See Figure 20-3, Figure 20-4, and Figure 20-5.

MEDICAL CHECKLIST			
LIST OF EFFECTIVE PAGES			
GENERIC		01/25/88	
REV I		01/31/03	
Sign Off.....	* ALL/GEN I	1-19	ALL/GEN I
ii	* ALL/GEN I	1-20	ALL/GEN I
iii	* ALL/GEN I	1-21	ALL/GEN I
iv	* ALL/GEN I	1-22	ALL/GEN I
v	* ALL/GEN I	1-23	ALL/GEN I
vi	* ALL/GEN I	1-24	ALL/GEN I
vii	ALL/GEN I	1-25	ALL/GEN I
viii	ALL/GEN I	1-26	ALL/GEN I
ix	ALL/GEN I	1-27	ALL/GEN I
x	ALL/GEN I	1-28	ALL/GEN I
xi	ALL/GEN I	1-29	ALL/GEN I
xii	ALL/GEN I	1-30	ALL/GEN I
1-1	ALL/GEN I	1-31	ALL/GEN I
1-2	ALL/GEN I	1-32	ALL/GEN I
1-3	ALL/GEN I	1-33	ALL/GEN I
1-4	ALL/GEN I	1-34	ALL/GEN I
1-5	ALL/GEN I	1-35	ALL/GEN I
1-6	ALL/GEN I	1-36	ALL/GEN I
1-7	ALL/GEN I	1-37	ALL/GEN I
1-8	ALL/GEN I	1-38	ALL/GEN I
1-9	ALL/GEN I	1-39	ALL/GEN I
1-10	ALL/GEN I	1-40	ALL/GEN I
1-11	ALL/GEN I	1-41	ALL/GEN I
1-12	ALL/GEN I	1-42	ALL/GEN I
1-13	ALL/GEN I	1-43	ALL/GEN I
1-14	ALL/GEN I	1-44	ALL/GEN I
1-15	ALL/GEN I	1-45	ALL/GEN I
1-16	ALL/GEN I	1-46	ALL/GEN I
1-17	ALL/GEN I	2-1	ALL/GEN I
1-18	ALL/GEN I	2-2	ALL/GEN I

* – Omit from flight book

iii

MED/ALL/GEN I

Figure 20-3. Typical LOEP

ENTRY CHECKLIST				
LIST OF EFFECTIVE PAGES				
		GENERIC 02/01/88		
		REV G	01/16/04	
Sign Off.....	*	ALL/GEN G	3-11.....	ALL/GEN G
ii	*	ALL/GEN G	3-12.....	ALL/GEN G
iii.....	*Δ	ALL/GEN G	3-13.....	ALL/GEN G
iv	*Δ	ALL/GEN G	3-14.....	ALL/GEN G
v	*	ALL/GEN G	3-15.....	ALL/GEN G
vi	*	ALL/GEN G	3-16.....	ALL/GEN G
vii	*	ALL/GEN G	3-17.....	ALL/GEN G
viii.....	*	ALL/GEN G	3-18.....	ALL/GEN G
ix	*	ALL/GEN G	3-19.....	ALL/GEN G
x	*	ALL/GEN G	3-20.....	ALL/GEN G
xi	*Δ	ALL/GEN G	3-21.....	ALL/GEN G
xii	*Δ	ALL/GEN G	3-22.....	ALL/GEN G
xiii.....	*	flt suppl	3-23.....	ALL/GEN G
xiv	*	flt suppl	3-24.....	ALL/GEN G
xv		ALL/GEN G	3-25.....	ALL/GEN G
xvi		ALL/GEN G	3-26.....	ALL/GEN G
1-1 (3 pgs).....	†	ALL/GEN G	3-27.....	ALL/GEN G
1-2 (3 pgs).....	†	ALL/GEN G	3-28.....	ALL/GEN G
2-1		ALL/GEN G	3-29.....	Δ ALL/GEN G
2-2 (6 pgs).....	†	ALL/GEN G	3-30.....	Δ ALL/GEN G
2-3 (6 pgs).....	†	ALL/GEN G	3-31.....	ALL/GEN G
2-4		ALL/GEN G	3-32.....	ALL/GEN G
2-5.....	Δ	ALL/GEN G	3-33.....	Δ ALL/GEN G
2-6.....	Δ	ALL/GEN G	3-34.....	Δ ALL/GEN G
3-1	Δ	ALL/GEN G	3-35.....	ALL/GEN G
3-2.....	Δ	ALL/GEN G	3-36.....	ALL/GEN G
FS 3-3		flt suppl	3-37.....	ALL/GEN G
FS 3-4		flt suppl	3-38.....	ALL/GEN G
3-5.....		ALL/GEN G	3-39.....	ALL/GEN G
3-6.....		ALL/GEN G	3-40.....	ALL/GEN G
3-7		ALL/GEN G	3-41.....	ALL/GEN G
3-8.....		ALL/GEN G	3-42.....	ALL/GEN G
3-9.....		ALL/GEN G	3-43.....	ALL/GEN G
3-10.....		ALL/GEN G	3-44.....	ALL/GEN G

* – Omit from flight book
Δ – Replace with page from Flight Supplement
† – Extra pages in crew copy only

vii

ENT/ALL/GEN G

Figure 20-4. LOEP for a generic book with an integrated flight supplement

ENTRY CHECKLIST
STS-114 FLIGHT SUPPLEMENT
LIST OF EFFECTIVE PAGES

FINAL 11/08/02
REV B 01/17/05

Sign Off..... *	generic	3-7	generic
ii..... *	generic	3-8	generic
Sign Off..... *	114/FIN B	3-9	generic
FS iv	114/FIN B	3-10	generic
v..... *	generic	3-11	generic
vi..... *	generic	3-12	generic
vii..... *	generic	3-13	generic
viii..... *	generic	3-14	generic
ix..... *	generic	3-15	generic
x..... *	generic	3-16	generic
FS xi	114/FIN B	3-17	generic
FS xii..... *	114/FIN B	3-18	generic
FS xiii..... *	114/FIN B	3-19	generic
FS xiv..... *	114/FIN B	3-20	generic
xv.....	generic	3-21	generic
xvi.....	generic	3-22	generic
1-1 (3 pgs)	† generic	3-23	generic
1-2 (3 pgs)	† generic	3-24	generic
2-1	generic	3-25	generic
2-2 (6 pgs)	† generic	3-26	generic
2-3 (6 pgs)	† generic	3-27	generic
2-4	generic	3-28	generic
FS 2-5.....	114/FIN B	FS 3-29	114/FIN B
FS 2-6.....	114/FIN B	FS 3-30	114/FIN B
FS 3-1.....	114/FIN B	3-31	generic
FS 3-2.....	114/FIN B	3-32	generic
FS 3-3.....	114/FIN B	FS 3-33	114/FIN B
FS 3-4.....	114/FIN B	FS 3-34	114/FIN B
3-5	generic	3-35	generic
3-6	generic	3-36	generic

* – Omit from flight book

† – Extra pages in crew copy only

FS xi

ENT/114/FIN B

Figure 20-5. LOEP for an integrated supplement

20.3.7 List of Fabricated Items (Cue Cards)

The list of fabricated items identifies associated documentation in non-book media (such as cue cards, transparencies, software, and Landing Sites tape, etc.) or special books (such as Landing Sites and Earth Observations, etc.) whose form, fit, and function are specified on pages in an FDF book. The List of Fabricated Items differs from a TOC in that it deals with the physical object versus the content.

Standards

- a. A List of Fabricated Items will be provided in each book containing such items.
- b. The List of Fabricated Items will follow the LOEP, entitled (Book Name) Cue Cards.
- c. If space is available for the entire list, the List of Fabricated Items will be placed on the last page of the LOEP; otherwise, it will start on a new page.
- d. *Change bars will mark changes to the titles, reference pages, and card numbers (per Section 21.0).*
- e. Fabricated items will be listed alphabetically by title (or other applicable identifier if there is no assigned title), followed by the *reference page and card number*. See Figure 20-6.

ORBIT OPS CUE CARDS

<u>Title</u>	<u>Ref. Page</u>	<u>Card No.</u>
WCCS COMM PLAN		
(Front)	CC 15-3	ORB OPS-1a/O/B
(Back).....	CC 15-4	ORB OPS-1b/O/B
ORBIT SPEC (R11) (Front).....	CC 15-5	ORB OPS-2a/O/I
PRIMARY C/W PARAMETER MATRIX (Back of ORBIT SPEC (R11))	CC 15-6	ORB OPS-2b/O/E
KU ANTENNA OVERLAY (COLOR MONITOR)	CC 15-7	ORB OPS-4a/O/B
URINE COLLECTION (w/o UMS) (Front)	CC 15-8	ORB OPS-5a/O/H
CONT WASTE COLLECTION – UCD/APOLLO BAG (Back of URINE COLLECTION (w/o UMS)).....	CC 15-9	ORB OPS-5b/O/G

Figure 20-6. List of Fabricated Items (Cue Cards)

Guideline

Multiple copy notations will not be added to the List of Fabricated Items nor will the quantity be added to separately produced print masters for fabricated items. When

multiple copies of a fabricated item are required, the quantity is listed in the FDF Manifest (JSC-19542).

20.3.8 Table of Contents

A TOC is included in most flight books but some books are designed for crew use without a TOC (e.g., Pocket C/Ls and Ascent C/Ls). However, TOCs are prepared for all FDF books because they are also used by flight controllers and other ground support personnel.

Standards:

- a. All FDF documents will contain a main TOC that will, at a minimum, include all section titles that appear in the document. Additional level of detail will vary, depending upon the nature of the book and the anticipated method of use.

Section titles as listed in the TOC will correspond to the full title given on the first page of the section in the book. Text on the tab may be abbreviated.
- b. An entry will be provided in the main TOC for all procedures that are to be annotated, as given in Section 20.3.8.1.
- c. A TOC entry, in either the main TOC or section/subsection TOC, will be provided for any procedure to which the crew might be directed by a timeline, another procedure, or the MCC.
 1. This standard includes procedures that are flown as cue cards or other non-book media.
 2. If a section TOC lists the procedures and subsection titles contained in that section, the main TOC need not list them.
 3. For books, such as the Ascent C/Ls, which are made of a continuous series of short, time-sequenced procedures and tables, the main TOC need list only section titles, except for procedures requiring annotation, per Section 20.3.8.1.
- d. The TOC for standalone generic books and corresponding nonintegrated supplements will list only the contents of the respective publications.
- e. The TOC for a generic book that has an integrated flight supplement will list only the content of the generic book. The content may include “filler” pages where supplemental pages are to be inserted.
- f. The TOC for a flight supplement that is integrated into a generic book will list the combined content of both the generic and supplemental pages. The page numbers for supplemental pages will include the “FS” (flight specific) prefix.
- g. Alternate versions of a procedure will have only one entry in the TOC, and the page number will be listed without a version prefix. (See Section 20.7 (I) (1).)

- h. For “not-flown” cue card configuration pages, the cue card titles will not be listed on the TOC unless that is also the title of a procedure. The cue card titles will be listed on the Fabricated Items Listing per Section 20.3.7. Individual procedure titles on a cue card will be given in either the main TOC or the TOC for the configuration section per Standard c above.
- i. Repeated words or abbreviations in successive entries will not be shown in TOCs. This standard provides a visual point of demarcation and should be used for consistency. However, this standard may be waived where a loss of clarity could result.

20.3.8.1 Hazard Control and Critical Item List Annotation

Standards

- a. Procedures designated as HC to satisfy operational safety concerns will be annotated with an “(HC)” after their titles in the main TOC.
- b. Procedures used as rationale for keeping hardware on the CIL will be annotated with a “(CIL)” after their titles in the main TOC.

Note: The “(HC)” and “(CIL)” identifiers will not be removed from an existing FDF TOC without an approved FDF Workflow Crew Procedure CR.

20.4 BODY OF FDF BOOKS

Standards

- a. FDF books will be organized using sections, subsections, and volumes as appropriate.
- b. Each section will begin on a new page.
- c. Each section's procedures or essential data will begin on the back of the section's first page.
- d. Procedures within a section will be sequential without page breaks, unless there is an operational requirement to begin on a new page.
- e. Sections will not be subdivided into subsections if the TOC is sufficient for the crew to find the procedure.
- f. Sections containing information for ground use will be placed at the back of the book. If more than one section is used, all ground use only sections will be separated from the remainder of the book with a divider page.

Guidelines

- a. Typical ways to organize books are alphabetically, chronologically, or by system.
- b. Very large books may be flown in multiple volumes for manageability. Likewise, small books may be combined for flight.

20.5 PAPER SIZE AND MARGINS

Printmasters for FDF books are prepared on 8 ½ x 11-inch pages. Bond copies are direct reproductions of these pages. Flight quality copies are cut to size as required.

Standards

- a. FDF books will be either large-format or small-format books.
 1. Large-format books are 8½ x 11 inches, containing mostly 8 x 11-inch pages.
 2. Small-format books are 6½ x 8 inches, containing mostly 5½ x 8-inch pages.

Exception:

To allow for incorporation of extensive real-time updates, the Flight Plan will be 9 x 11 inches overall, with mostly 8½ x 11-inch pages.

- b. On large format books and small format books, except for minor tab pages, image area placement will be the same for left and right facing pages (i.e., no dedicated left and right pages). This allows the masters to be reused in updates with different pagination requirements.
- c. Landscape pages will be oriented so that the page headers (top) on odd pages and the page footers (bottom) on even pages are near the bound side.
- d. The following measurements will be used. The margins include allowances for headers, footers, binding holes, tabs, and reproduction tolerances. See Table 20-1.

Table 20-1. FDF margin specifications

Book size* (in.)	Tabs	Margins/ Image area	English (in.)		Metric (cm)
Large format (8½ x 11)	None, 1 st level, or full	Short edge	.2		.5
		Long edge	.75		1.9
		Image area	7.0 x 10.6		17.8 x 26.9
Small format (6 x 8)	None, 1 st level, or full	Short edge	.2		.5
		Long edge	.7		1.8
		Image area	4.6 x 7.6		11.7 x 19.3
	2 nd level	Short edge	.2		.5
		Long edge	Tab side	1.1	2.8
			Bound side	.7	1.8
		Image area	4.1 x 7.6		10.4 x 19.3

*Overall size, including tabs. Margins given are based on this size paper.

20.6 TABS

Tabs identify major book divisions (sections) or give the crew quick access to standalone material. Tabs normally are not provided within book sections to separate material used in sequence or where page numbers from the TOC are sufficient.

Tabbed pages create extra work and cost in producing an FDF document. Therefore, they are discouraged unless essential for real-time use of the book. If tabs seem to be frivolous, the FDF Manager will review their use with the appropriate users to determine if they can be eliminated.

Terms

Tab	A protruding page or part of a page
Cut tab	A tab that is prepared on paper that is tab-height ($\frac{1}{2}$ inch) wider than that used for the bulk of the document pages. The tab title is printed in a designated place on this additional strip. Cutting away the excess paper, normally with a die cutter, produces the tab. Alternately, the tab titles may be printed on pre-cut tabbed pages to get the same result
Full (uncut) tab	A divider page consisting of a full sheet of paper that is tab-height; i.e., $\frac{1}{2}$ inch wider than that used for the bulk of the document pages
Ladder tab	One of a series of continuously shorter pages that allows text on the underlying page to serve as both a tab and an index (only used in pocket checklist books)
Major (cut) tab	Tabs used to identify major book divisions (sections)
Minor (cut) tab	Tabs used to identify subgroups of procedures (subsections), or identify individual procedures or other information when required to facilitate operations
Large tab	Tabs of 2 x 0.5-inch nominal size with 1.4 x 0.425-inch image area. Large tabs allow for a 5-tab series in a large format book and a 4-tab series in a small format book
Small tab	Tabs of 1 x 0.5-inch nominal size with 0.625 x 0.425-inch image area. Small tabs allow for an 8-tab series in a large format book and a 7-tab series in a small format book
Tab levels	Tabs that project $\frac{1}{2}$ -inch above the normal pages are first level tabs. Tabs whose tops are even with the normal pages are level two
Tab series	A tab series is composed of the number of cut tabs of a designated width that will fit along the long edge of a tab page

Information

- a. Printed tabs are formatted for flight-quality books only and are generally not usable in the bond copies. Tab titles appear on the bond copy pages because the same printmasters are used for both flight-quality books and bond copies.
- b. Tab pages are printed on either K-10 card stock or on reinforced bond paper for flight copies.
- c. Major tabs are normally differentiated from minor tabs by color but may also be differentiated by size or level.
- d. See Table 20-2 for materials and fabrication specifications.

Table 20-2. Flight book fabrication specifications

Books	Covers	Pages	Major tabs	Minor tabs
<u>Generic Books – Nominal Procedures</u> <i>(e.g., ENT, D/O, MAPS, REF, ORB OPS, EVA, PDRS, P/TV, etc.)</i>	White, K-10	White, reinforced bond	Green, K-10	White, reinforced bond
<u>Generic Books – Contingency or Emergency Procedures (non-pocket)</u> <i>(e.g., AESP, Cont D/O, IFM, MED C/L, MAL, SYS AOA)</i>	White, K-10 (vehicle generic)	White, reinforced bond	Green, K-10	White, reinforced bond (contingency) yellow, reinforced bond (emergency) pink, reinforced bond
<u>Generic Books – Contingency Procedures-Pockets</u> <i>(e.g., APCL, EPCL, OPCL)</i>	Tan (OV-102 & 104), green (OV-103 & 105), K-10	Yellow (except white front matter and white powerdown pages)	Yellow, K-10	Yellow, K-10
<u>Flight Supplements</u> <i>(e.g., ORB OPS, EVA, PDRS, P/TV, REF)</i>	Flight color, K-10	White, reinforced bond	Flight color, K-10	White, reinforced bond
<u>Flight-Specific Books</u> <i>(e.g., PL OPS, PL SYS DATA, RNDZ, PL PWR)</i>	Flight color, K-10	White, reinforced bond	Flight color, K-10	White, reinforced bond
<u>Flight-Specific Books - special</u> <i>(e.g., ASC, FLT PLN)</i>	Flight color, K-10	White, K-10	Flight color, K-10	White, reinforced bond

20.6.1 Tab Use

Standards

- a. Tabs will be used to identify sections or other logical groups of procedures within paper documents.
- b. The number of tabs will be minimized within a book.

20.6.1.1 Major and Minor Tabs

Standards

- a. Major tabs will be first level tabs.
- b. Minor tabs shall be used only to provide expedited access to materials within sections when required for operational efficiency.
- c. Minor tabs will be distinguishable from major tabs by color, size, or level.
 1. Color - Green or flight color for major tabs, white for minor tabs, yellow for contingency procedures, pink for emergency procedures. See Table 20-2.
 2. Size - Small or large.
 3. Level - First level for major tabs, second level for minor tabs. Waivers are required for second level tabs.

Guidelines

- a. Each flown book should have at least two major tabs. One tab would be superfluous.
- b. Major tabs may be used to group like procedures that are presented in alphabetical order by title. Each section tab will give the range of initial letters of procedures in that section (e.g., "C Thru E" in the Medical Checklist).

20.6.1.2 Large, Small, and Full Tabs

Standards

- a. Large and small tabs shall not be commingled within the same book. This facilitates book production through the use of a single die cutter.
- b. Full tabs (divider pages) will be used if the text in the divided areas serves distinctly different functions (such as the flight/non-flight parts of the Flight Plan).
- c. Full tabs shall be used to partition a book into standalone segments when required (such as multiple EVAs in the EVA C/L).
- d. Full tabs, when required, may be used in addition to cut tabs.

Guideline

Large cut tabs are preferred, allowing more room to write the section titles.

20.6.1.3 Ladder Tabs

Ladder tabs act as indexes within the sections of the Pocket C/Ls to allow rapid access to procedures requiring quick response.

Standards

- a. Only Pocket C/Ls will use ladder tabs
- b. Ladder tabs will be formatted to provide a 0.5-inch overlap on successive right hand pages for entering procedure titles.
- c. The maximum number of tabs in a ladder tab series is seven. This allows for two binding holes in the shortest (top) page.
- d. The title of procedures on the tabbed page will be entered on the right side of the tab. The title of the procedures on the facing page will be entered on the left side of the tab. (The page number is in the center of the tab.)

See Figure 20-7 for an example.

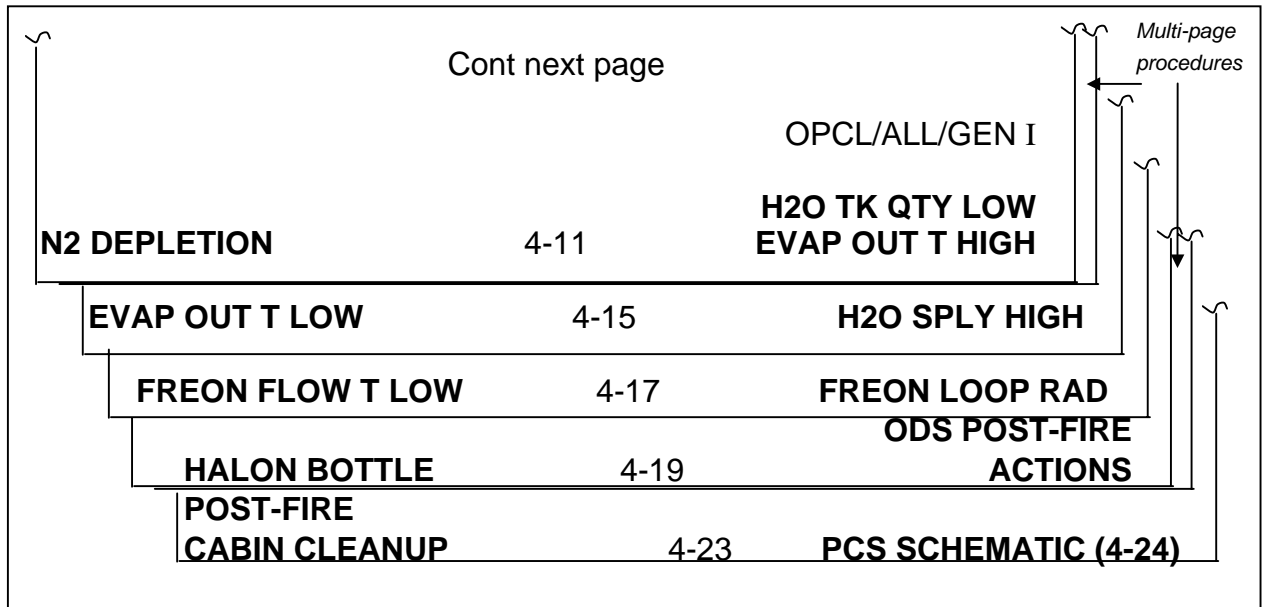

Figure 20-7. Typical ladder tab series

20.6.2 Tab Titles

Standards

- a. Tab titles for major tabs used to identify sections and subsections within a book will have the identical text on both sides.
- b. Tab titles for minor tabs required for quick access to time-critical data (normally in the AESP book and Pocket Checklists) shall identify the content found when the tabbed page is turned as shown in Figure 20-8. (i.e. The text on the tab will identify the material found on the reverse side of the page plus the next page after that if applicable.)

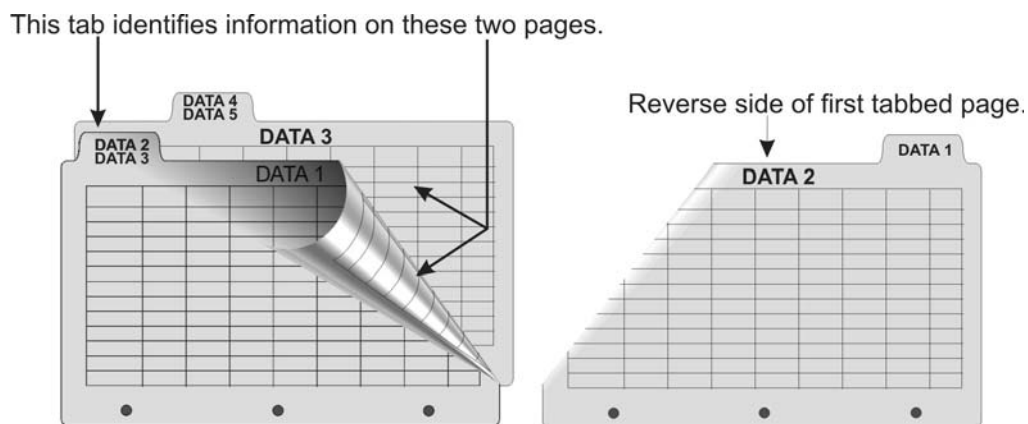

Figure 20-8. Tab titles for Quick Access

- c. Tab titles shall be concise. Abbreviations or acronyms will be used as appropriate. The length of text on tabs is significant because the tab must be cited when referencing data from book to book.
- d. Tab title font shall be upper-case 12-pt bold Arial or equivalent.
- e. Tab titles on cut tabs used to identify sections and subsections within a book shall be confined to two lines of text and shall be centered horizontally within the image area as shown in Figure 20-9.
- f. Tab titles on minor tabs required for quick access to time-critical data written parallel to the long edge of the page shall be confined to two lines of text and centered horizontally within the image area as shown in Figure 20.10.
- g. Tab titles on minor table required for quick access to time-critical data written parallel to the short edge of the page may be more than two lines but shall be confined to 1/2" width and centered vertically within the image area as shown in example in Figure 20.10.
- h. Single line titles on cut tabs will be on the second line.

- i. Titles on full (uncut) tab page shall be centered on the exposed (long) edge. The title will include a series of five dashes (- - - -) preceding and following the text. Fabrication personnel will be instructed to leave the page intact when incorporating an uncut divider.

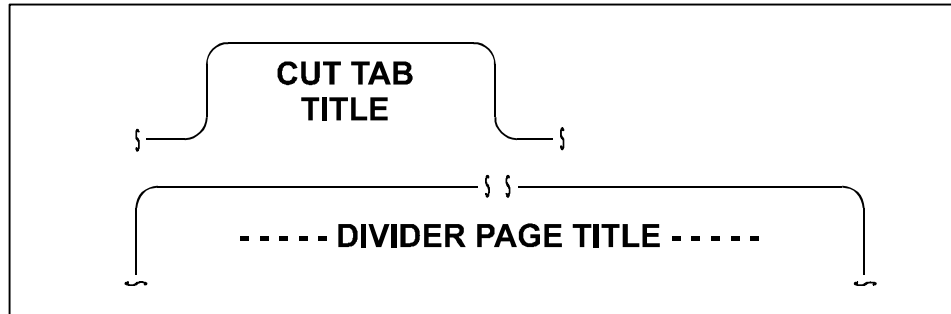

Figure 20-9. Tab titles

Exception

See Section 20.6.1.3 regarding ladder tabs for Pocket C/Ls.

20.6.3 Tabbed Page Format/Layout (Non-Ladder Tabs)

Standards

- a. The front of a major tab-page will contain a section title, a section TOC, or non-procedural supplementary material, such as a schematic. (FB pages are exceptions.)
- b. The front of a minor tab-page will contain the data at the end of the previous procedure or display "This Page Intentionally Blank."
- c. The contents of a section or subsection shall begin on the back of the tab page. (FB pages are exceptions.)

Exception:

If the section/subsection consists of multiple copies of data pads (forms), the back of the tab page may be intentionally blank; i.e., the pads begin on the first right-hand page of the section.

- d. The color of cut tab pages will be as given in Table 20-2.
- e. The page color for full tab (divider) pages in generic books with green major tabs will be blue.

- f. The page color for full tab (divider) pages in flight-specific books, books with white major cut tabs, and integrated books (both generic and flight supplements) will be green.
- g. A full tab divider shall not precede the first major (section) tab in a document.
- h. In nonintegrated flight supplements, major tabs and divider pages shall be color-coded to indicate the applicable flight.
- i. Integrated documents shall use white major tabs in both the generic book and the flight supplement.
- j. Tabs will provide for two lines of type.
- k. The lines of type shall run parallel to the “long” edge of the page, with the top of the wording up (landscape format) or to the user’s left (portrait format) on both the front and back of the tab.

Exception:

The text on AESP FB tabs consists of multiple short lines of type that run parallel to the “short” edge of the page.

20.6.4 Cut Tabs Location

Standards

- a. Major (section) tab pages shall be positioned such that the first tab is to the user's far left when viewed in a landscape format. The second section tab will be positioned to the immediate right of the first, etc. Each new series of tabs will begin at the far left.

Example:

For a 5-tab series in a book that has more than five sections, the tab for Section 6 is positioned to the left such that it is aligned behind the first (Section 1) tab. See Figure 20-10.

- b. If major and minor tabs are on the same level, the first minor (subsection) tab within each section shall be positioned such that it is to the immediate right of the major tab for that section. The second minor tab will be to the immediate right of the first, etc.

Example:

For a 5-tab series, within Section 1, the Subsection 1 tab is positioned in front of the tab for Section 2. The fifth minor tab (Subsection 5) is positioned behind the first (Section 1) tab. See Figure 20-10.

- c. If second level minor tabs are authorized, the first minor tab will be positioned to the user's far left, regardless of the position of the major tab. See Figure 20-11.

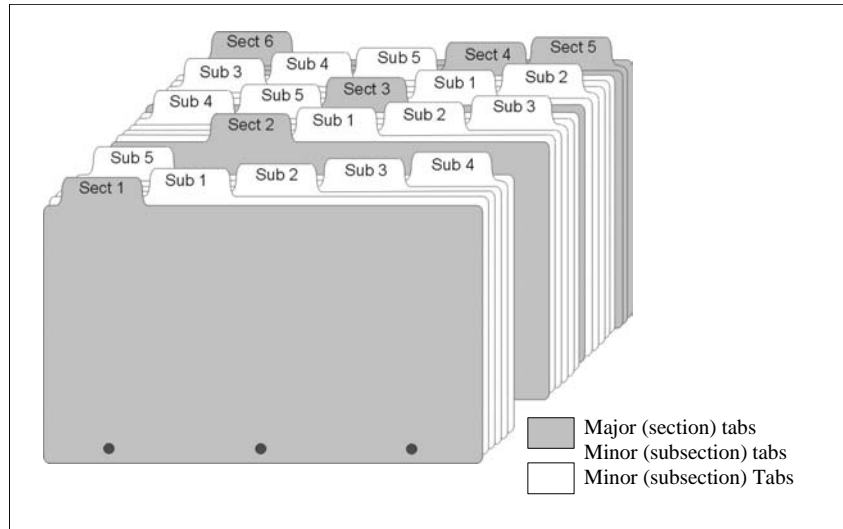

Figure 20-10. Tab locations – 5-tab series with same level, different color minor tabs

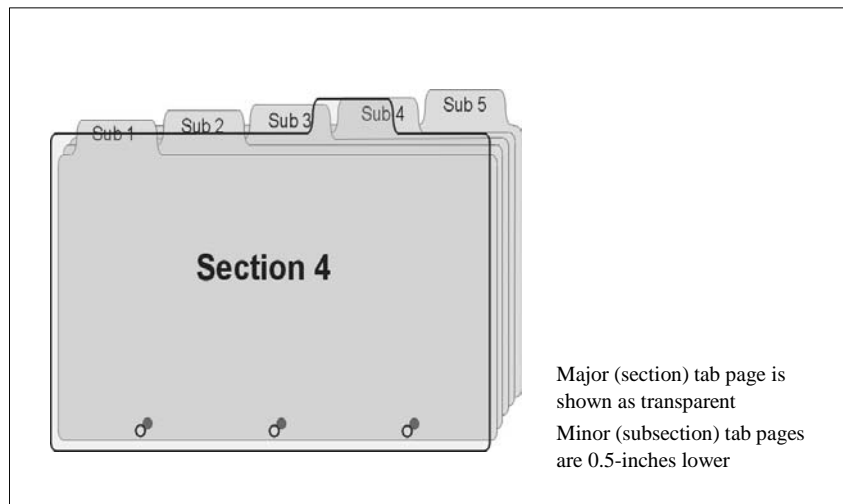

Figure 20-11. Tab locations – 5-tab series with 2nd level, minor tabs (same or different color)

20.7 PAGINATION

Standards

- a. All FDF document pages, including the signature page and intentionally blank pages, will be assigned unique page numbers (see Figure 20-12).
- b. Right-hand (front) page numbers will be odd and left-hand (back) page numbers will be even.
- c. Page numbers will be centered on the bottom line of each page.
- d. The back of the signature page and every page of front matter thereafter will have lower case sequential Roman numerals (beginning with ii; the signature page is understood to be i).
- e. Beginning with the first page of text and continuing throughout the document, the remaining pages will use Arabic numerals that indicate the section number and page sequence in the section (e.g., 1-1, 2-1, 3-1, 4-1). A hyphen will be used between the section and page numbers with no additional spaces.
- f. When additional pages must be inserted within the already established sequence of pages, new pages with lower case alphabetical suffixes shall be added.
 1. The new pages will start with an even page number.
 2. The letters “a,” “c,” “e,” etc., shall be considered “odd page numbers” and will appear on right-hand (front) pages.

Example:

2-7 and 2-8, 2-8a and 2-8b, 2-8c and 2-8d, and 2-9 and 2-10 shall be a front/back sequence beginning with 2-7 on a right-hand page.

- g. When an entire additional section must be inserted within the already established sequence of sections or multiple sections serving the same purpose (e.g., for different payloads), a capital letter will be added after the section number.

Example:

If an additional section is required between existing Sections 8 and 9, the page numbers for the new section are 8A-1, 8A-2, and 8A-3, etc.

- h. Material that is provided to the crew in a non-book media will be documented in a book for configuration control purposes. These fabricated items include cue cards, kneeboard cards, transparencies, videotapes, computer software, etc.

1. Pages that document the content and physical configuration (i.e., crop marks, Velcro placement, etc.) of fabricated items will have a “CC” (Configuration Control) page number prefix.

Examples:

CC 11-5, FS CC 12-2

2. “CC” pages that are not flown will be contained in a section titled “Cue Card Config.”
 3. Within the Configuration section, blank pages, header pages, and non-configuration data pages will be presented without the “CC.”
- i. Pages that are provided for the crew in FB format (i.e., book with self-restraining pages) will use an “FB” prefix.

Examples:

FB 2-4, FB 2-5

- j. Pages in flight-specific supplements will use the letters “FS” preceding the page number.

Examples:

FS 1-2, FS 3-4, FS CC 5-6

- k. Pages in the AESP that are to be inserted into the Mission Specialist (MS) copies of the flight-quality Ascent Pocket Checklist (ASC PKT) and Entry Pocket Checklist (ENT PKT) will have page codes preceded by “MS.”

Example:

MS 8-5

- l. When multiple (alternate) versions of a page are required in an otherwise generic book, a different uppercase alphabetical prefix is placed immediately in front of the section number for each alternate page. Some generic books support various flight configurations, though only one version of alternate pages is flown for a given flight.

Example:

A5-2, B5-2, CC A11-6

Exception:

Although a letter prefix to a page number normally indicates an alternate version, the letters “A” and “E” are used in the Asc/Ent Sys Procedures book to designate ascent phase and entry phase procedures, respectively. For example, page A6-2 is for ascent and page E6-2 is for entry.

1. The page number on both sides of an alternate page will have the same prefix, even if the material on one side remains generic.
2. If one version requires more pages than the other(s) so that the multiple versions maintain the same page number reference in the TOC, lower case alphabetical suffixes are used on the additional pages of the longer version to adjust the page count.

Examples:

C6-8a, C6-8b

3. If one version requires fewer pages than the other(s), so that the multiple versions maintain the same page number reference in the TOC, the remaining pages may be considered in the page count but omitted in the publication. See Standard q (below).
- m. On temporary pages, TEMP is added in front of the page number. Temporary pages are used in generic books to provide material that is changed for a specific flight only.

Examples:

TEMP 8-8, TEMP 12-5a, TEMP CC 13-7

Both sides of a temporary page will have the same prefix, even if the material on one side remains generic.

- n. Alternate and temporary pages shall have an applicability designator placed in the page footer. This is to allow quick, easy identification during use.

Examples:

OI30, 114, OV104

1. The applicability designator will be printed in large (approximately ¼ inch) bold letters in the lower right-hand corner.
2. The applicability designator will also be placed in front of the page number within parentheses.

Example:

(OV104) C3-25

3. The applicability designator will be printed the same on both sides of a page, even if one side is “generic.” (The page code for the generic page will reflect its actual applicability.)
4. Pages will not carry both an alternate and a temporary designator. Only one page will fly on a given flight, and since temporary pages take precedent for the affected flight, TEMP is sufficient.

Example:

A substitute page 5-2 may be TEMP 5-2 or A5-2, but not TEMP A5-2

- o. Pages to be extracted from other documents and inserted directly into an FDF book (such as foldout drawings) do not have FDF page numbers. The FDF book pages surrounding such material will be numbered as if the inserted pages did not exist. The page identifier (such as drawing number) for the extracted material will be listed in proper sequence with the FDF pages in the LOEP.
- p. A blank page within or at the end of a section will be numbered in the regular page sequence and identified with the annotation “This Page Intentionally Blank” centered on the page.
- q. Multiple intentionally blank pages will not be published. If two or more blank pages would otherwise be required to avoid a disruption in the page numbering sequence (never at the end of a section), the last left-hand page of text will have the annotation “Pages X-XX thru X-YY Intentionally Omitted.” XX is the number that would have been on the next right-hand page and YY is the end of the series of omitted pages.

Exception:

If there is no room to place the above annotation on the last left-hand page of text or if required for operational use, a single sheet of paper may be inserted at the location. The front side will have the annotation “This Page Intentionally Blank.” The backside will have the page omission statement. These two pages will be numbered in the regular page sequence.

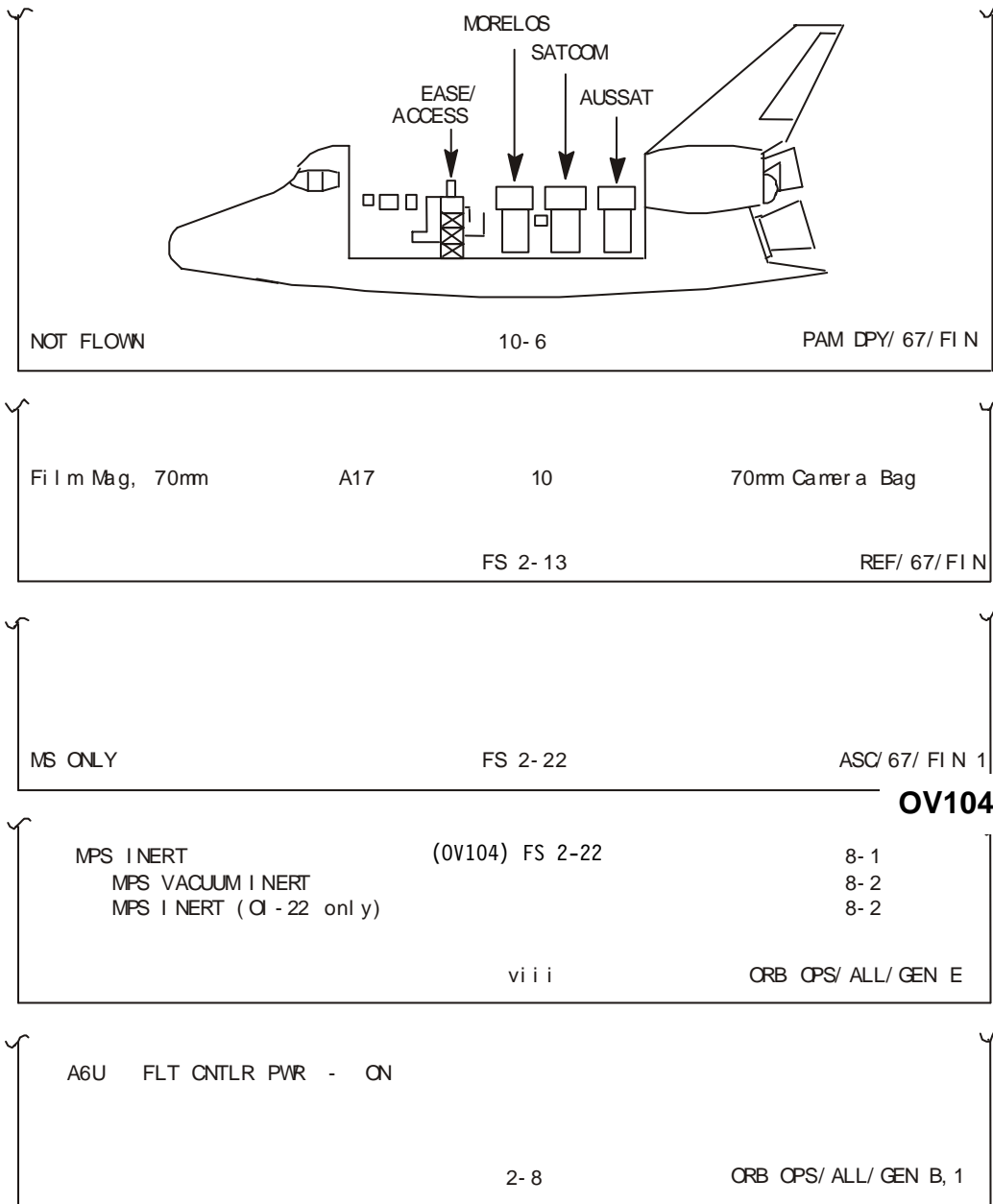

JSC 29031_006.cvn

Figure 20-12. Examples of the position of page notes, page numbers, and page codes (at bottom of pages from selected small checklists)

20.8 PAGE CODES

Standards

- a. Each page in an FDF book is identified with an FDF publication code or other tracking data.
- b. The FDF page code will identify the current version of the page.
- c. Any change on a page, either technical or non-technical, will require a revised page code.
- d. The code will appear at the lower right-hand corner of each page on the same line as the page number.

Exception:

In Pocket C/Ls, on pages with ladder tabs, the page code will be placed on the right-hand side above the tab image area.

- e. The FDF page code will be omitted if pages inserted from other documents contain sufficient version identification data for tracking (e.g., map number, drawing number). In some cases, it is not feasible to add FDF page codes to materials prepared by others and directly inserted into FDF documents.
- f. Prepared material (including cue cards) used directly in FDF books will retain any version identification data provided within the page image area of that material. The FDF page code is used on the LOEP, while the version identification data is used on the List of Fabricated Items.
- g. Page codes shall contain the following identifiers:

- | | | |
|---------------|---|----------------------------------------------------------------------------------------------------------------------------------|
| Book | – | Abbreviation defined in CPMP Annex A, Appendix C |
| Applicability | – | Flight (NASA identifier or “ALL.” An ALL indicates all flights on which the book is manifested) when no other restrictions apply |
| | – | Vehicle (last digit of assigned number; 3 = OV103) |
| | – | Payload (abbreviation as approved by the FDF Manager) |
| Issue | – | Major edition (PRE, BAS, FIN, or GEN), revision letter (A, B, C, etc.), and/or PCN number (1, 2, 3, etc.) |

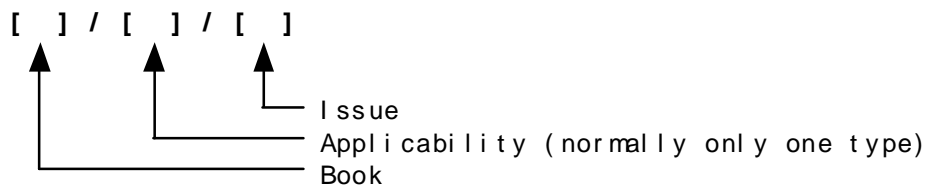

JSC-29031_015.cnv

Examples of correct page codes:

MAL/ALL/GEN B,1 – Malfunction procedures book/generic material (all flights and all vehicles)/published in the first PCN to the second revision of the generic edition.

ENT/110/FIN 3 – Entry Checklist Flight Supplement/some or all material applicable to flight STS-110 only/published in the third PCN to the Final edition.

MAL/3,4/GEN – Malfunction Procedures book/contains material applicable to vehicles OV-103 and OV-104 (not OV-105)/published in the generic edition.

D/O/3+/GEN C – Deorbit Prep book/contains material applicable to vehicles OV103 and subsequent vehicles/published in the generic edition, third revision.

PL OPS/FEE/PRE – Payload Operations Checklist/material is valid for all French Electrocardiograph Experiment (FEE) missions regardless of the flight or vehicle/published in the preliminary edition.

Examples of incorrect page codes:

REF FS/3/112/FIN – Either the flight designator or the vehicle designator is not required (only one vehicle is assigned to a given flight). Also, the “FS” is not required because it is part of the page number.

IUS DPY/108/IUS/PRE – The payload designator is redundant (the book is dedicated to IUS deploy missions).

FLT PLN/98/BAS A,1,2 – The “1” will not appear in the issue identifier (PCN-2 is the last update).

CONT DEORB/STS-110/Basic, Rev F, PCN 6 – Improper flight designator and abbreviations.

FLT PLN/100/FIN,1 – The comma will not be used unless a revision is indicated. This will appear corrected as FLT PLN/100/FIN 1.

20.9 PAGE NOTES

Page notes are used when required to identify pages with special fabrication requirements for flight books. They include pages that

- a. Do not fly as collated in the printed book
- b. Fly in books other than the one in which they are printed
- c. Fly only in selected onboard copies

- d. Do not fly at all
- e. Fly in a different media

Page notes expedite fabrication of onboard copies and also alert the ground controllers to what materials are available to the crew.

Standards

- a. The page note will be placed at the lower left corner of the page, in line with the page number.
- b. The page note will be the same type size as the page number.
- c. Notes relating to the flown/non-flown status of a page will be the same on the front and back.

Examples of page notes

CDR ONLY – Page will be placed in the commander’s copy of the book but not in any other onboard copies.

MS ONLY – Page will be placed in the mission specialist’s copy of the respective checklist but not in the other onboard copies.

FAB USE ONLY – Page shows material requiring special fabrication for the crew (e.g., cue card, CRT overlay, etc.). The page will not be in the onboard books.

NOT FLOWN – The page is not needed for in-flight operations and will not be in the onboard books nor in other onboard media (e.g., the Ascent Switch Configuration list in the Ascent Checklist).

20.10 DISTRIBUTION LIST

Standards

- a. Bond copies of FDF books will have a distribution list printed on the outside face of the back cover (see Figure 20-13). When additional space is required, the overflow will be printed on a second back page.
- b. Reprints will not have a distribution list unless special circumstances warrant one (e.g., a complete redistribution required to correct a misprint).
- c. Flight-quality copies will not contain a distribution list.
- d. The distribution list will identify the publication and issue, in addition to the individual recipients.

e. A note similar to the one below will appear on FDF distribution lists.

* NOTE *

* For changes in distribution or address *

* corrections contact the DO3/Procedures *

* Management Office; (281) 244-1184 or *

* The person@jsc.nasa.gov. *

Guideline

The distribution list normally will be generated using the automated Distribution List Generator (DLG). The DLG program requirements will dictate the format beyond what is given above.

FLIGHT DATA FILE DLG1:LIB:LIB ENT GEN F	** JSC OFFSITE **	USK-284/WALKER, A.F. 2807/CHERMARKI, D.	BOEING-CALIFORNIA 5301 BOLGA AVE. BLDG 17-7 70-45 HUNTINGTON BEACH CA 92647-2099 H017-0416/MORAN, M.M. H017-0416/GARAY, L. H019-E7522/FERGUS, K.H.
** JSC **	LOCKHEED-MARTIN-HOUSTON C70/REEDER, J.F.	NASA HEFC NASA-HEFC DOCUMENTATION REPOSITORY BUILDING 4493 MAIL CODE A033D MEFC, AL 35812 H002/HELTON, T. (2)	BOEING-HUNTSVILLE 499 BOEING BLVD. P.O. BOX 240002 HUNTSVILLE, AL 35824-6402 ATTN: SPACENAB DCC MAILSTOP: 30-54 JC-32/ADAMS, C. JC-32/JASKOLKA, C. JC-34/SPACENAB LIBRARY
	BOEING-HOUSTON 13100 SPACE CENTER BLVD. HOUSTON, TX 77059 H01-16/BETER, M.D. H01-19/PELLIAMS, C. 2C01/ASUNCION, C. 2C20/SHARP, S.L.	** U.S. MAIL **	BOEING-HUNTINGTON BEACH 5301 BOLGA AVENUE HUNTINGTON BEACH, CA 92647 H014-8463/HELL, S. H019-F754/OOSENS, M.H. H020-F606/HARPER, L. H019-F758/NOE, C. H028-0117/CAMBELL, M.L.
	** POUCH MAIL **	BOEING-HUNTINGTON BEACH 5301 BOLGA AVENUE HUNTINGTON BEACH, CA 92647 H014-8463/HELL, S. H019-F754/OOSENS, M.H. H020-F606/HARPER, L. H019-F758/NOE, C. H028-0117/CAMBELL, M.L.	DRAPER LABORATORIES 555 TECHNOLOGY SQUARE CAMBRIDGE, MA 02139-3539 77/EMPPER, D.
AD3/BRANCH DISTRIBUTION (3) CB/CS PDF REP (4) CB/GERNHARDT, M.L. CB/KILBATH, S. DAS/MOD LIB UPDATE TASK (13) DF22/DPS PDF REP (3) DF24/INCO PDF REP (4) DPS/PMACS LEAD OFFICER (3) DPS4/CREW ESCAPE DPS5/BOOSTER (3) DPS2/CMC GROUP LEAD (4) DPS4/PROP GROUP LEAD (5) DFT3/SALRC SYS GROUP LEAD (4) DPS2/RECON (5) DM/DM CONSOLE LIBRARY (2) DM/DM OFFICE LIBRARY DM3/BOOK MANAGER ENT (10) DM4/READ (5) DM4/JORDAN-MOORE, G. DM46/ENTRY FDO DM46/STICH, M.E. (5) DO352/TECH EDITOR DO353/BOND/BLUE SHELF (10) DO353/PDF FLIGHT LEAD DO353/PDF MGR/RESERVE (15) DO4/SHUTTLE FLT PLANNING (3) DO45/STDCO, M. DT14/CONTROL PROP (3) DT15/DPS/NAV LIBRARY DT16/SHUTTLE SYSTEMS (3) DT17/SHUTTLE COMMUNICATIONS (2) DX33/CREW SYSTEMS EC1/ROTTER, H.A. EN4/REVENY, D.E. EV14-LIB/ASD-14-LIB EV55/PASS PDF T40 GFS3/STIC (3) MGR/30 LIBRARY N062/MORAN, S. SD2/SUNDRON (2) ZK1/USAF TECHNICAL LIBRARY	UNITED SPACE ALLIANCE-FLORIDA 8600 ASTRONAUT BLVD. CAPE CANAVERAL, FL 32920 ATTN: USK-C09/GREEN, P. USK-C09/GREEN, P. (2)	JAMES AMERICA INC. 16055 SPACE CENTER, SUITE 240 HOUSTON, TX 77062 FRANCK, B.	TELEOVNE BROWN ENGINEERING CUMMINGS RESEARCH PARK 300 SPARKMAN DRIVE, RM P. O. BOX 70007 HUNTSVILLE, AL 35807-7007 MS 172/WEAVER, R.L.
	UNITED SPACE ALLIANCE-HOUSTON 16055 SPACE CENTER, SUITE 240 HOUSTON, TX 77062 FRANCK, B.	LOCKHEED MARTIN TECH OPS 5TH SPACE OPERATIONS SQUADRON ONIZUKA AIR STATION, BOX 061 1800 LOCKHEED WAY SUNNYVALE, CA 94087-1237 ATTN: DAN COYLE COYLE, D. (5)	***** Total 180 (04/26/92 - FERNANCA)
	BRA-DOWNEY AD40/PC MILLAN, B.J. FB94/DAVIS, R.E. H013-C328/STONE, J.S.	TITAN SYSTEMS 1002 GEMINI, SUITE 200 HOUSTON, TX 77058 ATTN: HOUSTON LIBRARY ATTN: HOUSTON LIBRARY	NOTE * FOR CHANGES * * IN DISTRIBUTION * * OR ADDRESS CORRECTIONS * * CONTACT THE * * PROCEDURES MANAGEMENT * * OFFICE AT MAILCODE DO3 * * OR (281) 244-1184 *
	NASA HEADQUARTERS ME/POSEY, G.		
	NASA KSC SE-82/ROUTIN, R. KSC/KSC TECH LIBRARY-D PW-K/BUNDY, A. TA-E-A/CREW QUARTERS USK-214/MOTTER, W.T. USK-247/HENSON, D. USK-247/HOOPER, J. (2)		

Figure 20-13. Typical FDF book distribution list

21.0 **CHANGE MARKING AND PUBLICATION STANDARDS**

Procedure Change Notations (PCNs) and/or revisions to FDF books notify all document users of changes to be made within a current milestone edition or major revision of a document. A PCN can be used to add, delete, or replace pages. A PCN can also provide instructions for user-inserted P&I changes. *A revision is used for changes that affect 50 percent or more of the book.*

Standards

- a. After an FDF procedure has gone through configuration management, any change from a previous publication must be identified.
- b. Change bars will be used to indicate changes.
- c. Change bars will be used only to denote changes made since the most recent publication *on the pages that have changed*.
- d. "Old" change indicators must be removed with each new publication *on the pages that have changed*.
 1. *In a revision, the "old" change indicators are removed from the entire book and "new" change indicators added.*
 2. *In a PCN, the "old" change indicators are removed only on the pages that have changed and "new" change indicators are added.*
- e. *Special applications of change marking:*
 1. *Mark only the title of new (added) procedures or those where more than 50 percent of the content has changed.*
 2. *Mark steps whose sequence has changed.*
 3. *Do not mark steps whose only changes are cascading step numbers.*
 4. *Mark new, deleted, or changed titles in the Table of Contents.*
 5. *Mark the location of a deleted line or series of lines with a change bar that is one-half line space (row height) high centered between the last line before the deletion and the first line after the deletion.*
 6. *Mark the increment of a cue card code on the cue card LOEP.*

Guidelines

Change bars are recommended for the following:

- a. All changed, deleted, or added technical data (text, tables, charts, and graphs) in the body, appendices, notes, etc.
- b. The addition of a new procedure (mark the title only)
- c. The complete revision of a procedure (mark the title only, even if the title has not changed)
- d. A change in the sequence of steps (but not cascading)
- e. The identification of a new, deleted, or technically changed title (in TOC)
- f. The deletion of a line or series of lines (use a change bar, approximately one-half normal length) in the location of the first line that was deleted

21.1 PAGE CHANGE NOTICE VS. REVISION

As known changes to a document accumulate between cycles, the changes are compiled and published in a milestone edition, revision, or a PCN. If changes are required after the normally scheduled milestone edition is published for a flight, a decision must be made as to whether a revision or a PCN is appropriate. Such a decision is also required when block updates to a generic book are to be implemented.

Good judgment must be used in timing all publications, especially PCN releases. The goal is to provide essential data in a timely manner without overburdening the user with continuous updates. The assigned book manager and FDF Coordinator work together to make the determination of the type of publication and the production schedule.

There are several criteria for determining whether an update should be in the form of a PCN or a revision. One criterion is the number of previous PCNs. However, the number of previous PCNs should not be the major criterion. Other considerations are as follows:

- a. Number of active PCNs – Subsequent PCNs may have replaced all the pages affected by one or more previous PCNs. (Some pages, such as the flight-specific powerdown pages in the Orbit Pocket C/L, are updated for each flight via a PCN. Those PCNs should generally be discounted when figuring the number of PCNs already published for a document.)
- b. Continuity of pages affected by the change – If the LOEP looks as though the changed pages were randomly sprinkled throughout the book, a revision may be in order

- c. Percentage of pages affected by the change – The rule of thumb is that the dividing line between revision and PCN is the requirement to change out over half of the book. This includes pages changed out because they are on the reverse side of updated pages
- d. Proximity to a planned milestone edition or a block update – If a new milestone edition or a block update is imminent and cannot (or should not) be accelerated for some reason, a PCN would be appropriate for the interim

Note: A revision scheduled solely to incorporate block updates should not be accelerated to accommodate a specific flight if it means the omission of already approved block changes. Any new revision is considered by the user to be the “latest and greatest.” To publish a revision that does not contain changes approved for the next block update would result in a loss of confidence in those knowledgeable of those changes

- e. Availability of resources to produce and review the revision – Because every print master page of a revision must be handled by word processors and editors, every page should be reviewed for inadvertent errors that creep in during print master preparation and printing

One factor not included above is that the prime users (crewmembers and flight controllers) are likely to have written personal notes in their copies of the books. Based on experience, changing out pages is preferred rather than recopying notes into a new book.

21.2 GENERAL PCN INFORMATION

The preferred approach in developing a PCN is to prepare and print new pages that the user inserts in place of the old pages. To expedite the development of a PCN or to bring late changes to the crew's attention, changes may be neatly penned onto the replacement page masters. Occasionally, it may be even more efficient to explain to the user how to mark a copy of the document to reflect a change. The latter is called a P&I change and is generally discouraged except where it would result in significant savings in time or resources. PCNs may contain both replacement pages, P&I changes, or both.

The cover of a book shall not be updated by a PCN unless the title of the book changes or if there is flight-related information such as payloads or deploy times that must be changed. If the cover is replaced, the PCN number is not added to the edition on the cover. Rather, a note stating "Cover replaced by PCN-X" is provided in the area reserved for notes to users.

The signoff page will not be updated by a PCN. This page does not fly and contains no information needed for a mission. The purpose of the signoff page is generally served by the PCN cover sheet.

21.3 PCN COVER SHEET

The PCN cover sheet (instruction page) identifies the approved CRs being implemented and the instructions necessary to incorporate the change(s) into a document. The PCN cover sheet may also contain other information regarding change control or use of the document. Refer to Figure 21-1 for format.

Each PCN cover sheet shall contain the following information:

- a. Identification of the document being updated (as given on its front cover).
 1. Title (include flight number, "flight supplement," or other designators as applicable)
 2. JSC number
 3. Issue (milestone edition and revision letter if any) and milestone publication date
- b. Sequential number of the new PCN and its publication date.
- c. Cover sheet page number and total number of cover sheet pages (e.g., Sheet 1 of 1).
- d. A list of approved change requests (FDF Workflow Crew Procedure CRs) being implemented via the PCN.

- e. Detailed instructions for pages to be added, deleted, replaced, or modified by the user.
- f. Notes to user, if required.
 - 1. The statement should normally begin with “NOTE: . . .”
 - 2. Very significant notes, such as those regarding flight applicability of the PCN, will be presented in a box to attract additional attention.
 - 3. To avoid clutter, boxes will not be used indiscriminately.
- g. The title and signature of the person (book manager) who prepared the PCN.
- h. The title and signature of approving authority (normally the same as the book being changed except that the branch chief is the highest level required).
- i. The total number of replacement pages enclosed with the PCN.
 - 1. This is normally an even number because both front and back pages are printed.
 - 2. PCN cover sheet(s) will not be counted.
 - 3. PCNs containing proprietary information will have two numbers. One is for those receiving the proprietary information and the other is for those not receiving the information.
- j. The standard direction to file the PCN instruction sheet itself behind the front cover of the document. All PCN instruction sheets are retained to create a cumulative record of updates.

21.4 PCN INSTRUCTIONS

PCN instructions are to be clear, concise, and arranged in a manner that is easy for the user to incorporate.

- a. Pages will normally be added, deleted, or replaced from the front of the book to the back. This allows the entire PCN to be incorporated in one pass through the book (unless P&I changes are to be made).
- b. P&I changes are normally done either before or after the other work.
- c. At a minimum, a separate numbered entry will be provided for each affected section.
- d. The word “page” or “pages” should be omitted when page numbers are given.

- e. The word “replace” followed by page numbers is understood to mean “replace the given pages with attached pages having the same numbers.”
- f. If replacement pages are not numbered the same as the originals, the replacement page numbers will be provided (e.g., “Replace 5-5 & 5-6 with 5-5 thru 5-6b”).
- g. Complete sections may be called out as such; however, the range of pages will be given in parentheses for sections replaced. For example: “Replace Section 2 (2-1 thru 2-20)”
- h. A series (range) may be identified with either “thru” or “through” (e.g., “Replace 3-7 through 3-14”)
- i. Front and back pages of a single sheet may be identified by either the ampersand symbol (&) or the word “and” (e.g., “4-5 & 4-6”)
- j. The user will be told where to add new material (e.g., “After 6-8, add 6-8a thru 6-8h”)

21.5 PEN-AND-INK INSTRUCTIONS

Detailed text may be required when instructing the user to make changes to existing pages. The desired result is correctness with minimum user anxiety.

- a. A separate numbered entry will normally be provided for each affected page.
- b. If the same change is to be made on several successive pages, the pages may be grouped under one entry.
- c. If more than one unrelated change is to be made on a page, a separate subentry will be made for each.
- d. After the page is identified, the specific location on the page will be identified.
 - 1. Physical placement on page (e.g., “near the top of the page”).
 - 2. Relative to a procedure, step, block, figure, table, etc. (e.g., “under Step 3”).
 - 3. Within a procedure, step, block, figure, table, and/or component thereof (e.g., “in column z”).
 - 4. A combination of the above separated by commas.

Note: Do not provide unnecessary information (e.g., if the change is within a table and there is only one table on the given page, the table need not be identified).

- e. After the location is identified, one of the following actions is normally given:
 - 1. insert . . . (or “add . . .”)
 - 2. move . . . to . . . (or “move . . . from . . . to . . .”)
 - 3. delete . . .
 - 4. change . . . to . . . (or “change from . . . to . . .”)
 - 5. replace . . . with . . .
- f. An ellipse (. . .) may be used where appropriate to represent existing information.
- g. If existing, replacement, or added text is used in the instruction sentence, that text should be enclosed in quotation marks. For example: Change “PL Pwr - OFF” to “PL MODE – OFF.”
- h. Quoted text should be in the same font as the original (or as close a facsimile as is available).
- i. Several occurrences of the same change in a single instruction should be identified by the number of such occurrences. For example: Replace “PL Pwr - OFF” with “PL MODE - OFF” (3 places).
- j. In addition to changes in the body of the page, each instruction will provide direction to update the page code on the affected page with the current PCN number followed by the notation “P&I.”
- k. If the PCN consists of a combination of change-out pages and P&I instructions, the printed LOEP will include the new page codes - including the “P&I” notation.
- l. If a printed LOEP is not provided, an instruction will be given to update the existing LOEP with the updated page codes (the page code on the LOEP page(s) will also be updated).

Note: To aid in incorporation of P&I changes into the flight articles, sample pages marked by the book manager should be provided. These pages do not replace the detailed instructions on the PCN, but are used in conjunction with the PCN for work on the actual flight copies. They are not reproduced for distribution.

SSP Flight Data File	PAGE CHANGE NOTICE	JSC-48027
MALFUNCTION PROCEDURES	GENERIC, REV F (Feb 9, 2004)	
PCN-1 (June 25, 2004) Sheet 1 of 1		
List of Implemented Change Requests (482s):		
MAL-1468*	MAL-1473A	MULTI-1653A
MAL-1469	MAL-1475	
MAL-1470C	MAL-1476	
MAL-1471D	MAL-1477B	
MAL-1472	MAL-1478	
*CCM-0142300-03-55		

NOTE
For STS-114 and subsequent flights

Incorporate the following:

1. Replace iii thru x, xv & xvi, xxi & xxii
2. Replace 2-19 thru 2-22, 2-27 & 2-28
3. Replace 6-1 & 6-2, 6-33 thru 6-46, 6-109 thru 6-112
After 6-112, add 6-113 thru 6-116
4. Replace 7-27 thru 7-30, 7-67 thru 7-70, 7-95 & 7-96, 7-109 & 7-110, 7-127 thru 7-142,
7-153 & 7-154, 7-161 thru 7-172, 7-193 & 7-194, 7-199 & 7-200, 7-255 thru 7-258,
7-261 & 7-262, 7-267 thru 7-274
5. Replace 8-7 & 8-8
6. Replace 10-21 & 10-22
7. Replace 12-1 & 12-2, 12-45 thru 12-48, 12-59 thru 12-64, 12-67 thru 12-70,
12-75 thru 12-78

Prepared by: _____
Book Manager

Approved by: _____
Manager, Shuttle Procedures Management

Accepted by: _____
FDF Manager

Encl: 126 pages

File this PCN immediately behind the front cover as a permanent record

Figure 21-1. Sample single-page PCN cover sheet (not to scale)

SSP Flight Data File	PAGE CHANGE NOTICE	JSC-48041
SYSTEMS AOA PROCEDURES	GENERIC, Rev D (May 17, 1993)	
PCN-4 (Mar 24, 1994) Sheet 1 of 1		
List of Implemented Change Requests (482s):		
REF-734	REF-738	MULTI-975
REF-735	REF-743	MULTI-986
REF-737	REF-745	
Incorporate the following:		
<ol style="list-style-type: none"> 1. Make the following pen and ink changes on current pages 3-19 and 3-20, 3-35 and 3-36. 4-5 thru 4-8, 4-35 thru 4-38: <ul style="list-style-type: none"> • Add the word 'TEMP' in front of each page number • Add the designator 'OI-22' conspicuously on each page (approximately 1/4-inch letters in lower right corner, if feasible) • Add '(P&I)' after/near each page code 2. Replace vii thru x 3. Replace 2-3 thru 2-8 4. Replace 3-1 thru 3-4, 3-9 and 3-10 Replace 3-13 thru 3-18 with attached 3-13 thru 3-20 (prior to page redesignated as TEMP 3-19) Replace 3-21 thru 3-24 After 3-24, add TEMP 3-23 and TEMP 3-24 Replace 3-25 and 3-26 After 3-34, add attached 3-35 and 3-36 (prior to page redesignated as TEMP 3-35) 5. Replace 4-3 and 4-4 After new page 4-4, add attached 4-5 thru 4-8 After new page 4-8, add TEMP 4-3 and TEMP 4-4 (prior to page redesignated as TEMP 4-5) Replace 4-13 thru 4-18 After 4-18, add 4-18a and 4-18b Replace 4-19 thru 4-24 After 4-34, add attached 4-35 thru 4-38 (prior to page redesignated as TEMP 4-35) Replace 4-39 and 4-40 		
Prepared by: _____ <div style="text-align: center; margin-left: 150px;">Book Manager</div>		
Approved by: _____ <div style="display: flex; justify-content: space-around; margin-left: 100px;"> <div style="text-align: center; width: 45%;">Head, Orbit Procedures and Flight Data File Section</div> <div style="text-align: center; width: 45%;">Chief, Space Shuttle Flight Planning Branch</div> </div>		
Encl: 70 pages		
		
<div style="border: 1px solid black; display: inline-block; padding: 2px 10px;">File this PCN immediately behind the front cover as a permanent record</div>		

Figure 21-2. Sample PCN cover sheet with pen and ink instructions (not to scale)

21.6 PCN REPLACEMENT PAGES

Replacement pages are normally provided with each PCN.

- a. The PCN print package will contain print masters for both front and back of each page to be replaced.

Note: A PCN may include pages without changes on them (printed exactly as in the current document) if the reverse side has changed or their inclusion will allow users to replace a significant size block of contiguous pages rather than many single pages sprinkled throughout the block. Attempts should be made to make incorporation of PCNs as simple as possible without using too much paper.

- b. Pages that are being reprinted for completeness should remain exactly as previously published. *Pages that have not changed shall remain the same.*
 1. Original page codes, text format, change bars, and typos (if any) will remain.
 2. The original print masters will be reused when feasible; otherwise, a “print master quality” copy of the original may be used.
- c. Printed replacement pages are not necessarily retyped.
 1. Required changes may be neatly penned onto old or new camera-ready masters to avoid a delay in publication.
 2. These changes are not considered P&I and are generally treated as normal replacement pages.
 3. Page code will be updated on marked-up old masters to reflect the new PCN (the notation “P&I” will not be added).

22.0 FLIGHT ERRATA PACKAGE (ERRATA PACK)

An errata package (errata pack) is prepared by the FDF Management Office for each flight, immediately prior to launch (Figure 22-1). It contains updates approved too late to allow for orderly publication of a formal update (revision or PCN). It can, at the FDF Manager's discretion, also be used to implement minor changes, which are not required for preflight training/familiarization and do not otherwise warrant publication as a PCN.

The errata pack is divided into three sections:

- a. Section A: Changes which must be uplinked real-time
 - 1. Required for use during nominal (scheduled) operations.
 - 2. Required for a very probable anomaly.
 - 3. Required for an anomaly which would not permit real-time uplink after need is identified.
- b. Section B: Changes that will be uplinked real-time, if required
 - 1. Need is identified by specified failure, operational circumstances, or other criteria.
 - 2. Operational circumstances must allow for real-time implementation.
 - 3. Format must allow for real-time implementation.
- c. Section C: Changes incorporated into the crew's flight books
 - 1. Documents the content of flight books.
 - 2. Allows ground users to keep their books in sync with flight book.
 - 3. Personal, proprietary, or sensitive data will be noted but the actual data will not be given.

All three of the above sections will be addressed. If there are no entries in Sections A or B, the word "none" will be inserted following the description.

The errata pack will be formatted as given in Figure 22-1 and described below.

- a. The MOD office standard font family (Arial, 11-point size) will be used for errata pack text, except where material is quoted from FDF documents.
- b. Cover.
 - 1. Flight will be identified.

2. Flight emblem (patch) may be used if available; otherwise, the SSP emblem will be used.
 3. TOC will list the sections and identify the attachments.
 4. Text describing the content will be provided as shown in Figure 22-1.
- c. All sections.
1. The content of the section will be described.
 2. Affected books will be listed alphabetically.
 3. A numbered entry will be made under each affected book for each change.
 4. Multiple changes affecting the same data will be grouped together as a single entry.
 5. The FDF Workflow Crew Procedure CR authorizing each change will be identified by control number and short title.
 6. Change requests affecting multiple books will be listed under each affected book.
 7. For generic books, change requests that are applicable to future flights will be followed by the symbol “¥.”
 8. All FDF Workflow Crew Procedure CRs approved for the given flight but which are not listed in a formally published document (milestone edition, revision, or PCN) are to be accounted for in the errata.
- d. Section A.
1. Each entry will have a short description of the change which is to be uplinked.
 2. Each entry will identify when in the mission flow the designated change must be available onboard.
- e. Section B.
1. Each entry will have a short description of the change which may be uplinked.
 2. Each entry will identify the condition under which the change must be uplinked.
- f. Section C.
1. Entries in this section will not be renumbered after the change has been incorporated into the crew’s flight book(s).

2. If subsequent changes are required after the affected data in the crew's flight books have been updated, a new numbered entry will be provided.
 3. Changes will normally be given as P&I instructions per the standards given in Section 21 for PCNs.
 4. Change-out pages will be provided with the errata only if P&I instructions are not practical. This facilitates rapid reproduction, distribution, and transmission of the entire errata to remote locations.
 5. Flight-specific data provided for each flight in the errata pack will have a standard flight-to-flight format.
 6. Due to the flight media and environment, the method of implementation of a specific change in the crew's flight books and that used by ground users may not be identical. However, the results will be the same if the instructions are followed.
 7. The term "Info:" will precede statements used to inform ground users of material that is not contained in the errata but is provided to the crew. This is usually extensive reference data or data requiring limited distribution.
 8. The term "Note: " will precede statements providing general information related to the use or status of an FDF document.
- g. Attachments.
1. Each attachment will have a sequential attachment number near the lower right edge.
 2. Each page of a multi-page attachment will have a page number listed after the attachment number. The format will be: "Attachment x (page n of m)."
 3. Each set of replacement/added pages will contain a page or card code. The code will identify the update as though it were PCN "X" (pages) or revision "X" (cards). If a subsequent replacement is required, "Y" or "Z" will be used sequentially.
 4. Card codes for new cards, transparencies, etc. will identify the associated book and have a unique card number. This can be any number not currently in use for any other card in the book.
 5. Pages provided as information (i.e., not intended to be inserted into a document per se) will identify the associated FDF book.
- h. Changes that are applicable to future flights and must be covered later by a formal publication will be identified. A list of FDF Workflow Crew Procedure CRs that were approved with implementation priority-3 that were not published for a given flight will

also be provided. The specifics of the latter group of changes are available on the workflow system for real-time uplink, if required. Refer to CPMP Annex B for more information on change implementation and errata packs.

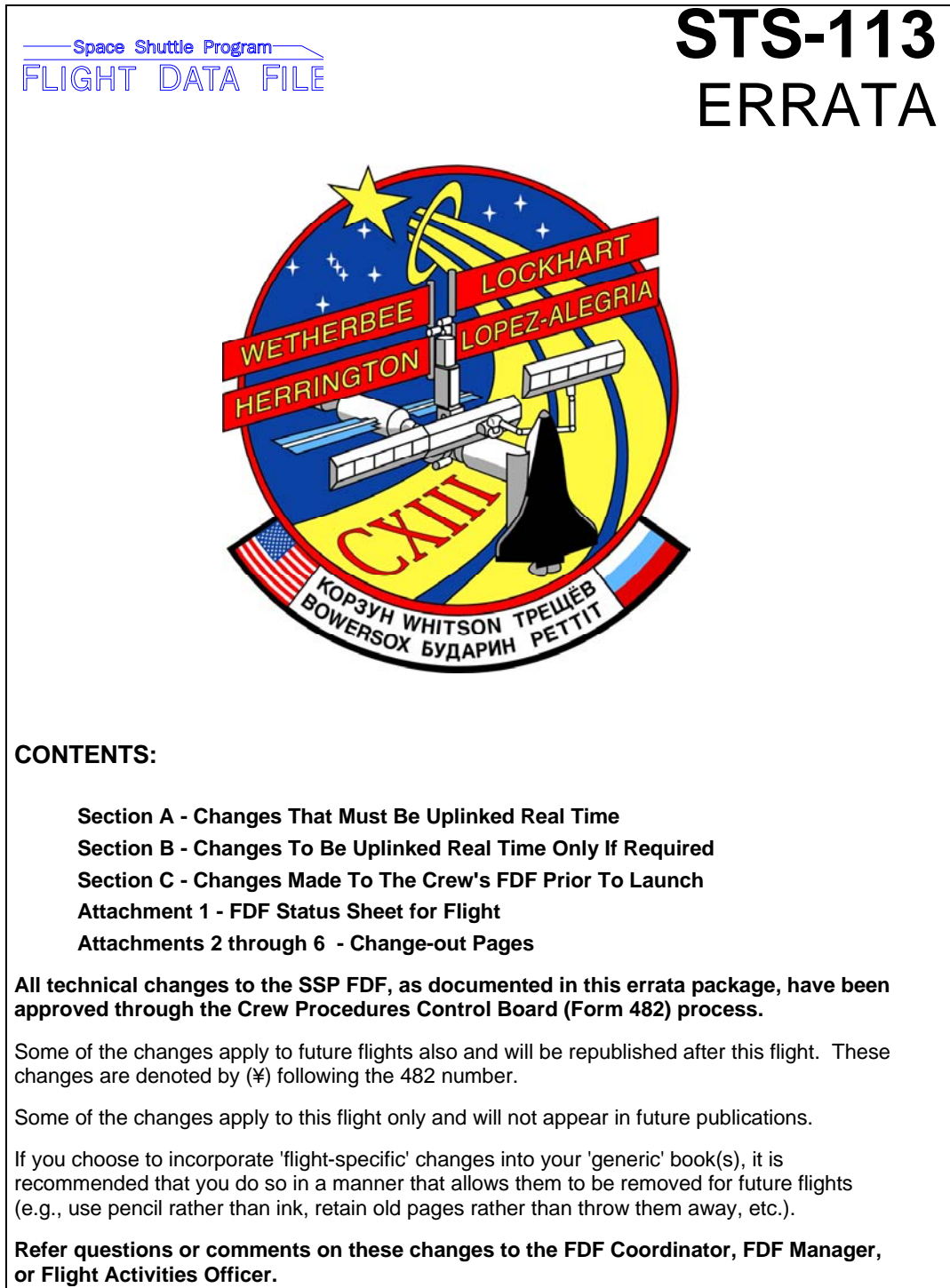

Figure 22-1. Typical cover of errata package

23.0 SIMULATION PACKAGES (SIM PACKS)

Some procedural changes are of such nature that they must be rapidly distributed to the simulators and MCC in order to avoid training with incorrect procedures. Occasionally, the timing of FDF publication schedules does not allow for the rapid distribution of procedural changes which are required for training. Therefore, a technique for a locally copied and incorporated change with a small distribution to key operational positions was developed: the simulation package (sim pack). A sim pack is essentially an informally prepared copy of an FDF publication with handwritten instructions and/or replacement pages.

The sim pack is reproduced locally and incorporated into MCC and simulator FDF sets.

The following instructions apply to sim packs:

- a. A sim pack form is completed as shown in Figure 23-1. All blocks are completed by the book manager except the sim pack number, date received, and FDF Manager's signature. The blocks are self-explanatory with a few possible exceptions:
 1. Cue card change? This is checked "yes" if the procedure being revised also has a cue card version of the procedure, which must be updated.
 2. The instruction section should be written like the detailed instructions for a PCN. Since sim packs normally contain replacement pages, this is generally limited to a list of pages being replaced. However, P&I instructions may be given in very simple cases, such as to change a single value on a page. When the changes are actually incorporated, the personnel involved may decide to P&I the change if it is simple or less time consuming than to replace the affected pages.
 3. Notes to the user, such as "Retain replaced pages for future use," should also be used in the instructions when appropriate.
 4. The comments box may contain special notes to the user such as "Return originals to book manager" or "Distribute to . . ."
 5. Either approved FDF Workflow Crew Procedure CR numbers must be given or a section head signature is required (with a phrase such as "supervisor deems mandatory for training" appearing in the AUTHORITY FOR CHANGE block).
- b. Replacement pages have some constraints. The input materials provided by the book manager must be of good quality to allow legible copies to be produced. Single-sided pages are required. Since the Controlled Document Production Area (CDPA) personnel provide only copying and distributing service for sim packs, the originals should be of bond copy size. However, if the pages are in a small C/L format, the proper crop marks will be used. The pages should be attached front to back as they will be inserted into the document. Thus, backs of changed pages should also be included, even if they have no changes.

- c. The sim pack is photocopied in duplex mode, so it is important that all fronts and backs be in the correct order. Also, black ink will be used, and all marks shall be within the crop marks or they will be cut off. "SIM-" is written in the lower right corner within the crop marks of each changed page. (CDPA personnel fill in the sim pack number following the "SIM-" notation.) ("SIM- " is not to be written on unchanged pages.) Should it be necessary to insert new pages prior to the end of a section, the pages should be numbered the same as the page they are to follow plus an alphabetical suffix. If new pages are added from different published books, the original page code (giving book, edition, etc.) shall be lined out and "SIM-" written in.
- d. When instructions to make P&I changes are submitted, an example of the P&Is will be provided to the CDPA personnel to be used as a guide for marking pages in the controlled sets in the Shuttle Mission Simulator (SMS), MCC, and elsewhere.
- e. Always use the latest version of the book when providing replacement pages. Never use pages with obsolete page codes or page codes not yet published.
- f. The sim pack's distribution list will list the affected book and flight (if applicable), the assigned sim pack number, and the title "SMS FLIGHT DATA FILE UPDATES."

In some cases, the data to be inserted into a document are unique to the SMS. This data should be labeled "SMS UNIQUE" on each page. SMS-unique pages should be added to the document rather than replaced.

In other cases, the data to be inserted into a document are still developmental. That is, it is desirable to have the procedures used and evaluated prior to formal adoption. With FDF management approval, the sim pack pages are each labeled "Developmental." As with the SMS-unique data, these pages are additions rather than replacements. Developmental data normally are not used in integrated sims. Also, distribution of developmental data is limited to SMS and directly affected Mission Operations Control Room (MOCR) sets.

SMS FDF CHANGE NOTIFICATION		SIM PACK	DATE INITIATED 11/10/04	DATE RECEIVED (PMO) 11/10/04
BOOK TITLE MALFUNCTION PROCEDURES		BK ISSUE (Ed, Rev, PCN) GENF,1	SIM PACK NUMBER SIM-67	
Change is for flights (Also give SMS load if load dependent): STS-114 & SUBS			SMS UNIQUE? <input type="checkbox"/> YES <input checked="" type="checkbox"/> NO	DEVELOPMENTAL? <input type="checkbox"/> YES <input checked="" type="checkbox"/> NO
FABRICATED ITEM CHANGE? <input checked="" type="checkbox"/> NONE <input type="checkbox"/> CUE CARDS <input type="checkbox"/> TRANSPARENCIES <input type="checkbox"/> Other _____				
INSTRUCTIONS TO USER: REMOVE AND REPLACE PAGES ECLS 6-13 & 6-14 6-89 & 6-90				
AUTHORITY FOR CHANGE* (Approved 482 numbers, approved issue at print shop, supervisors deem mandatory, etc.): Incorporates changes from MAL-1511 and MULT-1676 (not yet approved).				
*Refer to Crew Procedures Management Plan				
OTHER AFFECTED FDF BOOKS			Are all SIM PACKS submitted? <input checked="" type="checkbox"/> YES <input type="checkbox"/> NO	
IMPLEMENTATION REQUIREMENTS		<input type="checkbox"/> Limited Distribution (List in comments)	<input type="checkbox"/> NO EARLIER THAN _____ (Date and/or Sim ID)	
			<input checked="" type="checkbox"/> NO LATER THAN 11-22-04 (Date and/or Sim ID)	
BOOK MGR (Signature/Date) <i>Harold K. [Signature] 11/10/04</i>	SUPERVISOR (If required, Signature/Date) <i>Michael [Signature]</i>	FDF COORD or FDF MGR (Signature/Date) <i>Renee M. [Signature] 11/10/04</i>		
COMMENTS:				

MOD Form SP-1, AUG 1998

Figure 23-1. Sample sim pack instructions

24.0 EVA PROCEDURE STANDARDS

Procedures relating to EVA are performed by crewmembers situated both inside and outside the vehicle.

They are designated IV (Intravehicle) and EV (Extravehicle), respectively.

In some EVA procedures, performed by IVA crewmembers inside the orbiter, the EVA cuff C/L procedures being performed by the EVA crewmembers outside the orbiter are given for reference. This gives both sets of procedures in one place, showing the sequence of both IVA and EVA actions and allows the IVA crewmembers to know what the EVA crewmembers are doing so their actions can be coordinated. The EVA and IVA actions are indicated with crewmember designations of EV and IV, respectively.

The EVA procedures from the Cuff C/L are a replica of the Cuff C/L page as shown in Figure 24-1. The EVA procedures should be exactly the same as in the actual Cuff C/L. Space constraints may require some variation from normal FDF Preparation Standards as reflected in Figure 24-1.

Standards

- a. The procedure used by the IV crewmember shall be a replica of the procedure used by the EV crewmember.
- b. Because the media used by the EVA crew might be different than that used by the IVA crew, the format may not, by necessity, be the same as the IVA crew.

RMS/PRLA CONTINGENCY EVA (Cont)

FOR RMS/PRLA FAILURES (Cont):

<p>PRLA OPEN/CLOSE 9</p> <p>Refer to EVA RELEASABLE PAYLOAD RETENTION LATCHES figures, 14-11, 14-12, as reqd</p>		
<p>PRLA OPEN/CLOSE</p>		
<p>AIRLOCK – RATCHET WITH 7/16 SOCKET</p>		
IV	√PRLA PWR OFF	
EV	<ol style="list-style-type: none"> 1. Rotate ratchet in release direction (as marked above EVA drive) to shear pin 2. View yellow indicator as applicable 3. Continue to rotate drive 4-1/2 revs to disc gear train from drive shaft 	
	To open latch:	
	<ol style="list-style-type: none"> 4. Continue rotation in release direction (as marked above EVA drive) until latch open against stop 	
	To close latch:	
	<ol style="list-style-type: none"> 5. Rotate EVA drive in opposite direction of release (as marked above EVA drive) until latch closed against hardstop and over center 	
IV	√PRLA tb LAT	
	Cont next page	
EVA CUFF C/L	38	07/20/00
<p>PRLA OPEN/CLOSE (CONT)</p>		
EV	<ol style="list-style-type: none"> 6. Apply PRLA locking feature if applicable 	
	To lock:	
	<ol style="list-style-type: none"> 7. Rotate each bolt (2) cw 1/2 turn 	
	<p>For subsequent PRLA ops, release locking feature before operating EVA drive (2 bolts ccw 1/2 turn); relock after operation</p>	
EVA CUFF C/L	39	07/20/00
IV	MA73C:C	cb MCA PWR AC1 3Φ MID 1 – cl
	:D	AC2 3Φ MID 3 – cl
	To verify PL Latches op/cl:	
A6U	√PL RETEN LAT 1(2,3,4,5) tb – LAT(REL)	

Figure 24-1. IVA procedures showing integrated EVA (Cuff Checklist)/IVA procedure

25.0 ELECTRONIC DOCUMENTATION STANDARDS

25.1 CD-ROMS

Terms:

- CD Set – A collection of (related or unrelated) CDs placed in a container.
- FDF CDs – CDs whose content consists primarily of documents, imagery and other data controlled by the Crew Procedures Control Board (CPCB). FDF CDs may also include reference material similar to FDF that is controlled through other forums but documented with Workflow EZ482 to be flown with the FDF.
- POC CDs – CDs that contain software (applications, data, etc.) that is authorized for flight by the Portable Onboard Computer Control Board (POC CB).

General:

- See CPMP Annex B regarding configuration control of FDF Books CD content and media.
- FDF CDs and non-FDF POC CDs may be contained in the same CD binder. POC CDs (and other removable media) that do not contain FDF information are manifested with the FDF through agreement between the CPCB and the POC CB.
- The FDF CD binder consists of two to ten plastic sleeves which can hold two disks each. See section 25.1.3 for the FDF CD cover standards.
- The maximum number of CDs in a binder is 20 (two per sleeve) – or 19 if a table of contents is provided.

25.1.1 FDF CD Content

Standards:

- a. A CD volume name will be assigned when the CD is burned.
 - The volume name will reflect the title on the CD label.
 - The label title may be abbreviated for this purpose.

The intent is to assist the crew in locating the CD in the POC directory.
- b. Each FDF CD may contain the following in addition to the data files:
 - An introductory file that provides a table of contents or otherwise assists the crew in navigating within the CD

Guidelines:

- a. If the CD contains files for multiple sets of unrelated information, the files for each set of information should be in a separate folder with clear, distinct titles. In this case, an introductory file may be included in each folder.
- b. Each FDF Books CD should contain the following files in the root directory:
 - An FDF icon file: `fdf.ico`
 - A generic *Shelexec.exe* file and a CD-specific *Autorun.inf* file to display the FDF icon and automatically open the introductory file. Note: The CD auto-open feature is useful for ground users but is disabled on the PGSCs.

Example Autorun.inf file:

```
[autorun]

open=shelexec \~Start_Here.doc

icon=fdf.ico

[autorun.x86]

open=shelexec \~Start_Here.doc

icon=fdf.ico
```

"~Start_Here.doc" is the introductory file of the FDF Books CD (which is the first file the crew should open) in this example. The tilde is used in the example title to make the file appear at the top of the CD directory listing.

25.1.2 FDF CD-ROM Labels

Standards:

- a. Each FDF CD will be labeled with the following information (see Figure 25-1):
 - Title*
 - Disk ID*
 - Sequential disk number and total number of disks with the same title that constitute a single entity. (i.e., 1 of 1, 1 of 2, 2 of 2, etc.)*
 - NASA logo
 - NASA/JSC address element

- Official use notice
 - Identification of who and when the software was placed on the disk*
 - Notice to verify version
 - CD Code*
 - Sufficient blank space to insert notes* and/or comments* relative to the use content or use of the CD.
- b. Information identified above with asterisks may be hand written on the label.
- c. A Disk ID that uniquely identifies the individual disk will be assigned
- The Disk ID will normally be the purpose or position for which it was prepared (i.e., Flt – Prime, Flt – B/U, Fix Base, FAO, etc.).
 - A sequential number will be added to the Disk ID if more than one copy is prepared for the same purpose/position, (i.e., SMS 1, SMS 2, etc.)
- d. A CD code will be assigned to each FDF CD having unique content. This code will provide version configuration information and will be documented in the cue card (or configuration control) section of the related FDF book (along with a description of the CD content).
- e. CD codes will be similar to cue card codes (see Section 28.1) except that "CD" will be inserted. The format is:

Book abbreviation CD-sequential number/applicability/version

Examples:

MAPS CD-1/ALL/B

ORB OPS CD-2/ALL/A

PL OPS CD-1/199/A

- f. FDF CDs provided solely for training will be marked "TRAINING ONLY" in letters no less than approximately 3/16-inch high in bold lettering. This information may be hand written.

25.1.3 FDF CD Binder Cover

Standards:

- a. Each CD binder will have a front printed cover containing the following information as shown in Figure 25-2:
 - Series logo – "Space Shuttle Program Flight Data File"
 - Serial number – "JSC-CDn-*nnn*" where the first *n* is an assigned sequential number for each set on a given flight and the series of three *n*'s is the flight number
 - Crew/mission patch – the shuttle program patch may be used if the crew/mission patch is not available.
 - The title – "CD Set *n*" where *n* is the same assigned sequential number given as part of the serial number
- b. The back cover shall be blank
- c. The covers shall be white K-10 card stock

Guidelines:

- a. Images on the cover may be either color (normal) or black-and-white.
- b. A table of contents (TOC), along with corresponding sleeve tabs, should be provided if the number of disks exceeds ten – especially if there are multiple unrelated files on one or more CDs in a set
 - The table of contents is prepared to fit on an 8 ½ inch square sheet of bond paper with text areas as shown in Figure 25-3. (The sheet will be folded into quarters to fit into the first sleeve.)
 - It is preferred that the TOC fit into the first text area. However, if additional areas are used, "cont'd" will be inserted at the bottom of text area one.
 - Sleeve tabs will consist of one line of text (11-pt Arial) on a ¼ inch by 5 inch strip of K-10 card stock
 - The first sleeve will contain the table of contents and its tab will be titled accordingly (i.e., "Table of Contents")
 - Each tab will have a sequential number (starting with 1) preceding the title of the CD. (Table of contents will be "0")

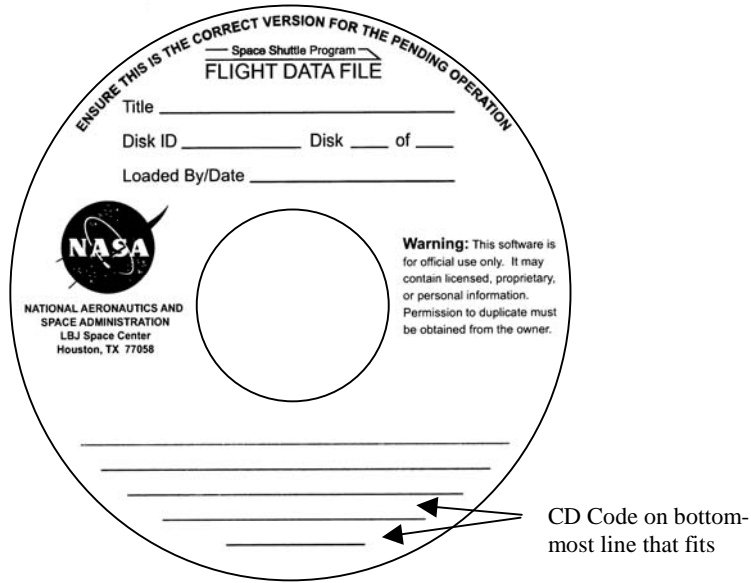

Figure 25-1. Blank FDF CD

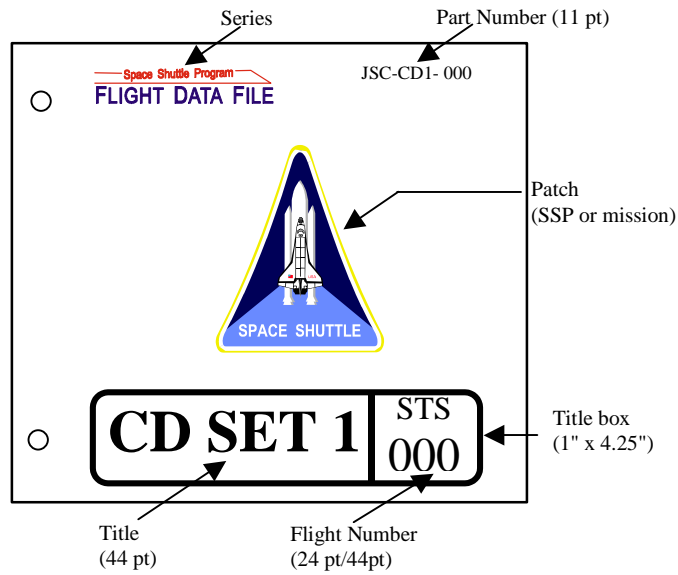

Figure 25-2. CD Binder Cover

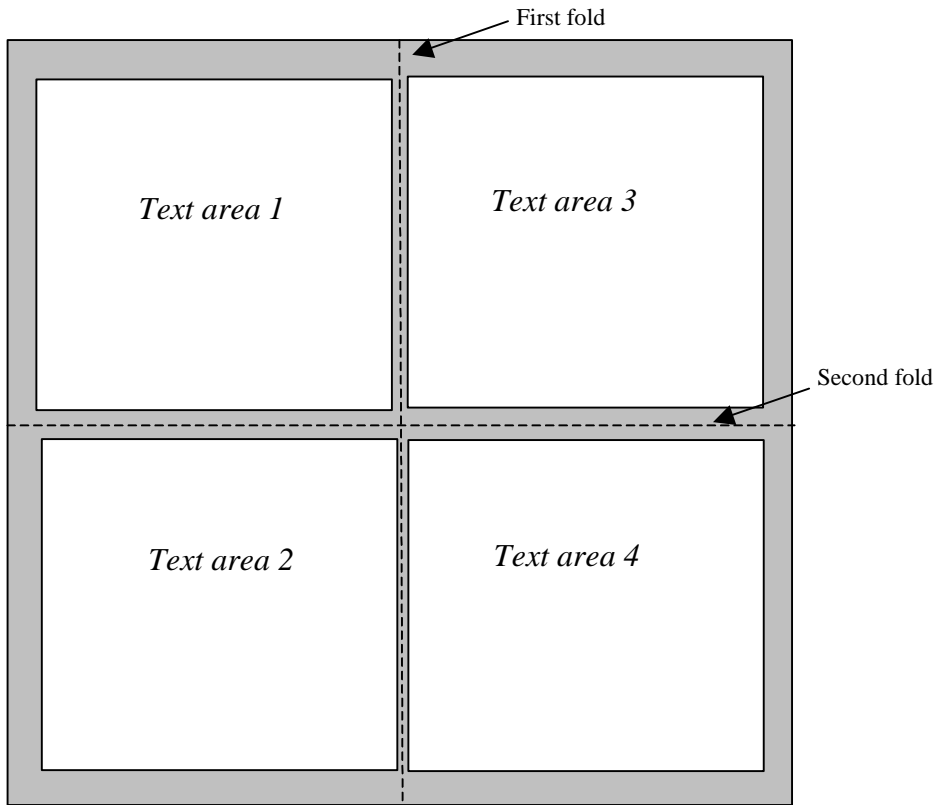

Figure 25-3. CD Set Index Image Area

26.0 TIMELINE FORMATS

TBD

27.0 REFERENCE DOCUMENTS

27.1 C/W AND FDA LIMITS TABLES

C/W and Fault Detection Annunciation (FDA) limits are provided in table form.

The following format will be used as the basis for specifying C/W and FDA limit information changes in the reference data books and other similar references:

PARAMETER NAME	C/W CH	H/W C/W		SOFTWARE ID	PASS SPEC	SM ALERT		B/U C/W		PRECONDITION (P) AND/OR BILEVEL STATE (BL)
		LOW	HIGH			LOW	HIGH	LOW	HIGH	

The following ground rules will be applicable:

- Use only the columns for which changes have occurred. This includes only the HIGH or LOW columns for H/W C/W, Backup (B/U) C/W, and SM ALERT.
- The parameter name will always be presented as given in the C/W and FDA Table in the Reference Data book, but no footnotes are shown.
- Engineering units will be shown in parentheses.
- If several changes that fit under different categories are done together, the minimum format that satisfies all of the above ground rules will be presented, and columns that are not applicable for a particular parameter will be left blank.

An example of combined changes with the minimum columns required:

PARAMETER NAME	C/W CH	H/W C/W		ENA/INH	PARA ID	SM ALERT LOW
		LO V(LO EU)	HI V(HI EU)			
CAB P	4	1.00(4.00)				
O2 FLOW 1	14			INH		
AV BAY FAN ΔP 1			2.50		0612642	1.45
GPC 1	5					

Note that extraneous data (such as Software (S/W) IDs when only a Hardware (H/W) parameter is to be changed) should be suppressed since this could lead to confusion.

27.2 DPS/CDMS DISPLAY DIAGRAMS

In the DPS/Command and Data Management System (CDMS) Dictionary and similar books, the use of color on CRT displays will be indicated as shown in Figure 27-1. Otherwise, CRT display diagrams will look as much like the actual displays as possible.

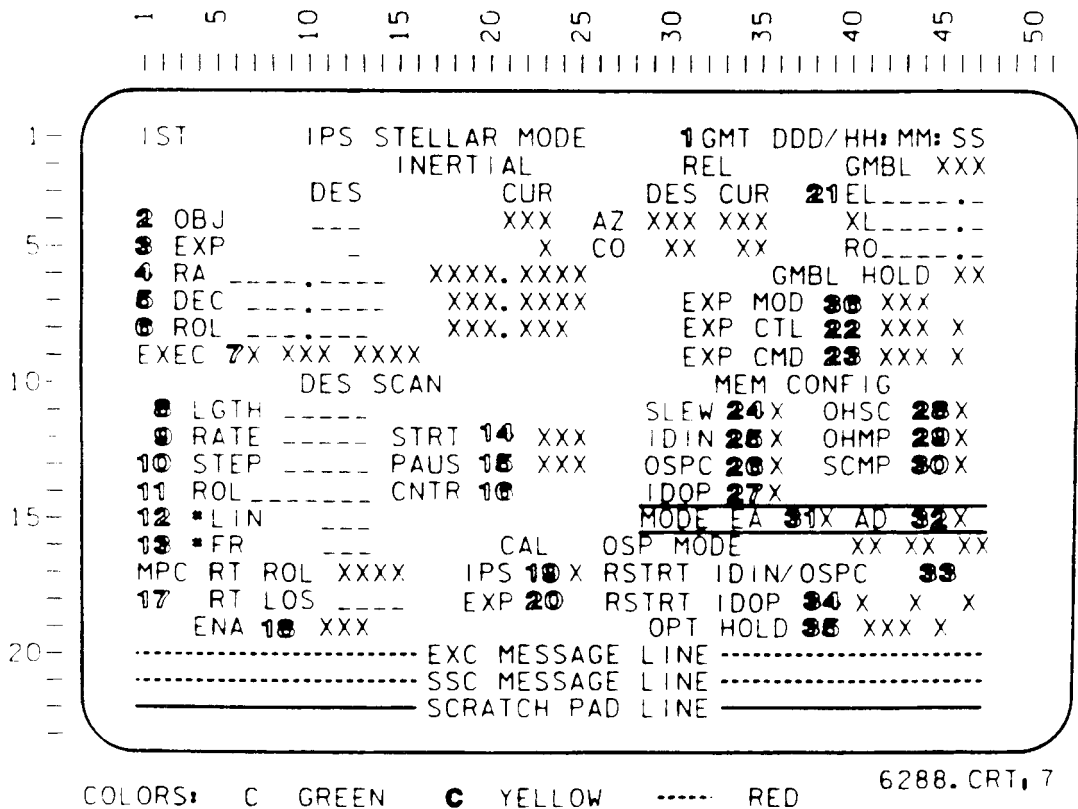

Figure 27-1. Color indications in CRT display diagram

28.0 CUE CARDS

The need for cue cards in various locations of the shuttle is dictated by the complexity and criticality of crew procedures. Location and accessibility are major constraints on cue card size and shape, thus requiring unique FDF standards.

28.1 CUE CARD PAGINATION, PAGE CODE, AND CARD CODE

Cue card pages will use the normal page numbering of the book in which they appear with a prefixed "CC" (e.g., CC 10-17). On the configuration section pages, the notation "FAB USE ONLY" will appear at the far left of the bottom of the page. Page codes will follow the same standards as the rest of the book.

Cue cards are treated as separately controlled graphics. The same version of a cue card may appear in more than one place within the controlling document. Cue cards thus have card codes that actually appear on the card as flown. The card codes are used to provide a separate tracking code. These card codes will contain the following identifiers:

- a. Book - Abbreviation given in CPMP Appendix A.
- b. Card number - A sequential card number followed by a letter designation for each face. The "a" will indicate the front of a card and the "b" will indicate the back of a card. For cards with more than two faces (e.g., hinged cards or the Orbital Maneuvering System (OMS)/Reaction Control System (RCS) slide rule and inserts), additional letters will be used for each printed surface (e.g., a, b, c, d or a, aa, b, bb). Overlays and fabricated transparencies have only one face and will use an "a" card number designator. Cue cards with duplicate front and back faces will use an "a,b" card-number designator on both faces (e.g., multiple fill-in forms). To avoid confusion on flight manifest records, the card numbers in flight supplement books will not duplicate the card numbers in related generic books. However, the card numbers used in a flight supplement will be reused for succeeding flight supplements if these numbers do not conflict with those used in the corresponding generic document. For example, the generic card numbers PDRS-1, PDRS-2, PDRS-3 will not be used in a flight supplement if these same numbers appear on the generic PDRS cue cards.
- c. Applicability - Optional, for use in flight supplements or other nongeneric applications (e.g., "IUS" for inertial upper stage flights). A flight number will be used for a cue card in flight supplements to prevent duplicating card codes used in similar flight supplements, but for different flights.
- d. Flight phase identifier - Optional (i.e., "A" for ascent, "O" for on-orbit, "D" for deorbit, and "E" for entry).
- e. Revision - A, B, C, etc., for the first, second, third, etc., revision since the adoption of a card code. New and changed cue card masters shall require a new revision

letter, regardless of the reason for a new cue card print master. The cue card code will remain unchanged if no actual changes are made to the format, size, or text of the cue card. Likewise, the revision code will remain unchanged as the book progresses through various milestones and PCNs if no actual changes are made to the cue card.

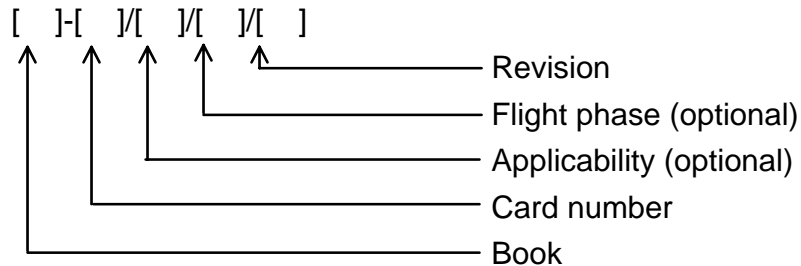

An example of a card code is as follows:

ASC-2a/112/A/B - The front of card 2 in the Ascent Checklist/STS-112 flight specific/card is applicable to the ascent flight phase/second card version since card codes were adopted.

The card code should appear at the lower-right corner of a card but may appear elsewhere if space is limited. The code may be placed sideways, if necessary, to appear distinct from the actual data on the card. When a dual-faced cue card receives a change to one face only (e.g., back only), the unchanged side or face should not be reprinted.

Pages in the DAP Book (published in the FLIGHT PLAN) and overlays will also be given card codes to uniquely identify them and assist in production and fabrication.

28.2 CUE CARD/VEHICLE COORDINATION

The vehicle/cue card interface is established by patches of hook Velcro on the cue card and patches of pile Velcro on the vehicle. This interface is documented in the Cue Cards and Procedural Decals book. The interface and the resolution of problems relative to card and Velcro size and shape are the responsibility of the Cue Cards and Procedural Decals book manager.

All cue cards and cue card changes including crop marks and Velcro positioning shall be coordinated with the Cue Cards and Procedural Decals book manager. Cue cards shall comply with regular prep standards to the extent possible. Any deviations shall be coordinated with the FDF Manager and the Astronaut Office FDF representative.

Cue cards are divided into the following two groups:

- a. Cue cards that fly in specific locations and have critical size, shape, or Velcro requirements. For this group, the specific requirements of each cue card shall be

coordinated with the Cue Card and Procedural Decals book manager. This group includes all cue cards published in the Ascent C/L, Entry C/L, and AESPs.

- b. Cue cards that do not fly in specific locations and are affected only by stowage and fabrication constraints. For this group, the maximum cue card size is 8-1/2 by 10-1/2 inches; these cue cards shall be coordinated (for fabrication and stowage) with the Cue Card and Procedural Decals book manager.

28.3 CUE CARD LOGISTICS

Logistics is the second major concern. Approximately 100 cue cards must be fabricated and stowed in terms of current content, size, shape, and Velcro requirements. For a given flight manifest, the current cue card configuration and content are given in one of the following forms (controlling documents):

- a. Cue cards contained in particular FDF books are designed as part of that book. Cue card content and configuration will be published in the cue card section of each FDF book (and/or applicable flight-specific Flight Supplement). See Section 20 for cue card treatment in the LOEP.
- b. Current versions and configurations of cue cards not printed in specific FDF books are compiled and printed in the Cue Card and Procedural Decals book (generic edition).

These controlling documents also provide ground controllers with exact copies of the content and configuration of all in-flight cue cards.

28.4 CUE CARD CONFIGURATION

The following “configuration elements” are illustrated in Figure 28-1 and Figure 28-2.

- a. Each cue card shall have crop marks or outlines to define its size and shape for fabrication. The correct crop marks (\oplus , \lrcorner , or \llcorner) will be used to assure appropriate trimming (see Figures 28–1 and 28–2). The \oplus indicates a full trim along two planes (i.e., an outside corner). The \lrcorner indicates a trim to the point of intersection (e.g., an inside corner). A dotted line (.....) will be used to indicate nonvertical or nonhorizontal cut edges. Also, areas to be cut out will be cross-hatched and the words “CUT OUT” will be added over the cross-hatching.
- b. Many cue cards will have a title (abbreviated as appropriate to conserve space) in 12-point Arial, positioned within the crop marks as part of the printed cue card.

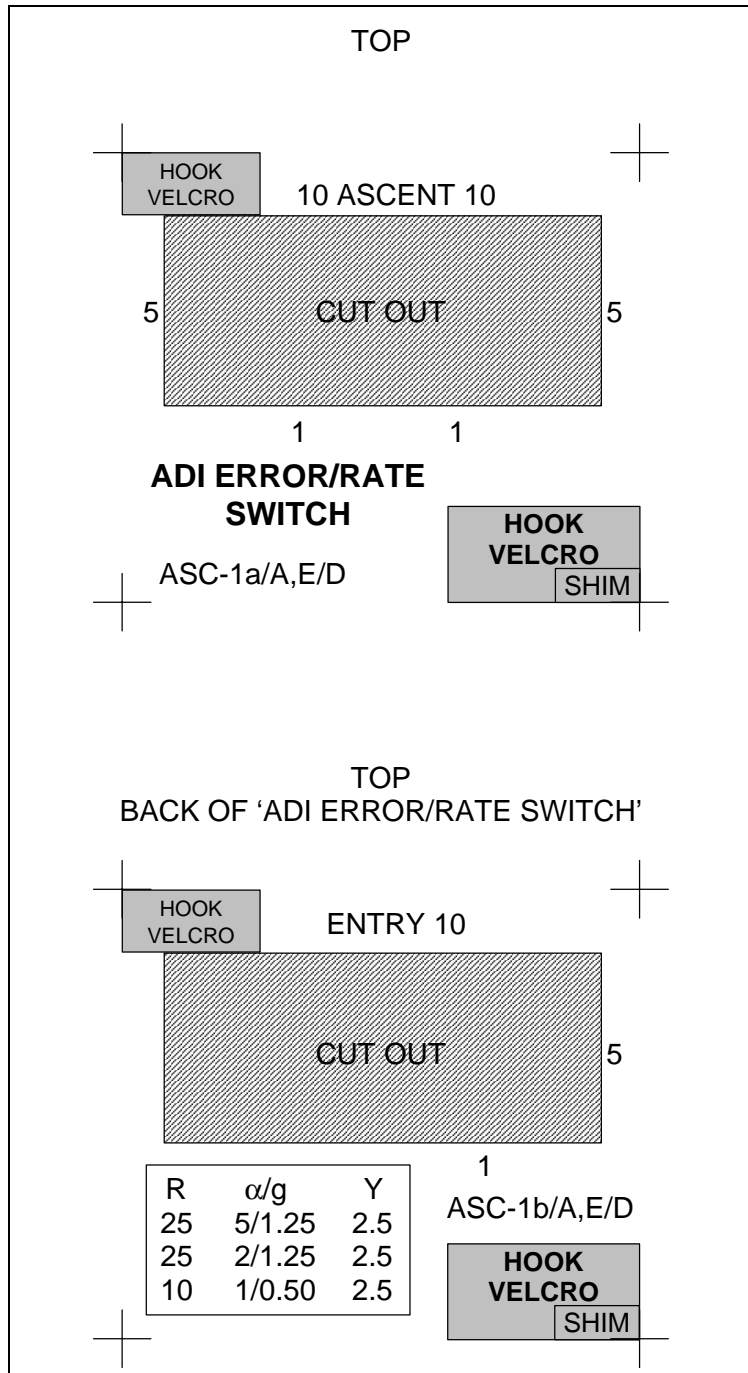

Figure 28-1. Example of a cue card master prepared for specific location

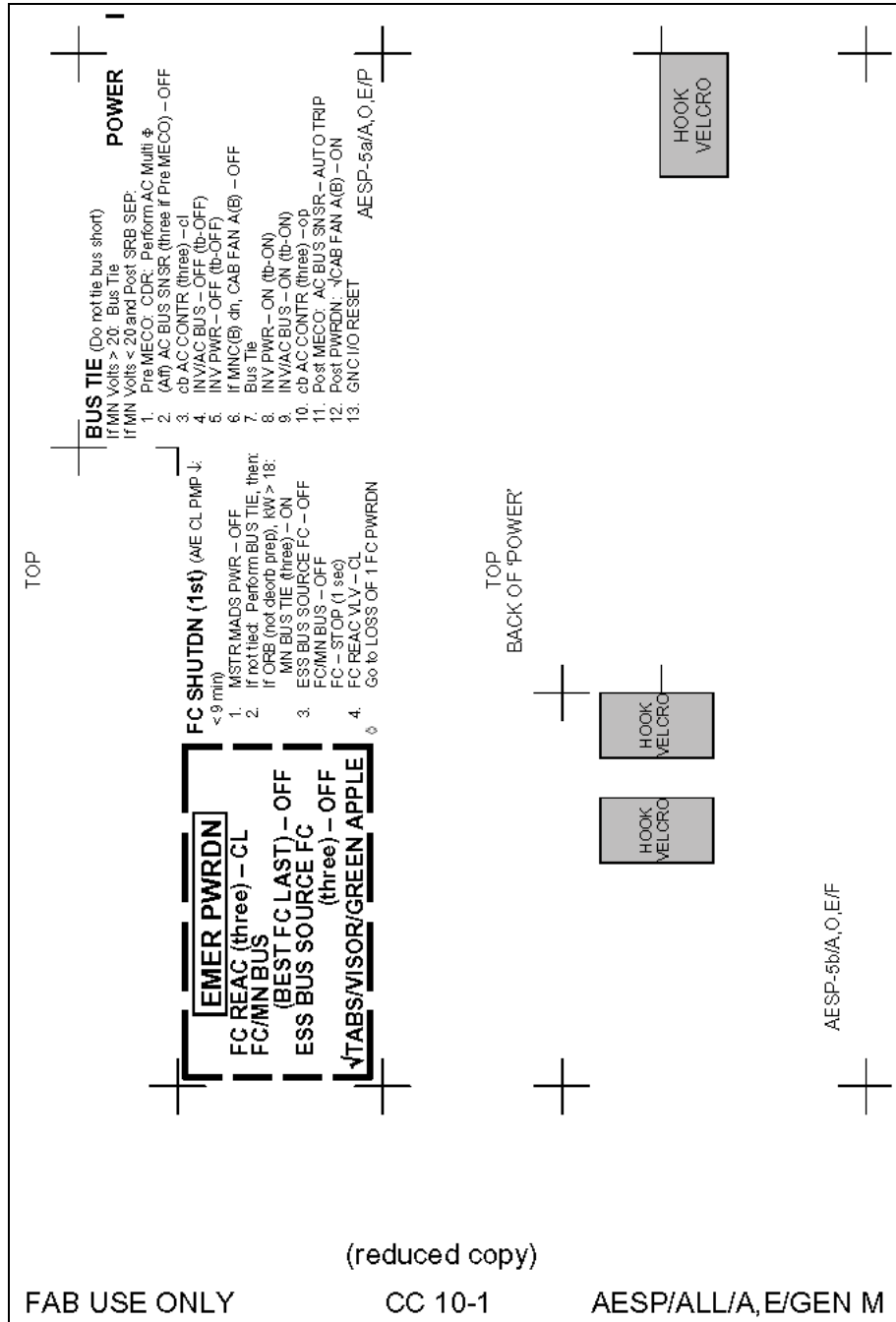

Figure 28-2. Example of a reduced cue card configuration page

- c. Fabrication notes and instructions shall be placed outside the crop marks or outline (i.e., outside the image area). As illustrated, fabrication instructions shall include (as a minimum) the following: (1) labeling the TOP on both the front and back of each cue card and (2) labeling the back of each cue card with the TITLE associated with the front.

- d. All cue cards have a “front” and “back.” Each side is printed and trimmed separately, then fabricated into a layout of the correct size, shape, and Velcro configuration. Crop marks for front and back must enclose identical image areas (i.e., front and back must match). If the front and back of a card are in different books (such as in a generic book and its flight supplement), there will be a note outside the crop marks indicating this.

Example:

FIRE/SMOKE
(ASCENT/ENTRY)
(AESP-7a), front of
FIRE/SMOKE (ORBIT)
appears in the
ASCENT/ENTRY SYSTEMS
PROCEDURES

- e. When the front and back of a card are in different books, the cue card code will be a special two-line designator. (This standard does not apply to flight supplements which may have a front in the generic and the back in the flight supplement, or vice versa.) In the controlling document for a particular face (i.e., “a” or “b”), the cue card will use a normal code. However, immediately below the code, a parenthetical notation will identify the phantom location for the same face, as if the card existed in the alternate book. The front and back shall carry the same card number. For example, if the front of Card 7 (flight phases A, O, E for Revision A) appears in the Ascent/Entry Systems Procedures book and the back of Card 7 appears in the Orbit Pocket C/L, the cue card codes will be configured and printed on the cue card masters as follows:

For a cue card in the Ascent/Entry Systems Procedures:
AESP-7a/A,O,E/A
(OPCL-7a)

For a cue card in the Orbit Pocket Checklist:
OPCL-7b/A,O,E/A
(AESP-7b)

- f. Generally, cue cards will have patches of hook Velcro to interface with patches of pile Velcro. However, a few cue cards are designed without Velcro patches. Cue cards designed for special locations shall have specific hook/pile interface coordination). Change bars shall be added as required, but placed outside the cue card crop marks.

- g. Some cue cards have procedures on one side (single sided); some have procedures on both sides (dual sided). Single-sided cue cards shall have Velcro on the back; dual-sided, both front and back.
- h. Cue cards may need to be reduced for inclusion in the parent document. In this case, the reduced cue card copy will bear the notation "(reduced copy)," which is printed outside the crop marks of the cue card in all lowercase letters and in parentheses. The cue card will be differentiated from the page copy by the designation "(FQ)" added after the page number on the actual cue card only.
- i. The page in an FDF book on which a cue card is printed will be formatted and paginated the same as any other page with graphics.

29.0 FLIP BOOK FORMATS

In a zero-g environment, C/Ls must be hand-held, tethered, or restrained in stowage. The FB evolved to fill the need for a small C/L that a crewmember could affix to the shuttle interior, flip the pages as necessary, and have both hands free for performing crew activities.

The FB is a hybrid C/L/cue-card document. The book is unique in that it has no front or back cover. It is paginated serially, but its page content and tab labels are arranged from front-to-back or from back-to-front. The five FDF FBs are the Commander and Pilot Ascent FBs (in the Ascent C/L as controlling document), the Pilot and Commander Window FBs, and Pilot Overhead FB (all three in the Ascent/Entry Systems Procedures as controlling document). See Figure 29-1.

FBs shall have the following “configuration elements”:

- a. FBs use the small book format with a row of small major tabs. Image areas for the tabs and the text are previously illustrated in Figure 20-9. Change bars will be placed inside the crop marks except for the AESP book pages.
- b. Each procedural page in an FB normally is tabbed. Crewmembers readily locate the book contents by glancing at tab titles that are printed in 10-point Arial bold for emphasis.
- c. Tab titles will reference the material on the pages hidden by the tab page (i.e., tab labels reference procedures on the two pages seen when the tab page is flipped).
- d. Pagination and page notes shall follow FDF standards (Section 20.0). Page numbers will have the prefix “FB” (e.g., FB 10-12).
- e. The Pilot and Commander Window FBs and Pilot Overhead FB are separated into two divisions: Powered Flight (A) and Glided Flight (E). For the flight books, the Powered Flight section and the Glided Flight section for each FB is separated by a strip, fabricated as part of the FB backboard.
- f. For the Ascent FBs, tab lines of type will run parallel to the long edge of the paper. For the Pilot Overhead FB and the Commander and Pilot Window FBs, tab lines of type will run parallel to the text. See Figure 29-1.
- g. FB pages will be held in position by patches of Velcro positioned in top corners of the pages (hook Velcro in top right-hand corners of odd-numbered pages, pile Velcro in top left-hand corners of even-numbered pages; see Figure 29-1).
- h. As per cue card standards, the locations of Velcro patches shall be designated for proper interface. Crop marks will designate the trim lines for both front and back printing. Holes are punched within a 1/2-inch binding area. Fabrication instructions and notes shall be positioned just outside the crop marks.

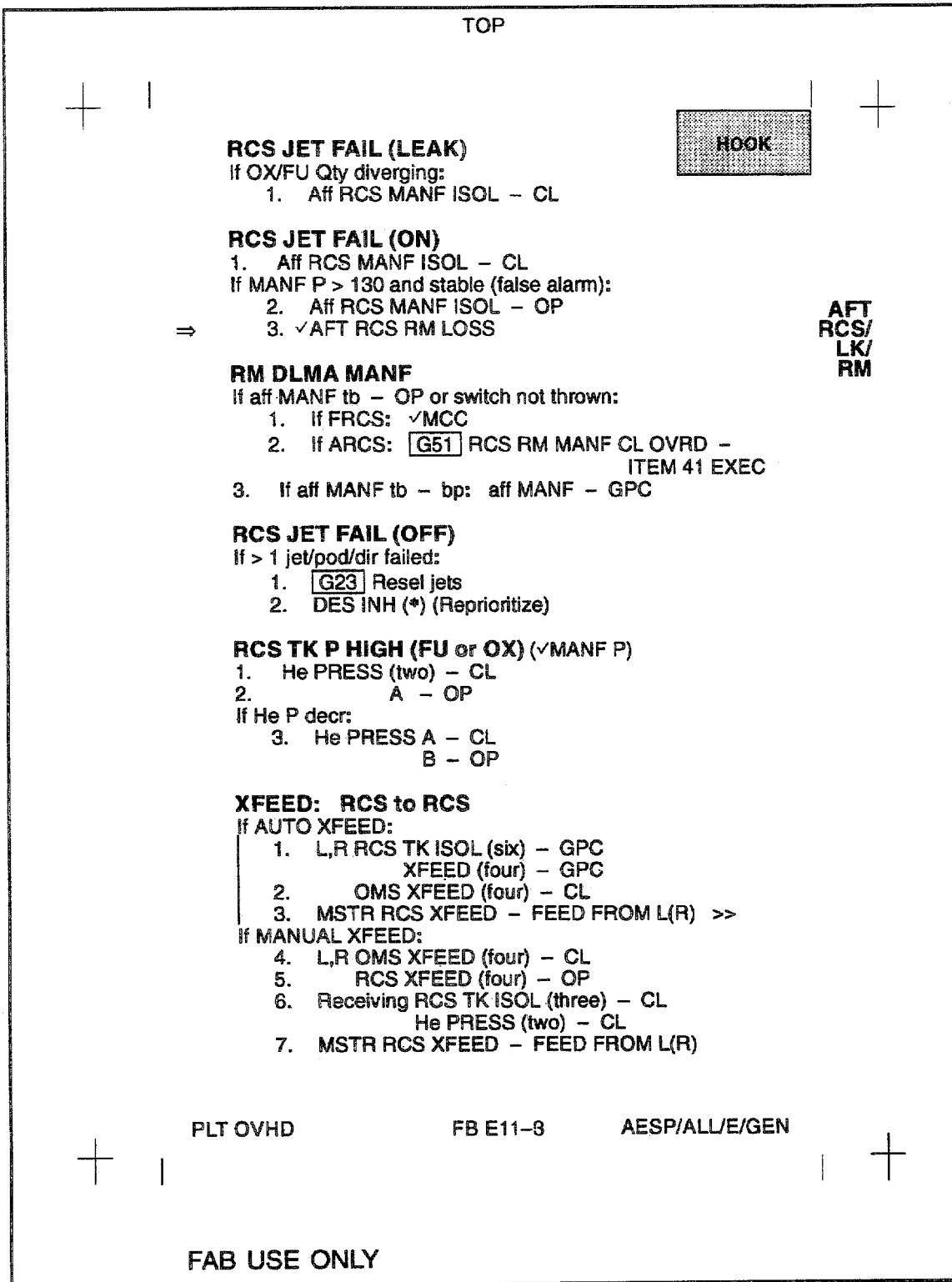

Figure 29-1. Example of a flip book page master

30.0 CCTV OVERLAYS

Occasionally, overlays are required for the Closed Circuit Television (CCTV) monitors. These fabricated items are handled the same as cue cards. The standard page code, as described in Section 20.7, is placed at the bottom of the page outside the image area. A separate tracking code is also used and actually appears on the overlay. Tracking code identifiers are the same as for cue cards and are described in Section 20.7. A note is added above the transparency fabrication "cut" line stating to "Fabricate as a Transparency." Dimensions and location of the identifiers and title are shown in Figure 30-1.

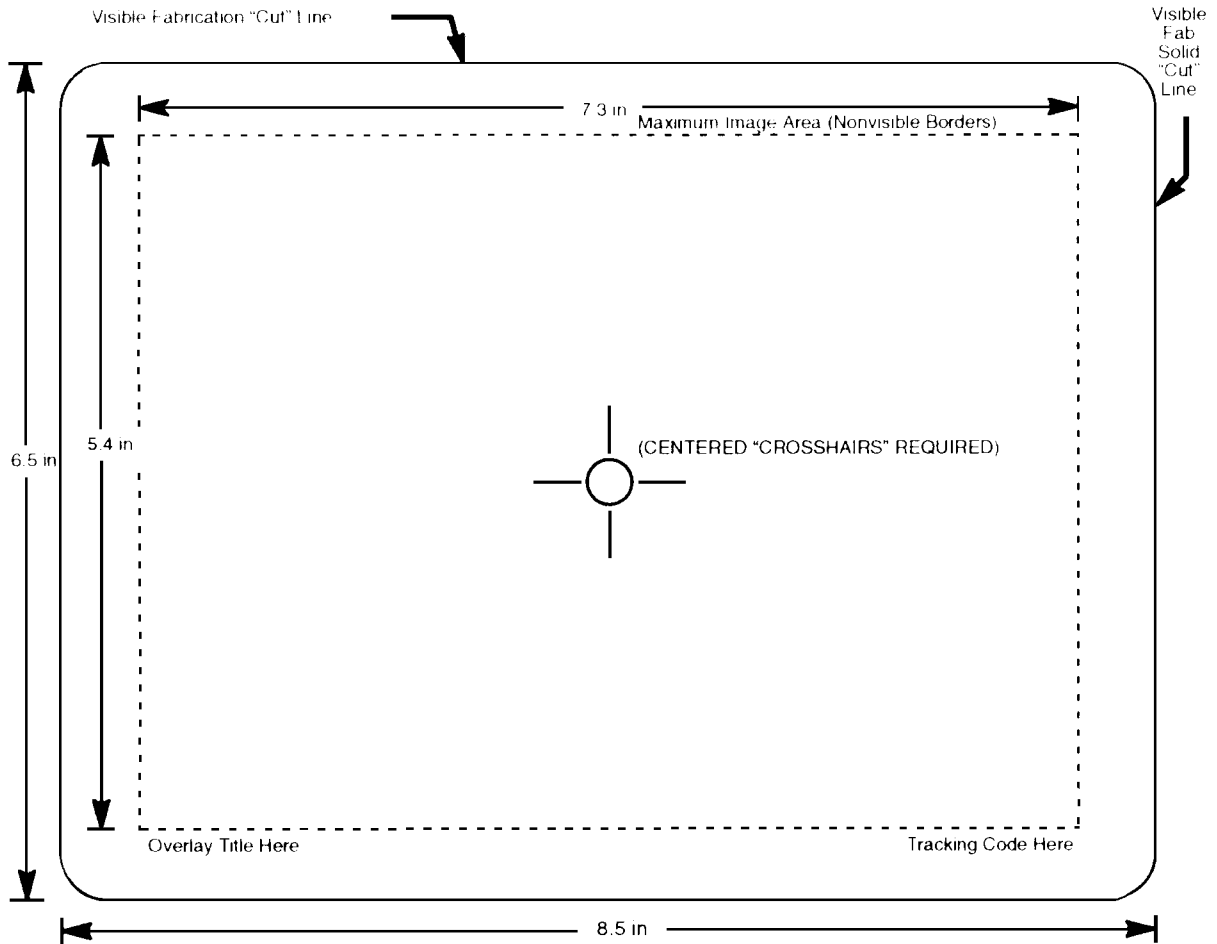

Figure 30-1. CCTV overlay template

31.0 WAIVERS

TBD

APPENDIX A
ACRONYMS AND ABBREVIATIONS

A&C	Activation and Control
AESP	Ascent/Entry Systems Procedure
AOS	Acquisition of Signal
APU	Auxiliary Power Unit
ASC PKT	Ascent Pocket Checklist
B/U	Backup
BFS	Backup Flight System
bp	barberpole
C/L	Checklist
C/W	Caution and Warning
cb	circuit breaker
CCTV	Closed Circuit Television
CDMS	Command and Data Management System
CDPA	Controlled Document Production Area
CD-ROM	Compact Disk-Read Only Memory
CIL	Critical Item List
Circ	Circulation
cl	closed
config	configuration
CPCB	Crew Procedures Control Board
CPMP	Crew Procedures Management Plan
CR	Change Request
CRT	Cathode Ray Tube
D&C	Display and Control
DAP	Digital Autopilot
DLG	Distribution List Generator
DN	Discrepancy Notice
DPS	Data Processing System
Dpy	Deploy
ECLSS	Environmental Control Life Support System
EI	Entry Interface
ENT PKT	Entry Pocket Checklist
EPS	Electrical Power System
erratta pack	Errata package
ET SEP	External Tank Separation
EV	Extravehicular
EVA	Extravehicular Activity
FAO	Flight Activities Officer
FB	Flip Book

FDA	Fault Detection Annunciation
FDf	Flight Data File
FOR	Flight Operations Review
FPS	Flight Planning System
FRP	Failure Recovery Procedure
FS	Flight Specific
GMT	Greenwich Mean Time
GPC	General Purpose Computer
GPO	Government Printing Office
H/W	Hardware
H2	Hydrogen
HC	Hazard Control
HIS	Horizontal Situation Indicator
ISS	International Space Station Program
ISSP	International Space Station Program
IUS	Inertial Upper Stage
IV	Intravehicular
IVA	Intravehicular Activity
JSC	Johnson Space Center
LICR	List of Implemented Change Requests
LOEP	List of Effective Pages
LOS	Loss of Signal
MCC	Mission Control Center
MECO	Main Engine Cutoff
MEDS	Multifunction Electronic Display System
MET	Mission Elapsed Time
MOCR	Mission Operations Control Room
MOD	Mission Operations Directorate
MPLM	Multipurpose Logistics Module
MPV	Manual Procedures Viewer
MS	Mission Specialist
NASA	National Aeronautics and Space Administration
O2	Oxygen
ODF	Operations Data File
OMS	Orbital Maneuvering System
op	open
OpNom	Operations Nomenclature (<i>ISS</i>)
OPR	Office of Primary Responsibility

ops	operations
PCN	Page Change Notice
PDF	Portable Document Format
PDRS	Payload Deployment and Retrieval System
PET	Phase Elapsed Time
PFDF	Payload Flight Data File
PGSC	Payload and General Support Computer
PIC	Procedure Identifier Code
PNOM	Procedural Nomenclature
prep	preparation
PRI	Primary
RCS	Reaction Control
RHC	Rotational Hand Controller
RMS	Remote Manipulator System
S/W	Software
SFOC	Space Flight Operations Contract
sim	simulation
sim pack	simulation package
SM	Systems Management
SMS	Shuttle Mission Simulator
SPTC	Speedbrake/Thrust Control
SSP	Space Shuttle Program
SSR	Special Subroutine
TACAN	Tactical Air Command and Navigation
TBD	To Be Determined
TBS	To Be Sent
THC	Translational Hand Controller
TIG	Time of Ignition
TOC	Table of Contents
TV	Television
VERN	Vernier

APPENDIX B PROOF MARKS

<i>STET, X, X, X</i>	Let it stand; disregard marks	<i>ƒ or ƒ</i>	Delete
<i>⌋</i>	Close up	<i>⌋</i>	Delete and close up
<i>^</i>	Caret; insert where indicated	<i>sp</i>	Spell out or verify spelling
<i>^</i> <i>^</i>	Insert comma, hyphen	<i>⊙, ⊙</i>	Insert period, colon
<i>#, 2#</i>	Leave blank line, two lines	<i>#, 2#</i>	Insert space, two spaces
<i>⌋ or ⌋</i>	Transpose words	<i>~</i>	Transpose letters
<i>¶ or ¶</i>	New paragraph	<i>no ¶ or no ¶</i>	No paragraph
<i>≡</i>	Capitalize	<i>/</i>	Lower case
<i>≡</i> <i>e</i>	Initial letter cap only	<i>⌋ ⌋</i>	Center text
<i>⌋</i>	Move left to point given	<i>⌋</i>	Move right to point given
<i>Ed:...</i>	Note to editor	<i>Auth:...</i>	Note to author
<i>s/b</i>	Should be		

- STET* *ap* *#*
 ¶ The purpose of these paragraphs is to demonstrate the proof marks which are commonly used in preparing FDF and other support mission/documentation.
- no ¶* Use of the above marks, although not all-inclusive, will:
- 1) Provide a common means of communicating intent
 - 2) Avoid ambiguity
 - 3) Shorten the time required for proofing and reviewing proofed manuscripts
- ¶ It is recommended that these marks also be used to denote proposed changes to published FDF books. The marked page can be submitted as an attachment to Form 482 (Crew PROCEDURES change Request).

SAMPLE PARAGRAPHS

The purpose of these two paragraphs is to demonstrate the proofmarks which are commonly used in preparing FDF and other mission support documentation. Use of the above marks, although not all-inclusive, will:

- 1) Provide a common means of communicating intent
- 2) Avoid ambiguity
- 3) Shorten time required for proofing and reviewing proofed manuscripts

It is recommended that these marks also be used to denote proposed changes to published FDF books. The marked page can be submitted as an attachment to Form 482 (Crew Procedures Change Request).

APPENDIX C
ABBREVIATIONS USED IN PROCEDURAL NOMENCLATURE

Note: When appropriate, an abbreviation listed as all capitals may be used as a lower-case or initial cap abbreviation. However, an abbreviation listed only in lower-case letters will not be used as an all-capital abbreviation.

ACCEL	Acceleration
ACK	Acknowledge
ACT	Actuator, Activation
ADAPT, ADP	Adapter
ADV	Advance
AIRLK, A/L	Airlock
ALT	Alternate, Altitude
ALTM	Altimeter
ANT	Antenna
ASC	Ascent
ASSY	Assembly
ATT	Attitude
AUD	Audio
AUX	Auxiliary
AV	Avionics
AZ	Azimuth
B/U	Backup
BATT	Battery
BDY	Body
BKHD	Bulkhead
BLR	Boiler
BRT	Bright
BYP	Bypass
C/W	Caution and Warning
CAB	Cabin
CAMR	Camera
cb	Circuit Breaker
CDR	Commander
CH	Channel
CHGR	Charger
CIRC	Circulation
CKT	Circuit
CL, cl	Close
CLR	Clear
CMD	Command
CNCT	Connect

CNTL	Control
CNTLR	Controller
COMM	Communication
COND	Condition
CONT	Contingency, Continue
CRIT	Critical
CTR	Center
DECR	Decrease
DEV	Develop
DISC	Discrete
DISCH	Discharge
DISCNCT	Disconnect
DISENG	Disengage
DISP	Display
DN	Down
DNLK	Downlink
DPY	Deploy
DR	Drive
DSBL	Disable
EL	Elevation
ELEC	Electric(al)
EMER	Emergency
ENA	Enable
ERR	Error
EVAP	Evaporator
EXEC	Execute
EXP	Experiment
FC	Fuel Cell
FDLN	Feedline
FLP	Flap
FLT	Flight
FREQ	Frequency
ft	Feet, foot
FU	Fuel
FUNC	Function
FWD	Forward
GEN	Generate
GMBL	Gimbal
GND	Ground
H2O	Water
H/W	Hardware
HDLN	Hardline

HDW	Hardware
He	Helium
HI	High
HORIZ	Horizontal
HTR	Heater
HUM	Humidity
HX	Heat Exchanger
HYD	Hydraulic
I/F	Interface
I'CNCT	Interconnect
ICOM	Intercom
in	Inch
INBD	Inboard
INCR	Increase
Ind	Indicator
INH	Inhibit
INIT	Initiate
INST	Instrument
INTCHGR, ICH	Interchanger
INTERM	Intermediate
ISOL	Isolation
L	Left
LAT	Latch
LDG	Landing
LK	Link
LN	Line
LO	Low
LOC	Location
LT, It	Light
LTG	Lighting
MAJ	Major
MAN	Manual
MANF	Manifold
MAX	Maximum
MECH	Mechanical
MED	Medium
MEM	Memory
MN	Main
MNVR	Maneuver
MON	Monitor
MSG	Message
MSN	Mission

MSTR	Master
NAV	Navigation
NITE	Night
NORM	Normal
NOZ	Nozzle
O2	Oxygen
OP, op	Open
OPER	Operate
OPR	Operator
OPS	Operation(s)
ORB	Orbiter
OSC	Oscillator
OUTBD	Outboard
OVR	Over
OVHD	Overhead
OXID	Oxidizer
P	Pitch
PARAM	Parameter
pb	Pushbutton
PED	Pedestal
PL	Payload
PLBK	Playback
PLT	Pilot
PNEU	Pneumatics
PNL	Panel
POSN	Position
PRESS	Pressure
PRI	Primary
PROP	Propellant, Propulsion
PTG	Pointing
PWR	Power
QTY	Quantity
R	Right, Roll
RAD	Radiator
RCD	Record
RCDR	Recorder
RCV	Receive
RDR	Radar
RDY	Ready
REAC	Reactant(s)
REF	Reference
REG	Regulator

REHYD	Rehydration
REJ	Reject
REL	Release
REQD, reqd	Required
RLF	Relief
RNG	Range
ROT	Rotation
RTN	Return
S/C	Spacecraft
S/W	Software
SAT	Saturation
SEC	Secondary
SEL	Select
SEP	Separation
SEQ	Sequence
SHUTDN	Shutdown
SIG	Signal
SNSR	Sensor
SPDBK	Speedbrake
SPKR	Speaker
SPLY	Supply
STAT	Status
STBD	Starboard
STBY	Standby
STO	Stow, Stowed
STR	Strength
sw	Switch
SYS	System
T/R	Transmit/Receive
tb	Talkback
TBL	Table
TEMP	Temperature
TERM	Terminate
TK	Tank
TLM	Telemetry
TNL	Tunnel
TW, tw	Thumbwheel
UMB	Umbilical
UPLK	Uplink
UTIL	Utility
VAC	Vacuum
VAR	Variable

VEL	Velocity
VERN	Vernier
VLV	Valve
VOL	Volume
VOLT	Voltage
XCVR	Transceiver
XDCR	Transducer
XFER	Transfer
XMIT	Transmit
XOVR	Crossover
Y	Yaw