

# All Vehicle D&C Procedural Nomenclature

## STS-121 (ULF1.1) Flight Supplement

---

**APCU/OIU/MPLM**

**Mission Operations Directorate  
Operations Division**

**Final  
May 5, 2006**

National Aeronautics and  
Space Administration

Lyndon B. Johnson Space Center  
Houston, Texas





MISSION OPERATIONS DIRECTORATE

**ALL VEHICLE D&C PROCEDURAL NOMENCLATURE  
PANEL CONFIGURATION  
STS-121 (ULF1.1) FLIGHT SUPPLEMENT**

Final  
May 5, 2006

PREPARED BY:

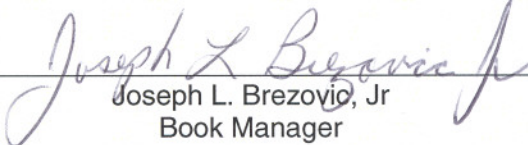
  
\_\_\_\_\_  
Joseph L. Brezovic, Jr  
Book Manager

APPROVED BY:

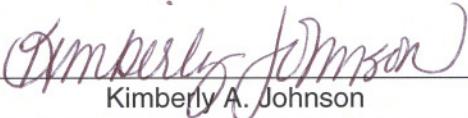
  
\_\_\_\_\_  
Kimberly A. Johnson  
Manager, Shuttle Procedures Management

This document is under the configuration control of the Crew Procedures Control Board (CPCB). All proposed changes must be submitted via FDF Workflow.

Distribution of this book is electronic format only. Requests for limited numbers of hard copies may be submitted via email to DO3/Book Manager and must include justification.

Incorporates the following:	
482#:	PNOM-0008 PNOM-0014 PNOM-0015 PNOM-0022

AREAS OF TECHNICAL RESPONSIBILITY

Book Manager

Joseph L. Brezovic, Jr

281-244-8325

## NOTES CONCERNING THE STRUCTURE AND PURPOSE OF THIS DOCUMENT

1. This flight supplement provides a standard nomenclature reference source for writing payloads-related crew procedures.
2. This publication addresses STS-121 panel configurations and locations along with the corresponding procedural nomenclature. The format in this flight supplement is analogous to that found in the All Vehicle D&C Procedural Nomenclature.
3. The reader should also reference the notes section of the baseline All Vehicle D&C Procedural Nomenclature for other information pertinent to the use of this supplement.
4. The sources of panel information in this document are
  - Spacecraft Operator Training Group and United Space Alliance Engineering Group “Spacecraft Operators Reference Manual (SORM).”  
<http://usago1.ksc.nasa.gov/usago/orgs/VP005/Sorm1/tocvol1.cfm>. February 16, 2005.
  - Flight Requirements Document (NSTS 17462-121 Rev 013 11-30-2005)
  - Crew Compartment Config DWG STS-121, DWG NO SGD32104444, Engineering Design Control Center.  
<http://edcc.isc.nasa.gov/edccsearch/>

Comments concerning this document should be submitted via email to DO3/J. Brezovic, International Operations Procedures Branch, telephone 281-244-8325.

This Page Intentionally Blank

## CONTENTS

### SWITCH IDENTITY LEGEND

### FLIGHT DECK AFT CONFIGURATION

- L10      Digital Television (DTV)/Shuttle Downlink Data Multiplexer (MUX)  
          Video Input Panel (VIP)  
          Video Tape Recorder (VTR)
  
- L11      Payload Data Interface Panel (PDIP 2)
  
- Standard Switch Panels (SSPs)
- L12      Combined SSP  
          Assembly Power Converter Unit (APCU)/Orbiter Interface Unit (OIU)/Multi Purpose  
          Logistics Module (MPLM)  
          SSP 2 MPLM Keel Cam  
          Payload Data Interface Panel (PDIP 1)
  
- R12      Wireless Video Combined Panels  
          Video Processing Unit (VPU)  
          Wireless Video System  
          Orbiter Space Vision System (OSVS) Patch Panel (OPP)  
          Orbiter Boom Sensor System (OBSS)

This Page Intentionally Blank



## SYMBOL IDENTITY LEGEND

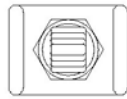

- THREE-POSITION SWITCH (SW)



- THREE-POSITION TALKBACK (TB)



- INDICATORS FOR MOMENTARY SWITCH POSITION

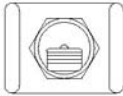

- TWO-POSITION SWITCH (SW)



- TWO-POSITION TALKBACK (TB)

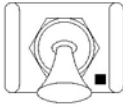

- TWO-POSITION LEVER LOCK (LL)  
\* ■ \* INDICATES LOCKED POSITION ON BOTTOM

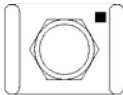

- THREE POSITION LEVER LOCK (LL)  
\* ■ \* INDICATES LOCKED POSITION ON TOP

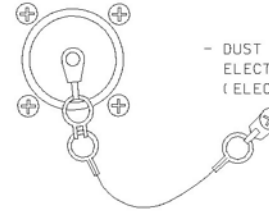

- DUST CAP WITH LANYARD COVERING ELECTRICAL CONNECTOR (ELECT CONN)



- CIRCUIT BREAKER (CB) (PUSH TO CLOSE)

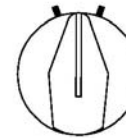

- ROTARY SELECT SWITCH (SEL)

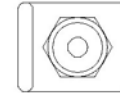

- THREE POSITION TOGGLE (SW)



- TWO-POSITION TOGGLE SWITCH (SW)



- PUSH BUTTON INDICATOR LIGHTS UP WHEN IN 'ON' POSITION



- 3-WAY SOLENOID VALVE

19409F\_SWIL. ART# 2

## SYMBOL IDENTITY LEGEND (Cont)

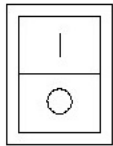

- TWO POSITION ROCKER SWITCH



- LED LIGHT



- PHONE CONNECTOR JACK



- CONNECTOR (PIN HOLES NOT SPECIFIC)

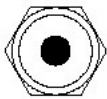

- COAXIAL CONNECTOR



- REMOTE SENSOR

19409F016\_121. ART: 1

# FLIGHT DECK AFT CONFIGURATION

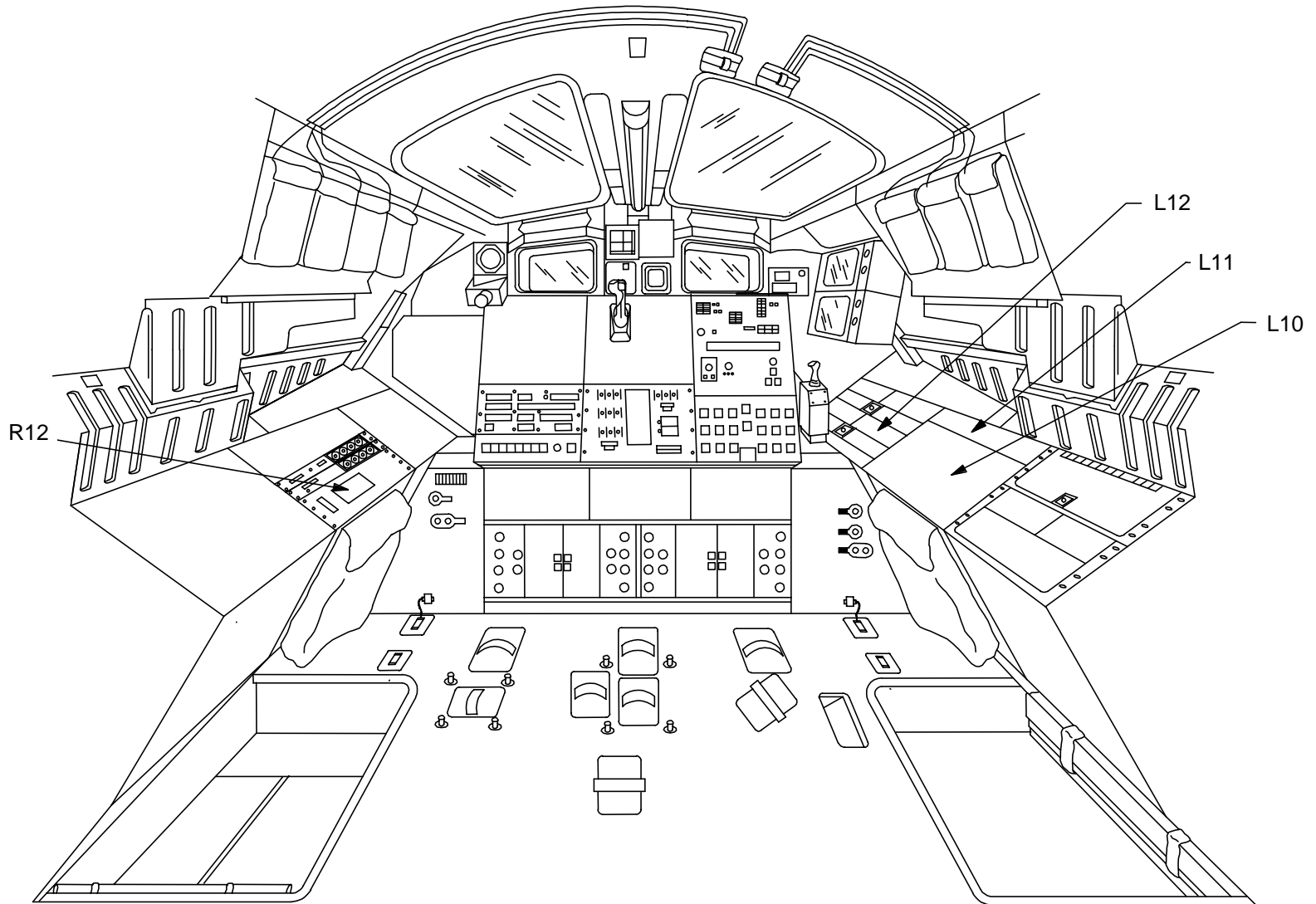

19409001\_121.PNL, 1

This Page Intentionally Blank

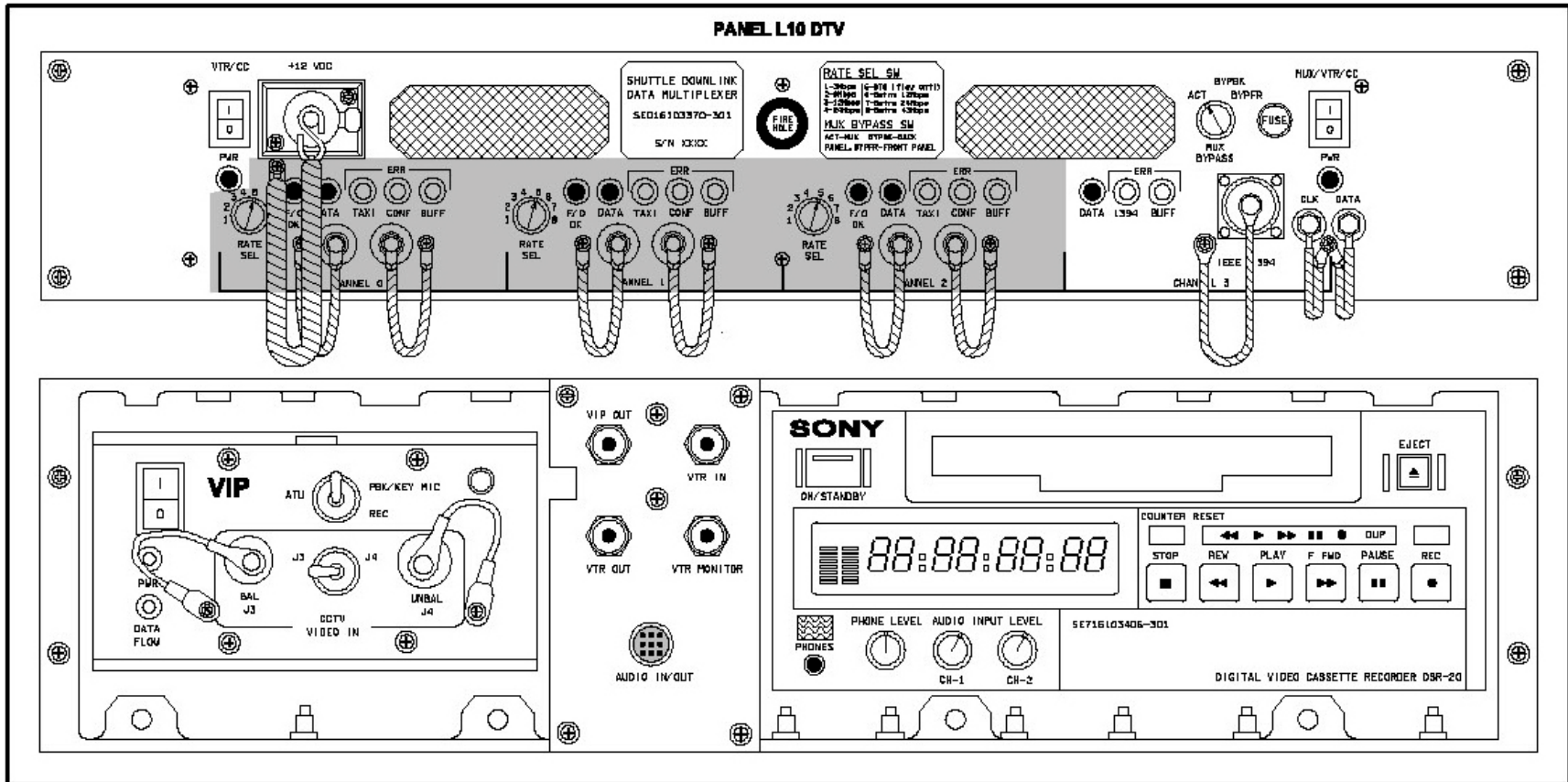

19409F002\_121.PNL\_1

■ Note: This area not applicable for STS-121

PANEL NOMENCLATURE

L10

DTV/SHUTTLE DOWNLINK DATA MULTIPLEXER

VTR/CC PWR – |  
– O

VTR/CC PWR – (LED It)

+12 VDC connector

MUX BYPASS – ACT  
– BYPBK  
– BYPFR

FUSE

MUX/VTR/CC – |  
– O

CHANNEL 3 DATA – (LED It)

CHANNEL 3 ERR 1394 – (LED It)

CHANNEL 3 ERR BUFF – (LED It)

CHANNEL 3 IEEE 1394 connector

CHANNEL 3 MUX/VTR/CC PWR – (LED It)

CHANNEL 3 CLK connector

DATA connector

PROCEDURE NOMENCLATURE

L10

DTV/MUX

VTR/CC PWR – on  
– off

VTR/CC PWR LED – LED on  
– LED off

+12 VDC conn

MUX BYPASS – ACT  
– BYPBK  
– BYPFR

FUSE

MUX/VTR/CC PWR – on  
– off

CH 3 DATA – LED on  
– LED off

CH 3 ERR 1394 – LED on  
– LED off

CH 3 ERR BUFF – LED on  
– LED off

CH 3 IEEE 1394 conn

CH 3 MUX/VTR/CC PWR – LED on  
– LED off

CH 3 CLK conn

DATA conn

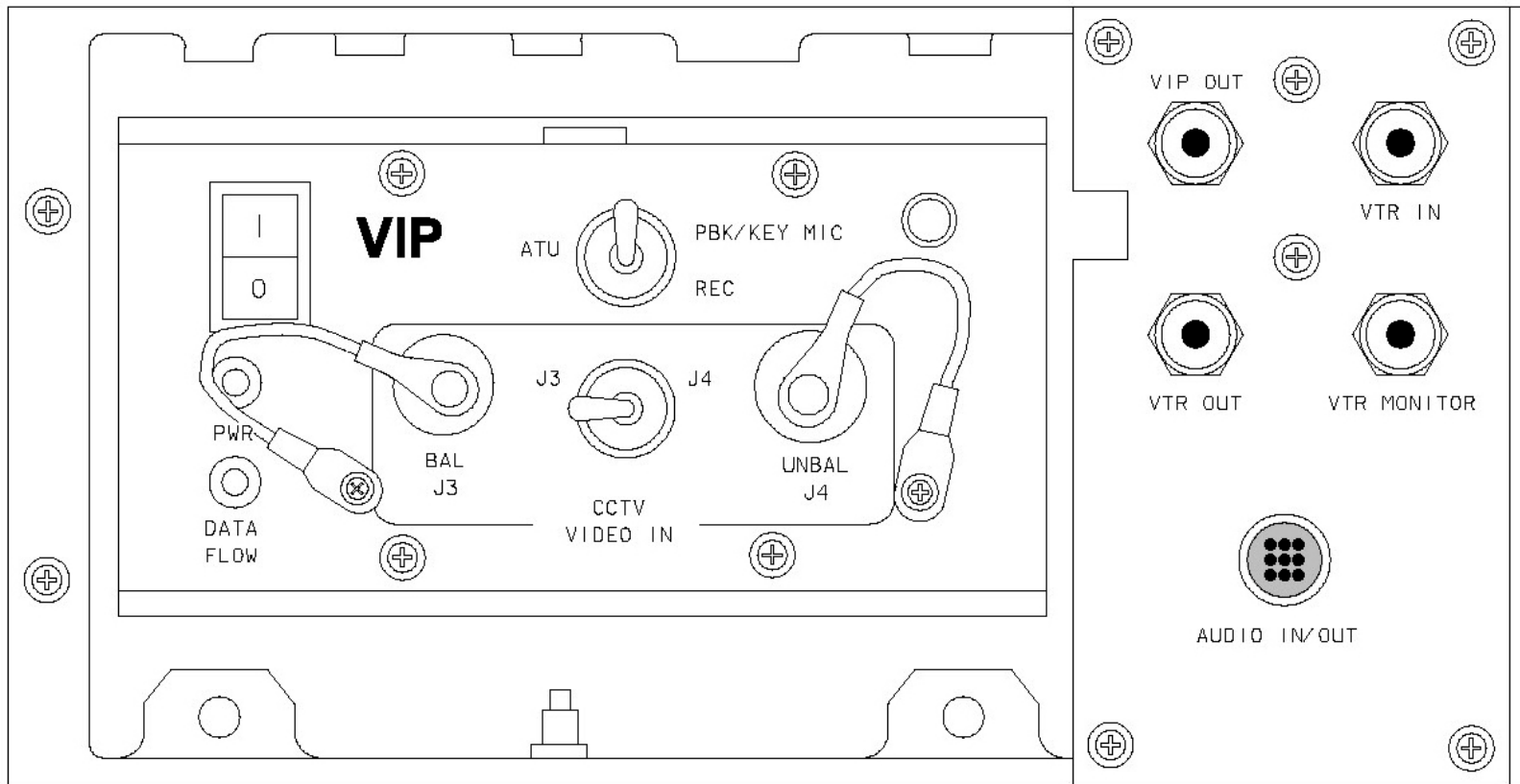

19409F009\_121. PNL 1

PANEL NOMENCLATURE

L10 (Cont)

VIP

VIP – |  
– O

ATU – PBK/KEY MIC  
– REC

PWR – (LED It)

DATA FLOW – (LED It)

CCTV VIDEO IN BAL – J3

CCTV VIDEO IN – J3  
– J4

CCTV VIDEO IN UNBAL – J4

VIP OUT coaxial connector

VTR IN coaxial connector

VTR OUT coaxial connector

VTR MONITOR coaxial connector

AUDIO IN/OUT connector

PROCEDURE NOMENCLATURE

L10 (Cont)

VIP

VIP PWR – on  
– off

ATU – PBK/KEY MIC  
– REC

PWR – LED on  
– LED off

DATA FLOW – LED on  
– LED off

BAL conn

CCTV VIDEO IN – J3  
– J4

UNBAL conn

VIP OUT conn

VTR IN conn

VTR OUT conn

VTR MONITOR conn

AUDIO IN/OUT conn



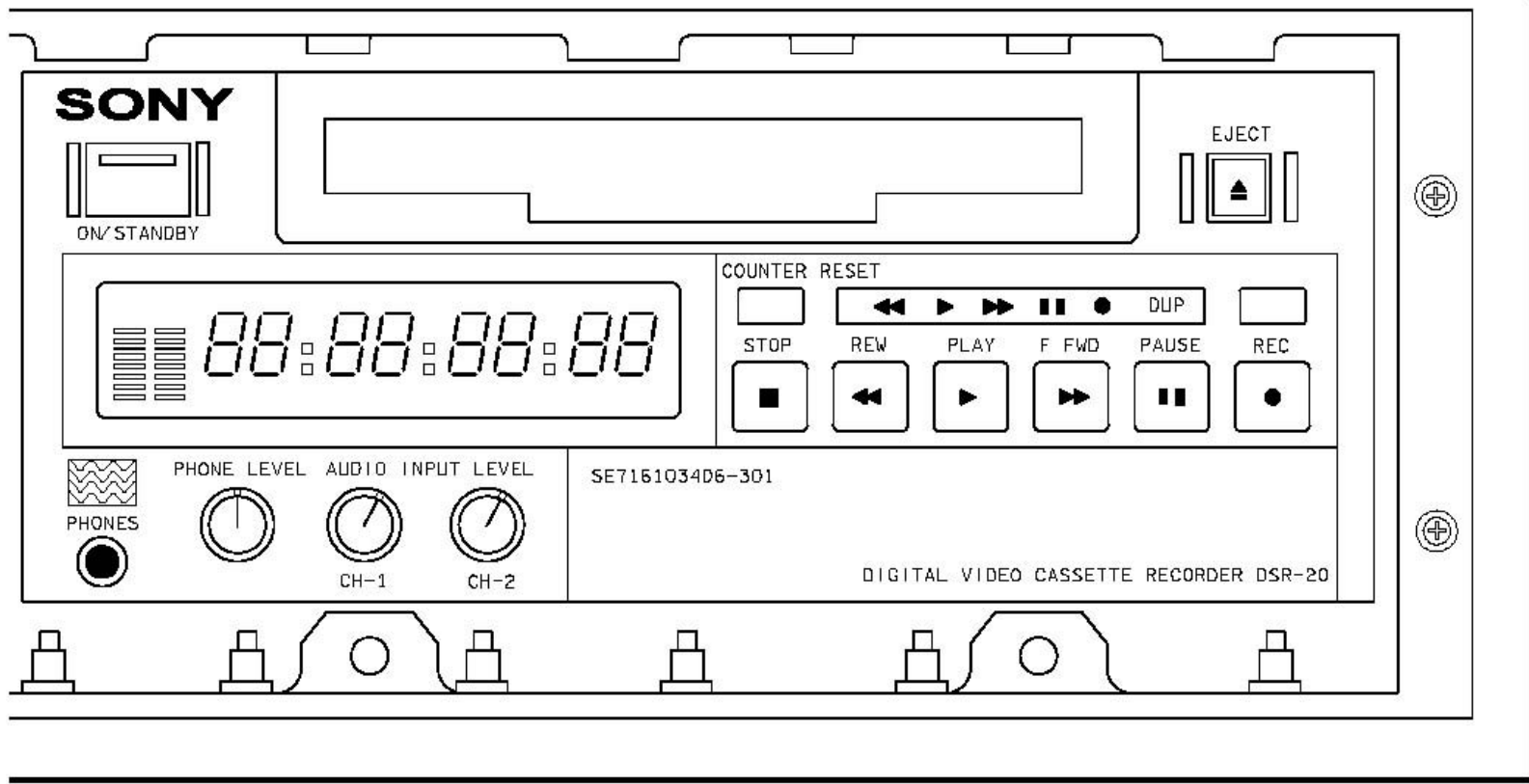

19409F013\_121.PNL; 1

## PANEL NOMENCLATURE

L10 (Cont)

VTR

ON/STANDBY – (pb)

EJECT – (pb)

Display – (LED level Its two columns: left Audio Channel 1,  
right Audio Channel 2)

Timer – (LED Its numbers)

COUNTER RESET – (pb)

STOP – (pb)

REW – (pb)

PLAY – (pb)

F FWD – (pb)

PAUSE – (pb)

REC – (pb)

DUP – (pb) N/A

PHONES connector jack

PHONE LEVEL select

AUDIO INPUT LEVEL CH-1 select

AUDIO INPUT LEVEL CH-2 select

## PROCEDURE NOMENCLATURE

L10 (Cont)

VTR

ON/STANDBY pb – push (LED on)  
– push (LED off)

EJECT pb – push

Display – (LED channel level on)

Timer – (LED numbers)

COUNTER RESET pb – push (display numbers go to 0)

STOP pb – push (LED indicators off)

REW pb – push (LED double left arrow on)

PLAY pb – push (LED right arrow on)

F FWD pb – push (LED double right arrow on)

PAUSE pb – push (LED double vertical arrows on)

REC pb – push (LED dot on)

DUP pb – N/A

Phones jack

PHONE LEVEL sel – as reqd

AUDIO INPUT LEVEL CH-1 sel – as reqd (display left column)

AUDIO INPUT LEVEL CH-2 sel – as reqd (display right column)

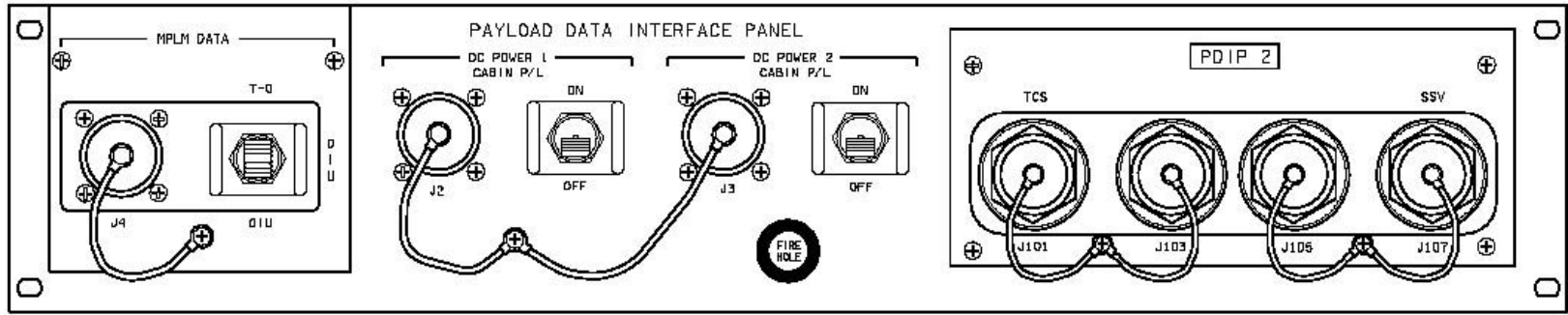

19409F007\_121. PNL, 1

PANEL NOMENCLATURE

L11

PAYLOAD DATA INTERFACE PANEL

MPLM DATA outlet

MPLM DATA – T-O  
– OIU  
– OIU

DC POWER 1 CABIN P/L outlet

DC POWER 1 CABIN P/L – ON  
– OFF

DC POWER 2 CABIN P/L – outlet

DC POWER 2 CABIN P/L – ON  
– OFF

TCS connector

SSV connector

PROCEDURE NOMENCLATURE

L11

PDIP 2

MPLM DATA outlet

MPLM DATA – T-O  
– OIU  
– OIU

DC PWR 1 outlet

DC PWR 1 – ON  
– OFF

DC PWR 2 outlet

DC PWR 2 – ON  
– OFF

TCS conn

SSV conn

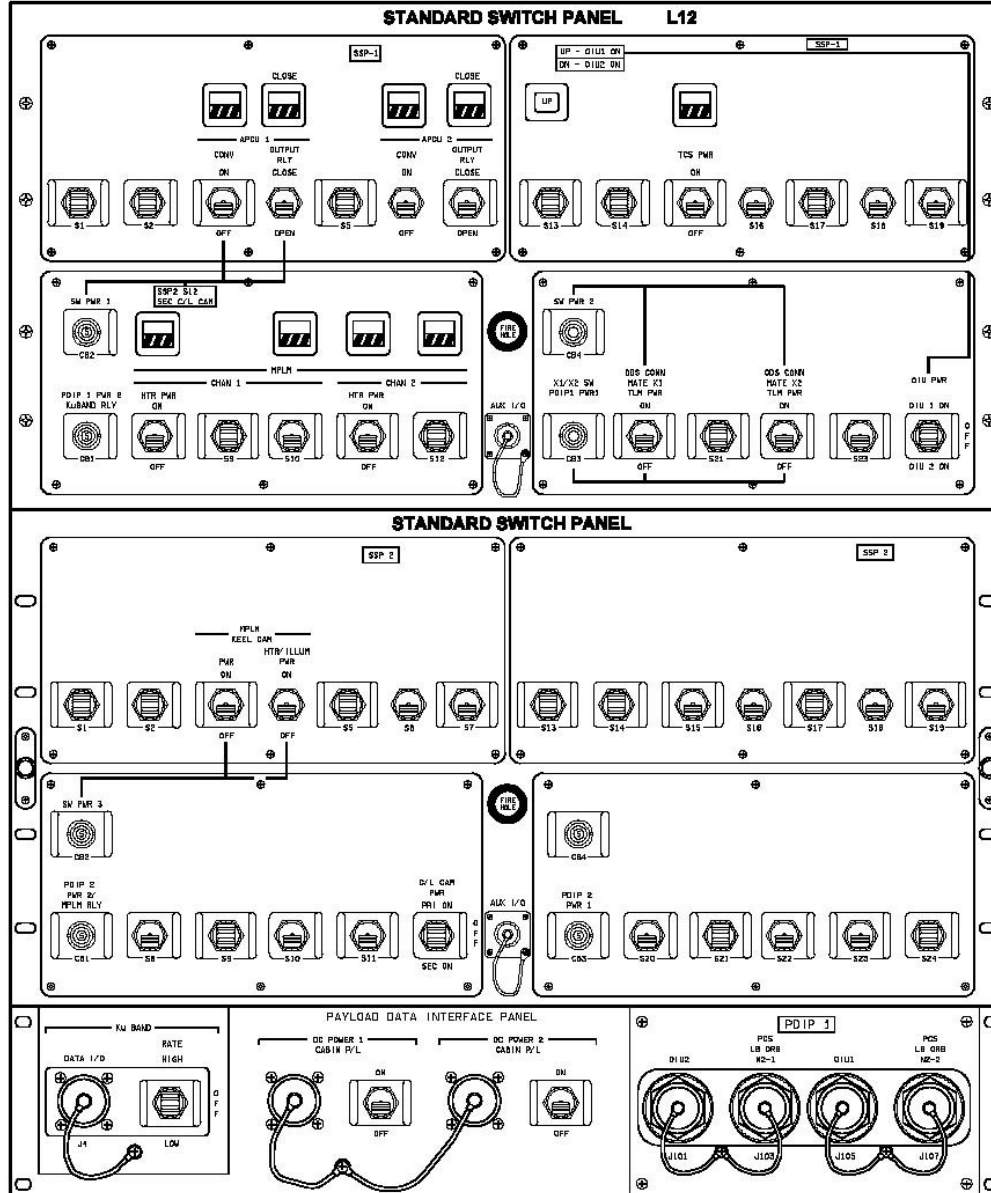

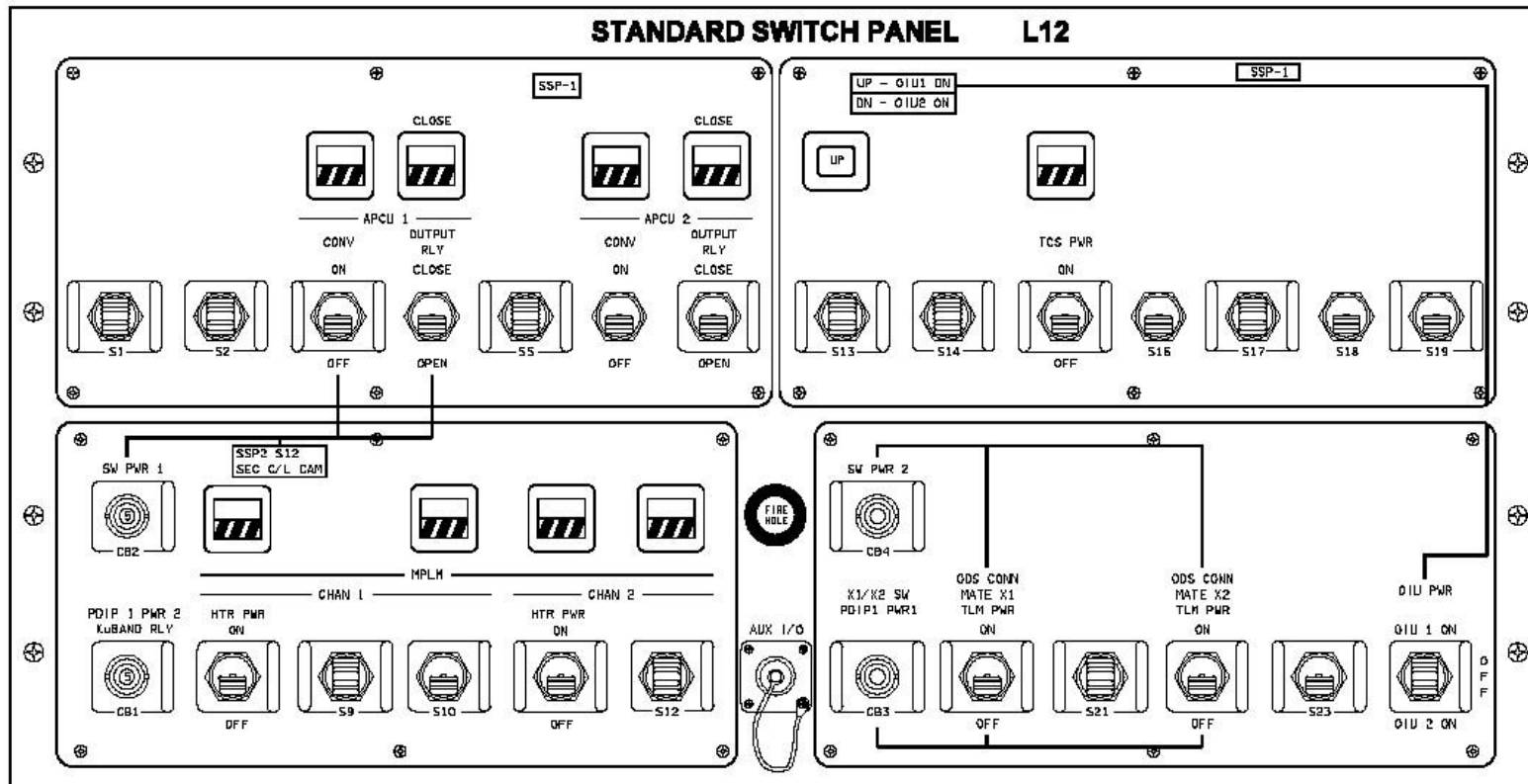

19409F004\_121. PNL 1

PANEL NOMENCLATURE

L12

APCU/OIU/MPLM

APCU 1 CONV – ON  
– OFF

APCU 1 CONV – (tb)

APCU 1 OUTPUT RLY – CLOSE  
– OPEN

APCU 1 CLOSE – (tb)

APCU 2 CONV – ON  
– OFF

APCU 2 CONV – (tb)

APCU 2 OUTPUT RLY – CLOSE  
– OPEN

APCU 2 CLOSE – (tb)

OIU PWR – (tb)

TCS PWR – ON  
– OFF

TCS PWR – (tb)

SW PWR 1 – (cb)

MPLM CHAN 1 HTR PWR ON – (tb)

MPLM CHAN 2 HTR PWR ON – (tb)

PDIP 1 PWR 2 KuBAND RLY – (cb)

PROCEDURE NOMENCLATURE

L12

APCU/OIU/MPLM

APCU 1 CONV – ON  
– OFF

APCU 1 CONV tb – gray  
– bp

APCU 1 OUTPUT RLY – CL  
– OP

APCU 1 CLOSE tb – gray  
– bp

APCU 2 CONV – ON  
– OFF

APCU 2 CONV tb – gray  
– bp

APCU 2 OUTPUT RLY – CL  
– OP

APCU 2 CLOSE tb – gray  
– bp

OIU PWR tb – UP (OIU 1 ON)  
– bp  
– DN (OIU 2 ON)

TCS PWR – ON  
– OFF

TCS PWR tb – gray  
– bp

cb SW PWR 1 – op  
– cl

MPLM CHAN 1 HTR PWR ON tb – gray  
– bp

MPLM CHAN 2 HTR PWR ON tb – gray  
– bp

cb PDIP 1 PWR 2/KuBAND RLY – op  
– cl

PANEL NOMENCLATURE

L12 (Cont)

APCU/OIU/MPLM

SW PWR 2 – (cb)

X1/X2 SW PDIP1 PWR1 – (cb)

ODS CONN MATE X1 TLM PWR – ON  
– OFF

ODS CONN MATE X2 TLM PWR – ON  
– OFF

OIU PWR – OIU 1 ON  
– OFF  
– OIU 2 ON

PROCEDURE NOMENCLATURE

L12 (Cont)

APCU/OIU/MPLM

cb SW PWR 2 – op  
– cl

cb X1/X2 SW PDIP1 PWR1 – op  
– cl

ODS CONN MATE X1 TLM PWR – ON  
– OFF

ODS CONN MATE X2 TLM PWR – ON  
– OFF

OIU PWR – OIU 1 ON  
– OFF  
– OIU 2 ON



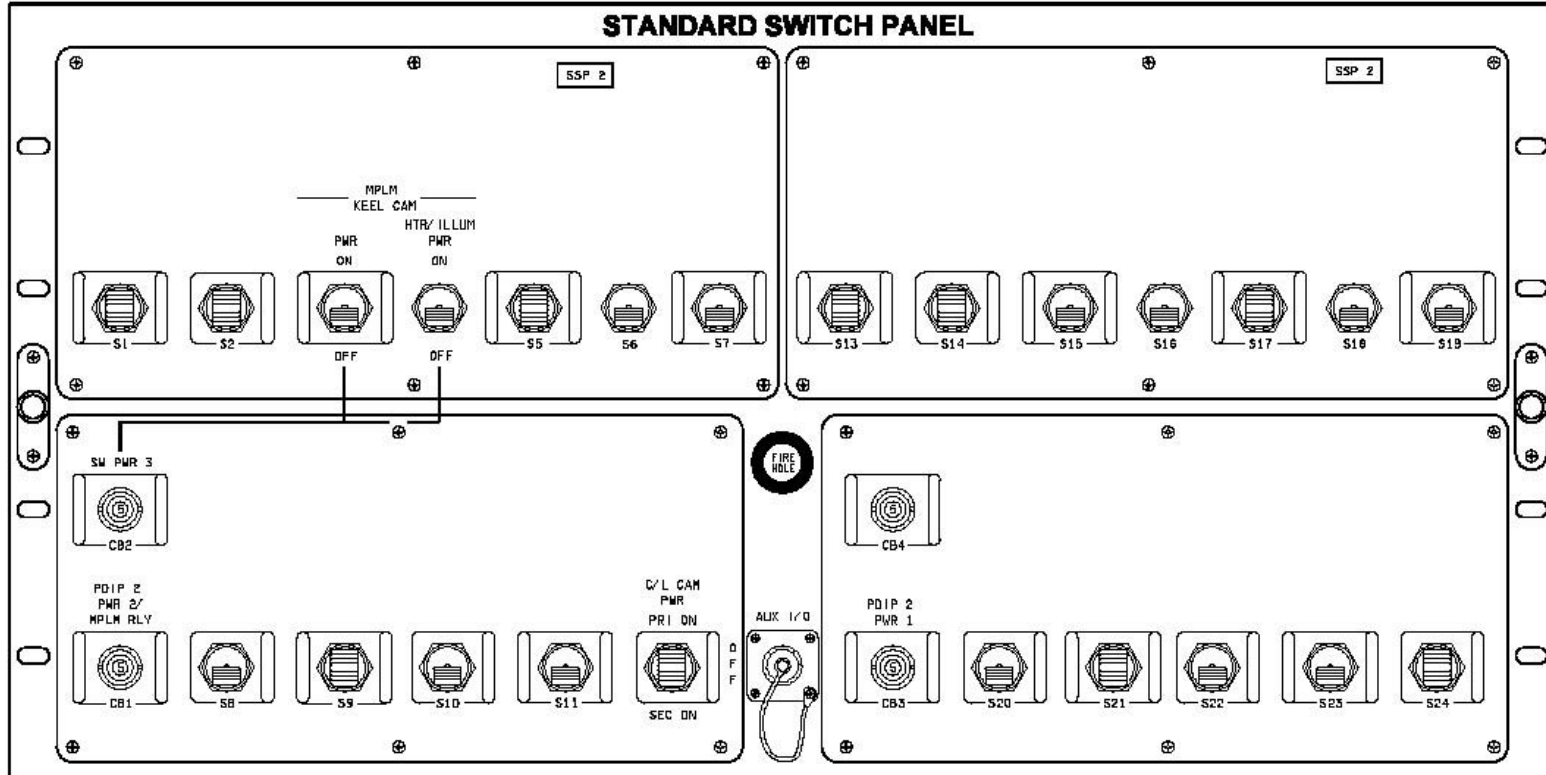

19409F005\_121. PNL 1

PANEL NOMENCLATURE

L12 (Cont)

STANDARD SWITCH PANEL SSP 2 MPLM KEEL CAM

KEEL CAM PWR – ON  
– OFF

KEEL CAM HTR/ILLUM PWR – ON  
– OFF

SW PWR 3 – (cb)

PDIP 2 PWR 2/MPLM RLY – (cb)

C/L CAM PWR – PRI ON  
– OFF  
– SEC ON

PDIP 2 PWR 1 – (cb)

PROCEDURE NOMENCLATURE

L12 (Cont)

MPLM KEEL CAM

KEEL CAM PWR – ON  
– OFF

KEEL CAM HTR/ILLUM PWR – ON  
– OFF

cb SW PWR 3 – op  
– cl

cb PDIP 2 PWR 2/MPLM RLY – op  
– cl

C/L CAM PWR – PRI ON  
– OFF  
– SEC ON

cb PDIP 2 PWR 1 – op  
– cl

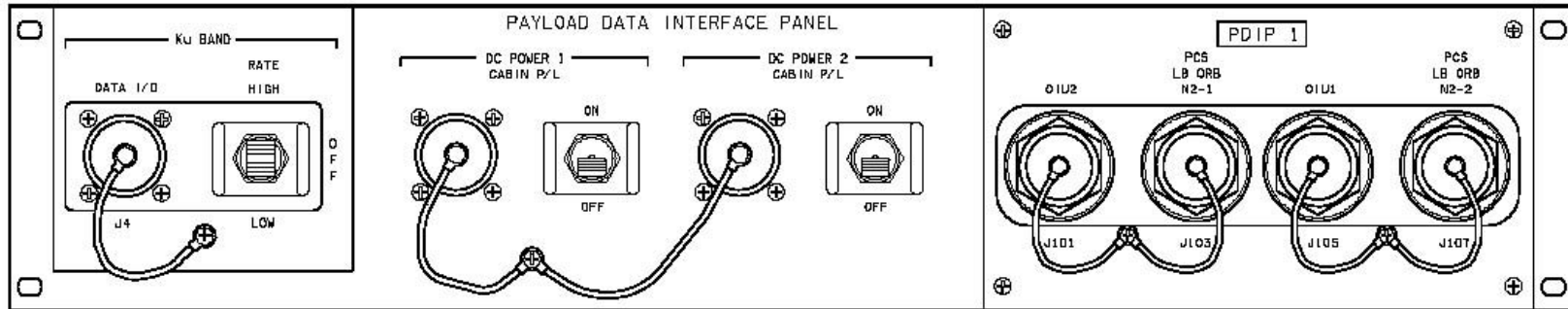

19409F006\_121. PNL, 1

PANEL NOMENCLATURE

L12 (Cont)

PAYLOAD DATA INTERFACE PANEL

Ku BAND DATA I/O connector

Ku BAND RATE – HIGH  
– OFF  
– LOW

DC POWER 1 CABIN P/L – outlet

DC POWER 1 CABIN P/L – ON  
– OFF

DC POWER 2 CABIN P/L – outlet

DC POWER 2 CABIN P/L – ON  
– OFF

OIU2 connector

PCS LB ORB N2-1 connector

OIU1 connector

PCS LB ORB N2-2 connector

PROCEDURE NOMENCLATURE

L12 (Cont)

PDIP 1

Ku BAND DATA I/O conn

Ku BAND RATE – HI  
– OFF  
– LO

DC PWR 1 outlet

DC PWR 1 – ON  
– OFF

DC PWR 2 outlet

DC PWR 2 – ON  
– OFF

OIU2 conn

PCS LB ORB N2-1 conn

OIU1 conn

PCS LB ORB N2-2 conn

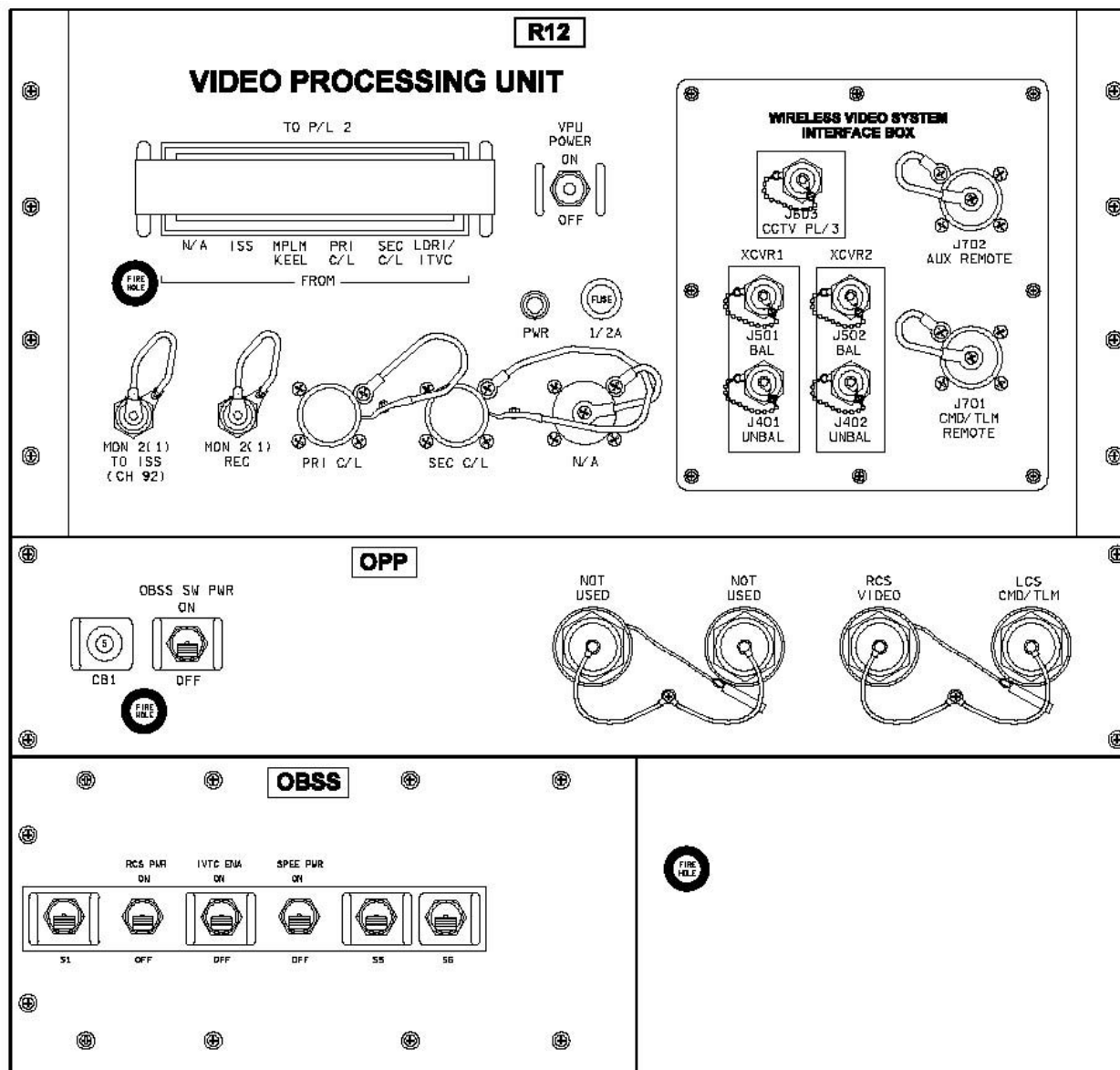

19409F008\_121\_PNL 1

**R12**

# VIDEO PROCESSING UNIT

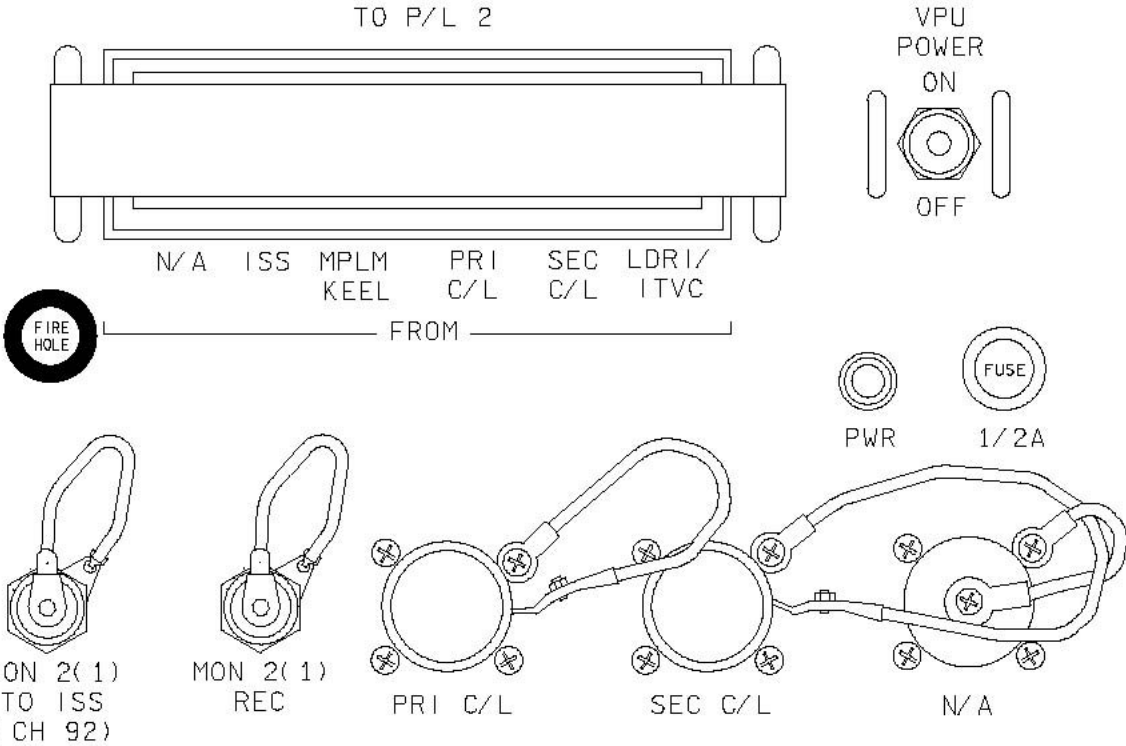

19409F010\_121. PNL; 1

PANEL NOMENCLATURE

R12

VIDEO PROCESSING UNIT

(Velcro strap covers jumper plugs)

- jumper – N/A
- ISS
- MPLM KEEL
- PRI C/L
- SEC C/L
- LDRI/ITVC

VPU POWER – ON  
– OFF

PWR – (LED It)

1/2A fuse

MON 2(1) TO ISS (CH 92) connectors

MON 2(1) REC connectors

PRI C/L connectors

SEC C/L connectors

PROCEDURE NOMENCLATURE

R12

VPU

(Velcro strap covers jumper plugs)

- jumper – N/A
- ISS
- MPLM KEEL
- PRI C/L
- SEC C/L
- LDRI/ITVC

VPU PWR – ON  
– OFF

PWR – LED on  
– LED off

1/2A fuse

MON 2(1) to ISS (CH 92) conn

MON 2(1) REC conn

PRI C/L conn

SEC C/L conn

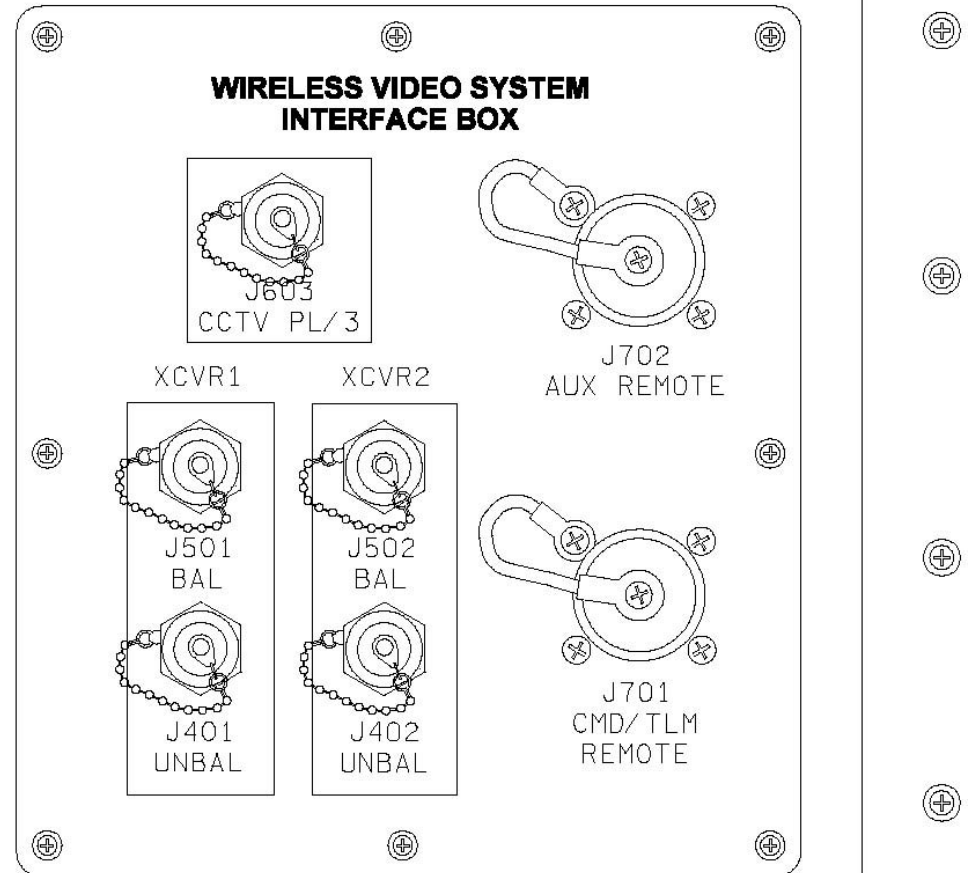

19409F011\_121.PNL# 1



PANEL NOMENCLATURE

R12 (Cont)

WIRELESS VIDEO SYSTEM

J603 CCTV PL/3 connector

J702 AUX REMOTE connector

XCVR1 J501 BAL connector

XCVR1 J401 UNBAL connector

XCVR2 J502 BAL connector

XCVR2 J402 UNBAL connector

J701 CMD/TLM REMOTE connector

PROCEDURE NOMENCLATURE

R12 (Cont)

WIRELESS VIDEO SYSTEM

CCTV PL/3 conn

AUX REMOTE conn

XCVR1 BAL conn

XCVR1 UNBAL conn

XCVR2 BAL conn

XCVR2 UNBAL conn

CMD/TLM REMOTE conn

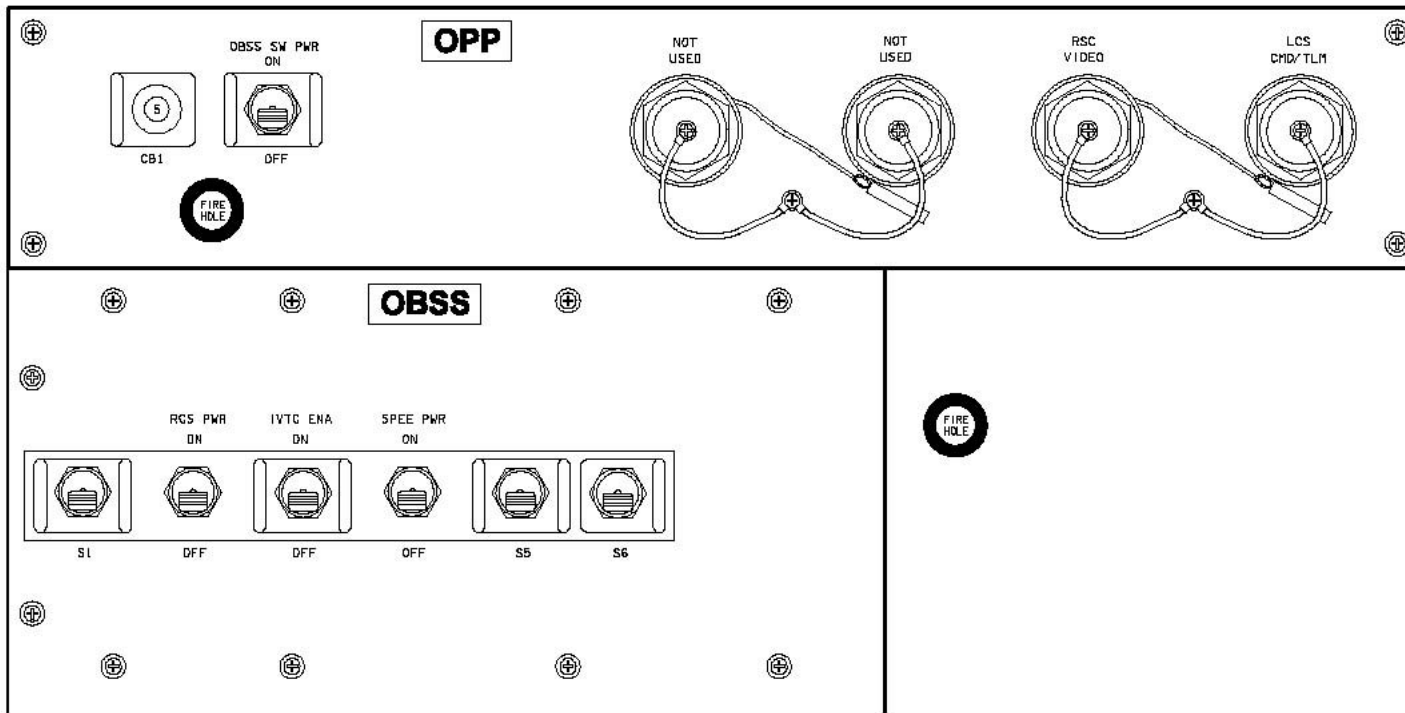

19409F015\_121. PNL# 1

PANEL NOMENCLATURE

R12 (Cont)

OPP

OBSS SW PWR – (cb)

OBSS SW PWR – ON  
– OFF

RCS VIDEO connector

LCS CMD/TLM connector

OBSS

RCS PWR – ON  
– OFF

ITVC ENA – ON  
– OFF

SPEE PWR – ON  
– OFF

PROCEDURE NOMENCLATURE

R12 (Cont)

OPP

cb OBSS SW PWR – op  
– cl

OBSS SW PWR – ON  
– OFF

RCS VIDEO conn

LCS CMD/TLM conn

OBSS

RCS PWR – ON  
– OFF

ITVC ENA – ON  
– OFF

SPEE PWR – ON  
– OFF

This Page Intentionally Blank