

# PDRS Operations Checklist

**Mission Operations Directorate  
EVA, Robotics, & Crew Systems  
Operations Division**

**Generic, Rev F  
February 23, 2007**

**NOTE**

For STS-117 and subsequent flights per schedule

National Aeronautics and  
Space Administration

**Lyndon B. Johnson Space Center**  
Houston, Texas





PDRS OPERATIONS CHECKLIST

GENERIC, REV F (February 23, 2007)

## PCN-2 (July 20, 2007) Sheet 1 of 1

List of Implemented Change Requests (482s):

PDRS-1054

PDRS-1055

**NOTE**

For STS-118 and subsequent flights

Incorporate the following:

1. Replace iii thru viii
2. Replace 1-3 and 1-4
3. Replace 2-3 and 2-4
4. Replace 4-1 thru 4-4
5. Replace section 7 (122 pages)
6. Replace 11-3 and 11-4
7. Replace CC 12-3 and CC 12-4

Prepared by:

  
Book Manager

Approved by:

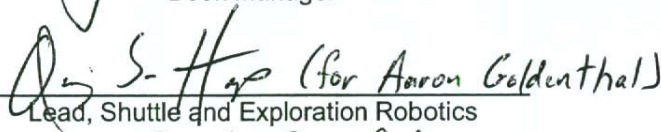
  
Lead, Shuttle and Exploration Robotics  
Operations Group

Accepted by:

  
Chief, Robotics Operations Branch

Encl: 140 pages

**File this PCN immediately behind the front cover as a permanent record**



<b>PDRS OPERATIONS CHECKLIST</b>	<b>GENERIC, REV F (February 23, 2007)</b>
----------------------------------	---

**PCN-1 (May 18, 2007) Sheet 1 of 1**

List of Implemented Change Requests (482s):

- PDRS-1050
- PDRS-1051
- PDRS-1052
- PDRS-1053

<p><b>NOTE</b> For STS-117 and subsequent flights</p>
---

Incorporate the following:

1. Replace iii thru vi
2. Replace 7-3 thru 7-8, 7-21 and 7-22, 7-25 and 7-26, 7-31 thru 7-34, 7-39 thru 7-46
3. Replace CC 12-7 and CC 12-8

**Prepared by:**   
 \_\_\_\_\_  
 Book Manager

**Approved by:**   
 \_\_\_\_\_  
 Lead, Shuttle and Exploration Robotics  
 Operations Group

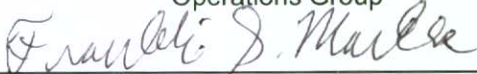
**Accepted by:**   
 \_\_\_\_\_  
 Chief, Robotics Operations Branch

Encl: 28 pages

<b>File this PCN immediately behind the front cover as a permanent record</b>
---



MISSION OPERATIONS DIRECTORATE

**PDRS OPERATIONS CHECKLIST**

GENERIC, REVISION F

February 23, 2007

PREPARED BY:

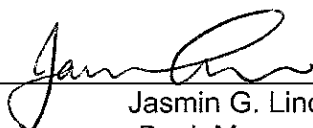

Jasmin G. Lindo  
Book Manager

APPROVED BY:



Aaron D. Goldenthal  
Lead, Robotics Systems Group

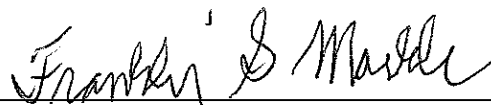

Franklin S. Markle  
Chief, Robotics Operations Branch

This document is under the configuration control of the Crew Procedures Control Board (CPCB). All proposed changes must be submitted via FDF Workflow Crew Procedure Change Request (CR) to DO3/FDF Manager.

Additional distribution of this book, for official use only, may be requested in writing to DO3/PMO Administrator. The request must include justification and requester's name, organization, position, and phone number. Contractor requests are made through the NASA or DOD organization supported. Deletions, reduction in quantity, or change of address may be submitted to DO3/FDF Management Office, 281-244-1184.

Incorporates the following:	
482#:	PDRS-1046 PDRS-1047

AREAS OF TECHNICAL RESPONSIBILITY

Book Manager

DX22/J. Lindo

281-483-5761



PDRS OPERATIONS CHECKLIST

**LIST OF EFFECTIVE PAGES**

GENERIC 08/08/88  
 REV F 02/23/07  
 PCN-1 05/18/07  
 PCN-2 07/20/07

Sign Off.....	*	ALL/GEN F	6-10 .....	ALL/GEN F
ii.....	*	ALL/GEN F	6-11 .....	ALL/GEN F
iii.....	*	ALL/GEN F,2	6-12 .....	ALL/GEN F
iv.....	*	ALL/GEN F,2	6-13 .....	ALL/GEN F
v.....	*	ALL/GEN F,2	6-14 .....	ALL/GEN F
vi.....	*	ALL/GEN F,2	6-15 .....	ALL/GEN F
vii.....	*	ALL/GEN F,2	6-16 .....	ALL/GEN F
viii.....	*	ALL/GEN F	6-17 .....	ALL/GEN F
ix.....		ALL/GEN F	6-18 .....	ALL/GEN F
x.....		ALL/GEN F	6-19 .....	ALL/GEN F
1-1.....		ALL/GEN F	6-20 .....	ALL/GEN F
1-2.....		ALL/GEN F	6-21 .....	ALL/GEN F
1-3.....		ALL/GEN F,2	6-22 .....	ALL/GEN F
1-4.....		ALL/GEN F	6-23 .....	ALL/GEN F
2-1.....		ALL/GEN F	6-24 .....	ALL/GEN F
2-2.....		ALL/GEN F	6-25 .....	ALL/GEN F
2-3.....		ALL/GEN F,2	6-26 .....	ALL/GEN F
2-4.....		ALL/GEN F,2	6-27 .....	ALL/GEN F
3-1.....		ALL/GEN F	6-28 .....	ALL/GEN F
3-2.....		ALL/GEN F	6-29 .....	ALL/GEN F
3-3.....		ALL/GEN F	6-30 .....	ALL/GEN F
3-4.....		ALL/GEN F	6-31 .....	ALL/GEN F
3-5.....		ALL/GEN F	6-32 .....	ALL/GEN F
3-6.....		ALL/GEN F	6-33 .....	ALL/GEN F
3-7.....		ALL/GEN F	6-34 .....	ALL/GEN F
3-8.....		ALL/GEN F	6-35 .....	ALL/GEN F
3-9.....		ALL/GEN F	6-36 .....	ALL/GEN F
3-10.....		ALL/GEN F	6-37 .....	ALL/GEN F
4-1.....		ALL/GEN F	6-38 .....	ALL/GEN F
4-2.....		ALL/GEN F,2	6-39 .....	ALL/GEN F
4-3.....		ALL/GEN F,2	6-40 .....	ALL/GEN F
4-4.....		ALL/GEN F	7-1 .....	ALL/GEN F,2
5-1.....		ALL/GEN F	7-2 .....	ALL/GEN F
5-2.....		ALL/GEN F	7-3 .....	ALL/GEN F,2
6-i.....		ALL/GEN F	7-4 .....	ALL/GEN F,2
6-ii.....		ALL/GEN F	7-5 .....	Δ ALL/GEN F,2
6-1.....		ALL/GEN F	7-6 .....	Δ ALL/GEN F,2
6-2.....		ALL/GEN F	7-7 .....	Δ ALL/GEN F,2
6-3.....		ALL/GEN F	7-8 .....	ALL/GEN F,2
6-4.....		ALL/GEN F	7-9 .....	Δ ALL/GEN F,2
6-5.....		ALL/GEN F	7-10 .....	Δ ALL/GEN F,2
6-6.....		ALL/GEN F	7-11 .....	Δ ALL/GEN F,2
6-7.....		ALL/GEN F	7-12 .....	Δ ALL/GEN F,2
6-8.....		ALL/GEN F	7-13 .....	Δ ALL/GEN F,2
6-9.....		ALL/GEN F	7-14 .....	Δ ALL/GEN F,2

\* – Omit from flight book

Δ – Color page for pre-assigned users

7-15.....	ALL/GEN F,2	7-69.....	ALL/GEN F
7-16.....	Δ ALL/GEN F,2	7-70.....	ALL/GEN F
7-17.....	Δ ALL/GEN F,2	7-71.....	Δ ALL/GEN F
7-18.....	Δ ALL/GEN F,2	7-72.....	Δ ALL/GEN F
7-19.....	Δ ALL/GEN F,2	7-73.....	ALL/GEN F
7-20.....	Δ ALL/GEN F,2	7-74.....	Δ ALL/GEN F
7-21.....	Δ ALL/GEN F,2	7-75.....	Δ ALL/GEN F
7-22.....	Δ ALL/GEN F,2	7-76.....	Δ ALL/GEN F
7-23.....	Δ ALL/GEN F,2	7-77.....	ALL/GEN F
7-24.....	ALL/GEN F,2	7-78.....	ALL/GEN F
7-25.....	Δ ALL/GEN F,2	7-79.....	ALL/GEN F,2
7-26.....	Δ ALL/GEN F,2	7-80.....	Δ ALL/GEN F
7-27.....	ALL/GEN F,2	7-81.....	ALL/GEN F
7-28.....	Δ ALL/GEN F,2	7-82.....	ALL/GEN F
7-29.....	Δ ALL/GEN F,2	7-83.....	Δ ALL/GEN F
7-30.....	Δ ALL/GEN F,2	7-84.....	Δ ALL/GEN F
7-31.....	Δ ALL/GEN F,2	7-85.....	ALL/GEN F
7-32.....	Δ ALL/GEN F,2	7-86.....	Δ ALL/GEN F
7-33.....	Δ ALL/GEN F,2	7-87.....	Δ ALL/GEN F
7-34.....	Δ ALL/GEN F,2	7-88.....	Δ ALL/GEN F
7-35.....	Δ ALL/GEN F,2	7-89.....	Δ ALL/GEN F
7-36.....	Δ ALL/GEN F,2	7-90.....	Δ ALL/GEN F
7-37.....	ALL/GEN F,2	7-91.....	Δ ALL/GEN F
7-38.....	Δ ALL/GEN F,2	7-92.....	Δ ALL/GEN F
7-39.....	Δ ALL/GEN F,2	7-93.....	Δ ALL/GEN F
7-40.....	Δ ALL/GEN F,2	7-94.....	Δ ALL/GEN F
7-41.....	Δ ALL/GEN F,2	7-95.....	Δ ALL/GEN F
7-42.....	Δ ALL/GEN F,2	7-96.....	Δ ALL/GEN F
7-43.....	Δ ALL/GEN F,2	7-97.....	Δ ALL/GEN F
7-44.....	Δ ALL/GEN F,2	7-98.....	Δ ALL/GEN F
7-45.....	Δ ALL/GEN F,2	7-99.....	Δ ALL/GEN F
7-46.....	Δ ALL/GEN F,2	7-100.....	Δ ALL/GEN F
7-47.....	ALL/GEN F,2	7-101.....	Δ ALL/GEN F
7-48.....	ALL/GEN F,2	7-102.....	Δ ALL/GEN F
7-49.....	ALL/GEN F,2	7-103.....	ALL/GEN F,2
7-50.....	ALL/GEN F,2	7-104.....	Δ ALL/GEN F,2
7-51.....	Δ ALL/GEN F,2	7-105.....	Δ ALL/GEN F,2
7-52.....	Δ ALL/GEN F,2	7-106.....	ALL/GEN F
7-53.....	Δ ALL/GEN F	7-107.....	Δ ALL/GEN F
7-54.....	ALL/GEN F	7-108.....	Δ ALL/GEN F
7-55.....	ALL/GEN F	7-109.....	Δ ALL/GEN F,2
7-56.....	Δ ALL/GEN F	7-110.....	Δ ALL/GEN F
7-57.....	ALL/GEN F	7-111.....	Δ ALL/GEN F,2
7-58.....	ALL/GEN F,2	7-112.....	Δ ALL/GEN F,2
7-59.....	Δ ALL/GEN F	7-113.....	Δ ALL/GEN F
7-60.....	Δ ALL/GEN F	7-114.....	Δ ALL/GEN F,2
7-61.....	ALL/GEN F	7-115.....	Δ ALL/GEN F,2
7-62.....	ALL/GEN F,2	7-116.....	Δ ALL/GEN F,2
7-63.....	Δ ALL/GEN F	7-117.....	Δ ALL/GEN F,2
7-64.....	Δ ALL/GEN F	7-118.....	Δ ALL/GEN F
7-65.....	ALL/GEN F	7-119.....	Δ ALL/GEN F
7-66.....	ALL/GEN F	7-120.....	Δ ALL/GEN F,2
7-67.....	Δ ALL/GEN F	7-121.....	Δ ALL/GEN F,2
7-68.....	Δ ALL/GEN F	7-122.....	Δ ALL/GEN F

Δ – Color page for pre-assigned users

8-1	ALL/GEN F	10-41	ALL/GEN F
8-2	ALL/GEN F	10-42	ALL/GEN F
8-3	ALL/GEN F	11-1	ALL/GEN F
8-4	ALL/GEN F	11-2	ALL/GEN F
9-1	ALL/GEN F	11-3	ALL/GEN F,2
9-2	ALL/GEN F	11-4	ALL/GEN F
9-3	ALL/GEN F	11-5	ALL/GEN F
9-4	ALL/GEN F	11-6	ALL/GEN F
9-5	ALL/GEN F	12-1	ALL/GEN F
9-6	ALL/GEN F	12-2	ALL/GEN F
9-7	ALL/GEN F	CC 12-3	ALL/GEN F,2
9-8	ALL/GEN F	CC 12-4	ALL/GEN F,2
9-9	ALL/GEN F	CC 12-5	ALL/GEN F
9-10	ALL/GEN F	CC 12-6	ALL/GEN F
10-1	ALL/GEN F	CC 12-7	ALL/GEN F
10-2	ALL/GEN F	CC 12-8	ALL/GEN F,1
10-3	ALL/GEN F	CC 12-9	ALL/GEN F
10-4	ALL/GEN F	CC 12-10	ALL/GEN F
10-5	ALL/GEN F		
10-6	ALL/GEN F		
10-7	ALL/GEN F		
10-8	ALL/GEN F		
10-9	ALL/GEN F		
10-10	ALL/GEN F		
10-11	ALL/GEN F		
10-12	ALL/GEN F		
10-13	ALL/GEN F		
10-14	ALL/GEN F		
10-15	ALL/GEN F		
10-16	ALL/GEN F		
10-17	ALL/GEN F		
10-18	ALL/GEN F		
10-19	ALL/GEN F		
10-20	ALL/GEN F		
10-21	ALL/GEN F		
10-22	ALL/GEN F		
10-23	ALL/GEN F		
10-24	ALL/GEN F		
10-25	ALL/GEN F		
10-26	ALL/GEN F		
10-27	ALL/GEN F		
10-28	ALL/GEN F		
10-29	ALL/GEN F		
10-30	ALL/GEN F		
10-31	ALL/GEN F		
10-32	ALL/GEN F		
10-33	ALL/GEN F		
10-34	ALL/GEN F		
10-35	ALL/GEN F		
10-36	ALL/GEN F		
10-37	ALL/GEN F		
10-38	ALL/GEN F		
10-39	ALL/GEN F		
10-40	ALL/GEN F		

PDRS OPS CUE CARDS

<u>Title</u>	<u>Ref. Page</u>	<u>Card No.</u>	
GENERIC END EFFECTOR CUE CARD – SHUTTLE NOT DOCKED OPS			
(Front).....	CC 12-3	PDRS-3a/O/K	
(Back).....	CC 12-3	PDRS-3b/O/G	
GENERIC END EFFECTOR CUE CARD – ISS/SHUTTLE DOCKED OPS			
(Front) .....	CC 12-4	PDRS-6a/O/C	
(Back).....	CC 12-4	PDRS-6b/O/A	
GRID OVERLAY .....	CC 12-5	PDRS-4a/O/E	
PDRS TARGET OVERLAY FOR CTVM.....	CC 12-6	PDRS-5a/O/E	
OBSS SCAN PATTERN CUE CARD – STBD & PORT			
(Front) .....	CC 12-7	PDRS-7a/O/A	
OBSS SCAN PATTERN CUE CARD – NOSE CAP			
(Back).....	CC 12-8	PDRS-7b/O/B	
OBSS SCAN PATTERN CUE CARD – WING GLOVE & CREW CABIN			
(Front) .....	CC 12-9	PDRS-8a/O/A	
(Back).....	CC 12-10	PDRS-8b/O/A	

NOTE

The procedures in this book have been developed in accordance with the intent stated in the CIL Retention Rationale and the Hazards Control List, as documented in the following PDRS Flight Rules:

- A12-3        TEMPERATURE CONSTRAINTS [CIL]
- A12-5        ORBITER AVOIDANCE MANEUVERS CONSTRAINT [CIL]
- A12-9        RMS MCIU BITE OVERRIDES [CIL]
- A12-11       ORBITER BOOM SENSOR SYSTEM (OBSS) THERMAL CONSTRAINTS [CIL]
- A12-12       ORBITER BOOM SENSOR SYSTEM (OBSS) POWER CONSTRAINTS [CIL]
- A12-74       INADVERTENT MPM CYCLING PROTECTION [CIL]
- A12-112      FIELD OF VIEW CONSTRAINT [CIL]
- A12-113      AUTO MODE ENTRY CONSTRAINT [CIL]
- A12-114      ORBITER PROXIMITY CONSTRAINTS [CIL]
- A12-115      INOPERATIVE BRAKE CONSTRAINT [CIL]
- A12-116      AUTO BRAKES CONSTRAINT [CIL]
- A12-117      CONTINGENCY STOP [CIL]
- A12-162      EE MODE SWITCH CONSTRAINTS [CIL]
- A12-163      CAPTURE AND RELEASE PROXIMITY CONSTRAINT [CIL]

This Page Intentionally Blank

<u>CONTENTS*</u>	<u>PAGE</u>
ON-ORBIT INITIALIZATION .....	1-1
RMS PWRUP .....	2-1
RMS CHECKOUT .....	3-1
RMS PWRDN .....	4-1
RMS DEACTIVATION .....	5-1
CONTINGENCY OPERATIONS .....	6-i
EXTERIOR SURVEYS .....	6-1
OBSS OPERATIONS .....	7-1
NOMINAL .....	7-3
OFF-NOMINAL .....	7-50
BACKUP CRADLE.....	8-1
RMS JETTISON ASSUMPTIONS AND NOTES.....	9-1
RMS JETTISON .....	9-3
REFERENCE DATA .....	10-1
MISCELLANEOUS PROCEDURES .....	11-1
CUE CARD CONFIGURATION .....	12-1

\*The procedures in this book have been developed in accordance with the intent stated in the CIL Retention Rationale and the Hazards Control List

This Page Intentionally Blank



ON-ORBIT INITIALIZATION

## ON-ORBIT INITIALIZATION

- ON-ORBIT  
INIT
1. RMS AC POWER  
MA73C:F    cb AC1 RMS PRI  $\Phi$ A – cl  
                 AC2 RMS B/U  $\Phi$ A – cl
  2. RMS TEMP MODE  
RMS PWR – PRI (MA)

### NOTE

If calling SPEC 94 for the first time,  
expect MA, GPC DATA It – on

### SM 94 PDRS CONTROL

I/O ON – ITEM 5 EXEC (\*)  
√GPC DATA It – off

SAFING – CANCEL  
√SAFING tb – bp

3. RMS SHOULDER BRACE RELEASE

### NOTE

Expect MA, C/W REACH LIM It – on  
(SP, EP), C/W SINGULAR It – on (EP)  
SM ALERT

RMS SEL – PORT  
√SAFING tb – gray  
SHLDR BRACE REL – PORT (hold for 2 sec following tb-gray)

If motor drive time > 12 sec, √MCC

### NOTE

Spurious fault msgs may occur  
when PORT RMS deselected

RMS SEL – OFF

4. PNL TEST  
Adjust pnl Itg as reqd

### CAUTION

Selection of PARAM – TEST for > 30 sec  
may cause pnl A8 to overheat

PARAM – TEST (MA) (< 30 sec)  
√IND 1,2,3: + 8.8.8.8  
√All A8 Its: on  
PARAM – POS X/Y/Z

5. RMS HTR ACT  
PARAM – PORT TEMP  
JOINT – CRIT TEMP ( $\sqrt{\text{IND}}$  (three) – blank)

If RMS ops not to be performed within 1 hr:

| PORT RMS HTR A(B) – AUTO

If RMS ops to be performed within 1 hr:

PORT RMS HTR (two) – AUTO

STBD RMS HTR (two) – AUTO

- R13L 6. CONFIGURE POWER  
PL BAY MECH PWR SYS (two) – ON

7. PORT MPM DEPLOY

SM 94 PDRS CONTROL

$\sqrt{\text{RMS PORT, ITEM 1}} - (*)$

$\sqrt{\text{PORT MPM DPLY (two)}} = 0$

- \* If either DPLY MSW shows '1', \*
- \* expect single motor time (68 sec max) \*

PORT RMS – DPY (tb-DPY) (68 sec max)  
– OFF

If motor drive time > 34 sec,  $\sqrt{\text{MCC}}$

8. STBD MPM DEPLOY  
If Starboard MPM installed:

CAUTION

Ku-Band Antenna must be deployed prior to STBD  
MPM deploy to prevent antenna/OBSS contact

SM 94 PDRS CONTROL

RMS STBD – ITEM 2 EXEC (\*)

$\sqrt{\text{STBD MPM DPLY (two)}} = 0$

- \* If either DPLY MSW shows '1', \*
- \* expect single motor time (68 sec max) \*

STBD RMS – DPY (tb-DPY) (68 sec max)  
– OFF

If motor drive time > 34 sec,  $\sqrt{\text{MCC}}$

SM 94 PDRS CONTROL

RMS PORT – ITEM 1 EXEC (\*)

- R13L 9. RECONFIGURE POWER  
PL BAY MECH PWR SYS (two) – OFF

This Page Intentionally Blank

RMS PWRUP

# RMS PWRUP

(Assumes RMS in TEMP MONTR MODE)

- A7U 1. PLB LTS, CCTV ACT  
PL BAY FLOOD (six) – as reqd

Perform ACTIVATION, OPERATIONS (TV Cue Card) for desired camrs  
Perform ILLUMINATOR OPS (TV Cue Card) as reqd

√Physical integrity of arm, EE, blankets

√PORT RMS HTR (two) – AUTO

- 2. RMS SEL (IDLE MODE)

√MODE – not DIRECT

√BRAKES – ON (tb-ON)

√RMS SEL – OFF

√PWR – PRI

### SM 94 PDRS CONTROL

√I/O ON, ITEM 5 – (\*)

√ENA, ITEM 9,11 – (\*)

√ENA, ITEM 28 – (\*)

### NOTE

If RMS cradled, expect MA, C/W  
REACH LIM It – on (SP, EP),  
SINGULAR It – on (EP)

RMS SEL – PORT (MA, SM ALERT)

√SAFING tb – gray

	X	Y	Z	PITCH	YAW	ROLL	PL ID
√	-1282	-108	-445	0	0	0	0
	SY	SP	EP	WP	WY	WR	
√	0.0	0.0	0.0	0.0	0.0	0.0	

√MCC if out of tolerance ( $\pm 0.5^\circ$ )

### SM 94 PDRS CONTROL

√WR R, ITEM 26: 3(4)

RMS  
PWRUP



R13L 6. RECONFIGURE POWER  
 PL BAY MECH PWR SYS (two) – OFF

```

  IF DOCKED TO ISS AND OBSS BERTHED
  MA73C:A      MCA LOGIC MNC MID 2 – ON
  :B          MNB MID 4 – ON
  
```

MA73C:C      cb MCA PWR AC2 3Φ MID 2 – op  
 :D              AC3 3Φ MID 4 – op

Record joint angles:

SY	SP	EP	WP	WY	WR

7. ARM UNCRADLE

<p><b>CAUTION</b>          Arm temperatures must be within          limits (no alarms) prior to uncradling</p>
--

RATE – as reqd (VERN within 10 ft)

PARAM – JOINT ANGLE

BRAKES – OFF (tb-OFF)

MODE – SINGLE, ENTER

SINGLE DR to PRE-CRADLE position (within 1°):

	SY	SP	EP	WP	WY	WR	
Cradle	0.0	0.0	0.0	0.0	0.0	0.0	
1: WP +				+5.0			
2: EP +			+1.0				
3: SP +		+25.0					
4: EP –			-25.0				
Pre-cradle	0.0	+25.0	-25.0	+5.0	0.0	0.0	
	X	Y	Z	PITCH	YAW	ROLL	PL ID
√	-1261	-146	-551	5	2	0	0

BRAKES – ON (tb-ON)

DAP: as reqd



RMS CHECKOUT

RMS C/O

## RMS CHECKOUT

(Assumes arm in pre-cradle position)

- A7U
1. TV CAMERA CONFIGURATION  
√ACTIVATION, OPERATIONS (TV Cue Card) performed for desired camrs  
√ILLUMINATOR OPS (TV Cue Card) as desired

2. SINGLE DRIVE TEST  
RATE – COARSE (RATE MIN tb-OFF)  
– VERN (RATE MIN tb-ON)  
PARAM – JOINT ANGLE  
JOINT – WY  
  
BRAKES – OFF (tb-OFF)  
MODE – SINGLE, ENTER

√No arm motion

Drive WY, WR, and SY  
√Correct joint responses

BRAKES – ON (tb-ON)

3. B/U DRIVE TEST  
√B/U PL REL – OFF  
B/U JOINT – WY

### NOTE

Spurious fault msgs may occur  
when PORT RMS deselected

RMS SEL – OFF  
PWR – B/U (SM ALERT, BCE BYP MCIU)  
SEL – PORT

√No arm motion

Drive each joint '+' and '-'  
√Correct joint responses

4. RECONFIGURE TO PRIMARY POWER  
RMS SEL – OFF  
PWR – PRI (MA)

SM 94 PDRS CONTROL

I/O ON – ITEM 5 EXEC (\*)

RMS SEL – PORT  
SAFING – CANCEL (tb-gray)

√WR R, ITEM 26: 3(4)

5. DIRECT DRIVE TEST  
BRAKES – OFF (tb-OFF)  
MODE – SINGLE, ENTER

SINGLE DR to PRE-CRADLE position (within 1°):

Pre-cradle	SY	SP	EP	WP	WY	WR	
	0.0	+25.0	-25.0	+5.0	0.0	0.0	
	X	Y	Z	PITCH	YAW	ROLL	PL ID
	-1261	-146	-551	5	2	0	0

JOINT – WP

√BRAKES – OFF (tb-OFF)  
MODE – DIRECT (lt off)

SINGLE/DIRECT DR – ‘+’

√Joint does not drive

DAP: VERN(FREE)

BRAKES – ON (tb-ON)

√DIRECT lt – on  
√No arm motion, then

For each joint:

√No arm oscillations before each ‘+’ and ‘-’ drive test  
√Correct joint responses and that only selected joint drives  
Record starting angle A  
Drive ‘+’ for 12 sec continuously, record angle B, check joint angle change greater than X, wait 3-5 sec  
Drive ‘-’ for 12 sec continuously, record angle C, check joint angle change greater than X  
If joint angle change not greater than X, √MCC before continuing to step 6

SY A = \_\_\_ B = \_\_\_ C = \_\_\_ X = 5.6

SP A = \_\_\_ B = \_\_\_ C = \_\_\_ X = 5.6

EP A = \_\_\_ B = \_\_\_ C = \_\_\_ X = 9.0

WP A = \_\_\_ B = \_\_\_ C = \_\_\_ X = 16.8

WY A = \_\_\_ B = \_\_\_ C = \_\_\_ X = 16.8

WR A = \_\_\_ B = \_\_\_ C = \_\_\_ X = 16.8

MODE – not DIRECT (lt off)

JOINT – WR

SINGLE/DIRECT DR – ‘+’

√Joint does not drive

DAP: as reqd

## 6. HAND CONTROLLER CHECK

SM 169 PDRS STATUS

BRAKES – OFF (tb-OFF)  
MODE – SINGLE, ENTER

SINGLE DR to (within 1°):

SY	SP	EP	WP	WY	WR	
0.0	+35.0	-25.0	+5.0	0.0	0.0	
X	Y	Z	PITCH	YAW	ROLL	PL ID
-1233	-179	-645	14	5	359	0

BRAKES – ON (tb-ON)

DAP: VERN(FREE)

RATE – COARSE (RATE MIN tb-OFF)

BRAKES – OFF (tb-OFF)  
MODE – TEST, ENTER

√No arm motion

THC, RHC – Each axis in turn, deflect hand controller gradually to hardstop

√No arm motion

√Actual rates zero

√Commanded rates at full deflection:

X, Y, Z – 2.0 ft/sec  
P, Y, R – 4.7 deg/sec

BRAKES – ON (tb-ON)

DAP: as reqd

#### 7. MANUAL AUGMENTED MODES CHECK

RATE – VERN (RATE MIN tb-ON)

PARAM – RATE P/Y/R

BRAKES – OFF (tb-OFF)

MODE – END EFF, ENTER

RHC – Command '+' then '-' for 2-3 sec in pitch, yaw, then roll

√Correct arm response, rates displayed on D&C LEDs

PARAM – VEL X/Y/Z

MODE – ORB UNL, ENTER

THC – Command '+' then '-' for 2-3 sec in X, Y, then Z

√Correct arm response, velocities displayed on D&C LEDs

THC – +X (OUT)

RATE HOLD – depress (mom)

Release THC

√Rate hold function, then

RATE HOLD – depress (mom)

√Arm motion stops

√Each mode light illuminates:

MODE – ORB LD, ENTER

– PL, ENTER

BRAKES – ON (tb-ON)

8. OPR CMD MODE (OCAS) CHECK

BRAKES – OFF (tb-OFF)  
 MODE – SINGLE, ENTER

SINGLE DR to (within 1°):

SY	SP	EP	WP	WY	WR	
0.0	+35.0	-25.0	+5.0	0.0	0.0	
X	Y	Z	PITCH	YAW	ROLL	PL ID
-1233	-179	-645	14	5	359	0

BRAKES – ON (tb-ON)

SM 94 PDRS CONTROL

√PL ID, ITEM 3: 0  
 √INIT ID, ITEM 24: 0

Load OPR CMD for checkout (Items 18-23)

-----  
 -1233, -119, -502, 317, 337, 355  
 -----

CMD CK, ITEM 25 EXEC (GOOD)

√RATE – VERN (RATE MIN tb-ON)

BRAKES – OFF (tb-OFF)  
 MODE – OPR CMD, ENTER

√AUTO SEQ READY It – on

```

* If error found in destination entries (Items 18-23): *
*   BRAKES – ON (tb-ON)                               *
*                                                         *
*   Enter corrected destination (Items 18-23)          *
*                                                         *
*   CMD CK, ITEM 25 EXEC (GOOD)                        *
*   BRAKES – OFF (tb-OFF)                              *
*   MODE – OPR CMD, ENTER                              *
*                                                         *
*   √AUTO SEQ READY It – on                            *
  
```

AUTO SEQ – PRO  
 After ~3 sec of arm motion,  
 AUTO SEQ – STOP

√Arm stops, then  
 AUTO SEQ – PRO

When AUTO SEQ IN PROG It – off,  
 BRAKES – ON (tb-ON)

	X	Y	Z	PITCH	YAW	ROLL	PL ID
√	-1233	-119	-502	317	337	355	0
	SY	SP	EP	WP	WY	WR	
√	0.0	+27.6	-28.7	-45.7	-9.1	+0.2	

If no EE ops planned, >>

9. EE CHECKOUT

NOTE

1. Record Camera B during EE Checkout
2. In each step, look for the expected motion in the monitor view; a step is considered successful if expected motion is completed, regardless of talkback/MSW indications
3. Cross check the EE talkbacks by checking the microswitch status on SM 169 PDRS STATUS. Note any discrepancies and continue
4. Pause 2 sec each time when taking EE Mode switch out of OFF and monitor for uncommanded motion
5. Response to Off-Nominal situations:
  - a. Note step(s) where the function fails to start/complete and continue
  - b. If uncommanded motion occurs at the time the EE Mode switch is taken out of OFF, immediately take EE Mode switch to OFF, note the step, and check MCC
  - c. If EE C&W ('S96 PDRS CKCRT EE', or 'PDRS DERIG') messages occur, note the step where the message annunciated and continue
  - d. When EE Checkout is complete/exited, reference RMS EE C/O FAILURE MATRIX (REF DATA) for failure impacts

CAUTION  
Monitor EE tb timing to prevent EE motor overtemp

A7U

VID OUT pb – MON 1(2)  
IN pb – B  
PAN, TILT, ZOOM – To view inside EE

V10	If recording view with V10: REC pb – Press simo √LCD displays red dot (10 min)
L10 (VTR)	If recording view with VTR: REC pb – Press, hold PLAY pb – Press, simo (√red dot displayed) (10 min)

a. EE MODE sw CAP/REL Check

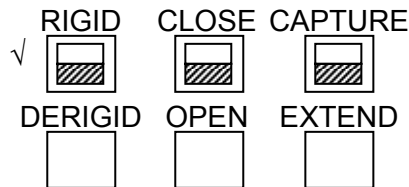

- √EE MODE – OFF  
CAPTURE sw – depress (3 sec)
- √OPEN tb – gray, no motion

If motion occurs:  
EE RELEASE sw – depress until OPEN tb – gray (3 sec max),  
go to step h (EE BACKUP RELEASE Checkout)

b. EE MAN CLOSE Checkout

EE MODE – MAN

EE CAPTURE sw – depress until snares closed or CLOSE tb – gray  
(3 sec max)

EE MODE – OFF

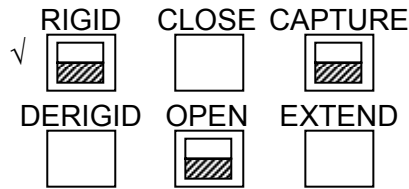

c. If snares not closed:

EE MODE – AUTO

CAPTURE sw – depress (mom)

After 3 sec max, EE MODE – OFF

If snares remain not closed, go to step i (EE MODE SW RIG/DERIG Check)

d. EE MAN OPEN Checkout

EE MODE – MAN

RELEASE sw – depress until snares open or OPEN tb – gray (3 sec max)

MODE – OFF

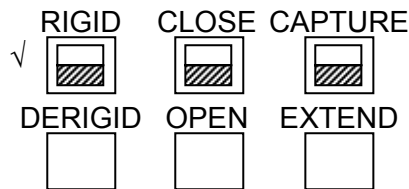

If snares not open, go to step g (EE AUTO OPEN Checkout)

e. EE AUTO CLOSE Checkout

EE MODE – AUTO

CAPTURE sw – depress (mom)

After 3 sec max, EE MODE – OFF

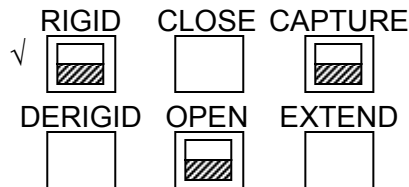

f. If snares not closed:

EE MODE – MAN

EE CAPTURE sw – depress until snares closed or CLOSE tb – gray  
(3 sec max)

EE MODE – OFF

- g. EE AUTO OPEN Checkout  
 EE MODE – AUTO  
 RELEASE sw – depress (mom)  
 After 3 sec max, EE MODE – OFF

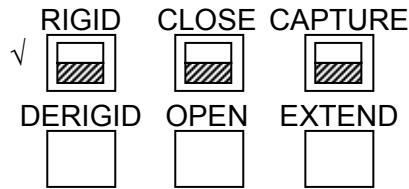

- h. EE BACKUP RELEASE Checkout  
 If snares open (expected condition):  
 EE MODE – AUTO  
 CAPTURE sw – depress (mom)  
 After 3 sec max, EE MODE – OFF  
 If snares remain open:  
 EE MODE – MAN  
 EE CAPTURE sw – depress until snares closed or CLOSE tb – gray  
 (3 sec max)  
 EE MODE – OFF  
 √B/U PL REL – OFF  
 B/U JOINT – WY

NOTE

Spurious fault msgs may occur when PORT RMS deselected

RMS SEL – OFF  
 PWR – B/U (SM ALERT, BCE BYP MCIU)  
 SEL – PORT

√Snares remain closed

Note duration of snare opening and inform MCC at next opportunity

Historical times: 8-34 sec

B/U PL REL – ON

√Snares open smoothly, fully

√Snares return to grooves

B/U release time: \_\_\_\_\_ sec

B/U PL REL – OFF  
 RMS SEL – OFF  
 PWR – PRI (MA)

SM 94 PDRS CONTROL

I/O ON – ITEM 5 EXEC (\*)

RMS SEL – PORT

SAFING – CANCEL (tb-gray)

√WR R, ITEM 26: 3(4)

If snares not open:

EE MODE – MAN

EE RELEASE sw – depress until snares open or OPEN tb – gray  
 (3 sec max)

EE MODE – OFF



i. EE MODE SW RIG/DERIG Check

- √ EE MODE – OFF
- MAN CONTR – RIGID (1 sec max)
- √ EXTEND tb – gray, no motion

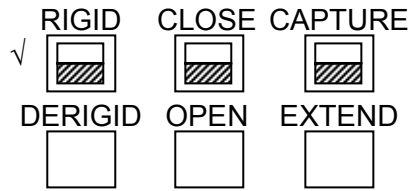

If motion occurs:  
Go to step k

j. EE CARRIAGE DRIVE CHECKOUT – RETRACT

- EE MODE – MAN
- MAN CONTR – RIGID until EXTEND tb – bp (1 sec max)
- MODE – OFF

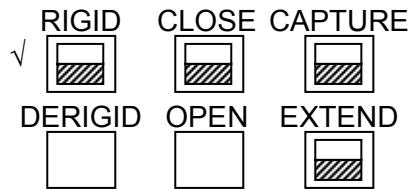

If no carriage motion, >>

k. EE CARRIAGE DRIVE CHECKOUT – EXTEND

- EE MODE – MAN
- MAN CONTR – DERIGID until EXTEND tb – gray (1 sec max)
- MODE – OFF

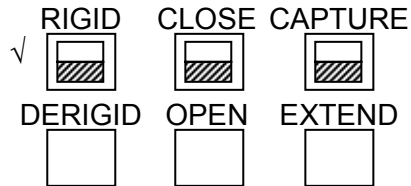

If motion in wrong direction, >>

- l. If EXTEND tb – bp:
  - EE MODE – AUTO
  - RELEASE sw – depress (mom)
  - After EXTEND tb – gray, EE MODE – OFF (1 sec max)

If no carriage motion, >>

m. EE MAN RIGIDIZE Checkout

- EE MODE – MAN
- MAN CONTR – RIGID until RIGID tb – gray (25 sec max)
- MODE – OFF

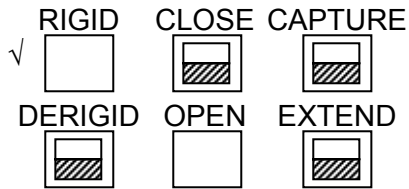

n. EE MAN DERIGIDIZE Checkout

EE MODE – MAN

MAN CONTR – DERIGID until DERIGID tb – gray (5 sec max)

MODE – OFF

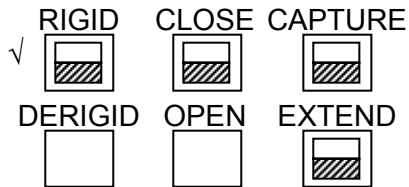

o. EE AUTO EXTEND Checkout

EE MODE – AUTO

RELEASE sw – depress (mom)

After EXTEND tb – gray, EE MODE – OFF (20 sec max, 25 if RIGID)

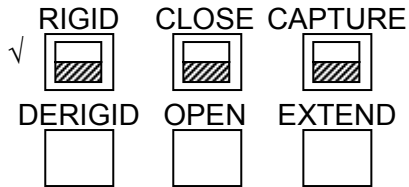

p. If DERIGID tb – gray and EXTEND tb – bp:

EE MODE – MAN

MAN CONTR – DERIGID until EXTEND tb – gray (25 sec max)

MODE – OFF

RMS PWRDN

RMS  
PWRDN

## RMS PWRDN

### 1. RMS PRECRADLE

RATE – as reqd (VERN within 10 ft)  
 MODE – as desired

Drive to PRE-CRADLE position (within 1"/1°):

X	Y	Z	PITCH	YAW	ROLL	PL ID
-1261	-146	-551	5	2	0	0
SY	SP	EP	WP	WY	WR	
0.0	+25.0	-25.0	+5.0	0.0	0.0	

BRAKES – ON (tb-ON)

If parking SRMS at Pre-Cradle overnight,  
 PARAM – PORT TEMP  
 JOINT – CRIT TEMP

### 2. RMS CRADLE

DAP: VERN(FREE)

PARAM – JOINT ANGLE  
 BRAKES – OFF (tb-OFF)  
 MODE – SINGLE, ENTER

SINGLE DR to CRADLE position:

	SY	SP	EP	WP	WY	WR	NOTES
Pre-cradle √	0.0	+25.0	-25.0	+5.0	0.0	0.0	√WR RANGE = 3(4)
1: EP +			+1.0				MA, SING, REACH, S/W STOP
2: SP –		0.0					MA
3: EP –			0.0				
4: WP –				0.0			
Cradle	0.0	0.0	0.0	0.0	0.0	0.0	
	X	Y	Z	PITCH	YAW	ROLL	PL ID
	-1282	-108	-445	0	0	0	0

√PORT RMS R-F-L tb (three) – gray

#### NOTE

Refer to SJ table in RMS PWRUP, step 6,  
 if needed to obtain R-F-L indication

### 3. CONFIGURE POWER

MA73C:C      cb MCA PWR AC2 3Φ MID 2 – cl  
 :D              AC3 3Φ MID 4 – cl

RMS  
PWRDN

**IF DOCKED TO ISS AND OBSS BERTHED**

NOTE

With LOGIC switches OFF:

1. KU will mode to standby
2. Mid and Aft MRLs will drive in single motor time
3. On SPEC 94, all MID 2 and AFT 1 msw indications = 0
4. MPM and MRL tbs remain bp

MA73C:A      MCA LOGIC MNC MID 2 – OFF  
:B                      MNB MID 4 – OFF

R13L            PL BAY MECH PWR SYS (two) – ON

4. PORT MRL LATCH

√PORT RMS R-F-L tb (three) – gray

SM 94 PDRS CONTROL

√RMS PORT, ITEM 1 – (\*)

√PORT AFT,MID,FWD LAT (six) = 0

- \* If any LAT MSW shows '1', ignore tb and \*
- \* drive MRL for single motor time (18 sec) \*

PORT RMS RETEN LAT – LAT (tb-LAT) (18 sec max)  
– OFF

If motor drive time > 8 sec, √MCC

BRAKES – ON (tb-ON)

DAP: as reqd

5. PORT MPM STOW

If Elbow Camr to payload interference problem exists with MPM stowed:

√Elbow Camr in aligned position

- Pan 90° from X-Axis
- Tilt per DECAL

CAUTION

Do not use Elbow Camr while any potential  
PL/Elbow Camr interference exists

SM 94 PDRS CONTROL

√RMS PORT, ITEM 1 – (\*)

√PORT MPM STO (two) = 0

- \* If either STO MSW shows '1', expect \*
- \* single motor time (68 sec max) \*

PORT RMS – STO (tb-STO) (68 sec max)  
– OFF

If motor drive time > 34 sec, √MCC

√BRAKES – ON (tb-ON)

6. STBD MPM STOW (If installed)

SM 94 PDRS CONTROL

RMS STBD – ITEM 2 EXEC (\*)

√STBD MPM STO (two) = 0

- \* If either STO MSW shows '1', expect \*
- \* single motor time (68 sec max) \*

STBD RMS – STO (tb-STO) (68 sec max)  
– OFF

If motor drive time > 34 sec, √MCC

SM 94 PDRS CONTROL

RMS PORT – ITEM 1 EXEC (\*)

R13L 7. RECONFIGURE POWER  
PL BAY MECH PWR SYS (two) – OFF

MA73C:A If docked to ISS and OBSS berthed:  
:B MCA LOGIC MNC MID 2 – ON  
MNB MID 4 – ON

A7U 8. CCTV, PLB LTS DEACT  
Perform DEACTIVATION (TV Cue Card) as reqd  
PORT RMS CAMR – ELBOW

9. RMS TEMP MON  
√BRAKES – ON (tb-ON)

NOTE

Spurious fault msgs may occur  
when PORT RMS deselected

RMS SEL – OFF  
√PWR – PRI

SM 94 PDRS CONTROL

√I/O ON – ITEM 5 (\*)

PARAM – PORT TEMP  
JOINT – CRIT TEMP

√PORT RMS HTR A(B) – AUTO  
B(A) – OFF

RMS DEACTIVATION

RMS  
DEACT

## RMS DEACTIVATION

1. RMS POWER OFF  
RMS PWR – OFF (SM ALERT, BCE BYP MCIU)  
PORT RMS HTR (two) – OFF  
STBD RMS HTR (two) – OFF
2. ORBITER/PDRS AC PWRDN  
MA73C:F    cb AC1 RMS PRI  $\Phi$ A – op  
                 AC2 RMS B/U  $\Phi$ A – op



CONTINGENCY OPERATIONS

----- CONT OPS -----

----- CONT OPS -----

This Page Intentionally Blank

## EXTERIOR SURVEYS

RMS EXTERIOR SURVEY ASSUMPTIONS AND NOTES.....	6-3
EXTERIOR SURVEY SETUP.....	6-4
EXTERIOR SURVEY A – PORT SIDE, ORBITER NOSE .....	6-5
B – ORBITER UNDERBODY .....	6-7
C – NOSE AND MAIN LANDING GEAR DOORS.....	6-10
D – ORBITER MIDBODY AND VENT DOORS.....	6-13
E – STBD SIDE, WING LEADING EDGE TO NOSE .....	6-16
F – STBD SIDE, UNDERBODY WING TO NOSE WITH STOWED MPM.....	6-19
G – STBD SIDE, NOSE.....	6-22
H – TOP SIDE, NOSE AND OVHD WINDOWS.....	6-24
I – TOP VIEW, STBD WING.....	6-27
J – TOP VIEW, PORT WING.....	6-29
K – PORT, OMS POD AND VERT TAIL .....	6-31
L – PORT, LEAD EDGE VERT TAIL .....	6-33
M – STBD SIDE, LEAD EDGE VERT TAIL AND OMS POD.....	6-35
SUPPLY/WASTE H2O DUMP NOZZLE SURVEY ARM CONFIG .....	6-37
SURVEY .....	6-38

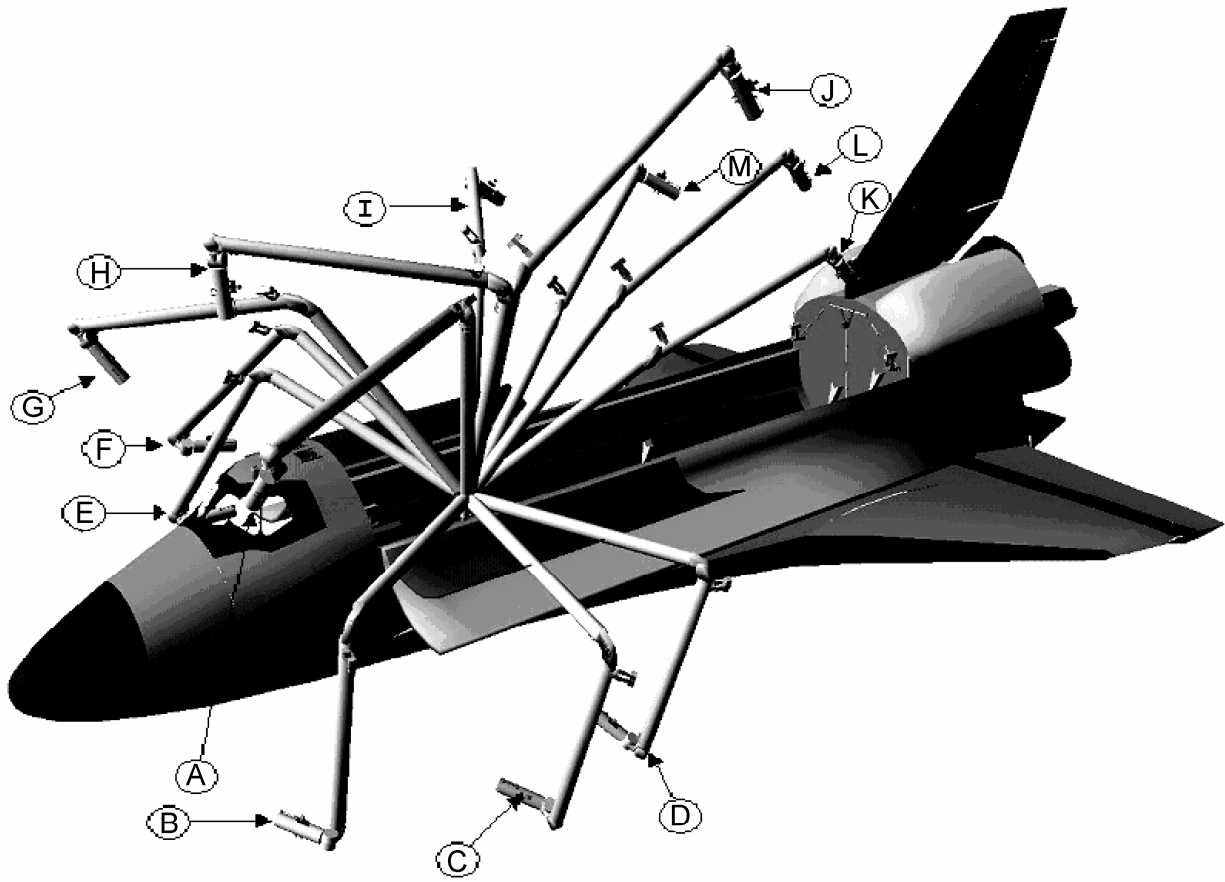

## **RMS EXTERIOR SURVEY ASSUMPTIONS AND NOTES**

### ASSUMPTIONS:

1. Procedures were developed assuming an empty payload bay. MCC will alter procedure if reqd for payload

### NOTES:

1. Stated times in beginning of survey are minimum times reqd to perform setup and survey
2. Procedures were developed so that wrist joint movements will not create RMS/orbiter structure clearance problems

## EXTERIOR SURVEY SETUP

### WARNING

Orbiter/RMS collision avoidance guaranteed only if surveys done in alphabetical sequence (e.g., B, D, E, G)

### NOTE

MCC to complete for optimum lighting (e.g., belly to space, use RMS light, etc) and DAP

### GNC UNIV PTG

For surveys:

	Att 1	Att 2	Att 3
TGT ID	_____	_____	_____
BODY VECT	_____	_____	_____
P	_____	_____	_____
Y	_____	_____	_____
OM	_____	_____	_____

DAP: \_\_\_\_/AUTO/VERN  
Init TRK, ITEM 19 EXEC (\*)

A7U

√PORT RMS CAMR – WRIST  
VID OUT pb – MON 2  
ZOOM – Full Zoom Out  
FOCUS – FAR (against stop)  
VID OUT pb – MON 1  
IN pb – B  
ZOOM – as reqd  
FOCUS – as reqd

### SM 94 PDRS CONTROL

√SOFT STOP, ITEM 7 – ENA (\*)  
√AUTO BRAKE, ITEM 9 – ENA (\*)  
√POS ENC CK, ITEM 11 – ENA (\*)

PARAM – JOINT ANGLE

**EXTERIOR SURVEY A – PORT SIDE, ORBITER NOSE (12 min reqd)**

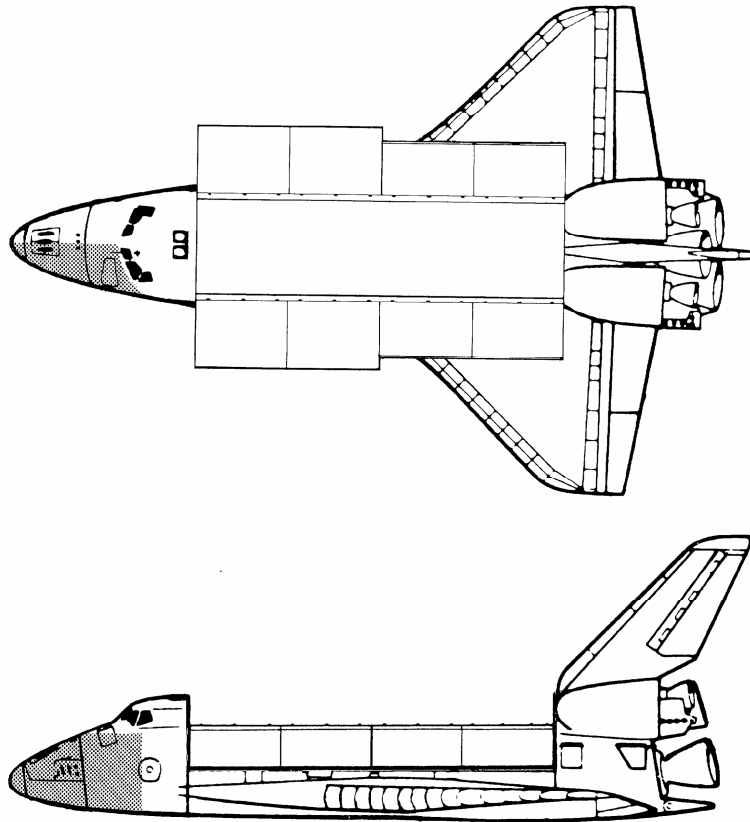

1. SETUP

√Attitude

V10 (L10  
(VTR))

√Tape remaining, 4 min reqd

BRAKES – OFF (tb-OFF)  
MODE – SINGLE, ENTER

SINGLE DR to within  $\pm 1^\circ$  of SY, SP, EP:

SY	SP	EP	WP	WY	WR	
+152.0	+81.0	-80.0	-100.0	+26.0	+140.0	
X	Y	Z	PITCH	YAW	ROLL	PL ID
-392	-289	-583	263	314	267	0

BRAKES – ON (tb-ON)

2. SURVEY

A7U

PORT RMS LIGHT – ON, as reqd  
ALC pb – as reqd  
GAMMA pb – as reqd

V10

If recording views with V10:

REC pbs – Press simo

√LCD displays red dot

If recording views with VTR:

L10

REC pb – Press, hold

(VTR)

PLAY pb – Press, simo (√red dot displayed)

RATE – VERN (RATE MIN tb-ON)

BRAKES – OFF (tb-OFF)  
 MODE – SINGLE, ENTER

SINGLE DR WP to -110°:

SY	SP	EP	WP	WY	WR	
+152.0	+81.0	-80.0	-110.0	+26.0	+140.0	
X	Y	Z	PITCH	YAW	ROLL	PL ID
-402	-285	-587	275	309	271	0

BRAKES – ON (tb-ON)

Stop recording

3. RECONFIGURE

If conducting survey B, C, or D:

Go to step 1 of that survey configuration

If conducting survey E, F, G, H, I, J, K, L, or M:

BRAKES – OFF (tb-OFF)  
 MODE – SINGLE, ENTER

SINGLE DR to (within 1°):

Initial	SY	SP	EP	WP	WY	WR	
√	+152.0	+81.0	-80.0	-110.0	+26.0	+140.0	
1: SY –	+90.0						
2: WP +				-100.0			
3: WY –					0.0		
4: WR +						+180.0	
Final	+90.0	+81.0	-80.0	-100.0	0.0	+180.0	
	X	Y	Z	PITCH	YAW	ROLL	PL ID
	-680	-463	-512	270	332	250	0

BRAKES – ON (tb-ON)

Go to step 1, next survey configuration

If survey finished:

BRAKES – OFF (tb-OFF)  
 MODE – SINGLE, ENTER

SINGLE DR to PRE-CRADLE position (within 1°):

Initial	SY	SP	EP	WP	WY	WR	
√	+152.0	+81.0	-80.0	-110.0	+26.0	+140.0	
1: SY –	0.0						
2: WP +				+5.0			
3: WY –					0.0		
4: WR –						0.0	
5: EP +			-25.0				
6: SP –		+25.0					
Pre-cradle	0.0	+25.0	-25.0	+5.0	0.0	0.0	
	X	Y	Z	PITCH	YAW	ROLL	PL ID
	-1261	-146	-551	5	2	0	0

BRAKES – ON (tb-ON)

A7U

PORT RMS LIGHT – OFF

DAP: as reqd

Mnvr back to attitude per FLIGHT PLAN



**EXTERIOR SURVEY B – ORBITER UNDERBODY (25 min reqd)**

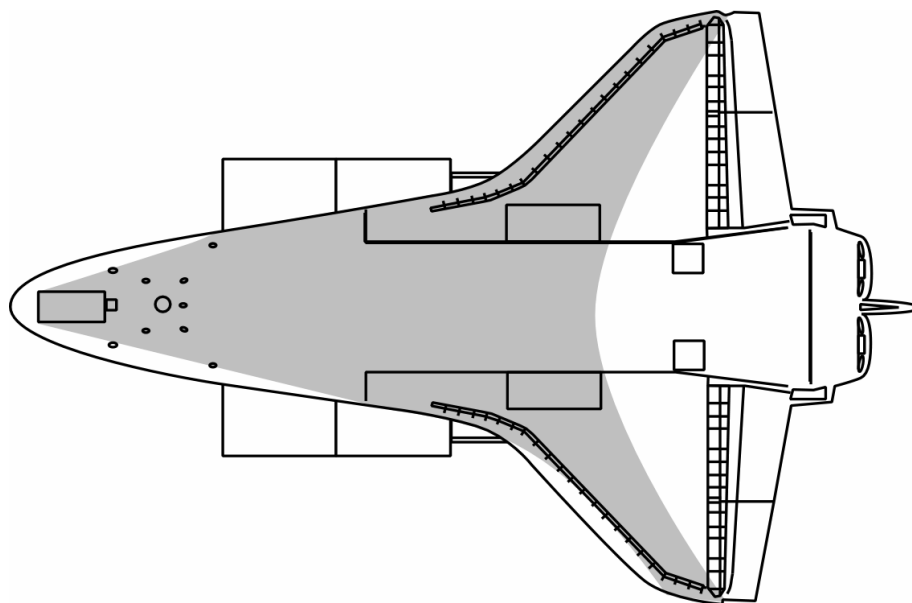

jsc48039\_001.cnv

**1. SETUP**

√Attitude

V10 (L10  
(VTR))

√Tape remaining, 15 min reqd

DAP: VERN(FREE)

**CAUTION**  
DO NOT SELECT DAP LO Z in this jet config

GNC 23 RCS

RCS FWD – ITEM 1 EXEC (\*)

JET DES F1L – ITEM 9 EXEC (\*)

F3L – ITEM 11 EXEC (\*)

F1D – ITEM 23 EXEC (\*)

F3D – ITEM 25 EXEC (\*)

**NOTE**

RMS appears in -Y star tracker  
Bright Object Sensor FOV

BRAKES – OFF (tb-OFF)

MODE – SINGLE, ENTER

SINGLE DR to within  $\pm 1^\circ$  of SY, SP, EP:

SY	SP	EP	WP	WY	WR	
+145.0	+10.0	-100.0	+110.0	+90.0 (MA)	0.0	
X	Y	Z	PITCH	YAW	ROLL	PL ID
-425	-133	-188	155	309	149	0

BRAKES – ON (tb-ON)

2. SURVEY
- A7U PORT RMS LIGHT – ON, as reqd  
ALC pb – as reqd  
GAMMA pb – as reqd
- V10 If recording views with V10:  
REC pbs – Press simo  
√LCD displays red dot
- L10 If recording views with VTR:  
REC pb – Press, hold  
(VTR) PLAY pb – Press, simo (√red dot displayed)

RATE – VERN (RATE MIN tb-ON)

BRAKES – OFF (tb-OFF)  
MODE – SINGLE, ENTER

SINGLE DR to (within 1°):

	SY	SP	EP	WP	WY	WR	
Initial	+145.0	+10.0	-100.0	+110.0	+90.0 (MA)	0.0	
1: WR +						+180.0	
2: WP –				-110.0			
3: WY –					+30.0		
4: WP +				-105.0			
5: WY +					+50.0		
6: WY –					-15.0		
7: WP +				-100.0			
8: WY +					0.0		
9: WY –					-45.0		
Final	+145.0	+10.0	-100.0	-100.0	-45.0	+180.0	
	X	Y	Z	PITCH	YAW	ROLL	PL ID
	-540	-169	-179	3	12	6	0

BRAKES – ON (tb-ON)

Stop recording

3. RECONFIGURE  
If conducting survey C:  
Go to step 1 of that survey configuration

When RMS clear of fwd RCS jets:

**GNC 23 RCS**

RCS FWD – ITEM 1 EXEC (\*)

JET DES F1L – ITEM 9 EXEC (no \*)

F3L – ITEM 11 EXEC (no \*)

F1D – ITEM 23 EXEC (no \*)

F3D – ITEM 25 EXEC (no \*)

If conducting survey D:

Go to step 1 of that survey configuration

If conducting survey E, F, G, H, I, J, K, L, or M:

BRAKES – OFF (tb-OFF)

MODE – SINGLE, ENTER

SINGLE DR to INTERMEDIATE position (within 1°):

Initial	√	SY	SP	EP	WP	WY	WR	
		+145.0	+10.0	-100.0	-100.0	-45.0	+180.0	
1: SP +			+80.0					
2: EP +				-80.0				
3: WY +						0.0		
4: SY –		+90.0						
Intermediate		+90.0	+80.0	-80.0	-100.0	0.0	+180.0	
		X	Y	Z	PITCH	YAW	ROLL	PL ID
		-680	-464	-509	270	330	250	0

BRAKES – ON (tb-ON)

Go to step 1, next survey configuration

If survey finished:

BRAKES – OFF (tb-OFF)

MODE – SINGLE, ENTER

SINGLE DR to PRE-CRADLE position (within 1°):

Intermediate	√	SY	SP	EP	WP	WY	WR	
		+145.0	+10.0	-100.0	-100.0	-45.0	+180.0	
1: EP +				-25.0				
2: WP +					+5.0			
3: WY +						0.0		
4: WR –							0.0	
5: SP +			+25.0					
6: SY –		0.0						
Pre-cradle		0.0	+25.0	-25.0	+5.0	0.0	0.0	
		X	Y	Z	PITCH	YAW	ROLL	PL ID
		-1261	-146	-551	5	2	0	0

BRAKES – ON (tb-ON)

A7U

PORT RMS LIGHT – OFF

DAP: as reqd

Mnvr back to attitude per FLIGHT PLAN

**EXTERIOR SURVEY C – NOSE AND MAIN LANDING GEAR DOORS**  
(15 min reqd – does not include RAD STOW)

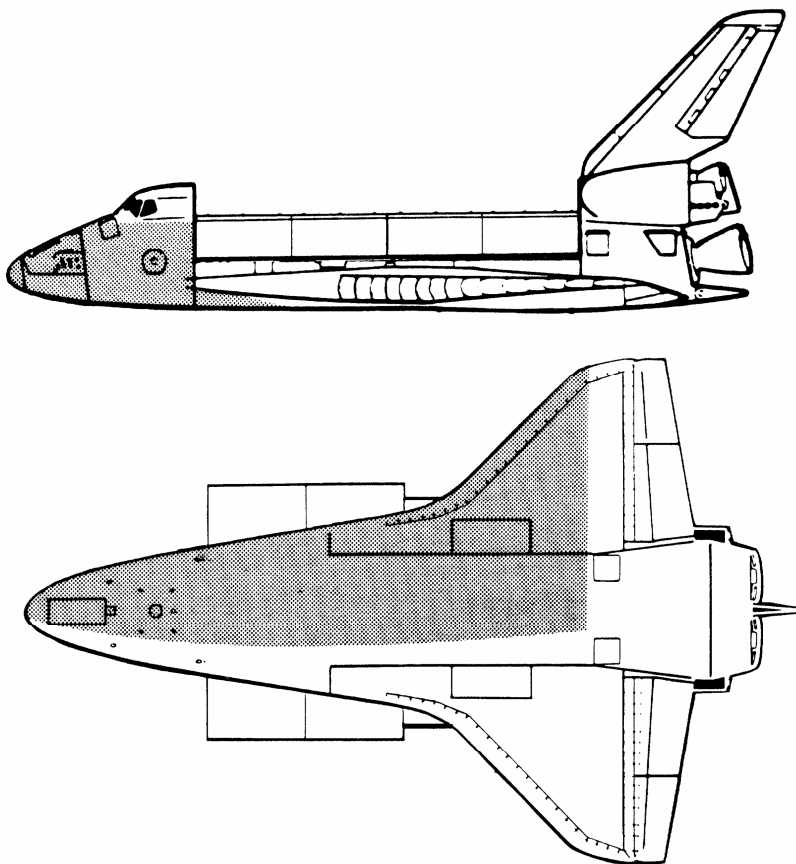

**WARNING**  
PORT RADIATOR must be stowed

1. SETUP  
If radiators deployed:  
Perform RAD STOW (ORB OPS, ECLS)

√Attitude

V10 (L10  
(VTR))

√Tape remaining, 5 min reqd

**CAUTION**  
Do not select DAP LO Z in this jet config

**GNC 23 RCS**

RCS FWD – ITEM 1 EXEC (\*)  
JET DES F1L – ITEM 9 EXEC (\*)  
F3L – ITEM 11 EXEC (\*)  
F1D – ITEM 23 EXEC (\*)  
F3D – ITEM 25 EXEC (\*)

BRAKES – OFF (tb-OFF)  
MODE – SINGLE, ENTER

SINGLE DR to within  $\pm 1^\circ$  of SY, SP, EP:

Initial	√	SY	SP	EP	WP	WY	WR	
		+145.0	+4.0	-101.0	-110.0	+45.0	+180.0	
1: SY	-	+90.0						
Final		+90.0	+4.0	-101.0	-110.0	+45.0	+180.0	
		X	Y	Z	PITCH	YAW	ROLL	PL ID
		-640	-190	-162	144	331	104	0

BRAKES – ON (tb-ON)

2. SURVEY

A7U PORT RMS LIGHT – ON, as reqd  
ALC pb – as reqd  
GAMMA pb – as reqd

V10 If recording views with V10:

REC pbs – Press simo  
√LCD displays red dot

L10 If recording views with VTR:

(VTR) REC pb – Press, hold  
PLAY pb – Press, simo (√red dot displayed)

RATE – VERN (RATE MIN tb-ON)

DAP: VERN(FREE)

BRAKES – OFF (tb-OFF)

MODE – SINGLE, ENTER

SINGLE DR WY to  $-90^\circ$ :

SY	SP	EP	WP	WY	WR	
+90.0	+4.0	-101.0	-110.0	-90.0 (MA)	+180.0	
X	Y	Z	PITCH	YAW	ROLL	PL ID
-736	-217	-134	0	0	27	0

BRAKES – ON (tb-ON)

Stop recording

3. RECONFIGURE

When RMS clear of fwd RCS jets:

GNC 23 RCS

RCS FWD – ITEM 1 EXEC (\*)

JET DES F1L – ITEM 9 EXEC (no \*)

F3L – ITEM 11 EXEC (no \*)

F1D – ITEM 23 EXEC (no \*)

F3D – ITEM 25 EXEC (no \*)

If conducting survey D:

Go to step 1 of that survey configuration

If conducting survey E, F, G, H, I, J, K, L, or M:

BRAKES – OFF (tb-OFF)

MODE – SINGLE, ENTER

SINGLE DR to INTERMEDIATE position (within 1°):

	SY	SP	EP	WP	WY	WR	
Initial	+90.0	+4.0	-101.0	-110.0	-90.0 (MA)	+180.0	
1: EP +			-80.0				
2: WP +				-100.0			
3: WY +					0.0		
4: SP +		+80.0					
Intermediate	+90.0	+80.0	-80.0	-100.0	0.0	+180.0	
	X	Y	Z	PITCH	YAW	ROLL	PL ID
	-680	-464	-509	270	330	250	0

BRAKES – ON (tb-ON)

If radiator deploy reqd:

Perform RAD DEPLOY (ORB OPS, ECLS)

Go to step 1, next survey configuration

If survey finished:

BRAKES – OFF (tb-OFF)

MODE – SINGLE, ENTER

SINGLE DR to PRE-CRADLE position (within 1°):

	SY	SP	EP	WP	WY	WR	
Initial	+90.0	+4.0	-101.0	-110.0	-90.0 (MA)	+180.0	
1: EP +			-25.0				
2: WP +				+5.0			
3: WY +					0.0		
4: WR –						0.0	
5: SP +		+25.0					
6: SY –	0.0						
Pre-cradle	0.0	+25.0	-25.0	+5.0	0.0	0.0	
	X	Y	Z	PITCH	YAW	ROLL	PL ID
	-1261	-146	-551	5	2	0	0

BRAKES – ON (tb-ON)

A7U

PORT RMS LIGHT – OFF

DAP: as reqd

Mnvr back to attitude per FLIGHT PLAN

**EXTERIOR SURVEY D – ORBITER MIDBODY AND VENT DOORS**  
 (20 min reqd – does not include RAD STOW)

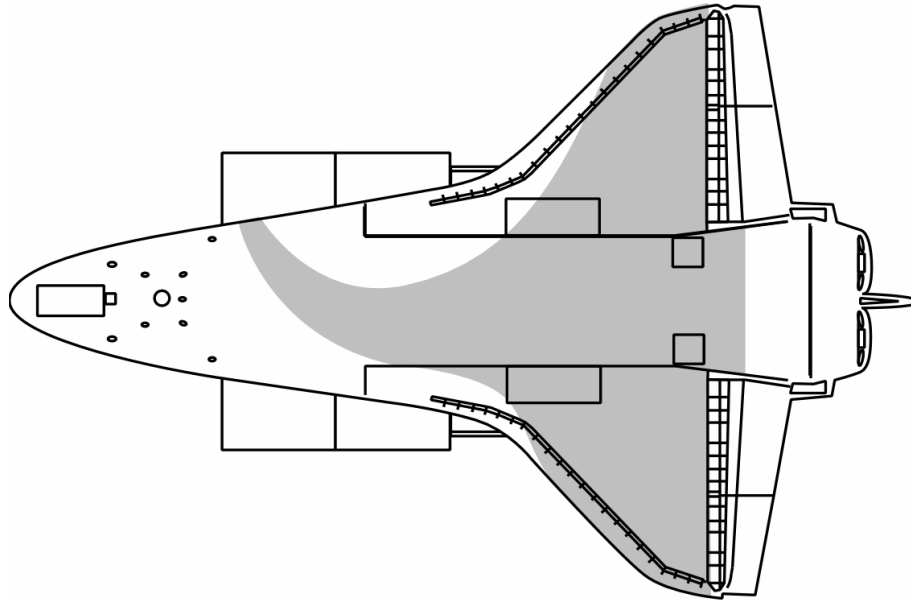

jsc48039\_002.cnv

**WARNING**  
 PORT RADIATOR must be stowed

1. SETUP  
 If radiators deployed:  
 Perform RAD STOW (ORB OPS, ECLS)

√Attitude

V10 (L10 (VTR))      √Tape remaining, 10 min reqd

BRAKES – OFF (tb-OFF)  
 MODE – SINGLE, ENTER

SINGLE DR to within  $\pm 1^\circ$  of SY, SP, EP:

Initial	√	SY	SP	EP	WP	WY	WR	
		+55.0	+30.0	-100.0	-112.0	0.0	+180.0	
1: SP –			+5.0					
Final		+55.0	+5.0	-100.0	-112.0	0.0	+180.0	
		X	Y	Z	PITCH	YAW	ROLL	PL ID
		-775	-161	-184	127	328	110	0

BRAKES – ON (tb-ON)

A7U 2. SURVEY  
 PORT RMS LIGHT – ON, as reqd  
 ALC pb – as reqd  
 GAMMA pb – as reqd

V10 If recording views with V10:  
 REC pbs – Press simo  
 √LCD displays red dot

L10 If recording views with VTR:  
 REC pb – Press, hold  
 (VTR) PLAY pb – Press, simo (√red dot displayed)

RATE – VERN (RATE MIN tb-ON)

DAP: VERN(FREE)

BRAKES – OFF (tb-OFF)  
 MODE – SINGLE, ENTER

SINGLE DR to (within 1°):

Initial	√	SY	SP	EP	WP	WY	WR	
		+55.0	+5.0	-100.0	-112.0	0.0	+180.0	
1: WY –						-105.0 (MA)		
2: WR –							+30.0	
3: WP +					+113.0			
4: WY +						-90.0 (MA)		
5: WY +						-45.0		
Final		+55.0	+5.0	-100.0	+113.0	-45.0	+30.0	
		X	Y	Z	PITCH	YAW	ROLL	PL ID
		-877	-227	-144	9	12	15	0

BRAKES – ON (tb-ON)

Stop recording

3. RECONFIGURE  
 BRAKES – OFF (tb-OFF)  
 MODE – SINGLE, ENTER

SINGLE DR to (within 1°):

Initial	√	SY	SP	EP	WP	WY	WR	
		+55.0	+5.0	-100.0	+113.0	-45.0	+30.0	
1: SP +			+80.0					
2: EP +				-80.0				
3: WP –					-100.0			
4: WY +						0.0		
Final		+55.0	+80.0	-80.0	-100.0	0.0	+30.0	
		X	Y	Z	PITCH	YAW	ROLL	PL ID
		-860	-411	-528	264	333	63	0

BRAKES – ON (tb-ON)



If radiator deploy reqd:

Perform RAD DEPLOY (ORB OPS, ECLS)

If conducting survey E, F, G, H, I, J, K, L, or M:

Go to step 1 of that survey configuration

If survey finished:

BRAKES – OFF (tb-OFF)

MODE – SINGLE, ENTER

SINGLE DR to PRE-CRADLE position (within 1°):

Initial  
1: SP –  
2: EP +  
3: WP +  
4: WR –  
5: SY –  
6: SP –  
Pre-cradle

√

SY	SP	EP	WP	WY	WR	
+55.0	+80.0	-80.0	-100.0	0.0	+30.0	
	+30.0					
		-25.0				
			+5.0			
					0.0	
0.0						
	+25.0					
0.0	+25.0	-25.0	+5.0	0.0	0.0	
X	Y	Z	PITCH	YAW	ROLL	PL ID
-1261	-146	-551	5	2	0	0

BRAKES – ON (tb-ON)

A7U

PORT RMS LIGHT – OFF

DAP: as reqd

Mnvr back to attitude per FLIGHT PLAN

**EXTERIOR SURVEY E – STBD SIDE, WING LEADING EDGE TO NOSE**  
(15 min reqd – does not include KU-BD ANT STOW)

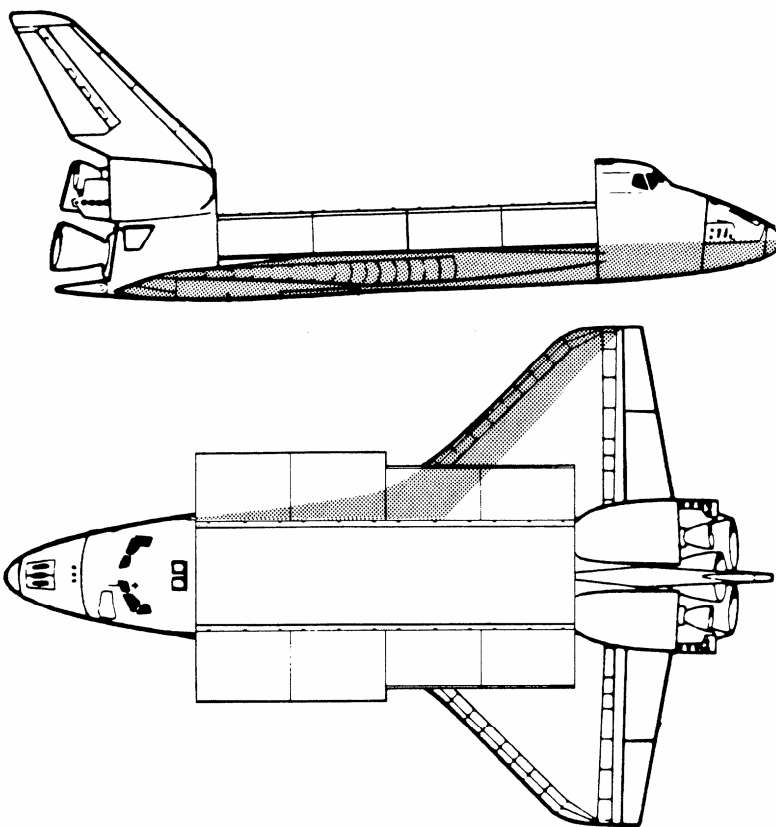

**WARNING**  
KU-BD ANT must be stowed

1. **SETUP**  
Perform KU-BD ANT STOW (ORB OPS, COMM/INST)

√Attitude

V10 (L10  
(VTR))

√Tape remaining, 5 min reqd

**CAUTION**  
Do not select DAP LO Z in this jet config

**GNC 23 RCS**

- RCS FWD – ITEM 1 EXEC (\*)
- JET DES F2R – ITEM 13 EXEC (\*)
- F4R – ITEM 15 EXEC (\*)
- F2D – ITEM 27 EXEC (\*)
- F4D – ITEM 29 EXEC (\*)

BRAKES – OFF (tb-OFF)  
MODE – SINGLE, ENTER

SINGLE DR to within  $\pm 1^\circ$  of SY, SP, EP:

	SY	SP	EP	WP	WY	WR	
Initial	-120.0		-78.0	-110.0	+60.0	+180.0	
1		+12.0					
Final	-120.0	+12.0	-78.0	-110.0	+60.0	+180.0	
	X	Y	Z	PITCH	YAW	ROLL	PL ID
	-562	+245	-349	358	359	3	0

BRAKES – ON (tb-ON)

2. SURVEY

A7U PORT RMS LIGHT – ON, as reqd  
ALC pb – as reqd  
GAMMA pb – as reqd

V10 If recording views with V10:

REC pbs – Press simo  
√LCD displays red dot

L10 If recording views with VTR:

REC pb – Press, hold  
(VTR) PLAY pb – Press, simo (√red dot displayed)

RATE – VERN (RATE MIN tb-ON)

DAP: VERN(FREE)

BRAKES – OFF (tb-OFF)  
MODE – SINGLE, ENTER

SINGLE DR WY to  $-75^\circ$ :

SY	SP	EP	WP	WY	WR	
-120.0	+12.0	-78.0	-110.0	-75.0 (MA)	+180.0	
X	Y	Z	PITCH	YAW	ROLL	PL ID
-466	+208	-336	200	41	129	0

BRAKES – ON (tb-ON)

Stop recording

3. RECONFIGURE

BRAKES – OFF (tb-OFF)  
MODE – SINGLE, ENTER

SINGLE DR to (within  $1^\circ$ ):

	SY	SP	EP	WP	WY	WR	
Initial	-120.0	+12.0	-78.0	-110.0	-75.0 (MA)	+180.0	
1: SP +		+30.0					
2: EP +			-30.0				
3: WY +					0.0		
Final	-120.0	+30.0	-30.0	-110.0	0.0	+180.0	
	X	Y	Z	PITCH	YAW	ROLL	PL ID
	-443	+259	-635	280	358	42	0

BRAKES – ON (tb-ON)

Perform KU-BD ANT DEPLOY (ORB OPS, COMM/INST)

If conducting survey F:  
Go to step 1 of that survey configuration

When RMS clear of fwd RCS jets:

**GNC 23 RCS**

RCS FWD – ITEM 1 EXEC (\*)

JET DES F2R – ITEM 13 EXEC (no \*)

F4R – ITEM 15 EXEC (no \*)

F2D – ITEM 27 EXEC (no \*)

F4D – ITEM 29 EXEC (no \*)

If conducting survey G, H, I, J, K, L, or M:  
Go to step 1 of that survey configuration

If survey finished:  
BRAKES – OFF (tb-OFF)  
MODE – SINGLE, ENTER

SINGLE DR to PRE-CRADLE position (within 1°):

	SY	SP	EP	WP	WY	WR	
√	-120.0	+30.0	-30.0	-110.0	0.0	+180.0	
1: SP –		+25.0					
2: EP +			-25.0				
3: WP +				+5.0			
4: WR –						0.0	
5: SY +	0.0						
Pre-cradle	0.0	+25.0	-25.0	+5.0	0.0	0.0	
	X	Y	Z	PITCH	YAW	ROLL	PL ID
	-1261	-146	-551	5	2	0	0

BRAKES – ON (tb-ON)

A7U PORT RMS LIGHT – OFF

DAP: as reqd

Mnvr back to attitude per FLIGHT PLAN

**EXTERIOR SURVEY F – STBD SIDE, UNDERBODY WING TO NOSE WITH STOWED MPM** (12 min reqd – does not include KU-BD ANT or RAD STOW)

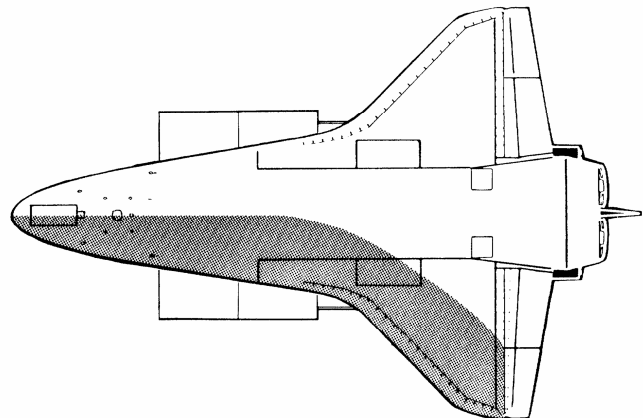
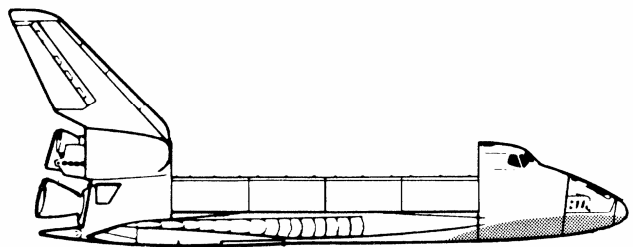

**WARNING**  
KU-BD ANT and STBD  
RAD must be stowed  
DAP must be in FREE or VERN

1. **SETUP**  
Perform KU-BD ANT STOW (ORB OPS, COMM/INST)

If radiators deployed:  
Perform RAD STOW (ORB OPS, ECLS)

Perform RMS PWRDN, steps 1, 2, 3, 4, 5  
Perform RMS PWRUP, steps 5, 6, 7

√Attitude

DAP: VERN(FREE)

V10 (L10  
(VTR))

√Tape remaining, 5 min reqd

**CAUTION**  
Do not select DAP LO Z in this jet config

**GNC 23 RCS**

- RCS FWD – ITEM 1 EXEC (\*)
- JET DES F2R – ITEM 13 EXEC (\*)
  - F4R – ITEM 15 EXEC (\*)
  - F2D – ITEM 27 EXEC (\*)
  - F4D – ITEM 29 EXEC (\*)

BRAKES – OFF (tb-OFF)  
 MODE – SINGLE, ENTER

SINGLE DR to within  $\pm 1^\circ$  of SY, SP, EP:

SY	SP	EP	WP	WY	WR	
-114.0	+23.0	-78.0	-112.0	+55.0	+192.0	
X	Y	Z	PITCH	YAW	ROLL	PL ID
-580	258	-423	350	7	24	0

BRAKES – ON (tb-ON)

2. SURVEY

A7U PORT RMS LIGHT – ON, as reqd  
 ALC pb – as reqd  
 GAMMA pb – as reqd

V10 If recording views with V10:

- REC pbs – Press simo
- √LCD displays red dot

L10 If recording views with VTR:

- REC pb – Press, hold
- PLAY pb – Press, simo (√red dot displayed)

RATE – VERN (RATE MIN tb-ON)

BRAKES – OFF (tb-OFF)  
 MODE – SINGLE, ENTER

SINGLE DR WY to  $-70^\circ$ :

SY	SP	EP	WP	WY	WR	
-114.0	+23.0	-78.0	-112.0	-70.0	+192.0	
X	Y	Z	PITCH	YAW	ROLL	PL ID
-484	+230	-416	203	38	131	0

BRAKES – ON (tb-ON)

Stop recording

3. RECONFIGURE

BRAKES – OFF (tb-OFF)  
 MODE – SINGLE, ENTER

SINGLE DR to (within 1°):

	SY	SP	EP	WP	WY	WR	
Initial	-114.0	+23.0	-78.0	-112.0	-70.0	+192.0	
1: SP +		+70.0					
2: WP +				+5.0			
3: WY +					0.0		
4: WR -						0.0	
Final	-114.0	+70.0	-78.0	+5.0	0.0	0.0	
	X	Y	Z	PITCH	YAW	ROLL	PL ID
	-500	+207	-765	148	299	124	0

BRAKES – ON (tb-ON)

When RMS clear of fwd RCS jets:

**GNC 23 RCS**

RCS FWD – ITEM 1 EXEC (\*)

JET DES F2R – ITEM 13 EXEC (no \*)

F4R – ITEM 15 EXEC (no \*)

F2D – ITEM 27 EXEC (no \*)

F4D – ITEM 29 EXEC (no \*)

Perform RMS PWRDN, steps 1, 2, 3, 4

If radiator deploy reqd:

Perform RAD DEPLOY (ORB OPS, ECLS)

Perform KU-BD ANT DEPLOY (ORB OPS, COMM/INST)

If conducting survey G, H, I, J, K, L, or M:

Perform RMS PWRUP, steps 4, 5, 6, 7

Go to step 1 of that survey configuration

If survey finished and MPM DPLY reqd:

Perform RMS PWRUP, steps 4, 6

A7U

PORT RMS LIGHT – OFF

DAP: as reqd

Mnvr back to attitude per FLIGHT PLAN

# EXTERIOR SURVEY G – STBD SIDE, NOSE (12 min reqd)

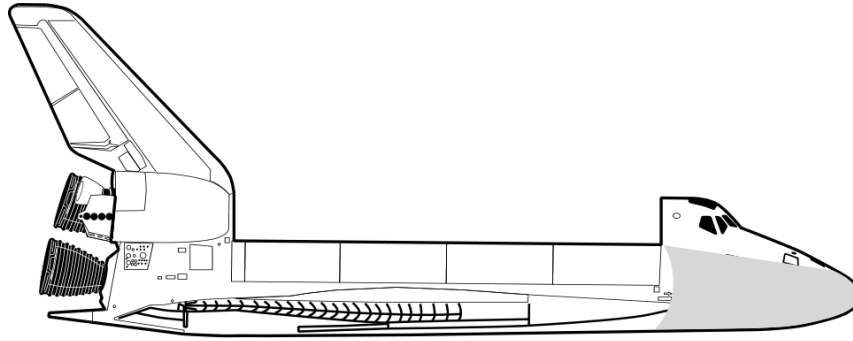

jsc48039\_006.cnv

## 1. SETUP

√Attitude

VTR: √Tape remaining, 2 min reqd

**GNC 23 RCS**

RCS FWD – ITEM 1 EXEC (\*)

JET DES F1U – ITEM 17 EXEC (\*)

F3U – ITEM 19 EXEC (\*)

F2U – ITEM 21 EXEC (\*)

BRAKES – OFF (tb-OFF)

MODE – SINGLE, ENTER

SINGLE DR to within  $\pm 1^\circ$  of SY, SP, EP:

SY	SP	EP	WP	WY	WR	
-127.0	+43.0	-68.0	-112.0	0.0	+220.0	
X	Y	Z	PITCH	YAW	ROLL	PL ID
-446	+183	-552	298	19	74	0

BRAKES – ON (tb-ON)

## A7U 2. SURVEY

PORT RMS LIGHT – ON, as reqd

ALC pb – as reqd

GAMMA pb – as reqd

V10 If recording views with V10:

REC pbs – Press simo

√LCD displays red dot

If recording views with VTR:

L10 REC pb – Press, hold

(VTR) PLAY pb – Press, simo (√red dot displayed)

RATE – VERN (RATE MIN tb-ON)

BRAKES – OFF (tb-OFF)

MODE – SINGLE, ENTER



SINGLE DR WY to -45°:

SY	SP	EP	WP	WY	WR	
-127.0	+43.0	-68.0	-112.0	-45.0	+220.0	
X	Y	Z	PITCH	YAW	ROLL	PL ID
-407	+166	-558	251	39	98	0

BRAKES – ON (tb-ON)

Stop recording

3. RECONFIGURE

If conducting survey H:

Go to step 1 of that survey configuration

When RMS clear of fwd RCS jets:

GNC 23 RCS

RCS FWD – ITEM 1 EXEC (\*)

JET DES F1U – ITEM 17 EXEC (no \*)

F3U – ITEM 19 EXEC (no \*)

F2U – ITEM 21 EXEC (no \*)

If conducting survey I, J, K, L, or M:

Go to step 1 of that survey configuration

If survey finished:

BRAKES – OFF (tb-OFF)

MODE – SINGLE, ENTER

SINGLE DR to PRE-CRADLE position (within 1°):

Initial	√	SY	SP	EP	WP	WY	WR	
		-127.0	+43.0	-68.0	-112.0	-45.0	+220.0	
1: EP +				-25.0				
2: WP +					+5.0			
3: WY +						0.0		
4: WR –							0.0	
5: SY +		0.0						
6: SP –			+25.0					
Pre-cradle		0.0	+25.0	-25.0	+5.0	0.0	0.0	
		X	Y	Z	PITCH	YAW	ROLL	PL ID
		-1261	-146	-551	5	2	0	0

BRAKES – ON (tb-ON)

A7U

PORT RMS LIGHT – OFF

DAP: as reqd

Mnvr back to attitude per FLIGHT PLAN

**EXTERIOR SURVEY H – TOP SIDE, NOSE AND OVHD WINDOWS (12 min reqd)**

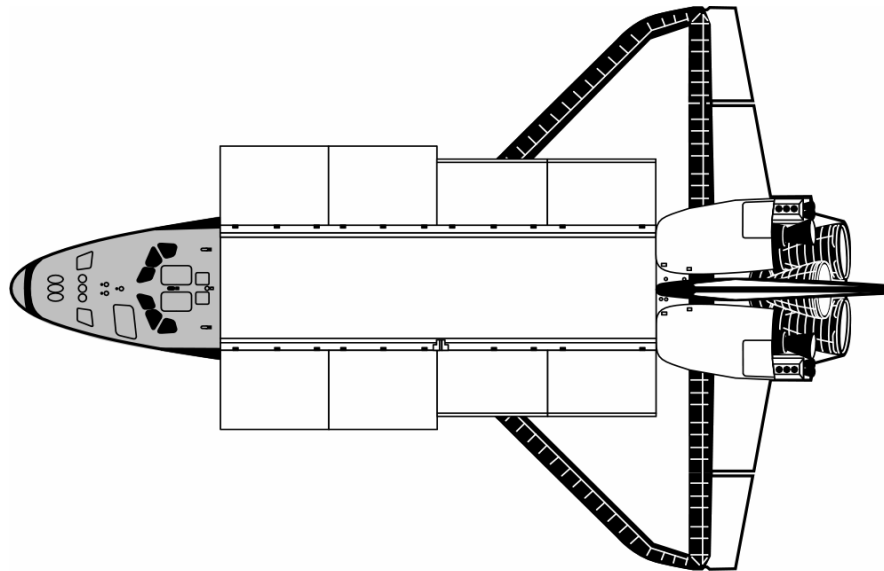

jsc48039\_003.cnv

1. SETUP

√Attitude

V10 (L10  
(VTR))

√Tape remaining, 5 min reqd

**GNC 23 RCS**

RCS FWD – ITEM 1 EXEC (\*)

JET DES F1U – ITEM 17 EXEC (\*)

F3U – ITEM 19 EXEC (\*)

F2U – ITEM 21 EXEC (\*)

NOTE

RMS appears in -Z star tracker  
Bright Object Sensor FOV

BRAKES – OFF (tb-OFF)

MODE – SINGLE, ENTER

SINGLE DR to within  $\pm 1^\circ$  of SY, SP, EP:

SY	SP	EP	WP	WY	WR	
-134.0	+94.0	-100.0	-98.0	-13.0	-209.0	
X	Y	Z	PITCH	YAW	ROLL	PL ID
-498	0	-650	270	0	0	0

BRAKES – ON (tb-ON)

A7U 2. SURVEY  
 PORT RMS LIGHT – ON, as reqd  
 ALC pb – as reqd  
 GAMMA pb – as reqd

V10 If recording views with V10:  
 REC pbs – Press simo  
 √LCD displays red dot

L10 If recording views with VTR:  
 REC pb – Press, hold  
 (VTR) PLAY pb – Press, simo (√red dot displayed)

BRAKES – OFF (tb-OFF)  
 MODE – ORB UNL, ENTER  
 THC – +X (OUT) to X = -275  
 RHC – -PITCH to PITCH = 262, then return to PITCH = 270  
 THC – -X (IN) to X = -498

BRAKES – ON (tb-ON)

Stop recording

3. RECONFIGURE

GNC 23 RCS

RCS FWD – ITEM 1 EXEC (\*)  
 JET DES F1U – ITEM 17 EXEC (no \*)  
 F3U – ITEM 19 EXEC (no \*)  
 F2U – ITEM 21 EXEC (no \*)

If conducting survey I, J, K, L, or M:  
 BRAKES – OFF  
 MODE – SINGLE, ENTER

SINGLE DR to (within 1°):

	SY	SP	EP	WP	WY	WR	
Initial	-134.0	+94.0	-100.0	-98.0	-13.0	-209.0	
1: SY +	-60.0						
2: EP +			-60.0				
3: WR +						0.0	
Final	-60.0	+94.0	-60.0	-98.0	-13.0	0.0	
	X	Y	Z	PITCH	YAW	ROLL	PL ID
	-792	-15	-845	272	312	278	0

If survey finished:

	SY	SP	EP	WP	WY	WR	
Initial	-134.0	+94.0	-100.0	-98.0	-13.0	-209.0	
1: SY +	0.0						
2: EP +			-40.0				
3: WP +				+5.0			
4: WY +					0.0		
5: WR +						0.0	
6: SP -		+25.0					
7: EP +			-25.0				
Pre-cradle	0.0	+25.0	-25.0	+5.0	0.0	0.0	
	X	Y	Z	PITCH	YAW	ROLL	PL ID
	-1261	-146	-551	5	2	0	0

BRAKES – ON (tb-ON)

A7U PORT RMS LIGHT – OFF

DAP: as reqd

Mnvr back to attitude per FLIGHT PLAN

**EXTERIOR SURVEY I – TOP VIEW, STBD WING (12 min reqd)**

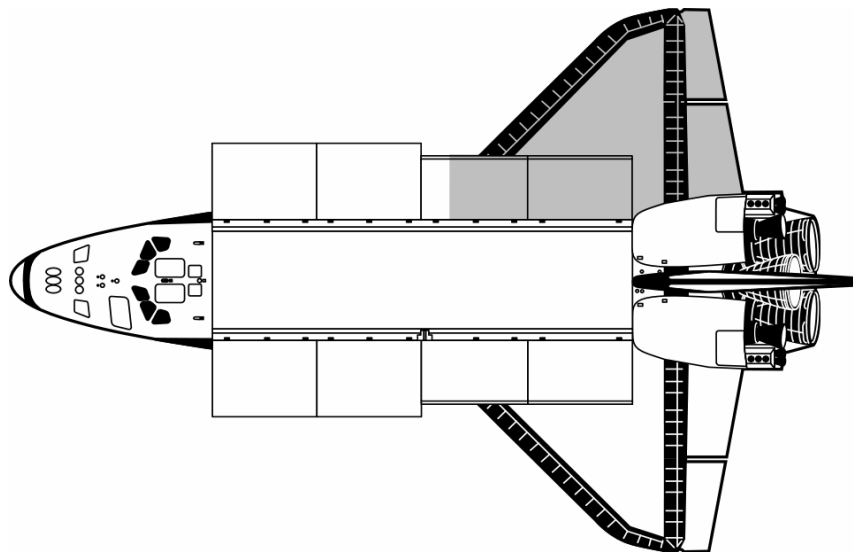

jsc48039\_004.cnv

1. SETUP

√Attitude

V10 (L10  
(VTR))

√Tape remaining, 5 min reqd

BRAKES – OFF (tb-OFF)  
MODE – SINGLE, ENTER

SINGLE DR to within  $\pm 1^\circ$  of SY, SP, EP:

SY	SP	EP	WP	WY	WR	
-60.0	+40.0	-50.0	-50.0	+45.0	+65.0	
X	Y	Z	PITCH	YAW	ROLL	PL ID
-964	+260	-643	323	351	12	0

BRAKES – ON (tb-ON)

2. SURVEY

A7U

PORT RMS LIGHT – ON, as reqd  
ALC pb – as reqd  
GAMMA pb – as reqd

V10

If recording views with V10:  
REC pbs – Press simo  
√LCD displays red dot

L10

(VTR)

If recording views with VTR:  
REC pb – Press, hold  
PLAY pb – Press, simo (√red dot displayed)

RATE – VERN (RATE MIN tb-ON)

BRAKES – OFF (tb-OFF)  
MODE – SINGLE, ENTER

SINGLE DR to (within 1°):

	SY	SP	EP	WP	WY	WR	
Initial	-60.0	+40.0	-50.0	-50.0	+45.0	+65.0	
1: WP -				-90.0			
2: WY -					+35.0		
3: WP +				-50.0			
Final	-60.0	+40.0	-50.0	-50.0	+35.0	+65.0	
	X	Y	Z	PITCH	YAW	ROLL	PL ID
	-959	+268	-640	317	343	11	0

BRAKES – ON (tb-ON)

Stop recording

3. RECONFIGURE

If conducting survey J, K, L, or M:

Go to step 1 of that survey configuration

If survey finished:

BRAKES – OFF (tb-OFF)

MODE – SINGLE, ENTER

SINGLE DR to PRE-CRADLE position (within 1°):

	SY	SP	EP	WP	WY	WR	
Initial	-60.0	+40.0	-50.0	-50.0	+35.0	+65.0	
1: SY +	0.0						
2: EP +			-25.0				
3: WP +				+5.0			
4: WY -					0.0		
5: WR -						0.0	
6: SP -		+25.0					
Pre-cradle	0.0	+25.0	-25.0	+5.0	0.0	0.0	
	X	Y	Z	PITCH	YAW	ROLL	PL ID
	-1261	-146	-551	5	2	0	0

BRAKES – ON (tb-ON)

A7U

PORT RMS LIGHT – OFF

DAP: as reqd

Mnvr back to attitude per FLIGHT PLAN

**EXTERIOR SURVEY J – TOP VIEW, PORT WING (12 min reqd)**

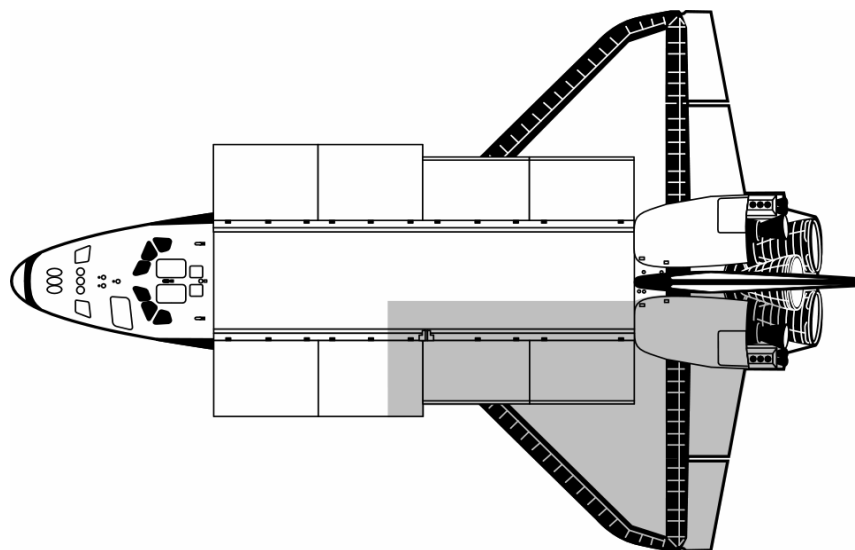

jsc48039\_005.cnv

1. SETUP

√Attitude

V10 (L10  
(VTR))

√Tape remaining, 5 min reqd

BRAKES – OFF (tb-OFF)  
MODE – SINGLE, ENTER

SINGLE DR to within  $\pm 1^\circ$  of SY, SP, EP:

SY	SP	EP	WP	WY	WR	
0.0	+84.0	-40.0	-102.0	+17.0	+10.0	
X	Y	Z	PITCH	YAW	ROLL	PL ID
-945	-252	-803	300	0	0	0

BRAKES – ON (tb-ON)

2. SURVEY

A7U

PORT RMS LIGHT – ON, as reqd  
ALC pb – as reqd  
GAMMA pb – as reqd

V10

If recording views with V10:

REC pbs – Press simo

√LCD displays red dot

If recording views with VTR:

L10

REC pb – Press, hold

(VTR)

PLAY pb – Press, simo (√red dot displayed)

RATE – VERN (RATE MIN tb-ON)

BRAKES – OFF (tb-OFF)  
 MODE – ORB UNL, ENTER  
 THC – +Z(DN) to Z = -600, then return to Z = -803

BRAKES – ON (tb-ON)

Stop recording

3. RECONFIGURE

If conducting survey K, L, or M:  
 Go to step 1 of that survey configuration

If survey finished:  
 BRAKES – OFF (tb-OFF)  
 MODE – SINGLE, ENTER

SINGLE DR to PRE-CRADLE position (within 1°):

Initial	√	SY	SP	EP	WP	WY	WR	
		0.0	+84.0	-40.0	-102.0	+17.0	+10.0	
1: EP +				-25.0				
2: WP +					+5.0			
3: WY –						0.0		
4: WR –							0.0	
5: SP –			+25.0					
Pre-cradle		0.0	+25.0	-25.0	+5.0	0.0	0.0	
		X	Y	Z	PITCH	YAW	ROLL	PL ID
		-1261	-146	-551	5	2	0	0

BRAKES – ON (tb-ON)

A7U PORT RMS LIGHT – OFF

DAP: as reqd

Mnvr back to attitude per FLIGHT PLAN



**EXTERIOR SURVEY K – PORT, OMS POD AND VERT TAIL (12 min reqd)**

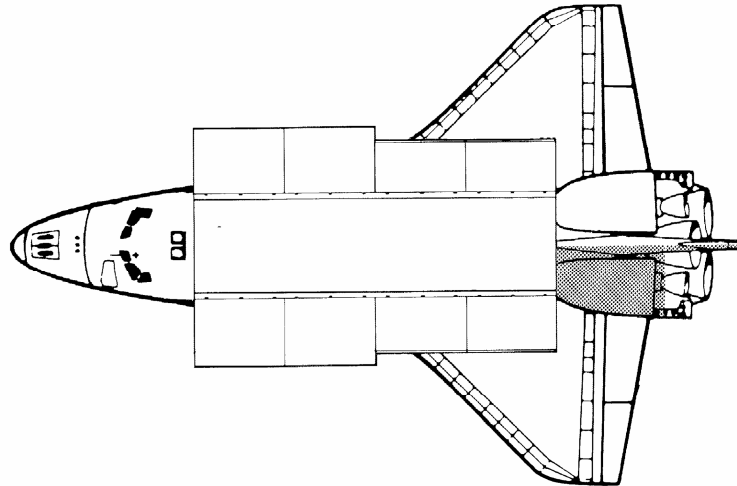
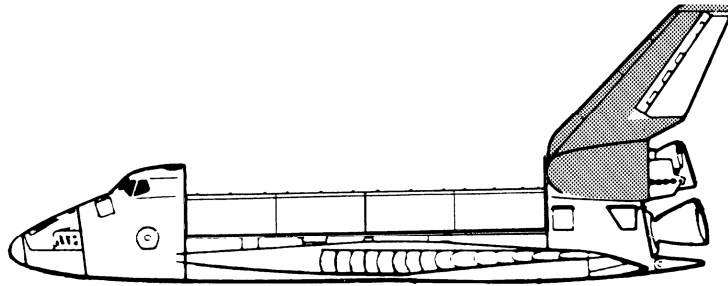

1. SETUP

√Attitude

V10 (L10  
(VTR))

√Tape remaining, 5 min reqd

BRAKES – OFF (tb-OFF)  
MODE – SINGLE, ENTER

SINGLE DR to within  $\pm 1^\circ$  of SY, SP, EP:

Initial	√	SY	SP	EP	WP	WY	WR	
		-7.0	+55.0	-10.0	-57.0	+10.0	+22.0	
	1: SP –		+21.0					
Final		-7.0	+21.0	-10.0	-57.0	+10.0	+22.0	
		X	Y	Z	PITCH	YAW	ROLL	PL ID
		-1236	-83	-550	315	351	11	0

BRAKES – ON (tb-ON)

2. SURVEY

A7U

PORT RMS LIGHT – ON, as reqd  
ALC pb – as reqd  
GAMMA pb – as reqd

V10 If recording views with V10:  
 REC pbs – Press simo  
 √LCD displays red dot  
 L10 If recording views with VTR:  
 REC pb – Press, hold  
 (VTR) PLAY pb – Press, simo (√red dot displayed)

RATE – VERN (RATE MIN tb-ON)

BRAKES – OFF (tb-OFF)  
 MODE – SINGLE, ENTER

Mnvr using WP, WY to perform survey

BRAKES – ON (tb-ON)

Stop recording

3. RECONFIGURE

If conducting survey L or M:  
 Go to step 1 of that survey configuration

If survey finished:  
 BRAKES – OFF (tb-OFF)  
 MODE – SINGLE, ENTER

SINGLE DR to PRE-CRADLE position (within 1°):

Initial	√	SY	SP	EP	WP	WY	WR	
		-7.0	+21.0	-10.0	-57.0	+10.0	+22.0	
1: SP +			+35.0					
2: WP +					+5.0			
3: WY –						0.0		
4: WR –							0.0	
5: EP –				-25.0				
6: SY +		0.0						
7: SP –			+25.0					
Pre-cradle		0.0	+25.0	-25.0	+5.0	0.0	0.0	
		X	Y	Z	PITCH	YAW	ROLL	PL ID
		-1261	-146	-551	5	2	0	0

BRAKES – ON (tb-ON)

A7U PORT RMS LIGHT – OFF

DAP: as reqd

Mnvr back to attitude per FLIGHT PLAN

**EXTERIOR SURVEY L – PORT, LEAD EDGE VERT TAIL (12 min reqd)**

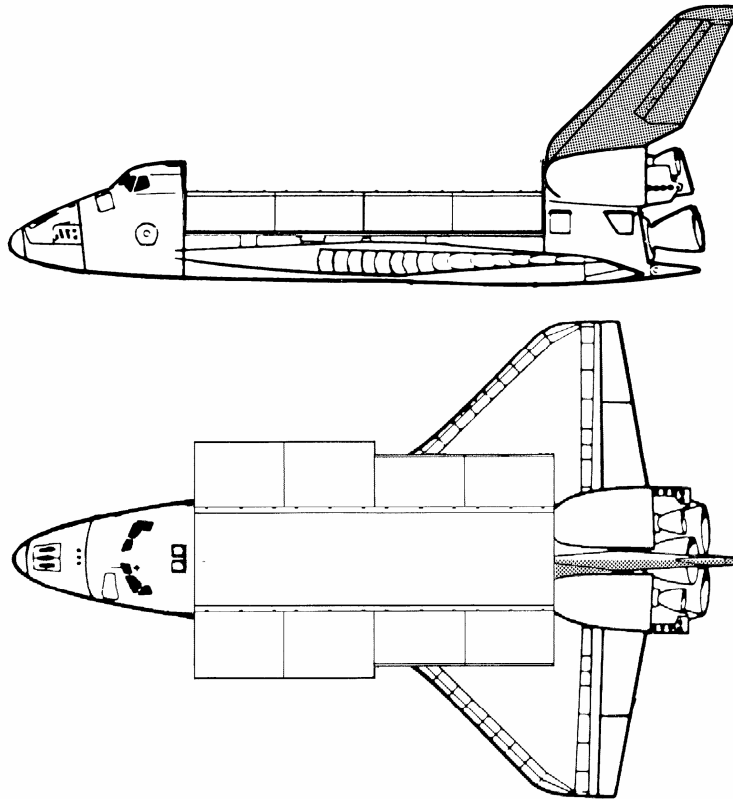

1. SETUP

√Attitude

V10 (L10  
(VTR))

√Tape remaining, 5 min reqd

BRAKES – OFF (tb-OFF)  
MODE – SINGLE, ENTER

SINGLE DR to within  $\pm 1^\circ$  of SY, SP, EP:

SY	SP	EP	WP	WY	WR	
-13.0	+42.0	-23.0	-66.0	+4.0	0.0	
X	Y	Z	PITCH	YAW	ROLL	PL ID
-1169	-74	-675	316	341	345	0

BRAKES – ON (tb-ON)

A7U

2. SURVEY

PORT RMS LIGHT – ON, as reqd

ALC pb – as reqd

GAMMA pb – as reqd

V10 If recording views with V10:  
 REC pbs – Press simo  
 √LCD displays red dot

L10 If recording views with VTR:  
 REC pb – Press, hold  
 (VTR) PLAY pb – Press, simo (√red dot displayed)

RATE – VERN (RATE MIN tb-ON)

BRAKES – OFF (tb-OFF)  
 MODE – SINGLE, ENTER

SINGLE DR WP to -20°:

SY	SP	EP	WP	WY	WR		
-13.0	+42.0	-23.0	-20.0	+4.0	0.0		
X	Y	Z	PITCH	YAW	ROLL	PL ID	
-1192	-86	-727	2	351	0	0	

BRAKES – ON (tb-ON)

Stop recording

3. RECONFIGURE

If conducting survey M:  
 Go to step 1 of that survey configuration

If survey finished:  
 BRAKES – OFF (tb-OFF)  
 MODE – SINGLE, ENTER

SINGLE DR to PRE-CRADLE position (within 1°):

Initial  
 1: SY +  
 2: SP –  
 3: EP –  
 4: WP +  
 5: WY –  
 Pre-cradle

SY	SP	EP	WP	WY	WR		
-13.0	+42.0	-23.0	-20.0	+4.0	0.0		
0.0							
	+25.0						
		-25.0					
			+5.0				
				0.0			
0.0	+25.0	-25.0	+5.0	0.0	0.0		
X	Y	Z	PITCH	YAW	ROLL	PL ID	
-1261	-146	-551	5	2	0	0	

BRAKES – ON (tb-ON)

A7U PORT RMS LIGHT – OFF

DAP: as reqd

Mnvr back to attitude per FLIGHT PLAN

**EXTERIOR SURVEY M – STBD SIDE, LEAD EDGE VERT TAIL AND OMS POD**  
 (12 min reqd)

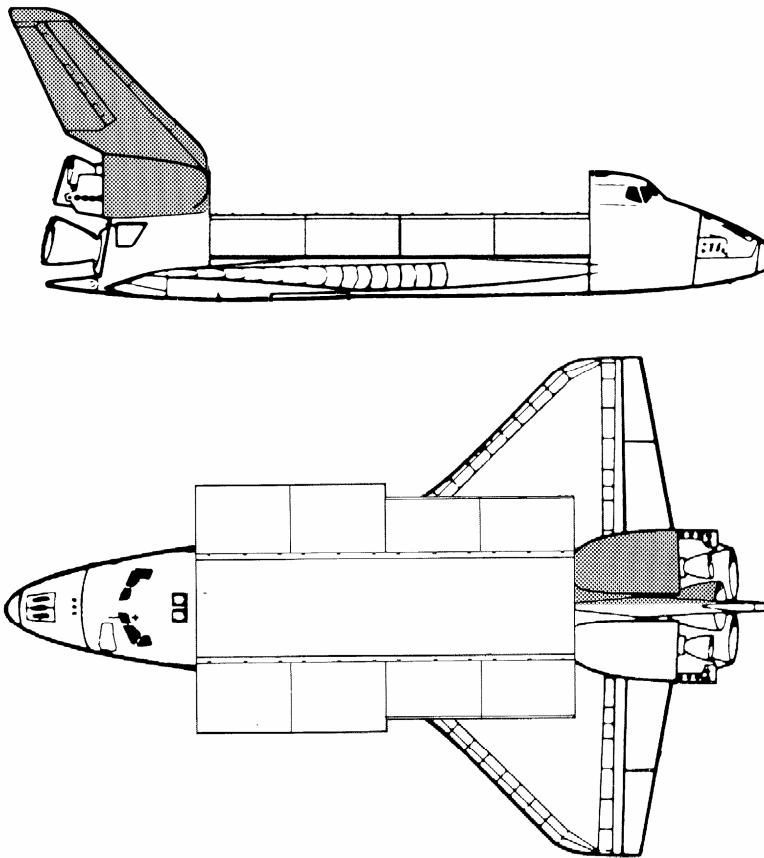

1. SETUP

√Attitude

V10 (L10 (VTR)) √Tape remaining, 5 min reqd

BRAKES – OFF (tb-OFF)  
 MODE – SINGLE, ENTER

SINGLE DR to within  $\pm 1^\circ$  of SY, SP, EP:

Initial 1: SP – Final	√	SY	SP	EP	WP	WY	WR	
		-37.0	+55.0	-10.0	-60.0	+56.0	+22.0	
			+21.0					
		-37.0	+21.0	-10.0	-60.0	+56.0	+22.0	
		X	Y	Z	PITCH	YAW	ROLL	PL ID
		-1139	+128	-641	325	16	350	0

BRAKES – ON (tb-ON)

2. SURVEY

A7U  
 PORT RMS LIGHT – ON, as reqd  
 ALC pb – as reqd  
 GAMMA pb – as reqd

V10 If recording views with V10:  
 REC pbs – Press simo  
 √LCD displays red dot  
 L10 If recording views with VTR:  
 REC pb – Press, hold  
 (VTR) PLAY pb – Press, simo (√red dot displayed)

RATE – VERN (RATE MIN tb-ON)

BRAKES – OFF (tb-OFF)  
 MODE – SINGLE, ENTER

SINGLE DR WP to 0°:

SY	SP	EP	WP	WY	WR	
-37.0	+21.0	-10.0	0.0	+56.0	+22.0	
X	Y	Z	PITCH	YAW	ROLL	PL ID
-1152	+122	-688	0	20	30	0

BRAKES – ON (tb-ON)

Stop recording

- RECONFIGURE  
 BRAKES – OFF (tb-OFF)  
 MODE – SINGLE, ENTER

SINGLE DR to PRE-CRADLE position (within 1°):

	SY	SP	EP	WP	WY	WR	
Initial	-37.0	+21.0	-10.0	0.0	+56.0	+22.0	
1: SP +		+35.0					
2: WP +				+5.0			
3: WY –					0.0		
4: WR –						0.0	
5: EP –			-25.0				
6: SY +	0.0						
7: SP –		+25.0					
Pre-cradle	0.0	+25.0	-25.0	+5.0	0.0	0.0	
X	Y	Z	PITCH	YAW	ROLL	PL ID	
-1261	-146	-551	5	2	0	0	

BRAKES – ON (tb-ON)

A7U PORT RMS LIGHT – OFF

DAP: as reqd

Mnvr back to attitude per FLIGHT PLAN

**SUPPLY/WASTE H2O DUMP NOZZLE SURVEY ARM CONFIG**

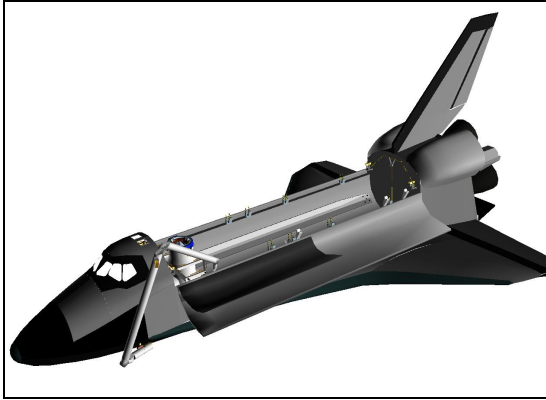

**BIRD'S EYE PORT**

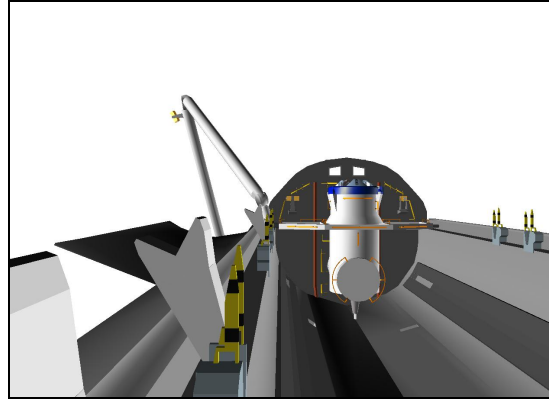

**CCTV B (0,0)**

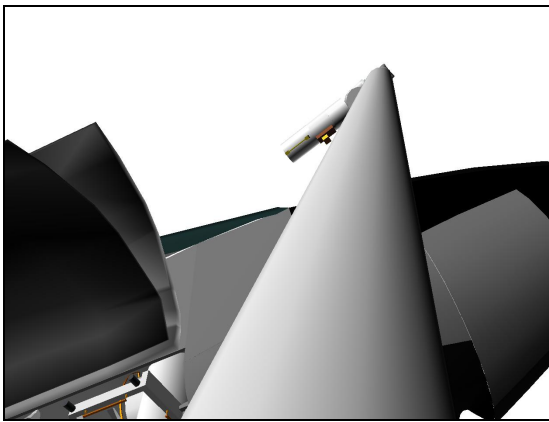

**ELBOW (-15,-25)**

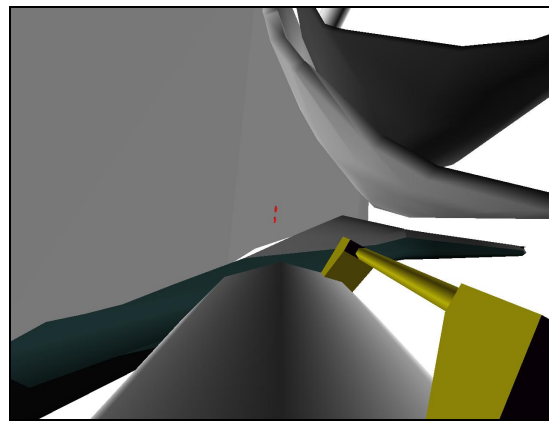

**END EFFECTOR**

## SUPPLY/WASTE H2O DUMP NOZZLE SURVEY

1. ORBITER MNVR TO DUMP ATTITUDE (Skip if performed per FLIGHT PLAN callout)

### NOTE

MCC to complete for optimum lighting, DAP, reqd tape time

#### GNC UNIV PTG

TGT ID \_\_\_\_\_  
BODY VECT \_\_\_\_\_  
P \_\_\_\_\_  
Y \_\_\_\_\_  
OM \_\_\_\_\_

A6U DAP: \_\_/AUTO/VERN(ALT)  
Init TRK, ITEM 19 EXEC (\*)

2. SETUP  
A7U VID OUT pb – MON 1  
IN pb – B  
VID OUT pb – MON 2  
IN pb – RMS

#### SM 94 PDRS CONTROL

√SOFT STOP, ITEM 7 – ENA (\*)  
√AUTO BRAKE, ITEM 9 – ENA (\*)  
√POS ENC CK, ITEM 11 – ENA (\*)

VTR: √Tape remaining, \_\_\_\_ min reqd

3. PRCS JET INHIBIT

#### CAUTION

Do not select DAP LO Z in this jet config

#### GNC 23 RCS

RCS FWD – ITEM 1 EXEC (\*)  
JET DES F1L – ITEM 9 EXEC (\*)  
F3L – ITEM 11 EXEC (\*)  
F1U – ITEM 17 EXEC (\*)  
F1D – ITEM 23 EXEC (\*)  
F3D – ITEM 25 EXEC (\*)

4. MNVR RMS TO SURVEY POSN

### NOTE

RMS appears in -Y star tracker  
Bright Object Sensor FOV

PARAM – JOINT ANGLE  
BRAKES – OFF (tb-OFF)  
MODE – SINGLE, ENTER



NOTE

Drive joints as specified in joint angle table below to ensure adequate clearance from structure. PAN and TILT Elbow Camr to monitor EE/orbiter clearance

SINGLE DR to (within 1°):

	SY	SP	EP	WP	WY	WR	
Pre-cradle ✓	0.0	+25.0	-25.0	+5.0	0.0	0.0	
1: SP +		+45.0					
2: WP -				-104.0			
3: WY -					-6.0		
4: WR +						+175.0	
5: SY +	+140.0						
6: EP -			-115.0				
7: SY +	+154.0						
Final	+154.0	+45.0	-115.0	-104.0	-6.0	+175.0	
	X	Y	Z	PITCH	YAW	ROLL	PL ID
	-494	-168	-324	1.0	339	354	0

BRAKES – ON (tb-ON)  
 ✓MODE – not DIRECT  
 JOINT – CRIT TEMP

5. SURVEY

NOTE

Lighting is critical to dump viewing. Optimal results achieved if EE Camr zoomed in and view is orthogonal to nozzle

- A7U PORT RMS LIGHT – ON  
 CAMERA – WRIST  
 ZOOM – IN (as reqd to view nozzle)  
 ALC pb – as reqd  
 GAMMA pb – as reqd
  
- V10 If recording views with V10:  
 REC pbs – Press simo  
 ✓LCD displays red dot
- L10 If recording views with VTR:  
 REC pb – Press, hold  
 (VTR) PLAY pb – Press, simo (✓red dot displayed)

When survey complete:  
 Stop recording

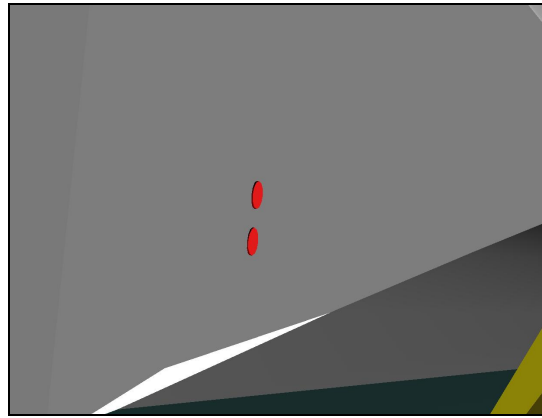

**END EFFECTOR (zoomed)**

6. MNVR RMS BACK TO PRE-CRADLE

BRAKES – OFF (tb-OFF)

MODE – SINGLE, ENTER

SINGLE DR to (within 1°):

Initial	√	SY	SP	EP	WP	WY	WR	
		+154.0	+45.0	-115.0	-104.0	-6.0	+175.0	
1: SY –		+140.0						
2: EP +				-25.0				
3: WP +					+5.0			
4: WY +						0.0		
5: WR –							0.0	
6: SY –		0.0						
7: SP –			+25.0					
Pre-cradle		0.0	+25.0	-25.0	+5.0	0.0	0.0	
		X	Y	Z	PITCH	YAW	ROLL	PL ID
		-1261	-146	-551	5	2	0	0

BRAKES – ON (tb-ON)

√MODE – not DIRECT

JOINT – CRIT TEMP

A7U PORT RMS LIGHT – OFF

7. PRCS JET ENABLE

GNC 23 RCS

RCS FWD – ITEM 1 EXEC (\*)

JET DES F1L – ITEM 9 EXEC (no \*)

F3L – ITEM 11 EXEC (no \*)

F1U – ITEM 17 EXEC (no \*)

F1D – ITEM 23 EXEC (no \*)

F3D – ITEM 25 EXEC (no \*)

8. DAP RECONFIGURATION

A6U DAP: as reqd

Mnvr back to attitude per FLIGHT PLAN

OBSS OPERATIONS

NOMINAL.....	7-3
OBSS UNBERTH.....	7-3
LDRI/IDC RCC SURVEY – STBD.....	7-9
– NOSE CAP.....	7-24
– PORT.....	7-31
BERTH.....	7-44
OFF-NOMINAL.....	7-50
OBSS SJ UNBERTH.....	7-50
BERTH.....	7-62
JETTISON.....	7-77
ITVC TILE ACREAGE SURVEY.....	7-83
RMS EE RCC WING SURVEY.....	7-103

**OBSS  
OPERATIONS**

This Page Intentionally Blank

# OBSS UNBERTH

**WARNING**  
For UNDOCKED ops only

NOTE

Stbd MPMs assumed deployed

1. SETUP

SM 94 PDRS CONTROL

√PL ID, ITEM 3: 0

√INIT ID, ITEM 24: 0

RHC

2. MNVR TO OBSS PRE-GRAPPLE

RATE – as reqd (VERN within 10 ft)

BRAKES – OFF (tb-OFF)

MODE – ORB UNL, ENTER

If first RMS ops for the mission:

Perform manual PLB survey, en route to OBSS PRE-GRAPPLE position

Mnvr to OBSS PRE-GRAPPLE posn:

X	Y	Z	PITCH	YAW	ROLL	PL ID
-680	+96	-513	270	350	1	0
SY	SP	EP	WP	WY	WR	
-90.0	+87.6	-129.5	-57.5	0.0	+110.4	

RATE – COARSE

MODE – SINGLE, ENTER

Adjust Wrist Roll:

Pre-Grapple 1: WR –	SY	SP	EP	WP	WY	WR	
	-90.0	+87.6	-129.5	-57.5	0.0	+110.4	
Pre-Grapple						-249.6*	
	-90.0	+87.6	-129.5	-57.5	0.0	-249.6	
	X	Y	Z	PITCH	YAW	ROLL	PL ID
	-680	+96	-513	270	350	1	0

\* WR RANGE = 2

BRAKES – ON (tb-ON)

**CAUTION**  
SPEE power must be applied within 90 min  
to prevent sensor package damage

STBD RMS HTR A,B (two) – OFF

A6U

EVENT TIMER MODE – UP

CNTL – START

R12(OBSS) √SPEE PWR – OFF

SSP1(OV-104) √APCU 1,2 CONV (two) – OFF

A15(OV-103,  
OV-105)

NOMINAL

3. OBSS GRAPPLE

- A7U CCTV – config for grapple
  - install PDRS TARGET OVERLAY FOR CTVM
  - RMS WRIST, ZOOM: 34.0 HFOV
  - FOCUS: 5 ft

Maintain eyepoint ~18 in when using grapple overlay

- A6U DAP: VERN(FREE)

- RHC RATE – VERN (RATE MIN tb-ON)
- BRAKES – OFF (tb-OFF)
- MODE – END EFF, ENTER

Mnvr to grapple envelope

CAUTION  
Monitor EE tb timing to prevent EE motor burnout

- EE MODE – AUTO
- CAPTURE – depress (mom)

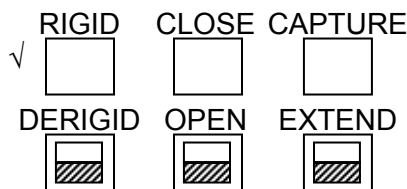

CRITICAL TIMES (28 sec total):  
 CAPTURE tb – gray, then  
 CLOSE tb – gray, 3 sec max, then  
 RIGID tb – gray, 25 sec max

- EE MODE – OFF
- BRAKES – ON (tb-ON)

SM 94 PDRS CONTROL  
 PL ID – ITEM 3 +1 EXEC  
 INIT ID – ITEM 24 +1 EXEC

Record POSN/ATT and Joint Angles in table below and in OBSS BERTH, step 4:

	X	Y	Z	PITCH	YAW	ROLL	PL ID
							1
Expected	-680	+105	-436	0	0	341	1
	SY	SP	EP	WP	WY	WR	
Expected	-90.0	+76.5	-134.6	-40.9	0.0	-250.0	

Review GENERIC END EFFECTOR CUE CARD – SHUTTLE NOT DOCKED OPS

4. CONFIGURE POWER

- MA73C:C cb MCA PWR AC3 3Φ MID 2 – op
  - ✓AC2 3Φ MID 2 – op
- MA73C:D ✓AC3 3Φ MID 4 – op
- R13L PL BAY MECH PWR SYS (two) – ON

A7U 5. STBD MRL RELEASE  
CCTV – config for unberth

A6U DAP: FREE

SM 94 PDRS CONTROL  
RMS STBD – ITEM 2 EXEC (\*)

√STBD AFT, MID, FWD REL (six) = 0

NOTE

Expect single motor drive time for MRL release

STBD RMS RETEN LAT – REL (tb-REL) (18 sec max)  
– OFF

If motor drive time > 18 sec, √MCC

SM 94 PDRS CONTROL  
RMS PORT – ITEM 1 EXEC (\*)

R13L 6. RECONFIGURE POWER  
PL BAY MECH PWR SYS (two) – OFF

MA73C:C cb MCA PWR AC3 3Φ MID 2 – cl  
√AC2 3Φ MID 2 – op

MA73C:D √AC3 3Φ MID 4 – op

Record joint angles:

SY	SP	EP	WP	WY	WR

7. MNVR TO OBSS HOVER

NOTE

For PL ID 1, the rates have been set such that Coarse is allowed within 10 feet of structure for all maneuvers

RHC √RATE – COARSE (RATE MIN tb-OFF)  
BRAKES – OFF (tb-OFF)  
MODE – PL, ENTER

Mnvr OBSS up (-Z) to OBSS HOVER, Z = -517

X	Y	Z	PITCH	YAW	ROLL	PL ID
-680	+133	-517	360	0	341	1
SY	SP	EP	WP	WY	WR	
-89.9	+80.2	-118.8	-59.8	+0.0	+109.9	

BRAKES – ON (tb-ON)  
MODE – not DIRECT

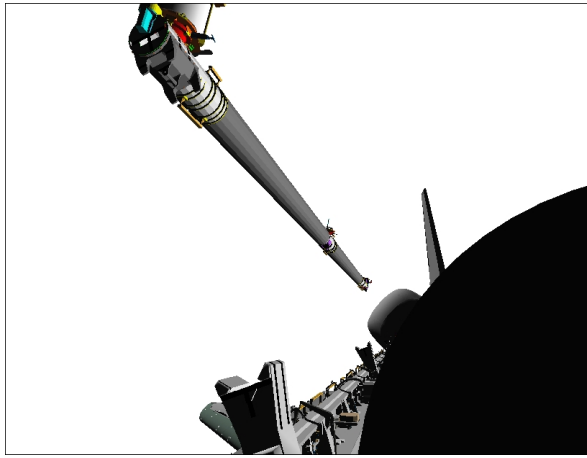

**CCTV D (-15,15)**

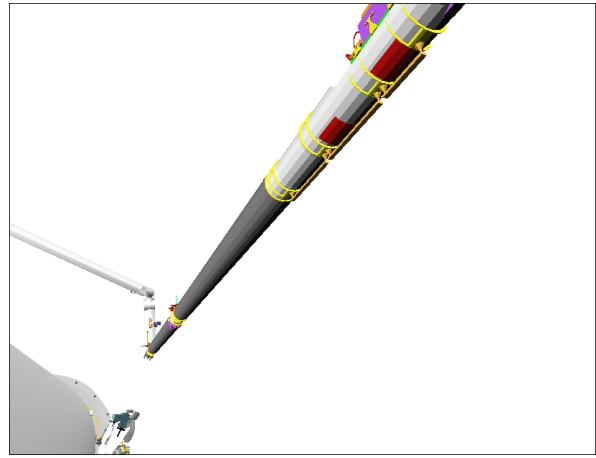

**CCTV C (25,25)**

DAP: A14/AUTO/VERN(FREE)

R12(OBSS) RSC PWR – OFF, ON

A6U If Verns failed, DAP: AUTO/ALT

In the following P/TV procedure, start 15-min timer upon applying SPEE power and inform MCC when timer is started:

Perform ACTIVATION (LDRI/ITVC Cue Card, PHOTO/TV)

Perform LCH ACTIVATION (LCS Cue Card, PHOTO/TV)

Perform LCC ACTIVATION (LCS Cue Card, PHOTO/TV)

A7U 8. RESET PTU  
DTV ← PL2

CAMR CMD PAN/TILT – HI RATE

PAN – L (to hard stop)

TILT – UP (to hard stop)

PAN/TILT – RESET, HI RATE (LO within 10°)

PAN: +103 (right)

TILT: -260 (down)

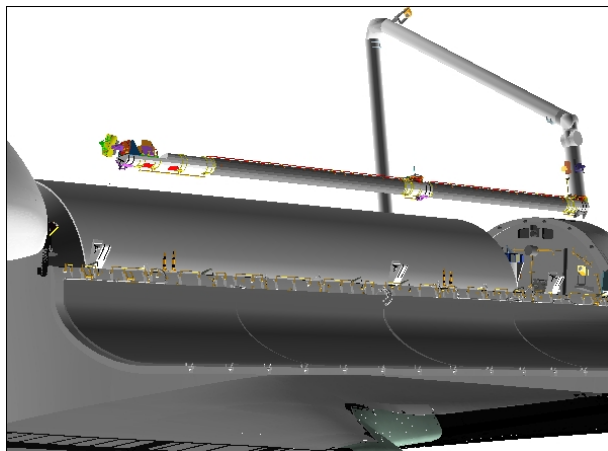

**BIRD'S EYE**

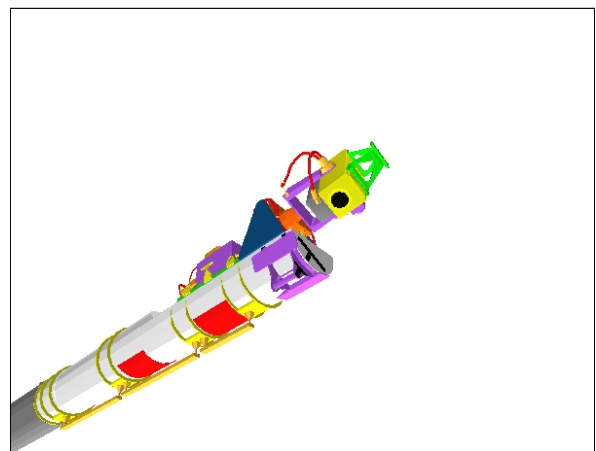

**CCTV C (50,50)**

If continuing OBSS ops for Late Inspection,  
Go to OBSS LDRI/IDC RCC SURVEY – STBD >>



9. LDRI CALIBRATION

NOTE

Ensure GMT is set on DSR-25

Verify 15 min SPEE warmup power timer expired

MUX 1 L ← MIDDECK

LDRI MODE 3 pb – push (LDRI video)

DTV ← PL2

PAN/TILT to match LDRI view shown below

Note PAN/TILT: \_\_\_\_\_, \_\_\_\_\_



**LDRI (103,-260)**

If LDRI calibration view of STBD sill presents unacceptable specular reflections,

A7U      PAN: +110 (right)  
            TILT: -220 (up)

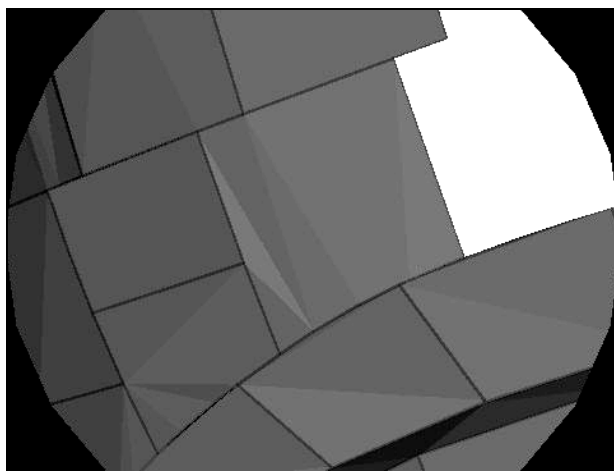

**LDRI (110,-220)**

L10(VTR)      On MCC GO,  
                    REC pb – push, hold  
                    PLAY pb – push, simo (red ●)

Record for 30 sec

MUX 1 L ← MIDDECK

A7U

LDRI MODE 4 pb – push (brighter LDRI video)

Record for 30 sec

LDRI MODE 5 pb – push (flickering LDRI video)

Record for 30 sec

LDRI MODE 6 pb – push (brighter flickering LDRI video)

Record for 30 sec

STOP pb – push (no red ●)

If continuing OBSS ops with Stbd RCC survey:

Mnvr to STBD SURVEY attitude per FLIGHT PLAN

Go to OBSS LDRI/IDC RCC SURVEY – STBD

<b>WARNING</b>
For UNDOCKED ops only
Stbd PLBD radiator must be stowed
APAS Docking Ring must be retracted

**NOTE**

Assumed starting posn is OBSS HOVER posn.

In case of SPEE pwr loss, reset RSC Illuminator, reset PTU, select correct LDRI mode.

Mnvr of SRMS/OBSS to STBD LDRI ACAS START posn may occur simo with Orbiter mnvr to STBD SURVEY attitude.

For PL ID 2, the rates have been set such that Coarse is allowed within 10 feet of structure for all maneuvers. Vern rates are only necessary for IDC scans

1. SETUP

**SM 94 PDRS CONTROL**

PL ID – ITEM 3 +2 EXEC

INIT ID – ITEM 24 +2 EXEC

AUTO MODES – ITEM 13 +1 +2 +3 +4 EXEC

For survey scan pattern, refer to OBSS SCAN PATTERN CUE CARDS – STBD & PORT, AND WING GLOVE & CREW CABIN

A7U

√DTV ← PL2

√LDRI MODE 6 pb – push (flickering LDRI video)

√PAN: +103

√TILT: -260

VIDEO OUT – as desired (not DTV)

2. MNVR TO FLAT FIELD POSN

<b>Mnvr to Flat Fields Clearance Views</b>	<b>Cameras</b>
OBSS-to-Wing	C, ELBOW
OBSS-to-PLBD	C, D
RMS-to-Orbiter	ELBOW, A

**NOTE**

Flat Field imagery is used to characterize sensor response. Daylight is NOT required

**SM 94 PDRS CONTROL**

√PL ID, ITEM 3: 2

√INIT ID, ITEM 24: 2

Load OPR CMD (Items 18-23)

-----  
 -1270, +350, -445, 0, 0, 11  
 -----

CMD CK, ITEM 25 EXEC (GOOD)

RATE – COARSE (RATE MIN tb-OFF)

BRAKES – OFF (tb-OFF)

MODE – OPR CMD, ENTER

√AUTO SEQ READY It – on

```

* If error found in destination entries (Items 18-23): *
*   BRAKES – ON (tb-ON) *
* * *
*   Enter corrected destination (Items 18-23) *
* * *
*   CMD CK, ITEM 25 EXEC (GOOD) *
* * *
*   BRAKES – OFF (tb-OFF) *
*   MODE – OPR CMD, ENTER *
* * *
* √AUTO SEQ READY It – on *
  
```

L10(VTR) REC pb – push, hold  
 PLAY pb – push, simo (red ●)

AUTO SEQ – PROCEED

When AUTO SEQ IN PROG It – off:

Verify FLAT FIELD posn:

X	Y	Z	PITCH	YAW	ROLL	PL ID
-1270	+350	-445	0	0	11	2
SY	SP	EP	WP	WY	WR	
-90.1	+25.0	-65.8	-57.6	0.0	-249.9	

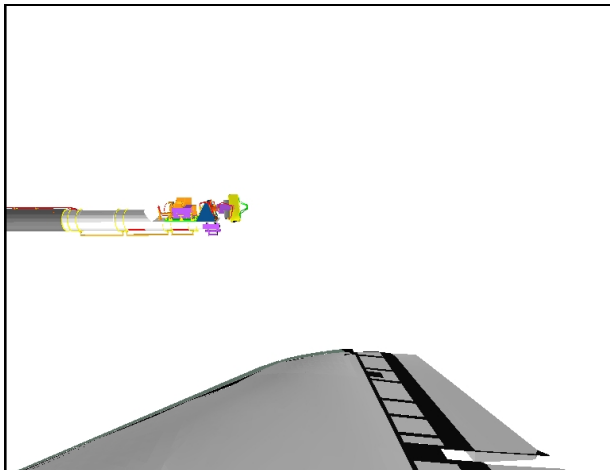

CCTV C (95,-4)

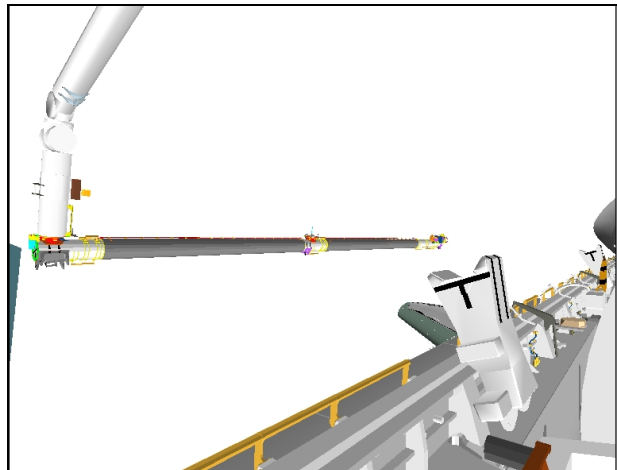

CCTV D (-40,0)

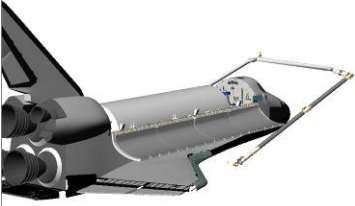

ACAS, pause pts **shaded in bold**, ● col indicates data recording (black = VTR on) (05:05)

Pt	X	Y	Z	PITCH	YAW	ROLL	●
1P	-1270	+350	-445	0	0	11	
2	-1200	+265	-445	0	0	11	
3	-1290	+320	-445	0	0	11	
4	-1140	+265	-445	0	0	11	
5	-1155	+290	-490	0	0	11	
6	-926	+300	-270	322	0	89	
7P	-909	+255	-274	337	10	82	



**BIRD'S EYE**

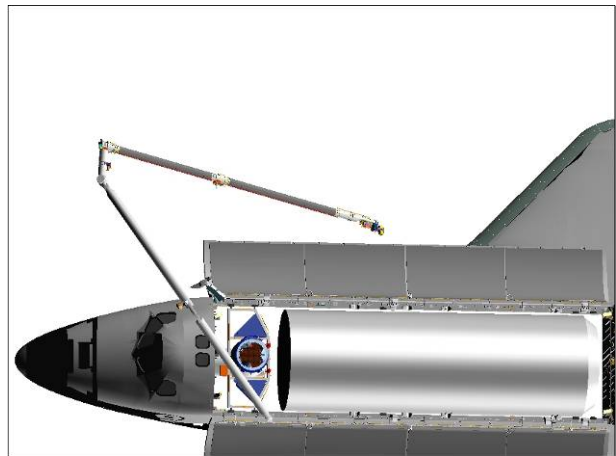

**OVERHEAD**

L10(VTR) When AUTO SEQ READY It – on:  
STOP pb – push (no red ●)

4. STBD LDRI ACAS, SECTION 1

√DTV ← PL2

√LDRI MODE 6 pb – push (flickering LDRI displayed)

- \* If not MODE 6: \*
- \* MUX 1 L ← MIDDECK \*
- \* LDRI MODE 6 pb – push (flickering LDRI displayed) \*
- \* DTV ← PL2 \*

PAN: +85 (left)

TILT: -93 (up)

PAN/TILT to match LDRI view shown below

On MCC GO,  
Note PAN/TILT: \_\_\_\_\_, \_\_\_\_\_

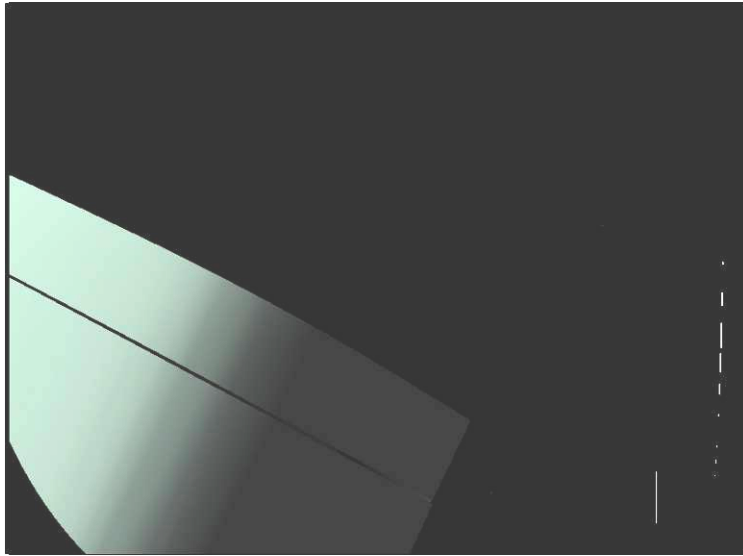

**LDRI (85,-93)**

VIDEO OUT – as desired (not DTV)

<b>Section 1 Clearance Views</b>	<b>Cameras</b>
OBSS-to-Wing	RSC, D, C
OBSS-to-PLBD	C, RSC, D[1]
RMS-to-Orbiter	A, ELBOW
[1] Good after X ~ -939(pt 7)	

LCC/PGSC Minimize, do not close LCC software  
sel 'Shuttle Apps' > 'IDC'

NOTE

Expect 'iport probe failed' message at first pwr on attempt.  
If message persists, see troubleshooting section

sel 'Power On'

- \* If 'Power On' button not gray: \*
- \* Pause 3 sec, then sel 'Power On' \*

√'AE' checked  
sel 'Scan Hi-Res'

L10(VTR) REC pb – push, hold  
PLAY pb – push, simo (red ●)

AUTO SEQ – PROCEED (IN PROG It on)

ACAS, pause pts **shaded in bold**, ● col indicates data recording (black = VTR on) and damage criteria (inches):

(06:50)

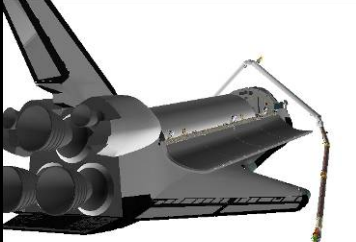
Pt	X	Y	Z	PITCH	YAW	ROLL	●
<b>7P</b>	<b>-909</b>	<b>+255</b>	<b>-274</b>	<b>337</b>	<b>10</b>	<b>82</b>	
8	-984	+260	-276	321	16	87	
9	-1025	+285	-273	304	6	62	
10	-1233	+508	-293	316	346	64	
11	-1300	+516	-272	326	349	55	
12	-1298	+482	-219	340	352	25	
<b>13P</b>	<b>-1328</b>	<b>+464</b>	<b>-221</b>	<b>348</b>	<b>346</b>	<b>12</b>	

LCC/PGSC When AUTO SEQ READY It – on:  
 sel 'Stop Scan'  
 √'Waiting for User Command' displayed

NOTE

LDR1 recording during camera tilt

A7U DTV ← PL2  
 CAM CMDS PAN/TILT – LOW RATE  
 √PAN: +85  
 TILT: -60 (up)  
 PAN/TILT to match LDR1 view shown below

On MCC GO,  
 Note PAN/TILT: \_\_\_\_\_, \_\_\_\_\_

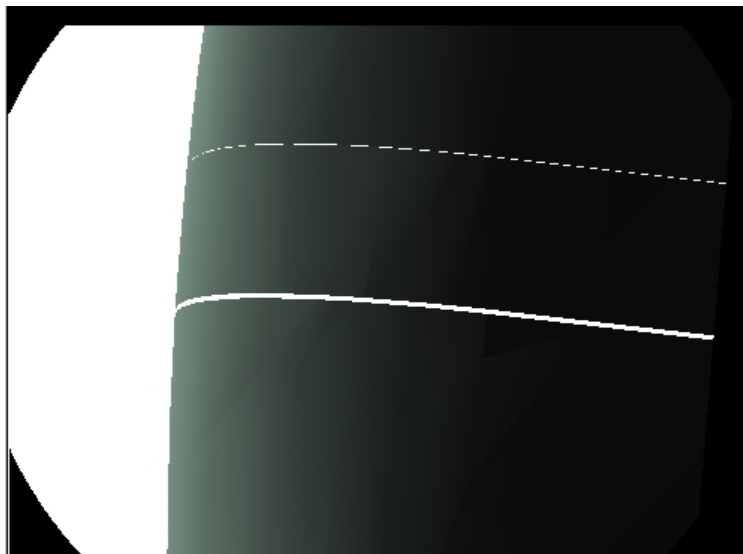

LDR1 (85,-60)



VIDEO OUT – as desired (not DTV)

If Late Inspection,  
Go to step 6

5. IDC/LCS CHARACTERIZATION

- L10(VTR) a. Setup  
BRAKES – ON (tb-ON)  
STOP pb – push (no red ●)

NOTE

LCS and IDC characterization images are obtained here to assess LCS and IDC sensor performance while looking at RCC

- LCC/PGSC b. LCS Characterization  
Allow arm motion to damp-out for 30 sec, then:  
Minimize, do not close IDC software  
Maximize LCC software  
sel 'Scanning' 'Detailed Area Scan'  
sel – Area Scan 11  
**cmd** Start Area Scan (verify Scan Status: Complete)  
  
sel – Area Scan 12  
**cmd** Start Area Scan (verify Scan Status: Complete)  
  
sel – Area Scan 13  
**cmd** Start Area Scan (verify Scan Status: Complete)

- LCC/PGSC c. IDC Characterization  
Minimize, do not close LCC software  
Maximize IDC software  
sel 'RCC-Day' or 'RCC-Night' from drop-down menu per real-time conditions  
sel 'Acquire Set'  
√'Acquiring Set' displayed  
√'Waiting for User Command' displayed after set

d. Reconfigure for Survey Activities

SM 94 PDRS CONTROL  
START PT – ITEM 17 +1 3 EXEC

BRAKES – OFF (tb-OFF)  
MODE – AUTO 1, ENTER (READY It on)

\* If unable to enter AUTO mode (no AUTO READY It): \*  
\* √POR coordinates and adjust as reqd \*

SM 169 PDRS STATUS  
Monitor ACAS progress



- L10(VTR) REC pb – push, hold  
PLAY pb – push, simo (red ●)

6. STBD LDRI ACAS, CONTINUE WITH SECTION 2 AND 3

Section 2 & 3 Clearance Views	Cameras
OBSS-to-PLBD	ELBOW[1], D[2], RSC, C[3]
OBSS-to-Wing	ELBOW[1], D[2], RSC, C[3]
RMS-to Orbiter	C, A, ELBOW[4]
[1] No good after X ~ -1120(pt 14) [2] No good between X ~ -962(pt 16) and X ~ -1014(pt 17)	[3] Good after X ~ -1024(pt 15) [4] Good after X ~ -1041(pt 19)

LCC/PGSC sel 'Scan Hi-Res'  
AUTO SEQ – PROCEED (IN PROG It on)

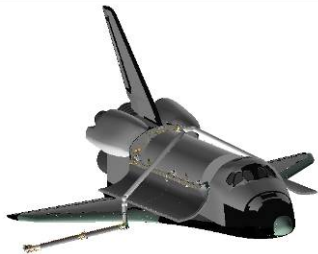
(08:25)

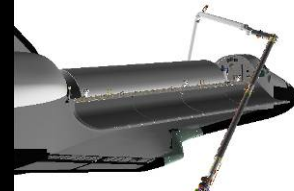
Pt	X	Y	Z	PITCH	YAW	ROLL	●
<b>13P</b>	<b>-1328</b>	<b>+464</b>	<b>-221</b>	<b>348</b>	<b>346</b>	<b>12</b>	
14	-1310	+448	-220	348	344	7	
15	-1066	+233	-199	335	9	28	
16	-1021	+211	-206	341	12	33	
17	-919	+213	-222	335	15	49	
18	-1019	+227	-210	339	11	37	
19	-1038	+267	-229	315	9	67	
20	-1268	+483	-236	335	350	44	
<b>21P</b>	<b>-1334</b>	<b>+531</b>	<b>-252</b>	<b>329</b>	<b>343</b>	<b>59</b>	

LCC/PGSC When AUTO SEQ READY It – on:  
L10(VTR) sel 'Stop Scan'  
STOP pb – push (no red ●)

A7U DTV ← PL2

√PAN: +85  
TILT: -75 (down)

PAN/TILT to match LDRI view shown below

On MCC GO,  
Note PAN/TILT: \_\_\_\_\_, \_\_\_\_\_

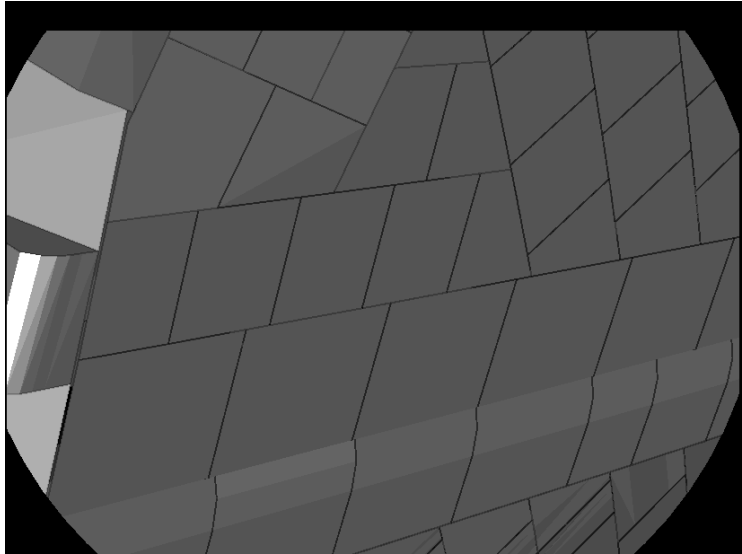

**LDRI (85,-75)**

VIDEO OUT – as desired (not DTV)

7. STBD LDRI ACAS, SECTION 4

<b>Section 4 Clearance Views</b>	<b>Cameras</b>
OBSS-to-PLBD	RSC[1], C, D
OBSS-to-Wing	RSC, D, C
RMS-to-Orbiter	A, ELBOW
[1] PLBD enters FOV after X ~ -1086(pt 24)	



NOTE

Clearance between Upper Boom and Docking Ring when retracted is approximately 18.8 inches at point 28P

LCC/PGSC sel 'Scan Hi-Res'  
L10(VTR) REC pb – push, hold  
PLAY pb – push, simo (red ●)

AUTO SEQ – PROCEED (IN PROG It on)

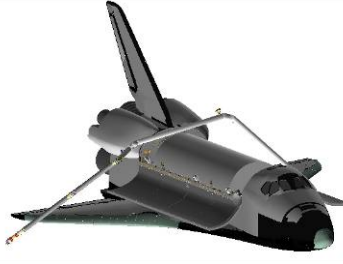
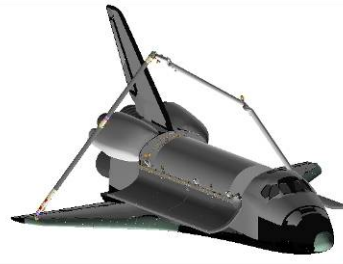
(08:15)

Pt	X	Y	Z	PITCH	YAW	ROLL	●
21P	-1334	+531	-252	329	343	59	
22	-1338	+538	-318	317	342	89	
23	-1274	+522	-317	308	339	90	
24	-1222	+479	-341	292	325	82	
25	-1029	+304	-315	275	340	71	
26	-1009	+284	-282	290	359	89	
27	-977	+263	-261	309	13	85	
28P	-923	+249	-253	323	16	77	

LCC/PGSC  
L10(VTR) When AUTO SEQ READY It – on:  
sel 'Stop Scan'  
STOP pb – push (no red ●)

If performing late inspection:  
BRAKES – ON (tb-ON)

**SM 94 PDRS CONTROL**

√PL ID, ITEM 3: 2

√INIT ID, ITEM 24: 2

Load OPR CMD (Items 18-23)

-----  
-922, +337, -290, 293, 358, 98  
-----

CMD CK, ITEM 25 EXEC (GOOD)

√RATE – COARSE (RATE MIN tb-OFF)

BRAKES – OFF (tb-OFF)

MODE – OPR CMD, ENTER

√AUTO SEQ READY It – on

\* If error found in destination entries (Items 18-23): \*

\* BRAKES – ON (tb-ON) \*

\* Enter corrected destination (Items 18-23) \*

\* CMD CK, ITEM 25 EXEC (GOOD) \*

\* BRAKES – OFF (tb-OFF) \*

\* MODE – OPR CMD, ENTER \*

\* √AUTO SEQ READY It – on \*

AUTO SEQ – PROCEED

When AUTO SEQ IN PROG It – off:

**SM 94 PDRS CONTROL**

START PT – ITEM 17 +4 1 EXEC

MODE – AUTO 1, ENTER

Go to step 11

8. INHIBIT NOSE JETS

O14:F, Pri RJDA LOGIC,DRIVER (eight) – ON  
 O15:F, √Pri RJDF LOGIC,DRIVER (eight) – OFF  
 O16:F  
 A6U DAP: A14/AUTO/ALT (Tail Only)

NOTE

Expect DAP RECONFIG message after  
 FRCS manifold 5 status overridden to close

**GNC 23 RCS**

RCS FWD – ITEM 1 EXEC (\*)  
 MANF VLVS OVRD 1 – ITEM 40 EXEC (CL)  
                           2 – ITEM 41 EXEC (CL)  
                           3 – ITEM 42 EXEC (CL)  
                           4 – ITEM 43 EXEC (CL)  
                           5 – ITEM 44 EXEC (CL)

9. STBD ITVC ACAS, WING GLOVE AND CREW CABIN (SECTION 5)

Wing Glove and Crew Cabin Clearance Views	Cameras
OBSS-to-PLBD	RSC[1], C, D
OBSS-to-Crew Cabin	C, D, RSC
RMS-to-Orbiter	A, ELBOW
[1] PLBD leaves FOV at X ~ -396(pt 33) and re-enters at X ~ -378(pt 34)	

A7U MUX 1 L ← MIDDECK  
 LDRI MODE 2 pb – push (ITVC video)

DTV ← PL2  
 ZOOM: 19.0 HFOV  
 FOCUS: 12 ft

PAN/TILT to match ITVC view shown below

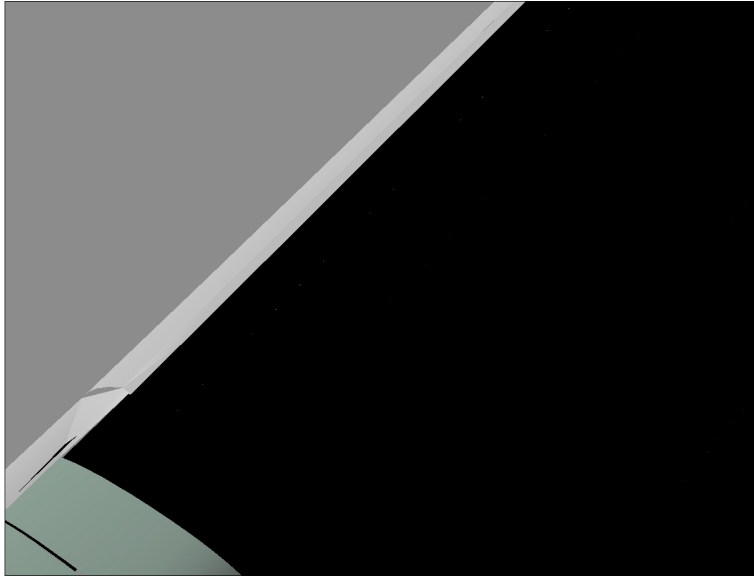

On MCC GO,  
Note PAN/TILT: \_\_\_\_\_, \_\_\_\_\_



**ITVC (85,-75)**

L10(VTR)

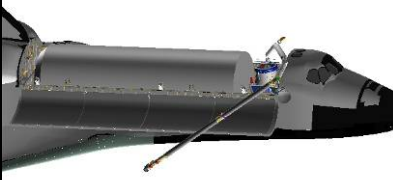
REC pb – push, hold  
PLAY pb – push, simo (red ●)

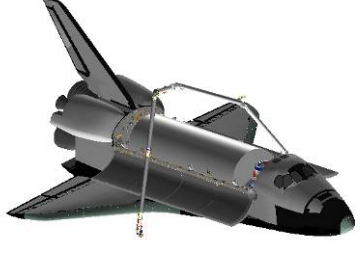
Pt	X	Y	Z	PITCH	YAW	ROLL	●
28P	-923	+249	-253	323	16	77	
29	-862	+319	-242	284	0	73	
30	-817	+295	-265	288	2	85	
31	-740	+295	-279	286	358	88	
32	-589	+290	-294	267	357	88	
33	-550	+293	-310	268	353	89	
34	-198	+177	-252	203	21	109	
35	-449	+270	-396	205	359	90	
36	-452	+272	-353	208	357	81	
37	-522	+272	-317	270	352	72	
38	-550	+293	-310	268	353	89	
39	-585	+291	-320	271	353	89	
40	-634	+291	-312	275	354	91	
41P	-922	+337	-290	293	358	98	

- When AUTO SEQ READY It – on:
- LCC/PGSC      sel 'Stop Scan'
  - sel 'Power Off'
  - L10(VTR)      STOP pb – push (no red ●)
  
  - A7U            MUX 1 L ← MIDDECK
  - LDR1 MODE 6 pb – push (brighter flickering LDR1 video)
  - VIDEO OUT – as desired (not DTV)
  
  - 10. ENABLE VERN NOSE JETS
  - GNC 23 RCS
  - RCS FWD – ITEM 1 EXEC (\*)
  - MANF VLVS OVRD 5 – ITEM 44 EXEC (OP)
  
  - A6U            DAP: VERN(FREE)

11. STBD LDRI ACAS, SECTIONS 6 AND 7

Sections 6 & 7 Clearance Views	Cameras
OBSS-to-PLBD	RSC[1], C, D
OBSS-to-Wing	C, D, RSC
RMS-to-Orbiter	A, ELBOW, B[2]
[1] PLBD leaves FOV at X ~ -1122(pt 44) and re-enters at X ~ -1151(pt 49)	[2] Good after X ~ -1380(pt 46)

PAN/TILT to match LDRI view shown below  
 Note PAN/TILT: \_\_\_\_\_, \_\_\_\_\_

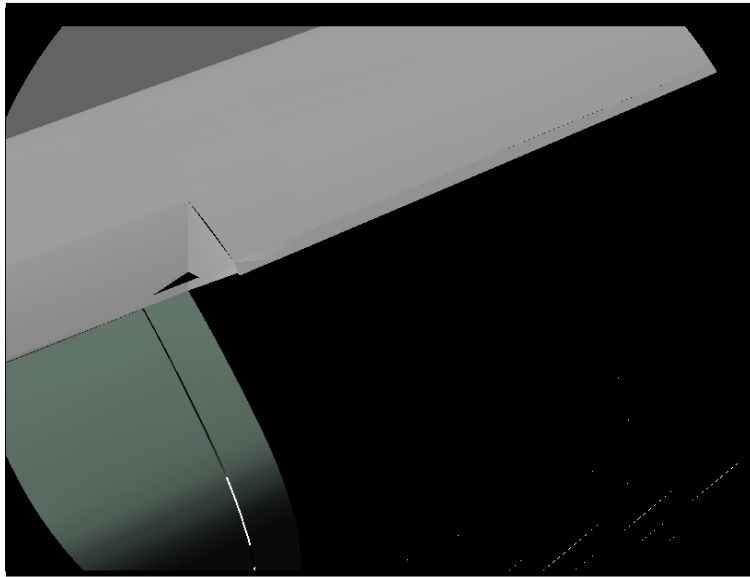

**LDRI (85,-75)**

L10(VTR) REC pb – push, hold  
 PLAY pb – push, simo (red ●)



AUTO SEQ – PROCEED (IN PROG It on)

(10:05)

Pt	X	Y	Z	PITCH	YAW	ROLL	●
<b>41P</b>	<b>-922</b>	<b>+337</b>	<b>-290</b>	<b>293</b>	<b>358</b>	<b>98</b>	<b>1</b>
42	-964	+297	-346	289	339	118	
43	-1029	+302	-330	271	335	75	
44	-1054	+304	-353	271	322	81	
45	-1276	+510	-364	305	310	100	
46	-1328	+529	-363	313	316	105	
47	-1391	+478	-395	320	306	166	<b>1/4</b>
48	-1292	+476	-390	299	298	121	
49	-1167	+367	-385	277	299	94	
50	-1096	+300	-376	269	307	92	
51	-1060	+281	-389	263	313	87	
52	-978	+283	-384	262	320	77	
<b>53P</b>	<b>-899</b>	<b>+284</b>	<b>-386</b>	<b>247</b>	<b>319</b>	<b>72</b>	<b>1</b>

L10(VTR) When AUTO SEQ IN PROG It – off:  
STOP pb – push (no red ●)

BRAKES – ON (tb-ON)

If continuing OBSS ops with Nose Cap survey:  
Mnvr Nose Cap Survey attitude per FLIGHT PLAN  
Go to OBSS LDRI/IDC RCC SURVEY – NOSE CAP

**OBSS LDRI/IDC RCC SURVEY – NOSE CAP (45 min)**

I

**WARNING**  
 For UNDOCKED ops only  
 Port PLBD radiator must be stowed

1. SETUP

SM 94 PDRS CONTROL

- √PL ID, ITEM 3: 2
- √INIT ID, ITEM 24: 2
  
- √AUTO MODE 2, ITEM 14: 2
- √3, ITEM 15: 3

2. INHIBIT NOSE JETS

- O14:F, √Pri RJDA LOGIC,DRIVER (eight) – ON
- O15:F, √Pri RJDF LOGIC,DRIVER (eight) – OFF
- O16:F

A6U                      When MNVR NOSE CAP SURVEY attitude complt,  
                                  DAP: A14/AUTO/ALT (Tail Only)

NOTE

Expect DAP RECONFIG message after FRCS  
 manifold 5 status overridden to close

GNC 23 RCS

- √RCS FWD, ITEM 1 (\*)
- √MANF VLVS OVRD 1 – ITEM 40 EXEC (CL)
  - √2 – ITEM 41 EXEC (CL)
  - √3 – ITEM 42 EXEC (CL)
  - √4 – ITEM 43 EXEC (CL)
  - 5 – ITEM 44 EXEC (CL)



3. MNVR TO NOSE CAP LDRI ACAS START POSN

Mnvr to Nose Cap ACAS Clearance Views	Cameras
OBSS-to-PLBD	ELBOW, C
OBSS-to-Orbiter	C[1], ELBOW[2], A, B[3], RSC[4]
RMS-to-Orbiter	A
OBSS-to-SRMS	B[5], ELBOW, A[6]
[1] No good after X ~ -778(pt 54)	[4] Nose Cap enter FOV at X ~ -257(pt 55)
[2] No good after X ~ -182(pt 55)	[5] No good after X ~ -464(pt 55)
[3] Good after X ~ -342(pt 55)	[6] Good after X ~ -357(pt 55)

- RHC                      √RATE     – COARSE (RATE MIN tb-off)
- BRAKES – OFF (tb-OFF)
- MODE     – AUTO 2, ENTER

SM 94 PDRS CONTROL

- √START POINT, ITEM 17: 54

Pt	X	Y	Z	PITCH	YAW	ROLL	•
54P	-899	+284	-386	247	319	72	
55	-550	-50	-900	100	295	345	
56	-150	+20	-355	241	312	350	
57P	-164	+20	-355	241	312	350	

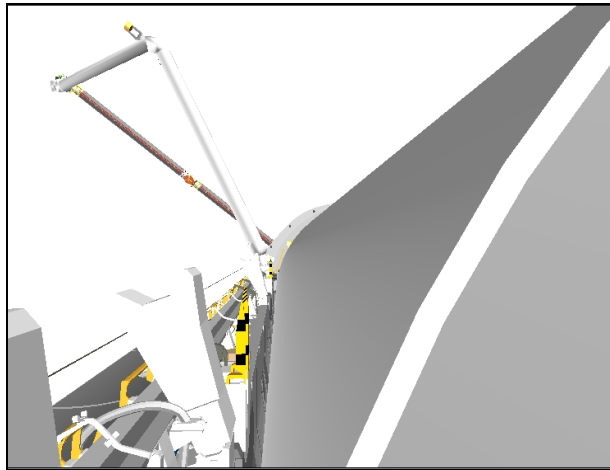

CCTV B (3,1)



CCTV A (90,42)

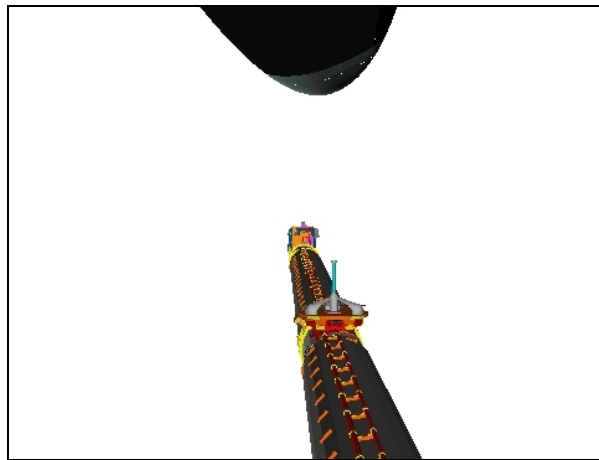

RSC

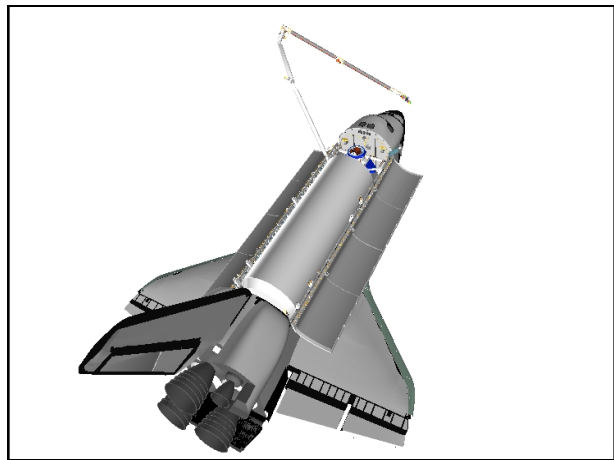

FLY CAM

A7U

4. NOSE CAP LDRI ACAS, SECTION 1

DTV ← PL2

√PAN: +85  
TILT: -60 (up)

PAN/TILT to match LDRI view shown below

On MCC GO,  
Note PAN/TILT: \_\_\_\_\_, \_\_\_\_\_

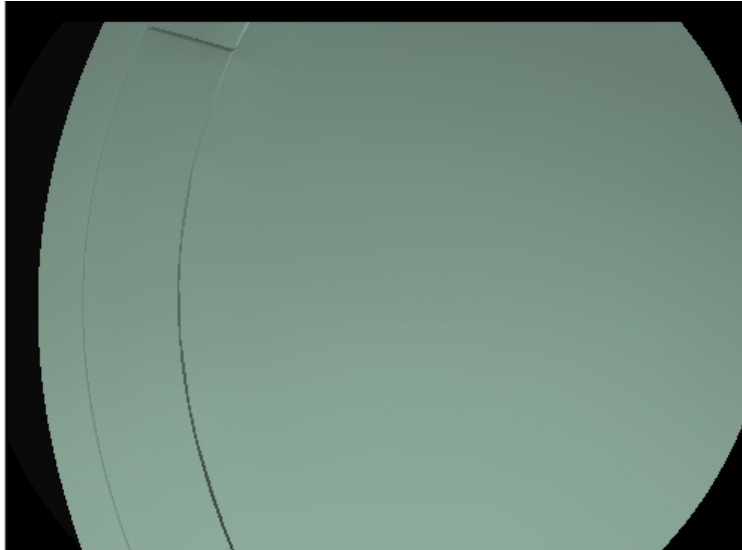

**LDRI (+85,-60)**

VIDEO OUT – as desired (not DTV)

For survey scan pattern, refer to OBSS SCAN PATTERN CUE CARD – NOSE CAP (CUE CARD CONFIG)

MODE – AUTO 3, ENTER (READY It on)

- \* If unable to enter AUTO mode (no AUTO READY It): \*
- \* √POR coordinates and adjust as reqd \*

SM 94 PDRS CONTROL

√START POINT, ITEM 17: 58

SM 169 PDRS STATUS

Monitor ACAS progress

Section 1 Clearance Views	Cameras
OBSS-to-Nose Cap	RSC, ELBOW[1], B, C[2] [3] [4]
RMS-to-Orbiter	B, ELBOW, A
[1] Elbow Cam is necessary to resolve clearances between OBSS and RMS between X ~ -181(pt. 74) and X ~ -185 (pt. 81)	[3] Window views may help to resolve clearances between X ~ -163(pt. 59) and X ~ -156(pt. 61)
[2] Cam C helps to resolve clearances between X ~ -162(pt. 58) and X ~ -163 (pt. 59)	[4] Elbow Cam is necessary to resolve clearances between X ~ -185(pt. 81) and X ~ -167(pt. 82)

LCC/PGSC sel 'Power On'





- \* If 'Power On' button not gray: \*
- \* Pause 3 sec, then sel 'Power On' \*

√'AE' checked

L10(VTR) sel 'Scan Hi-Res'  
 REC pb – push, hold  
 PLAY pb – push, simo (red ●)  
 AUTO SEQ – PROCEED (IN PROG It on)

ACAS, pause pts **shaded in bold**, ● col indicates data recording (black = VTR on) and damage criteria (inches):

(23:30)

Pt	X	Y	Z	PITCH	YAW	ROLL	●
<b>58P</b>	<b>-164</b>	<b>+20</b>	<b>-355</b>	<b>241</b>	<b>312</b>	<b>350</b>	
59	-155	+50	-373	240	314	1	
60	-170	+63	-305	262	328	17	
61	-170	+45	-330	260	328	17	
62	-145	+15	-315	240	300	330	
63	-157	+36	-319	228	286	312	
64	-155	-8	-336	209	295	292	
65	-164	+10	-288	222	289	279	
66	-158	+5	-320	224	292	300	
67	-170	+15	-380	226	295	357	
68	-155	+30	-335	235	305	357	
69	-160	+70	-340	249	330	35	
70	-202	+92	-330	260	327	49	
71	-180	+70	-360	249	329	30	
72	-181	+60	-395	238	297	15	
73	-179	+33	-405	226	295	357	
74	-185	-35	-400	180	300	310	
75	-179	-70	-360	161	316	268	
76	-171	-25	-370	163	310	273	
77	-170	-50	-300	163	314	245	
78	-205	-5	-245	182	292	230	
79	-210	+20	-255	154	296	195	
80	-208	+61	-265	147	293	187	
81	-175	+35	-252	151	302	189	
82	-184	-28	-256	254	308	309	
83	-165	+60	-295	140	295	195	

Pt	X	Y	Z	PITCH	YAW	ROLL	●
84	-165	-5	-305	186	295	258	
85	-165	-75	-340	186	295	258	
<b>86P</b>	<b>-181</b>	<b>-75</b>	<b>-340</b>	<b>186</b>	<b>295</b>	<b>258</b>	<b>1/4 ●</b>



When AUTO SEQ READY It – on:  
LCC/PGSC sel 'Stop Scan'  
sel 'Power Off'  
L10(VTR) STOP pb – push (no red ●)

A7U DTV ← PL2

PAN: +64 (left)  
TILT: -93 (down)

PAN/TILT to match LDRI view shown below

On MCC GO,  
Note PAN/TILT: \_\_\_\_\_, \_\_\_\_\_

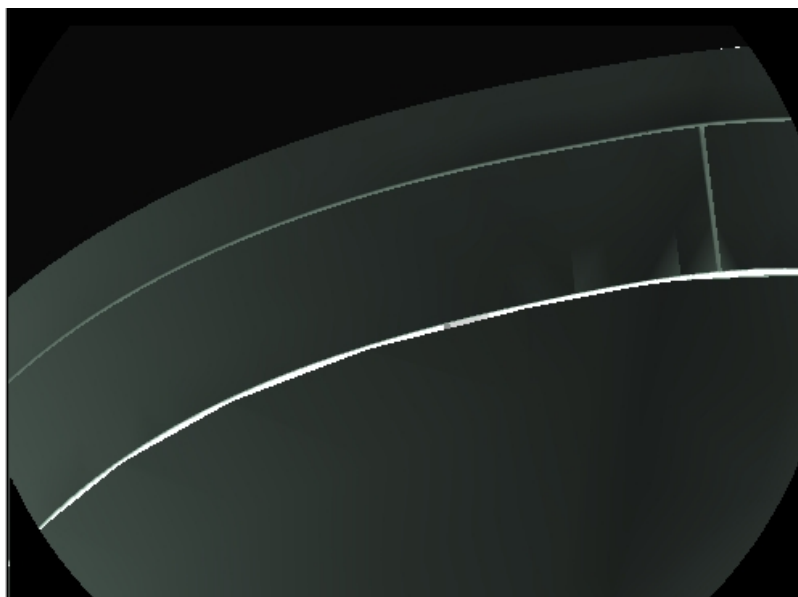

**LDRI (64,-93)**

VIDEO OUT – as desired (not DTV)

L10(VTR) REC pb – push, hold  
PLAY pb – push, simo (red ●)

AUTO SEQ – PROCEED (IN PROG It on)

(02:50)

Pt	X	Y	Z	PITCH	YAW	ROLL	●
87	-216	-65	-273	162	300	213	
88	-215	-35	-247	155	305	190	
<b>89P</b>	<b>-165</b>	<b>-45</b>	<b>-320</b>	<b>160</b>	<b>297</b>	<b>227</b>	<b>1/4</b>

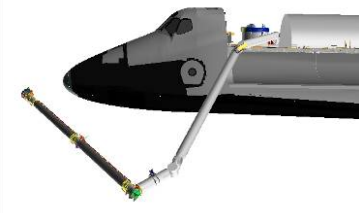

L10(VTR) When AUTO SEQ IN PROG It – off:  
 STOP pb – push (no red ●)

BRAKES – ON (tb-ON)

If continuing OBSS ops with PORT RCC survey:  
 Go to OBSS LDRI/IDC RCC SURVEY – PORT



**OBSS LDRI/IDC RCC SURVEY – PORT (90 min)**

**WARNING**  
 For UNDOCKED ops only  
 Port PLBD radiator must be stowed

1. SETUP

SM 94 PDRS CONTROL

- √PL ID, ITEM 3: 2
- √INIT ID, ITEM 24: 2

- AUTO MODES – ITEM 13 +5 +6 EXEC
- √AUTO MODE 4, ITEM 16: 4

2. MNVR TO PORT LDRI ACAS START POSN

RHC

- √RATE – COARSE (RATE MIN tb-OFF)
- BRAKES – OFF (tb-OFF)
- MODE – AUTO 4, ENTER



SM 94 PDRS CONTROL

- √START PT, ITEM 17: 90

Mnvr to Port ACAS Clearance Views	Cameras
OBSS-to-PLBD	ELBOW
OBSS-to-Nose Cap	ELBOW, RSC
RMS-to-Orbiter	B[1], A, ELBOW
OBSS-to-SRMS	B, ELBOW
[1] Good after X ~ -194(pt 90)	

AUTO SEQ – PROCEED (IN PROG It on)

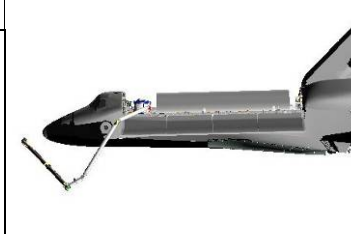
(09:15)

Pt	X	Y	Z	PITCH	YAW	ROLL	●
<b>90P</b>	<b>-165</b>	<b>-45</b>	<b>-320</b>	<b>160</b>	<b>297</b>	<b>227</b>	
91	-500	-280	-800	80	341	289	
92	-770	-290	-700	40	341	289	
93	-899	-290	-284	2	341	289	
<b>94P</b>	<b>-899</b>	<b>-252</b>	<b>-284</b>	<b>2</b>	<b>341</b>	<b>289</b>	

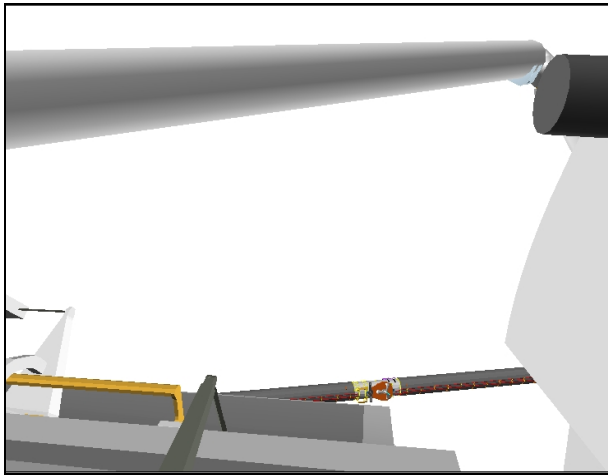

**CCTV A (83,-11)**

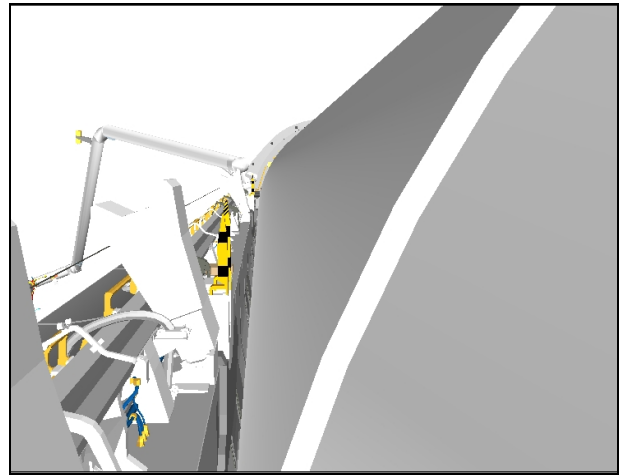

**CCTV B (5,-7)**

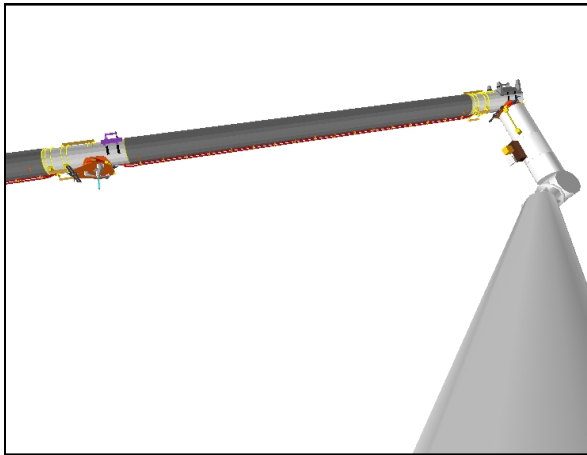

**ELBOW (-32,-11)**

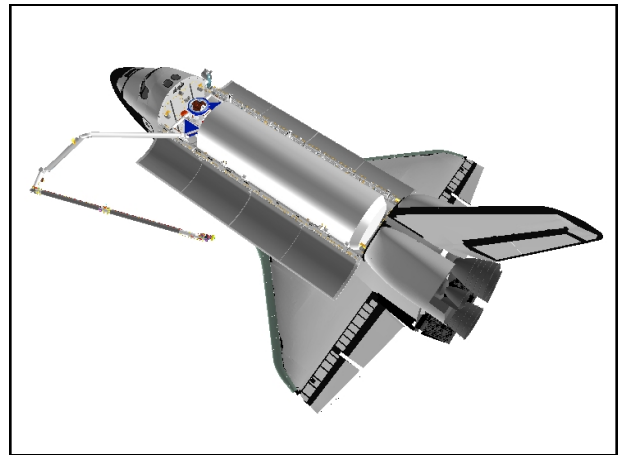

**FLY CAM**

3. ENABLE VERN NOSE JETS

When AUTO SEQ IN PROG It – off:

GNC 23 RCS

RCS FWD – ITEM 1 EXEC (\*)

MANF VLVS OVRD 5 – ITEM 44 EXEC (OP)

A6U

DAP: VERN(FREE)

Mnvr Port Survey attitude per FLIGHT PLAN

A7U

4. PORT LDRI ACAS, SECTION 1

DTV ← PL2

PAN: +100 (right)

TILT: -120 (down)

MUX 1 L ← MIDDECK

LDRI MODE 6 pb – push (flickering LDRI displayed)



DTV ← PL2

PAN/TILT to match LDRI view shown below

On MCC GO,

Note PAN/TILT: \_\_\_\_\_, \_\_\_\_\_



Pt	X	Y	Z	PITCH	YAW	ROLL	●
<b>95P</b>	<b>-899</b>	<b>-252</b>	<b>-284</b>	<b>2</b>	<b>341</b>	<b>289</b>	
96	-964	-254	-281	10	343	297	
97	-1027	-281	-267	13	347	304	
98	-1073	-322	-262	16	355	308	
99	-1208	-450	-257	15	7	319	1/4
100	-1255	-500	-266	14	3	316	
101	-1308	-518	-269	12	3	313	
<b>102P</b>	<b>-1367</b>	<b>-500</b>	<b>-230</b>	<b>336</b>	<b>350</b>	<b>326</b>	

When AUTO SEQ READY It – on:

LCC/PGSC  
L10(VTR)

sel 'Stop Scan'  
STOP pb – push (no red ●)

5. PORT LDRI ACAS, SECTIONS 2 AND 3

Sections 2 & 3 Clearance Views	Cameras
OBSS-to-PLBD	A, B, ELBOW, RSC
OBSS-to-Wing	A, B, ELBOW, RSC
RMS-to-Orbiter	A, B

A7U

DTV ← PL2

PAN: +85 (left)

TILT: -60 (up)

PAN/TILT to match LDRI view shown below

On MCC GO,

Note PAN/TILT: \_\_\_\_\_, \_\_\_\_\_

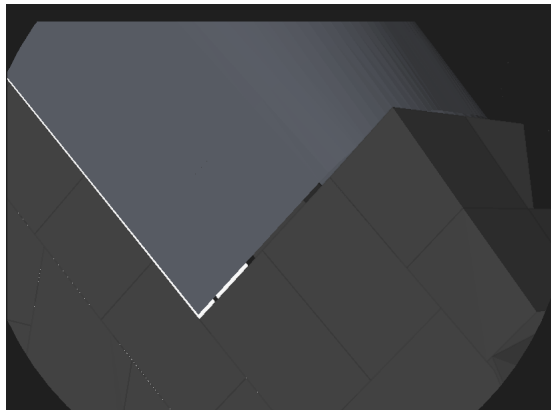



**LDRI (85,-60)**

VIDEO OUT – as desired (not DTV)

LCC/PGSC sel 'Scan Hi-Res'  
 L10(VTR) REC pb – push, hold  
 PLAY pb – push, simo (red ●)

AUTO SEQ – PROCEED (IN PROG It on)

(12:40)

Pt	X	Y	Z	PITCH	YAW	ROLL	●
<b>102P</b>	<b>-1367</b>	<b>-500</b>	<b>-230</b>	<b>336</b>	<b>350</b>	<b>326</b>	
103	-1303	-481	-229	329	349	320	
104	-1052	-212	-197	320	322	340	
105	-991	-186	-201	316	319	341	
106	-890	-188	-208	315	323	326	
107	-971	-215	-211	306	329	338	
108	-1018	-253	-218	294	332	313	
109	-1047	-253	-211	318	340	336	
110	-1172	-397	-230	305	345	311	
111	-1299	-484	-236	334	348	328	
112	-1317	-506	-252	327	352	316	
113	-1356	-546	-292	314	6	287	
<b>114P</b>	<b>-1323</b>	<b>-537</b>	<b>-315</b>	<b>346</b>	<b>348</b>	<b>282</b>	

When AUTO SEQ READY It – on:

LCC/PGSC sel 'Stop Scan'  
 L10(VTR) STOP pb – push (no red ●)

6. PORT LDRI ACAS, SECTION 4

Section 4 Clearance Views	Cameras
OBSS-to-PLBD	A[1], B[2], ELBOW, RSC
OBSS-to-Wing	A[1], B[2], ELBOW, RSC
RMS-to-Orbiter	A, B
[1] No good after X ~ -1028(pt 118)	[2] No good between X ~ -1028(pt 118) and X ~ -923(pt 121)

A7U

DTV ← PL2

PAN: +88 (right)  
 TILT: -120 (down)

PAN/TILT to match LDRI view shown below

On MCC GO,  
Note PAN/TILT: \_\_\_\_\_, \_\_\_\_\_

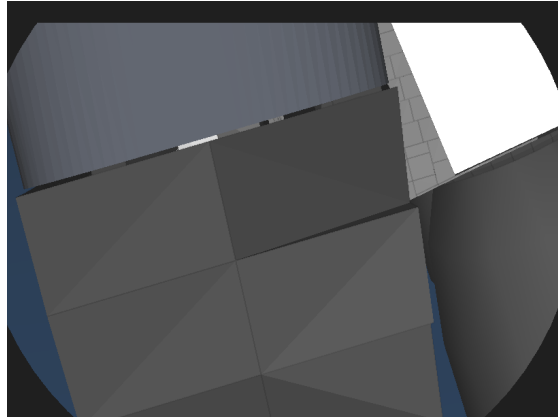

**LDRI (88,-120)**

VIDEO OUT – as desired (not DTV)

LCC/PGSC sel 'Scan Hi-Res'  
L10(VTR) REC pb – push, hold  
PLAY pb – push, simo (red ●)

AUTO SEQ – PROCEED (IN PROG It on)

(06:50)

Pt	X	Y	Z	PITCH	YAW	ROLL	●
<b>114P</b>	<b>-1323</b>	<b>-537</b>	<b>-315</b>	<b>346</b>	<b>348</b>	<b>282</b>	
115	-1244	-513	-305	353	357	287	
116	-1176	-450	-298	352	2	290	
117	-1106	-380	-295	352	4	291	
118	-1023	-300	-288	354	357	289	
119	-989	-275	-294	350	350	282	¼
120	-965	-267	-294	350	350	282	
121	-933	-261	-289	358	347	283	
122	-920	-256	-288	336	326	284	
<b>123P</b>	<b>-891</b>	<b>-310</b>	<b>-249</b>	<b>333</b>	<b>349</b>	<b>319</b>	

When AUTO SEQ READY It – on:

LCC/PGSC sel 'Stop Scan'  
L10(VTR) STOP pb – push (no red ●)

**IF PERFORMING LATE INSPECTION**

BRAKES – ON (tb-ON)

SM 94 PDRS CONTROL

√PL ID, ITEM 3: 2

√INIT ID, ITEM 24: 2

Load OPR CMD (Items 18-23)

-----  
-889, -294, -316, 317, 347, 288  
-----

CMD CK, ITEM 25 EXEC (GOOD)

√RATE – COARSE (RATE MIN tb-OFF)

BRAKES – OFF (tb-OFF)

MODE – OPR CMD, ENTER

√AUTO SEQ READY It – on

\* If error found in destination entries (Items 18-23): \*

\* BRAKES – ON (tb-ON) \*

\* \*

\* Enter corrected destination (Items 18-23) \*

\* \*

\* CMD CK, ITEM 25 EXEC (GOOD) \*

\* \*

\* BRAKES – OFF (tb-OFF) \*

\* MODE – OPR CMD, ENTER \*

\* \*

\* √AUTO SEQ READY It – on \*

AUTO SEQ – PROCEED

When AUTO SEQ IN PROG It – off:

SM 94 PDRS CONTROL

START PT – ITEM 17 +1 3 2 EXEC

MODE – AUTO 1, ENTER

Go to step 9

**7. INHIBIT NOSE JETS**

O14:F, √Pri RJDA LOGIC,DRIVER (eight) – ON  
O15:F, √Pri RJDF LOGIC,DRIVER (eight) – OFF  
O16:F  
A6U DAP: A14/AUTO/ALT (Tail Only)

**NOTE**

Expect DAP RECONFIG message after  
FRCS manifold 5 status overridden to close

**GNC 23 RCS**

- √RCS FWD – ITEM 1 EXEC (\*)
- √MANF VLVS OVRD 1 – ITEM 40 EXEC (CL)
  - √2 – ITEM 41 EXEC (CL)
  - √3 – ITEM 42 EXEC (CL)
  - √4 – ITEM 43 EXEC (CL)
  - 5 – ITEM 44 EXEC (CL)

8. PORT ITVC ACAS, WING GLOVE AND CREW CABIN (SECTION 5)

Wing Glove & Crew Cabin Clearance Views	Cameras
OBSS-to-PLBD	ELBOW, RSC[1], B
OBSS-to-Crew Cabin	ELBOW[2], B, RSC[3]
RMS-to-Orbiter	B, A
[1] PLBD leaves FOV at X ~ -417(pt 124) and re-enters at X ~ -408(pt 125)	[2] Only Cam B can resolve clearances between X ~ -356(pt 125) and X ~ -513 (pt 126), and between X ~ -556 (pt 128) and X ~ -740(pt 130) [3] Nose Cap enters FOV at X ~ -384(pt 125)

A7U

MUX 1 L ← MIDDECK  
LDR1 MODE 2 pb – push (ITVC video)

DTV ← PL2  
√ZOOM: 19.0 HFOV  
√FOCUS: 12 ft  
PAN: +100 (right)  
TILT: -100 (up)

PAN/TILT to match ITVC view shown below

On MCC GO,  
Note PAN/TILT: \_\_\_\_\_, \_\_\_\_\_

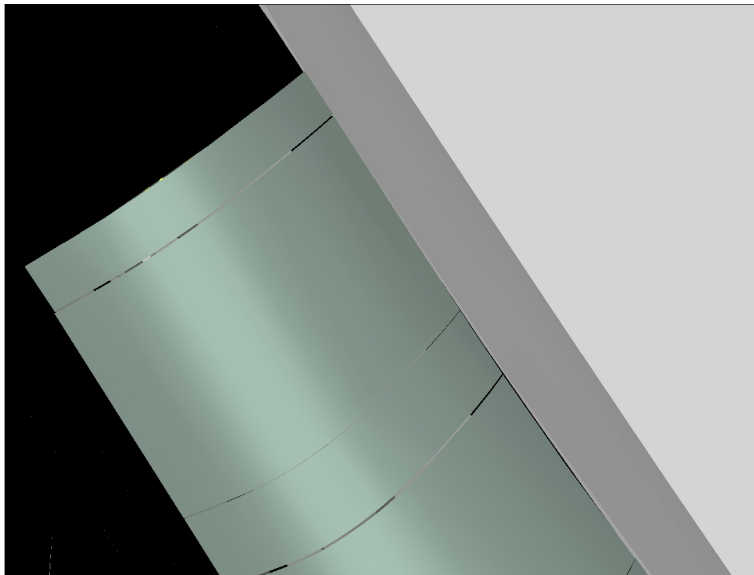

**ITVC (100,-100)**

VIDEO OUT – as desired (not DTV)



L10(VTR) REC pb – push, hold  
 PLAY pb – push, simo (red ●)

AUTO SEQ – PROCEED (IN PROG It on)

(14:10)

Pt	X	Y	Z	PITCH	YAW	ROLL	●
<b>123P</b>	<b>-891</b>	<b>-310</b>	<b>-249</b>	<b>333</b>	<b>349</b>	<b>319</b>	
124	-575	-287	-320	271	352	294	
125	-255	-205	-335	249	344	289	
126	-525	-283	-346	223	337	286	
127	-459	-275	-307	221	331	292	
128	-556	-283	-327	241	339	303	<b>3</b>
129	-573	-288	-320	264	348	301	
130	-702	-288	-320	270	348	301	
131	-904	-318	-332	319	350	290	
<b>132P</b>	<b>-889</b>	<b>-294</b>	<b>-316</b>	<b>317</b>	<b>347</b>	<b>288</b>	



L10(VTR) When AUTO SEQ READY It – on:  
 STOP pb – push (no red ●)

9. ENABLE NOSE JETS

GNC 23 RCS

√RCS FWD – ITEM 1 EXEC (\*)

- MANF VLVS OVRD 1 – ITEM 40 EXEC (OP)
- 2 – ITEM 41 EXEC (OP)
- 3 – ITEM 42 EXEC (OP)
- 4 – ITEM 43 EXEC (OP)
- 5 – ITEM 44 EXEC (OP)

A6U DAP: VERN(FREE)

O14:F, Pri RJDA LOGIC,DRIVER (eight) – OFF  
 O15:F, RJDA 1A L2/R2 DRIVER – ON  
 O16:F

Sections 6 & 7 Clearance Views	Cameras
OBSS-to-PLBD	B[1], A[2], ELBOW [3], RSC
OBSS-to-Wing	B[1], A[2], ELBOW, RSC
RMS-to-Orbiter	A, B
[1] No good between X ~ -1047(pt 133) and X ~ -1129(pt 134)	[2] Good between X ~ -1068(pt 134) and X ~ -903(pt 143) [3] No good after X ~ -1198(pt 139)

A7U

MUX 1 L ← MIDDECK  
LDRI MODE 6 pb – push (brighter flickering LDRI video)

DTV ← PL2  
PAN: +89 (left)  
TILT: -112 (down)

PAN/TILT to match LDRI view shown below

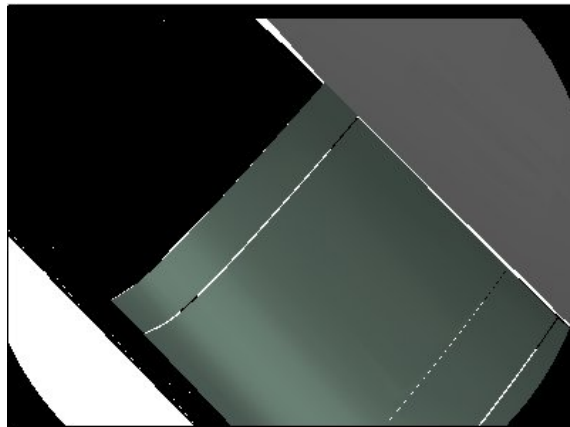

On MCC GO,  
Note PAN/TILT: \_\_\_\_\_, \_\_\_\_\_



**LDRI (89,-112)**

VIDEO OUT – as desired (not DTV)

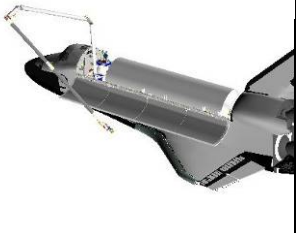
LCC/PGSC sel 'Scan Hi-Res'  
L10(VTR) REC pb – push, hold  
PLAY pb – push, simo (red ●)

Pt	X	Y	Z	PITCH	YAW	ROLL	•	
<b>132P</b>	<b>-889</b>	<b>-294</b>	<b>-316</b>	<b>317</b>	<b>347</b>	<b>288</b>	<b>1</b>	
133	-990	-272	-303	318	345	282		
134	-1081	-318	-360	344	352	241		
135	-1258	-491	-368	334	357	243		
136	-1345	-525	-369	339	359	245	1/4	
137	-1342	-480	-396	333	359	216		
138	-1290	-463	-396	329	358	215		
139	-1236	-427	-390	333	355	218		
140	-1120	-319	-390	339	351	222		
141	-1074	-305	-390	349	338	230		
142	-1040	-289	-390	352	347	237		
143	-1008	-287	-367	305	356	261		
<b>144P</b>	<b>-892</b>	<b>-294</b>	<b>-364</b>	<b>342</b>	<b>353</b>	<b>255</b>	<b>1</b>	

NOTE

LDR1 recording during camera pan/tilt reconfiguration.  
Pan must be performed prior to tilt

LCC/PGSC When AUTO SEQ IN PROG It – off:  
sel 'Stop Scan'  
sel 'Power Off'

A7U DTV ← PL2

CAM CMD5 PAN/TILT – LOW RATE  
PAN: +74 (left)  
TILT: -151 (down)

PAN/TILT to match LDRI view shown below

On MCC GO,  
Note PAN/TILT: \_\_\_\_\_, \_\_\_\_\_

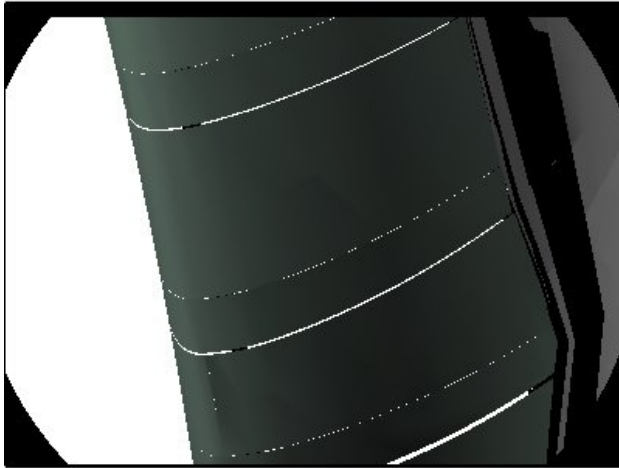

**LDRI (74,-151)**

L10(VTR) STOP pb – push (no red ●)

A7U MUX 1 L ← MIDDECK  
LDRI MODE 2 pb – push (ITVC video displayed)  
DTV ← PL2

10. MNVR TO OBSS HOVER

<b>Mnvr to OBSS High Hover Clearance Views</b>	<b>Cameras</b>
OBSS-to-PLBD	ELBOW, B, A[1]
OBSS-to-Tail	A, ELBOW, RSC[2], B
RMS-to-Orbiter	C, B, A
OBSS-to-RMS	B, ELBOW
[1] Good after X ~ -1014(pt 145)	[2] Tail leaves FOV at X ~ -1505(pt 145) and re-enters at X ~ -1541(pt 146)



RHC √RATE – COARSE (RATE MIN tb-OFF)  
MODE – AUTO 2, ENTER (READY lt on)

SM 94 PDRS CONTROL

√START PT, ITEM 17: 145

SM 169 PDRS STATUS

Monitor ACAS progress

Pt	X	Y	Z	PITCH	YAW	ROLL	●
145P	-892	-294	-364	342	353	255	
146	-1600	+25	-985	40	0	11	
147P	-1271	+134	-532	0	0	11	

Verify mnvr to OBSS HOVER posn complete:

	X	Y	Z	PITCH	YAW	ROLL	PL ID
√	-1271	+134	-532	0	0	11	2
	SY	SP	EP	WP	WY	WR	
√	-89.9	+80.2	-118.8	-59.8	+0.0	+109.9	

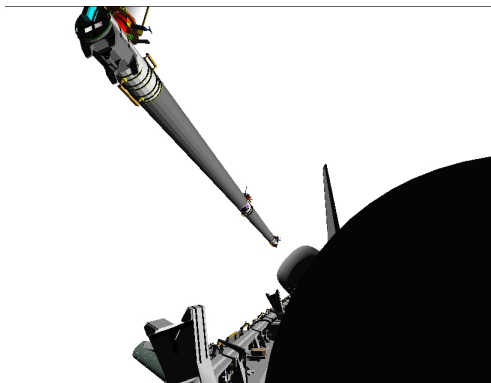

CCTV D (-10,15)

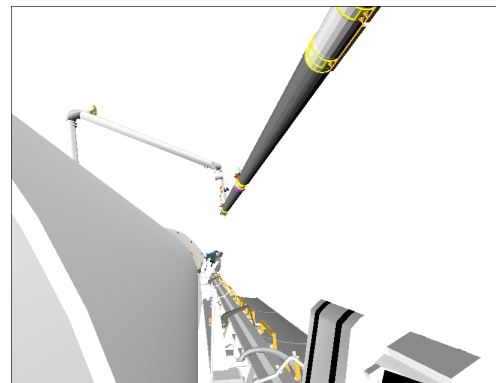

CCTV C (10,10)

BRAKES – ON (tb-ON)

Go to OBSS BERTH

# OBSS BERTH

**WARNING**  
For UNDOCKED ops only

## NOTE

Stbd MPMs assumed deployed

- A7U 1. SETUP  
CCTV – config for berth

SM 94 PDRS CONTROL

PL ID – ITEM 3 +1 EXEC  
INIT ID – ITEM 24 +1 EXEC

2. OBSS HOVER

Verify mnvr to OBSS HOVER posn complete:

	X	Y	Z	PITCH	YAW	ROLL	PL ID
√	-680	+133	-517	360	0	341	1
	SY	SP	EP	WP	WY	WR	
√	-89.9	+80.2	-118.8	-59.8	+0.0	+109.9	

√STBD RMS HTR A,B (two) – OFF

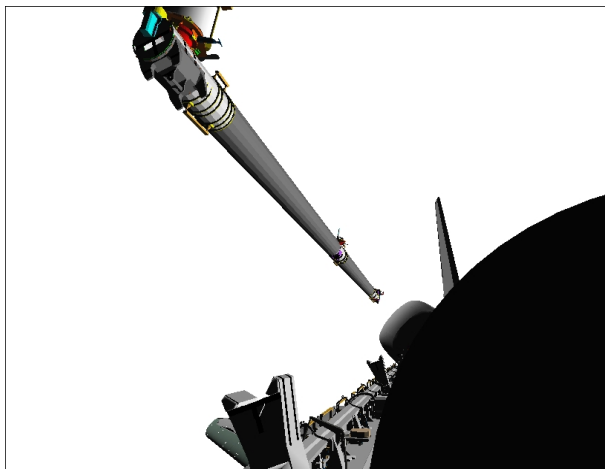

**CCTV D (-15,15)**

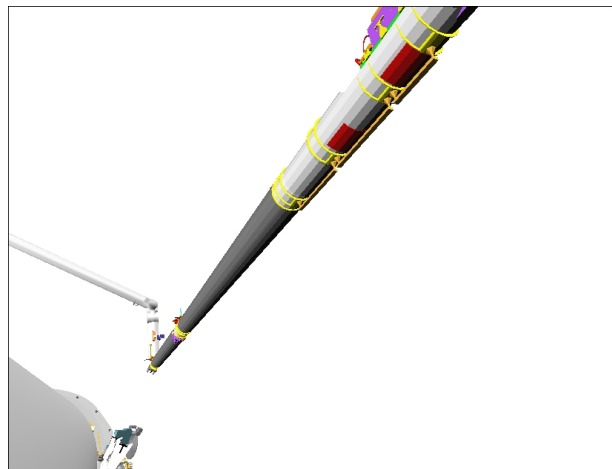

**CCTV C (25,25)**

- A7U 3. STOW PTU  
√DTV ← PL2

CAMR CMD PAN/TILT – HI RATE  
PAN – L (to hard stop)  
TILT – UP (to hard stop)  
PAN/TILT – RESET, HI RATE (LO within 10°)  
PAN: +108 (right)  
TILT: -175 (down)

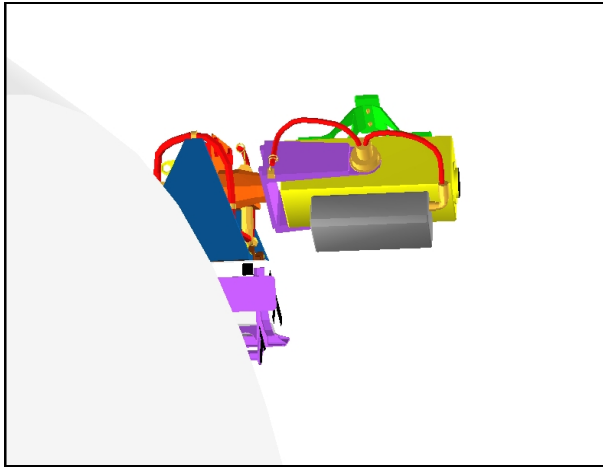

**CCTV B (82,16) HFOV: 15.0**

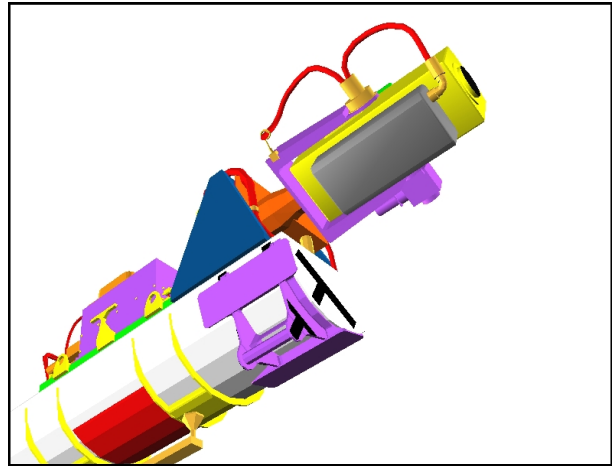

**CCTV C (50,50) HFOV: 40.0**

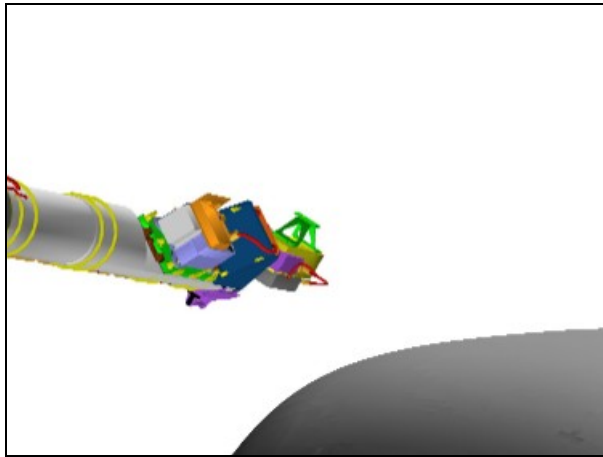

**ELBOW (52,-45) HFOV: 9.8 (full-in)**

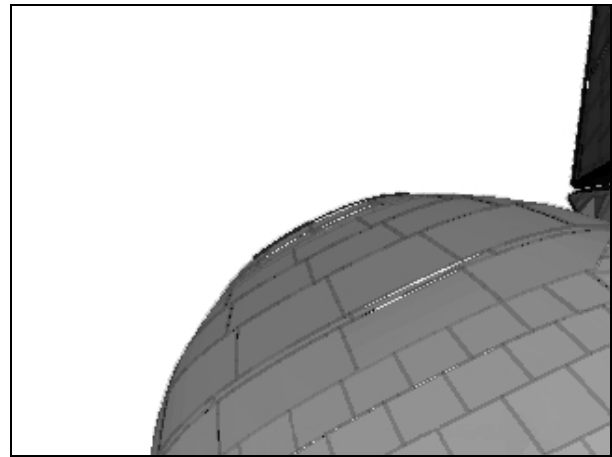

**OBSS ITVC (108,-175) HFOV: 53.8 (full-out)**

Perform LCC DEACTIVATION (LCS Cue Card, PHOTO/TV)  
 Perform LCH DEACTIVATION (LCS Cue Card, PHOTO/TV)

CAUTION  
 STBD RMS HTR power must be applied within  
 90 min to prevent sensor package damage

Perform DEACTIVATION (LDRI/ITVC Cue Card, PHOTO/TV)

4. OBSS BERTH

NOTE

If desired, REL values should be loaded prior  
 to selecting the starboard arm (ITEM 2 EXEC)

SM 94 PDRS CONTROL  
 RMS STBD – ITEM 2 EXEC (\*)

A6U

DAP: FREE

RHC           RATE    – VERN (RATE MIN tb-ON)  
 BRAKES – OFF (tb-OFF)  
 MODE        – PL, ENTER

**NOTE**

Refer to table in OBSS UNBERTH, step 3 for POSN/ATT and Joint Angles at GRAPPLE to fill in table below.

A negative pitch of up to 0.4 deg may be input prior to berthing the OBSS in order to gain the Aft RTL indications

Input 0.2 deg negative (-) PITCH starting at Z= -448 (Rel Z = -12)

Mnvr OBSS down (+Z) to OBSS BERTH:

	X	Y	Z	PITCH	YAW	ROLL	PL ID
							1
Expected	-680	+105	-436	0	0	341	1
	SY	SP	EP	WP	WY	WR	
Expected	-90.0	+76.5	-134.6	-40.9	0.0	+110.0	

√STBD R-F-L tb (three) – gray

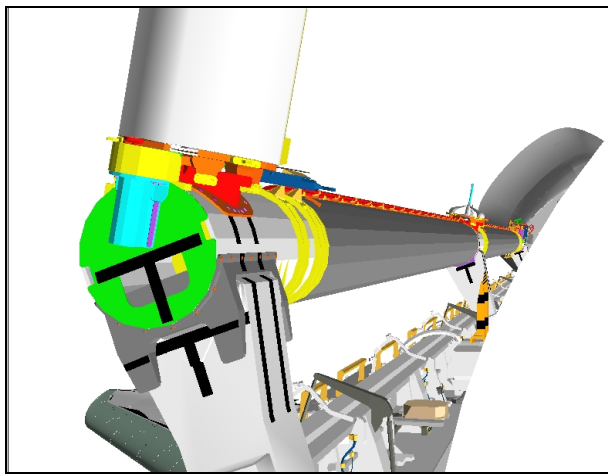

**CCTV D (-15,0) HFOV: 35.0**

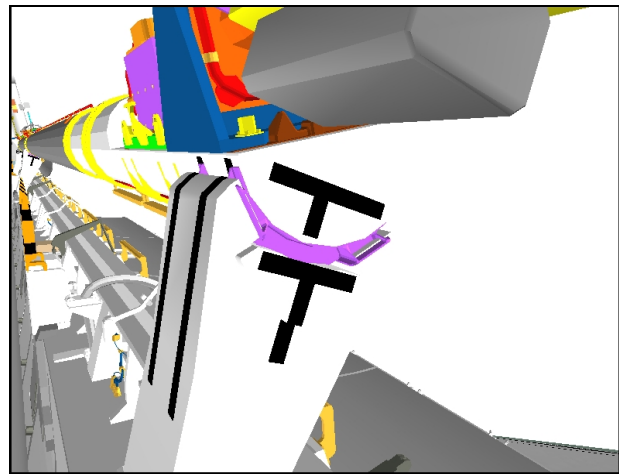

**CCTV C (30,-10) HFOV: 60.0**

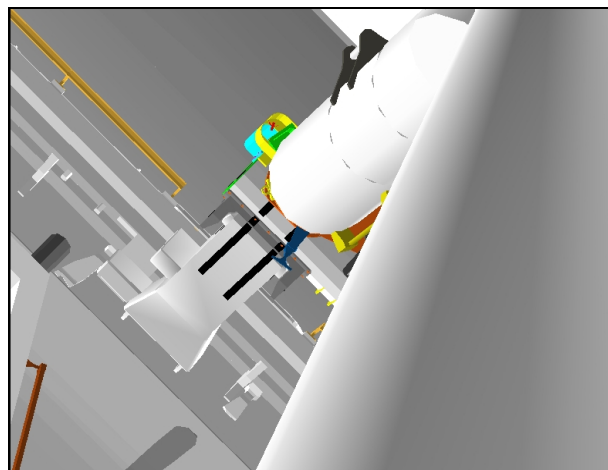

**ELBOW (-7,-12) HFOV: 15.0**



5. CONFIGURE POWER  
 MA73C:C    cb MCA PWR AC3 3Φ MID 2 – op  
                   √AC2 3Φ MID 2 – op  
 MA73C:D            √AC3 3Φ MID 4 – op  
 R13L        PL BAY MECH PWR SYS (two) – ON

6. STBD MRL LATCH  
 RATE – COARSE (RATE MIN tb-OFF)

SM 94 PDRS CONTROL

√STBD AFT, MID, FWD LAT (six) = 0

AUTO BRAKE INH – ITEM 10 EXEC (\*)

NOTE

Expect single motor drive time for MRL latching

STBD RMS RETEN LAT – LAT (tb-LAT) (18 sec max)  
 – OFF

If motor drive time > 18 sec, √MCC

MODE – TEST, ENTER  
 Wait 5 sec

BRAKES – ON (tb-ON)

SM 94 PDRS CONTROL

RMS PORT – ITEM 1 EXEC (\*)  
 AUTO BRAKE ENA – ITEM 9 EXEC (\*)

A6U        DAP: A1/AUTO/VERN(ALT)

7. RECONFIGURE POWER  
 R13L        PL BAY MECH PWR SYS (two) – OFF

- MA73C:C    cb MCA PWR AC3 3Φ MID 2 – cl  
                   √AC2 3Φ MID 2 – op  
 MA73C:D            √AC3 3Φ MID 4 – op

8. OBSS UNGRAPPLE  
 A7U        CCTV – config for ungrapple  
                   – RMS WRIST, ZOOM: 34.0 HFOV  
                   FOCUS: 5 ft

SM 94 PDRS CONTROL

PL ID – ITEM 3 +0 EXEC  
 INIT ID – ITEM 24 +0 EXEC

RHC        RATE – VERN (RATE MIN tb-ON)

BRAKES – OFF (tb-OFF)  
 MODE    – END EFF, ENTER

A6U        DAP: VERN(FREE)

**CAUTION**  
Monitor EE tb timing to prevent EE motor burnout

EE MODE – AUTO  
RELEASE sw – REL (mom)

When OPEN tb – gray, mnvr arm clear of grapple pin

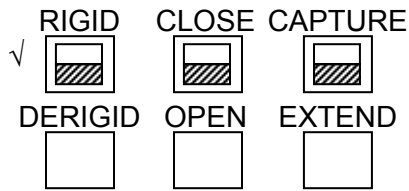

CRITICAL TIMES (28 sec total):  
DERIGID tb – gray, 5 sec max, then  
OPEN tb – gray, 3 sec max, then  
EXTEND tb – gray, 20 sec max

EE MODE – OFF

- \* If manual release reqd: \*
- \* EE MODE – MAN \*
- \* MAN CONTR – DERIGID (hold until DERIGID tb-gray, 5 sec max) \*
- \* RELEASE sw – depress (hold until OPEN tb-gray, 3 sec max) \*
- \* \*
- \* Mnvr arm clear of grapple pin, then: \*
- \* EE MAN CONTR – DERIGID (hold until EXTEND tb-gray, 20 sec max) \*
- \* MODE – OFF \*

STBD RMS HTR A,B (two) – AUTO

A6U

EVENT TIMER CNTL – STOP  
✓DAP A1/AUTO/VERN (ALT)

Mnvr to OBSS PRE-GRAPPLE posn:

X	Y	Z	PITCH	YAW	ROLL	PL ID
-680	+96	-513	270	350	1	0
SY	SP	EP	WP	WY	WR	
-90.0	+87.6	-129.5	-57.5	0.0	+110.4	

BRAKES – ON (tb-ON)

**GNC 23 RCS**

- ✓RCS FWD, ITEM 1: \*
- ✓MANF VLVS OVRD 1 – ITEM 40 EXEC (OP)
- 2 – ITEM 41 EXEC (OP)
- 3 – ITEM 42 EXEC (OP)
- 4 – ITEM 43 EXEC (OP)
- 5 – ITEM 44 EXEC (OP)

9. ARM PRE-CRADLE

**SM 94 PDRS CONTROL**

- ✓PL ID, ITEM 3: 0
- ✓INIT ID, ITEM 24: 0

RATE – as reqd (VERN within 10 ft)  
BRAKES – OFF (tb-OFF)  
MODE – as desired

Mnvr to PRE-CRADLE posn:

	SY	SP	EP	WP	WY	WR	
OBSS	-90.0	+87.6	-129.5	-57.5	0.0	+110.4	
PRE-GRAPPLE				+5.0			
1: WP +							
2: WR -						0.0	
3: EP +			-25.0				
4: SY +	0.0						
5: SP -		+25.0					
PRE-CRADLE	0.0	+25.0	-25.0	+5.0	0.0	0.0	
	X	Y	Z	PITCH	YAW	ROLL	PL ID
	-1261	-146	-551	5	2	0	0

BRAKES – ON (tb-ON)  
 MODE – not DIRECT  
 PARAM – PORT TEMP  
 JOINT – CRIT TEMP

OFF-NOMINAL

# OBSS SJ UNBERTH

I

**WARNING**  
For UNDOCKED ops only

NOTE

Stbd MPMs assumed deployed

1. SETUP

- CCTV – config as required
  - perform PAN/TILT RESET for PLB cameras
- ZOOM – full OUT

If SINGLE MODE available:

SM 94 PDRS CONTROL

- √PL ID, ITEM 3: 0
- √INIT ID, ITEM 24: 0

2. MNVR TO OBSS SJ PRE-GRAPPLE

If SINGLE MODE available:

- RHC
- RATE – as reqd (VERN within 10 ft)
  - BRAKES – OFF (tb-OFF)

MODE – best available

MNvr to OBSS SJ PRE-GRAPPLE posn:

	SY	SP	EP	WP	WY	WR	
PRE-CRADLE	0.0	+25.0	-25.0	+5.0	0.0	0.0	
1: SP +		+87.9					
2: SY -	-90.0						
3: WP -				-57.0			
4: WR -						-250.0*	
5: EP -			-129.8				
OBSS SJ PRE-GRAPPLE	-90.0	+87.9	-129.8	-57.0	0.0	-250.0	
	X	Y	Z	PITCH	YAW	ROLL	PL ID
	-680	+96	-513	270	350	1	0

\* WR RANGE = 2

- BRAKES – ON (tb-ON)
- MODE – not DIRECT
- JOINT – CRIT TEMP

OFF-NOMINAL

Start:

Step 1:

Drive SP (+) from +25.0° to +87.9°

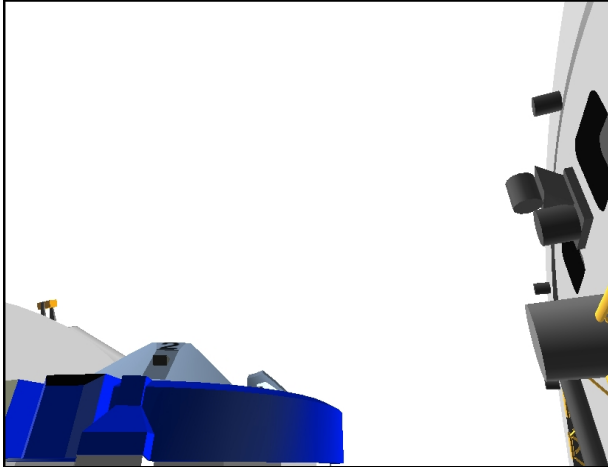

CCTV D (65,30)

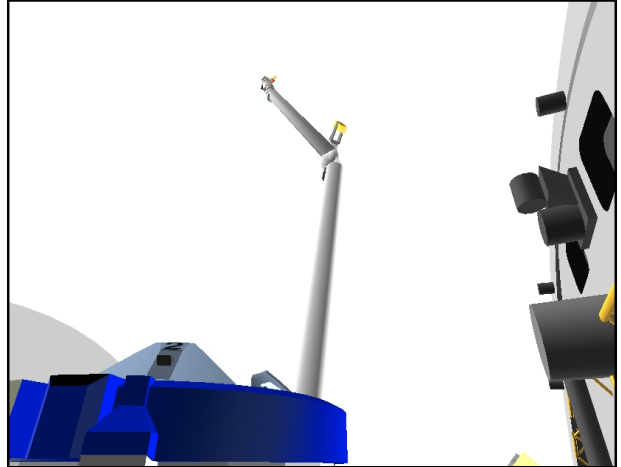

CCTV D (65,30)

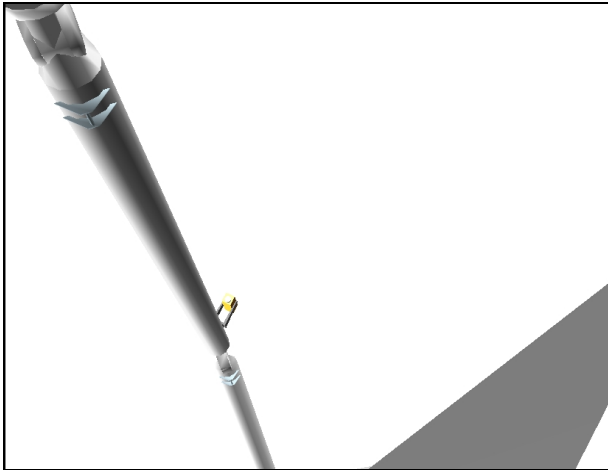

CCTV B (0,25)

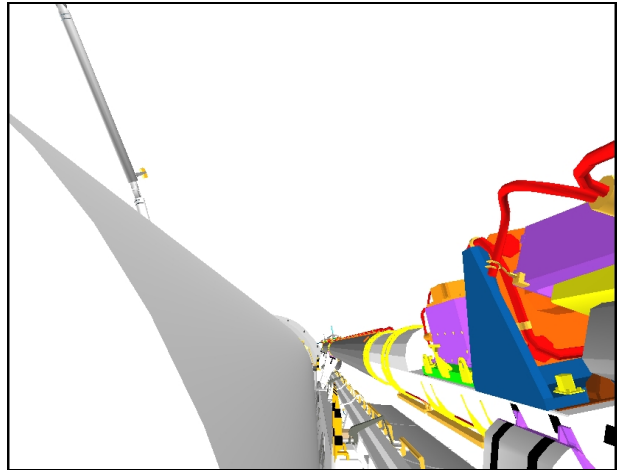

CCTV C (0,15)

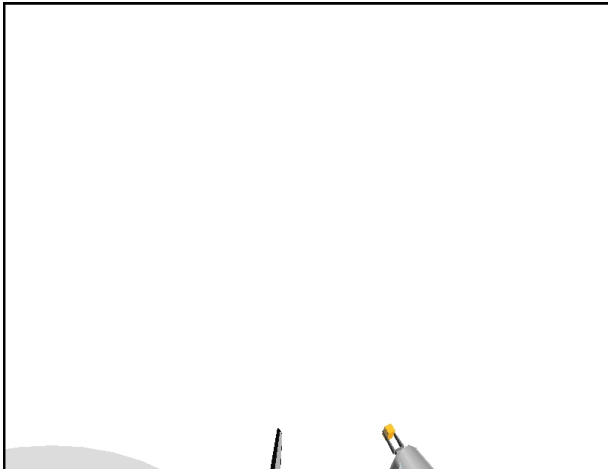

CCTV A (0,45)

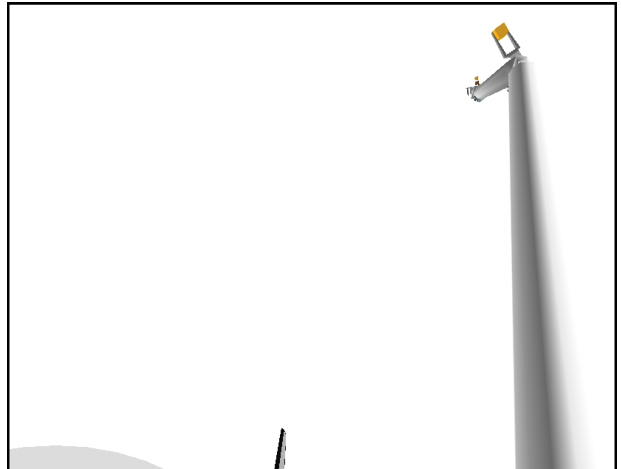

CCTV A (0,45)

Step 2:  
Drive SY (-) from 0.0° to -90.0°

Step 3:  
Drive WP (-) from +5.0° to -57.0°

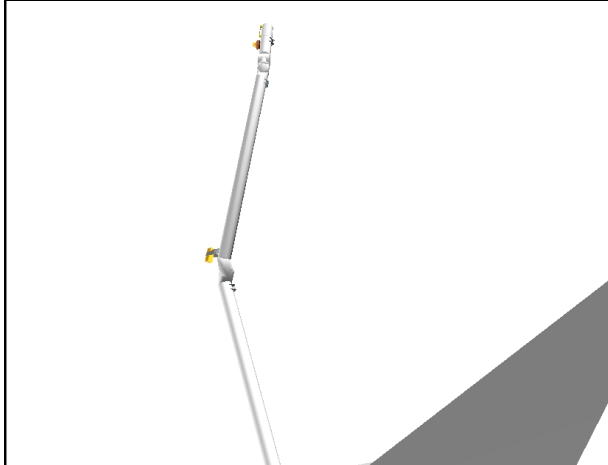

**CCTV B (0,25)**



**CCTV B (0,25)**

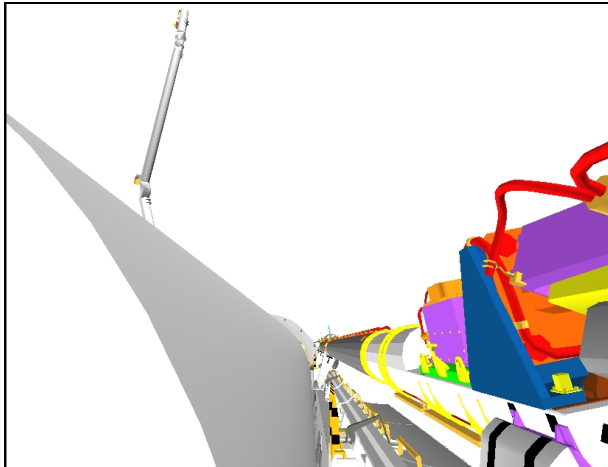

**CCTV C (0,15)**

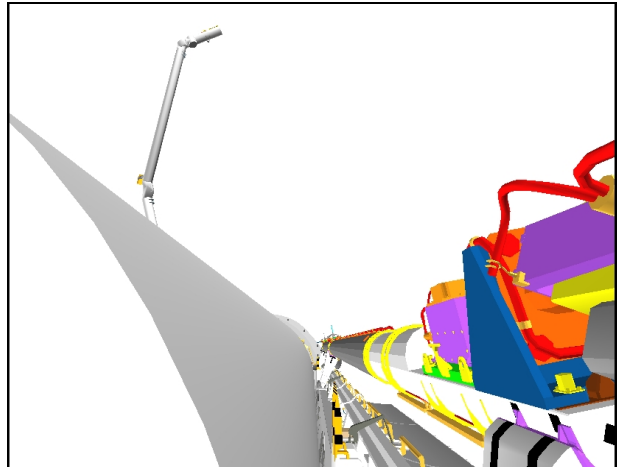

**CCTV C (0,15)**



**CCTV A (0,45)**

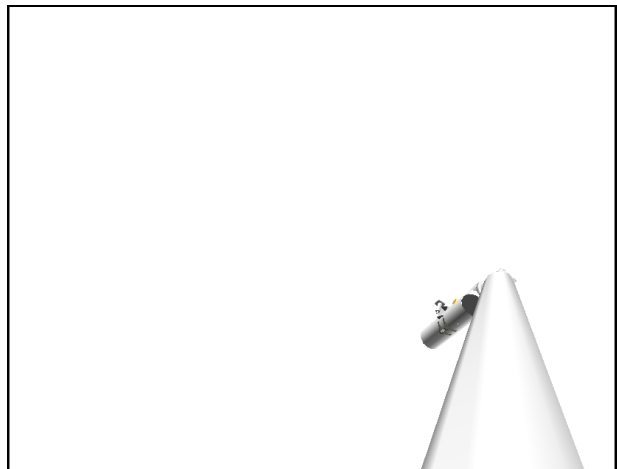

**ELBOW (-25,0)**

Step 4:

Drive WR (-) from  $0.0^\circ$  to  $-250.0^\circ$



**CCTV B (0,25)**

Step 5:

Drive EP (-) from  $-25.0^\circ$  to  $-129.8^\circ$

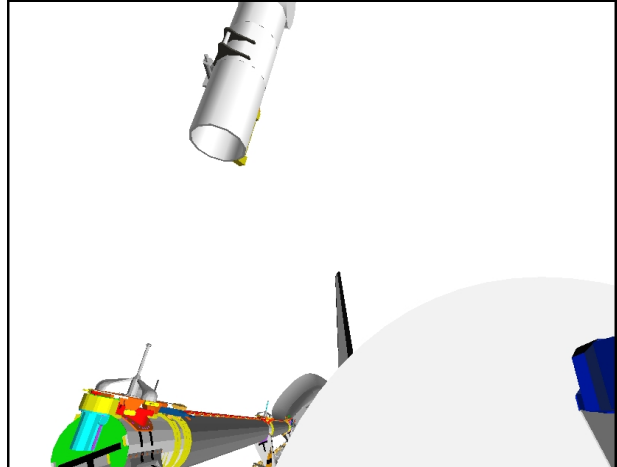

**CCTV D (0,25)**

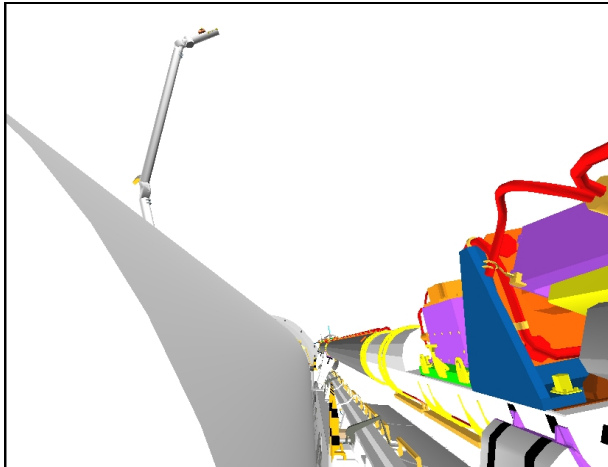

**CCTV C (0,15)**

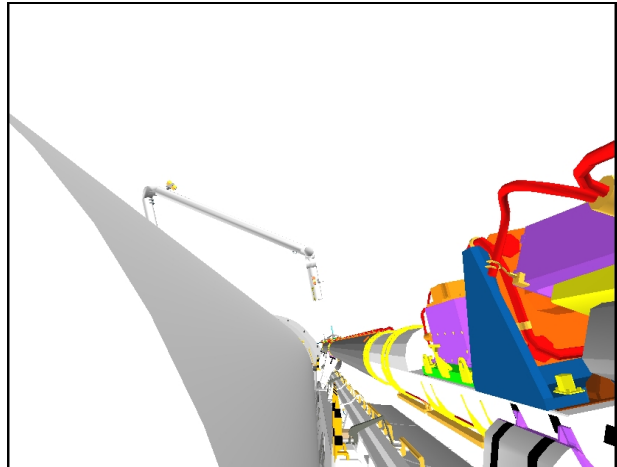

**CCTV C (0,15)**

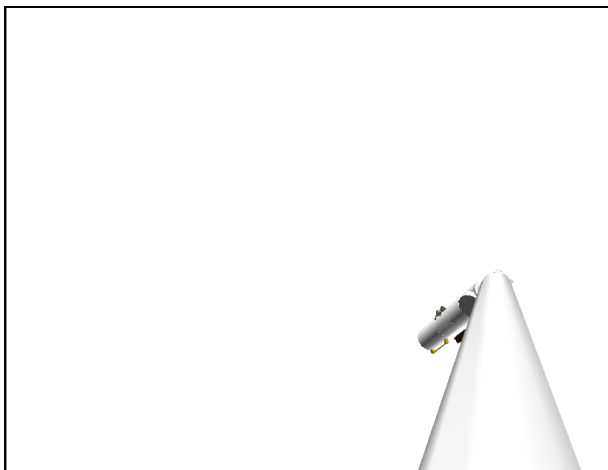

**ELBOW (-25,0)**

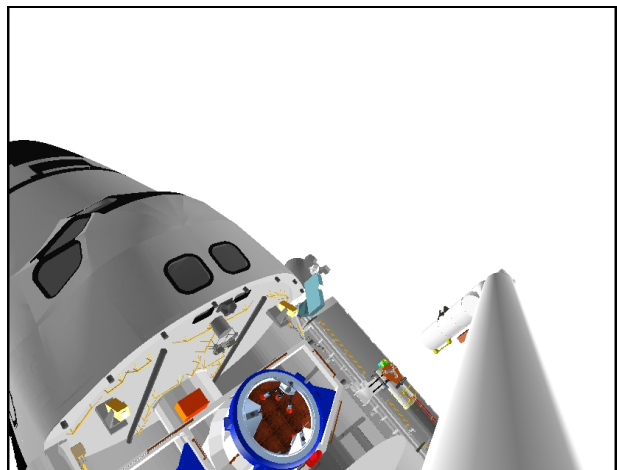

**ELBOW (-25,0)**

<p><b>CAUTION</b>          SPEE power must be applied within 90 min          to prevent sensor package damage</p>
---

STBD RMS HTR A,B (two) – OFF

A6U           EVENT TIMER MODE – UP  
                   CNTL – START

R12(OBSS) √SPEE PWR – OFF  
 SSP1(OV-104) √APCU 1,2 CONV (two) – OFF  
 A15(OV-103,  
       (OV-105)

3. OBSS GRAPPLE

A7U           CCTV – config for grapple  
                   – install PDRS TARGET OVERLAY FOR CTVM  
                   – RMS WRIST, ZOOM: 34.0 HFOV  
                   FOCUS: 5 ft

Maintain eyepoint ~18 in when using grapple overlay

RHC           If SINGLE MODE available:  
                   RATE – VERN (RATE MIN tb-ON)  
                   BRAKES – OFF (tb-OFF)

A6U           DAP: VERN(FREE)

MODE – best available

Mnvr to OBSS GRAPPLE posn:

	SY	SP	EP	WP	WY	WR
OBSS SJ PRE-GRAPPLE	-90.0	+87.9	-129.8	-57.0	0.0	-250.0
1: WP +				-40.9		
2: EP -			-134.6			
3: SP -		Until in grapple envelope				
Expected OBSS GRAPPLE	-90.0	+76.5	-134.6	-40.9	0.0	-250.0

Continue driving SP (-) until EE close to, but not over CAMs



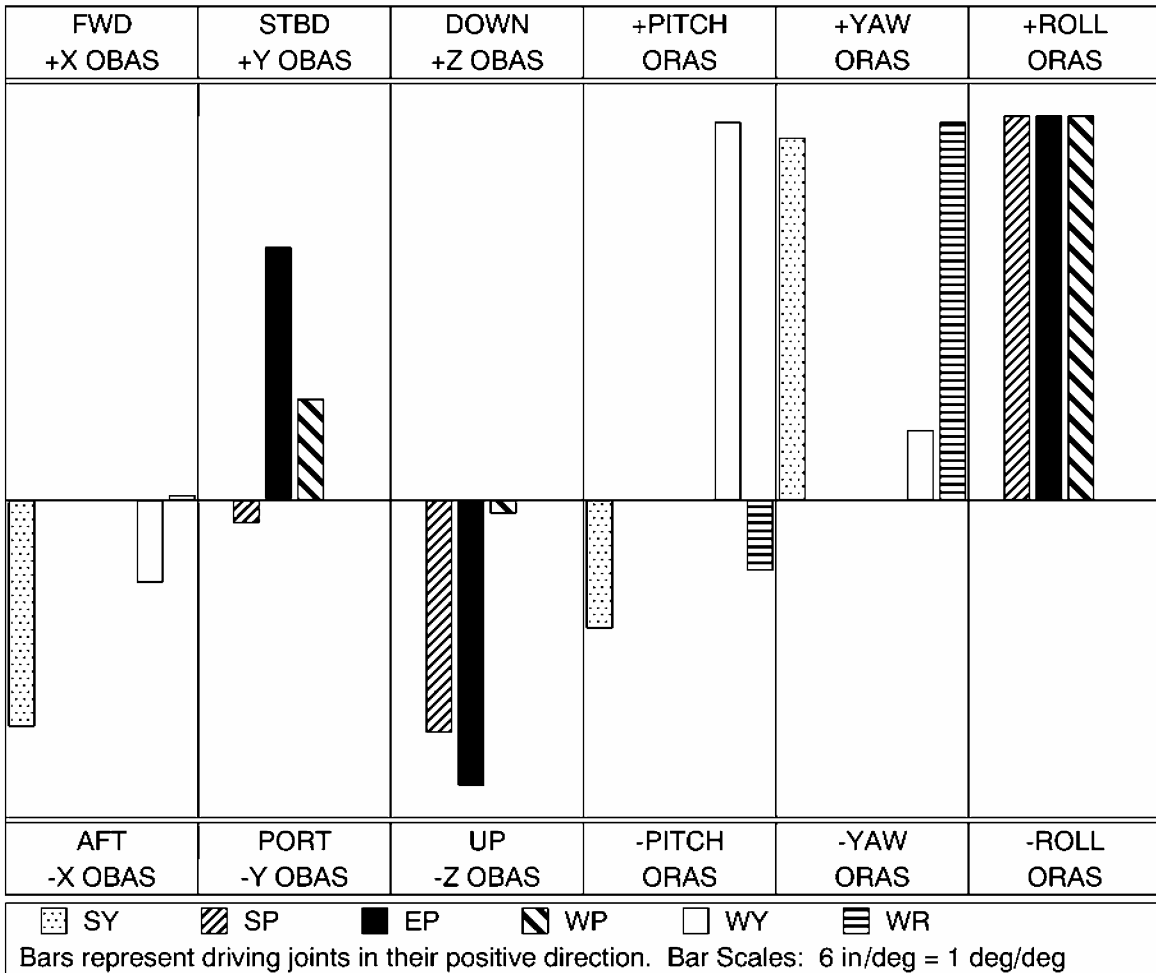

To get:	Drive:	To get:	Drive:
+X (fwd)	-SY, -WY	+PITCH	+WY
+Y (stbd)	+EP, +WP	+YAW	+WR, +SY
+Z (down)	-SP, -EP	+ROLL	+WP, +SP

Driving:	Results In:	Driving:	Results In:
+SY	-X (aft), +YAW	+WP	+Y (stbd), +ROLL
+SP	-Z (up), +ROLL	+WY	-X (aft), +PITCH
+EP	-Z (up), +ROLL	+WR	+YAW

$\Delta SY$	$\Delta SP$	$\Delta EP$	$\Delta WP$	$\Delta WY$	$\Delta WR$
-0.0	-11.4	-4.8	+16.1	+0.0	+0.0

Step 1:

Drive WP (+) from  $-57.0^\circ$  to  $-40.9^\circ$

Step 2:

Drive EP (-) from  $-129.8^\circ$  to  $-134.6^\circ$

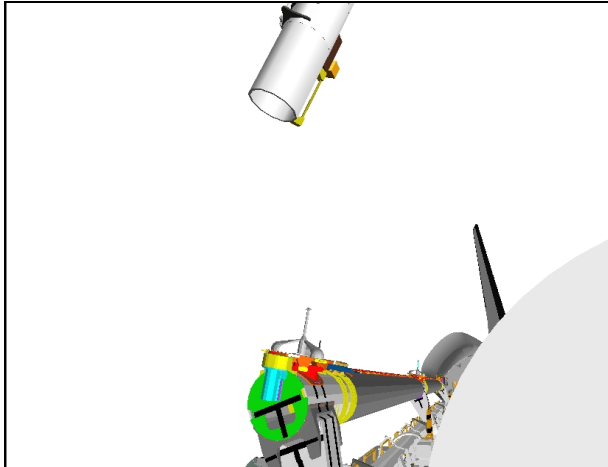

CCTV D (-20,20)

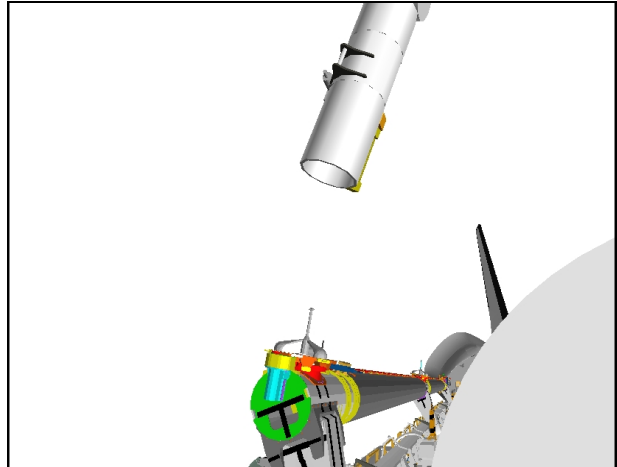

CCTV D (-20,20)

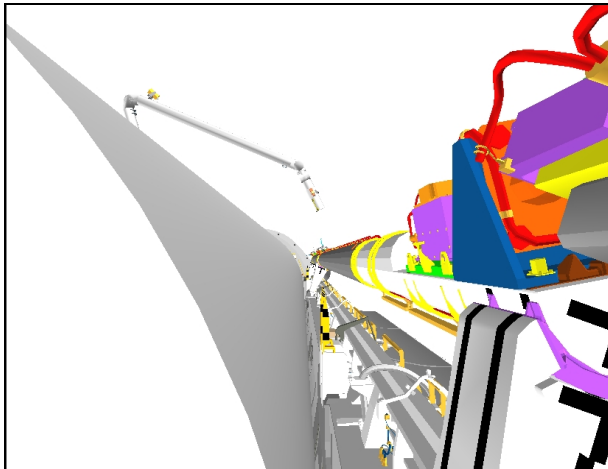

CCTV C (1,3)

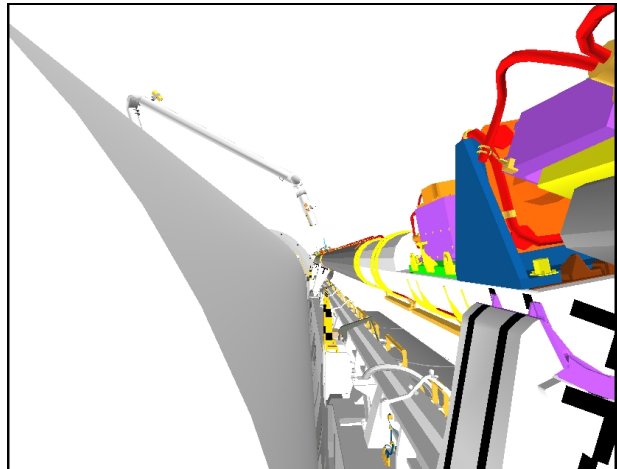

CCTV C (1,3)

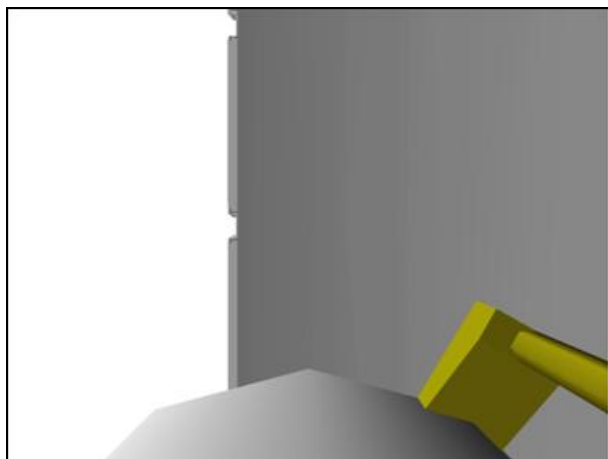

WRIST

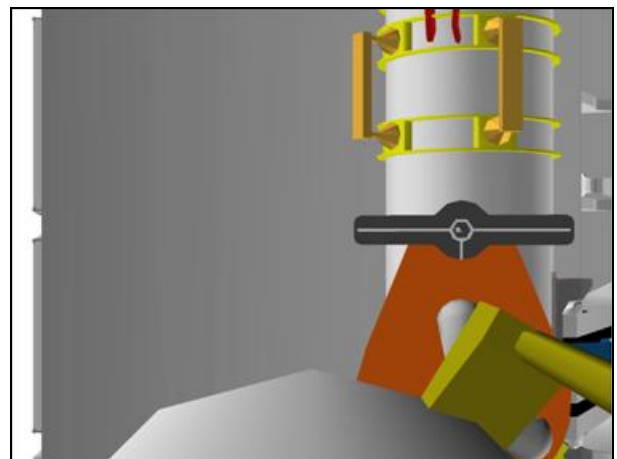

WRIST

**CAUTION**  
Monitor EE tb timing to prevent EE motor burnout

EE MODE – AUTO  
CAPTURE – depress (mom)

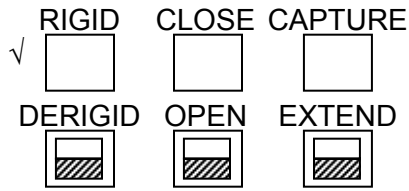

CRITICAL TIMES (28 sec total):  
CAPTURE tb – gray, then  
CLOSE tb – gray, 3 sec max, then  
RIGID tb – gray, 25 sec max

EE MODE – OFF

- \* If manual capture reqd: \*
- \* EE MODE – MAN \*
- \* CAPTURE sw – depress (hold until CLOSE tb-gray, 3 sec max) \*
- \* MAN CONTR – RIGID (hold until RIGID tb-gray, 25 sec max) \*
- \* MODE – OFF \*

BRAKES – ON (tb-ON)  
MODE – not DIRECT  
JOINT – CRIT TEMP

If SINGLE MODE available:  
**SM 94 PDRS CONTROL**  
PL ID – ITEM 3 +1 EXEC  
INIT ID – ITEM 24 +1 EXEC

If digitals available, record POSN/ATT and Joint Angles:

	X	Y	Z	PITCH	YAW	ROLL	PL ID
							1
Expected	-680	+105	-436	0	0	341	1
	SY	SP	EP	WP	WY	WR	
Expected	-90.0	+76.5	-134.6	-40.9	0.0	-250.0	

Review GENERIC END EFFECTOR CUE CARD – SHUTTLE NOT DOCKED OPS

4. CONFIGURE POWER  
MA73C:C    cb MCA PWR AC3 3Φ MID 2 – op  
                  ✓AC2 3Φ MID 2 – op  
          :D            ✓AC3 3Φ MID 4 – op
- R13L            PL BAY MECH PWR SYS (two) – ON

5. STBD MRL RELEASE  
A6U            DAP: FREE

**SM 94 PDRS CONTROL**  
RMS STBD – ITEM 2 EXEC (\*)  
✓STBD AFT, MID, FWD REL (six) = 0

NOTE

Expect single motor drive time for MRL release

STBD RMS RETEN LAT – REL (tb-REL) (18 sec max)  
– OFF

If motor drive time > 18 sec, √MCC

SM 94 PDRS CONTROL  
RMS PORT – ITEM 1 EXEC (\*)

6. RECONFIGURE POWER

R13L PL BAY MECH PWR SYS (two) – OFF

MA73C:C      cb MCA PWR AC3 3Φ MID 2 – cl  
                  √AC2 3Φ MID 2 – op  
:D               √AC3 3Φ MID 4 – op

If digitals available, record joint angles:

SY	SP	EP	WP	WY	WR

7. MNVR TO OBSS HOVER

A7U CCTV – config for unberth

If SINGLE MODE available:

RHC           RATE     – VERN (RATE MIN tb-ON)  
                 BRAKES – OFF (tb-OFF)

MODE – best available

Mnvr to OBSS SJ HOVER posn:

	SY	SP	EP	WP	WY	WR	
OBSS GRAPPLE	-90.0	+76.5	-134.6	-40.9	0.0	-250.0	
1: SP +		+79.8					
2: EP +			-123.1				
3: WP –				-55.7			
OBSS SJ HOVER	-90.0	+79.8	-123.1	-55.7	0.0	-250.0	
	X	Y	Z	PITCH	YAW	ROLL	PL ID
	-680	+126	-496	0	0	341	1

BRAKES – ON (tb-ON)  
MODE – not DIRECT  
JOINT – CRIT TEMP

Start:  
OBSS Grapple

Step 1:  
Drive SP (+) from +76.5° to +79.8°

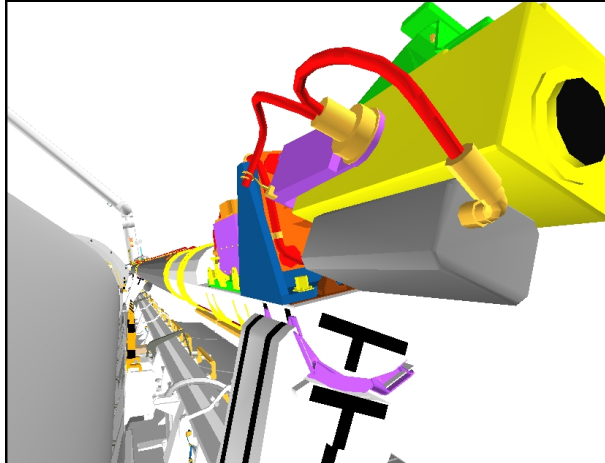

CCTV C (25,5)

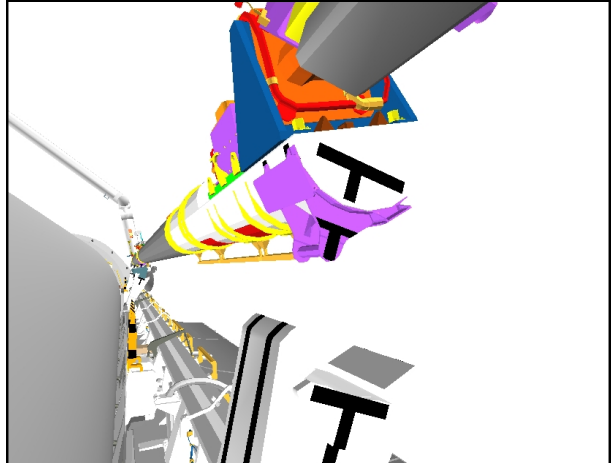

CCTV C (25,5)

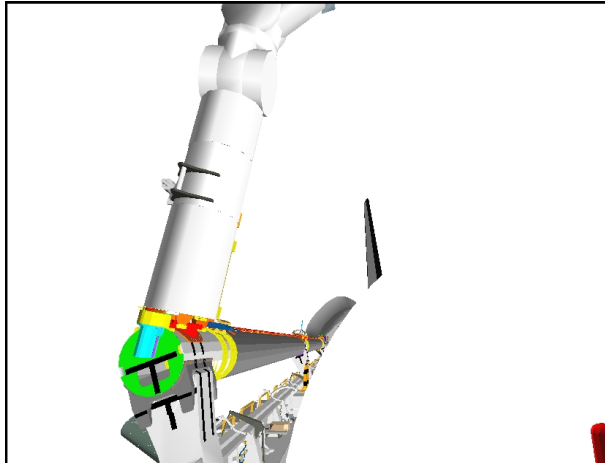

CCTV D (-5,15)



CCTV D (-5,15)

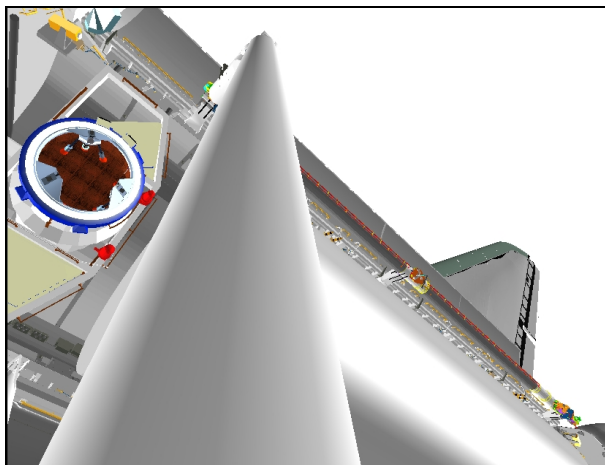

ELBOW (5,-30)

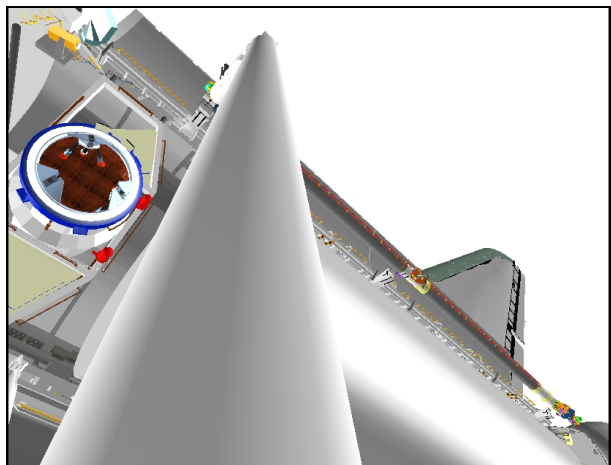

ELBOW (5,-30)

Step 2:  
Drive EP (+) from  $-134.6^\circ$  to  $-123.1^\circ$

Step 3:  
Drive WP (-) from  $-40.9^\circ$  to  $-55.7^\circ$

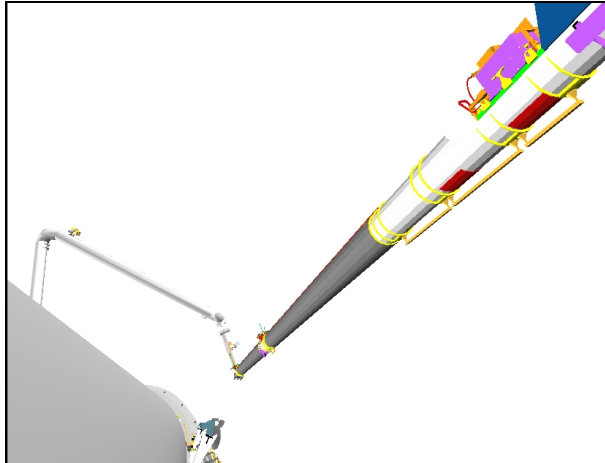

**CCTV C (15,25)**

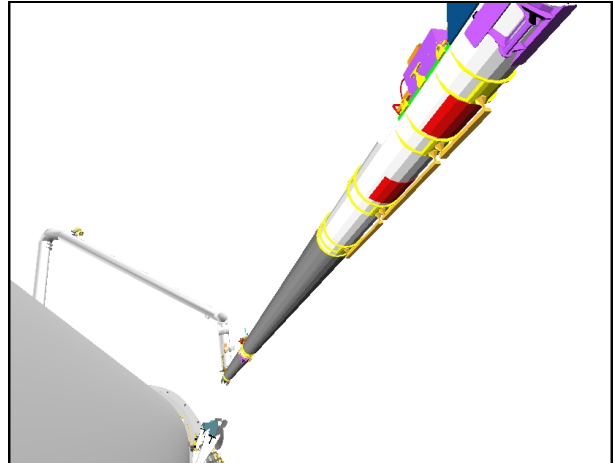

**CCTV C (15,25)**

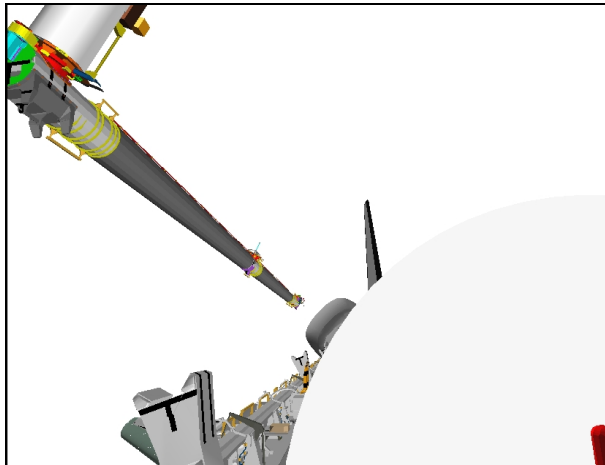

**CCTV D (-5,15)**

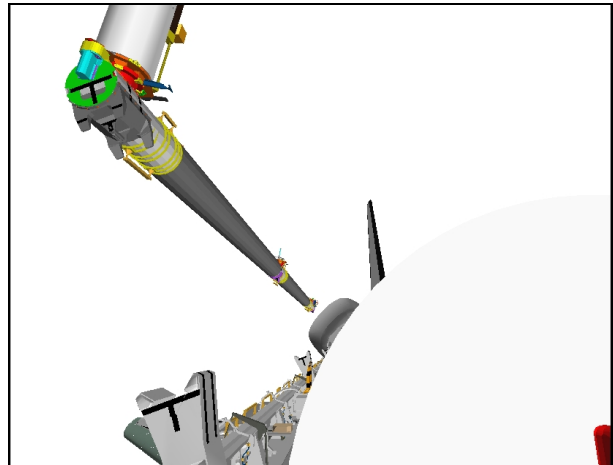

**CCTV D (-5,15)**

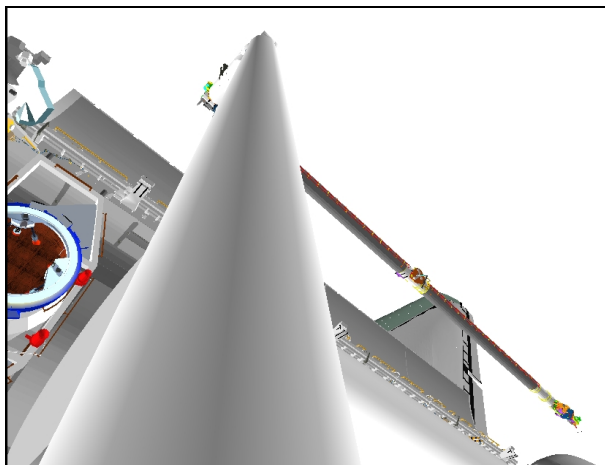

**ELBOW (5,-30)**

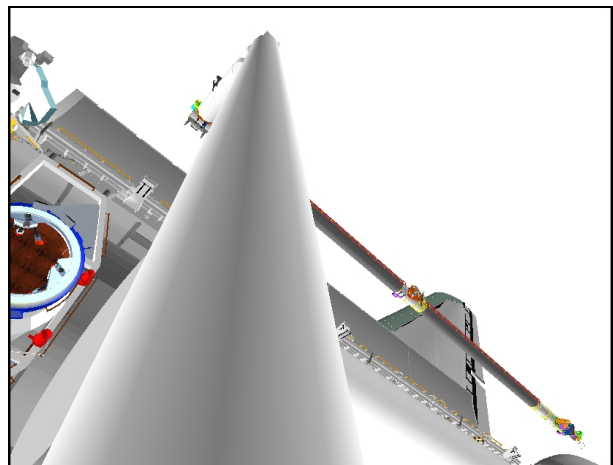

**ELBOW (5,-30)**

DAP: A14/AUTO/VERN(FREE)

A6U

If Verns failed, DAP: AUTO/ALT

In the following P/TV procedure, start 15-min timer upon applying SPEE power and inform MCC when timer is started:

Perform ACTIVATION (LDRI/ITVC Cue Card, PHOTO/TV)

Perform LCH ACTIVATION (LCS Cue Card, PHOTO/TV)

Perform LCC ACTIVATION (LCS Cue Card, PHOTO/TV)

Go to OBSS UNBERTH, steps 8 and 9

# OBSS SJ BERTH

I

<p style="text-align: center;"><b>WARNING</b> For UNDOCKED ops only</p>
---

## NOTE

Stbd MPMs assumed deployed

- A7U
1. SETUP  
CCTV – config for berth  
– perform PAN/TILT RESET for PLB cameras

If SINGLE MODE available:

SM 94 PDRS CONTROL
--------------------

PL ID – ITEM 3 +1 EXEC

INIT ID – ITEM 24 +1 EXEC

2. OBSS SJ HOVER

Verify mnvr to OBSS SJ HOVER posn complete:

X	Y	Z	PITCH	YAW	ROLL	PL ID
-680	+126	-496	0	0	341	1
SY	SP	EP	WP	WY	WR	
-90.0	+79.8	-123.1	-55.7	0.0	+110.0	

√BRAKES – ON (tb-ON)

√MODE – not DIRECT

√JOINT – CRIT TEMP

√STBD RMS HTR A,B (two) – OFF



OBSS Hover

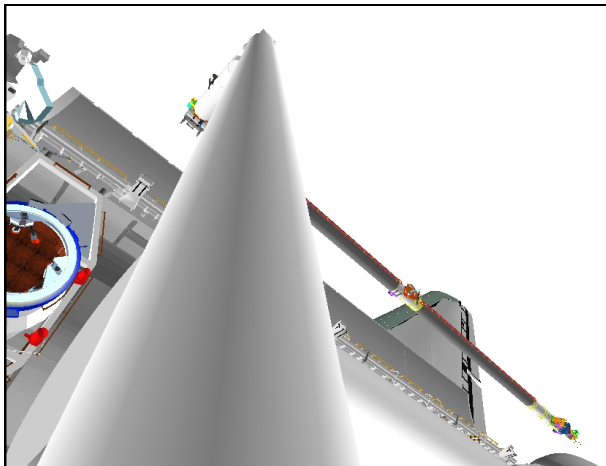

**ELBOW (5,-30)**

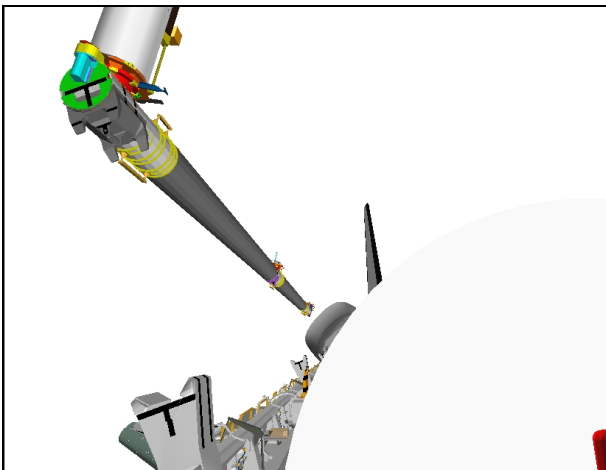

**CCTV D (-5,15)**

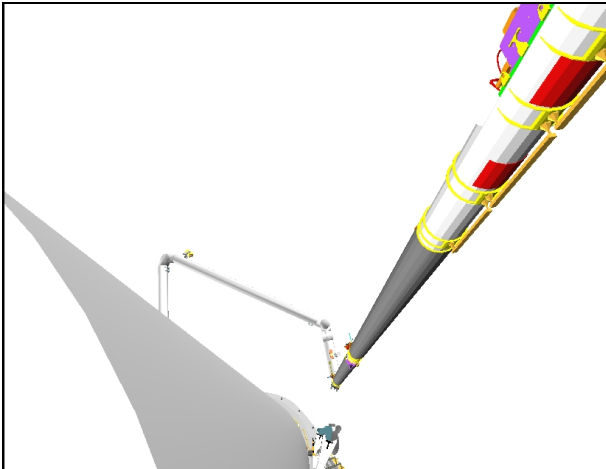

**CCTV C (0,25)**

A7U 3. STOW PTU  
√DTV ← PL2

CAMR CMD PAN/TILT – HI RATE  
PAN – L (to hard stop)  
TILT – UP (to hard stop)  
PAN/TILT – RESET, HI RATE (LO within 10°)  
PAN: +108 (right)  
TILT: -175 (down)

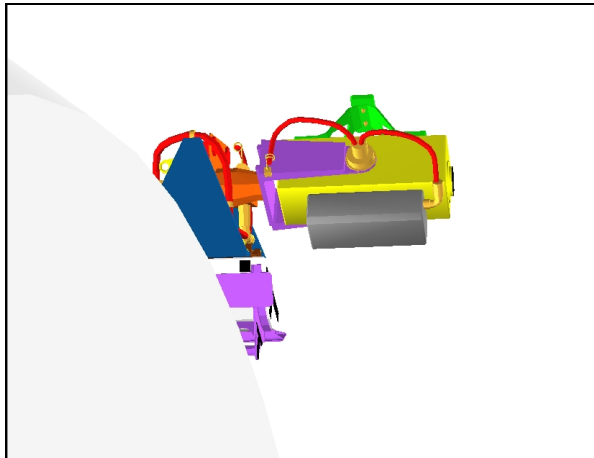

**CCTV B (82,16) HFOV: 15.0**

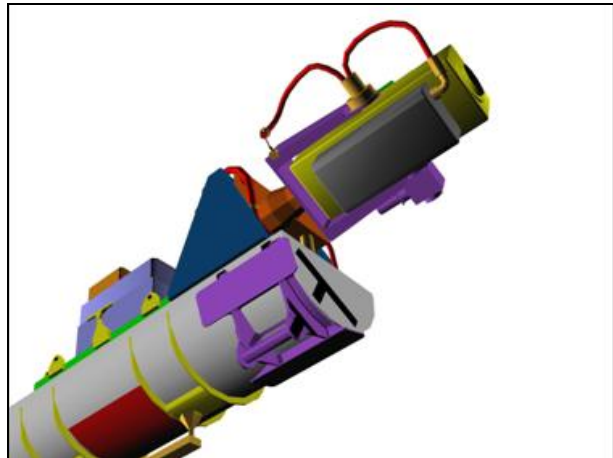

**CCTV C (50,50) HFOV: 40.0**

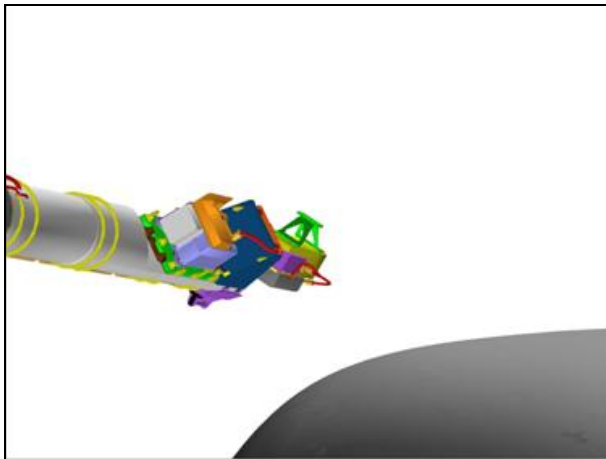

**ELBOW (52,-45) HFOV: 9.8 (full-in)**

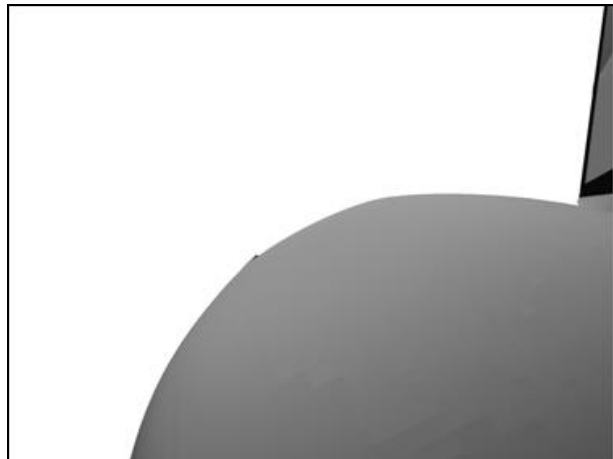

**OBSS ITVC (108,-175) HFOV: 53.8 (full-out)**

Perform LCC DEACTIVATION (LCS Cue Card, PHOTO/TV)  
Perform LCH DEACTIVATION (LCS Cue Card, PHOTO/TV)

**CAUTION**  
STBD RMS HTR power must be applied within  
90 min to prevent sensor package damage

Perform DEACTIVATION (LDRI/ITVC Cue Card, PHOTO/TV)

A7U 4. OBSS BERTH  
 CCTV – configure as required  
 ZOOM – full OUT

SM 94 PDRS CONTROL  
 RMS STBD – ITEM 2 EXEC (\*)

A6U DAP: FREE

RHC If SINGLE MODE available:  
 RATE – VERN (RATE MIN tb-ON)  
 BRAKES – OFF (tb-OFF)

MODE – best available

Mnvr to OBSS BERTH posn:

	SY	SP	EP	WP	WY	WR	
OBSS HOVER	-90.0	+79.8	-123.1	-55.7	0.0	+110.0	
1: WP +				-40.9			
2: EP -			-134.6				
3: SP -		+76.5					
Expected OBSS BERTH	-90.0	+76.5	-134.6	-40.9	0.0	+110.0	
	X	Y	Z	PITCH	YAW	ROLL	PL ID
	-680	+105	-436	0	0	341	1

√STBD RMS R-F-L tb (three) – gray  
 MODE – not DIRECT

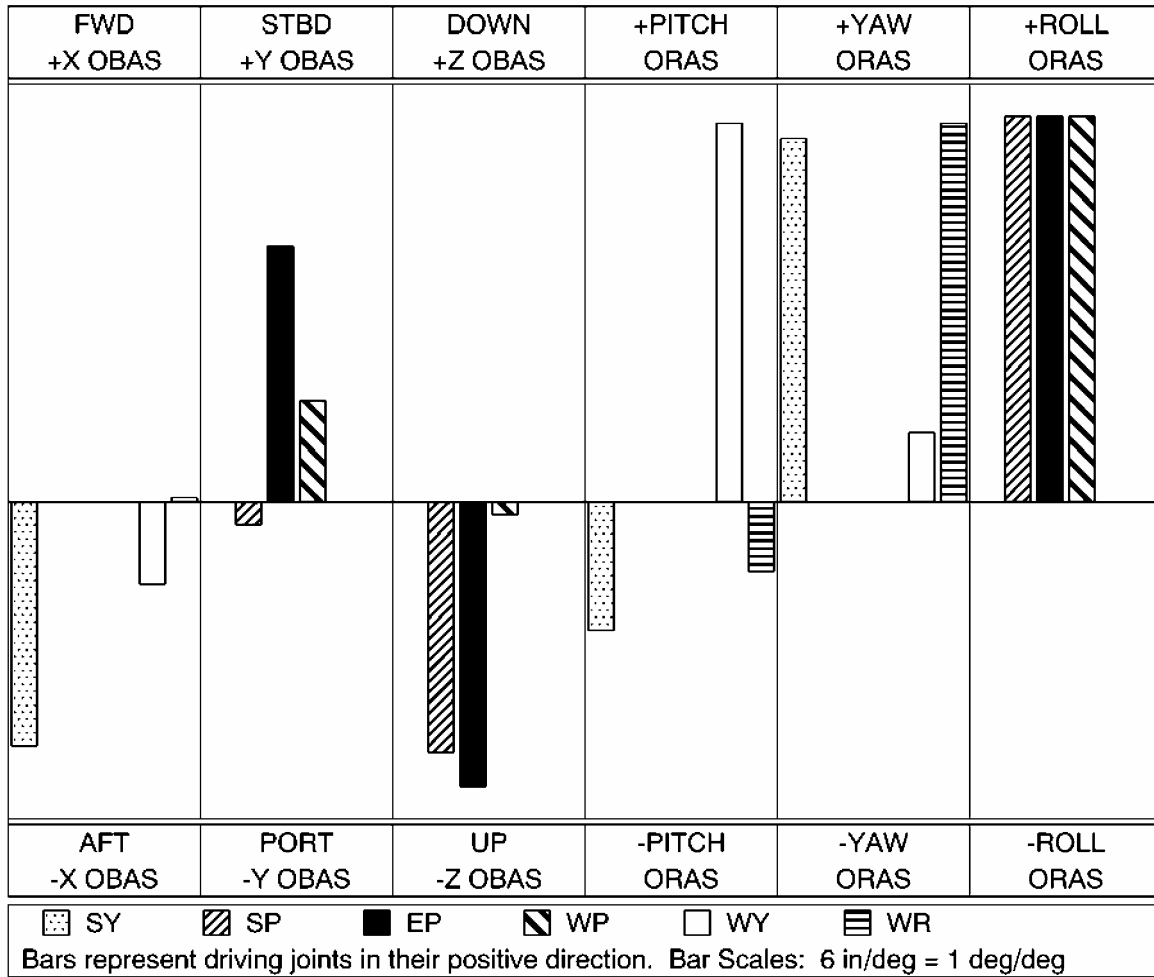

To get:	Drive:	To get:	Drive:
+X (fwd)	-SY, -WY	+PITCH	+WY
+Y (stbd)	+EP, +WP	+YAW	+WR, +SY
+Z (down)	-SP, -EP	+ROLL	+WP, +SP

Driving:	Results In:	Driving:	Results In:
+SY	-X (aft), +YAW	+WP	+Y (stbd), +ROLL
+SP	-Z (up), +ROLL	+WY	-X (aft), +PITCH
+EP	-Z (up), +ROLL	+WR	+YAW

$\Delta SY$	$\Delta SP$	$\Delta EP$	$\Delta WP$	$\Delta WY$	$\Delta WR$
+0.0	-3.3	-11.5	+14.8	+0.0	+0.0

Start:  
OBSS Hover

Step 1:  
Drive WP (+) from  $-55.7^\circ$  to  $-40.9^\circ$

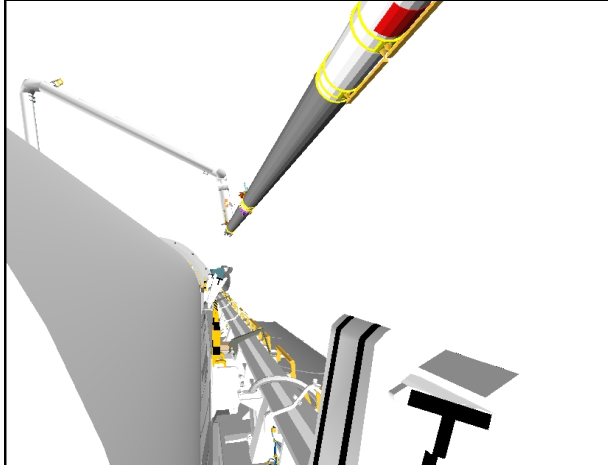

**CCTV C (15,5)**

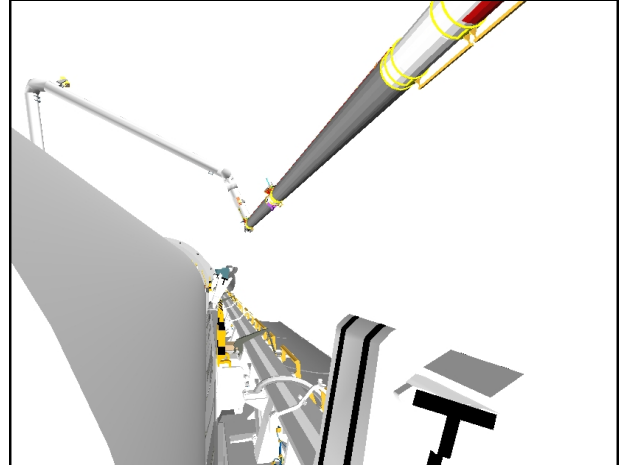

**CCTV C (15,5)**

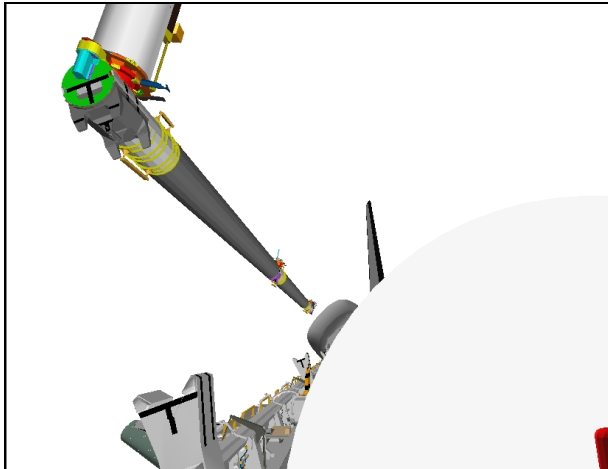

**CCTV D (-5,15)**

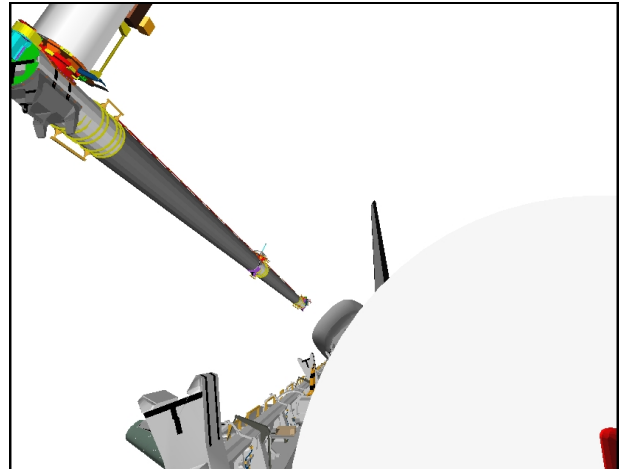

**CCTV D (-5,15)**

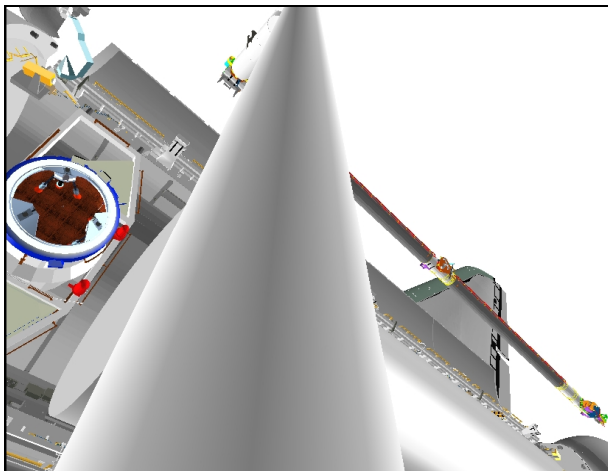

**ELBOW (0,-35)**

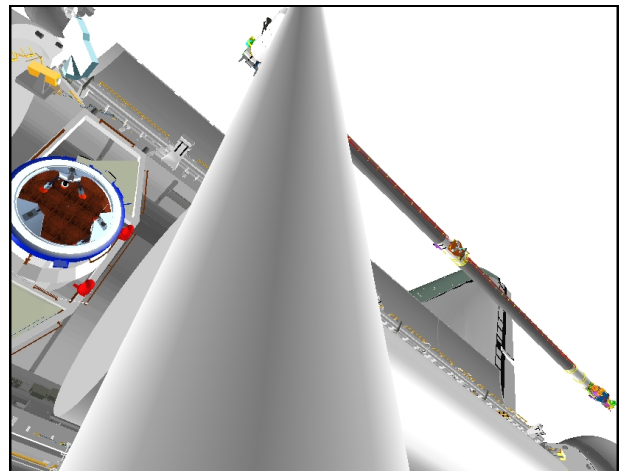

**ELBOW (0,-35)**

Step 2:

Drive EP (-) from  $-123.1^\circ$  to  $-134.6^\circ$

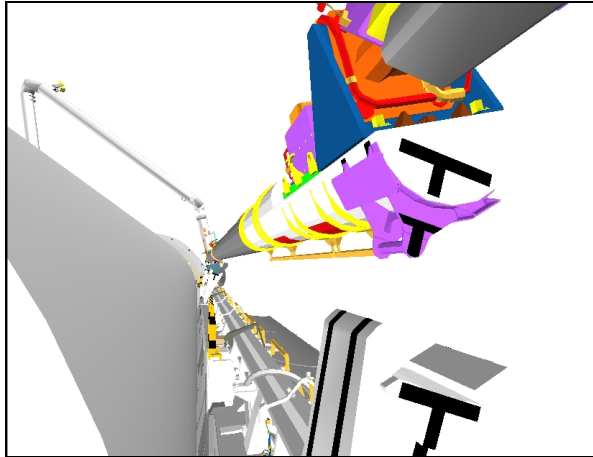

**CCTV C (15,5)**

Step 3:

Drive SP (-) from  $+79.8^\circ$  to  $+76.5^\circ$

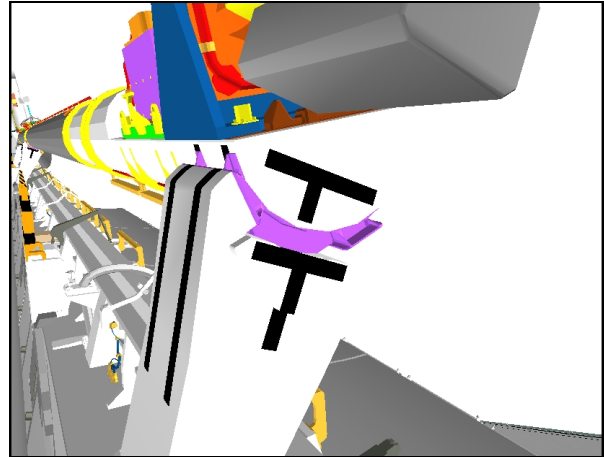

**CCTV C (30,-10) HFOV 60.0**

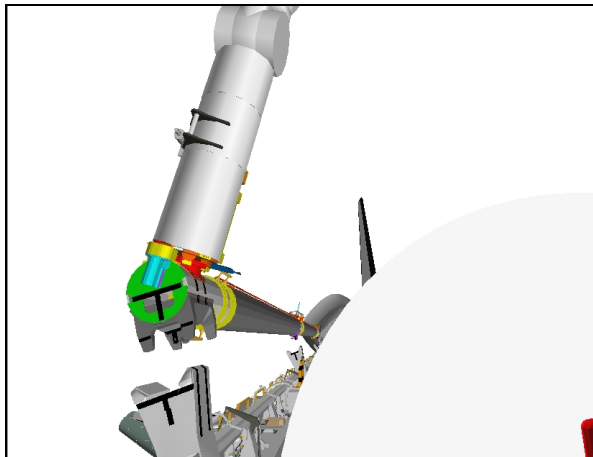

**CCTV D (-5,15)**

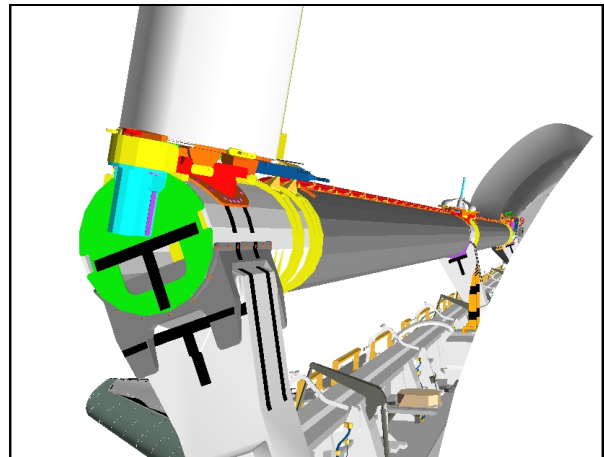

**CCTV D (-15,0) HFOV 35.0**

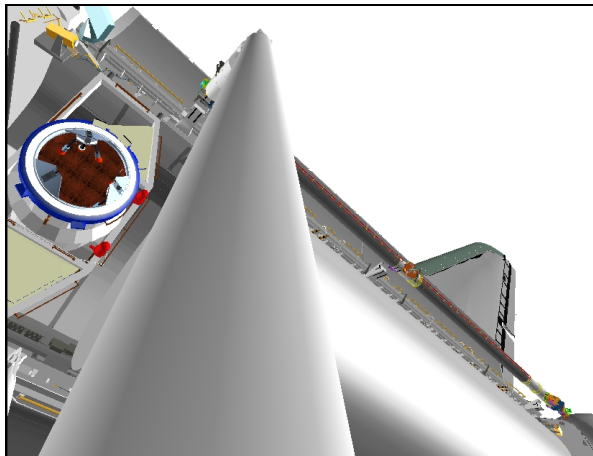

**ELBOW (5,-30)**

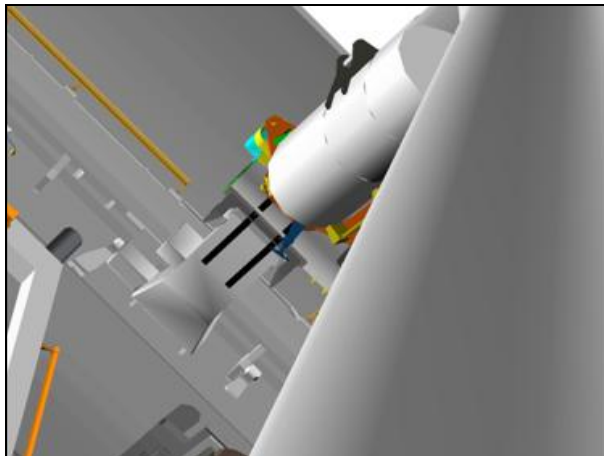

**ELBOW (-7,-12) HFOV 15.0**

5. CONFIGURE POWER  
MA73C:C    cb MCA PWR AC3 3Φ MID 2 – op  
                  √AC2 3Φ MID 2 – op  
          :D            √AC3 3Φ MID 4 – op

R13L            PL BAY MECH PWR SYS (two) – ON

6. STBD MRL LATCH  
RATE – COARSE (RATE MIN tb-OFF)

SM 94 PDRS CONTROL

√STBD AFT, MID, FWD LAT (six) = 0

If SINGLE MODE available:

AUTO BRAKE INH – ITEM 10 EXEC (\*)

NOTE

Expect single motor drive time for MRL latching

STBD RMS RETEN LAT – LAT (tb-LAT) (18 sec max)  
– OFF

If motor drive time > 18 sec, √MCC

SM 94 PDRS CONTROL

RMS PORT – ITEM 1 EXEC (\*)

If TEST MODE available,

MODE – TEST, ENTER

Wait 5 sec

√BRAKES – ON (tb-ON)

JOINT    – CRIT TEMP

If SINGLE MODE available:

SM 94 PDRS CONTROL

AUTO BRAKE ENA – ITEM 9 EXEC (\*)

A6U            DAP: A1/AUTO/VERN(ALT)

7. RECONFIGURE POWER  
R13L            PL BAY MECH PWR SYS (two) – OFF

MA73C:C    cb MCA PWR AC3 3Φ MID 2 – cl  
                  √AC2 3Φ MID 2 – op  
          :D            √AC3 3Φ MID 4 – op

8. OBSS UNGRAPPLE  
A7U            CCTV – configure for ungrapple  
                  – attach overlays as needed  
                  – RMS WRIST, ZOOM: 34.0 HFOV  
                          FOCUS: 5 ft

If SINGLE MODE available:

**SM 94 PDRS CONTROL**

PL ID – ITEM 3 +0 EXEC

INIT ID – ITEM 24 +0 EXEC

RHC

RATE – VERN (RATE MIN tb-ON)

BRAKES – OFF (tb-OFF)

MODE – best available

A6U

DAP: VERN(FREE)

<b>CAUTION</b>
Monitor EE tb timing to prevent EE motor burnout

EE MODE – MAN

MAN CONTR – DERIGID (hold until DERIGID tb-gray, 5 sec max)

RELEASE sw – depress (hold until OPEN tb-gray, 3 sec max)

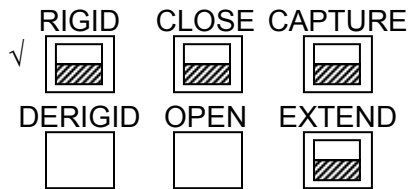

Drive SP (+) until arm clear of grapple pin

EE MAN CONTR – DERIGID (hold until EXTEND tb-gray, 20 sec max)

MODE – OFF

STBD RMS HTR A,B (two) – AUTO

A6U

EVENT TIMER CNTL – STOP

DAP: A1/AUTO/VERN(ALT)

Mnvr to OBSS SJ PRE-GRAPPLE posn:

	SY	SP	EP	WP	WY	WR	
OBSS BERTH	-90.0	+76.5	-134.6	-40.9	0.0	+110.0	
1: SP +		<b>+87.9</b>					
2: EP +			<b>-129.8</b>				
3: WP –				<b>-57.0</b>			
OBSS SJ PRE-GRAPPLE	-90.0	+87.9	-129.8	-57.0	0.0	+110.0	
	X	Y	Z	PITCH	YAW	ROLL	PL ID
	-680	+96	-513	270	350	1	0

BRAKES – ON (tb-ON)

MODE – not DIRECT

JOINT – CRIT TEMP



Start:  
OBSS Berth

Step 1:  
Drive SP (+) from +76.5° to +87.9°

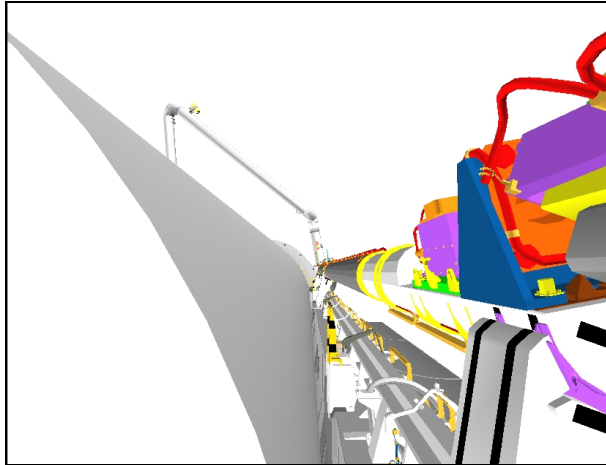

**CCTV C (0,5)**

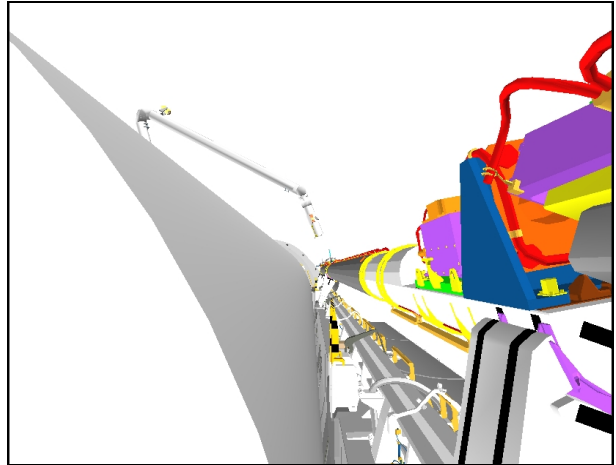

**CCTV C (0,5)**

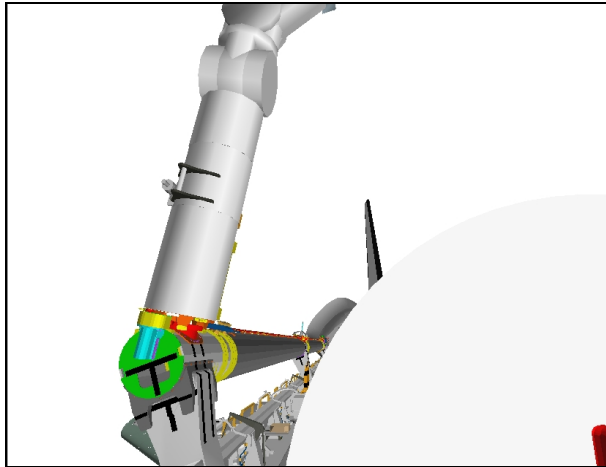

**CCTV D (-5,15)**

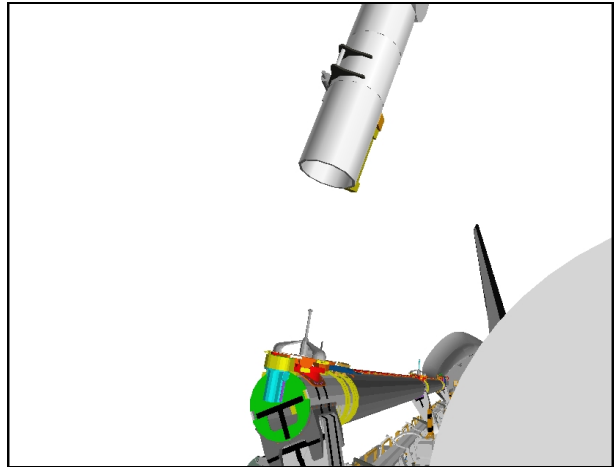

**CCTV D (-20,20)**

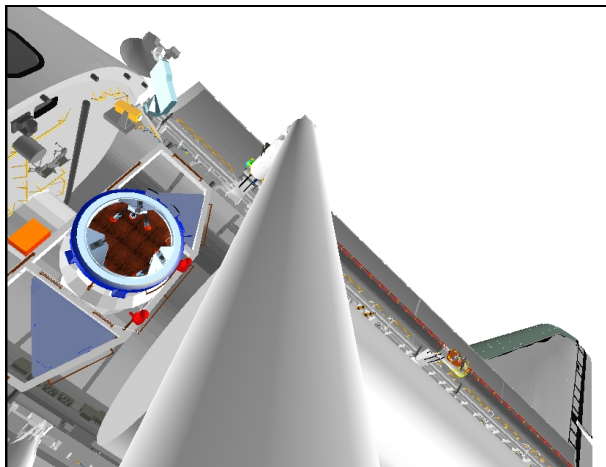

**ELBOW (0,-20)**

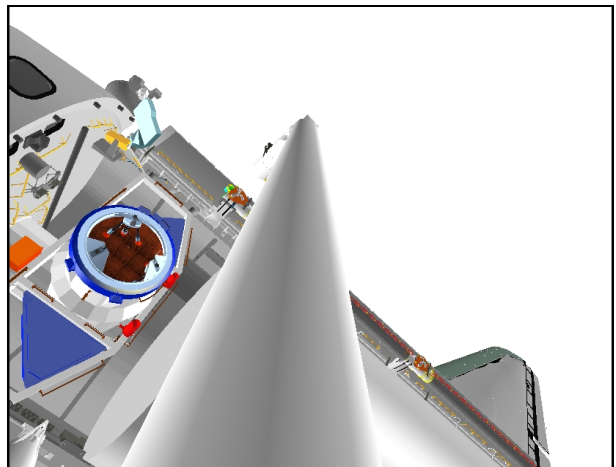

**ELBOW (0,-20)**

Step 2:  
Drive EP (+) from -134.6° to -129.8°

Step 3:  
Drive WP (-) from -40.9° to -57.0°

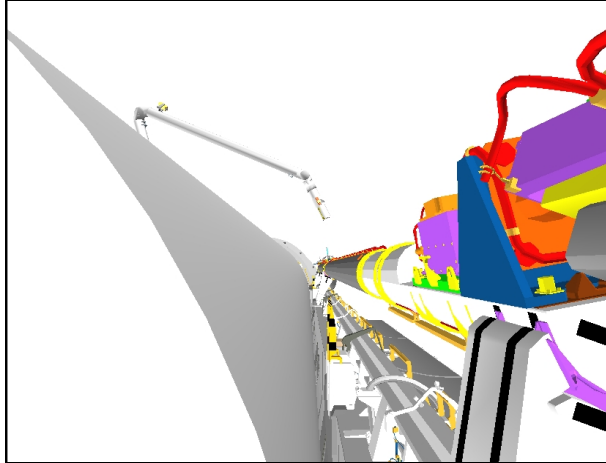

**CCTV C (0,5)**

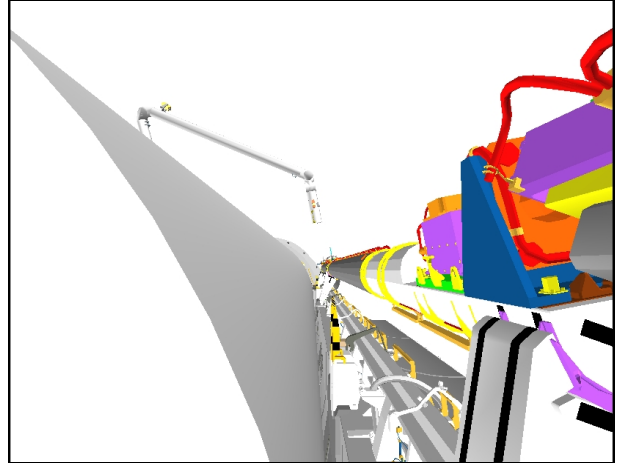

**CCTV C (0,5)**

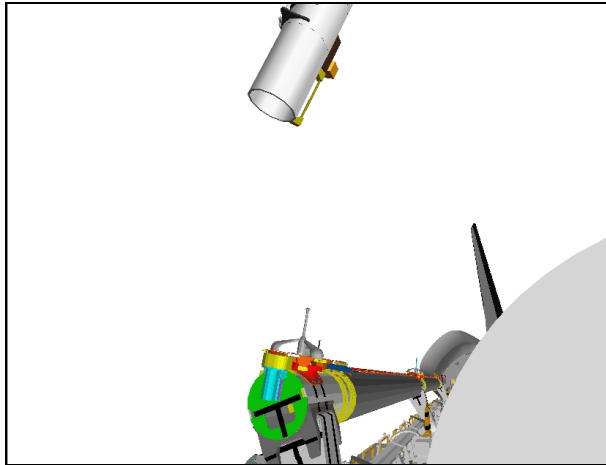

**CCTV D (-20,20)**

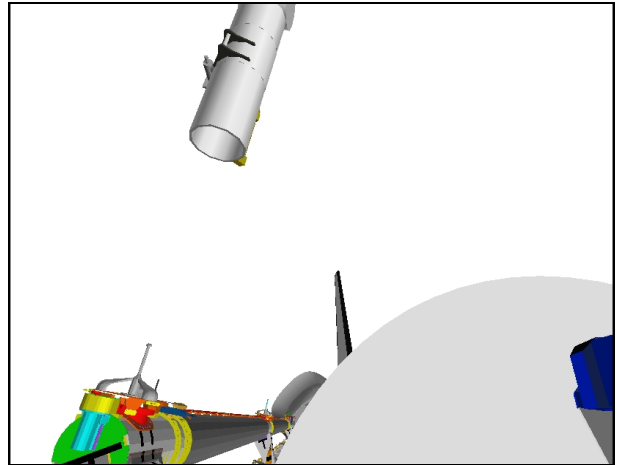

**CCTV D (0,25)**

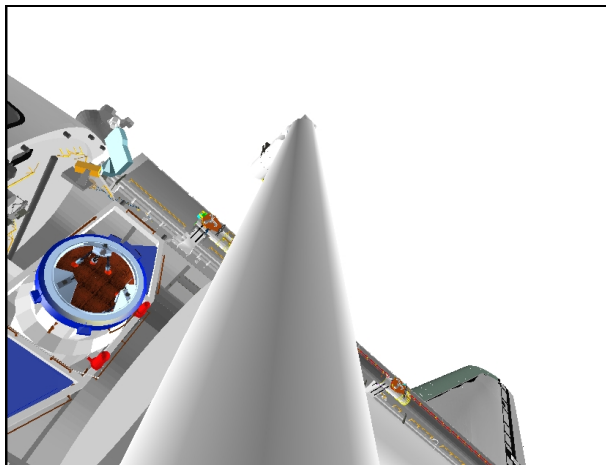

**ELBOW (0,-20)**

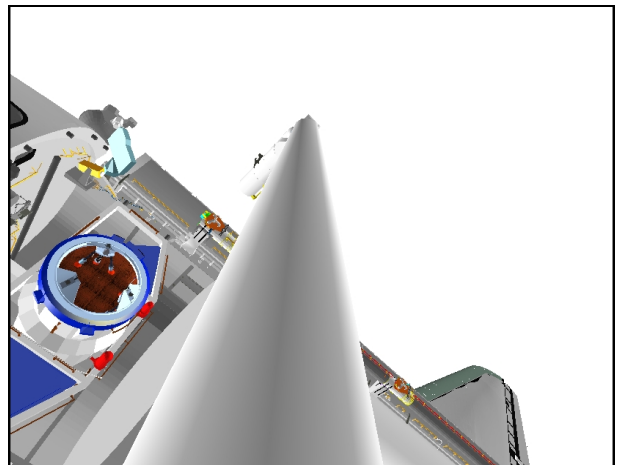

**ELBOW (0,-20)**

A7U 9. ARM PRE-CRADLE  
 CCTV – configure as required  
 ZOOM – full OUT

RHC If SINGLE MODE available:  
 RATE – as reqd (VERN within 10 ft)  
 BRAKES – OFF (tb-OFF)

MODE – best available

Mnvr to PRE-CRADLE posn:

	SY	SP	EP	WP	WY	WR	
OBSS SJ	-90.0	+87.9	-129.8	-57.0	0.0	+110.0	
PRE-GRAPPLE				+5.0			
1: WP +							
2: WR –						0.0	
3: EP +			-25.0				
4: SY +	0.0						
5: SP –		+25.0					
PRE-CRADLE	0.0	+25.0	-25.0	+5.0	0.0	0.0	
	X	Y	Z	PITCH	YAW	ROLL	PL ID
	-1261	-146	-551	5	2	0	0

BRAKES – ON (tb-ON)  
 MODE – not DIRECT  
 PARAM – PORT TEMP  
 JOINT – CRIT TEMP

Start:  
OBSS Pre-Grapple

Step 1:  
Drive WP (+) from  $-57.0^\circ$  to  $+5.0^\circ$

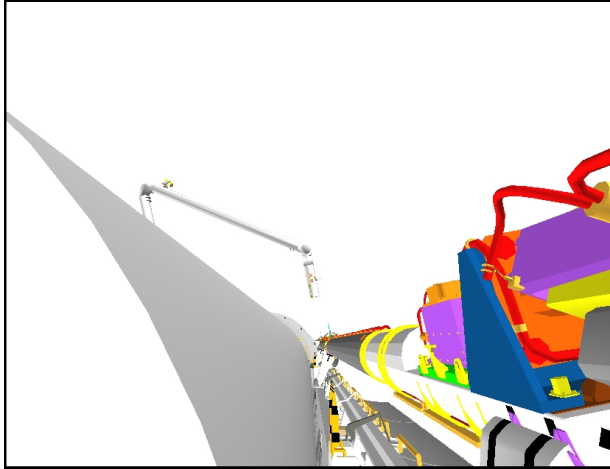

**CCTV C (0,15)**

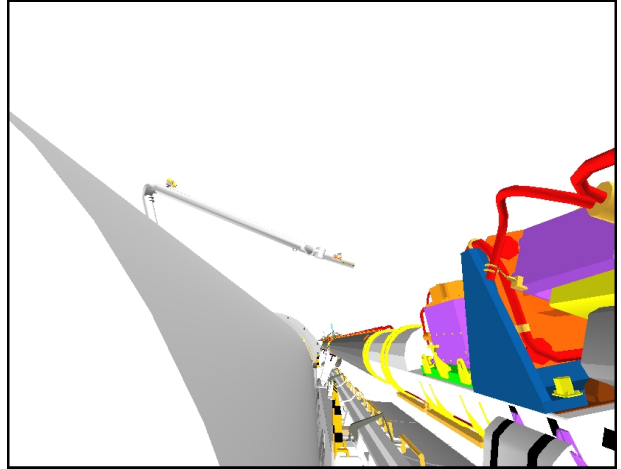

**CCTV C (0,15)**

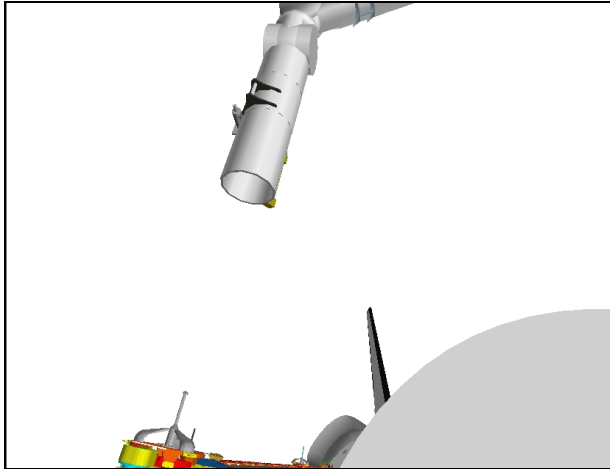

**CCTV D (-5,30)**

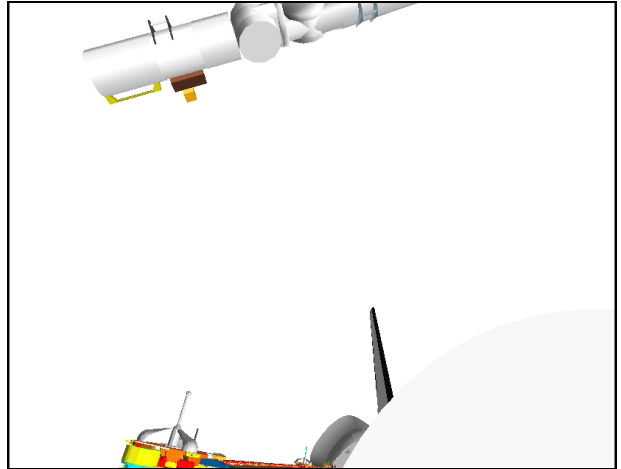

**CCTV D (-5,30)**

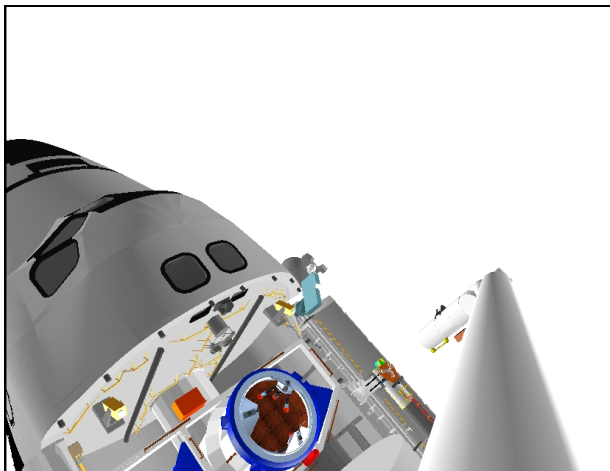

**ELBOW (-25,0)**

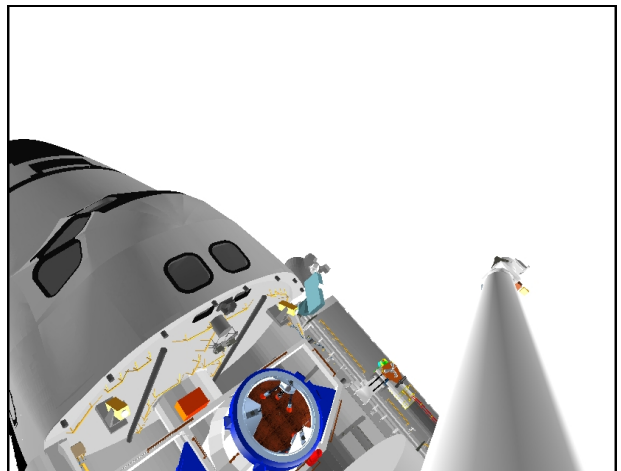

**ELBOW (-25,0)**

Step 2:  
Drive WR (-) from +110.0° to 0.0°

Step 3:  
Drive EP (+) from -129.8° to -25.0°

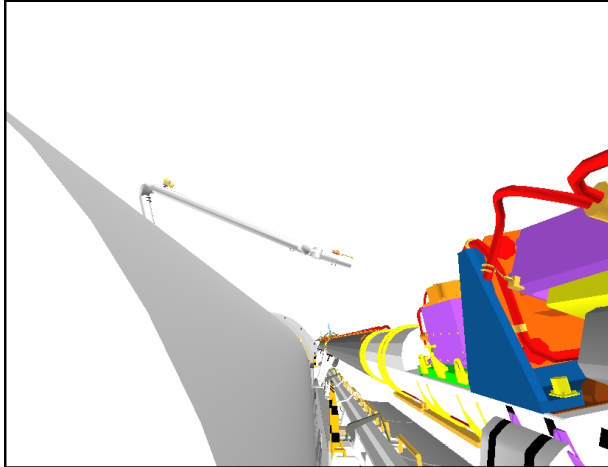

**CCTV C (0,15)**

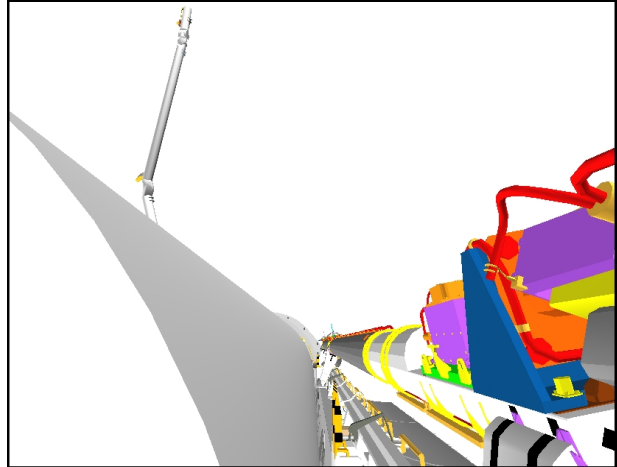

**CCTV C (0,15)**

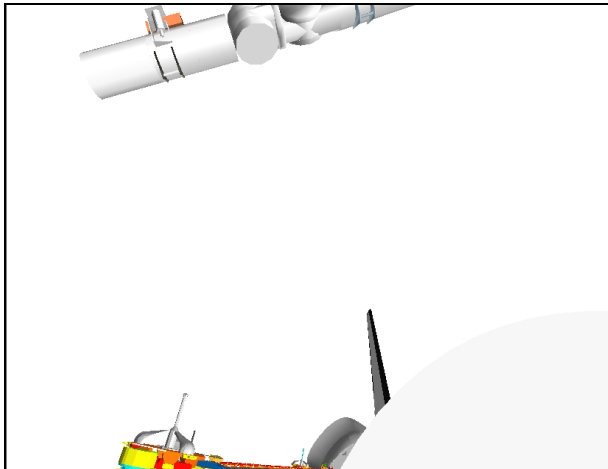

**CCTV D (-5,30)**

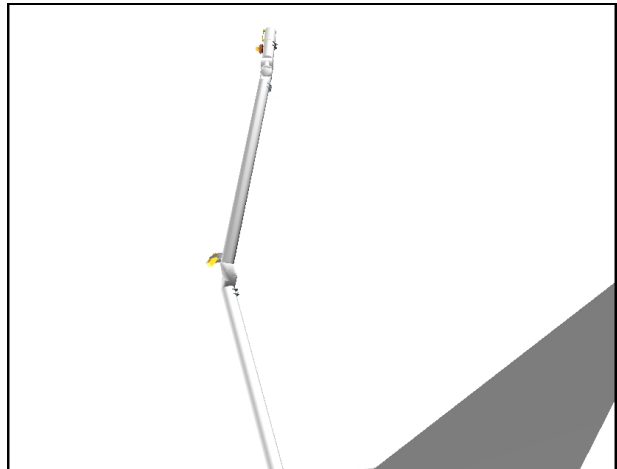

**CCTV B (0,25)**

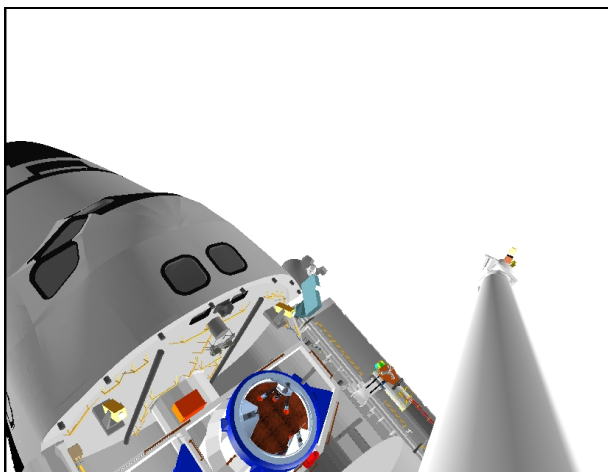

**ELBOW (-25,0)**



**CCTV A (0,45)**

Step 4:

Drive SY (+) from  $-90.0^\circ$  to  $0.0^\circ$

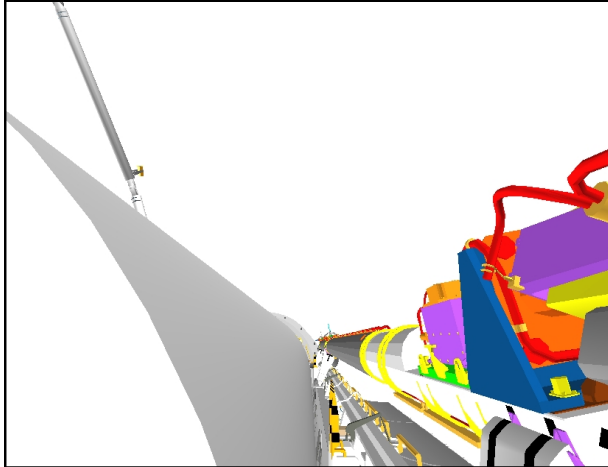

**CCTV C (0,15)**

Step 5:

Drive SP (-) from  $+87.9^\circ$  to  $+25.0^\circ$

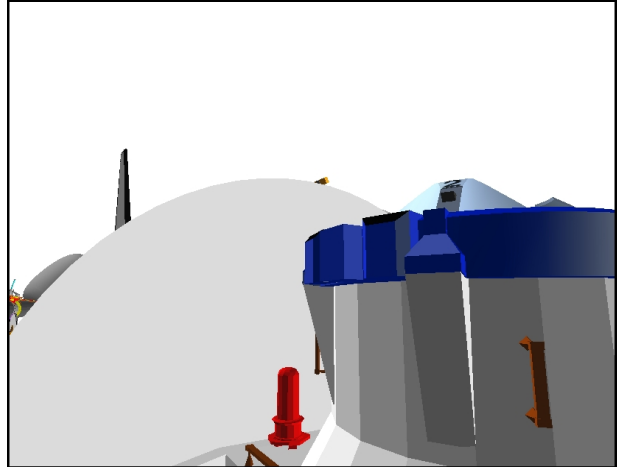

**CCTV D (30,10)**

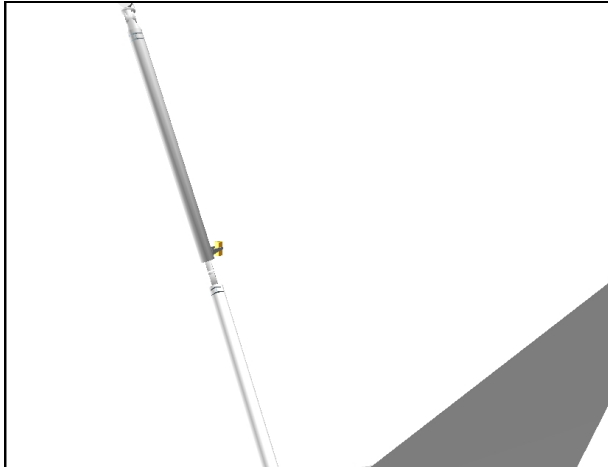

**CCTV B (0,25)**

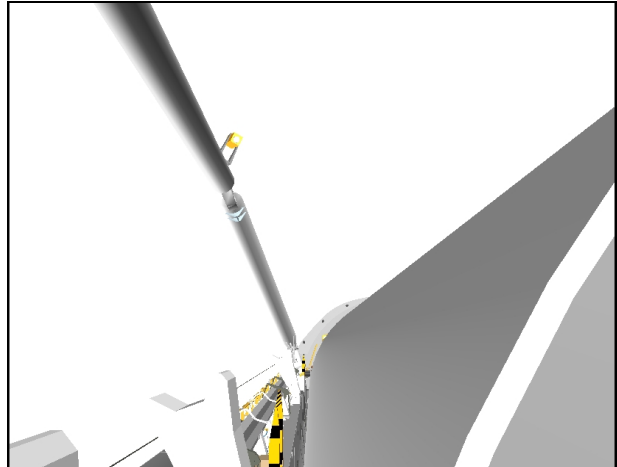

**CCTV B (0,10)**

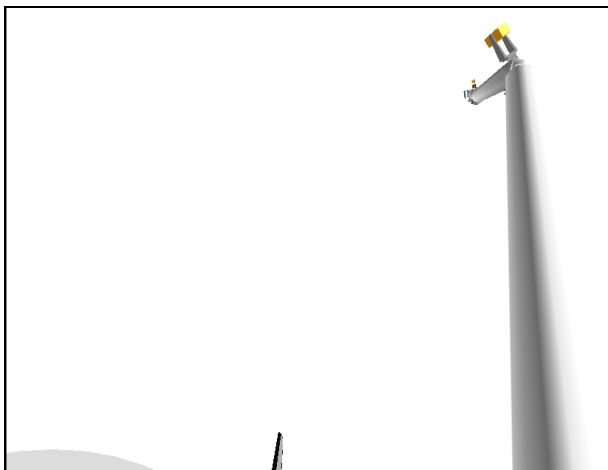

**CCTV A (0,45)**

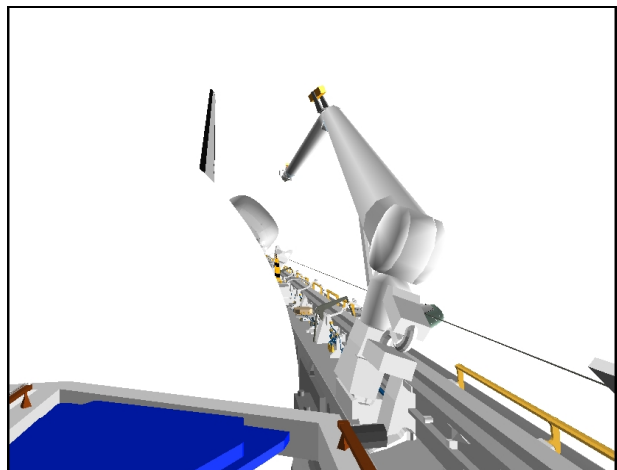

**CCTV A (10,0)**

## OBSS JETTISON

### ASSUMPTIONS:

1. DAP and RMS have been configured to provide stable position for OBSS prior to entering this procedure
2. For undocked ops only

### NOTES:

1. Jettison to be performed between sunrise and noon, if practical, to provide good visibility
2. DAP A used post-jettison for sep mnvr. DAP B (with mod in step 1) used while OBSS attached to RMS to keep loads down and ensure stable orbiter/payload/DAP
3. Jettison must occur greater than 1500 ft from ISS to avoid plume impingement damage
4. For emergency undock scenario, perform Shuttle Emergency Sep (RNDZ C/L) with 3 fps posigrade +X burn in step 3 prior to executing this procedure

**OBSS JETTISON**

**OBSS JETTISON**

1. SETUP

If Stbd MPMs expected to stow, go to step 4

If OBSS not latched:

Perform OBSS BERTH (NOMINAL), steps 1-7

If OBSS Berthed and SRMS not grappled:

Perform OBSS UNBERTH (NOMINAL), steps 1-3,  
sensor package timer not required

SM 94 PDRS CONTROL

√PL ID, ITEM 3: 1

√INIT ID, ITEM 24: 1

A14 √PYRO STARBOARD RMS (five) – SAFE  
√RMS LAT – SAFE

ML86B:D      cb MNA PYRO JETT SYS A STBD RMS – cl  
                  MNC PYRO JETT SYS B STBD RMS – cl  
√cb MNB PYRO JETT SYS A PORT RMS – op  
√MNC PYRO JETT SYS B PORT RMS – op

2. STARBOARD MPM JETTISON

a. Deadface Latches

R13L √PL BAY MECH PWR SYS (two) – OFF

A8L √STBD RMS RETEN LAT tb – LAT

A14 RMS LAT – DEADFACE

A8L √STBD RMS RETEN LAT tb – bp

b. Guillotine Wires at Latches

A14 PYRO STBD RMS ARM – GUILLOTINE  
Wait at least 1 sec, then  
PYRO STBD RMS LAT (three) – GUILLOTINE  
– SAFE





**CDR**

**MS**

3. AUTO MNVR TO -XLV, +ZVV  
GNC UNIV PTG  
√TGT ID: +2  
BODY VECT: +5  
P: +180  
Y: +0  
OM: +0  
TRK – ITEM 19 EXEC (CUR – \*)  
  
DAP: B/AUTO/VERN(ALT)

A6U

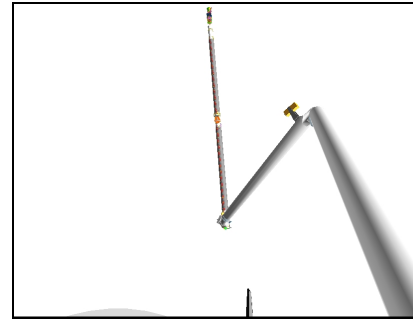

**CCTV A (-10,45)**

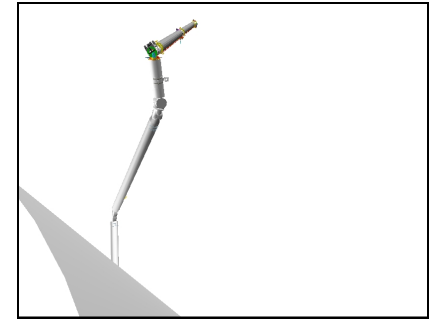

**CCTV C (0,35)**

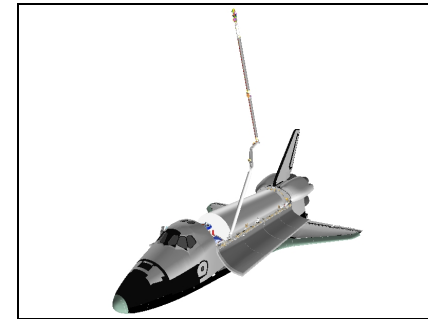

**BIRD'S EYE**

**CDR**

**MS**

On MS call, "OBSS at jettison position" -----

----- Report to CDR "OBSS at jettison position"

If attitude mnvr not complete:

DAP: ALT

GNC 20 DAP CONFIG

PRI ROT RATE (B7) – ITEM 30 +0.5 EXEC

5. OBSS RELEASE

MON 1	WRIST
MON 2	C(B)

3. CONFIGURE ORBITER FOR SEP MNVR

When mnvr to attitude complete:

√DAP: VERN(ALT)

When rates damped:

DAP: FREE

R12 (OBSS)

√SPEE PWR – OFF

SSP1(OV-104) √APCU 1,2 CONV (two) – OFF

A15(OV-103, OV-105)

SM 94 PDRS CONTROL

PL ID – ITEM 3 +0 EXEC

INIT ID – ITEM 24 +0 EXEC

FLT CNTLR PWR – ON

√DAP TRANS: PULSE/PULSE/PULSE, NO LO Z

X	Y	Z	PITCH	YAW	ROLL	PL ID
√ -1078	0	-754	25	0	1	0
SY	SP	EP	WP	WY	WR	
√ -29.5	+66.7	-68.5	+26.8	+18.9	-9.9	

Report to MS, "GO to release OBSS" -----

----- On CDR call, "GO to release OBSS"

RHC

√RATE – VERN (RATE MIN tb-ON)

BRAKES – OFF (tb-OFF)

MODE – END EFF, ENTER

CDR

MS

**CAUTION**  
Monitor EE tb timing to  
prevent EE motor burnout

EE MODE – AUTO  
RELEASE sw – REL (mom)

When OPEN tb – gray, mnvr arm clear of grapple pin

	RIGID	CLOSE	CAPTURE	<b>CRITICAL TIMES (28 sec total):</b> DERIGID tb – gray, 5 sec max, then OPEN tb – gray, 3 sec max, then EXTEND tb – gray, 20 sec max
√				
	DERIGID	OPEN	EXTEND	

EE MODE – OFF

BRAKES – ON (tb-ON)

On MS call, "GO to perform SEP mnvr"

Report to CDR, "GO to perform SEP mnvr"

A6U

4. SEP MNVR

DAP: A/FREE/VERN(ALT)

THC: +Z (out) 2 pulses (0.2 ft/sec)

When opening rate confirmed:

DAP TRANS: PULSE/PULSE/NORM

DAP: LVLH

THC: +Z (out) 5 sec (1.7 ft/sec)

FLT CNTLR PWR – OFF

DAP TRANS: PULSE/PULSE/PULSE

Report to MS, "SEP mnvr complete"

On CDR call, "SEP mnvr complete"

CRT

**GNC 20 DAP CONFIG**

Config DAP B to B7

6. RMS TO PRE-CRADLE

Go to RMS PWRDN, step 1

# OBSS ITVC TILE ACREAGE SURVEY

## 1. SETUP

SM 94 PDRS CONTROL

√ PL ID, ITEM 3: 2

√ INIT ID, ITEM 24: 2

Verify SSRMS at SURVEY SUPPORT VIEWING posn:

SR	SY	SP	EP	WP	WY	WR
+41.6	+61.1	+46.3	-61.3	-121.8	-39.1	-245.0

Verify MT at WS3, SSRMS on PDGF 3

A7U

CCTV – config as reqd

MON 1	SSRMS BASE ELBOW (LAB)
MON 2	RSC

## 2. MNVR TO STBD SCAN POSN

Mnvr to be uplinked realtime

STBD SCAN posn:

√ X	Y	Z	PITCH	YAW	ROLL	PL ID
-1433	+465	-128	338	344	23	2
√ SY	SP	EP	WP	WY	WR	
-53.4	+11.7	-60.6	-53.9	-24.6	+63.5	

### NOTE

At Stbd Scan posn, OBSS-to-Orbiter = 57 in

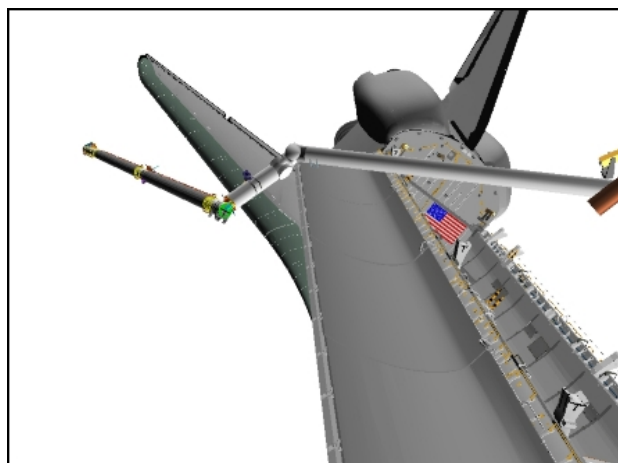

**SSRMS BASE ELBOW (-75,0)**



**RSC**

## 3. CONFIGURE OBSS ITVC FOR STBD SCAN

A7U

√ DTV ← PL2

If PTU reset reqd:

CAMR CMD PAN/TILT – HI RATE

PAN – L (to hard stop)

TILT – UP (to hard stop)

PAN/TILT – RESET, HI RATE (LO within 10°)

PAN: +105

TILT: -59

A7U

√CAMR CMD PAN/TILT – LO RATE  
ZOOM: 20.0 HFOV  
MUX 1 L ← MIDDECK  
LDRI MODE 2 pb – push (ITVC video)  
DTV ← PL2

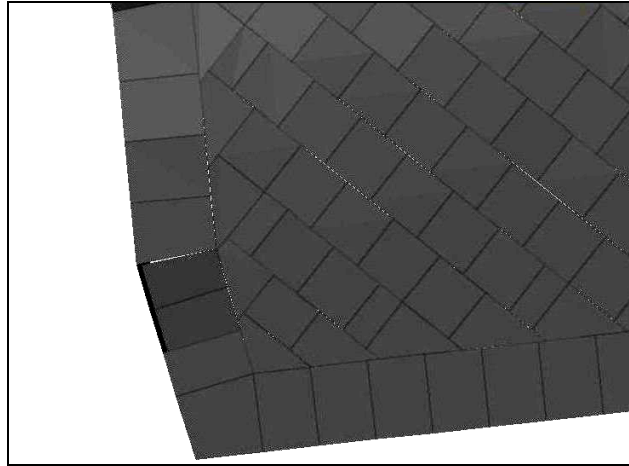

**OBSS ITVC (105,-59)**

√MCC to verify correct sensor view

4. PERFORM STBD SCAN

On MCC GO:

L10(VTR)

REC pb – push, hold  
PLAY pb – push, simo (red ●)

Drive PTU to sweep out the survey area:

	PAN	TILT
Start Config	+105	-59
1: Tilt (up)		-23
2: Pan (left)	+90	
3: Tilt (down)		-59
4: Pan (left)	+75	
5: Tilt (up)		-30
6: Pan (left)	+62	
7: Tilt (down)		-59
Final Config	+62	-59

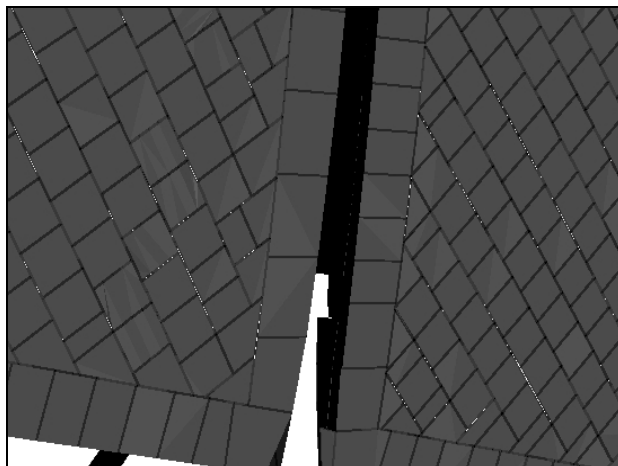

**OBSS ITVC (62,-59)**

5. MNVR TO PORT CONFIG 1

On MCC GO:

L10(VTR) STOP pb – push (no red ●)

NOTE

Min clearance during Port Config 1 mnvr (SJ step 4),  
 OBSS-to-Orbiter = 29 in. At Port Config 1 posn,  
 OBSS-to-Orbiter clearance = 164 in

Port Config 1 Clearance Views	Cameras
SJ step 1	C, D, RSC, SSRMS BASE ELBOW
SJ step 2	D, ELBOW
SJ step 3	C, D, SSRMS BASE ELBOW
SJ step 4	A, B, C, ELBOW, RSC
SJ step 5	A, B
SJ step 6	A, B, ELBOW
SJ step 7	A, B, ELBOW, P1 LOOB
SJ step 8	ELBOW, P1 LOOB, SSRMS TIP, RSC

RHC RATE – as reqd (VERN within 10 ft)  
 BRAKES – OFF (tb-OFF)  
 MODE – SINGLE, ENTER

Mnvr to PORT CONFIG 1 posn:

	SY	SP	EP	WP	WY	WR	
STBD SCAN	-53.4	+11.7	-60.6	-53.9	-24.6	+63.5	
1: WR –						+25.0	
2: WP +				-18.0			
3: SP +		+44.0					
4: SY +	+35.0						
5: WY +					+17.0		
6: SP –		+12.0					
7: EP –			-68.0				
8: WR –						-185.0	
PORT CONFIG 1	+35.0	+12.0	-68.0	-18.0	+17.0	-185.0	
	X	Y	Z	PITCH	YAW	ROLL	PL ID
	-445	-137	-85	184	347	184	2

BRAKES – ON (tb-ON)

PORT CONFIG 1

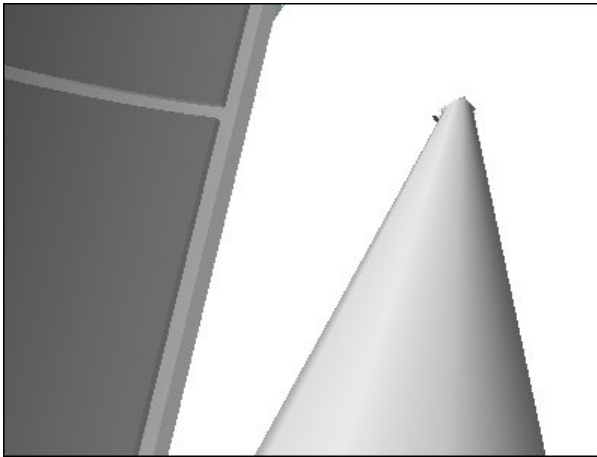

ELBOW (-21,-22)

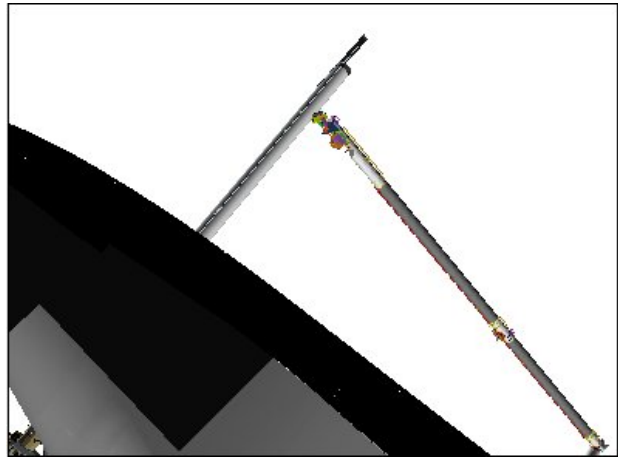

TIP ELBOW (-95,41)

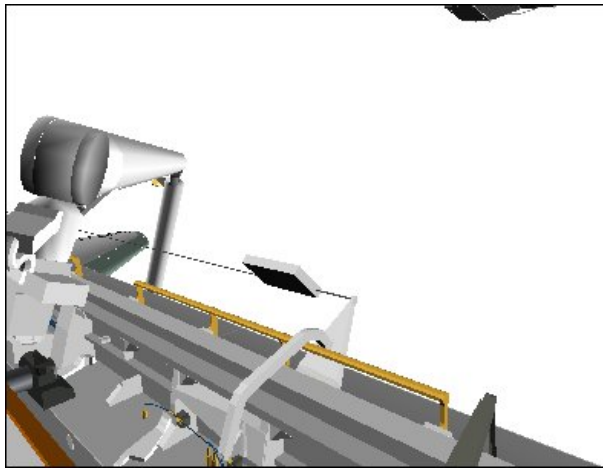

CCTV A (50,-10)

6. PERFORM PORT 1 SCAN

a. Port 1 Scan 1

NOTE

During Port 1 scan, OBSS-to-Orbiter = 131 in

A7U

CCTV – config as reqd

MON 1	SSRMS TIP ELBOW (SSRMS TIP LEE)
MON 2	ELBOW (RSC)

A7U

√DTV ← PL2

PAN: +75 (right)  
TILT: -110 (down)

√CAMR CMD PAN/TILT – LO RATE



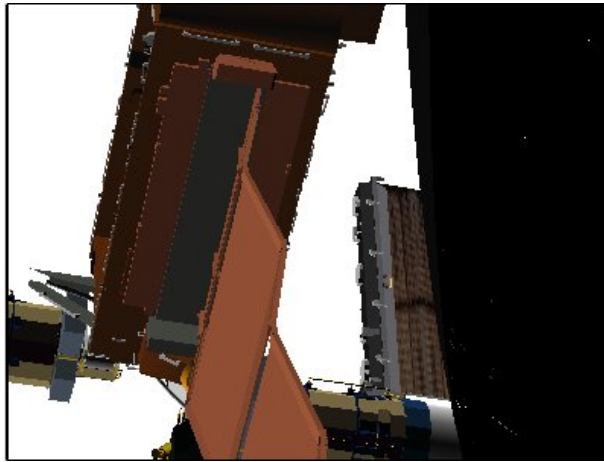

**OBSS ITVC (75,-110)**

√MCC to verify correct sensor view

- L10(VTR)      On MCC GO:  
                   REC pb – push, hold  
                   PLAY pb – push, simo (red ●)
- RHC            RATE    – VERN (RATE MIN tb-ON)  
                   BRAKES – OFF (tb-OFF)  
                   MODE    – SINGLE, ENTER
- Drive WR (+) to -34.0

X	Y	Z	PITCH	YAW	ROLL	PL ID
-1588	-105	-138	2	344	356	2
SY	SP	EP	WP	WY	WR	
+35.0	+12.0	-68.0	-18.0	+17.0	-34.0	

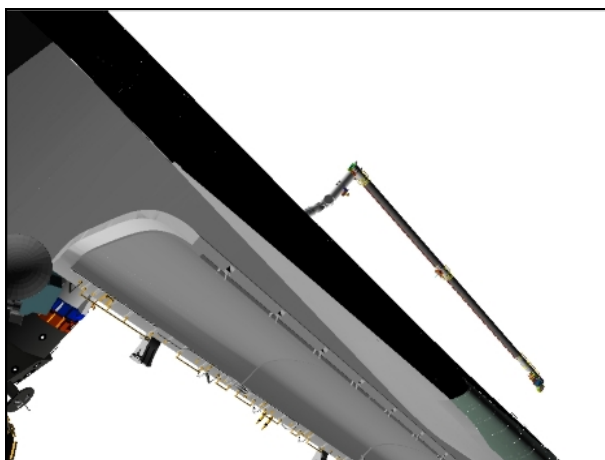

**TIP ELBOW (-75,15)**

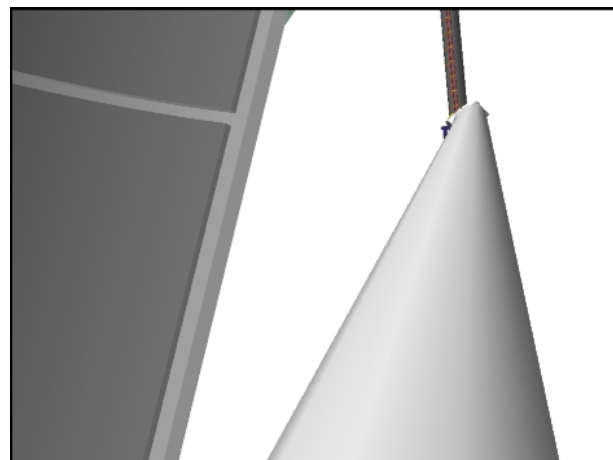

**ELBOW (-21,-22)**

b. Port 1 Scan 2

NOTE

The following and subsequent TILT cmds in step 6 are for the OBSS ITVC

A7U            TILT: -97 (up)

Drive WR (-) to -185.0

X	Y	Z	PITCH	YAW	ROLL	PL ID
-445	-137	-85	184	347	184	2
SY	SP	EP	WP	WY	WR	
+35.0	+12.0	-68.0	-18.0	+17.0	-185.0	



**TIP ELBOW (-95,35)**

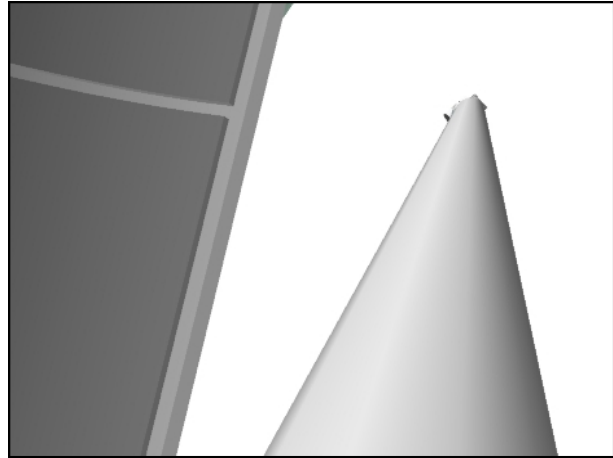

**ELBOW (-21,-22)**

A7U

- c. Port 1 Scan 3  
TILT: -84 (up)

Drive WR (+) to -34.0

X	Y	Z	PITCH	YAW	ROLL	PL ID
-1588	-105	-138	2	344	356	2
SY	SP	EP	WP	WY	WR	
+35.0	+12.0	-68.0	-18.0	+17.0	-34.0	

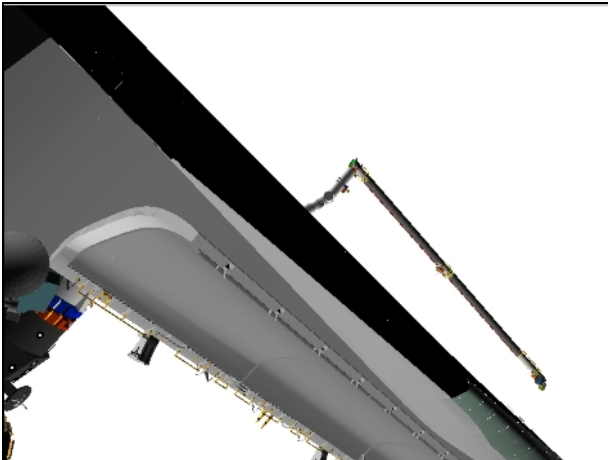

**TIP ELBOW (-75,15)**

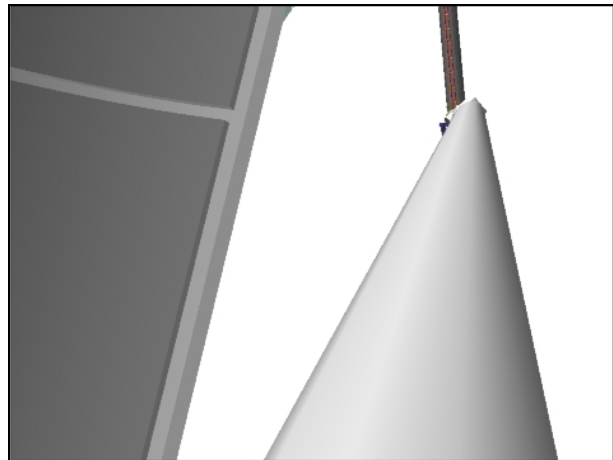

**ELBOW (-21,-22)**

A7U

- d. Port 1 Scan 4  
TILT: -71 (up)

Drive WR (-) to -180.0

X	Y	Z	PITCH	YAW	ROLL	PL ID
-459	-87	-82	184	342	184	2
SY	SP	EP	WP	WY	WR	
+35.0	+12.0	-68.0	-18.0	+17.0	-180.0	

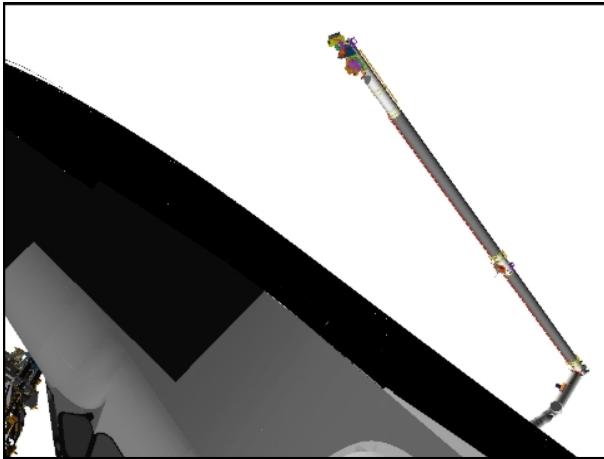

**TIP ELBOW (-95,35)**

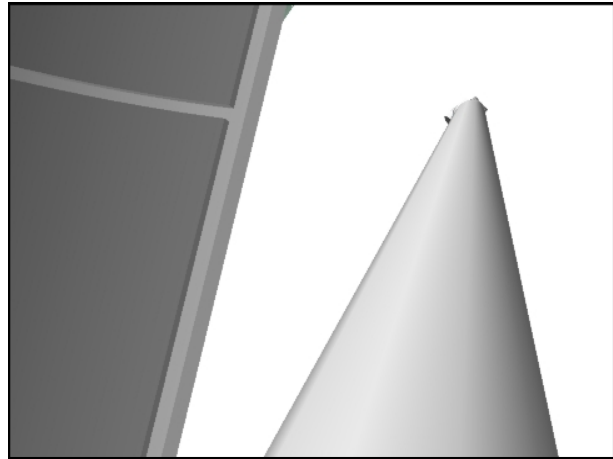

**ELBOW (-21,-22)**

A7U

- e. Port 1 Scan 5  
TILT: -58 (up)

Drive WR (+) to +7.0

X	Y	Z	PITCH	YAW	ROLL	PL ID
-1555	-517	-162	4	25	356	2
SY	SP	EP	WP	WY	WR	
+35.0	+12.0	-68.0	-18.0	+17.0	+7.0	

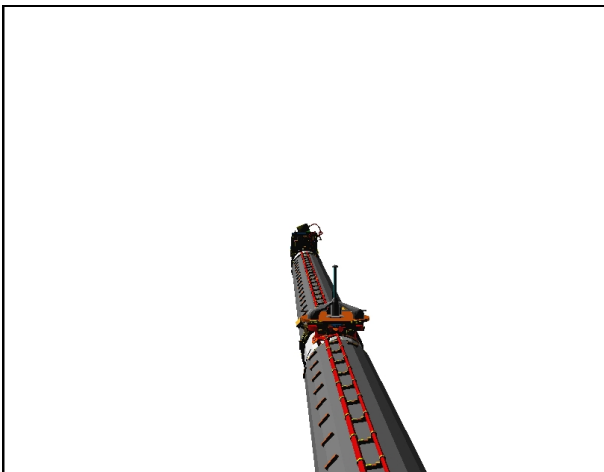

**RSC**

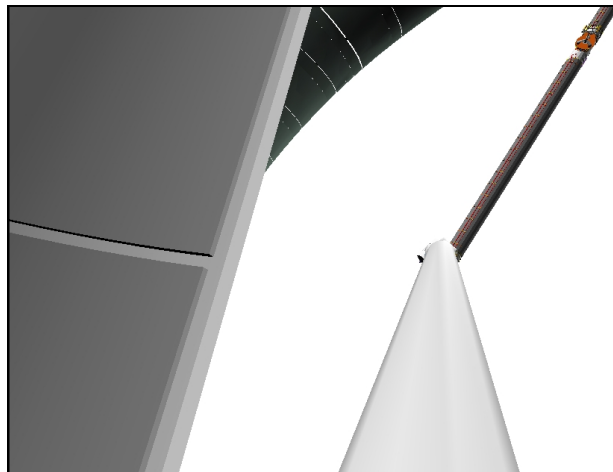

**ELBOW (-18,-4)**

A7U

- f. Port 1 Scan 6  
TILT: -45 (up)

Drive WR (-) to -178.0

X	Y	Z	PITCH	YAW	ROLL	PL ID
-466	-68	-81	184	340	184	2
SY	SP	EP	WP	WY	WR	
+35.0	+12.0	-68.0	-18.0	+17.0	-178.0	

BRAKES – ON (tb-ON)

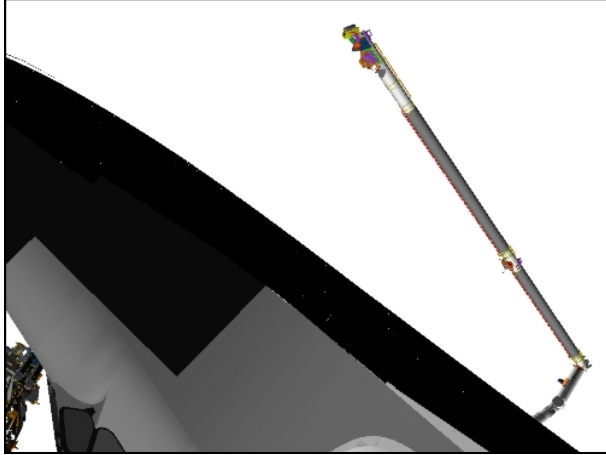

TIP ELBOW (-95,35)

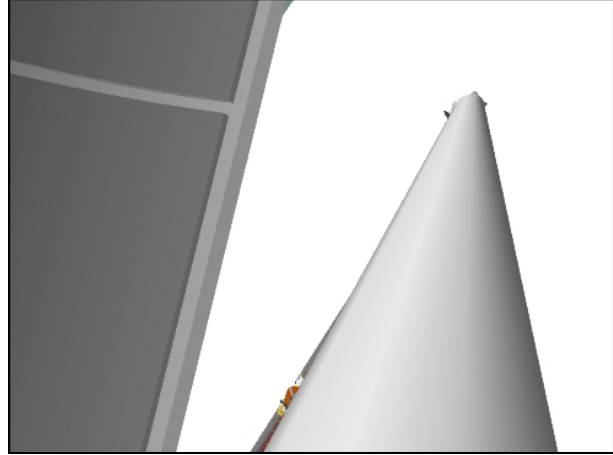

ELBOW (-21,-22)

7. MNVR TO NOSE CONFIG

On MCC GO:

L10(VTR) STOP pb – push (no red ●)

NOTE

At Nose Config final posn, OBSS-to-Orbiter = 143 in

Port Config 2 Clearance Views	Cameras
SJ steps 1 thru 4	A, ELBOW, SSRMS TIP ELBOW, SSRMS TIP LEE, RSC

RHC RATE – as reqd (VERN within 10 ft)  
BRAKES – OFF (tb-OFF)  
MODE – SINGLE, ENTER

Mnvr to NOSE CONFIG posn:

	SY	SP	EP	WP	WY	WR	
PORT CONFIG 1	+35.0	+12.0	-68.0	-18.0	+17.0	-178.0	
1: SY +	+74.0						
2: SP +		+26.0					
3: WY –					+15.0		
4: WP –				-23.0			
NOSE CONFIG	+74.0	+26.0	-68.0	-23.0	+15.0	-178.0	
	X	Y	Z	PITCH	YAW	ROLL	PL ID
	-480	+9	-126	185	302	196	2

BRAKES – ON (tb-ON)

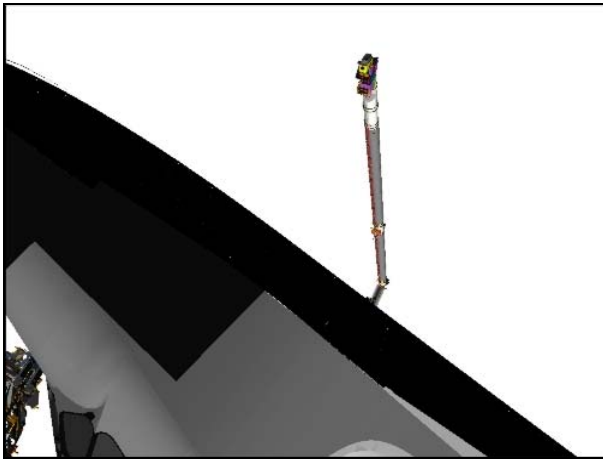

**TIP ELBOW (-95,35)**

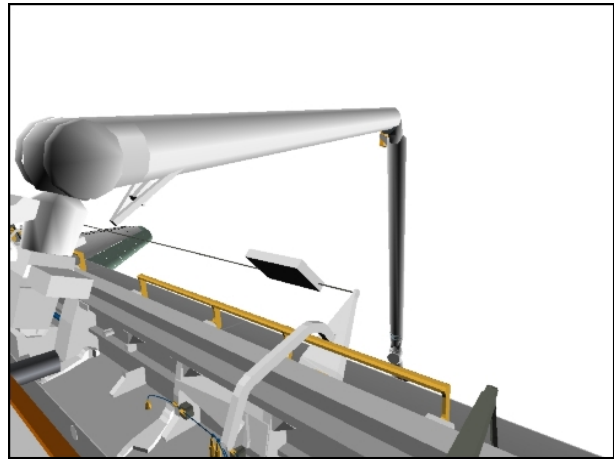

**CCTV A (50,-10)**

8. PERFORM NOSE SCAN

NOTE

During nose scan, OBSS-to-Orbiter = 132 in

A7U CCTV – config as reqd

MON 1	SSRMS TIP LEE (SSRMS TIP ELBOW)
MON 2	ELBOW (RSC)

A7U √DTV ← PL2

√PAN: +75  
TILT: -120 (down)

√CAMR CMD PAN/TILT – LO RATE

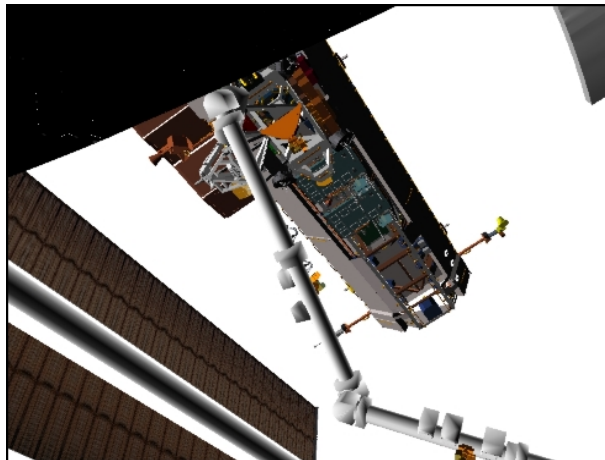

**OBSS ITVC (75,-120)**

√MCC to verify correct sensor view

L10(VTR) On MCC GO:  
REC pb – push, hold  
PLAY pb – push, simo (red ●)

RHC RATE – VERN (RATE MIN tb-ON)  
BRAKES – OFF (tb-OFF)  
MODE – SINGLE, ENTER

Drive WR (-) to -200.0

X	Y	Z	PITCH	YAW	ROLL	PL ID
-318	-141	-171	178	324	190	2
SY	SP	EP	WP	WY	WR	
+74.0	+26.0	-68.0	-23.0	+15.0	-200.0	

BRAKES – ON (tb-ON)

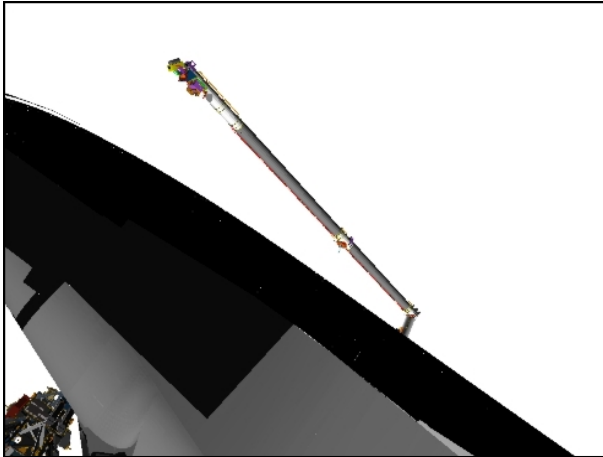

**TIP ELBOW (-98,+38)**



**TIP LEE**

9. MNVR TO PORT CONFIG 2

On MCC GO:

L10(VTR) STOP pb – push (no red ●)

NOTE

At Port Config 2 posn, OBSS-to-Orbiter = 120 in

Port Config 2 Clearance Views	Cameras
SJ steps 1 thru 2	ELBOW, SSRMS TIP LEE, SSRMS TIP ELBOW

RHC RATE – as reqd (VERN within 10 ft)  
 BRAKES – OFF (tb-OFF)  
 MODE – SINGLE, ENTER

Mnvr to PORT CONFIG 2 posn:

	SY	SP	EP	WP	WY	WR	
	+74.0	+26.0	-68.0	-23.0	+15.0	-200.0	
NOSE CONFIG							
1: WR +						-126.0	
2: WP –				-34.0			
PORT CONFIG 2	+74.0	+26.0	-68.0	-34.0	+15.0	-126.0	
	X	Y	Z	PITCH	YAW	ROLL	PL ID
	-973	+86	-141	355	288	6	2

BRAKES – ON (tb-ON)

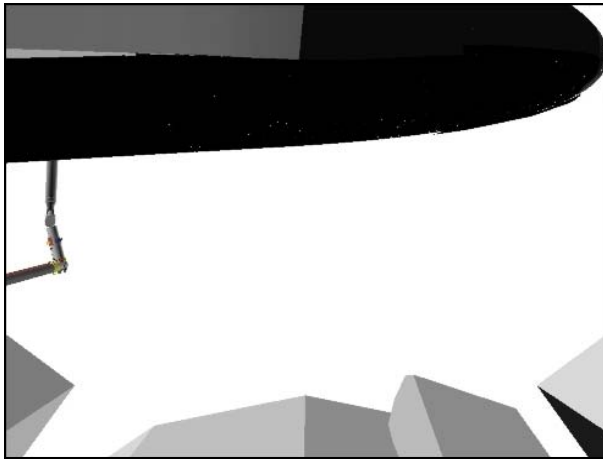

**TIP LEE**

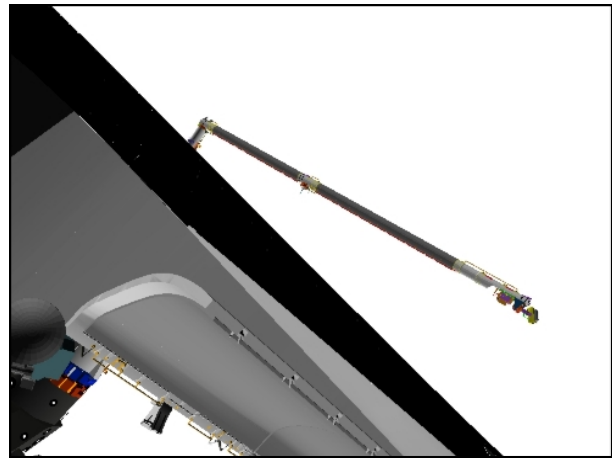

**TIP ELBOW (-76,21)**

10. PERFORM PORT 2 SCAN
  - a. Port 2 Scan 1

**NOTE**

During Port 2 scan, OBSS-to-Orbiter = 81 in

A7U CCTV – config as reqd

MON 1	SSRMS TIP LEE (SSRMS TIP ELBOW)
MON 2	ELBOW (RSC)

A7U √DTV ← PL2

√PAN: +75  
TILT: -115 (up)

√CAMR CMD PAN/TILT – LO RATE

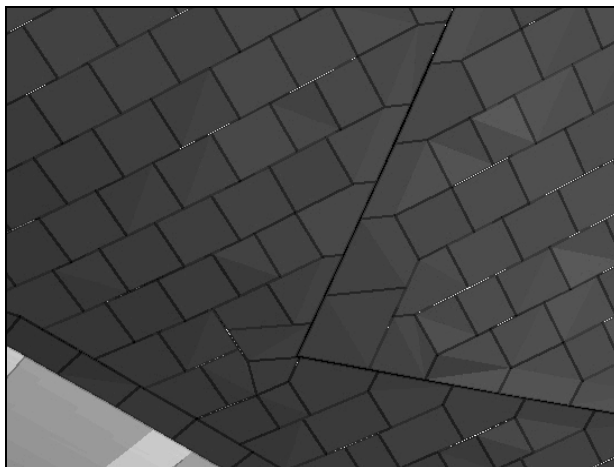

**OBSS ITVC (75,-115)**

√MCC to verify correct sensor view

L10(VTR) On MCC GO:  
REC pb – push, hold  
PLAY pb – push, simo (red ●)

RHC

RATE – VERN (RATE MIN tb-ON)

BRAKES – OFF (tb-OFF)

MODE – SINGLE, ENTER

Drive WR (+) to -73.0

X	Y	Z	PITCH	YAW	ROLL	PL ID
-1341	-284	-59	350	341	2	2
SY	SP	EP	WP	WY	WR	
+74.0	+26.0	-68.0	-34.0	+15.0	-73.0	

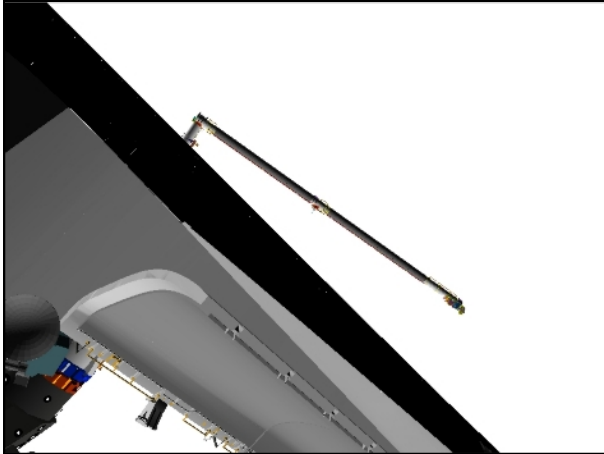

**TIP ELBOW (-76,21)**

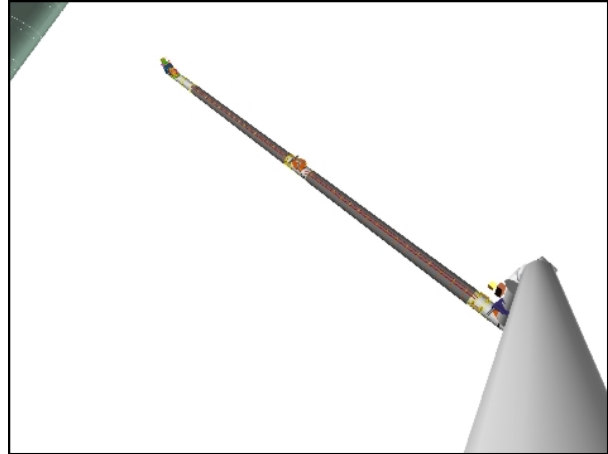

**ELBOW (-30,0)**

b. Port 2 Scan 2

NOTE

The following and subsequent TILT cmds in step 10 are for the OBSS ITVC

A7U

TILT: -102 (up)

Drive WR (-) to -139.0

X	Y	Z	PITCH	YAW	ROLL	PL ID
-845	+112	-166	11	275	22	2
SY	SP	EP	WP	WY	WR	
+74.0	+26.0	-68.0	-34.0	+15.0	-139.0	



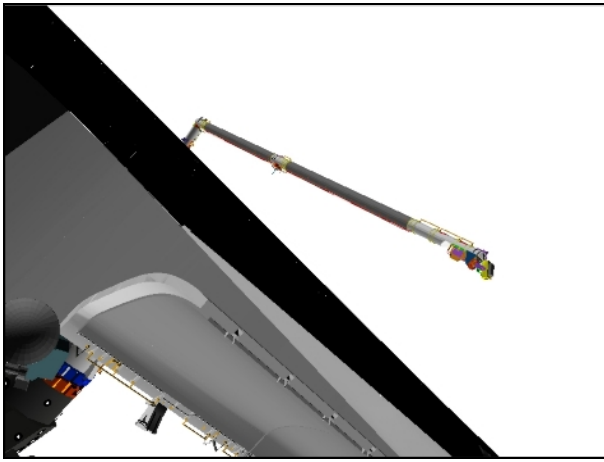

**TIP ELBOW (-76,21)**



**ELBOW (-40,-20)**

A7U

c. Port 2 Scan 3  
TILT: -89 (up)

Drive WR (+) to -60.0

X	Y	Z	PITCH	YAW	ROLL	PL ID
-1369	-414	-50	350	354	2	2
SY	SP	EP	WP	WY	WR	
+74.0	+26.0	-68.0	-34.0	+15.0	-60.0	

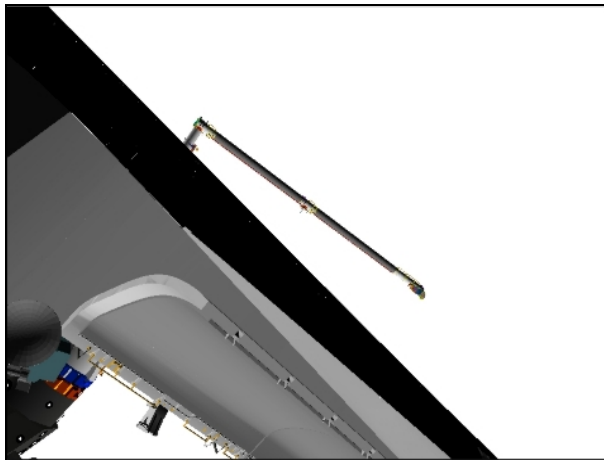

**TIP ELBOW (-76,21)**

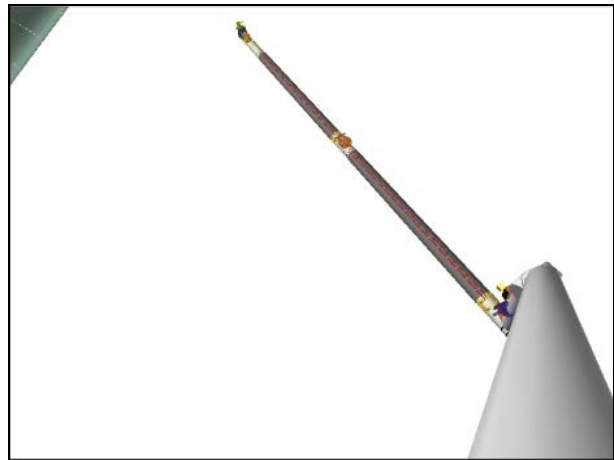

**ELBOW (-30,0)**

A7U

d. Port 2 Scan 4  
TILT: -76 (up)

Drive WR (-) to -147.0

X	Y	Z	PITCH	YAW	ROLL	PL ID
-764	+114	-181	138	274	149	2
SY	SP	EP	WP	WY	WR	
+74.0	+26.0	-68.0	-34.0	+15.0	-147.0	

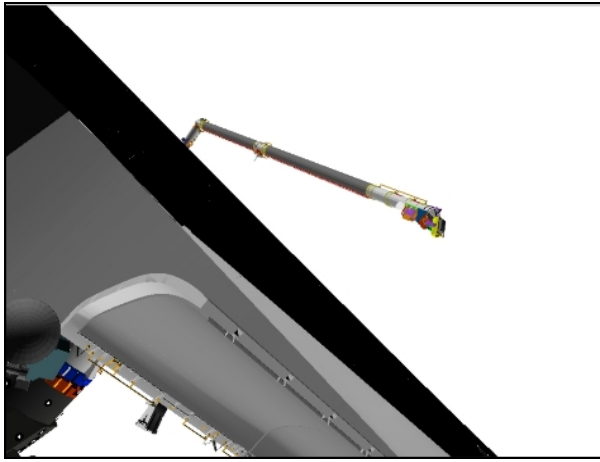

**TIP ELBOW (-76,21)**



**ELBOW (-40,-20)**

A7U

e. Port 2 Scan 5  
TILT: -63 (up)

Drive WR (+) to -62.0

X	Y	Z	PITCH	YAW	ROLL	PL ID
-1366	-394	-51	350	352	2	2
SY	SP	EP	WP	WY	WR	
+74.0	+26.0	-68.0	-34.0	+15.0	-62.0	

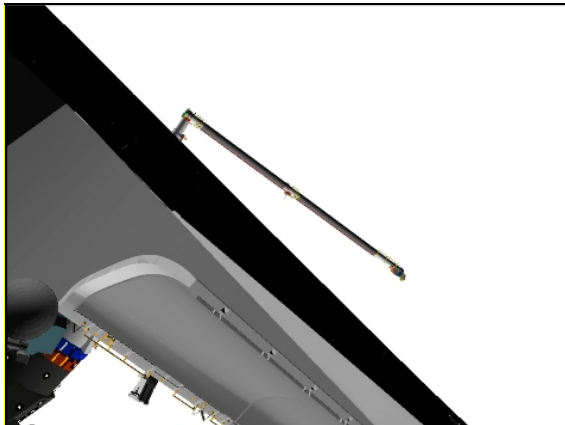

**TIP ELBOW (-76,21)**



**ELBOW (-30,0)**

A7U

f. Port 2 Scan 6  
TILT: -50 (up)

Drive WR (-) to -152.0

X	Y	Z	PITCH	YAW	ROLL	PL ID
-713	+109	-191	156	278	167	2
SY	SP	EP	WP	WY	WR	
+74.0	+26.0	-68.0	-34.0	+15.0	-152.0	

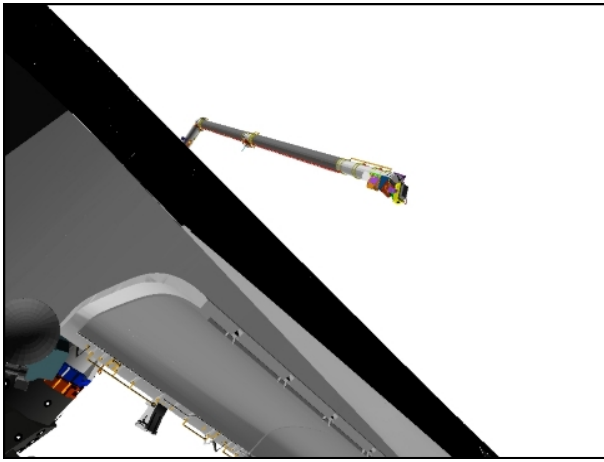

**TIP ELBOW (-76,21)**



**ELBOW (-40,-20)**

A7U

- g. Port 2 Scan 7  
TILT: -40 (up)

Drive WR (+) to -74.0

X	Y	Z	PITCH	YAW	ROLL	PL ID
-1338	-274	-60	350	340	2	2
SY	SP	EP	WP	WY	WR	
+74.0	+26.0	-68.0	-34.0	+15.0	-74.0	

BRAKES – ON (tb-ON)

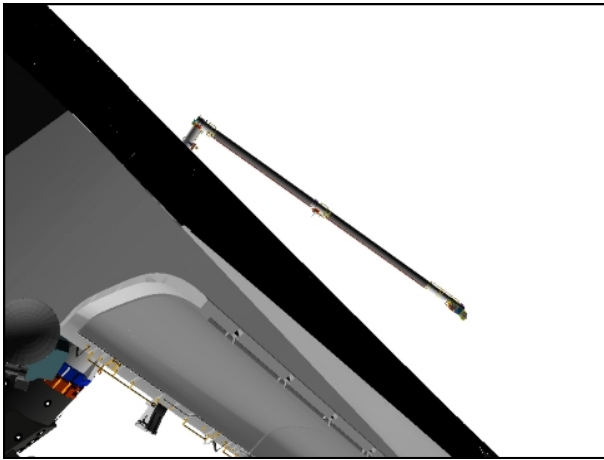

**TIP ELBOW (-76,21)**

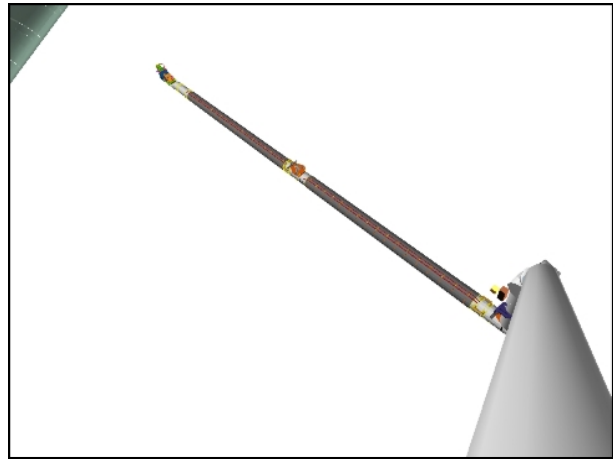

**ELBOW (-30,0)**

11. MNVR TO PORT CONFIG 3

On MCC GO:

L10(VTR) STOP pb – push (no red ●)

NOTE

At Port Config 3, OBSS-to-Orbiter = 240 in

Port Config 2 Clearance Views	Cameras
SJ step 1	A, ELBOW, SSRMS TIP LEE
SJ steps 2 thru 5	A, B, ELBOW
SJ step 6	A, B, ELBOW, SSRMS TIP LEE

RHC

RATE – as reqd (VERN within 10 ft)

BRAKES – OFF (tb-OFF)

MODE – SINGLE, ENTER

Mnvr to PORT CONFIG 3 posn:

	SY	SP	EP	WP	WY	WR	
PORT CONFIG 2	+74.0	+26.0	-68.0	-34.0	+15.0	-74.0	
1: SY +	+99.5						
2: SP +		+82.5					
3: EP -			-86.0				
4: WP +				-32.0			
5: WY +					+25.0		
6: WR -						-98.0	
PORT CONFIG 3	+99.5	+82.5	-86.0	-32.0	+25.0	-98.0	
	X	Y	Z	PITCH	YAW	ROLL	PL ID
	-1057	-491	-142	322	357	334	2

BRAKES – ON (tb-ON)

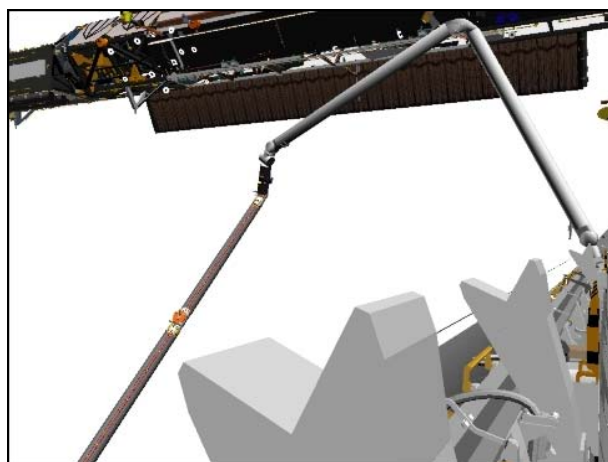

**CCTV B (-27,0)**

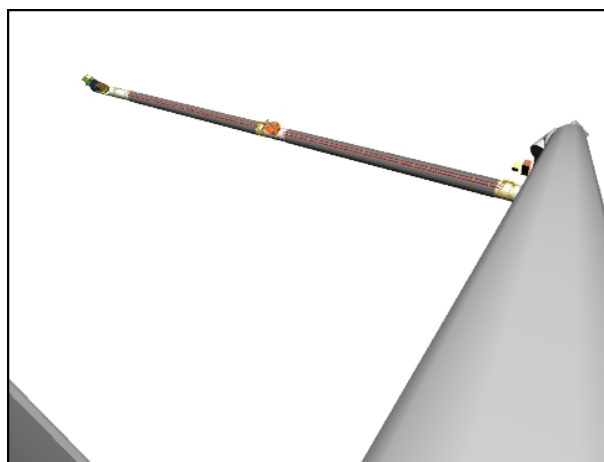

**ELBOW (-32,-20)**

12. PERFORM PORT 3 SCAN
  - a. Port 3 Scan 1

NOTE

During Port 3 scan, OBSS-to-Orbiter = 29 in

A7U CCTVB – config as reqd

MON 1	B (SSRMS TIP LEE)
MON 2	ELBOW (RSC)

A7U √DTV ← PL2

√PAN: +75  
TILT: -85 (down)

√CAMR CMD PAN/TILT – LO RATE



**OBSS ITVC (75,-85)**

√MCC to verify correct sensor view

L10(VTR)      On MCC GO:  
                   REC pb – push, hold  
                   PLAY pb – push, simo (red ●)

RHC            RATE    – VERN (RATE MIN tb-ON)  
                   BRAKES – OFF (tb-OFF)  
                   MODE    – SINGLE, ENTER

Drive WR (-) to -161.0

X	Y	Z	PITCH	YAW	ROLL	PL ID
-642	-35	-170	278	305	309	2
SY	SP	EP	WP	WY	WR	
+99.5	+82.5	-86.0	-32.0	+25.0	-161.0	

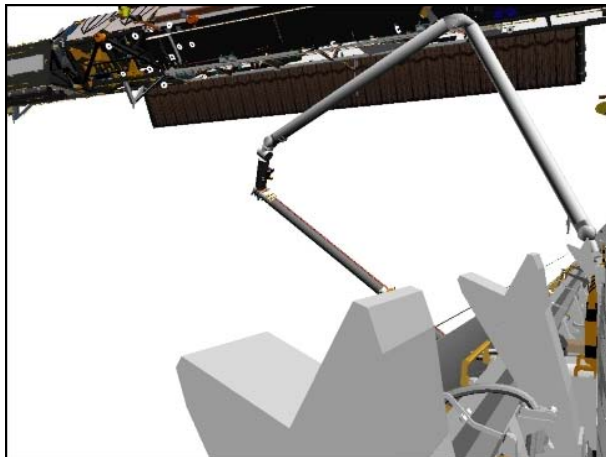

**CCTV B (-27,0)**



**RSC**

b. Port 3 Scan 2

NOTE

The following and subsequent TILT cmds in step 12 are for the OBSS ITVC

A7U

TILT: -72 (up)

Drive WR (+) to -108.0

X	Y	Z	PITCH	YAW	ROLL	PL ID
-1018	-400	-114	317	348	333	2
SY	SP	EP	WP	WY	WR	
+99.5	+82.5	-86.0	-32.0	+25.0	-108.0	

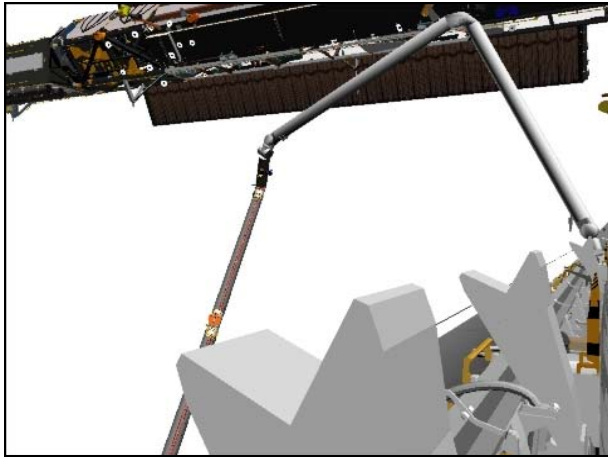

**CCTV B (-27,0)**

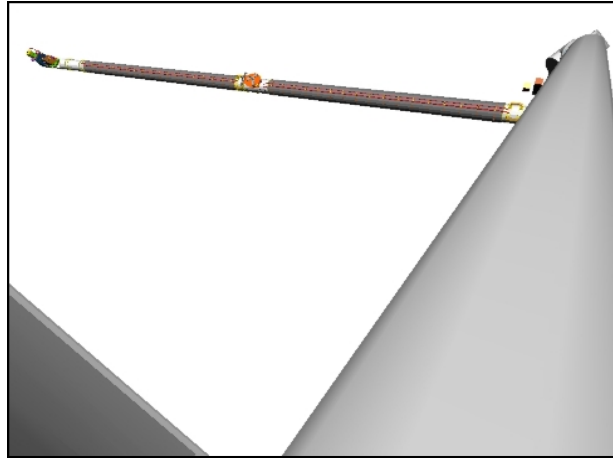

**ELBOW (-32,-30)**

c. Port 3 Scan 3

A7U

TILT: -59 (up)

Drive WR (-) to -162.0

X	Y	Z	PITCH	YAW	ROLL	PL ID
-633	-31	-175	277	305	308	2
SY	SP	EP	WP	WY	WR	
+99.5	+82.5	-86.0	-32.0	+25.0	-162.0	

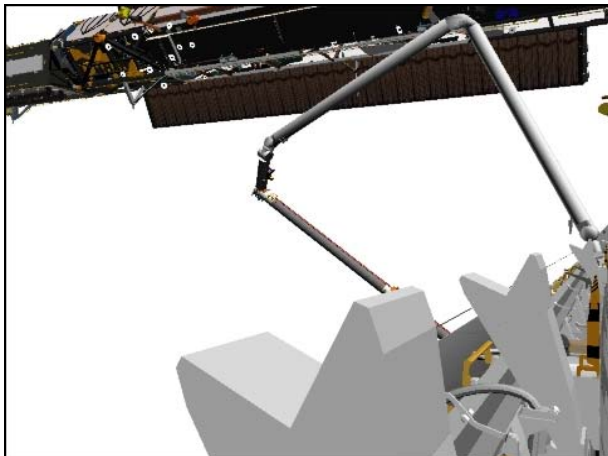

**CCTV B (-27,0)**

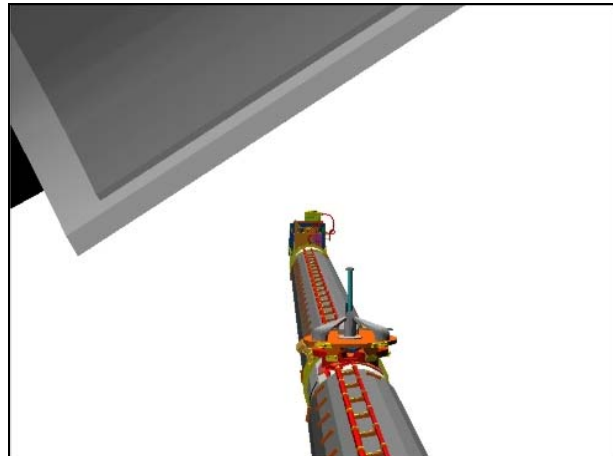

**RSC**

A7U d. Port 3 Scan 4  
TILT: -46 (up)

Drive WR (+) to -134.0

X	Y	Z	PITCH	YAW	ROLL	PL ID
-862	-186	-99	303	326	327	2
SY	SP	EP	WP	WY	WR	
+99.5	+82.5	-86.0	-32.0	+25.0	-134.0	

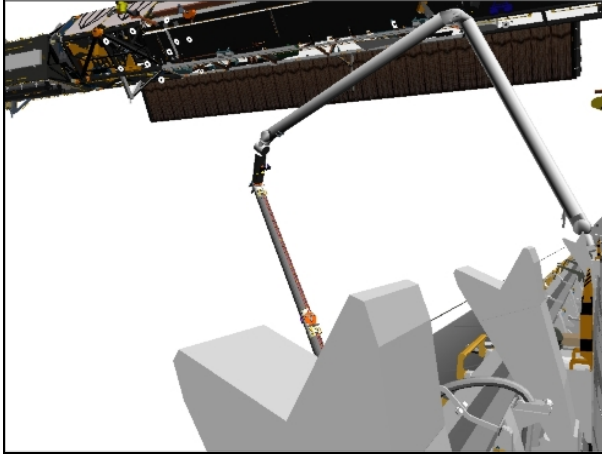

**CCTV B (-27,0)**

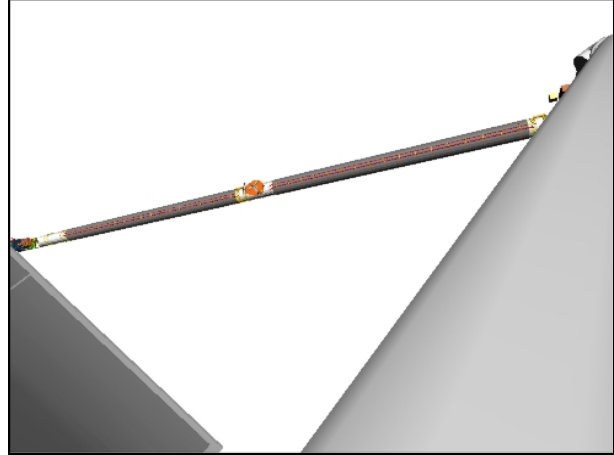

**ELBOW (-35,-30)**

A7U e. Port 3 Scan 5  
TILT: -33 (up)

Drive WR (-) to -162.0

X	Y	Z	PITCH	YAW	ROLL	PL ID
-633	-31	-175	277	305	308	2
SY	SP	EP	WP	WY	WR	
+99.5	+82.5	-86.0	-32.0	+25.0	-162.0	

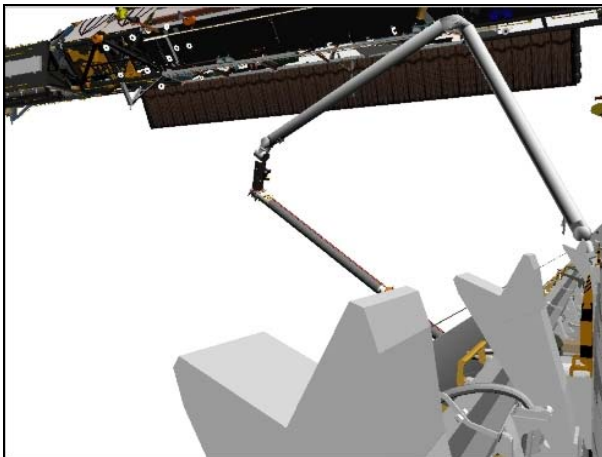

**CCTV B (-27,0)**

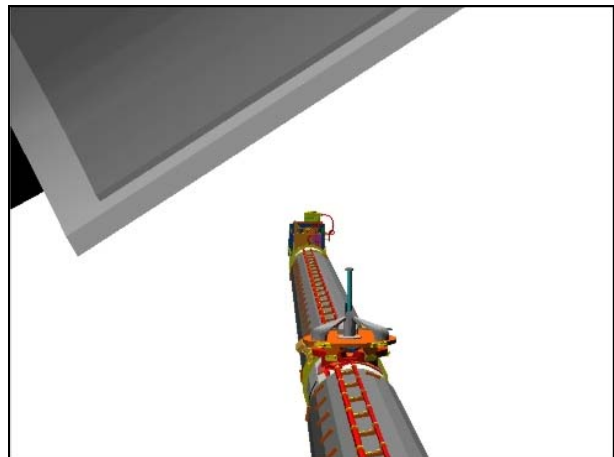

**RSC**

A7U

f. Port 3 Scan 6  
TILT: -23 (up)

Drive WR (+) to -146.0

X	Y	Z	PITCH	YAW	ROLL	PL ID
-769	-107	-120	294	316	322	2
SY	SP	EP	WP	WY	WR	
+99.5	+82.5	-86.0	-32.0	+25.0	-146.0	

BRAKES – ON (tb-ON)

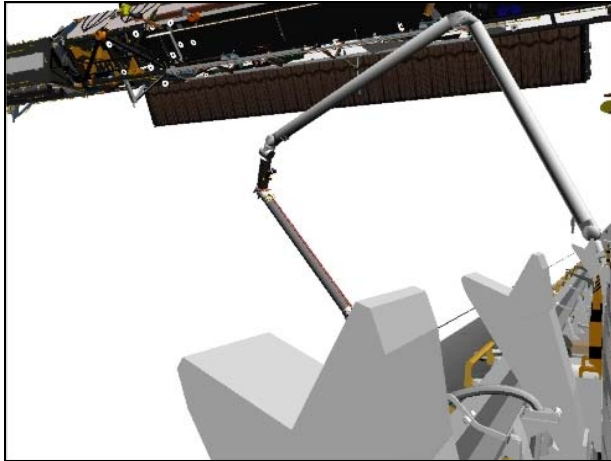

**CCTV B (-27,0)**

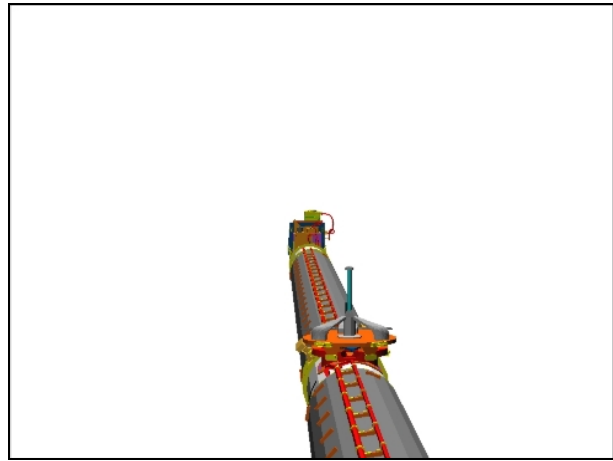

**RSC**



# RMS EE RCC WING SURVEY

I

**WARNING**  
 Port and stbd PLBD radiators must be stowed. Payload bay must be empty

**NOTE**

This survey may be performed while docked or undocked. Assumed starting posn is Pre-Cradle.

Daylight is required while survey data is being taken

1. SETUP

SM 94 PDRS CONTROL

PL ID – ITEM 3 +5 EXEC

INIT ID – ITEM 24 +5 EXEC

	X	Y	Z	PITCH	YAW	ROLL	PL ID
√	-1261	-146	-551	5	2	0	5
	SY	SP	EP	WP	WY	WR	
√	0.0	+25.0	-25.0	+5.0	0.0	0.0	

SM 94 PDRS CONTROL

AUTO MODES – ITEM 13 +1 +2 +3 +4 EXEC

If docked,  
 √MCC, SSRMS is clear for survey

RHC

2. MNVR TO STBD ACAS START

RATE – as reqd (VERN within 10 ft)

BRAKES – OFF (tb-OFF)

MODE – SINGLE, ENTER

Mnvr to STBD ACAS START posn:

	SY	SP	EP	WP	WY	WR	
PRE-CRADLE	0.0	+25.0	-25.0	+5.0	0.0	0.0	
1: SY –	-40.0						
2: WP –				-114.0			[1]
3: WY +					+29.5		
4: WR +						+118.8	
5: SP –		+15.0					
6: SY –	-59.4						
7: SP –		+3.0					[1]
8: EP –			-41.5				
STBD ACAS START posn	-59.4	+3.0	-41.5	-114.0	+29.5	+118.8	
	X	Y	Z	PITCH	YAW	ROLL	PL ID
	-914	+278	-378	273	47	21	5

[1] Approaching REACH LIMIT

BRAKES – ON (tb-ON)



NOTE

The STBD ACAS scans the upper surface of Panels 1→18.

If elbow camera reqd for clearance monitoring, auto sequence must be paused

STBD ACAS Clearance Views	Cameras
EE-to-RCC	ELBOW, LAB
RMS-to-PLBD	LAB
RMS-to-OBSS	D

AUTO SEQ – PROCEED (IN PROG It on)

ACAS, pause pts **shaded in bold**, ● col indicates data recording (black = VTR on):  
(07:15)

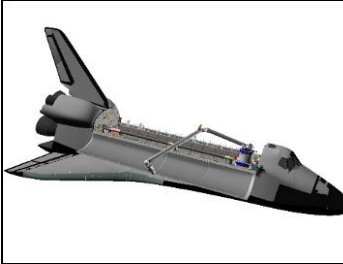
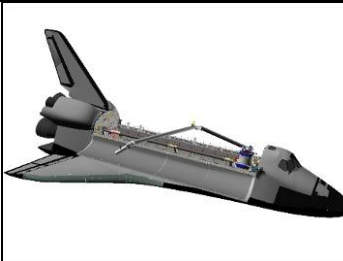
Pt	X	Y	Z	PITCH	YAW	ROLL	●	
<b>130P</b>	<b>-914</b>	<b>+278</b>	<b>-378</b>	<b>273</b>	<b>47</b>	<b>21</b>	●	
131	-919	+278	-377	281	47	21		
132	-931	+279	-380	299	46	9		
133	-955	+280	-379	310	39	32		
134	-990	+280	-381	312	28	38		
135	-1020	+284	-375	314	16	34		
136	-1037	+298	-385	319	2	34		
137	-1055	+300	-421	313	349	40		
<b>138P</b>	<b>-1061</b>	<b>+308</b>	<b>-430</b>	<b>320</b>	<b>342</b>	<b>47</b>	●	

When AUTO SEQ IN PROG It – off:  
BRAKES – ON (tb-ON)

L10(VTR) STOP pb – push (no red ●)

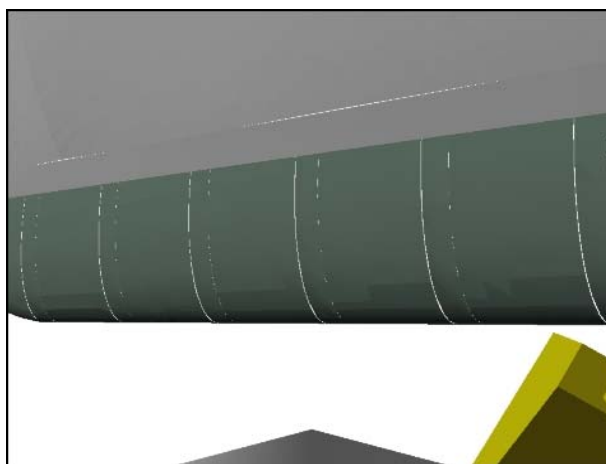

WRIST HFOV: 20.0

4. MNVR TO PORT UPPER ACAS START

SM 94 PDRS CONTROL

PL ID – ITEM 3 +0 EXEC

INIT ID – ITEM 24 +0 EXEC

√	X	Y	Z	PITCH	YAW	ROLL	PL ID
	-1061	+308	-430	320	342	47	5
	SY	SP	EP	WP	WY	WR	
√	-48.3	+6.0	-32.9	-24.4	+29.2	+87.2	

RHC

RATE – as reqd (VERN within 10 ft)

BRAKES – OFF (tb-OFF)

MODE – SINGLE, ENTER

If performing immediately after STBD ACAS:

Mnvr to PORT UPPER ACAS START posn:

		SY	SP	EP	WP	WY	WR	
STBD ACAS		-48.3	+6.0	-32.9	-24.4	+29.2	+87.2	
end								
1: SP +			+27.6					
2: EP +				-25.0				
3: SY +		+29.2						
4: WP –					-39.9			
5: WY –						-4.7		
6: WR –							+37.2	
7: EP –				-35.5				
PORT UPPER		+29.2	+27.6	-35.5	-39.9	-4.7	+37.2	
ACAS START								
	X	Y	Z	PITCH	YAW	ROLL	PL ID	
	-1163	-366	-379	309	0	52	5	

If performing from PRE-CRADLE:

Mnvr to PORT UPPER ACAS START posn:

		SY	SP	EP	WP	WY	WR	
PRE-CRADLE		0.0	+25.0	-25.0	+5.0	0.0	0.0	
1: SY +		+29.2						
2: SP +			+27.6					
3: WP –					-39.9			
4: WY –						-4.7		
5: WR +							+37.2	
6: EP –				-35.5				
PORT UPPER		+29.2	+27.6	-35.5	-39.9	-4.7	+37.2	
ACAS START								
	X	Y	Z	PITCH	YAW	ROLL	PL ID	
	-1163	-366	-379	309	0	52	5	

BRAKES – ON (tb-ON)

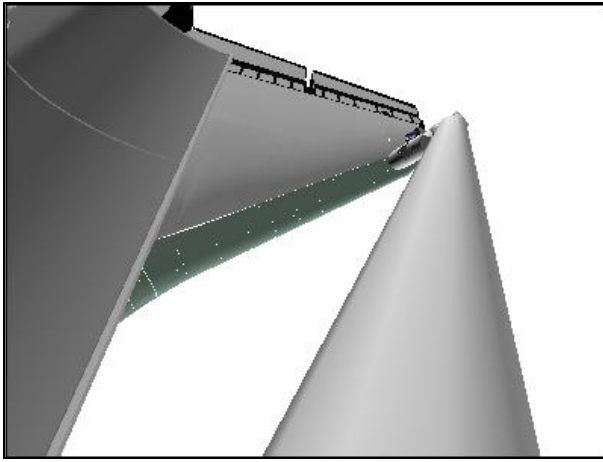

**ELBOW (-20,-22)**

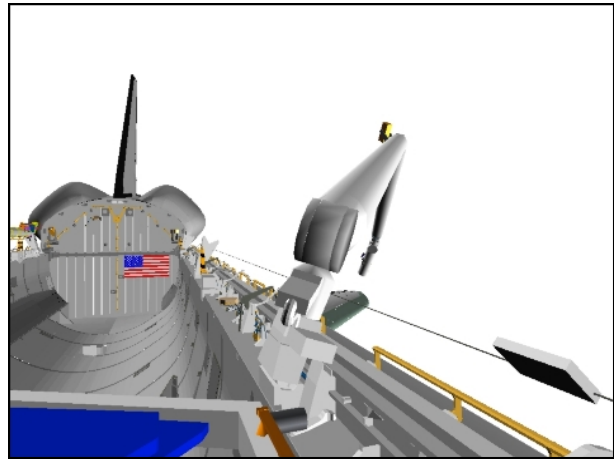

**CCTV A (20,0)**

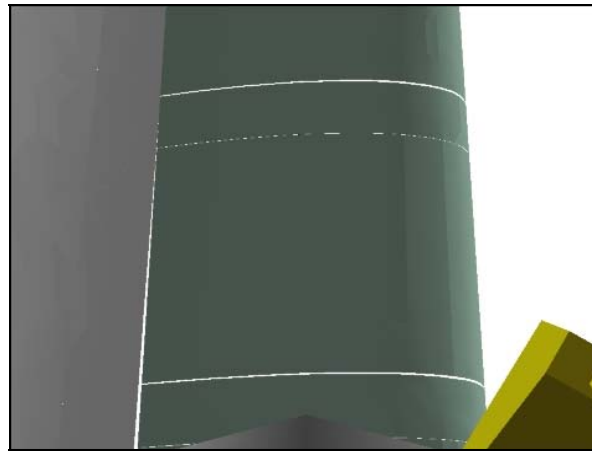

**WRIST HFOV: 20.0**

5. PORT UPPER ACAS

**SM 94 PDRS CONTROL**

√PL ID, ITEM 3: 5

√INIT ID, ITEM 24: 5

	X	Y	Z	PITCH	YAW	ROLL	PL ID
√	-1163	-366	-379	309	0	52	5
	SY	SP	EP	WP	WY	WR	
√	+29.2	+27.6	-35.5	-39.9	-4.7	+37.2	

RHC RATE – VERN (RATE MIN tb-ON)

L10(VTR) REC pb – push, hold  
PLAY pb – push, simo (red ●)

BRAKES – OFF (tb-OFF)  
MODE – AUTO 2, ENTER (READY It on)

- \* If unable to enter AUTO mode (no AUTO READY It): \*
- \* √Joint angles and adjust as reqd \*

**SM 94 PDRS CONTROL**

√START PT, ITEM 17: 10

**SM 169 PDRS STATUS**

Monitor ACAS progress

NOTE

The Port Upper ACAS scans upper surface of Panels 16→ 1

Port Upper ACAS Clearance Views	Cameras
RMS-to-PLBD	ELBOW, B
RMS overview	A
EE-to-RCC	B

AUTO SEQ – PROCEED (IN PROG It on)

(11:00)

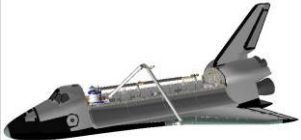
Pt	X	Y	Z	PITCH	YAW	ROLL	●
<b>139P</b>	<b>-1163</b>	<b>-366</b>	<b>-379</b>	<b>309</b>	<b>0</b>	<b>52</b>	
140	-1148	-359	-374	307	352	54	
141	-1133	-334	-369	306	353	52	
142	-1111	-323	-371	307	349	51	
143	-1090	-327	-370	308	335	53	
144	-1073	-313	-369	305	330	53	
145	-1058	-300	-370	304	327	54	
146	-1041	-288	-369	303	325	53	
147	-1015	-292	-375	296	310	34	
148	-997	-285	-363	297	305	33	
149	-957	-284	-336	309	291	39	
150	-952	-286	-340	292	288	25	
151	-936	-284	-339	280	288	12	
<b>152P</b>	<b>-908</b>	<b>-285</b>	<b>-333</b>	<b>292</b>	<b>285</b>	<b>25</b>	

When AUTO SEQ IN PROG It – off:

L10(VTR)

STOP pb – push (no red ●)

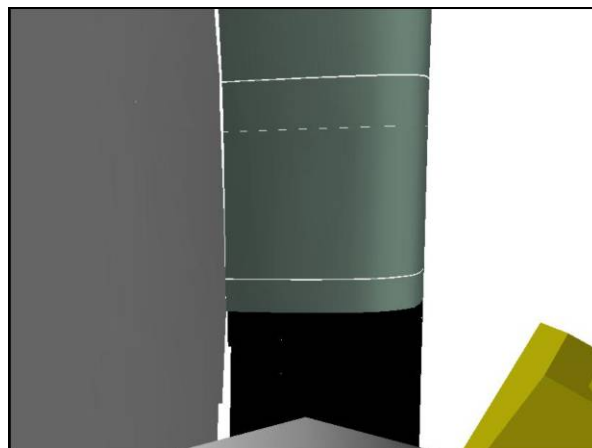

**WRIST HFOV: 20.0**

6. MNVR TO PORT UPPER APEX START

NOTE

RMS is approaching a display singularity at point 153. Between Pts 152 and 153, arm adjusts for Port Upper Apex scan

Clearance Views	Cameras
EE-to-RCC	A, ELBOW
Upper Arm	A, B
RMS-to-PLBD	B, ELBOW

AUTO SEQ – PROCEED (IN PROG It on)

(02:35)

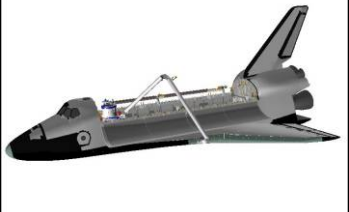
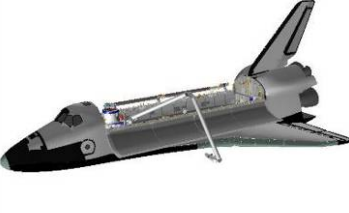
Pt	X	Y	Z	PITCH	YAW	ROLL	●
152P	-908	-285	-333	292	285	25	
153P	-911	-243	-294	53	275	146	

7. PORT UPPER APEX

A7U

CCTV – RMS WRIST, ZOOM: 10.0 HFOV

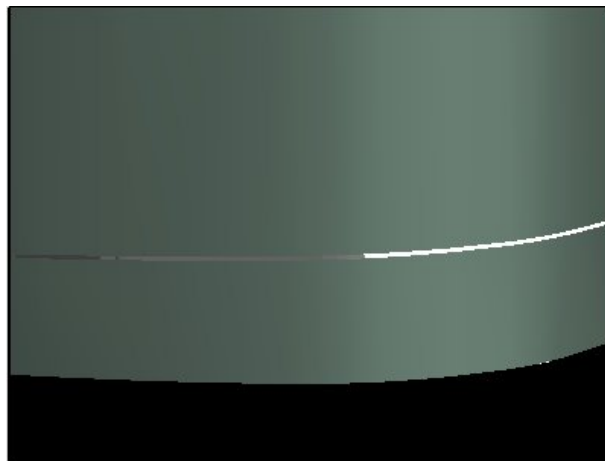

WRIST HFOV: 10.0

L10(VTR)

REC pb – push, hold  
PLAY pb – push, simo (red ●)



**NOTE**

The RMS is at a display singularity for points 153 through 155. The Port Upper Apex pass scans Panels 1→17

Port Upper Apex Clearance Views	Cameras
EE-to-RCC	A, ELBOW
RMS-to-PLBD	B, ELBOW

AUTO SEQ – PROCEED (IN PROG It on)

(12:00)

Pt	X	Y	Z	PITCH	YAW	ROLL	●
<b>153P</b>	<b>-911</b>	<b>-243</b>	<b>-294</b>	<b>53</b>	<b>275</b>	<b>146</b>	
154	-945	-263	-296	12	270	102	
155	-962	-263	-300	340	274	72	
156	-978	-258	-292	19	278	110	
157	-991	-268	-294	7	281	97	
158	-1000	-273	-295	0	287	89	
159	-1002	-290	-296	1	296	90	
160	-1017	-282	-302	352	303	84	
161	-1028	-293	-306	350	319	82	
162	-1061	-320	-305	354	321	84	
163	-1102	-354	-307	353	324	85	
164	-1139	-397	-306	358	326	87	
<b>165P</b>	<b>-1149</b>	<b>-420</b>	<b>-316</b>	<b>353</b>	<b>342</b>	<b>82</b>	

When AUTO SEQ IN PROG It – off:

L10(VTR)

STOP pb – push (no red ●)

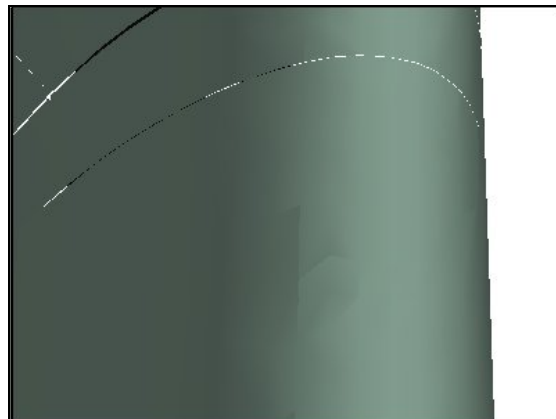

**WRIST HFOV: 10.0**



8. MNVR TO PORT LOWER APEX 1 START

NOTE

Between Pts 165 and 166, arm adjusts for first Port Lower Apex scan

Clearance Views	Cameras
EE-to-RCC	ELBOW
RMS-to-PLBD	A, B

AUTO SEQ – PROCEED (IN PROG It on)

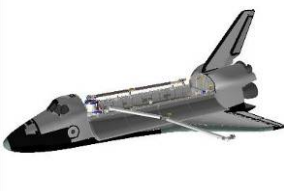
Pt	X	Y	Z	PITCH	YAW	ROLL	●
165P	-1149	-420	-316	353	342	82	
166P	-1151	-415	-304	359	344	89	

(01:00)

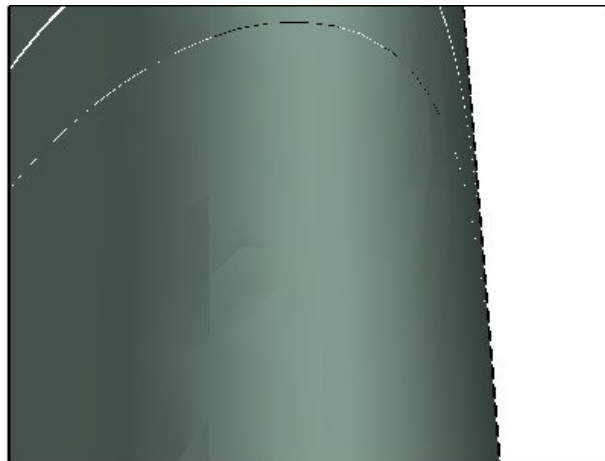

WRIST HFOV: 10.0

9. PORT LOWER APEX 1

NOTE



Port Lower Apex 1 pass scans Panels 17→12

Port Lower Apex 1 Clearance Views	Cameras
EE-to-RCC	ELBOW
RMS-to-PLBD	A, B

L10(VTR) REC pb – push, hold  
PLAY pb – push, simo (red ●)

AUTO SEQ – PROCEED (IN PROG It on)

(05:25)

Pt	X	Y	Z	PITCH	YAW	ROLL	●
<b>166P</b>	<b>-1151</b>	<b>-415</b>	<b>-304</b>	<b>359</b>	<b>344</b>	<b>89</b>	
167	-1146	-404	-301	0	333	87	
168	-1138	-392	-297	2	324	90	
169	-1115	-354	-258	34	344	113	
170	-1107	-336	-253	40	344	121	
<b>171P</b>	<b>-1090</b>	<b>-314</b>	<b>-247</b>	<b>46</b>	<b>343</b>	<b>122</b>	

When AUTO SEQ IN PROG It – off:  
BRAKES – ON (tb-ON)

L10(VTR) STOP pb – push (no red ●)



**WRIST HFOV: 10.0**

10. RECONFIG TO PORT LOWER APEX 2 START  
 RHC RATE – as reqd (VERN within 10 ft)  
 BRAKES – OFF (tb-OFF)  
 MODE – SINGLE, ENTER

Mnvr to PORT LOWER APEX 2 START posn:

	SY	SP	EP	WP	WY	WR	
PORT LOWER APEX 1 End	+37.7	+4.0	-44.8	+109.1	-53.7	+167.0	
1: WP –				-47.6			
2: WY –					-114.0		[1]
3: WR –						+13.5	
4: SY +	+39.0						
5: EP +			-36.6				
6: SP +		+6.1					
PORT LOWER APEX 2 START	+39.0	+6.1	-36.6	-47.6	-114.0	+13.5	
	X	Y	Z	PITCH	YAW	ROLL	PL ID
	-1094	-326	-251	51	324	121	5

[1] Expect SINGULAR It, Near REACH LIMIT

BRAKES – ON (tb-ON)

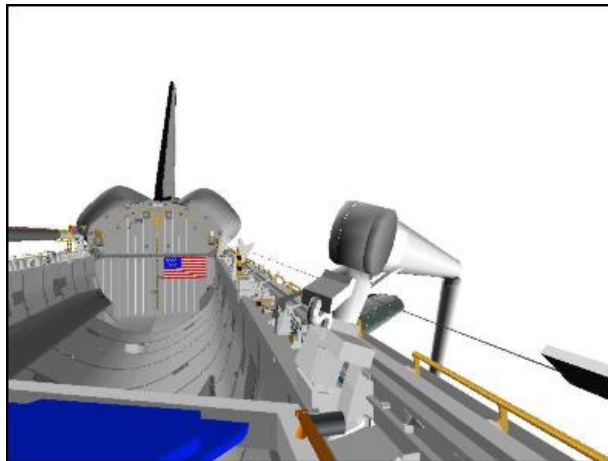

CCTV A (15,0)



FRONT



WRIST HFOV: 10.0



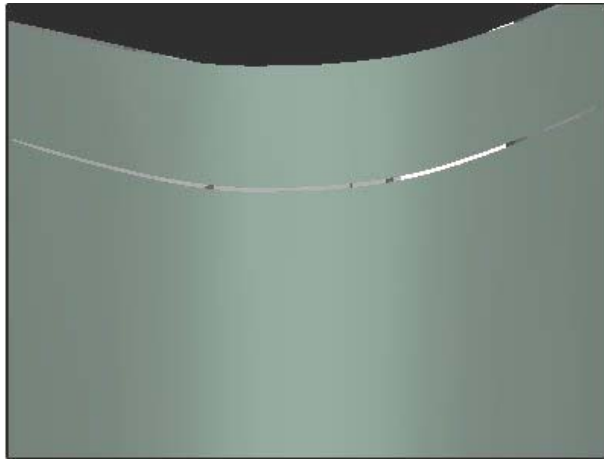

**WRIST HFOV: 10.0**

12. MNVR TO PORT LOWER 1 START

NOTE

Between Pts 179 and 180, arm adjusts for first Port Lower scan

Clearance Views	Cameras
EE-to-RCC	ELBOW
RMS-to-PLBD	A, B

AUTO SEQ – PROCEED (IN PROG It on)

(02:00)

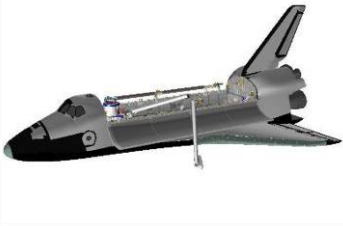
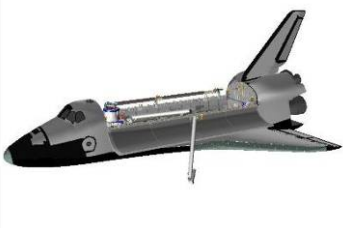
Pt	X	Y	Z	PITCH	YAW	ROLL	•
179P	-904	-236	-268	38	304	312	
180P	-890	-222	-235	41	324	324	

A7U 13. PORT LOWER 1  
CCTV – RMS WRIST, ZOOM: 20.0 HFOV

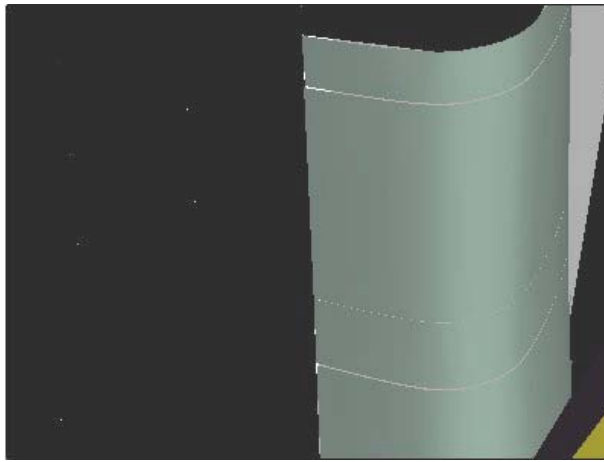

**WRIST HFOV: 20.0**

L10(VTR) REC pb – push, hold  
PLAY pb – push, simo (red ●)

NOTE

Port Lower 1 pass scans the underside of Panels 1→11

Port Lower 1 Clearance Views	Cameras
EE-to-RCC	ELBOW
RMS-to-PLBD	A, B

AUTO SEQ – PROCEED (IN PROG It on)

(04:00)

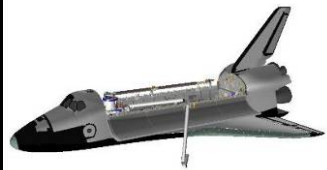
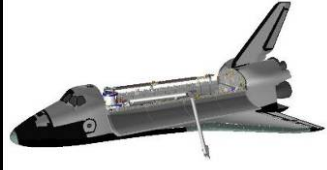
Pt	X	Y	Z	PITCH	YAW	ROLL	●
180P	-890	-222	-235	41	324	324	
181	-917	-227	-237	41	323	328	
182	-932	-232	-237	38	323	329	
183P	-977	-241	-241	53	315	340	

When AUTO SEQ IN PROG It – off:

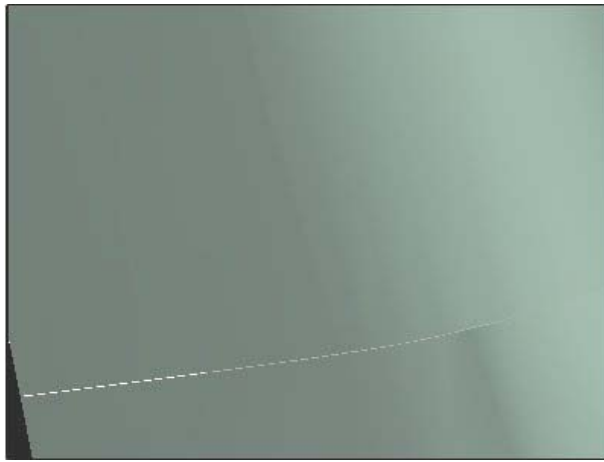

A7U CCTV – RMS WRIST, ZOOM: 10.0 HFOV



**WRIST HFOV: 10.0**

**AUTO SEQ – PROCEED (IN PROG It on)**

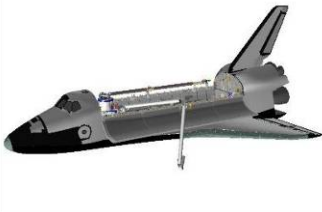
**(06:00)**

<b>Pt</b>	<b>X</b>	<b>Y</b>	<b>Z</b>	<b>PITCH</b>	<b>YAW</b>	<b>ROLL</b>	<b>●</b>
<b>183P</b>	<b>-977</b>	<b>-241</b>	<b>-241</b>	<b>53</b>	<b>315</b>	<b>340</b>	
184	-1001	-244	-246	55	313	325	
185	-1019	-257	-248	51	311	323	
186	-1021	-255	-240	44	323	320	
187	-1043	-272	-242	47	323	299	
188	-1064	-288	-244	48	324	301	
189	-1083	-314	-254	45	314	297	
<b>190P</b>	<b>-1091</b>	<b>-322</b>	<b>-252</b>	<b>40</b>	<b>324</b>	<b>295</b>	

When AUTO SEQ IN PROG It – off:  
BRAKES – ON (tb-ON)

L10(VTR) STOP pb – push (no red ●)

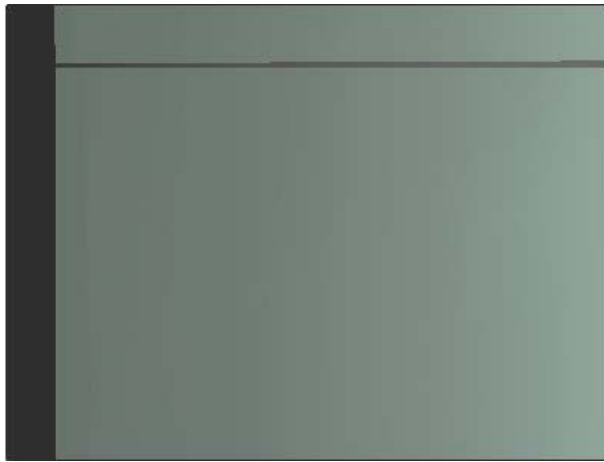

**WRIST HFOV: 10.0**

RHC 14. RECONFIG TO PORT LOWER 2 START  
 RATE – as reqd (VERN within 10 ft)  
 BRAKES – OFF (tb-OFF)  
 MODE – SINGLE, ENTER

Mnvr to PORT LOWER 2 START posn:

	SY	SP	EP	WP	WY	WR	
PORT LOWER 1 End	+39.1	+9.3	-41.7	-61.2	-107.1	+179.8	
1: SP –		+6.5					
2: EP –			-47.5				
3: SY –	+39.0						
4: WY +					-63.0		[1]
5: WP +				+114.0			[2]
6: WR –						-102.8	
PORT LOWER 2 START	+39.0	+6.5	-47.5	+114.0	-63.0	-102.8	
	X	Y	Z	PITCH	YAW	ROLL	PL ID
	-1081	-316	-250	43	335	206	5

[1] Expect SINGULAR It  
 [2] Near REACH LIMIT

BRAKES – ON (tb-ON)

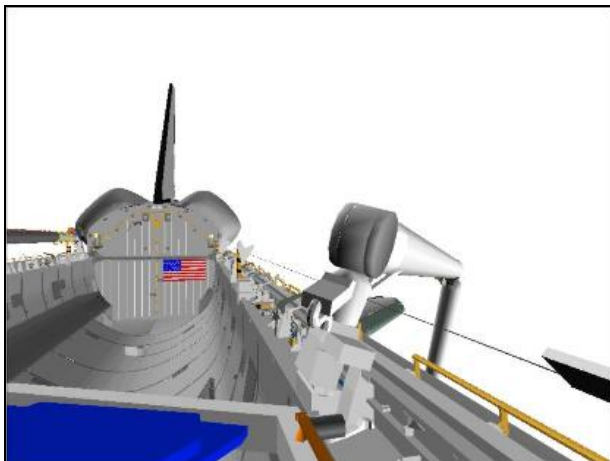

**CCTV A (15,0)**

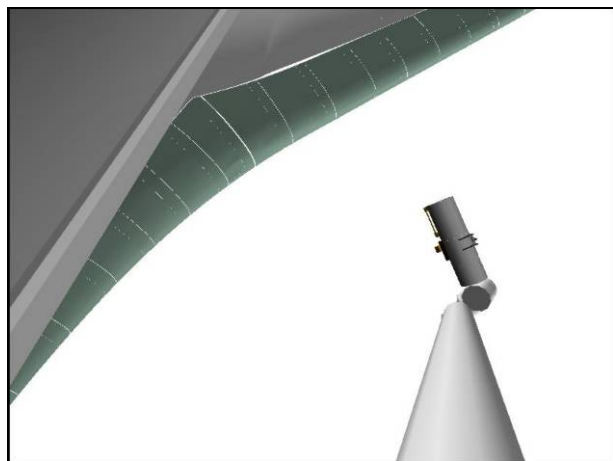



**ELBOW (-20,5)**





AUTO SEQ – PROCEED (IN PROG It on)

(02:00)

Pt	X	Y	Z	PITCH	YAW	ROLL	●
<b>191P</b>	<b>-1081</b>	<b>-316</b>	<b>-250</b>	<b>43</b>	<b>335</b>	<b>206</b>	
192	-1095	-327	-251	43	336	206	
193	-1106	-335	-250	39	347	207	
<b>194P</b>	<b>-1110</b>	<b>-343</b>	<b>-246</b>	<b>37</b>	<b>355</b>	<b>205</b>	

A7U When AUTO SEQ IN PROG It – off:  
CCTV – RMS WRIST, ZOOM: 20.0 HFOV

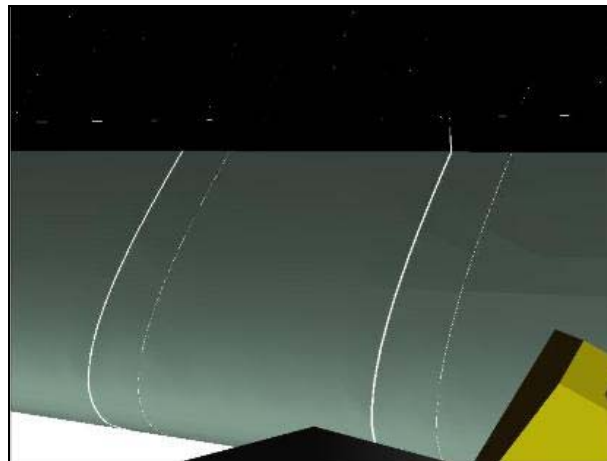

WRIST HFOV: 20.0

AUTO SEQ – PROCEED (IN PROG It on)

(01:45)

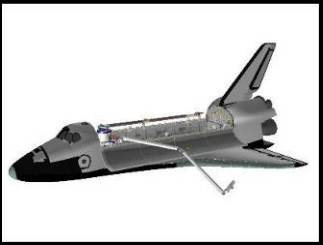
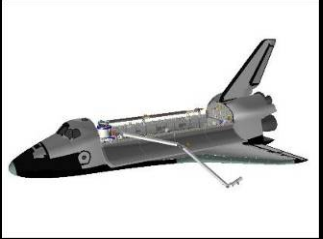
Pt	X	Y	Z	PITCH	YAW	ROLL	●
<b>194P</b>	<b>-1110</b>	<b>-343</b>	<b>-246</b>	<b>37</b>	<b>355</b>	<b>205</b>	
195	-1118	-364	-254	31	354	201	
196	-1126	-367	-253	29	4	202	
<b>197P</b>	<b>-1127</b>	<b>-373</b>	<b>-250</b>	<b>27</b>	<b>10</b>	<b>204</b>	

When AUTO SEQ IN PROG It – off:  
BRAKES – ON (tb-ON)

L10(VTR) STOP pb – push (no red ●)

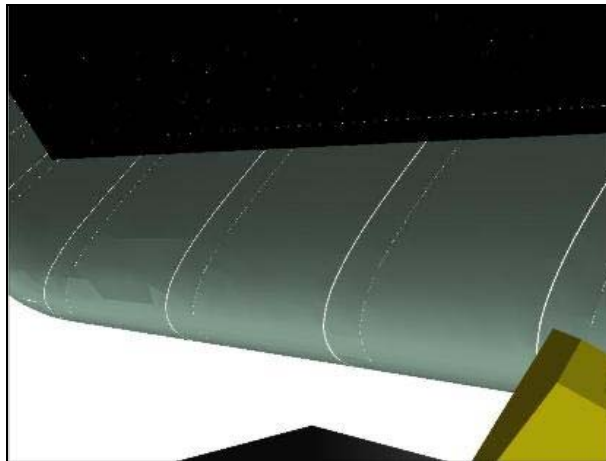

WRIST HFOV: 20.0

16. RETURN TO PRE-CRADLE

SM 94 PDRS CONTROL

PL ID – ITEM 3 +0 EXEC

INIT ID – ITEM 24 +0 EXEC

	X	Y	Z	PITCH	YAW	ROLL	PL ID
√	-1127	-373	-250	27	10	204	0
	SY	SP	EP	WP	WY	WR	
√	+38.3	+2.7	-33.8	+65.8	-32.5	-133.2	

RHC RATE – as reqd (VERN within 10 ft)  
BRAKES – OFF (tb-OFF)  
MODE – SINGLE, ENTER

Mnvr to PRE-CRADLE posn:

	SY	SP	EP	WP	WY	WR	
PORT LOWER 2 End	+38.3	+2.7	-33.8	+65.8	-32.5	-133.2	
1: WR +						0.0	
2: WY +					0.0		
3: WP -				+5.0			
4: EP +			-25.0				
5: SP +		+25.0					
6: SY -	0.0						
PRE-CRADLE	0.0	+25.0	-25.0	+5.0	0.0	0.0	
	X	Y	Z	PITCH	YAW	ROLL	PL ID
	-1261	-146	-551	5	2	0	0

BRAKES – ON (tb-ON)  
 MODE – not DIRECT  
 PARAM – PORT TEMP  
 JOINT – CRIT TEMP

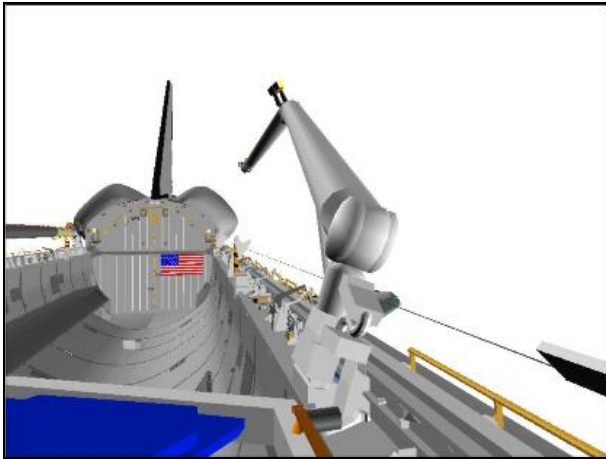

CCTV A (0,0)

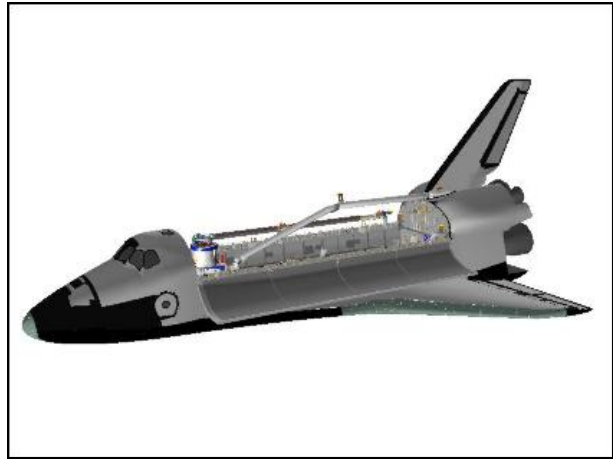

BIRD'S EYE

BACKUP CRADLE

BACKUP  
CRADLE

# BACKUP CRADLE

1. ARM CRADLE  
√BRAKES – ON (tb-ON)

DAP: VERN(FREE)

### NOTE

Spurious fault msgs may occur when PORT RMS deselected.

Use views from Camrs A, B, and/or Elbow to align WP and WY. WR = 0 when Wrist Camr aligned w/orbiter Z axis

RMS SEL – OFF  
PWR – B/U  
SEL – PORT

B/U DRIVE to approx:

SY	SP	EP	WP	WY	WR
0.0	+25.0	+1.0	+5.0	0.0	0.0

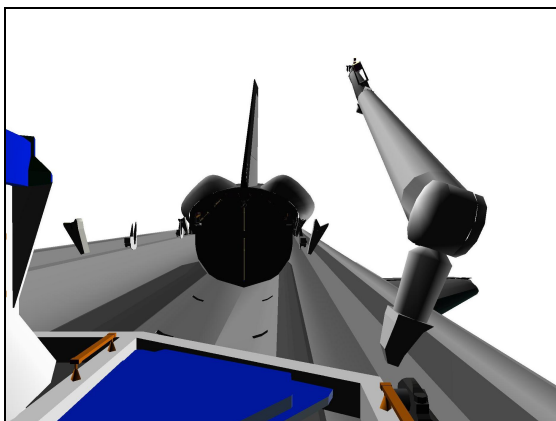

Figure 1.- Backup-cradle  
(Camera A: 0,0)

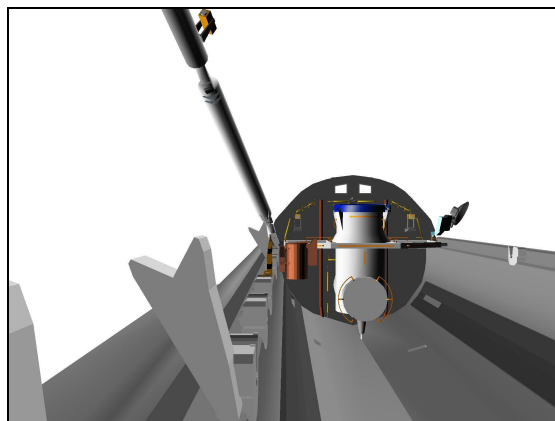

Figure 2.- Backup-cradle  
(Camera B: 0,0)

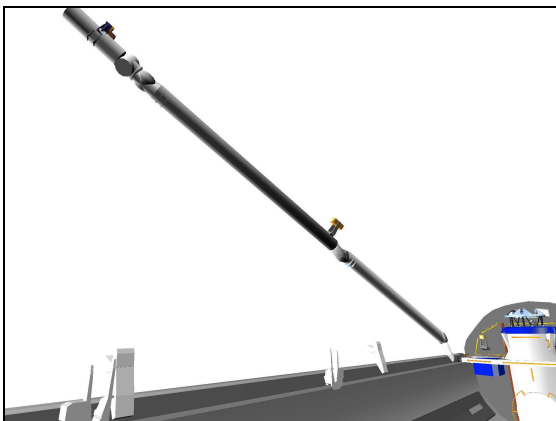

Figure 3.- Backup-cradle  
(Camera C: -40,18)

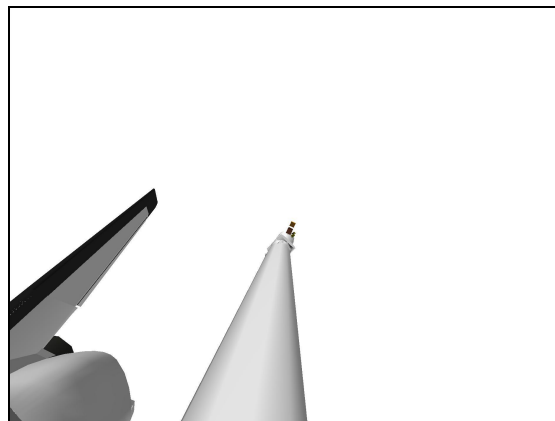

Figure 4.- Backup-cradle  
(RMS Elbow: 0,0)

BACKUP  
CRADLE

Drive SP to get FWD R-F-L, then  
EP to get MID R-F-L, then  
WP to get AFT R-F-L

2. LATCH/STOW ARM  
Go to RMS PWRDN, step 3

This Page Intentionally Blank



RMS JETTISON ASSUMPTIONS AND NOTES

JETT  
NOTES

## RMS JETTISON ASSUMPTIONS AND NOTES

### ASSUMPTIONS:

1. DAP and RMS have been configured to provide stable payload position (if attached) prior to entering this procedure
2. Jettison occurs greater than 1000 ft from ISS to avoid plume impingement damage

### NOTES:

1. Jettison to be performed between sunrise and noon, if possible, to provide good visibility
2. DAP callouts are shown for unloaded arm case
3. If payload attached, correct VRCS/ALT DAP parameters must be loaded into DAP B in CDR steps 1, 2. Parameters will come from PDRS FS or MCC. MCC will complete pad in MS step 2b
4. DAP A used post-jettison for sep mnvr. DAP B used while RMS attached to keep RMS loads down and ensure stable orbiter/payload/DAP

RMS JETTISON

RMS  
JETT

**CDR**

**RMS JETTISON** (may include PL)

1. SETUP  
 O14:F, √Pri RJD DRIVER, LOGIC (sixteen) – ON  
 O15:F,  
 O16:F  
 O14:E √cb DDU AFT (two) – cl  
  
 A6U SENSE: -Z  
  
 A7U √Lighting – as reqd  
  
 If no payload attached:  
 | Config DAP A,B to A7,B7  
 If payload attached:  
 | Config DAP A to A7, B per MCC  
  
 Unstow HHL  
  
 2. AUTO MNVR TO -XLV, +ZVV  

GNC UNIV PTG
--------------

 √TGT ID: +2  
 BODY VECT: +2  
 OM: +0  
  
 On MCC GO:  
 DAP: B/AUTO/VERN(ALT)  
  
 ITEM 19 EXEC (CUR – \*)

**MS**

**RMS JETTISON** (may include PL)

1. PWRUP RMS PYROS  
 √BRAKES – ON (tb-ON)  
  
 A14 √PYRO PORT RMS (five) – SAFE  
 √RMS LAT – SAFE  
  
 ML86B:D cb MNB PYRO JETT SYS A PORT RMS – cl  
 MNC PYRO JETT SYS B PORT RMS – cl  
 √cb MNA PYRO JETT SYS A STBD RMS – op  
 √cb MNC PYRO JETT SYS B STBD RMS – op
2. CONFIGURE SRMS IN PREPARATION FOR JETTISON  
 2a. If MPMs expected to stow, no joint failed, and jettisoning unloaded RMS:  
 If RMS latched, perform RMS PWRUP, steps 3, 5 thru 7  
  
 PARAM – JOINT ANGLE  
 BRAKES – OFF (tb-OFF)  
 MODE – SINGLE, ENTER  
  
 SINGLE DR to RMS JETTISON position ( $\pm 1^\circ$ ):  

	SY	SP	EP	WP	WY	WR
1: SP		+45				
2: EP			-45			
3: SY	-45					
Final	-45	+45	-45	ANY	ANY	ANY

 BRAKES – ON (tb-ON)

**CDR**

**MS**

3. CONFIGURE DAP FOR SRMS JETTISON  
 If RMS joint failed or jettisoning loaded RMS:

NOTE

Free drift during attitude maneuver acceptable to facilitate arm maneuvering

If reqd per MCC or no VERNs:  
 DAP: FREE

2b. If MPMs expected to stow and either joint failed or jettisoning loaded RMS:  
 √MCC for RMS mode and joint config for jettison

PARAM – JOINT ANGLE  
 Configure for MODE Entry  
 MODE – \_\_\_\_\_

Drive to JETTISON position ( $\pm 1^\circ$ ):

	SY	SP	EP	WP	WY	WR
1						
2						

√BRAKES – ON (tb-ON)  
 √MODE – not DIRECT (lt off)

Inform CDR RMS at Jettison position

When RMS at Jettison position:  
 DAP: B/AUTO/VERN(ALT)

2c. If MPMs won't stow (top part of MPMs being jettisoned):  
 If RMS not cradled and latched, perform RMS PWRDN, steps 1-4

Deadface Latches

√PL BAY MECH PWR SYS (two) – OFF

√PORT RMS RETEN LAT tb – LAT

RMS LAT – DEADFACE

√PORT RMS RETEN LAT tb – bp

R13L

A8L

A14

A8L

A14

Guillotine Wires at Latches  
 PYRO PORT RMS ARM – GUILLOTINE  
 Wait 1 sec, then  
 PYRO PORT RMS LAT (three) – GUILLOTINE  
 – SAFE

Jettison Latches  
 PYRO PORT RMS ARM – JETT  
 Wait 1 sec, then  
 PYRO PORT RMS LAT (three) – JETT  
 – SAFE  
 ARM – SAFE  
 RMS LAT – SAFE

Configure RMS for Jettison  
 PARAM – JOINT ANGLE  
 BRAKES – OFF (tb-OFF)  
 MODE – SINGLE, ENTER

SINGLE DR to RMS JETTISON position ( $\pm 1^\circ$ ):

	SY	SP	EP	WP	WY	WR
Initial ✓	0	0	0	0	0	0
:1: WP +				+5		
:2: EP +			+1			
:3: SP +		+45				
:4: EP -			-45			
:5: SY -	-45					
:Final	-45	+45	-45	+5	0	0

L BRAKES – ON (tb-ON)

- PWRDN RMS FOR JETTISON  
 PORT RMS HTR A,B (two) – OFF

NOTE

Spurious fault msgs may occur  
 when port RMS deselected

RMS SEL – OFF  
 PWR – OFF (SM ALERT, BCE BYP MCIU)



**CDR****MS**4. CONFIGURE ORBITER FOR SEP MNVR

Approximately 2 min prior to jettison,  
√Mnvr to Jettison attitude complete, then

DAP: FREE

√SENSE: -Z

FLT CNTLR PWR – ON

V10

If recording views with V10:

REC pbs – Press simo

√LCD displays red dot

L10

If recording views with VTR:

REC pb – Press, hold

(VTR)

PLAY pb – Press, simo (√red dot displayed)

Give MS GO to perform Jettison RMS

6. JETTISON RMS

A14

PYRO PORT RMS ARM – JETT

Wait 1 sec, then

PYRO PORT RMS SHLDR – JETT

Give CDR GO to perform sep mnvr

Track RMS/PL with camr of choice and HHL

5. SEP MNVR

√DAP TRANS: PULSE/PULSE/PULSE, NO LO Z

DAP: A/FREE/VERN(ALT)

THC: +Z (out) 2 pulses (0.2 ft/sec)

When jettisoned RMS confirmed moving out of payload bay:

DAP: TRANS: PULSE/PULSE/NORM

DAP: LVLH

THC: +Z (out) 5 sec (1.6 ft/sec)

FLT CNTLR PWR – OFF

Report HHL marks to MCC



**CDR**

**MS**

6. POST JETTISON ATTITUDE CLEANUP

Stop recording

GNC 20 DAP CONFIG

√CNTL ACCEL, ITEM 28: 0

√CNTL ACCEL, ITEM 48: 0

SEP +10 min:

√MCC for post-jettison attitude

Stow HHL

7. POST JETTISON RMS CLEANUP

PYRO PORT RMS SHLDR – SAFE

ARM – SAFE

ML86B:D

cb MNB PYRO JETT SYS A PORT RMS – op

MNC PYRO JETT SYS B PORT RMS – op

If reqd to stow MPM,

Go to RMS PWRDN, steps 3, 5 thru 7

This Page Intentionally Blank

## REFERENCE DATA

TEMPERATURE DATA .....	10-2
C&W LIMITS .....	10-2
JOINT TRAVEL LIMIT LOCATIONS .....	10-3
WRIST ROLL RANGE .....	10-4
RMS SINGULARITIES.....	10-5
SHOULDER YAW SINGULARITY .....	10-6
PORT MPM/MRL MOTOR AND CONTROL REQUIREMENTS.....	10-7
STBD MPM/MRL MOTOR AND CONTROL REQUIREMENTS .....	10-8
PORT MPM TALKBACKS AND MICROSWITCHES .....	10-9
STBD MPM TALKBACKS AND MICROSWITCHES .....	10-10
PORT/STBD MRL TALKBACKS AND MICROSWITCHES .....	10-11
PL ID 1 – OBSS UNBERTH/BERTH, FWD STRIKER BAR .....	10-12
2 – OBSS LDRI – POR @ PTU PIVOT .....	10-13
OBSS JOINT ANGLES VS POR COORDINATES .....	10-14
AUTO SEQUENCES .....	10-15
RMS GO/NO-GO CRITERIA (FLIGHT RULE A12-1001) .....	10-21
FLIGHT RULE REFERENCES .....	10-22
SPEC 95 ABE OVERRIDES .....	10-23
RMS MODE RESPONSE MATRIX.....	10-24
HAND CONTROLLER AXIS SWAP .....	10-25
RMS/EVA VOICE PROTOCOL (GCA) .....	10-26
ALL STOP PROTOCOL.....	10-27
ORBITER LOCATION CHART .....	10-28
END EFFECTOR CAPTURE/RELEASE SEQUENCE INFO .....	10-29
RMS EE C/O FAILURE MATRIX .....	10-30
PDRS EPS IMPACT TABLE .....	10-34
OI MDM/DSC IMPACT TABLE .....	10-40
MISCELLANEOUS RMS MOTION NOTES.....	10-41

## TEMPERATURE DATA

### RMS Temperatures:

#### NOTE

To read RMS temperatures:

PARAM – PORT TEMP

JOINT – as desired (see below)

'LED' temps measured at joints

'ABE' temps measured at electronics

JOINT SW SEL	IND #1 TEMP °F	IND #2 TEMP °F	IND #3 JOINT ID
SY	SY LED	SY,SP ABE	101
SP	SP LED	SY,SP ABE	102
EP	EP LED	EP ABE	103
WP	WP LED	WP,WY ABE	104
WY	WY LED	WP,WY ABE	105
WR	WR LED	WR ABE	106
EE	EE LED	EE ABE	107

### OBSS Temperatures:

#### NOTE

To read OBSS sensor temperatures:

PARAM – STBD TEMP

JOINT – as desired (see below)

JOINT SW SEL	IND #1 TEMP °F	IND #2 TEMP °F	IND #3 JOINT ID
SY	LDRI		201
SP	ITVC		202
EP	PTU		203
WP	LCS		204
WY			205
WR	Avionics Box 1	Avionics Box 2	206
EE			207

## C&W LIMITS

	LOWER LIMIT °F	UPPER LIMIT °F
LED/OPTICAL SCANNER	0	172
ABE EE	0	144
ABE SY,SP,EP,WP,WY,WR	0	106
LDRI	39	156
ITVC	21	119
PTU	8	138
LCS	39	119
AVIONICS BOX 1 & 2	8	128

REF DATA

# JOINT TRAVEL LIMIT LOCATIONS

JOINT	REACH LIMIT LOCATION	SOFT STOP LOCATION	MECHANICAL STOP LOCATION	SINGULARITY LOCATION
SY	+175.4° -175.4°	+177.4° -177.4°	+180° -180°	
SP	+2.6° +140.4°	+0.6° +142.4°	-2° +145°	
EP	-2.4° -155.6°	-0.4° -157.6°	+2.4° -161°	-7.6
WP	-114.4° +114.4°	-116.4° +116.4°	-121.4° +121.4°	
WY	-114.6° +114.6°	-116.6° +116.6°	-121.3° +121.3°	-75/-105 +75/+105
WR	-440° +440°	-442° +442°	-447° +447°	

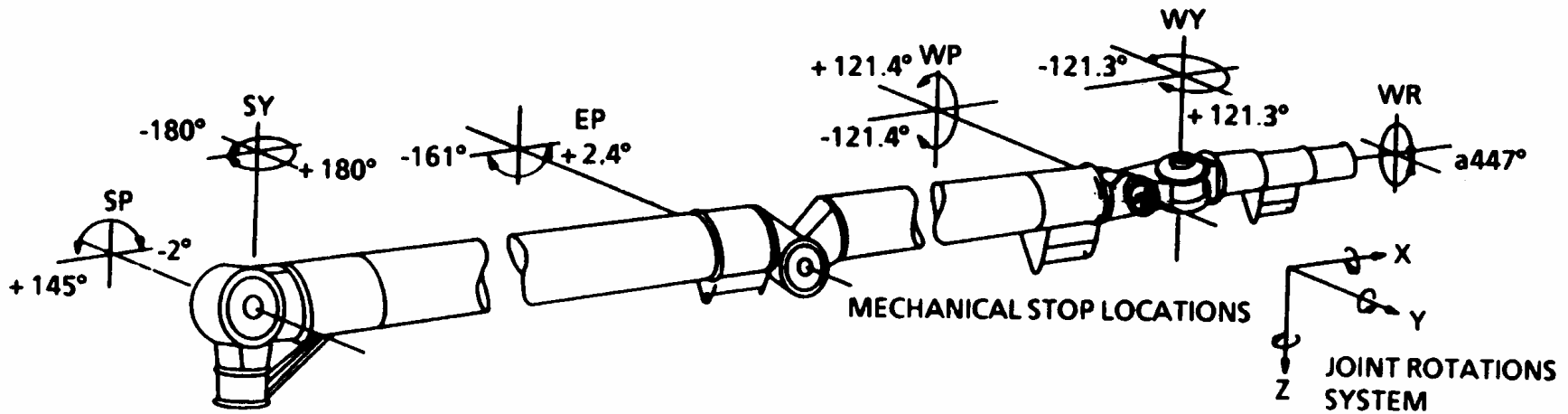

# WRIST ROLL RANGE

SPEC 94 WR RANGE X ITEM 26	WR JOINT ANGLE
1	$-450 \leq \Phi < -360$
2	$-360 \leq \Phi < -180$
3	$-180 \leq \Phi < 0$
4	$0 \leq \Phi < 180$
5	$180 \leq \Phi < 360$
6	$360 \leq \Phi < 450$

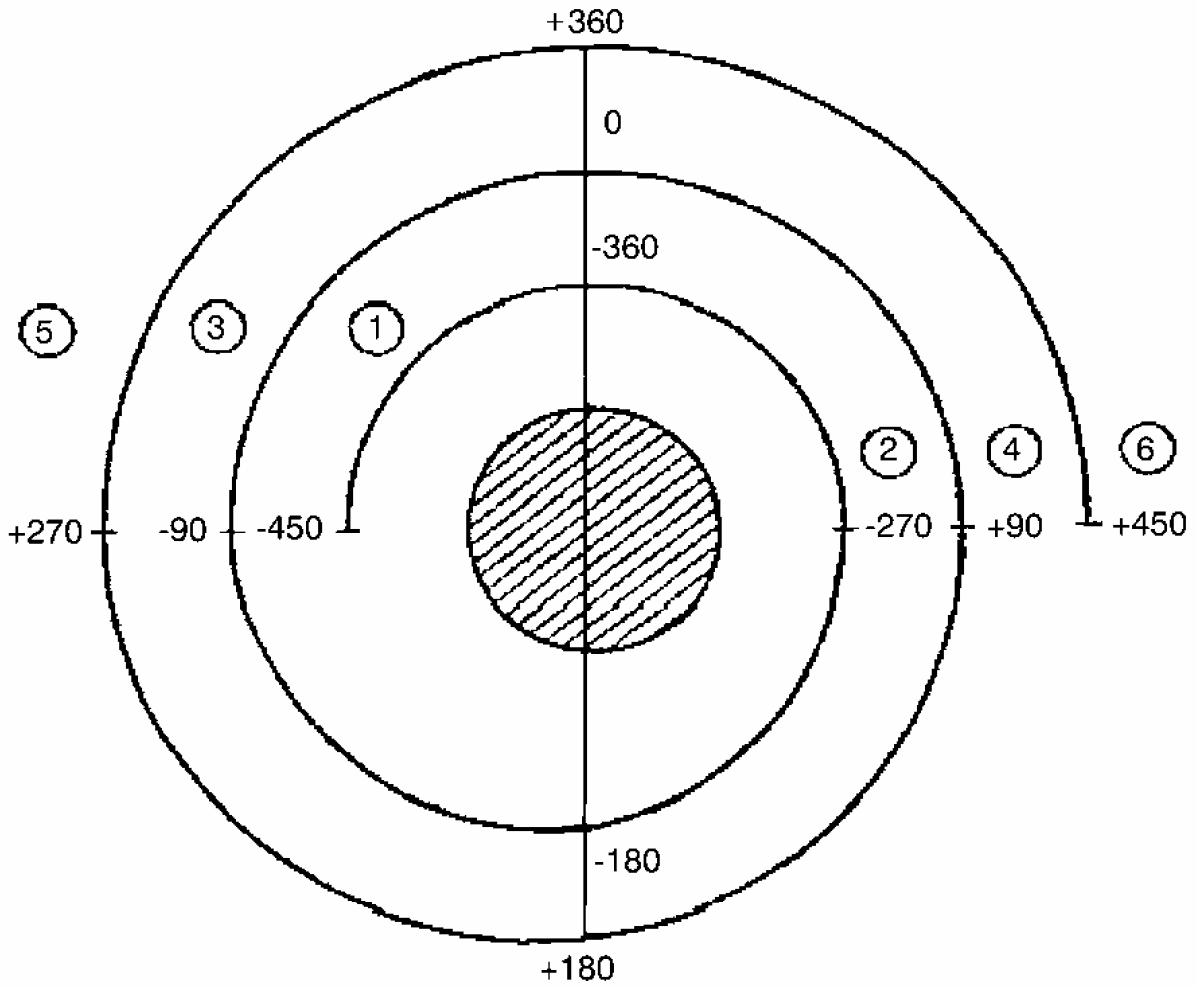

## RMS SINGULARITIES

1. Wrist Yaw Singularity → Occurs when the WY joint is at  $+75.0^\circ$  to  $+105.0^\circ$  or  $-75.0^\circ$  to  $-105.0^\circ$ . The DOF lost is the ability to rotate about the EP to WP arm boom.
2. Elbow Pitch Singularity → Occurs when the EP joint is  $-7.6^\circ$  or greater. The DOF lost is the ability to translate away from the shoulder joint.
3. Shoulder Yaw Singularity → Occurs when the WY joint is within a 3-ft cylinder around the SY axis. The DOF lost is the ability to translate perpendicular to the plane containing the booms of the arm.

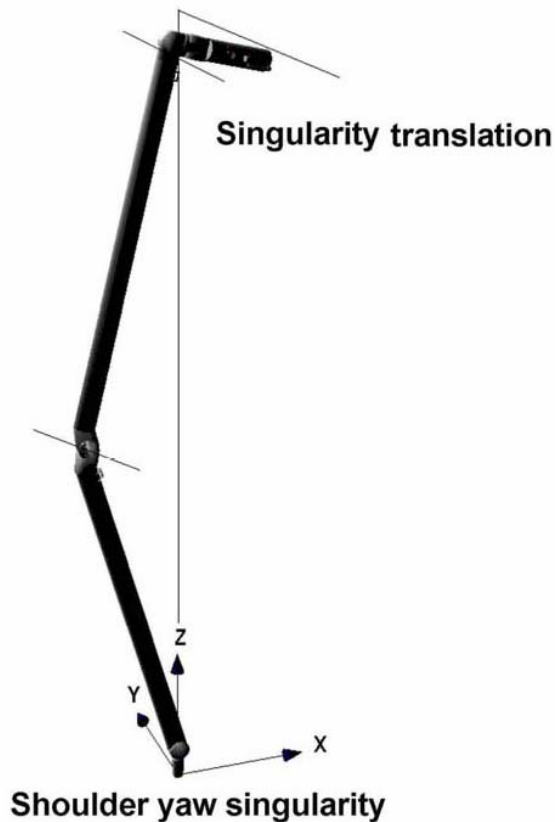
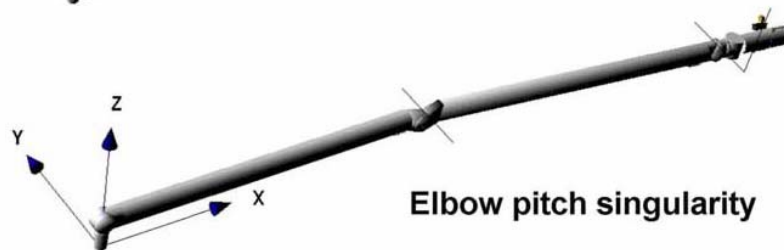
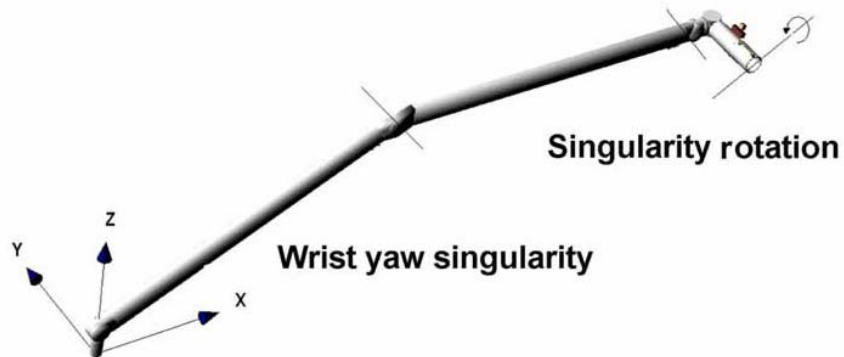

## SHOULDER YAW SINGULARITY

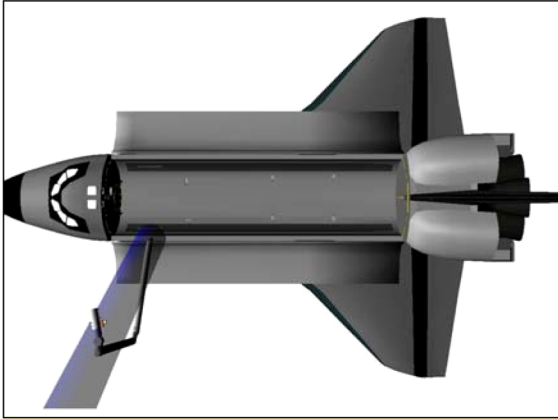

Overhead View

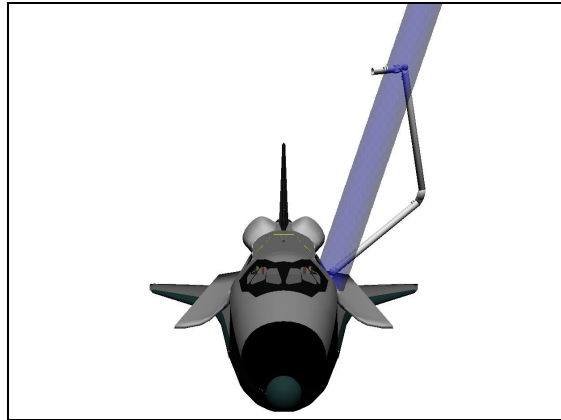

Front View



Port View

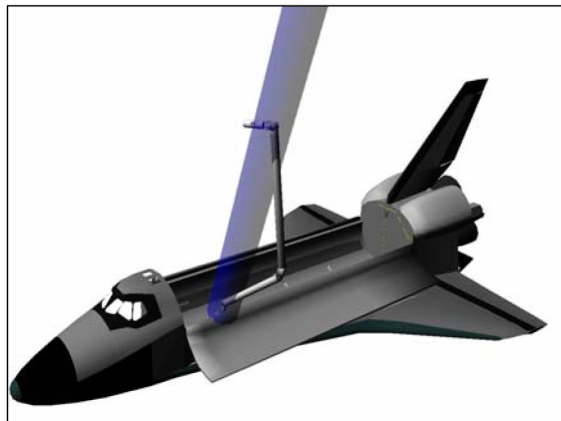

Bird's Eye Port View

NOTE: Shaded Region depicts area where SY Singularity appears



## PORT MPM/MRL MOTOR AND CONTROL REQUIREMENTS<sup>a</sup>

MRL		LOGIC POWER			MOTOR POWER					CMD PWR	DATA MDM
		RPC	CNTL	SW LOGIC	AC BUS PWR		PLB MECH	AC BUS ENA 1	AC BUS ENA 2		
FWD	SYS 1	MNB MPC2	BC3	MNB MMC2	AC2	AC2 PBM MMC2	SYS 1	BC1	BC2	AB1	OA2
	SYS 2	MNC MPC3	CA3	MNC MMC4	AC3	AC3 PBM MMC4	SYS 2	AB1 + CA1	AB2 + CA2	CA1	OA2
MID	SYS 1	MNA MPC1	AB3	MNA MMC1	AC1	AC1 PBM MMC1	SYS 1	AB1 + CA1	AB2 + CA2	AB1	OF4
	SYS 2	MNB MPC2	BC3	MNB MMC4	AC2	AC2 PBM MMC4	SYS 2	BC2	BC1	CA1	OA1
AFT	SYS 1	MNC MPC3	CA3	MNC MMC2	AC3	AC3 PBM MMC2	SYS 1	AB1 + CA1	AB2 + CA2	CA1	OA3
	SYS 2	MNA MPC1	AB3	MNA MMC3	AC1	AC1 PBM MMC3	SYS 2	AB1 + CA1	AB2 + CA2	AB1	OF1

<sup>a</sup>Loss of any one bus (some dual) will cause loss of motor drive capability

MPM	LOGIC POWER			MOTOR POWER					CMD PWR	DATA MDM			
	RPC	CNTL	SW LOGIC	AC BUS PWR		PLB MECH	AC BUS ENA 1	AC BUS ENA 2		SHLD	FWD	MID	AFT
SYS 1	MNC MPC3	CA3	MNC MMC4	AC3	AC3 PBM MMC4	SYS 2	AB1 + CA1	AB2 + CA2	CA2	OA2	OF1	OA1	OF1
SYS 2	MNB MPC2	BC3	MNB MMC2	AC2	AC2 PBM MMC2	SYS 1	BC1	BC2	BC1	OA2	OA3	OF4	OA3

<sup>a</sup>Loss of any one bus (some dual) will cause loss of motor drive capability

## STBD MPM/MRL MOTOR AND CONTROL REQUIREMENTS<sup>a</sup>

MRL		LOGIC POWER			MOTOR POWER					CMD PWR	DATA MDM
		RPC	CNTL	SW LOGIC	AC BUS PWR		PLB MECH	AC BUS ENA 1	AC BUS ENA 2		
FWD	SYS 1	MNB MPC2	BC3	MNB MMC4	AC3	AC3 PBM MMC4	SYS 2	AB1 + CA1	AB2 + CA2	CA1	OA2
	SYS 2	MNA MPC1	AB3	MNA MMC1	AC1	AC1 PBM MMC1	SYS 1	AB1 + CA1	AB2 + CA2	AB1	OF4
MID	SYS 1	MNB MPC2	BC3	MNB MMC4	AC2	AC2 PBM MMC4	SYS 2	BC2	BC1	AB1	OA1
	SYS 2	MNC MPC3	CA3	MNC MMC2	AC3	AC3 PBM MMC2	SYS 1	AB1 + CA1	AB2 + CA2	CA1	OA3
AFT	SYS 1	MNA MPC1	AB3	MNA MMC3	AC1	AC1 PBM MMC3	SYS 2	AB1 + CA1	AB2 + CA2	AB1	OF1
	SYS 2	MNB MPC2	BC3	MNB MMC2	AC2	AC2 PBM MMC2	SYS 1	BC1	BC2	CA1	OA2

<sup>a</sup>Loss of any one bus (some dual) will cause loss of motor drive capability

MPM	LOGIC POWER			MOTOR POWER					CMD PWR	DATA MDM		
	RPC	CNTL	SW LOGIC	AC BUS PWR		PLB MECH	AC BUS ENA 1	AC BUS ENA 2		FWD	MID	AFT
SYS 1	MNB MPC2	BC3	MNB MMC2	AC2	AC2 PBM MMC2	SYS 1	BC1	BC2	BC1	OA2	OA3	OF4
SYS 2	MNC MPC3	CA3	MNC MMC4	AC3	AC3 PBM MMC4	SYS 2	AB1 + CA1	AB2 + CA2	CA2	OA2	OF1	OA2

<sup>a</sup>Loss of any one bus (some dual) will cause loss of motor drive capability

# PORT MPM TALKBACKS AND MICROSWITCHES

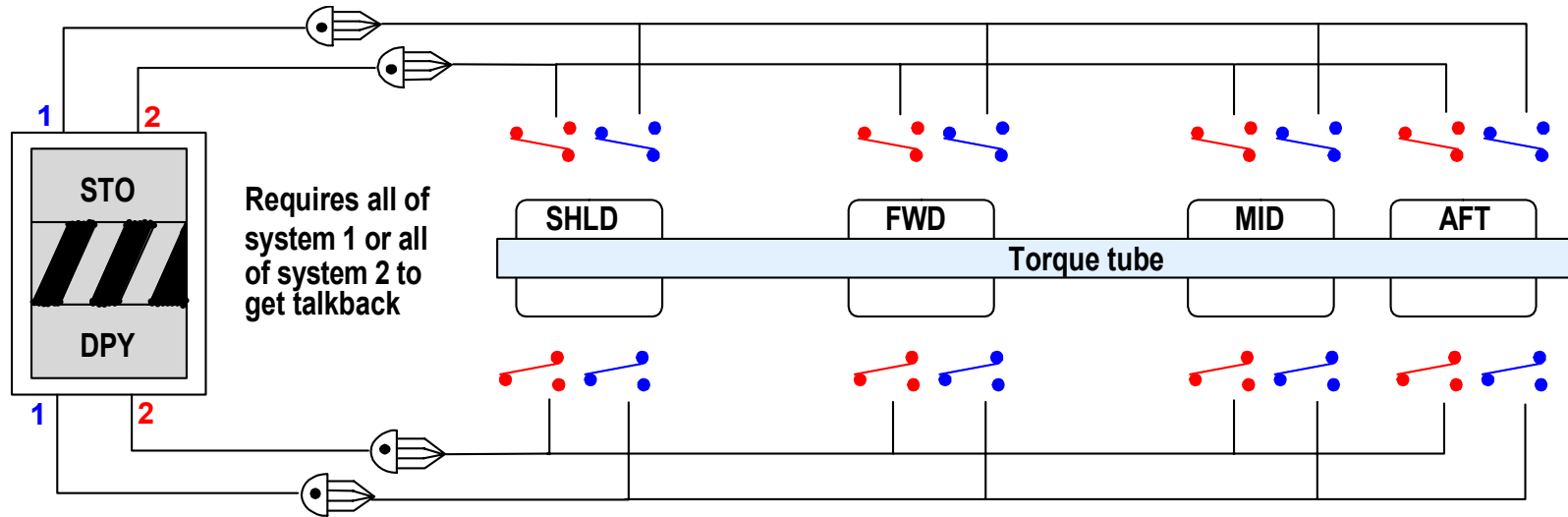

**SPEC 94**

PORT	STO / DPLY
MPM	X X X X

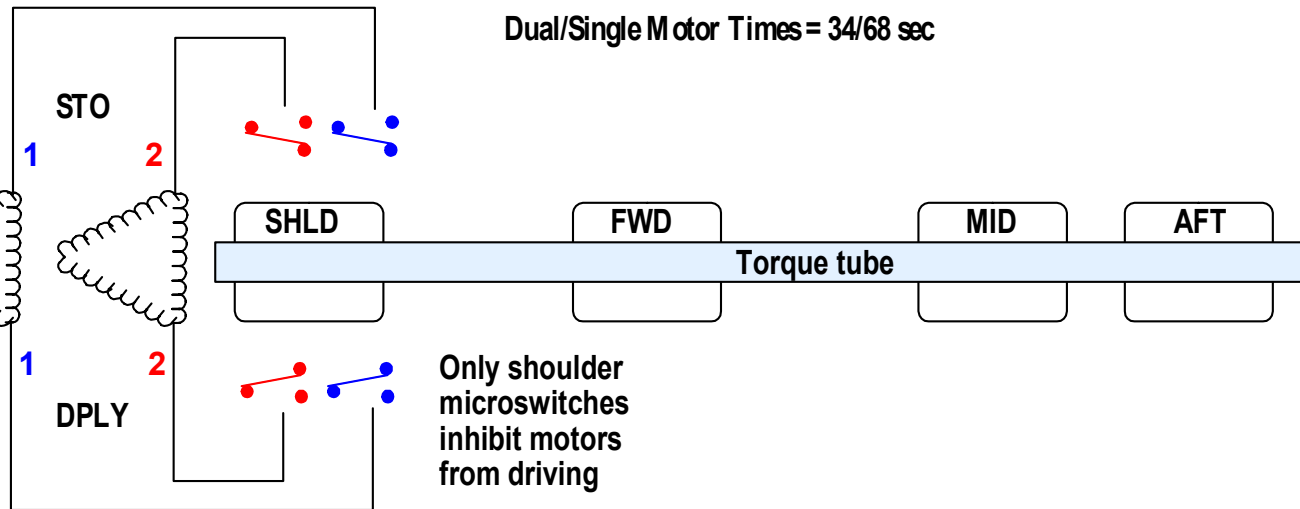

PL BAY MECH PWR drives motors

# STBD MPM TALKBACKS AND MICROSWITCHES

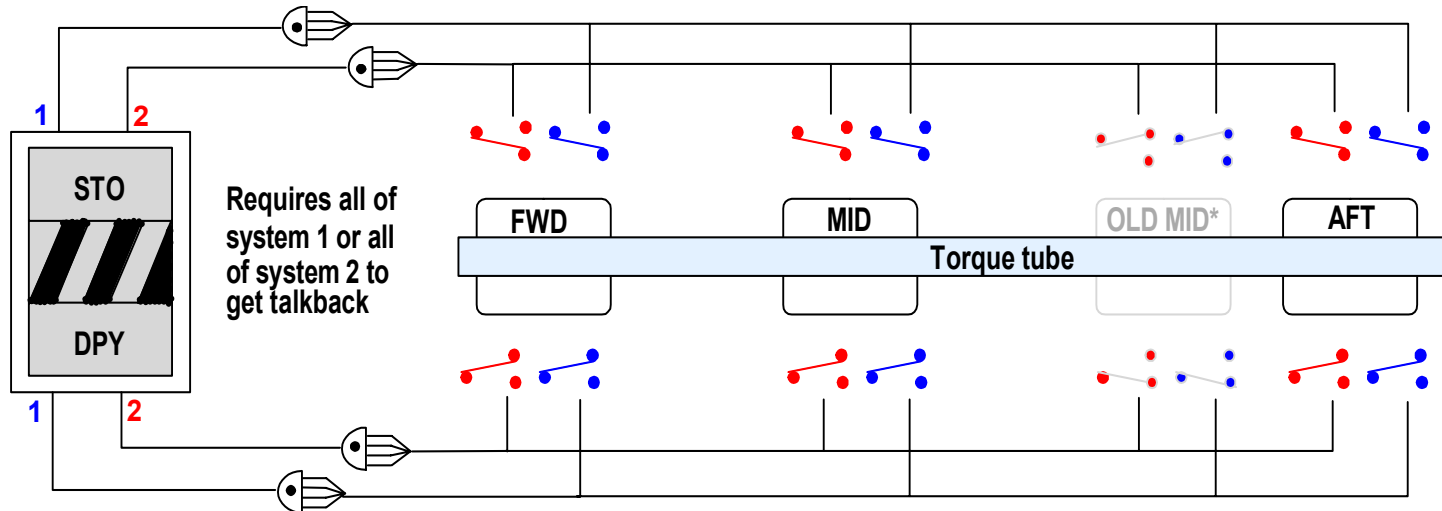

\*Pins have been shorted together to simulate inputs from unused "Old Mid" MPM location to maintain accuracy of Stbd MPM tb

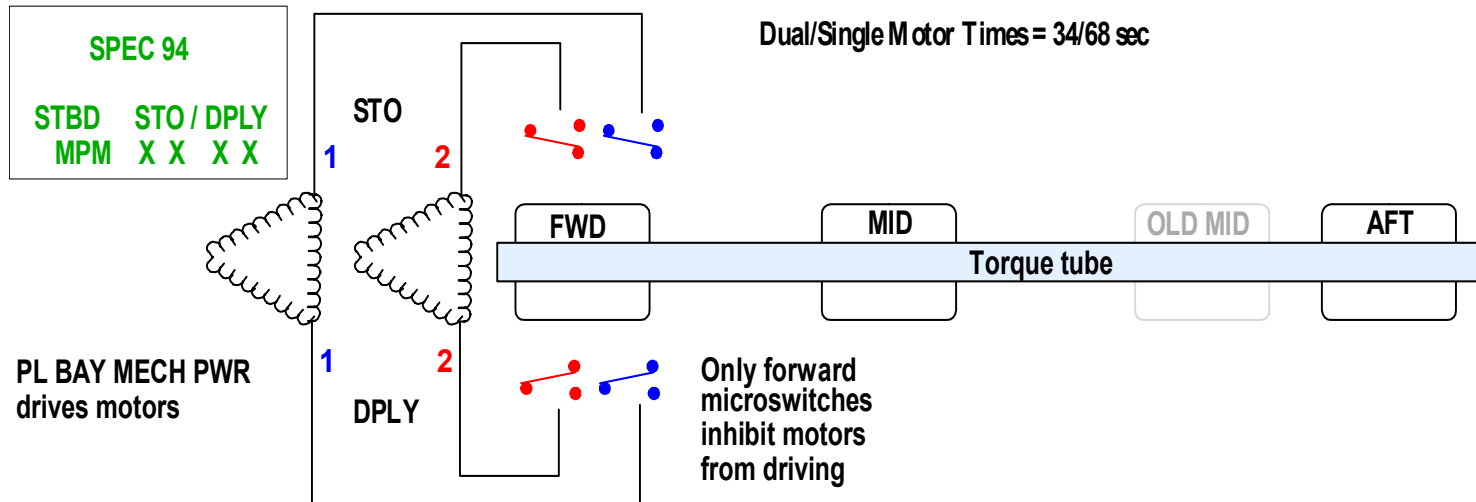

# PORT/STBD MRL TALKBACKS AND MICROSWITCHES

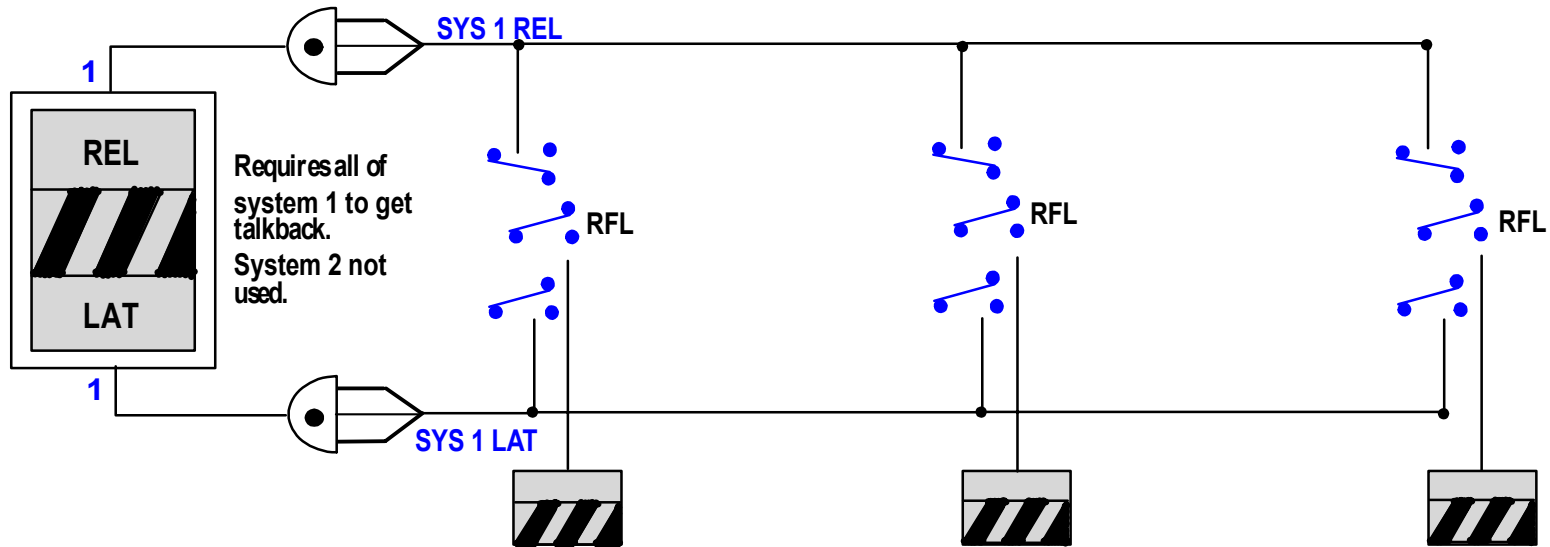

Requires all of system 1 to get talkback. System 2 not used.

PL BAY MECH PWR drives motors

Dual/Single Motor Times = 8/18 sec

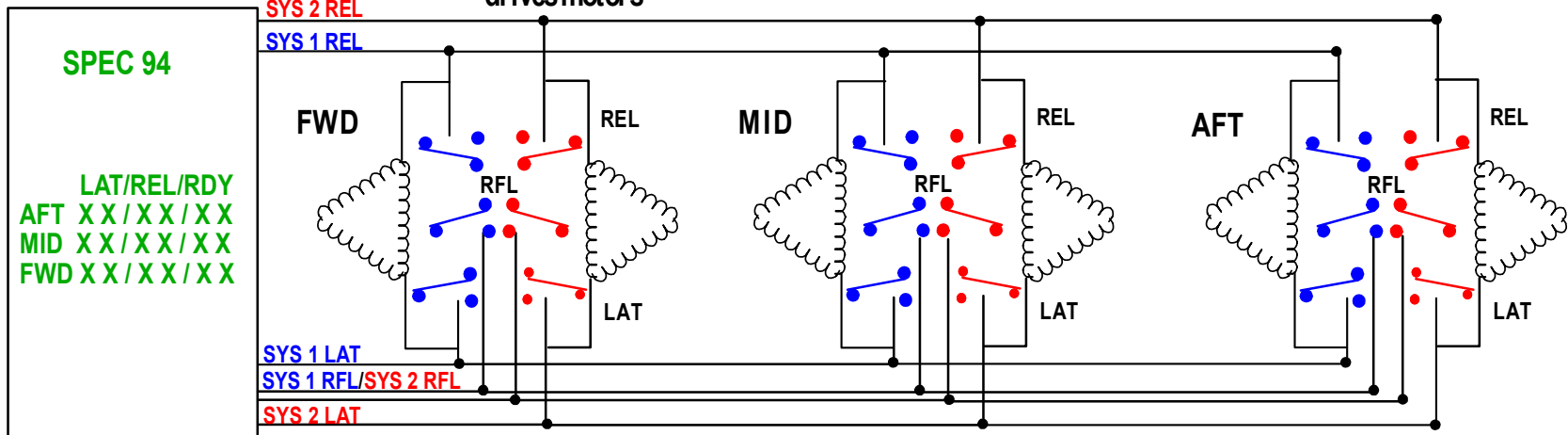

PL ID 1 – OBSS UNBERTH/BERTH, FWD STRIKER BAR

I

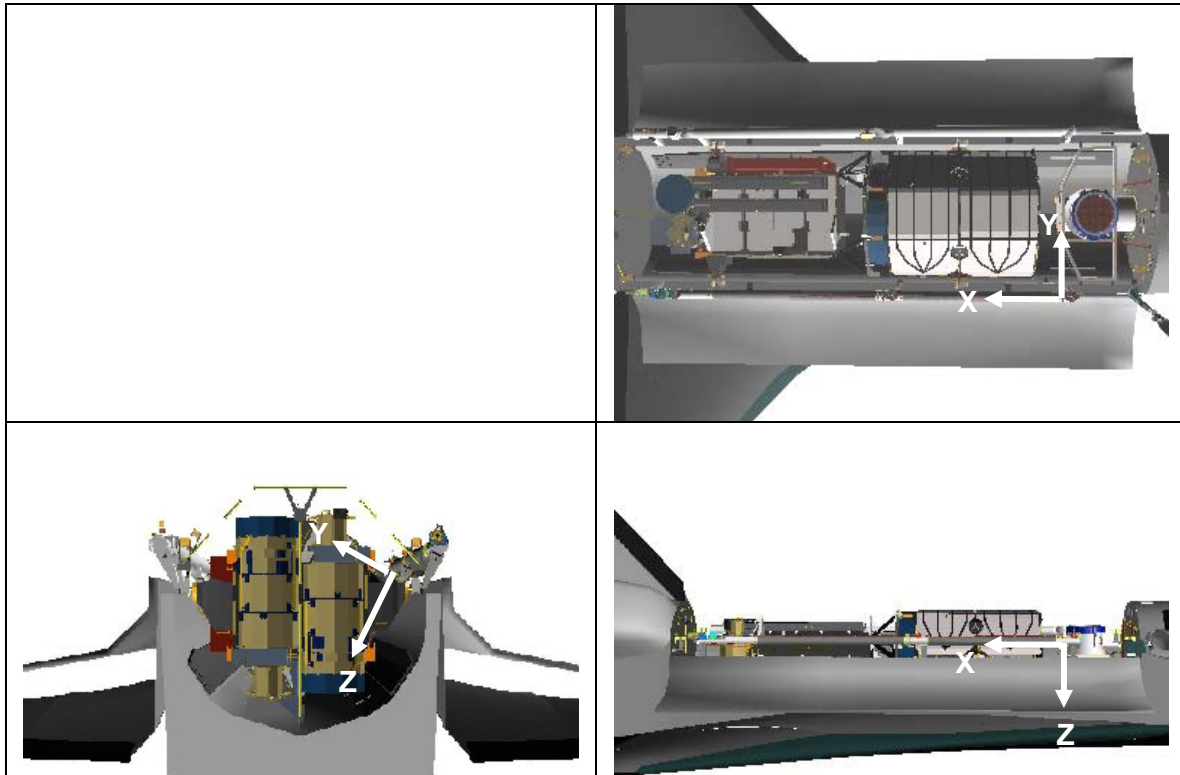

POR:

POR at OBSS fwd striker bar

PURPOSE:

OBSS unberth/berth

FOR RATES:

TRANS LIM ft/sec

ROT LIM deg/sec

COARSE

0.20

0.88

VERN

0.10

0.08

JOINT RATES:

SHOULDER LIM deg/sec

ELBOW LIM deg/sec

WRIST LIM deg/sec

COARSE

1.27

1.78

2.64

VERN

0.42

0.59

0.88

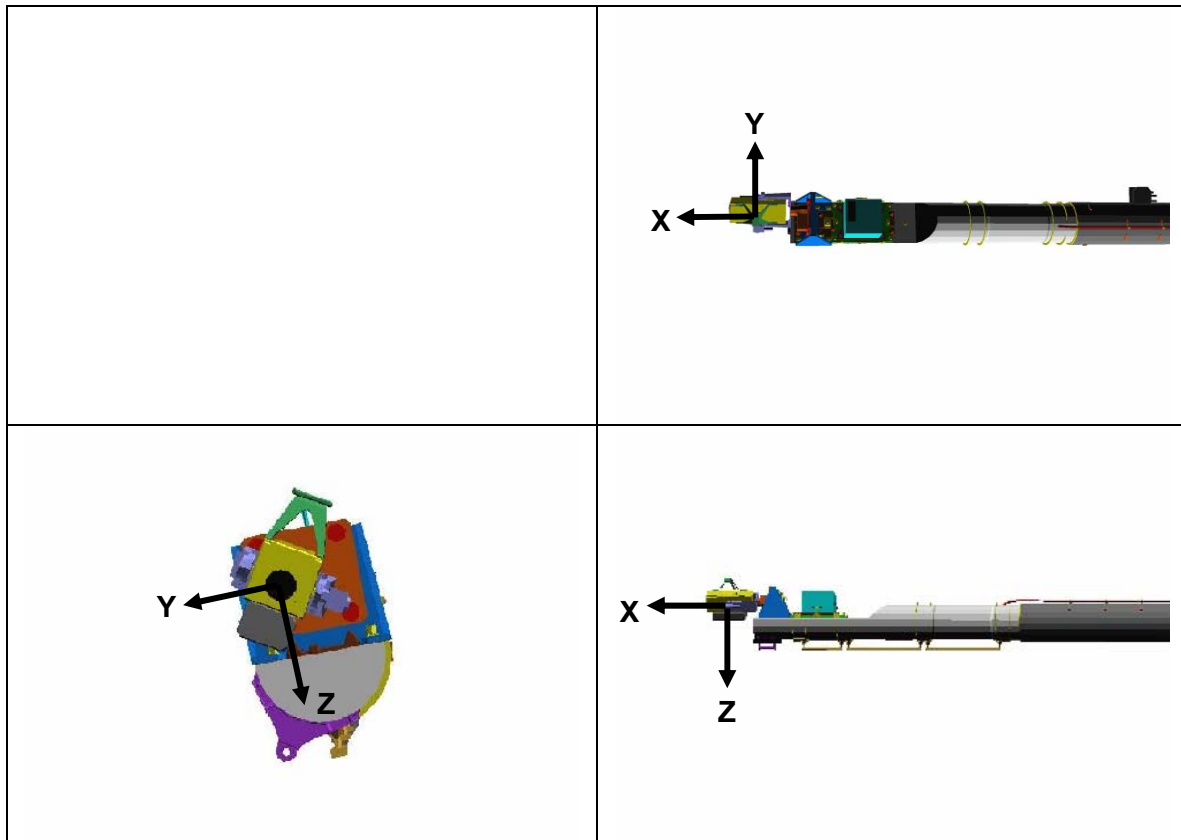

POR: POR at OBSS ITVC/LDRI PTU Pivot Point

PURPOSE: OBSS Surveys using LDRI/IDC

FOR RATES:	<u>COARSE</u>	<u>VERN</u>
TRANS LIM ft/sec	0.23	0.20
ROT LIM deg/sec	2.64	0.88

JOINT RATES:	<u>COARSE</u>	<u>VERN</u>
SHOULDER LIM deg/sec	1.27	0.42
ELBOW LIM deg/sec	1.78	0.59
WRIST LIM deg/sec	2.64	0.88

RATIONALE: The LDRI scan rate is 4.3 M/min (0.25 ft/s), while the IDC scan rate is 3.6 M/min (0.20 ft/s)

## OBSS JOINT ANGLES VS POR COORDINATES

I

### OBSS PRE-GRAPPLE

SY	SP	EP	WP	WY	WR		
-90.0	+87.6	-129.5	-57.5	0.0	-249.6		
X	Y	Z	PITCH	YAW	ROLL	PL ID	
-680	+96	-513	270	350	1	0	
-680	+95	-495	0	0	340	1	
-1271	+92	-510	0	0	10	2	

### OBSS GRAPPLE/BERTH (Expected Values)

SY	SP	EP	WP	WY	WR		
-90.0	+76.5	-134.6	-40.9	0.0	-250.0		
X	Y	Z	PITCH	YAW	ROLL	PL ID	
-680	+106	-454	270	350	1	0	
-680	+105	-435	0	0	341	1	
-1271	+106	-451	0	0	11	2	

### OBSS HOVER

SY	SP	EP	WP	WY	WR		
-90.0	+79.8	-123.1	-55.7	0.0	-250.0		
X	Y	Z	PITCH	YAW	ROLL	PL ID	
-680	+128	-514	270	350	1	0	
-680	+126	-496	0	0	341	1	
-1271	+127	-511	0	0	11	2	

### OBSS SJ PRE-GRAPPLE

SY	SP	EP	WP	WY	WR		
-90.0	+87.9	-129.8	-57.0	0.0	-250.0		
X	Y	Z	PITCH	YAW	ROLL	PL ID	
-680	+96	-513	270	350	1	0	
-680	+94	-495	0	0	341	1	
-998	+97	-506	0	0	11	2	

### OBSS JETTISON

SY	SP	EP	WP	WY	WR		
-29.5	+66.7	-68.5	+26.8	+18.9	-9.9		
X	Y	Z	PITCH	YAW	ROLL	PL ID	
-1078	-1	-745	25	0	1	0	
-1094	-5	-761	115	0	330	1	
-830	-2	-1290	115	0	0	2	



## OBSS AUTO SEQUENCES

Auto Seq ID	Auto posn	X/ SY	Y/ SP	Z/ EP	PITCH/ WP	YAW/ WY	ROLL/ WR	Pause
1	1	-1270	+350	-445	0	0	11	P
		-90.1	+25.0	-65.8	-57.6	0.0	-249.9	
1	2	-1200	+265	-445	0	0	11	
		-101.0	+42.0	-92.8	-47.5	-1.6	-239.1	
1	3	-1290	+320	-445	0	0	11	
		-87.3	+31.7	-77.0	-53.1	0.4	-252.7	
1	4	-1140	+265	-445	0	0	11	
		-109.8	+39.5	-87.8	-49.7	-2.9	-230.4	
1	5	-1155	+290	-490	0	0	11	
		-106.1	+39.3	-77.9	-59.5	-2.3	-234.1	
1	6	-926	+300	-270	322	0	89	
		-119.0	+46.7	-70.9	+1.4	+26.5	-201.2	
1	7	-909	+255	-274	337	10	82	P
		-127.9	+14.8	-41.0	-13.3	+36.8	-202.8	
1	8	-984	+260	-276	321	16	87	
		-105.9	+15.8	-21.1	-29.4	+23.8	-200.3	
1	9	-1025	+285	-273	304	6	62	
		-85.6	+35.6	-25.9	-51.4	-23.0	-199.3	
1	10	-1233	+508	-293	316	346	64	
		-70.8	+30.1	-33.0	-35.0	-43.5	-225	
1	11	-1300	+516	-272	326	349	55	
		-71.5	+18.8	-30.4	-42.8	-38.8	-242.5	
1	12	-1298	+482	-219	340	352	25	
		-79.0	+11.2	-48.5	-49.8	-22.4	-260.2	
1	13	-1328	+464	-221	348	346	12	P
		-74.9	+16.3	-74.3	-43.0	-12.2	-276.6	
1	14	-1310	+448	-220	348	344	7	
		-75.7	+21.8	-85.4	-41.9	-10.4	-278.6	
1	15	-1066	+233	-199	335	9	28	
		-107.2	+31.2	-77.3	-29.4	-14.2	-212.6	
1	16	-1021	+211	-206	341	12	33	
		-116.7	+20.2	-68.0	-26.1	-2.7	-203.7	
1	17	-919	+213	-222	335	15	49	
		-122.5	+12.2	-38.9	-36.6	+9.4	-192.8	
1	18	-1019	+227	-210	339	11	37	
		-115.7	+22.5	-67.7	-24.7	-1.9	-204.2	
1	19	-1038	+267	-229	315	9	67	
		-95.3	+42.9	-62.1	-22.4	-6.1	-201.6	
1	20	-1268	+483	-236	335	350	44	
		-79.2	+26.2	-65.0	-26.9	-29.3	-249.4	
1	21	-1334	+531	-252	329	343	59	P
		-65.4	+29.3	-58.9	-24.8	-45.6	-251.8	
1	22	-1338	+538	-318	317	342	89	
		-60.6	+18.3	-14.3	-14.3	-42.8	-210.9	
1	23	-1274	+522	-317	308	339	90	
		-58.6	+29.5	-23.2	-9.8	-44.1	-198.0	
1	24	-1222	+479	-341	292	325	82	
		-37.7	+39.3	-26.2	+18.0	-70.0	-153.3	
1	25	-1029	+304	-315	275	340	71	
		-41.4	+41.6	-5.3	-39.4	-69.2	-167.5	

## OBSS AUTO SEQUENCES (Cont)

Auto Seq ID	Auto posn	X/ SY	Y/ SP	Z/ EP	PITCH/ WP	YAW/ WY	ROLL/ WR	Pause
1	26	-1009	+284	-282	290	359	89	
		-73.4	+47.9	-31.1	-36.6	-17.0	-185.5	
1	27	-977	+263	-261	309	13	85	
		-97.6	+27.3	-25.9	-34.7	+10.6	-193.8	
1	28	-923	+249	-253	323	16	77	<b>P</b>
		-113.4	+8.9	-13.0	-39.0	+22.2	-194.5	
1	29	-862	+319	-242	284	0	73	
		-83.1	+40.1	-24.7	-40.2	-22.8	-177.6	
1	30	-817	+295	-265	288	2	85	
		-94.8	+40.3	-22.4	-40.8	+0.3	-176.2	
1	31	-740	+295	-279	286	358	88	
		-102.7	+48.8	-31.0	-36.2	+9.6	-172.0	
1	32	-589	+290	-294	267	357	88	
		-97.4	+45.0	-16.1	-45.3	+5.3	-154.9	
1	33	-550	+293	-310	268	353	89	
		-104.9	+52.4	-24.0	-41.2	+13.8	-154.7	
1	34	-198	+177	-252	203	21	109	
		-85.0	+26.4	-72.6	-0.1	-14.1	-102.7	
1	35	-449	+270	-396	205	359	90	
		-49.6	+43.6	-60.7	-6.9	-36.9	-110.4	
1	36	-452	+272	-353	208	357	81	
		-48.4	+47.9	-72.6	+10.9	-42.4	-107.2	
1	37	-522	+272	-317	270	352	72	
		-110.1	+55.5	-25.8	-40.6	+1.7	-156.1	
1	38	-550	+293	-310	268	353	89	
		-104.9	+52.4	-24.0	-41.2	+13.8	-154.7	
1	39	-585	+291	-320	271	353	89	
		-104.2	+47.4	-13.0	-47.2	+12.7	-157.9	
1	40	-634	+291	-312	275	354	91	
		-103.1	+49.0	-18.3	-44.4	+13.2	-161.9	
1	41	-922	+337	-290	293	358	98	<b>P</b>
		-89.3	+42.4	-26.9	-30.0	+5.9	-183.3	
1	42	-964	+297	-346	289	339	118	
		-72.3	+92.5	-78.7	-5.0	+2.4	-176.1	
1	43	-1029	+302	-330	271	335	75	
		-33.4	+43.8	-9.1	-18.6	-71.4	-147.0	
1	44	-1054	+304	-353	271	322	81	
		-17.0	+62.1	-46.2	+54.0	-70.7	-95.1	
1	45	-1276	+510	-364	305	310	100	
		-24.8	+50.3	-66.4	+95.5	-61.7	-113.9	
1	46	-1328	+529	-363	313	316	105	
		-32.4	+48.9	-67.4	+77.0	-62.2	-142.3	
1	47	-1391	+478	-395	320	306	166	
		-17.8	+47.4	-72.6	+78.3	-15.0	-130.9	
1	48	-1292	+476	-390	299	298	121	
		-9.7	+37.4	-49.3	+86.7	-41.3	-100.5	
1	49	-1167	+367	-385	277	299	94	
		+1.1	+45.8	-48.4	+97.1	-48.3	-69.4	

**OBSS AUTO SEQUENCES (Cont)**

Auto Seq ID	Auto posn	X/ SY	Y/ SP	Z/ EP	PITCH/ WP	YAW/ WY	ROLL/ WR	Pause
1	50	-1096	+300	-376	269	307	92	
		+1.9	+56.2	-49.9	+81.5	-56.5	-70.2	
1	51	-1060	+281	-389	263	313	87	
		-2.9	+48.6	-26.7	+58.0	-62.0	-75.5	
1	52	-978	+283	-384	262	320	77	
		-13.0	+63.5	-43.5	+58.4	-68.1	-79.5	
1	53	-899	+284	-386	247	319	72	P
		-9.7	+60.2	-46.1	+60.7	-64.5	-70.7	
2	54	-899	+284	-386	247	319	72	P
		-9.7	+60.2	-46.1	+60.7	-64.5	-70.7	
2	55	-550	-50	-900	100	295	345	
		+110.0	+46.1	-17.0	+100.3	-57.7	+69.9	
2	56	-150	+20	-355	241	312	350	
		+143.7	+75.9	-61.9	+13.4	+33.8	+153.8	
2	57	-164	+20	-355	241	312	350	P
		+142.3	+78.7	-65.4	+14.5	+35.0	+153.1	
3	58	-164	+20	-355	241	312	350	P
		+142.3	+78.7	-65.4	+14.5	+35.0	+153.1	
3	59	-155	+50	-373	240	314	1	
		+148.1	+84.0	-70.9	+23.9	+37.5	+152.1	
3	60	-170	+63	-305	262	328	17	
		+175.0	+56.5	-21.9	-22.8	+24.1	+185.5	
3	61	-170	+45	-330	260	328	17	
		+173.2	+51.3	-6.1	-31.1	+26.4	+184.7	
3	62	-145	+15	-315	240	300	330	
		+136.7	+51.4	-43.1	+0.9	+30.4	+150.1	
3	63	-157	+36	-319	228	286	312	
		+132.6	+21.8	-12.4	-10.1	+34.7	+141.3	
3	64	-155	-8	-336	209	295	292	
		+123.4	+50.4	-59.1	+12.5	+33.2	+137.7	
3	65	-164	+10	-288	222	289	279	
		+129.4	+29.9	-24.8	-28.2	+18.5	+151.8	
3	66	-158	+5	-320	224	292	300	
		+129.2	+41.4	-38.9	-7.6	+28.8	+146.3	
3	67	-170	+15	-380	226	295	357	
		+128.8	+46.0	-43.7	+61.1	+45.2	+104.2	
3	68	-155	+30	-335	235	305	357	
		+135.2	+66.8	-67.5	+47.2	+44.5	+130.4	
3	69	-160	+70	-340	249	330	35	
		+175.3	+85.2	-63.1	+8.8	+45.0	+181.3	
3	70	-202	+92	-330	260	327	49	
		+173.8	+68.8	-41.5	+3.2	+55.8	+172.6	
3	71	-180	+70	-360	249	329	30	
		+175.1	+88.4	-62.7	+3.8	+40.3	+181.4	
3	72	-181	+60	-395	238	297	15	
		+136.5	+54.5	-48.9	+61.4	+47.0	+108.2	
3	73	-179	+33	-405	226	295	357	
		+130.0	+53.8	-52.6	+61.1	+44.7	+106.0	

**OBSS AUTO SEQUENCES (Cont)**

Auto Seq ID	Auto posn	X/ SY	Y/ SP	Z/ EP	PITCH/ WP	YAW/ WY	ROLL/ WR	Pause
3	74	-185	-35	-400	180	300	310	
		+110.8	+42.4	-69.1	+89.7	+34.6	+87.0	
3	75	-179	-70	-360	161	316	268	
		+98.6	+28.0	-85.7	+88.5	+34.6	+91.9	
3	76	-171	-25	-370	163	310	273	
		+105.1	+33.6	-88.1	+89.2	+33.9	+94.0	
3	77	-170	-50	-300	163	314	245	
		+100.5	+25.8	-83.1	+57.9	+37.9	+112.4	
3	78	-205	-5	-245	182	292	230	
		+115.2	+26.7	-48.4	-14.1	+24.4	+148.9	
3	79	-210	+20	-255	154	296	195	
		+113.5	+10.5	-41.2	-18.8	+25.8	+146.4	
3	80	-208	+61	-265	147	293	187	
		+118.9	+9.2	-40.8	-19.6	+24.2	+145.8	
3	81	-175	+35	-252	151	302	189	
		+114.4	+8	-48.7	-11.7	+23.5	+140.8	
3	82	-184	-28	-256	254	308	309	
		+141.6	+45.8	-20.9	-38.5	+1.0	+167.5	
3	83	-165	+60	-295	140	295	195	
		+122.6	+0.9	-29.0	-9.1	+30.9	+134.4	
3	84	-165	-5	-305	186	295	258	
		+117.4	+40.3	-64.4	+14.2	+32.6	+135.7	
3	85	-165	-75	-340	186	295	258	
		+114.6	+29.0	-32.3	-6.9	+35.3	+136.3	
3	86	-181	-75	-340	186	295	258	P
		+113.0	+31.7	-37.2	-4.9	+36.9	+136.6	
3	87	-216	-65	-273	162	300	213	
		+105.7	+12.2	-33.7	-17.5	+33.5	+143.7	
3	88	-215	-35	-247	155	305	190	
		+104.7	+6.5	-39.6	-23.3	+25.7	+147.1	
3	89	-165	-45	-320	160	297	227	P
		+113.8	+14.2	-32.5	-2.3	+36.2	+131.5	
4	90	-165	-45	-320	160	297	227	P
		+113.8	+14.2	-32.5	-2.3	+36.2	+131.5	
4	91	-500	-280	-800	80	341	289	
		+129.3	+16.3	-56.1	+96.3	-50.5	+44.5	
4	92	-770	-290	-700	40	341	289	
		+137.1	+26.8	-51.2	+68.3	-68.9	+0.6	
4	93	-899	-290	-284	2	341	289	
		+135.0	+19.4	-47.1	+27.9	-63.6	-74.3	
4	94	-899	-252	-284	2	341	289	P
		+138.1	+23.8	-58.9	+35.3	-66.7	-74.2	
5	95	-899	-252	-284	2	341	289	P
		+138.1	+23.8	-58.9	+35.3	-66.7	-74.2	
5	96	-964	-254	-281	10	343	297	
		+131.3	+18.7	-68.2	+38.4	-60.5	-76.3	
5	97	-1027	-281	-267	13	347	304	
		+124.7	+16.1	-75.2	+39.9	-51.4	-77.4	
5	98	-1073	-322	-262	16	355	308	
		+120.7	+12.2	-81.9	+48.1	-42.7	-71.7	

## OBSS AUTO SEQUENCES (Cont)

Auto Seq ID	Auto posn	X/ SY	Y/ SP	Z/ EP	PITCH/ WP	YAW/ WY	ROLL/ WR	Pause
5	99	-1208	-450	-257	15	7	319	
		+97.9	+18.9	-97.1	+47.8	-13.6	-58.7	
5	100	-1255	-500	-266	14	3	316	
		+90.7	+21.9	-82.1	+34.1	-8.6	-58.4	
5	101	-1308	-518	-269	12	3	313	
		+83.6	+25.4	-81.6	+33.2	-0.1	-56.6	
5	102	-1367	-500	-230	336	350	326	<b>P</b>
		+67.6	+52.8	-47.0	-47.8	+31.9	-76.5	
5	103	-1303	-481	-229	329	349	320	
		+69.2	+63.6	-53.4	-44.9	+34.8	-86.1	
5	104	-1052	-212	-197	320	322	340	
		+84.	+66.0	-60.1	-61.5	+29.8	-112.2	
5	105	-991	-186	-201	316	319	341	
		+87.3	+67.2	-59.4	-63.0	+31.5	-118.5	
5	106	-890	-188	-208	315	323	326	
		+107.1	+76.7	-69.3	-46.7	+7.4	-134.4	
5	107	-971	-215	-211	306	329	338	
		+84.1	+85.2	-65.4	-69.6	+43.5	-113.4	
5	108	-1018	-253	-218	294	332	313	
		+59.3	+74.8	-39.0	-72.7	+56.0	-115.7	
5	109	-1047	-253	-211	318	340	336	
		+94.4	+102.0	-94.2	-50.1	+27.2	-108.9	
5	110	-1172	-397	-230	305	345	311	
		+56.3	+63.3	-22.2	-69.7	+56.4	-105.2	
5	111	-1299	-484	-236	334	348	328	
		+74.3	+57.9	-49.9	-50.1	+27.9	-83.1	
5	112	-1317	-506	-252	327	352	316	
		+65.4	+64.0	-46.9	-47.6	+40.1	-86.2	
5	113	-1356	-546	-292	314	6	287	
		+36.4	+70.8	-45.6	+5.0	+67.4	-138.9	
5	114	-1323	-537	-315	346	348	282	<b>P</b>
		+80.9	+49.1	-50.2	+5.9	+0.6	-87.1	
5	115	-1244	-513	-305	353	357	287	
		+93.4	+63.0	-95.3	+34.6	-4.2	-77.4	
5	116	-1176	-450	-298	352	2	290	
		+107.5	+76.4	-122.8	+46.3	-12.9	-76.9	
5	117	-1106	-380	-295	352	4	291	
		+129.7	+77.1	-134.2	+56.0	-33.1	-76.8	
5	118	-1023	-300	-288	354	357	289	
		+143.2	+59.7	-116.9	+57.7	-54.0	-76.3	
5	119	-989	-275	-294	350	350	282	
		+141.9	+62.4	-105.9	+54.8	-59.0	-73.1	
5	120	-965	-267	-294	350	350	282	
		+145.2	+59.3	-101.8	+54.9	-62.2	-71.7	
5	121	-933	-261	-289	358	347	283	
		+142.4	+37.4	-82.2	+57.6	-64.1	-64.6	

## OBSS AUTO SEQUENCES (Cont)

Auto Seq ID	Auto posn	X/ SY	Y/ SP	Z/ EP	PITCH/ WP	YAW/ WY	ROLL/ WR	Pause
5	122	-920	-256	-288	336	326	284	
		+121.1	+53.9	-52.5	-15.9	-53.9	-112.5	
5	123	-891	-310	-249	333	349	319	P
		+142.1	+74.0	-81.3	-26.3	-32.0	-123.2	
5	124	-575	-287	-320	271	352	294	
		+155.3	+96.8	-30.5	-53.2	-40.4	-146.1	
5	125	-255	-205	-335	249	344	289	
		+165.5	+88.2	-38.3	-33.2	-50.4	-164.3	
5	126	-525	-283	-346	223	337	286	
		+41.8	+65.7	-36.9	+18.8	+70.7	-247.8	
5	127	-459	-275	-307	221	331	292	
		+57.3	+67.9	-52.2	+23.5	+65.5	-240.3	
5	128	-556	-283	-327	241	339	303	
		+48.1	+76.0	-31.0	+18.4	+73.0	-245.1	
5	129	-573	-288	-320	264	348	301	
		+100.4	+96.4	-26.9	-59.4	+21.8	-164.8	
5	130	-702	-288	-320	270	348	301	
		+58.2	+91.1	-19.0	-58.2	+62.3	-168.5	
5	131	-904	-318	-332	319	350	290	
		+144.4	+95.3	-72.9	-25.5	-48.9	-114.5	
5	132	-889	-294	-316	317	347	288	P
		+143.7	+94.7	-73.2	-25.2	-50.2	-117.2	
5	133	-990	-272	-303	318	345	282	
		+126.3	+110.3	-92.0	-17.6	-39.1	-113.6	
5	134	-1081	-318	-360	344	352	241	
		+129.8	+85.6	-116.6	+93.9	-38.5	-44.4	
5	135	-1258	-491	-368	334	357	243	
		+83.4	+91.5	-91.4	+42.0	-9.1	-96.9	
5	136	-1345	-525	-369	339	359	245	
		+71.8	+81.7	-88.9	+49.3	+3.9	-101.1	
5	137	-1342	-480	-396	333	359	216	
		+67.2	+89.8	-87.7	+61.4	-13.0	-107.9	
5	138	-1290	-463	-396	329	358	215	
		+72.8	+95.5	-86.4	+54.2	-19.1	-104.7	
5	139	-1236	-427	-390	333	355	218	
		+88.3	+97.4	-97.0	+66.3	-23.3	-85.6	
5	140	-1120	-319	-390	339	351	222	
		+120.8	+97.3	-113.2	+95.0	-31.3	-45.5	
5	141	-1074	-305	-390	349	338	230	
		+115.5	+62.3	-83.9	+93.3	-34.8	-37.8	
5	142	-1040	-289	-390	352	347	237	
		+131.7	+66.4	-103.0	+106.8	-36.5	-29.3	
5	143	-1008	-287	-367	305	356	261	
		+137.2	+128.7	-76.4	-16.6	-51.9	-98.8	
5	144	-892	-294	-364	342	353	255	P
		+155.7	+62.3	-81.8	+91.5	-57.0	-23.9	
6	145	-892	-294	-364	342	353	255	P
		+155.7	+62.3	-81.8	+91.5	-57.0	-23.9	
6	146	-1600	+25	-985	40	0	11	
		-23.1	+45.6	-48.6	-51.4	+18.3	+26.3	
6	147	-1271	+134	-532	0	0	11	P
		-89.9	+80.2	-118.8	-59.8	+0.0	+109.9	

## RMS GO/NO-GO CRITERIA (FLIGHT RULE A12-1001)

CONTINUE OPERATIONS IF:							
	RMS UNCRADLE	CONTINUE UNLOADED	GRAPPLE UNBERTH	CONTINUE LOADED	HIGH PRIORITY	ENTRY	FLIGHT RULES REF.
A. SHOULDER BRACE REL (1)	0 ↓ [6]						{A12-91}
B. JETTISON SYSTEM (2)	1 ↓ [4]	1 ↓ [4]	1 ↓ [4]	1 ↓ [4]	1 ↓		{A12-181}
C. MPM STOW MOTORS (2)	0 ↓ [6]	0 ↓ [6]	0 ↓ [6]	0 ↓ [6]	2 ↓ [6]		{A12-72}
D. MRL LAT CAP (3)	[1]	[1]	[1]	[1]	[5]		{A12-73}
E. MPM (4) STOWED INDICATIONS (8)						[2]	{A12-72}
F. MPM (4) DEP INDICATIONS (8)	SHOULDER 1 ↓	SHOULDER 1 ↓	SHOULDER 1 ↓	SHOULDER 1 ↓	SHOULDER 1 ↓		{A12-72}
G. MRLs LATCHED (3)						1 ↓	{A12-73}
H. MANUAL AUG MODE (1)					3 ↓ [7]		{A12-111}
I. DIRECT MODE (1)	1 ↓	1 ↓	1 ↓	1 ↓			{A12-111}
J. SINGLE MODE (1)							{A12-111}
K. BACKUP MODE (1)	0 ↓	0 ↓	0 ↓	0 ↓			{A12-111}
L. BRAKES (6)	WRIST ROLL ↓	WRIST ROLL ↓	0 ↓	0 ↓	0 ↓		{A12-115}
M. AUTO BRAKES (1)	0 ↓ [3]	0 ↓ [3]	0 ↓ [3]	0 ↓ [3]	0 ↓ [3]		{A12-116}
N. CAPTURE & RIGIDIZE (2)			1 ↓		1 ↓		{A12-161}
O. DERIGIDIZE (2)			1 ↓	1 ↓	2 ↓		{A12-161}
P. RELEASE (2)			1 ↓ [6]	1 ↓ [6]			{A12-161}
Q. BACKUP, RELEASE (1)			0 ↓ [6]	0 ↓ [6]	2 ↓ [6]		{A12-161}
R. THERMAL (DEG F) -20(0), 176(172), LED -20(0), 147(144), ABE(EE) -20(0), 110(106) ABE(SPA)	REQUIRED	REQUIRED	REQUIRED	REQUIRED	REQUIRED		{A12-3}

@[113095-1809A] @[111298-6744] @[110900-7257]

### NOTES:

- [1] CONTINUE OPERATIONS IF ONE FAILURE WILL NOT RESULT IN THE INABILITY TO LATCH AT LEAST TWO MRLs
- [2] ONE AT THE SHOULDER AND ONE AT EITHER THE MID OR AFT PEDESTAL IS REQUIRED
- [3] OPERATIONS IN DIRECT AND BACKUP CAN CONTINUE WITH THE LOSS OF AUTOBRAKES
- [4] RMS SYSTEM REDUNDANCY OR JETT REDUNDANCY IFM REQUIRED. @[113095-1809A]
- [5] CONTINUE OPERATIONS EVEN IF ONE FAILURE WILL RESULT IN THE INABILITY TO LATCH AT LEAST TWO MRLs (ASSUMES CURRENTLY HAVE TWO-LATCH CAPABILITY). EVA CAPABILITY REQUIRED. @[110900-7257]
- [6] EVA CAPABILITY EXISTS FOR THE FOLLOWING CONTINGENCIES:
  - SHOULDER BRACE RELEASE
  - MPM DEPLOY/STOW
  - RMS STRAPDOWN
  - GRAPPLE FIXTURE (GF) RELEASE
- [7] ONE OF SINGLE, DIRECT, OR BACKUP REQUIRED FOR UNCRADLING. @[110900-7257]

## FLIGHT RULE REFERENCES

### DAP CONSTRAINTS TABLE

SCENARIO	CONDITION	VERN	PRCS ATT CONTROL	PRCS TRANS	OMS
<b>Unloaded (or EVA Ops &lt; 1000 lb)</b>	Pre-cradle or cradled with at least 2 of 3 MRLs latched	GO	GO	GO	GO
	< 5 ft from structure	GO	NO GO	NO GO	NO GO
	≥ 5 ft from structure	GO	GO	GO	NO GO
	Singularity/Reach Limit	GO	NO GO	NO GO	NO GO
	TEST mode	GO	NO GO	NO GO	NO GO
	EE Ops	GO	NO GO	NO GO	NO GO
	<b>Loaded (or EVA Ops &gt; 1000 lb)</b>	< 2 ft from structure	NO GO	NO GO	NO GO
Singularity/Reach Limit		NO GO	NO GO	NO GO	NO GO
TEST mode (unless grappled to a constrained PL)		NO GO	NO GO	NO GO	NO GO
Maneuvering 1000 lb < PL < 8000 lb (outside 2 ft)		GO	NO GO	NO GO	NO GO
Maneuvering PL > 8000 lb		NO GO	NO GO	NO GO	NO GO
Free Flyer EE Ops		NO GO	NO GO	NO GO	NO GO
Constrained Payload EE Ops		GO	NO GO	NO GO	NO GO
Grappled to a constrained PL	GO	GO	GO	GO	

### UNATTENDED ARM CONSTRAINTS

THE RMS MAY BE LEFT **UNATTENDED** IF:

- ARM SELECTED
- BRAKES ON
- MODE NOT DIRECT
- JOINT SWITCH IS CRIT TEMP
- MCIU MAINTAINS I/O WITH GPC
- RMS/PAYLOAD CLEARANCE **GREATER THAN 5 FT**

### ORBITER PROXIMITY CONSTRAINTS

Condition	GO IF:
Coarse	> 10 ft from structure
Rate Hold	> 10 ft or moving away from structure
OCAS/ACAS	> 5 ft from structure



## SPEC 95 ABE OVERRIDES

SPEC 95 MCIU Override: ABE OVRD	SPEC 96 Fault '↓'	Autobrakes
A	TACHOMETER MICROCOMPUTER POS ENCODER	YES YES YES
B	SPA CMTR MDA DMND BRAKE	YES YES YES
C	TACH TCO A/D CONV	YES YES
No override exists for these failures	MDA OVERCURRENT/ MOTOR DRV FAULT BACKUP RELAY DIRECT DRIVE BITE	NO NO NO

- A 2<sup>nd</sup> failure of a different type (A, B, or C) for a different joint may be overridden
- A 2<sup>nd</sup> failure of the same type (A, B, or C) for a different joint will be annunciated, will be protected by autobrakes, and cannot be overridden

For example, firmware cannot override two MDA Demand Voltage failures. If a subsequent failure occurs of the same type on another joint, it will be annunciated and protected by autobrakes

## RMS MODE RESPONSE MATRIX

		EE	ORB UNL/TEST	ORB LD			PL	SINGLE/IDLE	DIRECT
				NORM	FLY-CAMR	FLY-PL			
POR	POS/ATT	PL ID 0		PL ID X					
HC RESPONSE	THC	EEOS	OBAS	FCTS	FPTS	PLOS		N/A	
	RHC	EEOS	ORAS	FCRS	FPRS	PLOS			
CONSISTENCY CHK AND RATE LIMS	LRLF	PL ID X							
	NO LF	PL ID 0							

### NOTES:

1. PL ID 0 indicates tip of end effector. PL ID X indicates flight specific POR.
2. Fly-Payload Translation System (FPTS) and Fly-Payload Rotational System (FPRS) are defined by ITEMS 21 thru 23 on SPEC 94.
3. Fly-Camera Translation System (FCTS) and Fly-Camera Rotational System (FCRS) are opposite of FPTS and FPRS respectively.
4. While SPEC 94 ITEM 30 set to ORB, POR position is expressed in OBAS and POR attitude is expressed in ORAS. SPEC 94 ITEM 30 REL will display the errors between the current POR position/attitude and the desired POR position/attitude loaded on SPEC 94 ITEMS 18-23. REL will provide these errors such that the operator shall remove the errors (fly them to 0) as if they were commanding in the OBAS (for translations) and ORAS (for rotations) reference frames. As a result of the conversion of the HC inputs required in OBAS/ORAS, REL numbers may change with the mode selected.
5. The GPC loaded rate limit flag (LRLF) must be set in order to achieve loaded rate limits and loaded consistency checks in PL IDs 1 thru 5. If the LRLF is not set, software will assume unloaded rate limits and consistency check parameters independently of current PL ID. The LRLF is set when both EE CAPTURE and EE RIGID MSWs are gained (tb-gray). The LRLF is set to OFF when both EE CAPTURE and EE RIGID MSWs are lost (tb-bp) and EE DERIGID MSW is gained (tb-gray). In the event of EE CAPTURE or EE RIGID MSW failure, a SPEC 95 ITEM entry can be used to force the LRLF to be set.

To Set Loaded Rates:

Rig	Cl	Cap
<input type="checkbox"/>	<input type="checkbox"/>	<input type="checkbox"/>
Derig	Op	Ext
<input type="checkbox"/>	<input type="checkbox"/>	<input type="checkbox"/>

To Set Loaded Rates OFF:

Rig	Cl	Cap
<input type="checkbox"/>	<input type="checkbox"/>	<input type="checkbox"/>
Derig	Op	Ext
<input type="checkbox"/>	<input type="checkbox"/>	<input type="checkbox"/>

# HAND CONTROLLER AXIS SWAP

Lost THC Axis	Regain POR Translation Using SPEC 95 ITEMS 32,33
IN	UP
OUT	DOWN
LEFT	IN
RIGHT	OUT
UP	LEFT
DOWN	RIGHT

Lost RHC Axis	Regain POR Rotation Using SPEC 95 ITEMS 32,34
PITCH UP	ROLL RIGHT
PITCH DOWN	ROLL LEFT
YAW LEFT	PITCH DOWN
YAW RIGHT	PITCH UP
ROLL LEFT	YAW LEFT
ROLL RIGHT	YAW RIGHT

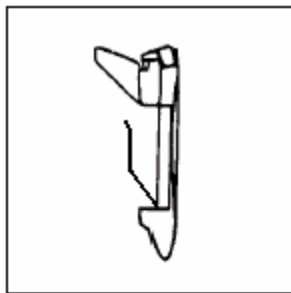

THC AXIS CHANGE  
ORB UNL MODE

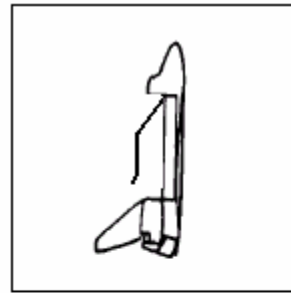

RHC AXIS CHANGE  
ORB UNL MODE

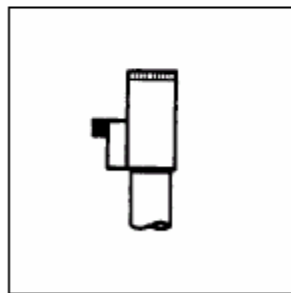

THC AXIS CHANGE  
EE MODE

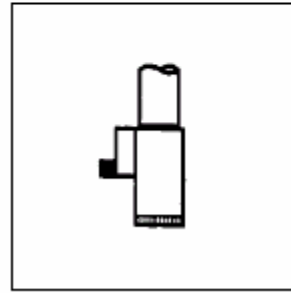

RHC AXIS CHANGE  
EE MODE

## RMS/EVA VOICE PROTOCOL (GCA)

### RMS Maneuvering SHUTTLE VOICE PROTOCOL for EVA Operations

COMMAND	MEANING
No More (commanded motion)	stop commanded motion only
Stop Motion	stop all motion
ALL STOP, ALL STOP, ALL STOP	stop all motion, brakes on (unexpected motion observed)

### BODY-REFERENCED COMMANDS (Translations relative to EVA crewmember)

TRANSLATIONAL COMMANDS	MEANING
IN	straight ahead (out of EVA's chest)
OUT	directly behind (out of EVA's back)
LEFT	to EVA's left
RIGHT	to EVA's right
UP	directly above EVA's head
DOWN	directly below EVA's feet

### (Rotations relative to EVA crewmember)

ROTATIONAL COMMANDS	MEANING
PITCH UP	rotate toward EVA's head
PITCH DOWN	rotate toward EVA's feet
YAW RIGHT	rotate about EVA's long axis to right
YAW LEFT	rotate about EVA's long axis to left
ROLL RIGHT	rotate toward EVA's right shoulder
ROLL LEFT	rotate toward EVA's left shoulder

### ORBITER-REFERENCED COMMANDS (used to command translations only)

COMMAND	MEANING
INTO THE BAY	OBAS +Z
OUT OF THE BAY	OBAS -Z
SHUTTLE FORWARD	toward orbiter's nose along OBAS +X axis
SHUTTLE AFT	toward orbiter's tail along OBAS -X axis
SHUTTLE PORT	toward orbiter port along OBAS -Y axis
SHUTTLE STARBOARD	toward orbiter starboard along OBAS +Y axis

### STATION-REFERENCED COMMANDS (used to command translations only)

COMMAND	MEANING
ZENITH	ISSACS -Z
NADIR	ISSACS +Z
STATION FORWARD	ISSACS +X
STATION AFT	ISSACS -X
STATION STARBOARD	ISSACS +Y
STATION PORT	ISSACS -Y

## ALL-STOP PROTOCOL

VOICE CMD TO CREW	MEANING	ACTION
<p><b>'Stop Motion'</b> (or other similar request for nominal stop of arm motion)</p>	<p>Stop commanded arm motion, situation is nominal</p>	<p>Smoothly release HCs to stop motion. If in Auto Mode, AUTO SEQ switch – STOP If motion continues, BRAKES – ON If motion still continues, RMS SELECT – OFF</p>
<p><b>'All Stop, All Stop, All Stop'</b></p>	<p>Emergency situation. Stop all motion immediately</p>	<p>Expediently release HCs and stop motion with BRAKES – ON If motion continues, RMS SELECT – OFF</p>

**Notes:**

1. This table is designed to protect for the worst-case situation (impending structural contact, dangerous EVA condition, unexpected arm motion, arm malfunction, etc)
2. Voice Commands can come from several sources: EVA, MCC, R2/M2, or any crewmember
3. The words "All Stop" are reserved for emergency situations (and repeated three times)
4. In an emergency situation, whoever is giving the "All Stop, All Stop, All Stop" voice command should consider repeating it, in case of poor comm
5. If "All Stop" is heard just once, the arm operator should quickly assess tone of voice and where it came from. If in doubt, treat as an emergency situation. When "All Stop" is heard twice or more, treat as an emergency situation

# ORBITER LOCATION CHART

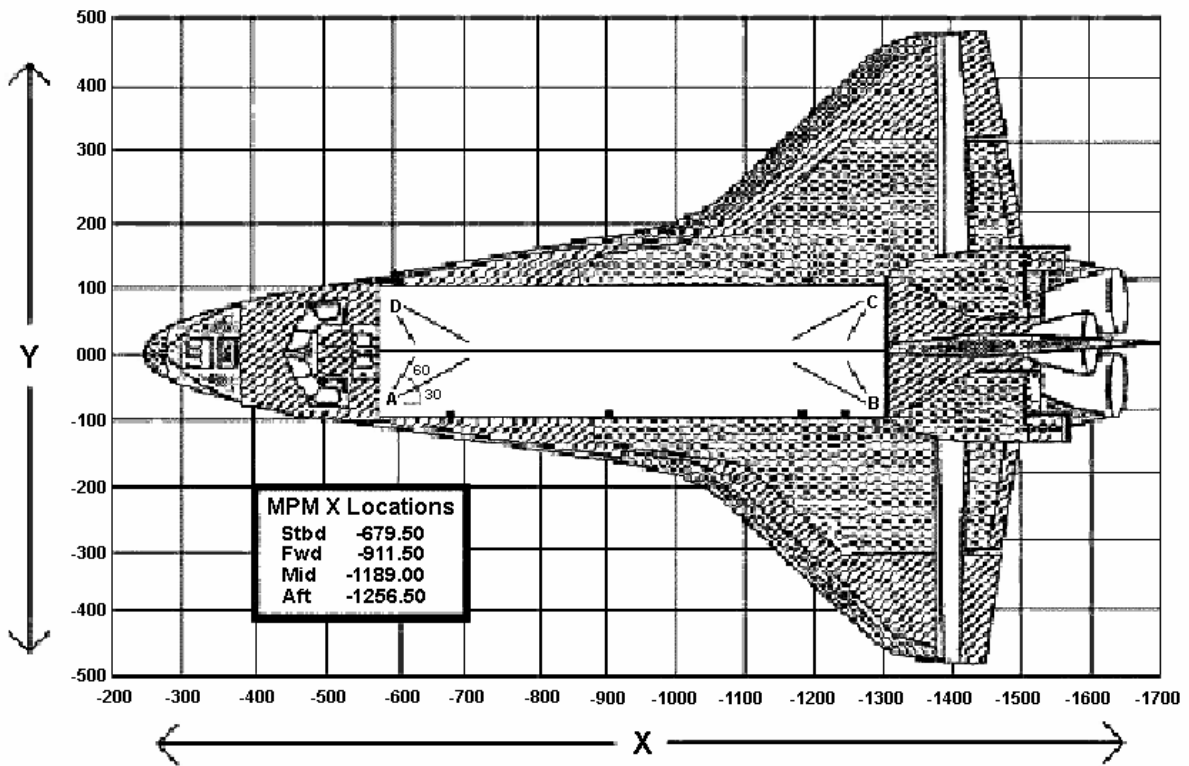
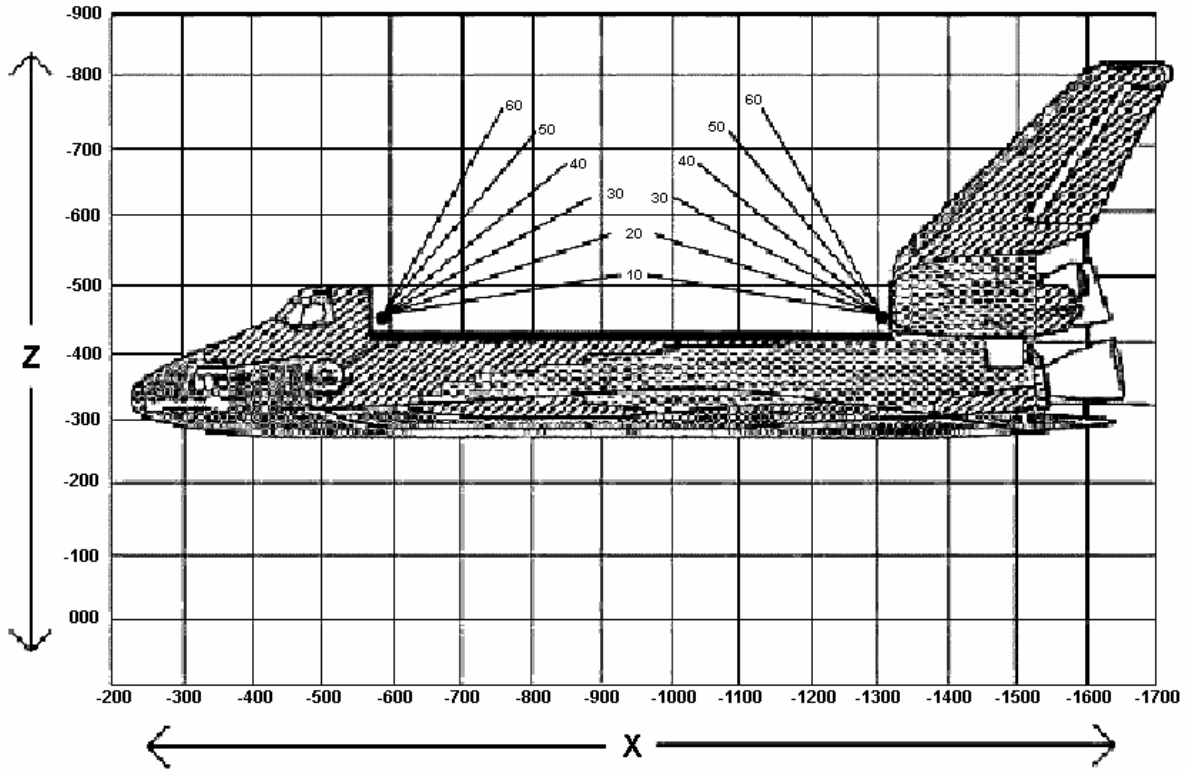

## END EFFECTOR CAPTURE/RELEASE SEQUENCE INFO

<u>CAPTURE (AUTO)</u>	<u>RELEASE (*DOBE)</u>
<p>EE mode: <b>AUTO</b>                      RHC trig: Down (momentary)                      EE mode: Off</p> <p>EE mode: <b>MAN</b>                      RHC trig: Down (hold until Close or 3 sec)                      EE R/D: Rigid (hold until Rigid or 25 sec)                      EE mode: Off</p> <p style="text-align: center;">                         3rd            1st                          (5s)            (3s)                          Rig            Cl            Cap  <span style="border: 1px solid black; padding: 2px;">6</span>            <span style="border: 1px solid black; padding: 2px;">3</span>            <span style="border: 1px solid black; padding: 2px;">2</span>                          Derig            Op            Ext  <span style="border: 1px solid black; padding: 2px;">5</span>            <span style="border: 1px solid black; padding: 2px;">1</span>            <span style="border: 1px solid black; padding: 2px;">4</span>                          (20s)                          2nd                     </p>	<p>EE mode: <b>AUTO</b> [If SJ: choose Man]                      RHC trig: Up (momentary)                      After Open: Backaway                      EE mode: Off</p> <p>EE mode: <b>MAN</b>                      EE R/D: Derigid (hold until Derigid or until 5 sec)                      RHC trig: Up (hold until Open or 3 sec)                      After Open: Backaway                      EE R/D: Derigid (hold until Extend or 20 sec)                      EE mode: Off</p> <p style="text-align: center;">                         Rig            Cl            Cap  <span style="border: 1px solid black; padding: 2px;">1</span>            <span style="border: 1px solid black; padding: 2px;">3</span>            <span style="border: 1px solid black; padding: 2px;">4</span>                          Derig            Op            Ext  <span style="border: 1px solid black; padding: 2px;">2</span>            <span style="border: 1px solid black; padding: 2px;">5</span>            <span style="border: 1px solid black; padding: 2px;">6</span>                          (5s)            (3s)            (20s)                          1st            2nd            3rd                     </p> <p>* DOBE – Derigid, Open, Backaway, Extend</p>

EE AUTO COMMAND LOGIC TRUTH TABLE

MCIU COMMAND	CRITICAL FLAG STATUS TO MCIU					
	EXTEND	CAPTURE	RIGID	OPEN	CLOSE	DERIGID
CAPTURE	X	X	X	X	OFF	X
RIGIDIZE	X	ON	OFF	X	ON	X
DERIGIDIZE	OFF	X	X	X	X	OFF
RELEASE	X	X	X	OFF	X	ON
DERIG. TO EXT	OFF	X	X	ON	X	ON

WHERE X = OFF OR ON

## RMS EE C/O FAILURE MATRIX

General notes:

1. Table is designed for a single failure only
2. Rows #1 through #29 are for steps where the expected motor function does not start, does not complete, or takes longer than expected time
3. Row #30 is for C&W that occurs during the procedure, but does not affect motor function
4. Rows #31 through #36 are for microswitch failures where motor function is not affected
5. Rows #37 through #41 are for uncommanded motion that occurs when the EE MODE sw is taken out of OFF

#	Problem	Failure	Impacts	Workaround	Notes
1	Step a	EE Mode sw Man Cap/Rel contact or pole shorted to Man	Auto Close/Open lost for pole failure. Otherwise, full EE functionality remains. However, Auto Rig/Derig will not start until RHC Cap/Rel sw is released. EE snares will drive (or stall) as long as RHC Cap/Rel sw is out of detent. Motor burnout could occur	EE Manual modes. Backup release. Trigger guard provides protection from uncommanded PL release	
2	Steps b, c, and j	(1) EEEU logic ckt, (2) EE mech, (3) EE motor module, (4) EE mode sw "fly-apart"	All EE functions lost	D&C IFM Kit for (4)	For (1), may receive 'S96 PDRS CKCRT EE.' For (4), crew can detect switch feels loose, and ground can detect loss of 10V pole
3	Steps b, c, k, and l	EEEU logic ckt	Close and derigidize lost	None. EE non-functional	
4	Steps b, c, and o	RHC Cap/Rel sw "fly-apart" or stuck	Close, Open, and Auto Rig/Derig lost	D&C IFM Kit	Crew should be able to detect that switch feels loose or stuck, and ground can detect loss of 10V pole
5	Steps b and c	(1) EE Mode sw Cap/Rel pole, (2) K2 relay, (3) EEEU logic ckt, (4) snare mech, (5) RHC Cap/Rel sw mech "hangup"	EE Auto and Man Close lost. Auto and Man Open may be lost. Direct Drive down for K2 relay (both poles)	D&C IFM Kit for (1), (2), or (5)	For (3), may receive 'S96 PDRS CKCRT EE.' For (5), crew can feel and ground can detect loss of 10V pole
6	Steps b, d, and j	(1) EE Man Contr sw derig contact short, (2) EE Man Zener diode stack, (3) D&C panel 28V filter	All EE Man functions lost. Direct drive lost and Safing tb – bp for (3)	Auto capture/release. Backup Release. D&C IFM Kit	EE Man Derig remains for (1) by using EE Mode sw to initiate. For (2), Man Open may be available with Close cmd and Man Derig may be available with Rigid cmd
7	Steps b and d	(1) RHC Cap/Rel sw Manual pole open, (2) EE Mode sw Manual Cap/Rel contact open	EE Man Close and Open lost	Auto capture/release. D&C IFM Kit	
8	Steps b and j	EE Man Zener diode	EE Man Close and Man Rigid lost	Auto Capture. D&C IFM Kit	Closing snares in Man will drive snares Open or stall motor. Rigidizing in Man will Extend carriage or stall motor
9	Step b	RHC Cap/Rel sw Manual Cap contact open	EE Manual Close lost	Auto capture. D&C IFM Kit	



## RMS EE C/O FAILURE MATRIX (Cont)

#	Problem	Failure	Impacts	Workaround	Notes
10	Steps d, g, and j	EEEEU logic ckt	Auto/Man Open and Rigid lost	None. EE non-functional	
11	Steps d, g, and k	EEEEU logic ckt	Auto/Man Open and Derigid lost	None. One grapple remains with carriage partially retracted	Commanding open will close the snares or stall motor, and commanding derigidize will rigidize or stall motor. PL alignment is critical due to smaller capture envelope
12	Steps d, g, k, and l	EEEEU logic ckt	Auto/Man Open and Derigid lost	None. One grapple remains with carriage partially retracted	PL alignment is critical due to smaller capture envelope
13	Steps d, g, and o	RHC Cap/Rel sw mechanical hangup	Auto/Man Open and Auto Derig lost	Manual Derigidize. Backup Release. D&C IFM Kit	Crew should be able to feel that sw does not go into detent
14	Steps d and g	EEEEU logic ckt	EE Auto and Man Open lost	Backup Release	May receive 'S96 PDRS CKCRT EE'
15	Steps d and k	EE Man Zener diode	EE Man Open and Derig lost	Auto release. D&C IFM Kit	Opening snares in Man will Close snares or stall motor. Derigidizing in Man will Rigidize carriage or stall motor
16	Step d	RHC Cap/Rel sw Manual Rel contact open	EE Manual Open lost	Auto/Backup release. D&C IFM Kit	
17	Steps e, g, and o	(1) RHC Cap/Rel sw Auto pole open, (2) EE Mode sw 10V pole or contact open, (3) MCIU auto logic, (4) D&C-to-MCIU word comm	All EE Auto functions lost. No limping in EE Man mode for (2) pole, or (4). For (1) and (4), RELEASE It cannot be extinguished using Capture switch. For (4), DERIGIDIZE It cannot be extinguished using MAN CONTR sw	Manual EE ops. Backup release. MCIU changeout for (3). Cycle I/O or RMS Select sw to extinguish RELEASE or DERIGIDIZE Its and to reset software checks	For (1), manual payload release will be accompanied by 'PDRS REL.' For (4), manual payload release will be accompanied by 'PDRS REL' and 'PDRS DERIG.' For (1), (2), or (4) ground can detect. For (3), 'S96 PDRS CKCRT EE'. For (4), step k accompanied by 'PDRS DERIG'
18	Steps e and g	EE Mode sw Auto Cap/Rel contact open	EE Auto Close and Open lost	Manual close/open. Backup release	
19	Step e	(1) RHC Cap/Rel sw Auto Cap contact open, (2) Close MSW failed to CLOSE, (3) MCIU auto logic	EE Auto Close lost. Auto Rigidize lost for (1) and possibly (3) No limping in EE MAN mode during Close for (1)	Manual close/rigidize. MCIU changeout for (3)	For (2) or (3), 'S96 PDRS CKCRT EE.' For (2), Derig MSW could also be affected if failure is in WR SPA. Ref rows #21 or #34 for impacts to Derig MSW
20	Steps g and o	(1) RHC Cap/Rel sw Auto Rel contact open, (2) MCIU auto logic	EE Auto Open and Derig lost	Manual open/derigidize. Backup release. MCIU changeout for (2)	For (1), manual payload release will be accompanied by 'PDRS REL.' For (2), 'S96 PDRS CKCRT EE'
21	Step g	(1) Open MSW failed OPEN, (2) Derig MSW failed to not DERIG, (3) MCIU auto logic	EE Auto Open lost. For (2), unable to clear Loaded Rate Limit Flag after PL Capture	Manual open. Backup release. For (2), to get unloaded rates after PL release, use SM94 PL ID 0. MCIU changeout for (3)	'S96 PDRS CKCRT EE.' For (1), Rigid MSW may also be affected if failure is in WY SPA. Ref row #35 for impacts to Rigid MSW
22	Step h	(1) Backup PL Release sw, (2) Backup Release clutch, (3) Backup drive mech failure	Backup PL release lost. One failure from loss of PL release capability	Auto/Man release	

## RMS EE C/O FAILURE MATRIX (Cont)

#	Problem	Failure	Impacts	Workaround	Notes
23	Steps i and o	EE Mode sw Rig/Derig pole shorted to Man	EE Auto Rigid/Derigid lost. EE carriage will drive or stall as long as EE Man Contr sw is out of detent. Motor burnout could occur	Manual Rigid/Derigid	
24	Step i	EE Mode sw Man Rig/Derig contact short	Full EE functionality remains. EE carriage will drive or stall as long as EE Man Contr sw is out of detent. Motor burnout could occur	Use EE Auto modes to minimize cycles on EE Man Contr sw	
25	Step j	(1) EE Man Contr sw contact or pole, (2) EE Mode sw Rig/Derig contact or pole, (3) EEEU logic ckt, (4) K1 relay, (5) carriage mech	EE Man Rigid lost (unable to test Derig, Auto Rigid)	Auto rigidize remains for (1) or (2) contact. D&C IFM Kit for (1), (2), or (4). None for (3) or (5)	Need GF to test Auto Rigid and Derigid function. Safing tb bp for (4) if both poles
26	Steps k and l	EEUU logic ckt	EE Auto and Man Derig lost	None. One grapple remains with carriage partially retracted	May receive 'S96 PDRS CKCRT EE.' PL alignment is critical due to smaller capture envelope
27	Steps k and n	EE Man Contr sw contact open	EE Man Derig lost	Auto release. D&C IFM kit	
28	Step o	(1) EE Mode sw Auto Rig/Derig contact open, (2) Extend MSW failed to EXTEND, (3) Open MSW failed to not OPEN, (4) MCIU auto logic	EE Auto Derig lost. Auto rigidize lost for (1) and possibly (4). For (3), motor will continue to drive until EE Mode sw OFF	Manual rig/derig. MCIU changeout for (4)	For (2) or (4), 'S96 PDRS CKCRT EE.' For (2), auto PL release lost if carriage retracted beyond Derig. Also, Capture MSW may also be affected if failure in WP SPA and may additionally receive 'PDRS REL.' For (3), only Derig-to-Extend lost. Also, Rigid MSW may also be affected if failure is in WY SPA. Ref row # 35 for impacts to Rigid MSW
29	Steps m, n, o, and p	(1) Carriage mechanical jam, (2) motor failure during motion	For (1) Auto/Man rigidize/derigidize lost. For (2) all EE functions lost	None. EE non-functional	
30	'PDRS DERIG' during Man Derigid	Man Contr sw 10V contact or pole	For pole failure, no limping during Man Rigidize and DERIGIDIZE It cannot be extinguished using MAN CONTR sw	EE Auto to prevent nuisance alarm and allow limping. Cycle I/O or RMS Select sw to extinguish DERIGIDIZE It and to reset software check	Ground can tell if pole failed
31	Capture MSW always indicating 'not CAPTURE'	Capture MSW logic circuit	CK CRT It when snares open. Auto Capture will continue and rigidize carriage without grapple fixture present. Loss of EE Release C/W. Inability to reset loaded rate limit flag	Use SM 94 PL ID 0 for unloaded rates	CK CRT It and 'S96 PDRS CKCRT EE' when snares Open
32	Close MSW always indicating 'not CLOSED'	Close MSW logic circuit	Loss of EE Auto rigidize function	EE Manual Rigidize. Terminate EE snare close function after 3 sec	
33	Extend MSW always indicating 'not EXTENDED'	Extend MSW logic circuit	Carriage will continue to drive (and stall) until EE mode sw OFF for EE Auto Release. Motor burnout possible	Time derigidize-to-extend function and terminate after 20 sec	

## RMS EE C/O FAILURE MATRIX (Cont)

#	Problem	Failure	Impacts	Workaround	Notes
34	Derig MSW always indicating DERIGID	Derig MSW logic circuit	EE Auto PL Release will open snares from fully Rigid position	EE Man modes. Derigidize carriage in EE Man (5 sec) prior to performing Auto PL release	CK CRT It and 'S96 PDRS CKCRT EE' when carriage is Rigid
35	Rigid MSW always indicating 'not RIGID'	Rigid MSW logic circuit	Carriage will continue to drive (and stall) during auto capture until EE Mode sw OFF. Motor burnout possible. Loss of Loaded Rate Limit Flag. Uncommanded Derigidize Warning lost	Time rigidize function and terminate after 25 sec. SM 95 available to set loaded rates after capture	
36	Rigid MSW always indicating RIGID	Rigid MSW logic circuit	Auto Rigid lost. Uncommanded Derigidize Warning lost	EE Man modes. Time manual rigidize function and terminate after 25 sec. PL ID 0 available for unloaded rates after PL release	CK CRT It and 'S96 PDRS CKCRT EE' when carriage is Derigid or Extend
37	Snares Close w/o cmd in EE Mode Man	RHC Cap/Rel sw contact or pole short	All EE Man functions lost except Close. If contact short, Open also available while holding sw. Motor burnout can occur while EE Mode sw – Man	EE auto modes. Backup release. D&C IFM Kit	
38	Snares Open w/o cmd in EE Mode Man	RHC Cap/Rel sw contact or pole short	All EE Man functions lost except Open. Motor burnout can occur while EE Mode sw – Man	EE auto modes. D&C IFM Kit	
39	Carriage rigidizes w/o cmd in EE Mode Man	EE Man Contr sw contact or pole short	All EE Man functions lost except Rigid. If contact short, Derigid available while holding sw. Motor burnout can occur while EE Mode sw – Man	EE auto modes. Backup release. D&C IFM Kit	
40	Snares Close w/o cmd in EE Mode Auto	RHC Cap/Rel sw contact or pole short	EE Auto Release lost. Auto Capture available using EE Mode sw to initiate. Limping present while EE Mode sw in Man unless Rigid	EE Man modes. Backup release	Ground can detect if contact or pole short. Uncommanded Release warning unavailable
41	Snares Open and carriage derigidizes w/o cmd in EE Mode Auto	RHC Cap/Rel sw contact or pole short	For contact short, all EE Auto functions remain, but Auto Capture will reverse after completion. If pole short, loss of Auto Cap and limping during Man Close	EE Man modes	Ground can detect if contact or pole short

# PDRS EPS IMPACT TABLE

Bus Lost			Equipment Lost	
MNA	FPC1	AC1 3Φ	ΦA	Shoulder Brace Release Mtr A8 Digitals Primary Panel Lighting
			PBM MMC1	Port Mid MRL Mtr Sys 1 Stbd Fwd MRL Mtr Sys 2 PRLA 1/Lat 1-5 Mtr Sys 1 PRLA 2/Lat 1-5 Mtr Sys 1 PRLA 3/Lat 1-5 Mtr Sys 1
			PBM MMC3	Port Aft MRL Mtr Sys 2 Stbd Aft MRL Mtr Sys 1
		O14&A8		MCIU Primary Power Payload Power Port & Stbd Heater Sys A D&C Panel
	R14		Monitor 1 Camera C Camera D	
	A6&A14		PRLA 1/Lat 1-5 Mtr Sys 1 PRLA 2/Lat 1-5 Mtr Sys 1 PRLA 3/Lat 1-5 Mtr Sys 1	
	MPC1		Primary Power Payload Power Port & Stbd Heater Sys A Port MPM STO/DEP tb	
	MMC1		Port Mid MRL Mtr Sys 1 Stbd Fwd MRL Mtr Sys 2 Port Mid MPM STO/DEP msw Sys 2 Port Mid MRL LAT/REL/RTL msw Sys 1 Stbd Aft MPM STO/DEP msw Sys 1 Stbd Fwd MRL LAT/REL/RTL msw Sys 2 Port MRL LAT/REL tb Port Mid MRL RTL tb Stbd MPM STO/DEP tb	
	MMC3		Port Aft MRL Mtr Sys 2 Stbd Aft MRL Mtr Sys 1 Port Aft MRL LAT/REL/RTL msw Sys 2 Stbd Aft MRL LAT/REL/RTL msw Sys 1 Port Fwd MPM STO/DEP msw Sys 1 Port Aft MPM STO/DEP msw Sys 1 Stbd Mid MPM STO/DEP msw Sys 2 Stbd MRL LAT/REL tb Stbd Aft MRL RTL tb	
	ML86B		Stbd MRL Deadface Relays Stbd Guillotine Sys A Stbd Jettison Sys A	

**PDRS EPS IMPACT TABLE (Cont)**

<b>Bus Lost</b>		<b>Equipment Lost</b>
CNTLAB1		Port Fwd MRL Mtr Sys 1 Port Mid MRL Mtr Sys 1 Port Aft MRL Mtr Sys 2 Stbd Fwd MRL Mtr Sys 2 Stbd Mid MRL Mtr Sys 1 Stbd Aft MRL Mtr Sys 1 PRLA 1/Lat 1-5 Mtr Sys 1 PRLA 2/Lat 1-5 Mtr Sys 1 PRLA 3/Lat 1-5 Mtr Sys 1
CNTLAB3	MNA MMC1	Port Mid MRL Mtr Sys 1 Stbd Fwd MRL Mtr Sys 2 Port Mid MPM STO/DEP msw Sys 2 Port Mid MRL LAT/REL/RTL msw Sys 1 Stbd Aft MPM STO/DEP msw Sys 1 Stbd Fwd MRL LAT/REL/RTL msw Sys 2 Stbd MPM STO/DEP tb Port MRL LAT/REL tb Port Mid MRL RTL tb
	MNA MMC3	Port Aft MRL Mtr Sys 2 Stbd Aft MRL Mtr Sys 1 Port Aft MRL LAT/REL/RTL msw Sys 2 Stbd Aft MRL LAT/REL/RTL msw Sys 1 Port Fwd MPM STO/DEP msw Sys 1 Port Aft MPM STO/DEP msw Sys 1 Stbd Mid MPM STO/DEP msw Sys 2 Stbd MRL LAT/REL tb Stbd Aft MRL RTL tb

**PDRS EPS IMPACT TABLE (Cont)**

Bus Lost			Equipment Lost	
MNB	FPC2	AC2 3Φ	ΦA	B/U Panel Lighting
			PBM MMC2	Port MPM Mtr Sys 2 Stbd MPM Mtr Sys 1 Port Fwd MRL Mtr Sys 1 Stbd Aft MRL Mtr Sys 2
			PBM MMC3	PRLA 1/Lat 1-5 Mtr Sys 2 PRLA 2/Lat 1-5 Mtr Sys 2 PRLA 3/Lat 1-5 Mtr Sys 2
			PBM MMC4	Port Mid MRL Mtr Sys 2 Stbd Mid MRL Mtr Sys 1
	O15&A7&A8			B/U Power Port & Stbd Heater Sys B
	R14			Monitor 2 VPU Camera A RMS (Elbow & Wrist) Cameras
	A6&A14			PRLA 1/Lat 1-5 Mtr Sys 2 PRLA 2/Lat 1-5 Mtr Sys 2 PRLA 3/Lat 1-5 Mtr Sys 2
	MPC2			B/U Power Port & Stbd Heater Sys B Port MPM STO/DEP tb
	MMC2			Port MPM Mtr Sys 2 Stbd MPM Mtr Sys 1 Port Fwd MRL Mtr Sys 1 Stbd Aft MRL Mtr Sys 2 Port Mid MPM STO/DEP msw Sys 1 Port Fwd MRL LAT/REL/RTL msw Sys 1 Stbd Aft MRL LAT/REL/RTL msw Sys 2 Port MRL LAT/REL tb Port Fwd MRL RTL tb
	MMC4			Port Mid MRL Mtr Sys 2 Stbd Fwd MRL Mtr Sys 1 Stbd Mid MRL Mtr Sys 1 Port Mid MRL LAT/REL/RTL msw Sys 2 Stbd Fwd MRL LAT/REL/RTL msw Sys 1 Stbd Mid MRL LAT/REL/RTL msw Sys 1 Port Shoulder MPM STO/DEP msw Sys 2 Stbd Fwd MPM STO/DEP msw Sys 1 Stbd MRL LAT/REL tb Stbd Fwd MRL RTL tb Stbd Mid MRL RTL tb
ML86B			Port MRL Deadface Relays Port Guillotine Sys A Port Jettison Sys A	

**PDRS EPS IMPACT TABLE (Cont)**

<b>Bus Lost</b>		<b>Equipment Lost</b>
CNTLBC1		Stbd MPM Mtr Sys 1 Port MPM Mtr Sys 2
	AC2 PBM MMC2	Port MPM Mtr Sys 2 Stbd MPM Mtr Sys 1 Port Fwd MRL Mtr Sys 1 Stbd Aft MRL Mtr Sys 2
	AC2 PBM MMC3	PRLA 1/Lat 1-5 Mtr Sys 2 PRLA 2/Lat 1-5 Mtr Sys 2 PRLA 3/Lat 1-5 Mtr Sys 2
	AC2 PBM MMC4	Port Mid MRL Mtr Sys 2 Stbd Mid MRL Mtr Sys 1
CNTLBC2	AC2 PBM MMC2	Port MPM Mtr Sys 2 Stbd MPM Mtr Sys 1 Port Fwd MRL Mtr Sys 1 Stbd Aft MRL Mtr Sys 2
	AC2 PBM MMC3	PRLA 1/Lat 1-5 Mtr Sys 2 PRLA 2/Lat 1-5 Mtr Sys 2 PRLA 3/Lat 1-5 Mtr Sys 2
	AC2 PBM MMC4	Port Mid MRL Mtr Sys 2 Stbd Mid MRL Mtr Sys 1
CNTLBC3	MNB MMC2	Port MPM Mtr Sys 2 Stbd MPM Mtr Sys 1 Port Fwd MRL Mtr Sys 1 Stbd Aft MRL Mtr Sys 2 Port Mid MPM STO/DEP msw Sys 1 Port Fwd MRL LAT/REL/RTL msw Sys 1 Stbd Aft MRL LAT/REL/RTL msw Sys 2 Port MRL LAT/REL tb Port Fwd MRL RTL tb
	MNB MMC4	Port Mid MRL Mtr Sys 2 Stbd Fwd MRL Mtr Sys 1 Stbd Mid MRL Mtr Sys 1 Port Mid MRL LAT/REL/RTL msw Sys 2 Stbd Fwd MRL LAT/REL/RTL msw Sys 1 Stbd Mid MRL LAT/REL/RTL msw Sys 1 Port Shoulder MPM STO/DEP msw Sys 2 Stbd Fwd MPM STO/DEP msw Sys 1 Stbd MRL LAT/REL tb Stbd Fwd MRL RTL tb Stbd Mid MRL RTL tb

**PDRS EPS IMPACT TABLE (Cont)**

Bus Lost			Equipment Lost	
MNC	FPC3	AC3 3Φ	PBM MMC2	Port Aft MRL Mtr Sys 1 Stbd Mid MRL Mtr Sys 2
			PBM MMC4	Port MPM Mtr Sys 1 Stbd MPM Mtr Sys 2 Port Fwd MRL Mtr Sys 2 Stbd Fwd MRL Mtr Sys 1
	R14		Camera B	
	MPC3	MMC2	Port Aft MRL Mtr Sys 1 Stbd Mid MRL Mtr Sys 2 Port Shoulder MPM STO/DEP msw Sys 1 Port Fwd MPM STO/DEP msw Sys 2 Stbd Fwd MPM STO/DEP msw Sys 2 Port Aft MRL LAT/REL/RTL msw Sys 1 Stbd Mid MRL LAT/REL/RTL msw Sys 2 Port MPM STO/DEP tb Port MRL LAT/REL tb Port Aft MRL RTL tb	
		MMC4	Port MPM Mtr Sys 1 Stbd MPM Mtr Sys 2 Port Fwd MRL Mtr Sys 2 Port Fwd MRL LAT/REL/RTL msw Sys 2 Port Aft MPM STO/DEP msw Sys 2 Stbd Mid MPM STO/DEP msw Sys 1 Stbd Aft MPM STO/DEP msw Sys 2 Stbd MPM STO/DEP tb	
	ML86B		Port Guillotine Sys B Stbd Guillotine Sys B Port Jettison Sys B Stbd Jettison Sys B	
CNTLCA1			Port Fwd MRL Mtr Sys 2 Port Mid MRL Mtr Sys 2 Port Aft MRL Mtr Sys 1 Stbd Fwd MRL Mtr Sys 1 Stbd Aft MRL Mtr Sys 2 Stbd Mid MRL Mtr Sys 2	
CNTLCA2			Port MPM Mtr Sys 1 Stbd MPM Mtr Sys 2	



**PDRS EPS IMPACT TABLE (Cont)**

<b>Bus Lost</b>		<b>Equipment Lost</b>
CNTLCA3	MNC MMC2	Port Aft MRL Mtr Sys 1 Stbd Mid MRL Mtr Sys 2 Port Shoulder MPM STO/DEP msw Sys 1 Port Fwd MPM STO/DEP msw Sys 2 Stbd Fwd MPM STO/DEP msw Sys 2 Port Aft MRL LAT/REL/RTL msw Sys 1 Stbd Mid MRL LAT/REL/RTL msw Sys 2 Port MPM STO/DEP tb Port MRL LAT/REL tb Port Aft MRL RTL tb
	MNC MMC4	Port MPM Mtr Sys 1 Stbd MPM Mtr Sys 2 Port Fwd MRL Mtr Sys 2 Port Fwd MRL LAT/REL/RTL msw Sys 2 Port Aft MPM STO/DEP msw Sys 2 Stbd Mid MPM STO/DEP msw Sys 1 Stbd Aft MPM STO/DEP msw Sys 2 Stbd MPM STO/DEP tb

**PDRS OI MDM/DSC IMPACT TABLE**

<b>MDM OF1</b>	
Port Aft MRL LAT/REL/RTL msw Sys 2 TLM	PRLA 3/Lat 1 LAT/REL/RTL Sys 2 TLM
Stbd Aft MRL LAT/REL/RTL msw Sys 1 TLM	PRLA 3/Lat 2 LAT/REL/RTL Sys 2 TLM
PRLA 2/Lat 2 LAT/REL/RTL Sys 2 TLM	PRLA 3/Lat 3 LAT/REL/RTL Sys 2 TLM
PRLA 2/Lat 3 LAT/REL/RTL Sys 2 TLM	PRLA 3/Lat 4 LAT/REL/RTL Sys 2 TLM
PRLA 2/Lat 4 LAT/REL/RTL Sys 2 TLM	PRLA 3/Lat 5 LAT/REL/RTL Sys 2 TLM
PRLA 2/Lat 5 LAT/REL/RTL Sys 2 TLM	
<b>MDM OF2</b>	
PRLA 1/Lat 1 LAT/REL/RTL Sys 2 TLM	PRLA 2/Lat 5 LAT/REL/RTL Sys 1 TLM
PRLA 1/Lat 2 LAT/REL/RTL Sys 2 TLM	PRLA 3/Lat 1 LAT/REL/RTL Sys 1 TLM
PRLA 1/Lat 3 LAT/REL/RTL Sys 2 TLM	PRLA 3/Lat 2 LAT/REL/RTL Sys 1 TLM
PRLA 1/Lat 4 LAT/REL/RTL Sys 2 TLM	PRLA 3/Lat 3 LAT/REL/RTL Sys 1 TLM
PRLA 1/Lat 5 LAT/REL/RTL Sys 2 TLM	PRLA 3/Lat 4 LAT/REL/RTL Sys 1 TLM
PRLA 2/Lat 1 LAT/REL/RTL Sys 2 TLM	PRLA 3/Lat 5 LAT/REL/RTL Sys 1 TLM
<b>MDM OF4</b>	
Port Mid MRL LAT/REL/RTL msw Sys 1 TLM	PRLA 2/Lat 2 LAT/REL/RTL Sys 1 TLM
Stbd Fwd MRL LAT/REL/RTL msw Sys 2 TLM	PRLA 2/Lat 3 LAT/REL/RTL Sys 1 TLM
Primary Power TLM	PRLA 2/Lat 4 LAT/REL/RTL Sys 1 TLM
B/U Power TLM	
<b>MDM OA1</b>	
Port Mid MRL LAT/REL/RTL msw Sys 2 TLM	Stbd Mid MRL LAT/REL/RTL msw Sys 1 TLM
<b>MDM OA2</b>	
Port Shoulder MPM STO/DEP msw Sys 1 TLM	Port Shoulder MPM STO/DEP msw Sys 2 TLM
Stbd Fwd MPM STO/DEP msw Sys 1 TLM	Stbd Fwd MPM STO/DEP msw Sys 2 TLM
Port Fwd MRL LAT/REL/RTL msw Sys 1 TLM	Port Fwd MRL LAT/REL/RTL msw Sys 2 TLM
Stbd Fwd MRL LAT/REL/RTL msw Sys 1 TLM	Stbd Aft MRL LAT/REL/RTL msw Sys 2 TLM
<b>MDM OA3</b>	
Port Aft MRL LAT/REL/RTL msw Sys 1 TLM	PRLA 1/Lat 3 LAT/REL/RTL Sys 1 TLM
Stbd Mid MRL LAT/REL/RTL msw Sys 2 TLM	PRLA 1/Lat 4 LAT/REL/RTL Sys 1 TLM
PRLA 1/Lat 1 LAT/REL/RTL Sys 1 TLM	PRLA 1/Lat 5 LAT/REL/RTL Sys 1 TLM
PRLA 1/Lat 2 LAT/REL/RTL Sys 1 TLM	PRLA 2/Lat 1 LAT/REL/RTL Sys 1 TLM

## MISCELLANEOUS RMS MOTION NOTES

Uncommanded Motion/Runaway Operator Response:

<b>Mode</b>	<b>1st Response</b>	<b>If no joy – 2nd Response</b>
Any Computer-Supported	BRAKES – ON	RMS SEL – OFF
DIRECT	MODE – Not DIRECT	RMS SEL – OFF
B/U	RMS SEL – OFF	RMS PWR – OFF

### Single Joint Ops (General)

Need to Pulse in Single when:

- near structure
- near Singularity or Reach Limit
- to control rates

NOTE: Always Pulse in Direct/Backup when within 10 ft to maintain vernier rates

### Cradle/Uncradle Notes

During Uncradle → Must Pulse EP

During Cradle → Must Pulse all Joints

This Page Intentionally Blank

MISCELLANEOUS PROCEDURES

OPERATOR COMMANDED MODE ..... 11-2  
RELATIVE POSITION/ATTITUDE DISPLAY ..... 11-4  
FLY-CAMERA/FLY-PAYLOAD COMMAND REFERENCE MODE ..... 11-5  
BACKUP RELEASE..... 11-6

MISC PROC

**OPERATOR COMMANDED MODE**

The following is shorthand notation that means “perform OPERATOR COMMANDED mode maneuver to shown position/attitude”

BRAKES – OFF (tb-OFF)

(“MODE – OPR CMD, ENTER” may or may not be shown)

OPERATOR COMMAND to: (or “OPR CMD to:”)

X	Y	Z	PITCH	YAW	ROLL	PL ID
data	data	data	data	data	data	0 to 5
SY	SP	EP	WP	WY	WR	
√ data	data	data	data	data	data	

Above callout performed in following manner:

**SM 94 PDRS CONTROL**

PL ID, ITEM 3 – (PL ID from above) EXEC  
 INIT ID, ITEM 24 – (PL ID from above) EXEC

END POS X, ITEM 18 -(X from above) EXEC  
     Y, ITEM 19 ±(Y from above) EXEC  
     Z, ITEM 20 -(Z from above) EXEC  
 END ATTP, ITEM 21 +(P from above) EXEC  
     Y, ITEM 22 +(Yaw from above) EXEC  
     R, ITEM 23 +(R from above) EXEC

CMD CK, ITEM 25 EXEC (GOOD or FAIL)

<b>WARNING</b>
CMD CK does not verify RMS trajectory will be clear of orbiter structure. RMS opr must monitor RMS/payload for collision hazard

<p><b>IF ITEM 25 – FAIL INDICATED</b></p> <p>Verify all entries correct, especially X,Z END POS (both neg)</p> <p>If corrections made, CMD CK, ITEM 25 EXEC (GOOD)</p> <p>If still no “GOOD”, no OPR CMD possible, consult MCC for new POS/ATT or MAL</p>
---

RATE – VERN, as reqd

BRAKES – OFF (tb-OFF)

MODE – OPR CMD, ENTER (OPR CMD It on)  
 √AUTO SEQ READY It – on

* If error found in destination entries (Items 18-23)	*	
* BRAKES – ON (tb-ON)	*	
* Enter corrected destination (Items 18-23)	*	
* CMD CK, ITEM 25 EXEC (GOOD)	*	
* BRAKES – OFF (tb-OFF)	*	
* MODE – OPR CMD, ENTER	*	
* √AUTO SEQ READY It – on	*	

AUTO SEQ – PRO (IN PROG It on)  
 √RMS moves as expected, then

When IN PROG It – off,  
 BRAKES – ON (tb-ON)

√RMS at desired POS/ATT, joint angles:

PARAM – POSITION X/Y/Z  
 √X,Y,Z = data shown

PARAM – ATTITUDE P/Y/R  
 √P/Y/R = data shown

PARAM – JOINT ANGLE  
 JOINT (six) – in turn  
 √Joint angles = data shown

## RELATIVE POSITION/ATTITUDE DISPLAY

The following outlines how to maneuver to RMS position utilizing REL mode via SM SPEC 94 PDRS CONTROL:

Enter target position using procedure OPERATOR COMMANDED MODE

**SM 94 PDRS CONTROL**

POR DISPLAY: ITEM 30 EXEC (REL)

Maneuver RMS until all digitals equal zero

√RMS at desired joint angles:

PARAM – JOINT ANGLE

JOINT (six) – in turn

√Joint angles = desired values

When use of REL mode complete, then

**SM 94 PDRS CONTROL**

POR DISPLAY: ITEM 30 EXEC (ORB)

√RMS at desired POS/ATT:

PARAM – POSITION X/Y/Z

√X,Y,Z = desired values

PARAM – ATTITUDE P/Y/R

√P,Y,R = desired values



## FLY-CAMERA/FLY-PAYLOAD COMMAND REFERENCE MODE

Operational Constraints:

Fly-Camera or Fly-Payload can only be selected if:

- ORB LD It – ON
- SM 94 PDRS CONTROL, ITEM 25: GOOD
- SM 94 PDRS CONTROL: ITEM 3 is equal to ITEM 24

While using Fly-Camera or Fly-Payload, the following SM 94 PDRS CONTROL ITEM entries are illegal: 1, 2, 3, 18-23, 24, 25

Enter the target position (ITEMS 18,19,20) and camera reference attitude (ITEMS 21,22,23) using the procedure OPERATOR COMMANDED MODE

**SM 94 PDRS CONTROL**

ORB LD CMD REF FLY CAMR (FLY-PL): ITEM 32(33) EXEC (\*)

Maneuver RMS to desired position

When use of Fly-Camera or Fly-Payload complete, then

**SM 94 PDRS CONTROL**

ORB LD CMD REF: ITEM 31 EXEC (\*)

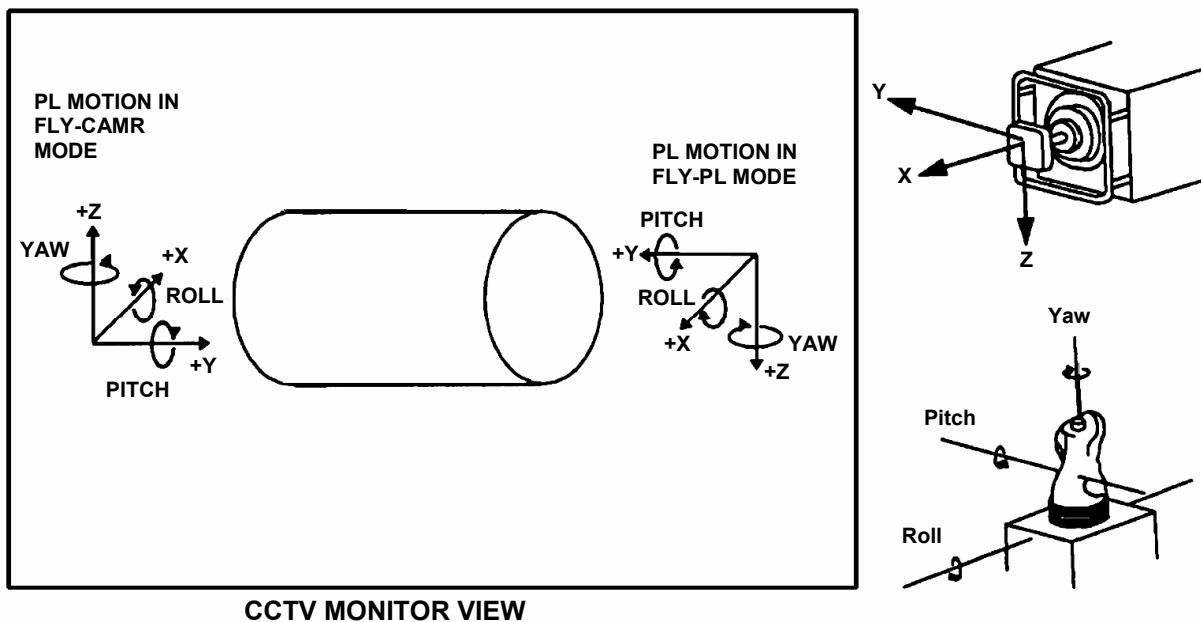

## BACKUP RELEASE

### 1. B/U PAYLOAD RELEASE

√B/U PL REL – OFF

SM 94 PDRS CONTROL

Record WR R \_\_\_\_\_

RMS SEL – OFF

PWR – B/U (SM ALERT and BCE BYP MCIU)

SEL – PORT

B/U PL REL – ON

Wait 10 sec

Maneuver RMS/orbiter away from PL

B/U PL REL – OFF

### 2. RECONFIGURE TO PRIMARY POWER

RMS SEL – OFF

PWR – PRI (MA)

SM 94 PDRS CONTROL

I/O ON – ITEM 5 EXEC (\*)

RMS SEL – PORT

SAFING – CANCEL (tb-gray)

If WR R different:

WR R – ITEM 26 + (recorded value) EXEC

√BRAKES – ON



This Page Intentionally Blank

TOP

HOOK  
VELCRO

**GENERIC END EFFECTOR CUE CARD –  
SHUTTLE NOT DOCKED OPS**

**MA – RELEASE or PL/EE Interface Suspect**

Stop maneuver

DAP: FREE

If PL/EE interface is suspect and RMS/PL config is unsafe:

PULL TEST (PL follows RMS or pin clear of EE)

If expedited release required:

MAN OPEN (√OPEN tb-gray, 3 sec max)

If no joy, B/U RELEASE (10 sec)

Maneuver arm to safe distance

**MA – DERIGIDIZE**

Stop maneuver

DAP: FREE

If OBSS grappled:

SPEE PWR – OFF

R12

MAN RIGIDIZE (√RIGID tb-gray, 25 sec max)

PDRS-3a/O/K

TOP

Back of 'GENERIC END EFFECTOR CUE CARD – SHUTTLE NOT DOCKED OPS'

HOOK  
VELCRO

PDRS-3b/O/G

(reduced copy)

TOP

HOOK  
VELCRO

**GENERIC END EFFECTOR CUE CARD –  
ISS/SHUTTLE DOCKED OPS**

**MA – RELEASE**

Stop maneuver

√DAP: FREE

If ISS CONTROL:

PCS MSS: SSRMS: Thrusters: Thruster Controls for MSS Ops

If 'Desat Request – Enable'

**cmd** 'Desat Request' – Inhibit (Verify – Inh)

**MA – DERIGIDIZE**

Stop maneuver

√DAP: FREE

If ISS CONTROL:

PCS MSS: SSRMS: Thrusters: Thruster Controls for MSS Ops

If 'Desat Request – Enable'

**cmd** 'Desat Request – Inhibit (Verify – Inh)

If OBSS grappled:

R12 SPEE PWR – OFF

MAN RIGIDIZE (√RIGID tb–gray, 25 sec max)

PDRS-6a/O/C

TOP

Back of 'GENERIC END EFFECTOR CUE CARD – SHUTTLE DOCKED OPS'

HOOK  
VELCRO

PDRS-6b/O/A

(reduced copy)

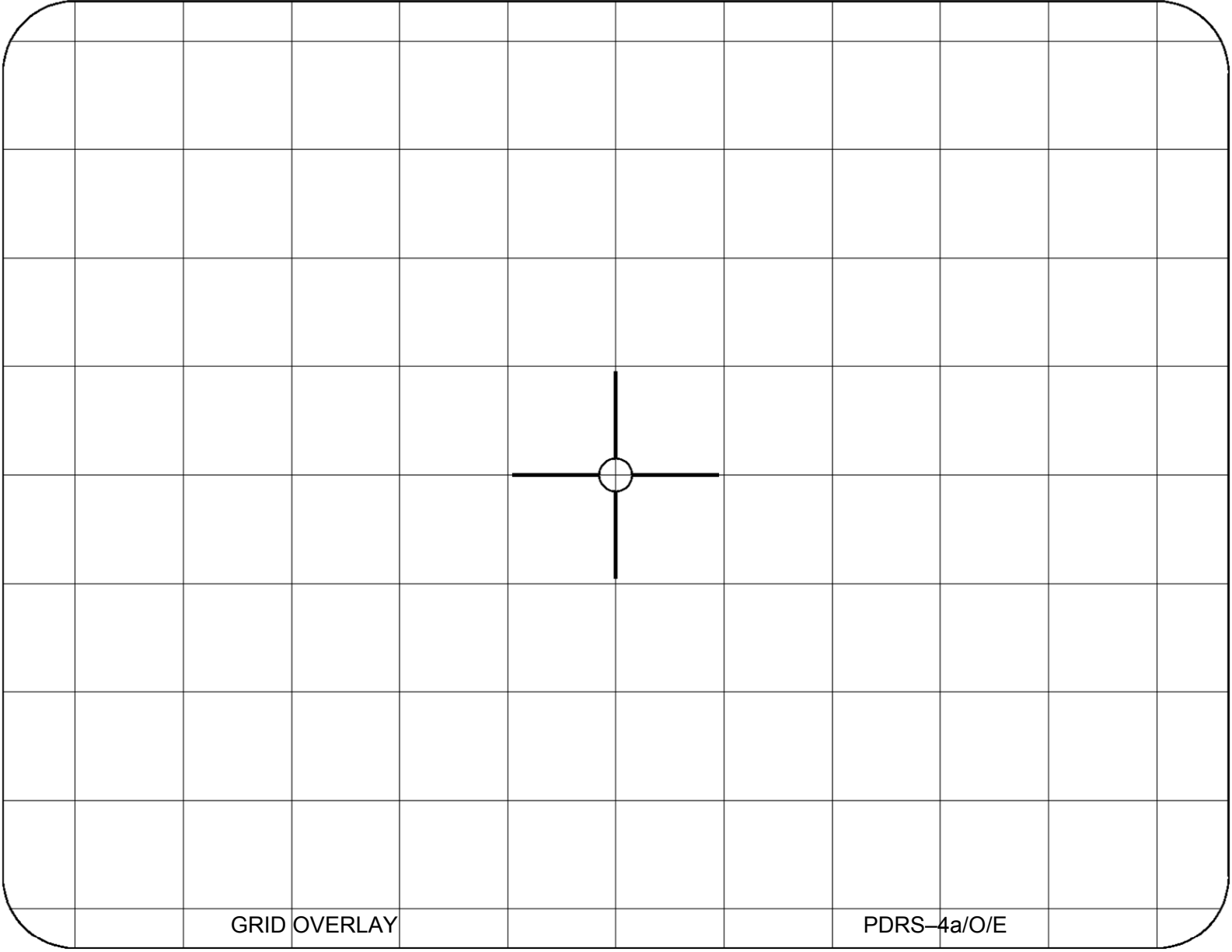

GRID OVERLAY

PDRS-4a/O/E

(reduced copy)

FAB USE ONLY

CC 12-5

PDRS/ALL/GEN F

Note: Fabricate as a transparency

ZOOM 34.0 HFOV  
FOCUS 5.0 FT  
EYEPOINT APPROX 18 IN

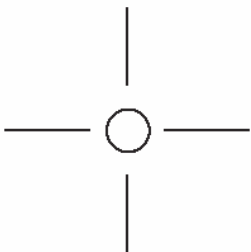

PDRS TARGET OVERLAY FOR CTVM

PDRS-5a/O/E

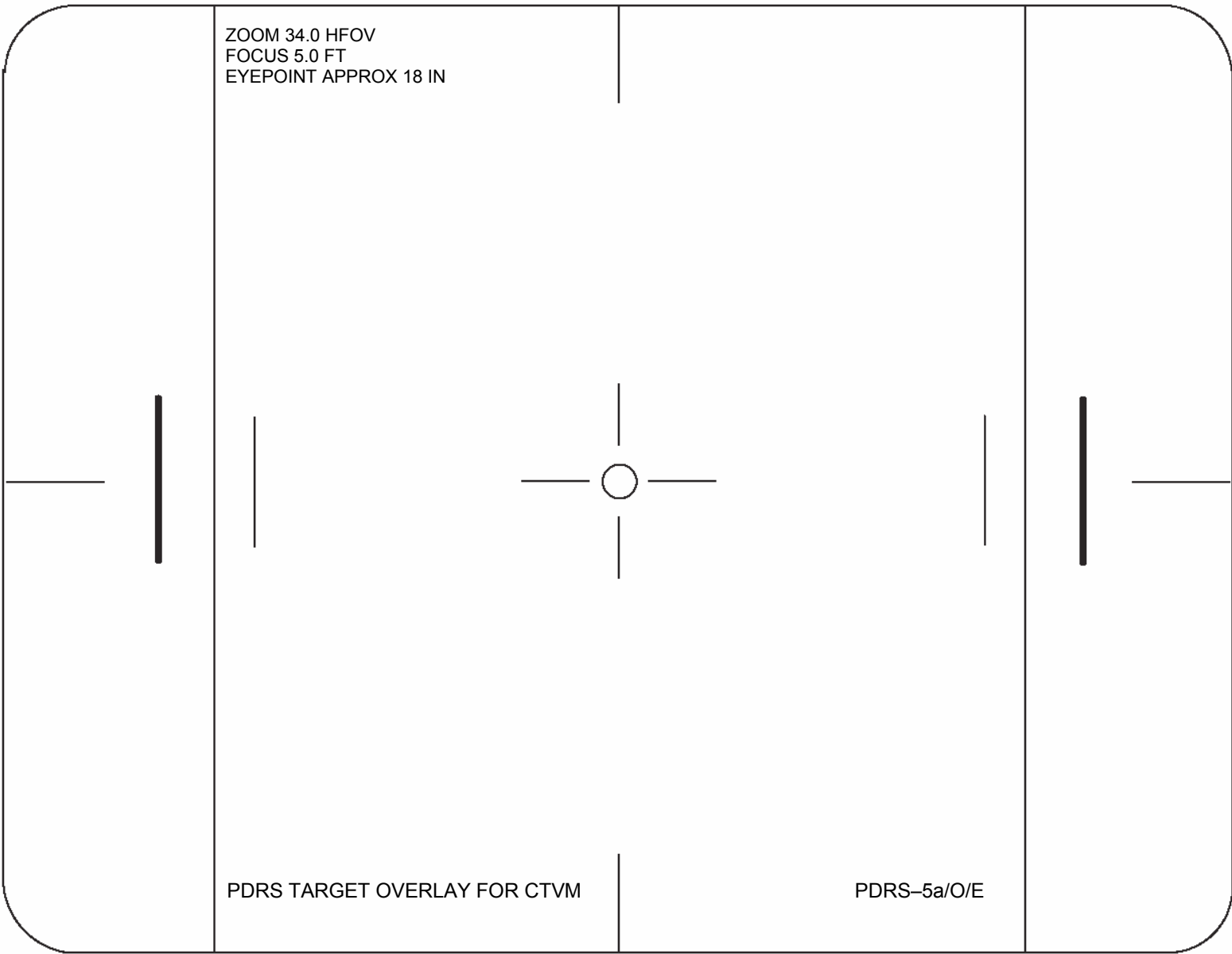

(reduced copy)



TOP

HOOK  
VELCRO

OBSS SCAN PATTERN CUE CARD – STBD & PORT

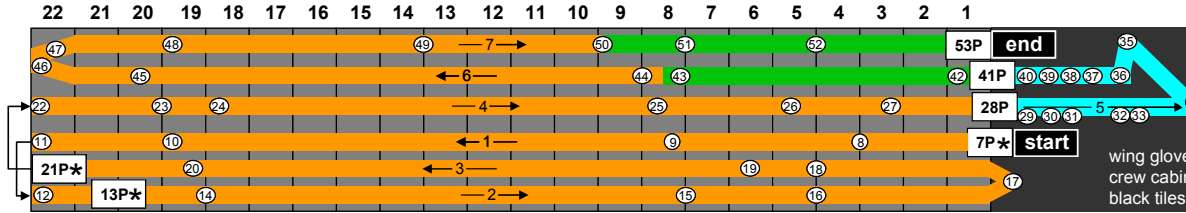
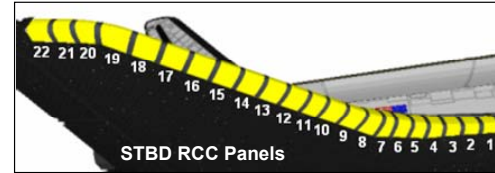
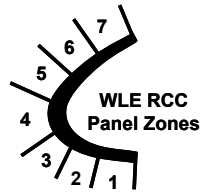

1P = ACAS pause pt      — 1 → = ACAS section and scan direction  
 ① = ACAS fly-by pt      \* = Reconfigure PTU

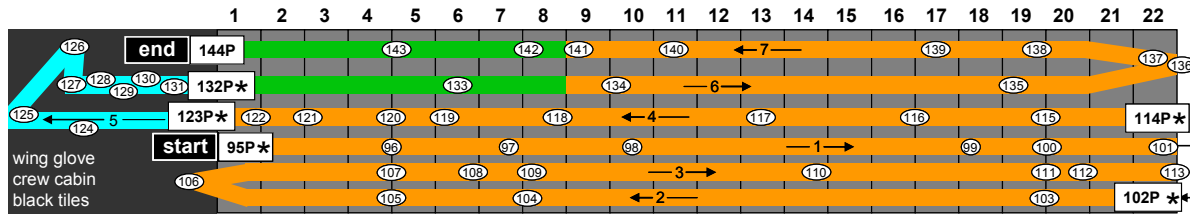

= 3 in damage detection  
 = 1 in damage detection  
 = 0.25 in damage & crack detection

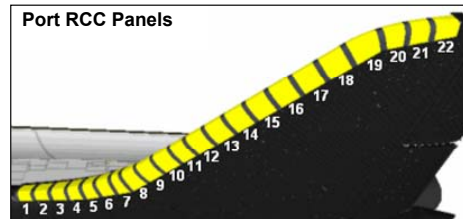

PDRS-7a/O/A

(reduced copy)

(reduced copy)

TOP  
Back of 'OBSS SCAN PATTERN CUE CARD – STBD & PORT'

HOOK  
VELCRO

OBSS SCAN PATTERN CUE CARD – NOSE CAP

**NOTE**  
Point 75 is NOT a pause point. The 1<sup>st</sup> ACAS section is separated here for graphical clarity

- = 1<sup>st</sup> ACAS Section
- = 2<sup>nd</sup> ACAS Section
- 1P = ACAS pause pt
- 1 = ACAS fly-by pt
- = Scan direction
- \*** = Reconfigure PTU

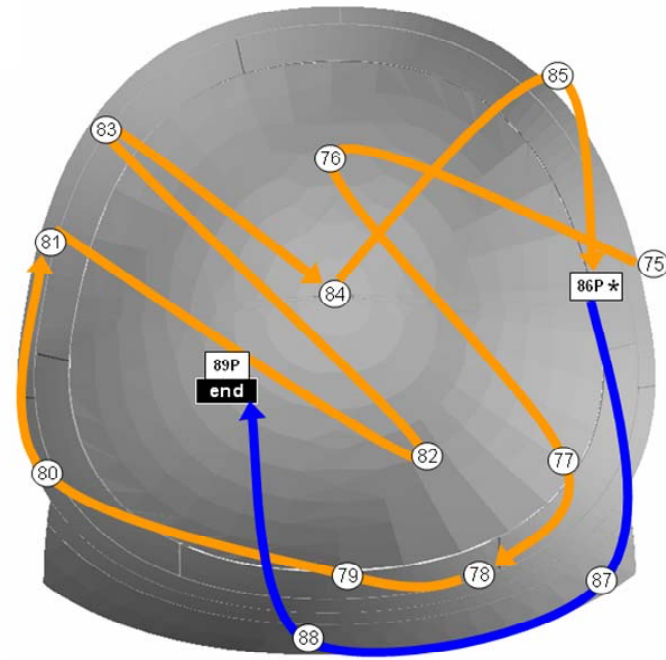
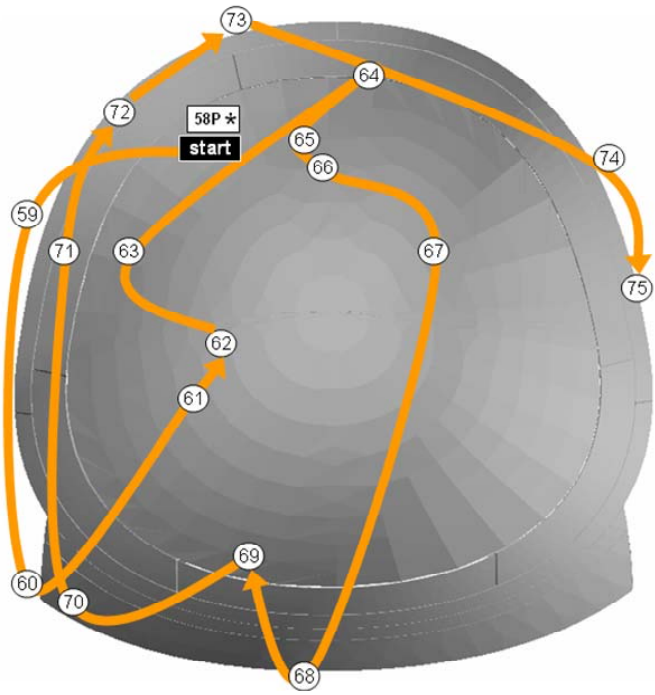

PDRS-7b/O/B

TOP

HOOK  
VELCRO

OBSS SCAN PATTERN CUE CARD – WING GLOVE & CREW CABIN

- = 3 in damage criteria
- 1P = ACAS pause pt
- 1 = ACAS fly-by pt
- = ACAS scan direction

STBD  
WING  
GLOVE  
&  
CREW  
CABIN

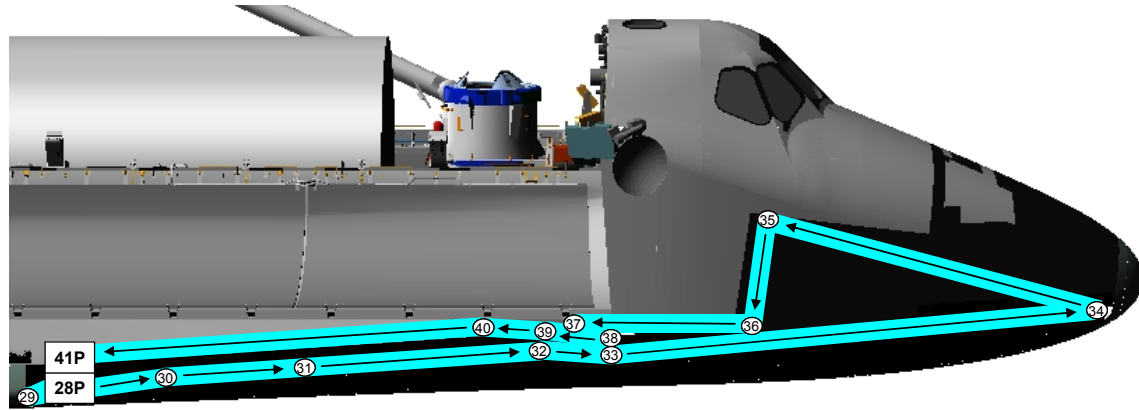

PORT  
WING  
GLOVE  
&  
CREW  
CABIN

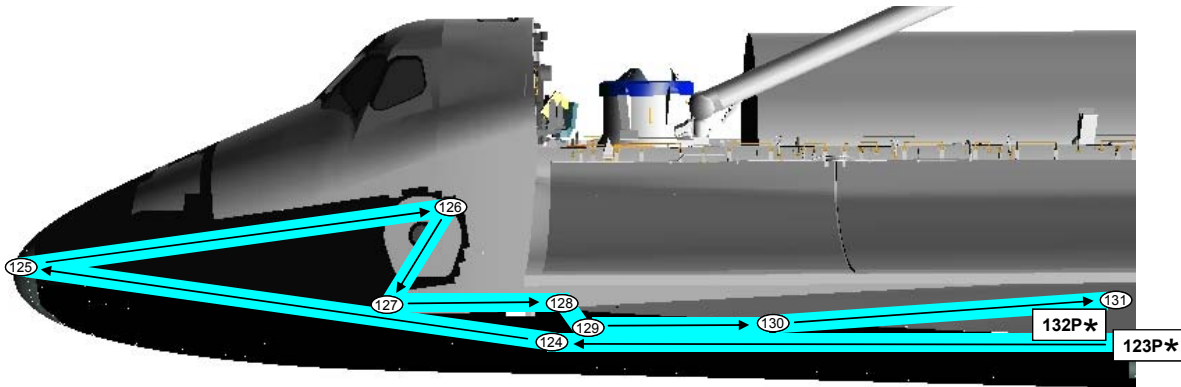

PDRS-8a/O/A

(reduced copy)

FAB USE ONLY

CC 12-10

PDRS/ALL/GEN F

(reduced copy)



TOP  
Back of 'OBSS SCAN PATTERN CUE CARD – WING GLOVE & CREW CABIN'

HOOK  
VELCRO



PDRS-8b/O/A



Space Shuttle Program  
FLIGHT DATA FILE

JSC-48039  
GENERIC, REV F

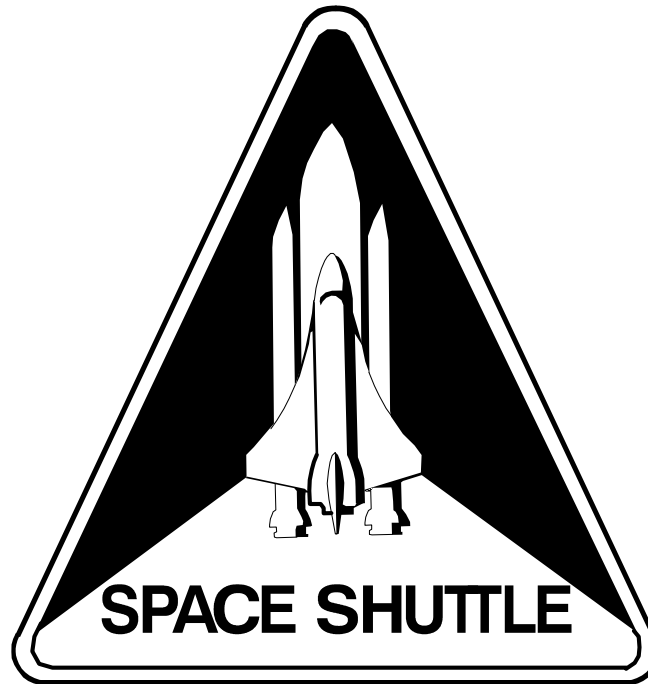

**PDRS OPS C/L**

**STS  
ALL**