

PDRS Operations Checklist

STS-115 Flight Supplement

**Mission Operations Directorate
EVA, Robotics, and Crew Systems
Operations Division**

**Final, Rev C
August 8, 2006**

National Aeronautics and
Space Administration

Lyndon B. Johnson Space Center
Houston, Texas



MISSION OPERATIONS DIRECTORATE

**PDRS OPERATIONS CHECKLIST
STS-115 FLIGHT SUPPLEMENT**

FINAL, REVISION C
August 8, 2006

PREPARED BY:



Sara E. Beck
Book Manager

APPROVED BY:

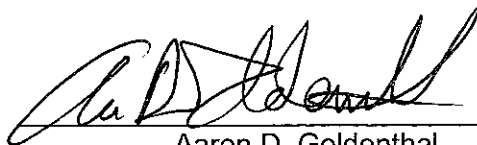

Aaron D. Goldenthal
Lead, Robotics Systems Group

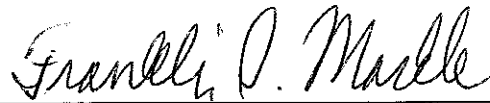

Franklin S. Markle
Chief, Robotics Operations Branch

This document is under the configuration control of the Crew Procedures Control Board (CPCB). All proposed changes must be submitted via FDF Workflow Crew Procedure Change Request (CR) to DO3/FDF Manager.

Additional distribution of this book, for official use only, may be requested in writing to DO3/PMO Administrator. The request must include justification and requester's name, organization, position, and phone number. Contractor requests are made through the NASA or DOD organization supported. Deletions, reduction in quantity, or change of address may be submitted to DO3/FDF Management Office, 281-244-1184.

Incorporates the following:	
482#:	PDRS-962(S) PDRS-1029 PDRS-1030 PDRS-1031

(S) – Requested change was superseded prior to implementation

AREAS OF TECHNICAL RESPONSIBILITY

Book Manager	DX22/S. Beck	281-483-0885
RMS Procedures	DX22/S. Wenger DX22/S. Beck	281-483-5898 281-483-0885
RMS Training	DX25/L. Toole	281-244-8199
RMS Analysis	DX24/M. Austin DX24/R. Christian	281-483-2964 281-483-8769
PRLA Procedures	DF52/J. Kling	281-483-0677

PDRS OPERATIONS CHECKLIST
 STS-115 FLIGHT SUPPLEMENT

LIST OF EFFECTIVE PAGES

FINAL 02/28/03
 REV C 08/08/06

Sign Off	*	115/FIN C	FS 2-21	115/FIN C
FS ii	*	115/FIN C	FS 2-22	115/FIN C
FS iii	*	115/FIN C	FS 2-23	115/FIN C
FS iv	*	115/FIN C	FS 2-24	115/FIN C
FS v	*	115/FIN C	FS 2-25	115/FIN C
FS vi	*	115/FIN C	FS 2-26	115/FIN C
FS vii	*	115/FIN C	FS 2-27	115/FIN C
FS viii	*	115/FIN C	FS 2-28	115/FIN C
FS ix		115/FIN C	FS 3-1	115/FIN C
FS x		115/FIN C	FS 3-2	115/FIN C
FS 1-1		115/FIN C	FS 3-3	115/FIN C
FS 1-2		115/FIN C	FS 3-4	115/FIN C
FS 1-3		115/FIN C	FS 3-5	115/FIN C
FS 1-4		115/FIN C	FS 3-6	115/FIN C
FS 1-5		115/FIN C	FS 3-7	115/FIN C
FS 1-6		115/FIN C	FS 3-8	115/FIN C
FS 1-7		115/FIN C	FS 3-9	115/FIN C
FS 1-8		115/FIN C	FS 3-10	115/FIN C
FS 1-9		115/FIN C	FS 3-11	115/FIN C
FS 1-10		115/FIN C	FS 3-12	115/FIN C
FS 1-11		115/FIN C	FS 3-13	115/FIN C
FS 1-12		115/FIN C	FS 3-14	115/FIN C
FS 1-13		115/FIN C	FS 3-15	115/FIN C
FS 1-14		115/FIN C	FS 3-16	115/FIN C
FS 1-15		115/FIN C	FS 3-17	115/FIN C
FS 1-16		115/FIN C	FS 3-18	115/FIN C
FS 2-1		115/FIN C	FS 3-19	115/FIN C
FS 2-2		115/FIN C	FS 3-20	115/FIN C
FS 2-3		115/FIN C	FS 3-21	115/FIN C
FS 2-4		115/FIN C	FS 3-22	115/FIN C
FS 2-5		115/FIN C	FS 3-23	115/FIN C
FS 2-6		115/FIN C	FS 3-24	115/FIN C
FS 2-7		115/FIN C	FS 3-25	115/FIN C
FS 2-8		115/FIN C	FS 3-26	115/FIN C
FS 2-9		115/FIN C	FS 3-27	115/FIN C
FS 2-10		115/FIN C	FS 3-28	115/FIN C
FS 2-11		115/FIN C	FS 3-29	115/FIN C
FS 2-12		115/FIN C	FS 3-30	115/FIN C
FS 2-13		115/FIN C	FS 3-31	115/FIN C
FS 2-14		115/FIN C	FS 3-32	115/FIN C
FS 2-15		115/FIN C	FS 3-33	115/FIN C
FS 2-16		115/FIN C	FS 3-34	115/FIN C
FS 2-17		115/FIN C	FS 3-35	115/FIN C
FS 2-18		115/FIN C	FS 3-36	115/FIN C
FS 2-19		115/FIN C	FS 3-37	115/FIN C
FS 2-20		115/FIN C	FS 3-38	115/FIN C

* – Omit from flight book

FS 3-39	115/FIN C	FS 3-93.....	115/FIN C
FS 3-40	115/FIN C	FS 3-94.....	115/FIN C
FS 3-41	115/FIN C	FS 3-95.....	115/FIN C
FS 3-42	115/FIN C	FS 3-96.....	115/FIN C
FS 3-43	115/FIN C	FS 3-97.....	115/FIN C
FS 3-44	115/FIN C	FS 3-98.....	115/FIN C
FS 3-45	115/FIN C	FS 3-99.....	115/FIN C
FS 3-46	115/FIN C	FS 3-100.....	115/FIN C
FS 3-47	115/FIN C	FS 3-101.....	115/FIN C
FS 3-48	115/FIN C	FS 3-102.....	115/FIN C
FS 3-49	115/FIN C	FS 3-103.....	115/FIN C
FS 3-50	115/FIN C	FS 3-104.....	115/FIN C
FS 3-51	115/FIN C	FS 3-105.....	115/FIN C
FS 3-52	115/FIN C	FS 3-106.....	115/FIN C
FS 3-53	115/FIN C	FS 3-107.....	115/FIN C
FS 3-54	115/FIN C	FS 3-108.....	115/FIN C
FS 3-55	115/FIN C	FS 3-109.....	115/FIN C
FS 3-56	115/FIN C	FS 3-110.....	115/FIN C
FS 3-57	115/FIN C	FS 3-111.....	115/FIN C
FS 3-58	115/FIN C	FS 3-112.....	115/FIN C
FS 3-59	115/FIN C	FS 3-113.....	115/FIN C
FS 3-60	115/FIN C	FS 3-114.....	115/FIN C
FS 3-61	115/FIN C	FS 3-115.....	115/FIN C
FS 3-62	115/FIN C	FS 3-116.....	115/FIN C
FS 3-63	115/FIN C	FS 3-117.....	115/FIN C
FS 3-64	115/FIN C	FS 3-118.....	115/FIN C
FS 3-65	115/FIN C	FS 3-119.....	115/FIN C
FS 3-66	115/FIN C	FS 3-120.....	115/FIN C
FS 3-67	115/FIN C	FS 3-121.....	115/FIN C
FS 3-68	115/FIN C	FS 3-122.....	115/FIN C
FS 3-69	115/FIN C	FS 3-123.....	115/FIN C
FS 3-70	115/FIN C	FS 3-124.....	115/FIN C
FS 3-71	115/FIN C	FS 4-1.....	115/FIN C
FS 3-72	115/FIN C	FS 4-2.....	115/FIN C
FS 3-73	115/FIN C	FS 4-3.....	115/FIN C
FS 3-74	115/FIN C	FS 4-4.....	115/FIN C
FS 3-75	115/FIN C	FS 4-5.....	115/FIN C
FS 3-76	115/FIN C	FS 4-6.....	115/FIN C
FS 3-77	115/FIN C	FS 4-7.....	115/FIN C
FS 3-78	115/FIN C	FS 4-8.....	115/FIN C
FS 3-79	115/FIN C	FS 4-9.....	115/FIN C
FS 3-80	115/FIN C	FS 4-10.....	115/FIN C
FS 3-81	115/FIN C	FS 4-11.....	115/FIN C
FS 3-82	115/FIN C	FS 4-12.....	115/FIN C
FS 3-83	115/FIN C	FS 4-13.....	115/FIN C
FS 3-84	115/FIN C	FS 4-14.....	115/FIN C
FS 3-85	115/FIN C	FS 4-15.....	115/FIN C
FS 3-86	115/FIN C	FS 4-16.....	115/FIN C
FS 3-87	115/FIN C	FS 4-17.....	115/FIN C
FS 3-88	115/FIN C	FS 4-18.....	115/FIN C
FS 3-89	115/FIN C	FS 4-19.....	115/FIN C
FS 3-90	115/FIN C	FS 4-20.....	115/FIN C
FS 3-91	115/FIN C	FS 4-21.....	115/FIN C
FS 3-92	115/FIN C	FS 4-22.....	115/FIN C

FS 4-23	115/FIN C	FS 4-77	115/FIN C
FS 4-24	115/FIN C	FS 4-78	115/FIN C
FS 4-25	115/FIN C	FS 4-79	115/FIN C
FS 4-26	115/FIN C	FS 4-80	115/FIN C
FS 4-27	115/FIN C	FS 4-81	115/FIN C
FS 4-28	115/FIN C	FS 4-82	115/FIN C
FS 4-29	115/FIN C	FS 4-83	115/FIN C
FS 4-30	115/FIN C	FS 4-84	115/FIN C
FS 4-31	115/FIN C	FS 4-85	115/FIN C
FS 4-32	115/FIN C	FS 4-86	115/FIN C
FS 4-33	115/FIN C	FS 4-87	115/FIN C
FS 4-34	115/FIN C	FS 4-88	115/FIN C
FS 4-35	115/FIN C	FS 4-89	115/FIN C
FS 4-36	115/FIN C	FS 4-90	115/FIN C
FS 4-37	115/FIN C	FS 4-91	115/FIN C
FS 4-38	115/FIN C	FS 4-92	115/FIN C
FS 4-39	115/FIN C	FS 4-93	115/FIN C
FS 4-40	115/FIN C	FS 4-94	115/FIN C
FS 4-41	115/FIN C	FS 4-95	115/FIN C
FS 4-42	115/FIN C	FS 4-96	115/FIN C
FS 4-43	115/FIN C	FS 4-97	115/FIN C
FS 4-44	115/FIN C	FS 4-98	115/FIN C
FS 4-45	115/FIN C	FS 4-99	115/FIN C
FS 4-46	115/FIN C	FS 4-100	115/FIN C
FS 4-47	115/FIN C	FS 4-101	115/FIN C
FS 4-48	115/FIN C	FS 4-102	115/FIN C
FS 4-49	115/FIN C	FS 4-103	115/FIN C
FS 4-50	115/FIN C	FS 4-104	115/FIN C
FS 4-51	115/FIN C	FS 4-105	115/FIN C
FS 4-52	115/FIN C	FS 4-106	115/FIN C
FS 4-53	115/FIN C	FS 4-107	115/FIN C
FS 4-54	115/FIN C	FS 4-108	115/FIN C
FS 4-55	115/FIN C	FS 4-109	115/FIN C
FS 4-56	115/FIN C	FS 4-110	115/FIN C
FS 4-57	115/FIN C	FS 4-111	115/FIN C
FS 4-58	115/FIN C	FS 4-112	115/FIN C
FS 4-59	115/FIN C	FS 4-113	115/FIN C
FS 4-60	115/FIN C	FS 4-114	115/FIN C
FS 4-61	115/FIN C	FS 4-115	115/FIN C
FS 4-62	115/FIN C	FS 4-116	115/FIN C
FS 4-63	115/FIN C	FS 4-117	115/FIN C
FS 4-64	115/FIN C	FS 4-118	115/FIN C
FS 4-65	115/FIN C	FS 4-119	115/FIN C
FS 4-66	115/FIN C	FS 4-120	115/FIN C
FS 4-67	115/FIN C	FS 4-121	115/FIN C
FS 4-68	115/FIN C	FS 4-122	115/FIN C
FS 4-69	115/FIN C	FS 4-123	115/FIN C
FS 4-70	115/FIN C	FS 4-124	115/FIN C
FS 4-71	115/FIN C	FS 4-125	115/FIN C
FS 4-72	115/FIN C	FS 4-126	115/FIN C
FS 4-73	115/FIN C	FS 4-127	115/FIN C
FS 4-74	115/FIN C	FS 4-128	115/FIN C
FS 4-75	115/FIN C	FS 4-129	115/FIN C
FS 4-76	115/FIN C	FS 4-130	115/FIN C

FS 4-131	115/FIN C	FS 4-185.....	115/FIN C
FS 4-132	115/FIN C	FS 4-186.....	115/FIN C
FS 4-133	115/FIN C	FS 4-187.....	115/FIN C
FS 4-134	115/FIN C	FS 4-188.....	115/FIN C
FS 4-135	115/FIN C	FS 4-189.....	115/FIN C
FS 4-136	115/FIN C	FS 4-190.....	115/FIN C
FS 4-137	115/FIN C	FS 4-191.....	115/FIN C
FS 4-138	115/FIN C	FS 4-192.....	115/FIN C
FS 4-139	115/FIN C	FS 4-193.....	115/FIN C
FS 4-140	115/FIN C	FS 4-194.....	115/FIN C
FS 4-141	115/FIN C	FS 4-195.....	115/FIN C
FS 4-142	115/FIN C	FS 4-196.....	115/FIN C
FS 4-143	115/FIN C	FS 4-197.....	115/FIN C
FS 4-144	115/FIN C	FS 4-198.....	115/FIN C
FS 4-145	115/FIN C	FS 4-199.....	115/FIN C
FS 4-146	115/FIN C	FS 4-200.....	115/FIN C
FS 4-147	115/FIN C	FS 4-201.....	115/FIN C
FS 4-148	115/FIN C	FS 4-202.....	115/FIN C
FS 4-149	115/FIN C	FS 4-203.....	115/FIN C
FS 4-150	115/FIN C	FS 4-204.....	115/FIN C
FS 4-151	115/FIN C	FS 4-205.....	115/FIN C
FS 4-152	115/FIN C	FS 4-206.....	115/FIN C
FS 4-153	115/FIN C	FS 4-207.....	115/FIN C
FS 4-154	115/FIN C	FS 4-208.....	115/FIN C
FS 4-155	115/FIN C	FS 4-209.....	115/FIN C
FS 4-156	115/FIN C	FS 4-210.....	115/FIN C
FS 4-157	115/FIN C	FS 4-211.....	115/FIN C
FS 4-158	115/FIN C	FS 4-212.....	115/FIN C
FS 4-159	115/FIN C	FS 4-213.....	115/FIN C
FS 4-160	115/FIN C	FS 4-214.....	115/FIN C
FS 4-161	115/FIN C	FS 4-215.....	115/FIN C
FS 4-162	115/FIN C	FS 4-216.....	115/FIN C
FS 4-163	115/FIN C	FS 5-1.....	115/FIN C
FS 4-164	115/FIN C	FS 5-2.....	115/FIN C
FS 4-165	115/FIN C	FS 5-3.....	115/FIN C
FS 4-166	115/FIN C	FS 5-4.....	115/FIN C
FS 4-167	115/FIN C	FS 5-5.....	115/FIN C
FS 4-168	115/FIN C	FS 5-6.....	115/FIN C
FS 4-169	115/FIN C	FS 5-7.....	115/FIN C
FS 4-170	115/FIN C	FS 5-8.....	115/FIN C
FS 4-171	115/FIN C	FS 5-9.....	115/FIN C
FS 4-172	115/FIN C	FS 5-10.....	115/FIN C
FS 4-173	115/FIN C	FS 5-11.....	115/FIN C
FS 4-174	115/FIN C	FS 5-12.....	115/FIN C
FS 4-175	115/FIN C	FS 5-13.....	115/FIN C
FS 4-176	115/FIN C	FS 5-14.....	115/FIN C
FS 4-177	115/FIN C	FS 5-15.....	115/FIN C
FS 4-178	115/FIN C	FS 5-16.....	115/FIN C
FS 4-179	115/FIN C	FS 5-17.....	115/FIN C
FS 4-180	115/FIN C	FS 5-18.....	115/FIN C
FS 4-181	115/FIN C	FS 5-19.....	115/FIN C
FS 4-182	115/FIN C	FS 5-20.....	115/FIN C
FS 4-183	115/FIN C	FS 5-21.....	115/FIN C
FS 4-184	115/FIN C	FS 5-22.....	115/FIN C

FS 5-23	115/FIN C	FS 5-81	115/FIN C
FS 5-24	115/FIN C	FS 5-82	115/FIN C
FS 5-25	115/FIN C	FS 5-83	115/FIN C
FS 5-26	115/FIN C	FS 5-84	115/FIN C
FS 5-27	115/FIN C	FS 5-85	115/FIN C
FS 5-28	115/FIN C	FS 5-86	115/FIN C
FS 5-29	115/FIN C	FS 5-87	115/FIN C
FS 5-30	115/FIN C	FS 5-88	115/FIN C
FS 5-31	115/FIN C	FS 5-89	115/FIN C
FS 5-32	115/FIN C	FS 5-90	115/FIN C
FS 5-33	115/FIN C	FS 5-91	115/FIN C
FS 5-34	115/FIN C	FS 5-92	115/FIN C
FS 5-35	115/FIN C	FS 5-93	115/FIN C
FS 5-36	115/FIN C	FS 5-94	115/FIN C
FS 5-37	115/FIN C	FS 5-95	115/FIN C
FS 5-38	115/FIN C	FS 5-96	115/FIN C
FS 5-39	115/FIN C	FS 5-97	115/FIN C
FS 5-40	115/FIN C	FS 5-98	115/FIN C
FS 5-41	115/FIN C	FS 5-99	115/FIN C
FS 5-42	115/FIN C	FS 5-100	115/FIN C
FS 5-43	115/FIN C	FS 5-101	115/FIN C
FS 5-44	115/FIN C	FS 5-102	115/FIN C
FS 5-45	115/FIN C	FS 5-103	115/FIN C
FS 5-46	115/FIN C	FS 5-104	115/FIN C
FS 5-47	115/FIN C	FS 6-1	115/FIN C
FS 5-48	115/FIN C	FS 6-2	115/FIN C
FS 5-49	115/FIN C	FS 6-3	115/FIN C
FS 5-50	115/FIN C	FS 6-4	115/FIN C
FS 5-51	115/FIN C	FS 6-5	115/FIN C
FS 5-52	115/FIN C	FS 6-6	115/FIN C
FS 5-53	115/FIN C	FS 6-7	115/FIN C
FS 5-54	115/FIN C	FS 6-8	115/FIN C
FS 5-55	115/FIN C	FS 6-9	115/FIN C
FS 5-56	115/FIN C	FS 6-10	115/FIN C
FS 5-57	115/FIN C	FS 6-11	115/FIN C
FS 5-58	115/FIN C	FS 6-12	115/FIN C
FS 5-59	115/FIN C	FS 6-13	115/FIN C
FS 5-60	115/FIN C	FS 6-14	115/FIN C
FS 5-61	115/FIN C	FS 6-15	115/FIN C
FS 5-62	115/FIN C	FS 6-16	115/FIN C
FS 5-63	115/FIN C	FS 6-17	115/FIN C
FS 5-64	115/FIN C	FS 6-18	115/FIN C
FS 5-65	115/FIN C	FS 6-19	115/FIN C
FS 5-66	115/FIN C	FS 6-20	115/FIN C
FS 5-67	115/FIN C	FS 6-21	115/FIN C
FS 5-68	115/FIN C	FS 6-22	115/FIN C
FS 5-69	115/FIN C	FS 6-23	115/FIN C
FS 5-70	115/FIN C	FS 6-24	115/FIN C
FS 5-71	115/FIN C	FS 6-25	115/FIN C
FS 5-72	115/FIN C	FS 6-26	115/FIN C
FS 5-73	115/FIN C	FS 6-27	115/FIN C
FS 5-74	115/FIN C	FS 6-28	115/FIN C
FS 5-75	115/FIN C	FS 7-1	115/FIN C
FS 5-76	115/FIN C	FS CC 7-2	115/FIN C
FS 5-77	115/FIN C	FS CC 7-3	115/FIN C
FS 5-78	115/FIN C	FS CC 7-4	115/FIN C
FS 5-79	115/FIN C	FS CC 7-5	115/FIN C
FS 5-80	115/FIN C	FS CC 7-6	115/FIN C

FS CC 7-7	115/FIN C
FS CC 7-8	115/FIN C
FS CC 7-9	115/FIN C
FS CC 7-10	115/FIN C
FS CC 7-11	115/FIN C
FS 7-12	115/FIN C

PDRS CUE CARDS

<u>Title</u>	<u>Ref. Page</u>	<u>Card No.</u>
P3/P4 SJ GRAPPLE WRIST CCTV OVERLAY	FS CC 7-2	PDRS-7a/115/O/C
P3/P4 SJ UNGRAPPLE WRIST CCTV OVERLAY	FS CC 7-3	PDRS-8a/115/O/B
OBSS LDRI SCAN PATTERN CUE CARD – STBD & PORT (Front)	FS CC 7-4	PDRS-10a/115/O/B
OBSS LDRI SCAN PATTERN CUE CARD – NOSE CAP (Back)	FS CC 7-5	PDRS-10b/115/O/B
OBSS IDC SCAN PATTERN CUE CARD – STBD & PORT (Front)	FS CC 7-6	PDRS-14a/115/O/A
OBSS IDC SCAN PATTERN CUE CARD – NOSE CAP (Back)	FS CC 7-7	PDRS-14b/115/O/A
OBSS LDRI SCAN PATTERN CUE CARD – DOCKED STBD (Front)	FS CC 7-8	PDRS-15a/115/O/A
(Back)	FS CC 7-9	PDRS-15b/115/O/A
OBSS SJ GRAPPLE AT HANDOFF OVERLAY	FS CC 7-10	PDRS-12a/115/O/A
OBSS SJ UNGRAPPLE AT HANDOFF OVERLAY	FS CC 7-11	PDRS-13a/115/O/A

<u>CONTENTS</u>	<u>PAGE</u>
<u>NOMINAL P3/P4 HANDOFF</u>	FS 1-1
P3/P4 GRAPPLE.....	FS 1-2
UNBERTH.....	FS 1-5
UNGRAPPLE.....	FS 1-12
<u>OFF-NOMINAL P3/P4 HANDOFF</u>	FS 2-1
SJ P3/P4 GRAPPLE.....	FS 2-2
UNBERTH.....	FS 2-9
UNGRAPPLE.....	FS 2-18
P3/P4 CONTINGENCY REBERTH.....	FS 2-22
<u>OBSS NOMINAL OPERATIONS</u>	FS 3-1
VERIFY UPLINKS.....	FS 3-2
OBSS UNBERTH.....	FS 3-4
ITVC/LDRI FLAT FIELDS.....	FS 3-10
BERTH.....	FS 3-13
HANDOFF FROM SSRMS (LAB) TO SRMS.....	FS 3-19
SRMS TO SSRMS (LAB).....	FS 3-24
MNVR FROM HANDOFF TO STBD LDRI ACAS START.....	FS 3-29
OBSS LDRI RCC SURVEY – STBD UNDOCKED.....	FS 3-31
– NOSE CAP.....	FS 3-50
– PORT.....	FS 3-66
– STBD DOCKED.....	FS 3-83
SRMS EE CAM CREW CABIN SURVEY.....	FS 3-113
<u>OBSS OFF-NOMINAL OPERATIONS</u>	FS 4-1
OBSS HANDOFF FROM SSRMS (WS3) TO SRMS.....	FS 4-2
SRMS TO SSRMS (WS3).....	FS 4-7
IDC RCC SURVEY – STBD.....	FS 4-12
– NOSE CAP.....	FS 4-21
– PORT.....	FS 4-35
OBSS SJ UNBERTH.....	FS 4-47
BERTH.....	FS 4-61
HANDOFF FROM SSRMS (LAB) TO SRMS.....	FS 4-76
SRMS TO SSRMS (LAB).....	FS 4-91
FLAT FIELDS.....	FS 4-101
JETTISON.....	FS 4-106
WITH MPMS.....	FS 4-111
EVA WLE RCC SURVEY.....	FS 4-117
ITVC TILE ACREAGE SURVEY.....	FS 4-169
RMS EE RCC WING SURVEY.....	FS 4-197
<u>OBSS SURVEY CAMERA VIEWS</u>	FS 5-1
OBSS LDRI RCC SURVEY CAMERA VIEWS – STBD UNDOCKED.....	FS 5-2
– NOSE CAP.....	FS 5-15
– PORT.....	FS 5-27
– STBD DOCKED.....	FS 5-39
IDC RCC SURVEY CAMERA VIEWS – STBD.....	FS 5-63
– NOSE CAP.....	FS 5-73
– PORT.....	FS 5-87
SRMS EE CAM CREW CABIN SURVEY CAMERA VIEWS.....	FS 5-97
<u>REFERENCE DATA</u>	FS 6-1
PL ID 1 – OBSS UNBERTH/BERTH, FWD STRIKER BAR.....	FS 6-2
2 – LARGE, NON-SURVEY OBSS MNVRS.....	FS 6-3
3 – OBSS LDRI – POR @ PTU PIVOT.....	FS 6-4

PL ID 4 – P3/P4 CENTER OF TRUNNIONS AT TRUNNION LEVEL.....	FS 6-5
5 – EE SURVEY	FS 6-6
5A (UPLINK) – OBSS IDC.....	FS 6-7
P3/P4 JOINT ANGLES VS POR COORDINATES.....	FS 6-8
PRLA CONFIGURATION	FS 6-10
INSTALL CAMERA MATRIX	FS 6-11
OBSS JOINT ANGLES VS POR COORDINATES.....	FS 6-13
AUTO SEQUENCES	FS 6-17
SRMS EE CAM SURVEYS JOINT ANGLES VS POR COORDINATES	FS 6-26
CREW CABIN SURVEY AUTO SEQUENCES	FS 6-27
<u>CUE CARD CONFIGURATION</u>	FS 7-1

NOMINAL P3/P4 HANDOFF

I

P3/P4 GRAPPLE	FS 1-2
UNBERTH	FS 1-5
UNGRAPPLE	FS 1-12

**NOMINAL P3/P4
HANDOFF**

P3/P4 GRAPPLE

- A7U 1. SETUP
 CCTV – config for grapple
 – RMS WRIST, zoom 34.0 HFOV
 focus 5 ft
 Maintain eyepoint ~18 in when using grapple overlay

SM 94 PDRS CONTROL

- √PL ID, ITEM 3: 0
- √INIT ID, ITEM 24: 0

CAUTION
 Payload Bay Flood Lights must be OFF
 until P3/P4 trunnions clear of V-guides

2. MNVR TO P3/P4 PRE-GRAPPLE POSN

MON 1	Elbow (EE)
MON 2	A (B)

- RATE – as required (VERN within 10 ft)
- BRAKES – OFF (tb-OFF)
- MODE – ORB UNL, ENTER

Mnvr to P3/P4 PRE-GRAPPLE posn:

X	Y	Z	PITCH	YAW	ROLL	PL ID
-829	-95	-501	270	311	271	0
SY	SP	EP	WP	WY	WR	
-1.2	+116.0	-141.2	-64.2	-29.3	-68.6	

BRAKES – ON (tb-ON)

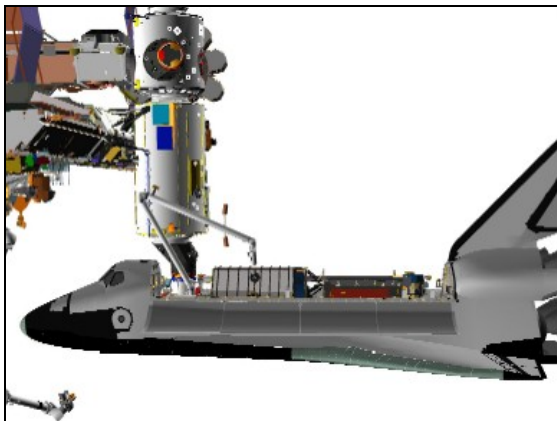

PORT

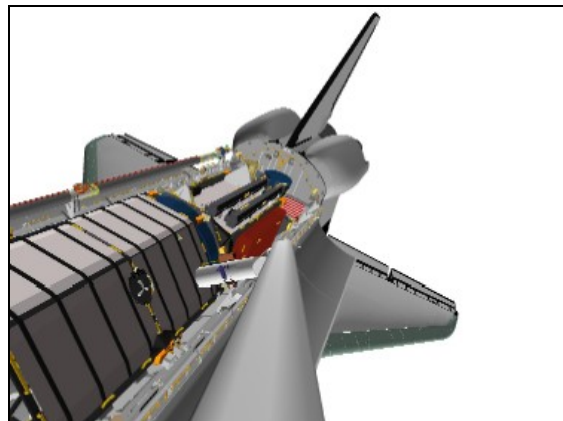

ELBOW (0,0)

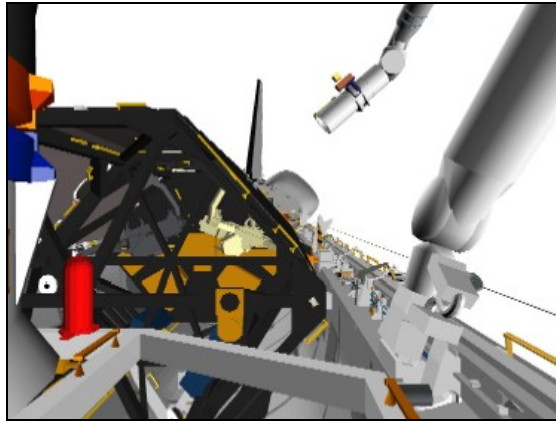

CCTV A (0,0)

3. P3/P4 GRAPPLE

MON 1	EE (Elbow)
MON 2	A (B)

RATE – VERN (RATE MIN tb-ON)
 BRAKES – OFF (tb-OFF)
 MODE – END EFF, ENTER

Mnvr to grapple envelope

CAUTION
 Monitor EE tb timing to prevent EE motor burnout

SM 169 PDRS STATUS

EE MODE – AUTO
 CAPTURE sw – depress (mom)

√	RIGID <input type="checkbox"/>	CLOSE <input type="checkbox"/>	CAPTURE <input type="checkbox"/>
	DERIGID <input checked="" type="checkbox"/>	OPEN <input checked="" type="checkbox"/>	EXTEND <input checked="" type="checkbox"/>

CRITICAL TIMES (28 sec total):
 CAPTURE tb – gray, then
 CLOSE tb – gray, 3 sec max, then
 RIGID tb – gray, 25 sec max

- * If manual grapple reqd: *
- * EE MODE – MAN *
- * CAPTURE sw – depress (hold until CLOSE tb-gray, 3 sec max) *
- * MAN CONTR – RIGID (hold until RIGID tb-gray, 25 sec max) *

EE MODE – OFF
 BRAKES – ON (tb-ON)

SM 94 PDRS CONTROL

PL ID, ITEM 3 +4 EXEC
 INIT ID, ITEM 24 +4 EXEC

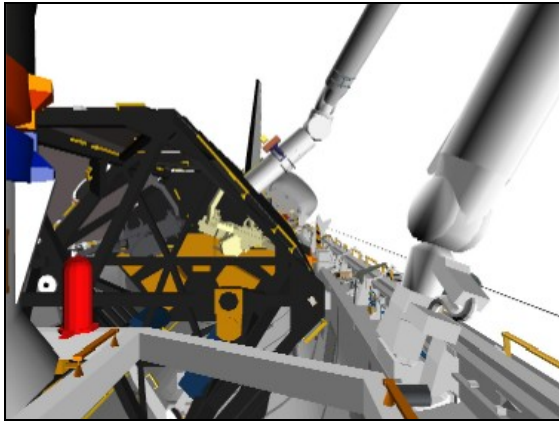

CCTV A (0,0)

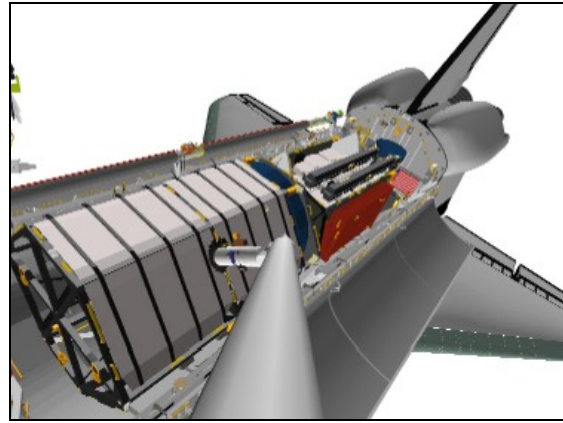

ELBOW (0,0)

Record POS/ATT and Joint Angles:

	X	Y	Z	PITCH	YAW	ROLL	PL ID
							4
Expected	-1002	0	-414	0	0	0	4
	SY	SP	EP	WP	WY	WR	
Expected	-12.3	+105.3	-147.1	-41.4	-28.6	-56.0	

Record POS/ATT and Joint Angles in P3/P4 CONTINGENCY REBERTH
(OFF-NOM P3/P4 HANDOFF)

Review GENERIC END EFFECTOR CUE CARD – ISS/SHUTTLE DOCKED OPS

P3/P4 UNBERTH

1. SETUP

A7U CCTV – config for unberth

MON 1	D/A Mux (Elbow)
MON 2	B/C Mux
DNLK MON 1	P1 Outboard Lower

SM 94 PDRS CONTROL

√PL ID, ITEM 3: 4
√INIT ID, ITEM 24: 4

√BRAKES – ON (tb-ON)

PCS MSS: SSRMS: Thrusters: Thruster Controls for MSS Ops

Verify 'Desat Request' Inhibit

If using Shuttle attitude control:
DAP: FREE

2. ACTIVATE LATCHES

MA73C:A MCA LOGIC MNC MID 2 – OFF
:B MCA LOGIC MNB MID 4 – OFF

A6U √PL RETEN LAT (five) – OFF
√PL SEL – MON
R13L BAY MECH PWR SYS (1,2) – ON
A6U RETEN LOGIC PWR SYS (1,2) – ON

SM 97 PL RETENTION

√PL SEL 1 RDY-FOR-LAT 1,2,3,4 (eight) – 1
√LAT 1,2,3,4 (eight) – 1
√2 RDY FOR LAT 1,2 (four) – 1
√LAT 1,2 (four) – 1

* If any rel msw shows '1', expect *
* single motor time (60 sec) *

3. AKA RELEASE

PL RETEN PL SEL – 2
√LAT 1,2 tb – LAT
√RDY 1,2 tb – gray

Note single motor times (> 30 sec)
PL RETEN LAT 1,2 – REL (tb-REL), 60 sec max
– OFF

4. PRLA RELEASE

Verify SSRMS in P3P4 Unberth Viewing posn

PL RETEN PL SEL – 1
√LAT 1,2,3,4 tb – LAT
√RDY 1,2,3,4 tb – gray

Note single motor times (> 30 sec)
PL RETEN LAT 1,2 (two) – REL (tb-REL), 60 sec max
– OFF
3,4 (two) – REL (tb-REL), 60 sec max
– OFF

5. DEACTIVATING LATCHES

R13L PL RETEN LOGIC PWR SYS (1,2) - OFF
 BAY MECH PWR SYS (1,2) - OFF

MA73C:A MCA LOGIC MNC MID 2 - ON
 :B MCA LOGIC MNB MID 4 - ON

6. MNVR TO P3/P4 INTERMEDIATE UNBERTH POSN

CAUTION

Monitor clearances between STBD trunnions and OBSS during unberrth. Minimum clearance of approximately 3 inches expected
 Gradually apply 2 inch Y bias starting at Z= -422 (+52 REL) and complete by Z = -434 (+40 REL)

NOTE

When US Lab camera shows obvious trunnion to OBSS clearance, use P1 Outboard Lower camera to monitor clearance between P3/P4 and US Lab

√RATE - VERN (RATE MIN tb-ON)
 BRAKES - OFF (tb-OFF)
 MODE - ORB LD, ENTER

Mnvr P3/P4 up until Z = -474
 √PL RETEN RDY 1,2,3,4 tb (four) - bp

MON 1	D/A Mux (Elbow)
MON 2	B/C Mux
DNLK MON 1	US Lab

Mnvr to P3/P4 INTERMEDIATE UNBERTH posn: apply 2 inch Y bias by Z = -434

X	Y	Z	PITCH	YAW	ROLL	PL ID
-1002	-2	-474	0	0	0	4
SY	SP	EP	WP	WY	WR	
-18.7	+115.1	-139.6	-55.3	-27.6	-48.7	

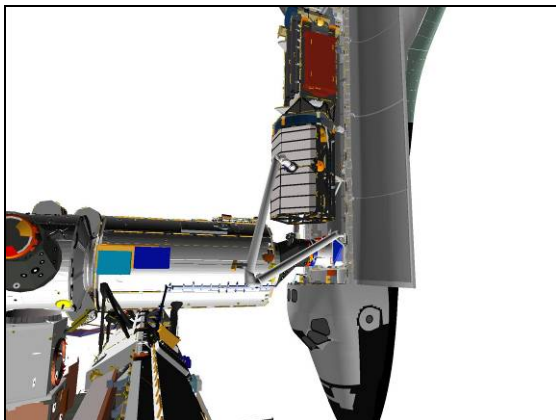

P1 OUTBOARD LOWER (110,10)

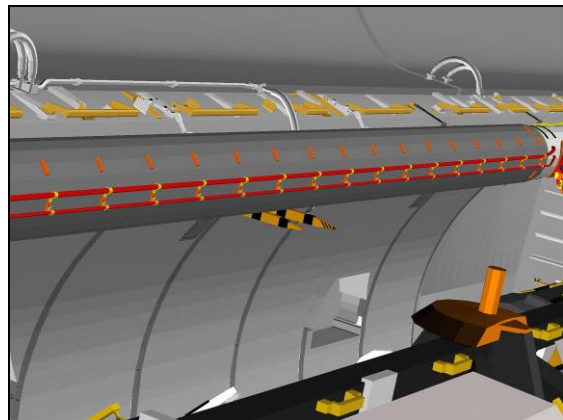

US LAB (-33,-28)

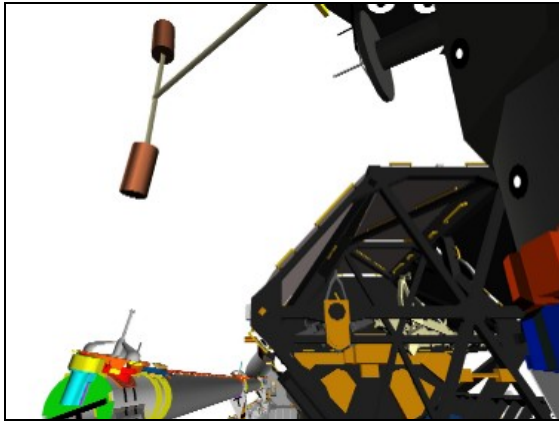

CCTV D (0,25)

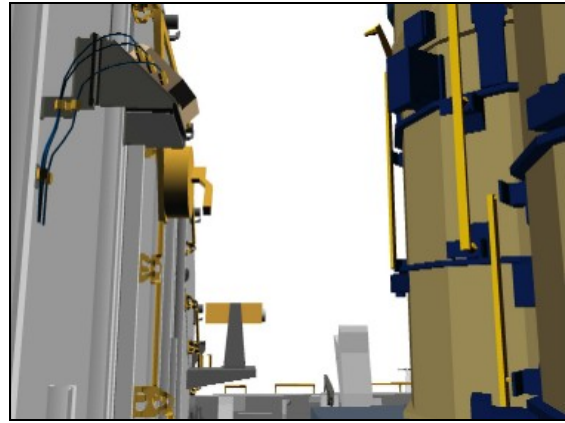

CCTV C (-85,10)

8. MNVR TO P3/P4 LOW HOVER POSN

MON 1	D (Elbow)
MON 2	C (B)
DNLK MON 1	P1 Outboard Lower

√RATE – VERN (RATE MIN tb-ON)

√BRAKES – OFF (tb-OFF)

√MODE – ORB LD

Mnvr P3/P4 up to Z = -580

Mnvr to P3/P4 LOW HOVER posn:

X	Y	Z	PITCH	YAW	ROLL	PL ID
-1020	-2	-580	0	0	0	4
SY	SP	EP	WP	WY	WR	
-27.2	+113.4	-117.3	-71.7	-25.8	-39.5	

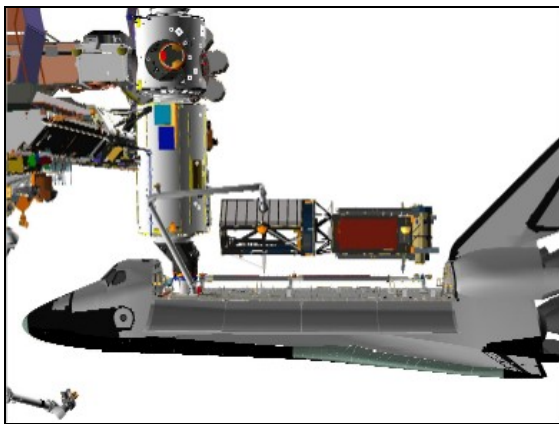

PORT

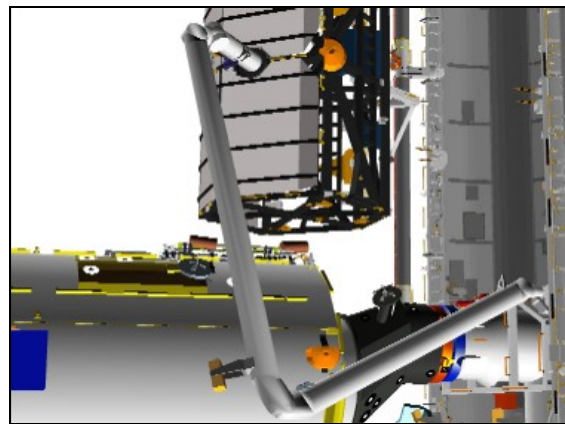

P1 OUTBOARD LOWER (106,11)

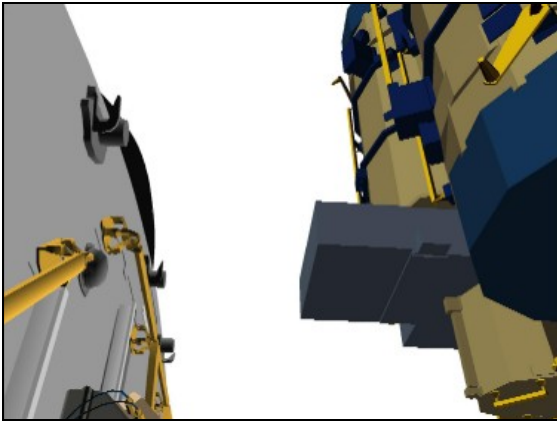

CCTV C (-85,40)

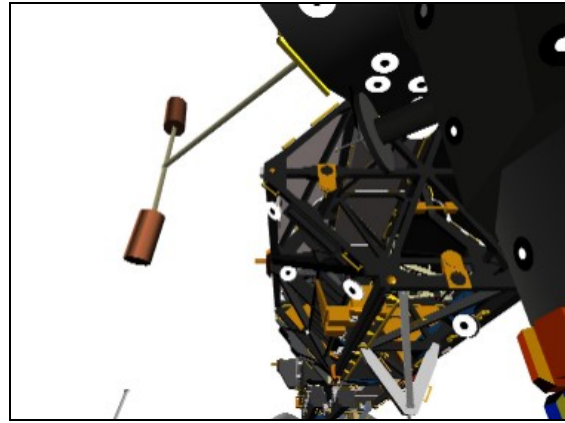

CCTV D (0,35)

If using ISS attitude control:
 √MCC if attitude maintenance reqd

If using Shuttle attitude control and attitude maintenance reqd:

DAP: LVLH

When rates damped:

DAP: FREE > 2 sec

DAP: AUTO

When in attitude:

DAP: FREE

9. MNVR TO P3/P4 AUTO SEQ START POSN

√RATE – VERN (RATE MIN tb-ON)

√BRAKES – OFF (tb-OFF)

√MODE – ORB LD

MON 1	A (Elbow)
MON 2	C (B)
DNLK MON 1	P1 Outboard Lower

NOTE

Use CCTV A or Elbow to monitor RMS upper boom to US Lab clearance.

Use CCTV B or C to monitor P4 keel pin to MPM clearance.

When Y = -100 (+90 REL), RATE HOLD for Y as desired

Mnvr P3/P4 port to Y = -190

Mnvr to P3/P4 AUTO SEQUENCE START posn within 2°/1° of:

X	Y	Z	PITCH	YAW	ROLL	PL ID
-1020	-190	-580	0	0	0	4
SY	SP	EP	WP	WY	WR	
+28.6	+109.8	-101.9	-112.9	-25.5	-102.0	

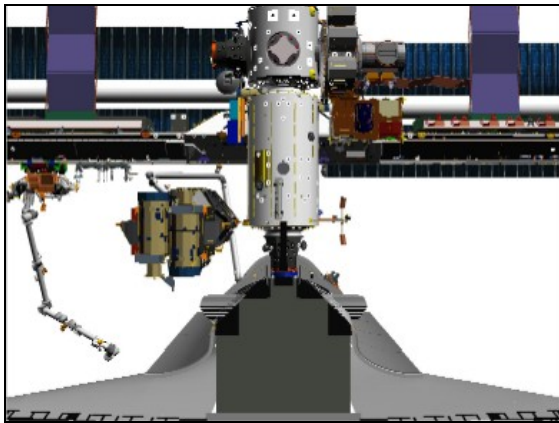

BACK

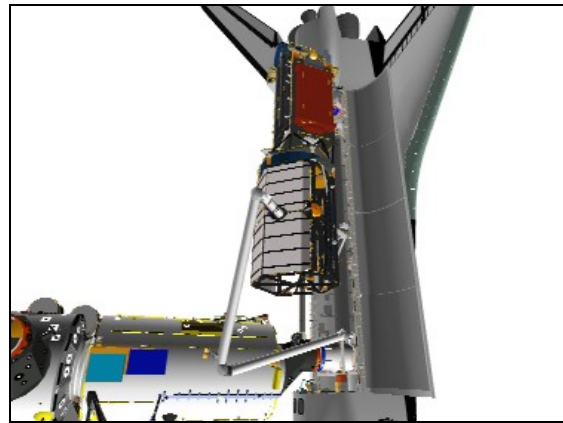

P1 OUTBOARD LOWER (110,25)

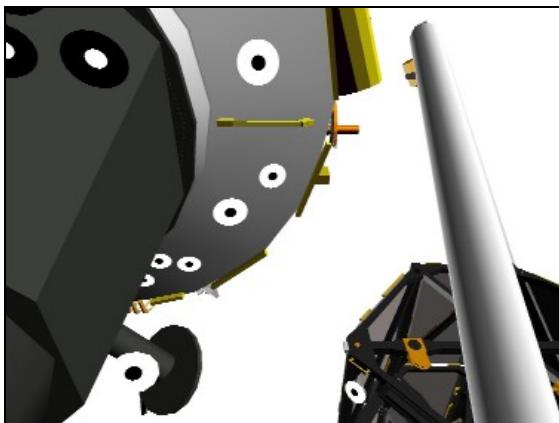

CCTV A (0,60)

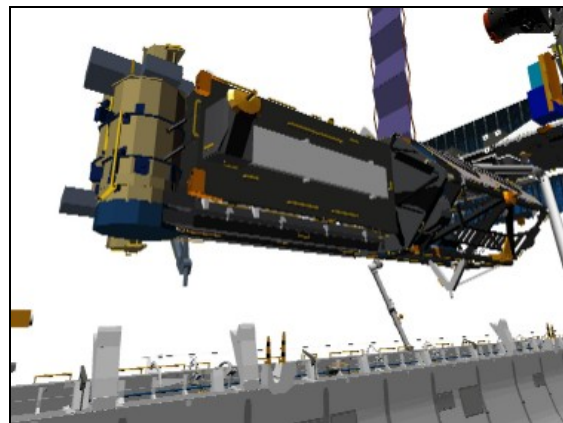

CCTV C (-55,15)

BRAKES – ON (tb-ON)
 ✓MODE – not DIRECT

If using ISS attitude control:
 ✓MCC if attitude maintenance reqd

If using Shuttle attitude control and attitude maintenance reqd:

DAP: LVLH
 When rates damped:
 DAP: FREE > 2 sec
 DAP: AUTO
 When in attitude:
 DAP: FREE

10. MNVR TO P3/P4 HANDOFF

MON 1	A (Elbow)
MON 2	B (C)
DNLK MON 1	P1 Outboard Lower

AUTO 1 – ITEM 13 +1 0 EXEC

✓RATE – VERN (RATE MIN tb-ON)
 BRAKES – OFF (tb-OFF)

MODE – AUTO 1, ENTER

√START PT, ITEM 17: 183

√READY It – ON
AUTO SEQ – PROCEED (IN PROG It on)

Auto Pos #	X/ SY	Y/ SP	Z/ EP	PITCH/ WP	YAW/ WY	ROLL/ WR	PL ID
183	-1020	-190	-580	0	0	0	4
	+28.6	+109.8	-101.9	-112.9	-25.5	-102.0	
184	-1020	-400	-500	0	0	298	4
	+48.2	+99.1	-96.1	-67.5	+21.1	-123.0	
185	-790	-598	-292	303	21	298	4
	+70.3	+65.9	-75.0	-74.1	+68.5	-118.9	

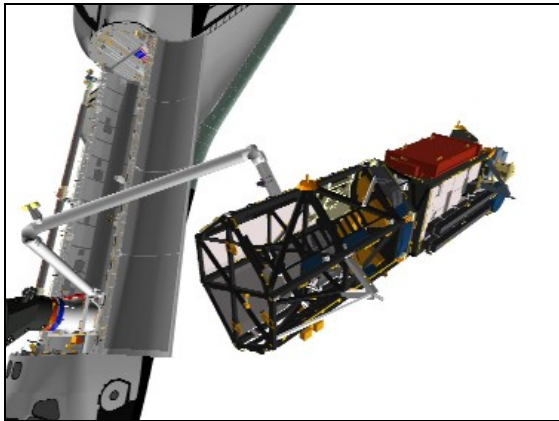

P1 OUTBOARD LOWER (145,20)

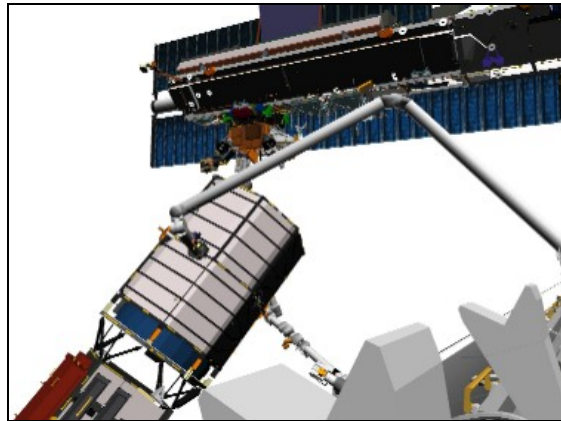

CCTV B (-30,5)

BRAKES – ON (tb-ON)
√MODE – not DIRECT

If using ISS attitude control:
√MCC if attitude maintenance reqd

If using Shuttle attitude control and attitude maintenance reqd:

GNC 20 DAP CONFIG

Load DAP A15

Wait 30 sec

DAP: LVLH

When rates damped:

DAP: FREE > 2 sec

DAP: AUTO

When in attitude:

DAP: FREE

Notify SSRMS operator that SRMS is at the P3/P4 Handoff posn and SRMS Brakes are on. GO for P3/P4 Pre-Grapple Maneuver

P3/P4 UNGRAPPLE

- A7U 1. SETUP
 CCTV – RMS WRIST, zoom 34.0 HFOV
 focus 5 ft

MON 1	EE (Elbow)
MON 2	A (B)
DNLK MON 1	P1 Outboard Lower

SM 94 PDRS CONTROL
 PL ID, ITEM 3: 0
 INIT ID, ITEM 24: 0

2. P3/P4 UNGRAPPLE
 √1.201 P3P4 HANDOFF complete and on SSRMS operator GO:

NOTE

CONTR ERR It and 'S96 PDRS CNTL' msg may occur due to Consistency/Envelope Check error

RATE – COARSE (RATE MIN tb-OFF)

SM 94 PDRS CONTROL

AUTO BRAKE INH – ITEM 10 EXEC (*)

BRAKES – OFF (tb-OFF)

MODE – TEST, ENTER
 Wait 5 sec

BRAKES – ON (tb-ON)

SM 94 PDRS CONTROL

AUTO BRAKE ENA – ITEM 9 EXEC (*)

RATE – VERN (RATE MIN tb-ON)

BRAKES – OFF (tb-OFF)

MODE – END EFF, ENTER

CAUTION

Monitor EE tb timing to prevent EE motor burnout

SM 169 PDRS STATUS

EE MODE – AUTO
 RELEASE sw – depress (mom)

When OPEN tb – gray, mnvr arm clear of grapple pin

√ RIGID	CLOSE	CAPTURE
<input checked="" type="checkbox"/>	<input checked="" type="checkbox"/>	<input checked="" type="checkbox"/>
DERIGID	OPEN	EXTEND
<input type="checkbox"/>	<input type="checkbox"/>	<input type="checkbox"/>

CRITICAL TIMES (28 sec total):

DERIGID tb – gray, 5 sec max, then

OPEN tb – gray, 3 sec max, then

EXTEND tb – gray, 20 sec max

EE MODE – OFF

- * If manual release required: *
- * EE MODE – MAN *
- * MAN CONTR – DERIGID (hold until DERIGID tb-gray, 5 sec max) *
- * RELEASE sw – depress (hold until OPEN tb-gray, 3 sec max) *
- * *
- * Mnv r arm clear, then *
- * EE MAN CONTR – DERIGID (hold until EXTEND *
- * tb-gray, 20 sec max) *
- * MODE – OFF *

3. MNVR SVS VIEWING

MON 1	B (C)
MON 2	A
DNLK MON 1	P1 Outboard Lower

- √RATE – VERN (RATE MIN tb-ON)
- √BRAKES – OFF (tb-OFF)
- MODE – SINGLE, ENTER

If using RSC for SVS:

Mnvr to SVS/RSC VIEWING posn:

	SY	SP	EP	WP	WY	WR	
~Ungrapple	+65.3	+65.3	-71.5	-89.7	+68.5	-105.3	
1: SY –	+57.1						
2: SP –		+38.2					
3: EP +			-42.1				
4: WP –				-98.6			
5: WY –					+41.3		
6: WR +						+128.8	
RSC Viewing	+57.1	+38.2	-42.1	-98.6	+41.3	+128.8	
	X	Y	Z	PITCH	YAW	ROLL	PL ID
	-901	-522	-382	230	358	154	0

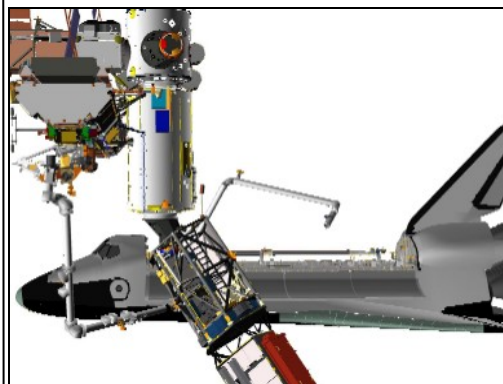

PORT

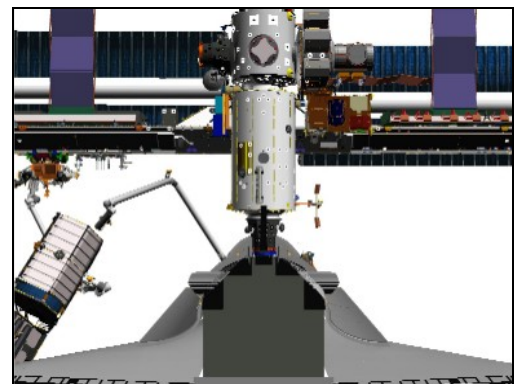

BACK

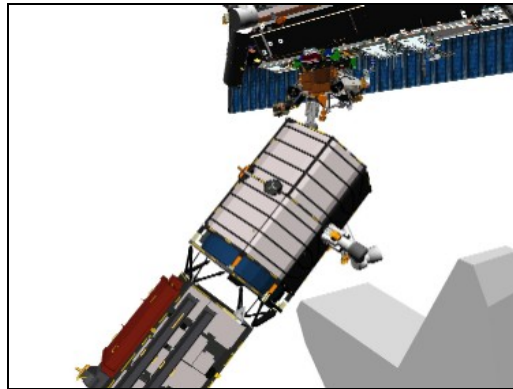

CCTV B (-40,0)

If using RMS Elbow for SVS:

Mnvr to SVS ELBOW CAM VIEWING posn:

	SY	SP	EP	WP	WY	WR	
~ Ungrapple	+65.3	+65.3	-71.5	-89.7	+68.5	-105.3	
1: SY -	+55.8						
2: SP -		+18.2					
3: EP +			-46.1				
Elbow Viewing	+55.8	+18.2	-46.1	-89.7	+68.5	-105.3	
	X	Y	Z	PITCH	YAW	ROLL	PL ID
	-901	-474	-224	207	15	269	0

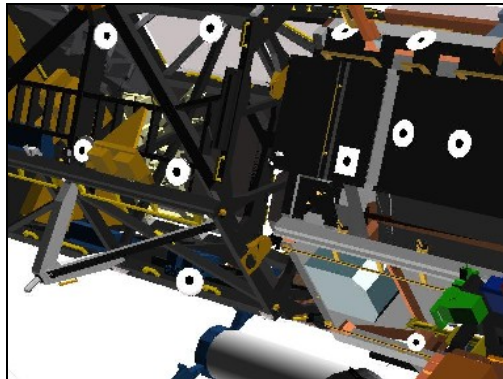

CCTV ELBOW (101.5,-5)

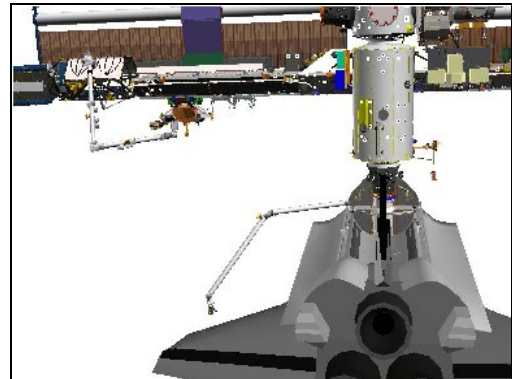

BACK

BRAKES – ON (tb-ON)

√MODE – not DIRECT

PARAM – PORT TEMP

JOINT – CRIT TEMP

Notify SSRMS operator that SRMS is in SVS Viewing position

4. CONFIGURE VIDEO FOR AVU SVS/RSC P3/P4 INSTALL

If using RSC for SVS:

R12

√VPU Green Jumper – ISS

√RSC Video Cable – PL3

A7U

Route video (if required):

VID OUT	VID IN
DNLK MON 1	PL 3
MON 2	PL 2

VIDEO OUT MON2 pb – push

If using RMS Elbow for SVS:

A7U

RMS CAMERA PORT – ELBOW

Route video (if required):

VID OUT	VID IN
DOWNLINK	RMS
MON 1	RMS

Set up SRMS Elbow Cam:

Cam	HFOV	Focus	ALC	Color Bal	Shutter	Gamma
Elbow	18.1	Far	AVG	Sun	OFF	OFF

VIDEO OUT MON 2 pb – push

This Page Intentionally Blank

OFF-NOMINAL P3/P4 HANDOFF

I

SJ P3/P4 GRAPPLE	FS 2-2
UNBERTH.....	FS 2-9
UNGRAPPLE.....	FS 2-18
P3/P4 CONTINGENCY REBERTH	FS 2-22

OFF-NOMINAL
P3/P4 HANDOFF

Step 1:

Drive SY- (for 1.2°)
From 0.0° to -1.2°

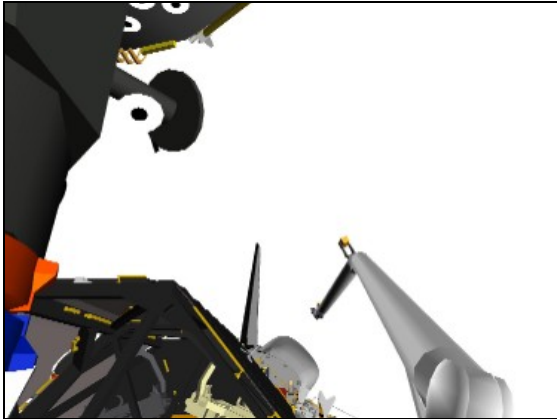

CCTV A (0,25)

Step 2:

Drive SP+ (for 75.0°)
+25.0° to +100.0°

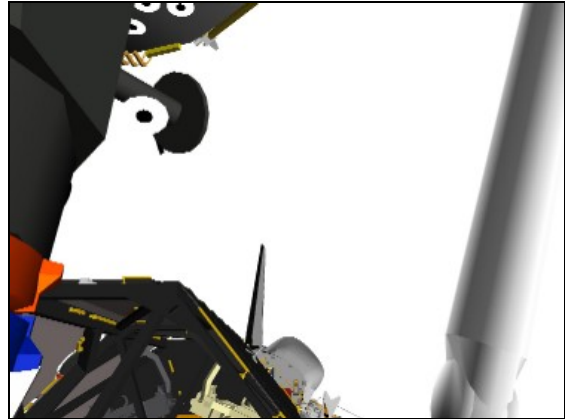

CCTV A (0,25)

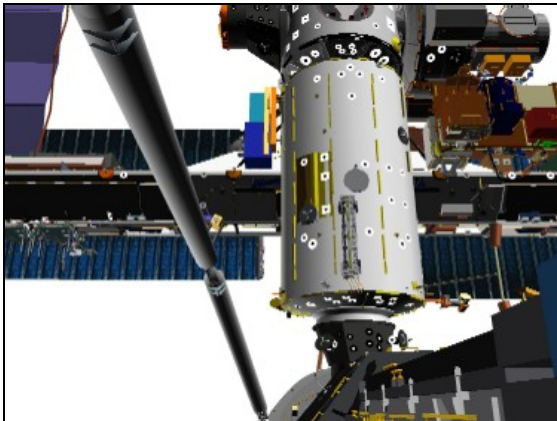

CCTV B (0,20)

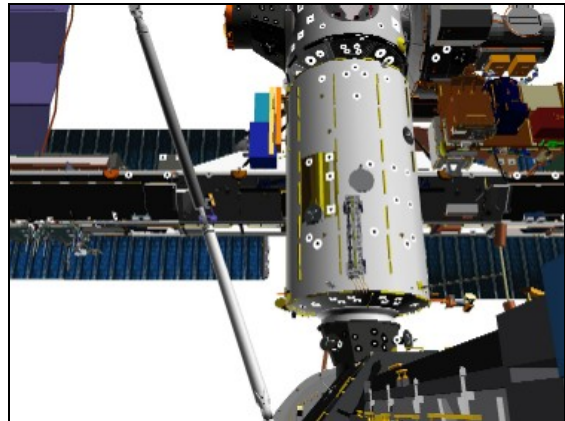

CCTV B (0,20)

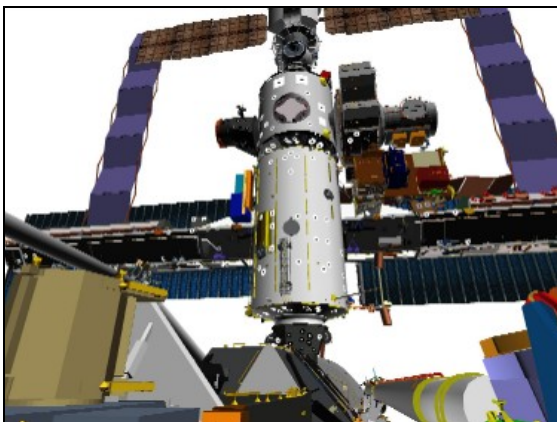

CCTV C (-10,25)

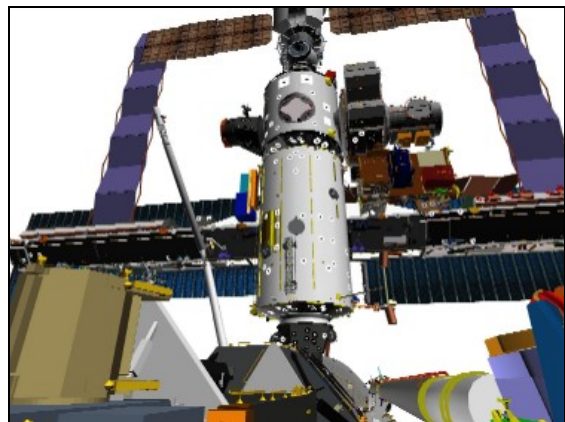

CCTV C (-10,25)

Step 3:

Drive EP- (for 116.2°)
From -25.0° to -141.2°

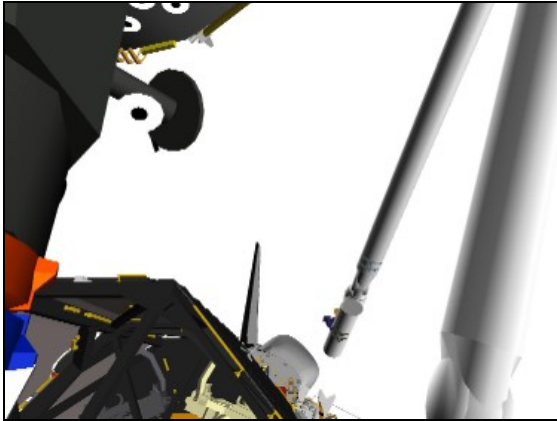

CCTV A (0,25)

Step 4:

Drive SP+ (for 16.0°)
From +100.0° to +116.0°

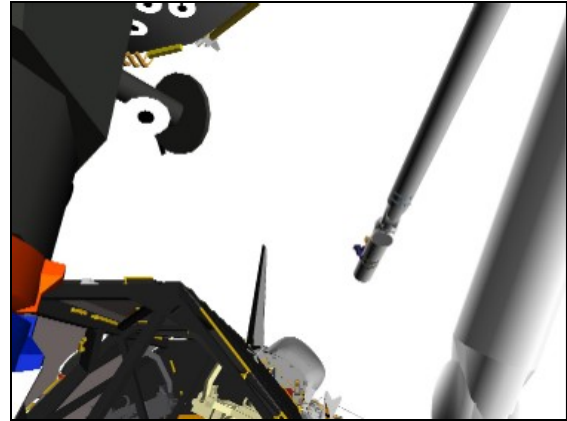

CCTV A (0,25)

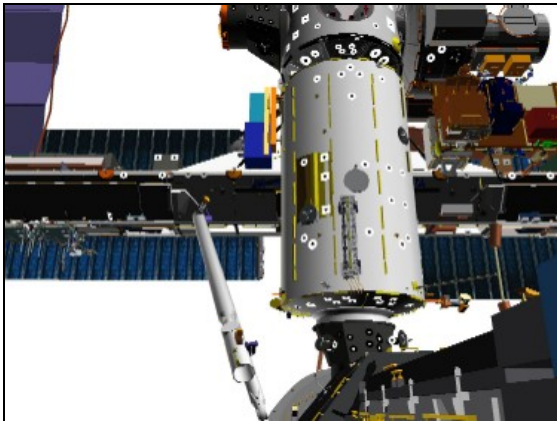

CCTV B (0,20)

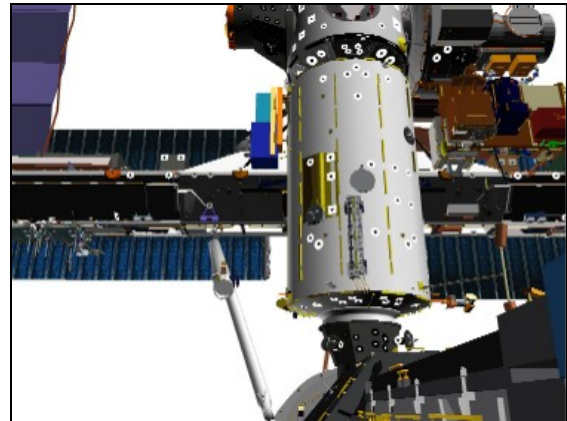

CCTV B (0,20)

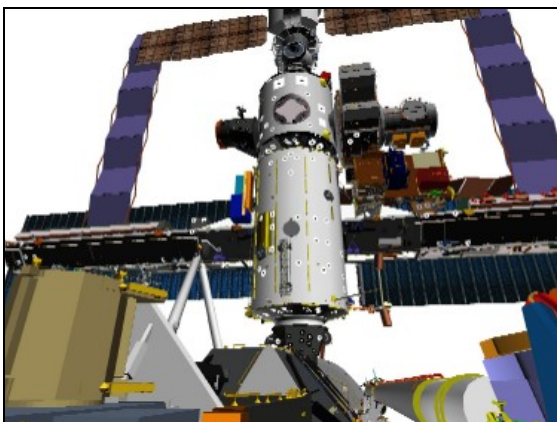

CCTV C (-10,25)

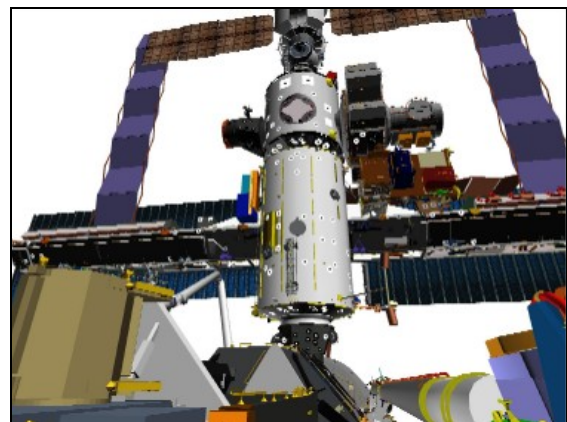

CCTV C (-10,25)

Step 5:

Drive WP- (for 69.2°)
From +5.0° to -64.2°

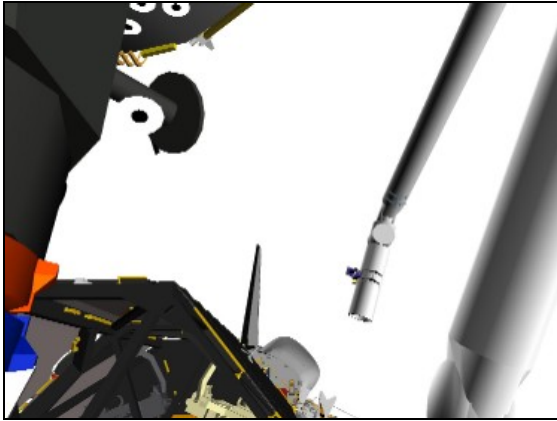

CCTV A (0,25)

Step 6:

Drive WY- (for 29.3°)
From 0.0° to -29.3°

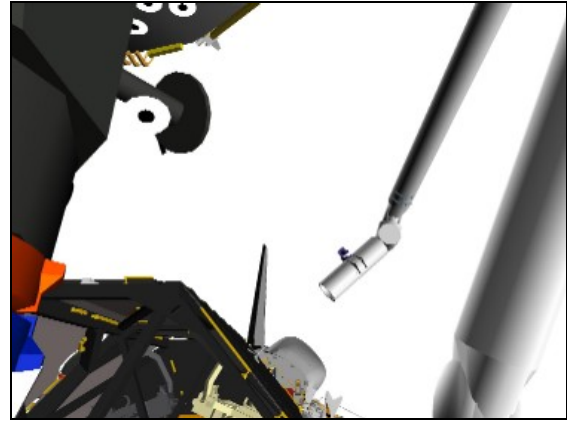

CCTV A (0,25)

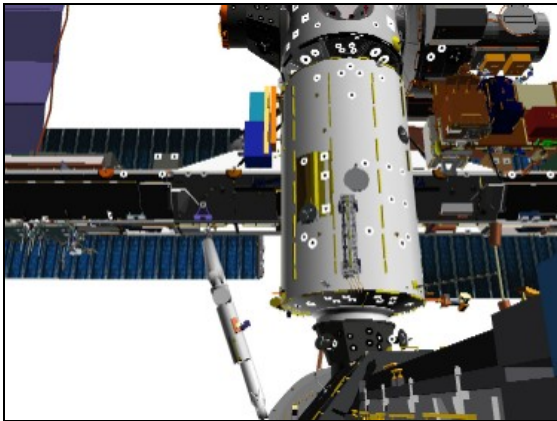

CCTV B (0,20)

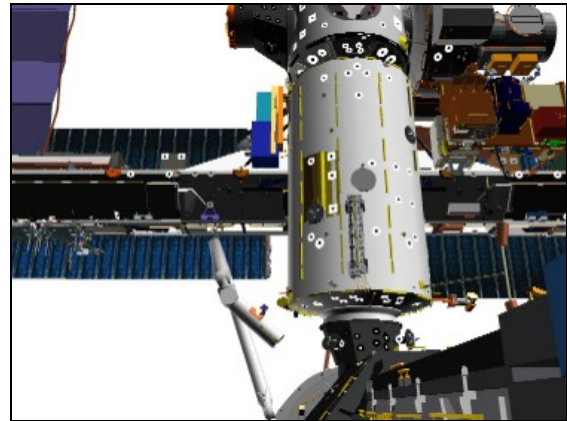

CCTV B (0,20)

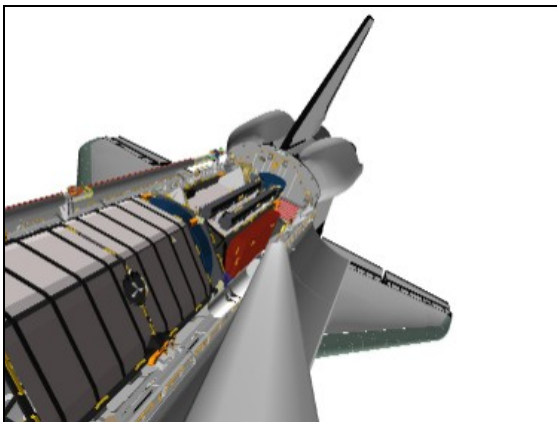

ELBOW (0,0)

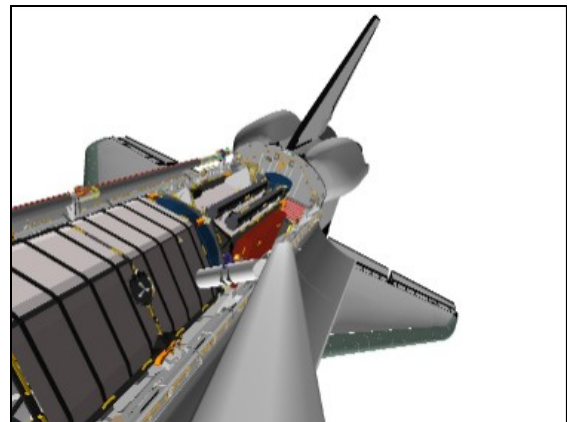

ELBOW (0,0)

Step 7:

Drive WR- (for 68.6°)

From 0.0° to -68.6°

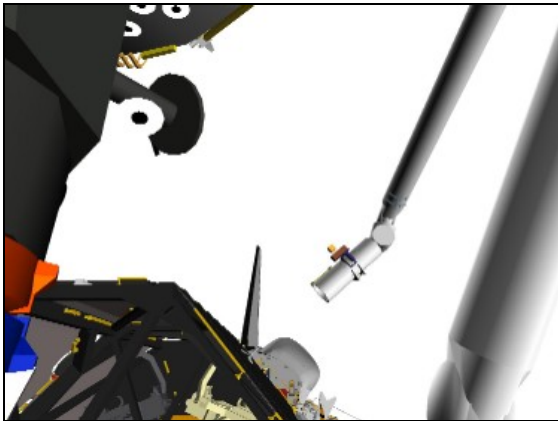

CCTV A (0,25)

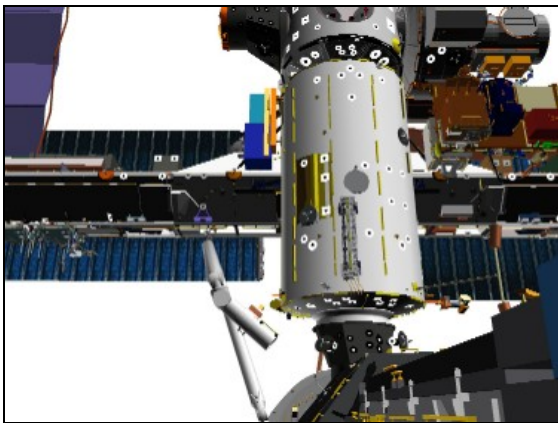

CCTV B (0,20)

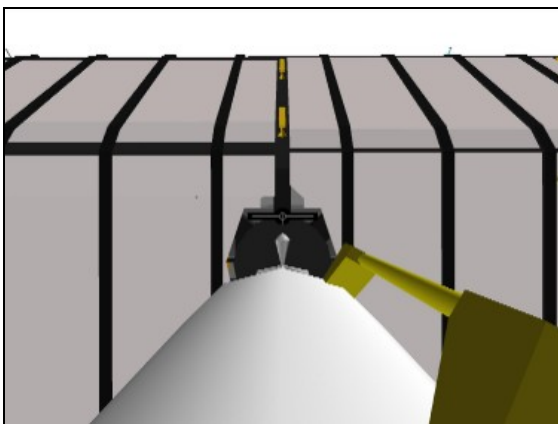

WRIST (0,0)

If SINGLE MODE:
 BRAKES – ON (tb-ON)
 MODE – not DIRECT

3. SJ MNVR TO P3/P4 GRAPPLE

√CCTV – config for grapple

MON 1	EE
MON 2	A (B)

If SINGLE MODE available:
 √RATE – VERN (RATE MIN tb-ON)
 BRAKES – OFF (tb-OFF)
 MODE – best available

Drive joints per P3/P4 SJ GRAPPLE WRIST CCTV OVERLAY and diagram until EE within grapple envelope

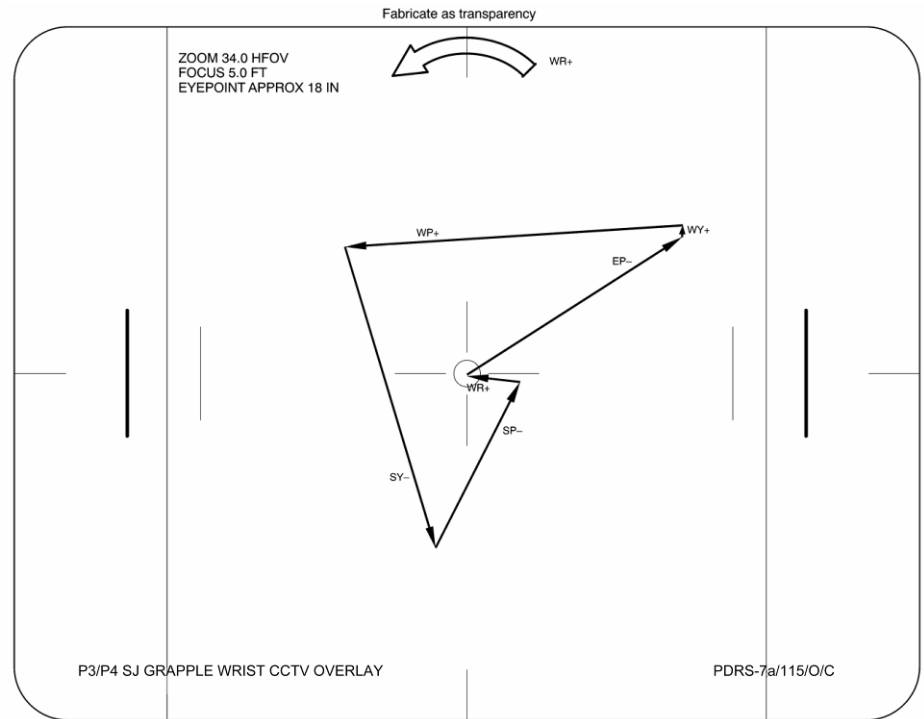

4. P3/P4 GRAPPLE

CAUTION
 Monitor EE tb timing to prevent EE motor burnout

EE MODE – AUTO (if available)
 CAPTURE sw – depress (mom)

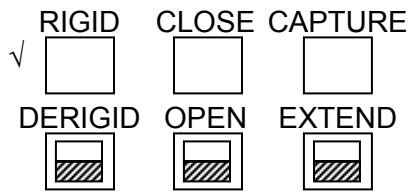

CRITICAL TIMES (28 sec total):
 CAPTURE tb – gray, then
 CLOSE tb – gray, 3 sec max, then
 RIGID tb – gray, 25 sec max

- * If manual grapple reqd: *
- * EE MODE – MAN *
- * CAPTURE sw – depress (hold until CLOSE tb-gray, 3 sec max) *
- * MAN CONTR – RIGID (hold until RIGID tb-gray, 25 sec max) *

EE MODE – OFF

If SINGLE MODE:
 BRAKES – ON (tb-ON)
 MODE – not DIRECT

SM 94 PDRS CONTROL
 PL ID, ITEM 3 +4 EXEC
 INIT ID, ITEM 24 +4 EXEC

Record POS/ATT and Joint Angles:

	X	Y	Z	PITCH	YAW	ROLL	PL ID
							4
Expected	-1002	0	-414	0	0	0	4
	SY	SP	EP	WP	WY	WR	
Expected	-12.3	+105.3	-147.1	-41.4	-28.6	-56.0	

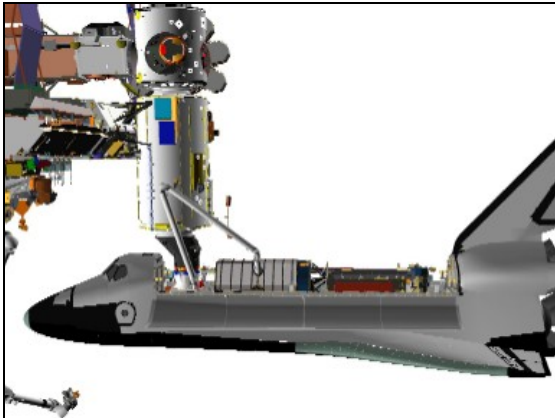

PORT

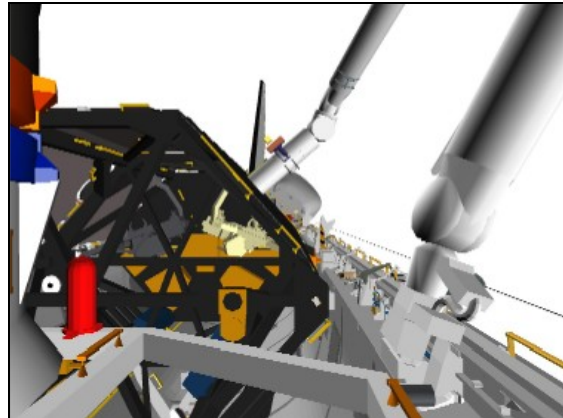

CCTV A (0,0)

Record POS/ATT and Joint Angles in P3/P4 CONTINGENCY REBERTH

Review GENERIC END EFFECTOR CUE CARD – ISS/SHUTTLE DOCKED OPS

SJ P3/P4 UNBERTH

1. SETUP
Perform P3/P4 UNBERTH, steps 1-5
2. SJ MNVR TO TOP OF V-GUIDES
If SINGLE MODE available:
RATE – as reqd (VERN within 10 ft)
BRAKES – OFF (tb-OFF)
MODE – best available

NOTE

Any error in Orbiter X should be biased forward prior to the start of step 3. Up to 6 inches allowed

A6U MnvR P3/P4 up until unconstrained
√PL RETEN RDY 1, 2, 3, 4 tb (four) – bp

Drive joint per SJ P3/P4 MNVR TO TOP OF V-GUIDE histogram until P3/P4 trunnions at top of V-guides

SJ P3/P4 MNVR TO TOP OF V-GUIDES

ΔSY	ΔSP	ΔEP	ΔWP	ΔWY	ΔWR
-2.9	+4.8	+2.6	-5.8	+0.4	+3.3

z	SY	SP	EP	WP	WY	WR
-414	-12.3	+105.3	-147.1	-41.5	-28.6	-56.0
-416	-12.6	+105.8	-146.9	-42.1	-28.6	-55.7
-418	-12.8	+106.2	-146.7	-42.6	-28.5	-55.4
-420	-13.1	+106.7	-146.5	-43.1	-28.5	-55.1
-422	-13.3	+107.1	-146.3	-43.5	-28.5	-54.9
-424	-13.5	+107.5	-146.1	-44.0	-28.4	-54.6
-426	-13.8	+107.9	-145.9	-44.5	-28.4	-54.3
-428	-14.0	+108.3	-145.7	-45.0	-28.4	-54.1
-430	-14.2	+108.7	-145.4	-45.5	-28.3	-53.8
-432	-14.5	+109.0	-145.2	-45.9	-28.3	-53.5
-434	-14.7	+109.4	-145.0	-46.4	-28.3	-53.2
-436	-15.0	+109.7	-144.7	-46.8	-28.2	-53.0
-438	-15.2	+110.1	-144.5	-47.3	-28.2	-52.7

SJ P3/P4 MNVR TO TOP OF V-GUIDES

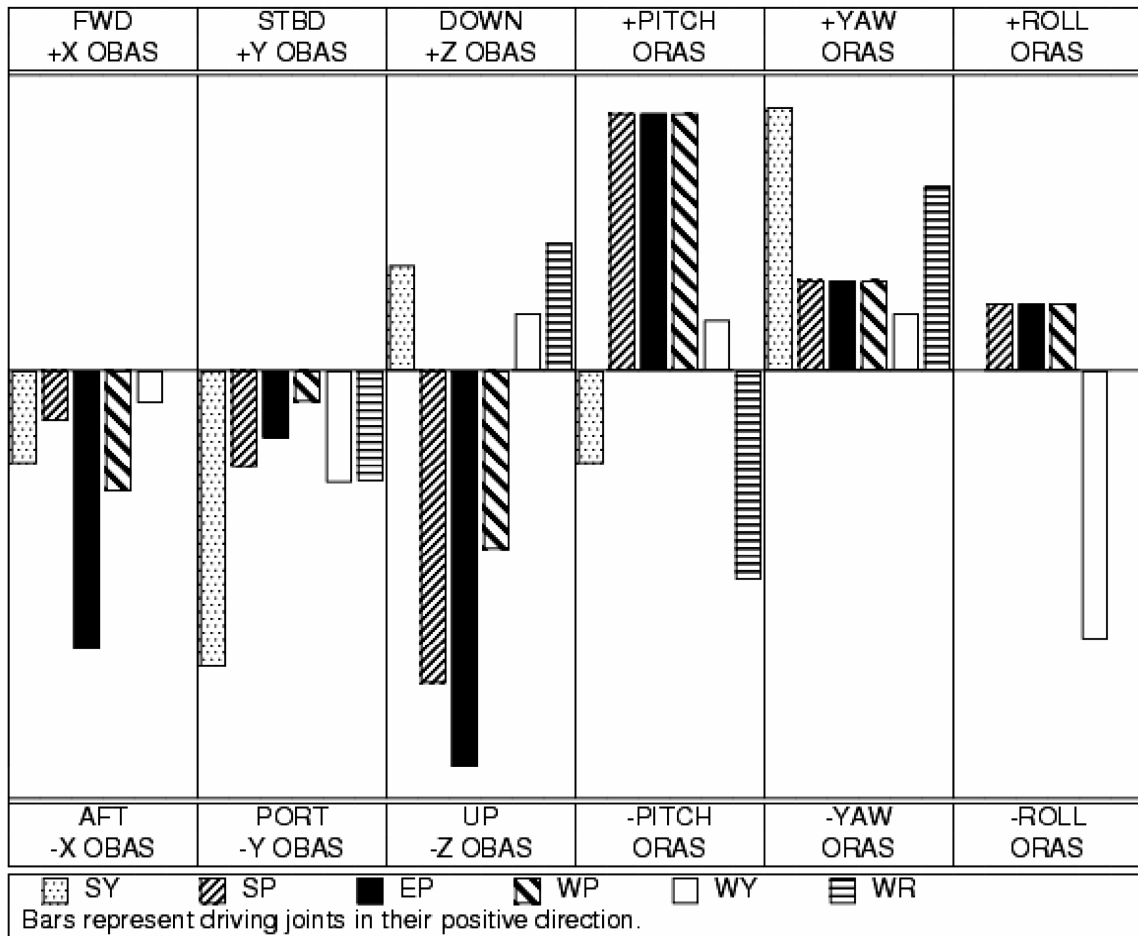

To get:	Drive:	To get:	Drive:
+X (fwd)	-EP, -WP	+PITCH	+WP, +SP
+Y (stbd)	-SY, -WY	+YAW	+SY, +WR
+Z (down)	-EP, -SP	+ROLL	-WY

Driving:	Results In:	Driving:	Results In:
+SY	-Y (port), +YAW	+WP	-Z (up), +PITCH
+SP	-Z (up), +PITCH	+WY	-Y (port), -ROLL
+EP	-Z (up), +PITCH	+WR	+Z (down), -PITCH

ΔSY	ΔSP	ΔEP	ΔWP	ΔWY	ΔWR
-2.9	+4.8	+2.6	-5.8	+0.4	+3.3

A7U PL BAY FLOOD AFT (two) – ON
MID (two) – ON
FWD (two) – ON

3. MNVR TO HANDOFF

If SINGLE MODE available:

RATE – as reqd (VERN within 10 ft)

BRAKES – OFF (tb-OFF)

MODE – best available

Mnvr to P3/P4 HANDOFF posn:

	SY	SP	EP	WP	WY	WR	
Top of V-Guides	-15.2	+110.1	-144.5	-47.3	-28.2	-52.7	
1: SP +		+110.6					
2: EP +			-141.0				
3: SP +		+120.0					
4: EP +			-75.0				
5: SP –		+80.0					
6: SY +	+70.3						
7: SP –		+65.9					
8: WR –						-118.9	
9: WY +					+68.5		
10: WP –				-74.1			
P3/P4 Handoff	+70.3	+65.9	-75.0	-74.1	+68.5	-118.9	
	X	Y	Z	PITCH	YAW	ROLL	PL ID
	-790	-598	-292	303	21	298	4

Step 1:

Drive SP+ (for 0.5°)
From +110.1° to +110.6°

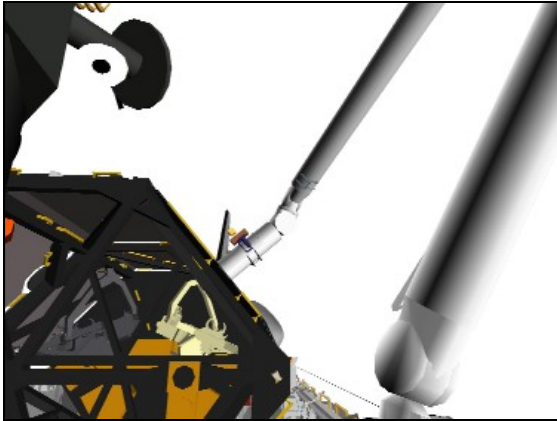

CCTV A (5,20)

Step 2:

Drive EP+ (for 3.5°)
From -144.5° to -141.0°

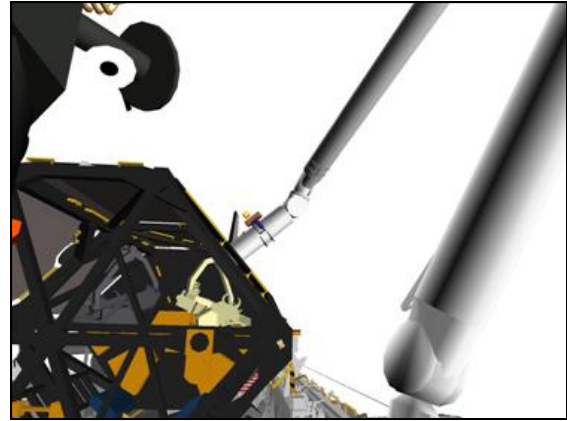

CCTV A (5,20)

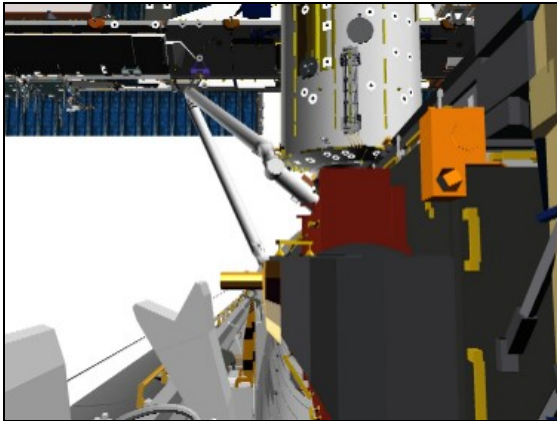

CCTV B (0,5)

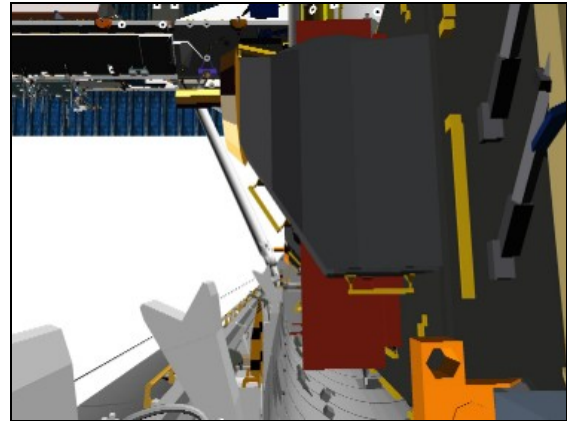

CCTV B (0,5)

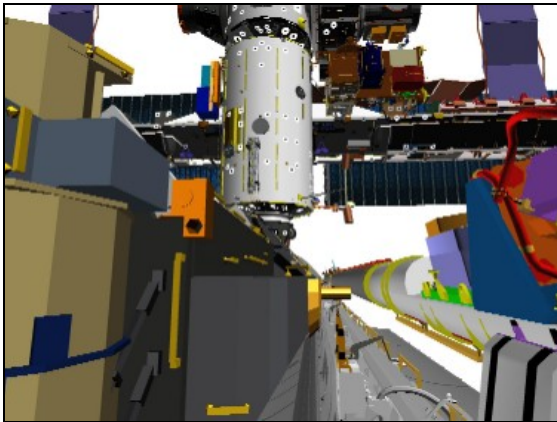

CCTV C (-5,10)

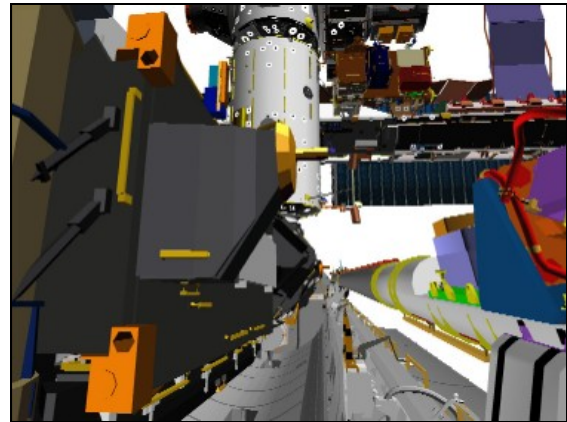

CCTV C (-5,10)

Step 3:

Drive SP+ (for 9.4°)
From +110.6° to +120.0°

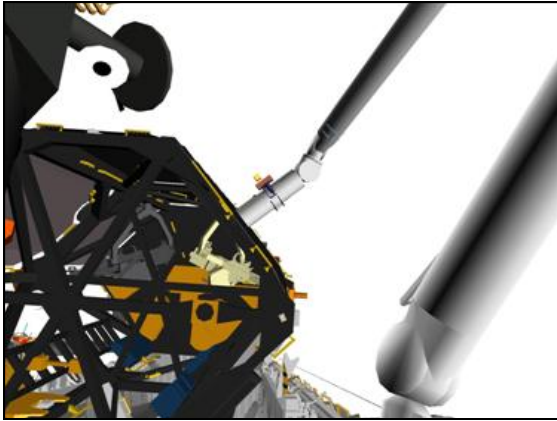

CCTV A (5,20)

Step 4:

Drive EP+ (for 66.0°)
From -141.0° to -75.0°

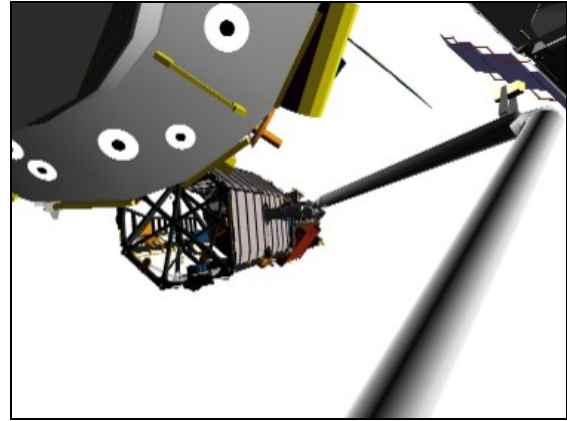

CCTV A (35,60)

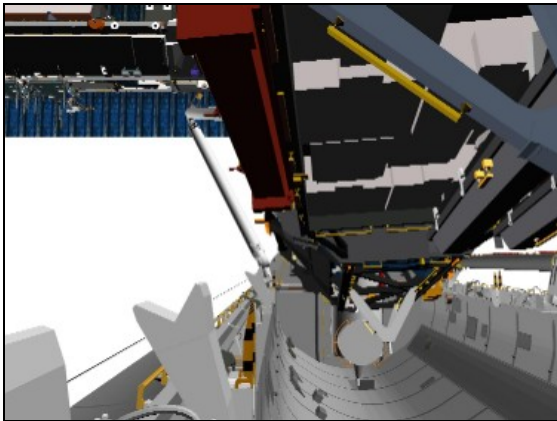

CCTV B (0,5)

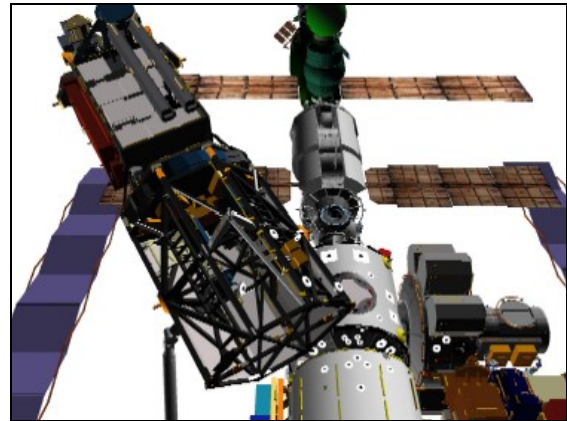

CCTV B (0,50)

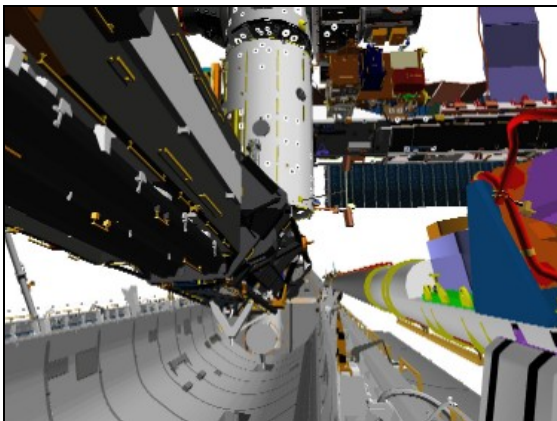

CCTV C (-5,10)

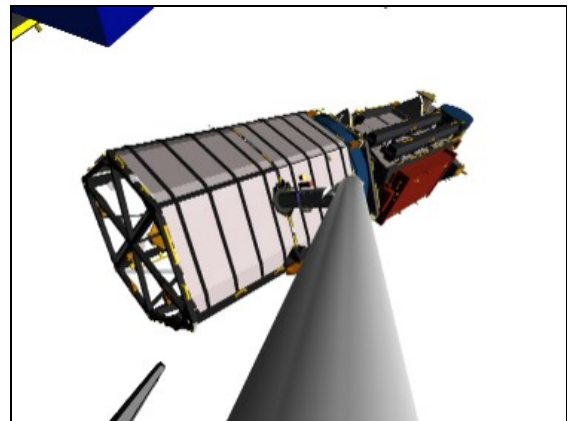

ELBOW (-10,-10)

Step 5:

Drive SP- (for 40°)
From +120° to +80°

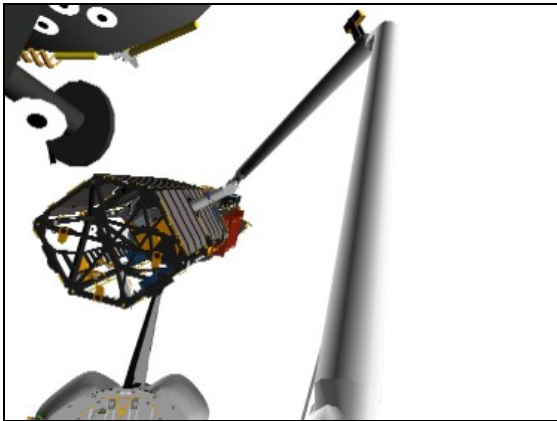

CCTV A (15,30)

Step 6:

Drive SY+ (for 85.5°)
From -15.2° to +70.3°

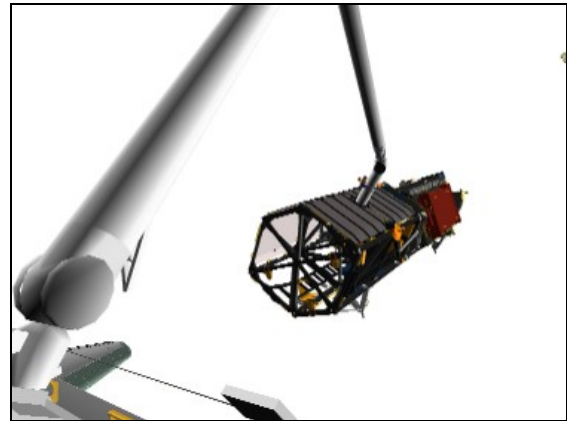

CCTV A (50,10)

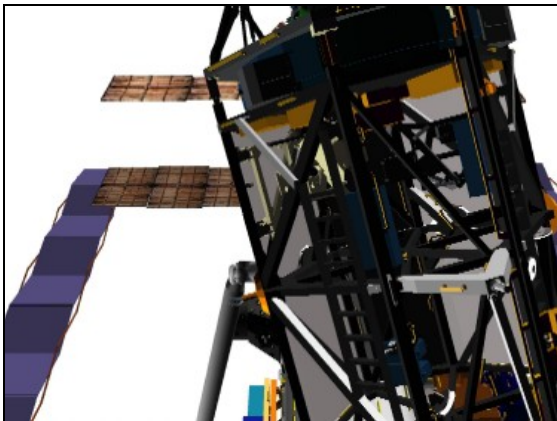

CCTV B (0,50)

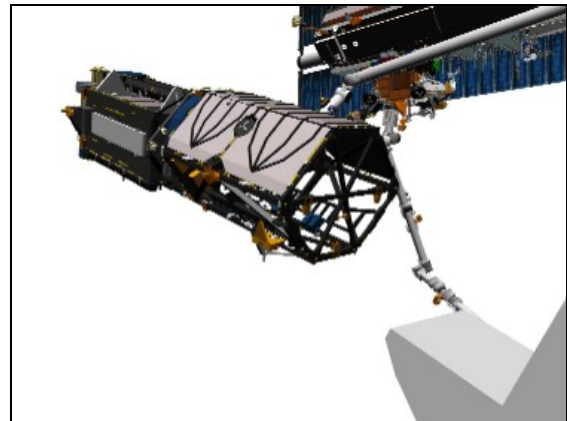

CCTV B (-45,0)

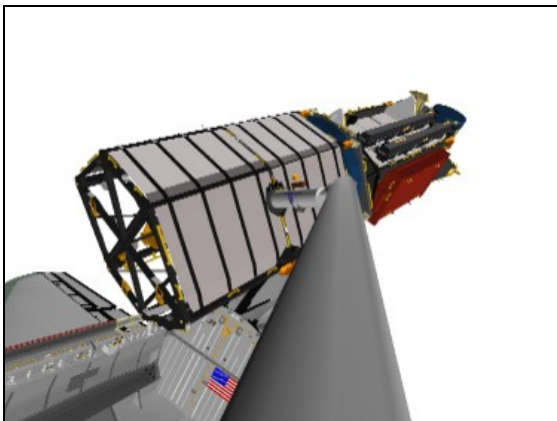

ELBOW (-10,-10)

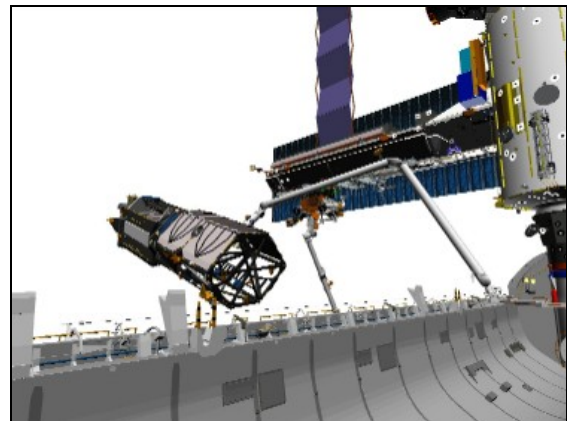

CCTV C (-45,10)

Step 7:

Drive SP- (for 14.1°)
From +80° to +65.9°

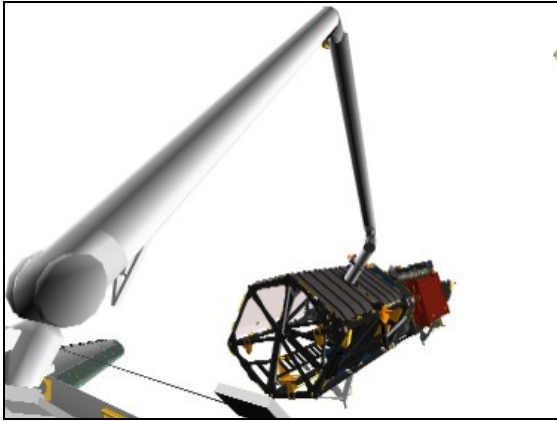

CCTV A (50,10)

Step 8:

Drive WR- (for 66.2°)
From -52.7° to -118.9°

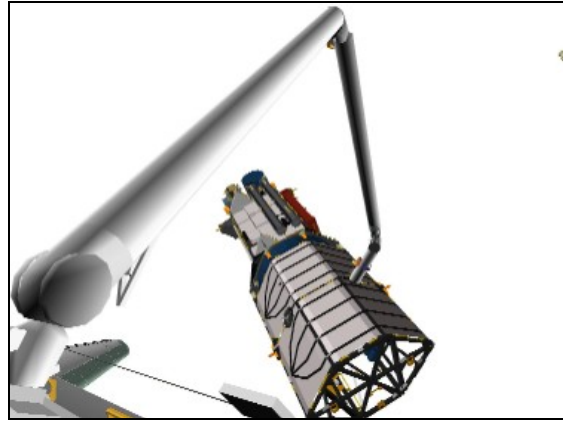

CCTV A (50,10)

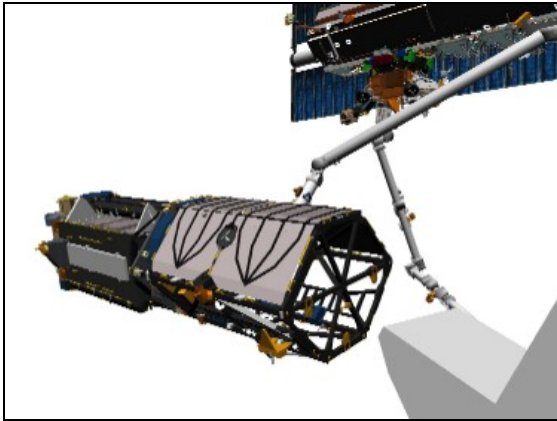

CCTV B (-45,0)

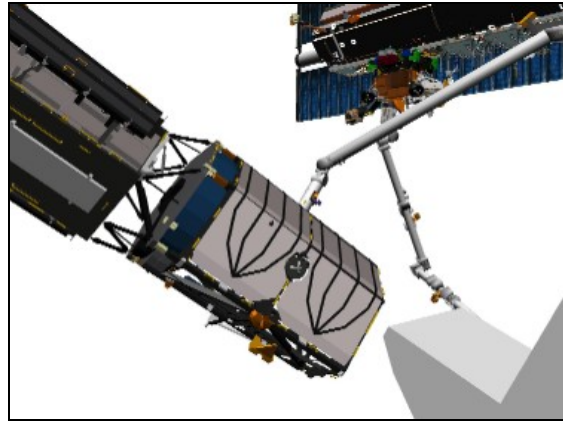

CCTV B (-45,0)

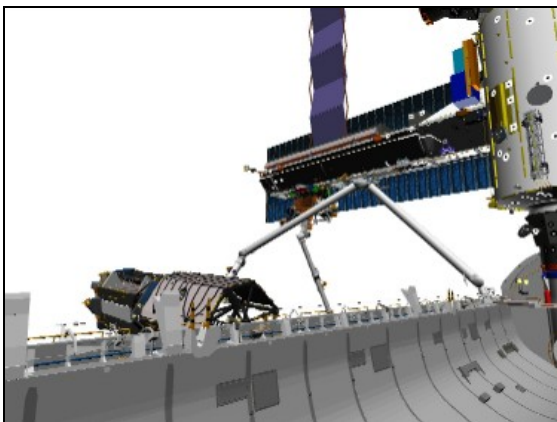

CCTV C (-45,10)

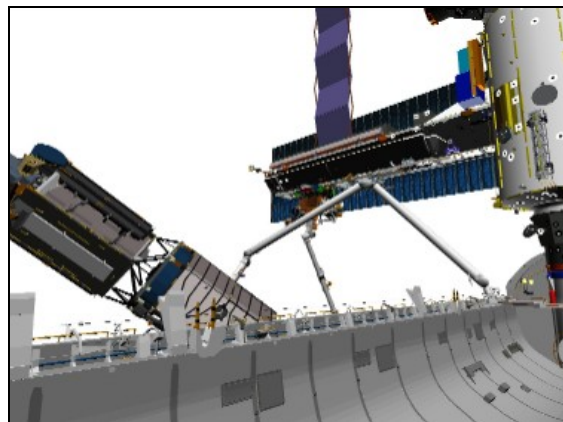

CCTV C (-45,10)

Step 9:

Drive WY+ (for 96.7)
From -28.2° to $+68.5^\circ$



CCTV A (50,10)

Step 10:

Drive WP- (for 26.8°)
From -47.3° to -74.1°

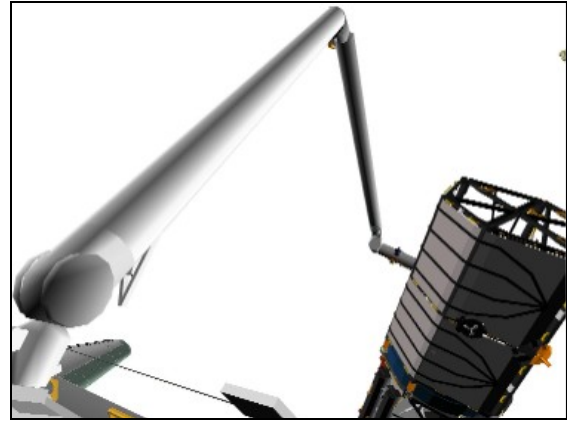

CCTV A (50,10)

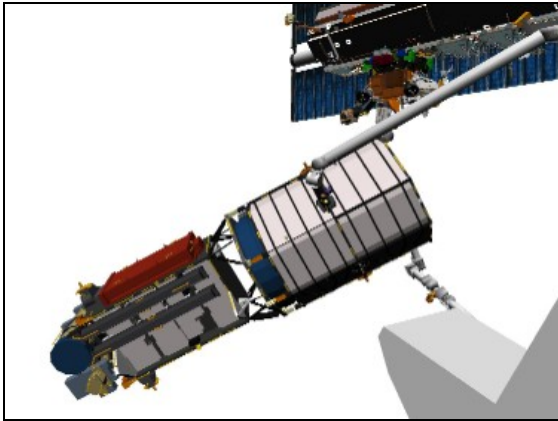

CCTV B (-45,0)

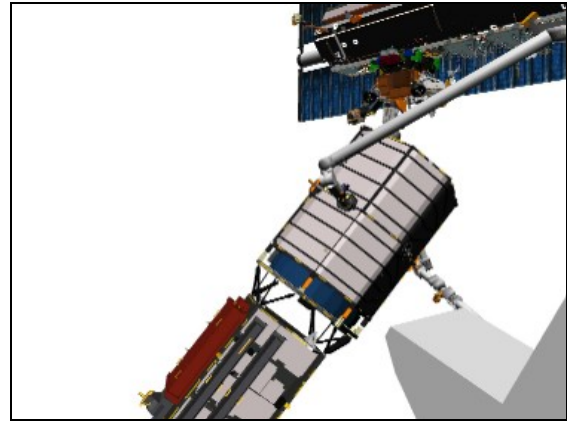

CCTV B (-45,0)

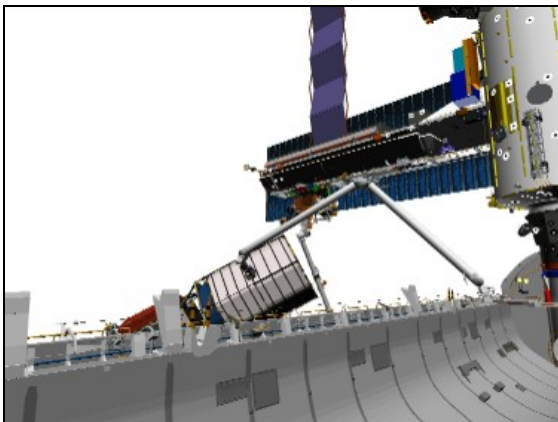

CCTV C (-45,10)

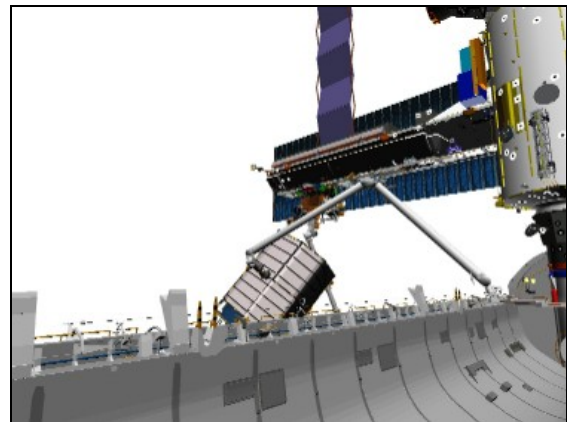

CCTV C (-45,10)

If SINGLE MODE:
BRAKES – ON (tb-ON)
MODE – not DIRECT

If using ISS attitude control:
√MCC if attitude maintenance reqd

If using Shuttle attitude control and attitude maintenance reqd:

GNC 20 DAP CONFIG
Load DAP A15
CNTL ACC – ITEM 28 +5 EXEC

Wait 30 sec
DAP: LVLH
When rates damped:
DAP: FREE > 2 sec
DAP: AUTO
When in attitude:
DAP: FREE

Notify SSRMS operator that SRMS is at the P3/P4 Handoff posn and SRMS
Brakes are on. GO for P3/P4 Pre-Grapple Maneuver

SJ P3/P4 UNGRAPPLE

- A7U 1. SETUP
 CCTV – config to monitor EE/Grapple fixture interface
 – RMS WRIST, zoom 34.0 HFOV
 focus 5 ft

SM 94 PDRS CONTROL
 PL ID, ITEM 3 +0 EXEC
 INIT ID, ITEM 24 +0 EXEC

2. P3/P4 UNGRAPPLE
 √1.201 P3P4 HANDOFF complete and on SSRMS operator GO

MON 1	EE
MON 2	A (Elbow)

If SINGLE MODE available:

NOTE

CONTR ERR It and 'S96 PDRS CNTL' msg may occur due to the Consistency/Envelope Check error

RATE – COARSE (RATE MIN tb-OFF)

SM 94 PDRS CONTROL

AUTO BRAKE INH – ITEM 10 EXEC (*)

BRAKES – OFF (tb-OFF)

MODE – TEST, ENTER
 Wait 5 sec

BRAKES – ON (tb-ON)

SM 94 PDRS CONTROL

AUTO BRAKE ENA – ITEM 9 EXEC (*)

RATE – VERN (RATE MIN tb-ON)

BRAKES – OFF (tb-OFF)

MODE – best available

<u>CAUTION</u>
Monitor EE tb timing to prevent EE motor burnout

EE MODE – MAN

MAN CONTR – DERIGID (hold until DERIGID tb-gray, 5 sec max)

RELEASE sw – depress (hold until OPEN tb-gray, 3 sec max)

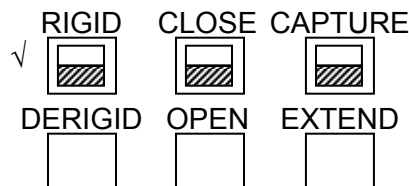

CRITICAL TIMES (28 sec total):

DERIGID tb – gray, 5 sec max, then

OPEN tb – gray, 3 sec max, then

3. MNVR ARM CLEAR OF P3/P4

Drive joints per P3/P4 SJ UNGRAPPLE WRIST CCTV OVERLAY until EE clear of grapple fixture

EE MAN CONTR – DERIG (hold until EXTEND tb-gray, 20 sec max)
MODE – OFF

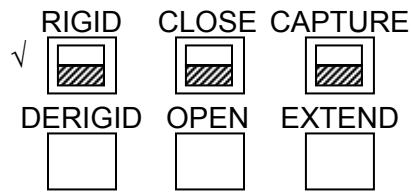

CRITICAL TIMES (28 sec total):
EXTEND tb – gray, 20 sec max

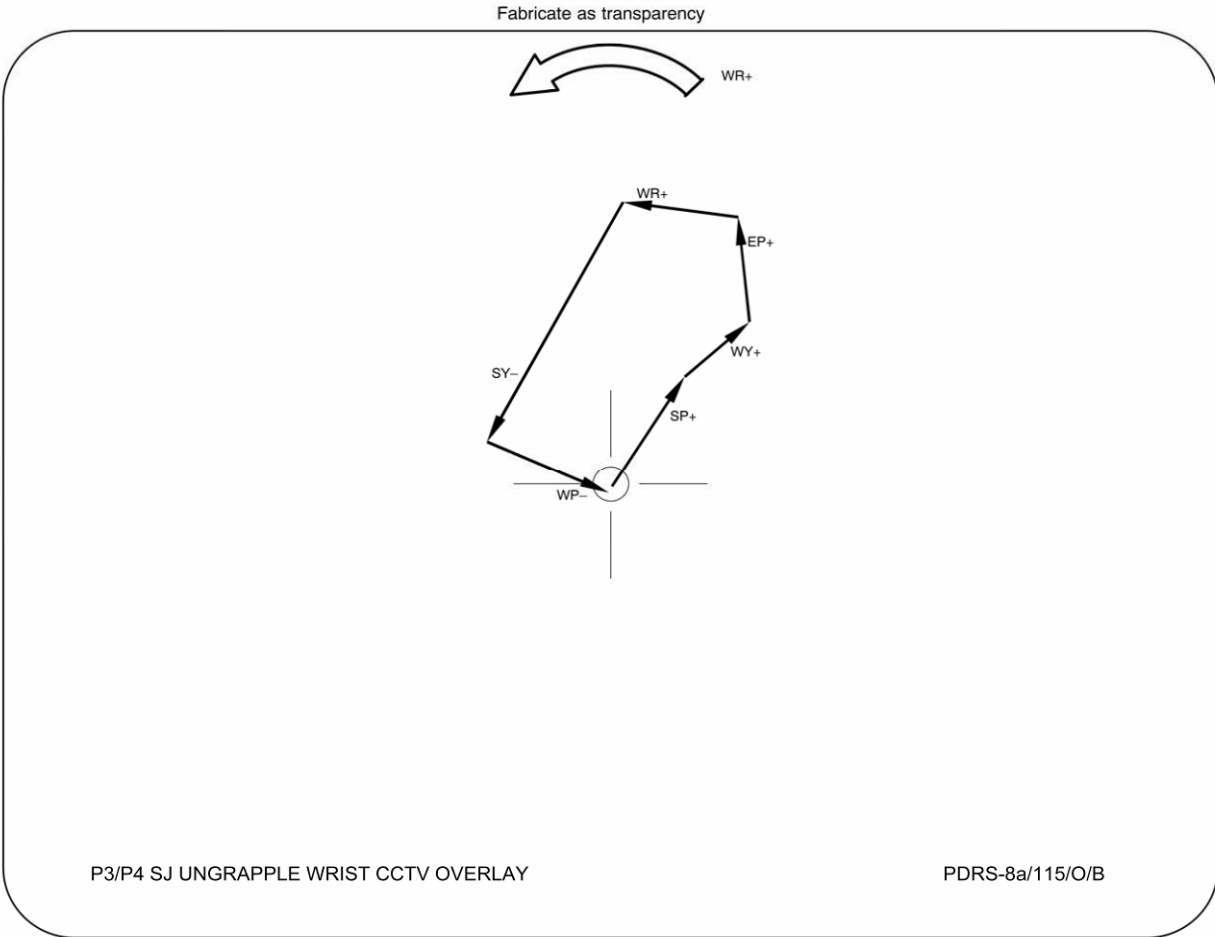

4. MNVR SVS VIEWING

MON 1	B (C)
MON 2	A
DNLK MON 1	P1 Outboard Lower

√RATE – VERN (RATE MIN tb-ON)

√BRAKES – OFF (tb-OFF)

MODE – SINGLE, ENTER

If using RSC for SVS:

Mnvr to SVS/RSC VIEWING posn:

	SY	SP	EP	WP	WY	WR	
~Ungrapple	+65.3	+65.3	-71.5	-89.7	+68.5	-105.3	
1: SY –	+57.1						
2: SP –		+38.2					
3: EP +			-42.1				
4: WP –				-98.6			
5: WY –					+41.3		
6: WR +						+128.8	
RSC Viewing	+57.1	+38.2	-42.1	-98.6	+41.3	+128.8	
	X	Y	Z	PITCH	YAW	ROLL	PL ID
	-901	-522	-382	230	358	154	0

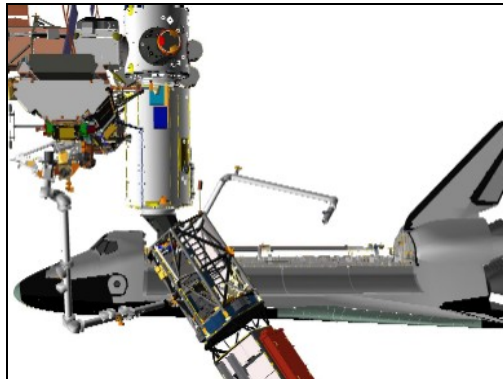

PORT

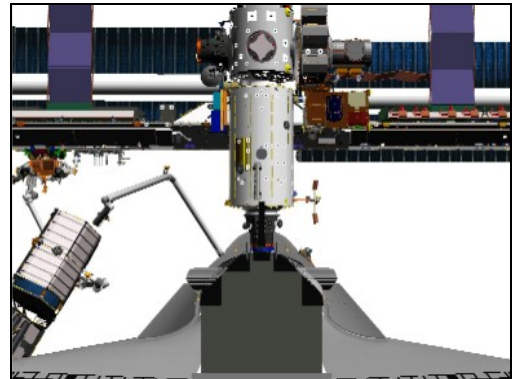

BACK

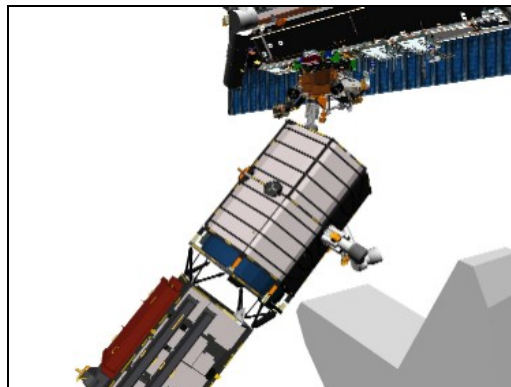

CCTV B (-40,0)

If using RMS Elbow for SVS:

Mnvr to SVS ELBOW CAM VIEWING posn:

	SY	SP	EP	WP	WY	WR	
~ Ungrapple	+65.3	+65.3	-71.5	-89.7	+68.5	-105.3	
1: SY -	+55.8						
2: SP -		+18.2					
3: EP +			-46.1				
Elbow Viewing	+55.8	+18.2	-46.1	-89.7	+68.5	-105.3	
	X	Y	Z	PITCH	YAW	ROLL	PL ID
	-901	-474	-224	207	15	269	0

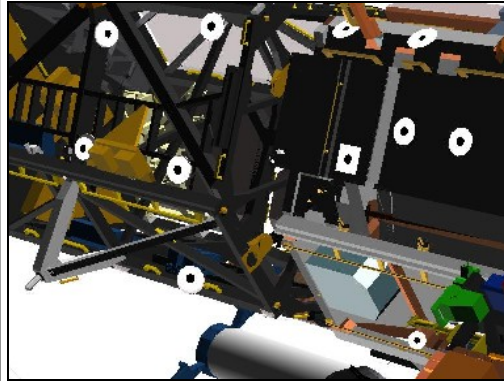

CCTV ELBOW (101.5,-5)



BACK

BRAKES – ON (tb-ON)
 ✓MODE – not DIRECT

Notify SSRMS operator that SRMS is in SVS Viewing position

5. CONFIGURE VIDEO FOR AVU SVS/RSC P3/P4 INSTALL

If using RSC for SVS:

R12 ✓VPU Green Jumper – ISS
 ✓RSC Video Cable – PL3

A7U Route video (if required):

VID OUT	VID IN
DNLK MON 1	PL 3
MON 2	PL 2

VIDEO OUT MON2 pb – push

If using RMS Elbow for SVS:

A7U RMS CAMERA PORT – ELBOW

Route video (if required):

VID OUT	VID IN
DOWNLINK	RMS
MON 1	RMS

Set up SRMS Elbow Cam:

Cam	HFOV	Focus	ALC	Color Bal	Shutter	Gamma
Elbow	18.1	Far	AVG	Sun	OFF	OFF

VIDEO OUT MON 2 pb – push

P3/P4 CONTINGENCY REBERTH

- A7U 1. SETUP
CCTV – config for reberth

SM 94 PDRS CONTROL

- √PL ID, ITEM 3: 4
√INIT ID, ITEM 24: 4

√BRAKES – ON (tb-ON)

2. MNVR TO P3/P4 LOW HOVER POSN

MON 1	C (B)
MON 2	A (Elbow)
DNLK MON 1	P1 Outboard Lower

RATE – VERN (RATE MIN tb-ON)

BRAKES – OFF (tb-OFF)

MODE – ORB LD, ENTER

NOTE

Use CCTV A or Elbow to monitor RMS upper boom to US Lab clearance.

Use CCTV C or B to monitor P4 keel pin to MPM clearance

Mnvr to P3/P4 LOW HOVER posn:

X	Y	Z	PITCH	YAW	ROLL	PL ID
-1020	-2	-580	0	0	0	4
SY	SP	EP	WP	WY	WR	
-27.2	+113.4	-117.3	-71.7	-25.8	-39.5	

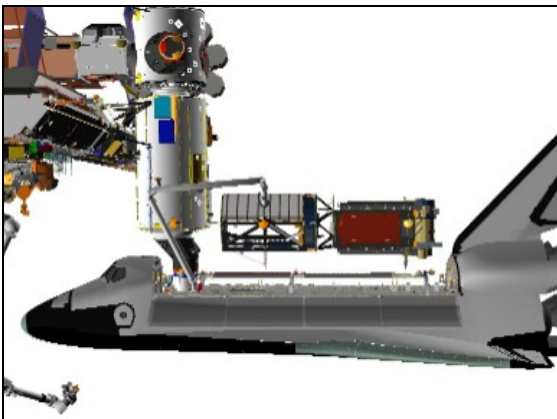

PORT

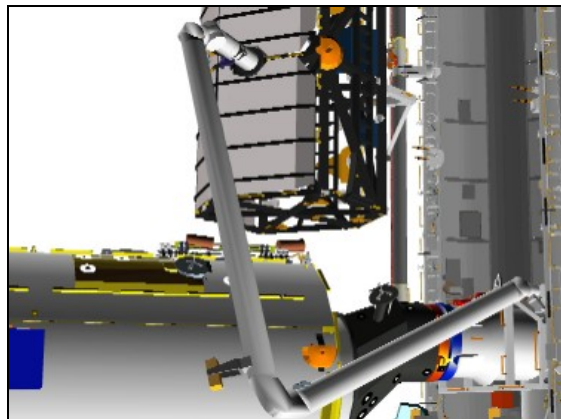

P1 OUTBOARD LOWER (106,11)

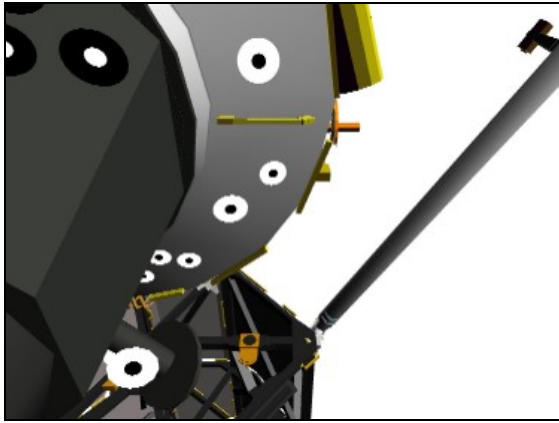

CCTV A (0,60)

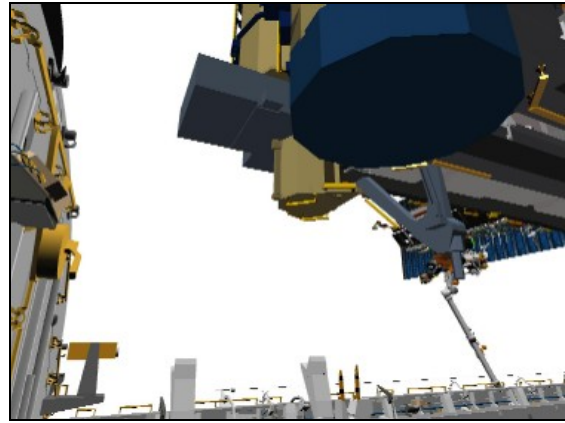

CCTV C (-65,20)

3. MNVR TO P3/P4 AFT POSN
 ✓RATE – VERN (RATE MIN tb-ON)
 ✓BRAKES – OFF (tb-OFF)
 ✓MODE – ORB LD

MON 1	C (B)
MON 2	D (Elbow)
DNLK MON 1	P1 Outboard Lower

Mnvr P3/P4 to Z = -474

Mnvr to P3/P4 AFT posn:

X	Y	Z	PITCH	YAW	ROLL	PL ID
-1020	-2	-474	0	0	0	4
SY	SP	EP	WP	WY	WR	
-16.8	+109.9	-136.2	-54.5	-27.9	-50.9	

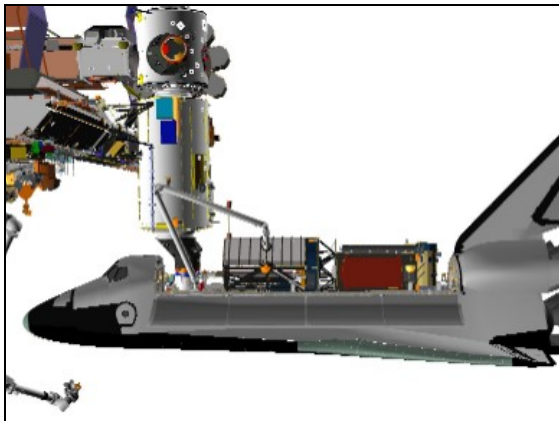

PORT



P1 OUTBOARD LOWER (110,20)

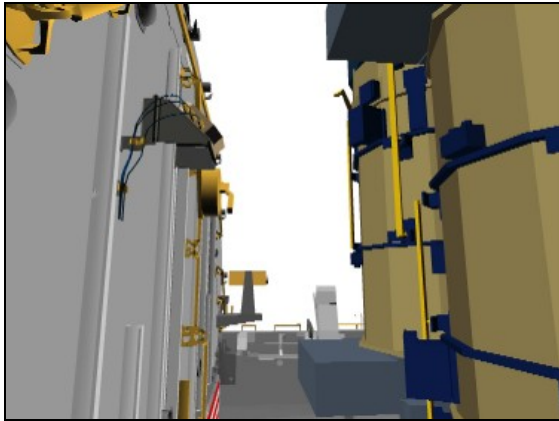

CCTV C (-85,10)

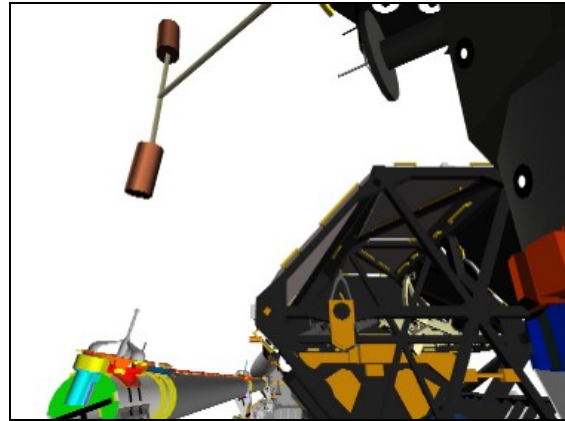

CCTV D (0,25)

4. MNVR TO P3/P4 INTERMEDIATE UNBERTH POSN

√RATE – VERN (RATE MIN tb-ON)

√BRAKES – OFF (tb-OFF)

√MODE – ORB LD

NOTE

Monitor clearance between P3/P4 and US Lab with US Lab camera or P1 Outboard Lower camera

MON 1	C (B)
MON 2	Elbow (P1 Outboard Lower)
DNLK MON 1	US Lab

Mnvr P3/P4 to X = -1002

Mnvr to P3/P4 INTERMEDIATE UNBERTH posn:

X	Y	Z	PITCH	YAW	ROLL	PL ID
-1002	-2	-474	0	0	0	4
SY	SP	EP	WP	WY	WR	
-18.7	+115.1	-139.6	-55.3	-27.6	-48.7	

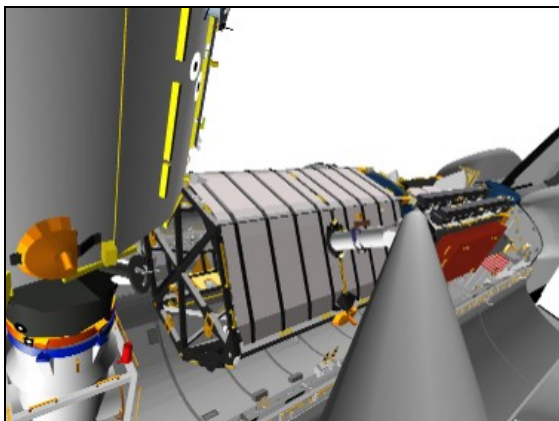

ELBOW (-20,-5)

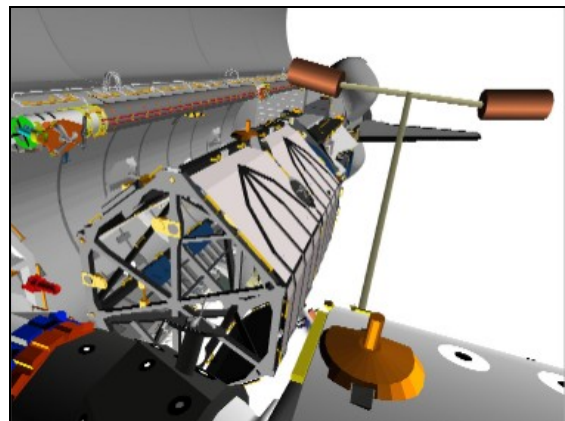

US LAB (-18,-44)

5. MNVR TO P3/P4 BERTH POSN

CAUTION

Monitor clearances between STBD trunnions and OBSS during reberth. Minimum clearance of approximately 3 inches expected

Gradually remove 2 inch Y bias starting at Z= -434 by Z = -422

NOTE

Use P1 Outboard Lower camera to monitor clearance between P3/P4 and US Lab. Use US Lab camera to monitor trunnion to OBSS clearance

- √RATE – VERN (RATE MIN tb-ON)
- √BRAKES – OFF (tb-OFF)
- √MODE – ORB LD

MON 1	D/A Mux
MON 2	B/C Mux
DNLK MON 1	US Lab

A7U

- PL BAY FLOOD AFT (two) – OFF
- MID (two) – OFF
- FWD (two) – OFF

Mnvr to P3/P4 BERTH posn (insert data from P3/P4 GRAPPLE):

X	Y	Z	PITCH	YAW	ROLL	PL ID
						4
SY	SP	EP	WP	WY	WR	

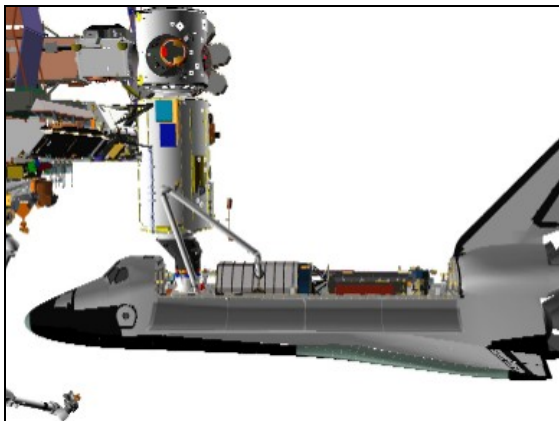

PORT

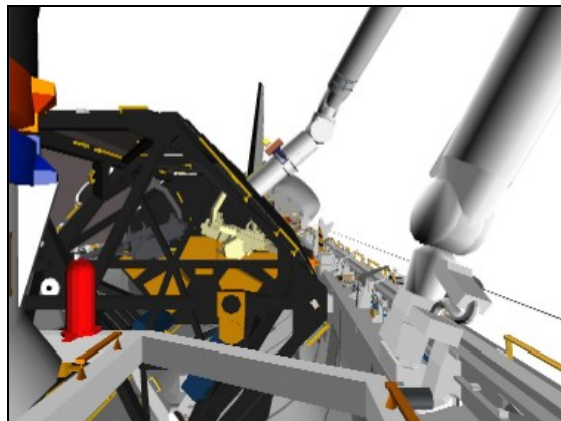

CCTV A (0,0)

6. ACTIVATE LATCHES
 MA73C:A MCA LOGIC MNC MID 2 – OFF
 :B MCA LOGIC MNB MID 4 – OFF

SM 97 PL RETENTION

√PL SEL 1 RDY-FOR-LAT 1,2,3,4 (eight) – 1
 √LAT 1,2,3,4 (eight) – 0

- * If any LAT msw shows '1', drive latch *
- * for single motor time (60 sec) *

Note single motor times (> 30 sec)

R13L PL BAY MECH PWR SYS (1,2) – ON
 A6U RETEN LOGIC PWR SYS (1,2) – ON

7. AKA LATCH

PL RETEN PL SEL – 2
 √LAT 1,2 tb – REL
 √RDY 1,2 tb – bp

Note single motor times (> 30 sec)

PL RETEN LAT 1,2 – LAT (tb-LAT), 60 sec max
 – OFF
 √RDY 1,2 tb – gray

8. PRLA LATCH

PL RETEN PL SEL – 1
 √LAT 1,2,3,4 tb – REL
 √RDY 1,2,3,4 tb – gray

Note single motor times (> 30 sec)

PL RETEN LAT 3,4 (two) – LAT (tb-LAT), 60 sec max
 – OFF
 1,2 (two) – LAT (tb-LAT), 60 sec max
 – OFF

BRAKES – ON (tb-ON)

9. DEACTIVATING LATCHES

R13L PL RETEN LOGIC PWR SYS (1,2) – OFF
 A6U BAY MECH PWR SYS (1,2) – OFF
 RETEN PL SEL – MON

MA73C:A MCA LOGIC MNC MID 2 – ON
 MA73C:B MCA LOGIC MNB MID 4 – ON

10. P3/P4 UNGRAPPLE SETUP

A7U CCTV – RMS WRIST, zoom 34.0 HFOV
 focus 5 ft

MON 1	EE
MON 2	A

SM 94 PDRS CONTROL

PL ID – ITEM 3 +0 EXEC
 INIT ID – ITEM 24 +0 EXEC

11. P3/P4 UNGRAPPLE
 RATE – VERN (RATE MIN tb-ON)
 BRAKES – OFF (tb-OFF)
 MODE – END EFF, ENTER

CAUTION
 Monitor EE tb timing to prevent EE motor burnout

NOTE
 When OPEN tb – gray, mnvr arm clear of GF and P3/P4

EE MODE – AUTO
 RELEASE sw – depress (mom)

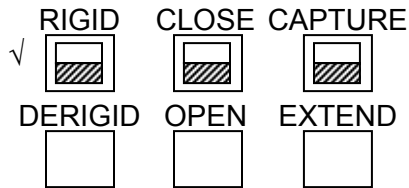

CRITICAL TIMES (28 sec total):
 DERIGID tb – gray, 5 sec max, then
 OPEN tb – gray, 3 sec max, then
 EXTEND tb – gray, 20 sec max

EE MODE – OFF

- * If manual release reqd: *
- * EE MODE – MAN *
- * MAN CONTR – DERIGID (hold until DERIGID *
- * tb-gray, 5 sec max) *
- * RELEASE sw – depress (hold until OPEN tb-gray, *
- * 3 sec max) *
- * *
- * Mnvr arm clear, then *
- * EE MAN CONTR – DERIGID (hold until EXTEND *
- * tb-gray, 20 sec max) *
- * MODE – OFF *

BRAKES – ON (tb-ON)
 √MODE – not DIRECT
 JOINT – CRIT TEMP

This Page Intentionally Blank

OBSS NOMINAL OPERATIONS

I

VERIFY UPLINKS..... FS 3-2
OBSS UNBERTH..... FS 3-4
 ITVC/LDRI FLAT FIELDS FS 3-10
 BERTH..... FS 3-13
 HANDOFF FROM SSRMS (LAB) TO SRMS..... FS 3-19
 SRMS TO SSRMS (LAB)..... FS 3-24
MNVR FROM HANDOFF TO STBD LDRI ACAS START FS 3-29
OBSS LDRI RCC SURVEY – STBD UNDOCKED FS 3-31
 – NOSE CAP..... FS 3-50
 – PORT FS 3-66
 – STBD DOCKED FS 3-83
SRMS EE CAM CREW CABIN SURVEY FS 3-113

OBSS NOMINAL
OPERATIONS

VERIFY UPLINKS

1. CHECK PL ID 1

SM 94 PDRS CONTROL

PL ID – ITEM 3 +1 EXEC
INIT ID – ITEM 24 +1 EXEC

√	SY	SP	EP	WP	WY	WR	
	0.0	+25.0	-25.0	+5.0	0.0	0.0	
√	X	Y	Z	PITCH	YAW	ROLL	PL ID
	-1279	-151	-553	95	359	328	1

2. CHECK PL ID 2

SM 94 PDRS CONTROL

PL ID – ITEM 3 +2 EXEC
INIT ID – ITEM 24 +2 EXEC

√	X	Y	Z	PITCH	YAW	ROLL	PL ID
	-1243	-143	-869	95	359	358	2

3. CHECK PL ID 3

SM 94 PDRS CONTROL

PL ID – ITEM 3 +3 EXEC
INIT ID – ITEM 24 +3 EXEC

√	X	Y	Z	PITCH	YAW	ROLL	PL ID
	-1216	-141	-1141	95	359	358	3

4. CHECK AUTOSEQUENCES 1, 2, AND 3 START POINTS

SM 94 PDRS CONTROL

AUTO 1 – ITEM 13 +1 +2 +3 EXEC

BRAKES – OFF (tb-OFF)
MODE – AUTO 1, ENTER

SM 94 PDRS CONTROL

√START PT, ITEM 17: 1

MODE – AUTO 2, ENTER

SM 94 PDRS CONTROL

√START PT, ITEM 17: 47

MODE – AUTO 3, ENTER

SM 94 PDRS CONTROL

√START PT, ITEM 17: 69

BRAKES – ON (tb-ON)

5. CHECK PL ID 4

SM 94 PDRS CONTROL

PL ID - ITEM 3 +4 EXEC
INIT ID - ITEM 24 +4 EXEC

√

X	Y	Z	PITCH	YAW	ROLL	PL ID
-1325	-321	-556	165	88	241	4

6. CHECK PL ID 5

SM 94 PDRS CONTROL

PL ID - ITEM 3 +5 EXEC
INIT ID - ITEM 24 +5 EXEC

√

X	Y	Z	PITCH	YAW	ROLL	PL ID
-1261	-146	-551	5	2	0	5

7. CHECK AUTOSEQUENCES 4 AND 5 START POINTS

SM 94 PDRS CONTROL

AUTO 1 - ITEM 13 +4 +5 EXEC

BRAKES - OFF (tb-OFF)
MODE - AUTO 1, ENTER

SM 94 PDRS CONTROL

√START PT, ITEM 17: 122

MODE - AUTO 2, ENTER

SM 94 PDRS CONTROL

√START PT, ITEM 17: 126

BRAKES - ON (tb-ON)

8. RESET TO PL ID 0

PL ID - ITEM 3 +0 EXEC
INIT ID - ITEM 24 +0 EXEC

√

X	Y	Z	PITCH	YAW	ROLL	PL ID
-1261	-146	-551	5	2	0	0

JOINT - CRIT TEMP

OBSS UNBERTH

WARNING
For UNDOCKED ops only

NOTE

Stbd MPMs assumed deployed

1. SETUP

SM 94 PDRS CONTROL

√PL ID, ITEM 3: 0

√INIT ID, ITEM 24: 0

If flight specific DAPs have not been loaded:

Load DAP A14 with permanent edits per STS-115 DAP A

CONFIGURATIONS (ORB OPS FS, DAP TABLES). This may be worked in parallel with the following steps 2-4

RHC 2. MNVR TO OBSS PRE-GRAPPLE

RATE – as reqd (VERN within 10 ft)

BRAKES – OFF (tb-OFF)

MODE – ORB UNL, ENTER

If first RMS ops for the mission:

Perform manual PLB survey, en route to OBSS PRE-GRAPPLE position

Mnvr to OBSS PRE-GRAPPLE posn:

X	Y	Z	PITCH	YAW	ROLL	PL ID
-680	+96	-513	270	350	1	0
SY	SP	EP	WP	WY	WR	
-90.0	+87.6	-129.5	-57.5	0.0	+110.4	

BRAKES – ON (tb-ON)

CAUTION

SPEE power must be applied within 90 min
to prevent sensor package damage

STBD RMS HTR A,B (two) – OFF

A6U EVENT TIMER MODE – UP

CNTL – START

R12(OBSS) √SPEE PWR – OFF

L12U(SSP1) √APCU 1 OUTPUT RLY – OP (tb-bp)

3. OBSS GRAPPLE

A7U CCTV – config for grapple

– install PDRS TARGET OVERLAY FOR CTVM

– RMS WRIST, ZOOM: 34.0 HFOV

FOCUS: 5 ft

Maintain eyepoint ~18 in when using grapple overlay

A6U DAP: VERN(FREE)

NOTE

Expect single motor drive time for MRL release

STBD RMS RETEN LAT – REL (tb-REL) (18 sec max)
– OFF

If motor drive time > 18 sec, √MCC

SM 94 PDRS CONTROL

RMS PORT – ITEM 1 EXEC (*)

6. RECONFIGURE POWER

R13L PL BAY MECH PWR SYS (two) – OFF

MA73C:C cb MCA PWR AC3 3Φ MID 2 – cl
√AC2 3Φ MID 2 – op

MA73C:D √AC3 3Φ MID 4 – op

Record joint angles:

SY	SP	EP	WP	WY	WR

7. MNVR TO OBSS HOVER

RHC √RATE – VERN (RATE MIN tb-ON)

BRAKES – OFF (tb-OFF)

MODE – PL, ENTER

Mnvr OBSS up (-Z) to OBSS HOVER, Z = -496

X	Y	Z	PITCH	YAW	ROLL	PL ID
-680	+126	-496	0	0	341	1
SY	SP	EP	WP	WY	WR	
-90.0	+79.8	-123.1	-55.7	0.0	+110.0	

BRAKES – ON (tb-ON)

MODE – not DIRECT

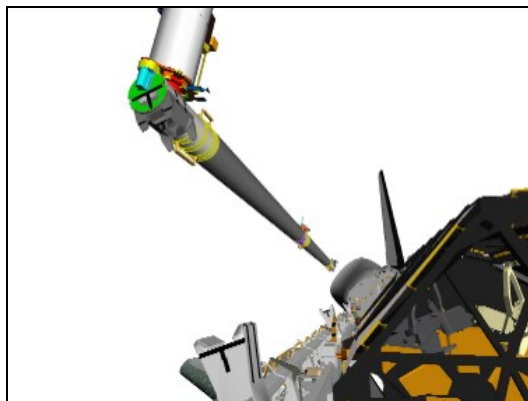

CCTV D (-15,15)

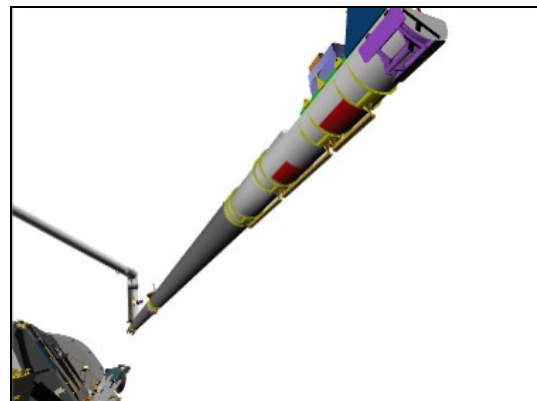

CCTV C (25,25)

DAP: A14/AUTO/VERN(FREE)

A6U If Verns failed, DAP: AUTO/ALT

In the following P/TV procedure, start 15 min timer upon applying SPEE power and inform MCC when timer is started:

Perform ACTIVATION (LDRI/ITVC Cue Card, PHOTO/TV)

Perform LCH ACTIVATION (LCS Cue Card, PHOTO/TV)

Perform LCC ACTIVATION (LCS Cue Card, PHOTO/TV)

- A7U
8. RESET PTU
 VIDEO OUT MON2 pb – push
 IN PL2(VPU) pb – push

CAMR CMD PAN/TILT – HI RATE
 PAN – L (to hard stop)
 TILT – UP (to hard stop)
 PAN/TILT – RESET, HI RATE (LO within 10°)
 PAN: +103 (right)
 TILT: -260 (down)

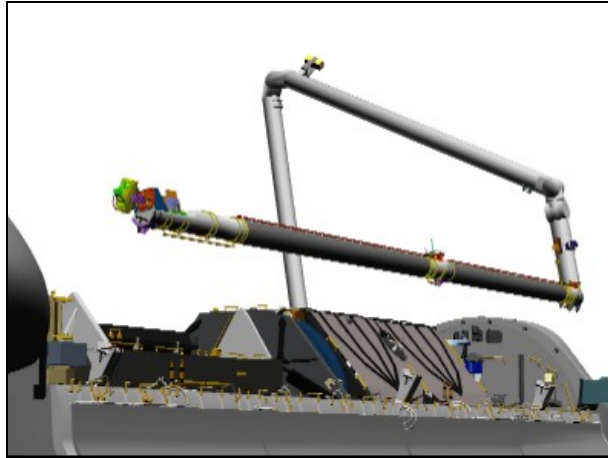

BIRD'S EYE

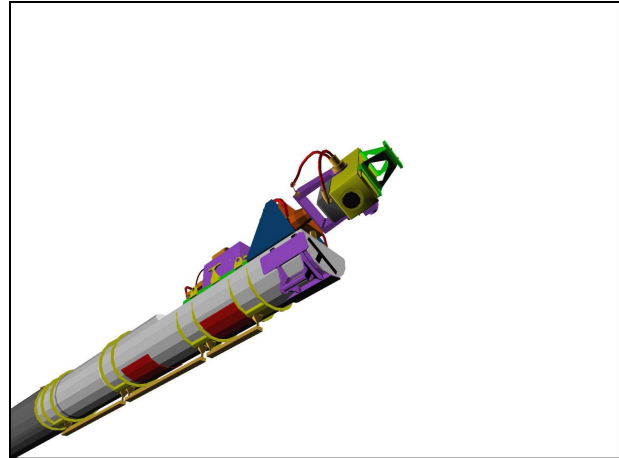

CCTV C (50,50)

9. LDRI CALIBRATION
 Verify 15 min SPEE warmup power timer expired
 ✓VIDEO OUT MUX 1 L pb – push (MIDDECK It on)

- a. Mode 3
 LDRI MODE 3 pb – push (LDRI video)
 VIDEO OUT MON 2 pb – push

PAN/TILT to match LDRI view shown below

Note PAN/TILT: _____, _____

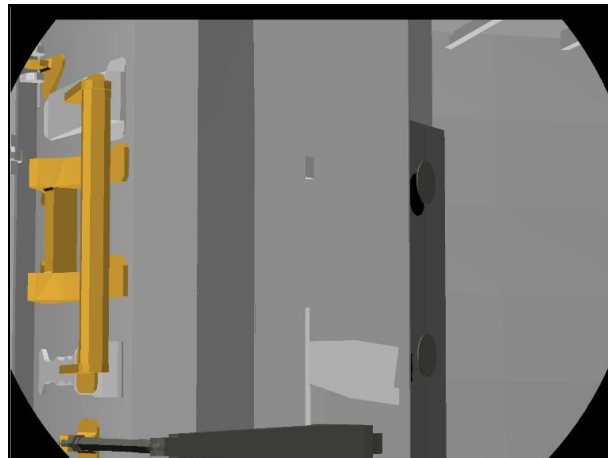

LDRI (103,-260)

If LDRI calibration view of STBD sill presents unacceptable specular reflections,

A7U PAN: +110 (right)
TILT: -220 (up)

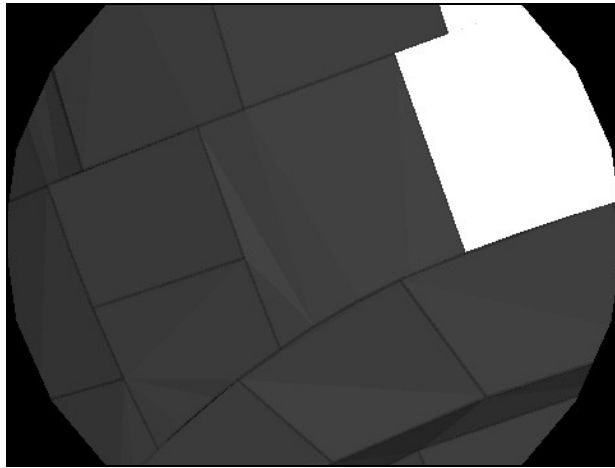

LDRI (110,-220)

L10(VTR) REC pb – push, hold
PLAY pb – push, simo (red ●)

NOTE

Wait for MCC GO before proceeding with calibration

Record for 30 sec

STOP pb – push (no red ●)

b. Mode 4

A7U VIDEO OUT MON 1 pb – push
LDRI MODE 4 pb – push (brighter LDRI video)

L10(VTR) REC pb – push, hold
PLAY pb – push, simo (red ●)

Record for 30 sec

STOP pb – push (no red ●)

c. Mode 5

A7U LDRI MODE 5 pb – push (flickering LDRI video)

L10(VTR) REC pb – push, hold
PLAY pb – push, simo (red ●)

Record for 30 sec

STOP pb – push (no red ●)

- A7U d. Mode 6
 LDRI MODE 6 pb – push (brighter flickering LDRI video)
- L10(VTR) REC pb – push, hold
 PLAY pb – push, simo (red ●)
- Record for 30 sec
- STOP pb – push (no red ●)

10. PROCEED TO FLAT FIELDS
On MCC GO, go to OBSS ITVC/LDRI FLAT FIELDS

OBSS ITVC/LDRI FLAT FIELDS

WARNING
For UNDOCKED ops only

NOTE

Assumed starting posn is OBSS Hover. Flat Field imagery is used to characterize sensor response. Daylight is required

1. SETUP

SM 94 PDRS CONTROL

PL ID – ITEM 3 +2 EXEC
INIT ID – ITEM 24 +2 EXEC

A7U √VIDEO OUT DTV pb – push (PL2 lt on)
 OUT MON2 pb – push
 IN PL2(VPU) pb – push

√PAN: +103
√TILT: -260

VIDEO IN – as desired (not PL2)

2. MNVR TO FLAT FIELD START POSN

RHC RATE – as reqd (VERN within 10 ft)
 BRAKES – OFF (tb-OFF)
 MODE – ORB LD, ENTER

Mnvr to FLAT FIELD START posn:

X	Y	Z	PITCH	YAW	ROLL	PL ID
-1001	+303	-501	0	0	24	2
-1273	+300	-505	0	0	24	3
SY	SP	EP	WP	WY	WR	
-89.6	+44.5	-84.6	-45.4	0.0	+109.6	

BRAKES – ON (tb-ON)

SM 94 PDRS CONTROL

PL ID – ITEM 3 +3 EXEC
INIT ID – ITEM 24 +3 EXEC

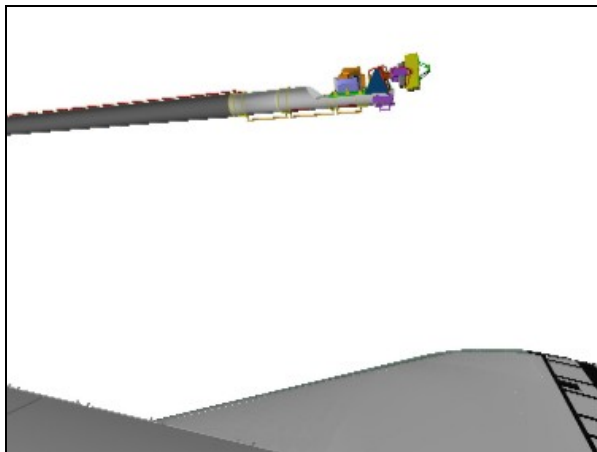

CCTV C (70,-5)

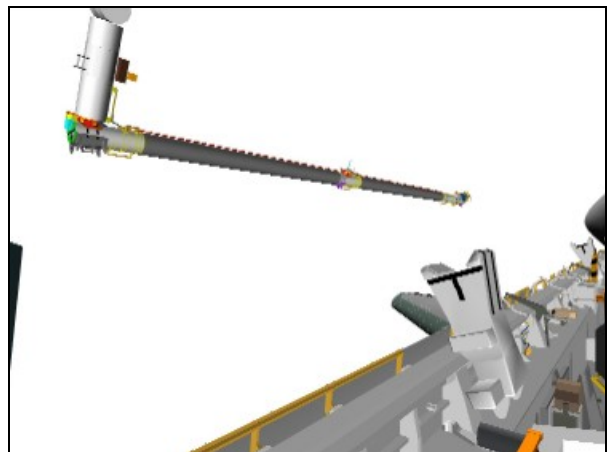

CCTV D (-40,0)

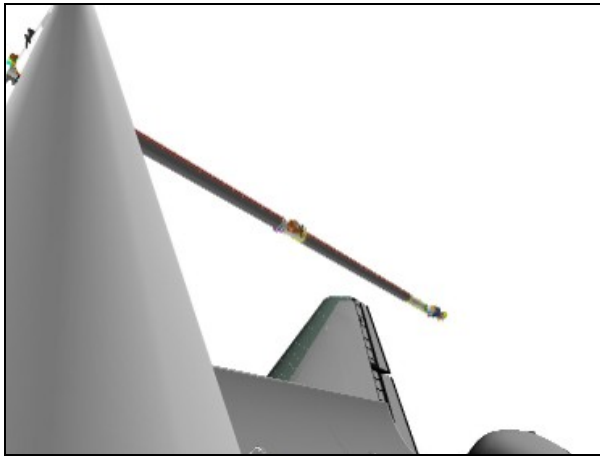

ELBOW (25,-35)

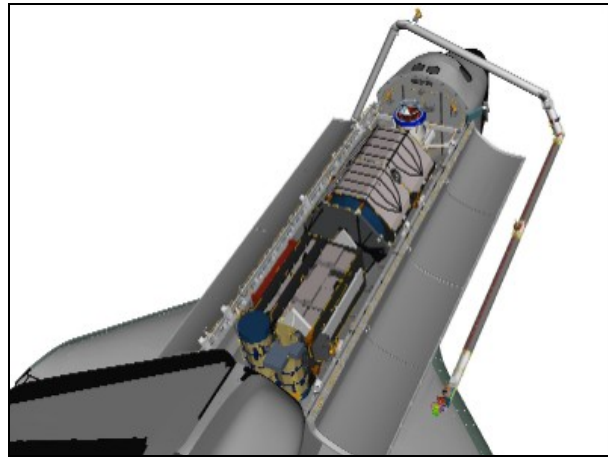

BIRD'S EYE

3. FLAT FIELDS

a. ITVC (Black Stretch)

- A7U VIDEO OUT MUX 1 L pb – push (MIDDECK lt on)
 LDRI MODE 1 pb – push (ITVC video)
 VIDEO OUT MON2 pb – push
 IN PL2 (VPU) pb – push

- ALC pb – push (lt on)
 PEAK pb – push (lt on)
 LT LEVEL pb – push (lt on)
 DAY pb – push (lt on)
 LT LEVEL pb – push (all MENU lts off)
 AP COR ON pb – push (lt on)
 FOCUS – NEAR (to stop)
 ZOOM: 10.0 HFOV

- L10(VTR) REC pb – push, hold
 PLAY pb – push, simo (red ●)

NOTE

Wait for MCC GO before proceeding with survey

- RHC On MCC GO,
 RATE – COARSE (RATE MIN tb-OFF)
 BRAKES – OFF (tb-OFF)
 MODE – ORB LD, ENTER

- THC Mnvr X to -1261 (pull)

b. ITVC (no Black Stretch)

- A7U GAM BLK STR pb – push (lt off)

- THC Mnvr X to -1273 (push)

- A7U
- c. LDRI Mode 5 (3-D, no Black Stretch)
 AP COR ON pb – push (lt off)
 GAM BLK STR pb – push (lt on)
 ALC pb – push
 AVG pb – push
- VIDEO OUT MUX 1 L pb – push (MIDDECK lt on)
 LDRI MODE 5 pb – push (flickering LDRI video)

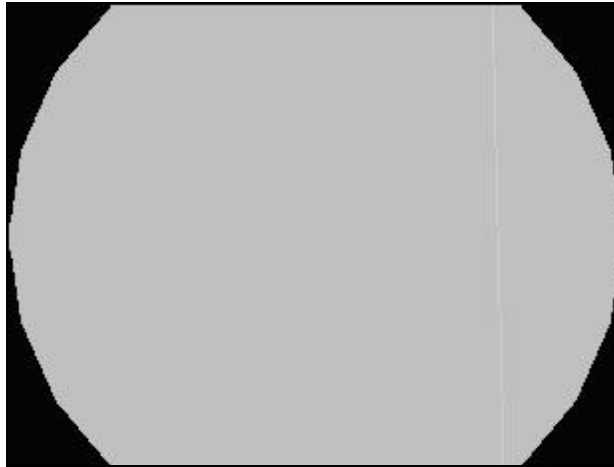

LDRI (103,-260)

THC Mnvr X to -1261 (pull)

- A7U
- d. LDRI Mode 6 (3-D, Black Stretch)
 LDRI MODE 6 pb – push (brighter flickering LDRI video)

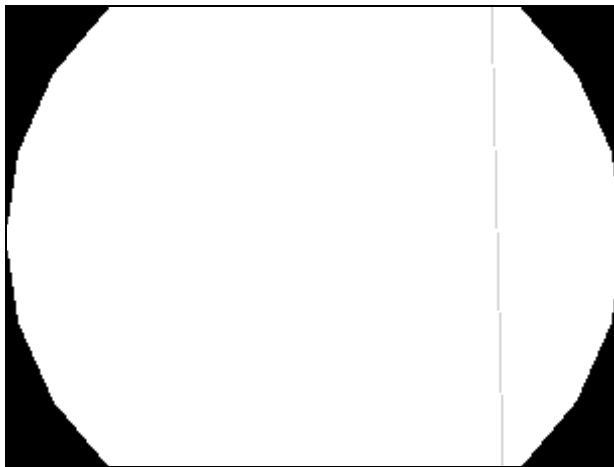

LDRI (103,-260)

THC Mnvr X to -1273 (push)

BRAKES – ON (tb-ON)

L10(VTR) STOP pb – push (no red ●)

4. MNVR TO STBD SURVEY ATTITUDE
 MNVR to STBD SURVEY attitude per FLIGHT PLAN
 Go to OBSS LDRI RCC SURVEY – STBD UNDOCKED

OBSS BERTH

WARNING
For UNDOCKED ops only

NOTE

Stbd MPMs assumed deployed

- A7U 1. SETUP
CCTV – config for berth

SM 94 PDRS CONTROL

PL ID – ITEM 3 +1 EXEC
INIT ID – ITEM 24 +1 EXEC

2. OBSS HOVER

Verify mnvr to OBSS HOVER posn complete:

X	Y	Z	PITCH	YAW	ROLL	PL ID
-680	+126	-496	0	0	341	1
SY	SP	EP	WP	WY	WR	
-90.0	+79.8	-123.1	-55.7	0.0	+110.0	

√STBD RMS HTR A,B (two) – OFF

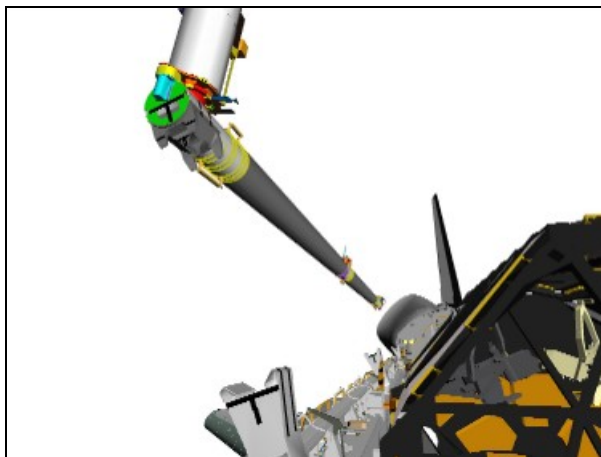

CCTV D (-15,15)

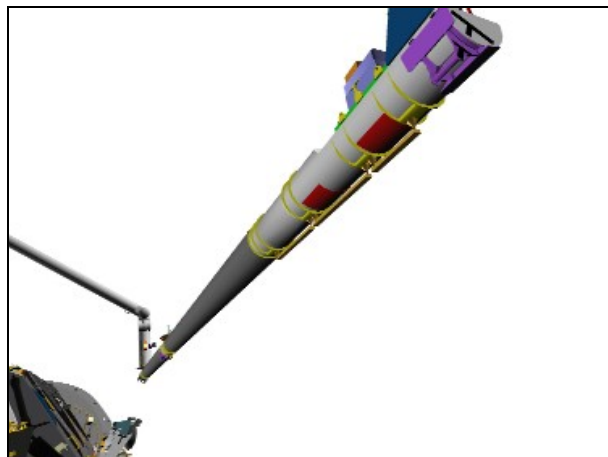

CCTV C (25,25)

- A7U 3. STOW PTU
VIDEO OUT MON2 pb – push
IN PL2(VPU) pb – push

CAMR CMD PAN/TILT – HI RATE

PAN – L (to hard stop)

TILT – UP (to hard stop)

PAN/TILT – RESET, HI RATE (LO within 10°)

PAN: +108 (right)

TILT: -175 (down)

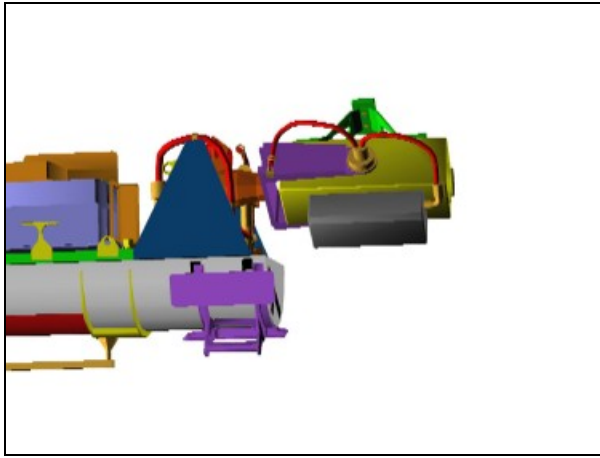

CCTV B (82,16) HFOV: 15.0

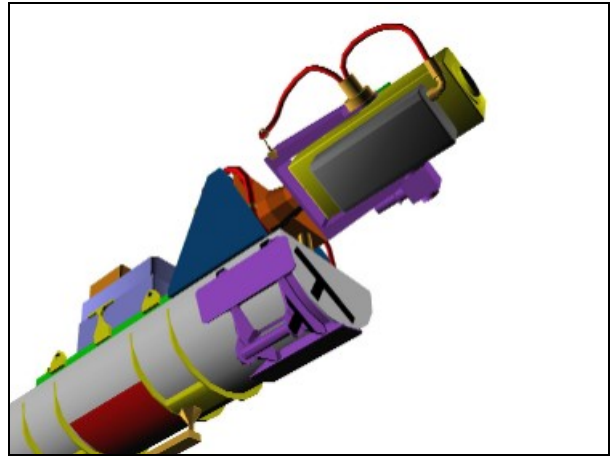

CCTV C (50,50) HFOV: 40.0

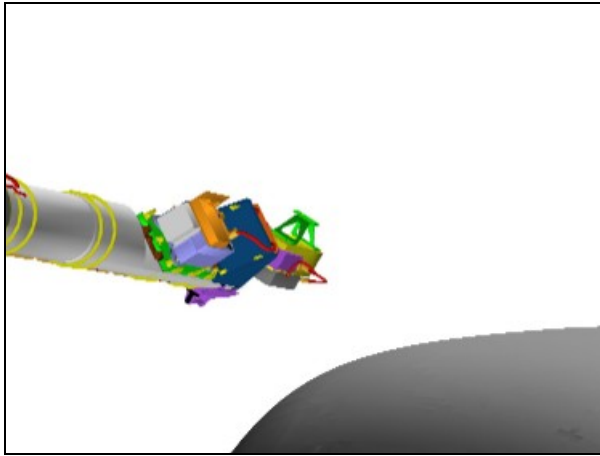

ELBOW (52,-45) HFOV: 9.8 (full-in)

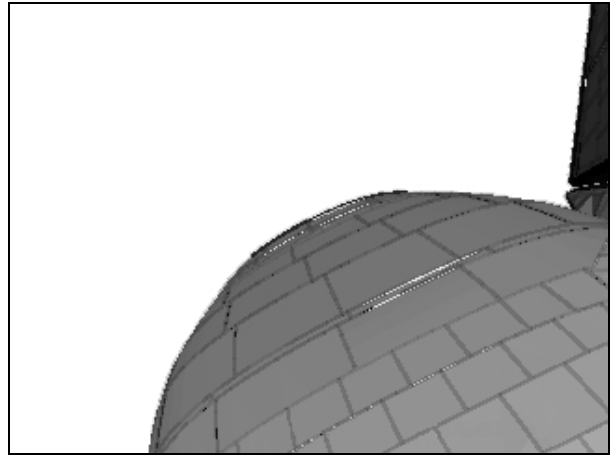

OBSS ITVC (108,-175) HFOV: 53.8 (full-out)

Perform LCC DEACTIVATION (LCS Cue Card, PHOTO/TV)
 Perform LCH DEACTIVATION (LCS Cue Card, PHOTO/TV)

CAUTION
 STBD RMS HTR power must be applied within
 90 min to prevent sensor package damage

Perform DEACTIVATION (LDRI/ITVC Cue Card, PHOTO/TV)

4. OBSS BERTH

SM 94 PDRS CONTROL

RMS STBD – ITEM 2 EXEC (*)

A6U

DAP: FREE

RHC

RATE – VERN (RATE MIN tb-ON)
 BRAKES – OFF (tb-OFF)
 MODE – PL, ENTER

6. STBD MRL LATCH
RATE – COARSE (RATE MIN tb-OFF)

SM 94 PDRS CONTROL

√STBD AFT, MID, FWD LAT (six) = 0

AUTO BRAKE INH – ITEM 10 EXEC (*)

NOTE

Expect single motor drive time for MRL latching

STBD RMS RETEN LAT – LAT (tb-LAT) (18 sec max)
– OFF

If motor drive time > 18 sec, √MCC

MODE – TEST, ENTER
Wait 5 sec

BRAKES – ON (tb-ON)

SM 94 PDRS CONTROL

RMS PORT – ITEM 1 EXEC (*)
AUTO BRAKE ENA – ITEM 9 EXEC (*)

A6U DAP: A1/AUTO/VERN(ALT)

7. RECONFIGURE POWER
R13L PL BAY MECH PWR SYS (two) – OFF

MA73C:C cb MCA PWR AC3 3Φ MID 2 – cl
√AC2 3Φ MID 2 – op

MA73C:D √AC3 3Φ MID 4 – op

8. OBSS UNGRAPPLE
A7U CCTV – config for ungrapple
– RMS WRIST, ZOOM: 34.0 HFOV
FOCUS: 5 ft

SM 94 PDRS CONTROL

PL ID – ITEM 3 +0 EXEC
INIT ID – ITEM 24 +0 EXEC

RHC RATE – VERN (RATE MIN tb-ON)

BRAKES – OFF (tb-OFF)
MODE – END EFF, ENTER

A6U DAP: VERN(FREE)

CAUTION
Monitor EE tb timing to prevent EE motor burnout

EE MODE – AUTO
RELEASE sw – REL (mom)

When OPEN tb – gray, mnvr arm clear of grapple pin

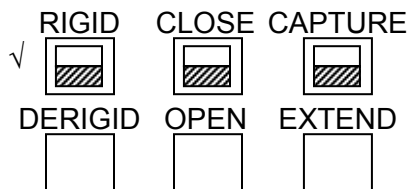

CRITICAL TIMES (28 sec total):
DERIGID tb – gray, 5 sec max, then
OPEN tb – gray, 3 sec max, then
EXTEND tb – gray, 20 sec max

EE MODE – OFF

- * If manual release reqd: *
- * EE MODE – MAN *
- * MAN CONTR – DERIGID (hold until DERIGID tb-gray, 5 sec max) *
- * RELEASE sw – depress (hold until OPEN tb-gray, 3 sec max) *
- * Mnvr arm clear of grapple pin, then: *
- * EE MAN CONTR – DERIGID (hold until EXTEND tb-gray, 20 sec max) *
- * MODE – OFF *

STBD RMS HTR A,B (two) – AUTO

A6U

EVENT TIMER CNTL – STOP

Mnvr to OBSS PRE-GRAPPLE posn:

X	Y	Z	PITCH	YAW	ROLL	PL ID
-680	+96	-513	270	350	1	0
SY	SP	EP	WP	WY	WR	
-90.0	+87.6	-129.5	-57.5	0.0	+110.4	

BRAKES – ON (tb-ON)

If proceeding to SRMS EE CAM CREW CABIN SURVEY >>

GNC 23 RCS

✓RCS FWD, ITEM 1: *

- ✓MANF VLVS OVRD 1 – ITEM 40 EXEC (OP)
- 2 – ITEM 41 EXEC (OP)
- 3 – ITEM 42 EXEC (OP)
- 4 – ITEM 43 EXEC (OP)
- 5 – ITEM 44 EXEC (OP)

9. ARM PRE-CRADLE

SM 94 PDRS CONTROL

√PL ID, ITEM 3: 0

√INIT ID, ITEM 24: 0

RATE – as reqd (VERN within 10 ft)

BRAKES – OFF (tb-OFF)

MODE – as desired

Mnvr to PRE-CRADLE posn:

	SY	SP	EP	WP	WY	WR	
OBSS	-90.0	+87.6	-129.5	-57.5	0.0	+110.4	
PRE-GRAPPLE				+5.0			
1: WP +							
2: WR -						0.0	
3: EP +			-25.0				
4: SY +	0.0						
5: SP -		+25.0					
PRE-CRADLE	0.0	+25.0	-25.0	+5.0	0.0	0.0	
	X	Y	Z	PITCH	YAW	ROLL	PL ID
	-1261	-146	-551	5	2	0	0

BRAKES – ON (tb-ON)

MODE – not DIRECT

PARAM – PORT TEMP

JOINT – CRIT TEMP

OBSS HANDOFF FROM SSRMS (LAB) TO SRMS

1. SETUP

SM 94 PDRS CONTROL

√PL ID, ITEM 3: 0

√INIT ID, ITEM 24: 0

A7U CCTV – config as reqd

2. PRE-GRAPPLE MNVR

On SSRMS Operator GO for mnvr to OBSS PRE-GRAPPLE AT HANDOFF posn,

RHC RATE – as reqd (VERN within 10 ft)

BRAKES – OFF (tb-OFF)

MODE – ORB UNL, ENTER

Mnvr to OBSS PRE-GRAPPLE AT HANDOFF posn:

X	Y	Z	PITCH	YAW	ROLL	PL ID
-1015	-362	-688	284	0	270	0
SY	SP	EP	WP	WY	WR	
+23.5	+63.5	-29.6	-102.9	+11.5	-98.6	

BRAKES – ON (tb-ON)

Notify SSRMS Operator that SRMS at OBSS PRE-GRAPPLE AT HANDOFF posn

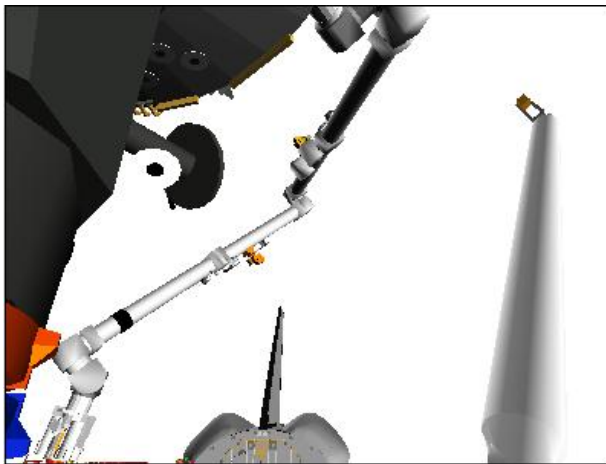

CCTV A (0,30)

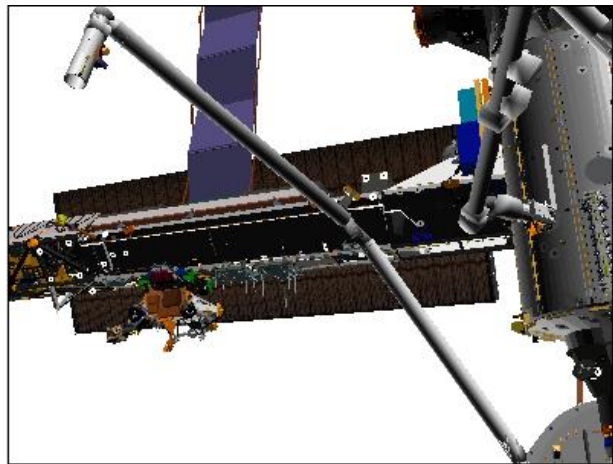

CCTV B (-20,20)

3. CONFIGURE POWER

CAUTION

SPEE power must be applied within 90 min to prevent sensor package damage

On SSRMS Operator GO to release STBD MRLs,
STBD RMS HTR A,B (two) – OFF

A6U EVENT TIMER MODE – UP
CNTL – START

CAUTION
Monitor EE tb timing to prevent EE motor burnout

EE MODE – AUTO
CAPTURE sw – depress (mom)

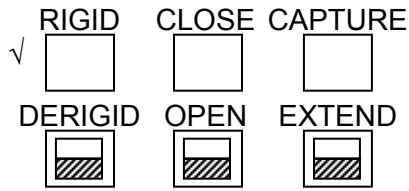

CRITICAL TIMES (28 sec total):
CAPTURE tb – gray, then
CLOSE tb – gray, 3 sec max, then
RIGID tb – gray, 25 sec max

EE MODE – OFF

MODE – TEST, ENTER
Wait 5 sec

BRAKES – ON (tb-ON)

SM 94 PDRS CONTROL

 PL ID – ITEM 3 +2 EXEC
 INIT ID – ITEM 24 +2 EXEC

Expected OBSS HANDOFF posn:

	X	Y	Z	PITCH	YAW	ROLL	PL ID
✓	-1031	-44	-610	284	270	270	2
	SY	SP	EP	WP	WY	WR	
✓	+25.8	+66.3	-49.0	-85.9	+10.7	-100.7	

* display singularity

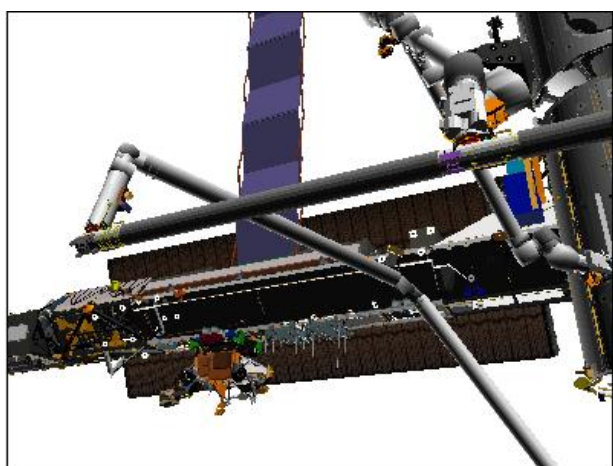

CCTV B (-25,25)

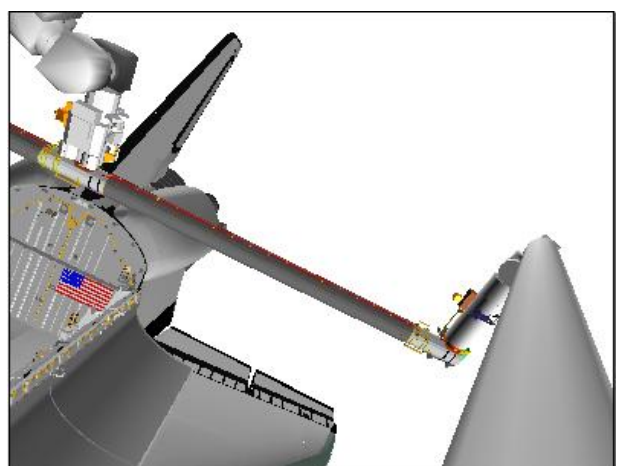

ELBOW (-30,-5)

- Perform ACTIVATION (LDRI/ITVC Cue Card, PHOTO/TV)
- Perform LCH ACTIVATION (LCS Cue Card, PHOTO/TV)
- Perform LCC ACTIVATION (LCS Cue Card, PHOTO/TV)

Perform LCC DEACTIVATION (LCS Cue Card, PHOTO/TV), steps 1 and 2

Give SSRMS Operator GO for OBSS Ungrapple

Review GENERIC END EFFECTOR CUE CARD – ISS/SHUTTLE DOCKED OPS

8. MNVR TO OBSS PARK

RHC

On SSRMS Operator GO for mnvr to OBSS PARK posn,

RATE – as required (VERN within 10 ft)

BRAKES – OFF (tb-OFF)

MODE – SINGLE, ENTER

Mnvr to OBSS PARK posn:

	SY	SP	EP	WP	WY	WR	
Handoff posn	+25.8	+66.3	-49.0	-85.9	+10.7	-100.7	
1: SY +	+84.0						
2: WR +						0.0	
3: WY –					0.0		
4: WP +				+5.0			
5: SP –		+25.0					
6: EP +			-25.0				
7: SY –	0.0						
OBSS Park	0.0	+25.0	-25.0	+5.0	0.0	0.0	
	X	Y	Z	PITCH	YAW	ROLL	PL ID
	-1243	-143	-869	95	359	358	2

BRAKES – ON (tb-ON)

MODE – not DIRECT

PARAM – PORT TEMP

JOINT – CRIT TEMP

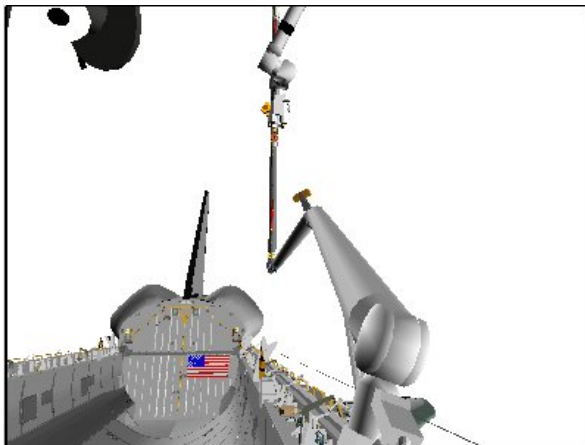

CCTV A (10,15)

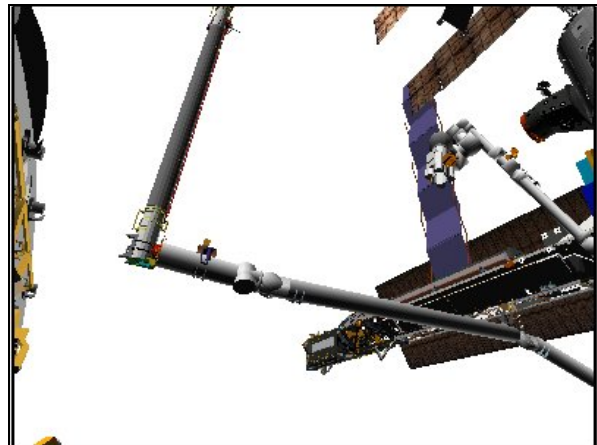

CCTV C (-60,30)

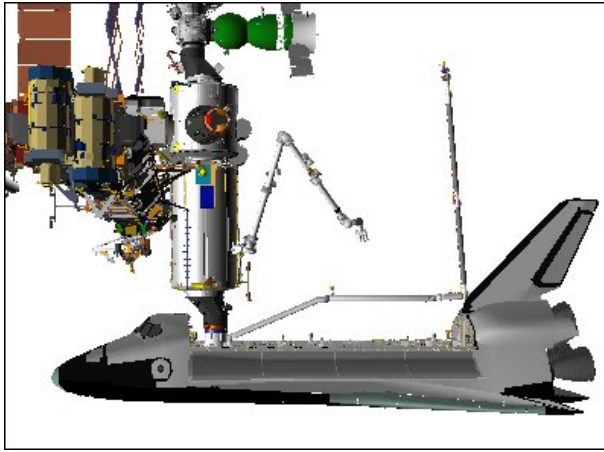

PORT

- A7U
9. RECONFIG PTU
VIDEO OUT MON2 pb – push
IN PL2(VPU) pb – push
- CAMR CMD PAN/TILT – HI RATE
PAN – L (to hard stop)
TILT – UP (to hard stop)
PAN/TILT – RESET, HI RATE (LO within 10°)
PAN: +75 (right)
TILT: -55 (dn)
- VIDEO OUT MUX 1 L pb – push (MIDDECK It on)
LDRI MODE 2 pb – push (ITVC video)

OBSS HANDOFF FROM SRMS TO SSRMS (LAB)

1. SETUP

SM 94 PDRS CONTROL

√PL ID, ITEM 3: 2

√INIT ID, ITEM 24: 2

A7U CCTV – config as reqd

Review GENERIC END EFFECTOR CUE CARD – ISS/SHUTTLE DOCKED OPS

2. MANEUVER TO OBSS HANDOFF

RHC On SSRMS Operator GO for mnvr to OBSS HANDOFF posn,
 RATE – as reqd (VERN within 10 ft)
 BRAKES – OFF (tb-OFF)
 MODE – SINGLE, ENTER

Mnvr to OBSS HANDOFF posn:

	SY	SP	EP	WP	WY	WR	
OBSS Park	0.0	+25.0	-25.0	+5.0	0.0	0.0	
1: SY +	+84.0						
2: EP -			-49.0				
3: SP +		+66.3					
4: WP -				-85.9			
5: WY +					+10.7		
6: WR -						-100.7	
7: SY -	+25.8						
Handoff Posn	+25.8	+66.3	-49.0	-85.9	+10.7	-100.7	
	X	Y	Z	PITCH	YAW	ROLL	PL ID
	-1031	-44	-610	284	270	270	2

* display singularity

BRAKES – ON (tb-ON)

Give SSRMS Operator GO for OBSS Grapple



CCTV A (0,30)

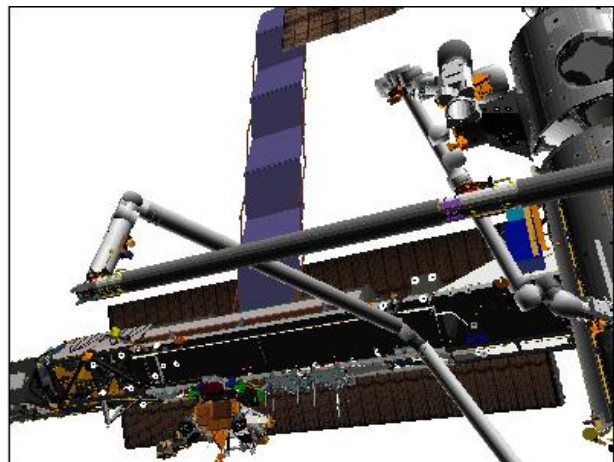

CCTV B (-25,30)

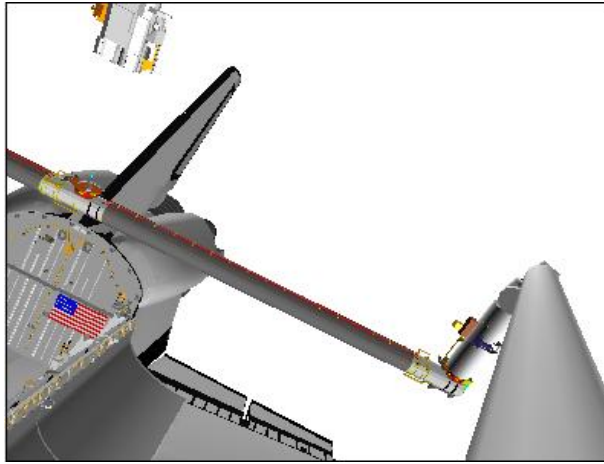

ELBOW (-30,0)

3. STOW PTU

A7U

On SSRMS Operator GO for OBSS Ungrapple,
 VIDEO OUT MON2 pb – push
 IN PL2(VPU) pb – push

CAMR CMD PAN/TILT – HI RATE

PAN – L (to hard stop)

TILT – UP (to hard stop)

PAN/TILT – RESET, HI RATE (LO within 10°)

PAN: +108 (right)

TILT: -175 (down)

Perform LCC DEACTIVATION (LCS Cue Card, PHOTO/TV)

Perform LCH DEACTIVATION (LCS Cue Card, PHOTO/TV)

CAUTION

STBD RMS HTR power must be applied within
 90 min to prevent sensor package damage

Perform DEACTIVATION (LDRI/ITVC Cue Card, PHOTO/TV)

4. OBSS UNGRAPPLE

A7U

CCTV – config for ungrapple

– RMS WRIST, ZOOM: 34.0 HFOV

FOCUS: 5 ft

NOTE

CONTR ERR It and 'S96 PDRS CNTL' msg may
 occur due to Consistency/Envelope Check error

RHC

RATE – COARSE (RATE MIN tb-OFF)

SM 94 PDRS CONTROL

AUTO BRAKE INH – ITEM 10 EXEC (*)

BRAKES – OFF (tb-OFF)
 MODE – TEST, ENTER
 Wait 5 sec

BRAKES – ON (tb-ON)







SM 94 PDRS CONTROL
 AUTO BRAKE ENA – ITEM 9 EXEC (*)
 PL ID – ITEM 3 +0 EXEC
 INIT ID – ITEM 24 +0 EXEC

RHC RATE – VERN (RATE MIN tb-ON)
 BRAKES – OFF (tb-OFF)
 MODE – END EFF, ENTER

CAUTION
 Monitor EE tb timing to prevent EE motor burnout

EE MODE – AUTO
 RELEASE sw – depress (mom)

When OPEN tb – gray, mnvr arm clear of grapple pin

<p>✓ RIGID  DERIGID </p>	<p>CLOSE  OPEN </p>	<p>CAPTURE  EXTEND </p>	<p><u>CRITICAL TIMES (28 sec total):</u> DERIGID tb – gray, 5 sec max, then OPEN tb – gray, 3 sec max, then EXTEND tb – gray, 20 sec max</p>
---	--	--	---

EE MODE – OFF

- * If manual release reqd: *
- * EE MODE – MAN *
- * MAN CONTR – DERIGID (hold until DERIGID tb-gray, 5 sec max) *
- * RELEASE sw – depress (hold until OPEN tb-gray, 3 sec max) *
- * Mnvr arm clear of grapple pin, then: *
- * EE MAN CONTR – DERIGID (hold until EXTEND tb-gray, 20 sec max) *
- * MODE – OFF *

RHC 5. MNVR TO OBSS PRE-GRAPPLE AT HANDOFF
 RATE – VERN (RATE MIN tb-ON)
 MODE – as desired

Mnvr to OBSS PRE-GRAPPLE AT HANDOFF posn:

X	Y	Z	PITCH	YAW	ROLL	PL ID
-1015	-362	-688	284	0	270	0
SY	SP	EP	WP	WY	WR	
+23.5	+63.5	-29.6	-102.9	+11.5	-98.6	

BRAKES – ON (tb-ON)
 MODE – not DIRECT
 JOINT – CRIT TEMP

Give SSRMS Operator GO to mnvr to Aft posn

9. RECONFIGURE POWER
 R13L PL BAY MECH PWR SYS (two) – OFF
 STBD RMS HTR A,B (two) – AUTO

A6U EVENT TIMER CNTL – STOP

SM 94 PDRS CONTROL

√STBD AFT, MID, FWD LAT (six) = 1
 RMS PORT – ITEM 1 EXEC (*)

MA73C:C cb MCA PWR AC3 3Φ MID 2 – cl
 √AC2 3Φ MID 2 – op

MA73C:D √AC3 3Φ MID 4 – op

Give SSRMS Operator GO for OBSS Ungrapple

10. MNVR TO PRE-CRADLE

RHC On SSRMS Operator GO,
 RATE – as reqd (VERN within 10 ft)
 BRAKES – OFF (tb-OFF)
 MODE – SINGLE, ENTER

Mnvr to PRE-CRADLE posn:

	SY	SP	EP	WP	WY	WR	
Pre-Grapple	+23.5	+63.5	-29.6	-102.9	+11.5	-98.6	
1: WR +						0.0	
2: WY -					0.0		
3: WP +				+5.0			
4: SP -		+25.0					
5: EP +			-25.0				
6: SY -	0.0						
Pre-Cradle	0.0	+25.0	-25.0	+5.0	0.0	0.0	
	X	Y	Z	PITCH	YAW	ROLL	PL ID
	-1261	-146	-551	5	2	0	0

BRAKES – ON (tb-ON)
 MODE – not DIRECT
 PARAM – PORT TEMP
 JOINT – CRIT TEMP

MNVR FROM HANDOFF TO STBD LDRI ACAS START

WARNING
For UNDOCKED ops only

1. SETUP

SM 94 PDRS CONTROL

- √ PL ID, ITEM 3: 2
- √ INIT ID, ITEM 24: 2

HANDOFF posn:

	X	Y	Z	PITCH	YAW	ROLL	PL ID	
√	-1031	-44	-610	284	270	270	2	* Display Singularity
	SY	SP	EP	WP	WY	WR		
√	+25.8	+66.3	-49.0	-85.9	+10.7	-100.7		

A7U CCTV – config as reqd

2. SJ MNVR TO STBD LDRI ACAS START

- RHC
- RATE – as reqd (VERN within 10 ft)
 - BRAKES – OFF (tb-OFF)
 - MODE – SINGLE, ENTER

Mnvr to STBD LDRI ACAS START posn:

	SY	SP	EP	WP	WY	WR	
Handoff	+25.8	+66.3	-49.0	-85.9	+10.7	-100.7	
1: SY –	-126.0						
2: WP +				-16.7			
3: WR +						+166.4	
4: WY +					+25.9		
5: SP –		+38.1					
6: EP –			-54.2				
STBD LDRI ACAS START	-126.0	+38.1	-54.2	-16.7	+25.9	+166.4	
	X	Y	Z	PITCH	YAW	ROLL	PL ID
	-639	+291	-434	322	2	79	2

BRAKES – ON (tb-ON)

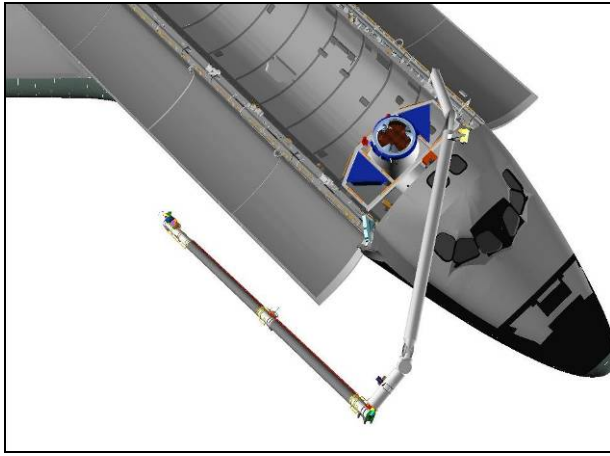

BIRD'S EYE

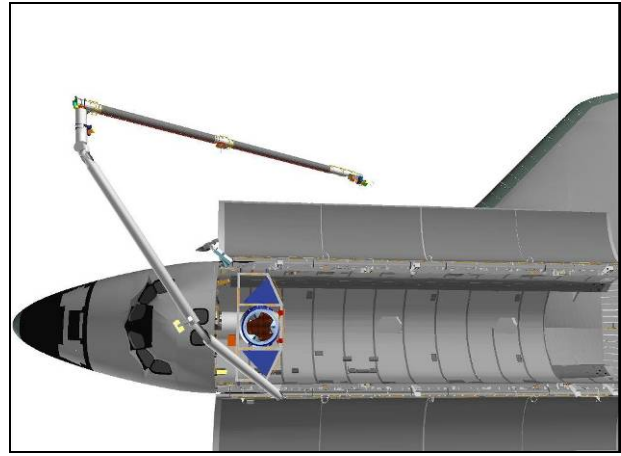

OVERHEAD

3. STBD LDRI SURVEY

SM 94 PDRS CONTROL

PL ID - ITEM 3 +3 EXEC

INIT ID - ITEM 24 +3 EXEC

Go to OBSS LDRI RCC SURVEY – STBD UNDOCKED steps 3-12

OBSS LDRI RCC SURVEY – STBD UNDOCKED

WARNING
For UNDOCKED ops only
Stbd PLBD radiator must be stowed
APAS Docking Ring must be retracted

NOTE

Assumed starting posn is last LDRI FF posn.

In case of SPEE pwr loss, reset RSC Illuminator,
reset PTU, select correct LDRI mode

1. SETUP

SM 94 PDRS CONTROL

√PL ID, ITEM 3: 3

√INIT ID, ITEM 24: 3

2. MNVR TO STBD LDRI ACAS START POSITION

SJ Mnvr Clearance Views	Cameras
OBSS-to-Wing	C[6], D[7], ELBOW[5], RSC[1,3,4]
OBSS-to-PLBD	C[6], D[7], ELBOW[5], RSC[2]
[1]Wing enters FOV at WR = +129	[5]Good until WR = +157
[2]PLBD enters FOV at WR = +130	[6]Good until WR = +160
[3]Good until WR = +141	[7]Good until WR = +164
[4]Good after WR = +151	

RHC

When MNVR STBD SURVEY attitude complt,

√RATE – VERN (RATE MIN tb-ON)

BRAKES – OFF (tb-OFF)

MODE – SINGLE, ENTER

Mnvr to STBD LDRI ACAS START posn:

	SY	SP	EP	WP	WY	WR	
Last FF Posn	-89.6	+44.5	-84.6	-45.4	0.0	+109.6	
1: EP +			-54.2				
2: SY -	-126.0						
3: WP +				-16.7			
4: WY +					+25.9		
5: WR +						+166.4	
6: SP -		+38.1					
STBD LDRI	-126.0	+38.1	-54.2	-16.7	+25.9	+166.4	
ACAS START	X	Y	Z	PITCH	YAW	ROLL	PL ID
	-854	+276	-266	322	2	79	3

BRAKES – ON (tb-ON)

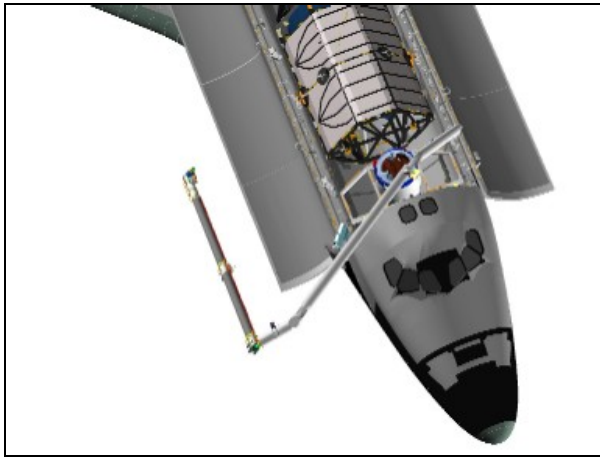

BIRD'S EYE

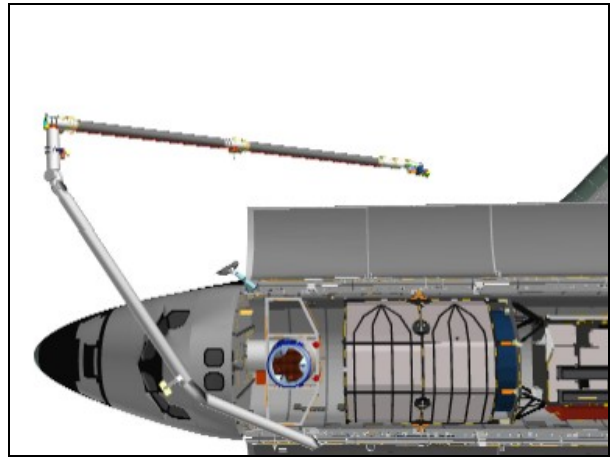

OVERHEAD

3. STBD LDRI ACAS, SECTION 1

NOTE

Section 1 scans RCC Zones 2 & 3 (oblique view), Panels 1 → 20

A7U

VIDEO OUT MON2 pb – push
IN PL2(VPU) pb – push

PAN: +95 (left)
TILT: -105 (up)

√VIDEO OUT MUX 1 L pb – push (MIDDECK It on)
√LDRI MODE 6 pb – push (flickering LDRI displayed)

PAN/TILT to match LDRI view shown below

Note PAN/TILT: _____, _____

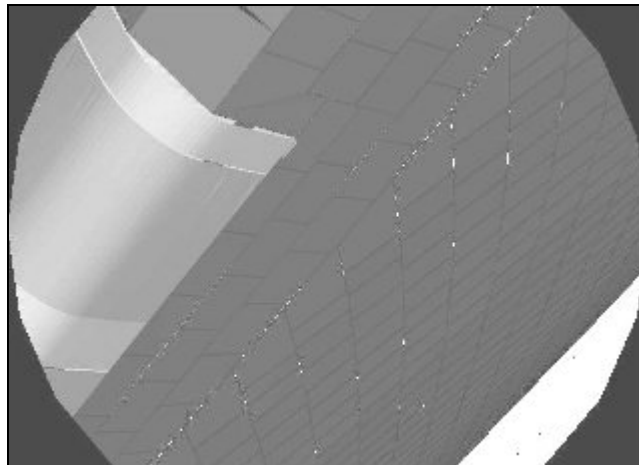

LDRI (95,-105)

VIDEO OUT MON2 pb – push
IN – as desired (not PL2)
√DTV – PL2 (LDRI video)

For survey scan pattern, refer to OBSS LDRI SCAN PATTERN CUE CARD – STBD & PORT

On MCC GO,
 AUTO SEQ – PROCEED (IN PROG It on)

ACAS, pause pts **shaded in bold**, ● col indicates data recording (black = VTR on) and damage criteria (inches):

Pt	X	Y	Z	PITCH	YAW	ROLL	●
1P	-854	+276	-266	322	2	79	
2	-941	+276	-261	322	2	73	
3	-1021	+282	-277	322	359	82	
4	-1228	+486	-281	326	354	69	
5P	-1255	+502	-281	326	352	67	

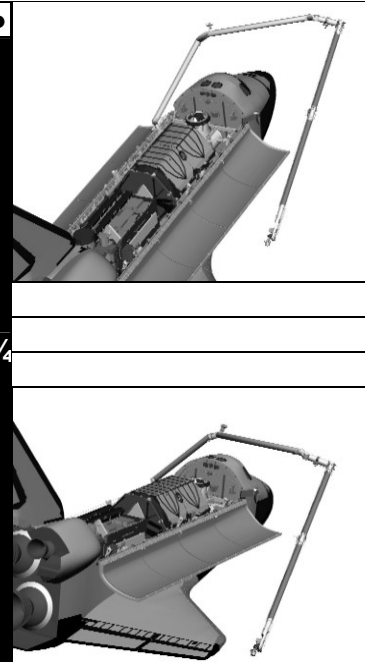

When AUTO SEQ READY It – on:
 L10(VTR) STOP pb – push (no red ●)

4. STBD LDRI ACAS, PREPARE FOR SECTION 2

NOTE

Between Pts 5 and 7, arm adjusts for survey of Zones 1 & 2.
 Section 2 then scans Zones 1 & 2, Panels 22 → 1.
 At Pt 6, Upper Arm-to-APAS = 20.6 in.
 At Pt 7, Upper Arm-to-P3/P4 = 12.7 in.
 Time between Pts 5 and 7 ~ 2:50 min

AUTO SEQ – PROCEED (IN PROG It on)

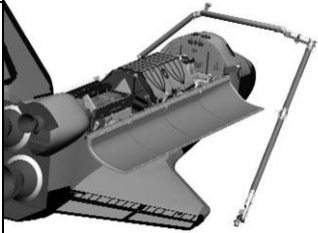
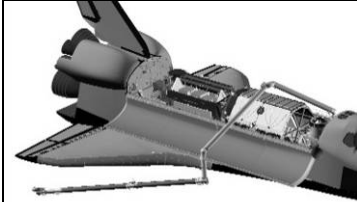
Pt	X	Y	Z	PITCH	YAW	ROLL	●
5P	-1255	+502	-281	326	352	67	
6	-1255	+502	-220	346	352	67	
7P	-1358	+477	-220	346	347	16	

5. LCS/IDC CHARACTERIZATION

NOTE

LCS and IDC characterization images are obtained here to assess LCS and IDC sensor performance while looking at RCC

a. LCS Characterization

LCC/PGSC

Allow arm motion to damp-out for 30 sec, then:
 sel 'Scanning' 'Detailed Area Scan'
 sel – Area Scan 14
cmd Start Area Scan (verify Scan Line - Done)

 sel – Area Scan 16
cmd Start Area Scan (verify Scan Line - Done)

 sel – Area Scan 17 LDA
cmd Start Area Scan (verify Scan Line - Done)

b. IDC Characterization

LCC/PGSC

Minimize, do not close LCC software
 Sel 'Shuttle Apps' > 'IDC'

NOTE

Expect 'iport probe failed' message at first pwr on attempt.
 If message persists, see troubleshooting section

Sel 'Power On' (pause 3 sec)
Sel 'Power On'

√'Use AE' checked
Sel 'Scan Lo-Res'

A7U VIDEO OUT MON2 pb – push
IN PL2 (VPU) pb – push

PAN: +82 (left)
TILT: -55 (up)

A7U PAN/TILT to illuminate IDC FOV

LCC/PGSC Resize and posn AE box on RCC (pause 2 sec)
Sel 'Scan Hi-Res'
Sel 'Stop Scan' after 30 sec
√'Waiting for User Command' displayed

Sel 'RCC-Day' or 'RCC-Night' from drop-down menu per real-time conditions
Sel 'Acquire Set'
√'Acquiring Set' displayed
√'Waiting for User Command' displayed after set

Sel 'Power off'

6. STBD LDRI ACAS, CONTINUE WITH SECTION 2

NOTE

At Pt 12, Upper Arm-to-APAS = 19 in.
Time between Pts 7 and 12 ~ 4:00 min

Section 2 Clearance Views	Cameras
OBSS-to-PLBD	C[2], D[1], ELBOW[4], RSC[3]
OBSS-to-Wing	D[1], ELBOW[4], RSC
[1]Good until X ~ -1275	[3]PLBD enters FOV at X ~ -1145
[2]Good until X ~ -1200	[4]Good until X ~ -1130

A7U

VIDEO OUT MON2 pb – push
IN PL2(VPU) pb – push

PAN: +80 (left)
TILT: -65 (up)

PAN/TILT to match LDRI view shown below

Note PAN/TILT: _____, _____

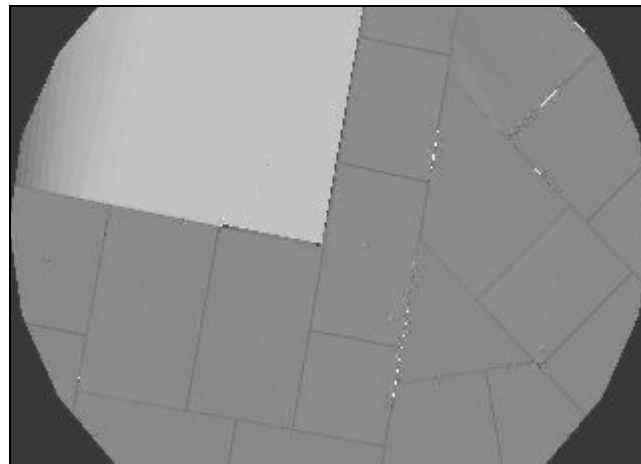

LDRI (80,-65)

VIDEO IN – as desired (not PL2)

L10(VTR)

REC pb – push, hold
PLAY pb – push, simo (red ●)

On MCC GO,
 AUTO SEQ – PROCEED (IN PROG It on)

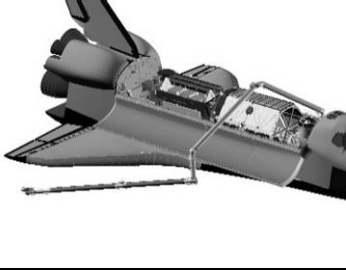
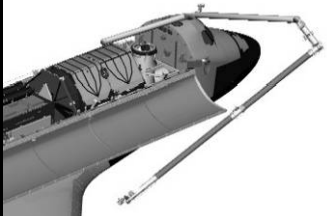
Pt	X	Y	Z	PITCH	YAW	ROLL	•
7P	-1358	+477	-220	346	347	16	
8	-1316	+463	-220	346	347	16	
9	-1294	+464	-222	346	347	19	
10	-1061	+218	-201	334	12	22	1/4
11	-1004	+200	-205	332	20	27	
12P	-930	+220	-225	323	19	54	

7. STBD LDRI ACAS, SECTION 3

NOTE

VTR not stopped between Sections 2 & 3. Section 3 scans
 RCC Zones 2 & 3, Panels 1 → 22. Run time ~ 4:55 min

Section 3 Clearance Views	Cameras
OBSS-to-PLBD	C[2], D[3], ELBOW, RSC[1]
OBSS-to-Wing	D, ELBOW, RSC
[1]PLBD leaves FOV at X ~ -1130 [2]Good after X ~ -1110 [3]Good after X ~ -1212	

AUTO SEQ – PROCEED (IN PROG It on)

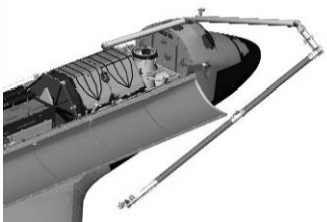
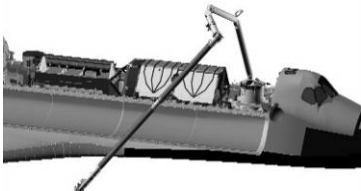
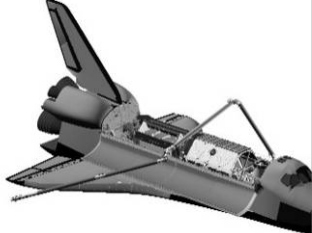
Pt	X	Y	Z	PITCH	YAW	ROLL	●
12P	-930	+220	-225	323	19	54	
13	-1012	+246	-228	325	14	55	
14	-1016	+245	-221	309	13	38	
15	-1252	+472	-233	337	343	30	
16	-1281	+497	-240	338	341	38	
17P	-1335	+540	-282	336	335	71	

L10(VTR) When AUTO SEQ READY It – on:
 STOP pb – push (no red ●)

8. STBD LDRI ACAS, SECTION 4

NOTE

Section 4 scans RCC Zone 4, Panels 22 → 1.
Run time ~ 7:00 min

Section 4 Clearance Views	Cameras
OBSS-to-PLBD	C[4], D[3], ELBOW[5], RSC[2]
OBSS-to-Wing	C[1,4], D[3], ELBOW[5], RSC
[1]Good after X ~ -1310 [2]PLBD enters FOV at X ~ -1075 [3]Good until X ~ -1056	[4]Good until X ~ -1038 [5]Good until X ~ -1000

A7U VIDEO OUT MON2 pb – push
IN PL2(VPU) pb – push

√PAN: +80
TILT: -90 (down)

PAN/TILT to match LDRI view shown below

Note PAN/TILT: _____, _____

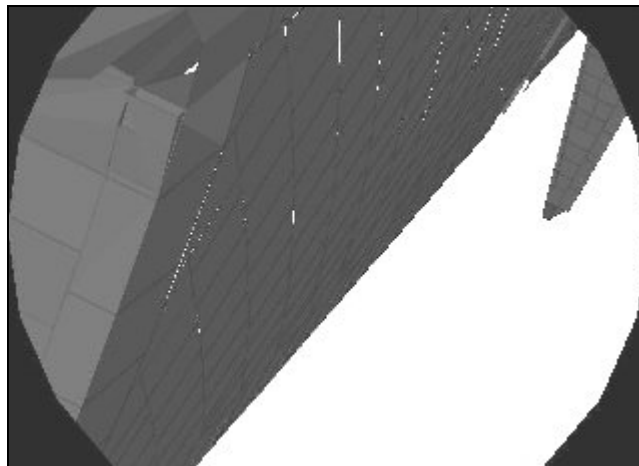

LDRI (80,-90)

VIDEO IN – as desired (not PL2)

L10(VTR) REC pb – push, hold
PLAY pb – push, simo (red ●)

AUTO SEQ – PROCEED (IN PROG It on)

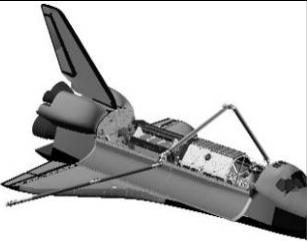
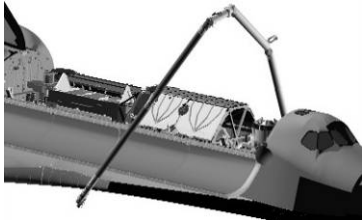
Pt	X	Y	Z	PITCH	YAW	ROLL	●
17P	-1335	+540	-282	336	335	71	
18	-1279	+527	-325	325	351	93	
19	-1227	+502	-300	329	344	74	
20	-1031	+303	-290	321	356	76	1/4
21	-1002	+276	-288	329	8	85	
22P	-915	+271	-282	311	10	81	

L10(VTR) When AUTO SEQ READY It – on:
 STOP pb – push (no red ●)

9. STBD LDRI ACAS, SECTION 5

NOTE

Between Pts 22 and 23, arm adjusts for survey of black tiles on fwd wing glove. Section 5 then scans apex of wing glove black tiles. Time between Pts 22 and 23 ~ 2:00 min

Section 5 Clearance Views	Cameras
OBSS-to-PLBD	C[3], RSC[2], ELBOW[1]
[1]Good after X ~ -905	
[2]Wing leaves FOV at X ~ -848	
[3]Good after X ~ -670	

AUTO SEQ – PROCEED (IN PROG It on)

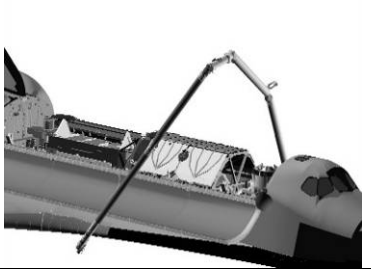
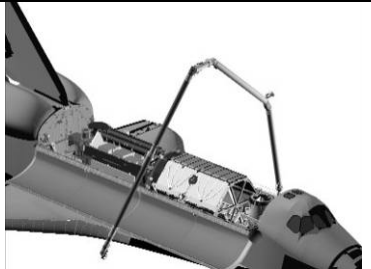
Pt	X	Y	Z	PITCH	YAW	ROLL	•
22P	-915	+271	-282	311	10	81	
23P	-906	+285	-304	294	359	84	

When AUTO SEQ READY It – on:

A7U VIDEO OUT MON2 pb – push
IN PL2(VPU) pb – push

√PAN: +80
TILT: -85 (up)

PAN/TILT to match LDRI view shown below

Note PAN/TILT: _____, _____

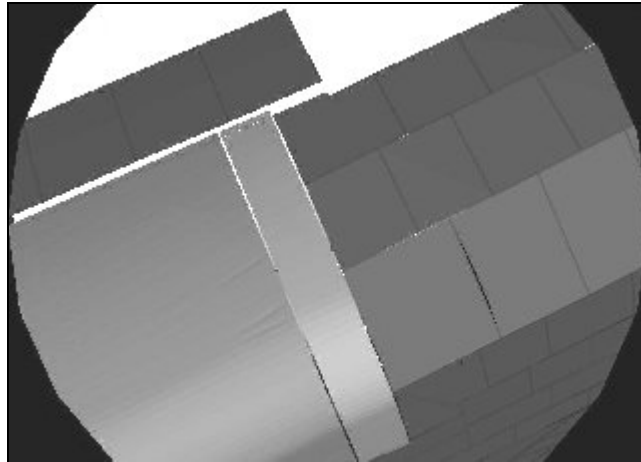

LDRI (80,-85)

VIDEO IN – as desired (not PL2)

NOTE

Time between Pts 23 and 26 ~ 2:40 min

L10(VTR) REC pb – push, hold
PLAY pb – push, simo (red ●)

AUTO SEQ – PROCEED (IN PROG It on)

Pt	X	Y	Z	PITCH	YAW	ROLL	●
23P	-906	+285	-304	294	359	84	
24	-733	+285	-299	289	357	84	
25	-686	+288	-320	276	354	86	3
26P	-562	+299	-343	266	350	87	

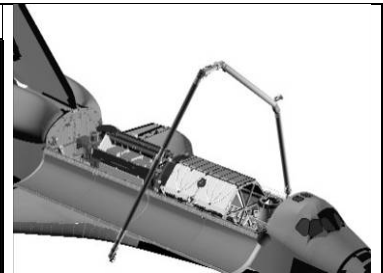

10. STBD LDRI ACAS, SECTION 6

NOTE

VTR is not stopped between sections 5 and 6. Section 6 scans top side of fwd wing glove, then continues aft for RCC Zones 5 & 6, Panels 1 → 8. Run time ~ 5:10 min

Section 6 Clearance Views	Cameras
OBSS-to-PLBD	C, D[1], ELBOW, RSC
OBSS-to-Wing	D[1,4], ELBOW[3], RSC[2]
[1]Good after X ~ -655	[3]Good after X ~ -921
[2]Wing enters FOV at X ~ -875	[4]Good until X ~ -980

AUTO SEQ – PROCEED (IN PROG It on)

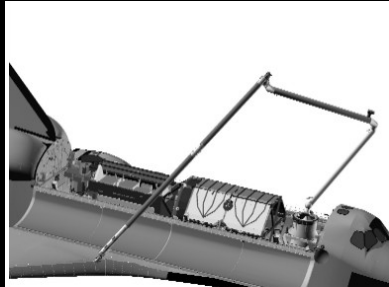
Pt	X	Y	Z	PITCH	YAW	ROLL	●
26P	-562	+299	-343	266	350	87	3 
27	-563	+286	-369	266	343	86	
28	-678	+286	-373	270	339	86	
29	-906	+284	-379	294	332	98	
30	-963	+284	-381	295	322	87	
31	-1028	+291	-372	302	322	94	
32P	-1051	+299	-359	302	322	92	1 

L10(VTR) When AUTO SEQ READY It – on:
STOP pb – push (no red ●)

11. STBD LDRI ACAS, SECTION 7

NOTE

Between Pts 32 and 33, arm adjusts to optimize remaining survey of Zones 5 & 6. Section 7 then scans Zones 5 & 6, Panels 9 → 22. Time between Pts 32 and 33 ~ 1:20 min

Section 7 Clearance Views	Cameras
OBSS-to-PLBD	C, D, ELBOW, RSC
OBSS-to-Wing	C, D[1], ELBOW, RSC[2]
[1]Good after X ~ -1110	
[2]PLBD leaves FOV at X ~ -1131	

AUTO SEQ – PROCEED (IN PROG It on)

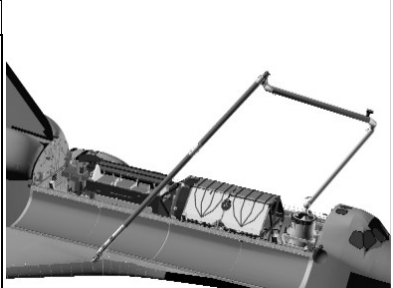
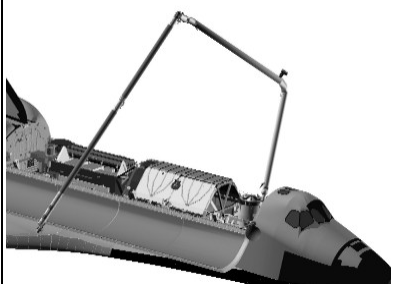
Pt	X	Y	Z	PITCH	YAW	ROLL	•
32P	-1051	+299	-359	302	322	92	
33P	-1047	+290	-358	291	336	83	

When AUTO SEQ READY It – on:

A7U VIDEO OUT MON2 pb – push
IN PL2(VPU) pb– push

√PAN: +80
TILT: -105 (down)

PAN/TILT to match LDRI view shown below

Note PAN/TILT: _____, _____

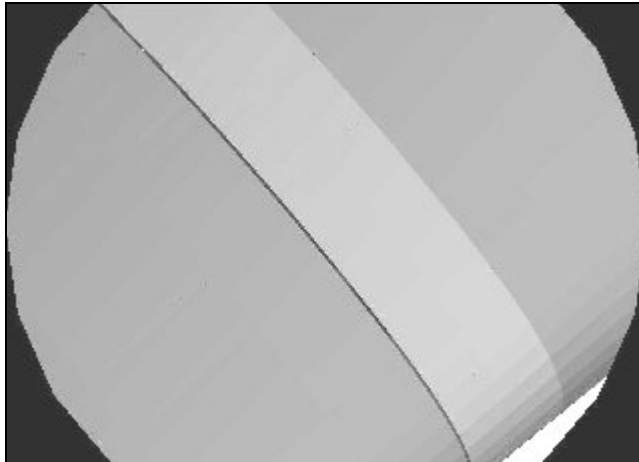

LDRI (80,-105)

VIDEO IN – as desired (not PL2)

NOTE

Time between Pts 33 and 37 ~ 3:45 min

L10(VTR) REC pb – push, hold
PLAY pb – push, simo (red ●)

AUTO SEQ – PROCEED (IN PROG It on)

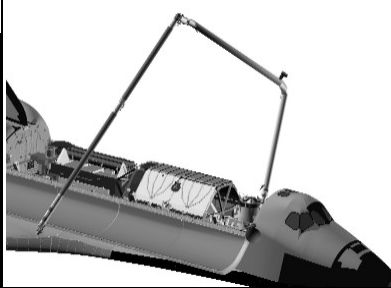
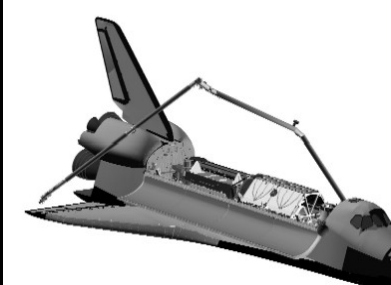
Pt	X	Y	Z	PITCH	YAW	ROLL	●
33P	-1047	+290	-358	291	336	83	
34	-1235	+453	-381	300	316	97	
35	-1259	+495	-367	308	333	99	
36	-1280	+499	-373	305	329	97	1/4
37P	-1325	+515	-370	311	334	101	

L10(VTR) When AUTO SEQ READY It – on:
STOP pb – push (no red ●)

12. STBD LDRI ACAS, SECTION 8

NOTE

Between Pts 37 and 38, arm adjusts for survey of Zone 6.
 Section 8 then scans Zone 6, Panels 22 → 1. Time
 between Pts 37 and 38 ~ 0:45 sec

Section 8 Clearance Views	Cameras
OBSS-to-PLBD	C, D[3,6], ELBOW[5], RSC[2]
OBSS-to-Wing	C, D[3,6,7,8], ELBOW[4], RSC[1]
[1]Good until X ~ -1205	[5]Good until X ~ -1027
[2]PLBD enters FOV at X ~ -1150	[6]Good after X ~ -1027
[3]Good until X ~ -1141	[7]Good until X ~ -1003
[4]Good until X ~ -1035	[8]Good after X ~ -973

AUTO SEQ – PROCEED (IN PROG It on)

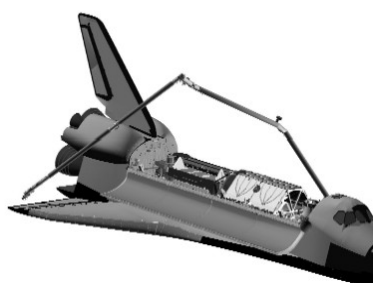
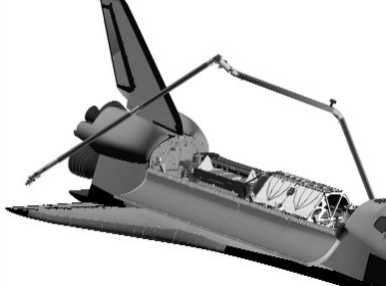
Pt	X	Y	Z	PITCH	YAW	ROLL	•
37P	-1325	+515	-370	311	334	101	
38P	-1347	+480	-395	314	332	103	

When AUTO SEQ READY It – on:

A7U VIDEO OUT MON2 pb – push
 IN PL2(VPU) pb – push

PAN: +50 (left)
 TILT: -115 (down)

PAN/TILT to match LDRI view shown below

Note PAN/TILT: _____, _____

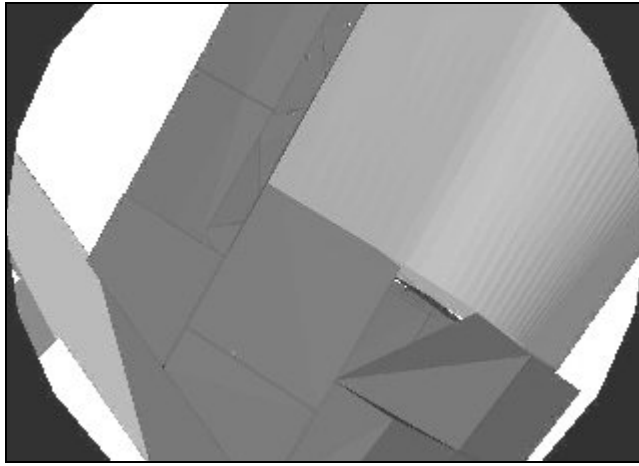

LDRI (50,-115)

VIDEO IN – as desired (not PL2)

NOTE

Between Pts 41 & 42, LDRI scan distance increases beyond 7 ft due to OBSS prox to STBD PLBD. Time between Pts 38 and 46 ~ 6:55 min

L10(VTR) REC pb – push, hold
PLAY pb – push, simo (red ●)

AUTO SEQ – PROCEED (IN PROG It on)

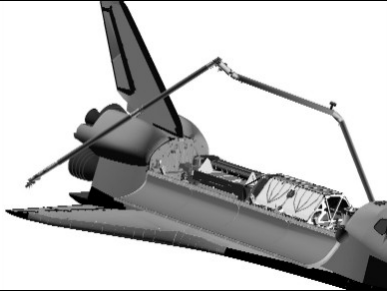
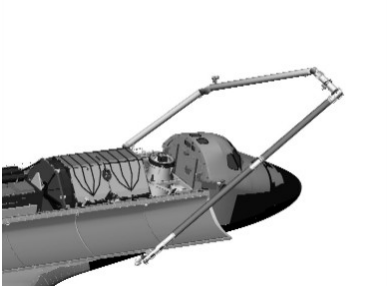
Pt	X	Y	Z	PITCH	YAW	ROLL	●
38P	-1347	+480	-395	314	332	103	1/4 
39	-1303	+474	-393	312	336	98	
40	-1282	+467	-390	312	337	94	
41	-1270	+448	-392	311	336	99	
42	-1077	+264	-408	305	335	94	
43	-1029	+272	-400	298	347	76	
44	-1002	+285	-385	305	355	72	
45	-970	+290	-365	316	4	65	
46P	-875	+288	-365	322	1	69	1 

When AUTO SEQ IN PROG It – off:
BRAKES – ON (tb-ON)

L10(VTR) STOP pb – push (no red ●)

A7U VIDEO OUT MUX 1 L pb – push (MIDDECK It on)
LDRI MODE 2 pb – push (ITVC video displayed)

VIDEO OUT MON2 pb – push
 IN PL2(VPU) pb – push

If continuing OBSS ops with Nose Cap survey:
 MNVR NOSE CAP SURVEY attitude per FLIGHT PLAN
 Go to OBSS LDRI RCC SURVEY – NOSE CAP >>

13. RETURN TO OBSS HOVER
 RHC RATE – as reqd (VERN within 10 ft)
 BRAKES – OFF (tb-OFF)
 MODE – SINGLE, ENTER

Mnvr to OBSS HOVER:

	SY	SP	EP	WP	WY	WR	
STBD LDRI	-120.8	+32.5	-23.7	-45.8	+12.8	+164.7	
ACAS End							
1: WR –						+70.0	
2: SP +		+79.8					
3: SY +	-90.0						
4: WP –				-55.7			
5: WY –					0.0		
6: EP –			-123.1				
7: WR +						+110.0	
OBSS HOVER	-90.0	+79.8	-123.1	-55.7	0.0	+110.0	
	X	Y	Z	PITCH	YAW	ROLL	PL ID
	-1271	+127	-511	0	0	11	3

BRAKES – ON (tb-ON)

OBSS LDRI RCC SURVEY – NOSE CAP

WARNING
Port PLBD radiator must be stowed

1. SETUP

SM 94 PDRS CONTROL

- √PL ID, ITEM 3: 3
- √INIT ID, ITEM 24: 3

- √AUTO MODE 2, ITEM 14: 2

2. INHIBIT NOSE JETS

If Orbiter Control Required:

- O14:F, √Pri RJDA LOGIC,DRIVER (eight) – ON
- O15:F, √Pri RJDF LOGIC,DRIVER (eight) – OFF
- O16:F

A6U When MNVR NOSE CAP SURVEY attitude complt,
DAP: A14/AUTO/ALT (Tail Only)

NOTE

Expect DAP RECONFIG message after FRCS
manifold 5 status overridden to close

GNC 23 RCS

- RCS FWD – ITEM 1 EXEC (*)
- MANF VLVS OVRD 1 – ITEM 40 EXEC (CL)
- 2 – ITEM 41 EXEC (CL)
- 3 – ITEM 42 EXEC (CL)
- 4 – ITEM 43 EXEC (CL)
- 5 – ITEM 44 EXEC (CL)

3. MNVR TO NOSE CAP LDRI ACAS START POSN

- RHC RATE – as reqd
- BRAKES – OFF (tb-OFF)
- MODE – SINGLE, ENTER

Mnvr to NOSE CAP LDRI ACAS START posn:

	SY	SP	EP	WP	WY	WR	
STBD LDRI	-120.8	+32.5	-23.7	-45.8	+12.8	+164.7	
ACAS End							
1: WR –						+81.5	
2: SP +		+48.8					
3: SY +	+156.6						
4: EP +			-19.1				
5: WP –				-47.9			
6: WY –					-9.1		
7: WR +						+162.6	
NOSE CAP	+156.6	+48.8	-19.1	-47.9	-9.1	+162.6	
ACAS Start							
	X	Y	Z	PITCH	YAW	ROLL	PL ID
	-187	+98	-348	260	303	315	3

BRAKES – ON (tb-ON)



FRONT

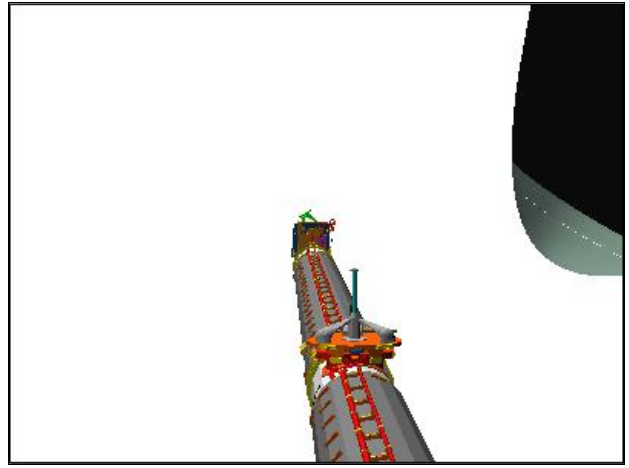

RSC

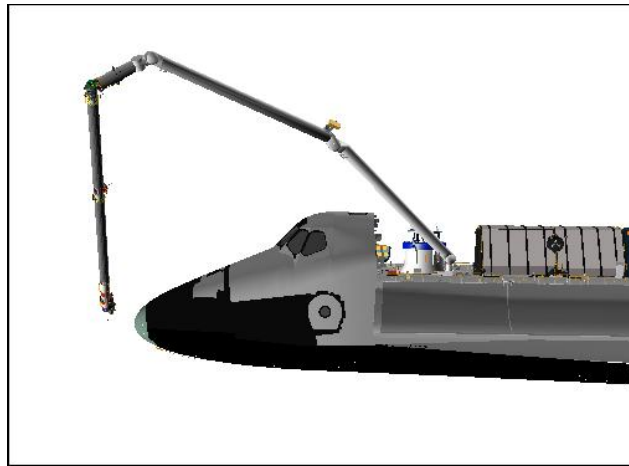

PORT

- A7U
4. NOSE CAP LDRI ACAS, SECTION 1
 VIDEO OUT MUX 1 L pb – push (MIDDECK It on)
 LDRI MODE 6 pb – push (flickering LDRI displayed)
- VIDEO OUT MON2 pb – push
 IN PL2(VPU) pb – push
- PAN: +0 (left)
 TILT: -45 (up)
- PAN/TILT to match LDRI view shown below
- Note PAN/TILT: _____, _____

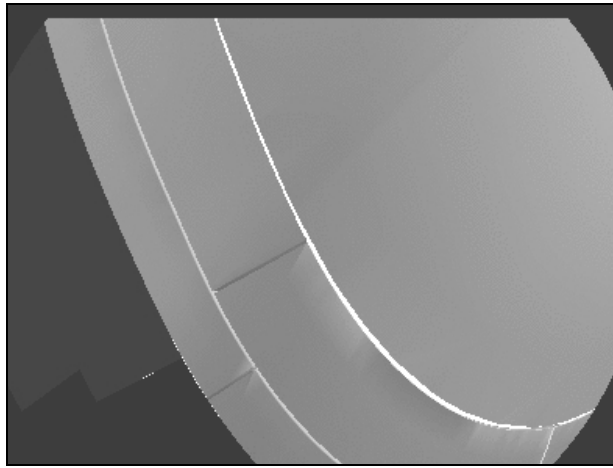

LDRI (0,-45)

VIDEO OUT MON 2 pb – push
IN – as desired (not PL2)

For survey scan pattern, refer to OBSS LDRI SCAN PATTERN CUE CARD – NOSE CAP (CUE CARD CONFIG)

For camera views, refer to OBSS LDRI RCC SURVEY CAMERA VIEWS – NOSE CAP (OBSS SURVEY CAMERA VIEWS)

RHC RATE – COARSE (RATE MIN tb-OFF)

BRAKES – OFF (tb-OFF)
MODE – AUTO 2, ENTER (READY It on)

- * If unable to enter AUTO mode (no AUTO READY It): *
- * √Joint angles and adjust as reqd *

SM 94 PDRS CONTROL

√START PT, ITEM 17: 47

SM 169 PDRS STATUS

Monitor ACAS progress

NOTE

Section 1 run time ~ 2:15 min

Section 1 Clearance Views	Cameras
RMS-to-PLBD	A, ELBOW
OBSS-to-Nose Cap	RSC[1], P1 LOOB[1], US LAB
[1]Good for all subsequent scan sections	

L10(VTR) REC pb – push, hold
PLAY pb – push, simo (red ●)

NOTE

Wait for MCC GO before proceeding with survey

On MCC GO,
AUTO SEQ – PROCEED (IN PROG It on)

ACAS, pause pts **shaded in bold**, ● col indicates data recording (black = VTR on) and damage criteria (inches):

Pt	X	Y	Z	PITCH	YAW	ROLL	●
47P	-187	+98	-348	260	303	315	
48	-160	+58	-371	221	302	274	1/4
49P	-177	+71	-381	227	305	291	



L10(VTR) When AUTO SEQ READY It – on:
STOP pb – push (no red ●)

5. NOSE CAP LDRI ACAS, SECTION 2

NOTE

Time between Pts 49 and 51 ~ 3:20 min

Section 2 Clearance Views	Cameras
RMS-to-PLBD	A, ELBOW
OBSS-to-Nose Cap	ELBOW[1], US LAB
[1]Good after Y ~ 57	

AUTO SEQ – PROCEED (IN PROG It on)

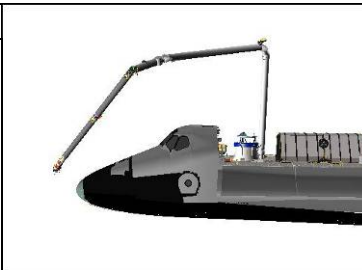
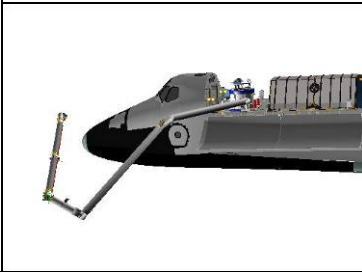
Pt	X	Y	Z	PITCH	YAW	ROLL	•
49P	-177	+71	-381	227	305	291	
50	-185	+27	-425	191	297	287	
51P	-181	+27	-403	154	289	281	

A7U

When AUTO SEQ READY It – on:
 VIDEO OUT MON2 pb – push
 IN PL2(VPU) pb – push

PAN: +75 (right)
 TILT: -55 (up)

PAN/TILT to match LDRI view shown below

Note PAN/TILT: _____, _____

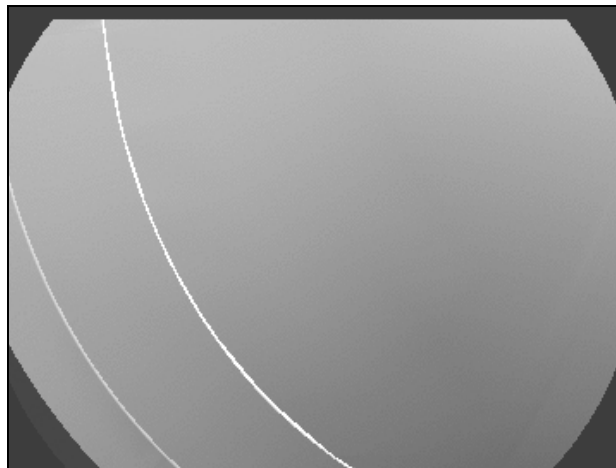

LDRI (75,-55)





NOTE

Time between Pts 51 and 56 ~ 6:20 min

VIDEO IN – as desired (not PL2)

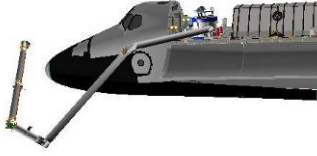
L10(VTR) REC pb – push, hold
PLAY pb – push, simo (red ●)

AUTO SEQ – PROCEED (IN PROG It on)

Pt	X	Y	Z	PITCH	YAW	ROLL	●
51P	-181	+27	-403	154	289	281	
52	-182	+7	-414	146	296	273	
53	-177	+31	-385	220	296	348	
54	-184	-26	-423	148	309	281	
55	-170	-65	-369	173	327	275	
56P	-148	-12	-332	169	306	250	

L10(VTR) When AUTO SEQ READY It – on:
STOP pb – push (no red ●)

6. NOSE CAP LDRI ACAS, SECTION 3

NOTE

Time between Pts 56 and 57 ~ 2:00 min

Section 3 Clearance Views	Cameras
RMS-to-PLBD	A, ELBOW
OBSS-to-Nose Cap	ELBOW[1], US LAB[2]
[1]Good until Z ~ -290	
[2]Good until Z ~ -292	

AUTO SEQ – PROCEED (IN PROG It on)

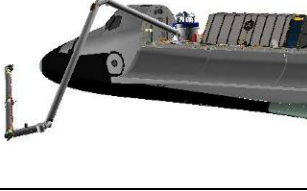
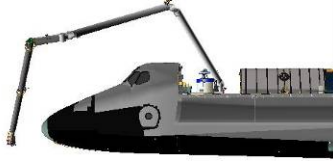
Pt	X	Y	Z	PITCH	YAW	ROLL	●
56P	-148	-12	-332	169	306	250	
57P	-155	+38	-300	233	297	309	

A7U

When AUTO SEQ READY It – on:
 VIDEO OUT MON2 pb – push
 IN PL2(VPU) pb – push

PAN: +75 (right)
 TILT: -43 (up)

PAN/TILT to match LDRI view shown below

Note PAN/TILT: _____, _____

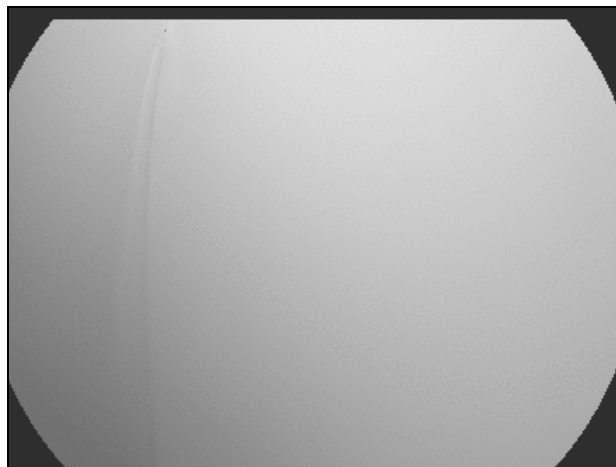

LDRI (75,-43)



NOTE

Time between Pts 57 and 59 ~ 2:55 min

VIDEO IN – as desired (not PL2)

L10(VTR) REC pb – push, hold
PLAY pb – push, simo (red ●)

AUTO SEQ – PROCEED (IN PROG It on)

Pt	X	Y	Z	PITCH	YAW	ROLL	●
57P	-155	+38	-300	233	297	309	
58	-183	+70	-273	184	282	237	1/4
59P	-209	+27	-228	238	298	266	

L10(VTR) When AUTO SEQ READY It – on:
STOP pb – push (no red ●)



7. NOSE CAP LDRI ACAS, SECTION 4

NOTE

Time between Pts 59 and 60 ~ 1:20 min

Section 4 Clearance Views	Cameras
RMS-to-PLBD	A, ELBOW
OBSS-to-Nose Cap	ELBOW[1][2]
[1]Good after Y ~ 6	
[2]Good until Y ~ -12	

AUTO SEQ – PROCEED (IN PROG It on)

Pt	X	Y	Z	PITCH	YAW	ROLL	●
59P	-209	+27	-228	238	298	266	
60P	-236	0	-234	217	287	242	

A7U

When AUTO SEQ READY It – on:
 VIDEO OUT MON2 pb – push
 IN PL2(VPU) pb – push

PAN: +85 (right)
 TILT: -73 (down)

PAN/TILT to match LDRI view shown below

Note PAN/TILT: _____, _____



LDRI (85,-73)



NOTE

Time between Pts 60 and 62 ~ 2:25 min

VIDEO IN – as desired (not PL2)

L10(VTR) REC pb – push, hold
PLAY pb – push, simo (red ●)

AUTO SEQ – PROCEED (IN PROG It on)

Pt	X	Y	Z	PITCH	YAW	ROLL	●
60P	-236	0	-234	217	287	242	
61	-235	-35	-244	238	298	267	1/4
62P	-232	-67	-249	222	312	257	

L10(VTR) When AUTO SEQ READY It – on:
STOP pb – push (no red ●)

8. NOSE CAP LDRI ACAS, SECTION 5

NOTE

Time between Pts 62 and 63 ~ 1:15 min

Section 5 Clearance Views	Cameras
RMS-to-PLBD	A, ELBOW
OBSS-to-Nose Cap	ELBOW[1][2][3], US LAB[4]
RMS-to-US LAB	A, B
[1]Good after Z ~ -268	[3]Good after Z ~ -297
[2]Good until Z ~ -274	[4]Good after Z ~ -322

AUTO SEQ – PROCEED (IN PROG It on)

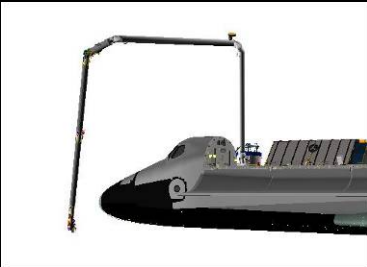
Pt	X	Y	Z	PITCH	YAW	ROLL	•
62P	-232	-67	-249	222	312	257	
63P	-191	-58	-267	234	322	268	

A7U

When AUTO SEQ READY It – on:
 VIDEO OUT MON2 pb – push
 IN PL2(VPU) pb – push

PAN: +65 (left)

TILT: -58 (up)

PAN/TILT to match LDRI view shown below

Note PAN/TILT: _____, _____



LDRI (65,-58)

NOTE

Minimum clearance RMS-to-US LAB = 43 in between pts 64-65.
 Clearance can be monitored with camera B. Time between
 Pts 63 and 66 ~ 4:00 min

VIDEO IN – as desired (not PL2)

L10(VTR) REC pb – push, hold
 PLAY pb – push, simo (red ●)

AUTO SEQ – PROCEED (IN PROG It on)

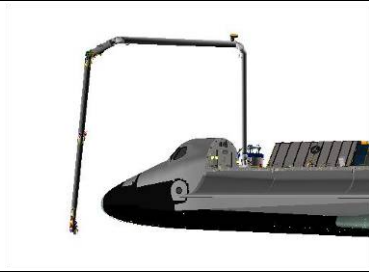
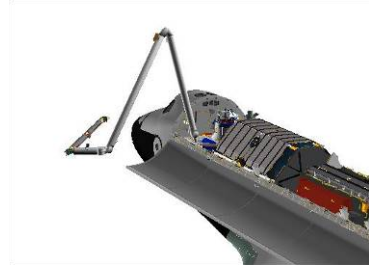
Pt	X	Y	Z	PITCH	YAW	ROLL	●
63P	-191	-58	-267	234	322	268	
64	-168	-13	-270	214	303	256	
65	-161	-40	-287	231	317	283	1/4
66P	-166	-60	-348	189	326	271	

L10(VTR) When AUTO SEQ READY It – on:
 STOP pb – push (no red ●)

9. NOSE CAP LDRI ACAS, SECTION 6

NOTE

Time between Pts 66 and 67 ~ 1:00 min

Section 6 Clearance Views	Cameras
RMS-to-PLBD	A, ELBOW
OBSS-to-Nose Cap	ELBOW, US LAB[1]
RMS-to-US LAB	A, B
[1]Good until Y ~ -80	

AUTO SEQ – PROCEED (IN PROG It on)

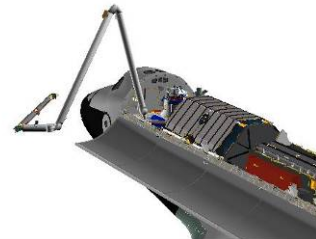
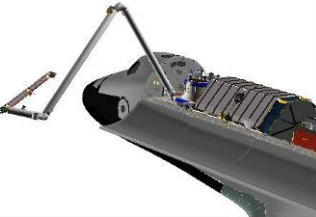
Pt	X	Y	Z	PITCH	YAW	ROLL	•
66P	-166	-60	-348	189	326	271	
67P	-179	-70	-381	185	316	280	

A7U

When AUTO SEQ READY It – on:
 VIDEO OUT MON2 pb – push
 IN PL2(VPU) pb – push

√PAN: +65
 TILT: -75 (down)

PAN/TILT to match LDRI view shown below

Note PAN/TILT: _____, _____

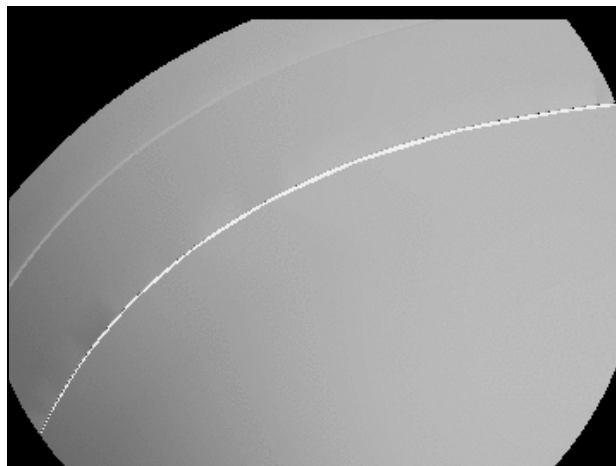

LDRI (65,-75)



NOTE

Minimum clearance RMS-to-US LAB = 49 in between pts 67-68.
 Clearance can be monitored with camera B. Time between
 Pts 67 and 68 ~ 1:50 min

VIDEO IN – as desired (not PL2)

L10(VTR) REC pb – push, hold
 PLAY pb – push, simo (red ●)

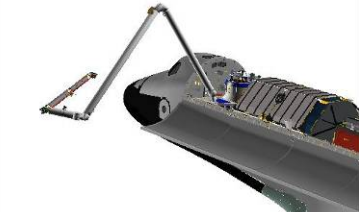
AUTO SEQ – PROCEED (IN PROG It on)

Pt	X	Y	Z	PITCH	YAW	ROLL	●
67P	-179	-70	-381	185	316	280	
68P	-182	-84	-305	221	320	274	

When AUTO SEQ IN PROG It – off:
 BRAKES – ON (tb-ON)

L10(VTR) STOP pb – push (no red ●)

A7U VIDEO OUT MUX 1 L pb – push (MIDDECK It on)
 LDRI MODE 2 pb – push (ITVC video displayed)

VIDEO OUT MON2 pb – push
 IN PL2(VPU) pb – push

10. MNVR TO NOSE JET CLEAR POSN

WARNING
 For UNDOCKED ops only

SM 94 PDRS CONTROL

PL ID – ITEM 3 +2 EXEC
 INIT ID – ITEM 24 +2 EXEC
 END POS – ITEM 18 -3 2 5 -7 4 8 -6 8 0 EXEC
 ATT – ITEM 21 +8 3 +3 9 +2 0 0 EXEC
 CMD CK – ITEM 25 EXEC (GOOD)

RHC RATE – as reqd (VERN within 10 ft)
 BRAKES – OFF (tb-OFF)
 MODE – OPR CMD, ENTER (READY It on)

AUTO SEQ – PROCEED (IN PROG It on)

When AUTO SEQ IN PROG It – off:
 BRAKES – ON (tb-ON)

	X	Y	Z	PITCH	YAW	ROLL	PL ID
√	-325	-748	-680	83	39	200	2
	SY	SP	EP	WP	WY	WR	
√	+129.0	+30.7	-29.0	-2.0	+34.5	-0.2	

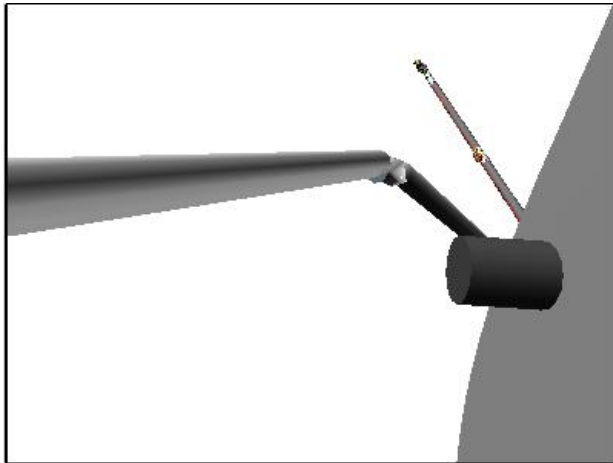

CCTV A (90,5)

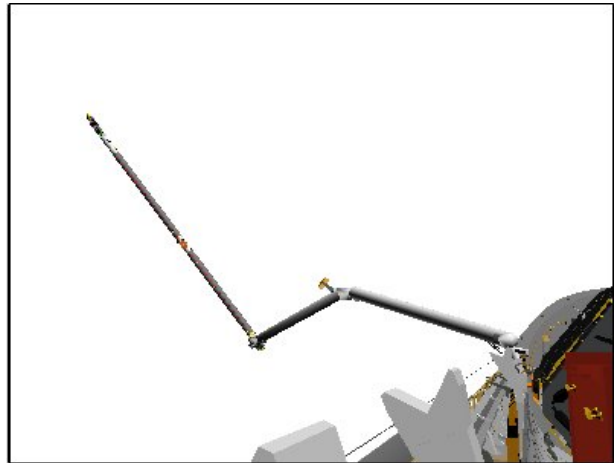

CCTV B (-20,10)

11. ENABLE VERN NOSE JETS

GNC 23 RCS

RCS FWD – ITEM 1 EXEC (*)
 MANF VLVS OVRD 5 – ITEM 44 EXEC (OP)

A6U DAP: VERN(FREE)

O14:F, Pri RJDA LOGIC,DRIVER (eight) – OFF

O15:F,
 O16:F

RJDA 1A L2/R2 DRIVER – ON

If continuing OBSS ops with PORT RCC survey:
 MNVR PORT SURVEY attitude per FLIGHT PLAN
 Go to OBSS LDRI RCC SURVEY – PORT >>

12. RETURN TO OBSS HOVER
 RHC RATE – as reqd (VERN within 10 ft)
 BRAKES – OFF (tb-OFF)
 MODE – SINGLE, ENTER

Mnvr to OBSS HOVER:

	SY	SP	EP	WP	WY	WR	
NOSE JET CLEAR	+129.0	+30.7	-29.0	-2.0	+34.5	-0.2	
1: SP +		+79.8					
2: SY -	-90.0						
3: EP -			-123.1				
4: WP -				-55.7			
5: WY -					0.0		
6: WR +						+110.0	
OBSS HOVER	-90.0	+79.8	-123.1	-55.7	0.0	+110.0	
	X	Y	Z	PITCH	YAW	ROLL	PL ID
	-998	+129	-507	0	0	11	2

BRAKES – ON (tb-ON)

GNC 23 RCS

√RCS FWD, ITEM 1: *

- MANF VLVS OVRD 1 – ITEM 40 EXEC (OP)
- 2 – ITEM 41 EXEC (OP)
- 3 – ITEM 42 EXEC (OP)
- 4 – ITEM 43 EXEC (OP)

A6U DAP: as reqd

OBSS LDRI RCC SURVEY – PORT

WARNING
 Port PLBD radiator must be stowed
 If DOCKED, SSRMS must be based on MBS.
 If SSRMS based on Lab PDGF, √MCC

1. SETUP

SM 94 PDRS CONTROL

PL ID – ITEM 3 +3 EXEC
 INIT ID – ITEM 24 +3 EXEC

GNC 23 RCS

√RCS FWD, ITEM 1: *
 √MANF VLVS OVRD 1, ITEM 40: CL
 √2, ITEM 41: CL
 √3, ITEM 42: CL
 √4, ITEM 43: CL

2. MNVR TO PORT LDRI ACAS START POSN

RHC

RATE – VERN (RATE MIN tb-ON)
 BRAKES – OFF (tb-OFF)
 MODE – SINGLE, ENTER

If performing while undocked:

When MNVR PORT SURVEY attitude complt,
 DAP: A14/AUTO/VERN

	X	Y	Z	PITCH	YAW	ROLL	PL ID
√	-355	-916	-892	83	39	200	3
	SY	SP	EP	WP	WY	WR	
√	+128.8	+30.3	-28.5	-2.0	+35.0	0.0	

Mnvr to PORT LDRI ACAS START posn:

	SY	SP	EP	WP	WY	WR	
NOSE JET CLEAR	+128.8	+30.3	-28.5	-2.0	+35.0	0.0	
1: SY +	+138.8						
2: SP –		+24.6					
3: EP –			-61.2				
4: WP +				+36.9			
5: WR –						-74.2	
6: WY –					-67.4		
PORT LDRI ACAS START	+138.8	+24.6	-61.2	+36.9	-67.4	-74.2	
	X	Y	Z	PITCH	YAW	ROLL	PL ID
	-899	-243	-284	2	341	289	3

BRAKES – ON (tb-ON)

If performing while docked:

	X	Y	Z	PITCH	YAW	ROLL	PL ID
√	-1216	-141	-1141	95	359	358	3
	SY	SP	EP	WP	WY	WR	
√	0.0	+25.0	-25.0	+5.0	0.0	0.0	

Mnvr to PORT LDRI ACAS START posn:

	SY	SP	EP	WP	WY	WR	
OBSS PARK	0.0	+25.0	-25.0	+5.0	0.0	0.0	
1: SY +	+100.0						
2: SP -		+24.6					
3: WP +				+36.9			
4: WR -						-74.2	
5: EP -			-61.2				
6: SY +	+138.8						
7: WY -					-67.4		
PORT LDRI ACAS Start	+138.8	+24.6	-61.2	+36.9	-67.4	-74.2	
	X	Y	Z	PITCH	YAW	ROLL	PL ID
	-899	-243	-284	2	341	289	3

BRAKES – ON (tb-ON)

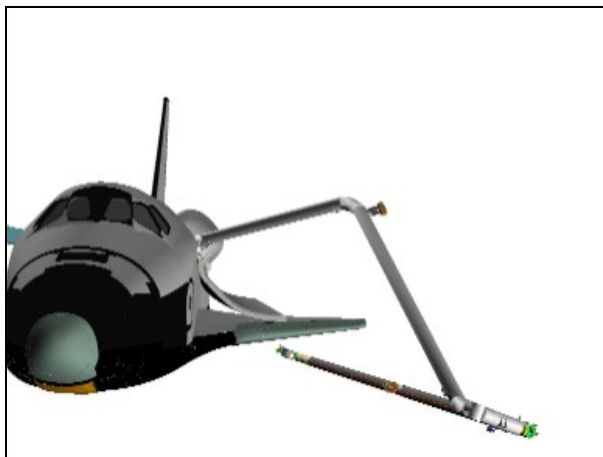

FRONT

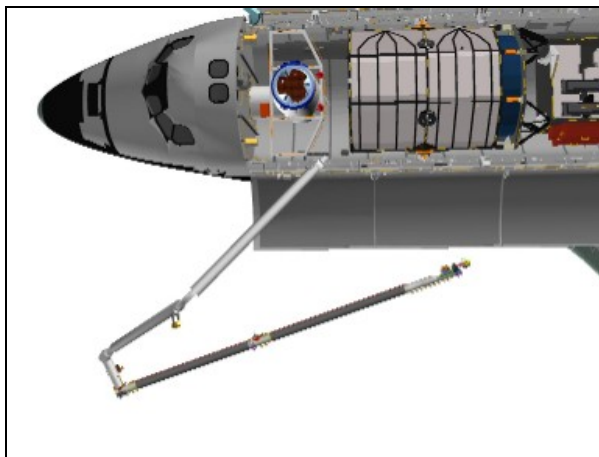

OVERHEAD



PORT

3. PORT LDRI ACAS, SECTION 1

NOTE

Section 1 scans RCC Zones 2 & 3 (oblique view), Panels 1 → 22

A7U √VIDEO OUT DTV pb – push (PL2 It on)
MON2 pb – push
IN PL2(VPU) pb – push

PAN: +100
TILT: -120

VIDEO OUT MUX 1 L pb – push (MIDDECK It on)
LDRI MODE 6 pb – push (flickering LDRI displayed)

PAN/TILT to match LDRI view shown below

Note PAN/TILT: _____, _____

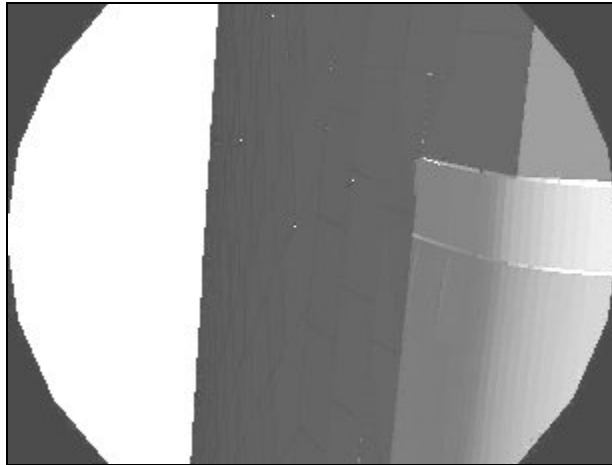

LDRI (100,-120)

VIDEO OUT MON2 pb – push
IN – as desired (not PL2)

RHC RATE – COARSE (RATE MIN tb-OFF)

For survey scan pattern, refer to OBSS LDRI SCAN PATTERN CUE CARD – STBD & PORT

For camera views, refer to OBSS LDRI RCC SURVEY CAMERA VIEWS – PORT (SURVEY CAMERA VIEWS)

SM 94 PDRS CONTROL

√AUTO MODE 3, ITEM 15: 3

BRAKES – OFF (tb-OFF)
MODE – AUTO 3, ENTER (READY It on)

- * If unable to enter AUTO mode (no AUTO READY It): *
- * √Joint angles and adjust as reqd *

SM 94 PDRS CONTROL

√START PT, ITEM 17: 69

SM 169 PDRS STATUS

Monitor ACAS progress

NOTE



Time between Pts 69 and 75 ~ 4:45 min

Section 1 Clearance Views	Cameras
RMS Upper Arm-to-Orbiter	A[1]
OBSS-to-PLBD	A[5], B[4], ELBOW, RSC[3]
OBSS-to-Wing	A[5], ELBOW, RSC[2]
[1]Good for all subsequent scan sections [2]Good after X ~ -1050 [3]PLBD leaves FOV at X ~ -1098	[4]Good after X ~ -1099 [5]Good after X ~ -1110

L10(VTR) REC pb – push, hold
PLAY pb – push, simo (red ●)

On MCC GO,
AUTO SEQ – PROCEED (IN PROG It on)

ACAS, pause pts **shaded in bold**, ● col indicates data recording (black = VTR on) and damage criteria (inches):

Pt	X	Y	Z	PITCH	YAW	ROLL	●	
69P	-899	-243	-284	2	341	289		
70	-958	-253	-278	2	341	293		
71	-1023	-277	-267	0	353	308		
72	-1057	-310	-267	0	356	307		
73	-1186	-442	-272	0	359	309		
74	-1265	-509	-274	0	350	309		
75P	-1324	-523	-274	0	348	315		

L10(VTR) When AUTO SEQ READY It – on:
STOP pb – push (no red ●)



4. PORT LDRI ACAS, SECTION 2

NOTE

Between Pts 75 and 76, arm adjusts for survey of Zones 1 & 2.
 Section 2 then scans RCC Zones 1 & 2, Panels 22 → 1. Time
 between Pts 75 and 76 ~ 1:50 min

Section 2 Clearance Views	Cameras
OBSS-to-PLBD	A[1], B[3], ELBOW, RSC[2]
OBSS-to-Wing	A[1], ELBOW, RSC
[1]Good until X ~ -1235 [2]PLBD enters FOV at X ~ -1198	[3]Good until X ~ -1157

AUTO SEQ – PROCEED (IN PROG It on)

Pt	X	Y	Z	PITCH	YAW	ROLL	●
75P	-1324	-523	-274	0	348	315	
76P	-1345	-496	-232	345	352	262	

When AUTO SEQ READY It – on:

A7U VIDEO OUT MON2 pb – push
 IN PL2(VPU) pb – push

PAN: +10 (left)
 TILT: -80 (up)

PAN/TILT to match LDRI view shown below

Note PAN/TILT: _____, _____

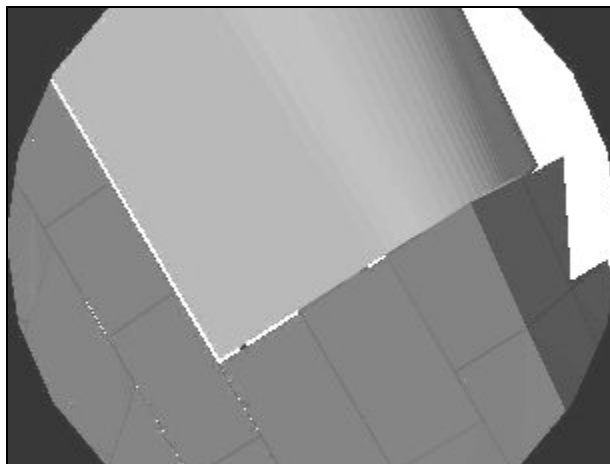

LDRI (10,-80)

VIDEO IN – as desired (not PL2)

NOTE

At Pt 85, WP of +110.2° approaches reach limit. Time between Pts 76 and 85 ~ 3:30 min

L10(VTR) REC pb – push, hold
PLAY pb – push, simo (red ●)

AUTO SEQ – PROCEED (IN PROG It on)

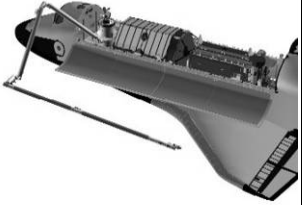
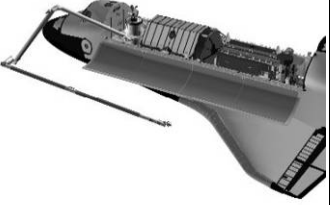
Pt	X	Y	Z	PITCH	YAW	ROLL	●
76P	-1345	-496	-232	345	352	262	
77	-1268	-456	-230	345	352	262	
78	-1175	-357	-219	345	345	262	
79	-1134	-315	-218	345	345	262	
80	-1097	-277	-214	345	345	262	
81	-1061	-238	-210	345	345	262	
82	-998	-216	-214	345	345	259	
83	-972	-211	-216	345	345	259	
84	-935	-206	-219	345	345	259	
85P	-906	-204	-220	345	345	259	

L10(VTR) When AUTO SEQ READY It – on:
STOP pb – push (no red ●)



5. PORT LDRI ACAS, SECTION 3

NOTE

Between Pts 85 & 86, arm adjusts for survey of Zones 2 & 3.
 Section 3 then scans Zones 2 & 3, Panels 1 → 22. At Pt 86,
 WP: +112.4°. Time between Pts 85 and 86 ~ 0:30 sec

Section 3 Clearance Views	Cameras
OBSS-to-PLBD	A[3], B[1], ELBOW, RSC[2]
OBSS-to-Wing	A[3], ELBOW, RSC
[1]Good after X ~ -1128 [2]PLBD leaves FOV at X ~ -1180	[3]Good after X ~ -1187

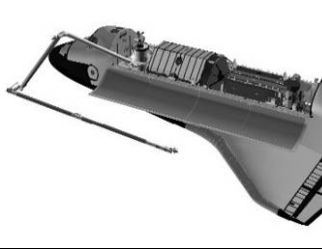
AUTO SEQ – PROCEED (IN PROG It on)

Pt	X	Y	Z	PITCH	YAW	ROLL	•
85P	-906	-204	-220	345	345	259	
86P	-898	-214	-230	347	348	259	

When AUTO SEQ READY It – on:

A7U VIDEO OUT MON2 pb – push
 IN PL2(VPU) pb – push

√PAN: +10
 TILT: -95 (down)

PAN/TILT to match LDRI view shown below

Note PAN/TILT: _____, _____

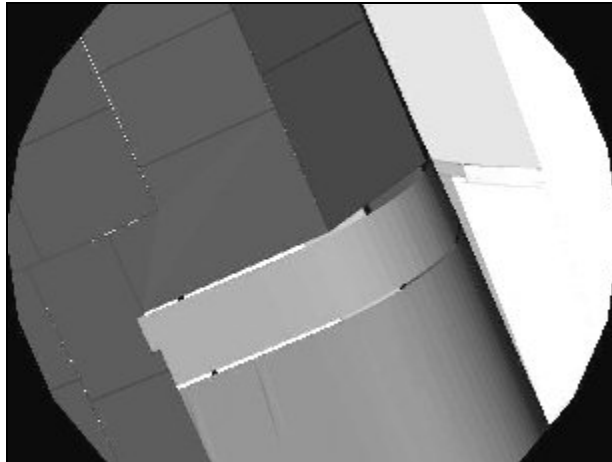

LDRI (10,-95)

VIDEO IN – as desired (not PL2)

NOTE

Time between Pts 86 and 93 ~ 3:30 min

L10(VTR) REC pb – push, hold
PLAY pb – push, simo (red ●)

AUTO SEQ – PROCEED (IN PROG It on)

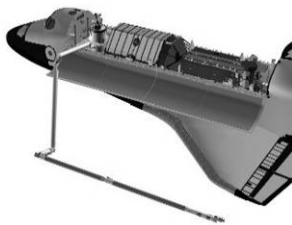
Pt	X	Y	Z	PITCH	YAW	ROLL	●
86P	-898	-214	-230	347	348	259	
87	-979	-231	-226	347	348	259	
88	-1034	-262	-231	347	348	259	
89	-1110	-338	-234	347	348	259	
90	-1183	-406	-238	353	356	254	1/4
91	-1244	-467	-242	354	356	254	
92	-1312	-504	-245	359	0	254	
93P	-1343	-511	-246	359	0	254	

L10(VTR) When AUTO SEQ READY It – on:
STOP pb – push (no red ●)

6. PORT LDRI ACAS, SECTION 4

NOTE

Between Pts 93 & 94, arm adjusts for survey of Zone 4.
 Section 4 then scans RCC Zone 4, Panels 22 → 1. Time
 between Pts 93 and 94 ~ 1:50 min

Section 4 Clearance Views	Cameras
OBSS-to-PLBD	A[3], B[4], ELBOW, RSC[2]
OBSS-to-Wing	A[3], B[1,4], ELBOW, RSC[5]
[1]Good after X ~ -1327	[4]Good until X ~ -1036
[2]PLBD enters FOV at X ~ -1067	[5]Good until X ~ -975
[3]Good until X ~ -1042	

AUTO SEQ – PROCEED (IN PROG It on)

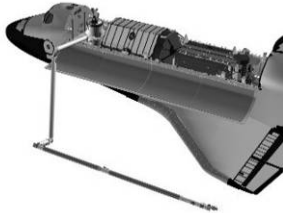
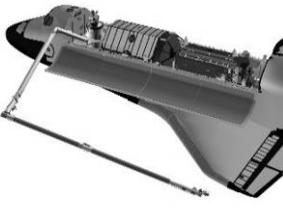
Pt	X	Y	Z	PITCH	YAW	ROLL	•
93P	-1343	-511	-246	359	0	254	
94P	-1323	-537	-315	346	348	282	

When AUTO SEQ READY It – on:

A7U VIDEO OUT MON2 pb – push
 IN PL2(VPU) pb – push

PAN: +88 (right)
 TILT: -120 (down)

PAN/TILT to match LDRI view shown below

Note PAN/TILT: _____, _____

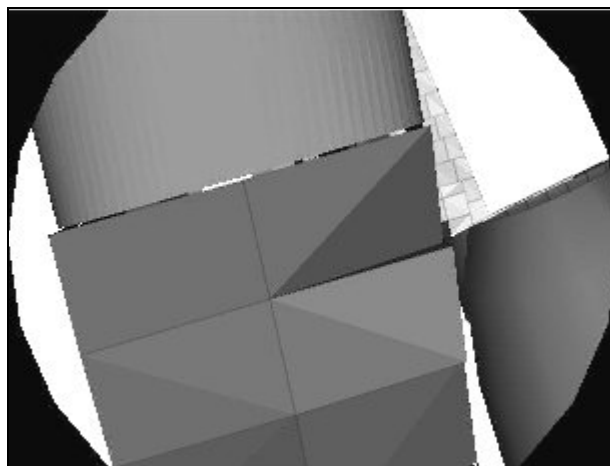

LDRI (88,-120)

VIDEO IN – as desired (not PL2)

NOTE

Time between Pts 94 and 102 ~ 6:05 min

L10(VTR) REC pb – push, hold
PLAY pb – push, simo (red ●)

AUTO SEQ – PROCEED (IN PROG It on)

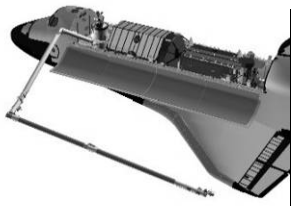
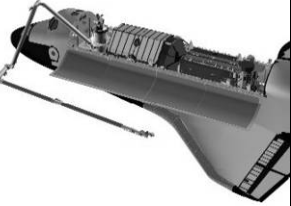
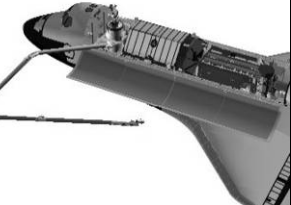
Pt	X	Y	Z	PITCH	YAW	ROLL	●
94P	-1323	-537	-315	346	348	282	
95	-1244	-513	-305	353	357	287	
96	-1176	-450	-298	352	2	290	
97	-1106	-380	-295	352	4	291	
98	-1023	-300	-288	354	357	289	
99	-989	-275	-294	350	350	282	
100	-965	-263	-294	350	350	282	
101	-933	-253	-289	358	347	283	
102P	-887	-248	-287	4	341	282	

When AUTO SEQ READY It – on:

L10(VTR) STOP pb – push (no red ●)

7. PORT LDRI ACAS, SECTION 5

NOTE

Between Pts 102 and 104, arm adjusts for survey of Zones 4 & 5. Section 5 then scans Zones 4 & 5, Panels 1 → 22. Time between Pts 102 and 104 ~ 1:35 min

Section 5 Clearance Views	Cameras
OBSS-to-PLBD	A[1], B[2], ELBOW, RSC[4]
OBSS-to-Wing	A[1,3,5], B[2], ELBOW, RSC[6]
[1]Good after X ~ -896	[4]PLBD leaves FOV at X ~ -1098
[2]Good after X ~ -1015	[5]Good after X ~ -1104
[3]Good until X ~ -1045	[6]Good after X ~ -1220

AUTO SEQ – PROCEED (IN PROG It on)

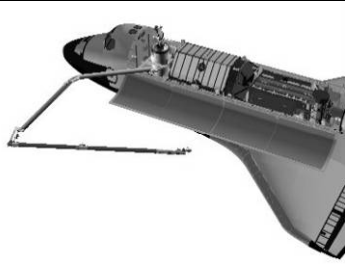
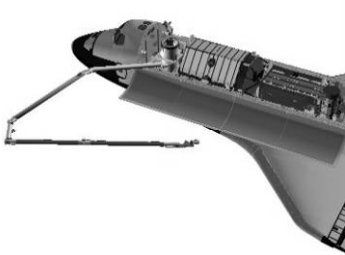
Pt	X	Y	Z	PITCH	YAW	ROLL	●
102P	-887	-248	-287	4	341	282	
103	-887	-285	-287	4	341	282	
104P	-897	-285	-331	2	336	302	

When AUTO SEQ READY It – on:

A7U VIDEO OUT MON2 pb – push
IN PL2(VPU) pb – push

PAN: +120 (right)
√TILT: -120 (down)

PAN/TILT to match LDRI view shown below

Note PAN/TILT: _____, _____

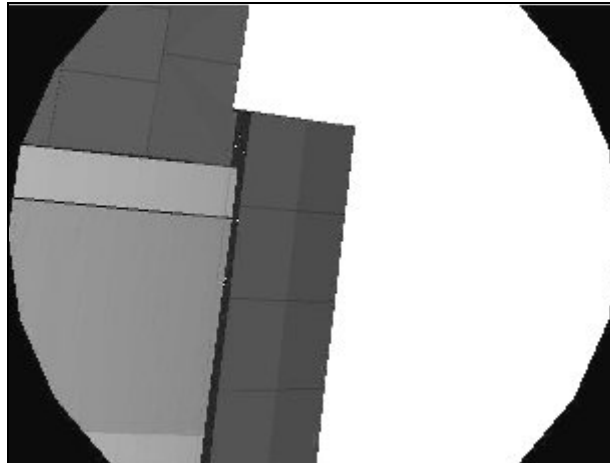

LDRI (120,-120)

VIDEO IN – as desired (not PL2)

NOTE

Time between Pts 104 and 114 ~ 7:15 min

L10(VTR) REC pb – push, hold
PLAY pb – push, simo (red ●)

AUTO SEQ – PROCEED (IN PROG It on)

Pt	X	Y	Z	PITCH	YAW	ROLL	●
104P	-897	-285	-331	2	336	302	1
105	-910	-285	-330	2	340	302	
106	-926	-285	-325	1	340	298	
107	-950	-287	-335	359	340	292	
108	-978	-289	-352	357	345	287	
109	-1020	-286	-332	350	350	297	1/4
110	-1074	-329	-341	342	1	292	
111	-1148	-401	-346	340	357	289	
112	-1229	-475	-357	333	359	289	
113	-1280	-503	-363	327	1	285	
114P	-1328	-517	-364	327	1	285	

When AUTO SEQ READY It – on:
 L10(VTR) STOP pb – push (no red ●)

8. PORT LDRI ACAS, SECTION 6

NOTE

Between Pts 114 & 115, arm adjusts for survey of Zone 6. Section 6 then scans Zone 6, Panels 22 → 5.
Time between Pts 114 and 115 ~ 1:25 min

Section 6 Clearance Views	Cameras
OBSS-to-PLBD	A[4,5], B, ELBOW, RSC[2,4]
OBSS-to-Wing	A[4,5], B, ELBOW[1], RSC[3,6]
[1]Good until X ~ -1264 [2]PLBD enters FOV at X ~ -1210 [3]Good until X ~ -1154 [4]Good until X ~ -1114	[5]Good after X ~ -1086 [6]Good after X ~ -1092

AUTO SEQ – PROCEED (IN PROG It on)

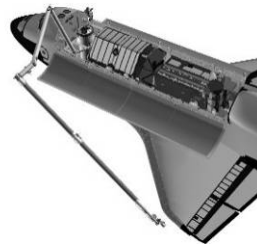
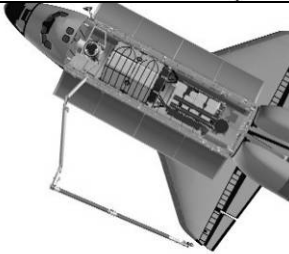
Pt	X	Y	Z	PITCH	YAW	ROLL	●
114P	-1328	-517	-364	327	1	285	
115P	-1338	-476	-389	345	357	254	

When AUTO SEQ READY It – on:

A7U VIDEO OUT MON2 pb – push
IN PL2(VPU) pb – push

PAN: +135 (right)
TILT: -110 (up)

PAN/TILT to match LDRI view shown below

Note PAN/TILT: _____, _____

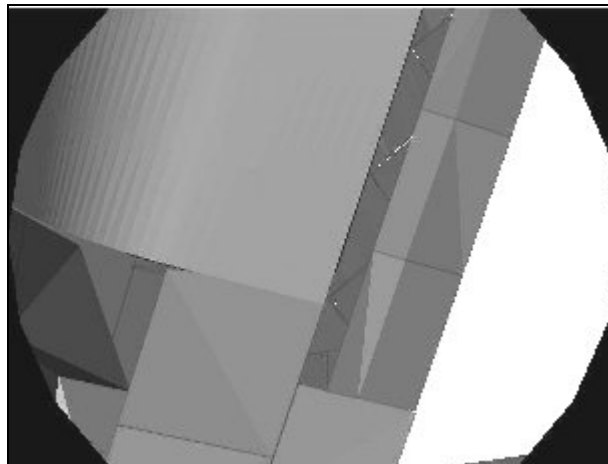

LDRI (135,-110)

VIDEO IN – as desired (not PL2)

NOTE

Time between Pts 115 and 121 ~ 3:50 min

L10(VTR) REC pb – push, hold
PLAY pb – push, simo (red ●)

AUTO SEQ – PROCEED (IN PROG It on)

Pt	X	Y	Z	PITCH	YAW	ROLL	●
115P	-1338	-476	-389	345	357	254	1/4
116	-1283	-453	-391	343	350	243	
117	-1166	-340	-392	343	350	243	
118	-1113	-285	-388	342	337	239	
119	-1071	-284	-378	352	332	270	
120	-1050	-279	-387	357	332	272	
121P	-985	-279	-386	1	331	281	1

When AUTO SEQ IN PROG It – off:
BRAKES – ON (tb-ON)

L10(VTR) STOP pb – push (no red ●)

A7U VIDEO OUT MUX 1 L pb – push (MIDDECK It on)
LDRI MODE 2 pb – push (ITVC video displayed)
VIDEO OUT MON2 pb – push
IN PL2(VPU) pb – push

RHC

9. MNVR TO OBSS HOVER/PARK POSN

RATE – as reqd (VERN within 10 ft)

BRAKES – OFF (tb-OFF)

MODE – as desired

SM 94 PDRS CONTROL

PL ID – ITEM 3 +2 EXEC

INIT ID – ITEM 24 +2 EXEC

If performing while undocked:

NOTE

The following Intermediate posn may be used if mnvring to OBSS Hover in Orbiter Loaded mode. If mnvring in Single mode, use the subsequent SJ table

INTERMEDIATE posn:

X	Y	Z	PITCH	YAW	ROLL	PL ID
-1120	-423	-720	29	0	11	2
SY	SP	EP	WP	WY	WR	
+62.2	+91.0	-83.9	-77.2	-21.8	-46.1	

Mnvr to OBSS HOVER posn:

	SY	SP	EP	WP	WY	WR	
PORT LDRI	+120.7	+42.9	-62.9	+32.8	-58.9	-67.5	
ACAS End					0.0		
1: WY +							
2: WR +						+30.0	
3: SP +		+79.8					
4: SY -	-90.0						
5: EP -			-123.1				
6: WP -				-55.7			
7: WR +						+110.0	
OBSS HOVER	-90.0	+79.8	-123.1	-55.7	0.0	+110.0	
X	Y	Z	PITCH	YAW	ROLL	PL ID	
-680	+126	-496	0	0	341	1	
-998	+129	-507	0	0	11	2	

BRAKES – ON (tb-ON)

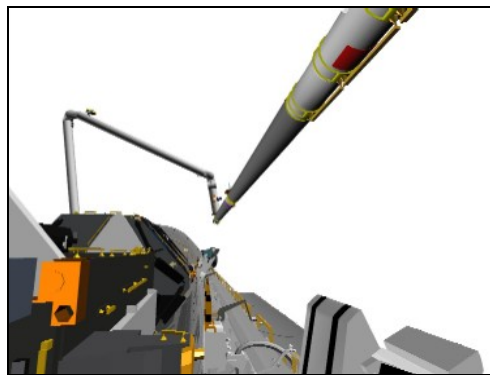

CCTV C (10,10)

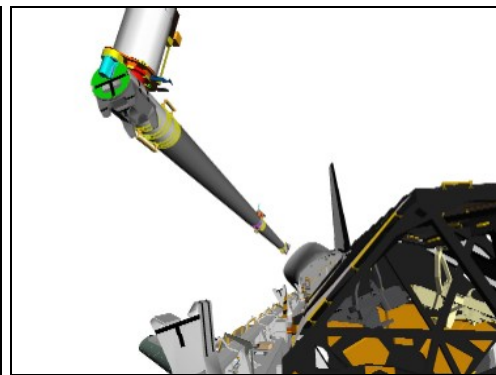

CCTV D (-10,15)

Go to OBSS BERTH >>

If performing while docked:

Mnvr to HANDOFF posn:

	SY	SP	EP	WP	WY	WR	
PORT LDR1	+120.7	+42.9	-62.9	+32.8	-58.9	-67.5	
ACAS END							
1: WY +					-10.0		
2: WP -				-85.9			
3: WR -						-100.7	
4: SP +		+66.3					
5: EP +			-49.0				
6: SY -	+25.8						
7: WY +					+10.7		
HANDOFF	+25.8	+66.3	-49.0	-85.9	+10.7	-100.7	
	X	Y	Z	PITCH	YAW	ROLL	PL ID
	-1031	-44	-610	284	270	270	2

* Display Singularity

BRAKES – ON (tb-ON)

MODE – not DIRECT

JOINT – CRIT TEMP

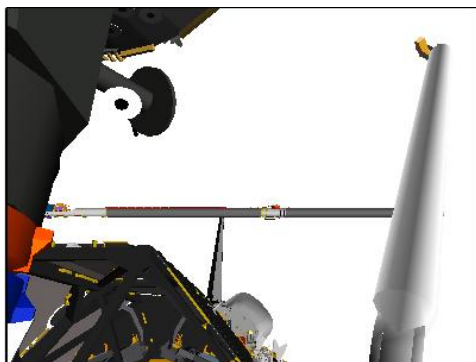

CCTV A (0,25)

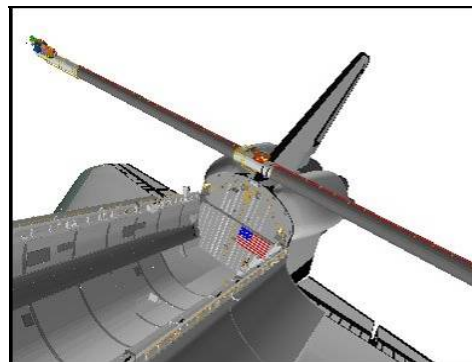

ELBOW (-60,0)

GNC 23 RCS

√RCS FWD, ITEM 1: *

MANF VLVS OVRD 1 – ITEM 40 EXEC (OP)

2 – ITEM 41 EXEC (OP)

3 – ITEM 42 EXEC (OP)

4 – ITEM 43 EXEC (OP)

A6U

DAP: as reqd

OBSS LDRI RCC SURVEY – STBD DOCKED

WARNING
Stbd PLBD radiator must be stowed

NOTE

Assumed starting posn is OBSS Handoff posn

1. **SETUP**

SM 94 PDRS CONTROL

√PL ID, ITEM 3: 2

√INIT ID, ITEM 24: 2

Verify SSRMS is at CLEARANCE posn:

SR	SY	SP	EP	WP	WY	WR
+34.0	+58.9	0.0	-82.6	-132.3	+16.8	-72.8

2. **MNVR TO DOCKED STBD LDRI ACAS START POSITION**

SJ Mnvr Clearance Views	Cameras
OBSS-to-Wing/PLBD	C, D, ELBOW, RSC, US LAB, SSRMS BASE ELBOW

NOTE

Expect C/W SINGULARITY in line 6 of the following single joint table.
SINGULARITY will extinguish between points 1 and 2 of the following ACAS

RHC

√RATE – VERN (RATE MIN tb-ON)

BRAKES – OFF (tb-OFF)

MODE – SINGLE, ENTER

Mnvr to DOCKED STBD LDRI ACAS START posn:

	SY	SP	EP	WP	WY	WR	
HANDOFF	+25.8	+66.3	-49.0	-85.9	+10.7	-100.7	
1: SY –	0.0						
2: WP +				+32.4			
3: SY –	-32.8						
4: WR –						-113.9	
5: SP +		+77.7					
6: WY –					-77.2		
7: EP –			-57.7				
DOCKED STBD LDRI ACAS START	-32.8	+77.7	-57.7	+32.4	-77.2	-113.9	
	X	Y	Z	PITCH	YAW	ROLL	PL ID
	-935	+154	-599	271	329	66	2

BRAKES – ON (tb-ON)

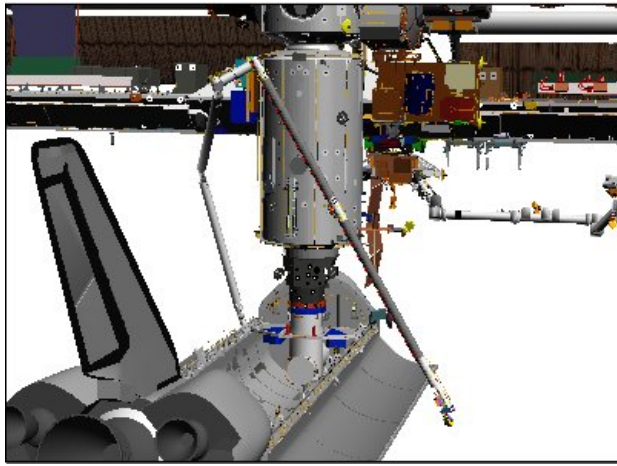

BIRD'S EYE



CCTV A (0,35)

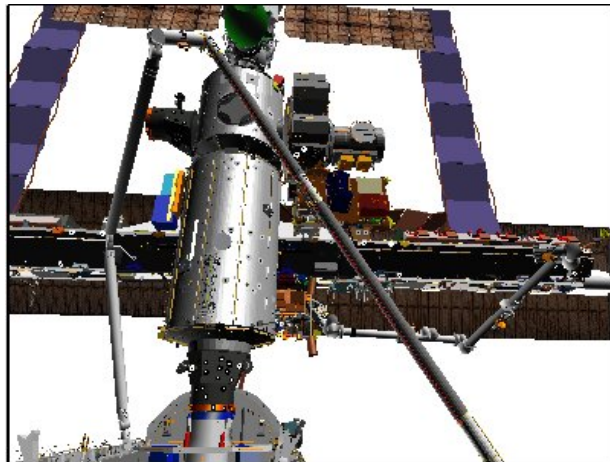

CCTV C (5,25)

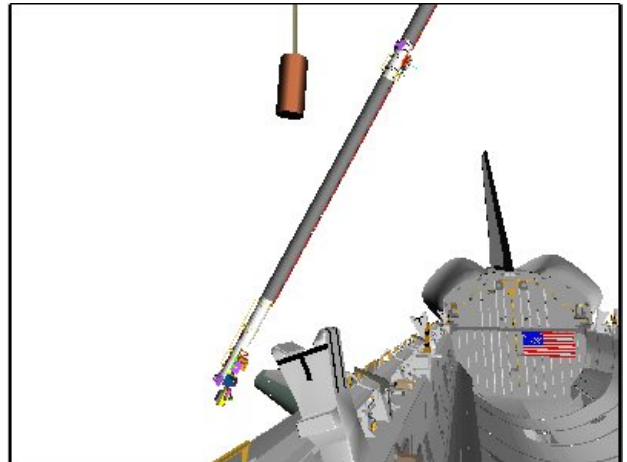

CCTV D (-20,10)

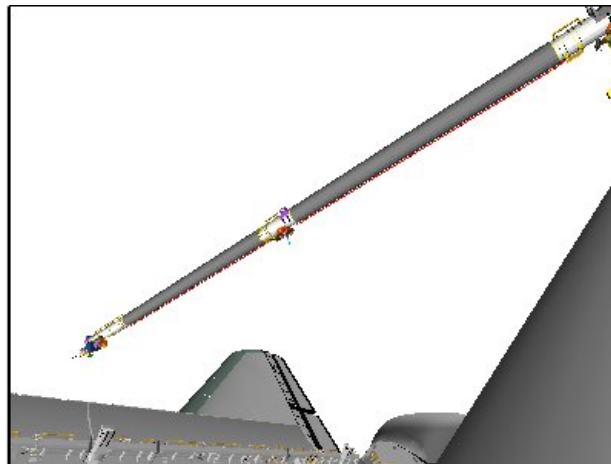

ELBOW (-40,-20)

3. STBD LDRI ACAS, SECTION 1

NOTE

Section 1 scans RCC Zone 6, Panels 1 → 7

A7U

VIDEO OUT MUX 1 L pb – push (MIDDECK lit on)
 LDRI MODE 6 pb – push (flickering LDRI displayed)

VIDEO OUT MON2 pb – push
IN PL2(VPU) pb – push

CAMR CMD PAN/TILT – HI RATE
PAN – L (to hard stop)
TILT – UP (to hard stop)
PAN/TILT – RESET
PAN: +54
TILT: -78

PAN/TILT to match LDRI view shown below

Note PAN/TILT: _____, _____

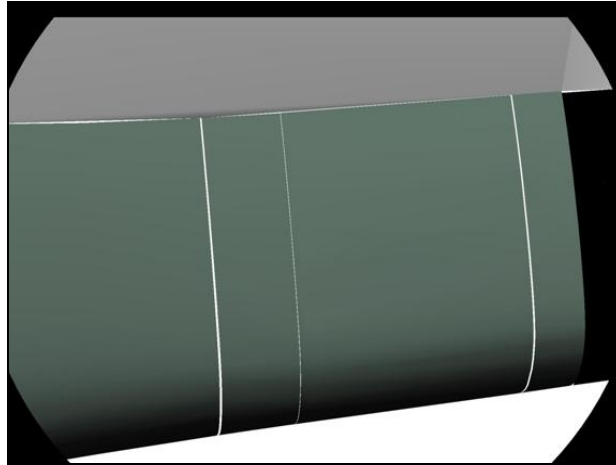

LDRI (54,-78)

VIDEO OUT MON2 pb – push
IN – as desired (not PL2)

√DTV – PL2 (LDRI video)

For survey scan pattern, refer to OBSS LDRI SCAN PATTERN CUE CARD – STBD DOCKED

For camera views, refer to OBSS LDRI RCC SURVEY CAMERA VIEWS – STBD DOCKED (SURVEY CAMERA VIEWS)

SM 94 PDRS CONTROL

PL ID – ITEM 3 +3 EXEC
INIT ID – ITEM 24 +3 EXEC

AUTO MODES – ITEM 13 +6 +2 +3 +7 EXEC

RHC

RATE – COARSE (RATE MIN tb-OFF)

BRAKES – OFF (tb-OFF)

MODE – AUTO 1, ENTER (READY It on)

* If unable to enter AUTO mode (no AUTO READY It): *
* √Joint angles and adjust as reqd *

SM 94 PDRS CONTROL

√START PT, ITEM 17: 130

SM 169 PDRS STATUS

Monitor ACAS progress

NOTE

Section 1 run time ~ 2:15 min

Section 1 Clearance Views	Cameras
OBSS-to-PLBD	C, D, ELBOW, RSC
UPPER ARM-to-US LAB	A, B

L10(VTR) REC pb – push, hold
PLAY pb – push, simo (red ●)

NOTE

Wait for MCC GO before proceeding with survey

On MCC GO,
AUTO SEQ – PROCEED (IN PROG It on)

ACAS, pause pts **shaded in bold**, ● col indicates data recording (black = VTR on) and damage criteria (inches):

Pt	X	Y	Z	PITCH	YAW	ROLL	●
130P	-940	+291	-363	271	329	66	●
131	-971	+287	-376	270	322	61	●
132P	-1031	+293	-377	270	322	63	●

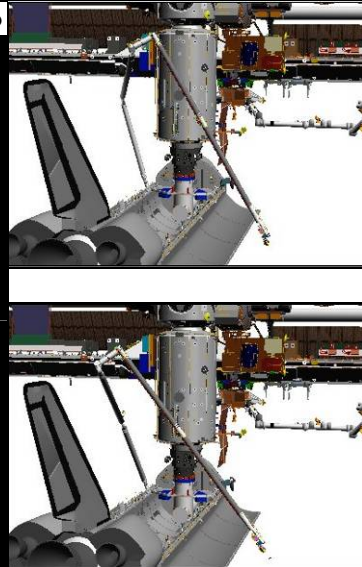

L10(VTR) When AUTO SEQ READY It – on:
STOP pb – push (no red ●)

4. STBD LDRI ACAS, CONTINUE SECTION 1

NOTE

Between Pts 132 and 133, arm adjusts for survey of Zone 6.
 Section 1 continues to scan Zone 6, Panels 7 → 15. Time
 between Pts 132 and 133 ~ 1:50 min

Section 1 Clearance Views	Cameras
OBSS-to-PLBD	C, D, ELBOW, RSC
UPPER ARM-to-US LAB	A, B

AUTO SEQ – PROCEED (IN PROG It on)

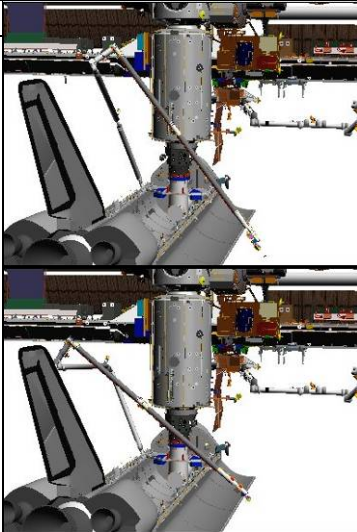
Pt	X	Y	Z	PITCH	YAW	ROLL	
132P	-1031	+293	-377	270	322	63	
133P	-1009	+265	-407	273	308	100	

A7U

When AUTO SEQ READY It – on:
 VIDEO OUT MON2 pb – push
 IN PL2(VPU) pb – push

PAN: +110 (right)
 TILT: -89 (down)

PAN/TILT to match LDRI view shown below

Note PAN/TILT: _____, _____

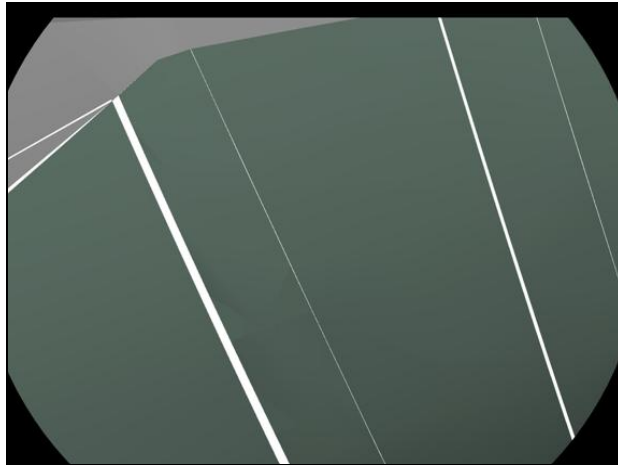

LDRI (+110,-89)

NOTE

Time between Pts 133 and 134 ~ 1:45 min

VIDEO IN – as desired (not PL2)

L10(VTR) REC pb – push, hold
PLAY pb – push, simo (red ●)

AUTO SEQ – PROCEED (IN PROG It on)

Pt	X	Y	Z	PITCH	YAW	ROLL	●
133P	-1009	+265	-407	273	308	100	●
134P	-1168	+384	-383	274	305	101	●

1

L10(VTR) When AUTO SEQ READY It – on:
STOP pb – push (no red ●)

5. STBD LDRI ACAS, CONTINUE SECTION 1

NOTE

Between Pts 134 and 135, arm adjusts for survey of Zone 6. Section 1 continues to scan Zone 6, Panels 15 → 22. At Pt 135, Upper Arm-to-US LAB = 60 in. Time between Pts 134 and 135 ~ 2:10 min

Section 1 Clearance Views	Cameras
OBSS-to-PLBD/WING	C, D, ELBOW, RSC, US LAB
UPPER ARM-to-US LAB	A, B

AUTO SEQ – PROCEED (IN PROG It on)

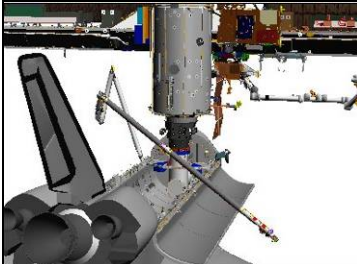
Pt	X	Y	Z	PITCH	YAW	ROLL	
134P	-1168	+384	-383	274	305	101	
135P	-1192	+352	-388	311	306	151	

A7U

When AUTO SEQ READY It – on:
 VIDEO OUT MON2 pb – push
 IN PL2(VPU) pb – push

PAN: +107 (left)
 TILT: -112 (down)

PAN/TILT to match LDRI view shown below

Note PAN/TILT: _____, _____

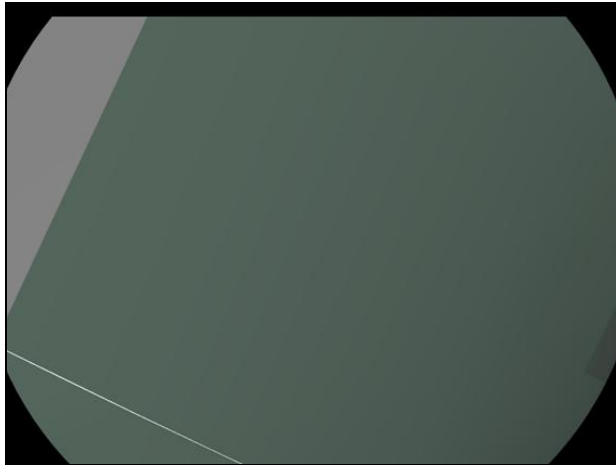

LDRI (+107,-112)

NOTE

Time between Pts 135 and 138 ~ 1:50 min

VIDEO IN – as desired (not PL2)

L10(VTR) REC pb – push, hold
PLAY pb – push, simo (red ●)

AUTO SEQ – PROCEED (IN PROG It on)

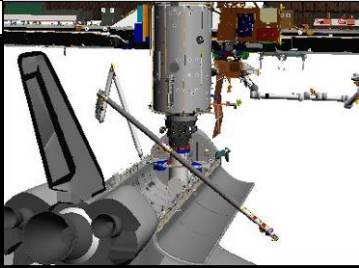
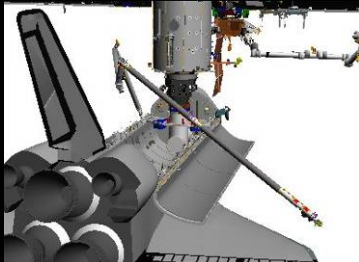
Pt	X	Y	Z	PITCH	YAW	ROLL	●
135P	-1192	+352	-388	311	306	151	
136	-1273	+431	-388	311	306	152	
137	-1294	+446	-388	311	306	152	1/4
138P	-1346	+459	-389	311	306	152	

L10(VTR) When AUTO SEQ READY It – on:
STOP pb – push (no red ●)

6. STBD LDRI ACAS, SECTION 2

NOTE

Between Pts 138 and 140, arm adjusts for survey of Zone 5.
 Section 2 then scans Zone 5, Panels 22 → 11. Time between
 Pts 138 and 140 ~ 2:10 min

Section 2 Clearance Views	Cameras
OBSS-to-Wing	C, D, ELBOW, RSC
UPPER ARM-to-US LAB	A, B

AUTO SEQ – PROCEED (IN PROG It on)

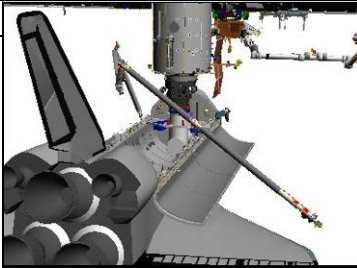
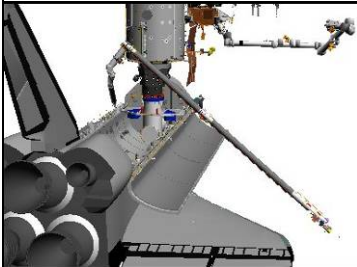
Pt	X	Y	Z	PITCH	YAW	ROLL	
138P	-1346	+459	-389	311	306	152	
139	-1311	+539	-436	311	306	152	
140P	-1309	+531	-343	294	308	105	

A7U

When AUTO SEQ READY It – on:
 VIDEO OUT MON2 pb – push
 IN PL2(VPU) pb – push

PAN: +110 (right)
 TILT: -67 (up)

PAN/TILT to match LDRI view shown below

Note PAN/TILT: _____, _____

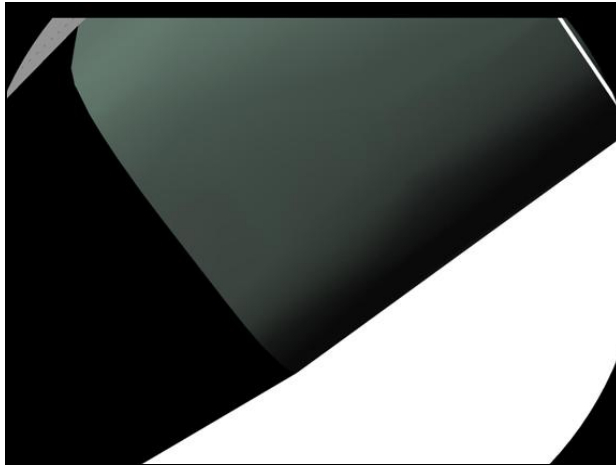

LDRI (+110,-67)

NOTE

Time between Pts 140 and 143 ~ 2:40 min

VIDEO IN – as desired (not PL2)

L10(VTR) REC pb – push, hold
PLAY pb – push, simo (red ●)

AUTO SEQ – PROCEED (IN PROG It on)

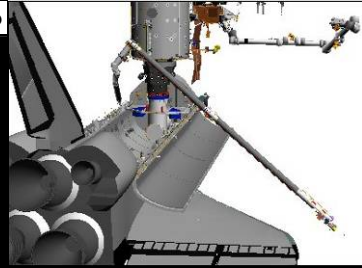
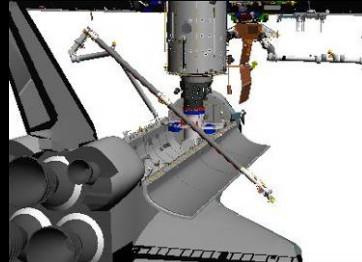
Pt	X	Y	Z	PITCH	YAW	ROLL	●
140P	-1309	+531	-343	294	308	105	
141	-1266	+504	-355	286	302	106	
142	-1169	+406	-352	278	301	99	
143P	-1067	+335	-336	265	310	80	

L10(VTR) When AUTO SEQ READY It – on:
STOP pb – push (no red ●)

7. STBD LDRI ACAS, CONTINUE SECTION 2

NOTE

Between Pts 143 and 144, arm adjusts for survey of Zone 5.
 Section 2 then scans Zone 5, Panels 10 → 6. Time between
 Pts 143 and 144 ~ 1:30 min

Section 2 Clearance Views	Cameras
OBSS-to-PLBD	C, D, ELBOW, RSC
UPPER ARM-to-US LAB	A, B

AUTO SEQ – PROCEED (IN PROG It on)

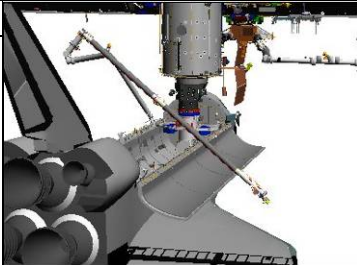
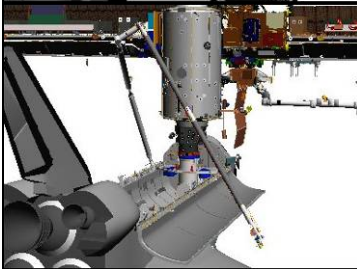
Pt	X	Y	Z	PITCH	YAW	ROLL	
143P	-1067	+335	-336	265	310	80	
144P	-1069	+320	-334	273	328	79	

A7U When AUTO SEQ READY It – on:
 VIDEO OUT MON2 pb – push
 IN PL2(VPU) pb – push

√PAN: +110
 TILT: -88 (down)

PAN/TILT to match LDRI view shown below

Note PAN/TILT: _____, _____

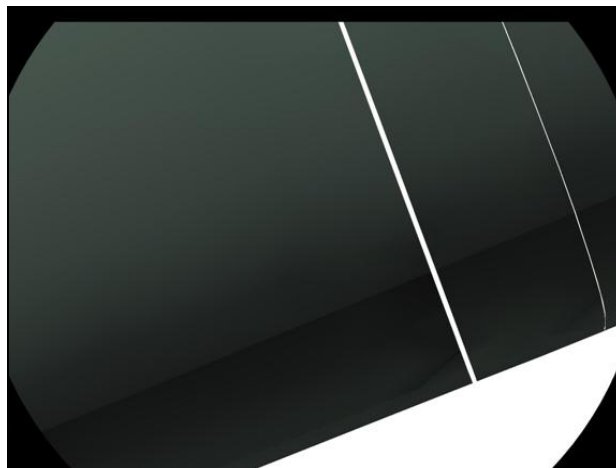

LDRI (+110,-88)



NOTE

Time between Pts 144 and 145 ~ 1:00 min

VIDEO IN – as desired (not PL2)

L10(VTR) REC pb – push, hold
PLAY pb – push, simo (red ●)

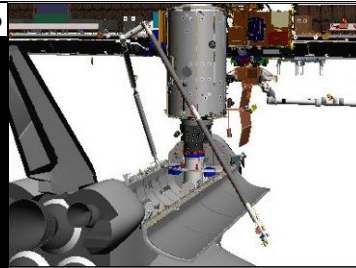
AUTO SEQ – PROCEED (IN PROG It on)

Pt	X	Y	Z	PITCH	YAW	ROLL	●
144P	-1069	+320	-334	273	328	79	
145P	-966	+289	-368	265	326	79	

A7U

When AUTO SEQ READY It – on:
VIDEO OUT MON2 pb – push
IN PL2(VPU) pb – push

PAN: +100 (left)
√TILT: -88

PAN/TILT to match LDRI view shown below

Note PAN/TILT: _____, _____

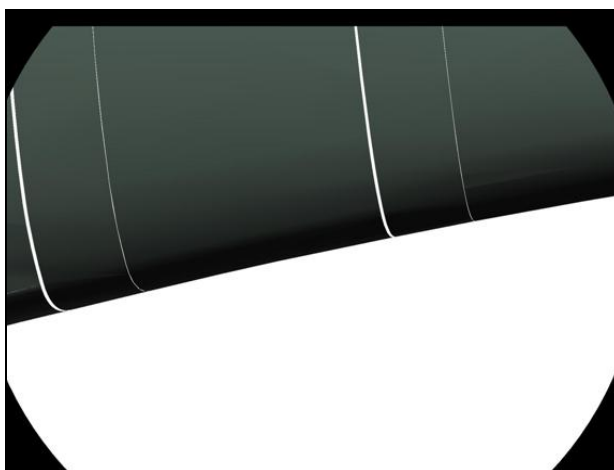

LDRI (+100,-88)

Record image for 30 sec

PAN: +88 (left)
√TILT: -88

PAN/TILT to match LDRI view shown below

Note PAN/TILT: _____, _____

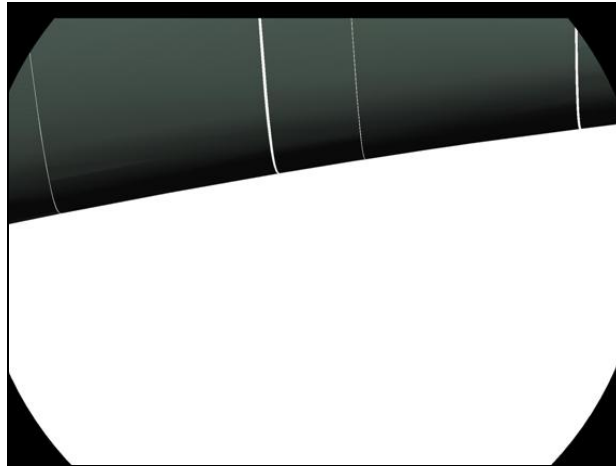

LDRI (+88,-88)

Record image for 30 sec

VIDEO IN – as desired (not PL2)

L10(VTR) STOP pb – push (no red ●)

8. STBD LDRI ACAS, SECTION 3

NOTE

Between Pts 145 and 147, arm adjusts for survey of Zones 4 & 5. Section 3 then scans Zones 4 & 5, Panels 10 → 19. At Pt 146, Upper Arm-to-US LAB = 66 in. At Pt 147, Lower Arm-to-US LAB = 86 in., Upper Arm-to-US LAB = 64 in. and OBSS-to-PLBD = 60 in. Time between Pts 145 and 147 ~ 1:40 min

Section 3 Clearance Views	Cameras
OBSS-to-PLBD	C, D, ELBOW, RSC, US LAB
UPPER ARM-to-US LAB	A, B
LOWER ARM-to-US LAB	ELBOW

AUTO SEQ – PROCEED (IN PROG It on)

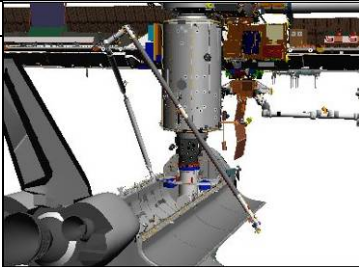
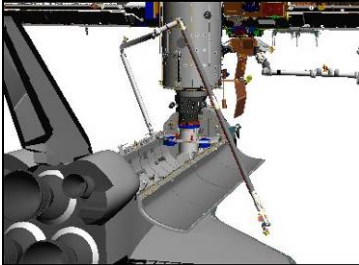
Pt	X	Y	Z	PITCH	YAW	ROLL	●
145P	-966	+289	-368	265	326	79	
146	-976	+300	-358	268	327	80	
147P	-1047	+331	-284	291	331	83	

A7U When AUTO SEQ READY It – on:
 VIDEO OUT MON2 pb – push
 IN PL2(VPU) pb – push

PAN: +115 (right)
 TILT: -62 (up)

PAN/TILT to match LDRI view shown below

Note PAN/TILT: _____, _____

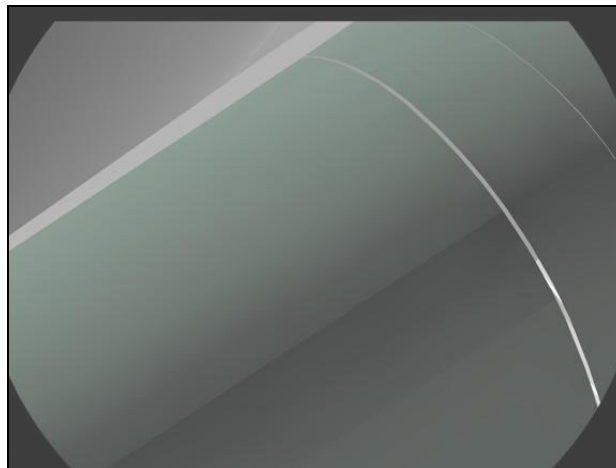

LDRI (+115,-62)

NOTE

Time between Pts 147 and 148 ~ 2:10 min

VIDEO IN – as desired (not PL2)

L10(VTR) REC pb – push, hold
 PLAY pb – push, simo (red ●)

AUTO SEQ – PROCEED (IN PROG It on)

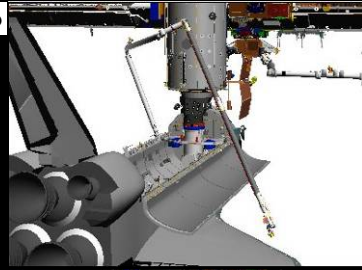
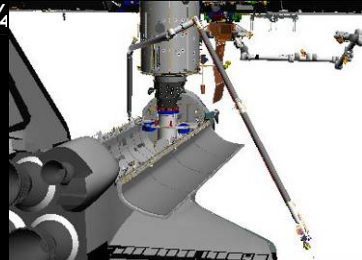
Pt	X	Y	Z	PITCH	YAW	ROLL	●
147P	-1047	+331	-284	291	331	83	
148P	-1230	+505	-291	296	328	85	

L10(VTR) When AUTO SEQ READY It – on:
STOP pb – push (no red ●)

9. STBD LDRI ACAS, CONTINUE SECTION 3

NOTE

Between Pts 148 and 149, arm adjusts for survey of Zones 4 & 5.
Section 3 continues to scan Zones 4 & 5, Panels 20 → 22. At Pt 149,
Upper Arm-to-US LAB = 18 in. Monitor clearance with Elbow camera
(-130, -20). Time between Pts 148 and 149 ~ 2:30 min

Section 3 Clearance Views	Cameras
OBSS-to-Wing	C, D, RSC, US LAB
UPPER ARM-to-US LAB	A, B, ELBOW, P1 LOOB

AUTO SEQ – PROCEED (IN PROG It on)

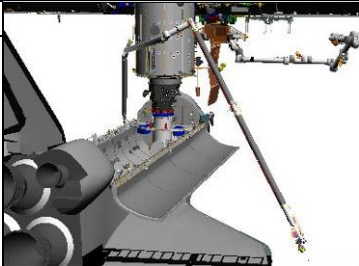
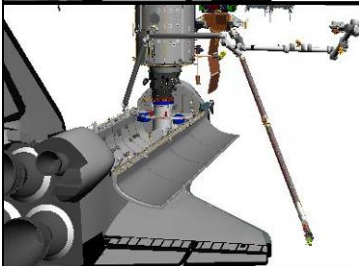
Pt	X	Y	Z	PITCH	YAW	ROLL	●
148P	-1230	+505	-291	296	328	85	
149P	-1275	+528	-297	322	335	31	

A7U When AUTO SEQ READY It – on:
 VIDEO OUT MON2 pb – push
 IN PL2(VPU) pb – push

PAN: +33 (left)
 TILT: -59 (up)

PAN/TILT to match LDRI view shown below

Note PAN/TILT: _____, _____

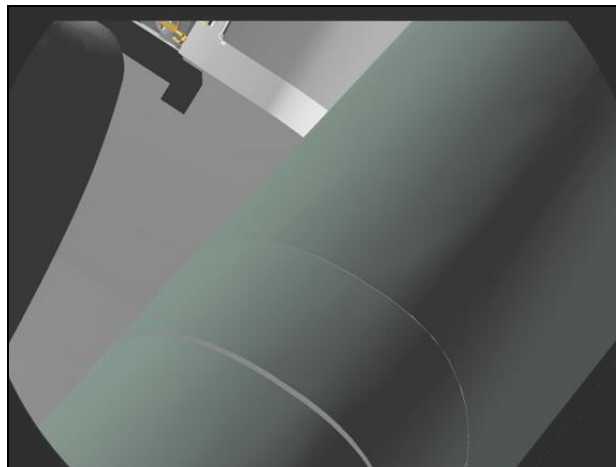

LDRI (+33,-59)

NOTE

Time between Pts 149 and 150 ~ 1:10 min. At Pt 150,
 Upper Arm-to-PMA2 = 35 in. Monitor clearance with
 Elbow camera (-130, -20)

VIDEO IN – as desired (not PL2)

L10(VTR) REC pb – push, hold
 PLAY pb – push, simo (red ●)

AUTO SEQ – PROCEED (IN PROG It on)

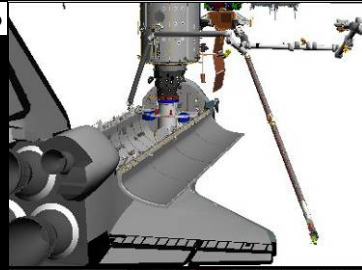
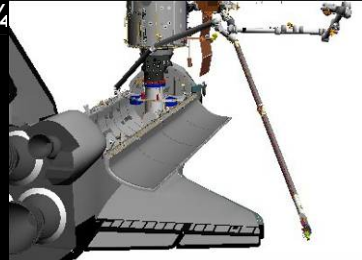
Pt	X	Y	Z	PITCH	YAW	ROLL	●
149P	-1275	+528	-297	322	335	31	
150P	-1340	+549	-296	322	335	31	

L10(VTR) When AUTO SEQ READY It – on:
STOP pb – push (no red ●)

10. STBD LDRI ACAS, SECTION 4

NOTE

Between Pts 150 and 152, arm adjusts for survey of Zone 4. Section 4 then scans Zone 4, Panels 22 → 9. At Pt 152, Upper Arm-to-PMA2 = 37 in. Monitor clearance with Elbow camera (-150, -20). Time between Pts 150 and 152 ~ 2:30 min

Section 4 Clearance Views	Cameras
OBSS-to-PLBD	C, D, RSC, US LAB
OBSS-to-Wing	D, RSC
UPPER ARM-to-PMA2	A, B, ELBOW

AUTO SEQ – PROCEED (IN PROG It on)

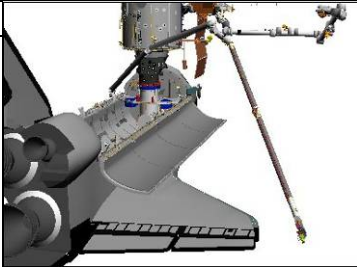
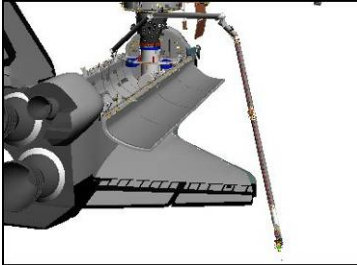
Pt	X	Y	Z	PITCH	YAW	ROLL	●
150P	-1340	+549	-296	322	335	31	
151	-1284	+690	-278	324	321	32	
152P	-1325	+510	-165	317	341	23	

A7U When AUTO SEQ READY It – on:
 VIDEO OUT MON2 pb – push
 IN PL2(VPU) pb – push

PAN: +85 (right)
 TILT: -45 (up)

PAN/TILT to match LDRI view shown below

Note PAN/TILT: _____, _____

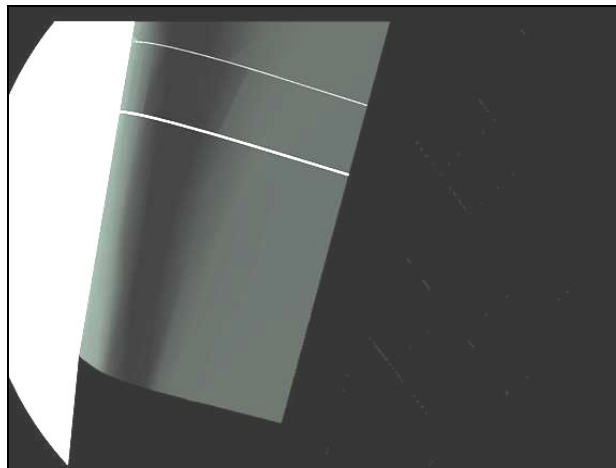

LDRI (+85,-45)

NOTE

Time between Pts 152 and 155 ~ 2:50 min. At Pt 155,
 Upper Arm-to-US LAB = 19 in. Monitor clearance with
 Elbow camera (-160, -20)

VIDEO IN – as desired (not PL2)

L10(VTR) REC pb – push, hold
 PLAY pb – push, simo (red ●)

AUTO SEQ – PROCEED (IN PROG It on)

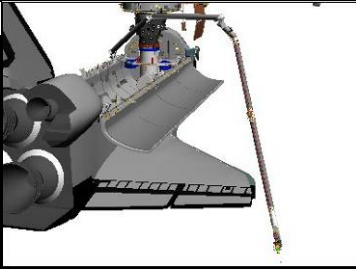
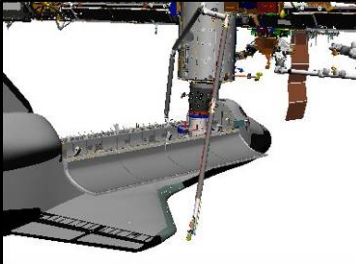
Pt	X	Y	Z	PITCH	YAW	ROLL	●
152P	-1325	+510	-165	317	341	23	
153	-1265	+472	-213	317	341	23	
154	-1066	+298	-212	291	354	34	1/4 
155P	-1053	+298	-210	290	354	34	

When AUTO SEQ IN PROG It – off:
BRAKES – ON (tb-ON)

L10(VTR) STOP pb – push (no red ●)

A7U VIDEO OUT MUX 1 L pb – push (MIDDECK It on)
LDRI MODE 2 pb – push (ITVC video displayed)
VIDEO OUT MON2 pb – push
IN – as desired (not PL2)

11. MANEUVER TO DOCKED STBD LDRI ACAS PART 2
 RHC RATE – as reqd (VERN within 10 ft)
 BRAKES – OFF (tb-OFF)
 MODE – SINGLE, ENTER

SJ Mnv Clearance Views	Cameras
OBSS-to-ORBITER	A, B, ELBOW, P1 LOWER OUTBOARD, SSRMS TIP ELBOW

Mnv to DOCKED STBD LDRI ACAS PART 2:

STBD LDRI ACAS 1 End	SY	SP	EP	WP	WY	WR	
1: WP +	-61.5	+42.5	-31.1	-99.7	-66.4	-247.0	
2: WR –				-17.4			-295.0
3: SY +	+67.7						
4: SP –		+34.1					
5: WY +					-0.6		
6: WR +							-131.7
7: EP –			-89.1				
STBD LDRI ACAS 2 START	+67.7	+34.1	-89.1	-17.4	-0.6	-131.7	
	X	Y	Z	PITCH	YAW	ROLL	PL ID
	-903	+183	-212	31	278	24	3

BRAKES – ON (tb-ON)

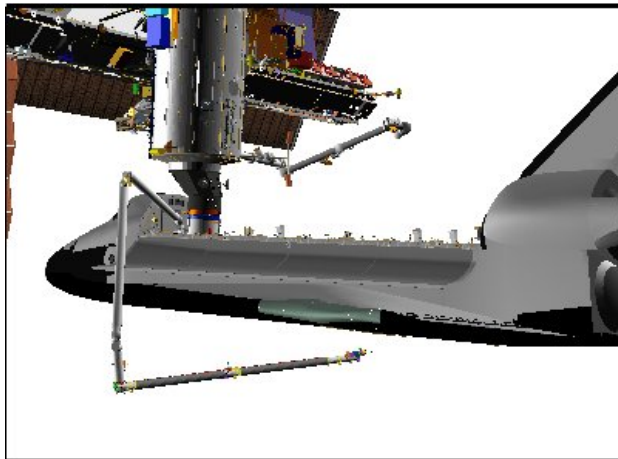

BIRD'S EYE

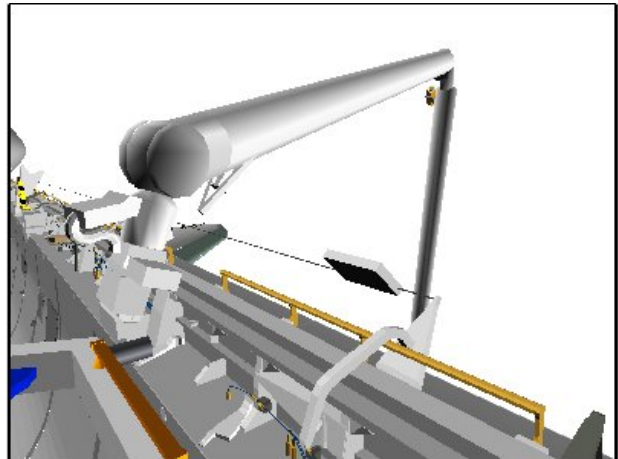

CCTV A (40,-10)

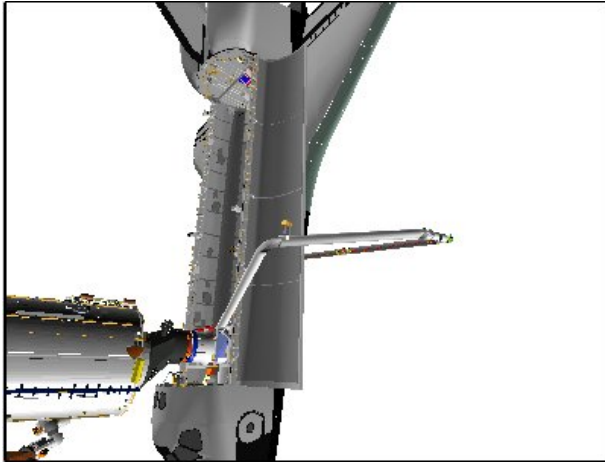

P1 LOWER OUTBOARD (120,15)

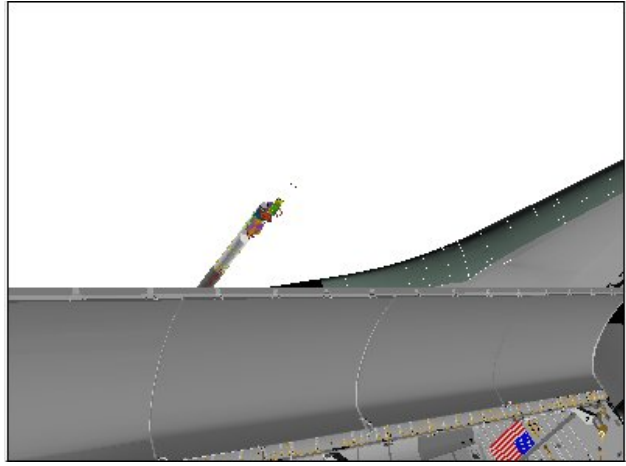

SSRMS TIP ELBOW (-80,50)

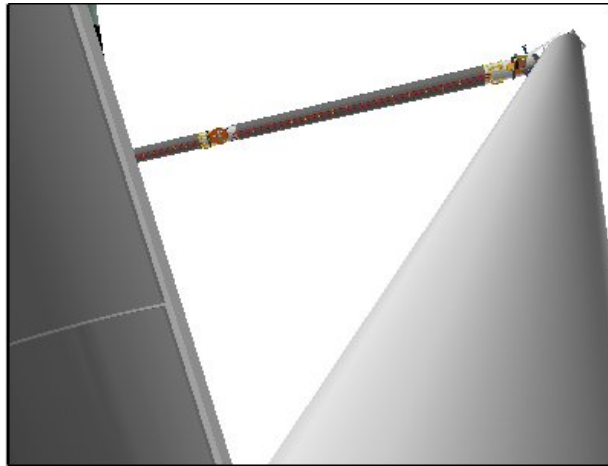

ELBOW (-30,-30)

- A7U
12. STBD LDRI ACAS, SECTION 5
 VIDEO OUT MUX 1 L pb – push (MIDDECK It on)
 LDRI MODE 6 pb – push (flickering LDRI displayed)
- VIDEO OUT MON2 pb – push
 IN PL2(VPU) pb – push
- PAN: +52 (left)
 TILT: -77 (down)

PAN/TILT to match LDRI view shown below

Note PAN/TILT: _____, _____

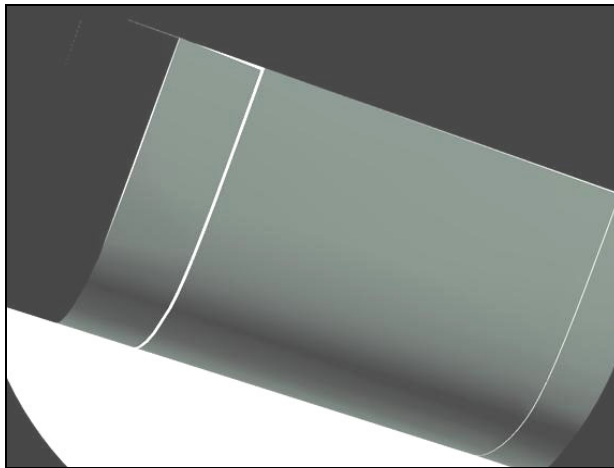

LDRI (52,-77)

VIDEO OUT MON2 pb – push
IN – as desired (not PL2)
√DTV – PL2 (LDRI video)

RHC

RATE – COARSE (RATE MIN tb-OFF)

BRAKES – OFF (tb-OFF)
MODE – AUTO 4, ENTER (READY lt on)

- * If unable to enter AUTO mode (no AUTO READY lt): *
- * √Joint angles and adjust as reqd *

SM 94 PDRS CONTROL

√START PT, ITEM 17: 156

SM 169 PDRS STATUS

Monitor ACAS progress

NOTE

Section 5 scans RCC Zones 1 & 2, Panels 1 → 10. At Pt 159, Lower Arm-to-PLBD = 56 in. Monitor clearance with Elbow camera (-30, -30). Section 5 run time ~ 1:40 min

Section 5 Clearance Views	Cameras
LOWER ARM-to-PLBD	A, B, ELBOW, P1 LOOB
OBSS-to-ORBITER	RSC, SSRMS TIP ELBOW

L10(VTR)

REC pb – push, hold
PLAY pb – push, simo (red ●)

NOTE

Wait for MCC GO before proceeding with survey. The ground needs to verify good LDRI video sync or survey data could be lost

On MCC GO,
 AUTO SEQ – PROCEED (IN PROG It on)

ACAS, pause pts **shaded in bold**, ● col indicates data recording (black = VTR on) and damage criteria (inches):

Pt	X	Y	Z	PITCH	YAW	ROLL	●
156P	-903	+183	-212	31	278	24	
157	-1008	+201	-214	15	291	357	
158	-1062	+224	-214	15	291	357	1/4
159P	-1111	+262	-208	11	298	345	

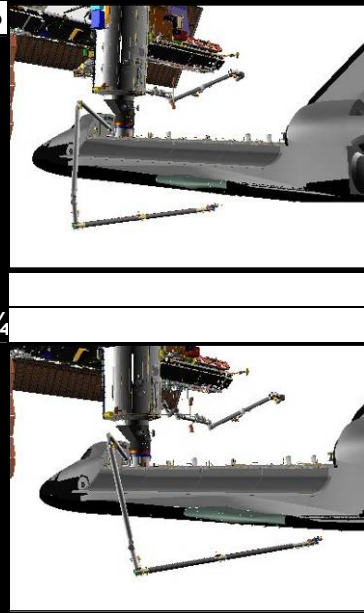

When AUTO SEQ READY It – on:
 L10(VTR) STOP pb – push (no red ●)

13. STBD LDRI ACAS, SECTION 6

NOTE

Between Pts 159 and 160, arm adjusts for survey of Zones 1 & 2.
 Section 6 scans Zones 1 & 2, Panels 9 → 1. Time between
 Pts 159 and 160 ~ 1:00 min

Section 6 Clearance Views	Cameras
LOWER ARM-to-PLBD	A, B, ELBOW, P1 LOOB
OBSS-to-ORBITER	RSC, SSRMS TIP ELBOW

AUTO SEQ – PROCEED (IN PROG It on)

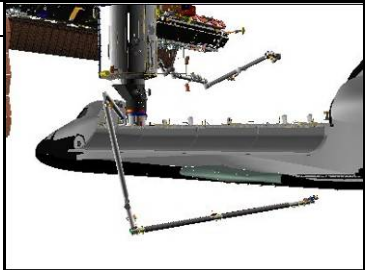
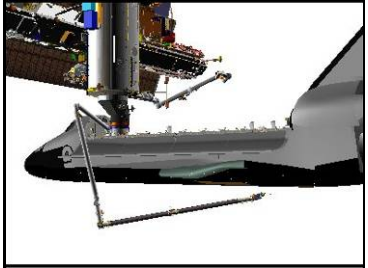
Pt	X	Y	Z	PITCH	YAW	ROLL	●
159P	-1111	+262	-208	11	298	345	
160P	-1028	+280	-238	18	298	7	

A7U

When AUTO SEQ READY It – on:
 VIDEO OUT MON2 pb – push
 IN PL2(VPU) pb – push

PAN: +16 (left)
 TILT: -90 (down)

PAN/TILT to match LDRI view shown below

Note PAN/TILT: _____, _____

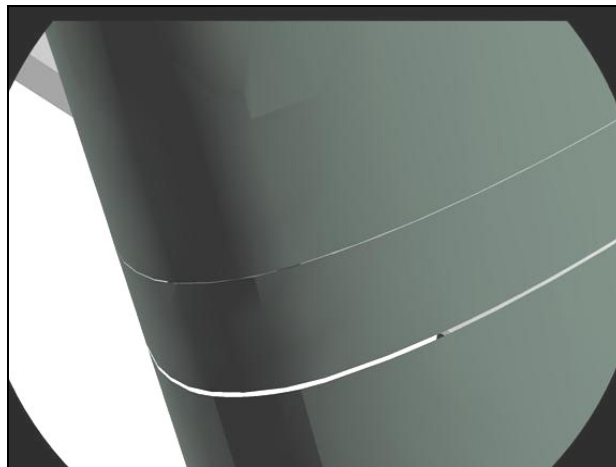

LDRI (+16,-90)

L10(VTR)

REC pb – push, hold
 PLAY pb – push, simo (red ●)

Record image for 30 sec

PAN: +20 (right)
 TILT: -80 (up)

PAN/TILT to match LDRI view shown below

Note PAN/TILT: _____, _____

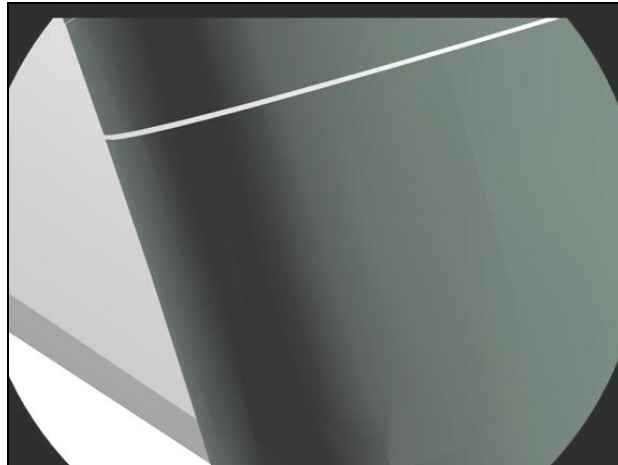

LDRI (+20,-80)

Record image for 30 sec

PAN: +23 (right)

TILT: -72 (up)

PAN/TILT to match LDRI view shown below

Note PAN/TILT: _____, _____

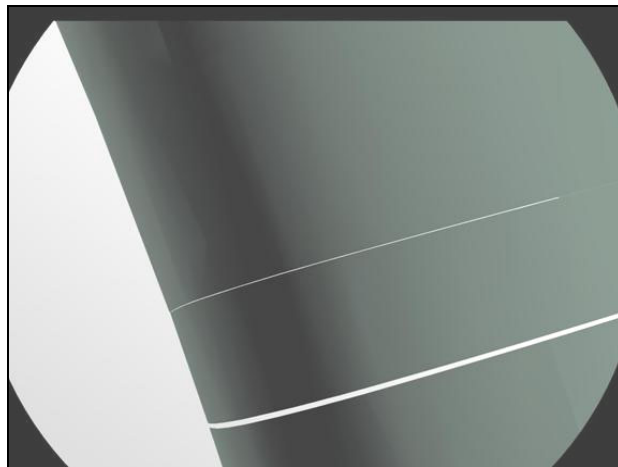

LDRI (+23,-72)

VIDEO IN – as desired (not PL2)

NOTE

Time between Pts 160 and 162 ~ 1:30 min

AUTO SEQ – PROCEED (IN PROG It on)

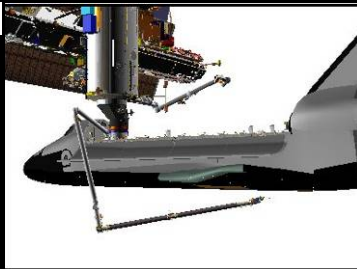
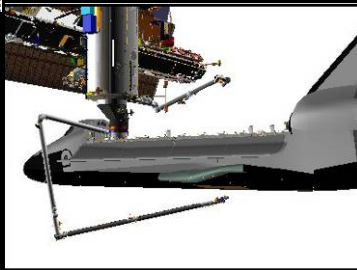
Pt	X	Y	Z	PITCH	YAW	ROLL	
160P	-1028	+280	-238	18	298	7	
161	-1007	+255	-238	18	299	9	
162P	-924	+228	-241	21	302	14	

A7U When AUTO SEQ READY It – on:
 VIDEO OUT MON2 pb – push
 IN PL2(VPU) pb – push

PAN: +30 (right)
 TILT: -65 (up)

PAN/TILT to match LDRI view shown below

Note PAN/TILT: _____, _____

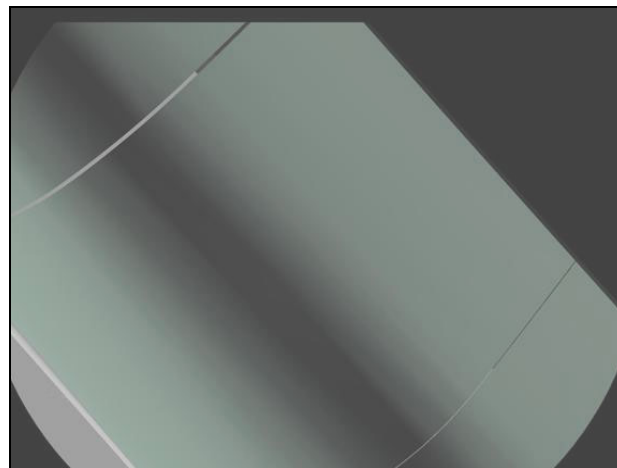

LDRI (+30,-65)

NOTE

Time between Pts 162 and 163 ~ 0:40 min

AUTO SEQ – PROCEED (IN PROG It on)

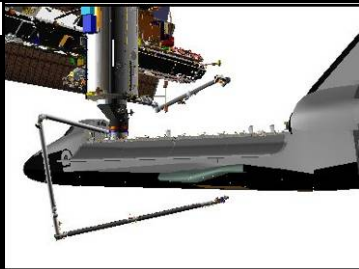
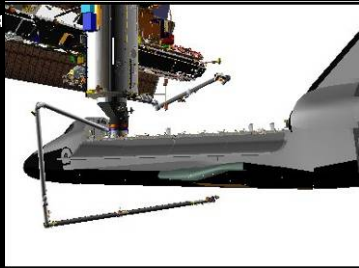
Pt	X	Y	Z	PITCH	YAW	ROLL	•
162P	-924	+228	-241	21	302	14	
163P	-892	+222	-235	15	301	11	

L10(VTR) When AUTO SEQ READY It – on:
STOP pb – push (no red •)

14. STBD LDRI ACAS, SECTION 7

NOTE

Between Pts 163 and 164, arm adjusts for survey of Zone 3.
Section 7 scans Zone 3, Panels 1 → 9. Time between
Pts 163 and 164 ~ 1:50 min

Section 7 Clearance Views	Cameras
LOWER ARM-to-PLBD	A, B, ELBOW, P1 LOOB
OBSS-to-ORBITER	RSC, SSRMS TIP ELBOW

AUTO SEQ – PROCEED (IN PROG It on)

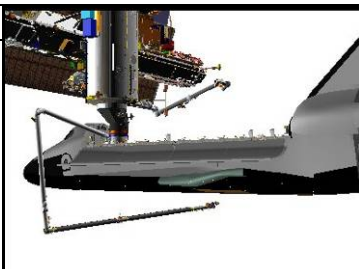
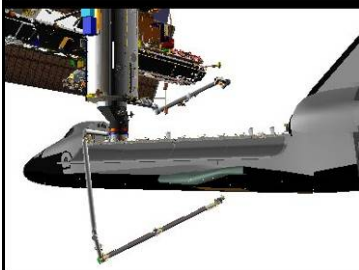
Pt	X	Y	Z	PITCH	YAW	ROLL	•
163P	-892	+222	-235	15	301	11	
164P	-903	+241	-246	67	288	61	

A7U

When AUTO SEQ READY It – on:
VIDEO OUT MON2 pb – push
IN PL2(VPU) pb – push

PAN: +47 (right)
TILT: -49 (up)

PAN/TILT to match LDRI view shown below

Note PAN/TILT: _____, _____

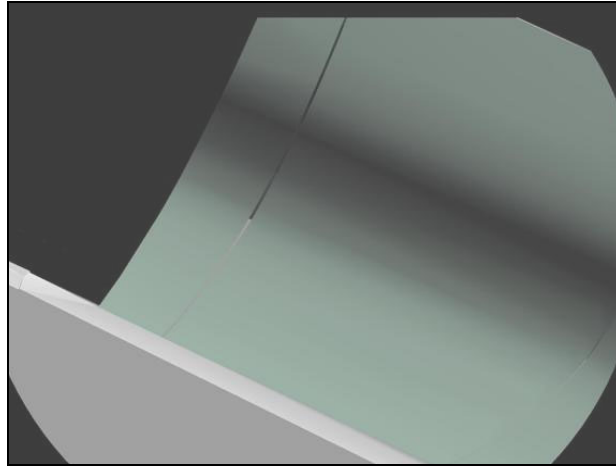

LDRI (+47,-49)

NOTE

Time between Pts 164 and 165 ~ 1:00 min

VIDEO IN – as desired (not PL2)

L10(VTR)

REC pb – push, hold
PLAY pb – push, simo (red ●)

AUTO SEQ – PROCEED (IN PROG It on)

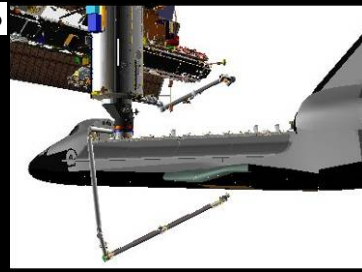
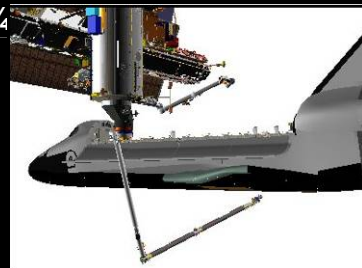
Pt	X	Y	Z	PITCH	YAW	ROLL	
164P	-903	+241	-246	67	288	61	
165P	-1008	+276	-246	67	288	61	

A7U

When AUTO SEQ READY It – on:
VIDEO OUT MON2 pb – push
IN PL2(VPU) pb – push

PAN: +34 (left)
TILT: -57 (down)

PAN/TILT to match LDRI view shown below

Note PAN/TILT: _____, _____

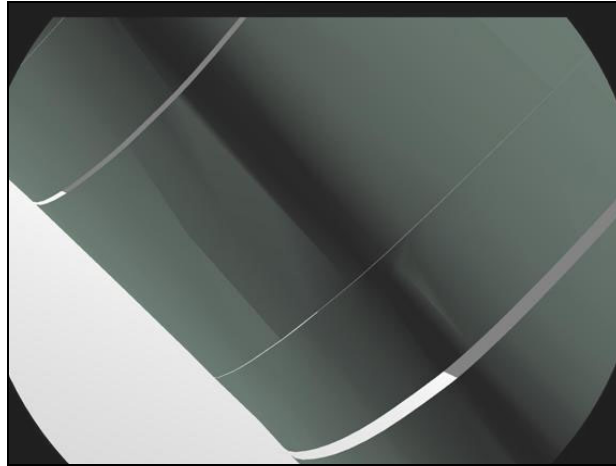

LDRI (+34,-57)

NOTE

Time between Pts 165 and 166 ~ 0:40 min. At Pt 166,
Lower Arm-to-PLBD = 51 in. Monitor clearance with
Elbow camera (-30, -30)

AUTO SEQ – PROCEED (IN PROG It on)

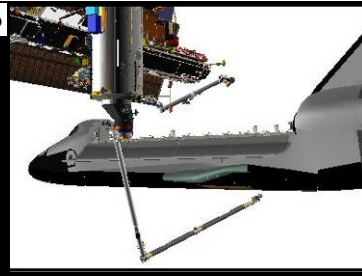
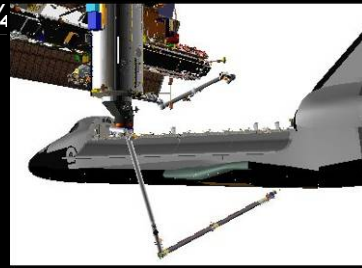
Pt	X	Y	Z	PITCH	YAW	ROLL	
165P	-1008	+276	-246	67	288	61	
166P	-1044	+306	-248	67	288	61	

When AUTO SEQ IN PROG It – off:
BRAKES – ON (tb-ON)

L10(VTR) STOP pb – push (no red ●)

A7U VIDEO OUT MUX 1 L pb – push (MIDDECK It on)
 LDRI MODE 2 pb – push (ITVC video displayed)
 VIDEO OUT MON2 pb – push
 IN – as desired (not PL2)

If continuing with DOCKED OBSS LDRI RCC SURVEY – NOSE CAP >>

15. RETURN TO OBSS HANDOFF
 RHC RATE – as reqd (VERN within 10 ft)
 BRAKES – OFF (tb-OFF)
 MODE – SINGLE, ENTER

Mnvr to OBSS HANDOFF:

	SY	SP	EP	WP	WY	WR	
DOCKED	+42.1	+7.3	-70.3	-19.4	-2.0	-105.2	
STBD LDRI							
ACAS END							
1: WY +					+11.0		
2: WR +						+10.0	
3: SP +		+66.3					
4: EP +			-49.0				
5: SY –	+25.8						
6: WY –					-20.0		
7: WR –						-100.7	
8: WP –				-85.9			
9: WY +					+10.7		
OBSS	+25.8	+66.3	-49.0	-85.9	+10.7	-100.7	
HANDOFF							
	X	Y	Z	PITCH	YAW	ROLL	PL ID
	-1029	+229	-614	188	270	74	3

* Display Singularity

BRAKES – ON (tb-ON)

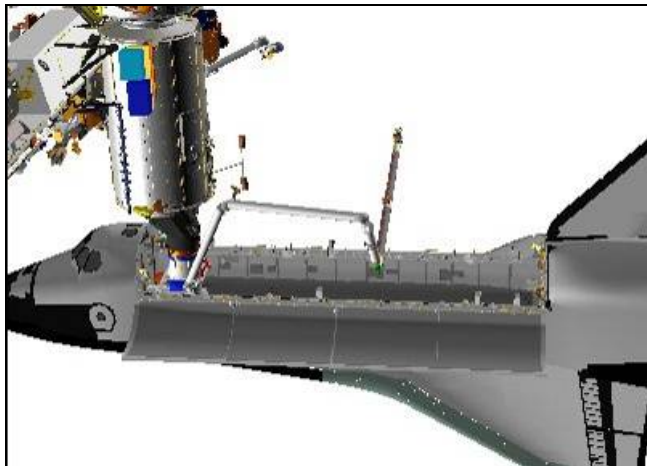

BIRD'S EYE

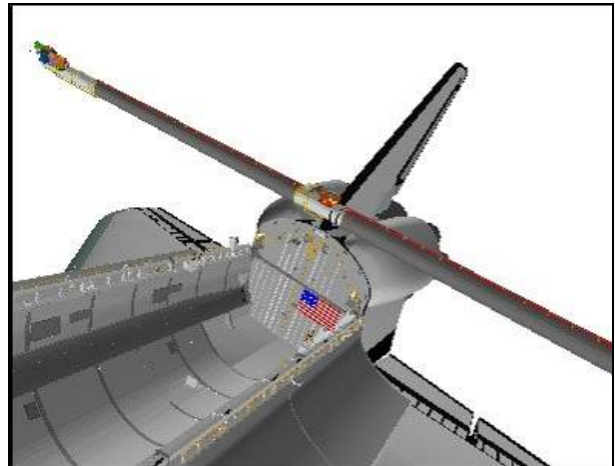

ELBOW (-60,0)

SRMS EE CAM CREW CABIN SURVEY

<u>WARNING</u> For UNDOCKED ops only Port and stbd PLBD radiators must be stowed
--

NOTE

Scanning (VTR recorded) portions of this procedure require daylight.
If step 7 not completed on FD3 15 min prior to reqd RNDZ OMS
burn, break out of procedure and return to Pre-Cradle

- A7U
1. SETUP
CCTV – RMS WRIST, ZOOM: 25.0 HFOV
VIDEO OUT DTV pb – push
IN RMS pb – push

SM 94 PDRS CONTROL

- √PL ID, ITEM 3: 0
- √INIT ID, ITEM 24: 0
- AUTO MODES – ITEM 13 +4 +5 EXEC

- A6U
2. INHIBIT NOSE JETS
√DAP: VERN(FREE)

GNC 23 RCS

- √RCS FWD – ITEM 1 EXEC (*)
- √MANF VLVS OVRD 1 – ITEM 40 EXEC (CL)
- 2 – ITEM 41 EXEC (CL)
- 3 – ITEM 42 EXEC (CL)
- 4 – ITEM 43 EXEC (CL)

3. MNVR TO STBD CREW CABIN POSN

NOTE

To assist with camera views, start posn is fwd, near nose cap

If mnvrng from OBSS PRE-GRAPPLE:

X	Y	Z	PITCH	YAW	ROLL	PL ID
-680	+96	-513	270	350	1	0
SY	SP	EP	WP	WY	WR	
-90.0	+87.6	-129.5	-57.5	0.0	+110.4	

SM 94 PDRS CONTROL

END POS – ITEM 18 -3 4 3 +1 1 8 -6 1 1 EXEC

ATT – ITEM 21 +2 3 9 +3 9 +1 0 1 EXEC

CMD CK – ITEM 25 EXEC (GOOD)

RHC

RATE – VERN (RATE MIN tb-ON)

BRAKES – OFF (tb-OFF)

MODE – OPR CMD, ENTER (READY lt on)

AUTO SEQ – PROCEED (IN PROG lt on)

When AUTO SEQ IN PROG lt – off:

BRAKES – ON (tb-ON)

X	Y	Z	PITCH	YAW	ROLL	PL ID
-343	+118	-611	239	39	101	0
SY	SP	EP	WP	WY	WR	
-135.0	+45.0	-57.4	-112.7	-59.3	+228.9	

NOTE

During next maneuver, Upper Arm-To-Crew Cabin = 13 in.

Upper Arm-To-APAS = 19 in. Monitor clearances with

SRMS Elbow and CCTV A

BRAKES – OFF (tb-OFF)

MODE – SINGLE, ENTER

Mnvr to STBD CREW CABIN SURVEY START posn:

	SY	SP	EP	WP	WY	WR	
OCAS End	-135.0	+45.0	-57.4	-112.7	-59.3	+228.9	
1: SP –		+17.2					
STBD CREW CABIN SURVEY START	-135.0	+17.2	-57.4	-112.7	-59.3	+228.9	
	X	Y	Z	PITCH	YAW	ROLL	PL ID
	-351	+180	-411	241	53	123	0

BRAKES – ON (tb-ON)

If mnvrng from SRMS PRE-CRADLE:

√	X	Y	Z	PITCH	YAW	ROLL	PL ID
	-1261	-146	-551	5	2	0	0
√	SY	SP	EP	WP	WY	WR	
	0.0	+25.0	-25.0	+5.0	0.0	0.0	

Mnvr to STBD CREW CABIN SURVEY START posn:

	SY	SP	EP	WP	WY	WR	
PRE-CRADLE	0.0	+25.0	-25.0	+5.0	0.0	0.0	
1: SP +		+45.0					
2: WR +						+228.2	
3: WY -					-59.5		
4: WP -				-112.6			
5: SY -	-90.0						
6: EP -			-57.5				
7: SP -		+17.2					
8: SY -	-134.9						[1,2]
STBD CREW CABIN SURVEY START	-134.9	+17.2	-57.5	-112.6	-59.5	+228.2	
	X	Y	Z	PITCH	YAW	ROLL	PL ID
	-351	+180	-411	241	53	123	0

[1]Upper Arm-To-Crew Cabin = 13 in

[2]Upper Arm-To-APAS = 19 in

BRAKES – ON (tb-ON)



STBD

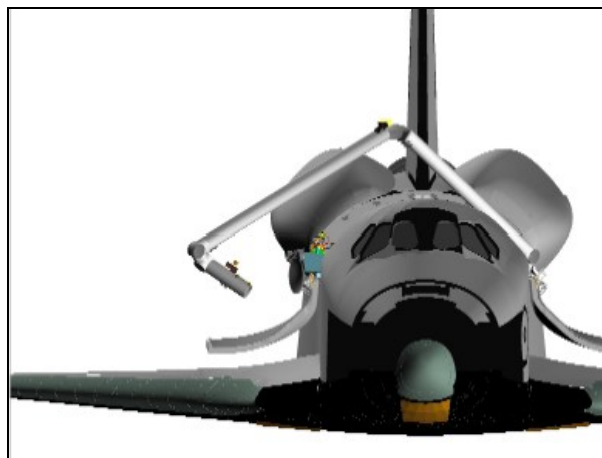

FRONT

4. STBD CREW CABIN SURVEY, SECTION 1

SM 94 PDRS CONTROL

PL ID – ITEM 3 +5 EXEC

INIT ID – ITEM 24 +5 EXEC

√	X	Y	Z	PITCH	YAW	ROLL	PL ID
	-351	+180	-411	241	53	123	5
√	SY	SP	EP	WP	WY	WR	
	-135.0	+17.2	-57.4	-112.7	-59.3	+228.9	

RHC

RATE – VERN (RATE MIN tb-ON)

A7U √CCTV – RMS WRIST

For camera views, refer to SRMS EE CAM CREW CABIN SURVEY CAMERA VIEWS (SURVEY CAMERA VIEWS)

L10(VTR) REC pb – push, hold
PLAY pb – push, simo (red ●)

BRAKES – OFF (tb-OFF)
MODE – AUTO 1, ENTER (READY lt on)

* If unable to enter AUTO mode (no AUTO READY lt): *
* √Joint angles and adjust as reqd *

SM 94 PDRS CONTROL

√START PT, ITEM 17: 122

SM 169 PDRS STATUS

Monitor ACAS progress

NOTE

Time between Pts 122 and 123 ~ 0:50 sec

Section 1 Clearance Views	Cameras
EE-to-Crew Cabin and Ku Dish	ELBOW[1]
Lower Arm-to-Crew Cabin	C, D, ELBOW[1]
Upper Arm-to-Docking Ring (Extended)	A
Upper Arm-to-Crew Cabin	A, B, ELBOW[1]
[1]ELBOW and WRIST cameras are mutually exclusive	

On MCC GO,
 AUTO SEQ – PROCEED (IN PROG It on)

ACAS, pause pts **shaded in bold**, ● col indicates data recording (black = VTR on) and damage criteria (inches):

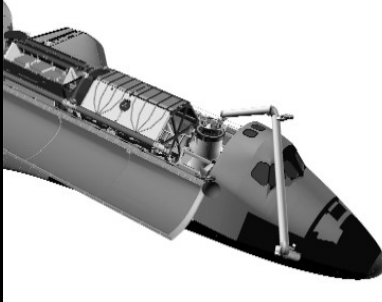
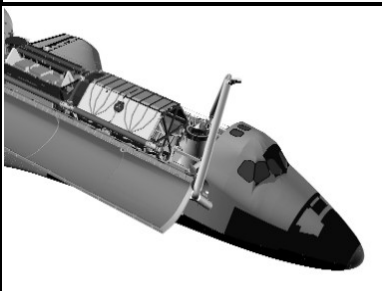
Pt	X	Y	Z	PITCH	YAW	ROLL	●	
122P	-351	+180	-411	241	53	123		
123P	-484	+230	-465	255	48	103	3	

L10(VTR) When AUTO SEQ IN PROG It – off:
 STOP pb – push (no red ●)

5. PREPARE FOR SECTION 2

NOTE

Between Pts 123 and 124, arm repositions back to start pt, preparing for completion of survey of STBD side of crew cabin. At Pt 124, Upper Arm-to-Crew Cabin = 13 in, Upper Arm-to-APAS = 19 in. Time between Pts 123 and 124 ~ 0:50 sec

AUTO SEQ – PROCEED (IN PROG It on)

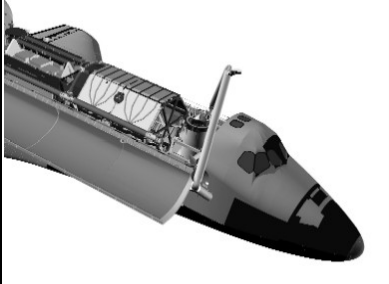
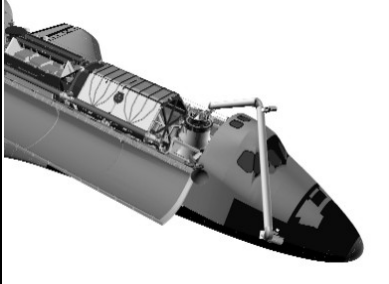
Pt	X	Y	Z	PITCH	YAW	ROLL	•
123P	-484	+230	-465	255	48	103	
124P	-351	+180	-411	241	53	123	

6. STBD CREW CABIN SURVEY, SECTION 2

NOTE

Time between Pts 124 and 125 ~ 1:30 min

Section 2 Clearance Views	Cameras
EE-to-Crew Cabin and Ku Dish	ELBOW[1]
Lower Arm-to-Crew Cabin	C, D, ELBOW[1]
Upper Arm-to-Docking Ring (Extended)	A
Upper Arm-to-Crew Cabin	A, B
[1]ELBOW and WRIST cameras are mutually exclusive	

A7U √CCTV – RMS WRIST

L10(VTR) REC pb – push, hold
 PLAY pb – push, simo (red ●)

AUTO SEQ – PROCEED (IN PROG It on)

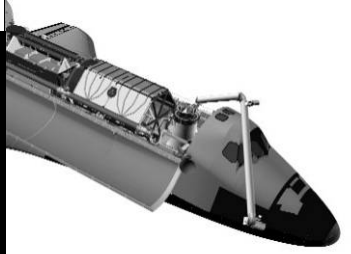
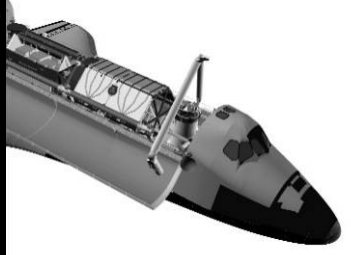
Pt	X	Y	Z	PITCH	YAW	ROLL	●
124P	-351	+180	-411	241	53	123	
125P	-548	+266	-478	270	38	45	

When AUTO SEQ IN PROG It – off:
 BRAKES – ON (tb-ON)

L10(VTR) STOP pb – push (no red ●)

RHC

7. MNVR TO PORT CREW CABIN SURVEY START POSN

RATE – as reqd (VERN within 10 ft)

BRAKES – OFF (tb-OFF)

MODE – SINGLE, ENTER

If performing immediately after STBD CREW CABIN SURVEY:

		Mnvr to PORT CREW CABIN SURVEY START posn:					
		SY	SP	EP	WP	WY	WR
STBD CREW CABIN SURVEY		-107.7	+28.3	-66.4	-108.1	-14.9	+164.2
	End						
1:	SP +		+53.3				
2:	SY +	+65.9					
3:	EP -			-94.3			
4:	WP +				-99.6		
5:	WY -					-36.5	
6:	WR +						+216.5
PORT CREW CABIN SURVEY START		+65.9	+53.3	-94.3	-99.6	-36.5	+216.5
	X	Y	Z	PITCH	YAW	ROLL	PL ID
	-840	-364	-333	324	291	323	5

If performing PORT CREW CABIN SURVEY from PRE-CRADLE:

	X	Y	Z	PITCH	YAW	ROLL	PL ID
√	-1261	-146	-551	5	2	0	0(5)
	SY	SP	EP	WP	WY	WR	
√	0.0	+25.0	-25.0	+5.0	0.0	0.0	

SM 94 PDRS CONTROL

PL ID – ITEM 3 +5 EXEC

INIT ID – ITEM 24 +5 EXEC

		Mnvr to PORT CREW CABIN SURVEY START posn:					
		SY	SP	EP	WP	WY	WR
PRE-CRADLE		0.0	+25.0	-25.0	+5.0	0.0	0.0
1:	SY +	+65.9					
2:	SP +		+53.3				
3:	EP -			-94.3			
4:	WP -				-99.6		
5:	WY -					-36.5	
6:	WR +						+216.5
PORT CREW CABIN SURVEY START		+65.9	+53.3	-94.3	-99.6	-36.5	+216.5
	X	Y	Z	PITCH	YAW	ROLL	PL ID
	-840	-364	-333	324	291	323	5

BRAKES – ON (tb-ON)

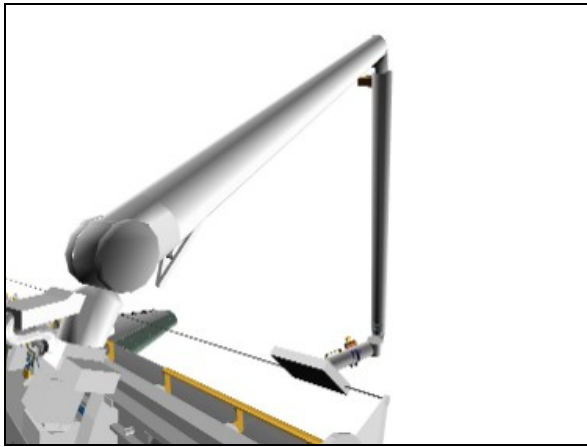

CCTV A (45,3)

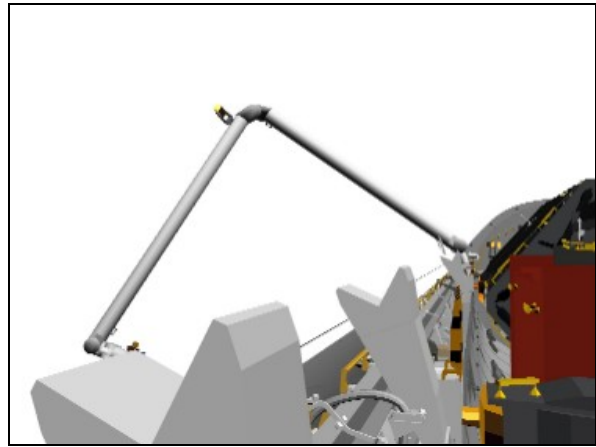

CCTV B (-17,2)

RHC 8. PORT CREW CABIN SURVEY, SECTION 1
RATE – VERN (RATE MIN tb-ON)

A7U √CCTV – RMS WRIST

L10(VTR) REC pb – push, hold
PLAY pb – push, simo (red ●)

BRAKES – OFF (tb-OFF)
MODE – AUTO 2, ENTER (READY lt on)

- * If unable to enter AUTO mode (no AUTO READY lt): *
- * √Joint angles and adjust as reqd *

SM 94 PDRS CONTROL

√START PT, ITEM 17: 126

SM 169 PDRS STATUS

Monitor ACAS progress

NOTE

Time between Pts 126 and 128 ~ 2:40 min

Section 1 Clearance Views	Cameras
EE-to-PLBD	A[1], B[2], ELBOW[3]
EE-to-Crew Cabin	B[2], ELBOW[3]
Lower Arm-to-Crew Cabin	A, B
[1]Lose sight of EE between Pts 116 and 117	
[2]Port MPMs block direct view of EE	
[3]ELBOW and WRIST cameras are mutually exclusive	

On MCC GO,
 AUTO SEQ – PROCEED (IN PROG It on)

ACAS, pause pts **shaded in bold**, ● col indicates data recording (black = VTR on) and damage criteria (inches):

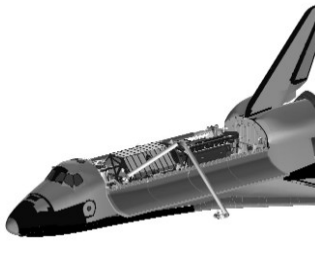
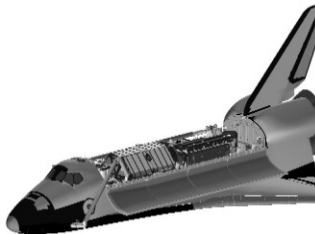
Pt	X	Y	Z	PITCH	YAW	ROLL	●	
126P	-840	-364	-333	324	291	323		
127	-517	-304	-275	19	279	23	3	
128P	-294	-244	-331	242	275	270		

9. PORT CREW CABIN SURVEY, SECTION 2

NOTE

VTR is not stopped between sections 1 and 2.
Time between Pts 128 and 129 ~ 1:15 min

Section 2 Clearance Views	Cameras
EE-to-Crew Cabin	B[1], ELBOW[2]
Lower Arm-to-Crew Cabin	A, B
[1]Port MPMs block direct view of EE	
[2]ELBOW and WRIST cameras are mutually exclusive	

AUTO SEQ – PROCEED (IN PROG It on)

Pt	X	Y	Z	PITCH	YAW	ROLL	●
128P	-294	-244	-331	242	275	270	●
129P	-518	-252	-385	300	281	348	

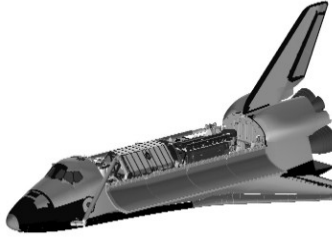
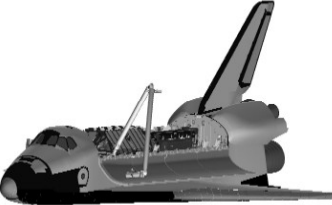
When AUTO SEQ IN PROG It – off:
BRAKES – ON (tb-ON)

L10(VTR) STOP pb – push (no red ●)

10. ENABLE NOSE JETS

GNC 23 RCS

RCS FWD – ITEM 1 EXEC (*)

MANF VLVS OVRD 1 – ITEM 40 EXEC (OP)

2 – ITEM 41 EXEC (OP)

3 – ITEM 42 EXEC (OP)

4 – ITEM 43 EXEC (OP)

A6U DAP: as reqd

11. MNVR TO PRE-CRADLE

SM 94 PDRS CONTROL

PL ID - ITEM 3 +0 EXEC
 INIT ID - ITEM 24 +0 EXEC

√	X	Y	Z	PITCH	YAW	ROLL	PL ID
	-518	-252	-385	300	281	348	0
√	SY	SP	EP	WP	WY	WR	
	+129.3	+69.9	-118.8	-97.8	+28.5	+227.4	

RHC RATE - as reqd (VERN within 10 ft)
 BRAKES - OFF (tb-OFF)
 MODE - SINGLE, ENTER

Mnvr to PRE-CRADLE:

	SY	SP	EP	WP	WY	WR	
PORT CREW CABIN SURVEY End	+129.3	+69.9	-118.8	-97.8	+28.5	+227.4	
1: WR -						0.0	
2: WY -					0.0		
3: WP +				+5.0			
4: EP +			-25.0				
5: SY -	0.0						
6: SP -		+25.0					
PRE-CRADLE	0.0	+25.0	-25.0	+5.0	0.0	0.0	
	X	Y	Z	PITCH	YAW	ROLL	PL ID
	-1261	-146	-551	5	2	0	0

BRAKES - ON (tb-ON)
 MODE - not DIRECT
 PARAM - PORT TEMP
 JOINT - CRIT TEMP

OBSS OFF-NOMINAL OPERATIONS

I

OBSS HANDOFF FROM SSRMS (WS3) TO SRMS.....	FS 4-2
SRMS TO SSRMS (WS3).....	FS 4-7
IDC RCC SURVEY – STBD.....	FS 4-12
– NOSE CAP.....	FS 4-21
– PORT.....	FS 4-35
OBSS SJ UNBERTH.....	FS 4-47
BERTH.....	FS 4-61
HANDOFF FROM SSRMS (LAB) TO SRMS.....	FS 4-76
SRMS TO SSRMS (LAB).....	FS 4-91
FLAT FIELDS.....	FS 4-101
JETTISON.....	FS 4-106
WITH MPMS.....	FS 4-111
EVA WLE RCC SURVEY.....	FS 4-117
ITVC TILE ACREAGE SURVEY.....	FS 4-169
RMS EE RCC WING SURVEY.....	FS 4-197

**OBSS OFF-NOM
OPERATIONS**

OBSS HANDOFF FROM SSRMS (WS3) TO SRMS

1. SETUP

SM 94 PDRS CONTROL

- √ PL ID, ITEM 3: 0
- √ INIT ID, ITEM 24: 0

A7U CCTV – config as reqd

2. PRE-GRAPPLE MNVR

RHC RATE – as reqd (VERN within 10 ft)
 BRAKES – OFF (tb-OFF)
 MODE – ORB UNL, ENTER

Mnvr to OBSS PRE-GRAPPLE AT HANDOFF posn:

X	Y	Z	PITCH	YAW	ROLL	PL ID
-966	-1	-625	285	0	271	0
SY	SP	EP	WP	WY	WR	
-33.3	+80.0	-90.0	-77.3	+23.8	-39.8	

BRAKES – ON (tb-ON)

Notify SSRMS Operator that SRMS at OBSS PRE-GRAPPLE AT HANDOFF posn

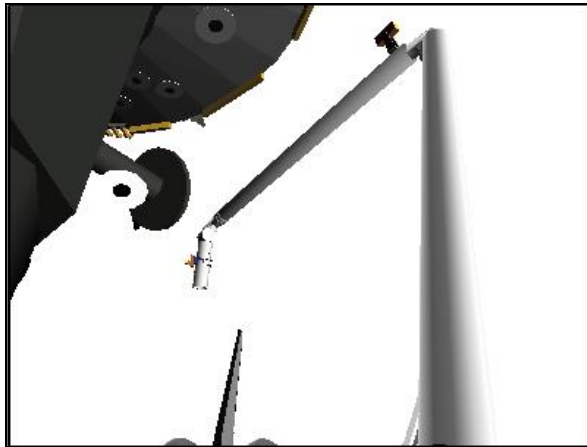

CCTV A (5,35)

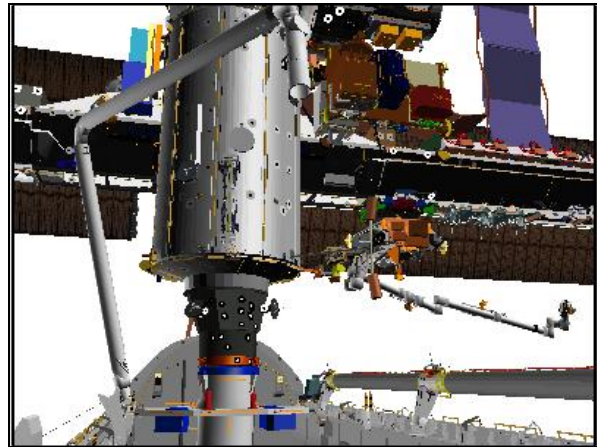

CCTV B (15,15)

3. CONFIGURE POWER

CAUTION
 SPEE power must be applied within 90 min
 to prevent sensor package damage

On SSRMS Operator GO to release STBD MRLs,
 STBD RMS HTR A,B (two) – OFF

A6U EVENT TIMER MODE – UP
 CNTL – START

OBSS OFF-NOM OPERATIONS

MA73C:C cb MCA PWR AC3 3Φ MID 2 – op
 √AC2 3Φ MID 2 – op
 MA73C:D √AC3 3Φ MID 4 – op
 R13L PL BAY MECH PWR SYS (two) – ON

4. STBD MRL RELEASE

SM 94 PDRS CONTROL

RMS STBD – ITEM 2 EXEC (*)
 √STBD AFT, MID, FWD REL (six) = 0

NOTE

Expect single motor drive time for MRL release

STBD RMS RETEN LAT – REL (tb-REL) (18 sec max)
 – OFF

If motor drive time > 18 sec, √MCC

SM 94 PDRS CONTROL

√STBD AFT, MID, FWD REL (six) = 1

5. RECONFIGURE POWER

R13L PL BAY MECH PWR SYS (two) – OFF

MA73C:C cb MCA PWR AC3 3Φ MID 2 – cl
 √AC2 3Φ MID 2 – op
 :D √AC3 3Φ MID 4 – op

Give SSRMS Operator GO for OBSS Unberth
 Monitor RFL Status

After OBSS Unberth,

SM 94 PDRS CONTROL

RMS PORT – ITEM 1 EXEC (*)

6. SETUP FOR GRAPPLE

A7U CCTV – config for grapple
 – install PDRS TARGET OVERLAY FOR CTVM
 – RMS WRIST, ZOOM: 34.0 HFOV
 FOCUS: 5 ft

Maintain eyepoint approx 18 in when using grapple overlay

R12(OBSS) √SPEE PWR – OFF
 L12U(SSP1) √APCU 1 OUTPUT RLY – OP (tb-bp)

7. OBSS GRAPPLE AT HANDOFF POSN

RHC On SSRMS Operator GO for SRMS OBSS Grapple,
 RATE – VERN (RATE MIN tb-ON)
 BRAKES – OFF (tb-OFF)
 MODE – END EFF, ENTER

Mnvr to grapple envelope

CAUTION
Monitor EE tb timing to prevent EE motor burnout

EE MODE – AUTO
CAPTURE sw – depress (mom)

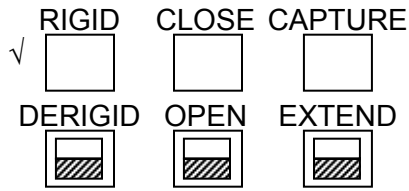

CRITICAL TIMES (28 sec total):
 CAPTURE tb – gray, then
 CLOSE tb – gray, 3 sec max, then
 RIGID tb – gray, 25 sec max

EE MODE – OFF

 MODE – TEST, ENTER
 Wait 5 sec

 BRAKES – ON (tb-ON)

SM 94 PDRS CONTROL
 PL ID – ITEM 3 +2 EXEC
 INIT ID – ITEM 24 +2 EXEC

Expected OBSS HANDOFF posn:

	X	Y	Z	PITCH	YAW	ROLL	PL ID
√	-986	+318	-554	15	270	0	2
	SY	SP	EP	WP	WY	WR	
√	-28.4	+75.5	-98.1	-62.5	+23.6	-45.1	

* display singularity

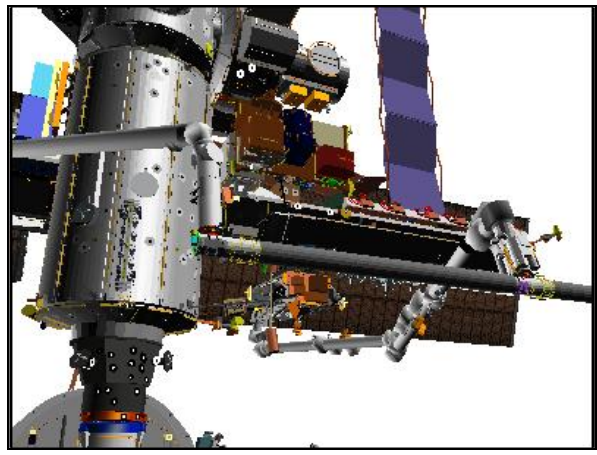

CCTV B (25,20)

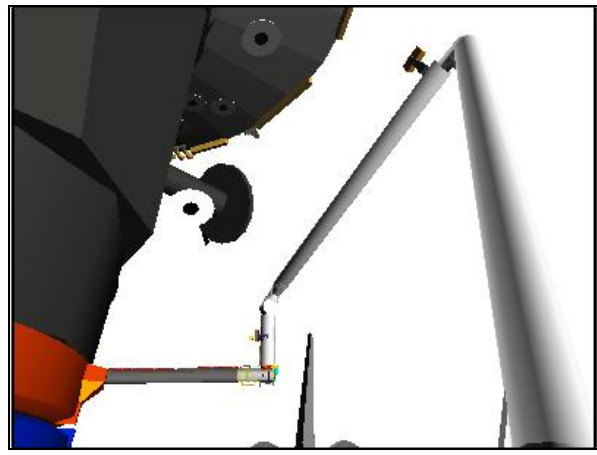

CCTV A (-5,35)

Perform ACTIVATION (LDRI/ITVC Cue Card, PHOTO/TV)

Perform LCH ACTIVATION (LCS Cue Card, PHOTO/TV)

Perform LCC ACTIVATION (LCS Cue Card, PHOTO/TV)

Perform LCC DEACTIVATION (LCS Cue Card, PHOTO/TV), steps 1 and 2

Give SSRMS Operator GO for OBSS Ungrapple

Review GENERIC END EFFECTOR CUE CARD – ISS/SHUTTLE DOCKED OPS

8. MNVR TO OBSS PARK

RHC

On SSRMS Operator GO for mnvr to OBSS PARK posn,

RATE – as required (VERN within 10 ft)

BRAKES – OFF (tb-OFF)

MODE – SINGLE, ENTER

Mnvr to OBSS PARK posn:

	SY	SP	EP	WP	WY	WR	
HANDOFF	-28.4	+75.5	-98.1	-62.5	+23.6	-45.1	
1: EP +			-25.0				
2: SP –		+25.0					
3: WR +						0.0	
4: WY –					0.0		
5: WP +				+5.0			
6: SY +	0.0						
OBSS PARK	0.0	+25.0	-25.0	+5.0	0.0	0.0	
	X	Y	Z	PITCH	YAW	ROLL	PL ID
	-1243	-143	-869	95	359	358	2

BRAKES – ON (tb-ON)

MODE – not DIRECT

PARAM – PORT TEMP

JOINT – CRIT TEMP

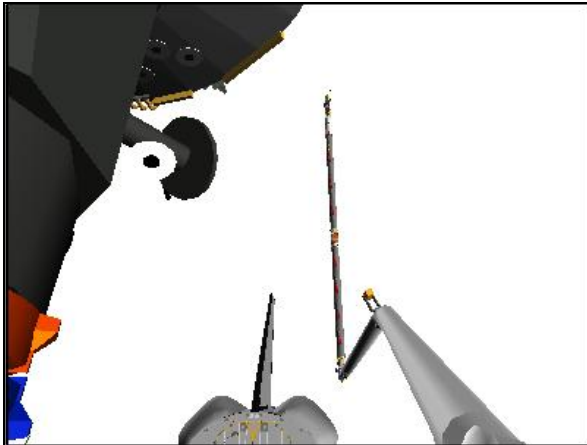

CCTV A (0,30)

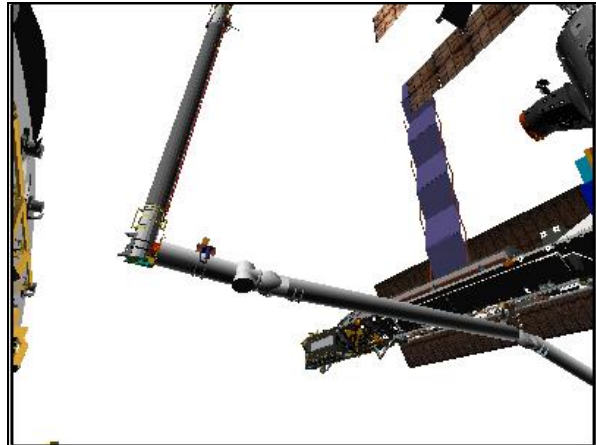

CCTV C (-60,30)

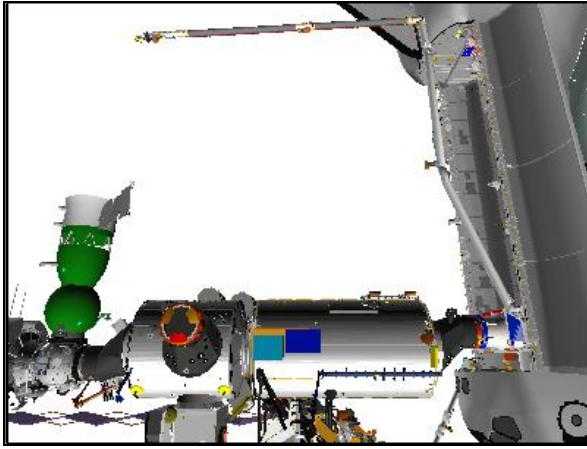

P1 LOWER OUTBOARD (90,20)

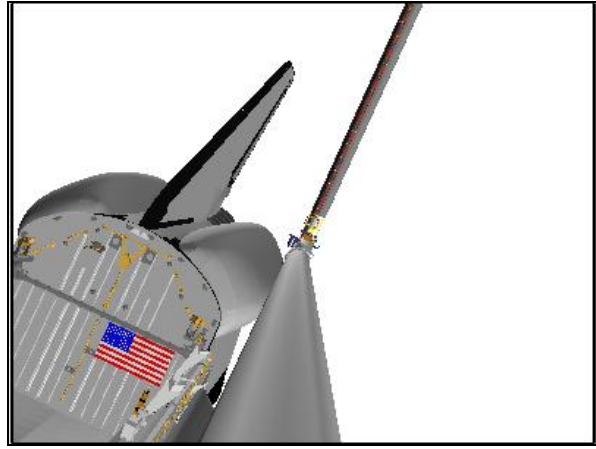

SRMS ELBOW (0,0)

A7U 9. RECONFIG PTU
VIDEO OUT MON2 pb – push
IN PL2(VPU) pb – push

CAMR CMD PAN/TILT – HI RATE
PAN – L (to hard stop)
TILT – UP (to hard stop)
PAN/TILT – RESET, HI RATE (LO within 10°)
PAN: +80 (right)
TILT: -35 (dn)

VIDEO OUT MUX 1 L pb – push (MIDDECK It on)
LDRI MODE 2 pb – push (ITVC video)

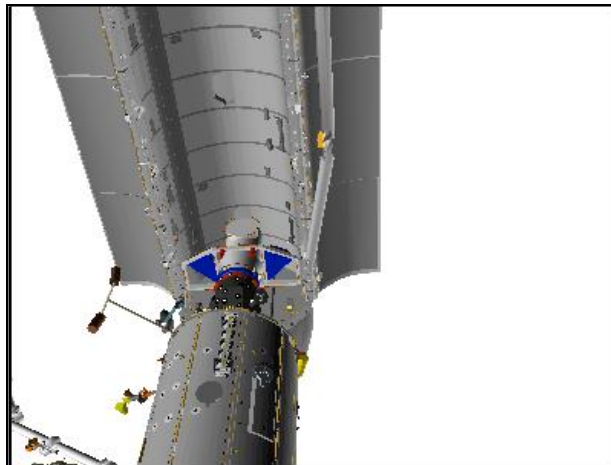

ITVC (80,-35)

OBSS HANDOFF FROM SRMS TO SSRMS (WS3)

1. SETUP

SM 94 PDRS CONTROL

√PL ID, ITEM 3: 3

√INIT ID, ITEM 24: 3

A7U CCTV – config as reqd

Review GENERIC END EFFECTOR CUE CARD – ISS/SHUTTLE DOCKED OPS

2. MANEUVER TO OBSS HANDOFF

RHC RATE – as reqd (VERN within 10 ft)

BRAKES – OFF (tb-OFF)

MODE – SINGLE, ENTER

Mnvr to OBSS HANDOFF posn:

	SY	SP	EP	WP	WY	WR	
OBSS PARK	0.0	+25.0	-25.0	+5.0	0.0	0.0	
1: SY –	-28.4						
2: WP –				-62.5			
3: WY +					+23.6		
4: WR –						-45.1	
5: SP +		+75.5					
6: EP –			-98.1				
HANDOFF	-28.4	+75.5	-98.1	-62.5	+23.6	-45.1	
	X	Y	Z	PITCH	YAW	ROLL	PL ID
	-986	+590	-561	15	270	0	3

* display singularity

BRAKES – ON (tb-ON)

Notify SSRMS Operator that SRMS at OBSS HANDOFF posn

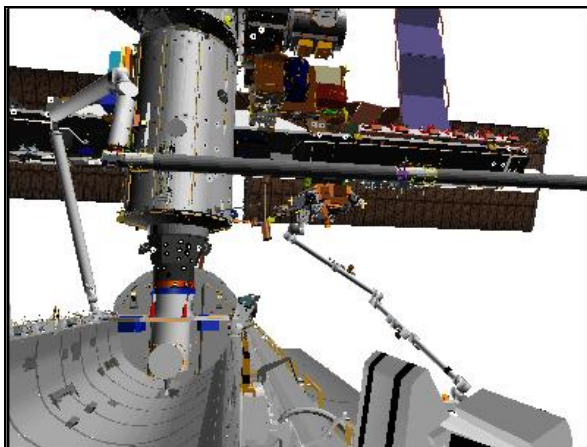

CCTV C (10,10)

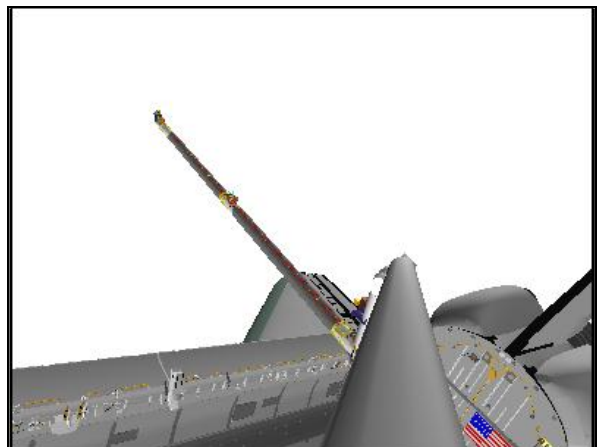

SRMS ELBOW (-15,0)

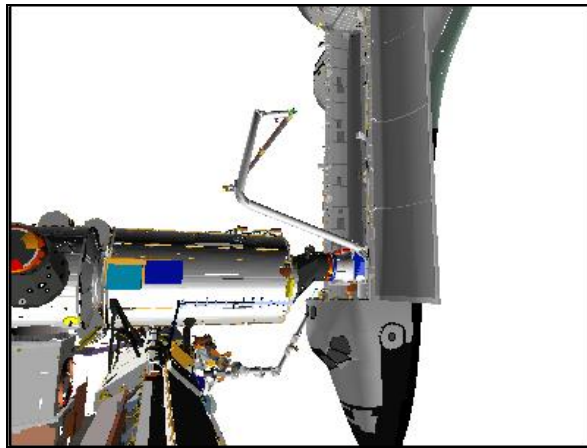

P1 LOWER OUTBOARD (110,8)

3. STOW PTU

A7U

On SSRMS Operator GO for OBSS Ungrapple,
 VIDEO OUT MON2 pb – push
 IN PL2(VPU) pb – push

CAMR CMD PAN/TILT – HI RATE

PAN – L (to hard stop)

TILT – UP (to hard stop)

PAN/TILT – RESET, HI RATE (LO within 10°)

PAN: +108 (right)

TILT: -175 (down)

Perform LCC DEACTIVATION (LCS Cue Card, PHOTO/TV)

Perform LCH DEACTIVATION (LCS Cue Card, PHOTO/TV)

CAUTION

STBD RMS HTR power must be applied within
 90 min to prevent sensor package damage

Perform DEACTIVATION (LDRI/ITVC Cue Card, PHOTO/TV)

4. OBSS UNGRAPPLE

A7U

CCTV – config for ungrapple

– RMS WRIST, ZOOM: 34.0 HFOV

FOCUS: 5 ft

NOTE

CONTR ERR It and 'S96 PDRS CNTL' msg may
 occur due to Consistency/Envelope Check error

RHC

RATE – COARSE (RATE MIN tb-OFF)

SM 94 PDRS CONTROL

AUTO BRAKE INH – ITEM 10 EXEC (*)

BRAKES – OFF (tb-OFF)
 MODE – TEST, ENTER
 Wait 5 sec

BRAKES – ON (tb-ON)

SM 94 PDRS CONTROL

AUTO BRAKE ENA – ITEM 9 EXEC (*)
 PL ID – ITEM 3 +0 EXEC
 INIT ID – ITEM 24 +0 EXEC

RHC

RATE – VERN (RATE MIN tb-ON)
 BRAKES – OFF (tb-OFF)
 MODE – END EFF, ENTER

CAUTION
 Monitor EE tb timing to prevent EE motor burnout

EE MODE – AUTO
 RELEASE sw – depress (mom)

When OPEN tb – gray, mnvr arm clear of grapple pin

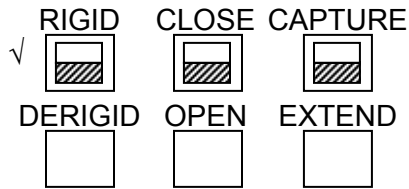

CRITICAL TIMES (28 sec total):
 DERIGID tb – gray, 5 sec max, then
 OPEN tb – gray, 3 sec max, then
 EXTEND tb – gray, 20 sec max

EE MODE – OFF

- * If manual release reqd: *
- * EE MODE – MAN *
- * MAN CONTR – DERIGID (hold until DERIGID tb-gray, 5 sec max) *
- * RELEASE sw – depress (hold until OPEN tb-gray, 3 sec max) *
- * Mnvr arm clear of grapple pin, then: *
- * EE MAN CONTR – DERIGID (hold until EXTEND tb-gray, 20 sec max) *
- * MODE – OFF *

RHC

5. MNVR TO OBSS PRE-GRAPPLE AT HANDOFF

RATE – VERN (RATE MIN tb-ON)
 MODE – as desired

Mnvr to OBSS PRE-GRAPPLE AT HANDOFF posn:

X	Y	Z	PITCH	YAW	ROLL	PL ID
-966	-1	-625	285	0	271	0
SY	SP	EP	WP	WY	WR	
-33.3	+80.0	-90.0	-77.3	+23.8	-39.8	

BRAKES – ON (tb-ON)
 MODE – not DIRECT
 JOINT – CRIT TEMP

Give SSRMS Operator GO to mnvr to Handoff Intermediate posn

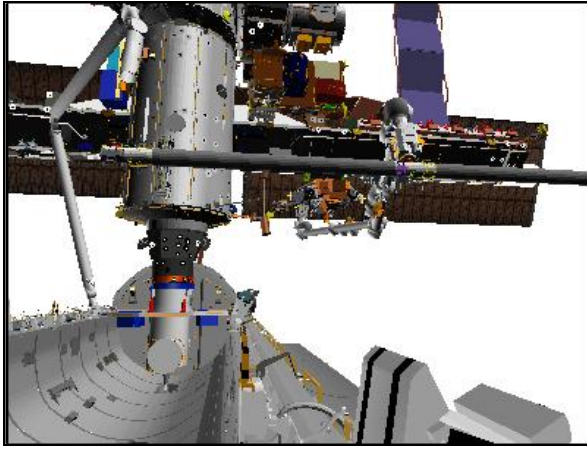

CCTV C (10,10)

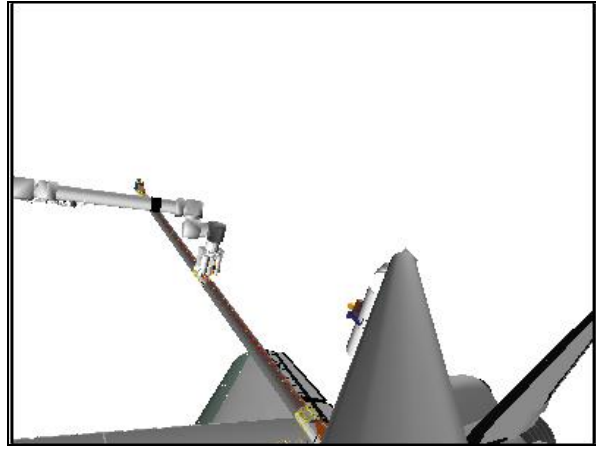

ELBOW (-15,0)

6. CONFIGURE CIRCUIT BREAKERS
 MA73C:C cb MCA PWR AC3 3Φ MID 2 – op
 √AC2 3Φ MID 2 – op
 MA73C:D √AC3 3Φ MID 4 – op

7. CONFIGURE FOR MONITORING
 On SSRMS notification to watch for STBD RMS RFLs,
 SM 94 PDRS CONTROL
 RMS STBD – ITEM 2 EXEC (*)

Notify SSRMS operator when STBD RMS R-F-L tb (three) – gray

8. STBD MRL LATCH
 On SSRMS Operator GO to latch STBD MRLs to Topological Capture,
 √STBD RMS R-F-L tb (three) – gray

SM 94 PDRS CONTROL
 √STBD AFT, MID, FWD LAT (six) = 0

R13L PL BAY MECH PWR SYS (two) – ON

NOTE

Expect single motor drive time for MRL latching (18 sec max).
 The following STBD RMS RETEN LAT – OFF and PL BAY
 MECH PWR SYS (two) – OFF actions are to be performed simo

Verify AOS for latching to Topological Capture

STBD RMS RETEN LAT – LAT (6 sec max)
 – OFF

R13L PL BAY MECH PWR SYS (two) – OFF

Give SSRMS Operator GO to Limp All SSRMS Joints and Derigidize

R13L On SSRMS Operator GO to continue STBD MRL latching,
 PL BAY MECH PWR SYS (two) – ON

STBD RMS RETEN LAT – LAT (tb-LAT) (12 sec max)
 – OFF

9. RECONFIGURE POWER
R13L PL BAY MECH PWR SYS (two) – OFF

STBD RMS HTR A,B (two) – AUTO

A6U EVENT TIMER CNTL – STOP

SM 94 PDRS CONTROL

√STBD AFT, MID, FWD LAT (six) = 1
RMS PORT – ITEM 1 EXEC (*)

MA73C:C cb MCA PWR AC3 3Φ MID 2 – cl

√AC2 3Φ MID 2 – op

MA73C:D √AC3 3Φ MID 4 – op

Give SSRMS Operator GO for OBSS Ungrapple

When SSRMS at SSRMS Stow posn, perform RMS PWRDN (PDRS, RMS PWRDN), step 1 only

OBSS IDC RCC SURVEY – STBD

WARNING
 For UNDOCKED ops only
 APAS Docking Ring must be retracted

NOTE

Assumed starting posn is end of ITVC/LDRI FLAT FIELDS

1. SETUP

SM 94 PDRS CONTROL

√PL ID, ITEM 3: 2

√INIT ID, ITEM 24: 2

	X	Y	Z	PITCH	YAW	ROLL	PLID
√	-1001	+303	-501	0	0	24	2
	SY	SP	EP	WP	WY	WR	
√	-89.6	+44.5	-84.6	-45.4	0.0	+109.6	

AUTO MODES – ITEM 13 +6 +7 +8 +9 EXEC

2. MNVR TO STBD IDC ACAS START POSITION

RHC

√RATE – VERN (RATE MIN tb-ON)

BRAKES – OFF (tb-OFF)

MODE – SINGLE, ENTER

Mnvr to STBD IDC ACAS START posn:

	SY	SP	EP	WP	WY	WR	
LDRI FF END	-89.6	+44.5	-84.6	-45.4	0.0	+109.6	
1: WP +				+103.5			
2: WR +						+280.8	
3: EP +			-76.1				
4: SP +		+71.3					
5: WY –					-64.8		
6: SY +	-13.2						
STBD IDC ACAS START	-13.2	+71.3	-76.1	+103.5	-64.8	+280.8	
	X	Y	Z	PITCH	YAW	ROLL	PL ID
	-1074	+168	-532	286	313	86	2

BRAKES – ON (tb-ON)



CCTV A (-10,30)

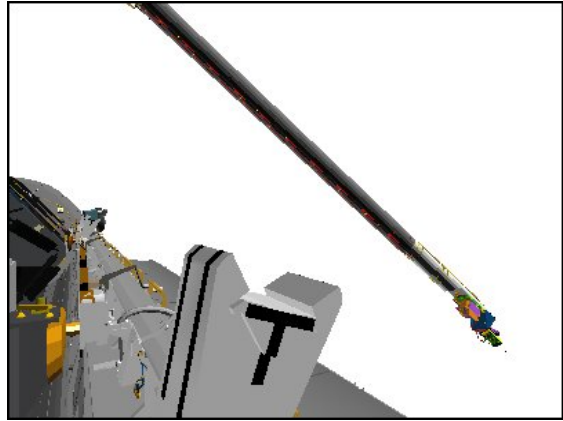

CCTV C (30,0)

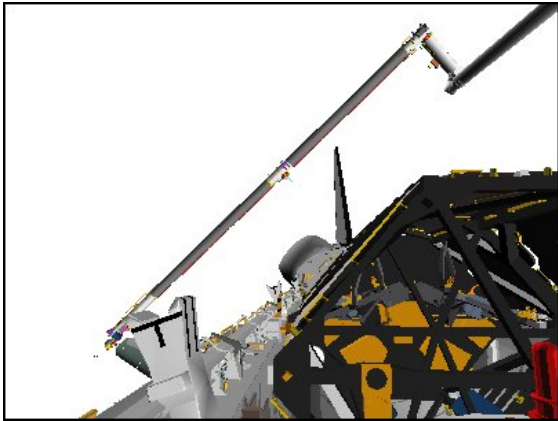

CCTV D (-5,10)

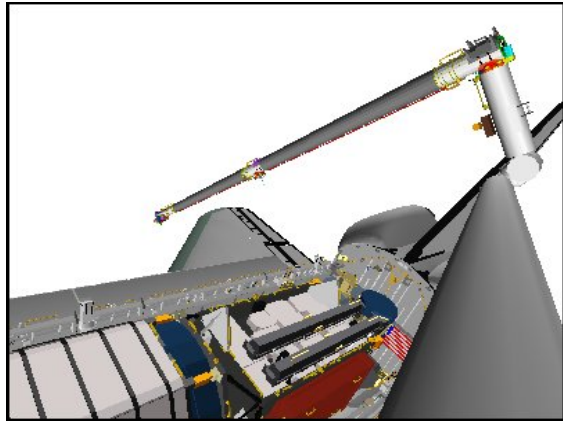

ELBOW (-30,-10)

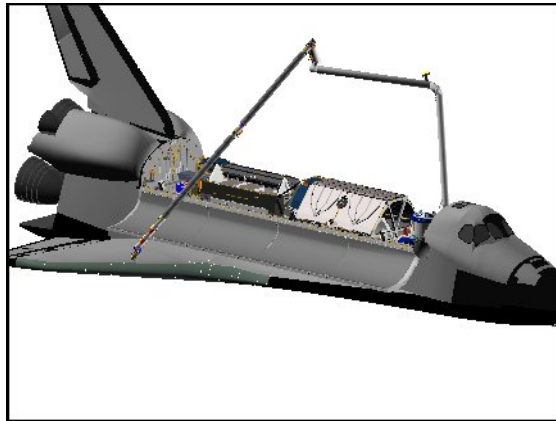

BIRD'S EYE

3. STBD IDC ACAS, SECTION 1

SM 94 PDRS CONTROL

PL ID – ITEM 3 +5 EXEC
 INIT ID – ITEM 24 +5 EXEC

NOTE

Section 1 scans RCC Zones 5 & 6, Panels 11 → 7. Time between Pts 130 and 132 ~ 1:10 min

Section 1 Clearance Views	Cameras
OBSS-to-PLBD	D, ELBOW, RSC
OBSS-to-Wing	C, ELBOW, RSC

RHC RATE – VERN (RATE MIN tb-ON)

- * If unable to enter AUTO mode (no AUTO READY It): *
- * √Joint angles and adjust as reqd *

BRAKES – OFF (tb-OFF)
 MODE – AUTO 1, ENTER (READY It on)

SM 94 PDRS CONTROL

√START PT, ITEM 17: 130

SM 169 PDRS STATUS

Monitor ACAS progress

LCC/PGSC sel 'Power On'

- Verify 'Use AE' checked
- sel 'Scan Lo-Res'
- √AE box centered in view (pause 2 sec)
- sel 'Scan Hi-Res'

AUTO SEQ – PROCEED (IN PROG It on)

ACAS, pause pts **shaded in bold**, ● col indicates damage criteria (inches)

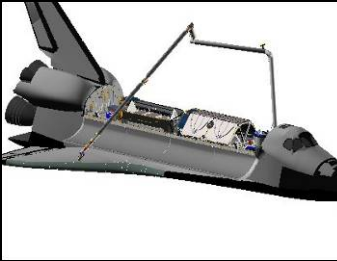
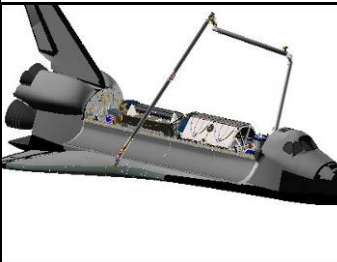
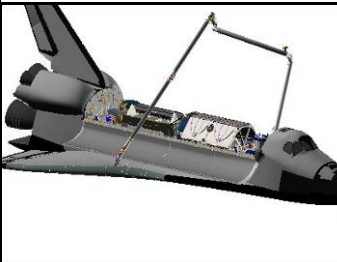
Pt	X	Y	Z	PITCH	YAW	ROLL	●
130P	-1123	+334	-374	292	43	266	
131	-1057	+284	-369	295	47	261	1/4 
132P	-1023	+276	-377	297	49	258	

LCC/PGSC When AUTO SEQ READY It – on:
 sel 'Stop Scan'

4. STBD IDC ACAS, SECTION 2

NOTE

Between Pts 132 and 133, arm is repositioned for scan of RCC zones 4-5. Expect C&W SINGULARITY between points 132 and 133. Section 2 then scans Panels 7 → 11. Time between Pts 132 and 133 ~ 3:00 min

Section 2 Clearance Views	Cameras
OBSS-to-PLBD	C, D, ELBOW, RSC
OBSS-to-Wing	C, ELBOW, RSC

AUTO SEQ – PROCEED (IN PROG It on)

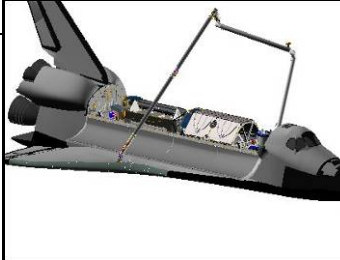
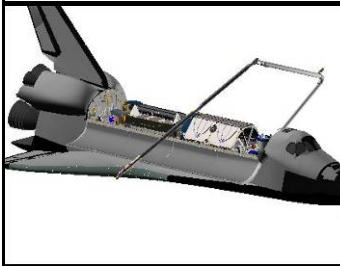
Pt	X	Y	Z	PITCH	YAW	ROLL	
132P	-1023	+276	-377	297	49	258	
133P	-992	+304	-342	328	58	254	

LCC/PGSC When AUTO SEQ READY It – on:
 sel 'Scan Lo-Res'
 √AE box centered in view (pause 2 sec)
 sel 'Scan Hi-Res'

NOTE

Time between Pts 133 and 134 ~ 1:40 min

AUTO SEQ – PROCEED (IN PROG It on)

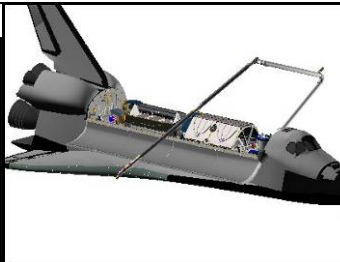
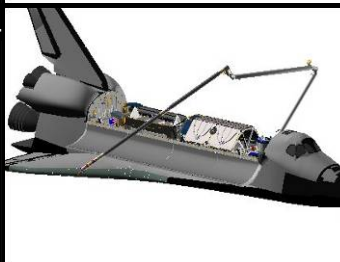
Pt	X	Y	Z	PITCH	YAW	ROLL	
133P	-992	+304	-342	328	58	254	
134P	-1104	+361	-348	310	52	272	

LCC/PGSC When AUTO SEQ READY It – on:
 sel 'Stop Scan'

5. STBD IDC ACAS, SECTION 3

NOTE

Between Pts 134 and 135, arm adjusts for scan of Zones 2-4.
 Section 3 then scans Zones 2-4, Panels 11 → 7. Time between
 Pts 134 and 135 ~ 1:40 min

Section 3 Clearance Views	Cameras
OBSS-to-PLBD	RSC
OBSS-to-WING	C, D, ELBOW, RSC

AUTO SEQ – PROCEED (IN PROG It on)

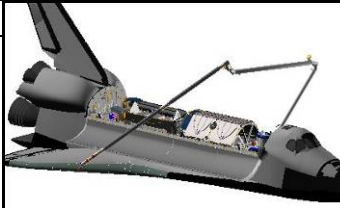
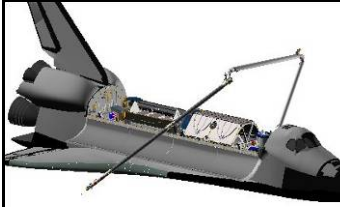
Pt	X	Y	Z	PITCH	YAW	ROLL	•
134P	-1104	+361	-348	310	52	272	
135P	-1080	+347	-285	14	46	219	

LCC/PGSC When AUTO SEQ READY It – on:
 sel 'Scan Lo-Res'
 √AE box centered in view (pause 2 sec)
 sel 'Scan Hi-Res'

NOTE

Time between Pts 135 and 137 ~ 1:20 min

AUTO SEQ – PROCEED (IN PROG It on)

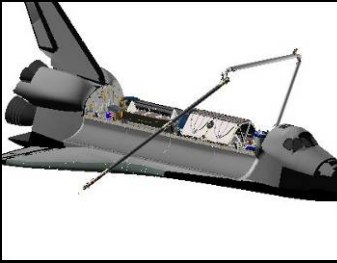
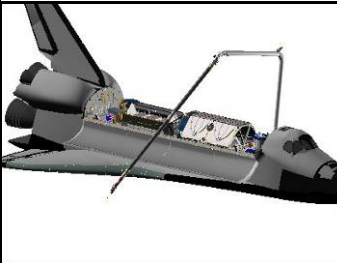
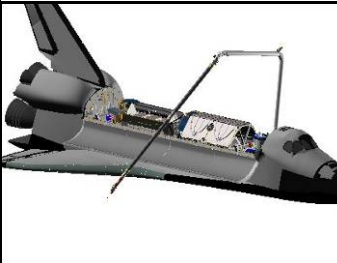
Pt	X	Y	Z	PITCH	YAW	ROLL	•
135P	-1080	+347	-285	14	46	219	
136	-1044	+304	-282	23	55	201	
137P	-1016	+297	-289	15	65	202	

LCC/PGSC When AUTO SEQ READY It – on:
sel 'Stop Scan'

6. STBD IDC ACAS, SECTION 4

NOTE

Between Pts 137 and 139, arm adjusts to scan Zones 2-3. Section 4 then scans Zones 2-3, Panels 7 → 11. Time between Pts 137 and 139 ~ 3:10 min

Section 4 Clearance Views	Cameras
OBSS-to-PLBD	RSC
OBSS-to-Wing	RSC
SRMS-to-ODS	A

AUTO SEQ – PROCEED (IN PROG It on)

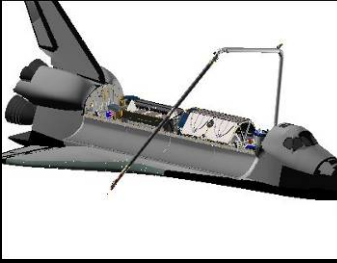
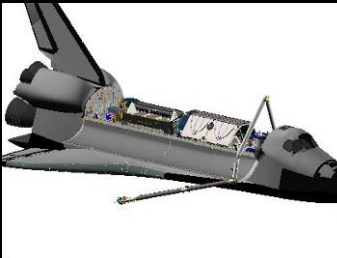
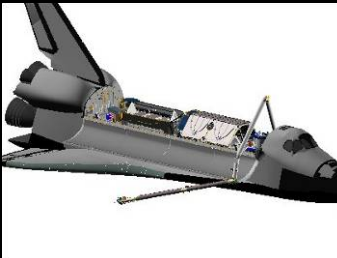
Pt	X	Y	Z	PITCH	YAW	ROLL	•
137P	-1016	+297	-289	15	65	202	
138	-1023	+275	-253	58	44	173	
139P	-1029	+235	-222	76	24	169	

LCC/PGSC When AUTO SEQ READY It – on:
sel 'Scan Lo-Res'
√AE box centered in view (pause 2 sec)
sel 'Scan Hi-Res'

NOTE

Time between Pts 139 and 140 ~ 1:20 min

AUTO SEQ – PROCEED (IN PROG It on)

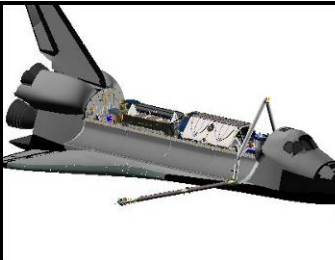
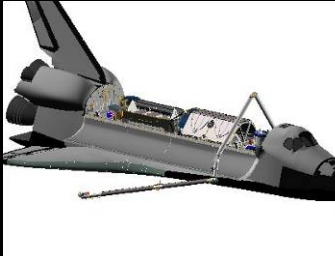
Pt	X	Y	Z	PITCH	YAW	ROLL	•
139P	-1029	+235	-222	76	24	169	
140P	-1119	+323	-229	75	23	178	1/4 

LCC/PGSC When AUTO SEQ READY It – on:
sel 'Stop Scan'

7. STBD IDC ACAS, SECTION 5

NOTE

Between Pts 140 and 141, arm adjusts to scan Zones 1-2. Section 5 then scans Zones 1-2, Panels 11 → 7.
Time between Pts 140 and 141 ~ 0:30 min

Section 5 Clearance Views	Cameras
OBSS-to-PLBD	RSC
OBSS-to-Wing	RSC
SRMS-to-ODS	A

AUTO SEQ – PROCEED (IN PROG It on)

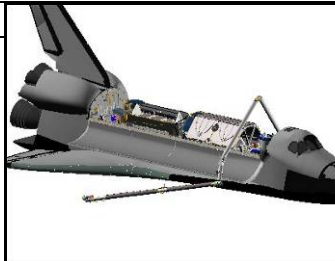
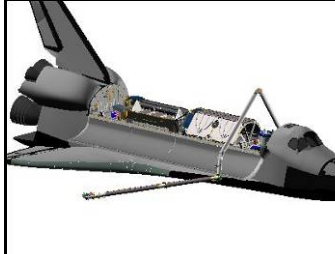
Pt	X	Y	Z	PITCH	YAW	ROLL	•
140P	-1119	+323	-229	75	23	178	
141P	-1128	+311	-224	74	23	178	

LCC/PGSC When AUTO SEQ IN PROG It – off:
 sel 'Scan Lo-Res'
 √AE box centered in view (pause 2 sec)
 sel 'Scan Hi-Res'

NOTE

Time between Pts 141 and 142 ~ 1:20 min

AUTO SEQ – PROCEED (IN PROG It on)

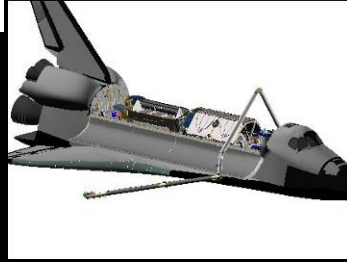
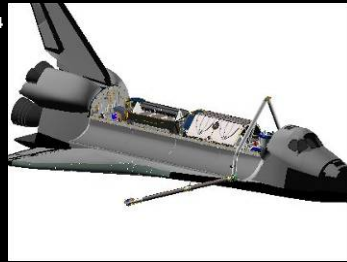
Pt	X	Y	Z	PITCH	YAW	ROLL	•
141P	-1128	+311	-224	74	23	178	
142P	-1033	+222	-212	75	23	166	

LCC/PGSC When AUTO SEQ IN PROG It – off:
 sel 'Stop Scan'
 sel 'Power off'

BRAKES – ON (tb-ON)

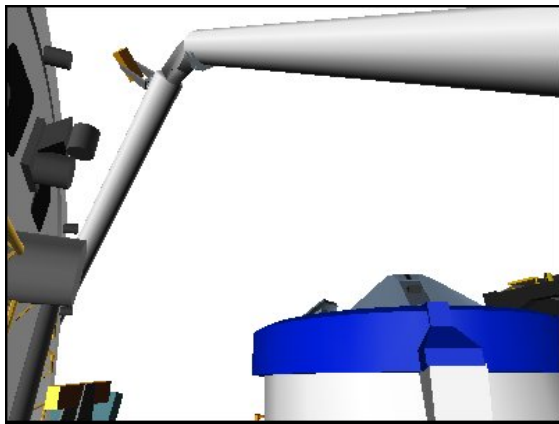

CCTV A (-65,25)

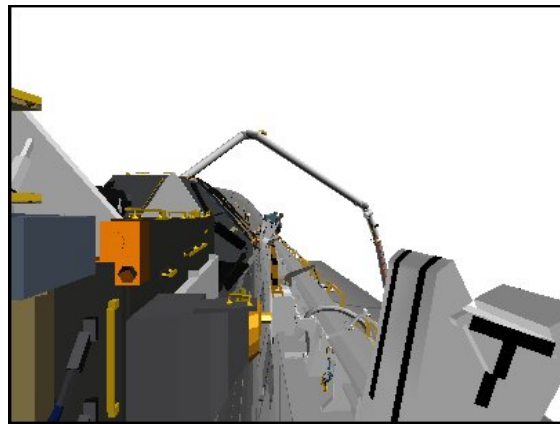

CCTV C (5,0)

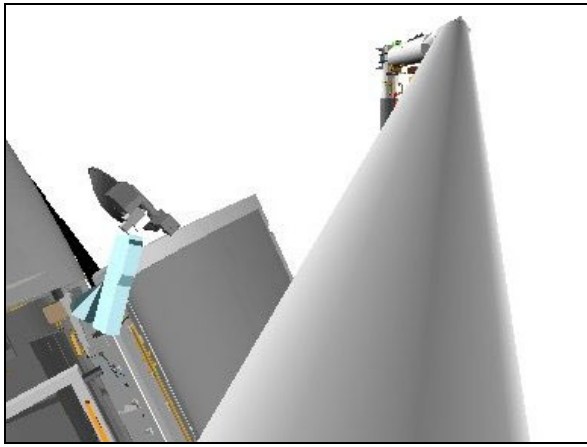

ELBOW (-20,-30)

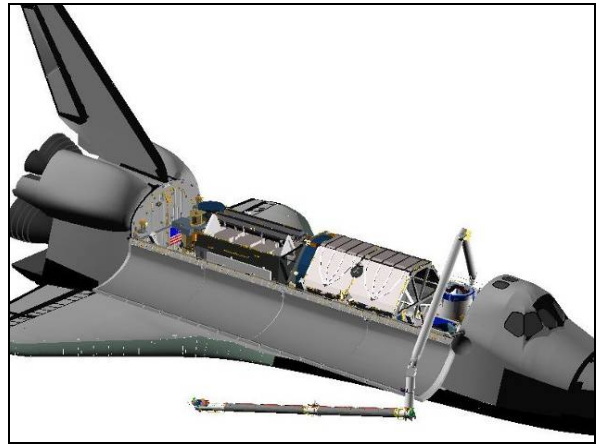

BIRD'S EYE

- RHC
8. CLEAN UP
 RATE – as reqd (VERN within 10 ft)
 BRAKES – OFF (tb-OFF)
 MODE – SINGLE, ENTER

If continuing OBSS ops with IDC Nose Cap survey:

Mnvr to LDRI STBD ACAS End:

IDC STBD ACAS End	SY	SP	EP	WP	WY	WR	
	-108.7	+20.8	-68.9	-33.5	-12.1	+149.1	
1: EP +			-23.7				
2: SP +		+32.5					
3: SY -	-120.8						
4: WP -				-45.8			
5: WY +					+12.8		
6: WR +						+164.7	
LDRI STBD ACAS End	-120.8	+32.5	-23.7	-45.8	+12.8	+164.7	
	X	Y	Z	PITCH	YAW	ROLL	PL ID
	-847	+286	-393	55	69	177	5

BRAKES – ON (tb-ON)

If returning immediately to OBSS Hover:

Mnvr to OBSS HOVER:

IDC STBD ACAS End	SY	SP	EP	WP	WY	WR	
	-108.7	+20.8	-68.9	-33.5	-12.1	+149.1	
1: WR -						+110.0	
2: SP +		+79.8					
3: SY +	-90.0						
4: WP -				-55.7			
5: WY +					0.0		
6: EP -			-123.1				
OBSS HOVER	-90.0	+79.8	-123.1	-55.7	0.0	+110.0	
	X	Y	Z	PITCH	YAW	ROLL	PL ID
	-1232	+130	-516	90	10	180	5

BRAKES – ON (tb-ON)

OBSS IDC RCC SURVEY – NOSE CAP

WARNING For UNDOCKED ops only Port PLBD radiator must be stowed
--

NOTE

Assumed starting posn is end of LDRI STBD ACAS End

1. SETUP

SM 94 PDRS CONTROL

√PL ID, ITEM 3: 5

√INIT ID, ITEM 24: 5

√	X	Y	Z	PITCH	YAW	ROLL	PLID
	-847	+286	-393	55	69	177	5
	SY	SP	EP	WP	WY	WR	
√	-120.8	+32.5	-23.7	-45.8	+12.8	+164.7	

√AUTO MODE 2, ITEM 14: 7

2. INHIBIT NOSE JETS

O14:F,
O15:F,
O16:F

√Pri RJDA LOGIC, DRIVER (eight) – ON

√Pri RJDF LOGIC, DRIVER (eight) – OFF

A6U

DAP: A14/AUTO/ALT (Tail Only)

NOTE

Expect DAP RECONFIG message after
FRCS manifold 5 status overridden to close

GNC 23 RCS

RCS FWD – ITEM 1 EXEC (*)

MANF VLVS OVRD 1 – ITEM 40 EXEC (CL)

2 – ITEM 41 EXEC (CL)

3 – ITEM 42 EXEC (CL)

4 – ITEM 43 EXEC (CL)

5 – ITEM 44 EXEC (CL)

- RHC 3. MNVr TO NOSE CAP IDC ACAS START POSITION
 RATE – as reqd (VERN within 10 ft)
 BRAKES – OFF (tb-OFF)
 MODE – SINGLE, ENTER

NOTE

Expect C/W SINGULARITY during lines 3 and 5 of the following single joint table

Mnvr to NOSE CAP IDC ACAS START posn:

	SY	SP	EP	WP	WY	WR	
LDR1 Stbd	-120.8	+32.5	-23.7	-45.8	+12.8	+164.7	
ACAS End							
1: WP +				+31.6			
2: WR +						+242.7	
3: SP +		+127.0					
4: SY –	-125.3						
5: EP –			-109.0				
6: WY –					-31.3		
Nose IDC	-125.3	+127.0	-109.0	+31.6	-31.3	+242.7	
ACAS Start							
	X	Y	Z	PITCH	YAW	ROLL	PL ID
	-198	-11	-408	318	356	191	5

BRAKES – ON (tb-ON)



CCTV A (40,20)

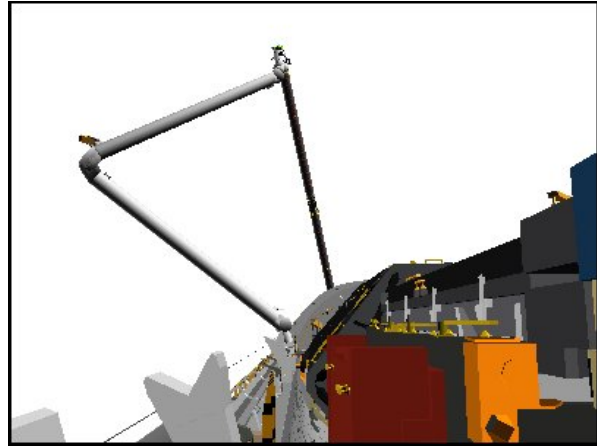

CCTV B (0,10)

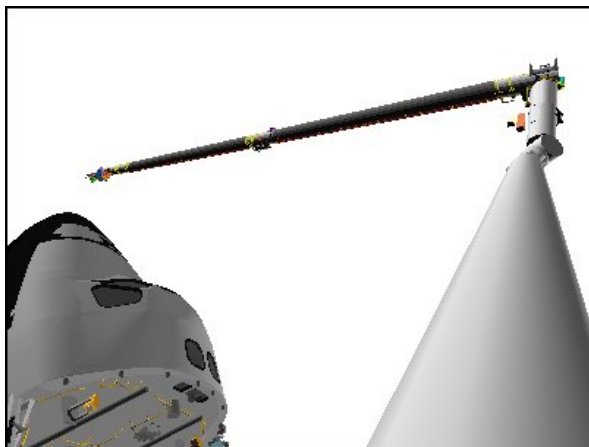

ELBOW (-30,-15)

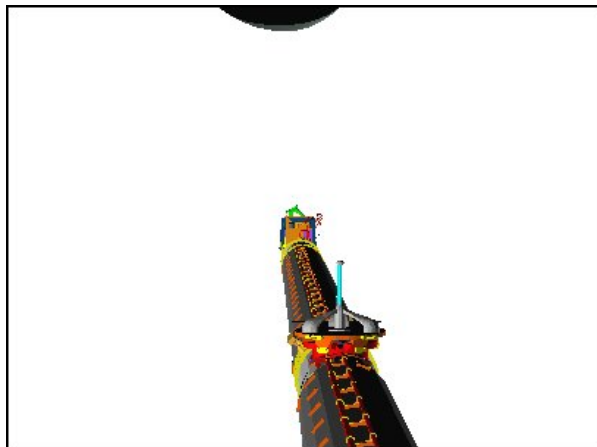

RSC

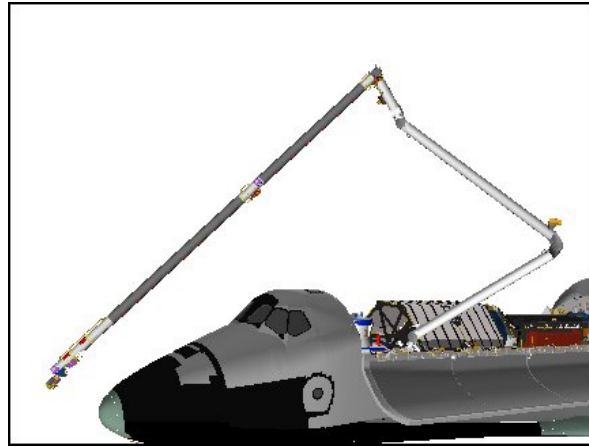

BIRD'S EYE

4. NOSE CAP IDC ACAS, SECTION 1

NOTE

Time between Pts 143 and 147 ~ 5:40 min

Section 1 Clearance Views	Cameras
OBSS-to-Nose Cap	ELBOW, RSC
SRMS-to-APAS	A, ELBOW
SRMS-to-Fwd Bulkhead	A, D, ELBOW

RHC

RATE – VERN (RATE MIN tb-ON)

- * If unable to enter AUTO mode (no AUTO READY It): *
- * √Joint angles and adjust as reqd *

BRAKES – OFF (tb-OFF)
 MODE – AUTO 2, ENTER (READY It on)

SM 94 PDRS CONTROL

√START PT, ITEM 17: 143

SM 169 PDRS STATUS

Monitor ACAS progress

LCC/PGSC sel 'Power On'

Verify 'Use AE' checked
 sel 'Scan Lo-Res'
 √AE box centered in view (pause 2 sec)
 sel 'Scan Hi-Res'

AUTO SEQ – PROCEED (IN PROG It on)

ACAS, pause pts **shaded in bold**, ● col indicates damage criteria (inches)

Pt	X	Y	Z	PITCH	YAW	ROLL	●
143P	-198	-11	-408	318	356	191	1/4
144	-198	+21	-403	319	7	178	
145	-202	+56	-380	332	32	141	
146	-209	+81	-342	354	52	116	
147P	-239	+77	-271	58	46	63	

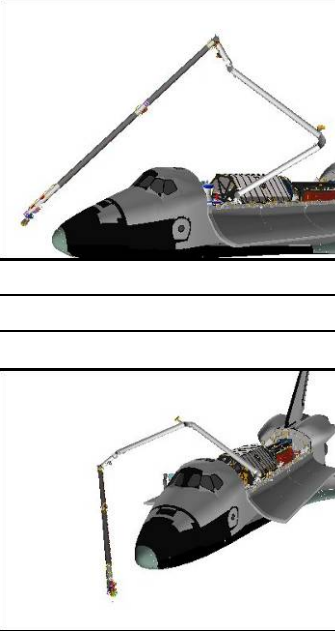

NOTE

Time between Pts 147 and 148 ~ 0:30 min

AUTO SEQ – PROCEED (IN PROG It on)

147P	-239	+77	-271	58	46	63	1/4
148P	-224	+70	-279	58	46	63	

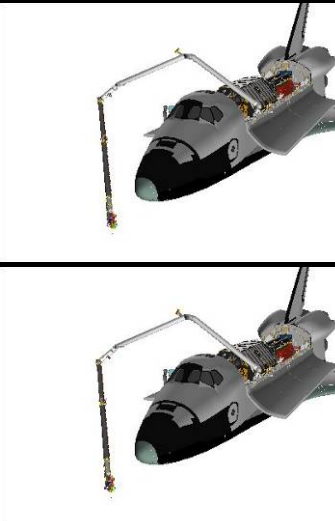

NOTE

Time between Pts 148 and 149 ~ 1:00 min

AUTO SEQ – PROCEED (IN PROG It on)

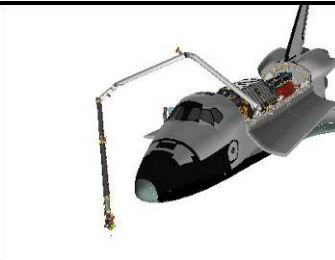
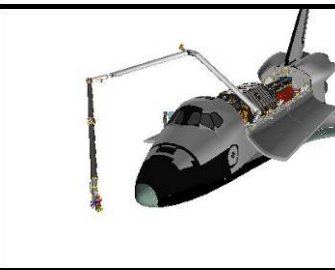
Pt	X	Y	Z	PITCH	YAW	ROLL	
148P	-224	+70	-279	58	46	63	
149P	-191	+73	-344	19	52	94	

LCC/PGSC When AUTO SEQ IN PROG It – off:
 sel 'Stop Scan'
 sel 'Power off'

BRAKES – ON (tb-ON)

RHC 5. MNVR TO NOSE CAP IDC ACAS POINT 150
 RATE – as reqd (VERN within 10 ft)
 BRAKES – OFF (tb-OFF)
 MODE – SINGLE, ENTER

NOTE

Expect C/W SINGULARITY during lines 3 and 6
of the following single joint table

Mnvr to NOSE CAP IDC ACAS POINT 150 posn:

	SY	SP	EP	WP	WY	WR	
NOSE IDC ACAS Pt 149	-96.9	+21.0	-54.8	+2.0	-29.6	+266.6	
1: WY +					+13.1		
2: WP +				+12.7			
3: SP +		+137.2					
4: WR –						+155.8	
5: SY +	+128.3						
6: EP –			-118.5				
NOSE IDC ACAS Pt 150	+128.3	+137.2	-118.5	+12.7	+13.1	+155.8	
	X	Y	Z	PITCH	YAW	ROLL	PL ID
	-205	-57	-383	336	319	217	5

BRAKES – ON (tb-ON)

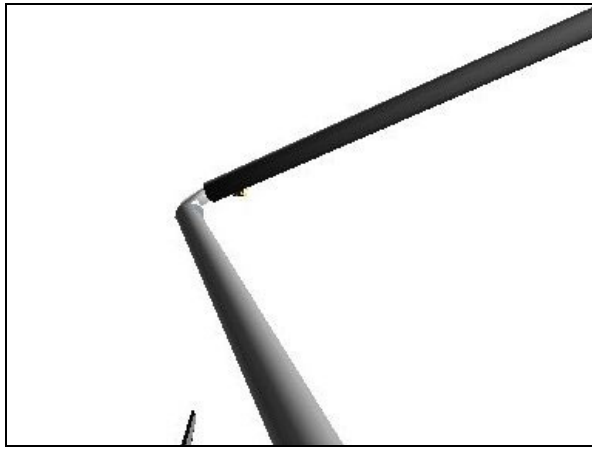

CCTV A (10,45)

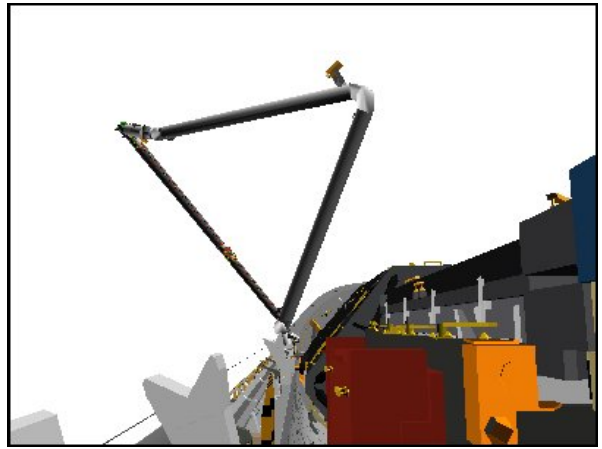

CCTV B (0,10)

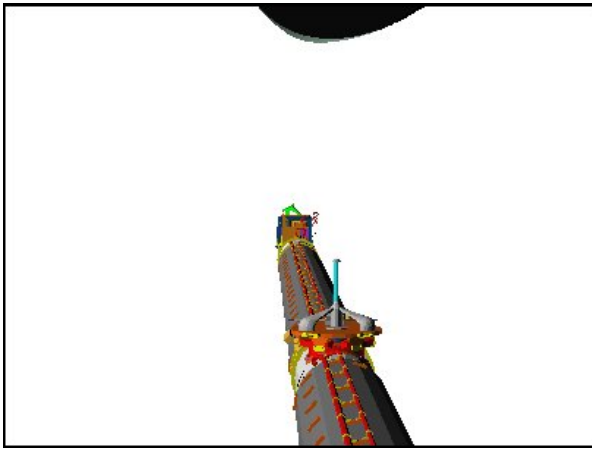

RSC

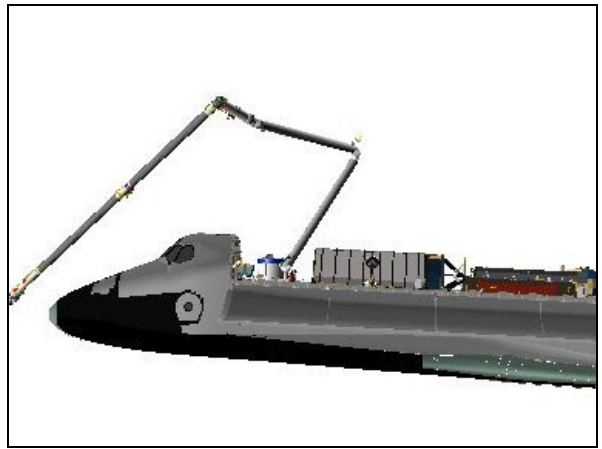

PORT

6. NOSE CAP IDC ACAS, SECTION 2

SM 94 PDRS CONTROL

√PL ID, ITEM 3: 5

√INIT ID, ITEM 24: 5

√AUTO MODE 3, ITEM 15: 8

NOTE

Time between Pts 150 and 153 ~ 4:15 min

Section 2 Clearance Views	Cameras
OBSS-to-Nose Cap	ELBOW, RSC
OBSS-to-PLBD	A, B, ELBOW
OBSS-to-Fwd Bulkhead	A, B

RHC

RATE – VERN (RATE MIN tb-ON)

* If unable to enter AUTO mode (no AUTO READY It): *

* √Joint angles and adjust as reqd *

BRAKES – OFF (tb-OFF)

MODE – AUTO 3, ENTER (READY It on)

SM 94 PDRS CONTROL

√START PT, ITEM 17: 150

SM 169 PDRS STATUS

Monitor ACAS progress

LCC/PGSC sel 'Power On'



Verify 'Use AE' checked

sel 'Scan Lo-Res'

√AE box centered in view (pause 2 sec)

sel 'Scan Hi-Res'



AUTO SEQ – PROCEED (IN PROG It on)

Pt	X	Y	Z	PITCH	YAW	ROLL	
150P	-205	-57	-383	336	319	217	
151	-204	-76	-337	6	314	259	
152	-213	-65	-293	40	326	272	¼
153P	-235	-50	-256	62	339	275	

NOTE

Time between Pts 153 and 154 ~ 1:00 min

AUTO SEQ – PROCEED (IN PROG It on)

Pt	X	Y	Z	PITCH	YAW	ROLL	•	
153P	-235	-50	-256	62	339	275		
154P	-234	-22	-253	61	332	272	1/4	

NOTE

Time between Pts 154 and 157 ~ 4:30 min

AUTO SEQ – PROCEED (IN PROG It on)

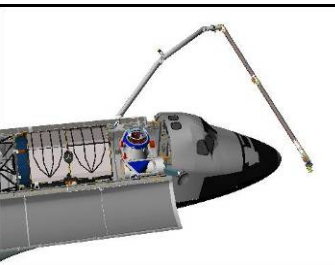
154P	-234	-22	-253	61	332	272		
155	-195	-2	-277	35	349	281		
156	-183	-4	-299	31	349	281	1/4	
157P	-168	+1	-331	5	348	259		

NOTE

Time between Pts 157 and 158 ~ 1:15 min

AUTO SEQ – PROCEED (IN PROG It on)

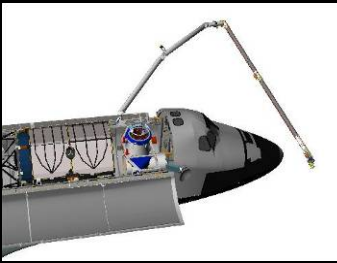
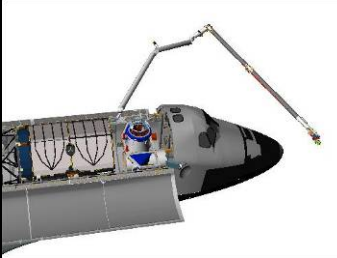
Pt	X	Y	Z	PITCH	YAW	ROLL	•
157P	-168	+1	-331	5	348	259	
158P	-163	-12	-382	336	346	261	1/4 

NOTE

Time between Pts 158 and 159 ~ 1:15 min

AUTO SEQ – PROCEED (IN PROG It on)

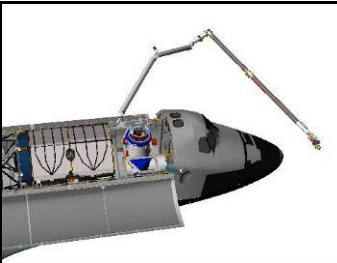
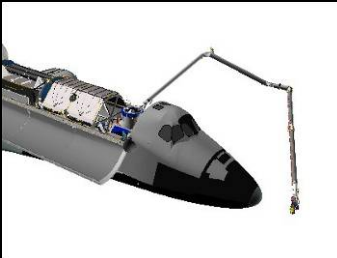
Pt	X	Y	Z	PITCH	YAW	ROLL	•
158P	-163	-12	-382	336	346	261	
159P	-173	-41	-348	5	337	260	1/4 

NOTE

Time between Pts 159 and 161 ~ 1:25 min

AUTO SEQ – PROCEED (IN PROG It on)

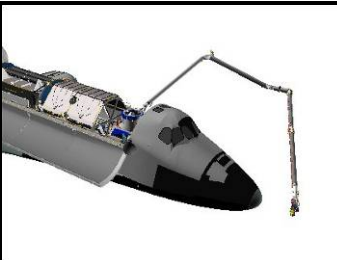
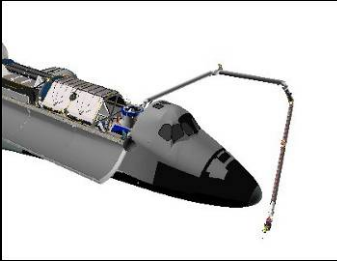
Pt	X	Y	Z	PITCH	YAW	ROLL	•
159P	-173	-41	-348	5	337	260	
160	-182	-47	-317	19	336	264	
161P	-219	-44	-264	62	339	275	

NOTE

Time between Pts 161 and 162 ~ 0:45 min

AUTO SEQ – PROCEED (IN PROG It on)

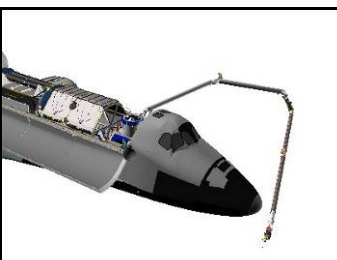
Pt	X	Y	Z	PITCH	YAW	ROLL	•
161P	-219	-44	-264	62	339	275	
162P	-196	-21	-284	33	341	267	

NOTE

Time between Pts 162 and 163 ~ 0:35 min

AUTO SEQ – PROCEED (IN PROG It on)

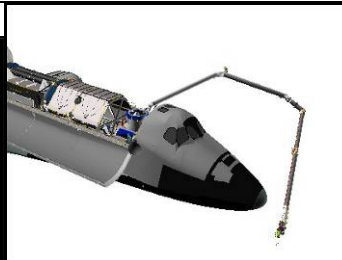
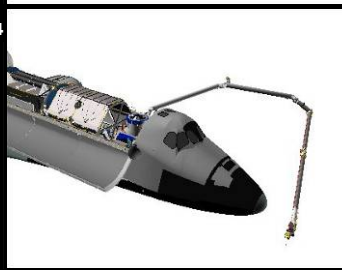
Pt	X	Y	Z	PITCH	YAW	ROLL	●
162P	-196	-21	-284	33	341	267	
163P	-175	-25	-302	33	341	267	1/4 

NOTE

Time between Pts 163 and 164 ~ 0:20 min

AUTO SEQ – PROCEED (IN PROG It on)

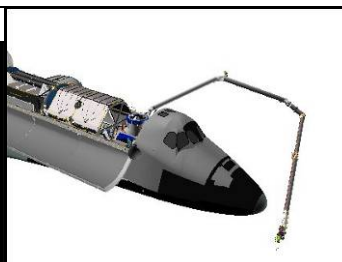
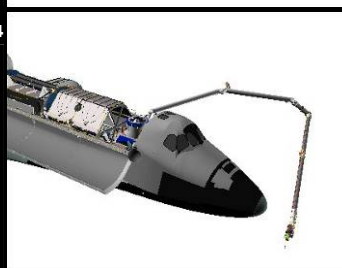
Pt	X	Y	Z	PITCH	YAW	ROLL	●
163P	-175	-25	-302	33	341	267	
164P	-180	-33	-297	33	341	267	1/4 

LCC/PGSC When AUTO SEQ IN PROG It – off:
 sel 'Stop Scan'
 sel 'Power off'

BRAKES – ON (tb-ON)

7. MNVR TO NOSE JET CLEAR POSN

RHC

a. Intermediate Maneuver

RATE – as reqd (VERN within 10 ft)
 BRAKES – OFF (tb-OFF)
 MODE – SINGLE, ENTER

Drive WR “-” to +110.0

INTERMEDIATE posn:

	X	Y	Z	PITCH	YAW	ROLL	PL ID
√	-9	-153	-638	33	341	309	5
	SY	SP	EP	WP	WY	WR	
√	+128.3	+28.6	-22.6	-29.4	+19.1	+110.0	

BRAKES – ON (tb-ON)

b. Nose Jet Clear Maneuver

SM 94 PDRS CONTROL

PL ID – ITEM 3 +2 EXEC
 INIT ID – ITEM 24 +2 EXEC
 END POS – ITEM 18 -3 2 5 -7 4 8 -6 8 0 EXEC
 ATT – ITEM 21 +8 3 +3 9 +2 0 0 EXEC
 CMD CK – ITEM 25 EXEC (GOOD)

RHC

RATE – COARSE (RATE MIN tb-OFF)

BRAKES – OFF (tb-OFF)
 MODE – OPR CMD, ENTER (READY It on)

AUTO SEQ – PROCEED (IN PROG It on)

When AUTO SEQ IN PROG It – off:
 BRAKES – ON (tb-ON)

NOSE JET CLEAR posn:

	X	Y	Z	PITCH	YAW	ROLL	PL ID
√	-325	-748	-680	83	39	200	2
	SY	SP	EP	WP	WY	WR	
√	+128.8	+30.3	-28.5	-2.0	+35.0	0.0	

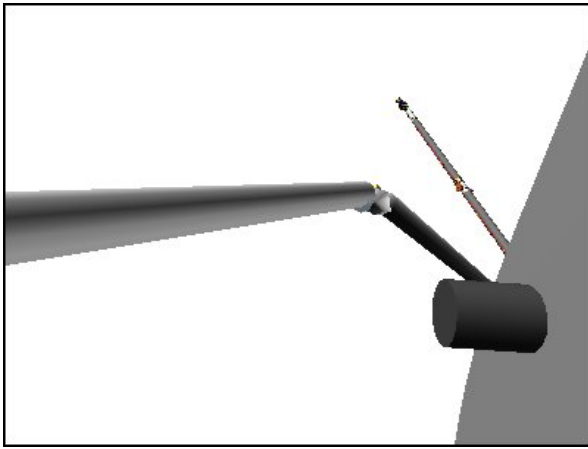

CCTV A (95,10)

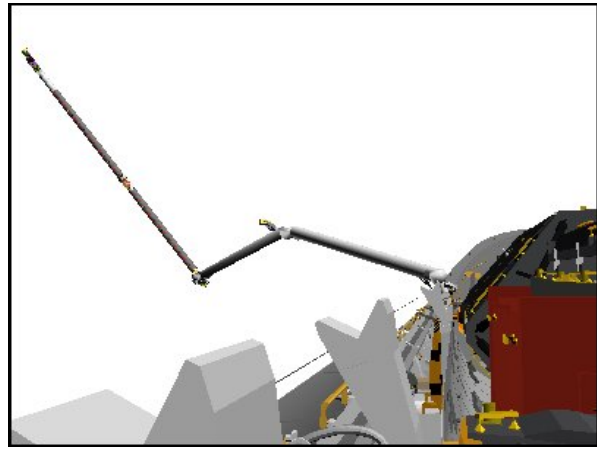

CCTV B (-15,5)

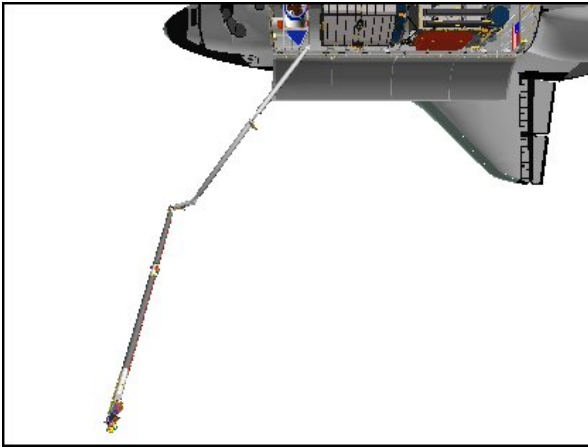

OVERHEAD

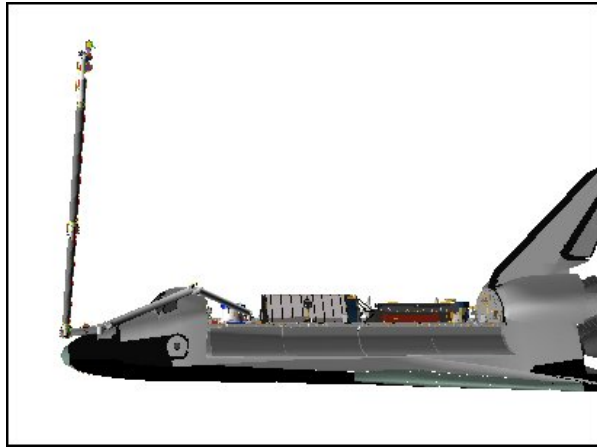

PORT

8. ENABLE NOSE JETS

GNC 23 RCS

RCS FWD – ITEM 1 EXEC (*)

MANF VLVS OVRD 5 – ITEM 44 EXEC (OP)

A6U DAP: VERN (FREE)

O14:F, Pri RJDA LOGIC,DRIVER (eight) – OFF

O15:F,

O16:F RJDA 1A L2/R2 DRIVER – ON

If continuing OBSS ops with IDC Port survey >>

- RHC 9. RETURN TO OBSS HOVER
 RATE – as reqd (VERN within 10 ft)
 BRAKES – OFF (tb-OFF)
 MODE – SINGLE, ENTER

Mnvr to OBSS HOVER posn:

	SY	SP	EP	WP	WY	WR	
NOSE JET CLEAR	+128.8	+30.3	-28.5	-2.0	+35.0	0.0	
1: WR +						+110.0	
2: SP +		+79.8					
3: SY -	-90.0						
4: WP -				-55.7			
5: WY -					0.0		
6: EP -			-123.1				
OBSS HOVER	-90.0	+79.8	-123.1	-55.7	0.0	+110.0	
	X	Y	Z	PITCH	YAW	ROLL	PL ID
	-998	+129	-507	0	0	11	2

BRAKES – ON (tb-ON)

GNC 23 RCS

√RCS FWD, ITEM 1: *

- MANF VLVS OVRD 1 – ITEM 40 EXEC (OP)
- 2 – ITEM 41 EXEC (OP)
- 3 – ITEM 42 EXEC (OP)
- 4 – ITEM 43 EXEC (OP)

A6U DAP: as reqd

OBSS IDC RCC SURVEY – PORT

WARNING
 For UNDOCKED ops only
 Port PLBD radiator must be stowed

NOTE

Assumed starting posn is end of IDC Nose Cap survey

1. SETUP

SM 94 PDRS CONTROL

√ PL ID – ITEM 3: 2

√ INIT ID – ITEM 24: 2

RHC

2. MNVR TO PORT IDC ACAS START POSN

RATE – as reqd (VERN within 10 ft)

BRAKES – OFF (tb-OFF)

MODE – SINGLE, ENTER

	X	Y	Z	PITCH	YAW	ROLL	PLID
√	-325	-748	-680	83	39	200	2
	SY	SP	EP	WP	WY	WR	
√	+128.8	+30.3	-28.5	-2.0	+35.0	0.0	

Mnvr to PORT IDC ACAS START posn:

	SY	SP	EP	WP	WY	WR	
NOSE JET CLEAR	+128.8	+30.3	-28.5	-2.0	+35.0	0.0	
1: SY –	+91.2						
2: SP +		+60.1					
3: WY –					+6.8		
4: WR –						-116.8	
5: EP –			-68.1				
6: WP –				-41.3			
PORT IDC ACAS START	+91.2	+60.1	-68.1	-41.3	+6.8	-116.8	
	X	Y	Z	PITCH	YAW	ROLL	PL ID
	-882	-378	-296	333	320	332	2

BRAKES – ON (tb-ON)

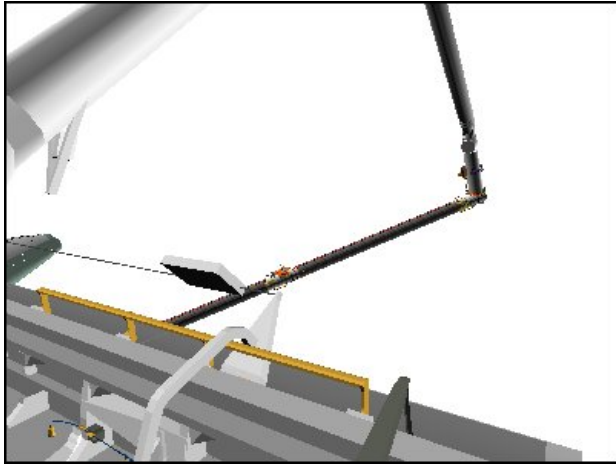

CCTV A (60,-10)

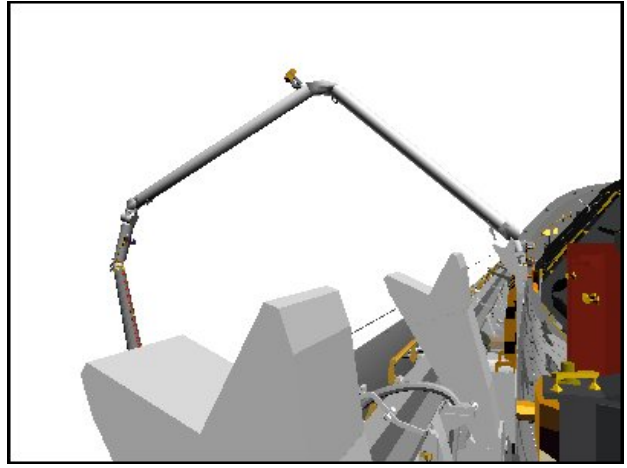

CCTV B (-20,0)

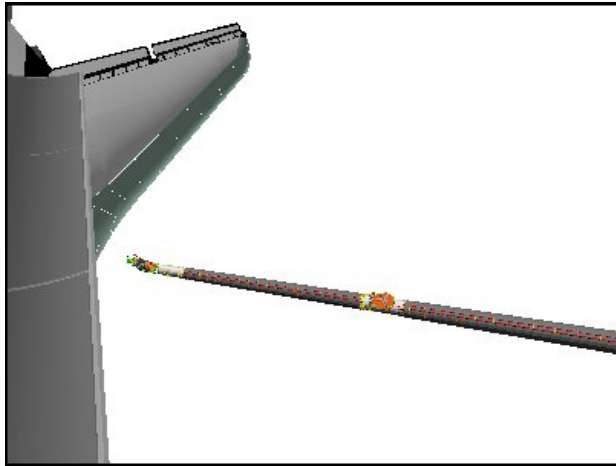

ELBOW (-60,0)

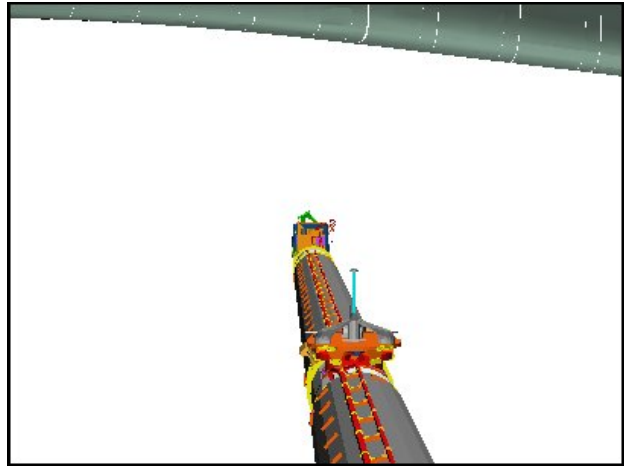

RSC

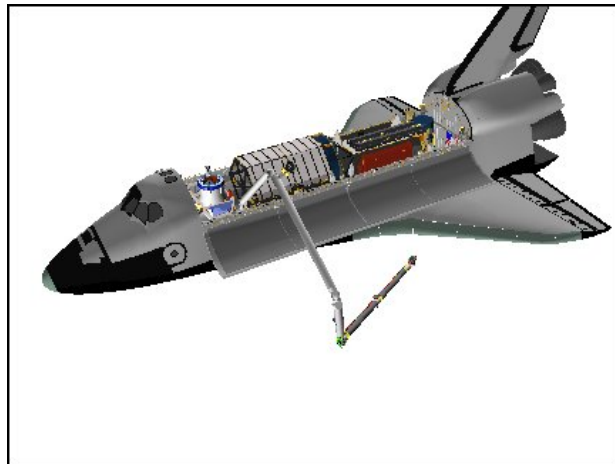

BIRD'S EYE

3. PORT IDC ACAS, SECTION 1

SM 94 PDRS CONTROL

PL ID – ITEM 3 +5 EXEC
INIT ID – ITEM 24 +5 EXEC

√	X	Y	Z	PITCH	YAW	ROLL	PLID
	-1043	-224	-223	82	339	223	5
√	SY	SP	EP	WP	WY	WR	
	+91.2	+60.1	-68.1	-41.3	+6.8	-116.8	

√AUTO MODE 4, ITEM 16: 9

RHC

√RATE – VERN (RATE MIN tb-ON)

- * If unable to enter AUTO mode (no AUTO READY It): *
- * √Joint angles and adjust as reqd *

BRAKES – OFF (tb-OFF)
MODE – AUTO 4, ENTER (READY It on)

SM 94 PDRS CONTROL

√START PT, ITEM 17: 165

SM 169 PDRS STATUS

Monitor ACAS progress

NOTE

Section 1 scans RCC Zones 1-2, Panels 7 → 11. Time between Pts 165 and 167 ~ 1:40 min

Section 1 Clearance Views	Cameras
RMS Upper Arm to PLBD	A, B
OBSS-to-PLBD	ELBOW
OBSS-to-Wing	ELBOW, RSC

LCC/PGSC On MCC GO:
sel 'Power On'

Verify 'Use AE' checked
sel 'Scan Lo-Res'
√AE box centered in view (pause 2 sec)
sel 'Scan Hi-Res'

AUTO SEQ – PROCEED (IN PROG It on)

ACAS, pause pts **shaded in bold**, ● col indicates data recording

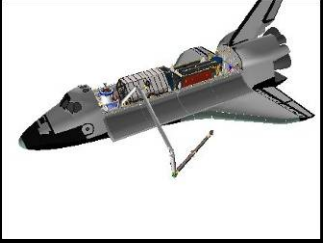
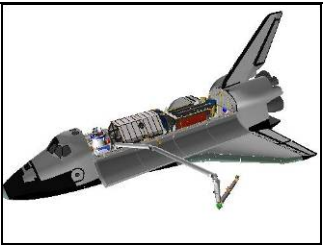
Pt	X	Y	Z	PITCH	YAW	ROLL	●	
165P	-1043	-224	-223	82	339	223		
166	-1064	-233	-219	82	339	223	1/4	
167P	-1131	-308	-228	78	336	222		

LCC/PGSC When AUTO SEQ READY It – on:
sel 'Stop Scan'

4. PORT IDC ACAS, SECTION 2

NOTE

Between points 167 and 168, arm adjusts to survey
RCC zones 2-3. Section 2 then scans panels 11 → 7.
Time between Pts 167 and 168 ~ 0:30 min

Section 2 Clearance Views	Cameras
RMS Upper Arm-to-PLBD	A, B
OBSS-to-PLBD	ELBOW
OBSS-to-Wing	ELBOW, RSC

AUTO SEQ – PROCEED (IN PROG It on)

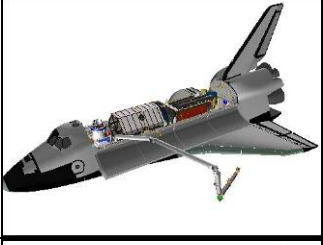
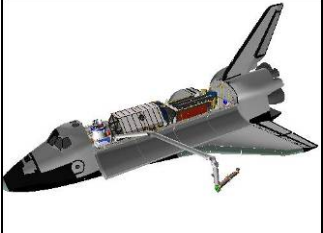
Pt	X	Y	Z	PITCH	YAW	ROLL	●	
167P	-1131	-308	-228	78	336	222		
168P	-1123	-315	-234	76	334	221		

LCC/PGSC When AUTO SEQ READY It – on:
sel 'Scan Lo-Res'
√AE box centered in view (pause 2 sec)
sel 'Scan Hi-Res'

5. PORT IDC ACAS, SECTION 3

NOTE

Between points 170 and 171, arm adjust to survey RCC zones 3-4.
 Section 3 then scans panels 7 → 11. Time between Pts 170 and 171 ~ 2:40 min

Section 3 Clearance Views	Cameras
RMS Upper Arm-to-PLBD	A, B
OBSS-to-PLBD	ELBOW
OBSS-to-Wing	ELBOW, RSC

AUTO SEQ – PROCEED (IN PROG It on)

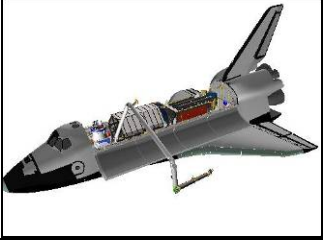
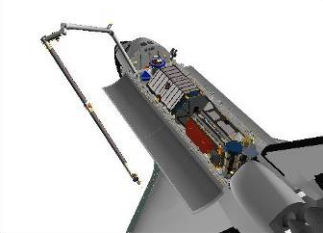

Pt	X	Y	Z	PITCH	YAW	ROLL	•
170P	-1032	-239	-227	76	334	221	
171P	-1008	-268	-262	44	311	213	

LCC/PGSC When AUTO SEQ READY It – on:
 sel 'Scan Lo-Res'
 √AE box centered in view (pause 2 sec)
 sel 'Scan Hi-Res'

NOTE

Time between Pts 171 and 174 ~ 1:15 min

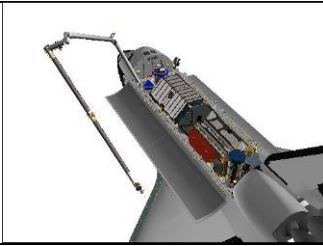
AUTO SEQ – PROCEED (IN PROG It on)

Pt	X	Y	Z	PITCH	YAW	ROLL	•
171P	-1008	-268	-262	44	311	213	
172	-1028	-284	-258	44	311	213	1/4
173	-1054	-306	-258	42	312	206	
174P	-1098	-339	-265	41	315	198	

LCC/PGSC When AUTO SEQ READY It – on:
 sel 'Stop Scan'

6. PORT IDC ACAS, SECTION 4



NOTE

Between points 174 and 177 arm adjusts to scan RCC zone 5. Section 4 then scans panels 11 → 7. Time between Pts 174 and 177 ~ 7:20 min

Section 4 Clearance Views	Cameras
RMS Upper Arm-to-PLBD	A, B
OBSS-to-PLBD	ELBOW
OBSS-to-Wing	B, RSC

RHC RATE – COARSE (RATE MIN tb-OFF)

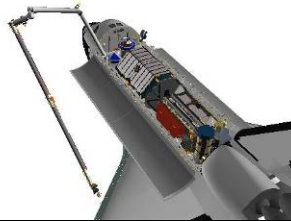
AUTO SEQ – PROCEED (IN PROG It on)

Pt	X	Y	Z	PITCH	YAW	ROLL	•
174P	-1098	-339	-265	41	315	198	
175	-1033	-343	-265	41	315	198	
176	-1030	-343	-361	115	315	198	
177P	-1124	-349	-359	273	312	336	

When AUTO SEQ READY It – on:

RHC RATE – VERN (RATE MIN tb-ON)

LCC/PGSC sel 'Scan Lo-Res'
 √AE box centered in view (pause 2 sec)
 sel 'Scan Hi-Res'

7. PORT IDC ACAS, SECTION 5

NOTE

Between points 179 and 180, arm adjusts to scan RCC zone 6.
 Section 5 then scans panels 7 → 11. Time between Pts 179
 and 180 ~ 0:40 min

Section 5 Clearance Views	Cameras
RMS Upper Arm-to-PLBD	A, B
OBSS-to-PLBD	ELBOW
OBSS-to-Wing	B, RSC

AUTO SEQ – PROCEED (IN PROG It on)

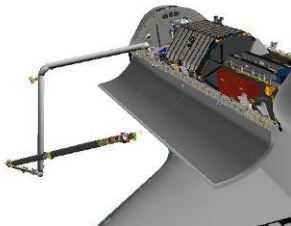

Pt	X	Y	Z	PITCH	YAW	ROLL	•
179P	-1047	-297	-364	264	304	326	
180P	-1070	-292	-370	259	304	325	

LCC/PGSC When AUTO SEQ READY It – on:
 sel 'Scan Lo-Res'
 √AE box centered in view (pause 2 sec)
 sel 'Scan Hi-Res'

NOTE

Time between Pts 180 and 182 ~ 1:10 min

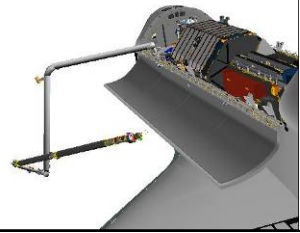
AUTO SEQ – PROCEED (IN PROG It on)

Pt	X	Y	Z	PITCH	YAW	ROLL	
180P	-1070	-292	-370	259	304	325	
181	-1148	-348	-375	273	312	335	
182P	-1124	-349	-359	273	312	336	

LCC/PGSC When AUTO SEQ IN PROG It – off:
 sel 'Stop Scan'
 sel 'Power off'

BRAKES – ON (tb-ON)

8. MNVR TO OBSS HOVER POSN

SM 94 PDRS CONTROL

PL ID – ITEM 3 +2 EXEC

INIT ID – ITEM 24 +2 EXEC

	X	Y	Z	PITCH	YAW	ROLL	PLID
√	-913	-418	-285	21	344	231	2
	SY	SP	EP	WP	WY	WR	
√	+96.6	+5.7	-57.3	+112.8	-1.2	-38.0	

RHC RATE – as reqd (VERN within 10 ft)
 BRAKES – OFF (tb-OFF)
 MODE – SINGLE, ENTER

Mnvr to OBSS HOVER posn:

	SY	SP	EP	WP	WY	WR	
PORT End	+96.6	+5.7	-57.3	+112.8	-1.2	-38.0	
1: SP +		+79.8					
2: WP -				0.0			
3: WY +					0.0		
4: WR +						+110.0	
5: SY -	-90.0						
6: WP -				-55.7			
7: EP -			-123.1				
OBSS HOVER	-90.0	+79.8	-123.1	-55.7	0.0	+110.0	
	X	Y	Z	PITCH	YAW	ROLL	PL ID
	-998	+129	-507	0	0	11	2

BRAKES – ON (tb-ON)

GNC 23 RCS

√RCS FWD, ITEM 1: *

- MANF VLVS OVRD 1 – ITEM 40 EXEC (OP)
- 2 – ITEM 41 EXEC (OP)
- 3 – ITEM 42 EXEC (OP)
- 4 – ITEM 43 EXEC (OP)

A6U

DAP: as reqd

OBSS HOVER posn:

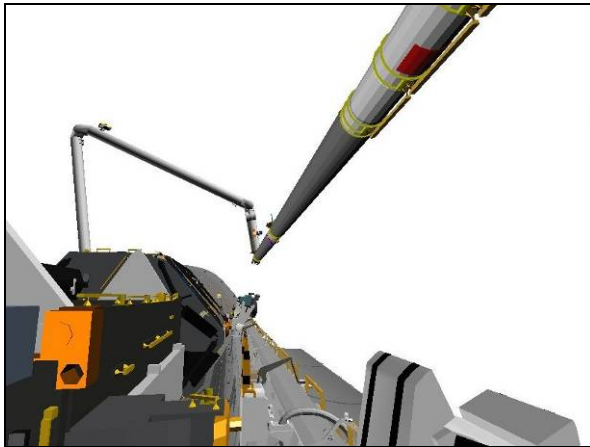

CCTV C (10,10)

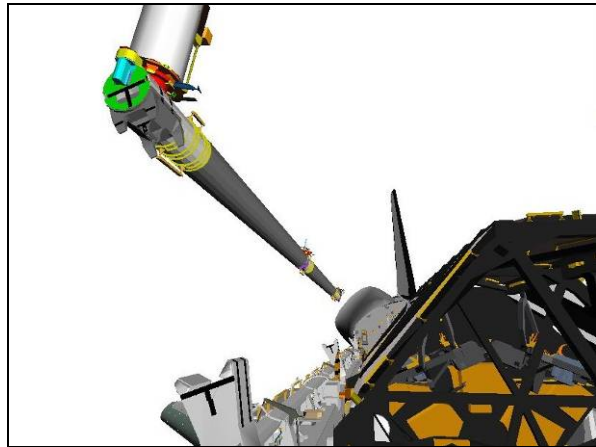

CCTV D (-10,15)

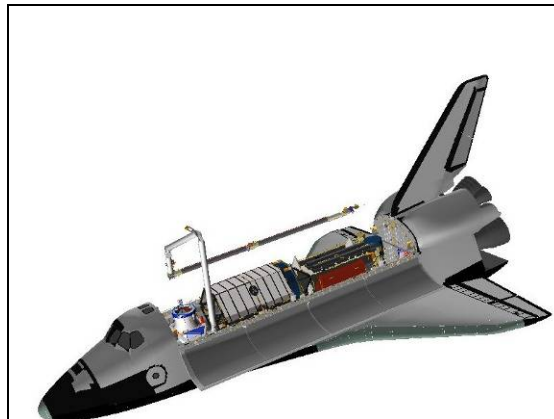

BIRD'S EYE

OBSS SJ UNBERTH

WARNING
For UNDOCKED ops only

NOTE

Stbd MPMs assumed deployed

1. SETUP

- CCTV – config as required
 - perform PAN/TILT RESET for PLB cameras
- ZOOM – full OUT

If SINGLE MODE available:

SM 94 PDRS CONTROL

- √PL ID, ITEM 3: 0
- √INIT ID, ITEM 24: 0

If flight specific DAPs have not been loaded:

Load DAP A14 with permanent edits per STS-115 DAP A CONFIGURATIONS (ORB OPS FS, DAP TABLES). This may be worked in parallel with the following steps 2-4

2. MNVR TO OBSS SJ PRE-GRAPPLE

If SINGLE MODE available:

- RHC
- RATE – as reqd (VERN within 10 ft)
 - BRAKES – OFF (tb-OFF)

MODE – best available

Mnvr to OBSS SJ PRE-GRAPPLE posn:

	SY	SP	EP	WP	WY	WR	
PRE-CRADLE	0.0	+25.0	-25.0	+5.0	0.0	0.0	
1: SP +		+87.9					
2: SY -	-90.0						
3: WP -				-57.0			
4: WR +						+110.0	
5: EP -			-129.8				
OBSS SJ PRE-GRAPPLE	-90.0	+87.9	-129.8	-57.0	0.0	+110.0	
	X	Y	Z	PITCH	YAW	ROLL	PL ID
	-680	+96	-513	270	350	1	0

- BRAKES – ON (tb-ON)
- MODE – not DIRECT
- JOINT – CRIT TEMP

Start:

Step 1:

Drive SP (+) from +25.0° to +87.9°

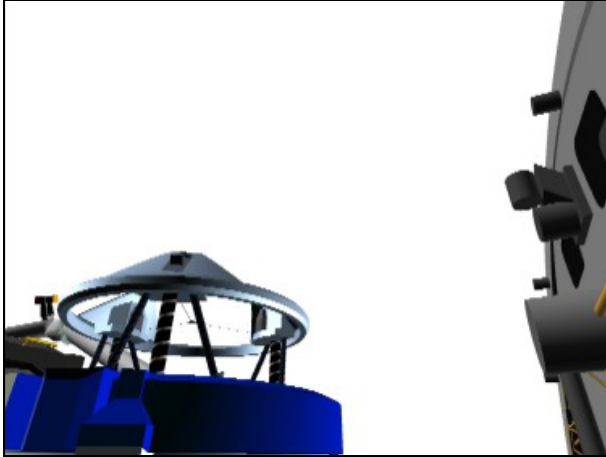

CCTV D (65,30)

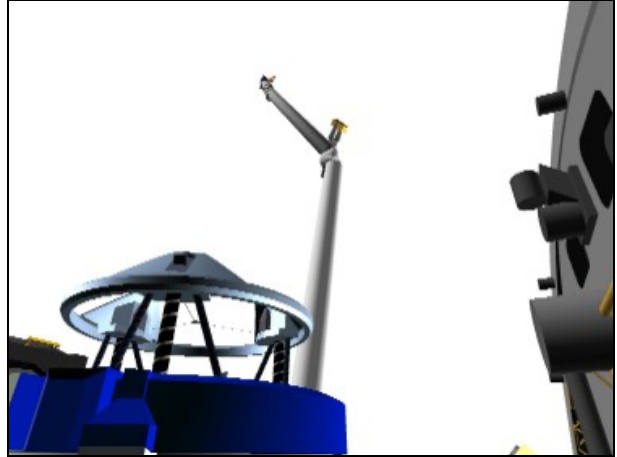

CCTV D (65,30)

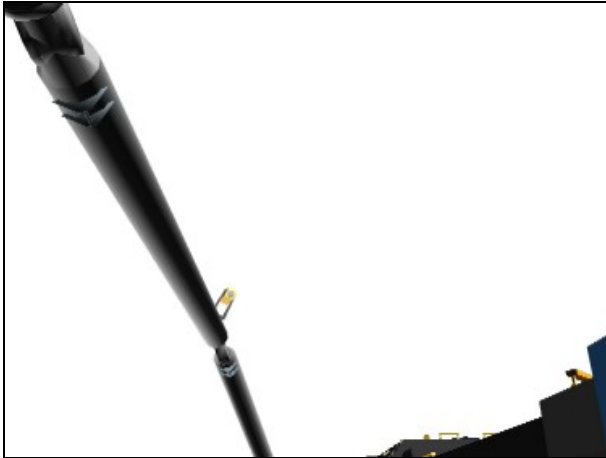

CCTV B (0,25)

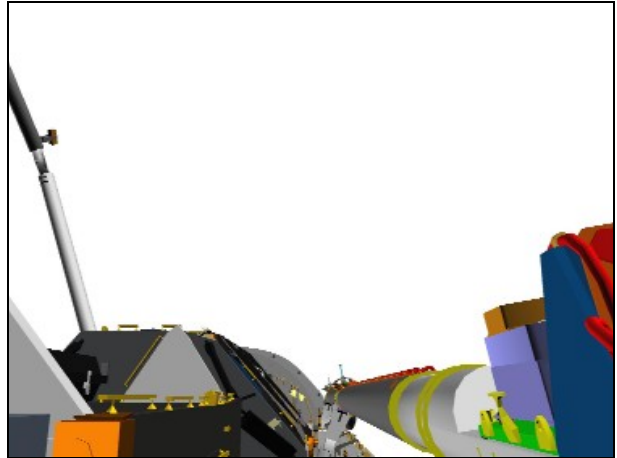

CCTV C (0,15)

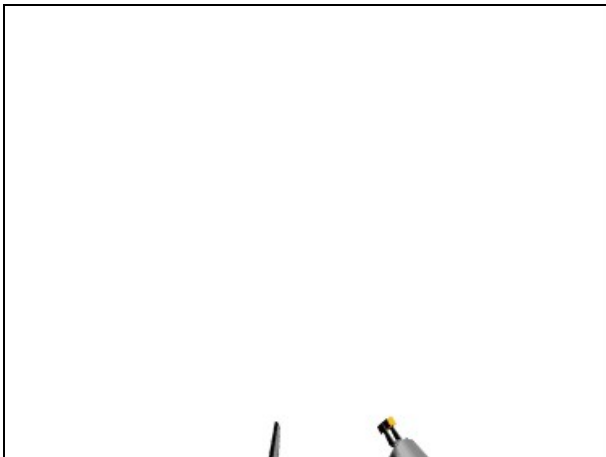

CCTV A (0,45)



CCTV A (0,45)

Step 2:

Drive SY (-) from 0.0° to -90.0°

Step 3:

Drive WP (-) from +5.0° to -57.0°



CCTV B (0,25)



CCTV B (0,25)

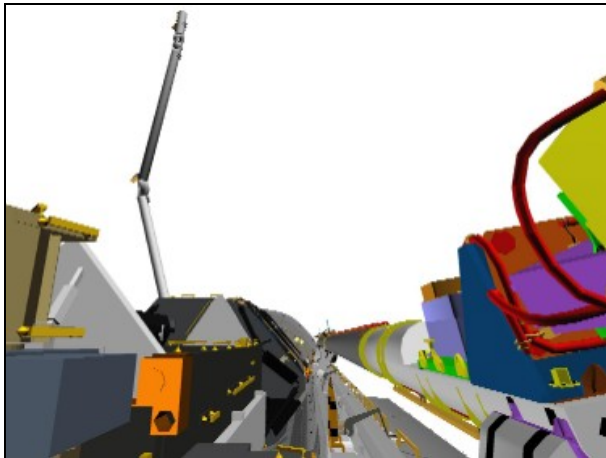

CCTV C (0,15)

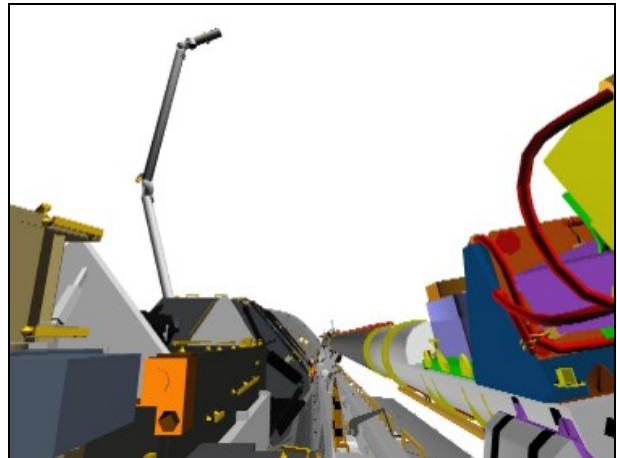

CCTV C (0,15)



CCTV A (0,45)

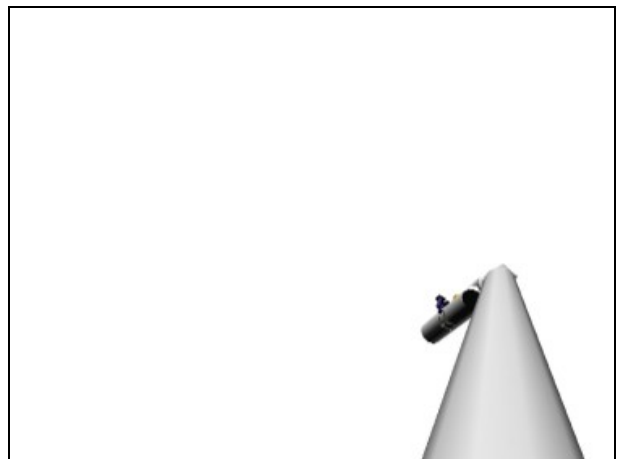

ELBOW (-25,0)

Step 4:

Drive WR (+) from 0.0° to +110.0°



CCTV B (0,25)

Step 5:

Drive EP (-) from -25.0° to -129.8°

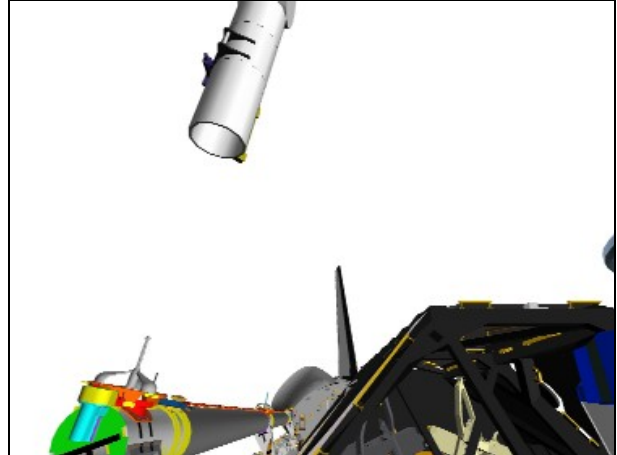

CCTV D (0,25)

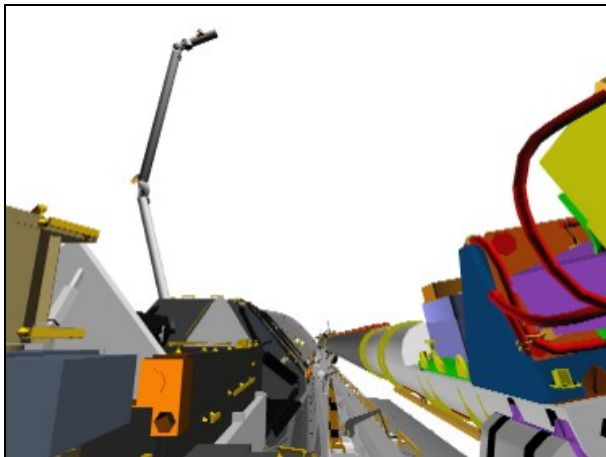

CCTV C (0,15)

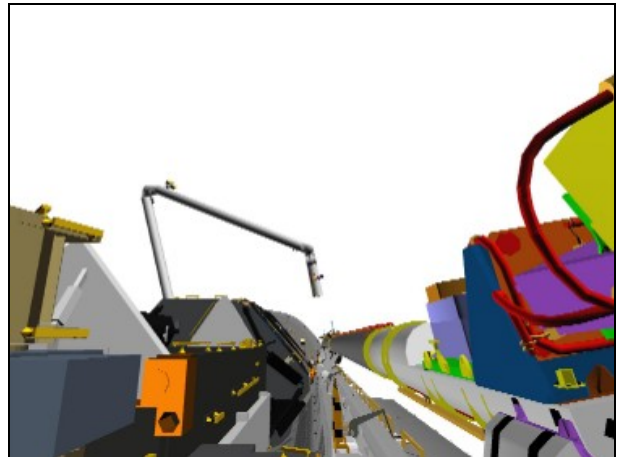

CCTV C (0,15)



ELBOW (-25,0)

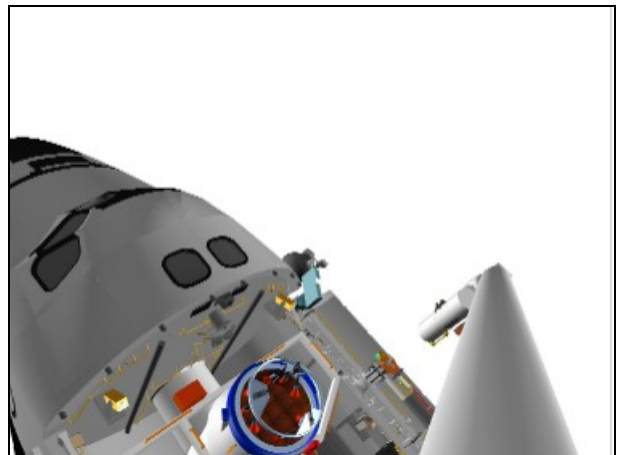

ELBOW (-25,0)

<p>CAUTION SPEE power must be applied within 90 min to prevent sensor package damage</p>

STBD RMS HTR A,B (two) – OFF

A6U EVENT TIMER MODE – UP
 CNTL – START

R12(OBSS) √SPEE PWR – OFF
 L12U(SSP1) √APCU 1 OUTPUT RLY – OP (tb-bp)

3. OBSS GRAPPLE

A7U CCTV – config for grapple
 – install PDRS TARGET OVERLAY FOR CTVM
 – RMS WRIST, ZOOM: 34.0 HFOV
 FOCUS: 5 ft

Maintain eyepoint ~18 in when using grapple overlay

RHC If SINGLE MODE available:
 RATE – VERN (RATE MIN tb-ON)
 BRAKES – OFF (tb-OFF)

A6U DAP: VERN(FREE)

MODE – best available

Mnvr to OBSS GRAPPLE posn:

	SY	SP	EP	WP	WY	WR
OBSS SJ PRE-GRAPPLE	-90.0	+87.9	-129.8	-57.0	0.0	+110.0
1: WP +				-40.9		
2: EP -			-134.6			
3: SP -		Until in grapple envelope				
Expected OBSS GRAPPLE	-90.0	+76.5	-134.6	-40.9	0.0	+110.0

Continue driving SP (-) until EE close to, but not over CAMs

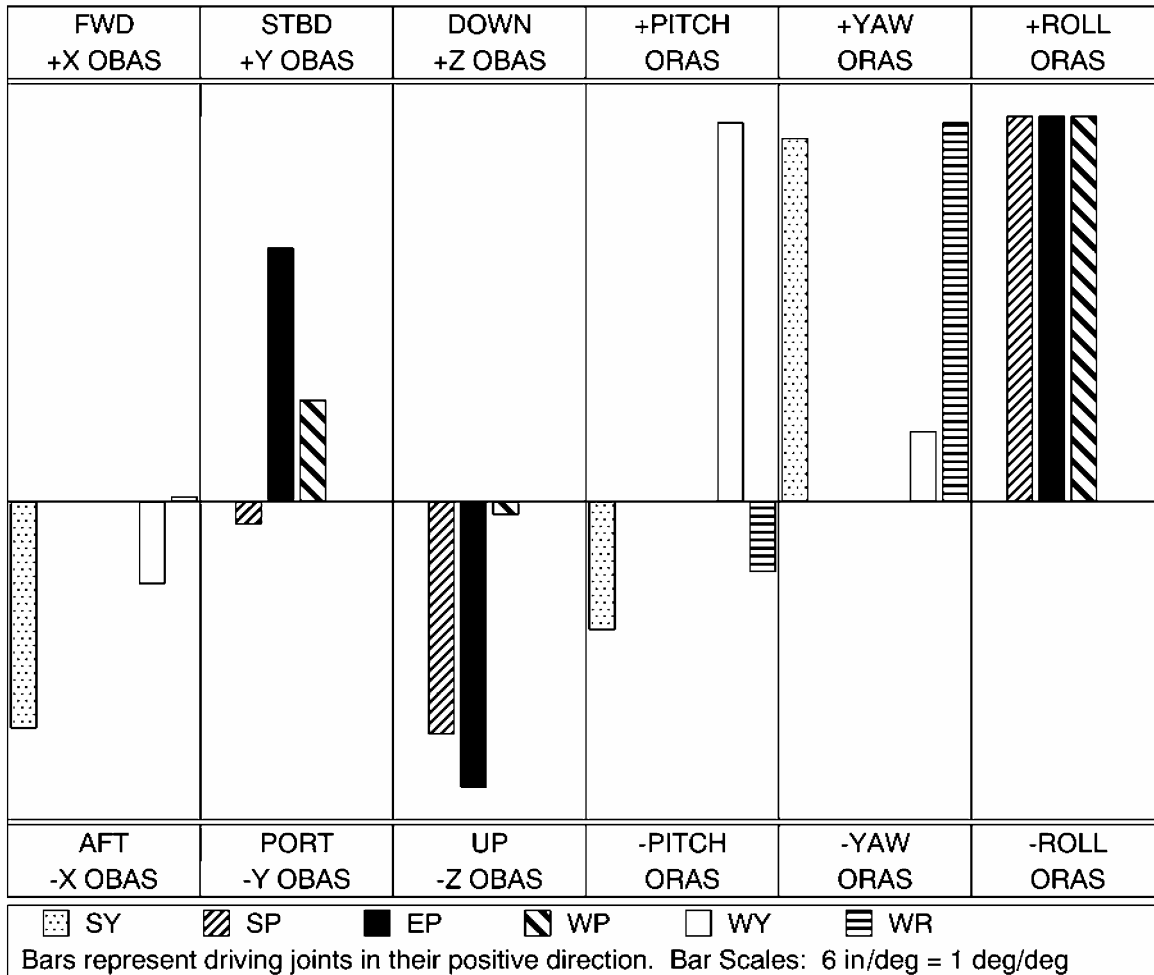

To get:	Drive:	To get:	Drive:
+X (fwd)	-SY, -WY	+PITCH	+WY
+Y (stbd)	+EP, +WP	+YAW	+WR, +SY
+Z (down)	-SP, -EP	+ROLL	+WP, +SP

Driving:	Results In:	Driving:	Results In:
+SY	-X (aft), +YAW	+WP	+Y (stbd), +ROLL
+SP	-Z (up), +ROLL	+WY	-X (aft), +PITCH
+EP	-Z (up), +ROLL	+WR	+YAW

ΔSY	ΔSP	ΔEP	ΔWP	ΔWY	ΔWR
-0.0	-11.4	-4.8	+16.1	+0.0	+0.0

Step 1:

Drive WP (+) from -57.0° to -40.9°

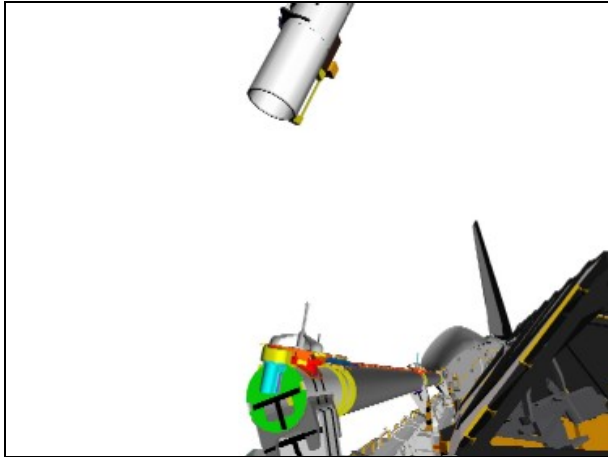

CCTV D (-20,20)

Step 2:

Drive EP (-) from -129.8° to -134.6°

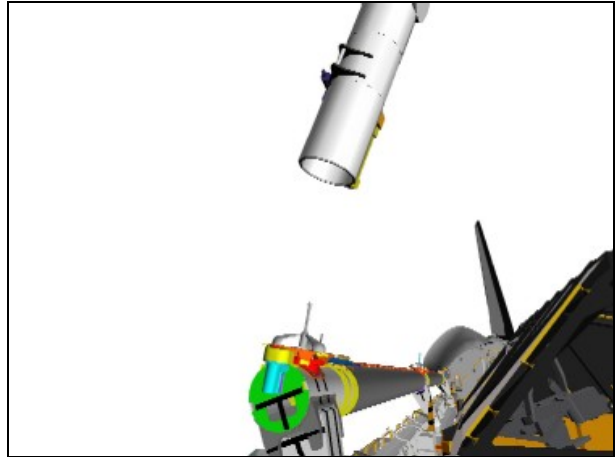

CCTV D (-20,20)

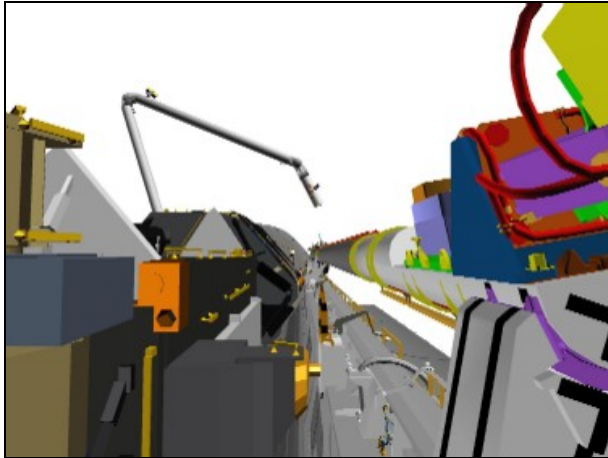

CCTV C (1,3)

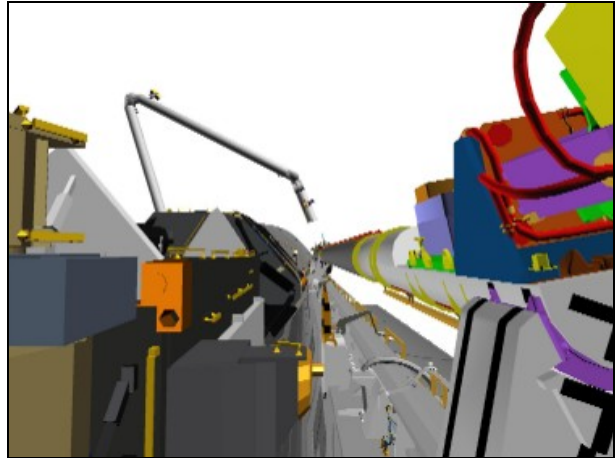

CCTV C (1,3)

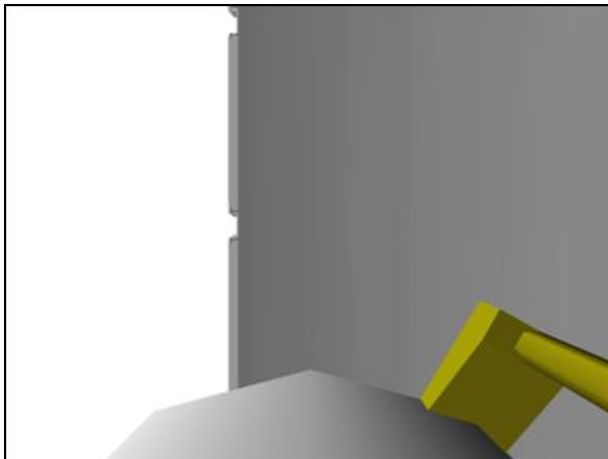

WRIST

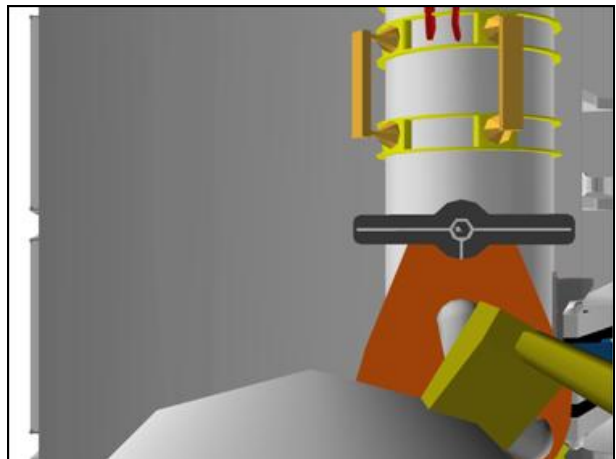

WRIST

CAUTION
Monitor EE tb timing to prevent EE motor burnout

EE MODE – AUTO
CAPTURE – depress (mom)

✓	RIGID <input type="checkbox"/>	CLOSE <input type="checkbox"/>	CAPTURE <input type="checkbox"/>
	DERIGID <input checked="" type="checkbox"/>	OPEN <input checked="" type="checkbox"/>	EXTEND <input checked="" type="checkbox"/>

CRITICAL TIMES (28 sec total):
CAPTURE tb – gray, then
CLOSE tb – gray, 3 sec max, then
RIGID tb – gray, 25 sec max

EE MODE – OFF

- * If manual capture reqd: *
- * EE MODE – MAN *
- * CAPTURE sw – depress (hold until CLOSE tb-gray, 3 sec max) *
- * MAN CONTR – RIGID (hold until RIGID tb-gray, 25 sec max) *
- * MODE – OFF *

BRAKES – ON (tb-ON)
MODE – not DIRECT
JOINT – CRIT TEMP

If SINGLE MODE available:

SM 94 PDRS CONTROL

 PL ID – ITEM 3 +1 EXEC
 INIT ID – ITEM 24 +1 EXEC

If digitals available, record POSN/ATT and Joint Angles:

	X	Y	Z	PITCH	YAW	ROLL	PL ID
							1
Expected	-680	+105	-436	0	0	341	1
	SY	SP	EP	WP	WY	WR	
Expected	-90.0	+76.5	-134.6	-40.9	0.0	+110.0	

Review GENERIC END EFFECTOR CUE CARD – SHUTTLE NOT DOCKED OPS

4. CONFIGURE POWER
 MA73C:C cb MCA PWR AC3 3Φ MID 2 – op
 ✓AC2 3Φ MID 2 – op
 :D ✓AC3 3Φ MID 4 – op
- R13L PL BAY MECH PWR SYS (two) – ON

5. STBD MRL RELEASE
DAP: FREE

SM 94 PDRS CONTROL

 RMS STBD – ITEM 2 EXEC (*)
 ✓STBD AFT, MID, FWD REL (six) = 0

NOTE

Expect single motor drive time for MRL release

STBD RMS RETEN LAT – REL (tb-REL) (18 sec max)
– OFF

If motor drive time > 18 sec, √MCC

SM 94 PDRS CONTROL
RMS PORT – ITEM 1 EXEC (*)

6. RECONFIGURE POWER

R13L PL BAY MECH PWR SYS (two) – OFF

MA73C:C cb MCA PWR AC3 3Φ MID 2 – cl
 √AC2 3Φ MID 2 – op
:D √AC3 3Φ MID 4 – op

If digitals available, record joint angles:

SY	SP	EP	WP	WY	WR

7. MNVR TO OBSS HOVER

A7U CCTV – config for unberth

If SINGLE MODE available:

RHC RATE – VERN (RATE MIN tb-ON)
 BRAKES – OFF (tb-OFF)

MODE – best available

Mnvr to OBSS HOVER posn:

	SY	SP	EP	WP	WY	WR	
OBSS GRAPPLE	-90.0	+76.5	-134.6	-40.9	0.0	+110.0	
1: SP +		+79.8					
2: EP +			-123.1				
3: WP –				-55.7			
OBSS HOVER	-90.0	+79.8	-123.1	-55.7	0.0	+110.0	
	X	Y	Z	PITCH	YAW	ROLL	PL ID
	-680	+126	-496	0	0	341	1

BRAKES – ON (tb-ON)

MODE – not DIRECT

JOINT – CRIT TEMP

Start:
OBSS Grapple

Step 1:
Drive SP (+) from +76.5° to +79.8°

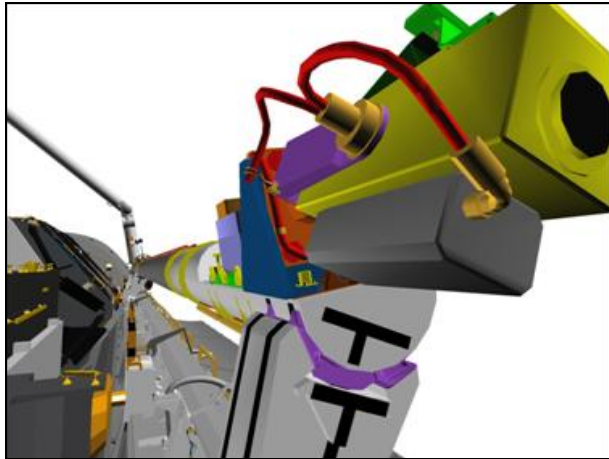

CCTV C (25,5)

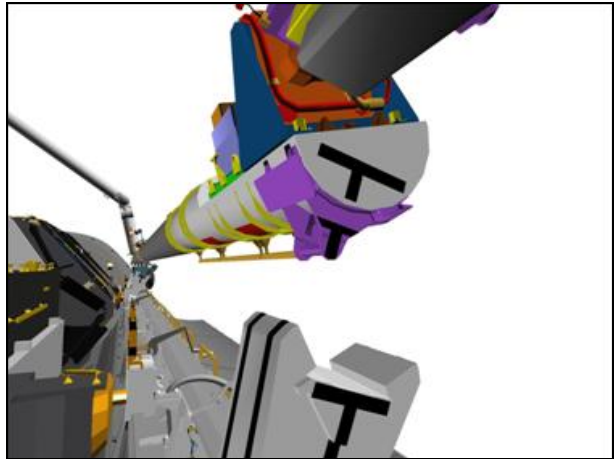

CCTV C (25,5)

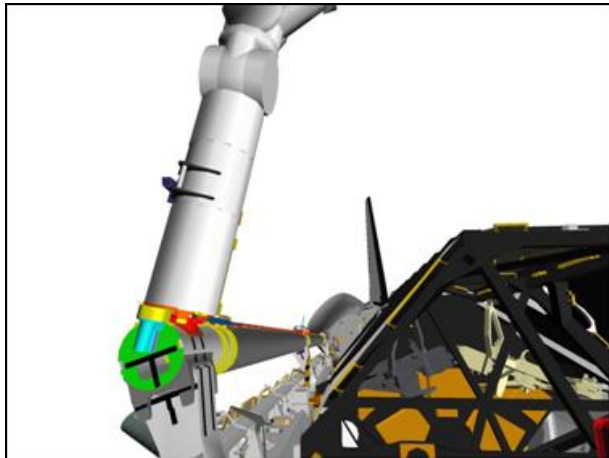

CCTV D (-5,15)

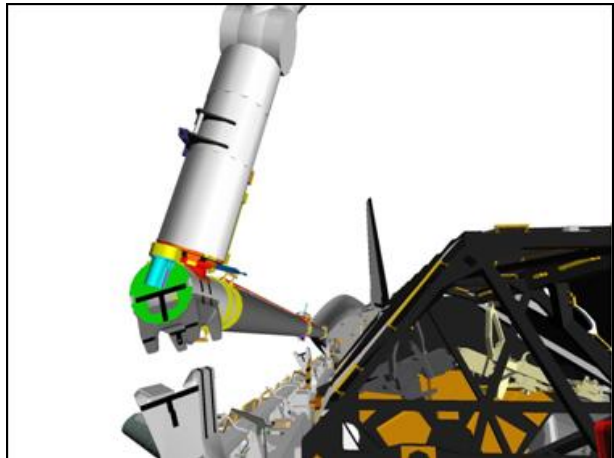

CCTV D (-5,15)

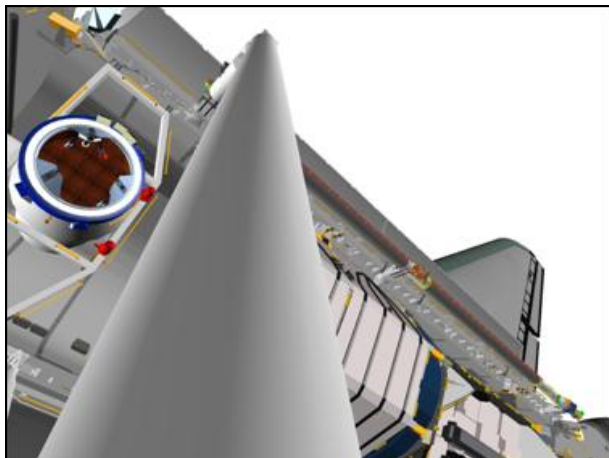

ELBOW (5,-30)

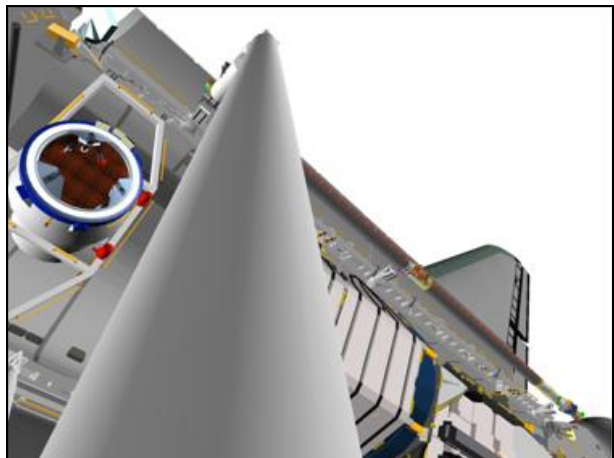

ELBOW (5,-30)

Step 2:

Drive EP (+) from -134.6° to -123.1°

Step 3:

Drive WP (-) from -40.9° to -55.7°



CCTV C (15,25)

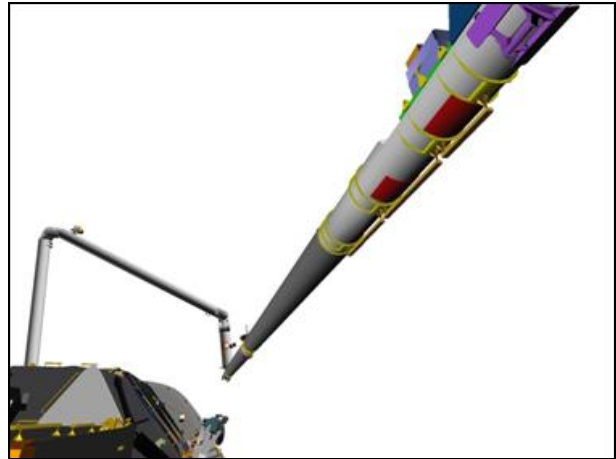

CCTV C (15,25)

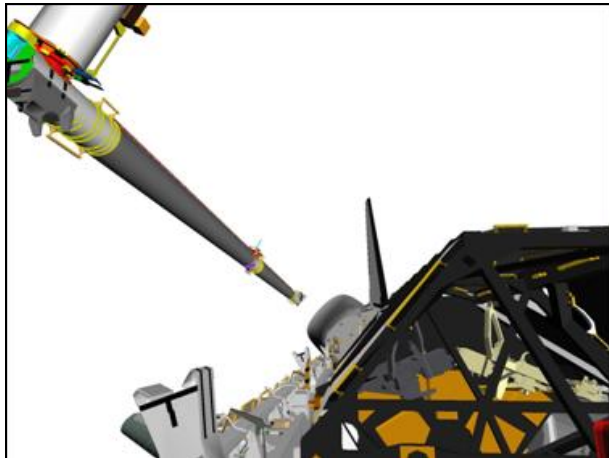

CCTV D (-5,15)

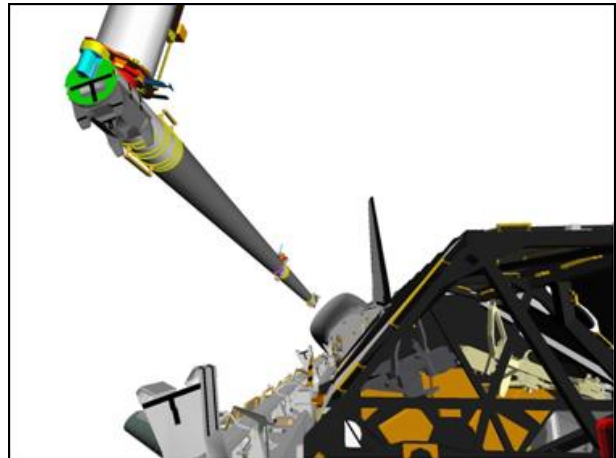

CCTV D (-5,15)

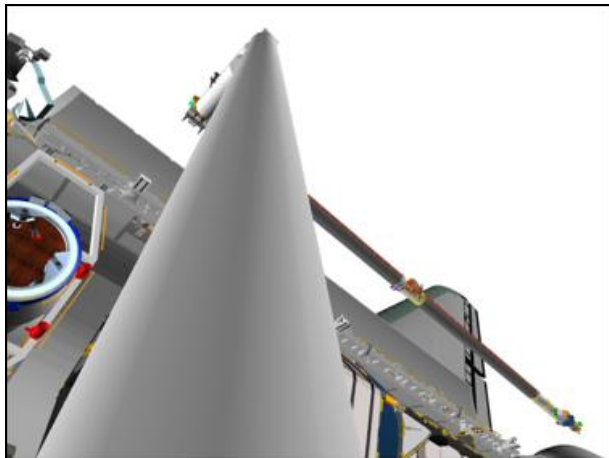

ELBOW (5,-30)

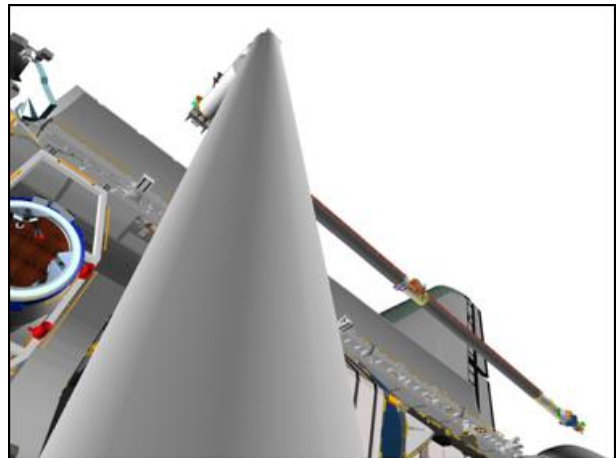

ELBOW (5,-30)

DAP: A14/AUTO/VERN(FREE)

A6U If Verns failed, DAP: AUTO/ALT

In the following P/TV procedure, start 15 min timer upon applying SPEE power and inform MCC when timer is started:

Perform ACTIVATION (LDRI/ITVC Cue Card, PHOTO/TV)

Perform LCH ACTIVATION (LCS Cue Card, PHOTO/TV)

Perform LCC ACTIVATION (LCS Cue Card, PHOTO/TV)

8. RESET PTU

A7U VIDEO OUT MON2 pb – push
IN PL2(VPU) pb – push

CAMR CMD PAN/TILT – HI RATE

PAN – L (to hard stop)

TILT – UP (to hard stop)

PAN/TILT – RESET, HI RATE (LO within 10°)

PAN: +103 (right)

TILT: -260 (down)

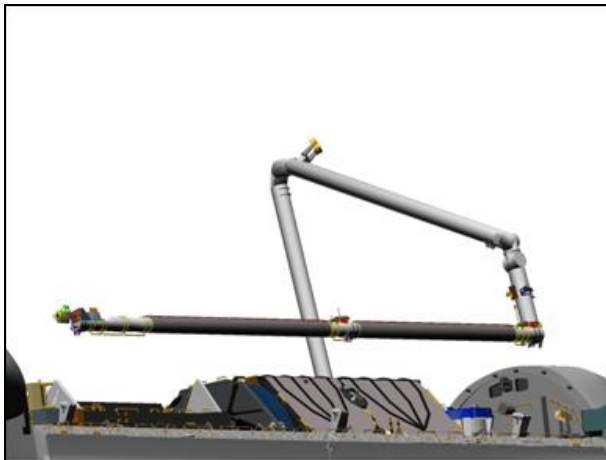

BIRD'S EYE

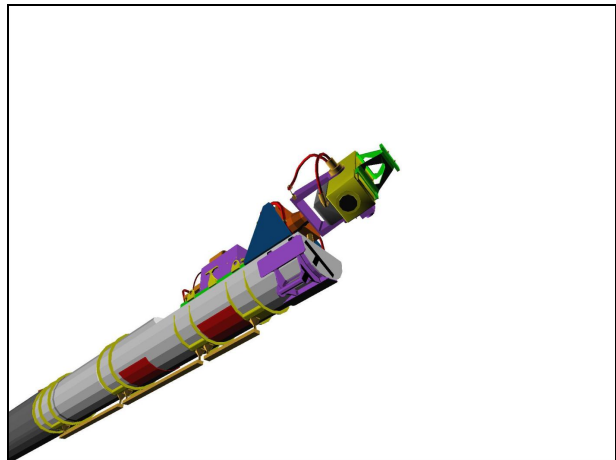

CCTV C (50,50)

9. LDRI CALIBRATION

Verify 15 min SPEE power timer expired

√VIDEO OUT MUX 1 L pb – push (MIDDECK It on)

a. Mode 3

LDRI MODE 3 pb – push (LDRI video)

VIDEO OUT MON 2 pb – push

PAN/TILT to match LDRI view shown below

Note PAN/TILT: ____.

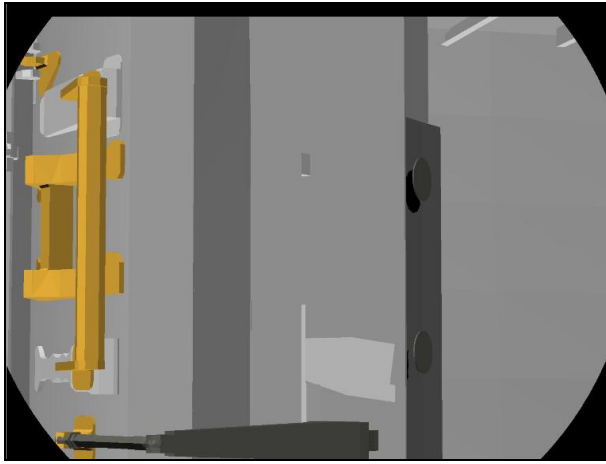

LDRI (103,-260)

If LDRI calibration view of STBD sill presents unacceptable specular reflections,

A7U PAN: +110 (right)
TILT: -220 (up)

LDRI (110,-220)

- L10(VTR) REC pb – push, hold
PLAY pb – push, simo (red ●)
Record for 30 sec
STOP pb – push (no red ●)

- b. Mode 4
VIDEO OUT MON 1 pb – push
LDR1 MODE 4 pb – push (brighter LDRI video)

- A7U
L10(VTR) REC pb – push, hold
PLAY pb – push, simo (red ●)
Record for 30 sec
STOP pb – push (no red ●)

- c. Mode 5
LDR1 MODE 5 pb – push (flickering LDRI video)

- A7U
L10(VTR) REC pb – push, hold
PLAY pb – push, simo (red ●)
Record for 30 sec
STOP pb – push (no red ●)

- A7U d. Mode 6
 LDRI MODE 6 pb – push (brighter flickering LDRI video)
- L10(VTR) REC pb – push, hold
 PLAY pb – push, simo (red ●)
- Record for 30 sec
- STOP pb – push (no red ●)

10. PROCEED TO SJ FLAT FIELDS
On MCC GO, go to OBSS SJ FLAT FIELDS

OBSS SJ BERTH

<p style="text-align: center;">WARNING For UNDOCKED ops only</p>

NOTE

Stbd MPMs assumed deployed

- A7U
1. SETUP
CCTV – config for berth
– perform PAN/TILT RESET for PLB cameras

If SINGLE MODE available:

SM 94 PDRS CONTROL

PL ID – ITEM 3 +1 EXEC

INIT ID – ITEM 24 +1 EXEC

2. OBSS HOVER

Verify mnvr to OBSS HOVER posn complete:

X	Y	Z	PITCH	YAW	ROLL	PL ID
-680	+126	-496	0	0	341	1
SY	SP	EP	WP	WY	WR	
-90.0	+79.8	-123.1	-55.7	0.0	+110.0	

√BRAKES – ON (tb-ON)

√MODE – not DIRECT

√JOINT – CRIT TEMP

√STBD RMS HTR A,B (two) – OFF

OBSS Hover

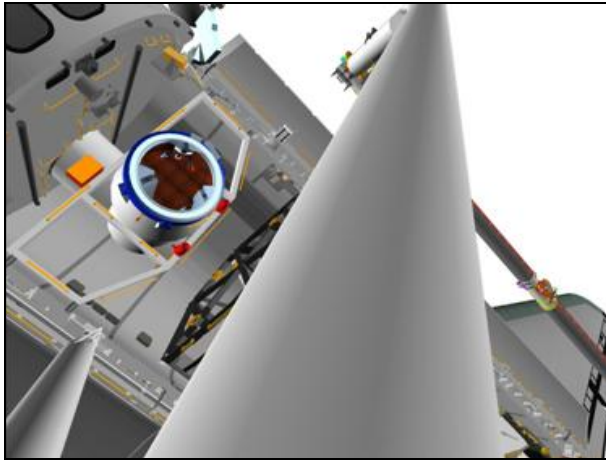

ELBOW (-15,-35)

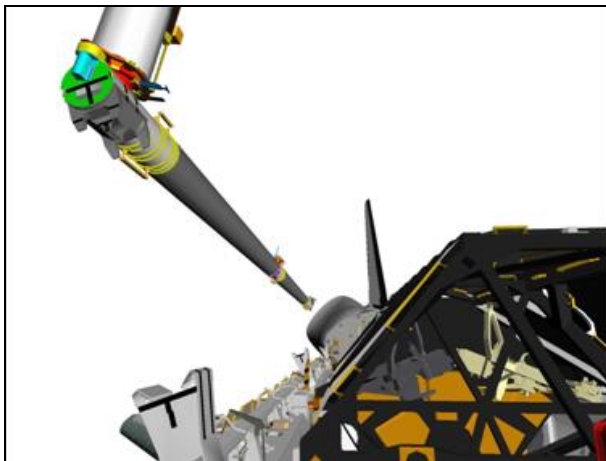

CCTV D (-5,15)

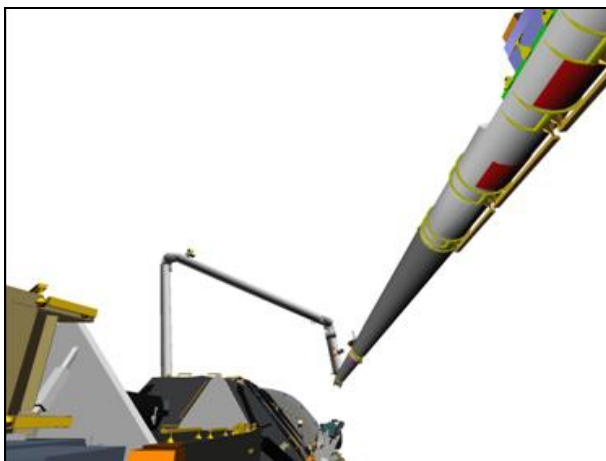

CCTV C (0,25)

- A7U 3. STOW PTU
 VIDEO OUT MON2 pb – push
 IN PL2(VPU) pb – push

CAMR CMD PAN/TILT – HI RATE
 PAN – L (to hard stop)
 TILT – UP (to hard stop)
 PAN/TILT – RESET, HI RATE (LO within 10°)
 PAN: +108 (right)
 TILT: -175 (down)

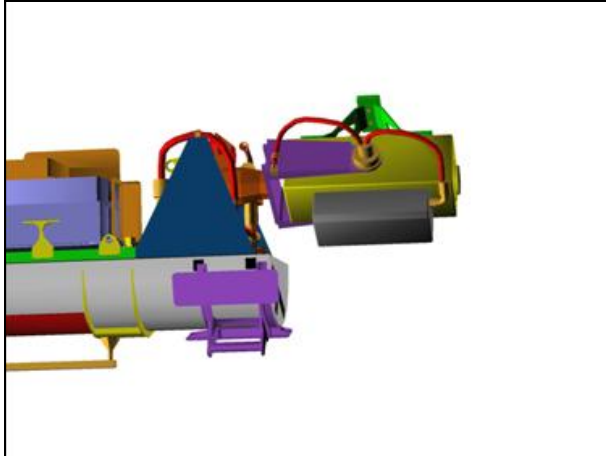

CCTV B (82,16) HFOV: 15.0

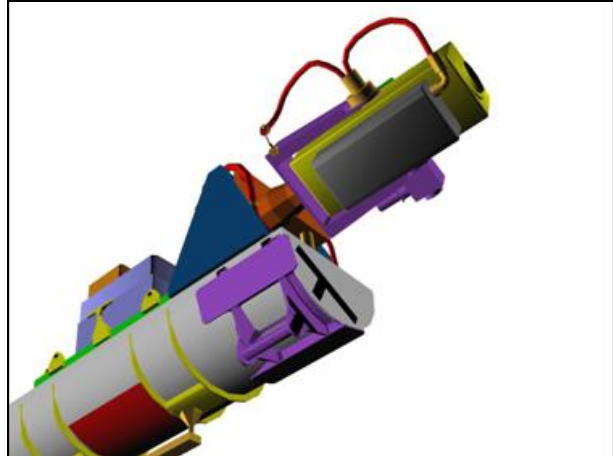

CCTV C (50,50) HFOV: 40.0

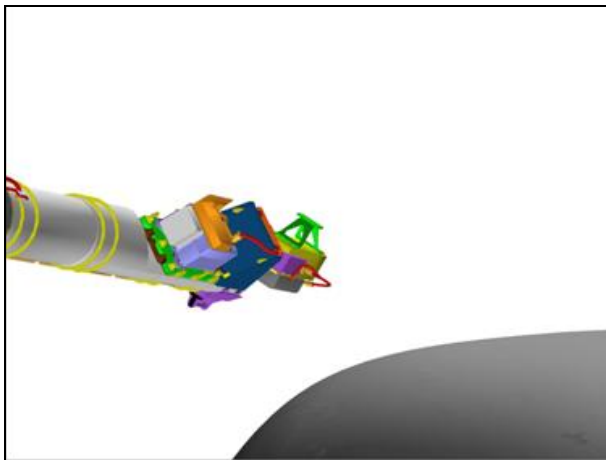

ELBOW (52,-45) HFOV: 9.8 (full-in)

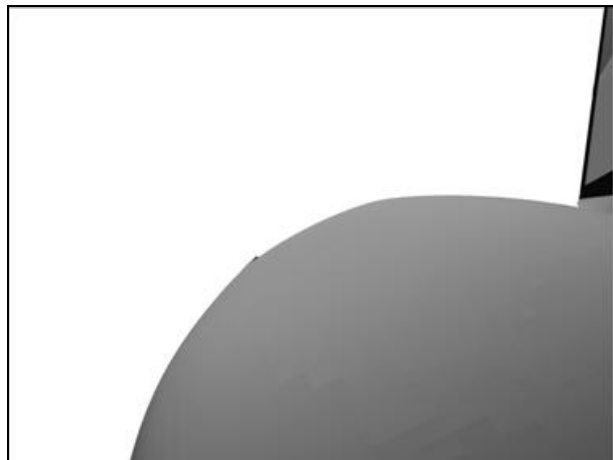

OBSS ITVC (108,-175) HFOV: 53.8 (full-out)

Perform LCC DEACTIVATION (LCS Cue Card, PHOTO/TV)
 Perform LCH DEACTIVATION (LCS Cue Card, PHOTO/TV)

CAUTION
 STBD RMS HTR power must be applied within
 90 min to prevent sensor package damage

Perform DEACTIVATION (LDRI/ITVC Cue Card, PHOTO/TV)

A7U 4. OBSS BERTH
 CCTV – configure as required
 ZOOM – full OUT

SM 94 PDRS CONTROL
 RMS STBD – ITEM 2 EXEC (*)

A6U DAP: FREE

RHC If SINGLE MODE available:
 RATE – VERN (RATE MIN tb-ON)
 BRAKES – OFF (tb-OFF)

MODE – best available

Mnvr to OBSS BERTH posn:

	SY	SP	EP	WP	WY	WR	
OBSS HOVER	-90.0	+79.8	-123.1	-55.7	0.0	+110.0	
1: WP +				-40.9			
2: EP -			-134.6				
3: SP -		+76.5					
Expected OBSS BERTH	-90.0	+76.5	-134.6	-40.9	0.0	+110.0	
	X	Y	Z	PITCH	YAW	ROLL	PL ID
	-680	+105	-436	0	0	341	1

√STBD RMS R-F-L tb (three) – gray
 MODE – not DIRECT

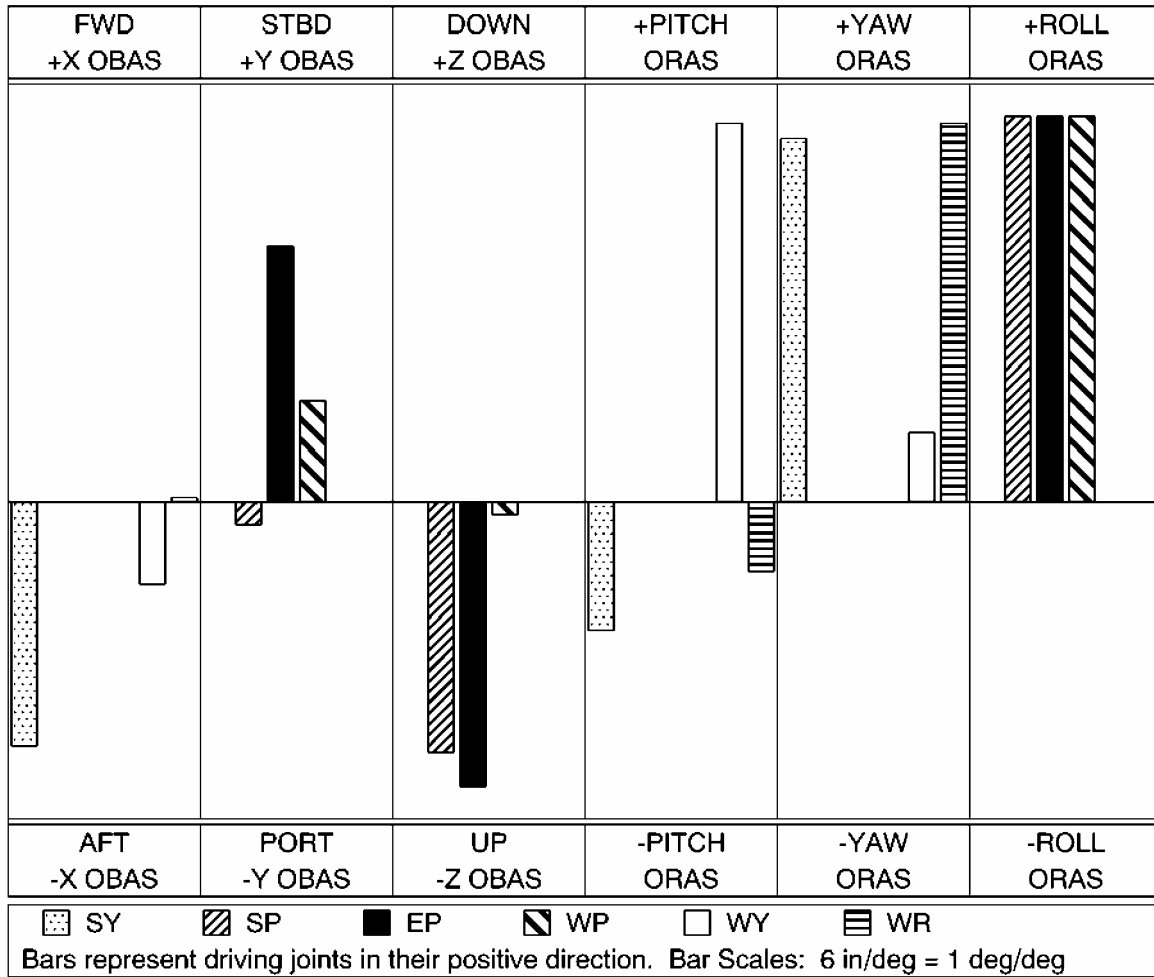

To get:	Drive:	To get:	Drive:
+X (fwd)	-SY, -WY	+PITCH	+WY
+Y (stbd)	+EP, +WP	+YAW	+WR, +SY
+Z (down)	-SP, -EP	+ROLL	+WP, +SP

Driving:	Results In:	Driving:	Results In:
+SY	-X (aft), +YAW	+WP	+Y (stbd), +ROLL
+SP	-Z (up), +ROLL	+WY	-X (aft), +PITCH
+EP	-Z (up), +ROLL	+WR	+YAW

ΔSY	ΔSP	ΔEP	ΔWP	ΔWY	ΔWR
+0.0	-3.3	-11.5	+14.8	+0.0	+0.0

Start:
OBSS Hover

Step 1:
Drive WP (+) from -55.7° to -40.9°

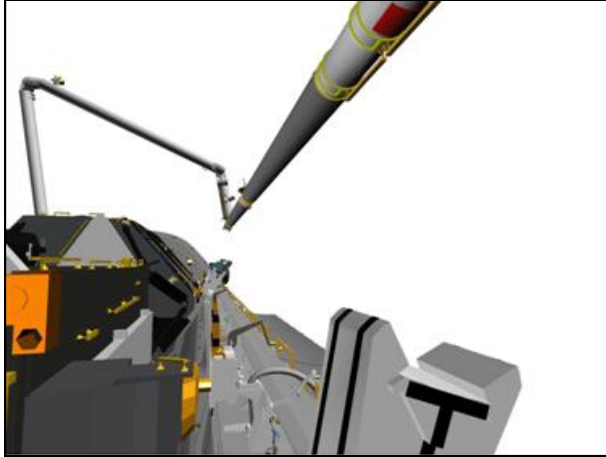

CCTV C (15,5)

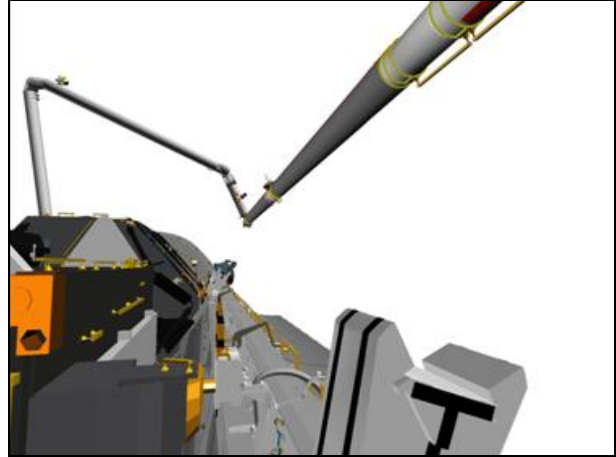

CCTV C (15,5)

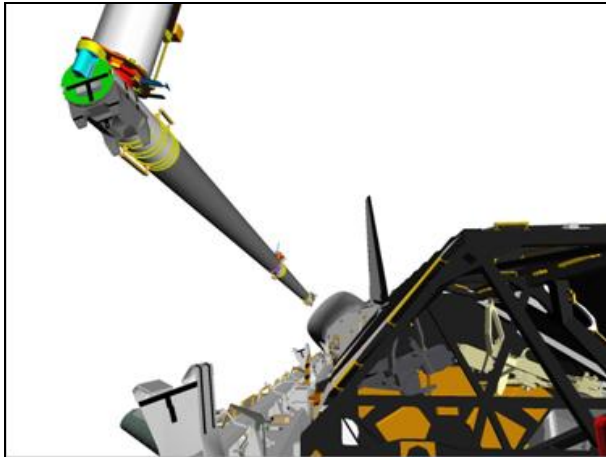

CCTV D (-5,15)

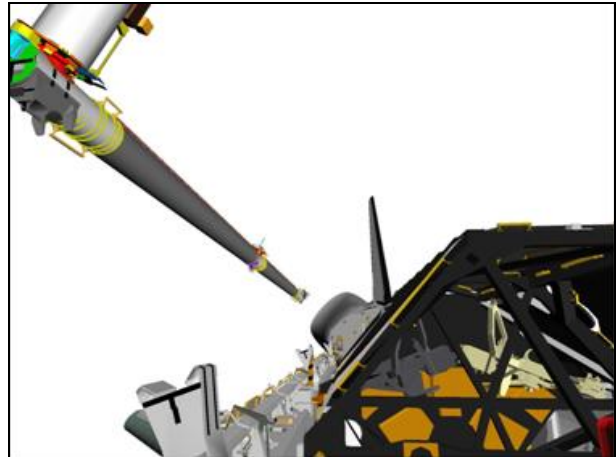

CCTV D (-5,15)

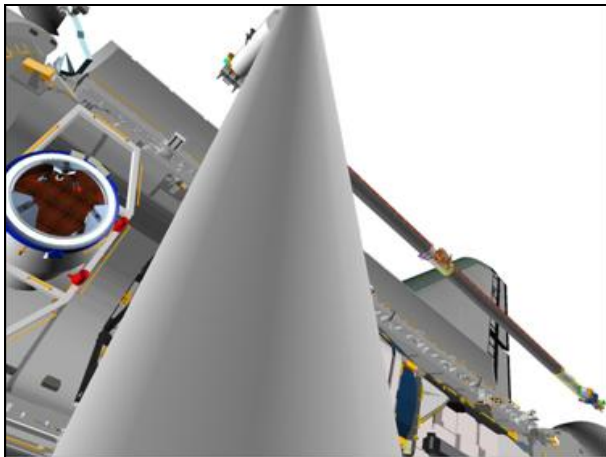

ELBOW (0,-35)

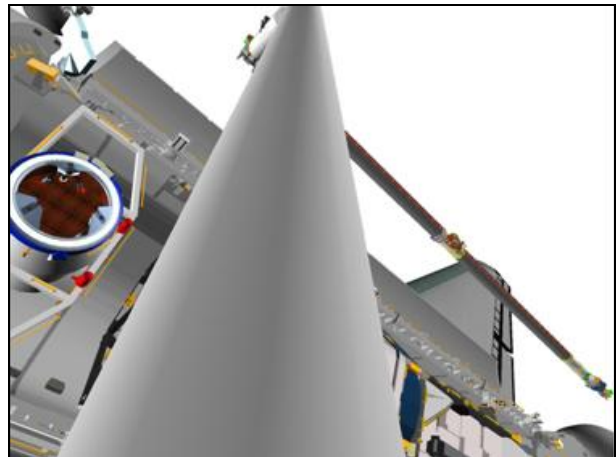

ELBOW (0,-35)

Step 2:

Drive EP (-) from -123.1° to -134.6°

Step 3:

Drive SP (-) from $+79.8^{\circ}$ to $+76.5^{\circ}$

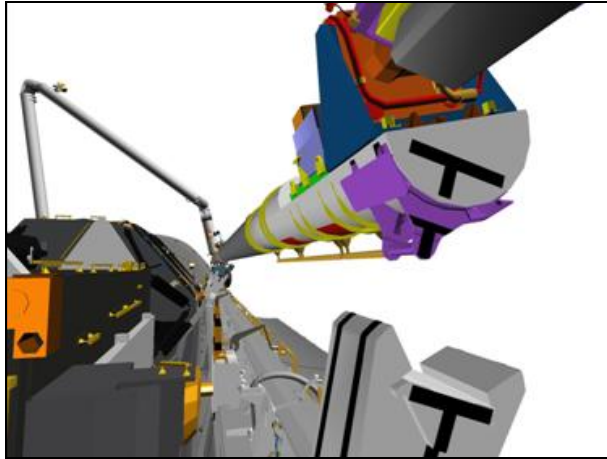

CCTV C (15,5)

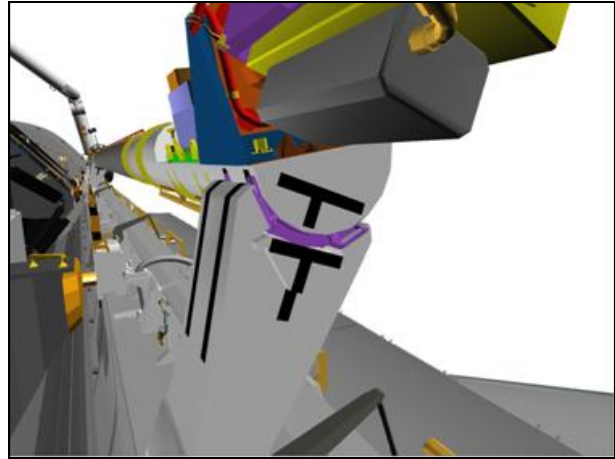

CCTV C (30,-10) HFOV 60.0

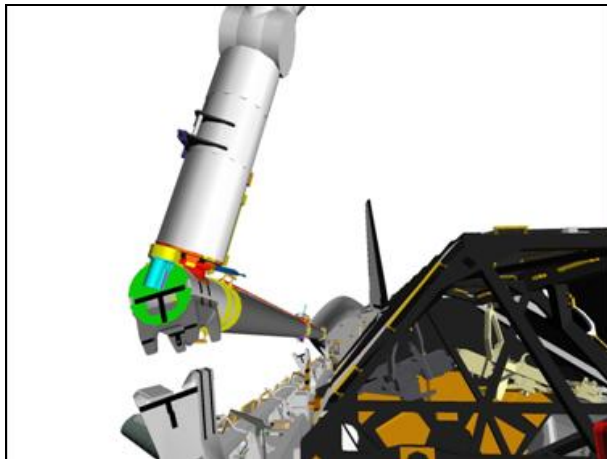

CCTV D (-5,15)

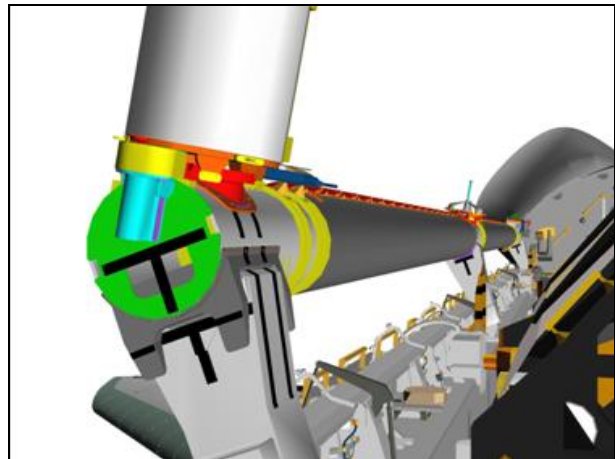

CCTV D (-15,0) HFOV 35.0

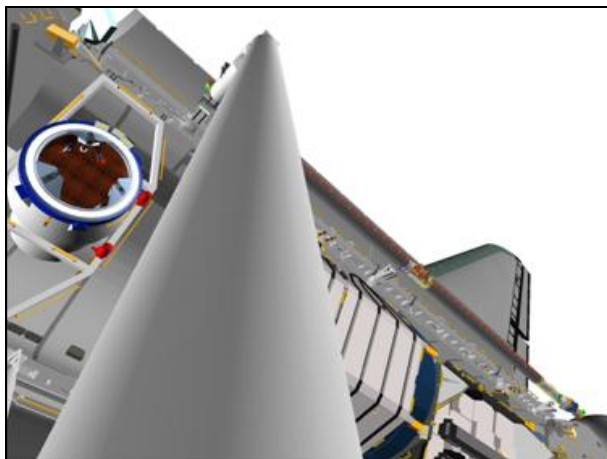

ELBOW (5,-30)

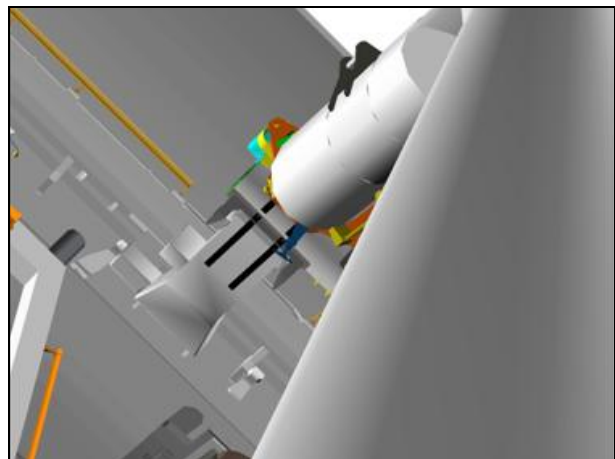

ELBOW (-7,-12) HFOV 15.0

5. CONFIGURE POWER
MA73C:C cb MCA PWR AC3 3Φ MID 2 – op
 √AC2 3Φ MID 2 – op
 :D √AC3 3Φ MID 4 – op

R13L PL BAY MECH PWR SYS (two) – ON

6. STBD MRL LATCH
RATE – COARSE (RATE MIN tb-OFF)
SM 94 PDRS CONTROL
√STBD AFT, MID, FWD LAT (six) = 0

If SINGLE MODE available:
 AUTO BRAKE INH – ITEM 10 EXEC (*)

NOTE

 Expect single motor drive time for MRL latching

STBD RMS RETEN LAT – LAT (tb-LAT) (18 sec max)
 – OFF

If motor drive time > 18 sec, √MCC

SM 94 PDRS CONTROL
RMS PORT – ITEM 1 EXEC (*)

If TEST MODE available,
 MODE – TEST, ENTER
 Wait 5 sec

√BRAKES – ON (tb-ON)
JOINT – CRIT TEMP

If SINGLE MODE available:
SM 94 PDRS CONTROL
 AUTO BRAKE ENA – ITEM 9 EXEC (*)

A6U DAP: A1/AUTO/VERN(ALT)

7. RECONFIGURE POWER
R13L PL BAY MECH PWR SYS (two) – OFF

MA73C:C cb MCA PWR AC3 3Φ MID 2 – cl
 √AC2 3Φ MID 2 – op
 :D √AC3 3Φ MID 4 – op

8. OBSS UNGRAPPLE
A7U CCTV – configure for ungrapple
 – attach overlays as needed
 – RMS WRIST, ZOOM: 34.0 HFOV
 FOCUS: 5 ft

If SINGLE MODE available:

SM 94 PDRS CONTROL

PL ID – ITEM 3 +0 EXEC

INIT ID – ITEM 24 +0 EXEC

RHC RATE – VERN (RATE MIN tb-ON)
BRAKES – OFF (tb-OFF)

MODE – best available

A6U DAP: VERN(FREE)

CAUTION
Monitor EE tb timing to prevent EE motor burnout

EE MODE – MAN

MAN CONTR – DERIGID (hold until DERIGID tb-gray, 5 sec max)

RELEASE sw – depress (hold until OPEN tb-gray, 3 sec max)

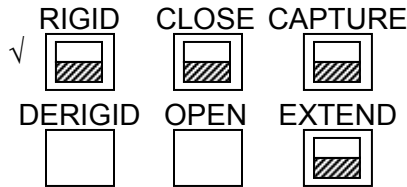

Drive SP (+) until arm clear of grapple pin

EE MAN CONTR – DERIGID (hold until EXTEND tb-gray, 20 sec max)

MODE – OFF

STBD RMS HTR A,B (two) – AUTO

A6U EVENT TIMER CNTL – STOP

DAP: A1/AUTO/VERN(ALT)

Mnvr to OBSS SJ PRE-GRAPPLE posn:

	SY	SP	EP	WP	WY	WR	
OBSS BERTH	-90.0	+76.5	-134.6	-40.9	0.0	+110.0	
1: SP +		+87.9					
2: EP +			-129.8				
3: WP –				-57.0			
OBSS SJ PRE-GRAPPLE	-90.0	+87.9	-129.8	-57.0	0.0	+110.0	
	X	Y	Z	PITCH	YAW	ROLL	PL ID
	-680	+96	-513	270	350	1	0

BRAKES – ON (tb-ON)

MODE – not DIRECT

JOINT – CRIT TEMP

Start:
OBSS Berth

Step 1:
Drive SP (+) from +76.5° to +87.9°

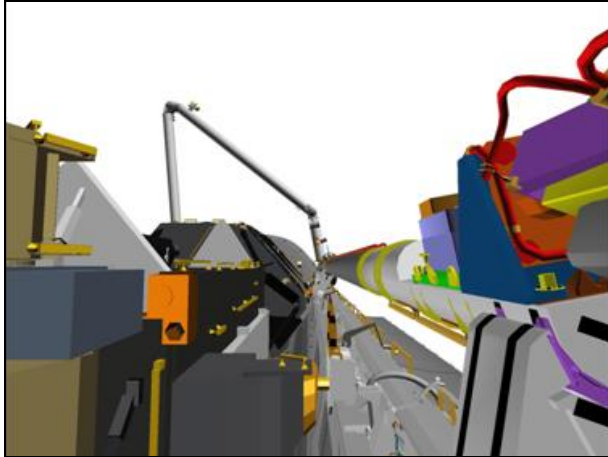

CCTV C (0,5)

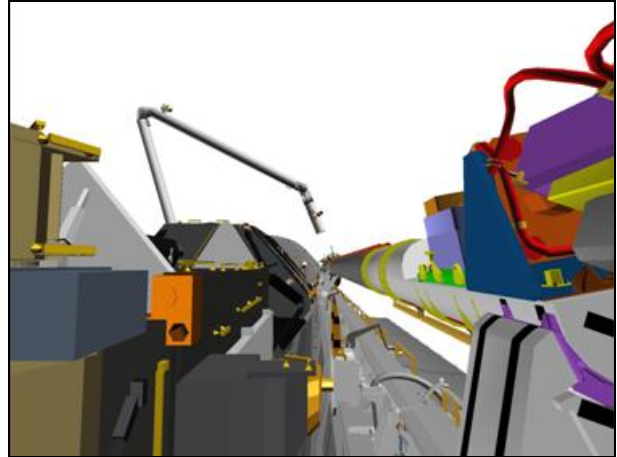

CCTV C (0,5)

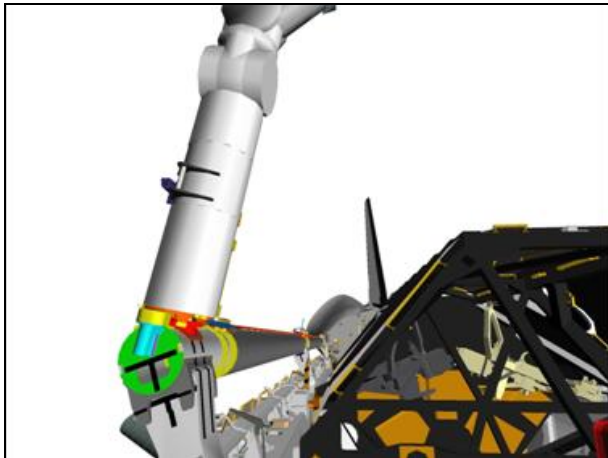

CCTV D (-5,15)

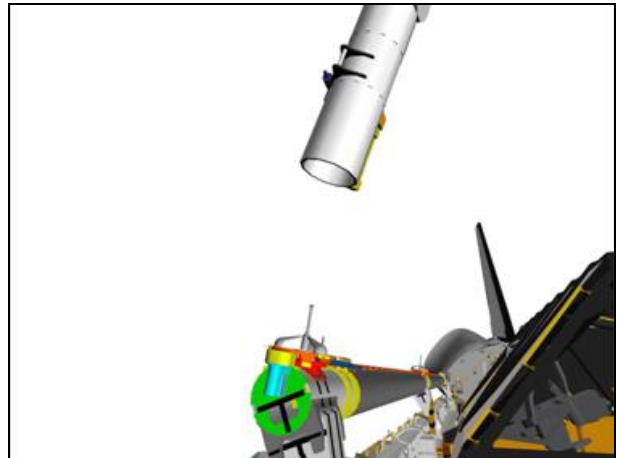

CCTV D (-20,20)

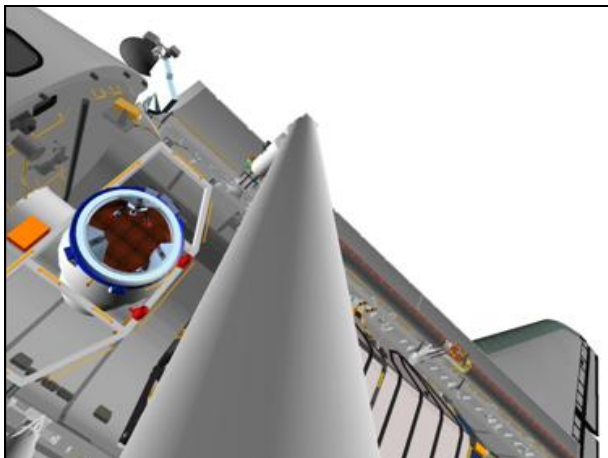

ELBOW (0,-20)

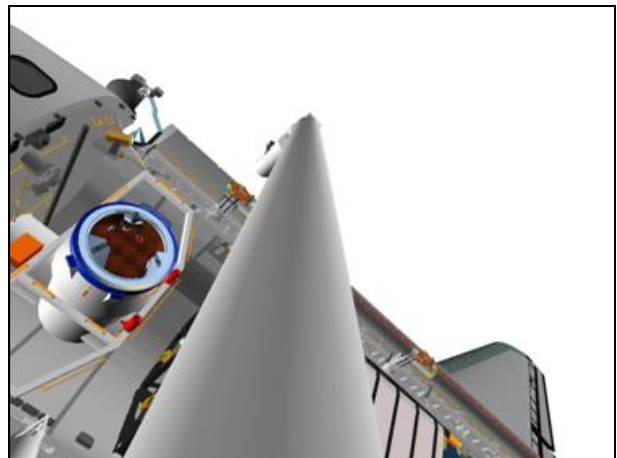

ELBOW (0,-20)

Step 2:

Drive EP (+) from -134.6° to -129.8°

Step 3:

Drive WP (-) from -40.9° to -57.0°

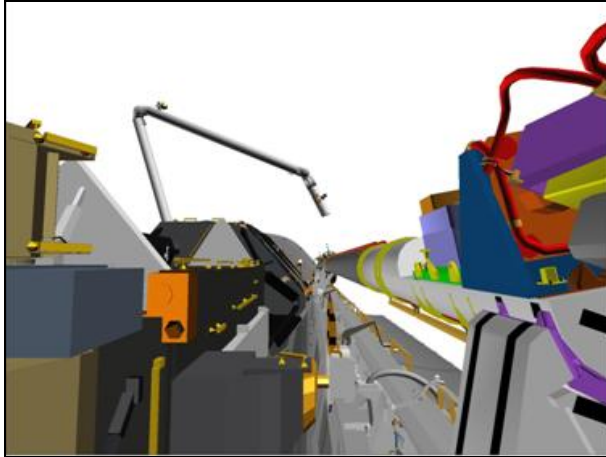

CCTV C (0,5)

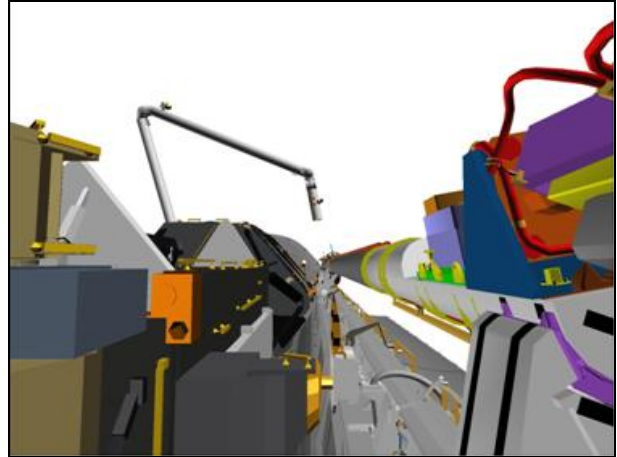

CCTV C (0,5)



CCTV D (-20,20)



CCTV D (0,25)

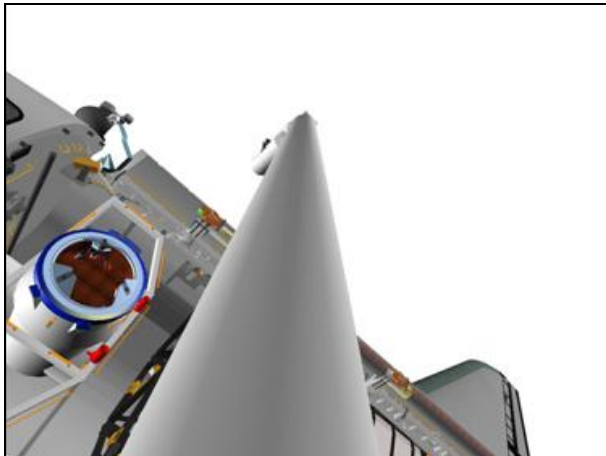

ELBOW (0,-20)

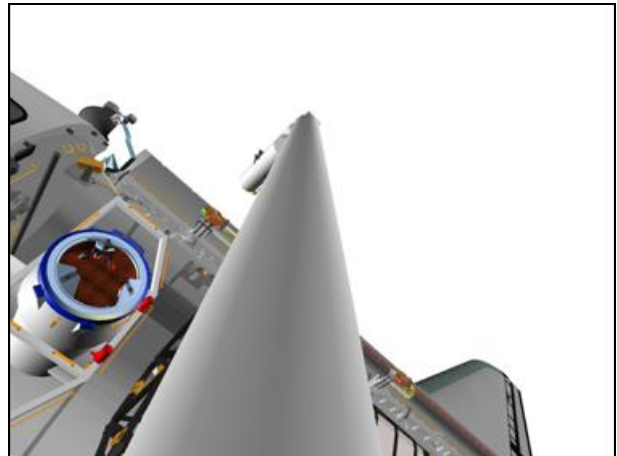

ELBOW (0,-20)

A7U 9. ARM PRE-CRADLE
 CCTV – configure as required
 ZOOM – full OUT

RHC If SINGLE MODE available:
 RATE – as reqd (VERN within 10 ft)
 BRAKES – OFF (tb-OFF)

MODE – best available

Mnvr to PRE-CRADLE posn:

	SY	SP	EP	WP	WY	WR	
OBSS SJ	-90.0	+87.9	-129.8	-57.0	0.0	+110.0	
PRE-GRAPPLE				+5.0			
1: WP +							
2: WR –						0.0	
3: EP +			-25.0				
4: SY +	0.0						
5: SP –		+25.0					
PRE-CRADLE	0.0	+25.0	-25.0	+5.0	0.0	0.0	
	X	Y	Z	PITCH	YAW	ROLL	PL ID
	-1261	-146	-551	5	2	0	0

BRAKES – ON (tb-ON)
 MODE – not DIRECT
 PARAM – PORT TEMP
 JOINT – CRIT TEMP

Start:
OBSS Pre-Grapple

Step 1:
Drive WP (+) from -57.0° to $+5.0^\circ$

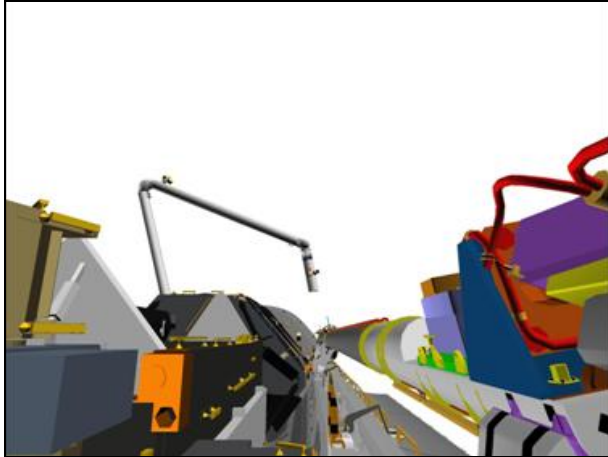

CCTV C (0,15)



CCTV C (0,15)



CCTV D (-5,30)

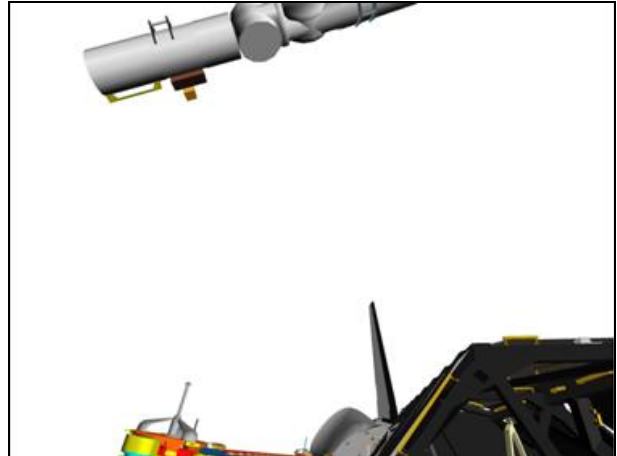

CCTV D (-5,30)

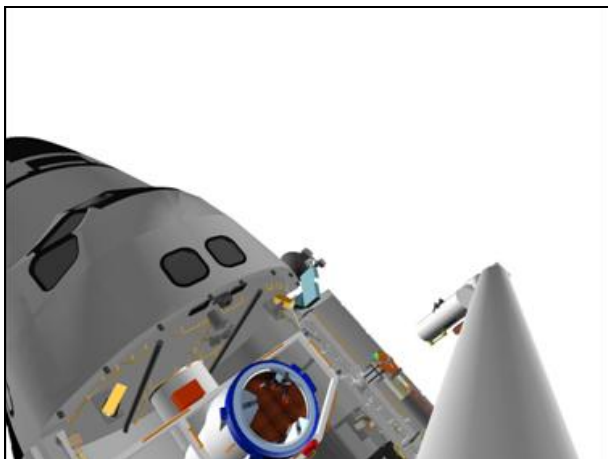

ELBOW (-25,0)

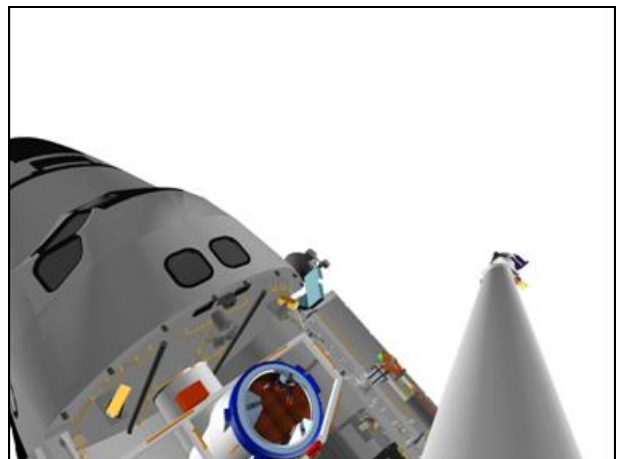

ELBOW (-25,0)

Step 2:

Drive WR (-) from +110.0° to 0.0°



CCTV C (0,15)

Step 3:

Drive EP (+) from -129.8° to -25.0°



CCTV C (0,15)

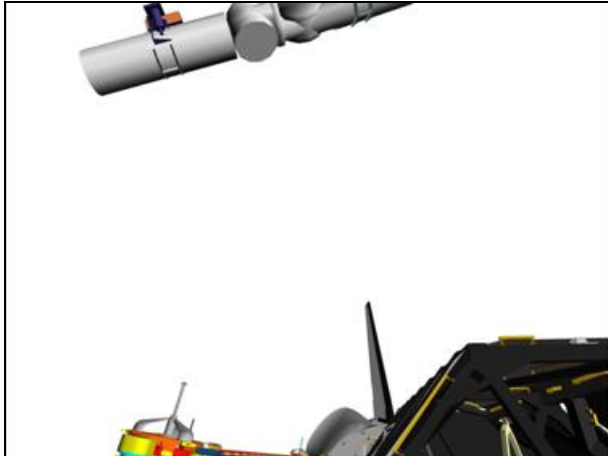

CCTV D (-5,30)



CCTV B (0,25)

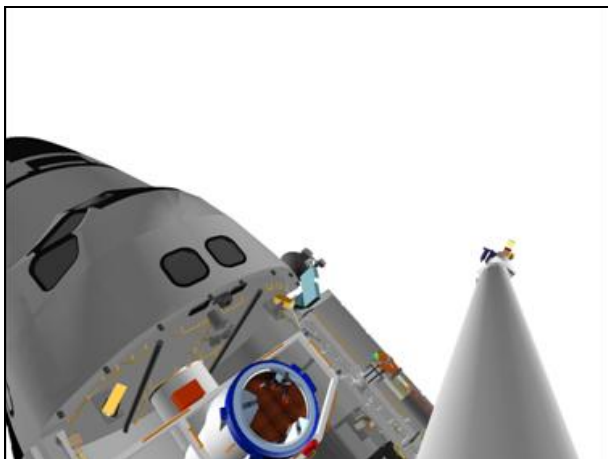

ELBOW (-25,0)



CCTV A (0,45)

Step 4:

Drive SY (+) from -90.0° to 0.0°



CCTV C (0,15)

Step 5:

Drive SP (-) from $+87.9^\circ$ to $+25.0^\circ$

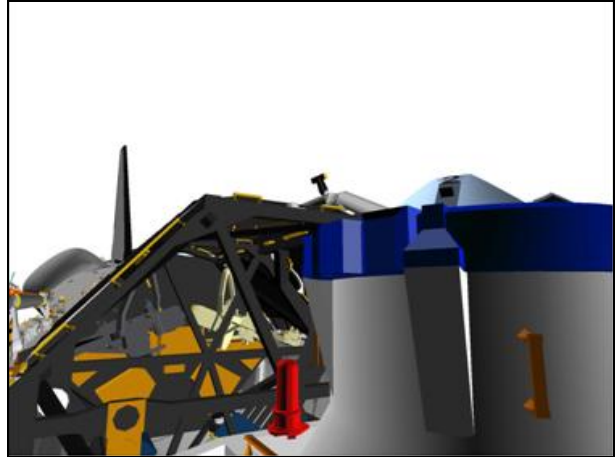

CCTV D (30,10)



CCTV B (0,25)

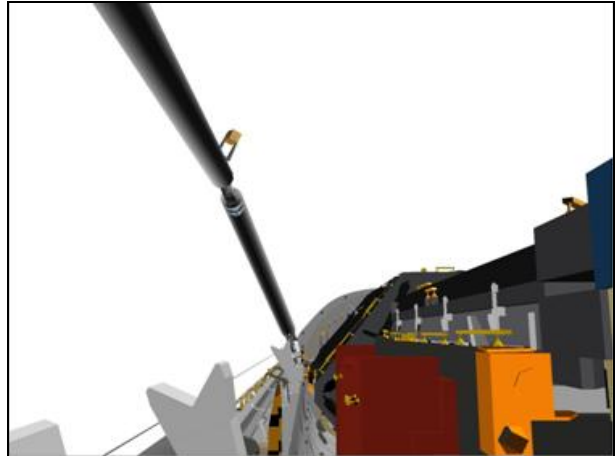

CCTV B (0,10)

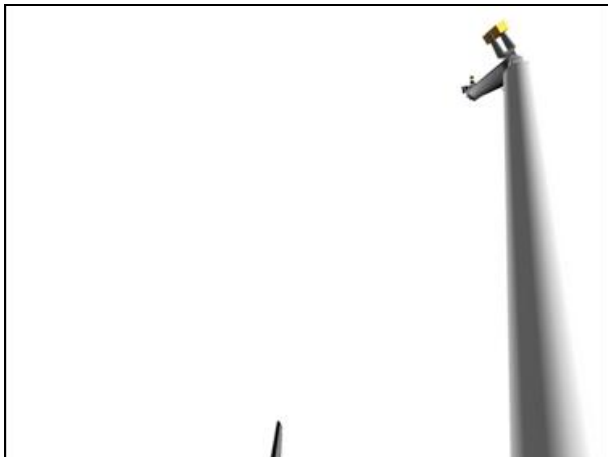

CCTV A (0,45)

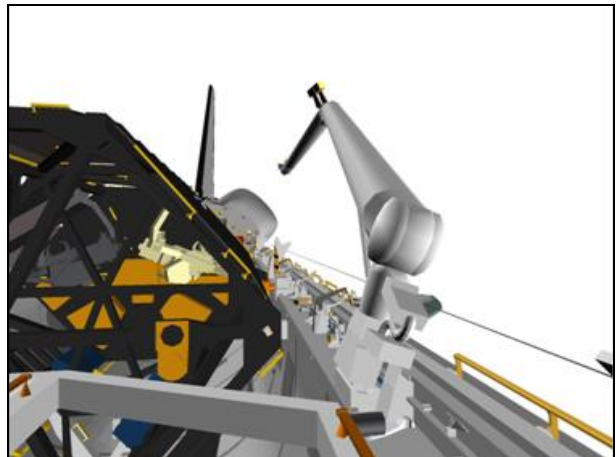

CCTV A (10,0)

OBSS SJ HANDOFF FROM SSRMS (LAB) TO SRMS

1. SETUP

If SINGLE MODE available:

SM 94 PDRS CONTROL

√PL ID, ITEM 3: 0

√INIT ID, ITEM 24: 0

A7U

CCTV – config as reqd

– perform PAN/TILT RESET for PLB cameras

ZOOM – full OUT

2. SJ OBSS PRE-GRAPPLE AT HANDOFF MANEUVER

On SSRMS Operator GO for mnvr to OBSS PRE-GRAPPLE AT HANDOFF posn,

If SINGLE MODE available:

RHC

RATE – as reqd (VERN within 10 ft)

BRAKES

– OFF (tb-OFF)

MODE – best available

Mnvr to OBSS PRE-GRAPPLE AT HANDOFF posn:

	SY	SP	EP	WP	WY	WR	
PRE-CRADLE	0.0	+25.0	-25.0	+5.0	0.0	0.0	
1: SY +	+23.5						
2: SP +		+63.5					
3: EP –			-29.6				
4: WP –				-102.9			
5: WY +					+11.5		
6: WR –						-98.6	
OBSS PRE-GRAPPLE AT HAND-OFF	+23.5	+63.5	-29.6	-102.9	+11.5	-98.6	
	X	Y	Z	PITCH	YAW	ROLL	PL ID
	-1015	-362	-688	284	0	270	0

BRAKES – ON (tb-ON)

MODE – not DIRECT

JOINT – CRIT TEMP

Notify SSRMS Operator that SRMS at OBSS PRE-GRAPPLE AT HANDOFF posn

Start:
Pre-Cradle

Step 1:
Drive SY (+) from 0.0° to +23.5°

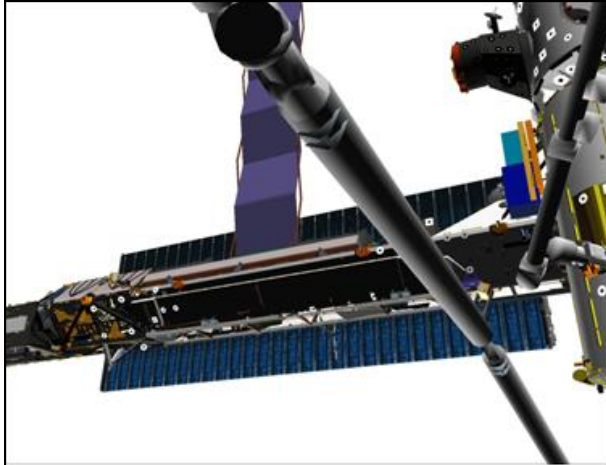

CCTV B (-25,25)

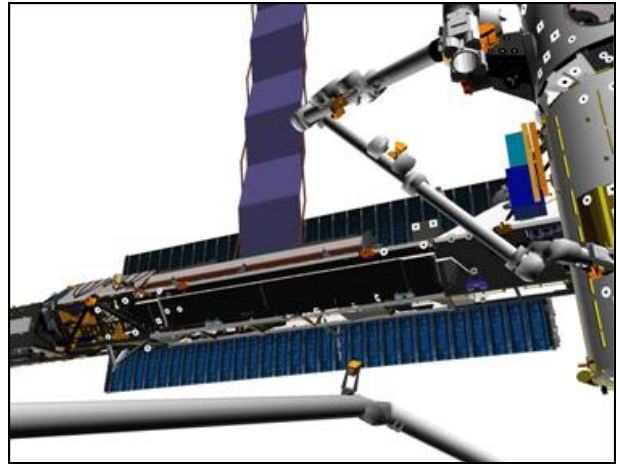

CCTV B (-25,25)

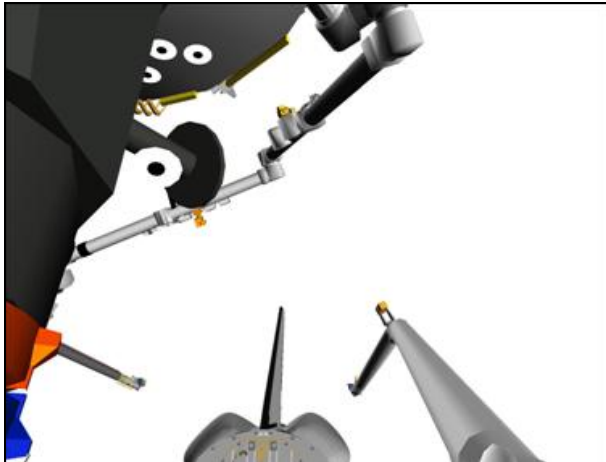

CCTV A (0,30)

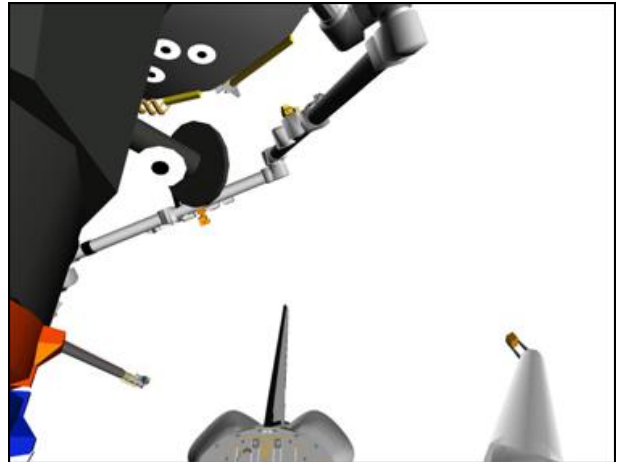

CCTV A (0,30)

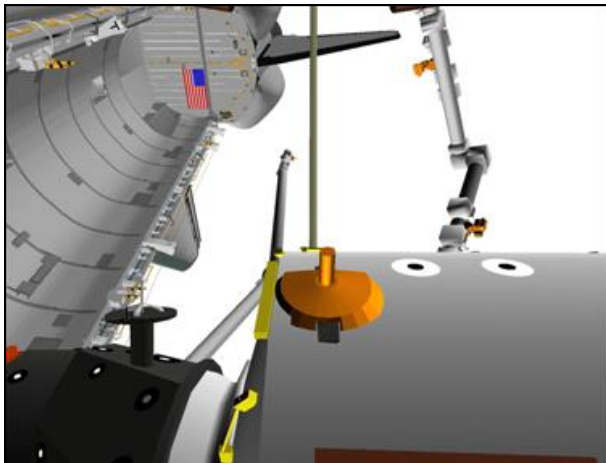

US LAB (0,-55)

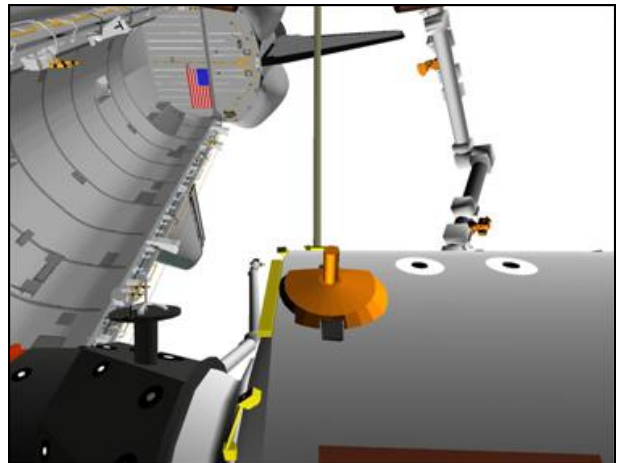

US LAB (0,-55)

Step 2:

Drive SP (+) from +25.0° to +63.5°



CCTV B (-25,25)

Step 3:

Drive EP (-) from -25.0° to -29.6°



CCTV B (-25,25)

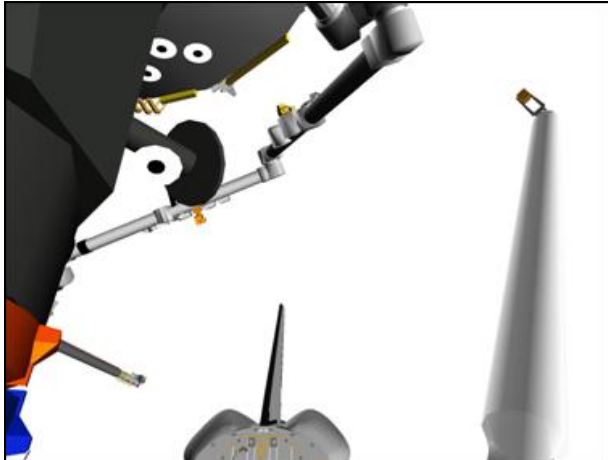

CCTV A (0,30)

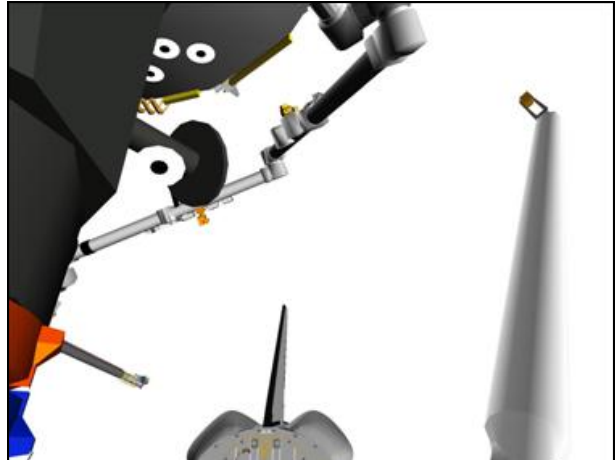

CCTV A (0,30)

Step 4:

Drive WP (-) from +5.0° to -102.9°

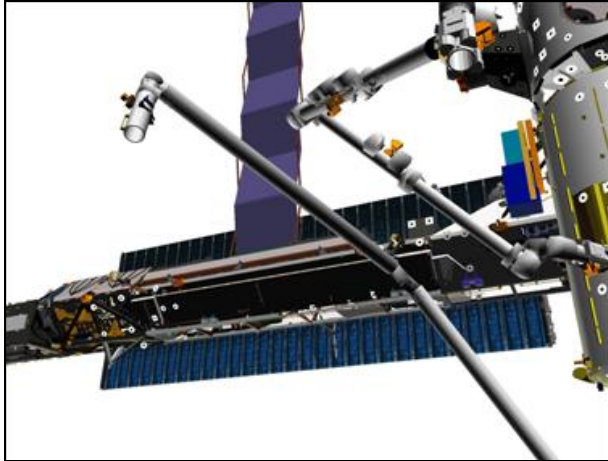

CCTV B (-25,25)

Step 5:

Drive WY (+) from 0.0° to +11.5°



CCTV B (-25,25)

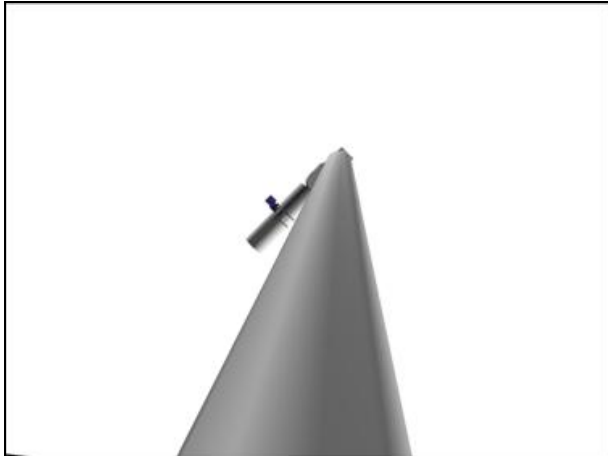

ELBOW (-5,-15)

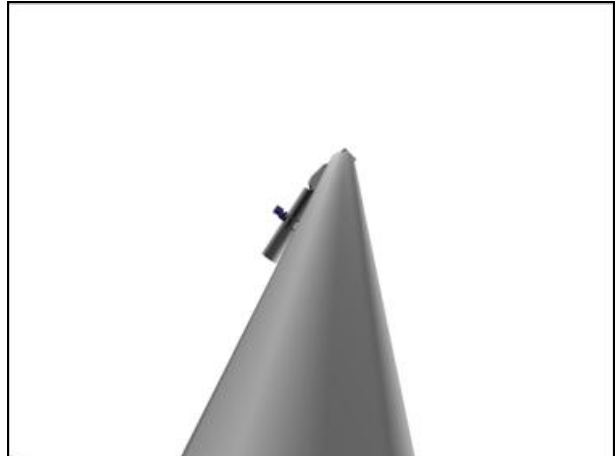

ELBOW (-5,-15)

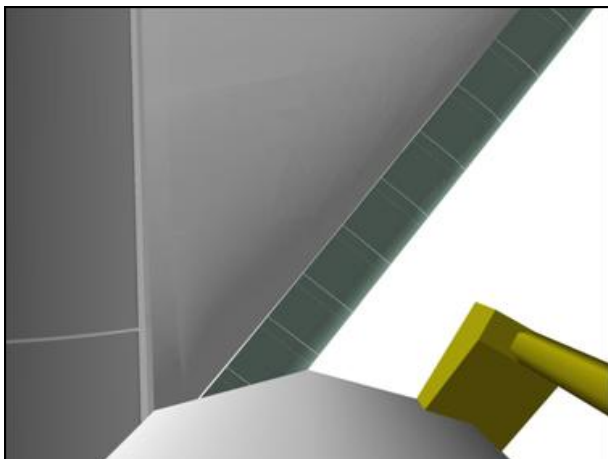

WRIST HFOV: 34.0

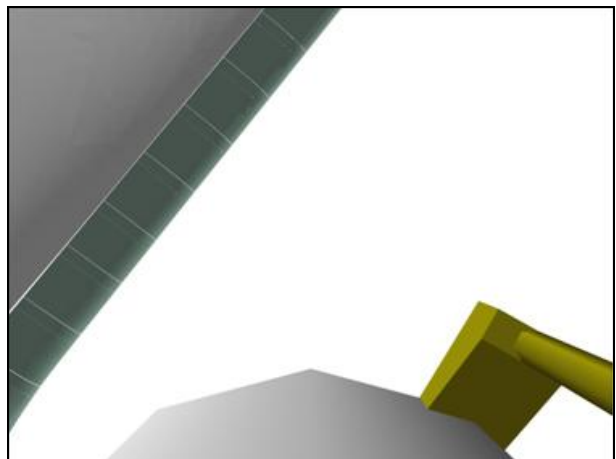

WRIST HFOV: 34.0

Step 6:

Drive WR (-) from 0.0° to -98.6°



CCTV B (-25,25)

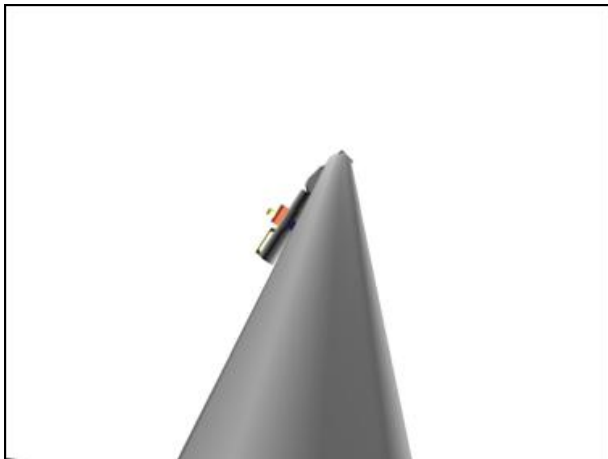

ELBOW (-5,-15)

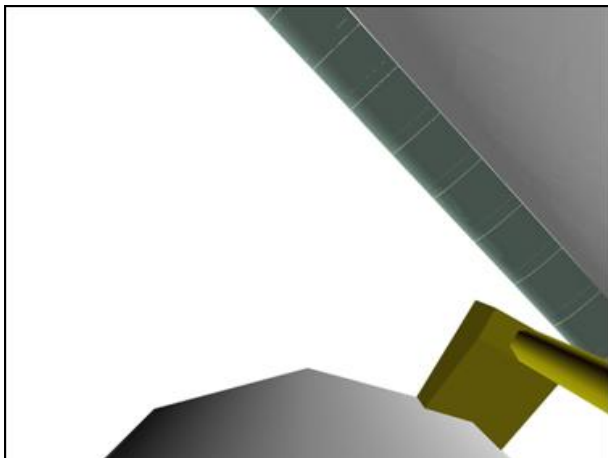

WRIST HFOV: 34.0

3. CONFIGURE POWER

CAUTION
SPEE power must be applied within 90 min
to prevent sensor package damage

On SSRMS Operator GO to release STBD MRLs,
STBD RMS HTR A,B (two) – OFF

- A6U EVENT TIMER MODE – UP
 CNTL – START
- MA73C:C cb MCA PWR AC3 3Φ MID 2 – op
 √AC2 3Φ MID 2 – op
:D √AC3 3Φ MID 4 – op
- R13L PL BAY MECH PWR SYS (two) – ON

4. STBD MRL RELEASE

SM 94 PDRS CONTROL

RMS STBD – ITEM 2 EXEC (*)
√STBD AFT, MID, FWD REL (six) = 0

NOTE

Expect single motor drive time for MRL release

STBD RMS RETEN LAT – REL (tb-REL) (18 sec max)
– OFF

If motor drive time > 18 sec, √MCC

SM 94 PDRS CONTROL
√STBD AFT, MID, FWD REL (six) = 1

5. RECONFIGURE POWER

- R13L PL BAY MECH PWR SYS (two) – OFF
- MA73C:C cb MCA PWR AC3 3Φ MID 2 – cl
 √AC2 3Φ MID 2 – op
:D √AC3 3Φ MID 4 – op

Give SSRMS Operator GO for OBSS Unberth
Monitor RFL Status

After OBSS Unberth,

SM 94 PDRS CONTROL
RMS PORT – ITEM 1 EXEC (*)

6. SETUP FOR GRAPPLE

- A7U CCTV – config for grapple
 – install PDRS TARGET OVERLAY FOR CTVM
 – RMS WRIST, ZOOM: 34.0 HFOV
 FOCUS: 5 ft
 Maintain eyepoint approx 18 in when using grapple overlay

- R12(OBSS) √SPEE PWR – OFF
L12U(SSP1) √APCU 1 OUTPUT RLY – OP (tb-bp)

7. SJ OBSS GRAPPLE AT HANDOFF

On SSRMS Operator GO for SRMS OBSS Grapple,

If SINGLE MODE available:

- RATE – VERN (RATE MIN tb-ON)
- OFF (tb-OFF)

RHC
BRAKES

MODE – best available

Drive joints per OBSS SJ HANDOFF SRMS GRAPPLE WRIST CCTV OVERLAY
and diagram until EE within grapple envelope

CAUTION
Monitor EE tb timing to prevent EE motor burnout

EE MODE – AUTO

CAPTURE sw – depress (mom)

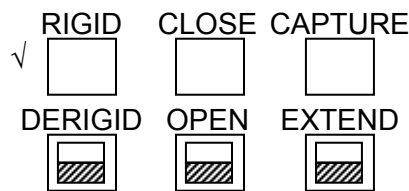

CRITICAL TIMES (28 sec total):

- CAPTURE tb – gray, then
- CLOSE tb – gray, 3 sec max, then
- RIGID tb – gray, 25 sec max

EE MODE – OFF

- * If manual capture required: *
- * EE MODE – MAN *
- * CAPTURE sw – depress (hold until CLOSE tb-gray, 3 sec max) *
- * MAN CONTR – RIGID (hold until RIGID tb-gray, 25 sec max) *
- * MODE – OFF *

If TEST mode available,
MODE – TEST, ENTER
Wait 5 sec

BRAKES – ON (tb-ON)
MODE – not DIRECT
JOINT – CRIT TEMP

OBSS SJ HANDOFF SRMS GRAPPLE

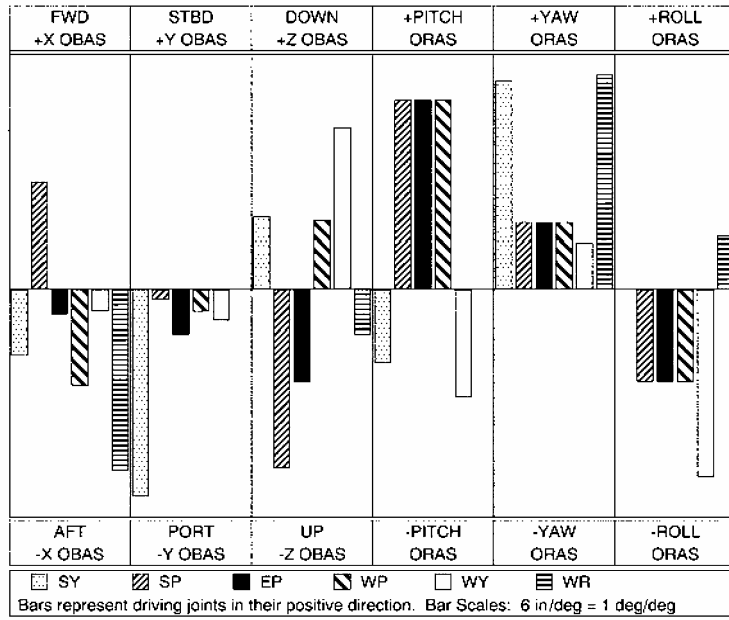

To get:	Drive:	To get:	Drive:
+X (fwd)	-WR, -WP	+PITCH	+EP, +WP
+Y (stbd)	-SY	+YAW	+WR, +SY
+Z (down)	+WY, -SP	+ROLL	-WY, -EP

Driving:	Results In:	Driving:	Results In:
+SY	-Y (port), +YAW	+WP	-X (aft), +PITCH
+SP	-Z (up), +PITCH	+WY	+Z (down), -ROLL
+EP	-Z (up), +PITCH	+WR	-X (aft), +YAW

ΔSY	ΔSP	ΔEP	ΔWP	ΔWY	ΔWR
+2.3	+2.8	-19.4	+17.0	-0.8	-2.1

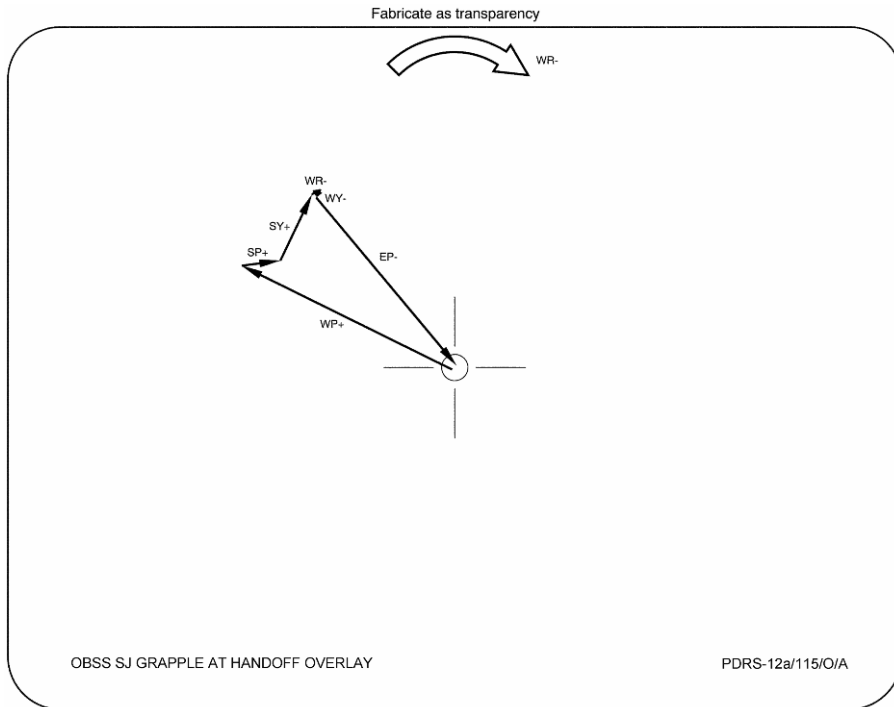

If SINGLE MODE available:

SM 94 PDRS CONTROL

PL ID – ITEM 3 +2 EXEC

INIT ID – ITEM 24 +2 EXEC

Expected OBSS HANDOFF posn:

X	Y	Z	PITCH	YAW	ROLL	PL ID
-1031	-44	-610	284	270	270	2
SY	SP	EP	WP	WY	WR	
+25.8	+66.3	-49.0	-85.9	+10.7	-100.7	

* display singularity

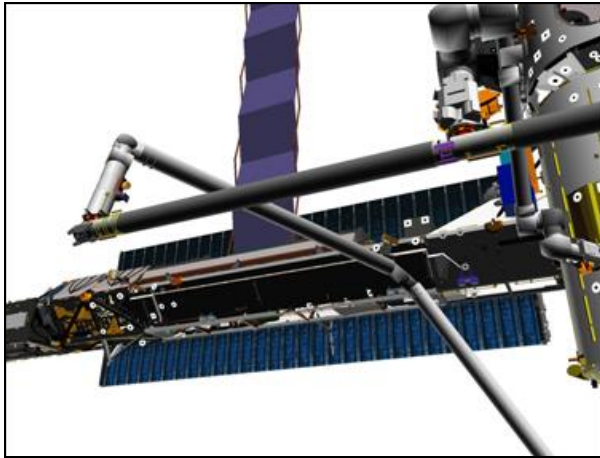

CCTV B (-25,25)

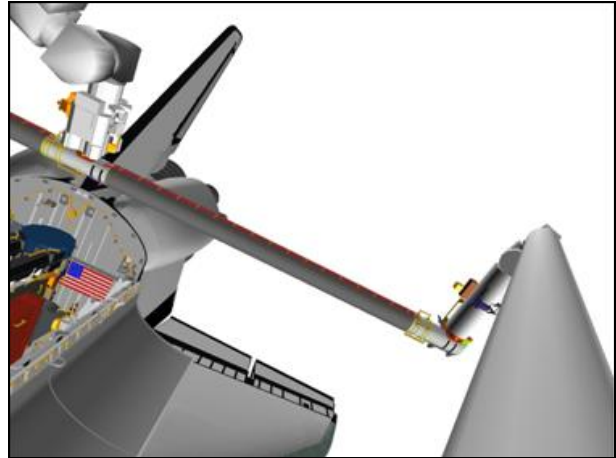

ELBOW (-30,-5)

Perform ACTIVATION (LDRI/ITVC Cue Card, PHOTO/TV)

Perform LCH ACTIVATION (LCS Cue Card, PHOTO/TV)

Perform LCC ACTIVATION (LCS Cue Card, PHOTO/TV)

Perform LCC DEACTIVATION (LCS Cue Card, PHOTO/TV), steps 1 and 2

Give SSRMS Operator GO for OBSS Ungrapple

Review GENERIC END EFFECTOR CUE CARD – ISS/SHUTTLE DOCKED OPS

8. MNVR TO OBSS PARK

On SSRMS Operator GO for mnvr to OBSS PARK posn,

RHC

RATE – as desired (VERN within 10 ft)

BRAKES – OFF (tb-OFF)

MODE – SINGLE, ENTER

Mnvr to OBSS PARK posn:

	SY	SP	EP	WP	WY	WR	
Handoff posn	+25.8	+66.3	-49.0	-85.9	+10.7	-100.7	
1: SY +	+70.0						
2: WR +						0.0	
3: WY -					0.0		
4: WP +				+5.0			
5: SP -		+25.0					
6: EP +			-25.0				
7: SY -	0.0						
OBSS Park	0.0	+25.0	-25.0	+5.0	0.0	0.0	
	X	Y	Z	PITCH	YAW	ROLL	PL ID
	-1243	-143	-869	95	359	358	2

BRAKES – ON (tb-ON)
 MODE – not DIRECT
 PARAM – PORT TEMP
 JOINT – CRIT TEMP

Start:
OBSS Handoff

Step 1:
Drive SY+ (for 44.2°)
From +25.8° to +70.0°

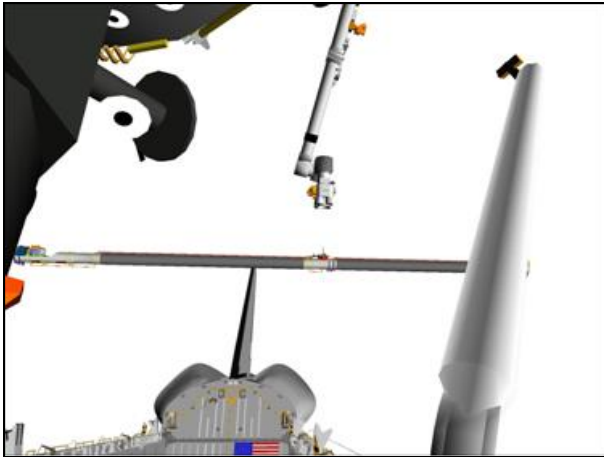

CCTV A (4,25)



CCTV A (45,25)

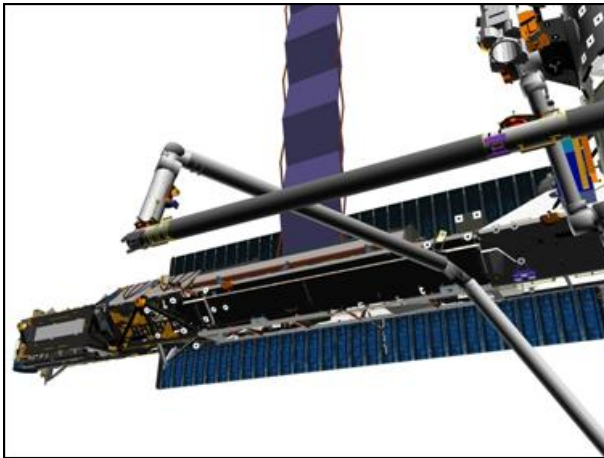

CCTV B (-30,25)

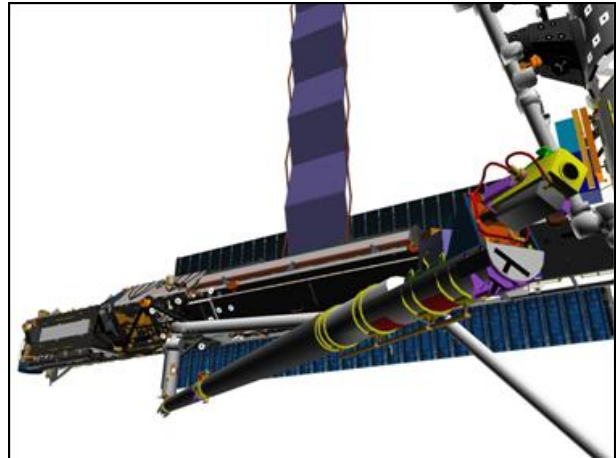

CCTV B (-30,25)

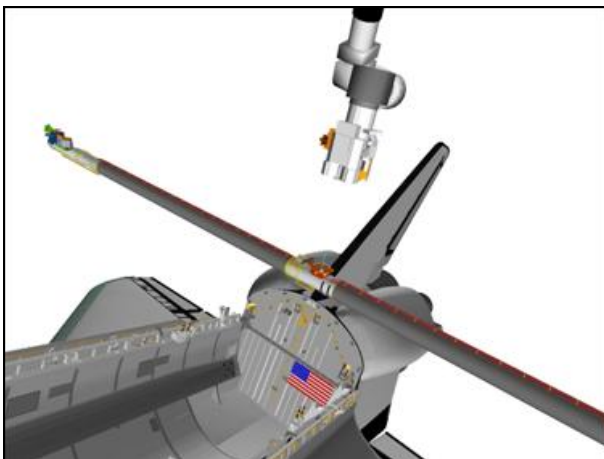

ELBOW (-60,10)

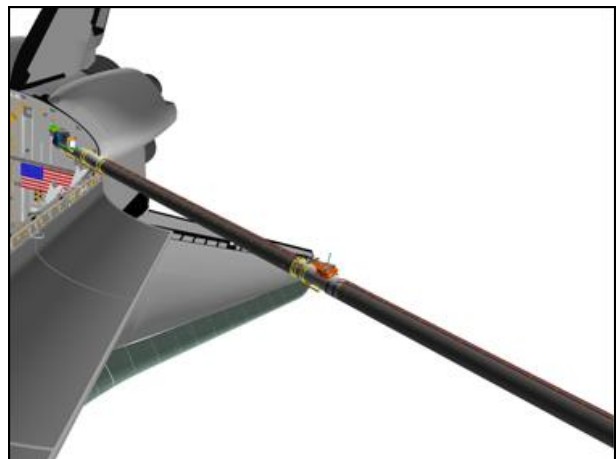

ELBOW (-60,10)

Step 2:

Drive WR+ (for 100.7°)
From -100.7° to 0.0°



CCTV A (45,25)

Step 3:

Drive WY- (for 10.7°)
From +10.7° to 0.0°



CCTV A (45,25)

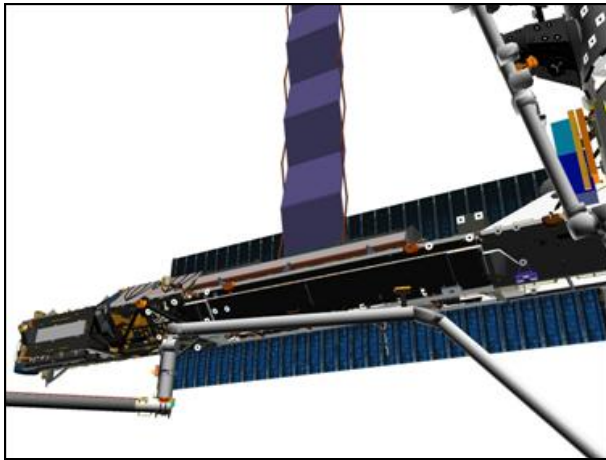

CCTV B (-30,25)

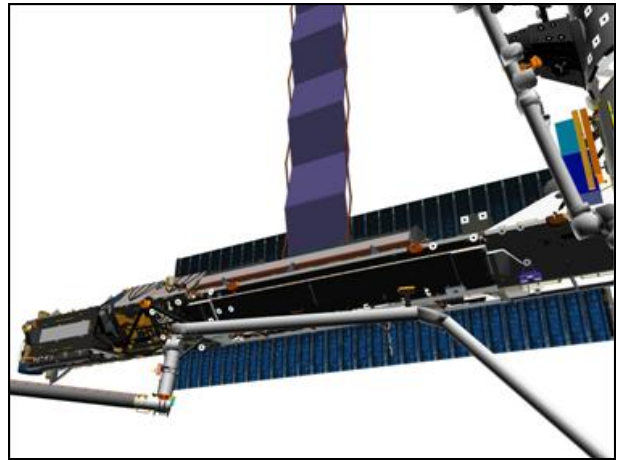

CCTV B (-30,25)

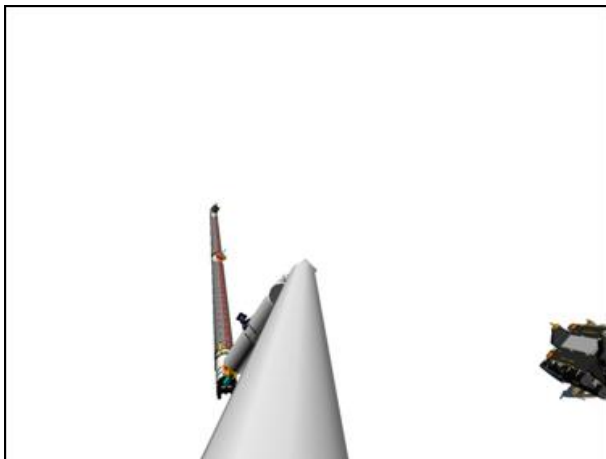

ELBOW (0,0)

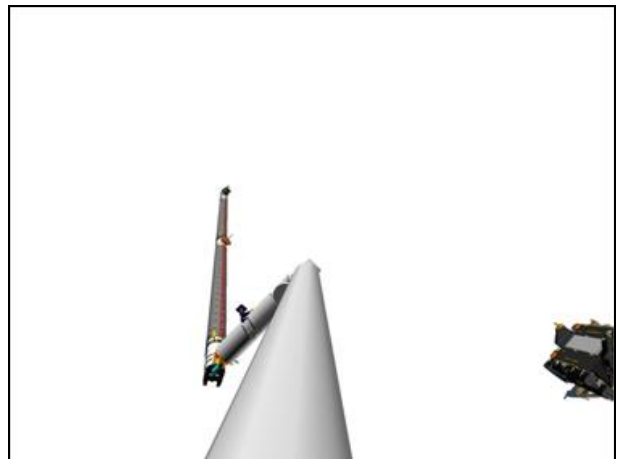

ELBOW (0,0)

Step 4:

Drive WP+ (for 90.9°)
From -85.9° to +5.0°



CCTV A (45,25)

Step 5:

Drive SP- (for 41.3°)
From +66.3° to +25.0°



CCTV A (45,0)

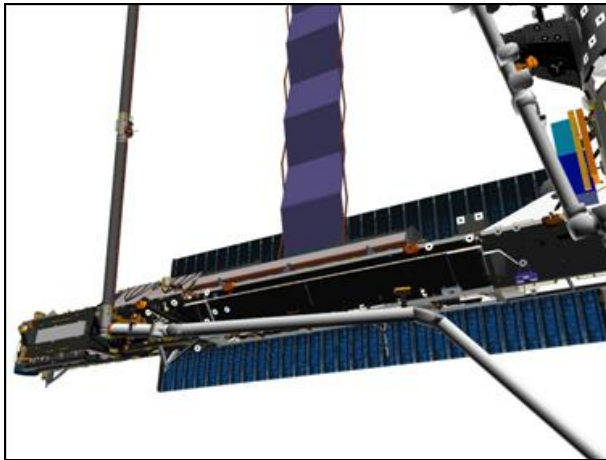

CCTV B (-30,25)

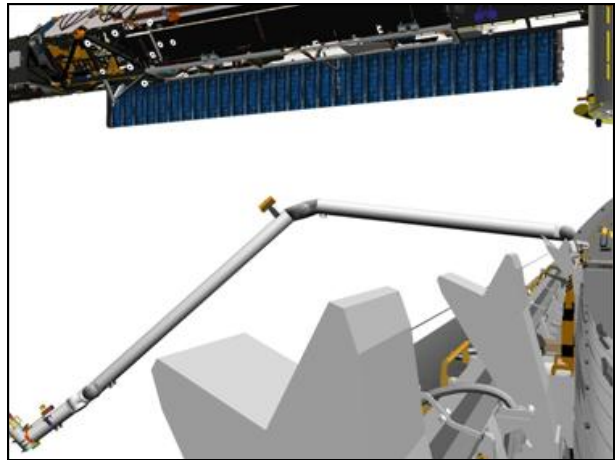

CCTV B (-25,0)

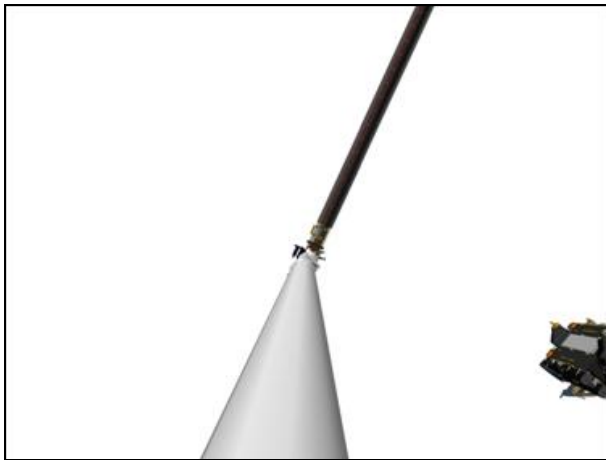

ELBOW (0,0)

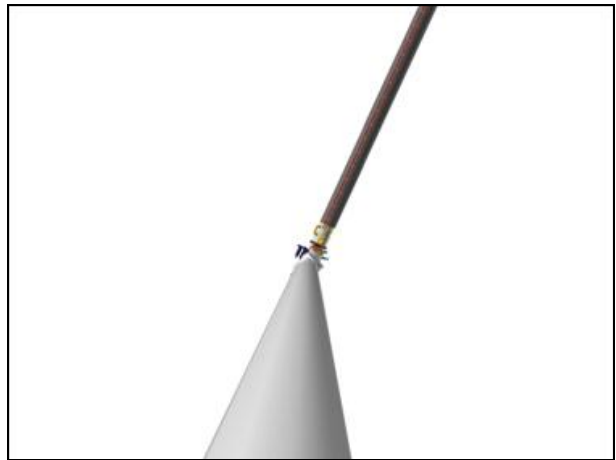

ELBOW (0,0)

Step 6:

Drive EP+ (for 24.0°)
From -49.0° to -25.0°



CCTV A (45,0)

Step 7:

Drive SY- (for 70.0°)
From +70.0° to 0.0°

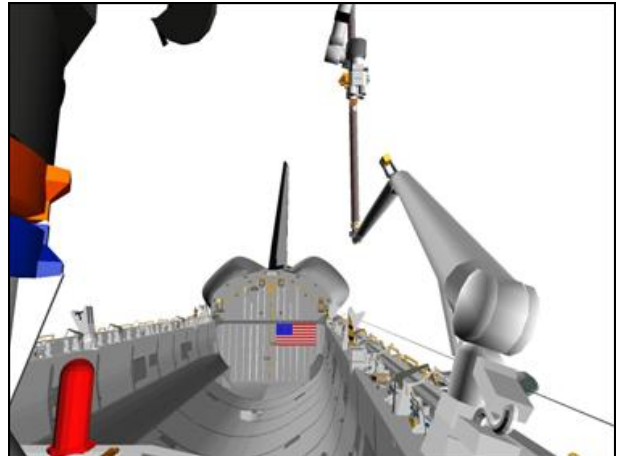

CCTV A (0,10)

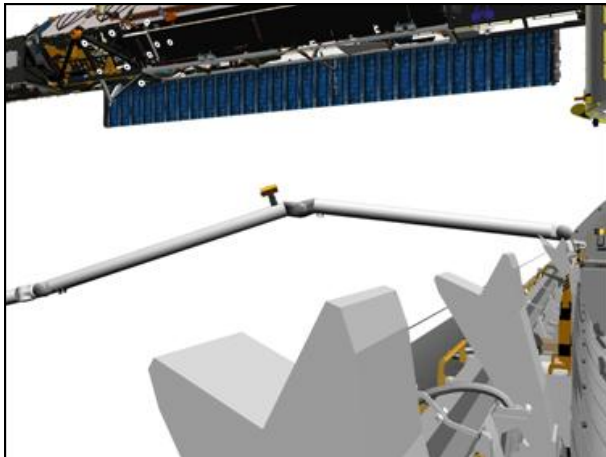

CCTV B (-25,0)



CCTV B (0,25)



ELBOW (0,0)

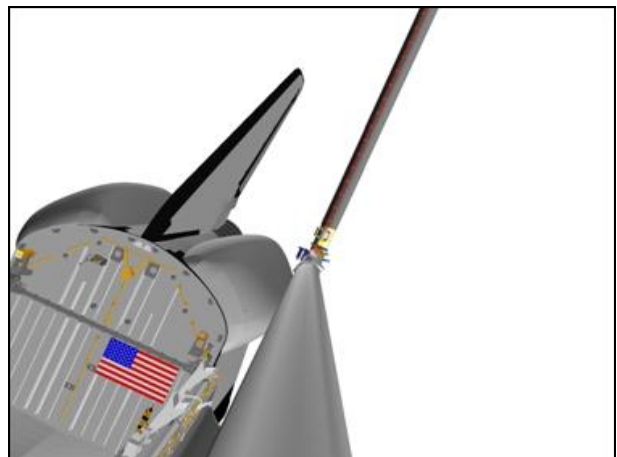

ELBOW (0,0)

- A7U
9. RECONFIG PTU
VIDEO OUT MON2 pb – push
IN PL2(VPU) pb – push
- CAMR CMD PAN/TILT – HI RATE
PAN – L (to hard stop)
TILT – UP (to hard stop)
PAN/TILT – RESET, HI RATE (LO within 10°)
PAN: +75 (right)
TILT: -55 (down)
- VIDEO OUT MUX 1 L pb – push (MIDDECK It on)
LDR1 MODE 2 pb – push (ITVC video)

OBSS SJ HANDOFF FROM SRMS TO SSRMS (LAB)

1. SETUP

If SINGLE MODE available:

SM 94 PDRS CONTROL

√PL ID, ITEM 3: 2

√INIT ID, ITEM 24: 2

A7U

CCTV – config as reqd

– perform PAN/TILT RESET for PLB cameras

Review GENERIC END EFFECTOR CUE CARD – ISS/SHUTTLE DOCKED OPS

2. MANEUVER TO OBSS HANDOFF

On SSRMS Operator GO for mnvr to OBSS HANDOFF posn,

If SINGLE MODE available:

RHC

RATE – as reqd (VERN within 10 ft)

BRAKES – OFF (tb-OFF)

MODE – best available

Mnvr to OBSS HANDOFF posn:

	SY	SP	EP	WP	WY	WR	
OBSS Park	0.0	+25.0	-25.0	+5.0	0.0	0.0	
1: SY +	+70.0						
2: EP –			-49.0				
3: SP +		+66.3					
4: WP –				-85.9			
5: WY +					+10.7		
6: WR –						-100.7	
7: SY –	+25.8						
Handoff Posn	+25.8	+66.3	-49.0	-85.9	+10.7	-100.7	
	X	Y	Z	PITCH	YAW	ROLL	PL ID
	-1031	-44	-610	284	270	270	2

* display singularity

BRAKES – ON (tb-ON)

MODE – not DIRECT

JOINT – CRIT TEMP

Give SSRMS Operator GO for OBSS Grapple

Start:
OBSS Park

Step 1:
Drive SY+ (for 70.0°)
From 0.0° to +70.0°

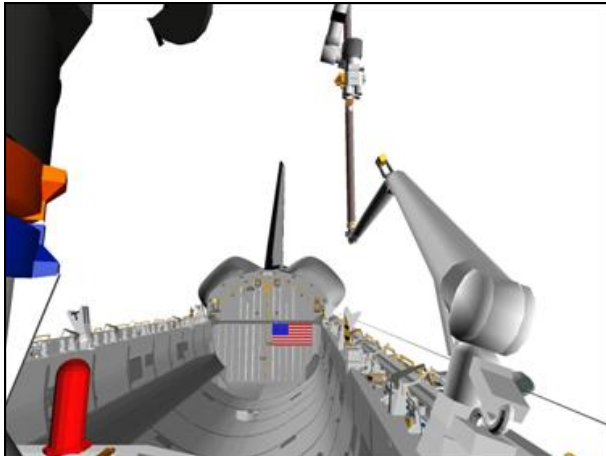

CCTV A (0,10)

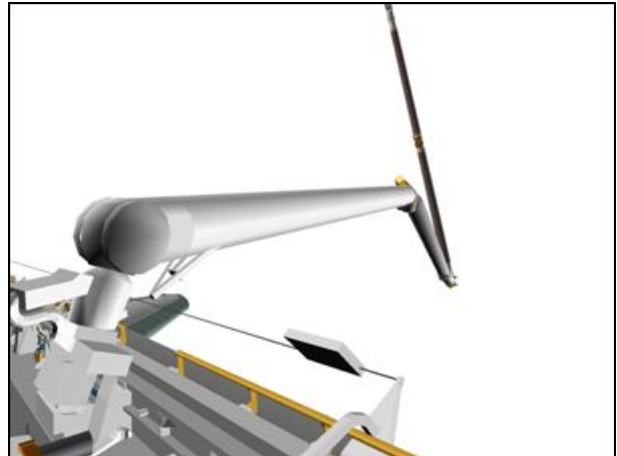

CCTV A (45,0)



CCTV B (0,25)

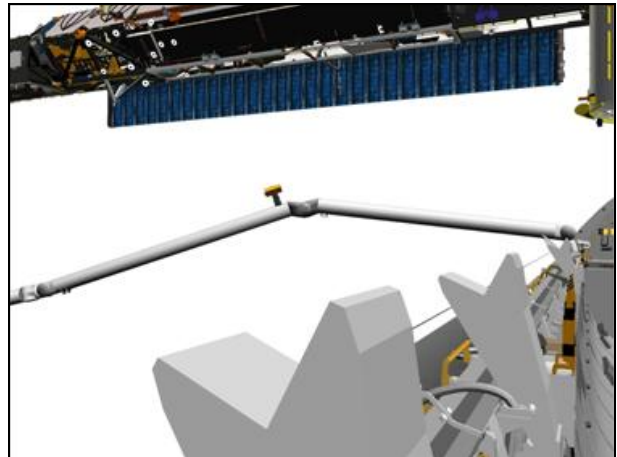

CCTV B (-25,0)

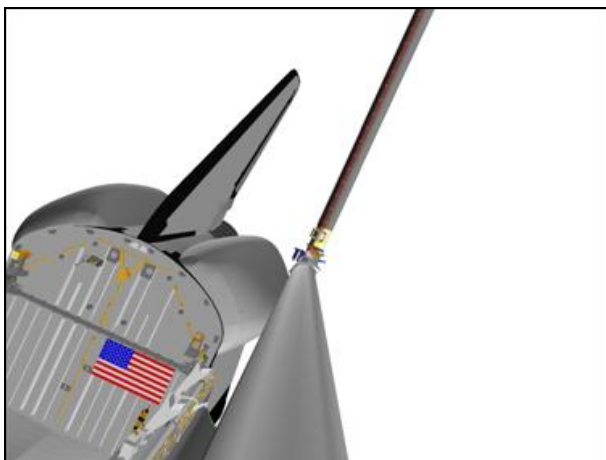

ELBOW (0,0)



ELBOW (0,0)

Step 2:

Drive EP- (for 24.0°)
From -25.0° to -49.0°



CCTV A (45,0)

Step 3:

Drive SP+ (for 41.3°)
From +25.0° to +66.3°



CCTV A (45,25)

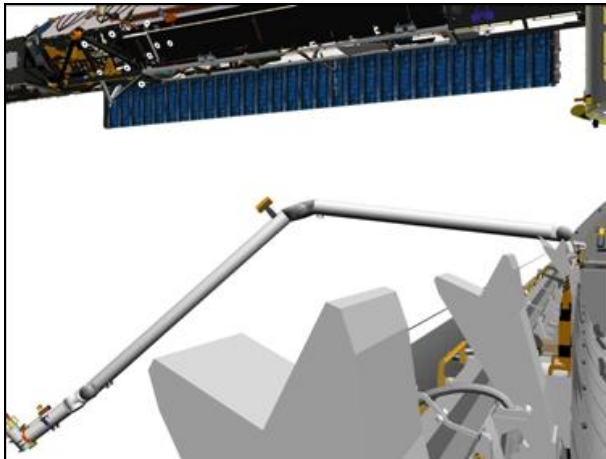

CCTV B (-25,0)

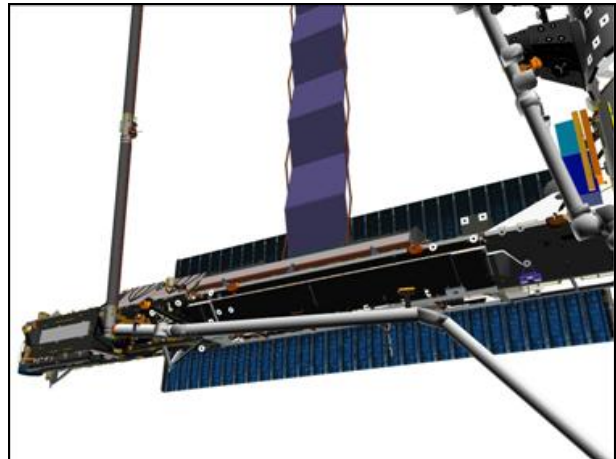

CCTV B (-30,25)



ELBOW (0,0)



ELBOW (0,0)

Step 4:

Drive WP- (for 90.9°)
From +5.0° to -85.9°



CCTV A (45,25)

Step 5:

Drive WY+ (for 10.7°)
From 0.0° to +10.7°



CCTV A (45,25)

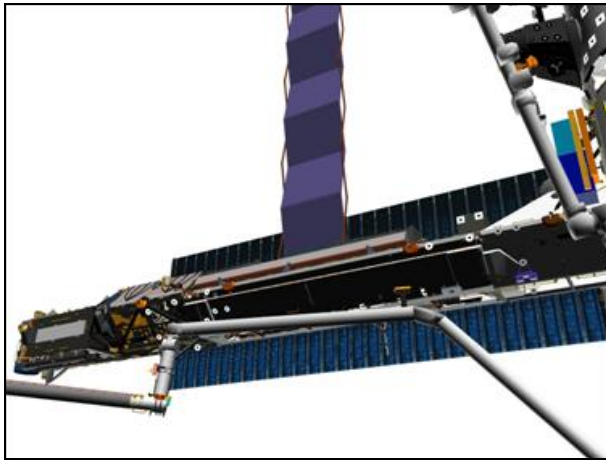

CCTV B (-30,25)

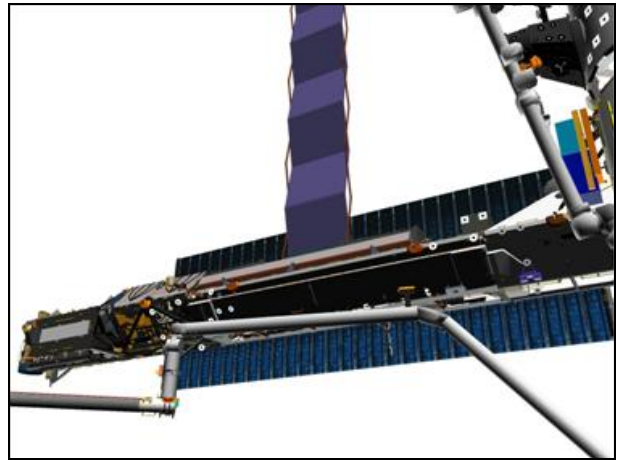

CCTV B (-30,25)

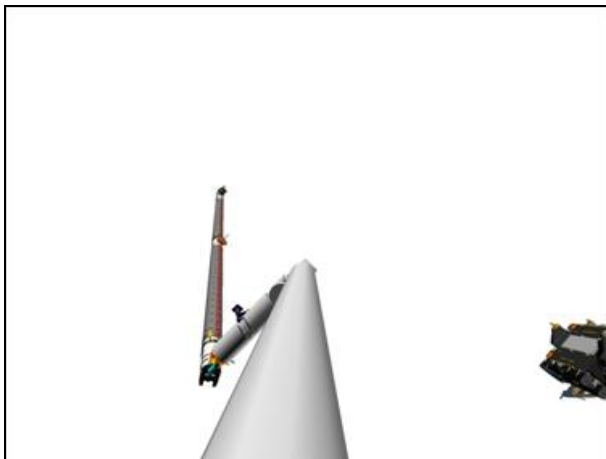

ELBOW (0,0)

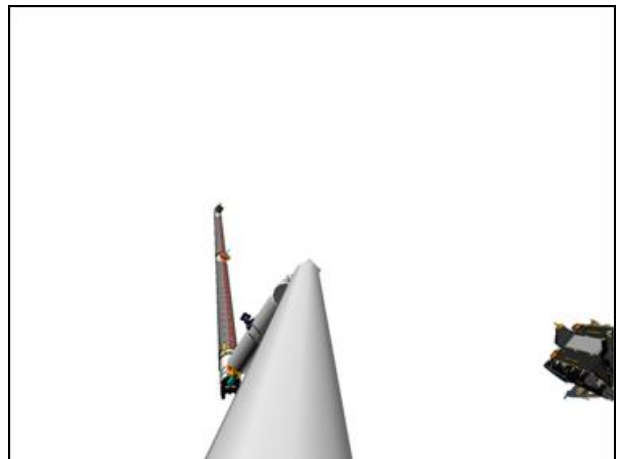

ELBOW (0,0)

Step 6:

Drive WR- (for 100.7°)
From 0.0° to -100.7°



CCTV A (45,25)

Step 7:

Drive SY- (for 44.2°)
From +70.0° to +25.8°



CCTV A (4,25)

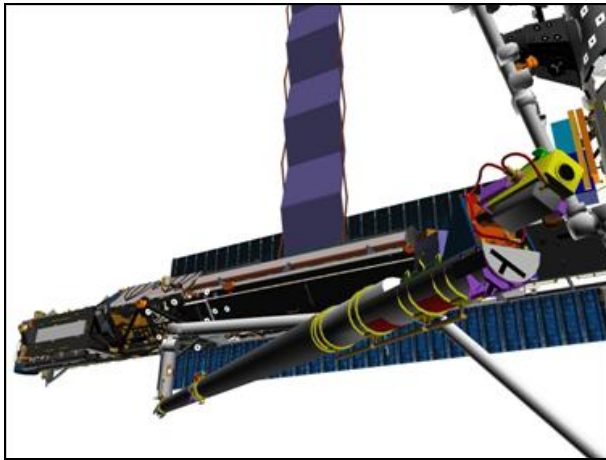

CCTV B (-30,25)

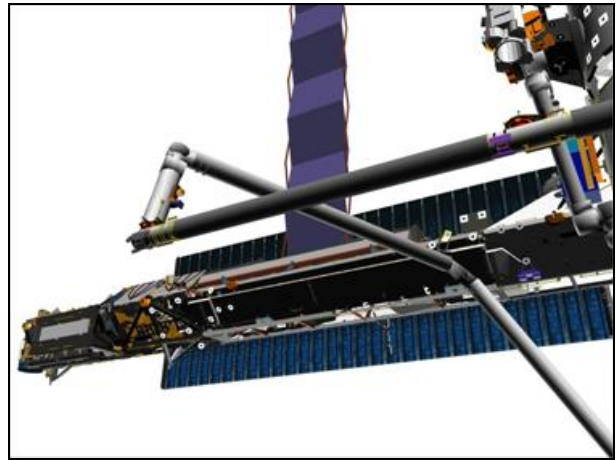

CCTV C (-30,25)

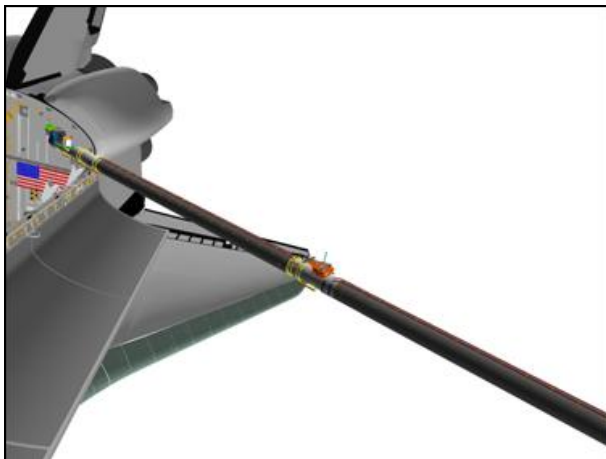

ELBOW (-60,10)

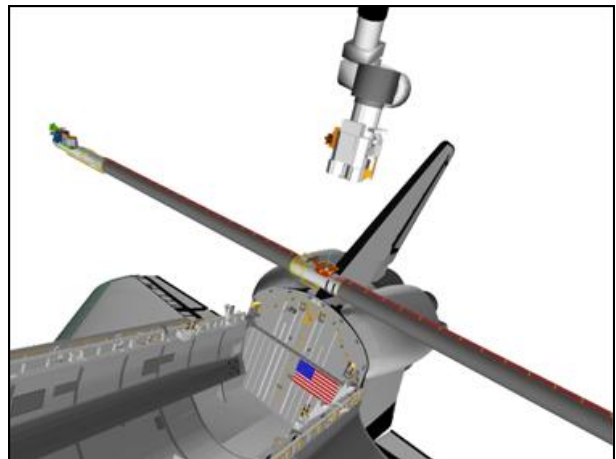

ELBOW (-60,10)

3. STOW PTU

A7U On SSRMS Operator GO for OBSS Ungrapple,
VIDEO OUT MON2 pb – push
IN PL2(VPU) pb – push

CAMR CMD PAN/TILT – HI RATE

PAN – L (to hard stop)

TILT – UP (to hard stop)

PAN/TILT – RESET, HI RATE (LO within 10°)

PAN: +108 (right)

TILT: -175 (down)

Perform LCC DEACTIVATION (LCS Cue Card, PHOTO/TV)

Perform LCH DEACTIVATION (LCS Cue Card, PHOTO/TV)

CAUTION

STBD RMS HTR power must be applied within
90 min to prevent sensor package damage

Perform DEACTIVATION (LDRI/ITVC Cue Card, PHOTO/TV)

4. OBSS UNGRAPPLE

A7U CCTV – config for ungrapple
– RMS WRIST, ZOOM: 34.0 HFOV
FOCUS: 5 ft

NOTE

CONTR ERR It and 'S96 PDRS CNTL' msg may
occur due to Consistency/Envelope Check error

If TEST MODE available:

RHC RATE – COARSE (RATE MIN tb-OFF)

SM 94 PDRS CONTROL

AUTO BRAKE INH – ITEM 10 EXEC (*)

BRAKES – OFF (tb-OFF)

MODE – TEST, ENTER

Wait 5 sec

BRAKES – ON (tb-ON)

SM 94 PDRS CONTROL

AUTO BRAKE ENA – ITEM 9 EXEC (*)

If SINGLE MODE available:

SM 94 PDRS CONTROL

PL ID – ITEM 3 +0 EXEC

INIT ID – ITEM 24 +0 EXEC

RHC RATE – VERN (RATE MIN tb-ON)

BRAKES – OFF (tb-OFF)

MODE – best available

CAUTION
Monitor EE tb timing to prevent EE motor burnout

EE MODE – MAN
 MAN CONTR – DERIGID (hold until DERIGID tb-gray, 5 sec max)
 RELEASE sw – depress (hold until OPEN tb-gray, 3 sec max)

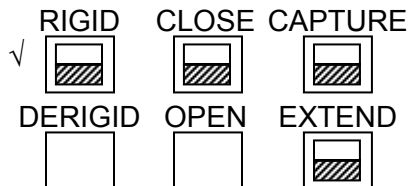

5. SJ MNVR TO OBSS PRE-GRAPPLE

Drive joints per OBSS SJ HANDOFF SRMS UNGRAPPLE WRIST CCTV OVERLAY and diagram until SRMS at OBSS PRE-GRAPPLE posn

EE MAN CONTR – DERIGID (hold until EXTEND tb-gray, 20 sec max)
 MODE – OFF

√POS/ATT and Joint Angles at OBSS PRE-GRAPPLE AT HANDOFF posn:

X	Y	Z	PITCH	YAW	ROLL	PL ID
-1015	-362	-688	284	0	270	0
SY	SP	EP	WP	WY	WR	
+23.5	+63.5	-29.6	-102.9	+11.5	-98.6	

BRAKES – ON (tb-ON)
 MODE – not DIRECT
 JOINT – CRIT TEMP

Give SSRMS Operator GO to mnvr to Aft posn

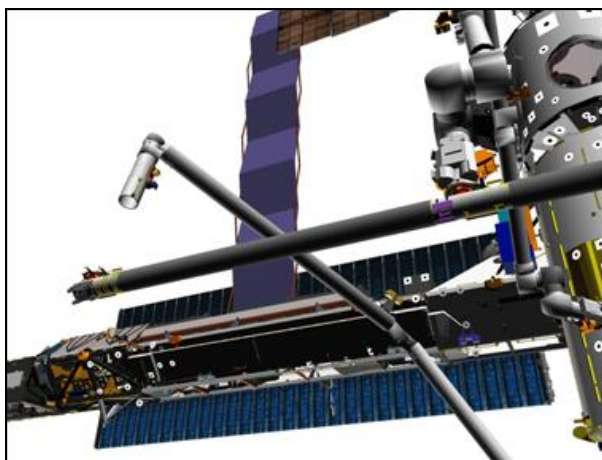

CCTV B (-25,30)

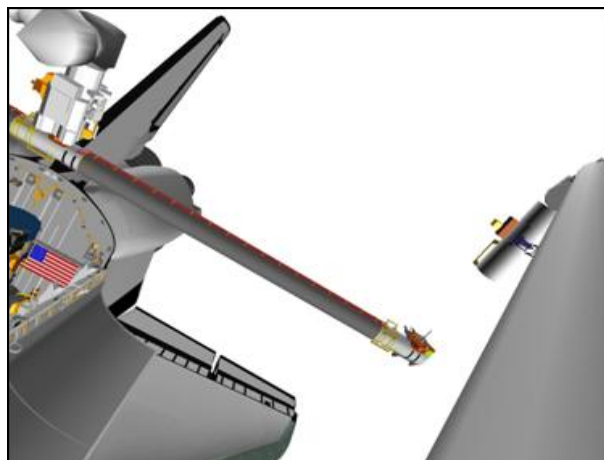

ELBOW (-35,-15)

OBSS SJ HANDOFF SRMS UNGRAPPLE

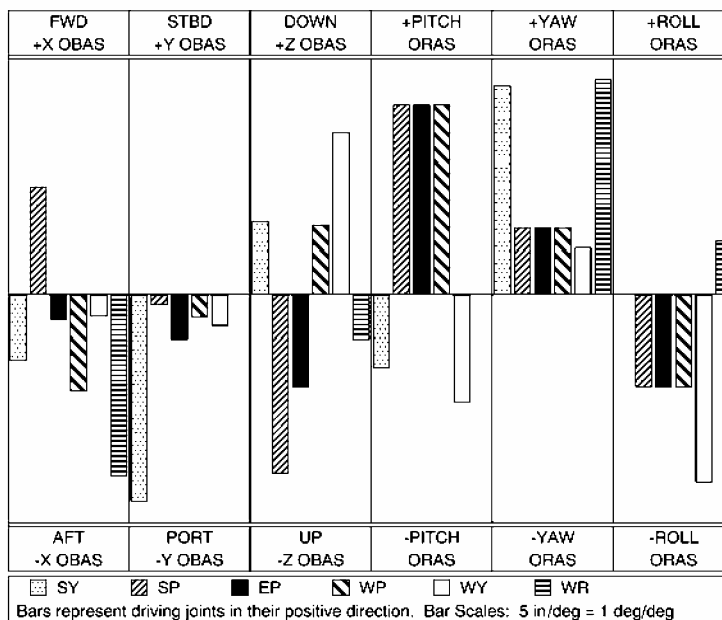

To get:	Drive:	To get:	Drive:
+X (fwd)	-WR, -WP	+PITCH	+EP, +WP
+Y (stbd)	-SY	+YAW	+WR, +SY
+Z (down)	+WY, -SP	+ROLL	-WY, -EP

Driving:	Results In:	Driving:	Results In:
+SY	-Y (port), +YAW	+WP	-X (aft), +PITCH
+SP	-Z (up), +PITCH	+WY	+Z (down), -ROLL
+EP	-Z (up), +PITCH	+WR	-X (aft), +YAW

ΔSY	ΔSP	ΔEP	ΔWP	ΔWY	ΔWR
-2.3	-2.8	+19.4	-17.0	+0.8	+2.1

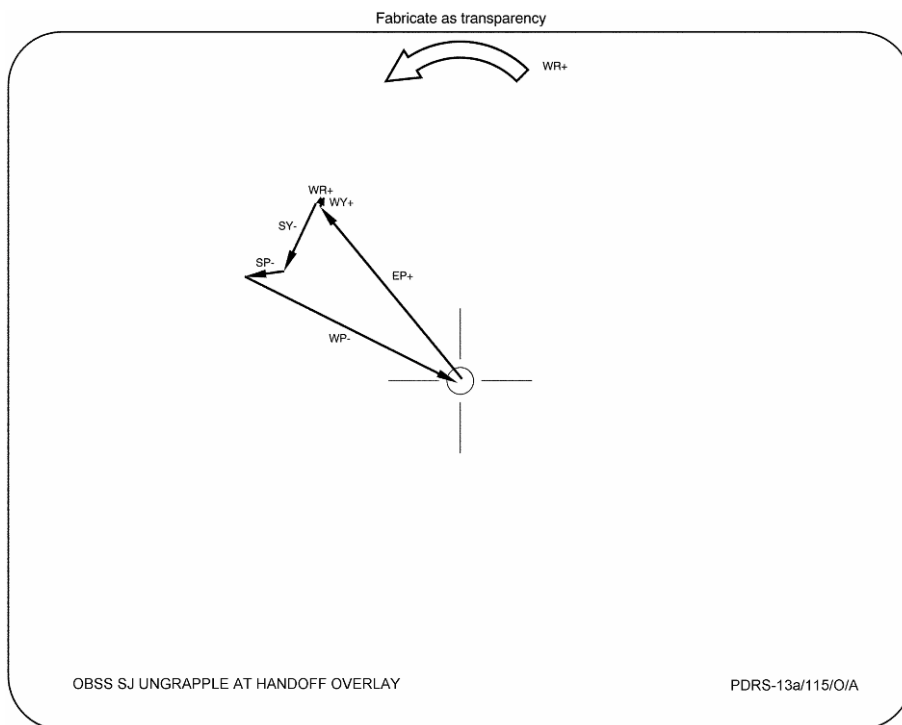

10. MNVR TO PRE-CRADLE

RHC On SSRMS Operator GO,
 RATE – as reqd (VERN within 10 ft)
 BRAKES – OFF (tb-OFF)
 MODE – SINGLE, ENTER

Mnvr to PRE-CRADLE posn:

	SY	SP	EP	WP	WY	WR	
Pre-Grapple	+23.5	+63.5	-29.6	-102.9	+11.5	-98.6	
1: WR +						0.0	
2: WY -					0.0		
3: WP +				+5.0			
4: SP -		+25.0					
5: EP +			-25.0				
6: SY -	0.0						
Pre-Cradle	0.0	+25.0	-25.0	+5.0	0.0	0.0	
	X	Y	Z	PITCH	YAW	ROLL	PL ID
	-1261	-146	-551	5	2	0	0

BRAKES – ON (tb-ON)
 MODE – not DIRECT
 PARAM – PORT TEMP
 JOINT – CRIT TEMP

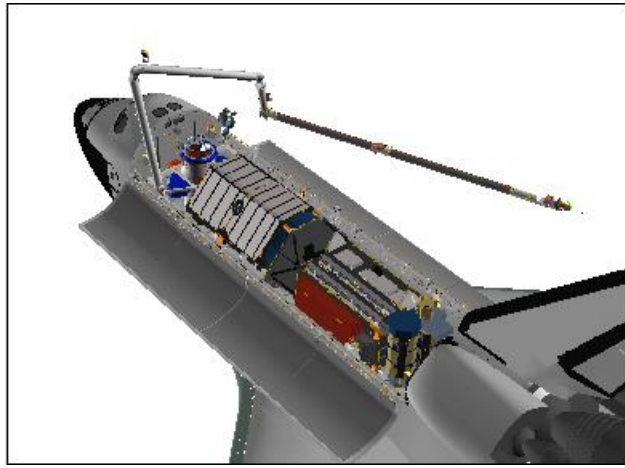

BIRD'S EYE

3. FLAT FIELDS

- A7U a. ITVC (Black Stretch)
 VIDEO OUT MUX 1 L pb – push (MIDDECK lt on)
 LDRI MODE 1 pb – push (ITVC video)
 VIDEO OUT MON2 pb – push
 IN PL2 (VPU) pb – push
- ALC pb – push
 PEAK pb – push
 LT LEVEL pb – push
 DAY pb – push
 LT LEVEL pb – push (all MENU lts off)
 AP COR ON pb – push (lt on)
 FOCUS – NEAR (to stop)
 ZOOM: 10.0 HFOV
- L10(VTR) REC pb – push, hold
 PLAY pb – push, simo (red ●)
- RHC √RATE – VERN (RATE MIN tb-ON)
 BRAKES – OFF (tb-OFF)
 MODE – SINGLE, ENTER
- Drive SY (+) to -87.0, then (-) to -90.0
- A7U b. ITVC (no Black Stretch)
 GAM BLK STR pb – push (lt off)
- Drive SY (+) to -87.0, then (-) to -90.0
- A7U c. LDRI Mode 5 (3-D, no Black Stretch)
 AP COR ON pb – push (lt off)
 GAM BLK STR pb – push (lt on)
 ALC pb – push
 AVG pb – push
- VIDEO OUT MUX 1 L pb – push (MIDDECK lt on)
 LDRI MODE 5 pb – push (flickering LDRI video)

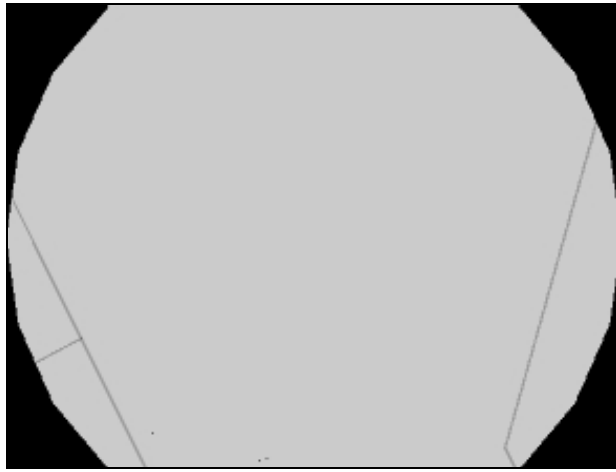

LDRI (90,-260)

Drive SY (+) to -87.0, then (-) to -90.0

- A7U d. LDRI Mode 6 (3-D, Black Stretch)
LDRI MODE 6 pb – push (brighter flickering LDRI video)

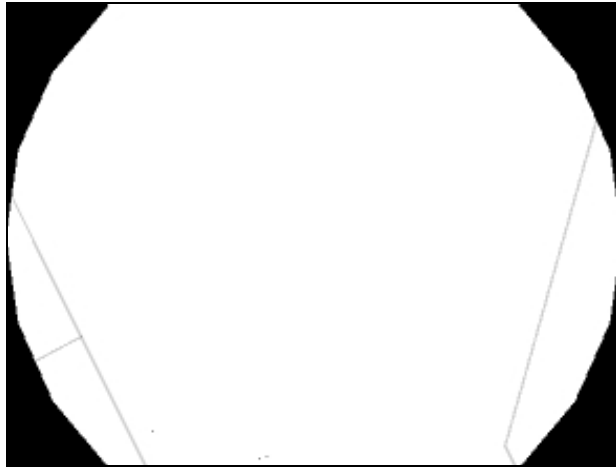

LDRI (90,-260)

Drive SY (+) to -87.0, then (-) to -90.0

BRAKES – ON (tb-ON)

- L10(VTR) STOP pb – push (no red ●)

4. SJ LCS CHARACTERIZATION

RHC √RATE – VERN (RATE MIN tb-ON)
 BRAKES – OFF (tb-OFF)
 MODE – SINGLE, ENTER

Mnvr to SJ LCS CHARACTERIZATION posn:

	SY	SP	EP	WP	WY	WR	
SJ FF START	-90.0	+79.8	-123.1	-55.7	0.0	+92.0	
1: WP +				-6.5			
2: WY –					-32.7		
3: WR +						+126.0	
SJ LCS CHAR	-90.0	+79.8	-123.1	-6.5	-32.7	+126.0	
	X	Y	Z	PITCH	YAW	ROLL	PL ID
	-903	+274	-392	328	342	50	2

BRAKES – ON (tb-ON)

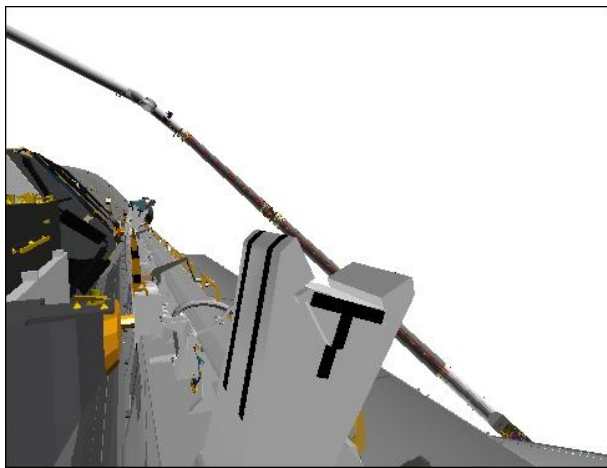

CCTV C (25,-5)

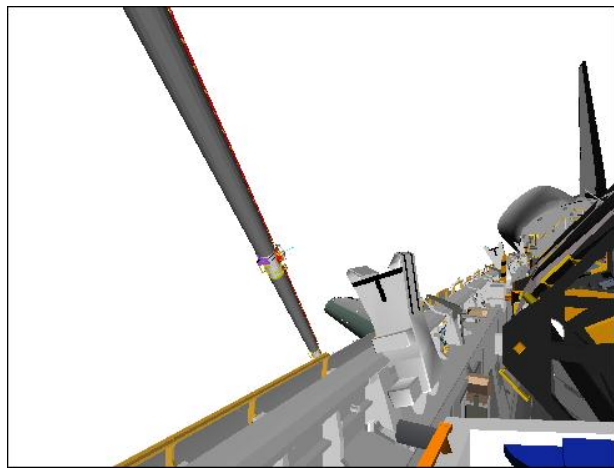

CCTV D (-30,0)

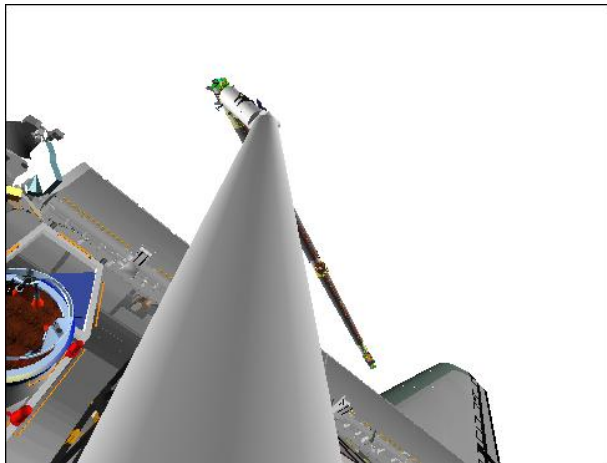

ELBOW (5,-20)

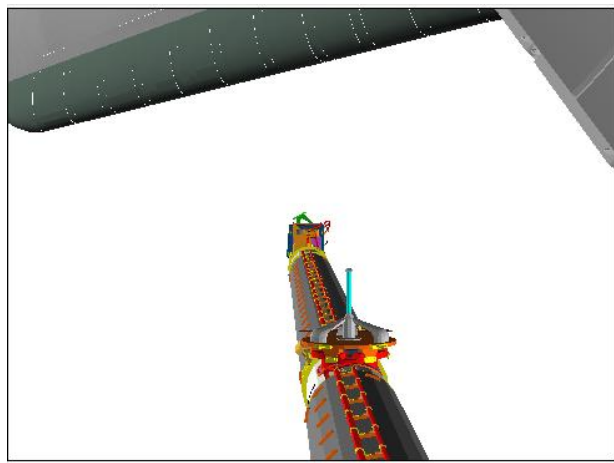

RSC

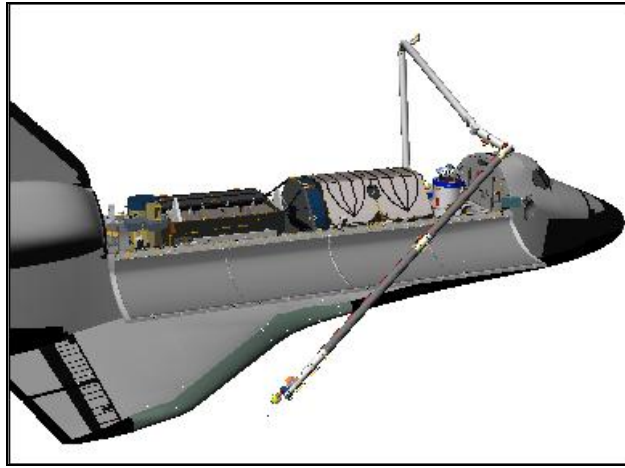

BIRD'S EYE

LCC/PGSC Allow arm motion to damp-out for 30 sec, then:
 'Scanning' 'Detailed Area Scan'
 sel – Test Scan
cmd Start Area Scan (verify Scan Line - Done)

On MCC GO, proceed to step 5

RHC 5. RETURN TO OBSS HOVER
 √RATE – VERN (RATE MIN tb-ON)
 BRAKES – OFF (tb-OFF)
 MODE – SINGLE, ENTER

Mnvr to OBSS HOVER posn:

	SY	SP	EP	WP	WY	WR	
SJ LCS CHAR	-90.0	+79.8	-123.1	-6.5	-32.7	+126.0	
1: WR –						+110.0	
2: WY +					0.0		
3: WP –				-55.7			
OBSS HOVER	-90.0	+79.8	-123.1	-55.7	0.0	+110.0	
	X	Y	Z	PITCH	YAW	ROLL	PL ID
	-998	+129	-507	0	0	11	2

BRAKES – ON (tb-ON)
 MODE – not DIRECT
 JOINT – CRIT TEMP

OBSS JETTISON

ASSUMPTIONS:

1. DAP and RMS have been configured to provide stable position for OBSS prior to entering this procedure
2. For undocked ops only

NOTES:

1. Jettison to be performed between sunrise and noon, if practical, to provide good visibility
2. DAP A used post-jettison for sep mnvr. DAP B (with mod in step 1) used while OBSS attached to RMS to keep loads down and ensure stable orbiter/payload/DAP
3. Jettison must occur greater than 1500 ft from ISS to avoid plume impingement damage
4. For emergency undock scenario, perform Shuttle Emergency Sep (RNDZ C/L) with 3 fps posigrade +X burn in step 3 prior to executing this procedure

CDR

MS

OBSS JETTISON

1. SETUP
 O14:F, O15:F, O16:F, O14:E √Pri RJD DRIVER, LOGIC (sixteen) – ON
 √cb DDU AFT (two) – cl
 A6U √SENSE: -Z
 √DAP: INRTL
 A7U √Lighting – as reqd
 GNC 20 DAP CONFIG
 CRT Config DAP A to A7, B to B7
 PRI ROT RATE (B7) – ITEM 30 +0.2 EXEC
 ALT RATE DB (B7) – ITEM 38 +0.2 EXEC
 VERN RATE DB (B7) – ITEM 45 +0.2 EXEC
 CNTL ACC (B7) – ITEM 48 +9 EXEC
2. AUTO MNVR TO -XLV, +ZVV
 GNC UNIV PTG
 √TGT ID: +2
 BODY VECT: +5
 P: +180
 Y: +0
 OM: +0
 TRK – ITEM 19 EXEC (CUR – *)
- A6U DAP: B/AUTO/VERN(ALT)

OBSS JETTISON

1. SETUP
- | | |
|-------|---|
| MON 1 | A |
| MON 2 | B |
- SM 94 PDRS CONTROL
 PL ID – ITEM 3 +2 EXEC
 INIT ID – ITEM 24 +2 EXEC
2. MNVR TO JETTISON POSN
 RATE – as reqd (VERN within 10 ft)
 BRAKES – OFF (tb-OFF)
 MODE – as desired

RHC

If coming from OBSS Park posn:

Mnvr to JETTISON posn (within 1°/1°):

	SY	SP	EP	WP	WY	WR	
OBSS Park	0.0	+25.5	-25.0	+5.0	0.0	0.0	
1:SP +		+40.0					
2:SY –	-22.5						
Jett	-22.5	+40.0	-25.0	+5.0	0.0	0.0	
	X	Y	Z	PITCH	YAW	ROLL	PL ID
	-1042	-37	-1046	116	7	13	2

If not coming from OBSS Park posn:

Mnvr to JETTISON posn (within 1°/1°):

X	Y	Z	PITCH	YAW	ROLL	PL ID
-1042	-37	-1046	116	7	13	2
SY	SP	EP	WP	WY	WR	
-22.5	+40.0	-25.0	+5.0	0.0	0.0	

BRAKES – ON (tb-ON)

CDR

MS

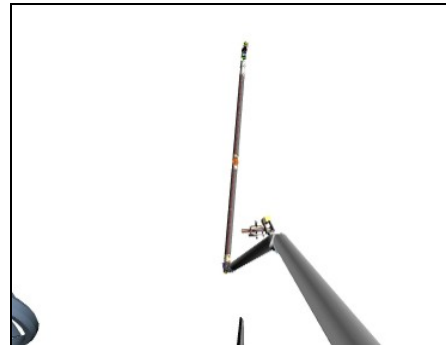

CCTV A (-5,45)



CCTV B (15,50)

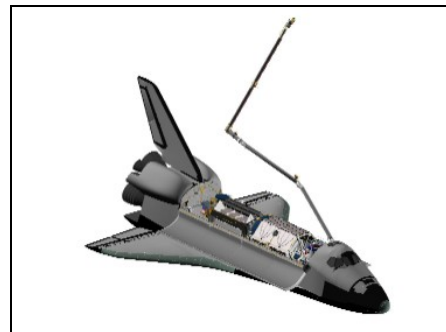

BIRD'S EYE

CDR

MS

A6U

On MS call, "OBSS at jettison position" -----

If attitude mnvr not complete:

DAP: ALT

GNC 20 DAP CONFIG

PRI ROT RATE (B7) – ITEM 30 +0.5 EXEC

3. CONFIGURE ORBITER FOR SEP MNVR

When mnvr to attitude complete:

√DAP: VERN(ALT)

When rates damped:

DAP: FREE

FLT CNTLR PWR – ON

√DAP TRANS: PULSE/PULSE/PULSE, NO LO Z

Report to MS, "GO to release OBSS" -----

Report to CDR "OBSS at jettison position"

3. OBSS RELEASE

MON 1	WRIST
MON 2	B(C,ELBOW)

SPEE PWR – OFF

R12
(OBSS)

SSP1

√APCU 1,2 CONV – OFF

√APCU 1 OUTPUT RLY – op (tb-bp)

SM 94 PDRS CONTROL

PL ID – ITEM 3 +0 EXEC

INIT ID – ITEM 24 +0 EXEC

X	Y	Z	PITCH	YAW	ROLL	PL ID
√ -1172	-2	-758	27	347	7	0
	SY	SP	EP	WP	WY	WR
√ -22.5	+40.0	-25.0	5.0	0.0	0.0	

On CDR call, "GO to release OBSS"

RHC

√RATE – VERN (RATE MIN tb-ON)

BRAKES – OFF (tb-OFF)

MODE – END EFF, ENTER

CDR

MS

CAUTION
Monitor EE tb timing to prevent EE motor burnout

EE MODE – AUTO
RELEASE sw – REL (mom)

When OPEN tb – gray, mnvr arm clear of grapple pin

	RIGID	CLOSE	CAPTURE	CRITICAL TIMES (28 sec total): DERIGID tb – gray, 5 sec max, then OPEN tb – gray, 3 sec max, then EXTEND tb – gray, 20 sec max
√				
	DERIGID	OPEN	EXTEND	

EE MODE – OFF

BRAKES – ON (tb-ON)

On MS call, "GO to perform SEP mnvr" ----- Report to CDR, "GO to perform SEP mnvr"

A6U

- 4. SEP MNVR
 DAP: A/FREE/VERN(ALT)
 THC: +Z (out) 2 pulses (0.2 ft/sec)
 When opening rate confirmed:
 DAP TRANS: PULSE/PULSE/NORM
 DAP: LVLH
 THC: +Z (out) 5 sec (1.7 ft/sec)
 FLT CNTLR PWR – OFF
 DAP TRANS: PULSE/PULSE/PULSE

Report to MS, "SEP mnvr complete" ----- On CDR call, "SEP mnvr complete"

CRT

GNC 20 DAP CONFIG
Config DAP B to B7

- 4. RMS TO PRE-CRADLE
Go to RMS PWRDN, step 1

OBSS JETTISON WITH MPMS

ASSUMPTIONS:

1. DAP and RMS have been configured to provide stable position for OBSS prior to entering this procedure
2. For undocked ops only

NOTES:

1. Jettison to be performed between sunrise and noon, if practical, to provide good visibility
2. DAP A used post-jettison for sep mnvr. DAP B (with mod in step 1) used while OBSS attached to RMS to keep loads down and ensure stable orbiter/payload/DAP
3. Jettison must occur greater than 1500 ft from ISS to avoid plume impingement damage
4. For emergency undock scenario, perform Shuttle Emergency Sep (RNDZ C/L) with 3 fps posigrade +X burn in step 3 prior to executing this procedure

OBSS JETTISON WITH MPMS

OBSS JETTISON WITH MPMS

1. SETUP

If OBSS not latched:

Perform OBSS BERTH (NOMINAL), steps 1-7

If OBSS Berthed and SRMS not grappled:

Perform OBSS UNBERTH (NOMINAL), steps 1-3,
sensor package timer not requiredSM 94 PDRS CONTROL

√PL ID, ITEM 3: 1

√INIT ID, ITEM 24: 1

A14 √PYRO STARBOARD RMS (five) – SAFE
√RMS LAT – SAFEML86B:D cb MNA PYRO JETT SYS A STBD RMS – cl
 MNC PYRO JETT SYS B STBD RMS – cl
√cb MNB PYRO JETT SYS A PORT RMS – op
√MNC PYRO JETT SYS B PORT RMS – op2. STARBOARD MPM JETTISONa. Deadface Latches

R13L √PL BAY MECH PWR SYS (two) – OFF

A8L √STBD RMS RETEN LAT tb – LAT

A14 RMS LAT – DEADFACE

A8L √STBD RMS RETEN LAT tb – bp

b. Guillotine Wires at LatchesA14 PYRO STBD RMS ARM – GUILLOTINE
Wait at least 1 sec, then
PYRO STBD RMS LAT (three) – GUILLOTINE
 – SAFE

CDR

MS

1. SETUP
 O14:F, √Pri RJD DRIVER, LOGIC (sixteen) – ON
 O15:F,
 O16:F
 O14:E √cb DDU AFT (two) – cl
 A6U √SENSE: -Z
 √DAP: INRTL
 A7U √Lighting – as reqd
 CRT GNC 20 DAP CONFIG
 Config DAP A to A7, B to B7
 PRI ROT RATE (B7) – ITEM 30 +0.2 EXEC
 ALT RATE DB (B7) – ITEM 38 +0.2 EXEC
 VERN RATE DB (B7) – ITEM 45 +0.2 EXEC
 CNTL ACC (B7) – ITEM 48 +9 EXEC

RHC

c. Jettison Latches
 PYRO STBD RMS ARM – JETT
 Wait at least 1 sec, then
 PYRO STBD RMS LAT (three) – JETT
 – SAFE
 PYRO STBD RMS ARM – SAFE
 RMS LAT – SAFE
 3. OBSS UNBERTH
 Perform OBSS UNBERTH (NOMINAL), step 7, up to
 and including MODE – not DIRECT

4. MNVR TO JETTISON POSN

MON 1	A
MON 2	C

SM 94 PDRS CONTROL
 PL ID – ITEM 3 +2 EXEC
 INIT ID – ITEM 24 +2 EXEC

RATE – as reqd (VERN within 10 ft)
 BRAKES – OFF (tb-OFF)
 MODE – as desired

Mnvr to JETTISON posn (within 1°/1°)

X	Y	Z	PITCH	YAW	ROLL	PL ID
-950	0	-1045	115	0	0	2
SY	SP	EP	WP	WY	WR	
-29.5	+66.7	-68.5	+26.8	+18.9	-9.9	

BRAKES – ON (tb-ON)

CDR

MS

3. AUTO MNVR TO -XLV, +ZVV
GNC UNIV PTG
√TGT ID: +2
BODY VECT: +5
P: +180
Y: +0
OM: +0
TRK – ITEM 19 EXEC (CUR – *)

A6U DAP: B/AUTO/VERN(ALT)

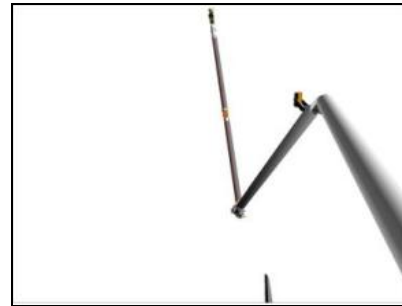

CCTV A (-10,45)



CCTV C (0,35)



BIRD'S EYE

CDR

MS

On MS call, "OBSS at jettison position" -----

----- Report to CDR "OBSS at jettison position"

If attitude mnvr not complete:

DAP: ALT

GNC 20 DAP CONFIG

PRI ROT RATE (B7) – ITEM 30 +0.5 EXEC

5. OBSS RELEASE

MON 1	WRIST
MON 2	C(B)

3. CONFIGURE ORBITER FOR SEP MNVR

When mnvr to attitude complete:

√DAP: VERN(ALT)

When rates damped:

DAP: FREE

FLT CNTLR PWR – ON

√DAP TRANS: PULSE/PULSE/PULSE, NO LO Z

R12
(OBSS)
SSP1

√SPEE PWR – OFF

√APCU 1,2 CONV – OFF

√APCU 1 OUTPUT RLY – op (tb-bp)

SM 94 PDRS CONTROL

PL ID – ITEM 3 +0 EXEC

INIT ID – ITEM 24 +0 EXEC

X	Y	Z	PITCH	YAW	ROLL	PL ID
√ -1078	0	-754	25	0	1	0
√ SY	SP	EP	WP	WY	WR	
√ -29.5	+66.7	-68.5	+26.8	+18.9	-9.9	

Report to MS, "GO to release OBSS" -----

----- On CDR call, "GO to release OBSS"

RHC

√RATE – VERN (RATE MIN tb-ON)

BRAKES – OFF (tb-OFF)

MODE – END EFF, ENTER

CDR

MS

CAUTION
Monitor EE tb timing to
prevent EE motor burnout

EE MODE – AUTO
RELEASE sw – REL (mom)

When OPEN tb – gray, mnvr arm clear of grapple pin

	RIGID	CLOSE	CAPTURE	CRITICAL TIMES (28 sec total): DERIGID tb – gray, 5 sec max, then OPEN tb – gray, 3 sec max, then EXTEND tb – gray, 20 sec max
√				
	DERIGID	OPEN	EXTEND	

EE MODE – OFF

BRAKES – ON (tb-ON)

On MS call, "GO to perform SEP mnvr"

Report to CDR, "GO to perform SEP mnvr"

A6U

4. SEP MNVR

DAP: A/FREE/VERN(ALT)

THC: +Z (out) 2 pulses (0.2 ft/sec)

When opening rate confirmed:

DAP TRANS: PULSE/PULSE/NORM

DAP: LVLH

THC: +Z (out) 5 sec (1.7 ft/sec)

FLT CNTLR PWR – OFF

DAP TRANS: PULSE/PULSE/PULSE

Report to MS, "SEP mnvr complete"

On CDR call, "SEP mnvr complete"

CRT

GNC 20 DAP CONFIG

Config DAP B to B7

6. RMS TO PRE-CRADLE

Go to RMS PWRDN, step 1

OBSS EVA WLE RCC SURVEY

NOTE

This procedure uses SRMS to mnvr EV crew on OBSS to survey the orbiter WLE RCC panels during the docked timeframe. ISS Cameras required for visual cues

1. SETUP

SM 94 PDRS CONTROL

PL ID - ITEM 3 +4 EXEC

INIT ID - ITEM 24 +4 EXEC

Ingress Clearance Views	Cameras
OBSS-to-PLBD	TIP ELBOW, ELBOW, C
RMS-to-Lab	C, A

Verify SSRMS is at SURVEY SUPPORT VIEWING posn:

SR	SY	SP	EP	WP	WY	WR
+80.0	+10.0	+40.0	-50.0	-110.0	-25.0	+115.0

For all OCAS mnvrs, if motion no longer apparent and POR within 1 in/1 deg but IN PROG It - on:
 AUTO SEQ - STOP

- Mnvr to Tether Posn
To be uplinked realtime
- Tether Posn

NOTE

At tether posn, OBSS-to-PLBD = 87.7 in, Upper Arm-to-PMA GF = 58.4 in

Verify in TETHER posn:

	X	Y	Z	PITCH	YAW	ROLL	PL ID
√	-1126	+345	-450	238	0	342	4
	SY	SP	EP	WP	WY	WR	
√	-32.7	+48.9	-72.0	-68.9	+21.7	-38.7	

Give EV GO to perform Tether Ops, GCA if reqd

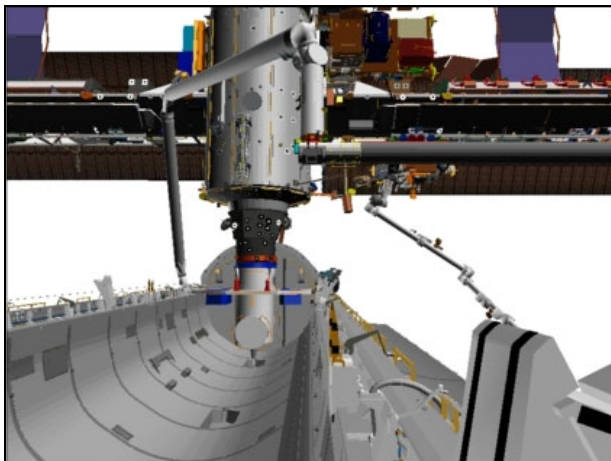

CCTV C (0,5)

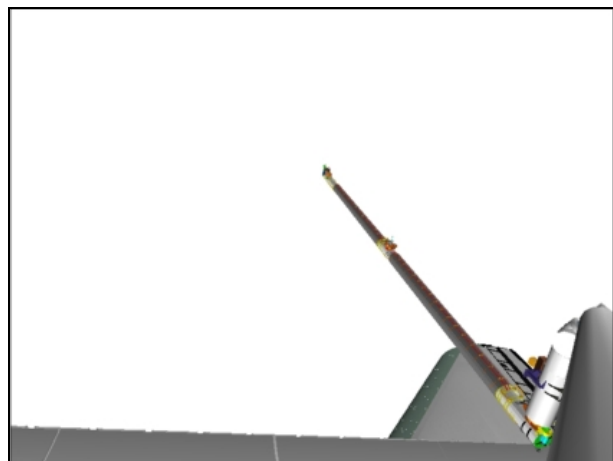

ELBOW (-35,5)

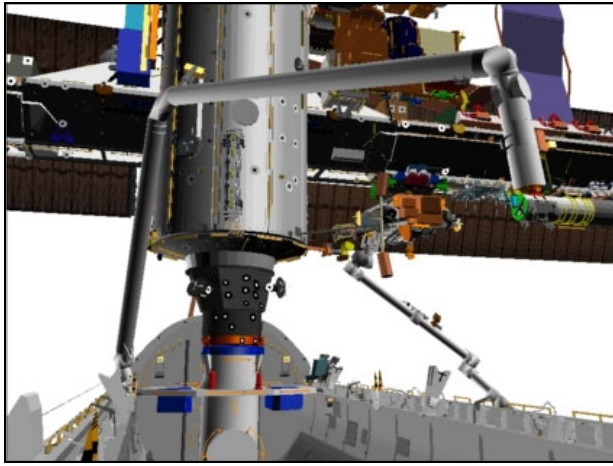

CCTVB (15,12)

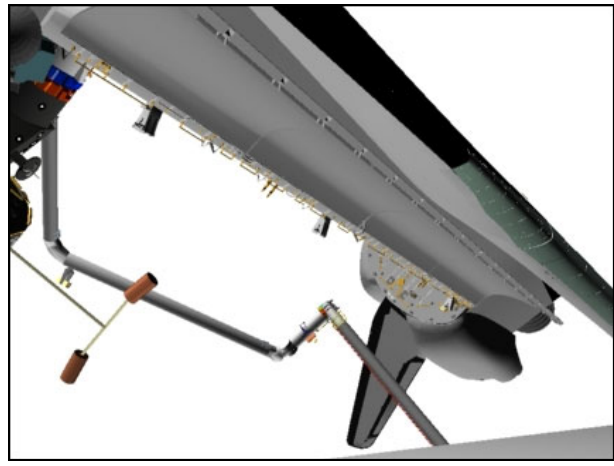

TIP ELBOW (-75,-5)

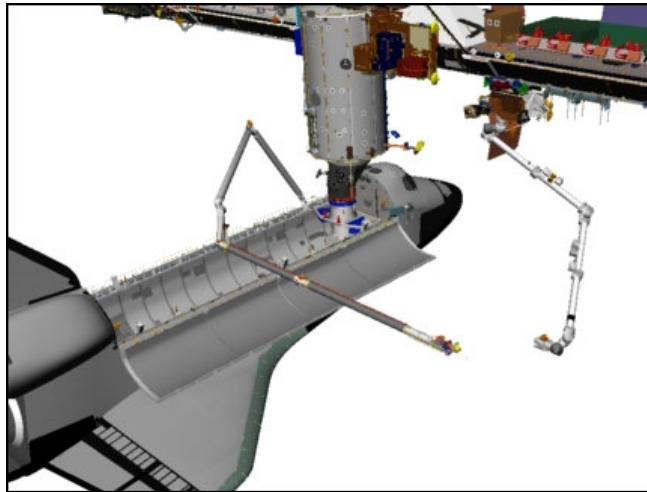

BIRD'S EYE

RHC

- c. APFR Config at Mid Striker Bar
- RATE – VERN (RATE MIN tb-ON)
- BRAKES – OFF (tb-OFF)
- MODE – ORB LD, ENTER

Mnvr OBSS Port (-Y) to EV1 Ingress posn, Y = +91

X	Y	Z	PITCH	YAW	ROLL	PL ID
-1126	+91	-450	238	0	342	4
SY	SP	EP	WP	WY	WR	
+1.3	+71.2	-86.9	-63.3	+19.0	-74.9	

BRAKES – ON (tb-ON)

Give EV GO to Install PAD, WIF Adapter, APFR (9, HH, E, 6), and Ingress GCA if reqd

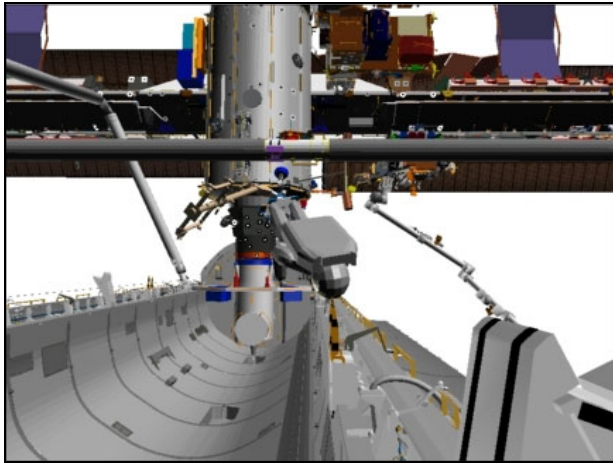

CCTV C (-10,4)

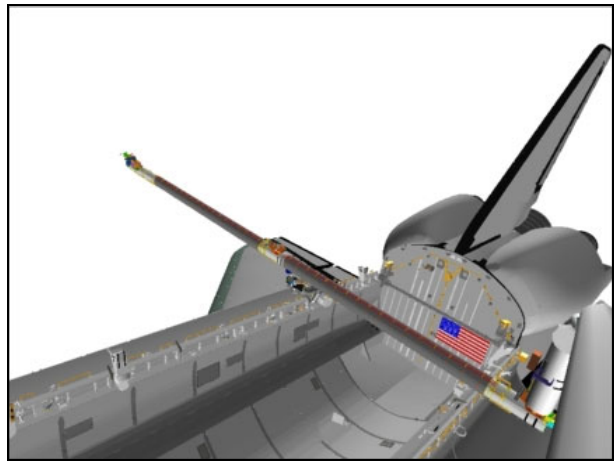

ELBOW (-35,5)

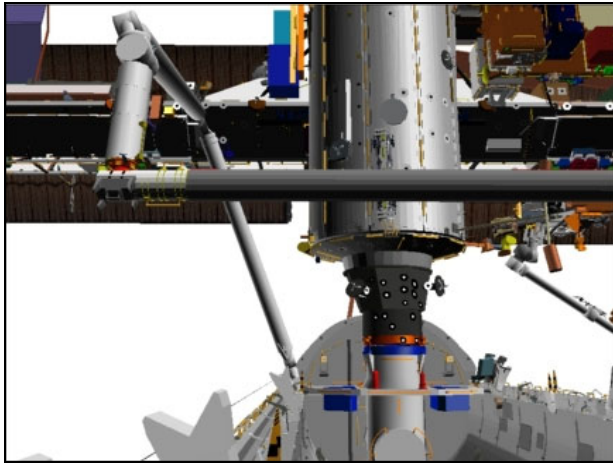

CCTV B (0,12)

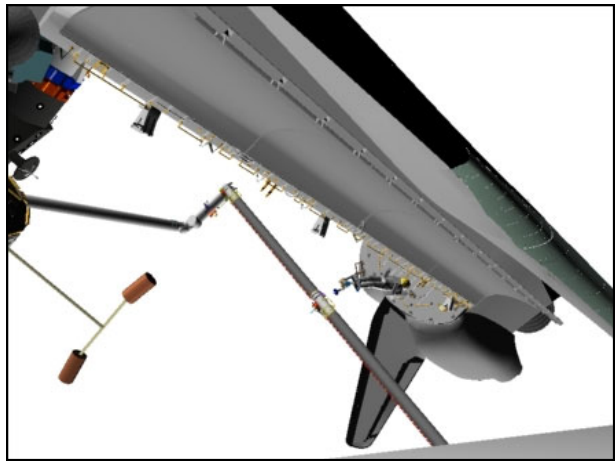

TIP ELBOW (-75,-5)

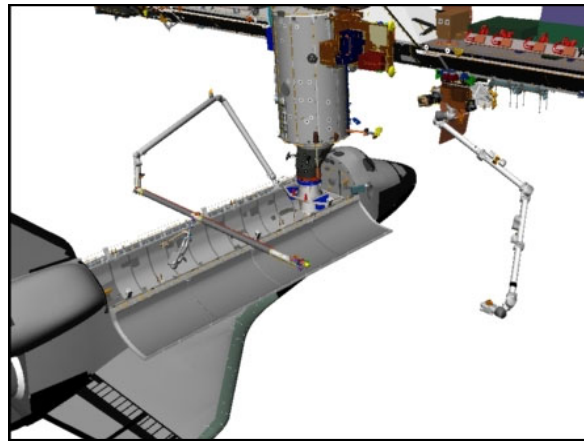

BIRD'S EYE

2. STBD T-SEALS 5-8
 a. Mnvr to Tether Posn

NOTE

Mnvr back to TETHER posn to prepare for SJ mnvr to APEX 5-8 SHOOT POSN. At end of mnvr Upper Arm-to-PMA GF = 58.4 in, OBSS-to-MPLM V-Guide = 77.8 in

BRAKES – OFF (tb-OFF)
 MODE – ORB LD, ENTER

Mnvr OBSS Stbd (+Y) to TETHER posn, Y = +345

X	Y	Z	PITCH	YAW	ROLL	PL ID
-1126	+345	-450	238	0	342	4
SY	SP	EP	WP	WY	WR	
-32.7	+48.9	-71.9	-69.0	+21.7	-38.6	

b. Mnvr to Apex 5-8 Shoot Posn

APEX Clearance Views	Cameras
OBSS-to-PLBD	LAB, TIP ELBOW
RMS-to-Lab/PMA and UHF Ant	ELBOW

NOTE

At end of mnvr OBSS-to-PLBD = 36.7 in, Upper Arm-to-PMA GF = 24.7 in, Lower Arm-to-UHF Antenna = 39.9 in

MODE – SINGLE, ENTER

Mnvr to APEX 5-8 SHOOT posn:

	SY	SP	EP	WP	WY	WR	
TETHER POSN	-32.7	+48.9	-71.9	-69.0	+21.7	-38.6	
1: SY –	-57.0						
2: EP +			-46.0				
3: SP –		+18.5					
4: SY –	-64.4						
5: WP +				-17.0			
6: WR –						-90.0	
7: WP +				+20.7			
8: WR –						-191.3	
9: WY +					+83.1		[1]
SHOOT 5-8	-64.4	+18.5	-46.0	+20.7	+83.1	-191.3	
	X	Y	Z	PITCH	YAW	ROLL	PL ID
	-998	+282	-270	14	56	221	4

[1] Expect SINGULAR It

BRAKES – ON (tb-ON)

Give EV GO to SHOOT STBD APEX

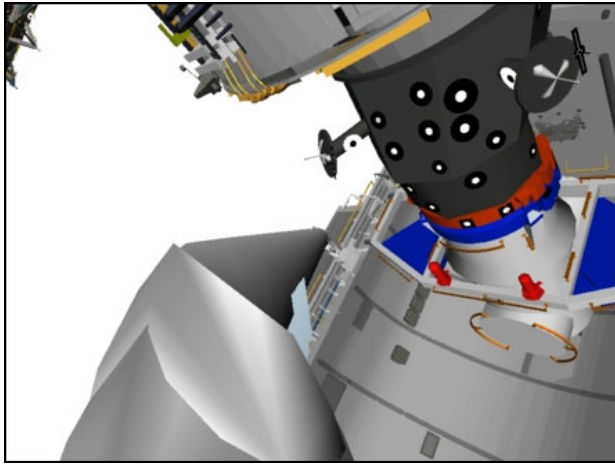

ELBOW (-148,-32)

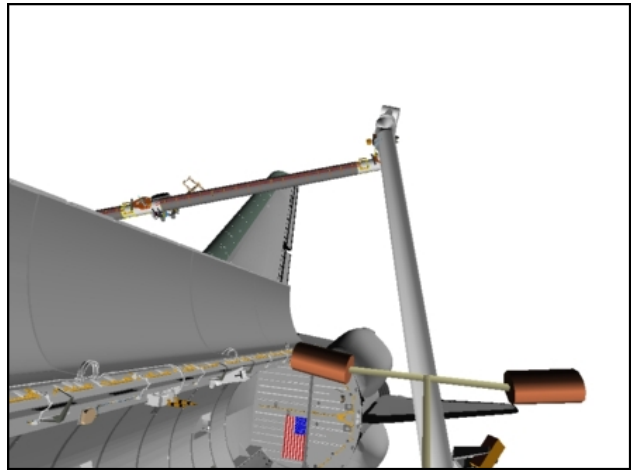

LAB (-14,-8)

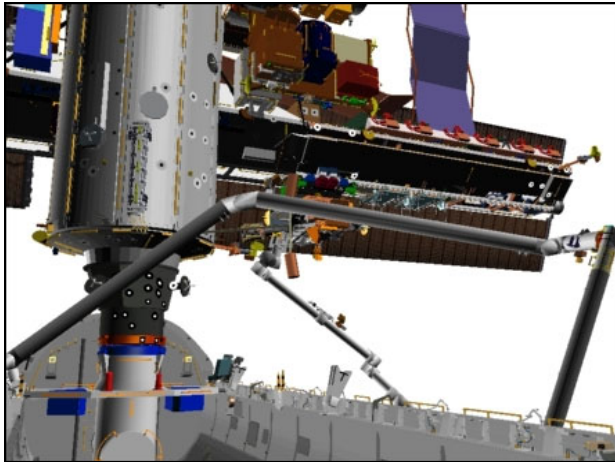

CCTV B (24,12)

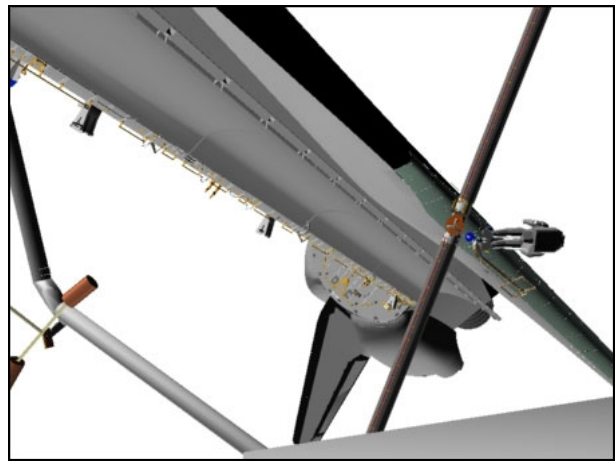

TIP ELBOW (-70,-5)

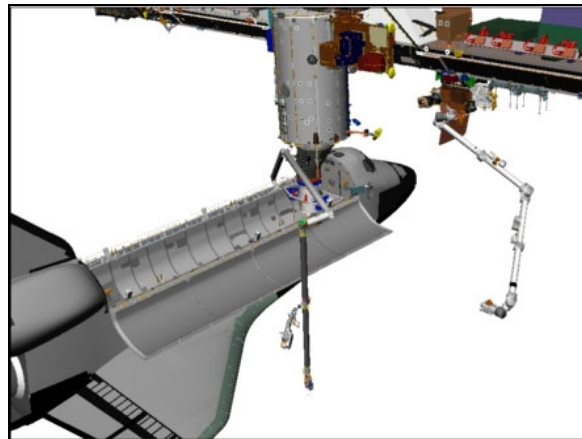

BIRD'S EYE

3. STBD T-SEALS 9 & 10
 - a. Mnvr to APEX 5-8 Pre-Posn

NOTE

At end of mnvr OBSS-to-PLBD = 68.1 in,
Upper Arm-to-PMA GF = 31.4 in

RHC

√RATE – VERN (RATE MIN tb-ON)
BRAKES – OFF (tb-OFF)
MODE – SINGLE, ENTER

Mnvr to PRE STBD T-SEAL 5-8 posn:

SHOOT 5-8
1: WR +
2: WY -
3: SY +
PRE 5-8

SY	SP	EP	WP	WY	WR		
-64.4	+18.5	-46.0	+20.7	+83.1	-191.3		
					-170.0		
				+72.5			
-60.0							
-60.0	+18.5	-46.0	+20.7	+72.5	-170.0		
X	Y	Z	PITCH	YAW	ROLL	PL ID	
-1063	+374	-276	349	53	258	4	

b. Mnvr to Apex 9 & 10 Pre-Posn

NOTE

At end of mnvr APFR on OBSS-to-PLBD = 64.7 in,
Upper Arm-to-PMA GF = 30.5 in

SM 94 PDRS CONTROL

END POS – ITEM 18 -1 0 6 6 +3 3 9 -3 3 1 EXEC
ATT – ITEM 21 +3 4 4 +5 4 +2 6 6 EXEC
CMD CK – ITEM 25 EXEC (GOOD)

MODE – OPR CMD, ENTER (READY It on)

AUTO SEQ – PROCEED (IN PROG It on)

When AUTO SEQ IN PROG It – off,

	X	Y	Z	PITCH	YAW	ROLL	PLID
√	-1066	+339	-331	344	54	266	4
	SY	SP	EP	WP	WY	WR	
√	-58.4	+33.8	-60.9	+21.5	+72.5	-166.7	

c. Mnvr to Apex 9 & 10 Shoot Posn

NOTE

At end of mnvr OBSS-to-PLBD = 39.1 in,
Upper Arm-to-PMA GF = 30.4 in

MODE – SINGLE, ENTER

Drive EP (-) to -67.5 to APEX 9 & 10 SHOOT posn

	X	Y	Z	PITCH	YAW	ROLL	PL ID
√	-1042	+312	-285	349	54	256	4
	SY	SP	EP	WP	WY	WR	
√	-58.4	+33.8	-67.5	+21.5	+72.5	-166.7	

BRAKES – ON (tb-ON)

Give EV GO to SHOOT STBD APEX

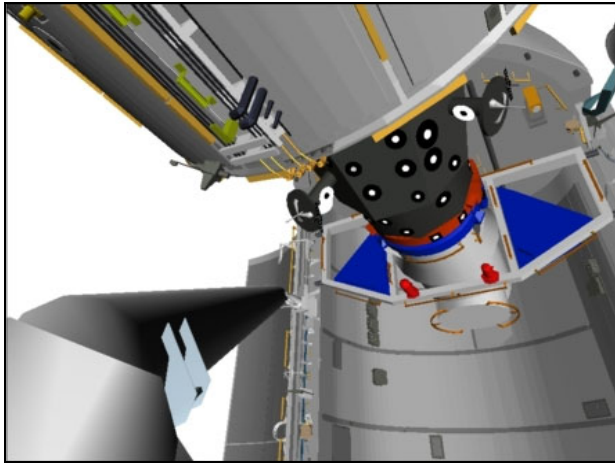

ELBOW (-120,-34)

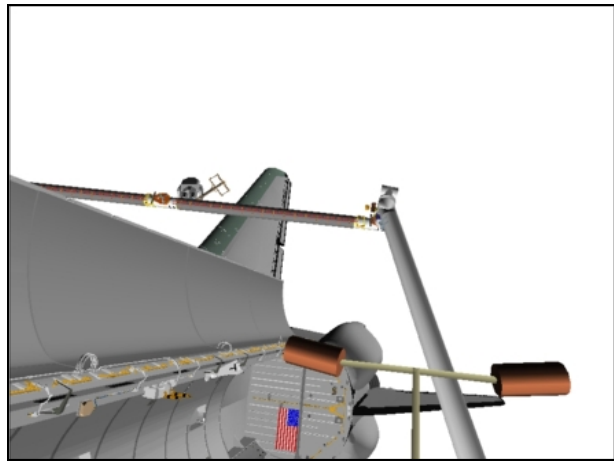

LAB (-14,-8)

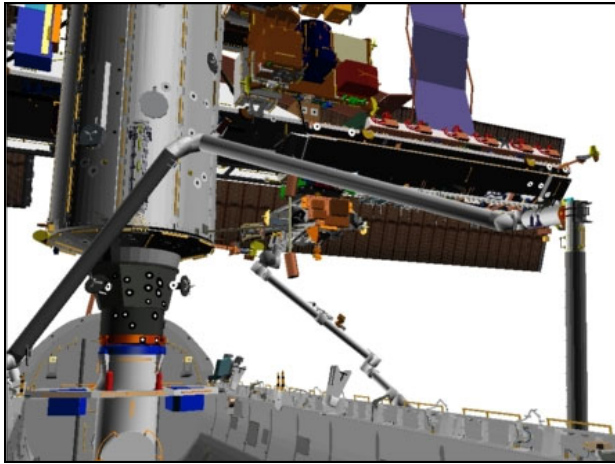

CCTV B (23,12)

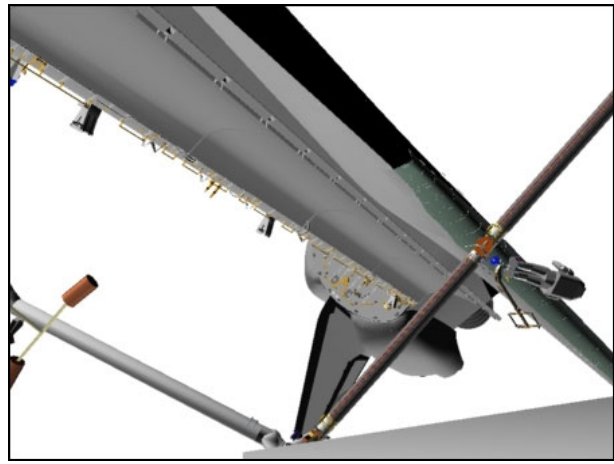

TIP ELBOW (-70,-5)

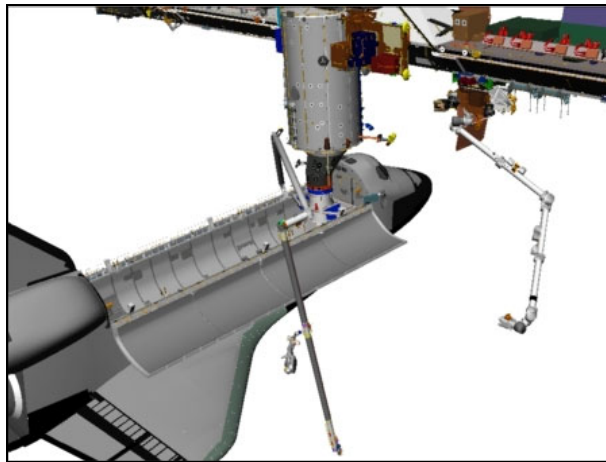

BIRD'S EYE

4. STBD T-SEAL 11
 - a. Mnvr to Apex 9 & 10 Pre-Posn

NOTE

At end of mnvr APFR on OBSS-to-PLBD = 64.6 in,
Upper Arm-to-PMA GF = 30.5 in

BRAKES – OFF (tb-OFF)
MODE – SINGLE, ENTER

Drive EP (+) to -60.8 to APEX 9 & 10 PRE-POSN

	X	Y	Z	PITCH	YAW	ROLL	PL ID
√	-1066	+339	-331	344	54	266	4
	SY	SP	EP	WP	WY	WR	
√	-58.4	+33.8	-60.8	+21.5	+72.5	-166.7	

b. Mnvr to Apex 11 Pre-Posn

NOTE

At end of mnvr OBSS-to-PLBD = 93.1 in,
Upper Arm-to-Lab = 32.1 in

SM 94 PDRS CONTROL

END POS – ITEM 18 -1 0 6 9 +3 9 3 -3 2 6 EXEC
ATT – ITEM 21 +3 2 7 +4 6 +2 9 1 EXEC
CMD CK – ITEM 25 EXEC (GOOD)

MODE – OPR CMD, ENTER (READY It on)

AUTO SEQ – PROCEED (IN PROG It on)

When AUTO SEQ IN PROG It – off,

	X	Y	Z	PITCH	YAW	ROLL	PL ID
√	-1069	+393	-326	327	46	291	4
	SY	SP	EP	WP	WY	WR	
√	-56.6	+37.0	-74.4	+27.1	+68.4	-144.7	

c. Mnvr to Apex 11 Shoot Posn

NOTE

At end of mnvr OBSS-to-PLBD = 53.4 in,
Upper Arm-to-Lab = 32.1 in

MODE – SINGLE, ENTER

Drive WR (-) to -158.4 to APEX 11 SHOOT posn

	X	Y	Z	PITCH	YAW	ROLL	PL ID
√	-1055	+341	-293	339	51	272	4
	SY	SP	EP	WP	WY	WR	
√	-56.6	+37.0	-74.4	+27.1	+68.4	-158.4	

BRAKES – ON (tb-ON)

Give EV GO to SHOOT STBD APEX

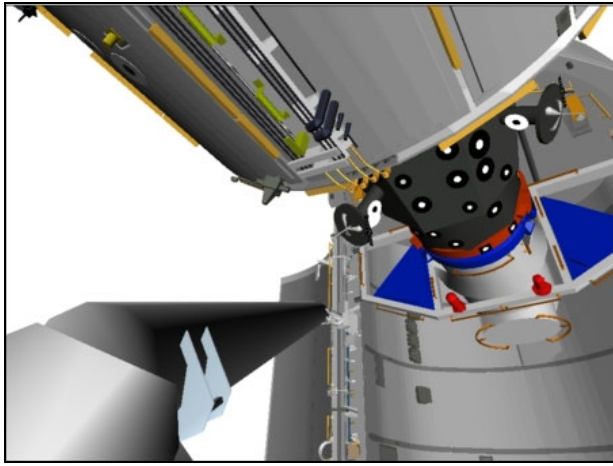

ELBOW (-120,-34)

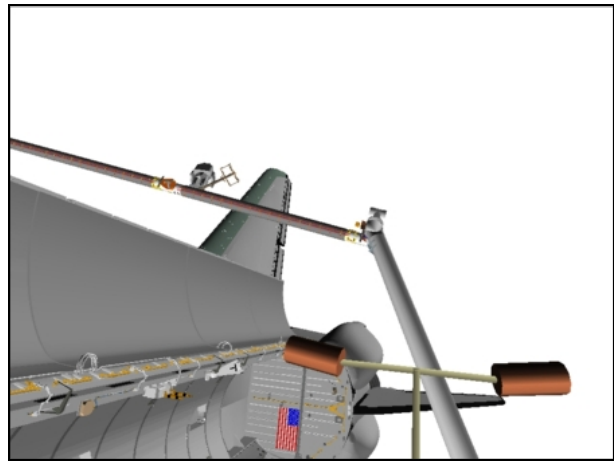

LAB (-14,-8)

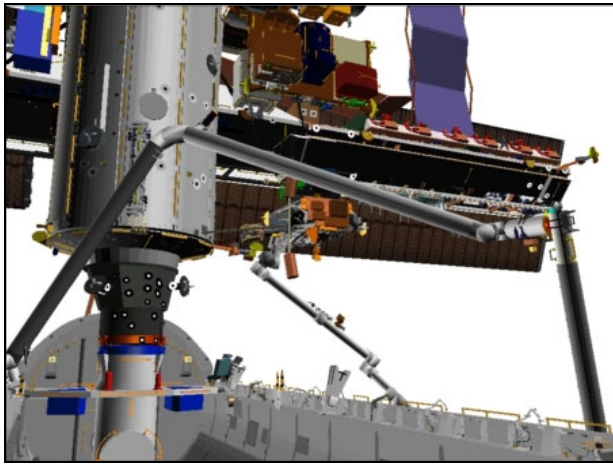

CCTV B (23,12)

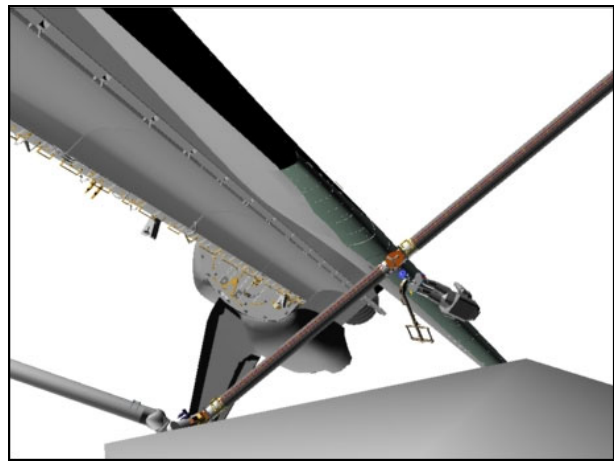

TIP ELBOW (-60,-5)

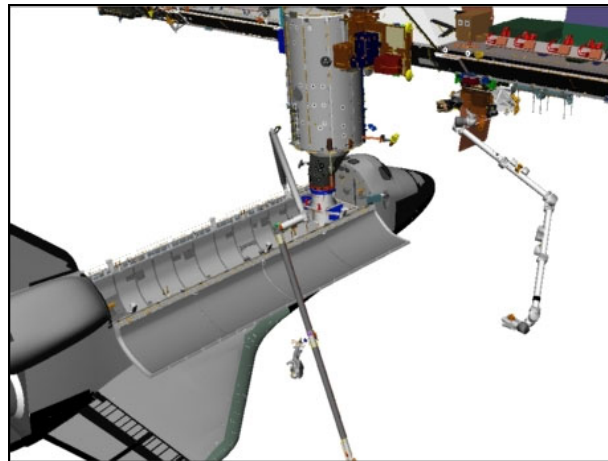

BIRD'S EYE

5. STBD T-SEAL 12
 - a. Mnvr to Apex 11 Pre-Posn

NOTE

At end of mnvr OBSS-to-PLBD = 93.1 in,
Upper Arm-to-Lab = 32.1 in

BRAKES – OFF (tb-OFF)
MODE – SINGLE, ENTER

Drive WR (+) to -144.7 to APEX 11 PRE-POSN

	X	Y	Z	PITCH	YAW	ROLL	PL ID
√	-1069	+392	-326	327	46	291	4
	SY	SP	EP	WP	WY	WR	
√	-56.6	+37.0	-74.4	+27.1	+68.4	-144.7	

b. Mnvr to Apex 12 Shoot Posn

NOTE

At end of mnvr OBSS-to-PLBD = 72.1 in,
Upper Arm-to-PDGF RU = 37.4 in, Upper
Arm-to-PMA GF = 31.9 in

SM 94 PDRS CONTROL

END POS – ITEM 18 -1 0 7 3 +3 6 1 -3 1 0 EXEC
ATT – ITEM 21 +3 4 8 +4 7 +2 6 5 EXEC
CMD CK – ITEM 25 EXEC (GOOD)

MODE – OPR CMD, ENTER (READY It on)

AUTO SEQ – PROCEED (IN PROG It on)

When AUTO SEQ IN PROG It – off:
BRAKES – ON (tb-ON)

	X	Y	Z	PITCH	YAW	ROLL	PL ID
√	-1073	+361	-310	348	47	265	4
	SY	SP	EP	WP	WY	WR	
√	-57.6	+31.8	-64.0	+29.5	+64.1	-168.5	

Give EV GO to SHOOT STBD APEX

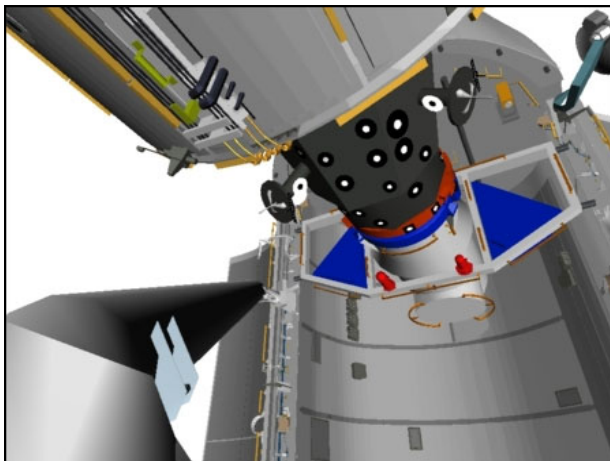

ELBOW (-120,-34)

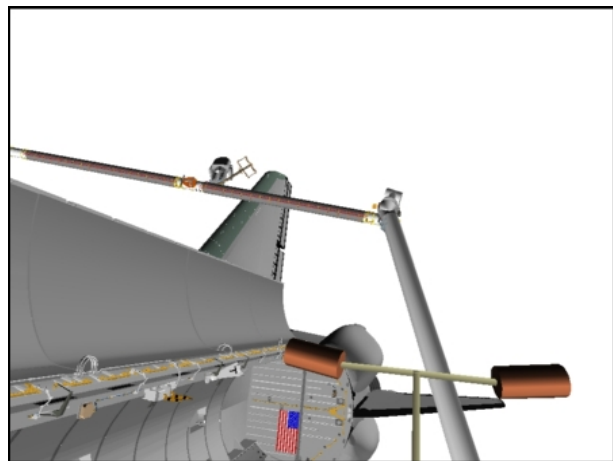

LAB (-14,-8)

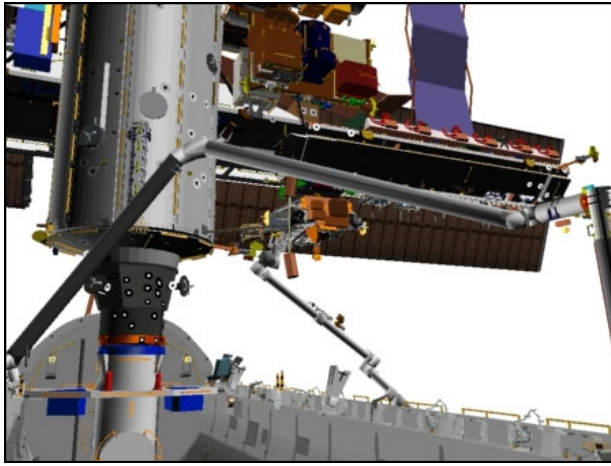

CCTV B (24,12)

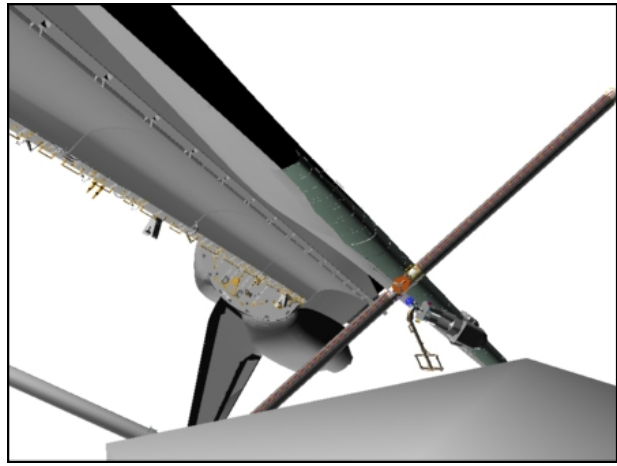

TIP ELBOW (-60,-5)

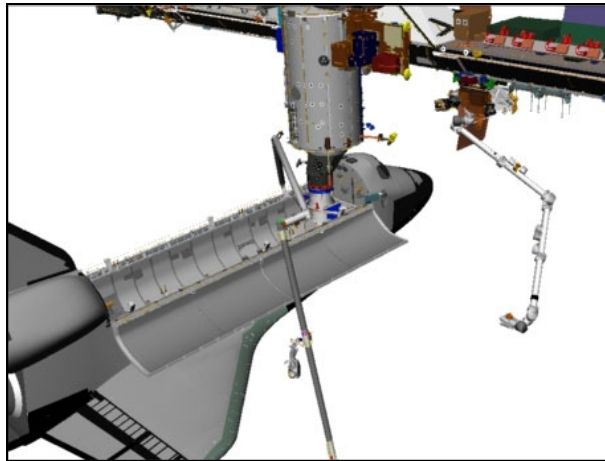

BIRD'S EYE

6. STBD T-SEALS APEX 13 & 14 SHOOT POSN

NOTE

At end of mnvr OBSS-to-PLBD = 88.5 in,
Upper Arm-to-PMA GF = 35.0 in

SM 94 PDRS CONTROL

END POS – ITEM 18 -1098 +375 -304 EXEC
ATT – ITEM 21 +349 +48 +263 EXEC
CMD CK – ITEM 25 EXEC (GOOD)

BRAKES – OFF (tb-OFF)

MODE – OPR CMD, ENTER (READY lt on)

AUTO SEQ – PROCEED (IN PROG lt on)

When AUTO SEQ IN PROG lt – off:

BRAKES – ON (tb-ON)

	X	Y	Z	PITCH	YAW	ROLL	PL ID
√	-1098	+375	-304	349	48	263	4
	SY	SP	EP	WP	WY	WR	
√	-56.4	+22.7	-48.8	+23.5	+63.7	-170.0	

Give EV GO to SHOOT STBD APEX

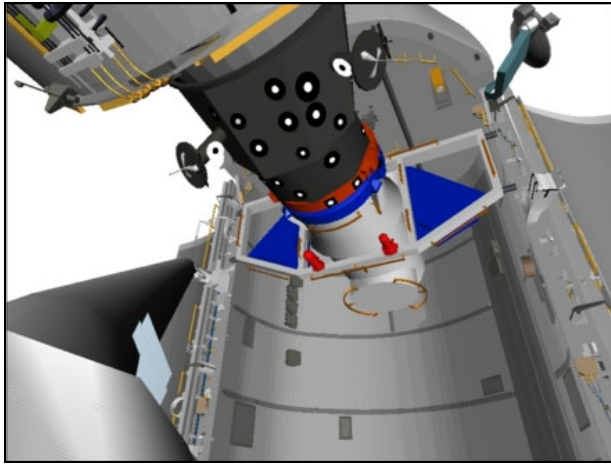

ELBOW (-124,-31)

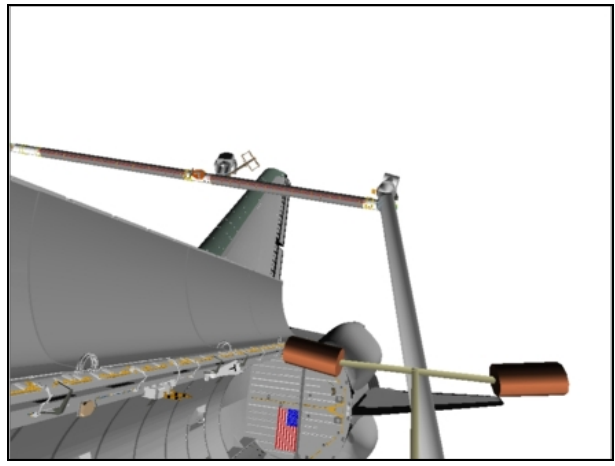

LAB (-14,-8)

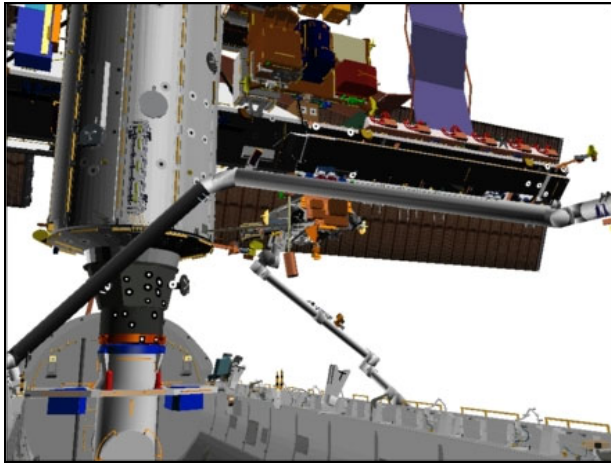

CCTV B (24,12)

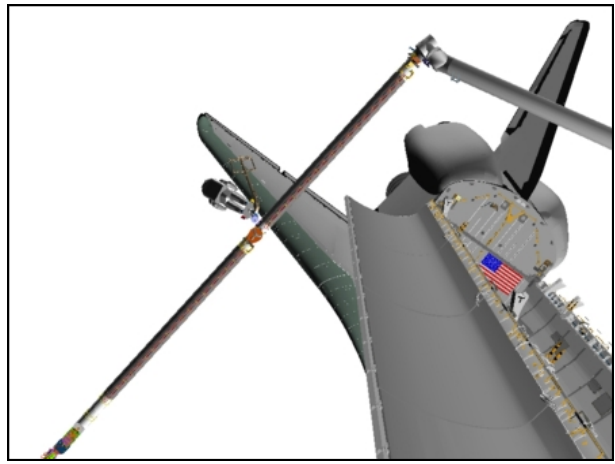

BASE ELBOW (-80,-10)

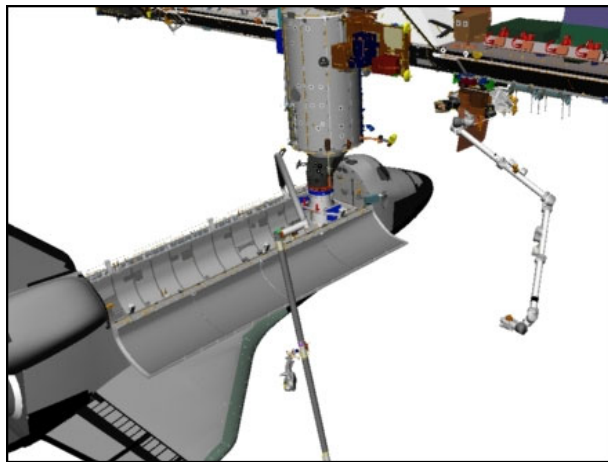

BIRD'S EYE

7. EV1/APFR EGRESS/RECONFIG

a. Mnvr to Intermediate Posn

Ingress Clearance Views	Cameras
OBSS-to-PLBD	TIP ELBOW, C
RMS-to-Lab	C, ELBOW

NOTE

At end of mnvr OBSS-to-PLBD = 97.6 in,
Upper Arm-to-PMA GF = 58.2 in

SM 94 PDRS CONTROL

END POS – ITEM 18 -1 1 2 7 +3 4 4 -4 6 0 EXEC

ATT – ITEM 21 +2 3 8 +0 +3 4 2 EXEC

CMD CK – ITEM 25 EXEC (GOOD)

BRAKES – OFF (tb-OFF)

MODE – OPR CMD, ENTER (READY It on)

AUTO SEQ – PROCEED (IN PROG It on)

When AUTO SEQ IN PROG It – off,

	X	Y	Z	PITCH	YAW	ROLL	PL ID
√	-1127	+344	-460	238	0	342	4
	SY	SP	EP	WP	WY	WR	
√	-32.9	+49.2	-70.4	-71.0	+21.7	-38.4	

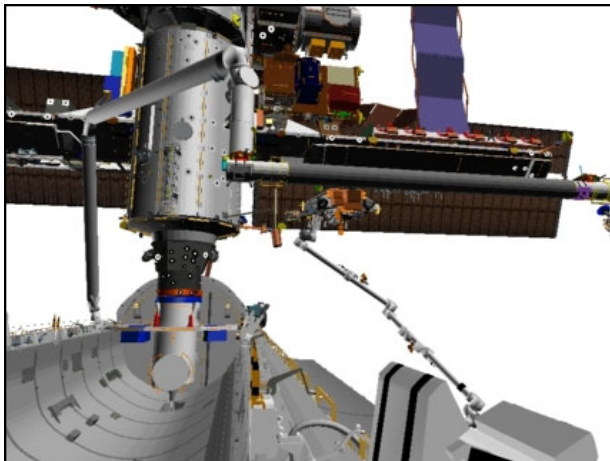

CCTV C (0,10)

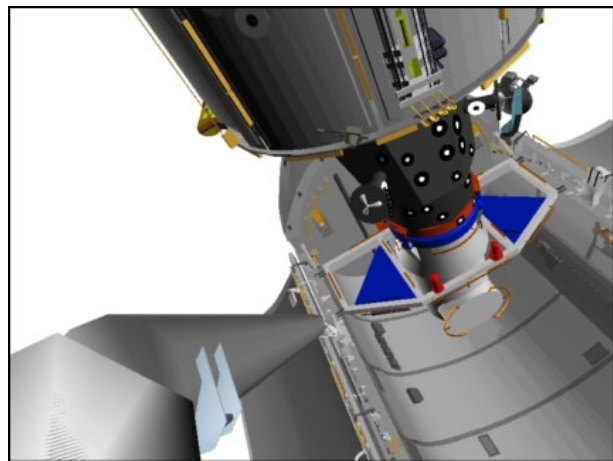

ELBOW (-124,-31)

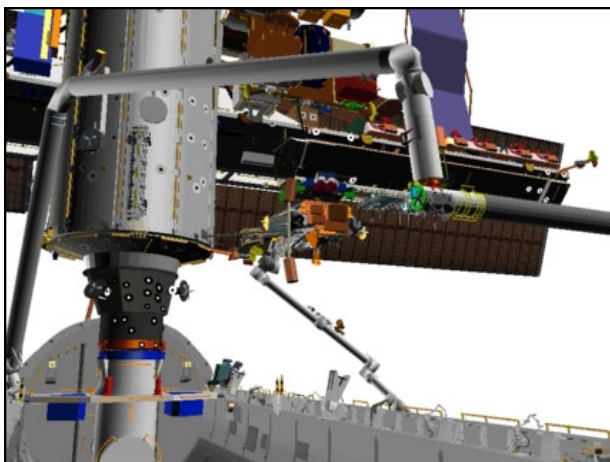

CCTV B (24,12)

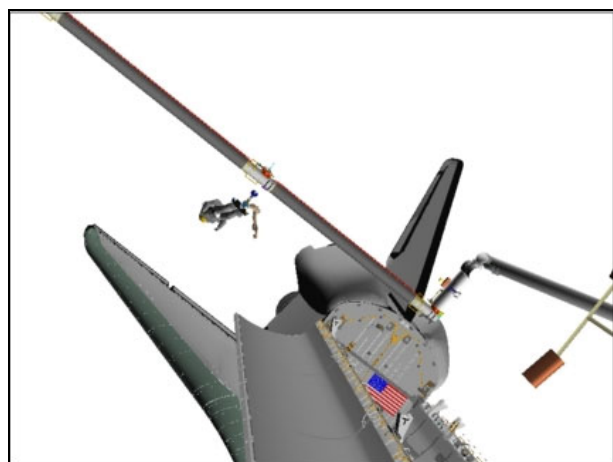

BASE ELBOW (-70,-15)

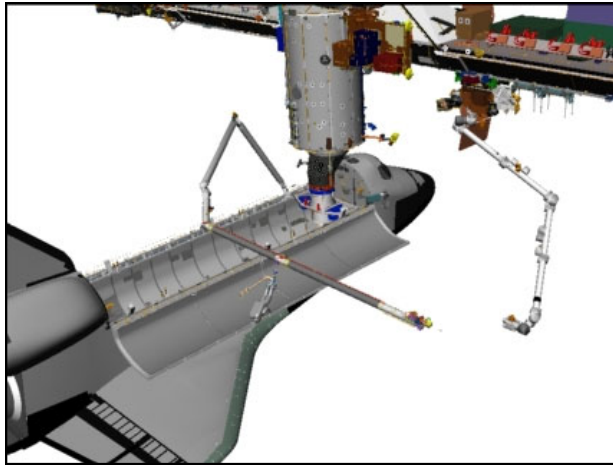

BIRD'S EYE

b. Mnvr to EV1/APFR Egress Posn

NOTE

At end of mnvr APFR on OBSS-to-Stbd Sill = 71.3 in, Upper Arm-to-PMA GF = 71.7 in

MODE – ORB LD, ENTER

Mnvr OBSS Port (-Y) to EV1/APFR EGRESS posn, Y = +91

√	X	Y	Z	PITCH	YAW	ROLL	PL ID
	-1127	+91	-460	238	0	342	4
√	SY	SP	EP	WP	WY	WR	
	+0.8	+71.5	-85.2	-65.4	+19.1	-74.4	

BRAKES – ON (tb-ON)

Give EV GO to EGRESS/REMOVE APFR
GCA if reqd

8. EV1 INGRESS/APFR INSTALL ON AFT STRIKER BAR

NOTE

This step mnvrs back to EV1/APFR EGRESS posn to prepare for OCAS to EV1/APFR INGRESS posn

Ingress Clearance Views	Cameras
OBSS-to-PLBD/Wing	TIP ELBOW
RMS-to-Lab/Sill	C

SM 94 PDRS CONTROL
 PL ID – ITEM 3 +1 EXEC
 INIT ID – ITEM 24 +1 EXEC

BRAKES – OFF (tb-OFF)
 MODE – ORB LD, ENTER

Verify posn is EV1/APFR EGRESS posn:

	X	Y	Z	PITCH	YAW	ROLL	PL ID
√	-1028	+443	-458	220	60	270	1
	SY	SP	EP	WP	WY	WR	
√	+0.8	+71.5	-85.2	-65.4	+19.1	-74.4	

NOTE

At end of mnvr, OBSS-to-Port Sill = 97.8 in

SM 94 PDRS CONTROL

END POS – ITEM 18 -1 1 6 6 +1 1 5 -4 8 8 EXEC

ATT – ITEM 21 +2 6 3 +5 3 +2 7 5 EXEC

CMD CK – ITEM 25 EXEC (GOOD)

MODE – OPR CMD, ENTER (READY lt on)

AUTO SEQ – PROCEED (IN PROG lt on)

When AUTO SEQ IN PROG lt – off:

BRAKES – ON (tb-ON)

	X	Y	Z	PITCH	YAW	ROLL	PL ID
√	-1166	+115	-488	263	53	275	1
	SY	SP	EP	WP	WY	WR	
√	+43.4	+32.7	-18.1	-49.9	-27.1	-102.9	

Give EV GO to INSTALL PAD/APFR/RECONFIG APFR (11, FF, A, 6) and

INGRESS

GCA if reqd

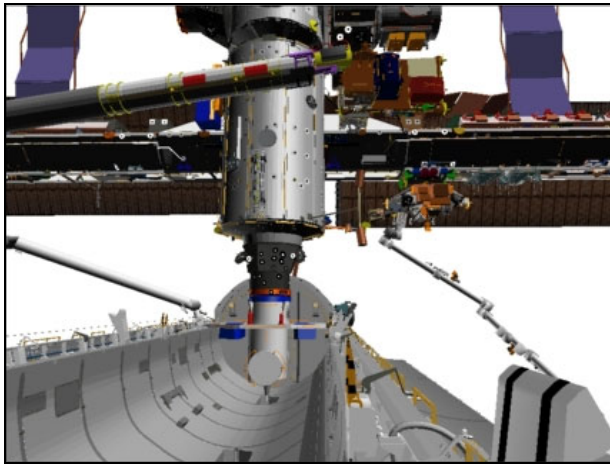

CCTV C (-2,10)

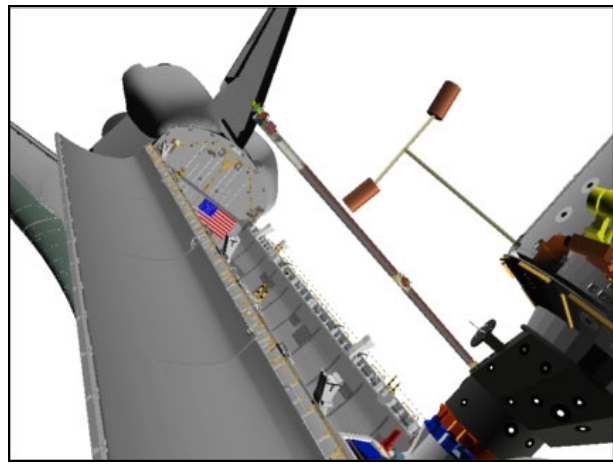

BASE ELBOW (-55,0)

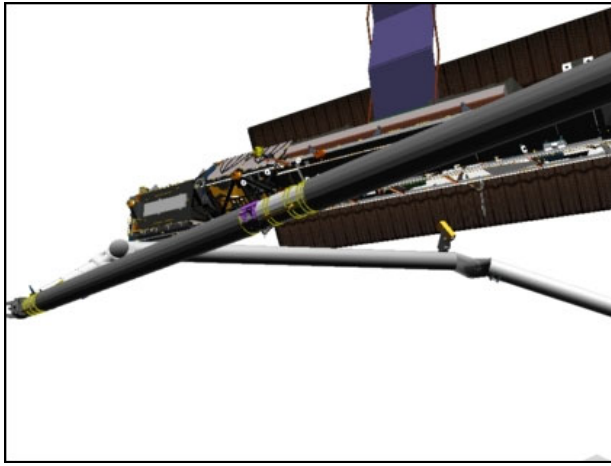

CCTV B (-39,12)

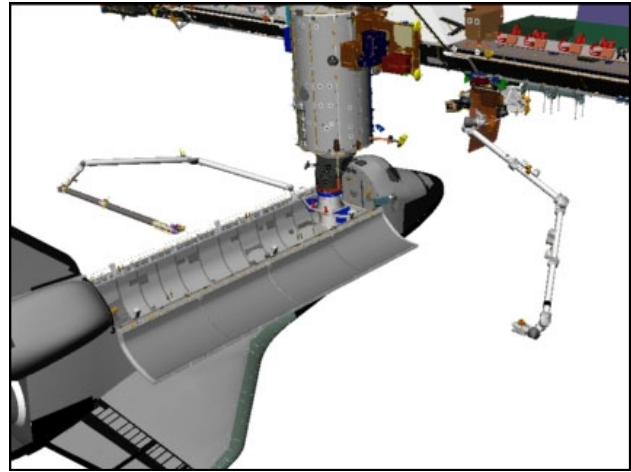

BIRD'S EYE

9. RETURN TO INGRESS/APFR POSN
 BRAKES – OFF (tb-OFF)
 MODE – ORB LD, ENTER

Reconfigure arm to INGRESS/APFR posn:

X	Y	Z	PITCH	YAW	ROLL	PL ID
-1166	+115	-488	263	53	275	1
SY	SP	EP	WP	WY	WR	
+43.4	+32.7	-18.1	-49.9	-27.1	-102.9	

10. STBD LOWER T-SEAL 21 SHOOT POSN

Lower Panel Clearance Views	Cameras
OBSS-to-PLBD/Wing	LAB, RSC
RMS-to-Lab	ELBOW

- a. OCAS 1/3

NOTE

At end of mnvr OBSS-to-PLBD = 79.8 in,
 Upper Arm-to-Lab = 66.6 in

SM 94 PDRS CONTROL

END POS – ITEM 18 -1 1 5 7 +7 1 1 -4 9 3 EXEC
 ATT – ITEM 21 +2 6 4 +5 5 +2 7 5 EXEC
 CMD CK – ITEM 25 EXEC (GOOD)

MODE – OPR CMD, ENTER (READY It on)

AUTO SEQ – PROCEED (IN PROG It on)

When AUTO SEQ IN PROG It – off,

	X	Y	Z	PITCH	YAW	ROLL	PL ID
√	-1157	+711	-493	264	55	275	1
	SY	SP	EP	WP	WY	WR	
√	-33.0	+47.6	-81.5	-4.8	+37.7	-60.9	

b. OCAS 2/3

NOTE

At end of mnvr Upper Arm-to-PMA GF = 41.5 in

SM 94 PDRS CONTROL

END POS – ITEM 18 -8 7 5 +7 2 9 -1 7 0 EXEC

ATT – ITEM 21 +1 4 +4 4 +1 9 5 EXEC

CMD CK – ITEM 25 EXEC (GOOD)

MODE – OPR CMD, ENTER (READY It on)

AUTO SEQ – PROCEED (IN PROG It on)

When AUTO SEQ IN PROG It – off,

	X	Y	Z	PITCH	YAW	ROLL	PL ID
√	-875	+729	-170	14	44	195	1
	SY	SP	EP	WP	WY	WR	
√	-50.5	+26.5	-52.6	+16.6	+20.8	-120.3	

c. OCAS 3/3

NOTE

At end of mnvr Upper Arm-to-PMA GF = 37.5 in,
OBSS-to-WLE = 66.6 in

SM 94 PDRS CONTROL

END POS – ITEM 18 -1 2 9 3 +4 8 2 -8 9 EXEC

ATT – ITEM 21 +8 0 +2 0 +1 7 1 EXEC

CMD CK – ITEM 25 EXEC (GOOD)

MODE – OPR CMD, ENTER (READY It on)

AUTO SEQ – PROCEED (IN PROG It on)

When AUTO SEQ IN PROG It – off:

BRAKES – ON (tb-ON)

	X	Y	Z	PITCH	YAW	ROLL	PL ID
√	-1293	+482	-89	80	20	171	1
	SY	SP	EP	WP	WY	WR	
√	-54.6	+22.3	-41.8	+28.6	+5.1	-179.6	

Give EV GO to SHOOT STBD LOWER

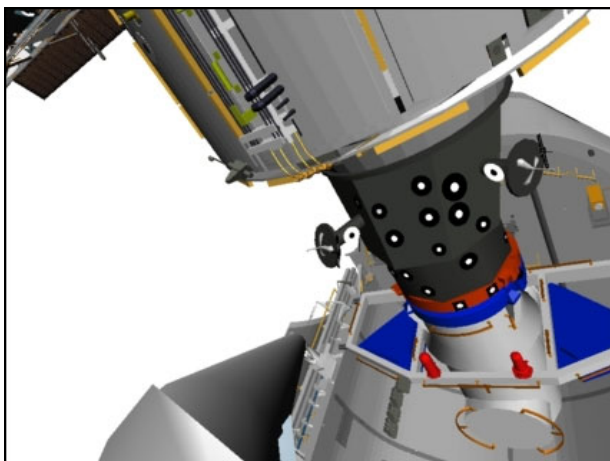

ELBOW (-148,-16)

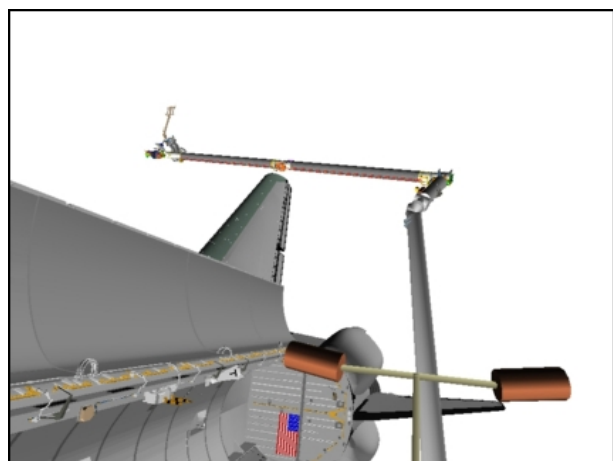

LAB (-14,-8)

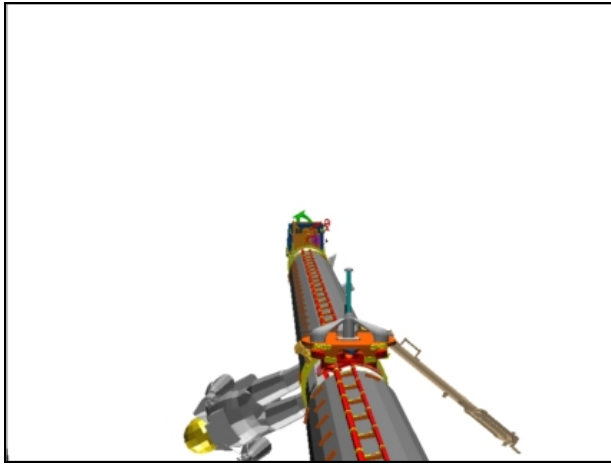

RSC

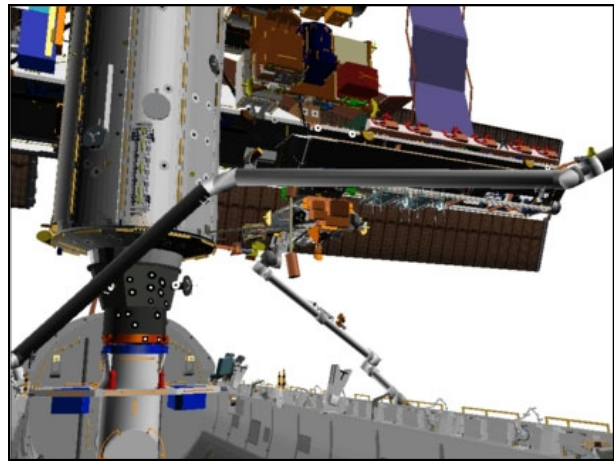

CCTV B (24,12)

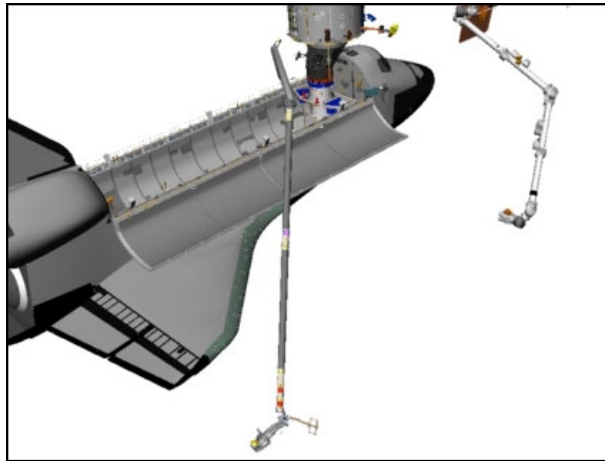

BIRD'S EYE

11. STBD LOWER T-SEAL 18 SHOOT POSN

NOTE

At end of mnvr OBSS-to-STBD Wing = 95.6 in,
Upper Arm-to-PMA GF = 32.6 in

SM 94 PDRS CONTROL

END POS – ITEM 18 -1 2 2 4 +4 7 4 -9 2 EXEC

ATT – ITEM 21 +7 6 +1 7 +1 7 5 EXEC

CMD CK – ITEM 25 EXEC (GOOD)

BRAKES – OFF (tb-OFF)

MODE – OPR CMD, ENTER (READY It on)

AUTO SEQ – PROCEED (IN PROG It on)

When AUTO SEQ IN PROG It – off:

BRAKES – ON (tb-ON)

	X	Y	Z	PITCH	YAW	ROLL	PL ID
√	-1224	+474	-92	76	17	175	1
	SY	SP	EP	WP	WY	WR	
√	-57.2	+31.1	-52.0	+25.9	+4.8	-177.4	

Give EV GO to SHOOT STBD LOWER

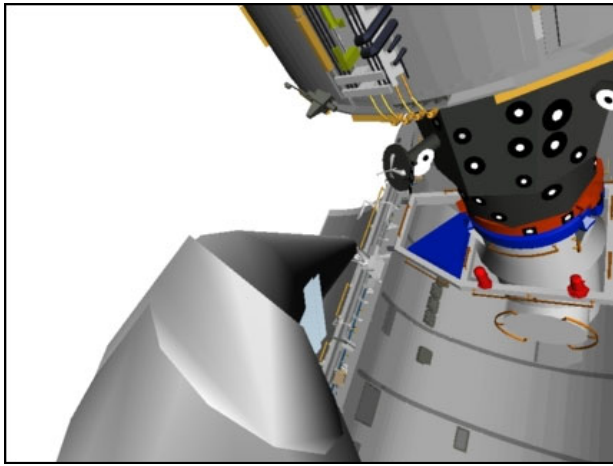

ELBOW (-148,-34)

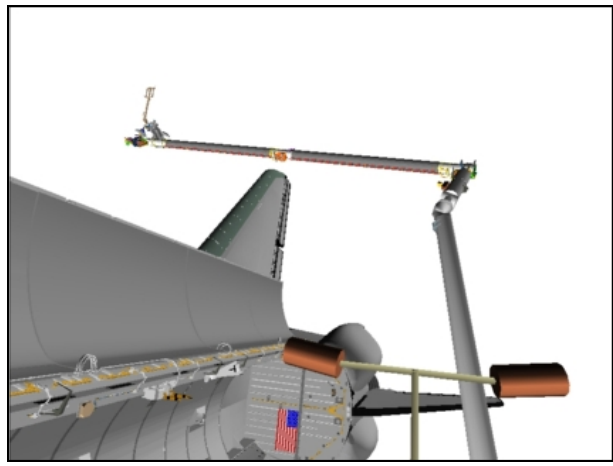

LAB (-14,-8)

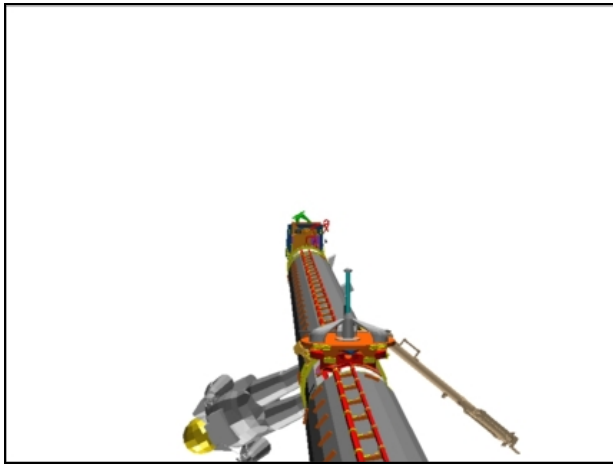

RSC

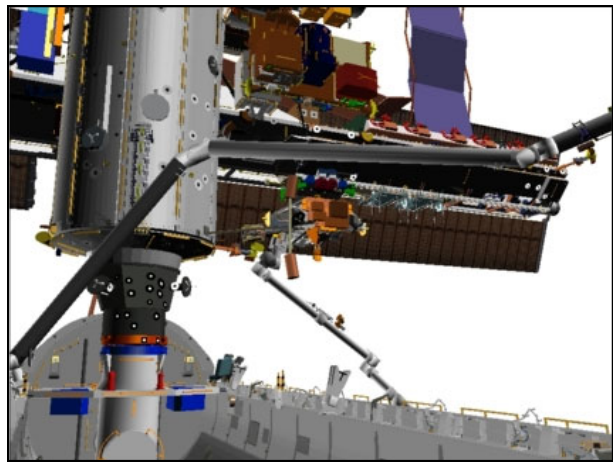

CCTV B (24,12)

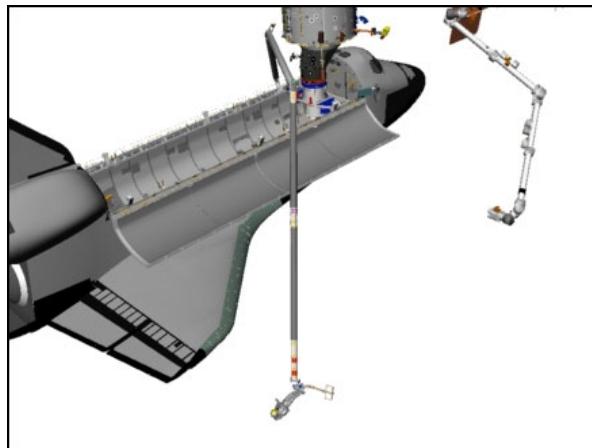

BIRD'S EYE

12. STBD LOWER T-SEAL 16 SHOOT POSN

NOTE

At end of mnvr Upper Arm-to-PMA GF = 25.1 in,
OBSS-to-Stbd Wing = 132.8 in

SM 94 PDRS CONTROL

END POS – ITEM 18 -1174 +471 -84 EXEC

ATT – ITEM 21 +75 +17 +172 EXEC

CMD CK – ITEM 25 EXEC (GOOD)

BRAKES – OFF (tb-OFF)

MODE – OPR CMD, ENTER (READY It on)

AUTO SEQ – PROCEED (IN PROG It on)

When AUTO SEQ IN PROG It – off:
BRAKES – ON (tb-ON)

	X	Y	Z	PITCH	YAW	ROLL	PL ID
√	-1174	+471	-84	75	17	172	1
	SY	SP	EP	WP	WY	WR	
√	-62.4	+32.6	-55.3	+26.6	+13.2	-177.7	

Give EV GO to SHOOT STBD LOWER

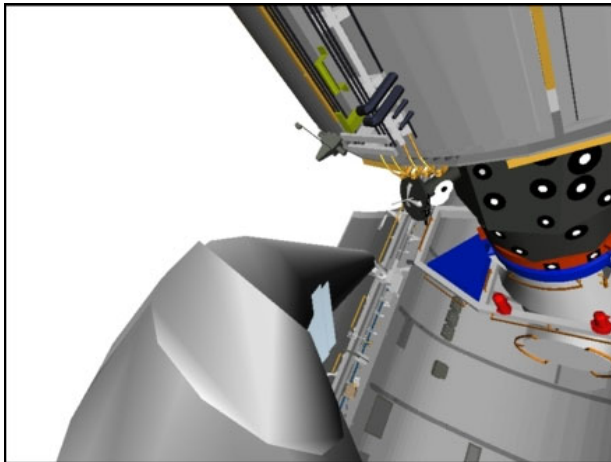

ELBOW (-148,-34)

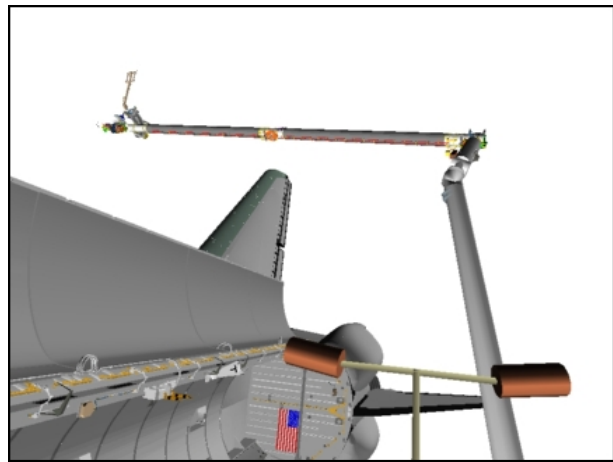

LAB (-14,-8)



RSC

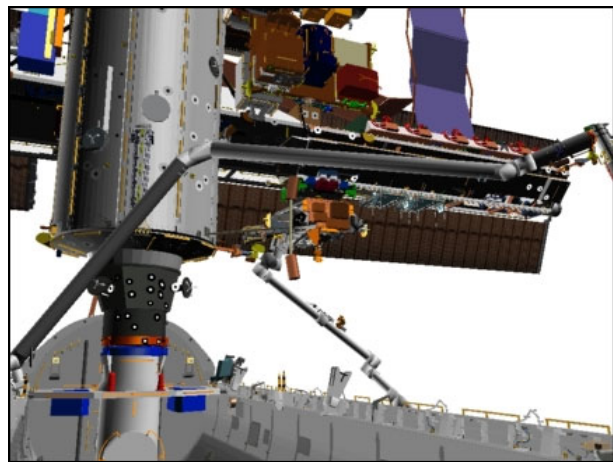

CCTV B (24,12)

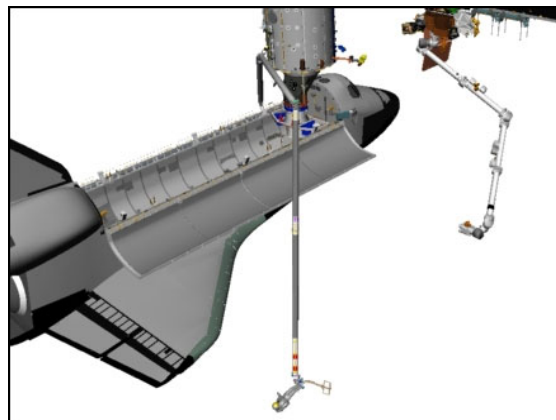

BIRD'S EYE

13. STBD LOWER T-SEAL 14 SHOOT POSN

NOTE

At end of mnvr OBSS-to-Wing = 68.8 in,
Upper Arm-to-PMA GF = 26.4 in

BRAKES – OFF (tb-OFF)
MODE – SINGLE, ENTER

Mnvr to SHOOT STBD T-SEAL 14 posn:

STBD	SY	SP	EP	WP	WY	WR	
T-SEAL 16	-62.4	+32.6	-55.3	+26.6	+13.2	-177.7	
1: SP –		+27.0					
2: EP +			-11.5				
3: WP –				-10.1			
4: WY +					+34.0		
5: WR –						-179.2	
STBD	-62.4	+27.0	-11.5	-10.1	+34.0	-179.2	
T-SEAL 14	X	Y	Z	PITCH	YAW	ROLL	PL ID
	-1165	+352	-212	75	23	152	1

BRAKES – ON (tb-ON)

Give EV GO to SHOOT STBD LOWER

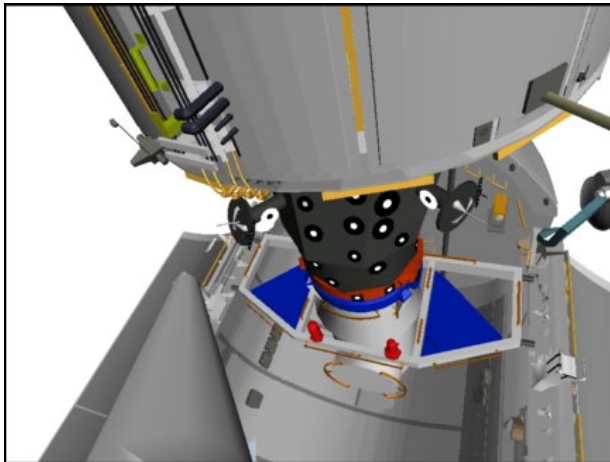

ELBOW (-155,-6)

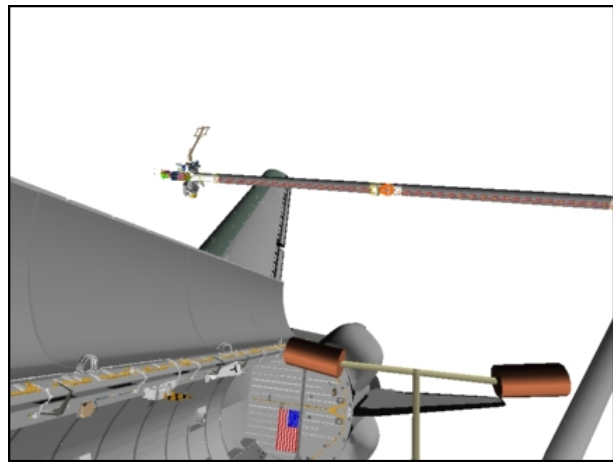

LAB (-14,-8)



RSC

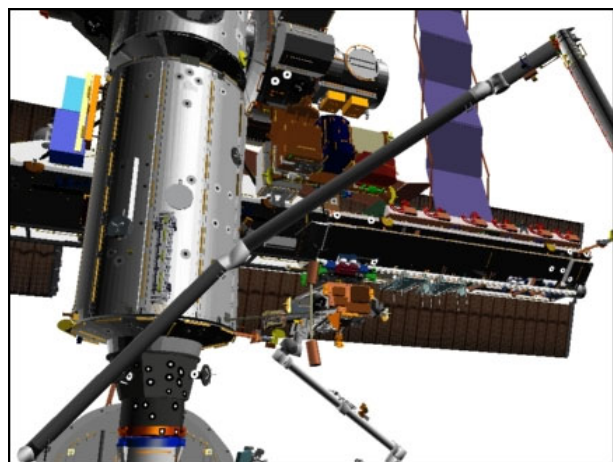

CCTV B (22,20)

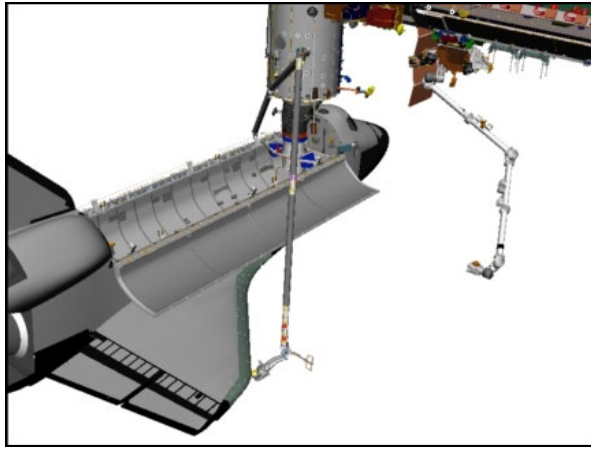

BIRD'S EYE

14. STBD LOWER T-SEAL 13 SHOOT POSN

NOTE

At end of mnvr OBSS-to-Wing = 80.0 in,
Upper Arm-to-PMA GF = 24.4 in

SM 94 PDRS CONTROL

END POS – ITEM 18 -1 1 4 7 +3 4 5 -2 1 7 EXEC
ATT – ITEM 21 +7 7 +3 1 +1 4 1 EXEC
CMD CK – ITEM 25 EXEC (GOOD)

BRAKES – OFF (tb-OFF)

MODE – OPR CMD, ENTER (READY It on)

AUTO SEQ – PROCEED (IN PROG It on)

When AUTO SEQ IN PROG It – off:

BRAKES – ON (tb-ON)

X	Y	Z	PITCH	YAW	ROLL	PL ID
-1147	+345	-217	77	31	141	1
SY	SP	EP	WP	WY	WR	
-62.8	+33.9	-21.9	-1.3	+46.2	-179.3	

Give EV GO to SHOOT STBD LOWER

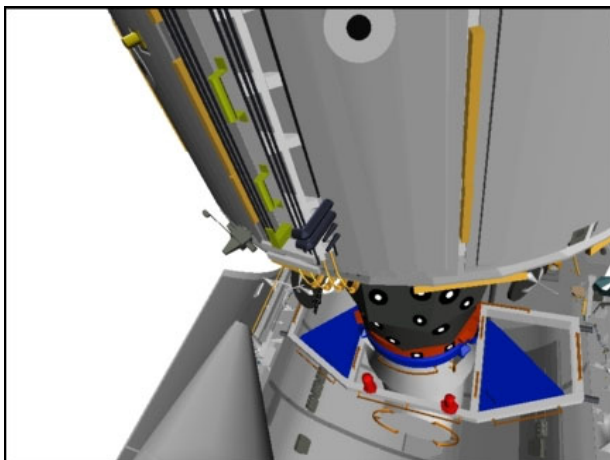

ELBOW (-155,-6)

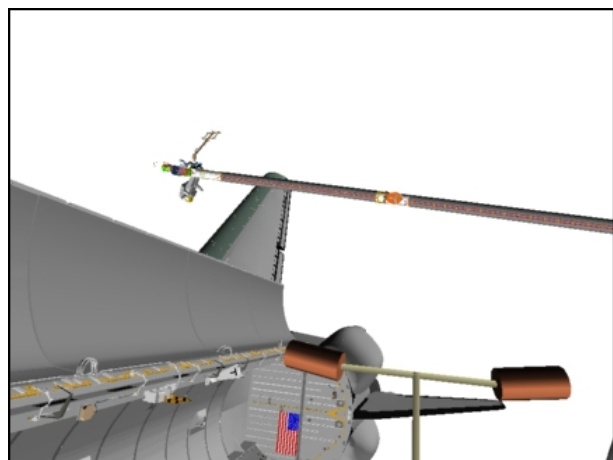

LAB (-14,-8)



RSC

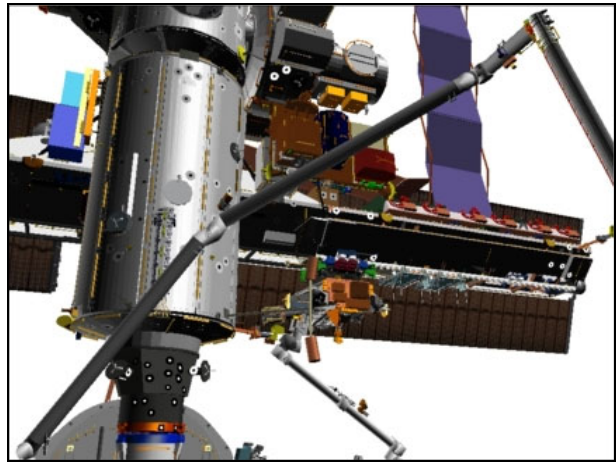

CCTV B (22,20)

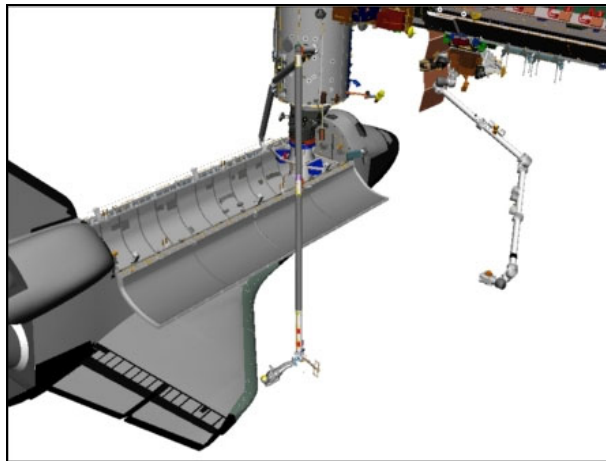

BIRD'S EYE

15. STBD LOWER T-SEAL 12 SHOOT POSN
 a. Mnvr to OCAS Clearance Stbd T-Seal 12 Posn

NOTE

At end of mnvr OBSS-to-Stbd Wing = 78.0 in,
 Upper Arm-to-Lab = 25.0 in

BRAKES – OFF (tb-OFF)
 MODE – SINGLE, ENTER

Mnvr to OCAS CLEARANCE STBD T-SEAL 12 posn:

STBD
 T-SEAL 13
 1: WR +
 2: SY +
 Pre STBD
 T-SEAL 12

SY	SP	EP	WP	WY	WR	
-62.8	+33.9	-21.9	-1.3	+46.2	-179.3	
					-170.5	
-55.1						
-55.1	+33.9	-21.9	-1.3	+46.2	-170.5	
X	Y	Z	PITCH	YAW	ROLL	PL ID
-1179	+376	-210	76	41	137	1

b. OCAS to Stbd T-Seal 12 Shoot Posn

NOTE

At end of mnvr OBSS-to-STBD Wing = 78.0 in,
Upper Arm-to-Lab = 25.0 in

SM 94 PDRS CONTROL

END POS – ITEM 18 $-1\ 1\ 2\ 4$ $+3\ 2\ 9$ $-2\ 1\ 9$ EXEC

ATT – ITEM 21 $+7\ 3$ $+3\ 4$ $+1\ 4\ 3$ EXEC

CMD CK – ITEM 25 EXEC (GOOD)

MODE – OPR CMD, ENTER (READY It on)

AUTO SEQ – PROCEED (IN PROG It on)

When AUTO SEQ IN PROG It – off:

BRAKES – ON (tb-ON)

	X	Y	Z	PITCH	YAW	ROLL	PL ID
√	-1124	+329	-219	73	34	143	1
	SY	SP	EP	WP	WY	WR	
√	-59.2	+49.1	-42.5	+0.8	+43.6	-172.6	

Give EV GO to SHOOT STBD LOWER

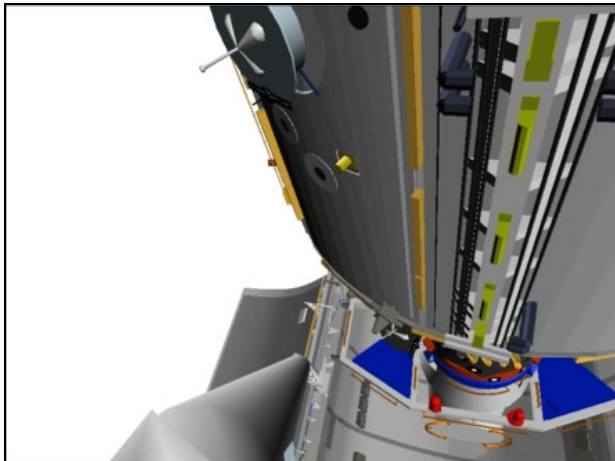

ELBOW (-148,-13)

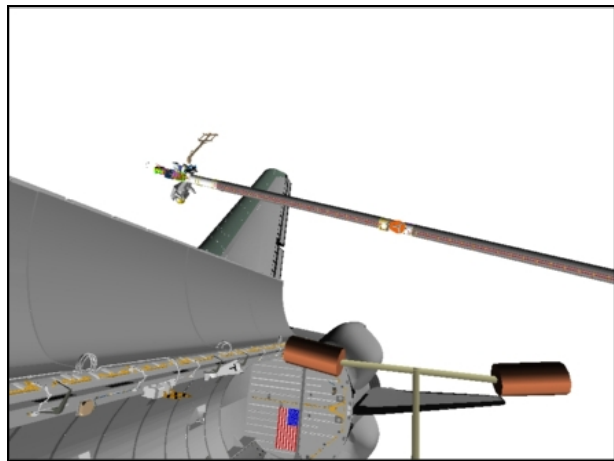

LAB (-14,-8)



RSC

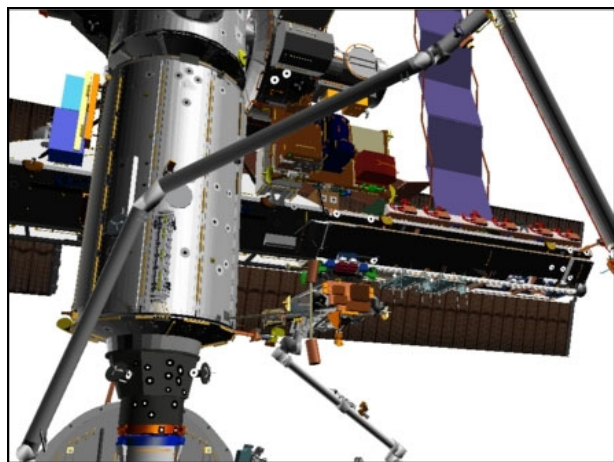

CCTV B (22,20)

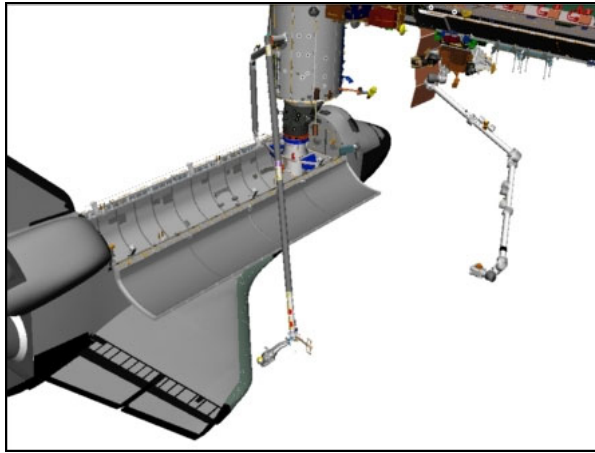

BIRD'S EYE

16. STBD LOWER T-SEAL 11 SHOOT POSN

NOTE

At end of mnvr OBSS-to-PLBD = 66.3 in,
Upper Arm-to-Lab = 24.6 in

SM 94 PDRS CONTROL

END POS – ITEM 18 -1 1 0 4 +2 9 5 -2 0 6 EXEC

ATT – ITEM 21 +7 9 +3 3 +1 3 5 EXEC

CMD CK – ITEM 25 EXEC (GOOD)

BRAKES – OFF (tb-OFF)

MODE – OPR CMD, ENTER (READY It on)

AUTO SEQ – PROCEED (IN PROG It on)

When AUTO SEQ IN PROG It – off:

BRAKES – ON (tb-ON)

√	X	Y	Z	PITCH	YAW	ROLL	PL ID
	-1104	+295	-206	79	33	135	1
	SY	SP	EP	WP	WY	WR	
√	-65.2	+53.7	-54.0	+14.4	+53.9	-182.3	

Give EV GO to SHOOT STBD LOWER

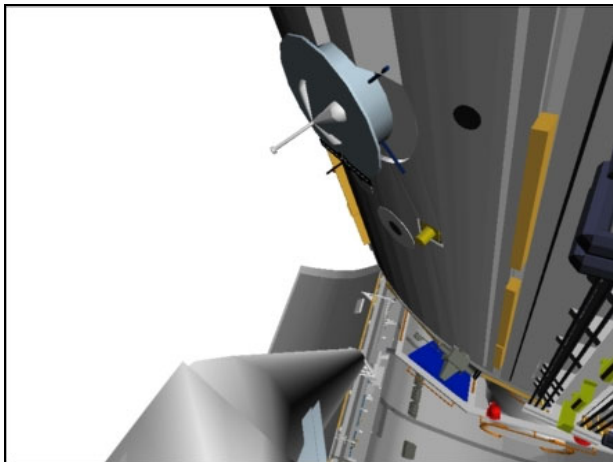

ELBOW (-147,-20)

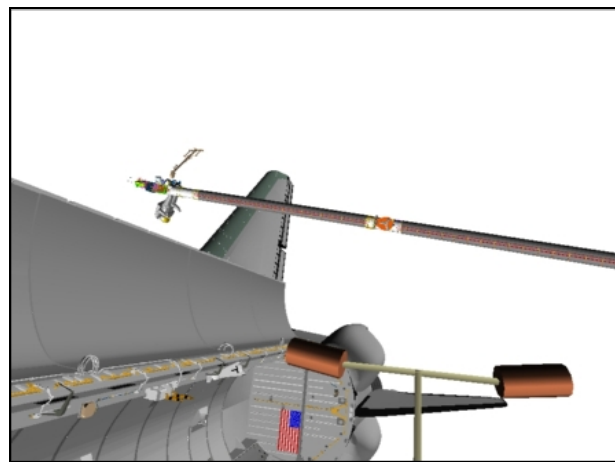

LAB (-14,-8)



RSC

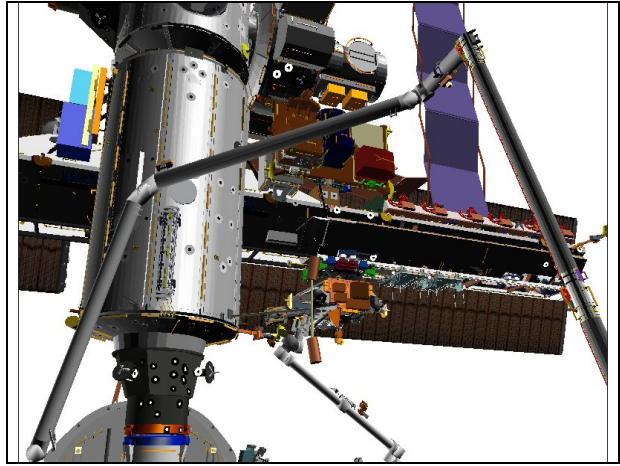

CCTV B (22,20)

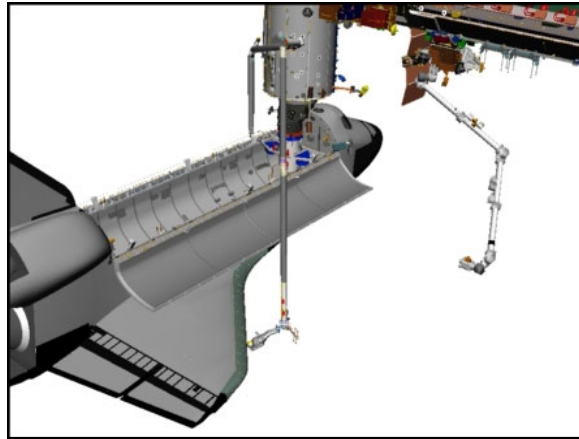

BIRD'S EYE

- 17. STBD T-SEAL 10
 - a. Mnvr to Clearance for OCAS

NOTE

At end of mnvr OBSS-to-Stbd Wing = 67.8 in,
Upper Arm-to-Lab = 29.1 in

BRAKES – OFF (tb-OFF)
MODE – SINGLE, ENTER

Mnvr to OCAS CLEARANCE STBD T-SEAL 11 posn:

STBD
T-SEAL 11
1: WR +
2: SY +
OCAS CLEAR

SY	SP	EP	WP	WY	WR	
-65.2	+53.7	-54.0	+14.4	+53.9	-182.3	
					-178.6	
-60.9						
-60.9	+53.7	-54.0	+14.4	+53.9	-178.6	
X	Y	Z	PITCH	YAW	ROLL	PL ID
-1122	+303	-200	79	37	132	1

b. Mnvr to Lower 10 Pre-Posn

NOTE

At end of mnvr OBSS-to-PLBD = 69.1 in,
Upper Arm-to-Lab PDGF = 34.7 in

SM 94 PDRS CONTROL

END POS – ITEM 18 -1 0 7 1 +3 2 3 -2 1 1 EXEC
ATT – ITEM 21 +7 3 +3 6 +1 4 5 EXEC
CMD CK – ITEM 25 EXEC (GOOD)

MODE – OPR CMD, ENTER (READY It on)

AUTO SEQ – PROCEED (IN PROG It on)

When AUTO SEQ IN PROG It – off,

	X	Y	Z	PITCH	YAW	ROLL	PL ID
√	-1071	+323	-211	73	36	145	1
	SY	SP	EP	WP	WY	WR	
√	-64.1	+66.8	-70.5	+13.7	+47.2	-172.7	

c. Mnvr to Lower 10 Shoot Posn

NOTE

At end of mnvr OBSS-to-PLBD = 33.1 in, OBSS-to-Stbd
Wing = 62.8 in, Upper Arm-to-PMA GF = 50.7 in

MODE – SINGLE, ENTER

Drive WR (-) to -177.7 to STBD T-SEAL 10 SHOOT posn

	X	Y	Z	PITCH	YAW	ROLL	PL ID
√	-1085	+273	-204	76	32	142	1
	SY	SP	EP	WP	WY	WR	
√	-64.1	+66.8	-70.5	+13.7	+47.2	-177.7	

BRAKES – ON (tb-ON)

Give EV GO to SHOOT STBD LOWER

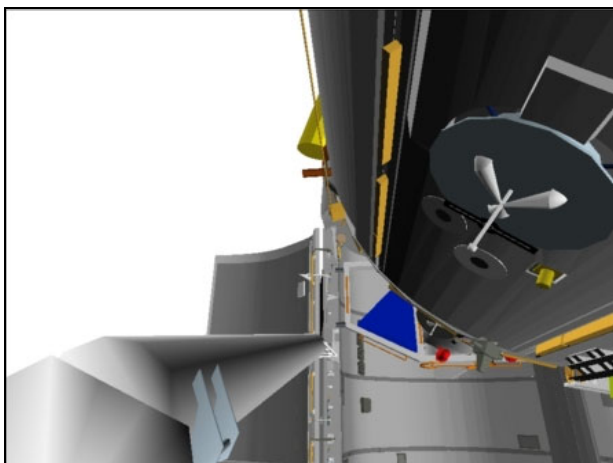

ELBOW (-124,-29)

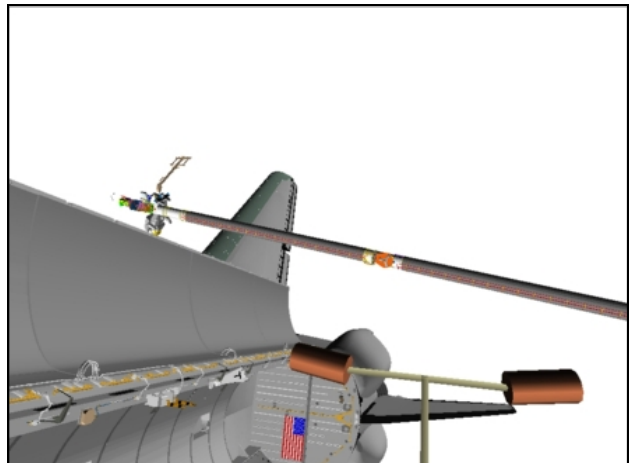

LAB (-14,-8)

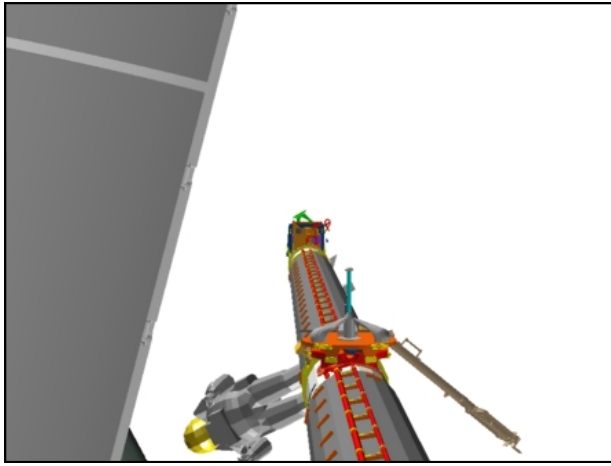

RSC

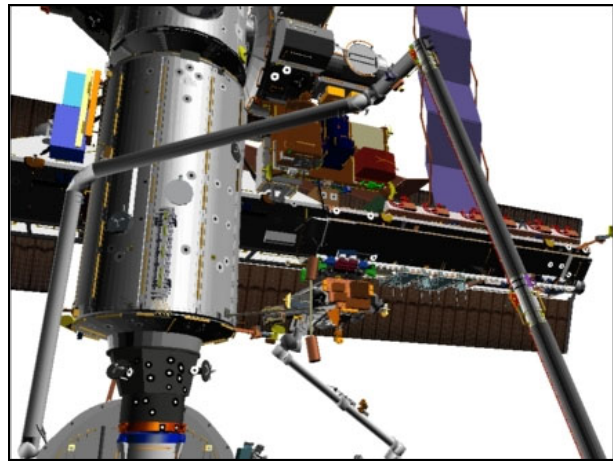

CCTV B (22,20)

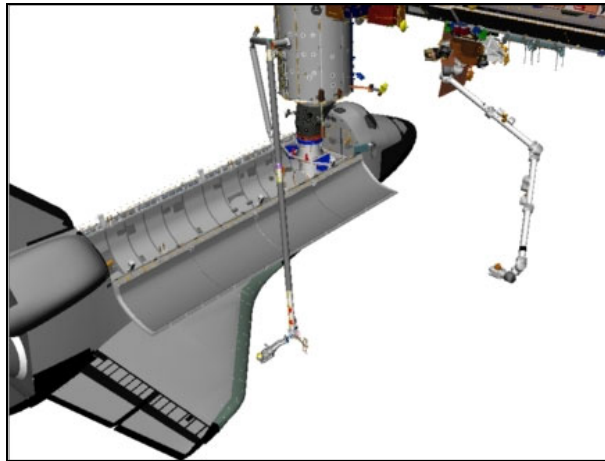

BIRD'S EYE

18. STBD T-SEAL 9

a. Mnvr to Lower 10 Pre-Posn

NOTE

At end of mnvr OBSS-to-PLBD = 69.1 in,
Upper Arm-to-Lab PDGF = 34.7 in

BRAKES – OFF (tb-OFF)
MODE – SINGLE, ENTER

Drive WR (+) to -172.7 to PRE STBD T-SEAL 10 posn

	X	Y	Z	PITCH	YAW	ROLL	PL ID
√	-1071	+323	-211	73	36	145	1
	SY	SP	EP	WP	WY	WR	
√	-64.1	+66.8	-70.5	+13.7	+47.2	-172.7	

b. Mnvr to Lower 9 Pre-Posn

NOTE

At end of mnvr OBSS-to-PLBD = 70.0 in,
Upper Arm-to-Lab = 25.9 in

SM 94 PDRS CONTROL

END POS – ITEM 18 -1 0 3 4 +3 0 4 -2 1 9 EXEC
ATT – ITEM 21 +6 4 +3 3 +1 4 1 EXEC
CMD CK – ITEM 25 EXEC (GOOD)

MODE – OPR CMD, ENTER (READY It on)

AUTO SEQ – PROCEED (IN PROG It on)

When AUTO SEQ IN PROG It – off,

	X	Y	Z	PITCH	YAW	ROLL	PL ID
√	-1034	+305	-219	64	33	141	1
	SY	SP	EP	WP	WY	WR	
√	-58.4	+40.2	-20.0	-25.9	+47.3	-162.7	

c. Mnvr to Lower 9 Shoot Posn

NOTE

At end of mnvr OBSS-to-PLBD = 36.4 in,
Upper Arm-to-Lab = 25.9 in

MODE – SINGLE, ENTER

Drive WR (-) to -167.0 to STBD T-SEAL 9 SHOOT posn

	X	Y	Z	PITCH	YAW	ROLL	PL ID
√	-1043	+260	-214	66	29	139	1
	SY	SP	EP	WP	WY	WR	
√	-58.4	+40.2	-20.0	-25.9	+47.3	-167.0	

BRAKES – ON (tb-ON)

Give EV GO to SHOOT STBD LOWER

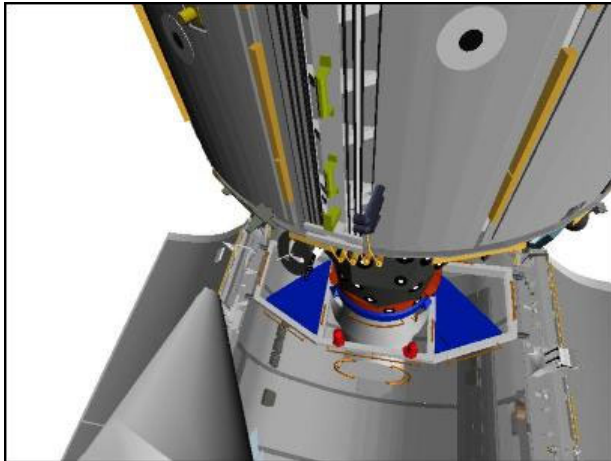

ELBOW (-152,-9)

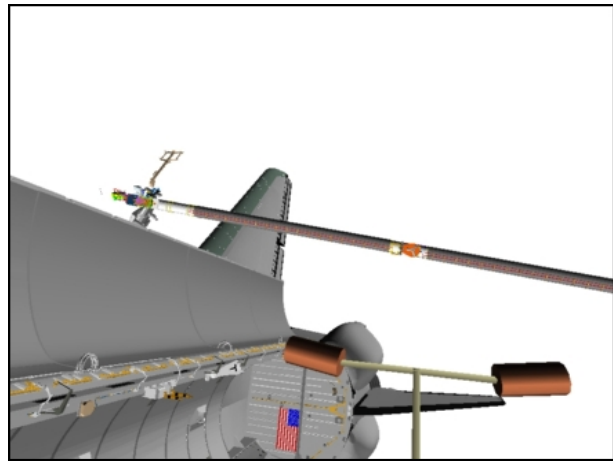

LAB (-14,-8)

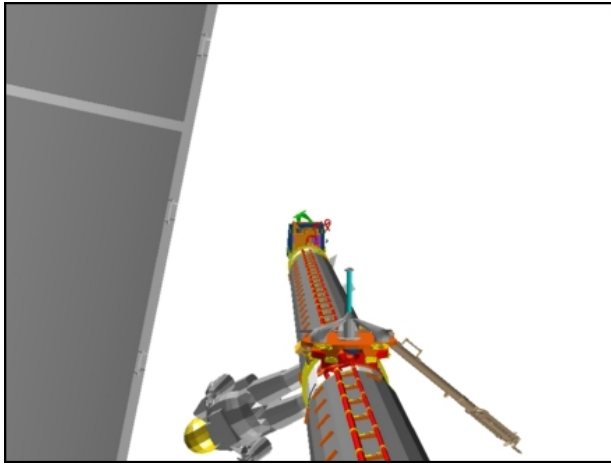

RSC

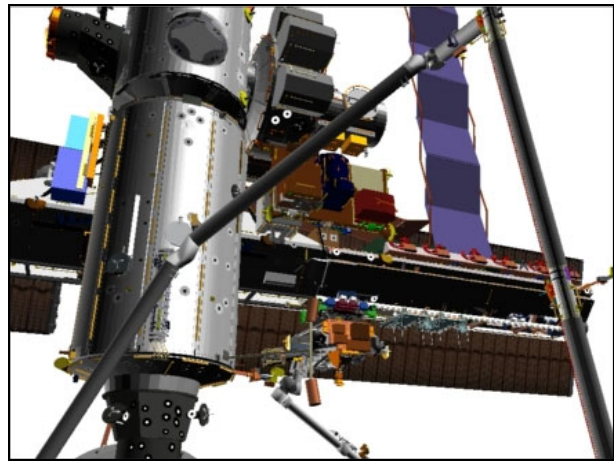

CCTV B (22,24)

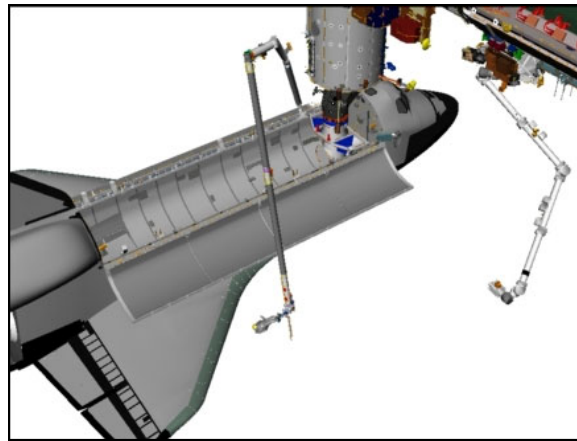

BIRD'S EYE

19. STBD T-SEAL 7 & 8

a. Mnvr to Lower 9 Pre-Posn

NOTE

At end of mnvr OBSS-to-PLBD = 70.0 in,
Upper Arm-to-Lab = 25.9 in

BRAKES – OFF (tb-OFF)
MODE – SINGLE, ENTER

Drive WR (+) to -162.7 to PRE STBD T-SEAL 9 posn

	X	Y	Z	PITCH	YAW	ROLL	PL ID
√	-1034	+305	-219	64	33	141	1
	SY	SP	EP	WP	WY	WR	
√	-58.4	+40.2	-20.0	-25.9	+47.3	-162.7	

b. Mnvr to Lower 7 & 8 Pre-Posn

NOTE

At end of mnvr OBSS-to-PLBD = 71.4 in,
Upper Arm-to-Lab = 29.9 in

SM 94 PDRS CONTROL

END POS – ITEM 18 -1 0 3 5 +2 9 2 -2 1 7 EXEC
ATT – ITEM 21 +7 2 +4 1 +1 2 2 EXEC
CMD CK – ITEM 25 EXEC (GOOD)

MODE – OPR CMD, ENTER (READY It on)

AUTO SEQ – PROCEED (IN PROG It on)

When AUTO SEQ IN PROG It – off,

	X	Y	Z	PITCH	YAW	ROLL	PL ID
√	-1035	+292	-217	72	41	122	1
	SY	SP	EP	WP	WY	WR	
√	-58.0	+36.7	-13.7	-26.3	+64.2	-162.4	

c. Mnvr to Lower 7 & 8 Shoot Posn

NOTE

At end of mnvr OBSS-to-PLBD = 34.2 in,
Upper Arm-to-Lab = 29.9 in

MODE – SINGLE, ENTER

Drive WR (-) to -167.0 to SHOOT STBD T-SEALS 7 & 8 posn

	X	Y	Z	PITCH	YAW	ROLL	PL ID
√	-1030	+244	-210	73	37	121	1
	SY	SP	EP	WP	WY	WR	
√	-58.0	+36.7	-13.7	-26.3	+64.2	-167.0	

BRAKES – ON (tb-ON)

Give EV GO to SHOOT STBD LOWER

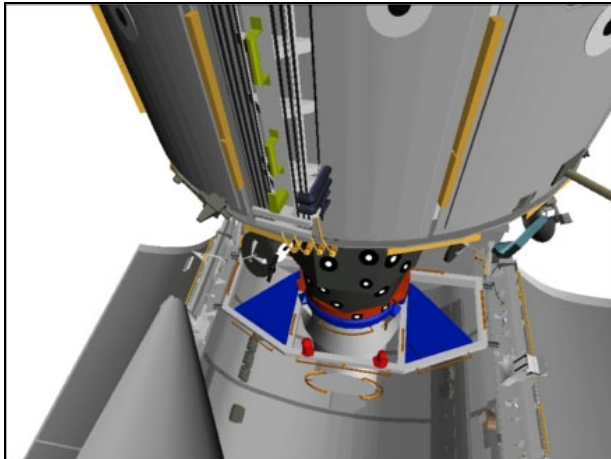

ELBOW (-152,-4)

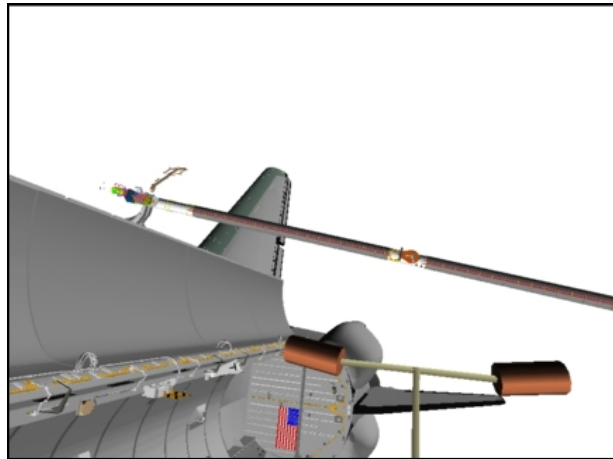

LAB (-14,-8)

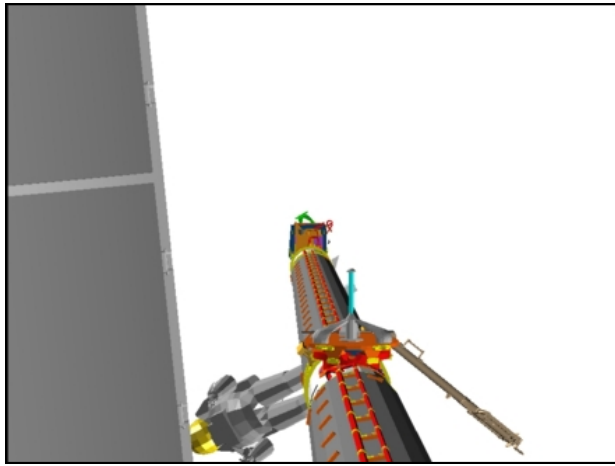

RSC

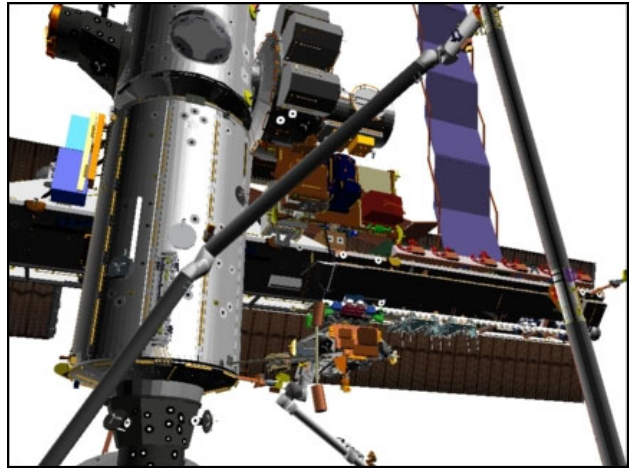

CCTV B (22,24)

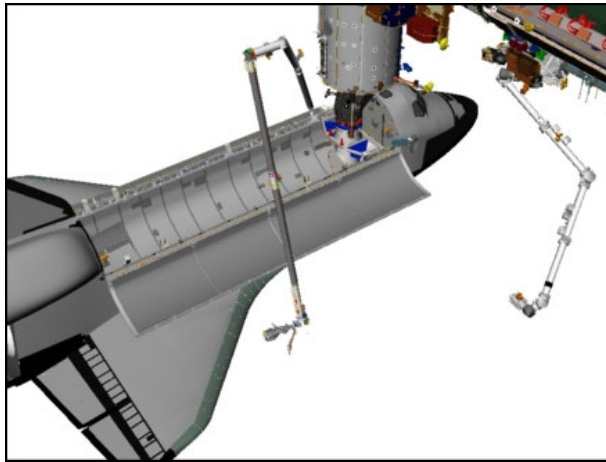

BIRD'S EYE

20. STBD T-SEALS 5 & 6

a. Mnvr to Clear for OCAS

NOTE

At end of mnvr OBSS-to-PLBD = 71.1 in,
Upper Arm-to-Lab = 29.9 in

BRAKES – OFF (tb-OFF)
MODE – SINGLE, ENTER

Drive WR (+) to -162.4 to PRE STBD T-SEALS 7 & 8 posn

√	X	Y	Z	PITCH	YAW	ROLL	PL ID
	-1035	+292	-217	72	41	122	1
	SY	SP	EP	WP	WY	WR	
√	-58.0	+36.7	-13.7	-26.3	+64.2	-162.4	

b. Mnvr to Lower 5 & 6 Pre-Posn

NOTE

At end of mnvr OBSS-to-PLBD = 78.3 in,
Upper Arm-to-Lab PDGF = 40.6 in

SM 94 PDRS CONTROL

END POS – ITEM 18 -1 0 4 6 +3 0 6 -2 4 1 EXEC
ATT – ITEM 21 +8 4 +5 4 +1 0 6 EXEC
CMD CK – ITEM 25 EXEC (GOOD)

MODE – OPR CMD, ENTER (READY It on)

AUTO SEQ – PROCEED (IN PROG It on)

When AUTO SEQ IN PROG It – off,

	X	Y	Z	PITCH	YAW	ROLL	PLID
√	-1046	+306	-241	84	54	106	1
	SY	SP	EP	WP	WY	WR	
√	-56.2	+62.7	-52.2	-7.7	+74.8	-157.0	[1]

[1] WY approaches singularity

c. Mnvr to Lower 5 & 6 Shoot Posn

NOTE

At end of mnvr OBSS-to-PLBD = 28.5 in,
Upper Arm-to-Lab PDGF = 40.6 in

MODE – SINGLE, ENTER

Drive WR (-) to -163.4 to SHOOT STBD T-SEALS 5 & 6 posn

	X	Y	Z	PITCH	YAW	ROLL	PLID
√	-1024	+245	-221	82	48	106	1
	SY	SP	EP	WP	WY	WR	
√	-56.2	+62.7	-52.2	-7.7	+74.8	-163.4	[1]

[1] WY approaches singularity

BRAKES – ON (tb-ON)

Give EV GO to SHOOT STBD LOWER

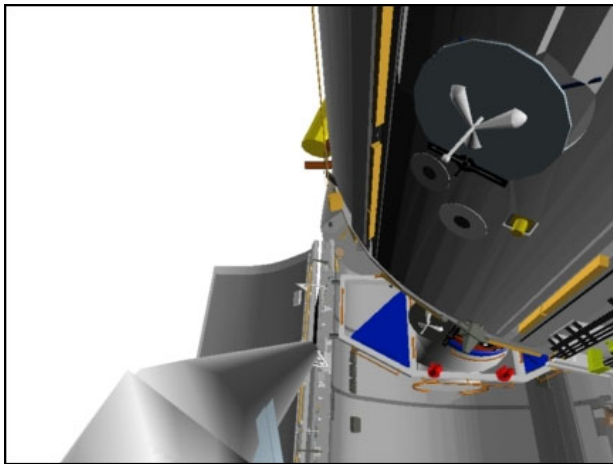

ELBOW (-141,-20)

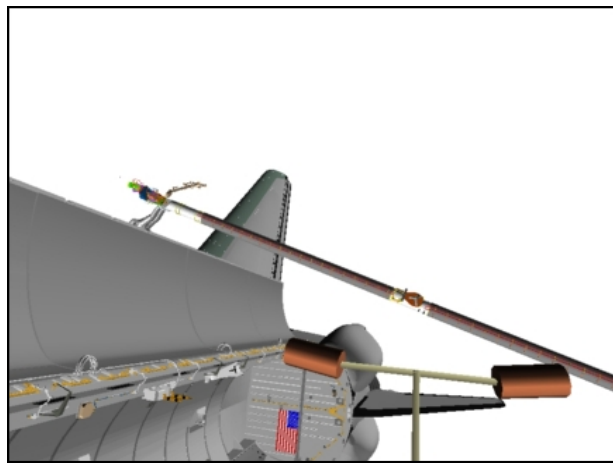

LAB (-14,-8)

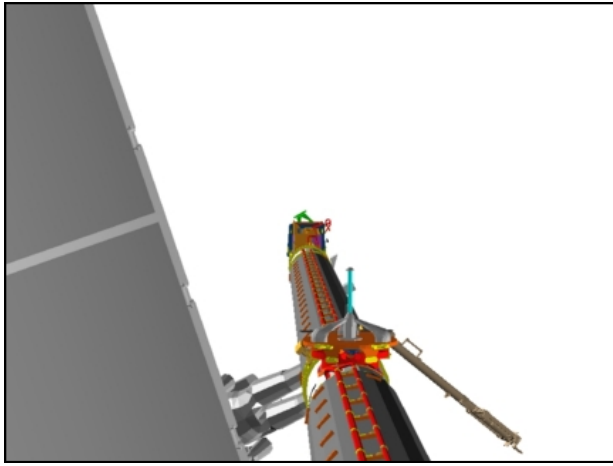

RSC

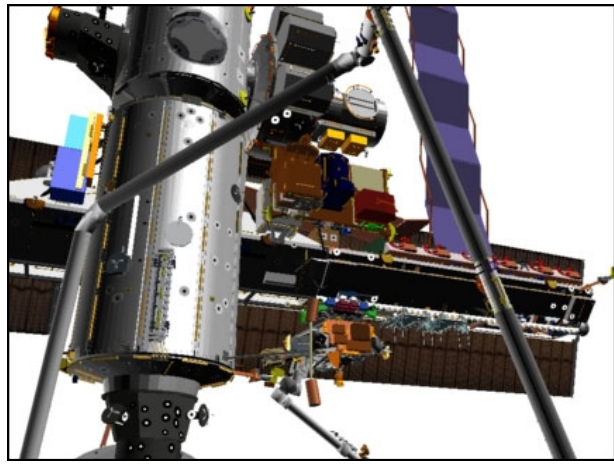

CCTV B (22,24)

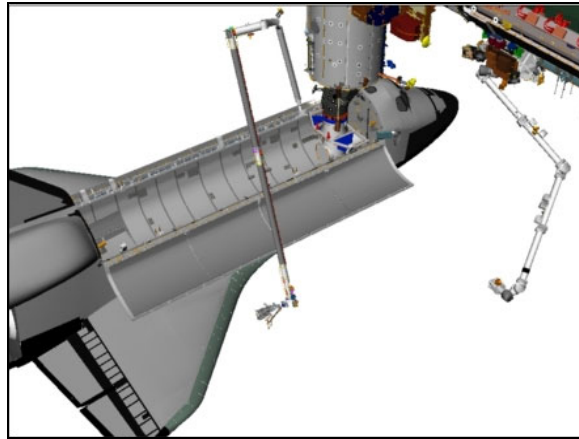

BIRD'S EYE

21. STBD T-SEAL 3

a. Mnvr to Lower 5 & 6 Pre-Posn

NOTE

At end of mnvr OBSS-to-PLBD = 78.3 in,
Upper Arm-to-Lab PDGF = 40.6 in

BRAKES – OFF (tb-OFF)
MODE – SINGLE, ENTER

Drive WR (+) to -157.0 to PRE STBD T-SEALS 5 & 6 posn

	X	Y	Z	PITCH	YAW	ROLL	PLID
√	-1046	+306	-241	84	54	106	1
	SY	SP	EP	WP	WY	WR	
√	-56.2	+62.7	-52.2	-7.7	+74.8	-157.0	[1]

[1] WY approaches singularity

b. Mnvr to Lower 3 Pre-Posn

NOTE

At end of mnvr OBSS-to-Stbd Wing = 69.6 in,
Upper Arm-to-PMA GF = 39.6 in

SM 94 PDRS CONTROL

END POS – ITEM 18 -1 0 9 2 +3 1 8 -1 0 8 EXEC
ATT – ITEM 21 +8 3 +4 5 +1 0 1 EXEC
CMD CK – ITEM 25 EXEC (GOOD)

MODE – OPR CMD, ENTER (READY It on)

AUTO SEQ – PROCEED (IN PROG It on)

When AUTO SEQ IN PROG It – off,

	X	Y	Z	PITCH	YAW	ROLL	PLID
√	-1092	+318	-108	83	45	101	1
	SY	SP	EP	WP	WY	WR	
√	-52.4	+24.6	-16.6	-6.4	+74.6	-165.9	[1]

[1] WY approaches singularity

c. Mnvr to Lower 3 Shoot Posn

NOTE

Expect SINGULAR It while driving WY. At end of mnvr
OBSS-to-PLBD = 63.9 in, Upper Arm-to-PMA GF = 39.6 in

MODE – SINGLE, ENTER

Drive WY (+) to +108.0 to STBD T-SEAL 3 SHOOT posn

	X	Y	Z	PITCH	YAW	ROLL	PL ID
√	-1002	+297	-99	103	44	57	1
	SY	SP	EP	WP	WY	WR	
√	-52.4	+24.6	-16.6	-6.4	+108.0	-165.9	

BRAKES – ON (tb-ON)

Give EV GO to SHOOT STBD LOWER

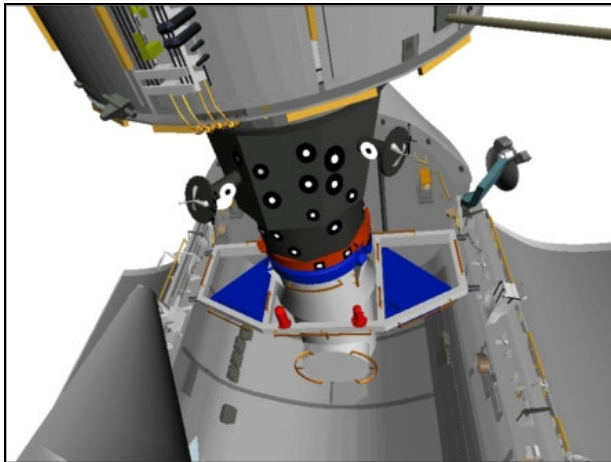

ELBOW (-146,-8)

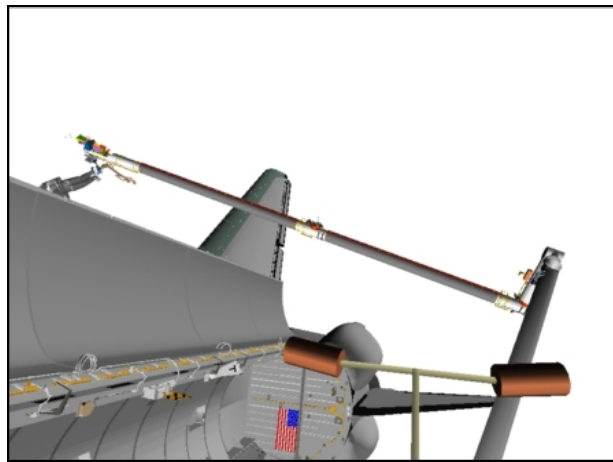

LAB (-23,-8)

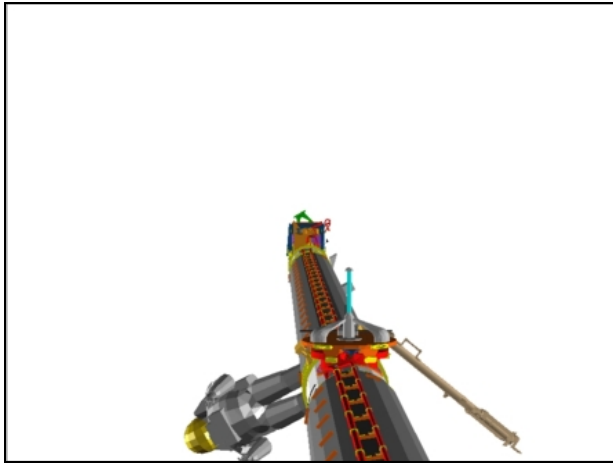

RSC

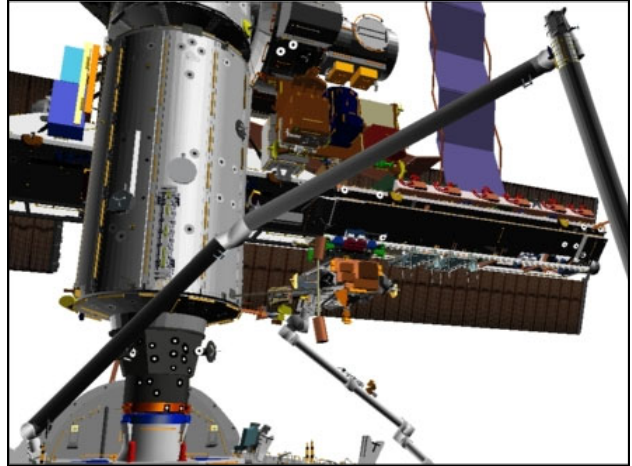

CCTV B (22,18)

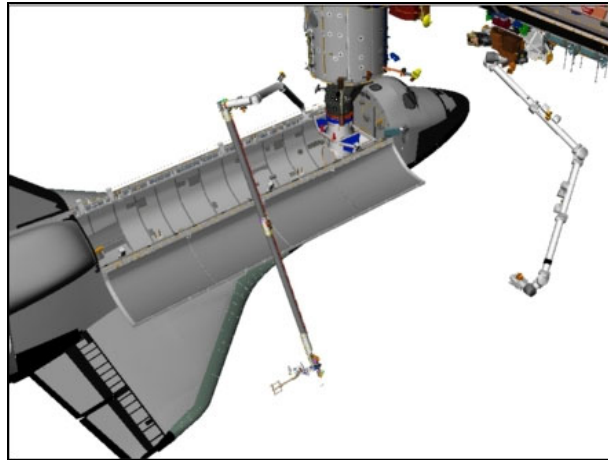

BIRD'S EYE

22. EV1 EGRESS/APFR RECONFIG

a. Mnvr to Lower 3 Clearance Posn

BRAKES – OFF (tb-OFF)

MODE – SINGLE, ENTER

Mnvr to STBD T-SEAL 3 CLEARANCE posn:

	SY	SP	EP	WP	WY	WR	
STBD T-SEAL 3 SHOOT Posn	-52.4	+24.6	-16.6	-6.4	+108.0	-165.9	
1: WY –					+74.6		[1]
2: WR +						-87.0	
STBD T-SEAL 3 CLEAR Posn	-52.4	+24.6	-16.6	-6.4	+74.6	-87.0	
	X	Y	Z	PITCH	YAW	ROLL	PL ID
	-1338	+757	-698	256	59	313	1

[1] Expect SINGULAR It

b. MNVR to EV1 APFR Aft Reconfig 1 Posn

Sill Clearance Views	Cameras
OBSS-to-PLBD	C, B, TIP ELBOW
RMS-to-Lab	C, ELBOW, A

NOTE

At end of mnvr OBSS-to-Port Sill = 98.2 in

SM 94 PDRS CONTROL

END POS – ITEM 18 -1 1 6 2 +1 1 5 -4 8 1 EXEC
 ATT – ITEM 21 +2 6 4 +5 5 +2 7 5 EXEC
 CMD CK – ITEM 25 EXEC (GOOD)

MODE – OPR CMD, ENTER (READY It on)

AUTO SEQ – PROCEED (IN PROG It on)

When AUTO SEQ IN PROG It – off:

BRAKES – ON (tb-ON)

√	X	Y	Z	PITCH	YAW	ROLL	PL ID
	-1162	+115	-481	264	55	275	1
	SY	SP	EP	WP	WY	WR	
√	+43.2	+34.4	-18.8	-49.3	-26.9	-103.9	

Give EV GO to EGRESS/Reconfig APFR (4, FF, L, 12) and INGRESS

GCA if reqd

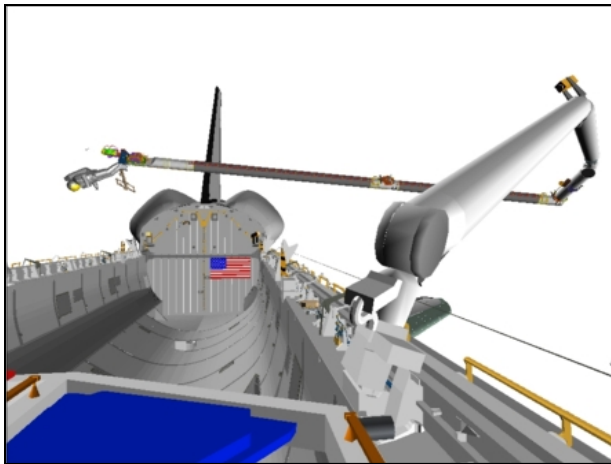

CCTV A (9,0)

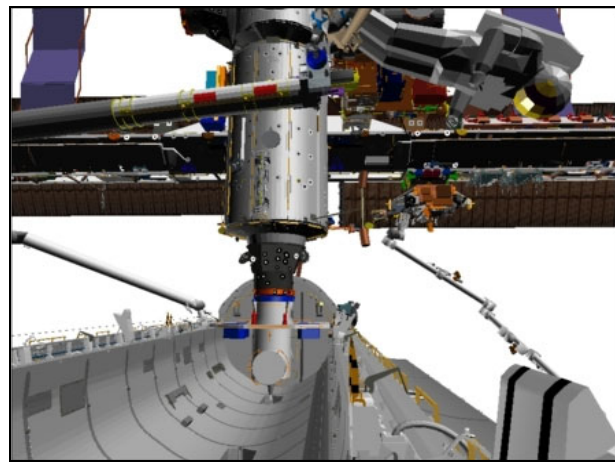

CCTV C (-2,10)

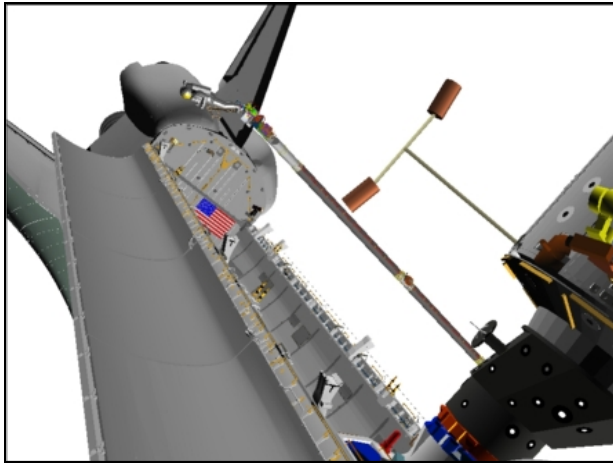

BASE ELBOW (-55,0)

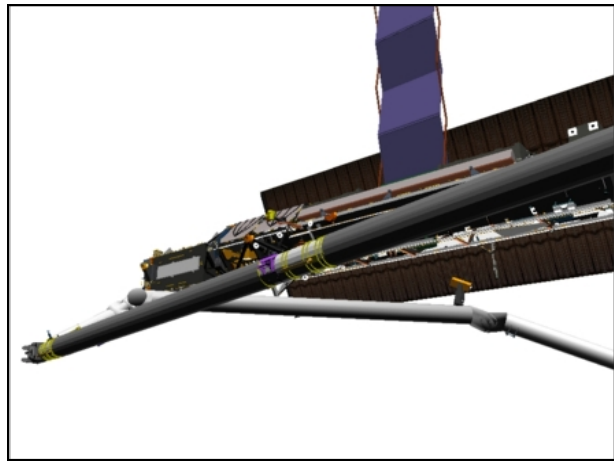

CCTV B (-40,18)

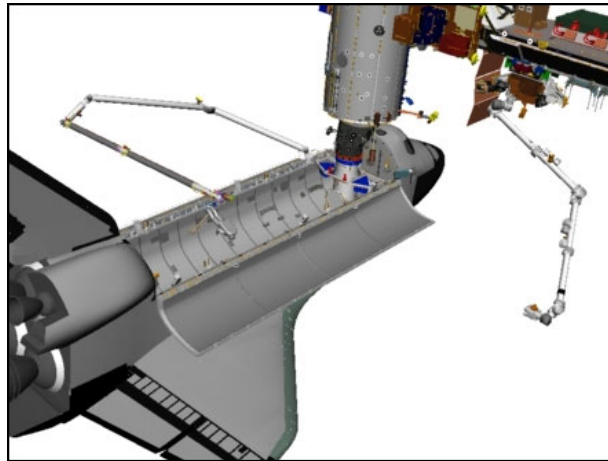

BIRD'S EYE

23. SILL CLEARANCE MNVR

NOTE

At end of mnvr, OBSS-to-Port Sill = 98.2 in

SM 94 PDRS CONTROL

PL ID - ITEM 3 +2 EXEC

INIT ID - ITEM 24 +2 EXEC

BRAKES - OFF (tb-OFF)

MODE - ORB LD, ENTER

Reconfigure arm to EV1 OCAS CLEARANCE posn:

X	Y	Z	PITCH	YAW	ROLL	PL ID
-1165	+146	-516	267	25	273	2
SY	SP	EP	WP	WY	WR	
+43.2	+34.4	-18.8	-49.3	-26.9	-103.9	

BRAKES - ON (tb-ON)

24. STBD APEX T-SEAL 21 SHOOT POSN

Aft Posn APEX Clearance Views	Cameras
OBSS-to-PLBD/Stbd Wing	D, LAB
RMS-to-Lab	ELBOW, A

NOTE

At end of mnvr Upper Arm-to-PMA GF = 48.2 in

SM 94 PDRS CONTROL

END POS – ITEM 18 -1 2 3 8 +6 2 5 -3 0 2 EXEC
 ATT – ITEM 21 +3 5 3 +5 9 +2 1 9 EXEC
 CMD CK – ITEM 25 EXEC (GOOD)

BRAKES – OFF (tb-OFF)

MODE – OPR CMD, ENTER (READY It on)

AUTO SEQ – PROCEED (IN PROG It on)

When AUTO SEQ IN PROG It – off:

BRAKES – ON (tb-ON)

	X	Y	Z	PITCH	YAW	ROLL	PL ID
√	-1238	+625	-302	353	59	219	2
	SY	SP	EP	WP	WY	WR	
√	-44.0	+31.7	-24.3	+7.1	+35.4	-143.9	

Give EV GO to SHOOT STBD APEX

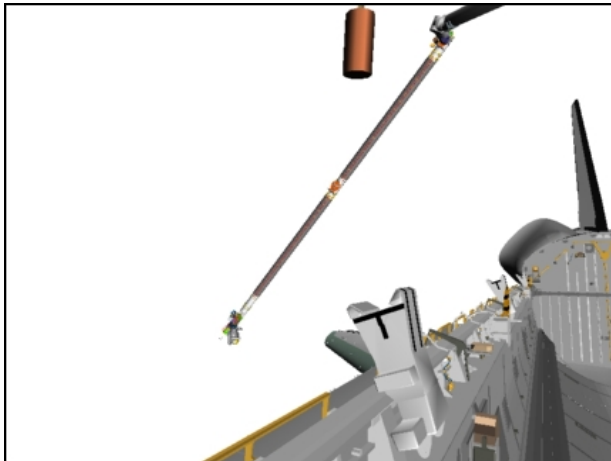

CCTV D (-30,5)

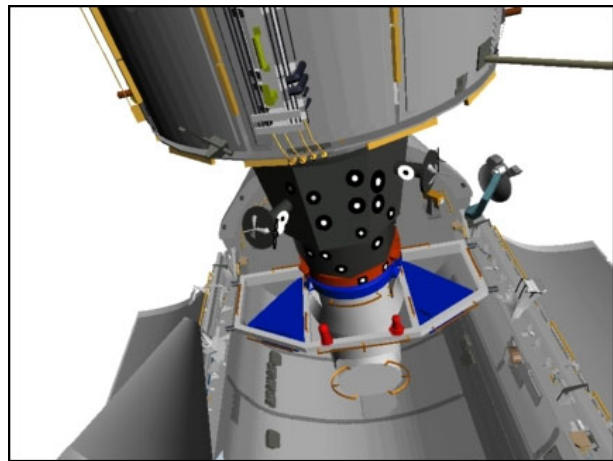

ELBOW (-146,-8)

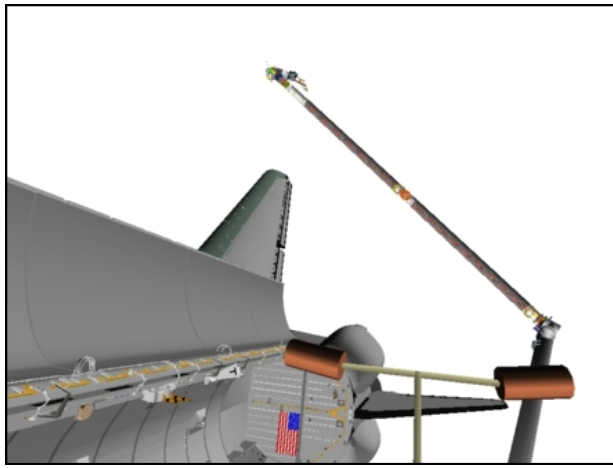

LAB (-14,-8)

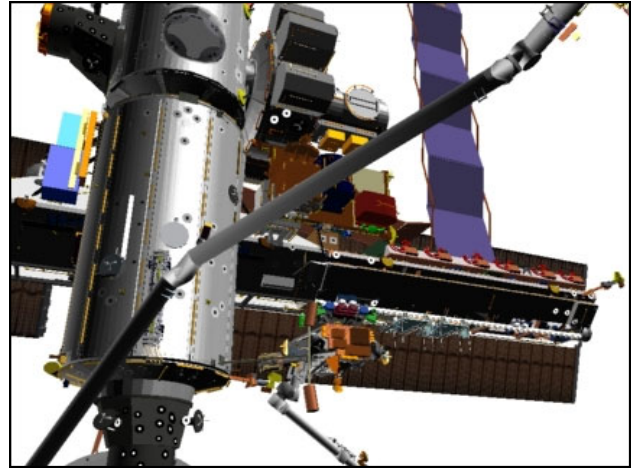

CCTV B (23,24)

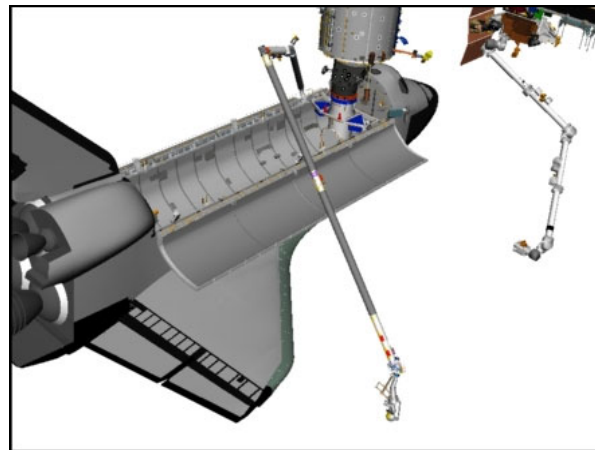

BIRD'S EYE

25. STBD APEX T-SEAL 19 SHOOT POSN

NOTE

At end of mnvr Upper Arm-to-PMA GF = 43.2 in

SM 94 PDRS CONTROL

END POS – ITEM 18 -1 1 7 2 +5 9 8 -2 7 6 EXEC

ATT – ITEM 21 +3 5 9 +5 8 +2 0 9 EXEC

CMD CK – ITEM 25 EXEC (GOOD)

BRAKES – OFF (tb-OFF)

MODE – OPR CMD, ENTER (READY It on)

AUTO SEQ – PROCEED (IN PROG It on)

When AUTO SEQ IN PROG It – off:

BRAKES – ON (tb-ON)

	X	Y	Z	PITCH	YAW	ROLL	PL ID
√	-1172	+598	-276	359	58	209	2
	SY	SP	EP	WP	WY	WR	
√	-48.2	+37.7	-31.1	+3.9	+38.7	-146.8	

Give EV GO to SHOOT STBD APEX

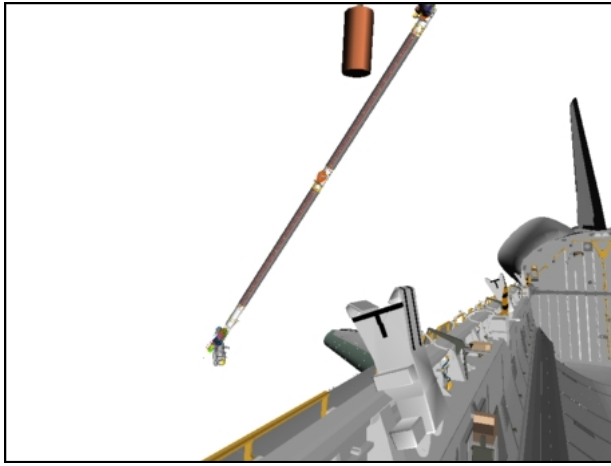

CCTVD (-30,-5)

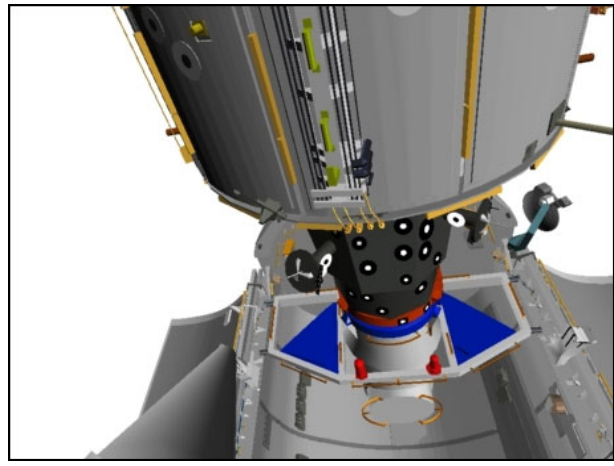

ELBOW (-146,-8)

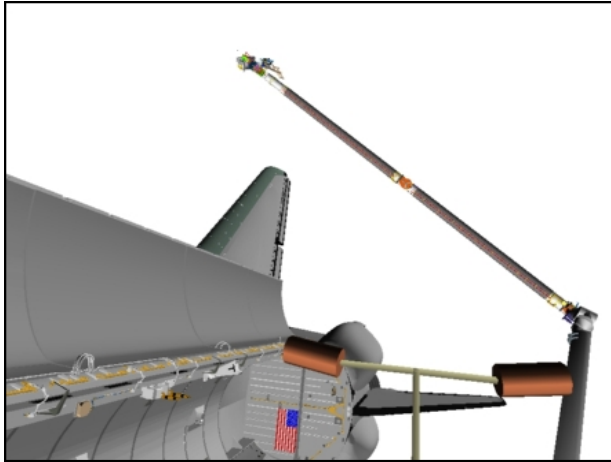

LAB (-14,-8)

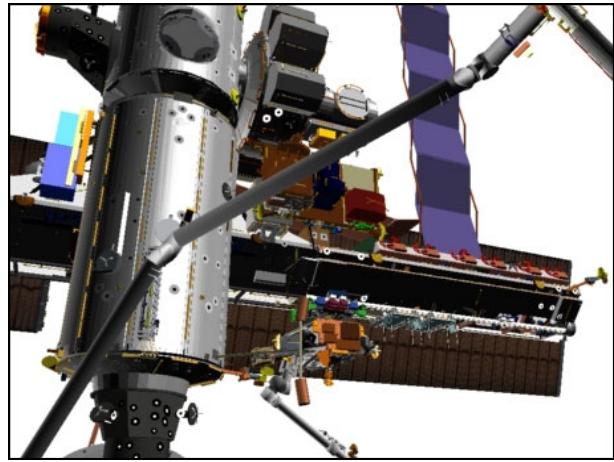

CCTVB (23,24)

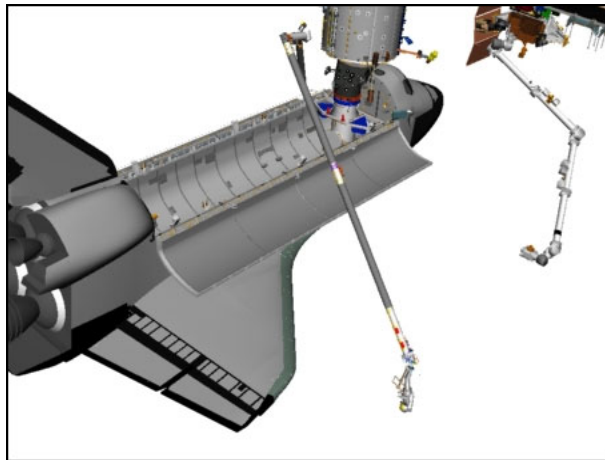

BIRD'S EYE

26. STBD APEX T-SEAL 17 SHOOT POSN

NOTE

At end of mnvr Lower Arm-to-Lab = 62.0 in

SM 94 PDRS CONTROL

END POS – ITEM 18 -1071 +500 -270 EXEC

ATT – ITEM 21 +356 +44 +214 EXEC

CMD CK – ITEM 25 EXEC (GOOD)

BRAKES – OFF (tb-OFF)

MODE – OPR CMD, ENTER (READY lt on)

AUTO SEQ – PROCEED (IN PROG It on)

When AUTO SEQ IN PROG It – off:
BRAKES – ON (tb-ON)

	X	Y	Z	PITCH	YAW	ROLL	PL ID
√	-1071	+500	-270	356	44	214	2
	SY	SP	EP	WP	WY	WR	
√	-32.4	+68.4	-75.2	+12.4	+10.6	-136.6	

Give EV GO to SHOOT STBD APEX

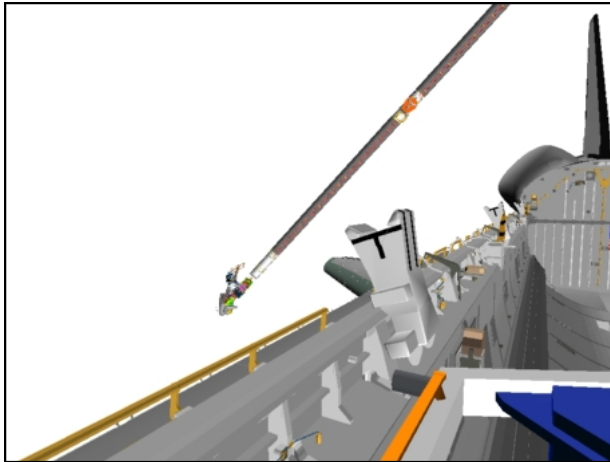

CCTV D (-30,-5)

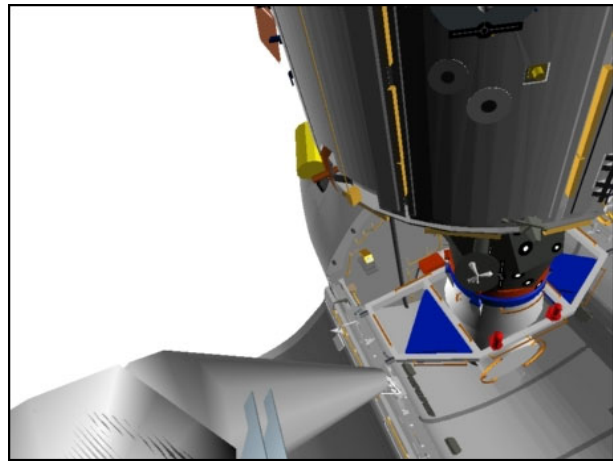

ELBOW (-130,-26)



LAB (-16,-2)

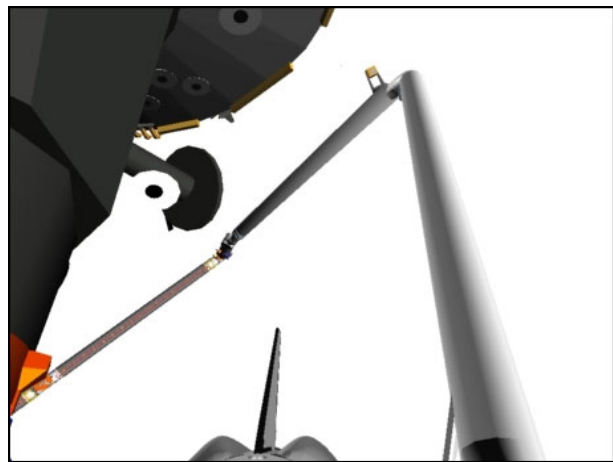

CCTV A (1,33)

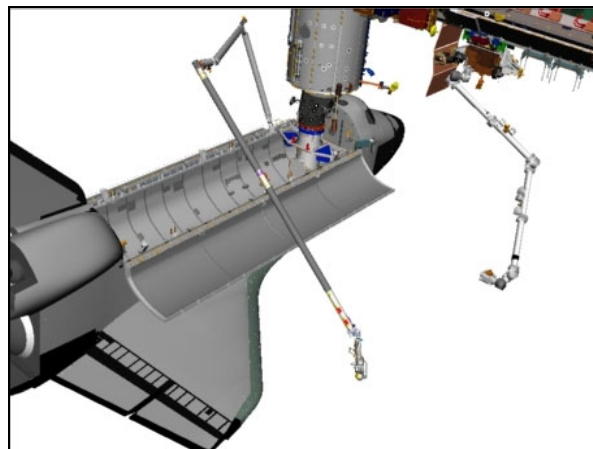

BIRD'S EYE

27. STBD APEX T-SEAL 3 SHOOT POSN

NOTE

At end of mnvr OBSS-to-PLBD = 75.0 in,
Lower Arm-to-Lab = 52.5 in

SM 94 PDRS CONTROL

END POS – ITEM 18 -924 +355 -243 EXEC

ATT – ITEM 21 +8 +73 +180 EXEC

CMD CK – ITEM 25 EXEC (GOOD)

BRAKES – OFF (tb-OFF)

MODE – OPR CMD, ENTER (READY It on)

AUTO SEQ – PROCEED (IN PROG It on)

When AUTO SEQ IN PROG It – off:

BRAKES – ON (tb-ON)

	X	Y	Z	PITCH	YAW	ROLL	PL ID
√	-924	+355	-243	8	73	180	2
	SY	SP	EP	WP	WY	WR	
√	-63.1	+81.9	-72.3	-20.6	+73.7	-140.9	

Give EV GO to SHOOT STBD APEX

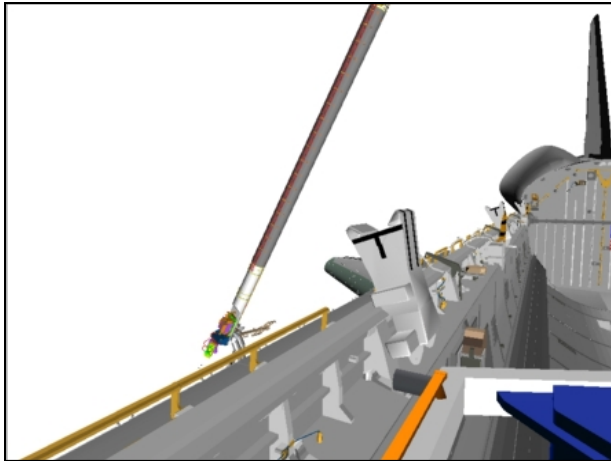

CCTV D (-30,-5)

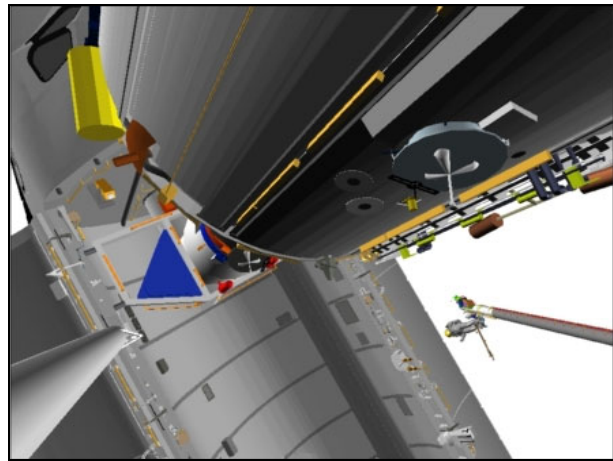

ELBOW (-85,-36)

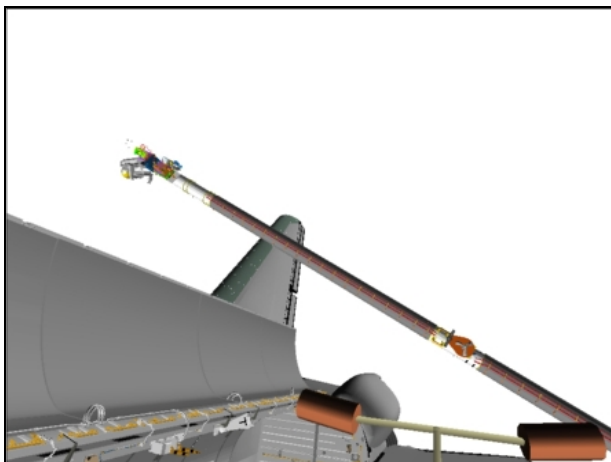

LAB (-16,-2)

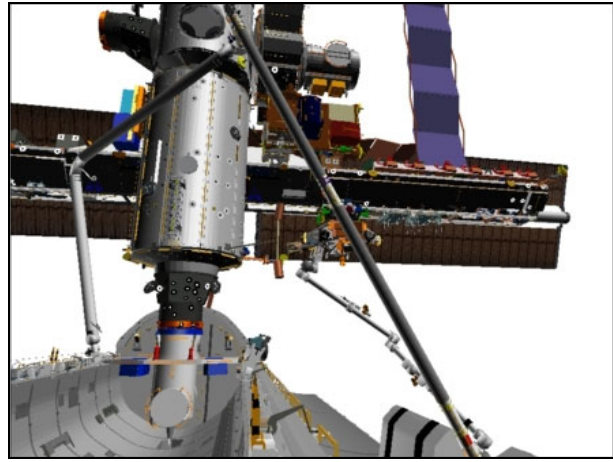

CCTV C (10,15)

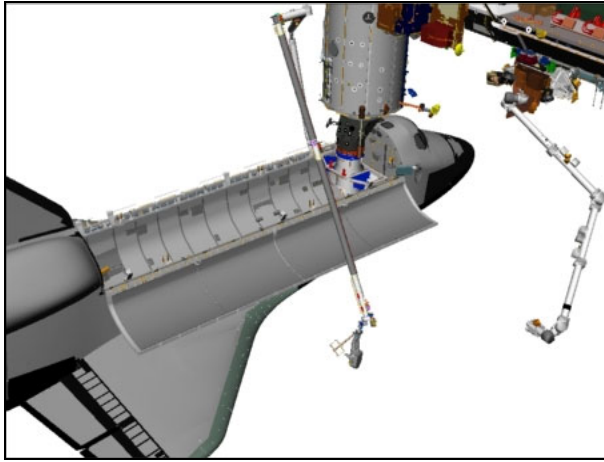

BIRD'S EYE

28. MNVR TO SILL CLEARANCE

a. Mnvr to PLBD Clearance Posn

BRAKES – OFF (tb-OFF)
 MODE – SINGLE, ENTER

Drive WR (+) to -100.0 to PLBD CLEARANCE posn

√	X	Y	Z	PITCH	YAW	ROLL	PL ID
	-1010	+647	-572	294	52	267	2
	SY	SP	EP	WP	WY	WR	
√	-63.1	+81.9	-72.3	-20.6	+73.7	-100.0	

b. Mnvr to EV1 APFR Aft Reconfig 2 Posn

Aft Posn APEX Clearance Views	Cameras
OBSS-to-PLBD	C, TIP ELBOW, A
RMS-to-Lab	C, ELBOW, A

NOTE

At end of mnvr OBSS-to-Port Sill = 97.4 in

SM 94 PDRS CONTROL

END POS – ITEM 18 -1 1 6 5 +1 4 6 -5 1 6 EXEC
 ATT – ITEM 21 +2 6 7 +2 5 +2 7 3 EXEC
 CMD CK – ITEM 25 EXEC (GOOD)

MODE – OPR CMD, ENTER (READY It on)

AUTO SEQ – PROCEED (IN PROG It on)

When AUTO SEQ IN PROG It – off:
 BRAKES – ON (tb-ON)

√	X	Y	Z	PITCH	YAW	ROLL	PL ID
	-1165	+146	-516	267	25	273	2
	SY	SP	EP	WP	WY	WR	
√	+43.0	+33.3	-17.2	-49.8	-27.1	-103.8	

Give EV GO to EGRESS/RECONFIG APFR (1, MM, H, 12)/INGRESS

GCA if reqd

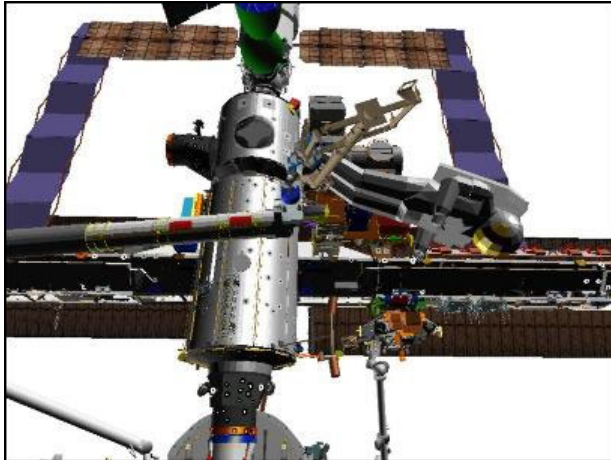

CCTV C (2,28)

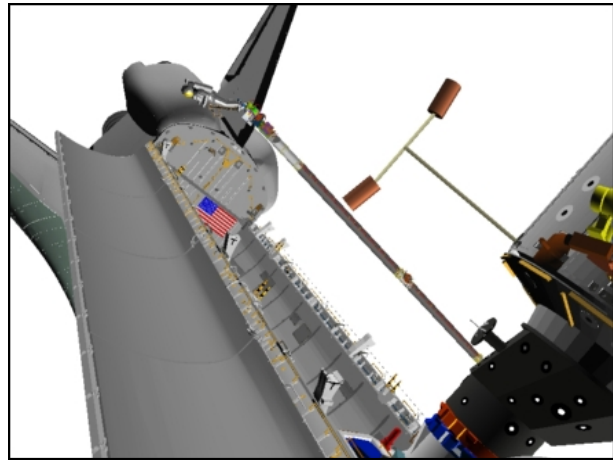

BASE ELBOW (-55,0)

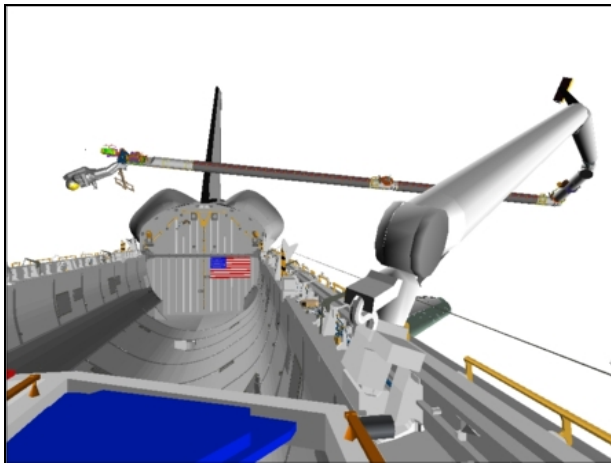

CCTV A (9,0)

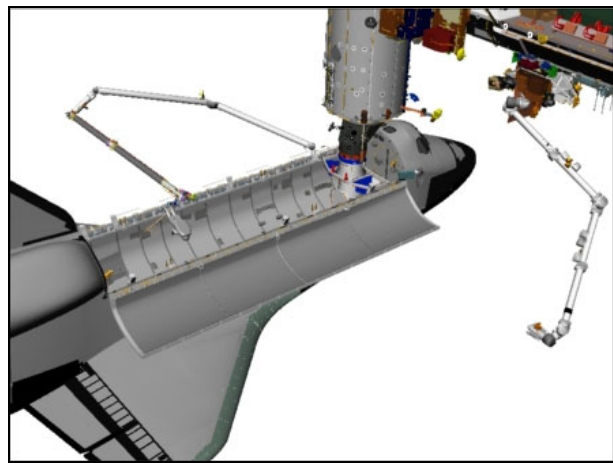

BIRD'S EYE

29. PORT T-SEAL 18

a. Mnvr to Port Sill Clearance Posn

SM 94 PDRS CONTROL

PL ID - ITEM 3 +3 EXEC

INIT ID - ITEM 24 +3 EXEC

BRAKES - OFF (tb-OFF)

MODE - ORB LD, ENTER

Reconfigure arm to PORT SILL CLEARANCE posn:

X	Y	Z	PITCH	YAW	ROLL	PL ID
-1192	+175	-553	256	341	291	3
SY	SP	EP	WP	WY	WR	
+43.0	+33.3	-17.2	-49.8	-27.1	-103.8	

b. Mnvr to APEX 18 Pre-Posn

NOTE

At end of mnvr OBSS-to-Port Sill = 80.9 in

SM 94 PDRS CONTROL

END POS – ITEM 18 -1182 -77 -529 EXEC
 ATT – ITEM 21 +282 +1 +316 EXEC
 CMD CK – ITEM 25 EXEC (GOOD)

MODE – OPR CMD, ENTER (READY It on)

AUTO SEQ – PROCEED (IN PROG It on)

When AUTO SEQ IN PROG It – off:

BRAKES – ON (tb-ON)

	X	Y	Z	PITCH	YAW	ROLL	PL ID
√	-1182	-77	-529	282	1	316	3
	SY	SP	EP	WP	WY	WR	
√	+80.3	+55.8	-32.0	-17.6	-49.6	-91.4	

c. Mnvr to Apex 18 Shoot Posn

APEX Clearance Views	Cameras
OBSS-to-PLBD	A, ELBOW, RSC
RMS-to-Lab	B

NOTE

At end of mnvr OBSS-to-Port Wing = 211.5 in,
 Upper Arm-to-Truss = 124.7 in

SM 94 PDRS CONTROL

END POS – ITEM 18 -1136 -590 -291 EXEC
 ATT – ITEM 21 +279 +344 +27 EXEC
 CMD CK – ITEM 25 EXEC (GOOD)

MODE – OPR CMD, ENTER (READY It on)

AUTO SEQ – PROCEED (IN PROG It on)

When AUTO SEQ IN PROG It – off:

BRAKES – ON (tb-ON)

	X	Y	Z	PITCH	YAW	ROLL	PL ID
√	-1136	-590	-291	279	344	27	3
	SY	SP	EP	WP	WY	WR	
√	+122.3	+62.4	-94.9	+16.2	-24.5	-82.2	

Give EV GO to SHOOT PORT APEX

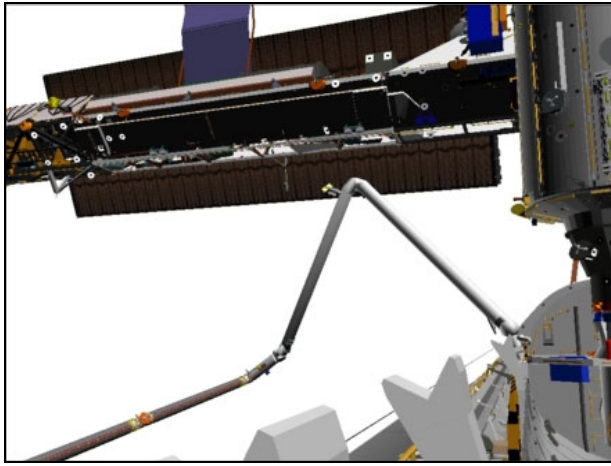

CCTV B (-20,9)

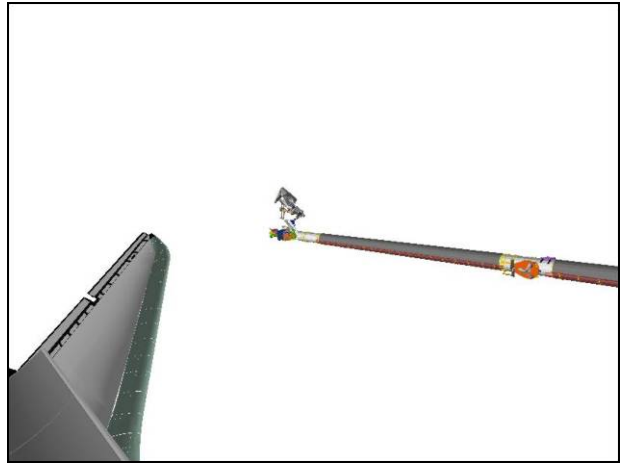

ELBOW (-70,25)

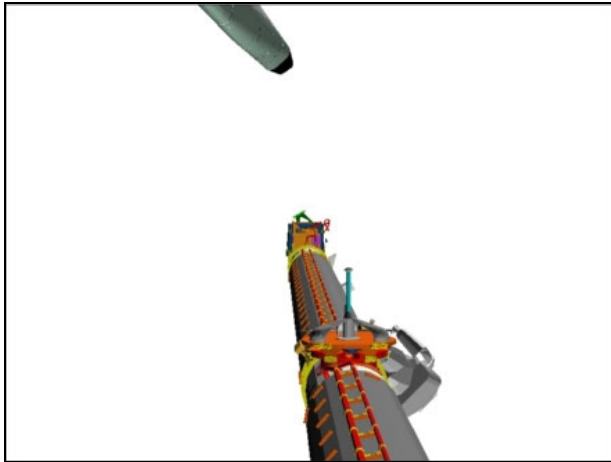

RSC

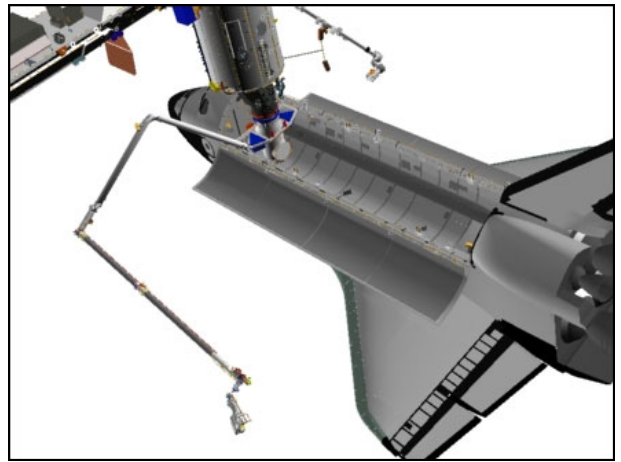

BIRD'S EYE

30. PORT APEX T-SEAL 21 SHOOT POSN

NOTE

At end of mnvr OBSS-to-Port Wing = 170 in,
Upper Arm-to-Lab = 93.2 in

SM 94 PDRS CONTROL

END POS – ITEM 18 -1 1 9 9 -5 8 8 -2 9 1 EXEC
ATT – ITEM 21 +2 7 9 +3 4 3 +2 6 EXEC
CMD CK – ITEM 25 EXEC (GOOD)

BRAKES – OFF (tb-OFF)

MODE – OPR CMD, ENTER (READY lt on)

AUTO SEQ – PROCEED (IN PROG lt on)

When AUTO SEQ IN PROG lt – off:

BRAKES – ON (tb-ON)

	X	Y	Z	PITCH	YAW	ROLL	PL ID
√	-1199	-588	-291	279	343	26	3
	SY	SP	EP	WP	WY	WR	
√	+113.2	+66.1	-99.6	+17.3	-16.7	-80.3	

Give EV GO to SHOOT PORT APEX

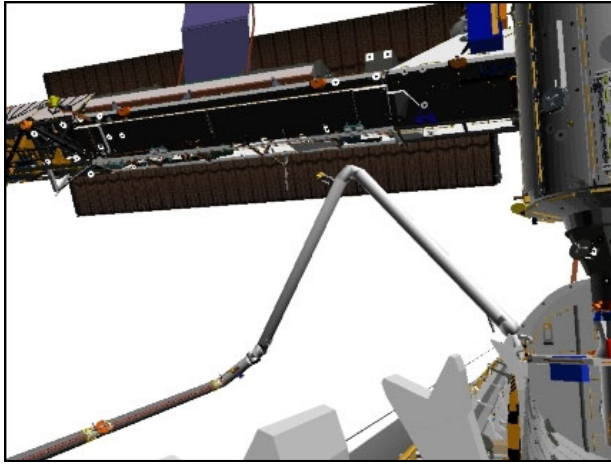

CCTV B (-20,9)

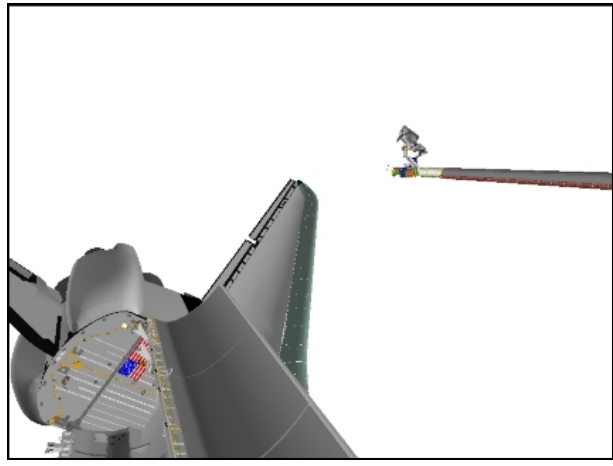

ELBOW (-82,20)

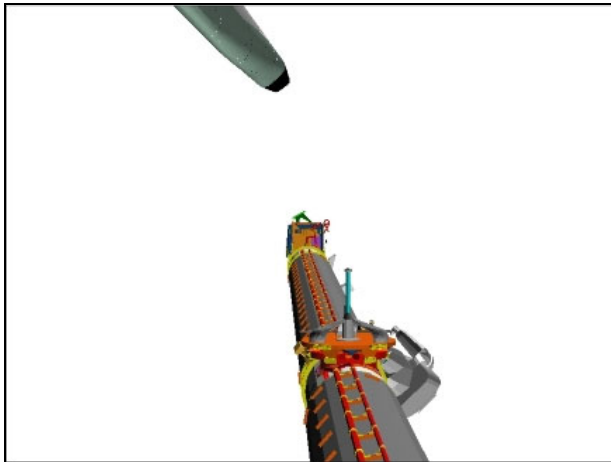

RSC

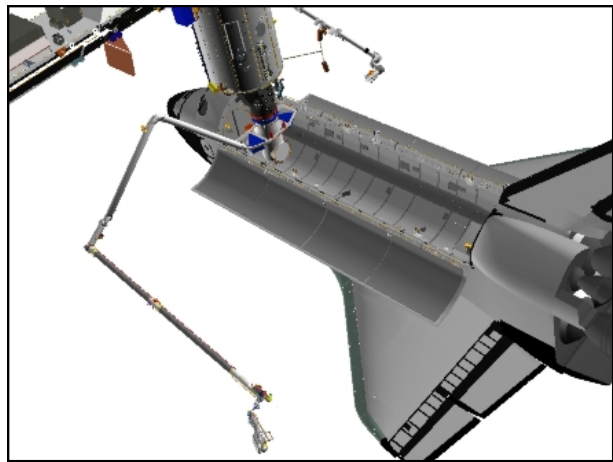

BIRD'S EYE

31. MNVR FOR APFR RECONFIG
 a. Mnvr to Pre OCAS to Port Posn
 BRAKES – OFF (tb-OFF)
 MODE – SINGLE, ENTER

Mnvr to PRE OCAS TO PORT posn:

	SY	SP	EP	WP	WY	WR	
APEX SHOOT	+113.2	+66.1	-99.6	+17.3	-16.7	-80.3	
1: EP +			-50.0				
2: SY -	+71.0						
PRE OCAS	+71.0	+66.1	-50.0	+17.3	-16.7	-80.3	
	X	Y	Z	PITCH	YAW	ROLL	PL ID
	-1438	-296	-596	295	23	336	3

- b. Mnvr to EV1 APFR Aft Reconfig 4 Posn

Port Sill Clearance Views	Cameras
OBSS-to-PLBD	A, B, RSC
RMS-to-Lab	A, B

NOTE

At end of mnvr OBSS-to-Port Sill = 61.2 in

SM 94 PDRS CONTROL

END POS – ITEM 18 -1 1 7 5 -6 3 -5 0 6 EXEC
ATT – ITEM 21 +2 8 1 +3 +3 1 3 EXEC
CMD CK – ITEM 25 EXEC (GOOD)

MODE – OPR CMD, ENTER (READY It on)

AUTO SEQ – PROCEED (IN PROG It on)

When AUTO SEQ IN PROG It – off:
BRAKES – ON (tb-ON)

	X	Y	Z	PITCH	YAW	ROLL	PL ID
√	-1175	-63	-506	281	3	313	3
	SY	SP	EP	WP	WY	WR	
√	+77.8	+53.5	-26.5	-21.5	-49.3	-95.1	

Give EV GO to EGRESS/Adjust APFR (1, MM, H, 9) and INGRESS

GCA if reqd

32. PORT T-SEALS 18 & 21

- a. Mnvr to Port Sill Clearance Posn
BRAKES – OFF (tb-OFF)
MODE – ORB LD, ENTER

Reconfigure arm to PORT SILL CLEARANCE posn:

	X	Y	Z	PITCH	YAW	ROLL	PL ID
	-1177	-61	-510	282	2	313	3
	SY	SP	EP	WP	WY	WR	
	+77.7	+53.6	-29.1	-18.5	-49.6	-93.4	

- b. Mnvr to Lower 18 & 21 Pre-Posn

LOWER Clearance Views	Cameras
OBSS-to-PLBD	A, ELBOW, RSC
RMS-to-Lab	B
RMS-to-PLBD	A, ELBOW

NOTE

At end of mnvr Lower Arm-to-PLBD = 121.7 in

SM 94 PDRS CONTROL

END POS – ITEM 18 -1 2 2 2 -7 1 7 -3 6 4 EXEC
ATT – ITEM 21 +3 1 2 +3 5 1 +4 6 EXEC
CMD CK – ITEM 25 EXEC (GOOD)

MODE – OPR CMD, ENTER (READY It on)

AUTO SEQ – PROCEED (IN PROG It on)

When AUTO SEQ IN PROG It – off,

	X	Y	Z	PITCH	YAW	ROLL	PL ID
√	-1222	-717	-364	312	351	46	3
	SY	SP	EP	WP	WY	WR	
√	+90.1	+25.5	-103.6	+57.6	+5.2	-38.6	

- c. Mnvr to Lower 18 & 21 Shoot Posn
 MODE – SINGLE, ENTER

Drive WR (-) to -73.7 to PORT T-SEALS 18 & 21 SHOOT posn

	X	Y	Z	PITCH	YAW	ROLL	PL ID
√	-1341	-475	-58	280	338	27	3
	SY	SP	EP	WP	WY	WR	
√	+90.1	+25.5	-103.6	+57.6	+5.2	-73.7	

BRAKES – ON (tb-ON)

Give EV GO to SHOOT PORT LOWER

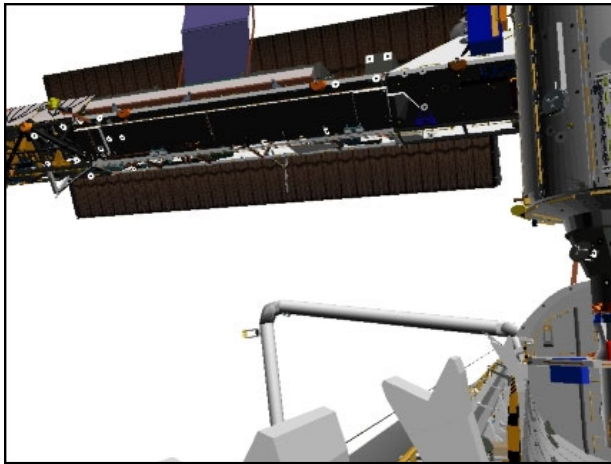

CCTV B (-20,11)

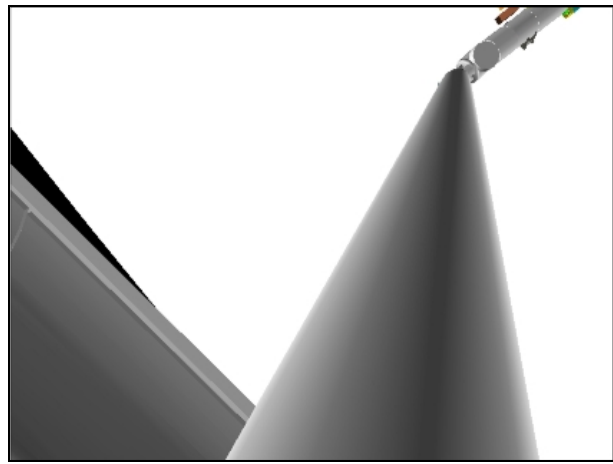

ELBOW (-19,-26)



RSC

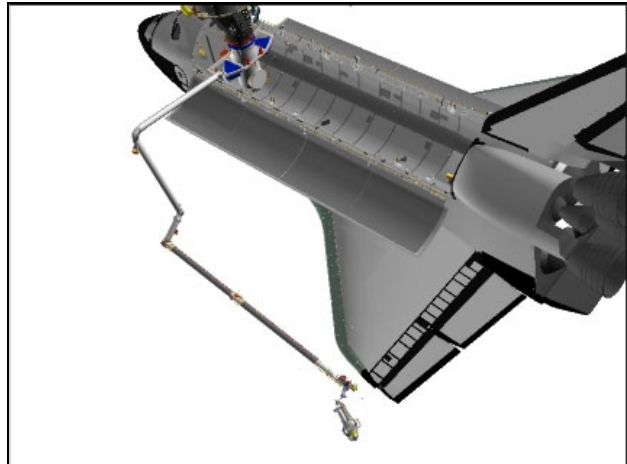

BIRD'S EYE

33. MNVR TO CLEAN-UP POSN

a. Mnvr to Lower 18 & 21 Pre-Posn

BRAKES – OFF (tb-OFF)
MODE – SINGLE, ENTER

Drive WR (+) to -38.6 to PORT T-SEALS 18 & 21 SHOOT posn

√	X	Y	Z	PITCH	YAW	ROLL	PL ID
	-1222	-717	-364	312	351	46	3
	SY	SP	EP	WP	WY	WR	
√	+90.1	+25.5	-103.6	+57.6	+5.2	-38.6	

b. OCAS to Port Sill Clearance Posn

Clean-up Clearance Views	Cameras
OBSS-to-PLBD/Sill	B, C
RMS-to-Lab	A

SM 94 PDRS CONTROL

END POS – ITEM 18 -1 1 7 7 -6 1 -5 1 0 EXEC

ATT – ITEM 21 +2 8 2 +2 +3 1 3 EXEC

CMD CK – ITEM 25 EXEC (GOOD)

MODE – OPR CMD, ENTER (READY It on)

AUTO SEQ – PROCEED (IN PROG It on)

When AUTO SEQ IN PROG It – off:
BRAKES – ON (tb-ON)

√	X	Y	Z	PITCH	YAW	ROLL	PL ID
	-1177	-61	-510	282	2	313	3
	SY	SP	EP	WP	WY	WR	
√	+77.7	+53.6	-29.1	-18.5	-49.6	-93.4	

Give EV GO to remove PAD, WIF ADAPTER, APFR

GCA if reqd

c. Mnvr to EV Egress Posn

BRAKES – OFF (tb-OFF)
MODE – ORB LD, ENTER

Reconfigure arm EV EGRESS posn:

√	X	Y	Z	PITCH	YAW	ROLL	PL ID
	-1177	-61	-510	282	2	313	3
	SY	SP	EP	WP	WY	WR	
√	+77.7	+53.6	-29.1	-18.5	-49.6	-93.4	

d. Mnvr to Port Untether Posn

NOTE

At end of mnvr OBSS-to-Port Sill = 63.4 in, OBSS-to-Stbd Sill = 79.5 in, Upper Arm-to-Lab = 81.0 in

SM 94 PDRS CONTROL

END POS – ITEM 18 -1 0 8 5 +5 4 1 -4 9 5 EXEC

ATT – ITEM 21 +2 0 7 +3 4 5 +2 8 5 EXEC

CMD CK – ITEM 25 EXEC (GOOD)

MODE – OPR CMD, ENTER (READY It on)

AUTO SEQ – PROCEED (IN PROG It on)

When AUTO SEQ IN PROG It – off:

BRAKES – ON (tb-ON)

	X	Y	Z	PITCH	YAW	ROLL	PL ID
√	-1085	+541	-495	207	345	285	3
	SY	SP	EP	WP	WY	WR	
√	-1.0	+69.0	-91.0	-57.2	+15.2	-72.9	

Give EV GO to remove TETHER

GCA if reqd

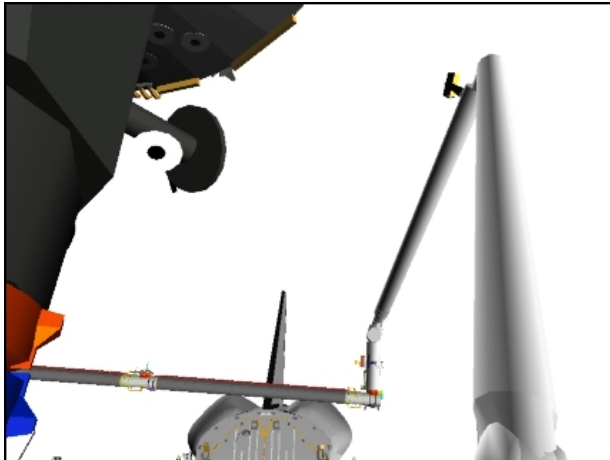

CCTV A (0,28)

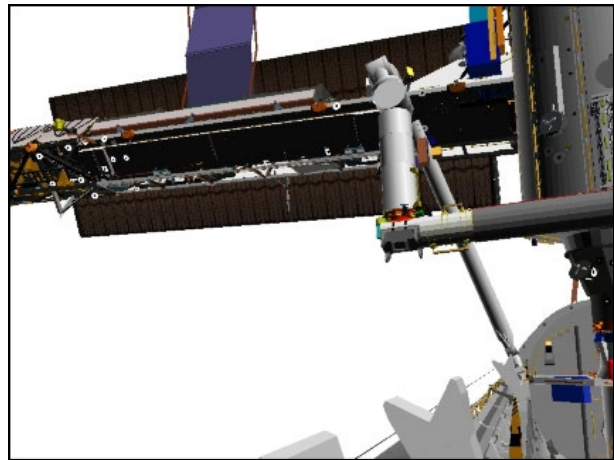

CCTV B (-20,11)

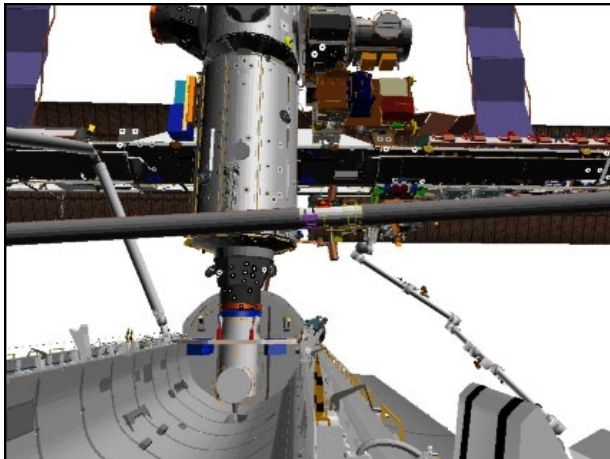

CCTV C (2,12)

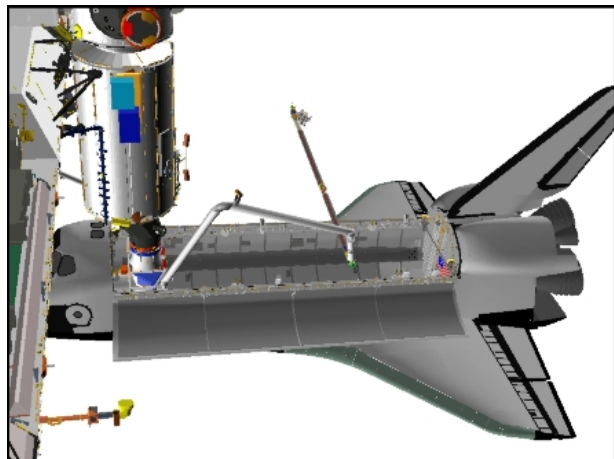

BIRD'S EYE

OBSS ITVC TILE ACREAGE SURVEY

1. SETUP

SM 94 PDRS CONTROL

√ PL ID, ITEM 3: 2

√ INIT ID, ITEM 24: 2

A7U

CCTV – config as reqd

MON 1	SSRMS BASE ELBOW (LAB)
MON 2	RSC

2. MNVR TO STBD SCAN POSN

Mnvr to be uplinked realtime

STBD Scan Posn:

	X	Y	Z	PITCH	YAW	ROLL	PL ID
√	-1189	+391	-224	338	344	23	2
	SY	SP	EP	WP	WY	WR	
√	-53.4	+11.7	-60.6	-53.9	-24.6	+63.5	

NOTE

At STBD Scan posn, OBSS-to-Orbiter = 57 in

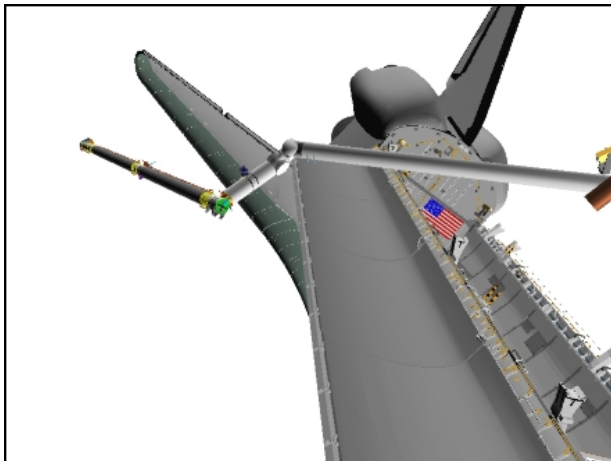

SSRMS BASE ELBOW (-75,0)

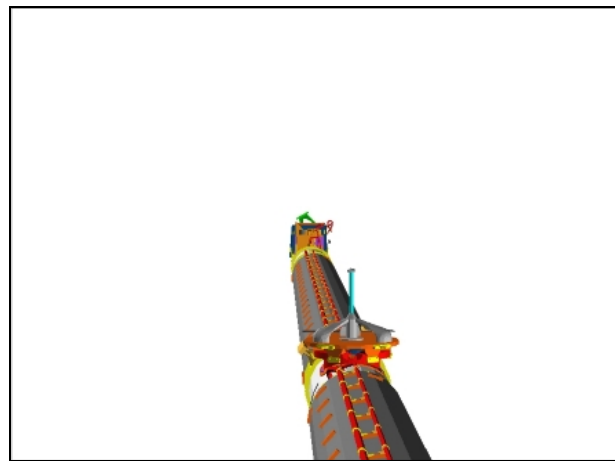

RSC

3. CONFIGURE OBSS ITVC FOR STBD SCAN

A7U

VIDEO OUT MON2 pb – push

IN PL2(VPU) pb – push

If PTU reset reqd:

CAMR CMD PAN/TILT – HI RATE

PAN – L (to hard stop)

TILT – UP (to hard stop)

PAN/TILT – RESET, HI RATE (LO within 10°)

PAN: +105

TILT: -59

A7U

√ CAMR CMD PAN/TILT – LO RATE

ZOOM: 20.0 HFOV

VIDEO OUT MUX 1 L pb – push (MIDDECK It on)

LDRI MODE 2 pb – push (ITVC video)

VIDEO OUT MON2 pb – push

IN PL2(VPU) pb – push

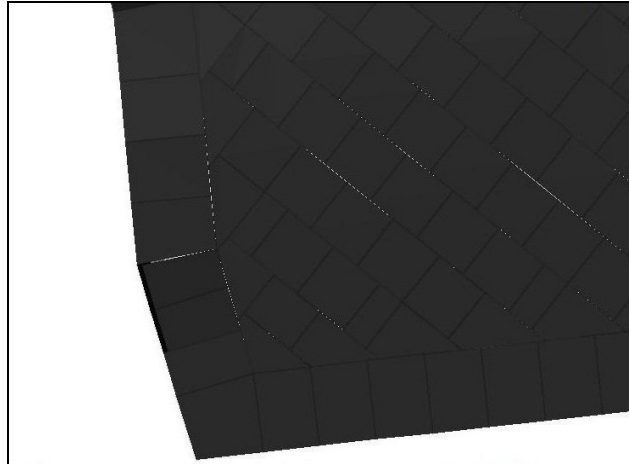

OBSS ITVC (105,-59)

√MCC to verify correct sensor view

4. PERFORM STBD SCAN

On MCC GO:

L10(VTR)

REC pb – push, hold

PLAY pb – push, simo (red ●)

Drive PTU to sweep out the survey area:

	PAN	TILT
Start Config	+105	-59
1: Tilt (up)		-23
2: Pan (left)	+90	
3: Tilt (down)		-59
4: Pan (left)	+75	
5: Tilt (up)		-30
6: Pan (left)	+62	
7: Tilt (down)		-59
Final Config	+62	-59

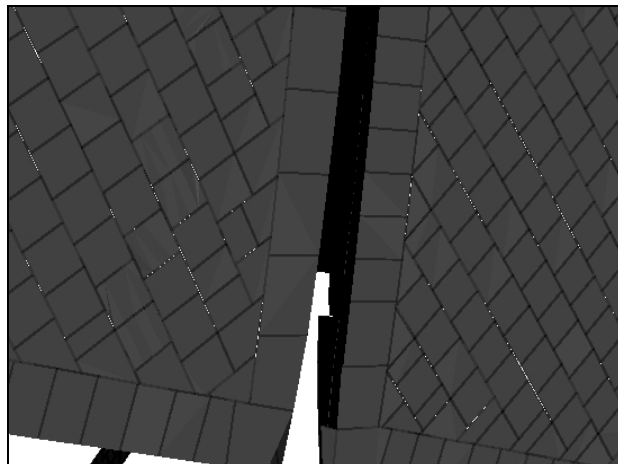

OBSS ITVC (62,-59)

5. MNVR TO PORT CONFIG 1

On MCC GO:

L10(VTR) STOP pb – push (no red ●)

NOTE

Min clearance during Port Config 1 mnvr (SJ step 15),
 OBSS-to-Orbiter = 37 in. At Port Config 1 posn,
 OBSS-to-Orbiter clearance = 164 in

Port Config 1 Clearance Views	Cameras
SJ step 1	C, ELBOW, SSRMS BASE ELBOW
SJ step 2	C, D, ELBOW, LAB
SJ steps 3 thru 7	C, D, LAB
SJ step 8	C, SSRMS BASE ELBOW, LAB
SJ step 9	A, C, B, ELBOW
SJ step 10	A, B, ELBOW, RSC
SJ steps 11 thru 13	A, B, RSC, OBSS ITVC
SJ step 14	A, RSC, SSRMS TIP ELBOW
SJ step 15	A, ELBOW, SSRMS TIP ELBOW

RHC RATE – as reqd (VERN within 10 ft)
 BRAKES – OFF (tb-OFF)
 MODE – SINGLE, ENTER

Mnvr to PORT CONFIG 1 posn:

	SY	SP	EP	WP	WY	WR	
STBD SCAN	-53.4	+11.7	-60.6	-53.9	-24.6	+63.5	
1: WY –					-35.0		
2: WR –						-53.0	
3: WP +				-25.0			
4: EP +			-40.0				
5: SP +		+20.0					
6: SY +	-25.0						
7: WR –						-95.0	
8: SP +		+53.0					
9: SY +	+100.0						
10: WR –						-185.0	
11: WY +					+17.0		
12: WP +				-18.0			
13: EP –			-68.0				
14: SP –		+12.0					
15: SY –	+35.0						
PORT CONFIG 1	+35.0	+12.0	-68.0	-18.0	+17.0	-185.0	
	X	Y	Z	PITCH	YAW	ROLL	PL ID
	-710	-198	-97	184	347	184	2

BRAKES – ON (tb-ON)

Start:
STBD Scan

Step 1:
Drive WY (-) from -24.6° to -35.0°

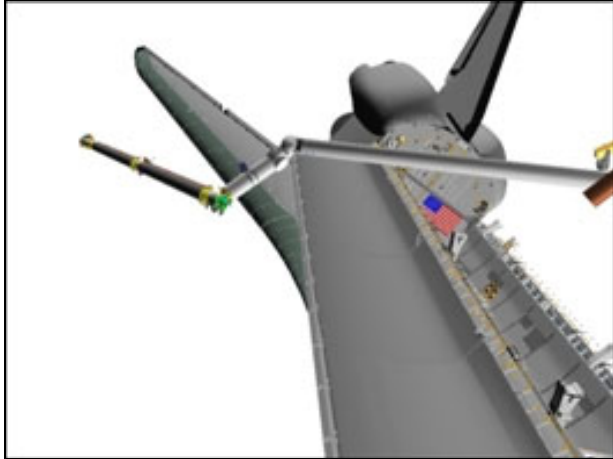

BASE ELBOW (-70,0)

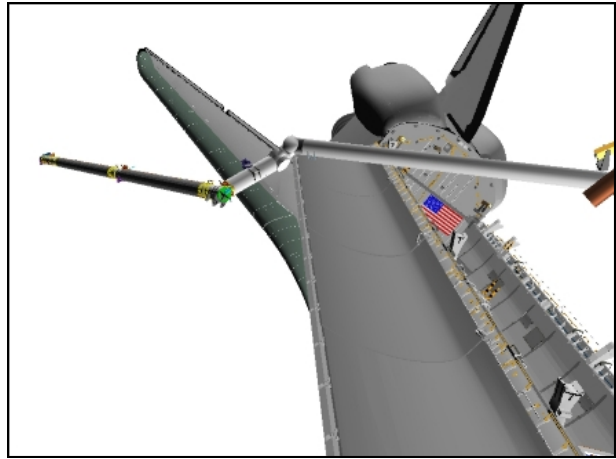

BASE ELBOW (-70,0)

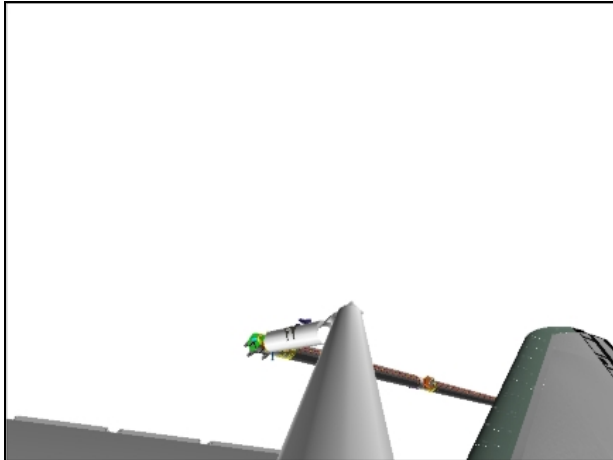

ELBOW (-6,6)



ELBOW (-6,6)

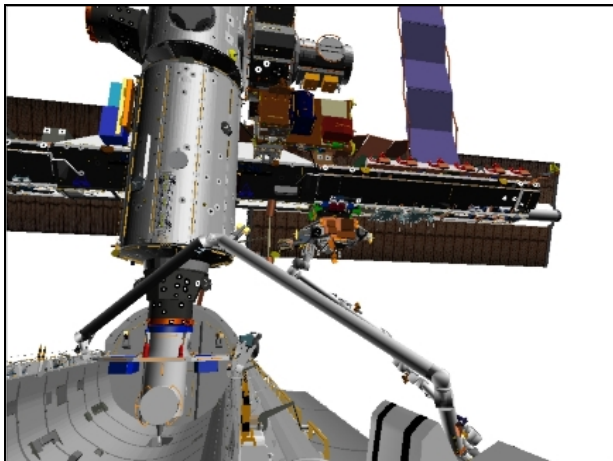

CCTV C (11,14)

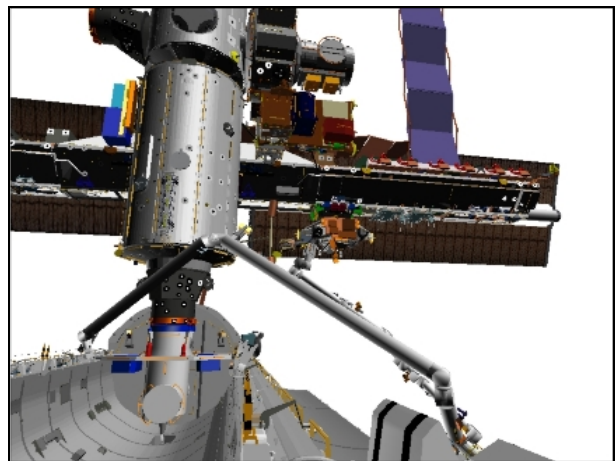

CCTV C (11,14)

Step 2:

Drive WR (-) from $+63.5^\circ$ to -53.0°



CCTV D (-55,9)

Step 3:

Drive WP (+) from -53.9° to -25.0°

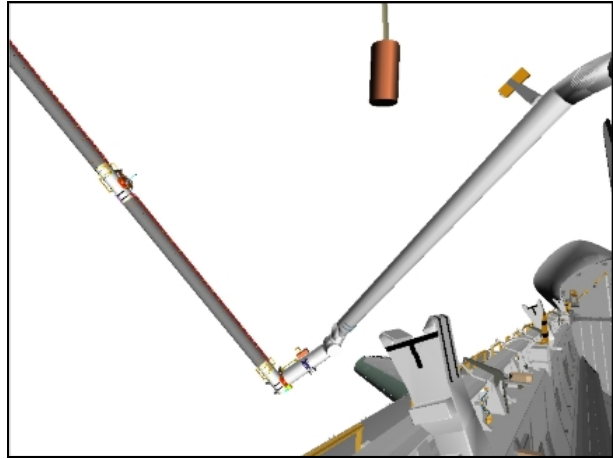

CCTV D (-34,9)



ELBOW (-6,6)

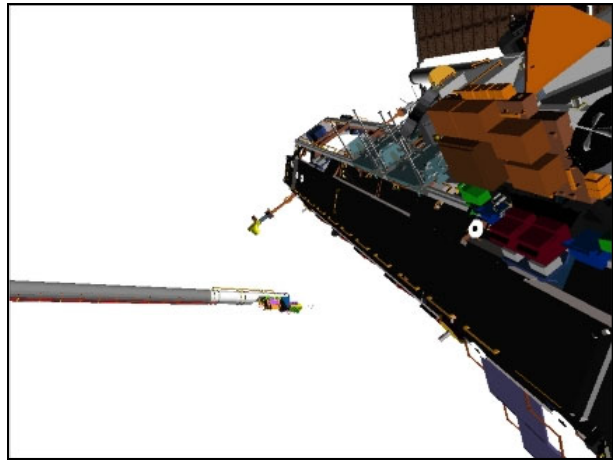

LAB (58,60)

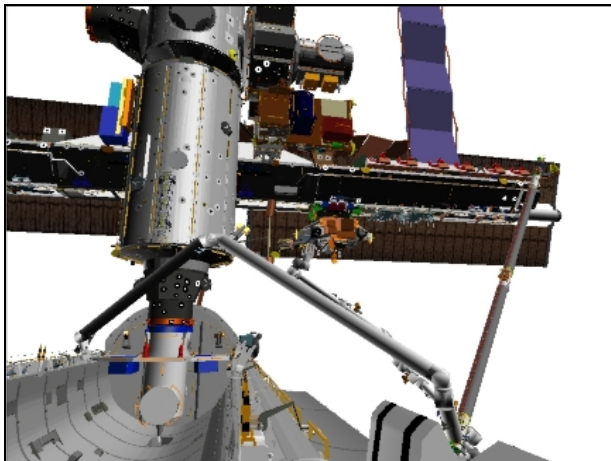

CCTV C (11,14)

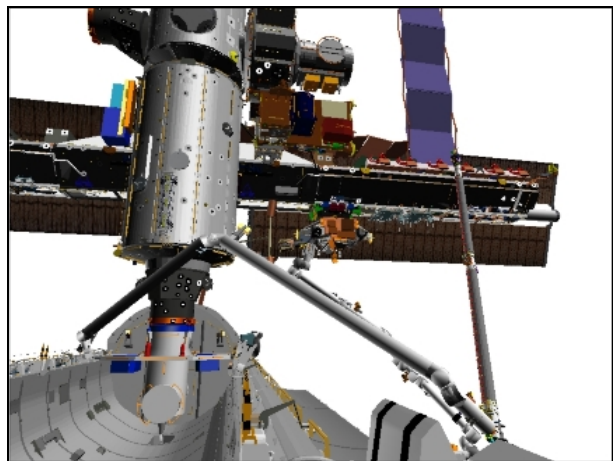

CCTV C (11,14)

Step 4:

Drive EP (+) from -60.6° to -40.0°

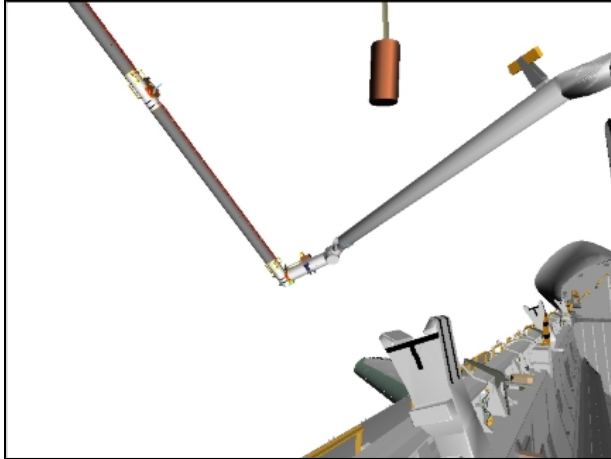

CCTV D (-34,9)

Step 5:

Drive SP (+) from $+11.7^\circ$ to $+20.0^\circ$

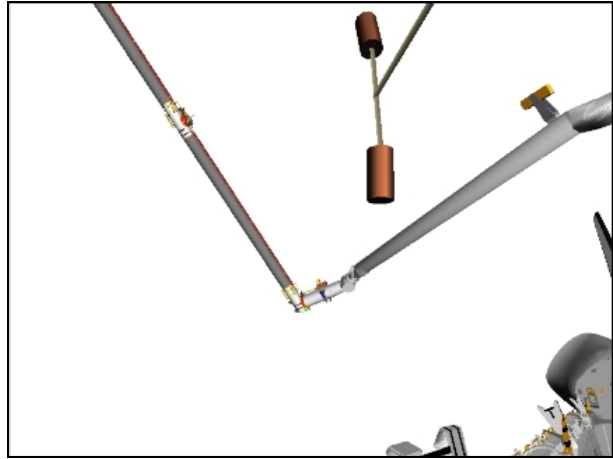

CCTV D (-34,22)

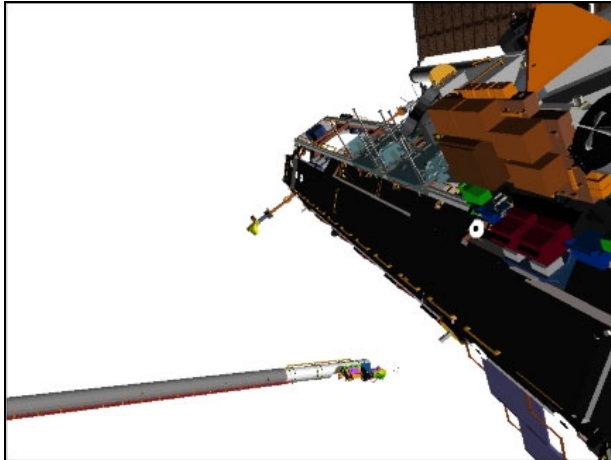

LAB (58,60)

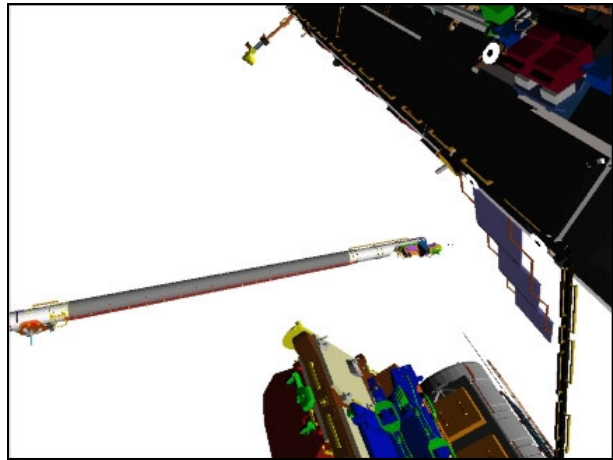

LAB (58,37)

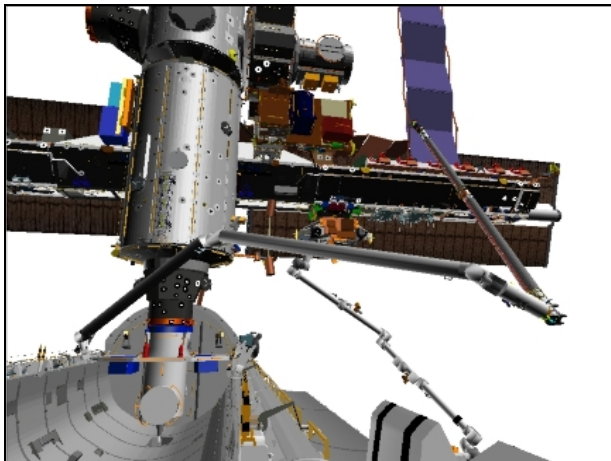

CCTV C (11,14)

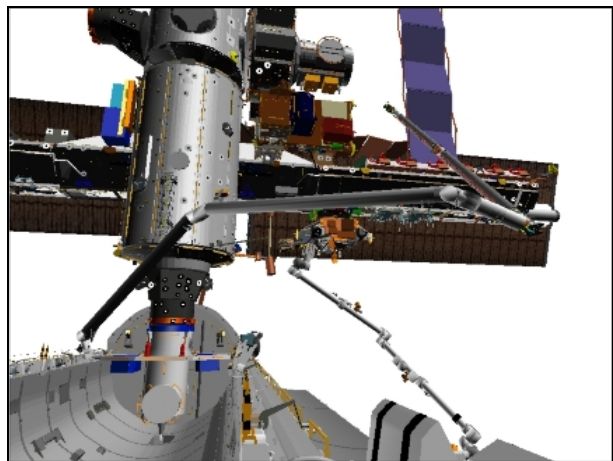

CCTV C (11,14)

Step 6:

Drive SY (+) from -53.4° to -25.0°

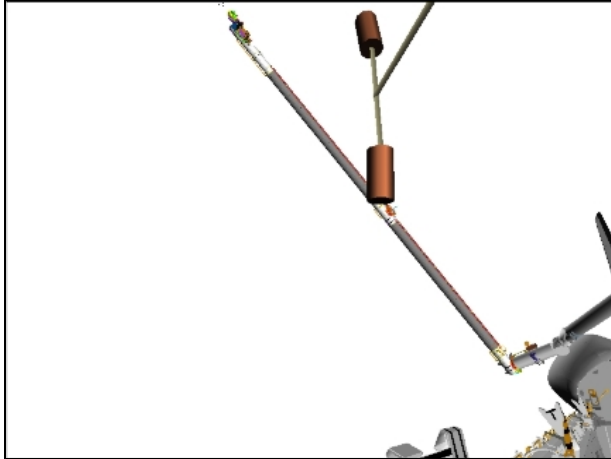

CCTV D (-34,22)

Step 7:

Drive WR (-) from -53.0° to -95.0°



CCTV D (-34,22)

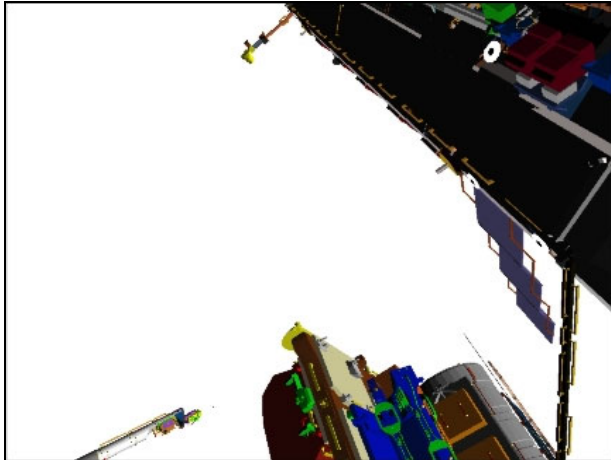

LAB (58,37)

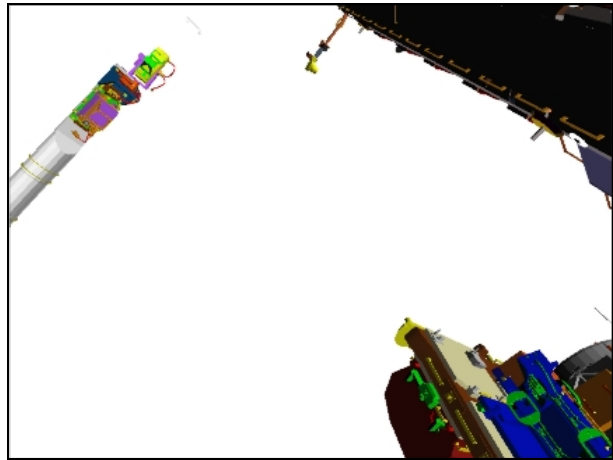

LAB (42,37)

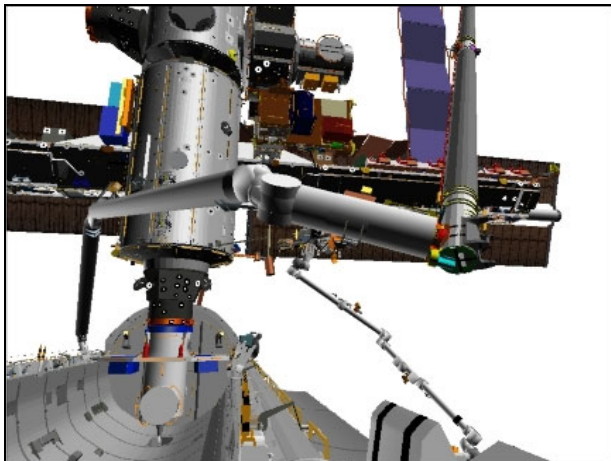

CCTV C (11,14)

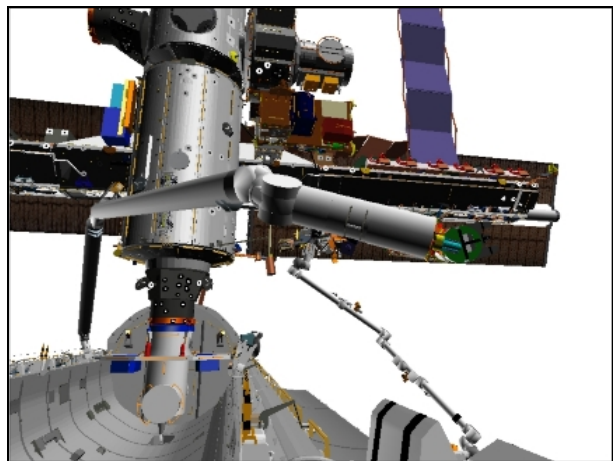

CCTV C (11,14)

Step 8:

Drive SP (+) from $+20.0^\circ$ to $+53.0^\circ$

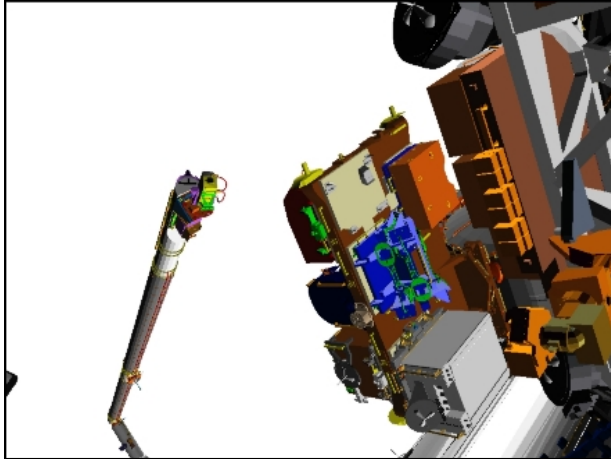

BASE ELBOW (-30,36)

Step 9:

Drive SY (+) from -25.0° to $+100.0^\circ$



ELBOW (-66,16)

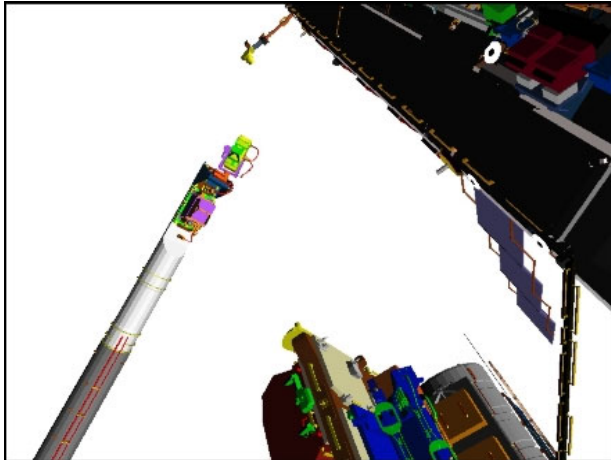

LAB (58,37)



CCTV A (55,10)

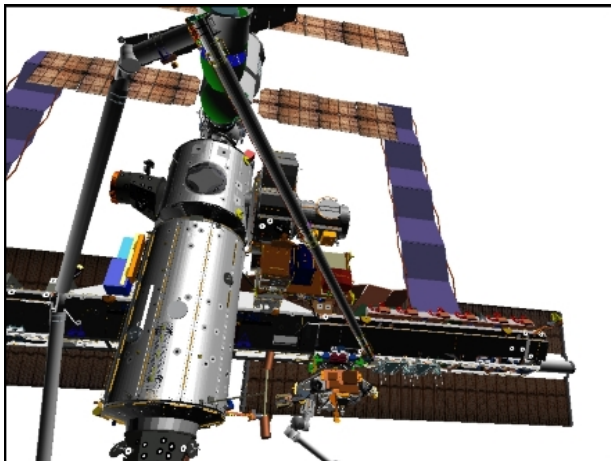

CCTV C (11,35)

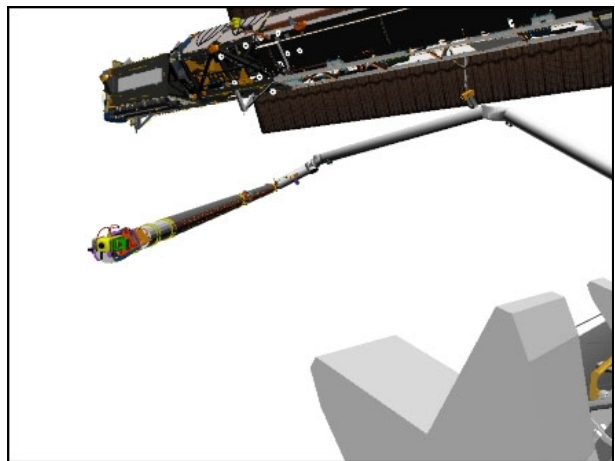

CCTV B (-37,0)

Step 10:

Drive WR (-) from -95.0° to -185.0°

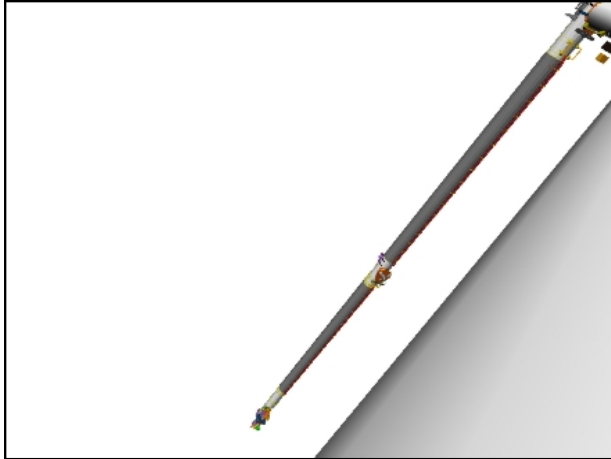

ELBOW (-40,-32)

Step 11:

Drive WY (+) from -35.0° to $+17.0^\circ$



RSC



CCTV A (57,2)

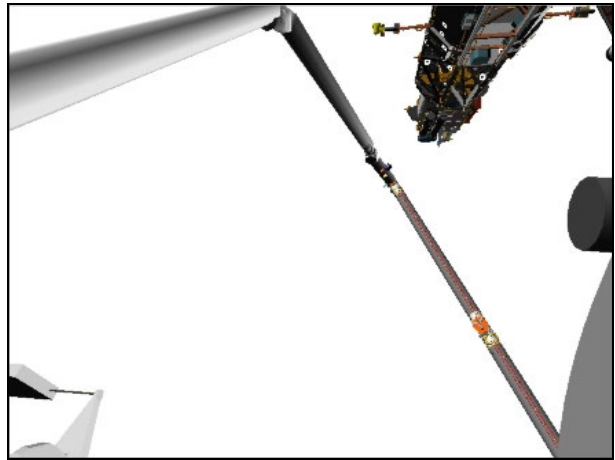

CCTV A (80,0)

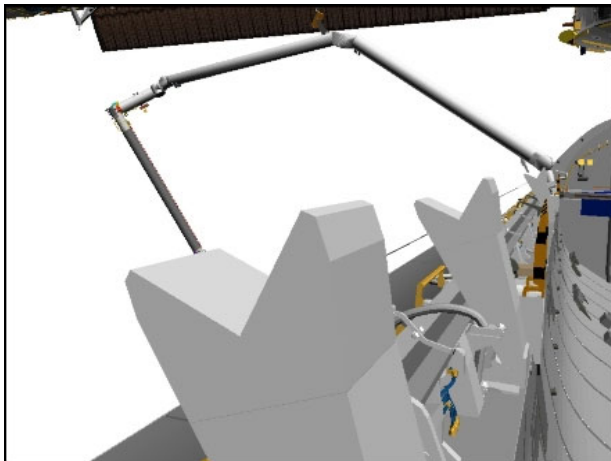

CCTV B (-23,-7)

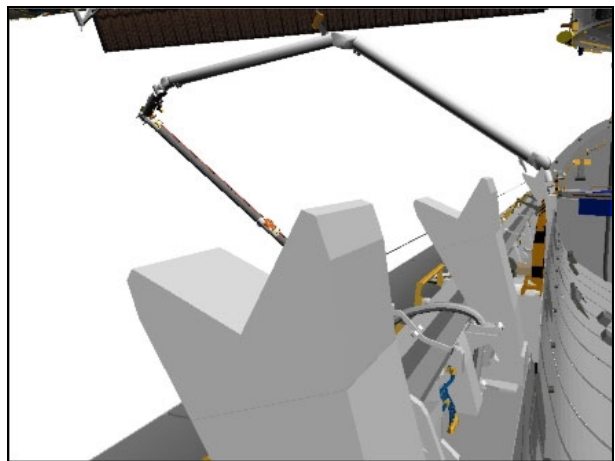

CCTV B (-23,-7)

Step 12:

Drive WP (+) from -25.0° to -18.0°



RSC

Step 13:

Drive EP (-) from -40.0° to -68.0°



RSC

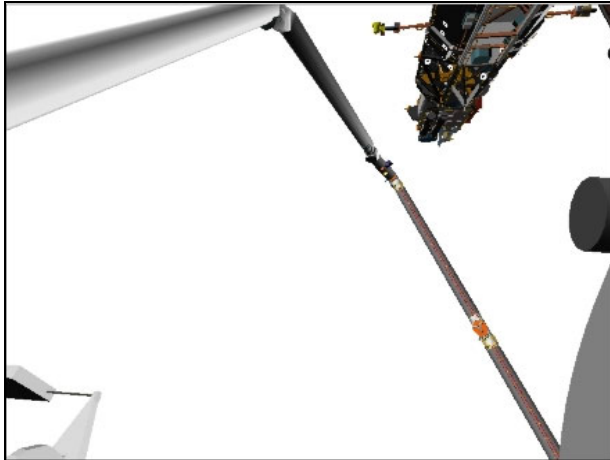

CCTV A (80,0)



CCTV A (80,-7)

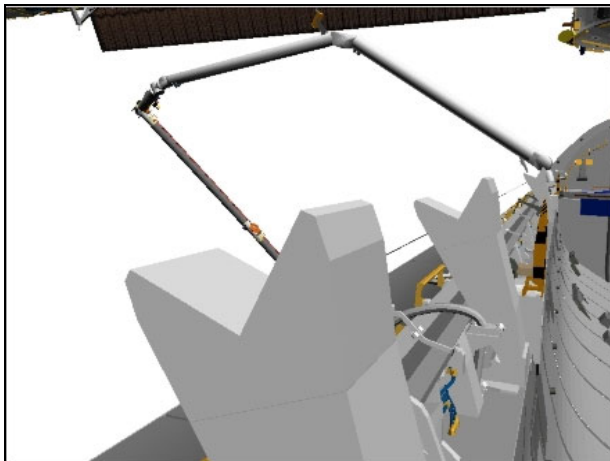

CCTV B (-23,-7)

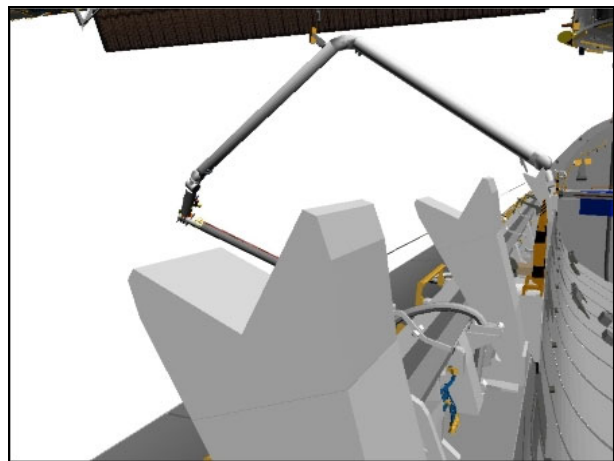

CCTV B (-23,-7)

Step 14:

Drive SP (-) from +53.0° to +12.0°

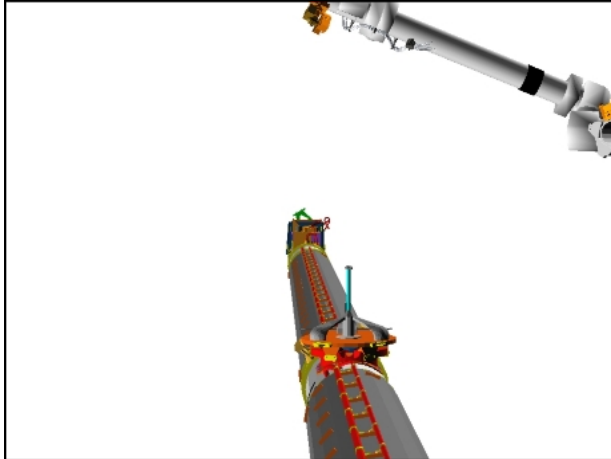

RSC

Step 15:

Drive SY (-) from +100.0° to +35.0°

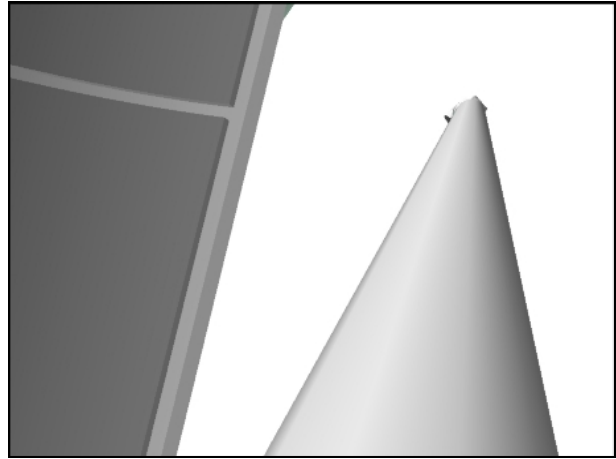

ELBOW (-21,-22)

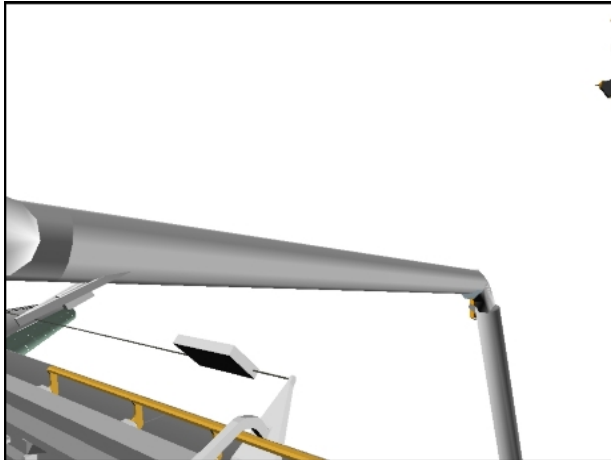

CCTV A (58,0)

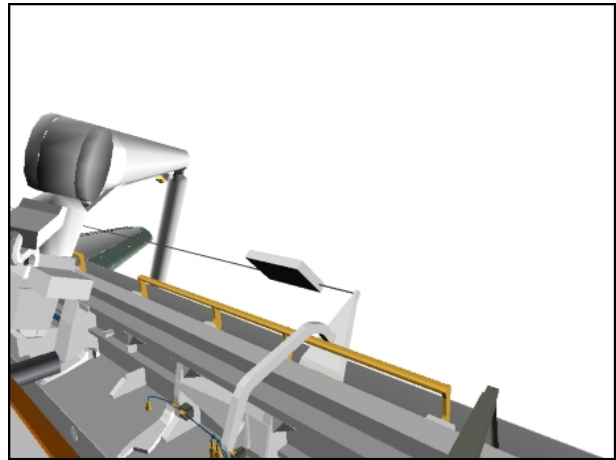

CCTV A (50,-10)

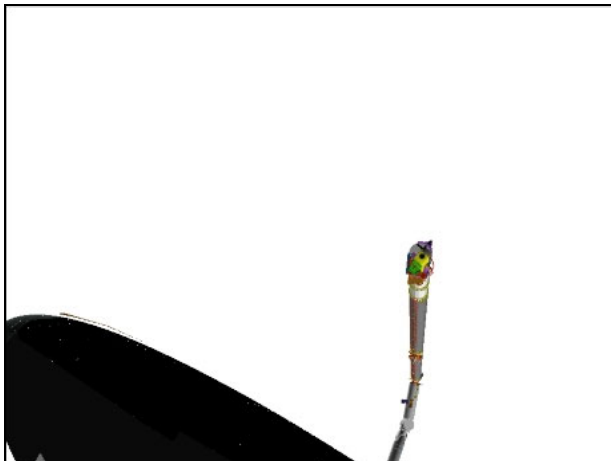

TIP ELBOW (-104,55)

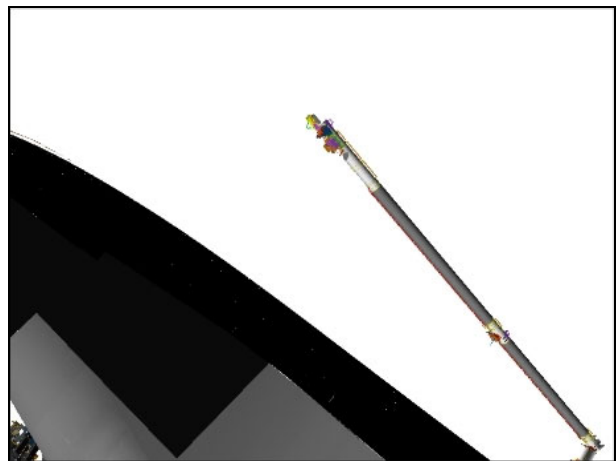

TIP ELBOW (-95,41)

6. PERFORM PORT 1 SCAN

a. Port 1 Scan 1

NOTE

During Port 1 scan, OBSS-to-Orbiter = 131 in

A7U CCTV – config as reqd

MON 1	SSRMS TIP ELBOW (SSRMS TIP LEE)
MON 2	ELBOW (RSC)

A7U √VIDEO OUT MON2 pb – push
 √IN PL2(VPU) pb – push

PAN: +75 (right)
 TILT: -110 (down)

√CAMR CMD PAN/TILT – LO RATE

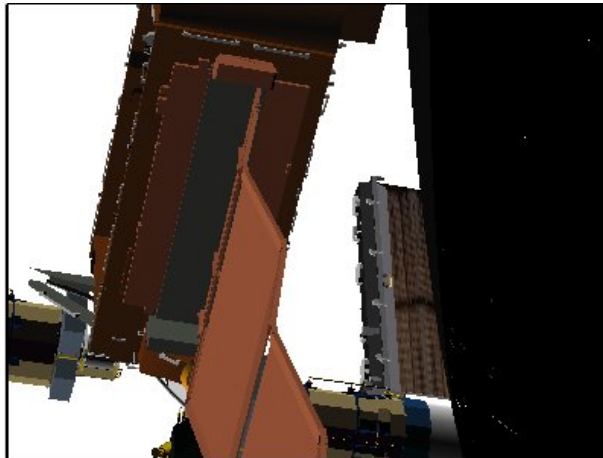

OBSS ITVC (75,-110)

√MCC to verify correct sensor view

L10(VTR) On MCC GO:
 REC pb – push, hold
 PLAY pb – push, simo (red ●)

RHC RATE – VERN (RATE MIN tb-ON)
 BRAKES – OFF (tb-OFF)
 MODE – SINGLE, ENTER

Drive WR (+) to -34.0

	X	Y	Z	PITCH	YAW	ROLL	PL ID
√	-1326	-180	-125	2	344	356	2
	SY	SP	EP	WP	WY	WR	
√	+35.0	+12.0	-68.0	-18.0	+17.0	-34.0	

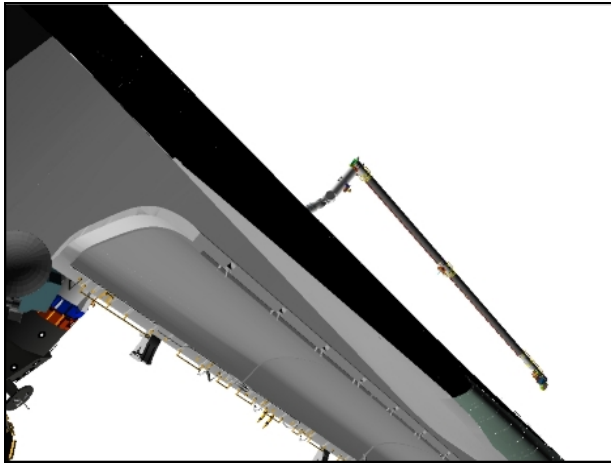

TIP ELBOW (-75,15)

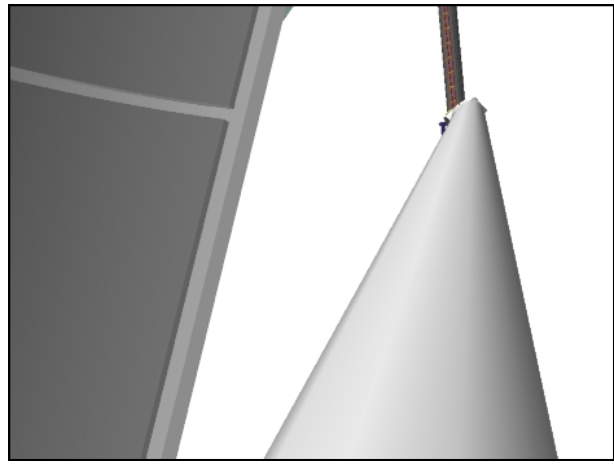

ELBOW (-21,-22)

b. Port 1 Scan 2

NOTE

The following and subsequent TILT cmds in step 6 are for the OBSS ITVC

A7U

TILT: -97 (up)

Drive WR (-) to -185.0

	X	Y	Z	PITCH	YAW	ROLL	PL ID
√	-710	-198	-97	184	347	184	2
	SY	SP	EP	WP	WY	WR	
√	+35.0	+12.0	-68.0	-18.0	+17.0	-185.0	

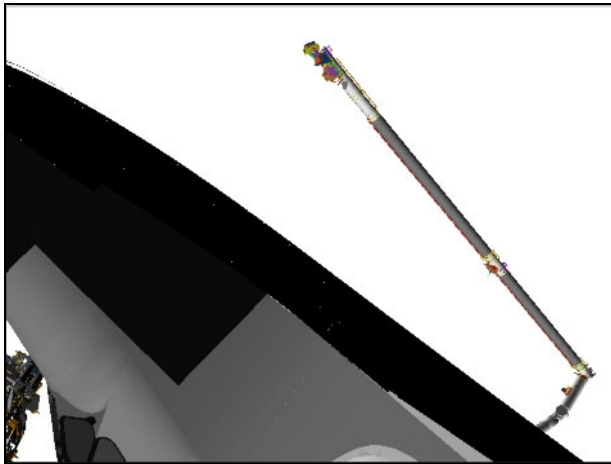

TIP ELBOW (-95,35)

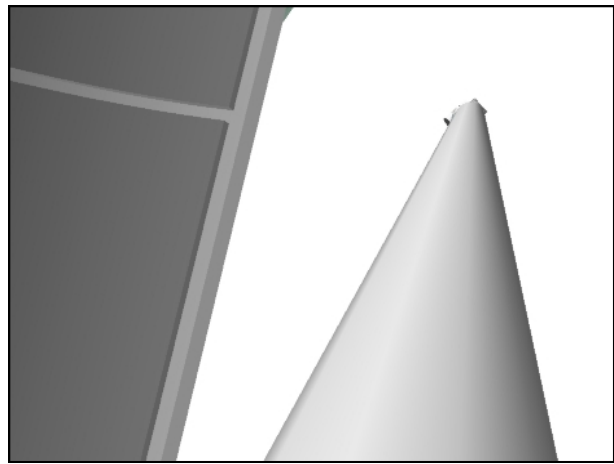

ELBOW (-21,-22)

c. Port 1 Scan 3

A7U

TILT: -84 (up)

Drive WR (+) to -34.0

	X	Y	Z	PITCH	YAW	ROLL	PL ID
√	-1326	-180	-125	2	344	356	2
	SY	SP	EP	WP	WY	WR	
√	+35.0	+12.0	-68.0	-18.0	+17.0	-34.0	

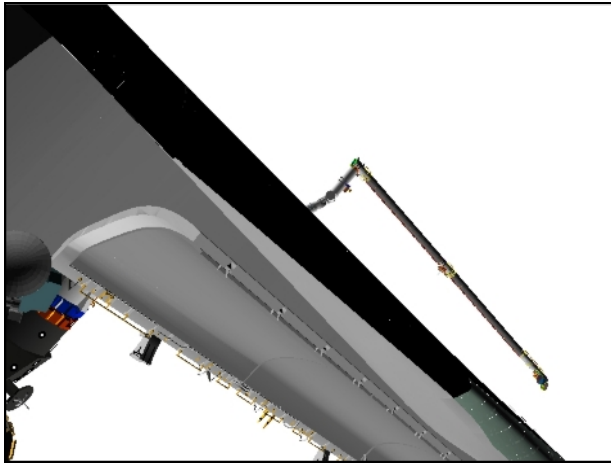

TIP ELBOW (-75,15)

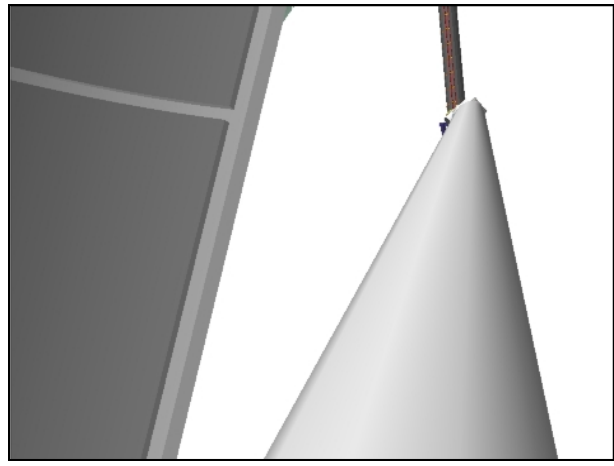

ELBOW (-21,-22)

A7U

d. Port 1 Scan 4
TILT: -71 (up)

Drive WR (-) to -180.0

	X	Y	Z	PITCH	YAW	ROLL	PL ID
√	-718	-172	-95	184	342	184	2
	SY	SP	EP	WP	WY	WR	
√	+35.0	+12.0	-68.0	-18.0	+17.0	-180.0	

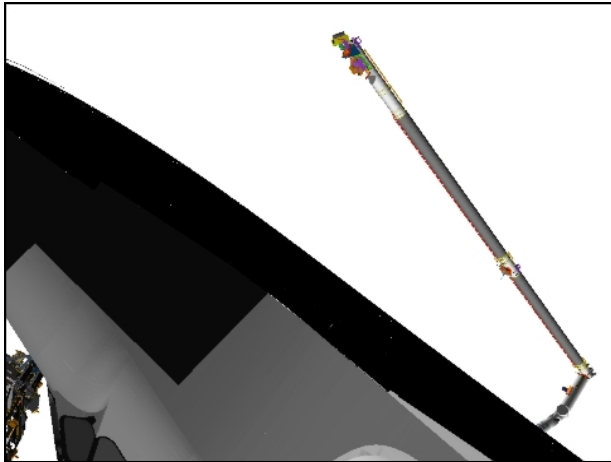

TIP ELBOW (-95,35)

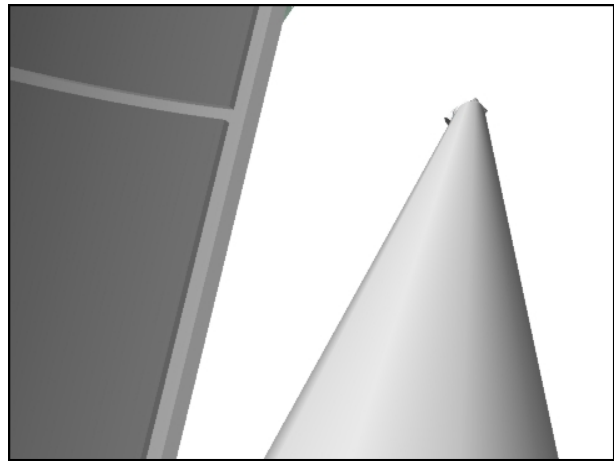

ELBOW (-21,-22)

A7U

e. Port 1 Scan 5
TILT: -58 (up)

Drive WR (+) to +7.0

	X	Y	Z	PITCH	YAW	ROLL	PL ID
√	-1308	-402	-138	4	25	356	2
	SY	SP	EP	WP	WY	WR	
√	+35.0	+12.0	-68.0	-18.0	+17.0	+7.0	

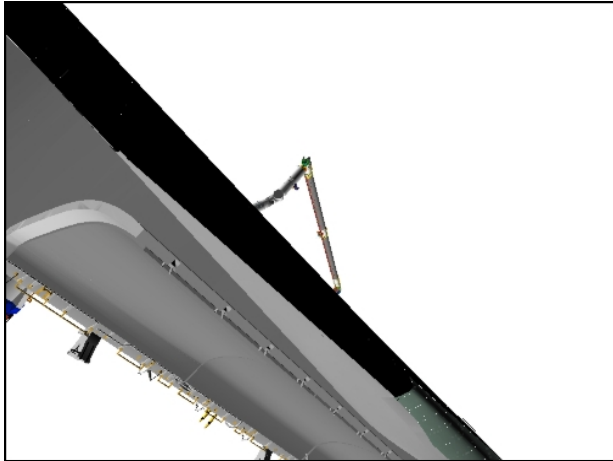

TIP ELBOW (-70,15)

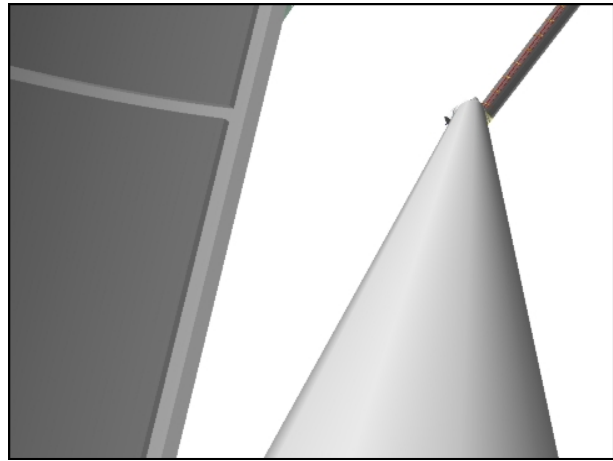

ELBOW (-21,-22)

A7U

f. Port 1 Scan 6
TILT: -45 (up)

Drive WR (-) to -178.0

	X	Y	Z	PITCH	YAW	ROLL	PL ID
√	-721	-161	-95	184	340	184	2
	SY	SP	EP	WP	WY	WR	
√	+35.0	+12.0	-68.0	-18.0	+17.0	-178.0	

BRAKES – ON (tb-ON)



TIP ELBOW (-95,35)

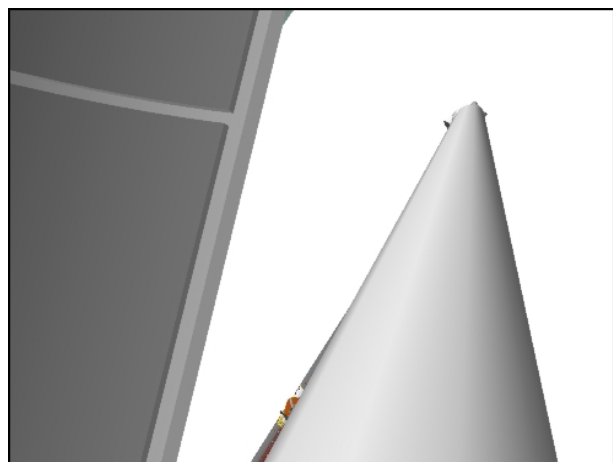

ELBOW (-21,-22)

7. MNVR TO NOSE CONFIG

On MCC GO:

L10(VTR) STOP pb – push (no red ●)

NOTE

At Nose Config final posn, OBSS-to-Orbiter = 143 in

Port Config 2 Clearance Views	Cameras
SJ steps 1 thru 4	A, ELBOW, SSRMS TIP ELBOW, SSRMS TIP LEE, RSC

RHC RATE – as reqd (VERN within 10 ft)
BRAKES – OFF (tb-OFF)
MODE – SINGLE, ENTER

Mnvr to NOSE CONFIG posn:

	SY	SP	EP	WP	WY	WR	
PORT CONFIG 1	+35.0	+12.0	-68.0	-18.0	+17.0	-178.0	
1: SY +	+74.0						
2: SP +		+26.0					
3: WY –					+15.0		
4: WP –				-23.0			
NOSE CONFIG	+74.0	+26.0	-68.0	-23.0	+15.0	-178.0	
	X	Y	Z	PITCH	YAW	ROLL	PL ID
	-624	-222	-135	185	302	196	2

BRAKES – ON (tb-ON)



TIP ELBOW (-95,35)

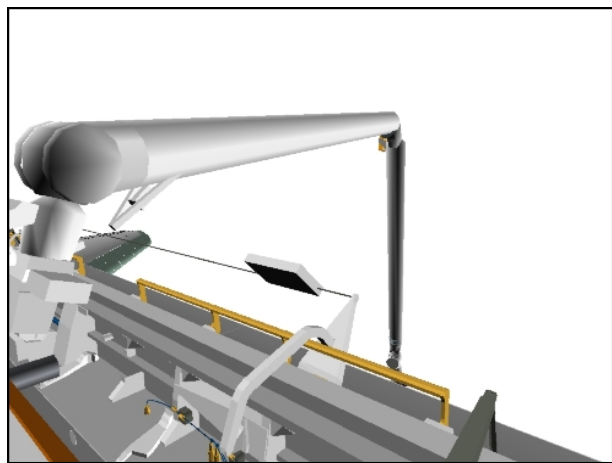

CCTV A (50,-10)

8. PERFORM NOSE SCAN

NOTE

During nose scan, OBSS-to-Orbiter = 132 in

A7U CCTV – config as reqd

MON 1	SSRMS TIP LEE (SSRMS TIP ELBOW)
MON 2	ELBOW (RSC)

A7U √VIDEO OUT MON2 pb – push
 √IN PL2(VPU) pb – push

√PAN: +75
 TILT: -120 (down)

√CAMR CMD PAN/TILT – LO RATE

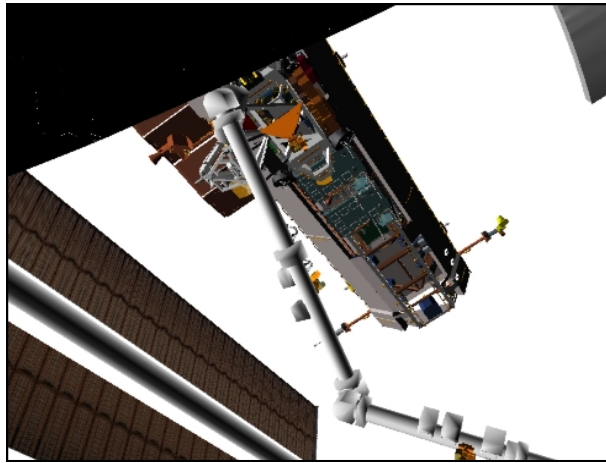

OBSS ITVC (75,-120)

√MCC to verify correct sensor view

L10(VTR) On MCC GO:
 REC pb – push, hold
 PLAY pb – push, simo (red ●)

RHC RATE – VERN (RATE MIN tb-ON)
 BRAKES – OFF (tb-OFF)
 MODE – SINGLE, ENTER

Drive WR (-) to -200.0

	X	Y	Z	PITCH	YAW	ROLL	PL ID
√	-537	-303	-160	178	324	190	2
	SY	SP	EP	WP	WY	WR	
√	+74.0	+26.0	-68.0	-23.0	+15.0	-200.0	

BRAKES – ON (tb-ON)

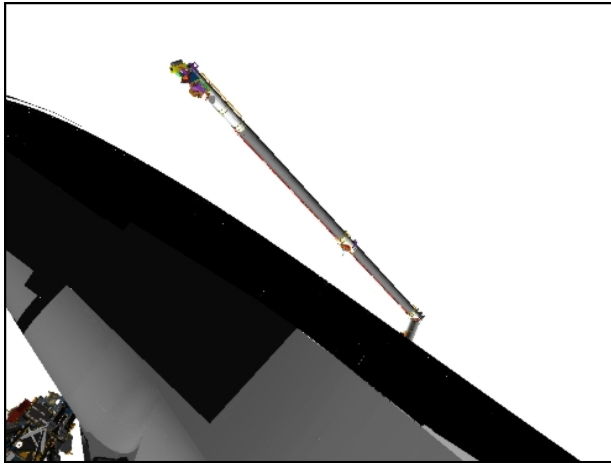

TIP ELBOW (-98,-38)

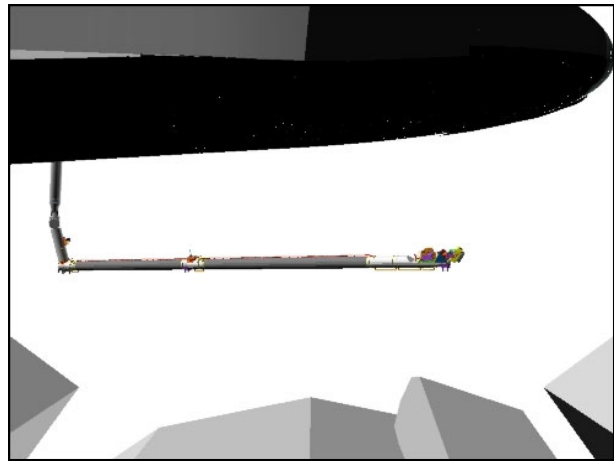

TIP LEE

9. MNVR TO PORT CONFIG 2

On MCC GO:

L10(VTR) STOP pb – push (no red ●)

NOTE

At Port Config 2 posn, OBSS-to-Orbiter = 120 in

Port Config 2 Clearance Views	Cameras
SJ steps 1 thru 2	ELBOW, SSRMS TIP LEE, SSRMS TIP ELBOW

RHC RATE – as reqd (VERN within 10 ft)
 BRAKES – OFF (tb-OFF)
 MODE – SINGLE, ENTER

Mnvr to PORT CONFIG 2 posn:

	SY	SP	EP	WP	WY	WR	
NOSE CONFIG	+74.0	+26.0	-68.0	-23.0	+15.0	-200.0	
1: WR +						-126.0	
2: WP –				-34.0			
PORT CONFIG 2	+74.0	+26.0	-68.0	-34.0	+15.0	-126.0	
	X	Y	Z	PITCH	YAW	ROLL	PL ID
	-888	-173	-143	355	288	6	2

BRAKES – ON (tb-ON)



TIP LEE

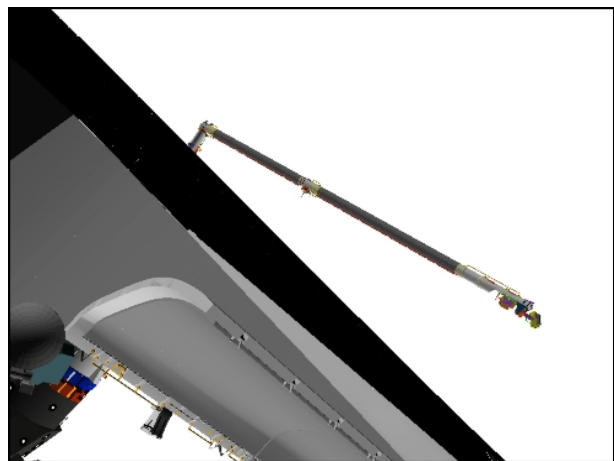

TIP ELBOW (-76,21)

10. PERFORM PORT 2 SCAN

a. Port 2 Scan 1

NOTE

During Port 2 scan, OBSS-to-Orbiter = 81 in

A7U CCTV – config as reqd

MON 1	SSRMS TIP LEE (SSRMS TIP ELBOW)
MON 2	ELBOW (RSC)

A7U √VIDEO OUT MON2 pb – push
 √IN PL2(VPU) pb – push

√PAN: +75
 TILT: -115 (up)

√CAMR CMD PAN/TILT – LO RATE

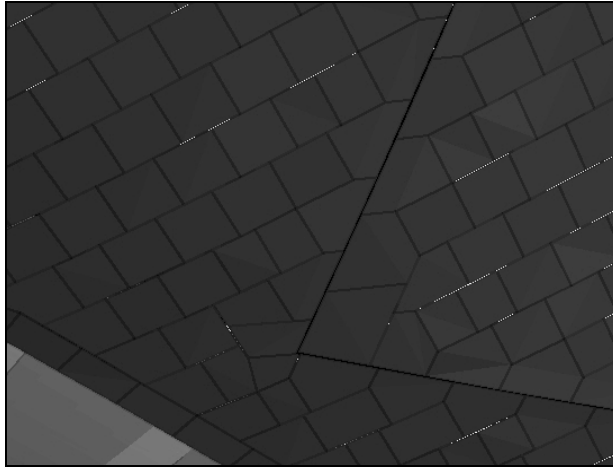

OBSS ITVC (75,-115)

√MCC to verify correct sensor view

L10(VTR) On MCC GO:
 REC pb – push, hold
 PLAY pb – push, simo (red ●)

RHC RATE – VERN (RATE MIN tb-ON)
 BRAKES – OFF (tb-OFF)
 MODE – SINGLE, ENTER

Drive WR (+) to -73.0

	X	Y	Z	PITCH	YAW	ROLL	PL ID
√	-1086	-372	-99	350	341	2	2
	SY	SP	EP	WP	WY	WR	
√	+74.0	+26.0	-68.0	-34.0	+15.0	-73.0	

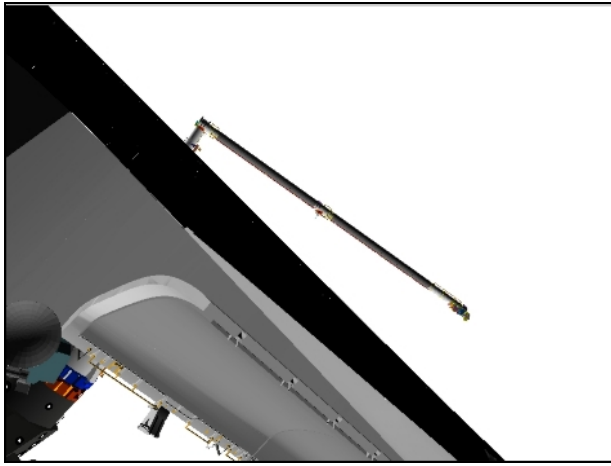

TIP ELBOW (-76,21)

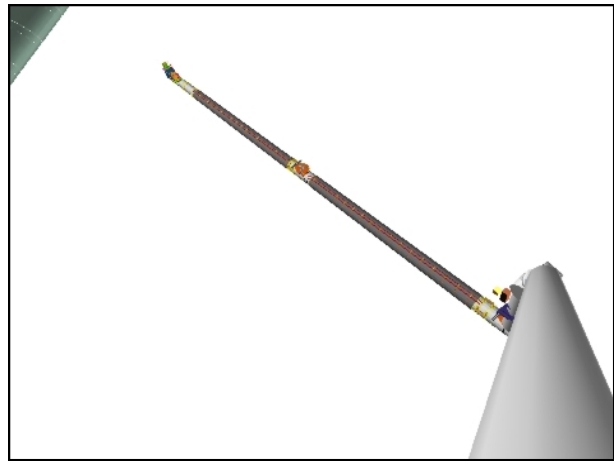

ELBOW (-30,0)

b. Port 2 Scan 2

NOTE

The following and subsequent TILT cmds in step 10 are for the OBSS ITVC

A7U

TILT: -102 (up)

Drive WR (-) to -139.0

	X	Y	Z	PITCH	YAW	ROLL	PL ID
√	-819	-159	-157	11	275	22	2
	SY	SP	EP	WP	WY	WR	
√	+74.0	+26.0	-68.0	-34.0	+15.0	-139.0	

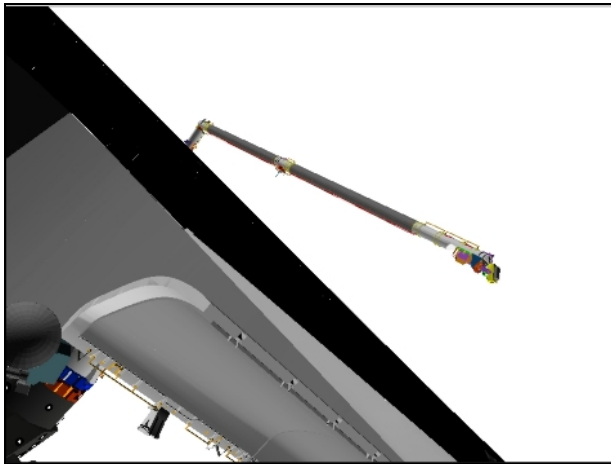

TIP ELBOW (-76,21)

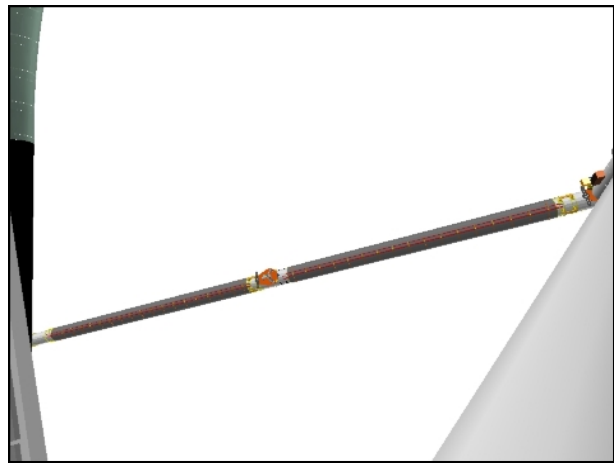

ELBOW (-40,-20)

A7U

c. Port 2 Scan 3
TILT: -89 (up)

Drive WR (+) to -60.0

	X	Y	Z	PITCH	YAW	ROLL	PL ID
√	-1101	-442	-94	350	354	2	2
	SY	SP	EP	WP	WY	WR	
√	+74.0	+26.0	-68.0	-34.0	+15.0	-60.0	

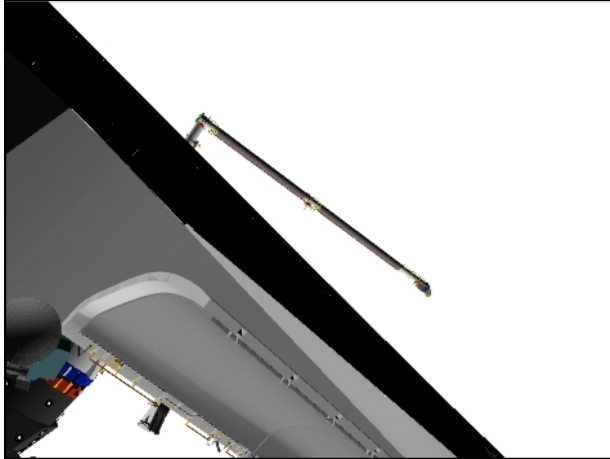

TIP ELBOW (-76,21)

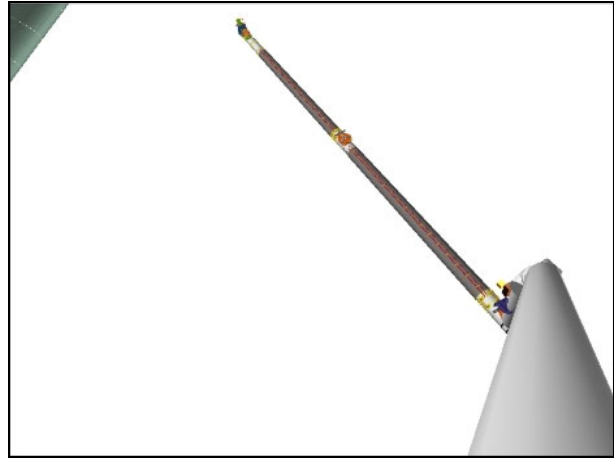

ELBOW (-30,0)

A7U

d. Port 2 Scan 4
TILT: -76 (up)

Drive WR (-) to -147.0

	X	Y	Z	PITCH	YAW	ROLL	PL ID
√	-775	-159	-165	138	274	149	2
	SY	SP	EP	WP	WY	WR	
√	+74.0	+26.0	-68.0	-34.0	+15.0	-147.0	

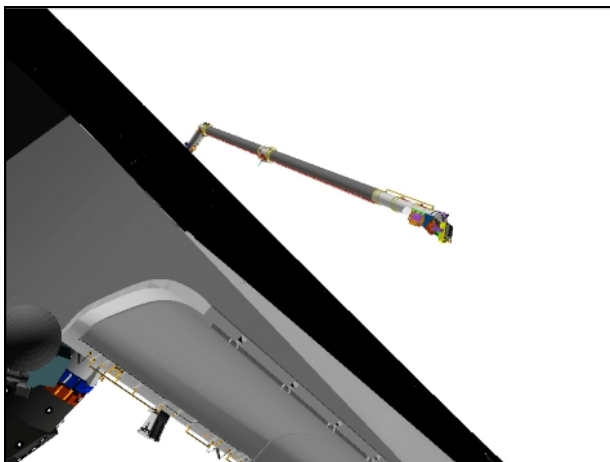

TIP ELBOW (-76,21)



ELBOW (-40,-20)

A7U

e. Port 2 Scan 5
TILT: -63 (up)

Drive WR (+) to -62.0

	X	Y	Z	PITCH	YAW	ROLL	PL ID
√	-1100	-431	-95	350	352	2	2
	SY	SP	EP	WP	WY	WR	
√	+74.0	+26.0	-68.0	-34.0	+15.0	-62.0	

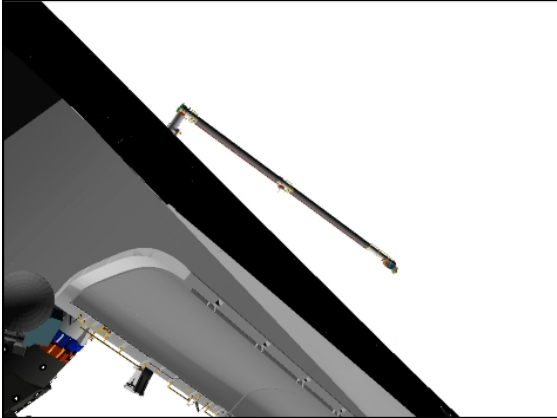

TIP ELBOW (-76,21)



ELBOW (-30,0)

A7U

f. Port 2 Scan 6
TILT: -50 (up)

Drive WR (-) to -152.0

	X	Y	Z	PITCH	YAW	ROLL	PL ID
√	-748	-161	-170	156	278	167	2
	SY	SP	EP	WP	WY	WR	
√	+74.0	+26.0	-68.0	-34.0	+15.0	-152.0	

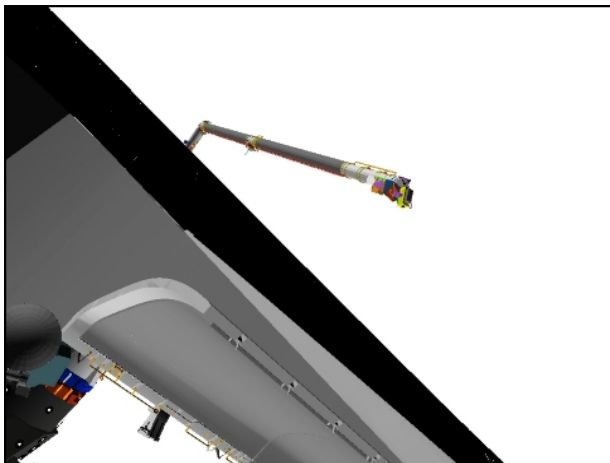

TIP ELBOW (-76,21)



ELBOW (-40,-20)

A7U

g. Port 2 Scan 7

TILT: -40 (up)

Drive WR (+) to -74.0

√	X	Y	Z	PITCH	YAW	ROLL	PL ID
	-1084	-366	-100	350	340	2	2
√	SY	SP	EP	WP	WY	WR	
	+74.0	+26.0	-68.0	-34.0	+15.0	-74.0	

BRAKES – ON (tb-ON)

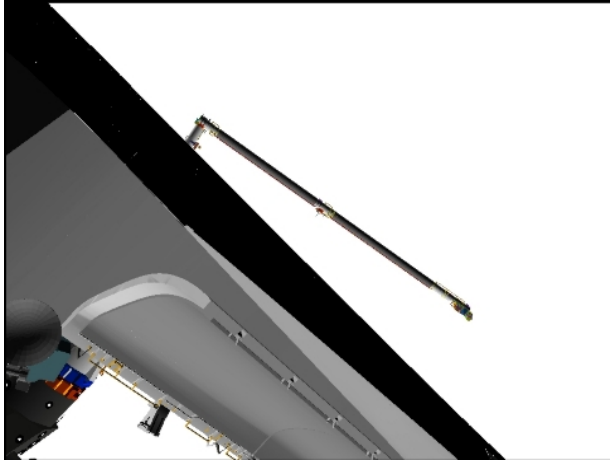

TIP ELBOW (-76,21)

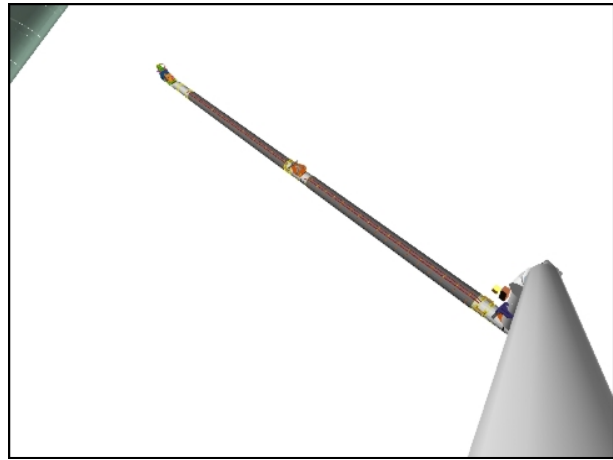

ELBOW (-30,0)

11. MNVR TO PORT CONFIG 3

On MCC GO:

L10(VTR) STOP pb – push (no red ●)

NOTE

At Port Config 3, OBSS-to-Orbiter = 240 in

Port Config 2 Clearance Views	Cameras
SJ step 1	A, ELBOW, SSRMS TIP LEE
SJ steps 2 thru 5	A, B, ELBOW
SJ step 6	A, B, ELBOW, SSRMS TIP LEE

RHC RATE – as reqd (VERN within 10 ft)

BRAKES – OFF (tb-OFF)

MODE – SINGLE, ENTER

Mnvr to PORT CONFIG 3 posn:

	SY	SP	EP	WP	WY	WR	
PORT CONFIG2	+74.0	+26.0	-68.0	-34.0	+15.0	-74.0	
1: SY +	+99.5						
2: SP +		+82.5					
3: EP –			-86.0				
4: WP +				-32.0			
5: WY +					+25.0		
6: WR –						-98.0	
PORT CONFIG3	+99.5	+82.5	-86.0	-32.0	+25.0	-98.0	
	X	Y	Z	PITCH	YAW	ROLL	PL ID
	-840	-505	-307	322	357	334	2

BRAKES – ON (tb-ON)

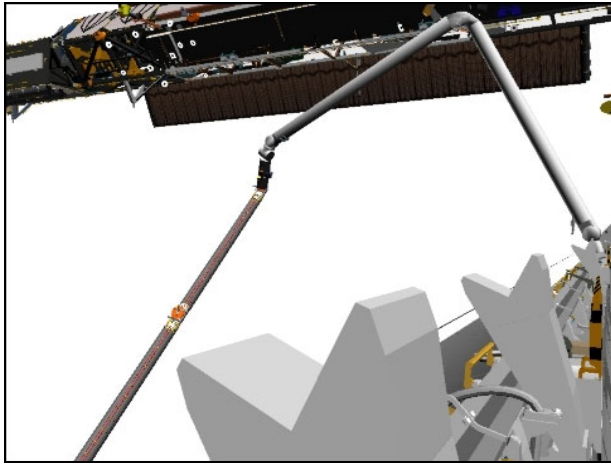

CCTV B (-27,0)

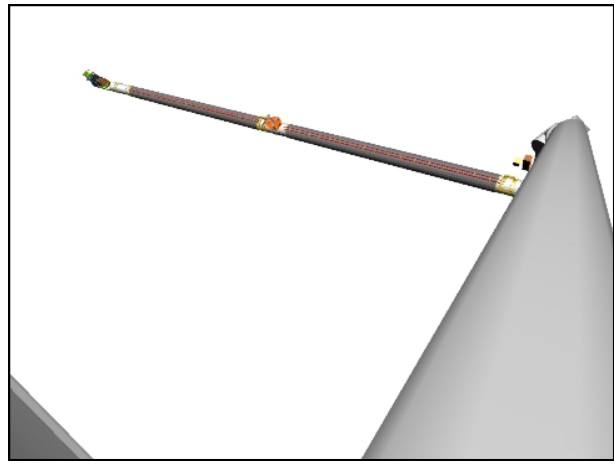

ELBOW (-32,-20)

12. PERFORM PORT 3 SCAN
 - a. Port 3 Scan 1

NOTE

During Port 3 scan, OBSS-to-Orbiter = 29 in

A7U CCTV – config as reqd

MON 1	B (SSRMS TIP LEE)
MON 2	ELBOW (RSC)

A7U √VIDEO OUT MON2 pb – push
 √IN PL2(VPU) pb – push

√PAN: +75
 TILT: -85 (down)

√CAMR CMD PAN/TILT – LO RATE



OBSS ITVC (75,-85)

√MCC to verify correct sensor view

L10(VTR) On MCC GO:
 REC pb – push, hold
 PLAY pb – push, simo (red ●)

RHC RATE – VERN (RATE MIN tb-ON)
 BRAKES – OFF (tb-OFF)
 MODE – SINGLE, ENTER

Drive WR (-) to -161.0

	X	Y	Z	PITCH	YAW	ROLL	PL ID
√	-616	-260	-323	278	305	309	2
	SY	SP	EP	WP	WY	WR	
√	+99.5	+82.5	-86.0	-32.0	+25.0	-161.0	

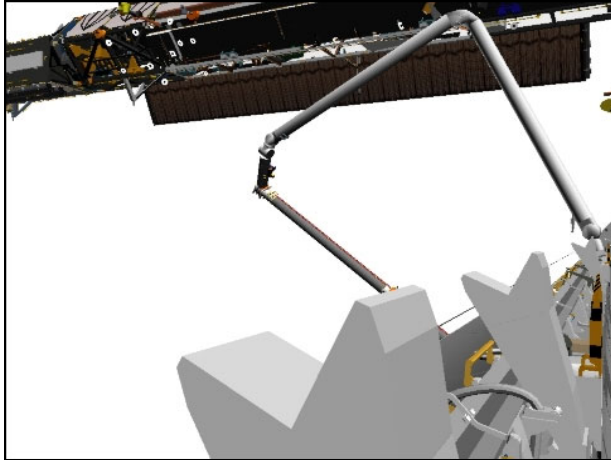

CCTV B (-27,0)

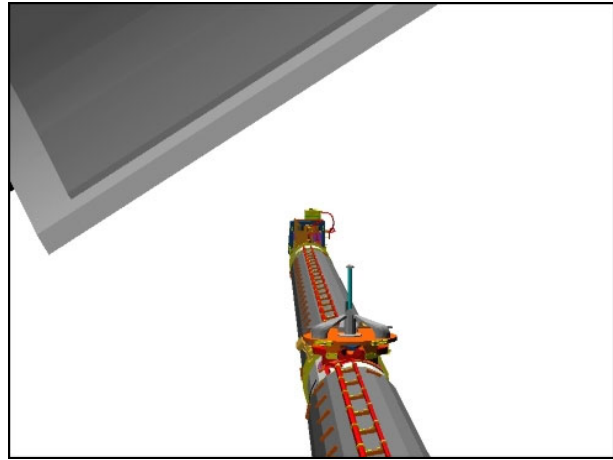

RSC

b. Port 3 Scan 2

NOTE

The following and subsequent TILT cmds in step 12 are for the OBSS ITVC

A7U TILT: -72 (up)

Drive WR (+) to -108.0

	X	Y	Z	PITCH	YAW	ROLL	PL ID
√	-819	-456	-292	317	348	333	2
	SY	SP	EP	WP	WY	WR	
√	+99.5	+82.5	-86.0	-32.0	+25.0	-108.0	

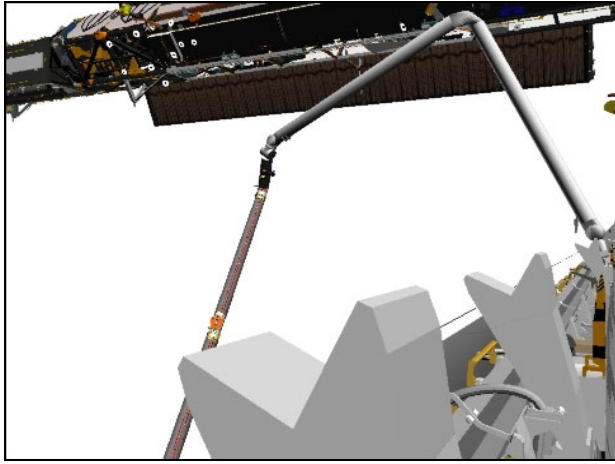

CCTV B (-27,0)

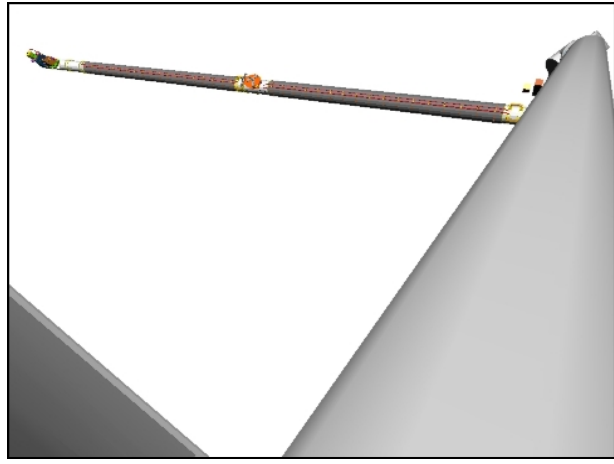

ELBOW (-32,-30)

A7U

c. Port 3 Scan 3

TILT: -59 (up)

Drive WR (-) to -162.0

	X	Y	Z	PITCH	YAW	ROLL	PL ID
√	-612	-258	-325	277	305	308	2
	SY	SP	EP	WP	WY	WR	
√	+99.5	+82.5	-86.0	-32.0	+25.0	-162.0	

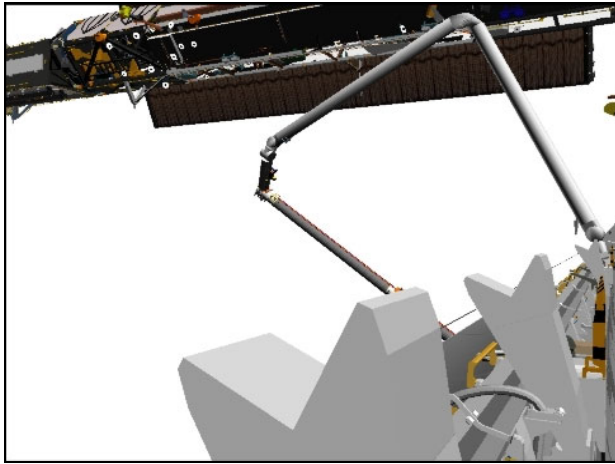

CCTV B (-27,0)

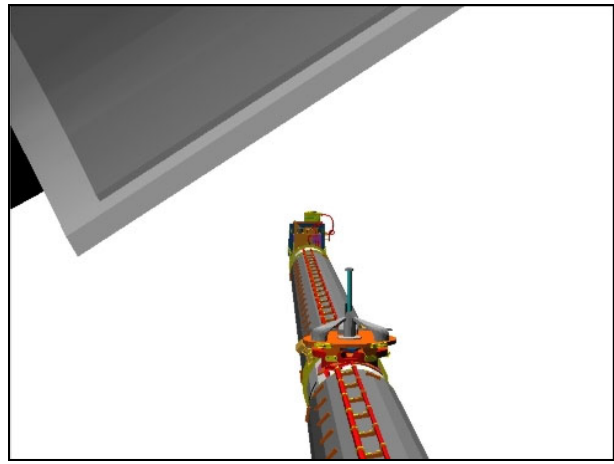

RSC

A7U

d. Port 3 Scan 4

TILT: -46 (up)

Drive WR (+) to -134.0

	X	Y	Z	PITCH	YAW	ROLL	PL ID
√	-735	-341	-284	303	326	327	2
	SY	SP	EP	WP	WY	WR	
√	+99.5	+82.5	-86.0	-32.0	+25.0	-134.0	

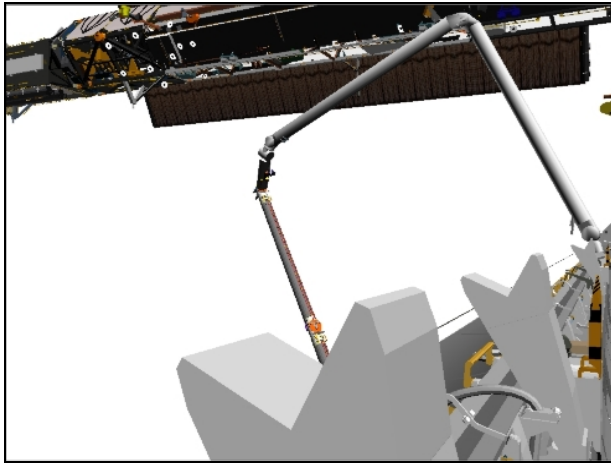

CCTV B (-27,0)

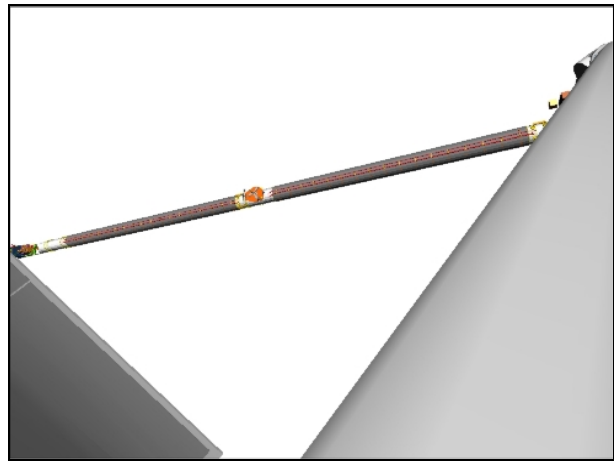

ELBOW (-35,-30)

A7U

e. Port 3 Scan 5

TILT: -33 (up)

Drive WR (-) to -162.0

	X	Y	Z	PITCH	YAW	ROLL	PL ID
√	-612	-258	-325	277	305	308	2
	SY	SP	EP	WP	WY	WR	
√	+99.5	+82.5	-86.0	-32.0	+25.0	-162.0	

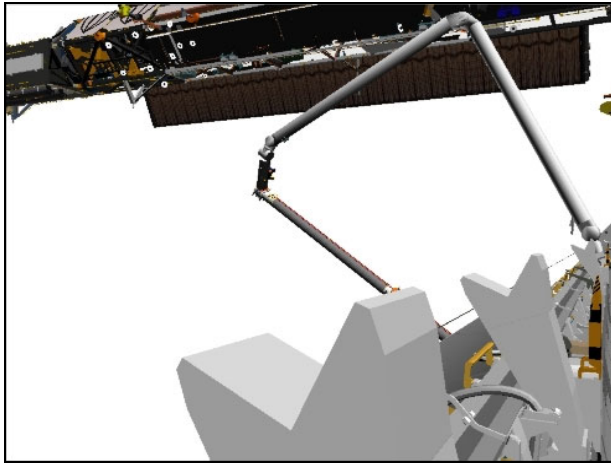

CCTV B (-27,0)

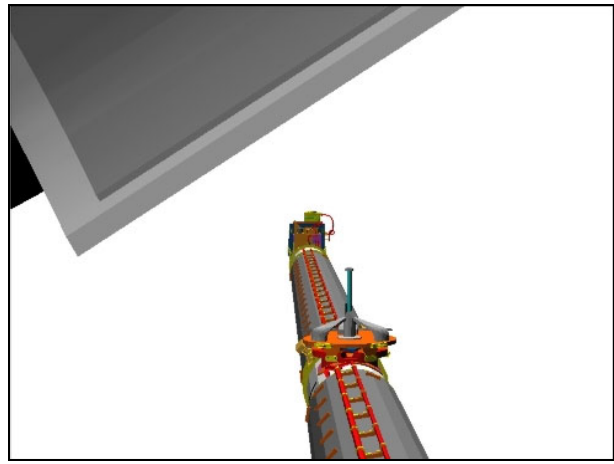

RSC

A7U

f. Port 3 Scan 6

TILT: -23 (up)

Drive WR (+) to -146.0

	X	Y	Z	PITCH	YAW	ROLL	PL ID
√	-685	-298	-296	294	316	322	2
	SY	SP	EP	WP	WY	WR	
√	+99.5	+82.5	-86.0	-32.0	+25.0	-146.0	

BRAKES – ON (tb-ON)

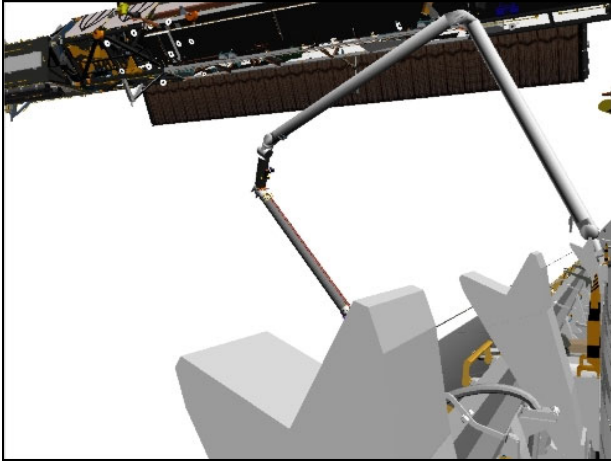

CCTV B (-27,0)

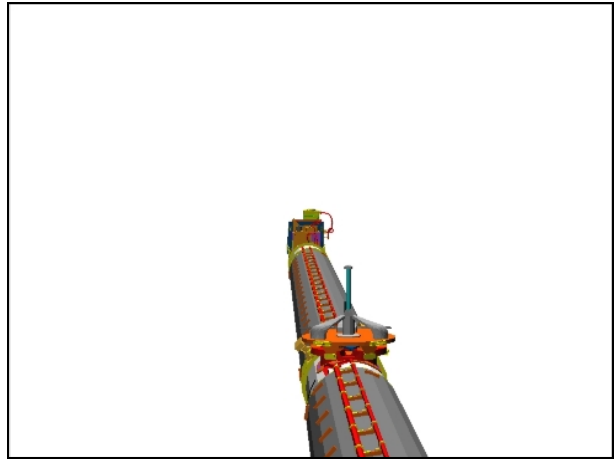

RSC

RMS EE RCC WING SURVEY

WARNING
 Port and stbd PLBD radiators must be stowed.
 P3/P4 must be installed

NOTE

This survey may be performed while docked or undocked and is intended to compliment the OBSS EVA WLE RCC SURVEY. Assumed starting posn is Pre-Cradle

1. SETUP

A7U

- √VIDEO OUT DTV pb – push
- √IN RMS pb – push
- CCTV – RMS WRIST, ZOOM: 20.0 HFOV

SM 94 PDRS CONTROL

PL ID – ITEM 3 +5 EXEC
 INIT ID – ITEM 24 +5 EXEC

	X	Y	Z	PITCH	YAW	ROLL	PL ID
√	-1261	-146	-551	5	2	0	5
	SY	SP	EP	WP	WY	WR	
√	0.0	+25.0	-25.0	+5.0	0.0	0.0	

SM 94 PDRS CONTROL

AUTO MODES – ITEM 13 +6 +7 +8 +9 EXEC

If docked,
 √MCC, SSRMS is clear for survey

2. MNVR TO STBD ACAS START

RHC

- RATE – as reqd (VERN within 10 ft)
- BRAKES – OFF (tb-OFF)
- MODE – SINGLE, ENTER

Mnvr to STBD ACAS START posn:

	SY	SP	EP	WP	WY	WR	
PRE-CRADLE	0.0	+25.0	-25.0	+5.0	0.0	0.0	
1: SY –	-40.0						
2: WP –				-114.0			[1]
3: WY +					+29.5		
4: WR +						+118.8	
5: SP –		+15.0					
6: SY –	-59.4						
7: SP –		+3.0					[1]
8: EP –			-41.5				
STBD ACAS START posn	-59.4	+3.0	-41.5	-114.0	+29.5	+118.8	
	X	Y	Z	PITCH	YAW	ROLL	PL ID
	-914	+278	-378	273	47	21	5

[1] Approaching REACH LIMIT

BRAKES – ON (tb-ON)

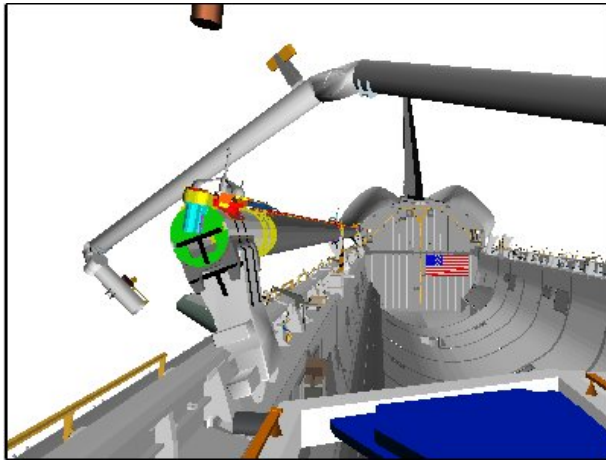

CCTV D (-10,0)

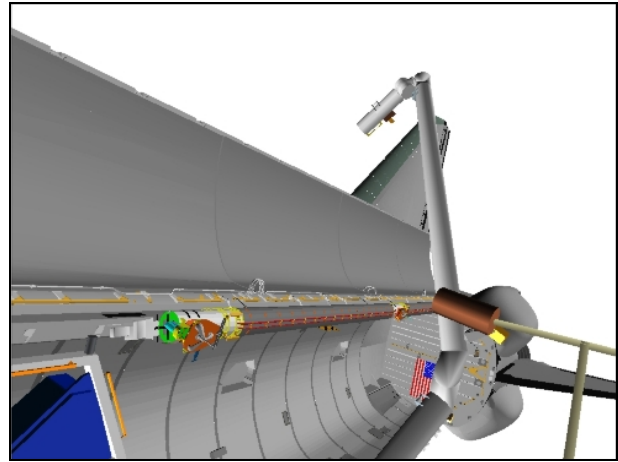

IF DOCKED: LAB (-35,-15)

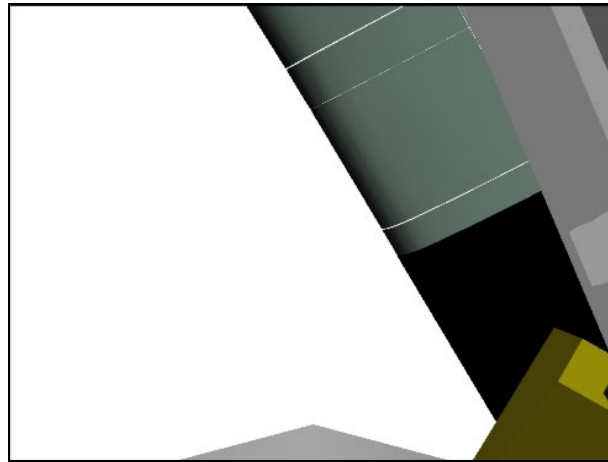

WRIST HFOV: 20.0

RHC 3. STBD ACAS
RATE – VERN (RATE MIN tb-ON)

L10(VTR) REC pb – push, hold
PLAY pb – push, simo (red ●)

BRAKES – OFF (tb-OFF)
MODE – AUTO 1, ENTER (READY lt on)

- * If unable to enter AUTO mode (no AUTO READY lt): *
- * √Joint angles and adjust as reqd *

SM 94 PDRS CONTROL

√START PT, ITEM 17: 130

SM 169 PDRS STATUS

Monitor ACAS progress

NOTE

The STBD ACAS scans the upper surface of Panels 1→18.
Time between Pts 130 and 138 ~ 7:15 min

STBD ACAS Clearance Views	Cameras
EE-to-RCC	ELBOW, LAB
RMS-to-PLBD	LAB
RMS-to-OBSS	D

If elbow camera reqd for clearance monitoring, auto sequence must be paused
AUTO SEQ – PROCEED (IN PROG It on)

ACAS, pause pts **shaded in bold**, ● col indicates data recording (black = VTR on):

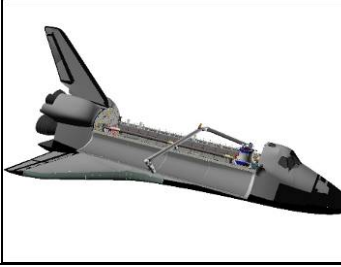
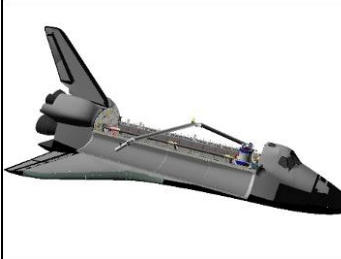
Pt	X	Y	Z	PITCH	YAW	ROLL	●	
130P	-914	+278	-378	273	47	21		
131	-919	+278	-377	281	47	21		
132	-931	+279	-380	299	46	9		
133	-955	+280	-379	310	39	32		
134	-990	+280	-381	312	28	38		
135	-1020	+284	-375	314	16	34		
136	-1037	+298	-385	319	2	34		
137	-1055	+300	-421	313	349	40		
138P	-1061	+308	-430	320	342	47		

When AUTO SEQ IN PROG It – off:
BRAKES – ON (tb-ON)

L10(VTR) STOP pb – push (no red ●)

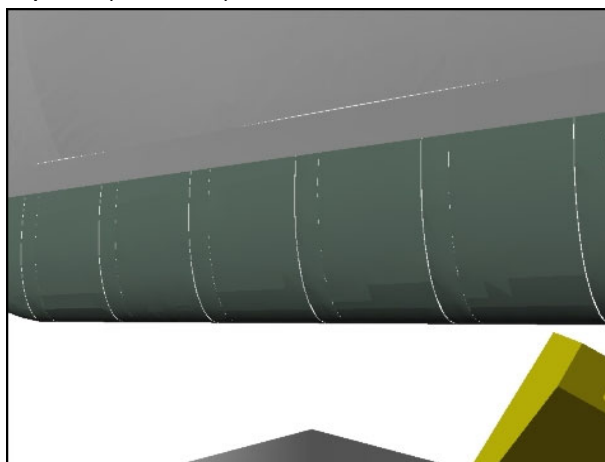

WRIST HFOV: 20.0

4. MNVR TO PORT UPPER ACAS START

SM 94 PDRS CONTROL

PL ID – ITEM 3 +0 EXEC

INIT ID – ITEM 24 +0 EXEC

√	X	Y	Z	PITCH	YAW	ROLL	PL ID
	-1061	+308	-430	320	342	47	0
√	SY	SP	EP	WP	WY	WR	
	-48.3	+6.0	-32.9	-24.4	+29.2	+87.2	

RHC

RATE – as reqd (VERN within 10 ft)

BRAKES – OFF (tb-OFF)

MODE – SINGLE, ENTER

If performing immediately after STBD ACAS:

Mnvr to PORT UPPER ACAS START posn:

		SY	SP	EP	WP	WY	WR	
STBD ACAS end		-48.3	+6.0	-32.9	-24.4	+29.2	+87.2	
1: SP +			+27.6					
2: EP +				-25.0				
3: SY +		+29.2						
4: WP –					-39.9			
5: WY –						-4.7		
6: WR –							+37.2	
7: EP –				-35.5				
PORT UPPER ACAS START		+29.2	+27.6	-35.5	-39.9	-4.7	+37.2	
	X	Y	Z	PITCH	YAW	ROLL	PL ID	
	-1163	-366	-379	309	0	52	0	

If performing from PRE-CRADLE:

Mnvr to PORT UPPER ACAS START posn:

		SY	SP	EP	WP	WY	WR	
PRE-CRADLE		0.0	+25.0	-25.0	+5.0	0.0	0.0	
1: SY +		+29.2						
2: SP +			+27.6					
3: WP –					-39.9			
4: WY –						-4.7		
5: WR +							+37.2	
6: EP –				-35.5				
PORT UPPER ACAS START		+29.2	+27.6	-35.5	-39.9	-4.7	+37.2	
	X	Y	Z	PITCH	YAW	ROLL	PL ID	
	-1163	-366	-379	309	0	52	0	

BRAKES – ON (tb-ON)

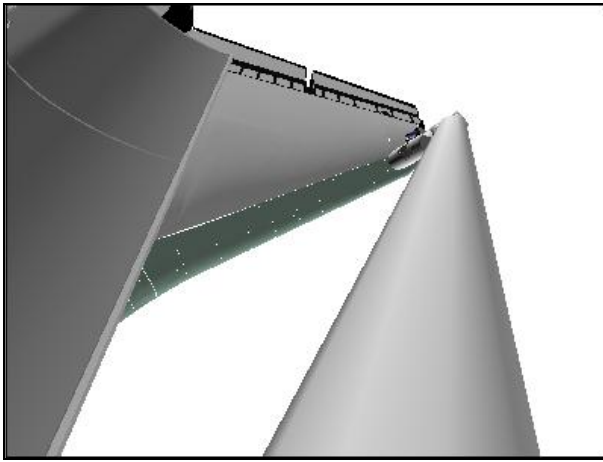

ELBOW (-20,-22)

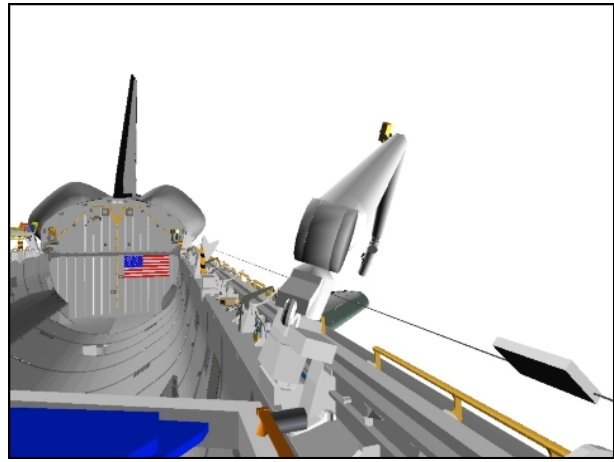

CCTVA (20,0)

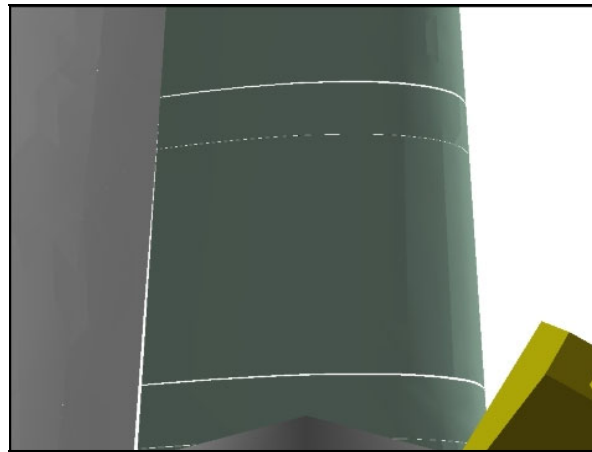

WRIST HFOV: 20.0

5. PORT UPPER ACAS

SM 94 PDRS CONTROL

PL ID - ITEM 3 +5 EXEC

INIT ID - ITEM 24 +5 EXEC

	X	Y	Z	PITCH	YAW	ROLL	PL ID
√	-1163	-366	-379	309	0	52	5
	SY	SP	EP	WP	WY	WR	
√	+29.2	+27.6	-35.5	-39.9	-4.7	+37.2	

RHC RATE - VERN (RATE MIN tb-ON)

L10(VTR) REC pb - push, hold
PLAY pb - push, simo (red ●)

BRAKES - OFF (tb-OFF)
MODE - AUTO 2, ENTER (READY It on)

- * If unable to enter AUTO mode (no AUTO READY It): *
- * √Joint angles and adjust as reqd *

SM 94 PDRS CONTROL

√START PT, ITEM 17: 139

SM 169 PDRS STATUS

Monitor ACAS progress

NOTE

The Port Upper ACAS scans upper surface of Panels 16→ 1.
Time between Pts 139 and 152 ~ 11:00 min

Port Upper ACAS Clearance Views	Cameras
RMS-to-PLBD	ELBOW, B
RMS overview	A
EE-to-RCC	B

AUTO SEQ – PROCEED (IN PROG It on)

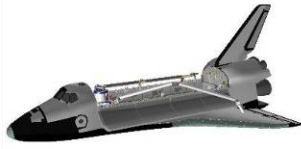
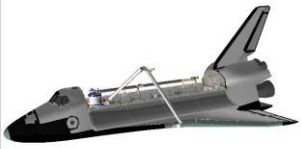
Pt	X	Y	Z	PITCH	YAW	ROLL	●
139P	-1163	-366	-379	309	0	52	
140	-1148	-359	-374	307	352	54	
141	-1133	-334	-369	306	353	52	
142	-1111	-323	-371	307	349	51	
143	-1090	-327	-370	308	335	53	
144	-1073	-313	-369	305	330	53	
145	-1058	-300	-370	304	327	54	
146	-1041	-288	-369	303	325	53	
147	-1015	-292	-375	296	310	34	
148	-997	-285	-363	297	305	33	
149	-957	-284	-336	309	291	39	
150	-952	-286	-340	292	288	25	
151	-936	-284	-339	280	288	12	
152P	-908	-285	-333	292	285	25	

When AUTO SEQ IN PROG It – off:

L10(VTR) STOP pb – push (no red ●)

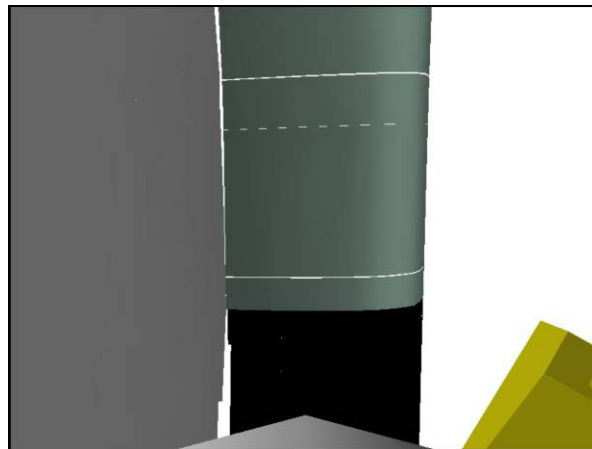

WRIST HFOV: 20.0

6. MNVR TO PORT UPPER APEX START

NOTE

RMS is approaching a display singularity at point 153.
Between Pts 152 and 153, arm adjusts for Port Upper
Apex scan. Time between Pts 152 and 153 ~ 2:35 min

Clearance Views	Cameras
EE-to-RCC	A, ELBOW
Upper Arm	A, B
RMS-to-PLBD	B, ELBOW

AUTO SEQ – PROCEED (IN PROG It on)

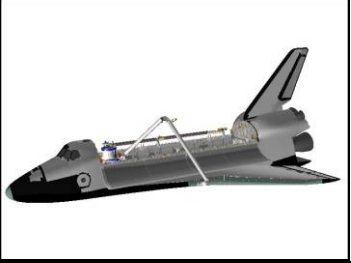
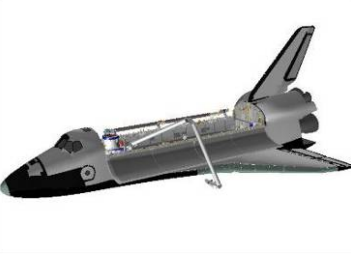
Pt	X	Y	Z	PITCH	YAW	ROLL	●
152P	-908	-285	-333	292	285	25	
153P	-911	-243	-294	53	275	146	

7. PORT UPPER APEX

A7U

CCTV – RMS WRIST, ZOOM: 10.0 HFOV

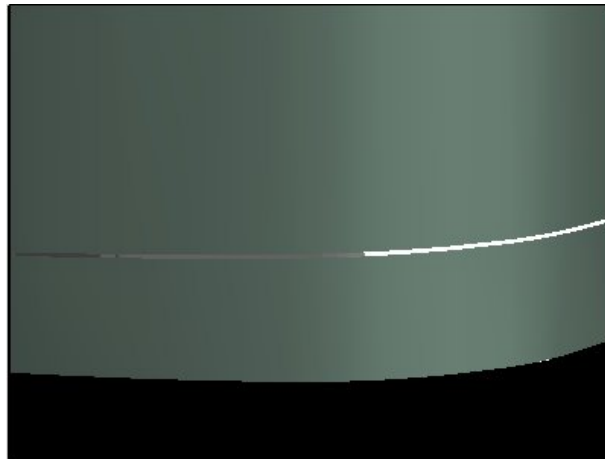

WRIST HFOV: 10.0

L10(VTR)



REC pb – push, hold
PLAY pb – push, simo (red ●)

NOTE

The RMS is at a display singularity for points 153 through 155. The Port Upper Apex pass scans Panels 1→17.
Time between Pts 153 and 165 ~ 12:00 min

Port Upper Apex Clearance Views	Cameras
EE-to-RCC	A, ELBOW
RMS-to-PLBD	B, ELBOW

AUTO SEQ – PROCEED (IN PROG It on)

Pt	X	Y	Z	PITCH	YAW	ROLL	●
153P	-911	-243	-294	53	275	146	
154	-945	-263	-296	12	270	102	
155	-962	-263	-300	340	274	72	
156	-978	-258	-292	19	278	110	
157	-991	-268	-294	7	281	97	
158	-1000	-273	-295	0	287	89	
159	-1002	-290	-296	1	296	90	
160	-1017	-282	-302	352	303	84	
161	-1028	-293	-306	350	319	82	
162	-1061	-320	-305	354	321	84	
163	-1102	-354	-307	353	324	85	
164	-1139	-397	-306	358	326	87	
165P	-1149	-420	-316	353	342	82	

When AUTO SEQ IN PROG It – off:

L10(VTR)

STOP pb – push (no red ●)

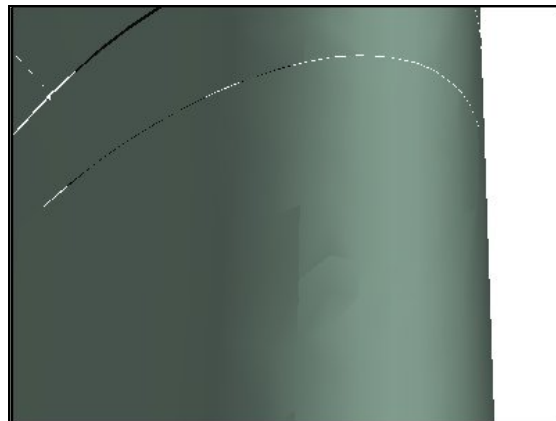

WRIST HFOV: 10.0



8. MNVR TO PORT LOWER APEX 1 START

NOTE

Between Pts 165 and 166, arm adjusts for first Port Lower Apex scan. Time between Pts 165 and 166 ~ 1:00 min

Clearance Views	Cameras
EE-to-RCC	ELBOW
RMS-to-PLBD	A, B

AUTO SEQ – PROCEED (IN PROG It on)

Pt	X	Y	Z	PITCH	YAW	ROLL	•
165P	-1149	-420	-316	353	342	82	
166P	-1151	-415	-304	359	344	89	

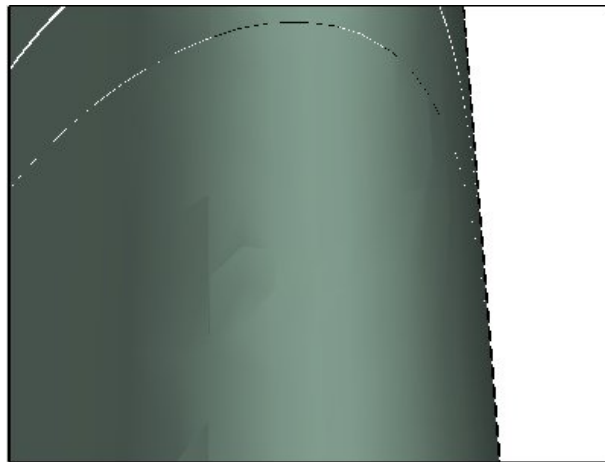

WRIST HFOV: 10.0

9. PORT LOWER APEX 1

NOTE

Port Lower Apex 1 pass scans Panels 17→12.
Time between Pts 166 and 171 ~ 5:25 min

Port Lower Apex 1 Clearance Views	Cameras
EE-to-RCC	ELBOW
RMS-to-PLBD	A, B

L10(VTR) REC pb – push, hold
PLAY pb – push, simo (red ●)

AUTO SEQ – PROCEED (IN PROG It on)

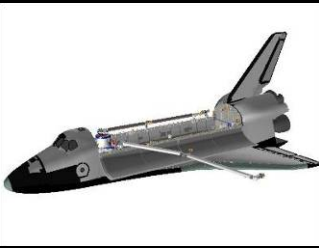
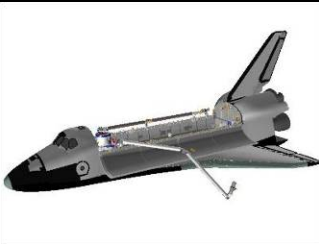
Pt	X	Y	Z	PITCH	YAW	ROLL	●
166P	-1151	-415	-304	359	344	89	
167	-1146	-404	-301	0	333	87	
168	-1138	-392	-297	2	324	90	
169	-1115	-354	-258	34	344	113	
170	-1107	-336	-253	40	344	121	
171P	-1090	-314	-247	46	343	122	

When AUTO SEQ IN PROG It – off:
BRAKES – ON (tb-ON)

L10(VTR) STOP pb – push (no red ●)



WRIST HFOV: 10.0

10. RECONFIG TO PORT LOWER APEX 2 START
 RHC RATE – as reqd (VERN within 10 ft)
 BRAKES – OFF (tb-OFF)
 MODE – SINGLE, ENTER

Mnvr to PORT LOWER APEX 2 START posn:

	SY	SP	EP	WP	WY	WR	
PORT LOWER APEX 1 End	+37.7	+4.0	-44.8	+109.1	-53.7	+167.0	
1: WP –				-47.6			
2: WY –					-114.0		[1]
3: WR –						+13.5	
4: SY +	+39.0						
5: EP +			-36.6				
6: SP +		+6.1					
PORT LOWER APEX 2 START	+39.0	+6.1	-36.6	-47.6	-114.0	+13.5	
	X	Y	Z	PITCH	YAW	ROLL	PL ID
	-1094	-326	-251	51	324	121	5

[1] Expect SINGULAR It, Near REACH LIMIT

BRAKES – ON (tb-ON)

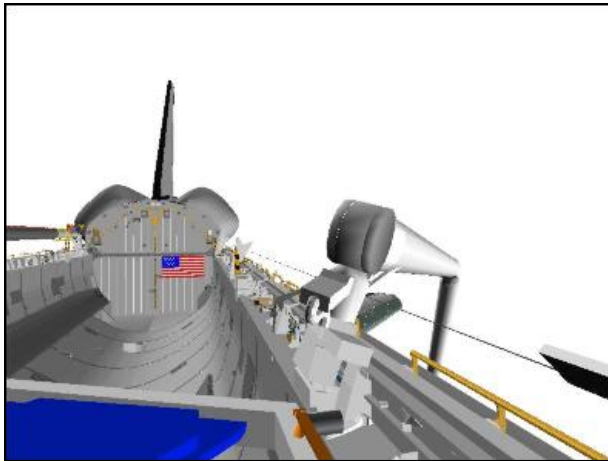

CCTV A (15,0)



FRONT



WRIST HFOV: 10.0

11. PORT LOWER APEX 2

RHC √RATE – VERN (RATE MIN tb-ON)

L10(VTR) REC pb – push, hold
 PLAY pb – push, simo (red ●)

 BRAKES – OFF (tb-OFF)
 MODE – AUTO 3, ENTER (READY lt on)

 * If unable to enter AUTO mode (no AUTO READY lt): *
 * √Joint angles and adjust as reqd *

SM 94 PDRS CONTROL

√START PT, ITEM 17: 172

SM 169 PDRS STATUS



Monitor ACAS progress

NOTE

Port Lower Apex 2 pass scans Panels 12→1.
Time between Pts 172 and 179 ~ 9:00 min

Port Lower Apex 2 Clearance Views	Cameras
EE-to-RCC	ELBOW
RMS-to-PLBD	A, B, ELBOW

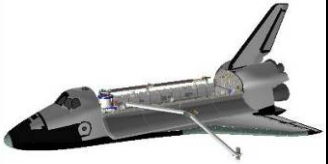
AUTO SEQ – PROCEED (IN PROG It on)

Pt	X	Y	Z	PITCH	YAW	ROLL	●
172P	-1094	-326	-251	51	324	121	
173	-1011	-254	-253	49	319	130	
174	-983	-250	-255	43	315	127	
175	-974	-246	-250	49	309	170	
176	-975	-252	-259	43	308	250	
177	-967	-251	-269	43	298	314	
178	-939	-243	-268	40	299	314	
179P	-904	-236	-268	38	304	312	

L10(VTR) When AUTO SEQ IN PROG It – off:
STOP pb – push (no red ●)

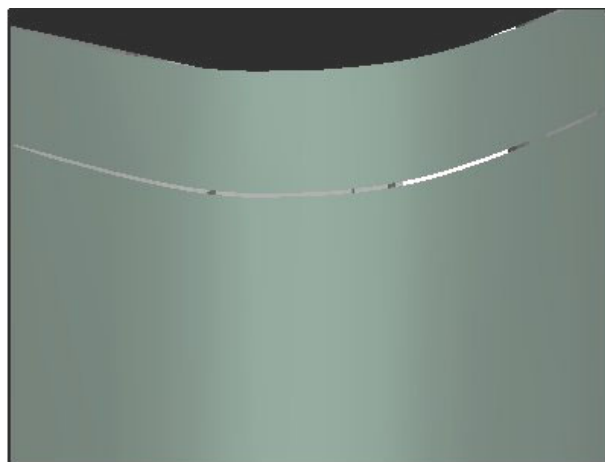

WRIST HFOV: 10.0



12. MNVR TO PORT LOWER 1 START

NOTE

Between Pts 179 and 180, arm adjusts for first Port Lower scan. Time between Pts 179 and 180 ~ 2:00 min

Clearance Views	Cameras
EE-to-RCC	ELBOW
RMS-to-PLBD	A, B

AUTO SEQ – PROCEED (IN PROG It on)

Pt	X	Y	Z	PITCH	YAW	ROLL	●
179P	-904	-236	-268	38	304	312	
180P	-890	-222	-235	41	324	324	

13. PORT LOWER 1
A7U CCTV – RMS WRIST, ZOOM: 20.0 HFOV

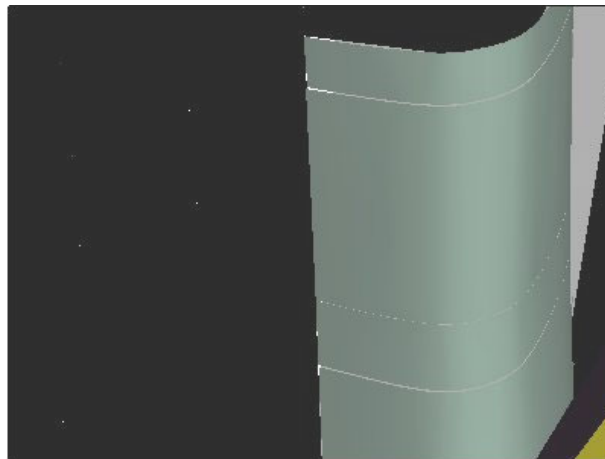

WRIST HFOV: 20.0

L10(VTR) REC pb – push, hold
PLAY pb – push, simo (red ●)

NOTE

Port Lower 1 pass scans the underside of Panels 1→11.
Time between Pts 180 and 183 ~ 4:00 min

Port Lower 1 Clearance Views	Cameras
EE-to-RCC	ELBOW
RMS-to-PLBD	A, B

AUTO SEQ – PROCEED (IN PROG It on)

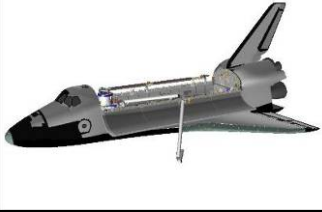
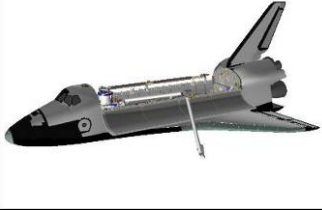
Pt	X	Y	Z	PITCH	YAW	ROLL	•
180P	-890	-222	-235	41	324	324	
181	-917	-227	-237	41	323	328	
182	-932	-232	-237	38	323	329	
183P	-977	-241	-241	53	315	340	

A7U

When AUTO SEQ IN PROG It – off:
CCTV – RMS WRIST, ZOOM: 10.0 HFOV

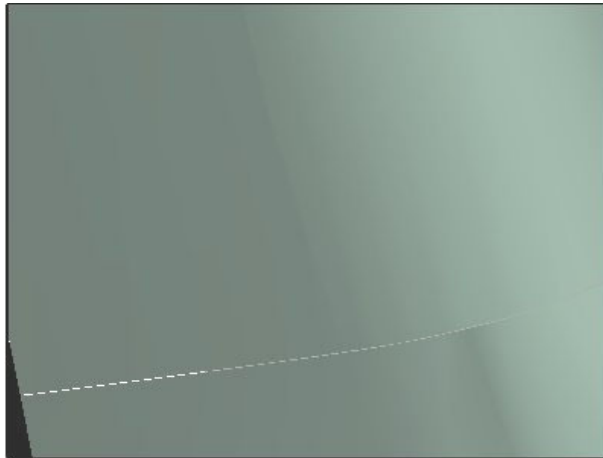

WRIST HFOV: 10.0

NOTE

Time between Pts 183 and 190 ~ 6:00 min

AUTO SEQ – PROCEED (IN PROG It on)

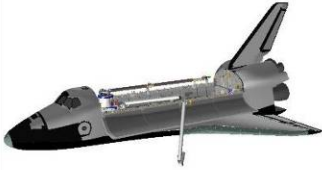
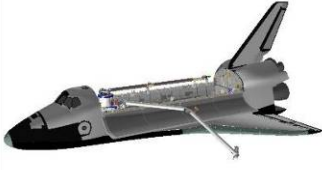
Pt	X	Y	Z	PITCH	YAW	ROLL	●
183P	-977	-241	-241	53	315	340	
184	-1001	-244	-246	55	313	325	
185	-1019	-257	-248	51	311	323	
186	-1021	-255	-240	44	323	320	
187	-1043	-272	-242	47	323	299	
188	-1064	-288	-244	48	324	301	
189	-1083	-314	-254	45	314	297	
190P	-1091	-322	-252	40	324	295	

When AUTO SEQ IN PROG It – off:
BRAKES – ON (tb-ON)

L10(VTR) STOP pb – push (no red ●)

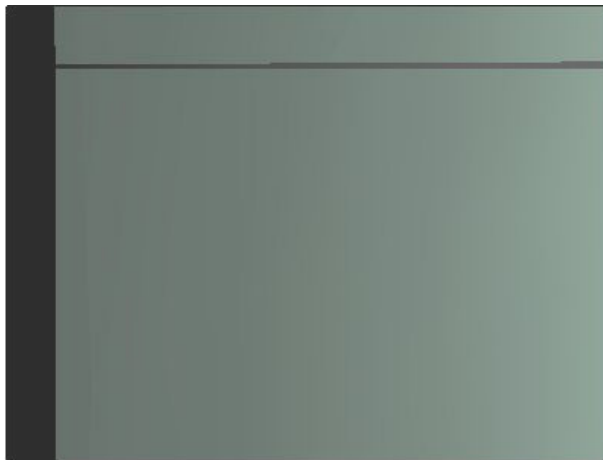

WRIST HFOV: 10.0

14. RECONFIG TO PORT LOWER 2 START
 RHC RATE – as reqd (VERN within 10 ft)
 BRAKES – OFF (tb-OFF)
 MODE – SINGLE, ENTER

Mnvr to PORT LOWER 2 START posn:

	SY	SP	EP	WP	WY	WR	
PORT LOWER 1 End	+39.1	+9.3	-41.7	-61.2	-107.1	+179.8	
1: SP –		+6.5					
2: EP –			-47.5				
3: SY –	+39.0						
4: WY +					-63.0		[1]
5: WP +				+114.0			[2]
6: WR –						-102.8	
PORT LOWER 2 START	+39.0	+6.5	-47.5	+114.0	-63.0	-102.8	
	X	Y	Z	PITCH	YAW	ROLL	PL ID
	-1081	-316	-250	43	335	206	5

[1] Expect SINGULAR It

[2] Near REACH LIMIT

BRAKES – ON (tb-ON)

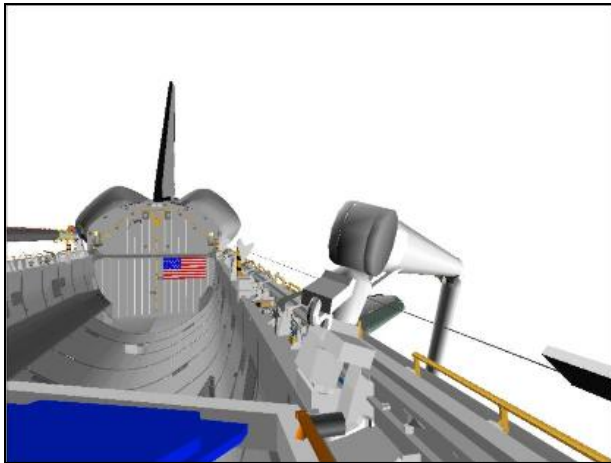

CCTV A (15,0)

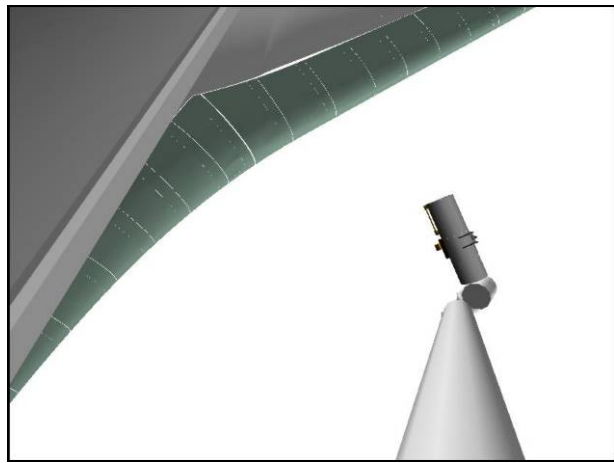

ELBOW (-20,5)



WRIST HFOV: 10.0

15. PORT LOWER 2
 RHC √RATE – VERN (RATE MIN tb-ON)

L10(VTR) REC pb – push, hold
 PLAY pb – push, simo (red ●)

BRAKES – OFF (tb-OFF)
 MODE – AUTO 4, ENTER (READY It on)

- * If unable to enter AUTO mode (no AUTO READY It): *
- * √Joint angles and adjust as reqd *

SM 94 PDRS CONTROL

√START PT, ITEM 17: 191

SM 169 PDRS STATUS

Monitor ACAS progress

NOTE

Port Lower 2 pass scans underside of Panels 11→18.
 Time between Pts 191 and 194 ~ 2:00 min

Port Lower 2 Clearance Views	Cameras
EE-to-RCC	ELBOW
RMS-to-PLBD	A, B, ELBOW

AUTO SEQ – PROCEED (IN PROG It on)

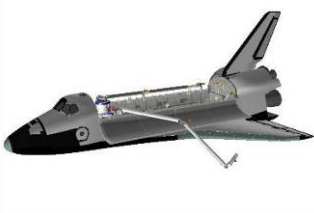
Pt	X	Y	Z	PITCH	YAW	ROLL	●
191P	-1081	-316	-250	43	335	206	
192	-1095	-327	-251	43	336	206	
193	-1106	-335	-250	39	347	207	
194P	-1110	-343	-246	37	355	205	

A7U When AUTO SEQ IN PROG It – off:
 CCTV – RMS WRIST, ZOOM: 20.0 HFOV

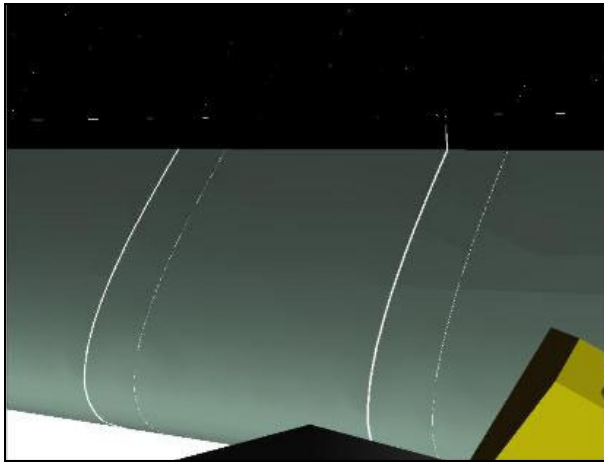

WRIST HFOV: 20.0

NOTE

Time between Pts 194 and 197 ~ 1:45 min

AUTO SEQ – PROCEED (IN PROG It on)

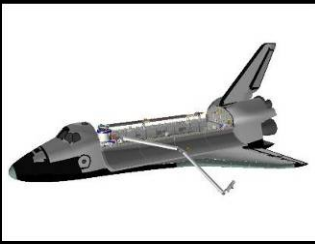
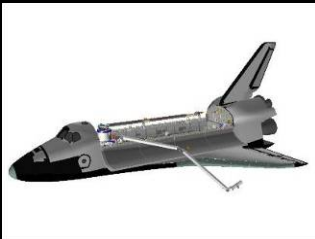
Pt	X	Y	Z	PITCH	YAW	ROLL	●
194P	-1110	-343	-246	37	355	205	
195	-1118	-364	-254	31	354	201	
196	-1126	-367	-253	29	4	202	
197P	-1127	-373	-250	27	10	204	

When AUTO SEQ IN PROG It – off:
BRAKES – ON (tb-ON)

L10(VTR) STOP pb – push (no red ●)

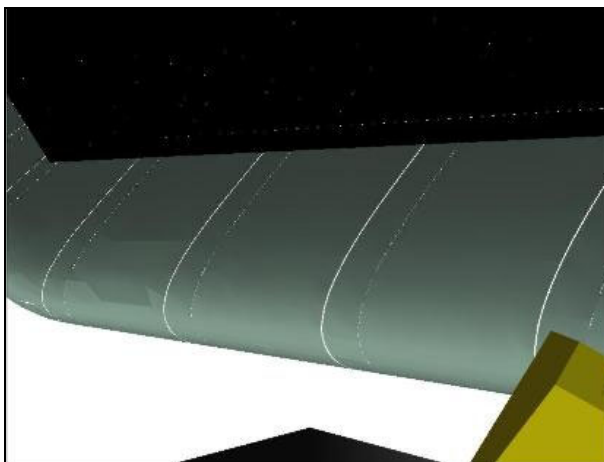

WRIST HFOV: 20.0

16. RETURN TO PRE-CRADLE

SM 94 PDRS CONTROL

PL ID - ITEM 3 +0 EXEC
 INIT ID - ITEM 24 +0 EXEC

√	X	Y	Z	PITCH	YAW	ROLL	PL ID
	-1127	-373	-250	27	10	204	0
√	SY	SP	EP	WP	WY	WR	
	+38.3	+2.7	-33.8	+65.8	-32.5	-133.2	

RHC RATE - as reqd (VERN within 10 ft)
 BRAKES - OFF (tb-OFF)
 MODE - SINGLE, ENTER

Mnvr to PRE-CRADLE posn:

PORT
 LOWER 2 End
 1: WR +
 2: WY +
 3: WP -
 4: EP +
 5: SP +
 6: SY -
 PRE-CRADLE

	SY	SP	EP	WP	WY	WR	
	+38.3	+2.7	-33.8	+65.8	-32.5	-133.2	
						0.0	
					0.0		
				+5.0			
			-25.0				
		+25.0					
	0.0						
	0.0	+25.0	-25.0	+5.0	0.0	0.0	
	X	Y	Z	PITCH	YAW	ROLL	PL ID
	-1261	-146	-551	5	2	0	0

BRAKES - ON (tb-ON)
 MODE - not DIRECT
 PARAM - PORT TEMP
 JOINT - CRIT TEMP

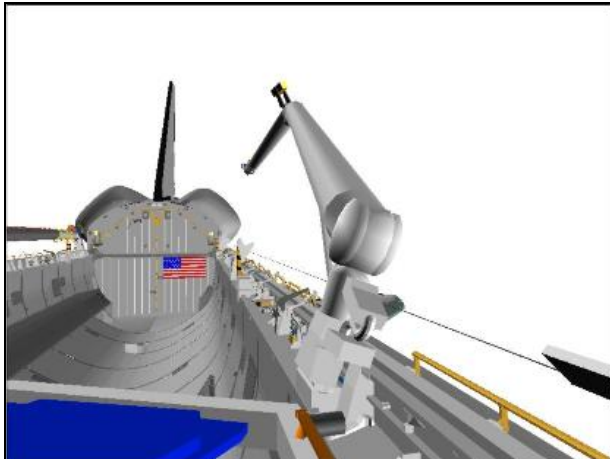

CCTV A (0,0)

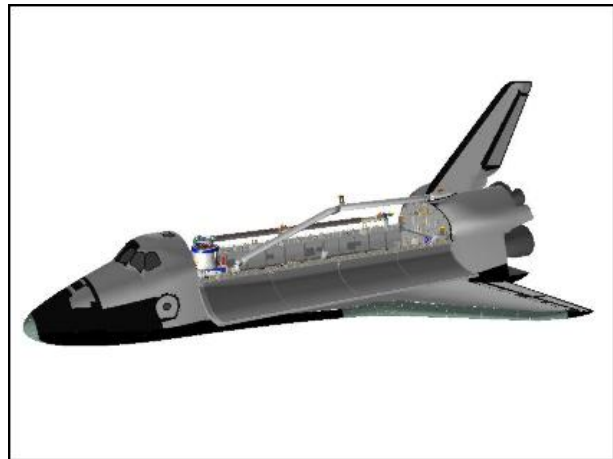

BIRD'S EYE

OBSS SURVEY CAMERA VIEWS

I

OBSS LDRI RCC SURVEY CAMERA VIEWS – STBD UNDOCKED	FS 5-2
– NOSE CAP	FS 5-15
– PORT	FS 5-27
– STBD DOCKED	FS 5-39
IDC RCC SURVEY CAMERA VIEWS – STBD.....	FS 5-63
– NOSE CAP	FS 5-73
– PORT	FS 5-87
SRMS EE CAM CREW CABIN SURVEY CAMERA VIEWS	FS 5-97

OBSS LDRI RCC SURVEY CAMERA VIEWS – STBD UNDOCKED

STBD UNDOCKED LDRI RCC SURVEY – Pause Pt 1

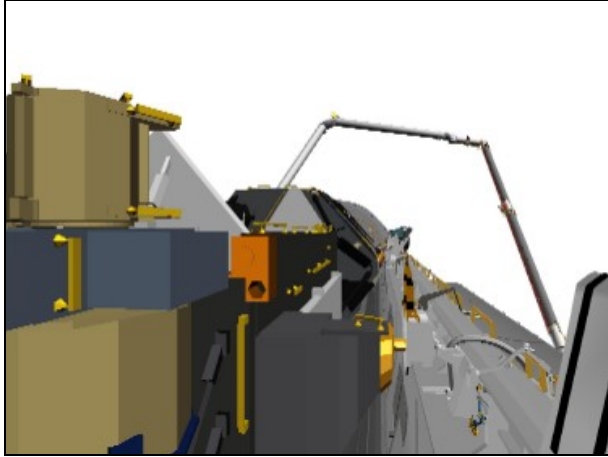

CCTV C (-10,0)

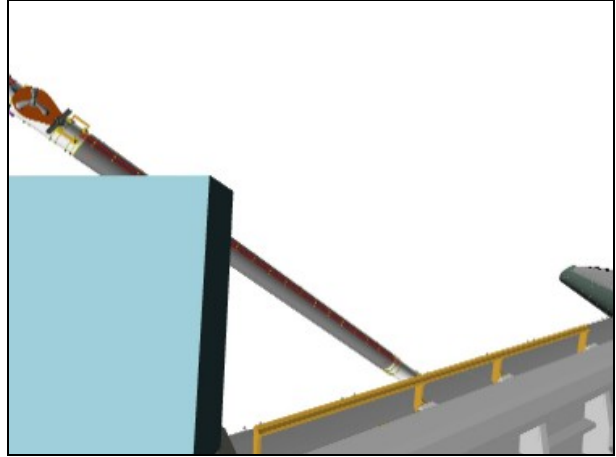

CCTV D (-60,-5)

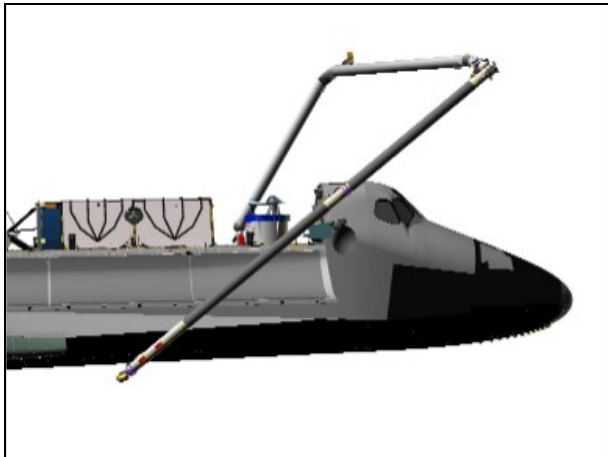

STBD

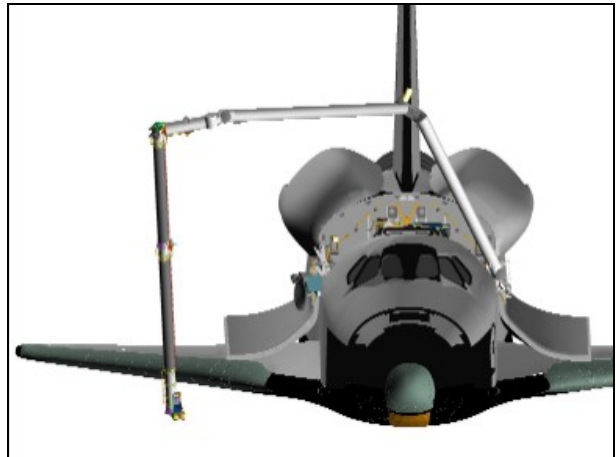

FRONT

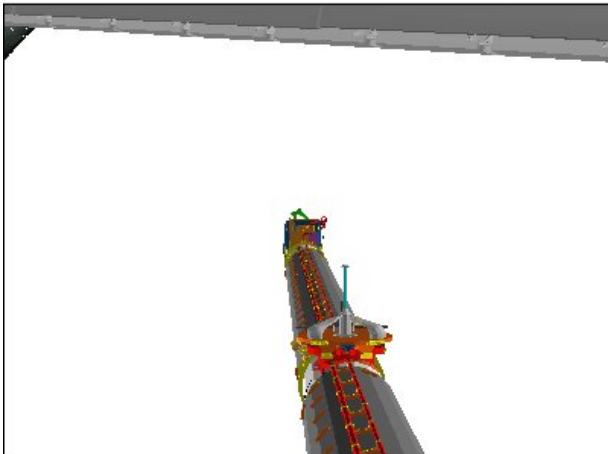

RSC

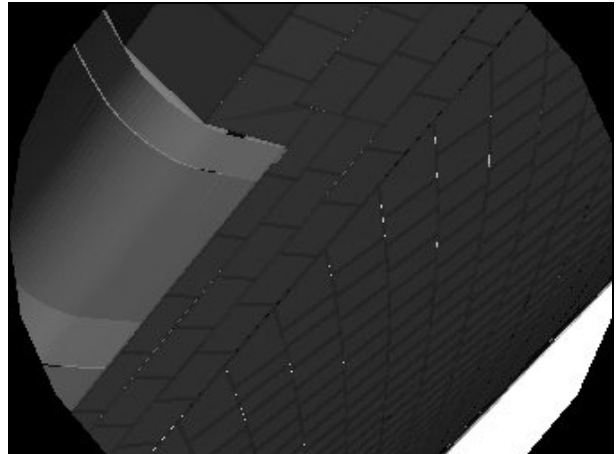

LDRI (95,-105)

OBSS SURVEY
CAMERA VIEWS

STBD UNDOCKED LDRI RCC SURVEY – Pause Pt 5

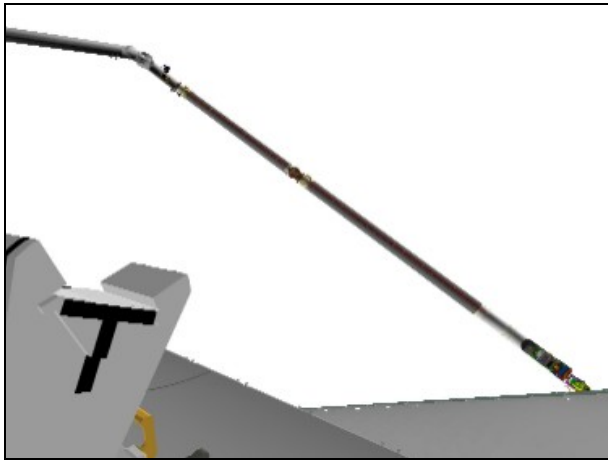

CCTV C (50,-5)

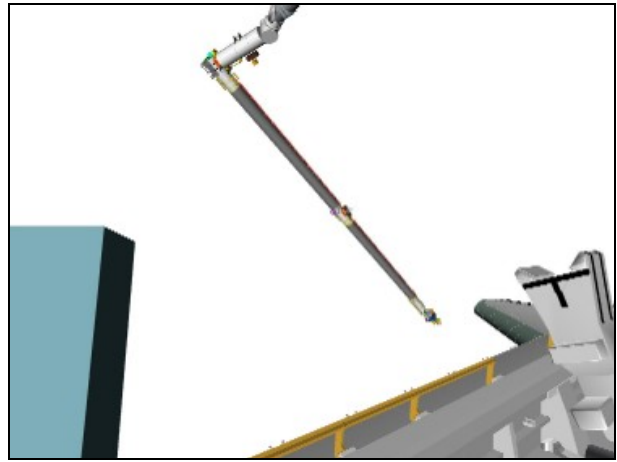

CCTV D (-50,0)

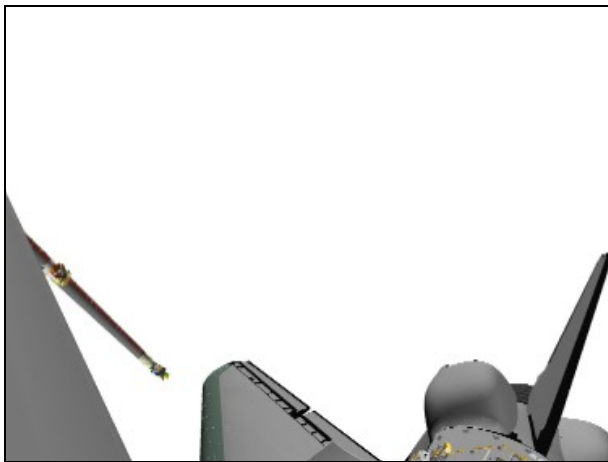

ELBOW (40,-35)

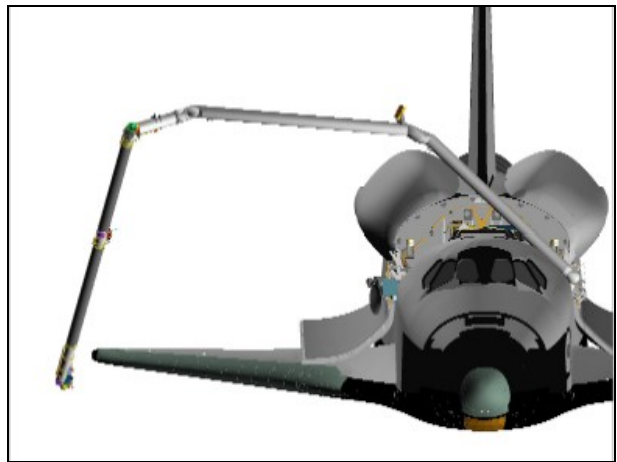

FRONT

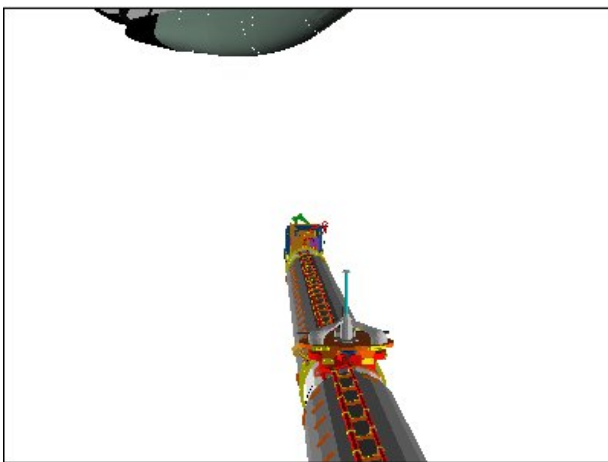

RSC

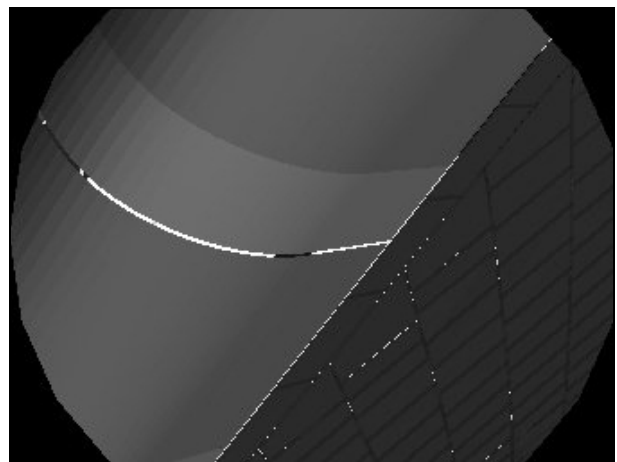

LDRI (95,-105)

STBD UNDOCKED LDRI RCC SURVEY – Pause Pt 7

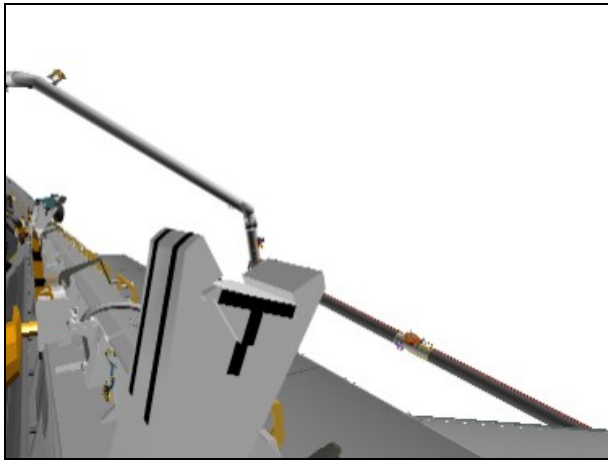

CCTV C (35,-5)

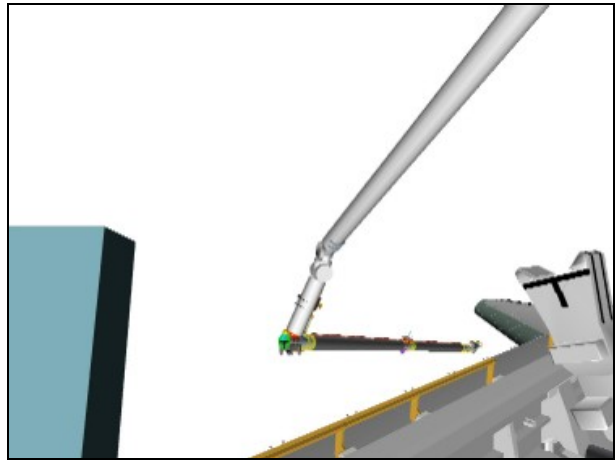

CCTV D (-50,0)

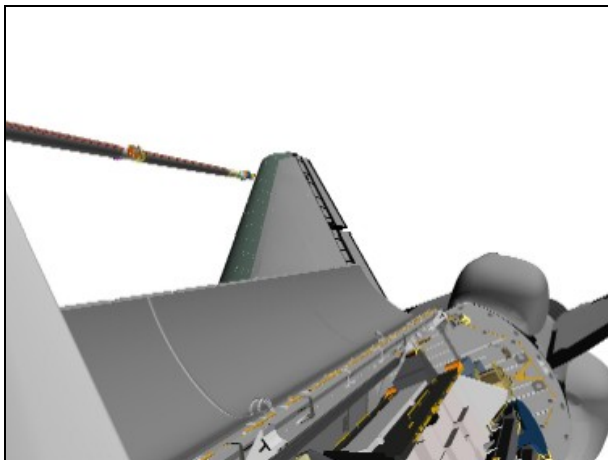

ELBOW (40,-35)

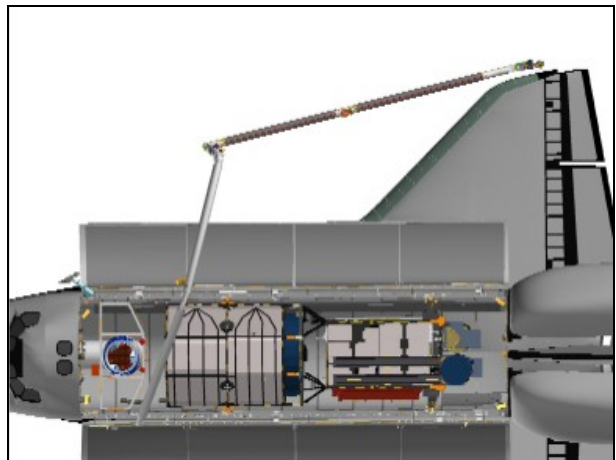

OVERHEAD



RSC

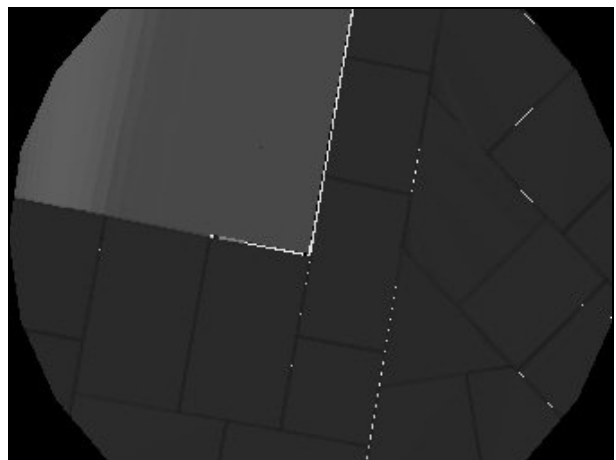

LDRI (80,-65)

STBD UNDOCKED LDRI RCC SURVEY – Pause Pt 12

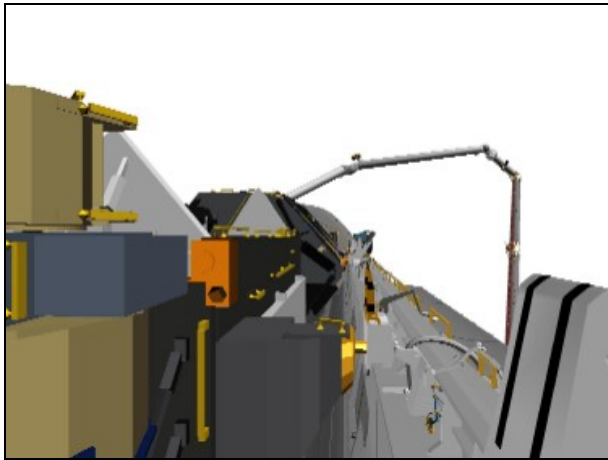

CCTV C (-5,0)

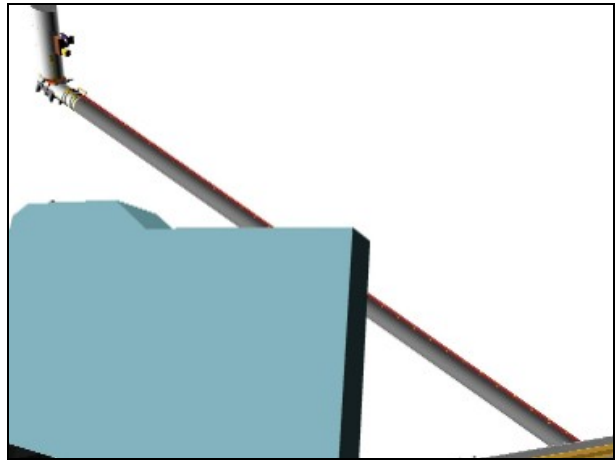

CCTV D (-75,0)

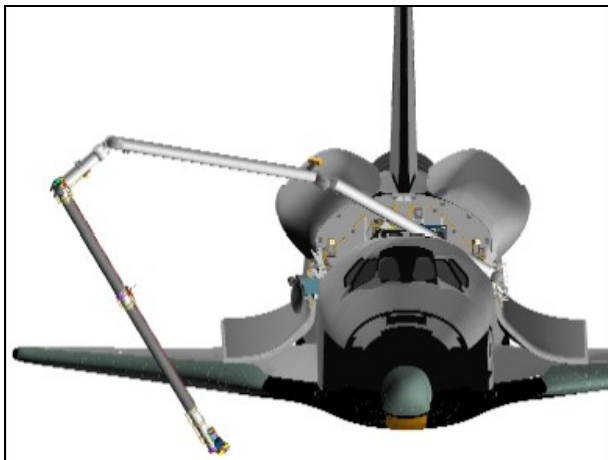

FRONT

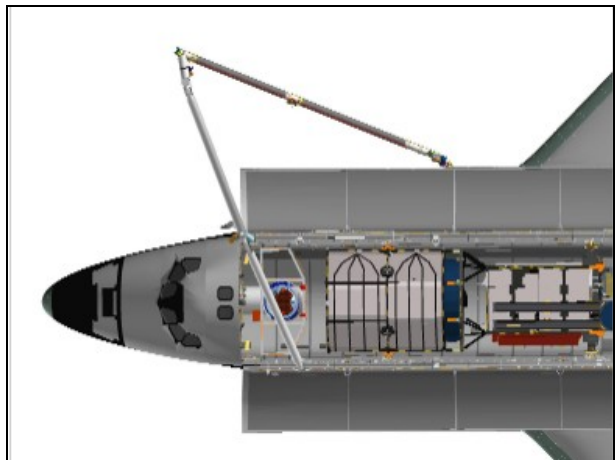

OVERHEAD

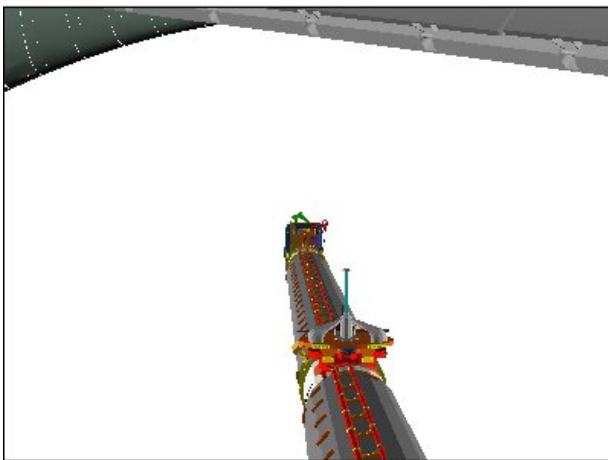

RSC

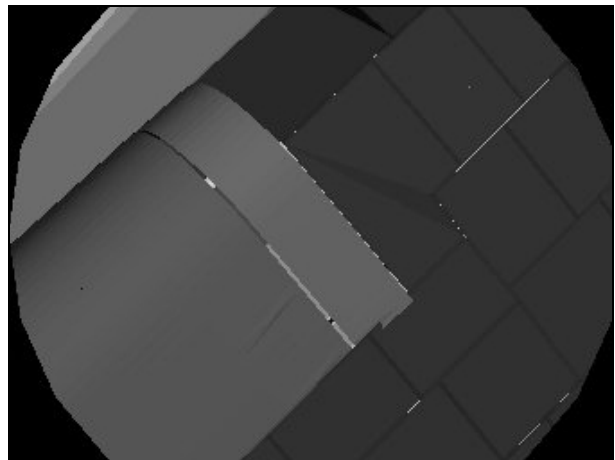

LDRI (80,-65)

STBD UNDOCKED LDRI RCC SURVEY – Pause Pt 17

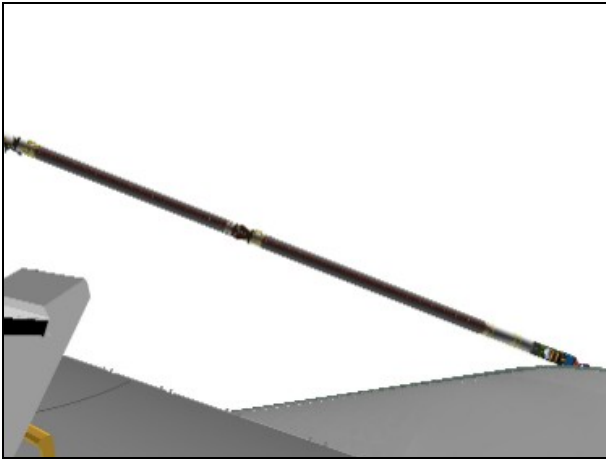

CCTV C (60,-5)

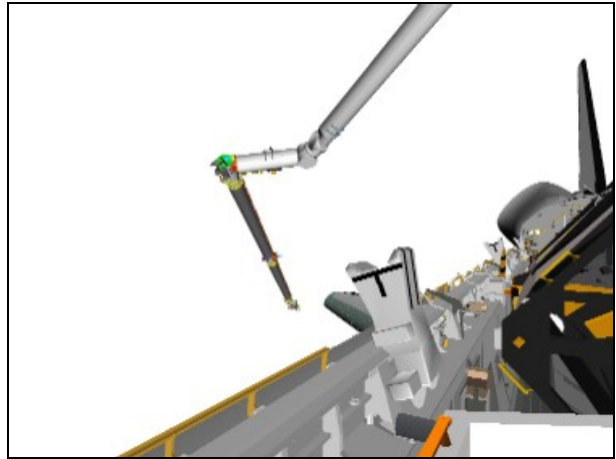

CCTV D (-30,0)

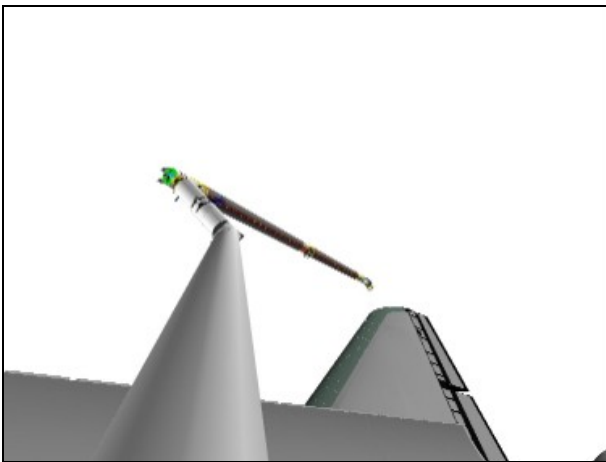

ELBOW (10,-5)

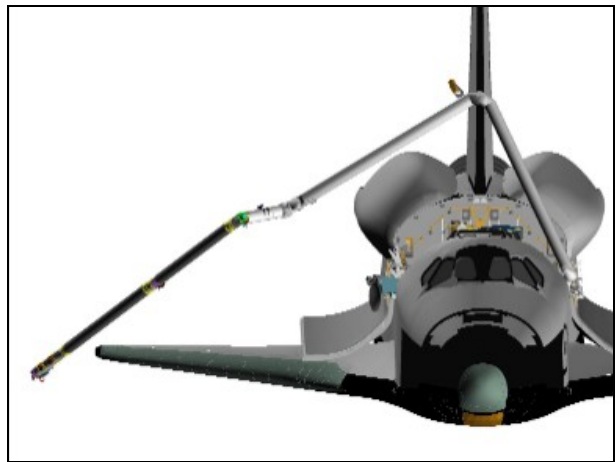

FRONT

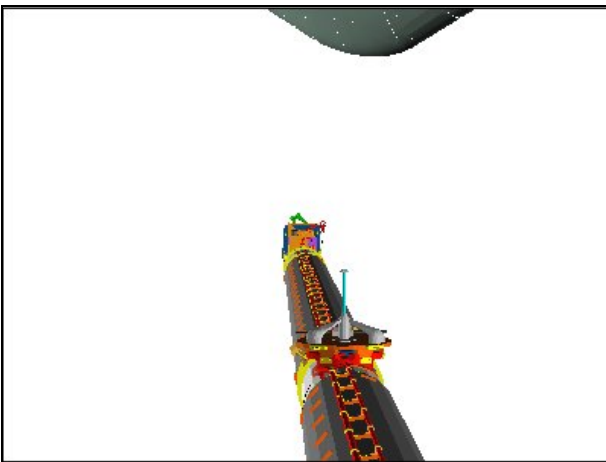

RSC

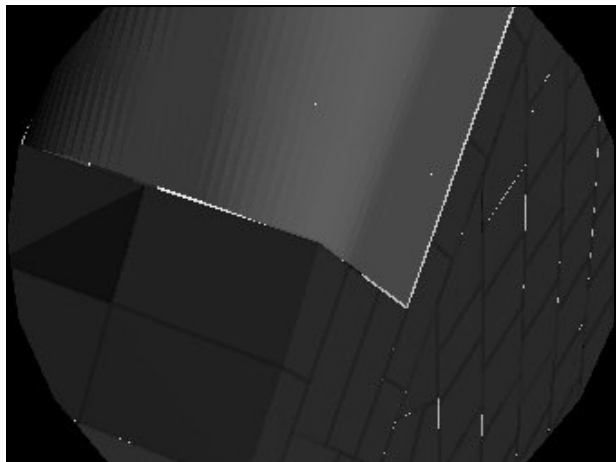

LDRI (80,-65)

STBD UNDOCKED LDRI RCC SURVEY – Pause Pt 22

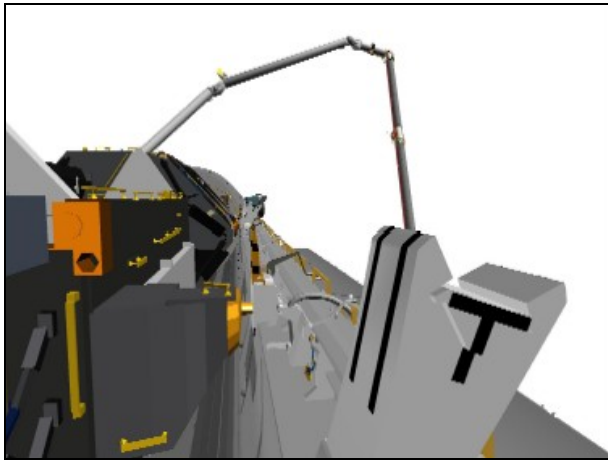

CCTV C (10,-5)

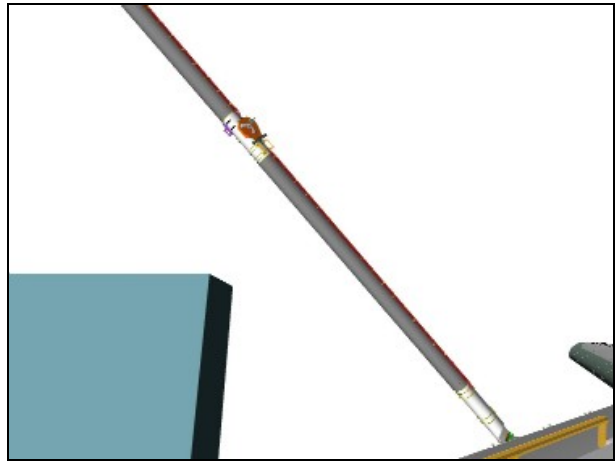

CCTV D (-60,5)

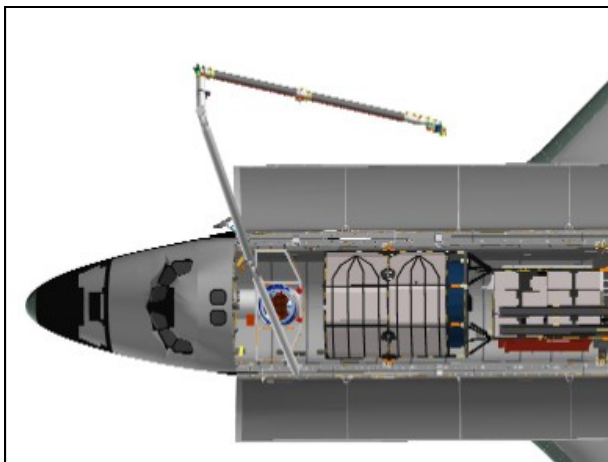

OVERHEAD

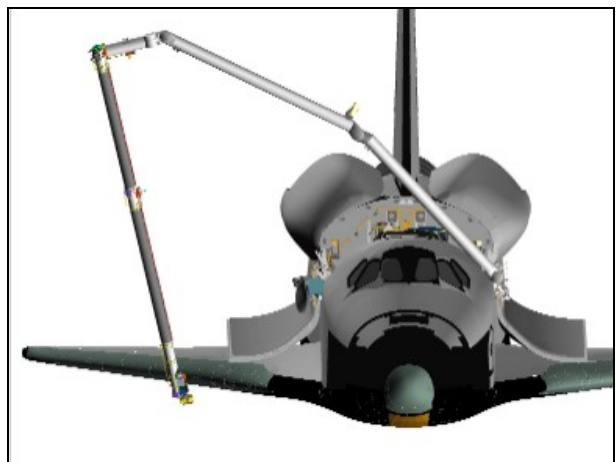

FRONT



RSC

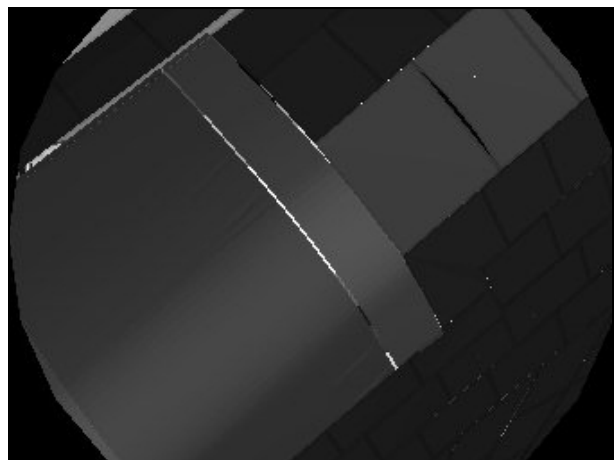

LDRI (80,-90)

STBD UNDOCKED LDRI RCC SURVEY – Pause Pt 23

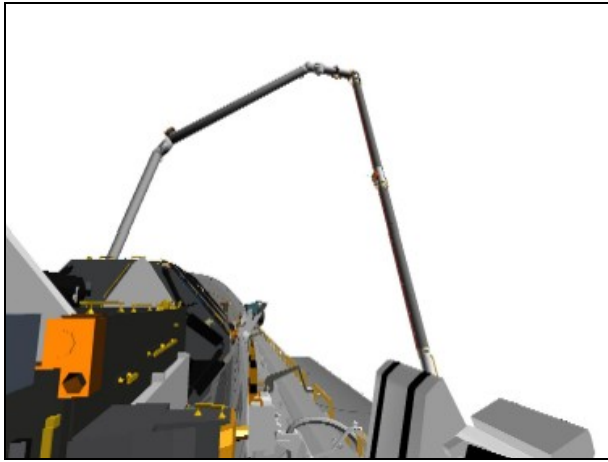

CCTV C (10,10)

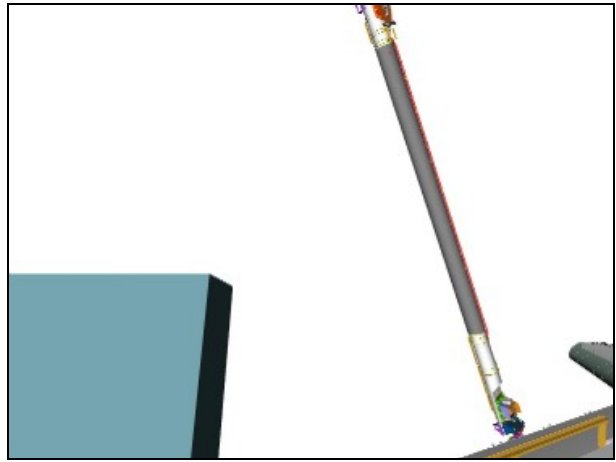

CCTV D (-60,5)

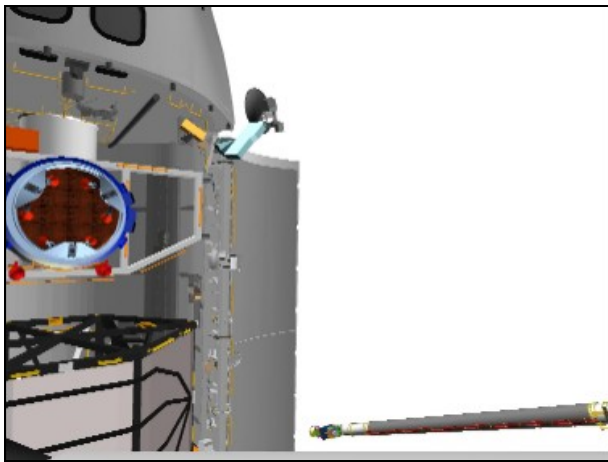

ELBOW (-90,-45)

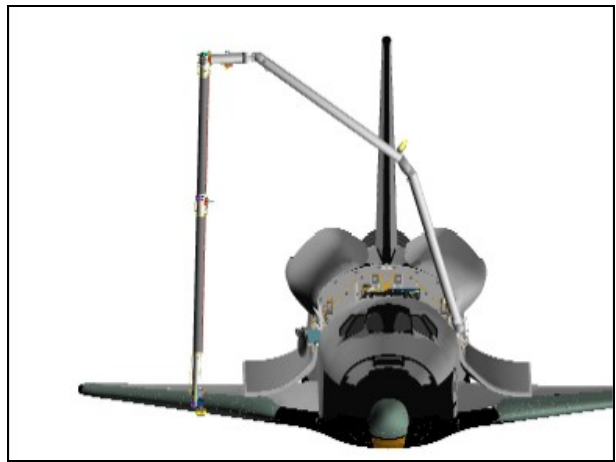

FRONT

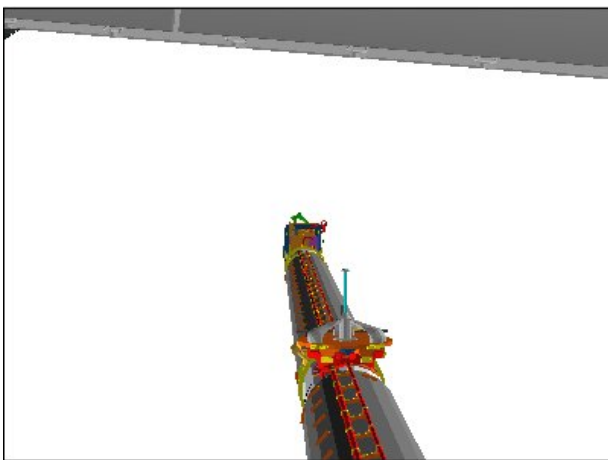

RSC

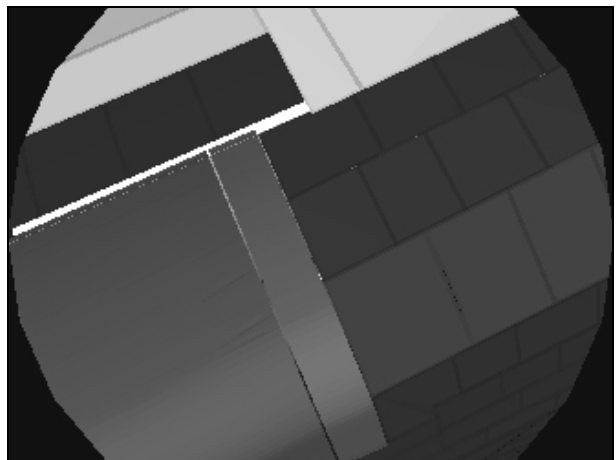

LDRI (80,-85)

STBD UNDOCKED LDRI RCC SURVEY – Pause Pt 26



CCTV C (10,10)

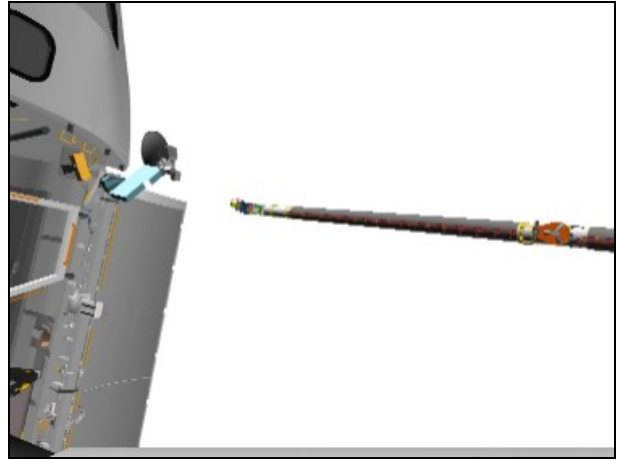

ELBOW (-90,-45)

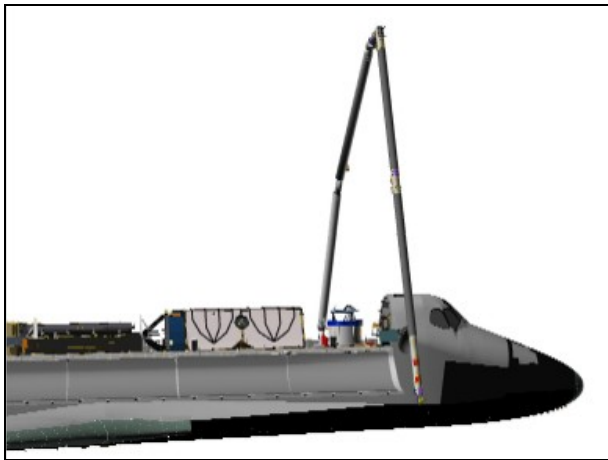

STBD



FRONT

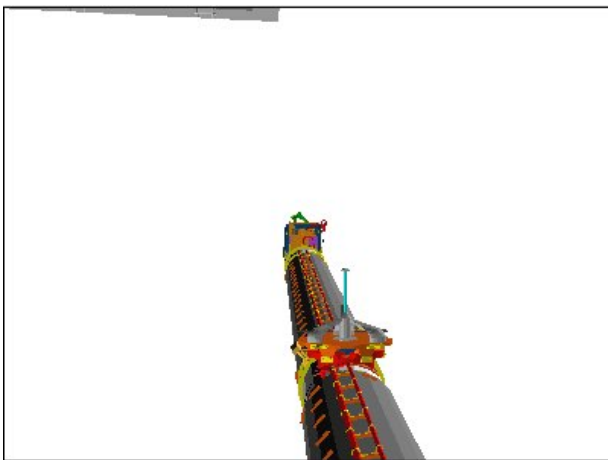

RSC

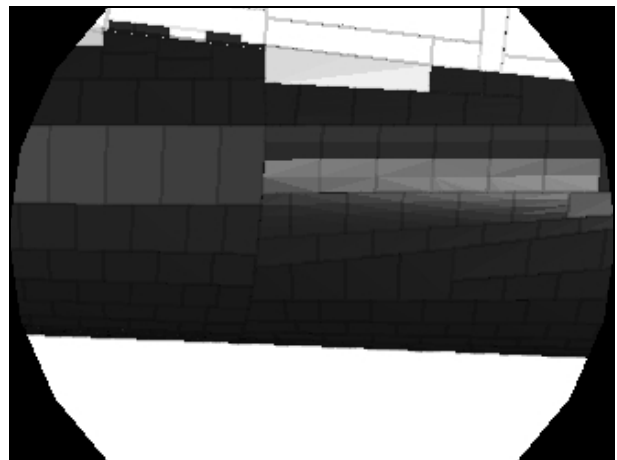

LDRI (80,-85)

STBD UNDOCKED LDRI RCC SURVEY – Pause Pt 32



CCTV C (10,10)

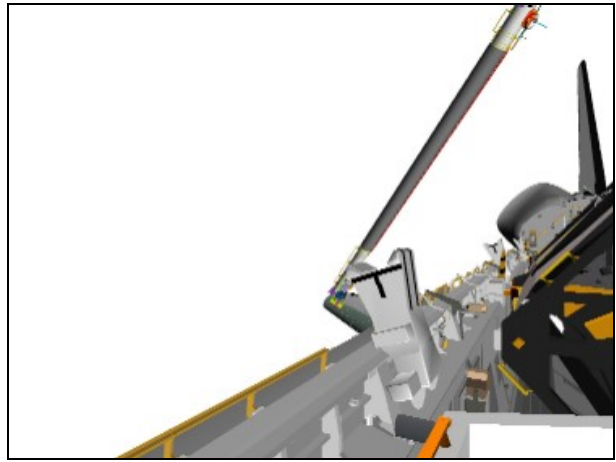

CCTV D (-30,0)

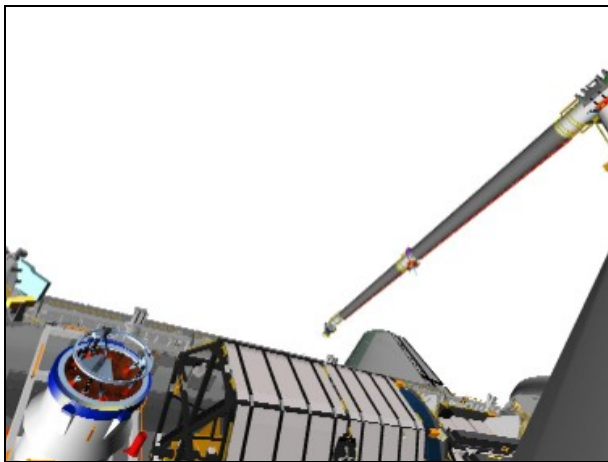

ELBOW (-40,-10)

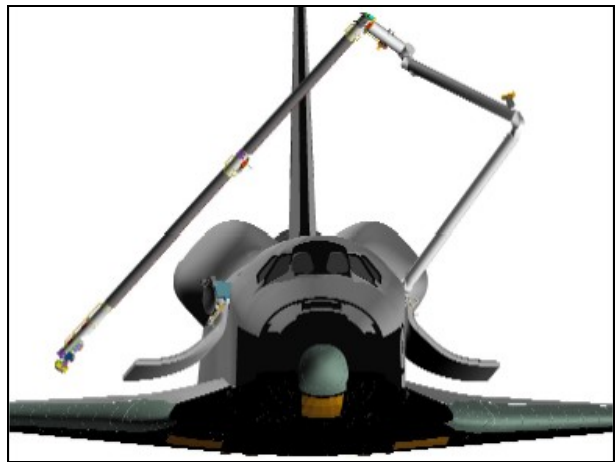

FRONT

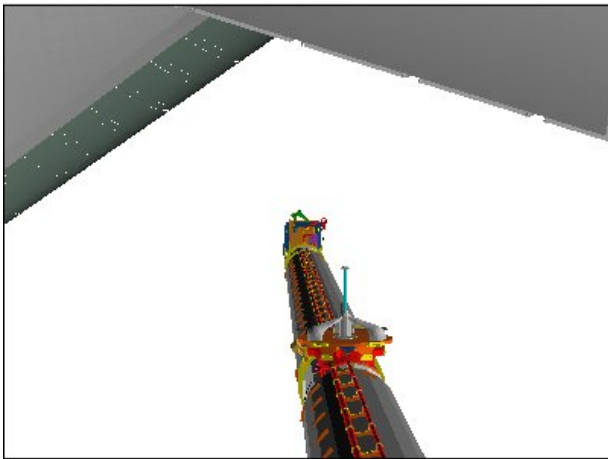

RSC

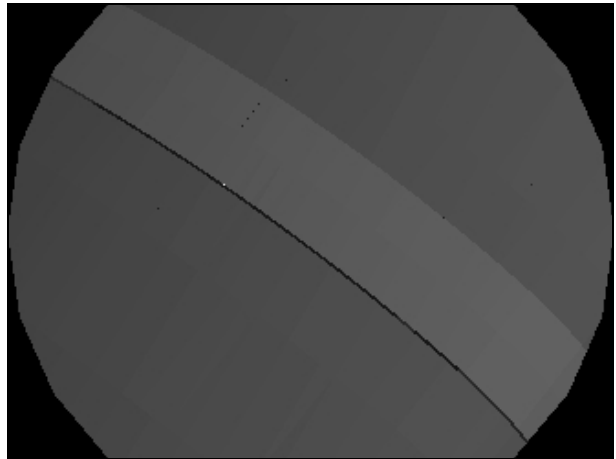

LDRI (80,-85)

STBD UNDOCKED LDRI RCC SURVEY – Pause Pt 33

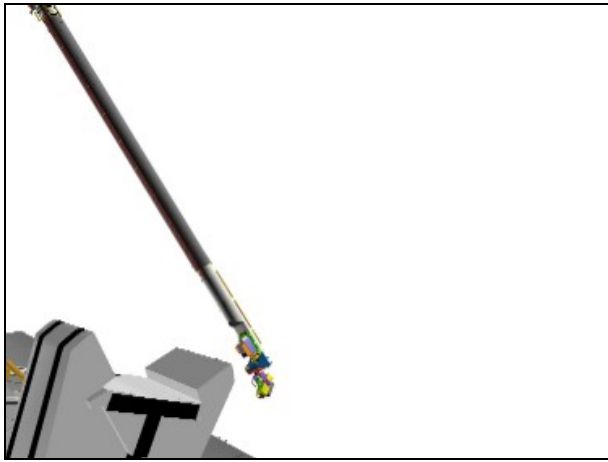

CCTV C (45,5)

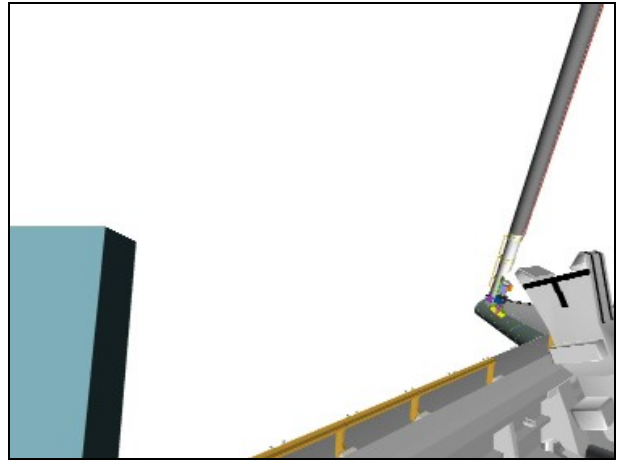

CCTV D (-50,0)

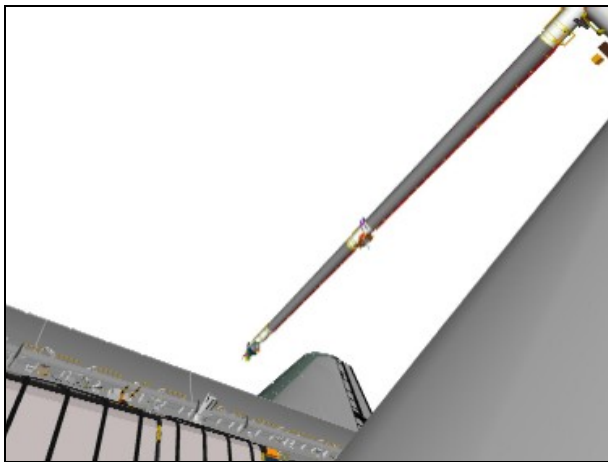

ELBOW (-40,-30)



FRONT

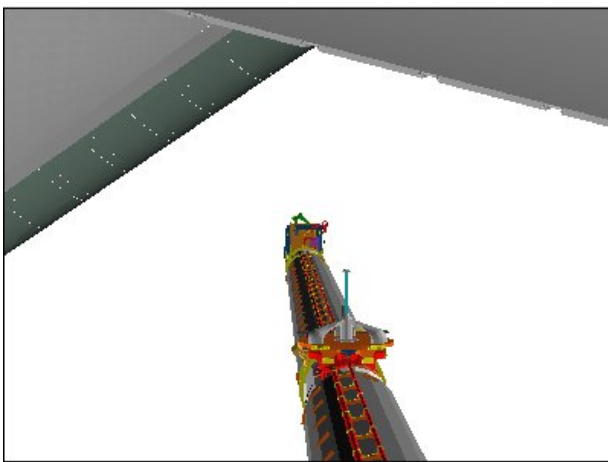

RSC

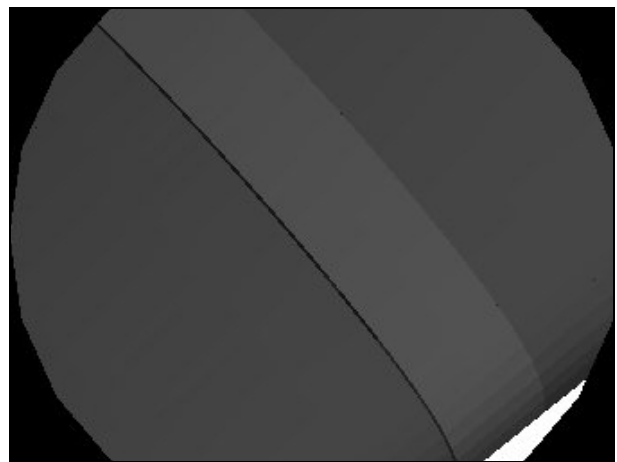

LDRI (80,-105)

STBD UNDOCKED LDRI RCC SURVEY – Pause Pt 37

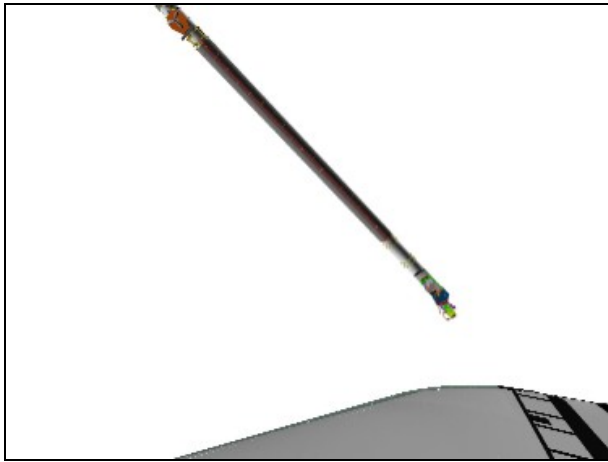

CCTV C (75,0)

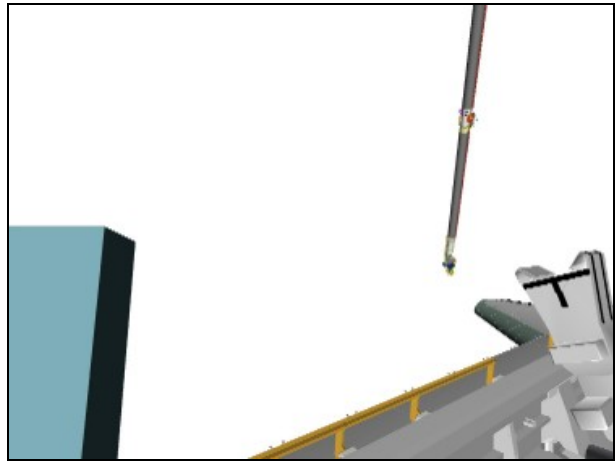

CCTV D (-50,0)

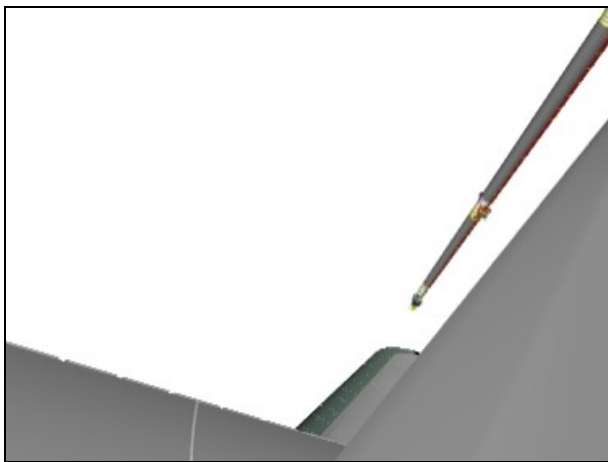

ELBOW (-40,-30)



FRONT

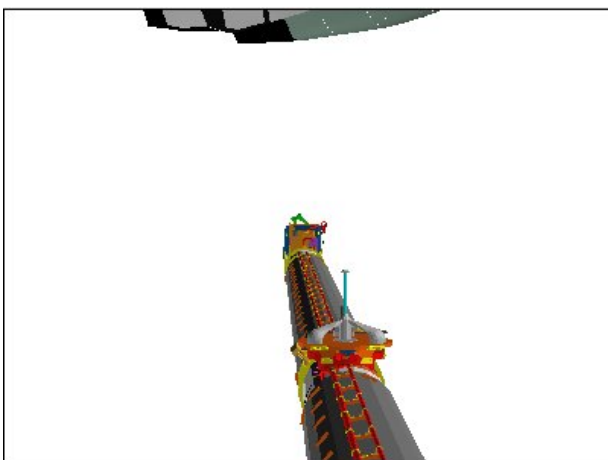

RSC

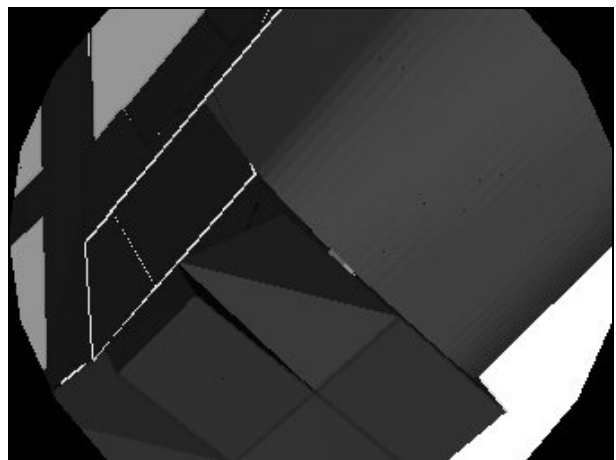

LDRI (80,-105)

STBD UNDOCKED LDRI RCC SURVEY – Pause Pt 38

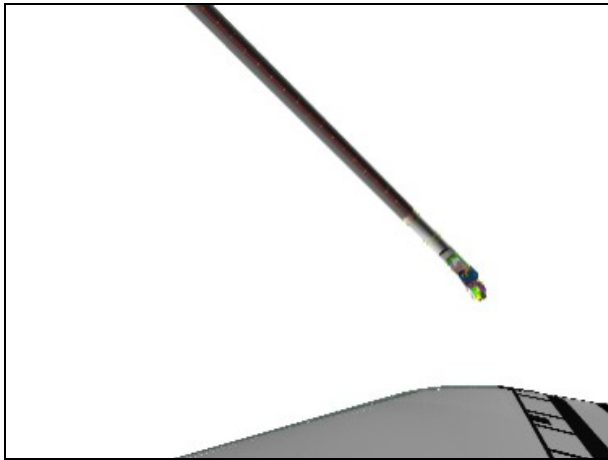

CCTV C (75,0)

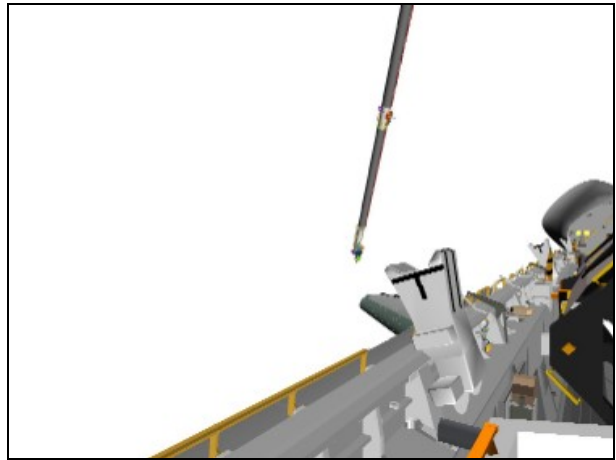

CCTV D (-35,0)

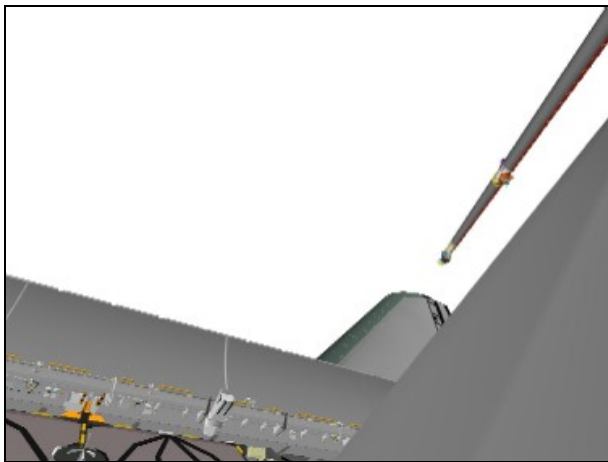

ELBOW (-40,-30)

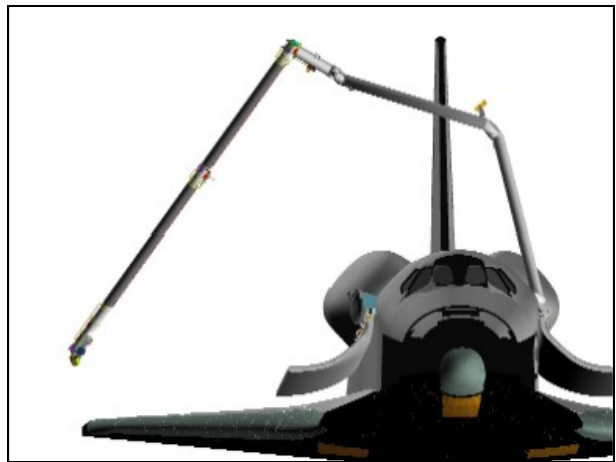

FRONT

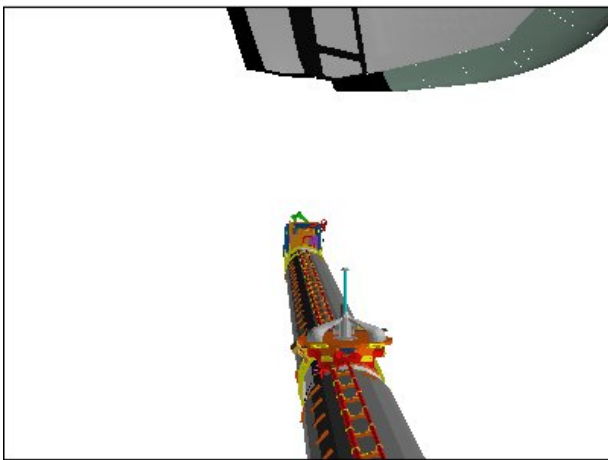

RSC

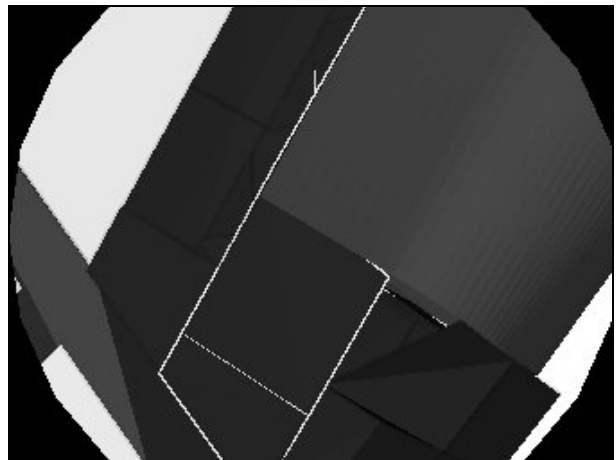

LDRI (50,-115)

STBD UNDOCKED LDRI RCC SURVEY – Pause Pt 46

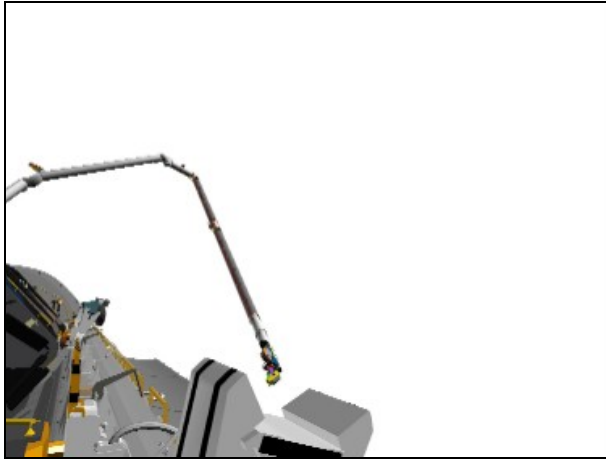

CCTV C (30,10)

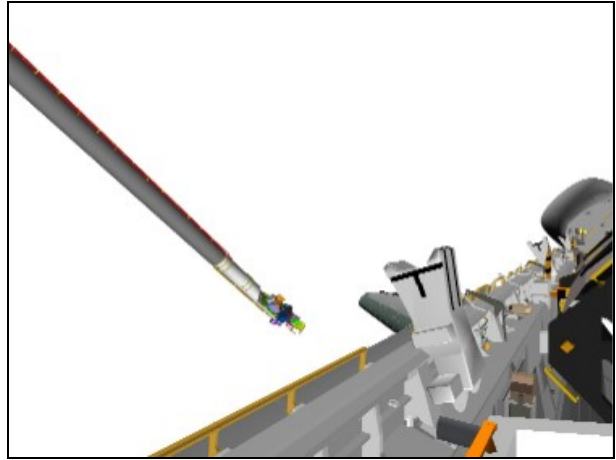

CCTV D (-35,0)

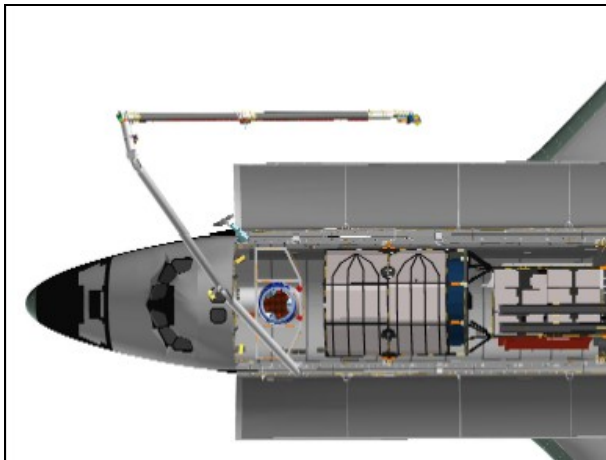

OVERHEAD



FRONT

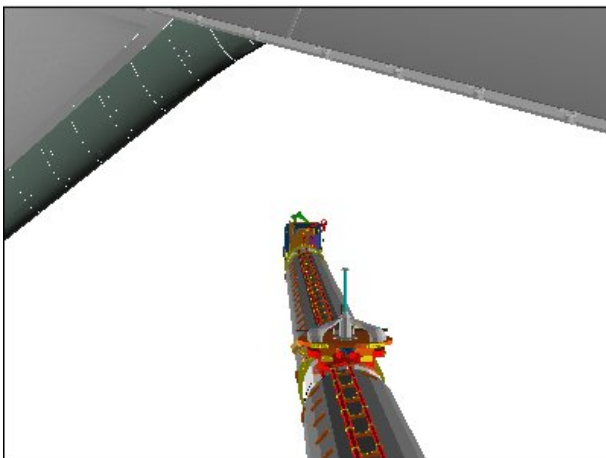

RSC

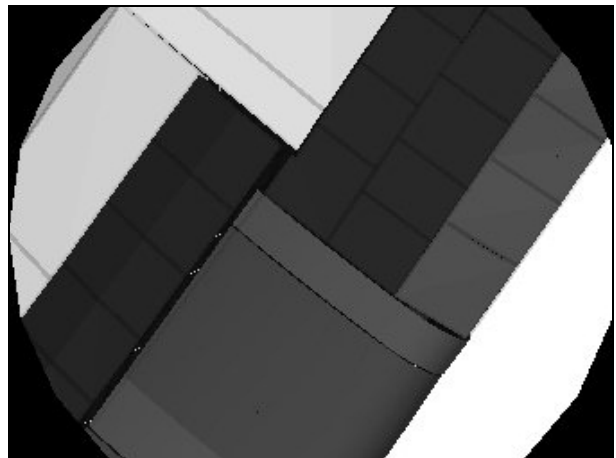

LDRI (50,-115)

OBSS LDRI RCC SURVEY CAMERA VIEWS – NOSE CAP

NOSE CAP LDRI RCC SURVEY – Pause Pt 47

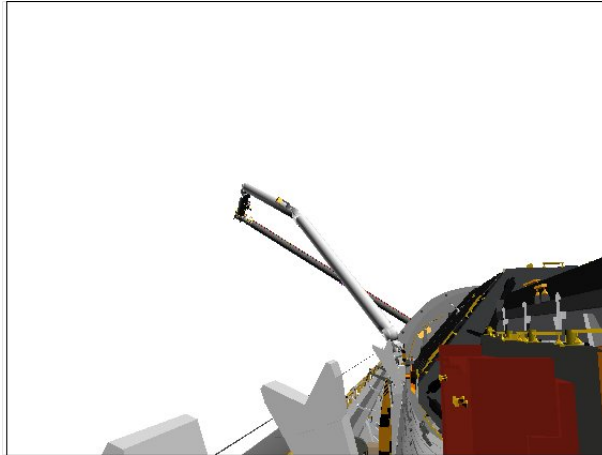

CCTV B (-10,10)

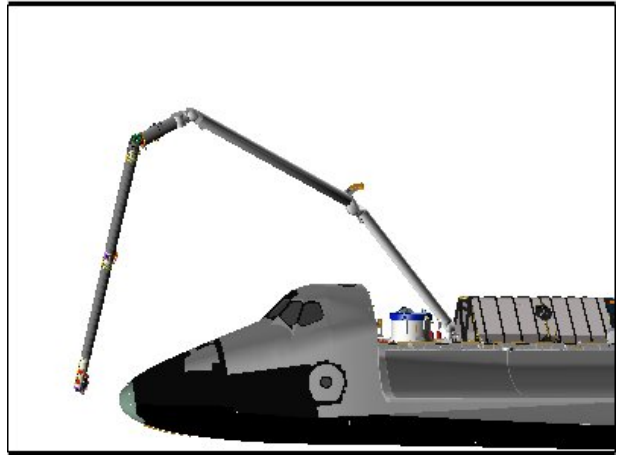

PORT

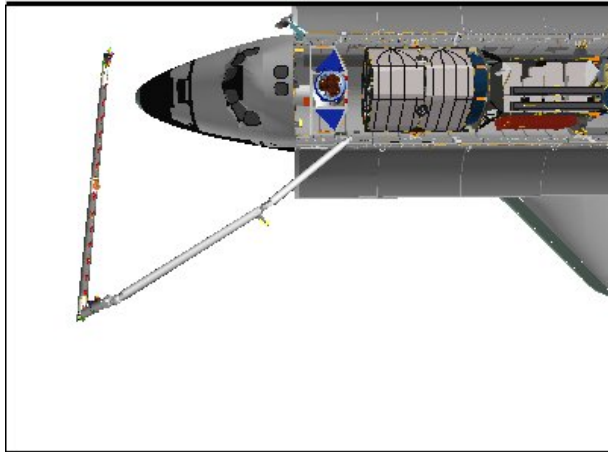

OVERHEAD



FRONT



RSC

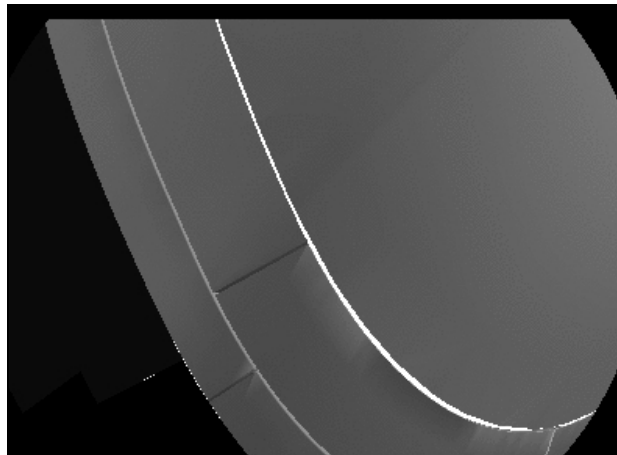

LDRI (0,-45)

NOTE

All LDRI views are shown after any pan/tilt changes at that position

NOSE CAP LDRI RCC SURVEY – Pause Pt 49

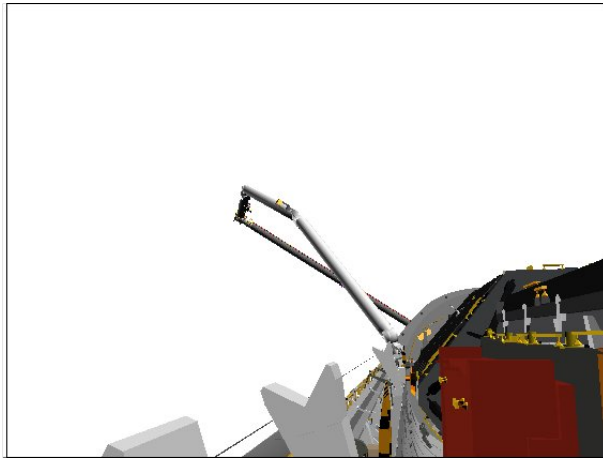

CCTV B (-10,10)

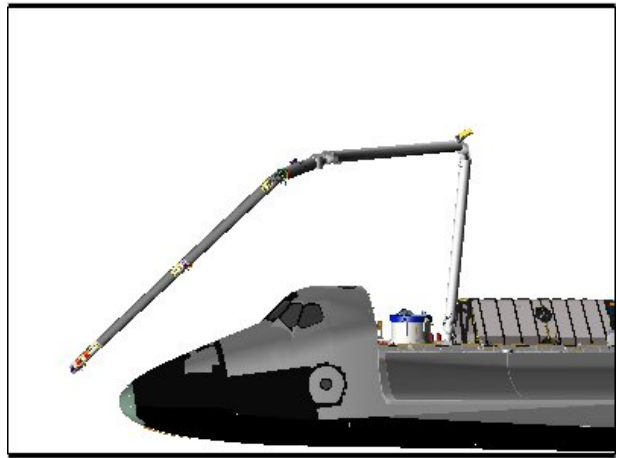

PORT

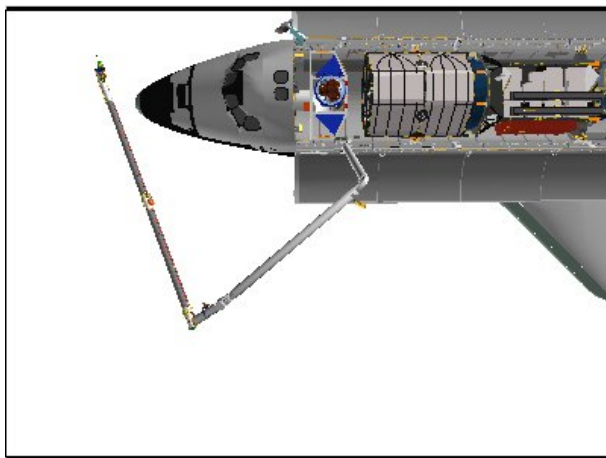

OVERHEAD



FRONT



RSC

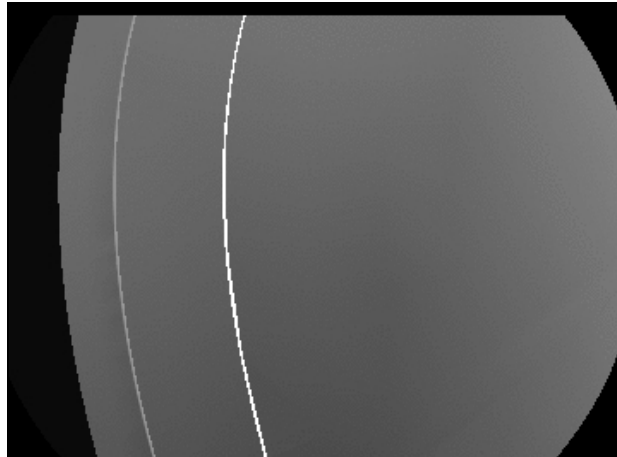

LDRI (0,-45)

NOSE CAP LDRI RCC SURVEY – Pause Pt 51

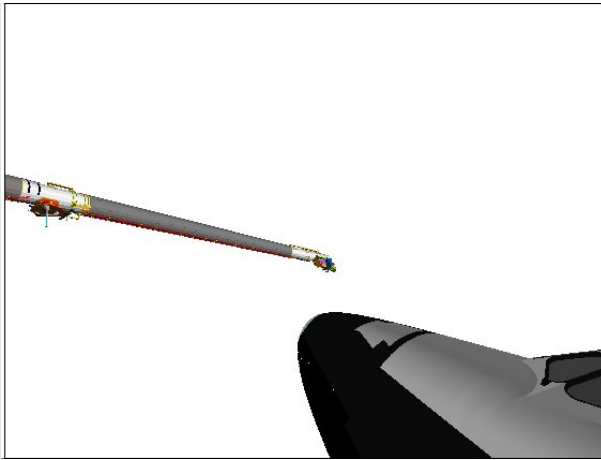

ELBOW (90,-60)

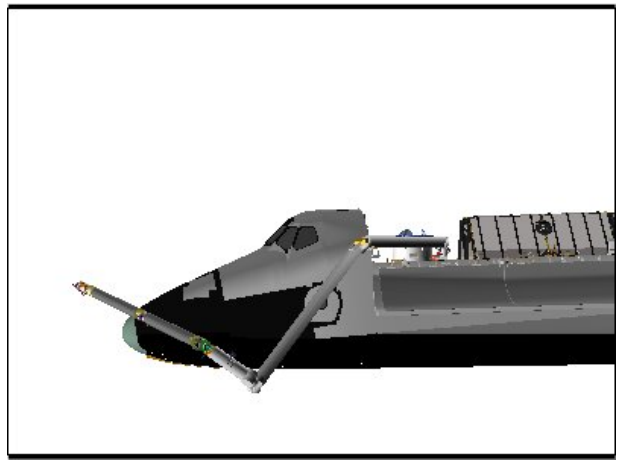

PORT

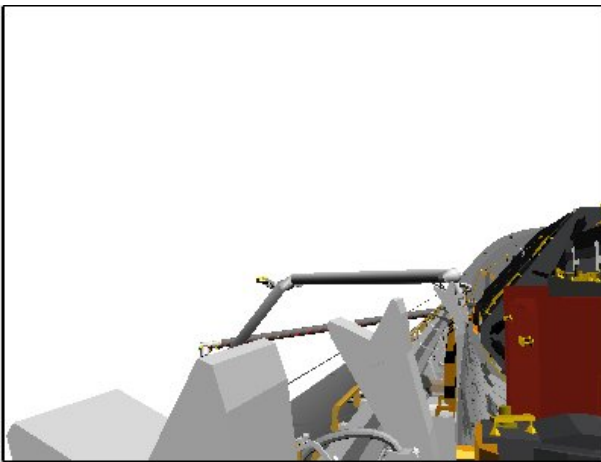

CCTV B (-16,4)



FRONT

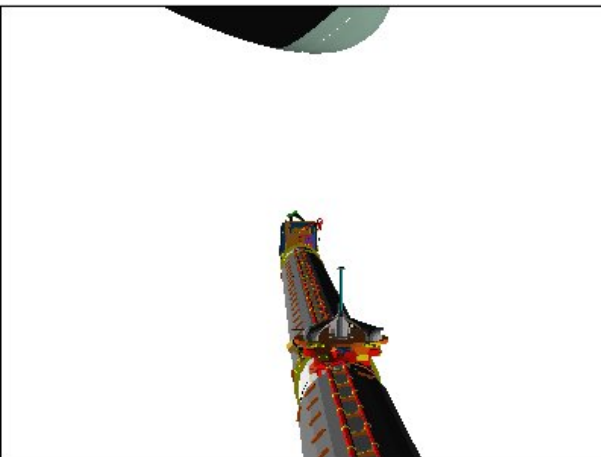

RSC

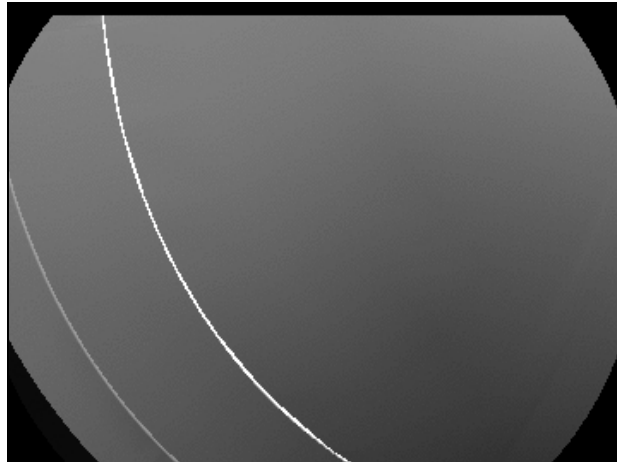

LDRI (75,-55)

NOSE CAP LDRI RCC SURVEY – Pause Pt 56

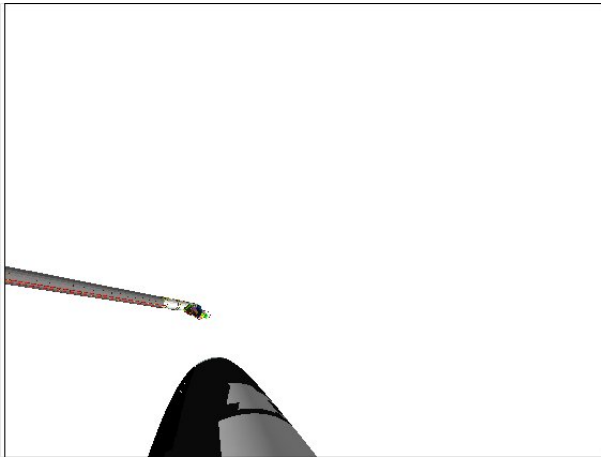

ELBOW (90,-60)

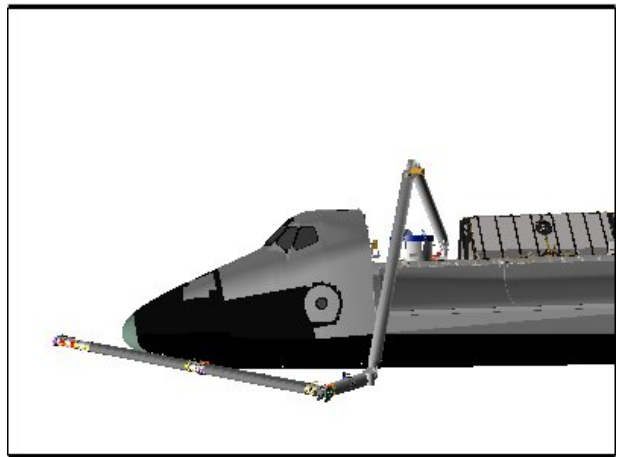

PORT

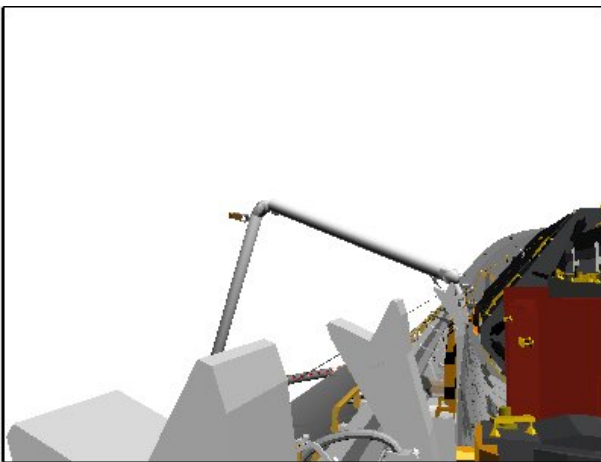

CCTV B (-16,4)

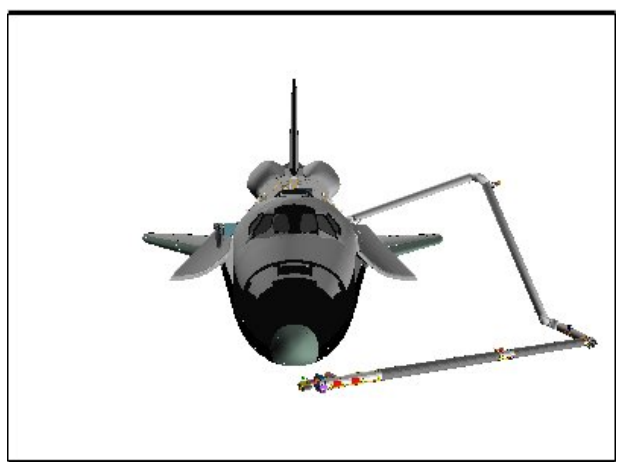

FRONT



RSC



LDRI (75,-55)

NOSE CAP LDRI RCC SURVEY – Pause Pt 57

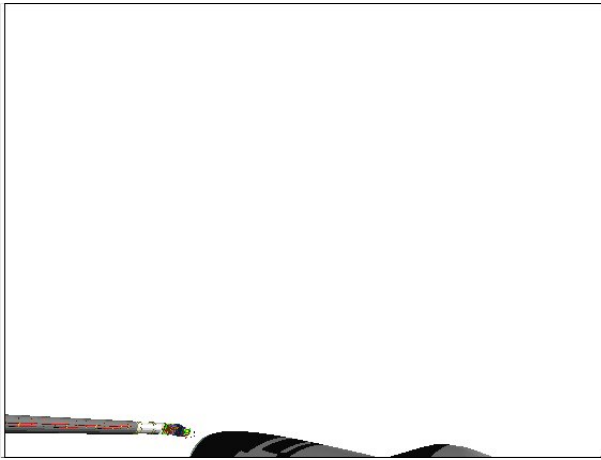

ELBOW (90,-60)

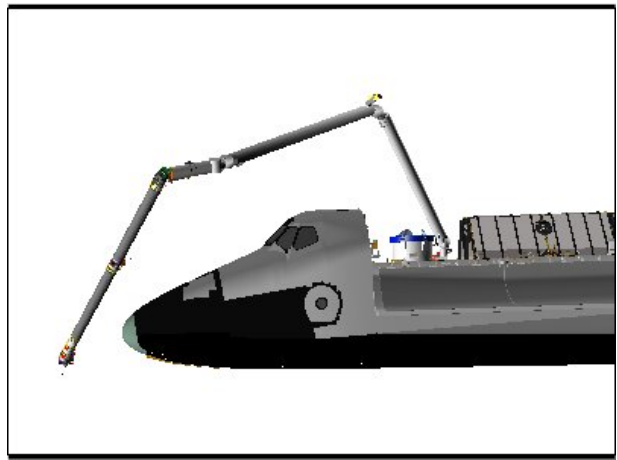

PORT

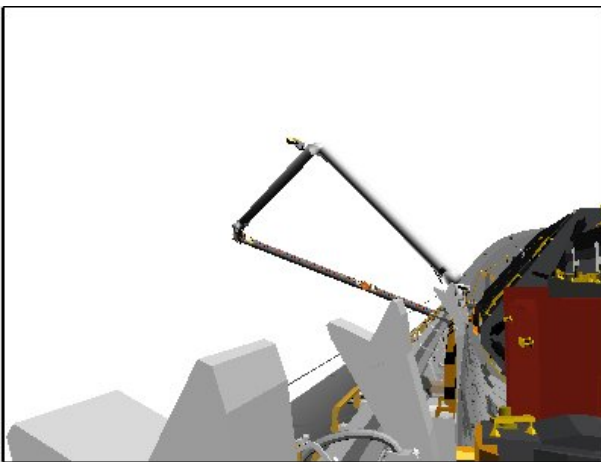

CCTV B (-16,4)

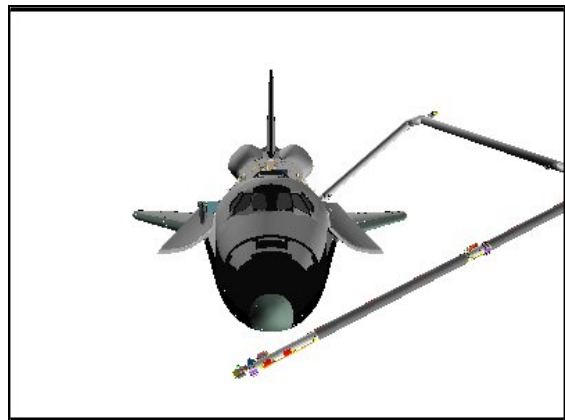

FRONT

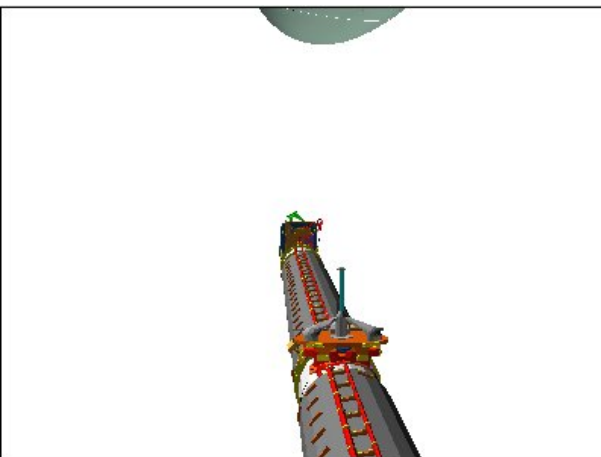

RSC

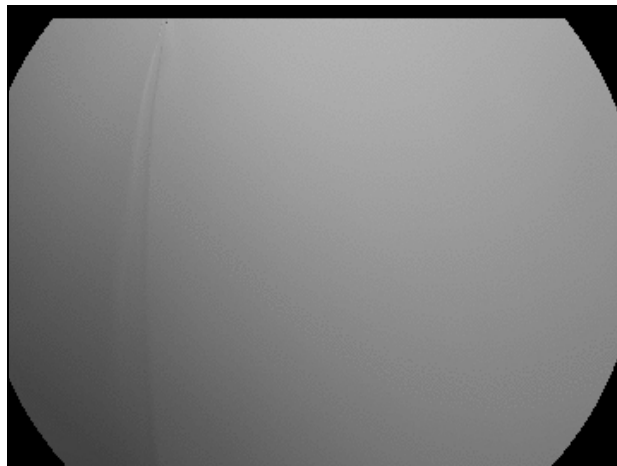

LDRI (75,-43)

NOSE CAP LDRI RCC SURVEY – Pause Pt 59

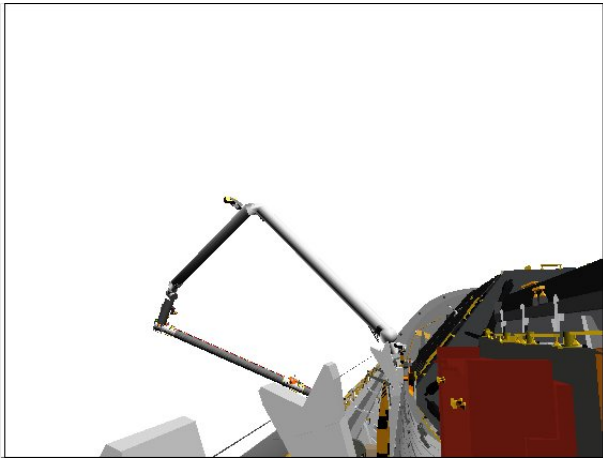

CCTV B (-10,10)

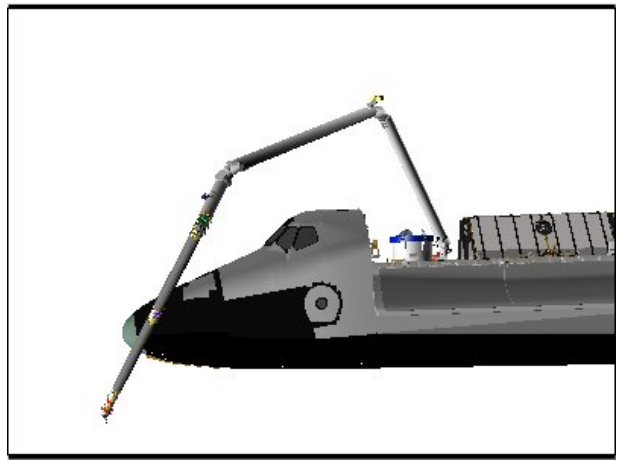

PORT



CCTV A (90,20)

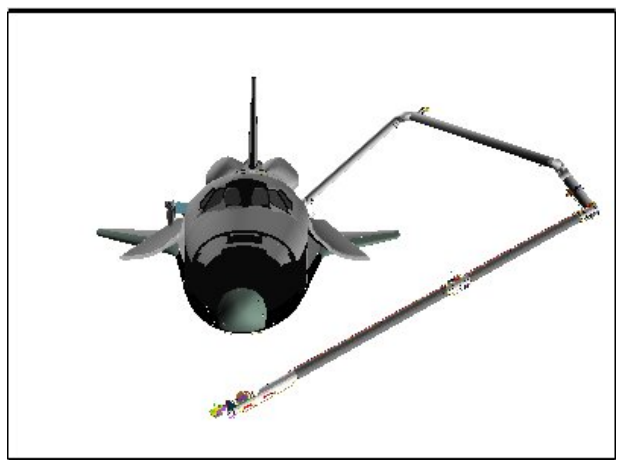

FRONT



RSC

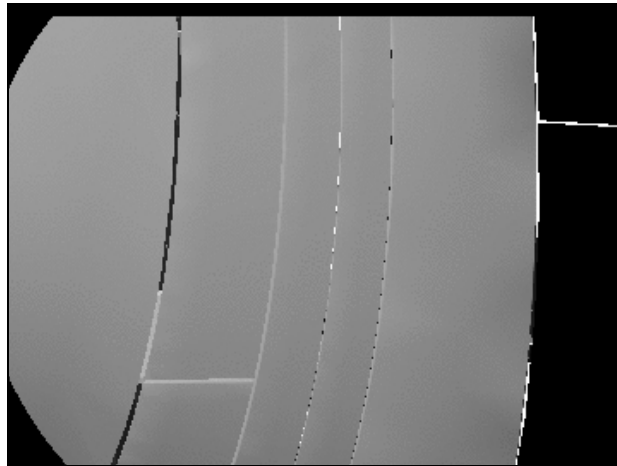

LDRI (75,-43)

NOSE CAP LDRI RCC SURVEY – Pause Pt 60

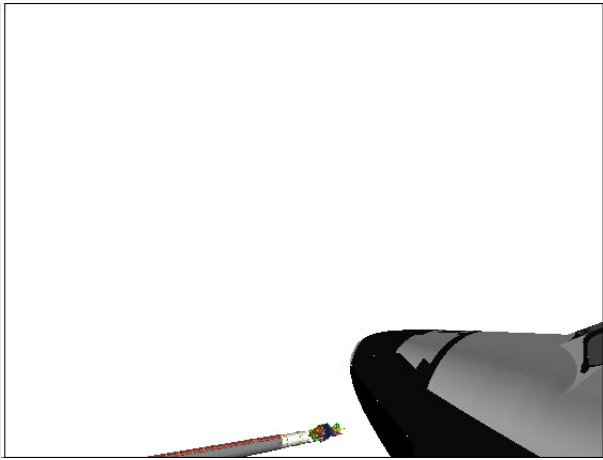

ELBOW (90,-60)

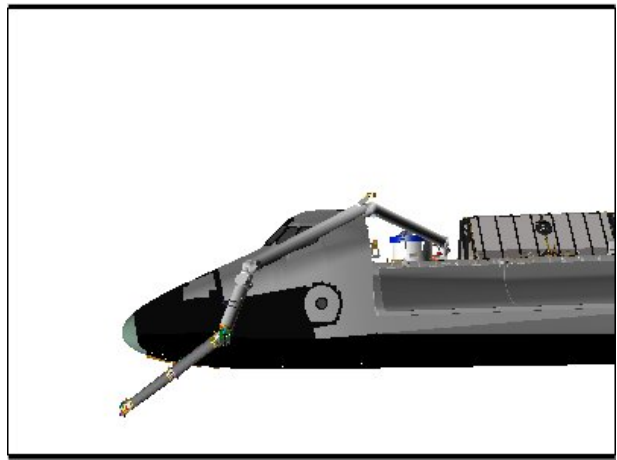

PORT

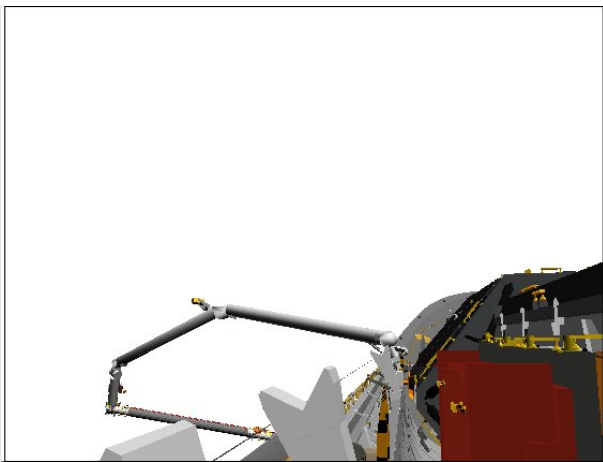

CCTV B (-10,10)

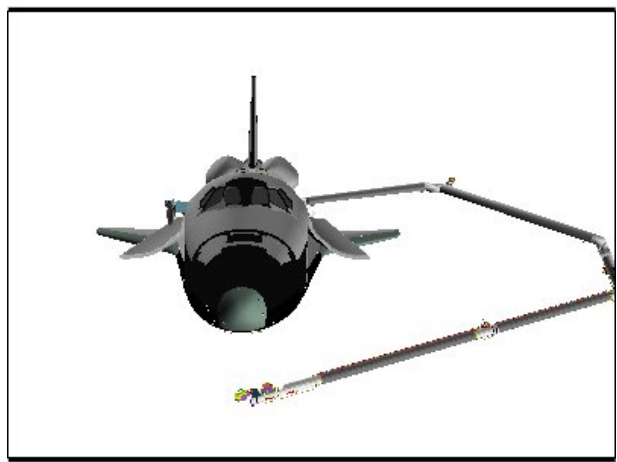

FRONT

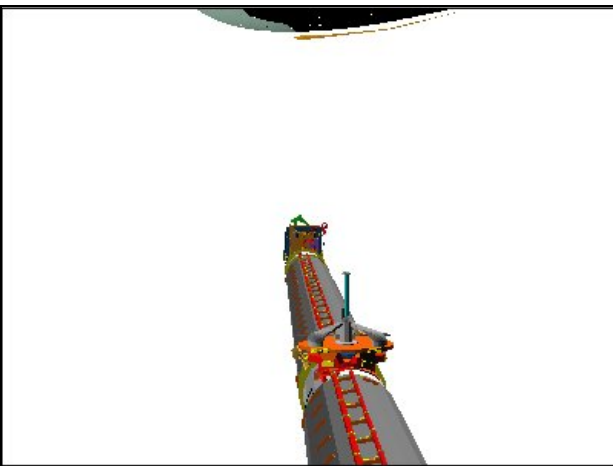

RSC

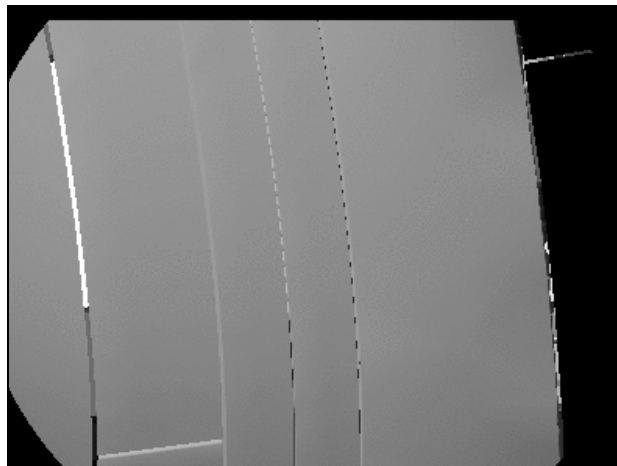

LDRI (85,-73)

NOSE CAP LDRI RCC SURVEY – Pause Pt 62

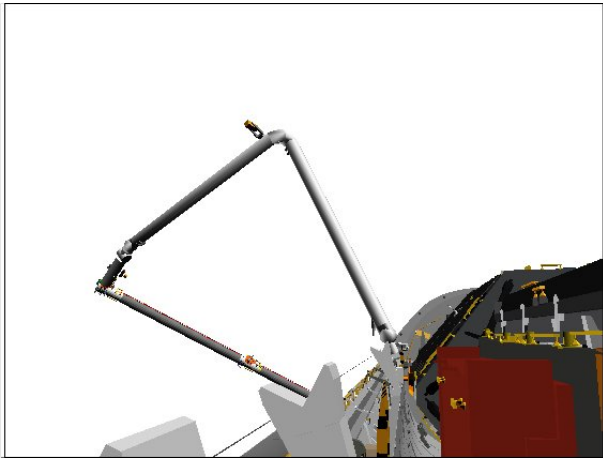

CCTV B (-10,10)

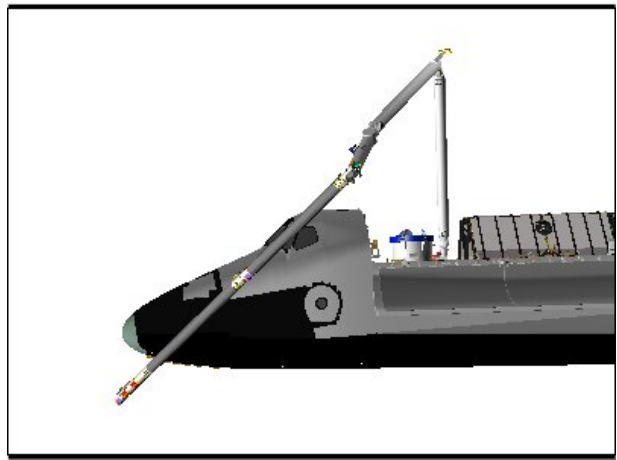

PORT

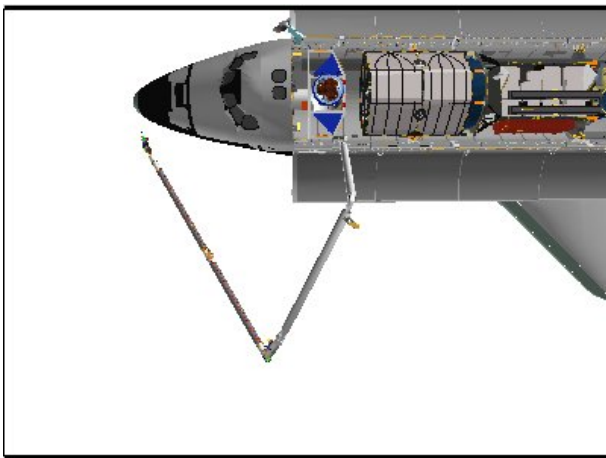

OVERHEAD

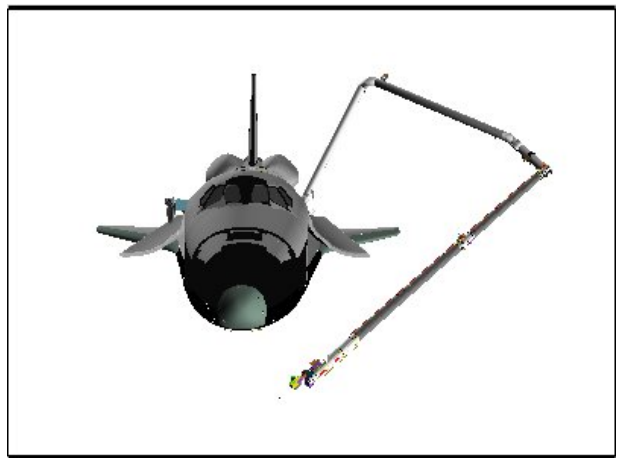

FRONT

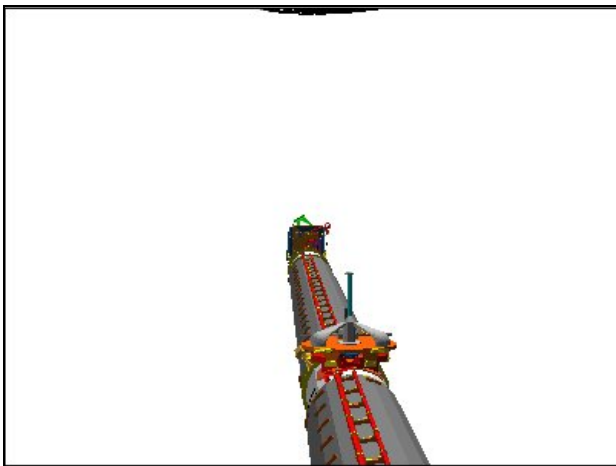

RSC

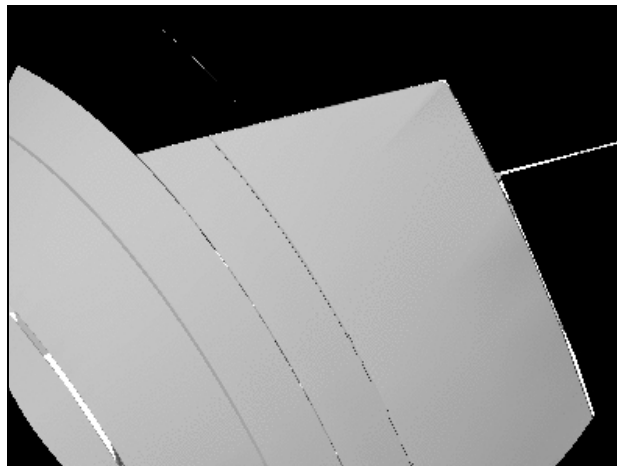

LDRI (85,-73)

NOSE CAP LDRI RCC SURVEY – Pause Pt 63

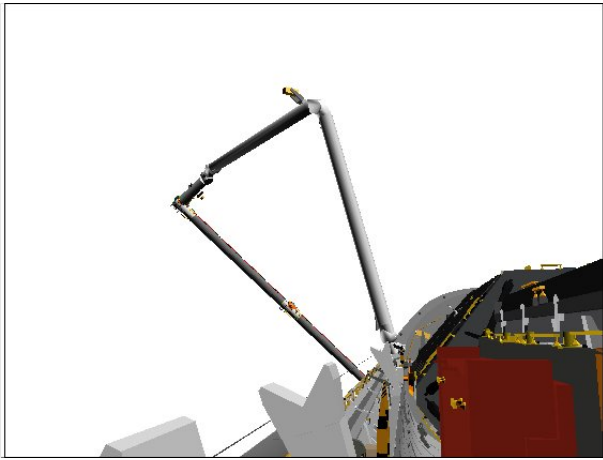

CCTV B (-10,10)

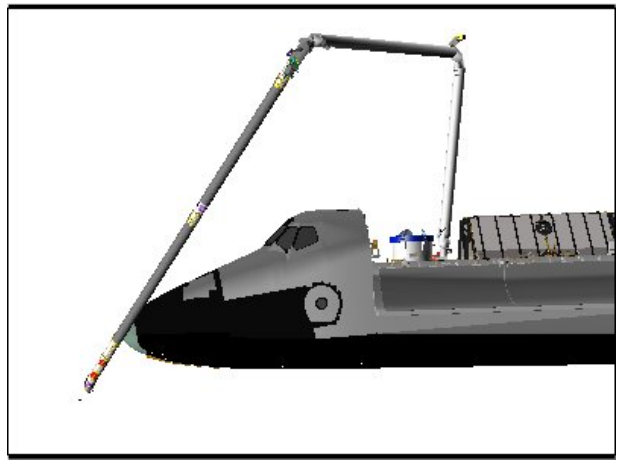

PORT

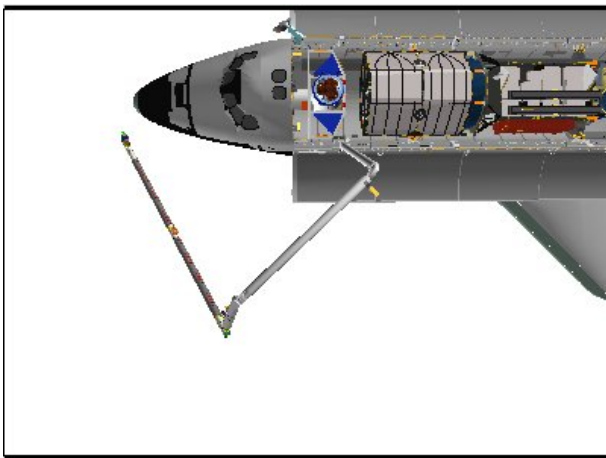

OVERHEAD

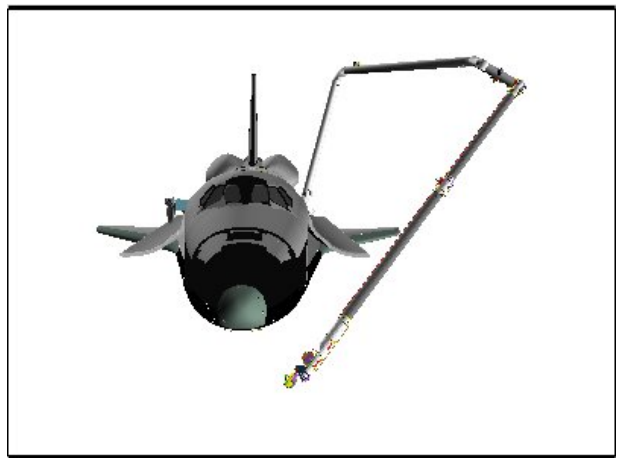

FRONT

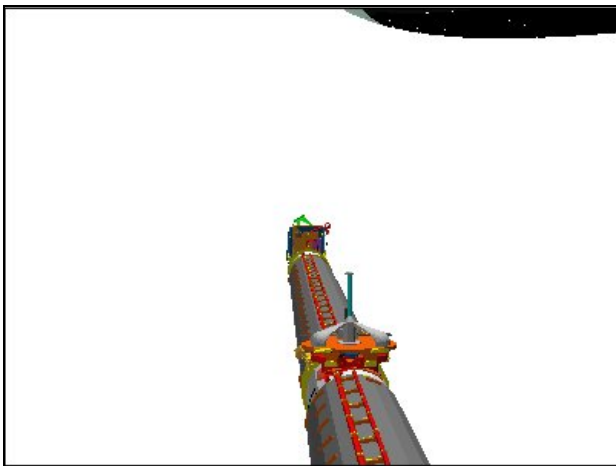

RSC



LDRI (65,-58)

NOSE CAP LDRI RCC SURVEY – Pause Pt 66



ELBOW (90,-60)

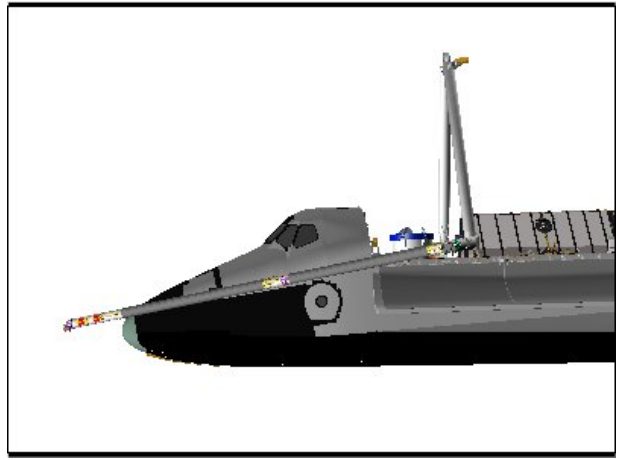

PORT

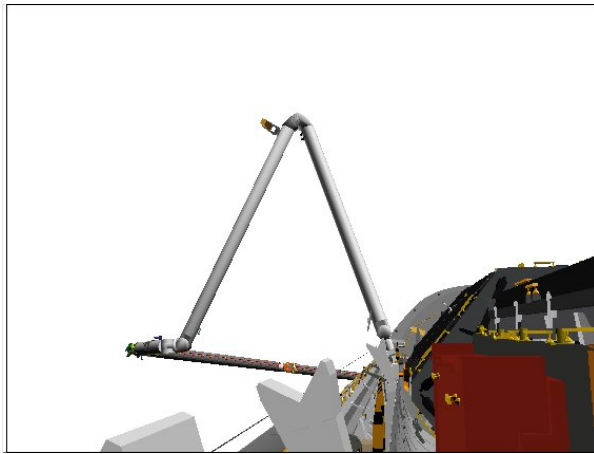

CCTV B (-10,10)

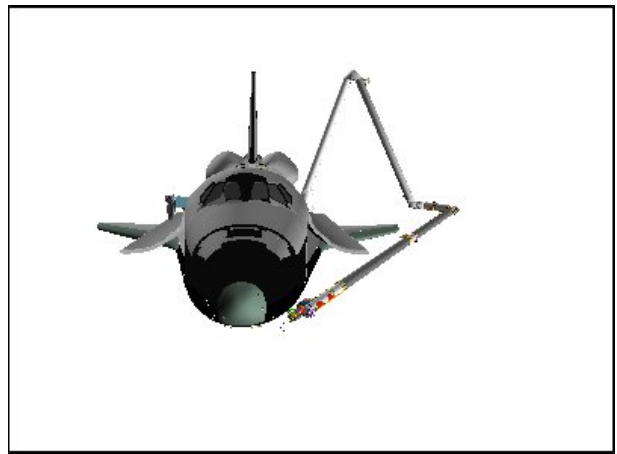

FRONT



RSC

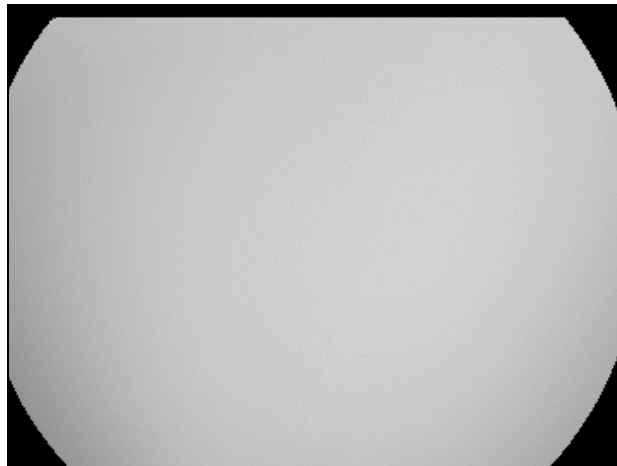

LDRI (65,-58)

NOSE CAP LDRI RCC SURVEY – Pause Pt 67

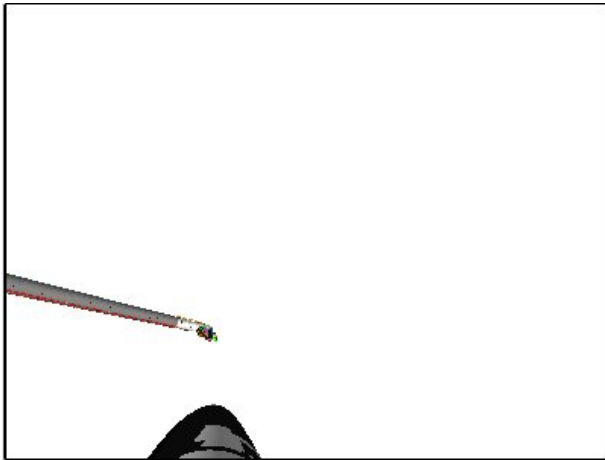

ELBOW (90,-60)

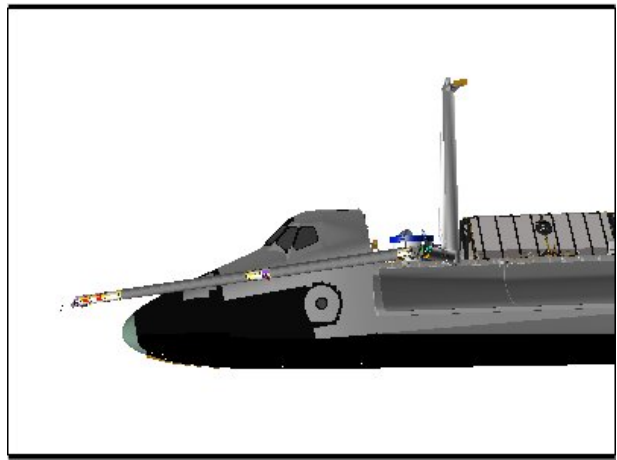

PORT

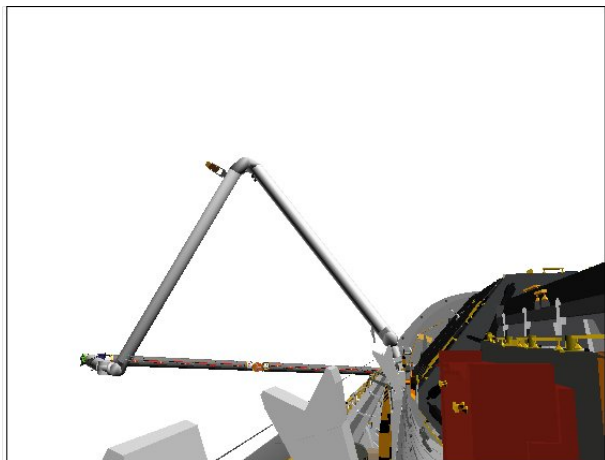

CCTV B (-10,10)



FRONT



RSC

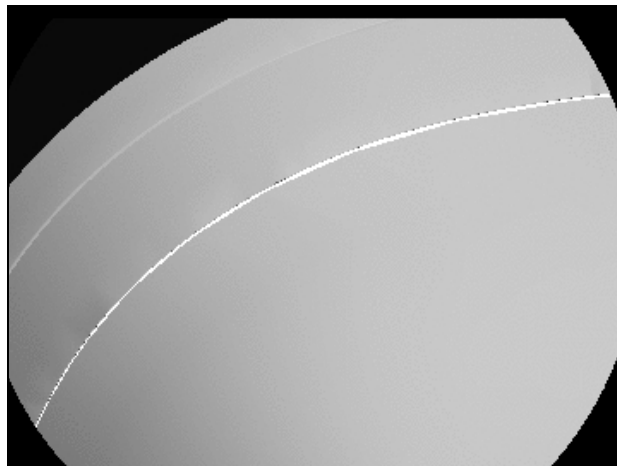

LDRI (65,-75)

NOSE CAP LDRI RCC SURVEY – Pause Pt 68

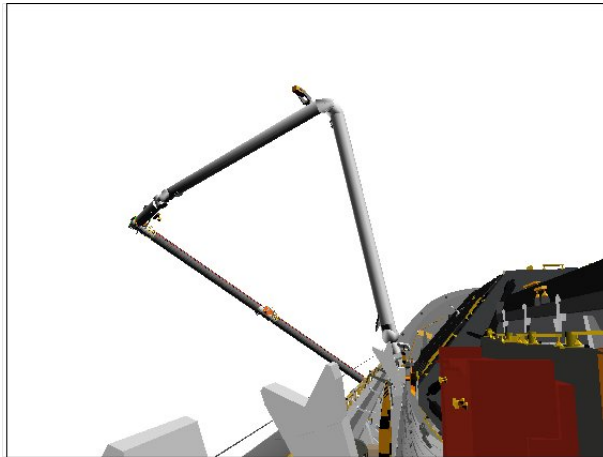

CCTV B (-10,10)

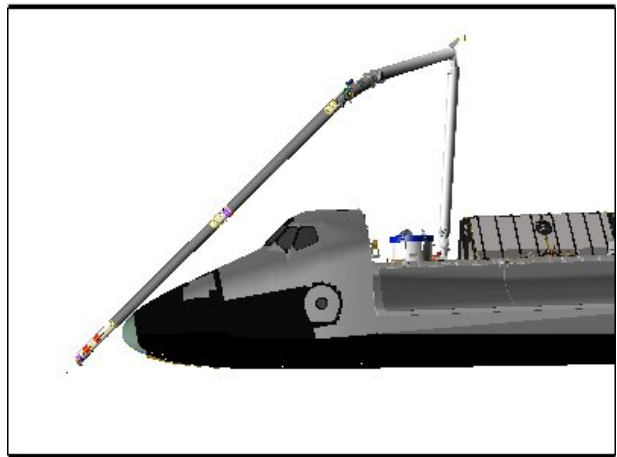

PORT

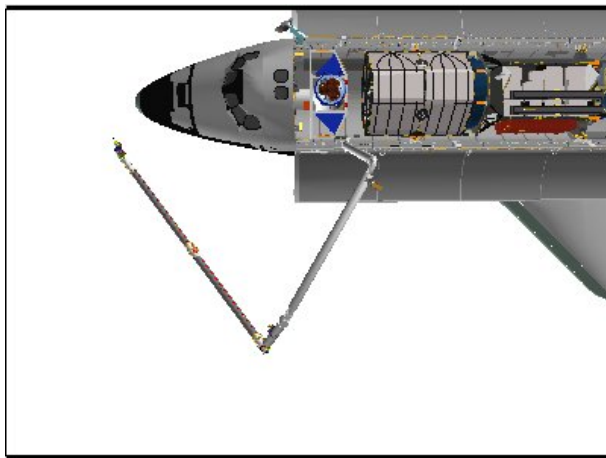

OVERHEAD

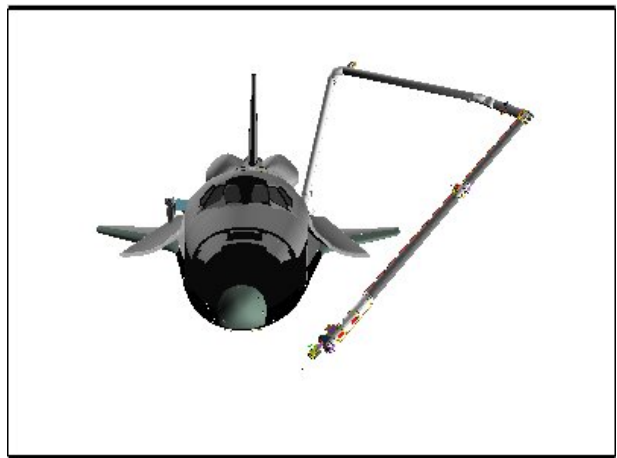

FRONT



RSC

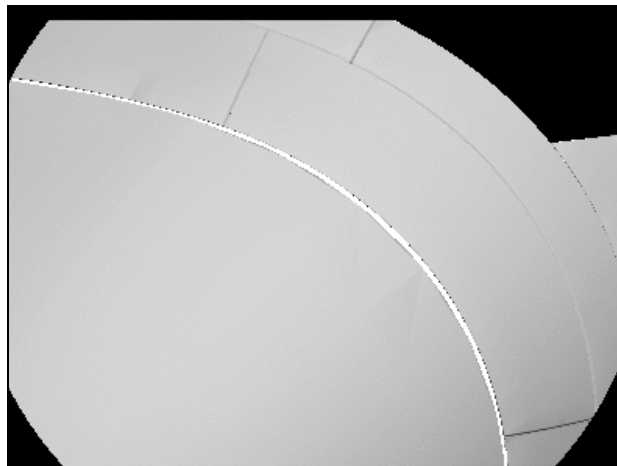

LDRI (65,-75)

OBSS LDRI RCC SURVEY CAMERA VIEWS – PORT

PORT LDRI RCC SURVEY – Pause Pt 69

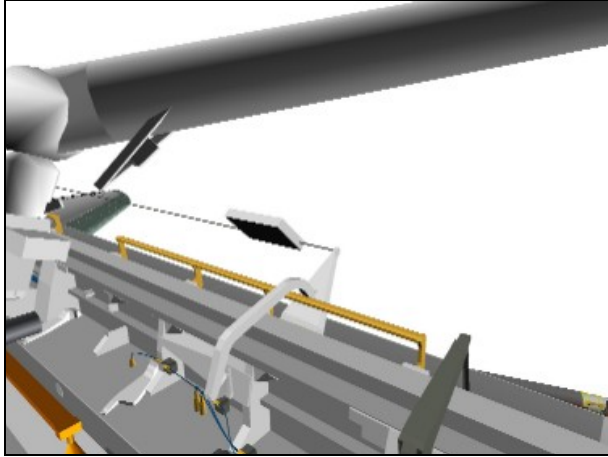

CCTV A (52,-15)

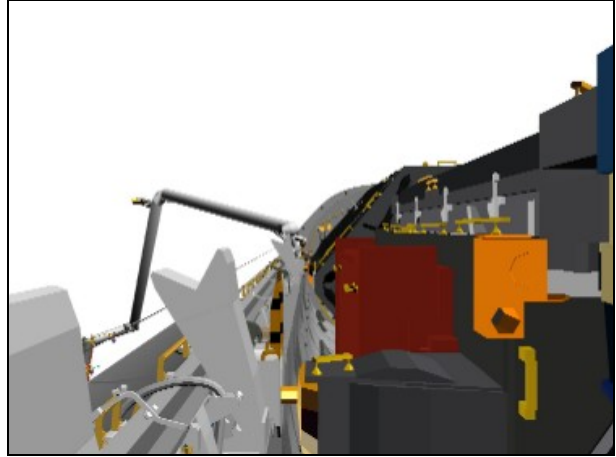

CCTV B (0,0)

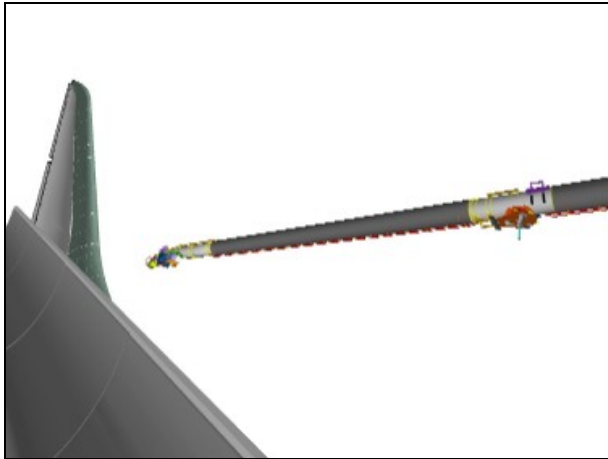

ELBOW (-85,-5)

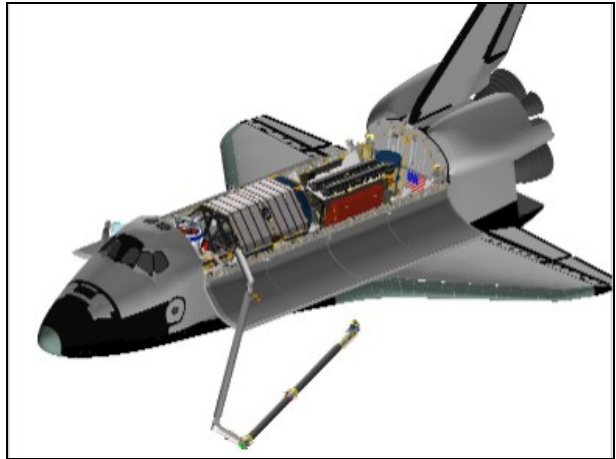

BIRD'S EYE



RSC

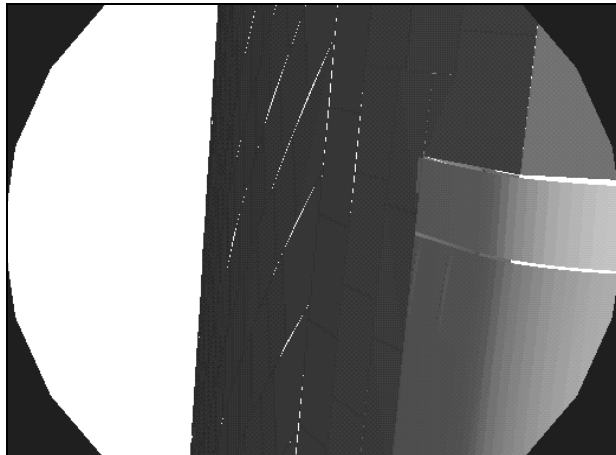

LDRI (100,-120)

PORT LDRI RCC SURVEY – Pause Pt 75

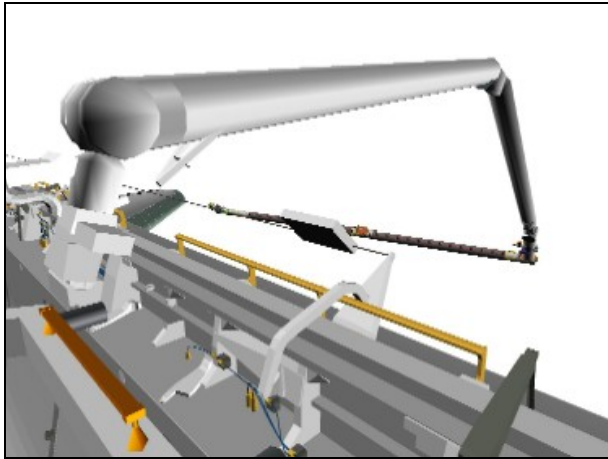

CCTV A (45,-15)

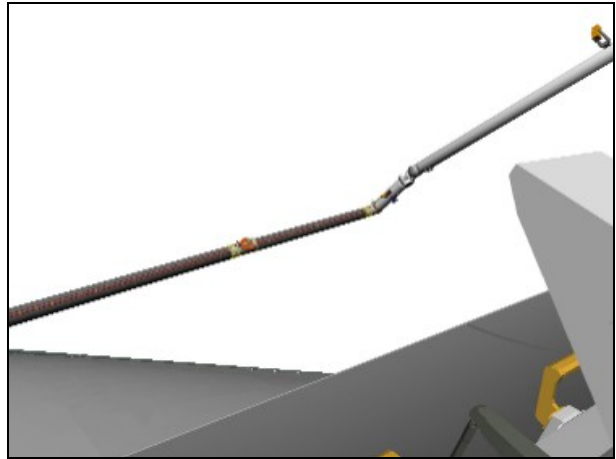

CCTV B (-52,-15)

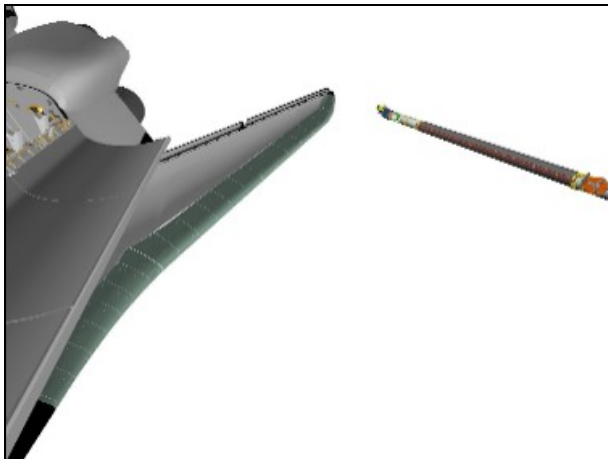

ELBOW (-70,15)

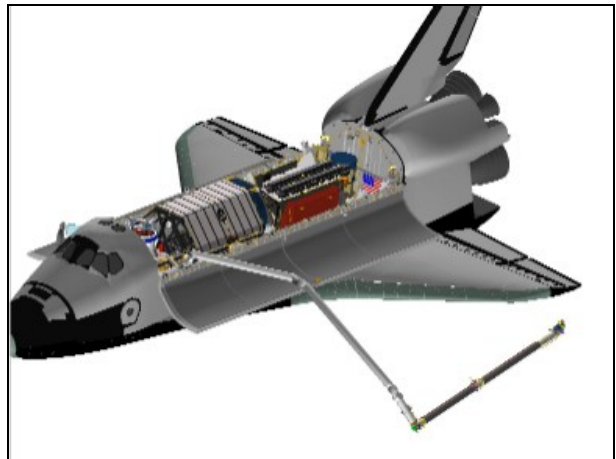

BIRD'S EYE

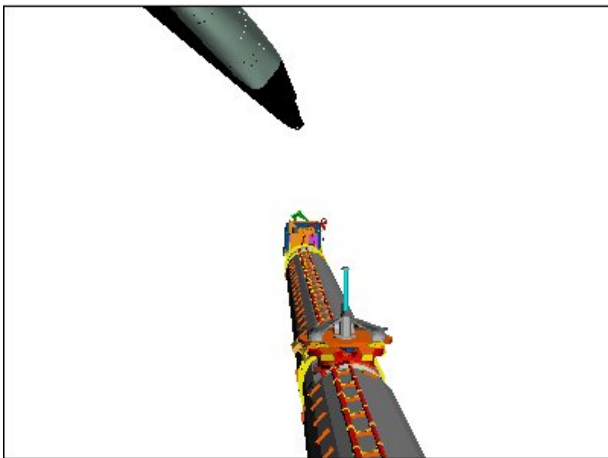

RSC

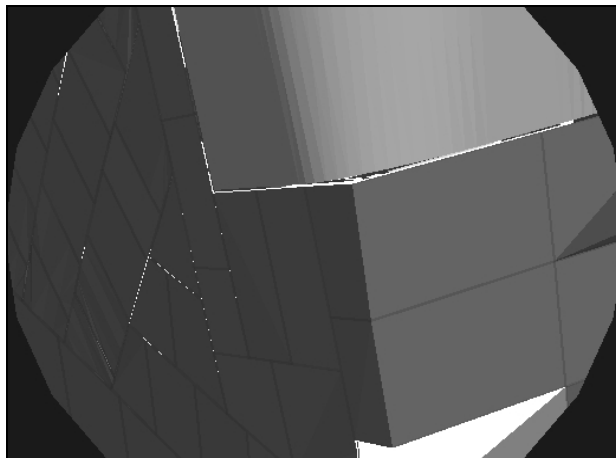

LDRI (100,-120)

PORT LDRI RCC SURVEY – Pause Pt 76



CCTV A (40,0)

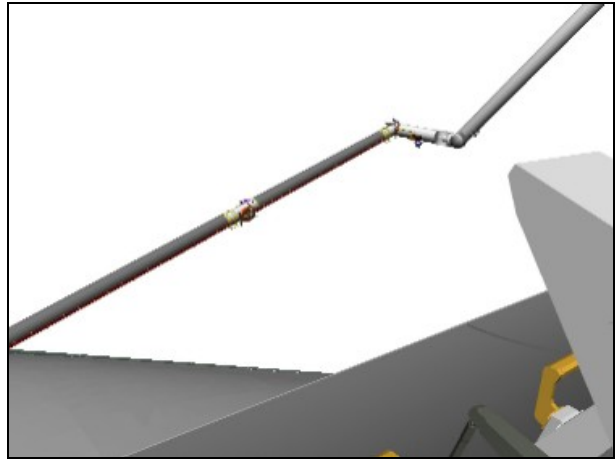

CCTV B (-52,-15)

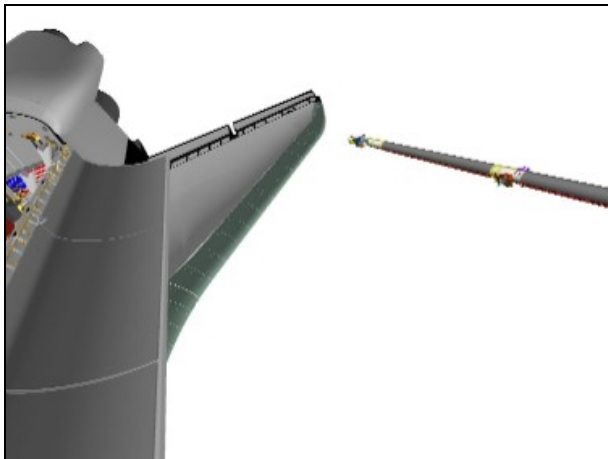

ELBOW (-50,15)

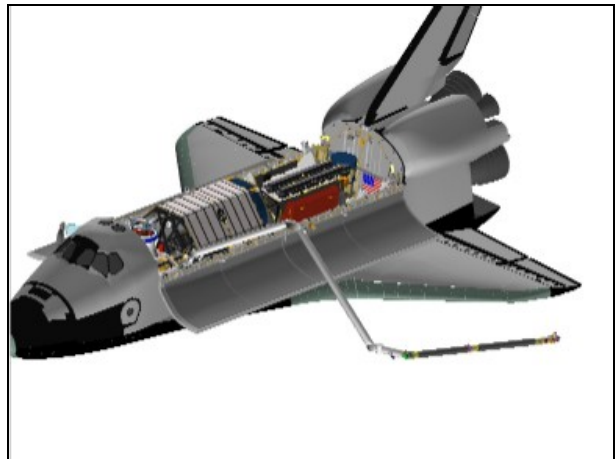

BIRD'S EYE

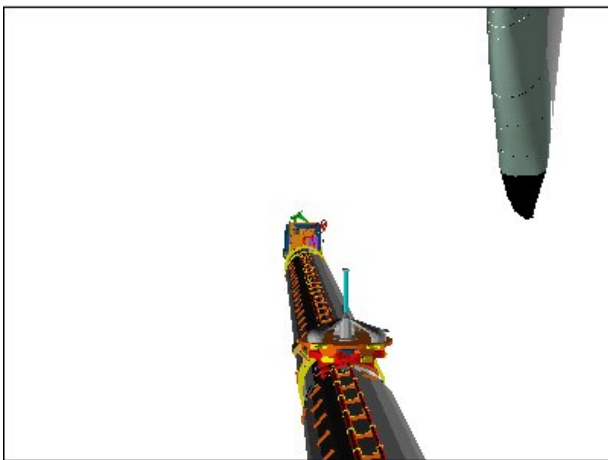

RSC

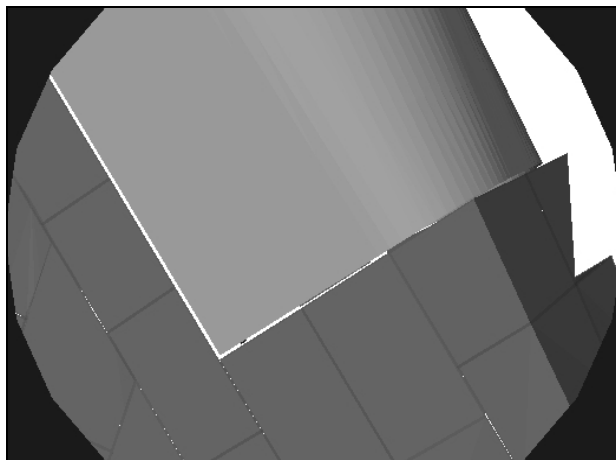

LDRI (10,-80)

PORT LDRI RCC SURVEY – Pause Pt 85

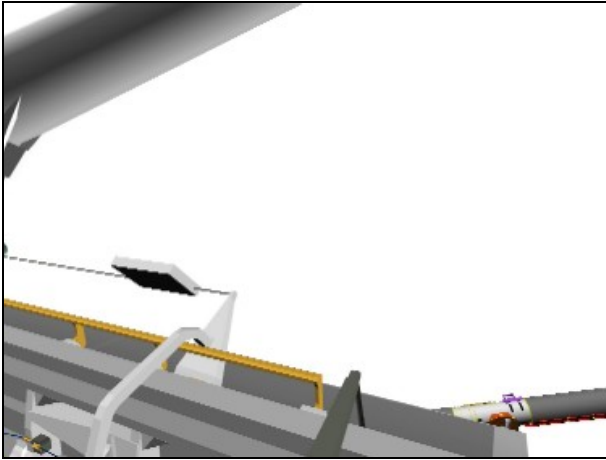

CCTV A (65,-10)

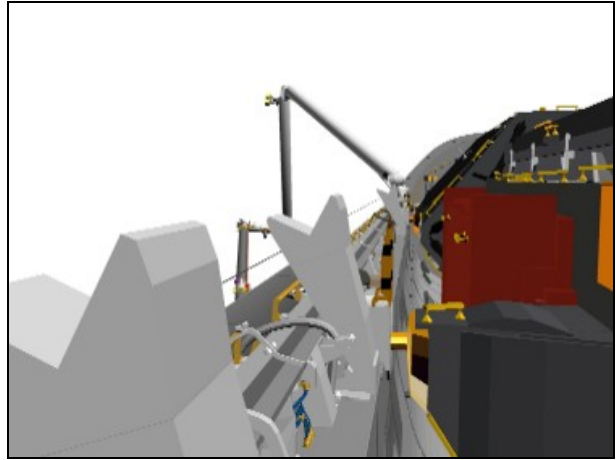

CCTV B (-10,-5)

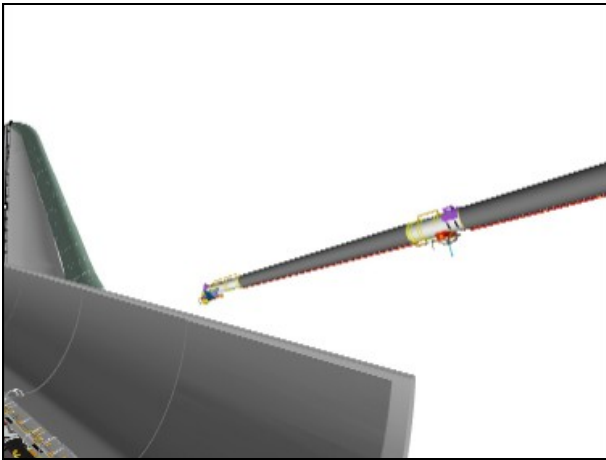

ELBOW (-75,-10)

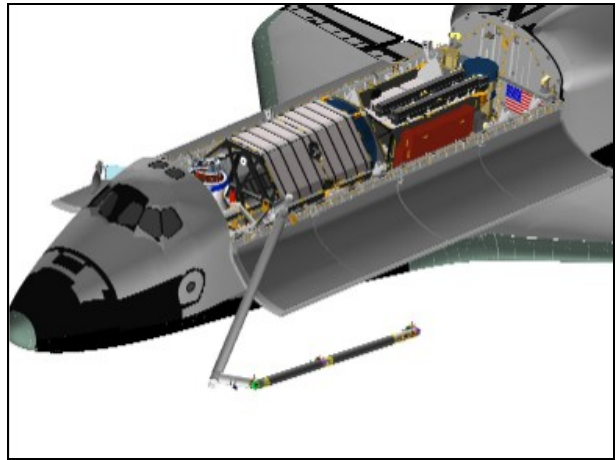

BIRD'S EYE

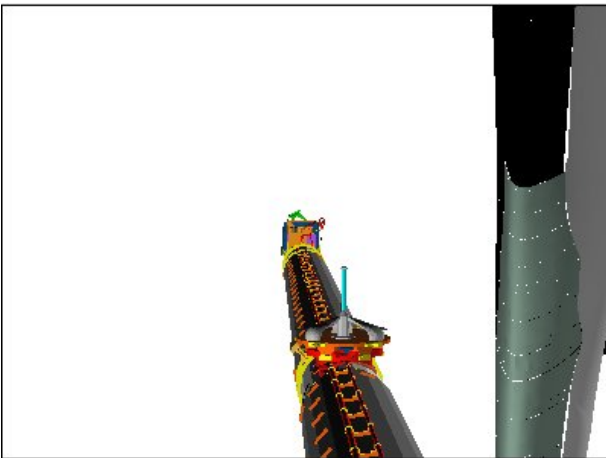

RSC

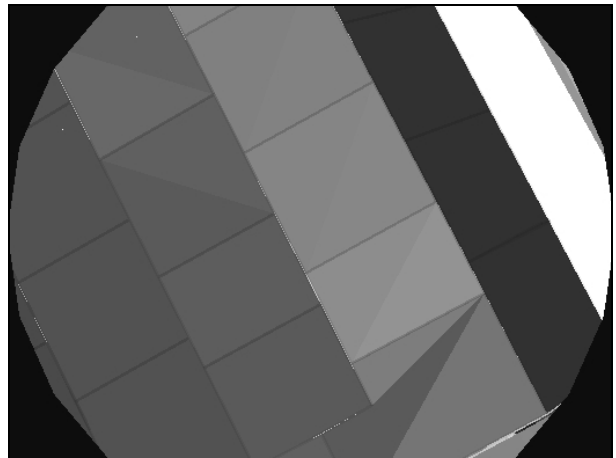

LDRI (10,-80)

PORT LDRI RCC SURVEY – Pause Pt 86

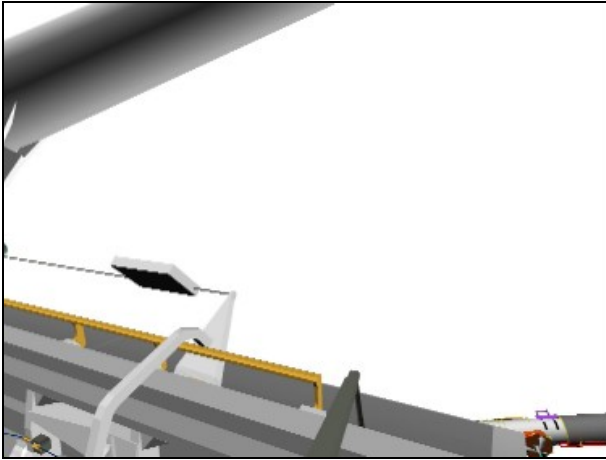

CCTV A (65,-10)

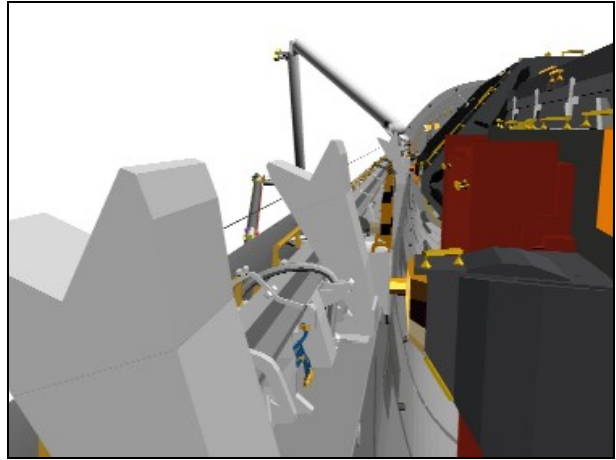

CCTV B (-10,-10)

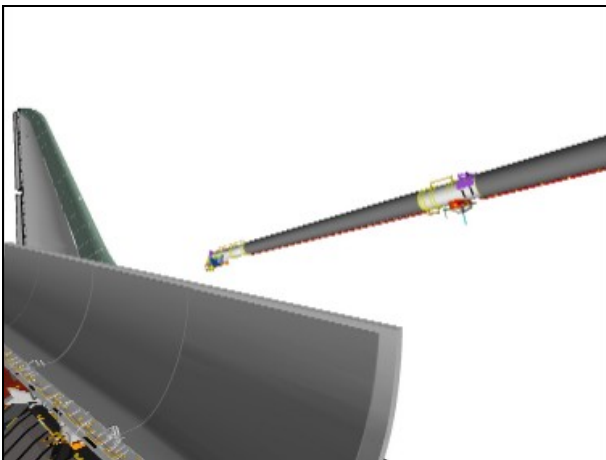

ELBOW (-78,-15)

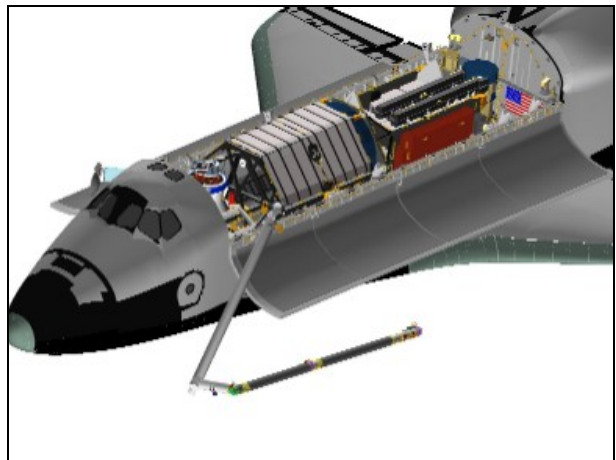

BIRD'S EYE



RSC

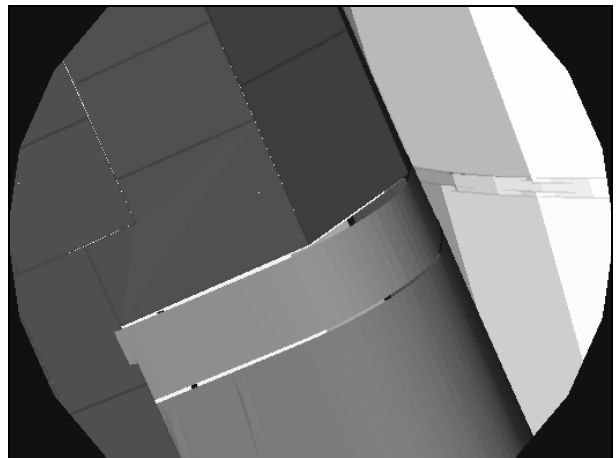

LDRI (10,-95)

PORT LDRI RCC SURVEY – Pause Pt 93

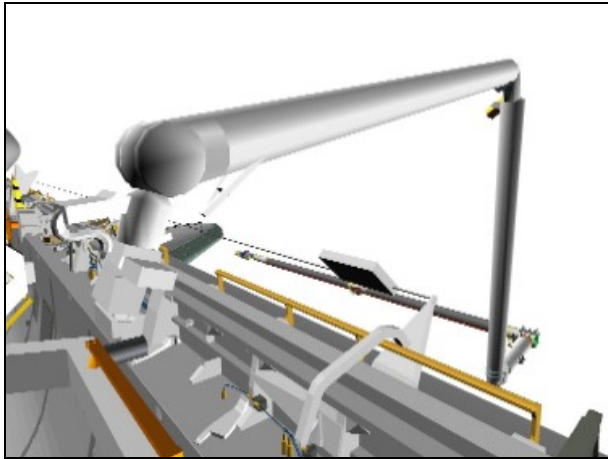

CCTV A (40,-10)

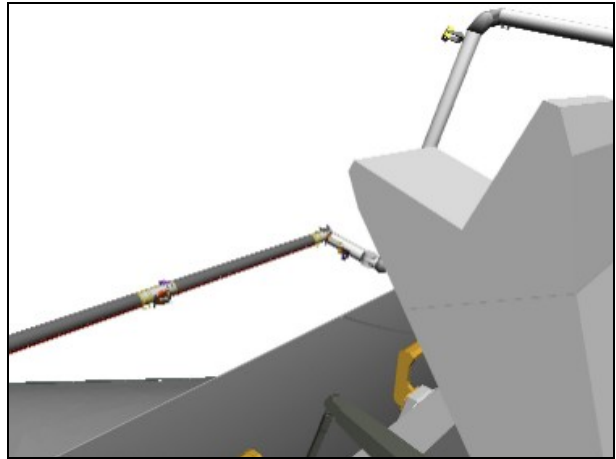

CCTV B (-40,-15)

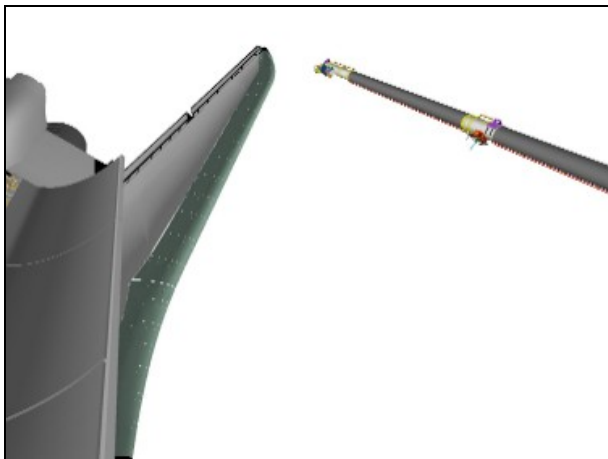

ELBOW (-45,25)

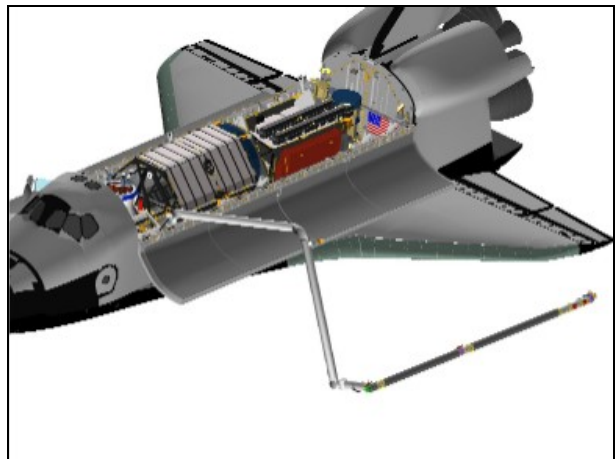

BIRD'S EYE

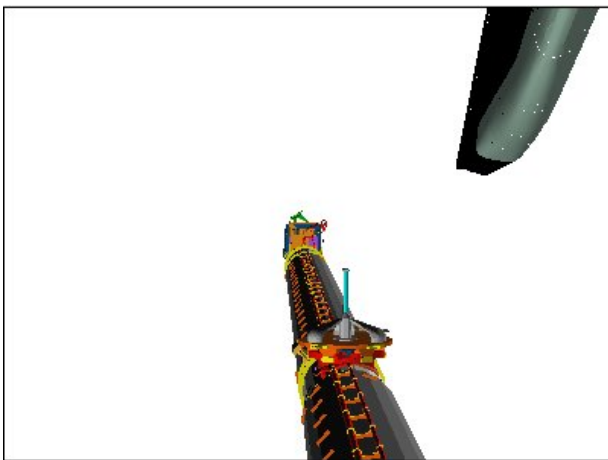

RSC

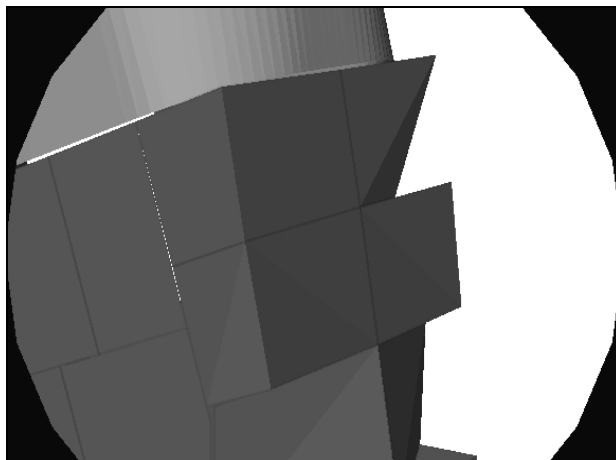

LDRI (10,-95)

PORT LDRI RCC SURVEY – Pause Pt 94

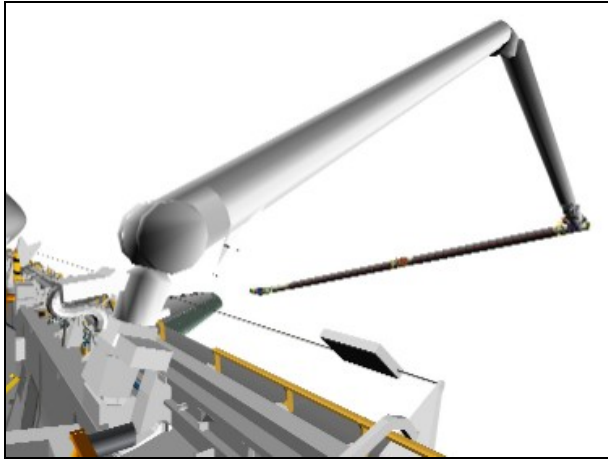

CCTV A (40,0)

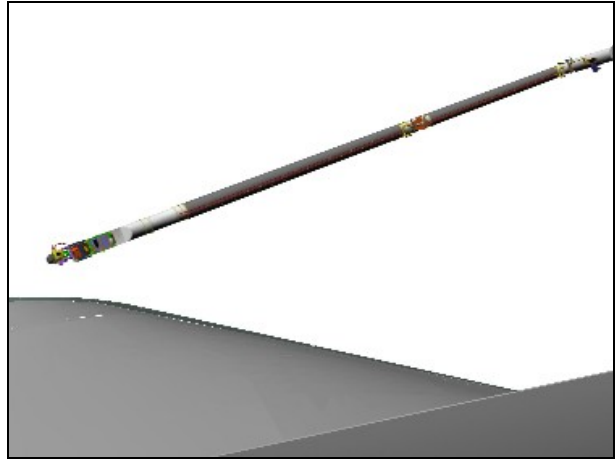

CCTV B (-70,-15)

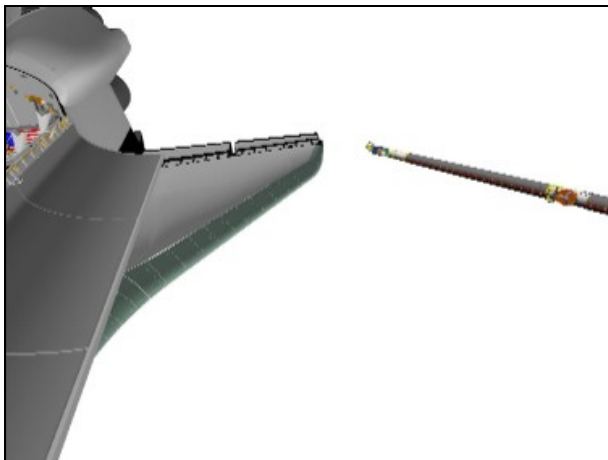

ELBOW (-65,10)

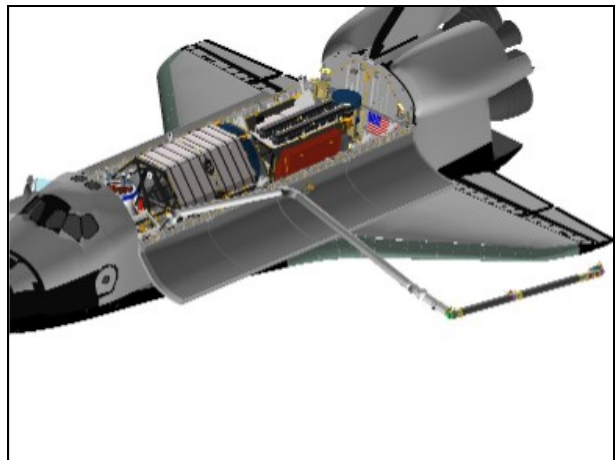

BIRD'S EYE

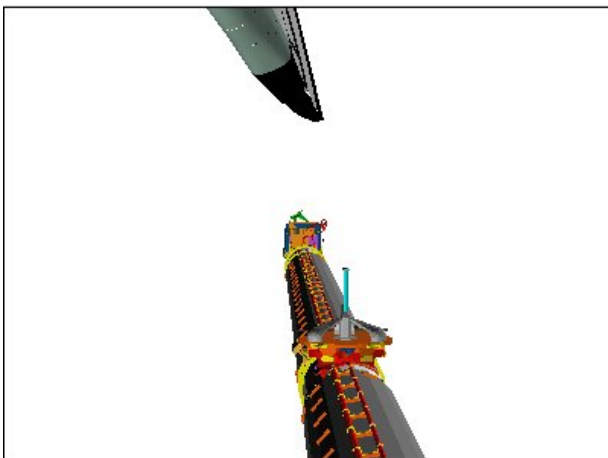

RSC

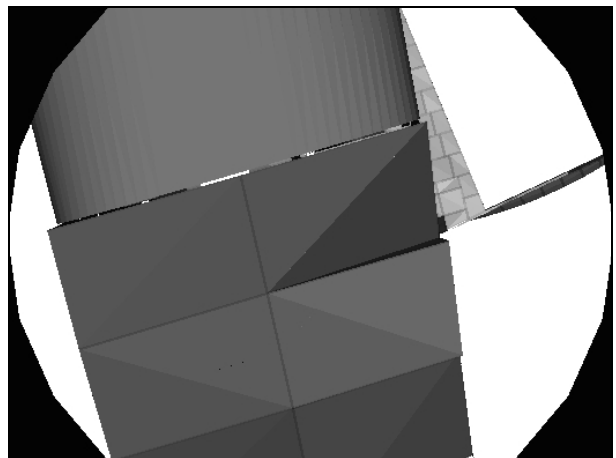

LDRI (88,-120)

PORT LDRI RCC SURVEY – Pause Pt 102

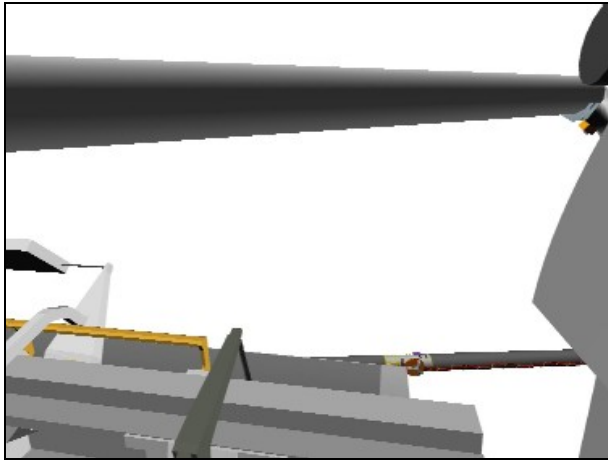

CCTV A (80,-15)

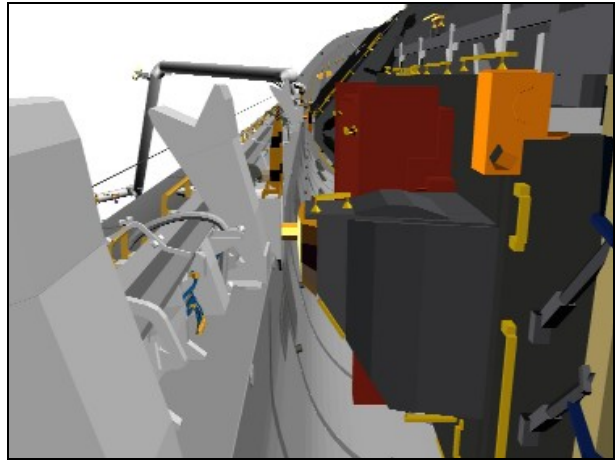

CCTV B (0,-15)

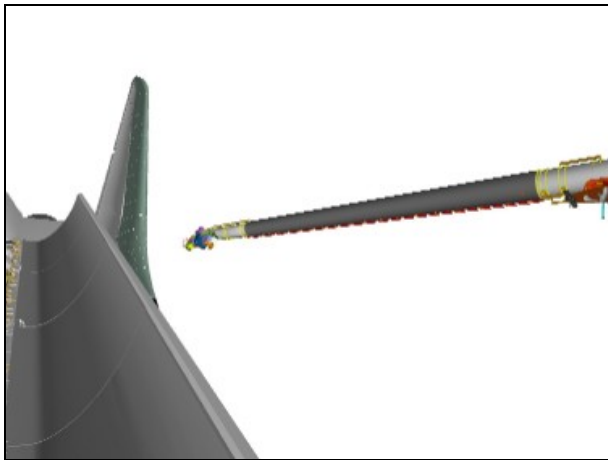

ELBOW (-95,-5)

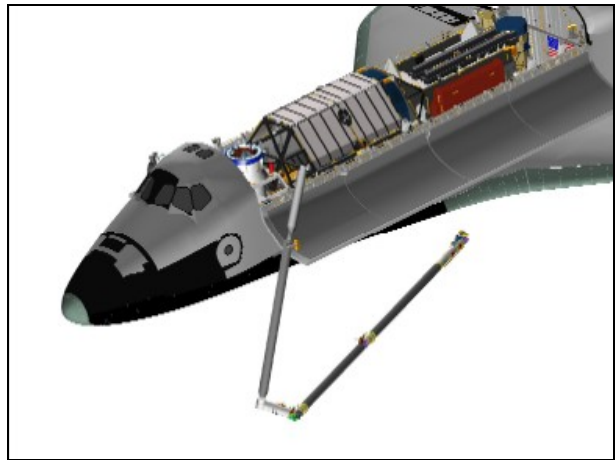

BIRD'S EYE

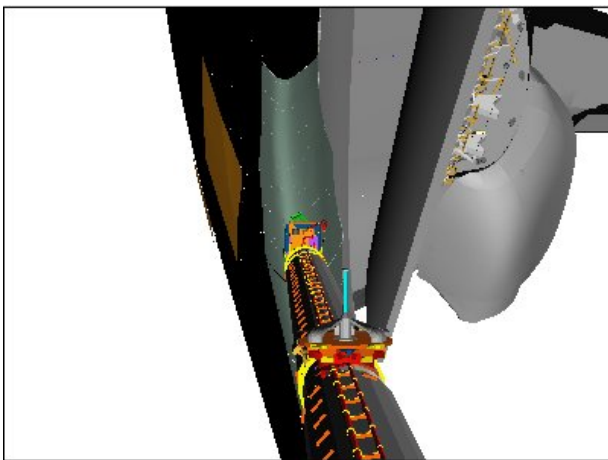

RSC

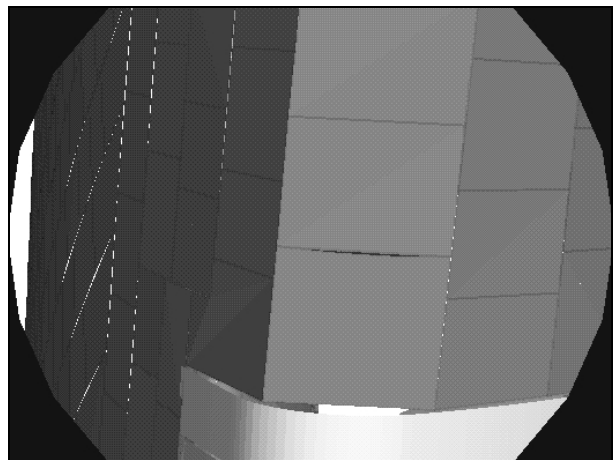

LDRI (88,-120)

PORT LDRI RCC SURVEY – Pause Pt 104

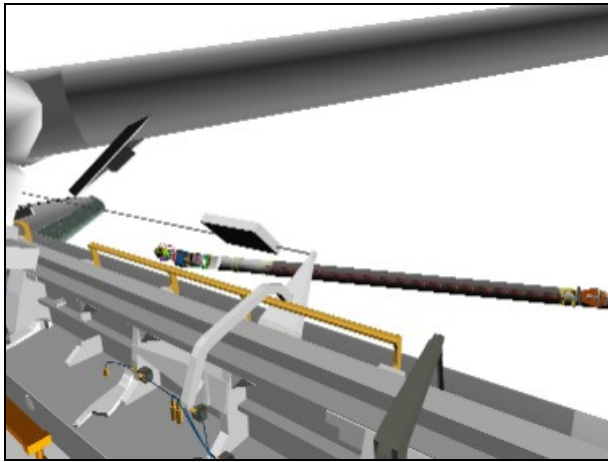

CCTV A (55,-15)

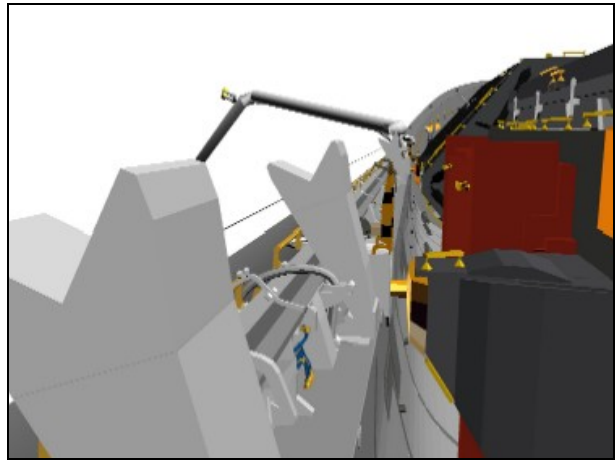

CCTV B (-10,-10)

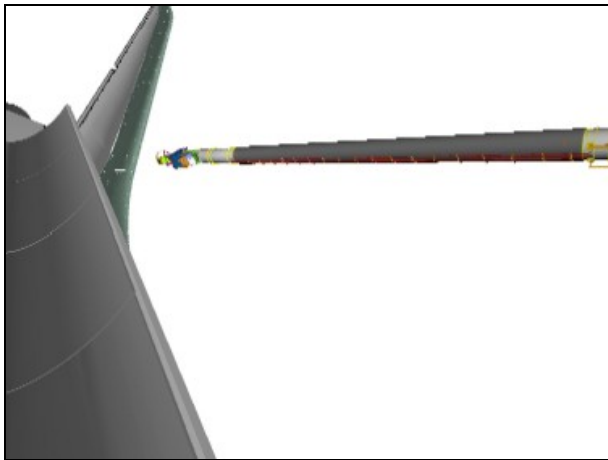

ELBOW (-100,-5)

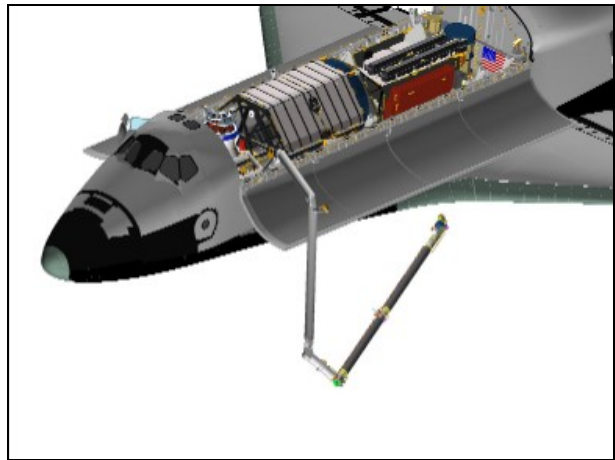

BIRD'S EYE

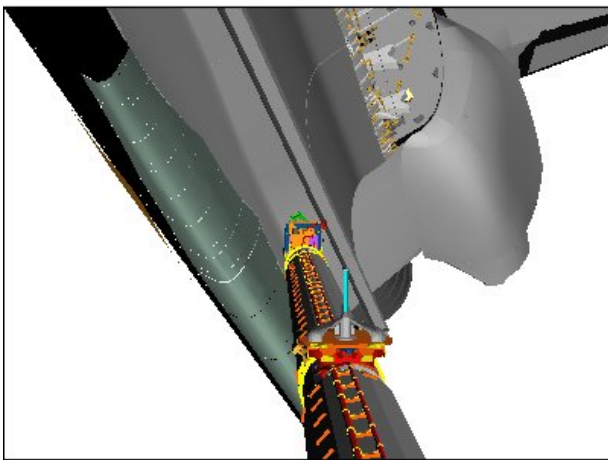

RSC

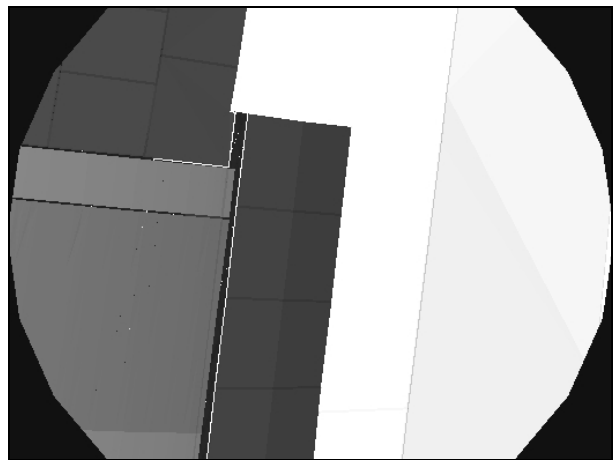

LDRI (120,-120)

PORT LDRI RCC SURVEY – Pause Pt 114

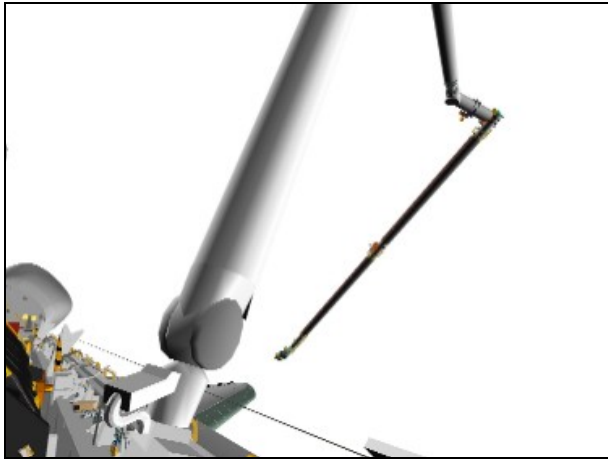

CCTV A (35,12)

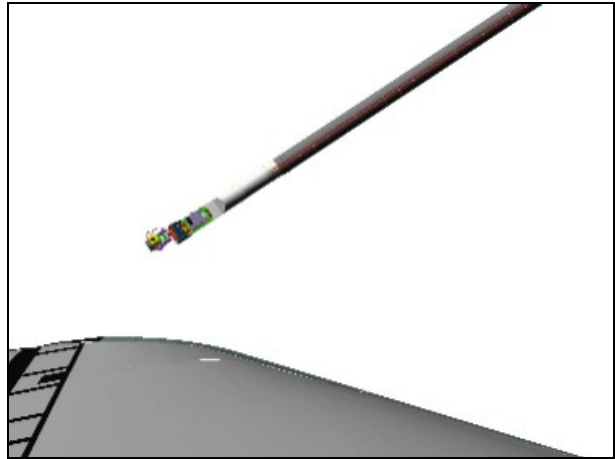

CCTV B (-80,-10)

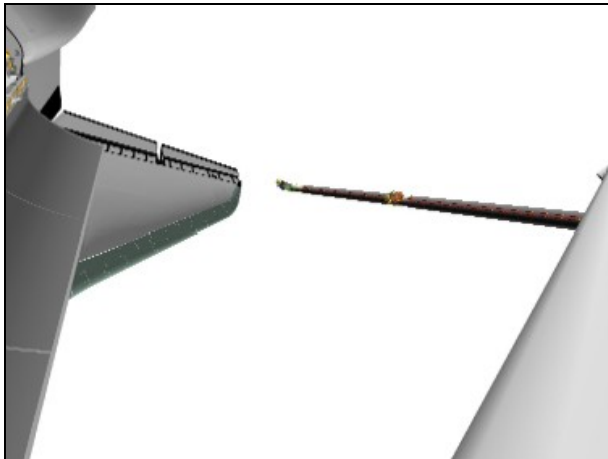

ELBOW (-38,-15)

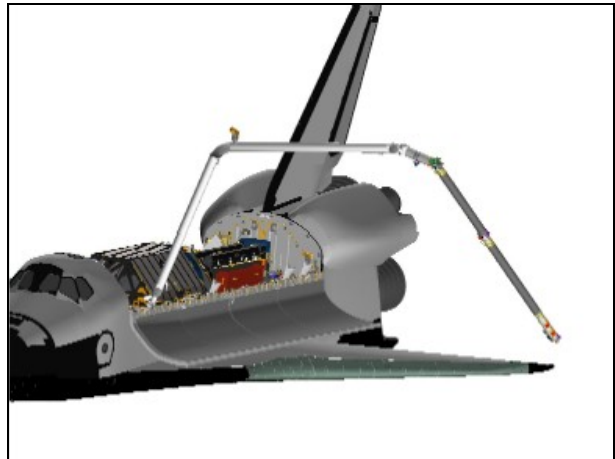

BIRD'S EYE

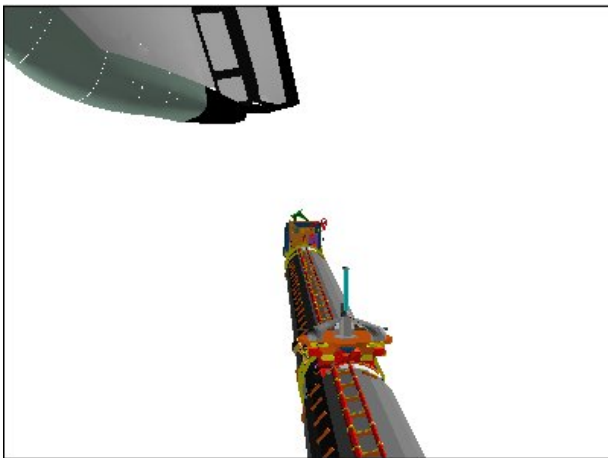

RSC

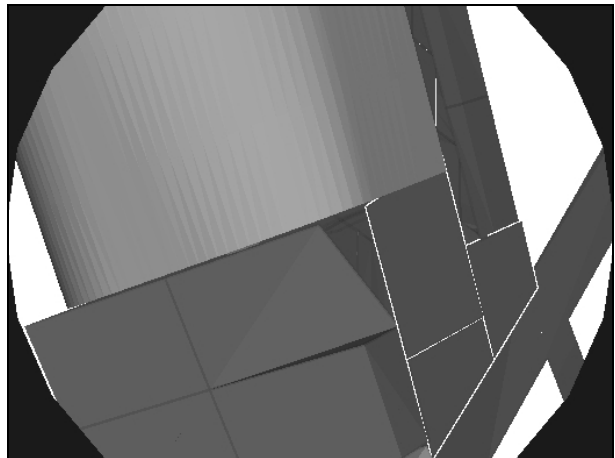

LDRI (120,-120)

PORT LDRI RCC SURVEY – Pause Pt 115

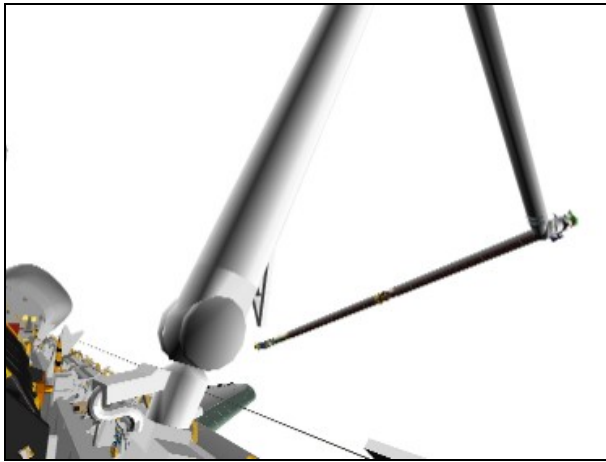

CCTV A (35,12)

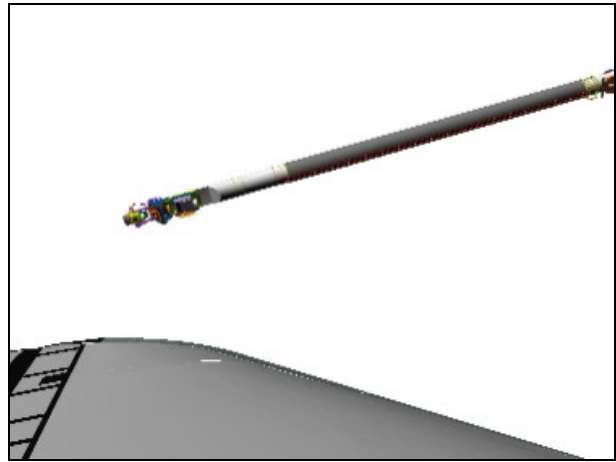

CCTV B (-80,-10)

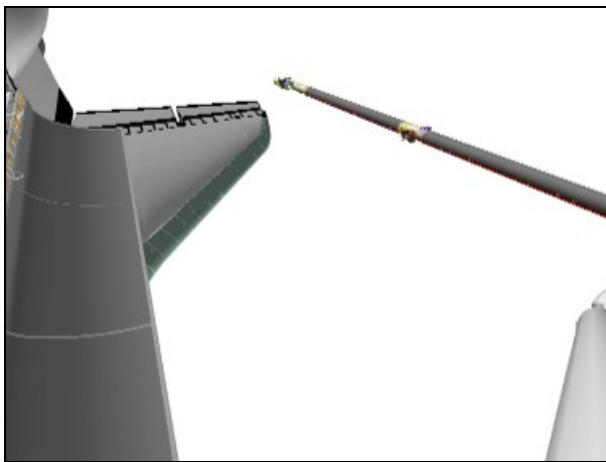

ELBOW (-35,5)

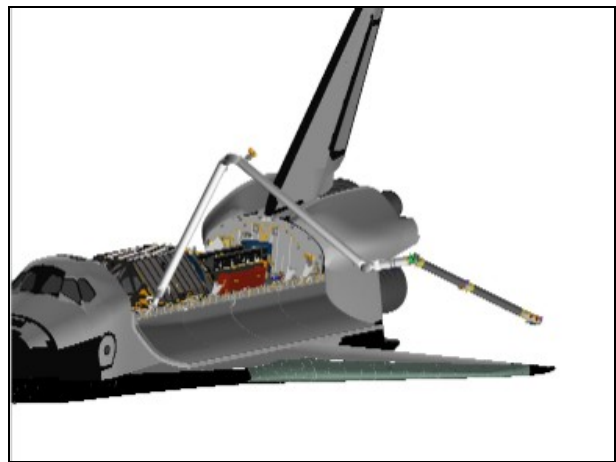

BIRD'S EYE

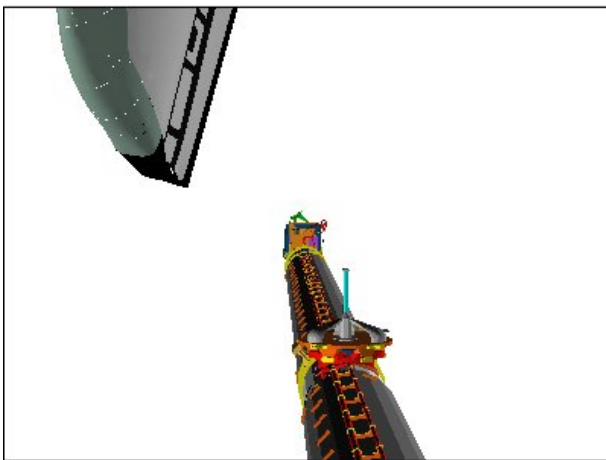

RSC

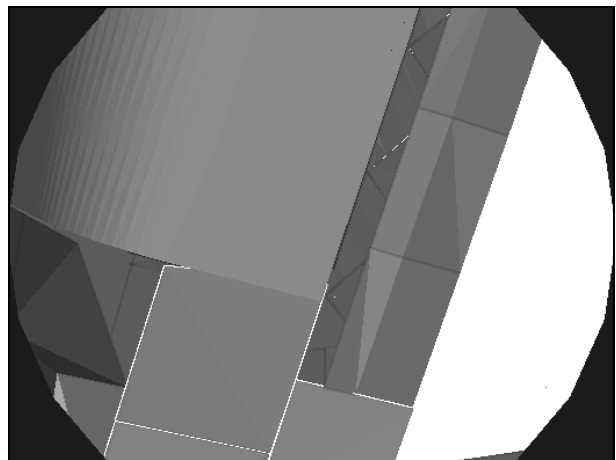

LDRI (135,-110)

PORT LDRI RCC SURVEY – Pause Pt 121

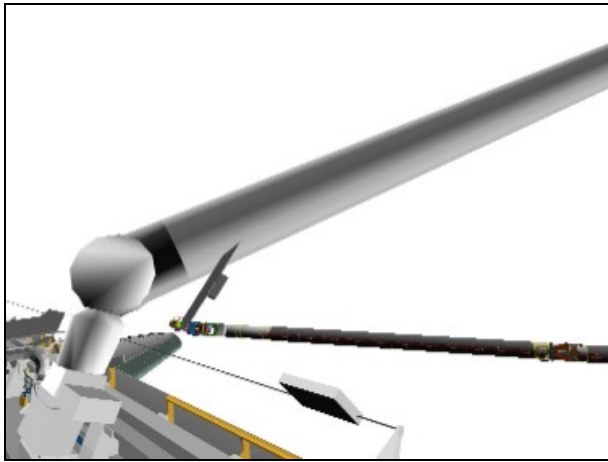

CCTV A (45,5)

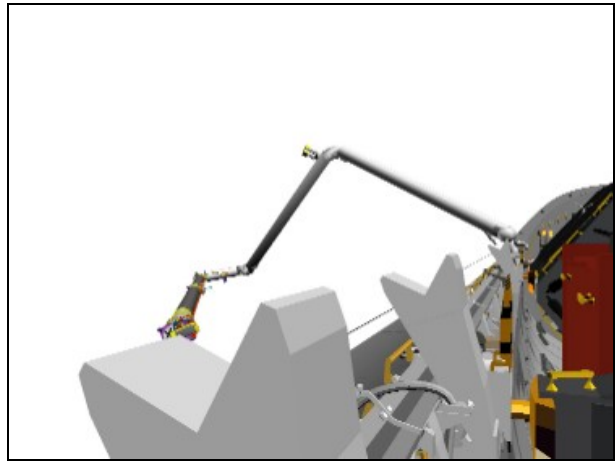

CCTV B (-20,0)

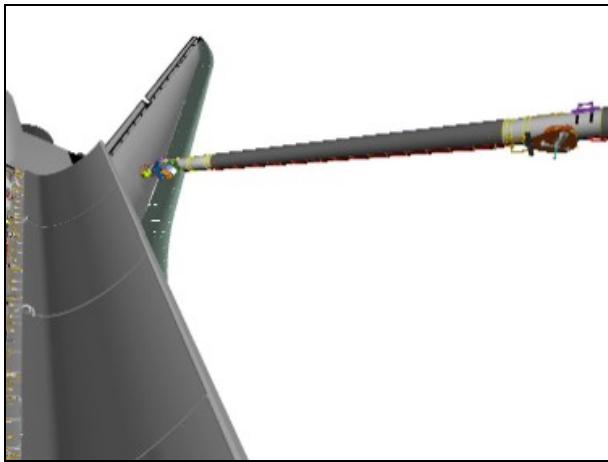

ELBOW (-88,0)

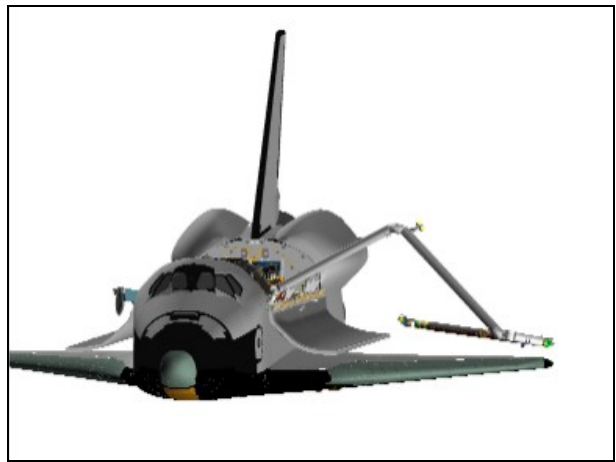

BIRD'S EYE

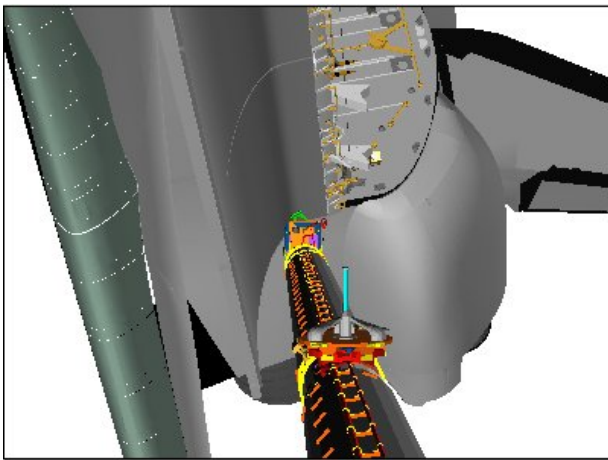

RSC

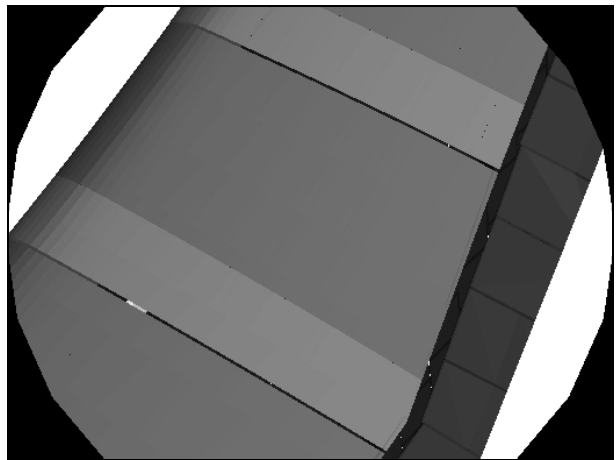

LDRI (135,-110)

OBSS LDRI RCC SURVEY CAMERA VIEWS – STBD DOCKED

STBD DOCKED LDRI RCC SURVEY – Pt 130

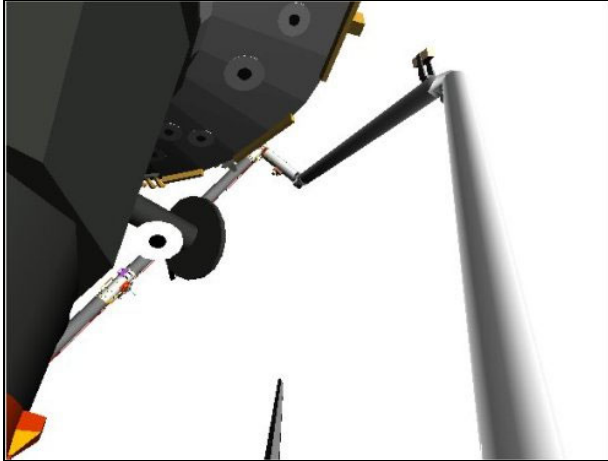

CCTV A (0,40)

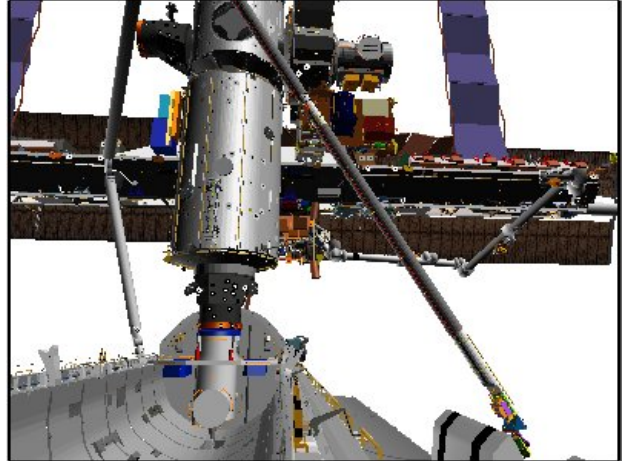

CCTV C (5,15)

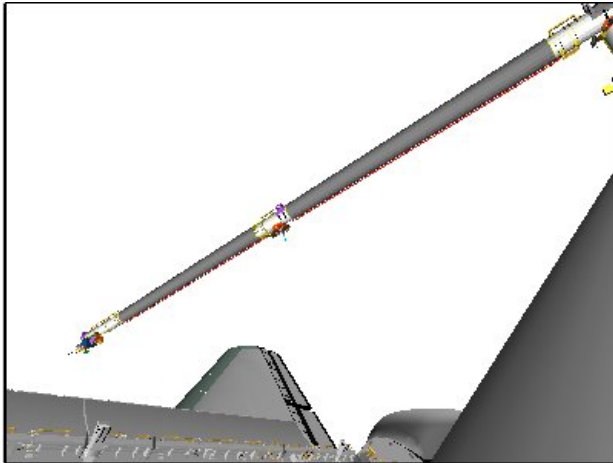

RMS ELBOW (-40,-20)

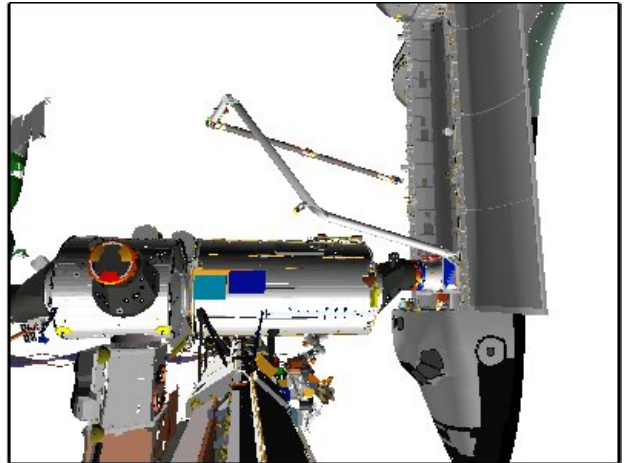

P1 LOOB (100,10)

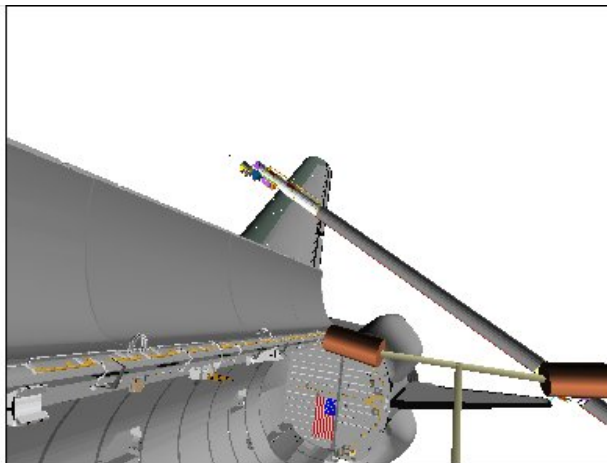

US LAB (-20,-10)

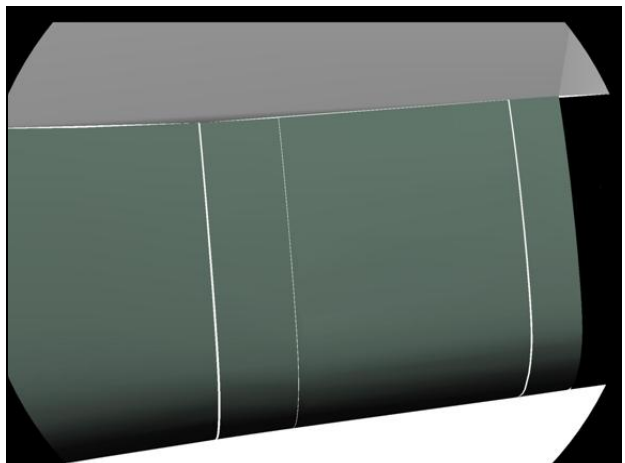

LDRI (54,-78)

NOTE

All LDRI views are shown after any pan/tilt changes at that position

STBD DOCKED LDRI RCC SURVEY – Pause Pt 132

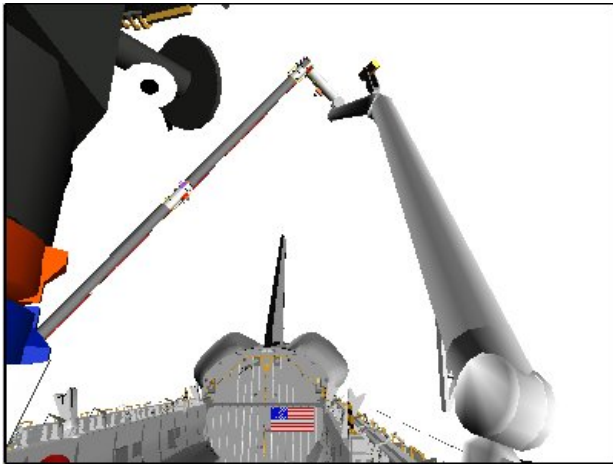

CCTV A (0,20)

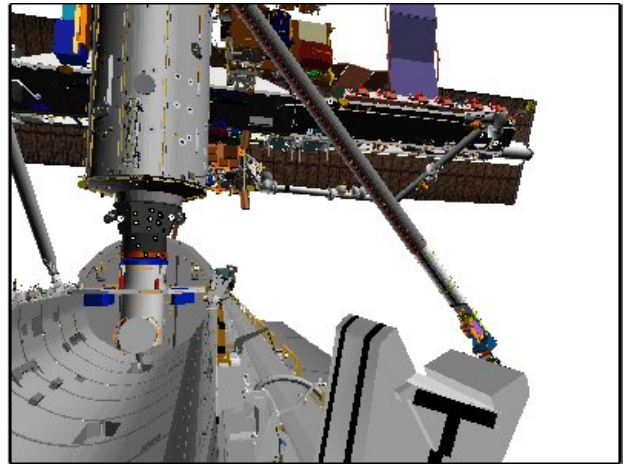

CCTV C (15,5)

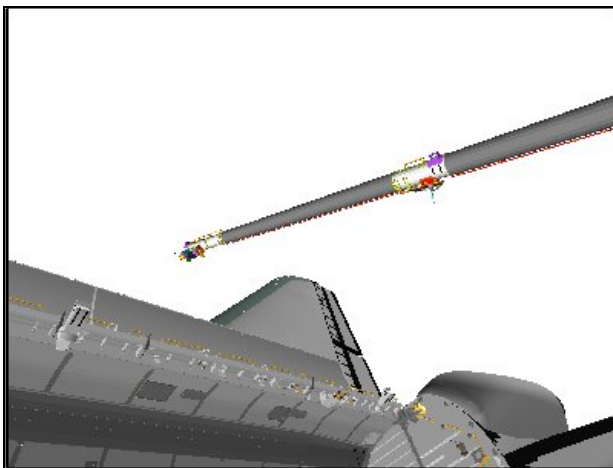

RMS ELBOW (-70,-20)

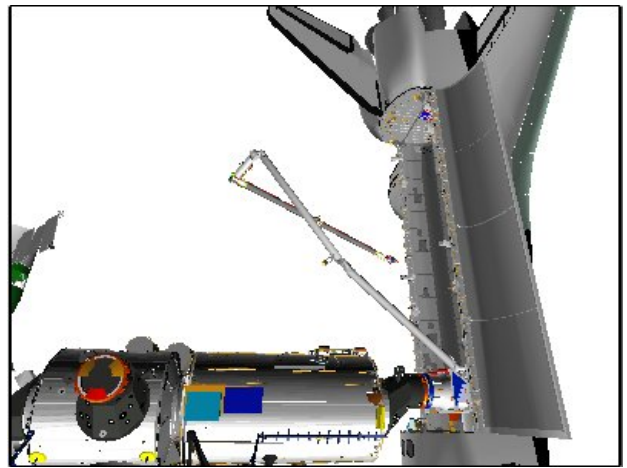

P1 LOOB (100,25)

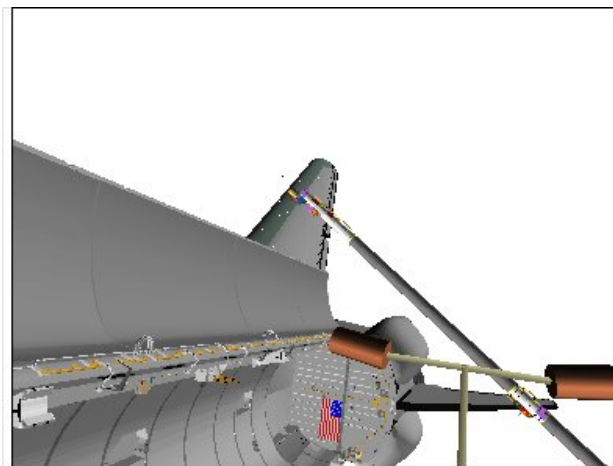

US LAB (-20,-10)

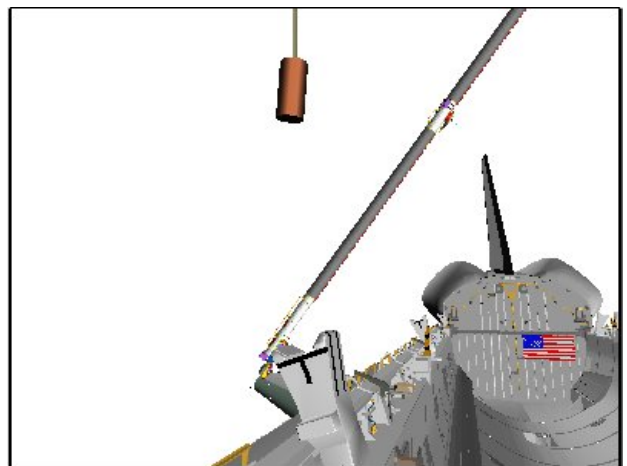

CCTV D (-20,10)

STBD DOCKED LDRI RCC SURVEY – Pause Pt 133

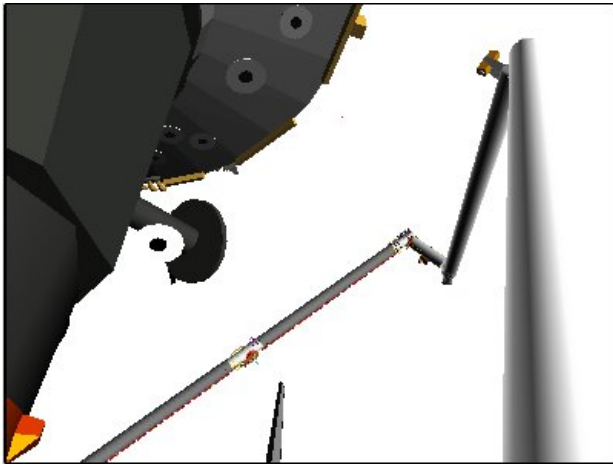

CCTV A (0,40)

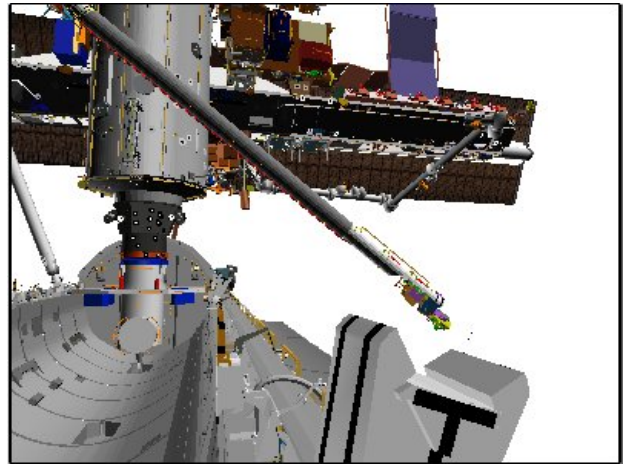

CCTV C (15,5)

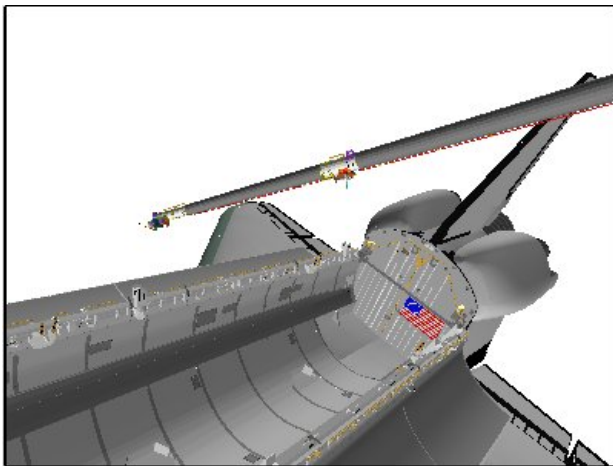

RMS ELBOW (-50,-10)

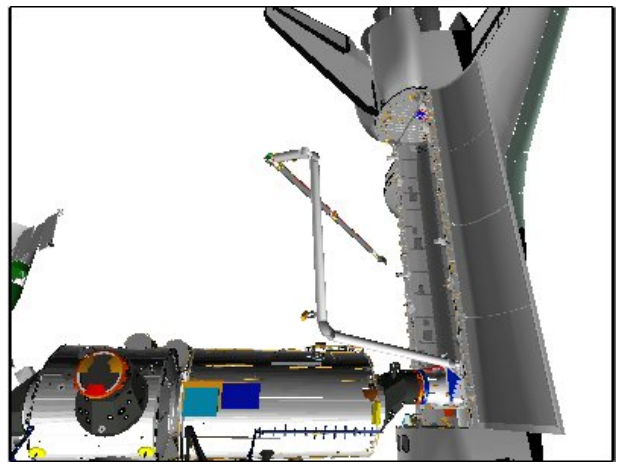

P1 LOOB (100,25)

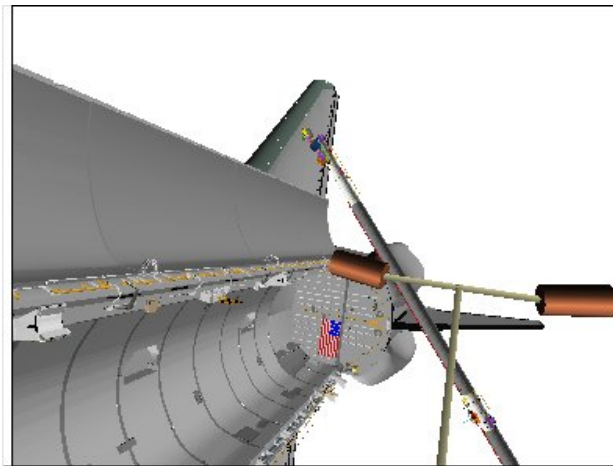

US LAB (-20,-20)

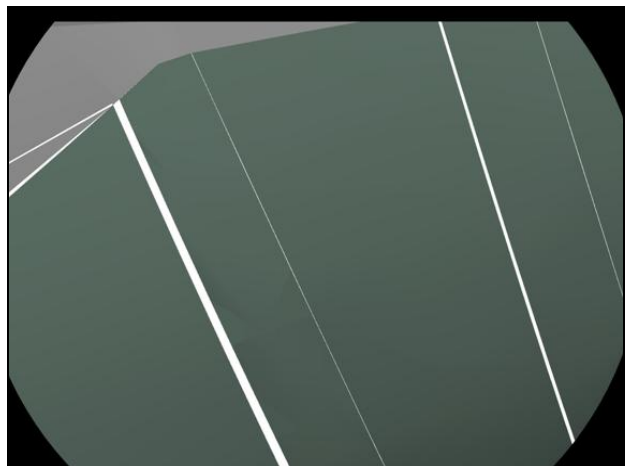

LDRI (110,-89)

STBD DOCKED LDRI RCC SURVEY – Pause Pt 134

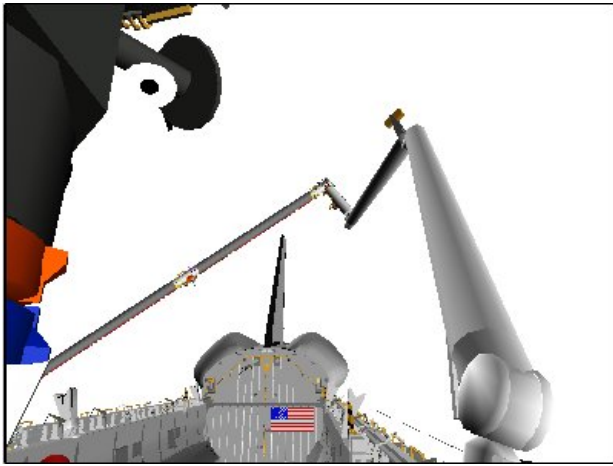

CCTV A (0,20)

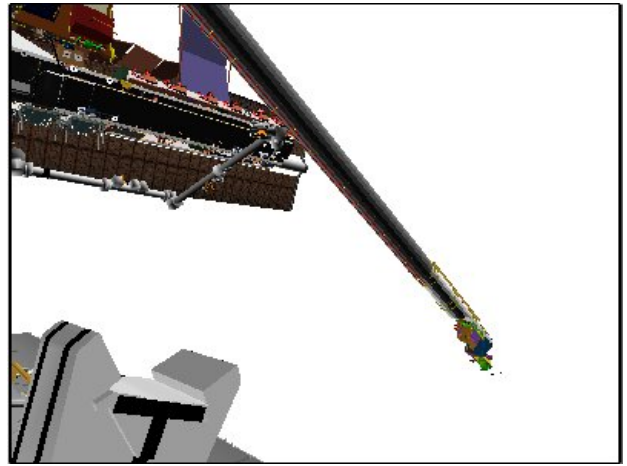

CCTV C (45,5)

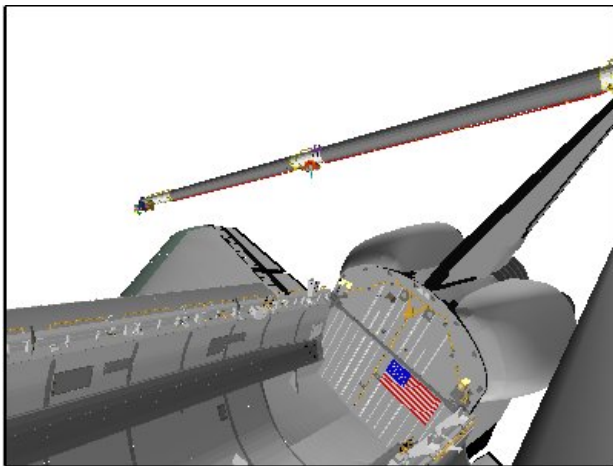

RMS ELBOW (-40,-10)

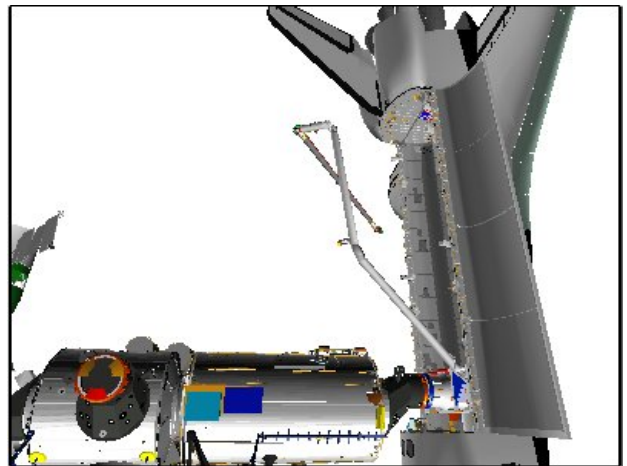

P1 LOOB (100,25)

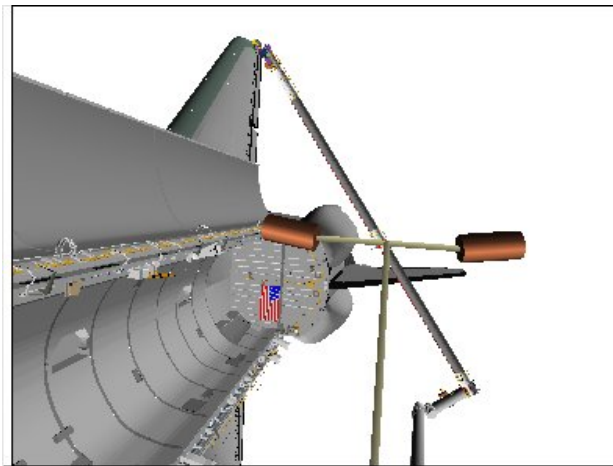

US LAB (-10,-25)

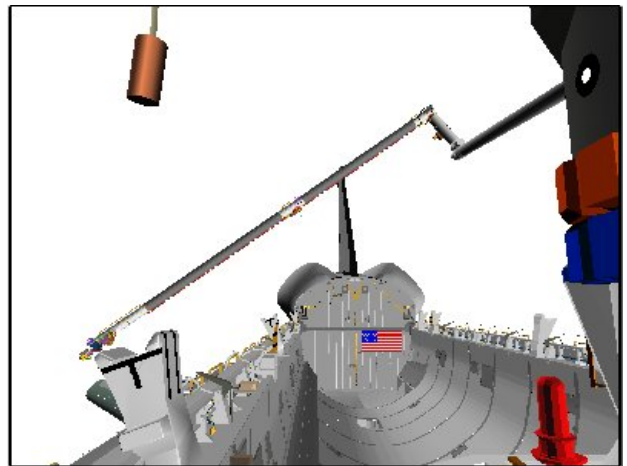

CCTV D (0,10)

STBD DOCKED LDRI RCC SURVEY – Pause Pt 135

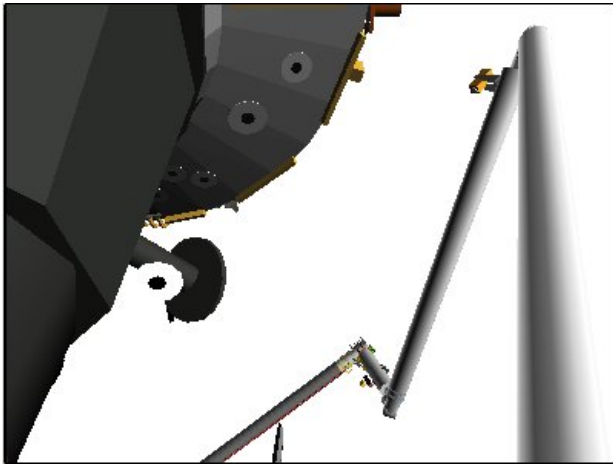

CCTV A (0,45)

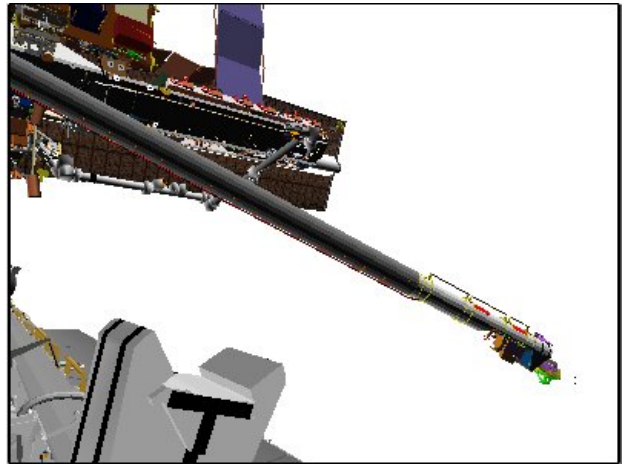

CCTV C (40,5)

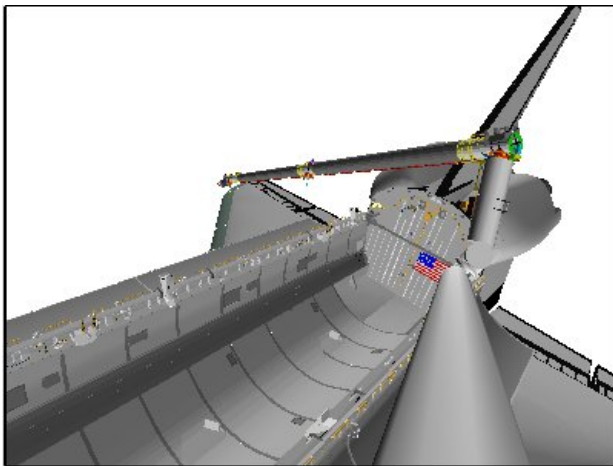

RMS ELBOW (-20,0)

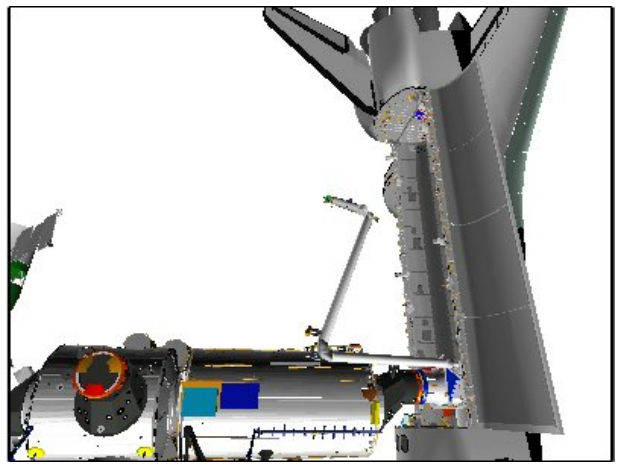

P1 LOOB (100,25)

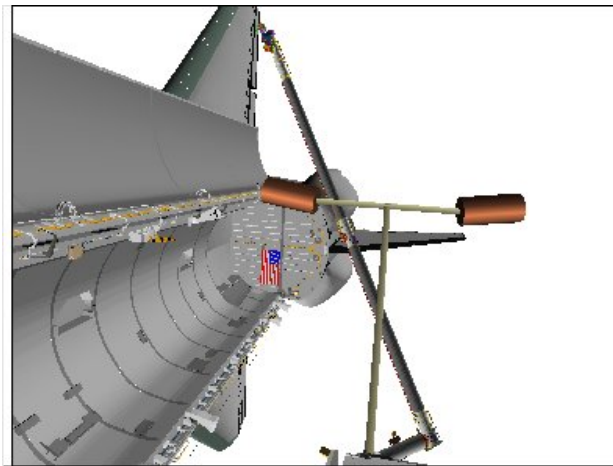

US LAB (-10,-30)



LDRI (107,-112)

STBD DOCKED LDRI RCC SURVEY – Pause Pt 138

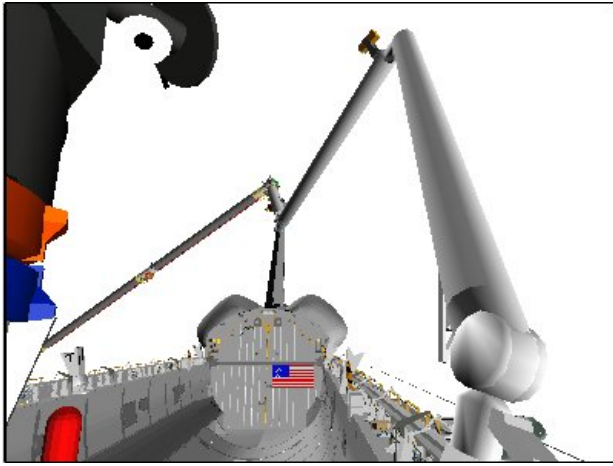

CCTV A (0,15)

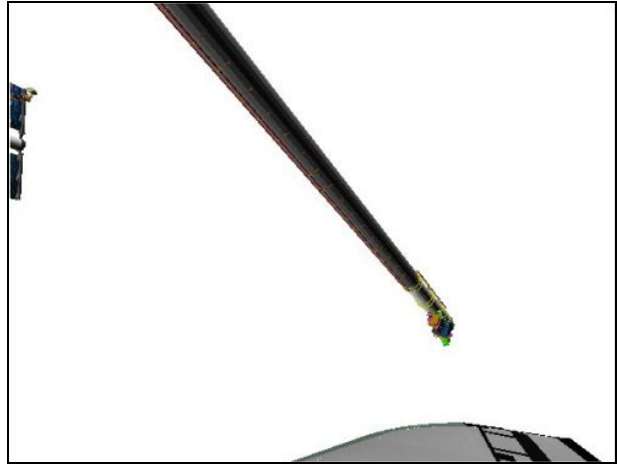

CCTV C (80,5)

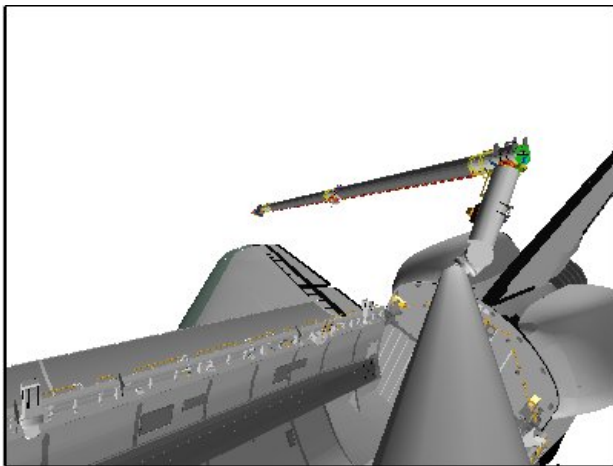

RMS ELBOW (-20,0)

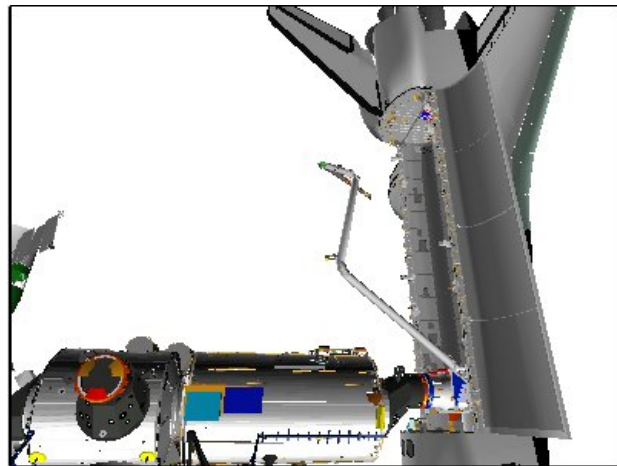

P1 LOOB (100,25)

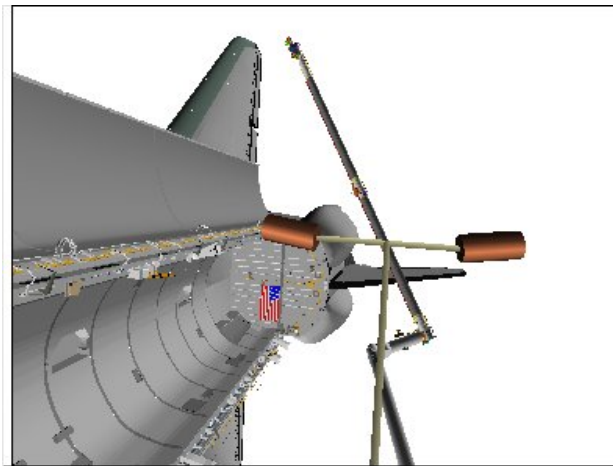

US LAB (-10,-25)

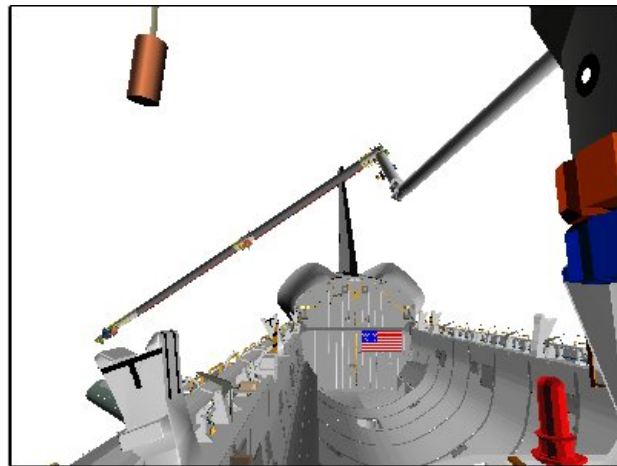

CCTV D (0,10)

STBD DOCKED LDRI RCC SURVEY – Pause Pt 140

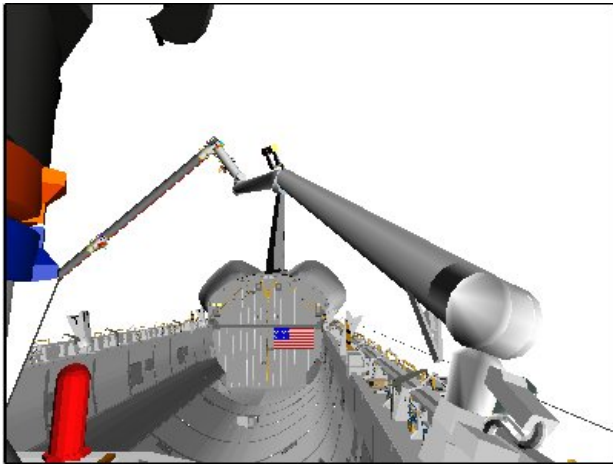

CCTV A (0,10)

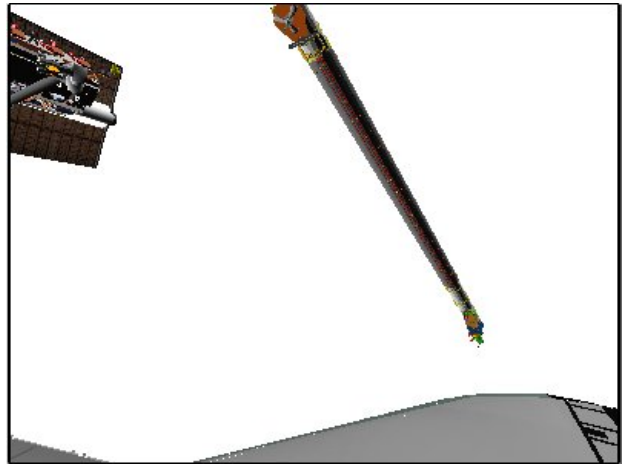

CCTV C (70,0)

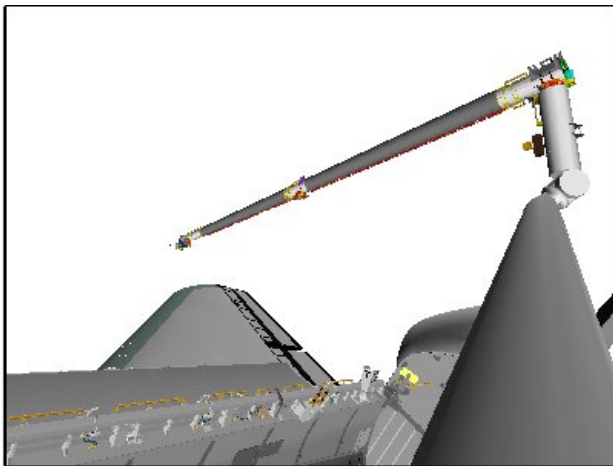

RMS ELBOW (-30,-10)

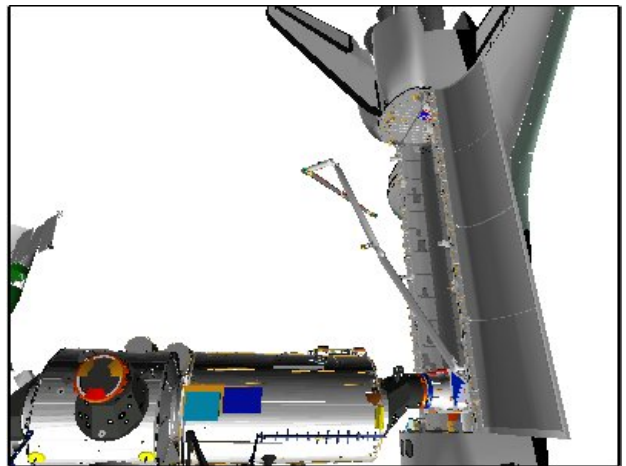

P1 LOOB (100,25)

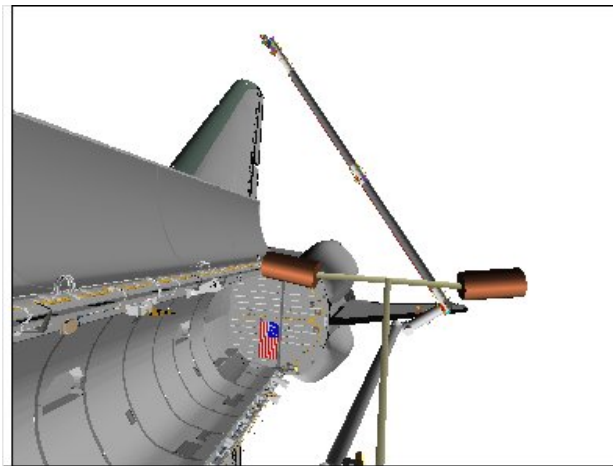

US LAB (-10,-20)

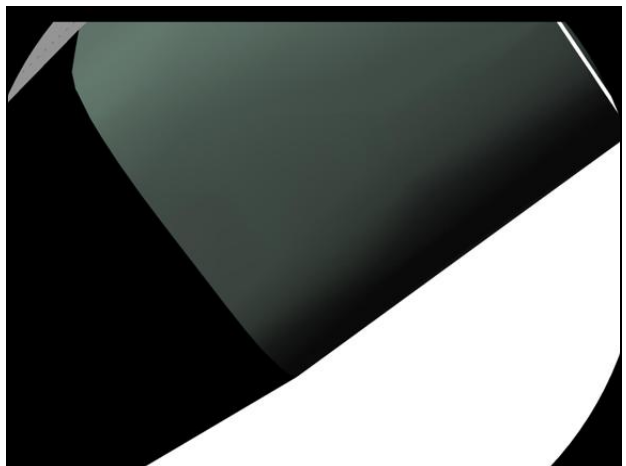

LDRI (110,-67)

STBD DOCKED LDRI RCC SURVEY – Pause Pt 143

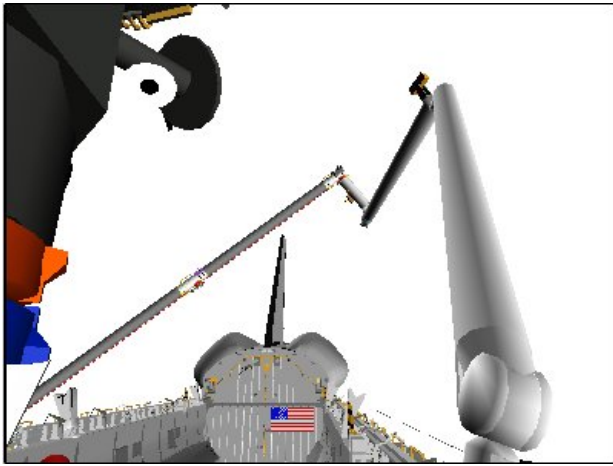

CCTV A (0,20)

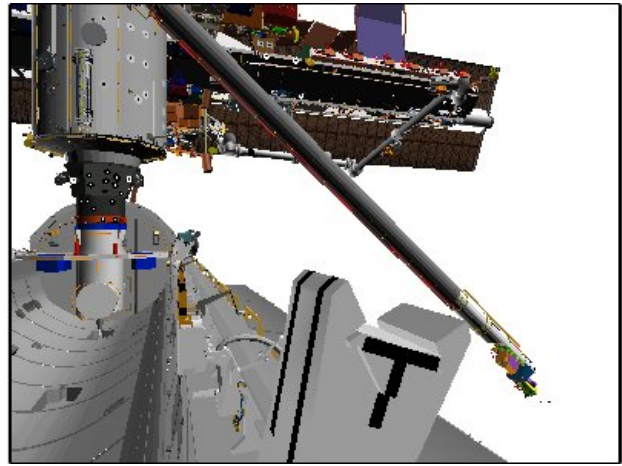

CCTV C (20,0)

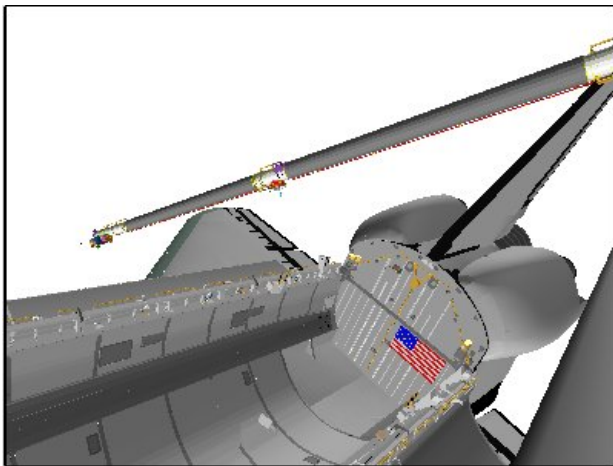

RMS ELBOW (-40,-10)

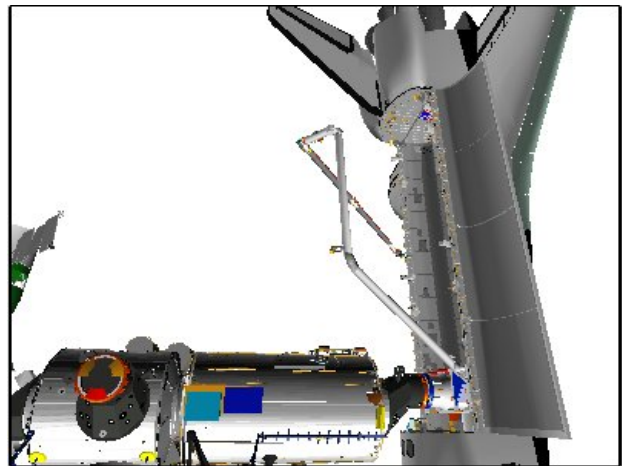

P1 LOOB (100,25)

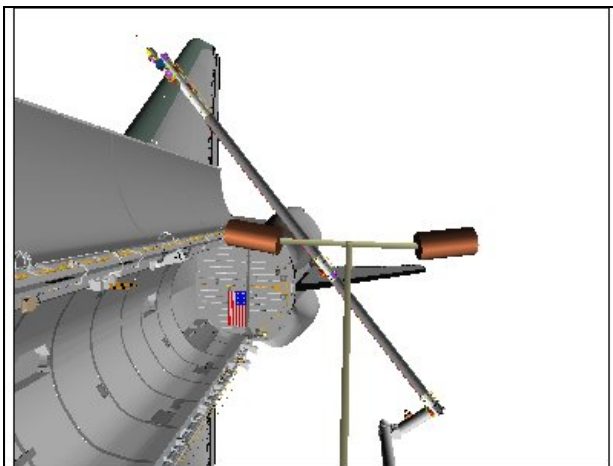

US LAB (-5,-25)

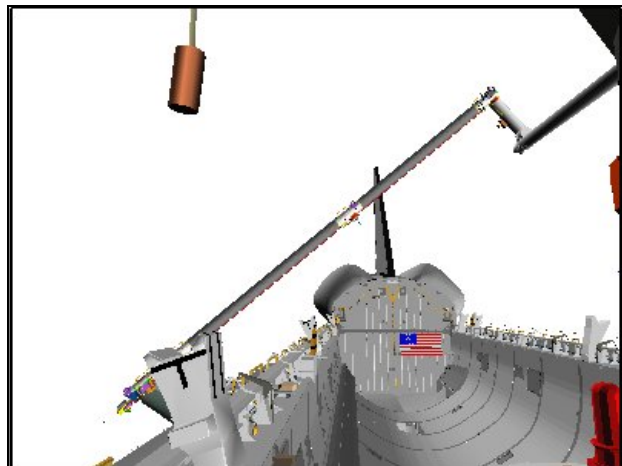

CCTV D (-5,10)

STBD DOCKED LDRI RCC SURVEY – Pause Pt 144

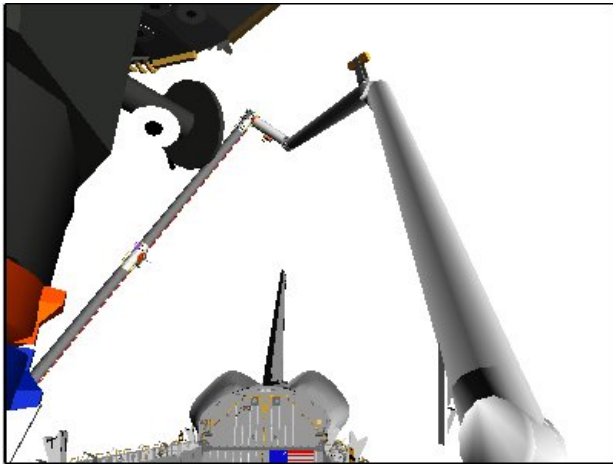

CCTV A (0,25)

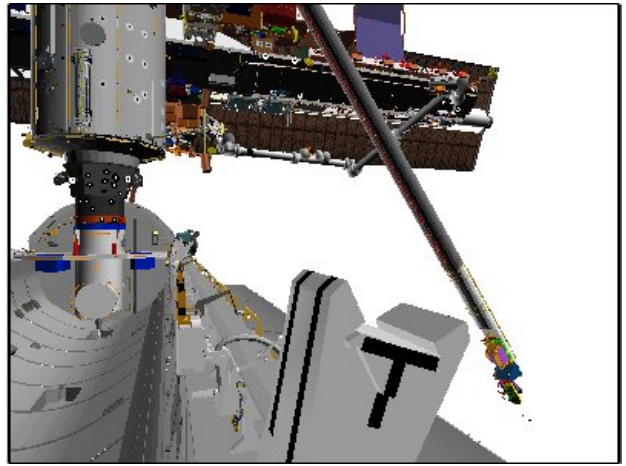

CCTV C (20,0)

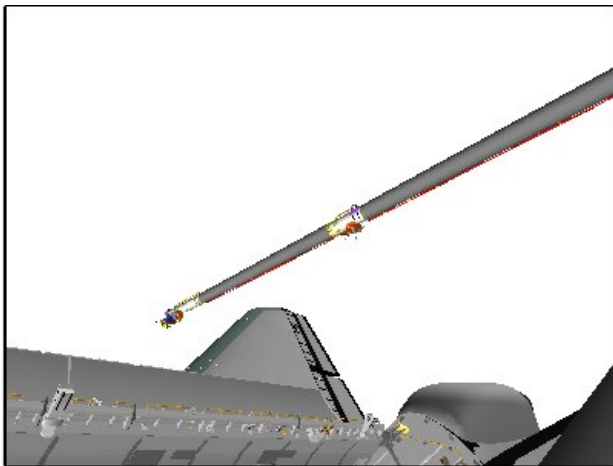

RMS ELBOW (-50,-20)

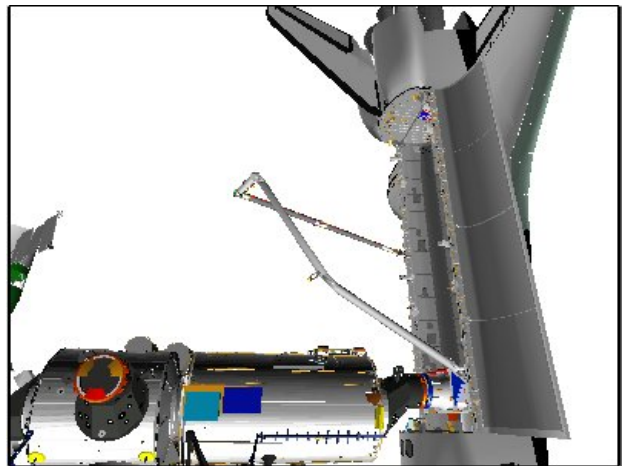

P1 LOOB (100,25)

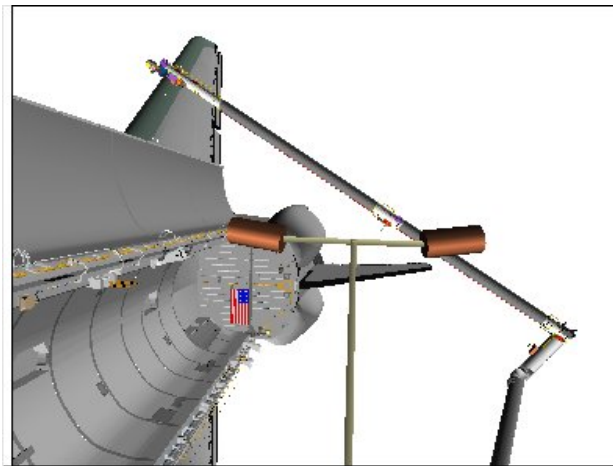

US LAB (-5,-25)

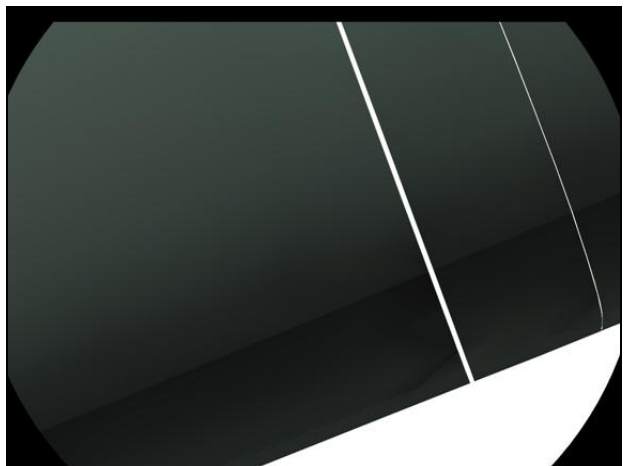

LDRI (110,-88)

STBD DOCKED LDRI RCC SURVEY – Pause Pt 145

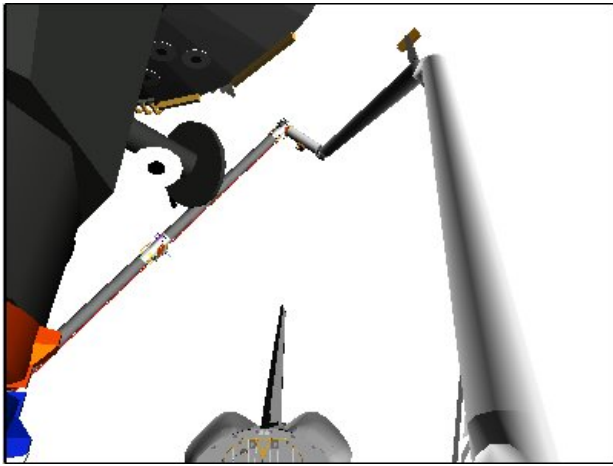

CCTV A (0,30)

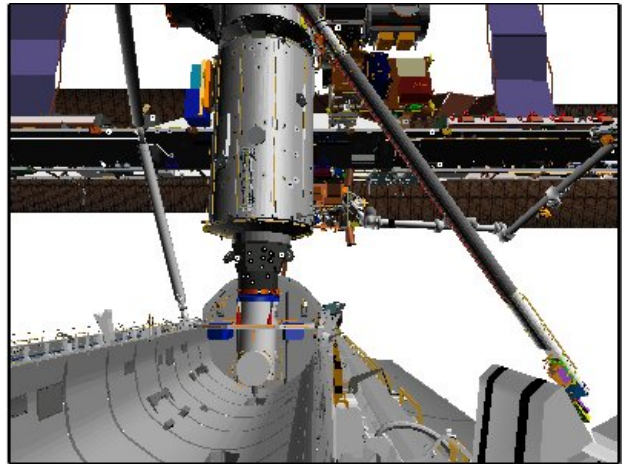

CCTV C (0,10)

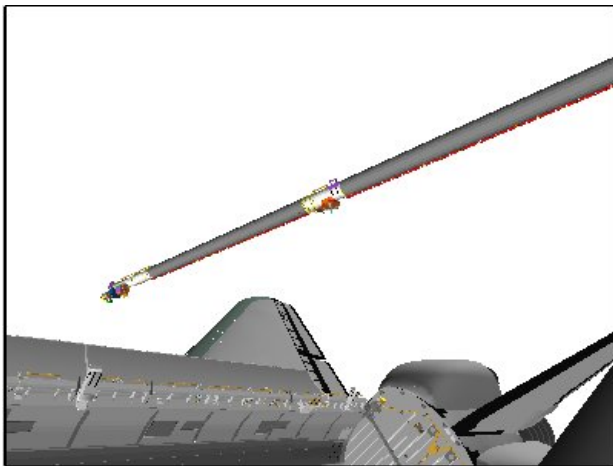

RMS ELBOW (-50,-20)

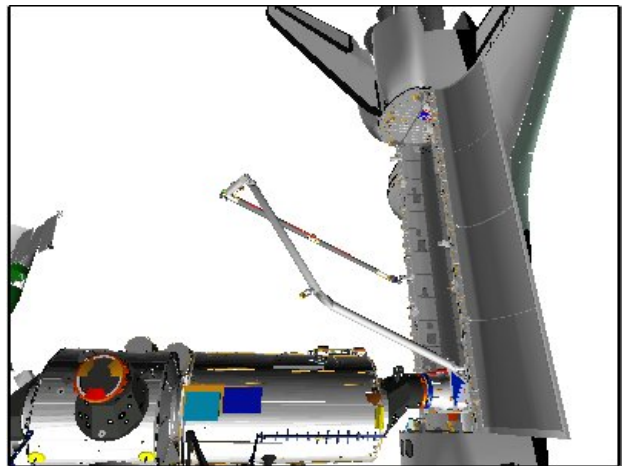

P1 LOOB (100,25)

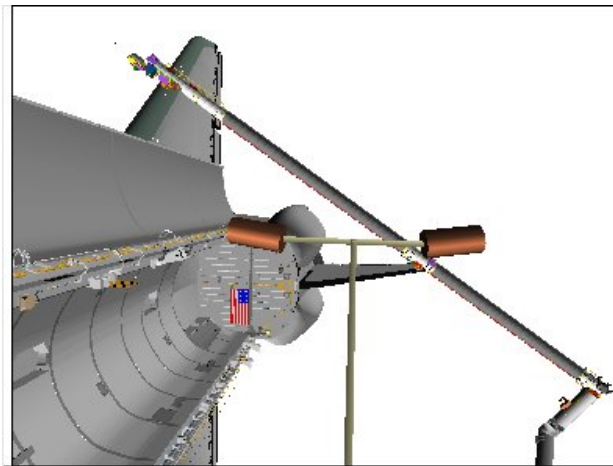

US LAB (-5,-25)

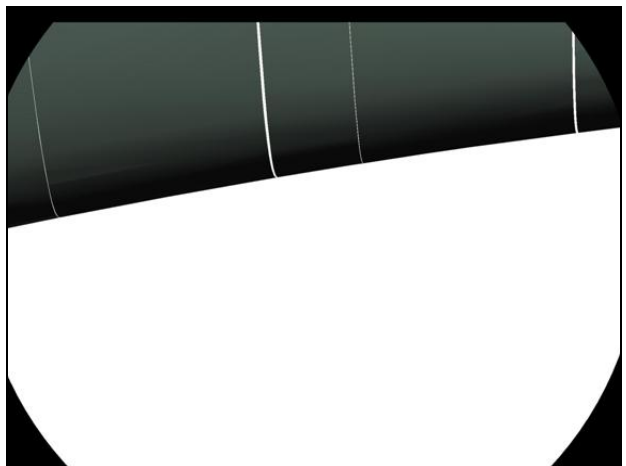

LDRI (88,-88)

STBD DOCKED LDRI RCC SURVEY – Pause Pt 147

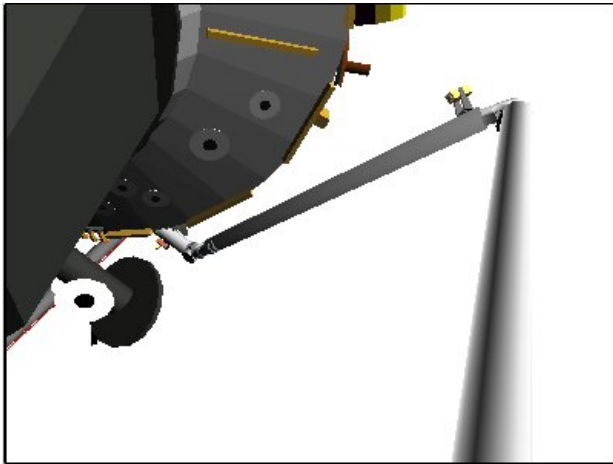

CCTV A (10,50)

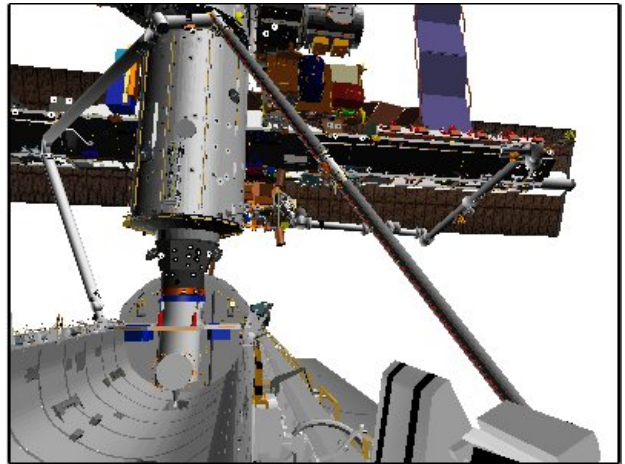

CCTV C (10,10)

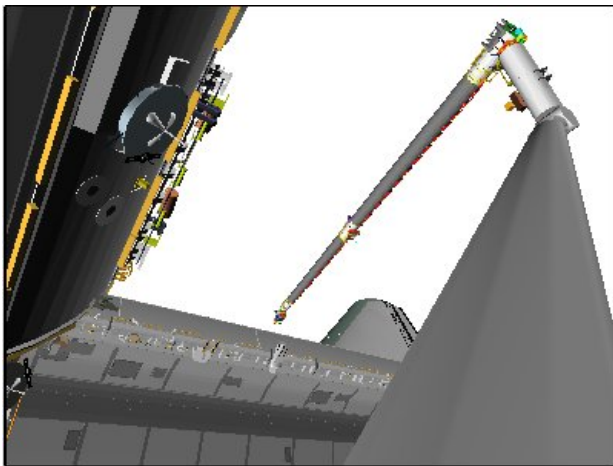

RMS ELBOW (-30,-20)

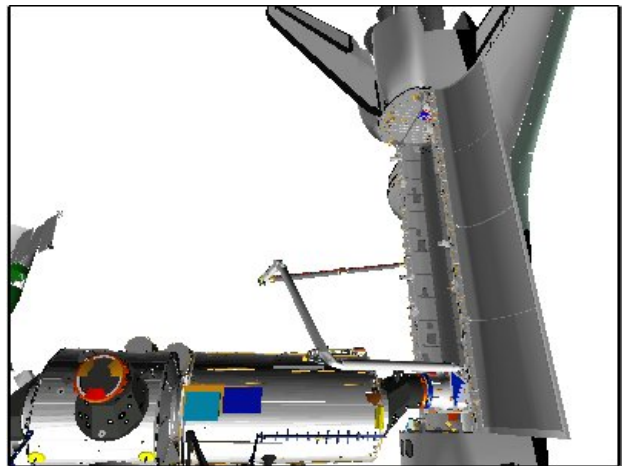

P1 LOOB (100,25)

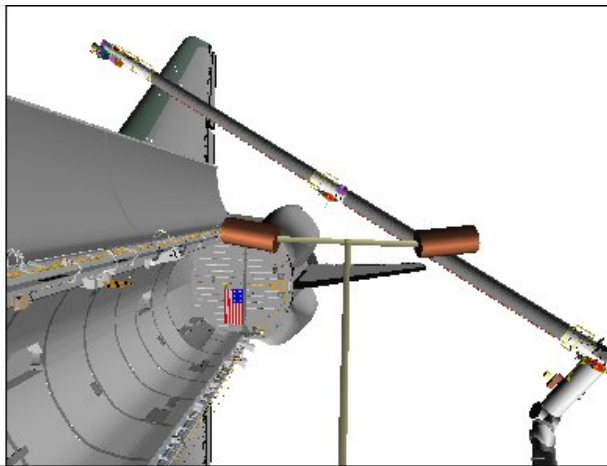

US LAB (-5,-25)

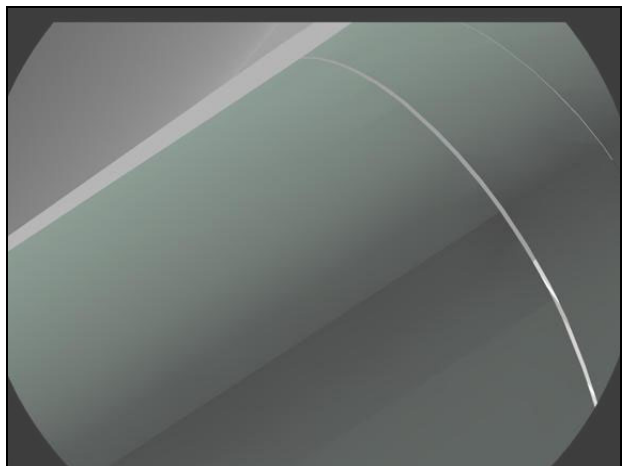

LDRI (115,-62)

STBD DOCKED LDRI RCC SURVEY – Pause Pt 148

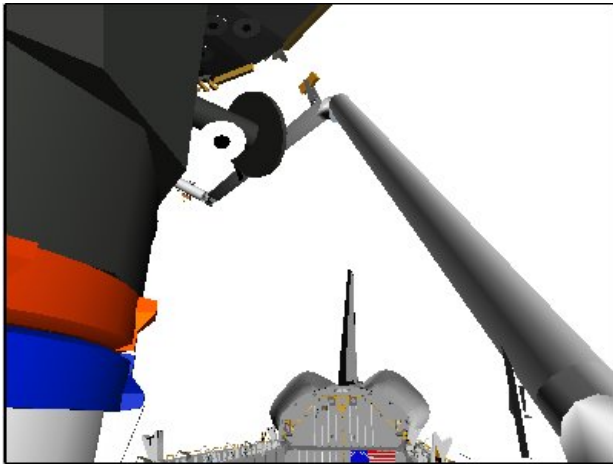

CCTV A (-10,25)

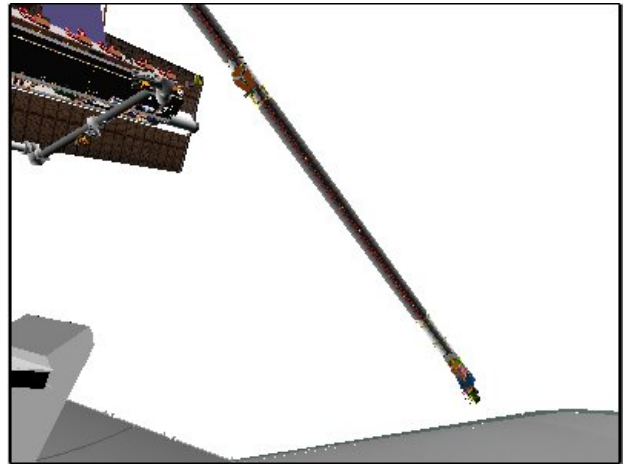

CCTV C (60,0)

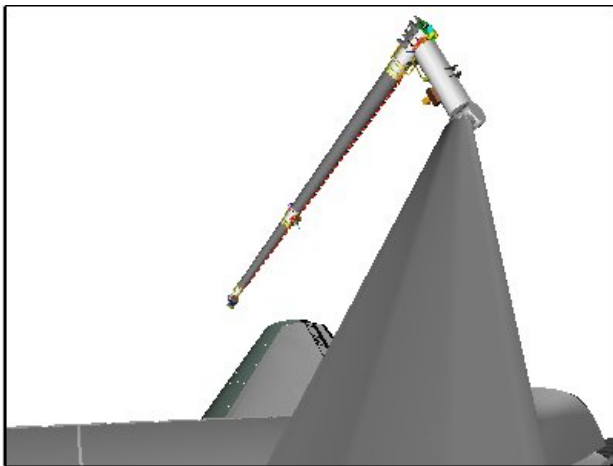

RMS ELBOW (-20,-20)

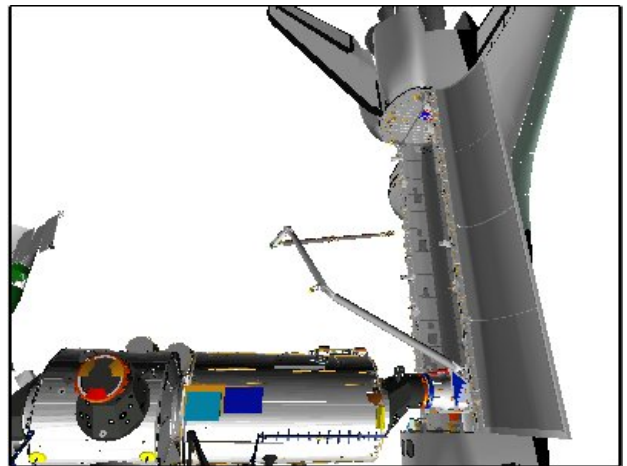

P1 LOOB (100,25)

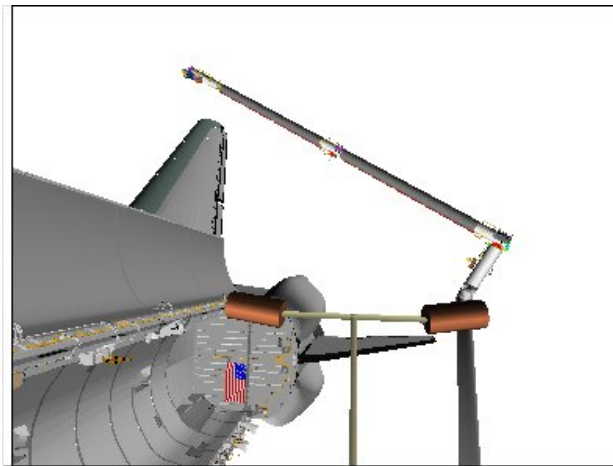

US LAB (-5,-15)

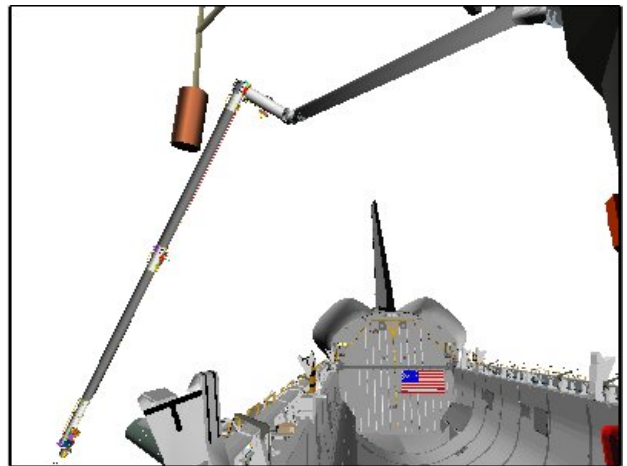

CCTV D (-5,15)

STBD DOCKED LDRI RCC SURVEY – Pause Pt 149

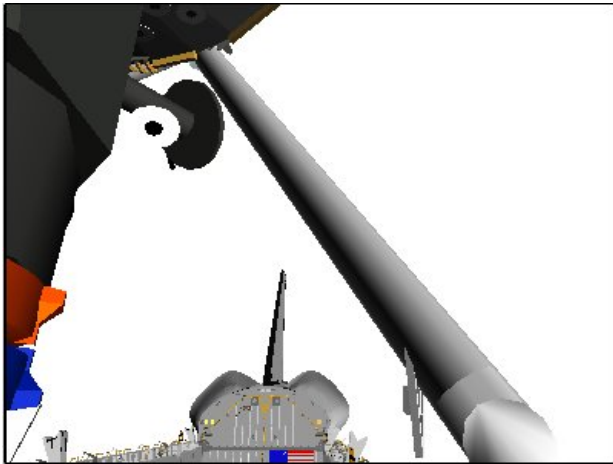

CCTV A (0,25)

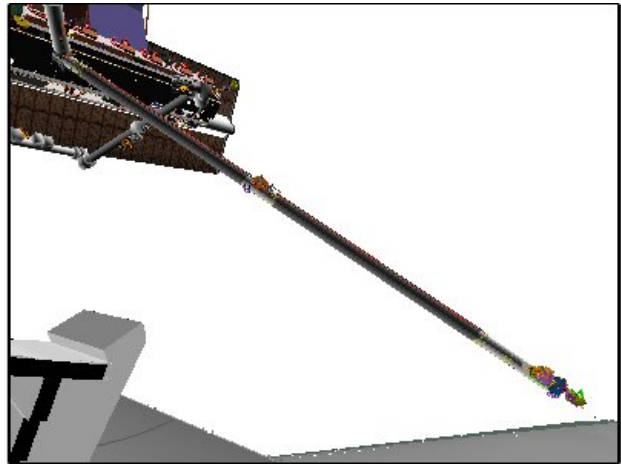

CCTV C (55,0)

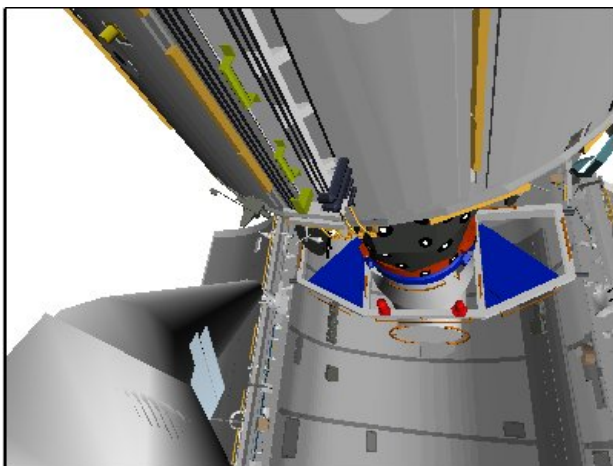

RMS ELBOW (-130,-30)

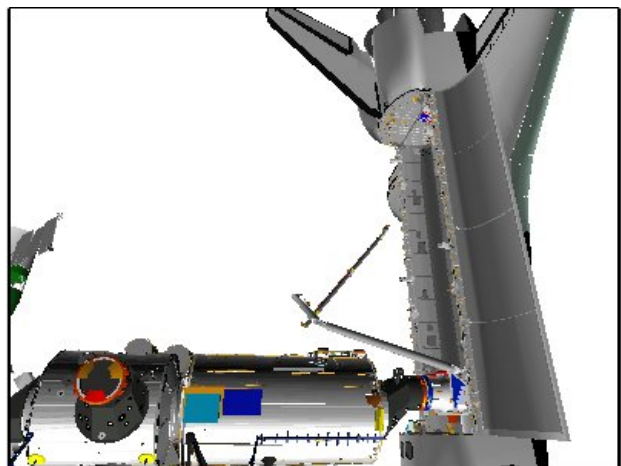

P1 LOOB (100,25)

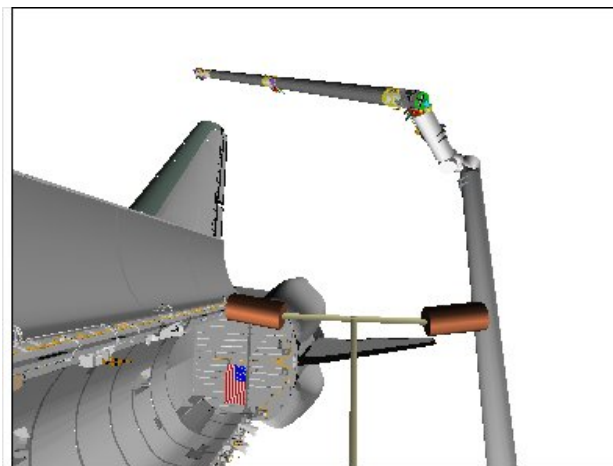

US LAB (-5,-15)

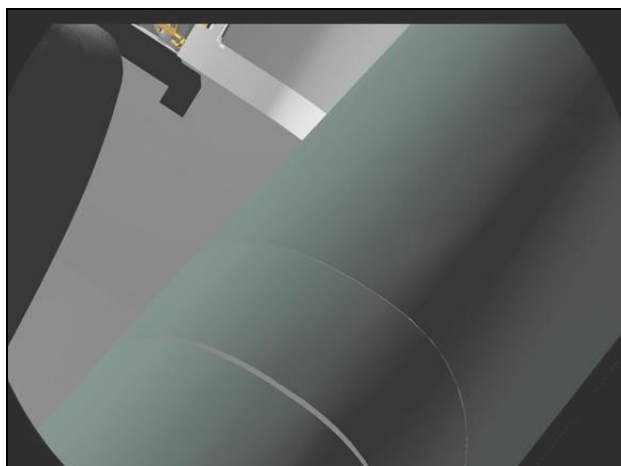

LDRI (33,-59)

STBD DOCKED LDRI RCC SURVEY – Pause Pt 150

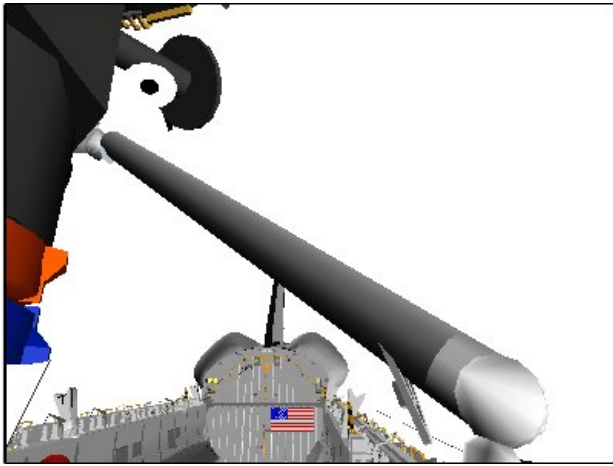

CCTV A (0,20)

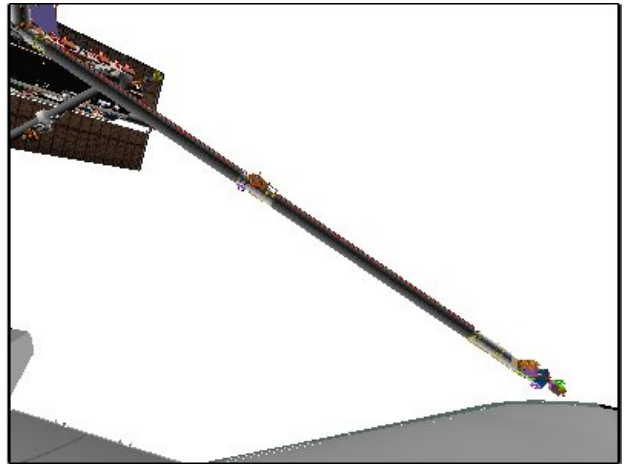

CCTV C (65,0)

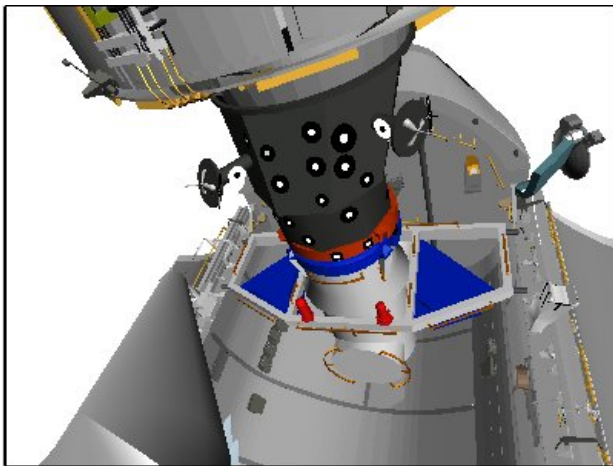

RMS ELBOW (-150,-10)

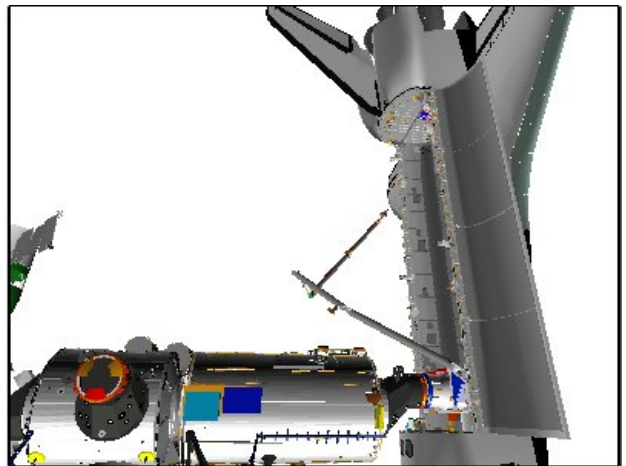

P1 LOOB (100,25)

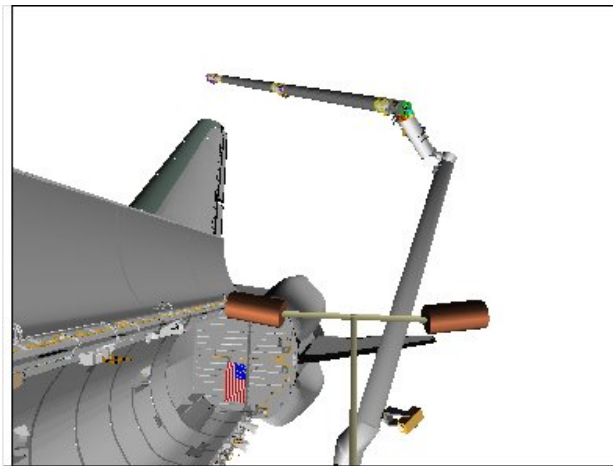

US LAB (-5,-15)

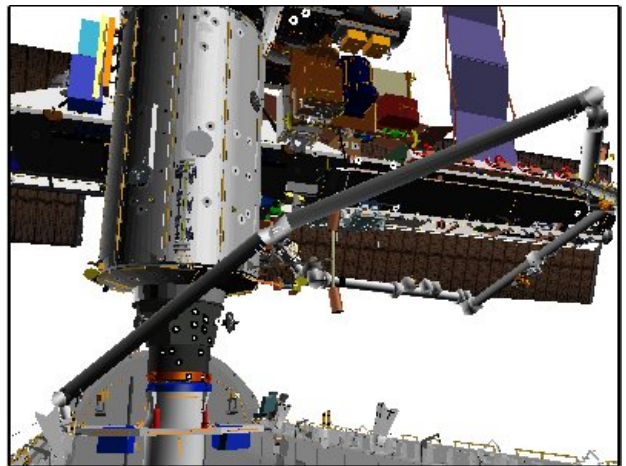

CCTV B (20,15)

STBD DOCKED LDRI RCC SURVEY – Pause Pt 152

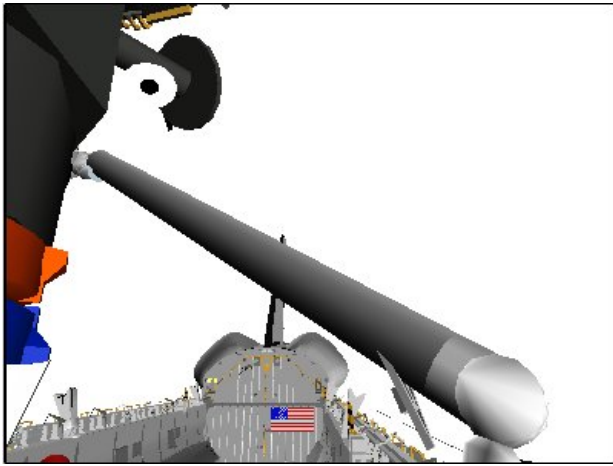

CCTV A (0,20)

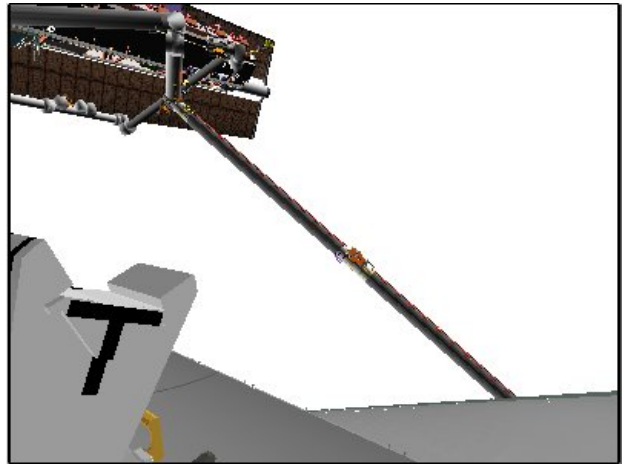

CCTV C (50,-5)

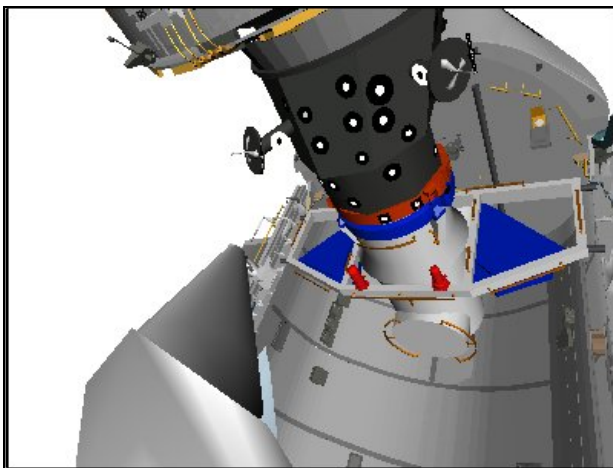

RMS ELBOW (-150,-20)

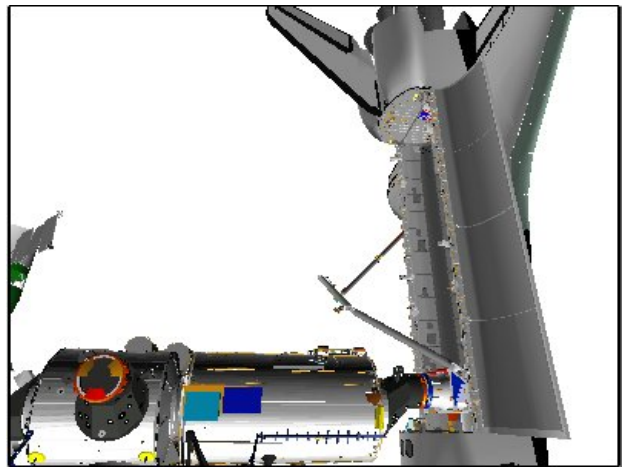

P1 LOOB (100,25)

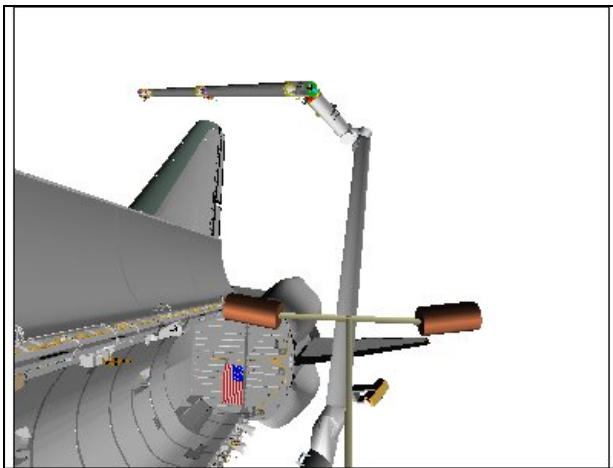

US LAB (-5,-15)

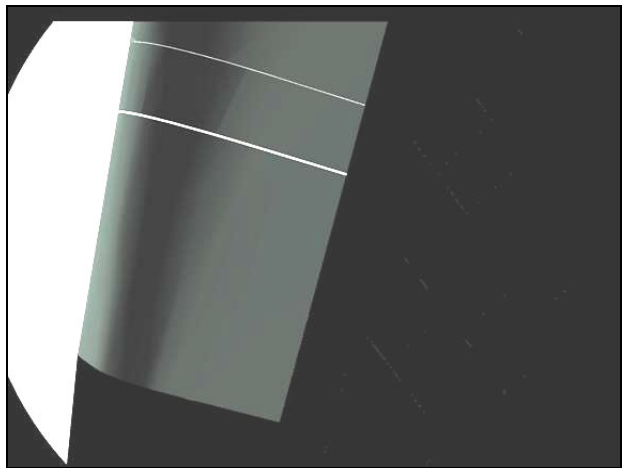

LDRI (85,-45)

STBD DOCKED LDRI RCC SURVEY – Pause Pt 155

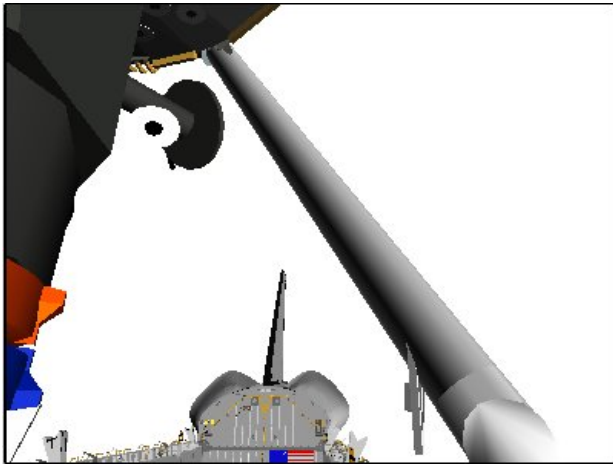

CCTV A (0,25)

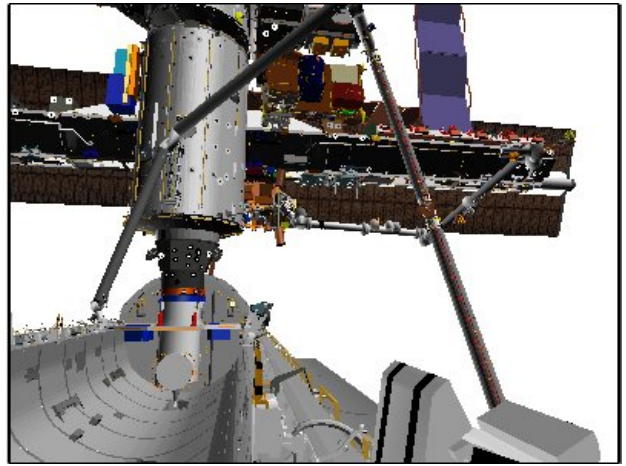

CCTV C (10,10)

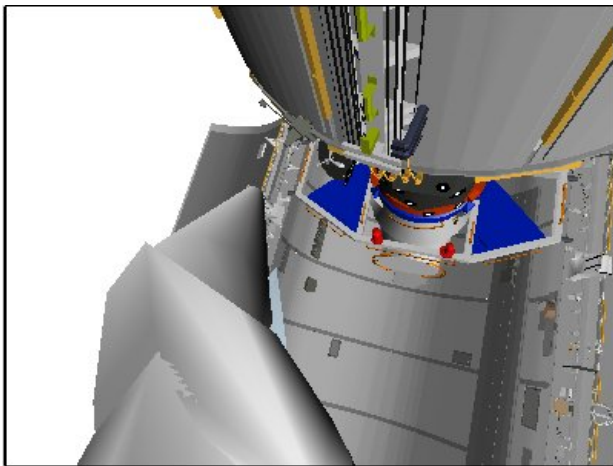

RMS ELBOW (-150,-30)

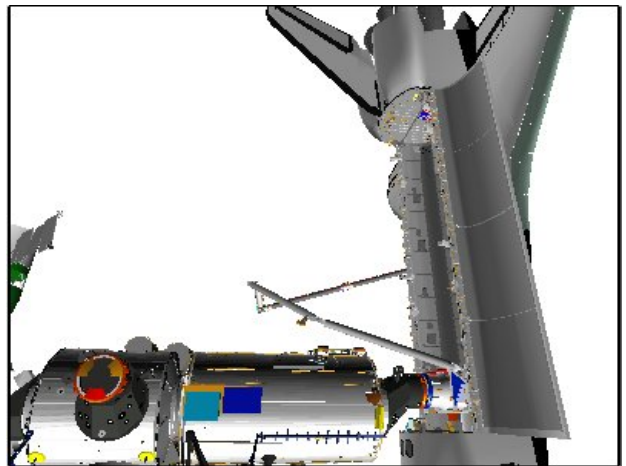

P1 LOOB (100,25)

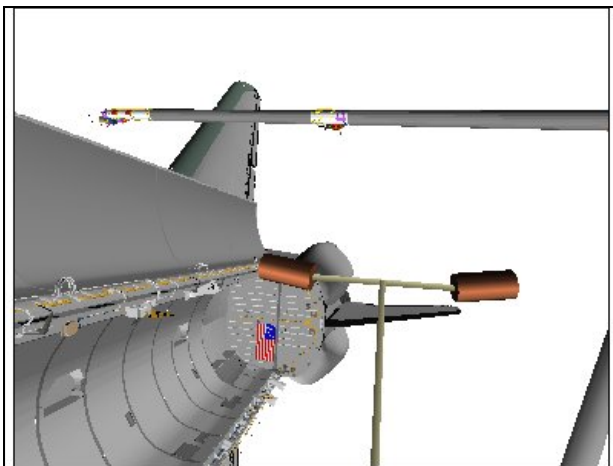

US LAB (-10,-20)

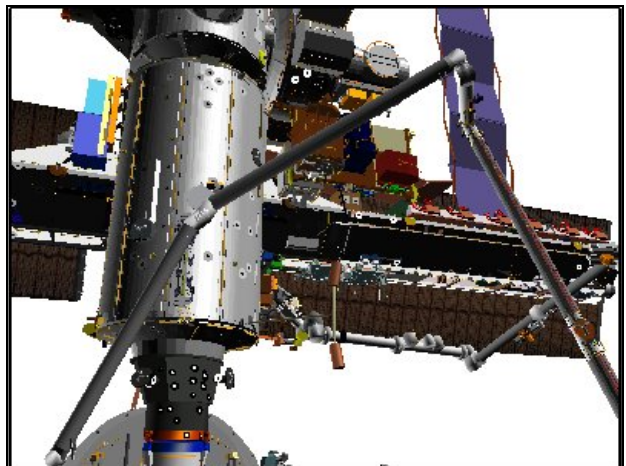

CCTV B (20,20)

STBD DOCKED LDRI RCC SURVEY – Pause Pt 156

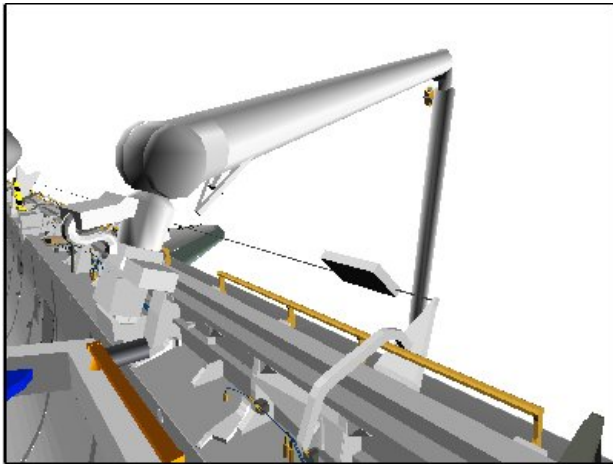

CCTV A (40,-5)

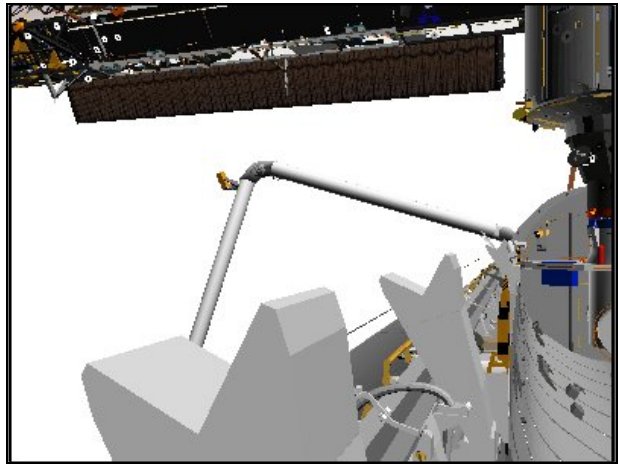

CCTV B (-20,0)

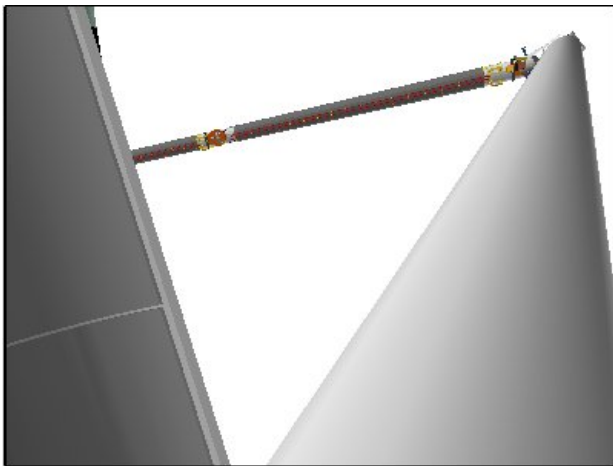

RMS ELBOW (-30,-30)

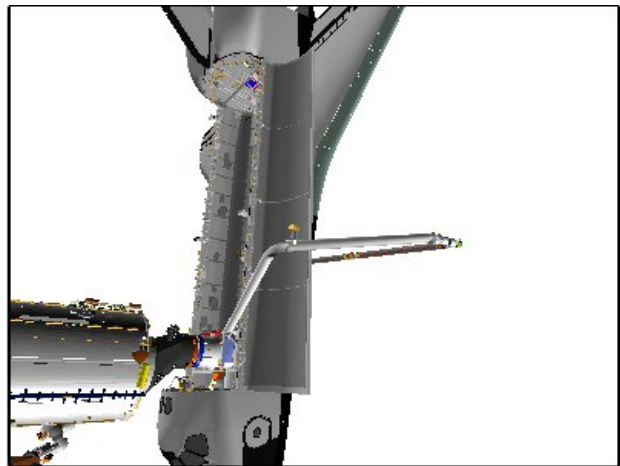

P1 LOOB (125,20)

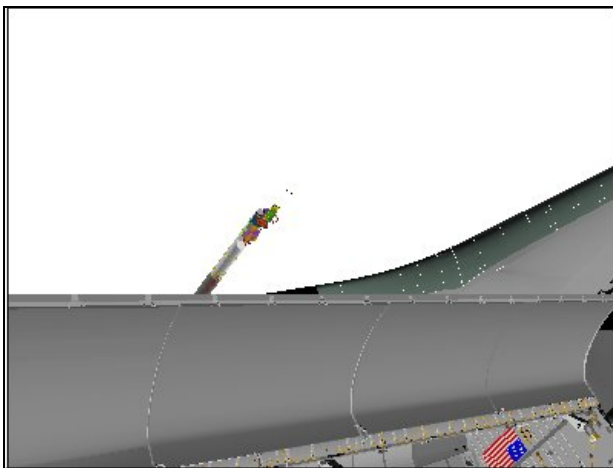

SSRMS TIP ELBOW (-80,50)

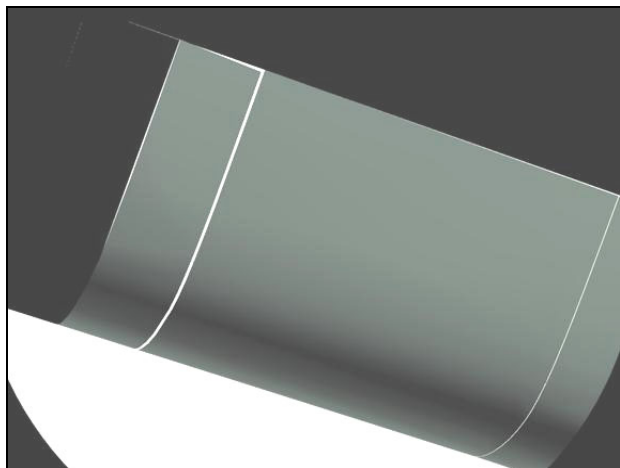

LDRI (52,-77)

STBD DOCKED LDRI RCC SURVEY – Pause Pt 159

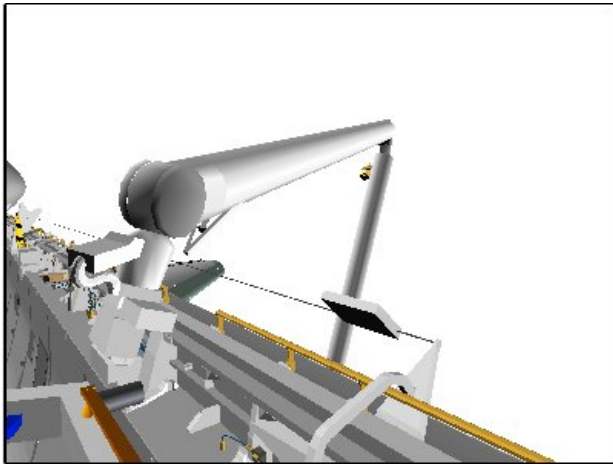

CCTV A (40,-5)

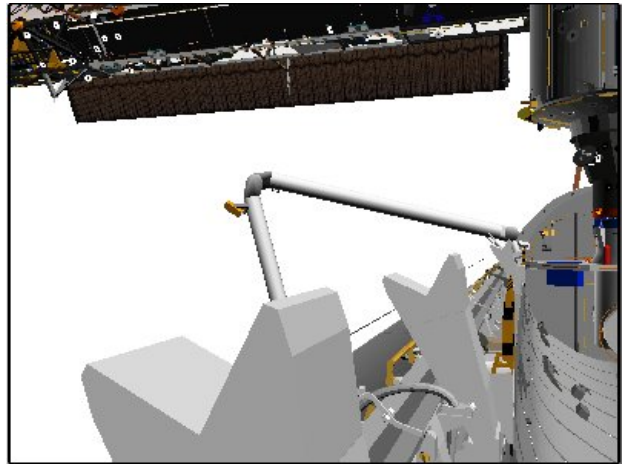

CCTV B (-20,0)

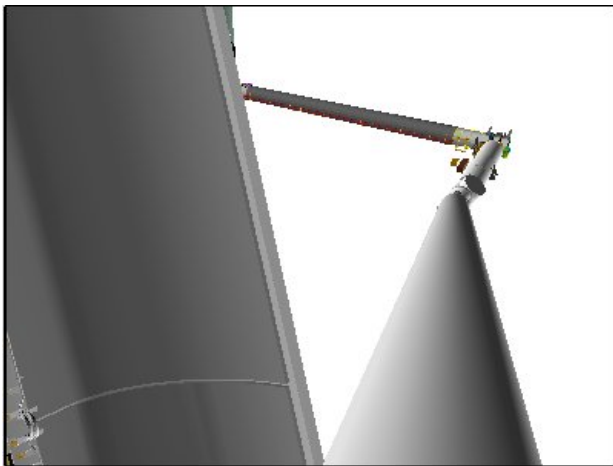

RMS ELBOW (-20,-10)

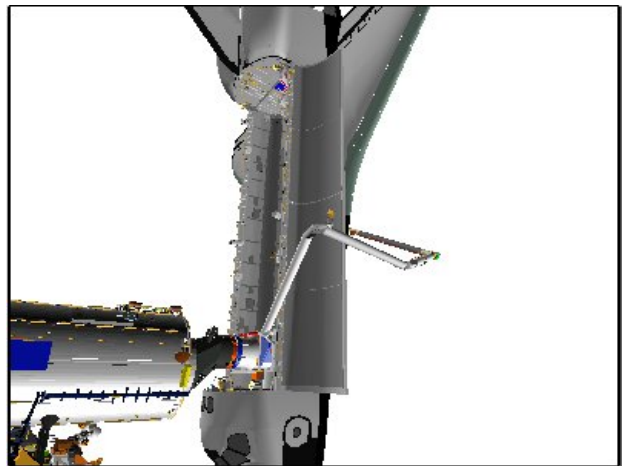

P1 LOOB (125,20)

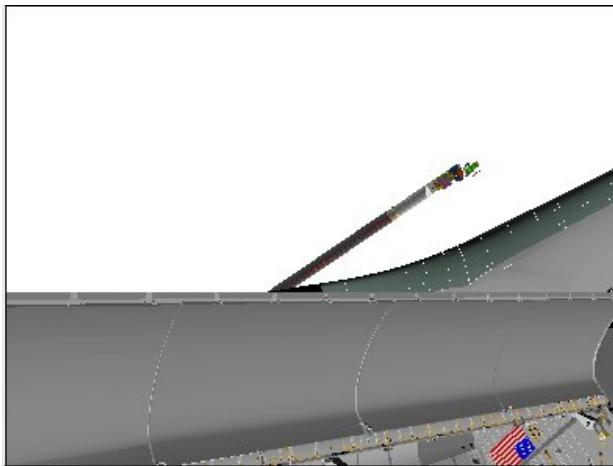

SSRMS TIP ELBOW (-80,50)

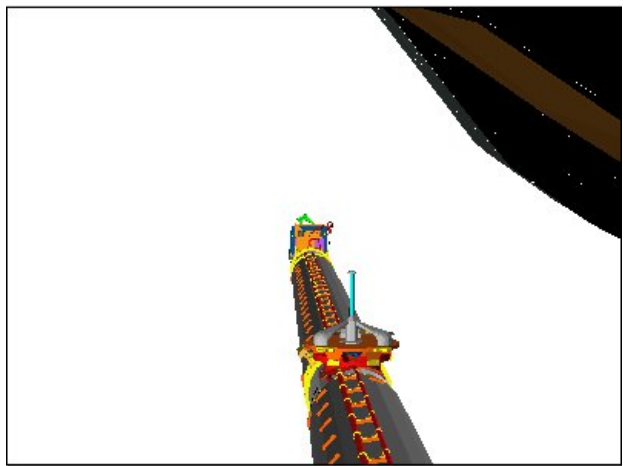

RSC

STBD DOCKED LDRI RCC SURVEY – Pause Pt 160

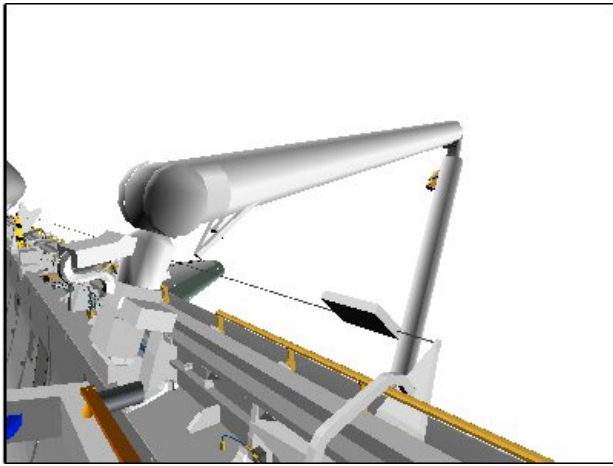

CCTV A (40,-5)

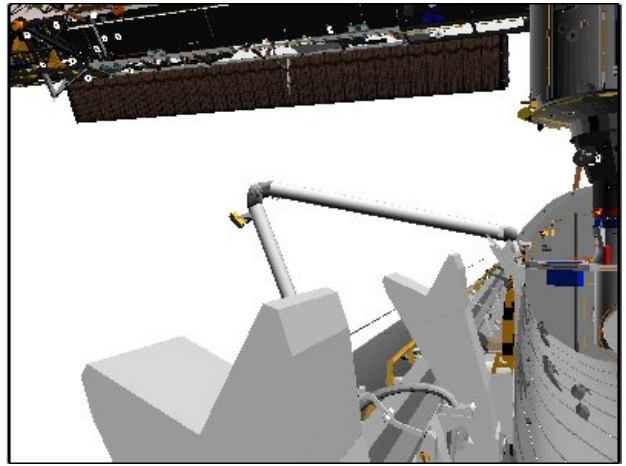

CCTV B (-20,0)

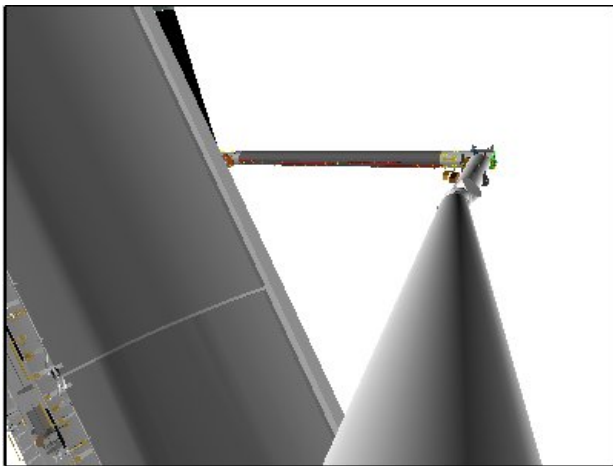

RMS ELBOW (-20,-10)

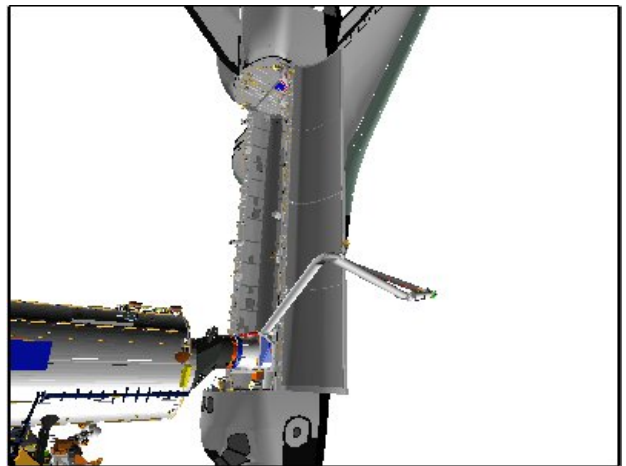

P1 LOOB (125,20)

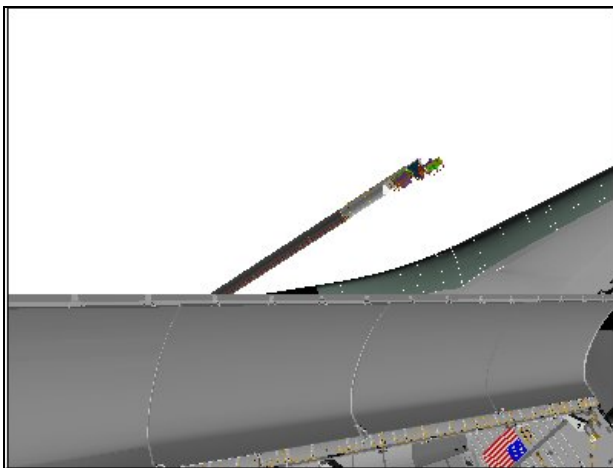

SSRMS TIP ELBOW (-80,50)

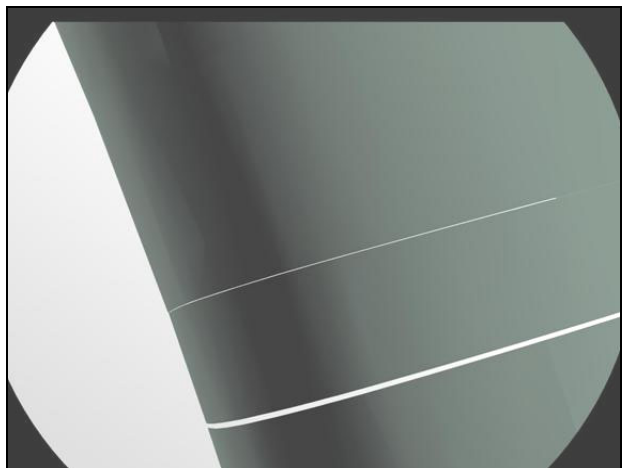

LDRI (23,-72)

STBD DOCKED LDRI RCC SURVEY – Pause Pt 162

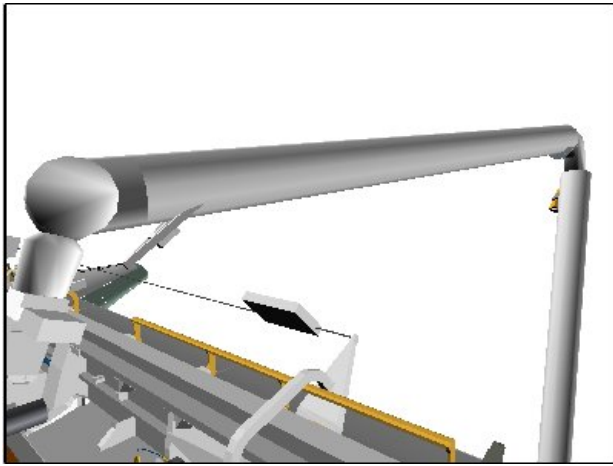

CCTV A (50,-5)

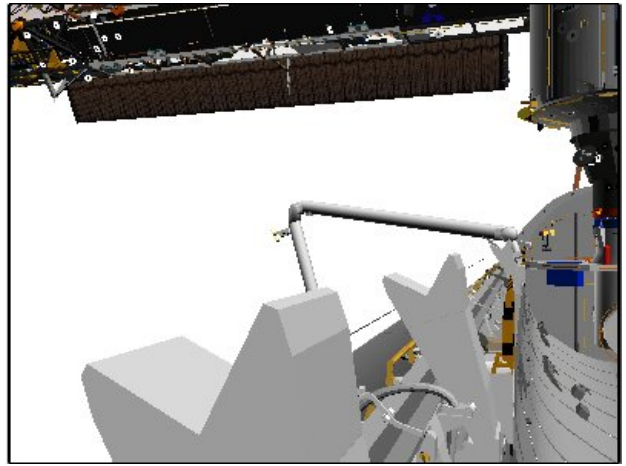

CCTV B (-20,0)

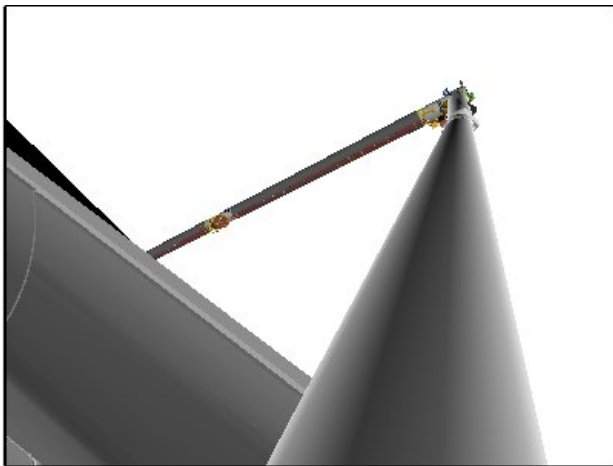

RMS ELBOW (-20,-20)

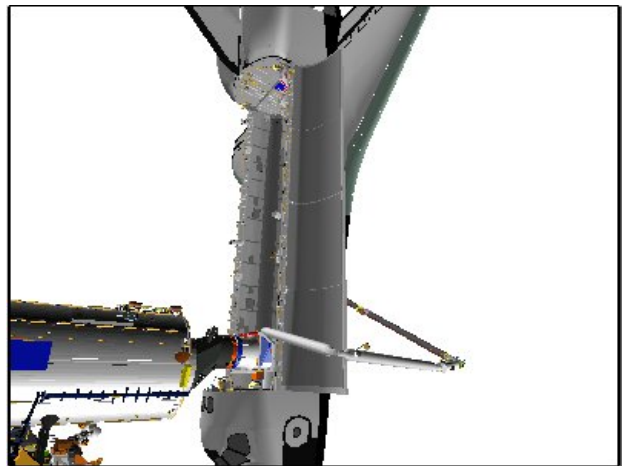

P1 LOOB (125,20)

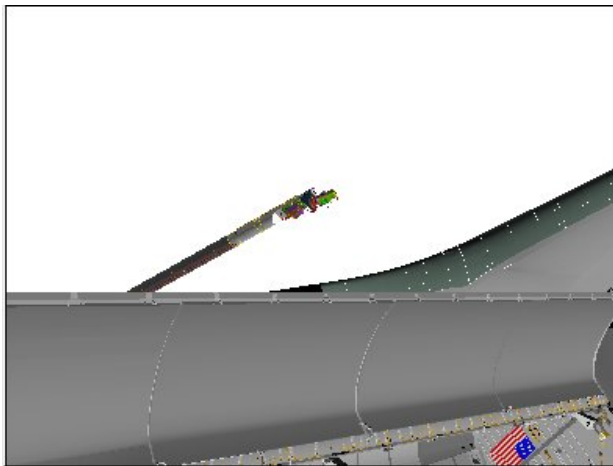

SSRMS TIP ELBOW (-80,50)

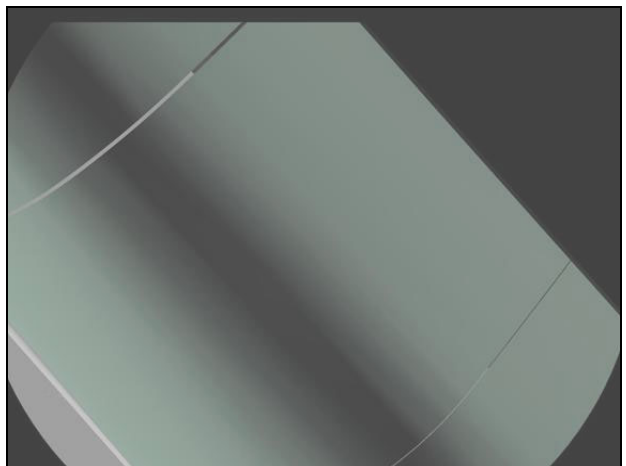

LDRI (30,-65)

STBD DOCKED LDRI RCC SURVEY – Pause Pt 163

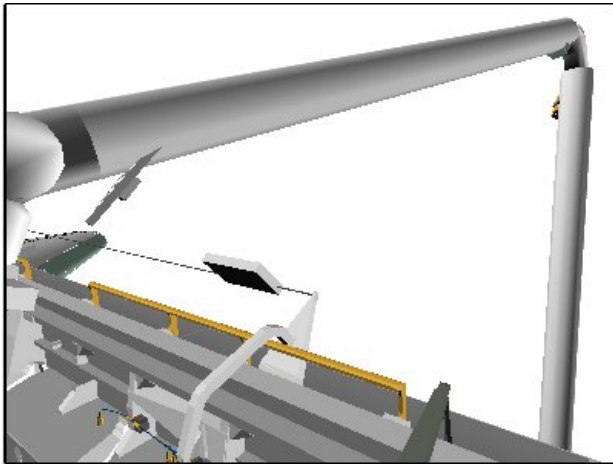

CCTV A (55,-10)

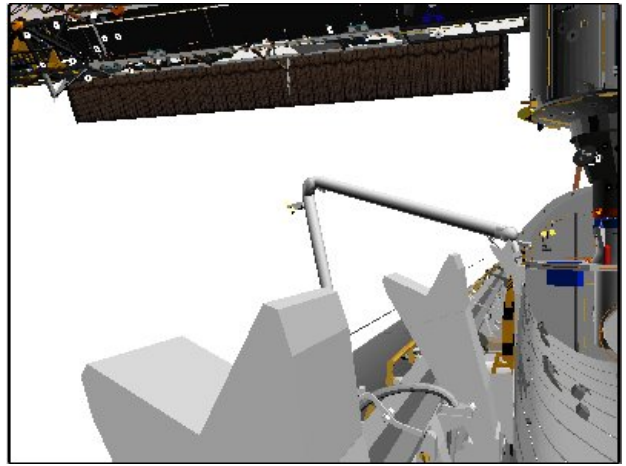

CCTV B (-20,0)

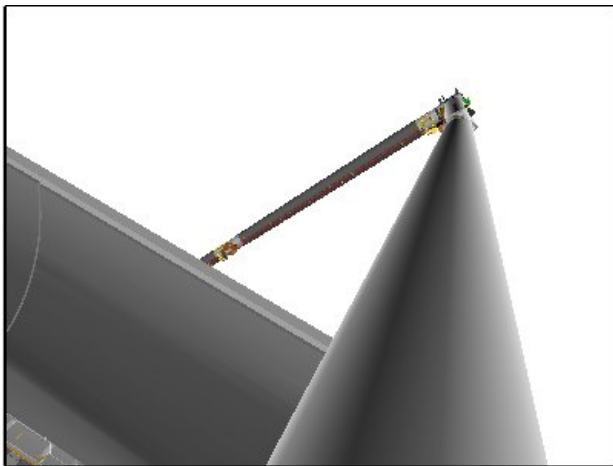

RMS ELBOW (-20,-20)

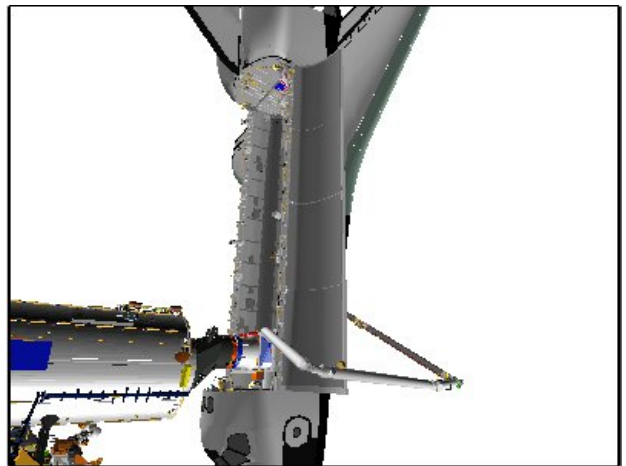

P1 LOOB (125,20)

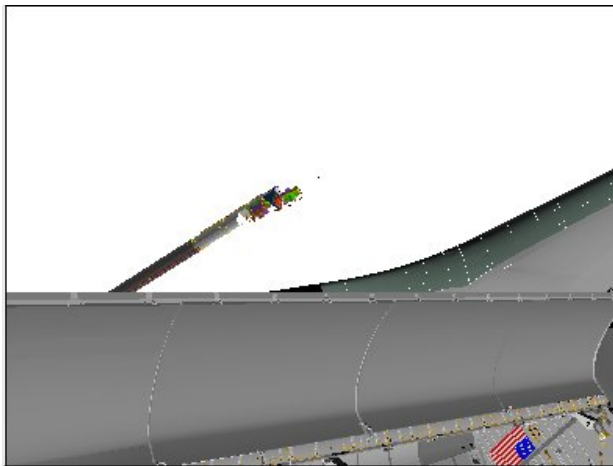

SSRMS TIP ELBOW (-80,50)

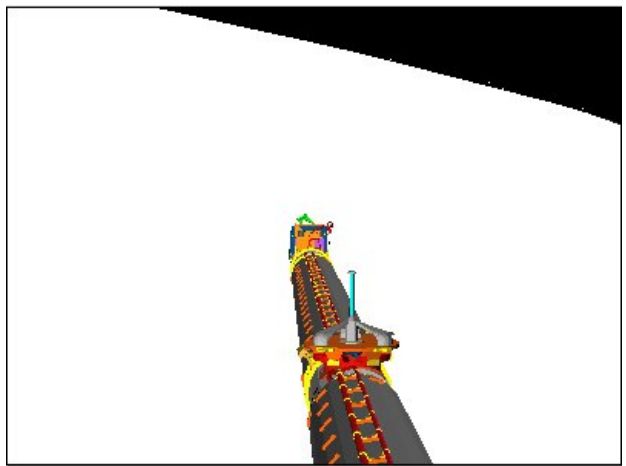

RSC

STBD DOCKED LDRI RCC SURVEY – Pause Pt 164

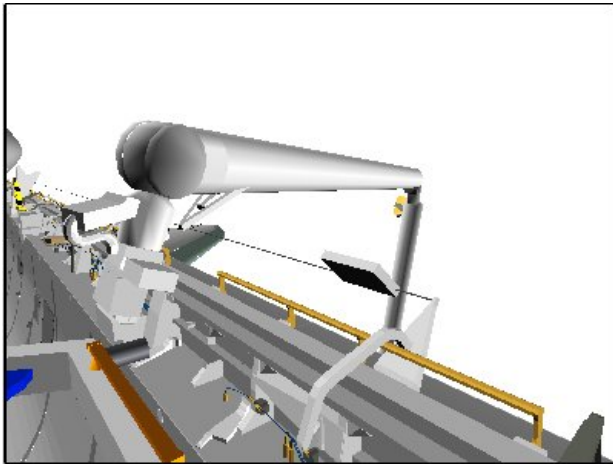

CCTV A (40,-10)

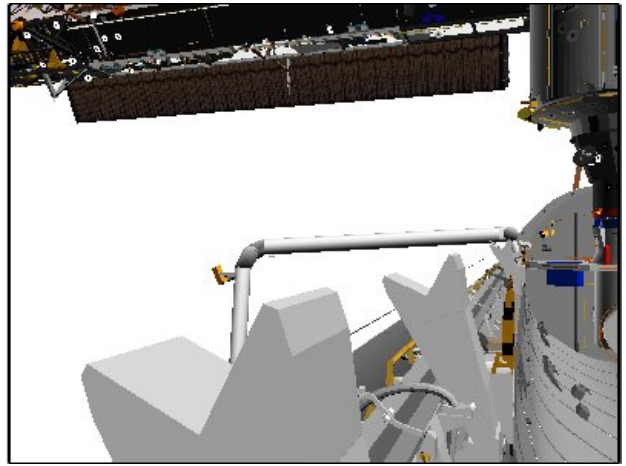

CCTV B (-20,0)

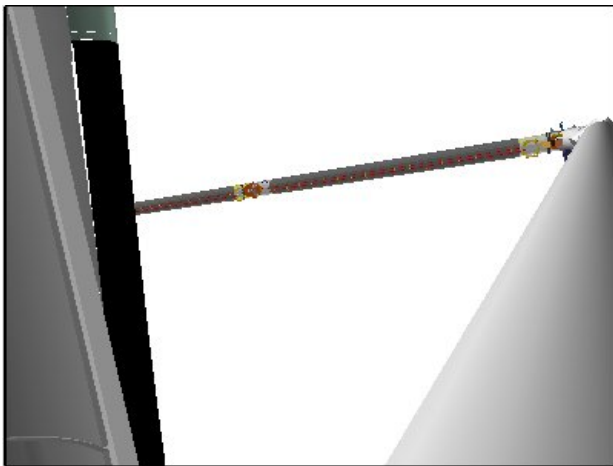

RMS ELBOW (-35,-20)

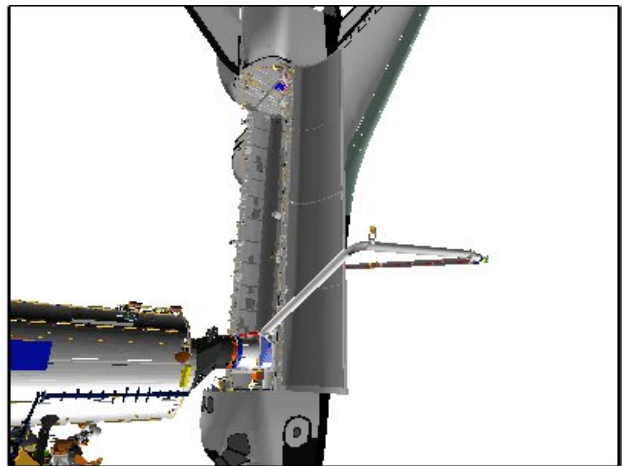

P1 LOOB (125,20)

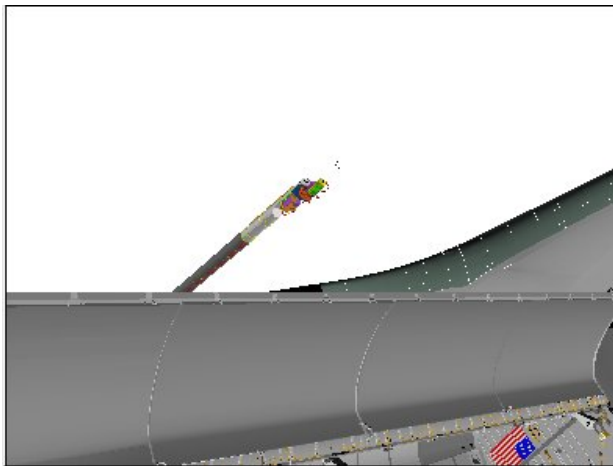

SSRMS TIP ELBOW (-80,50)

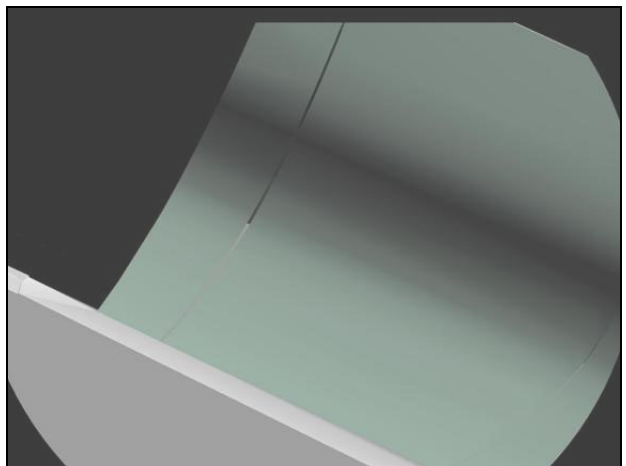

LDRI (47,-49)

STBD DOCKED LDRI RCC SURVEY – Pause Pt 165

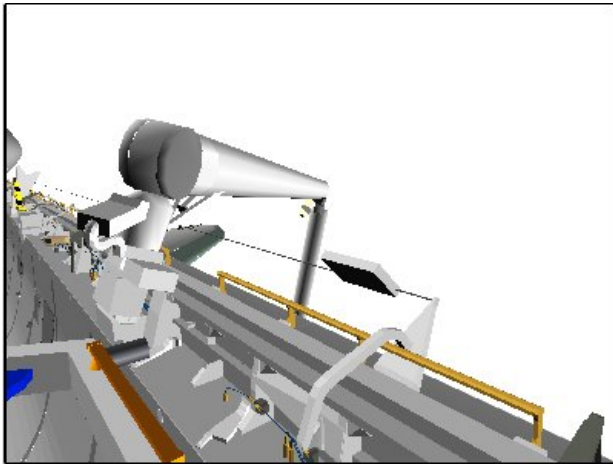

CCTV A (40,-10)

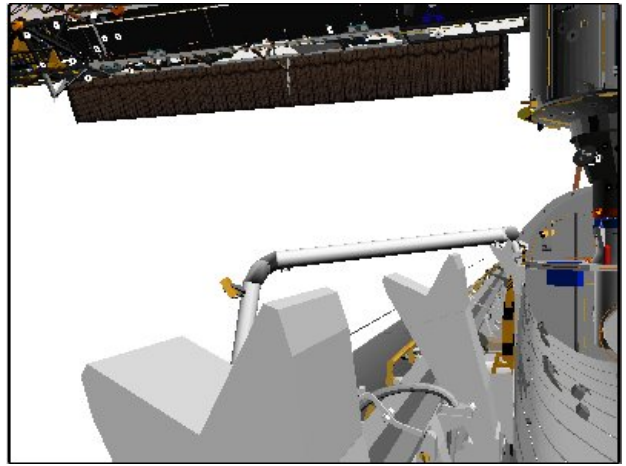

CCTV B (-20,0)

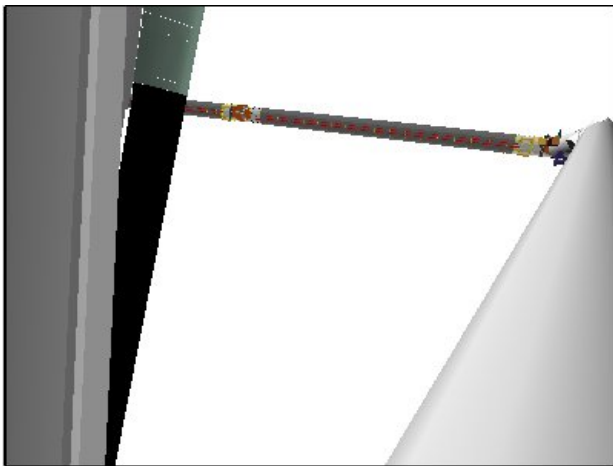

RMS ELBOW (-35,-20)

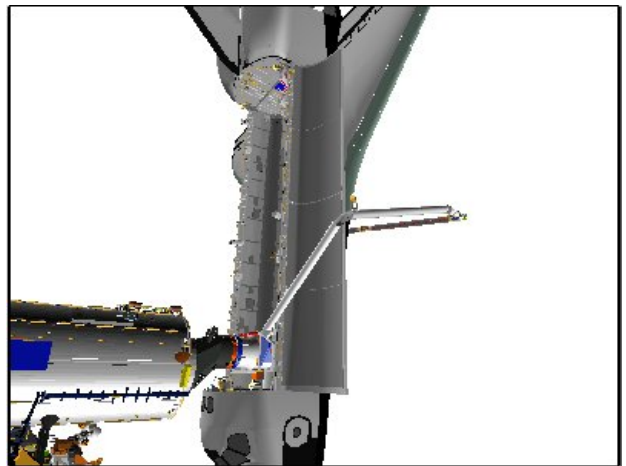

P1 LOOB (125,20)

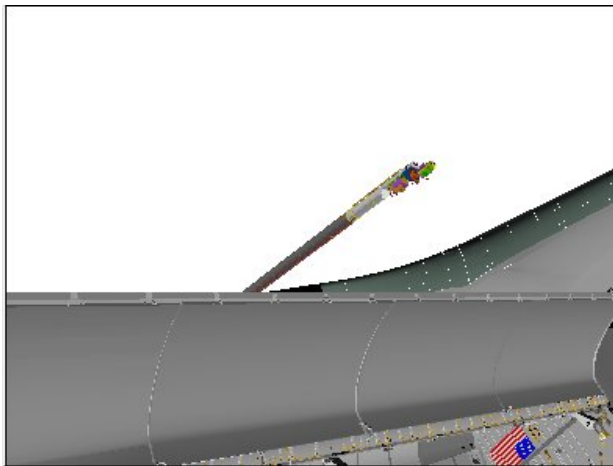

SSRMS TIP ELBOW (-80,50)

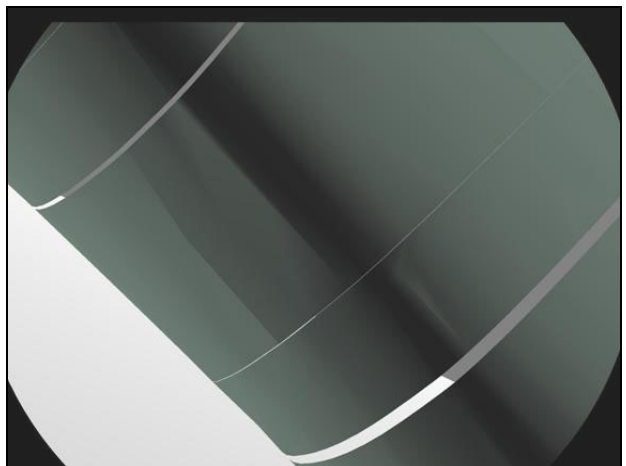

LDRI (34,-57)

STBD DOCKED LDRI RCC SURVEY – Pause Pt 166

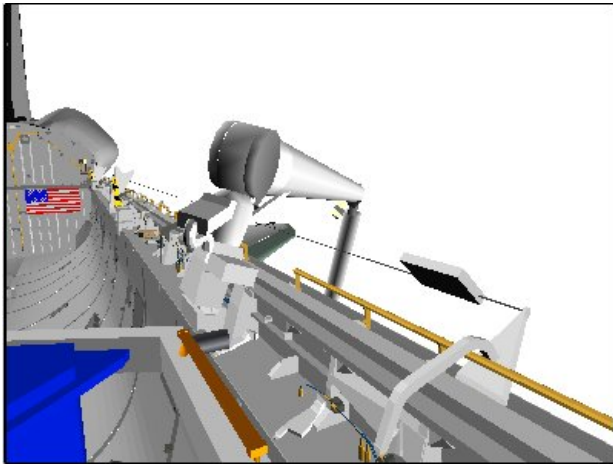

CCTV A (30,-10)

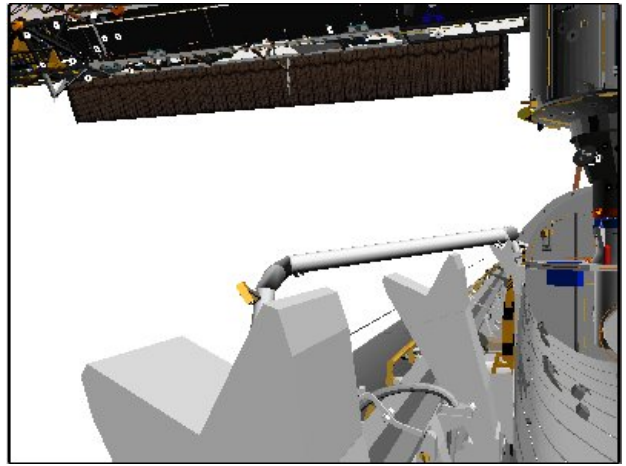

CCTV B (-20,0)

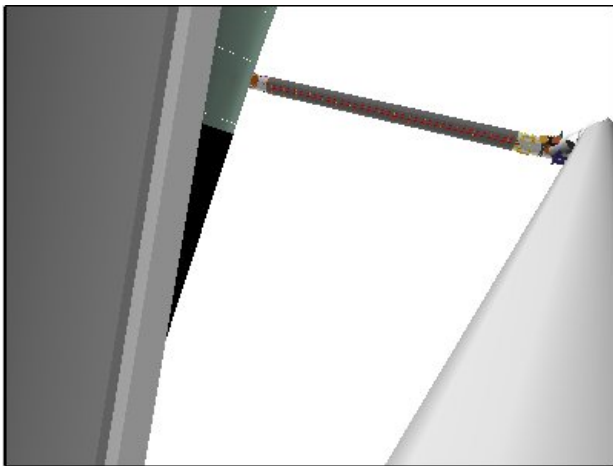

RMS ELBOW (-35,-20)

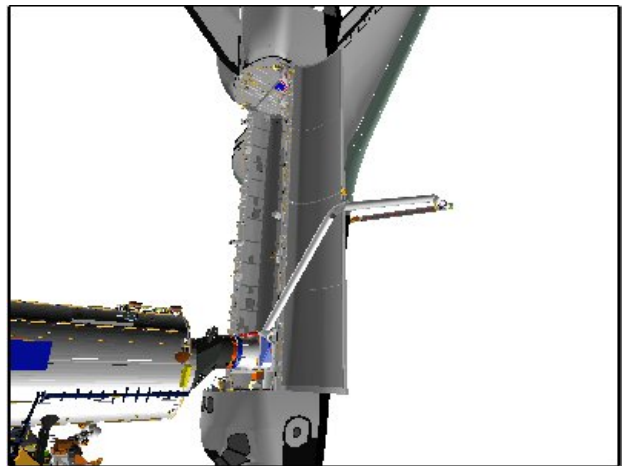

P1 LOOB (125,20)

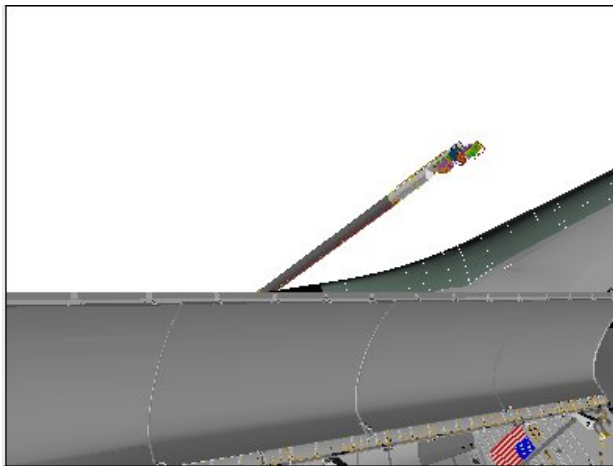

SSRMS TIP ELBOW (-80,50)



RSC

OBSS IDC RCC SURVEY CAMERA VIEWS – STBD

STBD IDC RCC SURVEY – Pause Pt 130

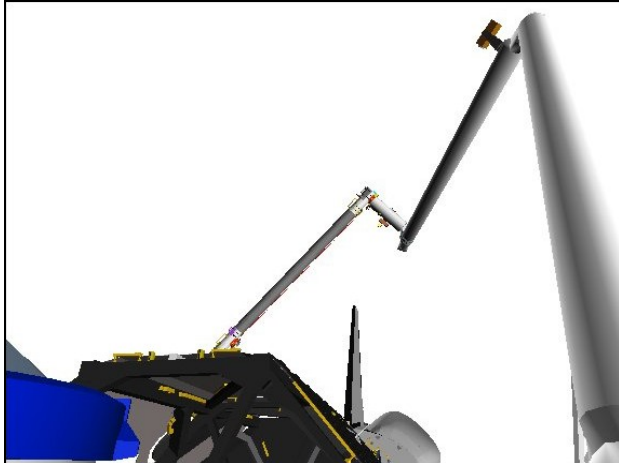

CCTV A (-10,30)

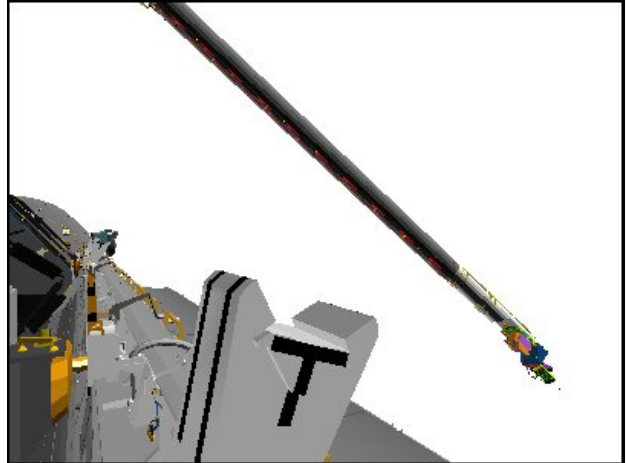

CCTV C (30,0)

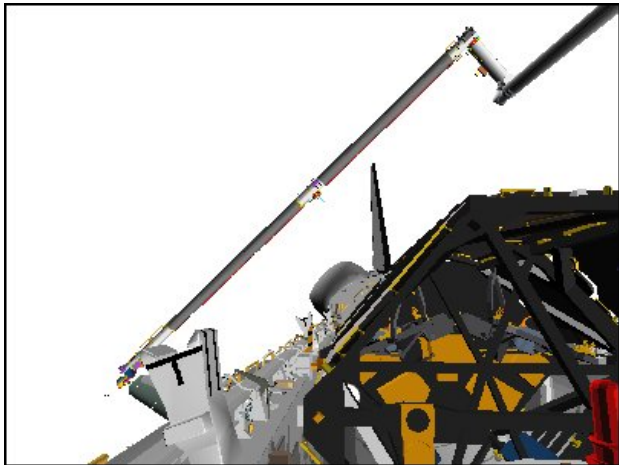

CCTV D (-5,10)

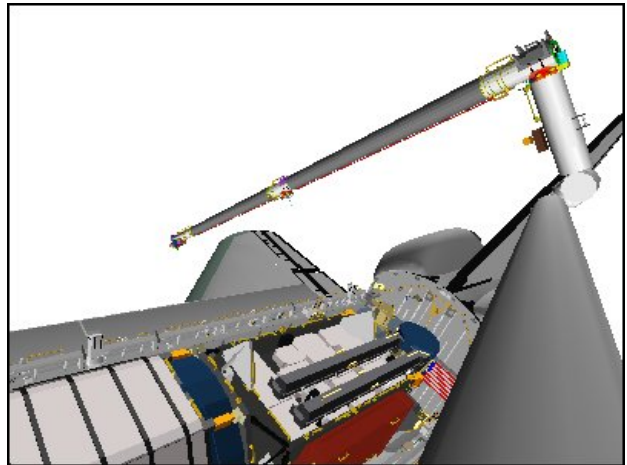

ELBOW (-30,0)

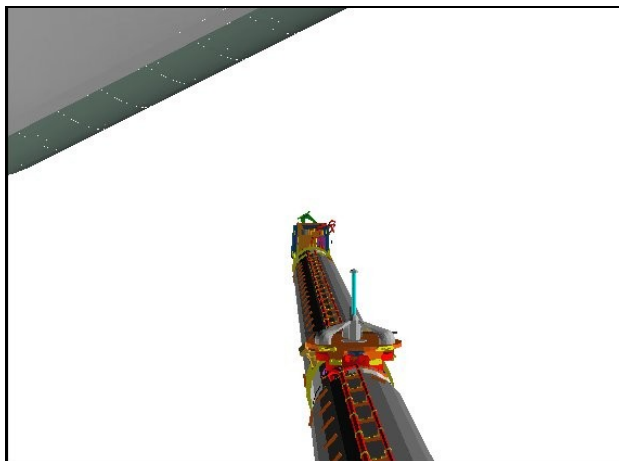

RSC

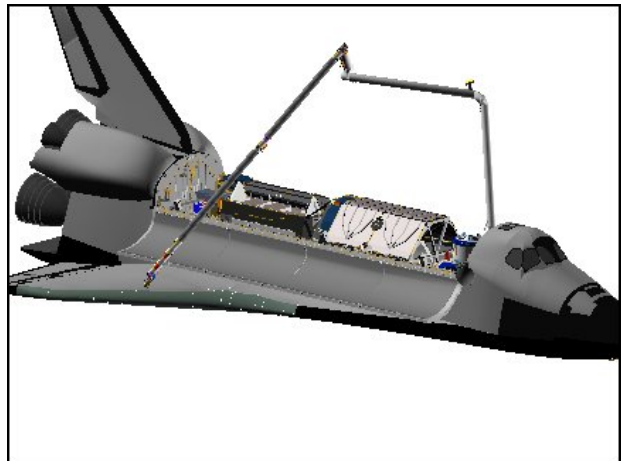

BIRD'S EYE

STBD IDC RCC SURVEY – Pause Pt 132



CCTV A (0,40)

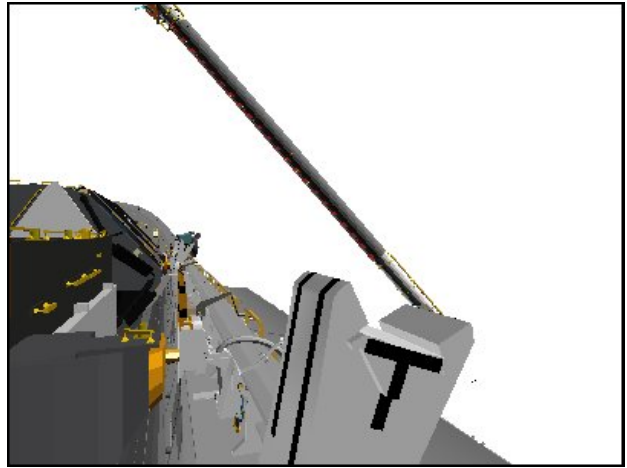

CCTV C (20,0)



CCTV D (0,15)

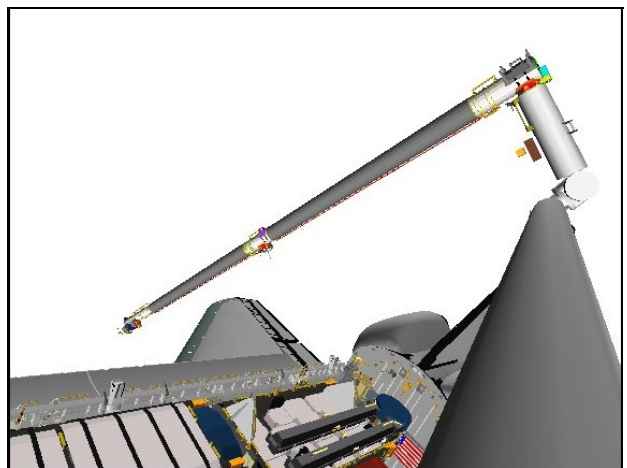

ELBOW (-30,-10)



RSC

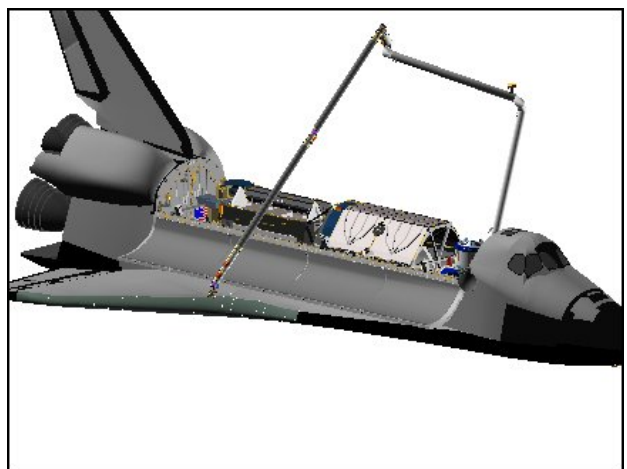

BIRD'S EYE

STBD IDC RCC SURVEY – Pause Pt 133

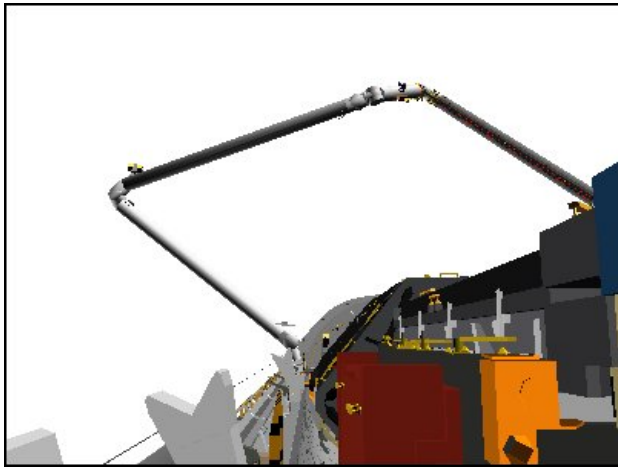

CCTV B (0,10)

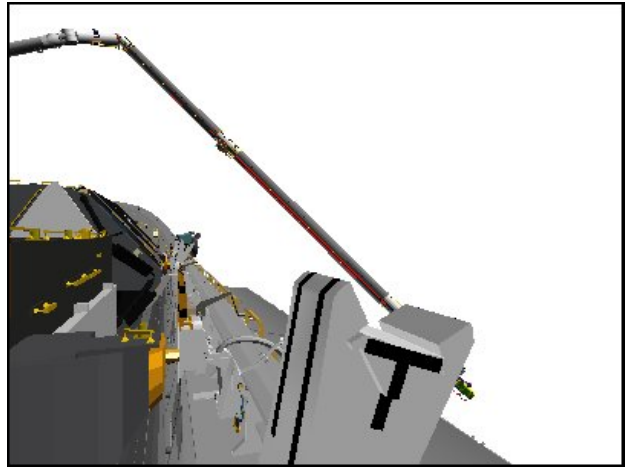

CCTV C (20,0)

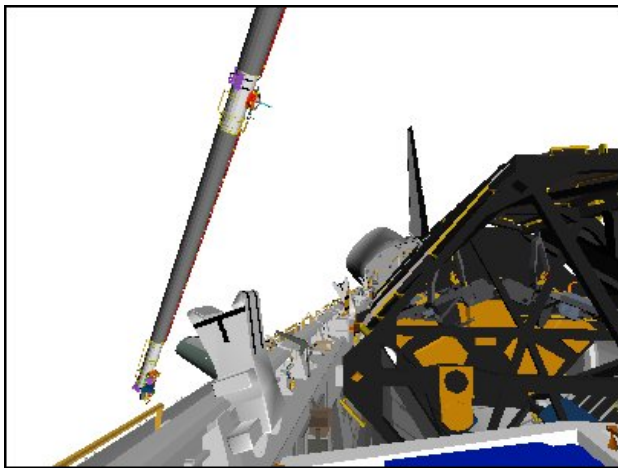

CCTV D (-10,5)

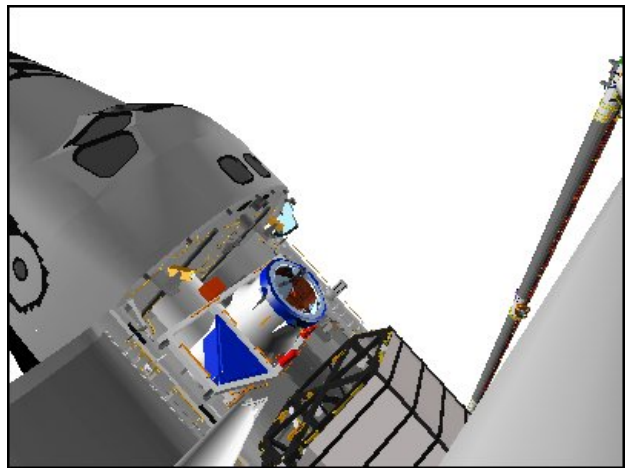

ELBOW (-40,-20)

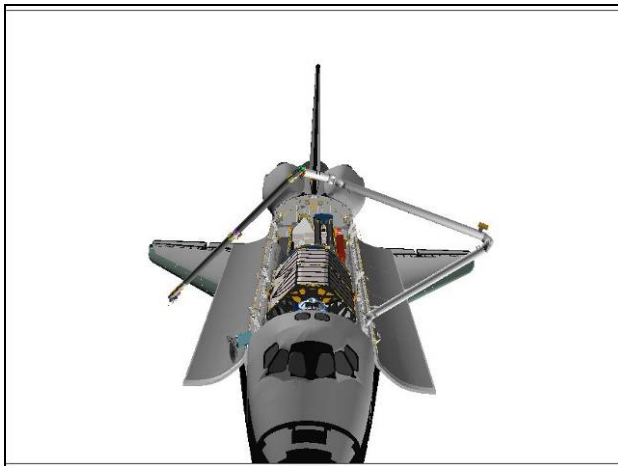

FRONT

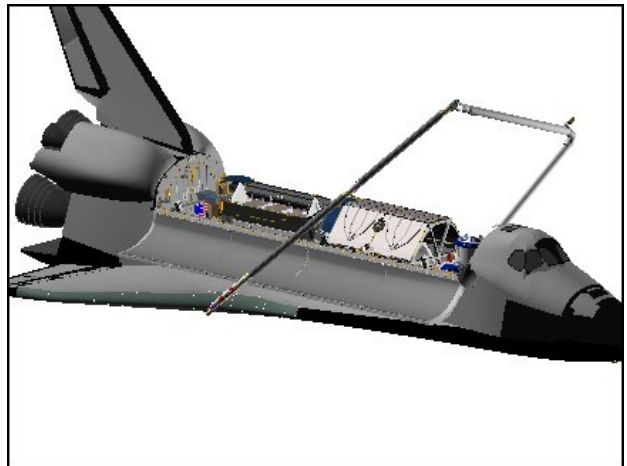

BIRD'S EYE

STBD IDC RCC SURVEY – Pause Pt 134

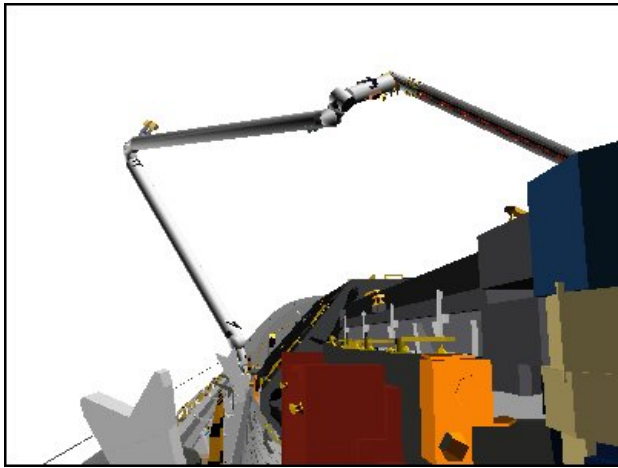

CCTV B (5,10)

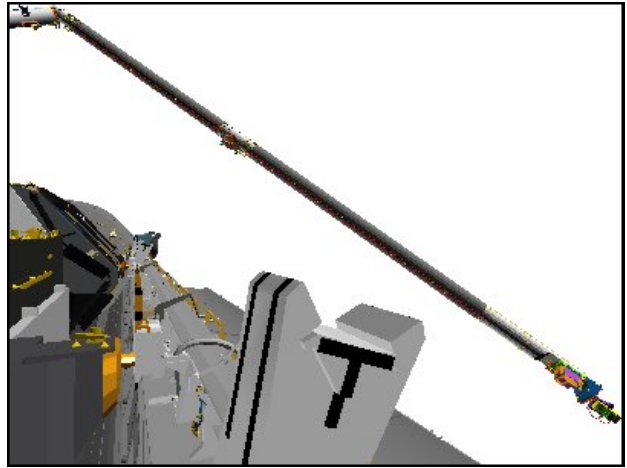

CCTV C (25,0)

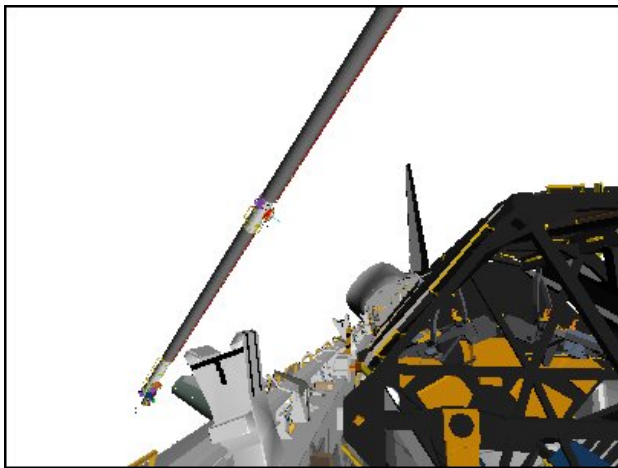

CCTV D (-10,10)

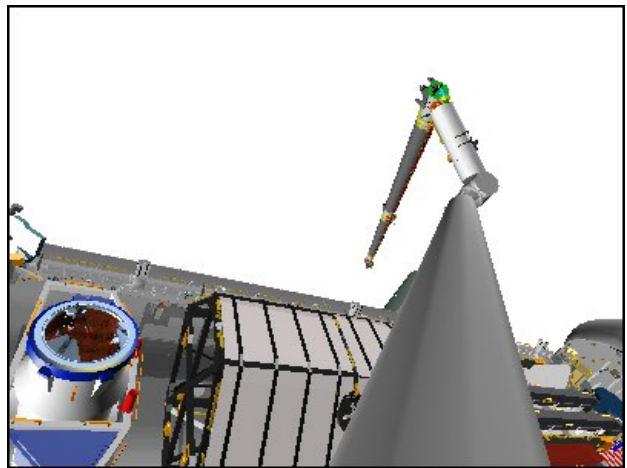

ELBOW (-20,-10)



RSC

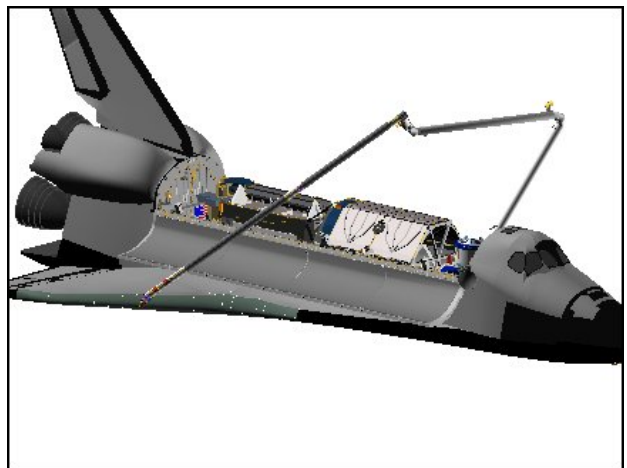

BIRD'S EYE

STBD IDC RCC SURVEY – Pause Pt 135

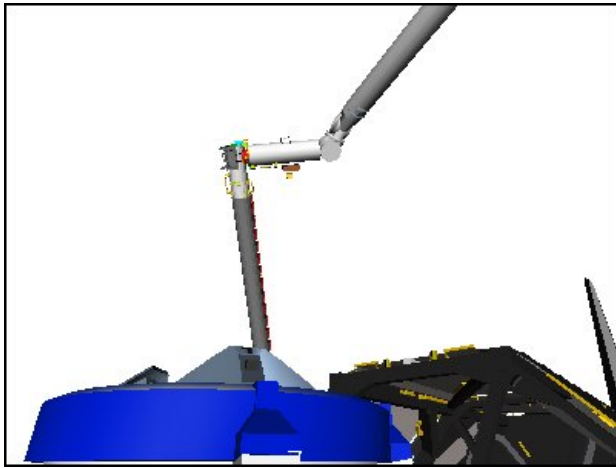

CCTV A (-40,30)

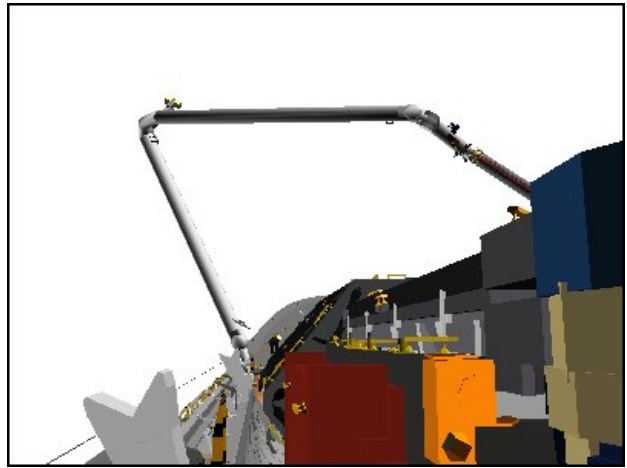

CCTV B (5,10)

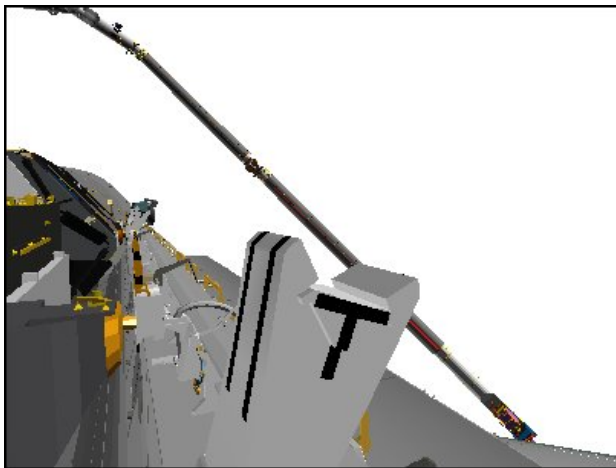

CCTV C (25,-5)

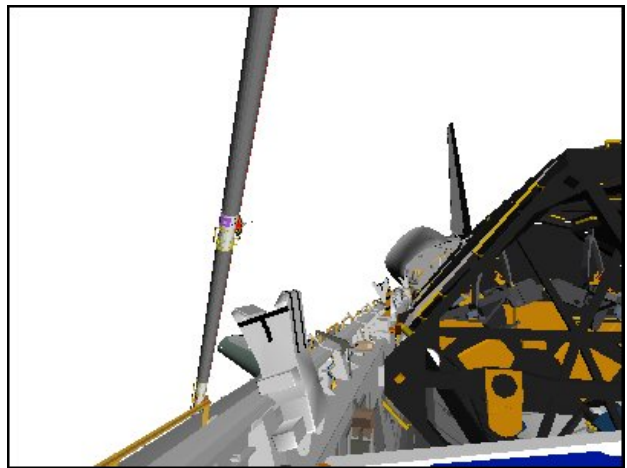

CCTV D (-15,5)



RSC

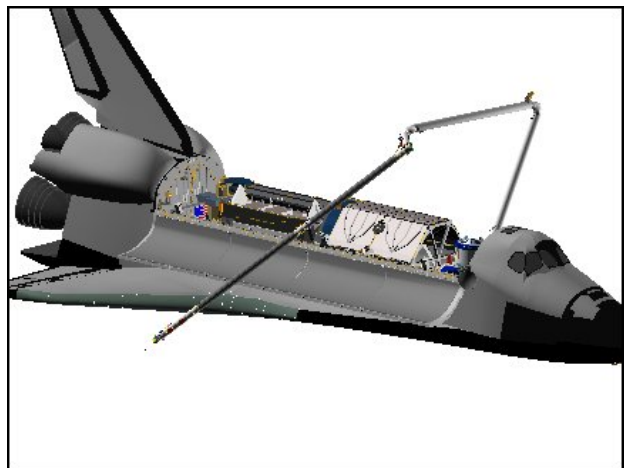

BIRD'S EYE

STBD IDC RCC SURVEY – Pause Pt 137

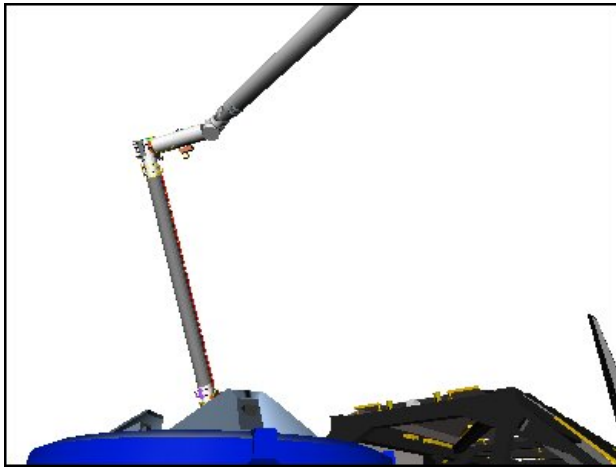

CCTV A (-40,35)

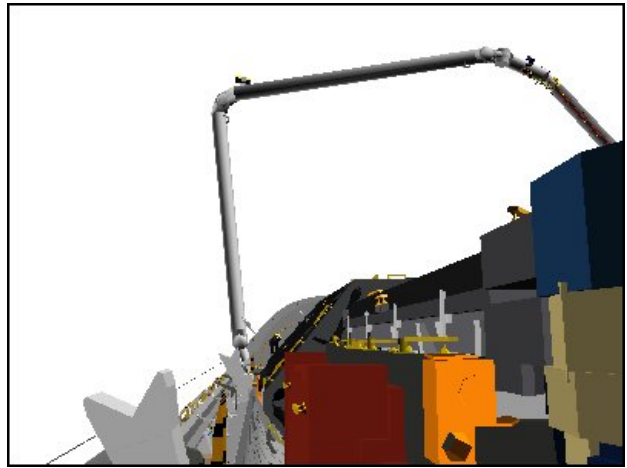

CCTV B (5,10)

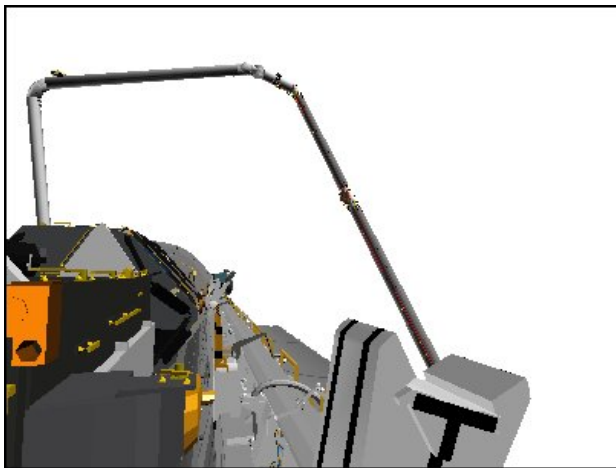

CCTV C (15,5)

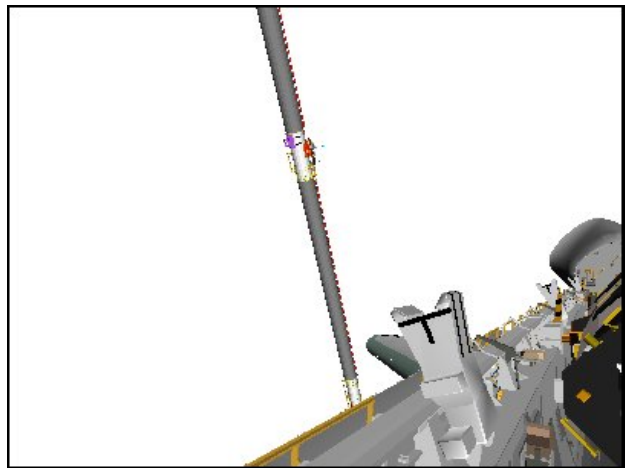

CCTV D (-35,5)

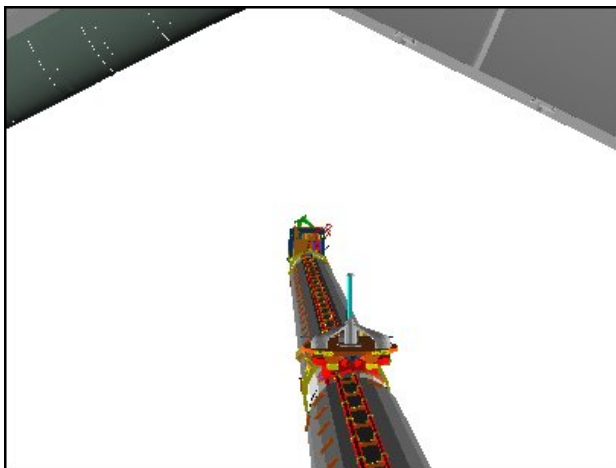

RSC

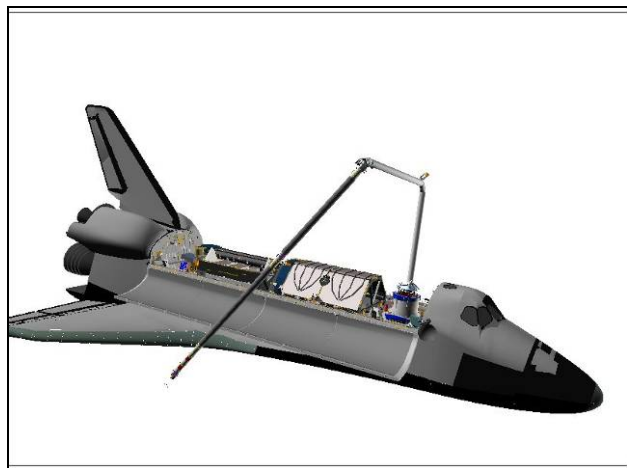

BIRD'S EYE

STBD IDC RCC SURVEY – Pause Pt 139

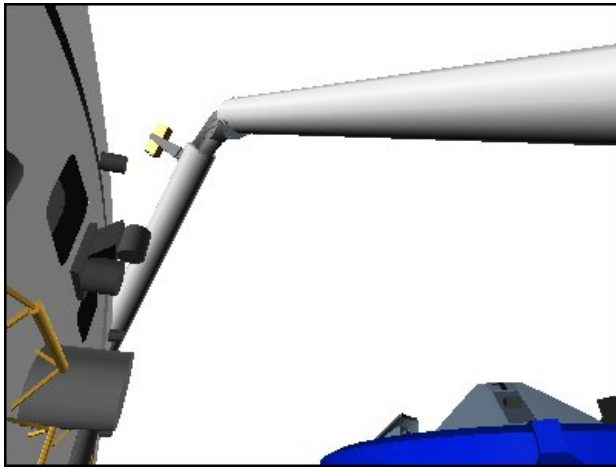

CCTV A (-70,35)

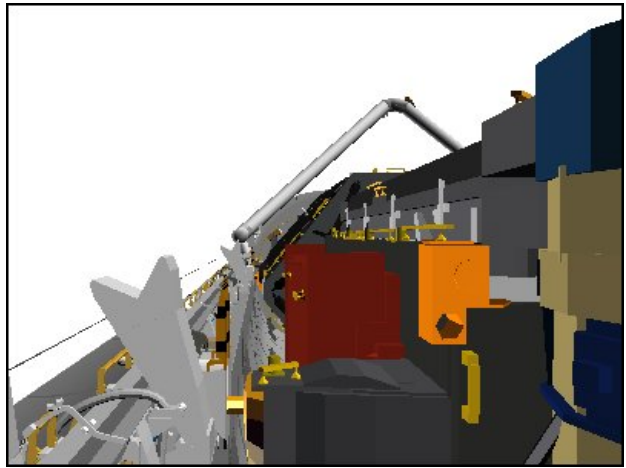

CCTV B (5,0)

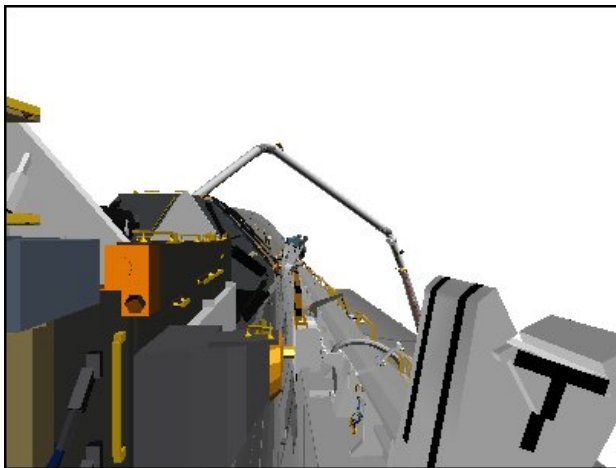

CCTV C (5,0)

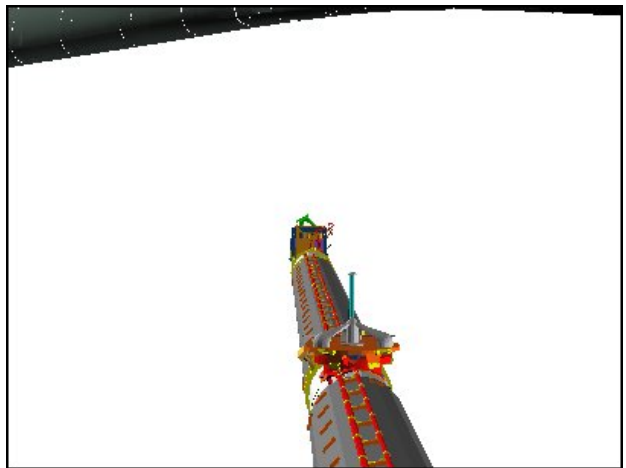

RSC

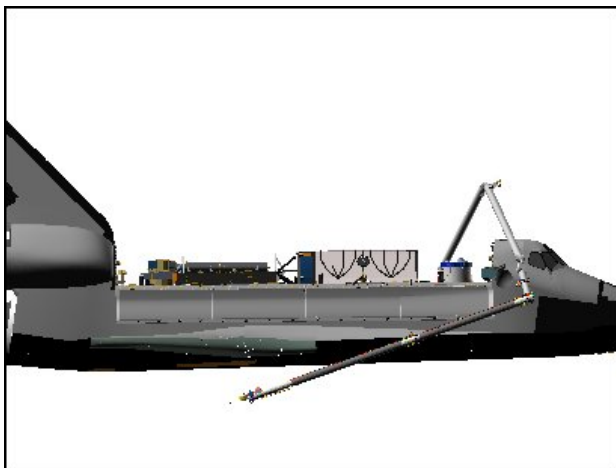

STARBOARD

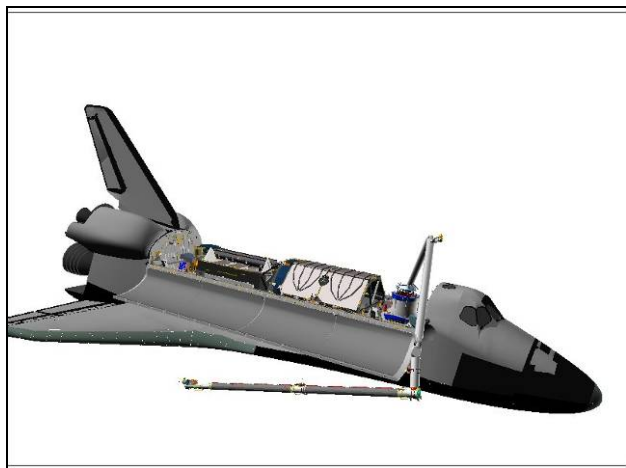

BIRD'S EYE

STBD IDC RCC SURVEY – Pause Pt 140

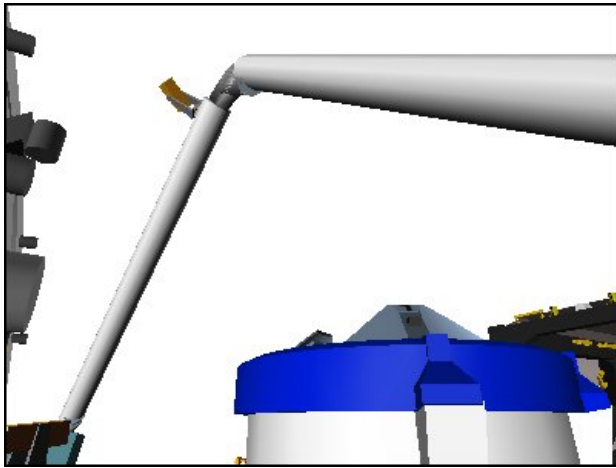

CCTV A (-60,25)

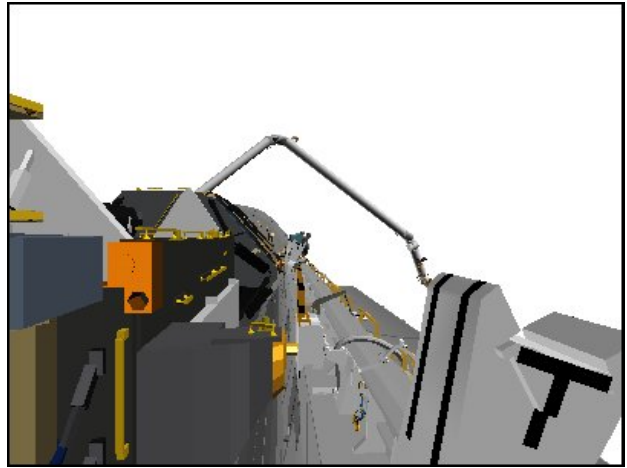

CCTV C (5,0)

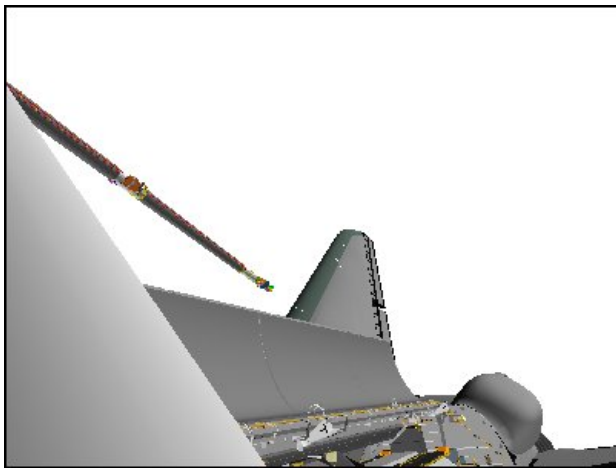

ELBOW (40,-50)

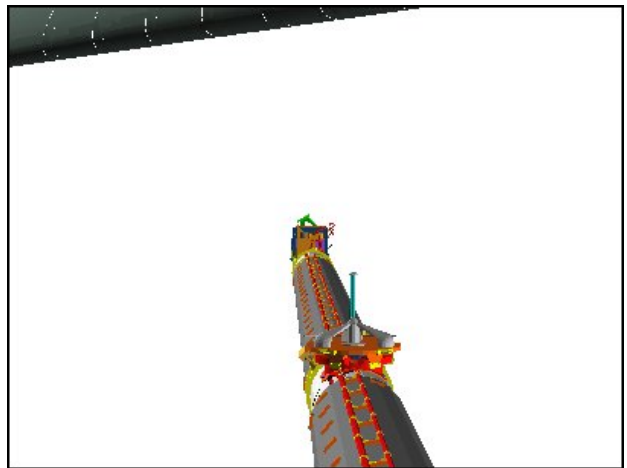

RSC



STARBOARD

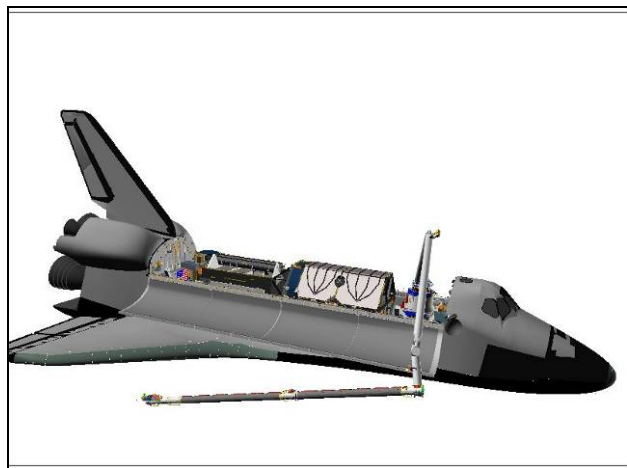

BIRD'S EYE

STBD IDC RCC SURVEY – Pause Pt 141

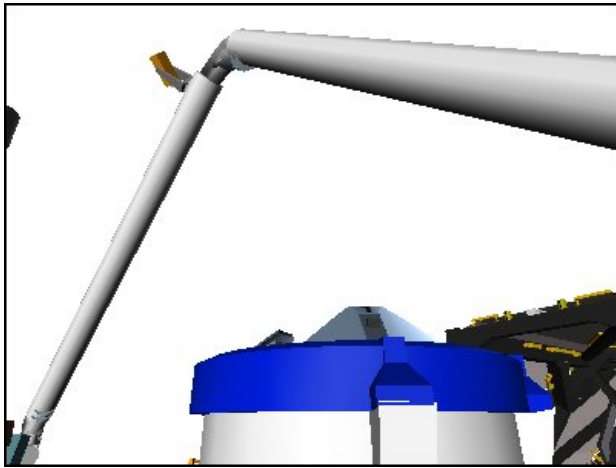

CCTV A (-55,25)

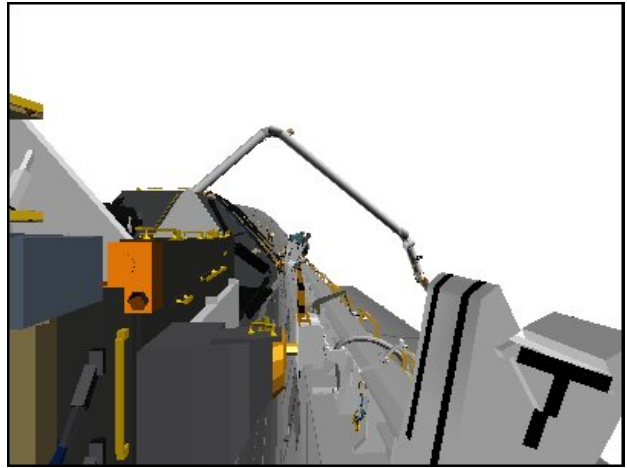

CCTV C (5,0)

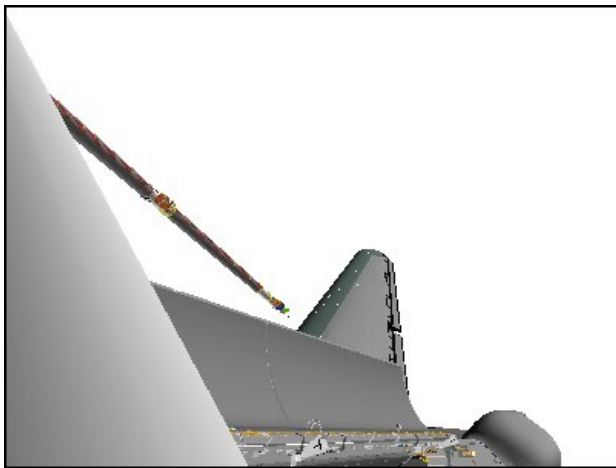

ELBOW (35,-45)

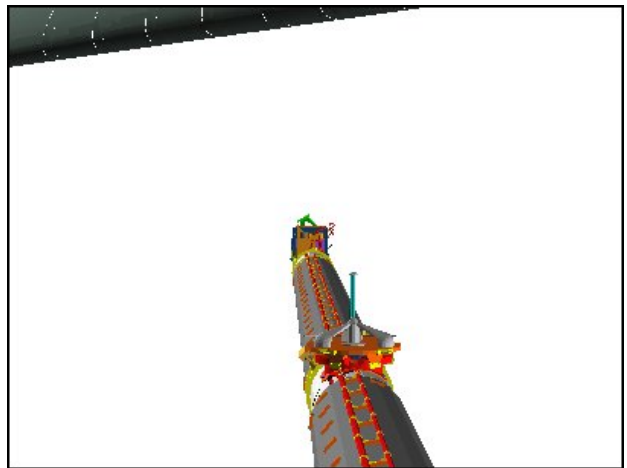

RSC

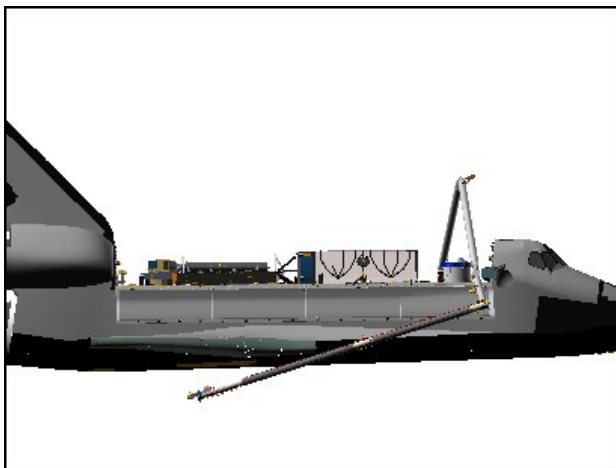

STARBOARD

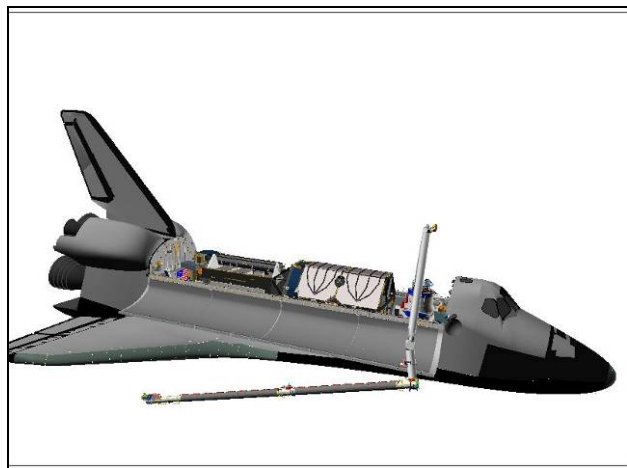

BIRD'S EYE

STBD IDC RCC SURVEY – Pause Pt 142

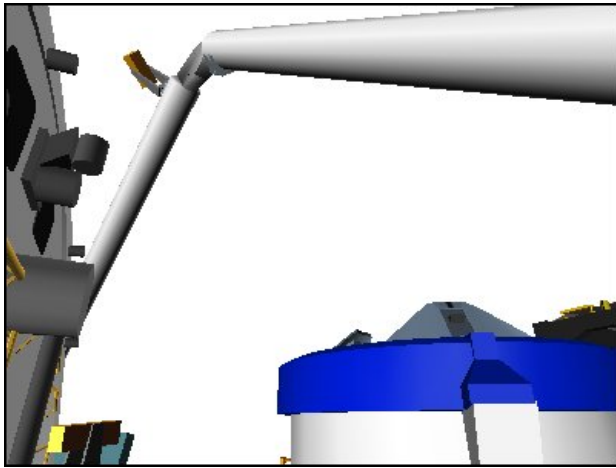

CCTV A (-65,25)

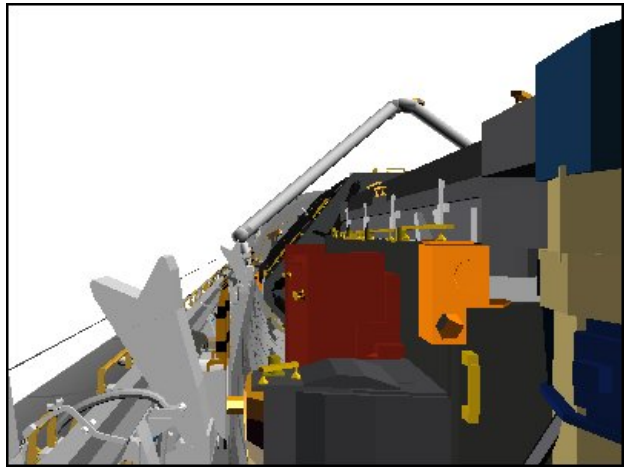

CCTV B (5,0)

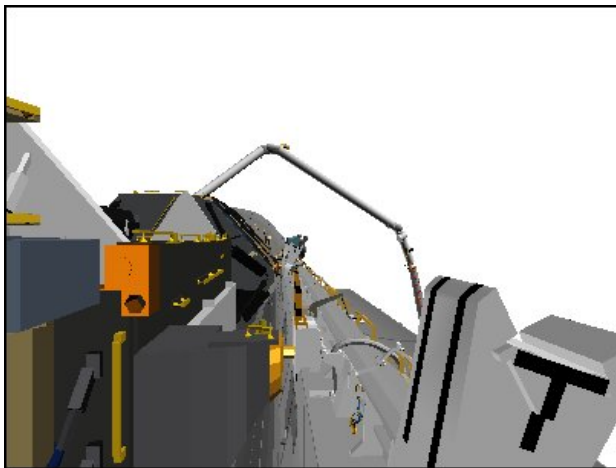

CCTV C (5,0)

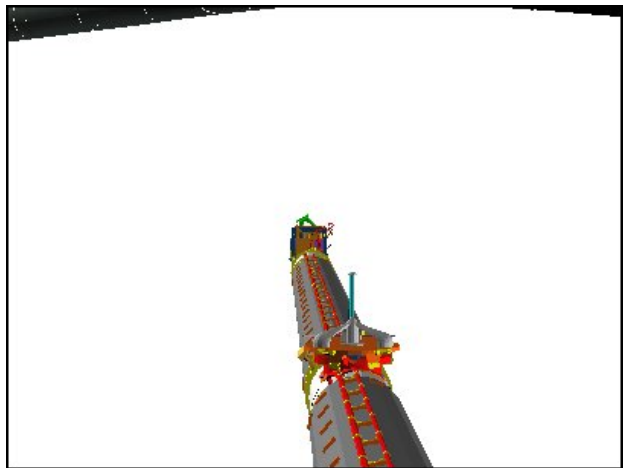

RSC

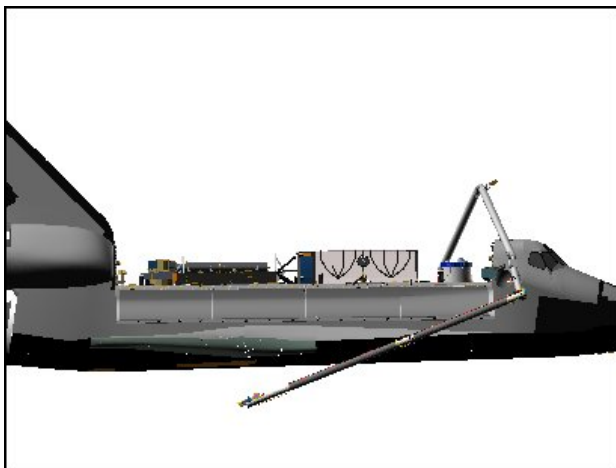

STARBOARD

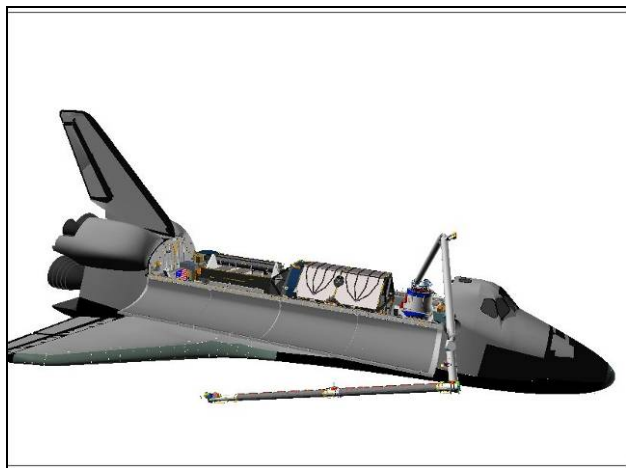

BIRD'S EYE

OBSS IDC RCC SURVEY CAMERA VIEWS – NOSE CAP

NOSE CAP IDC RCC SURVEY – Pause Pt 143

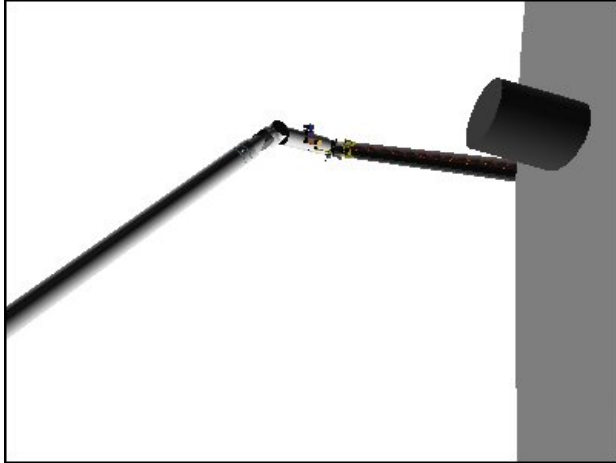

CCTV A (105,70)

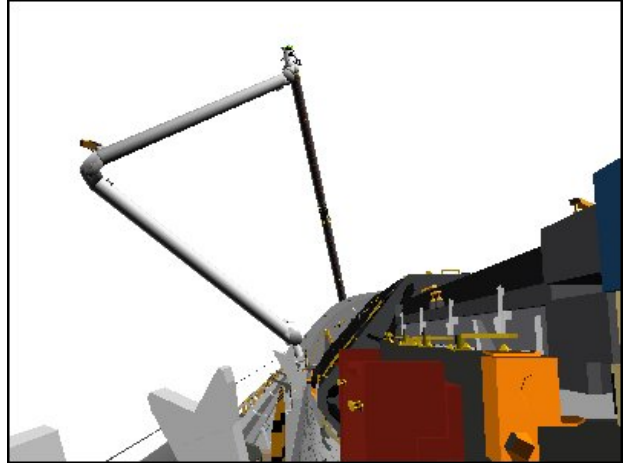

CCTV B (0,10)

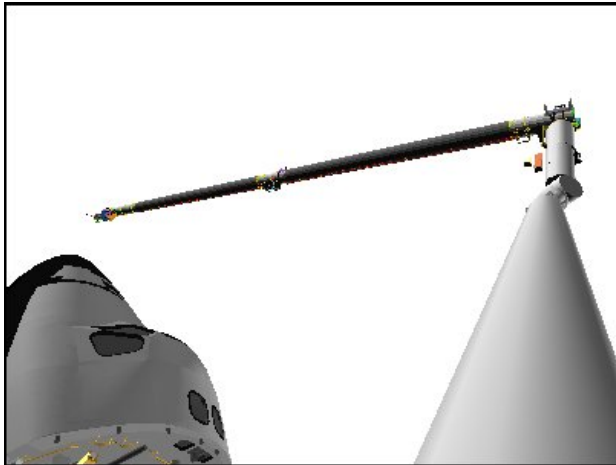

ELBOW (-30,-10)

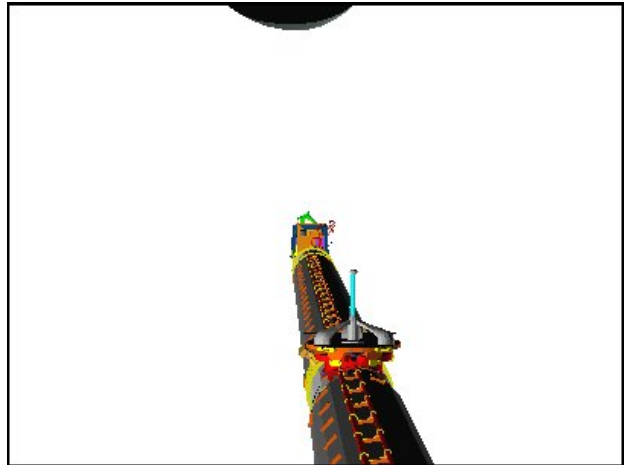

RSC

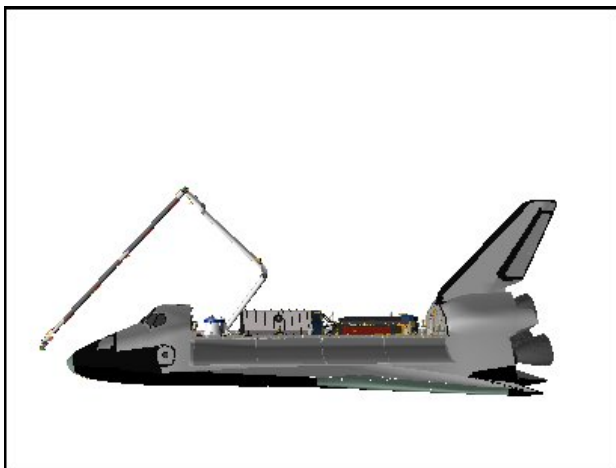

PORT

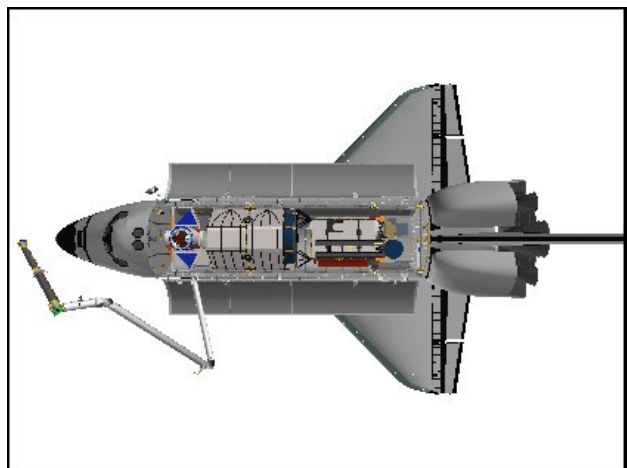

OVERHEAD

NOSE CAP IDC RCC SURVEY – Pause Pt 147

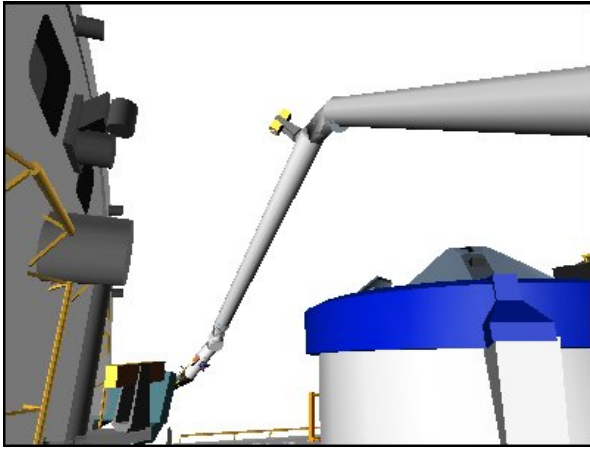

CCTV A (-70,20)

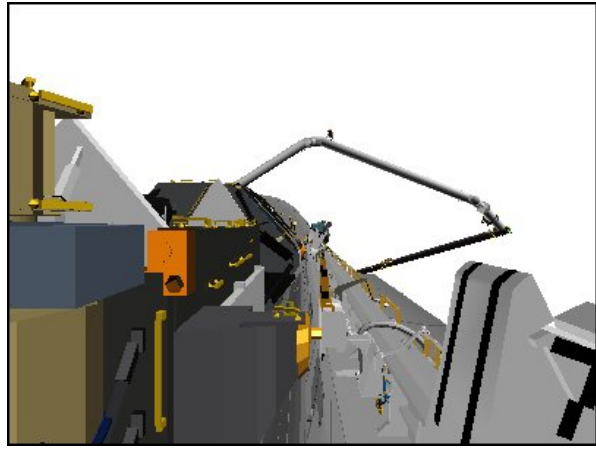

CCTV C (0,0)

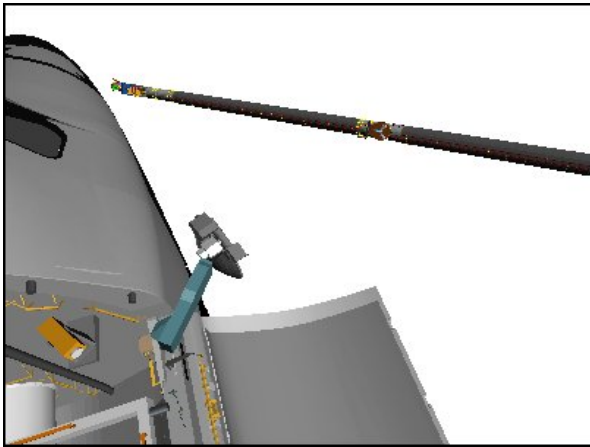

ELBOW (-60,-10)

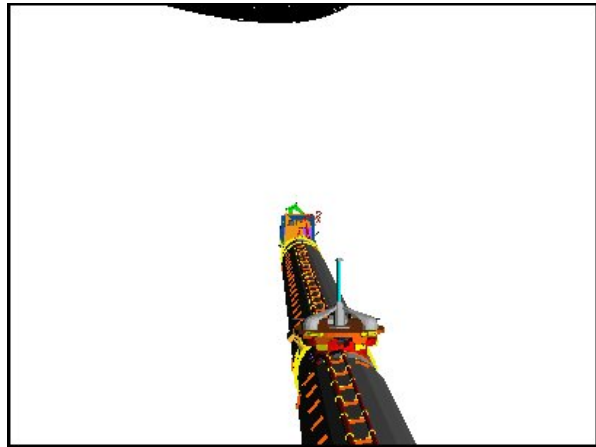

RSC

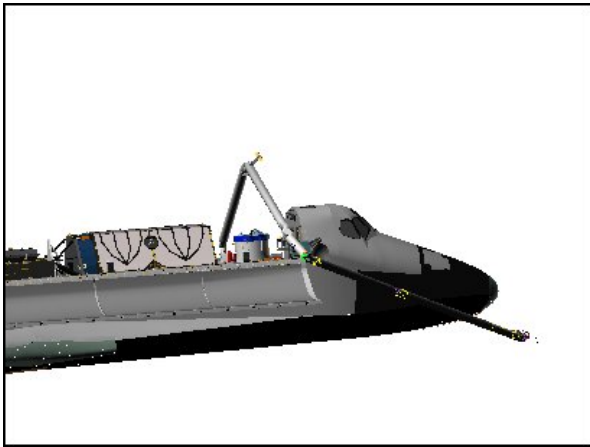

STARBOARD

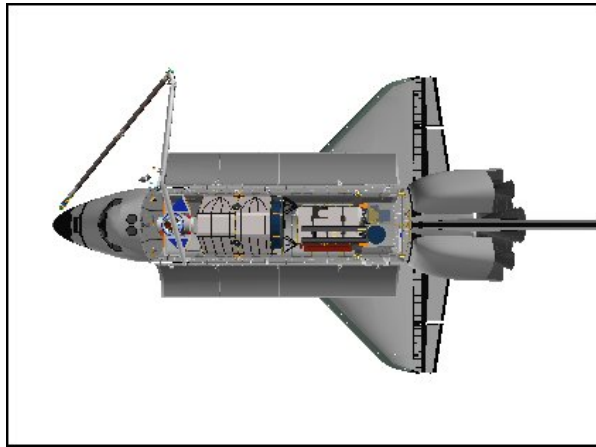

OVERHEAD

NOSE CAP IDC RCC SURVEY – Pause Pt 148

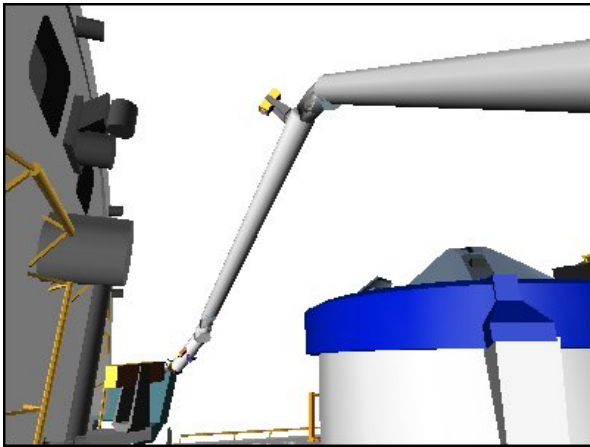

CCTV A (-70,20)

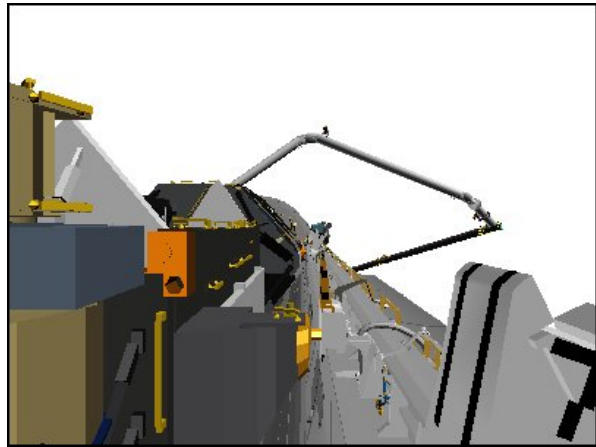

CCTV C (0,0)

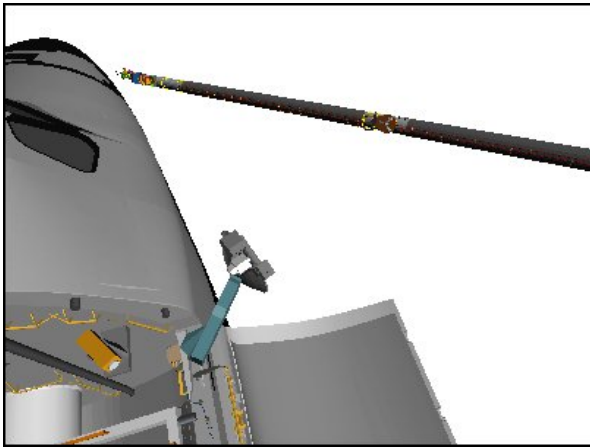

ELBOW (-60,-10)

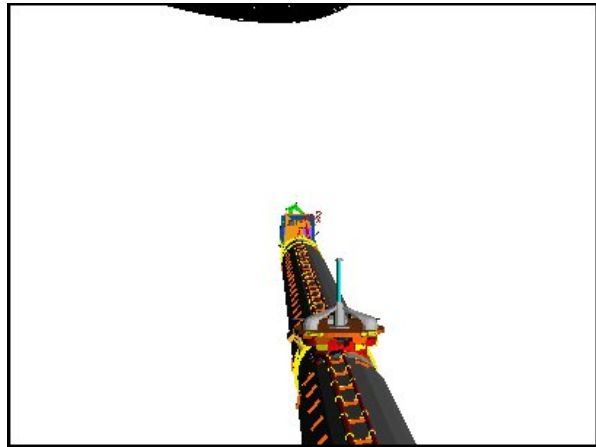

RSC

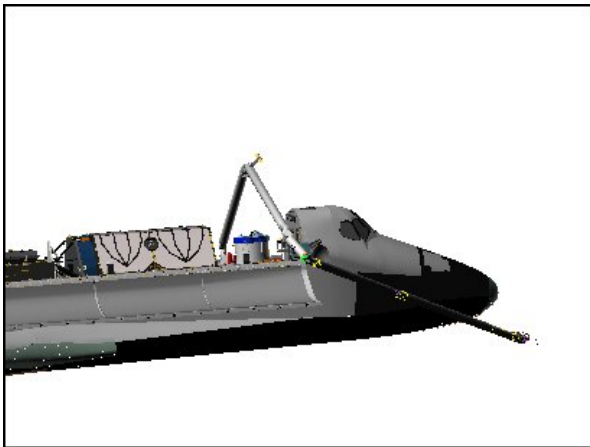

STARBOARD

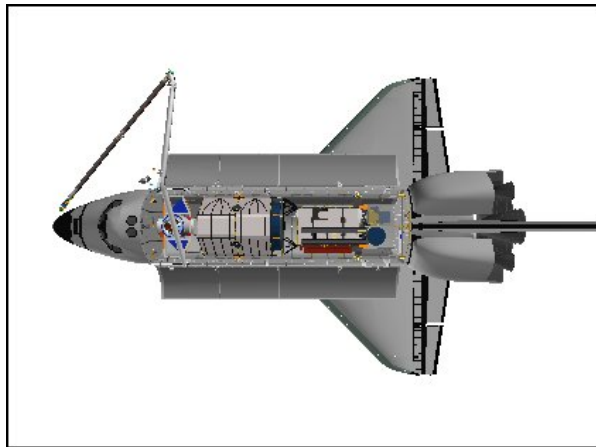

OVERHEAD

NOSE CAP IDC RCC SURVEY – Pause Pt 149

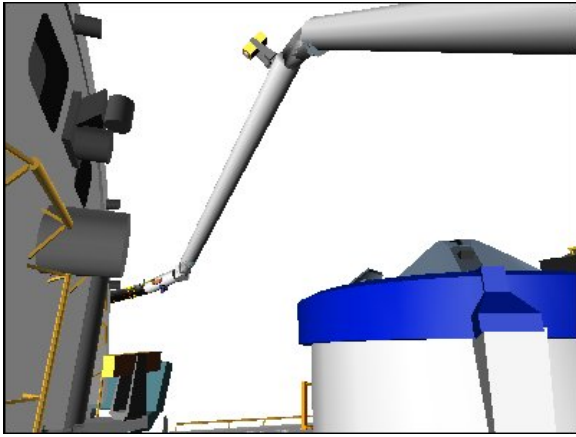

CCTV A (-70,20)

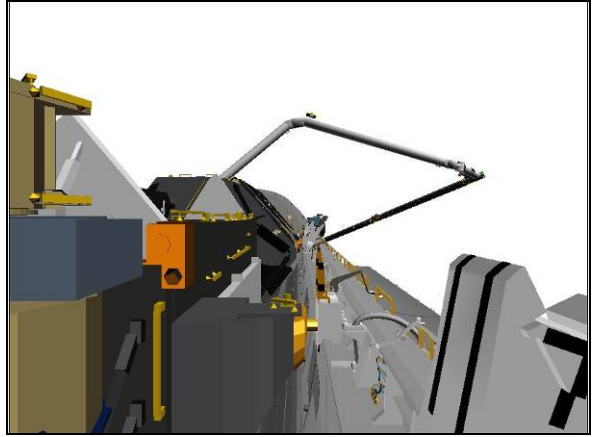

CCTV C (0,0)

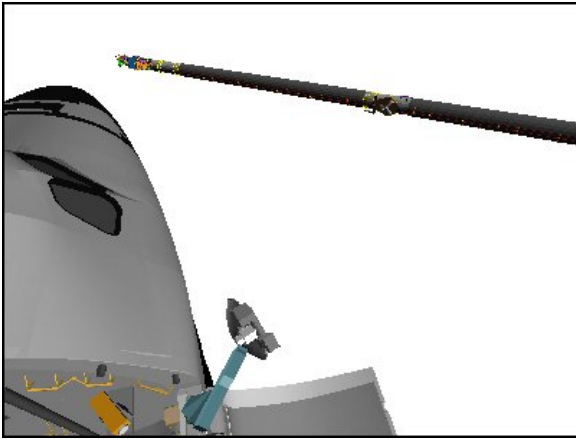

ELBOW (-60,-5)

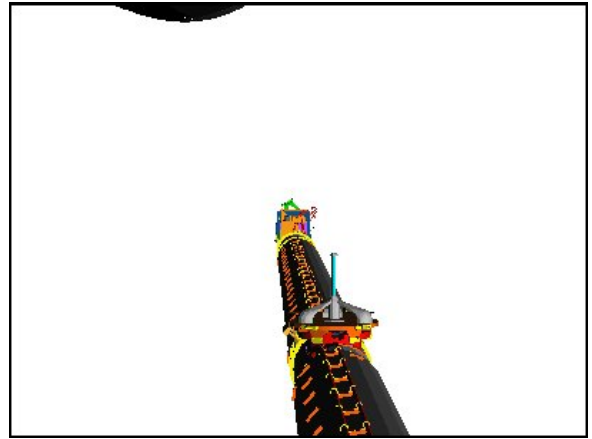

RSC

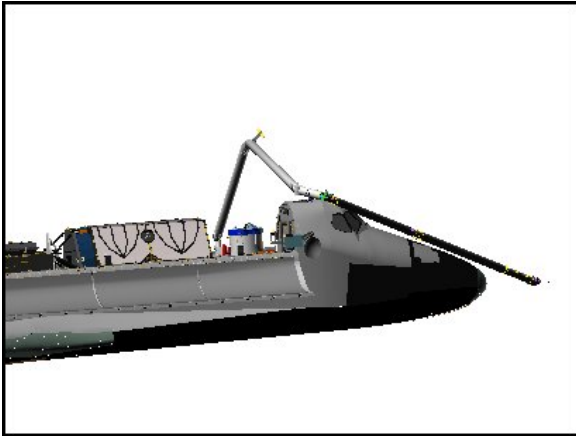

STARBOARD

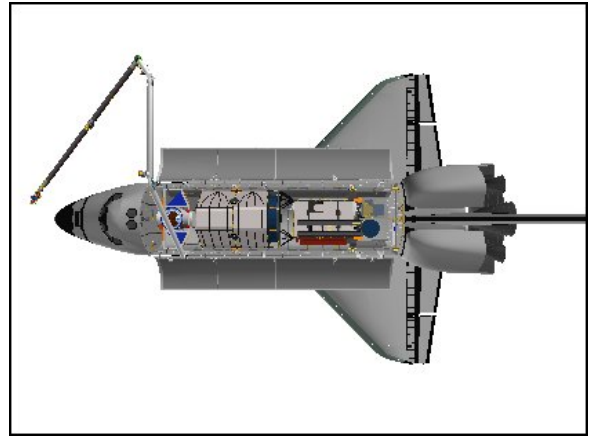

OVERHEAD

NOSE CAP IDC RCC SURVEY – Pause Pt 150

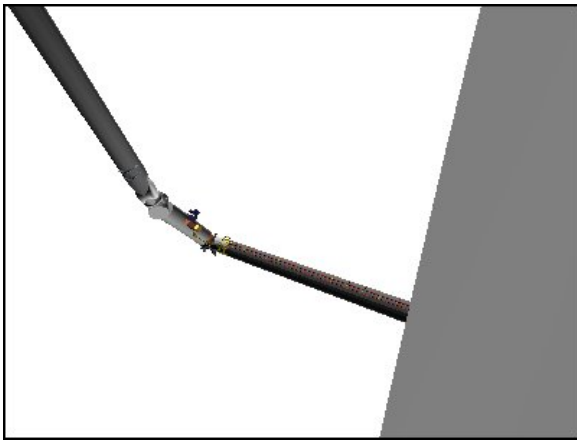

CCTV A (110,50)

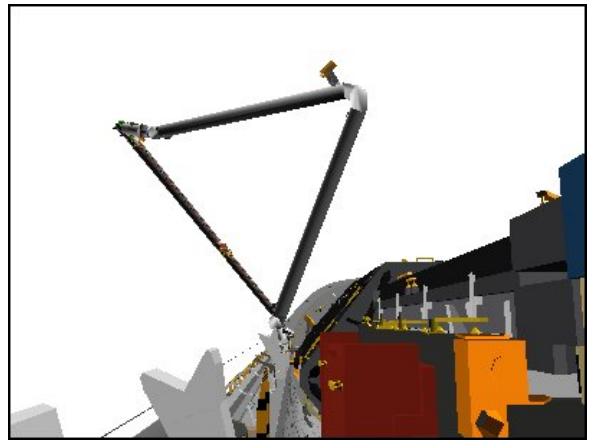

CCTV B (0,10)



CCTV D (65,30)

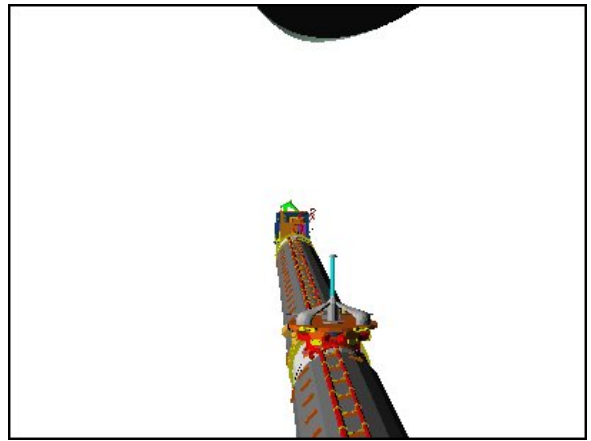

RSC

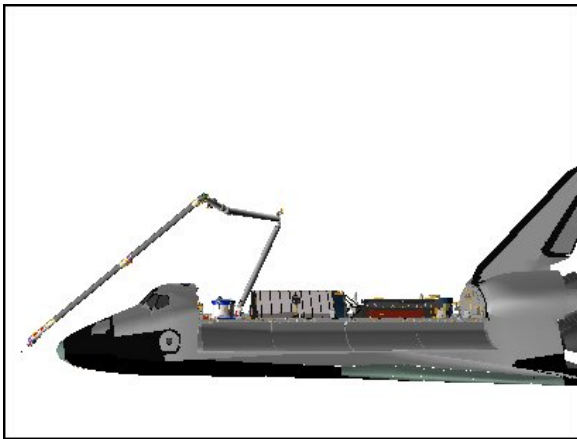

PORT

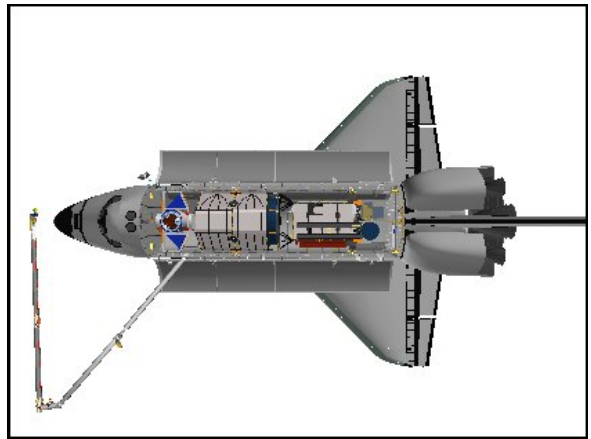

OVERHEAD

NOSE CAP IDC RCC SURVEY – Pause Pt 153

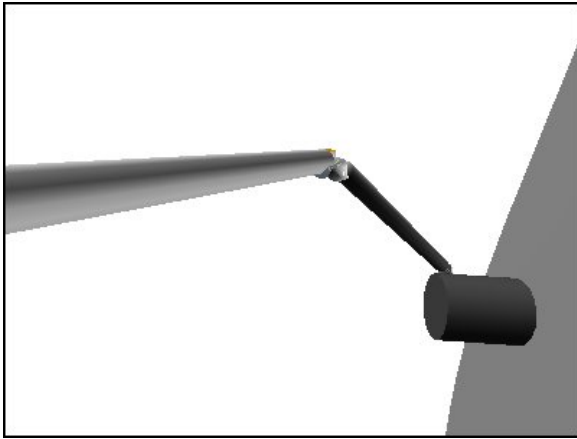

CCTV A (90,10)

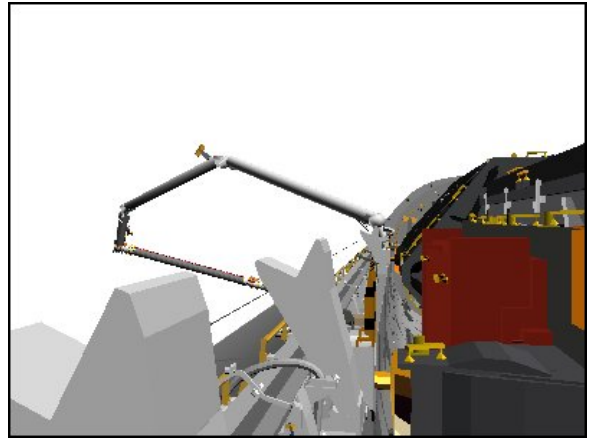

CCTV B (-10,0)

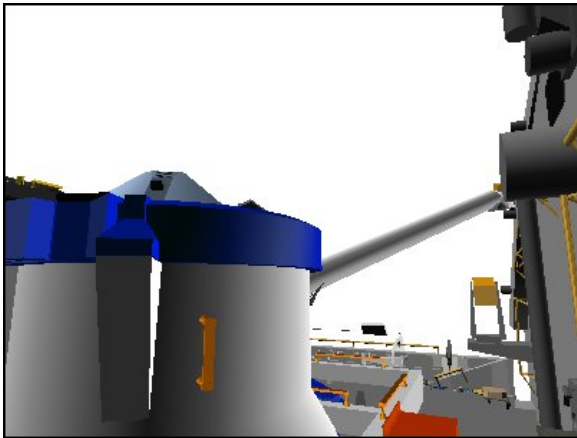

CCTV D (65,10)



RSC

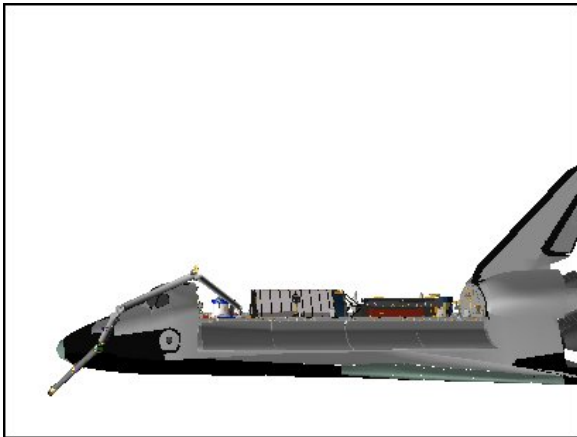

PORT

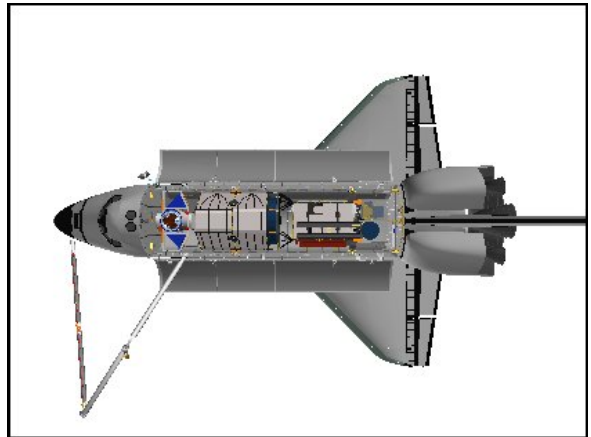

OVERHEAD

NOSE CAP IDC RCC SURVEY – Pause Pt 154

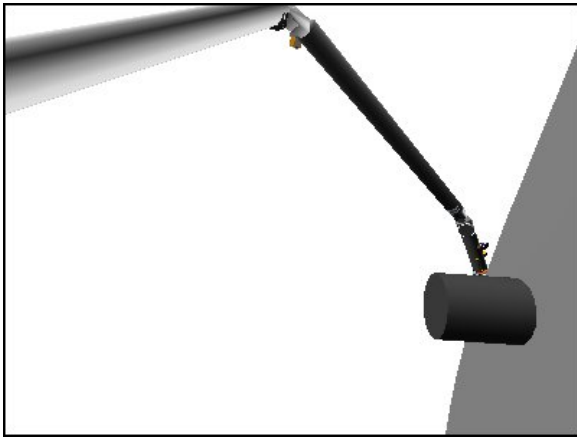

CCTV A (90,10)

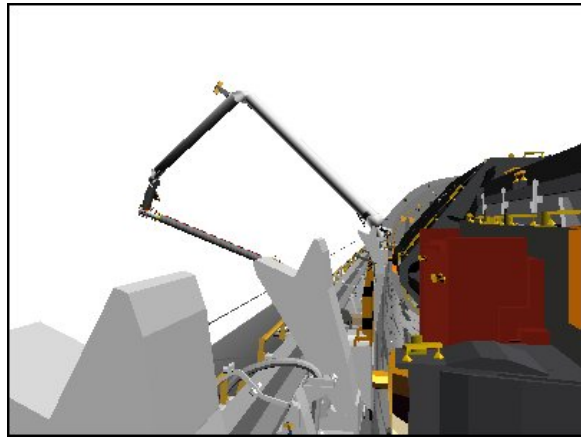

CCTV B (-10,0)

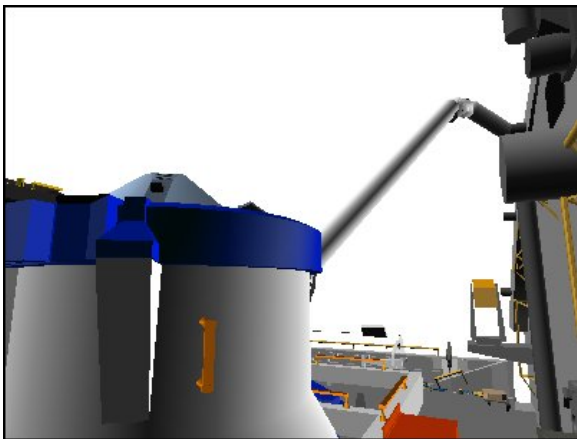

CCTV D (65,10)

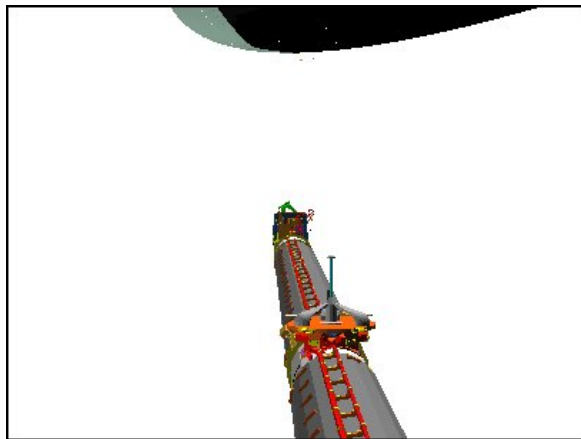

RSC

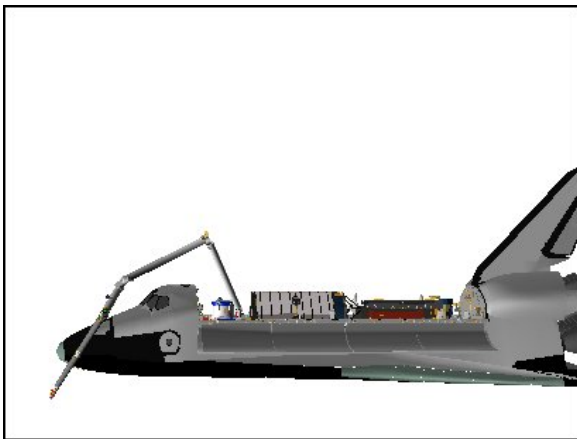

PORT

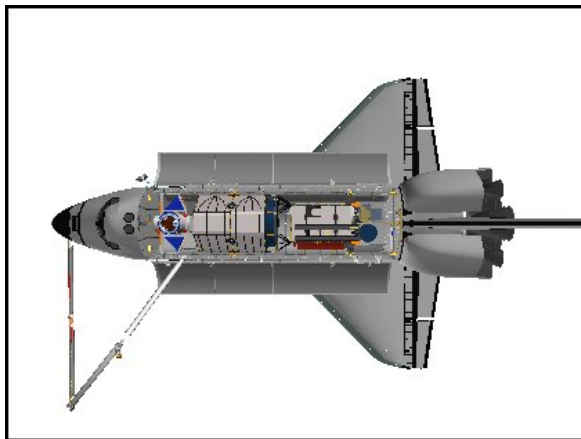

OVERHEAD

NOSE CAP IDC RCC SURVEY – Pause Pt 157

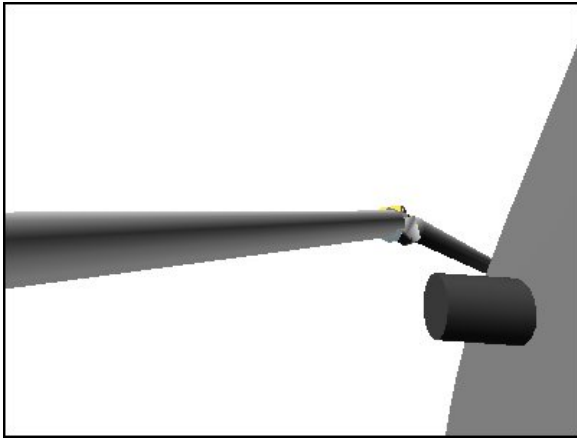

CCTV A (95,10)

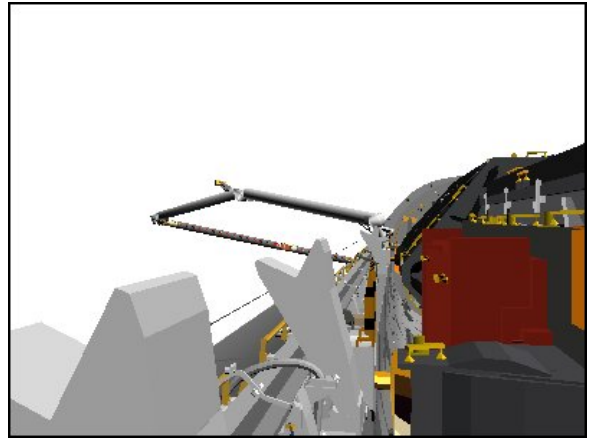

CCTV B (-10,0)

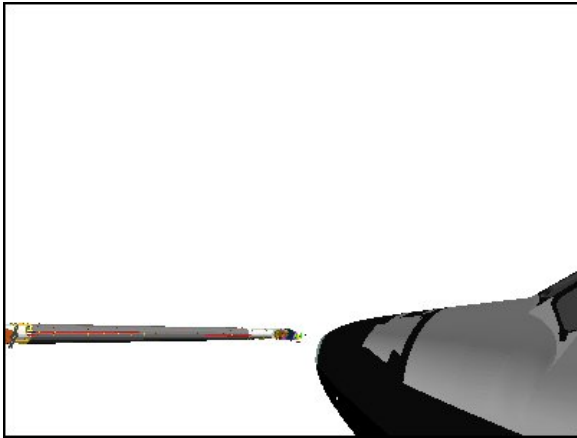

ELBOW (90,-60)

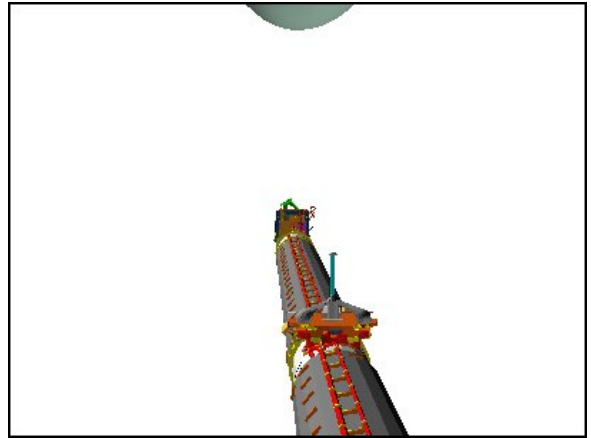

RSC

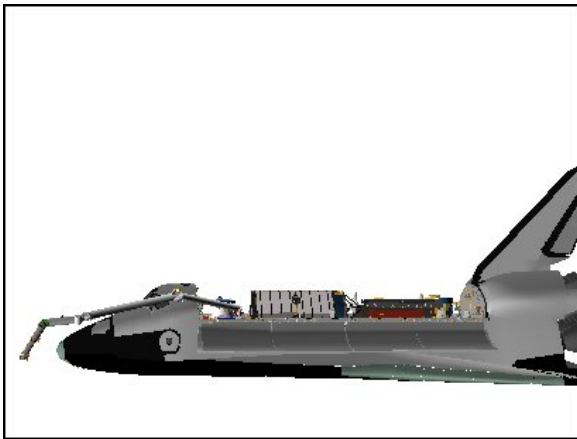

PORT

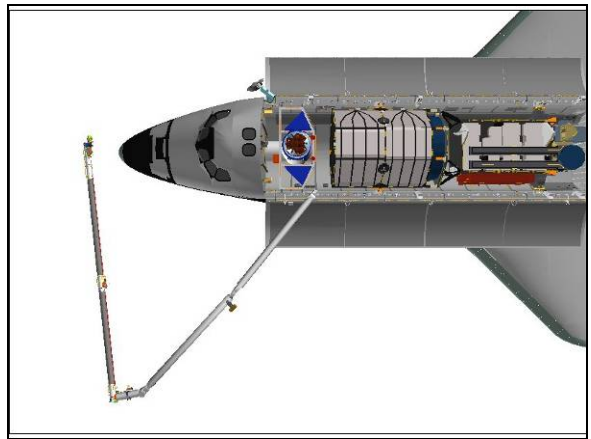

OVERHEAD

NOSE CAP IDC RCC SURVEY – Pause Pt 158

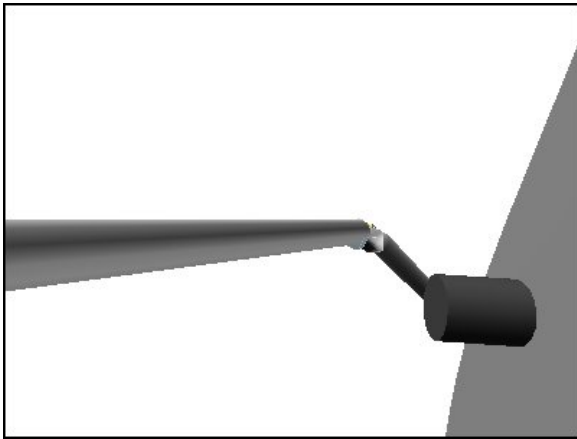

CCTV A (95,10)

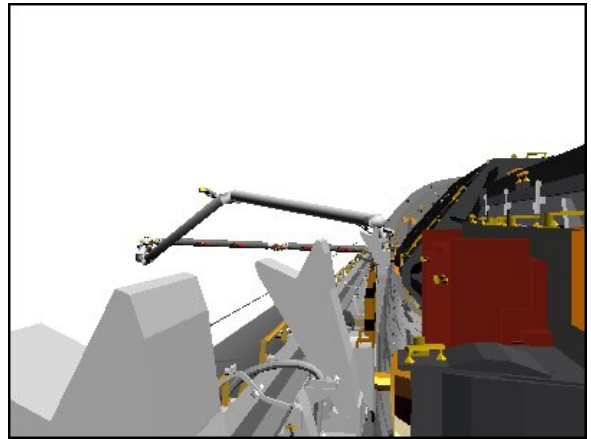

CCTV B (-10,0)

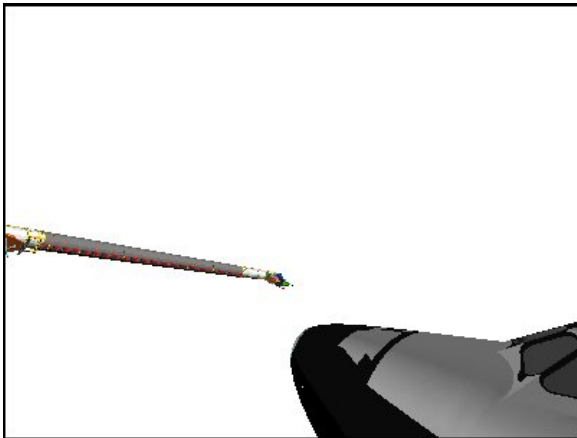

ELBOW (90,-60)



RSC

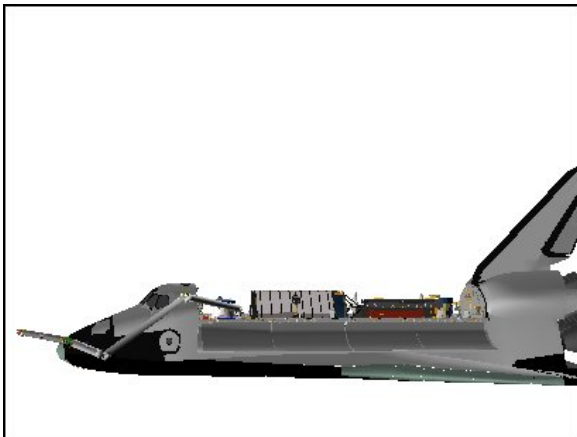

PORT

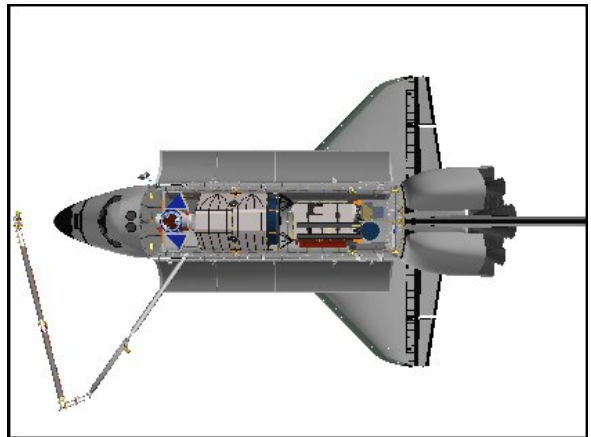

OVERHEAD

NOSE CAP IDC RCC SURVEY – Pause Pt 159



CCTV A (95,10)

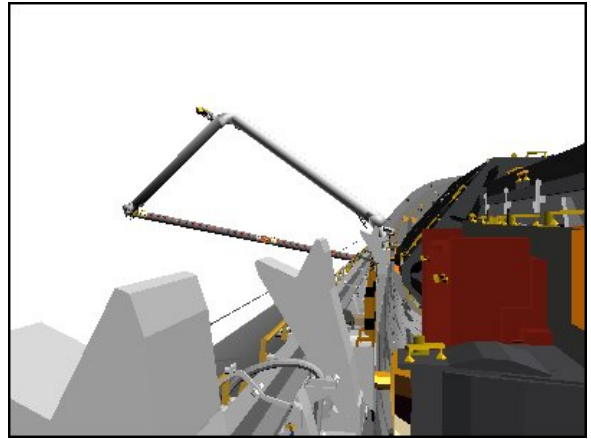

CCTV B (-10,0)

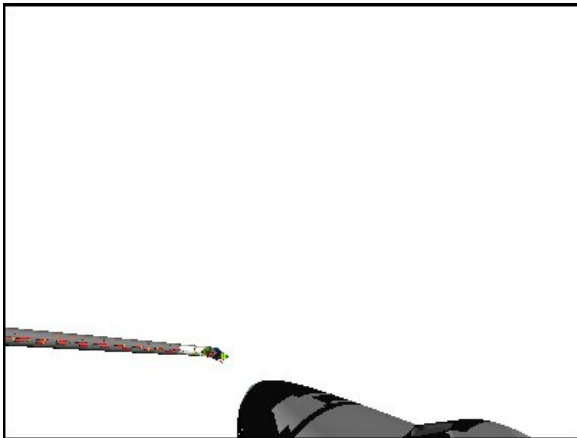

ELBOW (90,-60)



RSC

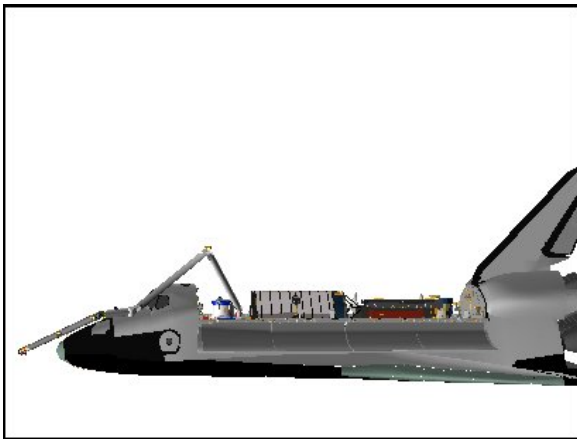

PORT

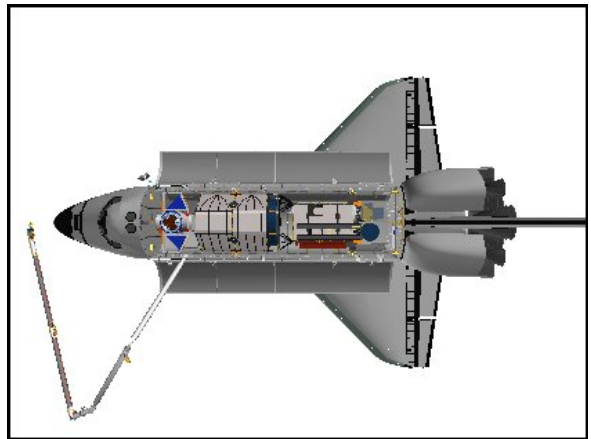

OVERHEAD

NOSE CAP IDC RCC SURVEY – Pause Pt 161

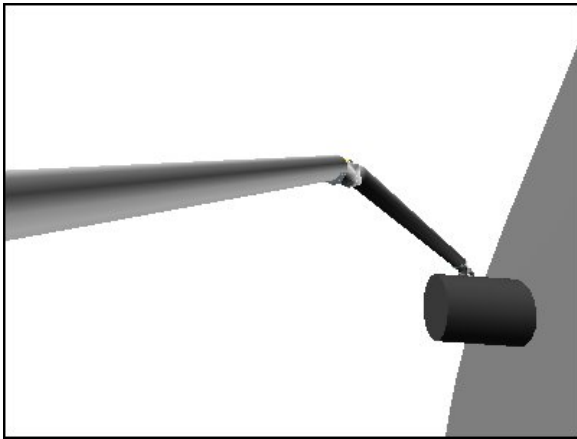

CCTV A (95,10)

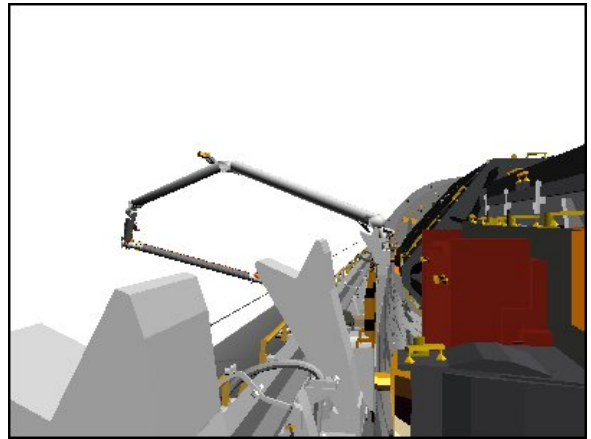

CCTV B (-10,0)



ELBOW (90,-60)



RSC

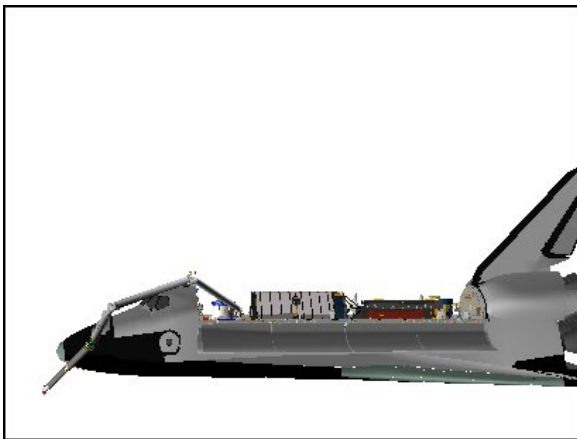

PORT

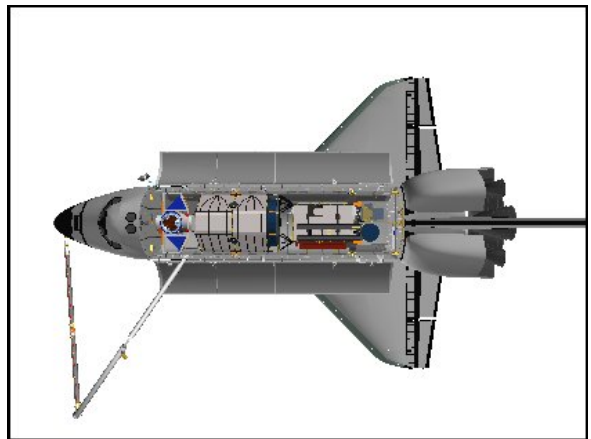

OVERHEAD

NOSE CAP IDC RCC SURVEY – Pause Pt 162

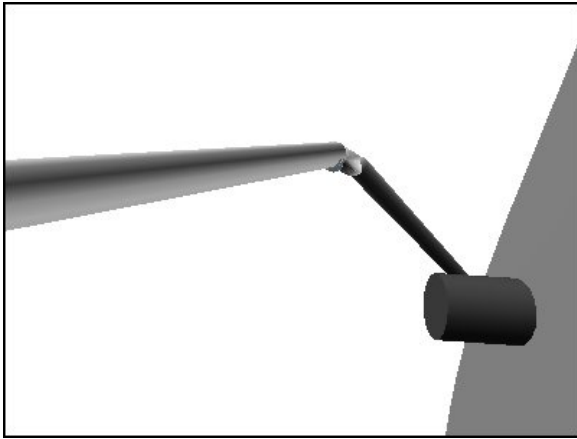

CCTV A (95,10)

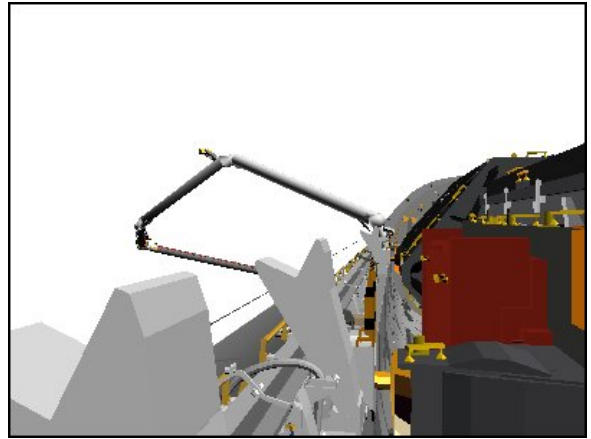

CCTV B (-10,0)

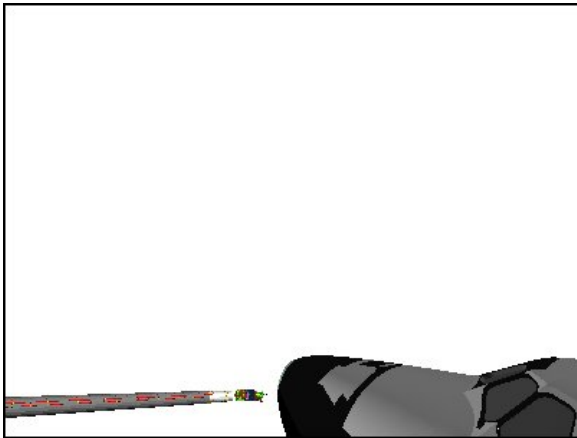

ELBOW (90,-60)

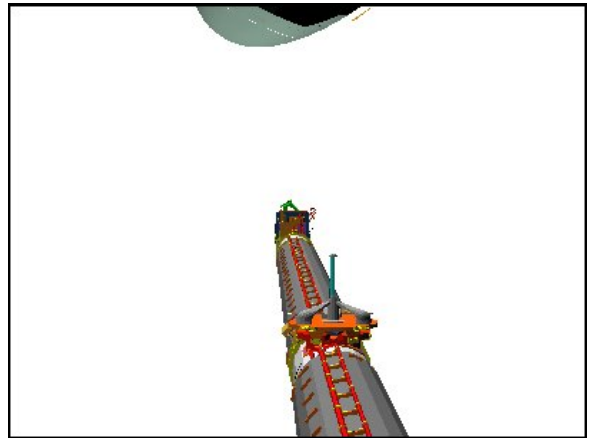

RSC

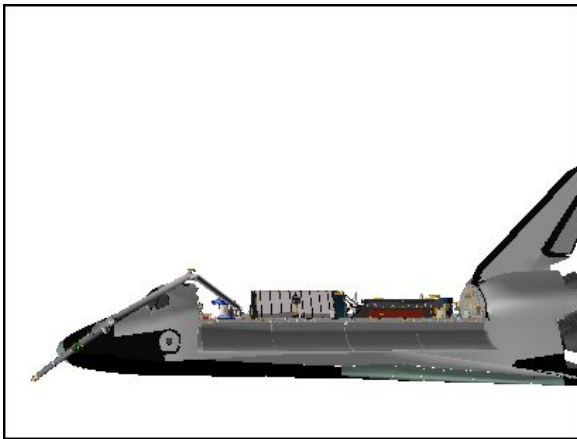

PORT

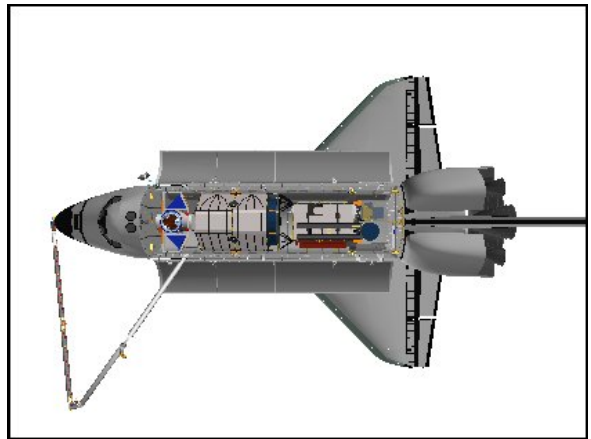

OVERHEAD

NOSE CAP IDC RCC SURVEY – Pause Pt 163

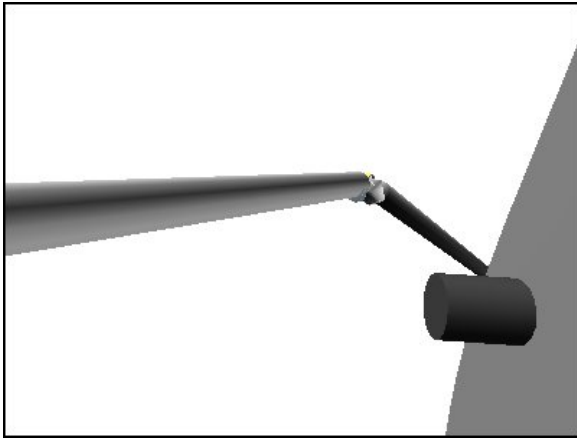

CCTV A (95,10)

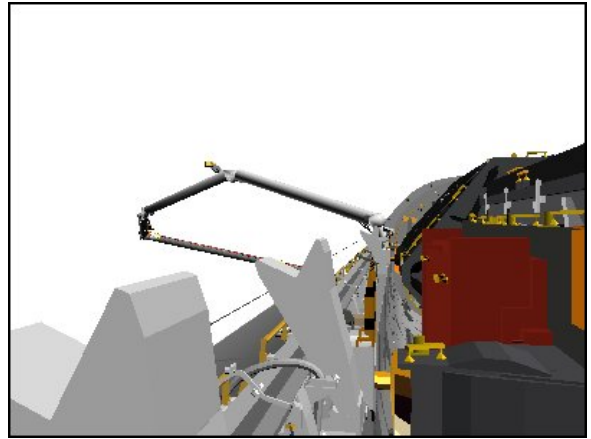

CCTV B (-10,0)

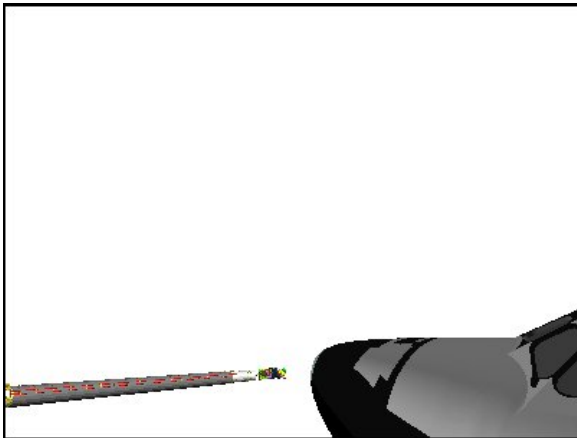

ELBOW (90,-60)



RSC

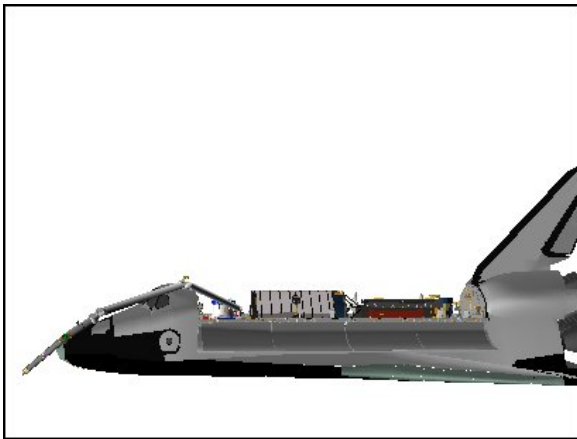

PORT

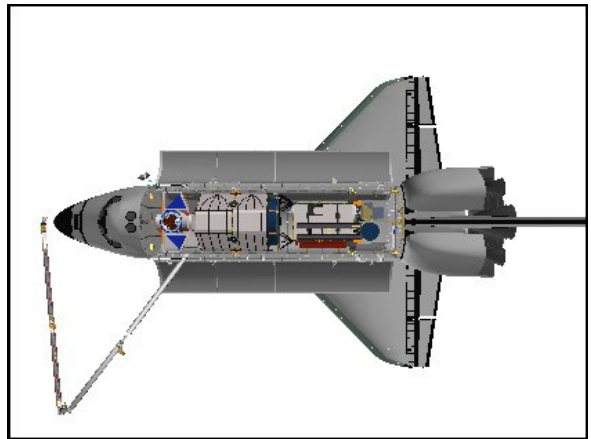

OVERHEAD

NOSE CAP IDC RCC SURVEY – Pause Pt 164

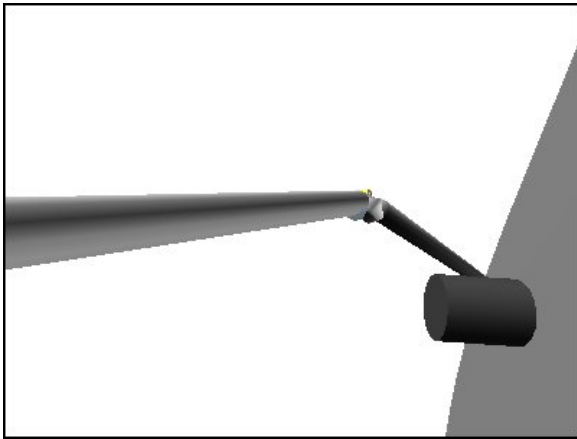

CCTV A (95,10)

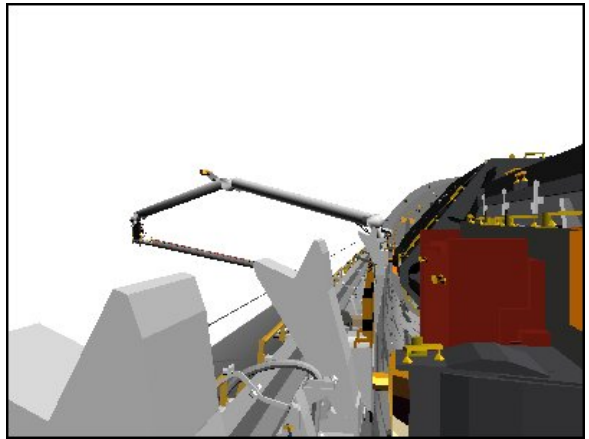

CCTV B (-10,0)

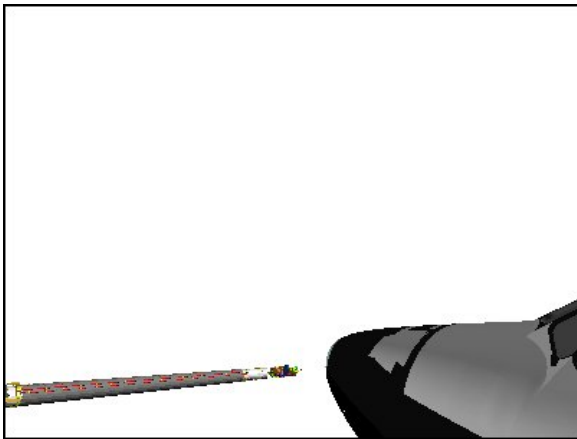

ELBOW (90,-60)



RSC

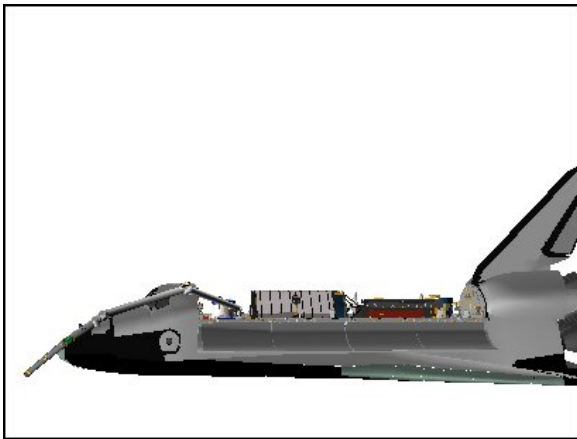

PORT

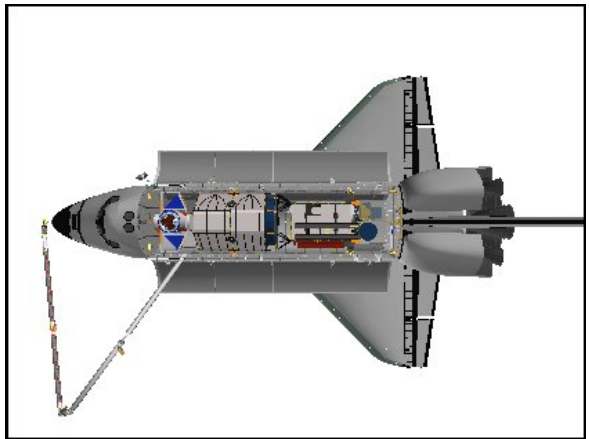

OVERHEAD

OBSS IDC RCC SURVEY CAMERA VIEWS – PORT

PORT IDC RCC SURVEY – Pause Pt 165

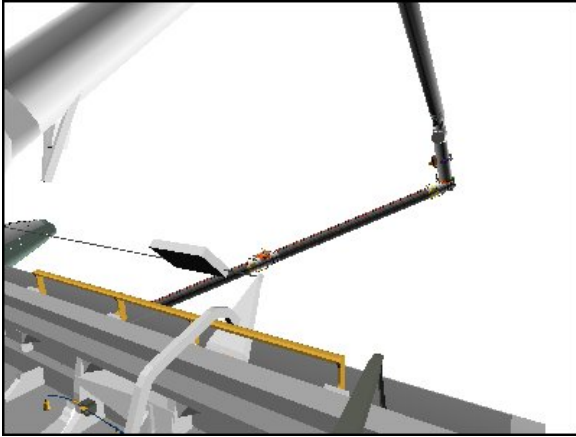

CCTV A (60,-10)

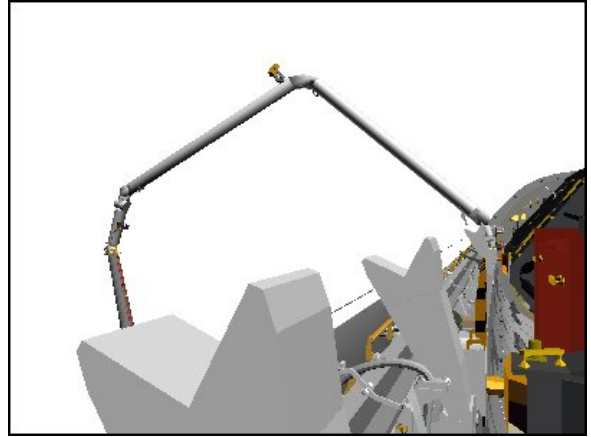

CCTV B (-20,0)

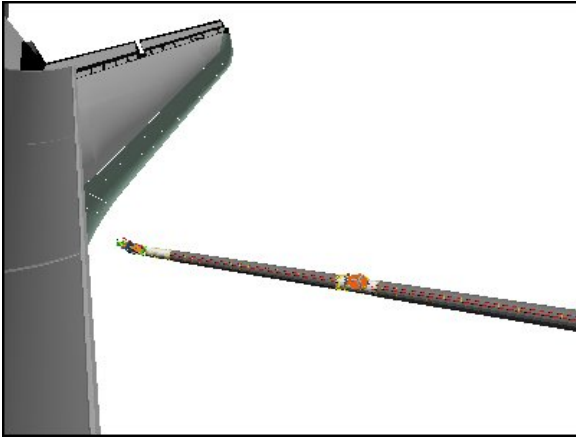

ELBOW (-60,0)

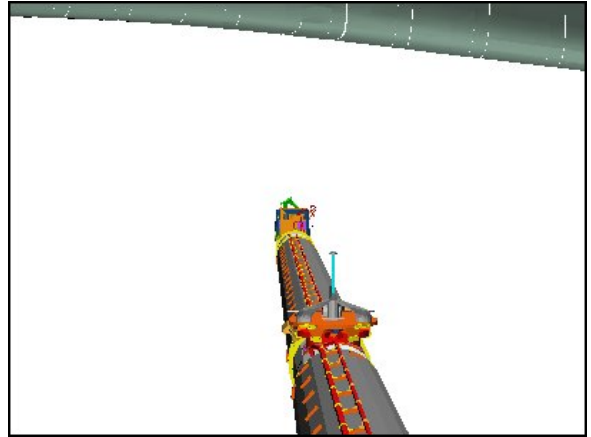

RSC



FRONT



PORT

PORT IDC RCC SURVEY – Pause Pt 167

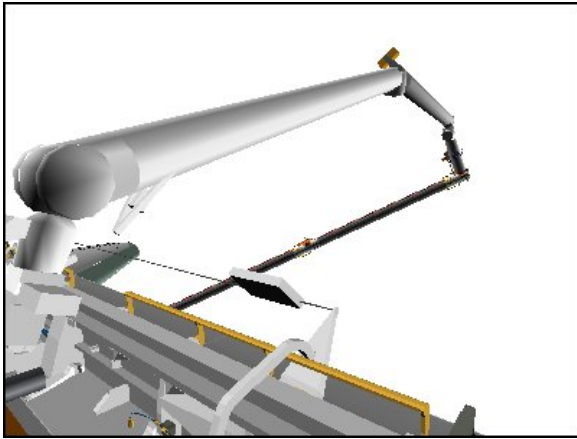

CCTV A (50,-6)

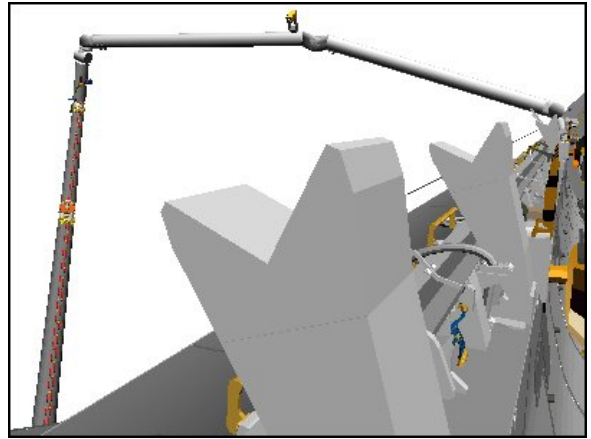

CCTV B (-26,-11)

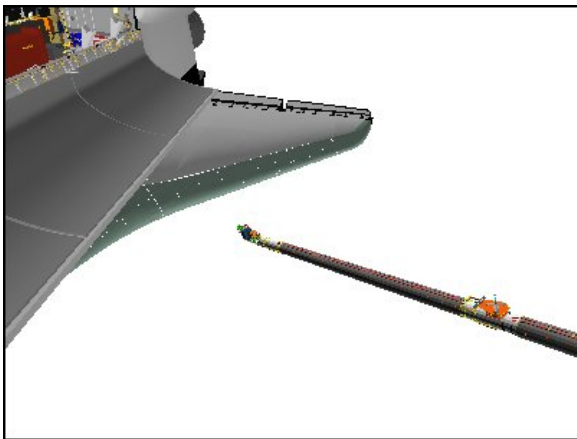

ELBOW (-83,4)

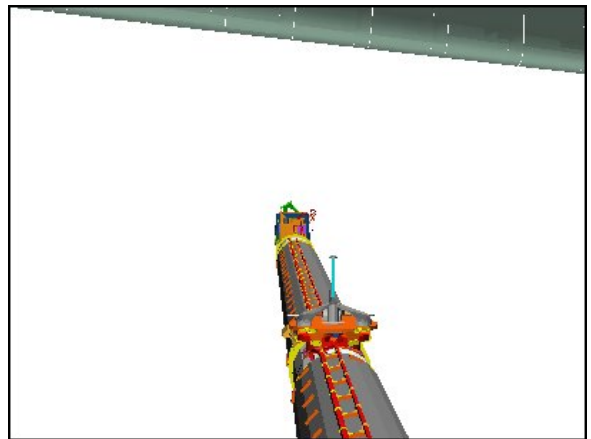

RSC



FRONT

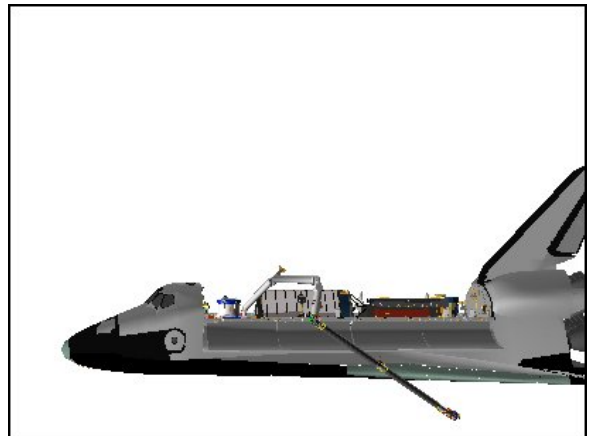

PORT

PORT IDC RCC SURVEY – Pause Pt 168

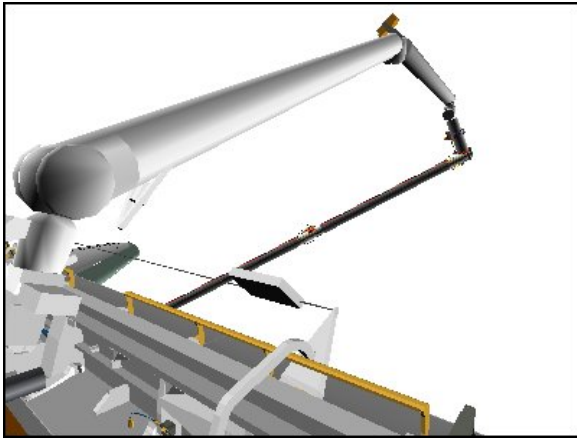

CCTV A (50,-6)

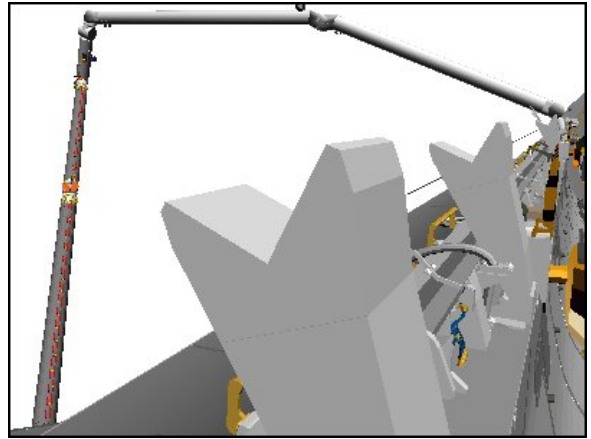

CCTV B (-26,-11)

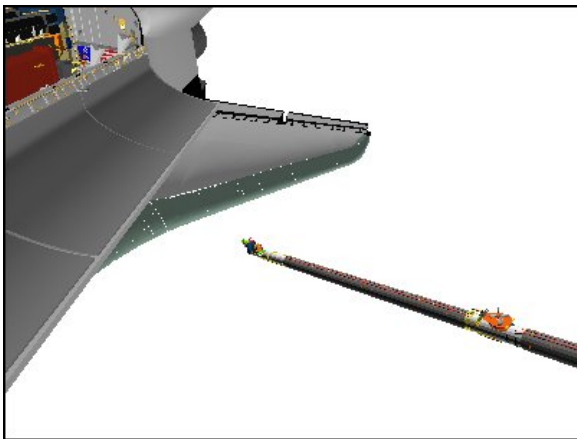

ELBOW (-83,4)

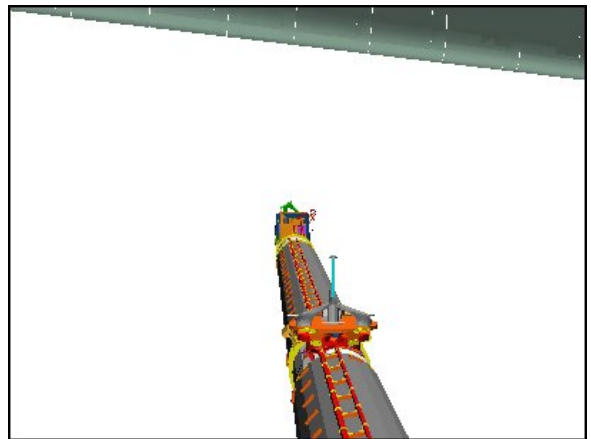

RSC



FRONT

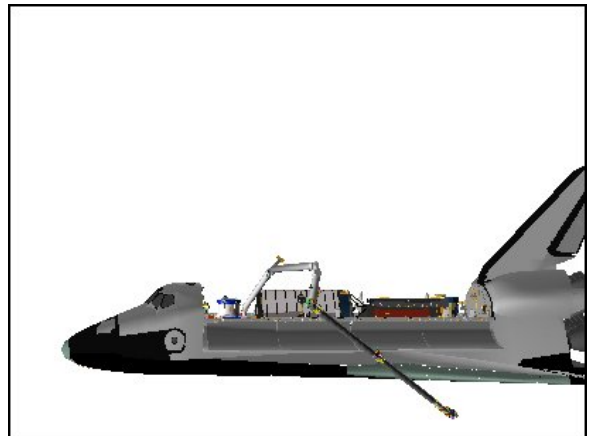

PORT

PORT IDC RCC SURVEY – Pause Pt 170

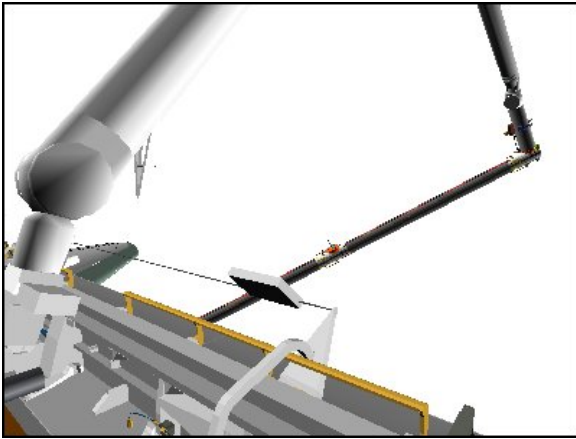

CCTV A (50,-6)

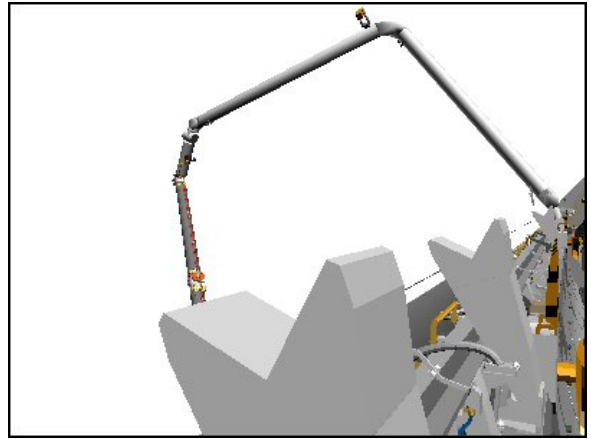

CCTV B (-26,-2)

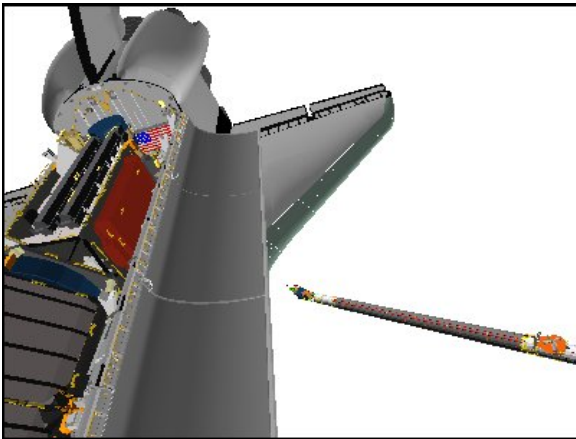

ELBOW (-83,4)



RSC



FRONT

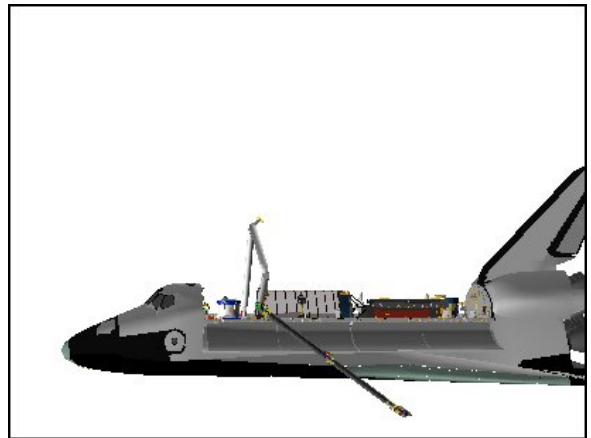

PORT

PORT IDC RCC SURVEY – Pause Pt 171

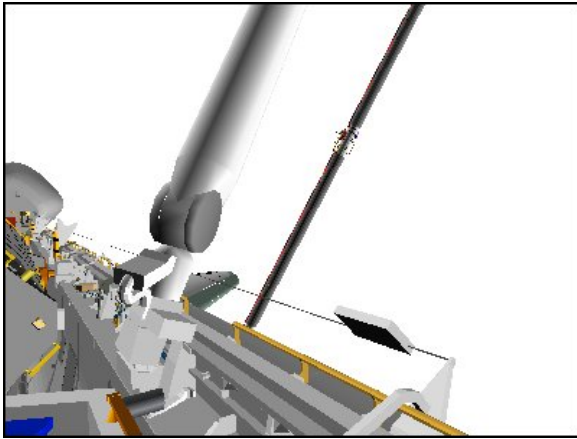

CCTV A (36,-1)

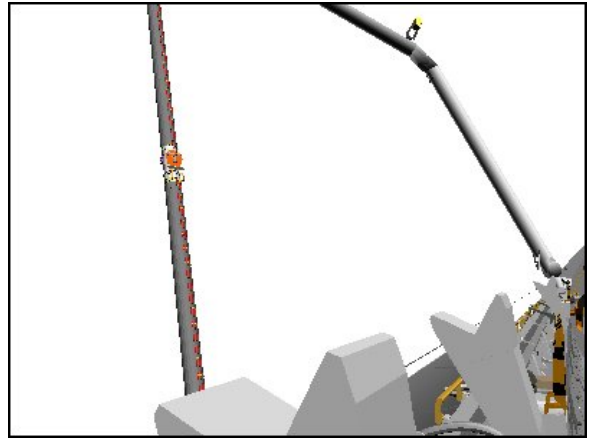

CCTV B (-26,5)

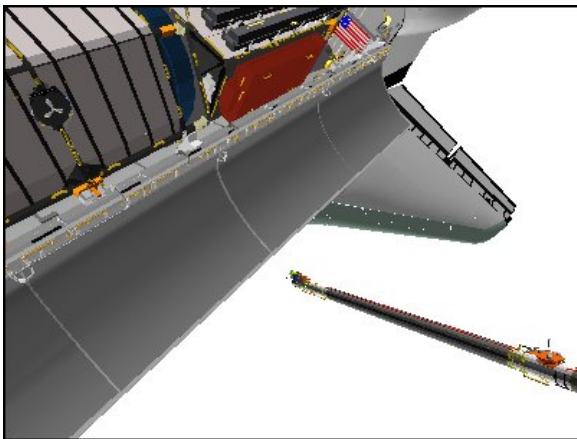

ELBOW (-93,-31)

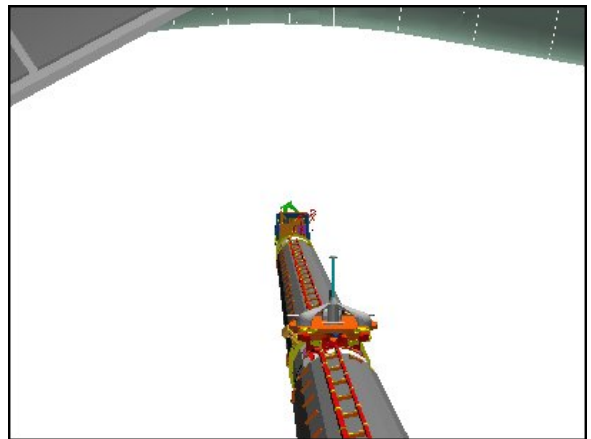

RSC



FRONT

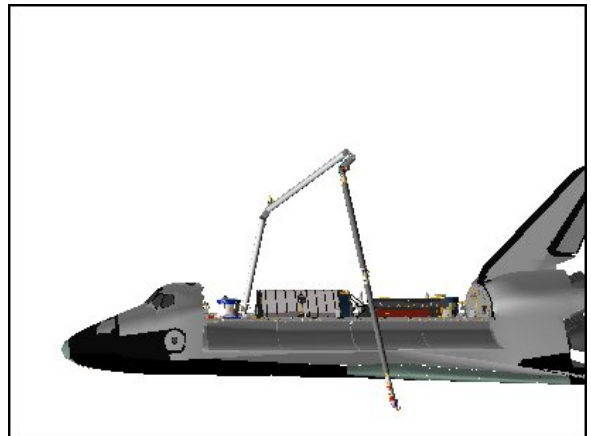

PORT

PORT IDC RCC SURVEY – Pause Pt 174

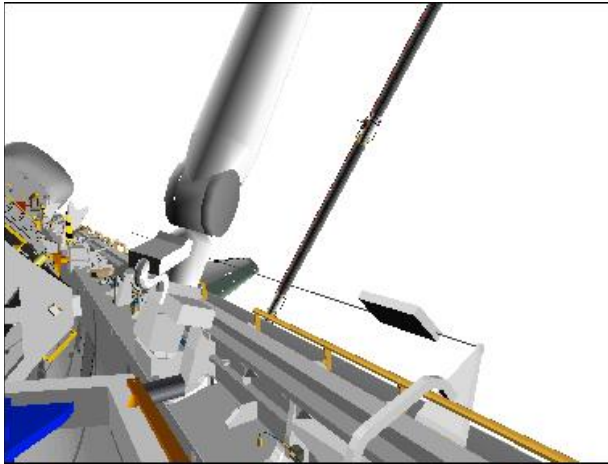

CCTV A (35,-5)

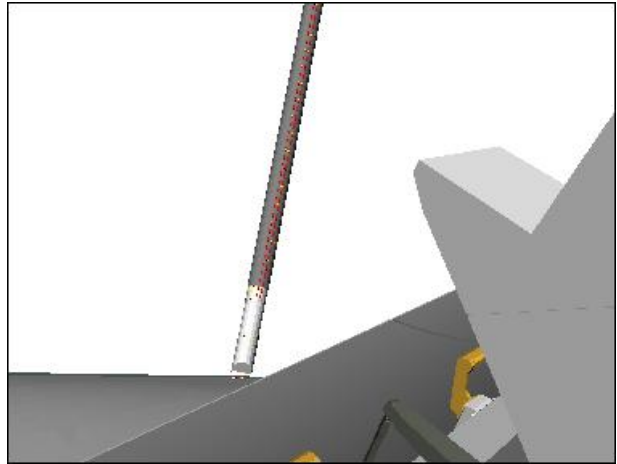

CCTV B (-45,-15)

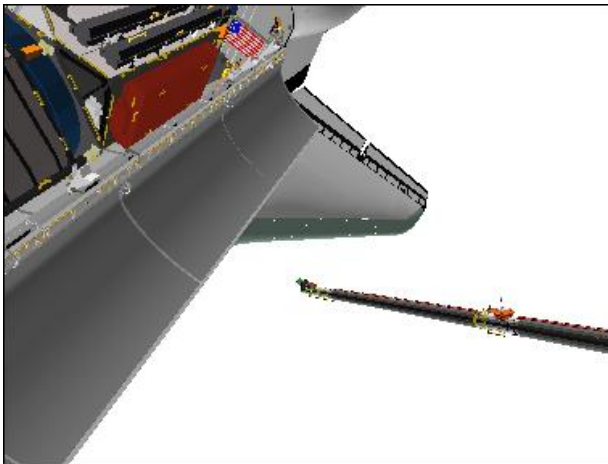

ELBOW (-75,-30)

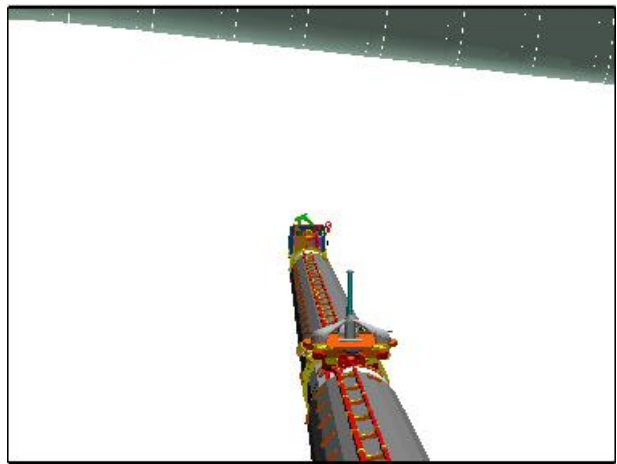

RSC



FRONT

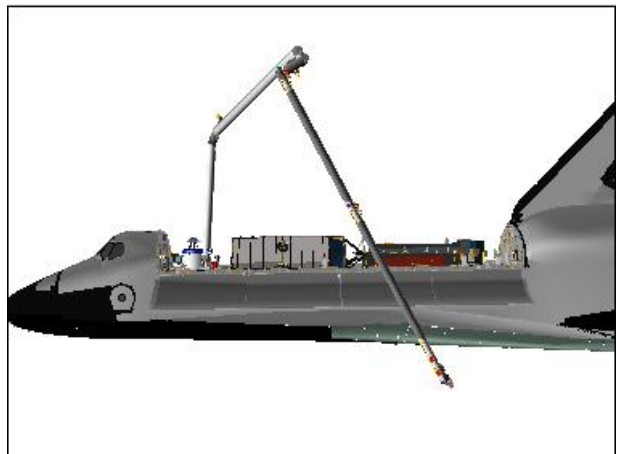

PORT

PORT IDC RCC SURVEY – Pause Pt 177

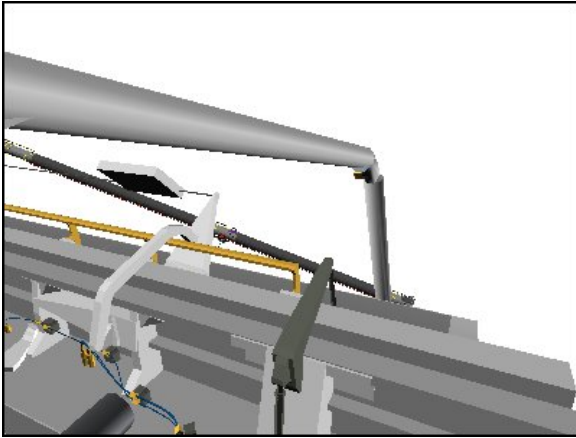

CCTV A (66,-21)



CCTV B (-53,-15)

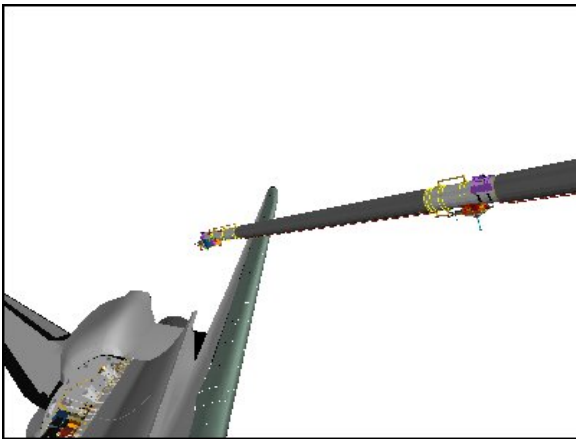

ELBOW (-83,39)

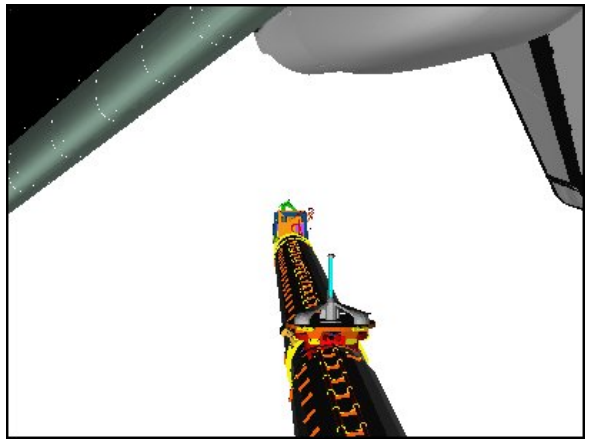

RSC

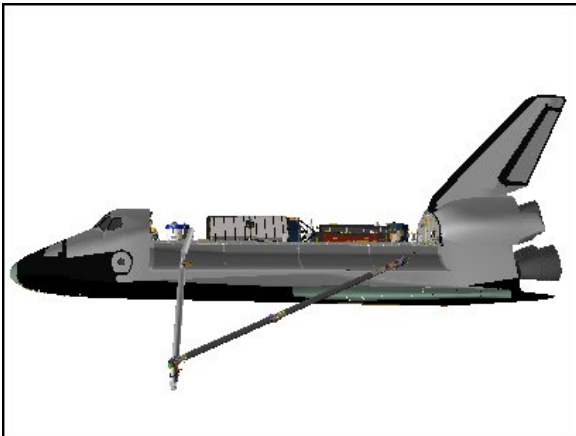

PORT

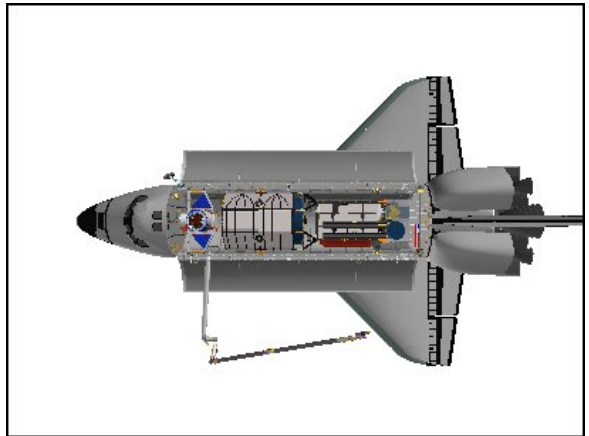

OVERHEAD

PORT IDC RCC SURVEY – Pause Pt 179

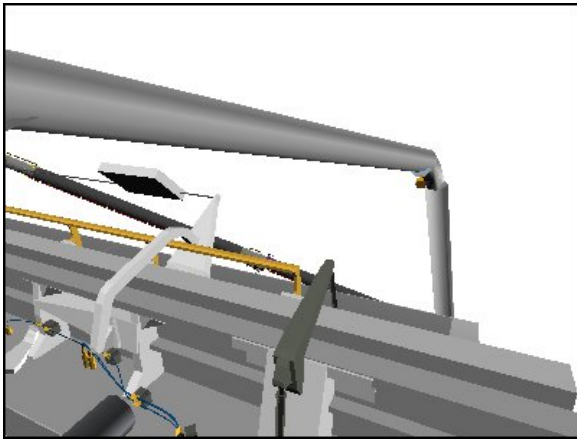

CCTV A (66,-21)

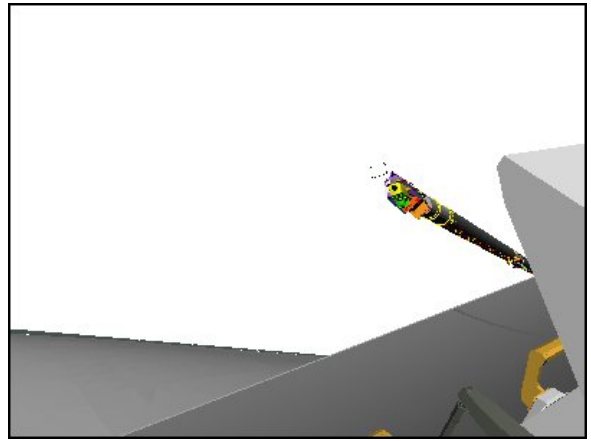

CCTV B (-53,-15)

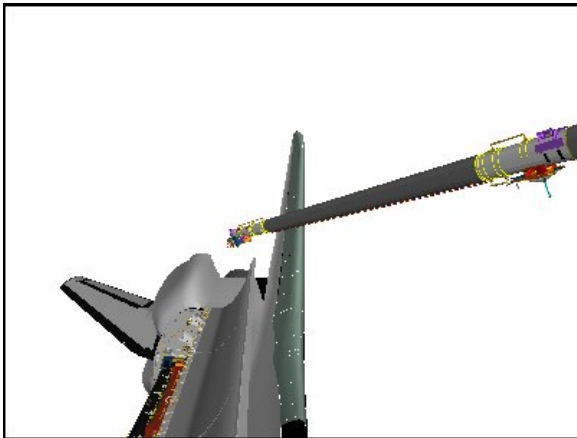

ELBOW (-95,23)

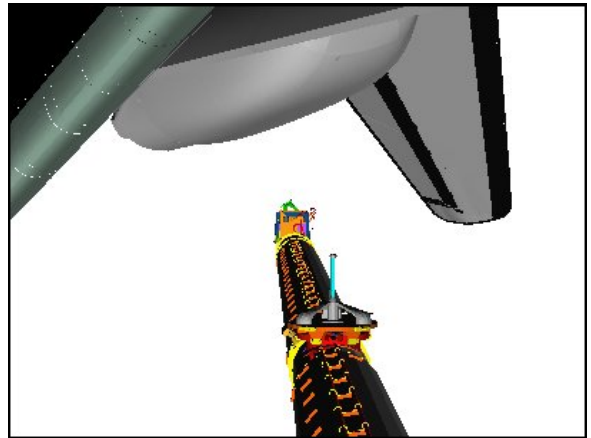

RSC

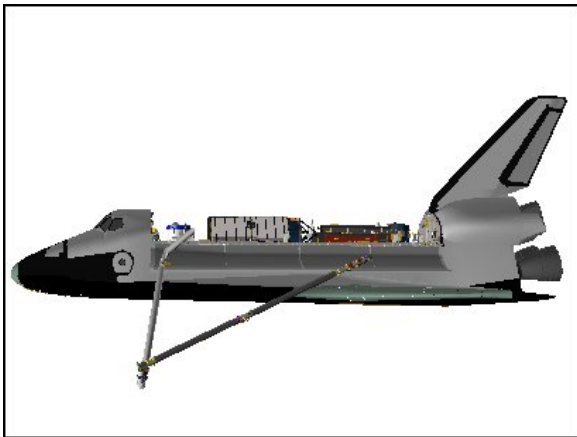

PORT

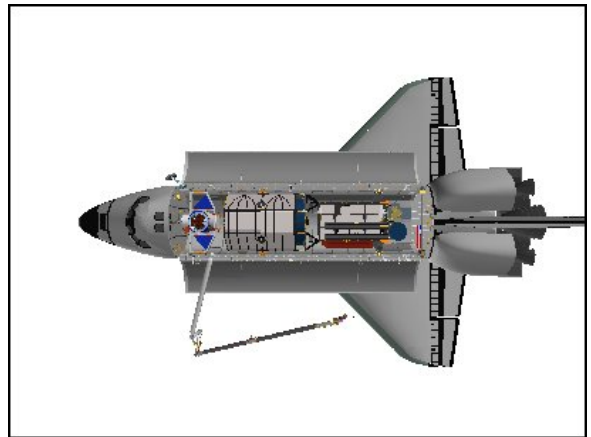

OVERHEAD

PORT IDC RCC SURVEY – Pause Pt 180

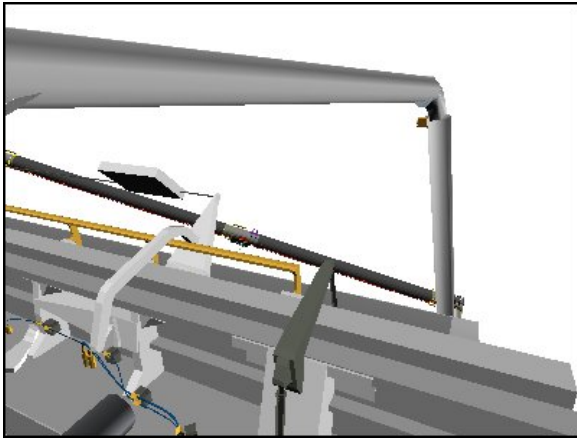

CCTV A (66,-21)

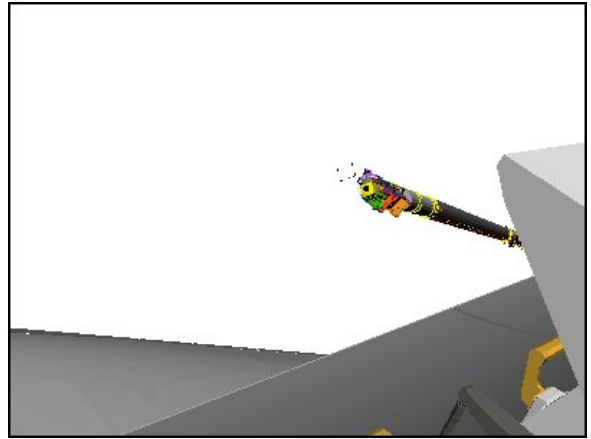

CCTV B (-53,-15)

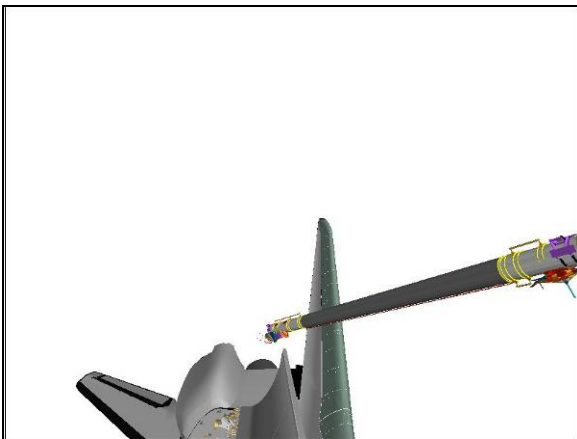

ELBOW (-95,35)

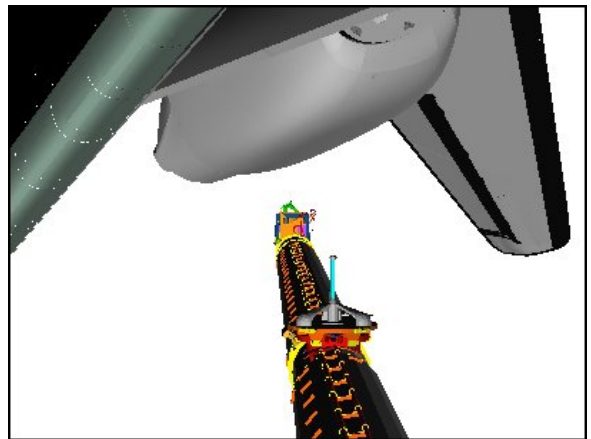

RSC

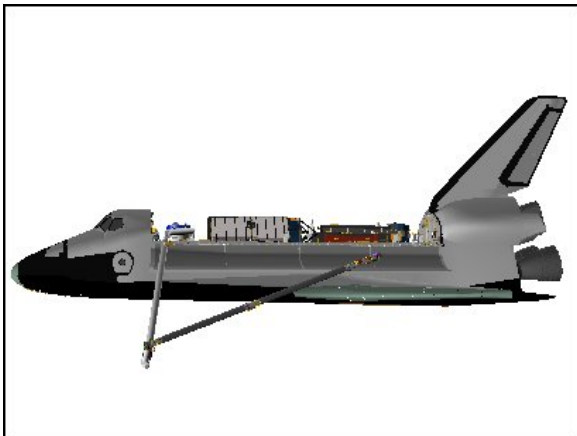

PORT

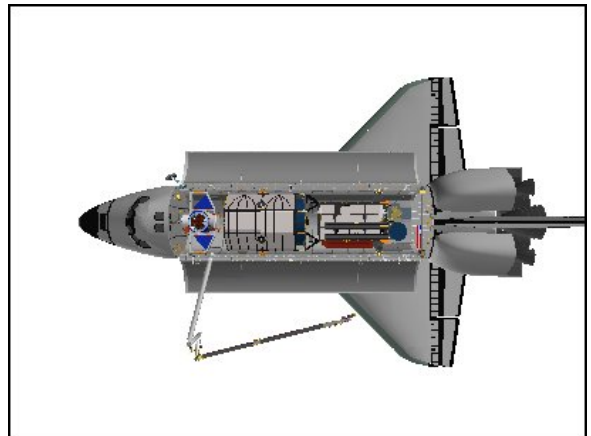

OVERHEAD

PORT IDC RCC SURVEY – Pause Pt 182

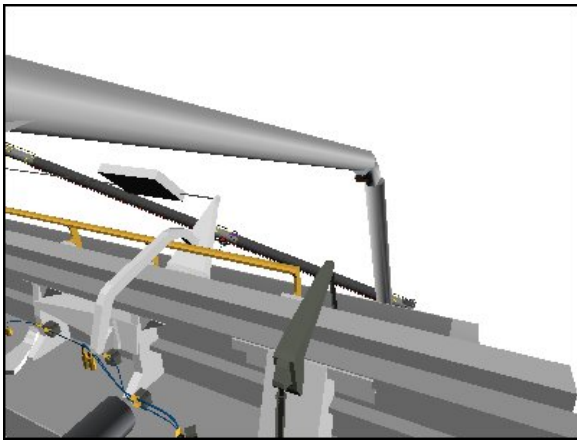

CCTV A (66,-21)



CCTV B (-53,-15)

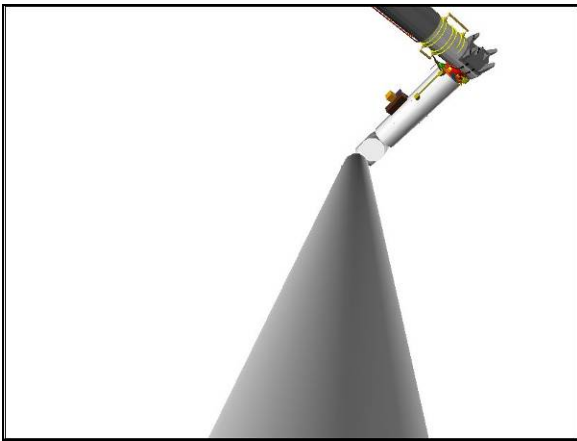

ELBOW (-10,-14)

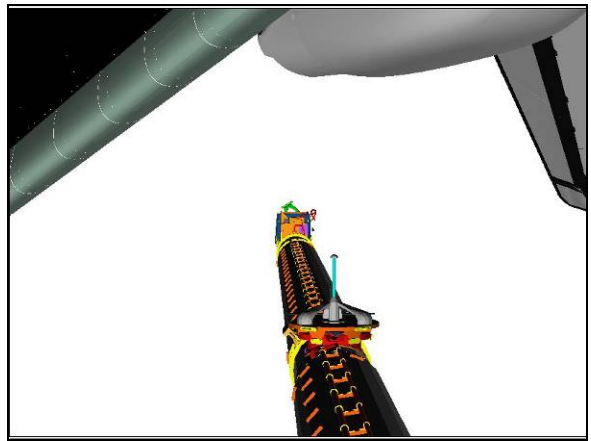

RSC

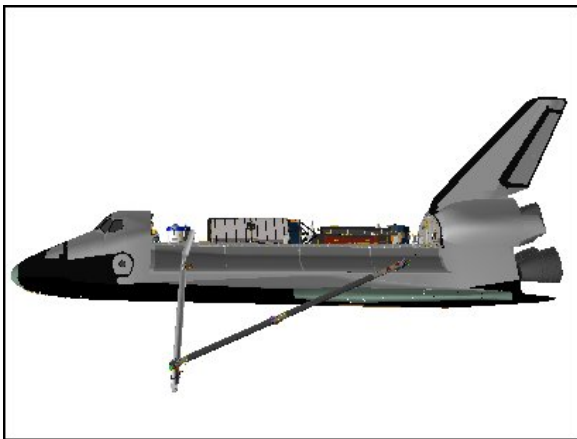

PORT

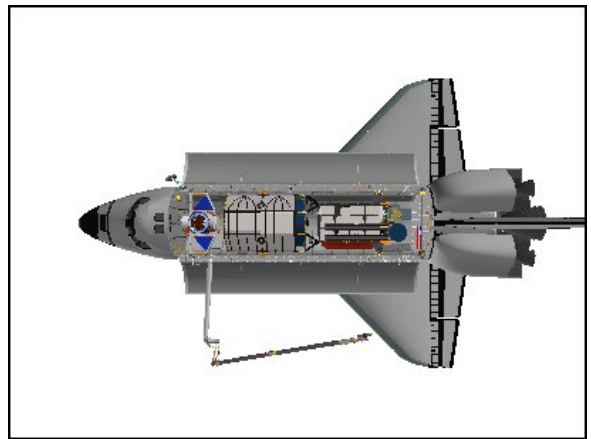

OVERHEAD

SRMS EE CAM CREW CABIN SURVEY CAMERA VIEWS

EE CREW CABIN SURVEY – Pause Pt 122

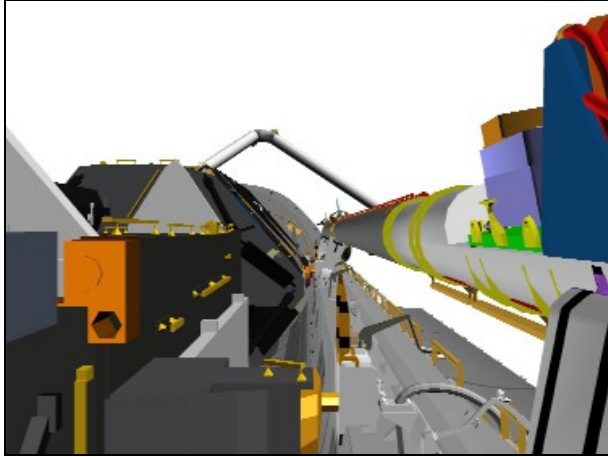

CCTV C (0,0)

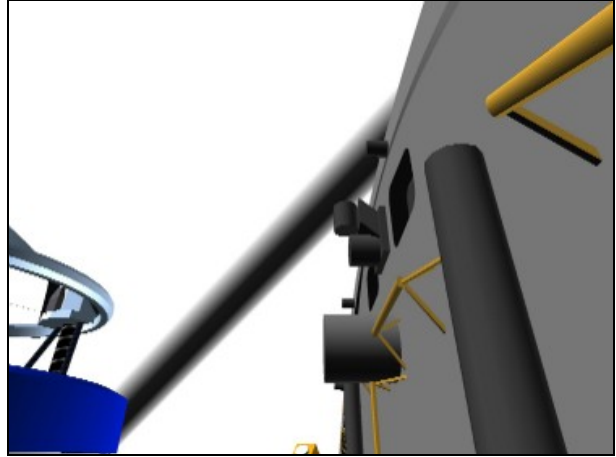

CCTV D (90,30)

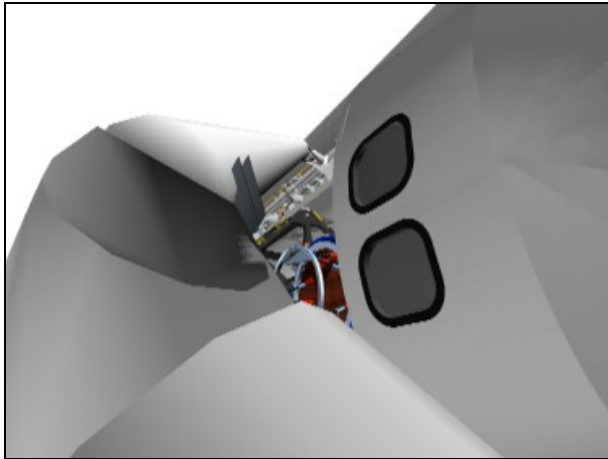

ELBOW (-135,-50)

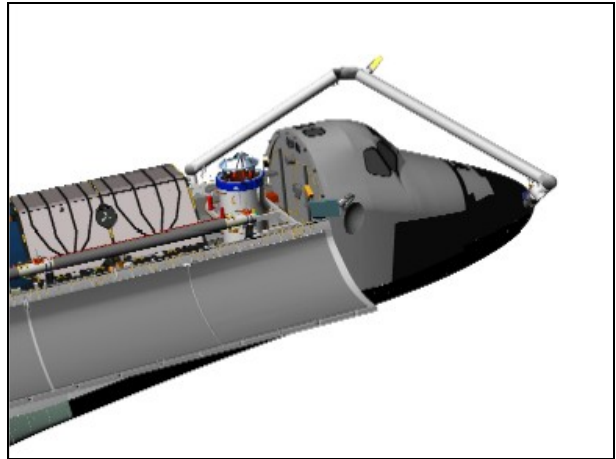

BIRD'S EYE

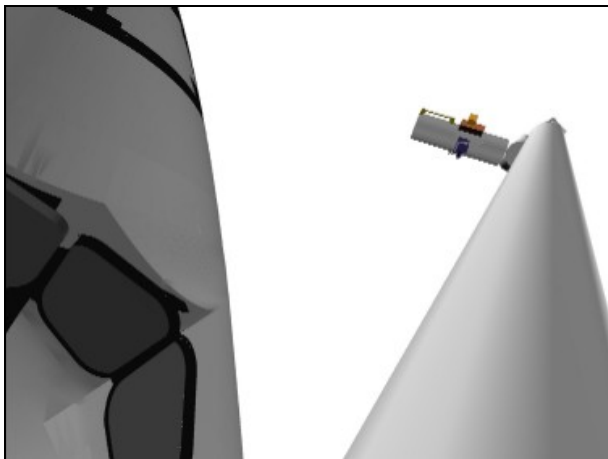

ELBOW (-30,-20)

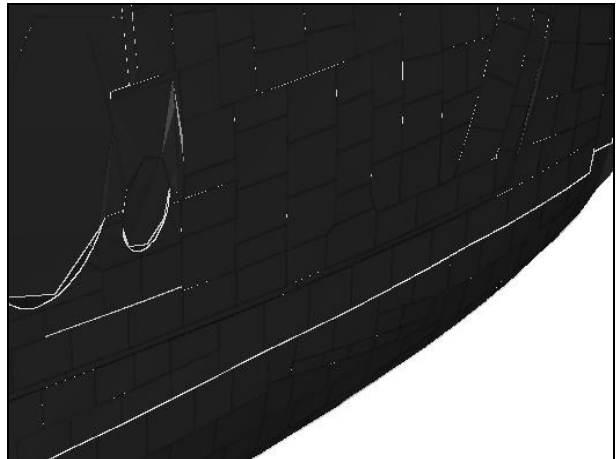

WRIST

EE CREW CABIN SURVEY – Pause Pt 123

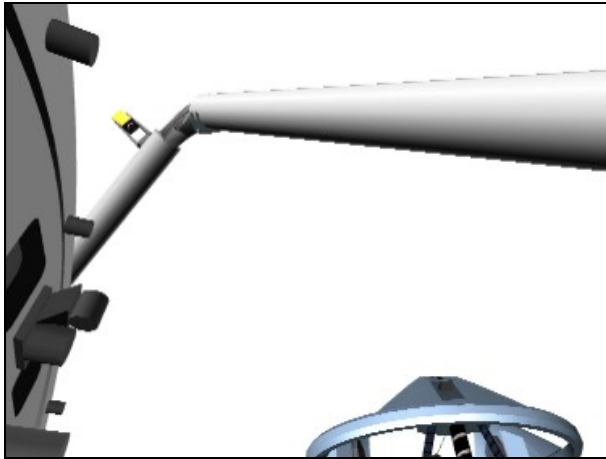

CCTV A (-65,45)

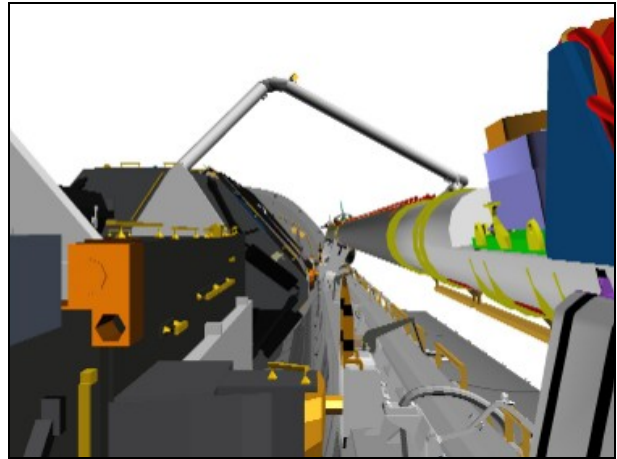

CCTV C (0,0)

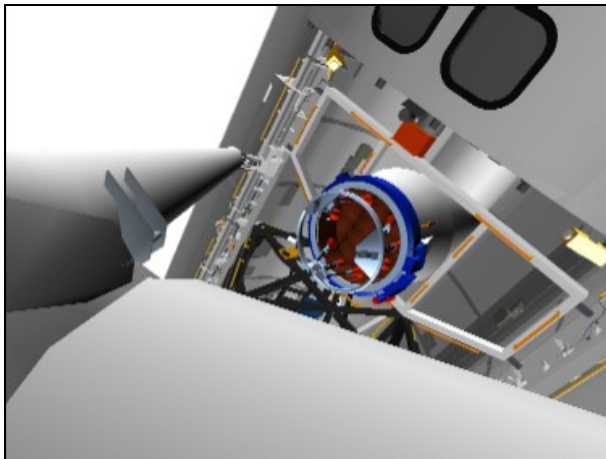

ELBOW A (-110,-55)

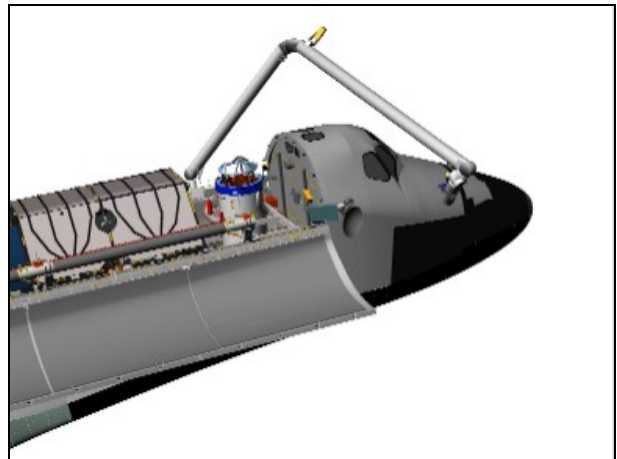

BIRD'S EYE



ELBOW B (-30,-25)

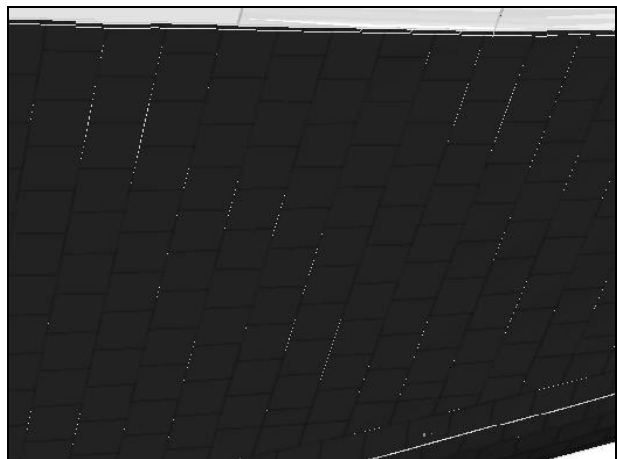

WRIST

EE CREW CABIN SURVEY – Pause Pt 124



CCTV A (-65,45)

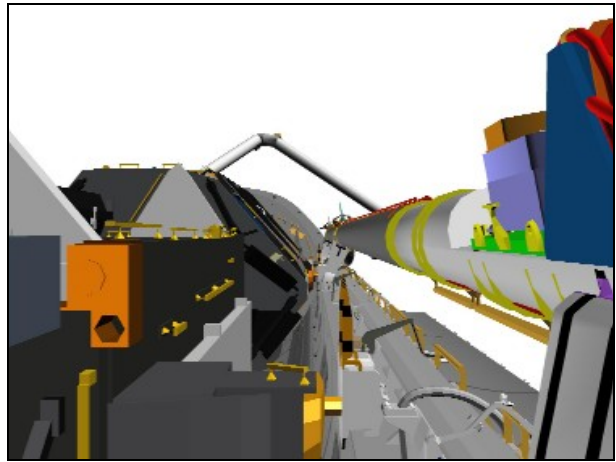

CCTV C (0,0)

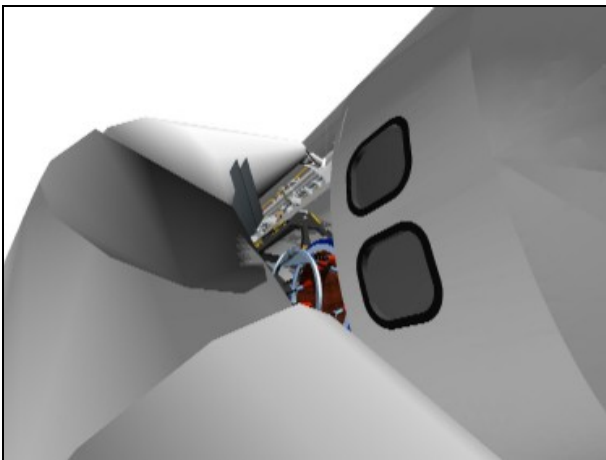

ELBOW (-135,-50)

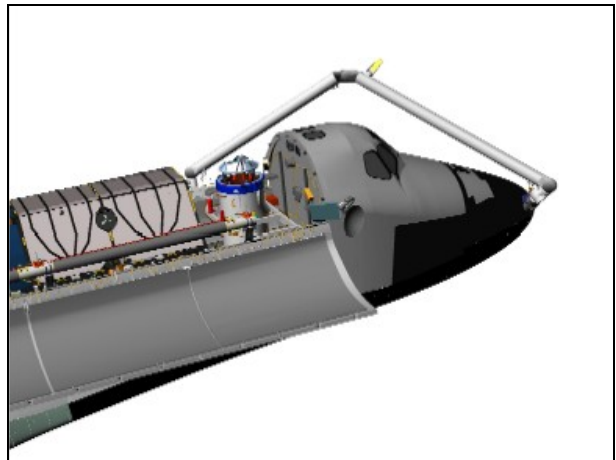

BIRD'S EYE

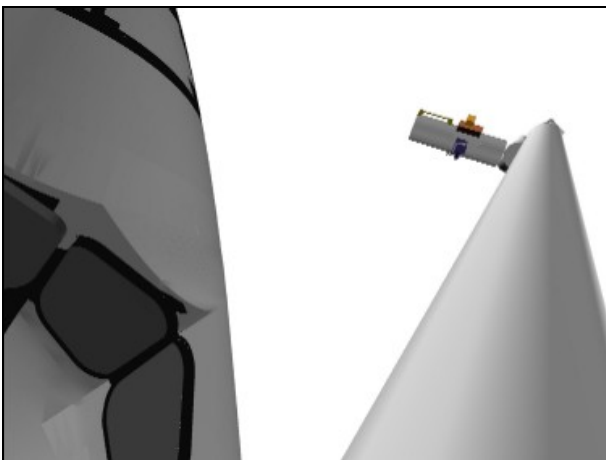

ELBOW (-30,-20)

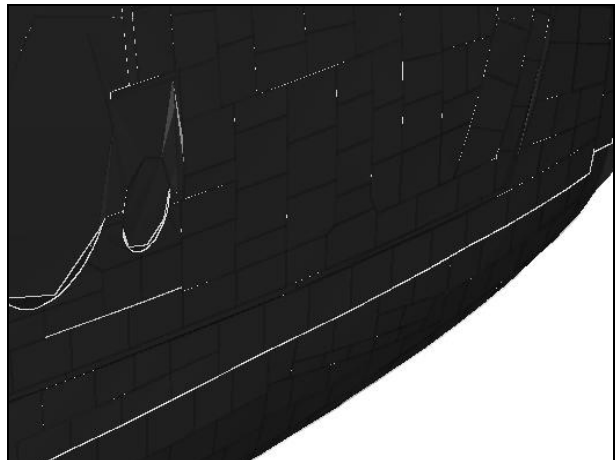

WRIST

EE CREW CABIN SURVEY – Pause Pt 125

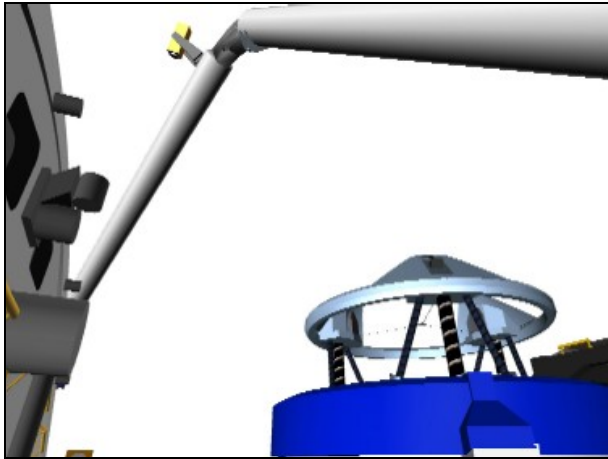

CCTV A (-65,30)

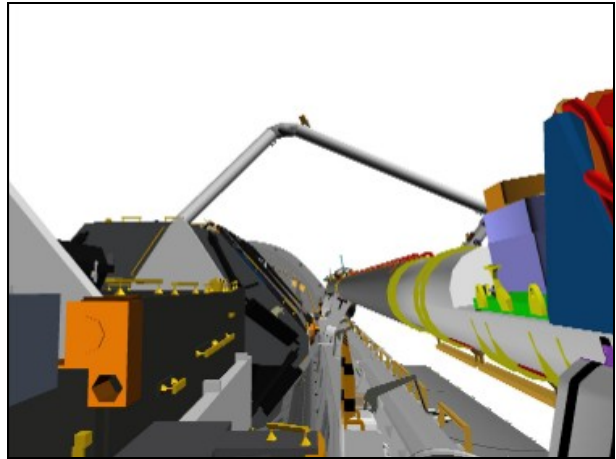

CCTV C (0,5)

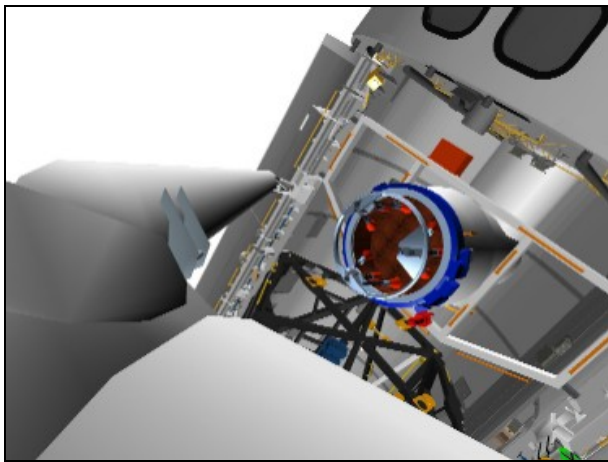

ELBOW (-120,-50)

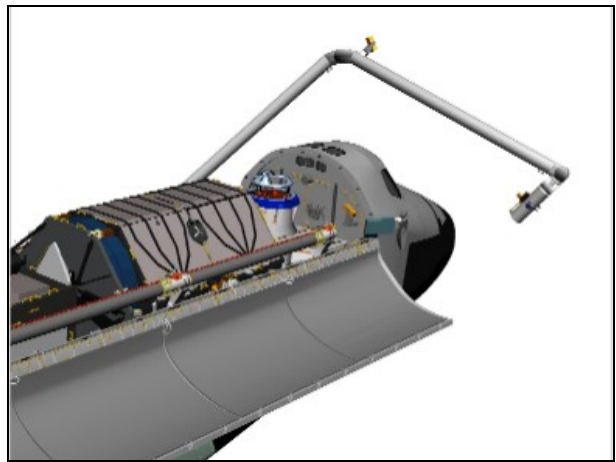

BIRD'S EYE

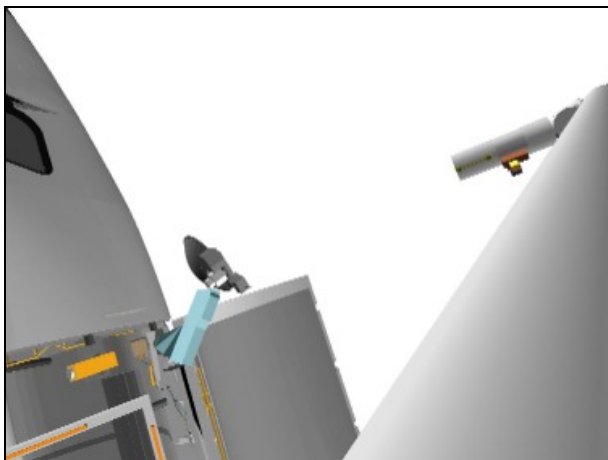

ELBOW (-35,-25)

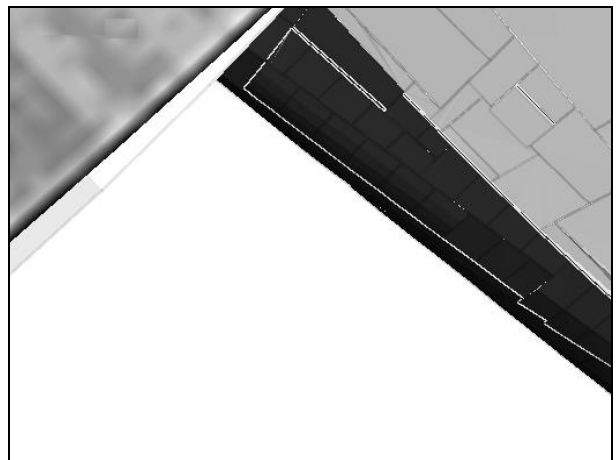

WRIST

EE CREW CABIN SURVEY – Pause Pt 126

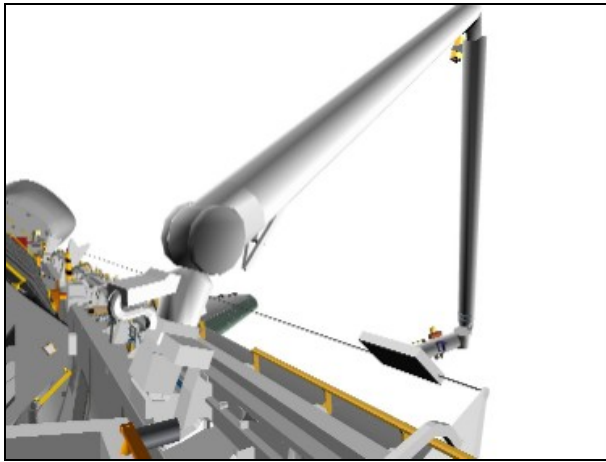

CCTV A (35,0)

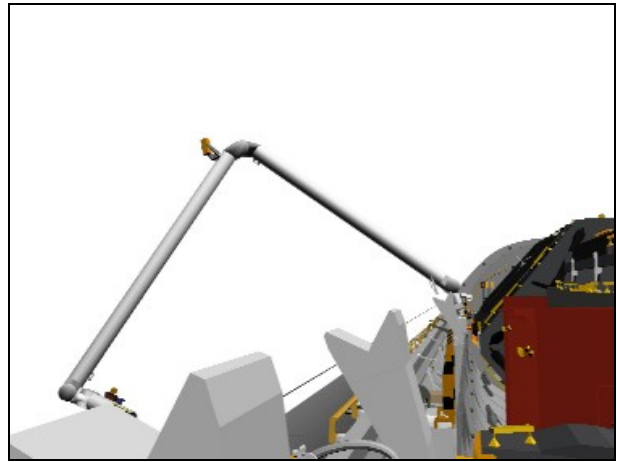

CCTV B (-15,5)

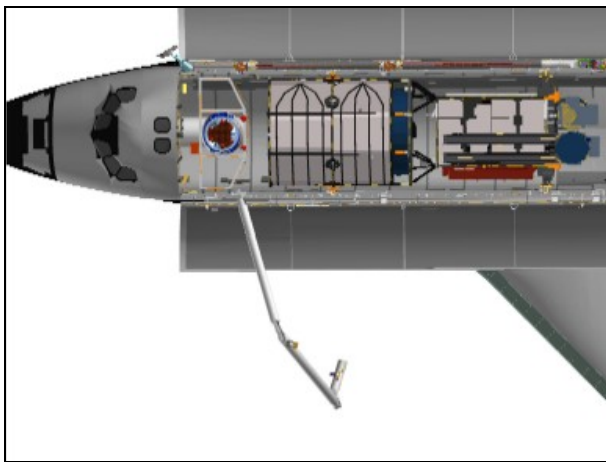

OVERHEAD

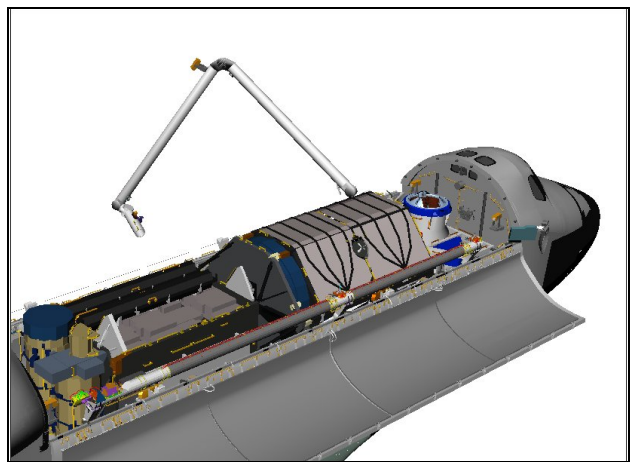

BIRD'S EYE

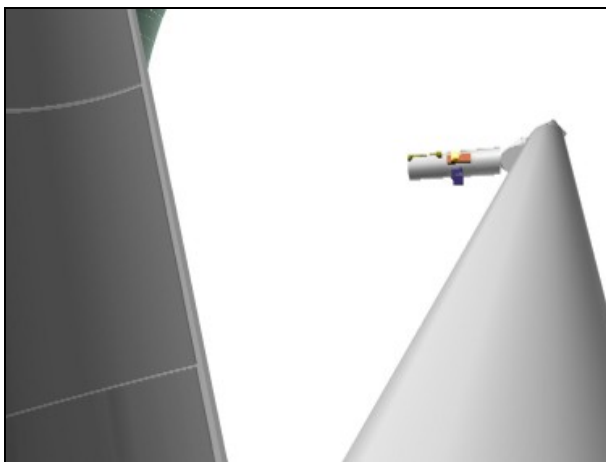

ELBOW (-30,-20)

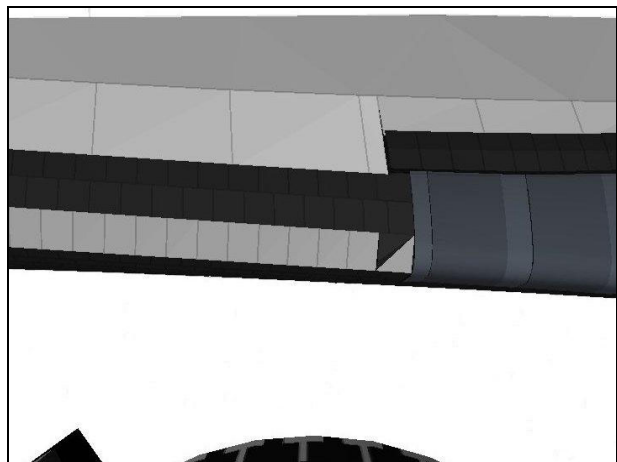

WRIST

EE CREW CABIN SURVEY – Pause Pt 128

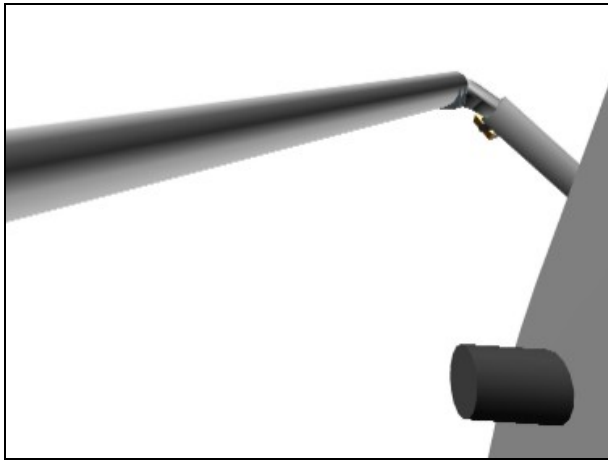

CCTV A (90,15)

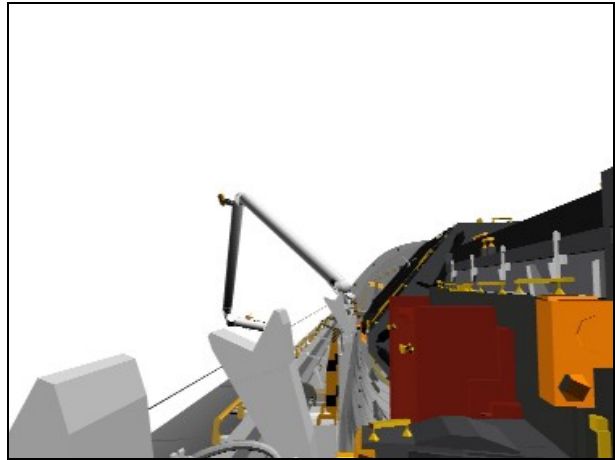

CCTV B (-5,5)

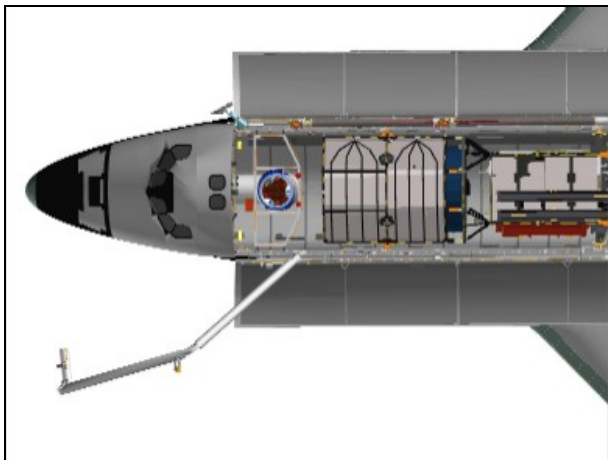

OVERHEAD

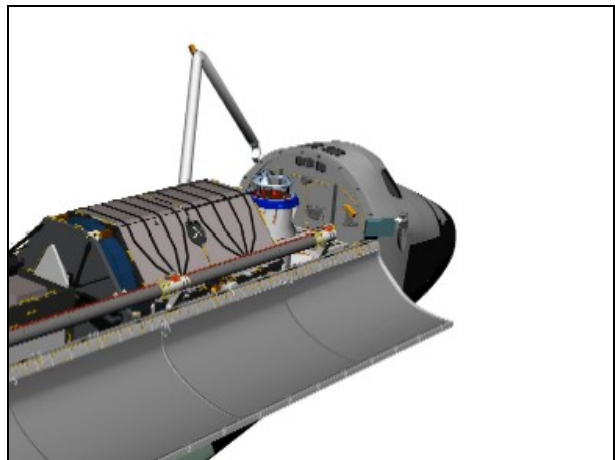

BIRD'S EYE

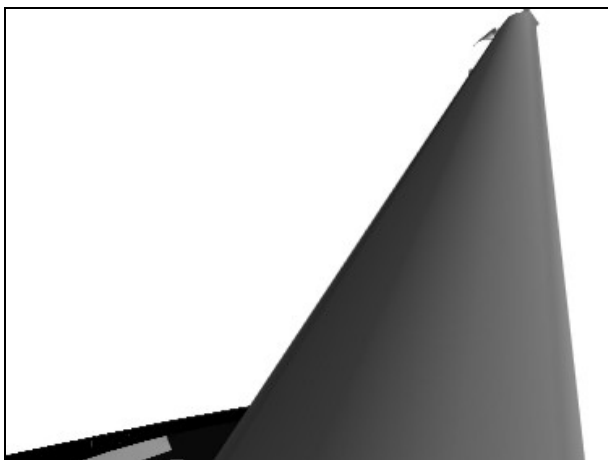

ELBOW (-25,-33)



WRIST

EE CREW CABIN SURVEY – Pause Pt 129



CCTV A (90,19)

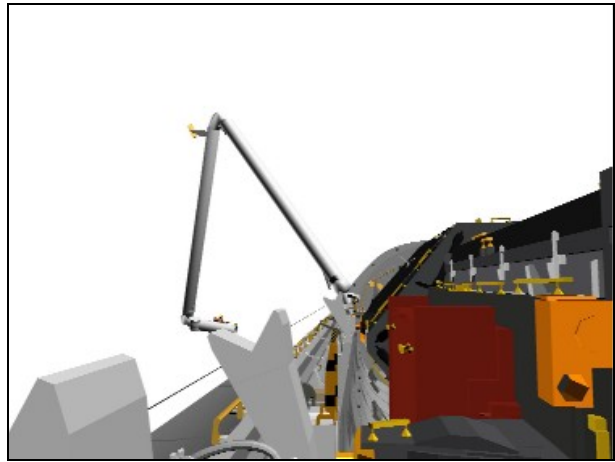

CCTV B (-5,5)

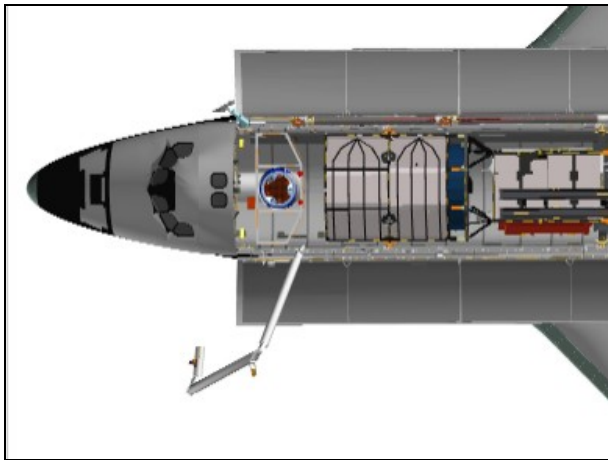

OVERHEAD

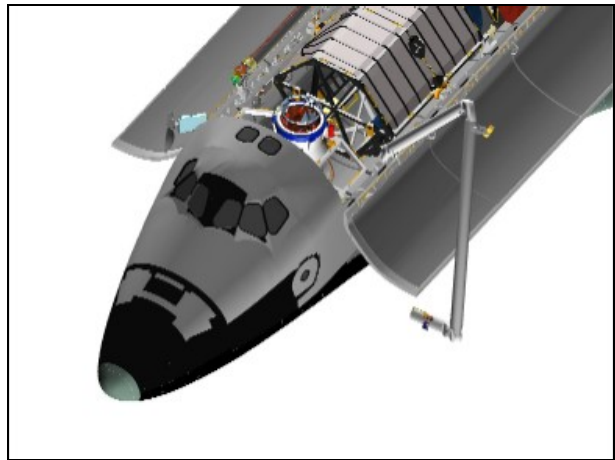

BIRD'S EYE

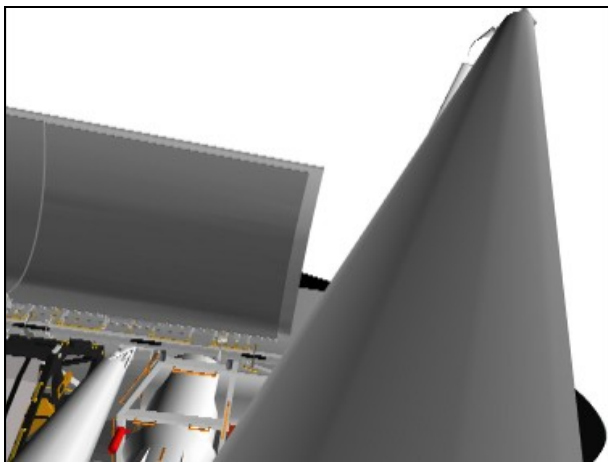

ELBOW (-25,-33)

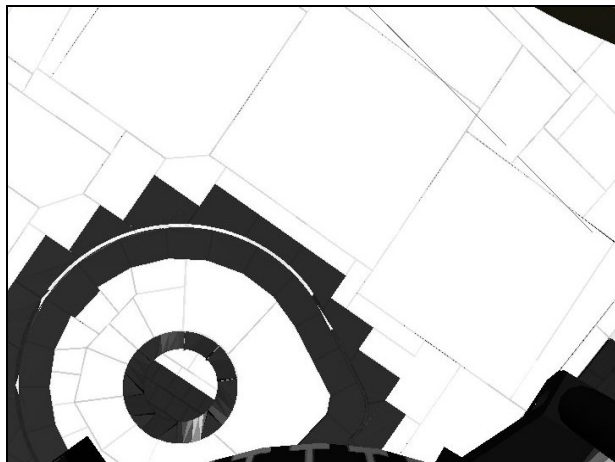

WRIST

This Page Intentionally Blank

REFERENCE DATA

I

PL ID 1 – OBSS UNBERTH/BERTH, FWD STRIKER BAR FS 6-2
2 – LARGE, NON-SURVEY OBSS MNVRS FS 6-3
3 – OBSS LDRI – POR @ PTU PIVOT FS 6-4
4 – P3/P4 CENTER OF TRUNNIONS AT TRUNNION LEVEL FS 6-5
5 – EE SURVEY FS 6-6
5A (UPLINK) – OBSS IDC FS 6-7
P3/P4 JOINT ANGLES VS POR COORDINATES FS 6-8
PRLA CONFIGURATION..... FS 6-10
INSTALL CAMERA MATRIX..... FS 6-11
OBSS JOINT ANGLES VS POR COORDINATES FS 6-13
AUTO SEQUENCES FS 6-17
SRMS EE CAM SURVEYS JOINT ANGLES VS POR COORDINATES..... FS 6-26
CREW CABIN SURVEY AUTO SEQUENCES..... FS 6-27

REFERENCE
DATA

PL ID 1 – OBSS UNBERTH/BERTH, FWD STRIKER BAR

REFERENCE
DATA

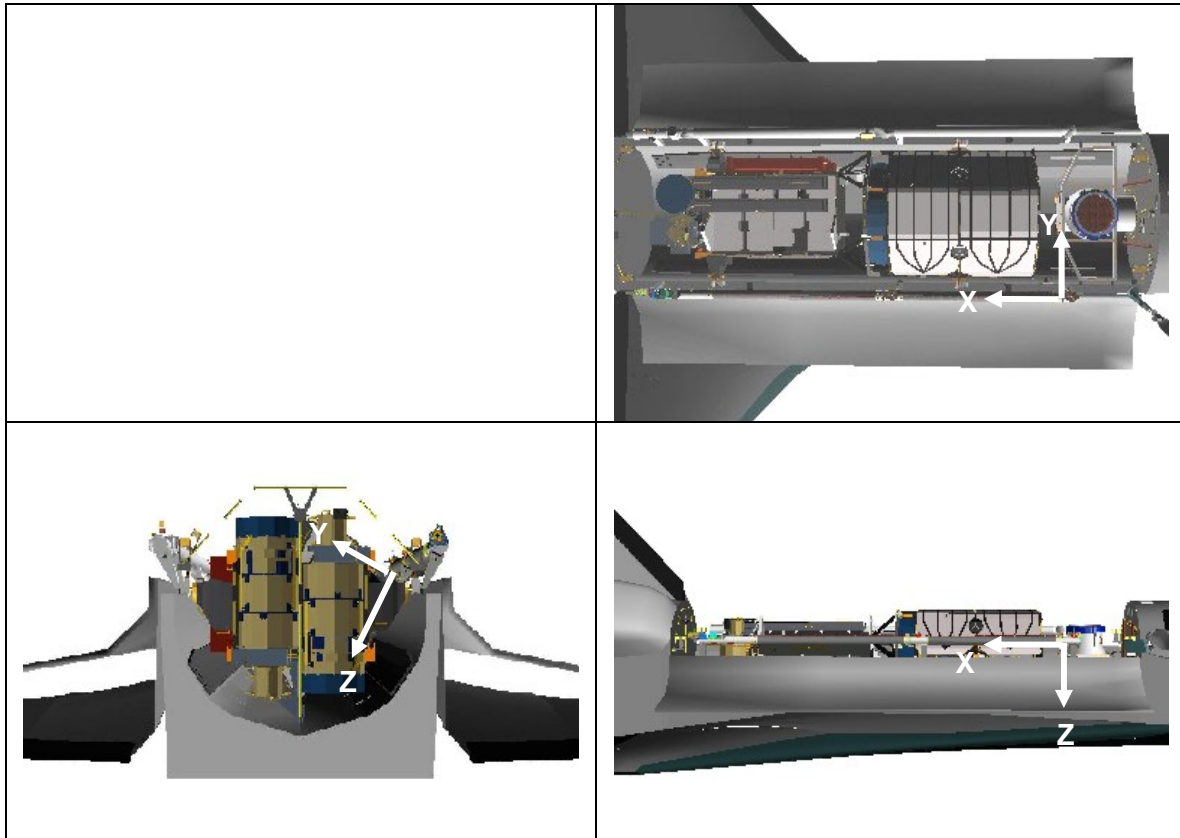

POR: POR at OBSS fwd striker bar

PURPOSE: OBSS unberth/berth

FOR RATES:	COARSE	VERN
TRANS LIM ft/sec	0.20	0.10
ROT LIM deg/sec	0.88	0.08

JOINT RATES:	COARSE	VERN
SHOULDER LIM deg/sec	0.42	0.42
ELBOW LIM deg/sec	0.59	0.59
WRIST LIM deg/sec	0.88	0.88

PL ID 2 – LARGE, NON-SURVEY OBSS MNVRS

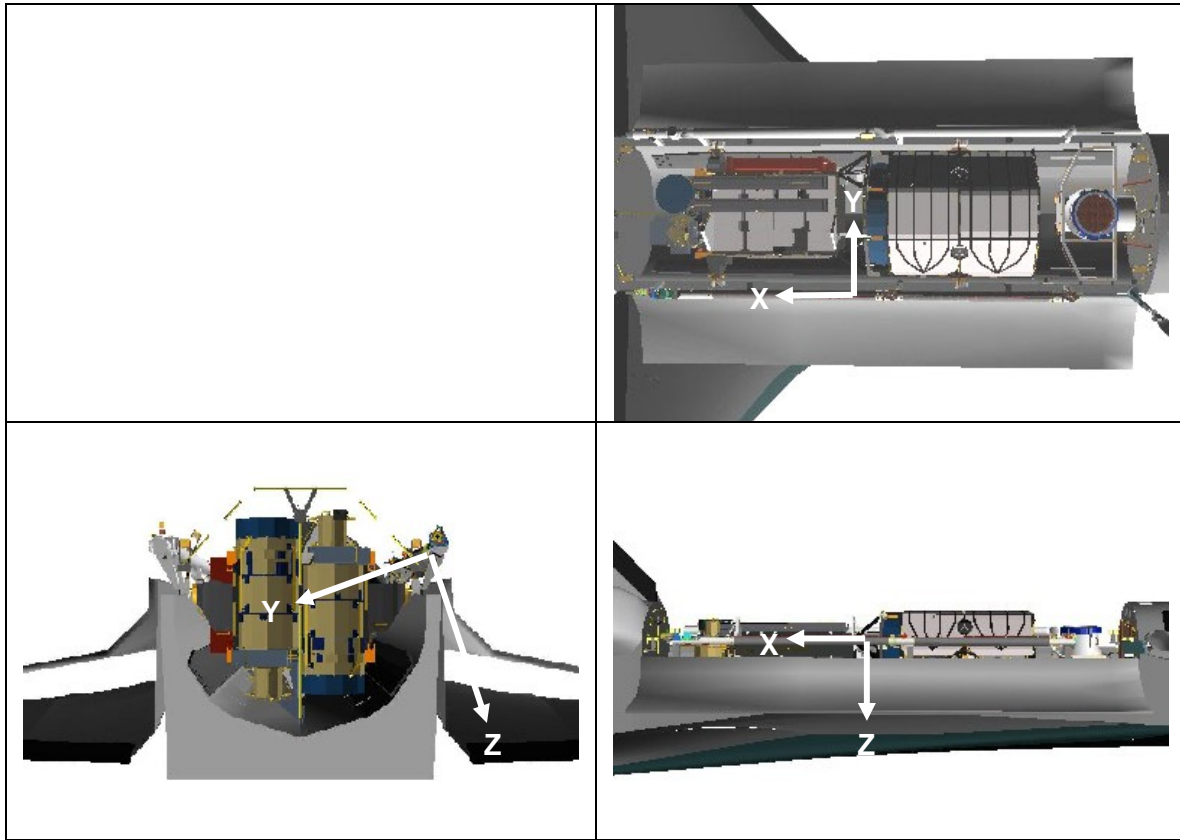

POR: POR at OBSS Center of Mass

PURPOSE: Large, non-survey OBSS maneuvers

FOR RATES:	COARSE	VERN
TRANS LIM ft/sec	0.70	0.23
ROT LIM deg/sec	2.64	0.88

JOINT RATES:	COARSE	VERN
SHOULDER LIM deg/sec	0.42	0.42
ELBOW LIM deg/sec	0.59	0.59
WRIST LIM deg/sec	0.88	0.88

PL ID 3 – OBSS LDRI – POR @ PTU PIVOT

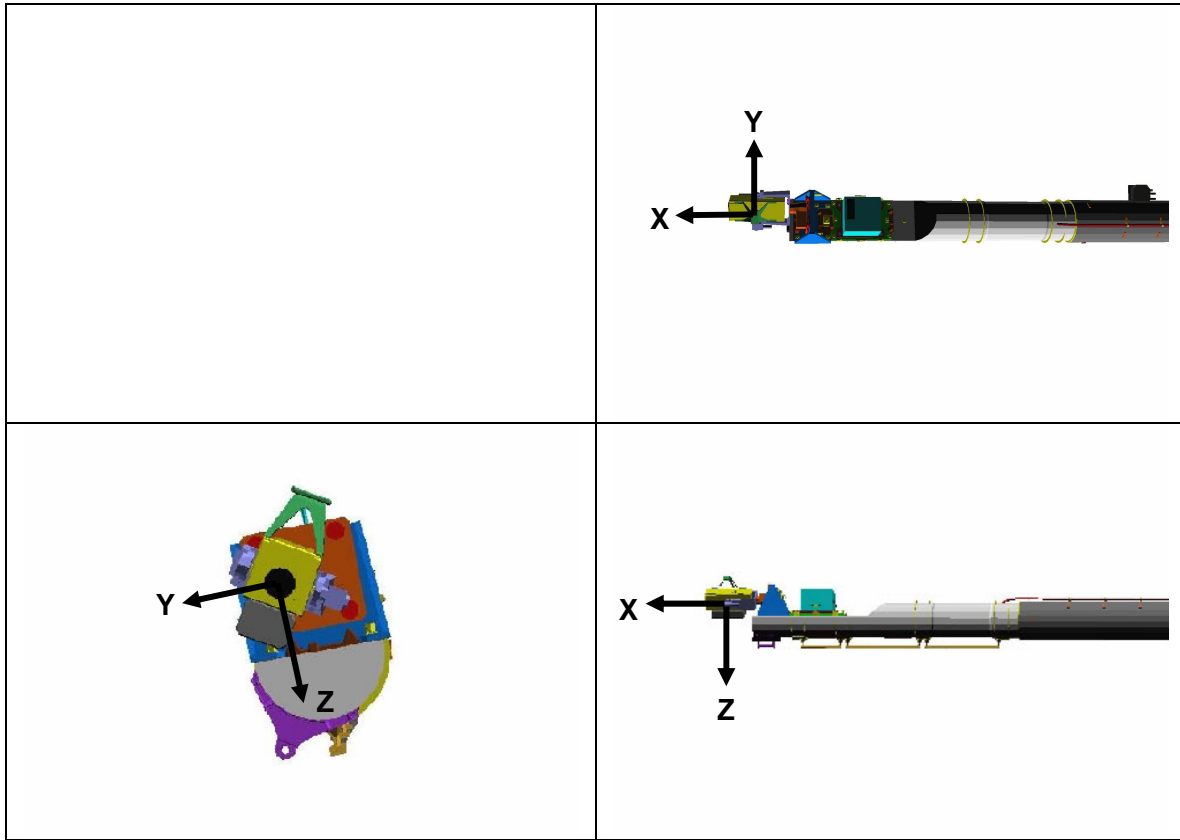

POR: POR at OBSS ITVC/LDRI PTU Pivot Point

PURPOSE: OBSS Surveys using LDRI

FOR RATES:	COARSE	VERN
TRANS LIM ft/sec	0.23	0.01
ROT LIM deg/sec	2.64	0.88

JOINT RATES:	COARSE	VERN
SHOULDER LIM deg/sec	0.42	0.42
ELBOW LIM deg/sec	0.59	0.59
WRIST LIM deg/sec	0.88	0.88

PL ID 4 – P3/P4 CENTER OF TRUNNIONS AT TRUNNION LEVEL

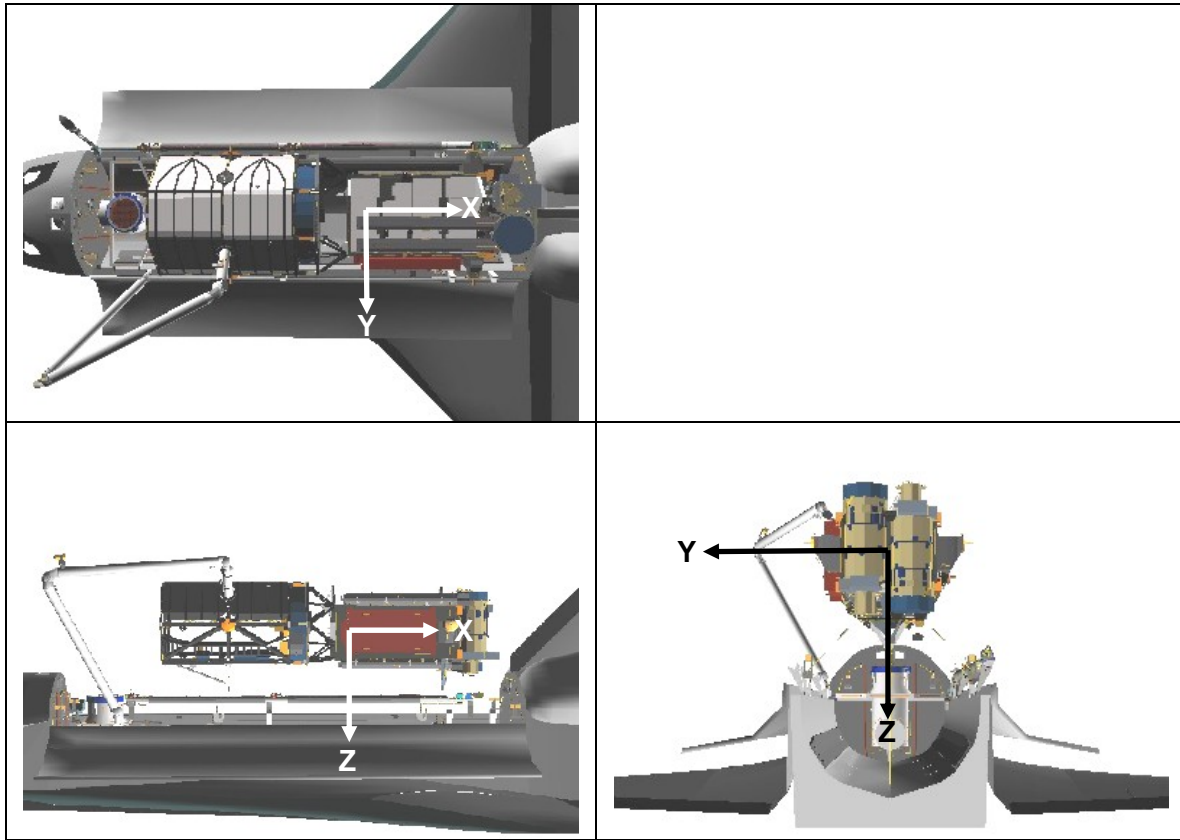

POR: P3/P4 Center of Trunnions at Trunnion Level

PURPOSE: P3/P4 operations

FOR RATES:	COARSE	VERN
TRANS LIM ft/sec	0.10	0.05
ROT LIM deg/sec	0.48	0.16

JOINT RATES:	COARSE	VERN
SHOULDER LIM deg/sec	0.23	0.10
ELBOW LIM deg/sec	0.32	0.11
WRIST LIM deg/sec	0.48	0.16

PL ID 5 – EE SURVEY

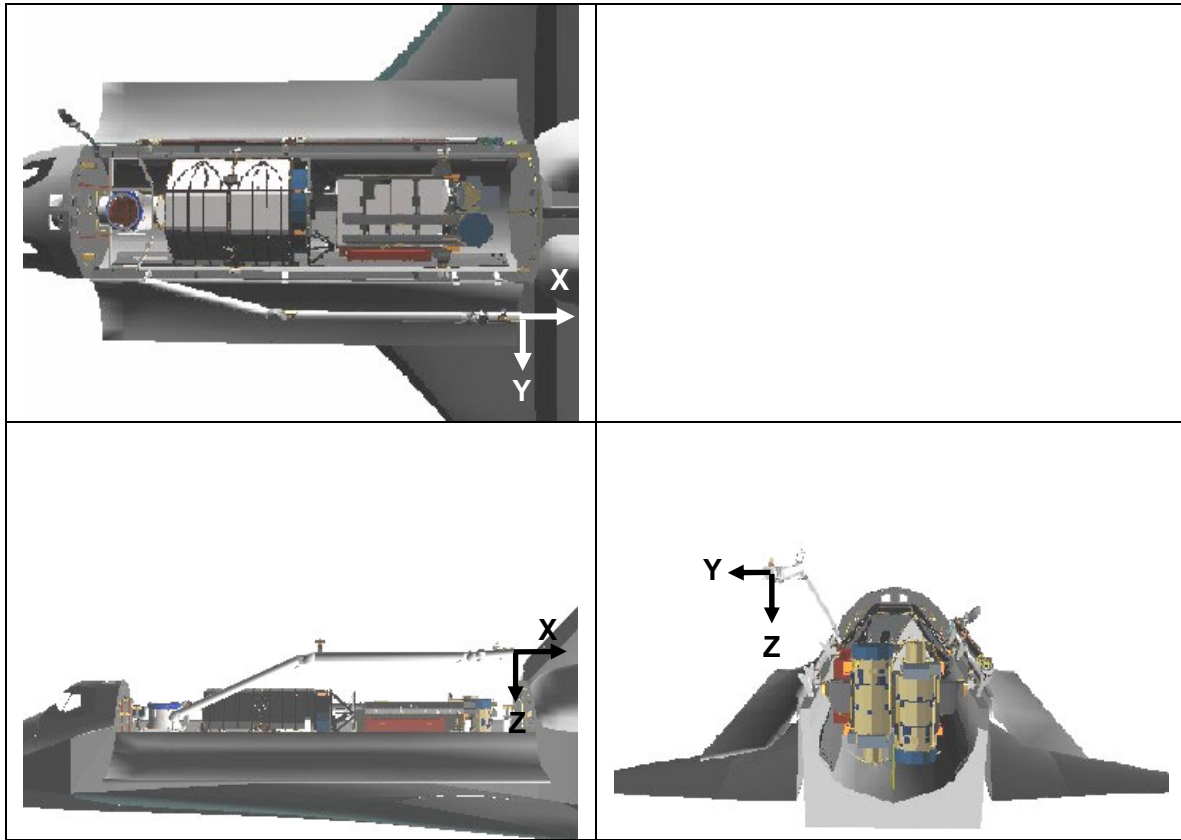

POR: POR at center of EE

PURPOSE: Crew Cabin Surveys using SRMS EE Camera

FOR RATES:	COARSE*	VERN
TRANS LIM ft/sec	0.61	0.44
ROT LIM deg/sec	2.64	0.88

JOINT RATES:	COARSE	VERN
SHOULDER LIM deg/sec	1.27	0.42
ELBOW LIM deg/sec	1.78	0.59
WRIST LIM deg/sec	2.64	0.88

* COARSE rates only apply if LRLF set

PL ID 5A (UPLINK) – OBSS IDC

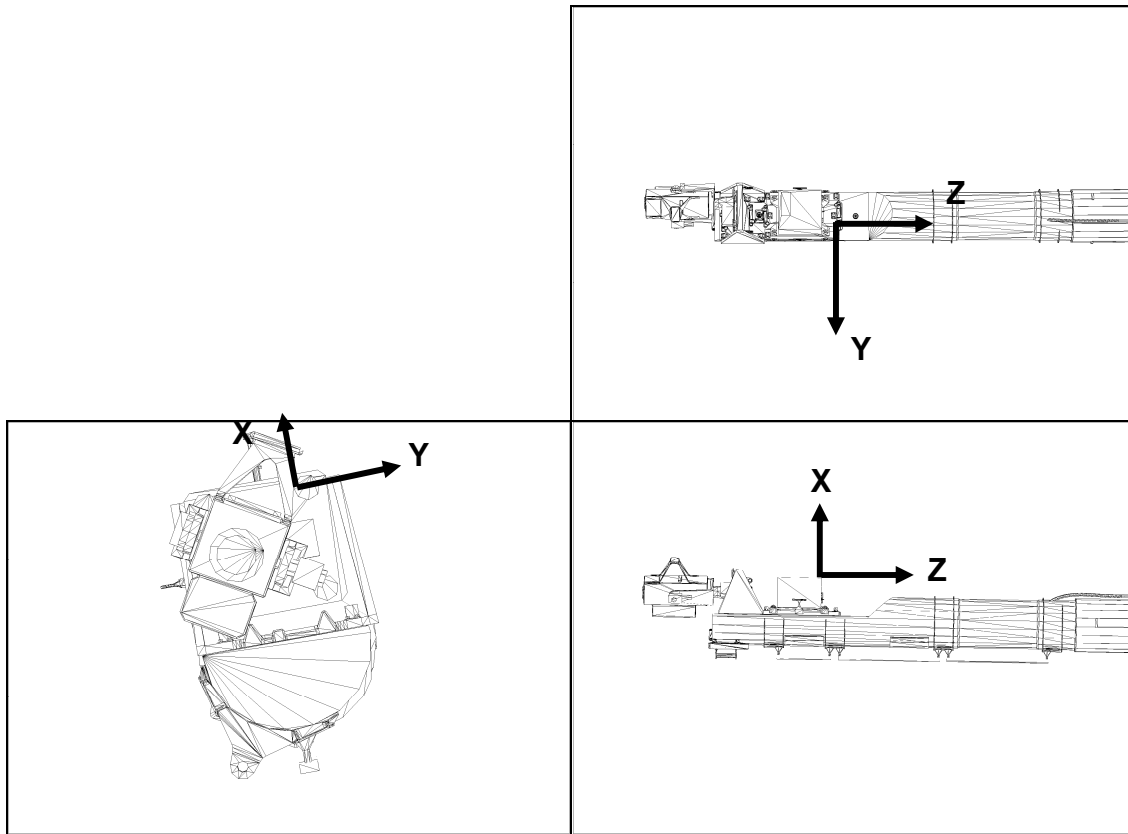

POR: POR at IDC Eyepoint

PURPOSE: OBSS Surveys using IDC

RATES:	COARSE	VERN
TRANS LIM ft/sec	0.23	0.01
ROT LIM deg/sec	2.64	0.88

JOINT RATES:	COARSE	VERN
SHOULDER LIM deg/sec	0.42	0.42
ELBOW LIM deg/sec	0.59	0.59
WRIST LIM deg/sec	0.88	0.88

P3/P4 JOINT ANGLES VS POR COORDINATES

P3/P4 PRE-GRAPPLE posn:

X	Y	Z	PITCH	YAW	ROLL	PL ID
-829	-95	-501	270	311	271	0
SY	SP	EP	WP	WY	WR	
-1.2	+116.0	-141.2	-64.2	-29.3	-68.6	

P3/P4 GRAPPLE posn:

X	Y	Z	PITCH	YAW	ROLL	PL ID
-1002	0	-414	0	0	0	4
SY	SP	EP	WP	WY	WR	
-12.3	+105.3	-147.1	-41.4	-28.6	-56.0	

P3/P4 INTERMEDIATE UNBERTH posn:

X	Y	Z	PITCH	YAW	ROLL	PL ID
-1002	-2	-474	0	0	0	4
SY	SP	EP	WP	WY	WR	
-18.7	+115.1	-139.6	-55.3	-27.6	-48.7	

P3/P4 AFT posn:

X	Y	Z	PITCH	YAW	ROLL	PL ID
-1020	-2	-474	0	0	0	4
SY	SP	EP	WP	WY	WR	
-16.8	+109.9	-136.2	-54.5	-27.9	-50.9	

P3/P4 LOW HOVER posn:

X	Y	Z	PITCH	YAW	ROLL	PL ID
-1020	-2	-580	0	0	0	4
SY	SP	EP	WP	WY	WR	
-27.2	+113.4	-117.3	-71.7	-25.8	-39.5	

P3/P4 AUTO SEQUENCE posn:

Auto Seq ID	Auto Pos #	X/ SY	Y/ SP	Z/ EP	PITCH/ WP	YAW/ WY	ROLL/ WR	PL ID
1	183	-1020	-190	-580	0	0	0	4
		+28.6	+109.8	-101.9	-112.9	-25.5	-102.0	
1	184	-1020	-400	-500	0	0	298	4
		+48.2	+99.1	-96.1	-67.5	+21.1	-123.0	
1	185	-790	-598	-292	303	21	298	4
		+70.3	+65.9	-75.0	-74.1	+68.5	-118.9	

P3/P4 HANDOFF posn:

X	Y	Z	PITCH	YAW	ROLL	PL ID
-790	-598	-292	303	21	298	4
SY	SP	EP	WP	WY	WR	
+70.3	+65.9	-75.0	-74.1	+68.5	-118.9	

SVS/RSC VIEWING posn:

X	Y	Z	PITCH	YAW	ROLL	PL ID
-901	-522	-382	230	358	154	0
SY	SP	EP	WP	WY	WR	
+57.1	+38.2	-42.1	-98.6	+41.3	+128.8	

SVS ELBOW CAM VIEWING posn:

X	Y	Z	PITCH	YAW	ROLL	PL ID
-901	-474	-224	207	15	269	0
SY	SP	EP	WP	WY	WR	
+55.8	+18.2	-46.1	-89.7	+68.5	-105.3	

P3/P4 PRLA CONFIGURATION

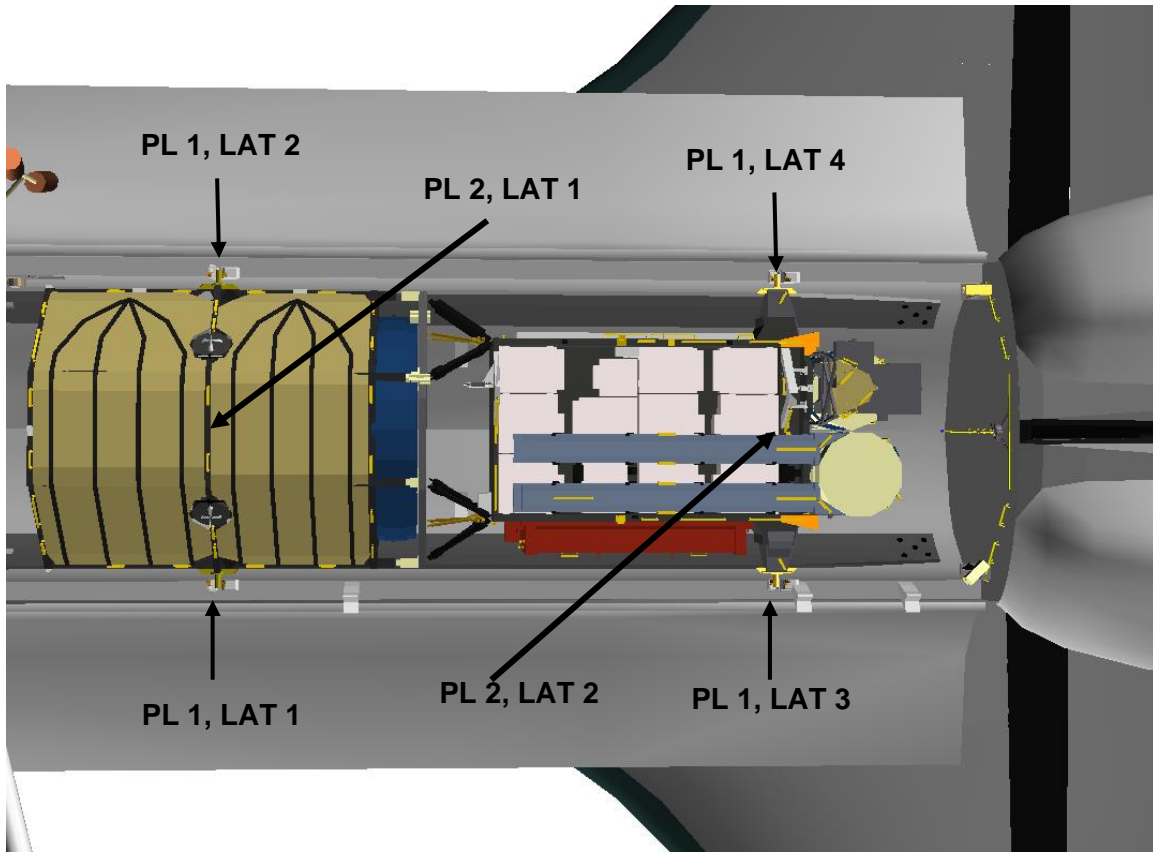



SEQUENCE	PL SEL	RELEASE	LATCH
AKA	2	1,2	1,2
PRLA	1	1,2 (forward)	3,4 (aft)
PRLA	1	3,4 (aft)	1,2 (forward)

P3/P4 INSTALL CAMERA MATRIX

	Task	Shuttle					Station					
		fdf	V10 Mon 1 (V10L)	V10 Mon 2 (CH92)	DNLK Mon 1 (CH 91)	DTV Mon 2 (V10R)	ODF	V10 L (V10 Mon 1)	RWS MON 1	RWS MON 2	RWS MON 3	V10R (DTV Mon 2)
1	P3/P4 Unberth Setup	FS 1-5 step 1	D/A Mux	B/C Mux	P1LO	Elbow	1.101 step 5		22: BELB Cargo Bay	09: P1LO Global	13: LAB Pins	
2	Mnvr to Intermediate Unberth	FS 1-6 step 6	C Stbd aft trunnion	B Port scuff plates	LAB View both pins	Elbow		22: BELB Cargo Bay	09: P1LO Global	13: LAB Pins		
3	Mnvr to Aft Posn	FS 1-7 step 7	C SSU clear	D UHF Ant	P1LO Lab clear	Elbow		22: BELB Cargo Bay	09: P1LO Lab	---		
4	Mnvr to Low Hover	FS 1-8 step 8	C Winch/SSU	D UHF Ant	P1LO Lab clear	Elbow		22: BELB Cargo Bay	09: P1LO Lab	---		
5	Mnvr to ACAS Start	FS 1-9 step 9	C Trunnion/MPM	A Elbow joint	BELB (P1LO) Track EE/Lab	Elbow		22: BELB EE/Lab	09: P1LO EE/Lab	---		
6	Mnvr to Handoff	FS 1-10 step 10	C MPM clear	A Upper boom to Lab	B Track EE	TELB (P1LO) Wing clear switch 1/2		---	09: P1LO Wing	24: TELB Wing		
7	P3P4 Pre-Grapple Mnvr		---	A Global	B Ortho for grapple	P1LO Global	1.201 step 1	92: A Global	09: P1LO (25: Tip LEE) LEE motion	24: TELB		
8	P3P4 Grapple		---	A Global	B Track LEE	P1LO Global	1.201 step 3	92: A Global	25: Tip LEE	91: B Ortho view		
9	P3/P4 Ungrapple Setup	FS 1-13 step 1	---	A Ortho	B (P1LO) Global	EE		---	---	91: B (09: P1LO)	EE	
10	To SVS Viewing	FS 1-14 step 3	C Track SRMS	A P1LO clear	B POA clear	Elbow		92: A	22: BELB	91: B	Elbow	
11	Setup for P3P4 Pre-Install Mnvr		---	A P1LO clear	B POA clear	Elbow	1.202 step 1	92: A	22: BELB	09: P1LO (91: B)	Elbow	
12	P3P4 Intermediate Mnvr		---	A P1LO clear	B POA clear	Elbow Track P3/P4	1.202 step 2.2	92: A	22: BELB	09: P1LO (91: B)	Elbow	
13	P3P4 Pre-Install Mnvr		---	A	B POA clear	Elbow Track P3/P4	1.202 step 2.3	92: A	22: BELB	91: B (09: P1LO)	Elbow	
14	AVU Pwrup & Target Acq		---	A Zoom to rails	SVS/RSC	Elbow		92: A	22: BELB	91: SVS/RSC	Elbow	
15	P3P4 Install Setup		---	A Zoom to rails	SVS/RSC	Elbow	1.202 step 3	92: A	22: BELB	91: SVS/RSC [see note 4]	Elbow	
16	Setup for P3P4 Ungrapple		---	B	---	---	1.203 step 1	92: B	25: Tip LEE	09: P1LO		

Legend:
A, B, C, D: Orbiter Payload Bay Camera A, B, C, D
Elbow: SRMS Elbow
EE: SRMS End Effector
SVS/RSC: RMS Side Video Camera (RSC)
---: No requirement; crew discretion

BELB: SSRMS Base Elbow (DCP: 22, PCS: 43)
TELB: SSRMS Tip Elbow (DCP: 24, PCS: 48)
Tip LEE: SSRMS Tip LEE (DCP: 25, PCS: 51)
P1LO: P1 Lower Outboard (DCP: 09, PCS: 19)
LAB: LAB STBD Zenith (DCP: 13, PCS: 28)

 ROBO Procedure
 PDRS Procedure

P3/P4 INSTALL CAMERA MATRIX (Cont)

Notes:

1. Cameras in parentheses are backup Camera options
2. If specific Cameras are not identified, DCPL 91 and 92 are displayed to the ISS crew for situational awareness
3. Enhance video is returned to the shuttle by routing camera ID 54 (Cupola Monitor 1) or 55 (Cupola Monitor 2) to VTR 2
4. ISS video or SVS/RSC video comes across on PL2 depending upon jumper position
5. Camera numbers on RWS MON 1 (Station), RWS MON 2 (Station), and RWS MON 3 (Station) are Camera numbers for RWS DCP routing

OBSS JOINT ANGLES VS POR COORDINATES

OBSS PRE-GRAPPLE

SY	SP	EP	WP	WY	WR
-90.0	+87.6	-129.5	-57.5	0.0	+110.4

X	Y	Z	PITCH	YAW	ROLL	PL ID
-680	+96	-513	270	350	1	0
-680	+94	-495	0	1	340	1
-998	+95	-505	0	1	10	2

OBSS GRAPPLE/BERTH (Expected Values)

SY	SP	EP	WP	WY	WR
-90.0	+76.5	-134.6	-40.9	0.0	+110.0

X	Y	Z	PITCH	YAW	ROLL	PL ID
-680	+106	-454	270	350	1	0
-680	+105	-436	0	0	341	1
-998	+108	-446	0	0	11	2

OBSS HOVER

SY	SP	EP	WP	WY	WR
-90.0	+79.8	-123.1	-55.7	0.0	+110.0

X	Y	Z	PITCH	YAW	ROLL	PL ID
-680	+127	-514	270	350	1	0
-680	+126	-496	0	0	341	1
-998	+129	-507	0	0	11	2
-1271	+127	-511	0	0	11	3

FLAT FIELD START

SY	SP	EP	WP	WY	WR
-89.6	+44.5	-84.6	-45.4	0.0	+109.6

X	Y	Z	PITCH	YAW	ROLL	PL ID
-683	+300	-508	270	336	1	0
-683	+303	-490	0	0	354	1
-1001	+303	-501	0	0	24	2
-1273	+300	-505	0	0	24	3

OBSS PARK

SY	SP	EP	WP	WY	WR
0.0	+25.0	-25.0	+5.0	0.0	0.0

X	Y	Z	PITCH	YAW	ROLL	PL ID
-1279	-151	-553	95	359	328	0
-1279	-151	-553	95	359	328	1
-1243	-143	-869	95	359	358	2
-1216	-141	-1141	95	359	358	3

OBSS SJ PRE-GRAPPLE

SY	SP	EP	WP	WY	WR
-90.0	+87.9	-129.8	-57.0	0.0	+110.0

X	Y	Z	PITCH	YAW	ROLL	PL ID
-680	+96	-513	270	350	1	0
-680	+94	-495	0	0	341	1
-998	+97	-506	0	0	11	2

STBD LDRI ACAS START

SY	SP	EP	WP	WY	WR
-126.0	+38.1	-54.2	-16.7	+25.9	+166.4

X	Y	Z	PITCH	YAW	ROLL	PL ID
-389	+294	-631	242	281	11	0
-385	+310	-625	322	2	49	1
-639	+291	-434	322	2	79	2
-854	+276	-266	322	2	79	3

NOSE CAP LDRI ACAS START

SY	SP	EP	WP	WY	WR
+156.6	+48.8	-19.1	-47.9	-9.1	+162.6

X	Y	Z	PITCH	YAW	ROLL	PL ID
-244	-396	-666	210	23	295	0
-233	-405	-655	260	303	285	1
-208	-132	-492	260	303	315	2
-187	+98	-348	260	303	315	3

PORT LDRI ACAS START

SY	SP	EP	WP	WY	WR
+138.8	+24.6	-61.2	+36.9	-67.4	-74.2

X	Y	Z	PITCH	YAW	ROLL	PL ID
-340	-433	-265	315	63	314	0
-346	-450	-264	2	341	259	1
-643	-336	-272	2	341	289	2
-899	-243	-284	2	341	289	3

STBD IDC ACAS START

SY	SP	EP	WP	WY	WR
-13.2	+71.3	-76.1	+103.5	-64.8	+280.8

X	Y	Z	PITCH	YAW	ROLL	PL ID
-1016	-71	-734	111	317	274	0
-1074	+168	-532	286	313	86	2
-1123	+334	-374	292	43	266	5

NOSE CAP IDC 1 ACAS START

SY	SP	EP	WP	WY	WR
-125.3	+127.0	-109.0	+31.6	-31.3	+242.7

X	Y	Z	PITCH	YAW	ROLL	PL ID
-564	-117	-808	138	4	350	0
-347	-58	-583	227	349	356	2
-198	-11	-408	318	356	191	5

NOSE CAP IDC 2 ACAS START

SY	SP	EP	WP	WY	WR
+128.3	+137.2	-118.5	+12.7	+13.1	+155.8

X	Y	Z	PITCH	YAW	ROLL	PL ID
-581	-309	-700	156	41	324	0
-359	-170	-519	220	333	313	2
-205	-57	-383	336	319	217	5

NOSE JET CLEAR POSN

SY	SP	EP	WP	WY	WR
+128.8	+30.3	-28.5	-2.0	+35.0	0.0

X	Y	Z	PITCH	YAW	ROLL	PL ID
-303	-547	-434	186	15	140	0
-285	-548	-435	83	39	170	1
-325	-748	-680	83	39	200	2
-355	-916	-892	83	39	200	3
-356	-894	-860	6	345	40	5

PORT IDC ACAS START

SY	SP	EP	WP	WY	WR
+91.2	+60.1	-68.1	-41.3	+6.8	-116.8

X	Y	Z	PITCH	YAW	ROLL	PL ID
-663	-578	-412	262	21	318	0
-882	-378	-296	333	320	332	2
-1043	-224	-223	82	339	223	5

OBSS PRE-GRAPPLE AT HANDOFF (SSRMS on LAB)

SY	SP	EP	WP	WY	WR
+23.5	+63.5	-29.6	-102.9	+11.5	-98.6

X	Y	Z	PITCH	YAW	ROLL	PL ID
-1015	-362	-688	284	0	270	0
-1024	-362	-672	314	270	270	1
-1014	-44	-680	284	270	270	2

*

*

*display singularity

OBSS HANDOFF (SSRMS on LAB) (Expected Values)

SY	SP	EP	WP	WY	WR
+25.8	+66.3	-49.0	-85.9	+10.7	-100.7

X	Y	Z	PITCH	YAW	ROLL	PL ID
-1031	-362	-618	284	0	270	0
-1041	-362	-602	314	270	270	1
-1031	-44	-610	284	270	270	2

*display singularity

OBSS PRE-GRAPPLE AT HANDOFF (SSRMS at WS3)

SY	SP	EP	WP	WY	WR
-33.3	+80.0	-90.0	-77.3	+23.8	-39.8

X	Y	Z	PITCH	YAW	ROLL	PL ID
-966	-1	-625	285	0	271	0
-975	-1	-610	316	270	271	1
-967	+317	-621	15	270	0	2

*display singularity

OBSS HANDOFF (SSRMS at WS3) (Expected Values)

SY	SP	EP	WP	WY	WR
-28.4	+75.5	-98.1	-62.5	+23.6	-45.1

X	Y	Z	PITCH	YAW	ROLL	PL ID
-984	-1	-558	285	360	271	0
-993	-1	-543	45	270	0	1
-986	+318	-554	15	270	0	2

*display singularity

OBSS JETTISON

SY	SP	EP	WP	WY	WR
-22.5	+40.0	-25.0	+5.0	0.0	0.0

X	Y	Z	PITCH	YAW	ROLL	PL ID
-1172	-3	-758	27	347	7	0
-1188	-3	-765	116	7	343	1
-1042	-37	-1046	116	7	13	2

OBSS JETTISON WITH MPM

SY	SP	EP	WP	WY	WR
-29.5	+66.7	-68.5	+26.8	+18.9	-9.9

X	Y	Z	PITCH	YAW	ROLL	PL ID
-1078	0	-754	25	0	1	0
-1094	-5	-761	115	0	330	1
-950	0	-1045	115	0	0	2

OBSS AUTO SEQUENCES

OBSS LDRI RCC SURVEY – STBD (PL ID 3)

Auto Seq ID	Auto posn	X/ SY	Y/ SP	Z/ EP	PITCH/ WP	YAW/ WY	ROLL/ WR	Pause
1	1	-854	+276	-266	322	2	79	P
		-126.0	+38.1	-54.2	-16.7	+25.9	+166.4	
1	2	-941	+276	-261	322	2	73	
		-116.2	+49.3	-73.4	-10.6	+12.9	+161.9	
1	3	-1021	+282	-277	322	359	82	
		-107.6	+61.5	-89.7	+2.7	+10.2	+155.2	
1	4	-1228	+486	-281	326	354	69	
		-81.3	+23.0	-39.2	-19.8	-23.5	+135.5	
1	5	-1255	+502	-281	326	352	67	P
		-77.8	+22.1	-37.2	-23.0	-28.8	+131.8	
1	6	-1255	+502	-220	346	352	67	
		-87.2	+6.0	-61.2	+14.4	-14.8	+118.2	
1	7	-1358	+477	-220	346	347	16	P
		-71.2	+13.6	-64.0	-48.2	-15.1	+81.9	
1	8	-1316	+463	-220	346	347	16	
		-76.3	+18.3	-73.9	-41.6	-15.8	+87.2	
1	9	-1294	+464	-222	346	347	19	
		-79.3	+19.6	-76.6	-36.5	-17.1	+91.1	
1	10	-1061	+218	-201	334	12	22	
		-105.5	+27.8	-69.2	-39.9	-18.0	+147.3	
1	11	-1004	+200	-205	332	20	27	
		-107.1	+10.3	-36.1	-52.7	-13.6	+157.7	
1	12	-930	+220	-225	323	19	54	P
		-110.5	+9.7	-18.2	-49.6	+2.6	+167.7	
1	13	-1012	+246	-228	325	14	55	
		-105.0	+27.9	-52.3	-30.2	-1.0	+158.6	
1	14	-1016	+245	-221	309	13	38	
		-89.4	+26.9	-27.7	-64.2	-32.0	+153.2	
1	15	-1252	+472	-233	337	343	30	
		-78.0	+38.5	-88.8	-32.9	-30.3	+94.0	
1	16	-1281	+497	-240	338	341	38	
		-73.3	+36.6	-87.6	-26.6	-33.8	+90.8	
1	17	-1335	+540	-282	336	335	71	P
		-60.7	+40.2	-87.7	+3.1	-53.8	+104.2	
1	18	-1279	+527	-325	325	351	93	
		-76.3	+12.9	-16.5	-8.8	-19.0	+142.7	
1	19	-1227	+502	-300	329	344	74	
		-78.9	+45.3	-79.4	+6.0	-31.6	+132.0	
1	20	-1031	+303	-290	321	356	76	
		-104.2	+65.3	-89.6	-3.1	+0.8	+154.3	
1	21	-1002	+276	-288	329	8	85	
		-112.7	+35.4	-62.8	-3.4	+24.1	+153.1	
1	22	-915	+271	-282	311	10	81	P
		-106.3	+26.5	-20.3	-40.1	+13.3	+168.8	
1	23	-906	+285	-304	294	359	84	P
		-90.9	+52.8	-37.4	-36.5	-5.1	+176.2	
1	24	-733	+285	-299	289	357	84	
		-107.2	+48.7	-27.1	-40.4	+9.6	+186.5	

OBSS LDRI RCC SURVEY – STBD (PL ID 3) (Cont)

Auto Seq ID	Auto posn	X/ SY	Y/ SP	Z/ EP	PITCH/ WP	YAW/ WY	ROLL/ WR	Pause
1	25	-686	+288	-320	276	354	86	
		-96.8	+51.1	-20.0	-45.0	+2.0	+195.7	
1	26	-562	+299	-343	266	350	87	P
		-100.7	+54.1	-19.5	-43.9	+8.3	+205.7	
1	27	-563	+286	-369	266	343	86	
		-103.2	+75.8	-45.1	-33.0	+10.3	+204.4	
1	28	-678	+286	-373	270	339	86	
		-89.2	+88.1	-59.3	-27.2	-4.8	+200.0	
1	29	-906	+284	-379	294	332	98	
		-84.2	+112.0	-91.7	-10.8	-9.3	+179.9	
1	30	-963	+284	-381	295	322	87	
		-41.1	+124.3	-105.8	+14.5	-63.6	+205.1	
1	31	-1028	+291	-372	302	322	94	
		-36.1	+125.2	-114.6	+28.0	-65.0	+205.9	
1	32	-1051	+299	-359	302	322	92	P
		-32.1	+119.9	-115.1	+41.1	-69.9	+213.7	
1	33	-1047	+290	-358	291	336	83	P
		-50.6	+87.2	-69.6	-16.4	-54.4	+181.0	
1	34	-1235	+453	-381	300	316	97	
		-28.1	+62.8	-68.6	+67.0	-64.2	+231.1	
1	35	-1259	+495	-367	308	333	99	
		-54.4	+51.8	-52.6	+11.2	-44.0	+172.4	
1	36	-1280	+499	-373	305	329	97	
		-46.8	+46.5	-41.7	+12.4	-53.3	+181.9	
1	37	-1325	+515	-370	311	334	101	P
		-52.2	+36.7	-31.6	+5.6	-45.4	+170.0	
1	38	-1347	+480	-395	314	332	103	P
		-47.5	+48.4	-48.5	+15.7	-50.5	+172.2	
1	39	-1303	+474	-393	312	336	98	
		-54.4	+47.5	-42.6	+0.7	-45.1	+165.0	
1	40	-1282	+467	-390	312	337	94	
		-56.7	+50.7	-46.9	-2.9	-45.3	+161.5	
1	41	-1270	+448	-392	311	336	99	
		-55.5	+57.9	-56.3	+4.8	-42.7	+166.4	
1	42	-1077	+264	-408	305	335	94	
		-62.0	+106.0	-88.2	-13.3	-38.6	+170.2	
1	43	-1029	+272	-400	298	347	76	
		-73.5	+70.1	-41.0	-46.1	-34.3	+166.2	
1	44	-1002	+285	-385	305	355	72	
		-89.5	+57.1	-35.0	-48.2	-17.9	+163.0	
1	45	-970	+290	-365	316	4	65	
		-103.8	+30.9	-13.3	-56.7	-3.7	+161.1	
1	46	-875	+288	-365	322	1	69	P
		-120.8	+32.5	-23.7	-45.8	+12.8	+164.7	

OBSS LDRI RCC SURVEY – NOSE CAP (PL ID 3)

Auto Seq ID	Auto posn	X/ SY	Y/ SP	Z/ EP	PITCH/ WP	YAW/ WY	ROLL/ WR	Pause
2	47	-187	+98	-348	260	303	315	P
		+156.6	+48.8	-19.1	-47.9	-9.1	+162.7	
2	48	-160	+58	-371	221	302	274	
		+136.3	+81.8	-80.6	-18.5	-0.5	+149.6	
2	49	-177	+71	-381	227	305	291	P
		+139.9	+91.1	-85.3	-12.6	+2.2	+152.6	
2	50	-185	+27	-425	191	297	287	
		+118.0	+67.6	-87.8	+39.6	+38.0	120.9	
2	51	-181	+27	-403	154	289	281	P
		+122.9	+15.3	-35.5	+72.8	+34.9	+87.0	
2	52	-182	+7	-414	146	296	273	
		+118.8	+14.5	-45.0	+80.9	+31.0	+83.3	
2	53	-177	+31	-385	220	296	348	
		+127.1	+57.0	-64.0	+66.4	+43.6	+106.8	
2	54	-184	-26	-423	148	309	281	
		+110.0	+18.5	-69.3	+103.9	+22.2	+78.6	
2	55	-170	-65	-369	173	327	275	
		+87.0	+52.1	-124.3	+103.1	+34.4	+96.8	
2	56	-148	-12	-332	169	306	250	P
		+110.3	+39.8	-86.1	+46.6	+33.9	+119.3	
2	57	-155	+38	-300	233	297	309	P
		+134.8	+56.5	-59.7	+0.2	+22.2	+150.9	
2	58	-183	+70	-273	184	282	237	
		+128.7	+19.6	-32.9	-20.0	+22.4	147.3	
2	59	-209	+27	-228	238	298	266	P
		+133.5	+56.2	-60.2	-32.4	-10.8	+157.6	
2	60	-236	0	-234	217	287	242	P
		+123.1	+25.5	-25.2	-48.5	+2.0	+159.0	
2	61	-235	-35	-244	238	298	267	
		+126.5	+48.5	-40.8	-42.8	-4.4	+161.9	
2	62	-232	-67	-249	222	312	257	P
		+113.5	+82.9	-88.2	-18.1	+1.4	+157.5	
2	63	-191	-58	-267	234	322	268	P
		+138.2	+97.2	-85.8	-26.2	-27.4	+159.0	
2	64	-168	-13	-270	214	303	256	
		+122.6	+66.1	-78.5	-13.9	+3.9	+151.1	
2	65	-161	-40	-287	231	317	283	
		+135.4	+90.3	-83.6	-13.4	-8.7	+159.2	
2	66	-166	-60	-348	189	326	271	P
		+89.3	+89.9	-134.7	+59.6	+34.4	+119.9	
2	67	-179	-70	-381	185	316	280	P
		+96.4	+71.7	-109.3	+63.5	+38.5	+111.1	
2	68	-182	-84	-305	221	320	274	P
		+118.3	+98.2	-94.2	-9.3	+3.9	+154.1	

OBSS LDRI RCC SURVEY – PORT (PL ID 3)

Auto Seq ID	Auto posn	X/ SY	Y/ SP	Z/ EP	PITCH/ WP	YAW/ WY	ROLL/ WR	Pause
3	69	-899	-243	-284	2	341	289	P
		+138.8	+24.6	-61.2	+36.9	-67.4	-74.2	
3	70	-958	-253	-278	2	341	293	
		+132.6	+32.0	-75.1	+35.2	-60.7	-81.4	
3	71	-1023	-277	-267	0	353	308	
		+137.2	+46.0	-105.8	+30.5	-49.2	-95.4	
3	72	-1057	-310	-267	0	356	307	
		+132.8	+48.4	-112.0	+39.0	-43.5	-88.9	
3	73	-1186	-442	-272	0	359	309	
		+104.6	+53.8	-108.0	+34.1	-14.5	-75.6	
3	74	-1265	-509	-274	0	350	309	
		+90.5	+36.5	-61.6	+5.1	-8.3	-76.5	
3	75	-1324	-523	-274	0	348	315	P
		+83.6	+27.0	-40.2	-12.7	-2.7	-75.7	
3	76	-1345	-496	-232	345	352	262	P
		+77.7	+52.1	-81.0	+53.7	+1.4	-89.2	
3	77	-1268	-456	-230	345	352	262	
		+88.0	+59.4	-96.4	+62.1	-7.9	-84.8	
3	78	-1175	-357	-219	345	345	262	
		+101.6	+58.8	-101.1	+67.7	-27.1	-78.2	
3	79	-1134	-315	-218	345	345	262	
		+109.9	+60.7	-108.7	+75.7	-34.5	-73.9	
3	80	-1097	-277	-214	345	345	262	
		+118.3	+60.1	-113.1	+83.9	-41.8	-68.6	
3	81	-1061	-238	-210	345	345	262	
		+127.4	+57.8	-115.3	+93.5	-49.4	-61.5	
3	82	-998	-216	-214	345	345	259	
		+138.2	+51.6	-106.7	+105.8	-56.4	-45.3	
3	83	-972	-211	-216	345	345	259	
		+141.7	+49.1	-101.8	+107.8	-58.5	-40.2	
3	84	-935	-206	-219	345	345	259	
		+145.8	+44.9	-93.5	+109.7	-60.7	-33.2	
3	85	-906	-204	-220	345	345	259	P
		+148.4	+40.9	-85.9	+110.2	-61.9	-28.4	
3	86	-898	-214	-230	347	348	259	P
		+151.6	+37.4	-83.2	+112.5	-60.5	-24.5	
3	87	-979	-231	-226	347	348	259	
		+142.8	+47.3	-102.3	+109.1	-56.1	-39.1	
3	88	-1034	-262	-231	347	348	259	
		+133.0	+54.0	-109.7	+100.1	-49.7	-51.4	
3	89	-1110	-338	-234	347	348	259	
		+115.4	+57.6	-106.2	+82.6	-35.9	-66.5	
3	90	-1183	-406	-238	353	356	254	
		+105.4	+47.4	-108.3	+97.8	-18.3	-66.4	
3	91	-1244	-467	-242	354	356	254	
		+94.2	+43.7	-95.2	+86.8	-8.9	-72.3	
3	92	-1312	-504	-245	359	0	254	
		+83.9	+33.3	-88.5	+90.8	+4.7	-74.5	
3	93	-1343	-511	-246	359	0	254	P
		+79.6	+32.4	-85.3	+88.9	+8.1	-77.0	

OBSS LDRI RCC SURVEY – PORT (PL ID 3) (Cont)

Auto Seq ID	Auto posn	X/ SY	Y/ SP	Z/ EP	PITCH/ WP	YAW/ WY	ROLL/ WR	Pause
3	94	-1323	-537	-315	346	348	282	P
		+80.9	+49.1	-50.2	+5.9	+0.6	-87.1	
3	95	-1244	-513	-305	353	357	287	
		+93.4	+63.0	-95.3	+34.6	-4.2	-77.4	
3	96	-1176	-450	-298	352	2	290	
		+107.4	+76.4	-122.8	+46.3	-12.9	-76.9	
3	97	-1106	-380	-295	352	4	291	
		+129.7	+77.1	-134.2	+56.0	-33.1	-76.8	
3	98	-1023	-300	-288	354	357	289	
		+143.2	+59.7	-116.9	+57.7	-54.0	-76.3	
3	99	-989	-275	-294	350	350	282	
		+141.9	+62.4	-105.9	+54.8	-59.0	-73.1	
3	100	-965	-263	-294	350	350	282	
		+145.7	+59.5	-102.4	+55.6	-62.7	-71.4	
3	101	-933	-253	-289	358	347	283	
		+143.2	+37.8	-83.6	+59.1	-64.9	-64.1	
3	102	-887	-248	-287	4	341	282	P
		+138.7	+16.1	-50.9	+54.8	-67.1	-54.1	
3	103	-887	-285	-287	4	341	282	
		+135.8	+11.3	-38.1	+44.8	-64.3	-56.4	
3	104	-897	-285	-331	2	336	302	P
		+131.8	+25.2	-40.2	-13.0	-60.8	-101.1	
3	105	-910	-285	-330	2	340	302	
		+134.6	+32.1	-56.2	-2.8	-60.3	-98.7	
3	106	-926	-285	-325	1	340	298	
		+133.5	+35.2	-62.3	+8.1	-60.4	-92.4	
3	107	-950	-287	-335	359	340	292	
		+132.0	+42.7	-71.3	+20.8	-59.9	-84.2	
3	108	-978	-289	-352	357	345	287	
		+135.7	+55.0	-89.7	+37.0	-59.1	-75.7	
3	109	-1020	-286	-332	350	350	297	
		+138.4	+76.6	-109.9	+18.9	-51.8	-94.3	
3	110	-1074	-329	-341	342	1	292	
		+144.5	+110.9	-131.3	+18.5	-47.0	-87.9	
3	111	-1148	-401	-346	340	357	289	
		+111.3	+106.5	-115.8	+9.9	-17.6	-89.7	
3	112	-1229	-475	-357	333	359	289	
		+82.7	+103.5	-95.1	-6.4	+14.9	-96.3	
3	113	-1280	-503	-363	327	1	285	
		+63.2	+97.6	-79.2	-9.6	+35.4	-106.0	
3	114	-1328	-517	-364	327	1	285	P
		+55.8	+89.2	-69.8	-9.5	+42.7	-107.5	
3	115	-1338	-476	-389	345	357	254	P
		+74.7	+86.1	-101.8	+49.9	+5.8	-92.3	
3	116	-1283	-453	-391	343	350	243	
		+85.0	+78.6	-87.6	+51.5	-12.6	-84.7	

OBSS LDRI RCC SURVEY – PORT (PL ID 3) (Cont)

Auto Seq ID	Auto posn	X/ SY	Y/ SP	Z/ EP	PITCH/ WP	YAW/ WY	ROLL/ WR	Pause
3	117	-1166	-340	-392	343	350	243	
		+110.2	+97.3	-115.5	+67.9	-30.3	-65.2	
3	118	-1113	-285	-388	342	337	239	
		+109.8	+80.0	-93.2	+69.6	-41.1	-56.1	
3	119	-1071	-284	-378	352	332	270	
		+112.1	+61.9	-80.6	+39.3	-48.8	-70.4	
3	120	-1050	-279	-387	357	332	272	
		+114.9	+55.2	-78.4	+45.7	-51.5	-63.9	
3	121	-985	-279	-386	1	331	281	P
		+120.7	+42.9	-62.9	+32.8	-58.9	-67.5	

STARBOARD RCC PNLS 7-11 IDC SCANS (IDC PL ID 5)

Auto Seq ID	Auto posn	X / SY	Y / SP	Z / EP	PITCH / WP	YAW / WY	ROLL / WR	Pause
6	130	-1123	+334	-374	292	43	266	P
		-13.2	+71.3	-76.1	+103.5	-64.8	+280.8	
6	131	-1057	+284	-369	295	47	261	
		-15.0	+83.1	-81.5	+96.2	-70.4	+282.4	
6	132	-1023	+276	-377	297	49	258	P
		-19.5	+88.5	-82.8	+79.9	-72.9	+270.7	
6	133	-992	+304	-342	328	58	254	P
		-76.9	+123.4	-126.1	+1.9	-40.0	+162.5	
6	134	-1104	+361	-348	310	52	272	P
		-43.6	+106.8	-127.4	+49.8	-67.4	+187.6	
6	135	-1080	+347	-285	14	46	219	P
		-68.3	+96.6	-119.2	-27.9	-59.1	+119.2	
6	136	-1044	+304	-282	23	55	201	
		-82.9	+80.9	-98.0	-20.6	-37.5	+146.5	
6	137	-1016	+297	-289	15	65	202	P
		-82.9	+77.1	-87.7	-17.4	-30.6	+157.9	
6	138	-1023	+275	-253	58	44	173	
		-100.3	+46.8	-76.5	-27.2	-16.9	+149.9	
6	139	-1029	+235	-222	76	24	169	P
		-111.4	+22.4	-72.4	-30.1	-10.2	+148.7	
6	140	-1119	+323	-229	75	23	178	P
		-101.1	+21.5	-76.3	-28.5	-13.1	+129.4	
6	141	-1128	+311	-224	74	23	178	P
		-100.1	+23.1	-80.3	-26.0	-13.3	+128.7	
6	142	-1033	+222	-212	75	23	166	P
		-108.7	+20.8	-68.9	-33.5	-12.1	+149.1	

NOSE CAP RCC 1 IDC SCANS (IDC PL ID 5)

Auto Seq ID	Auto posn	X / SY	Y / SP	Z / EP	PITCH / WP	YAW / WY	ROLL / WR	Pause
7	143	-198	-11	-408	318	356	191	P
		-125.3	+127.0	-109.0	+31.6	-31.3	+242.7	
7	144	-198	+21	-403	319	7	178	
		-107.0	+100.2	-99.7	+46.6	-37.8	+265.2	
7	145	-202	+56	-380	332	32	141	
		-98.8	+38.7	-61.1	+37.1	-39.9	+280.1	
7	146	-209	+81	-342	354	52	116	
		-92.9	+29.2	-68.7	+25.0	-34.9	+272.4	
7	147	-239	+77	-271	58	46	63	P
		-92.6	+13.8	-54.2	-17.7	-20.1	+253.6	
7	148	-224	+70	-279	58	46	63	P
		-94.5	+16.3	-56.8	-17.0	-19.1	+255.2	
7	149	-191	+73	-344	19	52	94	P
		-97.0	+21.7	-56.0	+2.8	-29.5	+266.8	

NOSE CAP RCC 2 IDC SCANS (IDC PL ID 5)

Auto Seq ID	Auto posn	X / SY	Y / SP	Z / EP	PITCH / WP	YAW / WY	ROLL / WR	Pause
8	150	-205	-57	-383	336	319	217	P
		+128.3	+137.2	-118.5	+12.7	+13.1	+155.8	
8	151	-204	-76	-337	6	314	259	
		+102.4	+89.3	-114.8	+37.5	+31.7	+132.7	
8	152	-213	-65	-293	40	326	272	
		+117.7	+69.3	-79.6	-8.2	+13.7	+152.8	
8	153	-235	-50	-256	62	339	275	P
		+124.7	+36.3	-33.4	-43.8	+0.8	+159.6	
8	154	-234	-22	-253	61	332	272	P
		+129.8	+57.2	-60.6	-31.7	-6.7	+159.3	
8	155	-195	-2	-277	35	349	281	
		+123.3	+11.7	-24.2	-19.3	+28.1	+144.4	
8	156	-183	-4	-299	31	349	281	
		+124.5	+8.6	-16.6	-20.3	+29.9	+141.4	
8	157	-168	+1	-331	5	348	259	P
		+132.6	+24.0	-16.3	-8.3	+34.5	+141.4	
8	158	-163	-12	-382	336	346	261	P
		+126.9	+24.3	-31.2	+44.1	+40.6	+107.7	
8	159	-173	-41	-348	5	337	260	P
		+123.4	+50.3	-58.7	+12.4	+33.3	+137.7	
8	160	-182	-47	-317	19	336	264	
		+123.3	+47.8	-54.6	-2.4	+27.3	+146.0	
8	161	-219	-44	-264	62	339	275	P
		+126.7	+34.6	-29.4	-46.2	-0.7	+158.3	
8	162	-196	-21	-284	33	341	267	P
		+127.4	+36.2	-39.4	-20.3	+19.9	+152.8	
8	163	-175	-25	-302	33	341	267	P
		+129.4	+30.9	-26.3	-27.8	+18.1	+151.9	
8	164	-180	-33	-297	33	341	267	P
		+128.3	+28.6	-22.6	-29.4	+19.1	+152.4	

PORT RCC PNL5 7-11 IDC SCANS (IDC PL ID 5)

Auto Seq ID	Auto posn	X / SY	Y / SP	Z / EP	PITCH / WP	YAW / WY	ROLL / WR	Pause
9	165	-1043	-224	-223	82	339	223	P
		+91.2	+60.1	-68.1	-41.3	+6.8	-116.8	
9	166	-1064	-233	-219	82	339	223	
		+88.4	+57.6	-64.5	-42.7	+8.7	-114.6	
9	167	-1131	-308	-228	78	336	222	P
		+78.7	+36.7	-16.4	-68.7	+18.8	-108.3	
9	168	-1123	-315	-234	76	334	221	P
		+78.6	+41.8	-20.3	-67.9	+20.8	-108.7	
9	169	-1057	-250	-226	76	334	221	
		+86.3	+67.3	-66.2	-45.7	+15.3	-114.6	
9	170	-1032	-239	-227	76	334	221	P
		+90.0	+70.2	-70.7	-43.5	+12.7	-117.2	
9	171	-1008	-268	-262	44	311	213	P
		+43.5	+79.4	-38.7	-76.3	+72.1	-112.3	
9	172	-1028	-284	-258	44	311	213	
		+43.2	+70.6	-26.5	-80.3	+72.4	-111.7	
9	173	-1054	-306	-258	42	312	206	
		+43.3	+77.8	-37.9	-78.7	+73.7	-103.8	
9	174	-1098	-339	-265	41	315	198	P
		+44.1	+81.2	-43.5	-85.4	+74.1	-88.1	
9	175	-1033	-343	-265	41	315	198	
		+55.9	+92.3	-56.6	-64.0	+64.6	-108.8	
9	176	-1030	-343	-361	115	315	198	
		+118.6	+41.7	-88.0	+15.8	-43.1	-84.6	
9	177	-1124	-349	-359	273	312	336	P
		+96.6	+5.7	-57.3	+112.8	-1.2	-38.0	
9	178	-1070	-312	-352	265	305	329	
		+104.5	+6.9	-63.0	+111.7	-11.3	-31.1	
9	179	-1047	-297	-364	264	304	326	P
		+106.5	+6.0	-62.4	+111.4	-13.2	-27.5	
9	180	-1070	-292	-370	259	304	325	P
		+106.0	+16.4	-74.8	+113.7	-15.6	-31.0	
9	181	-1148	-348	-375	273	312	335	
		+92.9	+8.2	-59.7	+112.8	+0.5	-40.2	
9	182	-1124	-349	-359	273	312	336	P
		+96.6	+5.7	-57.3	+112.8	-1.2	-38.0	

SRMS EE CAM SURVEYS JOINT ANGLES VS POR COORDINATES

STBD CREW CABIN SURVEY

SY	SP	EP	WP	WY	WR
-134.9	+17.2	-57.5	-112.6	-59.5	+228.2

X	Y	Z	PITCH	YAW	ROLL	PLID
-351	+180	-411	241	53	123	0
-351	+180	-411	241	53	123	5

PORT CREW CABIN SURVEY

SY	SP	EP	WP	WY	WR
+65.9	+53.3	-94.3	-99.6	-36.5	+216.5

X	Y	Z	PITCH	YAW	ROLL	PLID
-840	-364	-333	324	291	323	0
-840	-364	-333	324	291	323	5

SRMS EE CAM CREW CABIN SURVEY AUTO SEQUENCES

STBD CREW CABIN SURVEY (PL ID 5)

Auto Seq ID	Auto posn	X/ SY	Y/ SP	Z/ EP	PITCH/ WP	YAW/ WY	ROLL/ WR	Pause
4	122	-351	+180	-411	241	53	123	P
		-134.9	+17.2	-57.5	-112.6	-59.5	+228.2	
4	123	-484	+230	-465	255	48	103	P
		-116.2	+28.3	-69.7	-112.7	-33.9	+212.2	
4	124	-351	+180	-411	241	53	123	P
		-134.9	+17.2	-57.5	-112.6	-59.5	+228.2	
4	125	-548	+266	-478	270	38	45	P
		-107.7	+28.3	-66.4	-108.1	-14.9	+164.2	

PORT CREW CABIN SURVEY (PL ID 5)

5	126	-840	-364	-333	324	291	323	P
		+65.9	+53.3	-94.3	-99.6	-36.5	+216.5	
5	127	-517	-304	-275	19	279	23	
		+120.1	+39.4	-95.6	-106.2	+20.4	+194.7	
5	128	-294	-244	-331	242	275	270	P
		+150.4	+30.7	-64.5	-102.0	+54.5	+190.0	
5	129	-518	-252	-385	300	281	348	P
		+129.3	+69.9	-118.8	-97.8	+28.5	+227.4	

This Page Intentionally Blank

CUE CARD CONFIGURATION

P3/P4 SJ GRAPPLE WRIST CCTV OVERLAY.....	FS CC 7-2
UNGRAPPLE WRIST CCTV OVERLAY	FS CC 7-3
OBSS LDRI SCAN PATTERN CUE CARD – STBD & PORT	FS CC 7-4
– NOSE CAP	FS CC 7-5
IDC SCAN PATTERN CUE CARD – STBD & PORT	FS CC 7-6
– NOSE CAP	FS CC 7-7
LDRI SCAN PATTERN CUE CARD – DOCKED STBD	FS CC 7-8
SJ GRAPPLE AT HANDOFF OVERLAY	FS CC 7-10
UNGRAPPLE AT HANDOFF OVERLAY.....	FS CC 7-11

CUE CARD
CONFIGURATION

CUE CARD CONFIGURATION

Fabricate as transparency

ZOOM 34.0 HFOV
FOCUS 5.0 FT
EYEPOINT APPROX 18 IN

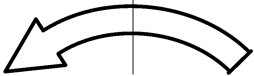

WR+

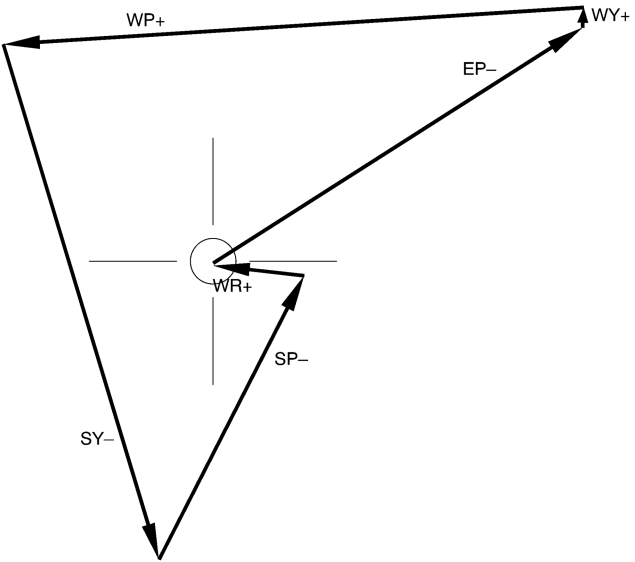

P3/P4 SJ GRAPPLE WRIST CCTV OVERLAY

PDRS-7a/115/O/C

FAB USE ONLY

FS CC 7-2

PDRS/115/FIN C

(reduced copy)

(reduced copy)

Fabricate as transparency

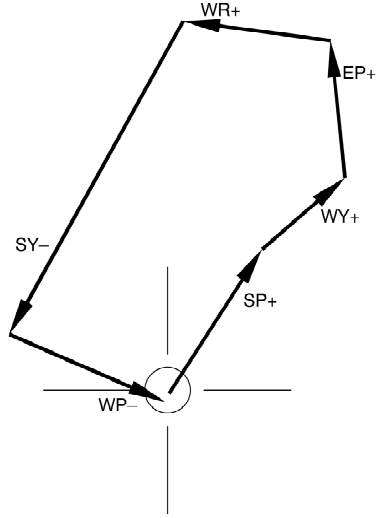

P3/P4 SJ UNGRAPPLE WRIST CCTV OVERLAY

PDRS-8a/115/O/B

TOP

HOOK
VELCRO

OBSS LDRI SCAN PATTERN CUE CARD – STBD & PORT

LDRI

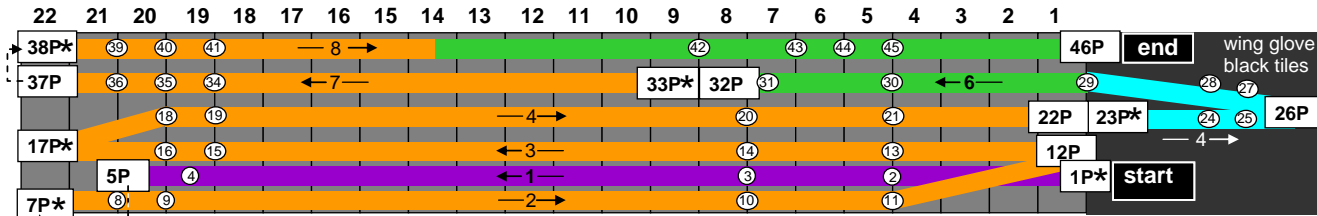
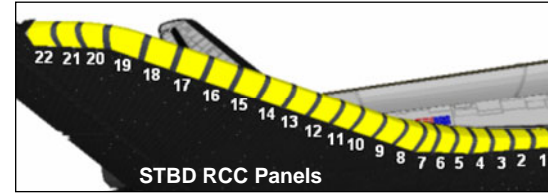
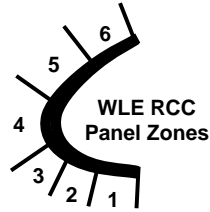

-----> = transitions (not scanning) — 1 → = ACAS section and scan direction
 1P* = ACAS pause pt * = Reconfig PTU
 ② = ACAS fly-by pt

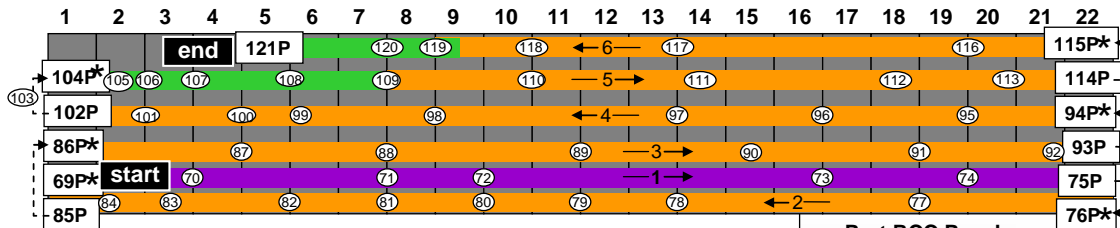

[Cyan] = 3 in damage detection
 [Green] = 1 in damage detection
 [Orange] = 0.25 in damage & crack detection
 [Purple] = Zones 2-3 oblique pass

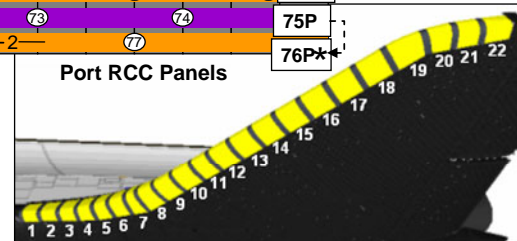

PDRS-10a/115/O/B

(reduced copy)

TOP
Back of 'OBSS LDRI SCAN PATTERN CUE CARD – STBD & PORT'

HOOK
VELCRO

OBSS LDRI SCAN PATTERN CUE CARD – NOSE CAP

LDRI

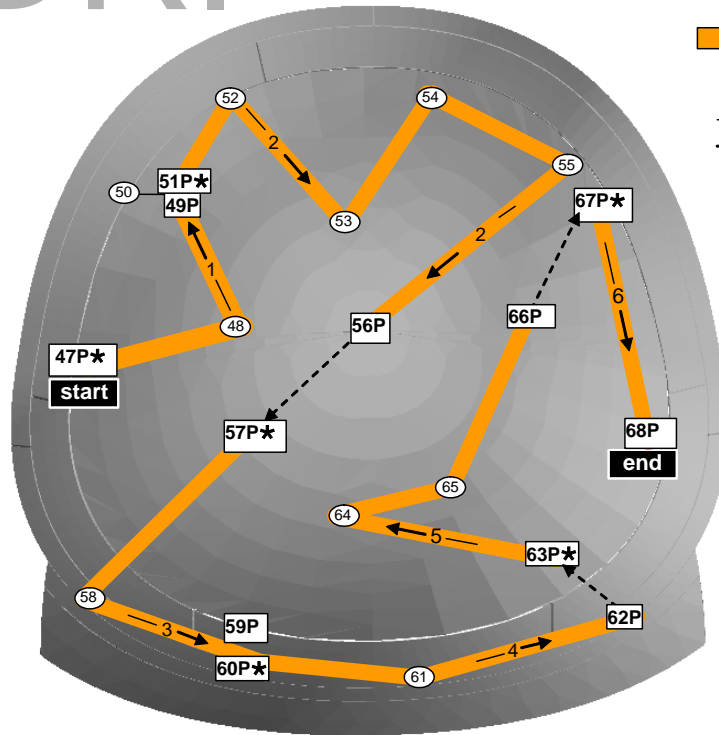

-  = 0.25 in damage criteria
- 1P** = ACAS pause pt
- ② = ACAS fly-by pt
- 1 → = ACAS section & scan direction
- - - - - → = non-scan transitions
- * = Reconfig PTU

(reduced copy)

TOP
Back of 'OBSS IDC SCAN PATTERN CUE CARD - STBD & PORT'

HOOK
VELCRO

OBSS IDC SCAN PATTERN CUE CARD - NOSE CAP

IDC

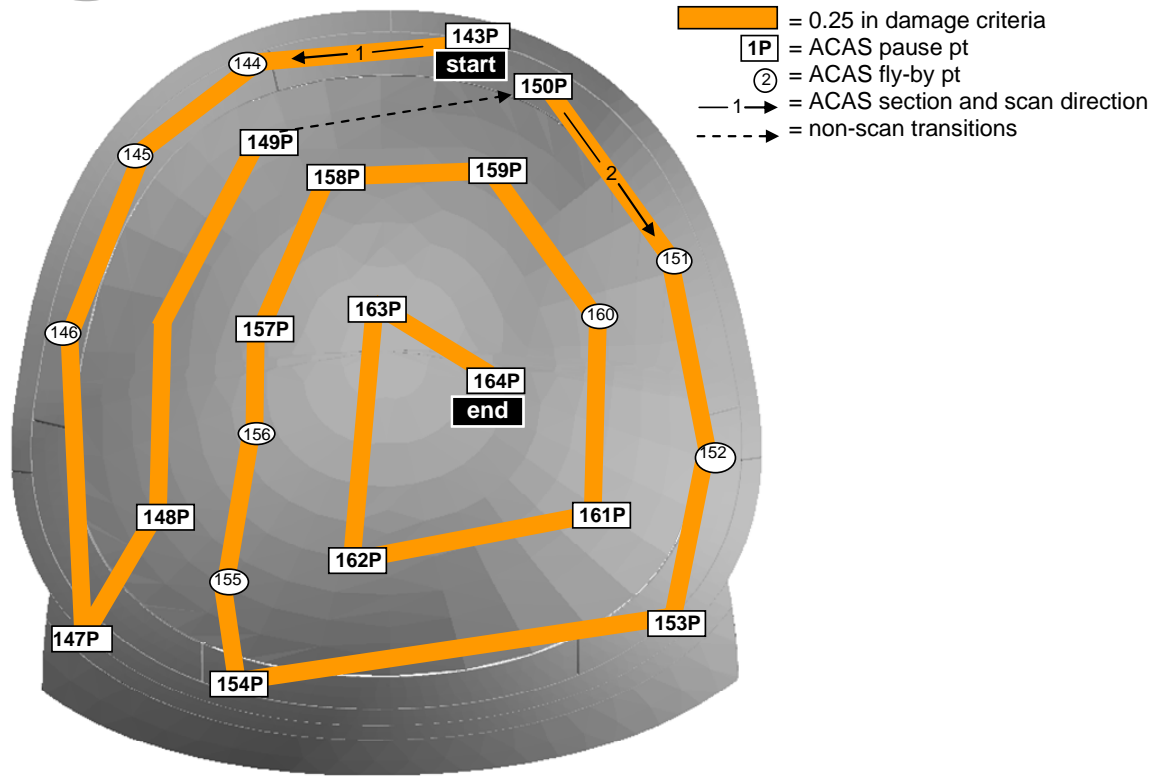

(reduced copy)

TOP

HOOK
VELCRO

OBSS LDRI SCAN PATTERN CUE CARD – DOCKED STBD

LDRI

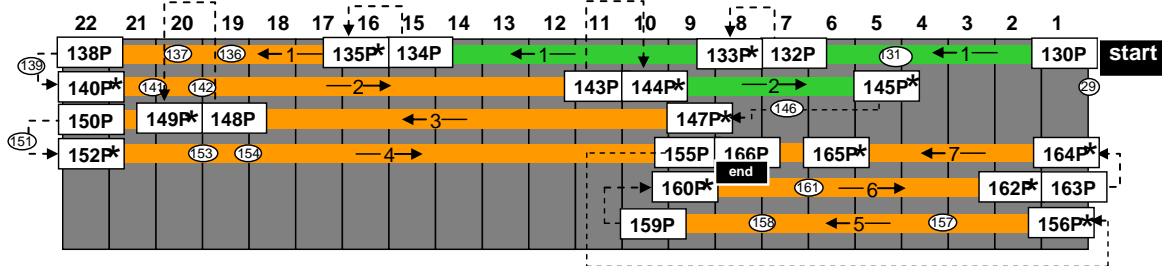
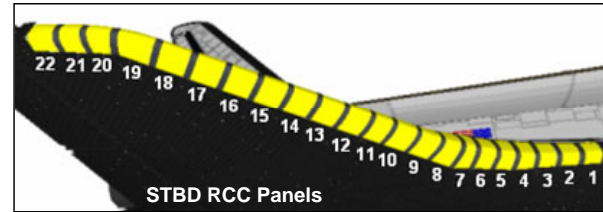
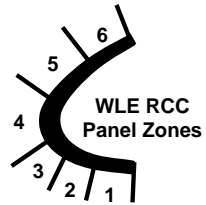

- > = transitions (not scanning)
- 1P = ACAS pause pt
- ② = ACAS fly-by pt
- 1→ = ACAS section and scan direction
- * = Reconfig PTU

- = 1 in damage detection
- = 0.25 in damage & crack

FAB USE ONLY

FS CC 7-9

PDRS/115/FIN C

(reduced copy)



TOP
Back of 'OBSS LDRI SCAN PATTERN CUE CARD – DOCKED STBD'

HOOK
VELCRO



PDRS-15b/115/O/A



Fabricate as transparency

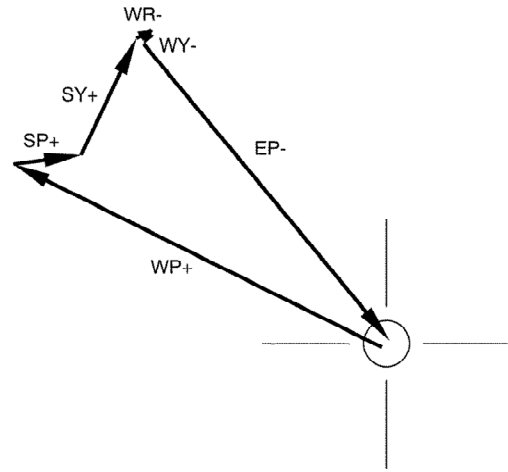

OBSS SJ GRAPPLE AT HANDOFF OVERLAY

PDRS-12a/115/O/A

(reduced copy)

Fabricate as transparency

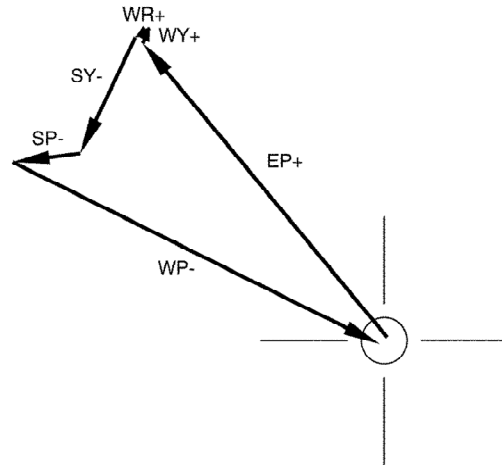

(reduced copy)

OBSS SJ UNGRAPPLE AT HANDOFF OVERLAY

PDRS-13a/115/O/A

This Page Intentionally Blank

Space Shuttle Program
FLIGHT DATA FILE

JSC-48040-115
FINAL, REV C



PDRS OPS C/L

**STS
115**