

# PDRS Operations Checklist

## STS-116 Flight Supplement

---

**Mission Operations Directorate  
EVA, Robotics, & Crew Systems  
Operations Division**

**Final  
November 14, 2006**

National Aeronautics and  
Space Administration

**Lyndon B. Johnson Space Center**  
Houston, Texas

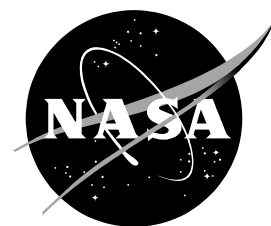



MISSION OPERATIONS DIRECTORATE

**PDRS OPERATIONS CHECKLIST  
STS-116 FLIGHT SUPPLEMENT**

FINAL  
November 14, 2006

PREPARED BY:

  
\_\_\_\_\_  
Amy I. Vande Zande  
Book Manager

APPROVED BY:

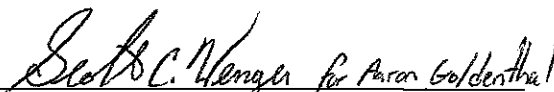
  
\_\_\_\_\_  
Aaron D. Goldenthal  
Lead, Robotics Systems Group

  
\_\_\_\_\_  
Franklin S. Marke  
Chief, Robotics Operations Branch

This document is under the configuration control of the Crew Procedures Control Board (CPCB). All proposed changes must be submitted via FDF Workflow Crew Procedure Change Request (CR) to DO3/FDF Manager.

Additional distribution of this book, for official use only, may be requested in writing to DO3/PMO Administrator. The request must include justification and requester's name, organization, position, and phone number. Contractor requests are made through the NASA or DOD organization supported. Deletions, reduction in quantity, or change of address may be submitted to DO3/FDF Management Office, 281-244-1184.

Incorporates the following:		
482#:	PDRS-967(S)	PDRS-1038
	PDRS-1033	PDRS-1039A
	PDRS-1034	PDRS-1040B
	PDRS-1035A	PDRS-1041A
	PDRS-1036A	PDRS-1042A
	PDRS-1037	PDRS-1043A

S – Superseded

AREAS OF TECHNICAL RESPONSIBILITY

Book Manager	DX22/A. Vande Zande	281-483-7550
RMS Procedures	DX22/A. Vande Zande	281-483-7550
	DX22/J. Hinke	281-483-4926
	DX22/S. Riley	281-483-7019
RMS Training	DX25/L. Toole	281-244-8199
	DX25/R. Deemer	281-483-0398
RMS Analysis	DX24/A. Covarrubia	281-483-8748
PRLA Procedures	DF51/K. McCluney	281-483-0867

PDRS OPERATIONS CHECKLIST  
 STS-116 FLIGHT SUPPLEMENT

**LIST OF EFFECTIVE PAGES**

	FINAL	11/14/06	
Sign Off.....	* 116/FIN	FS 2-23.....	116/FIN
FS ii.....	* 116/FIN	FS 2-24.....	116/FIN
FS iii.....	* 116/FIN	FS 2-25.....	116/FIN
FS iv.....	* 116/FIN	FS 2-26.....	116/FIN
FS v.....	* 116/FIN	FS 2-27.....	116/FIN
FS vi.....	* 116/FIN	FS 2-28.....	116/FIN
FS vii.....	* 116/FIN	FS 2-29.....	116/FIN
FS viii.....	* 116/FIN	FS 2-30.....	116/FIN
FS ix.....	116/FIN	FS 3-1.....	116/FIN
FS x.....	116/FIN	FS 3-2.....	116/FIN
FS 1-1.....	116/FIN	FS 3-3.....	116/FIN
FS 1-2.....	116/FIN	FS 3-4.....	116/FIN
FS 1-3.....	116/FIN	FS 3-5.....	116/FIN
FS 1-4.....	116/FIN	FS 3-6.....	116/FIN
FS 1-5.....	116/FIN	FS 3-7.....	116/FIN
FS 1-6.....	116/FIN	FS 3-8.....	116/FIN
FS 1-7.....	116/FIN	FS 4-1.....	116/FIN
FS 1-8.....	116/FIN	FS 4-2.....	116/FIN
FS 1-9.....	116/FIN	FS 4-3.....	116/FIN
FS 1-10.....	116/FIN	FS 4-4.....	116/FIN
FS 1-11.....	116/FIN	FS 4-5.....	116/FIN
FS 1-12.....	116/FIN	FS 4-6.....	116/FIN
FS 1-13.....	116/FIN	FS 5-1.....	116/FIN
FS 1-14.....	116/FIN	FS 5-2.....	116/FIN
FS 2-1.....	116/FIN	FS 5-3.....	116/FIN
FS 2-2.....	116/FIN	FS 5-4.....	116/FIN
FS 2-3.....	116/FIN	FS 5-5.....	116/FIN
FS 2-4.....	116/FIN	FS 5-6.....	116/FIN
FS 2-5.....	116/FIN	FS 5-7.....	116/FIN
FS 2-6.....	116/FIN	FS 5-8.....	116/FIN
FS 2-7.....	116/FIN	FS 5-9.....	116/FIN
FS 2-8.....	116/FIN	FS 5-10.....	116/FIN
FS 2-9.....	116/FIN	FS 5-11.....	116/FIN
FS 2-10.....	116/FIN	FS 5-12.....	116/FIN
FS 2-11.....	116/FIN	FS 5-13.....	116/FIN
FS 2-12.....	116/FIN	FS 5-14.....	116/FIN
FS 2-13.....	116/FIN	FS 5-15.....	116/FIN
FS 2-14.....	116/FIN	FS 5-16.....	116/FIN
FS 2-15.....	116/FIN	FS 5-17.....	116/FIN
FS 2-16.....	116/FIN	FS 5-18.....	116/FIN
FS 2-17.....	116/FIN	FS 5-19.....	116/FIN
FS 2-18.....	116/FIN	FS 5-20.....	116/FIN
FS 2-19.....	116/FIN	FS 5-21.....	116/FIN
FS 2-20.....	116/FIN	FS 5-22.....	116/FIN
FS 2-21.....	116/FIN	FS 6-1.....	116/FIN
FS 2-22.....	116/FIN	FS 6-2.....	116/FIN

\* – Omit from flight book

FS 6-3 .....	116/FIN	FS 8-36.....	116/FIN
FS 6-4 .....	116/FIN	FS 8-37.....	116/FIN
FS 6-5 .....	116/FIN	FS 8-38.....	116/FIN
FS 6-6 .....	116/FIN	FS 8-39.....	116/FIN
FS 6-7 .....	116/FIN	FS 8-40.....	116/FIN
FS 6-8 .....	116/FIN	FS 8-41.....	116/FIN
FS 6-9 .....	116/FIN	FS 8-42.....	116/FIN
FS 6-10 .....	116/FIN	FS 8-43.....	116/FIN
FS 6-11 .....	116/FIN	FS 8-44.....	116/FIN
FS 6-12 .....	116/FIN	FS 8-45.....	116/FIN
FS 6-13 .....	116/FIN	FS 8-46.....	116/FIN
FS 6-14 .....	116/FIN	FS 8-47.....	116/FIN
FS 6-15 .....	116/FIN	FS 8-48.....	116/FIN
FS 6-16 .....	116/FIN	FS 8-49.....	116/FIN
FS 7-1 .....	116/FIN	FS 8-50.....	116/FIN
FS 7-2 .....	116/FIN	FS 8-51.....	116/FIN
FS 7-3 .....	116/FIN	FS 8-52.....	116/FIN
FS 7-4 .....	116/FIN	FS 8-53.....	116/FIN
FS 7-5 .....	116/FIN	FS 8-54.....	116/FIN
FS 7-6 .....	116/FIN	FS 8-55.....	116/FIN
FS 8-1 .....	116/FIN	FS 8-56.....	116/FIN
FS 8-2 .....	116/FIN	FS 8-57.....	116/FIN
FS 8-3 .....	116/FIN	FS 8-58.....	116/FIN
FS 8-4 .....	116/FIN	FS 8-59.....	116/FIN
FS 8-5 .....	116/FIN	FS 8-60.....	116/FIN
FS 8-6 .....	116/FIN	FS 8-61.....	116/FIN
FS 8-7 .....	116/FIN	FS 8-62.....	116/FIN
FS 8-8 .....	116/FIN	FS 8-63.....	116/FIN
FS 8-9 .....	116/FIN	FS 8-64.....	116/FIN
FS 8-10 .....	116/FIN	FS 8-65.....	116/FIN
FS 8-11 .....	116/FIN	FS 8-66.....	116/FIN
FS 8-12 .....	116/FIN	FS 8-67.....	116/FIN
FS 8-13 .....	116/FIN	FS 8-68.....	116/FIN
FS 8-14 .....	116/FIN	FS 8-69.....	116/FIN
FS 8-15 .....	116/FIN	FS 8-70.....	116/FIN
FS 8-16 .....	116/FIN	FS 8-71.....	116/FIN
FS 8-17 .....	116/FIN	FS 8-72.....	116/FIN
FS 8-18 .....	116/FIN	FS 8-73.....	116/FIN
FS 8-19 .....	116/FIN	FS 8-74.....	116/FIN
FS 8-20 .....	116/FIN	FS 8-75.....	116/FIN
FS 8-21 .....	116/FIN	FS 8-76.....	116/FIN
FS 8-22 .....	116/FIN	FS 8-77.....	116/FIN
FS 8-23 .....	116/FIN	FS 8-78.....	116/FIN
FS 8-24 .....	116/FIN	FS 8-79.....	116/FIN
FS 8-25 .....	116/FIN	FS 8-80.....	116/FIN
FS 8-26 .....	116/FIN	FS 8-81.....	116/FIN
FS 8-27 .....	116/FIN	FS 8-82.....	116/FIN
FS 8-28 .....	116/FIN	FS 8-83.....	116/FIN
FS 8-29 .....	116/FIN	FS 8-84.....	116/FIN
FS 8-30 .....	116/FIN	FS 8-85.....	116/FIN
FS 8-31 .....	116/FIN	FS 8-86.....	116/FIN
FS 8-32 .....	116/FIN	FS 9-1.....	116/FIN
FS 8-33 .....	116/FIN	FS 9-2.....	116/FIN
FS 8-34 .....	116/FIN	FS 9-3.....	116/FIN
FS 8-35 .....	116/FIN	FS 9-4.....	116/FIN

FS 9-5 .....	116/FIN	FS 9-60.....	116/FIN
FS 9-6 .....	116/FIN	FS 9-61.....	116/FIN
FS 9-7 .....	116/FIN	FS 9-62.....	116/FIN
FS 9-8 .....	116/FIN	FS 9-63.....	116/FIN
FS 9-9 .....	116/FIN	FS 9-64.....	116/FIN
FS 9-10 .....	116/FIN	FS 9-65.....	116/FIN
FS 9-11 .....	116/FIN	FS 9-66.....	116/FIN
FS 9-12 .....	116/FIN	FS 9-67.....	116/FIN
FS 9-13 .....	116/FIN	FS 9-68.....	116/FIN
FS 9-14 .....	116/FIN	FS 9-69.....	116/FIN
FS 9-15 .....	116/FIN	FS 9-70.....	116/FIN
FS 9-16 .....	116/FIN	FS 9-71.....	116/FIN
FS 9-17 .....	116/FIN	FS 9-72.....	116/FIN
FS 9-18 .....	116/FIN	FS 9-73.....	116/FIN
FS 9-19 .....	116/FIN	FS 9-74.....	116/FIN
FS 9-20 .....	116/FIN	FS 9-75.....	116/FIN
FS 9-21 .....	116/FIN	FS 9-76.....	116/FIN
FS 9-22 .....	116/FIN	FS 9-77.....	116/FIN
FS 9-23 .....	116/FIN	FS 9-78.....	116/FIN
FS 9-24 .....	116/FIN	FS 9-79.....	116/FIN
FS 9-25 .....	116/FIN	FS 9-80.....	116/FIN
FS 9-26 .....	116/FIN	FS 9-81.....	116/FIN
FS 9-27 .....	116/FIN	FS 9-82.....	116/FIN
FS 9-28 .....	116/FIN	FS 9-83.....	116/FIN
FS 9-29 .....	116/FIN	FS 9-84.....	116/FIN
FS 9-30 .....	116/FIN	FS 9-85.....	116/FIN
FS 9-31 .....	116/FIN	FS 9-86.....	116/FIN
FS 9-32 .....	116/FIN	FS 9-87.....	116/FIN
FS 9-33 .....	116/FIN	FS 9-88.....	116/FIN
FS 9-34 .....	116/FIN	FS 9-89.....	116/FIN
FS 9-35 .....	116/FIN	FS 9-90.....	116/FIN
FS 9-36 .....	116/FIN	FS 9-91.....	116/FIN
FS 9-37 .....	116/FIN	FS 9-92.....	116/FIN
FS 9-38 .....	116/FIN	FS 9-93.....	116/FIN
FS 9-39 .....	116/FIN	FS 9-94.....	116/FIN
FS 9-40 .....	116/FIN	FS 9-95.....	116/FIN
FS 9-41 .....	116/FIN	FS 9-96.....	116/FIN
FS 9-42 .....	116/FIN	FS 9-97.....	116/FIN
FS 9-43 .....	116/FIN	FS 9-98.....	116/FIN
FS 9-44 .....	116/FIN	FS 9-99.....	116/FIN
FS 9-45 .....	116/FIN	FS 9-100.....	116/FIN
FS 9-46 .....	116/FIN	FS 9-101.....	116/FIN
FS 9-47 .....	116/FIN	FS 9-102.....	116/FIN
FS 9-48 .....	116/FIN	FS 9-103.....	116/FIN
FS 9-49 .....	116/FIN	FS 9-104.....	116/FIN
FS 9-50 .....	116/FIN	FS 9-105.....	116/FIN
FS 9-51 .....	116/FIN	FS 9-106.....	116/FIN
FS 9-52 .....	116/FIN	FS 9-107.....	116/FIN
FS 9-53 .....	116/FIN	FS 9-108.....	116/FIN
FS 9-54 .....	116/FIN	FS 9-109.....	116/FIN
FS 9-55 .....	116/FIN	FS 9-110.....	116/FIN
FS 9-56 .....	116/FIN	FS 9-111.....	116/FIN
FS 9-57 .....	116/FIN	FS 9-112.....	116/FIN
FS 9-58 .....	116/FIN	FS 9-113.....	116/FIN
FS 9-59 .....	116/FIN	FS 9-114.....	116/FIN

FS 9-115 .....	116/FIN	FS 9-170.....	116/FIN
FS 9-116 .....	116/FIN	FS 9-171.....	116/FIN
FS 9-117 .....	116/FIN	FS 9-172.....	116/FIN
FS 9-118 .....	116/FIN	FS 9-173.....	116/FIN
FS 9-119 .....	116/FIN	FS 9-174.....	116/FIN
FS 9-120 .....	116/FIN	FS 9-175.....	116/FIN
FS 9-121 .....	116/FIN	FS 9-176.....	116/FIN
FS 9-122 .....	116/FIN	FS 9-177.....	116/FIN
FS 9-123 .....	116/FIN	FS 9-178.....	116/FIN
FS 9-124 .....	116/FIN	FS 9-179.....	116/FIN
FS 9-125 .....	116/FIN	FS 9-180.....	116/FIN
FS 9-126 .....	116/FIN	FS 9-181.....	116/FIN
FS 9-127 .....	116/FIN	FS 9-182.....	116/FIN
FS 9-128 .....	116/FIN	FS 9-183.....	116/FIN
FS 9-129 .....	116/FIN	FS 9-184.....	116/FIN
FS 9-130 .....	116/FIN	FS 9-185.....	116/FIN
FS 9-131 .....	116/FIN	FS 9-186.....	116/FIN
FS 9-132 .....	116/FIN	FS 9-187.....	116/FIN
FS 9-133 .....	116/FIN	FS 9-188.....	116/FIN
FS 9-134 .....	116/FIN	FS 9-189.....	116/FIN
FS 9-135 .....	116/FIN	FS 9-190.....	116/FIN
FS 9-136 .....	116/FIN	FS 10-1.....	116/FIN
FS 9-137 .....	116/FIN	FS 10-2.....	116/FIN
FS 9-138 .....	116/FIN	FS 10-3.....	116/FIN
FS 9-139 .....	116/FIN	FS 10-4.....	116/FIN
FS 9-140 .....	116/FIN	FS 10-5.....	116/FIN
FS 9-141 .....	116/FIN	FS 10-6.....	116/FIN
FS 9-142 .....	116/FIN	FS 10-7.....	116/FIN
FS 9-143 .....	116/FIN	FS 10-8.....	116/FIN
FS 9-144 .....	116/FIN	FS 10-9.....	116/FIN
FS 9-145 .....	116/FIN	FS 10-10.....	116/FIN
FS 9-146 .....	116/FIN	FS 10-11.....	116/FIN
FS 9-147 .....	116/FIN	FS 10-12.....	116/FIN
FS 9-148 .....	116/FIN	FS 10-13.....	116/FIN
FS 9-149 .....	116/FIN	FS 10-14.....	116/FIN
FS 9-150 .....	116/FIN	FS 10-15.....	116/FIN
FS 9-151 .....	116/FIN	FS 10-16.....	116/FIN
FS 9-152 .....	116/FIN	FS 10-17.....	116/FIN
FS 9-153 .....	116/FIN	FS 10-18.....	116/FIN
FS 9-154 .....	116/FIN	FS 10-19.....	116/FIN
FS 9-155 .....	116/FIN	FS 10-20.....	116/FIN
FS 9-156 .....	116/FIN	FS 10-21.....	116/FIN
FS 9-157 .....	116/FIN	FS 10-22.....	116/FIN
FS 9-158 .....	116/FIN	FS 10-23.....	116/FIN
FS 9-159 .....	116/FIN	FS 10-24.....	116/FIN
FS 9-160 .....	116/FIN	FS 10-25.....	116/FIN
FS 9-161 .....	116/FIN	FS 10-26.....	116/FIN
FS 9-162 .....	116/FIN	FS 10-27.....	116/FIN
FS 9-163 .....	116/FIN	FS 10-28.....	116/FIN
FS 9-164 .....	116/FIN	FS 10-29.....	116/FIN
FS 9-165 .....	116/FIN	FS 10-30.....	116/FIN
FS 9-166 .....	116/FIN	FS 10-31.....	116/FIN
FS 9-167 .....	116/FIN	FS 10-32.....	116/FIN
FS 9-168 .....	116/FIN	FS 10-33.....	116/FIN
FS 9-169 .....	116/FIN	FS 10-34.....	116/FIN



FS 10-35 .....	116/FIN	FS 10-90.....	116/FIN
FS 10-36 .....	116/FIN	FS 10-91.....	116/FIN
FS 10-37 .....	116/FIN	FS 10-92.....	116/FIN
FS 10-38 .....	116/FIN	FS 10-93.....	116/FIN
FS 10-39 .....	116/FIN	FS 10-94.....	116/FIN
FS 10-40 .....	116/FIN	FS 10-95.....	116/FIN
FS 10-41 .....	116/FIN	FS 10-96.....	116/FIN
FS 10-42 .....	116/FIN	FS 10-97.....	116/FIN
FS 10-43 .....	116/FIN	FS 10-98.....	116/FIN
FS 10-44 .....	116/FIN	FS 10-99.....	116/FIN
FS 10-45 .....	116/FIN	FS 10-100.....	116/FIN
FS 10-46 .....	116/FIN	FS 10-101.....	116/FIN
FS 10-47 .....	116/FIN	FS 10-102.....	116/FIN
FS 10-48 .....	116/FIN	FS 10-103.....	116/FIN
FS 10-49 .....	116/FIN	FS 10-104.....	116/FIN
FS 10-50 .....	116/FIN	FS 11-1.....	116/FIN
FS 10-51 .....	116/FIN	FS 11-2.....	116/FIN
FS 10-52 .....	116/FIN	FS 11-3.....	116/FIN
FS 10-53 .....	116/FIN	FS 11-4.....	116/FIN
FS 10-54 .....	116/FIN	FS 11-5.....	116/FIN
FS 10-55 .....	116/FIN	FS 11-6.....	116/FIN
FS 10-56 .....	116/FIN	FS 11-7.....	116/FIN
FS 10-57 .....	116/FIN	FS 11-8.....	116/FIN
FS 10-58 .....	116/FIN	FS 11-9.....	116/FIN
FS 10-59 .....	116/FIN	FS 11-10.....	116/FIN
FS 10-60 .....	116/FIN	FS 11-11.....	116/FIN
FS 10-61 .....	116/FIN	FS 11-12.....	116/FIN
FS 10-62 .....	116/FIN	FS 11-13.....	116/FIN
FS 10-63 .....	116/FIN	FS 11-14.....	116/FIN
FS 10-64 .....	116/FIN	FS 11-15.....	116/FIN
FS 10-65 .....	116/FIN	FS 11-16.....	116/FIN
FS 10-66 .....	116/FIN	FS 11-17.....	116/FIN
FS 10-67 .....	116/FIN	FS 11-18.....	116/FIN
FS 10-68 .....	116/FIN	FS 11-19.....	116/FIN
FS 10-69 .....	116/FIN	FS 11-20.....	116/FIN
FS 10-70 .....	116/FIN	FS 11-21.....	116/FIN
FS 10-71 .....	116/FIN	FS 11-22.....	116/FIN
FS 10-72 .....	116/FIN	FS 11-23.....	116/FIN
FS 10-73 .....	116/FIN	FS 11-24.....	116/FIN
FS 10-74 .....	116/FIN	FS 12-1.....*	116/FIN
FS 10-75 .....	116/FIN	FS 12-2.....*	116/FIN
FS 10-76 .....	116/FIN	FS CC 12-3.....*	116/FIN
FS 10-77 .....	116/FIN	FS CC 12-4.....*	116/FIN
FS 10-78 .....	116/FIN	FS CC 12-5.....*	116/FIN
FS 10-79 .....	116/FIN	FS CC 12-6.....*	116/FIN
FS 10-80 .....	116/FIN	FS CC 12-7.....	116/FIN
FS 10-81 .....	116/FIN	FS CC 12-8.....	116/FIN
FS 10-82 .....	116/FIN	FS CC 12-9.....	116/FIN
FS 10-83 .....	116/FIN	FS CC 12-10.....	116/FIN
FS 10-84 .....	116/FIN	FS CC 12-11.....	116/FIN
FS 10-85 .....	116/FIN	FS CC 12-12.....	116/FIN
FS 10-86 .....	116/FIN		
FS 10-87 .....	116/FIN		
FS 10-88 .....	116/FIN		
FS 10-89 .....	116/FIN		

\* – Omit from flight book

PDRS CUE CARDS

<u>Title</u>	<u>Ref. Page</u>	<u>Card No.</u>
P5 SJ GRAPPLE WRIST CCTV OVERLAY .....	FS CC 12-3	PDRS-7a/116/O/A
P5 SJ UNGRAPPLE WRIST CCTV OVERLAY .....	FS CC 12-4	PDRS-8a/116/O/A
OBSS SJ GRAPPLE AT HANDOFF OVERLAY .....	FS CC 12-5	PDRS-9a/116/O/A
OBSS SJ UNGRAPPLE AT HANDOFF OVERLAY....	FS CC 12-6	PDRS-10a/116/O/A
OBSS LDRI SCAN PATTERN CUE CARD – STBD & PORT (Front) .....	FS CC 12-7	PDRS-11a/116/O/A
OBSS LDRI SCAN PATTERN CUE CARD – NOSE CAP (Back) .....	FS CC 12-8	PDRS-11b/116/O/B
OBSS IDC SCAN PATTERN CUE CARD – STBD & PORT (Front) .....	FS CC 12-9	PDRS-12a/116/O/B
OBSS IDC SCAN PATTERN CUE CARD – NOSE CAP (Back) .....	FS CC 12-10	PDRS-12b/116/O/A
OBSS LDRI SCAN PATTERN CUE CARD – STBD DOCKED (Front) .....	FS CC 12-11	PDRS-13a/116/O/B
(Back).....	FS CC 12-12	PDRS-13b/116/O/B

<u>CONTENTS</u>	<u>PAGE</u>
<u>NOMINAL P5 OPS</u> .....	FS 1-1
P5 GRAPPLE.....	FS 1-2
UNBERTH.....	FS 1-5
HANDOFF.....	FS 1-8
UNGRAPPLE.....	FS 1-11
 <u>OFF-NOMINAL P5 OPS</u> .....	 FS 2-1
P5 SJ GRAPPLE.....	FS 2-2
UNBERTH.....	FS 2-10
HANDOFF.....	FS 2-12
UNGRAPPLE.....	FS 2-18
CONTINGENCY REBERTH.....	FS 2-25
 <u>P5 REFERENCE DATA</u> .....	 FS 3-1
JOINT ANGLES VS POR COORDINATES.....	FS 3-2
P5 COORDINATE SYSTEM – PL ID 4.....	FS 3-3
PRLA CONFIGURATION.....	FS 3-4
RMS/P5 GO/NO-GO SUMMARY.....	FS 3-5
ATTITUDE CONTROL CONSTRAINTS.....	FS 3-6
P5 INSTALL CAMERA MATRIX.....	FS 3-7
 <u>VIEWING SUPPORT</u> .....	 FS 4-1
4B SAW RETRACT VIEWING.....	FS 4-2
CETA CART RELOCATION VIEWING.....	FS 4-5
 <u>CONTINGENCY SUPPORT</u> .....	 FS 5-1
P1 PUMP MODULE HANDOFF.....	FS 5-2
S1 PUMP MODULE HANDOFF.....	FS 5-9
MBSU R&R VIEWING.....	FS 5-15
4B SAW RETRACT VIEWING WITH OBSS.....	FS 5-17
CETA CART RELOCATION VIEWING WITH OBSS.....	FS 5-19
 <u>EVA 3</u> .....	 FS 6-1
APFR INSTALL/INGRESS.....	FS 6-2
SMDP ASSEMBLY.....	FS 6-5
STOW.....	FS 6-12
APFR EGRESS/REMOVAL.....	FS 6-13
CONTINGENCY SMDP STOW.....	FS 6-15
 <u>EVA REFERENCE DATA</u> .....	 FS 7-1
JOINT ANGLES VS POR COORDINATES.....	FS 7-2
EVA COORDINATE SYSTEM – PL ID 5.....	FS 7-4
– PL ID 4 (UPLINK).....	FS 7-5
RMS/EVA GO/NO-GO SUMMARY.....	FS 7-6
 <u>OBSS NOMINAL OPERATIONS</u> .....	 FS 8-1
OBSS UNBERTH.....	FS 8-2
ITVC/LDRI FLAT FIELDS.....	FS 8-8
BERTH.....	FS 8-10
HANDOFF FROM SSRMS TO SRMS.....	FS 8-16
SRMS TO SSRMS.....	FS 8-21
LDRI RCC SURVEY – STBD.....	FS 8-26
– NOSE CAP.....	FS 8-45
– PORT.....	FS 8-60
SRMS EE CAM UPPER SURFACE SURVEY.....	FS 8-76

<u>OBSS OFF-NOMINAL OPERATIONS</u> .....	FS 9-1
OBSS LDRI RCC SURVEY – STBD DOCKED.....	FS 9-2
IDC RCC SURVEY – STBD.....	FS 9-32
– NOSE CAP.....	FS 9-42
– PORT.....	FS 9-56
ITVC TILE ACREAGE SURVEY.....	FS 9-68
RMS EE RCC WING SURVEY.....	FS 9-96
OBSS SJ UNBERTH.....	FS 9-116
BERTH.....	FS 9-130
HANDOFF FROM SSRMS TO SRMS.....	FS 9-149
SRMS TO SSRMS.....	FS 9-164
FLAT FIELDS.....	FS 9-173
MNVR FROM UNDOCK TO OBSS HOVER.....	FS 9-178
OBSS JETTISON.....	FS 9-179
WITH MPMS.....	FS 9-184
<u>OBSS SURVEY CAMERA VIEWS</u> .....	FS 10-1
OBSS LDRI RCC SURVEY CAMERA VIEWS – STBD.....	FS 10-2
– NOSE CAP.....	FS 10-15
– PORT.....	FS 10-27
SRMS EE CAM CREW CABIN SURVEY CAMERA VIEWS.....	FS 10-39
OBSS LDRI RCC SURVEY CAMERA VIEWS – STBD DOCKED.....	FS 10-46
IDC RCC SURVEY CAMERA VIEWS – STBD.....	FS 10-70
– NOSE CAP.....	FS 10-80
– PORT.....	FS 10-94
<u>OBSS REFERENCE DATA</u> .....	FS 11-1
OBSS JOINT ANGLES VS POR COORDINATES.....	FS 11-2
AUTO SEQUENCES.....	FS 11-6
COORDINATE SYSTEM – PL ID 1.....	FS 11-16
2.....	FS 11-17
3.....	FS 11-18
5 (UPLINK).....	FS 11-19
GO/NO-GO CRITERIA.....	FS 11-20
ATTITUDE CONTROL CONSTRAINTS.....	FS 11-21
SRMS EE CAM SURVEYS JOINT ANGLES VS POR COORDINATES.....	FS 11-22
CREW CABIN SURVEY AUTO SEQUENCES.....	FS 11-23
RCC WING SURVEY COORDINATE SYSTEM – PL ID 5 (UPLINK).....	FS 11-24
<u>CUE CARD CONFIGURATION</u> .....	FS 12-1

NOMINAL P5 OPS

P5 GRAPPLE.....	FS 1-2
UNBERTH .....	FS 1-5
HANDOFF .....	FS 1-8
UNGRAPPLE .....	FS 1-11

**NOMINAL  
P5 OPS**

# P5 GRAPPLE

NOMINAL  
P5 OPS

## 1. P5 PRE-GRAPPLE

SM 94 PDRS CONTROL

√PL ID, ITEM 3: 0

√INIT ID, ITEM 24: 0

MON 1	DNLK
A	Elbow (EE)
MON 2	DTV
SSRMS Base Elb	D

RATE – as required (VERN within 10 ft)

BRAKES – OFF (tb-OFF)

MODE – as desired

Mnvr to P5 PRE-GRAPPLE posn:

X	Y	Z	PITCH	YAW	ROLL	PL ID
-1023	0	-509	315	0	331	0
SY	SP	EP	WP	WY	WR	
-24.1	+69.6	-105.5	-14.7	+30.3	-5.1	

BRAKES – ON (tb-ON)

√MODE – not DIRECT

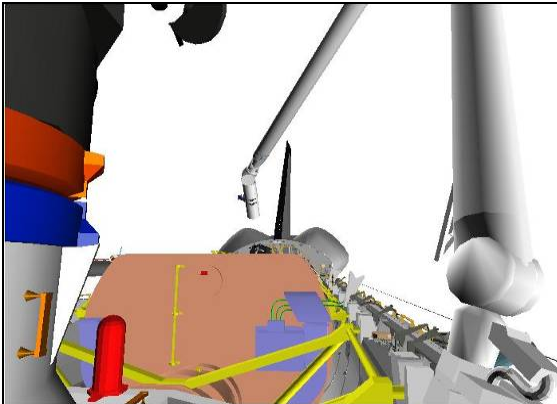

**CCTV A (-5,10)**

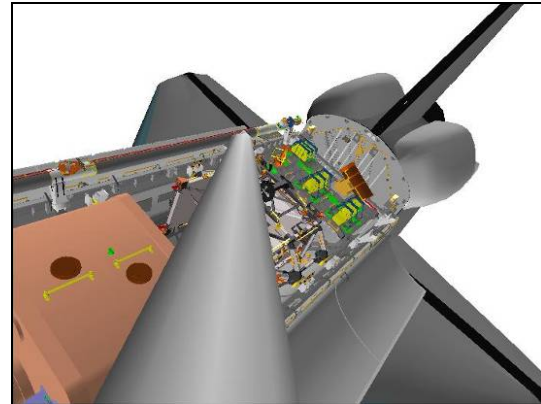

**SRMS ELBOW (5,-15)**

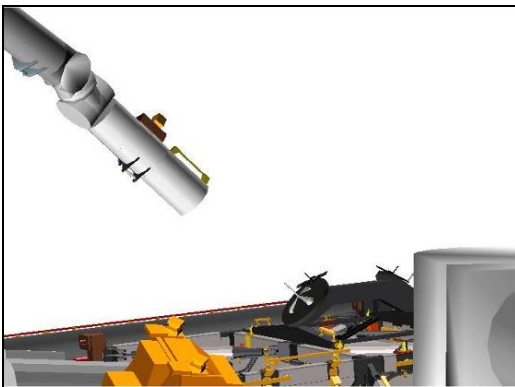

**SSRMS BASE ELBOW (122,-4)**

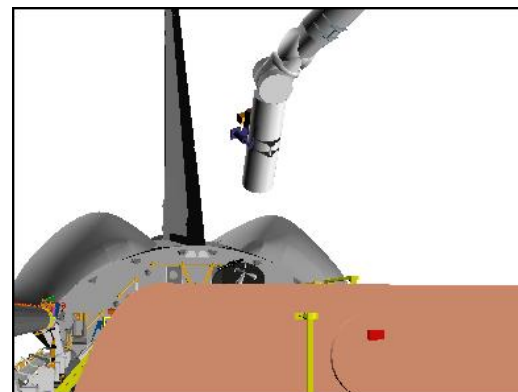

**CCTV D (10,7)**

A7U

2. P5 GRAPPLE

CCTV – config for grapple

– install PDRS TARGET OVERLAY FOR CTVM

– RMS WRIST, zoom 34.0 HFOV

focus 5 ft

Maintain eyepoint approx 18 in when using grapple overlay

MON 1	DNLK
A	EE (Elbow)
MON 2	DTV
SSRMS Base Elb	D

RATE – VERN (RATE MIN tb-ON)

BRAKES – OFF (tb-OFF)

MODE – END EFF, ENTER

Mnvr to grapple envelope

<u>CAUTION</u>
Monitor EE tb timing to prevent EE motor burnout

EE MODE – AUTO

CAPTURE sw – depress (mom)

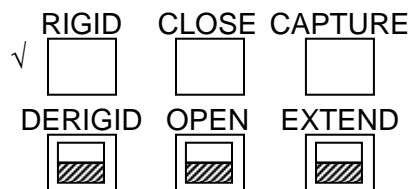

CRITICAL TIMES (28 sec total):

CAPTURE tb – gray, then

CLOSE tb – gray, 3 sec max, then

RIGID tb – gray, 25 sec max

EE MODE – OFF

BRAKES – ON (tb-ON)

SM 94 PDRS CONTROL
--------------------

PL ID – ITEM 3 +4 EXEC

INIT ID – ITEM 24 +4 EXEC

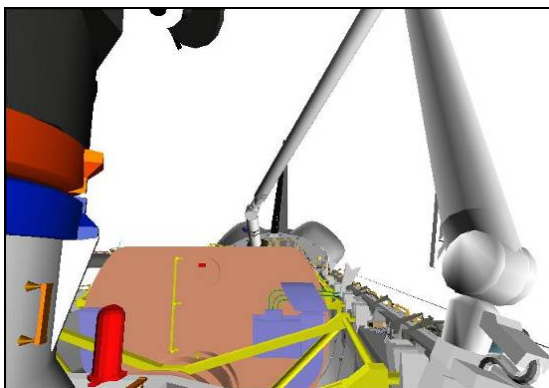

CCTV A (-5,10)

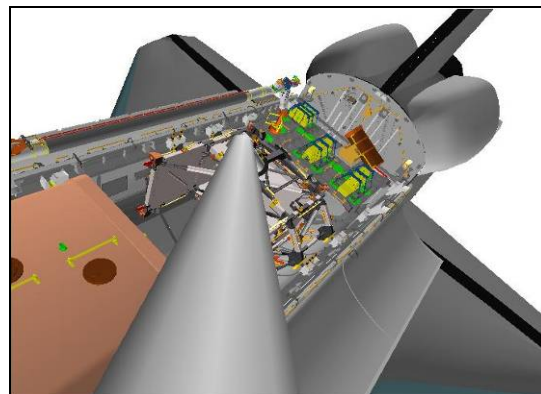

SRMS ELBOW (5,-15)

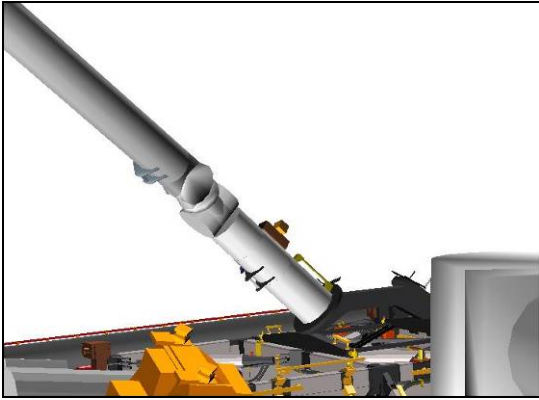

**SSRMS BASE ELBOW (122,-4)**

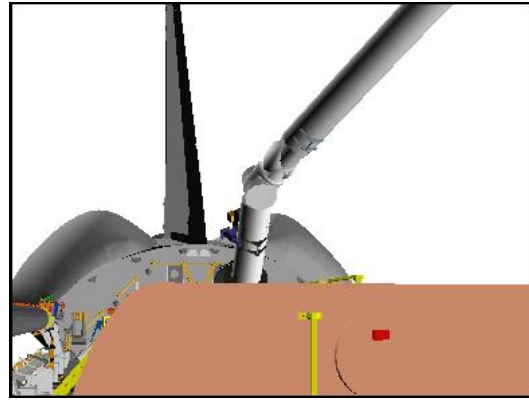

**CCTV D (10,7)**

Record POS/ATT and Joint Angles:

X	Y	Z	PITCH	YAW	ROLL	PL ID
						4
SY	SP	EP	WP	WY	WR	
Expected -19.4	+57.8	-97.8	-8.6	+27.2	-9.2	

Record POS/ATT and Joint Angles in P5 CONTINGENCY REBERTH  
(OFF-NOMINAL P5 OPS)

√'Desat Request' Inhibit

Review GENERIC END EFFECTOR CUE CARD – ISS/SHUTTLE DOCKED OPS



# P5 UNBERTH

## 1. SETUP

SM 94 PDRS CONTROL

√ PL ID, ITEM 3: 4

√ INIT ID, ITEM 24: 4

Enter LOW HOVER values for REL

X	Y	Z	PITCH	YAW	ROLL	PL ID
-1089	0	-575	0	0	0	4

A7U

CCTV – config for unberth

MON 1	DNLK
Lab Stbd Zenith → SSRMS Base Elb	Elbow
MON 2	DTV
B/C → C	A

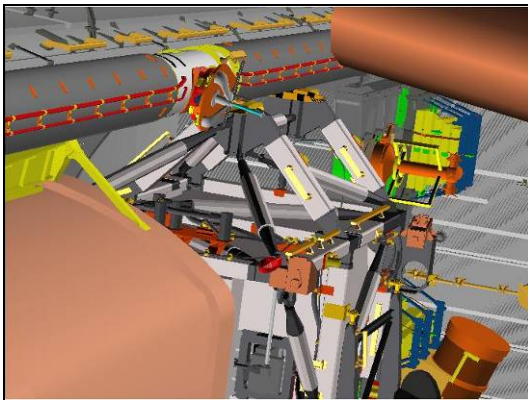

LAB STBD ZENITH (-20,-29)



SRMS ELBOW (-10,-5)



CCTV B (-2,-6)/CCTV C (2,-6)

## 2. ACTIVATE LATCHES

### NOTE

When LOGIC switches taken OFF, KU will mode to standby. MPM and MRL tbs – bp

MA73C:A MCA LOGIC MNC MID 2 – OFF  
:B MNB MID 4 – OFF

A6U √PL RETEN LAT(five) – OFF  
√PL SEL – 1  
R13L BAY MECH PWR SYS (1,2) – ON  
A6U RETEN LOGIC PWR SYS (1,2) – ON

### SM 97 PL RETENTION

√PL SEL 1 RDY-FOR-LAT 1,2,3,4,5 (ten) – 1  
√LAT 1,2,3,4,5 (ten) – 1

\* If any rel msw shows '1', expect \*  
\* single motor time (60 sec) \*

## 3. AKA RELEASE

√PL RETEN LAT 5 tb – LAT  
√RDY 5 tb – gray

Note single motor times (>30 sec)  
PL RETEN LAT 5 – REL (tb-REL), 60 sec max  
– OFF

## 4. PRLA RELEASE

√PL RETEN LAT 1,2,3,4 (four) tb – LAT  
√RDY 1,2,3,4 (four) tb – gray

Note single motor times (>30 sec)  
PL RETEN LAT 1,2 (two) – REL (tb-REL), 60 sec max  
– OFF  
3,4 (two) – REL (tb-REL), 60 sec max  
– OFF

## 5. DEACTIVATE LATCHES

PL RETEN LOGIC PWR SYS (1,2) – OFF

R13L PL BAY MECH PWR SYS (1,2) – OFF

MA73C:A MCA LOGIC MNC MID 2 – ON  
:B MNB MID 4 – ON

## 6. MNVR TO P5 LOW HOVER

RATE – VERN (RATE MIN tb-ON)  
BRAKES – OFF (tb-OFF)  
MODE – ORB LD, ENTER

Mnvr P5 up until unconstrained  
√PL RETEN RDY 1,2,3,4 tb (four) – bp

Mnvr to P5 LOW HOVER posn:

X	Y	Z	PITCH	YAW	ROLL	PL ID
-1089	0	-575	0	0	0	4
SY	SP	EP	WP	WY	WR	
-26.9	+67.2	-77.1	-42.0	+32.0	-2.6	

BRAKES – ON (tb-ON)

√MODE – not DIRECT

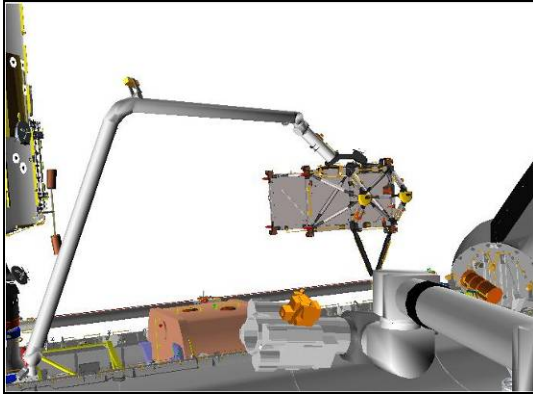

**SSRMS BASE ELBOW (118,0)**

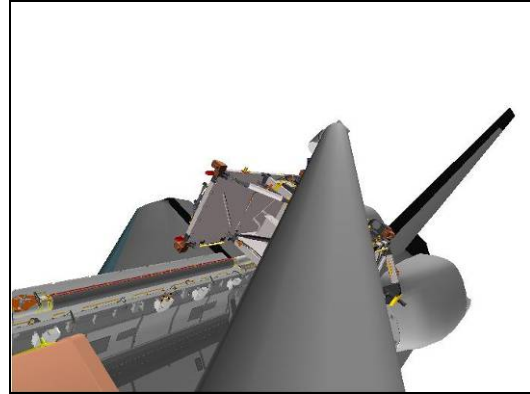

**SRMS ELBOW (-10,-15)**

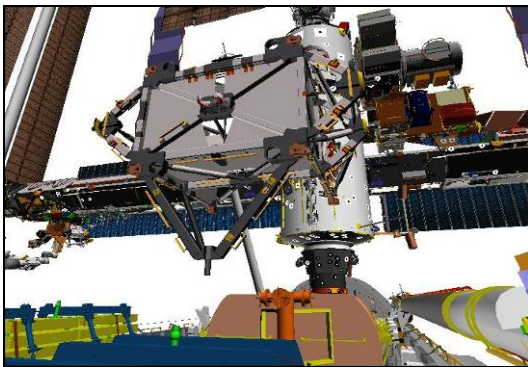

**CCTV C (-17,20)**

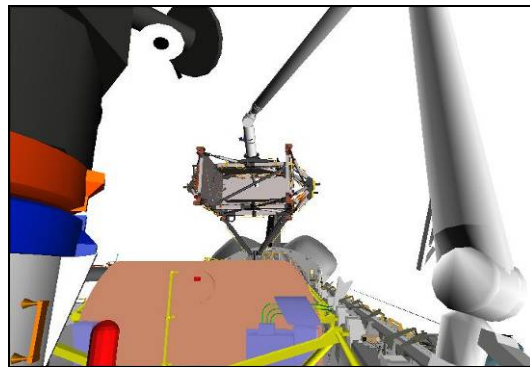

**CCTV A (-5,15)**

# P5 HANDOFF

## 1. SRMS MNVR TO P5 PORT

MON 1	DNLK
C (Elbow)	P1 LOOB (A)
MON 2	DTV
B (A)	A

RATE – VERN (RATE MIN tb-ON)

BRAKES – OFF (tb-OFF)

MODE – ORB LD, ENTER

Mnvr to P5 PORT posn:

X	Y	Z	PITCH	YAW	ROLL	PL ID
-1089	-250	-575	0	0	0	4
SY	SP	EP	WP	WY	WR	
+9.8	+77.2	-73.2	-46.1	+6.4	-30.8	

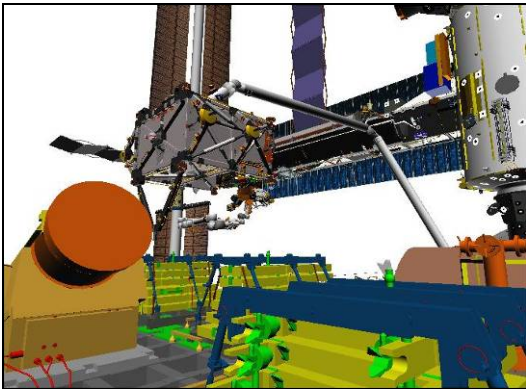

**CCTV C (-45,10)**

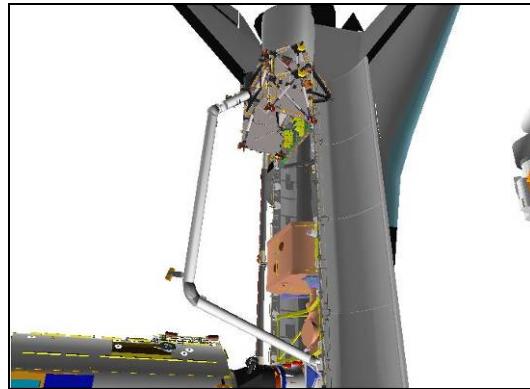

**P1 OUTBOARD LOWER (114,28)**

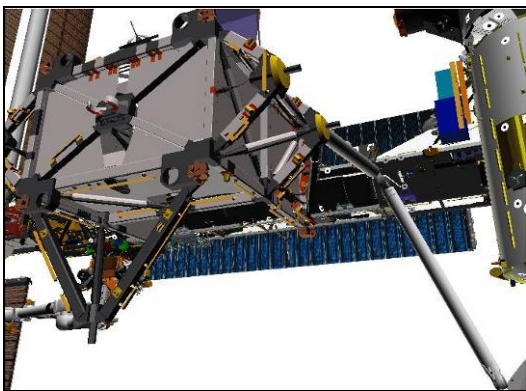

**CCTV B (-25,20)**

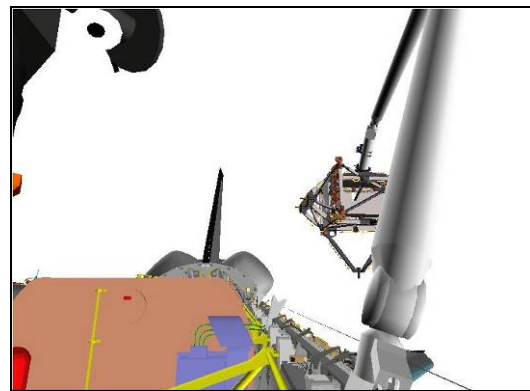

**CCTV A (5,15)**

2. SRMS MNVR TO P5 FORWARD

MON 1	DNLK
Elbow	P1 LOOB (A)
MON 2	DTV
B (A)	A

RATE – as required (VERN within 10 ft)

BRAKES – OFF (tb-OFF)

MODE – ORB LD, ENTER

Mnvr to P5 FORWARD posn (OCAS Valid):

X	Y	Z	PITCH	YAW	ROLL	PL ID
-674	-450	-388	0	0	0	4
SY	SP	EP	WP	WY	WR	
+102.4	+79.9	-98.1	-65.0	-47.8	-117.5	

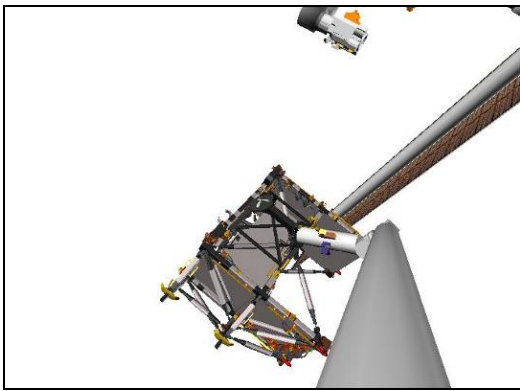

**SRMS ELBOW (-20,0)**

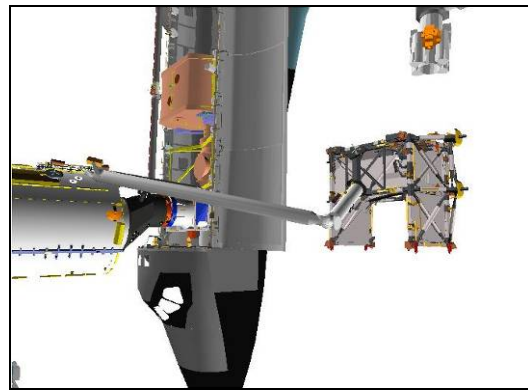

**P1 LOWER OUTBOARD (128,6)**

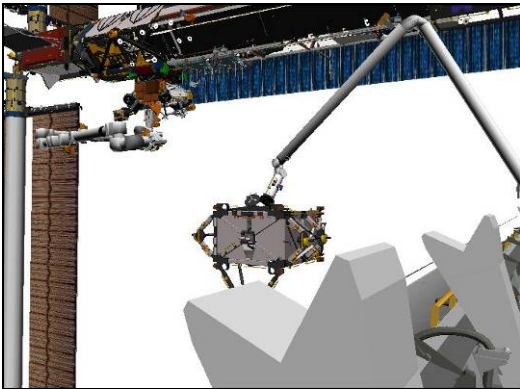

**CCTV B (-30,0)**

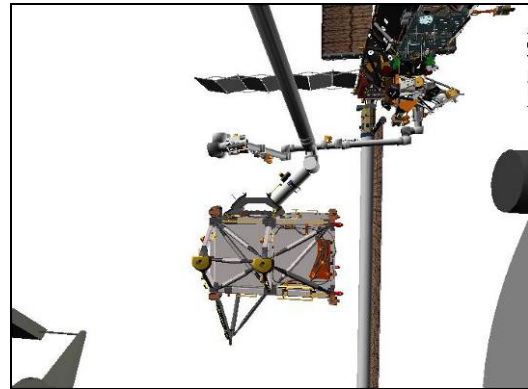

**CCTV A (80,0)**

### 3. SRMS MNVR TO P5 HANDOFF

MON 1	DNLK
Elbow	P1 LOOB (A)
MON 2	DTV
B (A)	A

RATE – VERN (RATE MIN tb-ON)

BRAKES – OFF (tb-OFF)

MODE – ORB LD, ENTER

Mnvr to P5 HANDOFF posn:

X	Y	Z	PITCH	YAW	ROLL	PL ID
-674	-594	-388	0	0	0	4
SY	SP	EP	WP	WY	WR	
+98.7	+48.2	-43.3	-84.1	-47.3	-112.1	

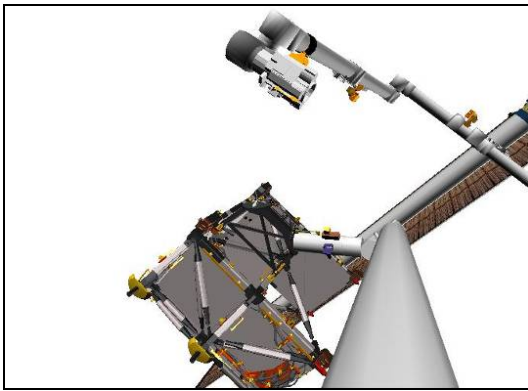

**SRMS ELBOW (-20,0)**

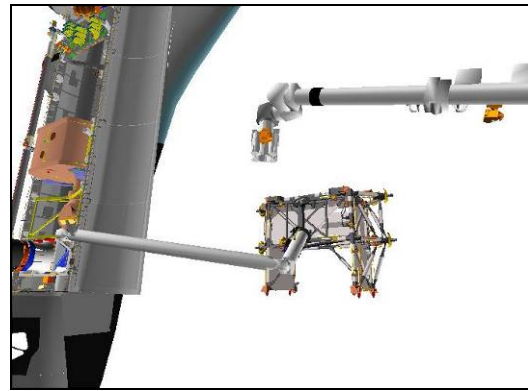

**P1 LOWER OUTBOARD (150,15)**

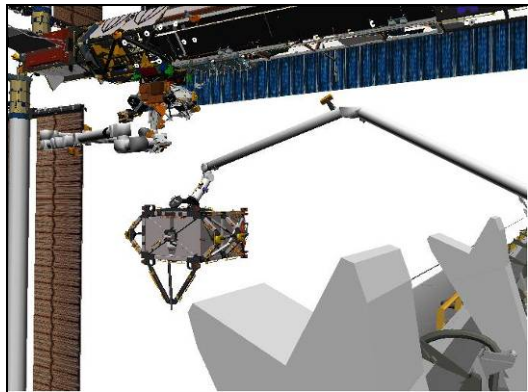

**CCTV B (-30,0)**

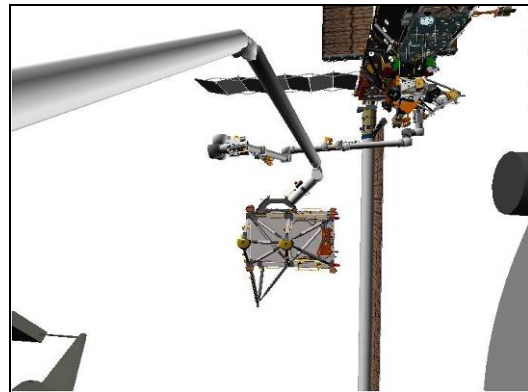

**CCTV A (80,0)**

BRAKES – ON (tb-ON)

√MODE – not DIRECT

Notify ISS, GO for P5 GRAPPLE

## P5 UNGRAPPLE

- A7U 1. SETUP  
 CCTV – RMS WRIST, zoom 34.0 HFOV  
 focus 5 ft

MON 1	DNLK
P1 LOOB	EE
MON 2	DTV
A (D)	B

2. P5 UNGRAPPLE  
 On ISS GO, perform P5 Ungrapple (verify SSRMS grappled to P5 with Brakes-ON)

SM 94 PDRS CONTROL  
 PL ID – ITEM 3 +0 EXEC  
 INIT ID – ITEM 24 +0 EXEC

Enter UNGRAPPLE BACKOFF values for REL

X	Y	Z	PITCH	YAW	ROLL	PL ID
-609	-594	-482	315	0	331	0

### NOTE

CONTR ERR It and 'S96 PDRS CNTL' msg may occur  
 due to Consistency/Envelope Check error

RATE – COARSE (RATE MIN tb-OFF)

SM 94 PDRS CONTROL  
 AUTO BRAKE INH – ITEM 10 EXEC (\*)

BRAKES – OFF (tb-OFF)

MODE – TEST, ENTER  
 Wait 5 sec

BRAKES – ON (tb-ON)

SM 94 PDRS CONTROL  
 AUTO BRAKE ENA – ITEM 9 EXEC (\*)

RATE – VERN (RATE MIN tb-ON)  
 BRAKES – OFF (tb-OFF)  
 MODE – END EFF, ENTER

**CAUTION**  
Monitor EE tb timing to prevent EE motor burnout

**NOTE**  
When OPEN tb-gray, mnvr arm clear of GF

EE MODE – AUTO  
RELEASE sw – depress (mom)

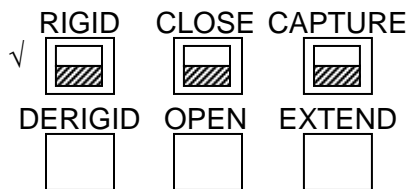

**CRITICAL TIMES (28 sec total):**  
DERIGID tb – gray, 5 sec max, then  
OPEN tb – gray, 3 sec max, then  
EXTEND tb – gray, 20 sec max

EE MODE – OFF

Mnvr to UNGRAPPLE BACKOFF posn:

X	Y	Z	PITCH	YAW	ROLL	PL ID
-609	-594	-482	315	0	331	0
SY	SP	EP	WP	WY	WR	
+104.3	+46.5	-32.1	-99.8	-48.0	-120.4	

BRAKES – ON (tb-ON)  
✓MODE – not DIRECT

- \* If manual release reqd: \*
- \* EE MODE – MAN \*
- \* MAN CONTR – DERIGID (hold until DERIGID tb-gray, \*
- 5 sec max) \*
- \* RELEASE sw – depress (hold until OPEN tb-gray, \*
- 3 sec max) \*
- \* Mnvr arm clear, then \*
- \* EE MAN CONTR – DERIGID (hold until EXTEND tb-gray, \*
- 20 sec max) \*
- \* MODE – OFF \*
- \* BRAKES – ON (tb-ON) \*

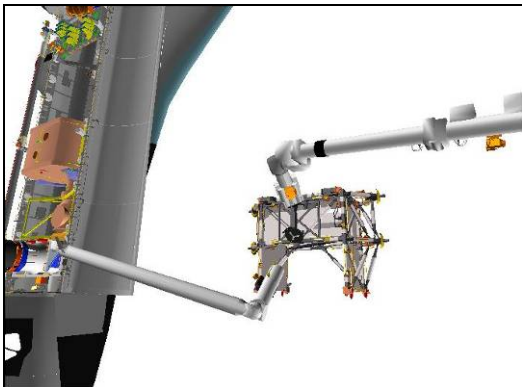

**P1 LOWER OUTBOARD (150,15)**

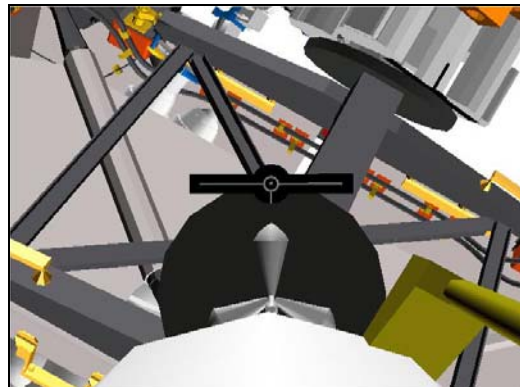

**SRMS EE**



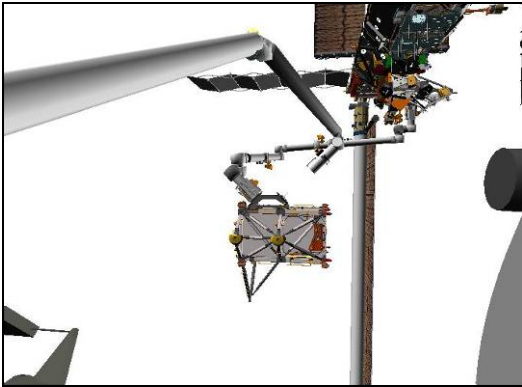

**CCTV A (80,0)**

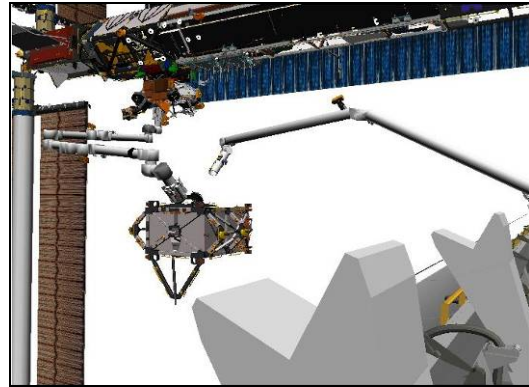

**CCTV B (-30,0)**

3. SRMS MNVR TO P5 INSTALL VIEW

MON 1	DNLK
P1 LOOB (SSRMS Base Elb)	Elbow → EE
MON 2	DTV
B	A

RATE – as required (VERN within 10 ft)  
 BRAKES – OFF (tb-OFF)  
 MODE – SINGLE, ENTER

Mnvr to P5 INSTALL VIEW posn:

	SY	SP	EP	WP	WY	WR	
Ungrapple Backoff	+104.3	+46.5	-32.1	-99.8	-48.0	-120.4	
1: SY +	+154.9						
2: SP -		+6.7					
3: EP -			-32.8				
4: WP +				+103.6			
5: WY +					-44.2		
6: WR +						+84.0	
P5 Install Viewing	+154.9	+6.7	-32.8	+103.6	-44.2	+84.0	
	X	Y	Z	PITCH	YAW	ROLL	PL ID
	-230	-335	-325	70	63	289	0

BRAKES – ON (tb-ON)  
 MODE – not DIRECT

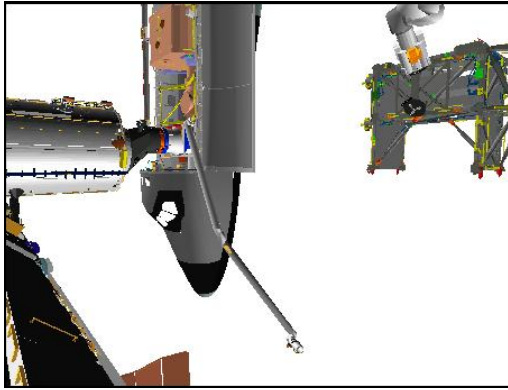

**P1 LOWER OUTBOARD (130,-5)**

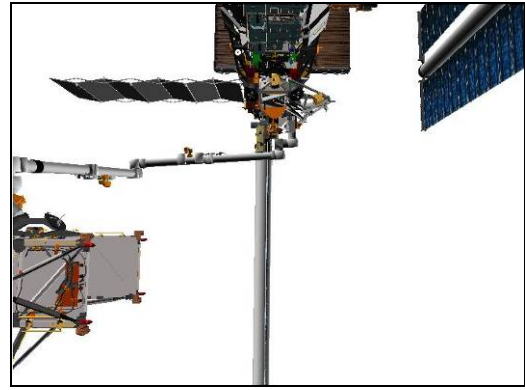

**SRMS ELBOW (-55,75)**



**CCTV B (-15,0)**

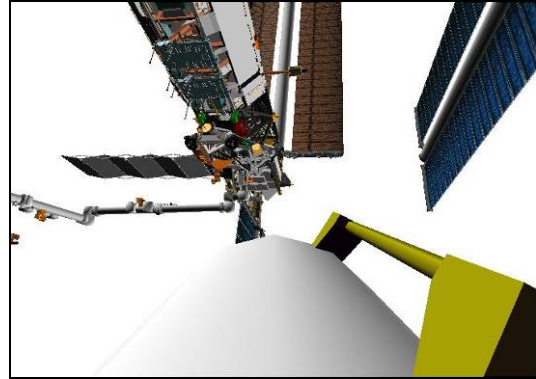

**SRMS EE**

OFF-NOMINAL P5 OPS

P5 SJ GRAPPLE .....	FS 2-2
UNBERTH .....	FS 2-10
HANDOFF .....	FS 2-12
UNGRAPPLE .....	FS 2-18
CONTINGENCY REBERTH.....	FS 2-25

**OFF-NOMINAL  
P5 OPS**

# P5 SJ GRAPPLE

- A7U 1. SJ MNVR TO PRE-GRAPPLE  
CCTV – perform PAN/TILT RESET

SM 94 PDRS CONTROL

- √PL ID, ITEM 3: 0
- √INIT ID, ITEM 24: 0

MON 1	DNLK
A	B
MON 2	DTV
SSRMS Base Elb	C

RATE – as required (VERN within 10 ft)  
BRAKES – OFF (tb-OFF)  
MODE – best available

Mnvr to PRE-GRAPPLE posn (reference pictures as reqd):

	SY	SP	EP	WP	WY	WR	
Pre-cradle	0.0	+25.0	-25.0	+5.0	0.0	0.0	
1: SP +		+69.6					
2: EP -			-105.5				
3: SY -	-24.1						
4: WP -				-14.7			
5: WY +					+30.3		
6: WR -						-5.1	
P5 Pre-grapple	-24.1	+69.6	-105.5	-14.7	+30.3	-5.1	
	X	Y	Z	PITCH	YAW	ROLL	PL ID
	-1023	0	-509	315	0	331	0

BRAKES – ON (tb-ON)  
MODE – not DIRECT

OFF-NOMINAL  
P5 OPS

Step 1:

Drive SP+ (for 44.6°)  
From +25.0 to +69.6

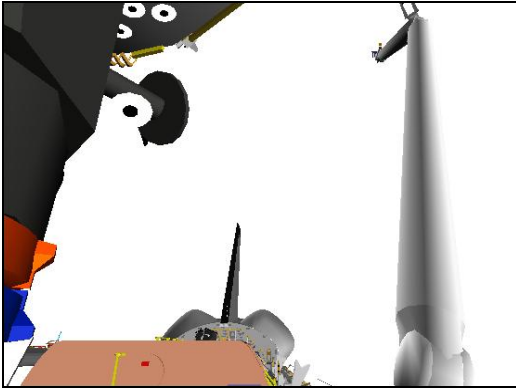

CCTV A (0,25)

Step 2:

Drive EP- (for 80.5°)  
From -25.0 to -105.5

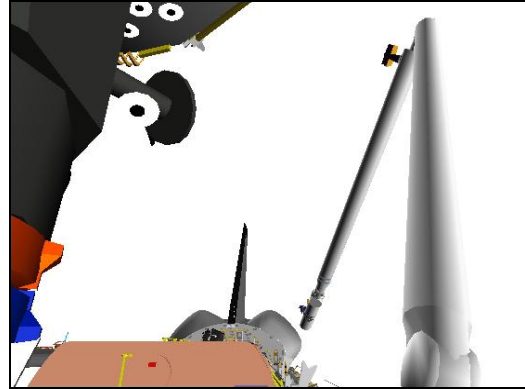

CCTV A (0,25)

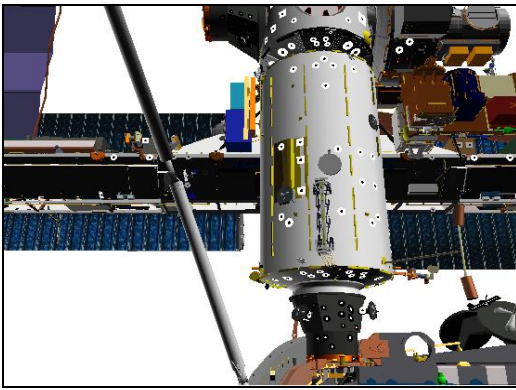

CCTV B (0,20)

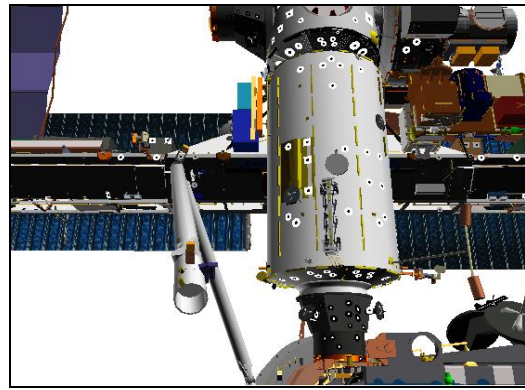

CCTV B (0,20)

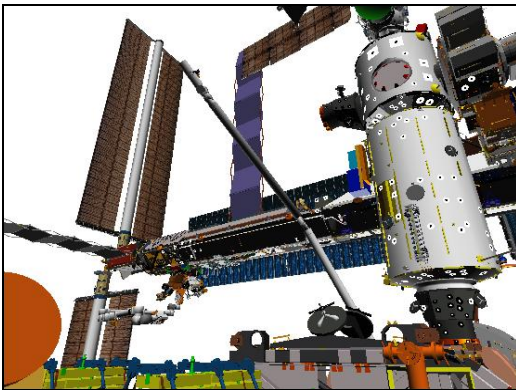

CCTV C (-35,25)

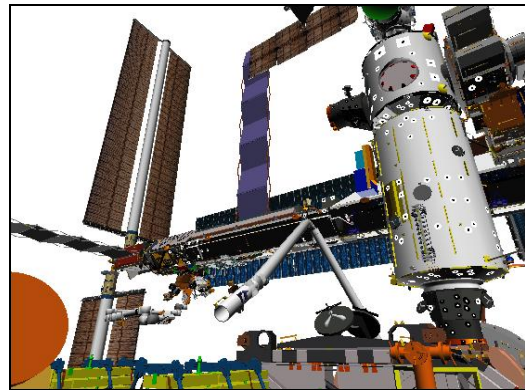

CCTV C (-35,25)

Step 3:

Drive SY- (for  $24.1^\circ$ )  
From 0.0 to -24.1

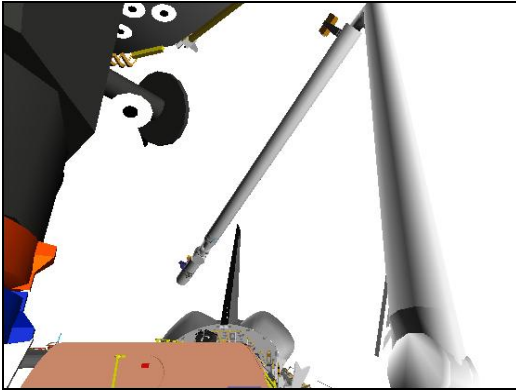

**CCTV A (0,25)**

Step 4:

Drive WP- (for  $19.7^\circ$ )  
From +5.0 to -14.7

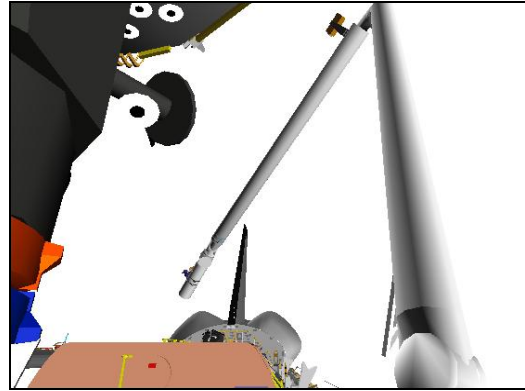

**CCTV A (0,25)**

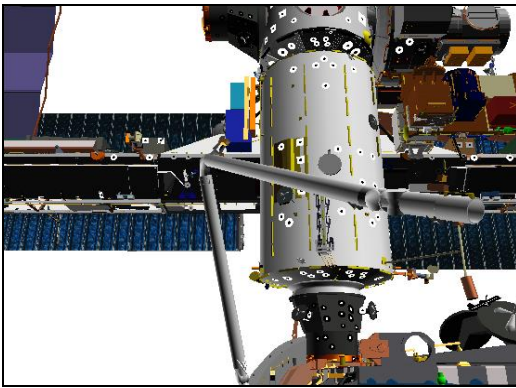

**CCTV B (0,20)**

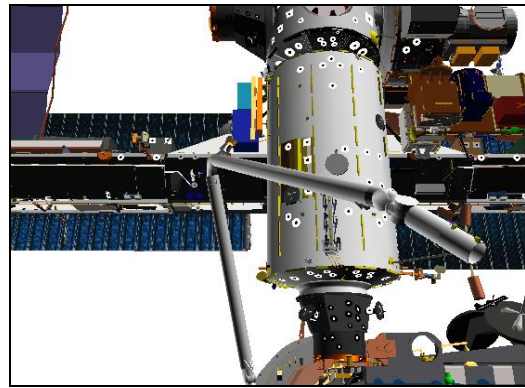

**CCTV B (0,20)**

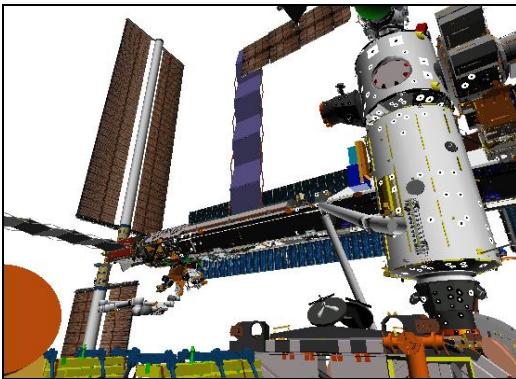

**CCTV C (-35,25)**

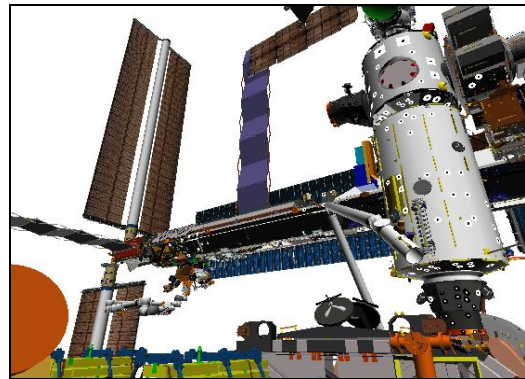

**CCTV C (-35,25)**

Step 5:

Drive WY+ (for 30.3°)  
From 0.0 to +30.3

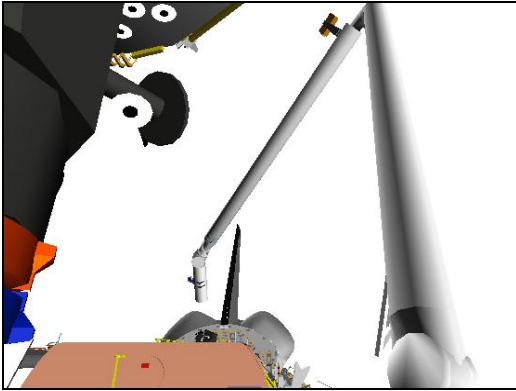

**CCTV A (0,25)**

Step 6:

Drive WR- (for 5.1°)  
From 0.0 to -5.1

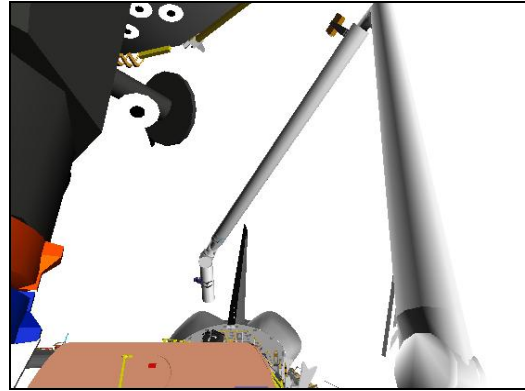

**CCTV A (0,25)**

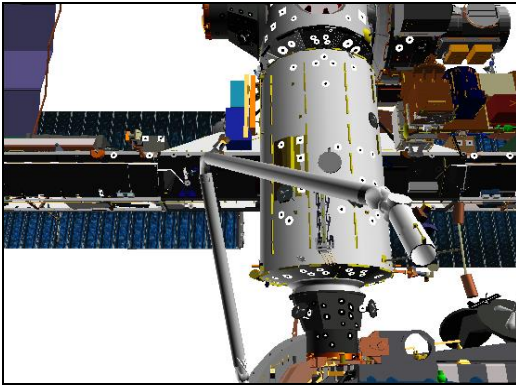

**CCTV B (0,20)**

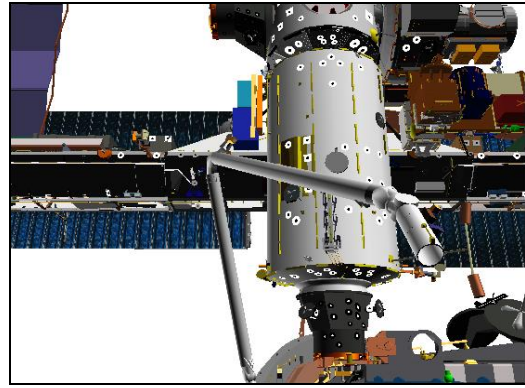

**CCTV B (0,20)**

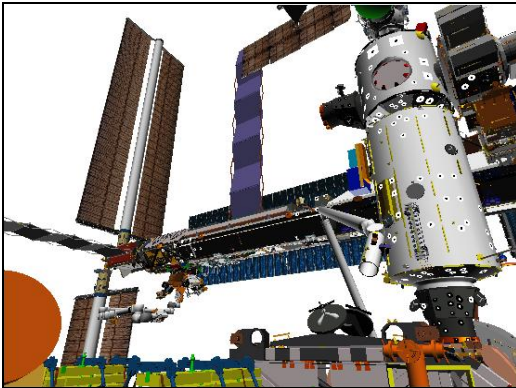

**CCTV C (-35,25)**

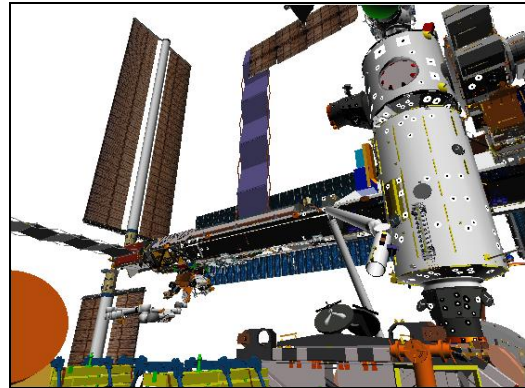

**CCTV C (-35,25)**

A7U

2. SJ MNVR TO P5 GRAPPLE

CCTV – config for grapple

- install PDRS TARGET OVERLAY FOR CTVM
- RMS WRIST, zoom 34.0 HFOV  
focus 5 ft
- fully zoom out for SJ pictures

Maintain eyepoint ~18 in when using grapple overlay

MON 1	DNLK
A	EE (Elbow)
MON 2	DTV
SSRMS Base Elb	D

RATE – VERN (RATE MIN tb-ON)

BRAKES – OFF (tb-OFF)

MODE – best available

Drive joints per P5 SJ GRAPPLE WRIST CCTV OVERLAY and diagram until EE within grapple envelope

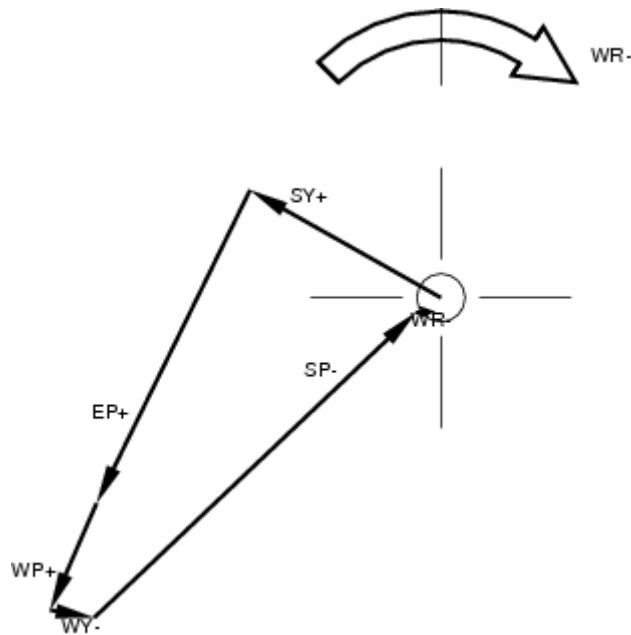



P5 SJ GRAPPLE WRIST CCTV OVERLAY

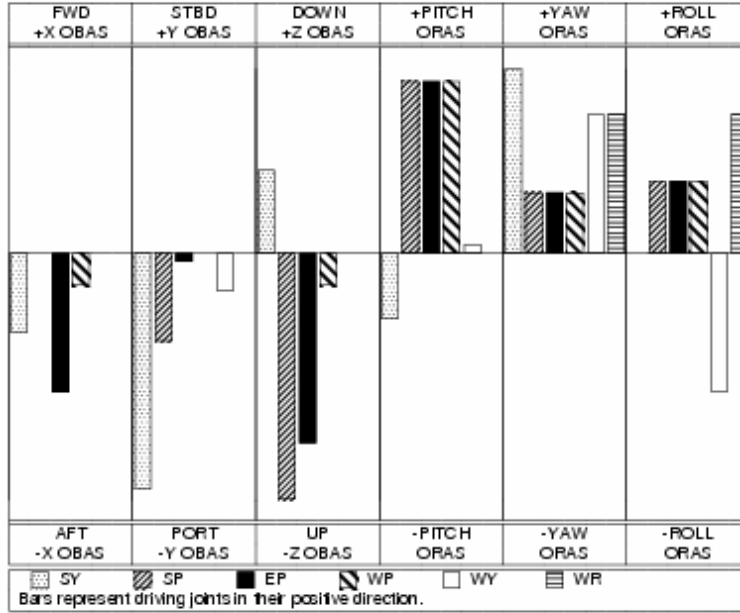

To get:	Drive:	To get:	Drive:	Driving:	Results In:	Driving:	Results In:
+X (fwd)	-EP, -SY	+PITCH	+WP, +EP	+SY	-Y (port), +YAW	+WP	-X (aft), +PITCH
+Y (stbd)	-SY, -SP	+YAW	+WR, +SY	+SP	-Z (up), +PITCH	+WY	-Y (port), -ROLL
+Z (down)	-SP, -EP	+ROLL	+WR, -WY	+EP	-Z (up), +PITCH	+WR	+YAW

$\Delta SY$	$\Delta SP$	$\Delta EP$	$\Delta WP$	$\Delta WY$	$\Delta WR$
+4.7	-11.8	+7.7	+6.2	-3.1	-4.1

### 3. P5 GRAPPLE

**CAUTION**  
Monitor EE tb timing to prevent EE motor burnout

EE MODE – AUTO (if available)  
CAPTURE sw – depress (mom)

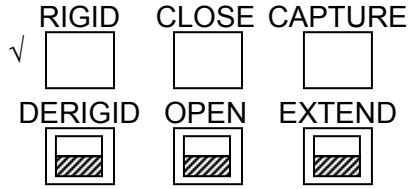

CRITICAL TIMES (28 sec total):  
 CAPTURE tb – gray, then  
 CLOSE tb – gray, 3 sec max, then  
 RIGID tb – gray, 25 sec max

- \* If manual grapple reqd: \*
- \* EE MODE – MAN \*
- \* CAPTURE sw – depress (hold until CLOSE tb-gray, \*
- 3 sec max) \*
- \* MAN CONTR – RIGID (hold until RIGID tb-gray, \*
- 25 sec max) \*

EE MODE – OFF

BRAKES – ON (tb-ON)  
MODE – not DIRECT

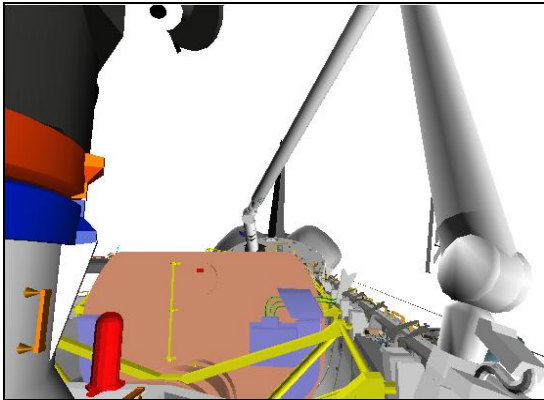

**CCTV A (-5,10)**

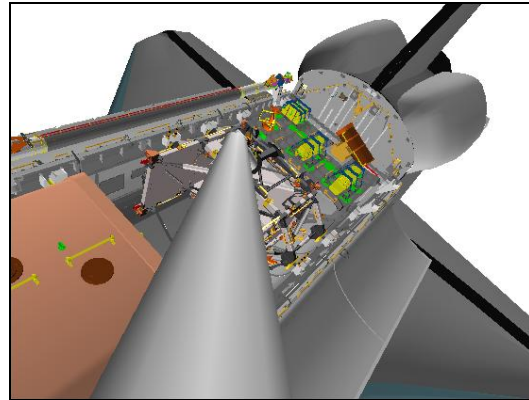

**SRMS ELBOW (5,-15)**

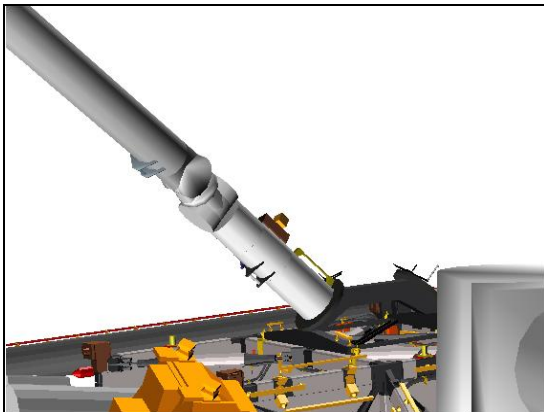

**SSRMS BASE ELBOW (122,-4)**

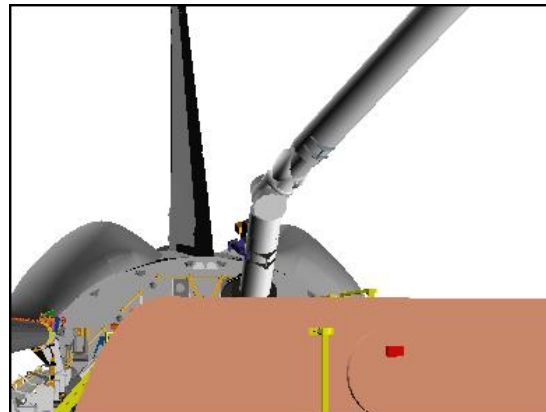

**CCTV D (10,7)**

SM 94 PDRS CONTROL

PL ID, ITEM 3 +4 EXEC

INIT ID, ITEM 24 +4 EXEC

Record POS/ATT and Joint Angles:

X	Y	Z	PITCH	YAW	ROLL	PL ID
						4
SY	SP	EP	WP	WY	WR	
-19.4	+57.8	-97.8	-8.6	+27.2	-9.2	

Expected

Record POS/ATT and Joint Angles in P5 CONTINGENCY REBERTH

√'Desat Request' Inhibit

I

Review GENERIC END EFFECTOR CUE CARD – ISS/SHUTTLE DOCKED OPS

# P5 SJ UNBERTH

1. SETUP  
Perform P5 UNBERTH, steps 1-5 (NOMINAL P5 OPS)
2. SJ MNVR TO CLEAR OF V-GUIDES  
RATE – as required (VERN within 10 ft)  
BRAKES – OFF (tb-OFF)  
MODE – best available

Drive joints per P5 SJ CLEAR V-GUIDES histogram until P5 trunnions at top of V-guides (Z = -440)

P5 SJ CLEAR V-GUIDES

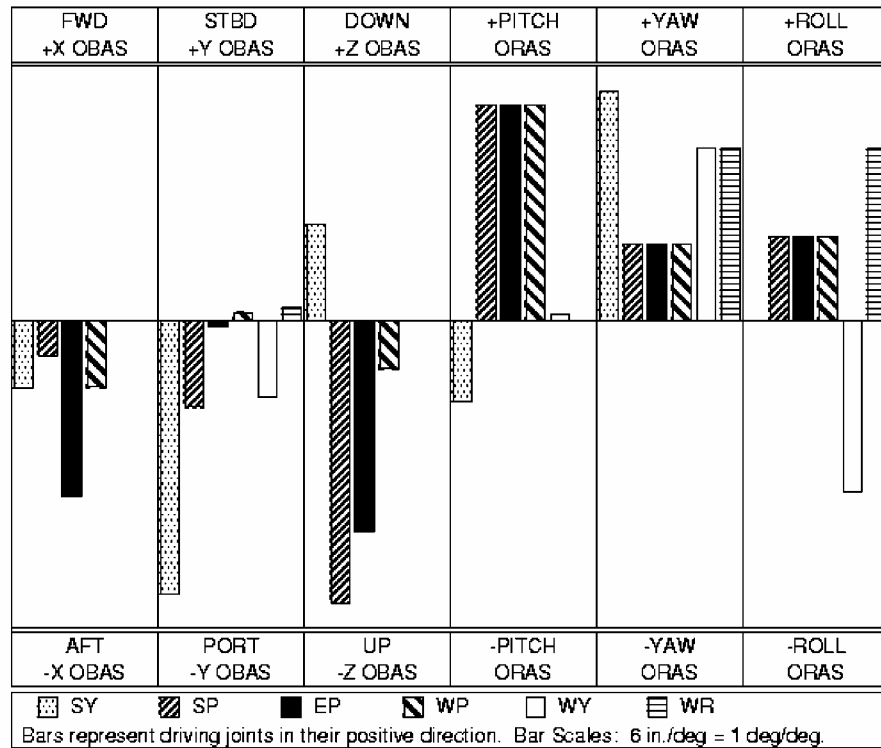

To get:	Drive:	To get:	Drive:
+X (fwd)	-EP, -WP	+PITCH	+WP, +EP
+Y (stbd)	-SY, -WY	+YAW	+SY, +WR
+Z (down)	-SP, -EP	+ROLL	+WR, -WY

Driving:	Results In:	Driving:	Results In:
+SY	-Y (port), +YAW	+WP	-X (aft), +PITCH
+SP	-Z (up), +PITCH	+WY	-Y (port), +YAW
+EP	-Z (up), +PITCH	+WR	+Y (stbd), +ROLL

$\Delta SY$	$\Delta SP$	$\Delta EP$	$\Delta WP$	$\Delta WY$	$\Delta WR$
-1.3	+2.8	+1.9	-5.1	+0.8	+1.1

## SUGGESTED JOINT ORDER

SP+  
SY-  
EP+  
WP-  
WY+, WR+ as reqd

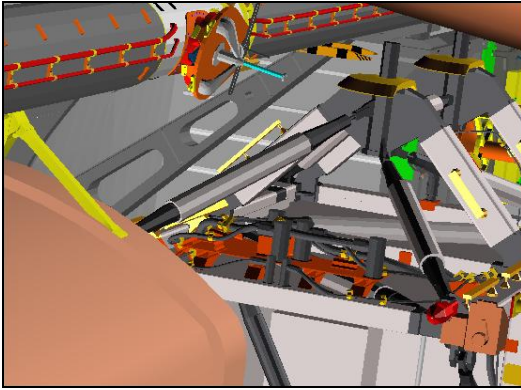

**LAB STBD ZENITH (-20,-29)**

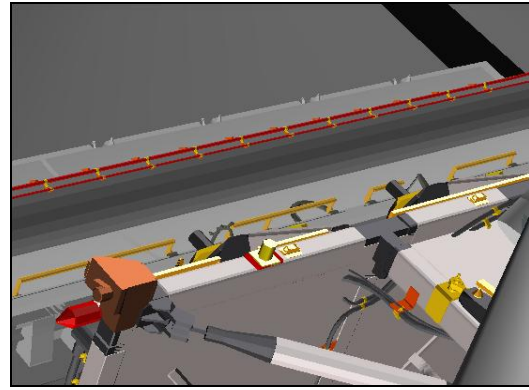

**SRMS ELBOW (-10,-5)**

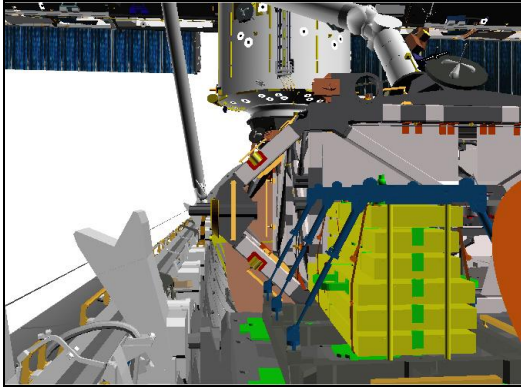

**CCTV B (5,0)**

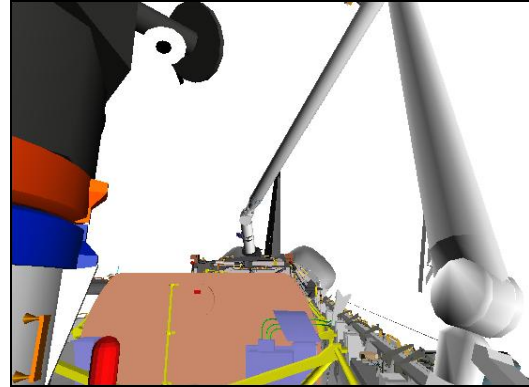

**CCTV A (-5,15)**

# P5 SJ HANDOFF

## 1. SJ MNVR TO P5 HANDOFF POSN

MON 1	DNLK
Lab Stbd Zenith → P1 LOOB (SSRMS Tip Elbow)	C (Elbow)
MON 2	DTV
A	B

RATE – as reqd (VERN within 10 ft)  
 BRAKES – OFF (tb-OFF)  
 MODE – best available

Mnvr to P5 HANDOFF posn (reference pictures as reqd):

	SY	SP	EP	WP	WY	WR	
P5 Clear of V-Guides	-20.7	+60.6	-95.9	-13.8	+28.0	-8.1	
1: SP +		+77.2					
2: EP +			-84.1				
3: SY +	+44.1						
4: EP +			-43.3				
5: SP –		+35.0					
6: SY +	+98.7						
7: WP –				-84.1			
8: WR –						-112.1	
9: WY –					-47.3		
10: SP +		+48.2					
P5 Handoff	+98.7	+48.2	-43.3	-84.1	-47.3	-112.1	
	X	Y	Z	PITCH	YAW	ROLL	PL ID
	-674	-594	-388	0	0	0	4

BRAKES – ON (tb-ON)  
 ✓MODE – not DIRECT

Notify ISS, GO for P5 GRAPPLE

Step 1:

Drive SP+ (for 16.6°)  
From +60.6 to +77.2

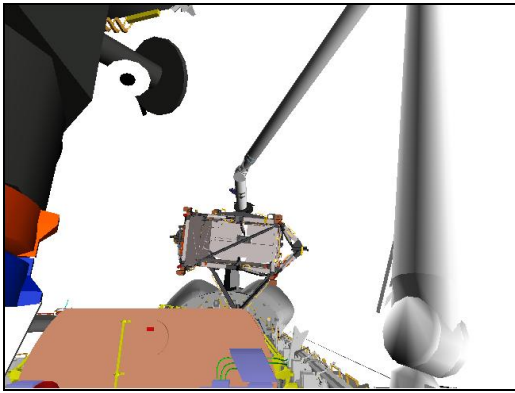

**CCTV A (0,20)**

Step 2:

Drive EP+ (for 11.8°)  
From -95.9 to -84.1

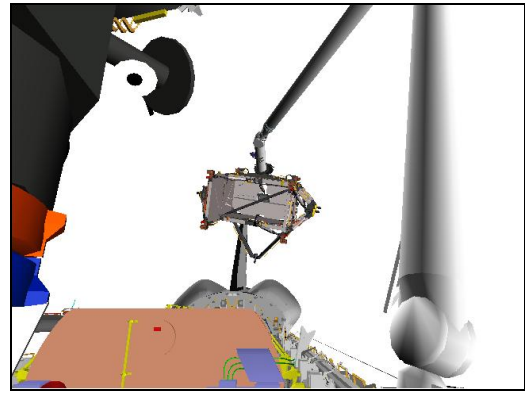

**CCTV A (0,20)**

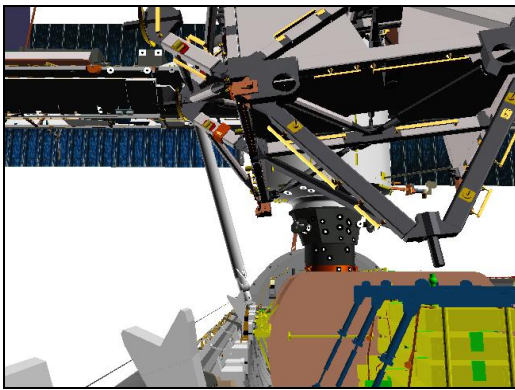

**CCTV B (0,10)**

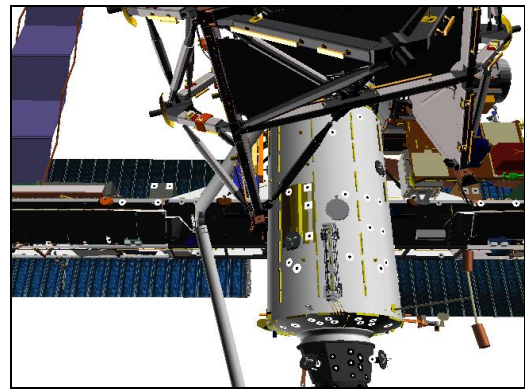

**CCTV B (0,25)**

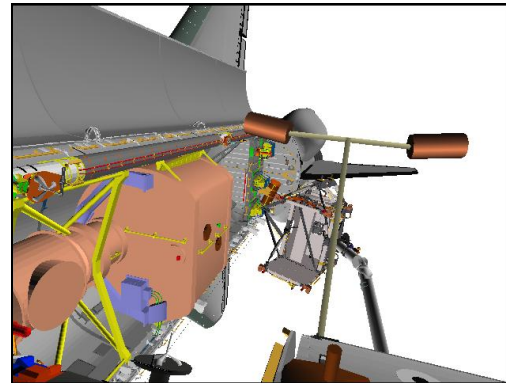

**LAB STBD ZENITH (-15,-35)**



**P1 LOWER OUTBOARD (120,25)**

Step 3:

Drive SY+ (for 64.8°)  
From -20.7 to +44.1

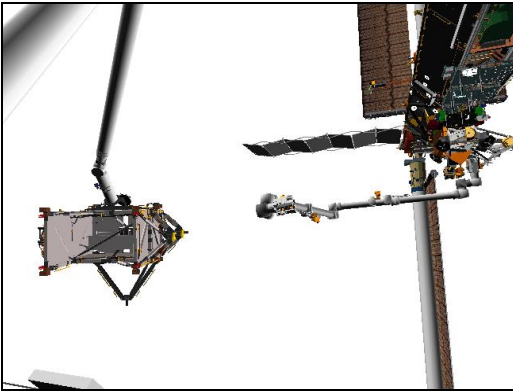

**CCTV A (70,10)**

Step 4:

Drive EP+ (for 40.8°)  
From -84.1 to -43.3



**CCTV A (70,10)**

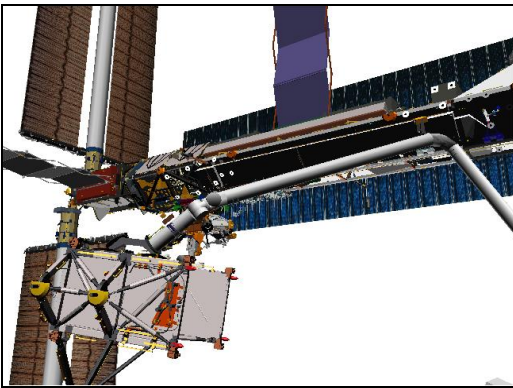

**CCTV B (-35,15)**

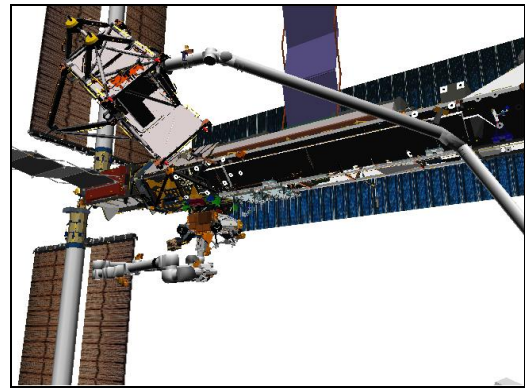

**CCTV B (-35,15)**

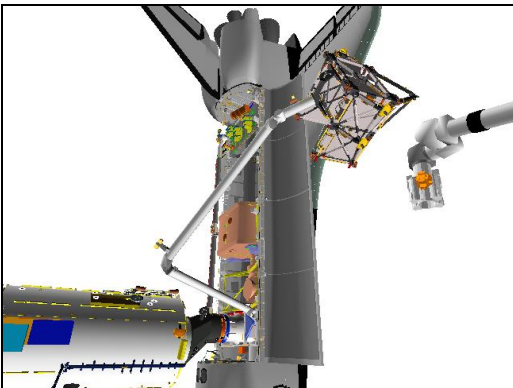

**P1 LOWER OUTBOARD (120,25)**

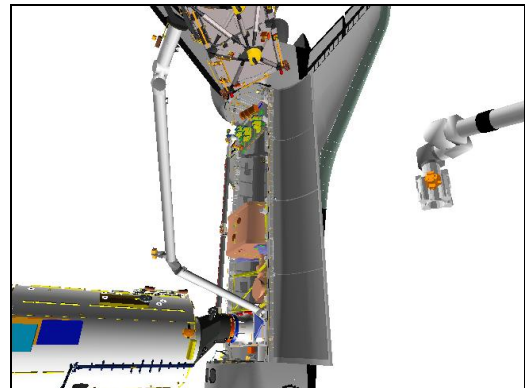

**P1 LOWER OUTBOARD (120,25)**



Step 5:

Drive SP- (for 42.2°)  
From +77.2 to +35.0

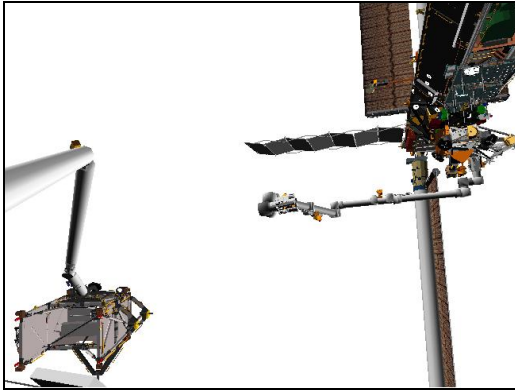

**CCTV A (70,10)**

Step 6:

Drive SY+ (for 54.6°)  
From +44.1 to +98.7

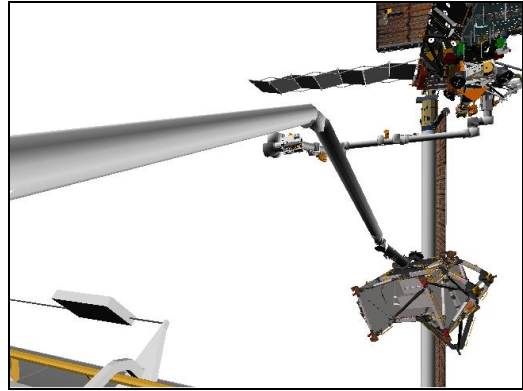

**CCTV A (70,0)**

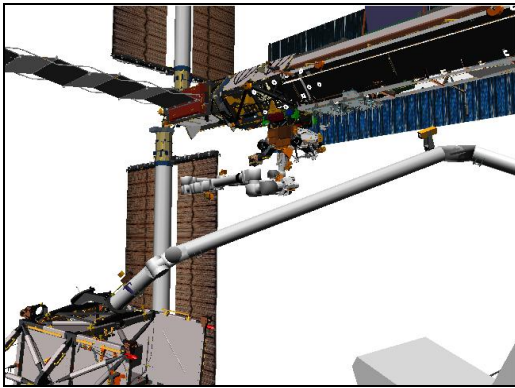

**CCTV B (-45,5)**

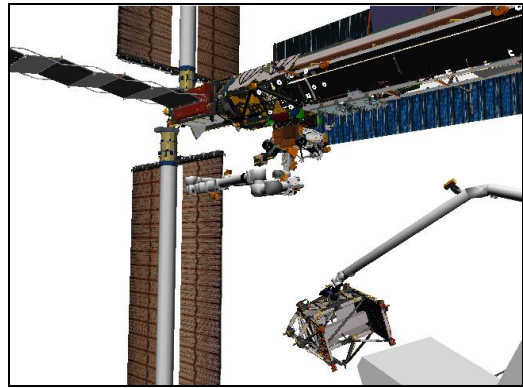

**CCTV B (-45,5)**

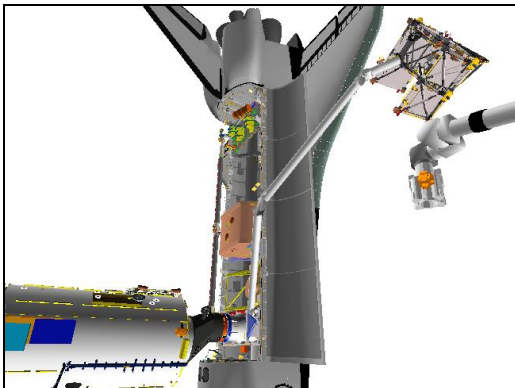

**P1 LOWER OUTBOARD (120,25)**

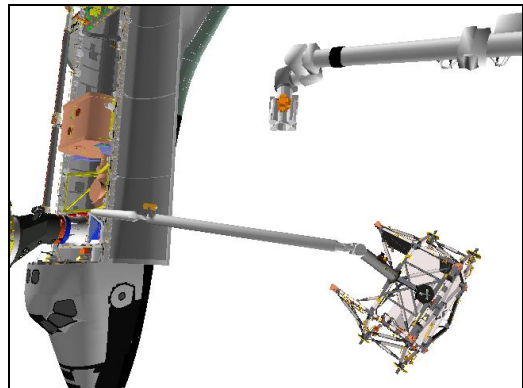

**P1 LOWER OUTBOARD (145,10)**

Step 7:

Drive WP- (for 70.3°)  
From -13.8 to -84.1

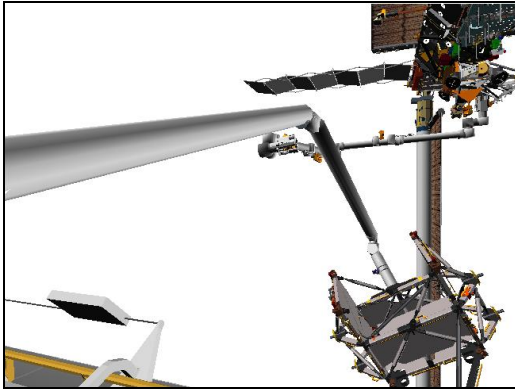

**CCTV A (70,0)**

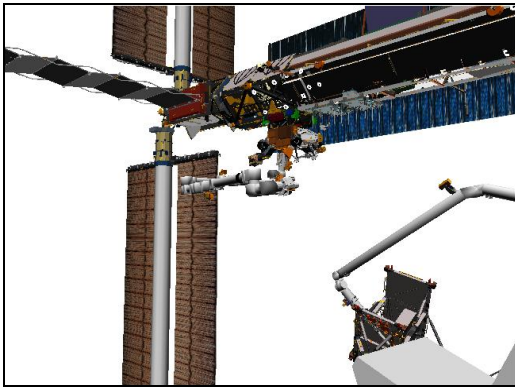

**CCTV B (-45,5)**

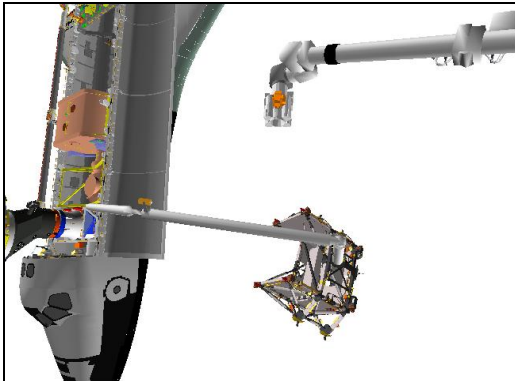

**P1 LOWER OUTBOARD (145,10)**

Step 8:

Drive WR- (for 104.0°)  
From -8.1 to -112.1

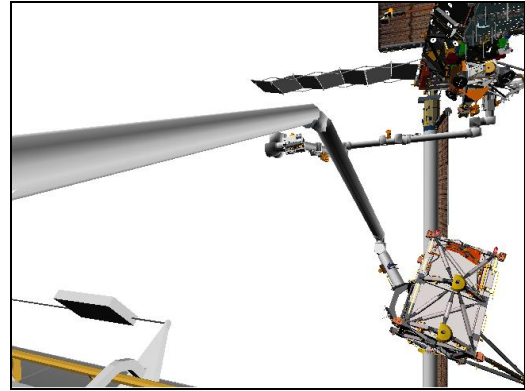

**CCTV A (70,0)**

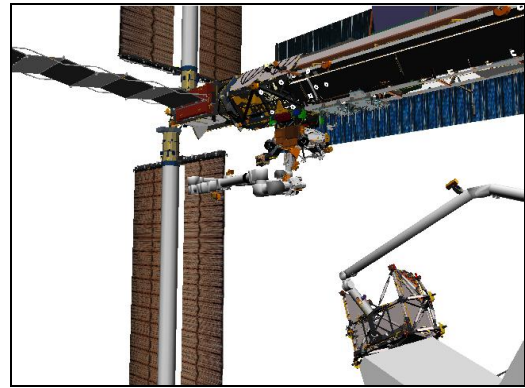

**CCTV B (-45,5)**

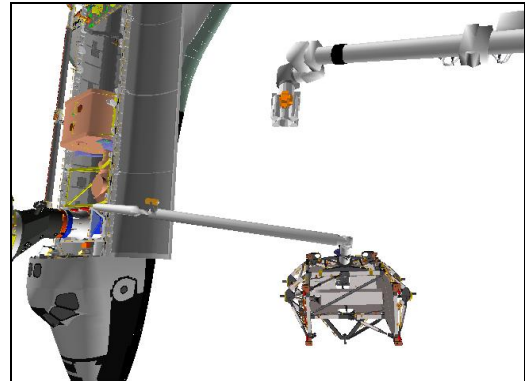

**P1 LOWER OUTBOARD (145,10)**

Step 9:

Drive WY- (for 75.3°)  
From +28.0 to -47.3

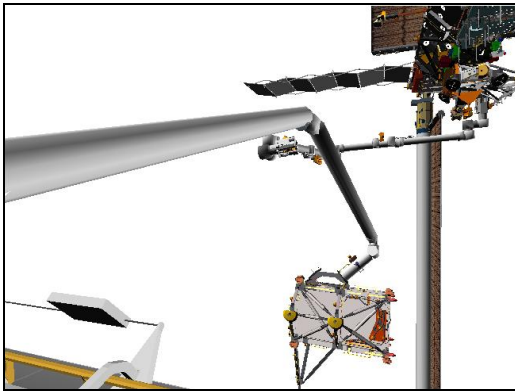

**CCTV A (70,0)**

Step 10:

Drive SP+ (for 13.2°)  
From +35.0 to +48.2

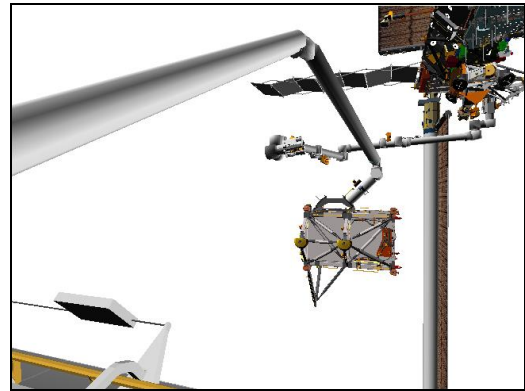

**CCTV A (70,0)**

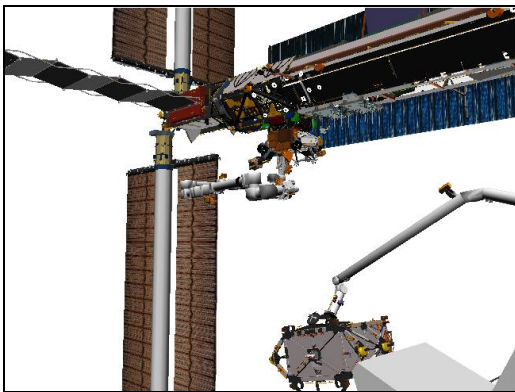

**CCTV B (-45,5)**

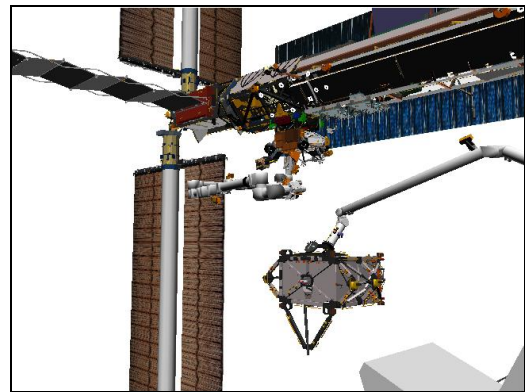

**CCTV B (-45,5)**

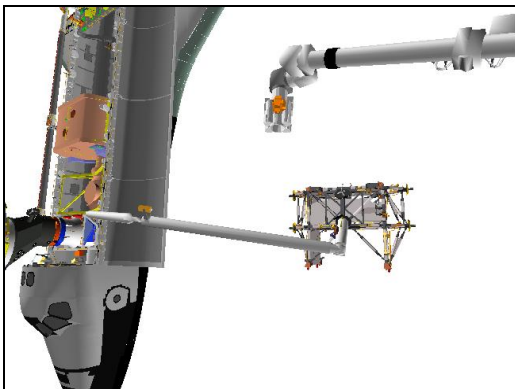

**P1 LOWER OUTBOARD (145,10)**

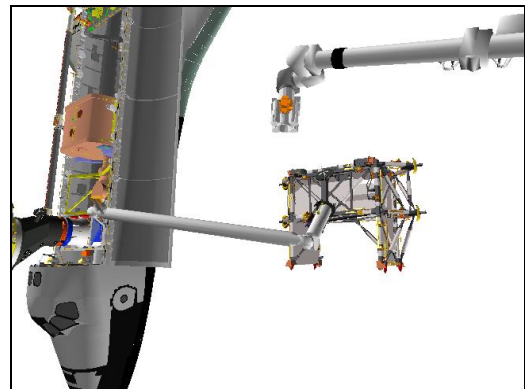

**P1 LOWER OUTBOARD (145,10)**

## P5 SJ UNGRAPPLE

- A7U 1. SETUP  
CCTV – RMS WRIST, zoom 34.0 HFOV  
focus 5 ft

MON 1	DNLK
P1 LOOB	EE (Elbow)
MON 2	DTV
A	B

2. P5 UNGRAPPLE  
On ISS GO, perform P5 Ungrapple (verify SSRMS grappled to P5 with Brakes-ON)

If SINGLE MODE available:

### NOTE

CONTR ERR It and 'S96 PDRS CNTL' msg may occur due to Consistency/Envelope Check error

RATE – COARSE (RATE MIN tb-OFF)

SM 94 PDRS CONTROL

AUTO BRAKE INH – ITEM 10 EXEC (\*)

BRAKES – OFF (tb-OFF)

MODE – TEST, ENTER

Wait 5 sec

BRAKES – ON (tb-ON)

SM 94 PDRS CONTROL

AUTO BRAKE ENA – ITEM 9 EXEC (\*)

PL ID – ITEM 3 +0 EXEC

INIT ID – ITEM 24 +0 EXEC

RATE – VERN (RATE MIN tb-ON)

BRAKES – OFF (tb-OFF)

MODE – best available

**CAUTION**  
Monitor EE tb timing to prevent EE motor burnout

EE MODE – MAN

MAN CONTR – DERIG (hold until DERIGID tb-gray, 5 sec max)

RELEASE sw – depress (hold until OPEN tb-gray, 3 sec max)

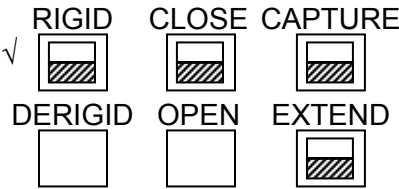

CRITICAL TIMES (8 sec total):  
DERIGID tb – gray, 5 sec max, then  
OPEN tb – gray, 3 sec max

3. MNVR ARM CLEAR OF P5  
Drive joints per P5 SJ UNGRAPPLE WRIST CCTV OVERLAY until EE clear of grapple fixture

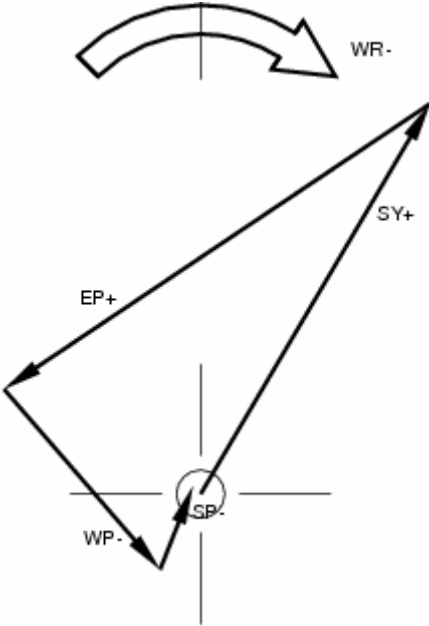

P5 SJ UNGRAPPLE WRIST CCTV OVERLAY

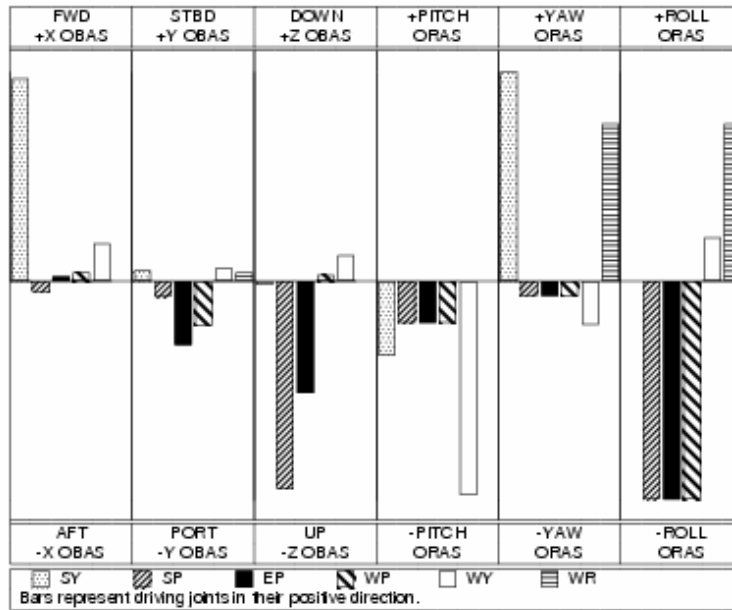

To get:	Drive:	To get:	Drive:
+X (fwd)	+SY	+PITCH	-WY
+Y (stbd)	-EP, -WP	+YAW	+SY, +WR
+Z (down)	-SP, -EP	+ROLL	-WP, -EP

Driving:	Results In:	Driving:	Results In:
+SY	+X (fwd), +YAW	+WP	-Y (port), -ROLL
+SP	-Z (up), -ROLL	+WY	+X (fwd), -PITCH
+EP	-Z (up), -ROLL	+WR	+Y (stbd), +YAW

$\Delta SY$	$\Delta SP$	$\Delta EP$	$\Delta WP$	$\Delta WY$	$\Delta WR$
+5.6	-1.7	+11.2	-15.7	-0.7	-8.3

BRAKES – ON (tb-ON)  
 ✓MODE – not DIRECT

EE MAN CONTR – DERIG (hold until EXTEND tb-gray, 20 sec max)  
 MODE – OFF

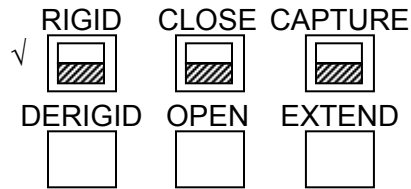

CRITICAL TIMES (20 sec total):  
 EXTEND tb – gray, 20 sec max

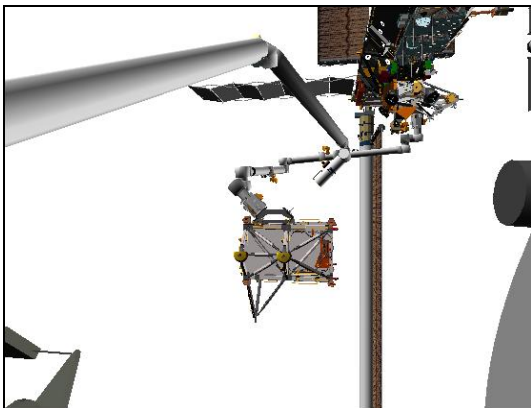

CCTV A (80,0)

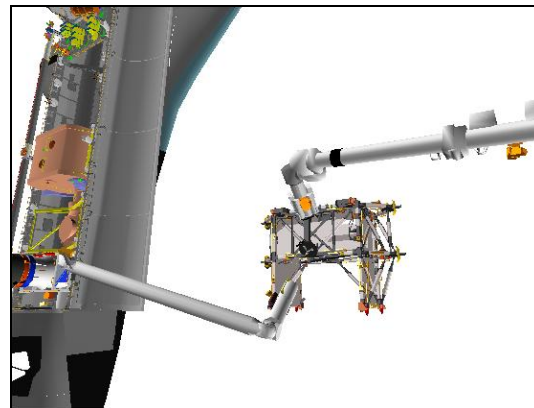

P1 LOWER OUTBOARD (150,15)

4. SRMS MNVR TO P5 INSTALL VIEW

MON 1	DNLK
SSRMS Base Elb (P1 LOOB)	Elbow (EE)
MON 2	DTV
B	A

RATE – as required (VERN within 10 ft)  
 BRAKES – OFF (tb-OFF)  
 MODE – best available

Mnvr to P5 INSTALL VIEW posn (reference pictures as reqd):

	SY	SP	EP	WP	WY	WR	
Ungrapple Backoff	+104.3	+46.5	-32.1	-99.8	-48.0	-120.4	
1: SY +	+154.9						
2: SP -		+6.7					
3: EP -			-32.8				
4: WP +				+103.6			
5: WY +					-44.2		
6: WR +						+84.0	
P5 Install Viewing	+154.9	+6.7	-32.8	+103.6	-44.2	+84.0	
	X	Y	Z	PITCH	YAW	ROLL	PL ID
	-230	-335	-325	70	63	289	0

BRAKES – ON (tb-ON)  
 MODE – not DIRECT

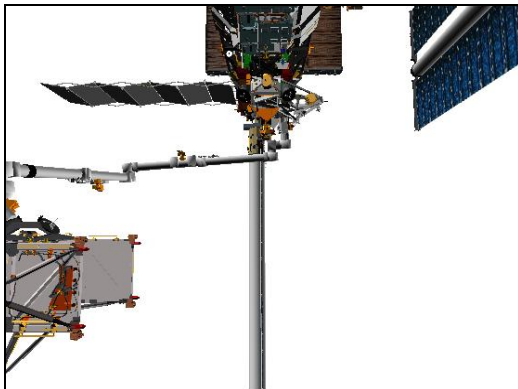

**SRMS ELBOW (-55,75)**

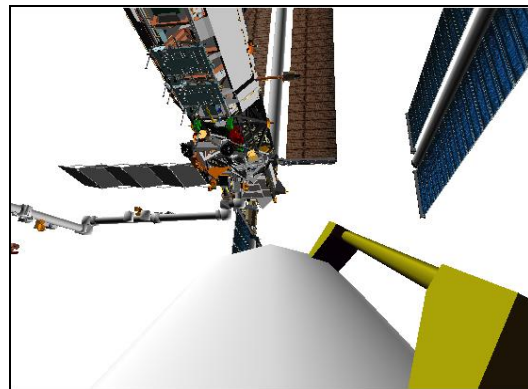

**SRMS EE**

Step 1:

Drive WP+ (for 203.4°)  
From -99.8 to +103.6

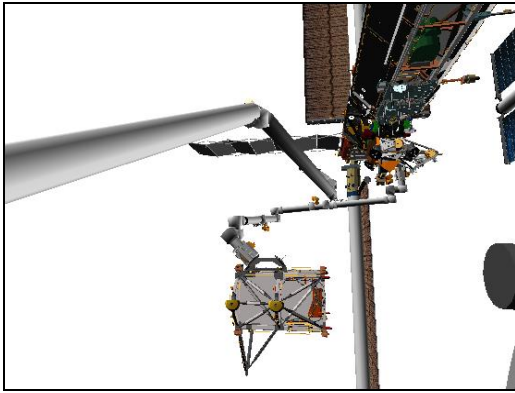

**CCTV A (80,10)**

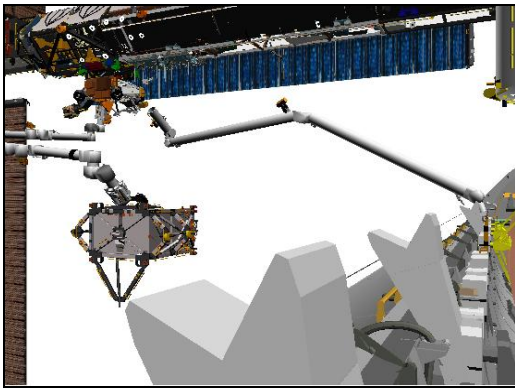

**CCTV B (-25,0)**

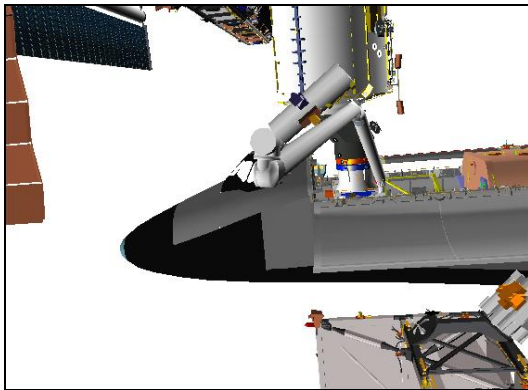

**SSRMS BASE ELBOW (90,-5)**

Step 2:

Drive WY+ (for 3.8°)  
From -48.0 to -44.2

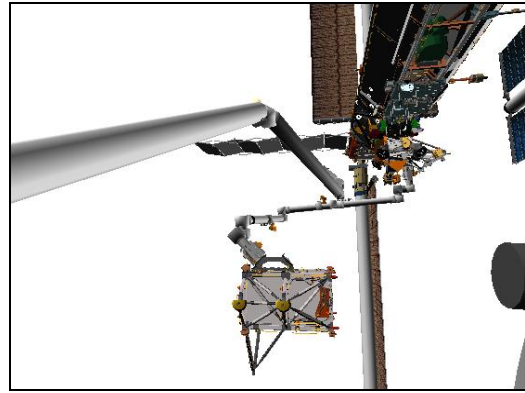

**CCTV A (80,10)**

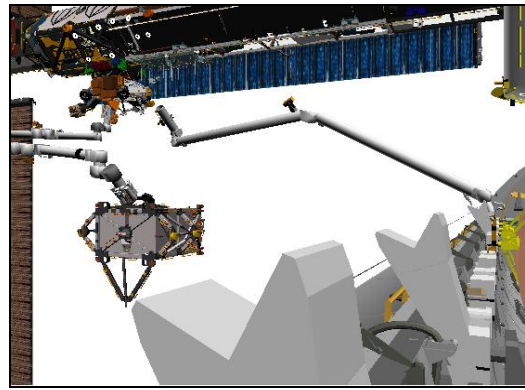

**CCTV B (-25,0)**

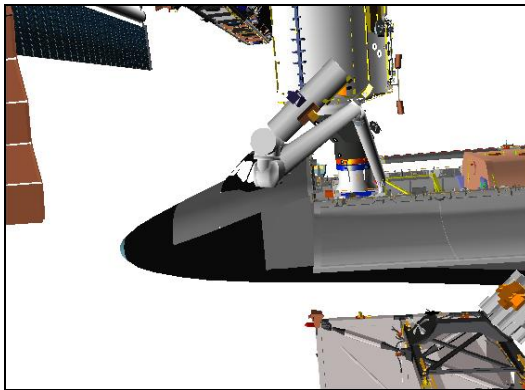

**SSRMS BASE ELBOW (90,-5)**



Step 3:

Drive WR+ (for 204.4°)  
From -120.4 to +84.0

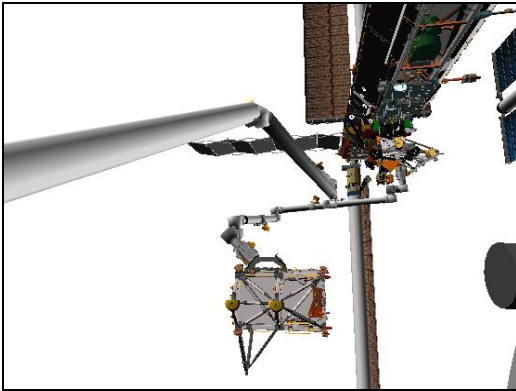

**CCTV A (80,10)**

Step 4:

Drive SY+ (for 50.6°)  
From +104.3 to +154.9

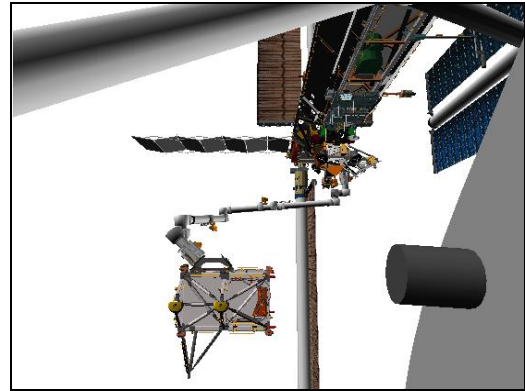

**CCTV A (90,10)**

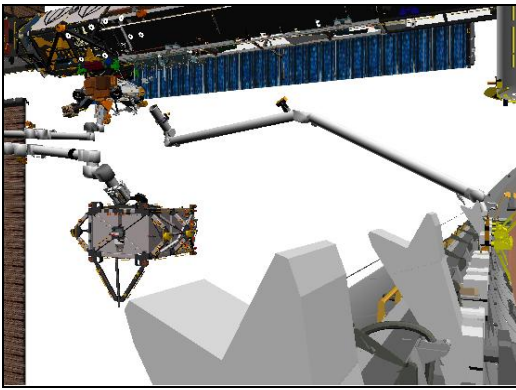

**CCTV B (-25,0)**

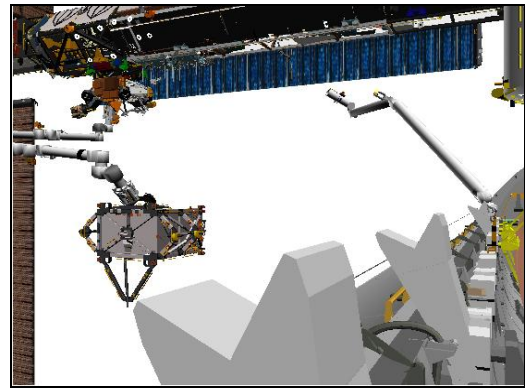

**CCTV B (-25,0)**

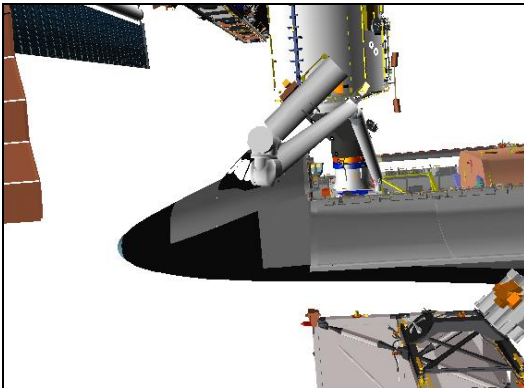

**SSRMS BASE ELBOW (90,-5)**

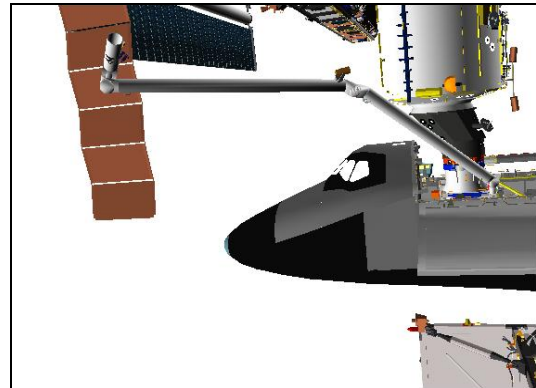

**SSRMS BASE ELBOW (80,-5)**

Step 5:

Drive SP- (for  $39.8^\circ$ )  
From +46.5 to +6.7

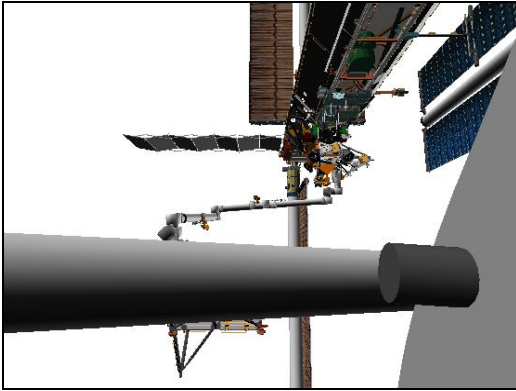

**CCTV A (90,10)**

Step 6:

Drive EP- (for  $0.7^\circ$ )  
From -32.1 to -32.8

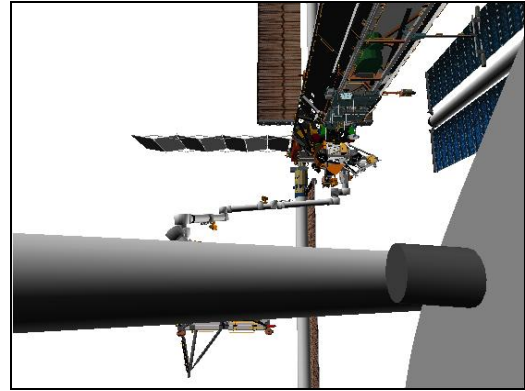

**CCTV A (90,10)**

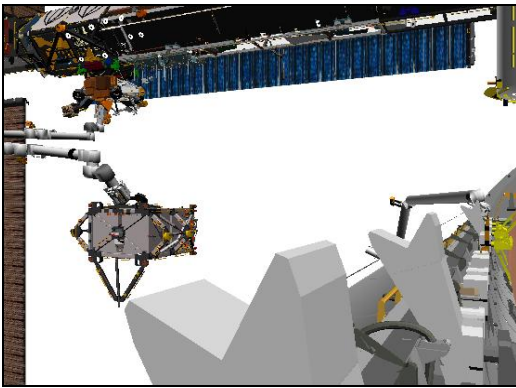

**CCTV B (-25,0)**

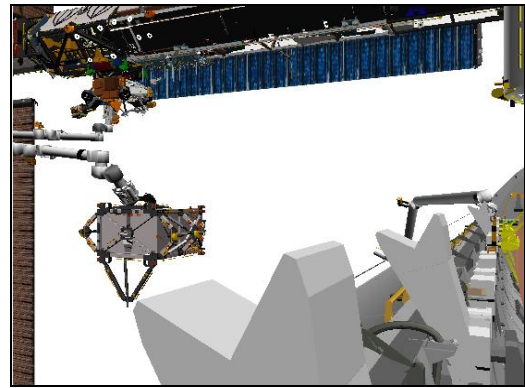

**CCTV B (-25,0)**

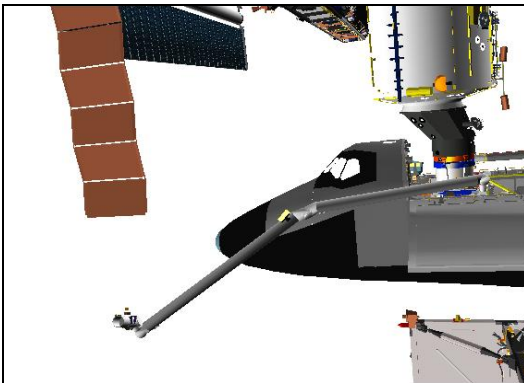

**SSRMS BASE ELBOW (80,-5)**

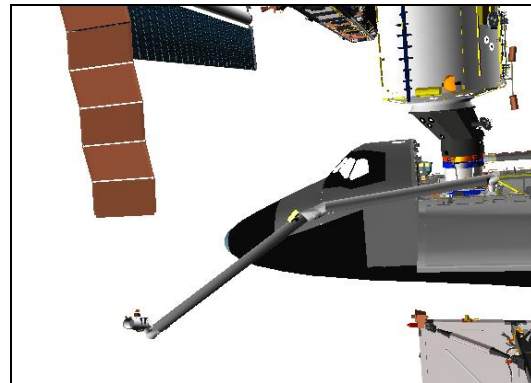

**SSRMS BASE ELBOW (80,-5)**

# P5 CONTINGENCY REBERTH

## 1. SRMS MNVR TO P5 FORWARD

MON 1	DNLK
P1 LOOB	Elbow
MON 2	DTV
A	B

RATE – as required (VERN within 10 ft)

BRAKES – OFF (tb-OFF)

MODE – ORB LD, ENTER

Mnvr to P5 FORWARD posn:

X	Y	Z	PITCH	YAW	ROLL	PL ID
-674	-450	-388	0	0	0	4
SY	SP	EP	WP	WY	WR	
+102.4	+79.9	-98.1	-65.0	-47.8	-117.5	

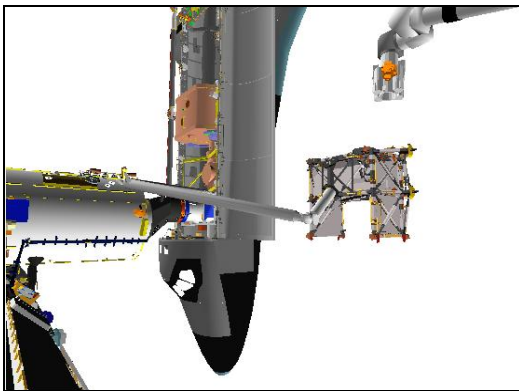

**P1 OUTBOARD LOWER (128,6)**

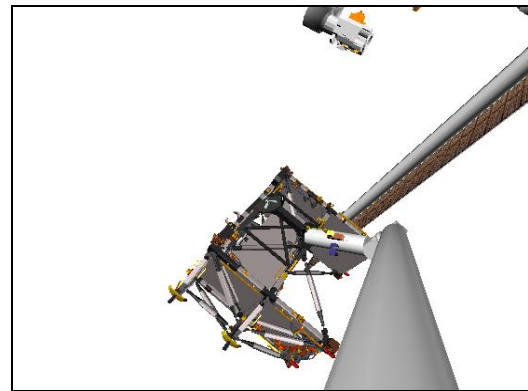

**SRMS ELBOW (-20,0)**

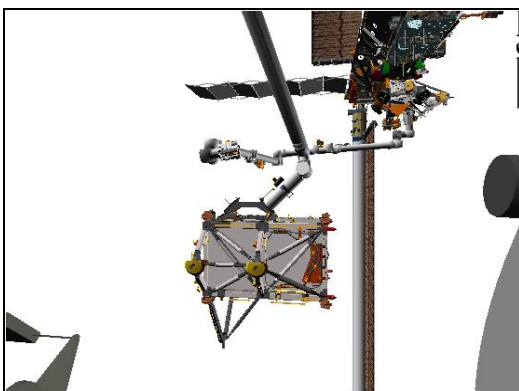

**CCTV A (80,0)**

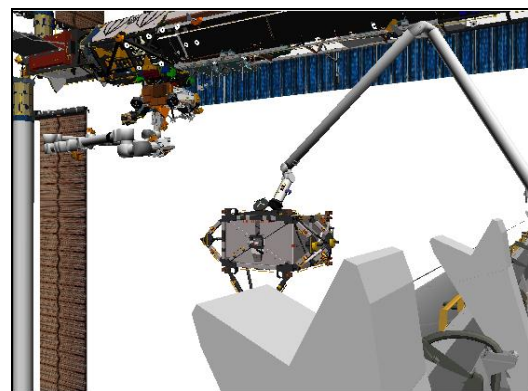

**CCTV B (-30,0)**

## 2. SRMS MNVR TO P5 PORT

MON 1	DNLK
P1 LOOB	Elbow (C)
MON 2	DTV
A	B

RATE – as required (VERN within 10 ft)

BRAKES – OFF (tb-OFF)

MODE – ORB LD, ENTER

Mnvr to P5 PORT posn:

X	Y	Z	PITCH	YAW	ROLL	PL ID
-1089	-250	-575	0	0	0	4
SY	SP	EP	WP	WY	WR	
+9.8	+77.2	-73.2	-46.1	+6.4	-30.8	

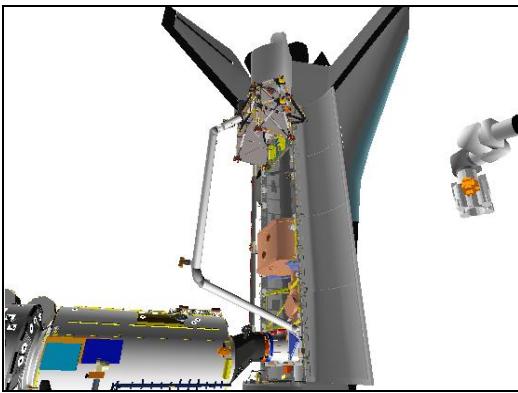

**P1 LOWER OUTBOARD (114,28)**

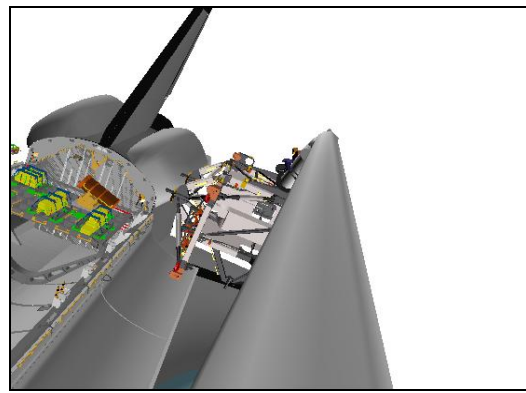

**SRMS ELBOW (-10,-15)**

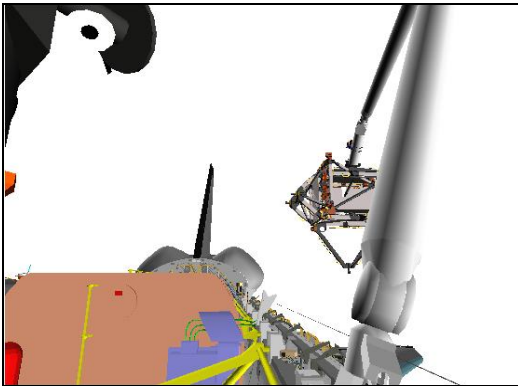

**CCTV A (5,15)**

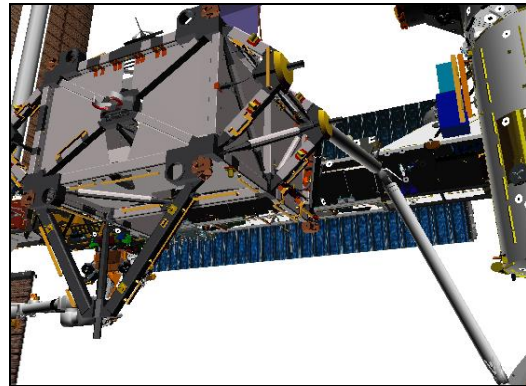

**CCTV B (-25,20)**

### 3. MNVR TO P5 LOW HOVER

MON 1	DNLK
P1 LOOB	C (Elbow)
MON 2	DTV
A	B

RATE – VERN (RATE MIN tb-ON)

BRAKES – OFF (tb-OFF)

MODE – ORB LD, ENTER

Mnvr to P5 LOW HOVER posn:

X	Y	Z	PITCH	YAW	ROLL	PL ID
-1089	0	-575	0	0	0	4
SY	SP	EP	WP	WY	WR	
-26.9	+67.2	-77.1	-42.0	+32.0	-2.6	

BRAKES – ON (tb-ON)

√MODE – not DIRECT

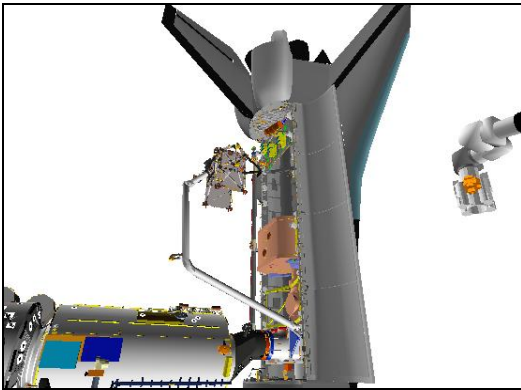

**P1 LOWER OUTBOARD (114,28)**

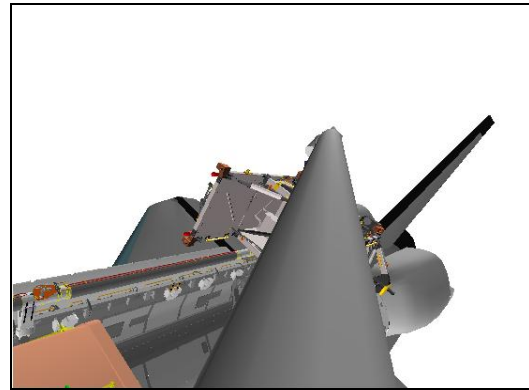

**SRMS ELBOW (-10,-15)**

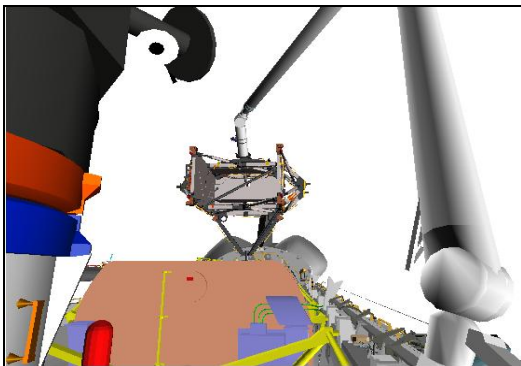

**CCTV A (-5,15)**

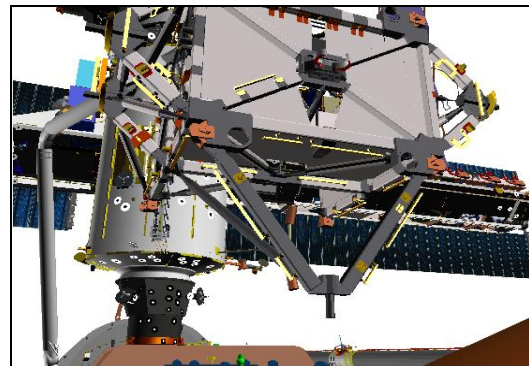

**CCTV B (20,20)**

4. MNVR TO P5 BERTHED

MON 1	DNLK
SSRMS Base Elbow → Lab Stbd Zenith	Elbow
MON 2	DTV
C → B/C	A

RATE – VERN (RATE MIN tb-ON)  
 BRAKES – OFF (tb-OFF)  
 MODE – ORB LD, ENTER

Mnvr to P5 BERTHED posn (insert data from P5 GRAPPLE):

X	Y	Z	PITCH	YAW	ROLL	PL ID
						4
SY	SP	EP	WP	WY	WR	

√PL RETEN RDY 1,2,3,4 tb (four) – gray  
 BRAKES – ON (tb-ON)  
 √MODE – not DIRECT

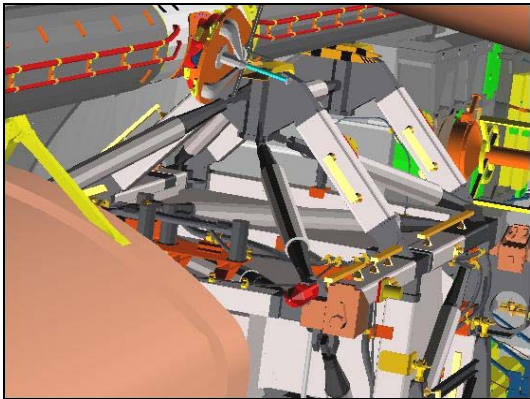

**LAB STBD ZENITH (-20,-29)**

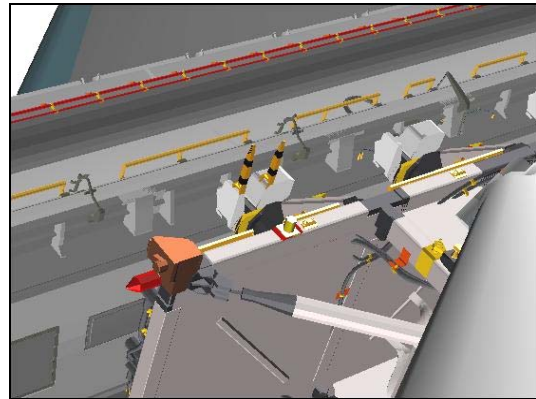

**SRMS ELBOW (-10,-5)**

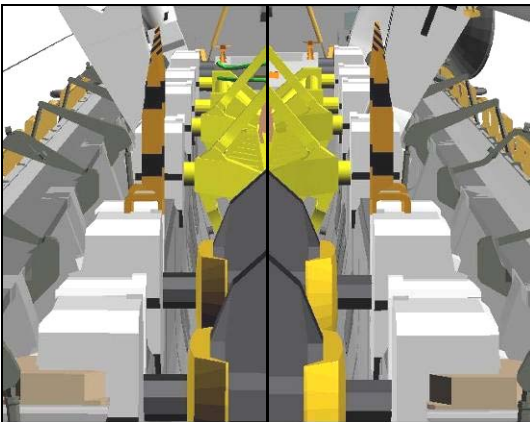

**CCTV B (-2,-6)/CCTV C (2,-6)**

5. ACTIVATE LATCHES

NOTE

When LOGIC switches taken OFF, KU will mode to standby. MPM and MRL tbs – bp

MA73C:A MCA LOGIC MNC MID 2 – OFF  
:B MNB MID 4 – OFF

A6U √PL RETEN LAT(five) – OFF  
√PL SEL – 1  
R13L BAY MECH PWR SYS (1,2) – ON  
A6U RETEN LOGIC PWR SYS (1,2) – ON

SM 97 PL RETENTION

√PL SEL 1 RDY-FOR-LAT 1,2,3,4 (eight) – 1  
√LAT 1,2,3,4,5 (ten) – 0

- \* If any lat msw shows '1', expect \*
- \* single motor time (60 sec) \*

6. AKA LATCH

√PL RETEN LAT 5 tb – REL  
√RDY 5 tb – bp

Note single motor times (>30 sec)  
PL RETEN LAT 5 – LAT (tb-LAT), 60 sec max  
– OFF  
√RDY 5 tb – gray

7. PRLA LATCH

√PL RETEN LAT 1,2,3,4 tb – REL  
√RDY 1,2,3,4 tb – gray

Note single motor times (>30 sec)  
PL RETEN LAT 1,2 (two) – LAT (tb-LAT), 60 sec max  
– OFF  
3,4 (two) – LAT (tb-LAT), 60 sec max  
– OFF

8. DEACTIVATE LATCHES

R13L PL RETEN LOGIC PWR SYS (1,2) – OFF  
BAY MECH PWR SYS (1,2) – OFF

MA73C:A MCA LOGIC MNC MID 2 – ON  
:B MNB MID 4 – ON

9. P5 UNGRAPPLE SETUP

A7U CCTV – RMS WRIST, zoom 34.0 HFOV  
focus 5 ft

MON 1	DNLK
SSRMS Base Elb	EE (Elbow)
MON 2	DTV
A	C

**SM 94 PDRS CONTROL**

PL ID – ITEM 3 +0 EXEC

INIT ID – ITEM 24 +0 EXEC

10. **P5 UNGRAPPLE**

RATE – VERN (RATE MIN tb-ON)

BRAKES – OFF (tb-OFF)

MODE – END EFF, ENTER

**CAUTION**

Monitor EE tb timing to prevent EE motor burnout

**NOTE**

When OPEN tb – gray, mnvr arm clear of GF

EE MODE – AUTO

RELEASE sw – depress (mom)

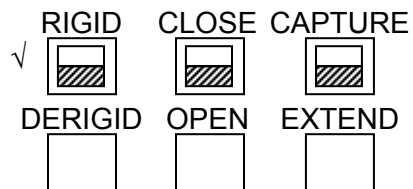

**CRITICAL TIMES (28 sec total):**

DERIGID tb – gray, 5 sec max, then

OPEN tb – gray, 3 sec max, then

EXTEND tb – gray, 20 sec max

EE MODE – OFF

BRAKES – ON (tb-ON)

√MODE – not DIRECT



P5 REFERENCE DATA

JOINT ANGLES VS POR COORDINATES .....	FS 3-2
P5 COORDINATE SYSTEM – PL ID 4 .....	FS 3-3
PRLA CONFIGURATION .....	FS 3-4
RMS/P5 GO/NO-GO SUMMARY .....	FS 3-5
ATTITUDE CONTROL CONSTRAINTS.....	FS 3-6
P5 INSTALL CAMERA MATRIX .....	FS 3-7

**P5 REFERENCE  
DATA**

## JOINT ANGLES VS POR COORDINATES

### P5 PRE-GRAPPLE

X	Y	Z	PITCH	YAW	ROLL	PL ID
-1023	0	-509	315	0	331	0
SY	SP	EP	WP	WY	WR	
-24.1	+69.6	-105.5	-14.7	+30.3	-5.1	

### P5 GRAPPLE

X	Y	Z	PITCH	YAW	ROLL	PL ID
-1066	0	-466	315	0	331	0
-1089	0	-414	0	0	0	4
SY	SP	EP	WP	WY	WR	
-19.4	+57.8	-97.8	-8.6	+27.2	-9.2	

### P5 LOW HOVER

X	Y	Z	PITCH	YAW	ROLL	PL ID
-1066	0	-627	315	0	331	0
-1089	0	-575	0	0	0	4
SY	SP	EP	WP	WY	WR	
-26.9	+67.2	-77.1	-42.0	+32.0	-2.6	

### P5 PORT

X	Y	Z	PITCH	YAW	ROLL	PL ID
-1066	-250	-627	315	0	331	0
-1089	-250	-575	0	0	0	4
SY	SP	EP	WP	WY	WR	
+9.8	+77.2	-73.2	-46.1	+6.4	-30.8	

### P5 FORWARD

X	Y	Z	PITCH	YAW	ROLL	PL ID
-651	-450	-440	315	0	331	0
-674	-450	-388	0	0	0	4
SY	SP	EP	WP	WY	WR	
+102.4	+79.9	-98.1	-65.0	-47.8	-117.5	

### P5 HANDOFF

X	Y	Z	PITCH	YAW	ROLL	PL ID
-651	-594	-440	315	0	331	0
-674	-594	-388	0	0	0	4
SY	SP	EP	WP	WY	WR	
+98.7	+48.2	-43.3	-84.1	-47.3	-112.1	

### UNGRAPPLE BACKOFF

X	Y	Z	PITCH	YAW	ROLL	PL ID
-609	-594	-482	315	0	331	0
SY	SP	EP	WP	WY	WR	
+104.3	+46.5	-32.1	-99.8	-48.0	-120.4	

### P5 INSTALL VIEW

X	Y	Z	PITCH	YAW	ROLL	PL ID
-230	-335	-325	70	63	289	0
SY	SP	EP	WP	WY	WR	
+154.9	+6.7	-32.8	+103.6	-44.2	+84.0	

P5 REFERENCE DATA

**P5 COORDINATE SYSTEM – PL ID 4**

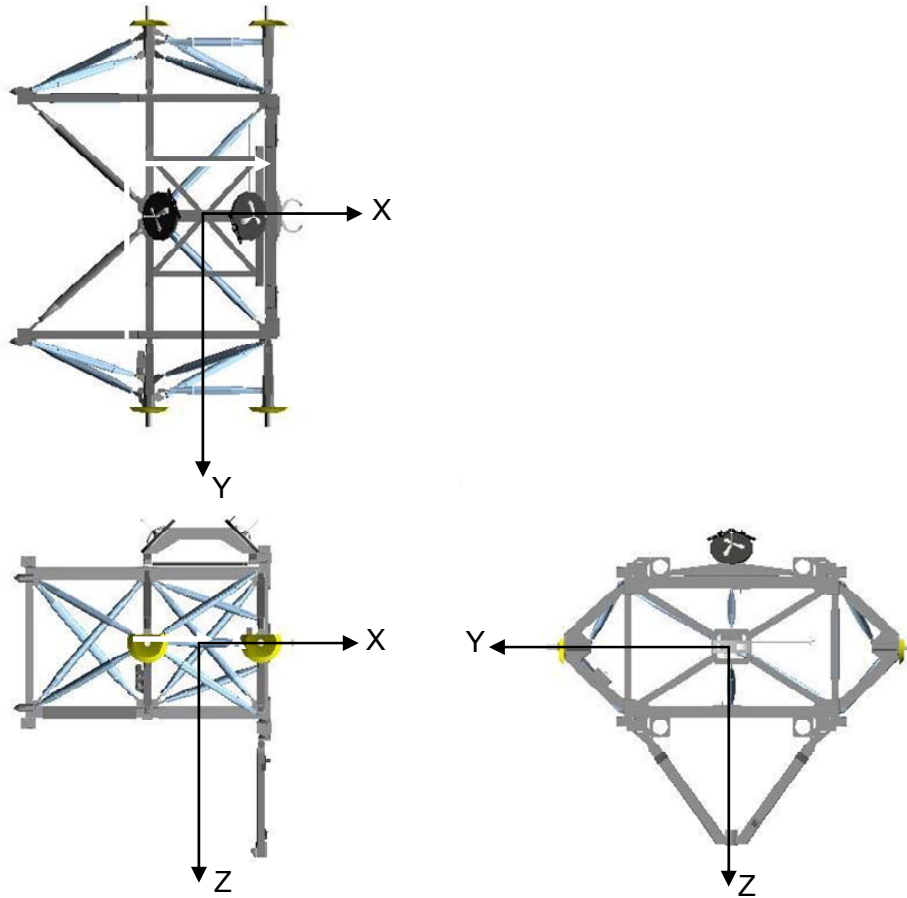

POR: At midpoint between forward and aft trunnions, at trunnion level

PURPOSE: P5 Unberth and Maneuvering

RATES:	<u>COARSE</u>	<u>VERN</u>
TRANS LIM ft/sec	0.36	0.12
ROT LIM deg/sec	1.43	0.48

# PRLA CONFIGURATION

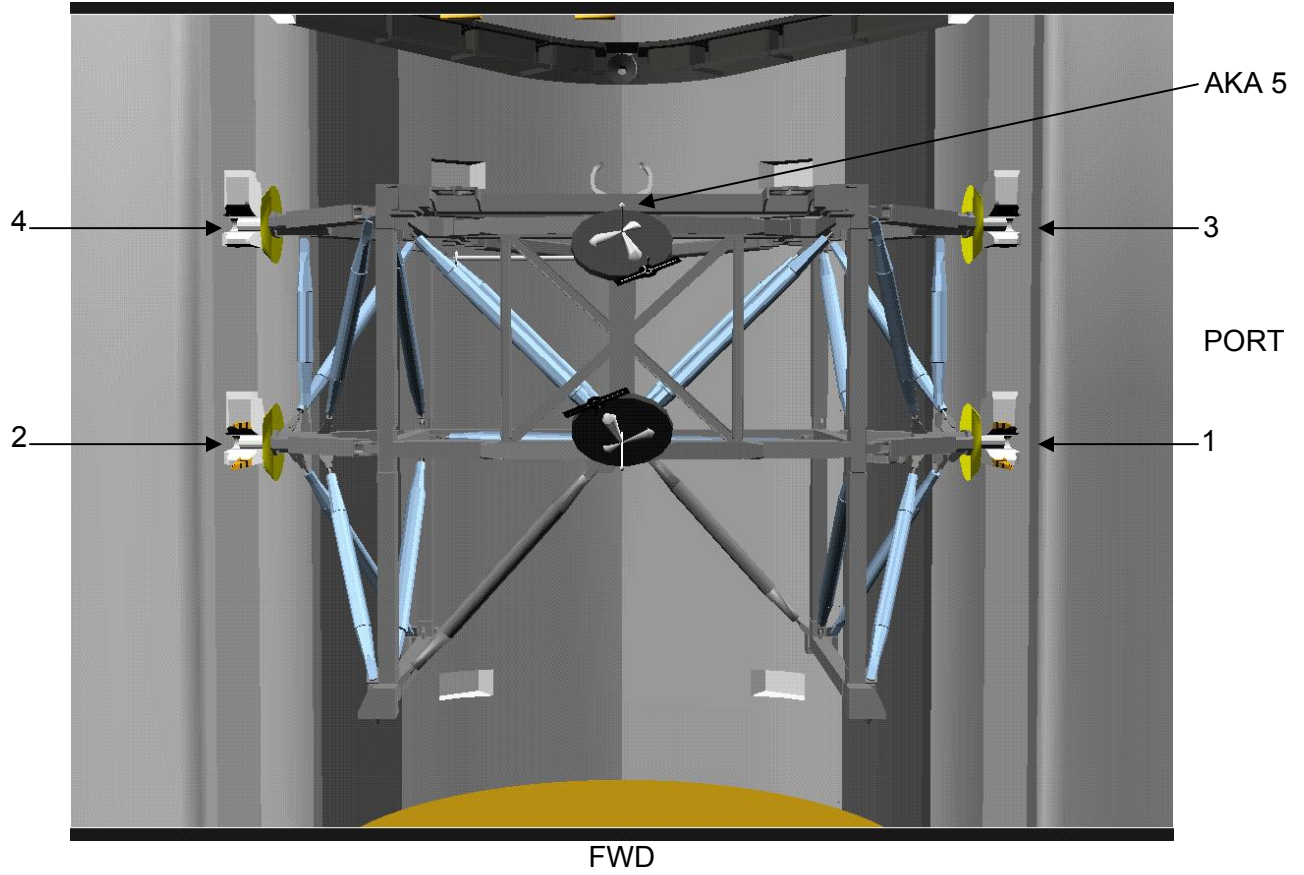

LAT/REL SEQUENCE	PL SEL	LAT/REL
AKA	1	5
PRLA	1	1,2 (fwds)
PRLA	1	3,4 (afts)

## RMS/P5 GO/NO-GO SUMMARY

THIS TABLE DOES NOT CONTAIN ANY FLIGHT SPECIFIC FLIGHT RULE EXCEPTIONS

CONTINUE OPS IF:	P5 OPERATIONS (HIGH PRIORITY)	FLT RULE REF
SHOULDER BRACE REL [1]	0 ↓ [1]	
JETTISON SYSTEM [2]	1 ↓ [2]	A12-181
MPM STOW MOTORS [2]	2 ↓ [1]	A12-72
MRL LATCH CAPABILITY [3]	3 ↓ [3]	A12-73
MPM [4] STOWED IND [8]		
MPM [4] DEPLOY IND [8]	SH 1 ↓	
MRLs LATCHED [3]		
MAN AUG MODE [1]		
SINGLE MODE [1]	3 ↓ [4]	A12-111
DIRECT MODE [1]		
BACKUP MODE [1]		
BRAKES [6]	0 ↓	
AUTO BRAKES [1]	0 ↓ [5]	
CAPTURE & RIGIDIZE [2]	1 ↓	
DERIGIDIZE [2]	2 ↓ [6]	A12-161
RELEASE [2]	2 ↓	A12-161
BACKUP RELEASE [1]		
THERMAL [DEG.F] -20[0], 176[172], LED -20[0], 147[144], ABE (EE) -20[0] 110[106] ABE (SPA)	REQD	A12-3

### NOTES:

- [1] EVA CAPABILITY EXISTS FOR THE FOLLOWING CONTINGENCIES:
- SHOULDER BRACE RELEASE
  - MPM DEPLOY/STOW
  - RMS STRAPDOWN
  - GRAPPLE FIXTURE (GF) RELEASE
- [2] IFM IS AVAILABLE TO RECOVER JETTISON SYSTEM; HIGH PRIORITY RMS ACTIVITIES MAY CONTINUE
- [3] CONTINUE OPERATIONS EVEN IF ONE FAILURE WILL RESULT IN THE INABILITY TO LATCH AT LEAST TWO MRLs (ASSUMES CURRENTLY HAVE TWO-LATCH CAPABILITY). EVA CAPABILITY REQUIRED
- [4] ONE OF SINGLE, DIRECT, OR BACKUP REQUIRED FOR UNCRADLING
- [5] OPERATIONS CAN CONTINUE IN DIRECT OR BACKUP WITH THE LOSS OF AUTO BRAKES. CAPTURE CAPABILITY DOES NOT EXIST IN BACKUP
- [6] WITHOUT THE CAPABILITY TO DERIGIDIZE/EXTEND THE SNARE CARRIAGE, FUTURE CAPTURE CAPABILITY IS LOST

# RMS/P5 ATTITUDE CONTROL CONSTRAINTS

ATTITUDE CONTROL & OPS [1]  P5 CONFIG		STS ATTITUDE CONTROL		ISS ATTITUDE CONTROL			OPERATIONS					
		VRCS	PRCS	CMG - TA		THRUSTERS ONLY	CREW EXERCISE (ISOLATED OR UN-ISOLATED)	EVA OPS	REBOOST (STS, SM, PROG)	UNDOCKING (STS/RS)	DOCKING (STS/RS)	PORT SARJ/ P4 BGA ROTATION
				MOM MGMT OR ATT HOLD	DESAT REQUEST							
P5 BERTHED IN PAYLOAD BAY		TBD	TBD						OK			
SRMS OPS	UNBERTH < 2 FT/5 FT [2]			OK	INH	NOT OK	OK					
	UNBERTH > 2 FT/5 FT TO LOW HOVER [2]			OK	ENA	OK	OK					
	AT P5 LOW HOVER	TBD	TBD	OK	ENA	OK	OK					
	MNVR FROM P5 LOW HOVER TO P5 PORT	TBD	TBD	OK	ENA	OK	OK					
	MNVR FROM P5 PORT TO P5 HANDOFF	TBD	TBD	OK	ENA	OK	OK					
	AT P5 HANDOFF WITH SSRMS UNGRAPPLED	TBD	TBD	OK	ENA	OK	OK					
SIM O	AT HANDOFF WITH BOTH SRMS & SSRMS GRAPPLED	TBD	TBD	OK	TBD	TBD						
SSRMS OPS	AT P5 HANDOFF WITH SRMS UNGRAPPLED	TBD	TBD	OK	ENA	OK	TBD	TBD	TBD	TBD	TBD	TBD
	MNVR TO P5 OVERNIGHT PARK	TBD	TBD	OK	ENA	OK	TBD	TBD	TBD	TBD	TBD	TBD
	AT P5 OVERNIGHT PARK	TBD	TBD	OK	ENA	OK	TBD	TBD	TBD	TBD	TBD	TBD
	MNVR TO P5 PREINSTALL POSITION	TBD	TBD	OK	ENA	OK	TBD	TBD	TBD	TBD	TBD	TBD
	AT P5 PRE-INSTALL	TBD	TBD	OK	ENA	OK	TBD	TBD	TBD	TBD	TBD	TBD
	MNVR TO SOFTDOCK			OK	TBD		TBD	TBD	TBD	TBD	TBD	TBD
	AT MODIFIED RTAS SOFTDOCK	TBD	TBD	OK	ENA	OK	TBD	TBD	TBD	TBD	TBD	TBD
	MODIFIED RTAS BOLTING IN PROGRESS	TBD	TBD	OK	TBD	OK	TBD	TBD	TBD	TBD	TBD	TBD
MODIFIED TRAS BOLTING COMPLETE	TBD	TBD	OK	TBD	OK	TBD	TBD	TBD	TBD	TBD	TBD	

NOTES:

- [1] KEY:  ACS OR OPS ALLOWED     ACS OR OPS NOT ALLOWED     NOT ANALYZED
- [2] MINIMUM DISTANCE CONSTRAINT IS 2 FT FOR VRCS AND SM THRUSTERS, 5 FT FOR PRCS

## P5 INSTALL CAMERA MATRIX

	Task	Shuttle				Station				
		MON 1	MON 2 (Orb Ch 1) (DCPL 92)	Downlink (Orb Ch 2) (DCPL 91)	DTV	Mon 1	Mon 2	Mon 3	To Orbiter	Downlink
P	P5 Grapple	A	SSRMS Base Elbow	Elbow (EE) → EE (Elbow)	D				43: Base Elbow	
P	P5 Unberth	Lab Stbd Zenith → SSRMS Base Elbow	B/C → C	Elbow	A				28: Lab Stbd Zenith 43: Base Elbow	
P	P5 Port	C (Elbow)	B (A)	P1 LOOB (A)	A				19: P1 LOOB	
P	P5 Forward	Elbow	B (A)	P1 LOOB (A)	A				19: P1 LOOB	
P	P5 Handoff Maneuver	Elbow	B (A)	P1 LOOB (A)	A				19: P1 LOOB	
R	SSRMS Grapple P5		A	B	B	92: A	25: Tip LEE	91: B		
P	SRMS Ungrapple P5	P1 LOOB	A (D)	EE	B				19: P1 LOOB	
P	P5 Install View	P1 LOOB (SSRMS Base Elbow)	B	Elbow → EE	A				43: Base Elbow (19: P1 LOOB)	
R	Maneuver to P5 Pre-Install		B	Elbow		24: Tip Elbow	92: B	09: P1 Outboard Lower → 22: Base Elbow		
R	P5 Install		B	Elbow		24: Tip Elbow	09: P1 Outboard Lower (92: B)	22: Base Elbow (91: SRMS Elbow)		
R	P5 Ungrapple			Elbow		24: Tip Elbow	25: Tip LEE	22: Base Elbow		
R	SSRMS Stow During EVA		B	Elbow		24: Tip Elbow	92: B	22: Base Elbow		

### Legend:

A, B, C, D: Orbiter Payload Bay Camera A, B, C, D

Elbow: SRMS Elbow

EE: SRMS End Effector

Base LEE: SSRMS Base LEE (DCP: 21, PCS: 40)

Base Elbow: SSRMS Base Elbow (DCP: 22, PCS: 43)

Tip Elbow: SSRMS TIP Elbow (DCP: 24, PCS: 48)

Tip LEE: SSRMS TIP LEE (DCP: 25, PCS: 51)

P1 LOOB: P1 Lower Outboard (DCP: 09, PCS: 19)

Lab Stbd Zenith: Lab Starboard Zenith (DCP: 13, PCS: 28)

R: ROBO Procedure

P: PDRS Procedure

1. Cameras in parentheses are backup camera options
2. If specific cameras are not identified, DCPL 91 and 92 are displayed to the ISS crew for situational awareness
3. Images displayed on monitors 1 and 2 are recorded on the Orbiter
4. ISS video comes to Orbiter on PL2. The desired source is routed to 11 – VTR 2
5. Camera numbers on Mon 1 (Station), Mon 2 (Station), and Mon 3 (Station) are camera numbers for RWS DCP routing. Camera numbers in To Orbiter (Station) and Downlink (Station) are for video routing via the PCS

This Page Intentionally Blank



VIEWING SUPPORT

4B SAW RETRACT VIEWING.....	FS 4-2
CETA CART RELOCATION VIEWING.....	FS 4-5

VIEWING  
SUPPORT

## 4B SAW RETRACT VIEWING

- A7U 1. SETUP  
CCTV – config for 4B SAW RETRACT viewing

MON 1	DNLK
A	Elbow (EE)
MON 2	DTV
B	P1 LOOB

SM 94 PDRS CONTROL

- √PL ID, ITEM 3: 0  
√INIT ID, ITEM 24: 0

### NOTE

During SAW Retraction, no arm motion is allowed while the SAW Motor is driving

2. MNVR TO 4B SAW RETRACT VIEWING POSN  
RATE – as required (VERN within 10 ft)  
BRAKES – OFF (tb-OFF)  
MODE – SINGLE, ENTER

Mnvr to 4B SAW RETRACT VIEWING posn:

	SY	SP	EP	WP	WY	WR	
Pre-Cradle	0.0	+25.0	-25.0	+5.0	0.0	0.0	
1: SP +		+35.0					
2: SY +	+136.0						
3: EP -			-47.0				
4: WP +				+86.6			
5: WY +					+62.6		
6: WR -						-23.2	
4B SAW	+136.0	+35.0	-47.0	+86.6	+62.6	-23.2	
	X	Y	Z	PITCH	YAW	ROLL	PL ID
	-290	-441	-464	139	338	173	0

- BRAKES – ON (tb-ON)  
√MODE – not DIRECT

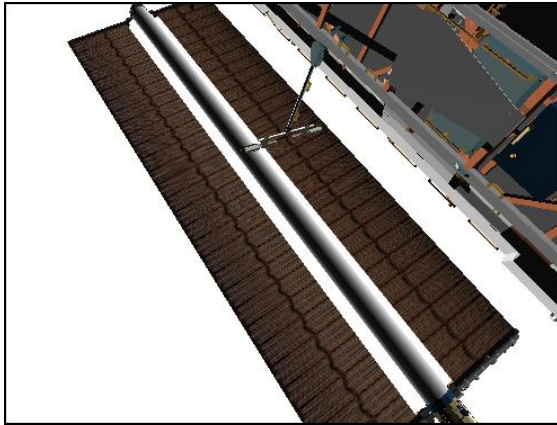

**SRMS ELBOW (58,14)**  
(P6 4B rotated at 163°)

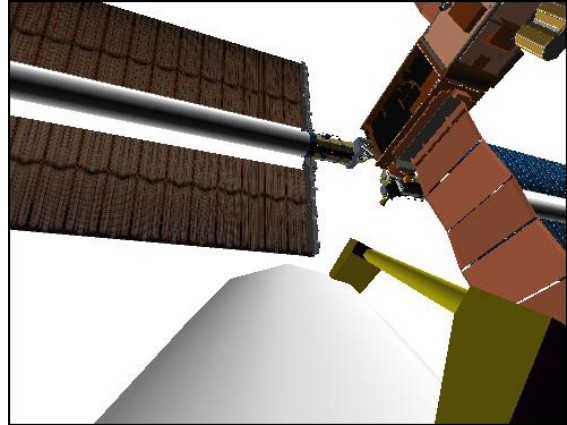

**SRMS EE**  
(P6 4B rotated at 163°)

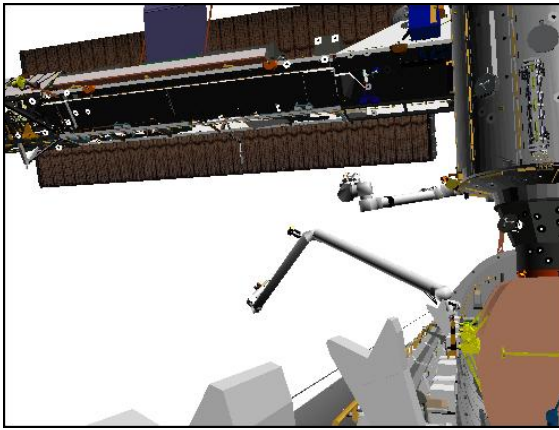

**CCTV B (-18,8)**  
(P6 4B rotated at 163°)

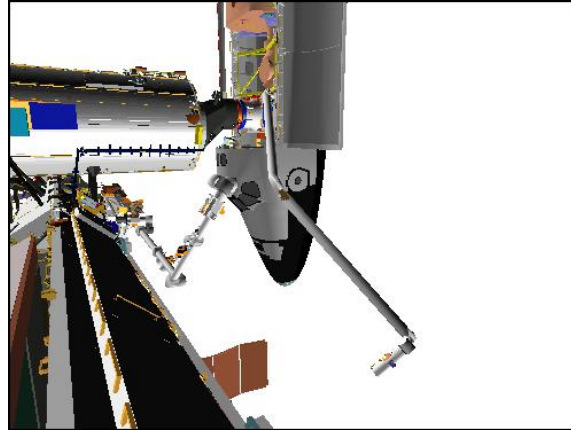

**P1 LOWER OUTBOARD (122,-11)**

NOTE

Pan and Tilt Elbow camera as required to view Blanket De-tension/  
Mast Deflection during 4B SAW Retraction. To view the leading  
edges of the P6 4B array at 56° or 236° once 4B is retracted and  
has 1 bay remaining, the recommended Elbow camera pan and tilt  
values are (74,-12). When 4B Retract Survey is complete,  
maneuver to SRMS Pre-Cradle position

3. MNVR TO SRMS PRE-CRADLE POSN  
 RATE – as required (VERN within 10 ft)  
 BRAKES – OFF (tb-OFF)  
 MODE – as desired

Mnvr to SRMS PRE-CRADLE posn:

	SY	SP	EP	WP	WY	WR	
4B SAW	+136.0	+35.0	-47.0	+86.6	+62.6	-23.2	
1: WR +						0.0	
2: WY –					0.0		
3: WP –				+5.0			
4: EP +			-25.0				
5: SY –	0.0						
6: SP –		+25.0					
Pre-Cradle	0.0	+25.0	-25.0	+5.0	0.0	0.0	
	X	Y	Z	PITCH	YAW	ROLL	PL ID
	-1261	-146	-551	5	2	0	0

- BRAKES – ON (tb-ON)  
 MODE – not DIRECT

# CETA CART RELOCATION VIEWING

1. SETUP  
 A7U CCTV – config for CETA CART RELOCATION viewing

MON 1	DNLK
B	Elbow (EE)
MON 2	DTV
A	C

SM 94 PDRS CONTROL

- √PL ID, ITEM 3: 0
- √INIT ID, ITEM 24: 0

2. MNVR TO CETA CART RELOCATION VIEWING POSN  
 RATE – as required (VERN within 10 ft)  
 BRAKES – OFF (tb-OFF)  
 MODE – SINGLE, ENTER

Mnvr to CETA CART RELOCATION VIEWING posn:

	SY	SP	EP	WP	WY	WR	
Pre-Cradle	0.0	+25.0	-25.0	+5.0	0.0	0.0	
1: SP +		+62.0					
2: WP +				+89.2			
3: WY +					+110.0*		
4: WR –						-41.6	
5: EP –			-93.9				
6: SY +	+162.2						
CETA Cart	+162.2	+62.0	-93.9	+89.2	+110.0	-41.6	
	X	Y	Z	PITCH	YAW	ROLL	PL ID
	-319	-190	-496	158	277	150	0

\* Expect SINGULAR It

- BRAKES – ON (tb-ON)
- √MODE – not DIRECT

### NOTE

Pan and Tilt Elbow camera as required for CETA cart relocation viewing

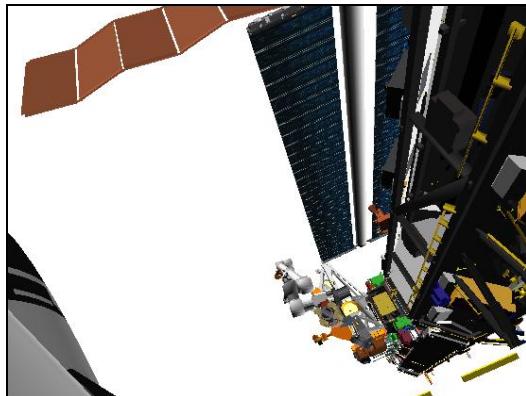

SRMS ELBOW (55,-45)

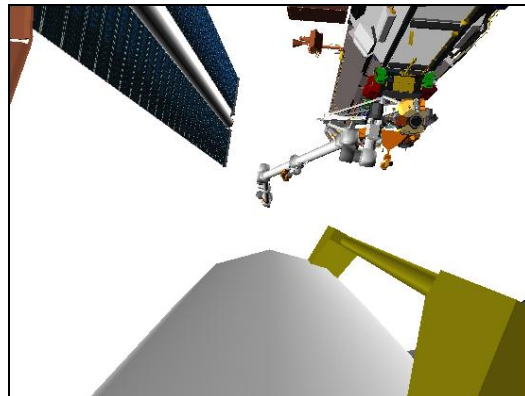

SRMS EE

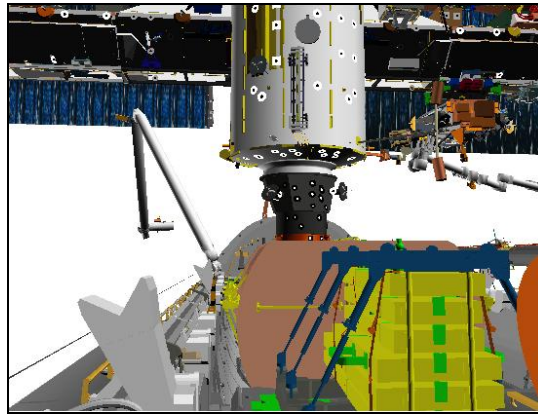

**CCTV B (5,5)**

**NOTE**

When CETA cart relocation viewing is complete, maneuver to SRMS Pre-Cradle position

**3. MNVR TO SRMS PRE-CRADLE POSN**

RATE – as required (VERN within 10 ft)

BRAKES – OFF (tb-OFF)

MODE – as desired

Mnvr to SRMS PRE-CRADLE posn:

	SY	SP	EP	WP	WY	WR	
CETA Cart	+162.2	+62.0	-93.9	+89.2	+110.0	-41.6	
1: SY –	0.0						
2: EP +			-25.0				
3: WR +						0.0	
4: WY –					0.0*		
5: WP –				+5.0			
6: SP –		+25.0					
Pre-Cradle	0.0	+25.0	-25.0	+5.0	0.0	0.0	
	X	Y	Z	PITCH	YAW	ROLL	PL ID
	-1261	-146	-551	5	2	0	0

\* Expect SINGULAR It

BRAKES – ON (tb-ON)

√MODE – not DIRECT

CONTINGENCY SUPPORT

P1 PUMP MODULE HANDOFF .....	FS 5-2
S1 PUMP MODULE HANDOFF .....	FS 5-9
MBSU R&R VIEWING .....	FS 5-15
4B SAW RETRACT VIEWING WITH OBSS.....	FS 5-17
CETA CART RELOCATION VIEWING WITH OBSS .....	FS 5-19

# P1 PUMP MODULE HANDOFF

1. SETUP  
 A7U CCTV – config for maneuver to Clearance

MON 1	DNLK
P1 LOOB	Elbow (EE)
MON 2	DTV
A	B

SM 94 PDRS CONTROL

- √PL ID, ITEM 3: 0  
 √INIT ID, ITEM 24: 0

2. MNVR TO P1 PUMP MODULE CLEARANCE POSN  
 RATE – as required (VERN within 10 ft)  
 BRAKES – OFF (tb-OFF)  
 MODE – SINGLE, ENTER

Mnvr to P1 PUMP MODULE CLEARANCE posn:

	SY	SP	EP	WP	WY	WR	
Pre-Cradle	0.0	+25.0	-25.0	+5.0	0.0	0.0	
1: SY +	+83.9						
2: SP +		+30.0					
3: EP –			-94.9				
4: WP +				+82.4			
5: WY –					-56.1		
6: WR –						-30.4	
Clearance	+83.9	+30.0	-94.9	+82.4	-56.1	-30.4	
	X	Y	Z	PITCH	YAW	ROLL	PL ID
	-767	-432	-209	1	28	313	0

- BRAKES – ON (tb-ON)  
 √MODE – not DIRECT

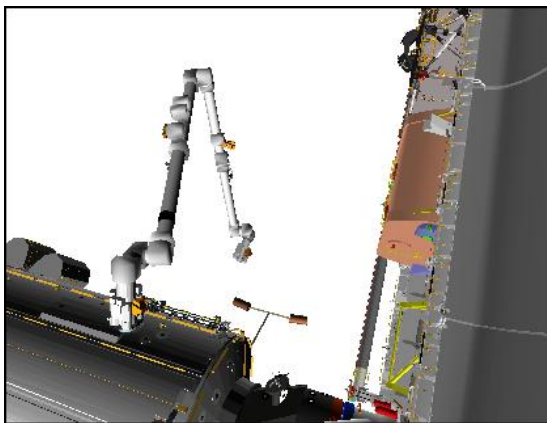

SRMS ELBOW (-110,-20)

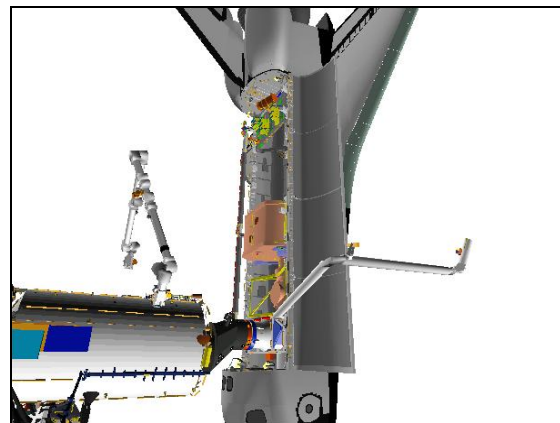

P1 LOWER OUTBOARD (120,22)

CONTINGENCY SUPPORT



3. MANEUVER TO P1 PUMP MODULE PRE-GRAPPLE POSN

Verify SSRMS at Handoff position

RATE – VERN (RATE MIN tb-ON)

BRAKES – OFF (tb-OFF)

MODE – ORB UNL, ENTER

Mnvr to P1 PUMP MODULE PRE-GRAPPLE posn:

X	Y	Z	PITCH	YAW	ROLL	PL ID
-767	-432	-520	1	28	313	0
SY	SP	EP	WP	WY	WR	
+81.5	+96.8	-116.0	+35.6	-53.8	-31.7	

BRAKES – ON (tb-ON)

√MODE – not DIRECT

4. P1 PUMP MODULE GRAPPLE

A7U

CCTV – config for grapple

– install PDRS TARGET OVERLAY FOR CTVM

– RMS WRIST, zoom 34.0 HFOV

focus 5 ft

Maintain eyepoint approx 18 in when using grapple overlay

MON 1	DNLK
SSRMS Base Elbow	EE
MON 2	DTV
A	B

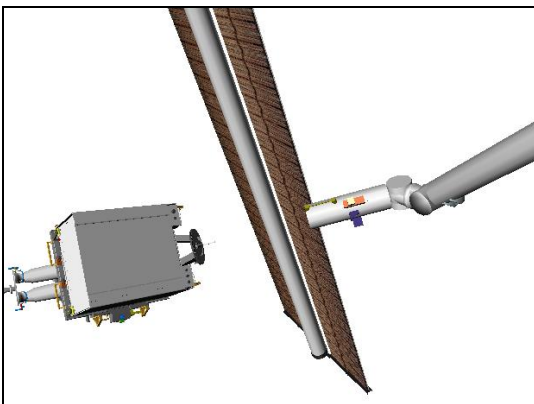

SSRMS BASE ELBOW (-100,0)

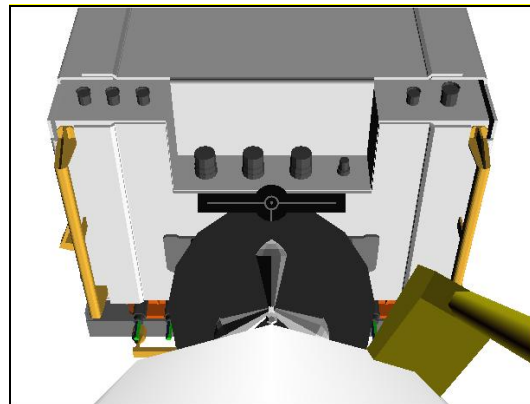

SRMS EE



CCTV A (45,19)

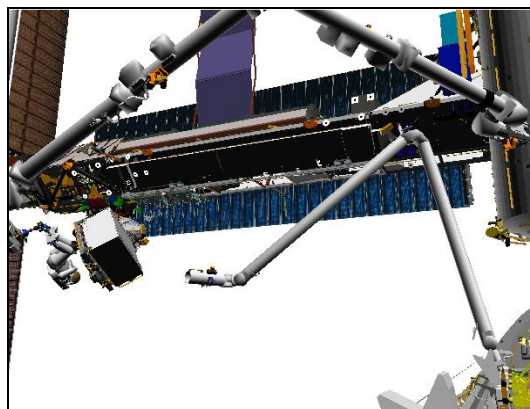

CCTV B (-24,14)

On ISS and EV GO, perform P1 Pump Module Grapple

RATE – VERN (RATE MIN tb-ON)  
BRAKES – OFF (tb-OFF)  
MODE – END EFF, ENTER

Mnvr to grapple envelope

**CAUTION**  
Monitor EE tb timing to prevent EE motor burnout

Inform EV of Pump Module Grapple

EE MODE – AUTO  
CAPTURE sw – depress (mom)

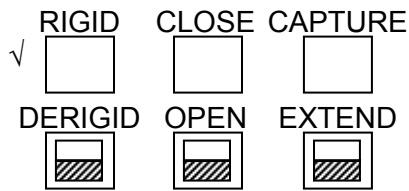

CRITICAL TIMES (28 sec total):  
CAPTURE tb – gray, then  
CLOSE tb – gray, 3 sec max, then  
RIGID tb – gray, 25 sec max

- \* If manual grapple reqd: \*
- \* EE MODE – MAN \*
- \* CAPTURE sw – depress (hold until CLOSE tb-gray, \*
- \* 3 sec max) \*
- \* MAN CONTR – RIGID (hold until RIGID tb-gray, \*
- \* 25 sec max) \*

EE MODE – OFF  
BRAKES – ON (tb-ON)

Give EV GO to untether from pump module

SM 94 PDRS CONTROL

PL ID – ITEM 3 +4 EXEC  
INIT ID – ITEM 24 +4 EXEC

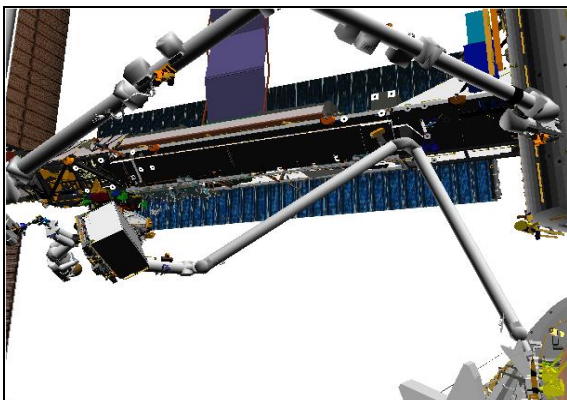

**CCTV B (-24,14)**

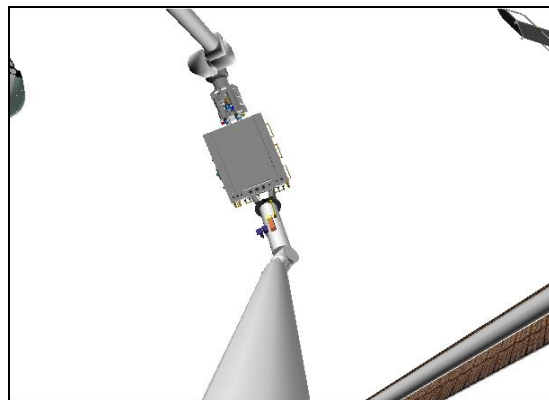

**SRMS ELBOW (0,5)**

Expected P1 PUMP MODULE HANDOFF posn:

X	Y	Z	PITCH	YAW	ROLL	PL ID
-868	-459	-542	29	353	307	4
SY	SP	EP	WP	WY	WR	
+70.9	+87.6	-104.3	+30.0	-43.5	-35.8	

5. MANEUVER TO CLEARANCE POSN

On EV GO, maneuver to Clearance position

A7U

CCTV – config for maneuver to Clearance

MON 1	DNLK
P1 LOOB	Elbow (EE)
MON 2	DTV
A	B

RATE – VERN (RATE MIN tb-ON)

BRAKES – OFF (tb-OFF)

MODE – END EFF, ENTER

Mnvr to P1 PUMP MODULE PRE-GRAPPLE posn:

X	Y	Z	PITCH	YAW	ROLL	PL ID
-811	-462	-501	44	8	328	0
-807	-427	-541	29	353	307	4
SY	SP	EP	WP	WY	WR	
+81.5	+96.8	-116.0	+35.6	-53.8	-31.7	

MODE – ORB LD, ENTER

Mnvr to CLEARANCE posn:

X	Y	Z	PITCH	YAW	ROLL	PL ID
-807	-427	-230	29	353	307	4
SY	SP	EP	WP	WY	WR	
+83.9	+30.0	-94.9	+82.4	-56.1	-30.4	

BRAKES – ON (tb-ON)

√MODE – not DIRECT

Give ISS GO to mnvr to ESP2 Clearance

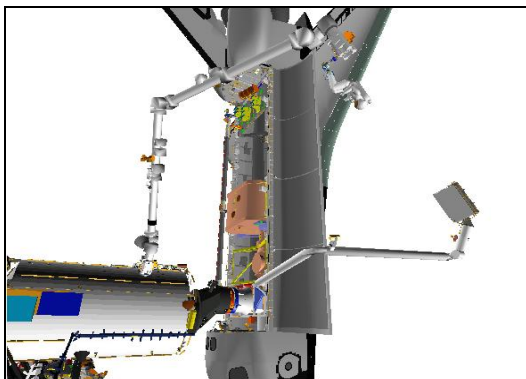

**P1 LOWER OUTBOARD (120,22)**



**CCTV A (60,10)**

6. MANEUVER BACK TO HANDOFF POSN  
 On ISS and EV GO, mnvr to Handoff position

RATE – VERN (RATE MIN tb-ON)  
 BRAKES – OFF (tb-OFF)  
 MODE – ORB LD, ENTER

Mnvr to P1 PUMP MODULE PRE-GRAPPLE posn:

X	Y	Z	PITCH	YAW	ROLL	PL ID
-807	-427	-541	29	353	307	4
SY	SP	EP	WP	WY	WR	
+81.5	+96.8	-116.0	+35.6	-53.8	-31.7	

MODE – END EFF, ENTER

Mnvr to P1 PUMP MODULE HANDOFF posn:

X	Y	Z	PITCH	YAW	ROLL	PL ID
-828	-464	-520	1	28	313	0
-868	-459	-542	29	353	307	4
SY	SP	EP	WP	WY	WR	
+70.9	+87.6	-104.3	+30.0	-43.5	-35.8	

BRAKES – ON (tb-ON)  
 ✓MODE – not DIRECT

Give SSRMS operator a GO to retrieve pump module

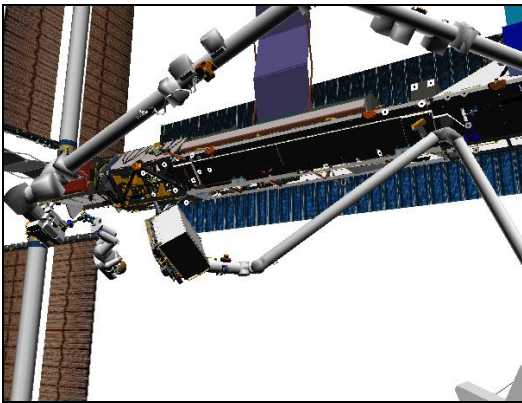

**CCTV B (-32,14)**

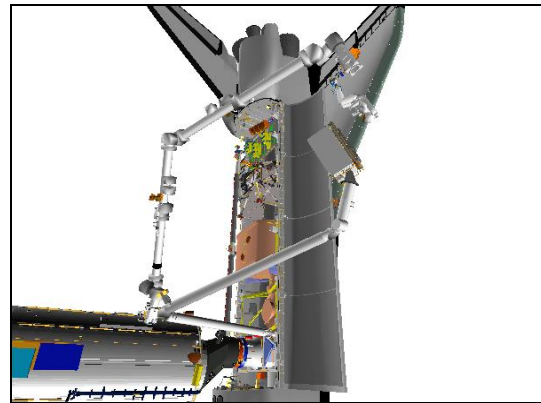

**P1 LOWER OUTBOARD (120,27)**

A7U

7. P1 PUMP MODULE UNGRAPPLE

CCTV – config for ungrapple  
 – install PDRS TARGET OVERLAY FOR CTVM  
 – RMS WRIST, zoom 34.0 HFOV  
 focus 5 ft

Maintain eyepoint approx 18 in when using grapple overlay







MON 1	DNLK
SSRMS Base Elbow	EE
MON 2	DTV
A	B

SM 94 PDRS CONTROL  
 PL ID – ITEM 3 +0 EXEC  
 INIT ID – ITEM 24 +0 EXEC







RATE – VERN (RATE MIN tb-ON)  
 BRAKES – OFF (tb-OFF)  
 MODE – END EFF, ENTER

**CAUTION**  
 Monitor EE tb timing to prevent EE motor burnout

On EV GO for Pump Module Derigidization:  
 EE MODE – MAN  
 MAN CONTR – DERIGID (hold until DERIG tb-gray)

√ RIGID  DERIGID 	CLOSE  OPEN 	CAPTURE  EXTEND 	<u>CRITICAL TIMES (28 sec total):</u> DERIGID tb – gray, 5 sec max
--	---	---	---

On EV GO for release:  
 EE RELEASE sw – depress (hold until OPEN tb-gray)

√ RIGID  DERIGID 	CLOSE  OPEN 	CAPTURE  EXTEND 	<u>CRITICAL TIMES (28 sec total):</u> OPEN tb – gray, 3 sec max
---	--	--	--

After EV has confirmed handoff, mnvr SRMS away from grapple pin

Expected P1 PUMP MODULE PRE-GRAPPLE posn:

X	Y	Z	PITCH	YAW	ROLL	PL ID
-767	-432	-520	1	28	313	0
SY	SP	EP	WP	WY	WR	
+81.5	+96.8	-116.0	+35.6	-53.8	-31.7	

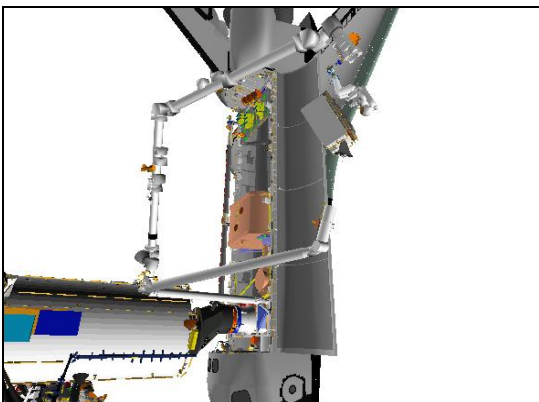

**P1 LOWER OUTBOARD (120,22)**

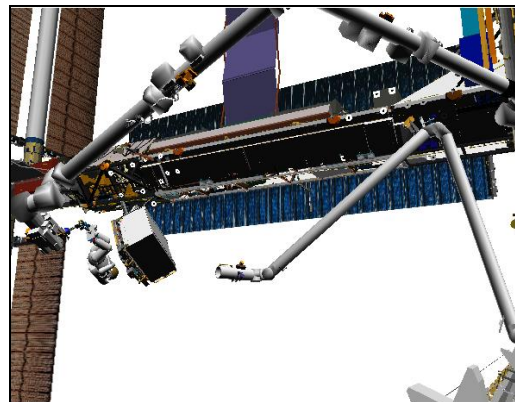

**CCTV B (-28,14)**

EE MAN CONTR – DERIGID (hold until EXTEND tb-gray)

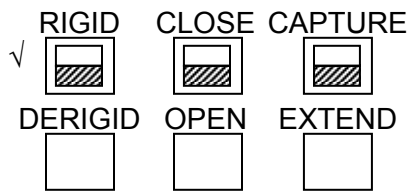

CRITICAL TIMES (28 sec total):  
EXTEND tb – gray, 20 sec max

EE MODE – OFF  
MODE – ORB UNL, ENTER

Mnvr to CLEARANCE posn:

X	Y	Z	PITCH	YAW	ROLL	PL ID
-767	-432	-209	1	28	313	0
SY	SP	EP	WP	WY	WR	
+83.9	+30.0	-94.9	+82.4	-56.1	-30.4	

BRAKES – ON (tb-ON)  
✓MODE – not DIRECT

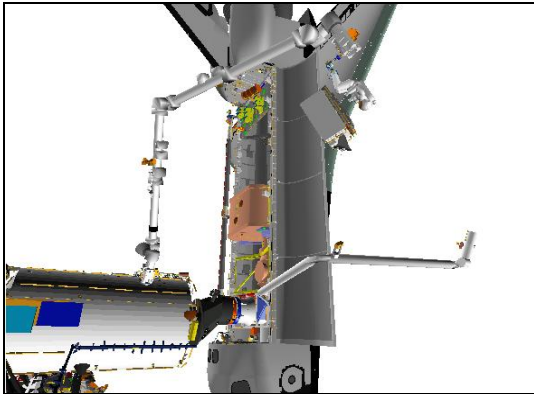

**P1 LOWER OUTBOARD (120,22)**

# S1 PUMP MODULE HANDOFF

I

- A7U 1. SETUP  
CCTV – config for maneuver to Pre-grapple

MON 1	DNLK
P1 LOOB (A)	Elbow (EE)
MON 2	DTV
C	D

SM 94 PDRS CONTROL

√PL ID, ITEM 3: 0  
√INIT ID, ITEM 24: 0

2. MNVR TO S1 PUMP MODULE PRE-GRAPPLE POSN  
RATE – as required (VERN within 10 ft)  
BRAKES – OFF (tb-OFF)  
MODE – SINGLE, ENTER

Mnvr to S1 Pump Module PRE-GRAPPLE posn:

	SY	SP	EP	WP	WY	WR	
Pre-Cradle	0.0	+25.0	-25.0	+5.0	0.0	0.0	
1: SY –	-35.9						
2: SP +		+54.6					
3: EP –			-61.8				
4: WP –				-54.5			
5: WY –					-53.7		
6: WR –						-160.2	
Pre-Grapple	-35.9	+54.6	-61.8	-54.5	-53.7	-160.2	
	X	Y	Z	PITCH	YAW	ROLL	PL ID
	-1018	+133	-665	222	289	91	0

BRAKES – ON (tb-ON)  
√MODE – not DIRECT



P1 LOWER OUTBOARD (100,10)

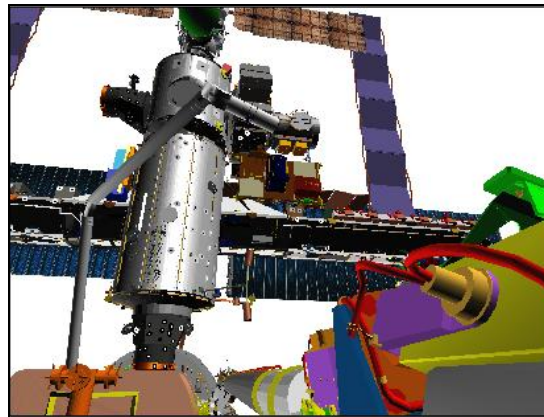

CCTV C (10,25)

A7U

3. SETUP FOR S1 PUMP MODULE GRAPPLE

CCTV – config for grapple

– install PDRS TARGET OVERLAY FOR CTVM

– RMS WRIST, zoom 34.0 HFOV

focus 5 ft

Maintain eyepoint approx 18 in when using grapple overlay

MON 1	DNLK
P1 LOOB (A)	EE
MON 2	DTV
C	D

4. S1 PUMP MODULE GRAPPLE

Verify SSRMS at Handoff position

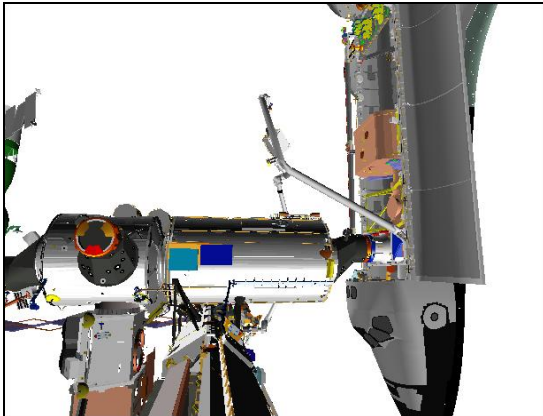

**P1 LOWER OUTBOARD (100,10)**

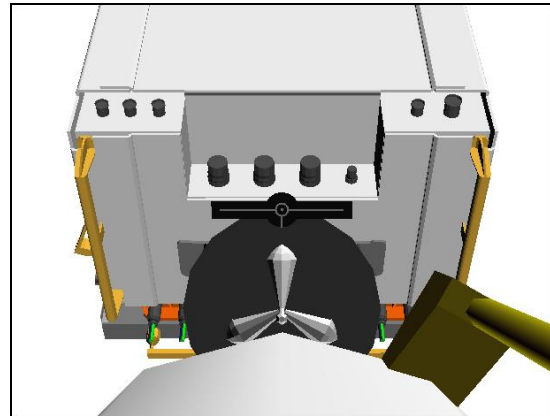

**SRMS EE**

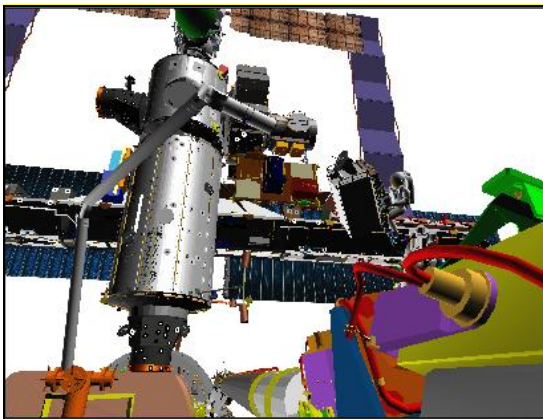

**CCTV C (10,25)**

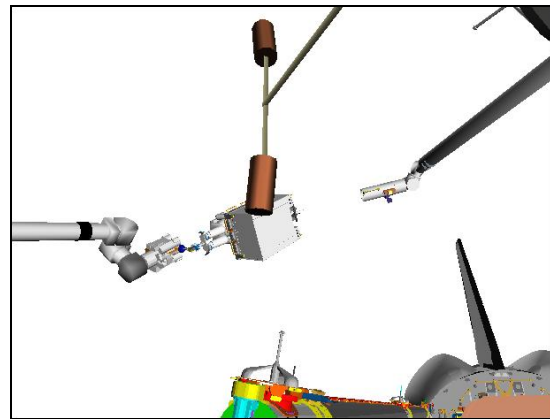

**CCTV D (-20,25)**

On ISS and EV GO, perform S1 Pump Module Grapple

RATE – VERN (RATE MIN tb-ON)

BRAKES – OFF (tb-OFF)

MODE – END EFF, ENTER

Mnvr to grapple envelope



**CAUTION**  
Monitor EE tb timing to prevent EE motor burnout

Inform EV of Pump Module Grapple

EE MODE – AUTO  
CAPTURE sw – depress (mom)

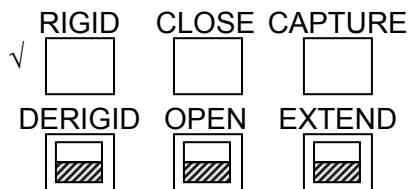

CRITICAL TIMES (28 sec total):  
CAPTURE tb – gray, then  
CLOSE tb – gray, 3 sec max, then  
RIGID tb – gray, 25 sec max

- \* If manual grapple reqd: \*
- \* EE MODE – MAN \*
- \* EE CAPTURE sw – depress (hold until CLOSE tb-gray, \*
- 3 sec max) \*
- \* EE MAN CONTR – RIGID (hold until RIGID tb-gray, \*
- 25 sec max) \*

EE MODE – OFF  
BRAKES – ON (tb-ON)

Give EV GO to untether from pump module

SM 94 PDRS CONTROL

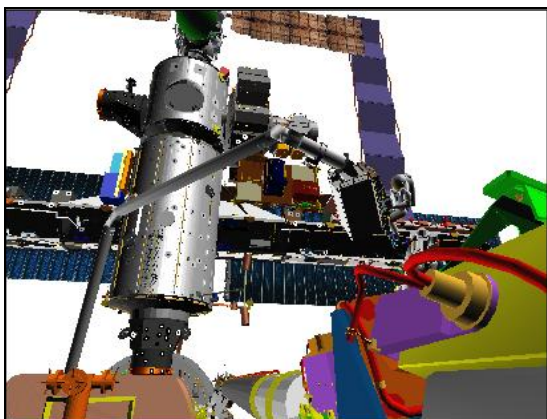
  
 PL ID – ITEM 3 +4 EXEC  
 INIT ID – ITEM 24 +4 EXEC

**CCTV C (10,25)**

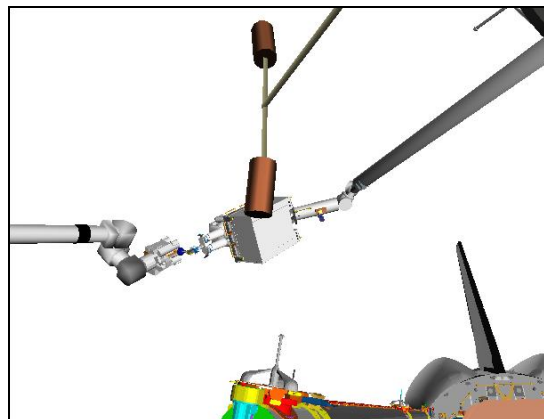

**CCTV D (-20,25)**

Expected S1 PUMP MODULE HANDOFF posn:

X	Y	Z	PITCH	YAW	ROLL	PL ID
-970	+228	-622	221	334	90	4
SY	SP	EP	WP	WY	WR	
-43.6	+46.7	-57.8	-42.3	-49.5	-149.7	

A7U

5. MANEUVER TO CLEARANCE POSN  
CCTV – config for maneuver to Clearance

MON 1	DNLK
P1 LOOB (A)	Elbow
MON 2	DTV
C	D

On EV GO, maneuver to Clearance position

RATE – VERN (RATE MIN tb-ON)  
BRAKES – OFF (tb-OFF)  
MODE – ORB LD, ENTER

Mnvr -Y to +168

Expected CLEARANCE posn:

X	Y	Z	PITCH	YAW	ROLL	PL ID
-970	+168	-622	221	334	90	4
SY	SP	EP	WP	WY	WR	
-38.1	+56.8	-69.5	-46.5	-52.7	-157.1	

BRAKES – ON (tb-ON)  
√MODE – not DIRECT

Give ISS GO to mnvr to Intermediate 3 position

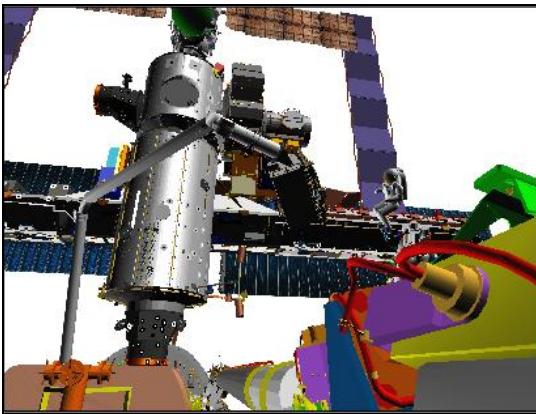

**CCTV C (10,25)**

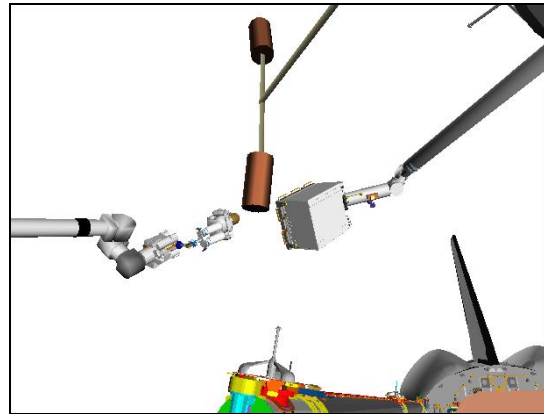

**CCTV D (-20,25)**

6. MANEUVER BACK TO HANDOFF POSN  
On ISS and EV GO, mnvr to Handoff position

RATE – VERN (RATE MIN tb-ON)  
BRAKES – OFF (tb-OFF)  
MODE – ORB LD, ENTER

Mnvr +Y to +228

Expected S1 PUMP MODULE HANDOFF posn:

X	Y	Z	PITCH	YAW	ROLL	PL ID
-970	+228	-622	221	334	90	4
SY	SP	EP	WP	WY	WR	
-43.6	+46.7	-57.8	-42.3	-49.5	-149.7	

BRAKES – ON (tb-ON)  
 ✓MODE – not DIRECT

Give SSRMS operator a GO to retrieve pump module

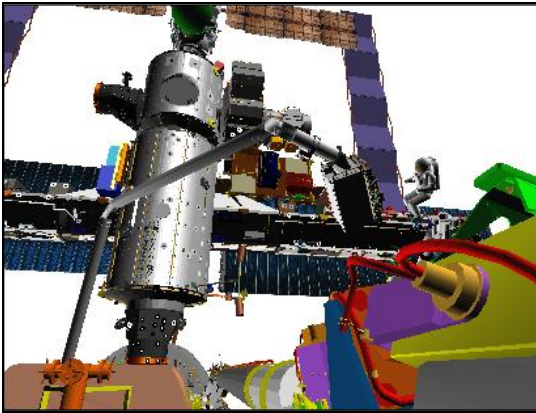

CCTV C (10,25)

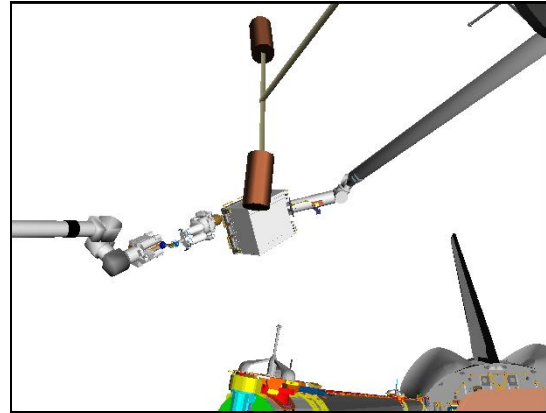

CCTV D (-20,25)

7. S1 PUMP MODULE UNGRAPPLE

A7U

- CCTV – config for ungrapple
- install PDRS TARGET OVERLAY FOR CTVM
- RMS WRIST, zoom 34.0 HFOV  
focus 5 ft

Maintain eyepoint approx 18 in when using grapple overlay

MON 1	DNLK
P1 LOOB (A)	EE
MON 2	DTV
C	D

SM 94 PDRS CONTROL

PL ID – ITEM 3 +0 EXEC  
 INIT ID – ITEM 24 +0 EXEC

RATE – VERN (RATE MIN tb-ON)  
 BRAKES – OFF (tb-OFF)  
 MODE – END EFF, ENTER

CAUTION  
 Monitor EE tb timing to prevent EE motor burnout

On EV GO for Pump Module Derigidization:

EE MODE – MAN  
 MAN CONTR – DERIGID (hold until DERIG tb-gray)

RIGID	CLOSE	CAPTURE
✓ <input type="checkbox"/>	<input type="checkbox"/>	<input type="checkbox"/>
DERIGID	OPEN	EXTEND
<input type="checkbox"/>	<input checked="" type="checkbox"/>	<input checked="" type="checkbox"/>

CRITICAL TIMES (28 sec total):  
 DERIGID tb – gray, 5 sec max

On EV GO for release:

EE RELEASE sw – depress (hold until OPEN tb-gray)

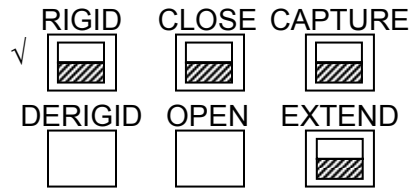

CRITICAL TIMES (28 sec total):  
OPEN tb – gray, 3 sec max

After EV has confirmed handoff, mnvr SRMS away from structure

Expected PRE-GRAPPLE posn:

X	Y	Z	PITCH	YAW	ROLL	PL ID
-1018	+133	-665	222	289	91	0
SY	SP	EP	WP	WY	WR	
-35.9	+54.6	-61.8	-54.5	-53.7	-160.2	

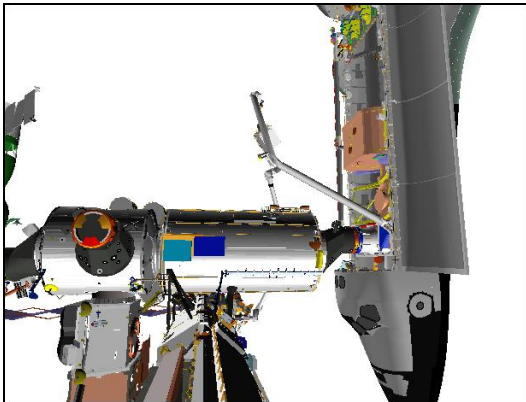

**P1 LOWER OUTBOARD (100,10)**

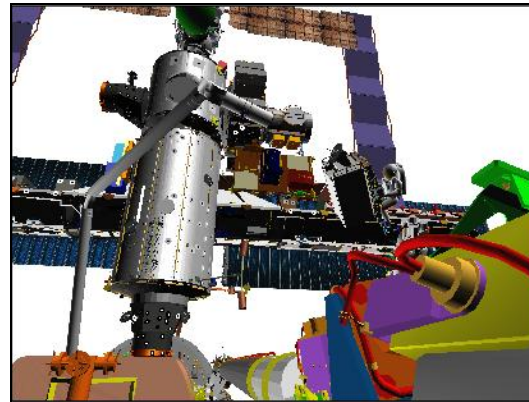

**CCTV C (10,25)**

EE MAN CONTR – DERIGID (hold until EXTEND tb-gray)

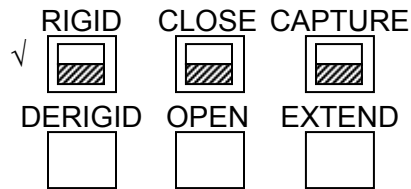

CRITICAL TIMES (28 sec total):  
EXTEND tb – gray, 20 sec max

EE MODE – OFF

BRAKES – ON (tb-ON)

√MODE – not DIRECT

# MBSU R&R VIEWING

- A7U 1. SETUP  
 CCTV – config for MBSU R&R Viewing

MON 1	DNLK
B	Elbow (EE)
MON 2	DTV
A	C

**SM 94 PDRS CONTROL**

- √PL ID, ITEM 3: 0
- √INIT ID, ITEM 24: 0

2. MNVR TO MBSU VIEWING POSN  
 RATE – as required (VERN within 10 ft)  
 BRAKES – OFF (tb-OFF)  
 MODE – SINGLE, ENTER

Mnvr to MBSU VIEWING posn:

	SY	SP	EP	WP	WY	WR	
Pre-Cradle	0.0	+25.0	-25.0	+5.0	0.0	0.0	
1: SP +		+62.0					
2: WP +				+89.2			
3: WY +					+110.0*		
4: WR –						-41.6	
5: EP –			-93.9				
6: SY +	+162.2						
MBSU View	+162.2	+62.0	-93.9	+89.2	+110.0	-41.6	
	X	Y	Z	PITCH	YAW	ROLL	PL ID
	-319	-190	-496	158	277	150	0

\* Expect SINGULAR It

- BRAKES – ON (tb-ON)
- √MODE – not DIRECT

### NOTE

Pan and Tilt Elbow camera as required for MBSU R&R Viewing

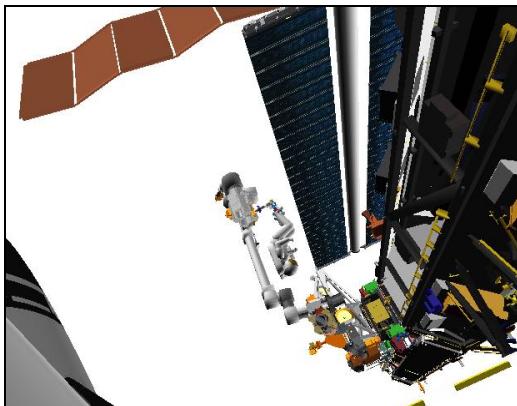

**SRMS ELBOW (55,-45)**

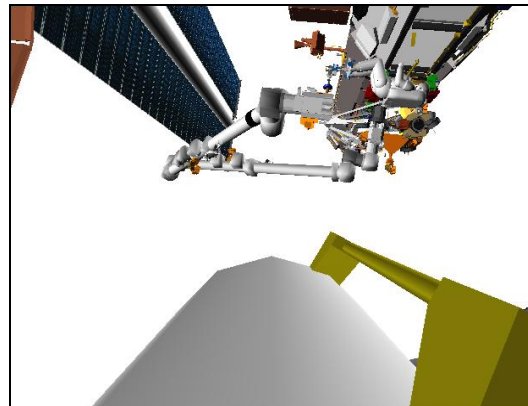

**SRMS EE**

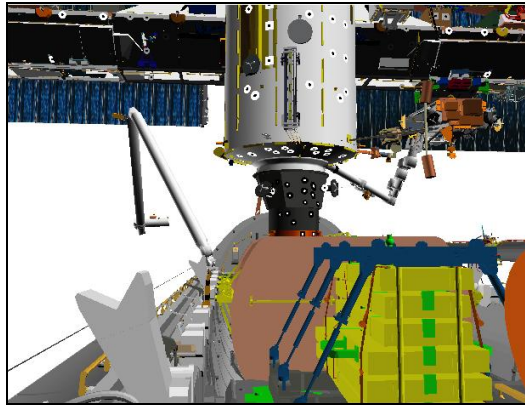

**CCTV B (5,5)**

**NOTE**

When MBSU R&R Viewing complete,  
maneuver to SRMS Pre-Cradle position

3. **MNVR TO SRMS PRE-CRADLE POSN**  
 RATE – as required (VERN within 10 ft)  
 BRAKES – OFF (tb-OFF)  
 MODE – SINGLE, ENTER

Mnvr to SRMS PRE-CRADLE posn:

	SY	SP	EP	WP	WY	WR	
MBSU View	+162.2	+62.0	-93.9	+89.2	+110.0	-41.6	
1: SY –	0.0						
2: EP +			-25.0				
3: WR +						0.0	
4: WY –					0.0*		
5: WP –				+5.0			
6: SP –		+25.0					
Pre-Cradle	0.0	+25.0	-25.0	+5.0	0.0	0.0	
	X	Y	Z	PITCH	YAW	ROLL	PL ID
	-1261	-146	-551	5	2	0	0

\* Expect SINGULAR It

BRAKES – ON (tb-ON)  
√MODE – not DIRECT

## 4B SAW RETRACT VIEWING WITH OBSS

### NOTE

The single joint table to mnvr to 4B SAW retract viewing with OBSS position can be found at end of focused inspection procedure

4B SAW RETRACT VIEWING WITH OBSS posn:

	X	Y	Z	PITCH	YAW	ROLL	PL ID
√	-230	-728	-561	107	48	227	2
	SY	SP	EP	WP	WY	WR	
√	+136.0	+35.0	-47.0	-19.2	-9.3	+7.2	

MON 1	DNLK
B (RSC)	OBSS ITVC
MON 2	DTV
Elbow	MBS Mast

### NOTE

During SAW Retraction, no arm motion is allowed while SAW Motor is driving

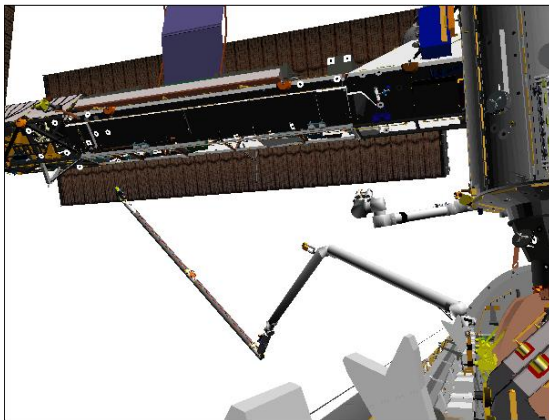

**CCTVB B (-20,10)**  
(P6 4B rotated at 163°)

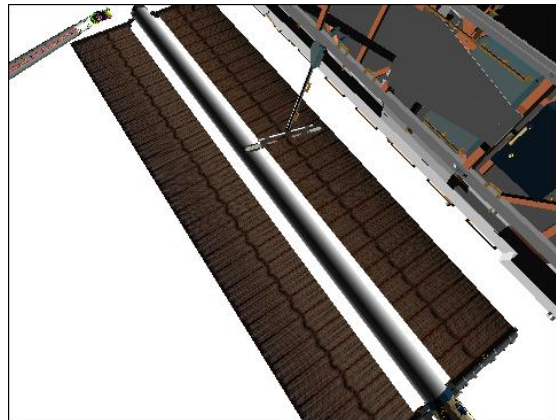

**SRMS ELBOW (58,14)**  
(P6 4B rotated at 163°)

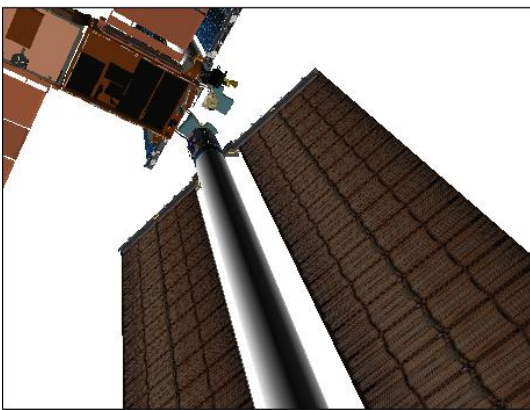

**OBSS ITVC (14,-66)**  
(P6 4B rotated at 163°)



**MBS MAST (0,0)**  
(P6 4B rotated at 163°)

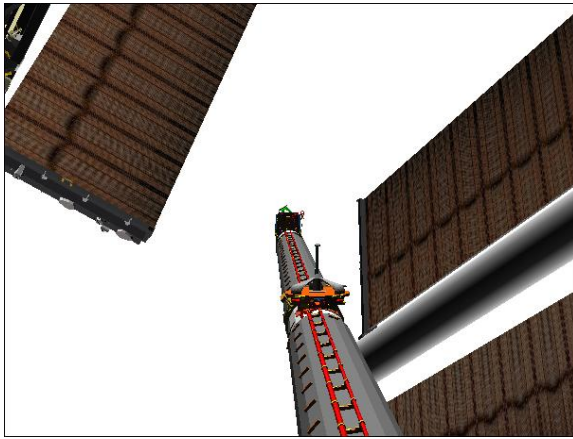

**RSC**  
**(P6 4B rotated at 163°)**

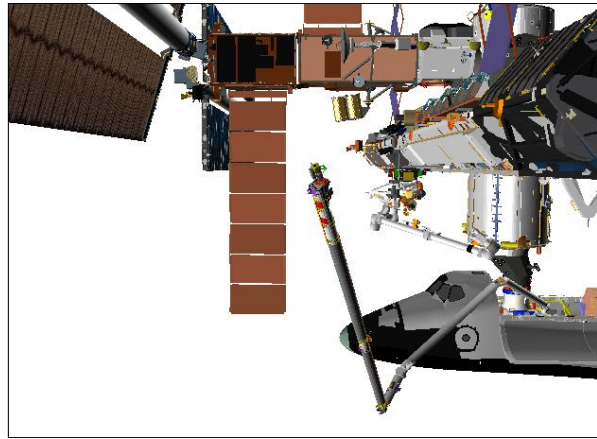

**PORT VIEW**  
**(P6 4B rotated at 163°)**

NOTE

Pan and Tilt Elbow camera as required to view Blanket De-tension/ Mast Deflection during 4B SAW Retraction. To view leading edges of P6 4B array at 56° or 236° once 4B is retracted and has 1 bay remaining, the recommended Elbow camera pan and tilt values are (74,-12)



# CETA CART RELOCATION VIEWING WITH OBSS

## 1. SETUP FOR MNVR TO CETA CART RELOCATION VIEWING WITH OBSS POSN

A7U CCTV – config for mnvr to CETA Cart Relocation Viewing with OBSS posn

MON 1	DNLK
B (RSC)	MBS Mast
MON 2	DTV
Elbow	C

**SM 94 PDRS CONTROL**

√PL ID, ITEM 3: 2

√INIT ID, ITEM 24: 2

## 2. MNVR TO CETA CART RELOCATION VIEWING WITH OBSS POSN

RATE – as required (VERN within 10 ft)

BRAKES – OFF (tb-OFF)

MODE – SINGLE, ENTER

Mnvr to CETA CART RELOCATION VIEWING WITH OBSS posn:

SAW Retract  
w/OBSS

1: EP –

2: SP +

3: WR –

4: SY +

CETA Cart  
w/OBSS

SY	SP	EP	WP	WY	WR	
+136.0	+35.0	-47.0	-19.2	-9.3	+7.2	
		-93.9				
	+62.0					
					-17.5	
+162.2						
+162.2	+62.0	-93.9	-19.2	-9.3	-17.5	
X	Y	Z	PITCH	YAW	ROLL	PL ID
-180	-525	-507	140	63	189	2

BRAKES – ON (tb-ON)

√MODE – not DIRECT

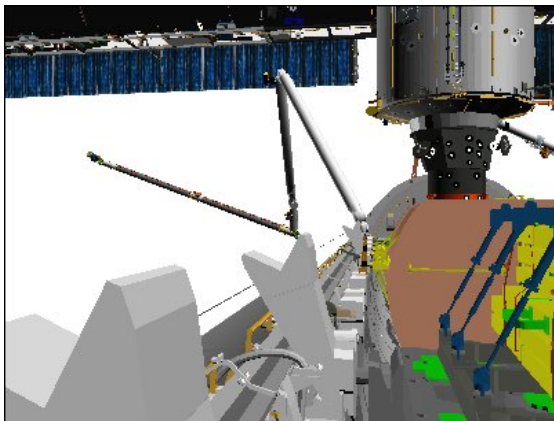

**CCTV B (-10,0)**



**MBS MAST (-5,10)**

- A7U 3. SETUP FOR CETA CART RELOCATION VIEWING WITH OBSS  
 CCTV – config for CETA Cart Relocation Viewing with OBSS

MON 1	DNLK
B (RSC)	OBSS ITVC
MON 2	DTV
Elbow	C

VPU Move green jumper to ITVC

NOTE

Pan and Tilt Elbow camera as required to provide big picture view for CETA Cart Relocation Viewing

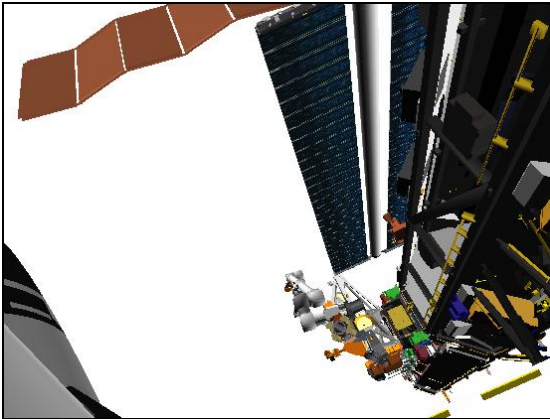

**SRMS ELBOW (55,-45)**

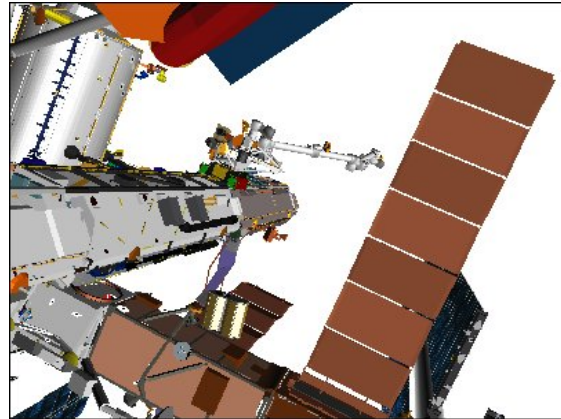

**OBSS ITVC (25,-23)**

4. MNVR TO OBSS HANDOFF POSN

NOTE

When CETA Cart Relocation Viewing complete, maneuver to OBSS Handoff position

CCTV – config for mnvr to OBSS Handoff posn

MON 1	DNLK
A	P1 LOOB
MON 2	DTV
Elbow	C

RATE – as required (VERN within 10 ft)  
 BRAKES – OFF (tb-OFF)  
 MODE – as desired

Mnvr to OBSS HANDOFF posn:

	SY	SP	EP	WP	WY	WR	
CETA Cart w/OBSS	+162.2	+62.0	-93.9	-19.2	-9.3	-17.5	
1: WR -						-45.1	
2: WP +				+30.0			
3: SY -	-28.4						
4: WY +					+23.6		
5: SP +		+75.5					
6: WP -				-62.5			
7: EP -			-98.1				
HANDOFF	-28.4	+75.5	-98.1	-62.5	+23.6	-45.1	
	X	Y	Z	PITCH	YAW	ROLL	PL ID
	-986	+318	-554	15	270	0	2

\* display singularity

BRAKES – ON (tb-ON)  
 ✓MODE – not DIRECT

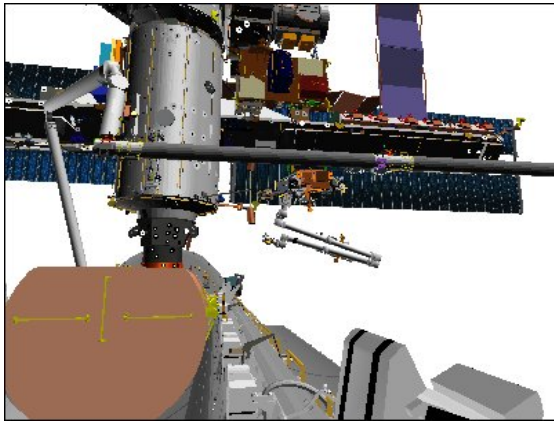

CCTVC C (10,10)

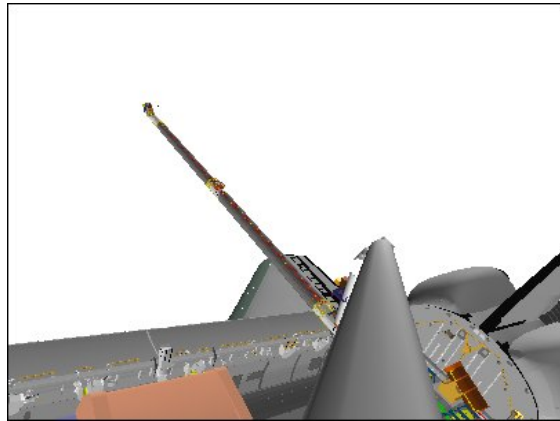

SRMS ELBOW (-15,0)

This Page Intentionally Blank

EVA 3

APFR INSTALL/INGRESS.....	FS 6-2
SMDP ASSEMBLY .....	FS 6-5
STOW.....	FS 6-12
APFR EGRESS/REMOVAL.....	FS 6-13
CONTINGENCY SMDP STOW .....	FS 6-15

**APFR INSTALL/INGRESS**

1. SETUP

SM 94 PDRS CONTROL

√PL ID, ITEM 3: 0

√INIT ID, ITEM 24: 0

RATE – as required (VERN within 10 ft)

BRAKES – OFF (tb-OFF)

MODE – as desired

Mnvr to APFR PRE-INSTALL posn:

APFR: 12/PP/F/6

X	Y	Z	PITCH	YAW	ROLL	PL ID
-783	-29	-809	90	359	162	0
SY	SP	EP	WP	WY	WR	
-59.6	+109.7	-109.1	+71.5	-10.2	+120.3	

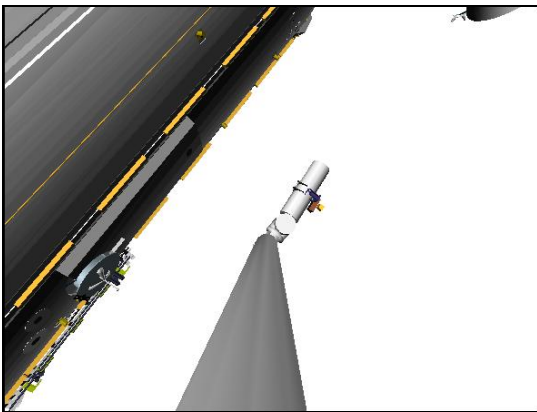

**SRMS ELBOW (0,0)**

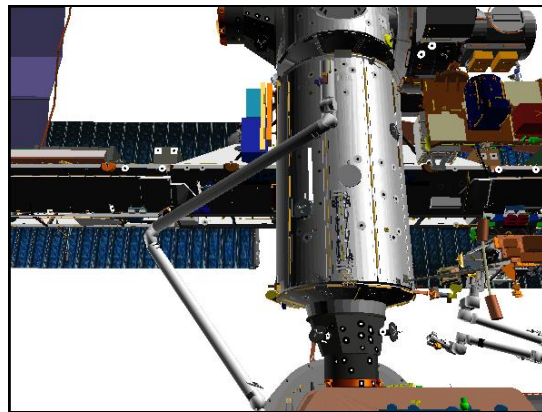

**CCTV B (0,20)**

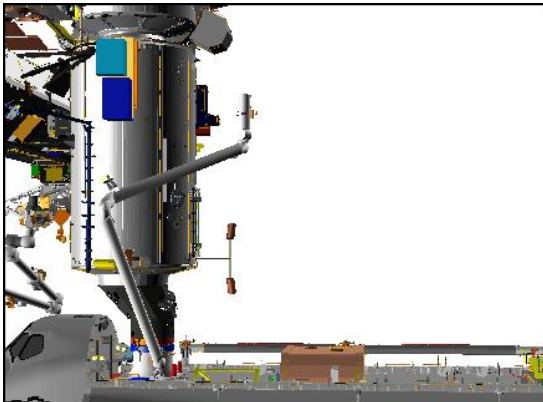

**PORT VIEW**

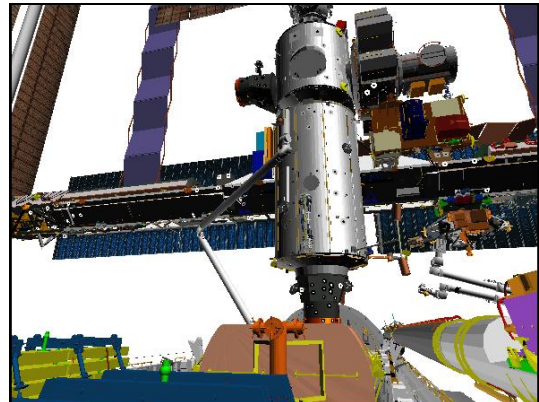

**CCTV C (-15,20)**

BRAKES – ON (tb-ON)

MODE – not DIRECT

2. APFR INSTALL  
 RATE – VERN (RATE MIN tb-ON)  
 BRAKES – OFF (tb-OFF)  
 MODE – as desired

NOTE

Monitor clearance between SRMS and the US LAB

Mnvr per EV GCA call to APFR INSTALL posn

BRAKES – ON (tb-ON)  
 MODE – not DIRECT

3. MNVR TO APFR INGRESS  
 RATE – as required (VERN within 10 ft)  
 BRAKES – OFF (tb-OFF)  
 MODE – as desired

NOTE

Monitor clearance between SRMS and the US LAB

Mnvr per EV GCA call to APFR INGRESS posn

Expected APFR INGRESS posn: APFR: 12/PP/F/6

X	Y	Z	PITCH	YAW	ROLL	PL ID
-783	-29	-768	90	359	162	0
-735	-29	-814	180	1	181	5
SY	SP	EP	WP	WY	WR	
-57.5	+112.3	-118.9	+79.0	-11.3	+122.6	

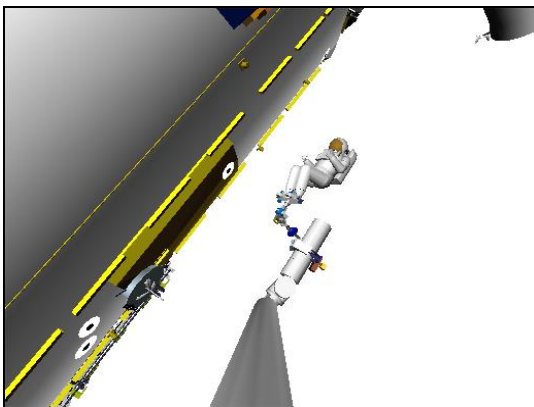

**SRMS ELBOW (0,10)**

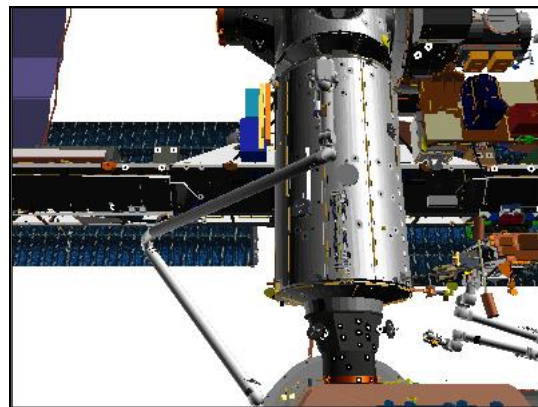

**CCTV B (0,20)**

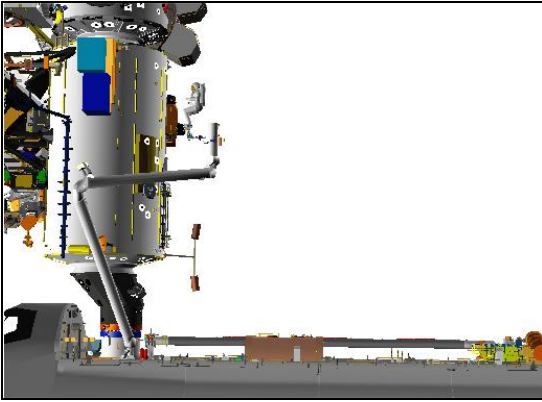

**PORT VIEW**

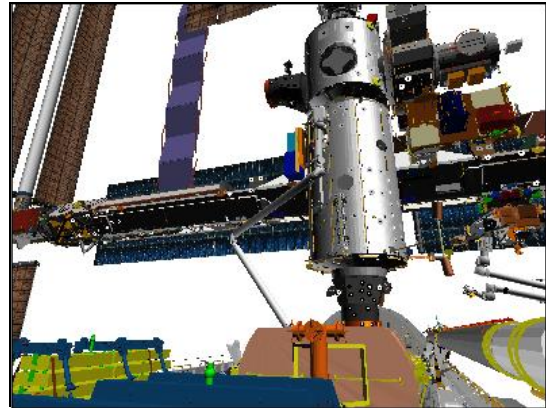

**CCTV C (-20,20)**

BRAKES – ON (tb-ON)  
MODE – not DIRECT

SM 94 PDRS CONTROL  
PL ID – ITEM 3 +5 EXEC  
INIT ID – ITEM 24 +5 EXEC

SM 95 PDRS OVERRIDE  
LOADED RATES – ITEM 14 EXEC (\*)



## SMDP ASSEMBLY

### 1. SRMS MNVR TO SMDP ADAPTER

RATE – as required (VERN within 10 ft)

BRAKES – OFF (tb-OFF)

MODE – as desired

Mnvr to ADAPTER posn:

APFR: 12/PP/F/6

X	Y	Z	PITCH	YAW	ROLL	PL ID
-1183	+61	-470	255	1	356	5
SY	SP	EP	WP	WY	WR	
-24.0	+42.2	-69.7	+10.2	+24.5	-12.0	

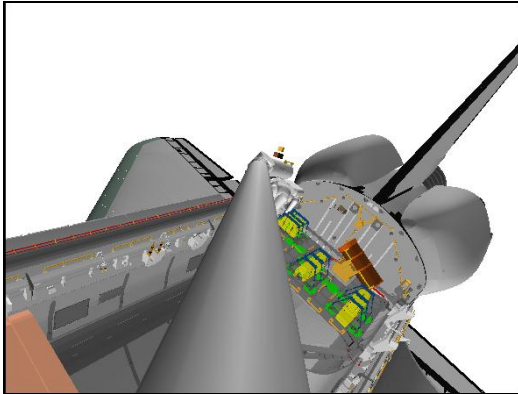

**SRMS ELBOW (0,-10)**

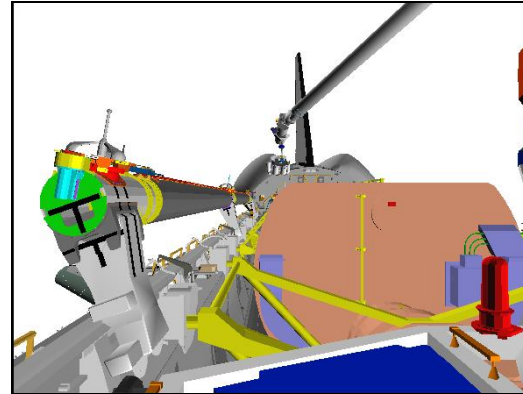

**CCTV D (0,0)**



**PORT VIEW**

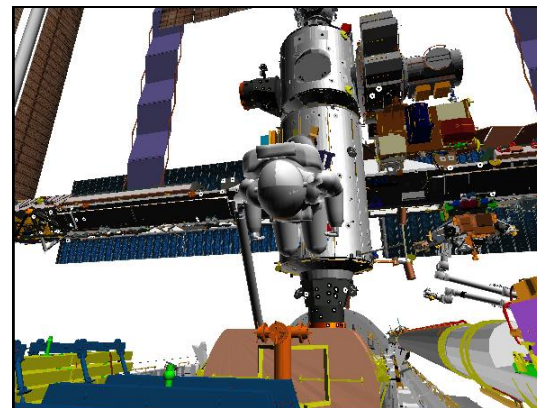

**CCTV C (-15,20)**

Mnvr per EV GCA call to final ADAPTER posn

BRAKES – ON (tb-ON)

MODE – not DIRECT

2. SRMS MNVR TO SMDP BUNDLE 4  
 RATE – as required (VERN within 10 ft)  
 BRAKES – OFF (tb-OFF)  
 MODE – as desired

Mnvr to BUNDLE 4 PRE-RETRIEVAL posn: APFR: 12/PP/F/6

X	Y	Z	PITCH	YAW	ROLL	PL ID
-1242	+61	-468	255	1	356	5
SY	SP	EP	WP	WY	WR	
-21.3	+27.8	-43.7	-1.0	+21.9	-12.9	

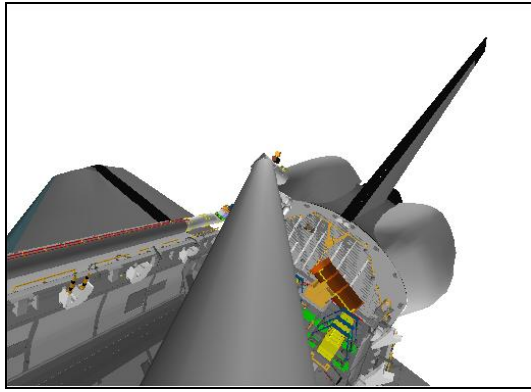

**SRMS ELBOW (0,-10)**

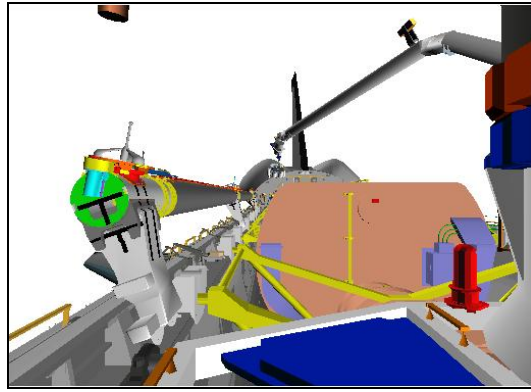

**CCTV D (0,0)**

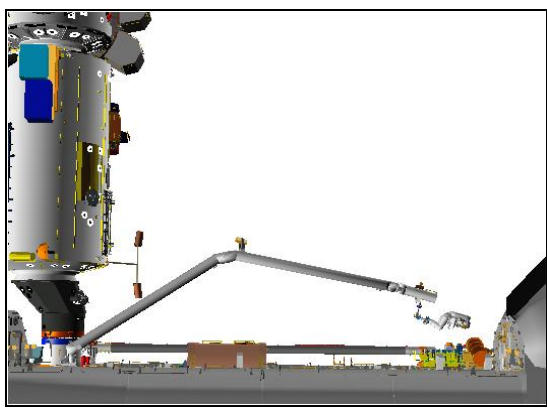

**PORT VIEW**

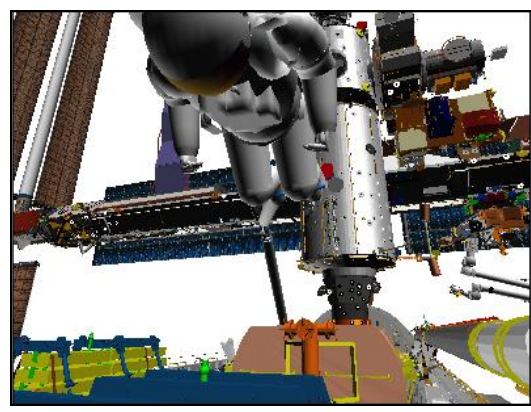

**CCTV C (-20,20)**

Mnvr per EV GCA call to final BUNDLE 4 RETRIEVAL posn

- BRAKES – ON (tb-ON)  
 MODE – not DIRECT

3. SRMS MNVR TO SMDP ADAPTER

RATE – as required (VERN within 10 ft)

BRAKES – OFF (tb-OFF)

MODE – as desired

Mnvr to BUNDLE 4 ADAPTER ASSEMBLY posn:

APFR: 12/PP/F/6

X	Y	Z	PITCH	YAW	ROLL	PL ID
-1200	+61	-468	255	1	356	5
SY	SP	EP	WP	WY	WR	
-23.1	+38.6	-63.2	+7.5	+23.7	-12.3	

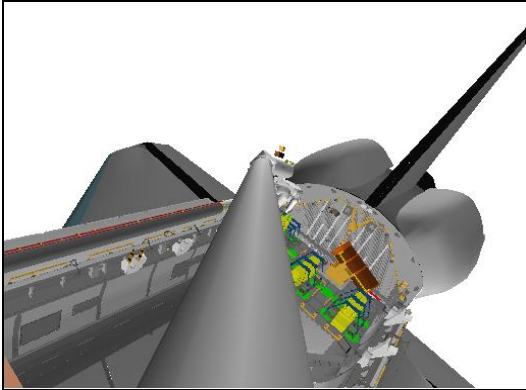

**SRMS ELBOW (0,-10)**

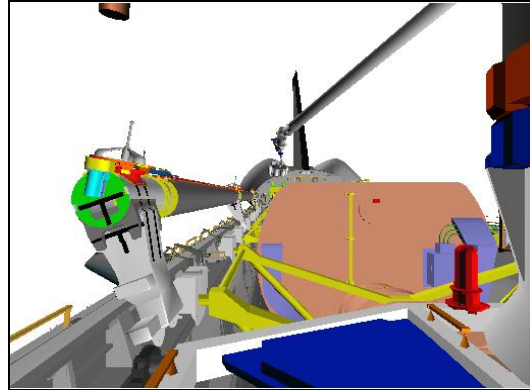

**CCTV D (0,0)**



**PORT VIEW**

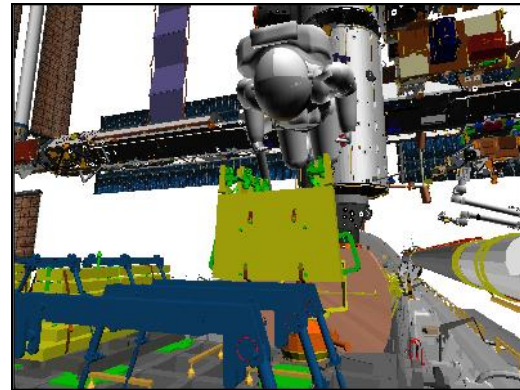

**CCTV C (-20,10)**

Mnvr per EV GCA call to final BUNDLE 4 ADAPTER ASSEMBLY posn

BRAKES – ON (tb-ON)

MODE – not DIRECT

4. SRMS MNVR TO SMDP BUNDLE 3  
 RATE – as required (VERN within 10 ft)  
 BRAKES – OFF (tb-OFF)  
 MODE – as desired

Mnvr to BUNDLE 3 PRE-RETRIEVAL posn:

APFR: 12/PP/F/6

X	Y	Z	PITCH	YAW	ROLL	PL ID
-1200	+1	-460	252	1	356	5
SY	SP	EP	WP	WY	WR	
-16.2	+44.2	-69.3	+6.1	+17.7	-13.4	

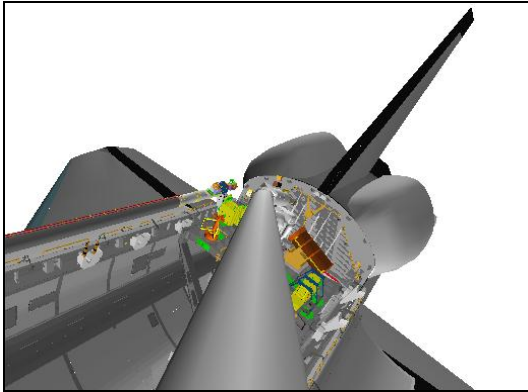

**SRMS ELBOW (0,-5)**

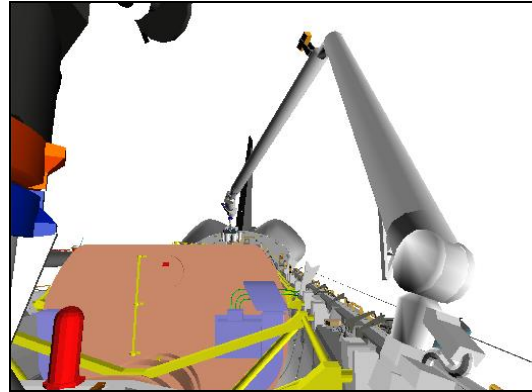

**CCTV A (0,10)**

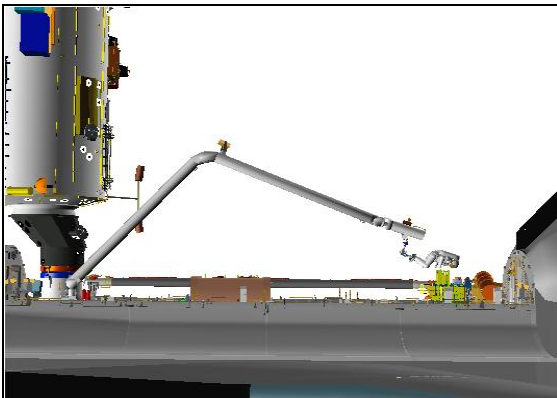

**PORT VIEW**

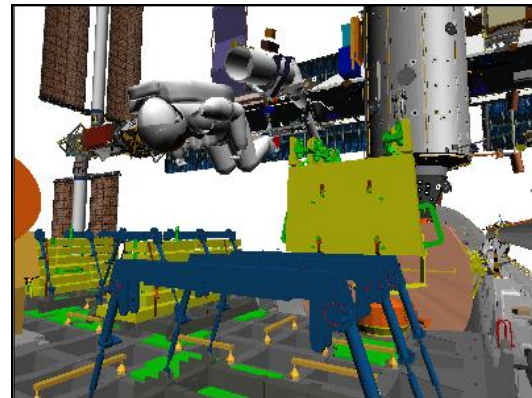

**CCTV C (-30,5)**

Mnvr per EV GCA call to final BUNDLE 3 RETRIEVAL posn

BRAKES – ON (tb-ON)  
 MODE – not DIRECT

5. SRMS MNVR TO SMDP ADAPTER

RATE – as required (VERN within 10 ft)

BRAKES – OFF (tb-OFF)

MODE – as desired

Mnvr to BUNDLE 3 ADAPTER ASSEMBLY posn:

APFR: 12/PP/F/6

X	Y	Z	PITCH	YAW	ROLL	PL ID
-1179	+57	-468	257	1	356	5
SY	SP	EP	WP	WY	WR	
-23.8	+43.8	-73.0	+14.1	+23.9	-13.1	

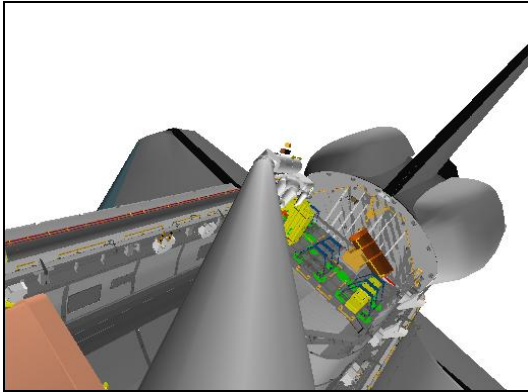

**SRMS ELBOW (0,-10)**

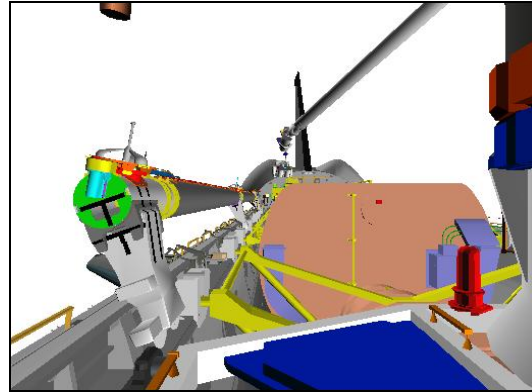

**CCTV D (0,0)**

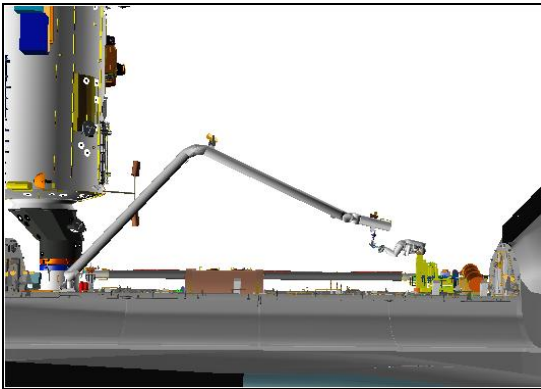

**PORT VIEW**

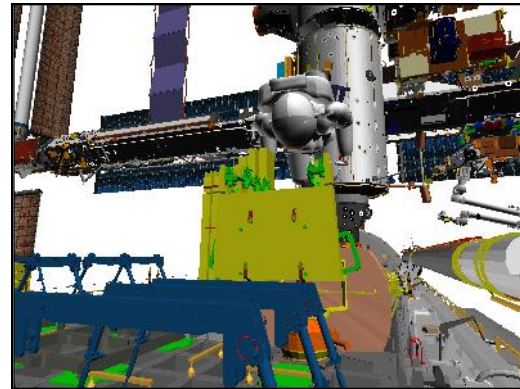

**CCTV C (-20,10)**

Mnvr per EV GCA call to final BUNDLE 3 ADAPTER ASSEMBLY posn

BRAKES – ON (tb-ON)

MODE – not DIRECT

6. SRMS MNVR TO SMDP BUNDLE 2  
 RATE – as required (VERN within 10 ft)  
 BRAKES – OFF (tb-OFF)  
 MODE – as desired

Mnvr to BUNDLE 2 PRE-RETRIEVAL posn: APFR: 12/PP/F/6

X	Y	Z	PITCH	YAW	ROLL	PL ID
-1207	-50	-455	252	1	356	5
SY	SP	EP	WP	WY	WR	
-9.9	+46.4	-70.3	+5.4	+11.6	-15.5	

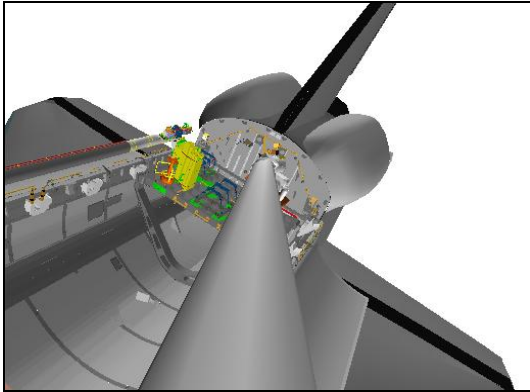

**SRMS ELBOW (0,-10)**

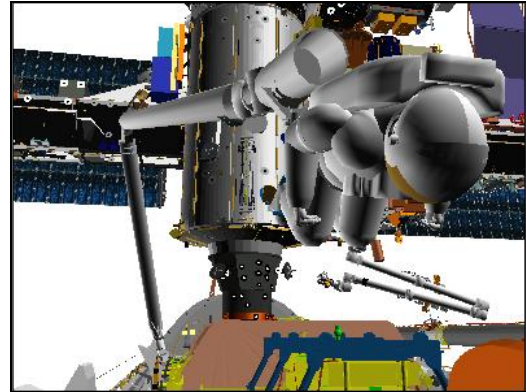

**CCTV B (10,15)**

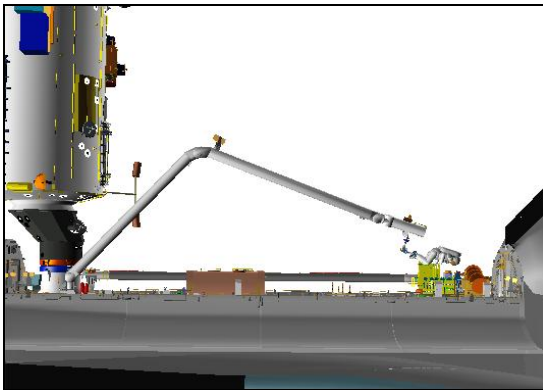

**PORT VIEW**

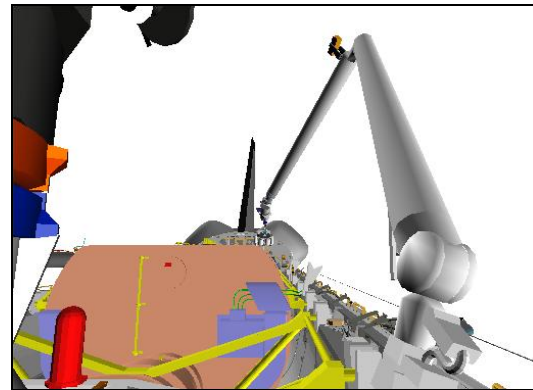

**CCTV A (0,10)**

Mnvr per EV GCA call to final BUNDLE 2 RETRIEVAL posn

- BRAKES – ON (tb-ON)  
 MODE – not DIRECT

7. SRMS MNVR TO SMDP ADAPTER  
 RATE – as required (VERN within 10 ft)  
 BRAKES – OFF (tb-OFF)  
 MODE – as desired

NOTE

Monitor clearance between SMDP Assembly and OBSS

Mnvr to BUNDLE 2 ADAPTER ASSEMBLY posn: APFR: 12/PP/F/6

X	Y	Z	PITCH	YAW	ROLL	PL ID
-1179	+57	-468	257	1	356	5
SY	SP	EP	WP	WY	WR	
-23.8	+43.8	-73.0	+14.1	+23.9	-13.1	

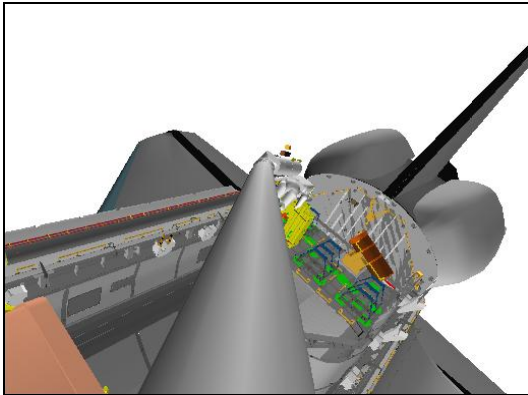

**SRMS ELBOW (0,-10)**

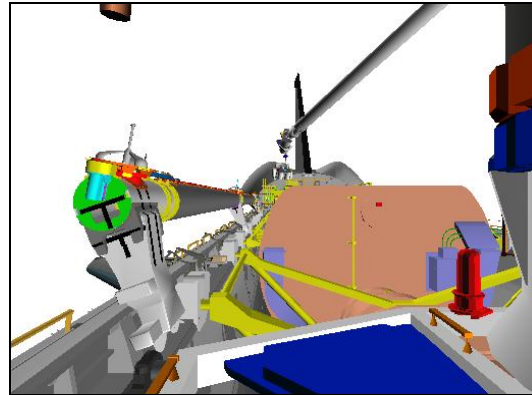

**CCTV D (0,0)**

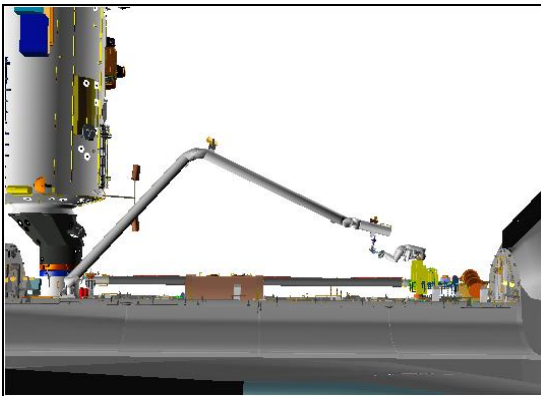

**PORT VIEW**

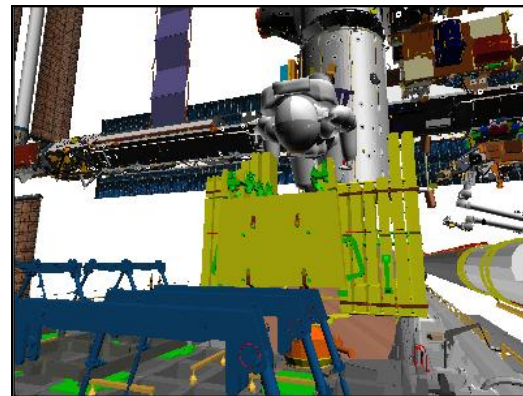

**CCTV C (-20,10)**

Mnvr per EV GCA call to final BUNDLE 2 ADAPTER ASSEMBLY posn

Mnvr per EV GCA call to ADAPTER RETRIEVAL posn

BRAKES – ON (tb-ON)  
 MODE – not DIRECT

If contingency stow required, go to CONTINGENCY SMDP STOW

## SMDP STOW

RATE – as required (VERN within 10 ft)

BRAKES – OFF (tb-OFF)

MODE – as desired

Mnvr to SMDP PRE-STOW posn:

APFR: 12/PP/F/6

X	Y	Z	PITCH	YAW	ROLL	PL ID
-703	-119	-1025	235	294	224	5
SY	SP	EP	WP	WY	WR	
-56.4	+102.1	-45.0	+9.1	-31.0	+45.7	

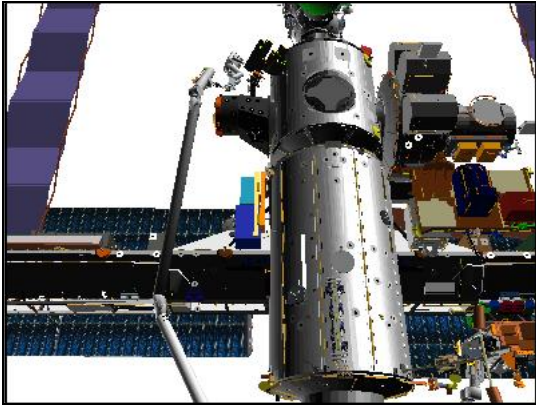

**CCTV B (0,30)**

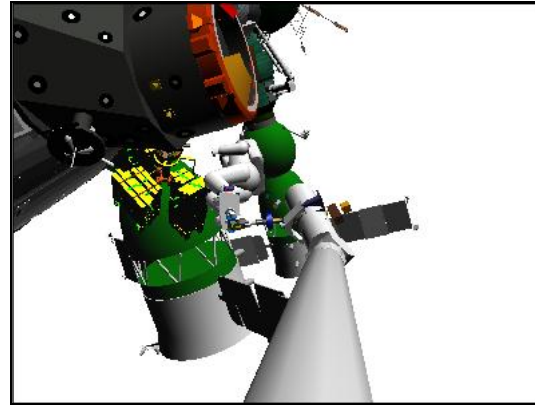

**SRMS ELBOW (-5,0)**

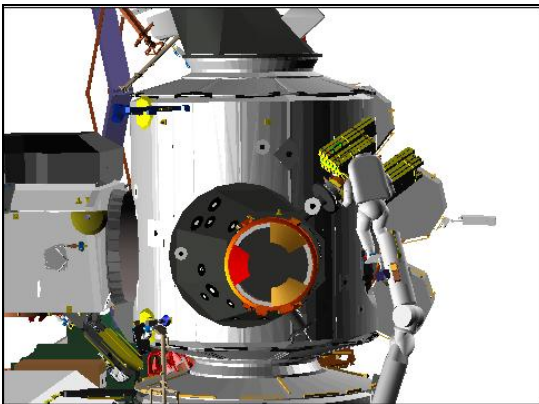

**PORT VIEW**

Mnvr per EV GCA call to final SMDP STOW posn

BRAKES – ON (tb-ON)

MODE – not DIRECT



## APFR EGRESS/REMOVAL

RATE – as required (VERN within 10 ft)  
 BRAKES – OFF (tb-OFF)  
 MODE – as desired

Mnvr to APFR PRE-EGRESS posn:

APFR: 12/PP/F/6

X	Y	Z	PITCH	YAW	ROLL	PL ID
-783	-29	-768	90	359	162	0
-735	-29	-814	180	1	181	5
SY	SP	EP	WP	WY	WR	
-57.5	+112.3	-118.9	+79.0	-11.3	+122.6	

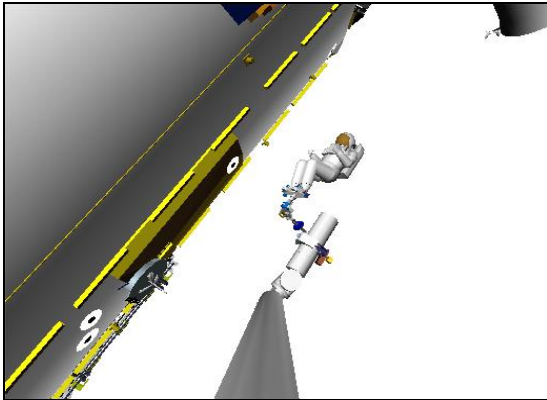

SRMS ELBOW (0,10)

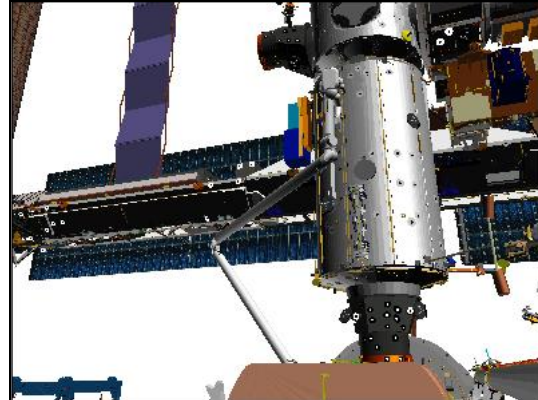

CCTV C (-20,20)

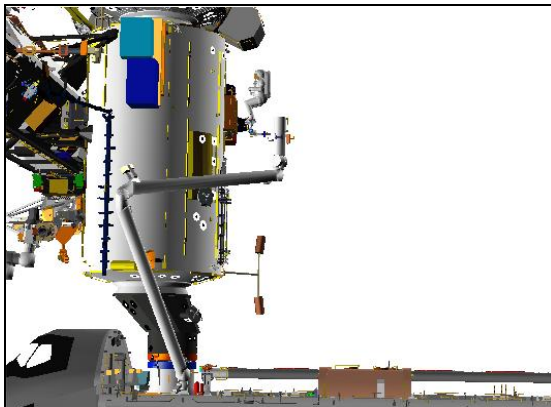

PORT VIEW

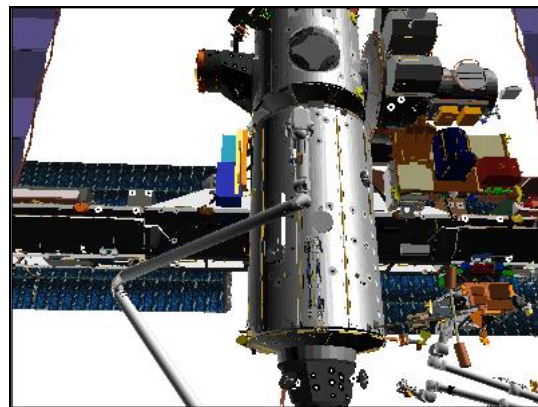

CCTV B (3,25)

Mnvr per EV GCA call to final APFR EGRESS posn

BRAKES – ON (tb-ON)  
 MODE – not DIRECT

**SM 94 PDRS CONTROL**

PL ID – ITEM 3 +0 EXEC  
 INIT ID – ITEM 24 +0 EXEC

**SM 95 PDRS OVERRIDE**

LOADED RATES – ITEM 14 EXEC ( )

RATE – as required (VERN within 10 ft)  
 BRAKES – OFF (tb-OFF)  
 MODE – as desired

Mnvr per EV GCA call to final APFR REMOVAL posn

|

BRAKES – ON (tb-ON)

MODE – not DIRECT

|

## CONTINGENCY SMDP STOW

RATE – as required (VERN within 10 ft)

BRAKES – OFF (tb-OFF)

MODE – as desired

Mnvr to CONTINGENCY SMDP PRE-STOW posn:

APFR: 12/PP/F/6

X	Y	Z	PITCH	YAW	ROLL	PL ID
-749	+30	-829	182	15	183	5
SY	SP	EP	WP	WY	WR	
-62.8	+95.7	-107.3	+82.7	-11.9	+131.1	

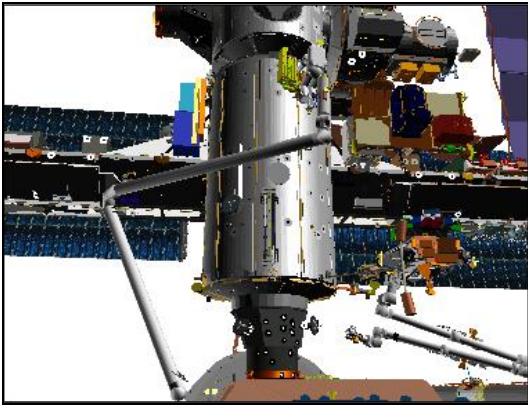

**CCTV B (7,20)**

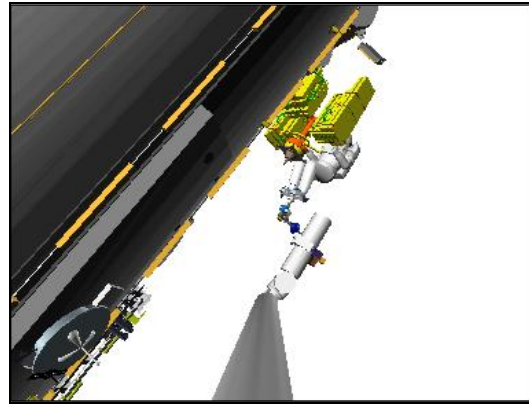

**SRMS ELBOW (0,10)**

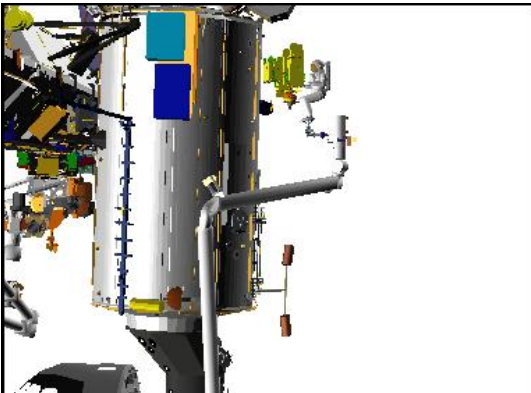

**PORT VIEW**

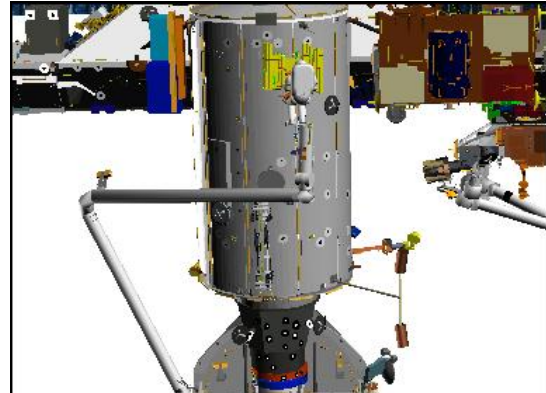

**BIRD'S EYE**

Mnvr per EV GCA call to final CONTINGENCY SMDP STOW posn

BRAKES – ON (tb-ON)

MODE – not DIRECT

Go to APFR EGRESS/REMOVAL

This Page Intentionally Blank

EVA REFERENCE DATA

JOINT ANGLES VS POR COORDINATES .....	FS 7-2
EVA COORDINATE SYSTEM – PL ID 5 .....	FS 7-4
– PL ID 4 (UPLINK).....	FS 7-5
RMS/EVA GO/NO-GO SUMMARY .....	FS 7-6

**EVA REFERENCE  
DATA**

## JOINT ANGLES VS POR COORDINATES

### APFR PRE-INSTALL

X	Y	Z	PITCH	YAW	ROLL	PL ID
-783	-29	-809	90	359	162	0
SY	SP	EP	WP	WY	WR	
-59.6	+109.7	-109.1	+71.5	-10.2	+120.3	

### APFR PRE-INGRESS

X	Y	Z	PITCH	YAW	ROLL	PL ID
-783	-29	-768	90	359	162	0
-735	-29	-814	180	1	181	5
SY	SP	EP	WP	WY	WR	
-57.5	+112.3	-118.9	+79.0	-11.3	+122.6	

### ADAPTER

X	Y	Z	PITCH	YAW	ROLL	PL ID
-1151	+58	-526	345	356	340	0
-1183	+61	-470	255	1	356	5
SY	SP	EP	WP	WY	WR	
-24.0	+42.2	-69.7	+10.2	+24.5	-12.0	

### BUNDLE 4 PRE-RETRIEVAL

X	Y	Z	PITCH	YAW	ROLL	PL ID
-1210	+59	-526	345	356	340	0
-1242	+61	-468	255	1	356	5
SY	SP	EP	WP	WY	WR	
-21.3	+27.8	-43.7	-1.0	+21.9	-12.9	

### BUNDLE 4 ADAPTER ASSEMBLY

X	Y	Z	PITCH	YAW	ROLL	PL ID
-1168	+58	-526	345	356	340	0
-1200	+61	-468	255	1	356	5
SY	SP	EP	WP	WY	WR	
-23.1	+38.6	-63.2	+7.5	+23.7	-12.3	

### BUNDLE 3 PRE-RETRIEVAL

X	Y	Z	PITCH	YAW	ROLL	PL ID
-1170	-2	-519	342	356	340	0
-1200	+1	-460	252	1	356	5
SY	SP	EP	WP	WY	WR	
-16.2	+44.2	-69.3	+6.1	+17.7	-13.4	

### BUNDLE 3 ADAPTER ASSEMBLY

X	Y	Z	PITCH	YAW	ROLL	PL ID
-1144	+55	-525	347	356	340	0
-1179	+57	-468	257	1	356	5
SY	SP	EP	WP	WY	WR	
-23.8	+43.8	-73.0	+14.1	+23.9	-13.1	

EVA REFERENCE DATA

## JOINT ANGLES VS POR COORDINATES (Cont)

### BUNDLE 2 PRE-RETRIEVAL

X	Y	Z	PITCH	YAW	ROLL	PL ID
-1177	-53	-515	342	356	340	0
-1207	-50	-455	252	1	356	5
SY	SP	EP	WP	WY	WR	
-9.9	+46.4	-70.3	+5.4	+11.6	-15.5	

### BUNDLE 2 ADAPTER ASSEMBLY

X	Y	Z	PITCH	YAW	ROLL	PL ID
-1144	+55	-525	347	356	340	0
-1179	+57	-468	257	1	356	5
SY	SP	EP	WP	WY	WR	
-23.8	+43.8	-73.0	+14.1	+23.9	-13.1	

### SMDP PRE-STOW

X	Y	Z	PITCH	YAW	ROLL	PL ID
-725	-175	-998	104	344	89	0
-703	-119	-1025	235	294	224	5
SY	SP	EP	WP	WY	WR	
-56.4	+102.1	-45.0	+9.1	-31.0	+45.7	

### APFR PRE-EGRESS

X	Y	Z	PITCH	YAW	ROLL	PL ID
-783	-29	-768	90	359	162	0
-735	-29	-814	180	1	181	5
SY	SP	EP	WP	WY	WR	
-57.5	+112.3	-118.9	+79.0	-11.3	+122.6	

### CONTINGENCY SMDP PRE-STOW

X	Y	Z	PITCH	YAW	ROLL	PL ID
-797	+40	-783	92	357	176	0
-749	+30	-829	182	15	183	5
SY	SP	EP	WP	WY	WR	
-62.8	+95.7	-107.3	+82.7	-11.9	+131.1	

# EVA COORDINATE SYSTEM – PL ID 5

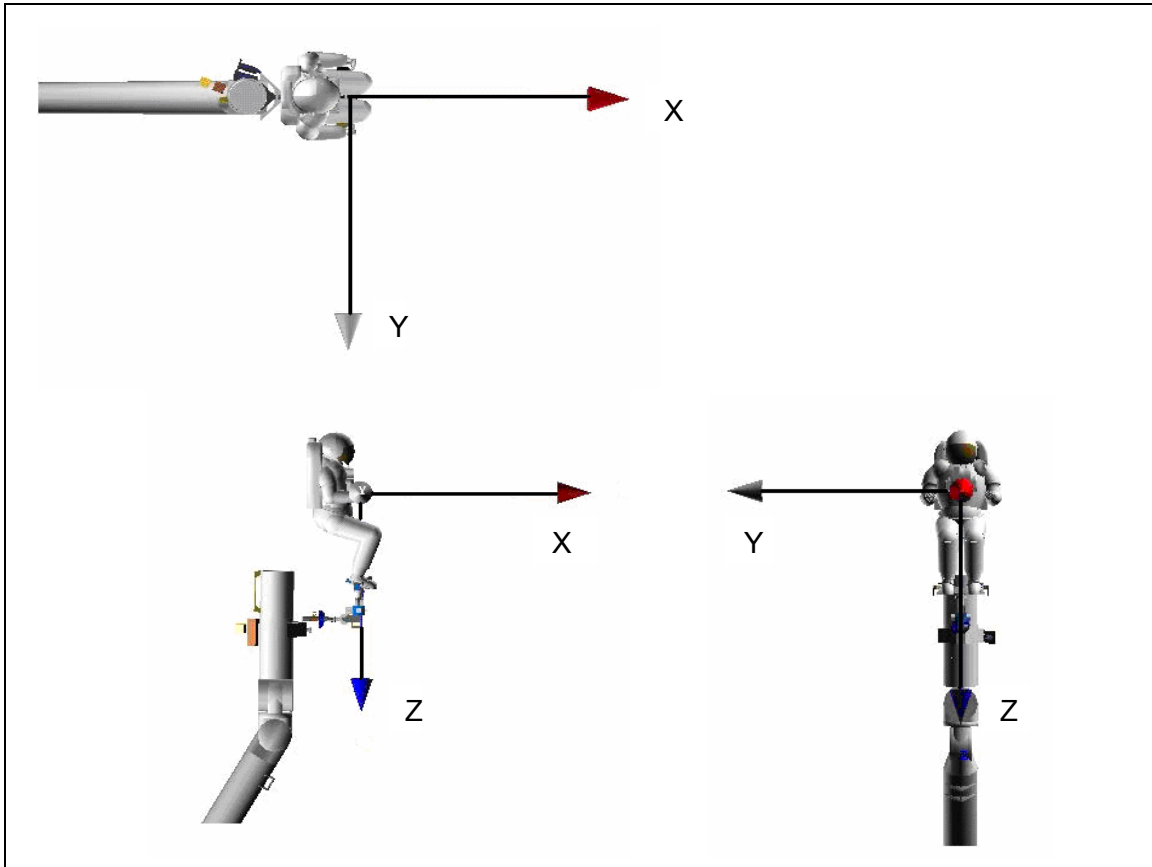

POR: At center of EVA's chest (EVA in APFR set at 12/PP/F/6)

PURPOSE: EVA Operations

RATES:	<u>COARSE</u>	<u>VERN</u>
TRANS LIM ft/sec	0.60	0.20
ROT LIM deg/sec	2.37	0.79



# EVA COORDINATE SYSTEM – PL ID 4 (UPLINK)

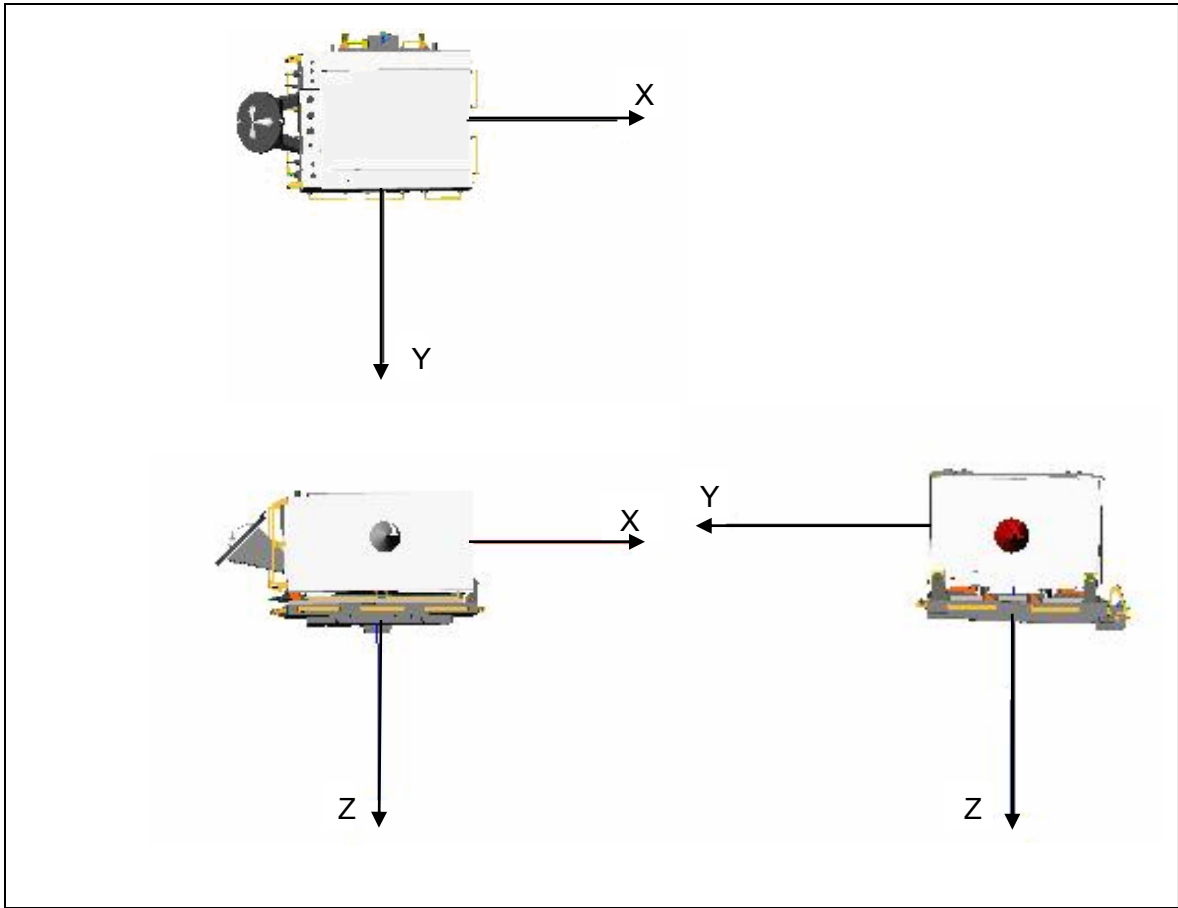

POR: At pump module geometric center

PURPOSE: EVA Operations

RATES:	<u>COARSE</u>	<u>VERN</u>
TRANS LIM ft/sec	0.53	0.18
ROT LIM deg/sec	2.13	0.71

## RMS/EVA GO/NO-GO SUMMARY

THIS TABLE DOES NOT CONTAIN ANY FLIGHT SPECIFIC FLIGHT RULE EXCEPTIONS

CONTINUE OPS IF:	EVA SUPPORT (HIGH PRIORITY)	FLT RULE REF
SHOULDER BRACE REL [1]		
JETTISON SYSTEM [2]	1 ↓ [2]	A12-181
MPM STOW MOTORS [2]	2 ↓ [1]	A12-72
MRL LATCH CAPABILITY [3]	1 ↓ [1]	A12-73
MPM [4] STOWED IND [8]		
MPM [4] DEPLOY IND [8]	SH 1 ↓	
MRLs LATCHED [3]		
MAN AUG MODE [1]		
SINGLE MODE [1]	3 ↓ [4]	A12-111
DIRECT MODE [1]		
BACKUP MODE [1]		
BRAKES [6]	0 ↓	
AUTO BRAKES [1]	0 ↓ [5]	
CAPTURE & RIGIDIZE [2]		
DERIGIDIZE [2]		A12-161
RELEASE [2]		A12-161
BACKUP RELEASE [1]		
THERMAL [DEG F] -20[0], 176[172], LED -20[0], 147[144], ABE (EE) -20[0] 110[106] ABE (SPA)	REQD	A12-3

### NOTES:

- [1] EVA CAPABILITY EXISTS FOR THE FOLLOWING CONTINGENCIES:
- SHOULDER BRACE RELEASE
  - MPM DEPLOY/STOW
  - RMS STRAPDOWN
  - GRAPPLE FIXTURE (GF) RELEASE
- [2] IFM IS AVAILABLE TO RECOVER JETTISON SYSTEM; HIGH PRIORITY RMS ACTIVITIES MAY CONTINUE
- [3] CONTINUE OPERATIONS EVEN IF ONE FAILURE WILL RESULT IN THE INABILITY TO LATCH AT LEAST TWO MRLs (ASSUMES CURRENTLY HAVE TWO-LATCH CAPABILITY). EVA CAPABILITY REQUIRED
- [4] ONE OF SINGLE, DIRECT, OR BACKUP REQUIRED FOR UNCRADLING
- [5] OPERATIONS CAN CONTINUE IN DIRECT OR BACKUP WITH THE LOSS OF AUTO BRAKES. CAPTURE CAPABILITY DOES NOT EXIST IN BACKUP
- [6] WITHOUT THE CAPABILITY TO DERIGIDIZE/EXTEND THE SNARE CARRIAGE, FUTURE CAPTURE CAPABILITY IS LOST

## OBSS NOMINAL OPERATIONS

OBSS UNBERTH.....	FS 8-2
ITVC/LDRI FLAT FIELDS .....	FS 8-8
BERTH.....	FS 8-10
HANDOFF FROM SSRMS TO SRMS .....	FS 8-16
SRMS TO SSRMS .....	FS 8-21
LDRI RCC SURVEY – STBD .....	FS 8-26
– NOSE CAP .....	FS 8-45
– PORT .....	FS 8-60
SRMS EE CAM UPPER SURFACE SURVEY .....	FS 8-76 I

**OBSS NOMINAL  
OPERATIONS**

# OBSS UNBERTH

**WARNING**  
For UNDOCKED ops only

## NOTE

Stbd MPMs assumed deployed

### 1. SETUP

SM 94 PDRS CONTROL

√PL ID, ITEM 3: 0

√INIT ID, ITEM 24: 0

If flight specific DAPs have not been loaded:

Load DAP A14 with permanent edits per STS-116 DAP A

CONFIGURATIONS (ORB OPS FS, DAP TABLES). This may be worked in parallel with the following steps 2-4

RHC

### 2. MNVR TO OBSS PRE-GRAPPLE

RATE – as reqd (VERN within 10 ft)

BRAKES – OFF (tb-OFF)

MODE – ORB UNL, ENTER

If first RMS ops for the mission:

Perform manual PLB survey, en route to OBSS PRE-GRAPPLE position

Mnvr to OBSS PRE-GRAPPLE posn:

X	Y	Z	PITCH	YAW	ROLL	PL ID
-680	+96	-513	270	350	1	0
SY	SP	EP	WP	WY	WR	
-90.0	+87.6	-129.5	-57.5	0.0	+110.4	

BRAKES – ON (tb-ON)

**CAUTION**  
SPEE power must be applied within 90 min  
to prevent sensor package damage

STBD RMS HTR A,B (two) – OFF

A6U

EVENT TIMER MODE – UP

CNTL – START

R12(OBSS) √SPEE PWR – OFF

L12U(SSP1) √APCU 1 OUTPUT RLY – OP (tb-bp)

### 3. OBSS GRAPPLE

A7U

CCTV – config for grapple

– install PDRS TARGET OVERLAY FOR CTVM

– RMS WRIST, ZOOM: 34.0 HFOV

FOCUS: 5 ft

Maintain eyepoint ~18 in when using grapple overlay

A6U

DAP: VERN(FREE)

OBSS NOMINAL OPERATIONS



STBD RMS RETEN LAT – REL (tb-REL) (18 sec max)  
 – OFF

If motor drive time > 18 sec, √MCC

SM 94 PDRS CONTROL

RMS PORT – ITEM 1 EXEC (\*)

6. RECONFIGURE POWER

R13L PL BAY MECH PWR SYS (two) – OFF

MA73C:C cb MCA PWR AC3 3Φ MID 2 – cl  
 √AC2 3Φ MID 2 – op

MA73C:D √AC3 3Φ MID 4 – op

Record joint angles:

SY	SP	EP	WP	WY	WR

7. MNVR TO OBSS HOVER

RHC √RATE – VERN (RATE MIN tb-ON)

BRAKES – OFF (tb-OFF)

MODE – PL, ENTER

Mnvr OBSS up (-Z) to OBSS HOVER, Z = -496

X	Y	Z	PITCH	YAW	ROLL	PL ID
-680	+126	-496	359.5	0	341	1
SY	SP	EP	WP	WY	WR	
-89.8	+80.0	-123.3	-55.2	-0.5	+109.8	

BRAKES – ON (tb-ON)

MODE – not DIRECT

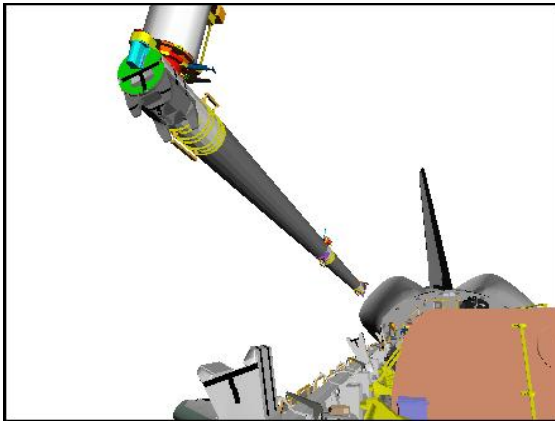

**CCTV D (-15,15)**

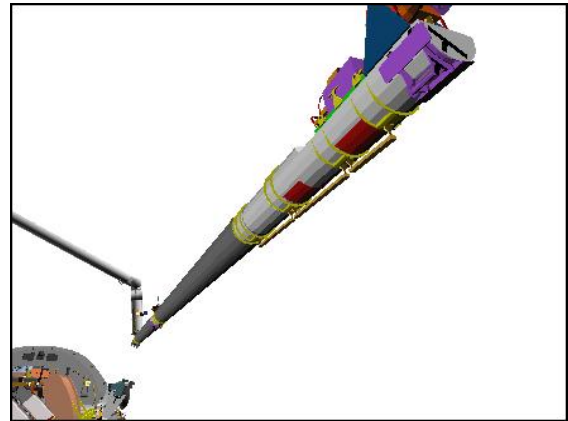

**CCTV C (25,25)**

DAP: A14/AUTO/VERN(ALT)

R12(OBSS) RSC PWR – OFF, ON

In the following P/TV procedure, start 15 min timer upon applying SPEE power and inform MCC when timer is started:

Perform ACTIVATION (LDR/ITVC Cue Card, PHOTO/TV)

SSP1 √APCU 1,2 CONV (two) – OFF (tb-bp)

Perform LCH ACTIVATION (LCS Cue Card, PHOTO/TV)

Perform LCC ACTIVATION (LCS Cue Card, PHOTO/TV)

- A7U  
8. RESET PTU  
MON2 ← PL2

CAMR CMD PAN/TILT – HI RATE

PAN – L (to hard stop)

TILT – UP (to hard stop)

PAN/TILT – RESET, HI RATE (LO within 10°)

PAN: +103 (right)

TILT: -260 (down)

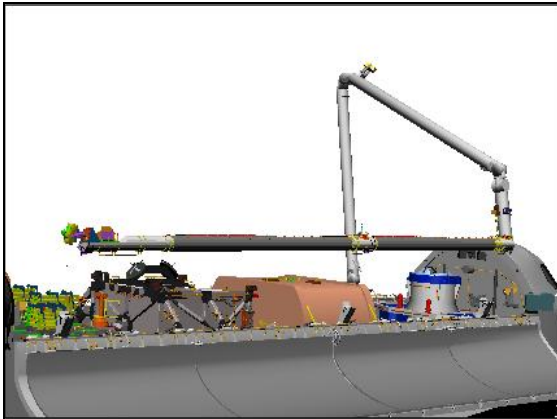

**BIRD'S EYE**

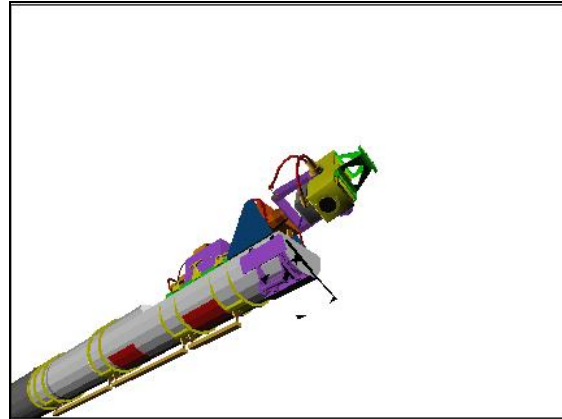

**CCTV C (50,50)**

9. LDRI CALIBRATION  
Verify 15 min SPEE warmup power timer expired

MUX 1 L ← MIDDECK

- a. Mode 3  
LDRI MODE 3 pb – push (LDRI video)  
MON2 ← PL2

PAN/TILT to match LDRI view shown below

Note PAN/TILT: \_\_\_\_\_, \_\_\_\_\_

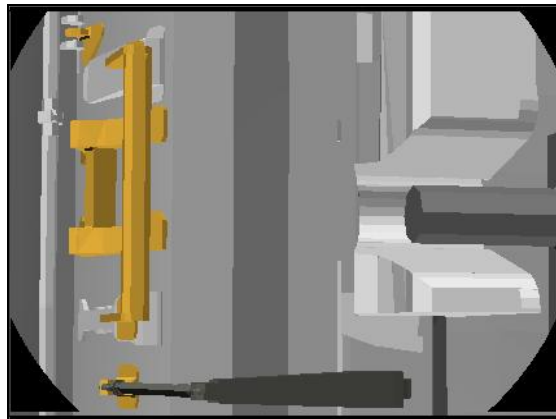

**LDRI (103,-260)**

If LDRI calibration view of STBD sill presents unacceptable specular reflections,

A7U PAN: +110 (right)  
TILT: -220 (up)

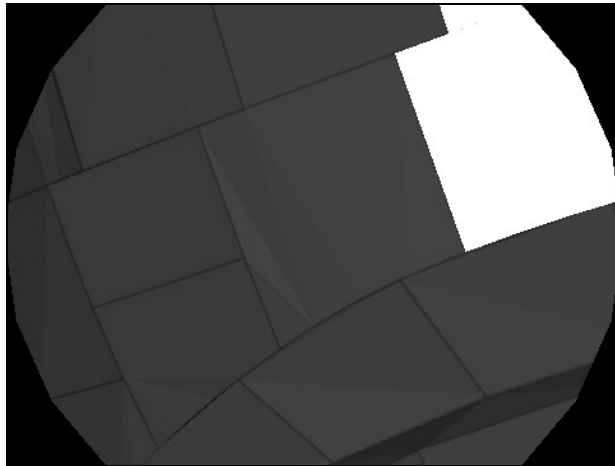

LDRI (110,-220)

√MON2 ← not PL2

L10(VTR)

REC pb – push, hold  
PLAY pb – push, simo (red ●)

NOTE

Wait for MCC GO before proceeding with calibration

Record for 30 sec

STOP pb – push (no red ●)

b. Mode 4

MUX 1 L ← MIDDECK

A7U

LDRI MODE 4 pb – push (brighter LDRI video)

L10(VTR)

REC pb – push, hold  
PLAY pb – push, simo (red ●)

Record for 30 sec

STOP pb – push (no red ●)

c. Mode 5

A7U

LDRI MODE 5 pb – push (flickering LDRI video)

L10(VTR)

REC pb – push, hold  
PLAY pb – push, simo (red ●)

Record for 30 sec

STOP pb – push (no red ●)



- A7U            d. Mode 6  
                  LDRI MODE 6 pb – push (brighter flickering LDRI video)
- L10(VTR)        REC pb – push, hold  
                  PLAY pb – push, simo (red ●)
- Record for 30 sec
- STOP pb – push (no red ●)

10. PROCEED TO FLAT FIELDS  
On MCC GO, go to OBSS ITVC/LDRI FLAT FIELDS

# OBSS ITVC/LDRI FLAT FIELDS

## NOTE

Assumed starting posn is OBSS Hover. Flat Field imagery is used to characterize sensor response. Daylight is NOT required

### 1. SETUP

**SM 94 PDRS CONTROL**

PL ID – ITEM 3 +2 EXEC

INIT ID – ITEM 24 +2 EXEC

A7U

MUX 1 L pb ← MIDDECK

√LDRI MODE 6 pb – push (flickering LDRI video)

DTV ← PL2

MON2 ← PL2

√PAN: +103

TILT: -270 (dn)

### 2. MNVR TO FLAT FIELD POSN

## NOTE

Tilt (lo rate) LDRI positive and negative between -270 and -250 during arm mnvr. Goal is to vary tilt to image white upper surface during mnvr

RHC

RATE – VERN (RATE MIN tb-ON)

BRAKES – OFF (tb-OFF)

MODE – ORB LD, ENTER

L10(VTR)

On MCC GO,

REC pb – push, hold

PLAY pb – push, simo (red ●)

Mnvr to FLAT FIELD posn:

X	Y	Z	PITCH	YAW	ROLL	PL ID
-1001	+303	-501	0	0	24	2
SY	SP	EP	WP	WY	WR	
-89.6	+44.5	-84.6	-45.4	0.0	+109.6	

BRAKES – ON (tb-ON)

L10(VTR)

STOP pb – push (no red ●)

**SM 94 PDRS CONTROL**

PL ID – ITEM 3 +3 EXEC

INIT ID – ITEM 24 +3 EXEC



**CCTV C (70,0)**

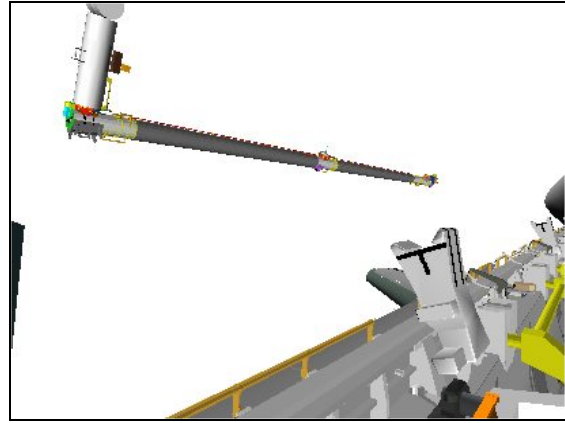

**CCTV D (-40,0)**

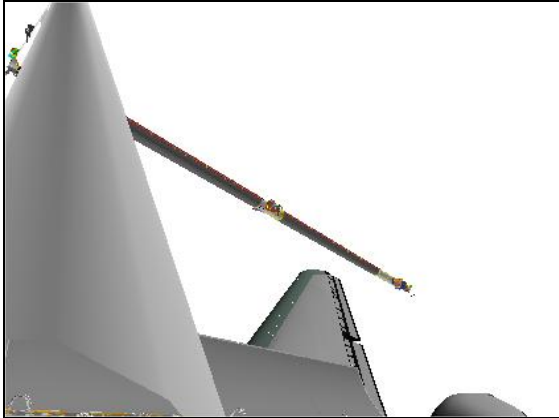

**ELBOW (25,-35)**

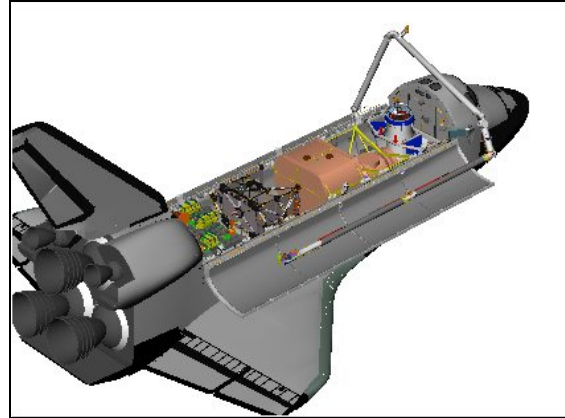

**BIRD'S EYE**

3. MNVR TO STBD SURVEY ATTITUDE  
Mnvr to STBD SURVEY attitude per FLIGHT PLAN  
Go to OBSS LDRI RCC SURVEY – STBD

# OBSS BERTH

**WARNING**  
For UNDOCKED ops only

## NOTE

Stbd MPMs assumed deployed

- A7U 1. SETUP  
CCTV – config for berth

SM 94 PDRS CONTROL

PL ID – ITEM 3 +1 EXEC  
INIT ID – ITEM 24 +1 EXEC

2. OBSS HOVER

Verify mnvr to OBSS HOVER posn complete:

X	Y	Z	PITCH	YAW	ROLL	PL ID
-680	+126	-496	359.5	0	341	1
SY	SP	EP	WP	WY	WR	
-89.8	+80.0	-123.3	-55.2	-0.5	+109.8	

√STBD RMS HTR A,B (two) – OFF

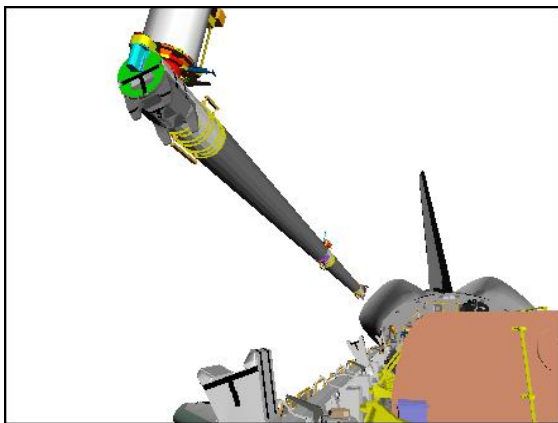

**CCTV D (-15,15)**

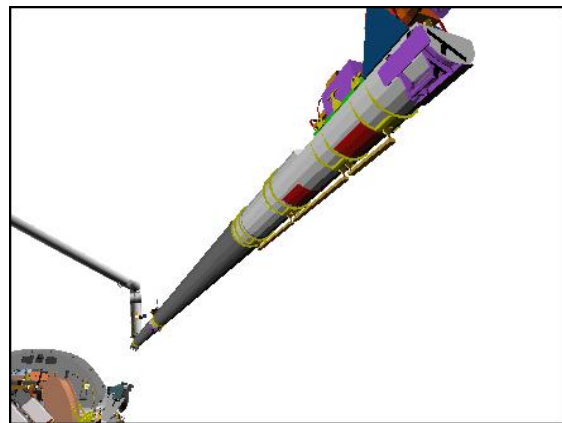

**CCTV C (25,25)**

- A7U 3. STOW PTU  
MON2 ← PL2

CAMR CMD PAN/TILT – HI RATE

PAN – L (to hard stop)

TILT – UP (to hard stop)

PAN/TILT – RESET, HI RATE (LO within 10°)

PAN: +108 (right)

TILT: -175 (down)

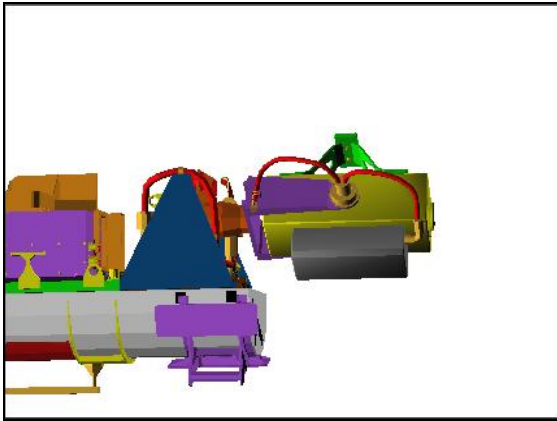

**CCTV B (82,16) HFOV: 15.0**

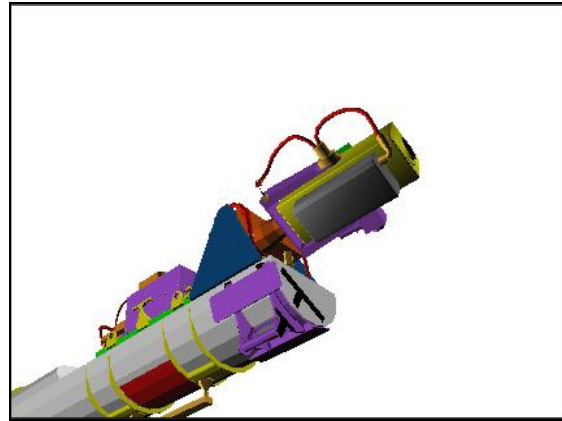

**CCTV C (50,50) HFOV: 40.0**

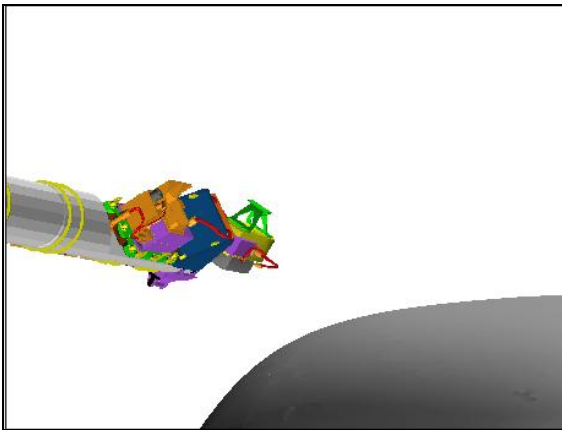

**ELBOW (52,-45) HFOV: 9.8 (full-in)**

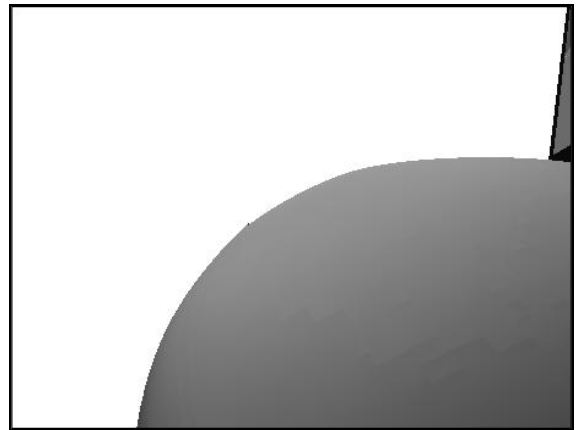

**OBSS ITVC (108,-175) HFOV: 53.8 (full-out)**

Perform LCC DEACTIVATION (LCS Cue Card, PHOTO/TV)  
Perform LCH DEACTIVATION (LCS Cue Card, PHOTO/TV)

**CAUTION**

STBD RMS HTR power must be applied within  
90 min to prevent sensor package damage

Perform DEACTIVATION (LDRI/ITVC Cue Card, PHOTO/TV)

4. OBSS BERTH

SM 94 PDRS CONTROL

Enter OBSS BERTH values for REL recorded in OBSS UNBERTH, step 3

X	Y	Z	PITCH	YAW	ROLL	PL ID
			359.5			1

RMS STBD – ITEM 2 EXEC (\*)

A6U DAP: FREE

RHC RATE – VERN (RATE MIN tb-ON)  
 BRAKES – OFF (tb-OFF)  
 MODE – PL, ENTER

Mnvr OBSS down (+Z) to OBSS BERTH

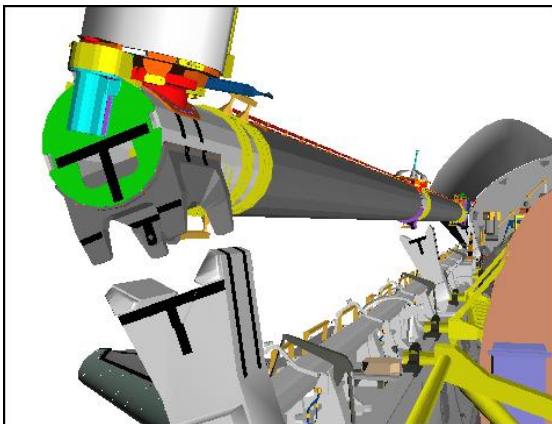

**CCTV D (-15,0) HFOV: 35.0**

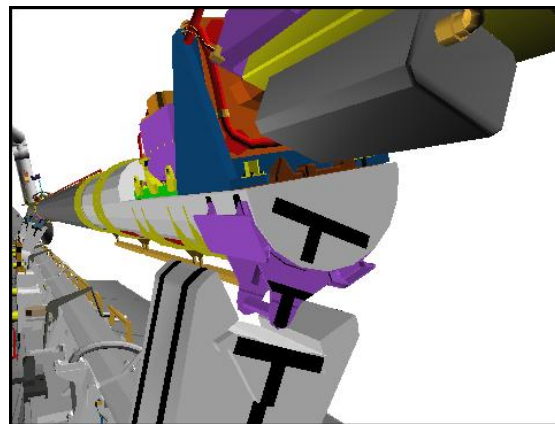

**CCTV C (30,0) HFOV: 60.0**

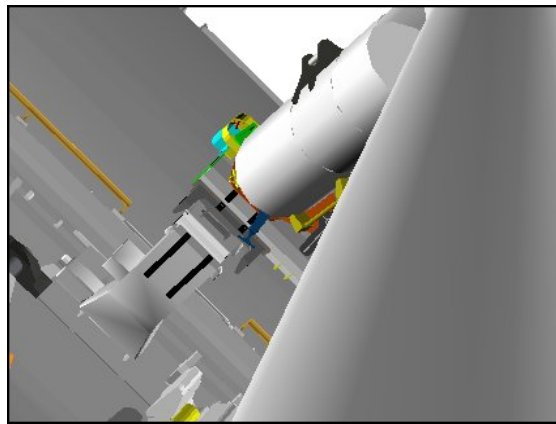

**ELBOW (-7,-12) HFOV: 15.0**

OBSS BERTH:

	X	Y	Z	PITCH	YAW	ROLL	PL ID
Expected	-680	+105	-436	359.5	0	341	1
	SY	SP	EP	WP	WY	WR	
Expected	-89.8	+76.7	-134.7	-40.5	-0.5	+109.8	

√STBD R-F-L tb (three) – gray

5. CONFIGURE POWER  
MA73C:C    cb MCA PWR AC3 3Φ MID 2 – op  
                  √AC2 3Φ MID 2 – op  
MA73C:D            √AC3 3Φ MID 4 – op  
  
R13L            PL BAY MECH PWR SYS (two) – ON

6. STBD MRL LATCH  
RATE – COARSE (RATE MIN tb-OFF)

SM 94 PDRS CONTROL

√STBD AFT, MID, FWD LAT (six) = 0

AUTO BRAKE INH – ITEM 10 EXEC (\*)

NOTE

Expect single motor drive time for MRL latching

STBD RMS RETEN LAT – LAT (tb-LAT) (18 sec max)  
– OFF

If motor drive time > 18 sec, √MCC

MODE – TEST, ENTER  
Wait 5 sec

BRAKES – ON (tb-ON)

SM 94 PDRS CONTROL

RMS PORT – ITEM 1 EXEC (\*)  
AUTO BRAKE ENA – ITEM 9 EXEC (\*)  
PL ID        – ITEM 3 +0 EXEC  
INIT ID – ITEM 24 +0 EXEC

A6U            DAP: A1/AUTO/VERN(ALT)

7. RECONFIGURE POWER  
R13L            PL BAY MECH PWR SYS (two) – OFF

MA73C:C    cb MCA PWR AC3 3Φ MID 2 – cl  
                  √AC2 3Φ MID 2 – op  
MA73C:D            √AC3 3Φ MID 4 – op

8. OBSS UNGRAPPLE

A7U CCTV – config for ungrapple  
 – RMS WRIST, ZOOM: 34.0 HFOV  
 FOCUS: 5 ft

RHC RATE – VERN (RATE MIN tb-ON)

BRAKES – OFF (tb-OFF)  
 MODE – END EFF, ENTER

A6U DAP: VERN(FREE)

CAUTION  
 Monitor EE tb timing to prevent EE motor burnout

EE MODE – AUTO  
 RELEASE sw – REL (mom)

When OPEN tb – gray, mnvr arm clear of grapple pin

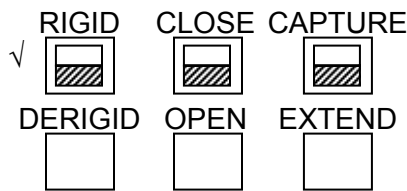

CRITICAL TIMES (28 sec total):  
 DERIGID tb – gray, 5 sec max, then  
 OPEN tb – gray, 3 sec max, then  
 EXTEND tb – gray, 20 sec max

EE MODE – OFF

- \* If manual release reqd: \*
- \* EE MODE – MAN \*
- \* MAN CONTR – DERIGID (hold until DERIGID tb-gray, 5 sec max) \*
- \* RELEASE sw – depress (hold until OPEN tb-gray, 3 sec max) \*
- \* Mnvr arm clear of grapple pin, then \*
- \* EE MAN CONTR – DERIGID (hold until EXTEND tb-gray, 20 sec max)\*
- \* MODE – OFF \*

Mnvr to OBSS PRE-GRAPPLE posn:

X	Y	Z	PITCH	YAW	ROLL	PL ID
-680	+96	-513	270	350	1	0
SY	SP	EP	WP	WY	WR	
-90.0	+87.6	-129.5	-57.5	0.0	+110.4	

BRAKES – ON (tb-ON)

STBD RMS HTR A,B (two) – AUTO

A6U EVENT TIMER CNTL – STOP

DAP: A1/AUTO/VERN(ALT)

If continuing SRMS ops with Upper Surface survey  
 Mnvr to UPPER SURFACE SURVEY attitude per FLIGHT PLAN  
 Go to SRMS EE CAM UPPER SURFACE SURVEY >>



**GNC 23 RCS**

√RCS FWD, ITEM 1: \*

- √MANF VLVS OVRD 1 – ITEM 40 EXEC (OP)
- √2 – ITEM 41 EXEC (OP)
- √3 – ITEM 42 EXEC (OP)
- √4 – ITEM 43 EXEC (OP)
- √5 – ITEM 44 EXEC (OP)

9. ARM PRE-CRADLE

**SM 94 PDRS CONTROL**

- √PL ID, ITEM 3: 0
- √INIT ID, ITEM 24: 0

RATE – as reqd (VERN within 10 ft)  
 BRAKES – OFF (tb-OFF)  
 MODE – as desired

Mnvr to PRE-CRADLE posn:

	SY	SP	EP	WP	WY	WR	
OBSS	-90.0	+87.6	-129.5	-57.5	0.0	+110.4	
PRE-GRAPPLE				+5.0			
1: WP +							
2: WR –						0.0	
3: EP +			-25.0				
4: SY +	0.0						
5: SP –		+25.0					
PRE-CRADLE	0.0	+25.0	-25.0	+5.0	0.0	0.0	
	X	Y	Z	PITCH	YAW	ROLL	PL ID
	-1261	-146	-551	5	2	0	0

BRAKES – ON (tb-ON)  
 MODE – not DIRECT  
 PARAM – PORT TEMP  
 JOINT – CRIT TEMP

## OBSS HANDOFF FROM SSRMS TO SRMS

### 1. SETUP

SM 94 PDRS CONTROL

√PL ID, ITEM 3: 0

√INIT ID, ITEM 24: 0

A7U CCTV – config as reqd

### 2. PRE-GRAPPLE MNVR

RHC RATE – as reqd (VERN within 10 ft)  
BRAKES – OFF (tb-OFF)  
MODE – ORB UNL, ENTER

Mnvr to OBSS PRE-GRAPPLE AT HANDOFF posn:

X	Y	Z	PITCH	YAW	ROLL	PL ID
-966	-1	-625	285	0	271	0
SY	SP	EP	WP	WY	WR	
-33.3	+80.0	-90.0	-77.3	+23.8	-39.8	

BRAKES – ON (tb-ON)

Notify SSRMS Operator that SRMS at OBSS PRE-GRAPPLE AT HANDOFF posn

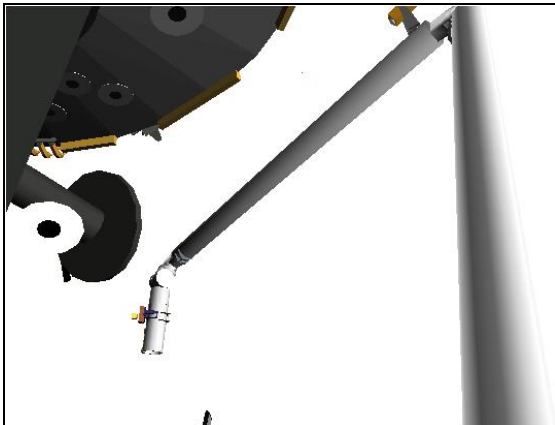

**CCTV A (4,40)**

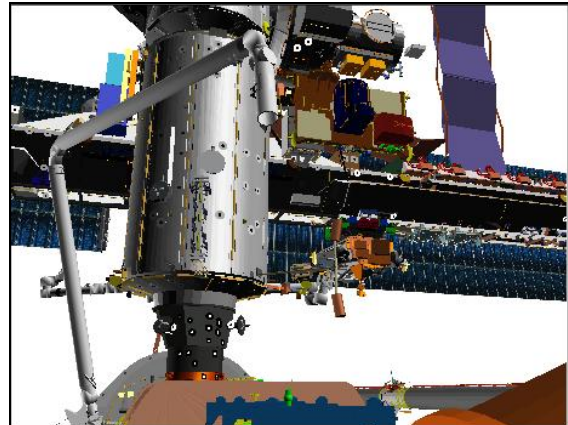

**CCTV B (17,18)**

### 3. CONFIGURE POWER

**CAUTION**  
SPEE power must be applied within 90 min  
to prevent sensor package damage

On SSRMS Operator GO to release STBD MRLs,  
STBD RMS HTR A,B (two) – OFF

A6U EVENT TIMER MODE – UP  
CNTL – START

MA73C:C      cb MCA PWR AC3 3Φ MID 2 – op  
                  √AC2 3Φ MID 2 – op  
MA73C:D      √AC3 3Φ MID 4 – op  
R13L          PL BAY MECH PWR SYS (two) – ON

4. STBD MRL RELEASE

SM 94 PDRS CONTROL

RMS STBD – ITEM 2 EXEC (\*)  
√STBD AFT, MID, FWD REL (six) = 0

NOTE

Expect single motor drive time for MRL release

STBD RMS RETEN LAT – REL (tb-REL) (18 sec max)  
– OFF

If motor drive time > 18 sec, √MCC

SM 94 PDRS CONTROL

√STBD AFT, MID, FWD REL (six) = 1

5. RECONFIGURE POWER

R13L          PL BAY MECH PWR SYS (two) – OFF

MA73C:C      cb MCA PWR AC3 3Φ MID 2 – cl  
                  √AC2 3Φ MID 2 – op  
                  √AC3 3Φ MID 4 – op  
                  :D

Give SSRMS Operator GO for OBSS Unberth  
Monitor RFL Status

After OBSS Unberth,

SM 94 PDRS CONTROL

RMS PORT – ITEM 1 EXEC (\*)

6. SETUP FOR GRAPPLE

A7U          CCTV – config for grapple  
                  – install PDRS TARGET OVERLAY FOR CTVM  
                  – RMS WRIST, ZOOM: 34.0 HFOV  
                                FOCUS: 5 ft

Maintain eyepoint approx 18 in when using grapple overlay

R12(OBSS) √SPEE PWR – OFF  
L12U(SSP1) √APCU 1 OUTPUT RLY – OP (tb-bp)

7. OBSS GRAPPLE AT HANDOFF POSN

RHC          On SSRMS Operator GO for SRMS OBSS Grapple,  
                  RATE    – VERN (RATE MIN tb-ON)  
                  BRAKES – OFF (tb-OFF)  
                  MODE    – END EFF, ENTER

Mnvr to grapple envelope

**CAUTION**  
Monitor EE tb timing to prevent EE motor burnout

EE MODE – AUTO  
CAPTURE sw – depress (mom)

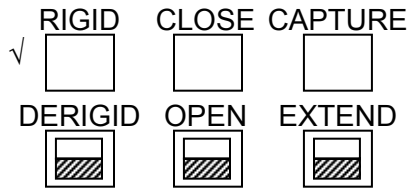

CRITICAL TIMES (28 sec total):  
CAPTURE tb – gray, then  
CLOSE tb – gray, 3 sec max, then  
RIGID tb – gray, 25 sec max

EE MODE – OFF  
  
MODE – TEST, ENTER  
Wait 5 sec  
  
BRAKES – ON (tb-ON)

SM 94 PDRS CONTROL

  
 PL ID – ITEM 3 +2 EXEC  
 INIT ID – ITEM 24 +2 EXEC

Expected OBSS HANDOFF posn:

	X	Y	Z	PITCH	YAW	ROLL	PL ID
√	-986	+318	-554	15	270	0	2
	SY	SP	EP	WP	WY	WR	
√	-28.4	+75.5	-98.1	-62.5	+23.6	-45.1	

\* display singularity

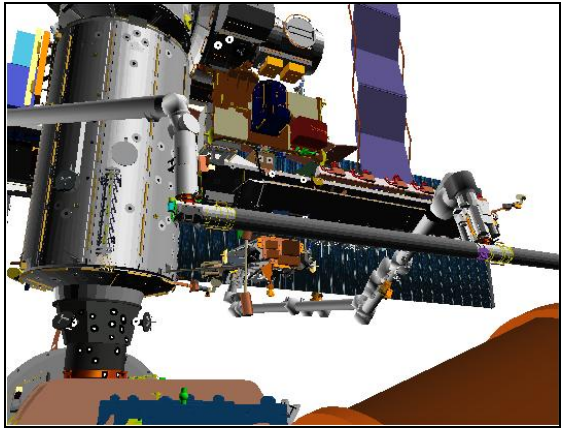

**CCTV B (26,18)**

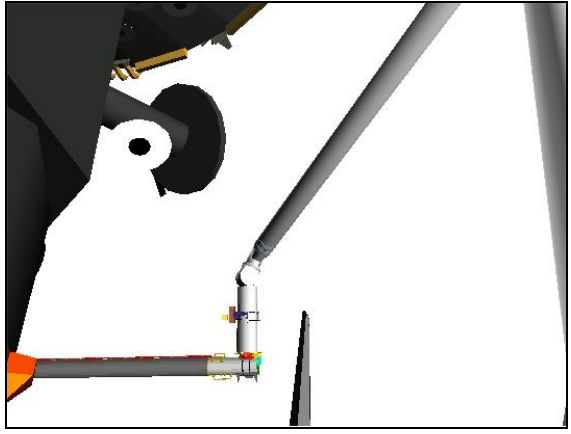

**CCTV A (-6,30)**

R12(OBSS) RSC PWR – OFF, ON

Perform ACTIVATION (LDRI/ITVC Cue Card, PHOTO/TV)

SSP1 √APCU 1,2 CONV (two) – OFF (tb-bp)

Perform LCH ACTIVATION (LCS Cue Card, PHOTO/TV)

Perform LCC ACTIVATION (LCS Cue Card, PHOTO/TV), steps 1 and 2

Give SSRMS Operator GO for OBSS Ungrapple

Review GENERIC END EFFECTOR CUE CARD – ISS/SHUTTLE DOCKED OPS

8. MNVR TO OBSS PARK

On SSRMS Operator GO for mnvr to OBSS PARK posn,  
 BRAKES – OFF (tb-OFF)  
 MODE – SINGLE, ENTER

Mnvr to OBSS PARK posn:

	SY	SP	EP	WP	WY	WR	
HANDOFF	-28.4	+75.5	-98.1	-62.5	+23.6	-45.1	
1: EP +			-25.0				
2: SP –		+25.0					
3: WR +						0.0	
4: WY –					0.0		
5: WP +				+5.0			
6: SY +	0.0						
OBSS PARK	0.0	+25.0	-25.0	+5.0	0.0	0.0	
	X	Y	Z	PITCH	YAW	ROLL	PL ID
	-1243	-143	-869	95	359	358	2

BRAKES – ON (tb-ON)  
 MODE – not DIRECT  
 PARAM – PORT TEMP  
 JOINT – CRIT TEMP

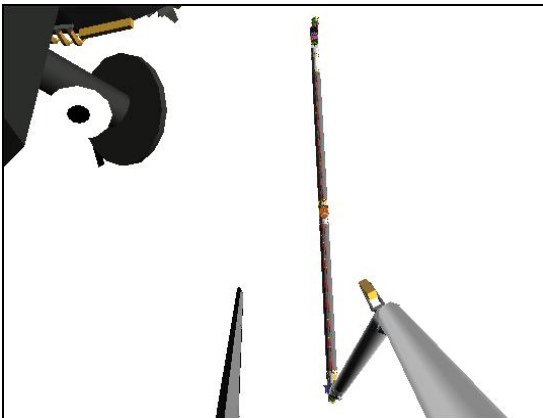

CCTV A (0,28)

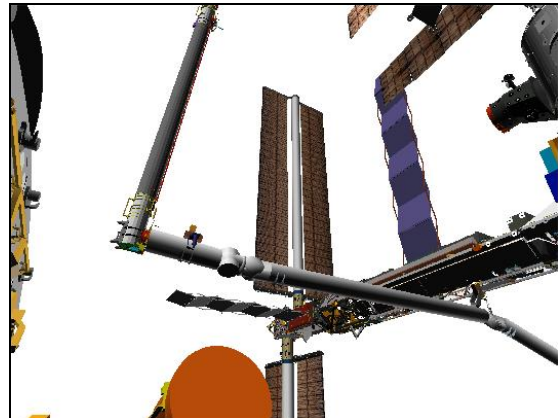

CCTV C (-60,30)

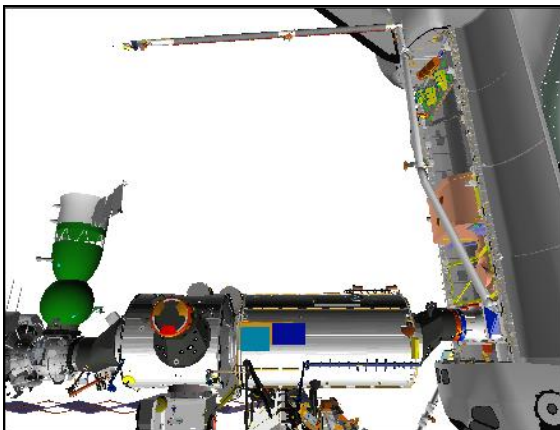

P1 LOWER OUTBOARD (90,20)

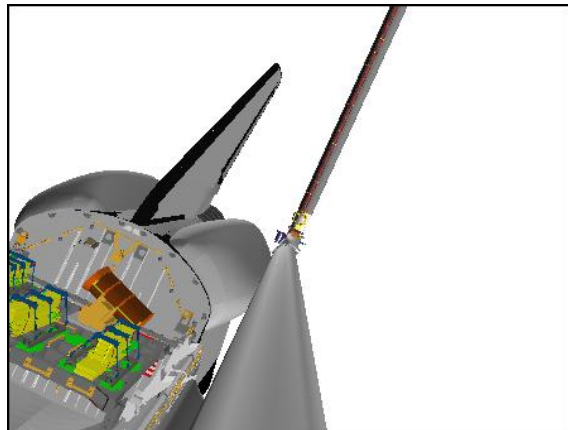

SRMS ELBOW (0,0)

A7U

9. RECONFIG PTU  
MON2 ← PL2

CAMR CMD PAN/TILT – HI RATE

PAN – L (to hard stop)

TILT – UP (to hard stop)

PAN/TILT – RESET, HI RATE (LO within 10°)

PAN: +80 (right)

TILT: -35 (dn)

MUX 1 L ← MIDDECK

LDRI MODE 2 pb – push (ITVC video)

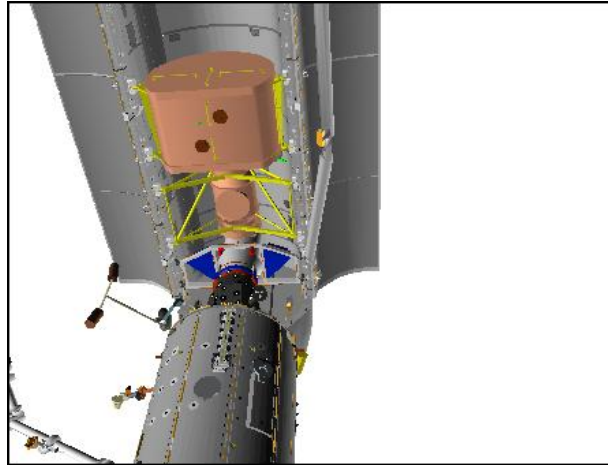

ITVC (80,-35)

# OBSS HANDOFF FROM SRMS TO SSRMS

## 1. SETUP

SM 94 PDRS CONTROL

√PL ID, ITEM 3: 2

√INIT ID, ITEM 24: 2

A7U CCTV – config as reqd

Review GENERIC END EFFECTOR CUE CARD – ISS/SHUTTLE DOCKED OPS

## 2. MANEUVER TO OBSS HANDOFF

RHC RATE – as reqd (VERN within 10 ft)

BRAKES – OFF (tb-OFF)

MODE – SINGLE, ENTER

Mnvr to OBSS HANDOFF posn:

	SY	SP	EP	WP	WY	WR	
OBSS PARK	0.0	+25.0	-25.0	+5.0	0.0	0.0	
1: SY –	-28.4						
2: WP –				-62.5			
3: WY +					+23.6		
4: WR –						-45.1	
5: SP +		+75.5					
6: EP –			-98.1				
HANDOFF	-28.4	+75.5	-98.1	-62.5	+23.6	-45.1	
	X	Y	Z	PITCH	YAW	ROLL	PL ID
	-986	+318	-554	15	270	0	2

\* display singularity

BRAKES – ON (tb-ON)

Notify SSRMS Operator that SRMS at OBSS HANDOFF posn

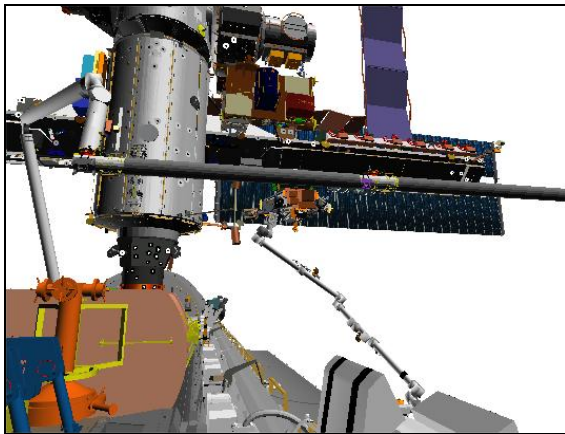

CCTV C (13,12)

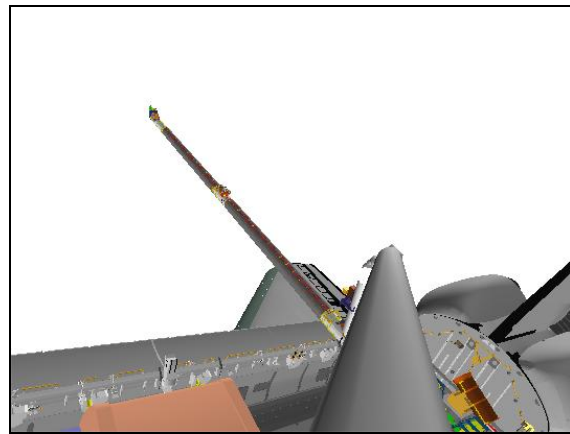

SRMS ELBOW (-15,0)

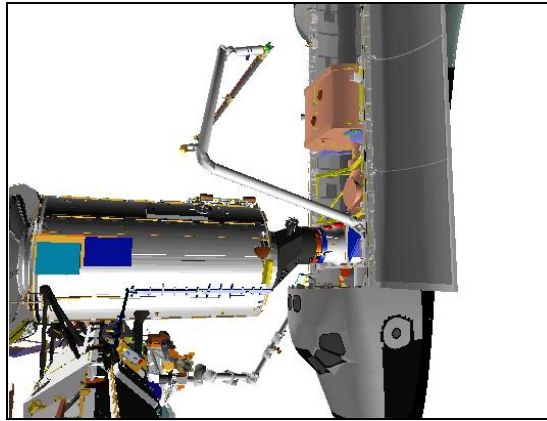

**P1 LOWER OUTBOARD (110,8)**

3. STOW PTU

A7U

On SSRMS Operator GO for OBSS Ungrapple,  
MON2 ← PL2

CAMR CMD PAN/TILT – HI RATE

PAN – L (to hard stop)

TILT – UP (to hard stop)

PAN/TILT – RESET, HI RATE (LO within 10°)

PAN: +108 (right)

TILT: -175 (down)

Perform LCC DEACTIVATION (LCS Cue Card, PHOTO/TV)

Perform LCH DEACTIVATION (LCS Cue Card, PHOTO/TV)

**CAUTION**

STBD RMS HTR power must be applied within  
90 min to prevent sensor package damage

Perform DEACTIVATION (LDRI/ITVC Cue Card, PHOTO/TV)

4. OBSS UNGRAPPLE

A7U

CCTV – config for ungrapple

– RMS WRIST, ZOOM: 34.0 HFOV

FOCUS: 5 ft

**NOTE**

CONTR ERR It and 'S96 PDRS CNTL' msg may  
occur due to Consistency/Envelope Check error

RHC

RATE – COARSE (RATE MIN tb-OFF)

**SM 94 PDRS CONTROL**

AUTO BRAKE INH – ITEM 10 EXEC (\*)



BRAKES – OFF (tb-OFF)  
 MODE – TEST, ENTER  
 Wait 5 sec

BRAKES – ON (tb-ON)







**SM 94 PDRS CONTROL**  
 AUTO BRAKE ENA – ITEM 9 EXEC (\*)  
 PL ID – ITEM 3 +0 EXEC  
 INIT ID – ITEM 24 +0 EXEC

RHC RATE – VERN (RATE MIN tb-ON)  
 BRAKES – OFF (tb-OFF)  
 MODE – END EFF, ENTER

**CAUTION**  
 Monitor EE tb timing to prevent EE motor burnout

EE MODE – AUTO  
 RELEASE sw – depress (mom)

When OPEN tb – gray, mnvr arm clear of grapple pin

√	RIGID 	CLOSE 	CAPTURE 	<u>CRITICAL TIMES (28 sec total):</u> DERIGID tb – gray, 5 sec max, then OPEN tb – gray, 3 sec max, then EXTEND tb – gray, 20 sec max
	DERIGID 	OPEN 	EXTEND 	

EE MODE – OFF

- \* If manual release reqd: \*
- \* EE MODE – MAN \*
- \* MAN CONTR – DERIGID (hold until DERIGID tb-gray, 5 sec max) \*
- \* RELEASE sw – depress (hold until OPEN tb-gray, 3 sec max) \*
- \* Mnvr arm clear of grapple pin, then \*
- \* EE MAN CONTR – DERIGID (hold until EXTEND tb-gray, 20 sec max)\*
- \* MODE – OFF \*

RHC 5. MNVR TO OBSS PRE-GRAPPLE AT HANDOFF  
 RATE – VERN (RATE MIN tb-ON)  
 MODE – as desired

Mnvr to OBSS PRE-GRAPPLE AT HANDOFF posn:

X	Y	Z	PITCH	YAW	ROLL	PL ID
-966	-1	-625	285	0	271	0
SY	SP	EP	WP	WY	WR	
-33.3	+80.0	-90.0	-77.3	+23.8	-39.8	

BRAKES – ON (tb-ON)  
 MODE – not DIRECT  
 JOINT – CRIT TEMP

Give SSRMS Operator GO to mnvr to Handoff Intermediate posn



9. RECONFIGURE POWER  
R13L PL BAY MECH PWR SYS (two) – OFF  
STBD RMS HTR A,B (two) – AUTO

A6U EVENT TIMER CNTL – STOP

SM 94 PDRS CONTROL

√STBD AFT, MID, FWD LAT (six) = 1  
RMS PORT – ITEM 1 EXEC (\*)

MA73C:C cb MCA PWR AC3 3Φ MID 2 – cl

√AC2 3Φ MID 2 – op

MA73C:D √AC3 3Φ MID 4 – op

Give SSRMS Operator GO for OBSS Ungrapple

On SSRMS Operator GO, go to and perform RMS PWRDN, step 1 only

I

# OBSS LDRI RCC SURVEY – STBD

<b>WARNING</b>
For UNDOCKED ops only
Stbd PLBD radiator must be stowed
APAS Docking Ring must be retracted

## NOTE

Assumed starting posn is last LDRI Flat Field posn.

In case of SPEE pwr loss, reset RSC Illuminator,  
reset PTU, select correct LDRI mode

### 1. SETUP

SM 94 PDRS CONTROL

√PL ID, ITEM 3: 3

√INIT ID, ITEM 24: 3

## NOTE

RMS mnvr and orbiter mnvr can be done simultaneously

When MNVR STBD SURVEY attitude complt,  
DAP: A14/AUTO/VERN(ALT)

### 2. MNVR TO STBD LDRI ACAS START POSN

SJ Mnvr Clearance Views	Cameras
OBSS-to-Wing	C[6], D[7], ELBOW[5], RSC[1,3,4]
OBSS-to-PLBD	C[6], D[7], ELBOW[5], RSC[2]
[1]Wing enters FOV at WR = +129	[5]Good until WR = +157
[2]PLBD enters FOV at WR = +130	[6]Good until WR = +160
[3]Good until WR = +141	[7]Good until WR = +164
[4]Good after WR = +151	

BRAKES – OFF (tb-OFF)  
MODE – SINGLE, ENTER

Mnvr to STBD LDRI ACAS START posn:

Last Flat Field Posn	SY	SP	EP	WP	WY	WR	
	-89.6	+44.5	-84.6	-45.4	0.0	+109.6	
1: EP +			-54.2				
2: SY -	-126.0						
3: WP +				-16.7			
4: WY +					+25.9		
5: WR +						+166.4	
6: SP -		+38.1					
STBD LDRI ACAS START	-126.0	+38.1	-54.2	-16.7	+25.9	+166.4	
	X	Y	Z	PITCH	YAW	ROLL	PL ID
	-854	+276	-266	322	2	79	3

BRAKES – ON (tb-ON)

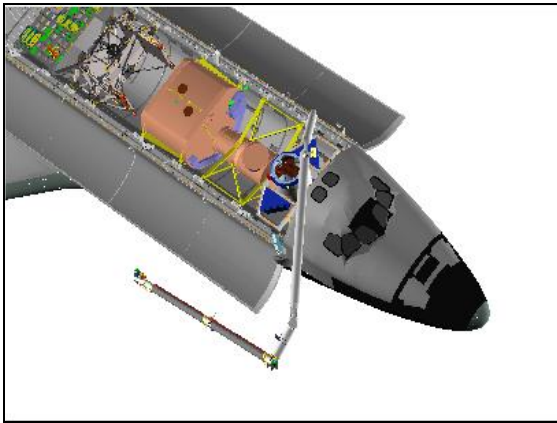

**BIRD'S EYE**

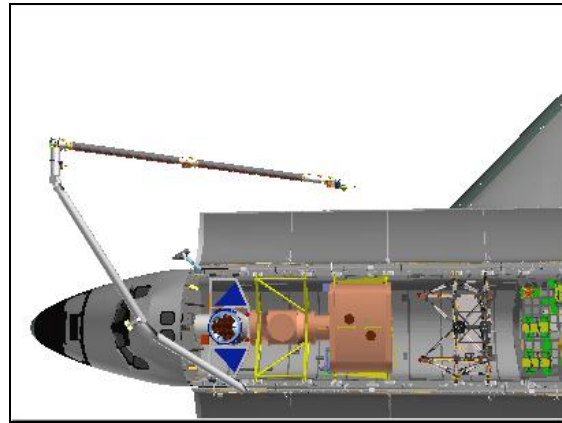

**OVERHEAD**

3. STBD LDRI ACAS, SECTION 1

NOTE

Section 1 scans RCC Zones 2 & 3 (oblique view), Panels 1 → 20

A7U

MON2 ← PL2

PAN: +95 (left)

TILT: -105 (up)

PAN/TILT to match LDRI view shown below

Note PAN/TILT: \_\_\_\_\_, \_\_\_\_\_

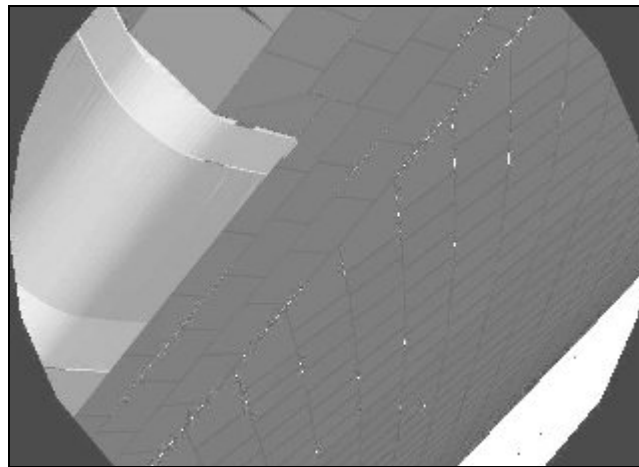

**LDRI (95,-105)**

√MUX 1 L ← MIDDECK

√LDRI MODE 6 pb – push (flickering LDRI displayed)

MON2 ← not PL2

√DTV ← PL2 (LDRI video)

For survey scan pattern, refer to OBSS LDRI SCAN PATTERN CUE CARD – STBD & PORT

For camera views, refer to OBSS LDRI RCC SURVEY CAMERA VIEWS – STBD (SURVEY CAMERA VIEWS)

**SM 94 PDRS CONTROL**

AUTO MODES – ITEM 13 +1 +2 +3 EXEC

RHC

RATE – COARSE (RATE MIN tb-OFF)

BRAKES – OFF (tb-OFF)

MODE – AUTO 1, ENTER (READY It on)

- \* If no AUTO READY It: \*
- \* √Joint angles and adjust as reqd \*

**SM 169 PDRS STATUS**

√LAST PT: 1

Monitor ACAS progress

NOTE

Section 1 run time ~ 3:15 min

Section 1 Clearance Views	Cameras
RMS Upper Arm-to-APAS	A[1]
OBSS-to-PLBD	C[4], D[5], ELBOW[2], RSC[3]
OBSS-to-Wing	D[5], ELBOW[2], RSC
[1]Good for all subsequent scan sections	[4]Good after X ~ -1080
[2]Good after X ~ -1028	[5]Good after X ~ -1105
[3]PLBD leaves FOV at X ~ -1065	

- \* If RSC failed: \*
- \* To regain OBSS-to-PLBD clearance view at any time during ACAS, \*
- \* perform CONTINGENCY LDRI CLEARANCE VIEW (LDRI/ITVC \*
- \* Cue Card, PHOTO/TV) \*

NOTE

Wait for MCC GO before proceeding with survey.

Ensure GMT is set on DSR-25

L10(VTR) On MCC GO,  
 REC pb – push, hold  
 PLAY pb – push, simo (red ●)

AUTO SEQ – PROCEED (IN PROG It on)

ACAS, pause pts shaded, ORAS/OBAS are in **bold**, Rel digitals are nonbold,  
 ● col indicates data recording (black = VTR on) and damage criteria (inches):

Pt	X	Y	Z	PITCH	YAW	ROLL	●
<b>1P</b> Δ	<b>-854</b> +87	<b>+276</b> 0	<b>-266</b> -5	<b>322</b> 0	<b>2</b> 4	<b>79</b> 5	●
2 Δ	+80	-6	+16	0	-3	-9	
3 Δ	+207	-204	+4	-6	11	8	
4 Δ	+27	-16	0	0	3	0	1/4
<b>5P</b>	<b>-1255</b>	<b>+502</b>	<b>-281</b>	<b>326</b>	<b>352</b>	<b>67</b>	●

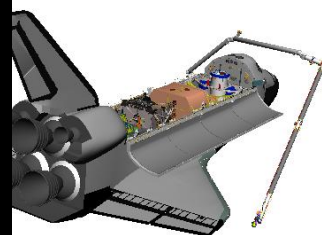
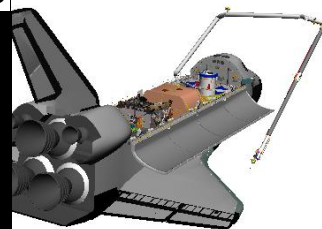

L10(VTR) When AUTO SEQ READY It – on:  
 STOP pb – push (no red ●)

4. STBD LDRI ACAS, PREPARE FOR SECTION 2

NOTE

Between Pts 5 and 7, arm adjusts for survey of Zones 1 & 2.  
 Section 2 then scans Zones 1 & 2, Panels 22 → 1.  
 At Pt 6, Upper Arm-to-APAS = 20.6 in.  
 Time between Pts 5 and 7 ~ 2:50 min

AUTO SEQ – PROCEED (IN PROG It on)

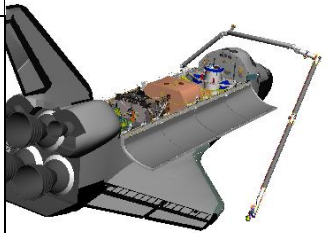
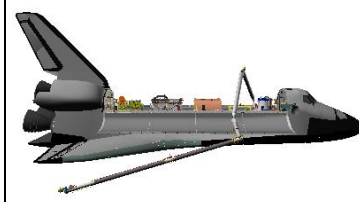
Pt	X	Y	Z	PITCH	YAW	ROLL	
5P Δ	-1255 0	+502 0	-281 -61	326 -20	352 0	67 0	
6 Δ	+103	+25	0	-15	11	49	
7P	-1358	+477	-220	346	347	16	

5. LCS/IDC CHARACTERIZATION

NOTE

LCS and IDC characterization images are obtained here to assess LCS and IDC sensor performance while looking at RCC

a. LCS Characterization

Allow arm motion to damp-out for 30 sec, then:

LCC/  
A31p

sel 'Scanning' 'Detailed Area Scan'

sel – Area Scan 14

**cmd** Start Area Scan (verify Scan Line - Complete)

sel – Area Scan 16

**cmd** Start Area Scan (verify Scan Line - Complete)

sel – Area Scan 17 LDA

**cmd** Start Area Scan (verify Scan Line - Complete)

b. IDC Characterization

LCC/A31p

Minimize, do not close LCC software

Sel 'Shuttle Apps' > 'IDC'



NOTE

Expect 'iport probe failed' message at first pwr on attempt.  
If message persists, see troubleshooting section

Sel 'Power On'

- \* If 'Power On' button not gray: \*
- \* Pause 3 sec, then sel 'Power On' \*

√'Use AE' checked  
Sel 'Scan Lo-Res'

MON2 ← PL2

PAN/TILT to illuminate IDC FOV

PAN: +82 (left)  
TILT: -55 (up)

LCC/A31p

Resize and posn AE box on RCC (pause 2 sec)  
Sel 'Scan Hi-Res'

Sel 'Stop Scan' after 30 sec

√'Waiting for User Command' displayed

Sel 'RCC-Day' or 'RCC-Night' from drop-down menu per real-time conditions  
Sel 'Acquire Set'

√'Acquiring Set' displayed

√'Waiting for User Command' displayed after set

6. STBD LDRI ACAS, CONTINUE WITH SECTION 2

NOTE

At Pt 12, Upper Arm-to-APAS = 19 in.  
Time between Pts 7 and 12 ~ 4:00 min

Section 2 Clearance Views	Cameras
OBSS-to-PLBD	C[2], D[1], ELBOW[4], RSC[3]
OBSS-to-Wing	D[1], ELBOW[4], RSC
[1]Good until X ~ -1275 [2]Good until X ~ -1200	[3]PLBD enters FOV at X ~ -1145 [4]Good until X ~ -1130

A7U

MON2 ← PL2

PAN: +80 (left)

TILT: -65 (dn)

PAN/TILT to match LDRI view shown below

Note PAN/TILT: \_\_\_\_\_, \_\_\_\_\_

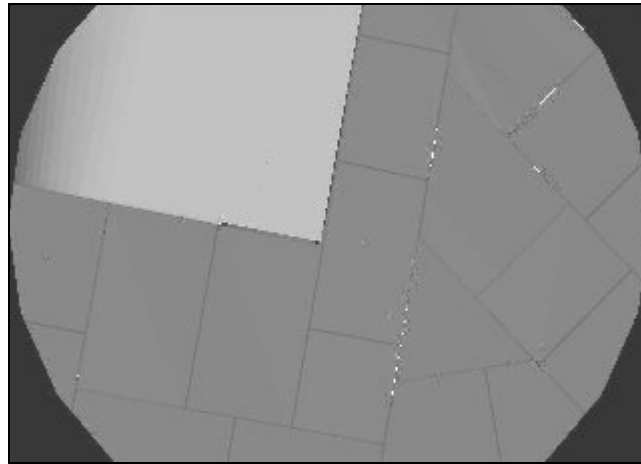

**LDRI (80,-65)**

MON2 ← not PL2

LCC/A31p

Sel 'Scan Hi-Res'

L10(VTR) On MCC GO,  
 REC pb – push, hold  
 PLAY pb – push, simo (red ●)

AUTO SEQ – PROCEED (IN PROG It on)

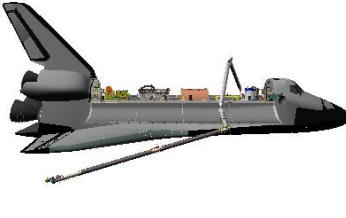
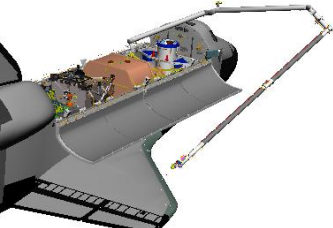
Pt	X	Y	Z	PITCH	YAW	ROLL	●
<b>7P</b>	<b>-1358</b>	<b>+477</b>	<b>-220</b>	<b>346</b>	<b>347</b>	<b>16</b>	
Δ	-42	+14	0	0	0	0	
8 Δ	-22	-1	+2	1	-1	-3	
9 Δ	-233	+246	-21	14	-24	9	
10 Δ	-57	+18	+4	1	-9	-1	
11 Δ	-74	-20	+20	-3	-12	-22	1/4
<b>12P</b>	<b>-930</b>	<b>+220</b>	<b>-225</b>	<b>323</b>	<b>19</b>	<b>54</b>	

LCC/A31p Sel 'Stop Scan'  
 Sel 'Power Off'



7. STBD LDRI ACAS, SECTION 3

NOTE

VTR not stopped between Sections 2 and 3. Section 3 scans RCC Zones 2 & 3, Panels 1 → 22. Run time ~ 4:55 min

Section 3 Clearance Views	Cameras
OBSS-to-PLBD	C[2], D[3], ELBOW, RSC[1]
OBSS-to-Wing	D, ELBOW, RSC
[1]PLBD leaves FOV at X ~ -1130 [2]Good after X ~ -1110 [3]Good after X ~ -1212	

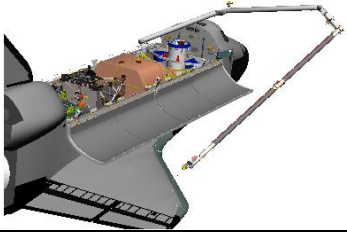
AUTO SEQ – PROCEED (IN PROG It on)

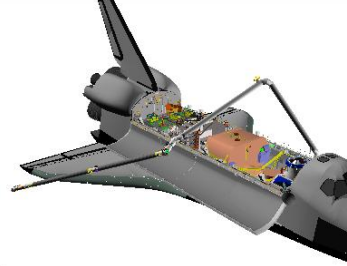
Pt	X	Y	Z	PITCH	YAW	ROLL	●
<b>12P</b> Δ	<b>-930</b> +82	<b>+220</b> -26	<b>-225</b> +3	<b>323</b> -2	<b>19</b> 4	<b>54</b> -4	
13 Δ	+4	+1	-7	19	14	9	
14 Δ	+236	-227	+12	-27	31	-5	
15 Δ	+29	-25	+7	1	-1	-8	
16 Δ	+54	-43	+42	12	-10	-30	
<b>17P</b>	<b>-1335</b>	<b>+540</b>	<b>-282</b>	<b>336</b>	<b>335</b>	<b>71</b>	

L10(VTR)      When AUTO SEQ READY It – on:  
 STOP pb – push (no red ●)

8. STBD LDRI ACAS, SECTION 4

NOTE

Section 4 scans RCC Zone 4, Panels 22 → 1.  
Run time ~ 7:00 min

Section 4 Clearance Views	Cameras
OBSS-to-PLBD	C[4], D[3], ELBOW[5], RSC[2]
OBSS-to-Wing	C[1,4], D[3], ELBOW[5], RSC
[1]Good after X ~ -1310 [2]PLBD enters FOV at X ~ -1075 [3]Good until X ~ -1056	[4]Good until X ~ -1038 [5]Good until X ~ -1000

A7U

MON2 ← PL2

√PAN: +80  
TILT: -90 (down)

PAN/TILT to match LDRI view shown below

Note PAN/TILT: \_\_\_\_\_, \_\_\_\_\_

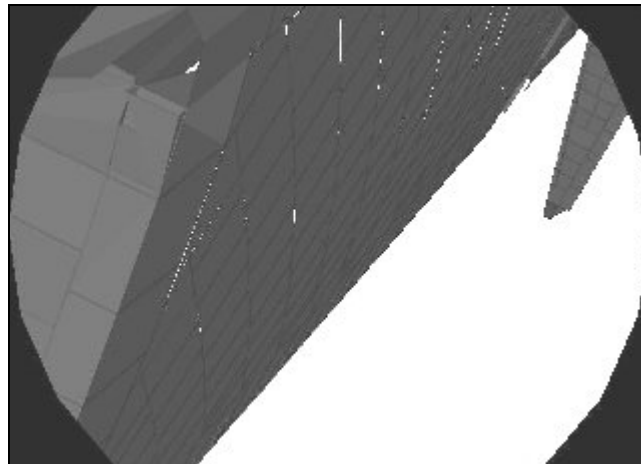

**LDRI (80,-90)**

MON2 ← not PL2

L10(VTR)

REC pb – push, hold  
PLAY pb – push, simo (red ●)

AUTO SEQ – PROCEED (IN PROG It on)

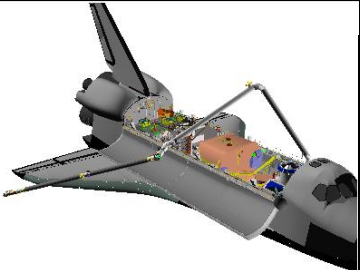
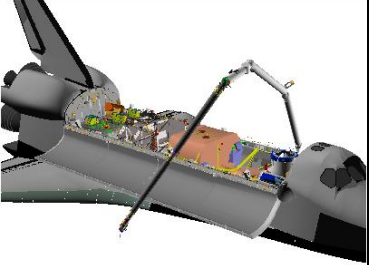
Pt	X	Y	Z	PITCH	YAW	ROLL	●
<b>17P</b> Δ	<b>-1335</b> -56	<b>+540</b> +13	<b>-282</b> +43	<b>336</b> 16	<b>335</b> -25	<b>71</b> -7	
18Δ	-52	+25	-25	-10	15	13	
19Δ	-196	+199	-10	9	-11	6	
20Δ	-29	+27	-2	-9	-15	-2	
21Δ	-87	+5	-6	19	2	4	
<b>22P</b>	<b>-915</b>	<b>+271</b>	<b>-282</b>	<b>311</b>	<b>10</b>	<b>81</b>	

L10(VTR)      When AUTO SEQ READY It – on:  
 STOP pb – push (no red ●)

9. STBD LDRI ACAS, SECTION 5

NOTE

Between Pts 22 and 23, arm adjusts for survey of black tiles on fwd wing glove. Section 5 then scans apex of wing glove black tiles. Time between Pts 22 and 23 ~ 1:20 min

Section 5 Clearance Views	Cameras
OBSS-to-PLBD	C[3], RSC[2], ELBOW[1]
[1]Good after X ~ -905 [2]Wing leaves FOV at X ~ -848 [3]Good after X ~ -670	

AUTO SEQ – PROCEED (IN PROG It on)

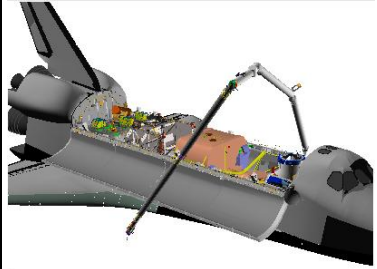
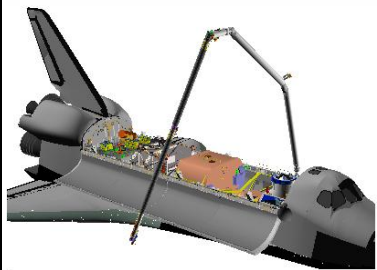
Pt	X	Y	Z	PITCH	YAW	ROLL	•
<b>22P</b> Δ	<b>-915</b> -9	<b>+271</b> -14	<b>-282</b> +22	<b>311</b> 17	<b>10</b> 2	<b>81</b> -11	
<b>23P</b>	<b>-906</b>	<b>+285</b>	<b>-304</b>	<b>294</b>	<b>359</b>	<b>84</b>	

When AUTO SEQ READY It – on:

A7U

MON2 ← PL2

√PAN: +80

TILT: -85 (up)

PAN/TILT to match LDRI view shown below

Note PAN/TILT: \_\_\_\_\_, \_\_\_\_\_

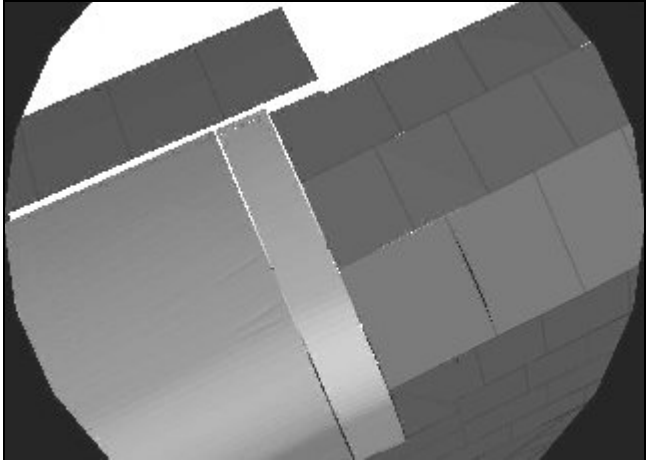

**LDRI (80,-85)**

MON2 ← not PL2

NOTE

Time between Pts 23 and 26 ~ 2:40 min

L10(VTR) REC pb – push, hold  
PLAY pb – push, simo (red ●)

AUTO SEQ – PROCEED (IN PROG It on)

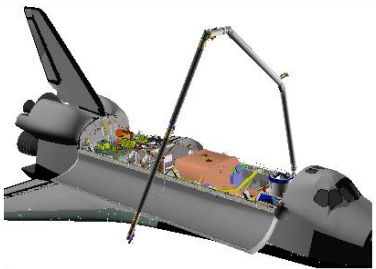
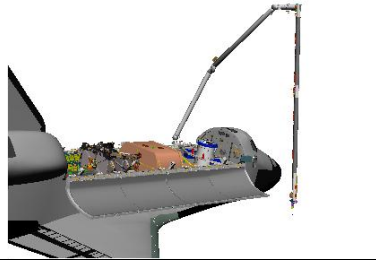
Pt	X	Y	Z	PITCH	YAW	ROLL	•
<b>23P</b> Δ	<b>-906</b> -173	<b>+285</b> 0	<b>-304</b> -5	<b>294</b> 5	<b>359</b> 1	<b>84</b> -2	
24 Δ	-47	-3	+21	13	-2	-3	
25 Δ	-124	-11	+23	10	-1	-4	<b>3</b>
<b>26P</b>	<b>-562</b>	<b>+299</b>	<b>-343</b>	<b>266</b>	<b>350</b>	<b>87</b>	



10. STBD LDRI ACAS, SECTION 6

NOTE

VTR is not stopped between sections 5 and 6. Section 6 scans top side of fwd wing glove, then continues aft for RCC Zones 5 & 6, Panels 1 → 8. Run time ~ 5:10 min

Section 6 Clearance Views	Cameras
OBSS-to-PLBD	C, D[1], ELBOW, RSC
OBSS-to-Wing	D[1,4], ELBOW[3], RSC[2]
[1]Good after X ~ -655	[3]Good after X ~ -921
[2]Wing enters FOV at X ~ -875	[4]Good until X ~ -980

AUTO SEQ – PROCEED (IN PROG It on)

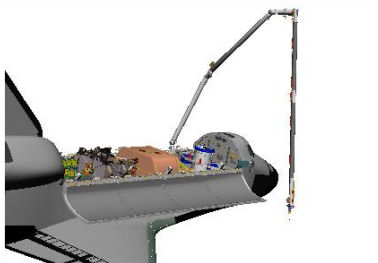
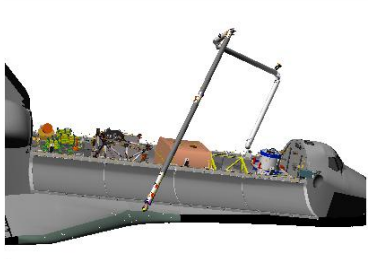
Pt	X	Y	Z	PITCH	YAW	ROLL	●
<b>26P</b> Δ	<b>-562</b> +1	<b>+299</b> +13	<b>-343</b> +26	<b>266</b> 0	<b>350</b> 1	<b>87</b> -7	<b>3</b> 
27 Δ	+115	0	+4	-4	0	-4	
28 Δ	+228	+2	+6	-20	-8	-11	
29 Δ	+57	0	+2	-7	13	-5	
30 Δ	+65	-7	-9	-3	-5	-3	
31 Δ	+23	-8	-13	-1	1	1	
<b>32P</b>	<b>-1051</b>	<b>+299</b>	<b>-359</b>	<b>302</b>	<b>322</b>	<b>92</b>	<b>1</b> 

L10(VTR) When AUTO SEQ READY It – on:  
STOP pb – push (no red ●)

11. STBD LDRI ACAS, SECTION 7

NOTE

Between Pts 32 and 33, arm adjusts to optimize remaining survey of Zones 5 & 6. Section 7 then scans Zones 5 & 6, Panels 9 → 22. Time between Pts 32 and 33 ~ 1:20 min

Section 7 Clearance Views	Cameras
OBSS-to-PLBD	C, D, ELBOW, RSC
OBSS-to-Wing	C, D[1], ELBOW, RSC[2]
[1]Good after X ~ -1110	
[2]PLBD leaves FOV at X ~ -1131	

AUTO SEQ – PROCEED (IN PROG It on)

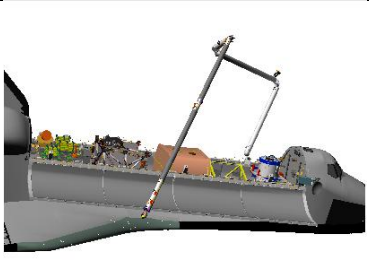
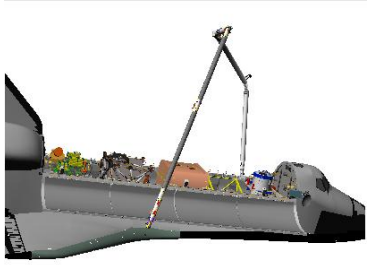
Pt	X	Y	Z	PITCH	YAW	ROLL	●
32P Δ	-1051 -4	+299 +9	-359 -1	302 6	322 2	92 16	
33P	-1047	+290	-358	291	336	83	

When AUTO SEQ READY It – on:

A7U

MON2 ← PL2

√PAN: +80

TILT: -105 (down)

PAN/TILT to match LDRI view shown below

Note PAN/TILT: \_\_\_\_\_, \_\_\_\_\_

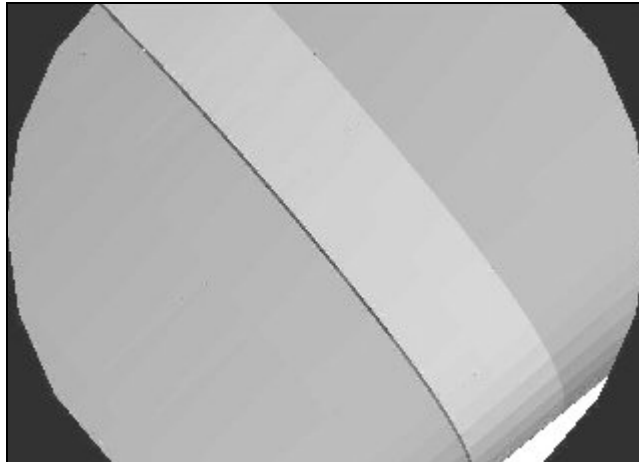

**LDRI (80,-105)**

MON2 ← not PL2

NOTE

Time between Pts 33 and 37 ~ 3:45 min

L10(VTR) REC pb – push, hold  
PLAY pb – push, simo (red ●)

AUTO SEQ – PROCEED (IN PROG It on)

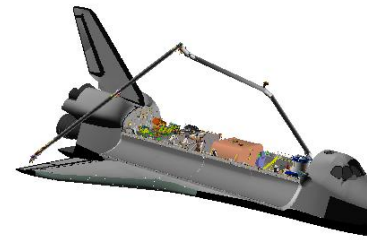
Pt	X	Y	Z	PITCH	YAW	ROLL	●
<b>33P</b> Δ	<b>-1047</b> +188	<b>+290</b> -163	<b>-358</b> +23	<b>291</b> -1	<b>336</b> -2	<b>83</b> -23	
34 Δ	+24	-42	-14	-6	-12	13	
35 Δ	+21	-4	+6	2	4	-2	
36 Δ	+45	-16	-3	-4	-6	2	1/4
<b>37P</b>	<b>-1325</b>	<b>+515</b>	<b>-370</b>	<b>311</b>	<b>334</b>	<b>101</b>	

L10(VTR) When AUTO SEQ READY It – on:  
STOP pb – push (no red ●)



12. STBD LDRI ACAS, SECTION 8

NOTE

Between Pts 37 and 38, arm adjusts for survey of Zone 6.  
 Section 8 then scans Zone 6, Panels 22 → 1. Time  
 between Pts 37 and 38 ~ 0:45 sec

Section 8 Clearance Views	Cameras
OBSS-to-PLBD	C, D[3,6], ELBOW[5], RSC[2]
OBSS-to-Wing	C, D[3,6,7,8], ELBOW[4], RSC[1]
[1]Good until X ~ -1205	[5]Good until X ~ -1027
[2]PLBD enters FOV at X ~ -1150	[6]Good after X ~ -1027
[3]Good until X ~ -1141	[7]Good until X ~ -1003
[4]Good until X ~ -1035	[8]Good after X ~ -973

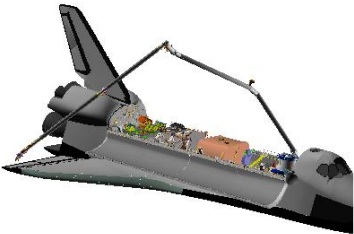
AUTO SEQ – PROCEED (IN PROG It on)

Pt	X	Y	Z	PITCH	YAW	ROLL	•
<b>37P</b> Δ	<b>-1325</b> +22	<b>+515</b> +35	<b>-370</b> +25	<b>311</b> -2	<b>334</b> 0	<b>101</b> -3	
<b>38P</b>	<b>-1347</b>	<b>+480</b>	<b>-395</b>	<b>314</b>	<b>332</b>	<b>103</b>	

When AUTO SEQ READY It – on:

A7U

MON2 ← PL2

PAN: +50 (left)

TILT: -115 (down)

PAN/TILT to match LDRI view shown below

Note PAN/TILT: \_\_\_\_\_, \_\_\_\_\_

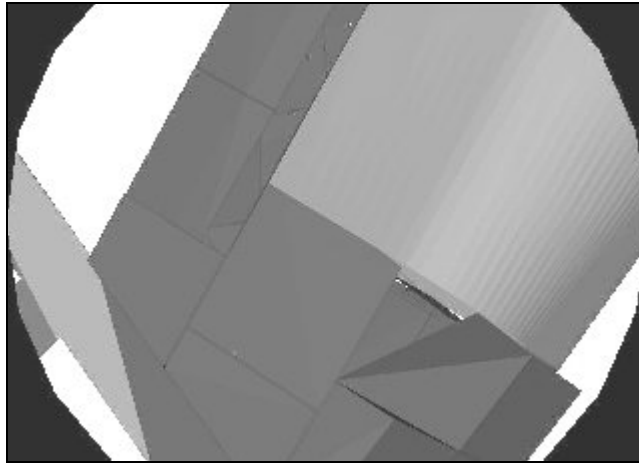

**LDRI (50,-115)**

MON2 ← not PL2

NOTE

Between Pts 41 and 42, LDRI scan distance increases beyond 7 ft due to OBSS prox to STBD PLBD. Time between Pts 38 and 46 ~ 6:55 min

L10(VTR) REC pb – push, hold  
PLAY pb – push, simo (red ●)

AUTO SEQ – PROCEED (IN PROG It on)

Pt	X	Y	Z	PITCH	YAW	ROLL	●
<b>38P</b> Δ	<b>-1347</b> -44	<b>+480</b> +6	<b>-395</b> -2	<b>314</b> 0	<b>332</b> 1	<b>103</b> 6	1/4
39 Δ	-21	+7	-3	-2	2	3	
40 Δ	-12	+19	+2	3	-3	-4	
41 Δ	-193	+184	+16	4	4	2	
42 Δ	-48	-8	-8	0	8	19	
43 Δ	-27	-13	-15	-8	-1	9	
44 Δ	-32	-5	-20	-11	-2	11	
45 Δ	-95	+2	0	-6	0	-5	
<b>46P</b>	<b>-875</b>	<b>+288</b>	<b>-365</b>	<b>322</b>	<b>1</b>	<b>69</b>	1

When AUTO SEQ IN PROG It – off:  
BRAKES – ON (tb-ON)

L10(VTR) STOP pb – push (no red ●)

A7U MUX 1 L ← MIDDECK  
LDRI MODE 2 pb – push (ITVC video displayed)

MON2 ← PL2

If continuing OBSS ops with undocked Nose Cap survey:  
 Mnvr to NOSE CAP SURVEY attitude per FLIGHT PLAN  
 Go to OBSS LDRI RCC SURVEY – NOSE CAP >>

- RHC 13. RETURN TO OBSS HOVER  
 RATE – as reqd (VERN within 10 ft)  
 BRAKES – OFF (tb-OFF)  
 MODE – SINGLE, ENTER

Mnvr to OBSS HOVER:

	SY	SP	EP	WP	WY	WR	
STBD LDRI	-120.8	+32.5	-23.7	-45.8	+12.8	+164.7	
ACAS End							
1: WR –						+70.0	
2: SP +		+80.0					
3: SY +	-89.8						
4: WP –				-55.2			
5: WY –					-0.5		
6: EP –			-123.3				
7: WR +						+109.8	
OBSS HOVER	-89.8	+80.0	-123.3	-55.2	-0.5	+109.8	
	X	Y	Z	PITCH	YAW	ROLL	PL ID
	-1271	+128	-506	359.5	0	11	3

BRAKES – ON (tb-ON)

# OBSS LDRI RCC SURVEY – NOSE CAP

**WARNING**  
Port PLBD radiator must be stowed

## 1. SETUP

SM 94 PDRS CONTROL

- √PL ID, ITEM 3: 3
- √INIT ID, ITEM 24: 3

CAMR CMD PAN/TILT – HI RATE

PAN – L (to hard stop)

TILT – UP (to hard stop)

PAN/TILT – RESET, HI RATE (LO within 10°)

## 2. INHIBIT NOSE JETS

- O14:F, √Pri RJDA LOGIC,DRIVER (eight) – ON
- O15:F, √Pri RJDF LOGIC,DRIVER (eight) – OFF
- O16:F

A6U

When mnvr to NOSE CAP SURVEY attitude complt,  
DAP: A14/AUTO/ALT (Tail Only)

### NOTE

Expect DAP RECONFIG message after  
FRCS manifold 5 status overridden to close

GNC 23 RCS

- √RCS FWD, ITEM 1: \*
- MANF VLVS OVRD 1 – ITEM 40 EXEC (CL)
- 2 – ITEM 41 EXEC (CL)
- 3 – ITEM 42 EXEC (CL)
- 4 – ITEM 43 EXEC (CL)
- 5 – ITEM 44 EXEC (CL)

## 3. MNVR TO NOSE CAP LDRI ACAS START POSN

BRAKES – OFF (tb-OFF)  
MODE – SINGLE, ENTER

Mnvr to NOSE CAP LDRI ACAS START posn:

	SY	SP	EP	WP	WY	WR	
STBD LDRI ACAS End	-120.8	+32.5	-23.7	-45.8	+12.8	+164.7	
1: WR –						+81.5	
2: SP +		+48.8					
3: SY +	+156.6						
4: EP +			-19.1				
5: WP –				-47.9			
6: WY –					-9.1		
7: WR +						+162.6	
NOSE CAP ACAS Start	+156.6	+48.8	-19.1	-47.9	-9.1	+162.6	
	X	Y	Z	PITCH	YAW	ROLL	PL ID
	-187	+98	-348	260	303	315	3

BRAKES – ON (tb-ON)

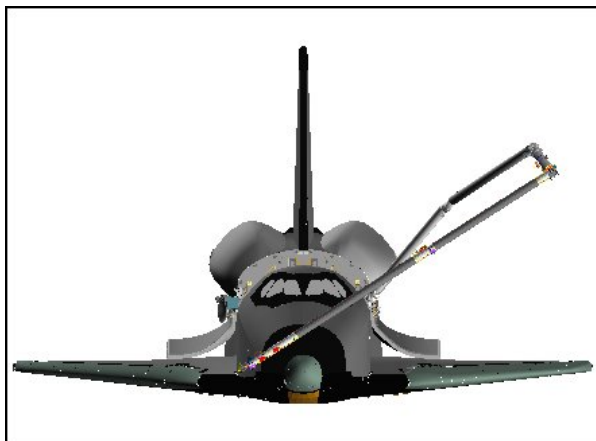

FRONT



RSC

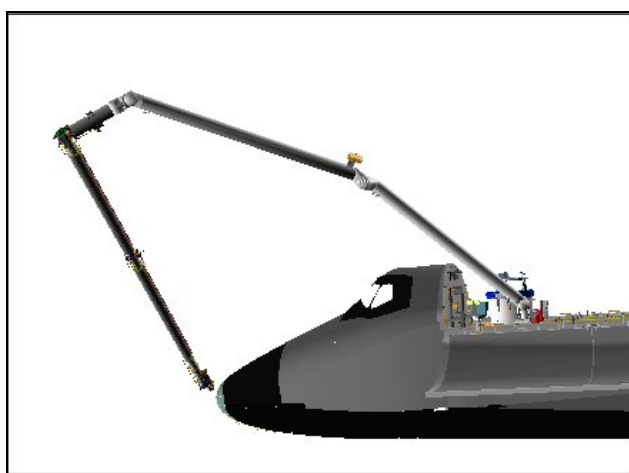

BIRD'S EYE

A7U

4. NOSE CAP LDRI ACAS, SECTION 1  
MUX 1 L ← MIDDECK  
LDRI MODE 6 pb – push (flickering LDRI displayed)

MON2 ← PL2

√PAN: +0  
TILT: -45 (dn)

PAN/TILT to match LDRI view shown below

Note PAN/TILT: \_\_\_\_\_, \_\_\_\_\_



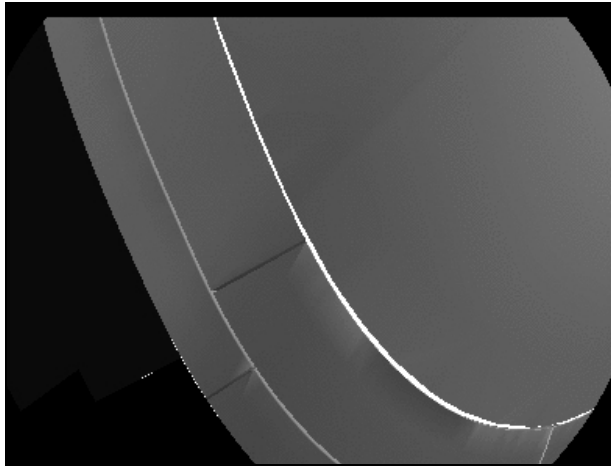

**LDRI (0,-45)**

MON 2 ← not PL2

For survey scan pattern, refer to OBSS LDRI SCAN PATTERN CUE CARD – NOSE CAP (CUE CARD CONFIG)

For camera views, refer to OBSS LDRI RCC SURVEY CAMERA VIEWS – NOSE CAP (SURVEY CAMERA VIEWS)

RHC

RATE – COARSE (RATE MIN tb-OFF)

BRAKES – OFF (tb-OFF)

MODE – AUTO 2, ENTER (READY It on)

\* If unable to enter AUTO mode (no AUTO READY It): \*

\* √Joint angles and adjust as reqd \*

**SM 169 PDRS STATUS**

√LAST PT: 47

Monitor ACAS progress

NOTE

Section 1 run time ~ 2:15 min

<b>Section 1 Clearance Views</b>	<b>Cameras</b>
RMS-to-PLBD	A, ELBOW
OBSS-to-Nose Cap	RSC[1], P1 LOOB[1], US LAB
[1]Good for all subsequent scan sections	



NOTE

Wait for MCC GO before proceeding with survey

L10(VTR) On MCC GO,  
 REC pb – push, hold  
 PLAY pb – push, simo (red ●)

AUTO SEQ – PROCEED (IN PROG It on)

ACAS, pause pts shaded, ORAS/OBAS are in **bold**, Rel digitals are nonbold,  
 ● col indicates data recording (black = VTR on) and damage criteria (inches):

Pt	X	Y	Z	PITCH	YAW	ROLL	●
<b>47P</b> Δ	<b>-187</b> -27	<b>+98</b> +40	<b>-348</b> +23	<b>260</b> 6	<b>303</b> 18	<b>315</b> -13	
48 Δ	+17	-13	+10	9	-4	9	
<b>49P</b>	<b>-177</b>	<b>+71</b>	<b>-381</b>	<b>227</b>	<b>305</b>	<b>291</b>	

L10(VTR) When AUTO SEQ READY It – on:  
 STOP pb – push (no red ●)



5. NOSE CAP LDRI ACAS, SECTION 2

NOTE

Time between Pts 49 and 51 ~ 3:20 min

Section 2 Clearance Views	Cameras
RMS-to-PLBD	A, ELBOW
OBSS-to-Nose Cap	ELBOW[1], US LAB
[1]Good after Y ~ 57	

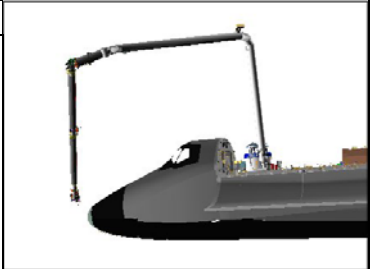
AUTO SEQ – PROCEED (IN PROG It on)

Pt	X	Y	Z	PITCH	YAW	ROLL	•
<b>49P</b> Δ	<b>-177</b> +8	<b>+71</b> +44	<b>-381</b> +44	<b>227</b> 32	<b>305</b> -7	<b>291</b> -4	
50 Δ	-4	0	-22	32	-8	1	
<b>51P</b>	<b>-181</b>	<b>+27</b>	<b>-403</b>	<b>154</b>	<b>289</b>	<b>281</b>	

A7U

When AUTO SEQ READY It – on:

MON2 ← PL2

PAN: +75 (right)

TILT: -55 (dn)

PAN/TILT to match LDRI view shown below

Note PAN/TILT: \_\_\_\_\_, \_\_\_\_\_

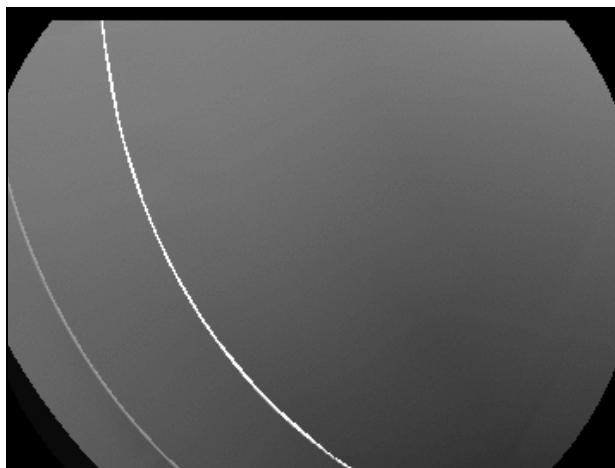

LDRI (75,-55)



**NOTE**

Time between Pts 51 and 56 ~ 6:20 min

MON2 ← not PL2

L10(VTR) REC pb – push, hold  
PLAY pb – push, simo (red ●)

AUTO SEQ – PROCEED (IN PROG It on)

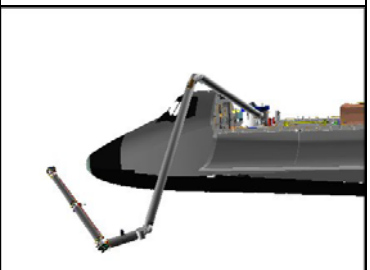
Pt	X	Y	Z	PITCH	YAW	ROLL	●
<b>51P</b> Δ	<b>-181</b> +1	<b>+27</b> +20	<b>-403</b> +11	<b>154</b> 1	<b>289</b> 5	<b>281</b> -6	
52 Δ	-5	-24	-29	-4	-3	-31	
53 Δ	+7	+57	+38	16	9	-35	
54 Δ	-14	+39	-54	-28	18	-6	
55 Δ	-22	-53	-37	-17	-21	-18	
<b>56P</b>	<b>-148</b>	<b>-12</b>	<b>-332</b>	<b>169</b>	<b>306</b>	<b>250</b>	

L10(VTR) When AUTO SEQ READY It – on:  
STOP pb – push (no red ●)



6. NOSE CAP LDRI ACAS, SECTION 3

NOTE

Time between Pts 56 and 57 ~ 2:00 min

Section 3 Clearance Views	Cameras
RMS-to-PLBD	A, ELBOW
OBSS-to-Nose Cap	ELBOW[1], US LAB[2]
[1]Good until Z ~ -290	
[2]Good until Z ~ -292	

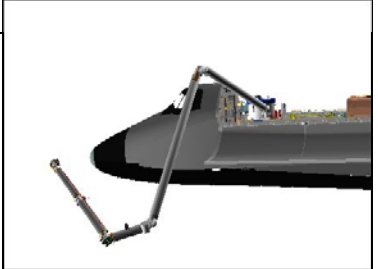
AUTO SEQ – PROCEED (IN PROG It on)

Pt	X	Y	Z	PITCH	YAW	ROLL	●
56P Δ	-148 +7	-12 -50	-332 -32	169 -8	306 -20	250 24	
57P	-155	+38	-300	233	297	309	

A7U

When AUTO SEQ READY It – on:  
MON2 ← PL2

√PAN: +75  
TILT: -43 (up 12°)

Note PAN/TILT: \_\_\_\_\_, \_\_\_\_\_

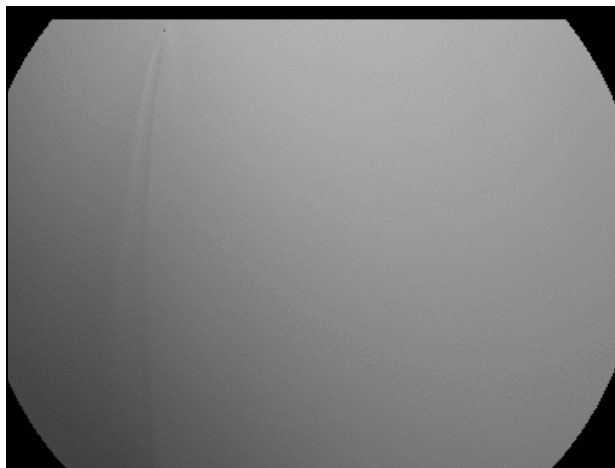

LDRI (75,-43)



NOTE

Time between Pts 57 and 59 ~ 2:55 min

MON2 ← not PL2

L10(VTR) REC pb – push, hold  
PLAY pb – push, simo (red ●)

AUTO SEQ – PROCEED (IN PROG It on)

Pt	X	Y	Z	PITCH	YAW	ROLL	●
<b>57P</b> Δ	<b>-155</b> +28	<b>+38</b> -32	<b>-300</b> -27	<b>233</b> -19	<b>297</b> 5	<b>309</b> -25	
58 Δ	+26	+43	-45	-27	4	18	1/4
<b>59P</b>	<b>-209</b>	<b>+27</b>	<b>-228</b>	<b>238</b>	<b>298</b>	<b>266</b>	

L10(VTR) When AUTO SEQ READY It – on:  
STOP pb – push (no red ●)

7. NOSE CAP LDRI ACAS, SECTION 4

NOTE

Time between Pts 59 and 60 ~ 1:20 min

Section 4 Clearance Views	Cameras
RMS-to-PLBD	A, ELBOW
OBSS-to-Nose Cap	ELBOW[1][2]
[1]Good after Y ~ 6	
[2]Good until Y ~ -12	

AUTO SEQ – PROCEED (IN PROG It on)

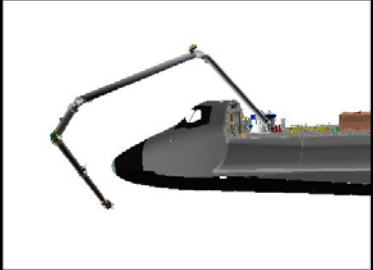
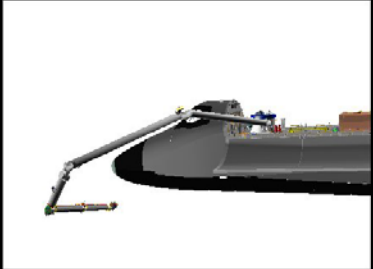
Pt	X	Y	Z	PITCH	YAW	ROLL	•
59P Δ	-209 +27	+27 +27	-228 +6	238 -1	298 0	266 -14	
60P	-236	0	-234	217	287	242	

A7U

When AUTO SEQ READY It – on:

MON2 ← PL2

PAN: +85 (right)

TILT: -73 (down)

PAN/TILT to match LDRI view shown below

Note PAN/TILT: \_\_\_\_\_, \_\_\_\_\_

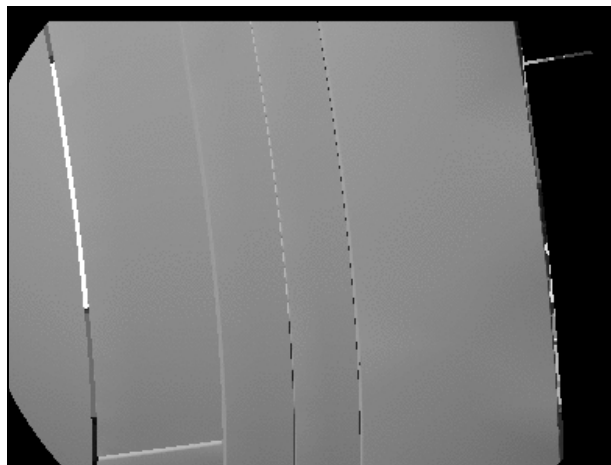

LDRI (85,-73)

NOTE

Time between Pts 60 and 62 ~ 2:25 min

MON2 ← not PL2

L10(VTR) REC pb – push, hold  
PLAY pb – push, simo (red ●)

AUTO SEQ – PROCEED (IN PROG It on)

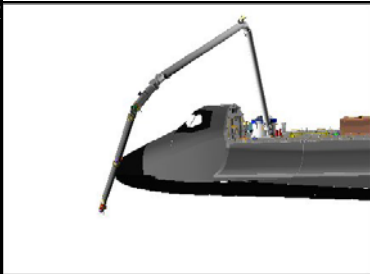
Pt	X	Y	Z	PITCH	YAW	ROLL	●
<b>60P</b> Δ	<b>-236</b> -1	<b>0</b> +35	<b>-234</b> +10	<b>217</b> 2	<b>287</b> 1	<b>242</b> 14	
61 Δ	-3	+32	+5	7	14	6	1/4
<b>62P</b>	<b>-232</b>	<b>-67</b>	<b>-249</b>	<b>222</b>	<b>312</b>	<b>257</b>	

L10(VTR) When AUTO SEQ READY It – on:  
STOP pb – push (no red ●)





8. NOSE CAP LDRI ACAS, SECTION 5

NOTE

Time between Pts 62 and 63 ~ 1:15 min

Section 5 Clearance Views	Cameras
RMS-to-PLBD	A, ELBOW
OBSS-to-Nose Cap	ELBOW[1][2][3], US LAB[4]
RMS-to-US LAB	A, B
[1]Good after Z ~ -268	[3]Good after Z ~ -297
[2]Good until Z ~ -274	[4]Good after Z ~ -322

AUTO SEQ – PROCEED (IN PROG It on)

Pt	X	Y	Z	PITCH	YAW	ROLL	•
<b>62P</b> Δ	<b>-232</b> -41	<b>-67</b> -9	<b>-249</b> +18	<b>222</b> -5	<b>312</b> 0	<b>257</b> 13	
<b>63P</b>	<b>-191</b>	<b>-58</b>	<b>-267</b>	<b>234</b>	<b>322</b>	<b>268</b>	

A7U

When AUTO SEQ READY It – on:

MON2 ← PL2

PAN: +65 (left)

TILT: -58 (up)

PAN/TILT to match LDRI view shown below

Note PAN/TILT: \_\_\_\_\_, \_\_\_\_\_



**LDRI (65,-58)**

NOTE

Minimum clearance RMS-to-US LAB = 43 in between Pts 64-65.  
 Clearance can be monitored with camera B.  
 Time between Pts 63 and 66 ~ 4:00 min

MON2 ← not PL2

L10(VTR) REC pb – push, hold  
 PLAY pb – push, simo (red ●)

AUTO SEQ – PROCEED (IN PROG It on)

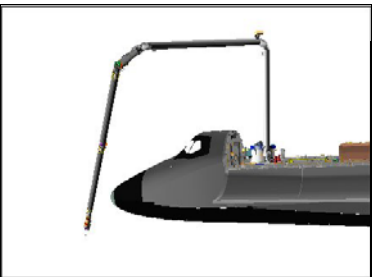
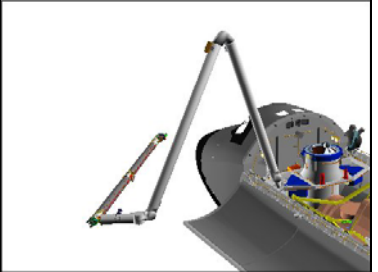
Pt	X	Y	Z	PITCH	YAW	ROLL	●
<b>63P</b> Δ	<b>-191</b> -23	<b>-58</b> -45	<b>-267</b> +3	<b>234</b> 10	<b>322</b> -10	<b>268</b> -18	
64 Δ	-7	+27	+17	4	-1	22	
65 Δ	+5	+20	+61	35	11	-7	
<b>66P</b>	<b>-166</b>	<b>-60</b>	<b>-348</b>	<b>189</b>	<b>326</b>	<b>271</b>	

L10(VTR) When AUTO SEQ READY It – on:  
 STOP pb – push (no red ●)



9. NOSE CAP LDRI ACAS, SECTION 6

NOTE

Time between Pts 66 and 67 ~ 1:00 min

Section 6 Clearance Views	Cameras
RMS-to-PLBD	A, ELBOW
OBSS-to-Nose Cap	ELBOW, US LAB[1]
RMS-to-US LAB	A, B
[1]Good until Y ~ -80	

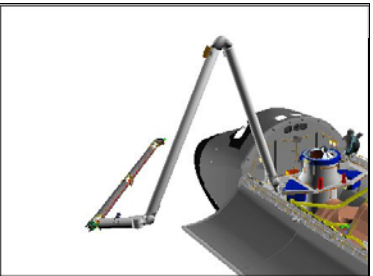
AUTO SEQ – PROCEED (IN PROG It on)

Pt	X	Y	Z	PITCH	YAW	ROLL	•
<b>66P</b> Δ	<b>-166</b> +13	<b>-60</b> +10	<b>-348</b> +33	<b>189</b> 10	<b>326</b> -10	<b>271</b> 7	
<b>67P</b>	<b>-179</b>	<b>-70</b>	<b>-381</b>	<b>185</b>	<b>316</b>	<b>280</b>	

A7U

When AUTO SEQ READY It – on:  
MON2 ← PL2

√PAN: +65  
TILT: -75 (down)

PAN/TILT to match LDRI view shown below

Note PAN/TILT: \_\_\_\_\_, \_\_\_\_\_

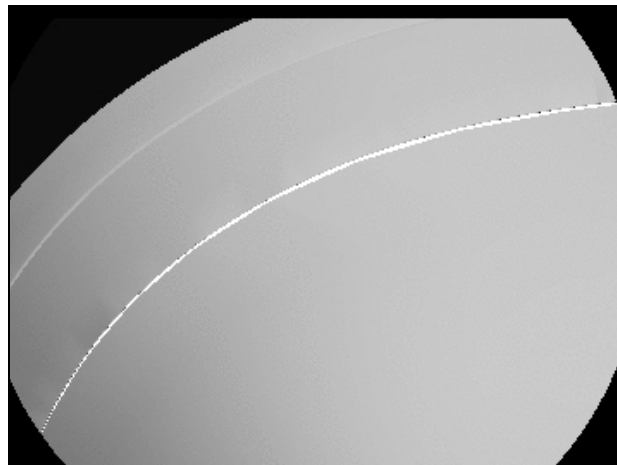

**LDRI (65,-75)**



NOTE

Minimum clearance RMS-to-US LAB = 49 in between Pts 67-68.  
 Clearance can be monitored with camera B.  
 Time between Pts 67 and 68 ~ 1:50 min

MON2 ← not PL2

L10(VTR) REC pb – push, hold  
 PLAY pb – push, simo (red ●)

AUTO SEQ – PROCEED (IN PROG It on)

Pt	X	Y	Z	PITCH	YAW	ROLL	●
67P Δ	-179 +3	-70 +14	-381 -76	185 -40	316 6	280 0	
68P	-182	-84	-305	221	320	274	¼ 

When AUTO SEQ IN PROG It – off:  
 BRAKES – ON (tb-ON)

L10(VTR) STOP pb – push (no red ●)

A7U MUX 1 L ← MIDDECK  
 LDRI MODE 2 pb – push (ITVC video displayed)

10. MNVR FROM NOSE CAP ACAS END POSN

SM 94 PDRS CONTROL

PL ID - ITEM 3 +2 EXEC  
 INIT ID - ITEM 24 +2 EXEC  
 END POS - ITEM 18 - 3 2 5 - 7 4 8 - 6 8 0 EXEC  
 ATT - ITEM 21 +8 3 +3 9 +2 0 0 EXEC  
 CMD CK - ITEM 25 EXEC (GOOD)

RHC RATE - as reqd (VERN within 10 ft)  
 BRAKES - OFF (tb-OFF)  
 MODE - OPR CMD, ENTER

AUTO SEQ - PROCEED (IN PROG It on)

When AUTO SEQ IN PROG It - off:  
 BRAKES - ON (tb-ON)

	X	Y	Z	PITCH	YAW	ROLL	PL ID
√	-325	-748	-680	83	39	200	2
	SY	SP	EP	WP	WY	WR	
√	+128.9	+30.8	-29.2	-2.0	+34.6	-0.1	

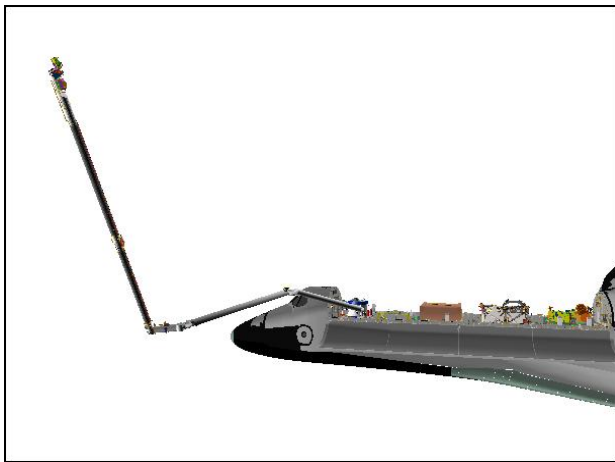

**BIRD'S EYE**

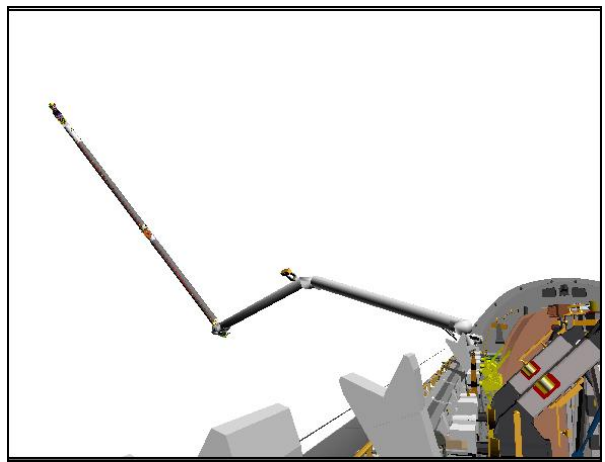

**CCTV B (-17,9)**

11. ENABLE VERN NOSE JETS

GNC 23 RCS

RCS FWD - ITEM 1 EXEC (\*)  
 MANF VLVS OVRD 5 - ITEM 44 EXEC (OP)

A6U DAP: VERN (FREE)

O14:F, Pri RJDA LOGIC, DRIVER (eight) - OFF

O15:F,  
 O16:F

RJDA 1A L2/R2 DRIVER - ON

If continuing OBSS ops with undocked Port Wing survey:  
 MnvR to PORT SURVEY attitude per FLIGHT PLAN  
 Go to OBSS LDRI RCC SURVEY - PORT

# OBSS LDRI RCC SURVEY – PORT

WARNING  
 Port PLBD radiator must be stowed  
 If DOCKED, SSRMS must be based on MBS.  
 If SSRMS based on Lab PDGF, √MCC

## 1. SETUP

SM 94 PDRS CONTROL

PL ID – ITEM 3 +3 EXEC

INIT ID – ITEM 24 +3 EXEC

GNC 23 RCS

√RCS FWD, ITEM 1: \*

√MANF VLVS OVRD 1, ITEM 40: CL

√2, ITEM 41: CL

√3, ITEM 42: CL

√4, ITEM 43: CL

## 2. MNVR TO PORT LDRI ACAS START POSN

BRAKES – OFF (tb-OFF)

MODE – SINGLE, ENTER

When MNVR PORT SURVEY attitude complt,

DAP: A14/AUTO/VERN

### NOTE

RMS mnvr and orbiter mnvr can be done simultaneously

	X	Y	Z	PITCH	YAW	ROLL	PL ID
√	-355	-917	-892	83	39	200	3
	SY	SP	EP	WP	WY	WR	
√	+128.9	+30.8	-29.2	-2.0	+34.6	-0.1	

Mnvr to PORT LDRI ACAS START posn:

	SY	SP	EP	WP	WY	WR	
NOSE JET CLEAR	+128.9	+30.8	-29.2	-2.0	+34.6	-0.1	
1: SY +	+138.8						
2: SP –		+24.6					
3: EP –			-61.2				
4: WP +				+36.9			
5: WR –						-74.2	
6: WY –					-67.4		
PORT LDRI ACAS START	+138.8	+24.6	-61.2	+36.9	-67.4	-74.2	
	X	Y	Z	PITCH	YAW	ROLL	PL ID
	-899	-243	-284	2	341	289	3

BRAKES – ON (tb-ON)

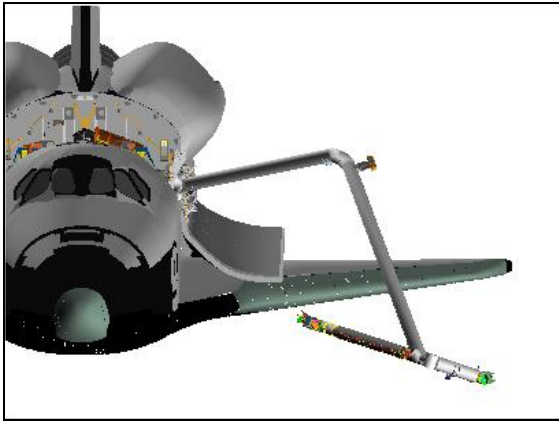

**FRONT**

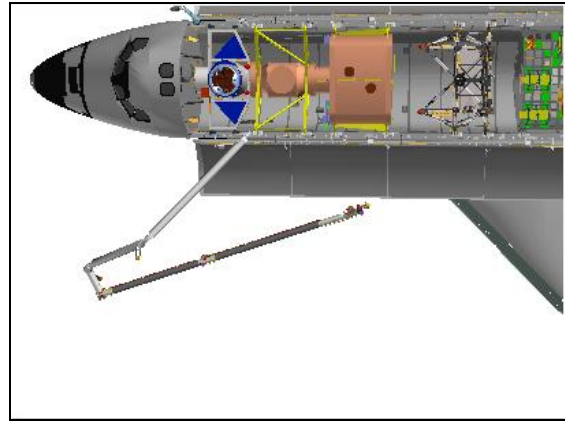

**OVERHEAD**

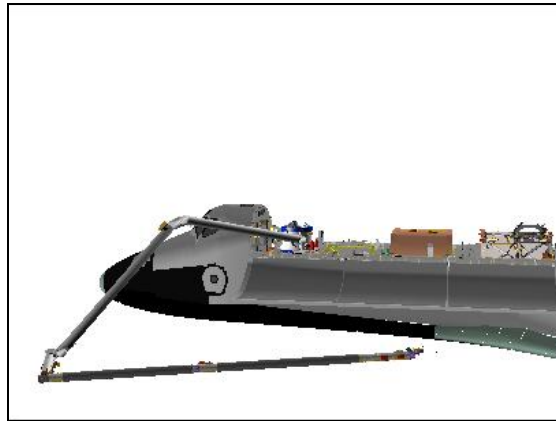

**PORT**

3. PORT LDRI ACAS, SECTION 1

NOTE

Section 1 scans RCC Zones 2 & 3 (oblique view), Panels 1 → 22

A7U

√DTV ← PL2  
MON2 ← PL2

PAN: +100 (right)  
TILT: -120 (dn)

MUX 1 L ← MIDDECK  
LDRI MODE 6 pb – push (flickering LDRI displayed)

PAN/TILT to match LDRI view shown below

Note PAN/TILT: \_\_\_\_\_, \_\_\_\_\_

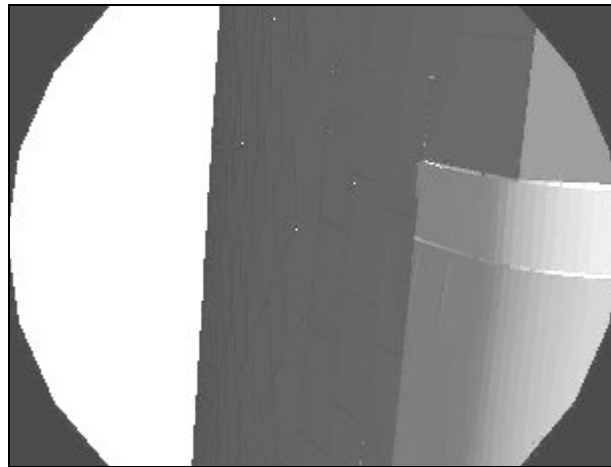

**LDRI (100,-120)**

MON2 ← not PL2

RHC

RATE – COARSE (RATE MIN tb-OFF)

For survey scan pattern, refer to OBSS LDRI SCAN PATTERN CUE CARD – STBD & PORT

For camera views, refer to OBSS LDRI RCC SURVEY CAMERA VIEWS – PORT (SURVEY CAMERA VIEWS)

**SM 94 PDRS CONTROL**

√AUTO MODE 3, ITEM 15: 3

BRAKES – OFF (tb-OFF)  
MODE – AUTO 3, ENTER (READY lt on)

\* If unable to enter AUTO mode (no AUTO READY lt): \*  
\* √Joint angles and adjust as reqd \*

**SM 169 PDRS STATUS**

√LAST PT: 69  
Monitor ACAS progress



NOTE

Time between Pts 69 and 75 ~ 4:45 min

Section 1 Clearance Views	Cameras
RMS Upper Arm-to-Orbiter	A[1]
OBSS-to-PLBD	A[5], B[4], ELBOW, RSC[3]
OBSS-to-Wing	A[5], ELBOW, RSC[2]
[1]Good for all subsequent scan sections [2]Good after X ~ -1050 [3]PLBD leaves FOV at X ~ -1098	[4]Good after X ~ -1099 [5]Good after X ~ -1110

NOTE

Wait for MCC GO before proceeding with survey

L10(VTR) On MCC GO,  
REC pb – push, hold  
PLAY pb – push, simo (red ●)

AUTO SEQ – PROCEED (IN PROG It on)

ACAS, pause pts shaded, ORAS/OBAS are in **bold**, Rel digitals are nonbold,  
● col indicates data recording (black = VTR on) and damage criteria (inches):

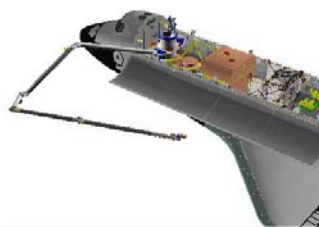
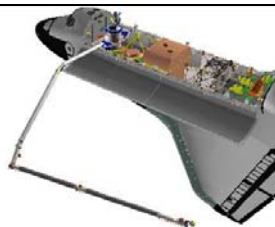
Pt	X	Y	Z	PITCH	YAW	ROLL	●	
<b>69P</b> Δ	<b>-899</b> +59	<b>-243</b> +10	<b>-284</b> -6	<b>2</b> 1	<b>341</b> 0	<b>289</b> -4		
70 Δ	+65	+24	-11	4	-12	-15		
71 Δ	+34	+33	0	0	-3	1		
72 Δ	+129	+132	+5	0	-3	-2		
73 Δ	+79	+67	+2	0	9	0		
74 Δ	+59	+14	0	1	2	-6		
<b>75P</b>	<b>-1324</b>	<b>-523</b>	<b>-274</b>	<b>0</b>	<b>348</b>	<b>315</b>		

L10(VTR) When AUTO SEQ READY It – on:  
STOP pb – push (no red ●)



4. PORT LDRI ACAS, SECTION 2

NOTE

Between Pts 75 and 76, arm adjusts for survey of Zones 1 & 2.  
 Section 2 then scans RCC Zones 1 & 2, Panels 22 → 1. Time  
 between Pts 75 and 76 ~ 1:25 min

Section 2 Clearance Views	Cameras
OBSS-to-PLBD	A[1], B[3], ELBOW, RSC[2]
OBSS-to-Wing	A[1], ELBOW, RSC
[1]Good until X ~ -1235 [2]PLBD enters FOV at X ~ -1198	[3]Good until X ~ -1157

AUTO SEQ – PROCEED (IN PROG It on)

Pt	X	Y	Z	PITCH	YAW	ROLL	●
75P Δ	-1324 +21	-523 -27	-274 -42	0 3	348 5	315 52	
76P	-1345	-496	-232	345	352	262	

When AUTO SEQ READY It – on:

A7U

MON2 ← PL2

PAN: +10 (left)

TILT: -80 (up)

PAN/TILT to match LDRI view shown below

Note PAN/TILT: \_\_\_\_\_, \_\_\_\_\_

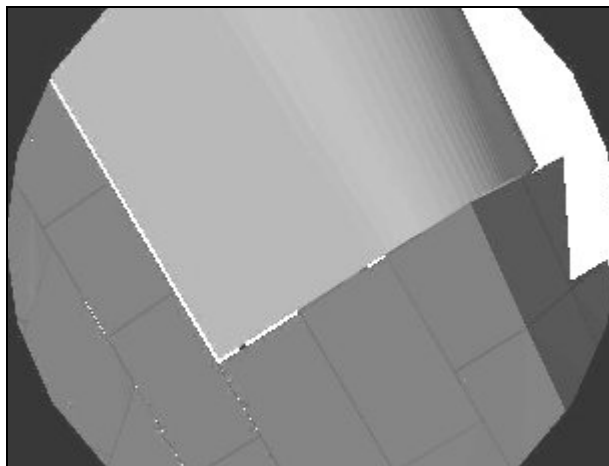

**LDRI (10,-80)**



MON2 ← not PL2

NOTE

At Pt 85, WP of +110.2° approaches reach limit. Time between Pts 76 and 85 ~ 3:30 min

L10(VTR) REC pb – push, hold  
PLAY pb – push, simo (red ●)

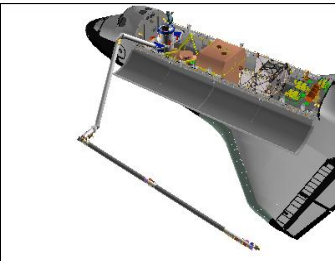
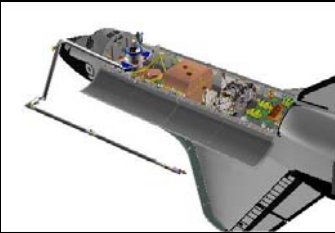
AUTO SEQ – PROCEED (IN PROG It on)

Pt	X	Y	Z	PITCH	YAW	ROLL	●
<b>76P</b> Δ	<b>-1345</b> -77	<b>-496</b> -40	<b>-232</b> -2	<b>345</b> 0	<b>352</b> 0	<b>262</b> 0	
77 Δ	-93	-99	-11	0	7	-2	
78 Δ	-41	-42	-1	0	0	0	
79 Δ	-37	-38	-4	0	0	0	
80 Δ	-36	-39	-4	0	0	0	
81 Δ	-63	-22	+4	-1	1	3	
82 Δ	-26	-5	+2	0	0	0	
83 Δ	-37	-5	+3	0	0	0	
84 Δ	-29	-2	+1	0	0	0	
<b>85P</b>	<b>-906</b>	<b>-204</b>	<b>-220</b>	<b>345</b>	<b>345</b>	<b>259</b>	

L10(VTR) When AUTO SEQ READY It – on:  
STOP pb – push (no red ●)

5. PORT LDRI ACAS, SECTION 3

NOTE

Between Pts 85 and 86, arm adjusts for survey of Zones 2 & 3.  
 Section 3 then scans Zones 2 & 3, Panels 1 → 22. At Pt 86,  
 WP: +112.4°. Time between Pts 85 and 86 ~ 0:30 sec

Section 3 Clearance Views	Cameras
OBSS-to-PLBD	A[3], B[1], ELBOW, RSC[2]
OBSS-to-Wing	A[3], ELBOW, RSC
[1]Good after X ~ -1128 [2]PLBD leaves FOV at X ~ -1180	[3]Good after X ~ -1187

AUTO SEQ – PROCEED (IN PROG It on)

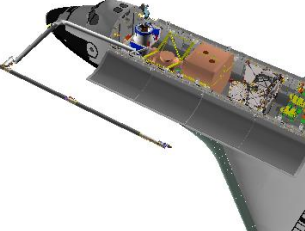
Pt	X	Y	Z	PITCH	YAW	ROLL	•
<b>85P</b> Δ	<b>-906</b> -8	<b>-204</b> +10	<b>-220</b> +10	<b>345</b> -2	<b>345</b> -3	<b>259</b> 1	
<b>86P</b>	<b>-898</b>	<b>-214</b>	<b>-230</b>	<b>347</b>	<b>348</b>	<b>259</b>	

When AUTO SEQ READY It – on:

A7U

MON2 ← PL2

√PAN: +10

TILT: -95 (down)

PAN/TILT to match LDRI view shown below

Note PAN/TILT: \_\_\_\_\_, \_\_\_\_\_

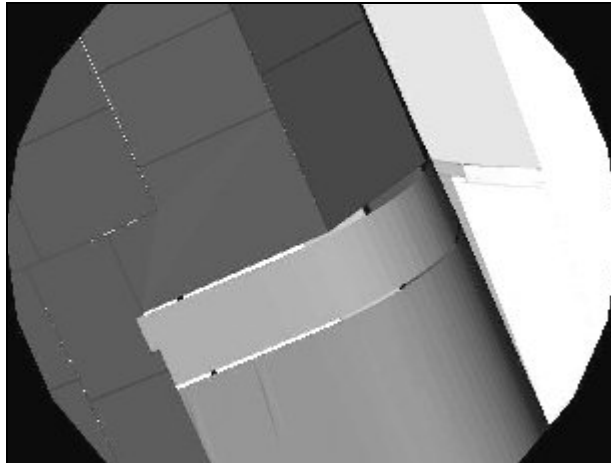

**LDRI (10,-95)**

MON2 ← not PL2

**NOTE**

Time between Pts 86 and 93 ~ 3:30 min

L10(VTR) REC pb – push, hold  
PLAY pb – push, simo (red ●)

AUTO SEQ – PROCEED (IN PROG It on)

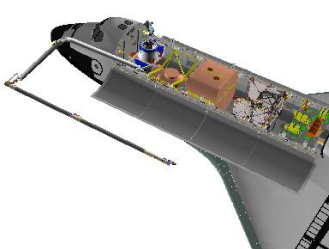
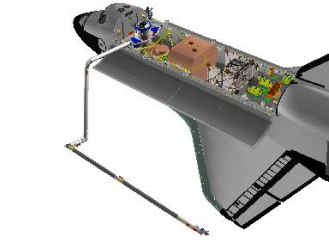
Pt	X	Y	Z	PITCH	YAW	ROLL	●
<b>86P</b> Δ	<b>-898</b> +81	<b>-214</b> +17	<b>-230</b> -4	<b>347</b> 0	<b>348</b> 0	<b>259</b> 0	
87 Δ	+55	+31	+5	0	0	0	
88 Δ	+76	+76	+3	0	0	0	
89 Δ	+73	+68	+4	-6	-7	6	
90 Δ	+61	+61	+4	-1	0	0	1/4
91 Δ	+68	+37	+3	-5	-4	0	
92 Δ	+31	+7	+1	0	0	0	
<b>93P</b>	<b>-1343</b>	<b>-511</b>	<b>-246</b>	<b>359</b>	<b>0</b>	<b>254</b>	

L10(VTR) When AUTO SEQ READY It – on:  
STOP pb – push (no red ●)



6. PORT LDRI ACAS, SECTION 4

NOTE

Between Pts 93 and 94, arm adjusts for survey of Zone 4.  
 Section 4 then scans RCC Zone 4, Panels 22 → 1. Time  
 between Pts 93 and 94 ~ 1:50 min

Section 4 Clearance Views	Cameras
OBSS-to-PLBD	A[3], B[4], ELBOW, RSC[2]
OBSS-to-Wing	A[3], B[1,4], ELBOW, RSC[5]
[1]Good after X ~ -1327	[4]Good until X ~ -1036
[2]PLBD enters FOV at X ~ -1067	[5]Good until X ~ -975
[3]Good until X ~ -1042	

AUTO SEQ – PROCEED (IN PROG It on)

Pt	X	Y	Z	PITCH	YAW	ROLL	●
<b>93P</b> Δ	<b>-1343</b> -20	<b>-511</b> +26	<b>-246</b> +69	<b>359</b> 17	<b>0</b> 4	<b>254</b> -30	
<b>94P</b>	<b>-1323</b>	<b>-537</b>	<b>-315</b>	<b>346</b>	<b>348</b>	<b>282</b>	

When AUTO SEQ READY It – on:

A7U

MON2 ← PL2

PAN: +88 (right)

TILT: -120 (down)

PAN/TILT to match LDRI view shown below

Note PAN/TILT: \_\_\_\_\_, \_\_\_\_\_

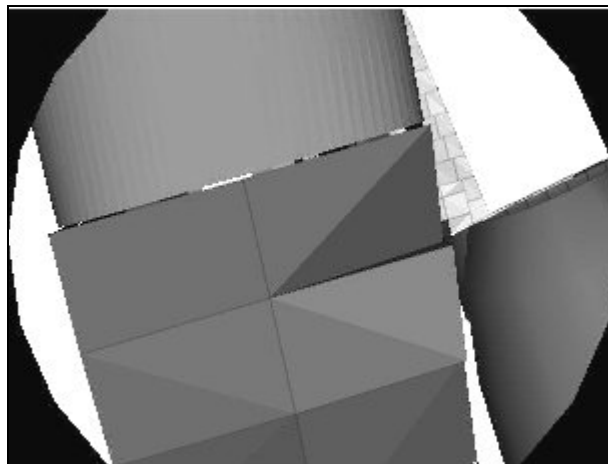

**LDRI (88,-120)**



MON2 ← not PL2

NOTE

Time between Pts 94 and 102 ~ 6:05 min

L10(VTR) REC pb – push, hold  
PLAY pb – push, simo (red ●)

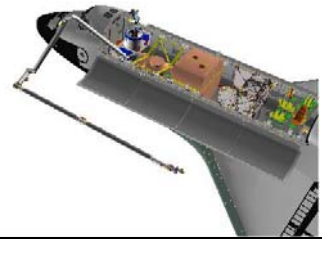
AUTO SEQ – PROCEED (IN PROG It on)

Pt	X	Y	Z	PITCH	YAW	ROLL	●
<b>94P</b> Δ	<b>-1323</b> -79	<b>-537</b> -24	<b>-315</b> -10	<b>346</b> -7	<b>348</b> -10	<b>282</b> -4	
95 Δ	-68	-63	-7	1	-5	-2	
96 Δ	-70	-70	-3	0	-2	-1	
97 Δ	-83	-80	-7	-2	7	1	
98 Δ	-34	-25	+6	3	8	6	
99 Δ	-24	-12	0	0	0	0	
100 Δ	-32	-10	-5	-8	3	-1	
101 Δ	-46	-5	-2	-6	6	1	
<b>102P</b>	<b>-887</b>	<b>-248</b>	<b>-287</b>	<b>4</b>	<b>341</b>	<b>282</b>	

L10(VTR) When AUTO SEQ READY It – on:  
STOP pb – push (no red ●)

7. PORT LDRI ACAS, SECTION 5

NOTE

Between Pts 102 and 104, arm adjusts for survey of Zones 4 & 5.  
 Section 5 then scans Zones 4 & 5, Panels 1 → 22. Time between  
 Pts 102 and 104 ~ 1:35 min

Section 5 Clearance Views	Cameras
OBSS-to-PLBD	A[1], B[2], ELBOW, RSC[4]
OBSS-to-Wing	A[1,3,5], B[2], ELBOW, RSC[6]
[1]Good after X ~ -896	[4]PLBD leaves FOV at X ~ -1098
[2]Good after X ~ -1015	[5]Good after X ~ -1104
[3]Good until X ~ -1045	[6]Good after X ~ -1220

AUTO SEQ – PROCEED (IN PROG It on)

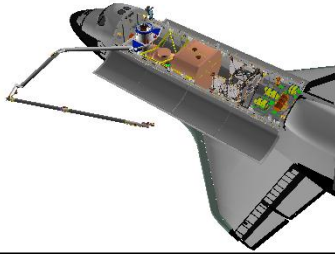
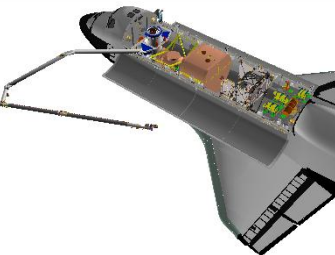
Pt	X	Y	Z	PITCH	YAW	ROLL	●
<b>102P</b> Δ	<b>-887</b> 0	<b>-248</b> +37	<b>-287</b> 0	<b>4</b> 0	<b>341</b> 0	<b>282</b> 0	
103 Δ	+10	0	+44	10	4	-19	
<b>104P</b>	<b>-897</b>	<b>-285</b>	<b>-331</b>	<b>2</b>	<b>336</b>	<b>302</b>	

When AUTO SEQ READY It – on:

A7U

MON2 ← PL2

PAN: +120 (right)

√TILT: -120



PAN/TILT to match LDRI view shown below

Note PAN/TILT: \_\_\_\_\_, \_\_\_\_\_

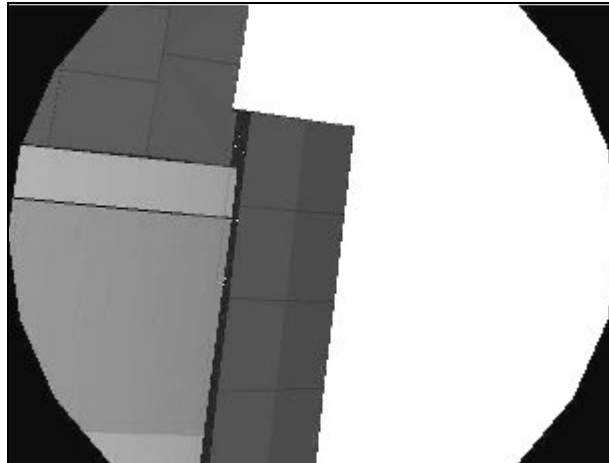

LDRI (120,-120)

MON2 ← not PL2

NOTE

Time between Pts 104 and 114 ~ 7:15 min

L10(VTR)

REC pb – push, hold

PLAY pb – push, simo (red ●)

AUTO SEQ – PROCEED (IN PROG It on)

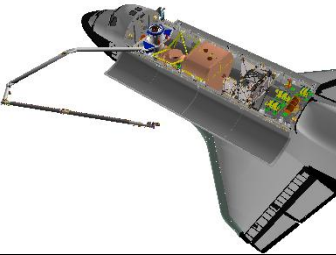
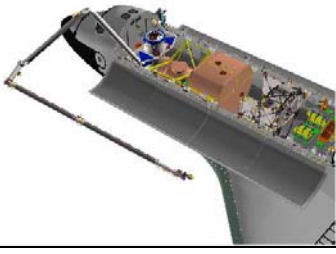
Pt	X	Y	Z	PITCH	YAW	ROLL	●
<b>104P</b> Δ	<b>-897</b> +13	<b>-285</b> 0	<b>-331</b> -1	<b>2</b> 0	<b>336</b> -4	<b>302</b> 0	
105 Δ	+16	0	-5	0	0	4	
106 Δ	+24	+2	+10	0	0	6	
107 Δ	+28	+2	+17	1	-5	5	
108 Δ	+42	-3	-20	9	-7	-9	1
109 Δ	+54	+43	+9	8	-9	8	
110 Δ	+74	+72	+5	2	5	2	
111 Δ	+81	+74	+11	7	-2	1	
112 Δ	+51	+28	+6	6	1	4	
113 Δ	+48	+14	+1	0	0	0	1/4
<b>114P</b>	<b>-1328</b>	<b>-517</b>	<b>-364</b>	<b>327</b>	<b>1</b>	<b>285</b>	

L10(VTR) When AUTO SEQ READY It – on:  
STOP pb – push (no red ●)

8. PORT LDRI ACAS, SECTION 6

NOTE

Between Pts 114 and 115, arm adjusts for survey of Zone 6. Section 6 then scans Zone 6, Panels 22 → 5.  
Time between Pts 114 and 115 ~ 1:25 min

Section 6 Clearance Views	Cameras
OBSS-to-PLBD	A[4,5], B, ELBOW, RSC[2,4]
OBSS-to-Wing	A[4,5], B, ELBOW[1], RSC[3,6]
[1]Good until X ~ -1264	[5]Good after X ~ -1086
[2]PLBD enters FOV at X ~ -1210	[6]Good after X ~ -1092
[3]Good until X ~ -1154	
[4]Good until X ~ -1114	

AUTO SEQ – PROCEED (IN PROG It on)

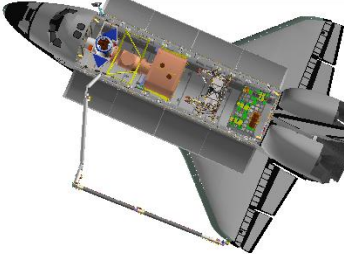
Pt	X	Y	Z	PITCH	YAW	ROLL	●
114P Δ	-1328 +10	-517 -41	-364 +25	327 -22	1 11	285 29	
115P	-1338	-476	-389	345	357	254	

When AUTO SEQ READY It – on:

A7U                      MON2 ← PL2  
  
PAN: +135 (right)  
TILT: -110 (up)

PAN/TILT to match LDRI view shown below

Note PAN/TILT: \_\_\_\_\_, \_\_\_\_\_

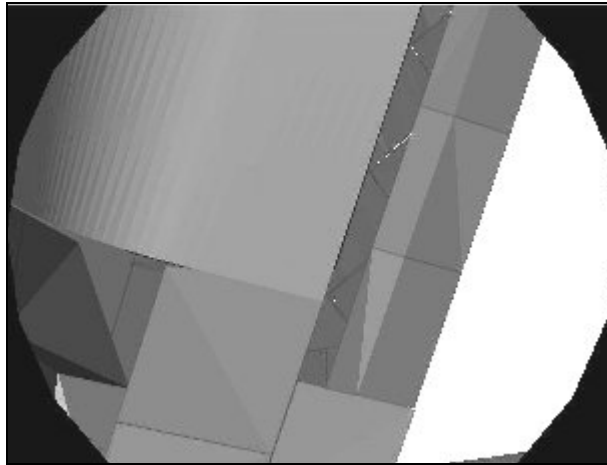

**LDRI (135,-110)**

MON2 ← not PL2

**NOTE**

Time between Pts 115 and 121 ~ 3:50 min

L10(VTR) REC pb – push, hold  
PLAY pb – push, simo (red ●)

**AUTO SEQ – PROCEED (IN PROG It on)**

Pt	X	Y	Z	PITCH	YAW	ROLL	●
<b>115P</b>	<b>-1338</b>	<b>-476</b>	<b>-389</b>	<b>345</b>	<b>357</b>	<b>254</b>	1/4
Δ	-55	-23	+2	0	10	9	
116 Δ	-117	-113	+1	0	0	0	
117 Δ	-53	-55	-4	0	14	0	
118 Δ	-42	-1	-10	3	-2	-28	
119 Δ	-21	-5	+9	-4	0	-2	
120 Δ	-65	0	-1	0	1	-8	1
<b>121P</b>	<b>-985</b>	<b>-279</b>	<b>-386</b>	<b>1</b>	<b>331</b>	<b>281</b>	

When AUTO SEQ IN PROG It – off:  
BRAKES – ON (tb-ON)

L10(VTR) STOP pb – push (no red ●)

A7U MUX 1 L ← MIDDECK  
 LDRI MODE 2 pb – push (ITVC video displayed)  
 MON2 ← PL2

RHC 9. MNVR TO OBSS HOVER/PARK POSN  
 RATE – as reqd (VERN within 10 ft)  
 BRAKES – OFF (tb-OFF)  
 MODE – as desired

Mnvr to OBSS HOVER posn:

	SY	SP	EP	WP	WY	WR	
PORT LDRI	+120.7	+42.9	-62.9	+32.8	-58.9	-67.5	
ACAS End							
1: WY +					-0.5		
2: WR +						+30.0	
3: SP +		+80.0					
4: SY -	-89.8						
5: EP -			-123.3				
6: WP -				-55.2			
7: WR +						+109.8	
OBSS HOVER	-89.8	+80.0	-123.3	-55.2	-0.5	+109.8	
	X	Y	Z	PITCH	YAW	ROLL	PL ID
	-1271	+128	-506	359.5	0	11	3

BRAKES – ON (tb-ON)

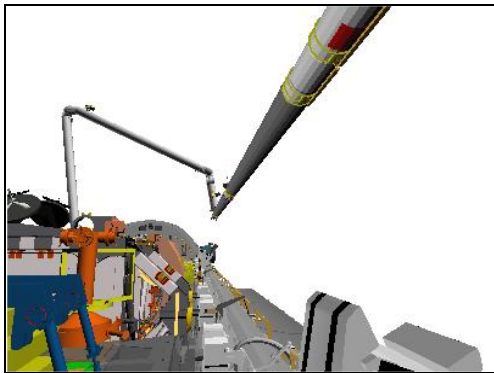

CCTV C (10,10)

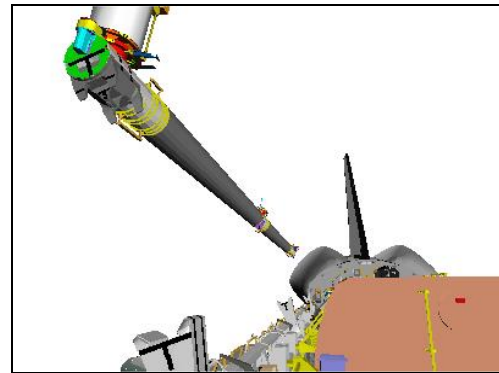

CCTV D (-10,15)

Go to OBSS BERTH >>

# SRMS EE CAM UPPER SURFACE SURVEY

I

<u>WARNING</u> For UNDOCKED ops only Port and stbd PLBD radiators must be stowed
--

## NOTE

Scanning (VTR recorded) portions of this procedure require daylight.  
If step 7 not completed on FD2 15 min prior to reqd RNDZ OMS  
burn, break out of procedure and return to Pre-Cradle

- A7U 1. SETUP  
CCTV – RMS WRIST, ZOOM: 25.0 HFOV  
DTV ← RMS

<u>SM 94 PDRS CONTROL</u>
---------------------------

- √PL ID, ITEM 3: 0
- √INIT ID, ITEM 24: 0
- AUTO MODES – ITEM 13 +4 +5 EXEC

- A6U 2. INHIBIT NOSE JETS  
Verify in UPPER SURFACE SURVEY attitude  
√DAP: A1/AUTO/VERN(FREE)

<u>GNC 23 RCS</u>
-------------------

- √RCS FWD, ITEM 1: \*
- √MANF VLVS OVRD 1 – ITEM 40 EXEC (CL)
  - √2 – ITEM 41 EXEC (CL)
  - √3 – ITEM 42 EXEC (CL)
  - √4 – ITEM 43 EXEC (CL)

- RHC 3. MNVR TO STBD CREW CABIN POSN  
RATE – as reqd (VERN within 10 ft)  
BRAKES – OFF (tb-OFF)  
MODE – SINGLE, ENTER

## NOTE

To assist with camera views, start posn is fwd, near nose cap

If starting at OBSS PRE-GRAPPLE:

√	X	Y	Z	PITCH	YAW	ROLL	PL ID
	-680	+96	-513	270	350	1	0
	SY	SP	EP	WP	WY	WR	
√	-90.0	+87.6	-129.5	-57.5	0.0	+110.4	

Mnvr to STBD CREW CABIN SURVEY START posn:

	SY	SP	EP	WP	WY	WR	
OBSS PRE-GRAPPLE	-90.0	+87.6	-129.5	-57.5	0.0	+110.4	
1: EP +			-57.5				
2: WR +						+228.2	
3: WY -					-59.5		
4: WP -				-112.6			
5: SP -		+17.2					
6: SY -	-134.9						
STBD CREW CABIN SURVEY START	-134.9	+17.2	-57.5	-112.6	-59.5	+228.2	
	X	Y	Z	PITCH	YAW	ROLL	PL ID
	-351	+180	-411	241	53	123	0

[1,2]

[1]Upper Arm-To-Crew Cabin = 13 in

[2]Upper Arm-To-APAS = 19 in

If starting at PRE-CRADLE:

√	X	Y	Z	PITCH	YAW	ROLL	PL ID
	-1261	-146	-551	5	2	0	0
	SY	SP	EP	WP	WY	WR	
√	0.0	+25.0	-25.0	+5.0	0.0	0.0	

Mnvr to STBD CREW CABIN SURVEY START posn:

	SY	SP	EP	WP	WY	WR	
PRE-CRADLE	0.0	+25.0	-25.0	+5.0	0.0	0.0	
1: SP +		+45.0					
2: WR +						+228.2	
3: WY -					-59.5		
4: WP -				-112.6			
5: SY -	-90.0						
6: EP -			-57.5				
7: SP -		+17.2					
8: SY -	-134.9						
STBD CREW CABIN SURVEY START	-134.9	+17.2	-57.5	-112.6	-59.5	+228.2	
	X	Y	Z	PITCH	YAW	ROLL	PL ID
	-351	+180	-411	241	53	123	0

[1,2]

[1]Upper Arm-To-Crew Cabin = 13 in

[2]Upper Arm-To-APAS = 19 in

BRAKES – ON (tb-ON)

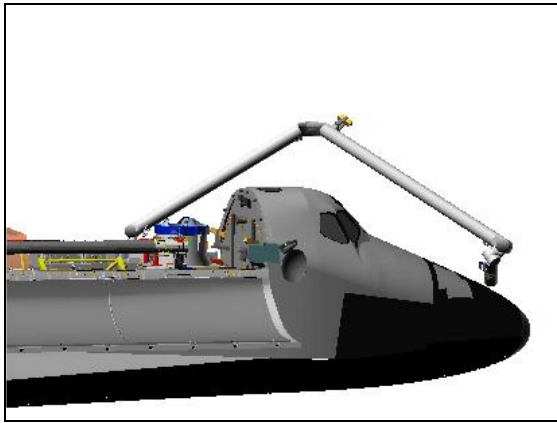

**STBD**



**FRONT**

RHC 4. STBD CREW CABIN SURVEY, SECTION 1  
RATE – VERN (RATE MIN tb-ON)

A7U √CCTV – RMS WRIST

For camera views, refer to SRMS EE CAM UPPER SURFACE SURVEY  
CAMERA VIEWS (SURVEY CAMERA VIEWS)

BRAKES – OFF (tb-OFF)  
MODE – AUTO 1, ENTER (READY It on)

- \* If unable to enter AUTO mode (no AUTO READY It): \*
- \* √Joint angles and adjust as reqd \*

SM 169 PDRS STATUS

√LAST PT: 122  
Monitor ACAS progress



NOTE

Time between Pts 122 and 123 ~ 0:50 sec

Section 1 Clearance Views	Cameras
EE-to-Crew Cabin and Ku Dish	ELBOW[1]
Lower Arm-to-Crew Cabin	C, D, ELBOW[1]
Upper Arm-to-Docking Ring (Extended)	A
Upper Arm-to-Crew Cabin	A, B, ELBOW[1]
[1]ELBOW and WRIST cameras are mutually exclusive	

L10(VTR) On MCC GO,  
 REC pb – push, hold  
 PLAY pb– push, simo (red ●)

AUTO SEQ – PROCEED (IN PROG It on)

ACAS, pause pts shaded, ORAS/OBAS are in **bold**, Rel digitals are nonbold,  
 ● col indicates data recording (black = VTR on) and damage criteria (inches):

Pt	X	Y	Z	PITCH	YAW	ROLL	●
122P Δ	-351 +133	+180 -50	-411 +54	241 2	53 10	123 -10	
123P	-484	+230	-465	255	48	103	3

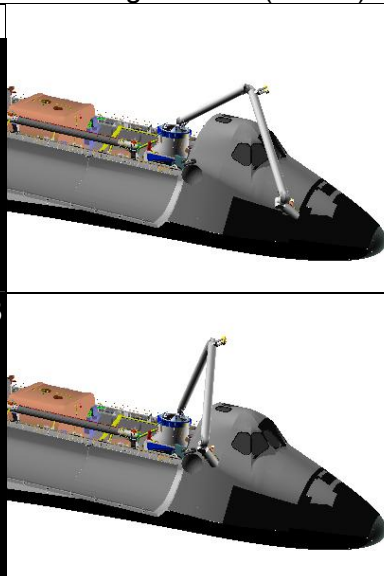

L10(VTR) When AUTO SEQ IN PROG It – off:  
 STOP pb – push (no red ●)

5. PREPARE FOR SECTION 2

NOTE

Between Pts 123 and 124, arm repositions back to start pt, preparing for completion of survey of STBD side of crew cabin. At Pt 124, Upper Arm-to-Crew Cabin = 13 in, Upper Arm-to-APAS = 19 in. Time between Pts 123 and 124 ~ 0:50 sec

AUTO SEQ – PROCEED (IN PROG It on)

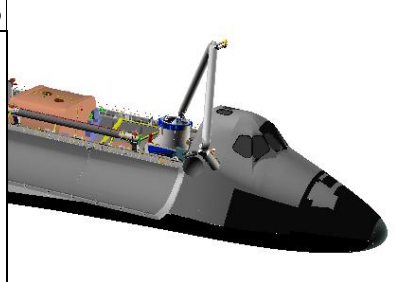
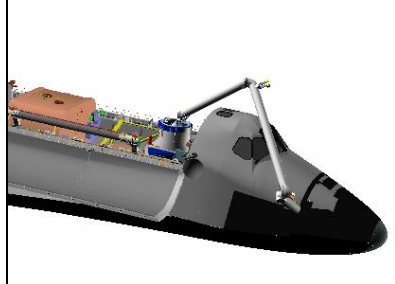
Pt	X	Y	Z	PITCH	YAW	ROLL	•
123P Δ	-484 -133	+230 +50	-465 -54	255 -1	48 -10	103 9	
124P	-351	+180	-411	241	53	123	

6. STBD CREW CABIN SURVEY, SECTION 2

NOTE

Time between Pts 124 and 125 ~ 1:30 min

Section 2 Clearance Views	Cameras
EE-to-Crew Cabin and Ku Dish	ELBOW[1]
Lower Arm-to-Crew Cabin	C, D, ELBOW[1]
Upper Arm-to-Docking Ring (Extended)	A
Upper Arm-to-Crew Cabin	A, B
[1]ELBOW and WRIST cameras are mutually exclusive	

A7U      √CCTV – RMS WRIST

L10(VTR)    REC pb – push, hold  
 PLAY pb – push, simo (red ●)

AUTO SEQ – PROCEED (IN PROG It on)

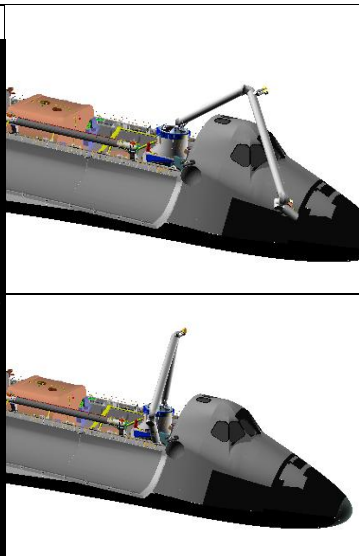
Pt	X	Y	Z	PITCH	YAW	ROLL	●
124P Δ	-351 +197	+180 -86	-411 +67	241 46	53 36	123 -43	3 
125P	-548	+266	-478	270	38	45	

When AUTO SEQ IN PROG It – off:  
 BRAKES – ON (tb-ON)

L10(VTR)    STOP pb – push (no red ●)

RHC

7. MNVR TO PORT CREW CABIN SURVEY START POSN

RATE – as reqd (VERN within 10 ft)

BRAKES – OFF (tb-OFF)

MODE – SINGLE, ENTER

If performing immediately after STBD CREW CABIN SURVEY:

		Mnvr to PORT CREW CABIN SURVEY START posn:					
		SY	SP	EP	WP	WY	WR
STBD CREW CABIN SURVEY		-107.7	+28.3	-66.4	-108.1	-14.9	+164.2
	End						
1:	SP +		+53.3				
2:	SY +	+65.9					
3:	EP -			-94.3			
4:	WP +				-99.6		
5:	WY -					-36.5	
6:	WR +						+216.5
PORT CREW CABIN SURVEY	START	+65.9	+53.3	-94.3	-99.6	-36.5	+216.5
	X	Y	Z	PITCH	YAW	ROLL	PL ID
	-840	-364	-333	324	291	323	0

If starting at PRE-CRADLE:

	X	Y	Z	PITCH	YAW	ROLL	PL ID
√	-1261	-146	-551	5	2	0	0
	SY	SP	EP	WP	WY	WR	
√	0.0	+25.0	-25.0	+5.0	0.0	0.0	
		Mnvr to PORT CREW CABIN SURVEY START posn:					
		SY	SP	EP	WP	WY	WR
PRE-CRADLE		0.0	+25.0	-25.0	+5.0	0.0	0.0
1:	SY +	+65.9					
2:	SP +		+53.3				
3:	EP -			-94.3			
4:	WP -				-99.6		
5:	WY -					-36.5	
6:	WR +						+216.5
PORT CREW CABIN SURVEY	START	+65.9	+53.3	-94.3	-99.6	-36.5	+216.5
	X	Y	Z	PITCH	YAW	ROLL	PL ID
	-840	-364	-333	324	291	323	0

BRAKES – ON (tb-ON)

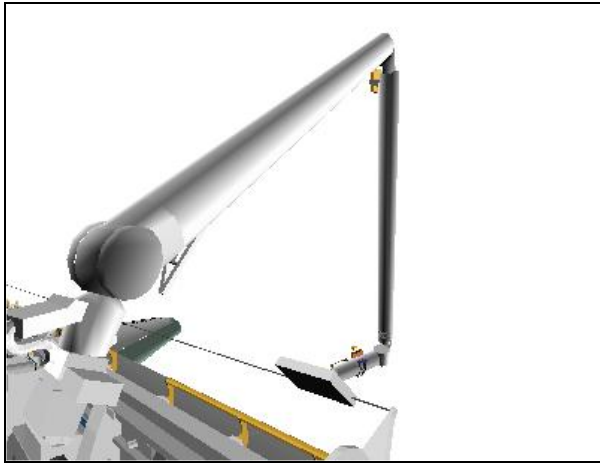

**CCTV A (45,3)**

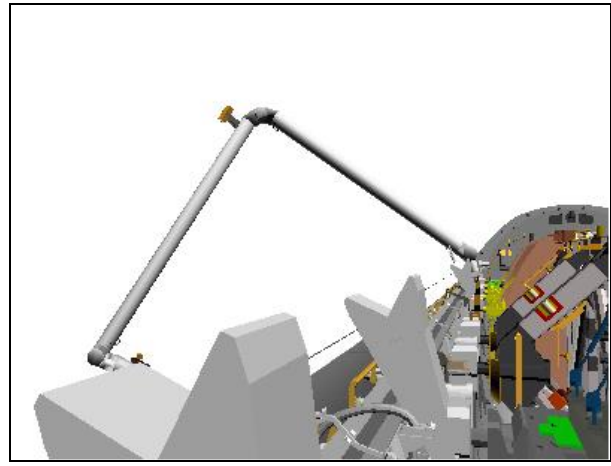

**CCTV B (-17,2)**

RHC 8. PORT CREW CABIN SURVEY, SECTION 1  
 RATE – VERN (RATE MIN tb-ON)

A7U √CCTV – RMS WRIST

L10(VTR) REC pb – push, hold  
 PLAY pb – push, simo (red ●)

BRAKES – OFF (tb-OFF)  
 MODE – AUTO 2, ENTER (READY It on)

- \* If unable to enter AUTO mode (no AUTO READY It): \*
- \* √Joint angles and adjust as reqd \*

SM 169 PDRS STATUS

√LAST PT: 126  
 Monitor ACAS progress

NOTE

Time between Pts 126 and 128 ~ 2:10 min

Section 1 Clearance Views	Cameras
EE-to-PLBD	A[1], B[2], ELBOW[3]
EE-to-Crew Cabin	B[2], ELBOW[3]
Lower Arm-to-Crew Cabin	A, B
[1]Lose sight of EE between Pts 127 and 128	
[2]Port MPMs block direct view of EE	
[3]ELBOW and WRIST cameras are mutually exclusive	

On MCC GO,  
 AUTO SEQ – PROCEED (IN PROG It on)

ACAS, pause pts shaded, ORAS/OBAS are in **bold**, Rel digitals are nonbold,  
 ● col indicates data recording (black = VTR on) and damage criteria (inches):

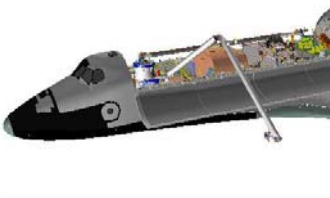
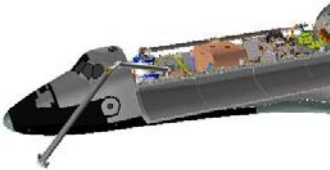
Pt	X	Y	Z	PITCH	YAW	ROLL	●	
<b>126P</b> Δ	<b>-840</b> -323	<b>-364</b> -60	<b>-333</b> -58	<b>324</b> 5	<b>291</b> 8	<b>323</b> -17		
127 Δ	-223	-60	+56	24	11	4	<b>3</b>	
<b>128P</b>	<b>-294</b>	<b>-244</b>	<b>-331</b>	<b>242</b>	<b>275</b>	<b>270</b>		

9. PORT CREW CABIN SURVEY, SECTION 2

NOTE

VTR is not stopped between sections 1 and 2.  
Time between Pts 128 and 129 ~ 1:05 min

Section 2 Clearance Views	Cameras
EE-to-Crew Cabin	B[1], ELBOW[2]
Lower Arm-to-Crew Cabin	A, B
[1]Port MPMs block direct view of EE	
[2]ELBOW and WRIST cameras are mutually exclusive	

AUTO SEQ – PROCEED (IN PROG It on)

Pt	X	Y	Z	PITCH	YAW	ROLL	●
128P Δ	-294 +224	-244 +8	-331 +54	242 20	275 -9	270 6	●
129P	-518	-252	-385	300	281	348	3 ●

When AUTO SEQ IN PROG It – off:  
BRAKES – ON (tb-ON)

L10(VTR) STOP pb – push (no red ●)

10. ENABLE NOSE JETS

GNC 23 RCS

√RCS FWD, ITEM 1: \*

- MANF VLVS OVRD 1 – ITEM 40 EXEC (OP)
- 2 – ITEM 41 EXEC (OP)
- 3 – ITEM 42 EXEC (OP)
- 4 – ITEM 43 EXEC (OP)

A6U DAP: as reqd

11. MNVR TO PRE-CRADLE

	X	Y	Z	PITCH	YAW	ROLL	PL ID
√	-518	-252	-385	300	281	348	0
	SY	SP	EP	WP	WY	WR	
√	+129.1	+70.1	-118.9	-97.9	+28.4	+227.4	

RHC RATE – as reqd (VERN within 10 ft)  
 BRAKES – OFF (tb-OFF)  
 MODE – SINGLE, ENTER

Mnvr to PRE-CRADLE:

	SY	SP	EP	WP	WY	WR	
PORT CREW	+129.1	+70.1	-118.9	-97.9	+28.4	+227.4	
CABIN							
SURVEY End							
1: WR –						0.0	
2: WY –					0.0		
3: WP +				+5.0			
4: EP +			-25.0				
5: SY –	0.0						
6: SP –		+25.0					
PRE-CRADLE	0.0	+25.0	-25.0	+5.0	0.0	0.0	
	X	Y	Z	PITCH	YAW	ROLL	PL ID
	-1261	-146	-551	5	2	0	0

BRAKES – ON (tb-ON)  
 MODE – not DIRECT  
 PARAM – PORT TEMP  
 JOINT – CRIT TEMP



## OBSS OFF-NOMINAL OPERATIONS

I

OBSS LDRI RCC SURVEY – STBD DOCKED .....	FS 9-2
IDC RCC SURVEY – STBD .....	FS 9-32
– NOSE CAP .....	FS 9-42
– PORT .....	FS 9-56
ITVC TILE ACREAGE SURVEY .....	FS 9-68
RMS EE RCC WING SURVEY .....	FS 9-96
OBSS SJ UNBERTH .....	FS 9-116
BERTH .....	FS 9-130
HANDOFF FROM SSRMS TO SRMS .....	FS 9-149
SRMS TO SSRMS .....	FS 9-164
FLAT FIELDS .....	FS 9-173
MNVR FROM UNDOCK TO OBSS HOVER .....	FS 9-178
OBSS JETTISON .....	FS 9-179
WITH MPMS .....	FS 9-184

OBSS  
OFF-NOM OPS

# OBSS LDRI RCC SURVEY – STBD DOCKED

**WARNING**  
Stbd PLBD radiator must be stowed

**NOTE**

Assumed starting posn is OBSS Handoff posn

1. **SETUP**

SM 94 PDRS CONTROL

√PL ID, ITEM 3: 2

√INIT ID, ITEM 24: 2

Verify SSRMS is at Survey Support Viewing posn

2. **MNVR TO STBD DOCKED LDRI ACAS START POSITION**

SJ Mnvr Clearance Views	Cameras
OBSS-to-Wing/PLBD	C, D, ELBOW, RSC, US LAB, SSRMS BASE ELBOW

**NOTE**

Expect C/W SINGULARITY in line 6 of the following single joint table.  
SINGULARITY will extinguish between Points 1 and 2 of the following ACAS

BRAKES – OFF (tb-OFF)  
MODE – SINGLE, ENTER

Mnvr to STBD DOCKED LDRI ACAS START posn:

	SY	SP	EP	WP	WY	WR	
Handoff	-28.4	+75.5	-98.1	-62.5	+23.6	-45.1	
1: WP +				+32.4			
2: SY -	-32.8						
3: WR -						-113.9	
4: SP +		+77.7					
5: EP +			-57.7				
6: WY -					-77.2		
STBD DOCKED LDRI ACAS Start	-32.8	+77.7	-57.7	+32.4	-77.2	-113.9	
	X	Y	Z	PITCH	YAW	ROLL	PL ID
	-935	+154	-599	271	329	66	2

BRAKES – ON (tb-ON)

OBSS  
OFF-NOM OPS

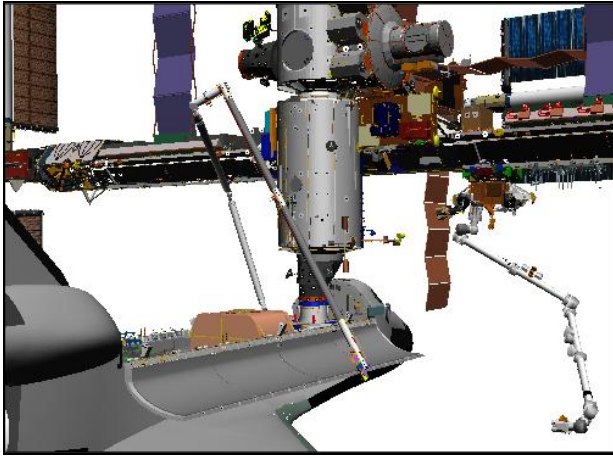

**BIRD'S EYE**

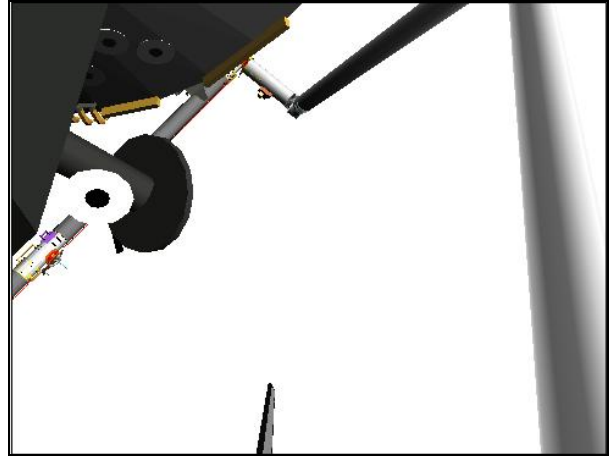

**CCTV A (0,35)**

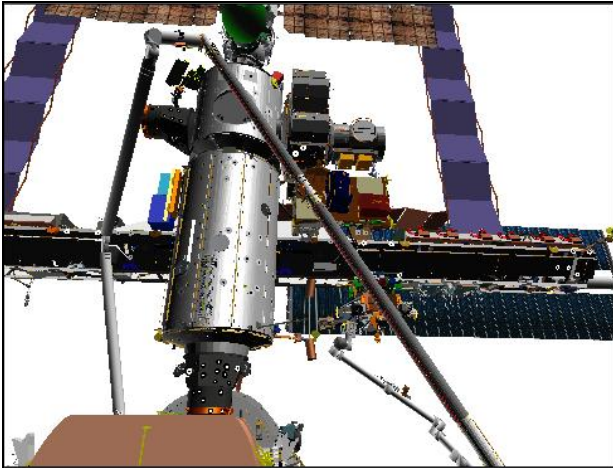

**CCTV C (5,25)**

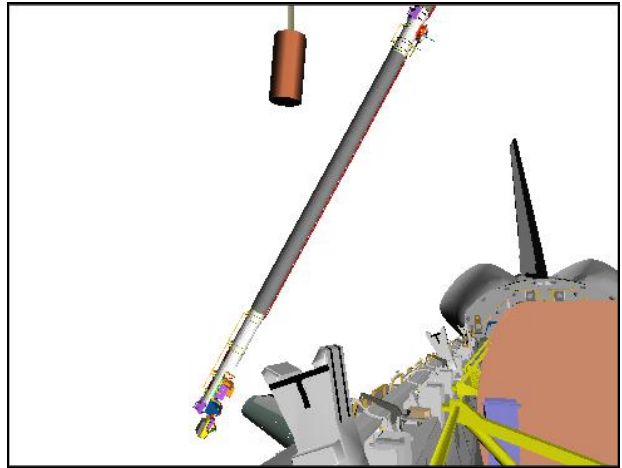

**CCTV D (-20,10)**

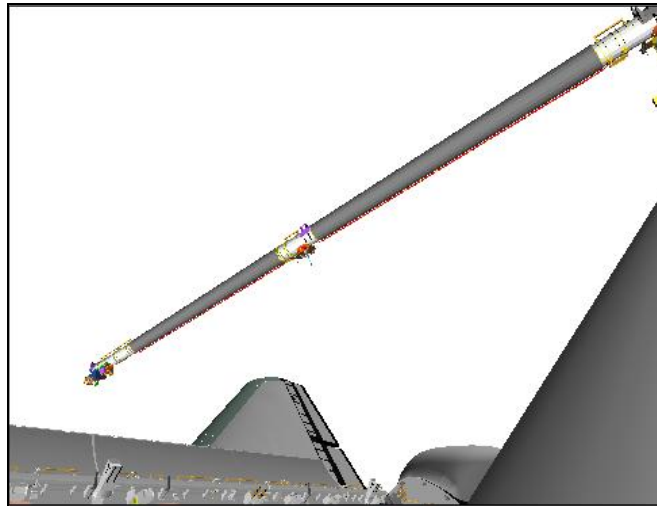

**ELBOW (-40,-20)**

3. STBD LDRI ACAS, SECTION 1

NOTE

Section 1 scans RCC Zone 6, Panels 1 → 7

A7U

MUX 1 L ← MIDDECK

LDRI MODE 6 pb – push (flickering LDRI displayed)

MON2 ← PL2

CAMR CMD PAN/TILT – HI RATE

PAN – L (to hard stop)

TILT – UP (to hard stop)

PAN/TILT – RESET, HI RATE (LO within 10°)

PAN: +54

TILT: -78

PAN/TILT to match LDRI view shown below

Note PAN/TILT: \_\_\_\_\_, \_\_\_\_\_

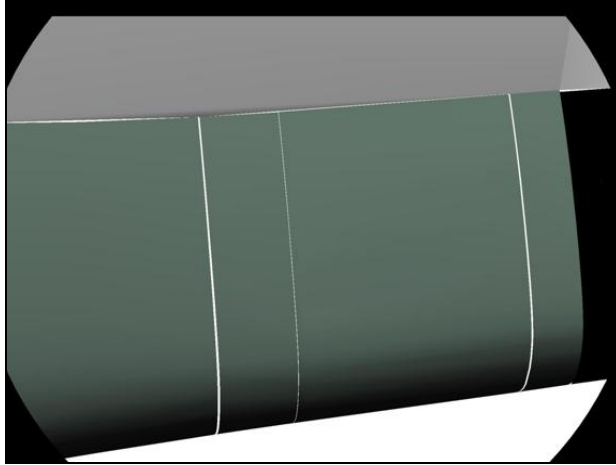

**LDRI (54,-78)**

MON2 ← not PL2

√DTV – PL2 (LDRI video)

For survey scan pattern, refer to OBSS LDRI SCAN PATTERN CUE CARD – STBD DOCKED (CUE CARD CONFIG)

For camera views, refer to OBSS LDRI RCC SURVEY CAMERA VIEWS – STBD DOCKED (SURVEY CAMERA VIEWS)

**SM 94 PDRS CONTROL**

PL ID – ITEM 3 +3 EXEC

INIT ID – ITEM 24 +3 EXEC

AUTO MODES – ITEM 13 +6 +7 EXEC

RHC

RATE – COARSE (RATE MIN tb-OFF)

BRAKES – OFF (tb-OFF)

MODE – AUTO 1, ENTER (READY It on)

\* If unable to enter AUTO mode (no AUTO READY It): \*

\* √Joint angles and adjust as reqd \*

**SM 169 PDRS STATUS**

√LAST PT: 130

Monitor ACAS progress

NOTE

Section 1 run time ~ 2:15 min

Section 1 Clearance Views	Cameras
OBSS-to-PLBD	C, D, ELBOW, RSC
UPPER ARM-to-US LAB	A, B

NOTE

Wait for MCC GO before proceeding with survey

L10(VTR) On MCC GO,  
 REC pb – push, hold  
 PLAY pb – push, simo (red ●)

AUTO SEQ – PROCEED (IN PROG It on)

ACAS, pause pts shaded, ORAS/OBAS are in **bold**, Rel digitals are nonbold,  
 ● col indicates data recording (black = VTR on) and damage criteria (inches):

Pt	X	Y	Z	PITCH	YAW	ROLL	●
<b>130P</b> Δ	<b>-940</b> +31	<b>+291</b> +4	<b>-363</b> +13	<b>271</b> -2	<b>329</b> +4	<b>66</b> -7	●
131 Δ	+60	-6	+1	+1	-2	0	1
<b>132P</b>	<b>-1031</b>	<b>+293</b>	<b>-377</b>	<b>270</b>	<b>322</b>	<b>63</b>	●

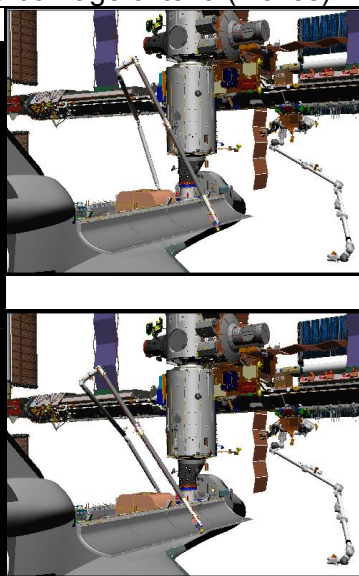

L10(VTR) When AUTO SEQ READY It – on:  
 STOP pb – push (no red ●)

4. STBD LDRI ACAS, CONTINUE SECTION 1

NOTE

Between Pts 132 and 133, arm adjusts for survey of Zone 6.  
 Section 1 continues to scan Zone 6, Panels 7 → 15. Time  
 between Pts 132 and 133 ~ 1:50 min

Section 1 Clearance Views	Cameras
OBSS-to-PLBD	C, D, ELBOW, RSC
UPPER ARM-to-US LAB	A, B

AUTO SEQ – PROCEED (IN PROG It on)

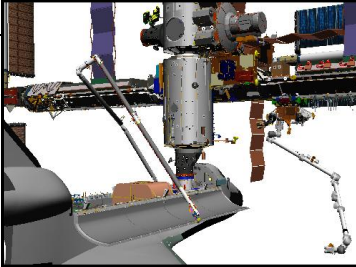
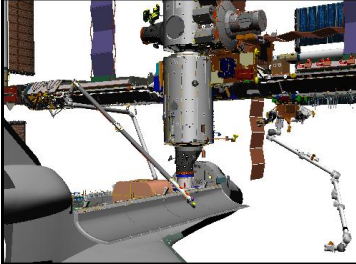
Pt	X	Y	Z	PITCH	YAW	ROLL	●
132P Δ	-1031 -22	+293 +28	-377 +30	270 +22	322 -28	63 -9	
133P	-1009	+265	-407	273	308	100	

When AUTO SEQ READY It – on:

A7U

MON2 ← PL2

PAN: +110 (right)

TILT: -89 (down)

PAN/TILT to match LDRI view shown below

Note PAN/TILT: \_\_\_\_\_, \_\_\_\_\_

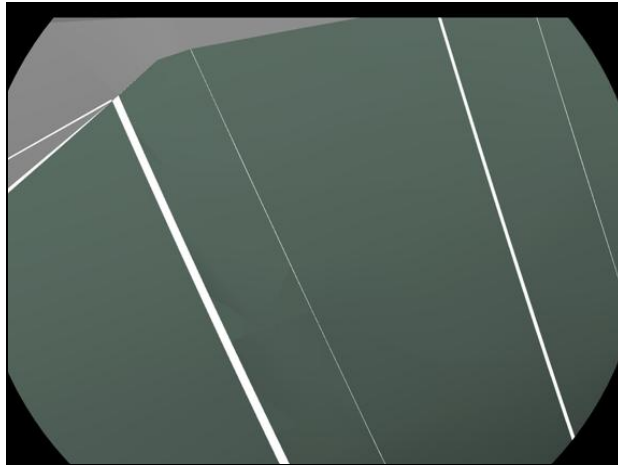

**LDRI (+110,-89)**

NOTE

Time between Pts 133 and 134 ~ 1:45 min

MON2 ← not PL2

L10(VTR) REC pb – push, hold  
PLAY pb – push, simo (red ●)

AUTO SEQ – PROCEED (IN PROG It on)

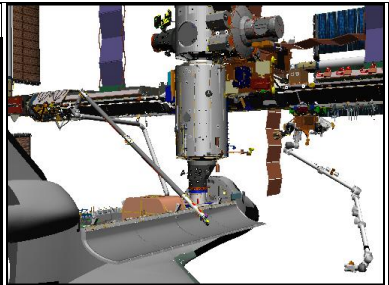
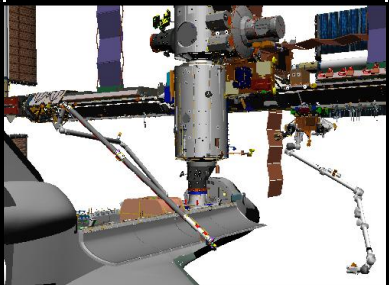
Pt	X	Y	Z	PITCH	YAW	ROLL	●
133P Δ	-1009 +159	+265 -119	-407 -24	273 0	308 0	100 -3	
134P	-1168	+384	-383	274	305	101	1 

L10(VTR) When AUTO SEQ READY It – on:  
STOP pb – push (no red ●)

5. STBD LDRI ACAS, CONTINUE SECTION 1

NOTE

Between Pts 134 and 135, arm adjusts for survey of Zone 6. Section 1 continues to scan Zone 6, Panels 15 → 22. At Pt 135, Upper Arm-to-US LAB = 60 in. Time between Pts 134 and 135 ~ 2:10 min

Section 1 Clearance Views	Cameras
OBSS-to-PLBD/WING	C, D, ELBOW, RSC, US LAB
UPPER ARM-to-US LAB	A, B

AUTO SEQ – PROCEED (IN PROG It on)

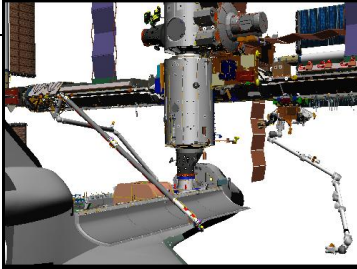
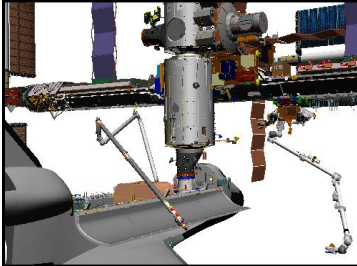
Pt	X	Y	Z	PITCH	YAW	ROLL	•
134P Δ	-1168 +24	+384 +32	-383 +5	274 +2	305 -27	101 -10	
135P	-1192	+352	-388	311	306	151	

When AUTO SEQ READY It – on:

A7U

MON2 ← PL2

PAN: +107 (left)

TILT: -112 (down)



PAN/TILT to match LDRI view shown below

Note PAN/TILT: \_\_\_\_\_, \_\_\_\_\_

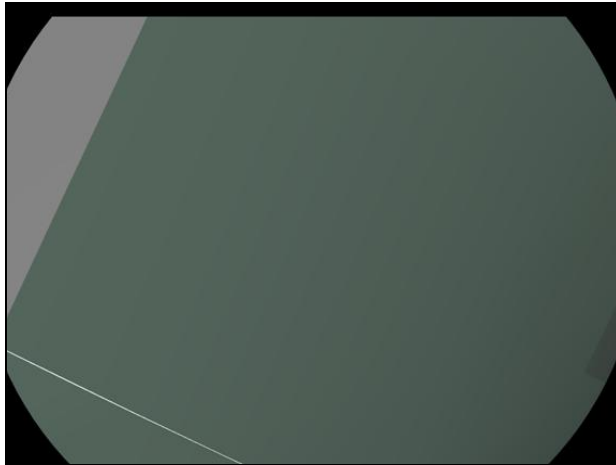

**LDRI (+107,-112)**

NOTE

Time between Pts 135 and 138 ~ 1:50 min

MON2 ← not PL2

L10(VTR) REC pb – push, hold  
PLAY pb – push, simo (red ●)

AUTO SEQ – PROCEED (IN PROG It on)

Pt	X	Y	Z	PITCH	YAW	ROLL	●
135P Δ	-1192 +81	+352 -79	-388 0	311 1	306 0	151 0	
136 Δ	+21	-15	0	0	0	0	
137 Δ	+52	-13	+1	0	0	0	
138P	-1346	+459	-389	311	306	152	

L10(VTR) When AUTO SEQ READY It – on:  
STOP pb – push (no red ●)

6. STBD LDRI ACAS, SECTION 2

NOTE

Between Pts 138 and 140, arm adjusts for survey of Zone 5.  
 Section 2 then scans Zone 5, Panels 22 → 11. Time between  
 Pts 138 and 140 ~ 2:10 min

Section 2 Clearance Views	Cameras
OBSS-to-Wing	C, D, ELBOW, RSC
UPPER ARM-to-US LAB	A, B

AUTO SEQ – PROCEED (IN PROG It on)

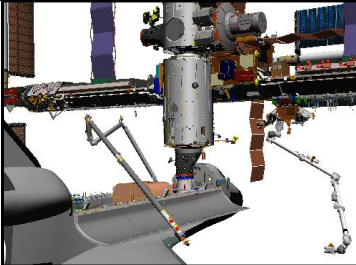
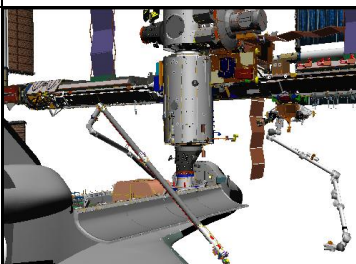
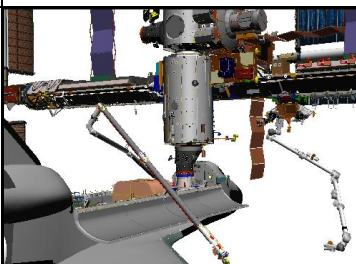
Pt	X	Y	Z	PITCH	YAW	ROLL	●
<b>138P</b> Δ	<b>-1346</b> -35	<b>+459</b> -80	<b>-389</b> +47	<b>311</b> 0	<b>306</b> 0	<b>152</b> 0	
139 Δ	-2	+8	-93	-25	+19	+21	
<b>140P</b>	<b>-1309</b>	<b>+531</b>	<b>-343</b>	<b>294</b>	<b>308</b>	<b>105</b>	

A7U When AUTO SEQ READY It – on:  
 MON2 ← PL2

PAN: +110 (right)  
 TILT: -67 (up)

PAN/TILT to match LDRI view shown below

Note PAN/TILT: \_\_\_\_\_, \_\_\_\_\_

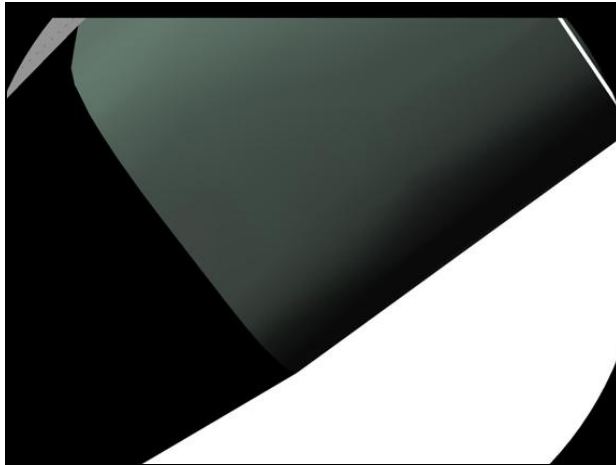

**LDRI (+110,-67)**

NOTE

Time between Pts 140 and 143 ~ 2:40 min

MON2 ← not PL2

L10(VTR) REC pb – push, hold  
PLAY pb – push, simo (red ●)

AUTO SEQ – PROCEED (IN PROG It on)

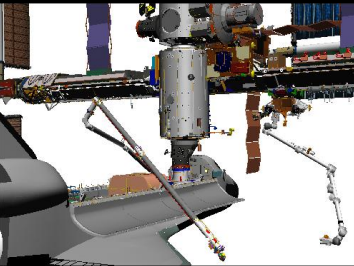
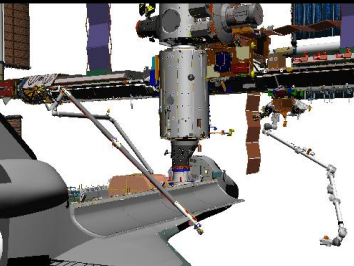
Pt	X	Y	Z	PITCH	YAW	ROLL	●
<b>140P</b> Δ	<b>-1309</b> -43	<b>+531</b> +27	<b>-343</b> +12	<b>294</b> 9	<b>308</b> 1	<b>105</b> -6	
141 Δ	-97	+98	-3	2	4	0	
142 Δ	-102	+71	-16	-4	11	10	1/4
<b>143P</b>	<b>-1067</b>	<b>+335</b>	<b>-336</b>	<b>265</b>	<b>310</b>	<b>80</b>	

When AUTO SEQ READY It – on:

L10(VTR) STOP pb – push (no red ●)

7. STBD LDRI ACAS, CONTINUE SECTION 2

NOTE

Between Pts 143 and 144, arm adjusts for survey of Zone 5.  
 Section 2 then scans Zone 5, Panels 10 → 6. Time between  
 Pts 143 and 144 ~ 1:30 min

Section 2 Clearance Views	Cameras
OBSS-to-PLBD	C, D, ELBOW, RSC
UPPER ARM-to-US LAB	A, B

AUTO SEQ – PROCEED (IN PROG It on)

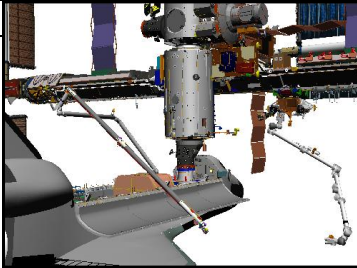
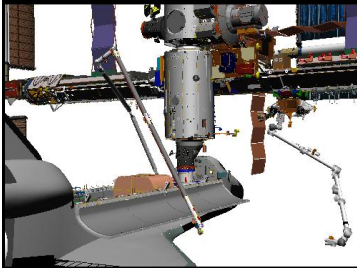
Pt	X	Y	Z	PITCH	YAW	ROLL	
143P Δ	-1067 +2	+335 +15	-336 -2	265 -9	310 0	80 18	
144P	-1069	+320	-334	273	328	79	

A7U

When AUTO SEQ READY It – on:

MON2 ← PL2

√PAN: +110

TILT: -88 (down)

PAN/TILT to match LDRI view shown below

Note PAN/TILT: \_\_\_\_\_, \_\_\_\_\_

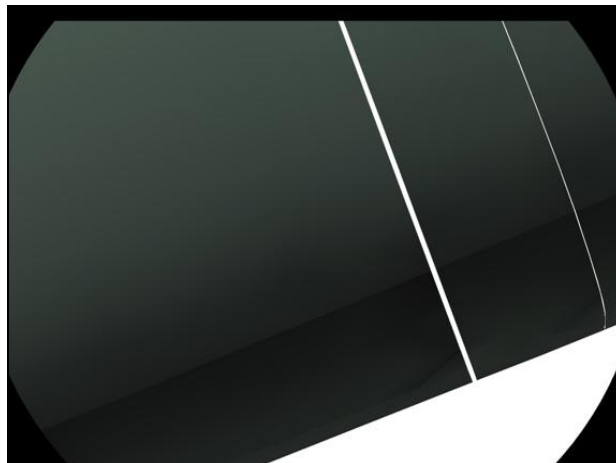

LDRI (+110,-88)

NOTE

Time between Pts 144 and 145 ~ 1:00 min

MON2 ← not PL2

L10(VTR) REC pb – push, hold  
PLAY pb – push, simo (red ●)

AUTO SEQ – PROCEED (IN PROG It on)

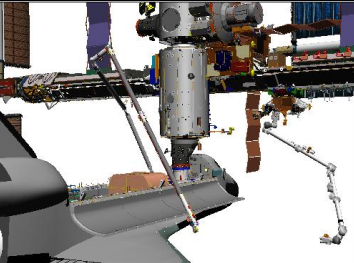
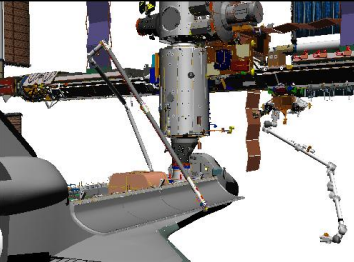
Pt	X	Y	Z	PITCH	YAW	ROLL	●
144P Δ	-1069 -103	+320 +31	-334 +34	273 8	328 0	79 -2	
145P	-966	+289	-368	265	326	79	

When AUTO SEQ READY It – on:  
MON2 ← PL2

A7U

PAN: +100 (left)  
√TILT: -88

PAN/TILT to match LDRI view shown below

Note PAN/TILT: \_\_\_\_\_, \_\_\_\_\_

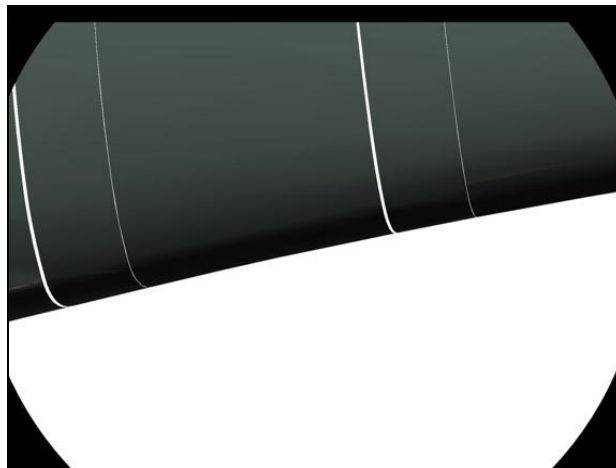

LDRI (+100,-88)

Record image for 30 sec

PAN: +88 (left)  
√TILT: -88

PAN/TILT to match LDRI view shown below

Note PAN/TILT: \_\_\_\_\_, \_\_\_\_\_

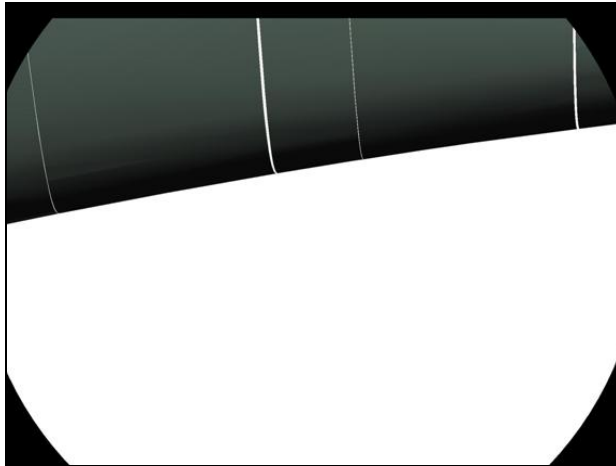

**LDRI (+88,-88)**

Record image for 30 sec

MON2 ← not PL2

L10(VTR) STOP pb – push (no red ●)

8. STBD LDRI ACAS, SECTION 3

NOTE

Between Pts 145 and 147, arm adjusts for survey of Zones 4 & 5. Section 3 then scans Zones 4 & 5, Panels 10 → 19. At Pt 146, Upper Arm-to-US LAB = 66 in. At Pt 147, Lower Arm-to-US LAB = 86 in., Upper Arm-to-US LAB = 64 in. and OBSS-to-PLBD = 60 in. Time between Pts 145 and 147 ~ 1:40 min

<b>Section 3 Clearance Views</b>	<b>Cameras</b>
OBSS-to-PLBD	C, D, ELBOW, RSC, US LAB
UPPER ARM-to-US LAB	A, B
LOWER ARM-to-US LAB	ELBOW

AUTO SEQ – PROCEED (IN PROG It on)

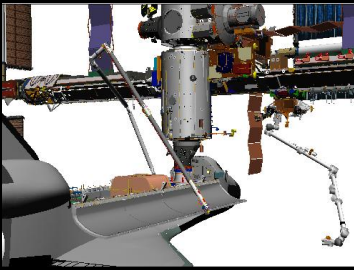
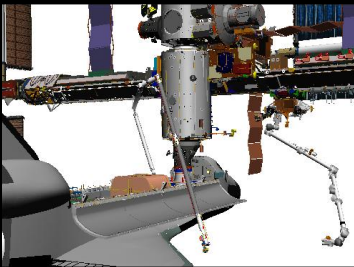
Pt	X	Y	Z	PITCH	YAW	ROLL	●
145P Δ	-966 +10	+289 -11	-368 -10	265 -2	326 -1	79 1	
146 Δ	71	-31	-74	-21	-4	3	
147P	-1047	+331	-284	291	331	83	

A7U When AUTO SEQ READY It – on:  
MON2 ← PL2

PAN: +115 (right)  
TILT: -62 (up)

PAN/TILT to match LDRI view shown below

Note PAN/TILT: \_\_\_\_\_, \_\_\_\_\_

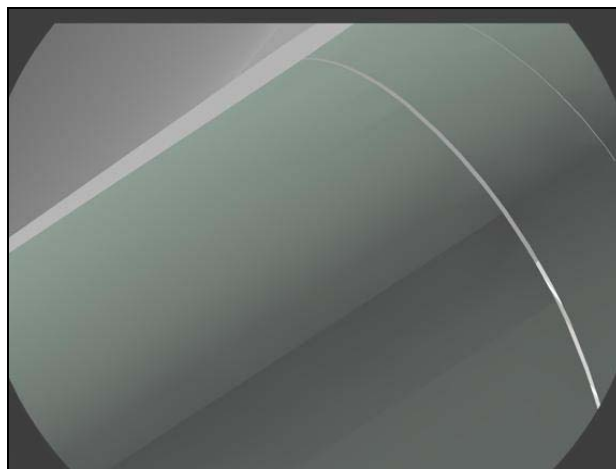

LDRI (+115,-62)

NOTE

Time between Pts 147 and 148 ~ 2:10 min

MON2 ← not PL2

L10(VTR) REC pb – push, hold  
PLAY pb – push, simo (red ●)

AUTO SEQ – PROCEED (IN PROG It on)

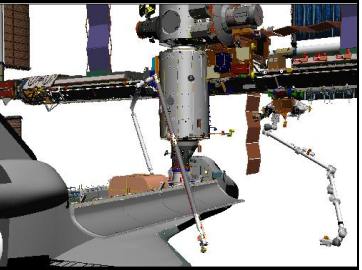
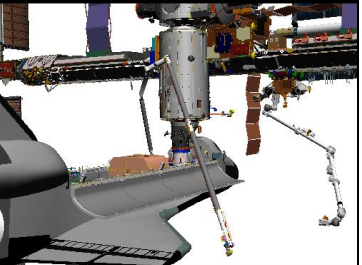
Pt	X	Y	Z	PITCH	YAW	ROLL	●
147P Δ	-1047 +183	+331 -174	-284 +7	291 -4	331 0	83 -4	
148P	-1230	+505	-291	296	328	85	

L10(VTR) When AUTO SEQ READY It – on:  
STOP pb – push (no red ●)

9. STBD LDRI ACAS, CONTINUE SECTION 3

NOTE

Between Pts 148 and 149, arm adjusts for survey of Zones 4 & 5.  
Section 3 continues to scan Zones 4 & 5, Panels 20 → 22. At  
Pt 149, Upper Arm-to-US LAB = 18 in. Monitor clearance with Elbow  
camera (-130, -20). Time between Pts 148 and 149 ~ 2:30 min

Section 3 Clearance Views	Cameras
OBSS-to-Wing	C, D, RSC, US LAB
UPPER ARM-to-US LAB	A, B, ELBOW, P1 LOOB

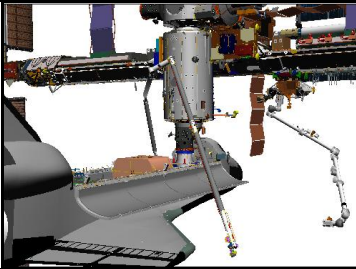
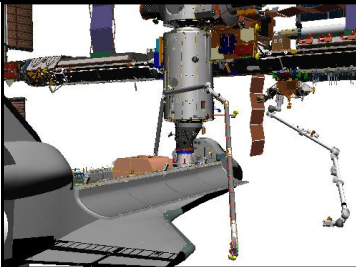

AUTO SEQ – PROCEED (IN PROG It on)

Pt	X	Y	Z	PITCH	YAW	ROLL	●
148P Δ	-1230 +45	+505 -23	-291 +6	296 -59	328 12	85 46	
149P	-1275	+528	-297	322	335	31	

A7U When AUTO SEQ READY It – on:  
MON2 ← PL2

PAN: +33 (left)  
TILT: -59 (up)

PAN/TILT to match LDRI view shown below

Note PAN/TILT: \_\_\_\_\_, \_\_\_\_\_

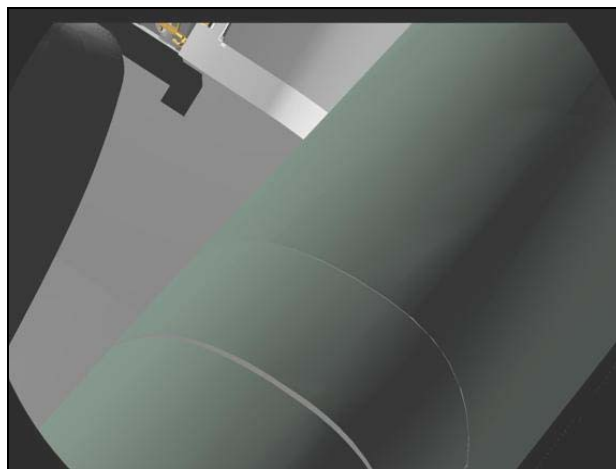

**LDRI (+33,-59)**

**NOTE**

Time between Pts 149 and 150 ~ 1:10 min. At Pt 150,  
Upper Arm-to-PMA2 = 35 in. Monitor clearance with  
Elbow camera (-130, -20)

MON2 ← not PL2

L10(VTR) REC pb – push, hold  
PLAY pb – push, simo (red ●)

AUTO SEQ – PROCEED (IN PROG It on)

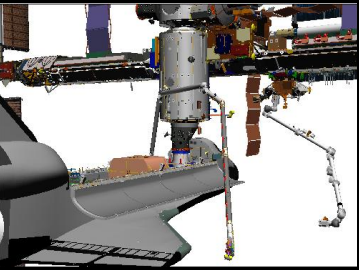
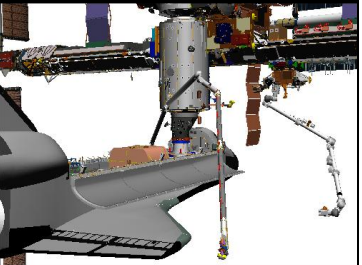
Pt	X	Y	Z	PITCH	YAW	ROLL	●
149P Δ	-1275 +65	+528 -21	-297 -1	322 0	335 0	31 0	
150P	-1340	+549	-296	322	335	31	

L10(VTR) When AUTO SEQ READY It – on:  
STOP pb – push (no red ●)

10. STBD LDRI ACAS, SECTION 4

NOTE

Between Pts 150 and 152, arm adjusts for survey of Zone 4. Section 4 then scans Zone 4, Panels 22 → 9. At Pt 150, Upper Arm-to-PMA2 = 35 in. Monitor clearance with Elbow camera (-150, -20). Time between Pts 150 and 152 ~ 2:30 min

Section 4 Clearance Views	Cameras
OBSS-to-PLBD	C, D, RSC, US LAB
OBSS-to-Wing	D, RSC
UPPER ARM-to-PMA2	A, B, ELBOW

AUTO SEQ – PROCEED (IN PROG It on)

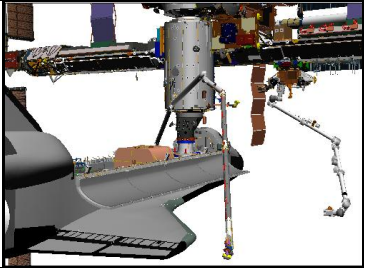
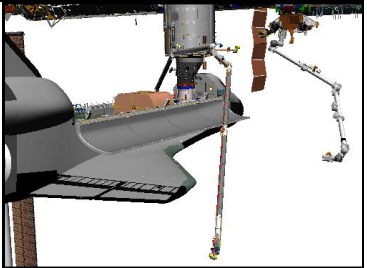
Pt	X	Y	Z	PITCH	YAW	ROLL	●
150P Δ	-1340 -56	+549 -141	-296 -18	322 -1	335 11	31 -9	
151 Δ	+41	+180	-113	4	-10	19	
152P	-1325	+510	-165	317	341	23	

A7U

When AUTO SEQ READY It – on:  
MON2 ← PL2

PAN: +85 (right)  
TILT: -45 (up)

PAN/TILT to match LDRI view shown below

Note PAN/TILT: \_\_\_\_\_, \_\_\_\_\_

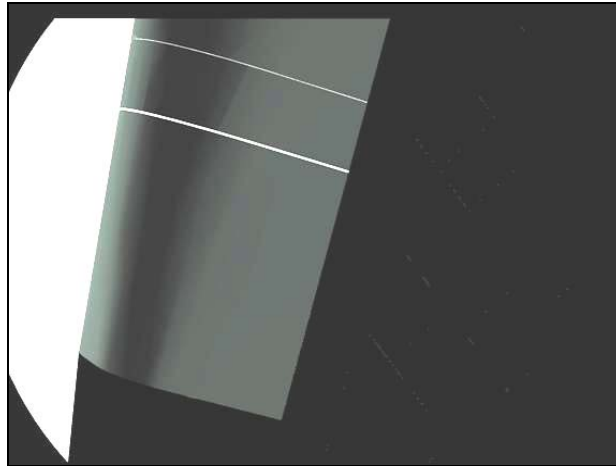

LDRI (+85,-45)

NOTE

Time between Pts 152 and 155 ~ 2:50 min. At Pt 155, Upper Arm-to-US LAB = 19 in. Monitor clearance with Elbow camera (-160, -20)

MON2 ← NOT PL2

L10(VTR) REC pb – push, hold  
PLAY pb – push, simo (red ●)

AUTO SEQ – PROCEED (IN PROG It on)

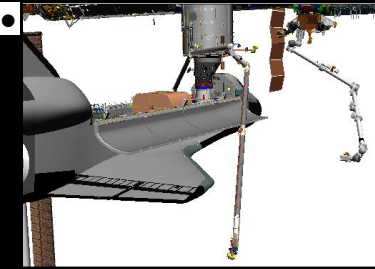
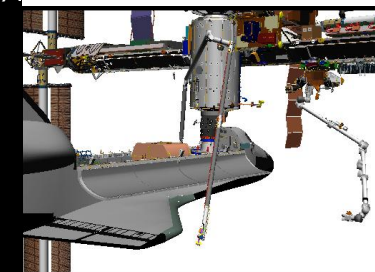
Pt	X	Y	Z	PITCH	YAW	ROLL	●
<b>152P</b> Δ	<b>-1325</b> -60	<b>+510</b> +38	<b>-165</b> +48	<b>317</b> 0	<b>341</b> 0	<b>23</b> 0	
153 Δ	-199	174	-1	30	-15	9	
154 Δ	-13	0	-2	1	0	0	1/4
<b>155P</b>	<b>-1053</b>	<b>+298</b>	<b>-210</b>	<b>290</b>	<b>354</b>	<b>34</b>	

When AUTO SEQ IN PROG It – off:  
BRAKES – ON (tb-ON)

L10(VTR) STOP pb – push (no red ●)

A7U MUX 1 L ← MIDDECK  
LDR1 MODE 2 pb – push (ITVC video displayed)  
MON2 ← not PL2

11. MANEUVER TO DOCKED STBD LDRI ACAS PART 2

BRAKES – OFF (tb-OFF)

MODE – SINGLE, ENTER

SJ Mnvr Clearance Views	Cameras
OBSS-to-ORBITER	A, B, ELBOW, P1 LOOB, SSRMS TIP ELBOW

Mnvr to DOCKED STBD LDRI ACAS PART 2:

STBD LDRI  
ACAS 1 End

- 1: WP +
- 2: WR -
- 3: SY +
- 4: SP -
- 5: WY +
- 6: WR +
- 7: EP -

STBD LDRI  
ACAS 2 START

SY	SP	EP	WP	WY	WR	
-61.5	+42.5	-31.1	-99.7	-66.4	-247.0	
			-17.4			
					-295.0	
+67.7						
	+34.1					
				-0.6		
					-131.7	
		-89.1				
+67.7	+34.1	-89.1	-17.4	-0.6	-131.7	
X	Y	Z	PITCH	YAW	ROLL	PL ID
-903	+183	-212	31	278	24	3

BRAKES – ON (tb-ON)

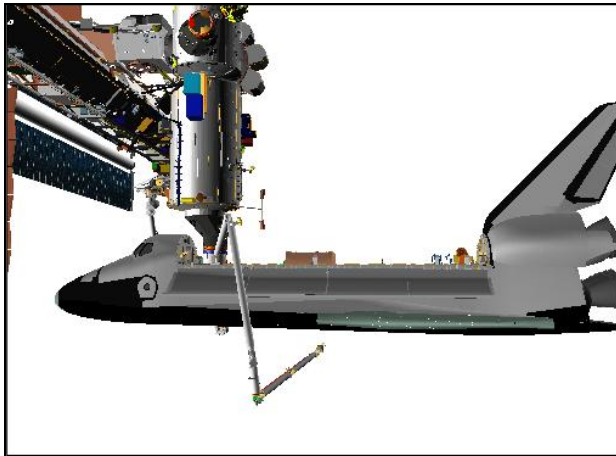

**BIRD'S EYE**

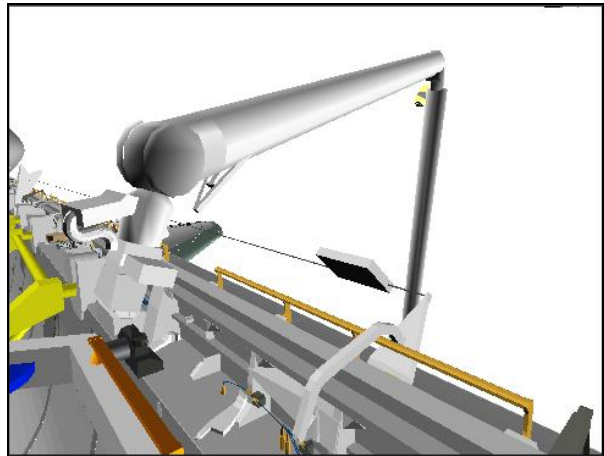

**CCTV A (40,-10)**

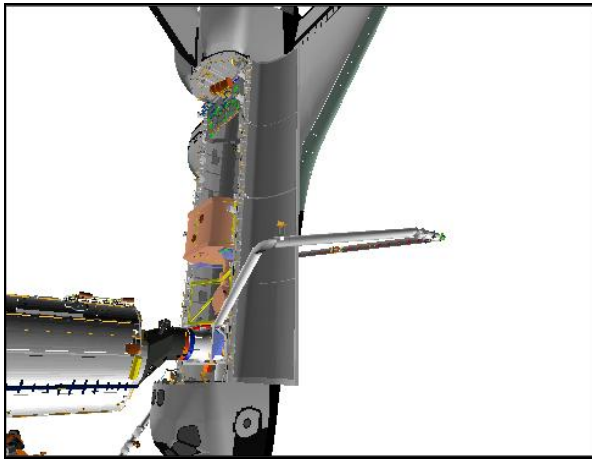

**P1 LOWER OUTBOARD (130,20)**

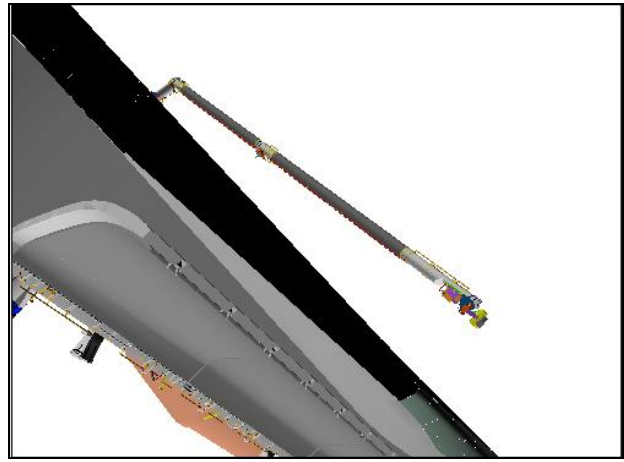

**SSRMS TIP ELBOW (-70,15)**

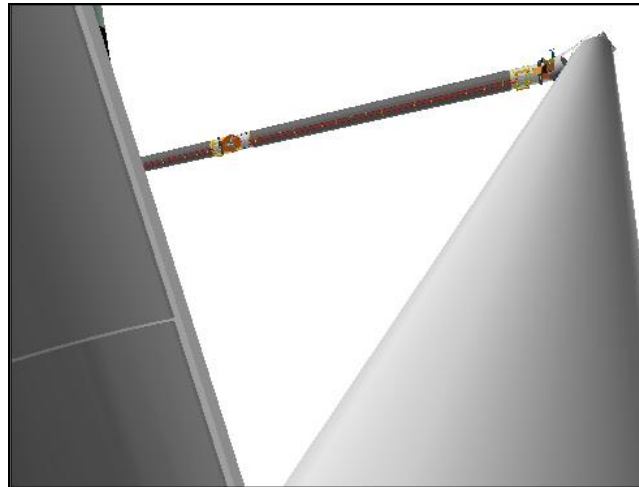

**ELBOW (-30,-30)**

A7U

12. STBD LDRI ACAS, SECTION 5

MUX 1 L ← MIDDECK

LDRI MODE 6 pb – push (flickering LDRI displayed)

MON2 ← PL2

PAN: +52 (left)

TILT: -77 (down)

PAN/TILT to match LDRI view shown below

Note PAN/TILT: \_\_\_\_\_, \_\_\_\_\_

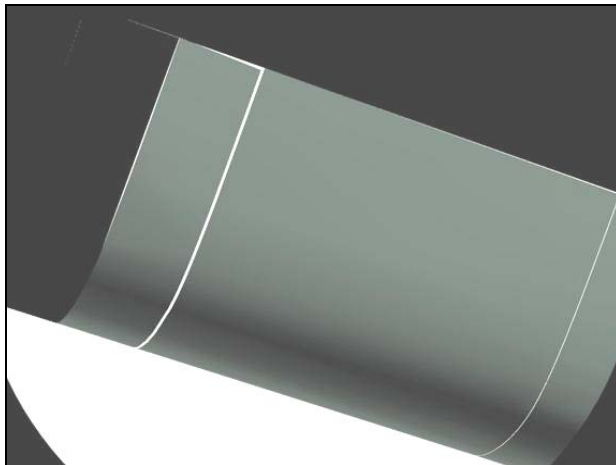

**LDRI (52,-77)**

MON2 ← NOT PL2  
√DTV – PL2 (LDRI video)

RHC √RATE – COARSE (RATE MIN tb-OFF)

BRAKES – OFF (tb-OFF)  
MODE – AUTO 2, ENTER (READY It on)

- \* If unable to enter AUTO mode (no AUTO READY It): \*
- \* √Joint angles and adjust as reqd \*

**SM 169 PDRS STATUS**

√LAST PT: 156  
Monitor ACAS progress

**NOTE**

Section 5 scans RCC Zones 1 & 2, Panels 1 → 10. At Pt 159, Lower Arm-to-PLBD = 56 in. Monitor clearance with Elbow camera (-30, -30). Section 5 run time ~ 1:40 min

<b>Section 5 Clearance Views</b>	<b>Cameras</b>
LOWER ARM-to-PLBD	A, B, ELBOW, P1 LOOB
OBSS-to-ORBITER	RSC, SSRMS TIP ELBOW

**NOTE**

Wait for MCC GO before proceeding with survey

L10(VTR) On MCC GO,  
REC pb – push, hold  
PLAY pb – push, simo (red ●)

AUTO SEQ – PROCEED (IN PROG It on)

ACAS, pause pts **shaded in bold**, ● col indicates data recording (black = VTR on) and damage criteria (inches):

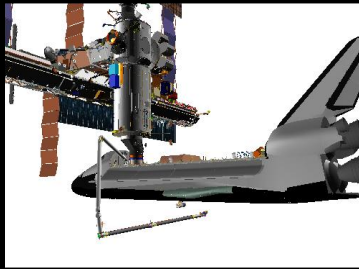
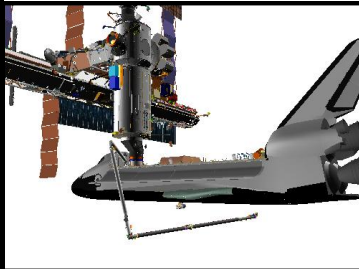
Pt	X	Y	Z	PITCH	YAW	ROLL	●
<b>156P</b> Δ	<b>-903</b> +105	<b>+183</b> -18	<b>-212</b> +2	<b>31</b> -10	<b>278</b> -14	<b>24</b> 0	
157 Δ	54	-23	0	0	0	0	1/4
158 Δ	49	-38	-6	-7	-8	3	
<b>159P</b>	<b>-1111</b>	<b>+262</b>	<b>-208</b>	<b>11</b>	<b>298</b>	<b>345</b>	

L10(VTR) When AUTO SEQ READY It – on:  
STOP pb – push (no red ●)

13. STBD LDRI ACAS, SECTION 6

NOTE

Between Pts 159 and 160, arm adjusts for survey of Zones 1 & 2.  
Section 6 scans Zones 1 & 2, Panels 9 → 1. Time between  
Pts 159 and 160 ~ 1:00 min

Section 6 Clearance Views	Cameras
LOWER ARM-to-PLBD	A, B, ELBOW, P1 LOOB
OBSS-to-ORBITER	RSC, SSRMS TIP ELBOW

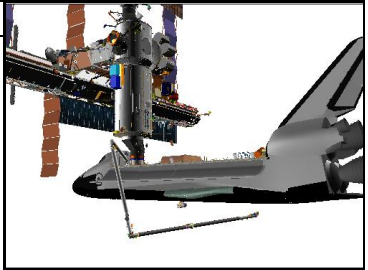
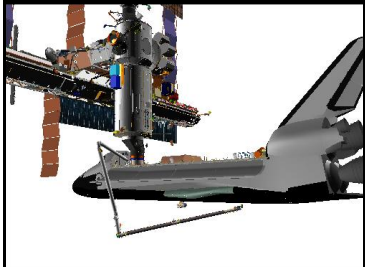

AUTO SEQ – PROCEED (IN PROG It on)

Pt	X	Y	Z	PITCH	YAW	ROLL	●
159P Δ	-1111 -83	+262 -18	-208 +30	11 13	298 2	345 -10	
160P	-1028	+280	-238	18	298	7	

A7U When AUTO SEQ READY It – on:  
MON2 ← PL2

PAN: +16 (left)  
TILT: -90 (down)

PAN/TILT to match LDRI view shown below

Note PAN/TILT: \_\_\_\_\_, \_\_\_\_\_

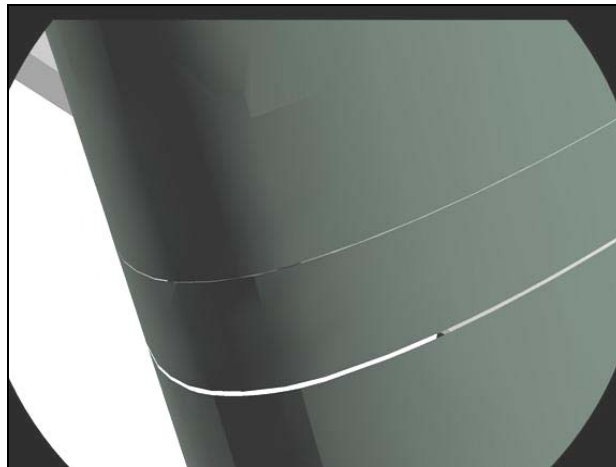

**LDRI (+16,-90)**

L10(VTR) REC pb – push, hold  
PLAY pb – push, simo (red ●)

Record image for 30 sec

PAN: +20 (right)  
TILT: -80 (up)

PAN/TILT to match LDRI view shown below

Note PAN/TILT: \_\_\_\_\_, \_\_\_\_\_

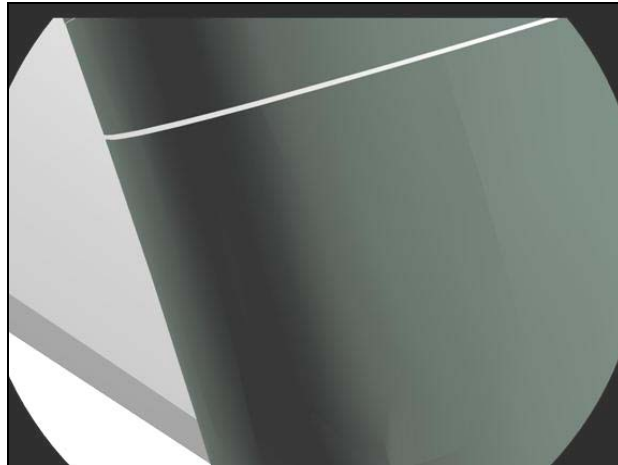

**LDRI (+20,-80)**

Record image for 30 sec

PAN: +23 (right)

TILT: -72 (up)

PAN/TILT to match LDRI view shown below

Note PAN/TILT: \_\_\_\_\_, \_\_\_\_\_



**LDRI (+23,-72)**

MON2 ← not PL2

NOTE

Time between Pts 160 and 162 ~ 1:30 min

AUTO SEQ – PROCEED (IN PROG It on)

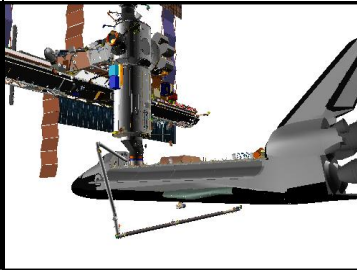
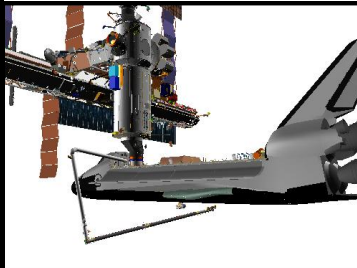
Pt	X	Y	Z	PITCH	YAW	ROLL	●
160P Δ	-1028 -21	+280 +25	-238 0	18 2	298 -1	7 -1	
161 Δ	-83	27	3	1	-2	-3	
162P	-924	+228	-241	21	302	14	

A7U

When AUTO SEQ READY It – on:  
MON2 ← PL2

PAN: +30 (right)  
TILT: -65 (up)

PAN/TILT to match LDRI view shown below

Note PAN/TILT: \_\_\_\_\_, \_\_\_\_\_

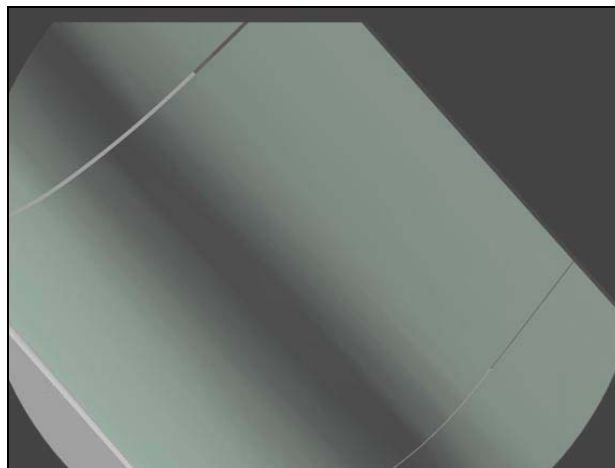

LDRI (+30,-65)

NOTE

Time between Pts 162 and 163 ~ 0:40 min

MON2 ← not PL2

AUTO SEQ – PROCEED (IN PROG It on)

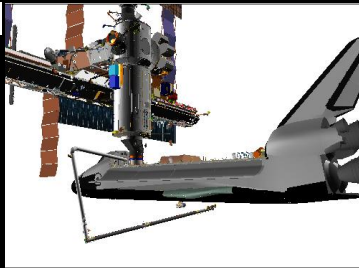
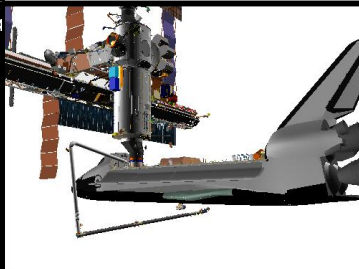
Pt	X	Y	Z	PITCH	YAW	ROLL	●
162P Δ	-924 -32	+228 +6	-241 -6	21 6	302 1	14 3	
163P	-892	+222	-235	15	301	11	1/4 

L10(VTR) When AUTO SEQ READY It – on:  
STOP pb – push (no red ●)

14. STBD LDRI ACAS, SECTION 7

NOTE

Between Pts 163 and 164, arm adjusts for survey of Zone 3.  
Section 7 scans Zone 3, Panels 1 → 9. Time between  
Pts 163 and 164 ~ 1:50 min

Section 7 Clearance Views	Cameras
LOWER ARM-to-PLBD	A, B, ELBOW, P1 LOOB
OBSS-to-ORBITER	RSC, SSRMS TIP ELBOW

AUTO SEQ – PROCEED (IN PROG It on)

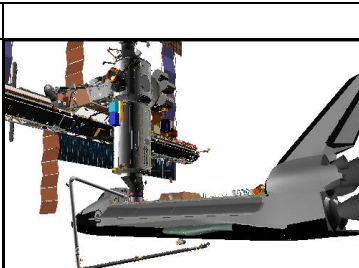
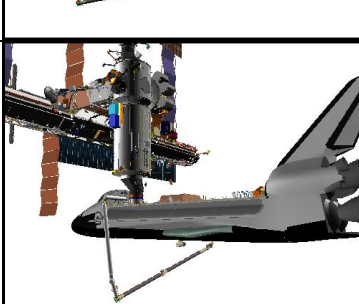
Pt	X	Y	Z	PITCH	YAW	ROLL	●
163P Δ	-892 +11	+222 -19	-235 +11	15 -4	301 23	11 -7	
164P	-903	+241	-246	67	288	61	

A7U

When AUTO SEQ READY It – on:

MON2 ← PL2

PAN: +47 (right)

TILT: -49 (up)

PAN/TILT to match LDRI view shown below

Note PAN/TILT: \_\_\_\_\_, \_\_\_\_\_

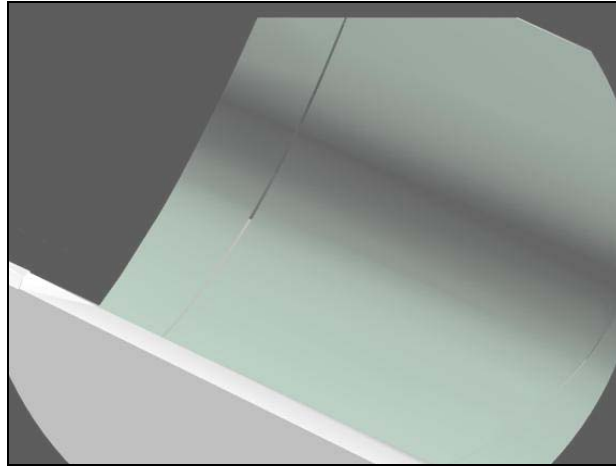

**LDRI (+47,-49)**

NOTE

Time between Pts 164 and 165 ~ 1:00 min

MON2 ←NOT PL2

L10(VTR)

REC pb – push, hold

PLAY pb – push, simo (red ●)

AUTO SEQ – PROCEED (IN PROG It on)

Pt	X	Y	Z	PITCH	YAW	ROLL	
<b>164P</b> Δ	<b>-903</b> +105	<b>+241</b> -35	<b>-246</b> 0	<b>67</b> 0	<b>288</b> 0	<b>61</b> 0	
<b>165P</b>	<b>-1008</b>	<b>+276</b>	<b>-246</b>	<b>67</b>	<b>288</b>	<b>61</b>	

A7U

When AUTO SEQ READY It – on:

MON2 ← PL2

PAN: +34 (left)

TILT: -57 (down)

PAN/TILT to match LDRI view shown below

Note PAN/TILT: \_\_\_\_\_, \_\_\_\_\_

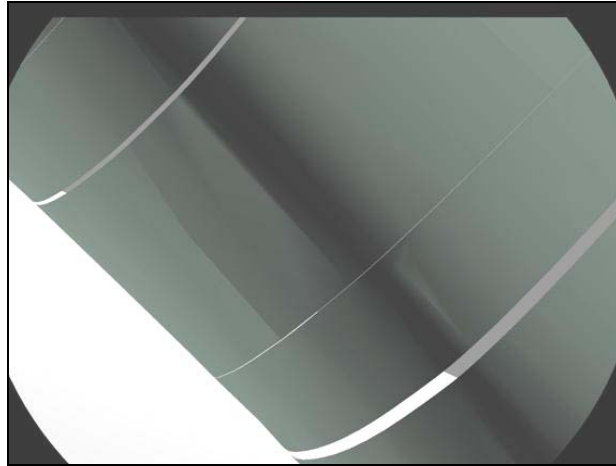

**LDRI (+34,-57)**

MON2 ← not PL2

NOTE

Time between Pts 165 and 166 ~ 0:40 min. At Pt 166,  
Lower Arm-to-PLBD = 51 in. Monitor clearance with  
Elbow camera (-30, -30)

AUTO SEQ – PROCEED (IN PROG It on)

Pt	X	Y	Z	PITCH	YAW	ROLL	
<b>165P</b> Δ	<b>-1008</b> +36	<b>+276</b> -30	<b>-246</b> 2	<b>67</b> 0	<b>288</b> 0	<b>61</b> 0	
<b>166P</b>	<b>-1044</b>	<b>+306</b>	<b>-248</b>	<b>67</b>	<b>288</b>	<b>61</b>	

When AUTO SEQ IN PROG It – off:

BRAKES – ON (tb-ON)

L10(VTR) STOP pb – push (no red ●)

A7U MUX 1 L ← MIDDECK  
 LDRI MODE 2 pb – push (ITVC video displayed)  
 MON2 ← not PL2

If continuing with OBSS LDRI RCC SURVEY – NOSE CAP  
 √MCC >>

RHC 15. MNVR TO UNDOCK  
 RATE – as reqd (VERN within 10 ft)  
 BRAKES – OFF (tb-OFF)  
 MODE – SINGLE, ENTER

Mnvr to UNDOCK:

	SY	SP	EP	WP	WY	WR	
STBD DOCKED LDRI ACAS END	+42.1	+7.3	-70.3	-19.4	-2.0	-105.2	
1: WY +					+11.0		
2: WR +						+10.0	
3: SP +		+66.3					
4: EP +			-49.0				
5: SY –	+25.8						
6: WY –					-20.0		
7: WR –						-100.7	
8: WP –				-85.9			
9: WY +					+10.7		
UNDOCK	+25.8	+66.3	-49.0	-85.9	+10.7	-100.7	
	X	Y	Z	PITCH	YAW	ROLL	PL ID
	-1029	+229	-614	188	270	74	3

\* Display Singularity

BRAKES – ON (tb-ON)

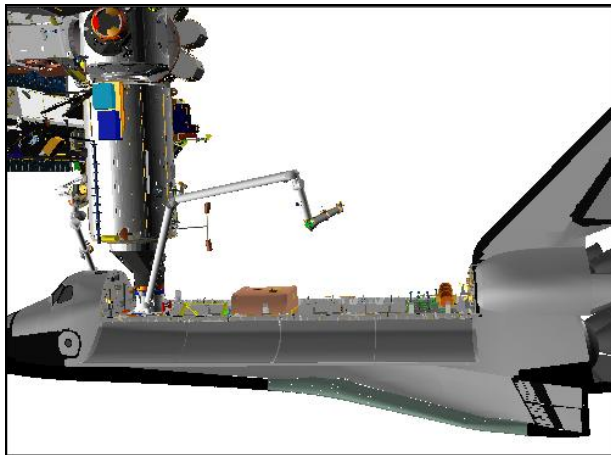

BIRD'S EYE

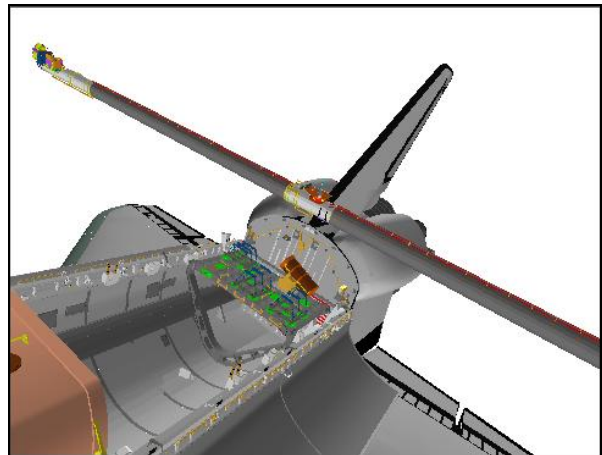

ELBOW (-60,0)

# OBSS IDC RCC SURVEY – STBD

**WARNING**  
 For UNDOCKED ops only  
 APAS Docking Ring must be retracted

**NOTE**

Assumed starting posn is end of OBSS ITVC/LDRI FLAT FIELDS.  
 PLID uplink is required

1. SETUP

SM 94 PDRS CONTROL

√ PL ID, ITEM 3: 2

√ INIT ID, ITEM 24: 2

AUTO MODES – ITEM 13 +6 +7 +8 +9 EXEC

	X	Y	Z	PITCH	YAW	ROLL	PLID
√	-1001	+303	-501	0	0	24	2
	SY	SP	EP	WP	WY	WR	
√	-89.6	+44.5	-84.6	-45.4	0.0	+109.6	

2. MNVR TO STBD IDC ACAS START POSITION

BRAKES – OFF (tb-OFF)

MODE – SINGLE, ENTER

Mnvr to STBD IDC ACAS START posn:

	SY	SP	EP	WP	WY	WR	
LDRI FLAT FIELD END	-89.6	+44.5	-84.6	-45.4	0.0	+109.6	
1: WP +				+103.5			
2: WR +						+280.8	
3: EP +			-76.1				
4: SP +		+71.3					
5: WY –					-64.8		
6: SY +	-13.2						
STBD IDC ACAS START	-13.2	+71.3	-76.1	+103.5	-64.8	+280.8	
	X	Y	Z	PITCH	YAW	ROLL	PL ID
	-1074	+168	-532	286	313	86	2

BRAKES – ON (tb-ON)



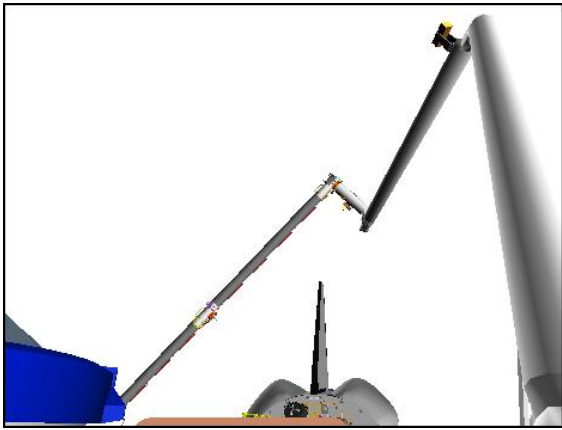

**CCTV A (-10,30)**

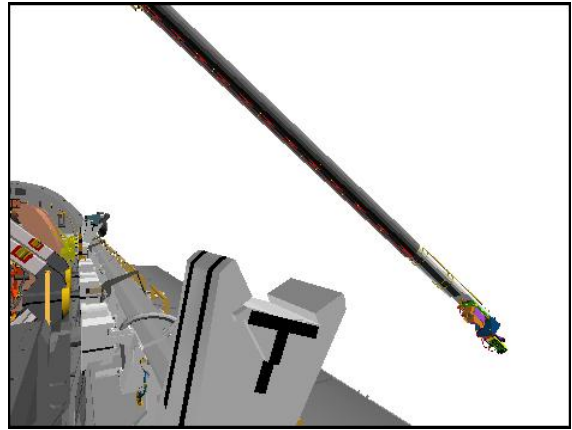

**CCTV C (30,0)**

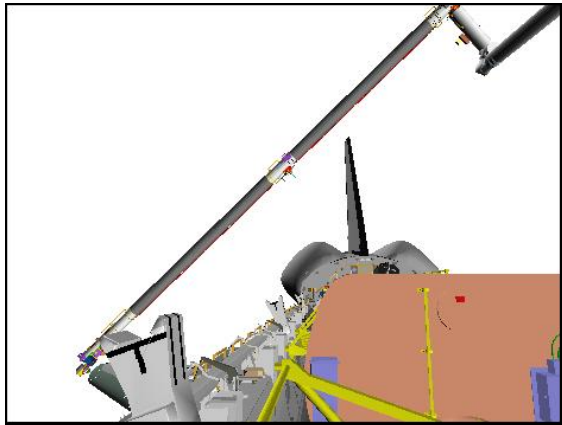

**CCTV D (-5,10)**

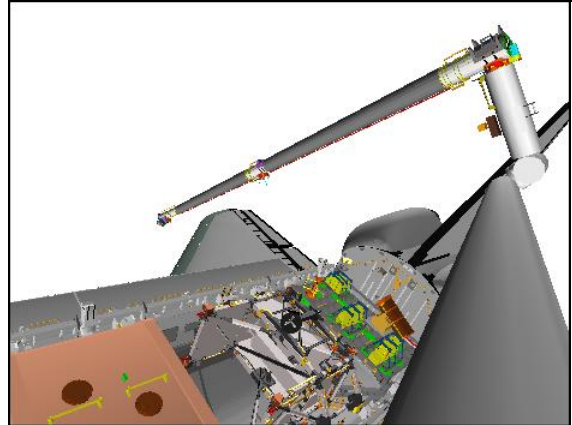

**ELBOW (-30,-10)**

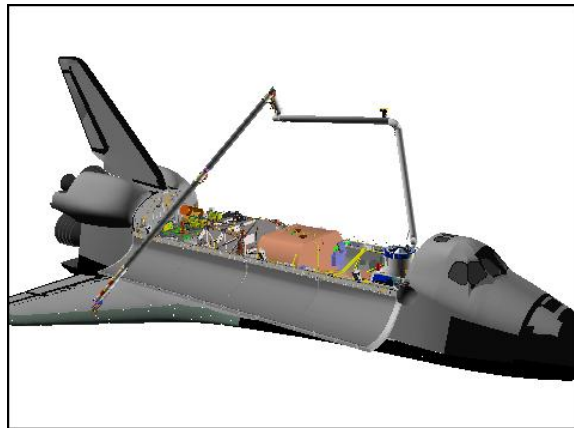

**BIRD'S EYE**

3. STBD IDC ACAS, SECTION 1

**SM 94 PDRS CONTROL**

PL ID – ITEM 3 +5 EXEC  
 INIT ID – ITEM 24 +5 EXEC

NOTE

Section 1 scans RCC Zones 5 & 6, Panels 11 → 7.  
 Time between Pts 130 and 132 ~ 1:10 min

Section 1 Clearance Views	Cameras
OBSS-to-PLBD	D, ELBOW, RSC
OBSS-to-Wing	C, ELBOW, RSC

RHC RATE – VERN (RATE MIN tb-ON)

- \* If unable to enter AUTO mode (no AUTO READY It): \*
- \* √Joint angles and adjust as reqd \*

BRAKES – OFF (tb-OFF)  
 MODE – AUTO 1, ENTER (READY It on)

**SM 169 PDRS STATUS**

√LAST PT: 130  
 Monitor ACAS progress

LCC/A31p sel 'Power On'

- \* If 'Power On' button not gray: \*
- \* Pause 3 seconds, then sel 'Power On' \*

Verify 'Use AE' checked  
 sel 'Scan Lo-Res'  
 √AE box centered in view (pause 2 sec)  
 sel 'Scan Hi-Res'

AUTO SEQ – PROCEED (IN PROG It on)

ACAS, pause pts shaded, ORAS/OBAS are in **bold**, Rel digitals are nonbold,  
 ● col indicates data recording (black = Scanning) and damage criteria (inches):

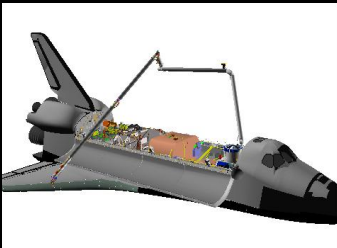
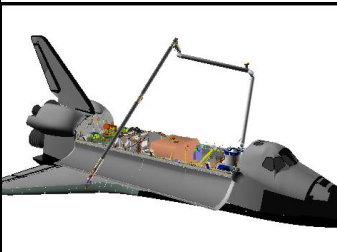
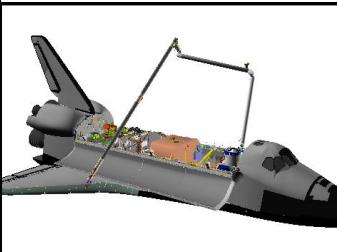
Pt	X	Y	Z	PITCH	YAW	ROLL	●
<b>130P</b> Δ	<b>-1123</b> -66	<b>+334</b> +50	<b>-374</b> -5	<b>292</b> 0	<b>43</b> 2	<b>266</b> 6	
131 Δ	-34	+8	+8	0	1	3	1/4 
<b>132P</b>	<b>-1023</b>	<b>+276</b>	<b>-377</b>	<b>297</b>	<b>49</b>	<b>258</b>	

LCC/A31p      When AUTO SEQ READY It – on:  
                   sel ‘Stop Scan’

4. STBD IDC ACAS, SECTION 2

NOTE

Between Pts 132 and 133, arm is repositioned for scan of RCC Zones 4-5. Expect C&W SINGULARITY between Points 132 and 133. Section 2 then scans Panels 7 → 11. Time between Pts 132 and 133 ~ 3:00 min

Section 2 Clearance Views	Cameras
OBSS-to-PLBD	C, D, ELBOW, RSC
OBSS-to-Wing	C, ELBOW, RSC

AUTO SEQ – PROCEED (IN PROG It on)

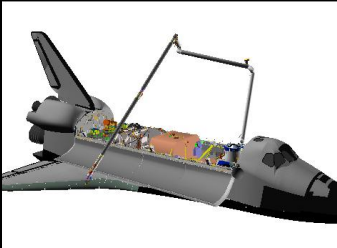
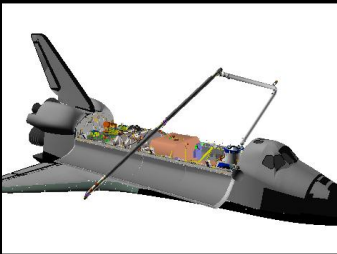
Pt	X	Y	Z	PITCH	YAW	ROLL	•
<b>132P</b> Δ	<b>-1023</b> -31	<b>+276</b> -28	<b>-377</b> -35	<b>297</b> -27	<b>49</b> -6	<b>258</b> 7	
<b>133P</b>	<b>-992</b>	<b>+304</b>	<b>-342</b>	<b>328</b>	<b>58</b>	<b>254</b>	

LCC/A31p      When AUTO SEQ READY It – on:  
                   sel ‘Scan Lo-Res’  
                   √AE box centered in view (pause 2 sec)  
                   sel ‘Scan Hi-Res’



LCC/A31p      When AUTO SEQ READY It – on:  
                   sel ‘Scan Lo-Res’  
                   √AE box centered in view (pause 2 sec)  
                   sel ‘Scan Hi-Res’

NOTE

Time between Pts 135 and 137 ~ 1:20 min

AUTO SEQ – PROCEED (IN PROG It on)

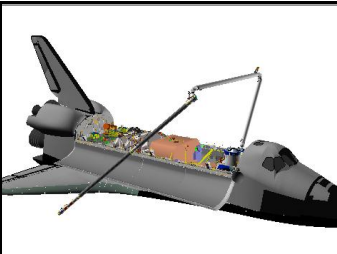
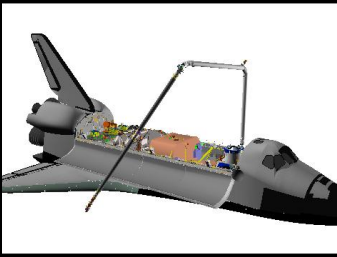
Pt	X	Y	Z	PITCH	YAW	ROLL	●
<b>135P</b> Δ	<b>-1080</b> -36	<b>+347</b> +43	<b>-285</b> -3	<b>14</b> 6	<b>46</b> -12	<b>219</b> 9	
136 Δ	-28	+7	+7	7	-10	-3	¼
<b>137P</b>	<b>-1016</b>	<b>+297</b>	<b>-289</b>	<b>15</b>	<b>65</b>	<b>202</b>	

LCC/A31p      When AUTO SEQ READY It – on:  
                   sel ‘Stop Scan’

6. STBD IDC ACAS, SECTION 4

NOTE

Between Pts 137 and 139, arm adjusts to scan Zones 2-3.  
 Section 4 then scans Zones 2-3, Panels 7 → 11. Time  
 between Pts 137 and 139 ~ 3:10 min

Section 4 Clearance Views	Cameras
OBSS-to-PLBD	RSC
OBSS-to-Wing	RSC
SRMS-to-ODS	A

AUTO SEQ – PROCEED (IN PROG It on)

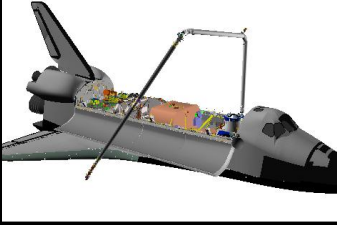
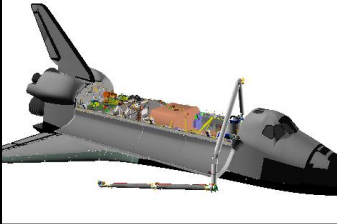
Pt	X	Y	Z	PITCH	YAW	ROLL	•
<b>137P</b> Δ	<b>-1016</b> +7	<b>+297</b> +22	<b>-289</b> -36	<b>15</b> -19	<b>65</b> 2	<b>202</b> 26	
138 Δ	+6	+40	-31	-16	2	20	
<b>139P</b>	<b>-1029</b>	<b>+235</b>	<b>-222</b>	<b>76</b>	<b>24</b>	<b>169</b>	

LCC/A31p

When AUTO SEQ READY It – on:

sel 'Scan Lo-Res'

√AE box centered in view (pause 2 sec)

sel 'Scan Hi-Res'



LCC/A31p When AUTO SEQ IN PROG It – off:  
 sel 'Scan Lo-Res'  
 √AE box centered in view (pause 2 sec)  
 sel 'Scan Hi-Res'

NOTE

Time between Pts 141 and 142 ~ 1:20 min

AUTO SEQ – PROCEED (IN PROG It on)

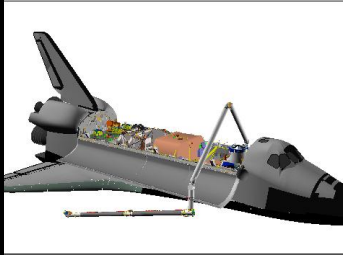
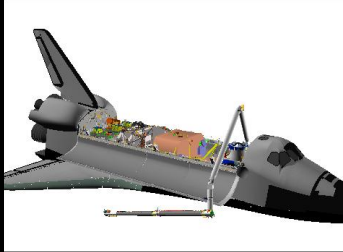
Pt	X	Y	Z	PITCH	YAW	ROLL	•
141P Δ	-1128 -95	+311 +89	-224 -12	74 4	23 -11	178 3	
142P	-1033	+222	-212	75	23	166	1/4 

LCC/A31p When AUTO SEQ IN PROG It – off:  
 sel 'Stop Scan'  
 sel 'Power off'

BRAKES – ON (tb-ON)

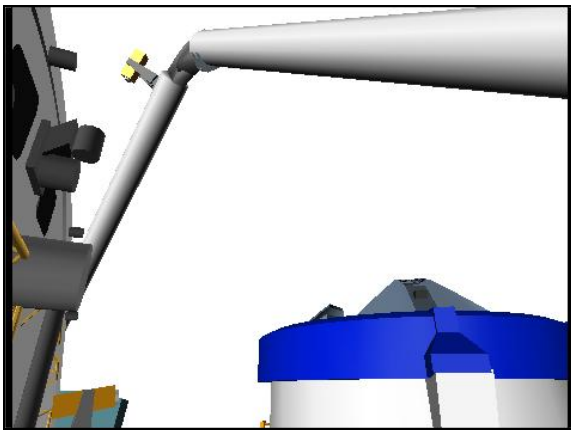

CCTV A (-65,25)

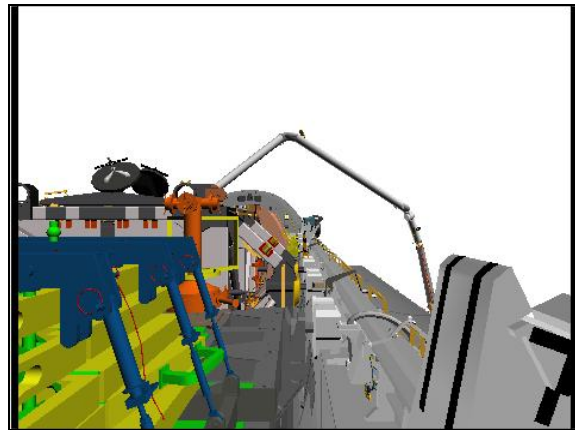

CCTV C (0,0)



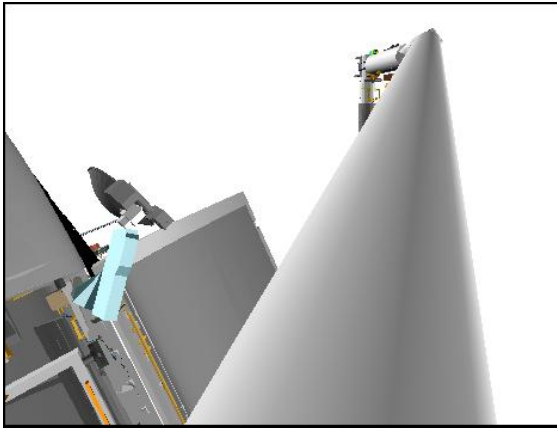

**ELBOW (-20,-30)**

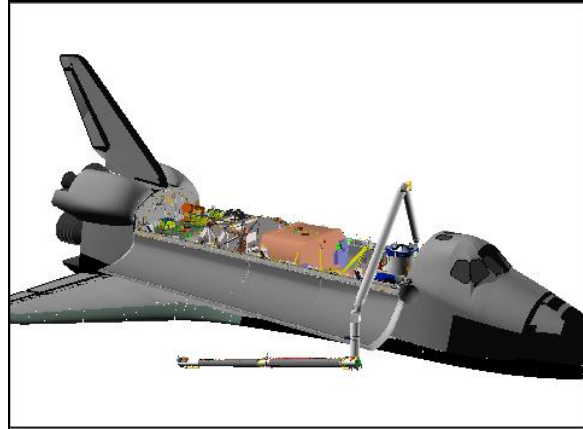

**BIRD'S EYE**

RHC

8. CLEAN UP

- RATE – as reqd (VERN within 10 ft)
- BRAKES – OFF (tb-OFF)
- MODE – SINGLE, ENTER

If continuing OBSS ops with IDC Nose Cap survey:

Mnvr to LDRI STBD ACAS End:

	SY	SP	EP	WP	WY	WR	
IDC STBD ACAS End	-108.7	+20.8	-68.9	-33.5	-12.1	+149.1	
1: EP +			-23.7				
2: SP +		+32.5					
3: SY -	-120.8						
4: WP -				-45.8			
5: WY +					+12.8		
6: WR +						+164.7	
LDRI STBD ACAS End	-120.8	+32.5	-23.7	-45.8	+12.8	+164.7	
	X	Y	Z	PITCH	YAW	ROLL	PL ID
	-847	+286	-393	55	69	177	5

BRAKES – ON (tb-ON)

If returning immediately to OBSS Hover:

Mnvr to OBSS HOVER:

	SY	SP	EP	WP	WY	WR	
IDC STBD ACAS End	-108.7	+20.8	-68.9	-33.5	-12.1	+149.1	
1: WR -						+109.8	
2: SP +		+80.0					
3: SY +	-89.8						
4: WP -				-55.2			
5: WY +					-0.5		
6: EP -			-123.3				
OBSS HOVER	-89.8	+80.0	-123.3	-55.2	-0.5	+109.8	
	X	Y	Z	PITCH	YAW	ROLL	PL ID
	-1232	131	-511	90	11	180	5

BRAKES – ON (tb-ON)

# OBSS IDC RCC SURVEY – NOSE CAP

<b>WARNING</b> For UNDOCKED ops only Port PLBD radiator must be stowed
--

## NOTE

Assumed starting posn is end of LDRI STBD ACAS End.  
PLID uplink is required

### 1. SETUP

SM 94 PDRS CONTROL
--------------------

- √PL ID, ITEM 3: 5
- √INIT ID, ITEM 24: 5
- √AUTO MODES – ITEM 14 +7 +8 EXEC

	X	Y	Z	PITCH	YAW	ROLL	PLID
√	-847	+286	-393	55	69	177	5
	SY	SP	EP	WP	WY	WR	
√	-120.8	+32.5	-23.7	-45.8	+12.8	+164.7	

### 2. INHIBIT NOSE JETS

- O14:F, √Pri RJDA LOGIC, DRIVER (eight) – ON
- O15:F, √Pri RJDF LOGIC, DRIVER (eight) – OFF
- O16:F

A6U            DAP: A14/AUTO/ALT (Tail Only)

## NOTE

Expect DAP RECONFIG message after  
FRCS manifold 5 status overridden to close

GNC 23 RCS
------------

- √RCS FWD, ITEM 1: \*
- MANF VLVS OVRD 1 – ITEM 40 EXEC (CL)
- 2 – ITEM 41 EXEC (CL)
- 3 – ITEM 42 EXEC (CL)
- 4 – ITEM 43 EXEC (CL)
- 5 – ITEM 44 EXEC (CL)

- RHC 3. MNVR TO NOSE CAP IDC ACAS START POSITION  
 RATE – as reqd (VERN within 10 ft)  
 BRAKES – OFF (tb-OFF)  
 MODE – SINGLE, ENTER

NOTE

Expect C/W SINGULARITY during lines 3 and 5 of the following single joint table

Mnvr to NOSE CAP IDC ACAS START posn:

	SY	SP	EP	WP	WY	WR	
LDRI Stbd ACAS End	-120.8	+32.5	-23.7	-45.8	+12.8	+164.7	
1: WP +				+31.6			
2: WR +						+242.7	
3: SP +		+127.0					
4: SY -	-125.3						
5: EP -			-109.0				
6: WY -					-31.3		
Nose IDC ACAS Start	-125.3	+127.0	-109.0	+31.6	-31.3	+242.7	
	X	Y	Z	PITCH	YAW	ROLL	PL ID
	-198	-11	-408	318	356	191	5

BRAKES – ON (tb-ON)

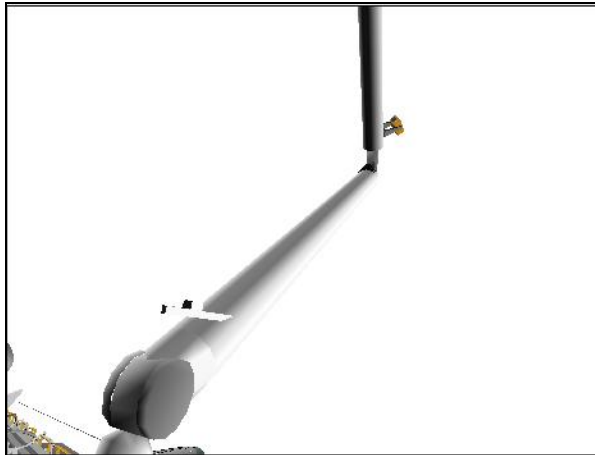

CCTV A (40,20)

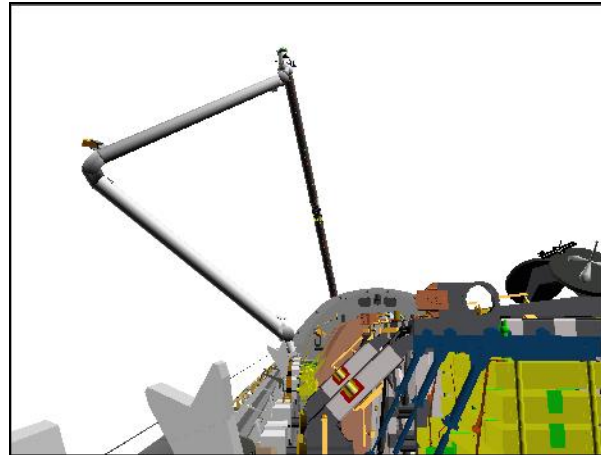

CCTV B (0,10)

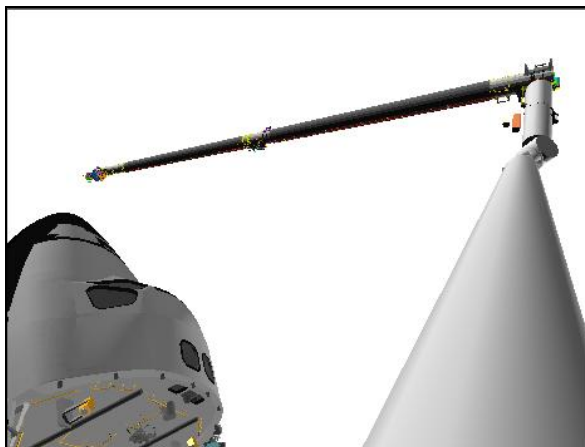

ELBOW (-30,-15)

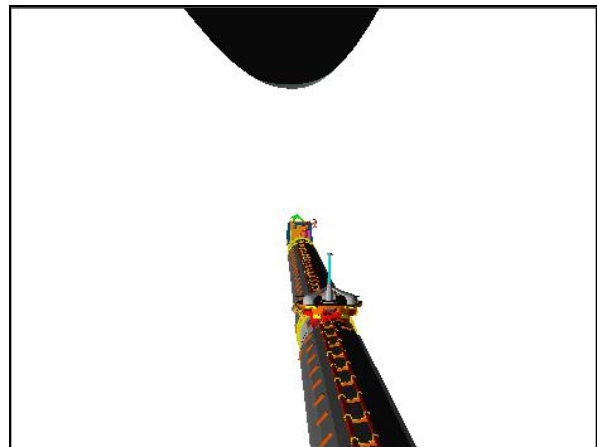

RSC



AUTO SEQ – PROCEED (IN PROG It on)

ACAS, pause pts shaded, ORAS/OBAS are in **bold**, Rel digitals are nonbold,  
 ● col indicates data recording (black = Scanning) and damage criteria (inches):

Pt	X	Y	Z	PITCH	YAW	ROLL	●
<b>143P</b>	<b>-198</b>	<b>-11</b>	<b>-408</b>	<b>318</b>	<b>356</b>	<b>191</b>	●
Δ	0	+32	-5	0	0	17	
144 Δ	+4	-35	-23	0	0	43	
145 Δ	+7	-25	-38	-2	-14	23	
146 Δ	+30	+4	-71	-18	-16	31	1/4
<b>147P</b>	<b>-239</b>	<b>+77</b>	<b>-271</b>	<b>58</b>	<b>46</b>	<b>63</b>	●

NOTE

Time between Pts 147 and 148 ~ 0:30 min

AUTO SEQ – PROCEED (IN PROG It on)

Pt	X	Y	Z	PITCH	YAW	ROLL	●
<b>147P</b>	<b>-239</b>	<b>+77</b>	<b>-271</b>	<b>58</b>	<b>46</b>	<b>63</b>	●
Δ	-15	+7	+8	0	0	0	
<b>148P</b>	<b>-224</b>	<b>+70</b>	<b>-279</b>	<b>58</b>	<b>46</b>	<b>63</b>	1/4

**NOTE**

Time between Pts 148 and 149 ~ 1:00 min

AUTO SEQ – PROCEED (IN PROG It on)

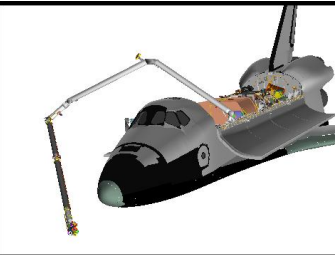
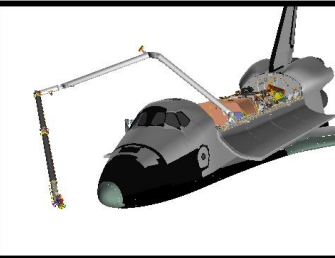
Pt	X	Y	Z	PITCH	YAW	ROLL	
148P Δ	-224 -33	+70 -3	-279 +65	58 16	46 5	63 -20	
149P	-191	+73	-344	19	52	94	

LCC/A31p      When AUTO SEQ IN PROG It – off:  
                   sel 'Stop Scan'  
                   sel 'Power off'

BRAKES – ON (tb-ON)

RHC            5. MNVR TO NOSE CAP IDC ACAS POINT 150  
 RATE        – as reqd (VERN within 10 ft)  
 BRAKES – OFF (tb-OFF)  
 MODE        – SINGLE, ENTER

**NOTE**

Expect C/W SINGULARITY during lines 3 and 6  
 of the following single joint table

Mnvr to NOSE CAP IDC ACAS POINT 150 posn:

	SY	SP	EP	WP	WY	WR	
NOSE IDC ACAS Pt 149	-96.9	+21.0	-54.8	+2.0	-29.6	+266.6	
1: WY +					+13.1		
2: WP +				+12.7			
3: SP +		+137.2					
4: WR –						+155.8	
5: SY +	+128.3						
6: EP –			-118.5				
NOSE IDC ACAS Pt 150	+128.3	+137.2	-118.5	+12.7	+13.1	+155.8	
	X	Y	Z	PITCH	YAW	ROLL	PL ID
	-205	-57	-383	336	319	217	5

BRAKES – ON (tb-ON)

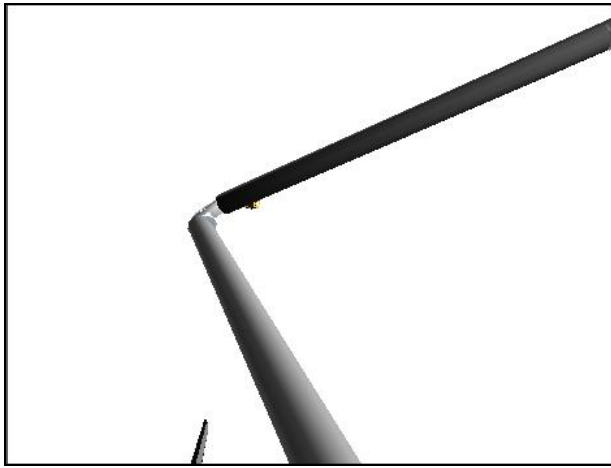

**CCTV A (10,45)**

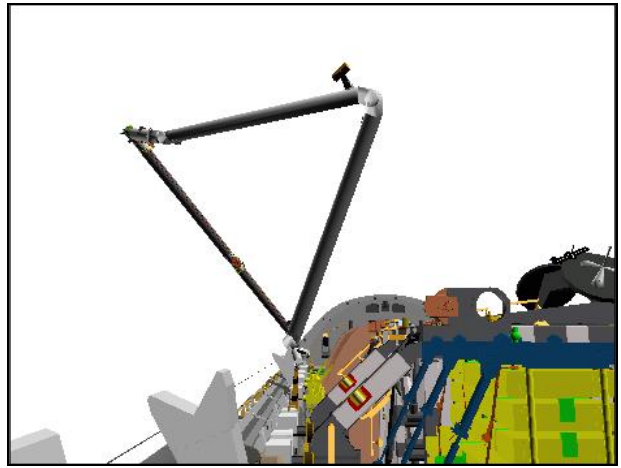

**CCTV B (0,10)**

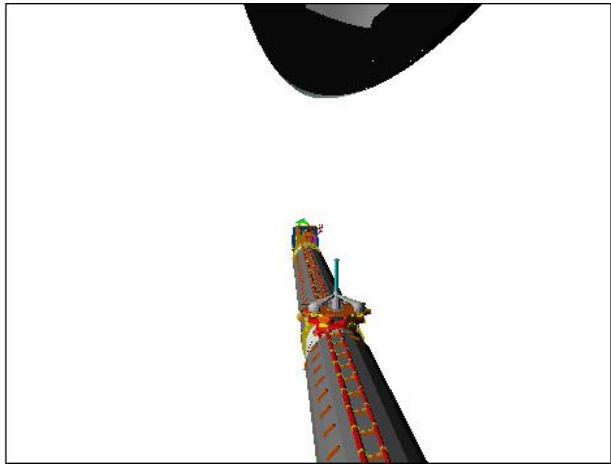

**RSC**

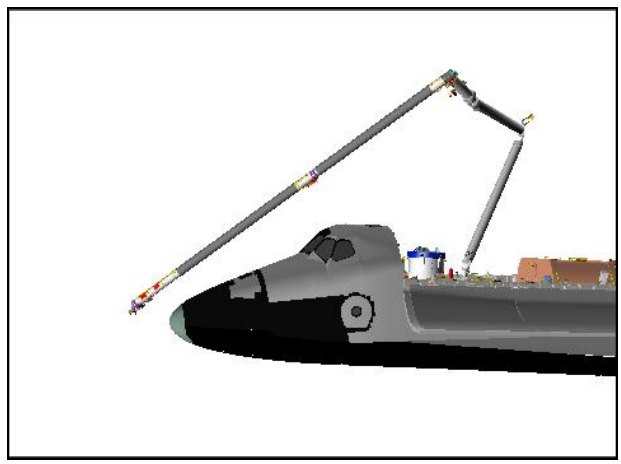

**PORT**

6. NOSE CAP IDC ACAS, SECTION 2

**SM 94 PDRS CONTROL**

√PL ID, ITEM 3: 5

√INIT ID, ITEM 24: 5

NOTE

Time between Pts 150 and 153 ~ 4:15 min

Section 2 Clearance Views	Cameras
OBSS-to-Nose Cap	ELBOW, RSC
OBSS-to-PLBD	A, B, ELBOW
OBSS-to-Fwd Bulkhead	A, B

RHC RATE – VERN (RATE MIN tb-ON)

\* If unable to enter AUTO mode (no AUTO READY It): \*

\* √Joint angles and adjust as reqd \*

BRAKES – OFF (tb-OFF)

MODE – AUTO 3, ENTER (READY It on)

**SM 169 PDRS STATUS**

Monitor ACAS progress

√LAST PT: 150

LCC/A31p sel 'Power On'



Verify 'Use AE' checked

sel 'Scan Lo-Res'

√AE box centered in view (pause 2 sec)

sel 'Scan Hi-Res'

AUTO SEQ – PROCEED (IN PROG It on)

Pt	X	Y	Z	PITCH	YAW	ROLL	
150P Δ	-205 -1	-57 +19	-383 -46	336 0	319 0	217 -31	
151 Δ	+9	-11	-44	9	-12	-10	
152 Δ	+22	-15	-37	-21	-4	-13	1/4
153P	-235	-50	-256	62	339	275	



NOTE

Time between Pts 153 and 154 ~ 1:00 min

AUTO SEQ – PROCEED (IN PROG It on)

Pt	X	Y	Z	PITCH	YAW	ROLL	•
153P Δ	-235 -1	-50 -28	-256 -3	62 0	339 1	275 8	1/4
154P	-234	-22	-253	61	332	272	

NOTE

Time between Pts 154 and 157 ~ 3:30 min

AUTO SEQ – PROCEED (IN PROG It on)

Pt	X	Y	Z	PITCH	YAW	ROLL	•
154P Δ	-234 -39	-22 -20	-253 +24	61 28	332 -9	272 -17	1/4
155 Δ	-12	+2	+22	4	0	0	
156 Δ	-15	-5	+32	22	-2	22	
157P	-168	+1	-331	5	348	259	

NOTE

Time between Pts 157 and 158 ~ 1:15 min

AUTO SEQ – PROCEED (IN PROG It on)

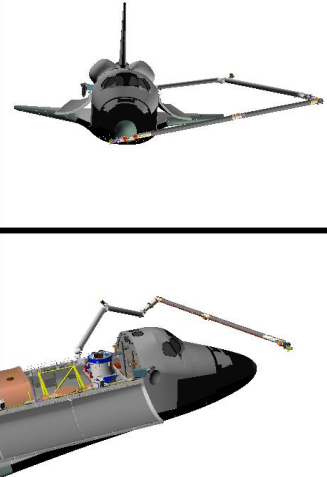
Pt	X	Y	Z	PITCH	YAW	ROLL	•
157P Δ	-168 -5	+1 +13	-331 +51	5 30	348 1	259 -3	
158P	-163	-12	-382	336	346	261	

NOTE

Time between Pts 158 and 159 ~ 1:15 min

AUTO SEQ – PROCEED (IN PROG It on)

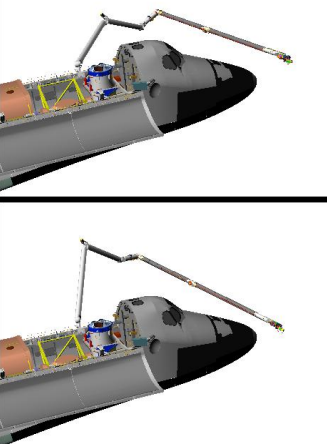
Pt	X	Y	Z	PITCH	YAW	ROLL	•
158P Δ	-163 +10	-12 +29	-382 -34	336 -30	346 9	261 2	
159P	-173	-41	-348	5	337	260	

NOTE

Time between Pts 159 and 161 ~ 1:25 min

AUTO SEQ – PROCEED (IN PROG It on)

Pt	X	Y	Z	PITCH	YAW	ROLL	•
<b>159P</b> Δ	<b>-173</b> +9	<b>-41</b> +6	<b>-348</b> -31	<b>5</b> -12	<b>337</b> 2	<b>260</b> -3	
160 Δ	+37	-3	-53	-38	7	-8	1/4
<b>161P</b>	<b>-219</b>	<b>-44</b>	<b>-264</b>	<b>62</b>	<b>339</b>	<b>275</b>	

NOTE

Time between Pts 161 and 162 ~ 0:45 min

AUTO SEQ – PROCEED (IN PROG It on)

Pt	X	Y	Z	PITCH	YAW	ROLL	•
<b>161P</b> Δ	<b>-219</b> -23	<b>-44</b> -23	<b>-264</b> +20	<b>62</b> 27	<b>339</b> -6	<b>275</b> 5	
162P	-196	-21	-284	33	341	267	1/4

NOTE

Time between Pts 162 and 163 ~ 0:35 min

AUTO SEQ – PROCEED (IN PROG It on)

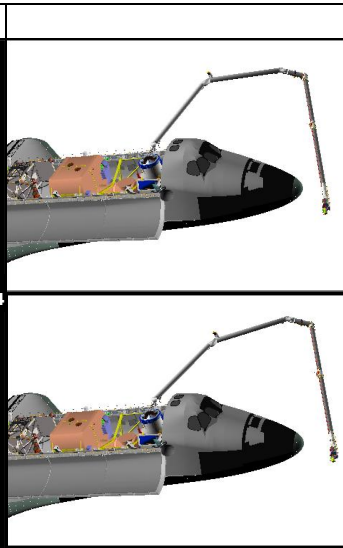
Pt	X	Y	Z	PITCH	YAW	ROLL	●
162P Δ	-196 -21	-21 +4	-284 +18	33 0	341 0	267 0	
163P	-175	-25	-302	33	341	267	

NOTE

Time between Pts 163 and 164 ~ 0:20 min

AUTO SEQ – PROCEED (IN PROG It on)

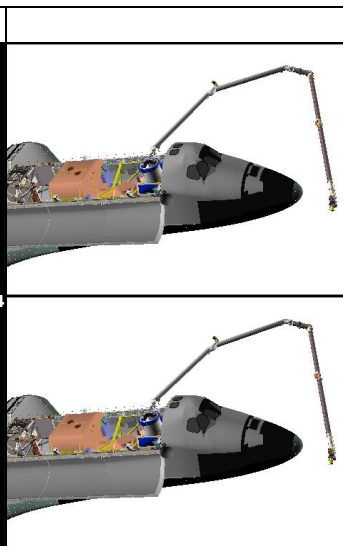
Pt	X	Y	Z	PITCH	YAW	ROLL	●
163P Δ	-175 +5	-25 +8	-302 -5	33 0	341 0	267 0	
164P	-180	-33	-297	33	341	267	

LCC/A31p      When AUTO SEQ IN PROG It – off:  
                     sel 'Stop Scan'  
                     sel 'Power off'

BRAKES – ON (tb-ON)

7. MNVR TO NOSE JET CLEAR POSN

- RHC a. Intermediate Maneuver  
 RATE – as reqd (VERN within 10 ft)  
 BRAKES – OFF (tb-OFF)  
 MODE – SINGLE, ENTER

Drive WR “-” to +110.0

INTERMEDIATE posn:

	X	Y	Z	PITCH	YAW	ROLL	PL ID
√	-9	-153	-638	33	341	309	5
	SY	SP	EP	WP	WY	WR	
√	+128.3	+28.6	-22.6	-29.4	+19.1	+110.0	

BRAKES – ON (tb-ON)

- b. Nose Jet Clear Maneuver

SM 94 PDRS CONTROL

PL ID – ITEM 3 +2 EXEC

INIT ID – ITEM 24 +2 EXEC

END POS – ITEM 18 -3 2 5 -7 4 8 -6 8 0 EXEC

ATT – ITEM 21 +8 3 +3 9 +2 0 0 EXEC

CMD CK – ITEM 25 EXEC (GOOD)

- RHC RATE – COARSE (RATE MIN tb-OFF)

BRAKES – OFF (tb-OFF)

MODE – OPR CMD, ENTER (READY It on)

AUTO SEQ – PROCEED (IN PROG It on)

When AUTO SEQ IN PROG It – off:

BRAKES – ON (tb-ON)

NOSE JET CLEAR posn:

	X	Y	Z	PITCH	YAW	ROLL	PL ID
√	-325	-748	-680	83	39	200	2
	SY	SP	EP	WP	WY	WR	
√	+128.8	+30.3	-28.5	-2.0	+35.0	0.0	

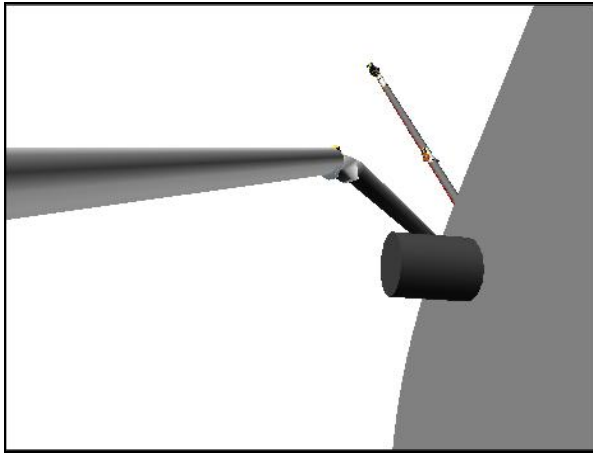

**CCTV A (95,5)**

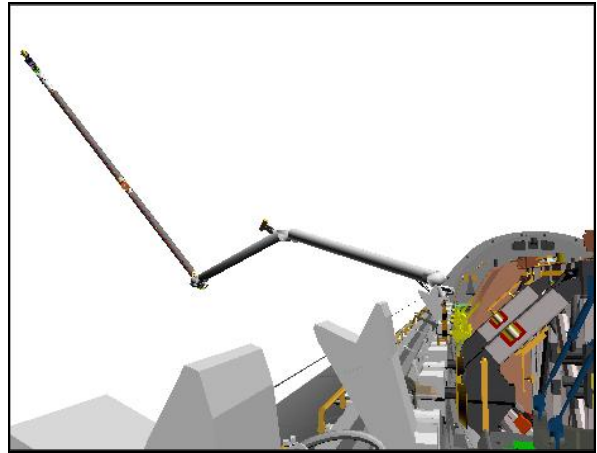

**CCTV B (-15,5)**

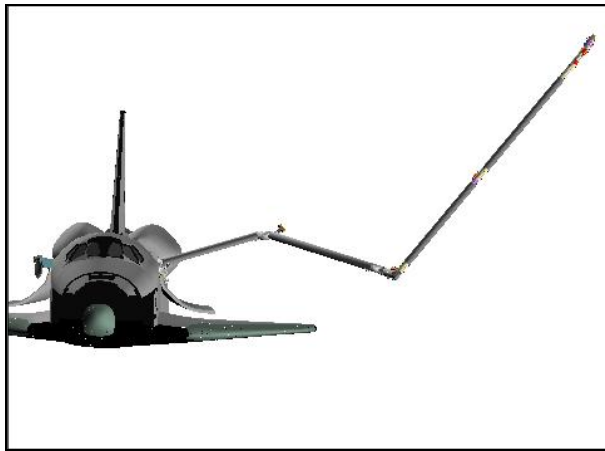

**FRONT**

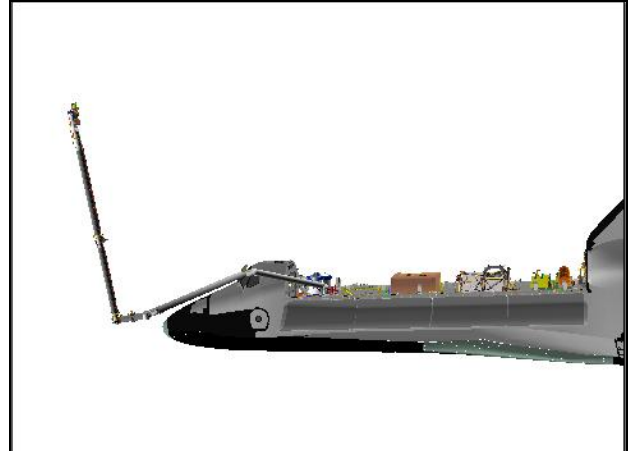

**PORT**

8. ENABLE VERN NOSE JETS

GNC 23 RCS

- √RCS FWD, ITEM 1: \*
- MANF VLVS OVRD 5 – ITEM 44 EXEC (OP)

A6U            DAP: VERN (FREE)

O14:F,        √Pri RJDA LOGIC,DRIVER (eight) – OFF

O15:F,

O16:F        √RJDA 1A L2/R2 DRIVER – ON

If continuing OBSS ops with IDC Port survey >>

9. RETURN TO OBSS HOVER  
 BRAKES – OFF (tb-OFF)  
 MODE – SINGLE, ENTER

Mnvr to OBSS HOVER posn:

	SY	SP	EP	WP	WY	WR	
NOSE JET CLEAR	+128.8	+30.3	-28.5	-2.0	+35.0	0.0	
1: WR +						+109.8	
2: SP +		+80.0					
3: SY -	-89.8						
4: WP -				-55.2			
5: WY -					-0.5		
6: EP -			-123.3				
OBSS HOVER	-89.8	+80.0	-123.3	-55.2	-0.5	+109.8	
	X	Y	Z	PITCH	YAW	ROLL	PL ID
	-998	+129	-504	0	0	11	2

BRAKES – ON (tb-ON)

GNC 23 RCS

√RCS FWD, ITEM 1: \*

- MANF VLVS OVRD 1 – ITEM 40 EXEC (OP)  
 2 – ITEM 41 EXEC (OP)  
 3 – ITEM 42 EXEC (OP)  
 4 – ITEM 43 EXEC (OP)

A6U

DAP: as reqd

# OBSS IDC RCC SURVEY – PORT

**WARNING**  
 For UNDOCKED ops only  
 Port PLBD radiator must be stowed

**NOTE**

Assumed starting posn is end of IDC Nose Cap survey.  
 PLID uplink is required

1. SETUP

SM 94 PDRS CONTROL

- √ PL ID – ITEM 3: 2
- √ INIT ID – ITEM 24: 2

2. MNVR TO PORT IDC ACAS START POSN

BRAKES – OFF (tb-OFF)  
 MODE – SINGLE, ENTER

	X	Y	Z	PITCH	YAW	ROLL	PLID
√	-325	-748	-680	83	39	200	2
	SY	SP	EP	WP	WY	WR	
√	+128.8	+30.3	-28.5	-2.0	+35.0	0.0	

Mnvr to PORT IDC ACAS START posn:

	SY	SP	EP	WP	WY	WR	
NOSE JET CLEAR	+128.8	+30.3	-28.5	-2.0	+35.0	0.0	
1: SY –	+91.2						
2: SP +		+60.1					
3: WY –					+6.8		
4: WR –						-116.8	
5: EP –			-68.1				
6: WP –				-41.3			
PORT IDC ACAS START	+91.2	+60.1	-68.1	-41.3	+6.8	-116.8	
	X	Y	Z	PITCH	YAW	ROLL	PL ID
	-882	-378	-296	333	320	332	2

BRAKES – ON (tb-ON)



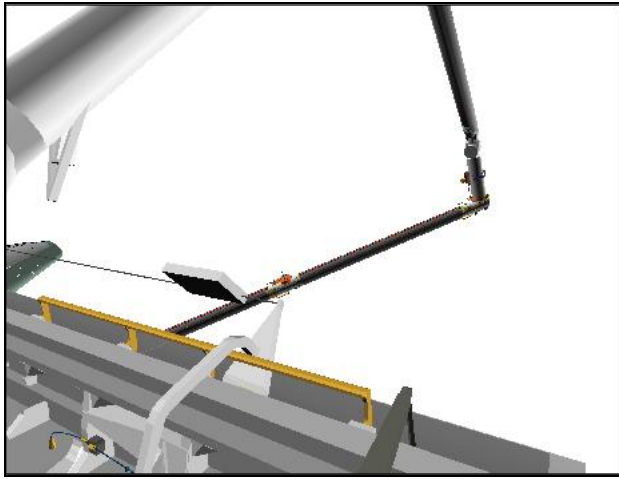

**CCTV A (60,-10)**

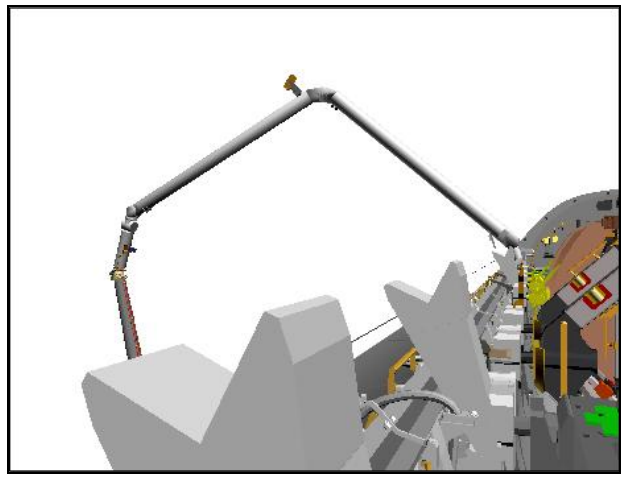

**CCTV B (-20,0)**

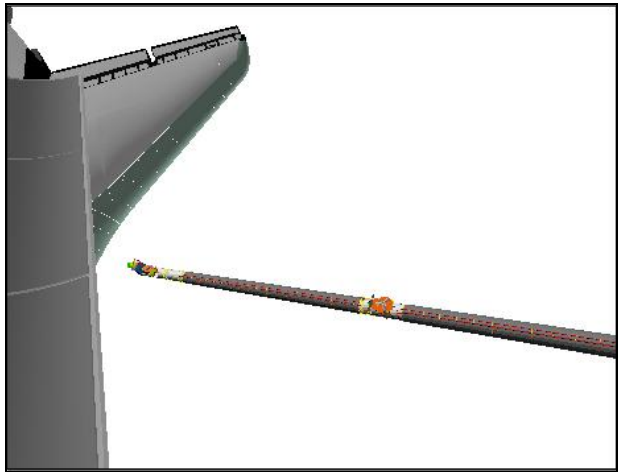

**ELBOW (-60,0)**

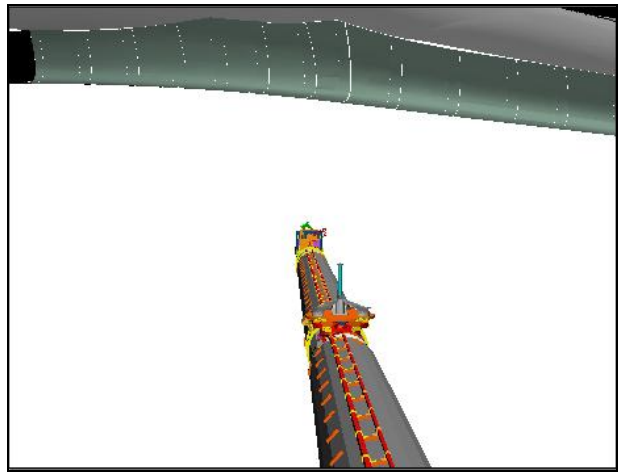

**RSC**

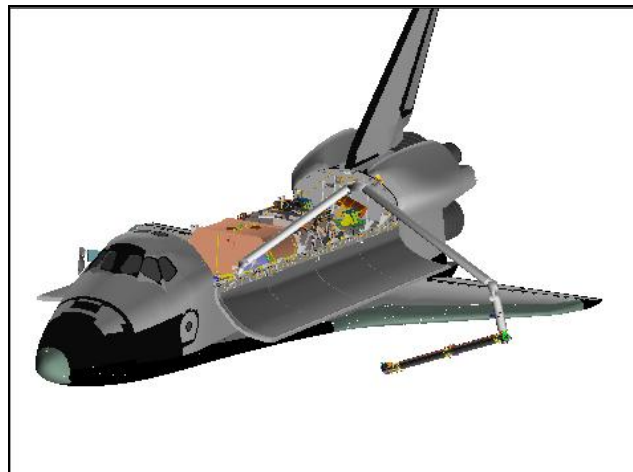

**BIRD'S EYE**

3. PORT IDC ACAS, SECTION 1

SM 94 PDRS CONTROL

PL ID – ITEM 3 +5 EXEC

INIT ID – ITEM 24 +5 EXEC

√AUTO MODE 4, ITEM 16: 9

√	X	Y	Z	PITCH	YAW	ROLL	PLID
	-1043	-224	-223	82	339	223	5
√	SY	SP	EP	WP	WY	WR	
	+91.2	+60.1	-68.1	-41.3	+6.8	-116.8	

RHC

√RATE – VERN (RATE MIN tb-ON)

\* If unable to enter AUTO mode (no AUTO READY It): \*

\* √Joint angles and adjust as reqd \*

BRAKES – OFF (tb-OFF)

MODE – AUTO 4, ENTER (READY It on)

SM 169 PDRS STATUS

√LAST PT: 165

Monitor ACAS progress

NOTE

Section 1 scans RCC Zones 1-2, Panels 7 → 11. Time between Pts 165 and 167 ~ 1:40 min

Section 1 Clearance Views	Cameras
RMS Upper Arm to PLBD	A, B
OBSS-to-PLBD	ELBOW
OBSS-to-Wing	ELBOW, RSC

LCC/A31p

On MCC GO:

sel 'Power On'

\* If 'Power On' button not gray: \*

\* Pause 3 seconds, then sel 'Power On' \*

Verify 'Use AE' checked

sel 'Scan Lo-Res'



√AE box centered in view (pause 2 sec)

sel 'Scan Hi-Res'

AUTO SEQ – PROCEED (IN PROG It on)

ACAS, pause pts shaded, ORAS/OBAS are in **bold**, Rel digitals are nonbold,

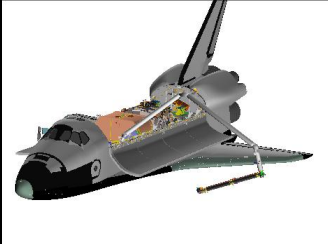
• col indicates data recording (black = Scanning) and damage criteria (inches):

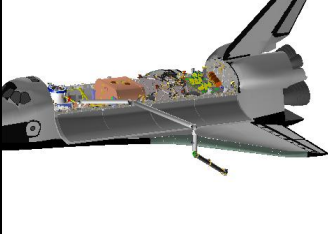
Pt	X	Y	Z	PITCH	YAW	ROLL	•
<b>165P</b> Δ	<b>-1043</b> +21	<b>-224</b> +9	<b>-223</b> -4	<b>82</b> 0	<b>339</b> 0	<b>223</b> 0	
166 Δ	+67	+75	+9	4	0	3	
<b>167P</b>	<b>-1131</b>	<b>-308</b>	<b>-228</b>	<b>78</b>	<b>336</b>	<b>222</b>	

LCC/A31p When AUTO SEQ READY It – on:  
sel 'Stop Scan'

4. PORT IDC ACAS, SECTION 2

NOTE

Between Points 167 and 168, arm adjusts to survey

RCC Zones 2-3. Section 2 then scans Panels 11 → 7.

Time between Pts 167 and 168 ~ 0:30 min

Section 2 Clearance Views	Cameras
RMS Upper Arm-to-PLBD	A, B
OBSS-to-PLBD	ELBOW
OBSS-to-Wing	ELBOW, RSC

AUTO SEQ – PROCEED (IN PROG It on)

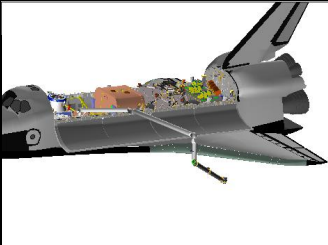
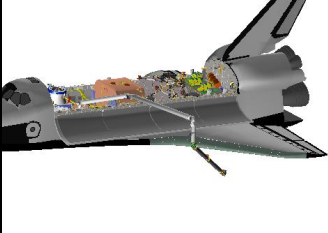
Pt	X	Y	Z	PITCH	YAW	ROLL	•
<b>167P</b> Δ	<b>-1131</b> -8	<b>-308</b> +7	<b>-228</b> +6	<b>78</b> 2	<b>336</b> 0	<b>222</b> 2	
<b>168P</b>	<b>-1123</b>	<b>-315</b>	<b>-234</b>	<b>76</b>	<b>334</b>	<b>221</b>	

LCC/A31p When AUTO SEQ READY It – on:  
sel 'Scan Lo-Res'  
√AE box centered in view (pause 2 sec)  
sel 'Scan Hi-Res'



5. PORT IDC ACAS, SECTION 3

NOTE

Between Points 170 and 171, arm adjust to survey RCC Zones 3-4.  
 Section 3 then scans Panels 7 → 11. Time between Pts 170 and 171 ~ 2:40 min

Section 3 Clearance Views	Cameras
RMS Upper Arm-to-PLBD	A, B
OBSS-to-PLBD	ELBOW
OBSS-to-Wing	ELBOW, RSC

AUTO SEQ – PROCEED (IN PROG It on)

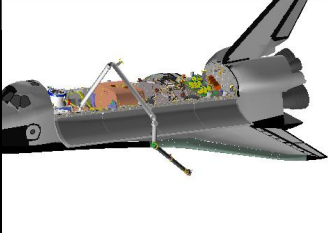
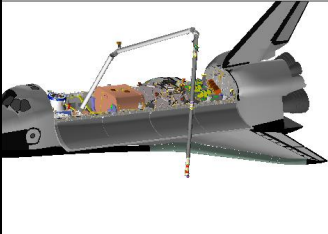
Pt	X	Y	Z	PITCH	YAW	ROLL	•
170P Δ	-1032 -24	-239 +29	-227 +35	76 25	334 11	221 21	
171P	-1008	-268	-262	44	311	213	

LCC/A31p

When AUTO SEQ READY It – on:

- sel 'Scan Lo-Res'
- √AE box centered in view (pause 2 sec)
- sel 'Scan Hi-Res'



6. PORT IDC ACAS, SECTION 4

NOTE

Between Points 174 and 177 arm adjusts to scan RCC  
 Zone 5. Section 4 then scans Panels 11 → 7. Time  
 between Pts 174 and 177 ~ 7:20 min

Section 4 Clearance Views	Cameras
RMS Upper Arm-to-PLBD	A, B
OBSS-to-PLBD	ELBOW
OBSS-to-Wing	B, RSC

RHC RATE – COARSE (RATE MIN tb-OFF)

AUTO SEQ – PROCEED (IN PROG It on)

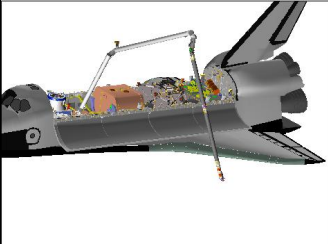
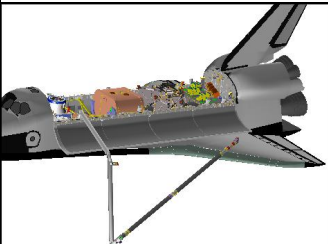
Pt	X	Y	Z	PITCH	YAW	ROLL	•
<b>174P</b> Δ	<b>-1098</b> -65	<b>-339</b> +4	<b>-265</b> 0	<b>41</b> 0	<b>315</b> 0	<b>198</b> 0	
175 Δ	-3	0	+96	-74	0	0	
176 Δ	+94	+6	-2	-8	-31	78	
<b>177P</b>	<b>-1124</b>	<b>-349</b>	<b>-359</b>	<b>273</b>	<b>312</b>	<b>336</b>	

RHC When AUTO SEQ READY It – on:  
 RATE – VERN (RATE MIN tb-ON)

LCC/A31p sel 'Scan Lo-Res'  
 √AE box centered in view (pause 2 sec)  
 sel 'Scan Hi-Res'





7. PORT IDC ACAS, SECTION 5

NOTE

Between Points 179 and 180, arm adjusts to scan RCC Zone 6.  
 Section 5 then scans Panels 7 → 11. Time between Pts 179  
 and 180 ~ 0:40 min

Section 5 Clearance Views	Cameras
RMS Upper Arm-to-PLBD	A, B
OBSS-to-PLBD	ELBOW
OBSS-to-Wing	B, RSC

AUTO SEQ – PROCEED (IN PROG It on)

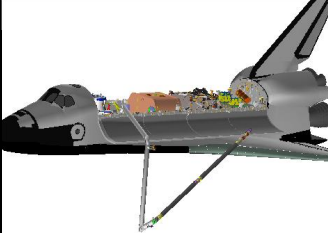
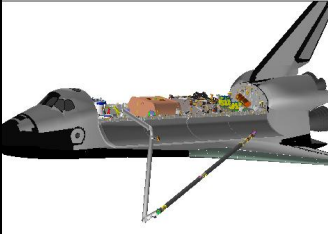
Pt	X	Y	Z	PITCH	YAW	ROLL	•
179P Δ	-1047 +23	-297 -5	-364 +6	264 4	304 1	326 0	
180P	-1070	-292	-370	259	304	325	

LCC/A31p



When AUTO SEQ READY It – on:

- sel 'Scan Lo-Res'
- √AE box centered in view (pause 2 sec)
- sel 'Scan Hi-Res'

NOTE

Time between Pts 180 and 182 ~ 1:10 min

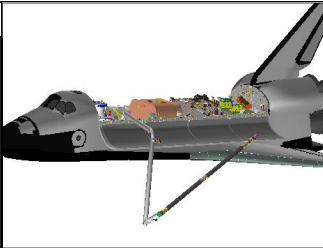
AUTO SEQ – PROCEED (IN PROG It on)

Pt	X	Y	Z	PITCH	YAW	ROLL	
180P Δ	-1070 +78	-292 +56	-370 +5	259 -6	304 -6	325 8	
181 Δ	-24	+1	-16	1	-1	0	1/4
182P	-1124	-349	-359	273	312	336	

LCC/A31p      When AUTO SEQ IN PROG It – off:  
                   sel 'Stop Scan'  
                   sel 'Power off'

BRAKES – ON (tb-ON)

8. MNVR TO OBSS HOVER POSN

SM 94 PDRS CONTROL

PL ID      – ITEM 3 +2 EXEC  
 INIT ID – ITEM 24 +2 EXEC

	X	Y	Z	PITCH	YAW	ROLL	PLID
√	-913	-418	-285	21	344	231	2
	SY	SP	EP	WP	WY	WR	
√	+96.6	+5.7	-57.3	+112.8	-1.2	-38.0	

BRAKES – OFF (tb-OFF)  
 MODE    – SINGLE, ENTER

Mnvr to OBSS HOVER posn:

	SY	SP	EP	WP	WY	WR	
PORT End	+96.6	+5.7	-57.3	+112.8	-1.2	-38.0	
1: SP +		+80.0					
2: WP -				0.0			
3: WY +					-0.5		
4: WR +						+109.8	
5: SY -	-89.8						
6: WP -				-55.2			
7: EP -			-123.3				
OBSS HOVER	-89.8	+80.0	-123.3	-55.2	-0.5	+109.8	
	X	Y	Z	PITCH	YAW	ROLL	PL ID
	-998	+129	-504	359.5	0	11	2

BRAKES – ON (tb-ON)

GNC 23 RCS

√RCS FWD, ITEM 1: \*

- MANF VLVS OVRD 1 – ITEM 40 EXEC (OP)
- 2 – ITEM 41 EXEC (OP)
- 3 – ITEM 42 EXEC (OP)
- 4 – ITEM 43 EXEC (OP)

A6U

DAP: as reqd

OBSS HOVER posn:

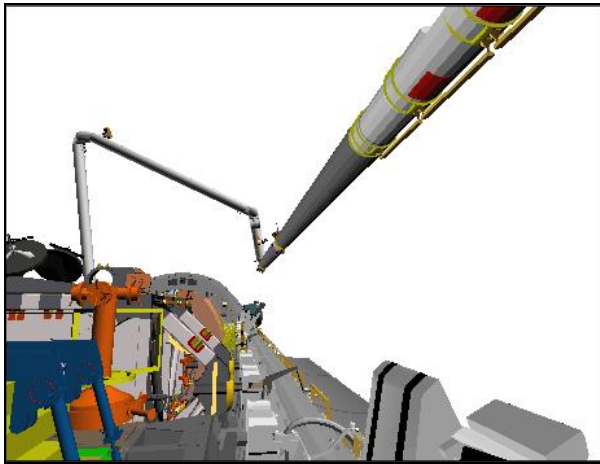

CCTV C (10,10)

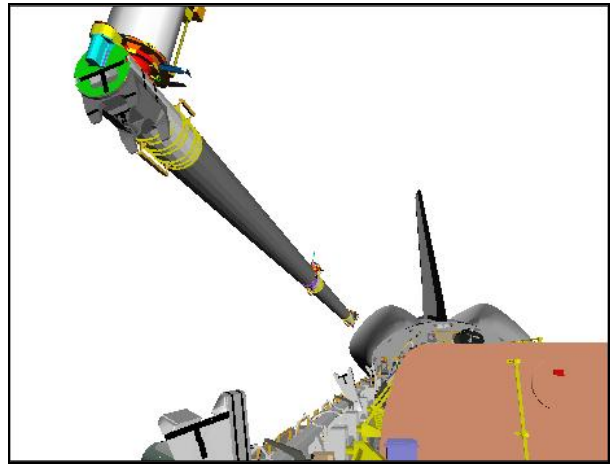

CCTV D (-10,15)

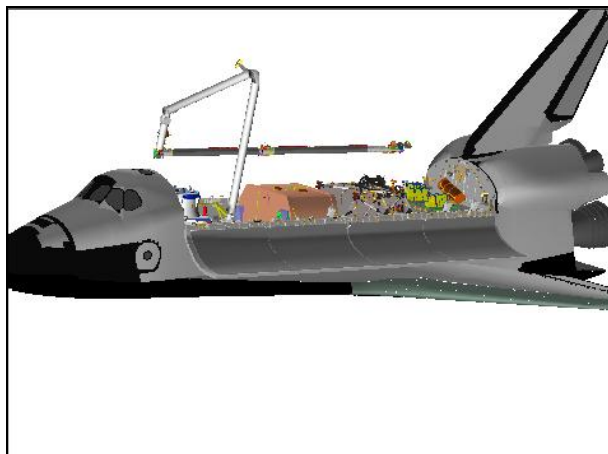

BIRD'S EYE

# OBSS ITVC TILE ACREAGE SURVEY

## 1. SETUP

SM 94 PDRS CONTROL

√ PL ID, ITEM 3: 2

√ INIT ID, ITEM 24: 2

A7U CCTV – config as reqd

MON 1	SSRMS BASE ELBOW (LAB)
MON 2	RSC

## 2. MNVR TO STBD SCAN POSN

Mnvr to be uplinked realtime

STBD SCAN posn:

	X	Y	Z	PITCH	YAW	ROLL	PL ID
√	-1189	+391	-224	338	344	23	2
	SY	SP	EP	WP	WY	WR	
√	-53.4	+11.7	-60.6	-53.9	-24.6	+63.5	

### NOTE

At STBD Scan posn, OBSS-to-Orbiter = 57 in

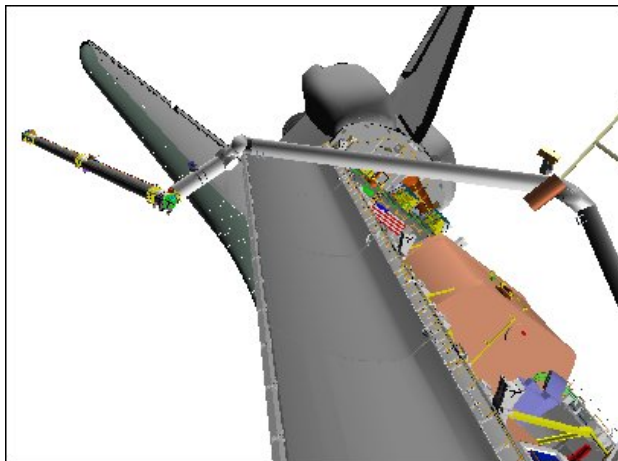

**SSRMS BASE ELBOW (-70,0)**

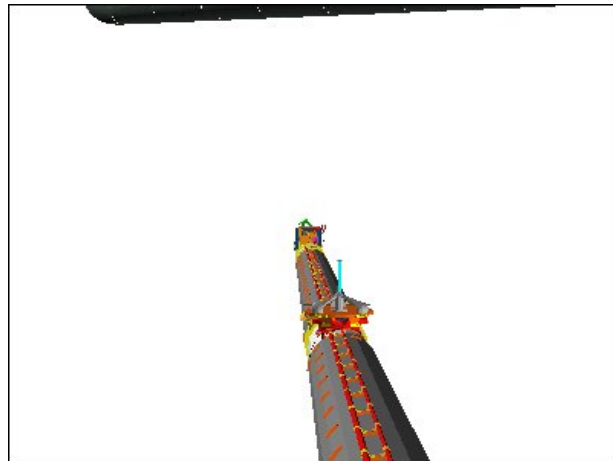

**RSC**

## 3. CONFIGURE OBSS ITVC FOR STBD SCAN

A7U MON2 ← PL2

If PTU reset reqd:

CAMR CMD PAN/TILT – HI RATE

PAN – L (to hard stop)

TILT – UP (to hard stop)

PAN/TILT – RESET, HI RATE (LO within 10°)

PAN: +105

TILT: -59

A7U CAMR CMD PAN/TILT – LO RATE  
ZOOM: 20.0 HFOV

MUX 1 L ← MIDDECK  
 LDRI MODE 2 pb – push (ITVC video)

MON2 ← PL2

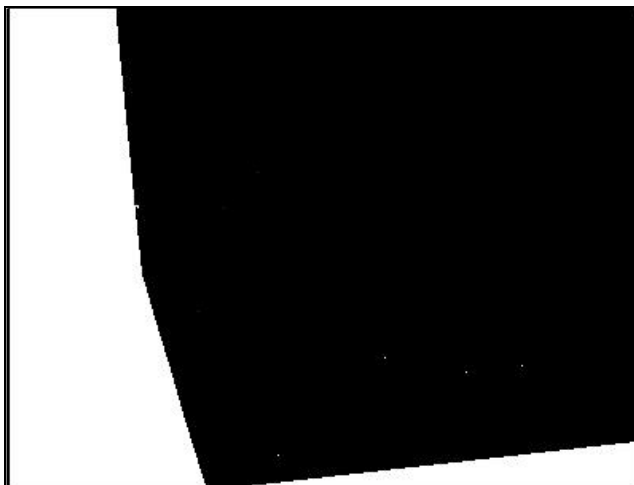

**OBSS ITVC (105,-59)**

√MCC to verify correct sensor view

4. PERFORM STBD SCAN

On MCC GO:

L10(VTR)

REC pb – push, hold

PLAY pb – push, simo (red ●)

Drive PTU to sweep out the survey area:

	PAN	TILT
Start Config	+105	-59
1: Tilt (up)		-23
2: Pan (left)	+90	
3: Tilt (down)		-59
4: Pan (left)	+75	
5: Tilt (up)		-30
6: Pan (left)	+62	
7: Tilt (down)		-59
Final Config	+62	-59



**OBSS ITVC (62,-59)**

5. MNVR TO PORT CONFIG 1

On MCC GO:

L10(VTR) STOP pb – push (no red ●)

NOTE

Min clearance during Port Config 1 mnvr (SJ step 15),  
 OBSS-to-Orbiter = 37 in. At Port Config 1 posn,  
 OBSS-to-Orbiter clearance = 164 in

Port Config 1 Clearance Views	Cameras
SJ step 1	C, ELBOW, SSRMS BASE ELBOW
SJ step 2	C, D, ELBOW, LAB
SJ steps 3 thru 7	C, D, LAB
SJ step 8	C, SSRMS BASE ELBOW, LAB
SJ step 9	A, C, B, ELBOW
SJ step 10	A, B, ELBOW, RSC
SJ steps 11 thru 13	A, B, RSC, OBSS ITVC
SJ step 14	A, RSC, SSRMS TIP ELBOW
SJ step 15	A, ELBOW, SSRMS TIP ELBOW

RHC RATE – as reqd (VERN within 10 ft)  
 BRAKES – OFF (tb-OFF)  
 MODE – SINGLE, ENTER

Mnvr to PORT CONFIG 1 posn:

	SY	SP	EP	WP	WY	WR	
STBD SCAN	-53.4	+11.7	-60.6	-53.9	-24.6	+63.5	
1: WY –					-35.0		
2: WR –						-53.0	
3: WP +				-25.0			
4: EP +			-40.0				
5: SP +		+20.0					
6: SY +	-25.0						
7: WR –						-95.0	
8: SP +		+53.0					
9: SY +	+100.0						
10: WR –						-185.0	
11: WY +					+17.0		
12: WP +				-18.0			
13: EP –			-68.0				
14: SP –		+12.0					
15: SY –	+35.0						
PORT CONFIG 1	+35.0	+12.0	-68.0	-18.0	+17.0	-185.0	
	X	Y	Z	PITCH	YAW	ROLL	PL ID
	-710	-198	-97	184	347	184	2

BRAKES – ON (tb-ON)

Start:  
STBD Scan

Step 1:  
Drive WY (-) from  $-24.6^{\circ}$  to  $-35.0^{\circ}$

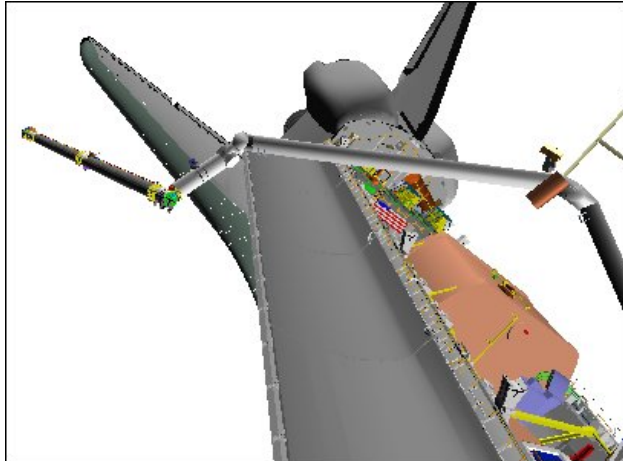

**BASE ELBOW (-70,0)**

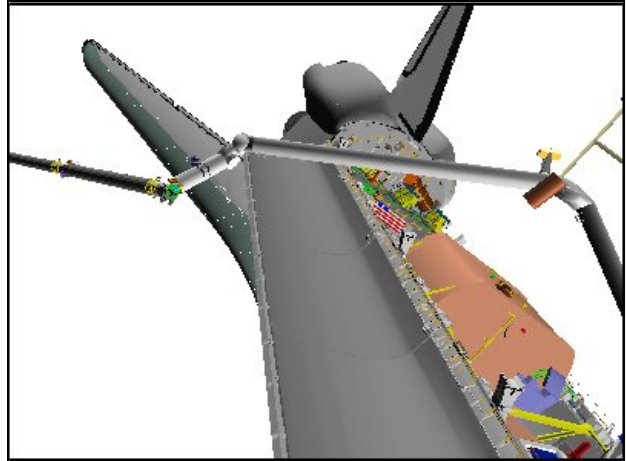

**BASE ELBOW (-70,0)**

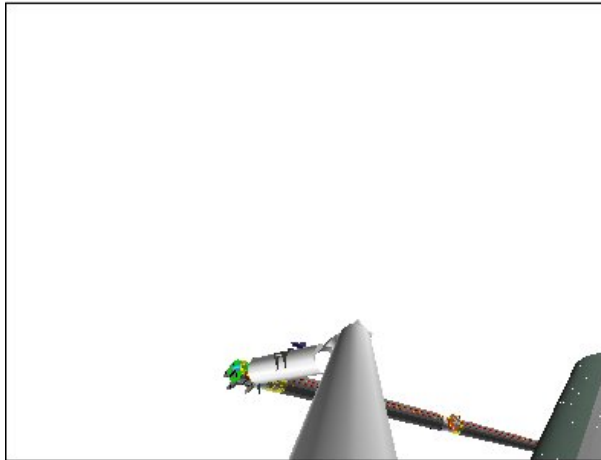

**ELBOW (-6,6)**

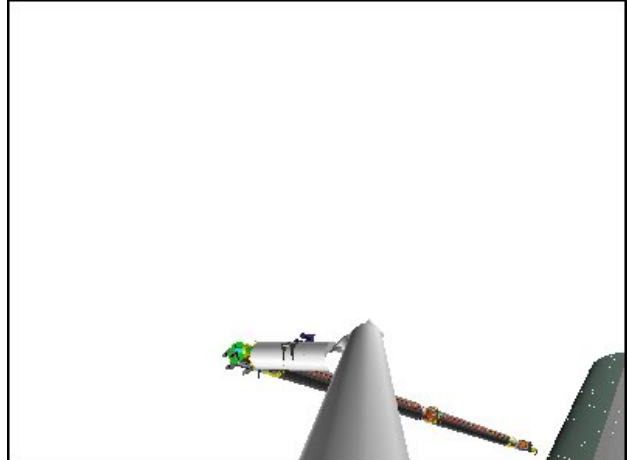

**ELBOW (-6,6)**

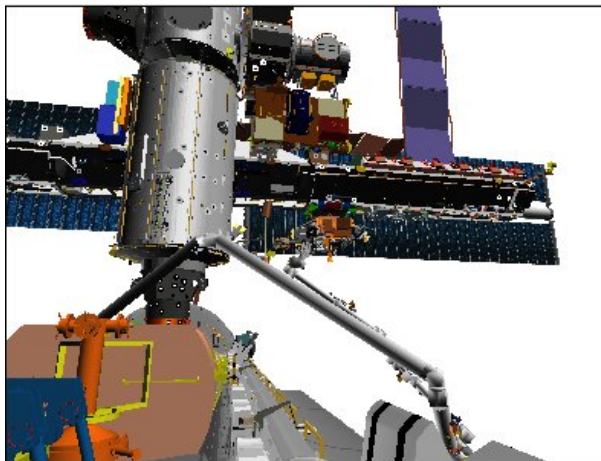

**CCTV C (11,14)**

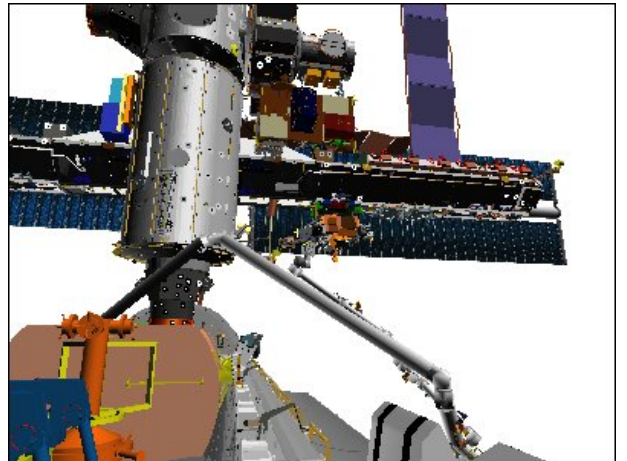

**CCTV C (11,14)**

Step 2:

Drive WR (-) from  $+63.5^\circ$  to  $-53.0^\circ$

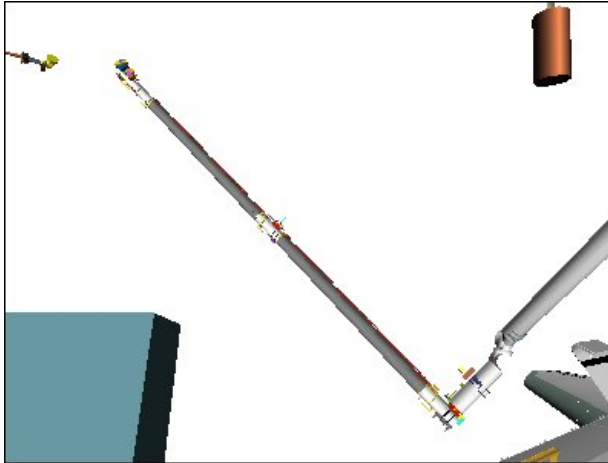

**CCTV D (-55,9)**

Step 3:

Drive WP (+) from  $-53.9^\circ$  to  $-25.0^\circ$

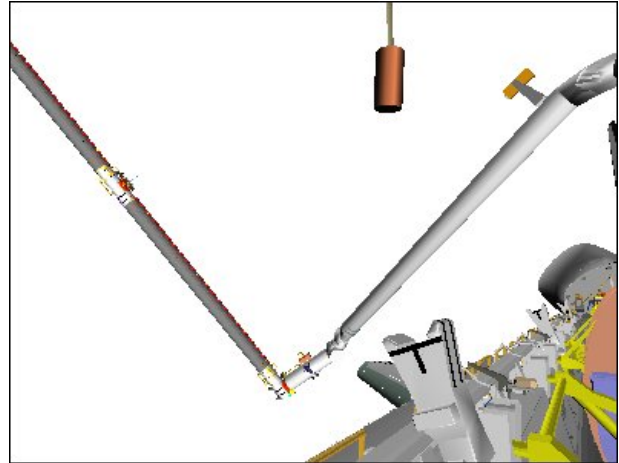

**CCTV D (-34,9)**

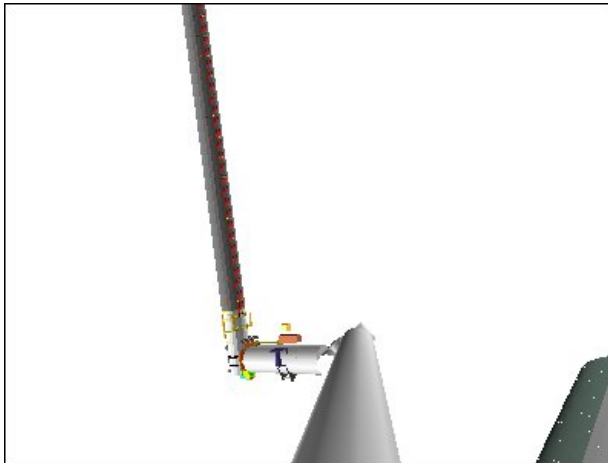

**ELBOW (-6,6)**

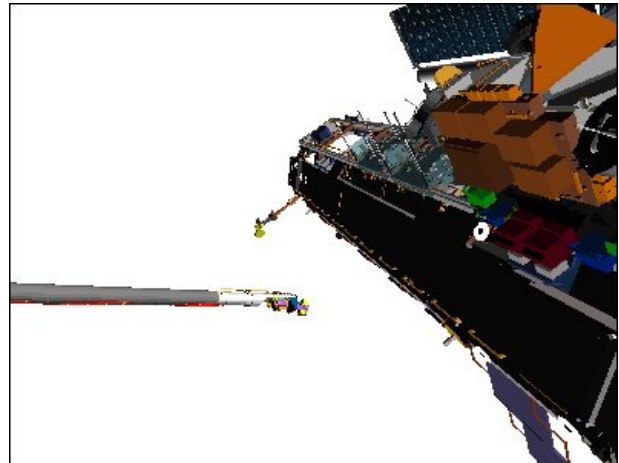

**LAB (58,60)**

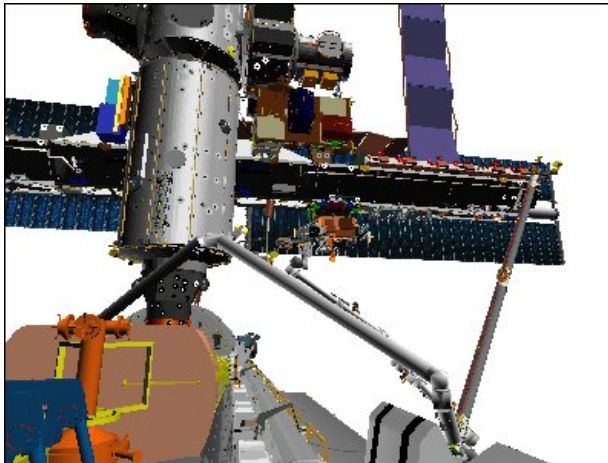

**CCTV C (11,14)**

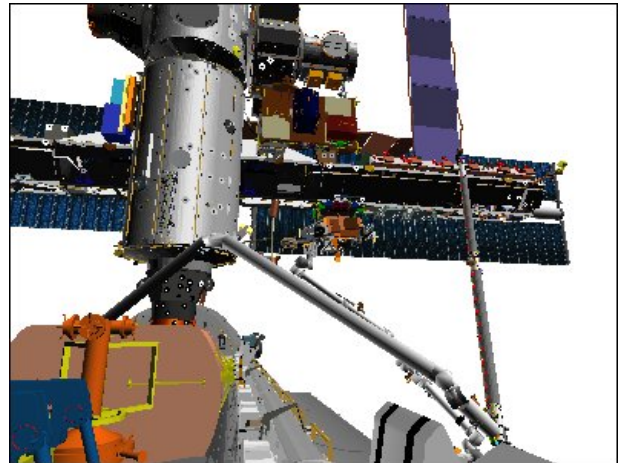

**CCTV C (11,14)**



Step 4:

Drive EP (+) from  $-60.6^\circ$  to  $-40.0^\circ$

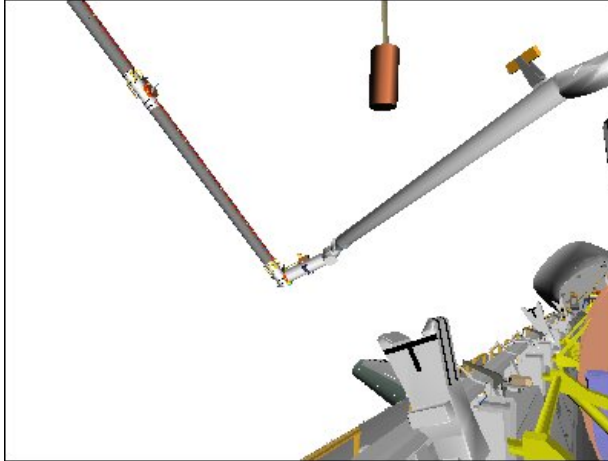

**CCTV D (-34,9)**

Step 5:

Drive SP (+) from  $+11.7^\circ$  to  $+20.0^\circ$



**CCTV D (-34,22)**

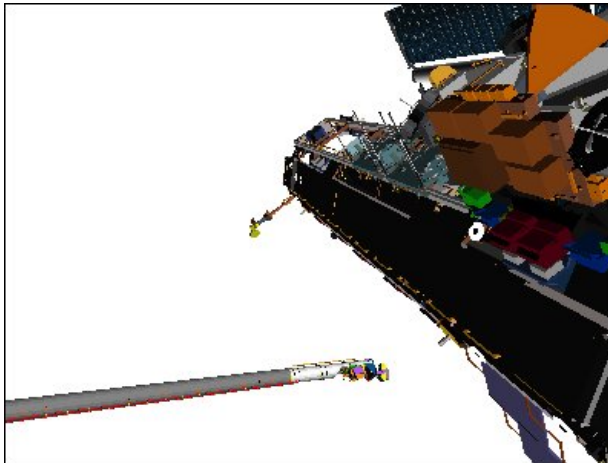

**LAB (58,60)**

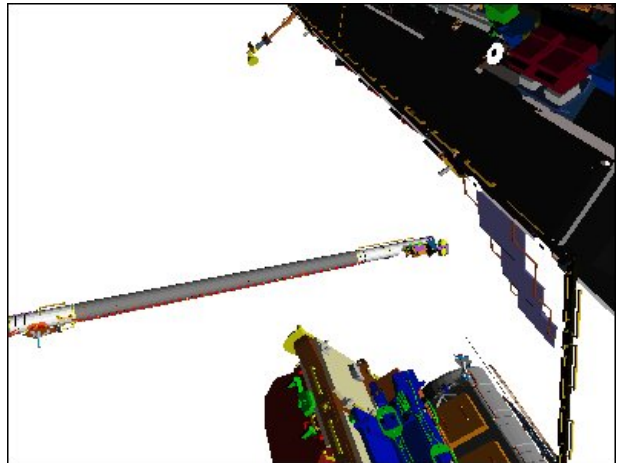

**LAB (58,37)**

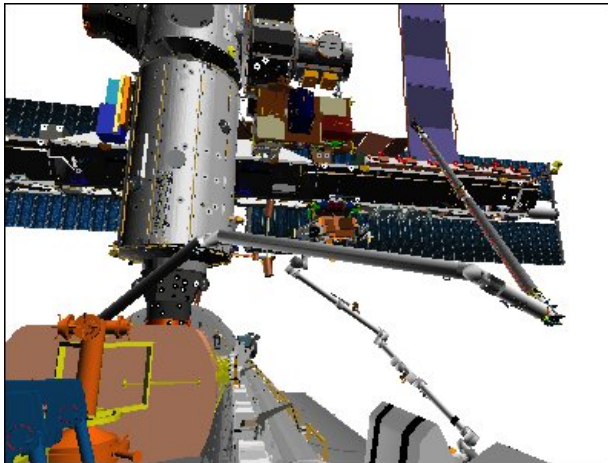

**CCTV C (11,14)**

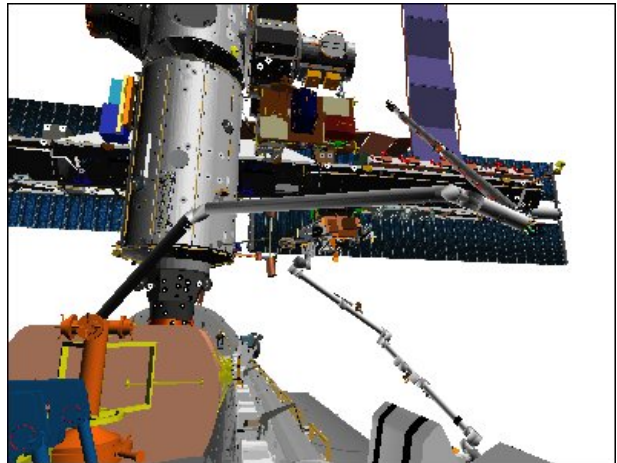

**CCTV C (11,14)**

Step 6:

Drive SY (+) from  $-53.4^\circ$  to  $-25.0^\circ$

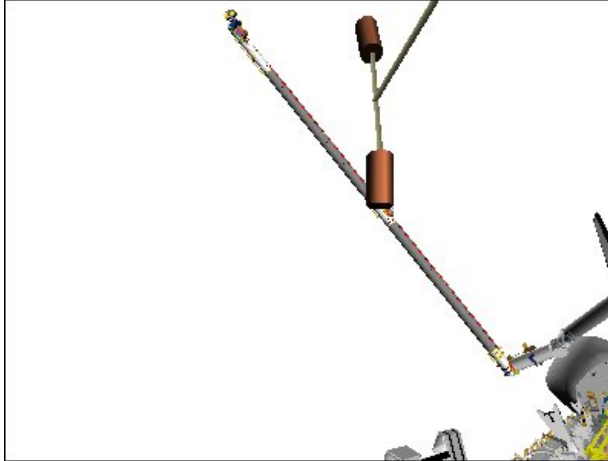

**CCTV D (-34,22)**

Step 7:

Drive WR (-) from  $-53.0^\circ$  to  $-95.0^\circ$



**CCTV D (-34,22)**

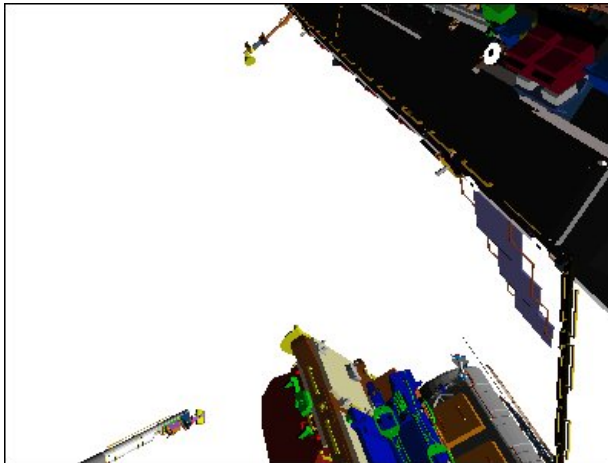

**LAB (58,37)**

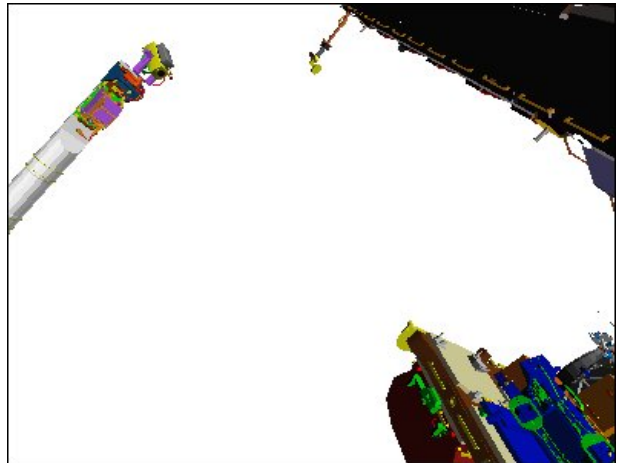

**LAB (42,37)**

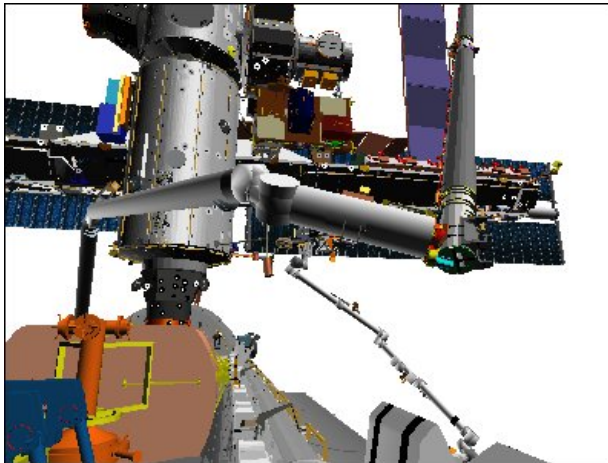

**CCTV C (11,14)**

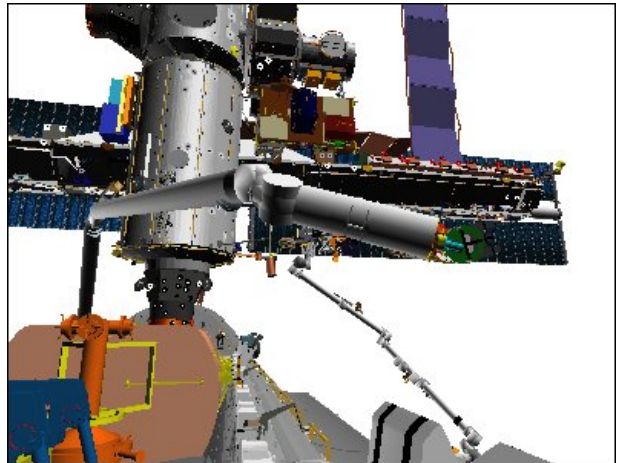

**CCTV C (11,14)**

Step 8:

Drive SP (+) from  $+20.0^\circ$  to  $+53.0^\circ$

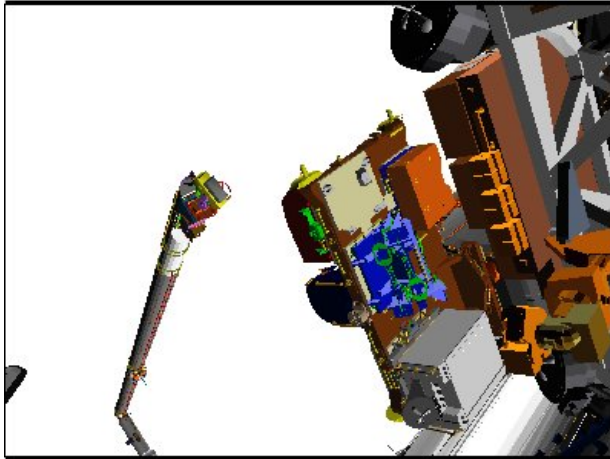

**BASE ELBOW (-30,36)**

Step 9:

Drive SY (+) from  $-25.0^\circ$  to  $+100.0^\circ$



**ELBOW (-66,16)**

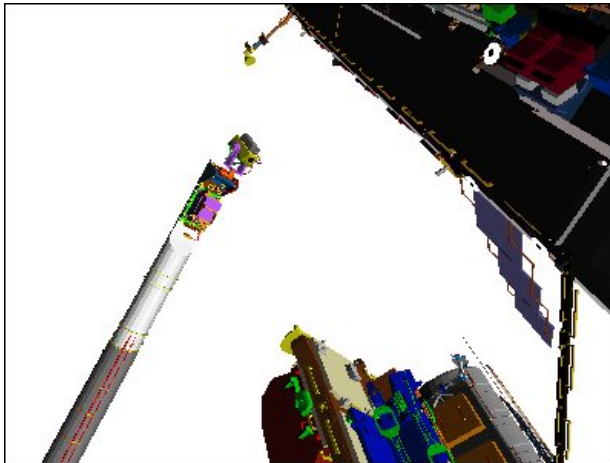

**LAB (58,37)**



**CCTV A (55,10)**

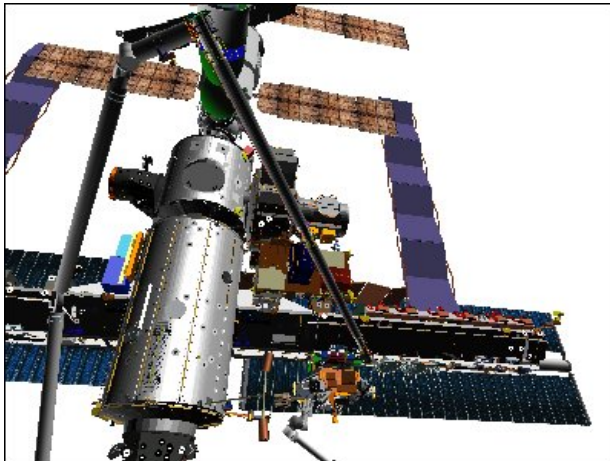

**CCTV C (11,35)**

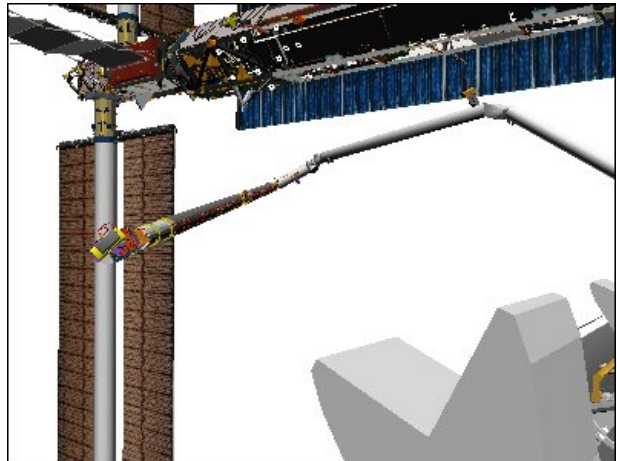

**CCTV B (-37,0)**

Step 10:  
Drive WR (-) from -95.0° to -185.0°

Step 11:  
Drive WY (+) from -35.0° to +17.0°

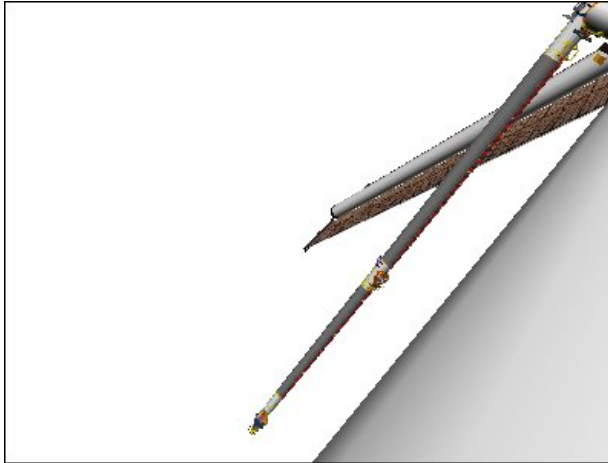

**ELBOW (-40,-32)**

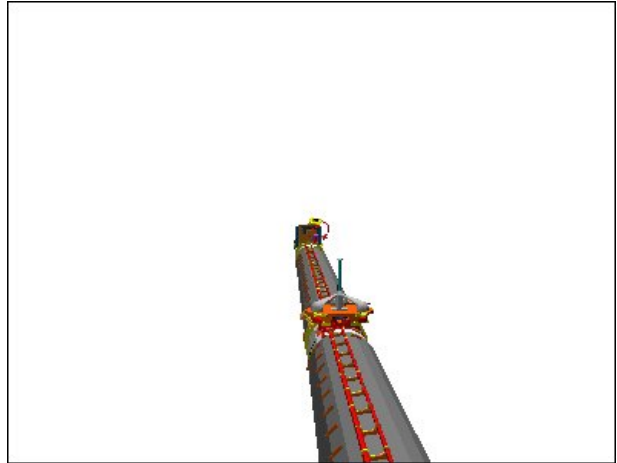

**RSC**



**CCTV A (57,2)**



**CCTV A (80,0)**

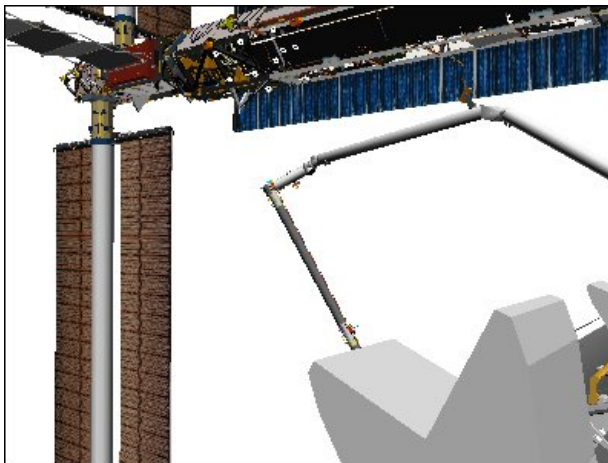

**CCTV B (-23,-7)**

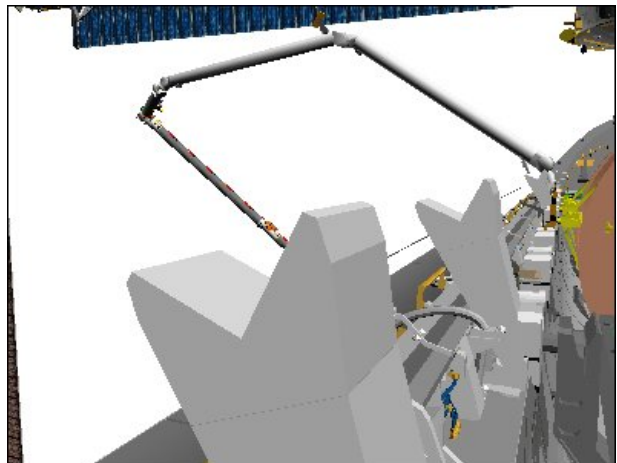

**CCTV B (-23,-7)**

Step 12:

Drive WP (+) from  $-25.0^\circ$  to  $-18.0^\circ$

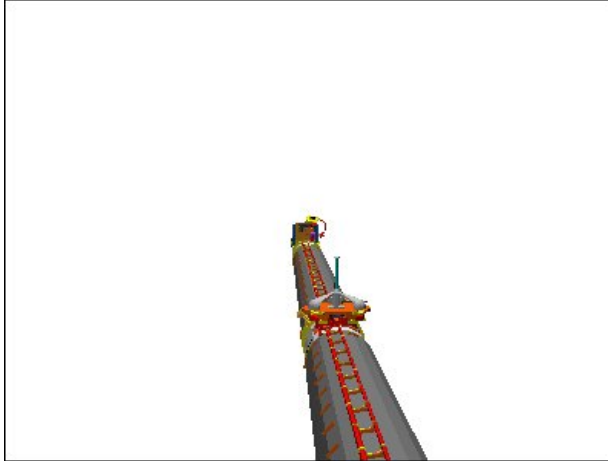

RSC

Step 13:

Drive EP (-) from  $-40.0^\circ$  to  $-68.0^\circ$

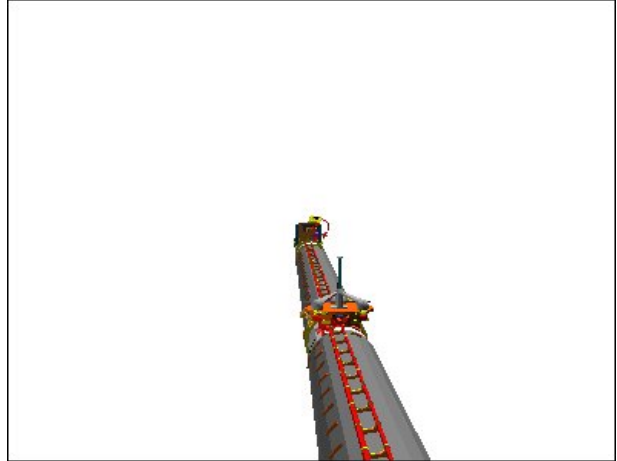

RSC



CCTV A (80,0)



CCTV A (80,-7)

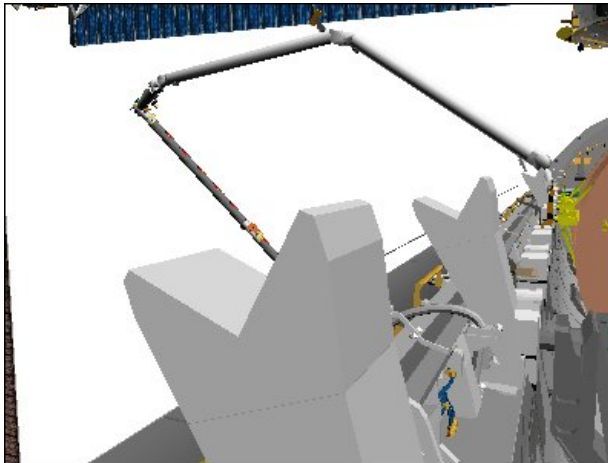

CCTV B (-23,-7)

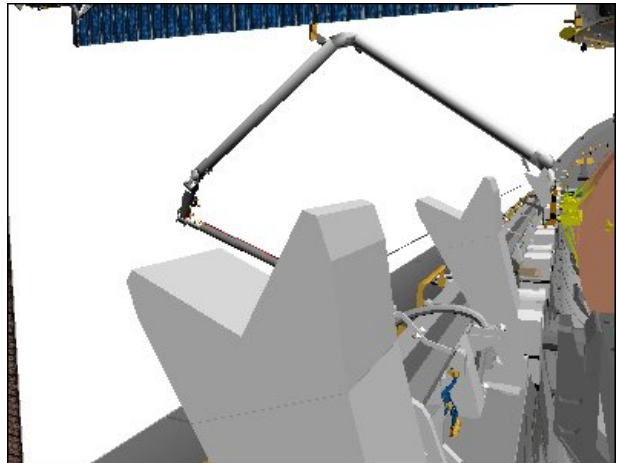

CCTV B (-23,-7)

Step 14:

Drive SP (-) from +53.0° to +12.0°

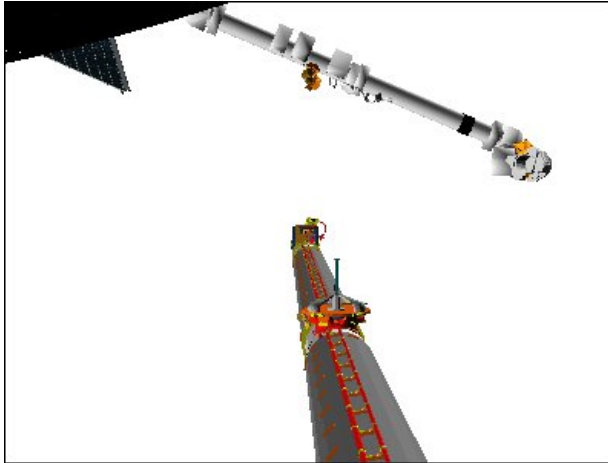

**RSC**

Step 15:

Drive SY (-) from +100.0° to +35.0°

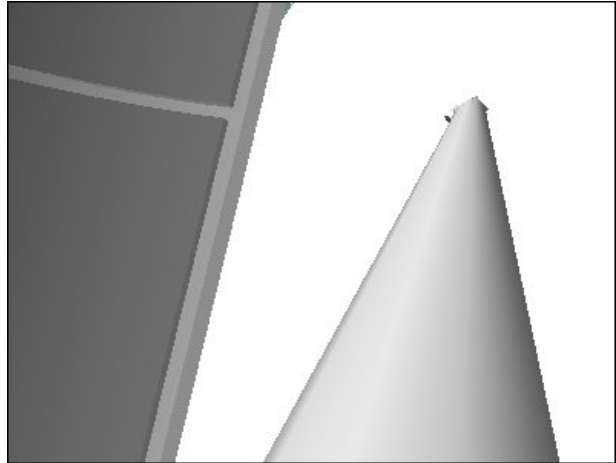

**ELBOW (-21,-22)**

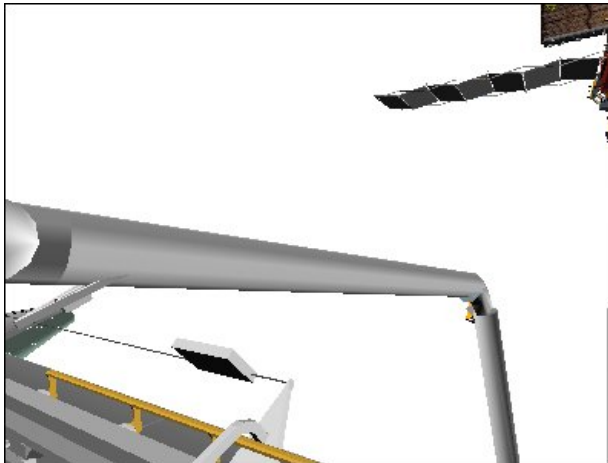

**CCTV A (58,0)**

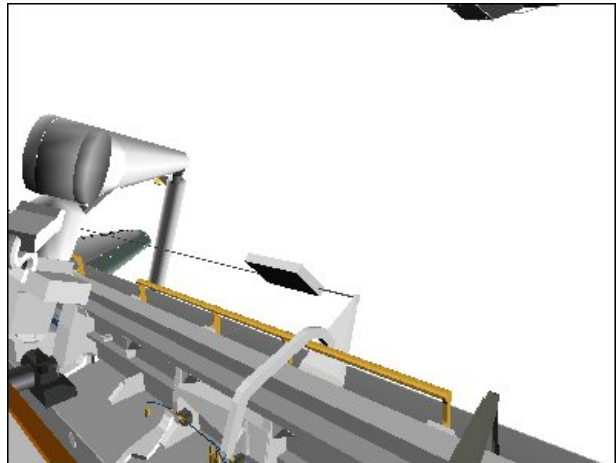

**CCTV A (50,-10)**

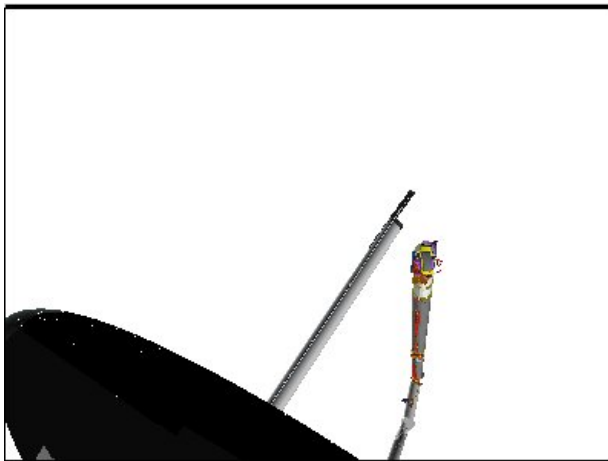

**TIP ELBOW (-104,55)**

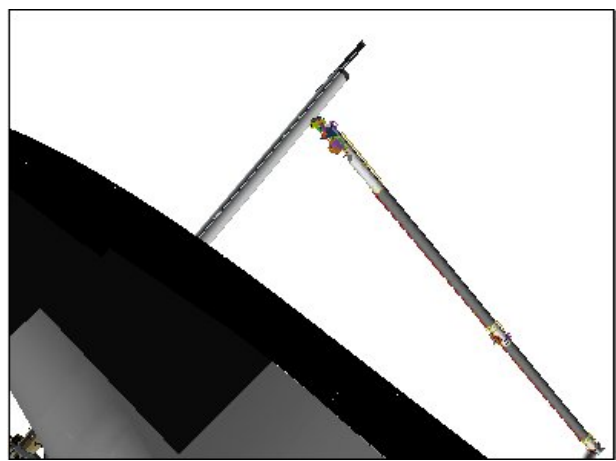

**TIP ELBOW (-95,41)**

6. PERFORM PORT 1 SCAN

a. Port 1 Scan 1

NOTE

During Port 1 scan, OBSS-to-Orbiter = 131 in

A7U CCTV – config as reqd

MON 1	SSRMS TIP ELBOW (SSRMS TIP LEE)
MON 2	ELBOW (RSC)

A7U √MON2 ← PL2

PAN: +75 (right)  
TILT: -110 (down)

√CAMR CMD PAN/TILT – LO RATE

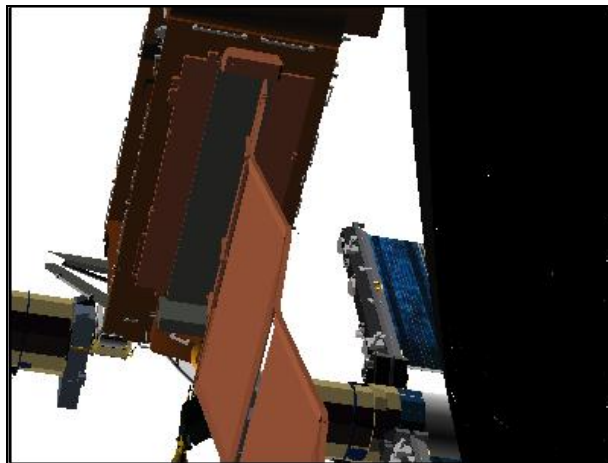

**OBSS ITVC (75,-110)**

√MCC to verify correct sensor view

L10(VTR) On MCC GO:  
REC pb – push, hold  
PLAY pb – push, simo (red ●)

BRAKES – OFF (tb-OFF)  
MODE – SINGLE, ENTER

Drive WR (+) to -34.0

	X	Y	Z	PITCH	YAW	ROLL	PL ID
√	-1326	-180	-125	2	344	356	2
	SY	SP	EP	WP	WY	WR	
√	+35.0	+12.0	-68.0	-18.0	+17.0	-34.0	

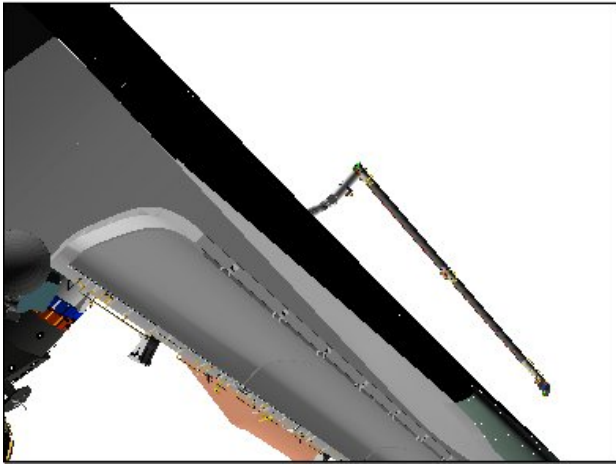

**TIP ELBOW (-75,15)**

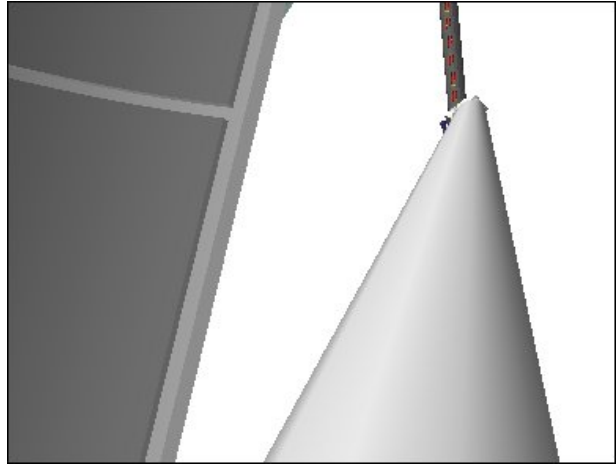

**ELBOW (-21,-22)**

b. Port 1 Scan 2

NOTE

The following and subsequent TILT cmds in step 6 are for the OBSS ITVC

A7U

TILT: -97 (up)

Drive WR (-) to -185.0

	X	Y	Z	PITCH	YAW	ROLL	PL ID
√	-710	-198	-97	184	347	184	2
	SY	SP	EP	WP	WY	WR	
√	+35.0	+12.0	-68.0	-18.0	+17.0	-185.0	

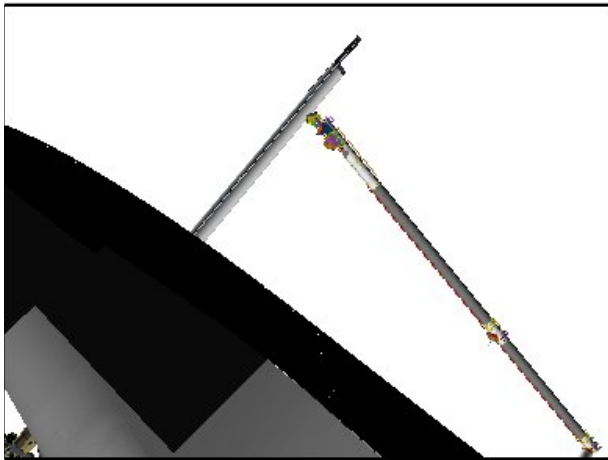

**TIP ELBOW (-95,41)**

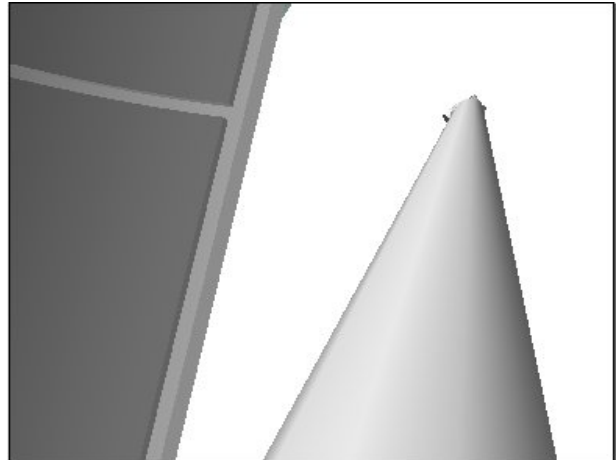

**ELBOW (-21,-22)**

c. Port 1 Scan 3

A7U

TILT: -84 (up)

Drive WR (+) to -34.0

	X	Y	Z	PITCH	YAW	ROLL	PL ID
√	-1326	-180	-125	2	344	356	2
	SY	SP	EP	WP	WY	WR	
√	+35.0	+12.0	-68.0	-18.0	+17.0	-34.0	



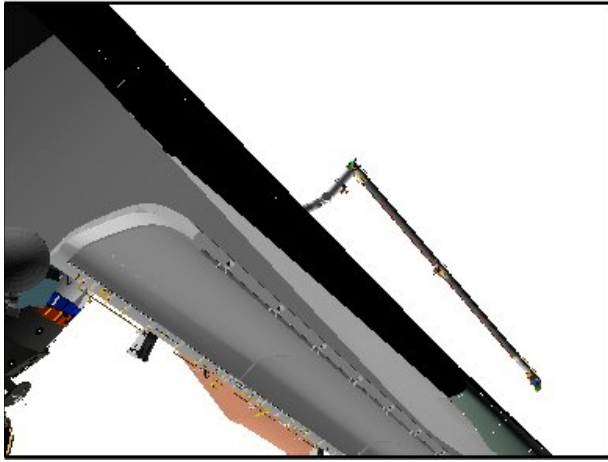

**TIP ELBOW (-75,15)**

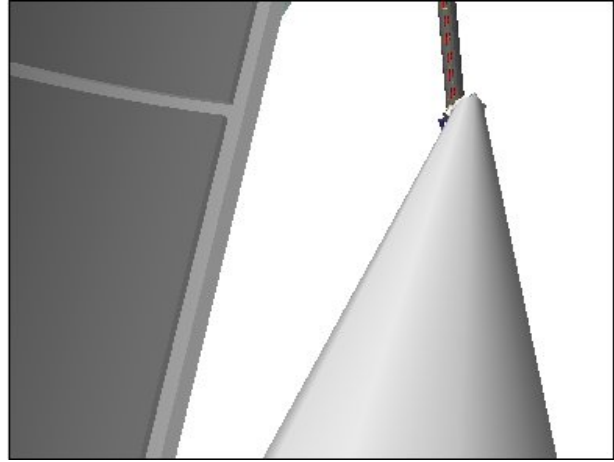

**ELBOW (-21,-22)**

A7U

d. Port 1 Scan 4  
TILT: -71 (up)

Drive WR (-) to -180.0

	X	Y	Z	PITCH	YAW	ROLL	PL ID
√	-718	-172	-95	184	342	184	2
	SY	SP	EP	WP	WY	WR	
√	+35.0	+12.0	-68.0	-18.0	+17.0	-180.0	

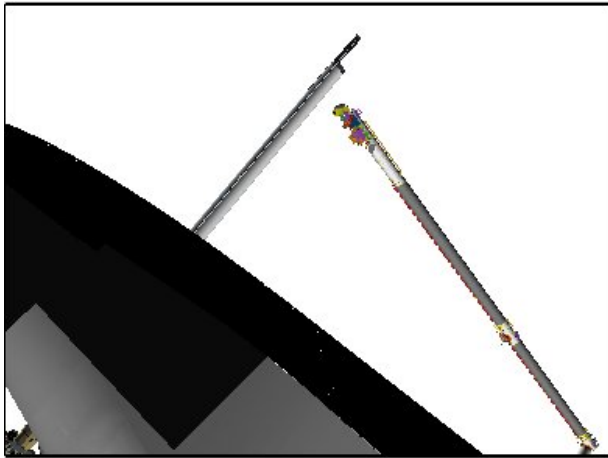

**TIP ELBOW (-95,41)**

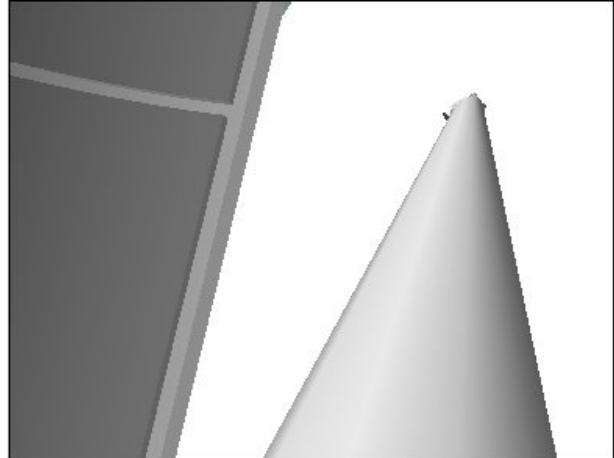

**ELBOW (-21,-22)**

A7U

e. Port 1 Scan 5  
TILT: -58 (up)

Drive WR (+) to +7.0

	X	Y	Z	PITCH	YAW	ROLL	PL ID
√	-1308	-402	-138	4	25	356	2
	SY	SP	EP	WP	WY	WR	
√	+35.0	+12.0	-68.0	-18.0	+17.0	+7.0	

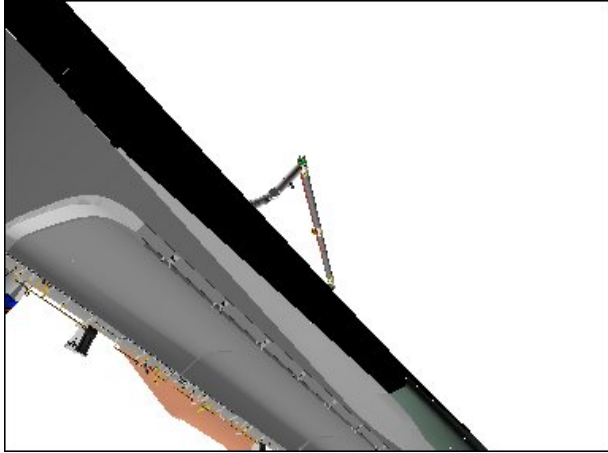

**TIP ELBOW (-70,15)**

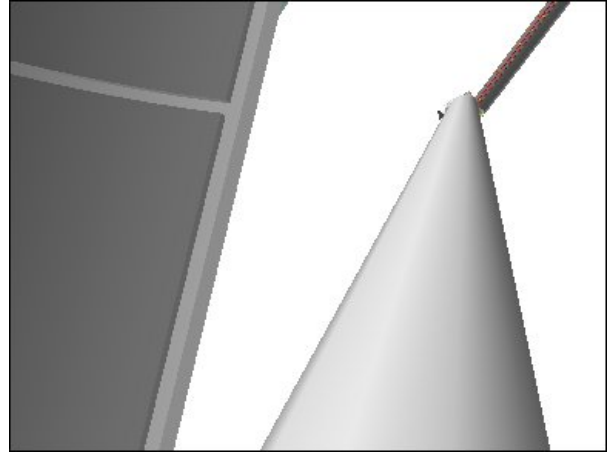

**ELBOW (-21,-22)**

A7U

f. Port 1 Scan 6  
TILT: -45 (up)

Drive WR (-) to -178.0

	X	Y	Z	PITCH	YAW	ROLL	PL ID
√	-721	-161	-95	184	340	184	2
	SY	SP	EP	WP	WY	WR	
√	+35.0	+12.0	-68.0	-18.0	+17.0	-178.0	

BRAKES – ON (tb-ON)



**TIP ELBOW (-95,41)**

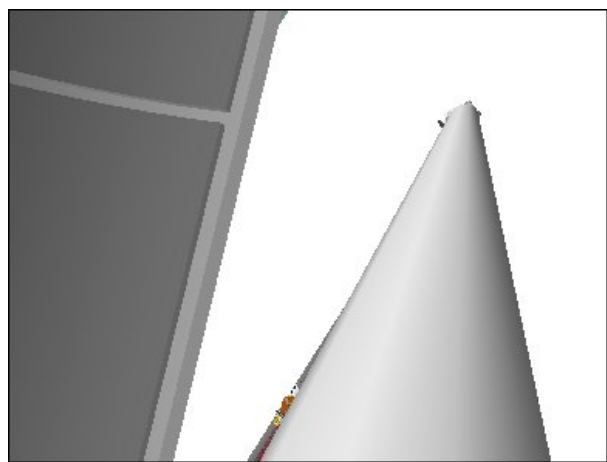

**ELBOW (-21,-22)**

7. MNVR TO NOSE CONFIG

On MCC GO:

L10(VTR) STOP pb – push (no red ●)

NOTE

At Nose Config final posn, OBSS-to-Orbiter = 143 in

Port Config 2 Clearance Views	Cameras
SJ steps 1 thru 4	A, ELBOW, SSRMS TIP ELBOW, SSRMS TIP LEE, RSC

BRAKES – OFF (tb-OFF)

MODE – SINGLE, ENTER

Mnvr to NOSE CONFIG posn:

	SY	SP	EP	WP	WY	WR	
PORT CONFIG 1	+35.0	+12.0	-68.0	-18.0	+17.0	-178.0	
1: SY +	+74.0						
2: SP +		+26.0					
3: WY –					+15.0		
4: WP –				-23.0			
NOSE CONFIG	+74.0	+26.0	-68.0	-23.0	+15.0	-178.0	
	X	Y	Z	PITCH	YAW	ROLL	PL ID
	-624	-222	-135	185	302	196	2

BRAKES – ON (tb-ON)

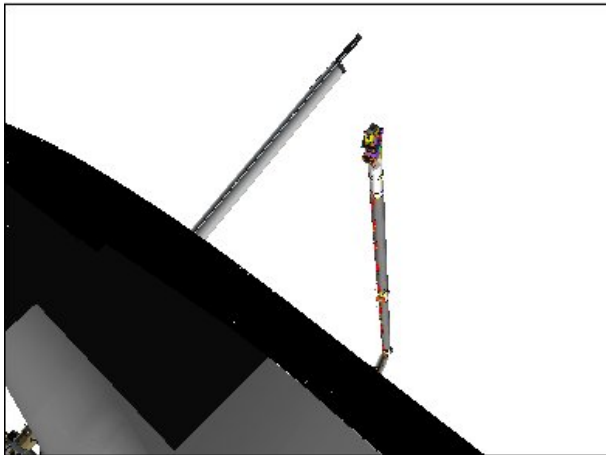

TIP ELBOW (-95,41)

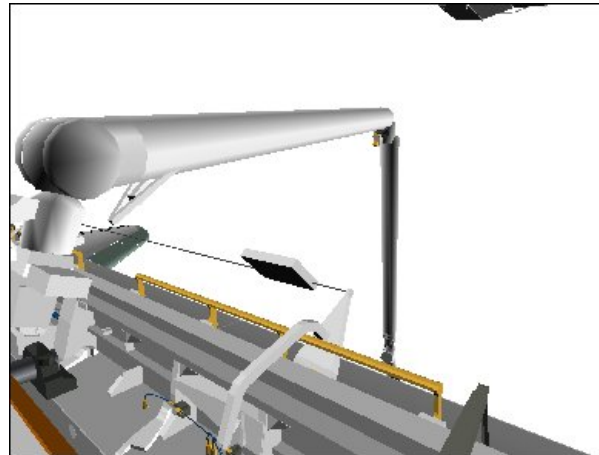

CCTV A (50,-10)

8. PERFORM NOSE SCAN

NOTE

During nose scan, OBSS-to-Orbiter = 132 in

A7U CCTV – config as reqd

MON 1	SSRMS TIP LEE (SSRMS TIP ELBOW)
MON 2	ELBOW (RSC)

A7U √MON2 ← PL2

√PAN: +75  
TILT: -120 (down)

√CAMR CMD PAN/TILT – LO RATE

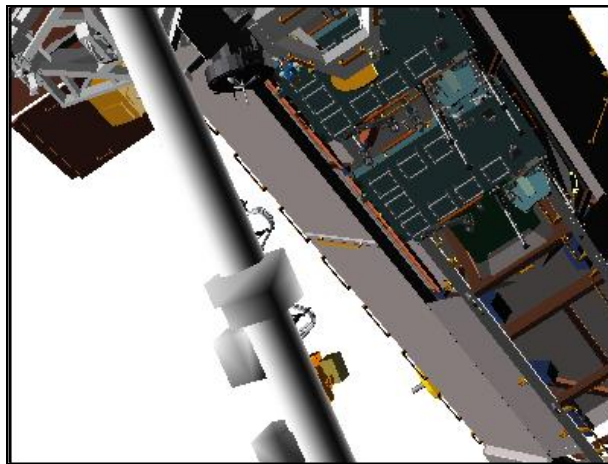

**OBSS ITVC (75,-120)**

√MCC to verify correct sensor view

L10(VTR) On MCC GO:  
REC pb – push, hold  
PLAY pb – push, simo (red ●)

BRAKES – OFF (tb-OFF)  
MODE – SINGLE, ENTER

Drive WR (-) to -200.0

	X	Y	Z	PITCH	YAW	ROLL	PL ID
√	-537	-303	-160	178	324	190	2
	SY	SP	EP	WP	WY	WR	
√	+74.0	+26.0	-68.0	-23.0	+15.0	-200.0	

BRAKES – ON (tb-ON)

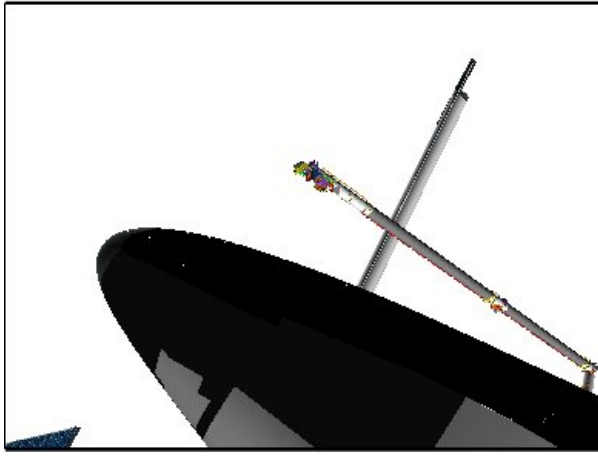

**TIP ELBOW (-115,46)**

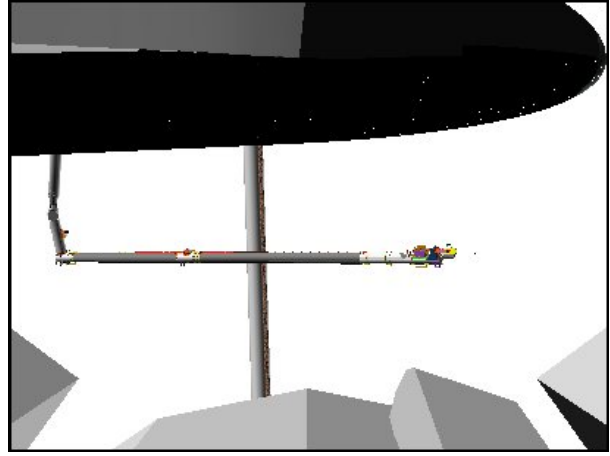

**TIP LEE**

9. MNVR TO PORT CONFIG 2

On MCC GO:

L10(VTR) STOP pb – push (no red ●)

NOTE

At Port Config 2 posn, OBSS-to-Orbiter = 120 in

Port Config 2 Clearance Views	Cameras
SJ steps 1 thru 2	ELBOW, SSRMS TIP LEE, SSRMS TIP ELBOW

BRAKES – OFF (tb-OFF)  
MODE – SINGLE, ENTER

Mnvr to PORT CONFIG 2 posn:

	SY	SP	EP	WP	WY	WR	
NOSE CONFIG	+74.0	+26.0	-68.0	-23.0	+15.0	-200.0	
1: WR +						-126.0	
2: WP –				-34.0			
PORT CONFIG 2	+74.0	+26.0	-68.0	-34.0	+15.0	-126.0	
	X	Y	Z	PITCH	YAW	ROLL	PL ID
	-888	-173	-143	355	288	6	2

BRAKES – ON (tb-ON)

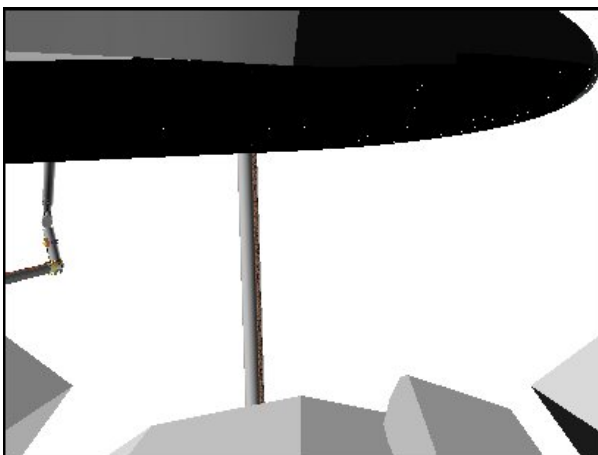

**TIP LEE**

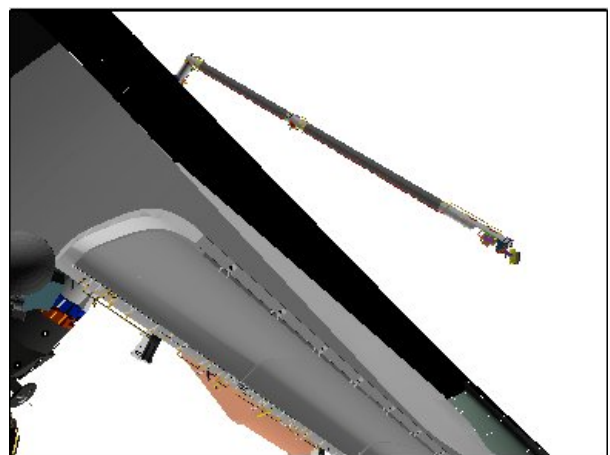

**TIP ELBOW (-95,20)**

10. PERFORM PORT 2 SCAN

a. Port 2 Scan 1

NOTE

During Port 2 scan, OBSS-to-Orbiter = 81 in

A7U CCTV – config as reqd

MON 1	SSRMS TIP LEE (SSRMS TIP ELBOW)
MON 2	ELBOW (RSC)

A7U √MON2 ← PL2

√PAN: +75  
TILT: -115 (up)

√CAMR CMD PAN/TILT – LO RATE

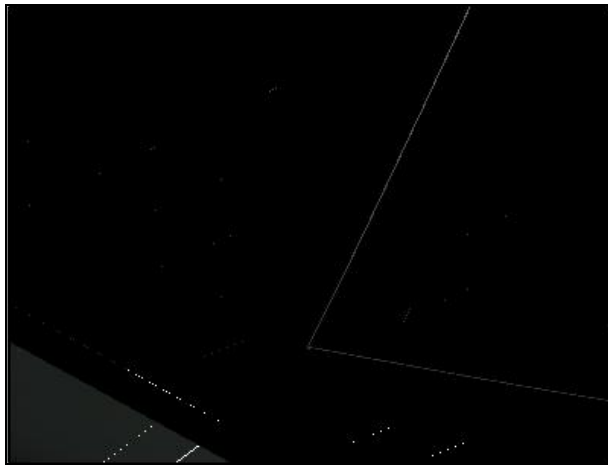

**OBSS ITVC (75,-115)**

√MCC to verify correct sensor view

L10(VTR) On MCC GO:  
REC pb – push, hold  
PLAY pb – push, simo (red ●)

BRAKES – OFF (tb-OFF)  
MODE – SINGLE, ENTER

Drive WR (+) to -73.0

	X	Y	Z	PITCH	YAW	ROLL	PL ID
√	-1086	-372	-99	350	341	2	2
	SY	SP	EP	WP	WY	WR	
√	+74.0	+26.0	-68.0	-34.0	+15.0	-73.0	

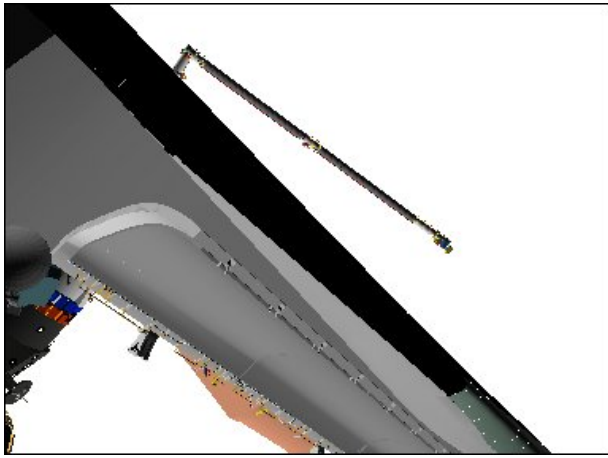

**TIP ELBOW (-75,15)**

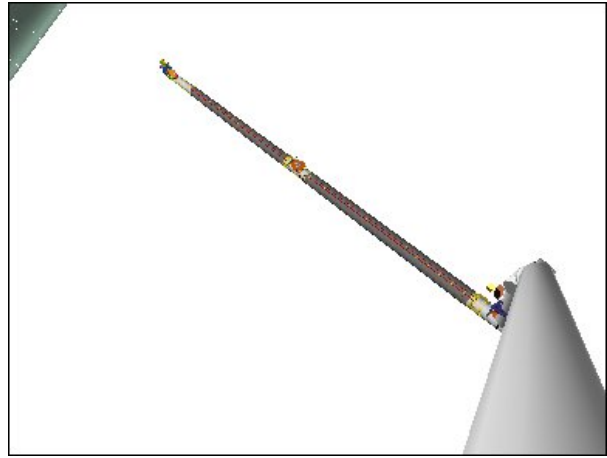

**ELBOW (-30,0)**

b. Port 2 Scan 2

NOTE

The following and subsequent TILT cmds in step 10 are for the OBSS ITVC

A7U

TILT: -102 (up)

Drive WR (-) to -139.0

√	X	Y	Z	PITCH	YAW	ROLL	PL ID
	-819	-159	-157	11	275	22	2
	SY	SP	EP	WP	WY	WR	
√	+74.0	+26.0	-68.0	-34.0	+15.0	-139.0	

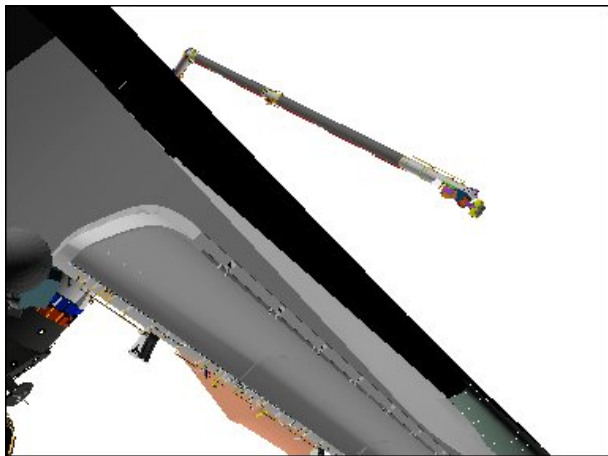

**TIP ELBOW (-75,15)**

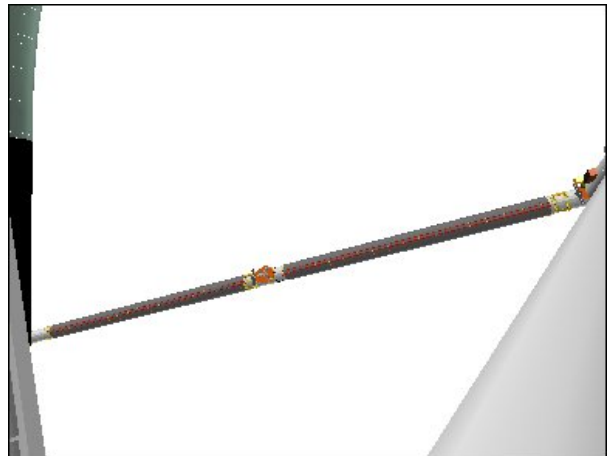

**ELBOW (-40,-20)**

A7U

c. Port 2 Scan 3  
TILT: -89 (up)

Drive WR (+) to -60.0

	X	Y	Z	PITCH	YAW	ROLL	PL ID
√	-1101	-442	-94	350	354	2	2
	SY	SP	EP	WP	WY	WR	
√	+74.0	+26.0	-68.0	-34.0	+15.0	-60.0	

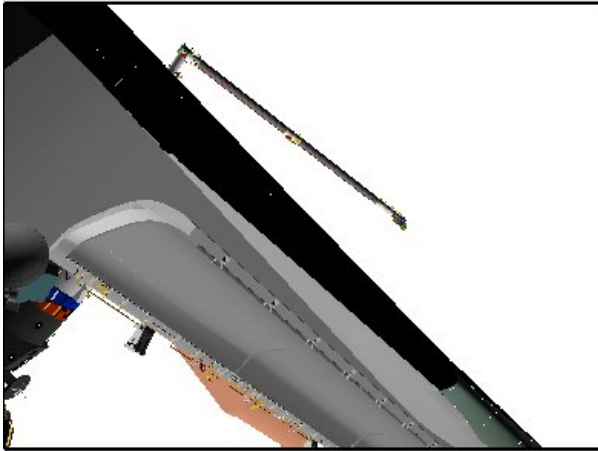

**TIP ELBOW (-75,15)**



**ELBOW (-30,0)**

A7U

d. Port 2 Scan 4  
TILT: -76 (up)

Drive WR (-) to -147.0

	X	Y	Z	PITCH	YAW	ROLL	PL ID
√	-775	-159	-165	138	274	149	2
	SY	SP	EP	WP	WY	WR	
√	+74.0	+26.0	-68.0	-34.0	+15.0	-147.0	

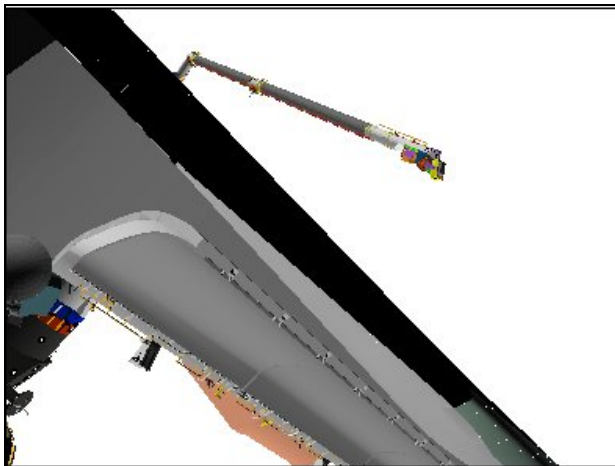

**TIP ELBOW (-75,15)**



**ELBOW (-40,-20)**



A7U

e. Port 2 Scan 5  
TILT: -63 (up)

Drive WR (+) to -62.0

	X	Y	Z	PITCH	YAW	ROLL	PL ID
√	-1100	-431	-95	350	352	2	2
	SY	SP	EP	WP	WY	WR	
√	+74.0	+26.0	-68.0	-34.0	+15.0	-62.0	

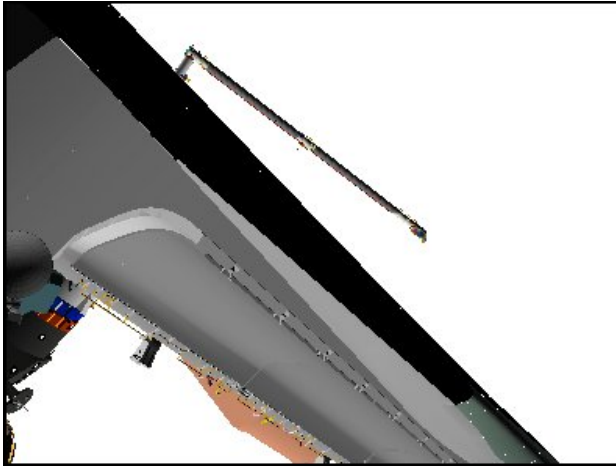

**TIP ELBOW (-75,15)**



**ELBOW (-30,0)**

A7U

f. Port 2 Scan 6  
TILT: -50 (up)

Drive WR (-) to -152.0

	X	Y	Z	PITCH	YAW	ROLL	PL ID
√	-748	-161	-170	156	278	167	2
	SY	SP	EP	WP	WY	WR	
√	+74.0	+26.0	-68.0	-34.0	+15.0	-152.0	

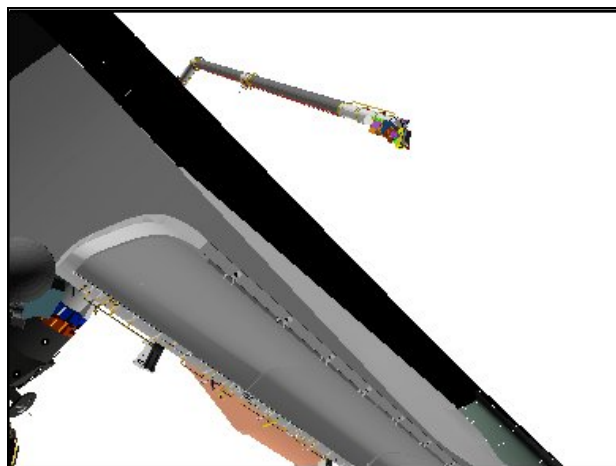

**TIP ELBOW (-75,15)**



**ELBOW (-40,-20)**

A7U

g. Port 2 Scan 7  
TILT: -40 (up)

Drive WR (+) to -74.0

√	X	Y	Z	PITCH	YAW	ROLL	PL ID
	-1084	-366	-100	350	340	2	2
	SY	SP	EP	WP	WY	WR	
√	+74.0	+26.0	-68.0	-34.0	+15.0	-74.0	

BRAKES – ON (tb-ON)

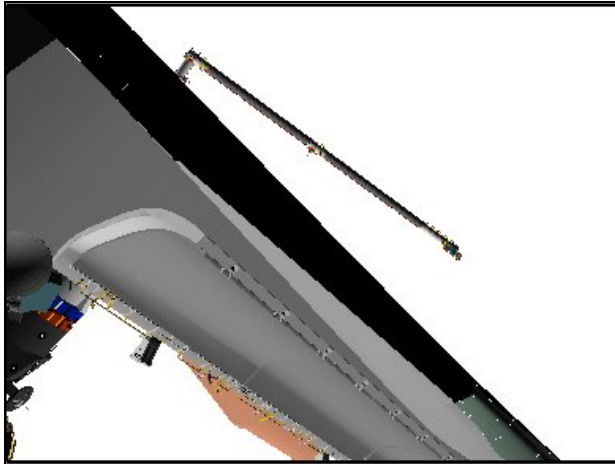

**TIP ELBOW (-75,15)**

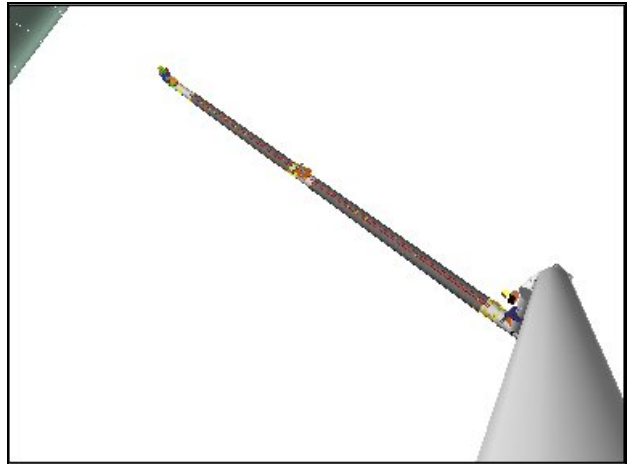

**ELBOW (-30,0)**

11. MNVR TO PORT CONFIG 3

On MCC GO:

L10(VTR) STOP pb – push (no red ●)

NOTE

At Port Config 3, OBSS-to-Orbiter = 240 in

Port Config 2 Clearance Views	Cameras
SJ step 1	A, ELBOW, SSRMS TIP LEE
SJ steps 2 thru 5	A, B, ELBOW
SJ step 6	A, B, ELBOW, SSRMS TIP LEE

BRAKES – OFF (tb-OFF)  
MODE – SINGLE, ENTER

Mnvr to PORT CONFIG 3 posn:

	SY	SP	EP	WP	WY	WR	
PORT CONFIG2	+74.0	+26.0	-68.0	-34.0	+15.0	-74.0	
1: SY +	+99.5						
2: SP +		+82.5					
3: EP –			-86.0				
4: WP +				-32.0			
5: WY +					+25.0		
6: WR –						-98.0	
PORT CONFIG3	+99.5	+82.5	-86.0	-32.0	+25.0	-98.0	
	X	Y	Z	PITCH	YAW	ROLL	PL ID
	-840	-505	-307	322	357	334	2

BRAKES – ON (tb-ON)

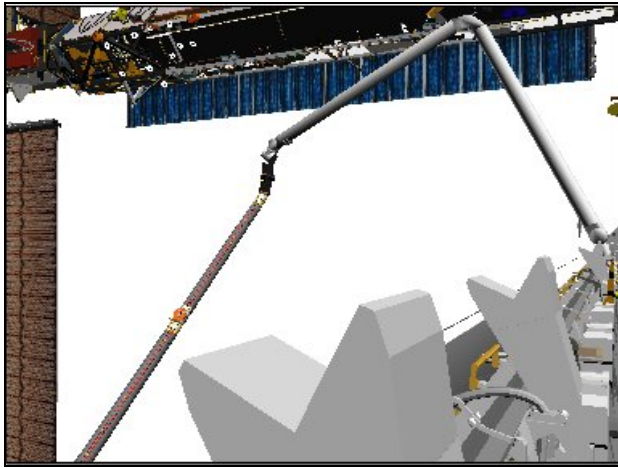

**CCTV B (-27,0)**

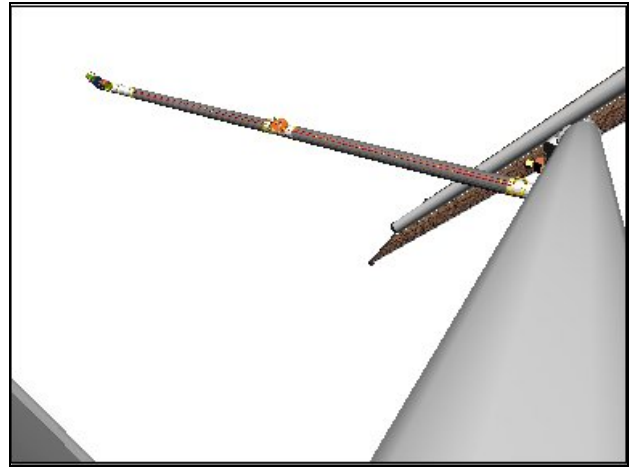

**ELBOW (-32,-20)**

12. PERFORM PORT 3 SCAN
  - a. Port 3 Scan 1

NOTE

During Port 3 scan, OBSS-to-Orbiter = 29 in

A7U CCTV – config as reqd

MON 1	B (SSRMS TIP LEE)
MON 2	ELBOW (RSC)

A7U ✓MON2 ← PL2

✓PAN: +75  
TILT: -85 (down)

✓CAMR CMD PAN/TILT – LO RATE

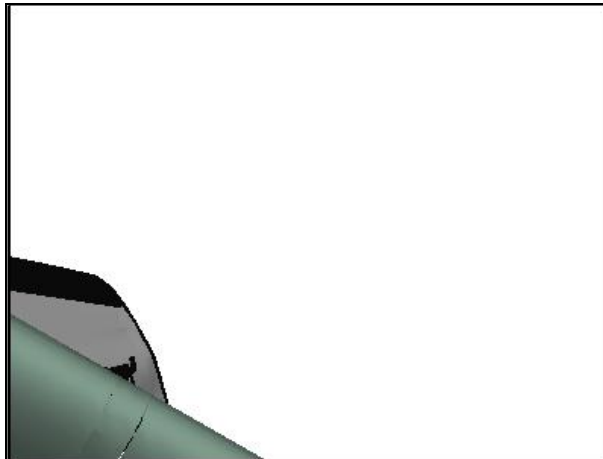

**OBSS ITVC (75,-85)**

✓MCC to verify correct sensor view

L10(VTR) On MCC GO:  
REC pb – push, hold  
PLAY pb – push, simo (red ●)

BRAKES – OFF (tb-OFF)  
 MODE – SINGLE, ENTER

Drive WR (-) to -161.0

	X	Y	Z	PITCH	YAW	ROLL	PL ID
√	-616	-260	-323	278	305	309	2
	SY	SP	EP	WP	WY	WR	
√	+99.5	+82.5	-86.0	-32.0	+25.0	-161.0	

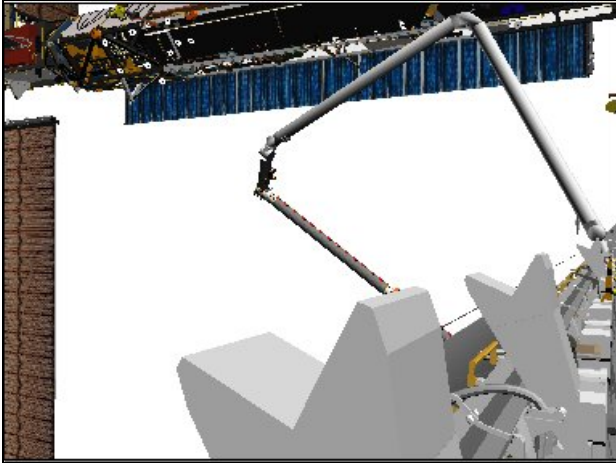

**CCTV B (-27,0)**

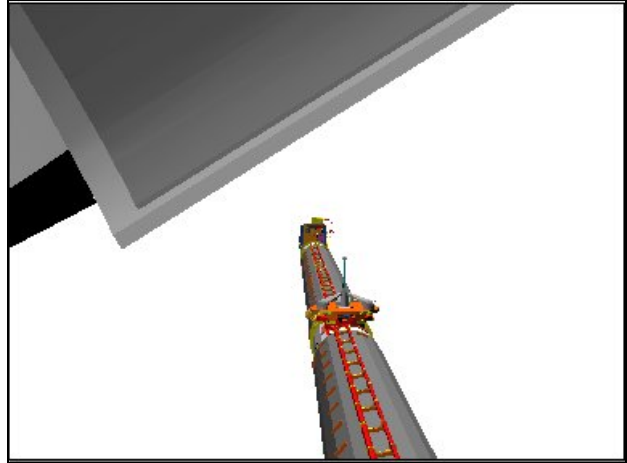

**RSC**

b. Port 3 Scan 2

NOTE

The following and subsequent TILT cmds in step 12  
 are for the OBSS ITVC

A7U

TILT: -72 (up)

Drive WR (+) to -108.0

	X	Y	Z	PITCH	YAW	ROLL	PL ID
√	-819	-456	-292	317	348	333	2
	SY	SP	EP	WP	WY	WR	
√	+99.5	+82.5	-86.0	-32.0	+25.0	-108.0	

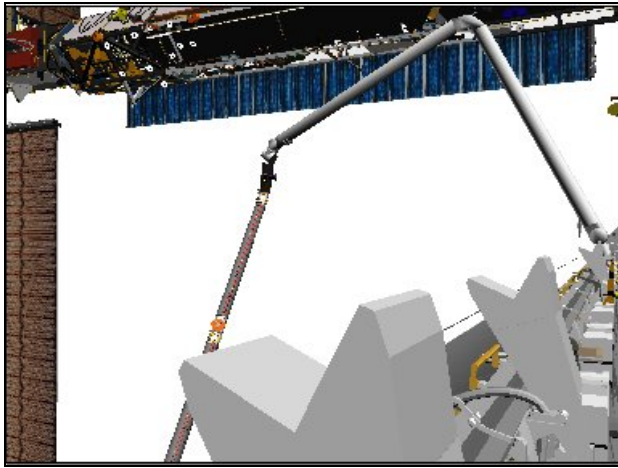

**CCTV B (-27,0)**

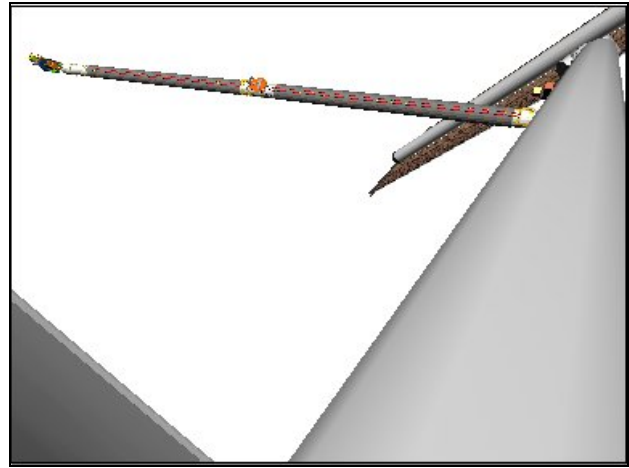

**ELBOW (-32,-30)**

A7U

c. Port 3 Scan 3  
TILT: -59 (up)

Drive WR (-) to -162.0

	X	Y	Z	PITCH	YAW	ROLL	PL ID
√	-612	-258	-325	277	305	308	2
	SY	SP	EP	WP	WY	WR	
√	+99.5	+82.5	-86.0	-32.0	+25.0	-162.0	

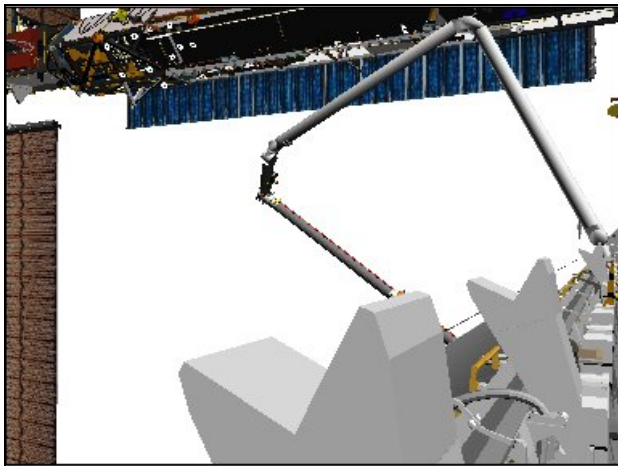

**CCTV B (-27,0)**

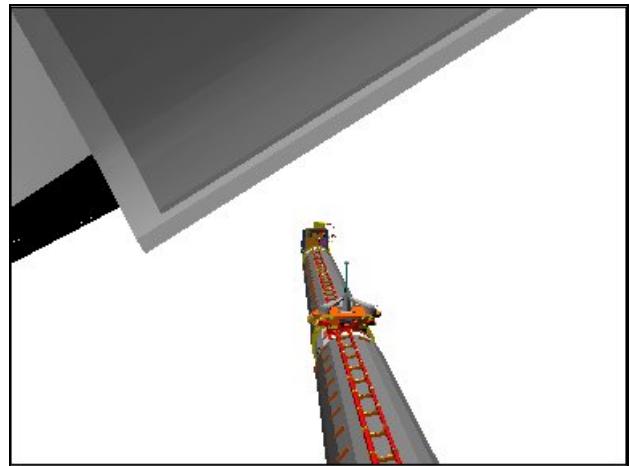

**RSC**

A7U

d. Port 3 Scan 4  
TILT: -46 (up)

Drive WR (+) to -134.0

	X	Y	Z	PITCH	YAW	ROLL	PL ID
√	-735	-341	-284	303	326	327	2
	SY	SP	EP	WP	WY	WR	
√	+99.5	+82.5	-86.0	-32.0	+25.0	-134.0	

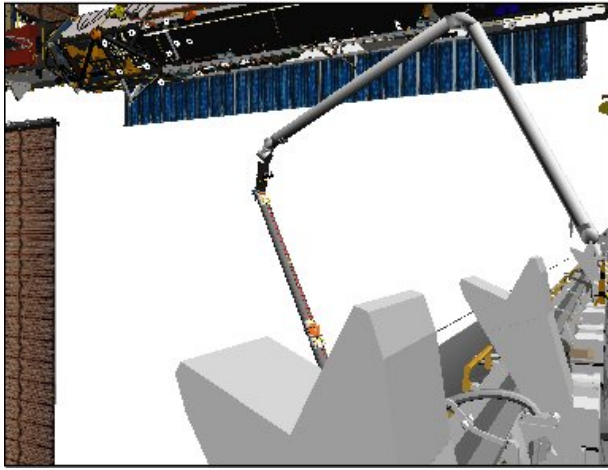

**CCTV B (-27,0)**

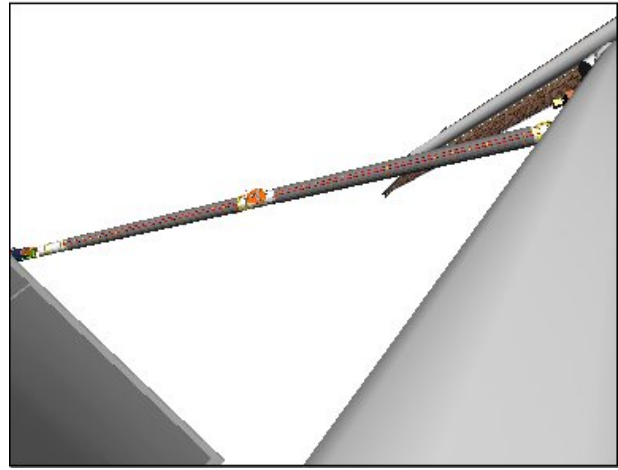

**ELBOW (-35,-30)**

A7U

e. Port 3 Scan 5  
TILT: -33 (up)

Drive WR (-) to -162.0

	X	Y	Z	PITCH	YAW	ROLL	PL ID
√	-612	-258	-325	277	305	308	2
	SY	SP	EP	WP	WY	WR	
√	+99.5	+82.5	-86.0	-32.0	+25.0	-162.0	

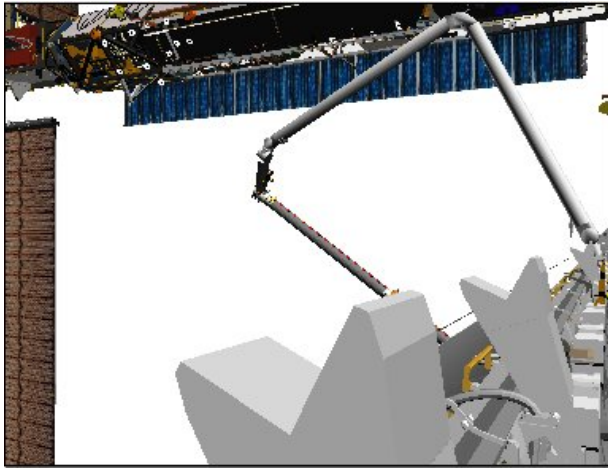

**CCTV B (-27,0)**

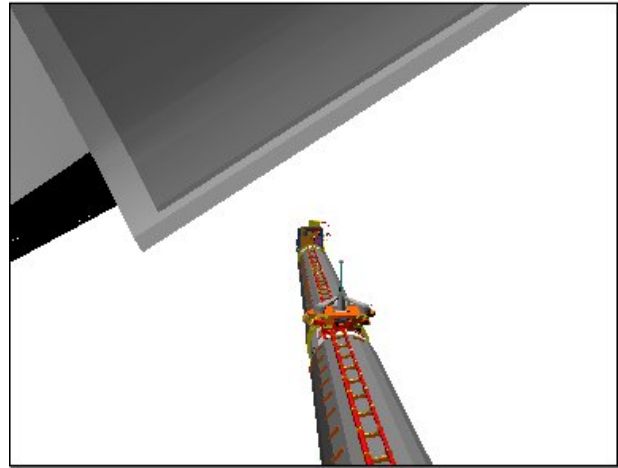

**RSC**

A7U

f. Port 3 Scan 6  
TILT: -23 (up)

Drive WR (+) to -146.0

	X	Y	Z	PITCH	YAW	ROLL	PL ID
√	-685	-298	-296	294	316	322	2
	SY	SP	EP	WP	WY	WR	
√	+99.5	+82.5	-86.0	-32.0	+25.0	-146.0	

BRAKES – ON (tb-ON)

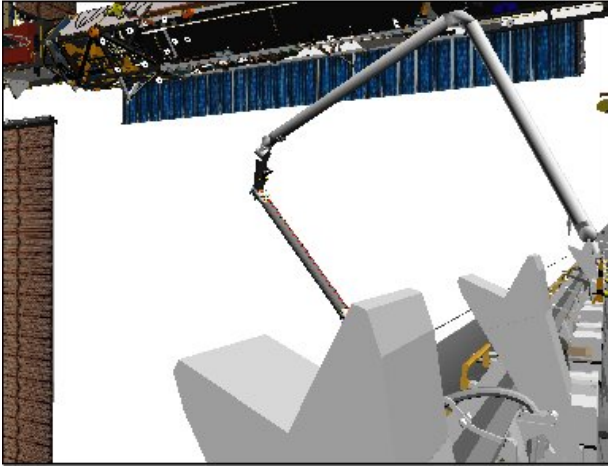

**CCTV B (-27,0)**

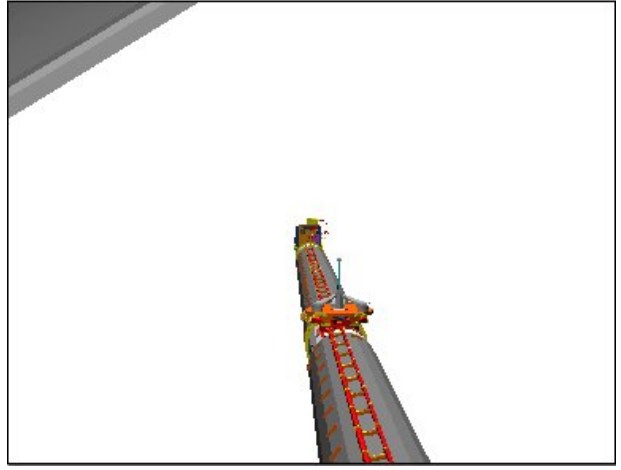

**RSC**

# RMS EE RCC WING SURVEY

**WARNING**  
Port and stbd PLBD radiators must be stowed

NOTE

This survey may be performed while docked or undocked. Assumed starting posn is Pre-Cradle

1. SETUP

A7U

√DTV ← RMS  
CCTV – RMS WRIST, ZOOM: 20.0 HFOV

SM 94 PDRS CONTROL

PL ID – ITEM 3 +5 EXEC  
INIT ID – ITEM 24 +5 EXEC

	X	Y	Z	PITCH	YAW	ROLL	PL ID
√	-1261	-146	-551	5	2	0	5
	SY	SP	EP	WP	WY	WR	
√	0.0	+25.0	-25.0	+5.0	0.0	0.0	

SM 94 PDRS CONTROL

AUTO MODES – ITEM 13 +6 +7 +8 +9 EXEC

2. MNVR TO STBD ACAS START

RHC

RATE – as reqd (VERN within 10 ft)  
BRAKES – OFF (tb-OFF)  
MODE – SINGLE, ENTER

Mnvr to STBD ACAS START posn:

	SY	SP	EP	WP	WY	WR	
PRE-CRADLE	0.0	+25.0	-25.0	+5.0	0.0	0.0	
1: SY –	-40.0						
2: WP –				-114.0			[1]
3: WY +					+29.5		
4: WR +						+118.8	
5: SP –		+15.0					
6: SY –	-59.4						
7: SP –		+3.0					[1]
8: EP –			-41.5				
STBD ACAS START posn	-59.4	+3.0	-41.5	-114.0	+29.5	+118.8	
	X	Y	Z	PITCH	YAW	ROLL	PL ID
	-914	+278	-378	273	47	21	5

[1] Near REACH LIMIT

BRAKES – ON (tb-ON)



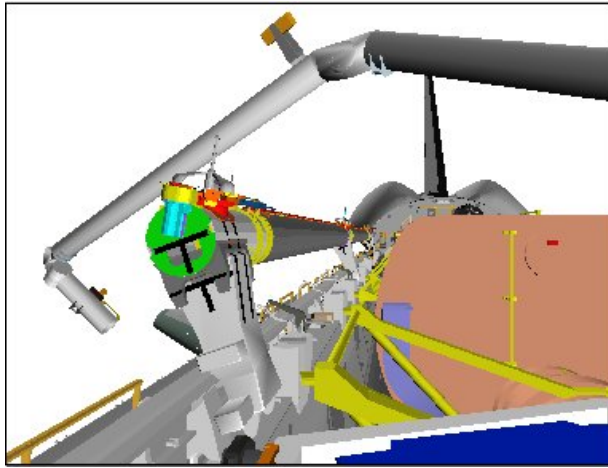

**CCTV D (-10,0)**

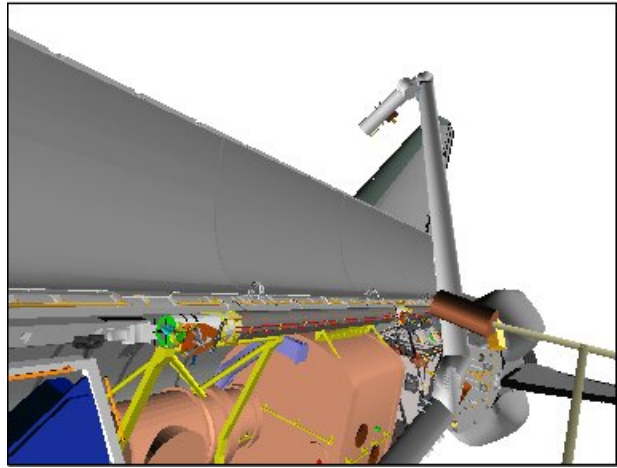

**If Docked: LAB (-35,-15)**

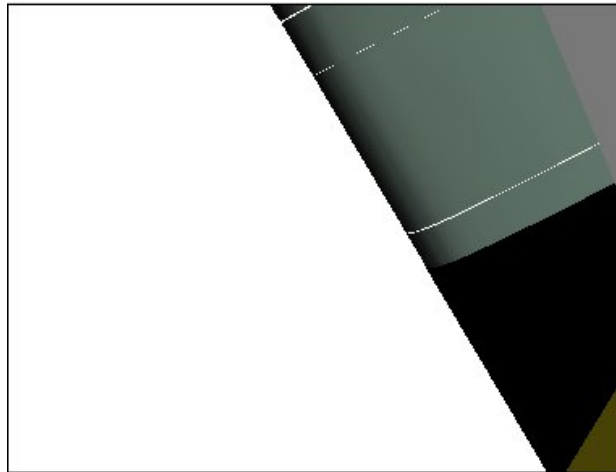

**WRIST HFOV: 20.0**

RHC 3. STBD ACAS  
RATE – VERN (RATE MIN tb-ON)

L10(VTR) REC pb – push, hold  
PLAY pb – push, simo (red ●)

BRAKES – OFF (tb-OFF)  
MODE – AUTO 1, ENTER (READY lt on)

- \* If unable to enter AUTO mode (no AUTO READY lt): \*
- \* √Joint angles and adjust as reqd \*

SM 169 PDRS STATUS

√LAST PT: 130  
Monitor ACAS progress

**NOTE**

The STBD ACAS scans the upper surface of Panels 1→18.  
Time between Pts 130 and 138 ~ 7:15 min

STBD ACAS Clearance Views	Cameras
EE-to-RCC	ELBOW
RMS-to-PLBD/EE-to-RCC	LAB
RMS-to-OBSS	D

AUTO SEQ – PROCEED (IN PROG It on)

ACAS, pause pts shaded, ORAS/OBAS are in **bold**, Rel digitals are nonbold,  
● col indicates data recording (black = VTR on) and damage criteria (inches):

Pt	X	Y	Z	PITCH	YAW	ROLL	●
<b>130P</b> Δ	<b>-914</b> +5	<b>+278</b> 0	<b>-378</b> -1	<b>273</b> -8	<b>47</b> 0	<b>21</b> 0	●
131 Δ	+12	-1	+3	-10	8	3	
132 Δ	+24	-1	-1	-28	-6	-17	
133 Δ	+35	0	+2	-5	4	-11	
134 Δ	30	-4	-6	0	11	-6	
135 Δ	17	-14	+10	-4	11	-9	
136 Δ	+18	-2	+36	7	4	-14	
137 Δ	+6	-8	+9	-5	1	-10	
<b>138P</b>	<b>-1061</b>	<b>+308</b>	<b>-430</b>	<b>320</b>	<b>342</b>	<b>47</b>	●

When AUTO SEQ IN PROG It – off:  
BRAKES – ON (tb-ON)

L10(VTR) STOP pb – push (no red ●)

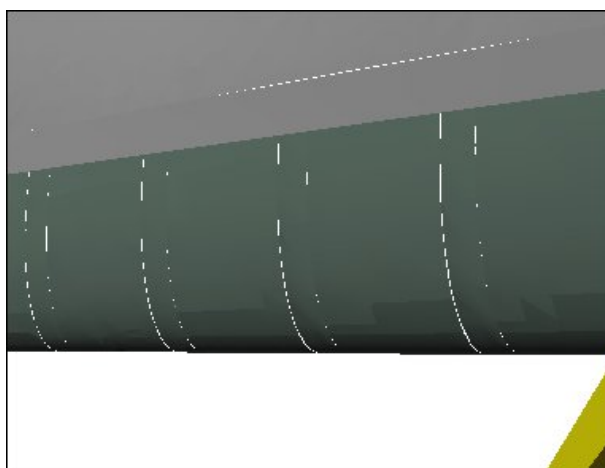

WRIST HFOV: 20.0

4. MNVR TO PORT UPPER ACAS START

SM 94 PDRS CONTROL

PL ID – ITEM 3 +0 EXEC

INIT ID – ITEM 24 +0 EXEC

√	X	Y	Z	PITCH	YAW	ROLL	PL ID
	-1061	+308	-430	320	342	47	0
	SY	SP	EP	WP	WY	WR	
√	-48.3	+6.0	-32.9	-24.4	+29.2	+87.2	

RHC

RATE – as reqd (VERN within 10 ft)

BRAKES – OFF (tb-OFF)

MODE – SINGLE, ENTER

If performing immediately after STBD ACAS:

Mnvr to PORT UPPER ACAS START posn:

		SY	SP	EP	WP	WY	WR	
STBD ACAS		-48.3	+6.0	-32.9	-24.4	+29.2	+87.2	
end								
1: SP +			+27.6					
2: EP +				-25.0				
3: SY +		+29.2						
4: WP –					-39.9			
5: WY –						-4.7		
6: WR –							+37.2	
7: EP –				-35.5				
PORT UPPER		+29.2	+27.6	-35.5	-39.9	-4.7	+37.2	
ACAS START								
	X	Y	Z	PITCH	YAW	ROLL	PL ID	
	-1163	-366	-379	309	0	52	0	

If performing from PRE-CRADLE:

Mnvr to PORT UPPER ACAS START posn:

		SY	SP	EP	WP	WY	WR	
PRE-CRADLE		0.0	+25.0	-25.0	+5.0	0.0	0.0	
1: SY +		+29.2						
2: SP +			+27.6					
3: WP –					-39.9			
4: WY –						-4.7		
5: WR +							+37.2	
6: EP –				-35.5				
PORT UPPER		+29.2	+27.6	-35.5	-39.9	-4.7	+37.2	
ACAS START								
	X	Y	Z	PITCH	YAW	ROLL	PL ID	
	-1163	-366	-379	309	0	52	0	

BRAKES – ON (tb-ON)

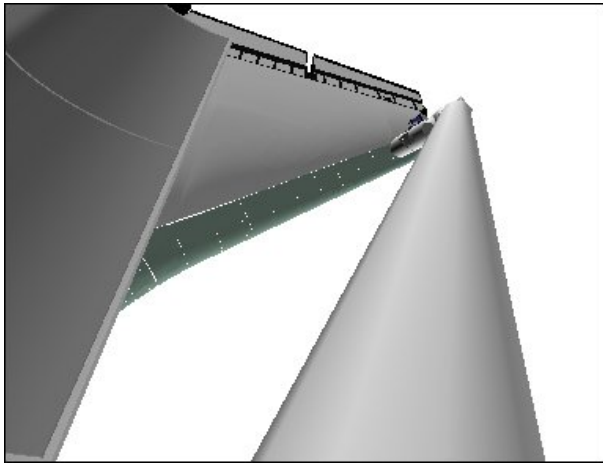

**ELBOW (-20,-22)**

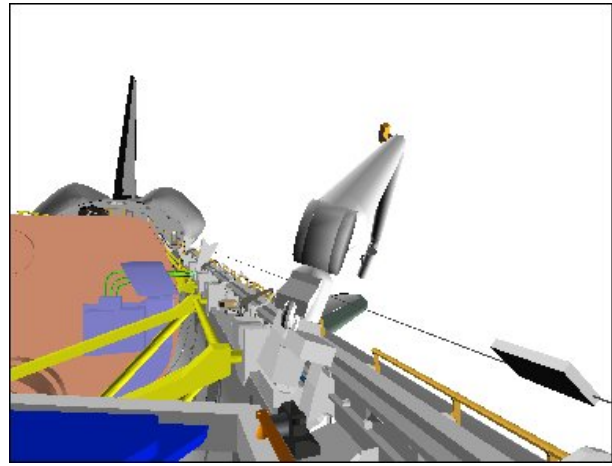

**CCTV A (20,0)**

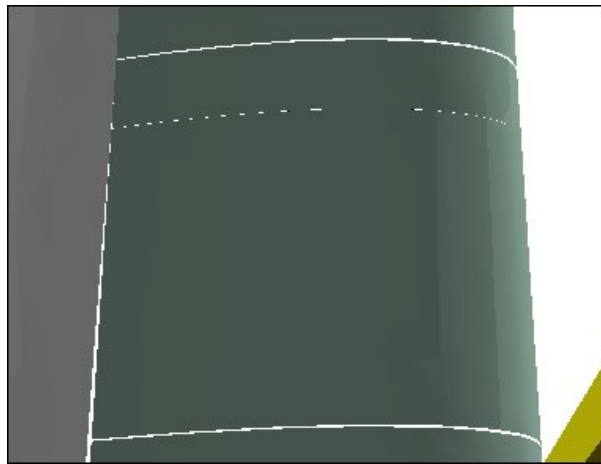

**WRIST HFOV: 20.0**

**5. PORT UPPER ACAS**

**SM 94 PDRS CONTROL**

PL ID - ITEM 3 +5 EXEC

INIT ID - ITEM 24 +5 EXEC

	X	Y	Z	PITCH	YAW	ROLL	PL ID
√	-1163	-366	-379	309	0	52	5
	SY	SP	EP	WP	WY	WR	
√	+29.2	+27.6	-35.5	-39.9	-4.7	+37.2	

RHC RATE - VERN (RATE MIN tb-ON)

L10(VTR) REC pb - push, hold  
PLAY pb - push, simo (red ●)

BRAKES - OFF (tb-OFF)  
MODE - AUTO 2, ENTER (READY It on)

\* If unable to enter AUTO mode (no AUTO READY It): \*  
\* √Joint angles and adjust as reqd \*

**SM 169 PDRS STATUS**

√LAST PT: 139  
Monitor ACAS progress

NOTE

The Port Upper ACAS scans upper surface of Panels 16 → 1.  
Time between Pts 139 and 152 ~ 11:00 min

Port Upper ACAS Clearance Views	Cameras
RMS-to-PLBD	ELBOW
RMS overview	A
EE-to-RCC/RMS-to-PLBD	B

AUTO SEQ – PROCEED (IN PROG It on)

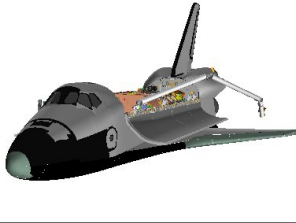
Pt	X	Y	Z	PITCH	YAW	ROLL	●
<b>139P</b>	<b>-1163</b>	<b>-366</b>	<b>-379</b>	<b>309</b>	<b>0</b>	<b>52</b>	
Δ	-15	-7	-5	2	3	-7	
140 Δ	-15	-25	-5	1	1	2	
141 Δ	-22	-11	+2	-1	3	-3	
142 Δ	-21	+4	-1	0	7	-12	
143 Δ	-17	-14	-1	3	3	-4	
144 Δ	-15	-13	+1	2	1	-3	
145 Δ	-17	-12	-1	1	2	-1	
146 Δ	-26	+4	+6	-5	20	-5	
147 Δ	-18	-7	-12	-2	3	-4	
148 Δ	-40	-1	-27	-6	6	-13	
149 Δ	-5	+2	4	4	6	0	
150 Δ	-16	-2	-1	0	4	1	
151 Δ	-28	+1	-6	0	-3	-4	
<b>152P</b>	<b>-908</b>	<b>-285</b>	<b>-333</b>	<b>292</b>	<b>285</b>	<b>25</b>	

When AUTO SEQ IN PROG It – off:

L10(VTR) STOP pb – push (no red ●)

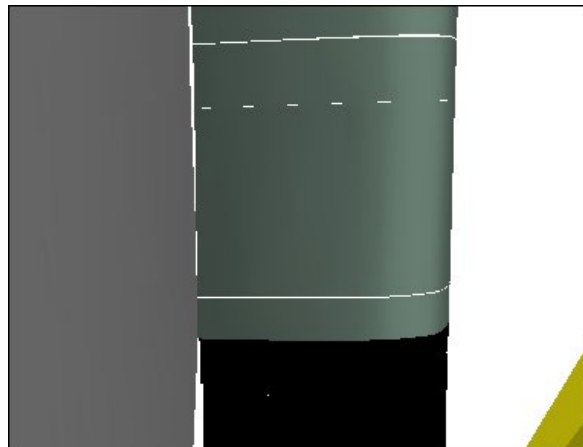

**WRIST HFOV: 20.0**

6. MNVR TO PORT UPPER APEX START

NOTE

Between Pts 152 and 153, arm adjusts for Port Upper Apex scan.  
Time between Pts 152 and 153 ~ 2:35 min

Clearance Views	Cameras
EE-to-RCC/RMS-to-PLBD	ELBOW
Upper Arm/EE-to-RCC	A
Upper Arm/RMS-to-PLBD	B

AUTO SEQ – PROCEED (IN PROG It on)

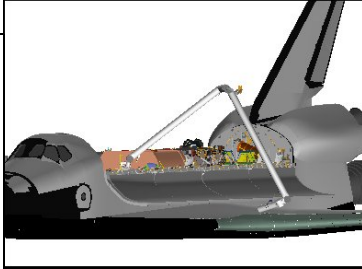
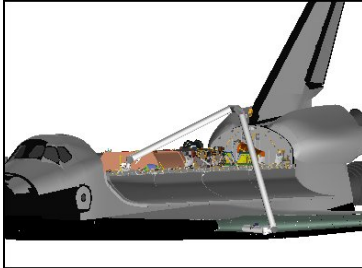
Pt	X	Y	Z	PITCH	YAW	ROLL	•
152P Δ	-908 3	-285 -42	-333 -39	292 0	285 3	25 -18	
153P	-911	-243	-294	53	275	146	

7. PORT UPPER APEX

A7U

CCTV – RMS WRIST, ZOOM: 10.0 HFOV

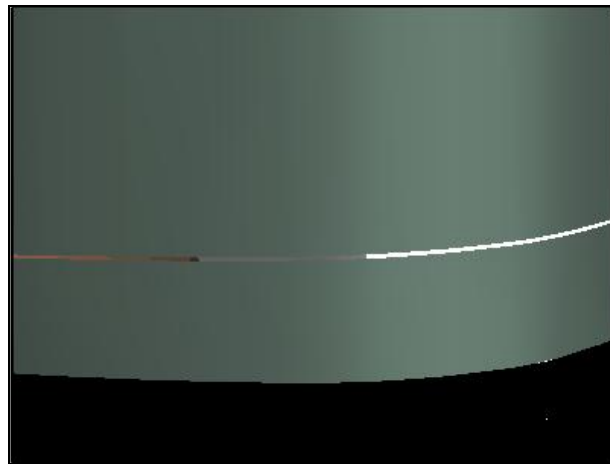

WRIST HFOV: 10.0

L10(VTR)

REC pb – push, hold  
PLAY pb – push, simo (red ●)

**NOTE**

The Port Upper Apex pass scans Panels 1 → 17. Time between Pts 153 and 165 ~ 12:00 min. The RMS is in a display singularity for Points 153 through 155

<b>Port Upper Apex Clearance Views</b>	<b>Cameras</b>
EE-to-RCC/RMS-to-PLBD	ELBOW
EE-to-RCC	A
RMS-to-PLBD	B

AUTO SEQ – PROCEED (IN PROG It on)

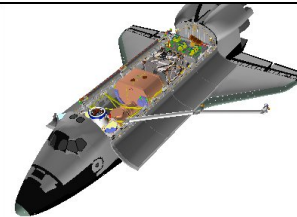
<b>Pt</b>	<b>X</b>	<b>Y</b>	<b>Z</b>	<b>PITCH</b>	<b>YAW</b>	<b>ROLL</b>	<b>●</b>
<b>153P</b> Δ	<b>-911</b> +34	<b>-243</b> +20	<b>-294</b> +2	<b>53</b> -3	<b>275</b> 3	<b>146</b> 4	
154 Δ	+17	0	+4	2	-4	1	
155 Δ	+16	-5	-8	-1	-4	-4	
156 Δ	+13	+10	+2	-1	-3	1	
157 Δ	+9	+5	+1	-1	-6	2	
158 Δ	+2	+17	+1	0	-9	-1	
159 Δ	+15	-8	+6	4	-7	4	
160 Δ	+11	+11	+4	1	-16	4	
161 Δ	+33	+27	-1	-3	-2	-1	
162 Δ	+41	+34	+2	2	-3	0	
163 Δ	+37	+43	-1	-4	-2	-2	
164 Δ	+10	+23	10	4	-15	6	
<b>165P</b>	<b>-1149</b>	<b>-420</b>	<b>-316</b>	<b>353</b>	<b>342</b>	<b>82</b>	

When AUTO SEQ IN PROG It – off:

L10(VTR)                      STOP pb – push (no red ●)

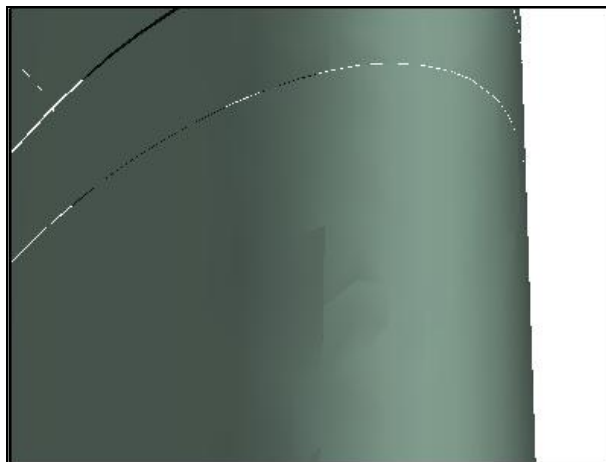

**WRIST HFOV: 10.0**

8. MNVR TO PORT LOWER APEX 1 START

NOTE

Between Pts 165 and 166, arm adjusts for first Port Lower Apex scan.  
Time between Pts 165 and 166 ~ 1:00 min

Clearance Views	Cameras
EE-to-RCC	ELBOW
RMS-to-PLBD	A
RMS-to-PLBD	B

AUTO SEQ – PROCEED (IN PROG It on)

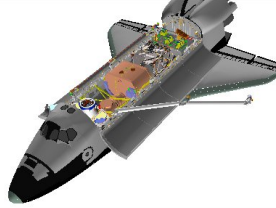
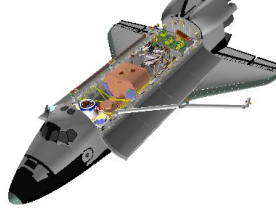
Pt	X	Y	Z	PITCH	YAW	ROLL	•
<b>165P</b>	<b>-1149</b>	<b>-420</b>	<b>-316</b>	<b>353</b>	<b>342</b>	<b>82</b>	
$\Delta$	+2	-5	-12	-4	-2	-7	
<b>166P</b>	<b>-1151</b>	<b>-415</b>	<b>-304</b>	<b>359</b>	<b>344</b>	<b>89</b>	

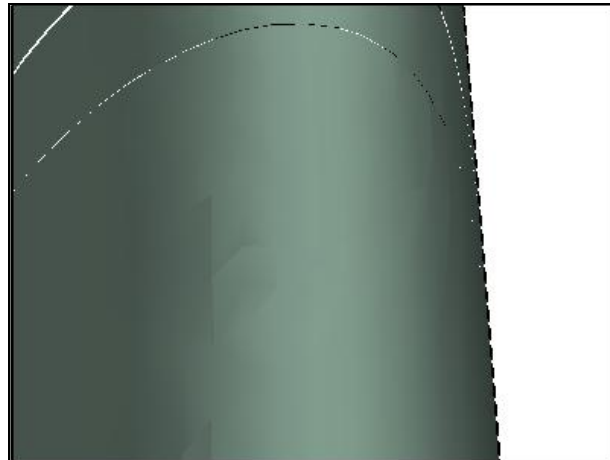

WRIST HFOV: 10.0



9. PORT LOWER APEX 1

NOTE

Port Lower Apex 1 pass scans Panels 17→12.  
Time between Pts 166 and 171 ~ 5:25 min

Port Lower Apex 1 Clearance Views	Cameras
EE-to-RCC	ELBOW
RMS-to-PLBD	A
RMS-to-PLBD	B

L10(VTR) REC pb – push, hold  
PLAY pb – push, simo (red ●)

AUTO SEQ – PROCEED (IN PROG It on)

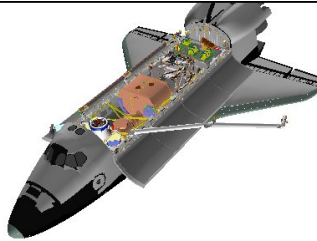
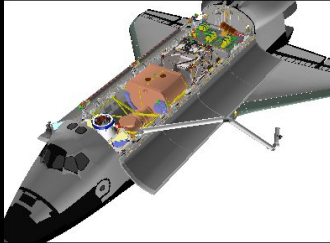
Pt	X	Y	Z	PITCH	YAW	ROLL	●
<b>166P</b>	<b>-1151</b>	<b>-415</b>	<b>-304</b>	<b>359</b>	<b>344</b>	<b>89</b>	
Δ	-5	-11	-3	-2	11	2	
167 Δ	-8	-12	-4	0	9	-2	
168 Δ	-23	-38	-39	-23	-7	-28	
169 Δ	-8	-18	-5	-4	5	-6	
170 Δ	-17	-22	-6	-6	1	0	
<b>171P</b>	<b>-1090</b>	<b>-314</b>	<b>-247</b>	<b>46</b>	<b>343</b>	<b>122</b>	

When AUTO SEQ IN PROG It – off:  
BRAKES – ON (tb-ON)

L10(VTR) STOP pb – push (no red ●)



**WRIST HFOV: 10.0**

RHC 10. RECONFIG TO PORT LOWER APEX 2 START  
 RATE – as reqd (VERN within 10 ft)  
 BRAKES – OFF (tb-OFF)  
 MODE – SINGLE, ENTER

Mnvr to PORT LOWER APEX 2 START posn:

	SY	SP	EP	WP	WY	WR	
PORT LOWER APEX 1 End	+37.7	+4.0	-44.8	+109.1	-53.7	+167.0	
1: WP –				-47.6			
2: WY –					-114.0		[1]
3: WR –						+13.5	
4: SY +	+39.0						
5: EP +			-36.6				
6: SP +		+6.1					
PORT LOWER APEX 2 START	+39.0	+6.1	-36.6	-47.6	-114.0	+13.5	
	X	Y	Z	PITCH	YAW	ROLL	PL ID
	-1094	-326	-251	51	324	121	5

[1] Expect SINGULAR It, near REACH LIMIT

BRAKES – ON (tb-ON)

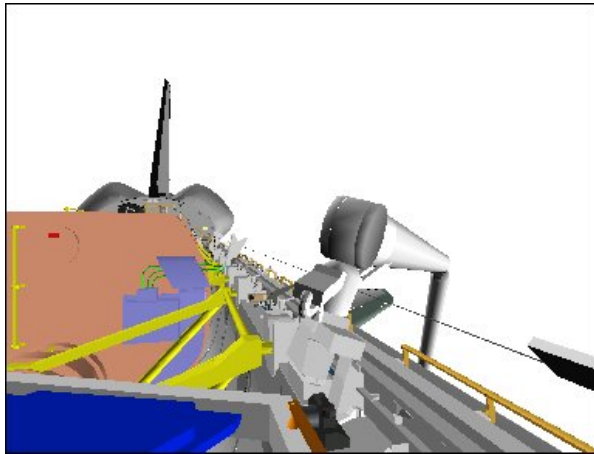

CCTV A (15,0)



FRONT

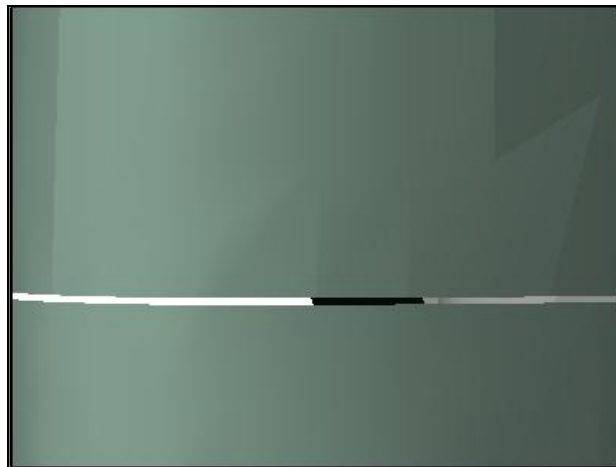

WRIST HFOV: 10.0

11. PORT LOWER APEX 2

RHC           √RATE – VERN (RATE MIN tb-ON)

L10(VTR)      REC pb – push, hold  
                  PLAY pb – push, simo (red ●)

                  BRAKES – OFF (tb-OFF)

                  MODE   – AUTO 3, ENTER (READY lt on)

                  \* If unable to enter AUTO mode (no AUTO READY lt): \*

                  \*    √Joint angles and adjust as reqd                   \*

SM 169 PDRS STATUS
--------------------

√LAST PT: 172

Monitor ACAS progress

**NOTE**

Port Lower Apex 2 pass scans Panels 12 → 1.  
Time between Pts 172 and 179 ~ 9:00 min

<b>Port Lower Apex 2 Clearance Views</b>	<b>Cameras</b>
RMS-to-PLBD/EE-to-RCC	ELBOW
RMS-to-PLBD	A
RMS-to-PLBD	B

AUTO SEQ – PROCEED (IN PROG It on)

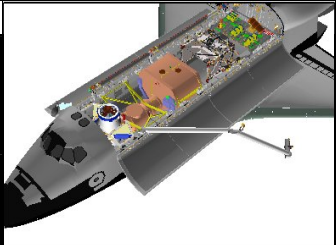
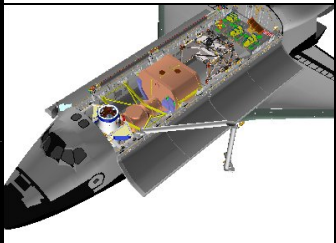
<b>Pt</b>	<b>X</b>	<b>Y</b>	<b>Z</b>	<b>PITCH</b>	<b>YAW</b>	<b>ROLL</b>	<b>●</b>
<b>172P</b>	<b>-1094</b>	<b>-326</b>	<b>-251</b>	<b>51</b>	<b>324</b>	<b>121</b>	
<b>Δ</b>	<b>-83</b>	<b>-72</b>	<b>+2</b>	<b>8</b>	<b>9</b>	<b>-1</b>	
173 Δ	-28	-4	+2	4	1	4	
174 Δ	-9	-4	-5	31	20	-22	
175 Δ	+1	+6	+9	76	8	-47	
176 Δ	-8	-1	+10	60	16	-31	
177 Δ	-28	-8	-1	3	-1	-1	
178 Δ	-35	-7	0	0	-5	-2	
<b>179P</b>	<b>-904</b>	<b>-236</b>	<b>-268</b>	<b>38</b>	<b>304</b>	<b>312</b>	

L10(VTR)      When AUTO SEQ IN PROG It – off:  
STOP pb – push (no red ●)

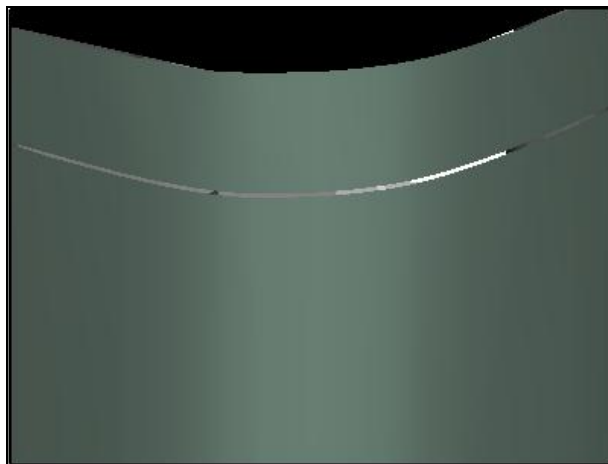

**WRIST HFOV: 10.0**

12. MNVR TO PORT LOWER 1 START

NOTE

Between Pts 179 and 180, arm adjusts for first Port Lower scan. Time between Pts 179 and 180 ~ 2:00 min

Clearance Views	Cameras
EE-to-RCC	ELBOW
RMS-to-PLBD	A
RMS-to-PLBD	B

AUTO SEQ – PROCEED (IN PROG It on)

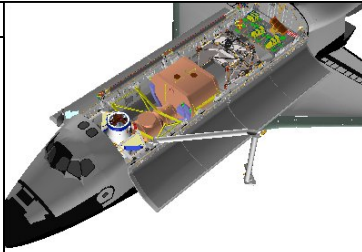
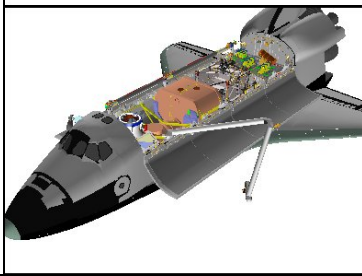
Pt	X	Y	Z	PITCH	YAW	ROLL	●
<b>179P</b> Δ	<b>-904</b> -14	<b>-236</b> -14	<b>-268</b> -33	<b>38</b> 4	<b>304</b> -11	<b>312</b> -19	
<b>180P</b>	<b>-890</b>	<b>-222</b>	<b>-235</b>	<b>41</b>	<b>324</b>	<b>324</b>	

13. PORT LOWER 1  
A7U CCTV – RMS WRIST, ZOOM: 20.0 HFOV

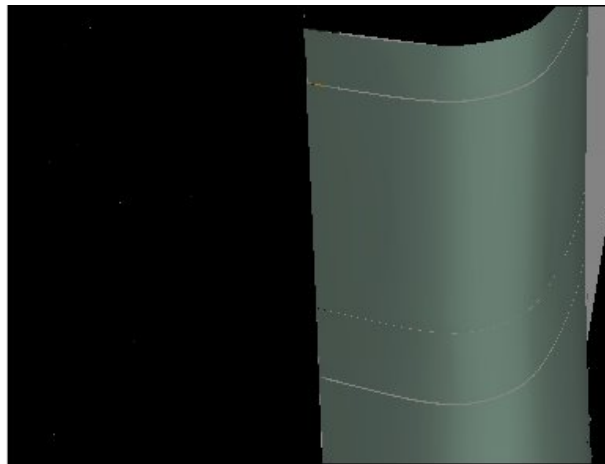

**WRIST HFOV: 20.0**

- L10(VTR) REC pb – push, hold  
PLAY pb – push, simo (red ●)

**NOTE**

Port Lower 1 pass scans the underside of Panels 1 → 11.  
Time between Pts 180 and 183 ~ 4:00 min

Port Lower 1 Clearance Views	Cameras
EE-to-RCC	ELBOW
RMS-to-PLBD	A
RMS-to-PLBD	B

AUTO SEQ – PROCEED (IN PROG It on)

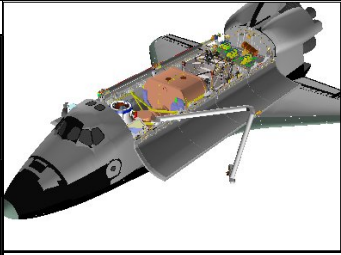
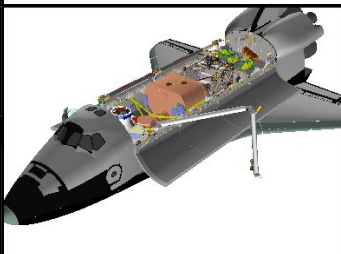
Pt	X	Y	Z	PITCH	YAW	ROLL	•
<b>180P</b> Δ	<b>-890</b> +27	<b>-222</b> +5	<b>-235</b> +2	<b>41</b> 2	<b>324</b> 3	<b>324</b> -2	
181 Δ	15	5	0	4	1	-1	
182 Δ	45	9	4	-8	12	1	
<b>183P</b>	<b>-977</b>	<b>-241</b>	<b>-241</b>	<b>53</b>	<b>315</b>	<b>340</b>	

A7U      When AUTO SEQ IN PROG It – off:  
            CCTV – RMS WRIST, ZOOM: 10.0 HFOV

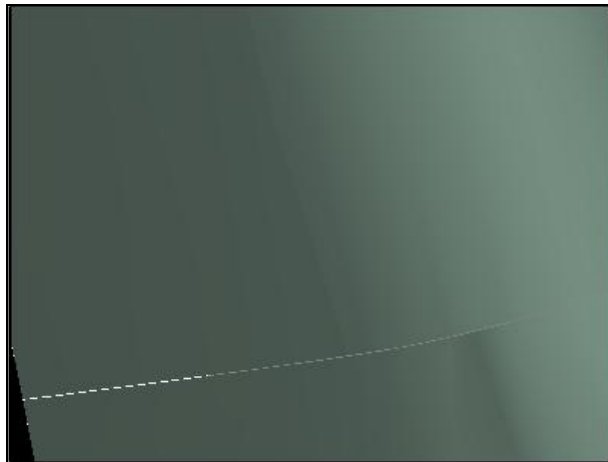

**WRIST HFOV: 10.0**

NOTE

Time between Pts 183 and 190 ~ 6:00 min

AUTO SEQ – PROCEED (IN PROG It on)

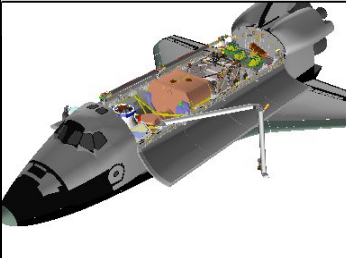
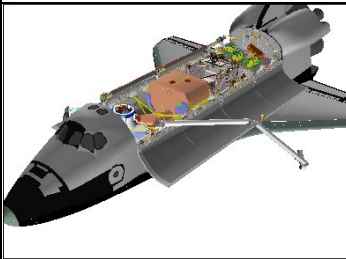
Pt	X	Y	Z	PITCH	YAW	ROLL	●
<b>183P</b>	<b>-977</b>	<b>-241</b>	<b>-241</b>	<b>53</b>	<b>315</b>	<b>340</b>	
Δ	+24	+3	+5	-12	-8	7	
184 Δ	+18	+13	+2	3	0	2	
185 Δ	+2	-2	-8	4	-10	-7	
186 Δ	+22	+17	+2	-15	-13	10	
187 Δ	+21	+16	+2	0	1	-2	
188 Δ	+19	+26	+10	0	5	9	
189 Δ	+8	+8	-2	3	-9	-5	
<b>190P</b>	<b>-1091</b>	<b>-322</b>	<b>-252</b>	<b>40</b>	<b>324</b>	<b>295</b>	

When AUTO SEQ IN PROG It – off:  
BRAKES – ON (tb-ON)

L10(VTR) STOP pb – push (no red ●)



WRIST HFOV: 10.0

RHC 14. RECONFIG TO PORT LOWER 2 START  
 RATE – as reqd (VERN within 10 ft)  
 BRAKES – OFF (tb-OFF)  
 MODE – SINGLE, ENTER

Mnvr to PORT LOWER 2 START posn:

	SY	SP	EP	WP	WY	WR	
PORT LOWER 1 End	+39.1	+9.3	-41.7	-61.2	-107.1	179.8	
1: SP –		+6.5					
2: EP –			-47.5				
3: SY –	+39.0						
4: WY +					-63.0		[1]
5: WP +				+114.0			[2]
6: WR –						-102.8	
PORT LOWER 2 START	+39.0	+6.5	-47.5	+114.0	-63.0	-102.8	
	X	Y	Z	PITCH	YAW	ROLL	PL ID
	-1081	-316	-250	43	335	206	5

[1] Expect SINGULAR It

[2] Near REACH LIMIT

BRAKES – ON (tb-ON)

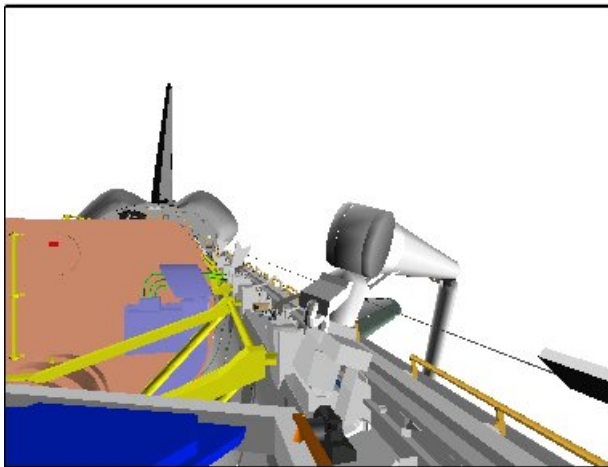

CCTV A (15,0)

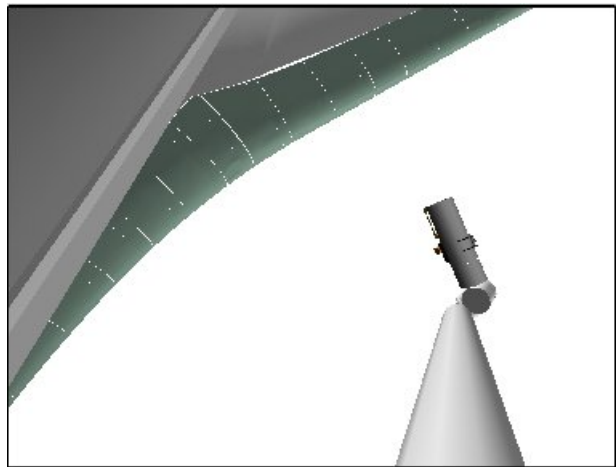

ELBOW (-20,5)

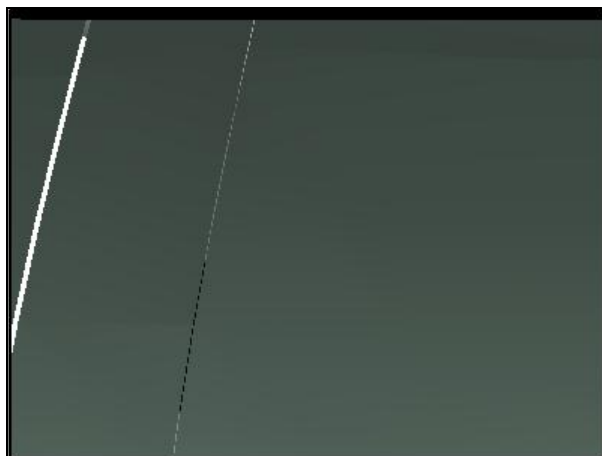

WRIST HFOV: 10.0





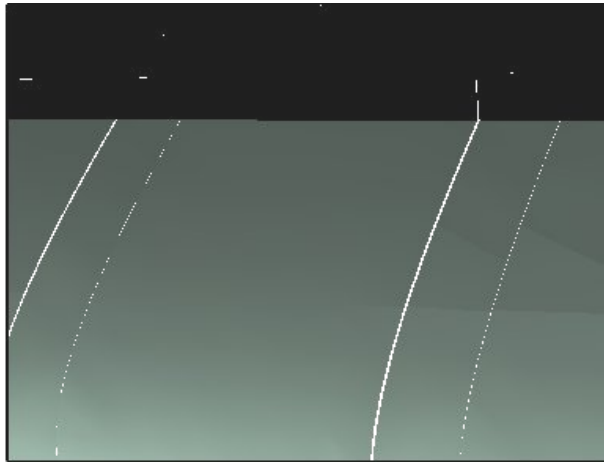

**WRIST HFOV: 20.0**

NOTE

Time between Pts 195 and 198 ~ 1:45 min

AUTO SEQ – PROCEED (IN PROG It on)

Pt	X	Y	Z	PITCH	YAW	ROLL	●
<b>194P</b>	<b>-1110</b>	<b>-343</b>	<b>-246</b>	<b>37</b>	<b>355</b>	<b>205</b>	
Δ	+8	+21	+8	6	-1	4	
195 Δ	+8	+3	-1	2	-8	-6	
196 Δ	+1	+6	-3	2	-4	-5	
<b>197P</b>	<b>-1127</b>	<b>-373</b>	<b>-250</b>	<b>27</b>	<b>10</b>	<b>204</b>	

When AUTO SEQ IN PROG It – off:  
BRAKES – ON (tb-ON)

L10(VTR) STOP pb – push (no red ●)

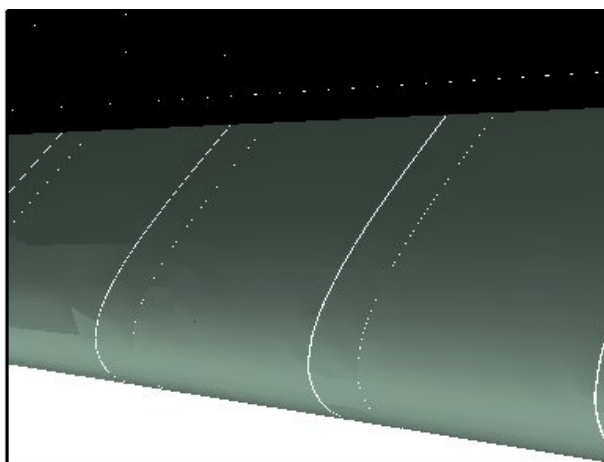

**WRIST HFOV: 20.0**

16. RETURN TO PRE-CRADLE

SM 94 PDRS CONTROL

PL ID - ITEM 3 +0 EXEC  
 INIT ID - ITEM 24 +0 EXEC

√	X	Y	Z	PITCH	YAW	ROLL	PL ID
	-1127	-373	-250	27	10	204	0
√	SY	SP	EP	WP	WY	WR	
	+38.3	+2.7	-33.8	+65.8	-32.5	-133.2	

RHC RATE - as reqd (VERN within 10 ft)  
 BRAKES - OFF (tb-OFF)  
 MODE - SINGLE, ENTER

Mnvr to PRE-CRADLE posn:

PORT  
 LOWER 2 End  
 1: WR +  
 2: WY +  
 3: WP -  
 4: EP +  
 5: SP +  
 6: SY -  
 PRE-CRADLE

	SY	SP	EP	WP	WY	WR	
	+38.3	+2.7	-33.8	+65.8	-32.5	-133.2	
						0.0	
					0.0		
				+5.0			
			-25.0				
		+25.0					
	0.0						
	0.0	+25.0	-25.0	+5.0	0.0	0.0	
	X	Y	Z	PITCH	YAW	ROLL	PL ID
	-1261	-146	-551	5	2	0	0

BRAKES - ON (tb-ON)  
 MODE - not DIRECT  
 PARAM - PORT TEMP  
 JOINT - CRIT TEMP

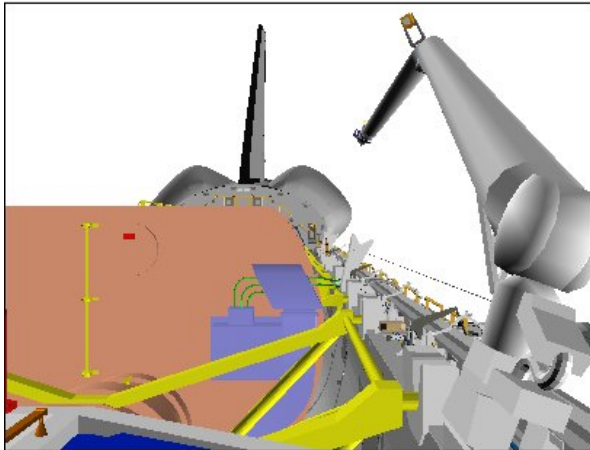

CCTV A (0,0)

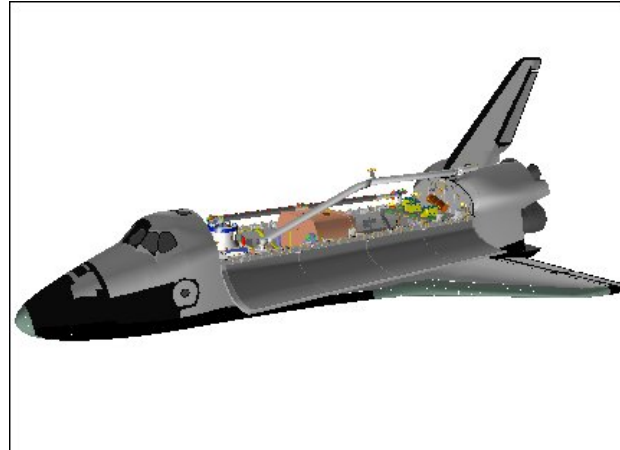

BIRD'S EYE

# OBSS SJ UNBERTH

**WARNING**  
For UNDOCKED ops only

NOTE

Stbd MPMs assumed deployed

1. SETUP

- CCTV – config as required
  - perform PAN/TILT RESET for PLB cameras
- ZOOM – full OUT

SM 94 PDRS CONTROL

- √PL ID, ITEM 3: 0
- √INIT ID, ITEM 24: 0

If flight specific DAPs have not been loaded:

Load DAP A14 with permanent edits per STS-116 DAP A CONFIGURATIONS (ORB OPS FS, DAP TABLES). This may be worked in parallel with the following steps 2-4

2. MNVR TO OBSS SJ PRE-GRAPPLE

If SINGLE MODE available:

- RHC
- RATE – as reqd (VERN within 10 ft)
  - BRAKES – OFF (tb-OFF)

MODE – best available

Mnvr to OBSS SJ PRE-GRAPPLE posn:

	SY	SP	EP	WP	WY	WR	
PRE-CRADLE	0.0	+25.0	-25.0	+5.0	0.0	0.0	
1: SP +		+87.9					
2: SY -	-90.0						
3: WP -				-57.0			
4: WR +						+110.0	
5: EP -			-129.8				
OBSS SJ PRE-GRAPPLE	-90.0	+87.9	-129.8	-57.0	0.0	+110.0	
	X	Y	Z	PITCH	YAW	ROLL	PL ID
	-680	+96	-513	270	350	1	0

- BRAKES – ON (tb-ON)
- MODE – not DIRECT
- JOINT – CRIT TEMP

Start:

Step 1:

Drive SP (+) from +25.0° to +87.9°

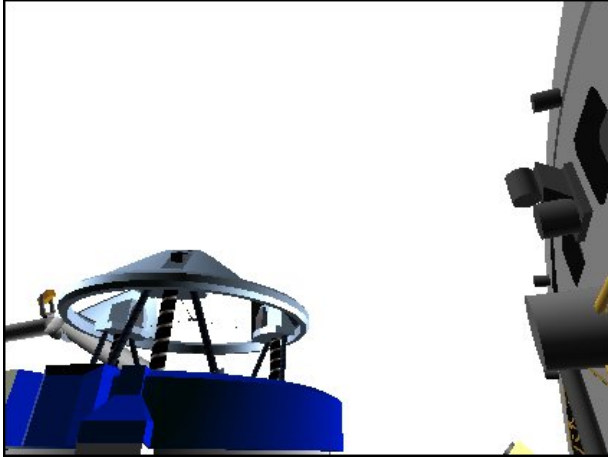

CCTV D (65,30)

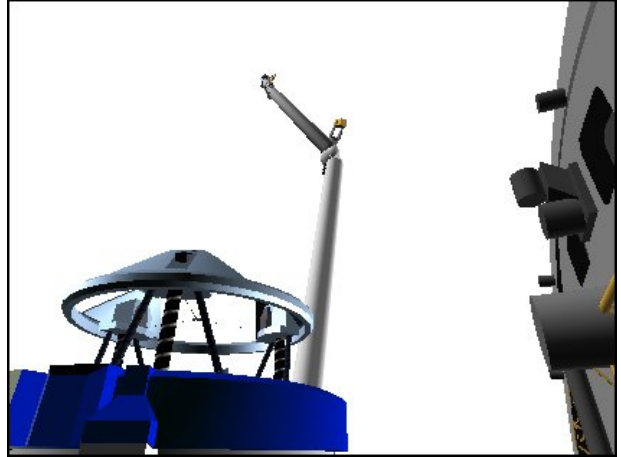

CCTV D (65,30)

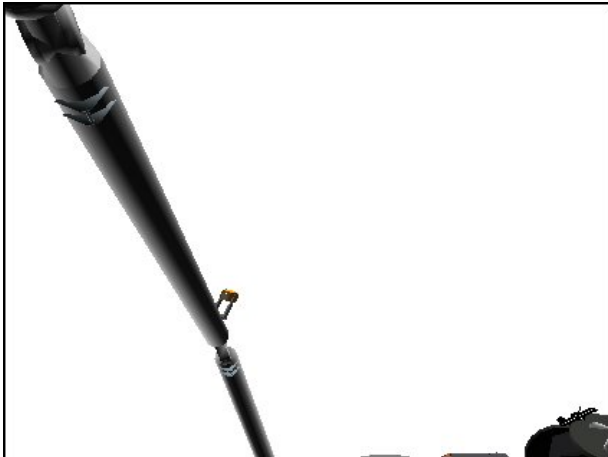

CCTV B (0,25)

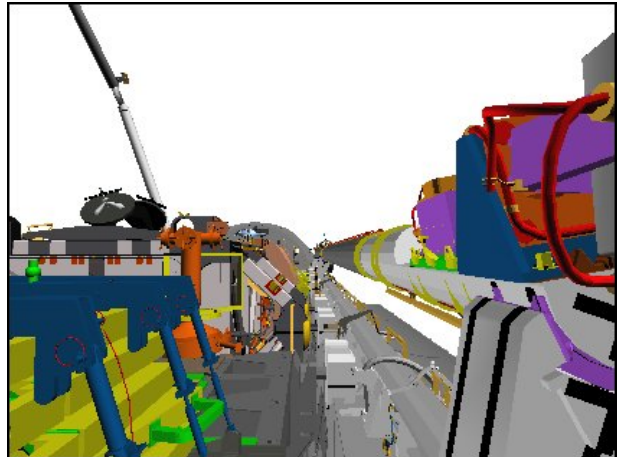

CCTV C (0,15)

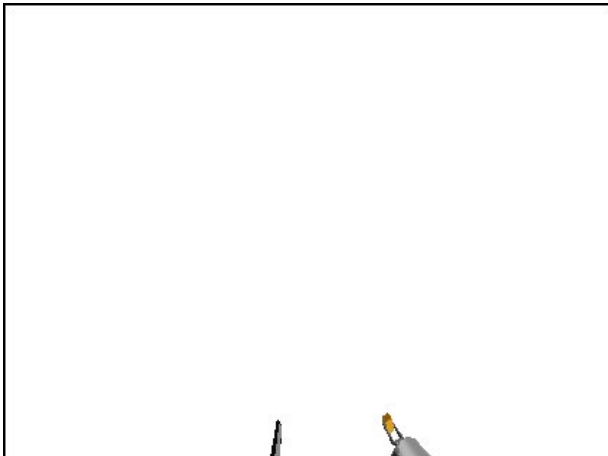

CCTV A (0,45)

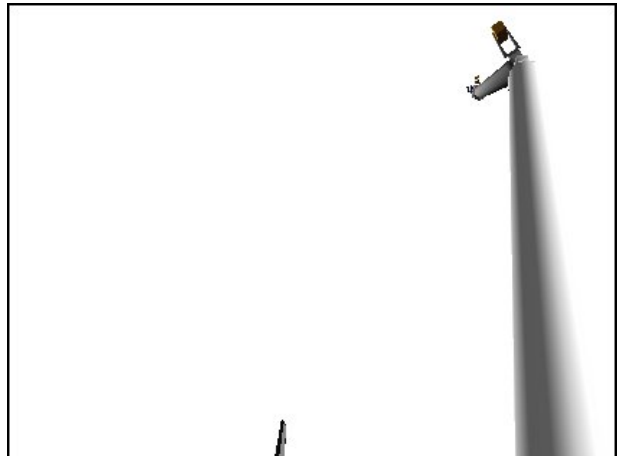

CCTV A (0,45)

Step 2:  
Drive SY (-) from 0.0° to -90.0°

Step 3:  
Drive WP (-) from +5.0° to -57.0°



**CCTV B (0,25)**



**CCTV B (0,25)**

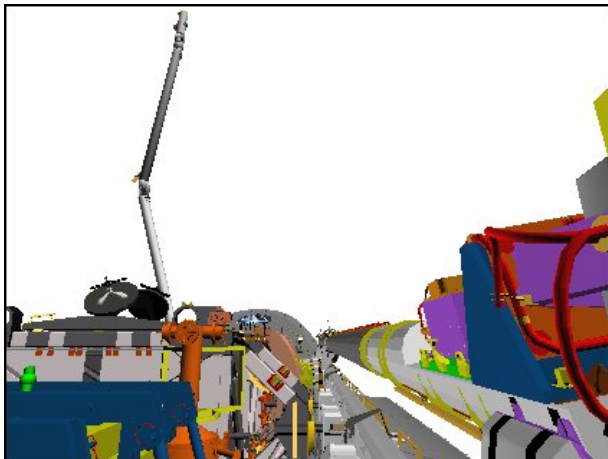

**CCTV C (0,15)**

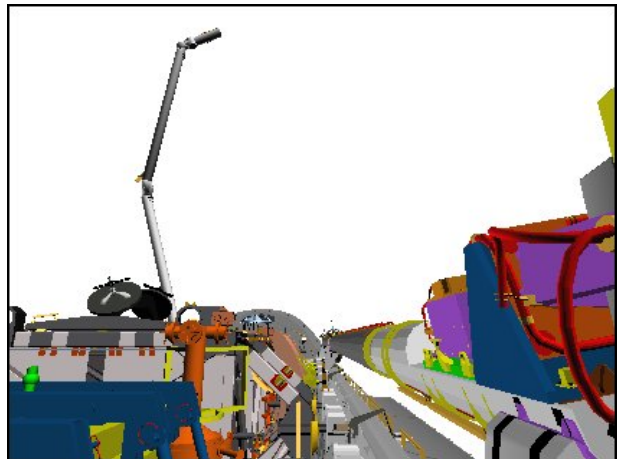

**CCTV C (0,15)**



**CCTV A (0,45)**

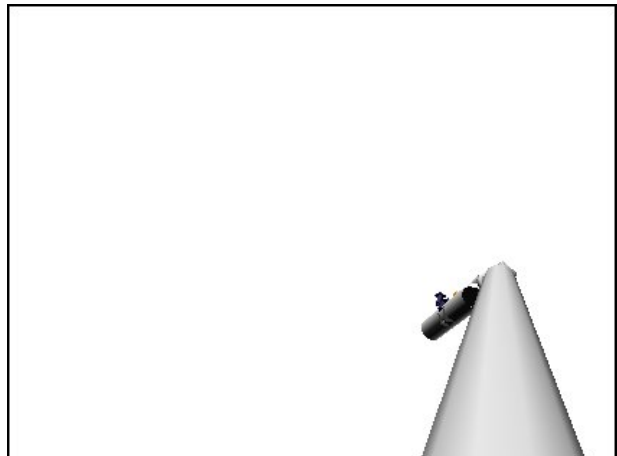

**ELBOW (-25,0)**

Step 4:

Drive WR (+) from 0.0° to +110.0°



**CCTV B (0,25)**

Step 5:

Drive EP (-) from -25.0° to -129.8°

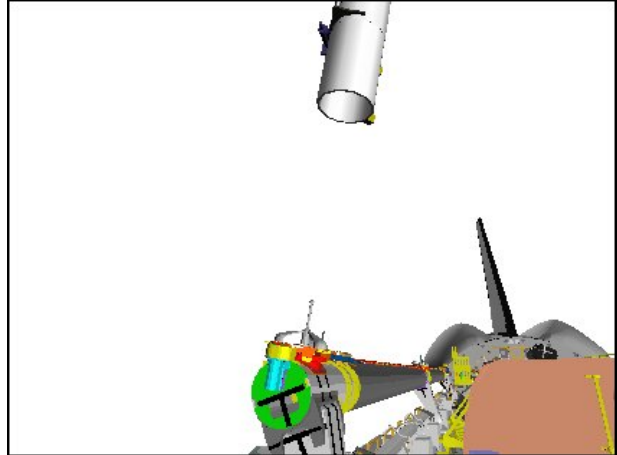

**CCTV D (0,25)**

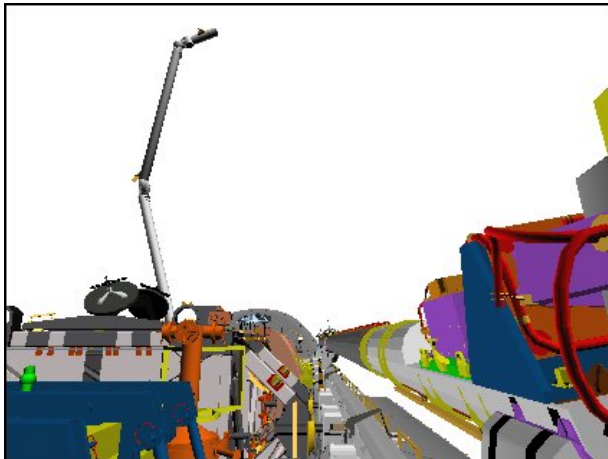

**CCTV C (0,15)**

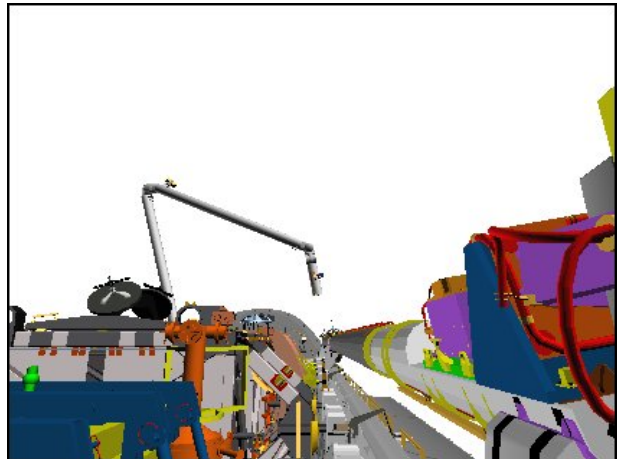

**CCTV C (0,15)**

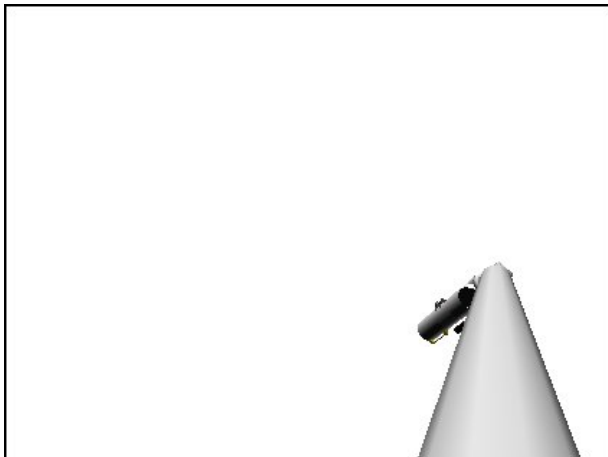

**ELBOW (-25,0)**

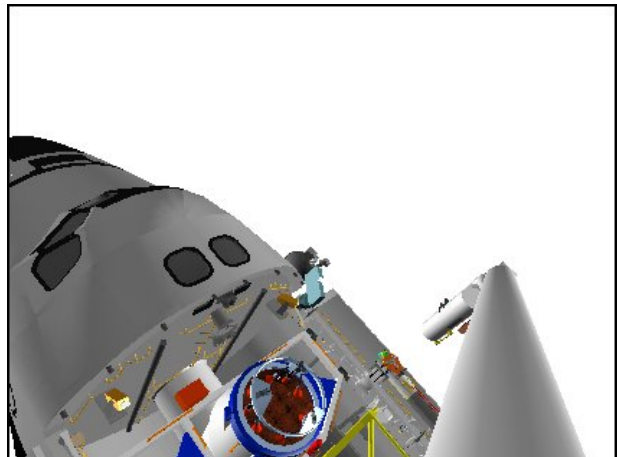

**ELBOW (-25,0)**

<p><b>CAUTION</b>          SPEE power must be applied within 90 min          to prevent sensor package damage</p>
---

STBD RMS HTR A,B (two) – OFF

A6U           EVENT TIMER MODE – UP  
                   CNTL – START

R12(OBSS) √SPEE PWR – OFF  
 L12U(SSP1) √APCU 1 OUTPUT RLY – OP (tb-bp)

3. OBSS GRAPPLE

A7U           CCTV – config for grapple  
                   – install PDRS TARGET OVERLAY FOR CTVM  
                   – RMS WRIST, ZOOM: 34.0 HFOV  
                   FOCUS: 5 ft

Maintain eyepoint ~18 in when using grapple overlay

RHC           If SINGLE MODE available:  
                   RATE – VERN (RATE MIN tb-ON)  
                   BRAKES – OFF (tb-OFF)

A6U           DAP: VERN(FREE)

MODE – best available

Mnvr to OBSS GRAPPLE posn:

	SY	SP	EP	WP	WY	WR
OBSS SJ PRE-GRAPPLE	-90.0	+87.9	-129.8	-57.0	0.0	+110.0
1: WP +				-40.9		
2: EP -			-134.6			
3: SP -		Until in grapple envelope				
Expected OBSS GRAPPLE	-90.0	+76.5	-134.6	-40.9	0.0	+110.0

Continue driving SP (-) until EE close to, but not over CAMs



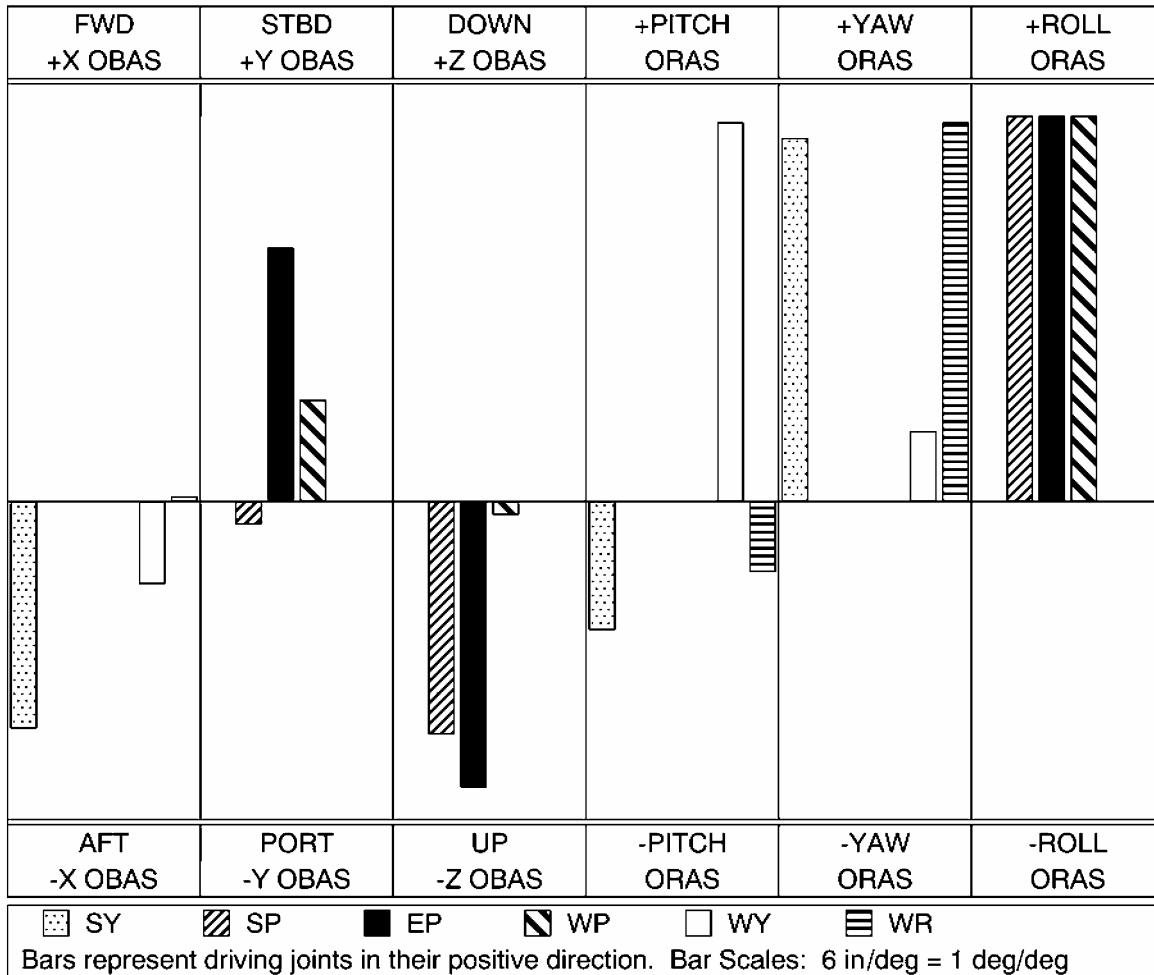

To get:	Drive:	To get:	Drive:
+X (fwd)	-SY, -WY	+PITCH	+WY
+Y (stbd)	+EP, +WP	+YAW	+WR, +SY
+Z (down)	-SP, -EP	+ROLL	+WP, +SP

Driving:	Results In:	Driving:	Results In:
+SY	-X (aft), +YAW	+WP	+Y (stbd), +ROLL
+SP	-Z (up), +ROLL	+WY	-X (aft), +PITCH
+EP	-Z (up), +ROLL	+WR	+YAW

$\Delta$ SY	$\Delta$ SP	$\Delta$ EP	$\Delta$ WP	$\Delta$ WY	$\Delta$ WR
-0.0	-11.4	-4.8	+16.1	+0.0	+0.0

Step 1:

Drive WP (+) from  $-57.0^\circ$  to  $-40.9^\circ$

Step 2:

Drive EP (-) from  $-129.8^\circ$  to  $-134.6^\circ$

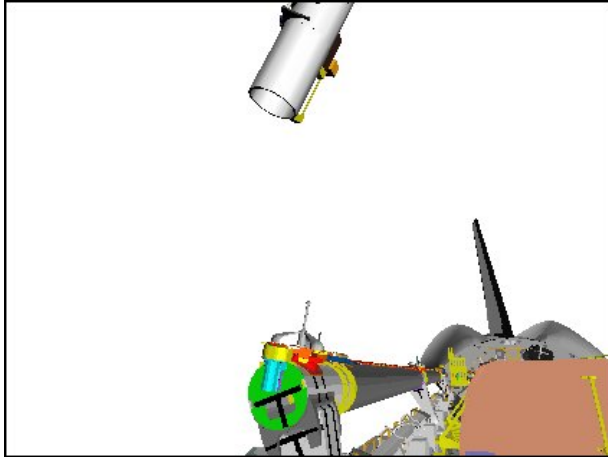

CCTV D (-20,20)

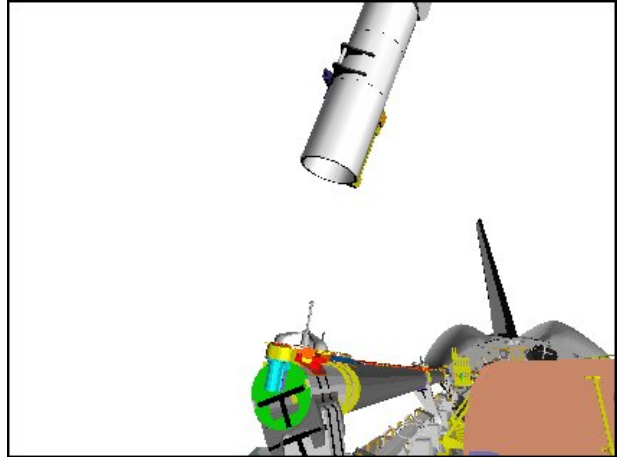

CCTV D (-20,20)

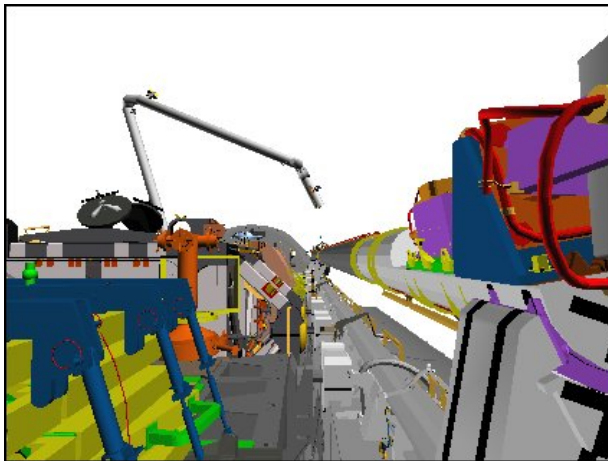

CCTV C (1,3)

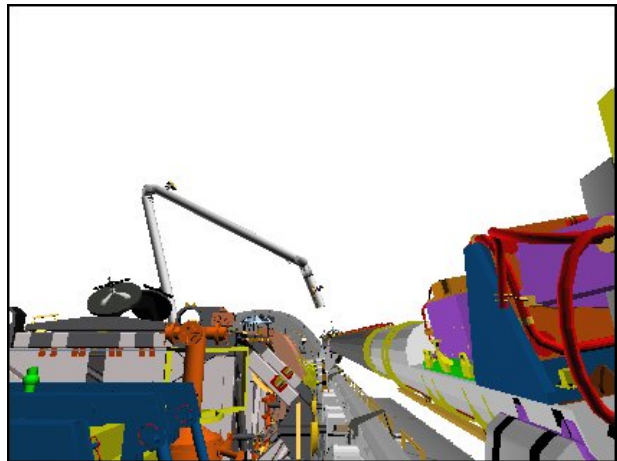

CCTV C (1,3)

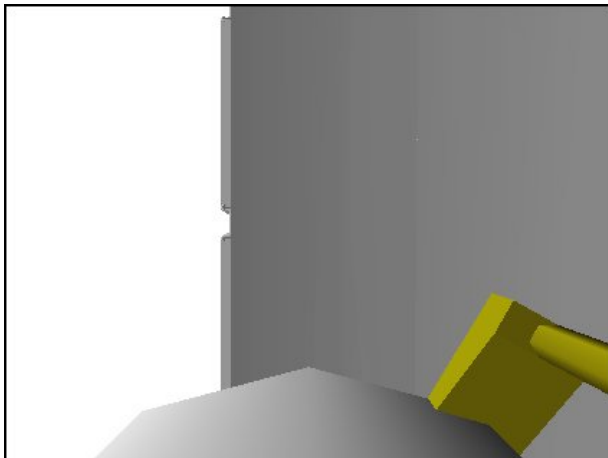

WRIST

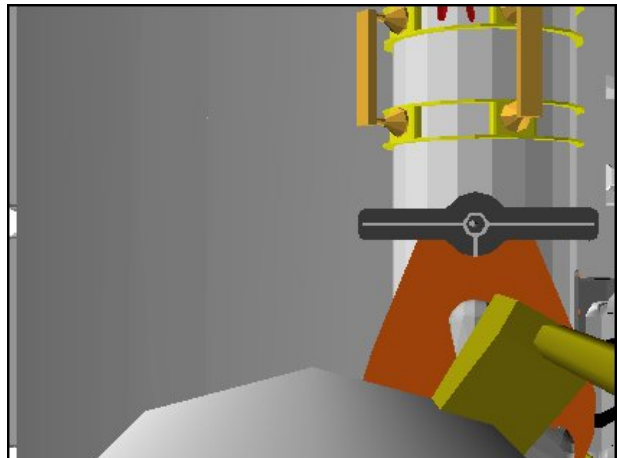

WRIST

**CAUTION**  
Monitor EE tb timing to prevent EE motor burnout

EE MODE – AUTO  
CAPTURE – depress (mom)

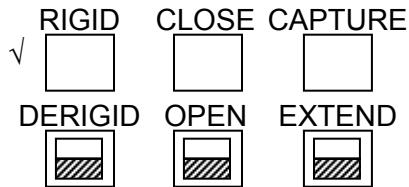

CRITICAL TIMES (28 sec total):  
CAPTURE tb – gray, then  
CLOSE tb – gray, 3 sec max, then  
RIGID tb – gray, 25 sec max

EE MODE – OFF

- \* If manual capture reqd: \*
- \* EE MODE – MAN \*
- \* CAPTURE sw – depress (hold until CLOSE tb-gray, 3 sec max) \*
- \* MAN CONTR – RIGID (hold until RIGID tb-gray, 25 sec max) \*
- \* MODE – OFF \*

BRAKES – ON (tb-ON)  
MODE – not DIRECT  
JOINT – CRIT TEMP

SM 94 PDRS CONTROL

  
 PL ID – ITEM 3 +1 EXEC  
 INIT ID – ITEM 24 +1 EXEC

If digitals available, record POSN/ATT and Joint Angles:

	X	Y	Z	PITCH	YAW	ROLL	PL ID
							1
Expected	-680	+105	-436	0	0	341	1
	SY	SP	EP	WP	WY	WR	
Expected	-90.0	+76.5	-134.6	-40.9	0.0	+110.0	

Review GENERIC END EFFECTOR CUE CARD – SHUTTLE NOT DOCKED OPS

4. CONFIGURE POWER  
 MA73C:C cb MCA PWR AC3 3Φ MID 2 – op  
           √AC2 3Φ MID 2 – op  
 :D           √AC3 3Φ MID 4 – op
- R13L PL BAY MECH PWR SYS (two) – ON

5. STBD MRL RELEASE  
DAP: FREE

SM 94 PDRS CONTROL

  
 RMS STBD – ITEM 2 EXEC (\*)  
 √STBD AFT, MID, FWD REL (six) = 0

NOTE

Expect single motor drive time for MRL release

STBD RMS RETEN LAT – REL (tb-REL) (18 sec max)  
– OFF

If motor drive time > 18 sec, √MCC

SM 94 PDRS CONTROL  
RMS PORT – ITEM 1 EXEC (\*)

6. RECONFIGURE POWER

R13L PL BAY MECH PWR SYS (two) – OFF

MA73C:C cb MCA PWR AC3 3Φ MID 2 – cl  
√AC2 3Φ MID 2 – op  
:D √AC3 3Φ MID 4 – op

If digitals available, record joint angles:

SY	SP	EP	WP	WY	WR

7. MNVR TO OBSS HOVER

A7U CCTV – config for unberth

If SINGLE MODE available:

RHC RATE – VERN (RATE MIN tb-ON)  
BRAKES – OFF (tb-OFF)

MODE – best available

Mnvr to OBSS SJ HOVER posn:

	SY	SP	EP	WP	WY	WR	
OBSS GRAPPLE	-90.0	+76.5	-134.6	-40.9	0.0	+110.0	
1: SP +		+79.8					
2: EP +			-123.1				
3: WP –				-55.7			
OBSS SJ HOVER	-90.0	+79.8	-123.1	-55.7	0.0	+110.0	
	X	Y	Z	PITCH	YAW	ROLL	PL ID
	-680	+126	-496	0	0	341	1

BRAKES – ON (tb-ON)  
MODE – not DIRECT  
JOINT – CRIT TEMP

Start:  
OBSS Grapple

Step 1:  
Drive SP (+) from +76.5° to +79.8°

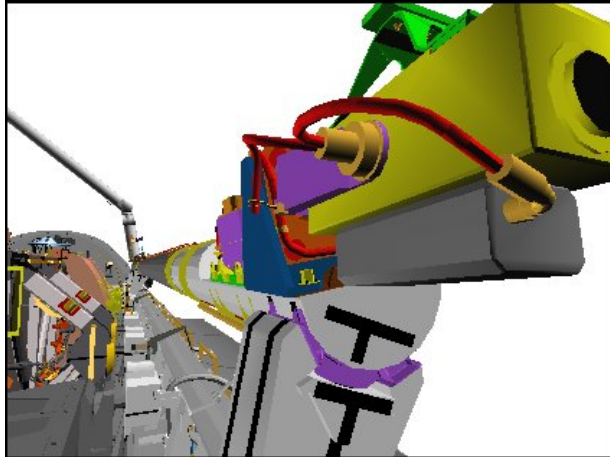

CCTV C (25,5)

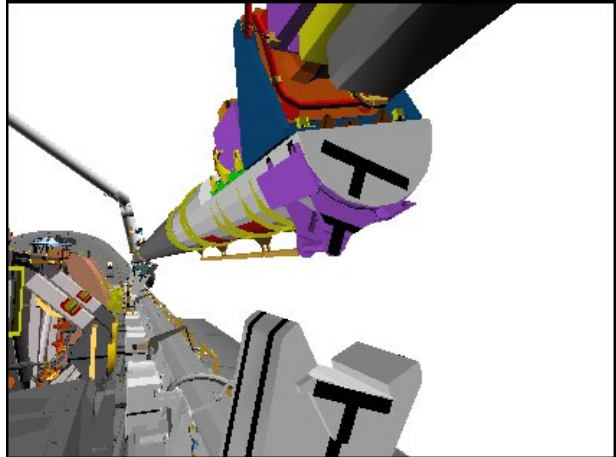

CCTV C (25,5)

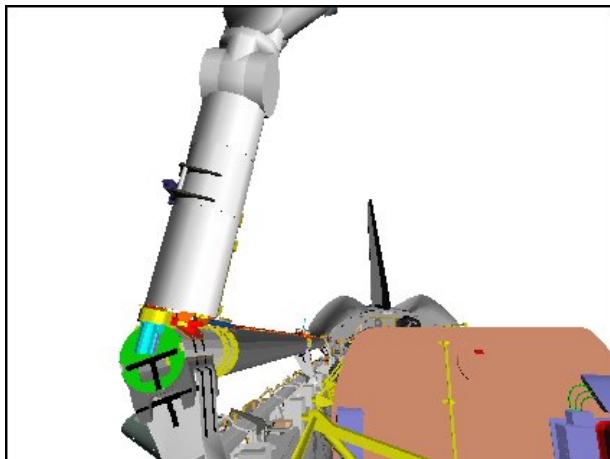

CCTV D (-5,15)

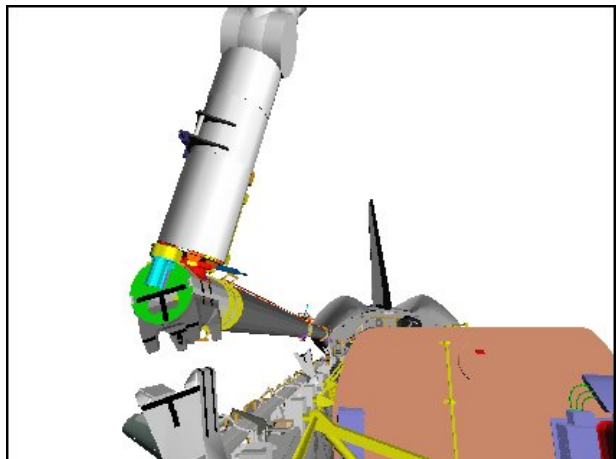

CCTV D (-5,15)

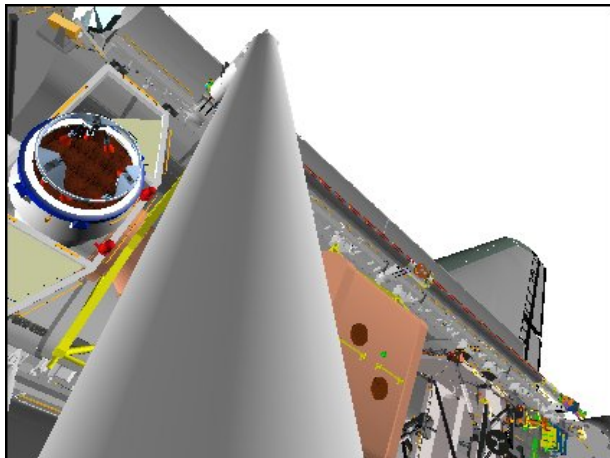

ELBOW (5,-30)

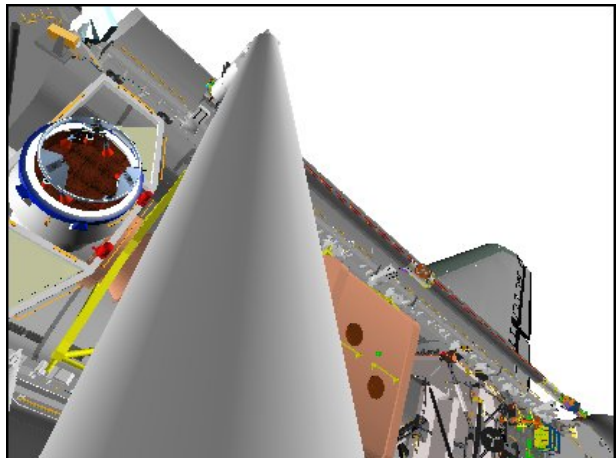

ELBOW (5,-30)

Step 2:  
Drive EP (+) from  $-134.6^{\circ}$  to  $-123.1^{\circ}$

Step 3:  
Drive WP (-) from  $-40.9^{\circ}$  to  $-55.7^{\circ}$

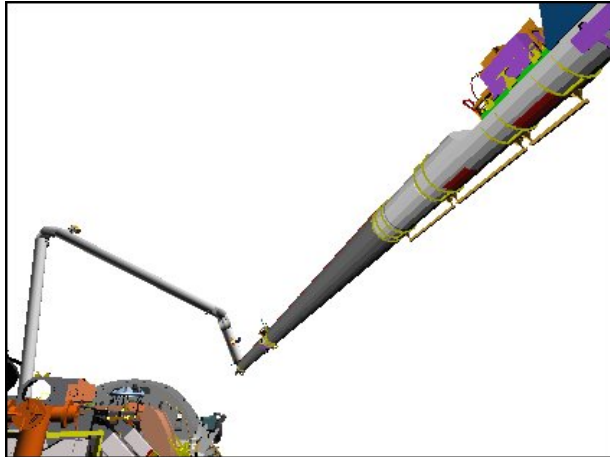

**CCTV C (15,25)**

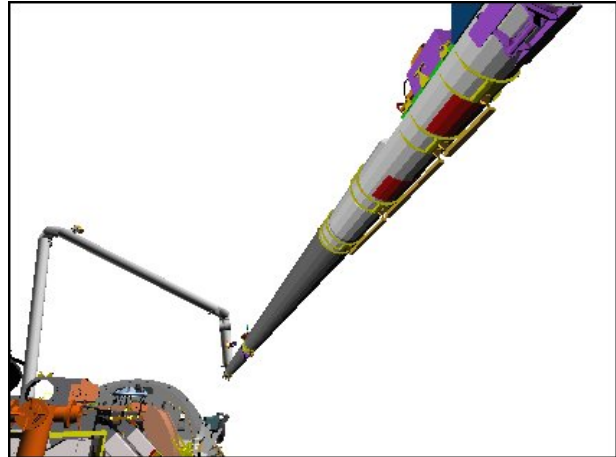

**CCTV C (15,25)**

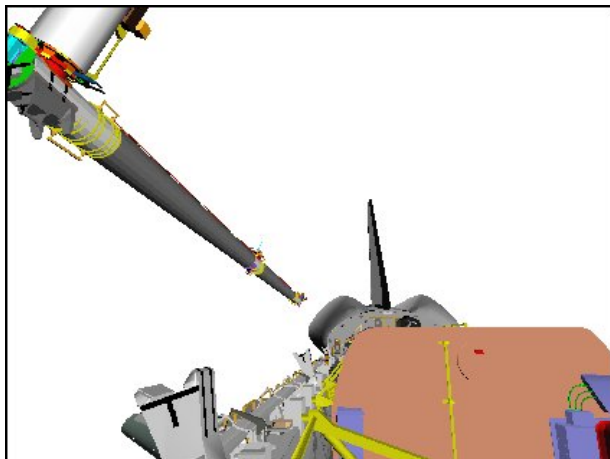

**CCTV D (-5,15)**

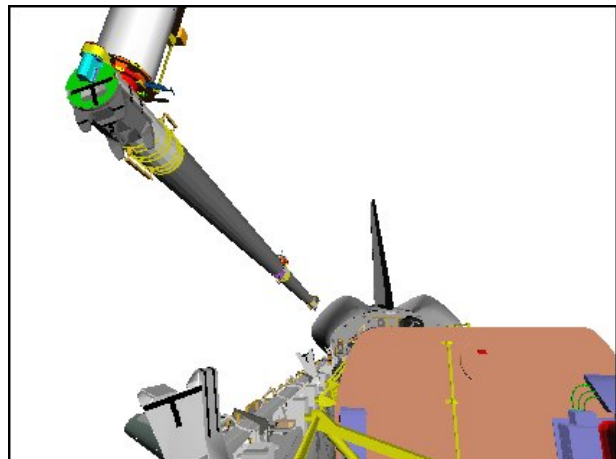

**CCTV D (-5,15)**

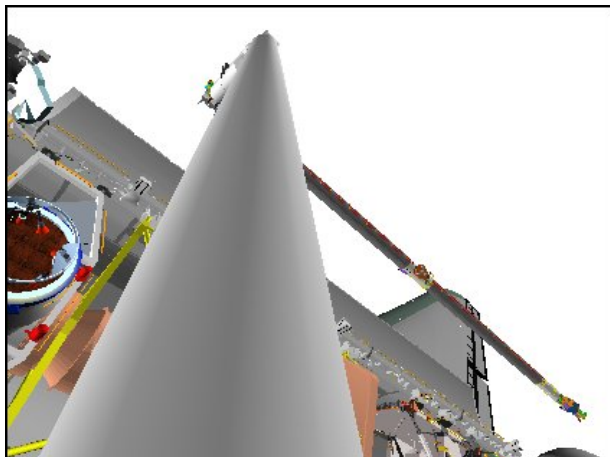

**ELBOW (5,-30)**

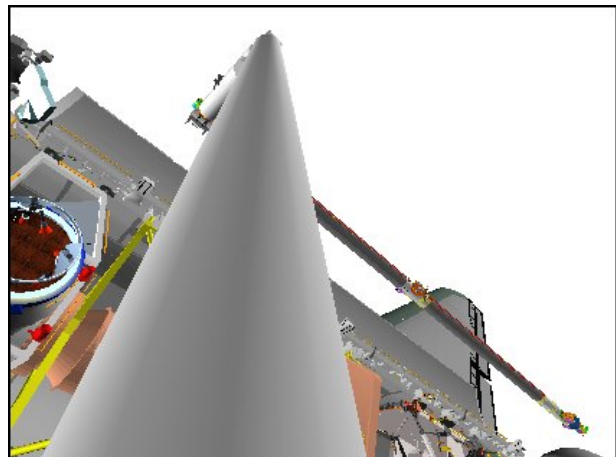

**ELBOW (5,-30)**

DAP: A14/AUTO/VERN(ALT)

In the following P/TV procedure, start 15 min timer upon applying SPEE power and inform MCC when timer is started:

Perform ACTIVATION (LDRI/ITVC Cue Card, PHOTO/TV)

SSP1      √APCU 1,2 CONV (two) – OFF (tb-bp)

Perform LCH ACTIVATION (LCS Cue Card, PHOTO/TV)

Perform LCC ACTIVATION (LCS Cue Card, PHOTO/TV)

A7U      8. RESET PTU  
MON2 ← PL2

CAMR CMD PAN/TILT – HI RATE

PAN      – L (to hard stop)

TILT      – UP (to hard stop)

PAN/TILT – RESET, HI RATE (LO within 10°)

PAN: +103 (right)

TILT: -260 (down)

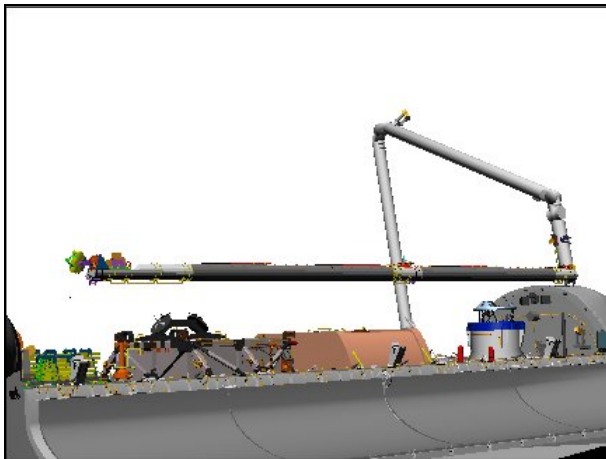

**BIRD'S EYE**

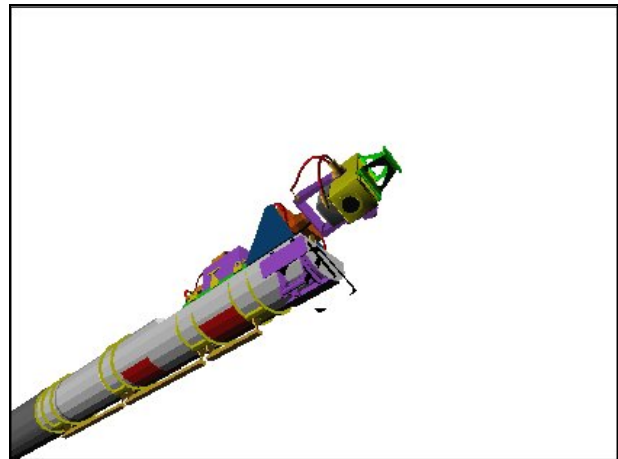

**CCTV C (50,50)**

9. LDRI CALIBRATION

Verify 15 min SPEE warmup power timer expired

MUX 1 L ← MIDDECK

a. Mode 3

LDRI MODE 3 pb – push (LDRI video)

MON 2 ← PL2

PAN/TILT to match LDRI view shown below

Note PAN/TILT: \_\_\_\_\_.\_\_\_\_

MON2 ← not PL2

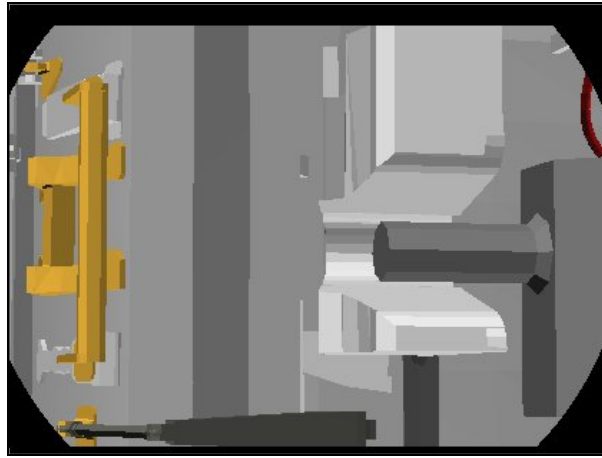

**LDRI (103,-260)**

If LDRI calibration view of STBD sill presents unacceptable specular reflections,

A7U PAN: +110 (right)  
TILT: -220 (up)

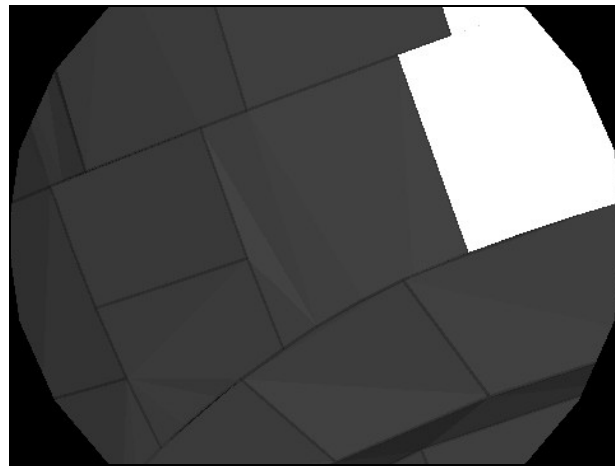

**LDRI (110,-220)**

L10(VTR)

REC pb – push, hold  
PLAY pb – push, simo (red ●)

NOTE

Wait for MCC GO before proceeding with calibration

Record for 30 sec

STOP pb – push (no red ●)

b. Mode 4

MUX 1 L ← MIDDECK

A7U

LDRI MODE 4 pb – push (brighter LDRI video)

L10(VTR)

REC pb – push, hold  
PLAY pb – push, simo (red ●)

Record for 30 sec

STOP pb – push (no red ●)



A7U c. Mode 5  
LDRI MODE 5 pb – push (flickering LDRI video)

L10(VTR) REC pb – push, hold  
PLAY pb – push, simo (red ●)

Record for 30 sec

STOP pb – push (no red ●)

A7U d. Mode 6  
LDRI MODE 6 pb – push (brighter flickering LDRI video)

L10(VTR) REC pb – push, hold  
PLAY pb – push, simo (red ●)

Record for 30 sec

STOP pb – push (no red ●)

10. PROCEED TO SJ FLAT FIELDS  
On MCC GO, go to OBSS SJ FLAT FIELDS

## OBSS SJ BERTH

<b>WARNING</b> For UNDOCKED ops only
---

### NOTE

Stbd MPMs assumed deployed

- A7U
1. SETUP  
CCTV – perform PAN/TILT RESET for PLB cameras  
– config for berth

SM 94 PDRS CONTROL
--------------------

PL ID – ITEM 3 +1 EXEC  
INIT ID – ITEM 24 +1 EXEC

2. OBSS SJ HOVER

Verify mnvr to OBSS SJ HOVER posn complete:

X	Y	Z	PITCH	YAW	ROLL	PL ID
-680	+126	-496	0	0	341	1
SY	SP	EP	WP	WY	WR	
-90.0	+79.8	-123.1	-55.7	0.0	+110.0	

√BRAKES – ON (tb-ON)

√MODE – not DIRECT

√JOINT – CRIT TEMP

√STBD RMS HTR A,B (two) – OFF

OBSS Hover

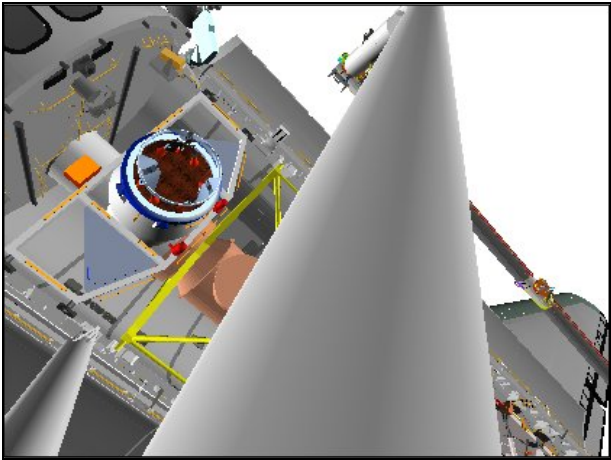

**ELBOW (-15,-35)**

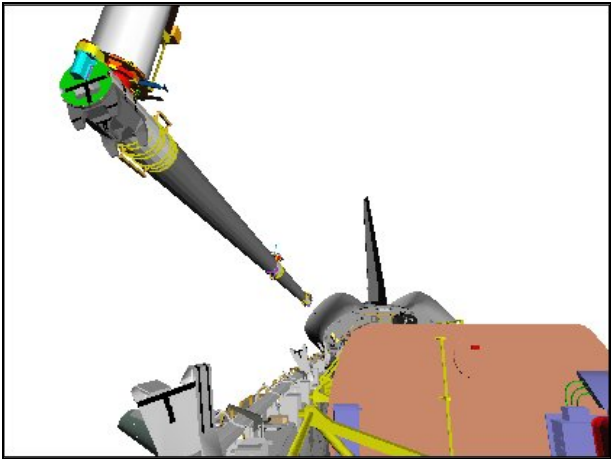

**CCTV D (-5,15)**

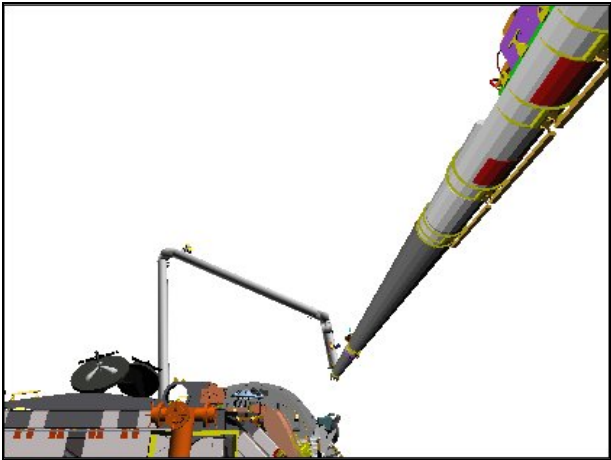

**CCTV C (0,25)**

A7U 3. STOW PTU  
MON2 ← PL2

CAMR CMD PAN/TILT – HI RATE

PAN – L (to hard stop)

TILT – UP (to hard stop)

PAN/TILT – RESET, HI RATE (LO within 10°)

PAN: +108 (right)

TILT: -175 (down)

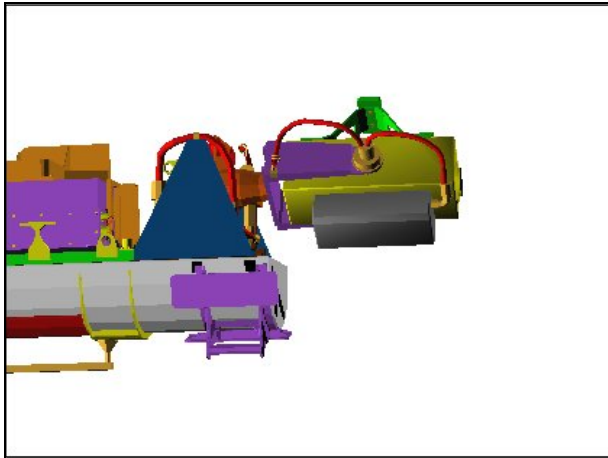

**CCTV B (82,16) HFOV: 15.0**

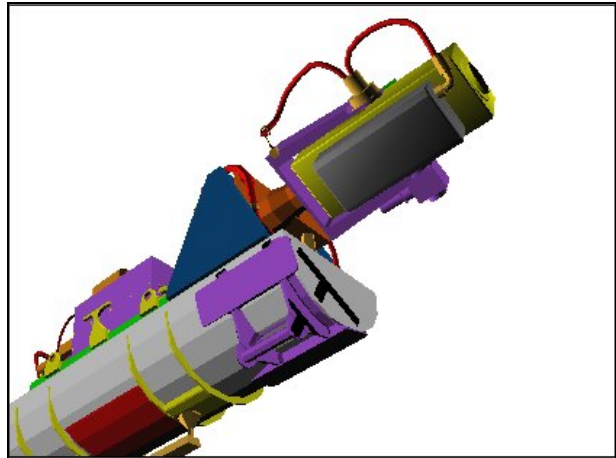

**CCTV C (50,50) HFOV: 40.0**

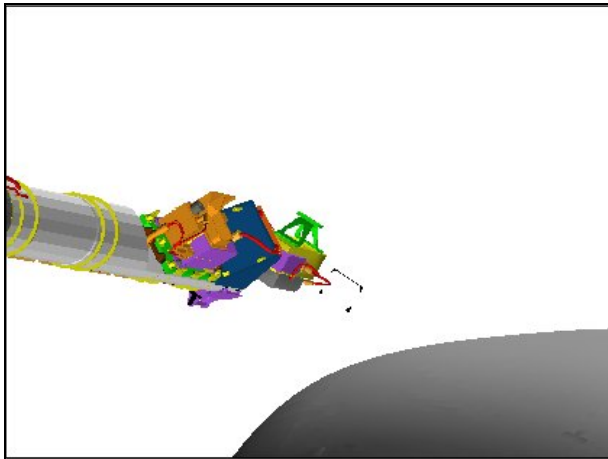

**ELBOW (52,-45) HFOV: 9.8 (full-in)**

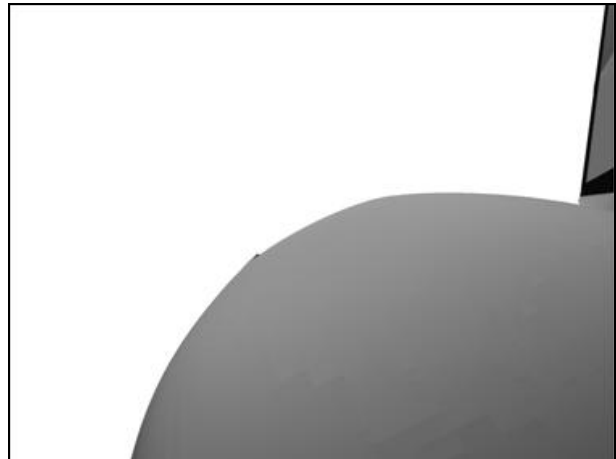

**OBSS ITVC (108,-175) HFOV: 53.8 (full-out)**

Perform LCC DEACTIVATION (LCS Cue Card, PHOTO/TV)

Perform LCH DEACTIVATION (LCS Cue Card, PHOTO/TV)

**CAUTION**

STBD RMS HTR power must be applied within  
90 min to prevent sensor package damage

Perform DEACTIVATION (LDRI/ITVC Cue Card, PHOTO/TV)

A7U 4. OBSS BERTH  
 CCTV – configure as required  
 ZOOM – full OUT

SM 94 PDRS CONTROL  
 RMS STBD – ITEM 2 EXEC (\*)

A6U DAP: FREE

RHC If SINGLE MODE available:  
 RATE – VERN (RATE MIN tb-ON)  
 BRAKES – OFF (tb-OFF)

MODE – best available

Mnvr to OBSS SJ BERTH posn:

	SY	SP	EP	WP	WY	WR	
OBSS SJ HOVER	-90.0	+79.8	-123.1	-55.7	0.0	+110.0	
1: SY +	-89.8						
2: WY -					-0.5		
3: WR -						+109.8	
4: WP +				-40.5			
5: EP -			-134.7				
6: SP -		+76.5					
OBSS SJ BERTH	-89.8	+76.5	-134.7	-40.5	-0.5	+109.8	
	X	Y	Z	PITCH	YAW	ROLL	PL ID
	-680	+105	-436	359.5	0	341	1

√STBD RMS R-F-L tb (three) – gray  
 MODE – not DIRECT

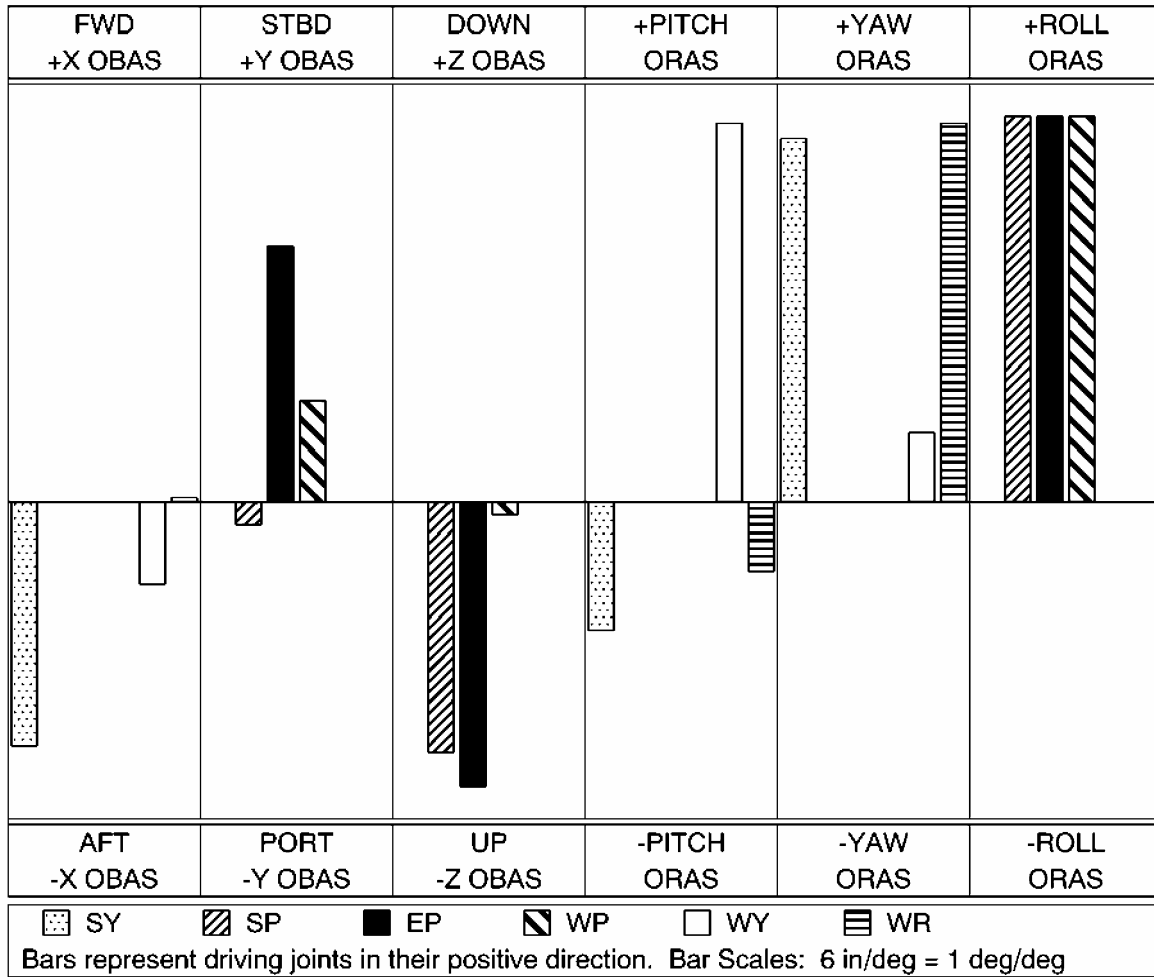

To get:	Drive:	To get:	Drive:
+X (fwd)	-SY, -WY	+PITCH	+WY
+Y (stbd)	+EP, +WP	+YAW	+WR, +SY
+Z (down)	-SP, -EP	+ROLL	+WP, +SP

Driving:	Results In:	Driving:	Results In:
+SY	-X (aft), +YAW	+WP	+Y (stbd), +ROLL
+SP	-Z (up), +ROLL	+WY	-X (aft), +PITCH
+EP	-Z (up), +ROLL	+WR	+YAW

$\Delta$ SY	$\Delta$ SP	$\Delta$ EP	$\Delta$ WP	$\Delta$ WY	$\Delta$ WR
+0.0	-3.3	-11.5	+14.8	+0.0	+0.0

Start:  
OBSS Hover

Step 1:  
Drive SY (+) from  $-90.0^\circ$  to  $-89.8^\circ$

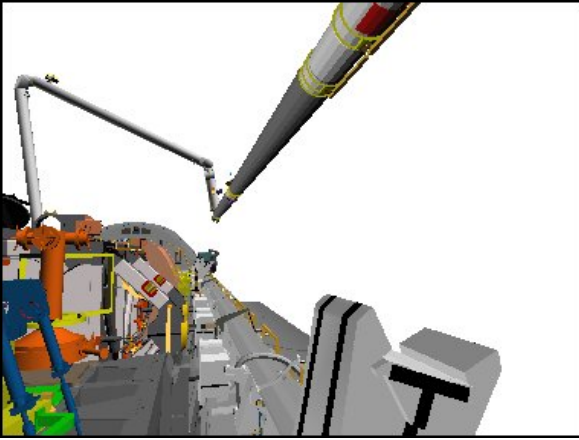

**CCTV C (15,5)**

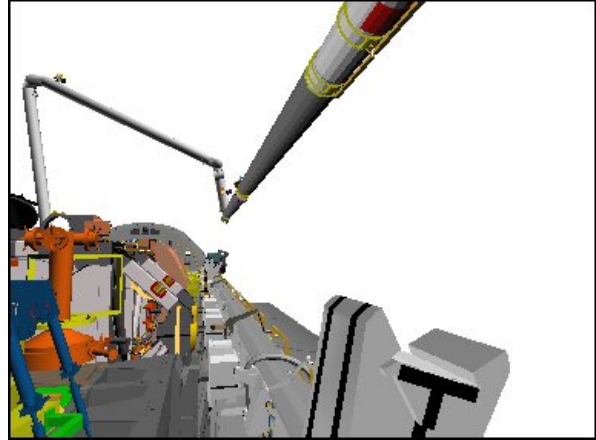

**CCTV C (15,5)**

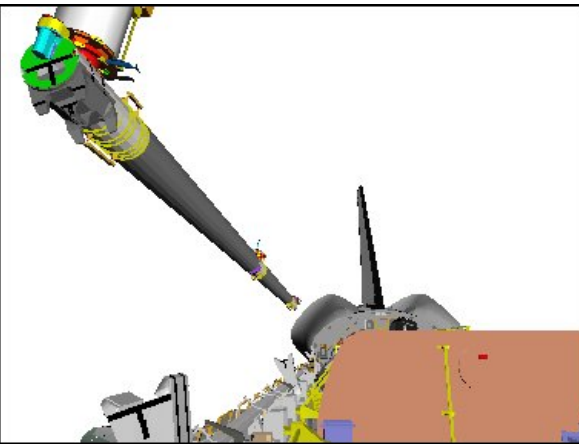

**CCTV D (-5,15)**

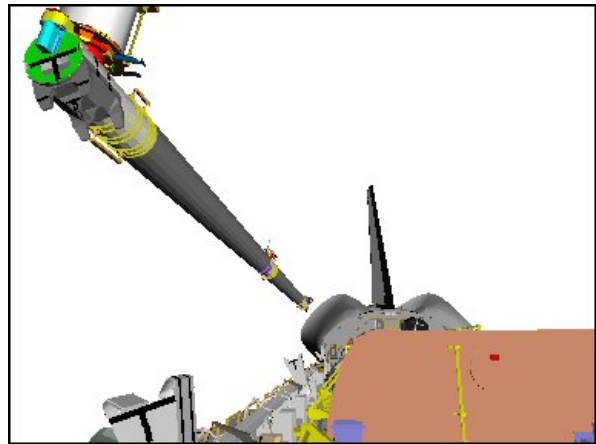

**CCTV D (-5,15)**

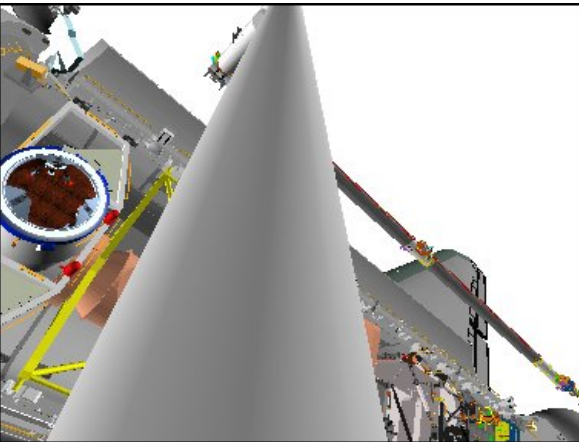

**ELBOW (0,-35)**

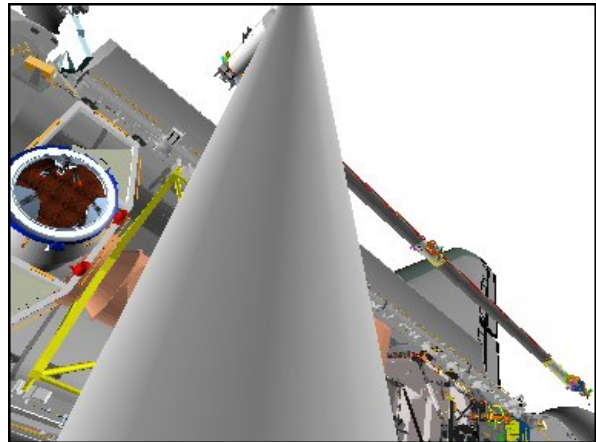

**ELBOW (0,-35)**

Step 2:

Drive WY (-) from 0.0° to -0.5°

Step 3:

Drive WR (-) from +110.0° to +109.8°

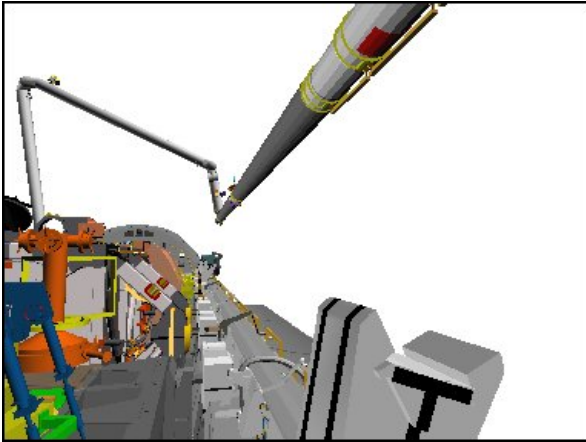

**CCTV C (15,5)**

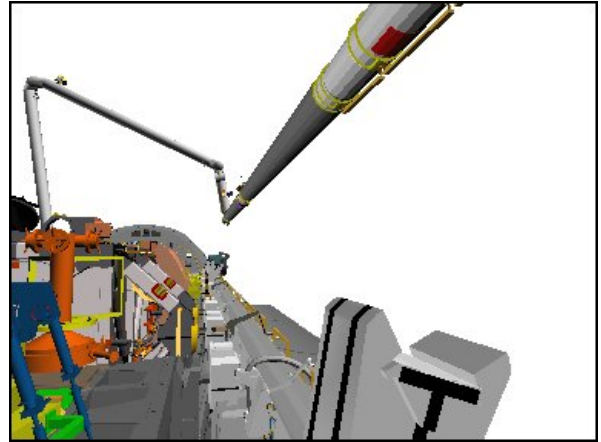

**CCTV C (30,-10)**

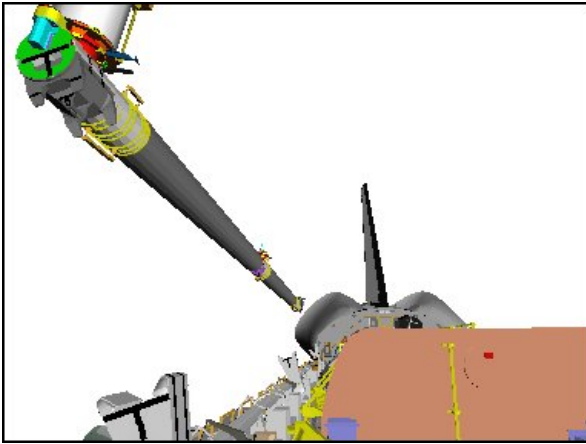

**CCTV D (-5,15)**

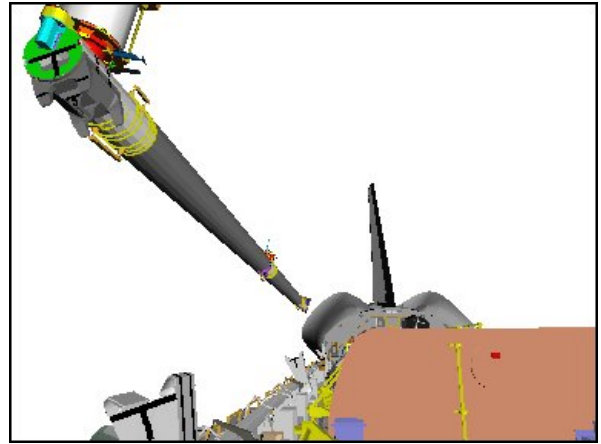

**CCTV D (-15,0)**

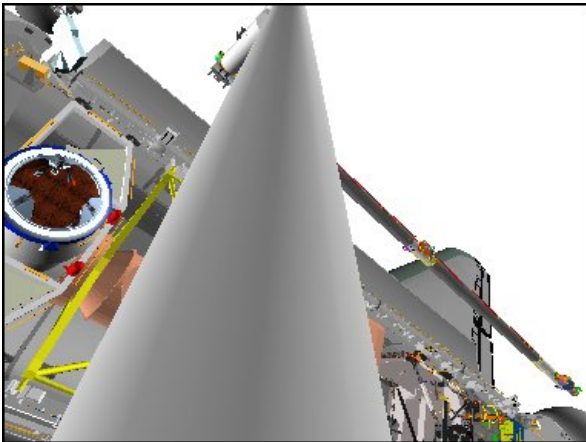

**ELBOW (5,-30)**

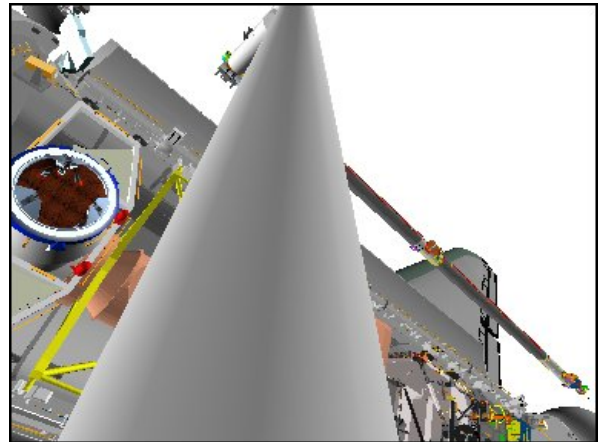

**ELBOW (-7,-12)**



Step 4 :

Drive WP (+) from  $-55.7^\circ$  to  $-40.5^\circ$

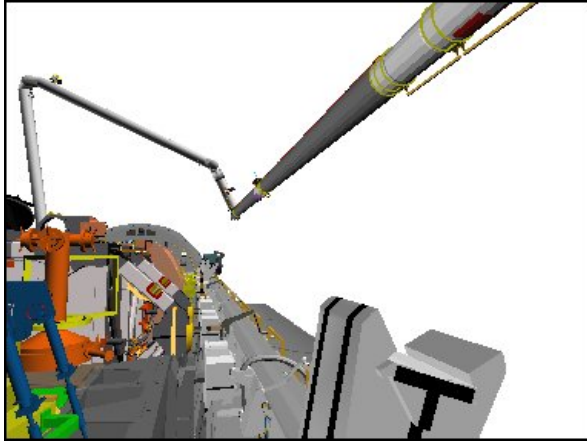

**CCTV C (15,5)**

Step 5:

Drive EP (-) from  $-123.1^\circ$  to  $-134.7^\circ$

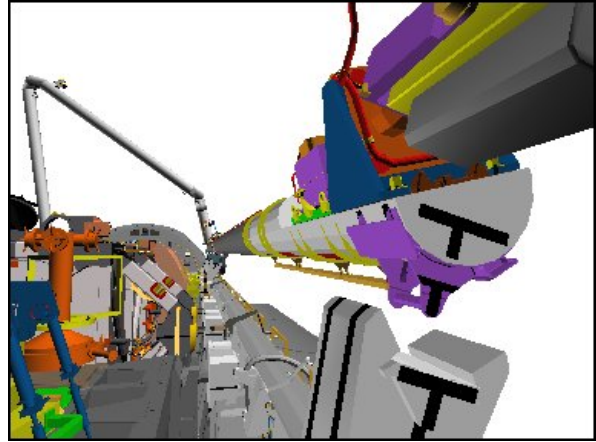

**CCTV C (15,5)**

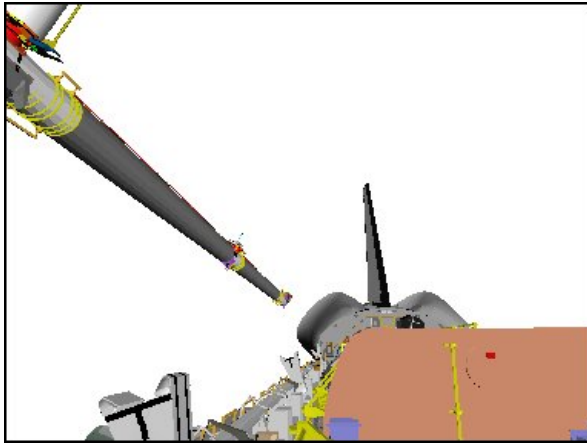

**CCTV D (-5,15)**

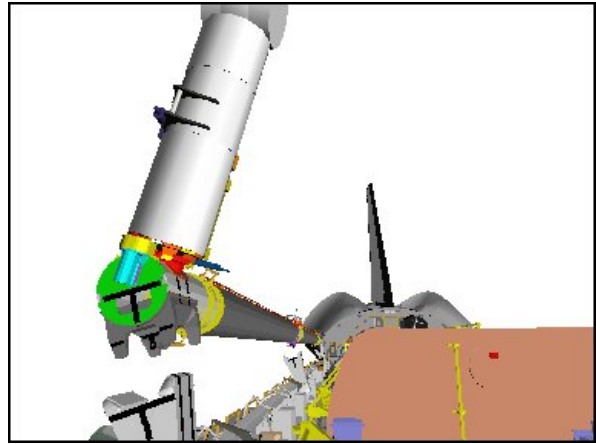

**CCTV D (-5,15)**

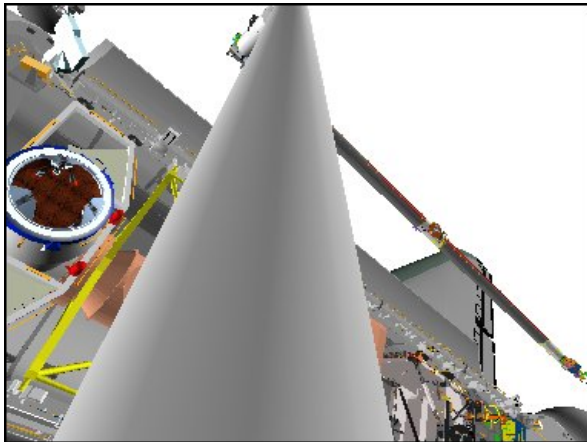

**ELBOW (0,-35)**

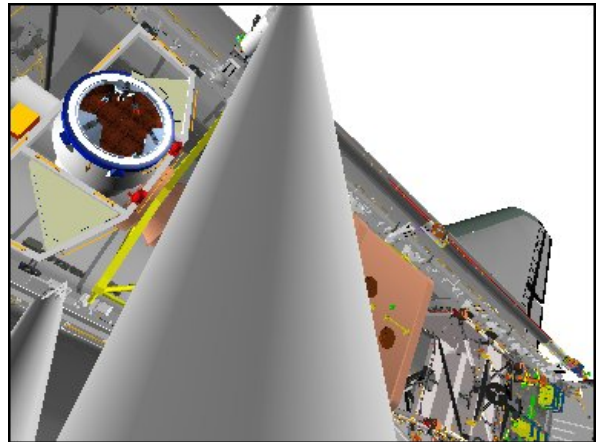

**ELBOW (5,-30)**

Step 6:

Drive SP (-) from +79.8° to +76.5°

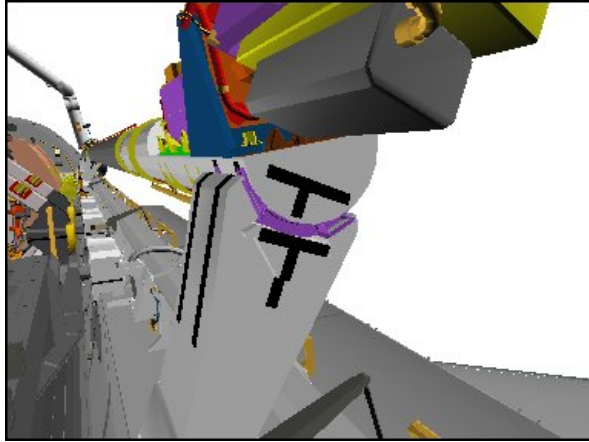

**CCTV C (30,-10) HFOV 60.0**

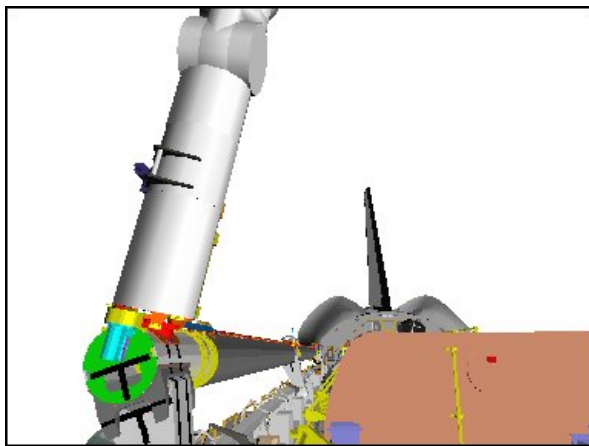

**CCTV D (-15,0) HFOV 35.0**

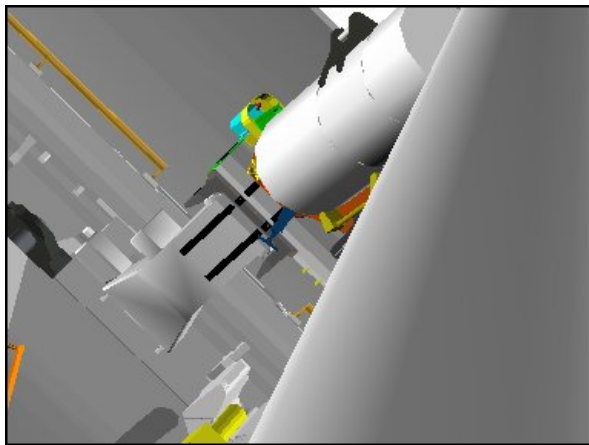

**ELBOW (-7,-12) HFOV 15.0**

5. CONFIGURE POWER  
MA73C:C    cb MCA PWR AC3 3Φ MID 2 – op  
                  √AC2 3Φ MID 2 – op  
          :D            √AC3 3Φ MID 4 – op

R13L            PL BAY MECH PWR SYS (two) – ON

6. STBD MRL LATCH  
RATE – COARSE (RATE MIN tb-OFF)  
SM 94 PDRS CONTROL  
√STBD AFT, MID, FWD LAT (six) = 0

If SINGLE MODE available:  
    AUTO BRAKE INH – ITEM 10 EXEC (\*)

NOTE

    Expect single motor drive time for MRL latching

STBD RMS RETEN LAT – LAT (tb-LAT) (18 sec max)  
    – OFF

If motor drive time > 18 sec, √MCC

SM 94 PDRS CONTROL  
RMS PORT – ITEM 1 EXEC (\*)

If TEST MODE available,  
    MODE – TEST, ENTER  
    Wait 5 sec

√BRAKES – ON (tb-ON)  
JOINT    – CRIT TEMP

If SINGLE MODE available:  
SM 94 PDRS CONTROL  
    AUTO BRAKE ENA – ITEM 9 EXEC (\*)

A6U            DAP: A1/AUTO/VERN(ALT)

7. RECONFIGURE POWER  
R13L            PL BAY MECH PWR SYS (two) – OFF

MA73C:C    cb MCA PWR AC3 3Φ MID 2 – cl  
                  √AC2 3Φ MID 2 – op  
          :D            √AC3 3Φ MID 4 – op

8. OBSS UNGRAPPLE  
A7U            CCTV – configure for ungrapple  
                  – attach overlays as needed  
                  – RMS WRIST, ZOOM: 34.0 HFOV  
                                FOCUS: 5 ft

SM 94 PDRS CONTROL  
PL ID        – ITEM 3 +0 EXEC  
INIT ID – ITEM 24 +0 EXEC

RHC RATE – VERN (RATE MIN tb-ON)  
 BRAKES – OFF (tb-OFF)

MODE – best available

A6U DAP: VERN(FREE)

**CAUTION**  
 Monitor EE tb timing to prevent EE motor burnout

EE MODE – MAN

MAN CONTR – DERIGID (hold until DERIGID tb-gray, 5 sec max)

RELEASE sw – depress (hold until OPEN tb-gray, 3 sec max)

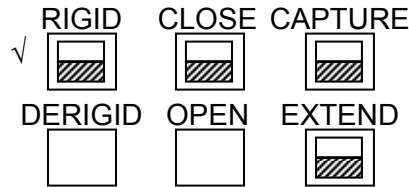

Drive SP (+) until arm clear of grapple pin

EE MAN CONTR – DERIGID (hold until EXTEND tb-gray, 20 sec max)

MODE – OFF

STBD RMS HTR A,B (two) – AUTO

A6U EVENT TIMER CNTL – STOP

DAP: A1/AUTO/VERN(ALT)

Mnvr to SJ PRE-GRAPPLE posn:

	SY	SP	EP	WP	WY	WR	
OBSS SJ BERTH	-89.8	+76.5	-134.7	-40.5	-0.5	+109.8	
1: SP +		+87.9					
2: EP +			-129.8				
3: WP -				-57.0			
4: SY -	-90.0						
5: WY +					0.0		
6: WR +						+110.0	
OBSS SJ PRE-GRAPPLE	-90.0	+87.9	-129.8	-57.0	0.0	+110.0	
	X	Y	Z	PITCH	YAW	ROLL	PL ID
	-680	+96	-513	270	350	1	0

BRAKES – ON (tb-ON)

MODE – not DIRECT

JOINT – CRIT TEMP

Start:  
OBSS Berth

Step 1:  
Drive SP (+) from +76.5° to +87.9°

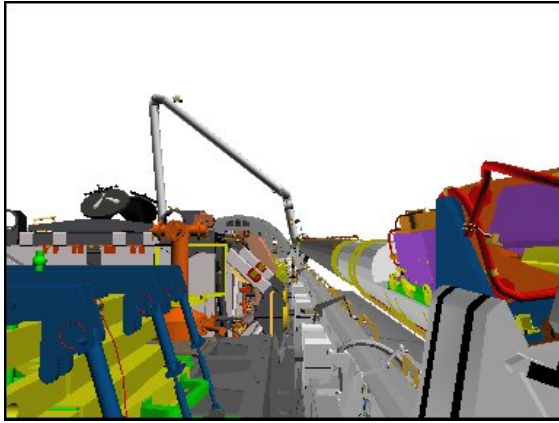

CCTV C (0,5)

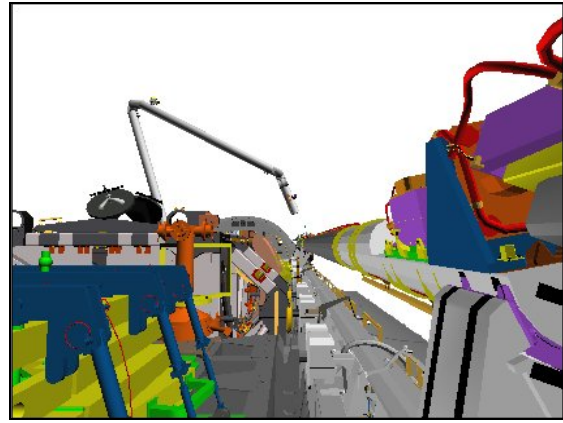

CCTV C (0,5)

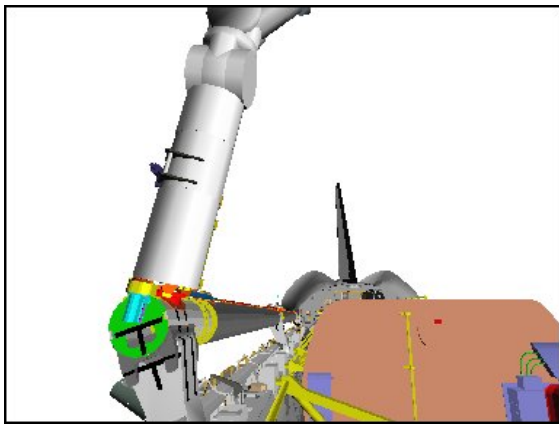

CCTV D (-5,15)

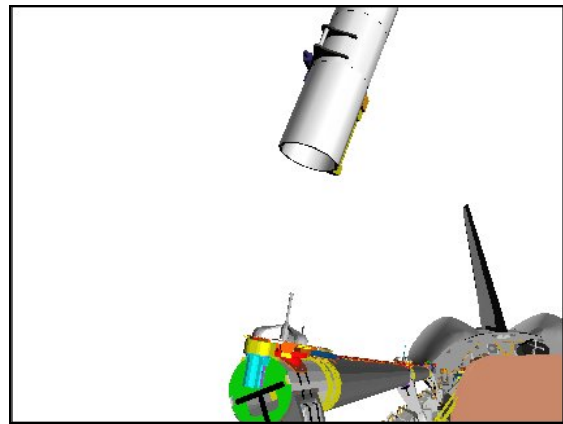

CCTV D (-20,20)

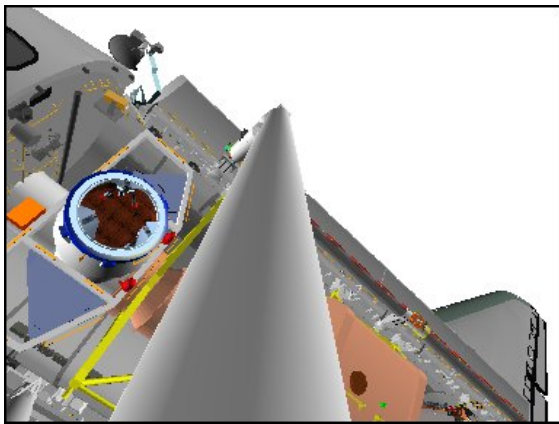

ELBOW (0,20)

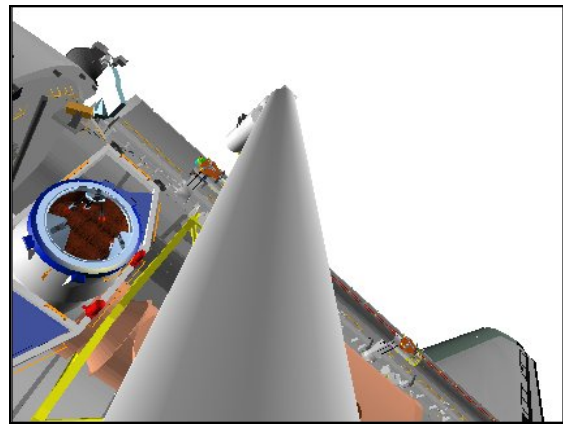

ELBOW (0,20)

Step 2:

Drive EP (+) from  $-134.6^\circ$  to  $-129.8^\circ$

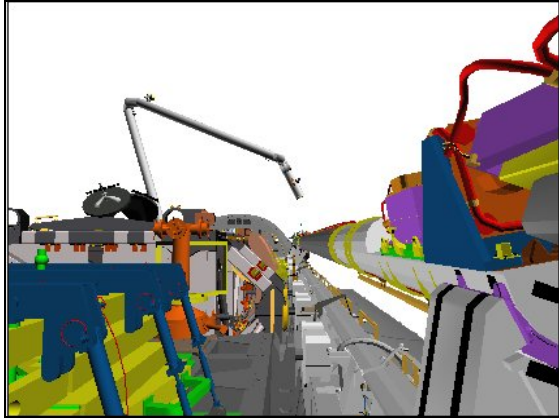

**CCTV C (0,5)**

Step 3:

Drive WP (-) from  $-40.9^\circ$  to  $-57.0^\circ$

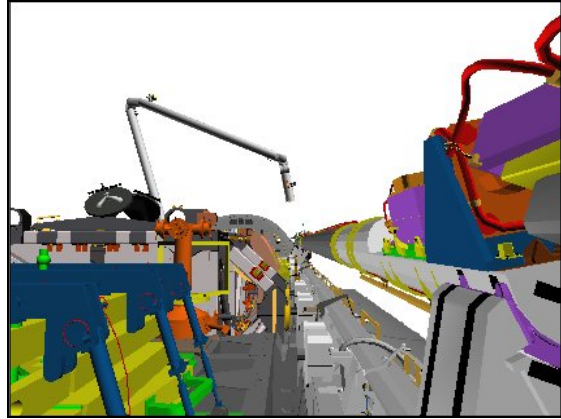

**CCTV C (0,5)**

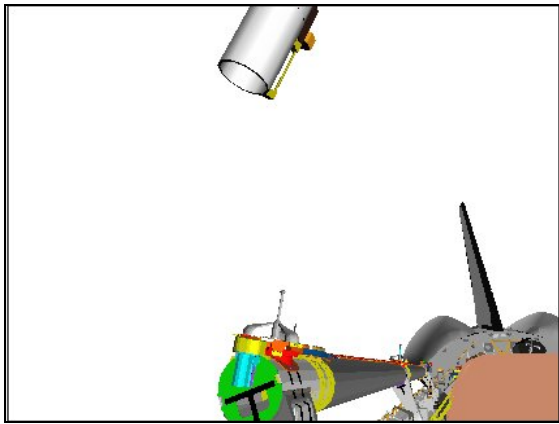

**CCTV D (-20,20)**

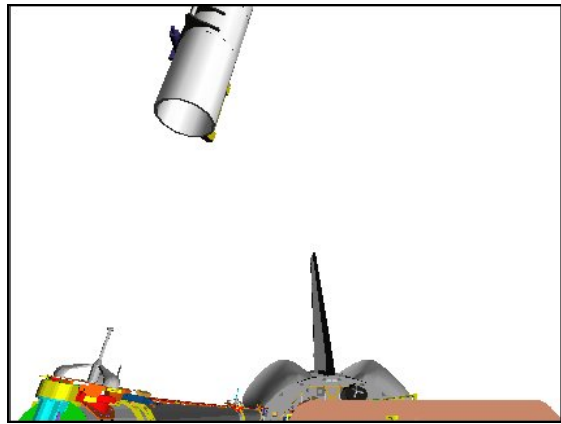

**CCTV D (0,25)**

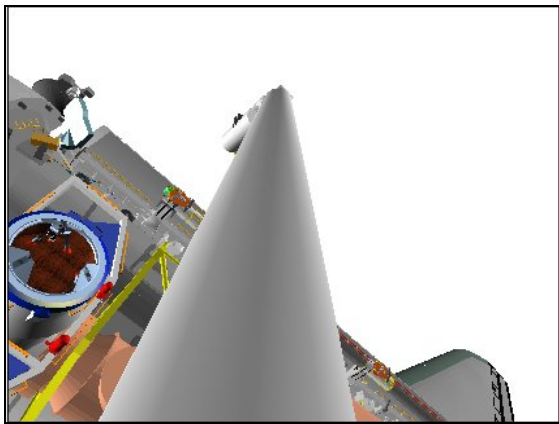

**ELBOW (0,20)**

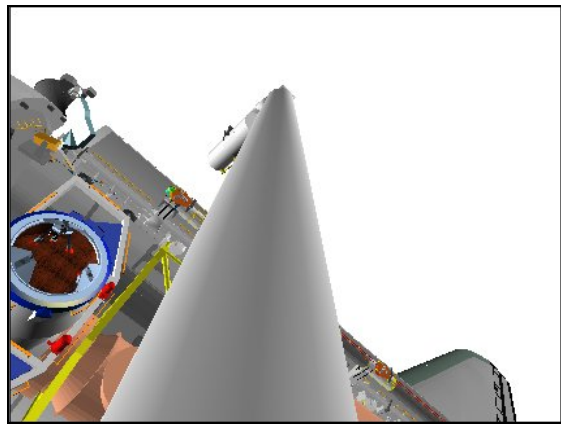

**ELBOW (0,20)**

Step 4:

Drive SY (-) from  $-89.8^\circ$  to  $-90.0^\circ$

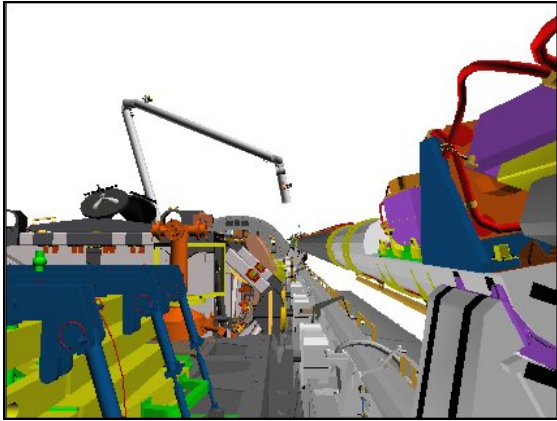

**CCTV C (0,5)**

Step 5:

Drive WY (+) from  $-0.5^\circ$  to  $0.0^\circ$

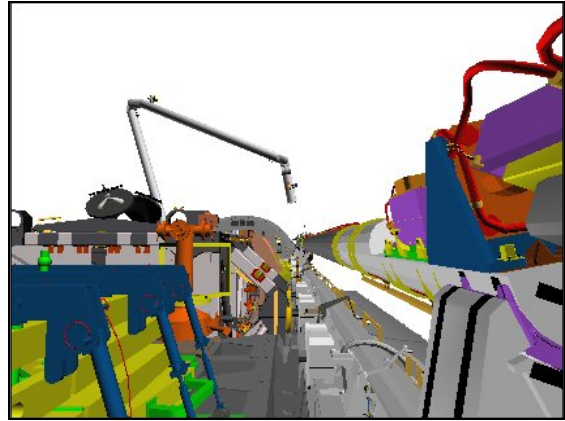

**CCTV C (0,5)**

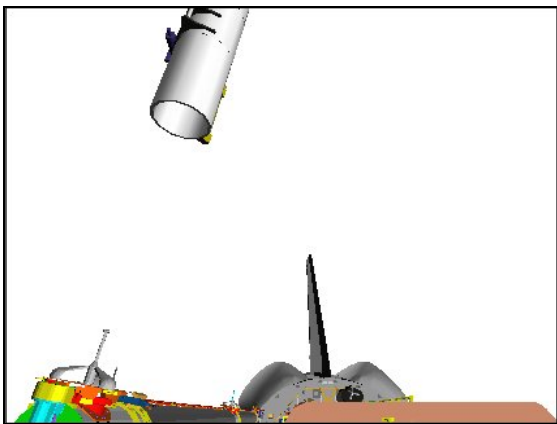

**CCTV D (-20,20)**

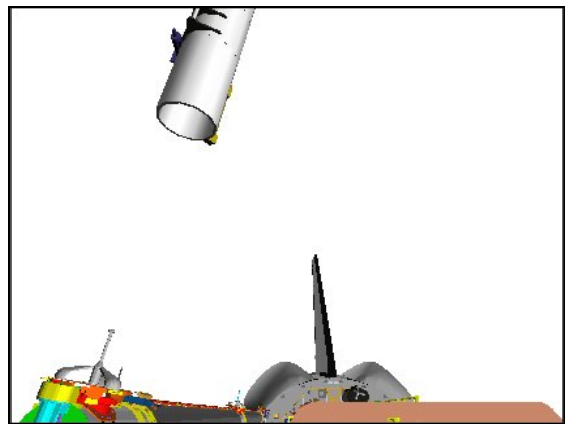

**CCTV D (-20,20)**

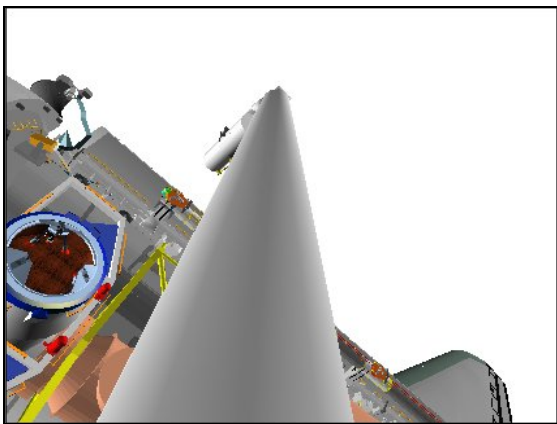

**ELBOW (0,20)**

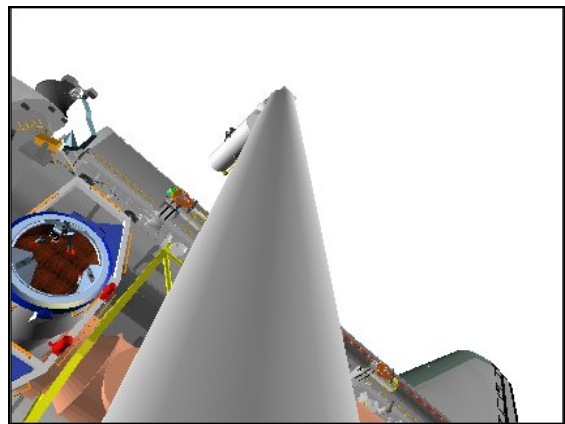

**ELBOW (0,20)**

Step 6:

Drive WP (+) from 109.8° to 110.0°

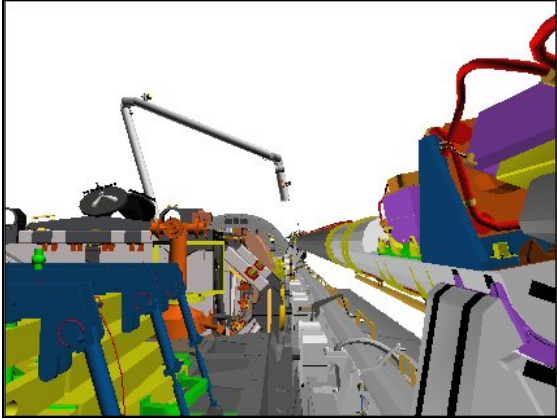

**CCTV C (0,5)**

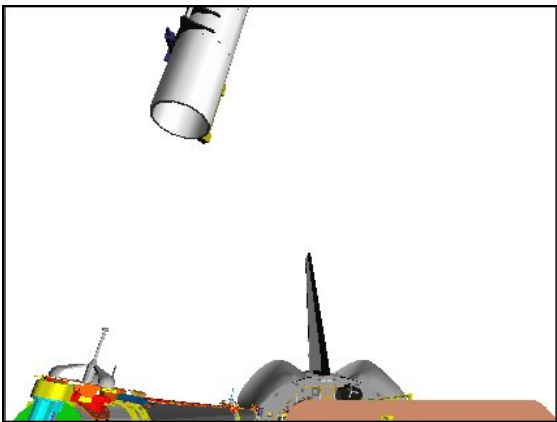

**CCTV D (-20,20)**

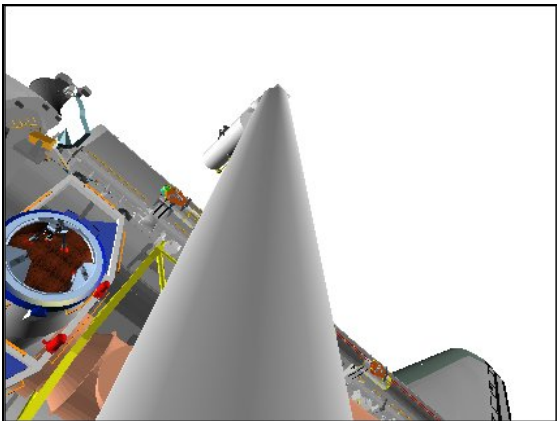

**ELBOW (0,20)**



A7U 9. ARM PRE-CRADLE  
 CCTV – configure as required  
 ZOOM – full OUT

RHC If SINGLE MODE available:  
 RATE – as reqd (VERN within 10 ft)  
 BRAKES – OFF (tb-OFF)

MODE – best available

Mnvr to PRE-CRADLE posn:

	SY	SP	EP	WP	WY	WR	
OBSS SJ	-90.0	+87.9	-129.8	-57.0	0.0	+110.0	
PRE-GRAPPLE				+5.0			
1: WP +							
2: WR –						0.0	
3: EP +			-25.0				
4: SY +	0.0						
5: SP –		+25.0					
PRE-CRADLE	0.0	+25.0	-25.0	+5.0	0.0	0.0	
	X	Y	Z	PITCH	YAW	ROLL	PL ID
	-1261	-146	-551	5	2	0	0

BRAKES – ON (tb-ON)  
 MODE – not DIRECT  
 PARAM – PORT TEMP  
 JOINT – CRIT TEMP

Start:  
OBSS Pre-Grapple

Step 1:  
Drive WP (+) from  $-57.0^\circ$  to  $+5.0^\circ$

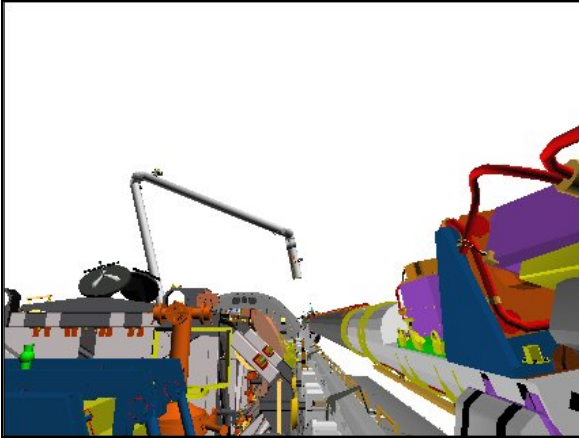

**CCTV C (0,15)**

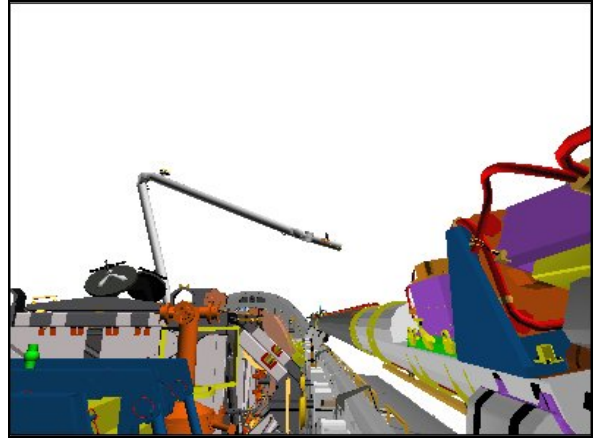

**CCTV C (0,15)**

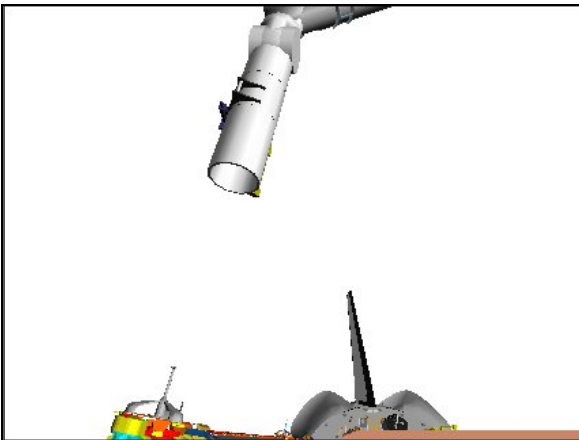

**CCTV D (-5,30)**

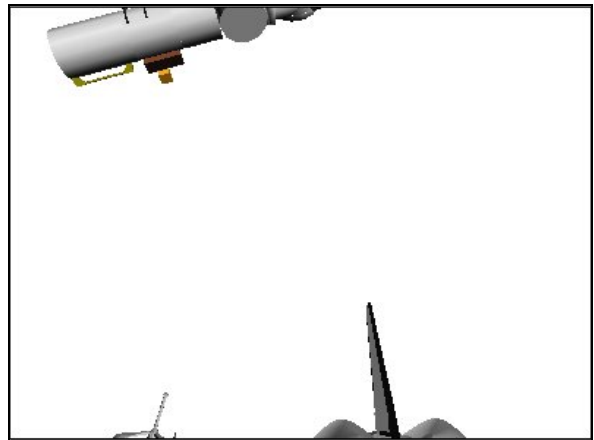

**CCTV D (-5,30)**

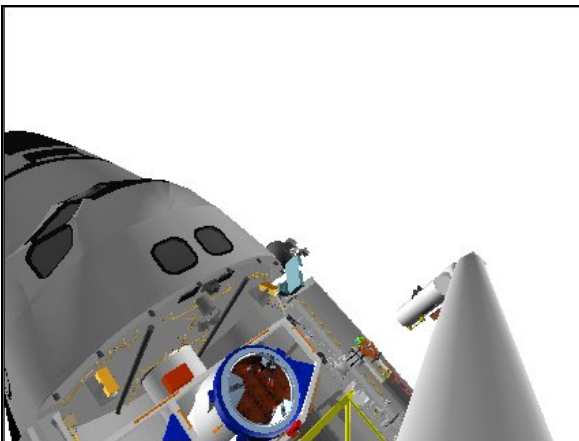

**ELBOW (-25,0)**

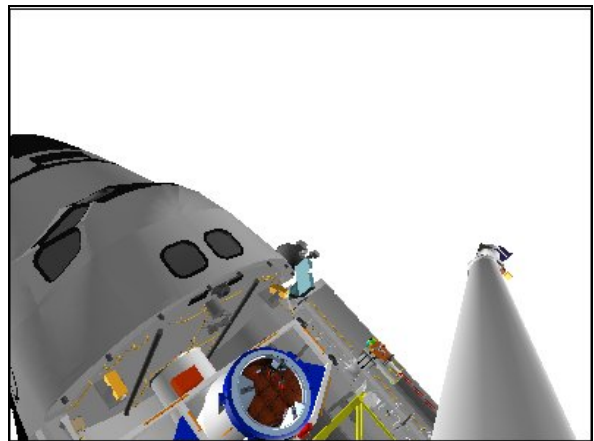

**ELBOW (-25,0)**

Step 2:

Drive WR (-) from +110.0° to 0.0°

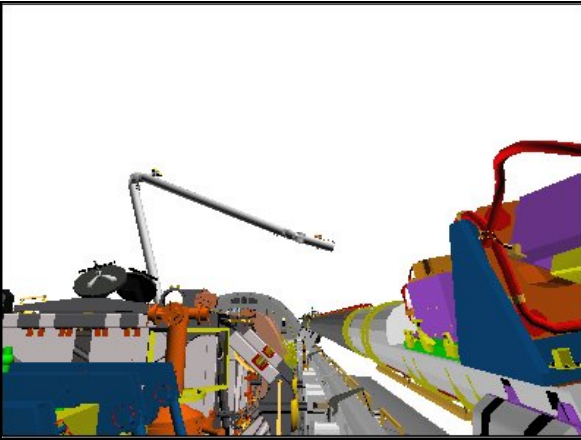

**CCTV C (0,15)**

Step 3:

Drive EP (+) from -129.8° to -25.0°

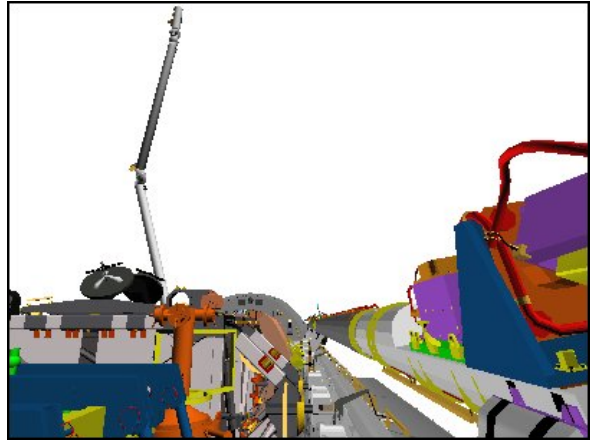

**CCTV C (0,15)**

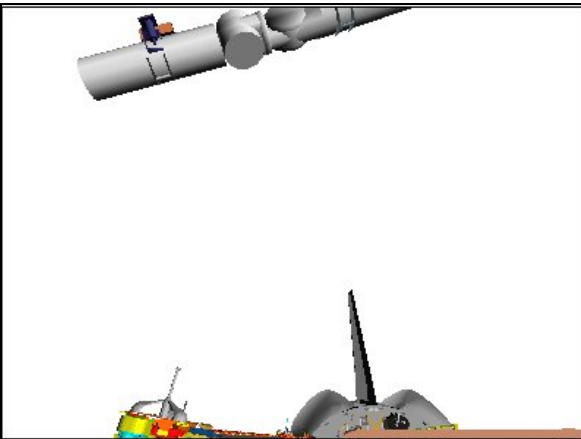

**CCTV D (-5,30)**



**CCTV B (0,25)**

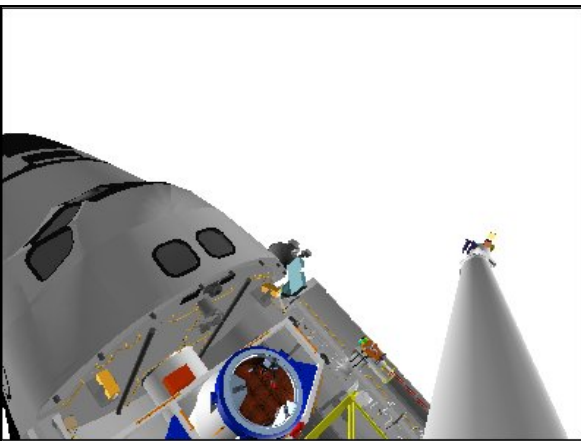

**ELBOW (-25,0)**



**CCTV A (0,45)**

Step 4:

Drive SY (+) from  $-90.0^\circ$  to  $0.0^\circ$

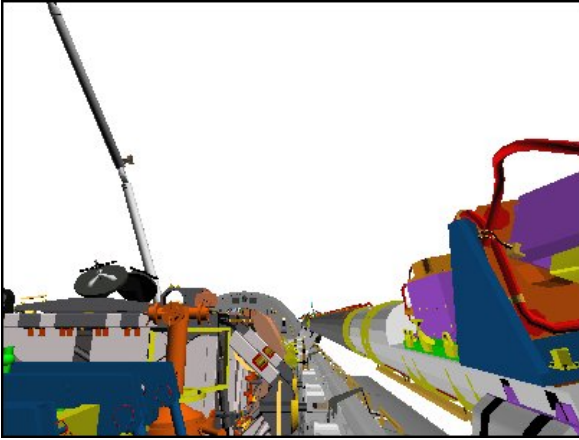

**CCTV C (0,15)**

Step 5:

Drive SP (-) from  $+87.9^\circ$  to  $+25.0^\circ$

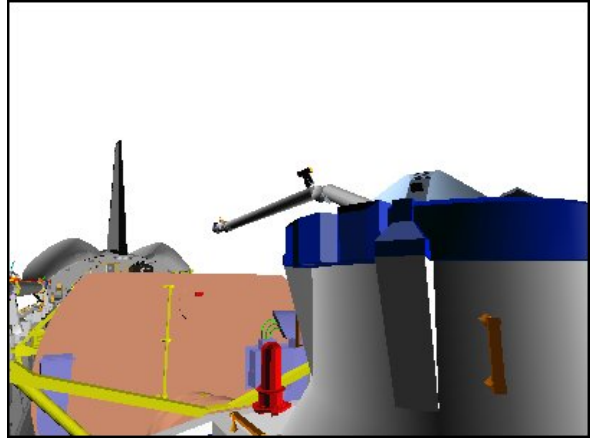

**CCTV D (30,10)**

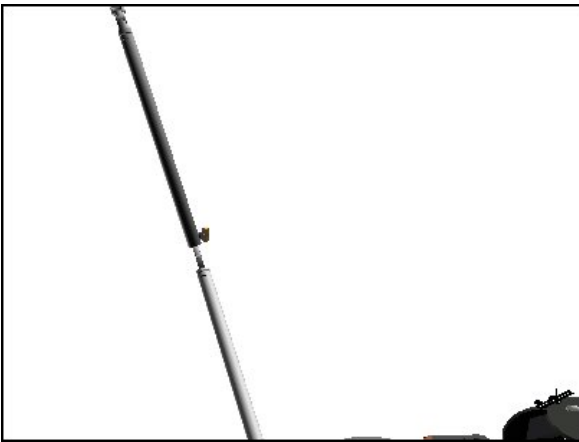

**CCTV B (0,25)**

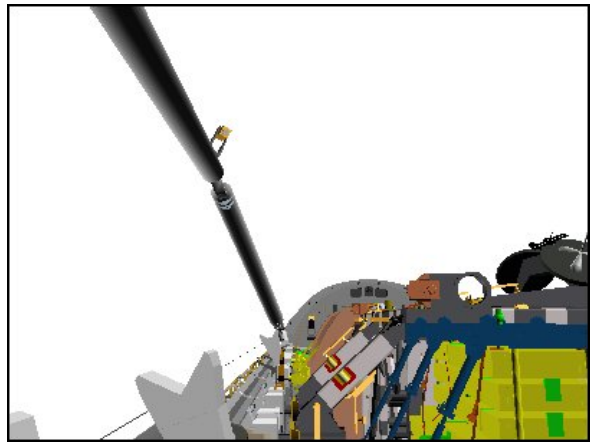

**CCTV B (0,10)**

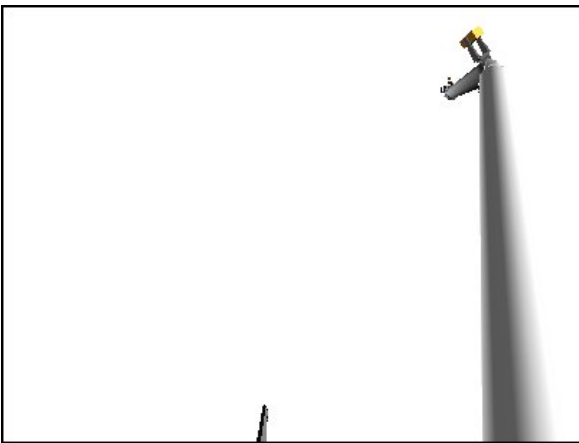

**CCTV A (0,45)**

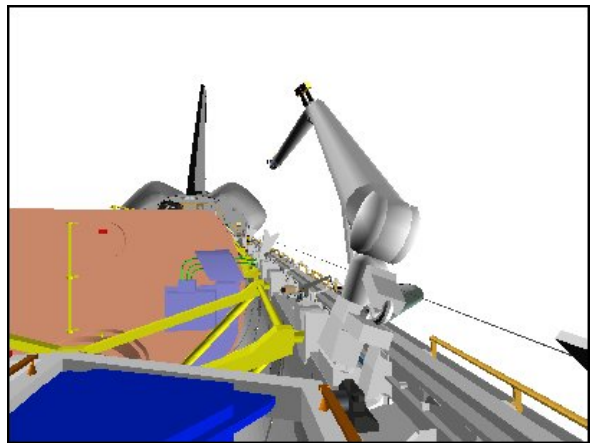

**CCTV A (10,0)**

# OBSS SJ HANDOFF FROM SSRMS TO SRMS

## 1. SETUP

SM 94 PDRS CONTROL

√PL ID, ITEM 3: 0

√INIT ID, ITEM 24: 0

A7U CCTV – perform PAN/TILT RESET for PLB cameras  
 – config as reqd  
 – fully zoom out for SJ pictures

## 2. SJ OBSS PRE-GRAPPLE AT HANDOFF MANEUVER

If SINGLE MODE available:

RHC RATE – as reqd (VERN within 10 ft)  
 BRAKES – OFF (tb-OFF)

MODE – best available

Mnvr to OBSS PRE-GRAPPLE AT HANDOFF posn:

	SY	SP	EP	WP	WY	WR	
PRE-CRADLE	0.0	+25.0	-25.0	+5.0	0.0	0.0	
1: SY –	-33.3						
2: SP +		+80.0					
3: EP –			-90.0				
4: WP –				-77.3			
5: WY +					+23.8		
6: WR –						-39.8	
OBSS PRE-GRAPPLE AT HAND-OFF	-33.3	+80.0	-90.0	-77.3	+23.8	-39.8	
	X	Y	Z	PITCH	YAW	ROLL	PL ID
	-966	-1	-625	285	0	271	0

BRAKES – ON (tb-ON)

MODE – not DIRECT

JOINT – CRIT TEMP

Notify SSRMS Operator that SRMS at OBSS PRE-GRAPPLE AT HANDOFF posn

Start:  
Pre-Cradle

Step 1:  
Drive SY - (for 33.3°)  
From 0.0° to -33.3°

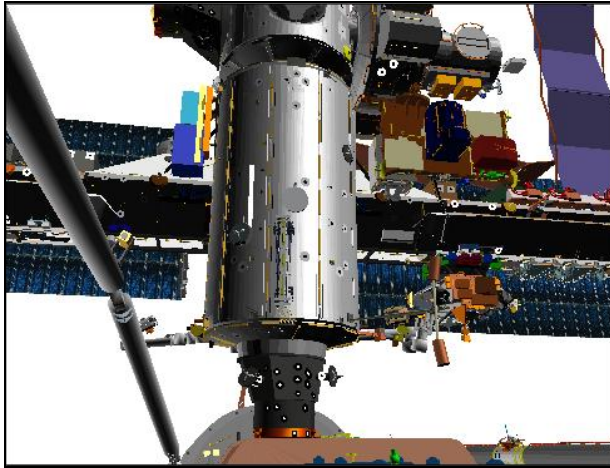

CCTV B (10,20)

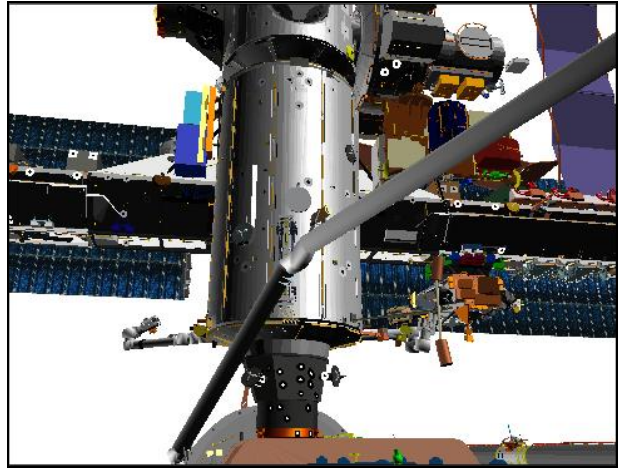

CCTV B (10,20)

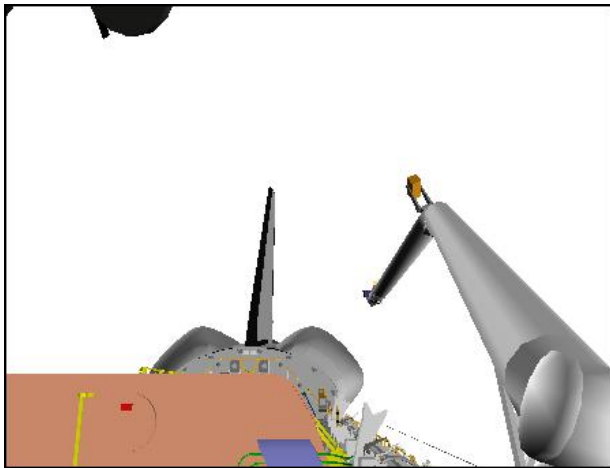

CCTV A (0,15)

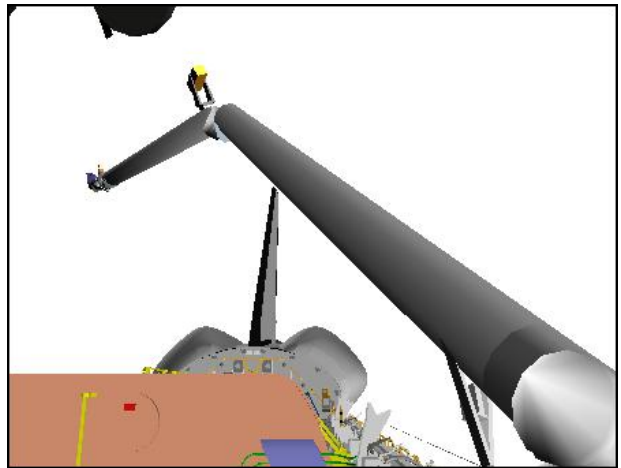

CCTV A (0,15)

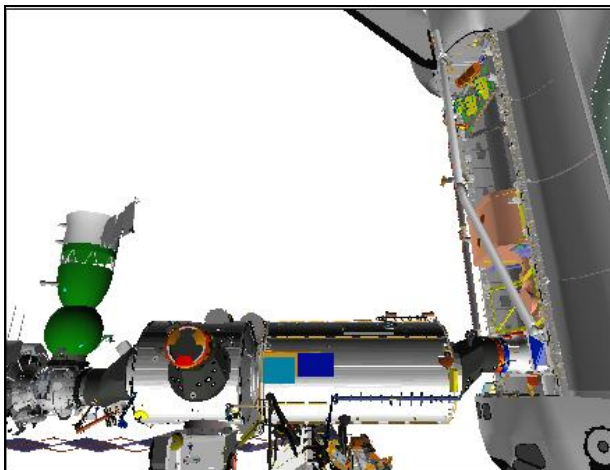

P1 LOWER OUTBOARD (90,20)

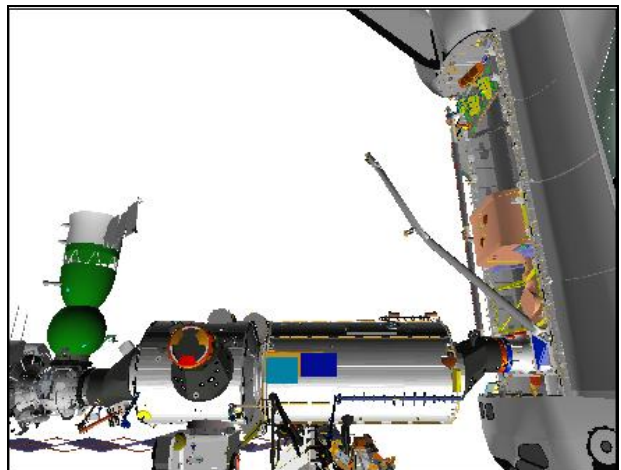

P1 LOWER OUTBOARD (90,20)

Step 2:

Drive SP + (for 55°)  
From +25.0° to +80.0°

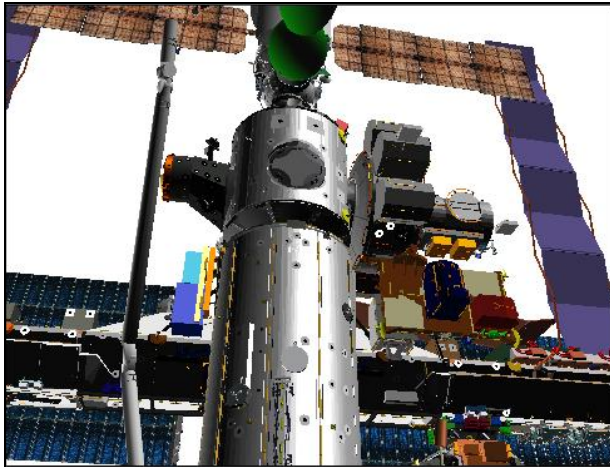

**CCTV B (10,35)**

Step 3:

Drive EP - (for 65°)  
From -25.0° to -90.0°

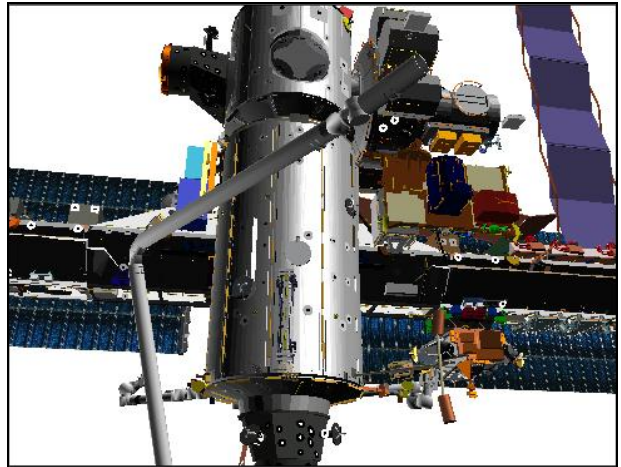

**CCTV B (10,25)**

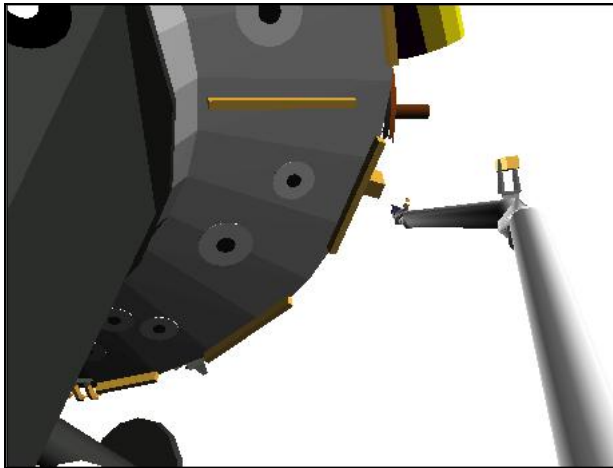

**CCTV A (0,60)**

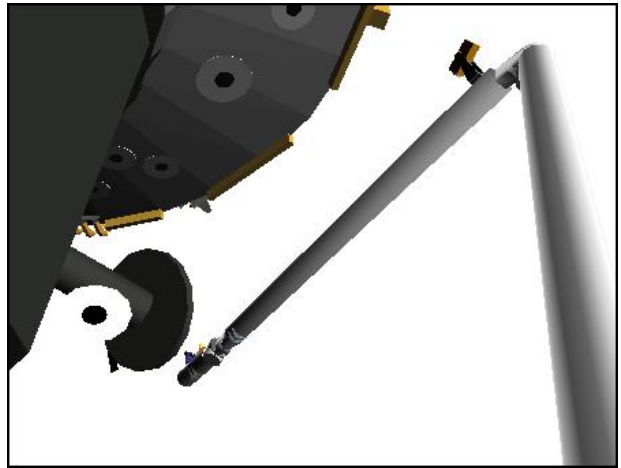

**CCTV A (0,45)**

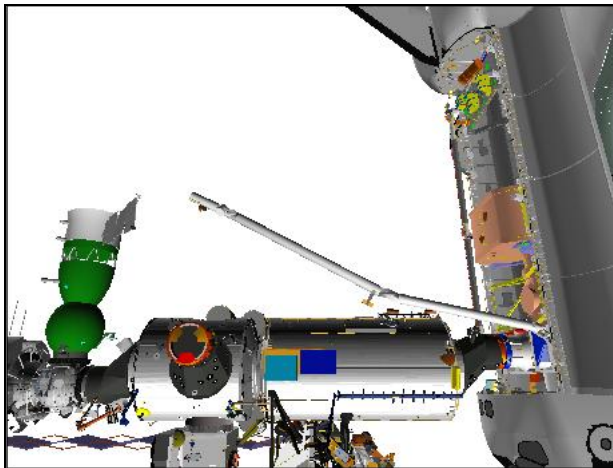

**P1 LOWER OUTBOARD (90,20)**

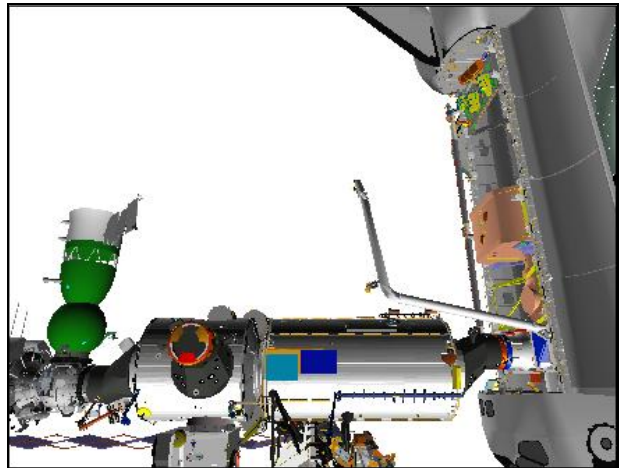

**P1 LOWER OUTBOARD (90,20)**

Step 4:

Drive WP - (for 82.3°)  
From +5.0° to -77.3°

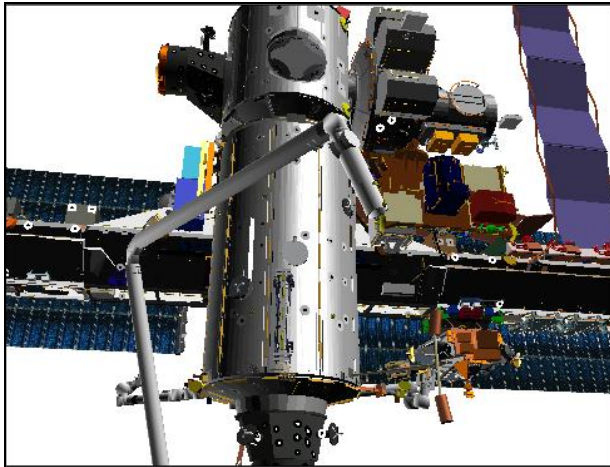

**CCTV B (10,25)**

Step 5:

Drive WY + (for 23.8°)  
From 0.0° to +23.8°

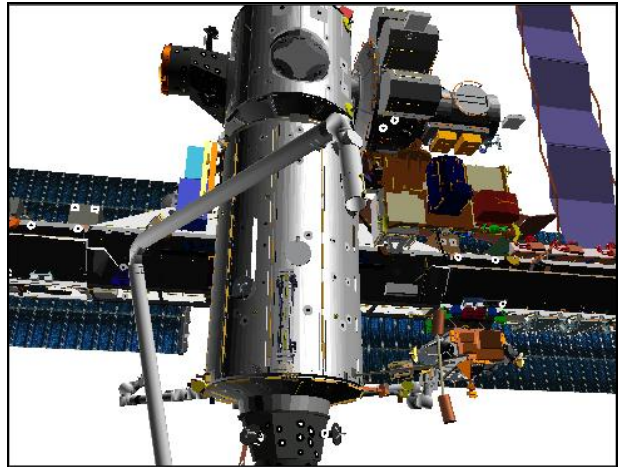

**CCTV B (10,25)**

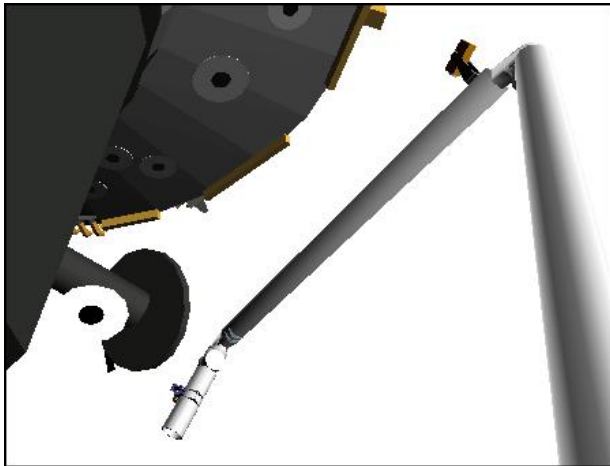

**CCTV A (0,45)**

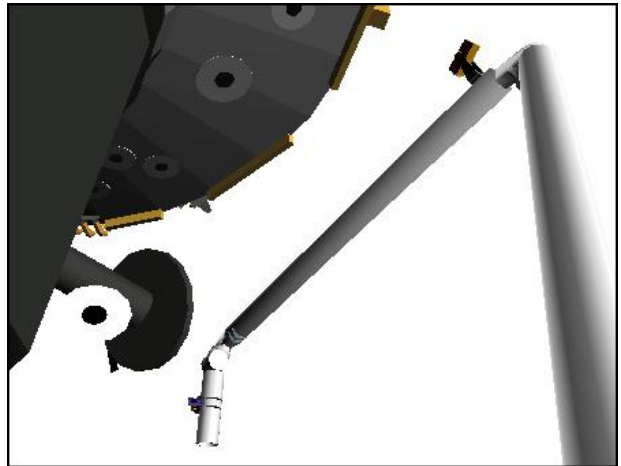

**CCTV A (0,45)**

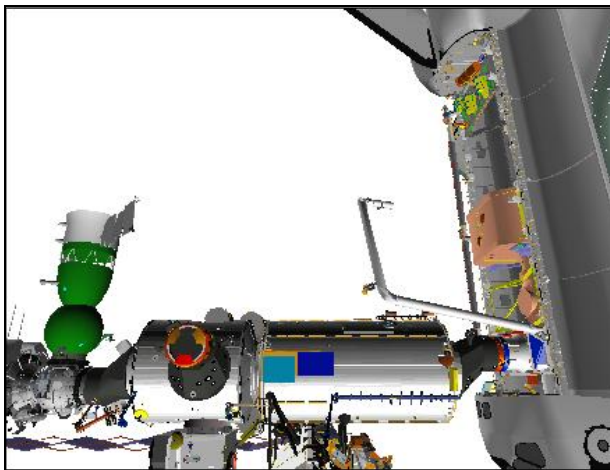

**P1 LOWER OUTBOARD (90,20)**

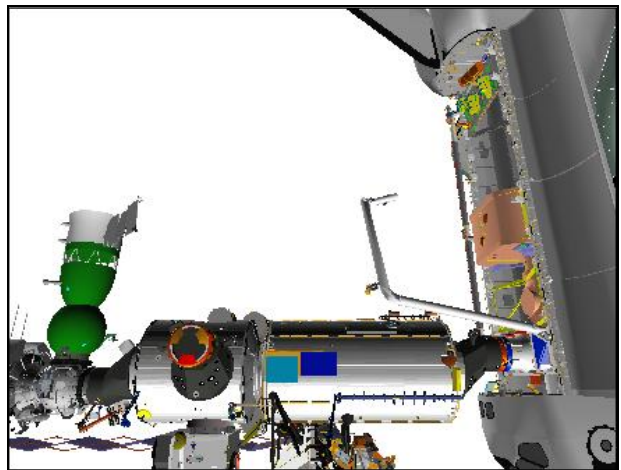

**P1 LOWER OUTBOARD (90,20)**



Step 6:

Drive WR - (for 39.8°)

From 0.0° to -39.8°

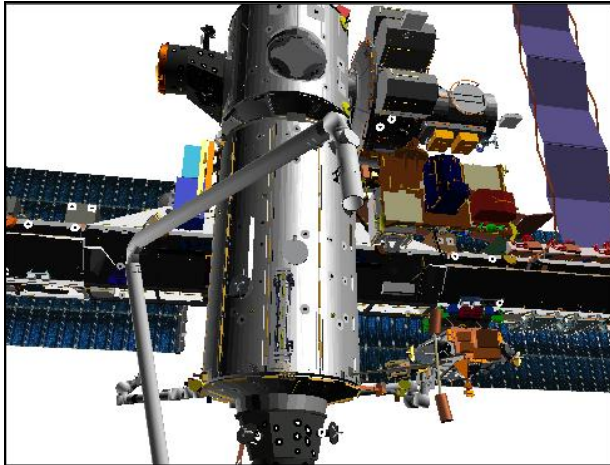

**CCTV B (10,25)**

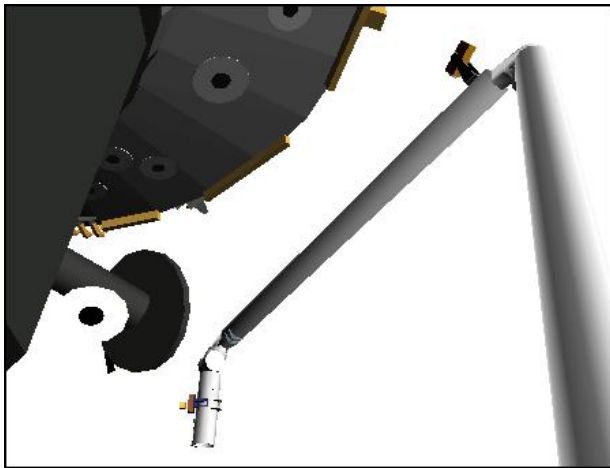

**CCTV A (0,45)**

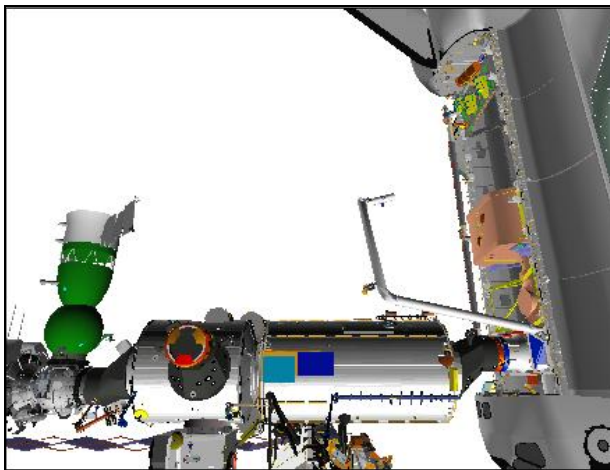

**P1 LOWER OUTBOARD (90,20)**

3. CONFIGURE POWER

**CAUTION**  
SPEE power must be applied within 90 min  
to prevent sensor package damage

On SSRMS Operator GO to release STBD MRLs,  
STBD RMS HTR A,B (two) – OFF

- A6U           EVENT TIMER MODE – UP  
                  CNTL – START
- MA73C:C      cb MCA PWR AC3 3Φ MID 2 – op  
                  √AC2 3Φ MID 2 – op  
:D             √AC3 3Φ MID 4 – op
- R13L           PL BAY MECH PWR SYS (two) – ON

4. STBD MRL RELEASE

**SM 94 PDRS CONTROL**

RMS STBD – ITEM 2 EXEC (\*)  
√STBD AFT, MID, FWD REL (six) = 0

**NOTE**  
Expect single motor drive time for MRL release

STBD RMS RETEN LAT – REL (tb-REL) (18 sec max)  
– OFF  
If motor drive time > 18 sec, √MCC

**SM 94 PDRS CONTROL**

√STBD AFT, MID, FWD REL (six) = 1

5. RECONFIGURE POWER

- R13L           PL BAY MECH PWR SYS (two) – OFF
- MA73C:C      cb MCA PWR AC3 3Φ MID 2 – cl  
                  √AC2 3Φ MID 2 – op  
:D             √AC3 3Φ MID 4 – op

Give SSRMS Operator GO for OBSS Unberth  
Monitor RFL Status

After OBSS Unberth,  
**SM 94 PDRS CONTROL**  
RMS PORT – ITEM 1 EXEC (\*)

6. SETUP FOR GRAPPLE

- A7U           CCTV – config for grapple  
                  – install PDRS TARGET OVERLAY FOR CTVM  
                  – RMS WRIST, ZOOM: 34.0 HFOV  
                  FOCUS: 5 ft  
                  Maintain eyepoint approx 18 in when using grapple overlay

- R12(OBSS) √SPEE PWR – OFF  
L12U(SSP1) √APCU 1 OUTPUT RLY – OP (tb-bp)

7. SJ OBSS GRAPPLE AT HANDOFF

On SSRMS Operator GO for SRMS OBSS Grapple,

If SINGLE MODE available:

RHC

RATE – VERN (RATE MIN tb-ON)

BRAKES – OFF (tb-OFF)

MODE – best available

Drive joints per OBSS SJ GRAPPLE AT HANDOFF OVERLAY and diagram until EE within grapple envelope

CAUTION  
Monitor EE tb timing to prevent EE motor burnout

EE MODE – AUTO

CAPTURE sw – depress (mom)

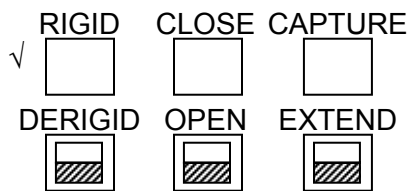

CRITICAL TIMES (28 sec total):

CAPTURE tb – gray, then

CLOSE tb – gray, 3 sec max, then

RIGID tb – gray, 25 sec max

EE MODE – OFF

- \* If manual capture required: \*
- \* EE MODE – MAN \*
- \* CAPTURE sw – depress (hold until CLOSE tb-gray, 3 sec max) \*
- \* MAN CONTR – RIGID (hold until RIGID tb-gray, 25 sec max) \*
- \* MODE – OFF \*

If TEST mode available,  
MODE – TEST, ENTER  
Wait 5 sec

BRAKES – ON (tb-ON)  
MODE – not DIRECT  
JOINT – CRIT TEMP

### OBSS SJ GRAPPLE AT HANDOFF OVERLAY

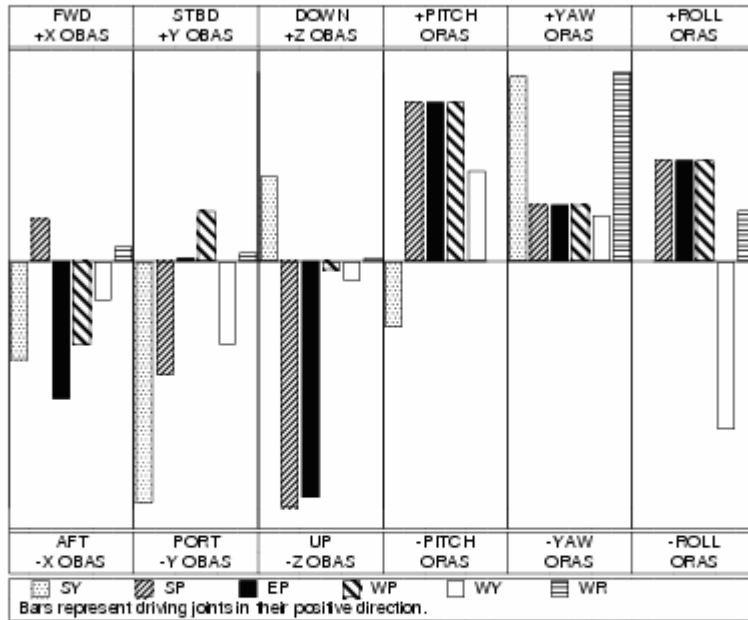

To get:	Drive:
+X (fwd)	-EP, -WP
+Y (stbd)	-SY, -SP
+Z (down)	-SP, -EP

To get:	Drive:
+PITCH	+WP, +EP
+YAW	+WR, +SY
+ROLL	-WY, +WP

Driving:	Results In:
+SY	-Y (port), +YAW
+SP	-Z (up), +PITCH
+EP	-Z (up), +PITCH

Driving:	Results In:
+WP	-X (aft), +PITCH
+WY	-Y (port), -ROLL
+WR	+X (fwd), +YAW

$\Delta SY$	$\Delta SP$	$\Delta EP$	$\Delta WP$	$\Delta WY$	$\Delta WR$
+4.9	-4.5	-8.1	+14.8	-0.2	-5.3

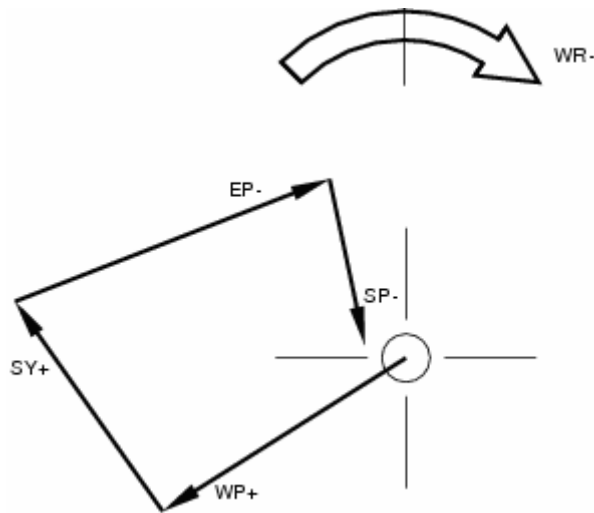

**SM 94 PDRS CONTROL**

PL ID – ITEM 3 +2 EXEC  
 INIT ID – ITEM 24 +2 EXEC

Expected OBSS HANDOFF posn:

	X	Y	Z	PITCH	YAW	ROLL	PL ID
√	-986	318	-554	15	270	0	2 *
	SY	SP	EP	WP	WY	WR	
√	-28.4	+75.5	-98.1	-62.5	+23.6	-45.1	

\* display singularity

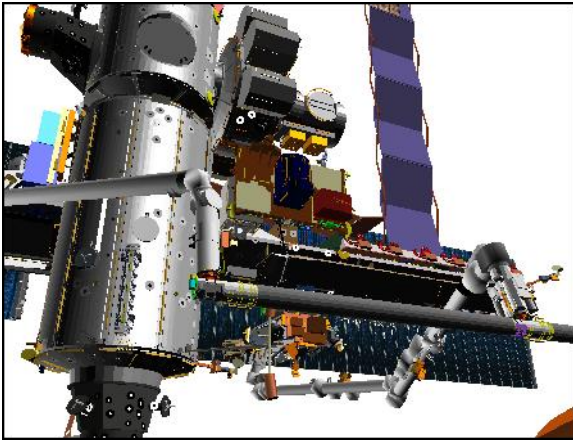

**CCTV B (24,25)**

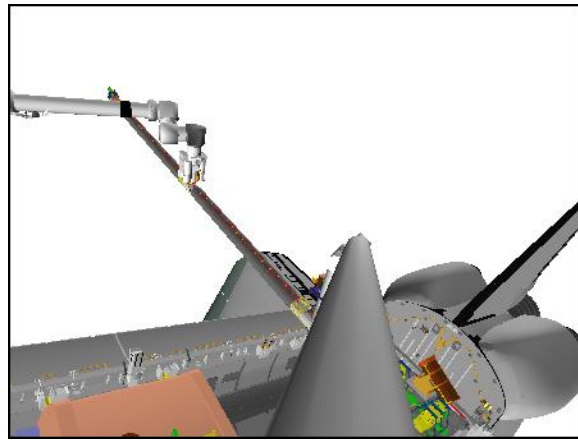

**SRMS ELBOW (-10,-2)**

R12(OBSS) RSC PWR – OFF, ON

Perform ACTIVATION (LDRI/ITVC Cue Card, PHOTO/TV)

SSP1 √APCU 1,2 CONV (two) – OFF (tb-bp)

Perform LCH ACTIVATION (LCS Cue Card, PHOTO/TV)

Perform LCC ACTIVATION (LCS Cue Card, PHOTO/TV), steps 1 and 2

Give SSRMS Operator GO for OBSS Ungrapple

Review GENERIC END EFFECTOR CUE CARD – ISS/SHUTTLE DOCKED OPS

8. MNVR TO OBSS PARK

On SSRMS Operator GO for mnvr to OBSS PARK posn,

If SINGLE MODE available:

RHC RATE – as desired (VERN within 10 ft)  
 BRAKES – OFF (tb-OFF)

MODE – best available

Mnvr to OBSS PARK posn:

	SY	SP	EP	WP	WY	WR	
Handoff	-28.4	+75.5	-98.1	-62.5	+23.6	-45.1	
1: EP +			-25.0				
2: SP -		+25.0					
3: WR +						0.0	
4: WY -					0.0		
5: WP +				+5.0			
6: SY +	0.0						
OBSS Park	0.0	+25.0	-25.0	+5.0	0.0	0.0	
	X	Y	Z	PITCH	YAW	ROLL	PL ID
	-1243	-143	-869	95	359	358	2

BRAKES – ON (tb-ON)  
 MODE – not DIRECT  
 PARAM – PORT TEMP  
 JOINT – CRIT TEMP

Start:  
OBSS Handoff

Step 1:  
Drive EP + (for 73.1°)  
From -98.1° to -25.0°

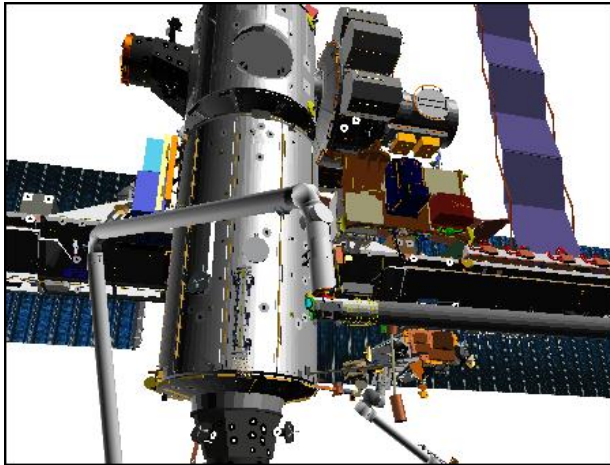

**CCTV B (14,25)**

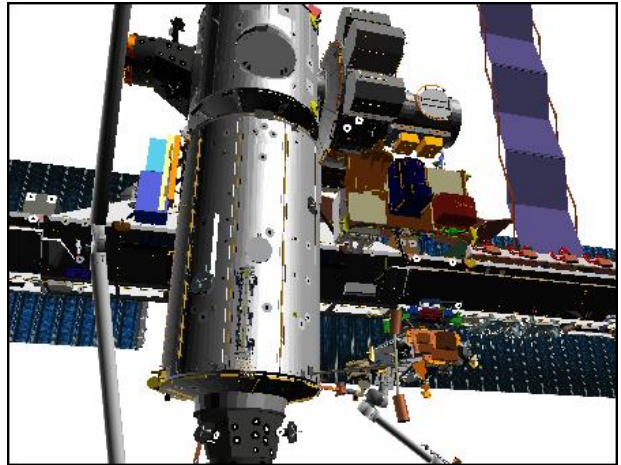

**CCTV B (14,25)**

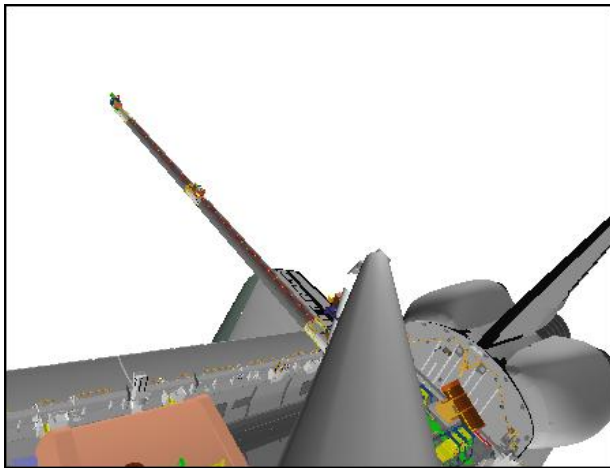

**SRMS ELBOW (-10,-2)**

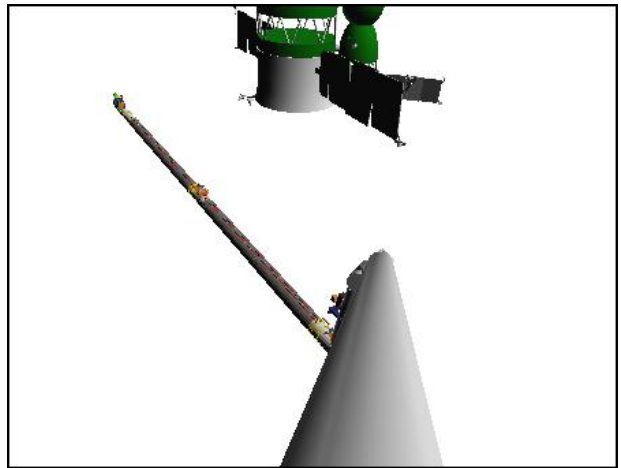

**SRMS ELBOW (-10,-2)**

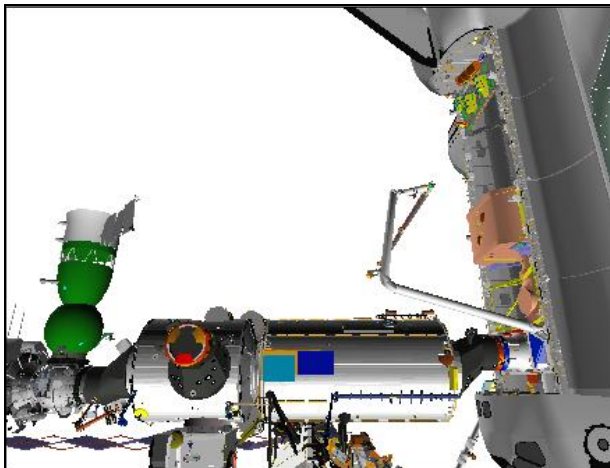

**P1 LOWER OUTBOARD (90,20)**

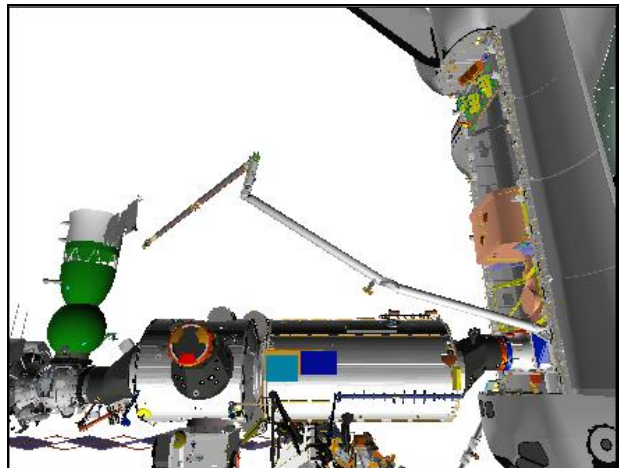

**P1 LOWER OUTBOARD (90,20)**

Step 2:

Drive SP - (for 50.5°)  
From +75.5° to +25.0°



CCTV B (24,20)

Step 3:

Drive WR + (for 45.1°)  
From -45.1° to 0.0°

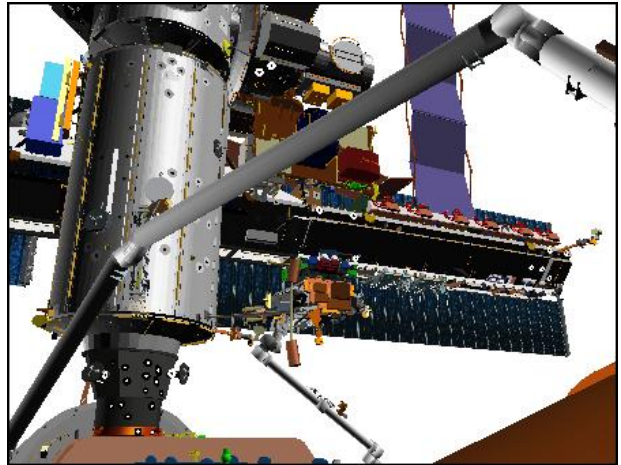

CCTV B (24,20)

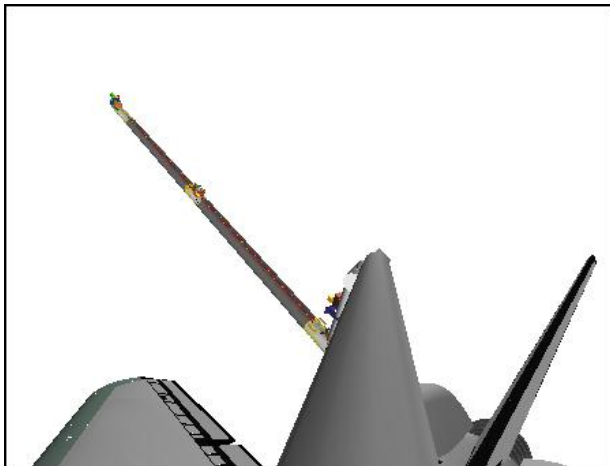

SRMS ELBOW (-10,-2)

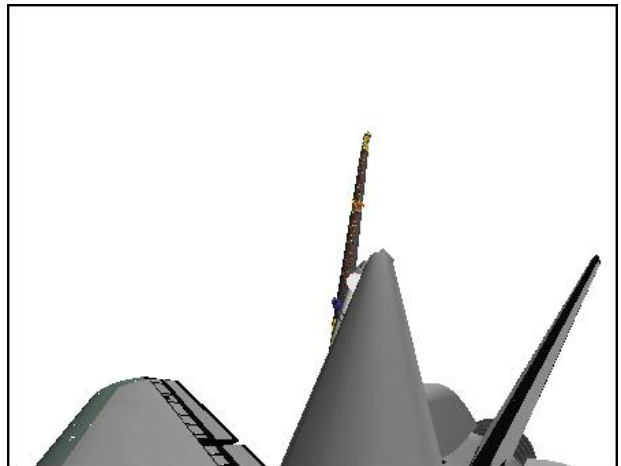

SRMS ELBOW (-10,-2)

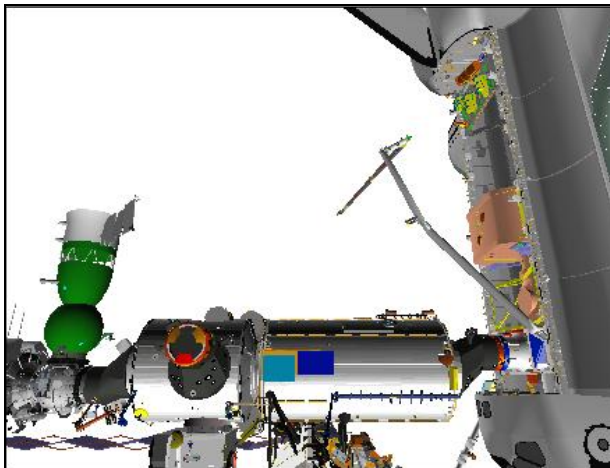

P1 LOWER OUTBOARD (90,20)

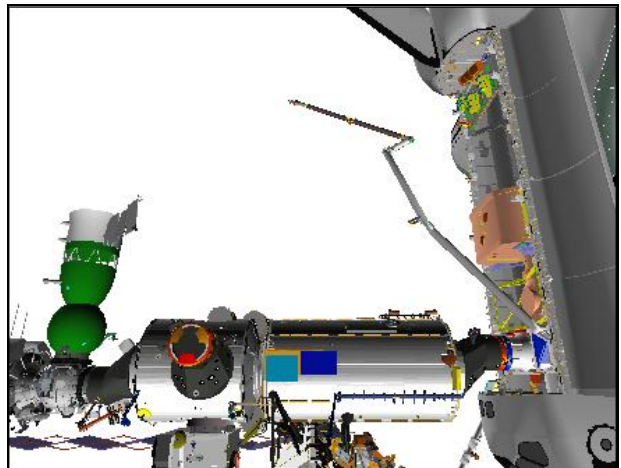

P1 LOWER OUTBOARD (90,20)



Step 4:

Drive WY - (for 23.6°)  
From +23.6° to 0.0°

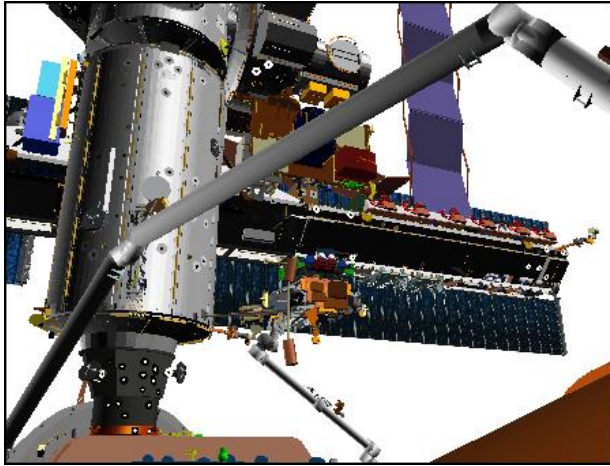

CCTV B (24,20)

Step 5:

Drive WP + (for 67.5°)  
From -62.5° to +5.0°

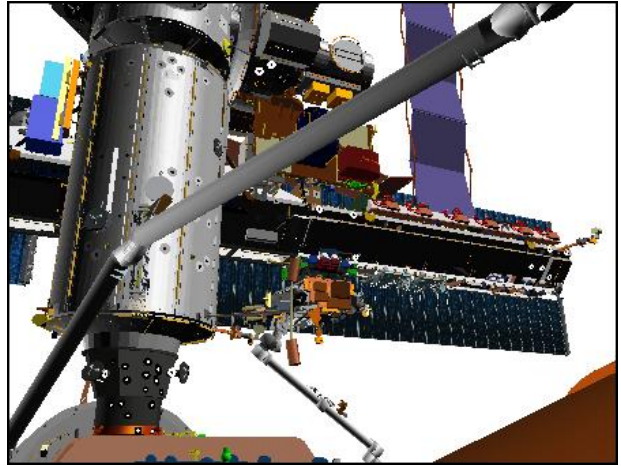

CCTV B (24,20)

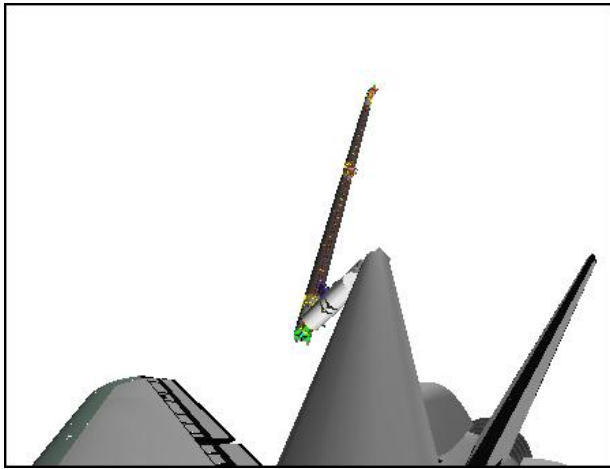

SRMS ELBOW (-10,-2)

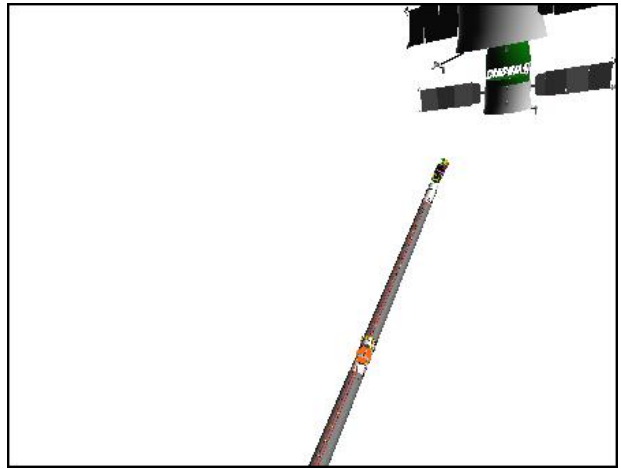

SRMS ELBOW (10,48)

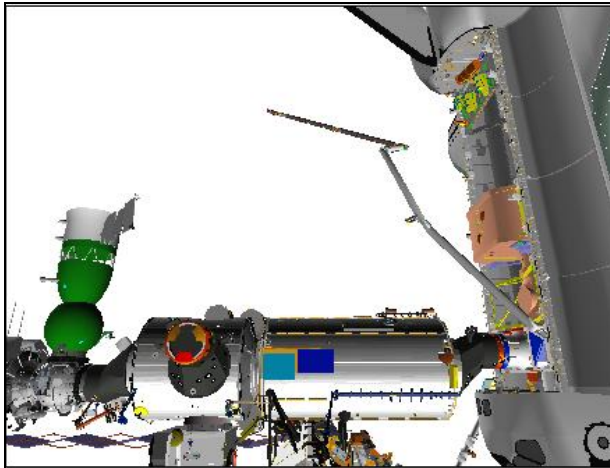

P1 LOWER OUTBOARD (90,20)

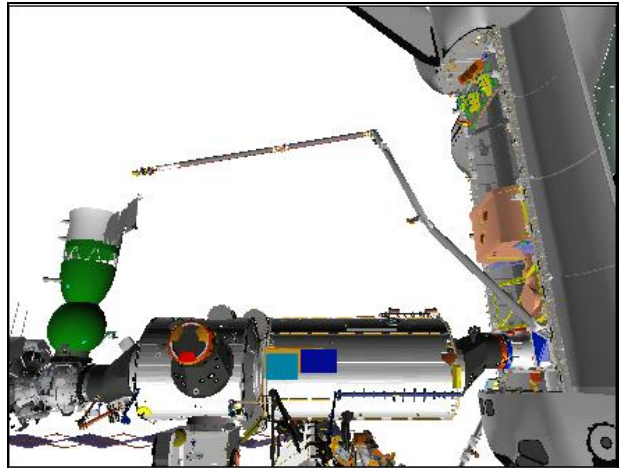

P1 LOWER OUTBOARD (90,20)

Step 6:

Drive SY + (for 28.4°)

From -28.4° to 0.0°

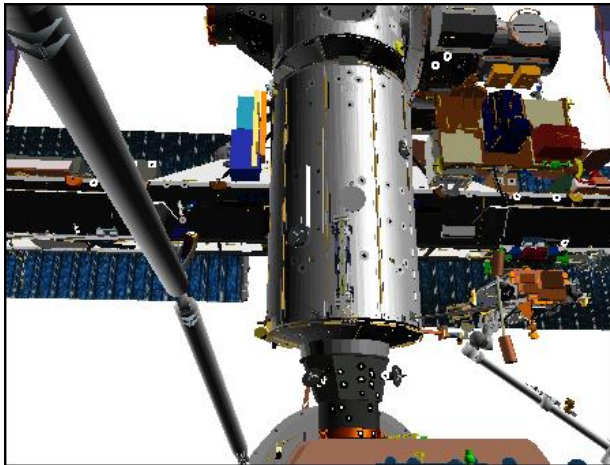

**CCTV B (4,20)**

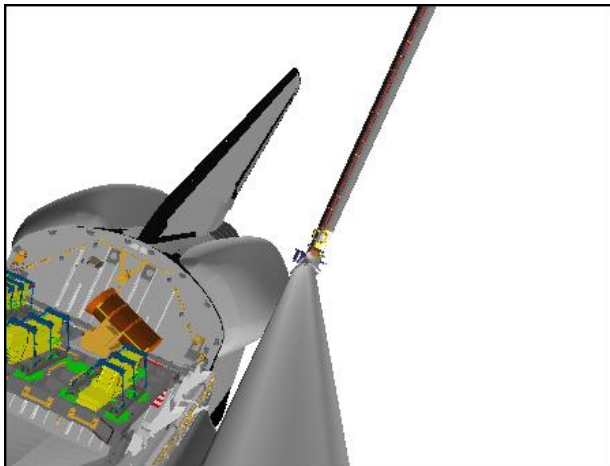

**SRMS ELBOW (0,0)**

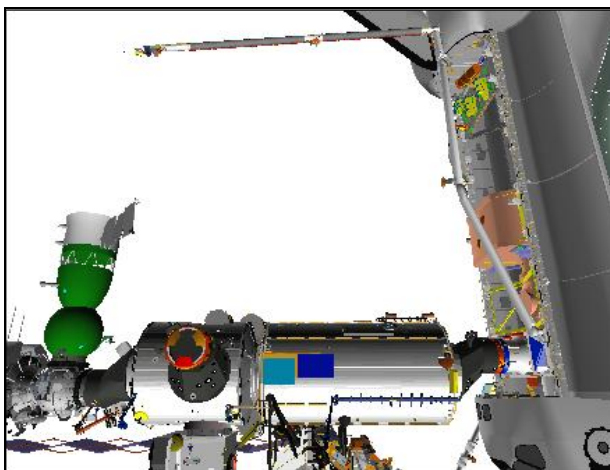

**P1 LOWER OUTBOARD (90,20)**

A7U 9. RECONFIG PTU  
MON2 ← PL2

CAMR CMD PAN/TILT – HI RATE  
PAN – L (to hard stop)  
TILT – UP (to hard stop)  
PAN/TILT – RESET, HI RATE (LO within 10°)  
PAN: +80 (right)  
TILT: -35 (down)

MUX 1 L ← MIDDECK  
LDRI MODE 2 pb – push (ITVC video)

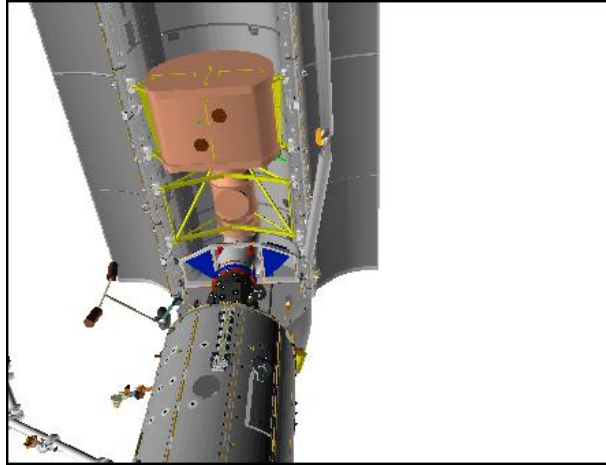

**ITVC (80,-35)**

# OBSS SJ HANDOFF FROM SRMS TO SSRMS

## 1. SETUP

SM 94 PDRS CONTROL

√PL ID, ITEM 3: 2

√INIT ID, ITEM 24: 2

A7U CCTV – perform PAN/TILT RESET for PLB cameras  
– config as reqd

Review GENERIC END EFFECTOR CUE CARD – ISS/SHUTTLE DOCKED OPS

## 2. MANEUVER TO OBSS HANDOFF

If SINGLE MODE available:

RHC RATE – as reqd (VERN within 10 ft)  
BRAKES – OFF (tb-OFF)

MODE – best available

Mnvr to OBSS HANDOFF posn:

	SY	SP	EP	WP	WY	WR	
OBSS Park	0.0	+25.0	-25.0	+5.0	0.0	0.0	
1: SY –	-28.4						
2: WP –				-62.5			
3: WY +					+23.6		
4: WR –						-45.1	
5: SP +		+75.5					
6: EP –			-98.1				
Handoff	-28.4	+75.5	-98.1	-62.5	+23.6	-45.1	
	X	Y	Z	PITCH	YAW	ROLL	PL ID
	-986	+318	-554	15	270	0	2

\* display singularity

BRAKES – ON (tb-ON)  
MODE – not DIRECT  
JOINT – CRIT TEMP

Notify SSRMS Operator that SRMS at OBSS HANDOFF posn

Start:  
OBSS Park

Step 1:  
Drive SY - (for 28.4°)  
From 0.0° to -28.4°

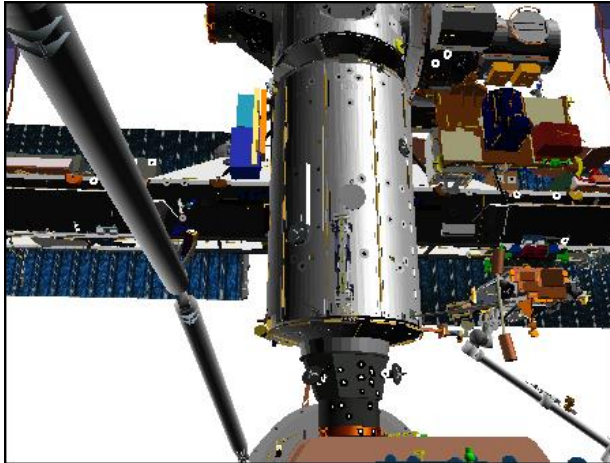

CCTV B (4,20)



CCTV B (24,20)

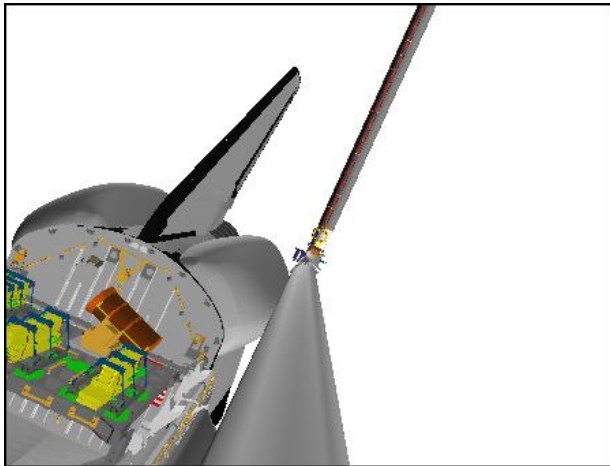

SRMS ELBOW (0,0)

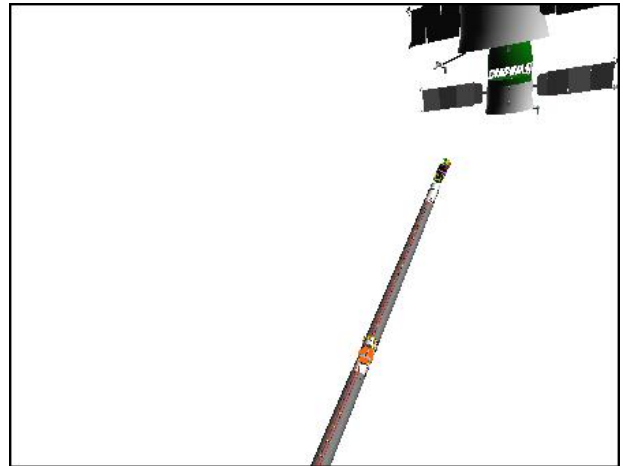

SRMS ELBOW (10,48)

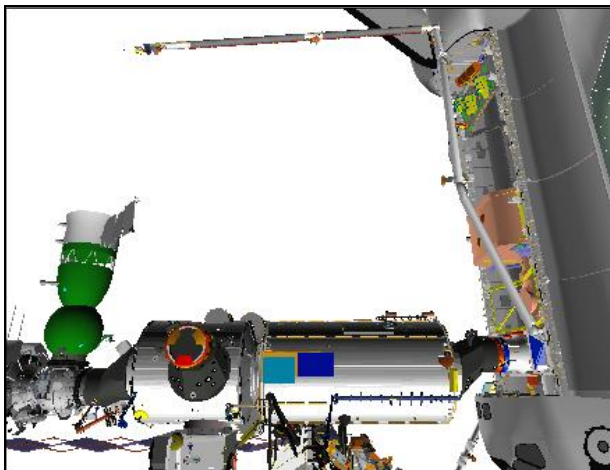

P1 LOWER OUTBOARD (90,20)

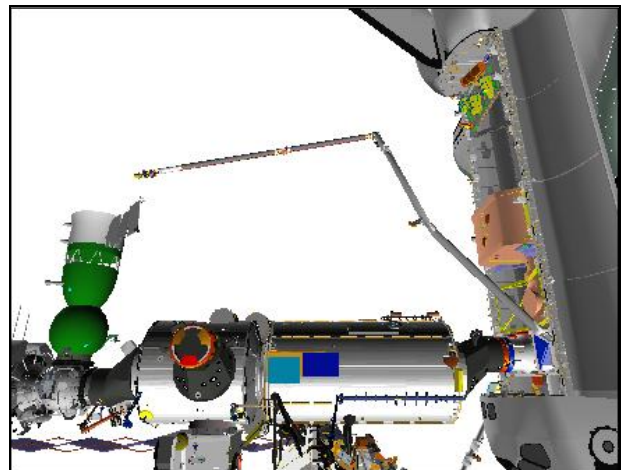

P1 LOWER OUTBOARD (90,20)

Step 2:

Drive WP - (for 67.5°)  
From +5.0° to -62.5°

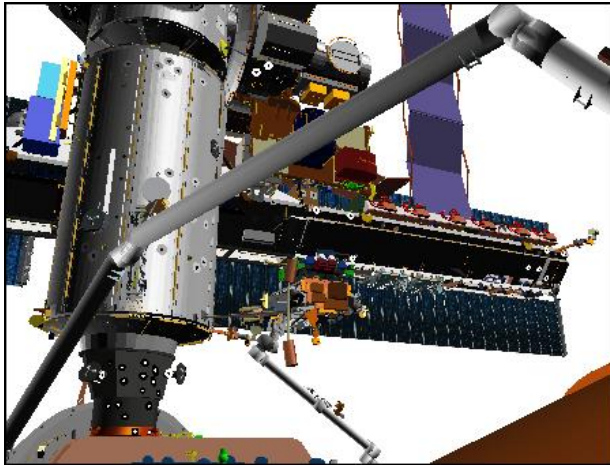

CCTV B (24,20)

Step 3:

Drive WY + (for 23.6°)  
From +0.0° to +23.6°

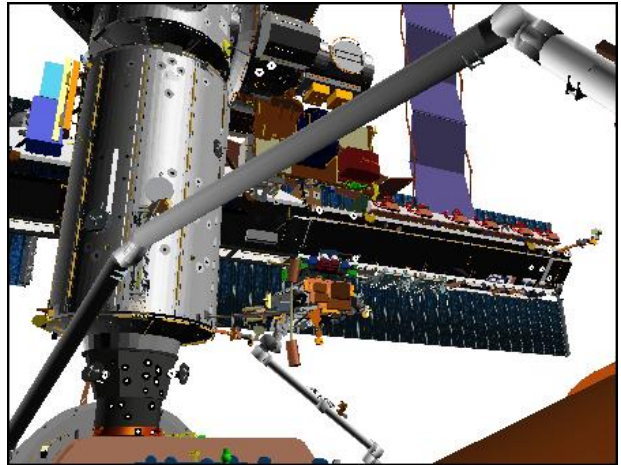

CCTV B (24,20)

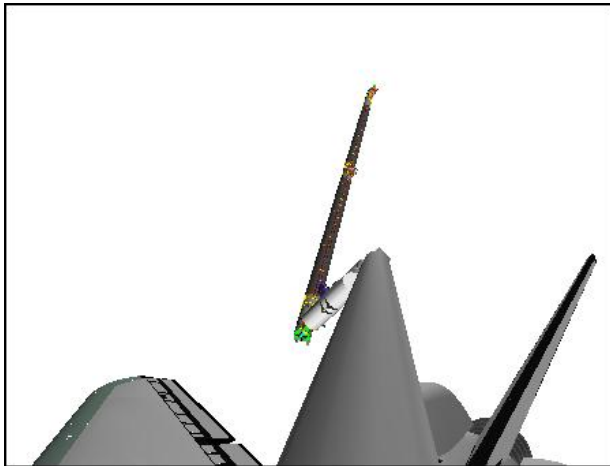

SRMS ELBOW (-10,-2)

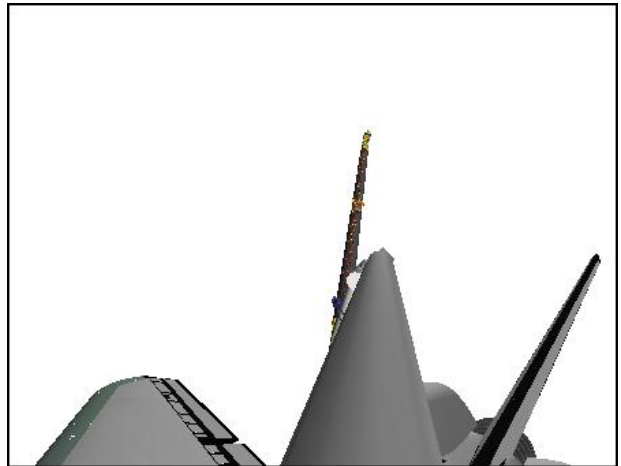

SRMS ELBOW (-10,-2)

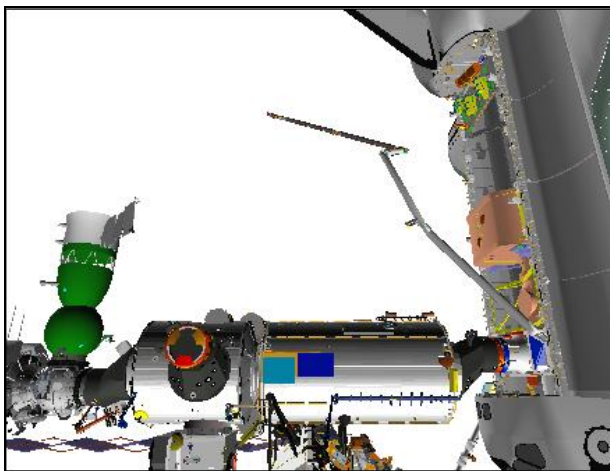

P1 LOWER OUTBOARD (90,20)

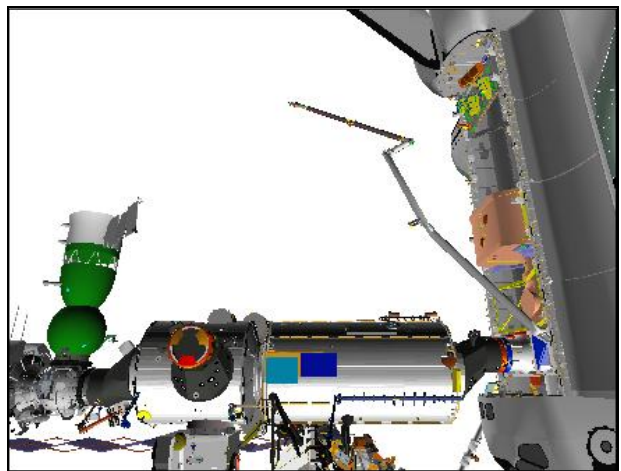

P1 LOWER OUTBOARD (90,20)

Step 4:

Drive WR - (for 45.1°)  
From 0.0° to -45.1°

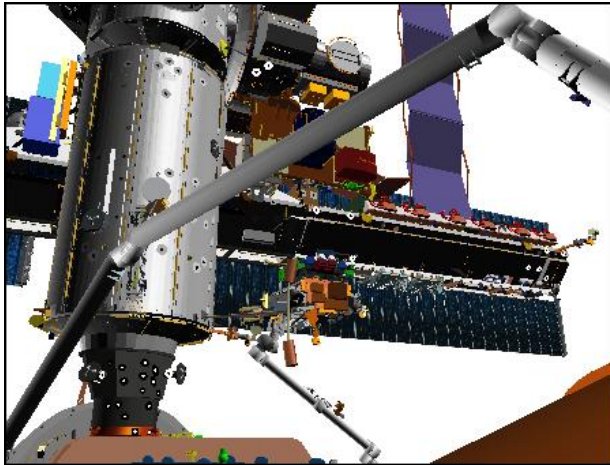

CCTV B (24,20)

Step 5:

Drive SP + (for 50.5°)  
From +25.0° to +75.5°

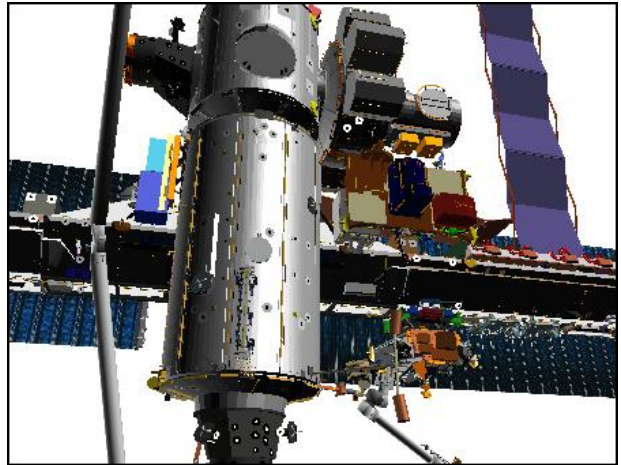

CCTV B (14,25)

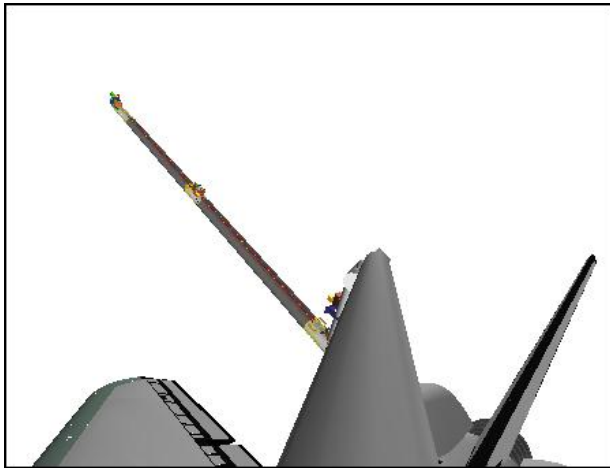

SRMS ELBOW (-10,-2)

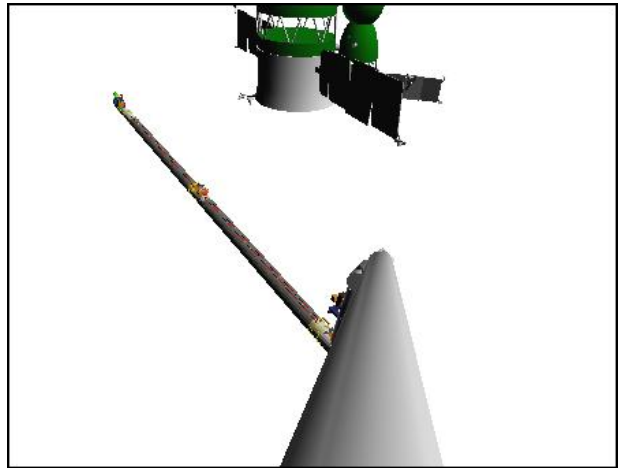

SRMS ELBOW (-10,-2)

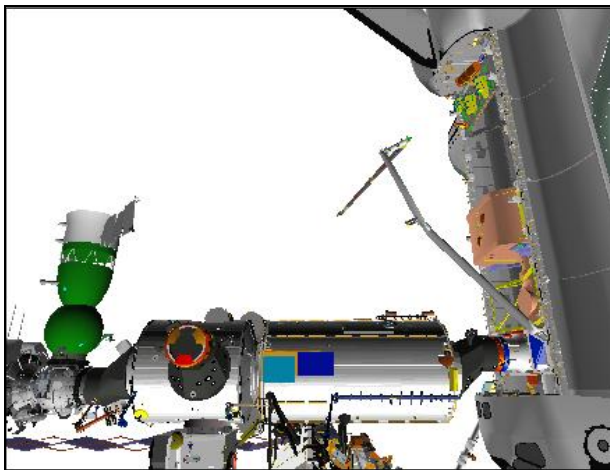

P1 LOWER OUTBOARD (90,20)

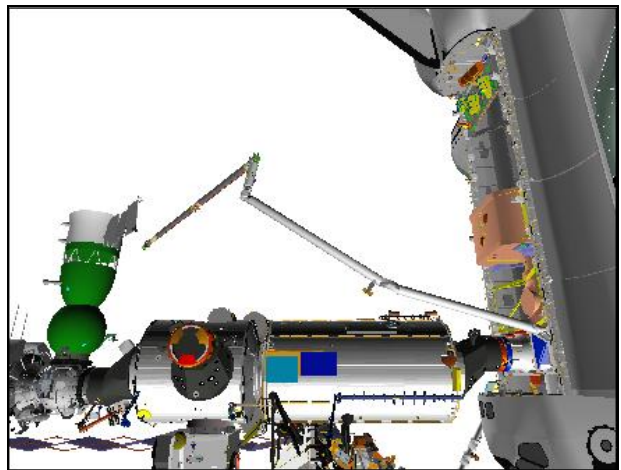

P1 LOWER OUTBOARD (90,20)

Step 6:

Drive EP - (for 73.1°)

From -25.0° to -98.1°

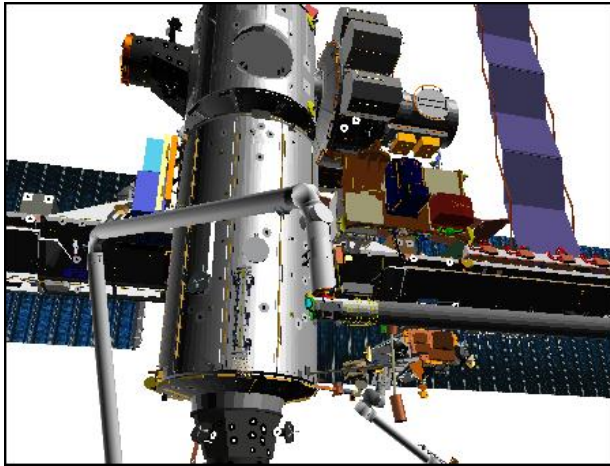

**CCTV B (14,25)**

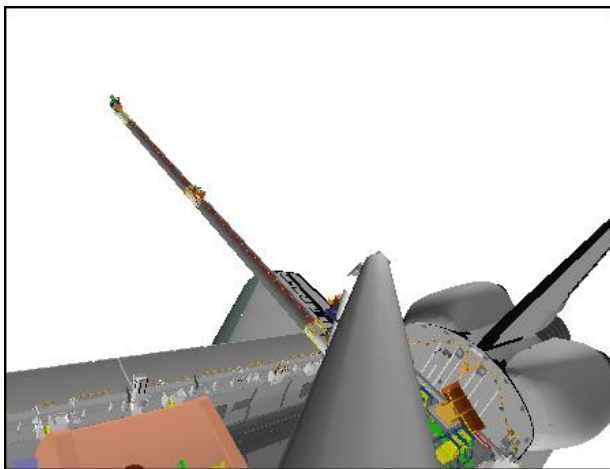

**SRMS ELBOW (-10,-2)**

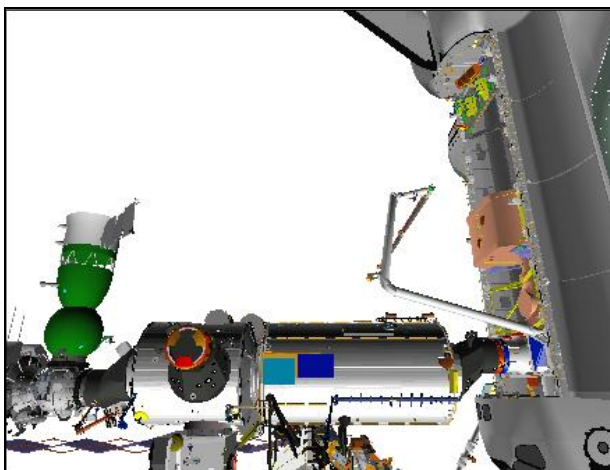

**P1 LOWER OUTBOARD (90,20)**



3. STOW PTU

A7U On SSRMS Operator GO for OBSS Ungrapple,  
MON2 ← PL2

CAMR CMD PAN/TILT – HI RATE

PAN – L (to hard stop)

TILT – UP (to hard stop)

PAN/TILT – RESET, HI RATE (LO within 10°)

PAN: +108 (right)

TILT: -175 (down)

Perform LCC DEACTIVATION (LCS Cue Card, PHOTO/TV)

Perform LCH DEACTIVATION (LCS Cue Card, PHOTO/TV)

CAUTION

STBD RMS HTR power must be applied within  
90 min to prevent sensor package damage

Perform DEACTIVATION (LDRI/ITVC Cue Card, PHOTO/TV)

4. OBSS UNGRAPPLE

A7U CCTV – config for ungrapple  
– RMS WRIST, ZOOM: 34.0 HFOV  
FOCUS: 5 ft

NOTE

CONTR ERR It and 'S96 PDRS CNTL' msg may  
occur due to Consistency/Envelope Check error

If TEST MODE available:

RHC RATE – COARSE (RATE MIN tb-OFF)

SM 94 PDRS CONTROL

AUTO BRAKE INH – ITEM 10 EXEC (\*)

BRAKES – OFF (tb-OFF)

MODE – TEST, ENTER

Wait 5 sec

BRAKES – ON (tb-ON)

SM 94 PDRS CONTROL

AUTO BRAKE ENA – ITEM 9 EXEC (\*)

SM 94 PDRS CONTROL

PL ID – ITEM 3 +Q EXEC

INIT ID – ITEM 24 +Q EXEC

If SINGLE MODE available:

RHC RATE – VERN (RATE MIN tb-ON)

BRAKES – OFF (tb-OFF)

MODE – best available

**CAUTION**  
Monitor EE tb timing to prevent EE motor burnout

EE MODE – MAN

MAN CONTR – DERIGID (hold until DERIGID tb-gray, 5 sec max)

RELEASE sw – depress (hold until OPEN tb-gray, 3 sec max)

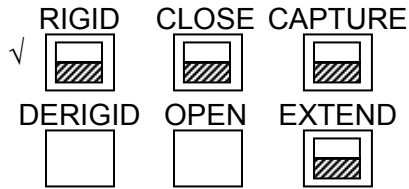

5. SJ MNVR TO OBSS PRE-GRAPPLE

Drive joints per OBSS SJ HANDOFF SRMS UNGRAPPLE WRIST CCTV OVERLAY and diagram until SRMS at OBSS PRE-GRAPPLE posn

EE MAN CONTR – DERIGID (hold until EXTEND tb-gray, 20 sec max)  
MODE – OFF

√POS/ATT and Joint Angles at OBSS PRE-GRAPPLE AT HANDOFF posn:

X	Y	Z	PITCH	YAW	ROLL	PL ID
-966	-1	-625	285	0	271	0
SY	SP	EP	WP	WY	WR	
-33.3	+80.0	-90.0	-77.3	+23.8	-39.8	

BRAKES – ON (tb-ON)  
MODE – not DIRECT  
JOINT – CRIT TEMP

Give SSRMS Operator GO to mnvr to Handoff Intermediate posn

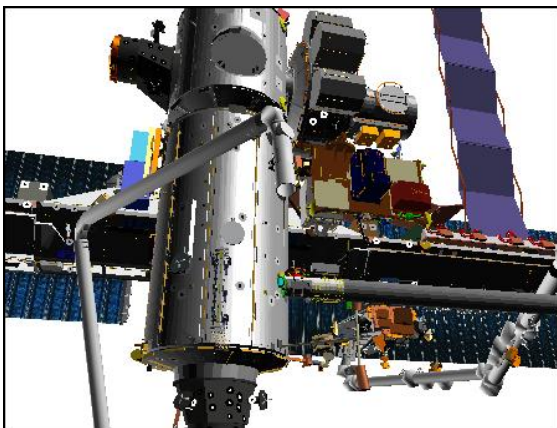

**CCTV B (14,25)**

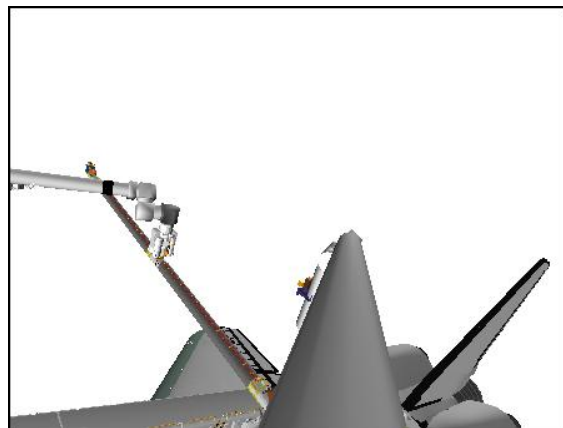

**ELBOW (-10,-2)**

### OBSS SJ UNGRAPPLE AT HANDOFF OVERLAY

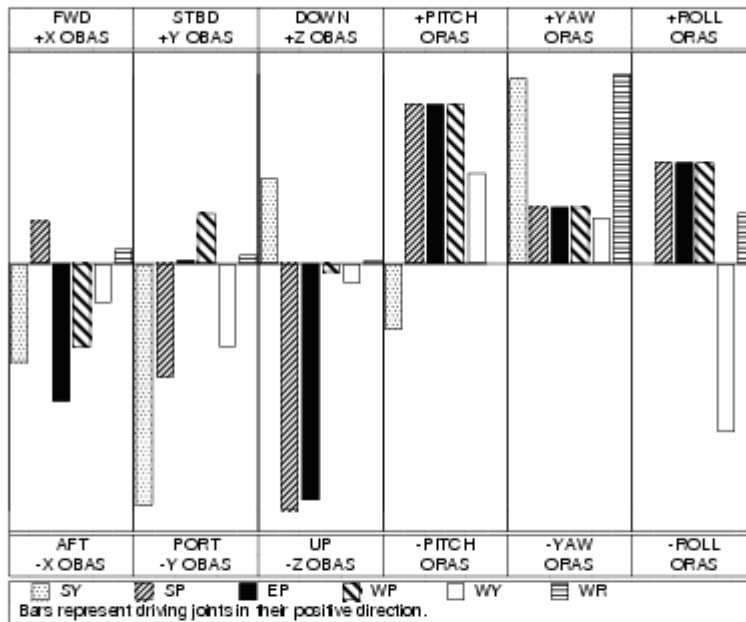

To get:	Drive:	To get:	Drive:	Driving:	Results In:	Driving:	Results In:
+X (fwd)	-EP, -WP	+PITCH	+WP, +EP	+SY	-Y (port), +YAW	+WP	-X (aft), +PITCH
+Y (stbd)	-SY, -SP	+YAW	+WR, +SY	+SP	-Z (up), +PITCH	+WY	-Y (port), -ROLL
+Z (down)	-SP, -EP	+ROLL	-WY, +WP	+EP	-Z (up), +PITCH	+WR	+X (fwd), +YAW

$\Delta SY$	$\Delta SP$	$\Delta EP$	$\Delta WP$	$\Delta WY$	$\Delta WR$
-4.9	+4.5	+8.1	-14.8	+0.2	+5.3

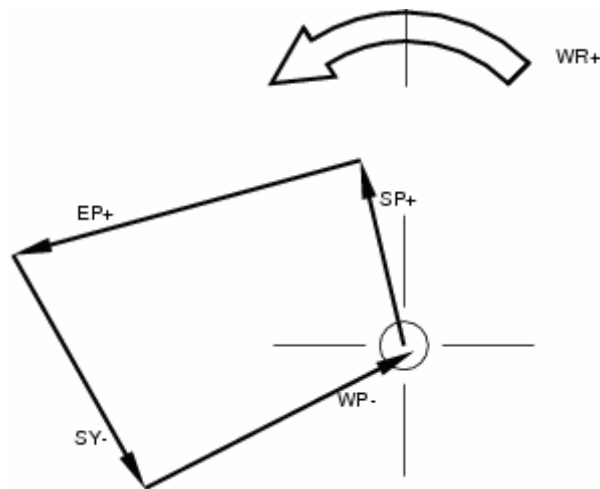

6. CONFIGURE CIRCUIT BREAKERS

MA73C:C      cb MCA PWR AC3 3Φ MID 2 – op  
                      √AC2 3Φ MID 2 – op  
:D                   √AC3 3Φ MID 4 – op

7. CONFIGURE FOR MONITORING

On SSRMS notification to watch for STBD RMS RFLs,

SM 94 PDRS CONTROL

RMS STBD – ITEM 2 EXEC (\*)

Notify SSRMS operator when STBD RMS R-F-L tb (three) – gray

8. STBD MRL LATCH

On SSRMS Operator GO to latch STBD MRLs to Topological Capture,

√STBD RMS R-F-L tb (three) – gray

SM 94 PDRS CONTROL

√STBD AFT, MID, FWD LAT (six) = 0

R13L            PL BAY MECH PWR SYS (two) – ON

NOTE

Expect single motor drive time for MRL latching (18 sec max).

The following STBD RMS RETEN LAT – OFF and PL BAY  
MECH PWR SYS (two) – OFF actions are to be performed simo

Verify AOS for latching to Topological Capture

STBD RMS RETEN LAT – LAT (6 sec, tb remains bp)  
– OFF

R13L            PL BAY MECH PWR SYS (two) – OFF

Give SSRMS Operator GO to Limp All SSRMS Joints and Derigidize

R13L            On SSRMS Operator GO to continue STBD MRL latching,  
PL BAY MECH PWR SYS (two) – ON

STBD RMS RETEN LAT – LAT (tb-LAT) (12 sec max)  
– OFF

9. RECONFIGURE POWER

R13L            PL BAY MECH PWR SYS (two) – OFF

STBD RMS HTR A,B (two) – AUTO

A6U            EVENT TIMER CNTL – STOP

SM 94 PDRS CONTROL

√STBD AFT, MID, FWD LAT (six) = 1  
RMS PORT – ITEM 1 EXEC (\*)

MA73C:C      cb MCA PWR AC3 3Φ MID 2 – cl

                      √AC2 3Φ MID 2 – op  
:D                   √AC3 3Φ MID 4 – op

Give SSRMS Operator GO for OBSS Ungripple

On SSRMS Operator GO, perform RMS PWRDN, step 1 only

# OBSS SJ FLAT FIELDS

**WARNING**  
For UNDOCKED ops only

## NOTE

Assumed starting posn is OBSS HOVER

### 1. SETUP

SM 94 PDRS CONTROL

PL ID - ITEM 3 +2 EXEC

INIT ID - ITEM 24 +2 EXEC

√	SY	SP	EP	WP	WY	WR	
	-90.0	+79.8	-123.1	-55.7	0.0	+110.0	
	X	Y	Z	PITCH	YAW	ROLL	PL ID
√	-998	+129	-507	0	0	11	2

A7U

√DTV ← PL2  
MON2 ← PL2

PAN: +90  
√TILT: -260

MON2 ← not PL2

RHC

### 2. MNVR TO SJ FLAT FIELD START

RATE - VERN (RATE MIN tb-ON)

BRAKES - OFF (tb-OFF)

MODE - SINGLE, ENTER

Drive WR (-) to +92.0

BRAKES - ON (tb-ON)

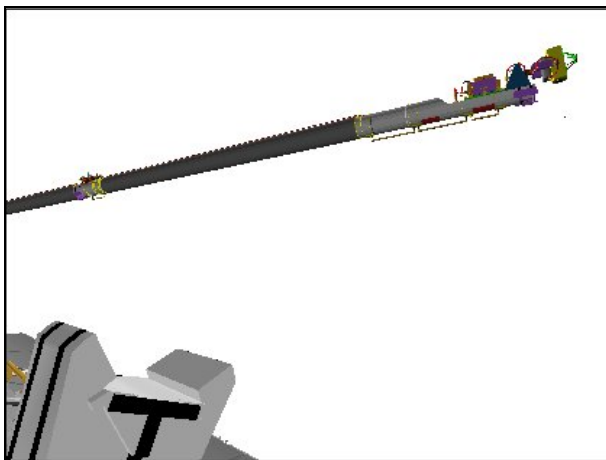

CCTV C (45,5)

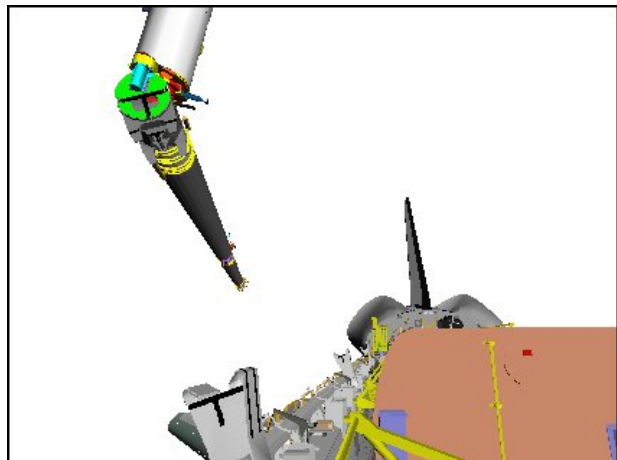

CCTV D (-10,15)

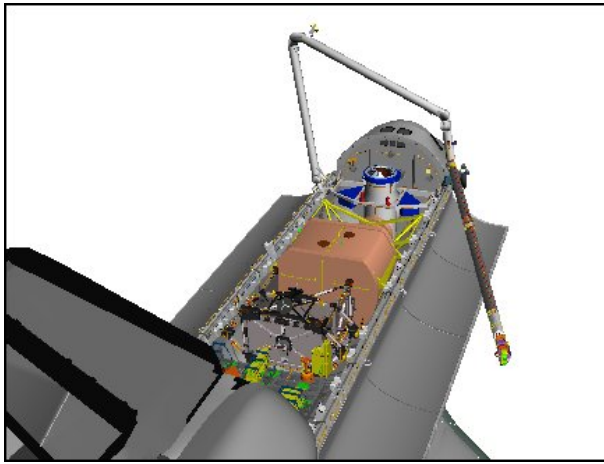

**BIRD'S EYE**

3. FLAT FIELDS

- A7U      a. ITVC (Black Stretch)  
 MUX 1 L ← MIDDECK  
 LDRI MODE 1 pb – push (ITVC video)  
 MON2 ← PL2
- ALC pb            – push  
 PEAK pb          – push  
 LT LEVEL pb     – push  
 DAY pb            – push  
 LT LEVEL pb     – push (all MENU lts off)  
 AP COR ON pb – push (lt on)  
 FOCUS            – NEAR (to stop)  
 ZOOM: 10.0 HFOV
- L10(VTR)      REC pb – push, hold  
 PLAY pb – push, simo (red ●)
- RHC            √RATE    – VERN (RATE MIN tb-ON)  
 BRAKES – OFF (tb-OFF)  
 MODE          – SINGLE, ENTER
- Drive SY (+) to -87.0, then (-) to -90.0
- A7U      b. ITVC (no Black Stretch)  
 GAM BLK STR pb – push (lt off)
- Drive SY (+) to -87.0, then (-) to -90.0
- A7U      c. LDRI Mode 5 (3-D, no Black Stretch)  
 AP COR ON pb    – push (lt off)  
 GAM BLK STR pb – push (lt on)  
 ALC pb            – push  
 AVG pb            – push
- MUX 1 L ← MIDDECK  
 LDRI MODE 5 pb – push (flickering LDRI video)

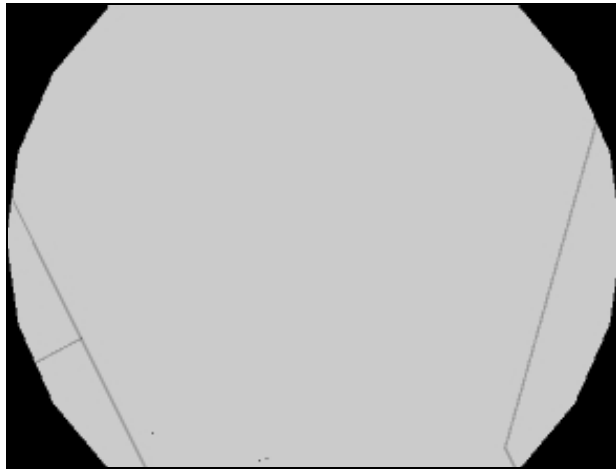

**LDRI (90,-260)**

Drive SY (+) to -87.0, then (-) to -90.0

A7U

- d. LDRI Mode 6 (3-D, Black Stretch)  
LDRI MODE 6 pb – push (brighter flickering LDRI video)

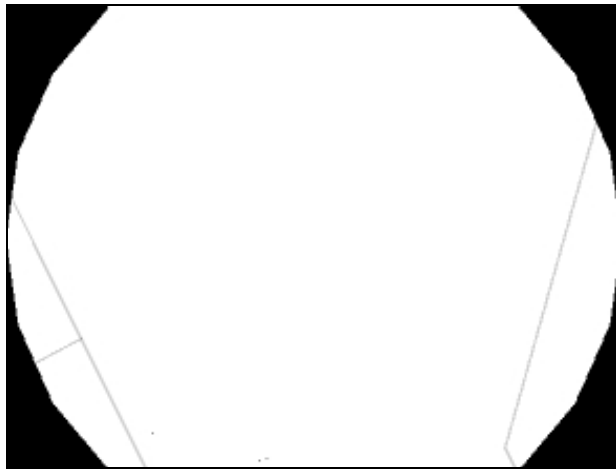

**LDRI (90,-260)**

Drive SY (+) to -87.0, then (-) to -90.0

BRAKES – ON (tb-ON)

L10(VTR)

STOP pb – push (no red ●)

4. SJ LCS CHARACTERIZATION

RHC      √RATE – VERN (RATE MIN tb-ON)  
           BRAKES – OFF (tb-OFF)  
           MODE – SINGLE, ENTER

Mnvr to SJ LCS CHARACTERIZATION posn:

	SY	SP	EP	WP	WY	WR	
SJ FF START	-90.0	+79.8	-123.1	-55.7	0.0	+92.0	
1: WP +				-6.5			
2: WY –					-32.7		
3: WR +						+126.0	
SJ LCS CHAR	-90.0	+79.8	-123.1	-6.5	-32.7	+126.0	
	X	Y	Z	PITCH	YAW	ROLL	PL ID
	-903	+274	-392	328	342	50	2

BRAKES – ON (tb-ON)

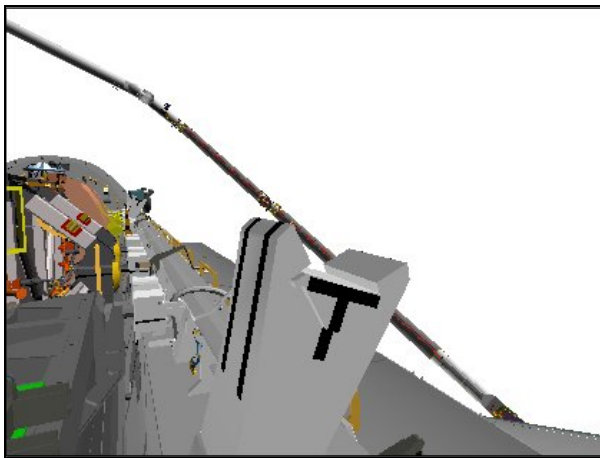

CCTV C (25,-6)

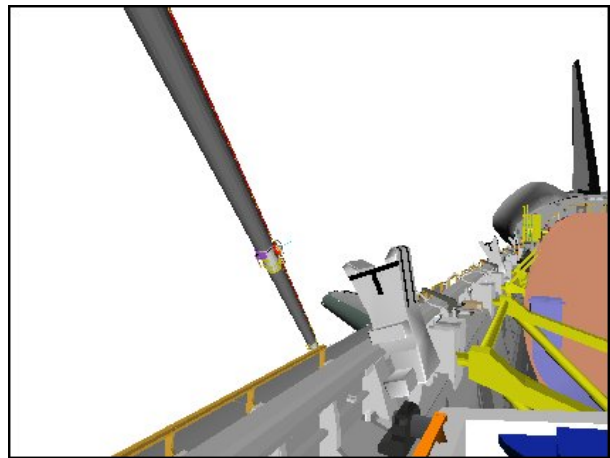

CCTV D (-30,0)

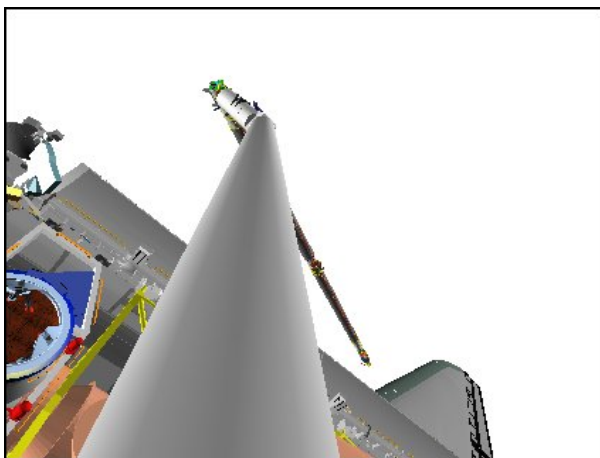

ELBOW (5,-20)

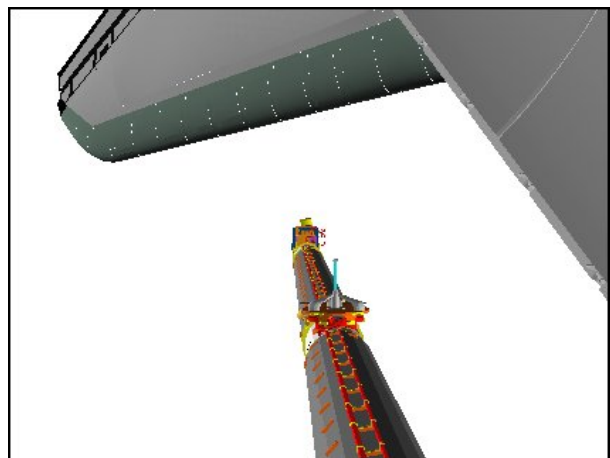

RSC



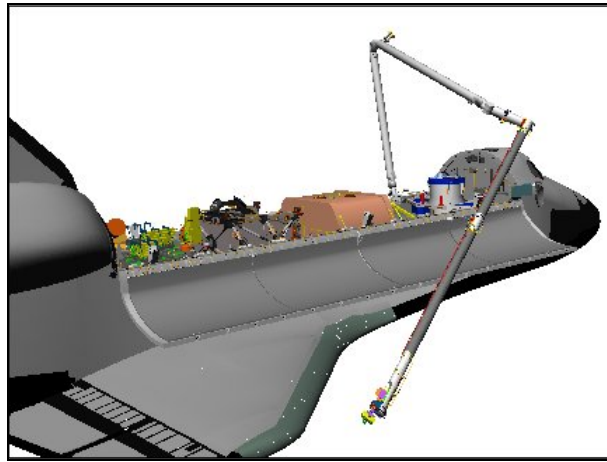

**BIRD'S EYE**

LCC/A31p Allow arm motion to damp-out for 30 sec, then  
 sel 'Scanning' 'Detailed Area Scan'  
 sel – Area Scan 14  
**cmd** Start Area Scan (verify Scan Line - Complete)

sel – Area Scan 16  
**cmd** Start Area Scan (verify Scan Line - Complete)

sel – Area Scan 17 LDA  
**cmd** Start Area Scan (verify Scan Line - Complete)

On MCC GO, proceed to step 5

RHC 5. RETURN TO OBSS HOVER  
 √RATE – VERN (RATE MIN tb-ON)  
 BRAKES – OFF (tb-OFF)  
 MODE – SINGLE, ENTER

Mnvr to OBSS HOVER posn:

	SY	SP	EP	WP	WY	WR	
SJ LCS CHAR	-90.0	+79.8	-123.1	-6.5	-32.7	+126.0	
1: WR –						+109.8	
2: WY +					-0.5		
3: WP –				-55.2			
OBSS HOVER	-89.8	+80.0	-123.3	-55.2	-0.5	+109.8	
	X	Y	Z	PITCH	YAW	ROLL	PL ID
	-998	+129	-504	359.5	0	11	2

BRAKES – ON (tb-ON)  
 MODE – not DIRECT  
 JOINT – CRIT TEMP

# MNVR FROM UNDOCK TO OBSS HOVER

**WARNING**  
For UNDOCKED ops only

## 1. SETUP

SM 94 PDRS CONTROL

√ PL ID, ITEM 3: 2

√ INIT ID, ITEM 24: 2

UNDOCK posn:

	X	Y	Z	PITCH	YAW	ROLL	PL ID
√	-1031	-44	-610	14	270	0	2
	SY	SP	EP	WP	WY	WR	
√	+25.8	+66.3	-49.0	-85.9	+10.7	-100.7	

\* display singularity

A7U CCTV – config as reqd

## 2. SJ MNVR TO OBSS HOVER

RHC RATE – as reqd (VERN within 10 ft)

BRAKES – OFF (tb-OFF)

MODE – SINGLE, ENTER

Mnvr to OBSS HOVER posn:

	SY	SP	EP	WP	WY	WR	
Undock	+25.8	+66.3	-49.0	-85.9	+10.7	-100.7	
1: SP +		+80.0					
2: SY -	-89.8						
3: WR +						+109.8	
4: WY -					-0.5		
5: WP +				-55.2			
6: EP -			-123.3				
OBSS Hover	-89.8	+80.0	-123.3	-55.2	-0.5	+109.8	
	X	Y	Z	PITCH	YAW	ROLL	PL ID
	-998	+129	-504	359.5	0	11	2

BRAKES – ON (tb-ON)

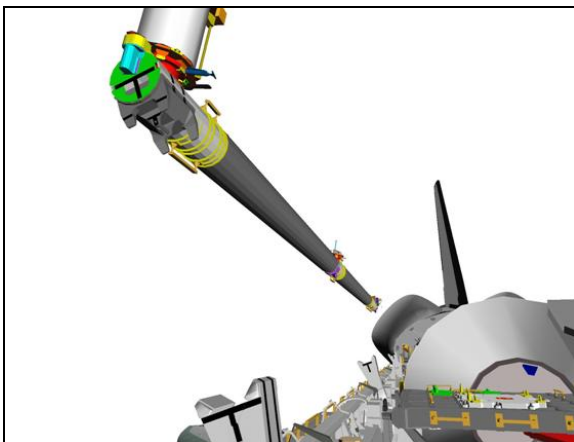

**CCTV D (-15,15)**

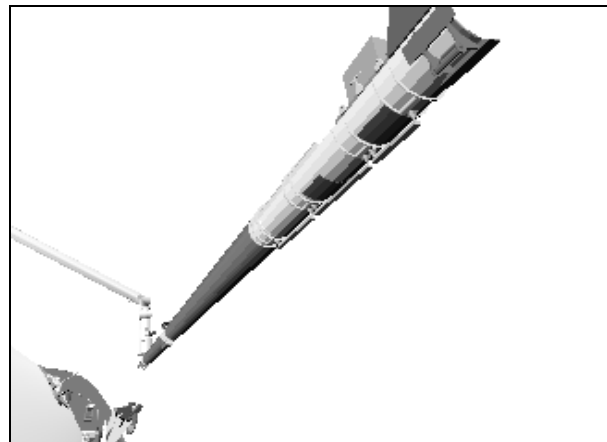

**CCTV C (25,25)**

## 3. OBSS BERTH

Go to OBSS BERTH (OBSS NOMINAL OPERATIONS)

## OBSS JETTISON

### ASSUMPTIONS:

1. DAP and RMS have been configured to provide stable position for OBSS prior to entering this procedure
2. For undocked ops only

### NOTES:

1. Jettison to be performed between sunrise and noon, if practical, to provide good visibility
2. DAP A used post-jettison for sep mnvr. DAP B (with mod in step 1) used while OBSS attached to RMS to keep loads down and ensure stable orbiter/payload/DAP
3. Jettison must occur greater than 1500 ft from ISS to avoid plume impingement damage
4. For emergency undock scenario, perform Shuttle Emergency Sep (RNDZ C/L) with 3 fps posigrade +X burn in step 3 prior to executing this procedure

**CDR**

**MS**

**OBSS JETTISON**

1. SETUP  
 O14:F, O15:F, O16:F, O14:E     √Pri RJD DRIVER, LOGIC (sixteen) – ON  
                   √cb DDU AFT (two) – cl  
 A6U           √SENSE: -Z  
                   √DAP: INRTL  
 A7U           √Lighting – as reqd  
  
                   GNC 20 DAP CONFIG  
 CRT           Config DAP A to A7, B to B7  
                   PRI ROT RATE (B7) – ITEM 30 +0.2 EXEC  
                   ALT RATE DB (B7) – ITEM 38 +0.2 EXEC  
                   VERN RATE DB (B7) – ITEM 45 +0.2 EXEC  
                   CNTL ACC (B7) – ITEM 48 +9 EXEC  
  
 2. AUTO MNVR TO -XLV, +ZVV  
                   GNC UNIV PTG  
                   √TGT ID: +2  
                   BODY VECT: +5  
                   P: +180  
                   Y: +0  
                   OM: +0  
                   TRK – ITEM 19 EXEC (CUR – \*)  
  
 A6U           DAP: B/AUTO/VERN(ALT)

**OBSS JETTISON**

1. SETUP
- |       |   |
|-------|---|
| MON 1 | A |
| MON 2 | B |
- SM 94 PDRS CONTROL  
 PL ID       – ITEM 3 +2 EXEC  
 INIT ID – ITEM 24 +2 EXEC
2. MNVR TO JETTISON POSN  
 RATE       – as reqd (VERN within 10 ft)  
 BRAKES – OFF (tb-OFF)  
 MODE       – as desired
- RHC
- If coming from OBSS Park posn:  
 Mnvr to JETTISON posn:
- |           |       |       |       |       |     |      |      |
|-----------|-------|-------|-------|-------|-----|------|------|
|           | SY    | SP    | EP    | WP    | WY  | WR   |      |
| OBSS Park | 0.0   | +25.0 | -25.0 | +5.0  | 0.0 | 0.0  |      |
| 1: SP+    |       | +40.0 |       |       |     |      |      |
| 2: SY-    | -22.5 |       |       |       |     |      |      |
| Jett      | -22.5 | +40.0 | -25.0 | +5.0  | 0.0 | 0.0  |      |
|           | X     | Y     | Z     | PITCH | YAW | ROLL | PLID |
|           | -1042 | -37   | -1046 | 116   | 7   | 13   | 2    |
- If not coming from OBSS Park posn:  
 Mnvr to JETTISON posn (within 1"/1°):
- |       |       |       |       |     |      |       |
|-------|-------|-------|-------|-----|------|-------|
| X     | Y     | Z     | PITCH | YAW | ROLL | PL ID |
| -1042 | -37   | -1046 | 116   | 7   | 13   | 2     |
| SY    | SP    | EP    | WP    | WY  | WR   |       |
| -22.5 | +40.0 | -25.0 | +5.0  | 0.0 | 0.0  |       |
- BRAKES – ON (tb-ON)

CDR

MS

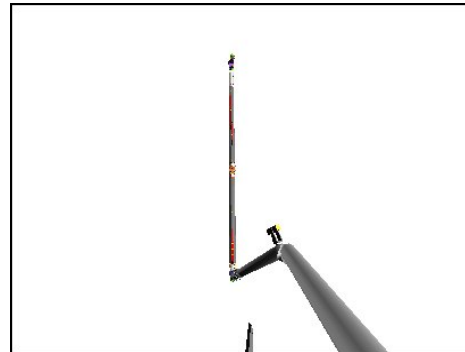

**CCTV A (-5,45)**



**CCTV B (15,50)**

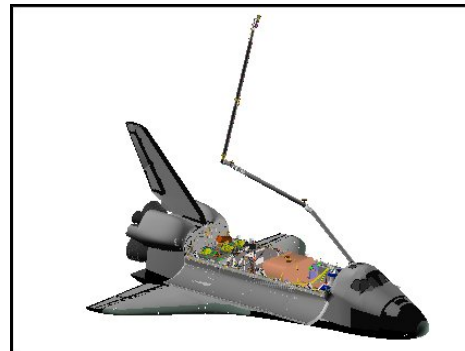

**BIRD'S EYE**

**CDR**

**MS**

On MS call, "OBSS at jettison position" -----

----- Report to CDR "OBSS at jettison position"

A6U

If attitude mnvr not complete:

DAP: ALT

GNC 20 DAP CONFIG
-------------------

PRI ROT RATE (B7) - ITEM 30 +0.5 EXEC

3. CONFIGURE ORBITER FOR SEP MNVR

When mnvr to attitude complete:

√DAP: VERN(ALT)

When rates damped:

DAP: FREE

FLT CNTLR PWR - ON

√DAP TRANS: PULSE/PULSE/PULSE, NO LO Z

3. OBSS RELEASE

MON 1	WRIST
MON 2	B(C,ELBOW)

R12  
(OBSS)

SPEE PWR - OFF

SSP1

√APCU 1,2 CONV - OFF

√APCU 1 OUTPUT RLY - op (tb-bp)

SM 94 PDRS CONTROL
--------------------

PL ID - ITEM 3 +0 EXEC

INIT ID - ITEM 24 +0 EXEC

X	Y	Z	PITCH	YAW	ROLL	PL ID
√ -1172	-2	-758	27	347	7	0
	SY	SP	EP	WP	WY	WR
√ -22.5	+40.0	-25.0	5.0	0.0	0.0	

Report to MS, "GO to release OBSS" -----

----- On CDR call, "GO to release OBSS"

RHC

√RATE - VERN (RATE MIN tb-ON)

BRAKES - OFF (tb-OFF)

MODE - END EFF, ENTER







CDR

MS

**CAUTION**  
Monitor EE tb timing to prevent EE motor burnout

EE MODE – AUTO  
RELEASE sw – REL (mom)

When OPEN tb – gray, mnvr arm clear of grapple pin

	RIGID	CLOSE	CAPTURE	<b>CRITICAL TIMES (28 sec total):</b> DERIGID tb – gray, 5 sec max, then OPEN tb – gray, 3 sec max, then EXTEND tb – gray, 20 sec max
√				
	DERIGID	OPEN	EXTEND	
				

EE MODE – OFF

BRAKES – ON (tb-ON)

On MS call, "GO to perform SEP mnvr" ----- Report to CDR, "GO to perform SEP mnvr"

A6U

- 4. SEP MNVR  
 DAP: A/FREE/VERN(ALT)  
 THC: +Z (out) 2 pulses (0.2 ft/sec)  
 When opening rate confirmed:  
     DAP TRANS: PULSE/PULSE/NORM  
     DAP: LVLH  
     THC: +Z (out) 5 sec (1.7 ft/sec)  
 FLT CNTLR PWR – OFF  
 DAP TRANS: PULSE/PULSE/PULSE

Report to MS, "SEP mnvr complete" ----- On CDR call, "SEP mnvr complete"

CRT

**GNC 20 DAP CONFIG**  
Config DAP B to B7

- 4. RMS TO PRE-CRADLE  
Go to RMS PWRDN, step 1

## OBSS JETTISON WITH MPMS

### ASSUMPTIONS:

1. DAP and RMS have been configured to provide stable position for OBSS prior to entering this procedure
2. For undocked ops only

### NOTES:

1. Jettison to be performed between sunrise and noon, if practical, to provide good visibility
2. DAP A used post-jettison for sep mnvr. DAP B (with mod in step 1) used while OBSS attached to RMS to keep loads down and ensure stable orbiter/payload/DAP
3. Jettison must occur greater than 1500 ft from ISS to avoid plume impingement damage
4. For emergency undock scenario, perform Shuttle Emergency Sep (RNDZ C/L) with 3 fps posigrade +X burn in step 3 prior to executing this procedure







**CDR**

**MS**

3. AUTO MNVR TO -XLV, +ZVV

GNC UNIV PTG

√TGT ID: +2

BODY VECT: +5

P: +180

Y: +0

OM: +0

TRK - ITEM 19 EXEC (CUR - \*)

A6U

DAP: B/AUTO/VERN(ALT)

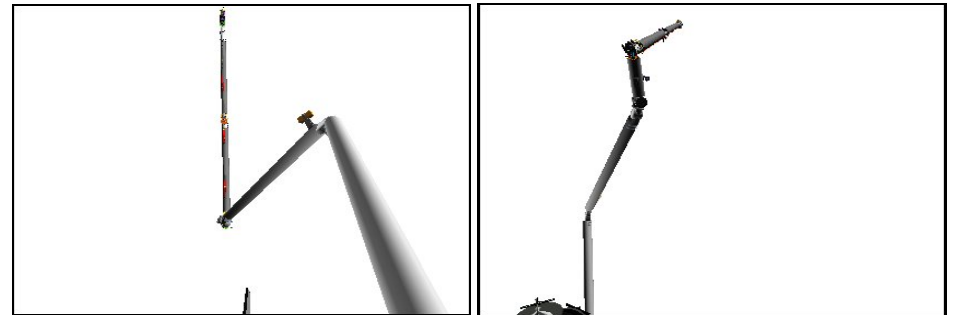

**CCTV A (-10,45)**

**CCTV C (0,35)**

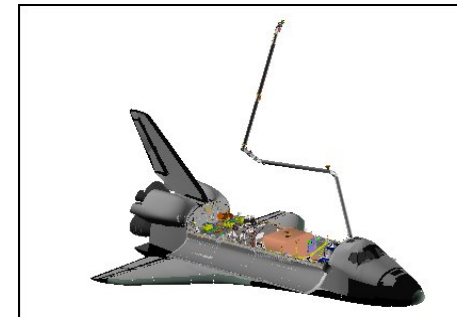

**BIRD'S EYE**

**CDR**

**MS**

On MS call, "OBSS at jettison position" -----

----- Report to CDR "OBSS at jettison position"

If attitude mnvr not complete:

DAP: ALT

GNC 20 DAP CONFIG

PRI ROT RATE (B7) – ITEM 30 +0.5 EXEC

5. OBSS RELEASE

MON 1	WRIST
MON 2	C(B)

3. CONFIGURE ORBITER FOR SEP MNVR

When mnvr to attitude complete:

√DAP: VERN(ALT)

When rates damped:

DAP: FREE

R12  
(OBSS)  
SSP1

√SPEE PWR – OFF

√APCU 1,2 CONV – OFF

√APCU 1 OUTPUT RLY – op (tb-bp)

FLT CNTLR PWR – ON

√DAP TRANS: PULSE/PULSE/PULSE, NO LO Z

SM 94 PDRS CONTROL

PL ID – ITEM 3 +0 EXEC

INIT ID – ITEM 24 +0 EXEC

X	Y	Z	PITCH	YAW	ROLL	PL ID
√ -1078	0	-754	25	0	1	0
√ SY	SP	EP	WP	WY	WR	
√ -29.5	+66.7	-68.5	+26.8	+18.9	-9.9	

Report to MS, "GO to release OBSS" -----

----- On CDR call, "GO to release OBSS"

RHC

√RATE – VERN (RATE MIN tb-ON)

BRAKES – OFF (tb-OFF)

MODE – END EFF, ENTER

**CDR**

**MS**

**CAUTION**  
Monitor EE tb timing to  
prevent EE motor burnout

EE MODE – AUTO  
RELEASE sw – REL (mom)

When OPEN tb – gray, mnvr arm clear of grapple pin

	RIGID	CLOSE	CAPTURE	<b>CRITICAL TIMES (28 sec total):</b>	
√					DERIGID tb – gray, 5 sec max, then
	DERIGID	OPEN	EXTEND		OPEN tb – gray, 3 sec max, then
				EXTEND tb – gray, 20 sec max	

EE MODE – OFF

BRAKES – ON (tb-ON)

On MS call, "GO to perform SEP mnvr"

Report to CDR, "GO to perform SEP mnvr"

A6U

4. SEP MNVR

DAP: A/FREE/VERN(ALT)

THC: +Z (out) 2 pulses (0.2 ft/sec)

When opening rate confirmed:

DAP TRANS: PULSE/PULSE/NORM

DAP: LVLH

THC: +Z (out) 5 sec (1.7 ft/sec)

FLT CNTLR PWR – OFF

DAP TRANS: PULSE/PULSE/PULSE

Report to MS, "SEP mnvr complete"

On CDR call, "SEP mnvr complete"

CRT

**GNC 20 DAP CONFIG**

Config DAP B to B7

6. RMS TO PRE-CRADLE

Go to RMS PWRDN, step 1

This Page Intentionally Blank

OBSS SURVEY CAMERA VIEWS

OBSS LDRI RCC SURVEY CAMERA VIEWS – STBD.....	FS 10-2
– NOSE CAP.....	FS 10-15
– PORT.....	FS 10-27
SRMS EE CAM CREW CABIN SURVEY CAMERA VIEWS.....	FS 10-39
OBSS LDRI RCC SURVEY CAMERA VIEWS – STBD DOCKED.....	FS 10-46
IDC RCC SURVEY CAMERA VIEWS – STBD.....	FS 10-70
– NOSE CAP.....	FS 10-80
– PORT.....	FS 10-94

# OBSS LDRI RCC SURVEY CAMERA VIEWS – STBD

## NOTE

All LDRI views are shown after any pan/tilt changes at that position

### STBD LDRI RCC SURVEY – Pause Pt 1

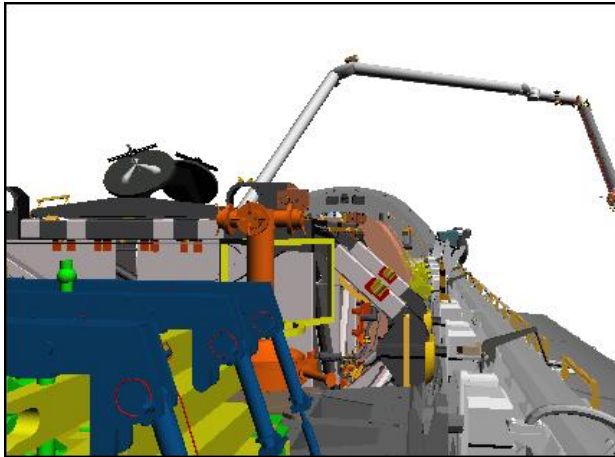

CCTV C (-10,0)

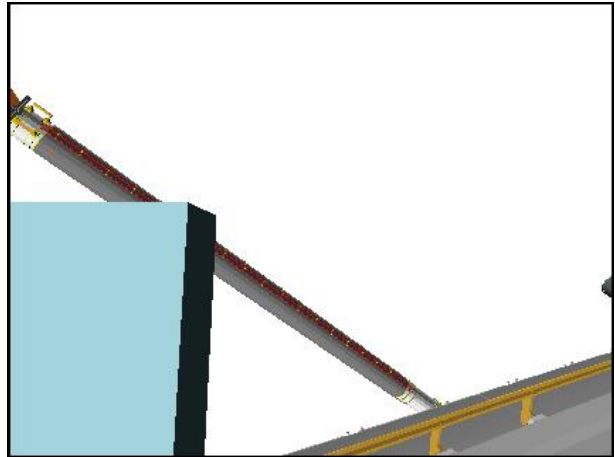

CCTV D (-60,-5)

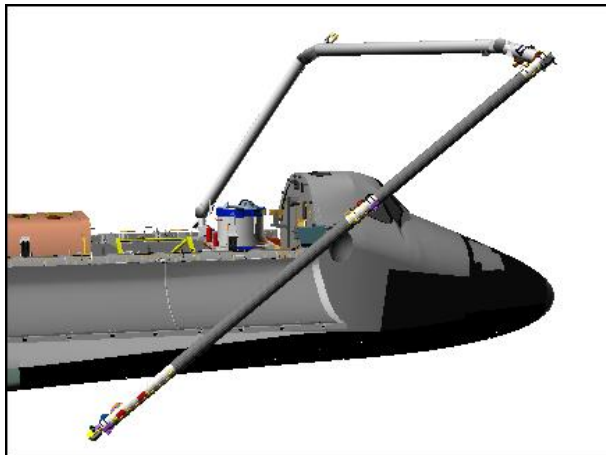

STBD

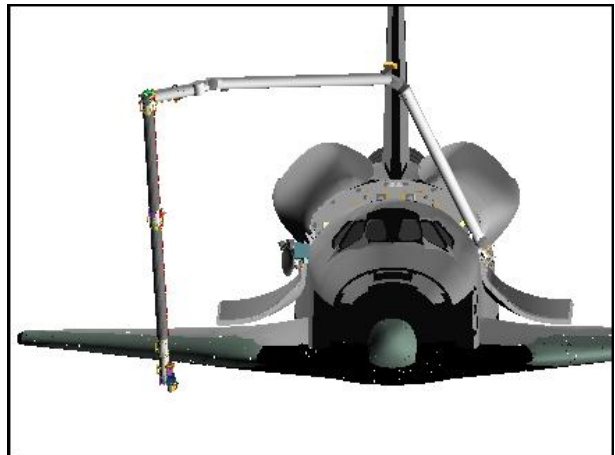

FRONT



RSC

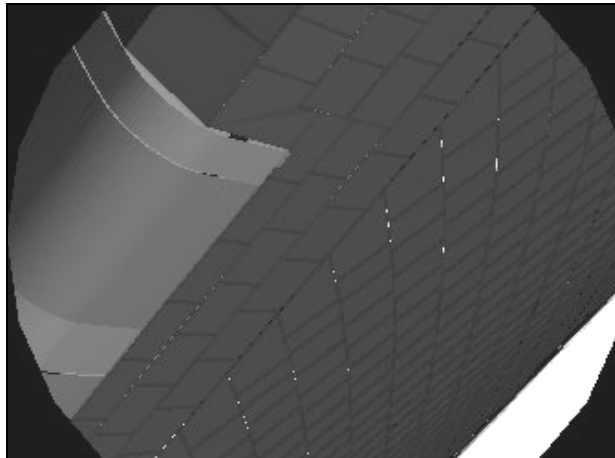

LDRI (95,-105)

OBSS SURVEY  
CAMERA VIEWS



STBD LDRI RCC SURVEY – Pause Pt 5

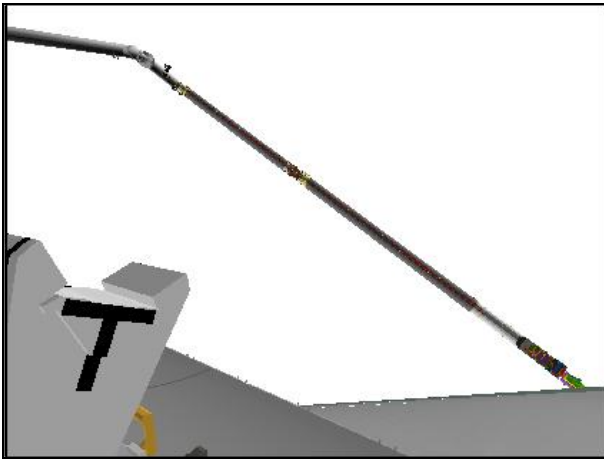

CCTV C (50,-5)

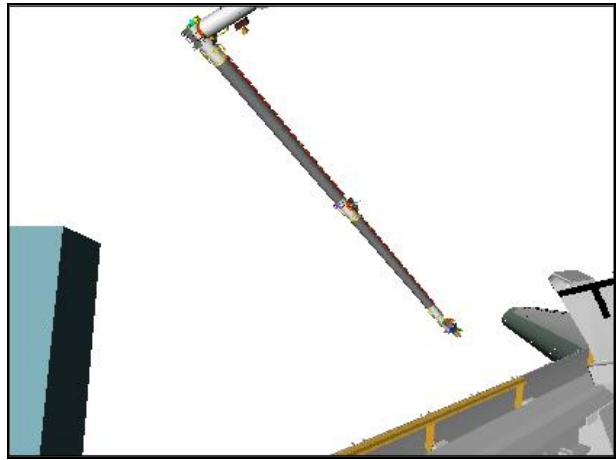

CCTV D (-50,0)

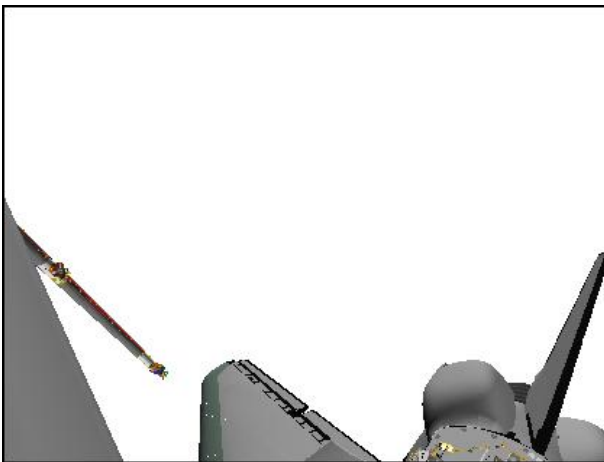

ELBOW (40,-35)

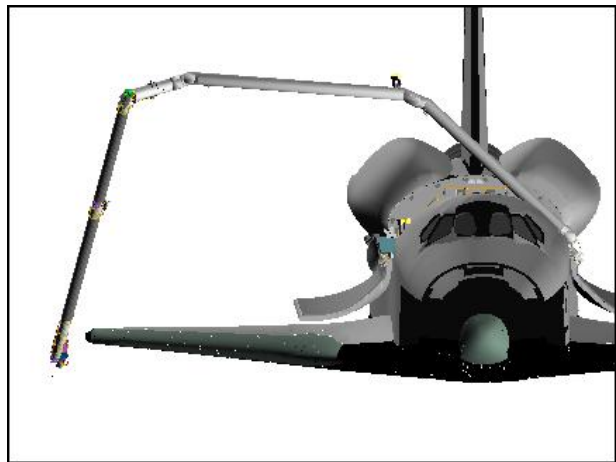

FRONT

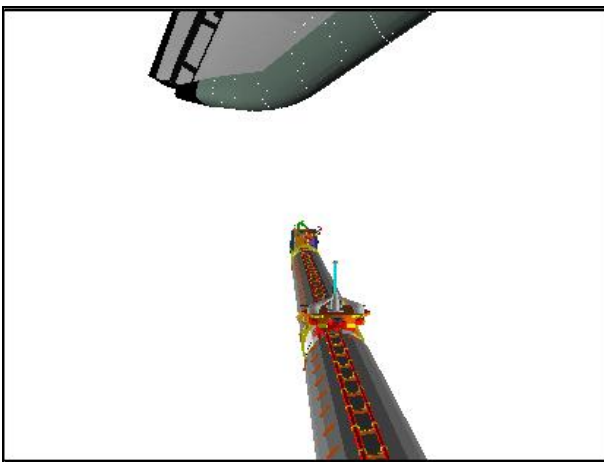

RSC

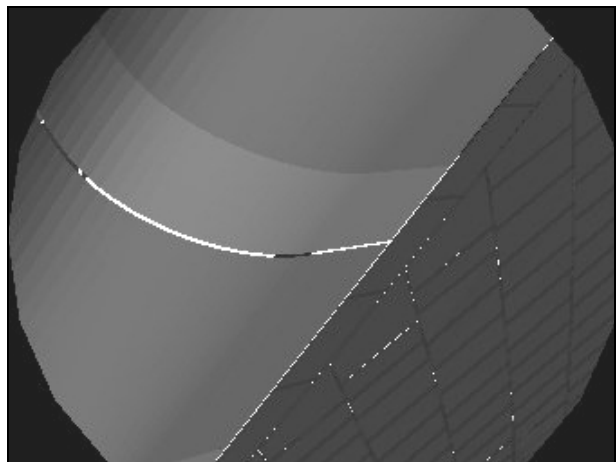

LDRI (95,-105)

STBD LDRI RCC SURVEY – Pause Pt 7

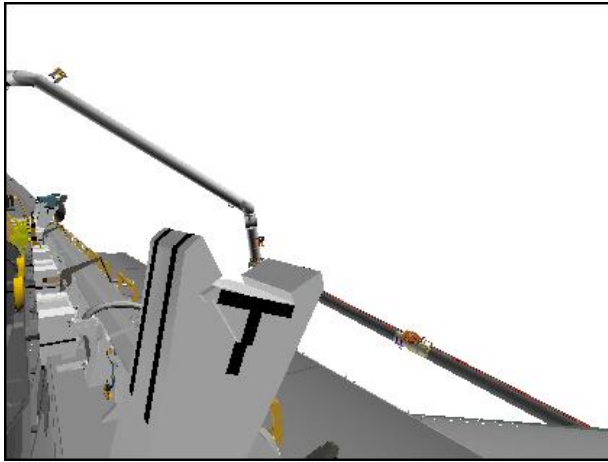

CCTV C (35,-5)

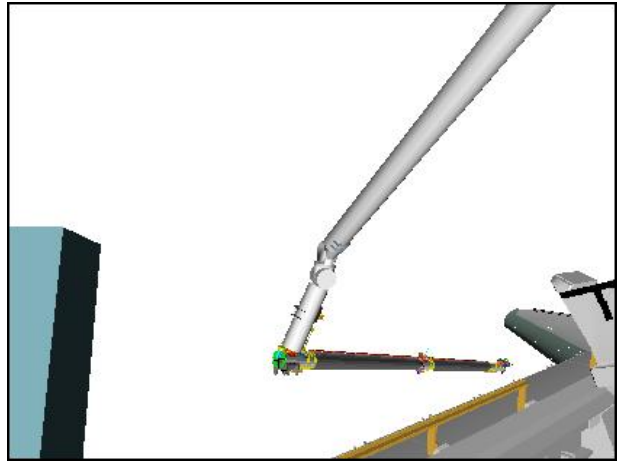

CCTV D (-50,0)

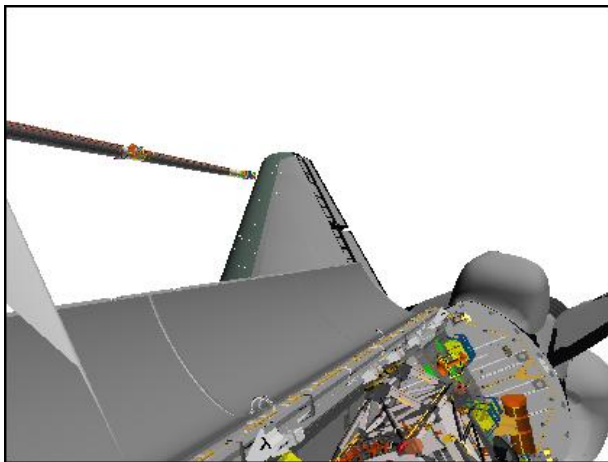

ELBOW (40,-35)

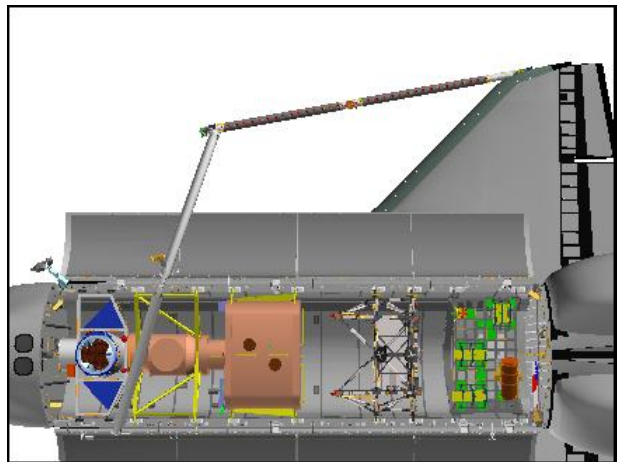

OVERHEAD

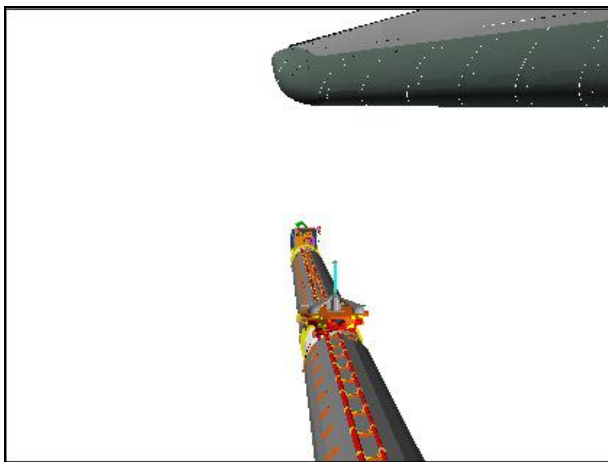

RSC

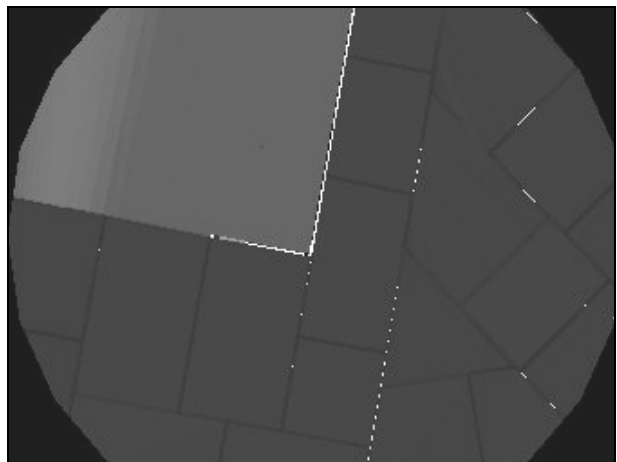

LDRI (80,-65)

STBD LDRI RCC SURVEY – Pause Pt 12

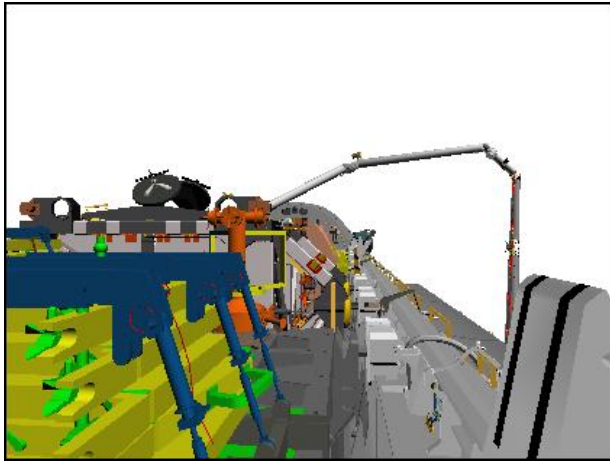

CCTV C (-5,0)

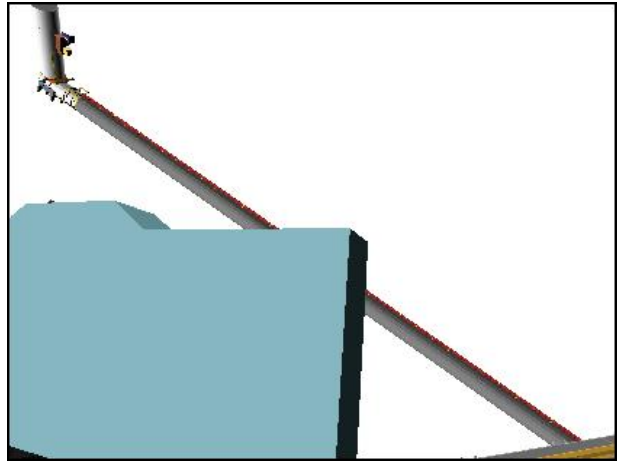

CCTV D (-75,0)

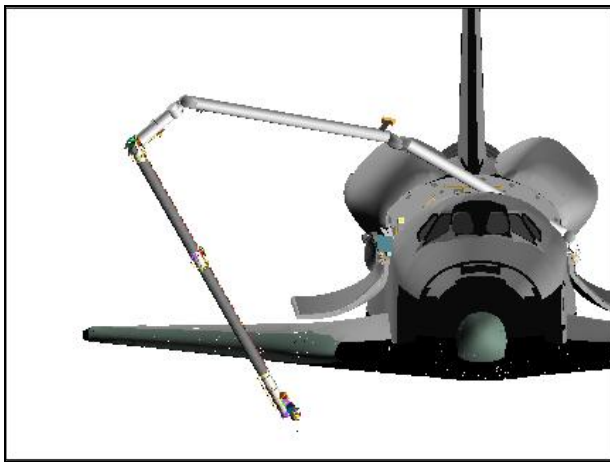

FRONT

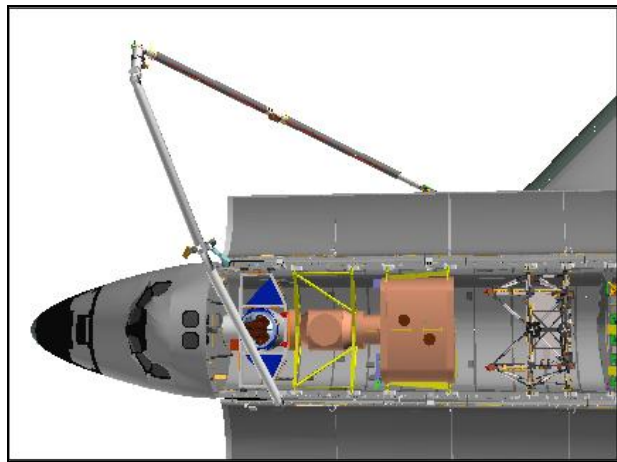

OVERHEAD

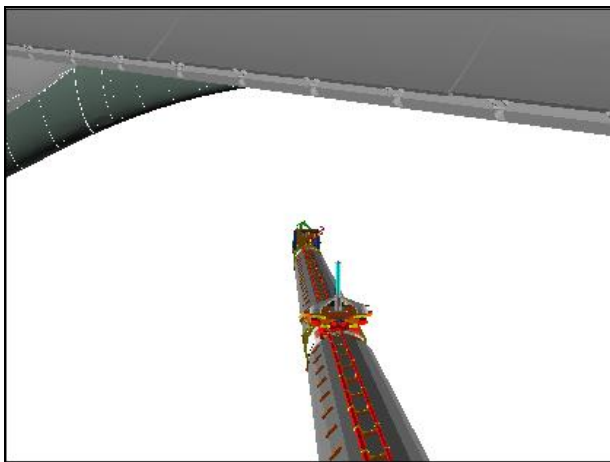

RSC

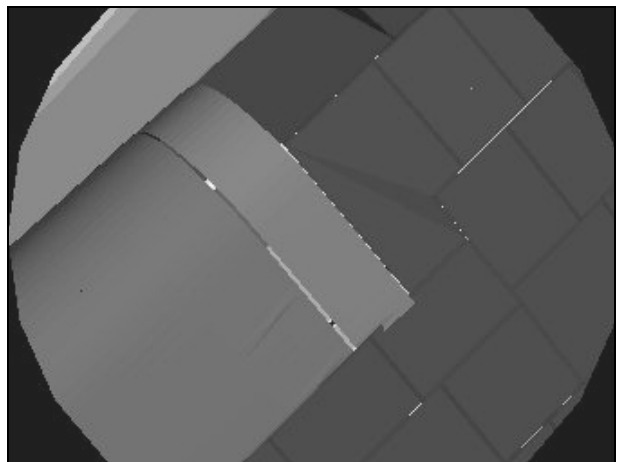

LDRI (80,-65)

STBD LDRI RCC SURVEY – Pause Pt 17

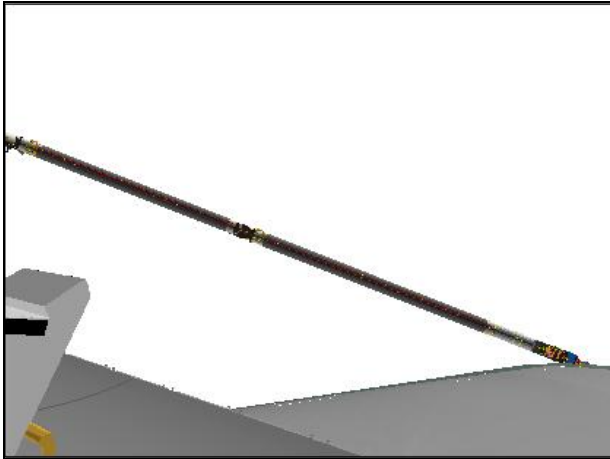

CCTV C (60,-5)

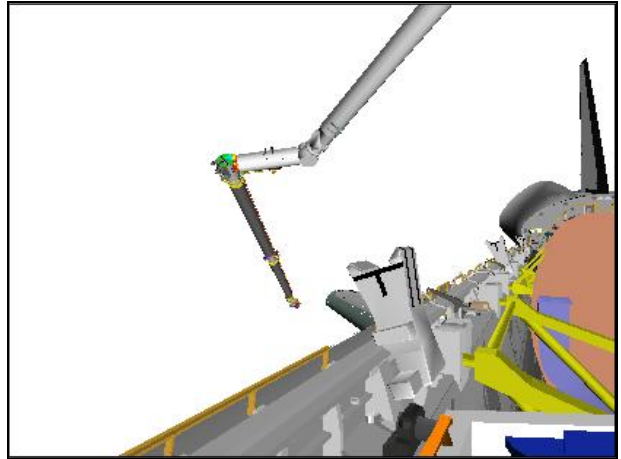

CCTV D (-30,0)

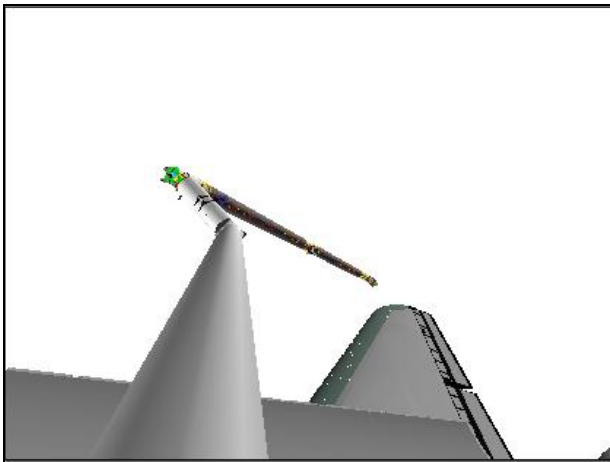

ELBOW (10,-5)

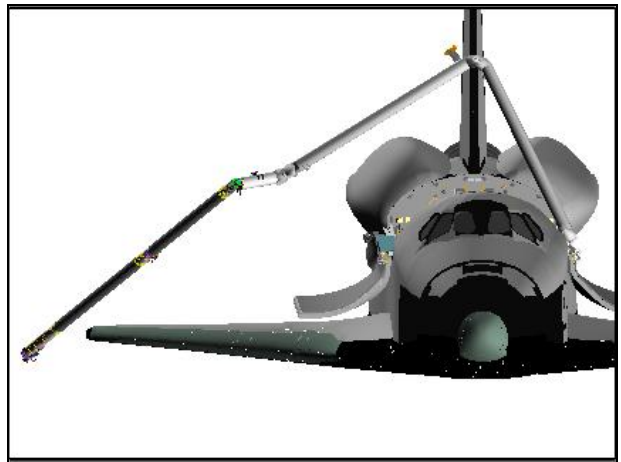

FRONT

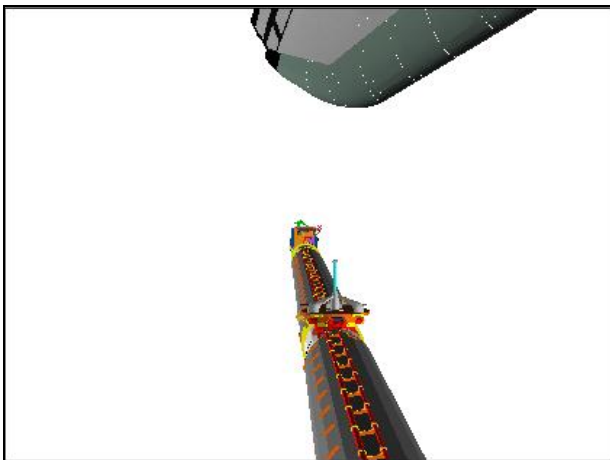

RSC

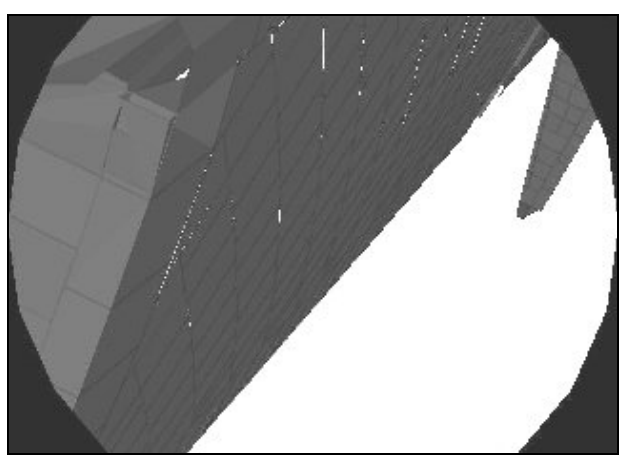

LDRI (80,-90)

STBD LDRI RCC SURVEY – Pause Pt 22

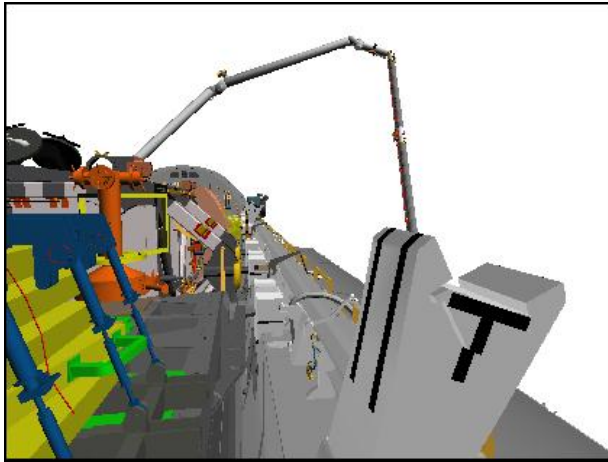

CCTV C (10,-5)

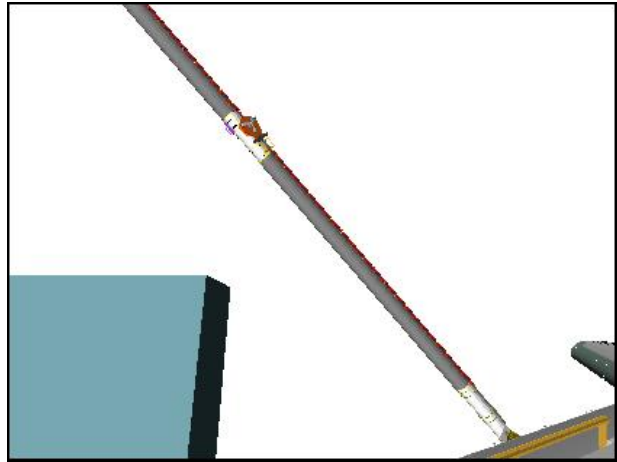

CCTV D (-60,5)

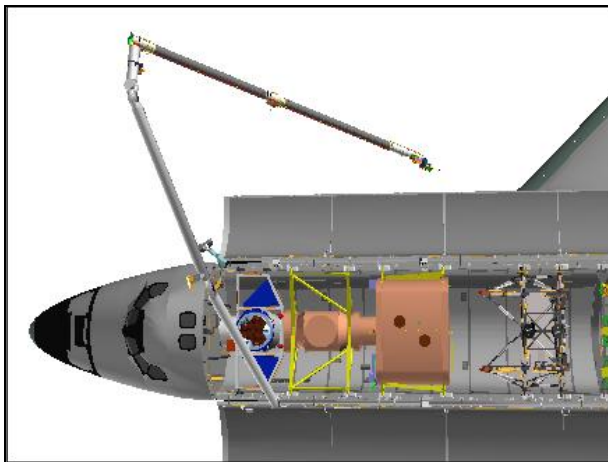

OVERHEAD

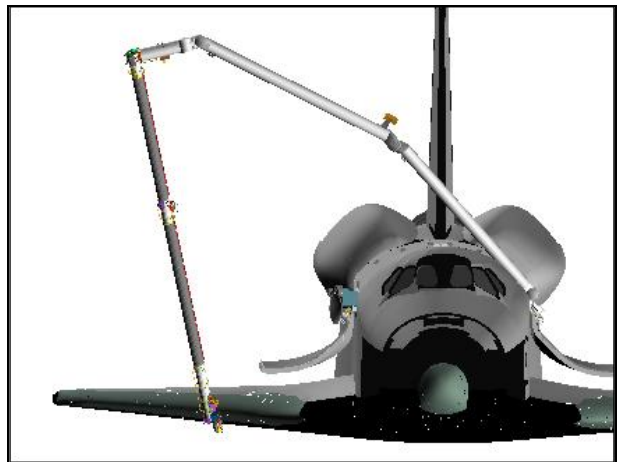

FRONT

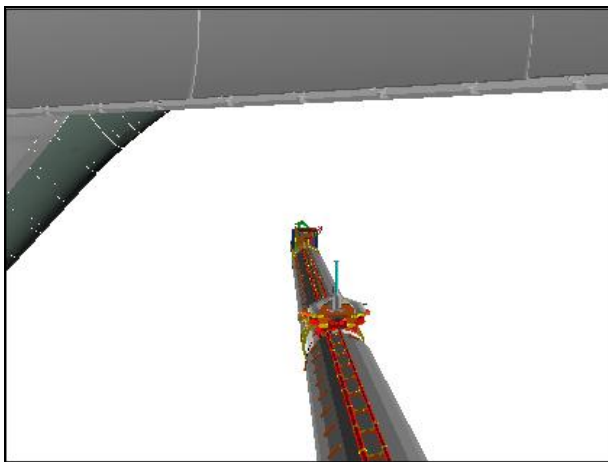

RSC

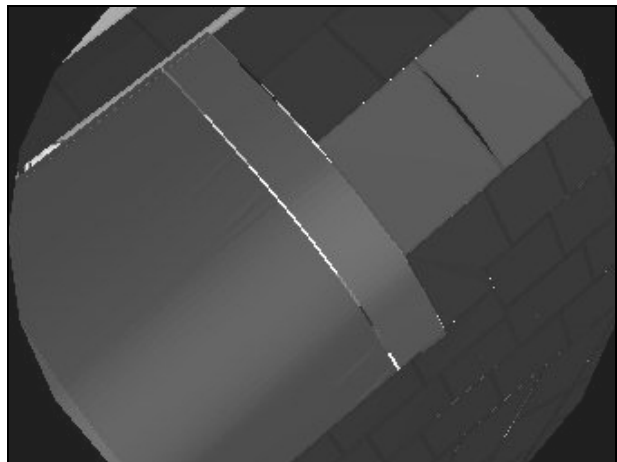

LDRI (80,-90)

STBD LDRI RCC SURVEY – Pause Pt 23

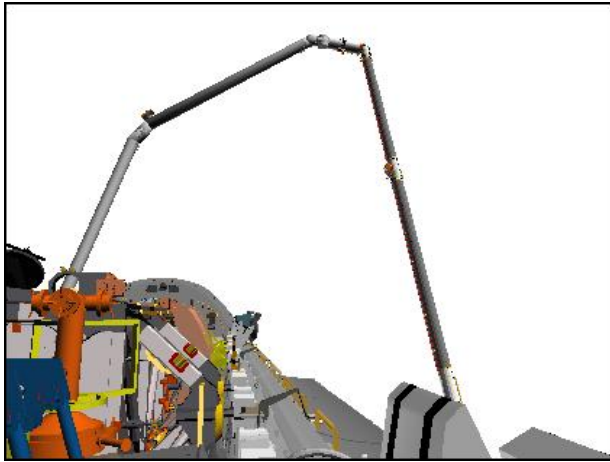

CCTV C (10,10)

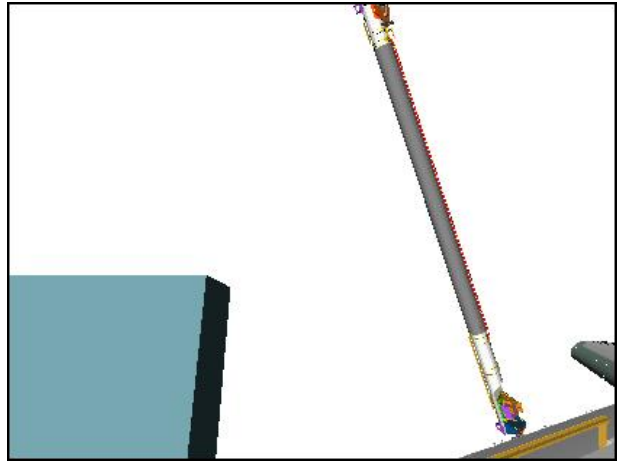

CCTV D (-60,5)

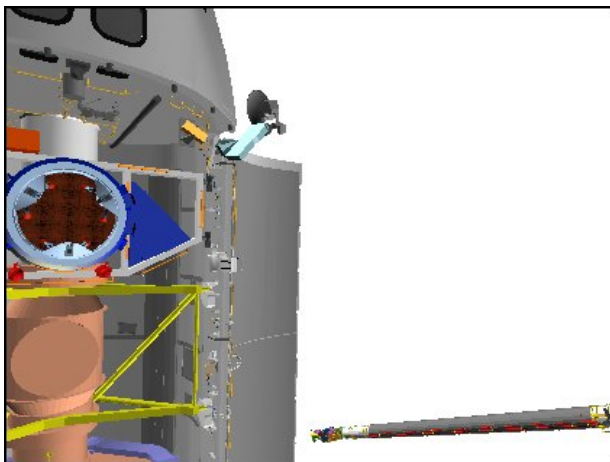

ELBOW (-90,-45)

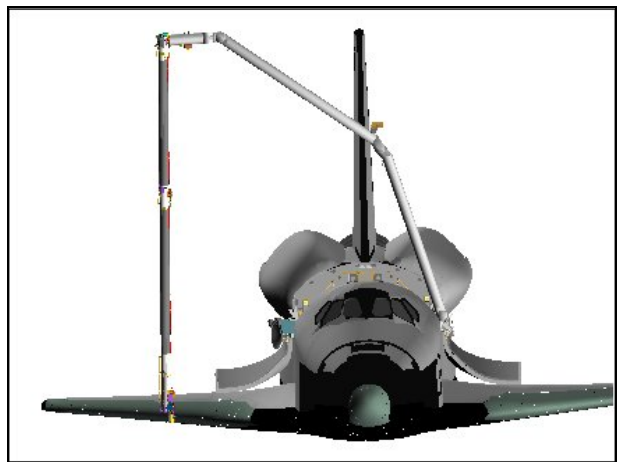

FRONT

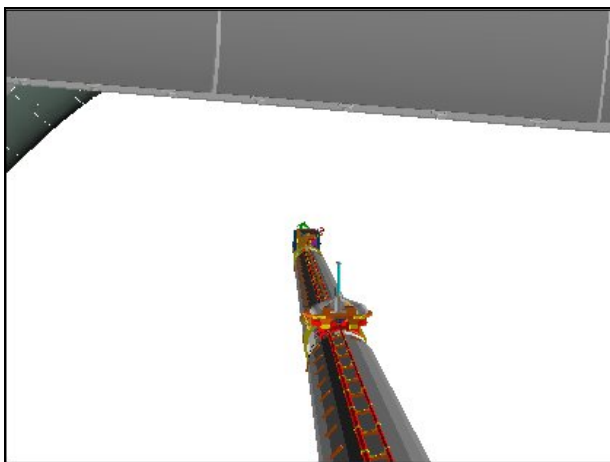

RSC

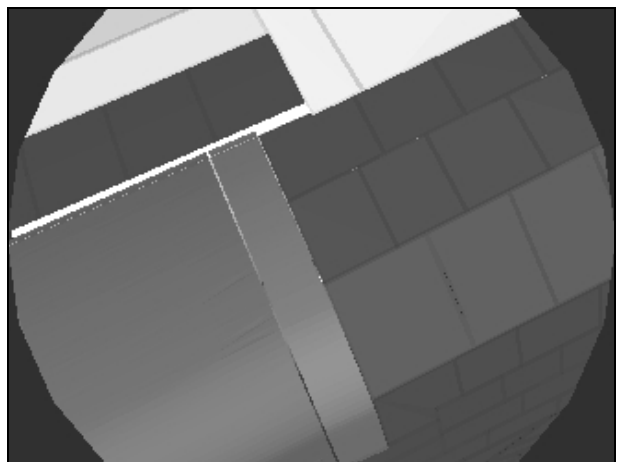

LDRI (80,-85)

STBD LDRI RCC SURVEY – Pause Pt 26

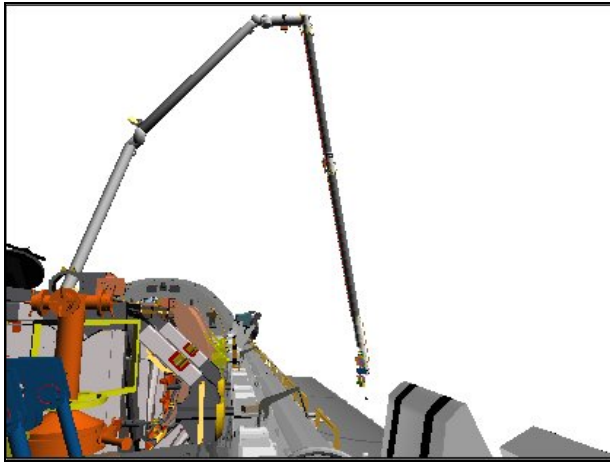

CCTV C (10,10)

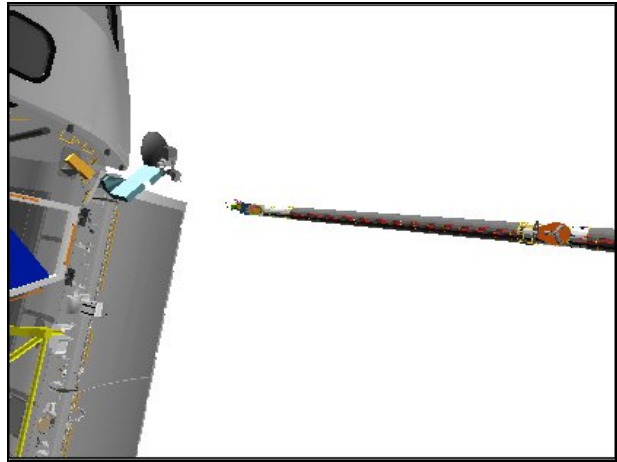

ELBOW (-90,-45)

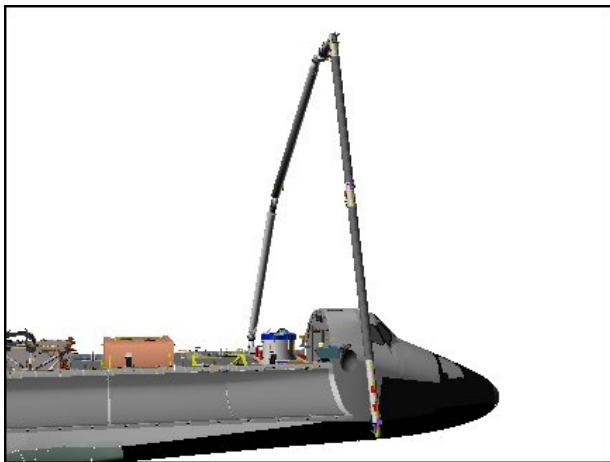

STBD

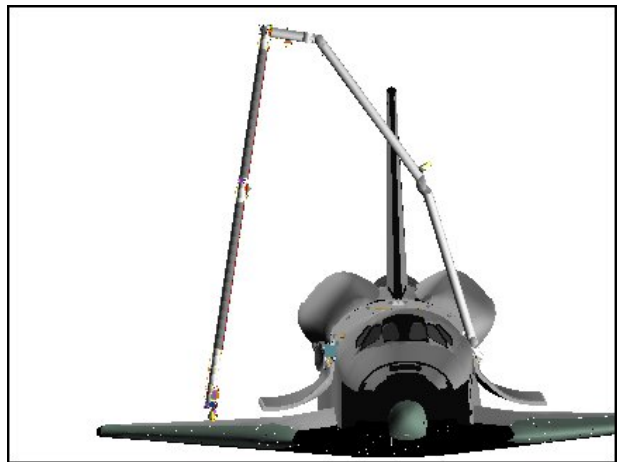

FRONT

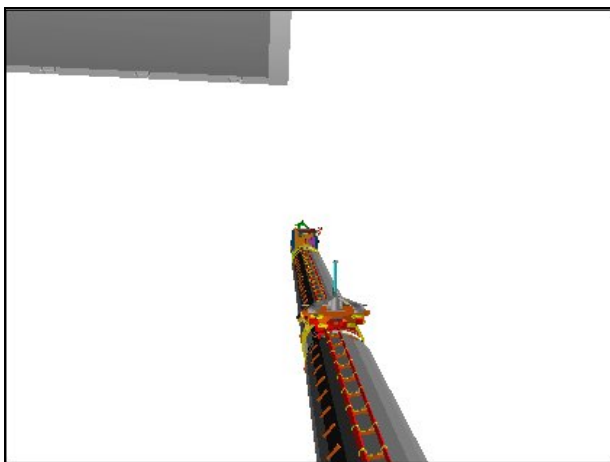

RSC

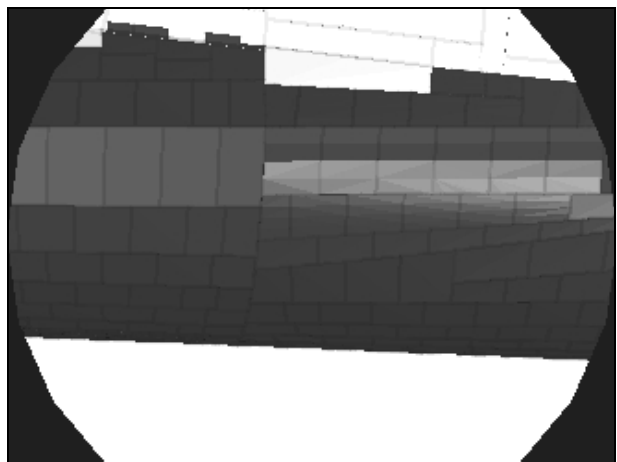

LDRI (80,-85)

STBD LDRI RCC SURVEY – Pause Pt 32

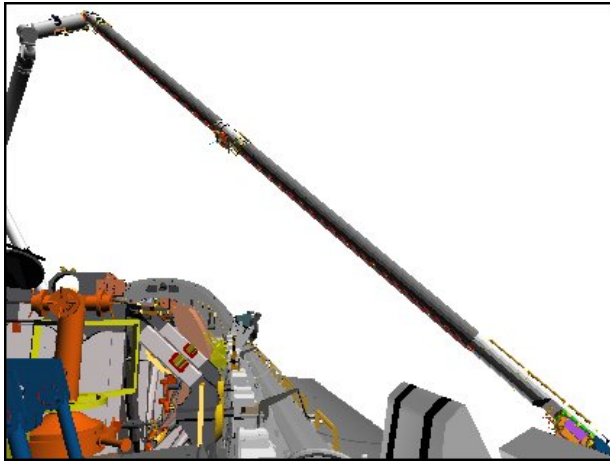

CCTV C (10,10)

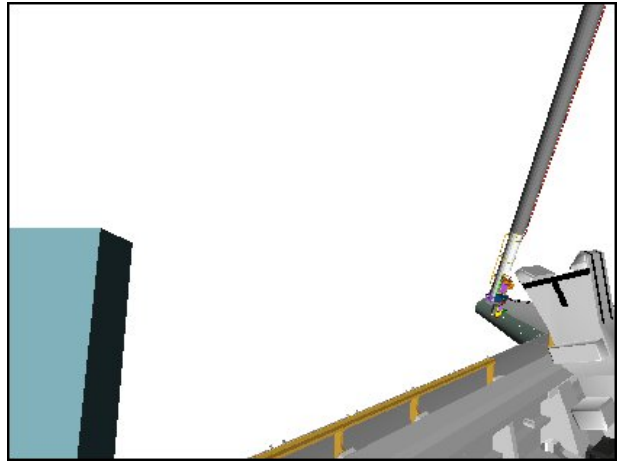

CCTV D (-30,0)

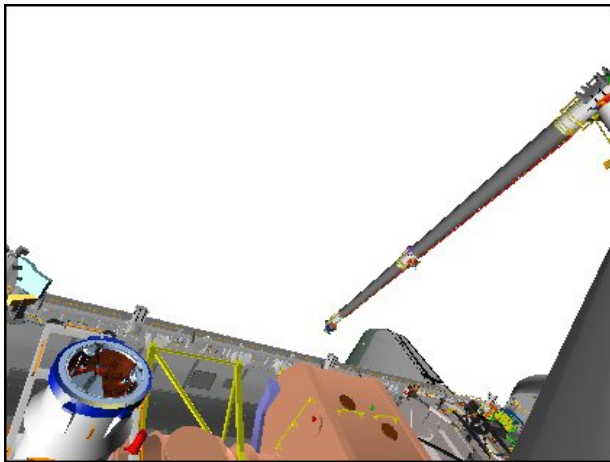

ELBOW (-40,-10)



FRONT

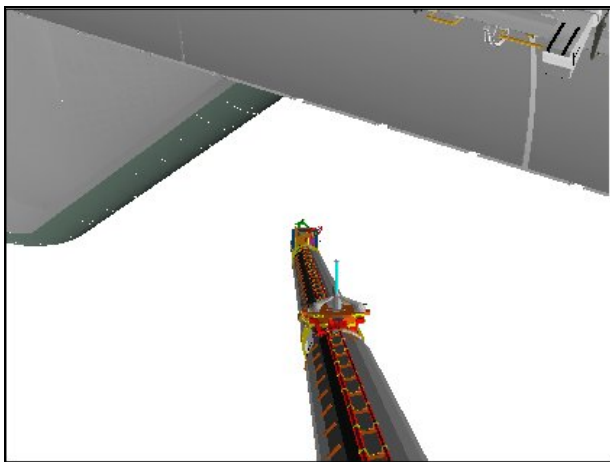

RSC

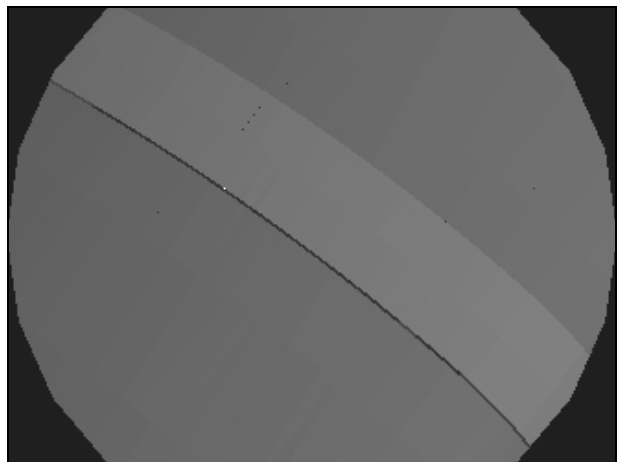

LDRI (80,-85)



STBD LDRI RCC SURVEY – Pause Pt 33

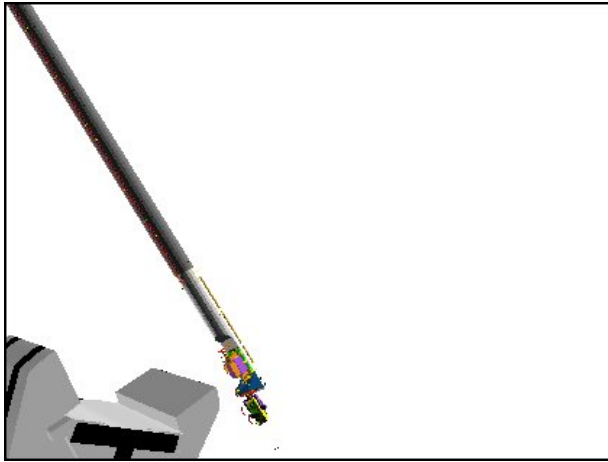

CCTV C (45,5)

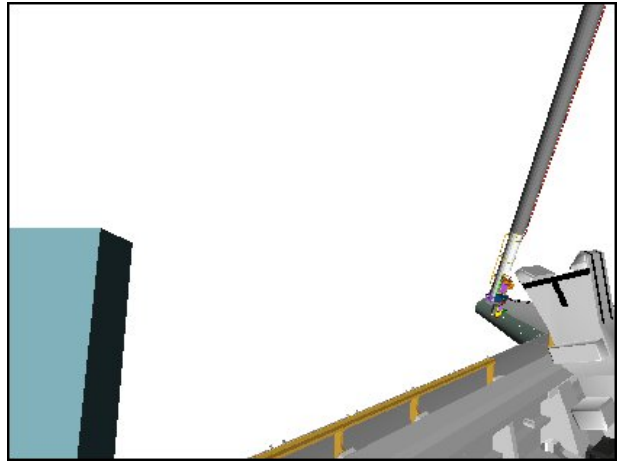

CCTV D (-50,0)

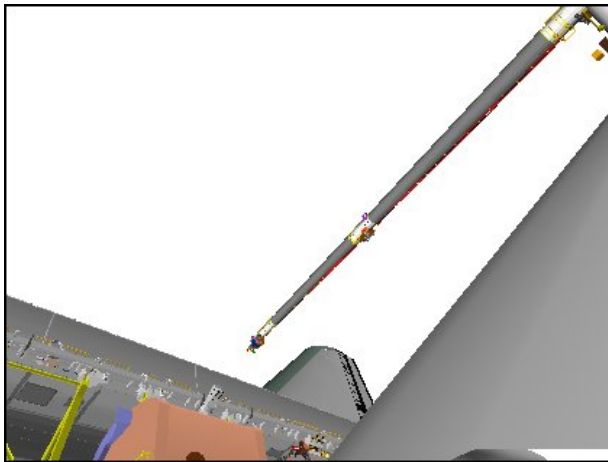

ELBOW (-40,-30)

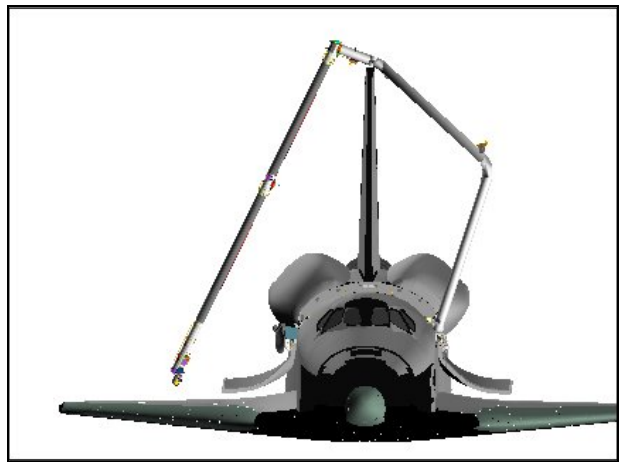

FRONT

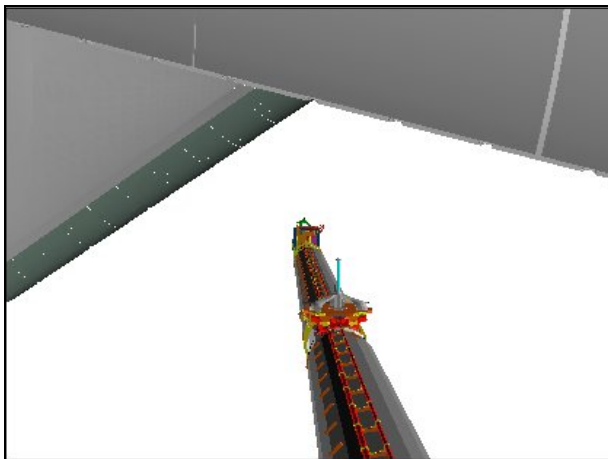

RSC

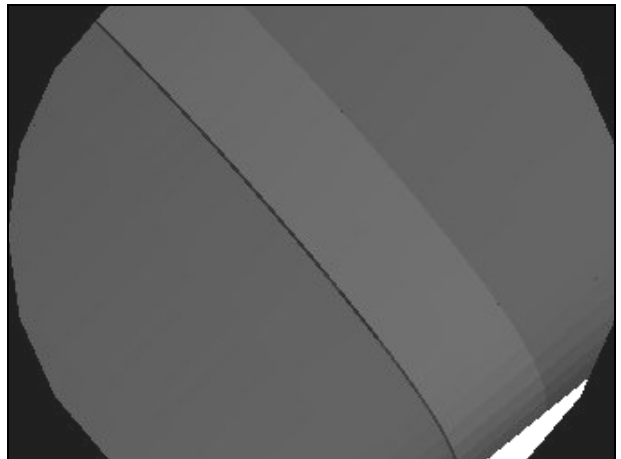

LDRI (80,-105)

STBD LDRI RCC SURVEY – Pause Pt 37

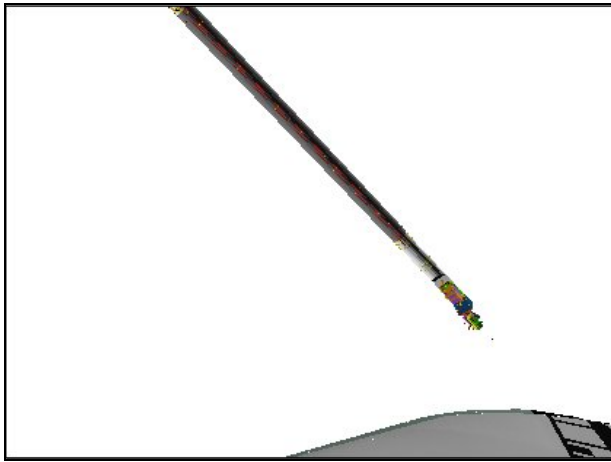

CCTV C (75,0)

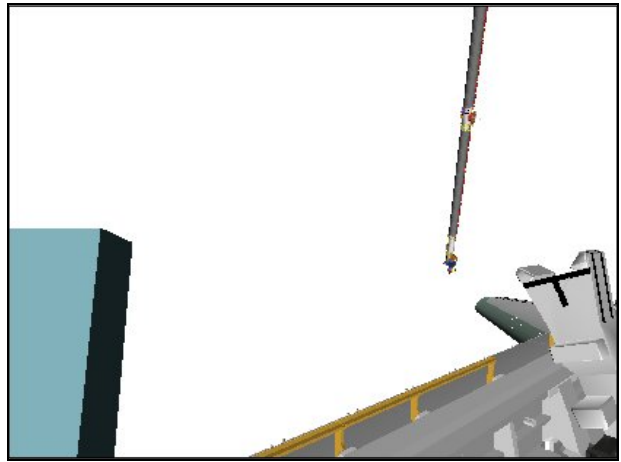

CCTV D (-50,0)

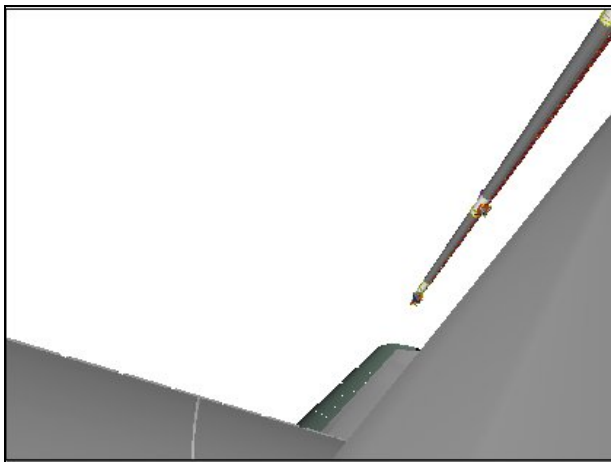

ELBOW (-40,-30)

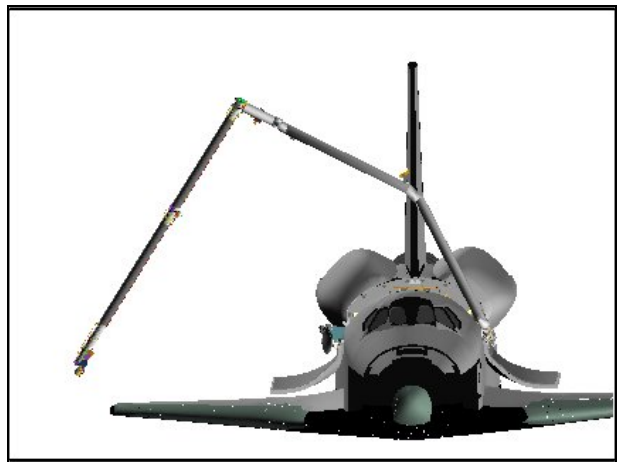

FRONT

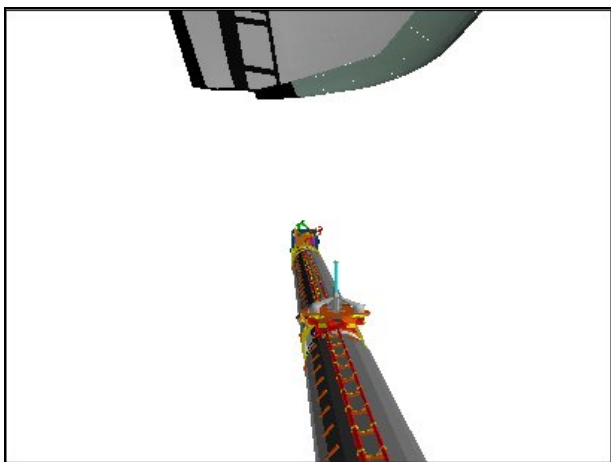

RSC

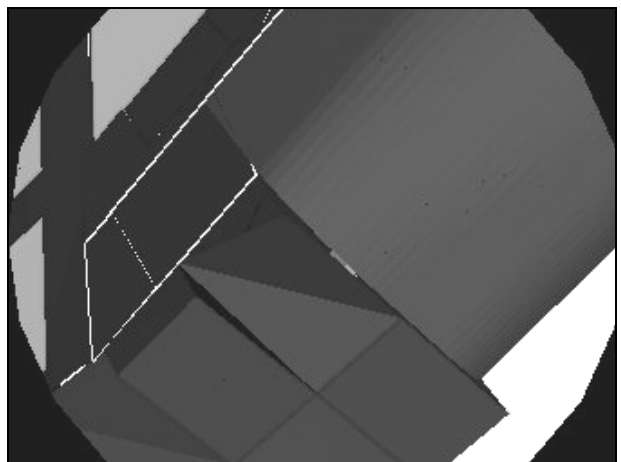

LDRI (80,-105)

STBD LDRI RCC SURVEY – Pause Pt 38

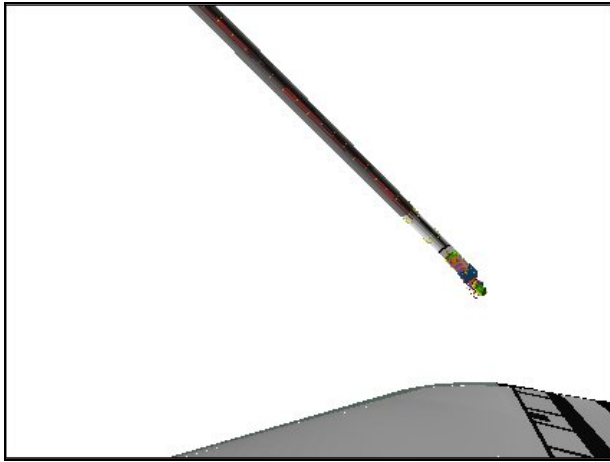

CCTV C (75,0)

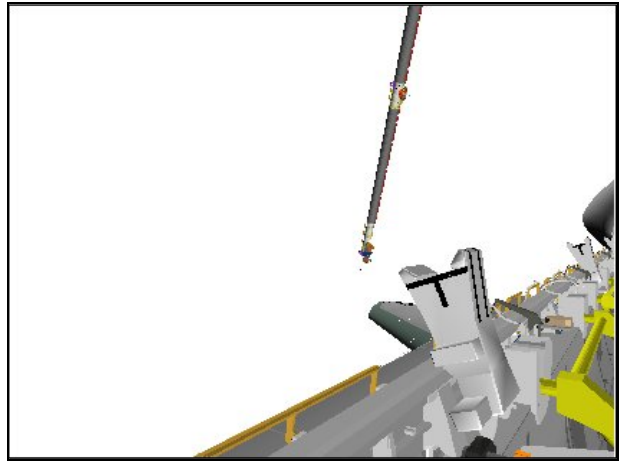

CCTV D (-35,0)

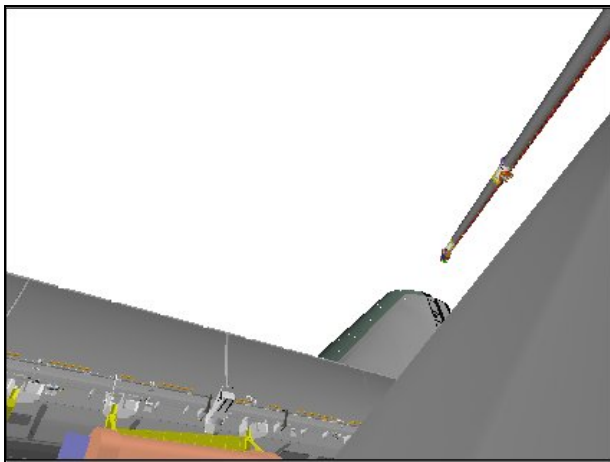

ELBOW (-40,-30)

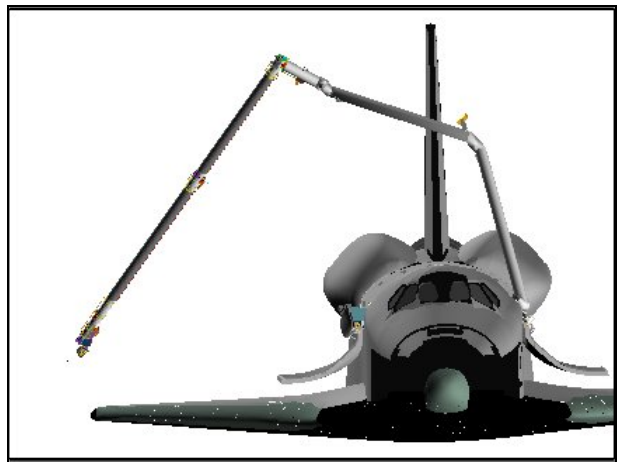

FRONT

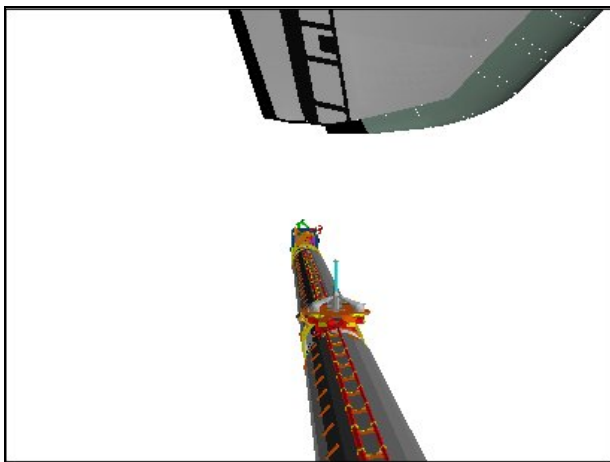

RSC

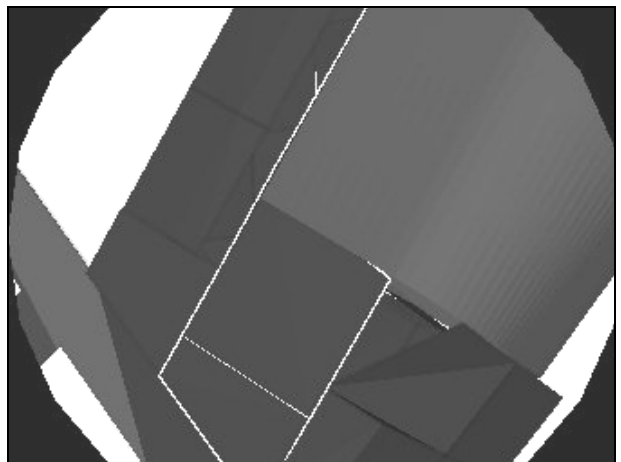

LDRI (50,-115)

STBD LDRI RCC SURVEY – Pause Pt 46

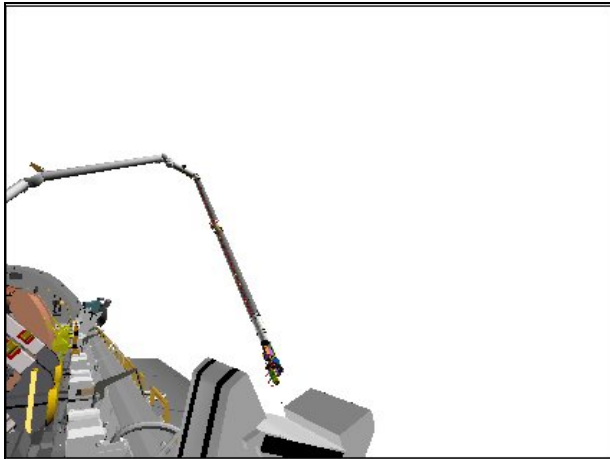

CCTV C (30,10)

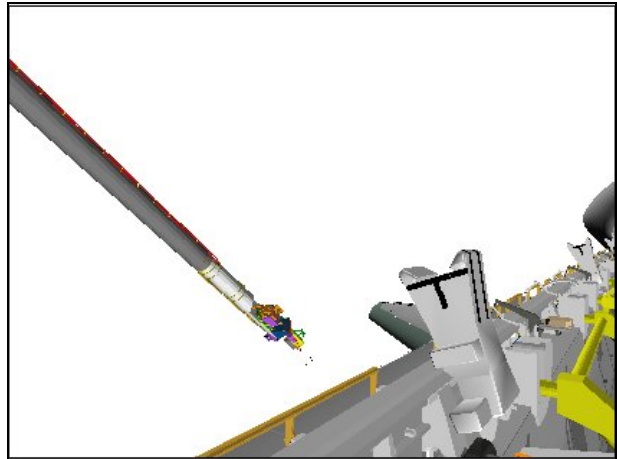

CCTV D (-35,0)

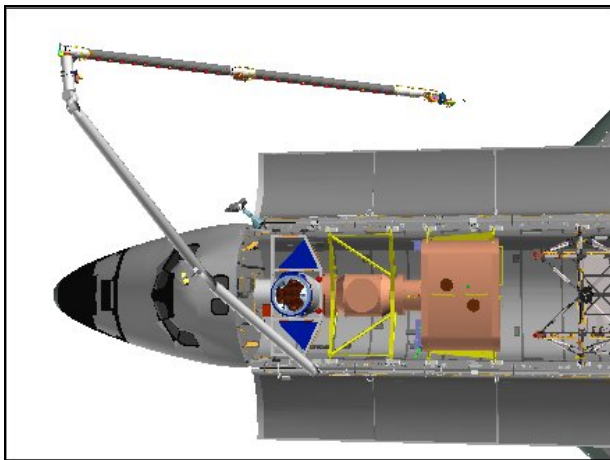

OVERHEAD



FRONT

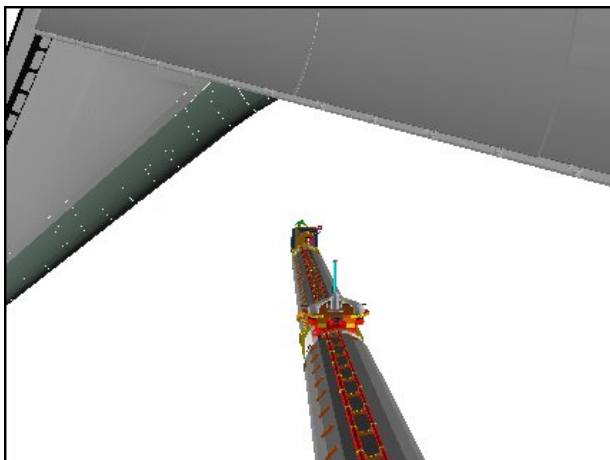

RSC

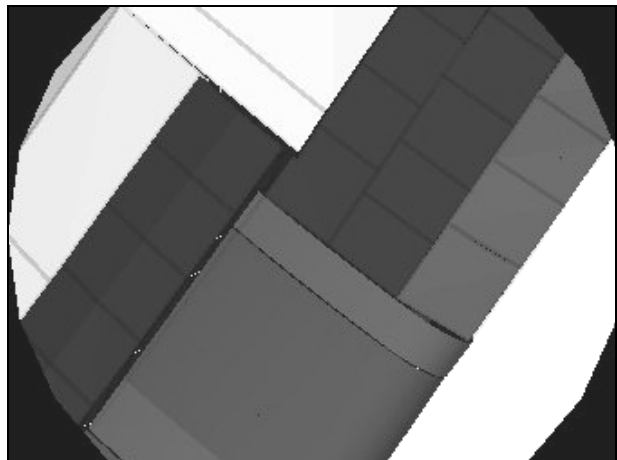

LDRI (50,-115)

# OBSS LDRI RCC SURVEY CAMERA VIEWS – NOSE CAP

NOSE CAP LDRI RCC SURVEY – Pause Pt 47

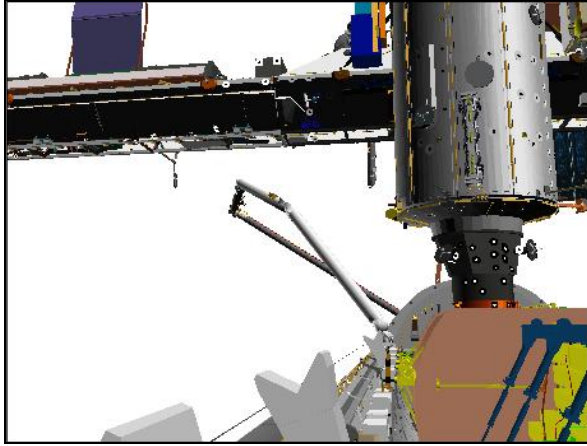

CCTV B (-10,10)

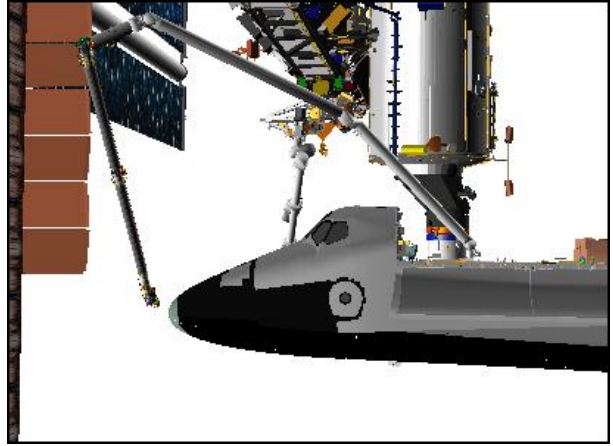

PORT



US LAB (-155,-15)

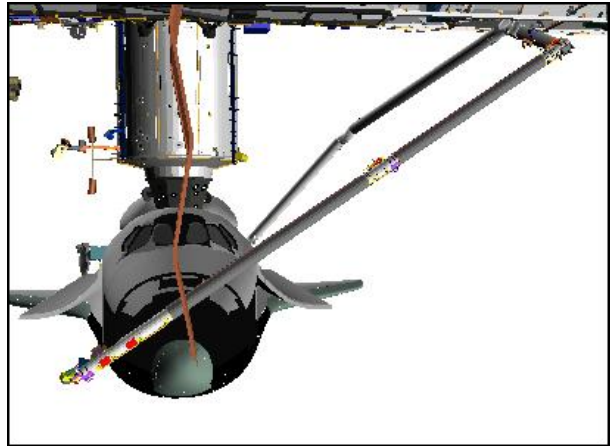

FRONT

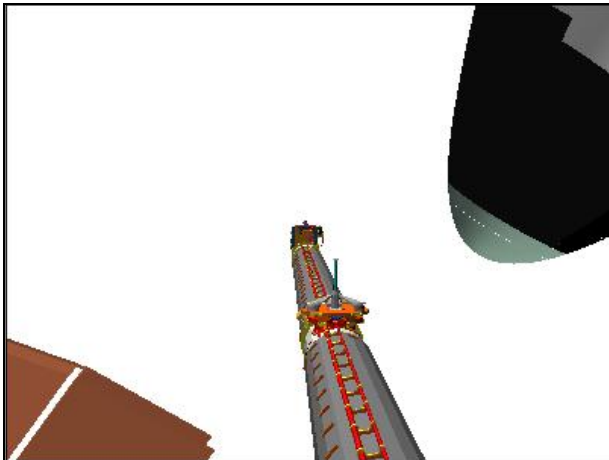

RSC

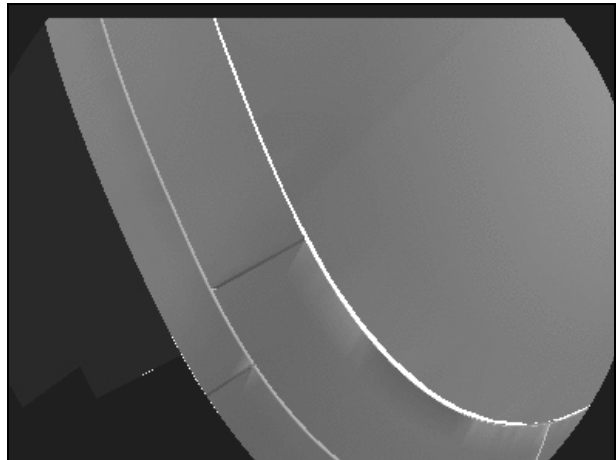

LDRI (0,-45)

NOSE CAP LDRI RCC SURVEY – Pause Pt 49

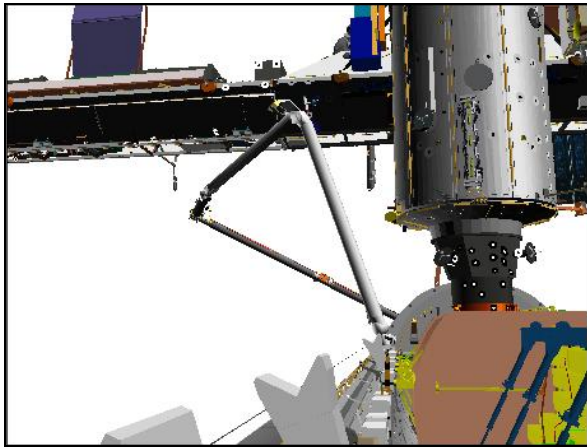

CCTV B (-10,10)



PORT



US LAB (-155,-15)



FRONT

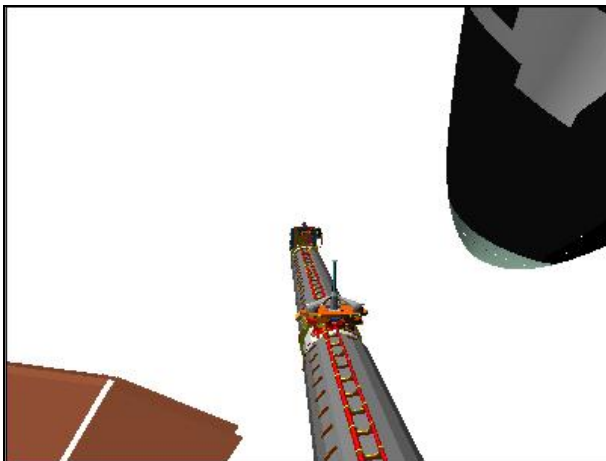

RSC

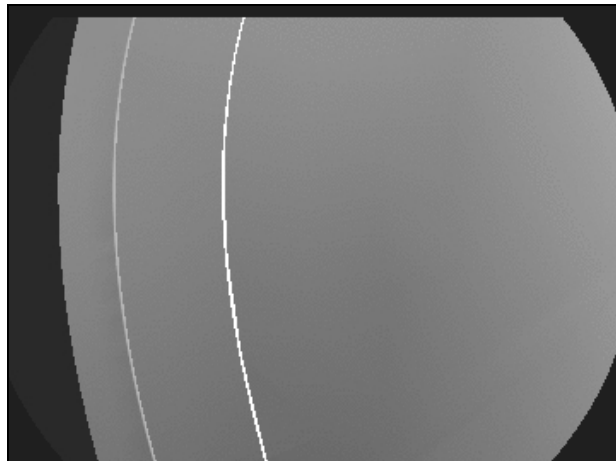

LDRI (0,-45)

NOSE CAP LDRI RCC SURVEY – Pause Pt 51

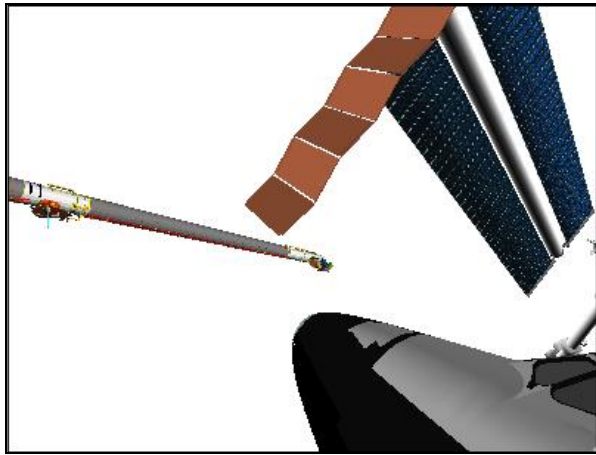

ELBOW (90,-60)

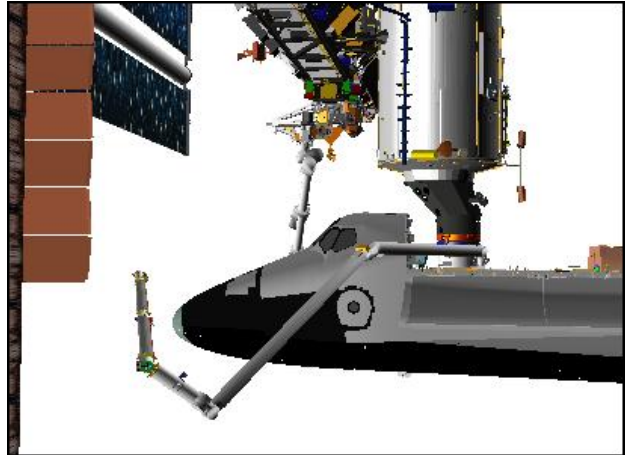

PORT

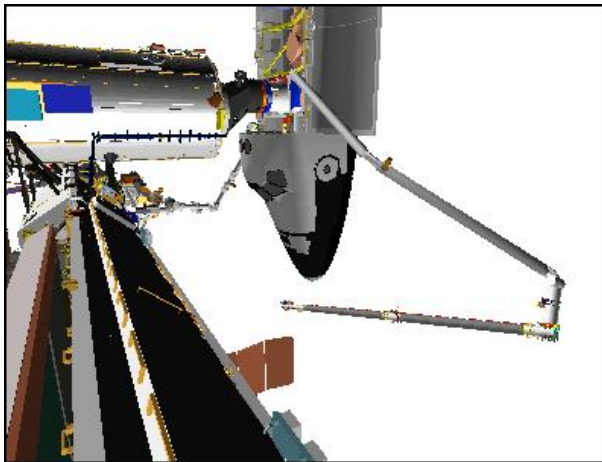

P1 LOOB (120,-15)



FRONT

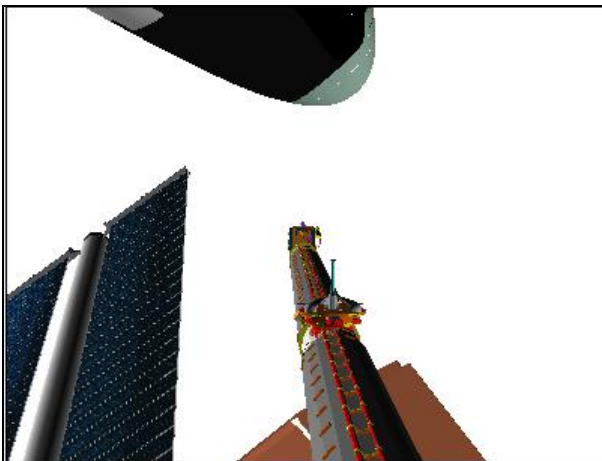

RSC

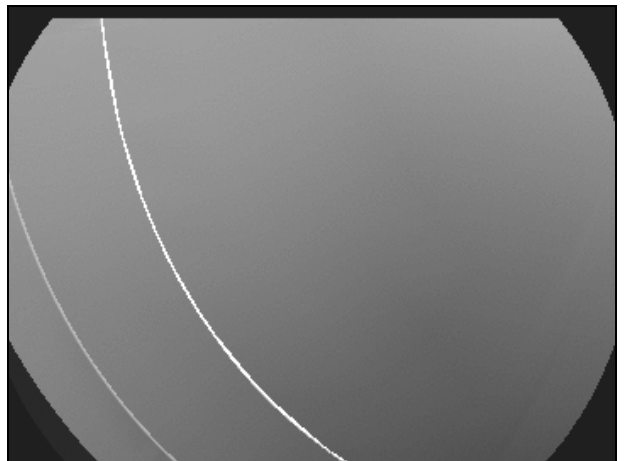

LDRI (75,-55)

NOSE CAP LDRI RCC SURVEY – Pause Pt 56

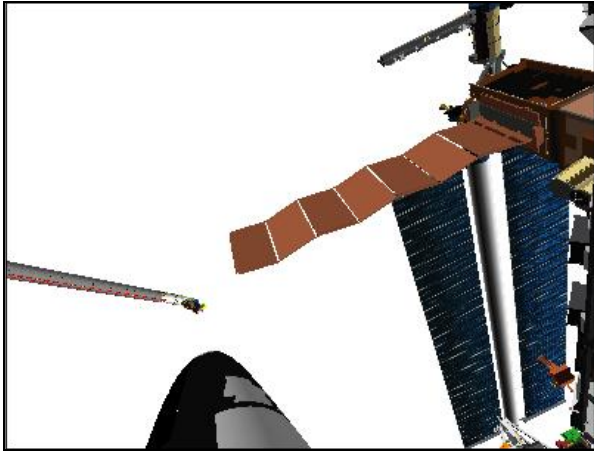

ELBOW (90,-60)



PORT

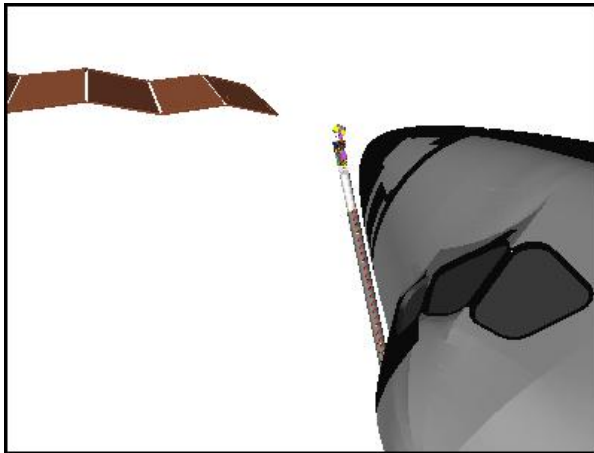

US LAB (-155,-15)

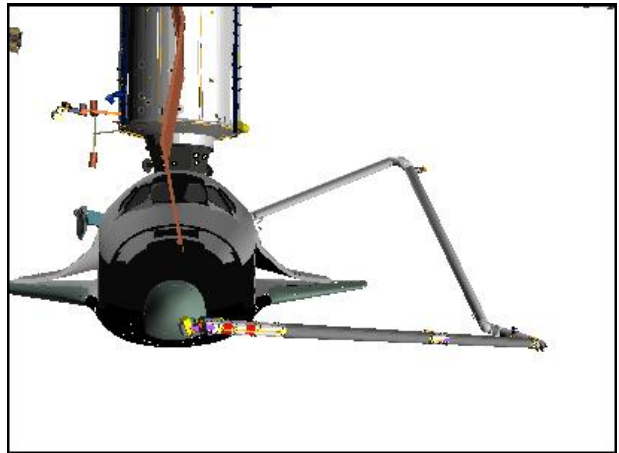

FRONT

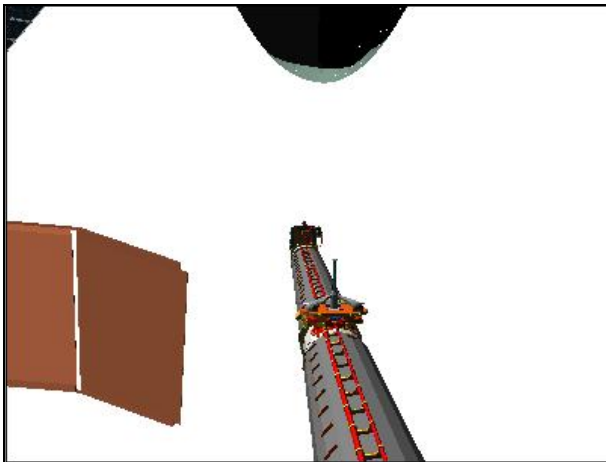

RSC



LDRI (75,-55)



NOSE CAP LDRI RCC SURVEY – Pause Pt 57

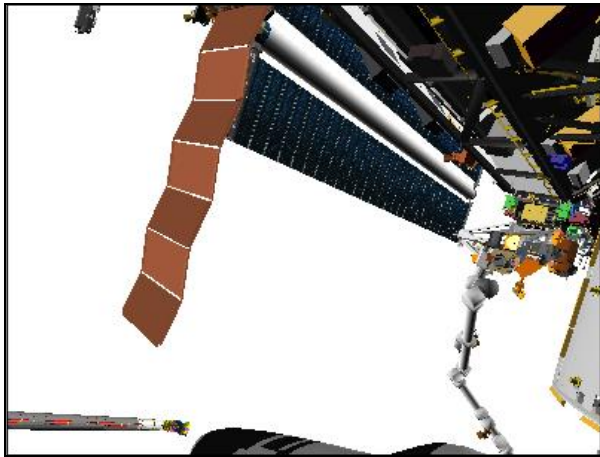

**ELBOW (90,-60)**



**PORT**



**US LAB (-155,-15)**

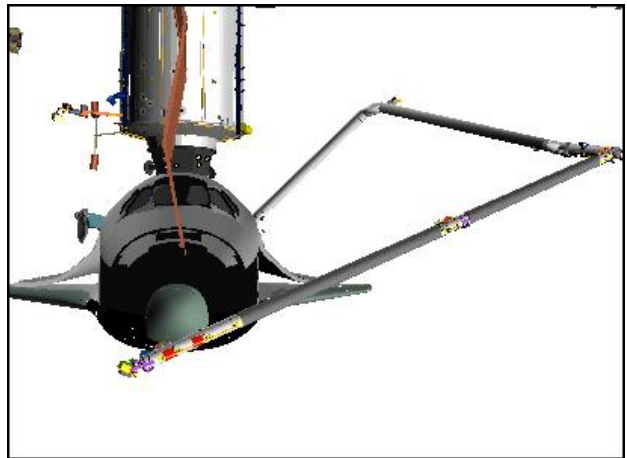

**FRONT**

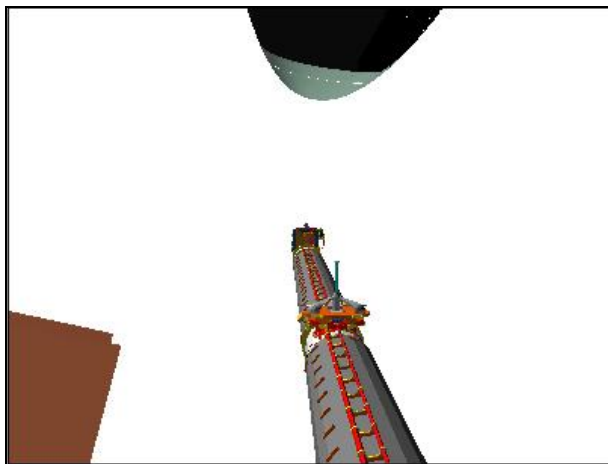

**RSC**

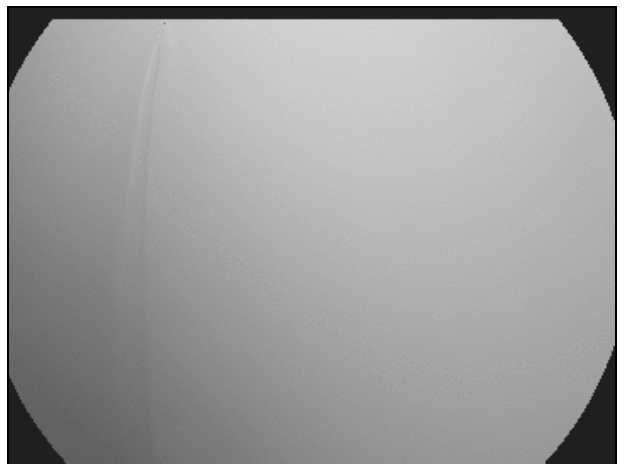

**LDRI (75,-43)**

NOSE CAP LDRI RCC SURVEY – Pause Pt 59

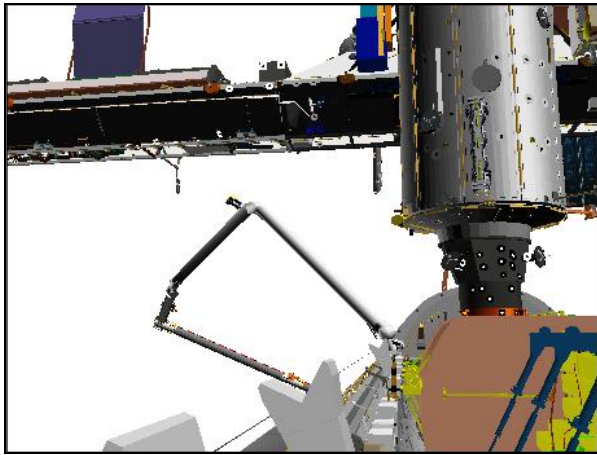

CCTV B (-10,10)



PORT

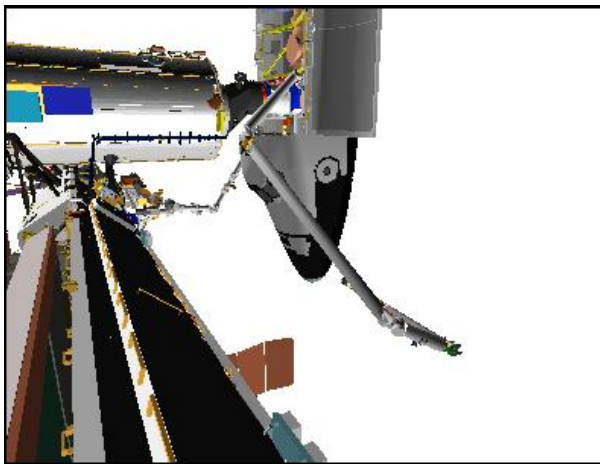

P1 LOOB (120,-15)

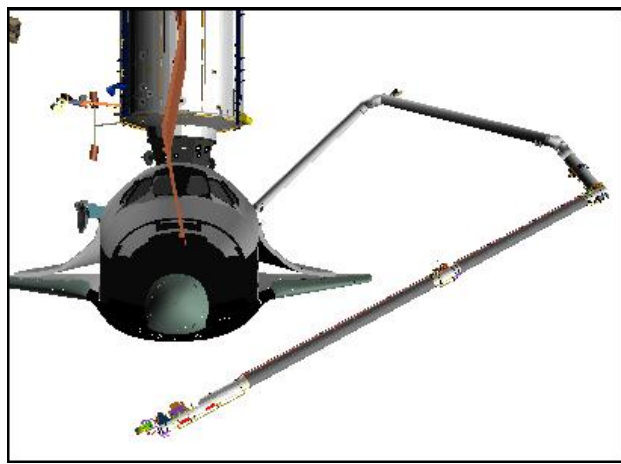

FRONT

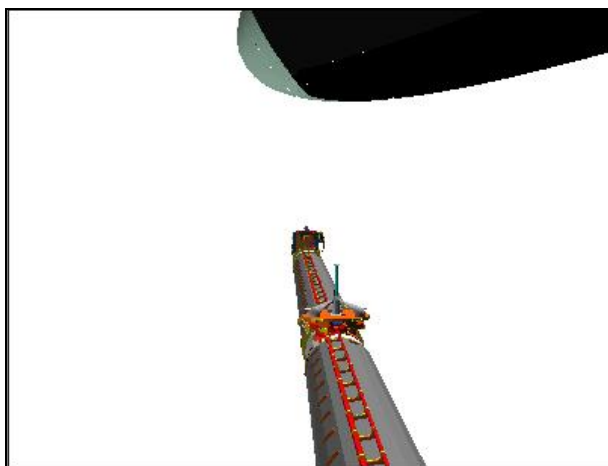

RSC

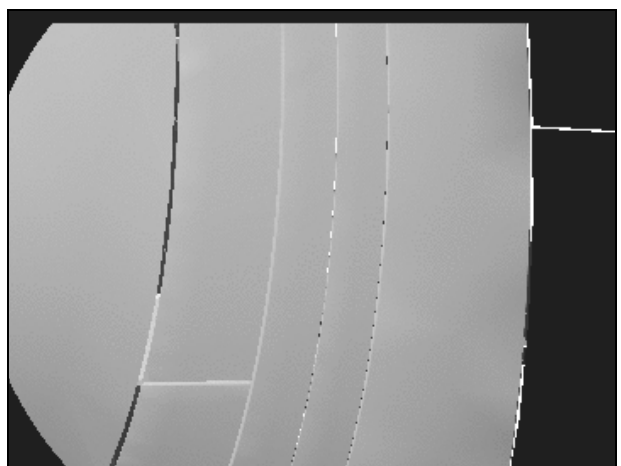

LDRI (75,-43)

NOSE CAP LDRI RCC SURVEY – Pause Pt 60

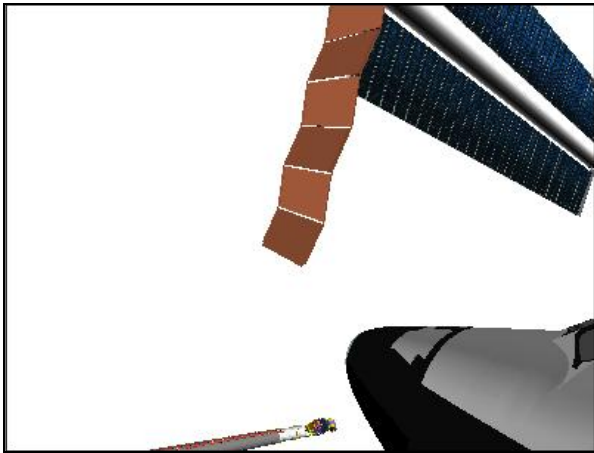

**ELBOW (90,-60)**

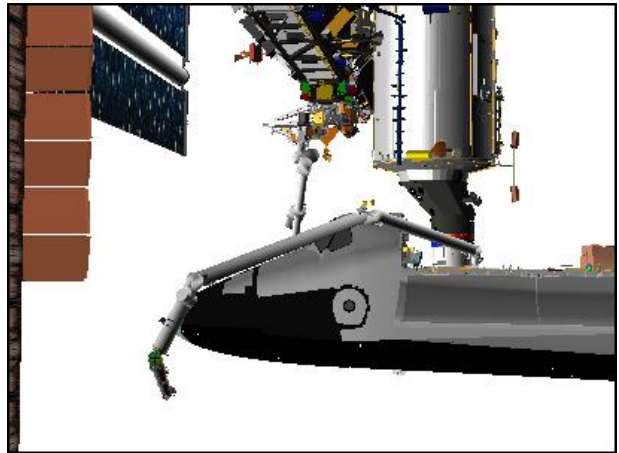

**PORT**

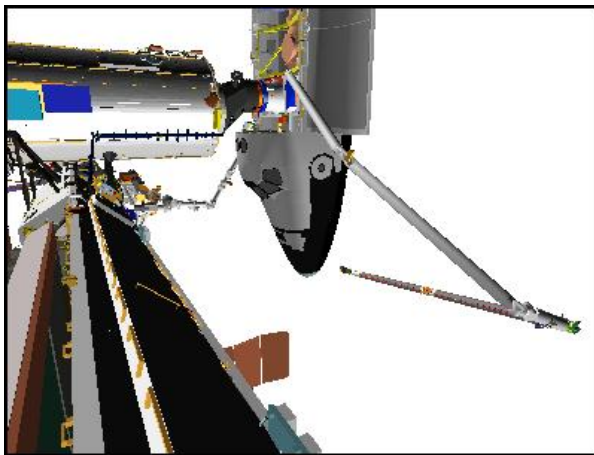

**P1 LOOB (120,-15)**

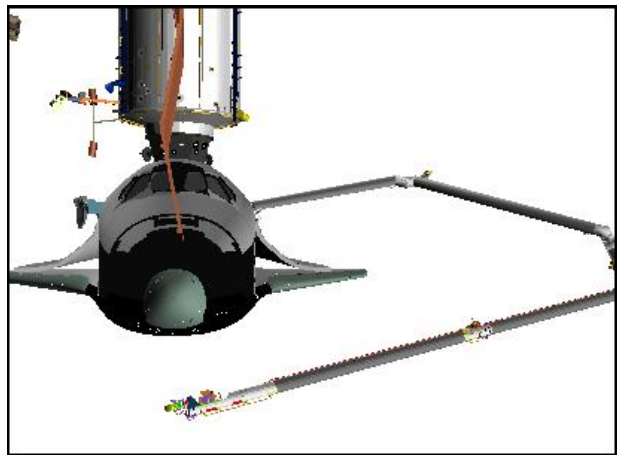

**FRONT**



**RSC**

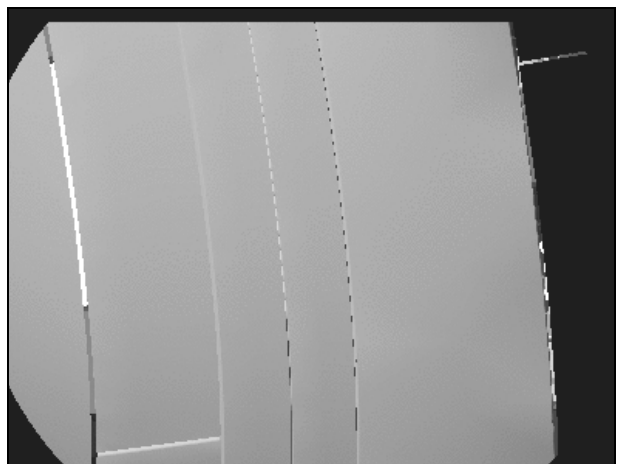

**LDRI (85,-73)**

NOSE CAP LDRI RCC SURVEY – Pause Pt 62

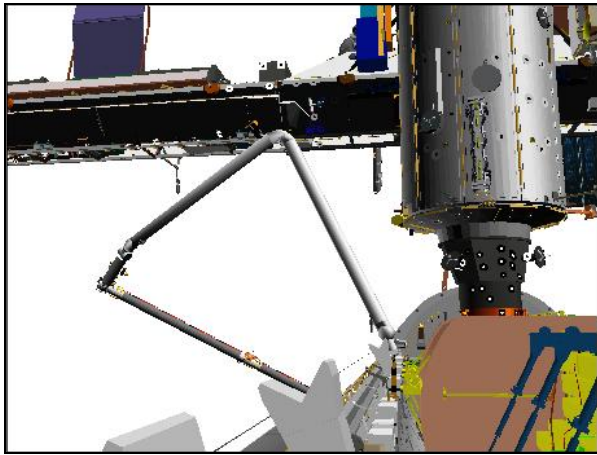

CCTV B (-10,10)

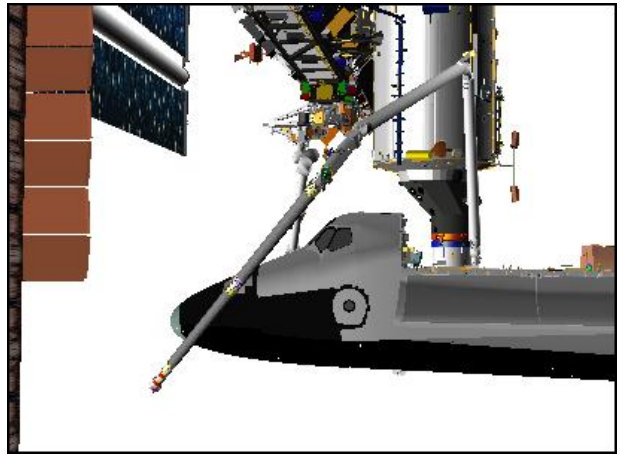

PORT

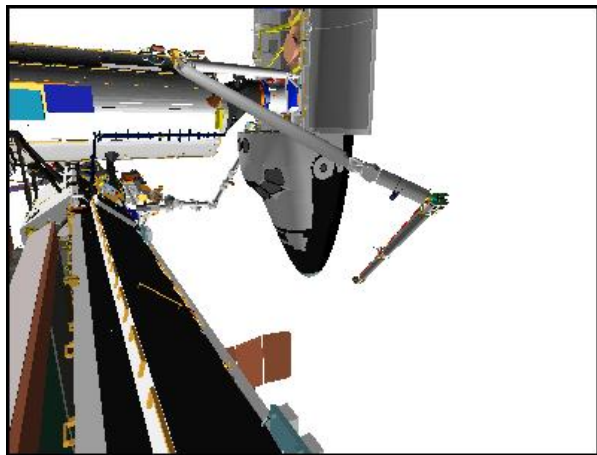

P1 LOOB (120,-15)

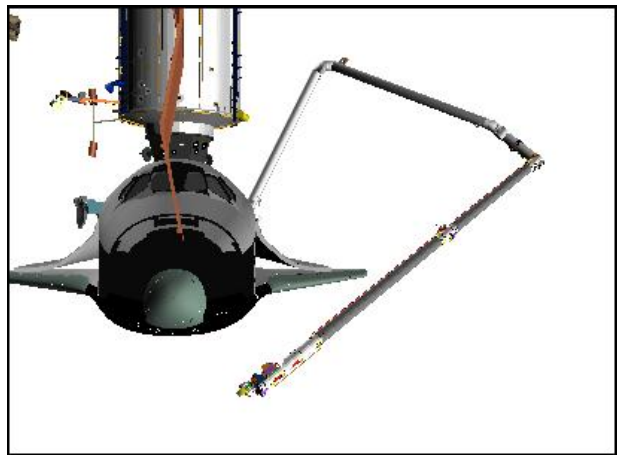

FRONT



RSC

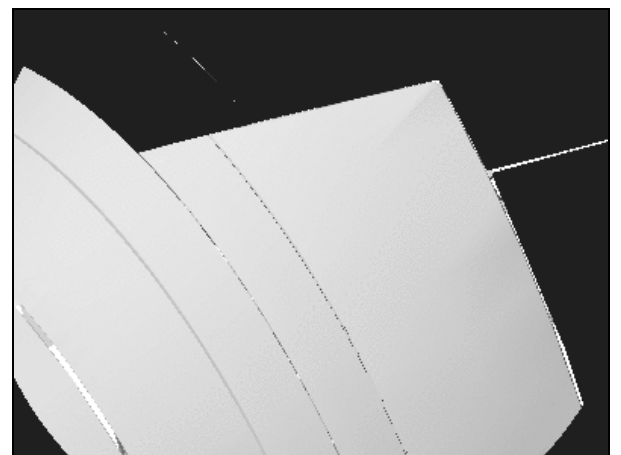

LDRI (85,-73)

NOSE CAP LDRI RCC SURVEY – Pause Pt 63

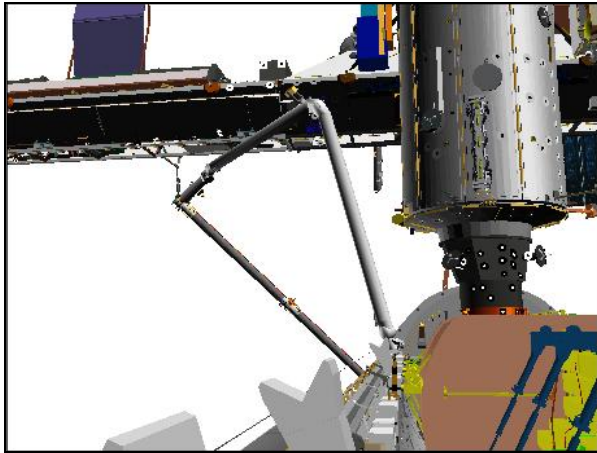

CCTV B (-10,10)

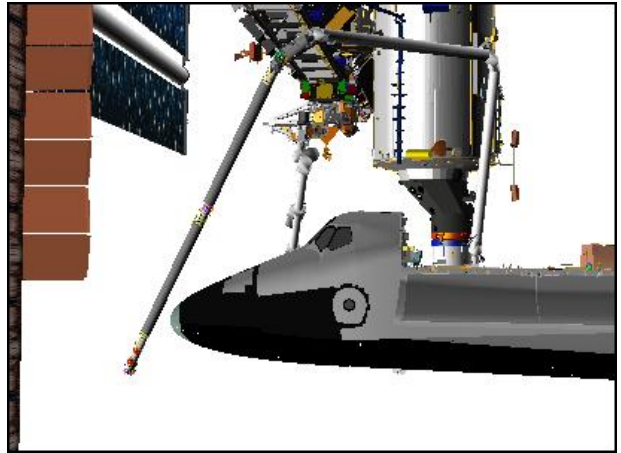

PORT

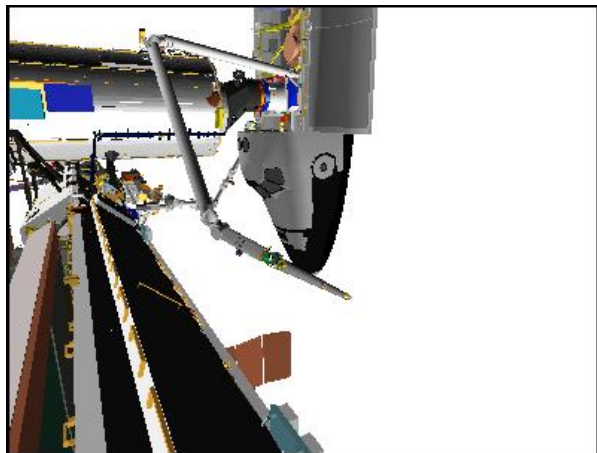

P1 LOOB (120,-15)

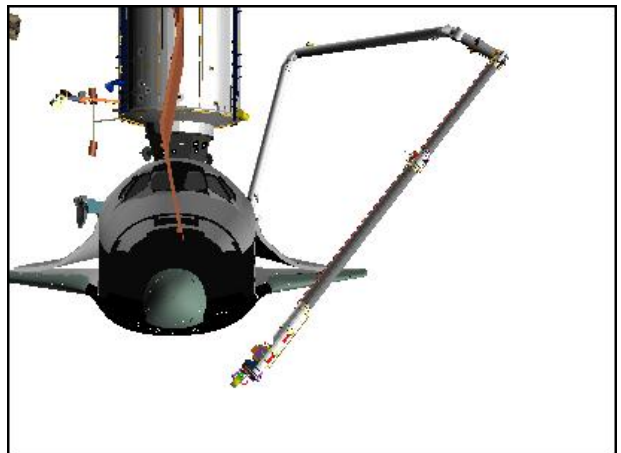

FRONT



RSC

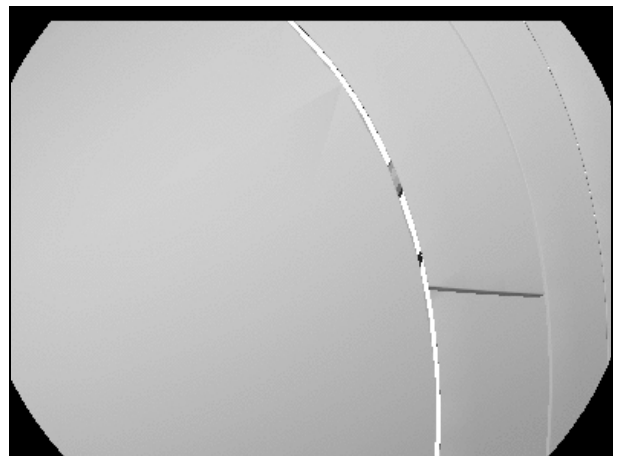

LDRI (65,-58)

NOSE CAP LDRI RCC SURVEY – Pause Pt 66

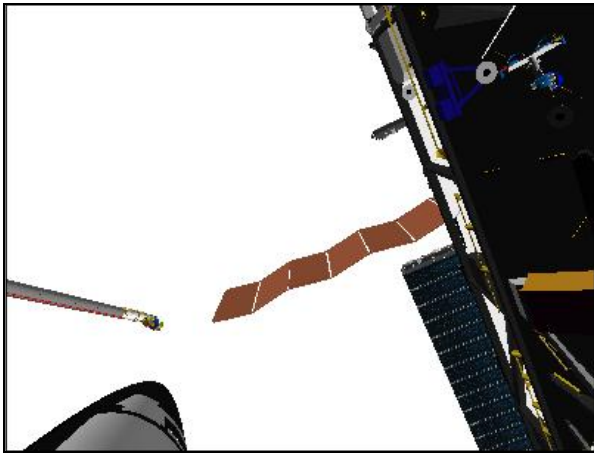

ELBOW (90,-60)



PORT



US LAB (-155,-15)

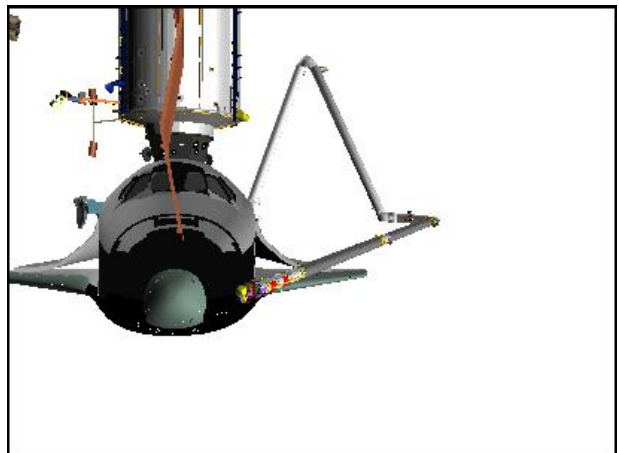

FRONT

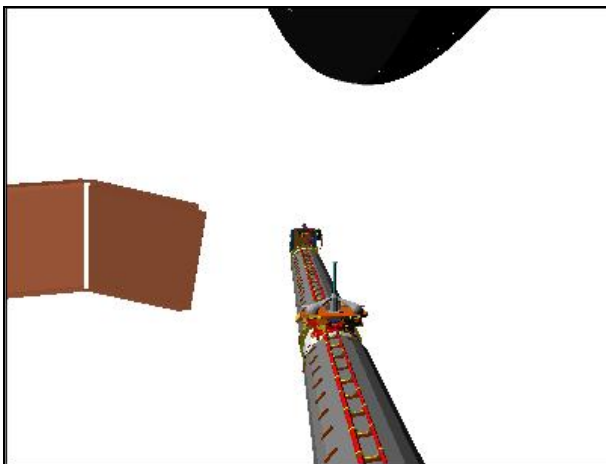

RSC

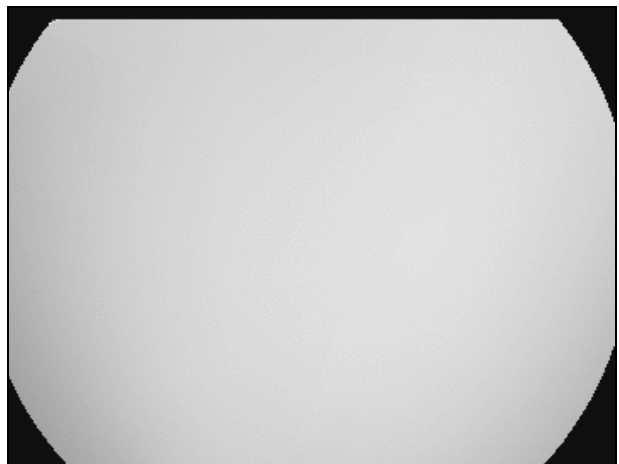

LDRI (65,-58)

NOSE CAP LDRI RCC SURVEY – Pause Pt 67

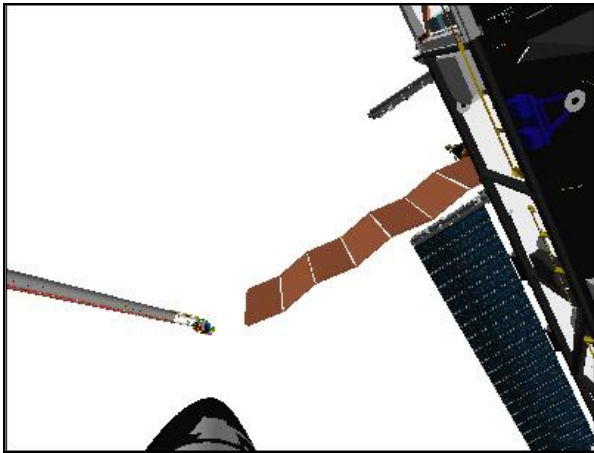

**ELBOW (90,-60)**

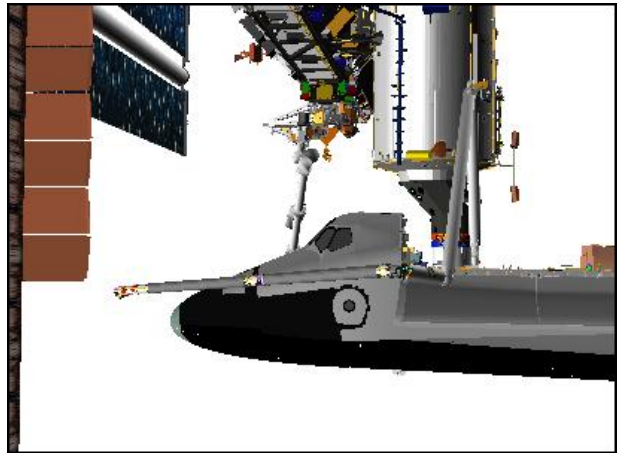

**PORT**



**US LAB (-155,-15)**

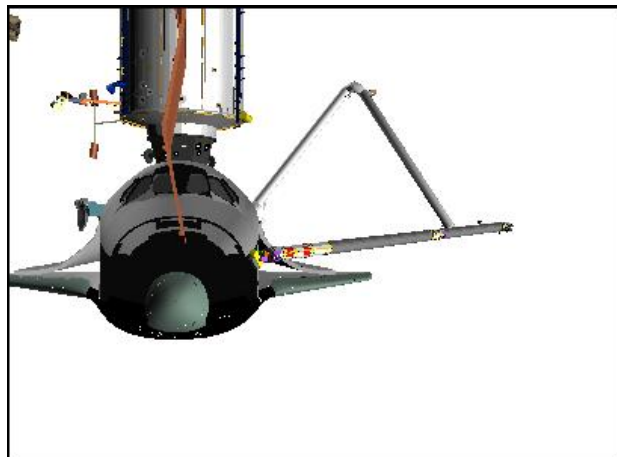

**FRONT**

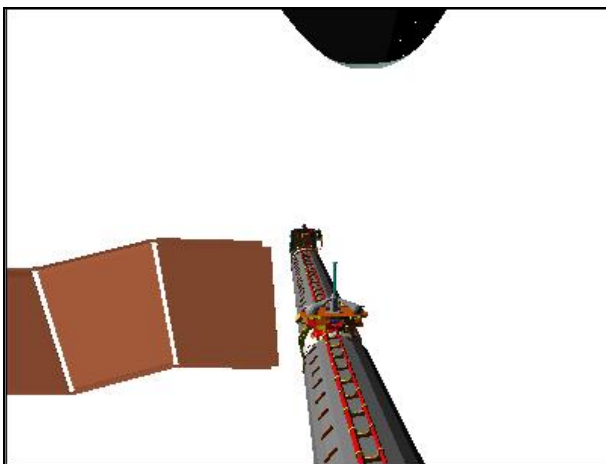

**RSC**

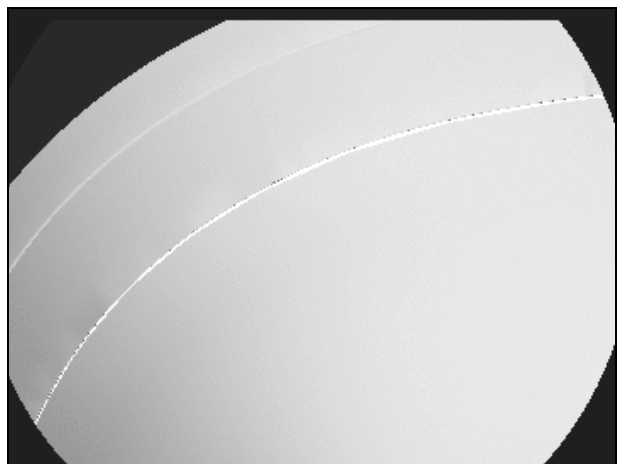

**LDRI (65,-75)**

NOSE CAP LDRI RCC SURVEY – Pause Pt 68

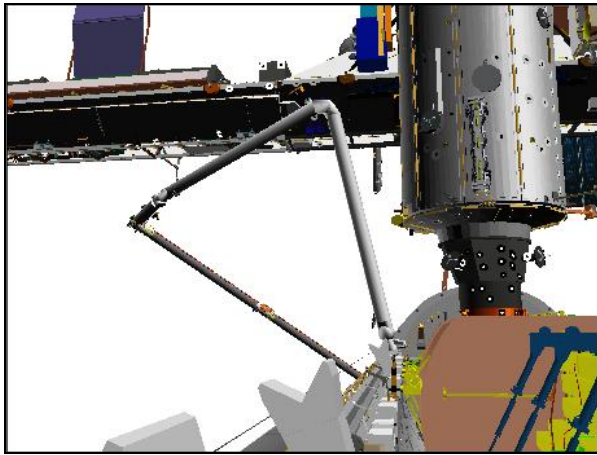

CCTV B (-10,10)

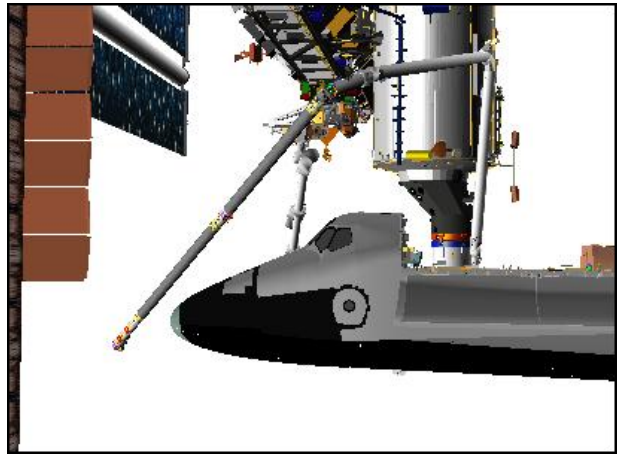

PORT

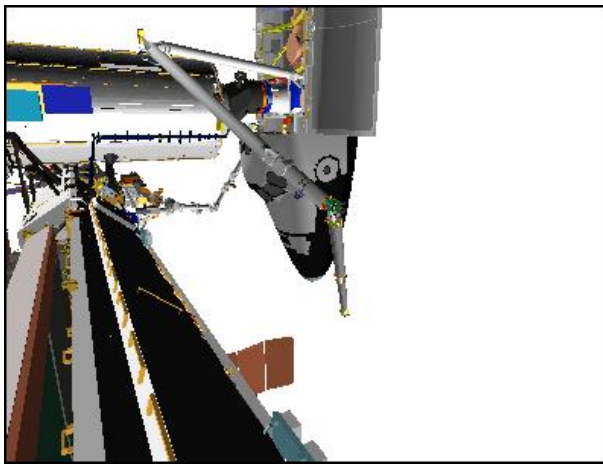

P1 LOOB (120,-15)

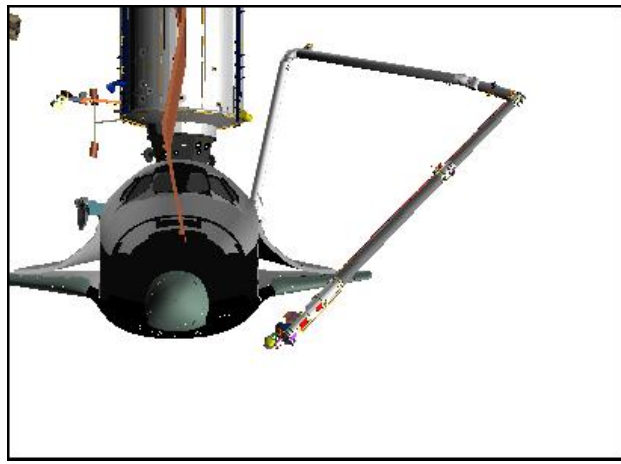

FRONT

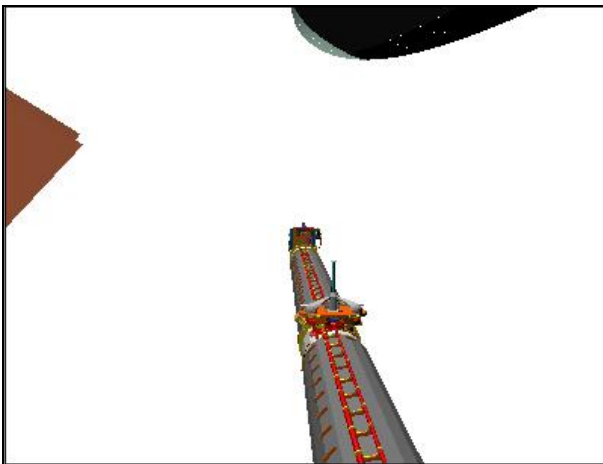

RSC

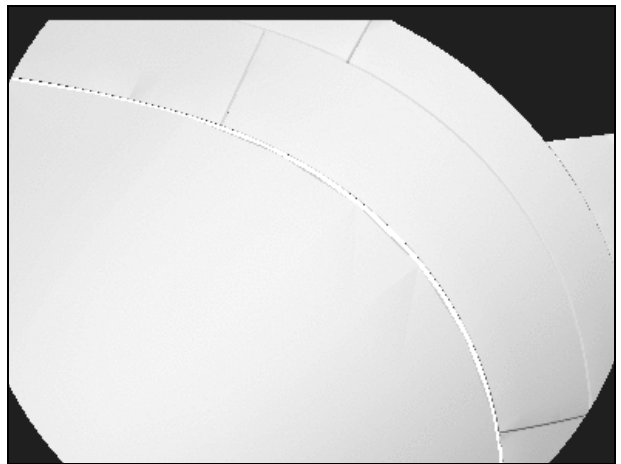

LDRI (65,-75)



# OBSS LDRI RCC SURVEY CAMERA VIEWS – PORT

PORT LDRI RCC SURVEY – Pause Pt 69

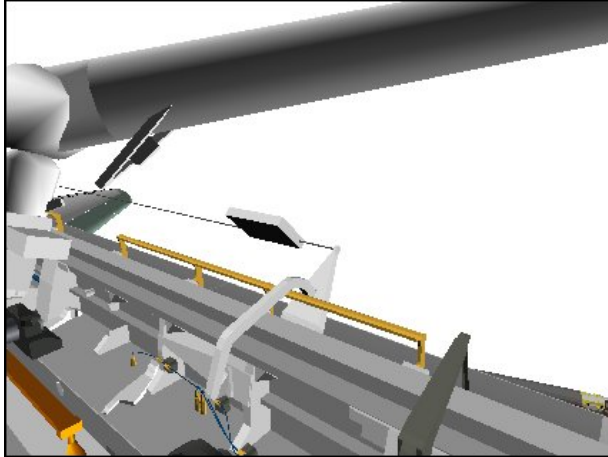

**CCTV A (52,-15)**

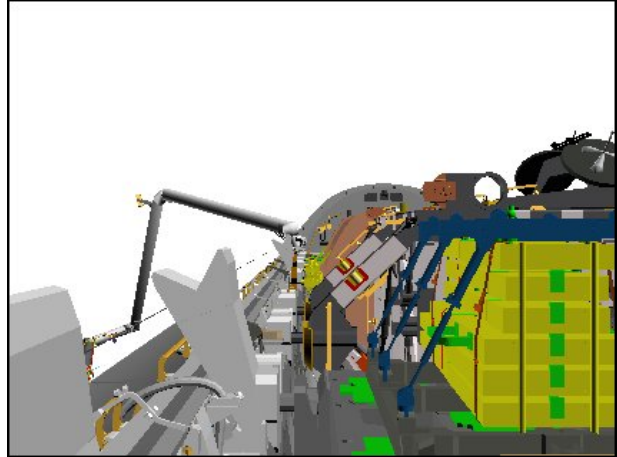

**CCTV B (0,0)**

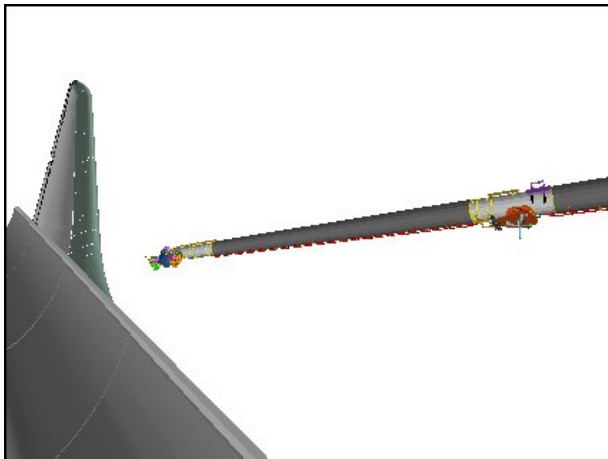

**ELBOW (-85,-5)**

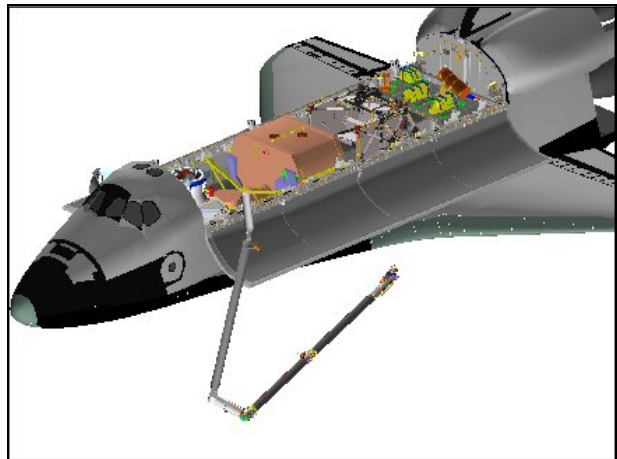

**BIRD'S EYE**

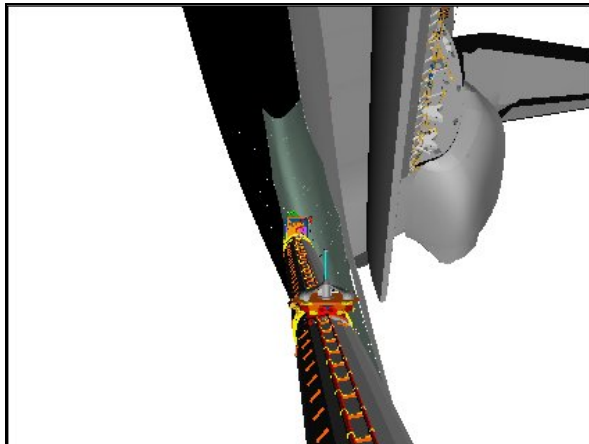

**RSC**

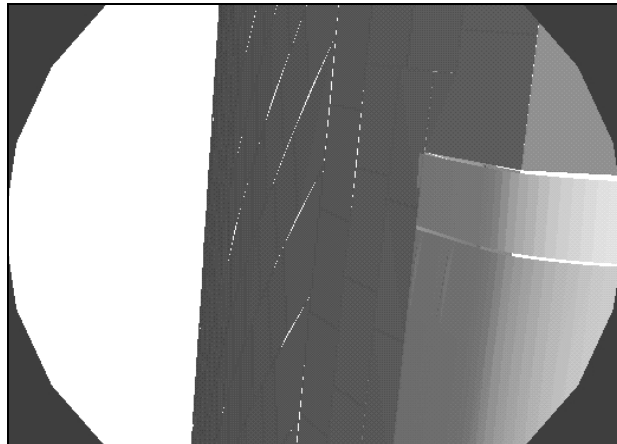

**LDRI (100,-120)**

PORT LDRI RCC SURVEY – Pause Pt 75

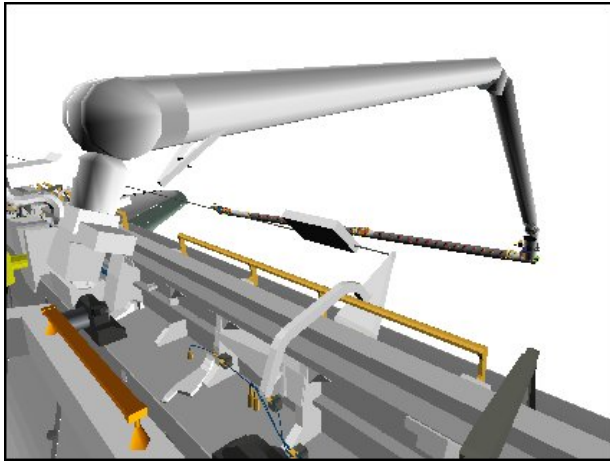

**CCTV A (45,-15)**



**CCTV B (-52,-15)**

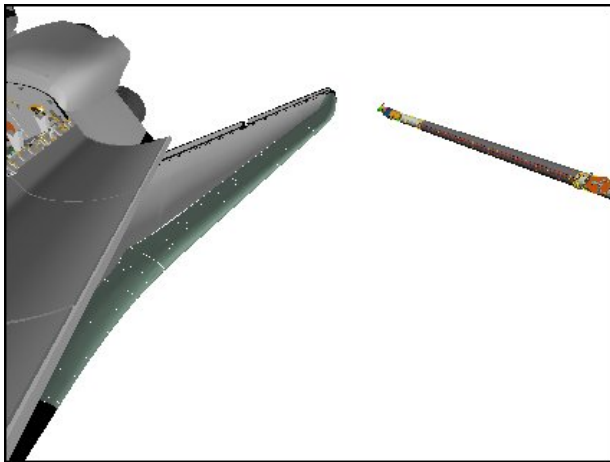

**ELBOW (-70,15)**

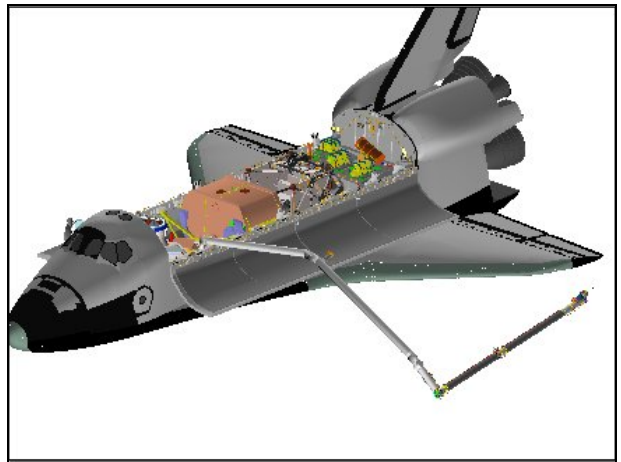

**BIRD'S EYE**

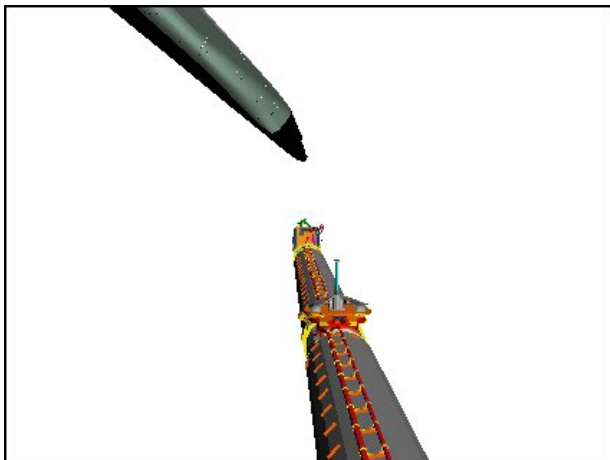

**RSC**

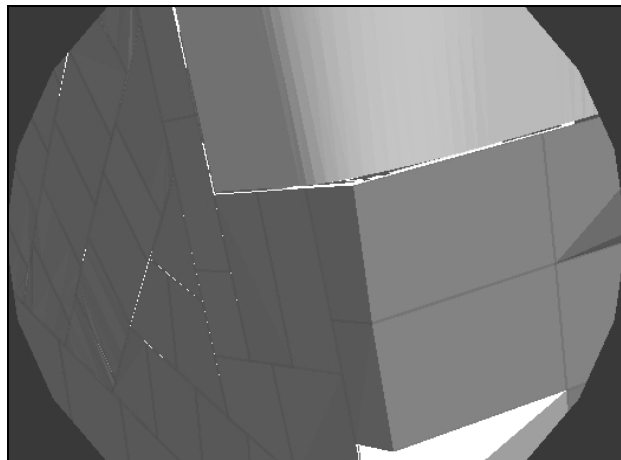

**LDRI (100,-120)**

PORT LDRI RCC SURVEY – Pause Pt 76

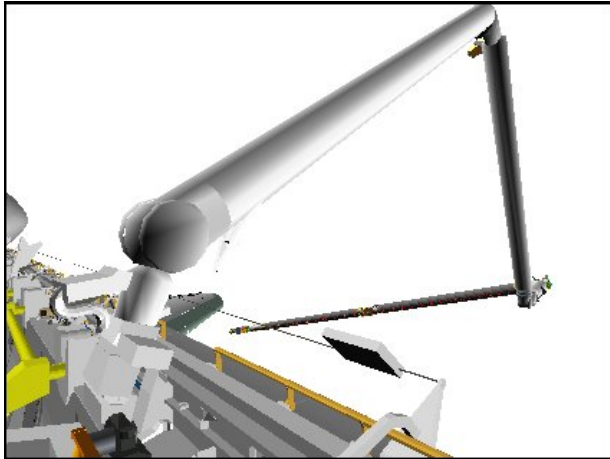

CCTV A (40,0)

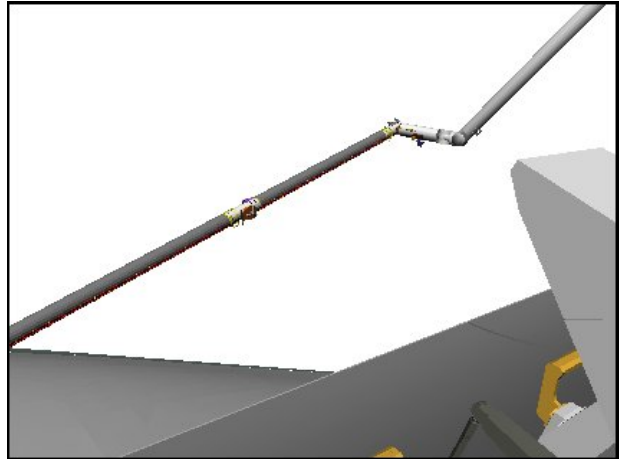

CCTV B (-52,-15)

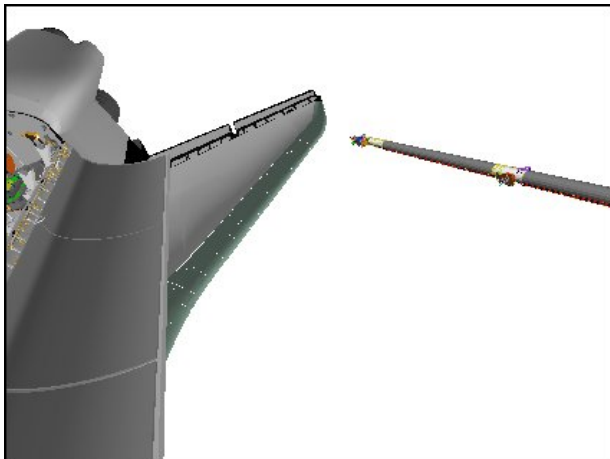

ELBOW (-50,15)

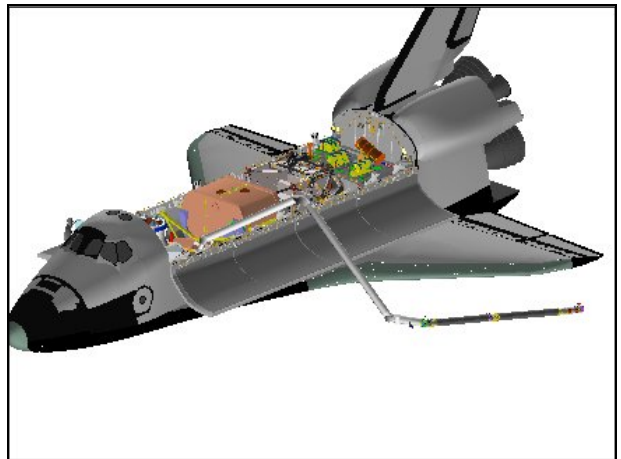

BIRD'S EYE

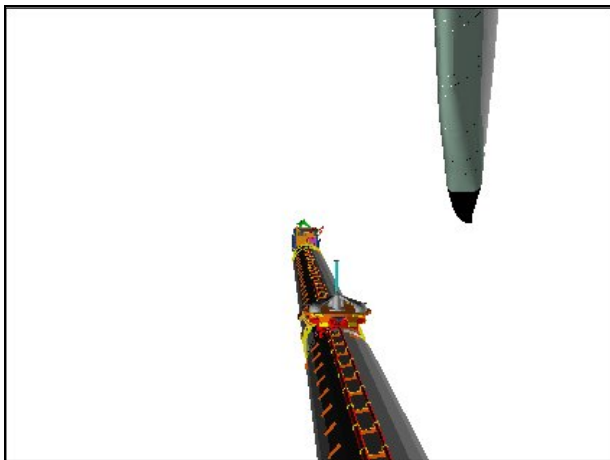

RSC

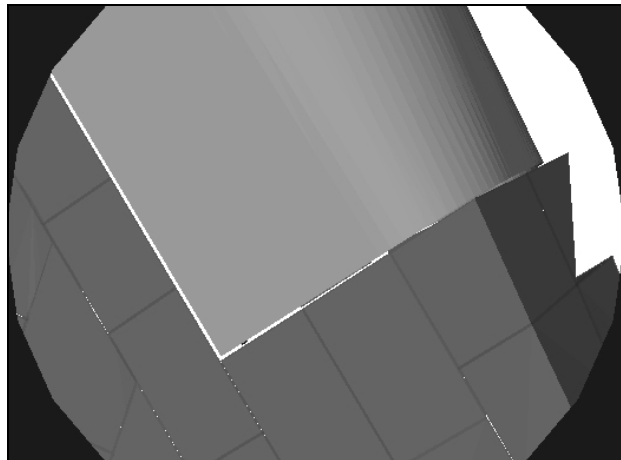

LDRI (10,-80)

PORT LDRI RCC SURVEY – Pause Pt 85

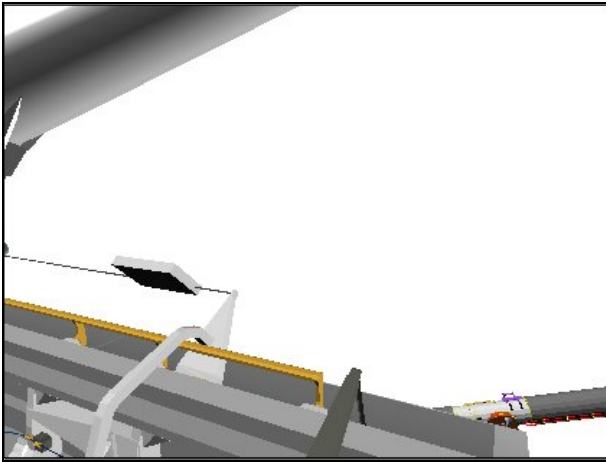

CCTV A (65,-10)

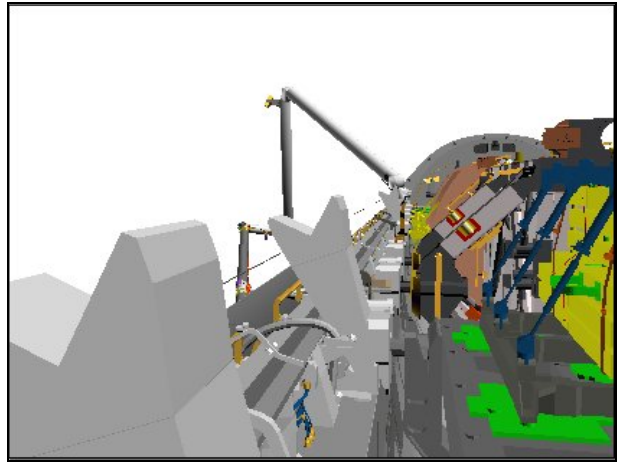

CCTV B (-10,-5)

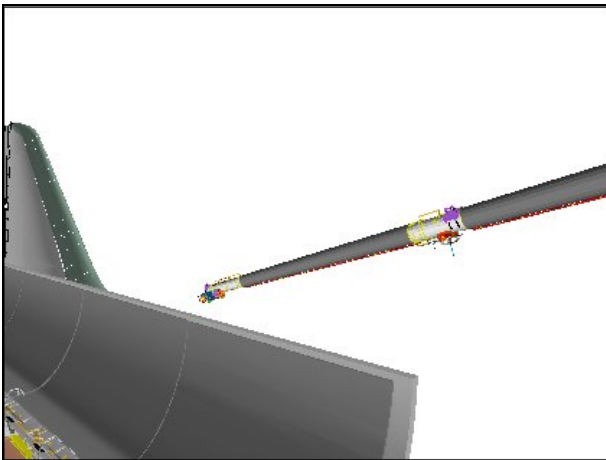

ELBOW (-75,-10)

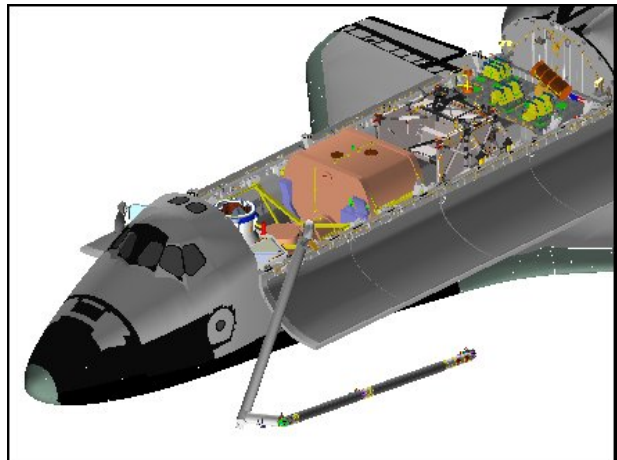

BIRD'S EYE



RSC

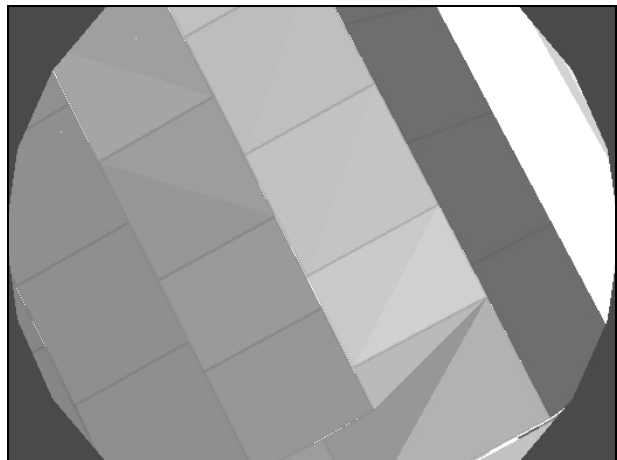

LDRI (10,-80)

PORT LDRI RCC SURVEY – Pause Pt 86

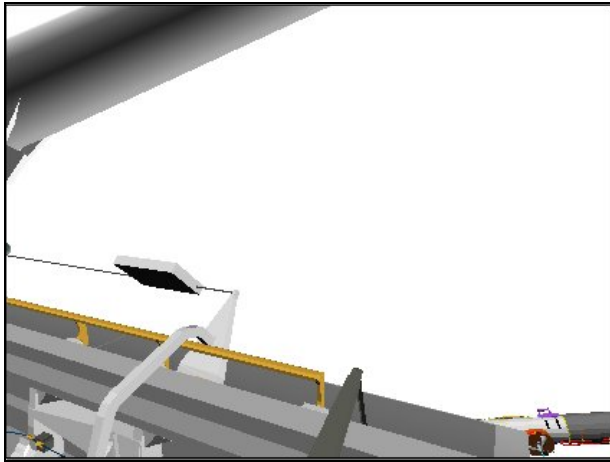

**CCTV A (65,-10)**

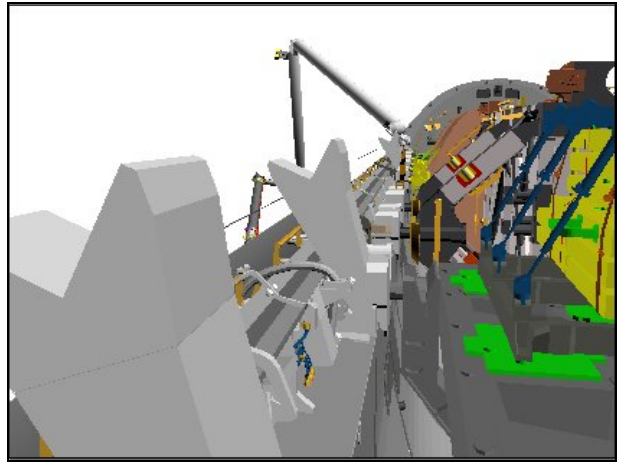

**CCTV B (-10,-10)**

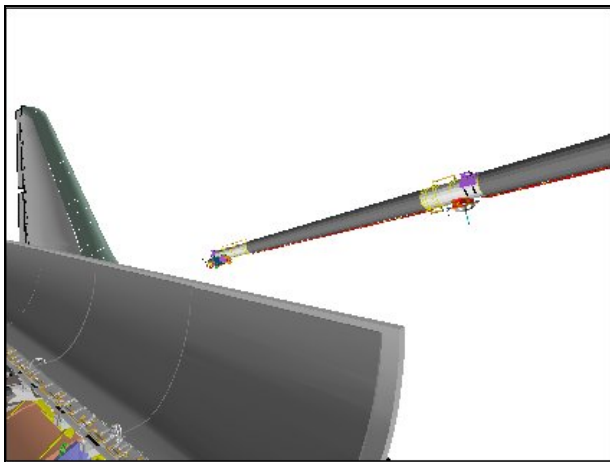

**ELBOW (-78,-15)**

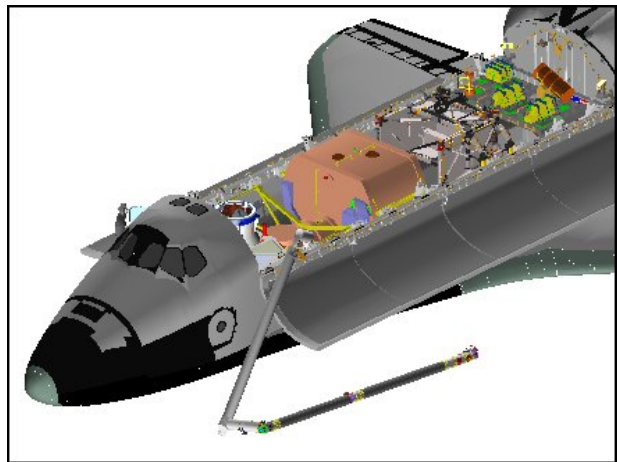

**BIRD'S EYE**



**RSC**

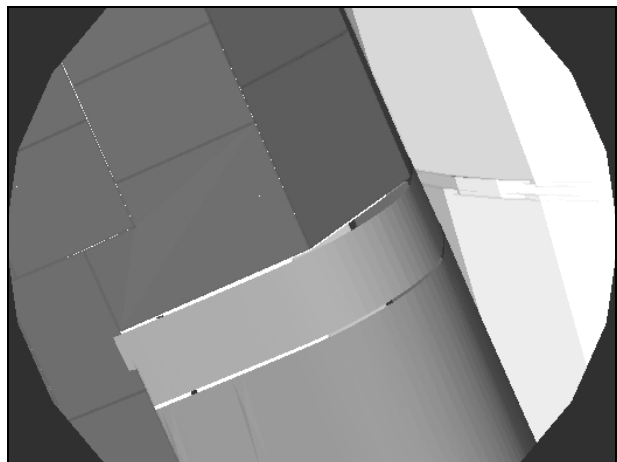

**LDRI (10,-95)**

PORT LDRI RCC SURVEY – Pause Pt 93

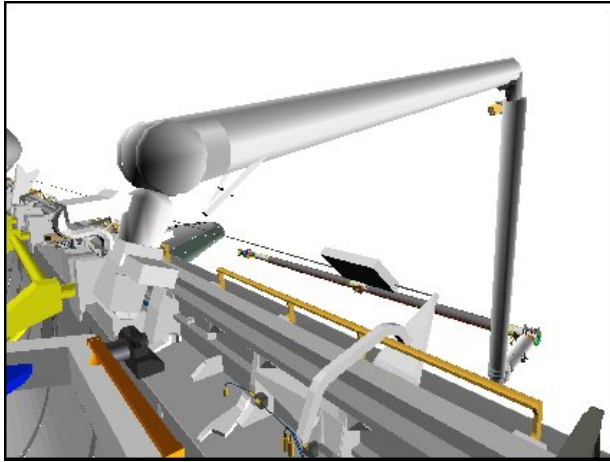

**CCTV A (40,-10)**

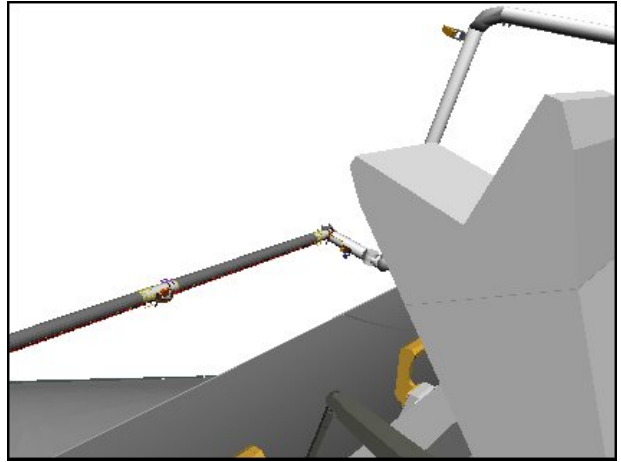

**CCTV B (-40,-15)**

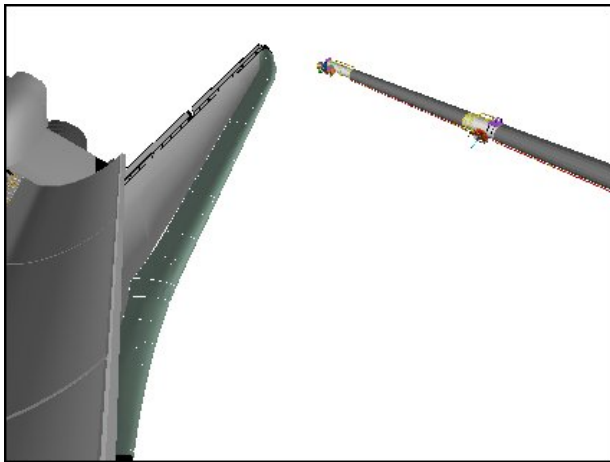

**ELBOW (-45,25)**

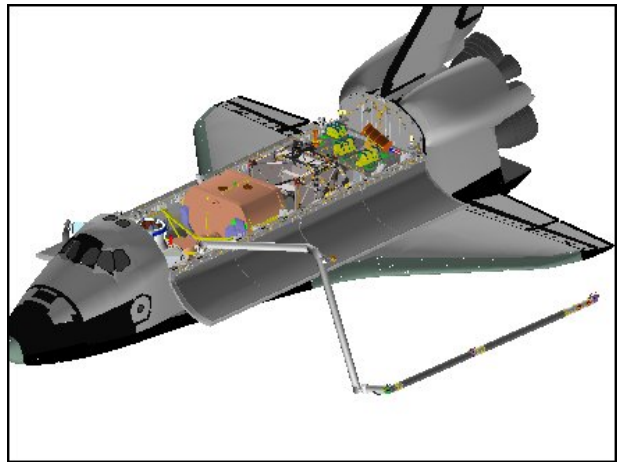

**BIRD'S EYE**



**RSC**

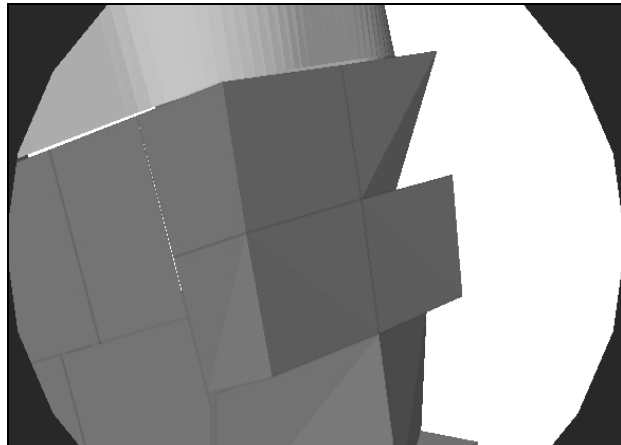

**LDRI (10,-95)**

PORT LDRI RCC SURVEY – Pause Pt 94

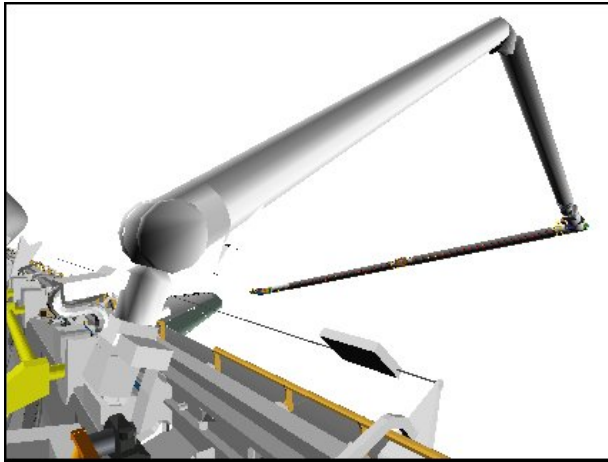

CCTV A (40,0)

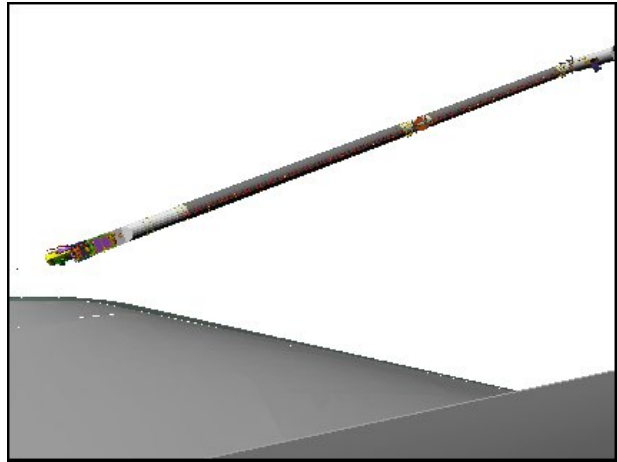

CCTV B (-70,-15)

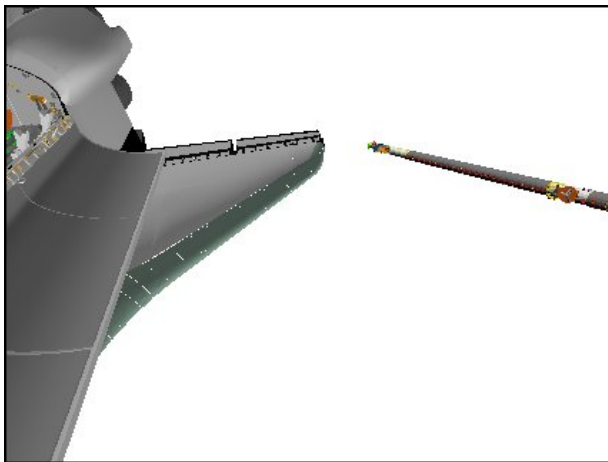

ELBOW (-65,10)

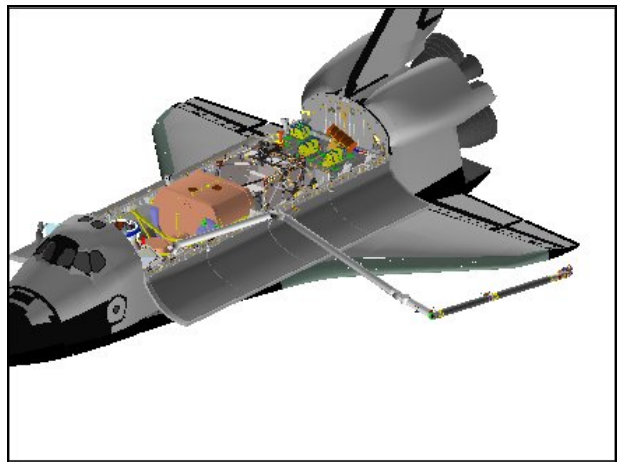

BIRD'S EYE

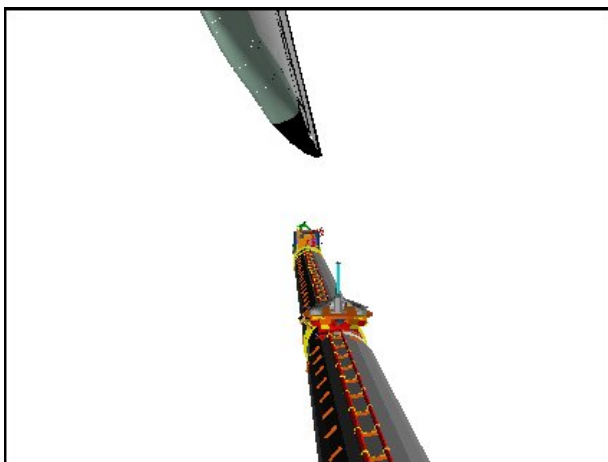

RSC

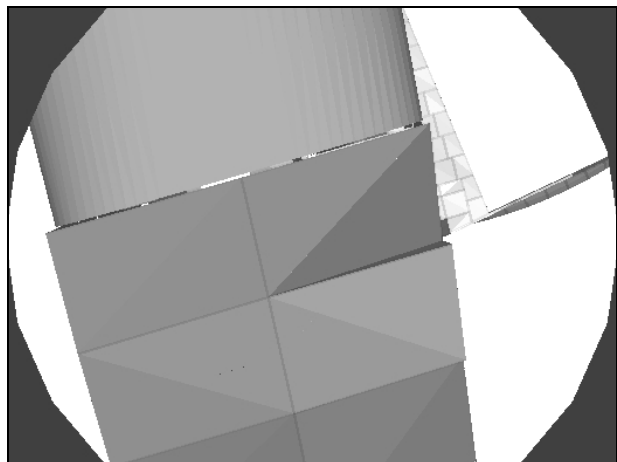

LDRI (88,-120)

PORT LDRI RCC SURVEY – Pause Pt 102

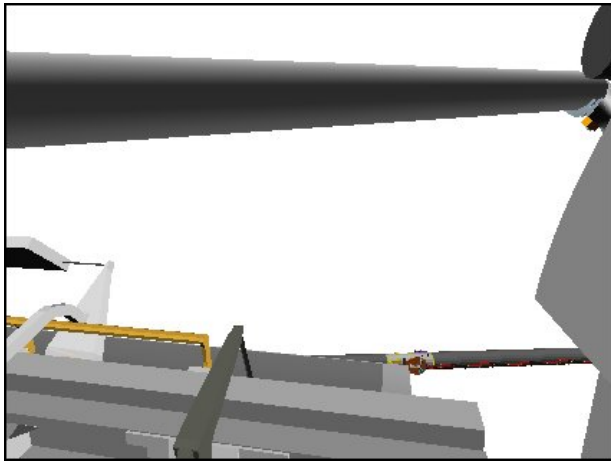

**CCTV A (80,-15)**

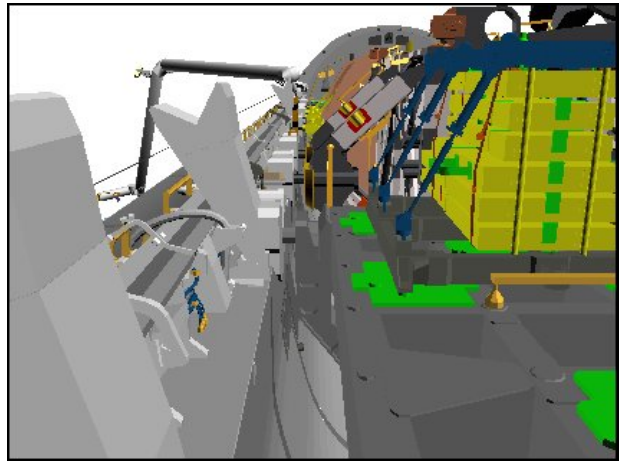

**CCTV B (0,-15)**

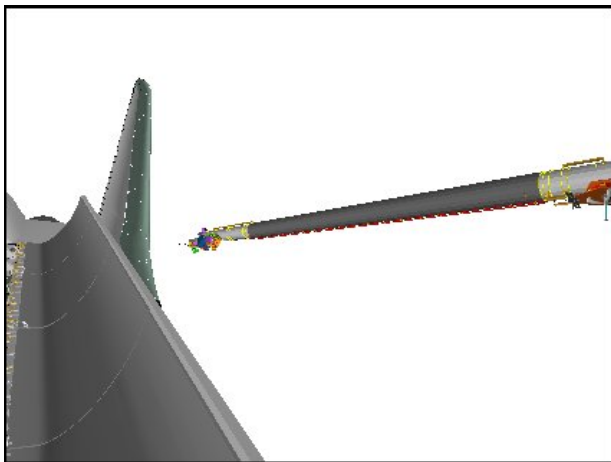

**ELBOW (-95,-5)**

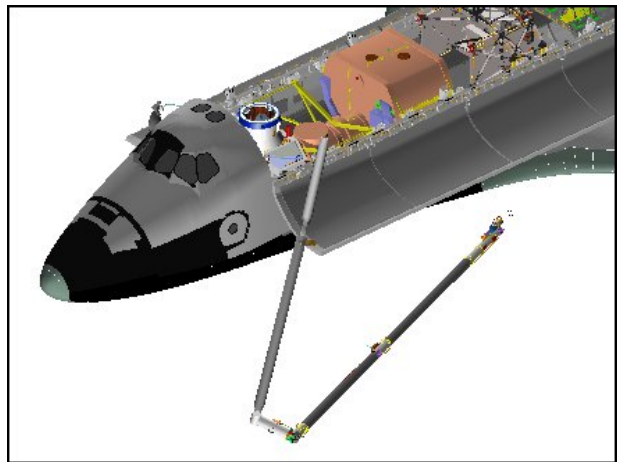

**BIRD'S EYE**

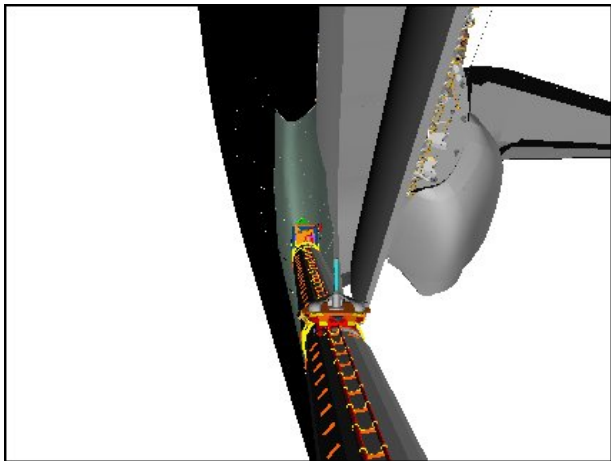

**RSC**

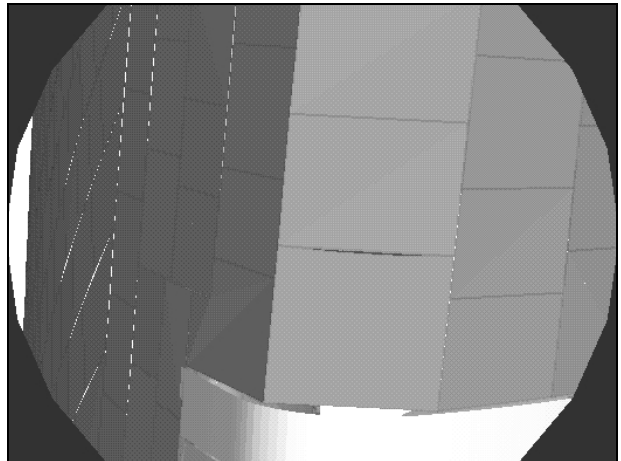

**LDRI (88,-120)**



PORT LDRI RCC SURVEY – Pause Pt 104

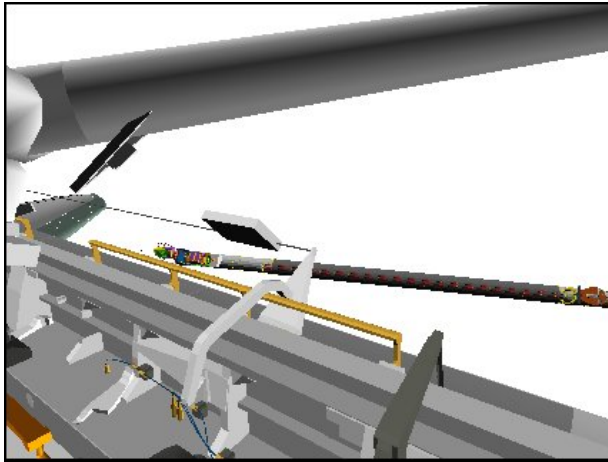

**CCTV A (55,-15)**

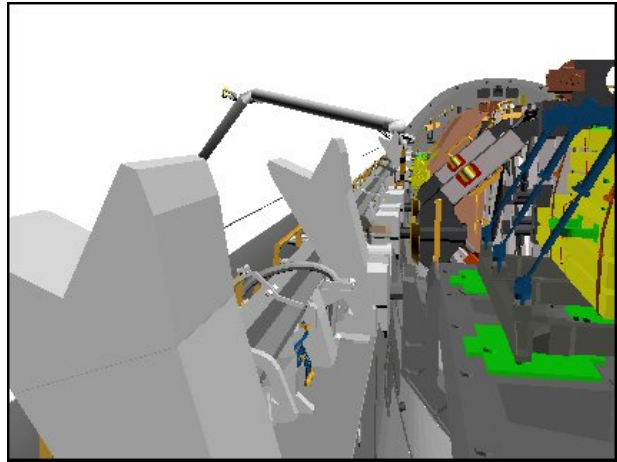

**CCTV B (-10,-10)**

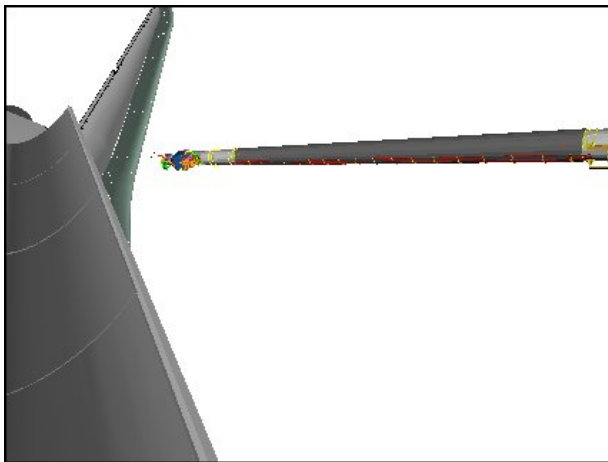

**ELBOW (-100,-5)**

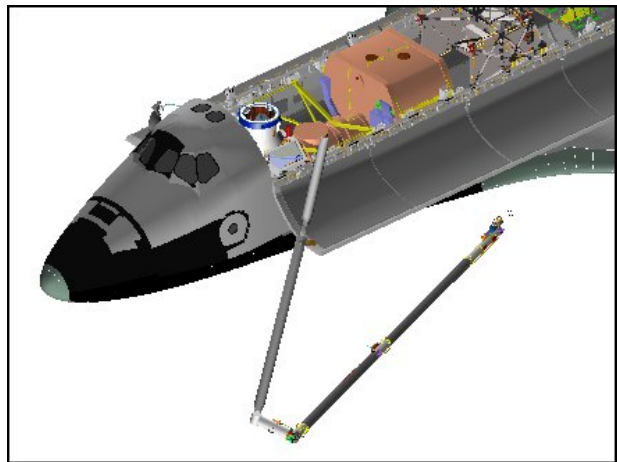

**BIRD'S EYE**

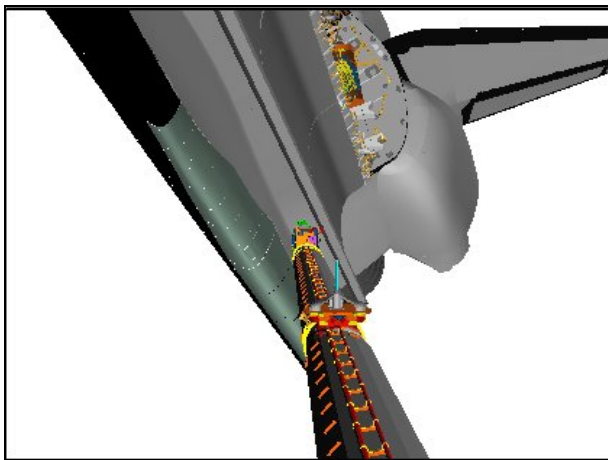

**RSC**

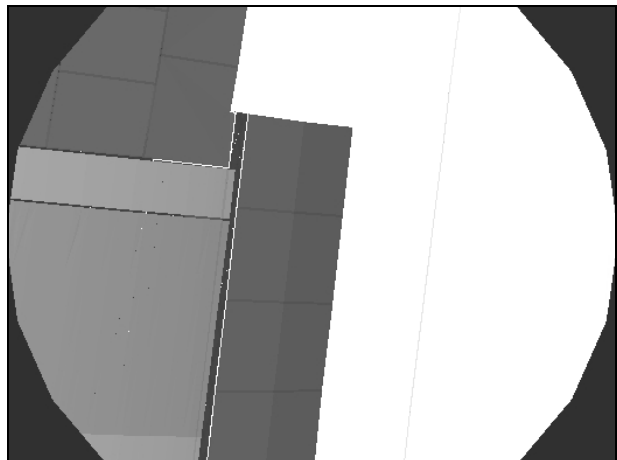

**LDRI (120,-120)**

PORT LDRI RCC SURVEY – Pause Pt 114



CCTV A (35,12)

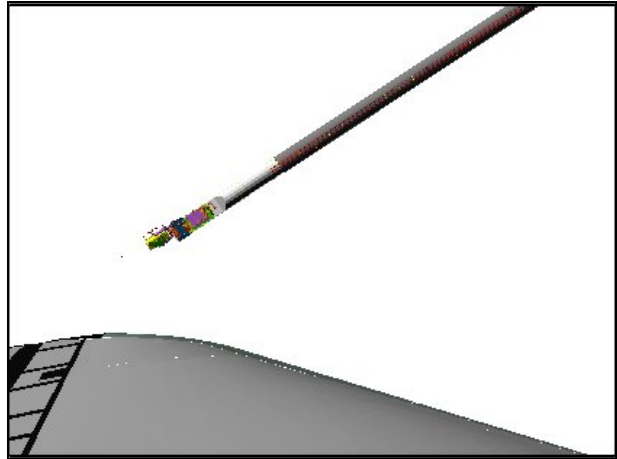

CCTV B (-80,-10)

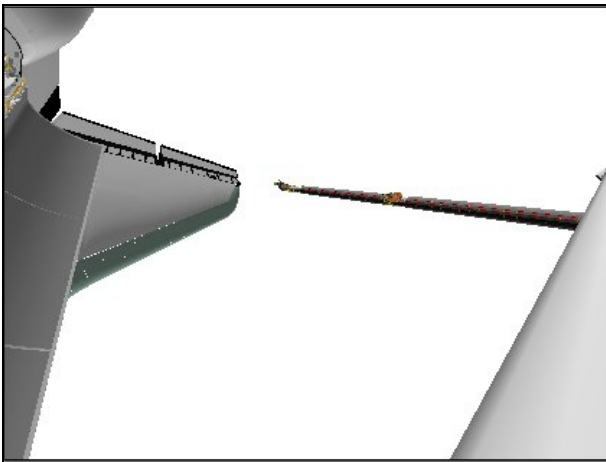

ELBOW (-38,-15)

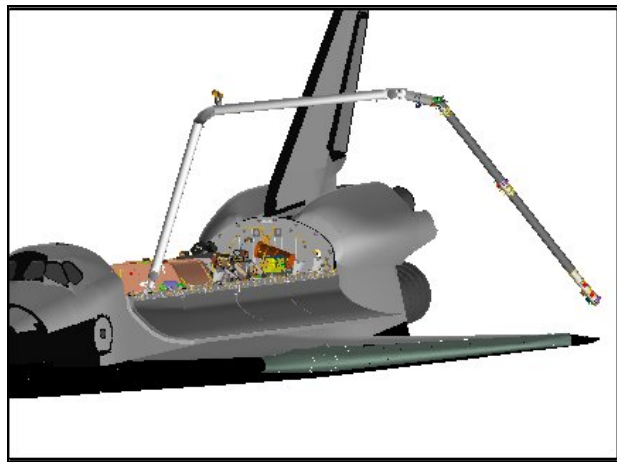

BIRD'S EYE

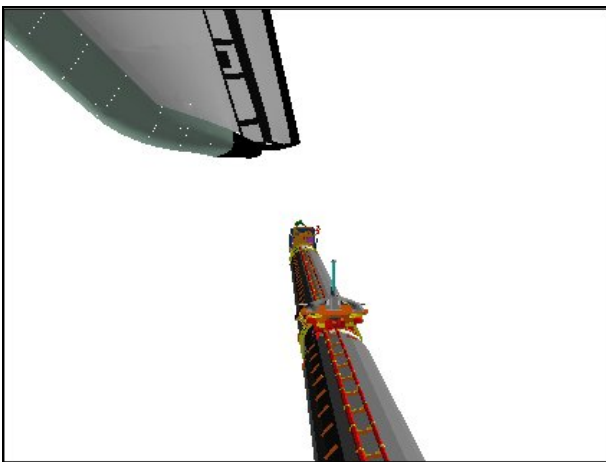

RSC

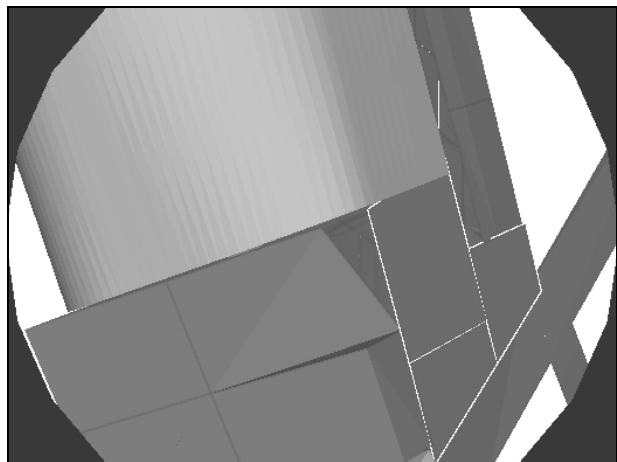

LDRI (120,-120)

PORT LDRI RCC SURVEY – Pause Pt 115

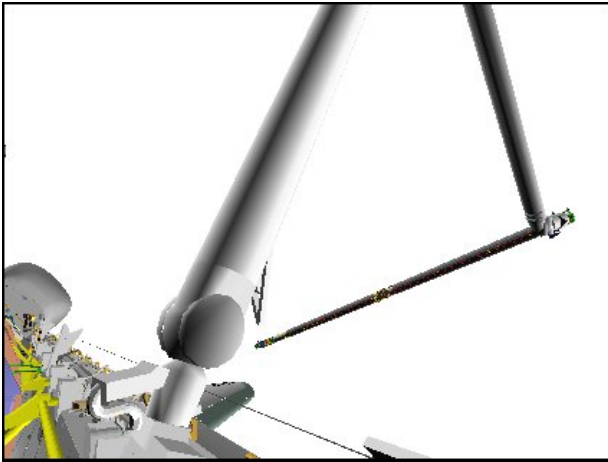

**CCTV A (35,12)**

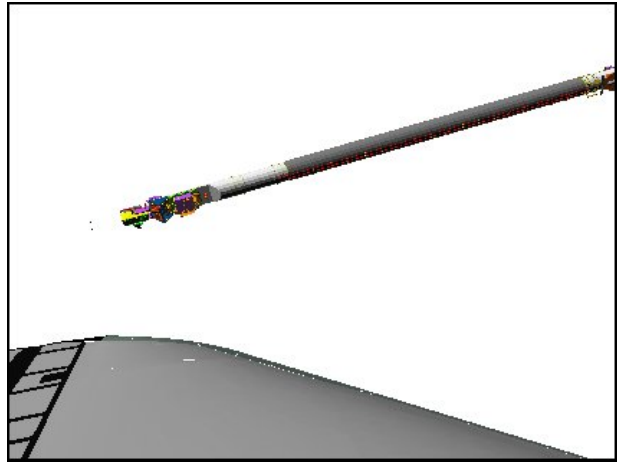

**CCTV B (-80,-10)**

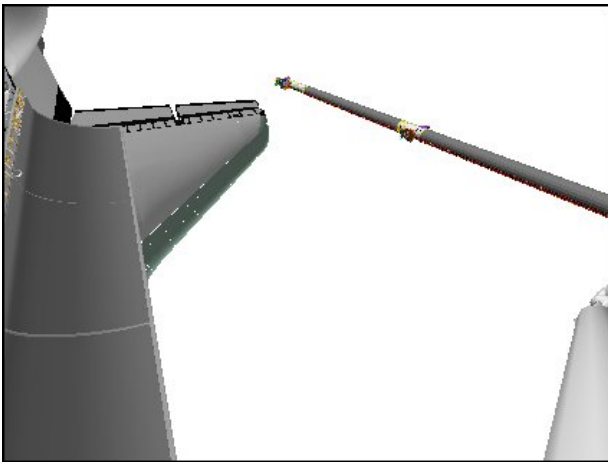

**ELBOW (-35,5)**

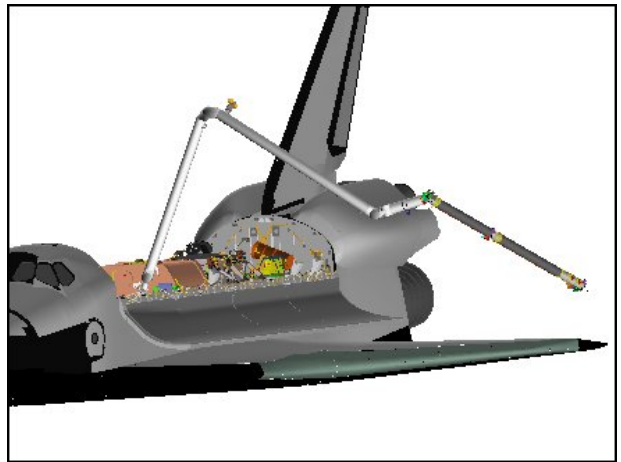

**BIRD'S EYE**

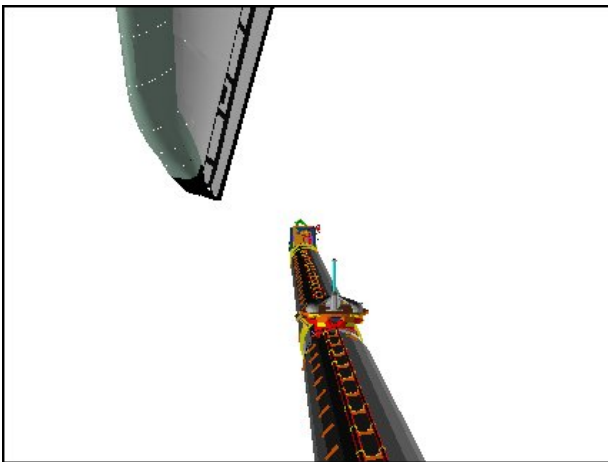

**RSC**

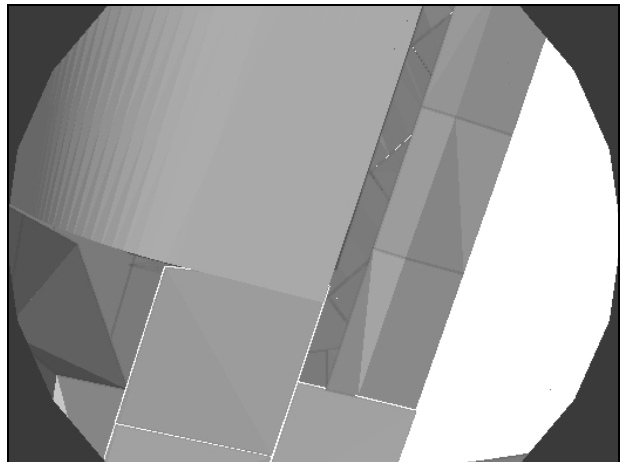

**LDRI (135,-110)**

PORT LDRI RCC SURVEY – Pause Pt 121

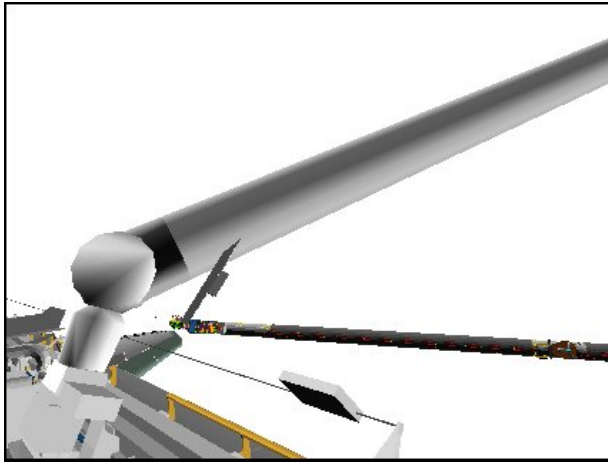

**CCTV A (45,5)**

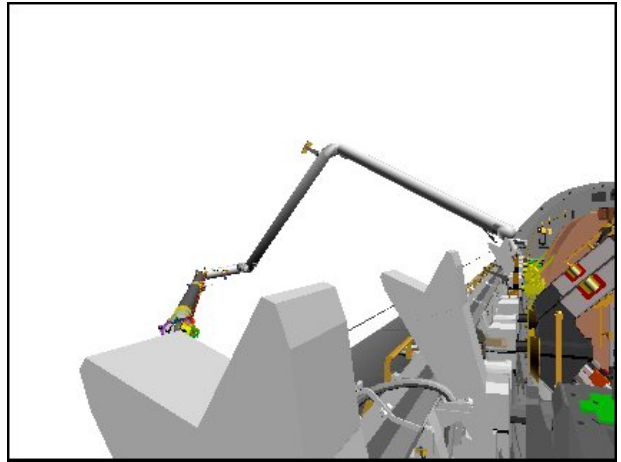

**CCTV B (-20,0)**

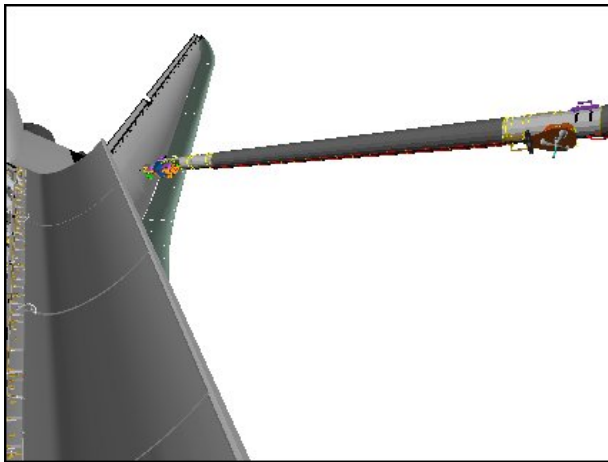

**ELBOW (-88,0)**

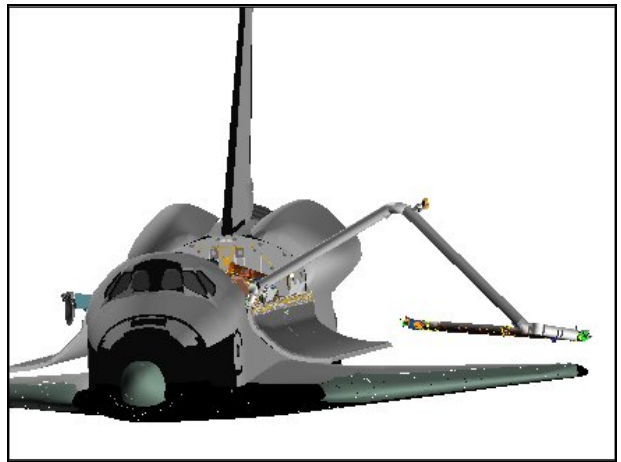

**BIRD'S EYE**

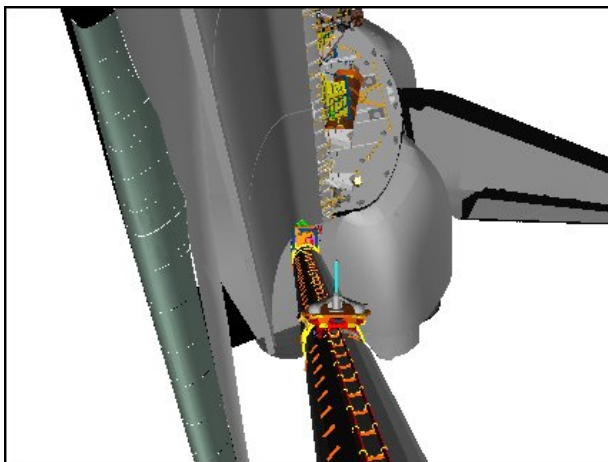

**RSC**

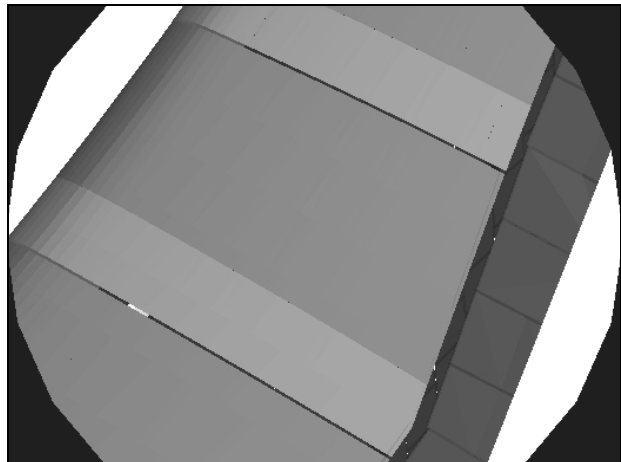

**LDRI (135,-110)**

# SRMS EE CAM CREW CABIN SURVEY CAMERA VIEWS

EE CREW CABIN SURVEY – Pause Pt 122

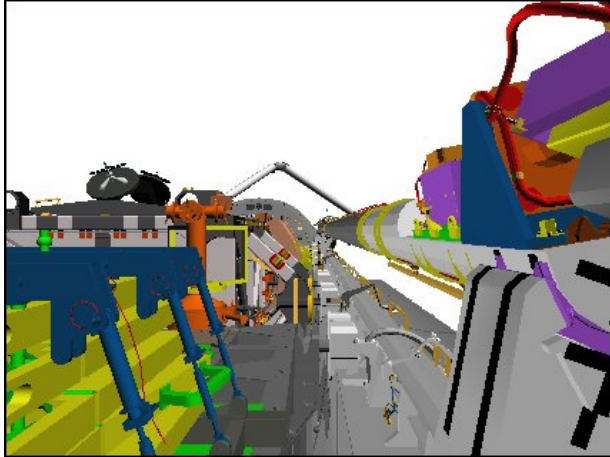

CCTV C (0,0)

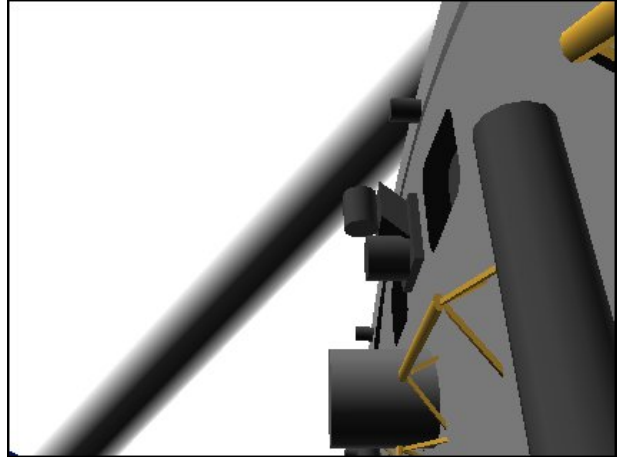

CCTV D (90,30)

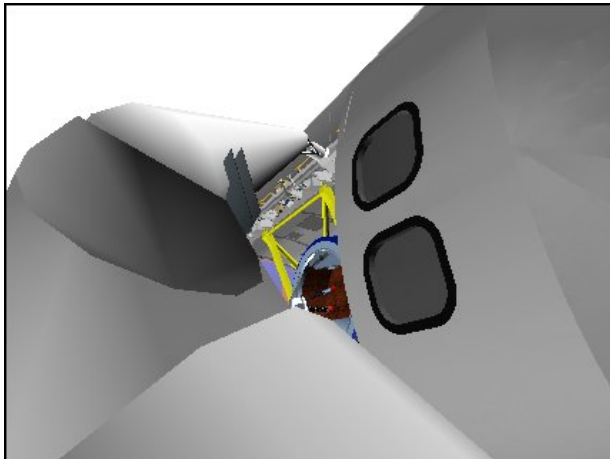

ELBOW (-135,-50)



BIRD'S EYE

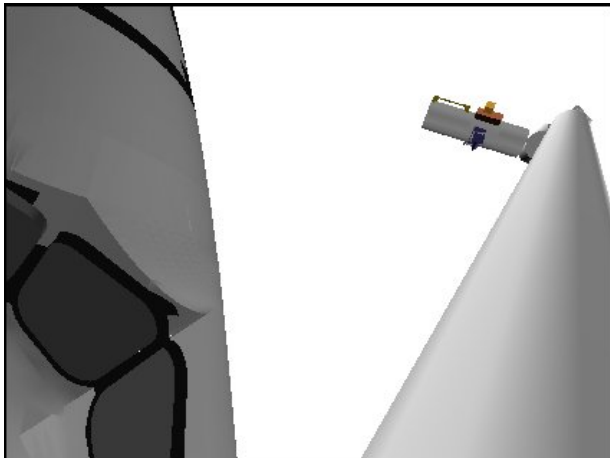

ELBOW (-30,-20)

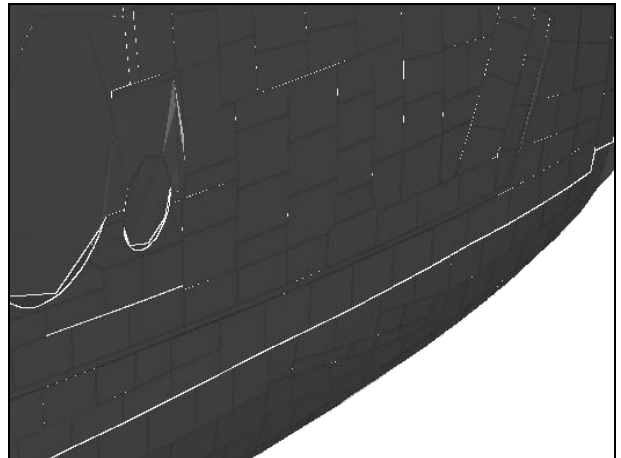

WRIST

EE CREW CABIN SURVEY – Pause Pt 123

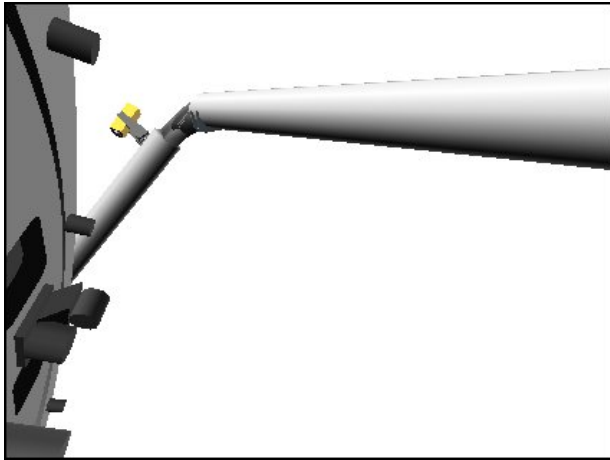

CCTV A (-65,45)

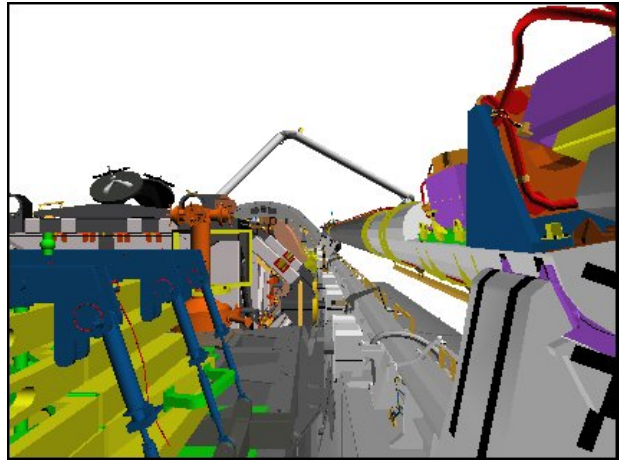

CCTV C (0,0)

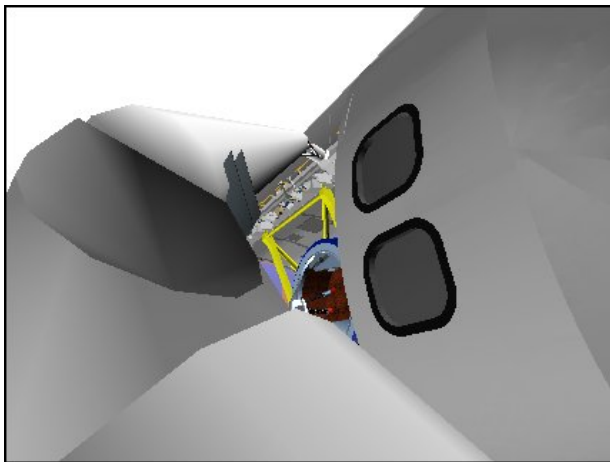

ELBOW (-110,-55)



BIRD'S EYE

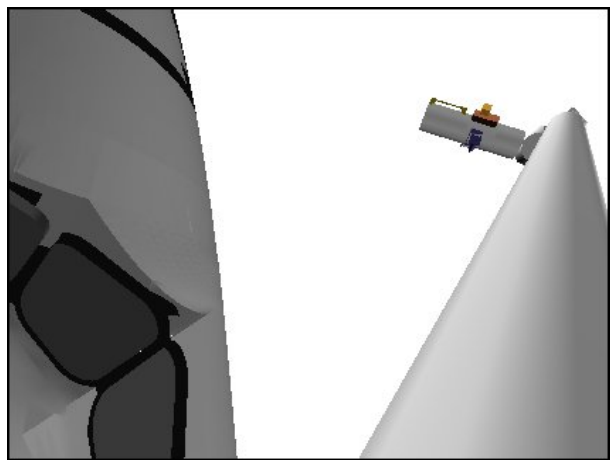

ELBOW (-30,-25)

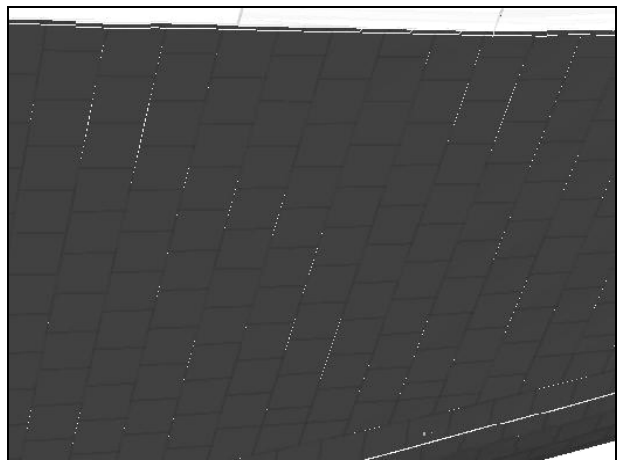

WRIST

EE CREW CABIN SURVEY – Pause Pt 124

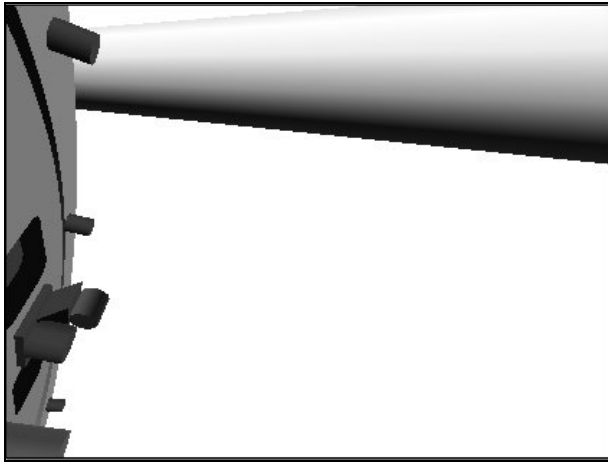

CCTV A (-65,45)

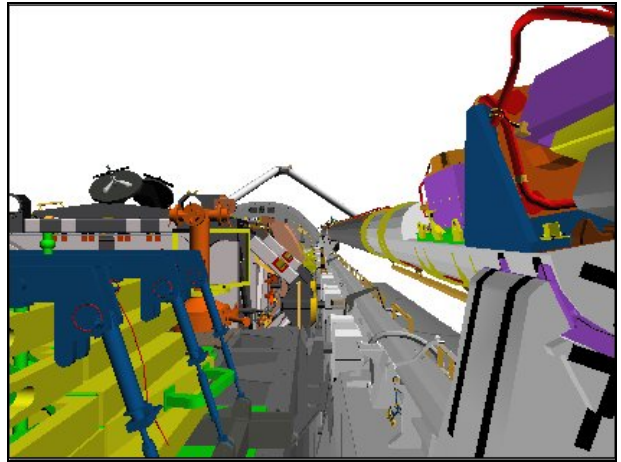

CCTV C (0,0)

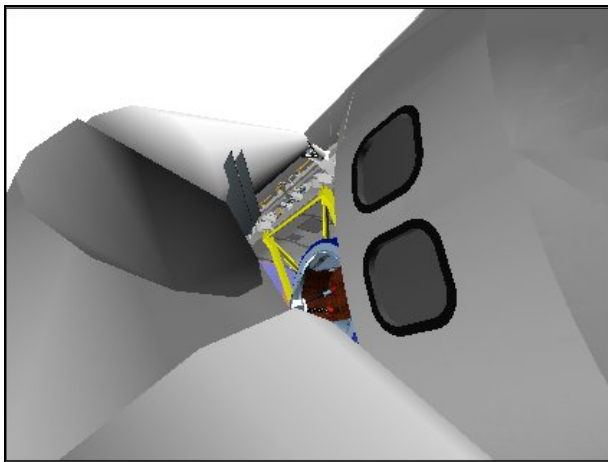

ELBOW (-135,-50)



BIRD'S EYE

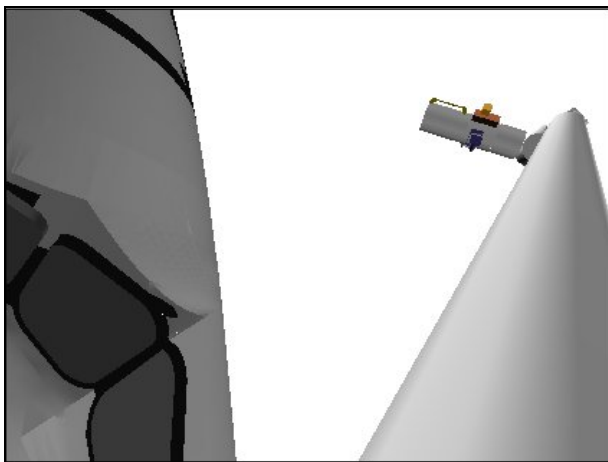

ELBOW (-30,-20)

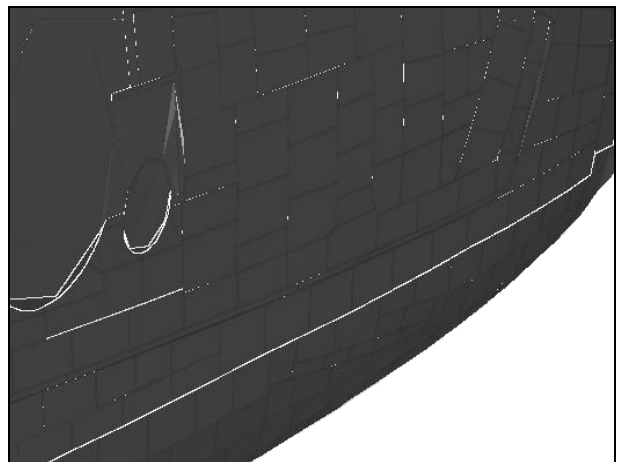

WRIST

EE CREW CABIN SURVEY – Pause Pt 125

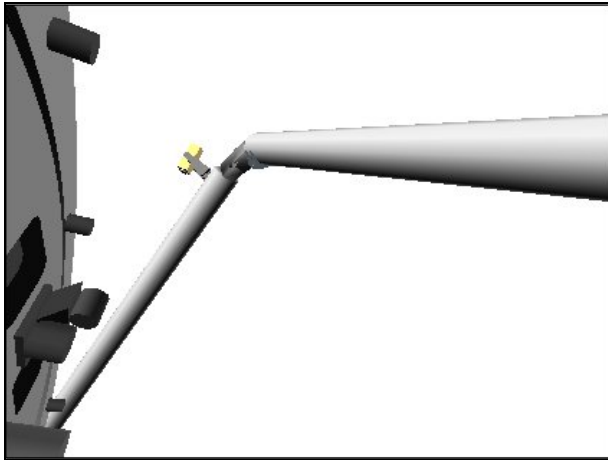

CCTV A (-65,30)

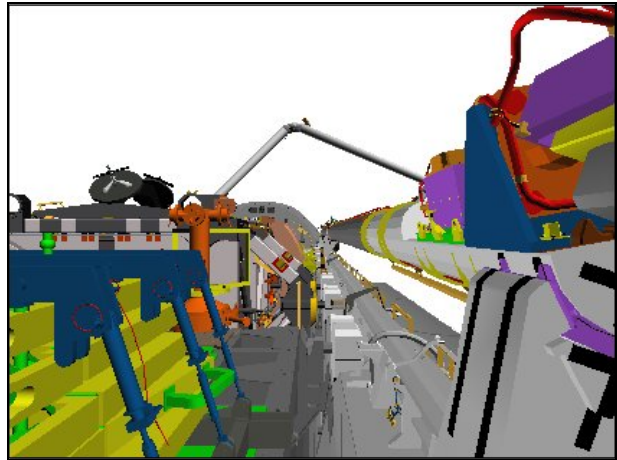

CCTV C (0,5)

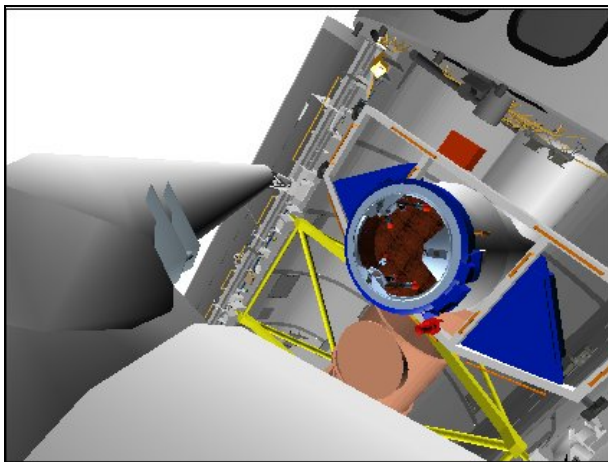

ELBOW (-120,-50)

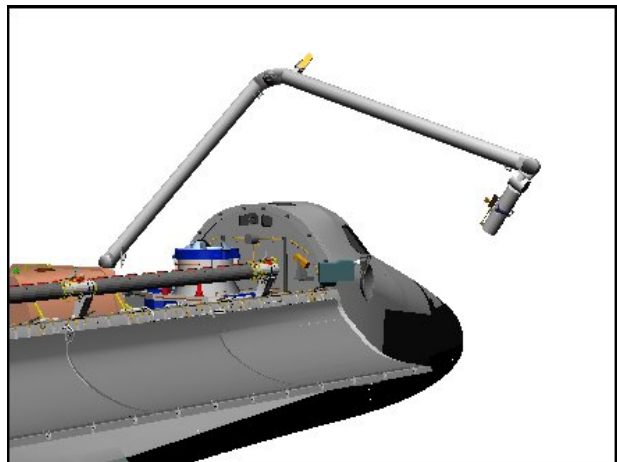

BIRD'S EYE

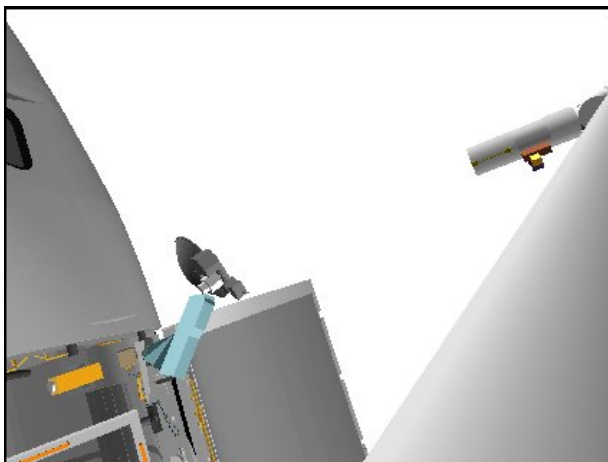

ELBOW (-35,-25)

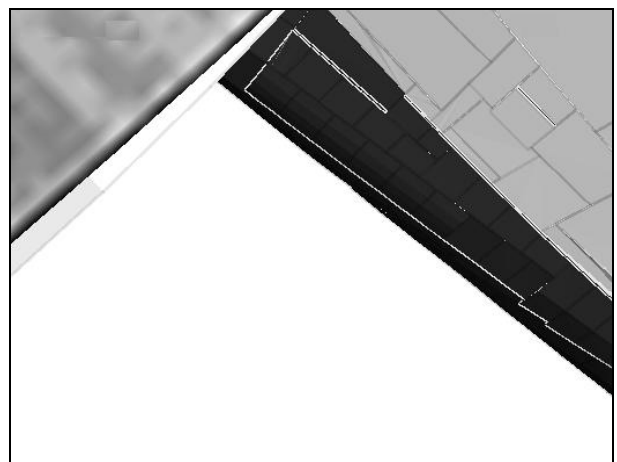

WRIST



EE CREW CABIN SURVEY – Pause Pt 126

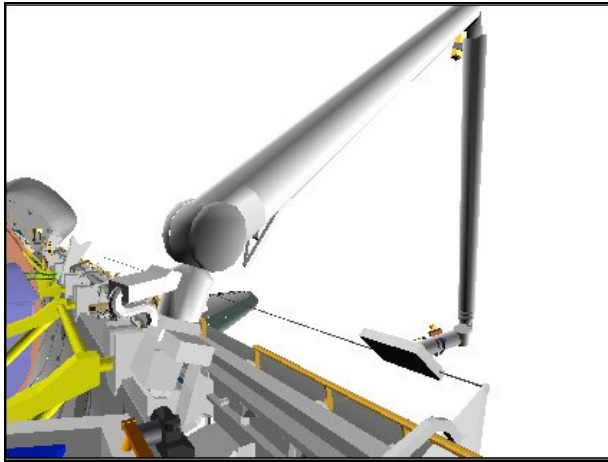

CCTV A (35,0)

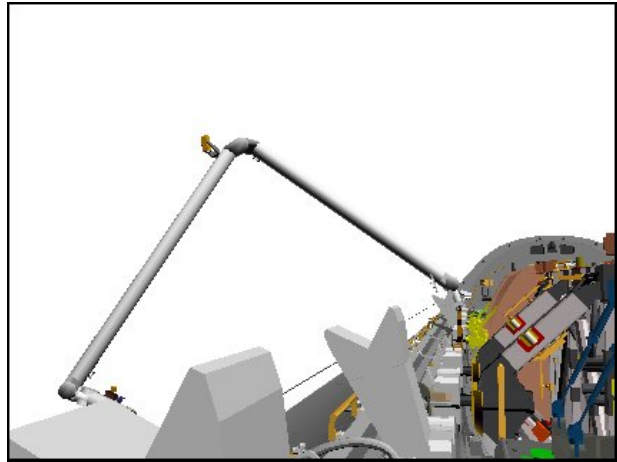

CCTV B (-15,5)

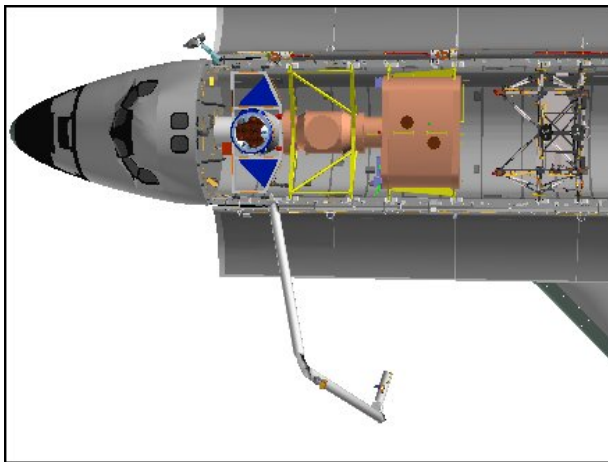

OVERHEAD

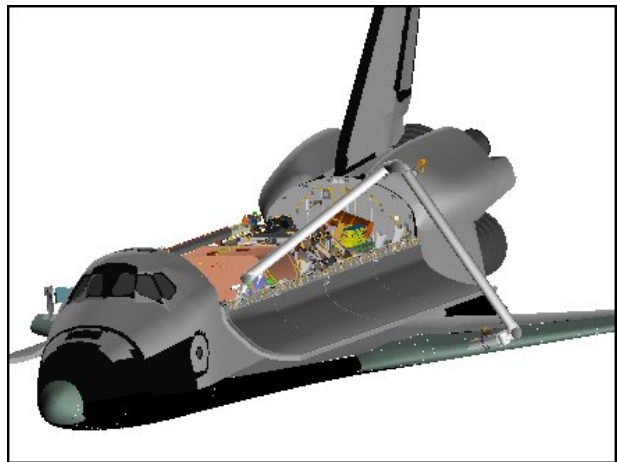

BIRD'S EYE

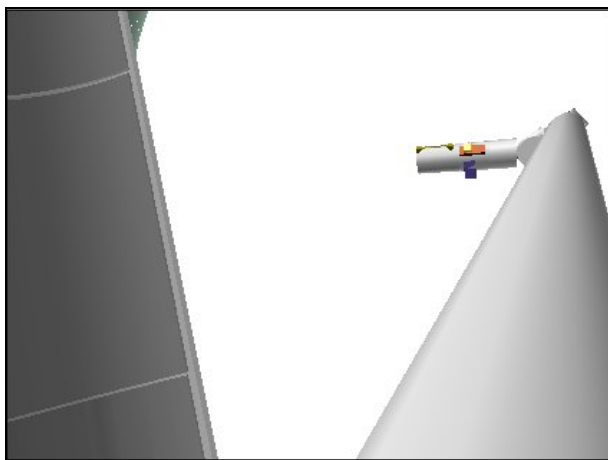

ELBOW (-30,-20)

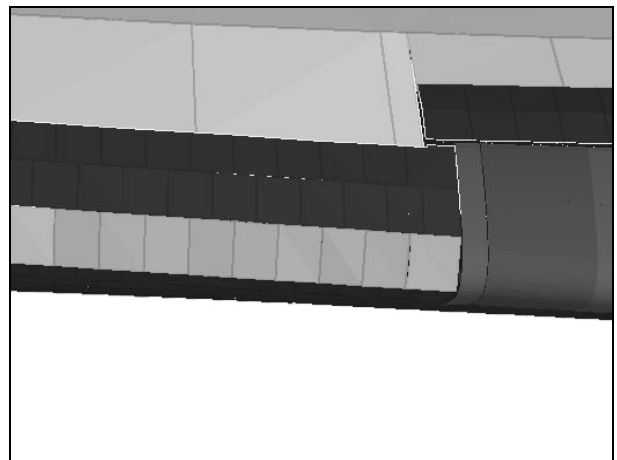

WRIST

EE CREW CABIN SURVEY – Pause Pt 128

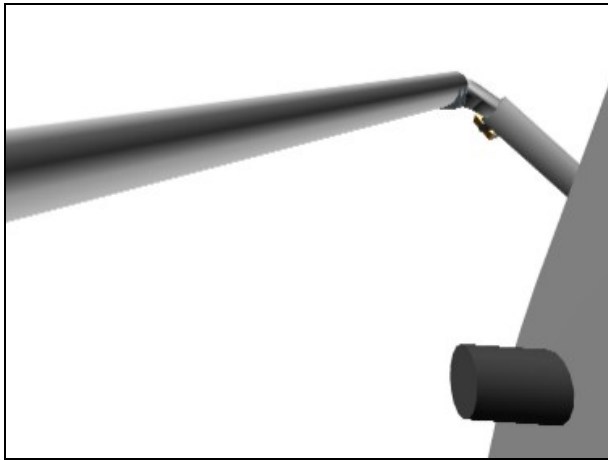

**CCTV A (90,15)**

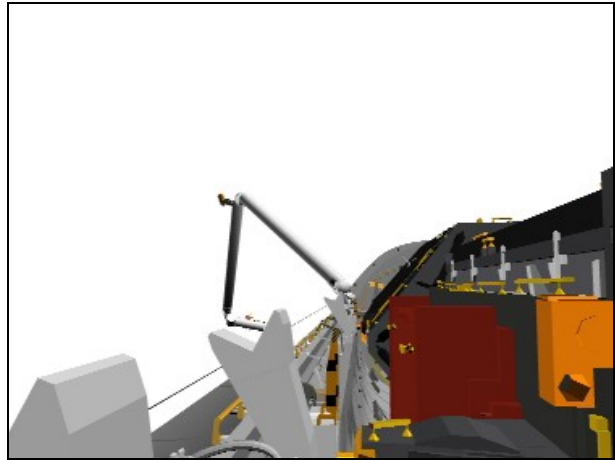

**CCTV B (-5,5)**

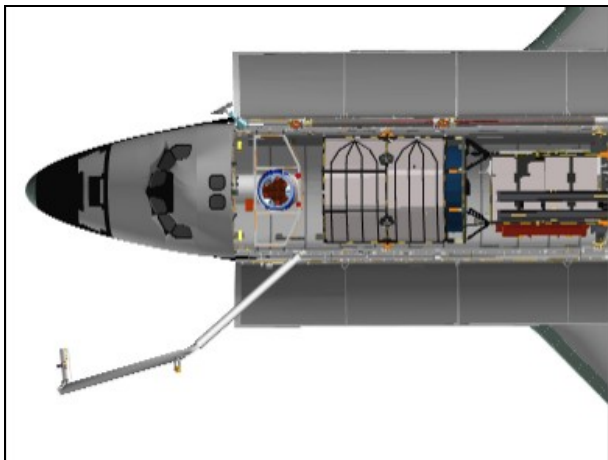

**OVERHEAD**

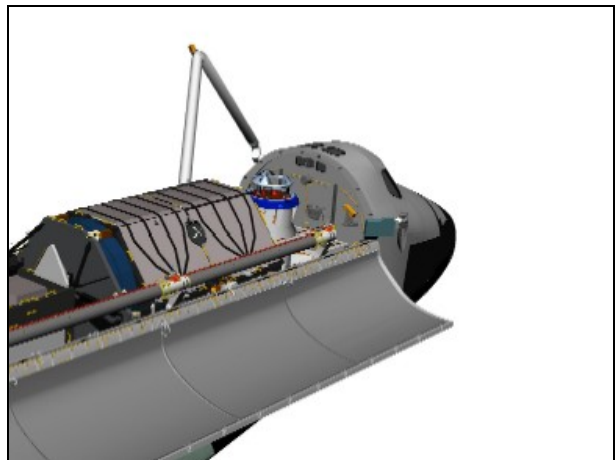

**BIRD'S EYE**

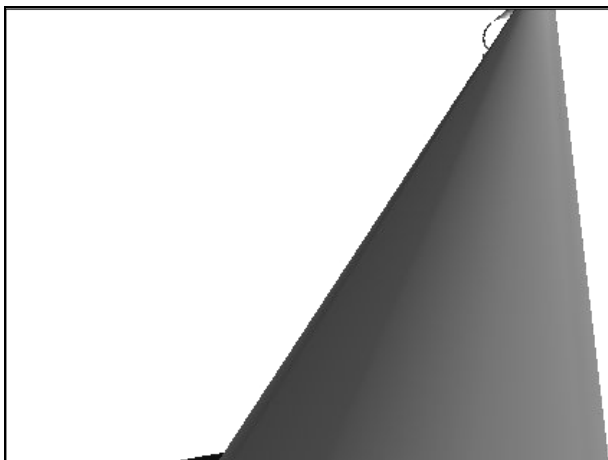

**ELBOW (-25,-33)**

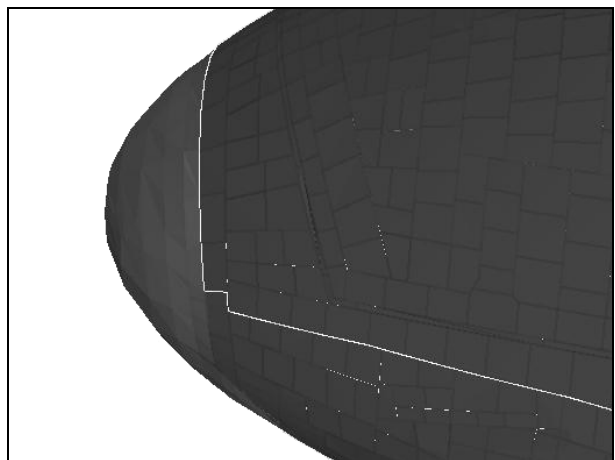

**WRIST**

EE CREW CABIN SURVEY – Pause Pt 129

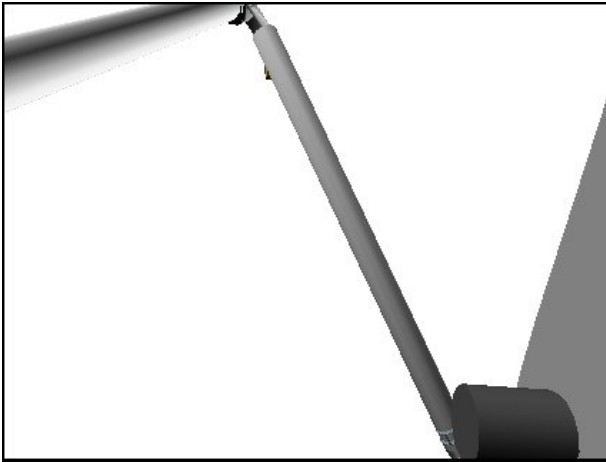

**CCTV A (90,19)**

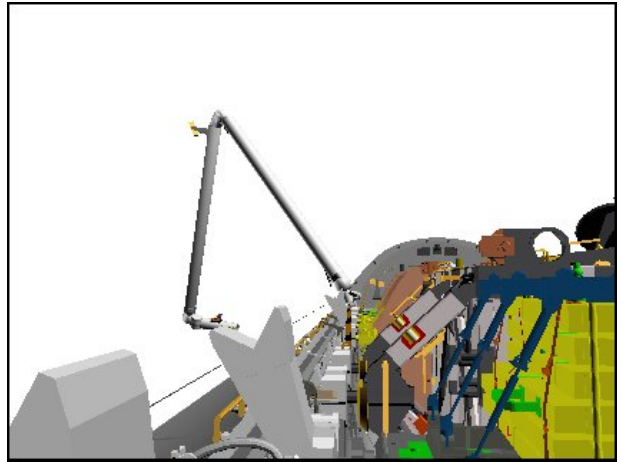

**CCTV B (-5,5)**

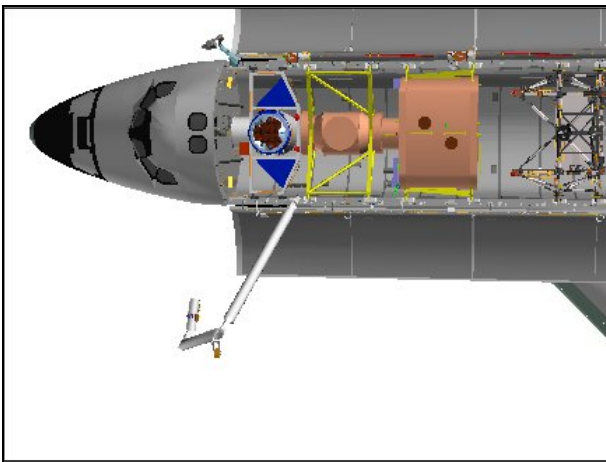

**OVERHEAD**

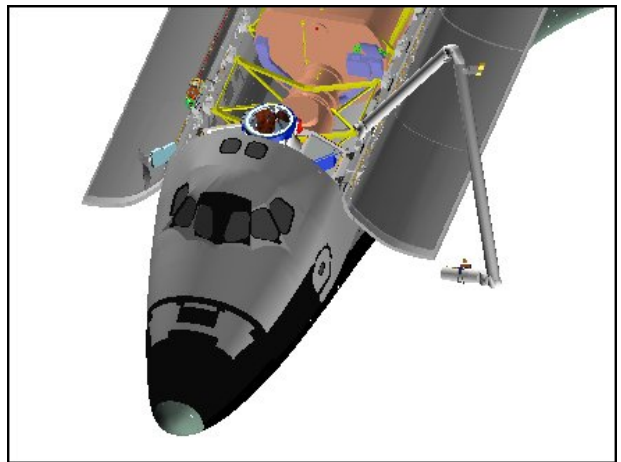

**BIRD'S EYE**

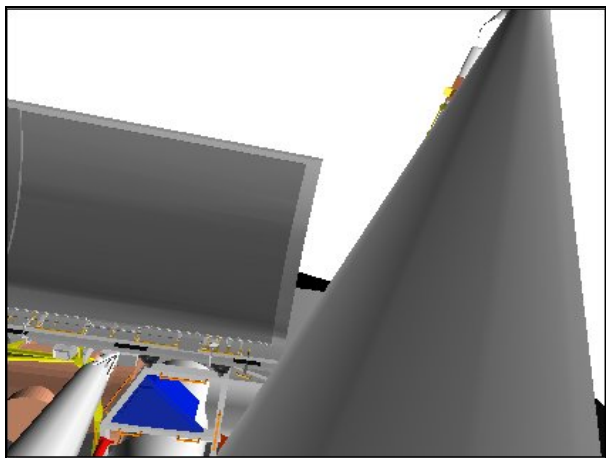

**ELBOW (-25,-33)**

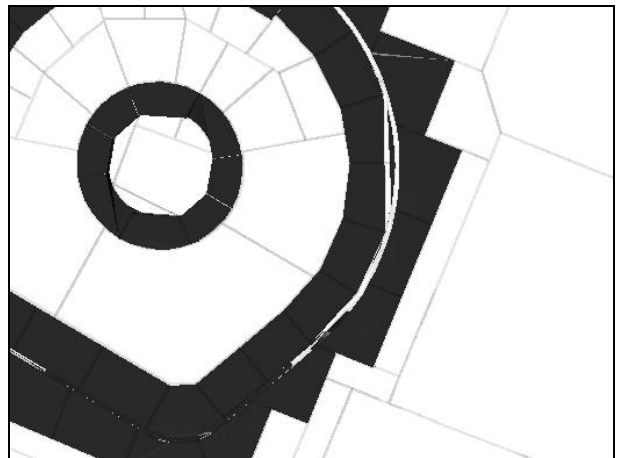

**WRIST**

**OBSS LDRI RCC SURVEY CAMERA VIEWS – STBD DOCKED**

**STBD DOCKED LDRI RCC SURVEY – Pt 130**

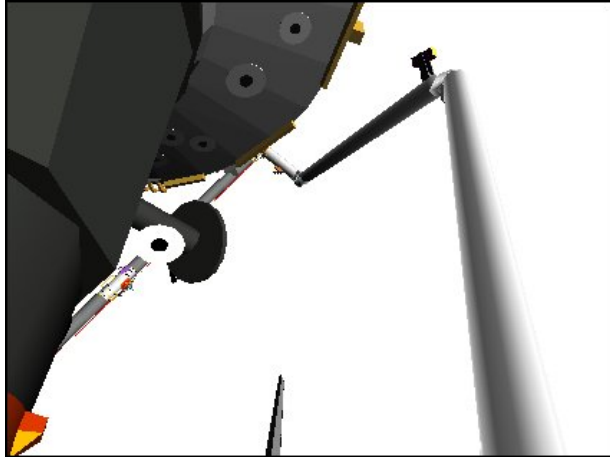

**CCTV A (0,40)**

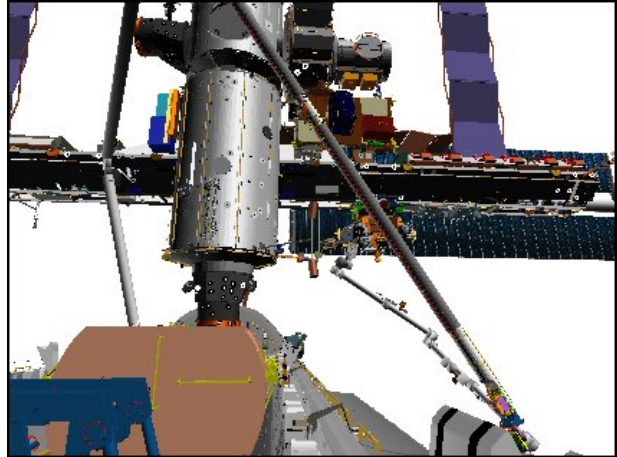

**CCTV C (5,15)**

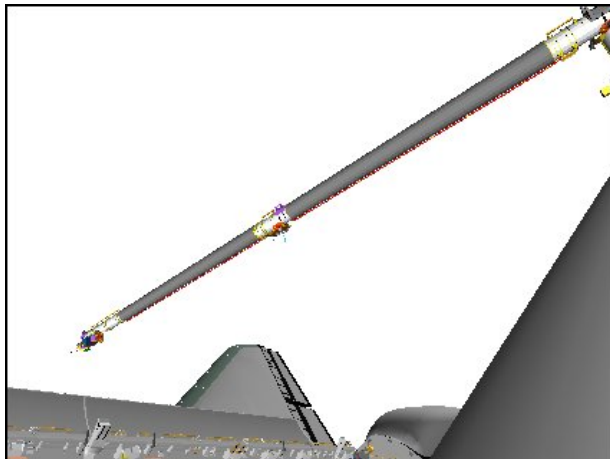

**RMS ELBOW (-40,-20)**

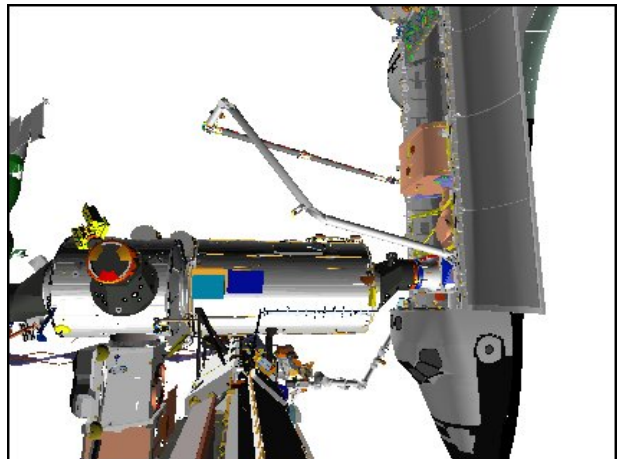

**P1 LOOB (100,10)**

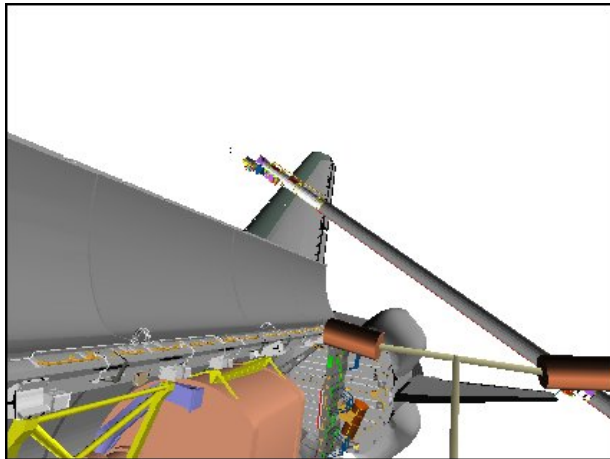

**US LAB (-20,-10)**

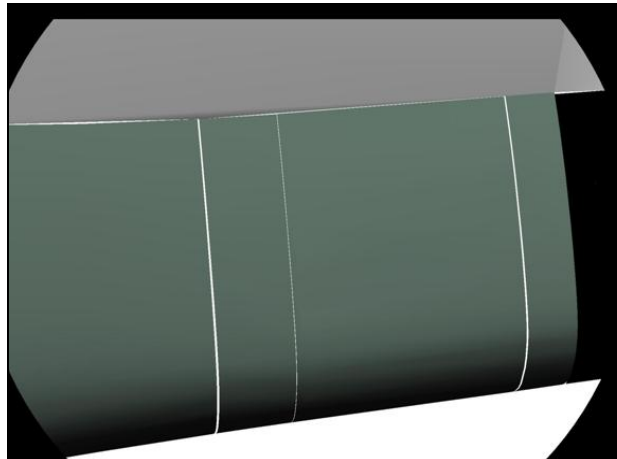

**LDRI (54,-78)**

**NOTE**

All LDRI views are shown after any pan/tilt changes at that position

STBD DOCKED LDRI RCC SURVEY – Pause Pt 132

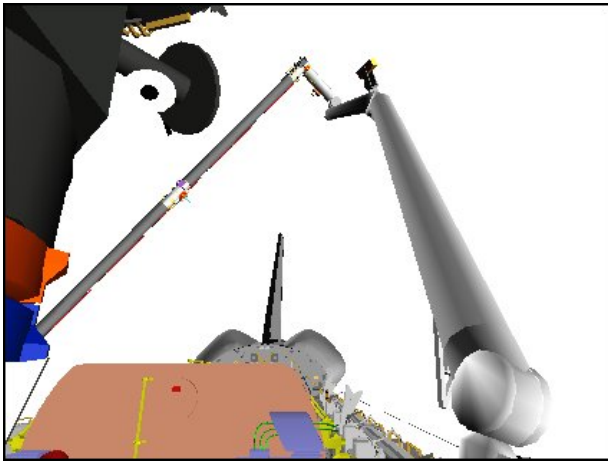

CCTV A (0,20)

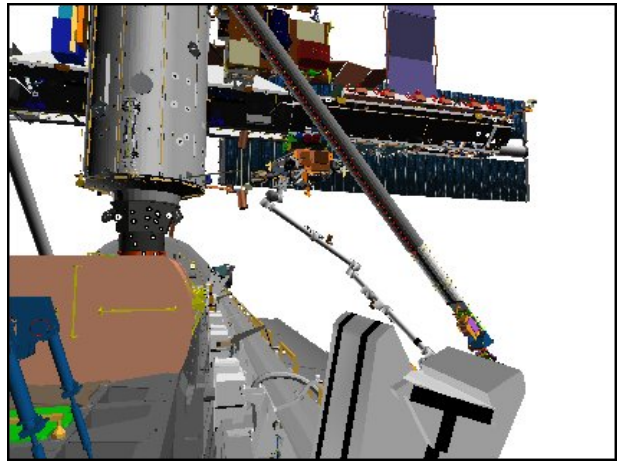

CCTV C (15,5)

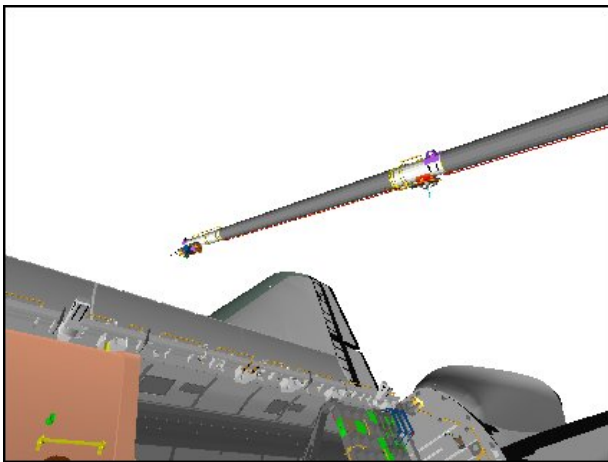

RMS ELBOW (-70,-20)

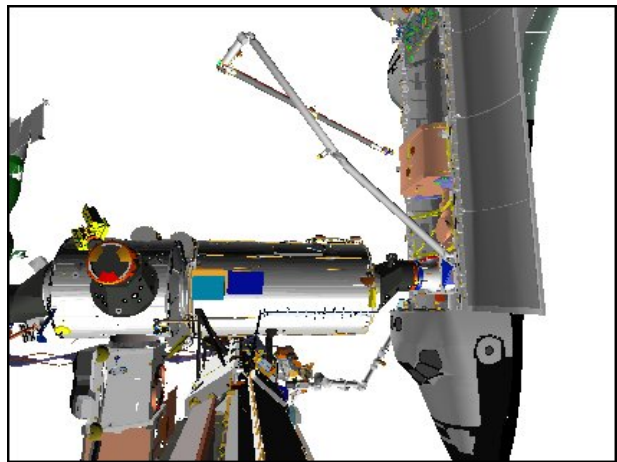

P1 LOOB (100,25)

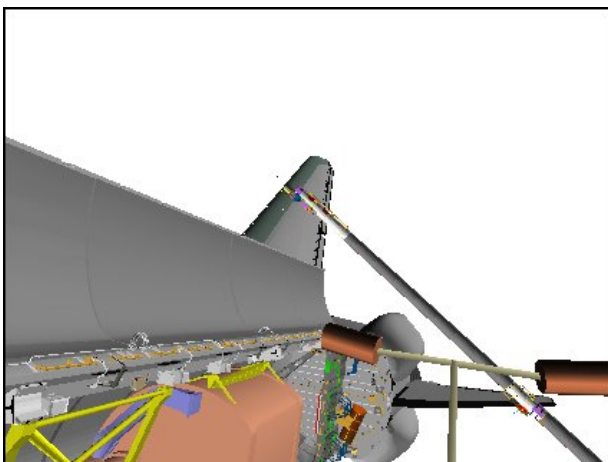

US LAB (-20,-10)

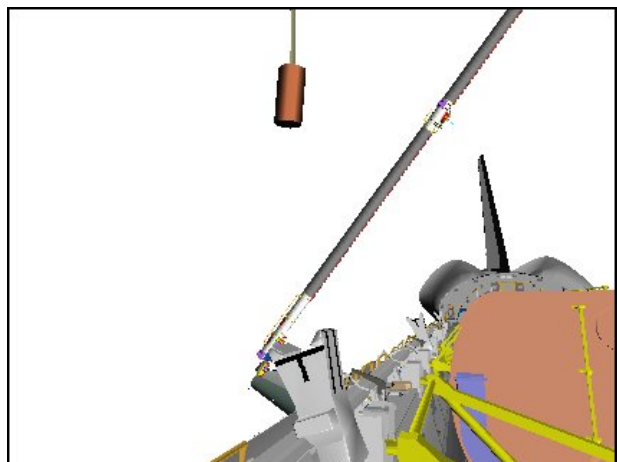

CCTV D (-20,10)

STBD DOCKED LDRI RCC SURVEY – Pause Pt 133

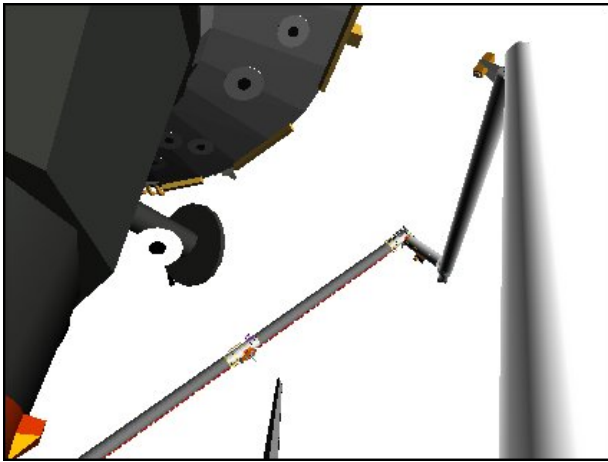

**CCTV A (0,40)**

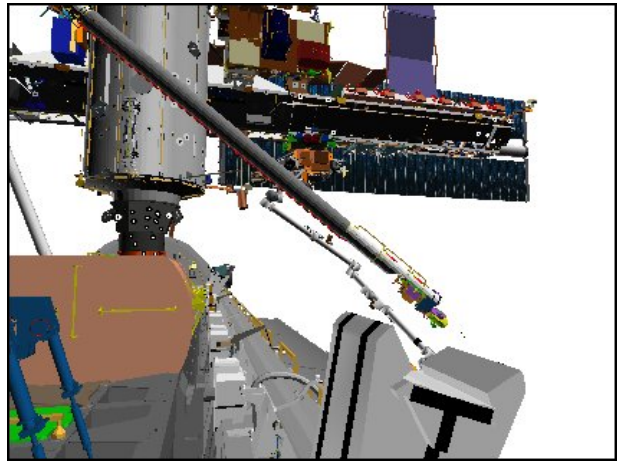

**CCTV C (15,5)**

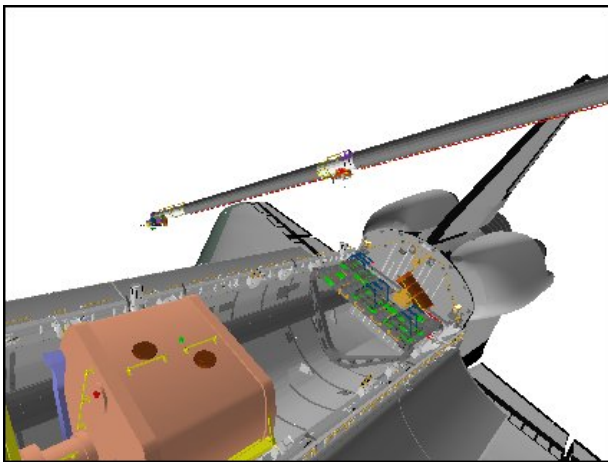

**RMS ELBOW (-50,-10)**

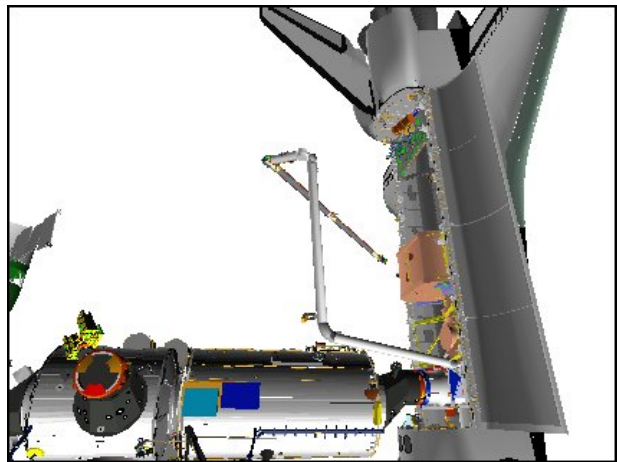

**P1 LOOB (100,25)**

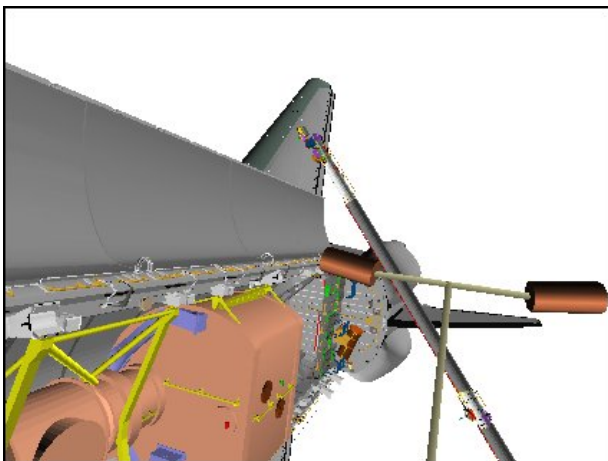

**US LAB (-20,-20)**

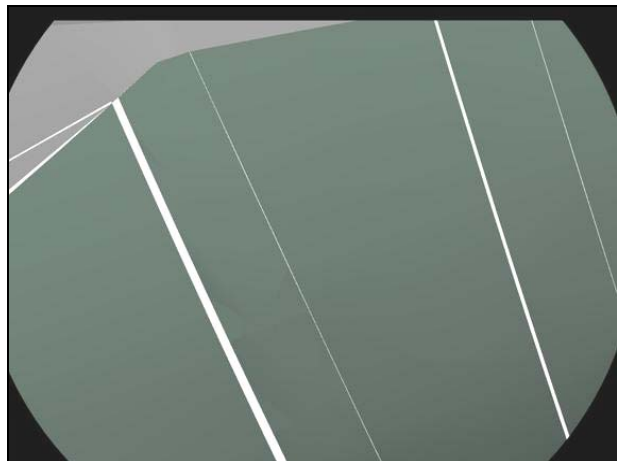

**LDRI (110,-89)**

STBD DOCKED LDRI RCC SURVEY – Pause Pt 134

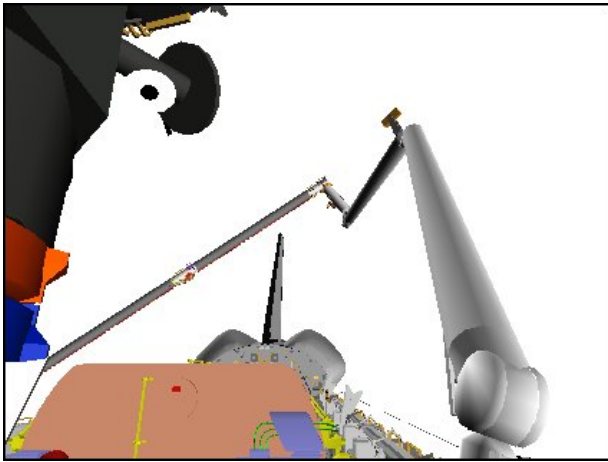

CCTV A (0,20)

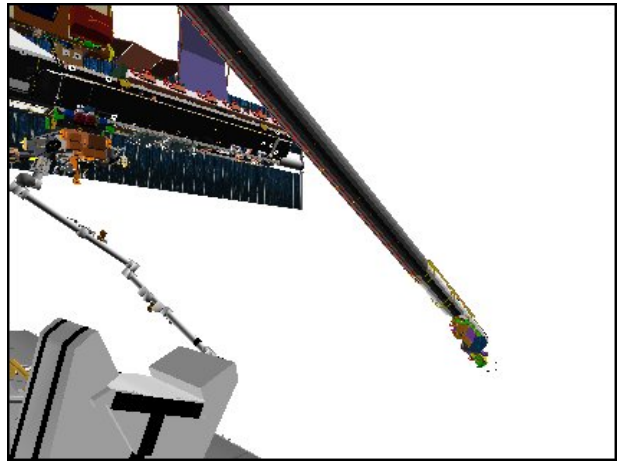

CCTV C (45,5)

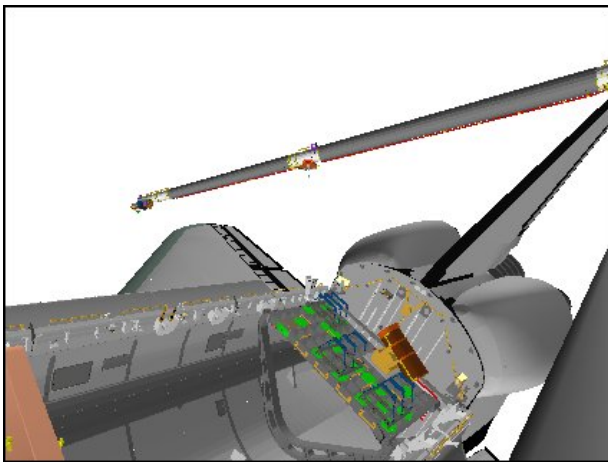

RMS ELBOW (-40,-10)

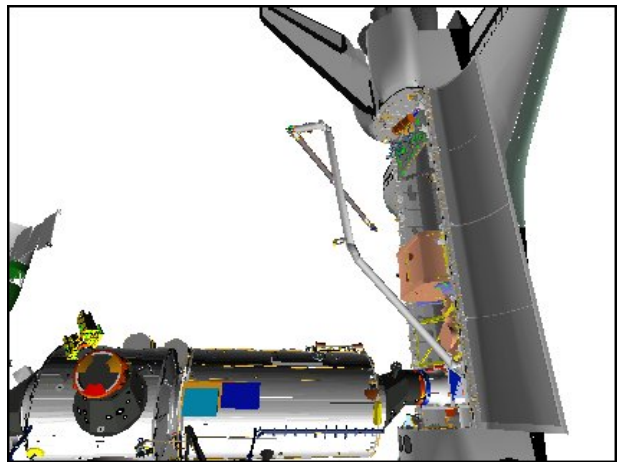

P1 LOOB (100,25)

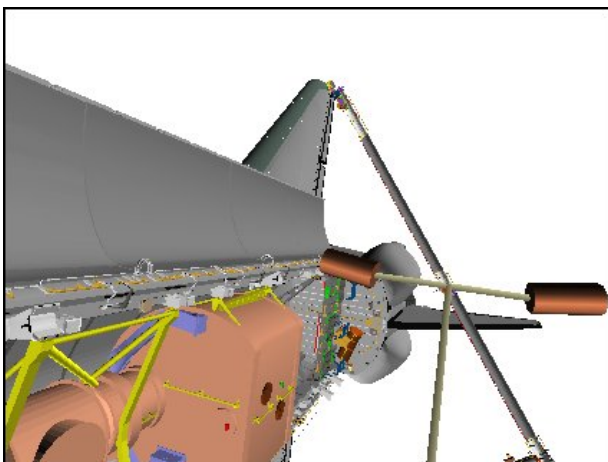

US LAB (-10,-25)

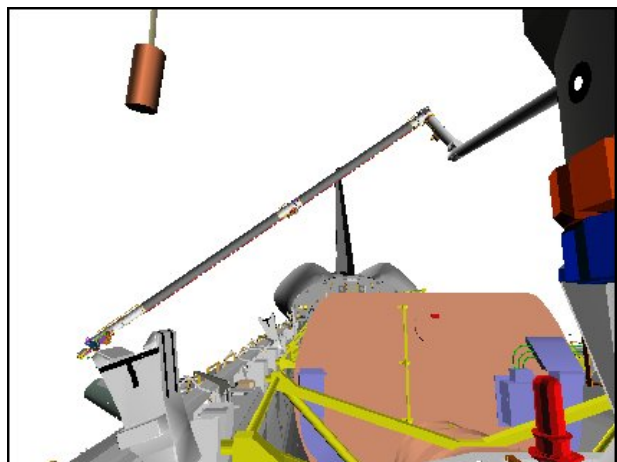

CCTV D (0,10)

STBD DOCKED LDRI RCC SURVEY – Pause Pt 135

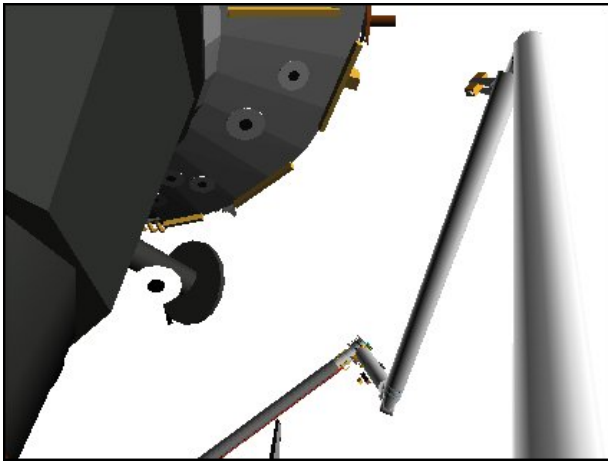

CCTV A (0,45)

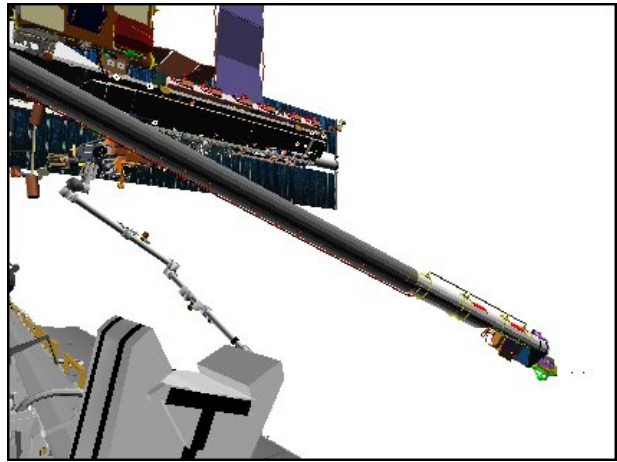

CCTV C (40,5)

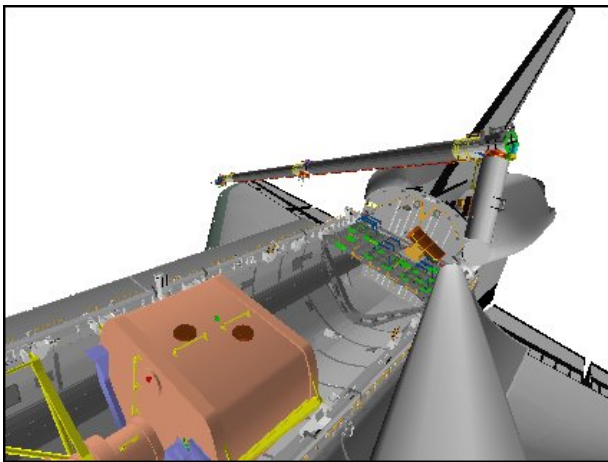

RMS ELBOW (-20,0)

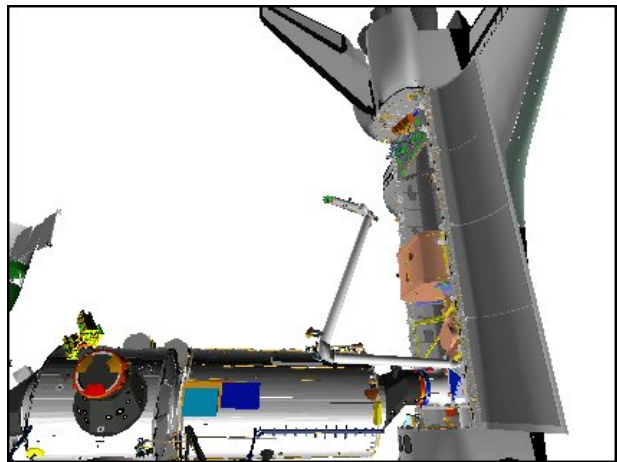

P1 LOOB (100,25)

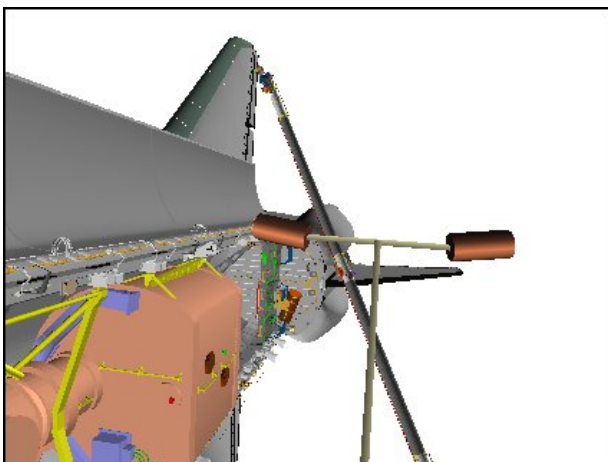

US LAB (-10,-30)

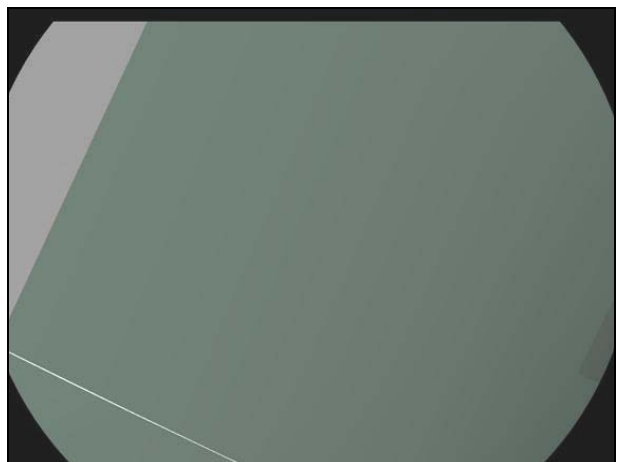

LDRI (107,-112)



STBD DOCKED LDRI RCC SURVEY – Pause Pt 138

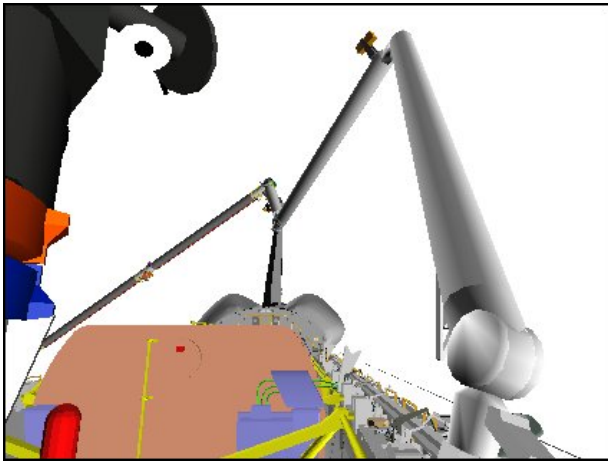

CCTV A (0,15)

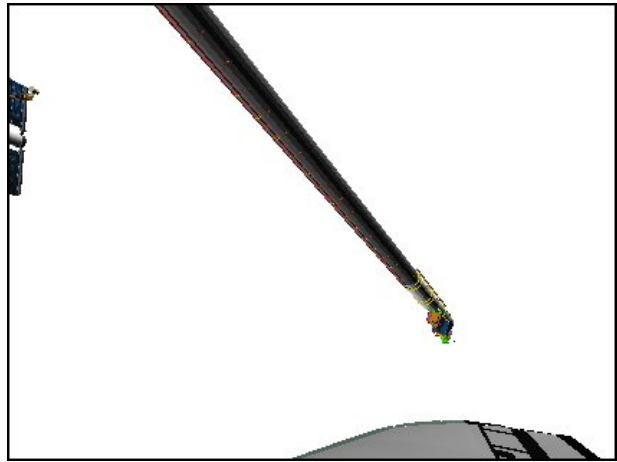

CCTV C (80,5)

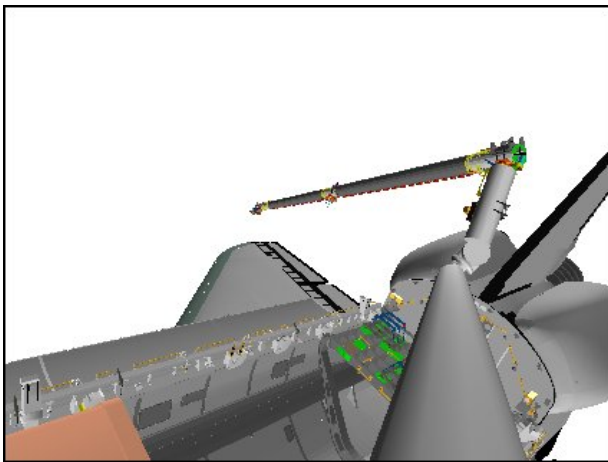

RMS ELBOW (-20,0)

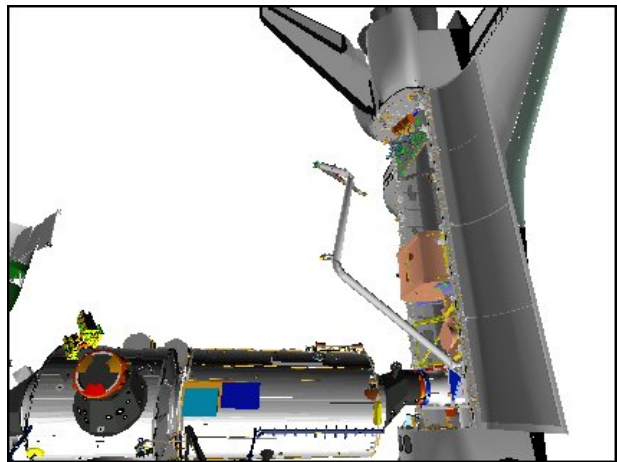

P1 LOOB (100,25)

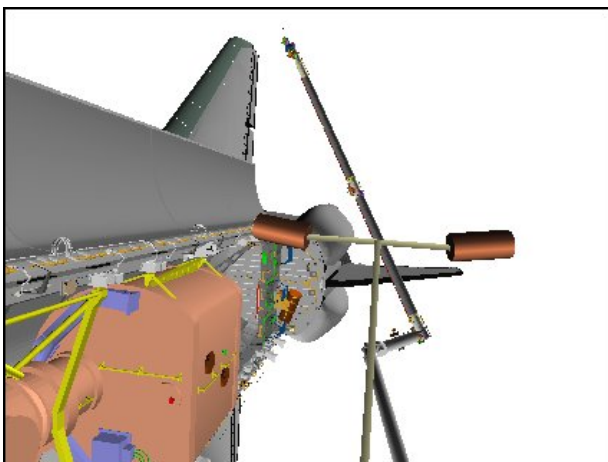

US LAB (-10,-25)

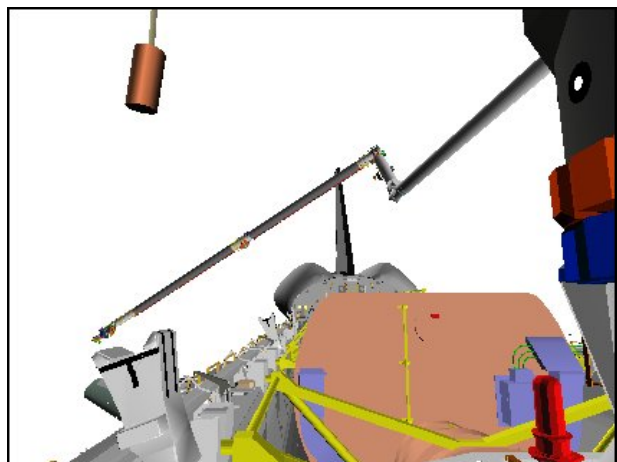

CCTV D (0,10)

STBD DOCKED LDRI RCC SURVEY – Pause Pt 140

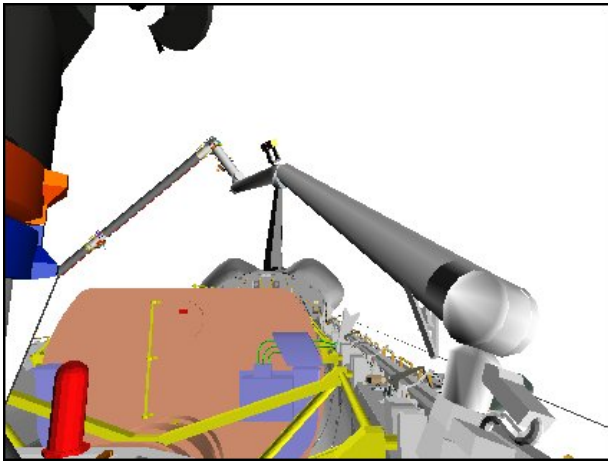

CCTV A (0,10)



CCTV C (70,0)

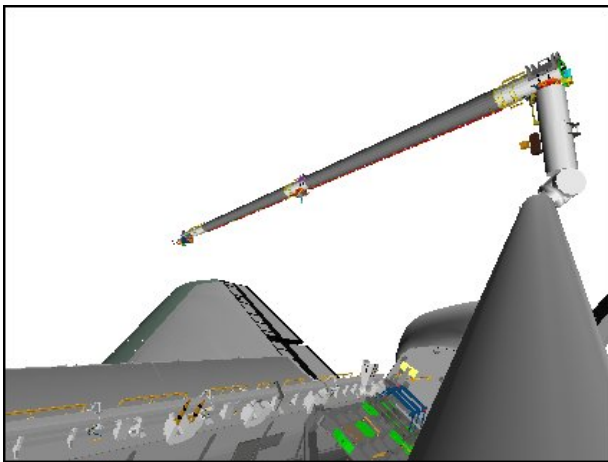

RMS ELBOW (-30,-10)

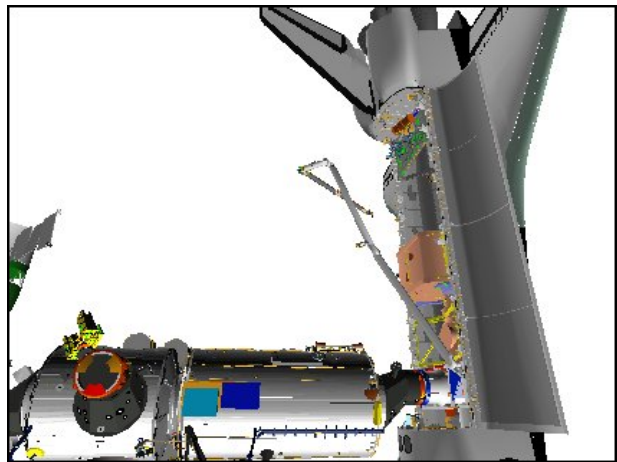

P1 LOOB (100,25)

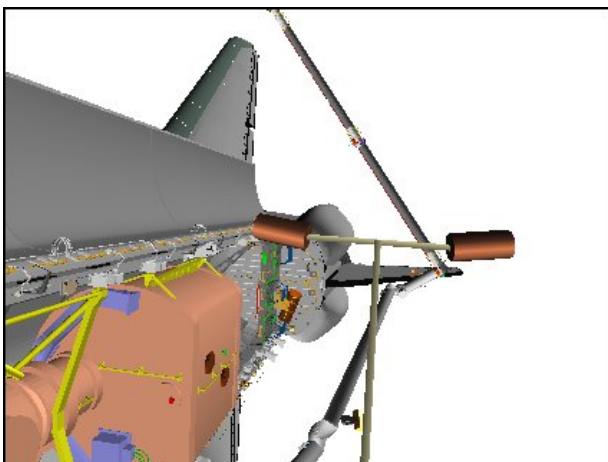

US LAB (-10,-20)

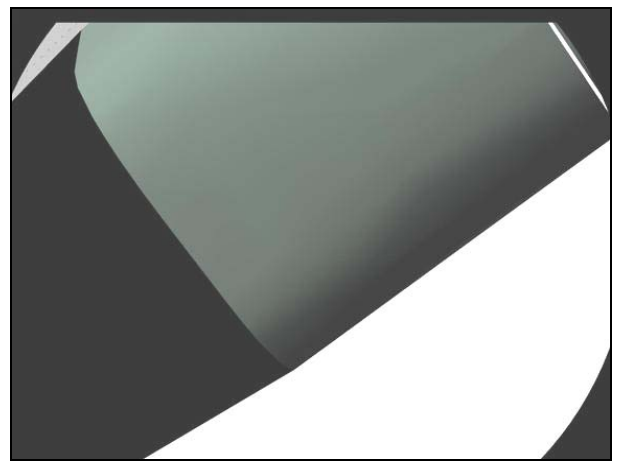

LDRI (110,-67)

STBD DOCKED LDRI RCC SURVEY – Pause Pt 143

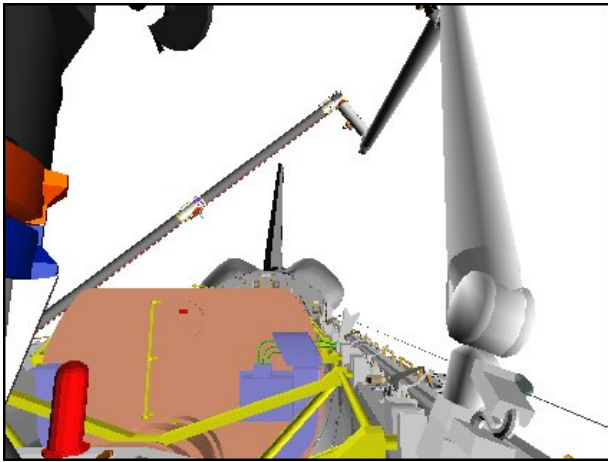

CCTV A (0,20)

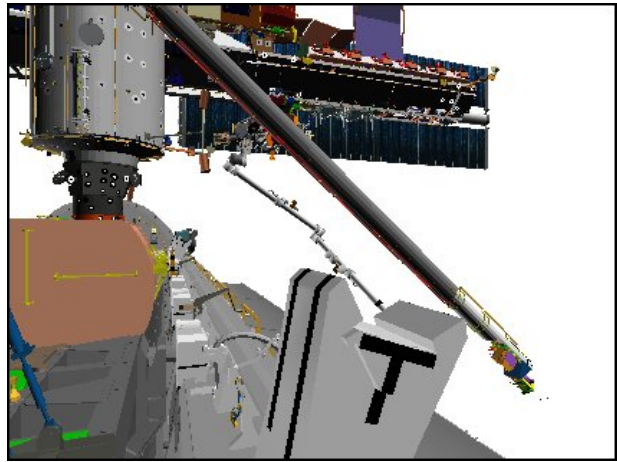

CCTV C (20,0)

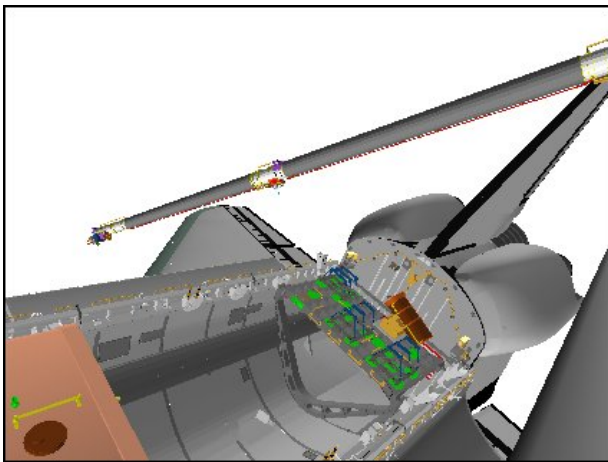

RMS ELBOW (-40,-10)

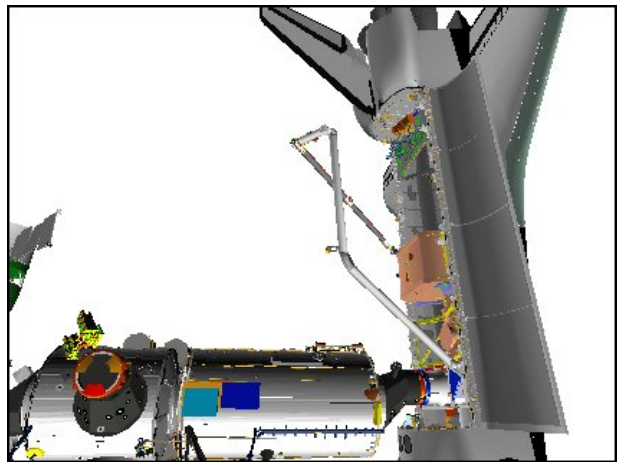

P1 LOOB (100,25)

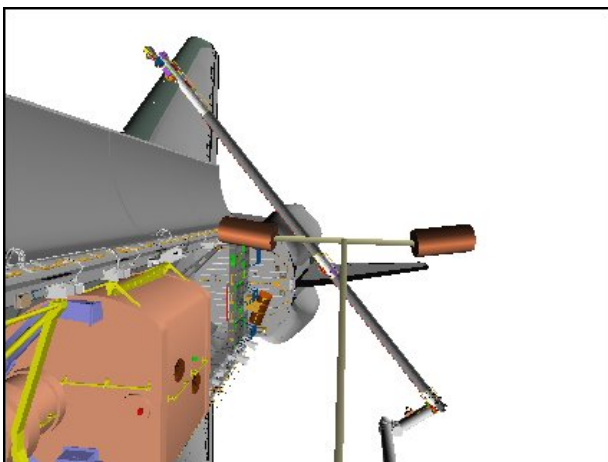

US LAB (-5,-25)

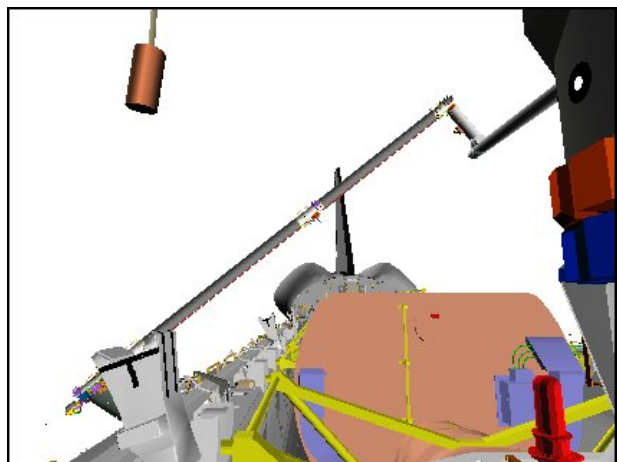

CCTV D (-5,10)

STBD DOCKED LDRI RCC SURVEY – Pause Pt 144

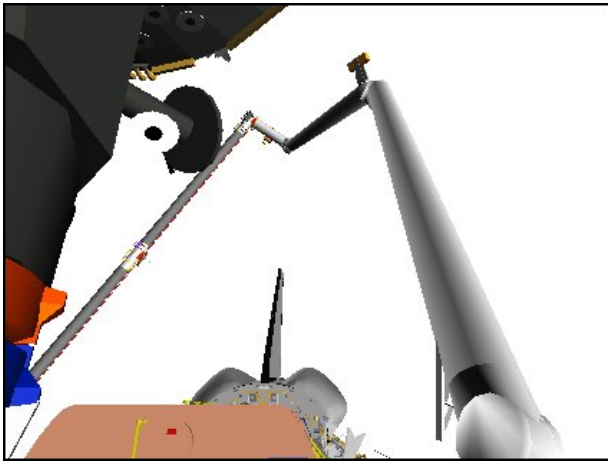

CCTV A (0,25)

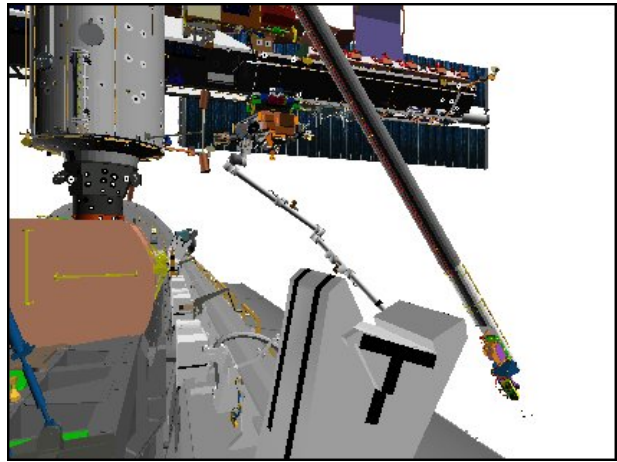

CCTV C (20,0)

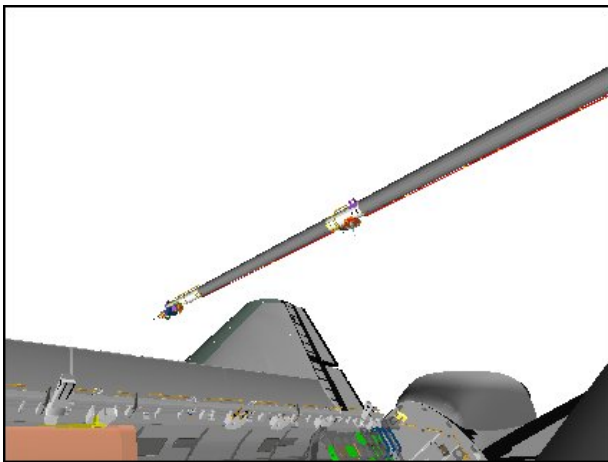

RMS ELBOW (-50,-20)

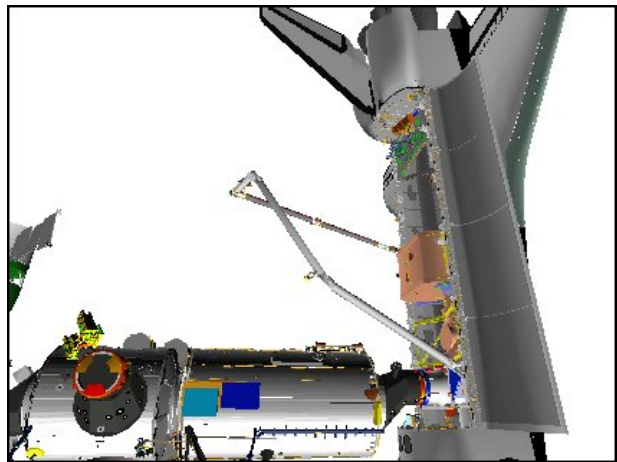

P1 LOOB (100,25)

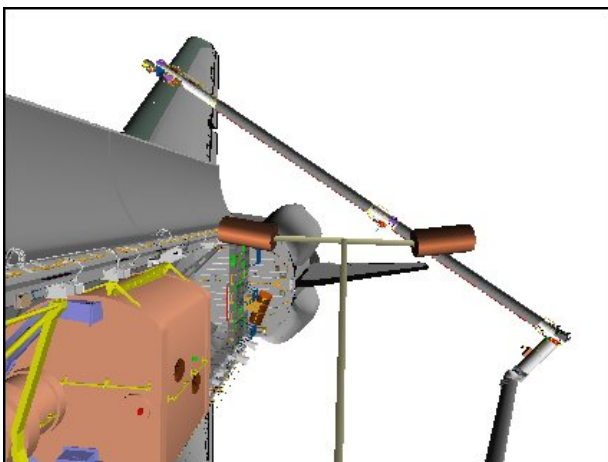

US LAB (-5,-25)

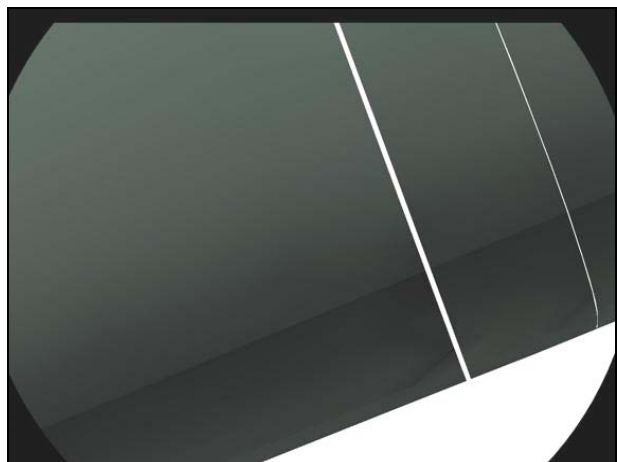

LDRI (110,-88)

STBD DOCKED LDRI RCC SURVEY – Pause Pt 145

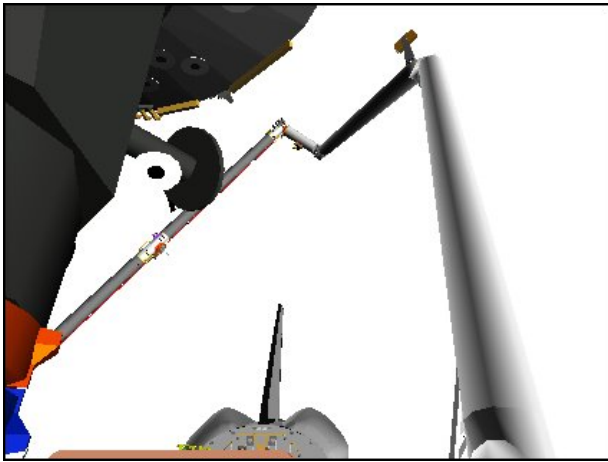

CCTV A (0,30)

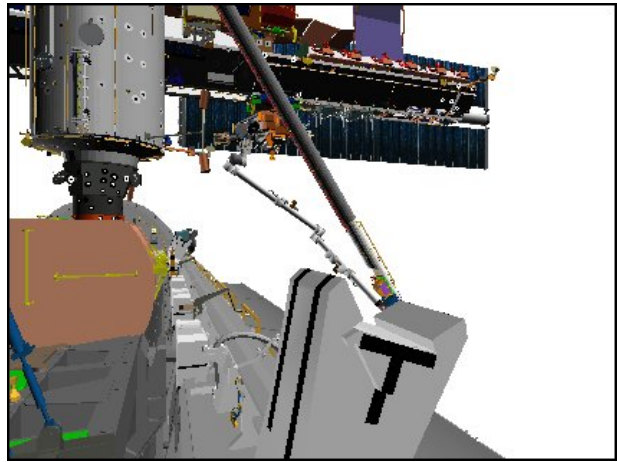

CCTV C (0,10)

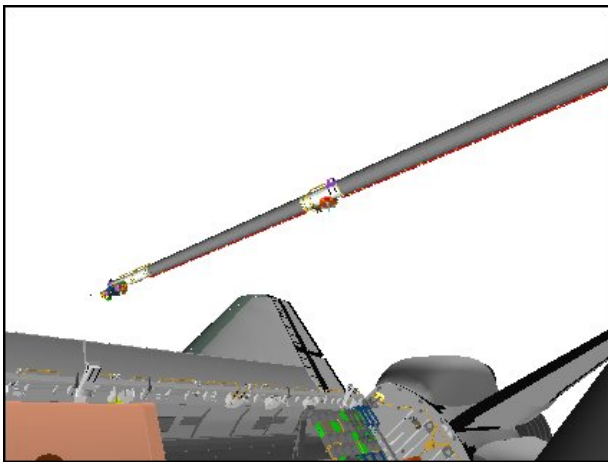

RMS ELBOW (-50,-20)

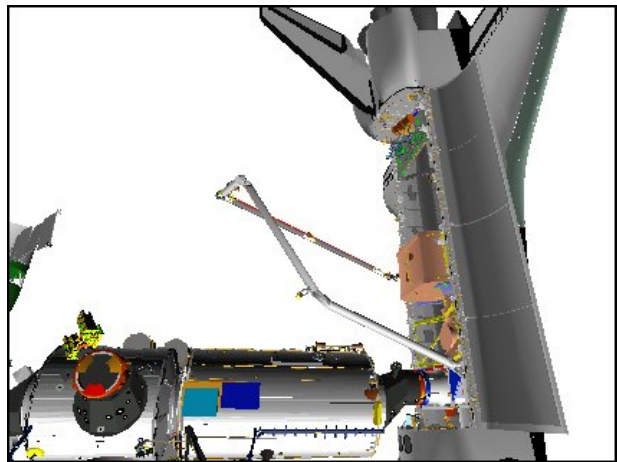

P1 LOOB (100,25)

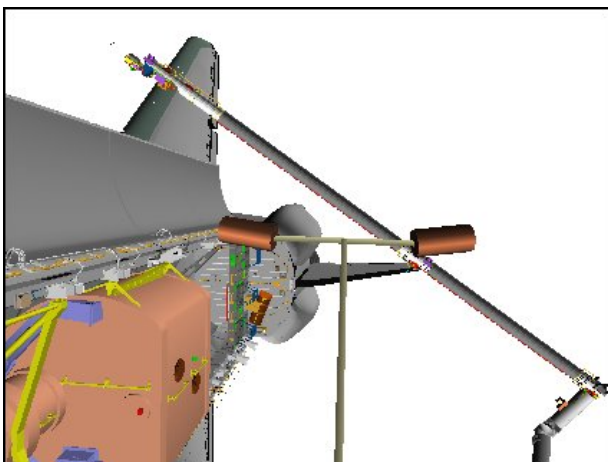

US LAB (-5,-25)

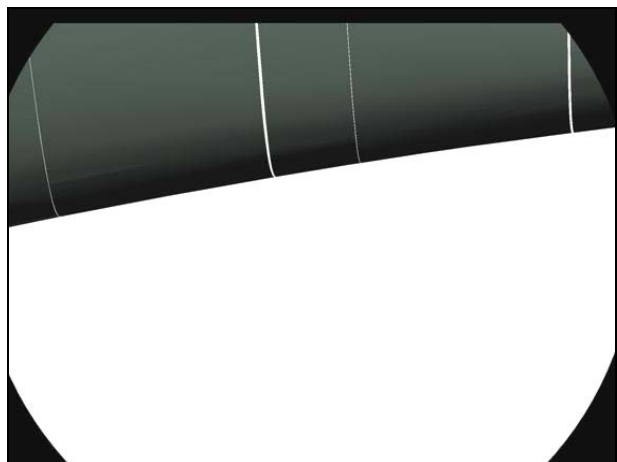

LDRI (88,-88)

STBD DOCKED LDRI RCC SURVEY – Pause Pt 147

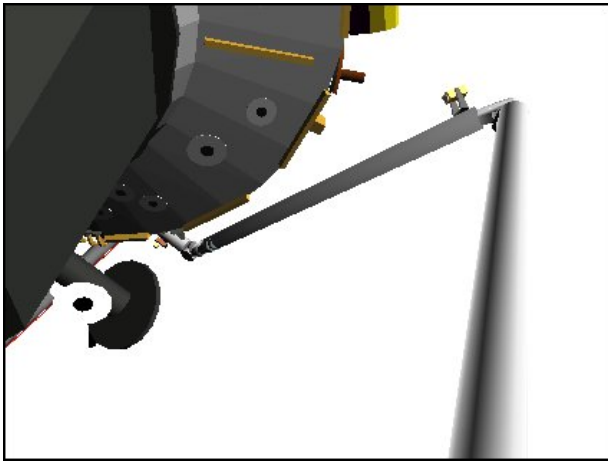

**CCTV A (10,50)**

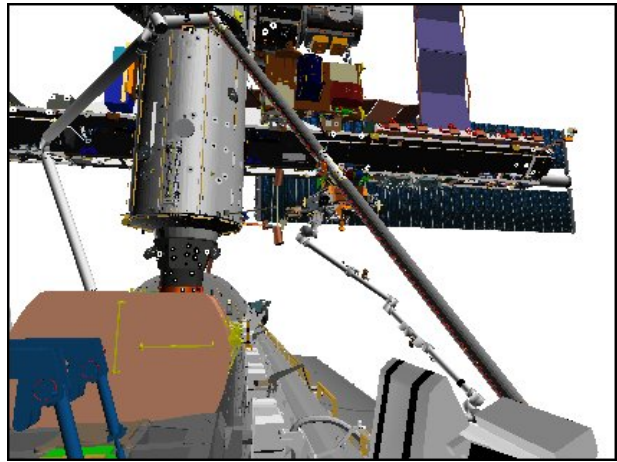

**CCTV C (10,10)**

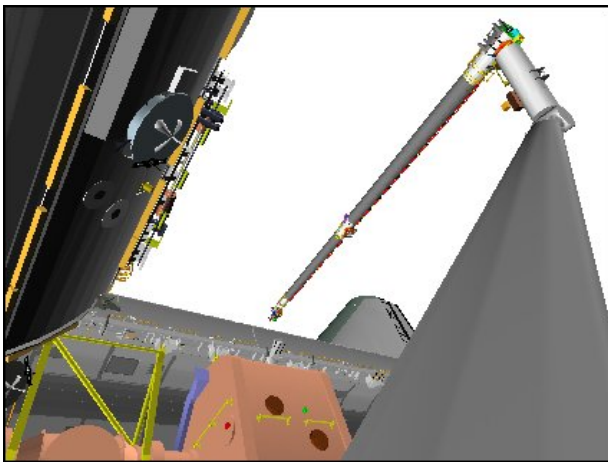

**RMS ELBOW (-30,-20)**

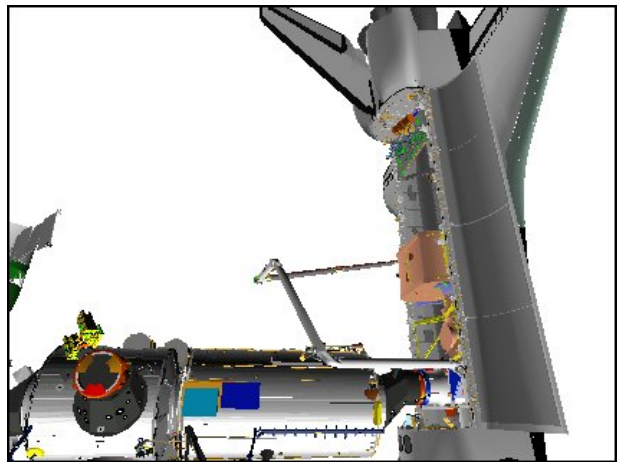

**P1 LOOB (100,25)**

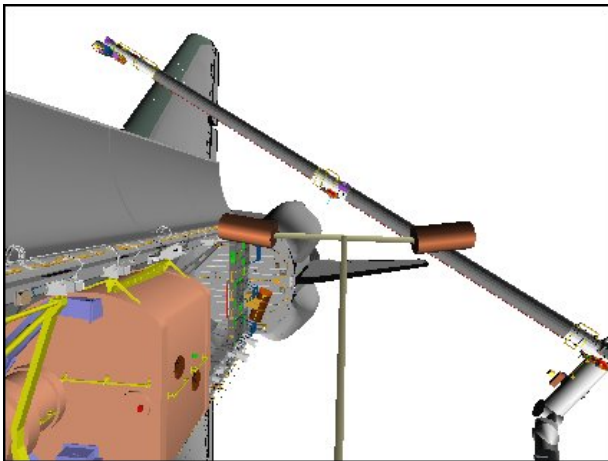

**US LAB (-5,-25)**

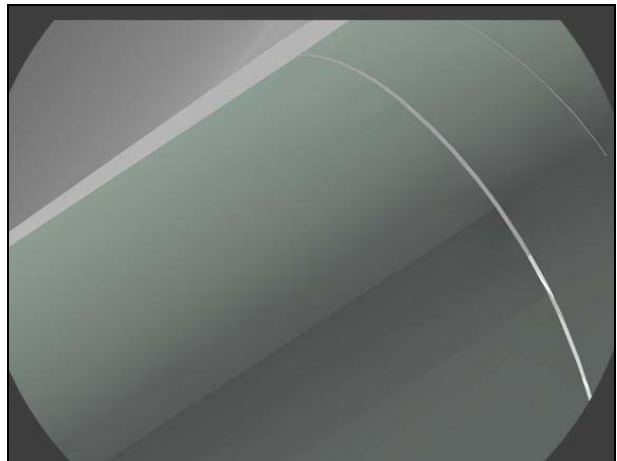

**LDRI (115,-62)**

STBD DOCKED LDRI RCC SURVEY – Pause Pt 148

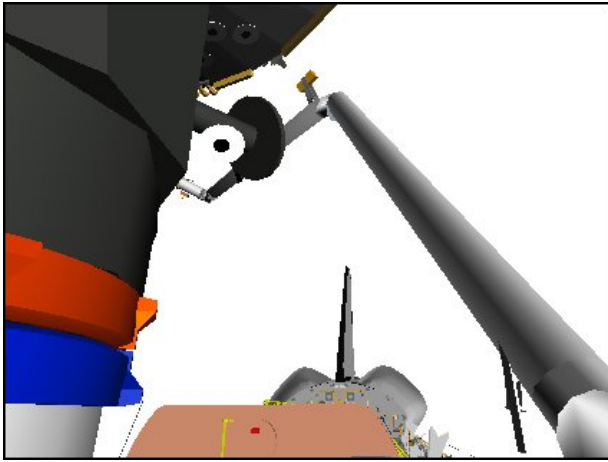

**CCTV A (-10,25)**

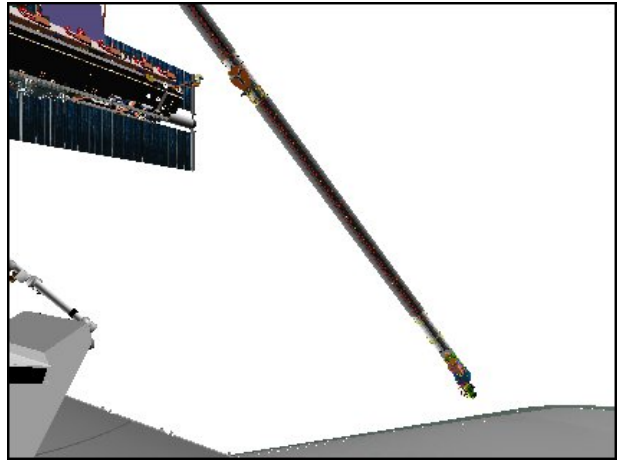

**CCTV C (60,0)**

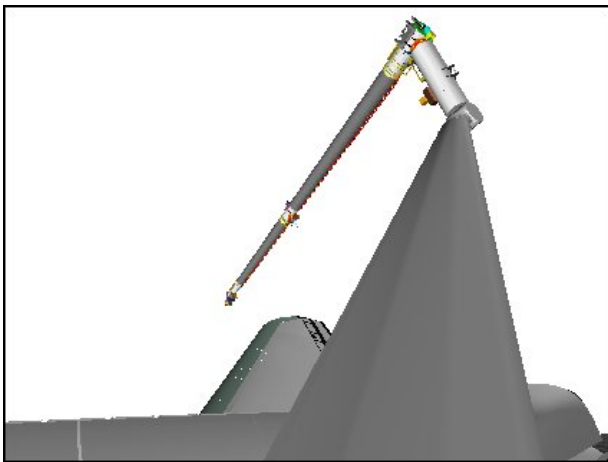

**RMS ELBOW (-20,-20)**

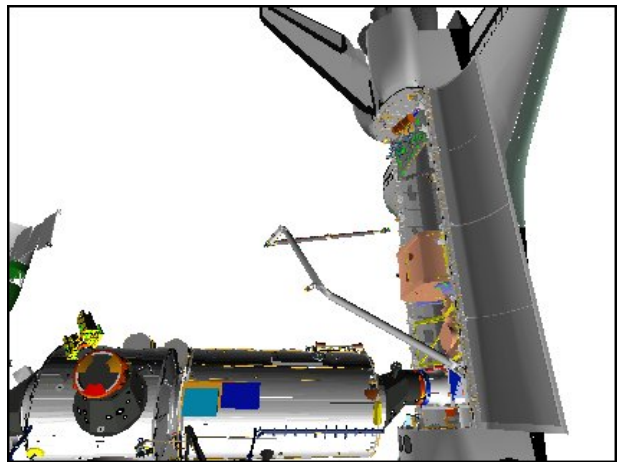

**P1 LOOB (100,25)**

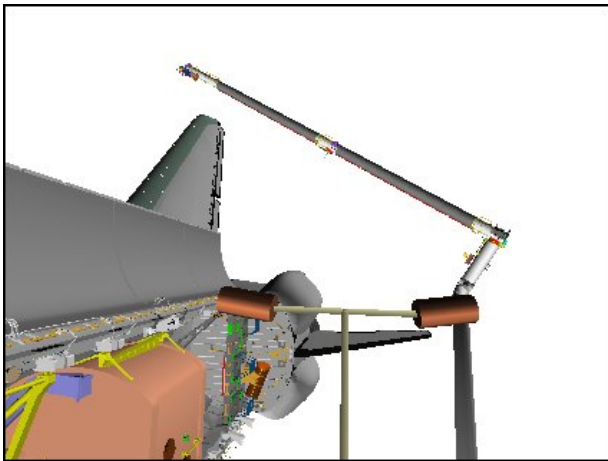

**US LAB (-5,-15)**

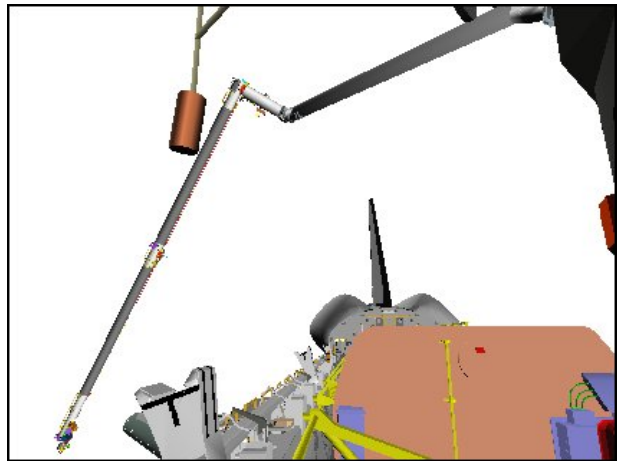

**CCTV D (-5,15)**

STBD DOCKED LDRI RCC SURVEY – Pause Pt 149

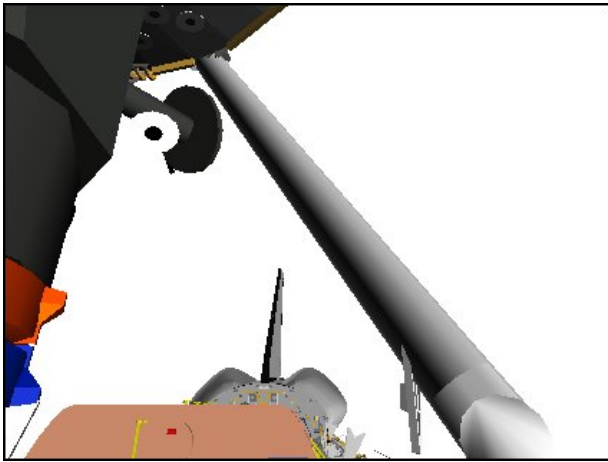

**CCTV A (0,25)**

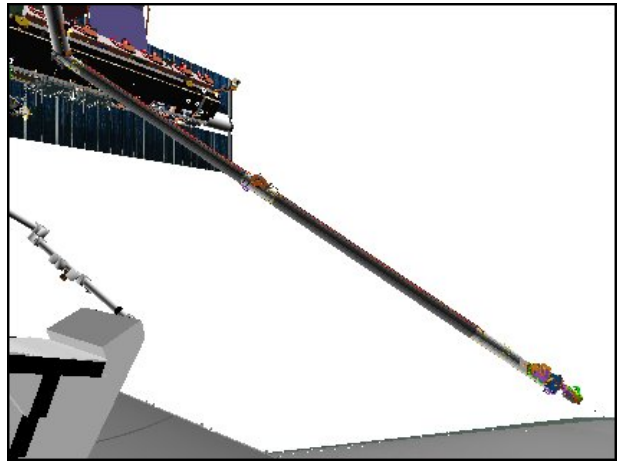

**CCTV C (55,0)**

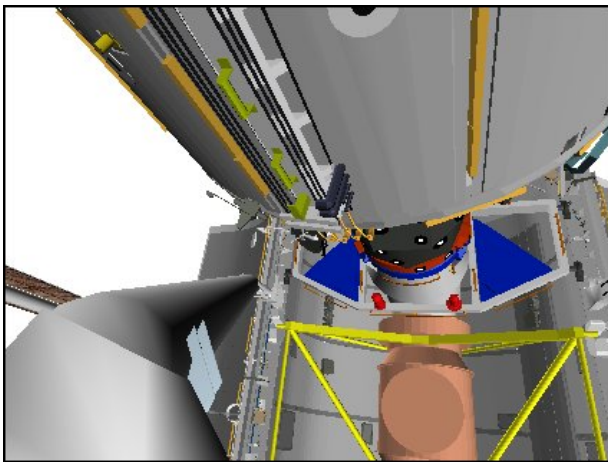

**RMS ELBOW (-130,-30)**

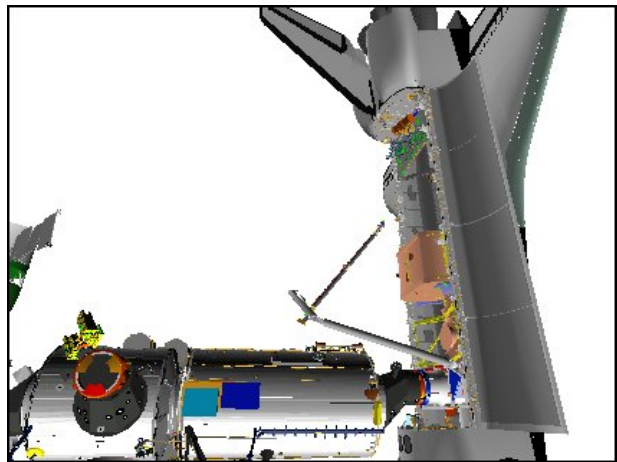

**P1 LOOB (100,25)**

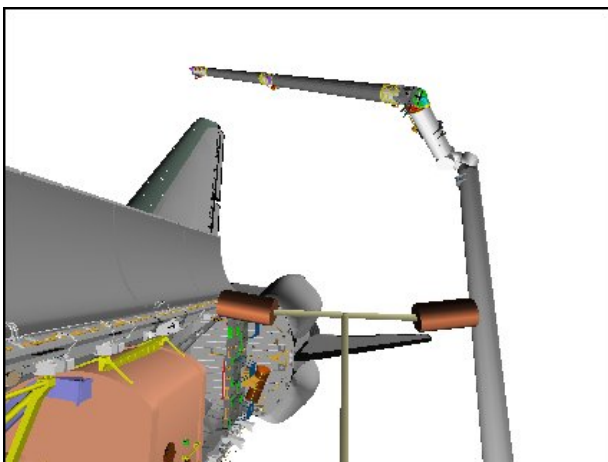

**US LAB (-5,-15)**

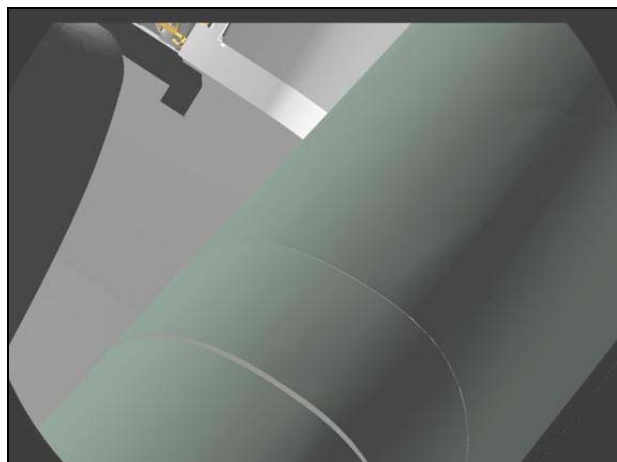

**LDRI (33,-59)**



STBD DOCKED LDRI RCC SURVEY – Pause Pt 150

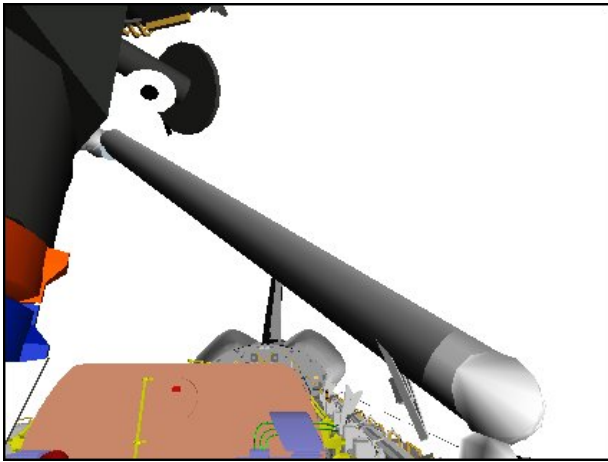

**CCTV A (0,20)**

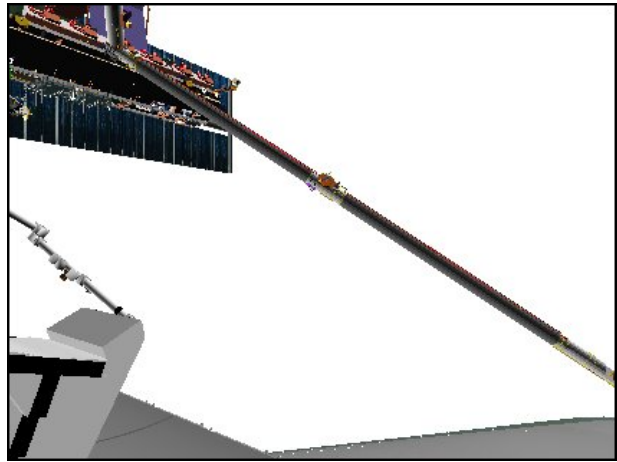

**CCTV C (65,0)**

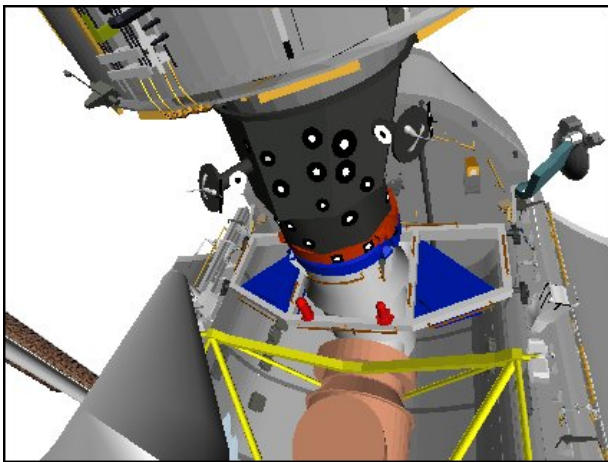

**RMS ELBOW (-150,-10)**

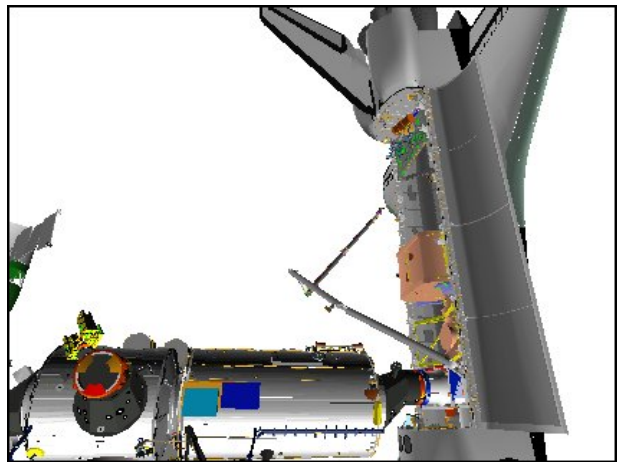

**P1 LOOB (100,25)**

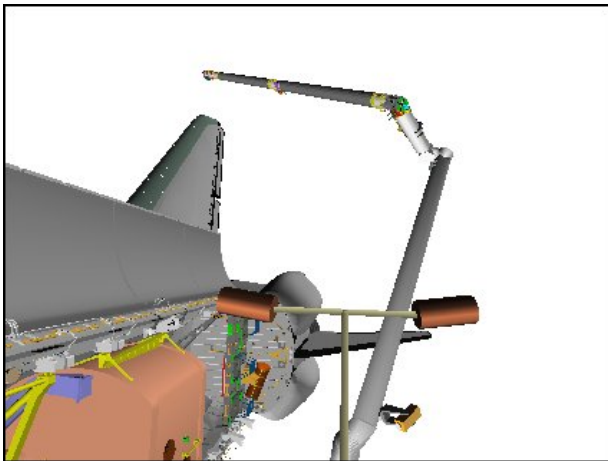

**US LAB (-5,-15)**

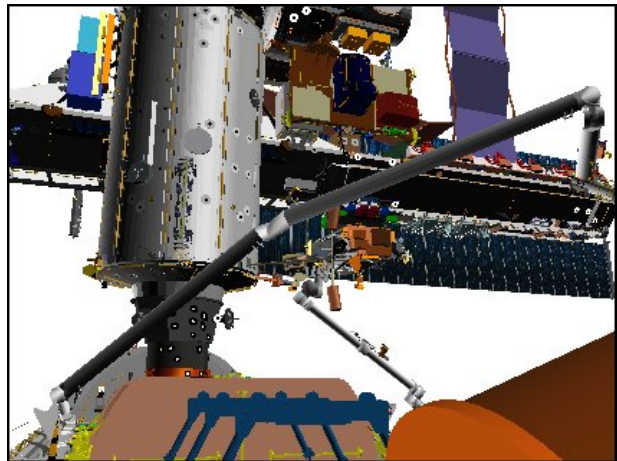

**CCTV B (20,15)**

STBD DOCKED LDRI RCC SURVEY – Pause Pt 152

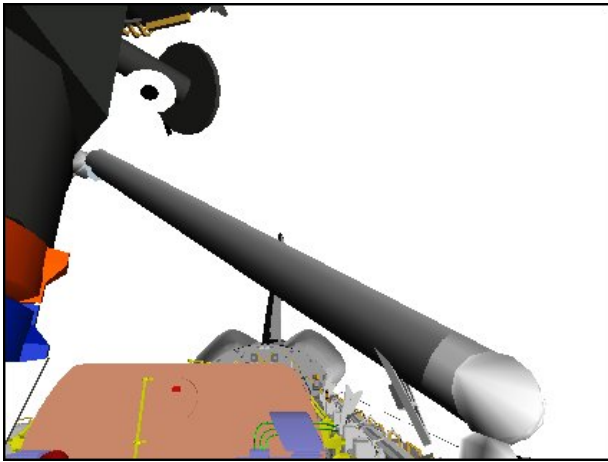

CCTV A (0,20)

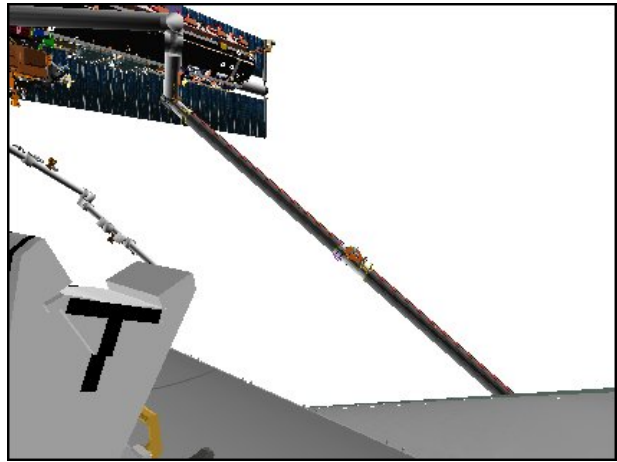

CCTV C (50,-5)

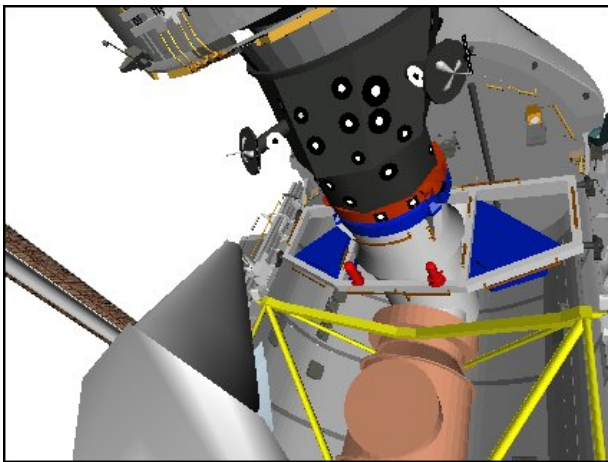

RMS ELBOW (-150,-20)

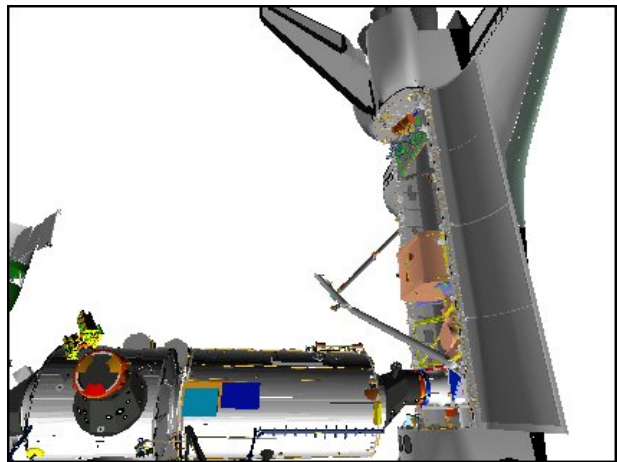

P1 LOOB (100,25)

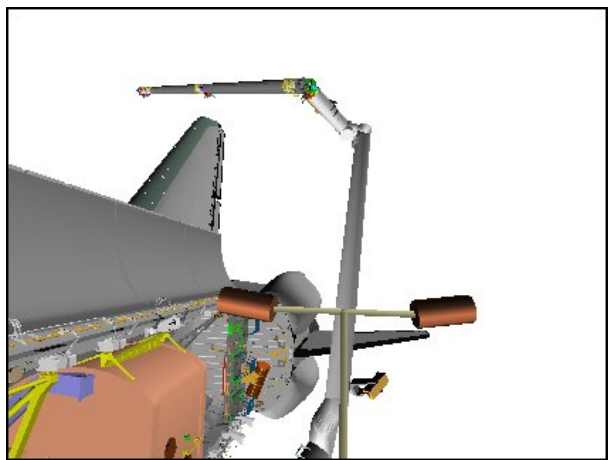

US LAB (-5,-15)

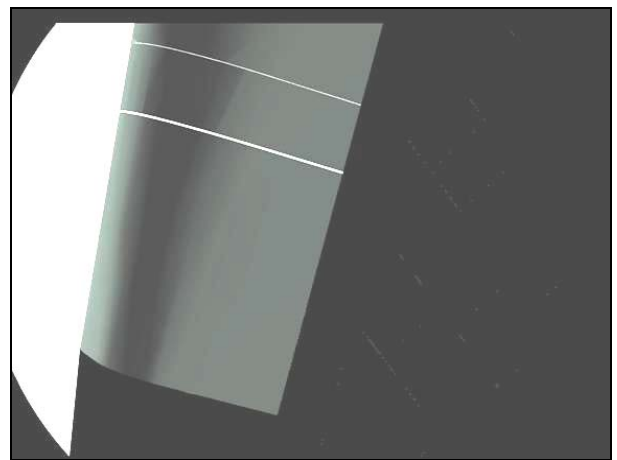

LDRI (85,-45)

STBD DOCKED LDRI RCC SURVEY – Pause Pt 155

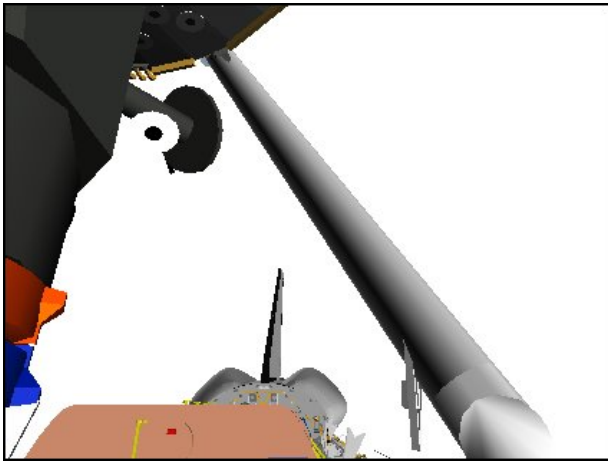

**CCTV A (0,25)**

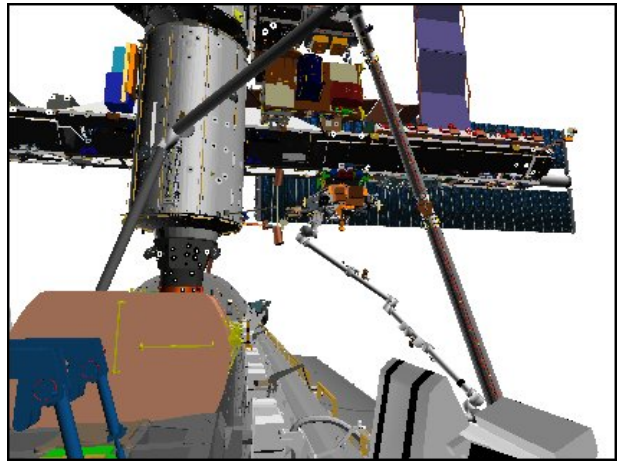

**CCTV C (10,10)**

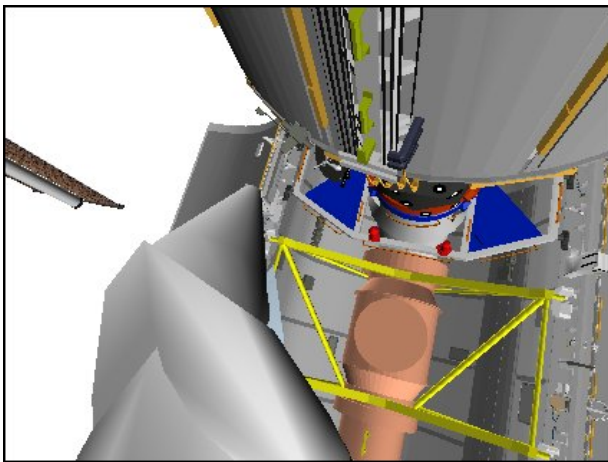

**RMS ELBOW (-150,-30)**

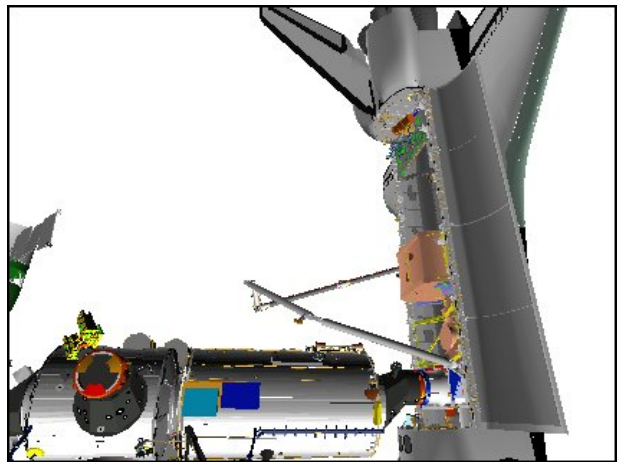

**P1 LOOB (100,25)**

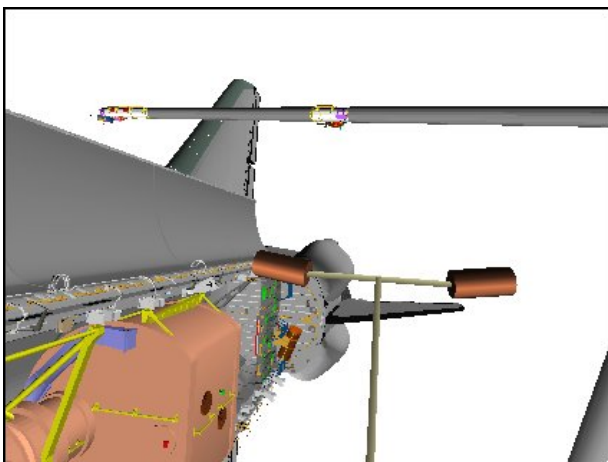

**US LAB (-10,-20)**

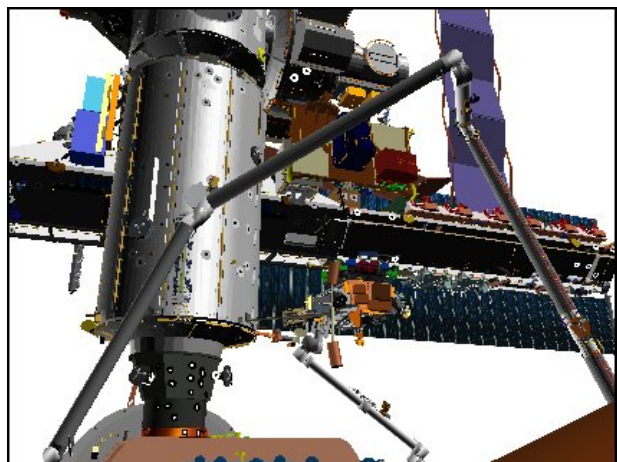

**CCTV B (20,20)**

STBD DOCKED LDRI RCC SURVEY – Pause Pt 156

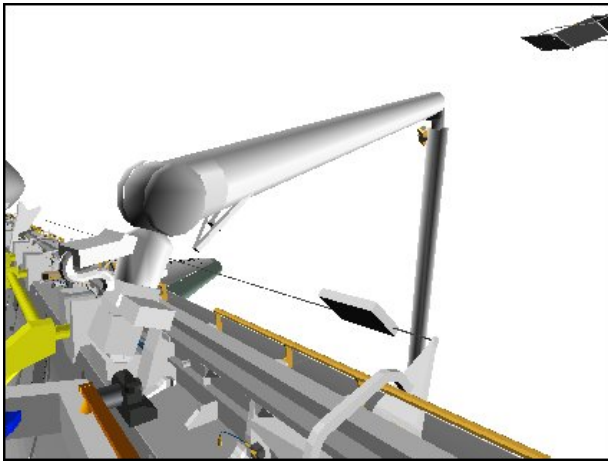

**CCTV A (40,-5)**

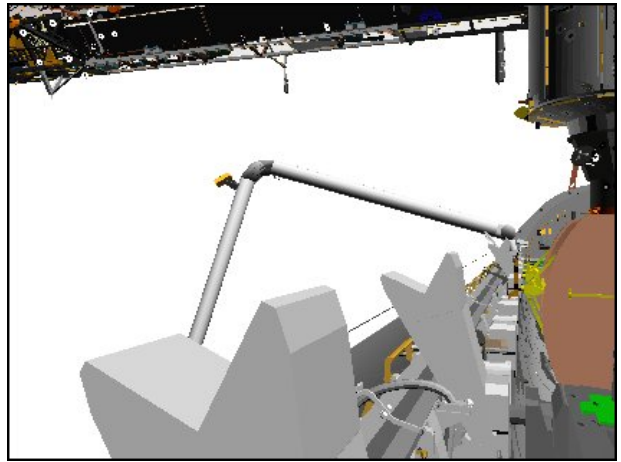

**CCTV B (-20,0)**

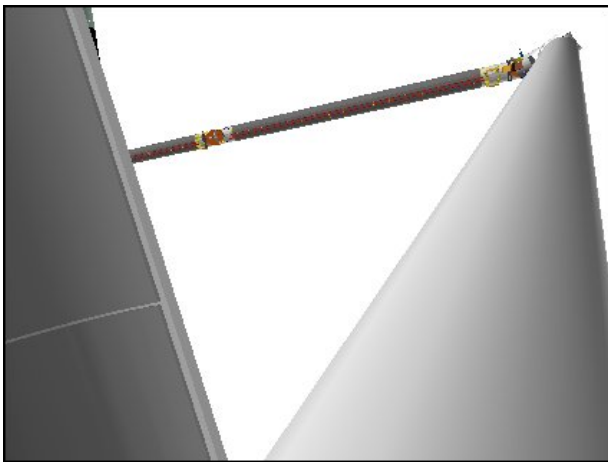

**RMS ELBOW (-30,-30)**

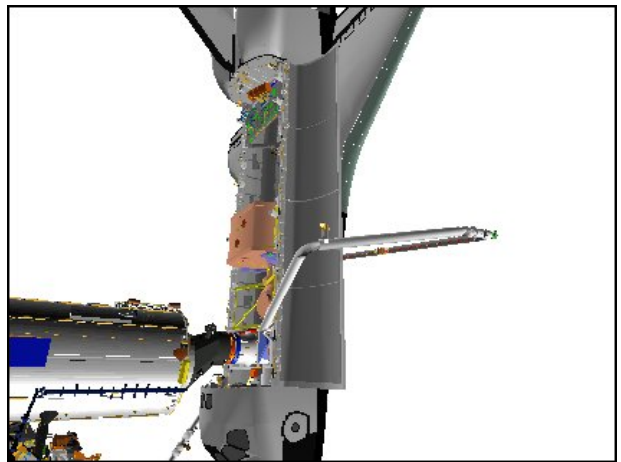

**P1 LOOB (125,20)**

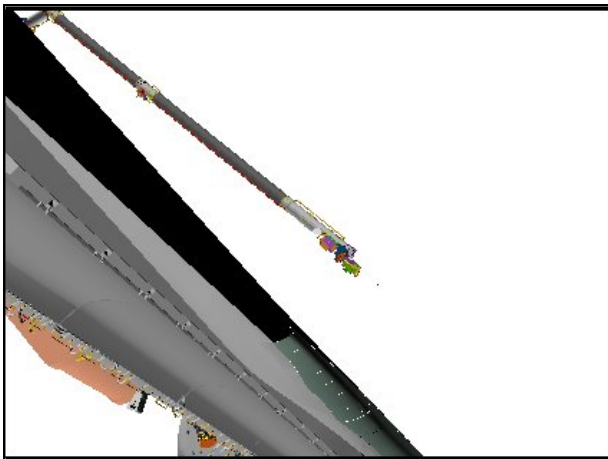

**SSRMS TIP ELBOW (-60,10)**

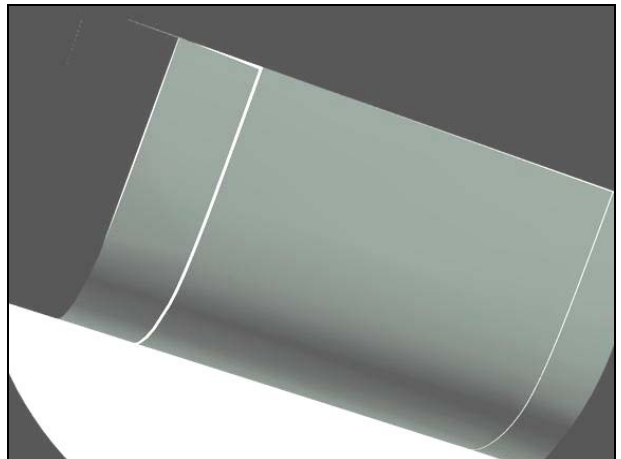

**LDRI (52,-77)**

STBD DOCKED LDRI RCC SURVEY – Pause Pt 159

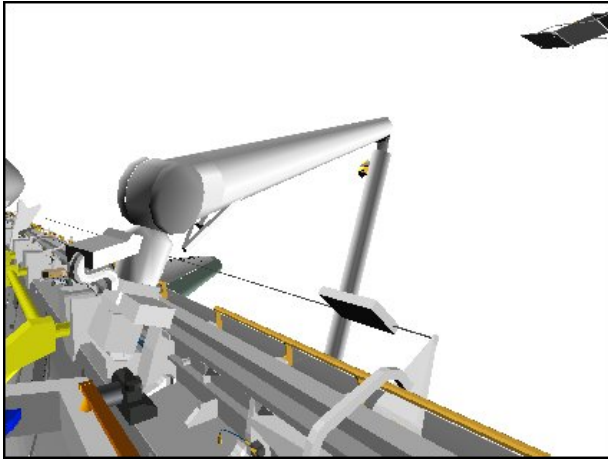

**CCTV A (40,-5)**

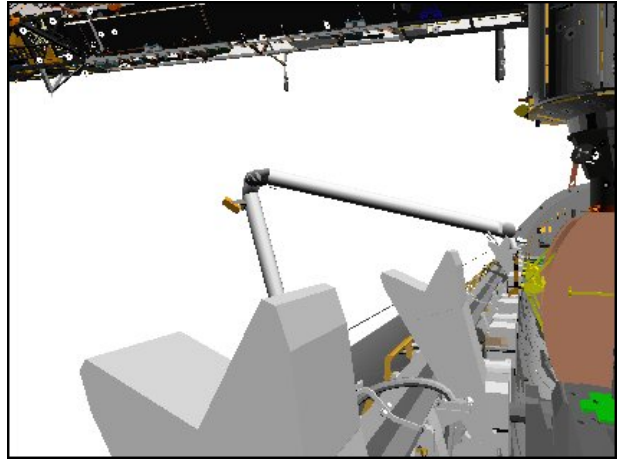

**CCTV B (-20,0)**

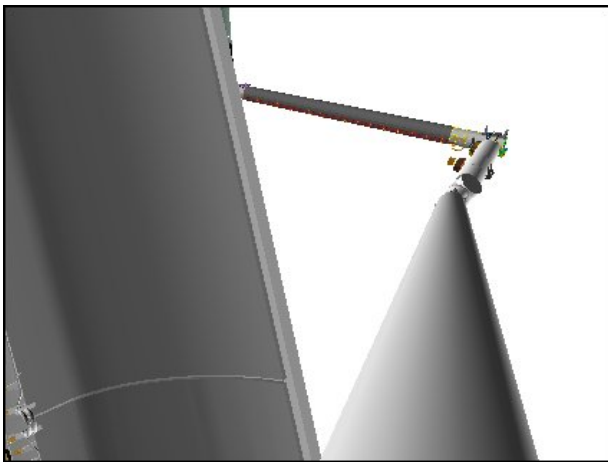

**RMS ELBOW (-20,-10)**

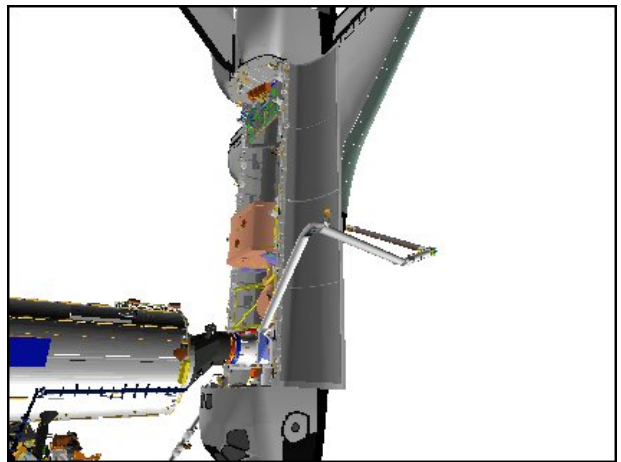

**P1 LOOB (125,20)**

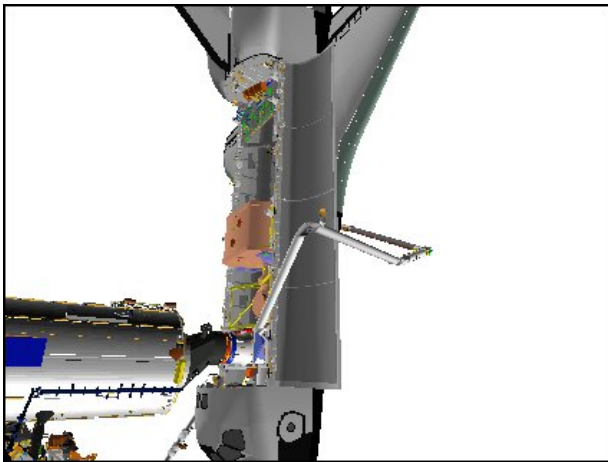

**SSRMS TIP ELBOW (-60,10)**

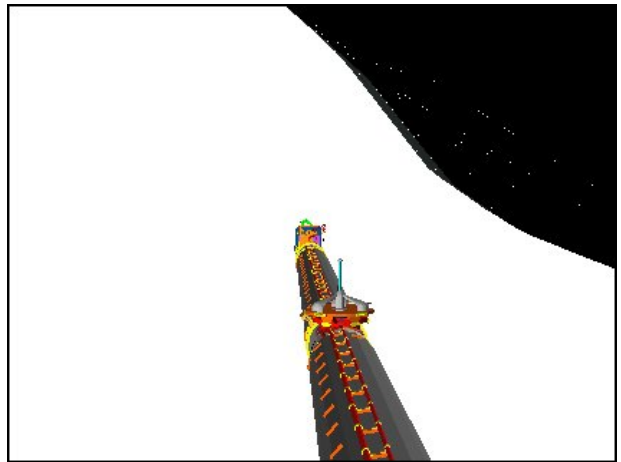

**RSC**

STBD DOCKED LDRI RCC SURVEY – Pause Pt 160

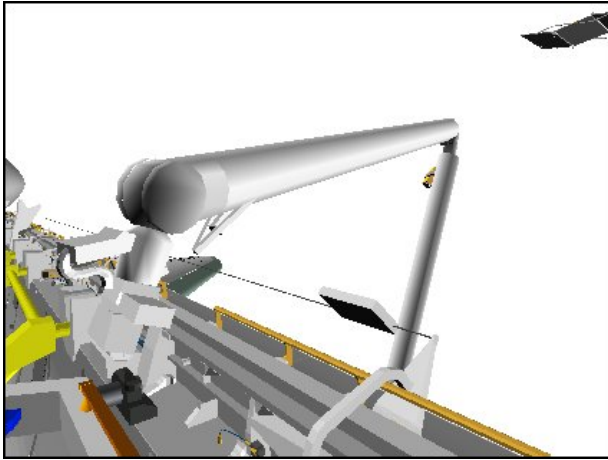

**CCTV A (40,-5)**

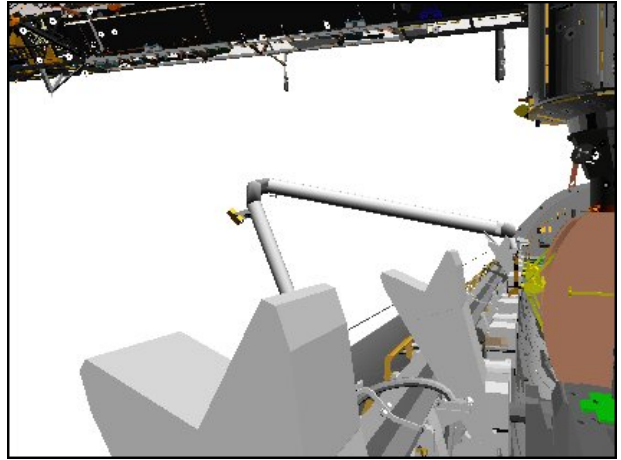

**CCTV B (-20,0)**

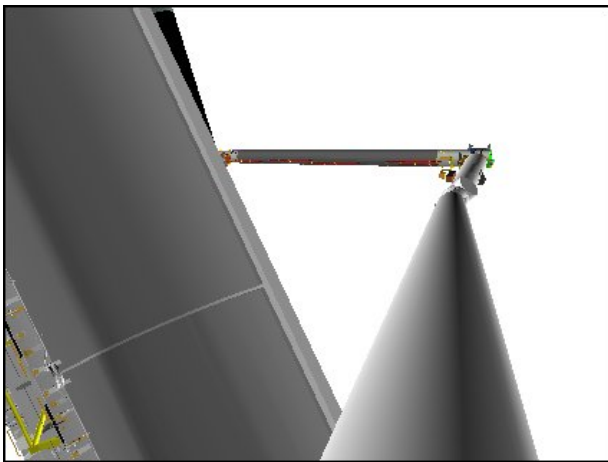

**RMS ELBOW (-20,-10)**

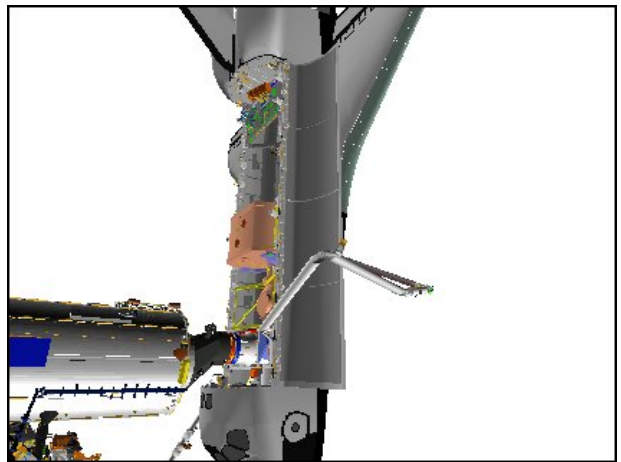

**P1 LOOB (125,20)**

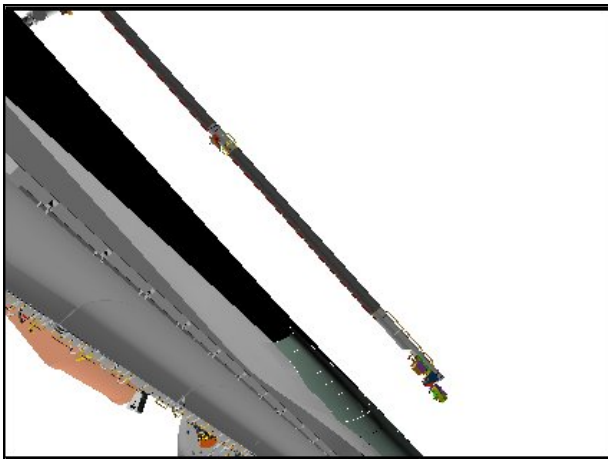

**SSRMS TIP ELBOW (-60,10)**

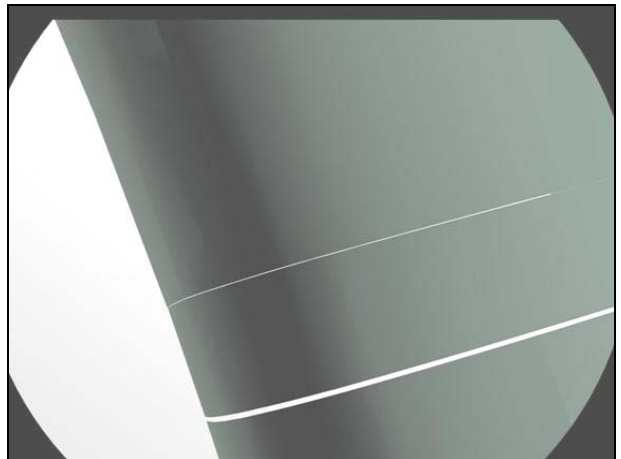

**LDRI (23,-72)**

STBD DOCKED LDRI RCC SURVEY – Pause Pt 162

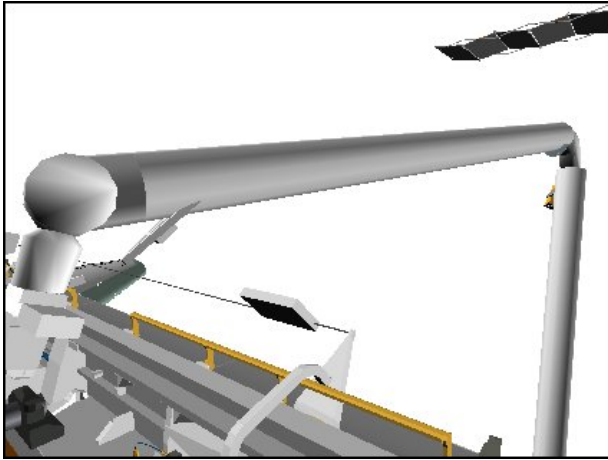

**CCTV A (50,-5)**

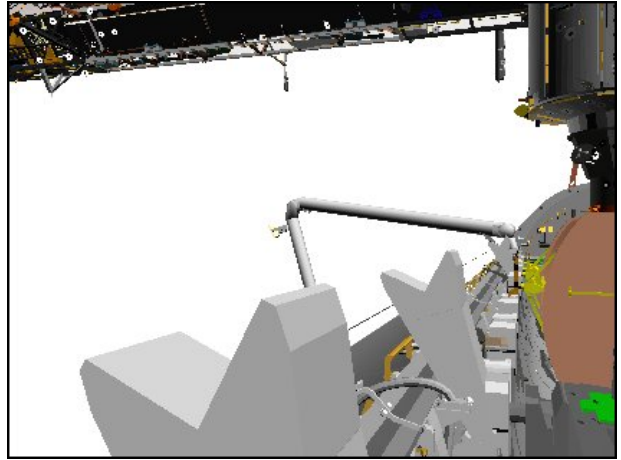

**CCTV B (-20,0)**

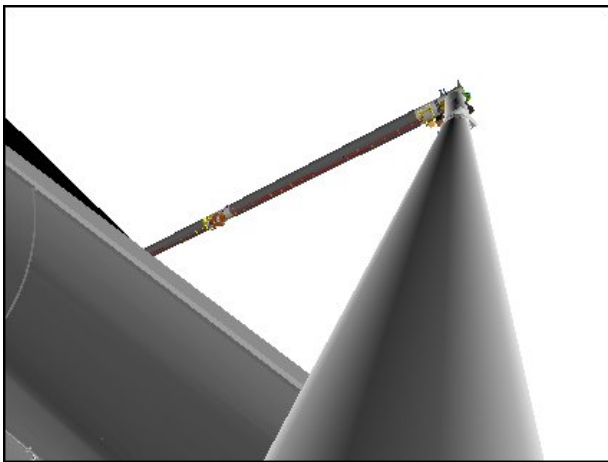

**RMS ELBOW (-20,-20)**

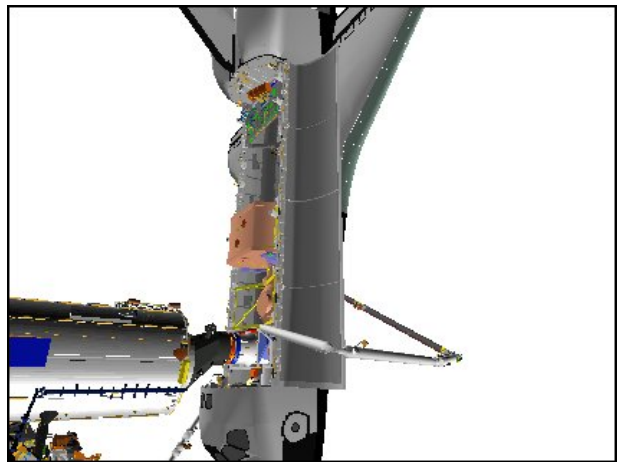

**P1 LOOB (125,20)**

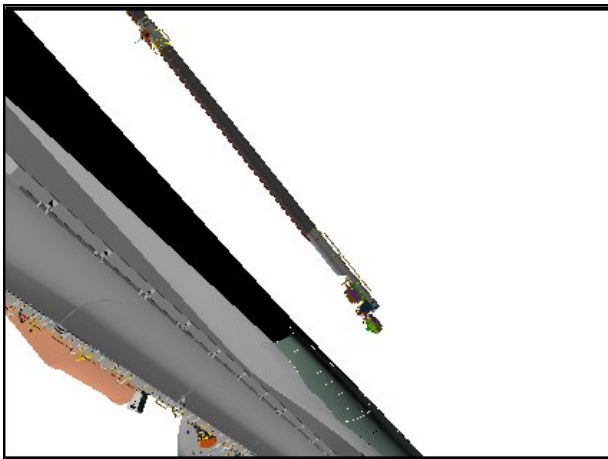

**SSRMS TIP ELBOW (-60,10)**

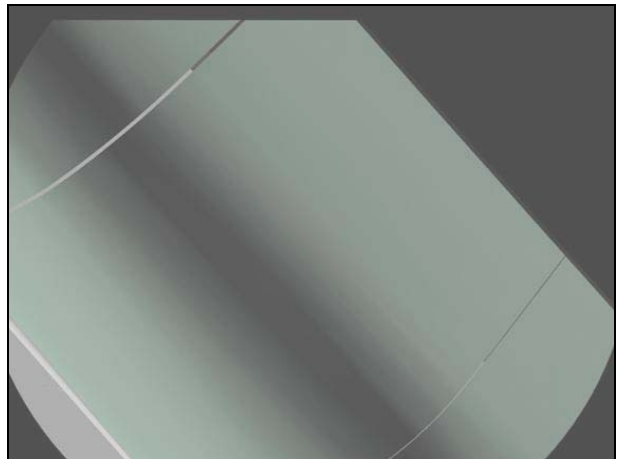

**LDRI (30,-65)**

STBD DOCKED LDRI RCC SURVEY – Pause Pt 163

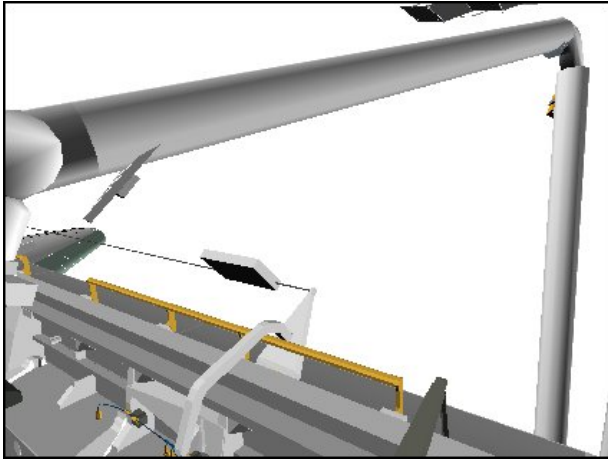

**CCTV A (55,-10)**

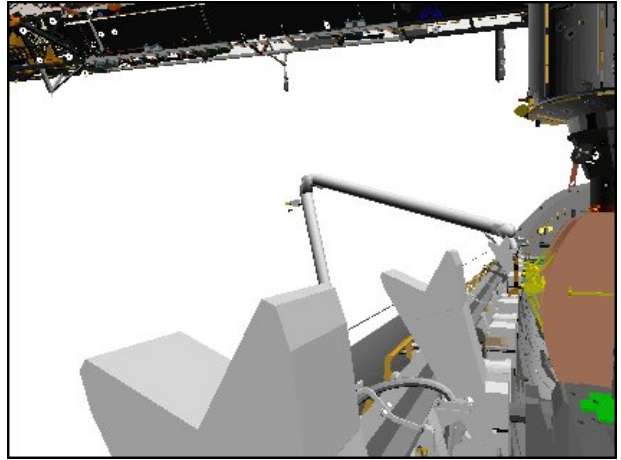

**CCTV B (-20,0)**

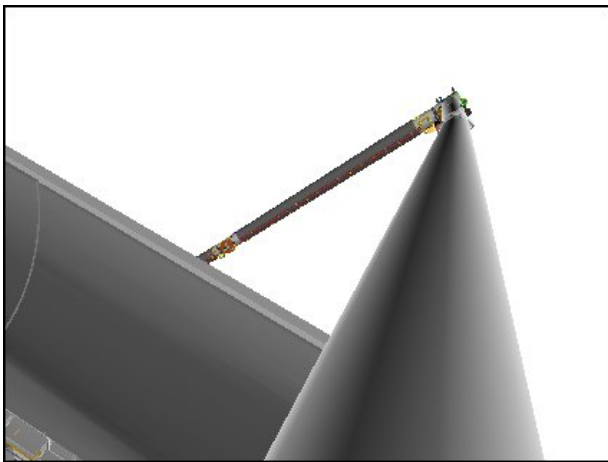

**RMS ELBOW (-20,-20)**

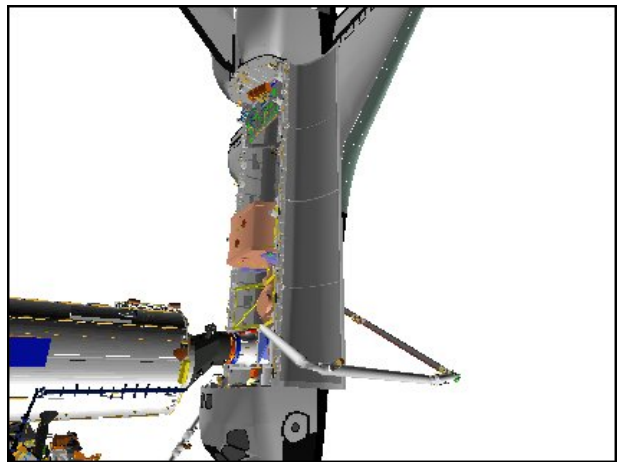

**P1 LOOB (125,20)**

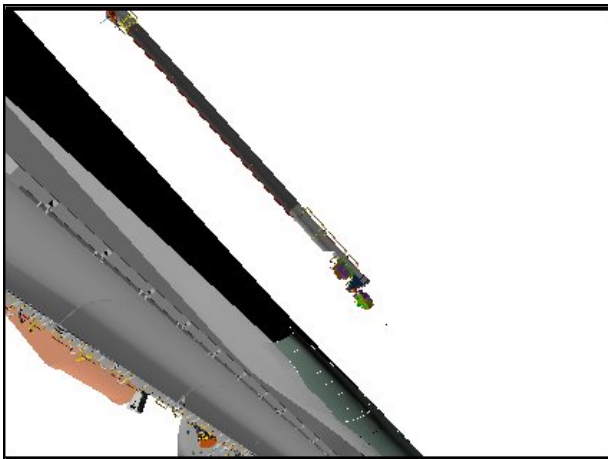

**SSRMS TIP ELBOW (-60,10)**

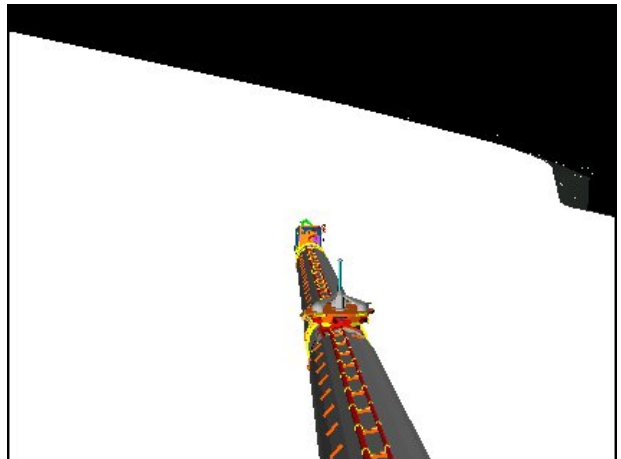

**RSC**



STBD DOCKED LDRI RCC SURVEY – Pause Pt 164

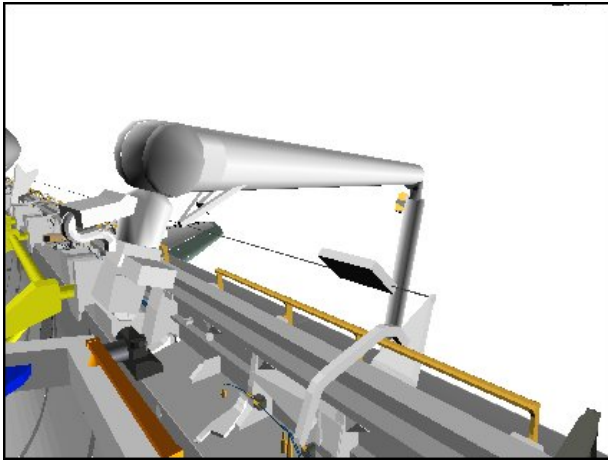

**CCTV A (40,-10)**

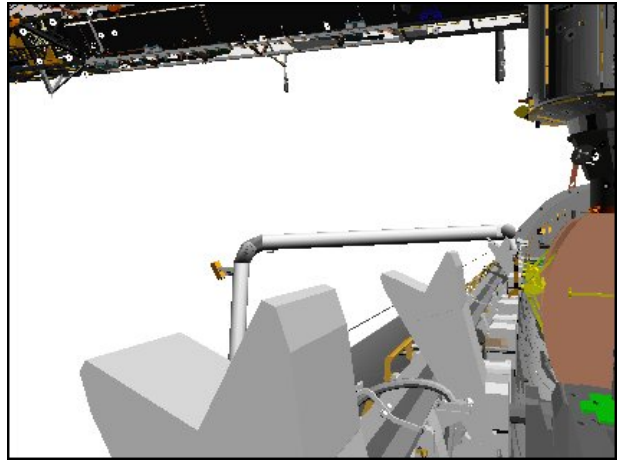

**CCTV B (-20,0)**

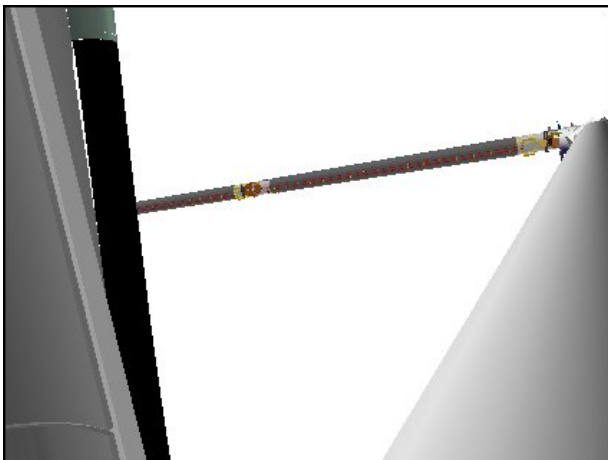

**RMS ELBOW (-35,-20)**

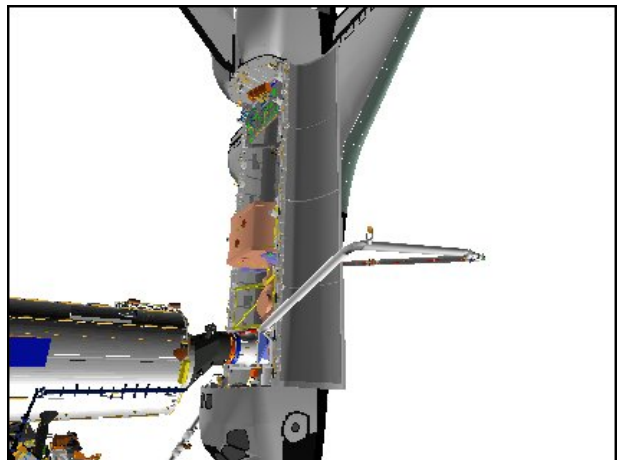

**P1 LOOB (125,20)**

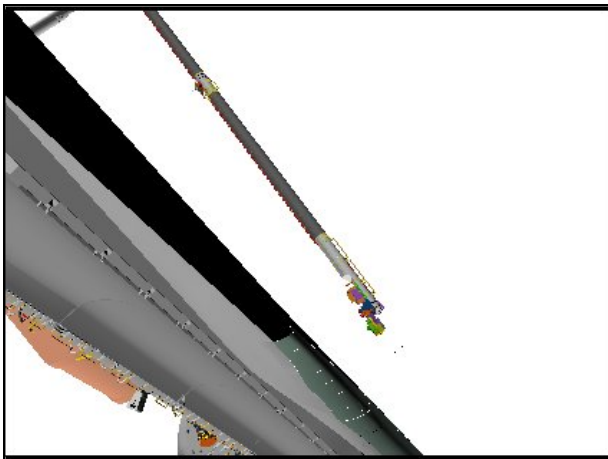

**SSRMS TIP ELBOW (-60,10)**

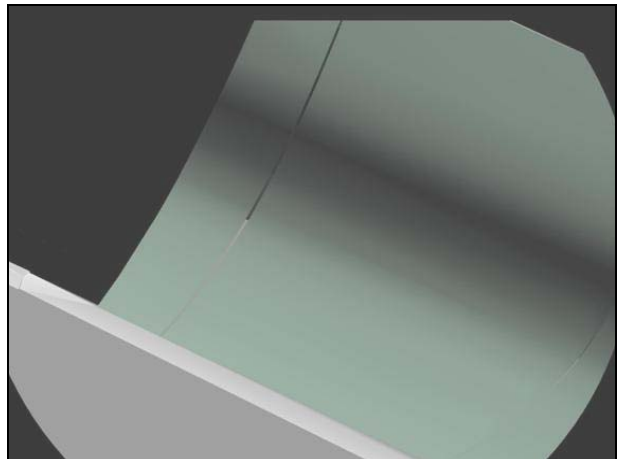

**LDRI (47,-49)**

STBD DOCKED LDRI RCC SURVEY – Pause Pt 165

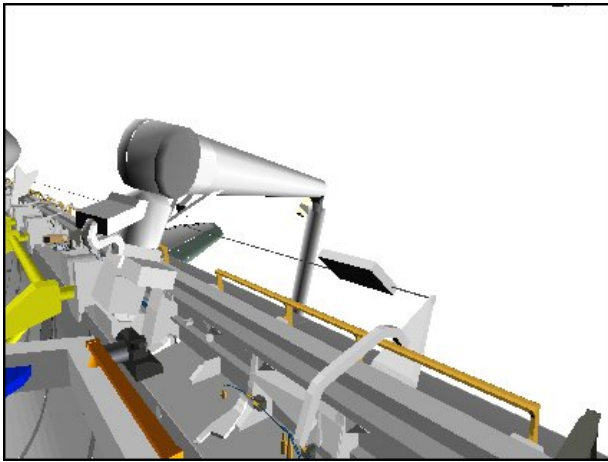

**CCTV A (40,-10)**

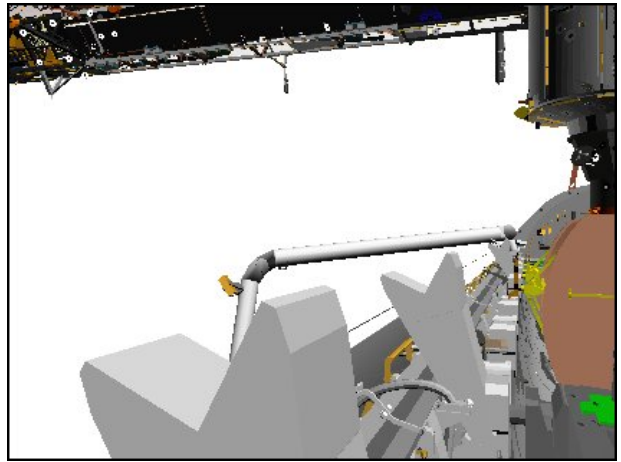

**CCTV B (-20,0)**

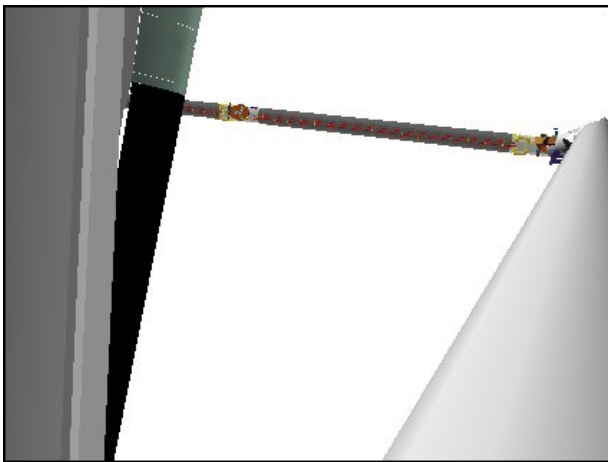

**RMS ELBOW (-35,-20)**

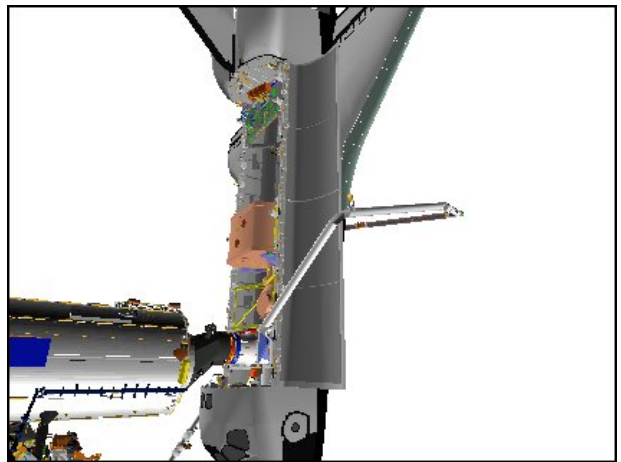

**P1 LOOB (125,20)**

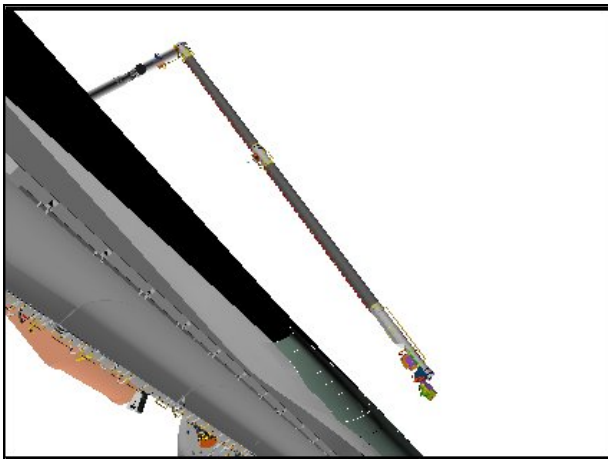

**SSRMS TIP ELBOW (-60,10)**

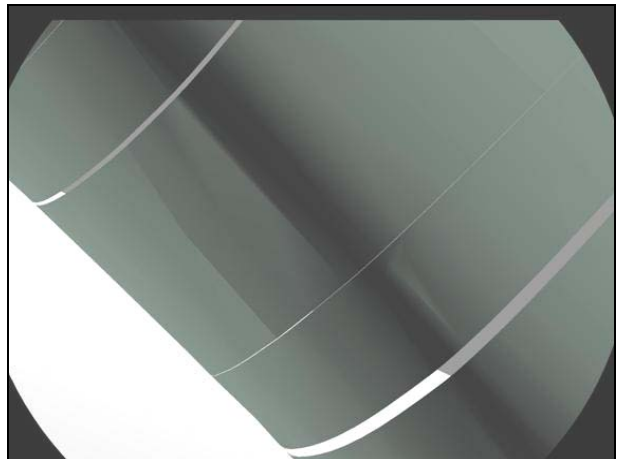

**LDRI (34,-57)**

STBD DOCKED LDRI RCC SURVEY – Pause Pt 166

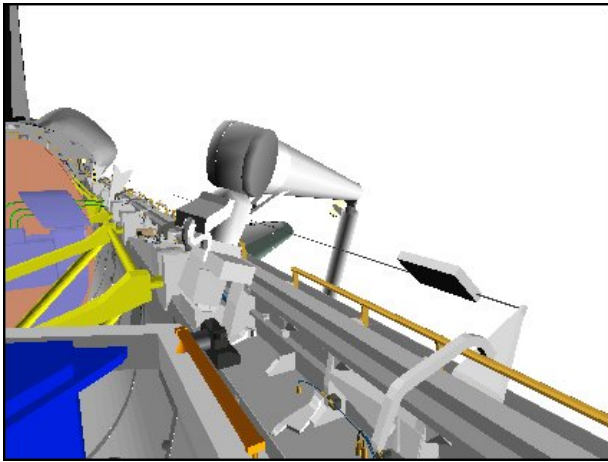

**CCTV A (30,-10)**

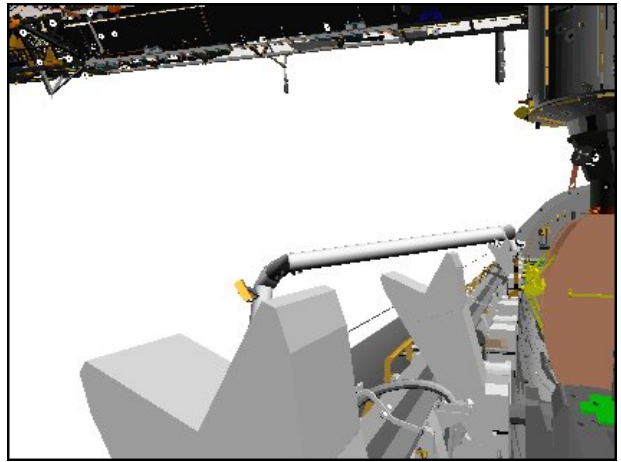

**CCTV B (-20,0)**

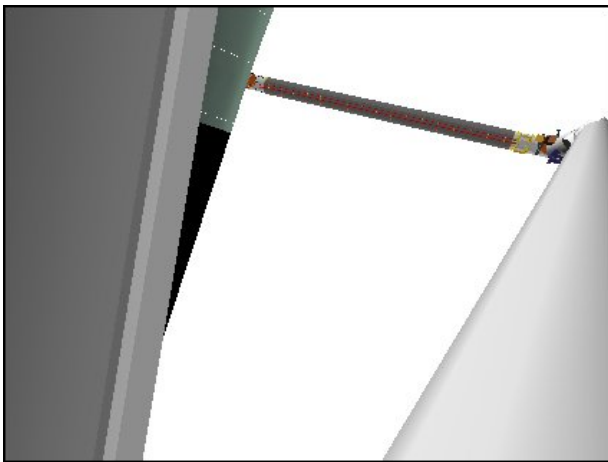

**RMS ELBOW (-35,-20)**

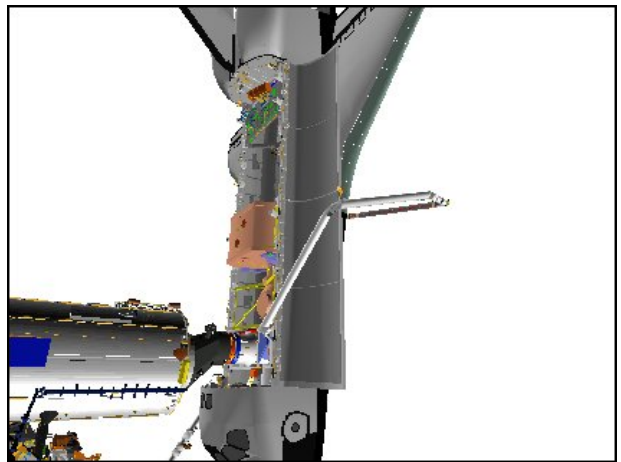

**P1 LOOB (125,20)**

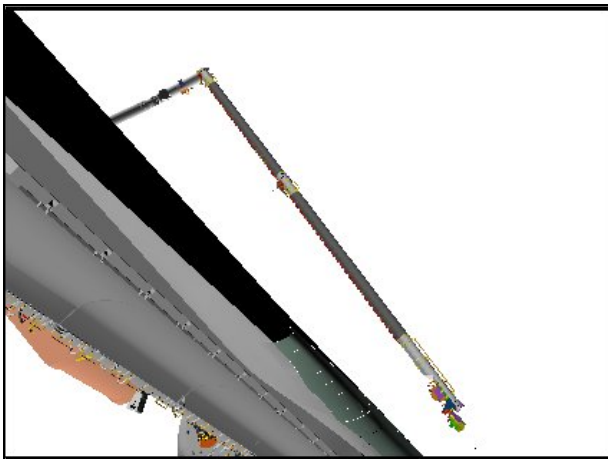

**SSRMS TIP ELBOW (-60,10)**

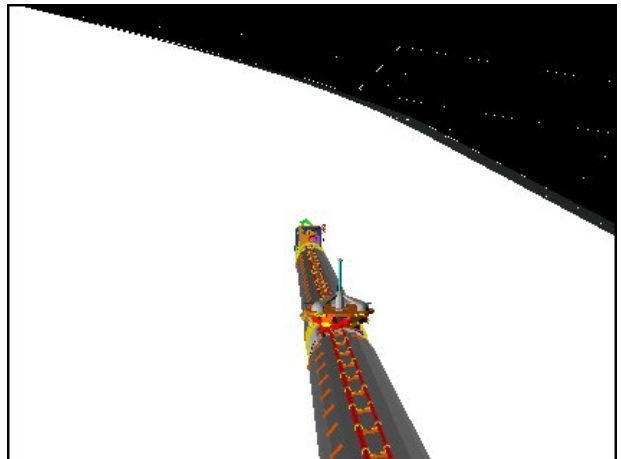

**RSC**

**OBSS IDC RCC SURVEY CAMERA VIEWS – STBD**

STARBOARD IDC RCC SURVEY – Pause Pt 130



**CCTV A (-10,30)**

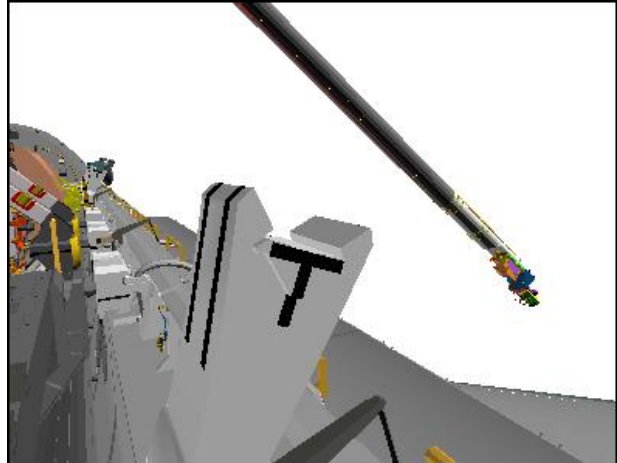

**CCTV C (30,-10)**

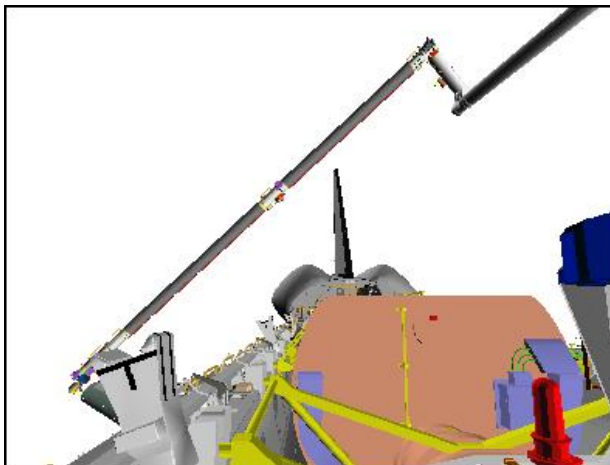

**CCTV D (0,10)**

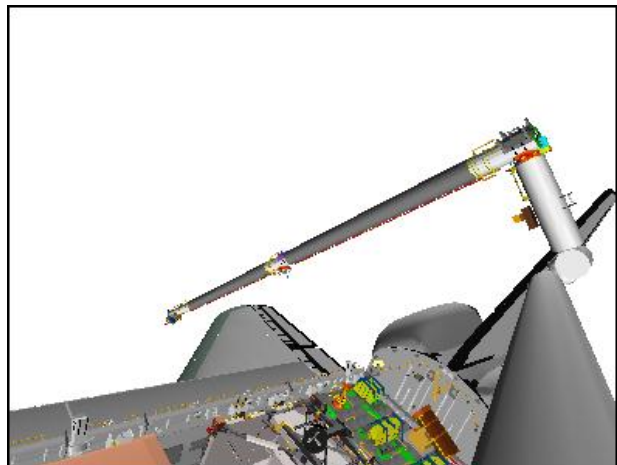

**ELBOW (-30,0)**

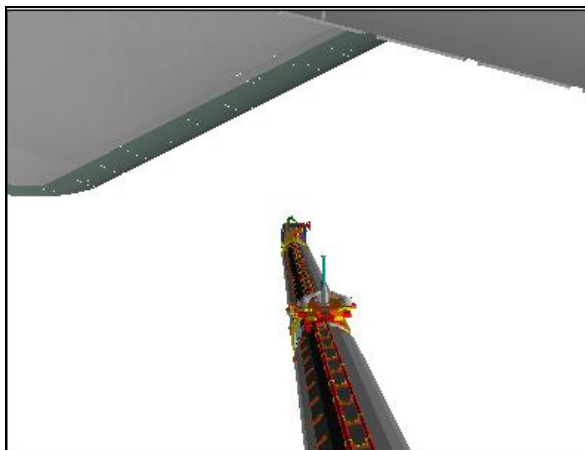

**RSC**

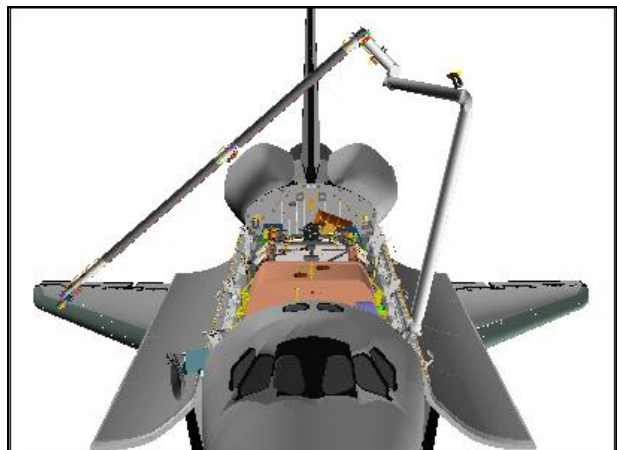

**BIRD'S EYE**

STARBOARD IDC RCC SURVEY – Pause Pt 132



CCTV A (0,40)

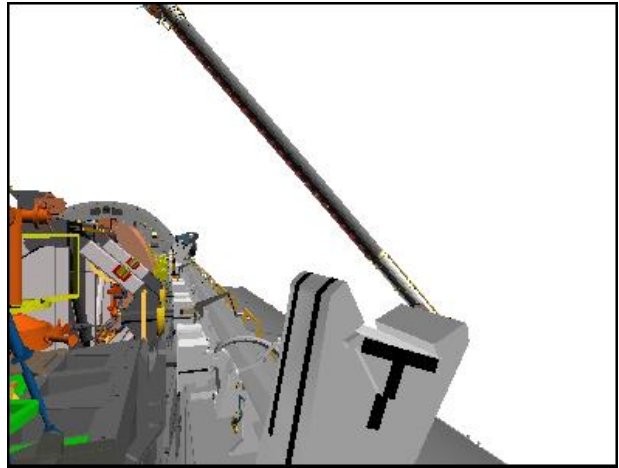

CCTV C (20,0)

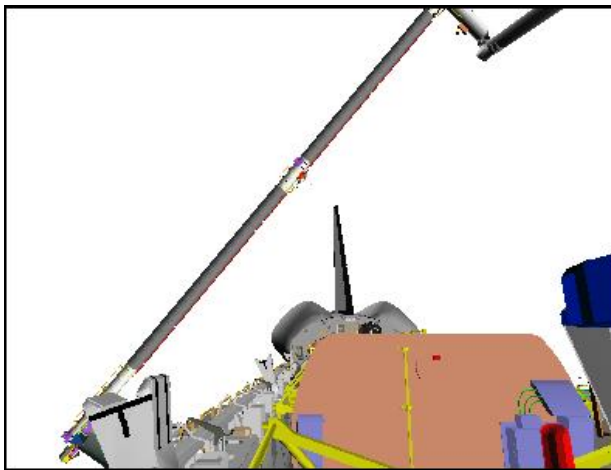

CCTV D (0,15)

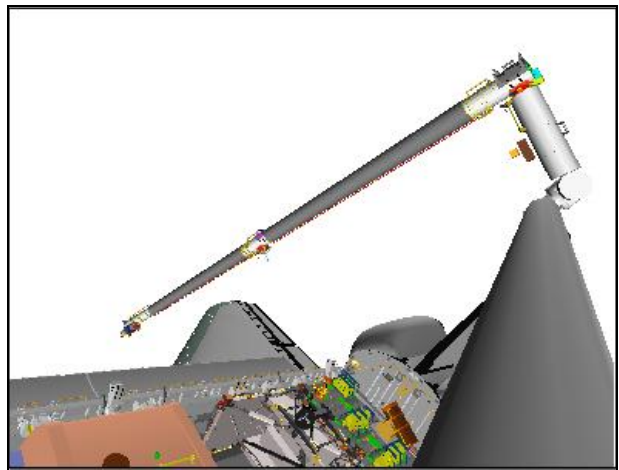

ELBOW (-30,-10)

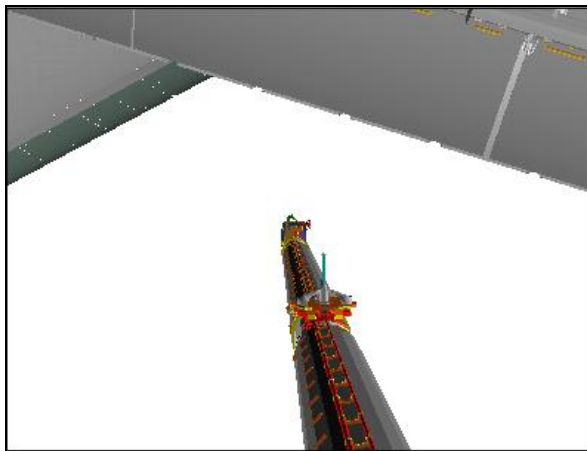

RSC

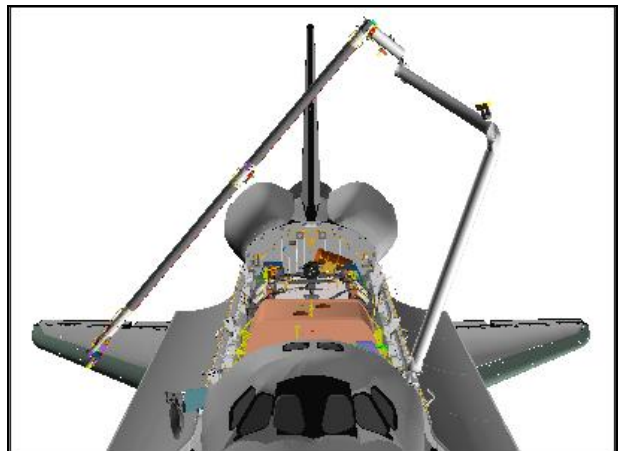

BIRD'S EYE

STARBOARD IDC RCC SURVEY – Pause Pt 133

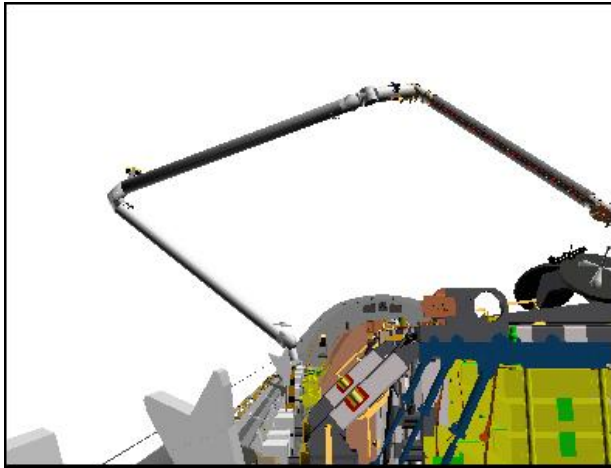

**CCTV B (0,10)**

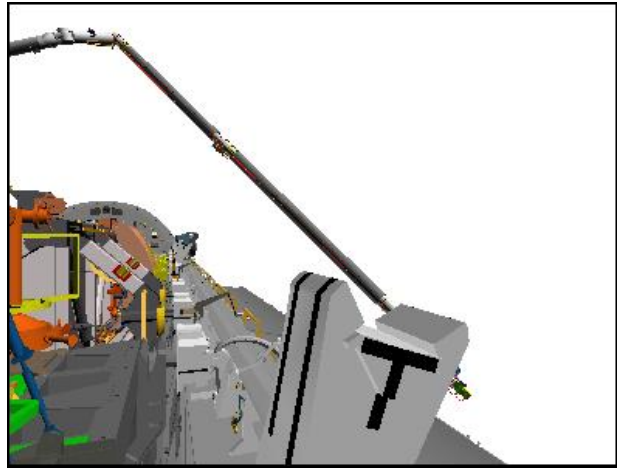

**CCTV C (20,0)**

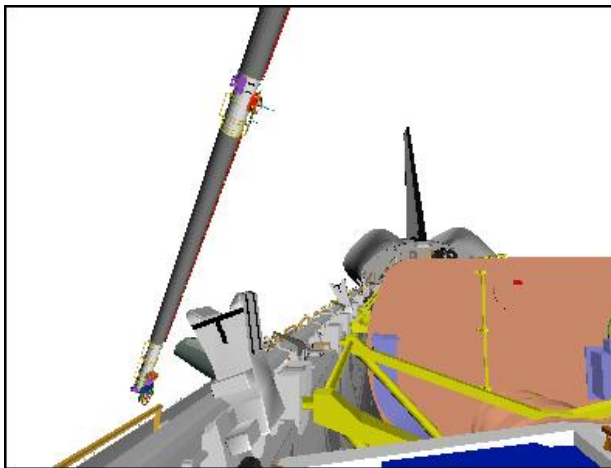

**CCTV D (-10,5)**

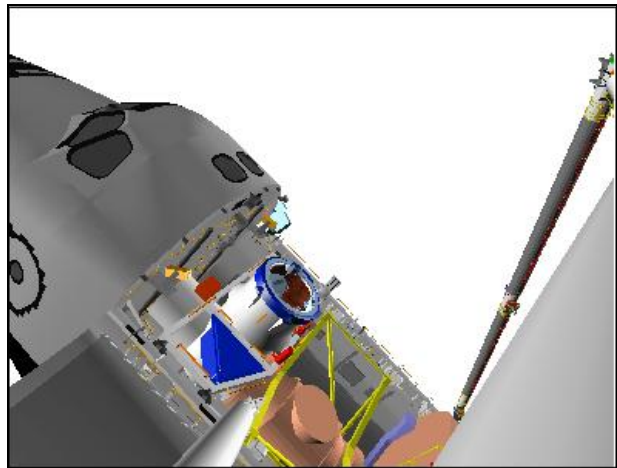

**ELBOW (-40,-20)**

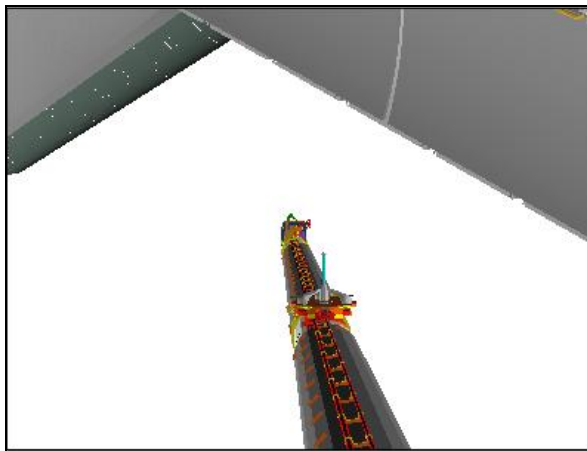

**RSC**

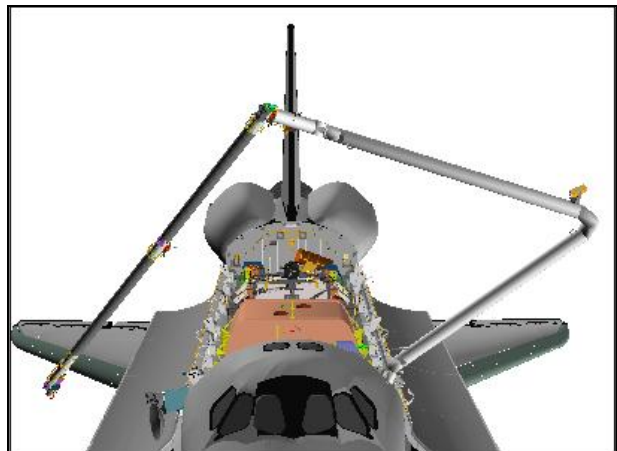

**BIRD'S EYE**

STARBOARD IDC RCC SURVEY – Pause Pt 134



**CCTV B (5,10)**

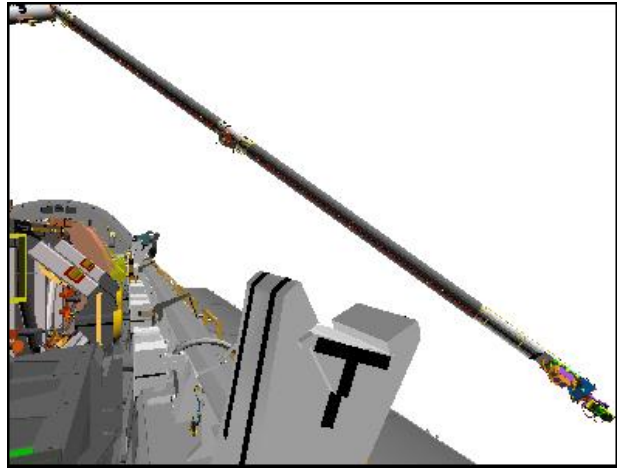

**CCTV C (25,0)**

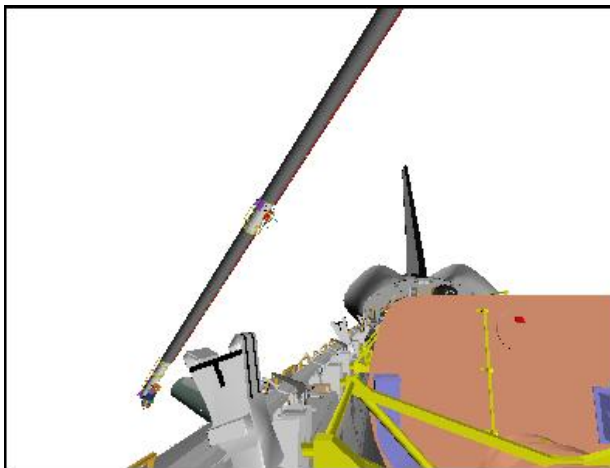

**CCTV D (-10,10)**

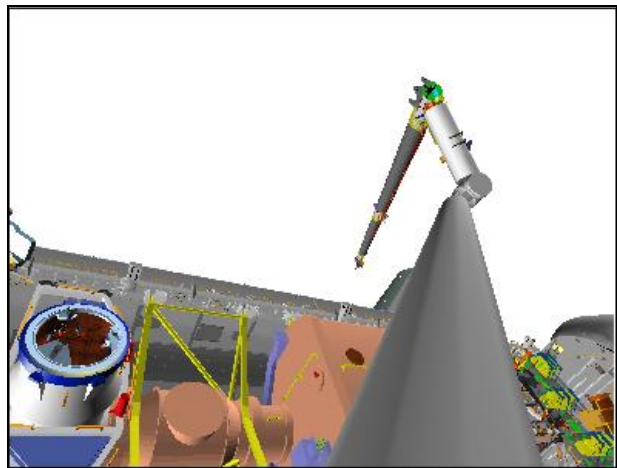

**ELBOW (-20,-10)**

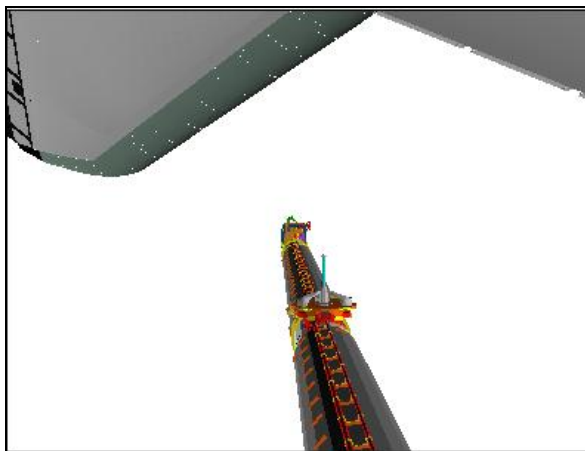

**RSC**

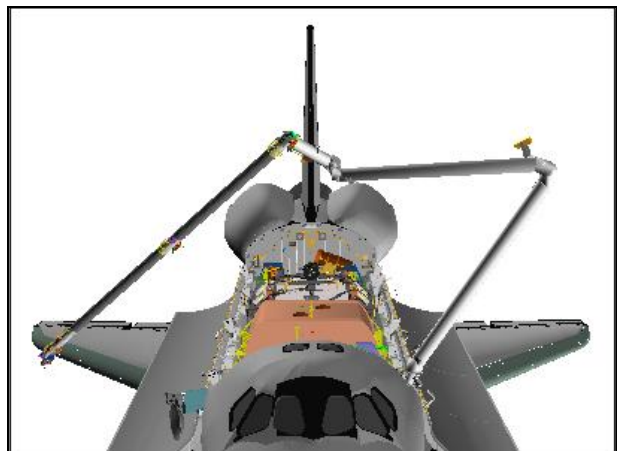

**BIRD'S EYE**

STARBOARD IDC RCC SURVEY – Pause Pt 135

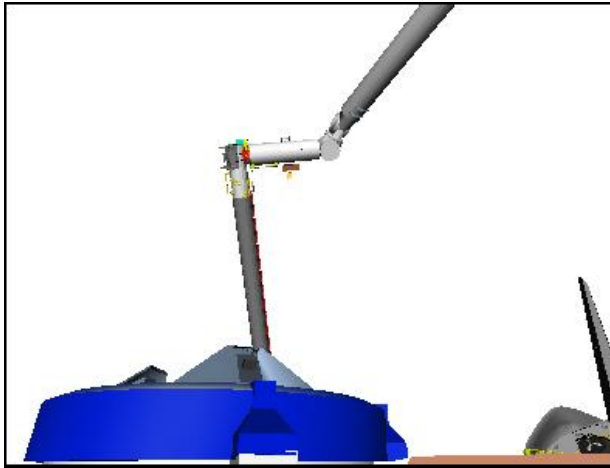

**CCTV A (-40,30)**



**CCTV B (5,10)**

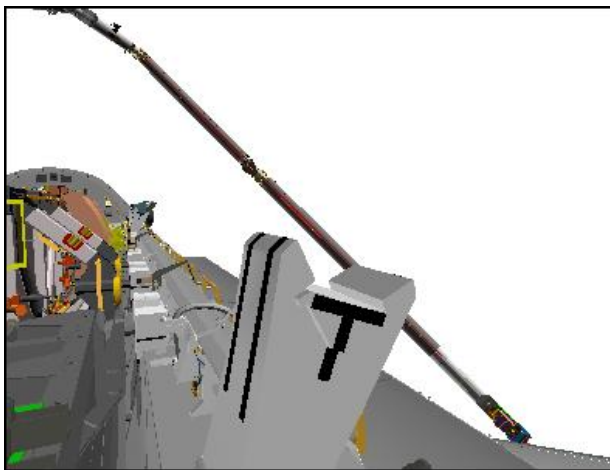

**CCTV C (25,-5)**

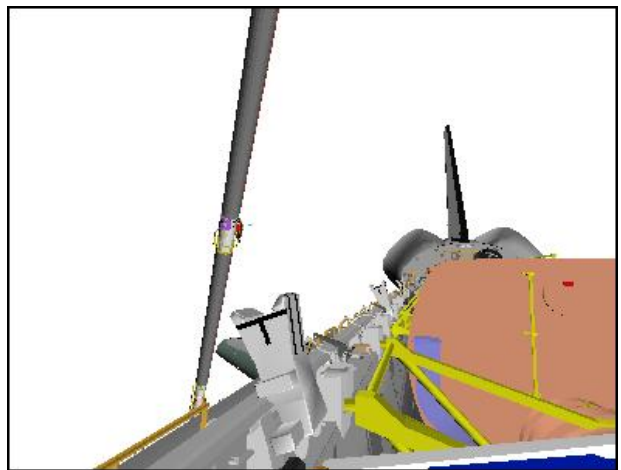

**CCTV D (-15,5)**

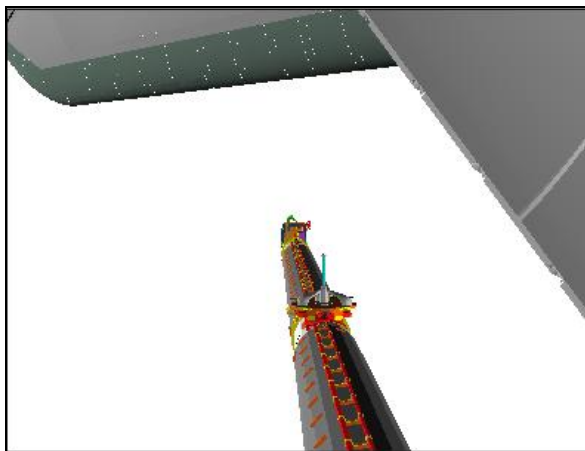

**RSC**

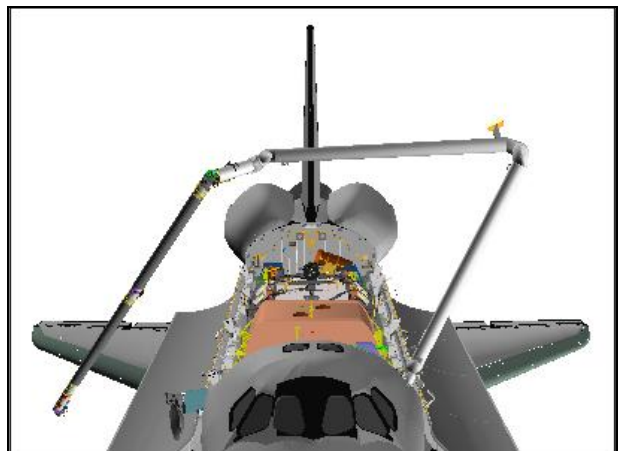

**BIRD'S EYE**



STARBOARD IDC RCC SURVEY – Pause Pt 137

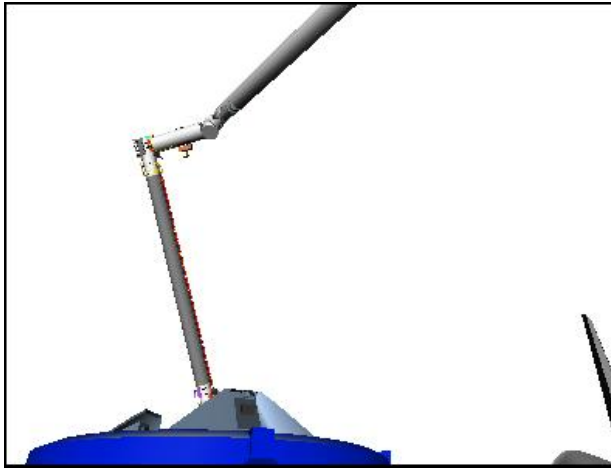

**CCTV A (-40,35)**

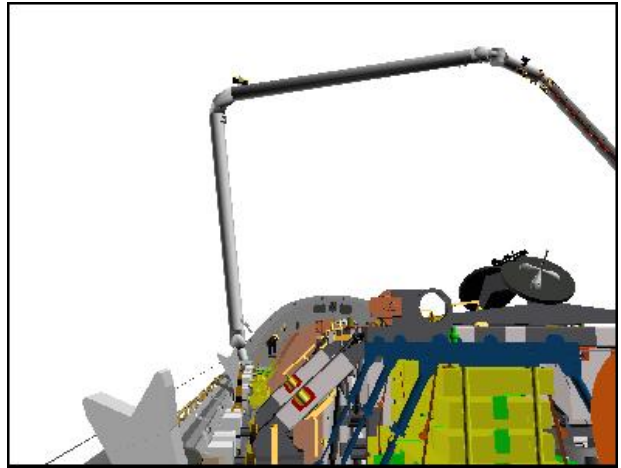

**CCTV B (5,10)**

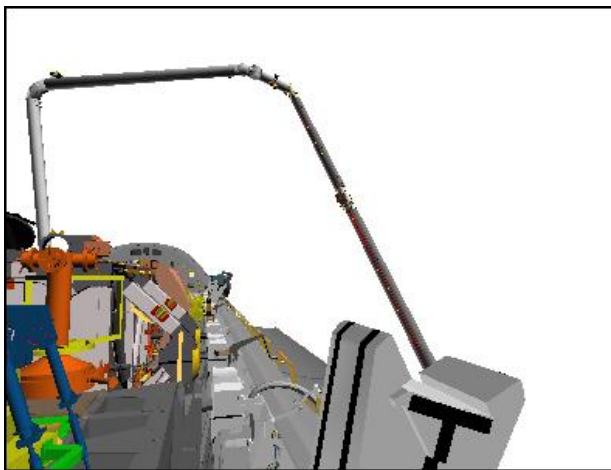

**CCTV C (15,5)**

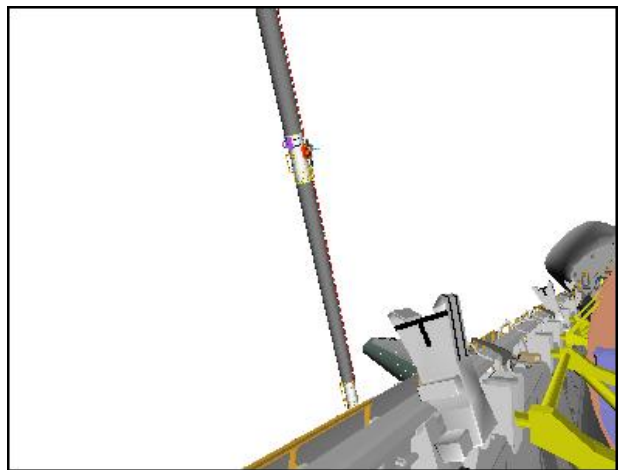

**CCTV D (-35,5)**

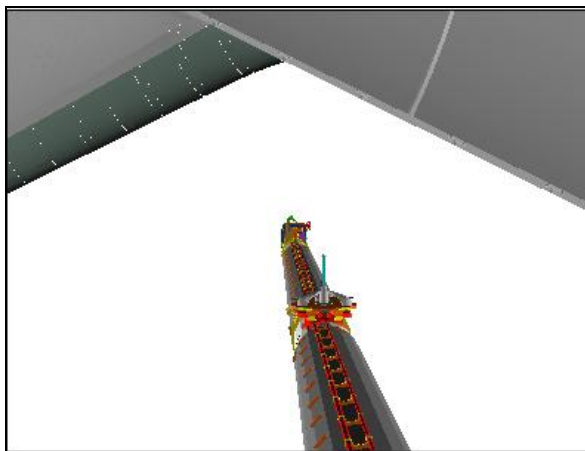

**RSC**

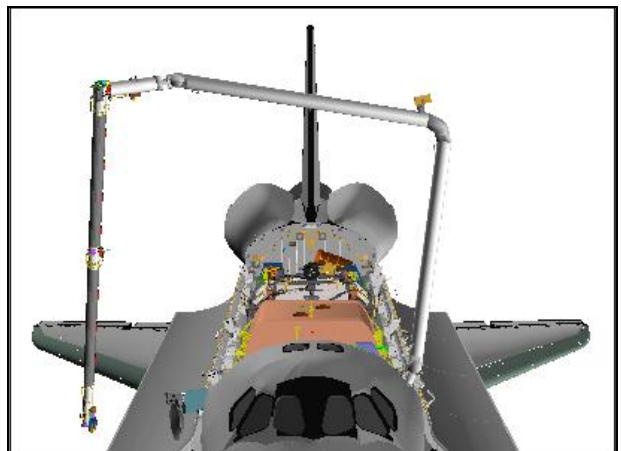

**BIRD'S EYE**

STARBOARD IDC RCC SURVEY – Pause Pt 139

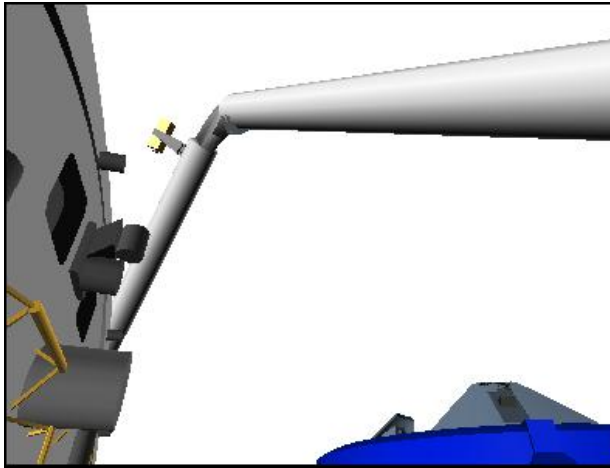

CCTV A (-70,35)

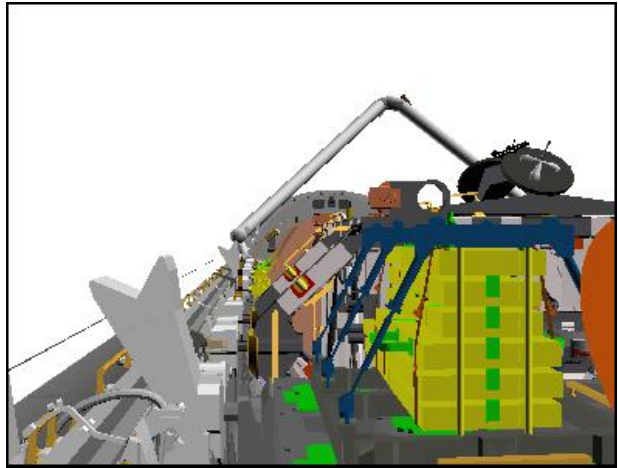

CCTV B (5,0)

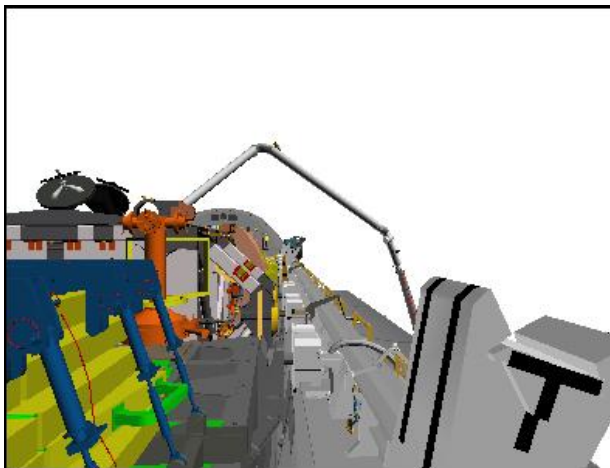

CCTV C (5,0)

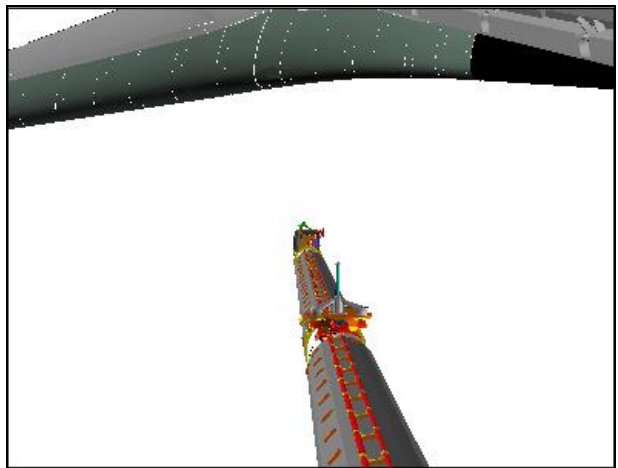

RSC



STARBOARD

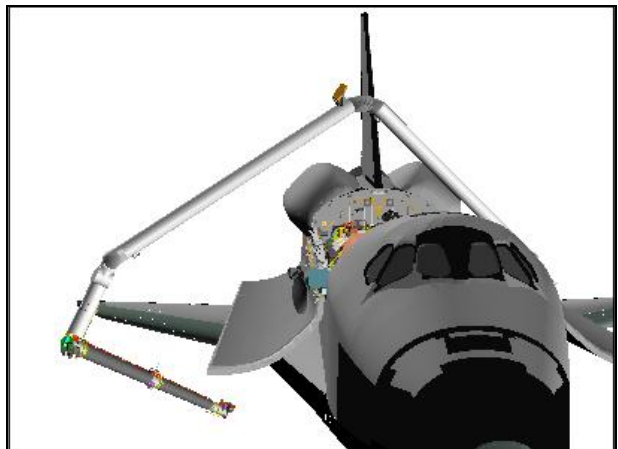

BIRD'S EYE

STARBOARD IDC RCC SURVEY – Pause Pt 140

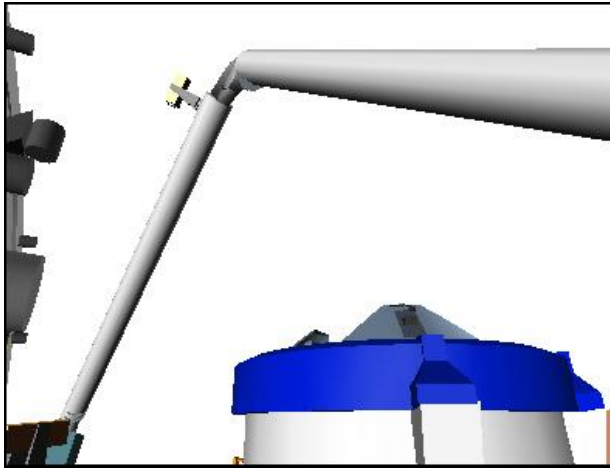

CCTV A (-60,25)

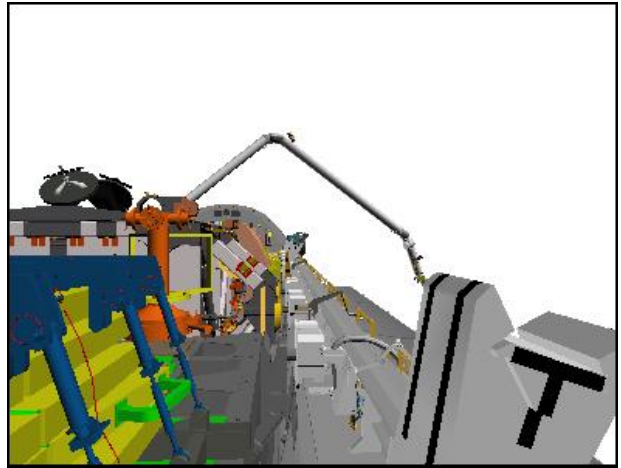

CCTV C (5,0)

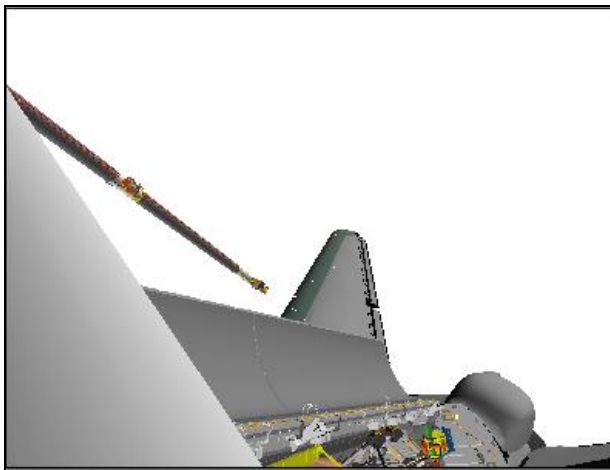

ELBOW (40,-50)

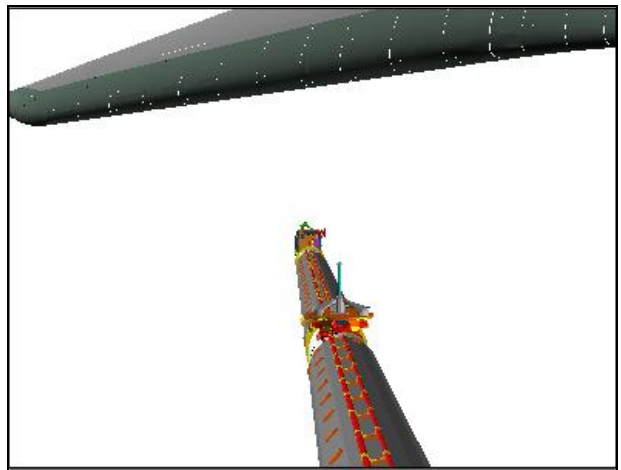

RSC

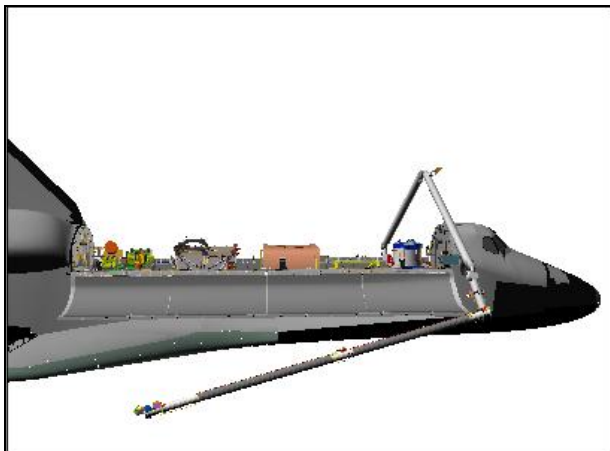

STARBOARD

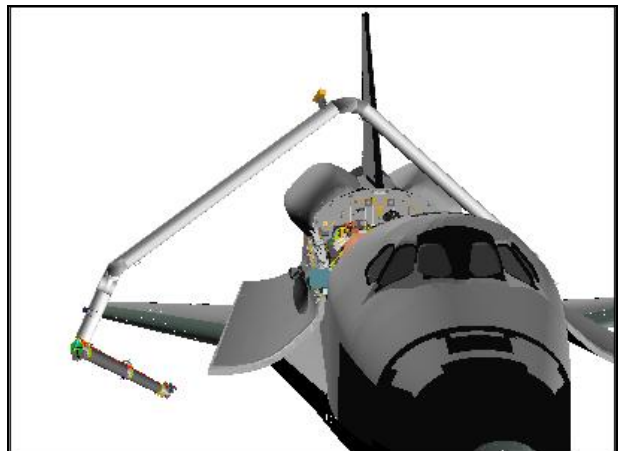

BIRD'S EYE

STARBOARD IDC RCC SURVEY – Pause Pt 141

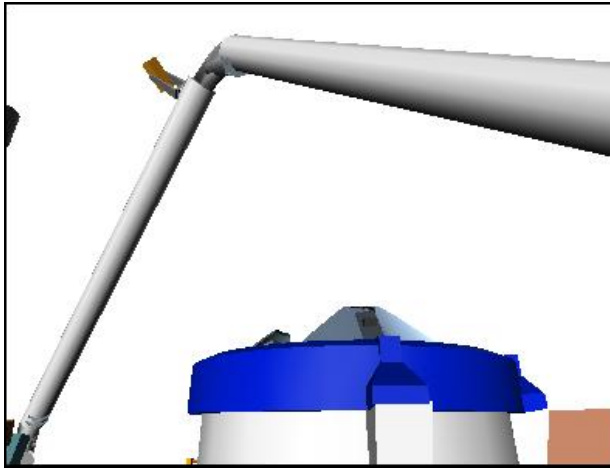

CCTV A (-55,25)

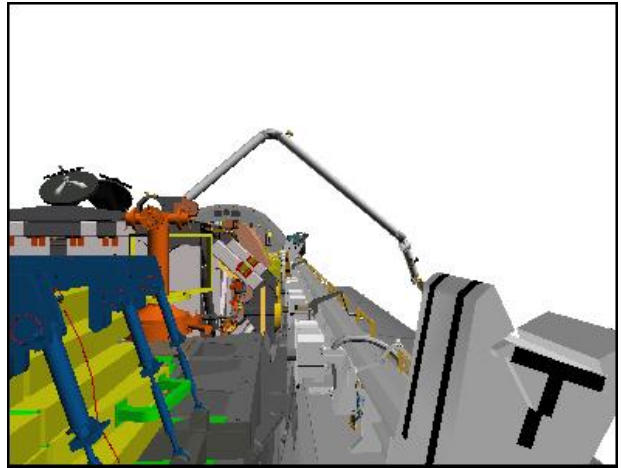

CCTV C (5,0)

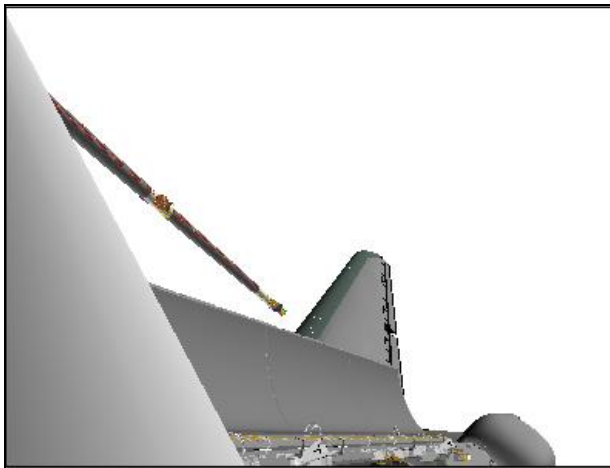

ELBOW (35,-45)

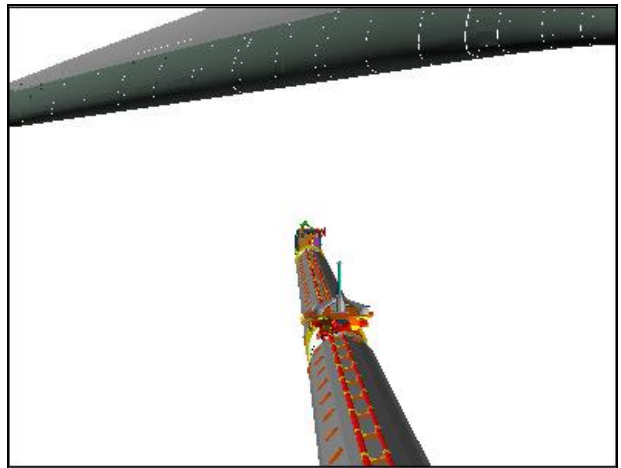

RSC

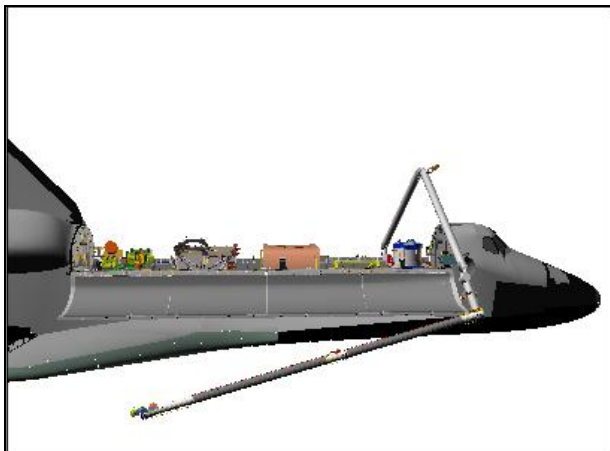

STARBOARD

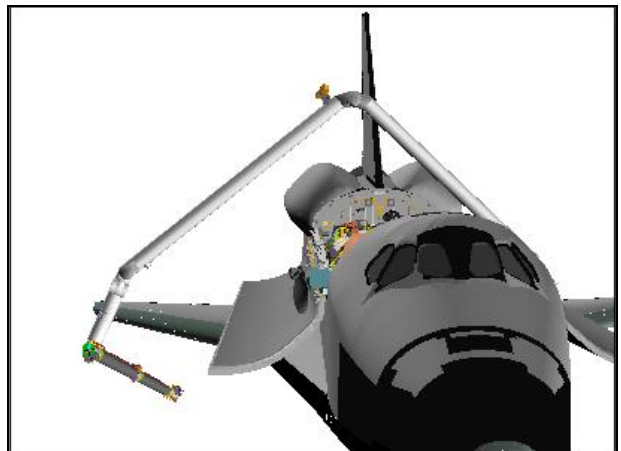

BIRD'S EYE

STARBOARD IDC RCC SURVEY – Pause Pt 142

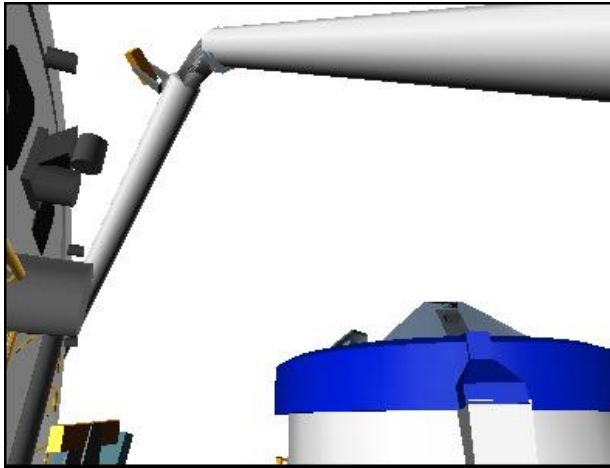

CCTV A (-65,25)

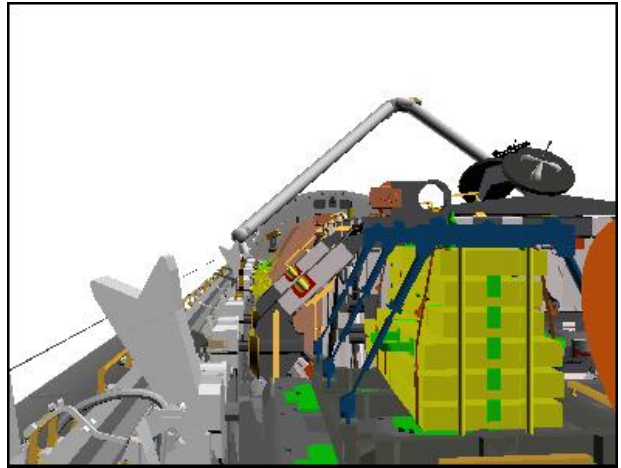

CCTV B (5,0)

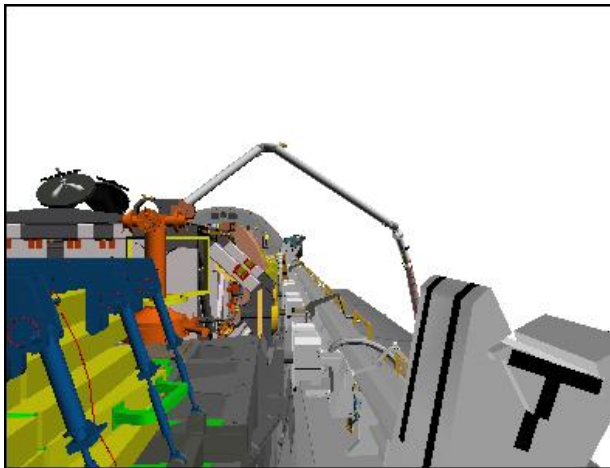

CCTV C (5,0)

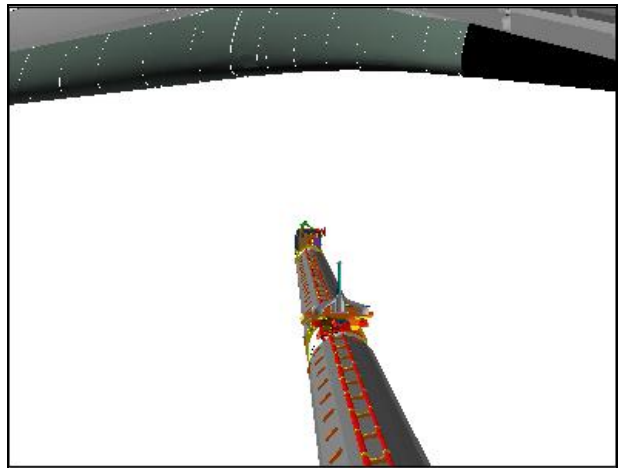

RSC



STARBOARD

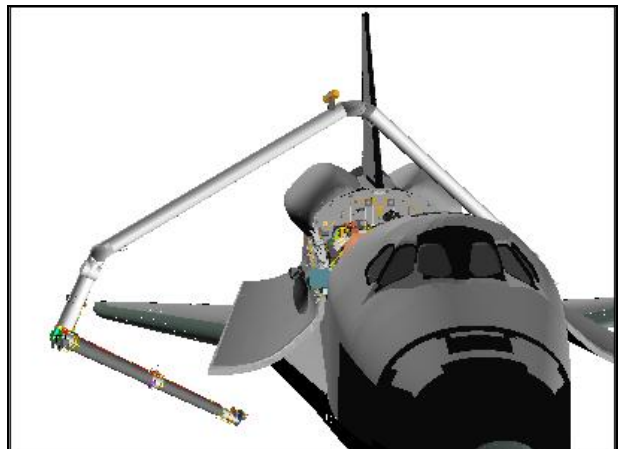

BIRD'S EYE

# OBSS IDC RCC SURVEY CAMERA VIEWS – NOSE CAP

NOSE CAP IDC RCC SURVEY – Pause Pt 143

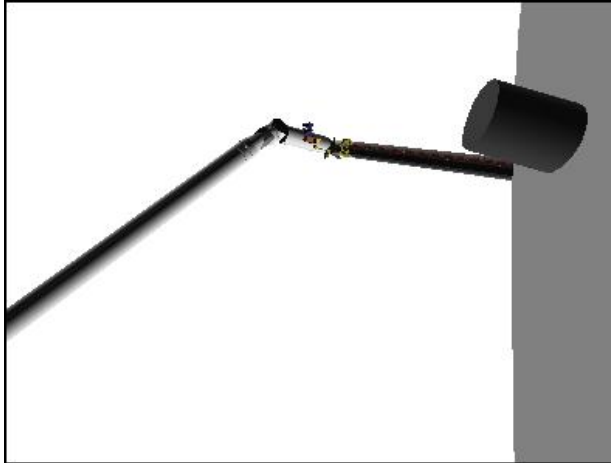

**CCTV A (105,70)**

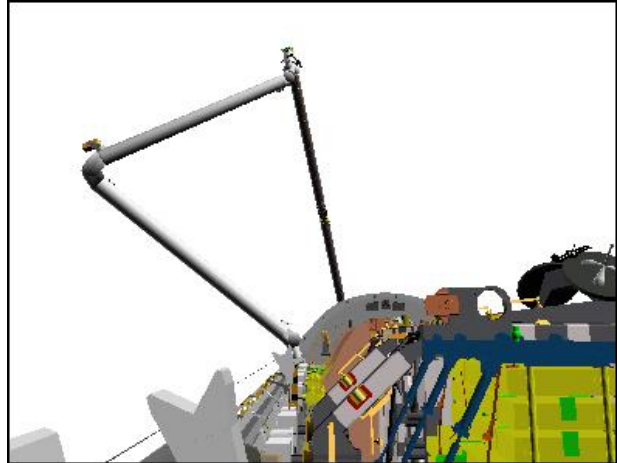

**CCTV B (0,10)**

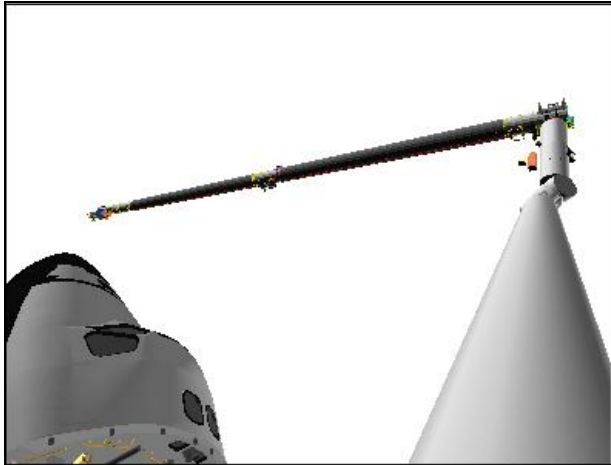

**ELBOW (-30,-10)**

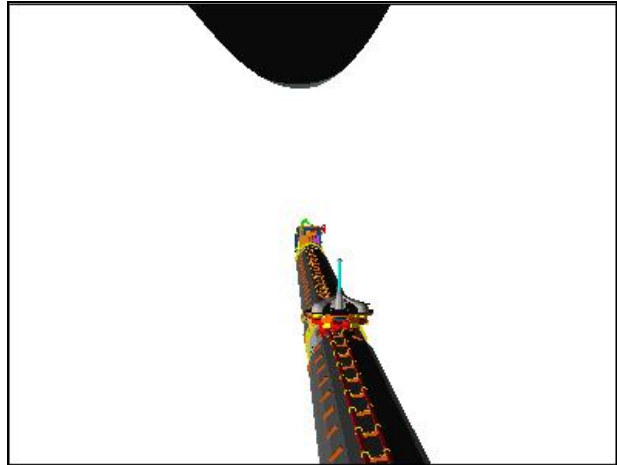

**RSC**

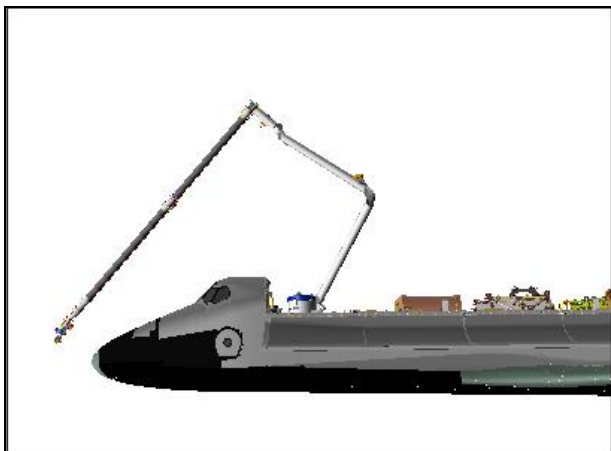

**PORT**

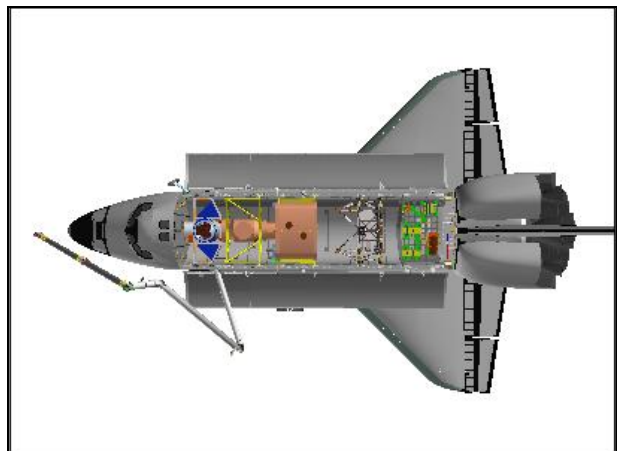

**OVERHEAD**

NOSE CAP IDC RCC SURVEY – Pause Pt 147

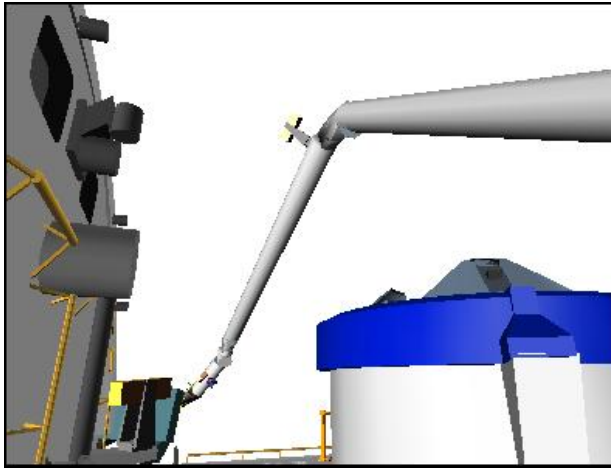

CCTV A (-70,20)

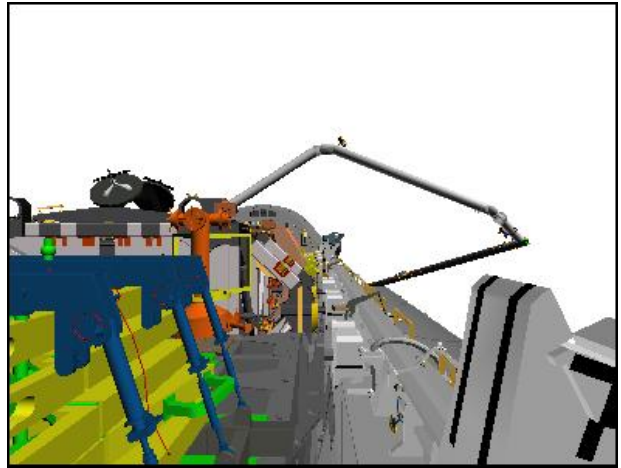

CCTV C (0,0)

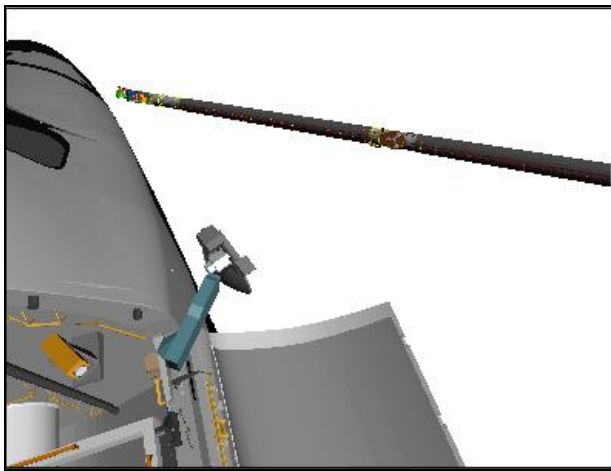

ELBOW (-60,-10)

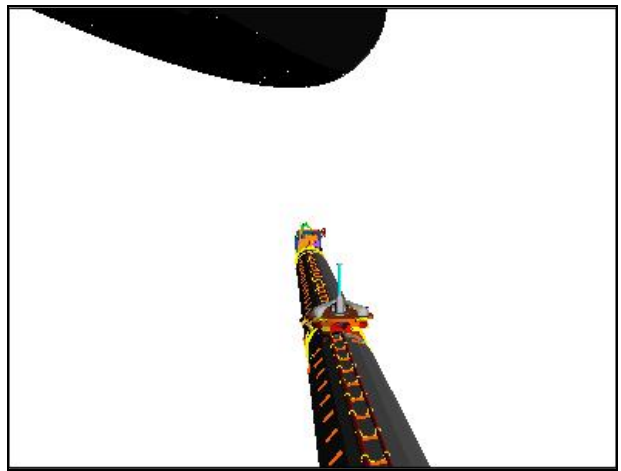

RSC

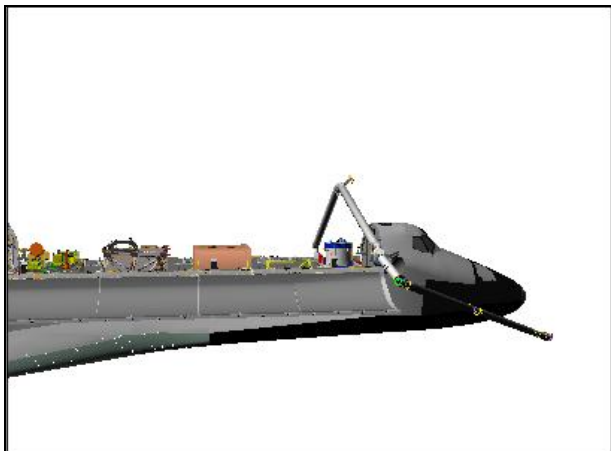

STARBOARD

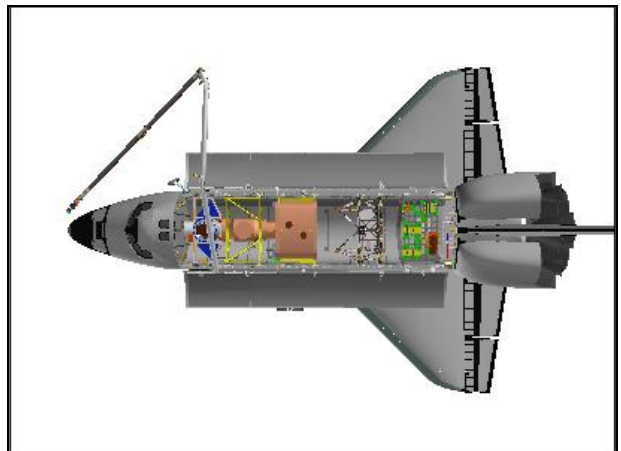

OVERHEAD

NOSE CAP IDC RCC SURVEY – Pause Pt 148

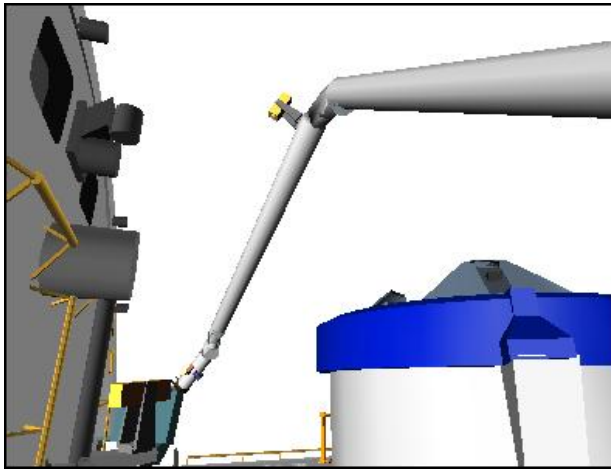

CCTV A (-70,20)

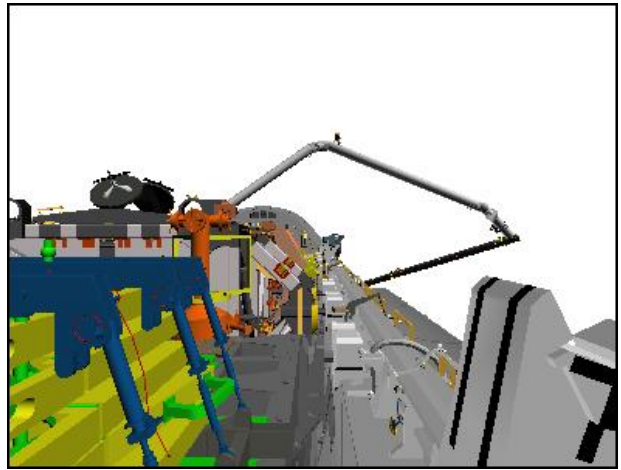

CCTV C (0,0)

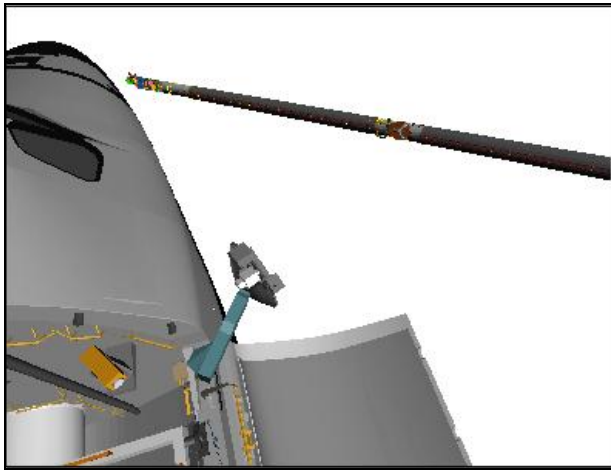

ELBOW (-60,-10)

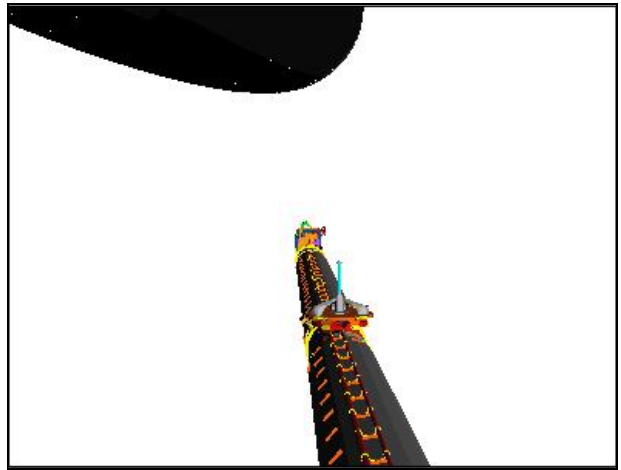

RSC

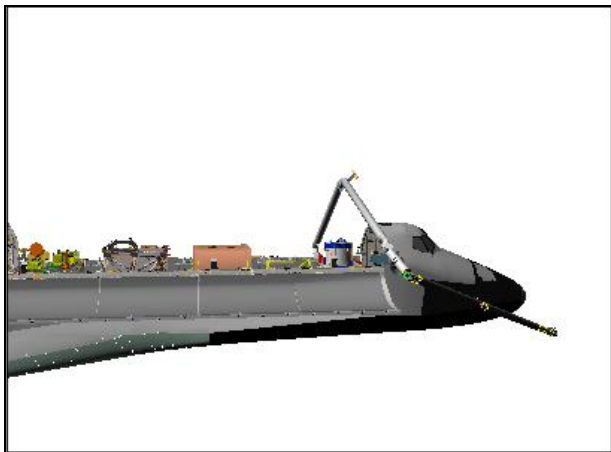

STARBOARD

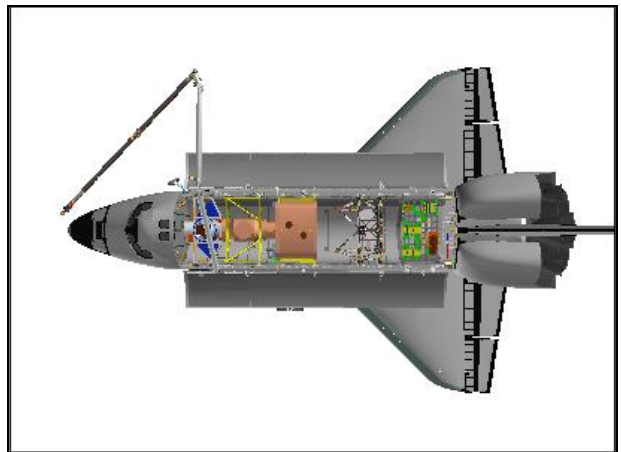

OVERHEAD



NOSE CAP IDC RCC SURVEY – Pause Pt 149

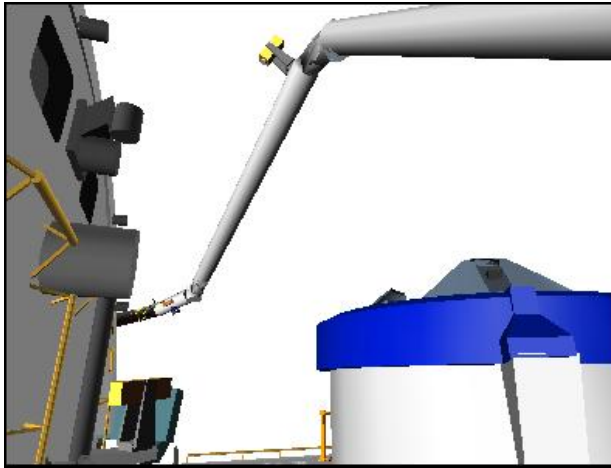

CCTV A (-70,20)

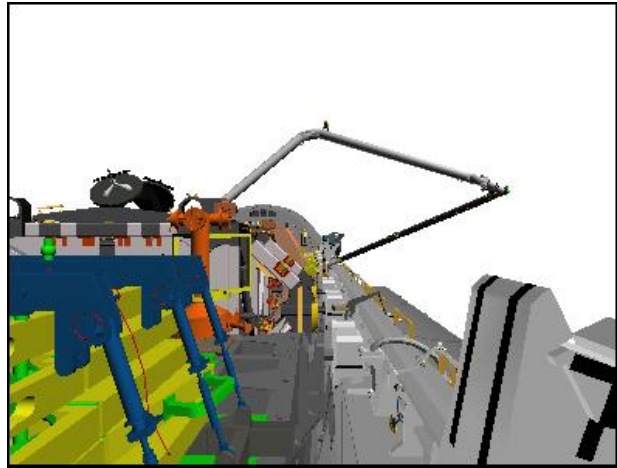

CCTV C (0,0)

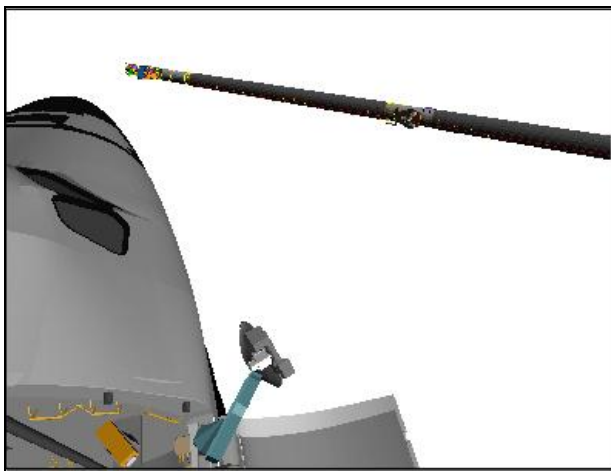

ELBOW (-60,-5)

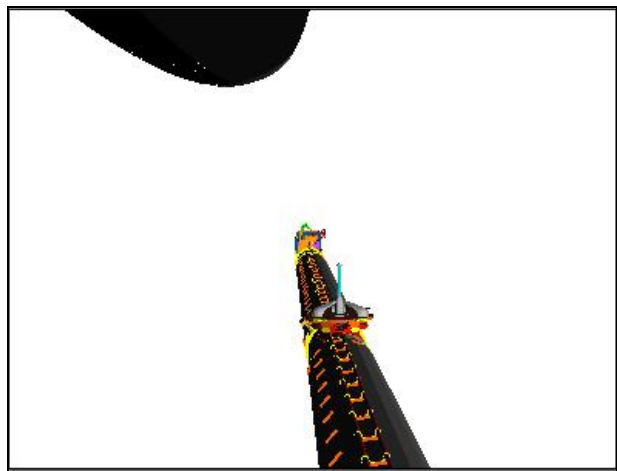

RSC

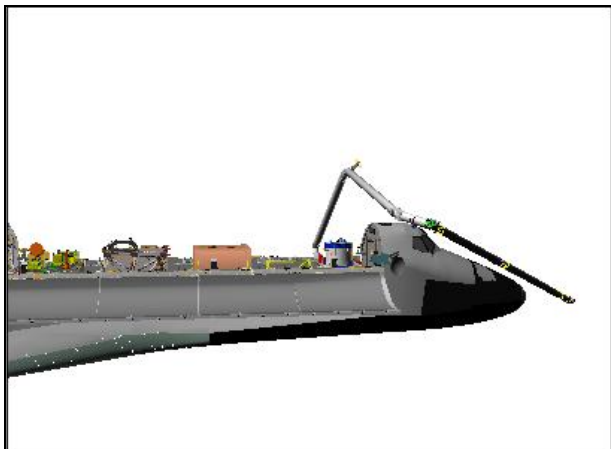

STARBOARD

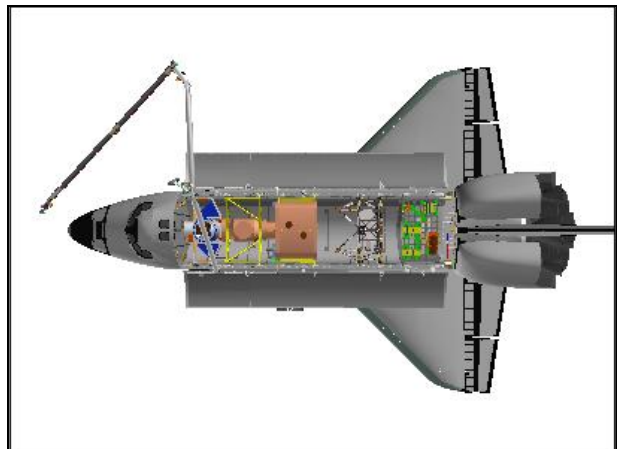

OVERHEAD

NOSE CAP IDC RCC SURVEY – Pause Pt 150

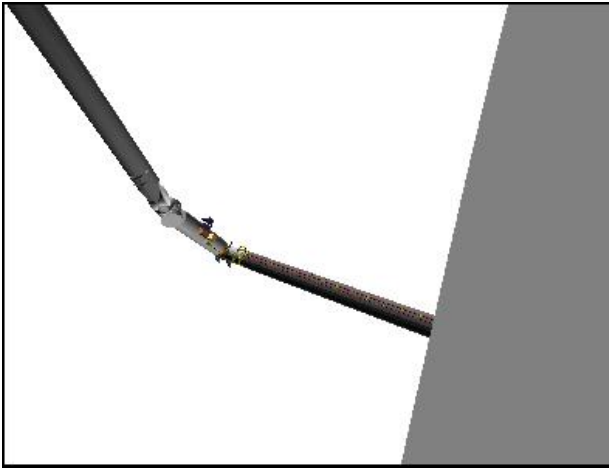

**CCTV A (110,50)**

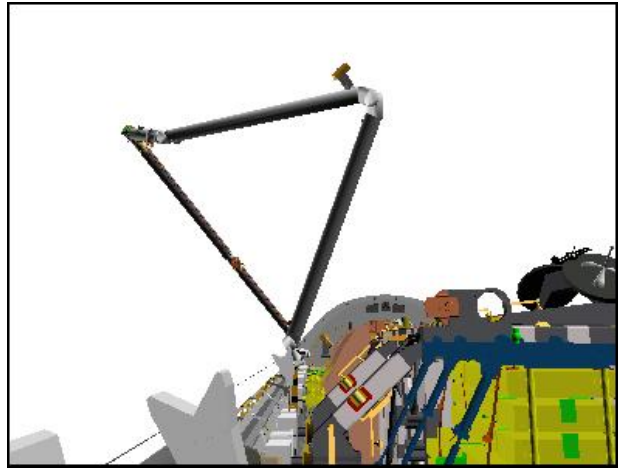

**CCTV B (0,10)**



**CCTV D (65,30)**

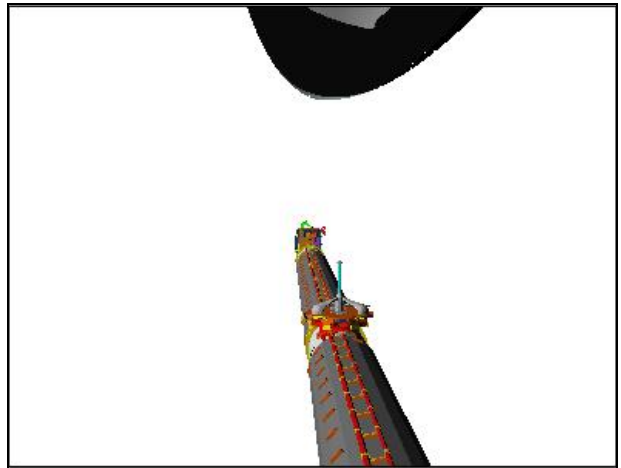

**RSC**

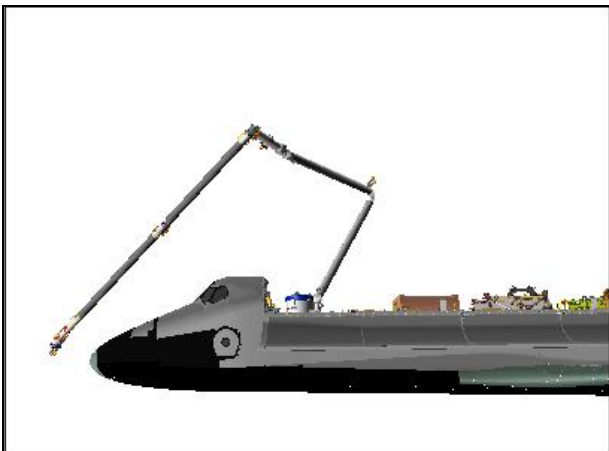

**PORT**

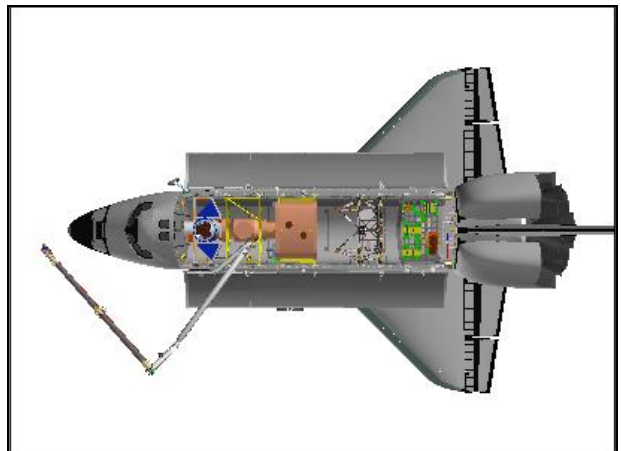

**OVERHEAD**

NOSE CAP IDC RCC SURVEY – Pause Pt 153

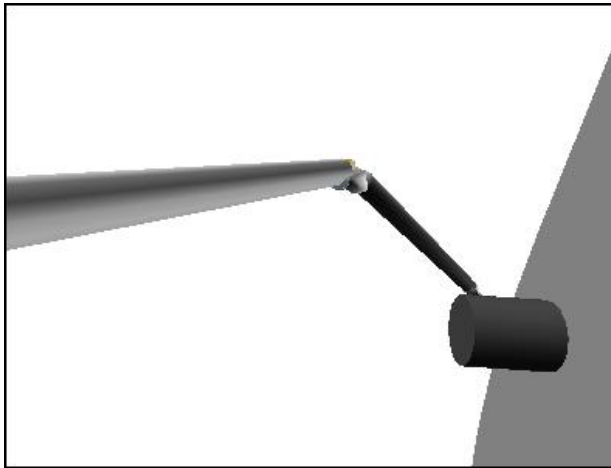

CCTV A (90,10)

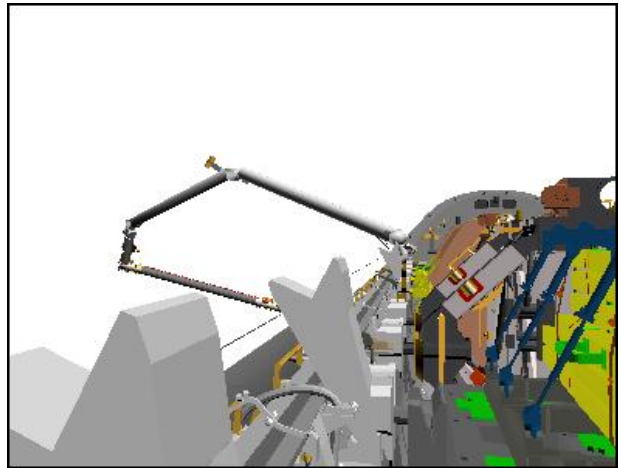

CCTV B (-10,0)

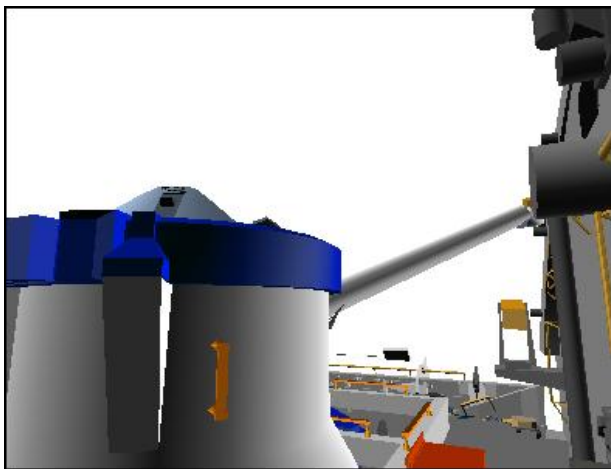

CCTV D (65,10)



RSC

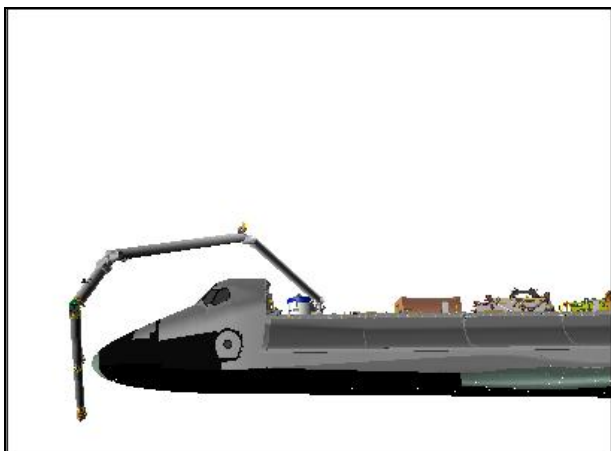

PORT

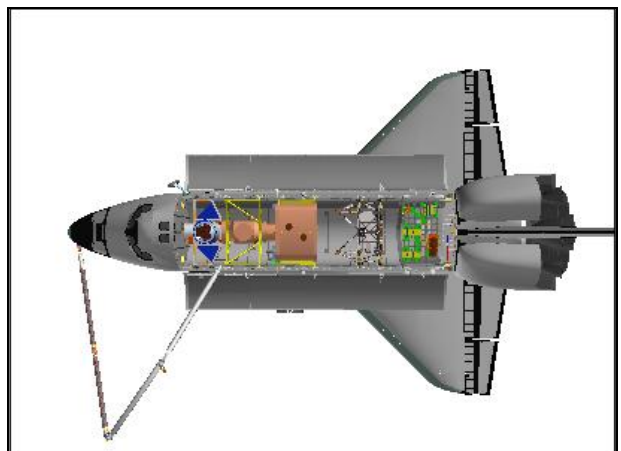

OVERHEAD

NOSE CAP IDC RCC SURVEY – Pause Pt 154

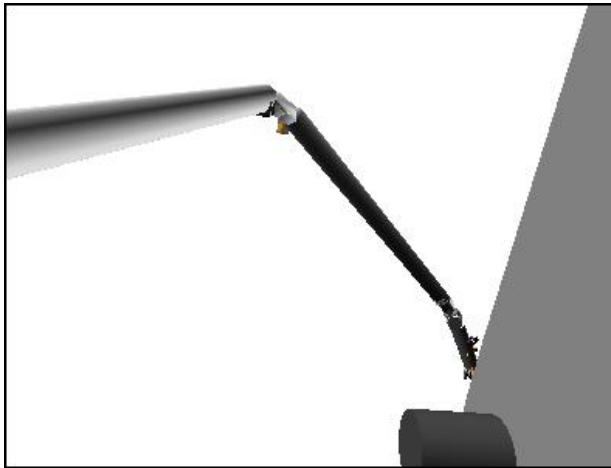

**CCTV A (95,20)**

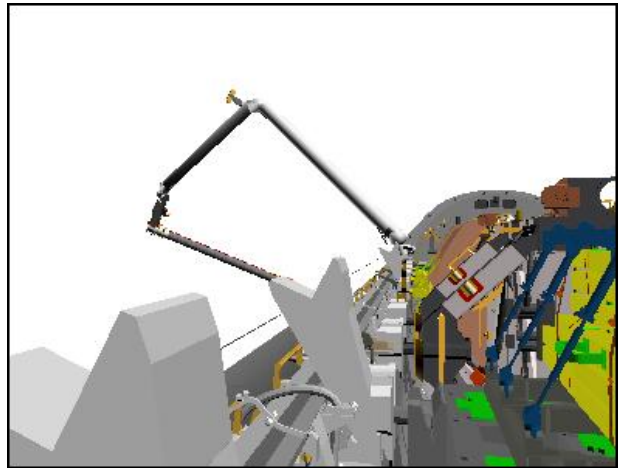

**CCTV B (-10,0)**



**CCTV D (65,10)**

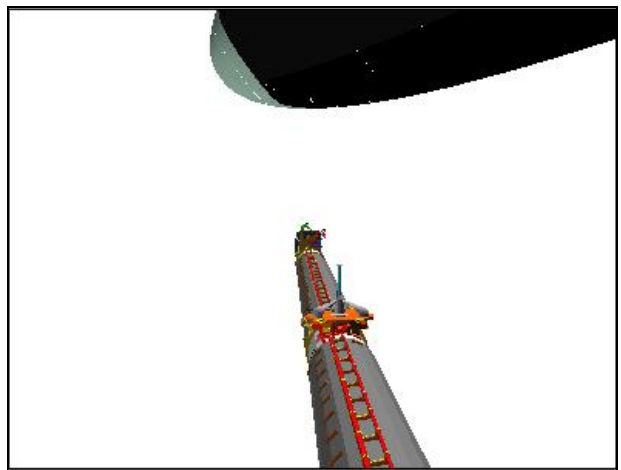

**RSC**

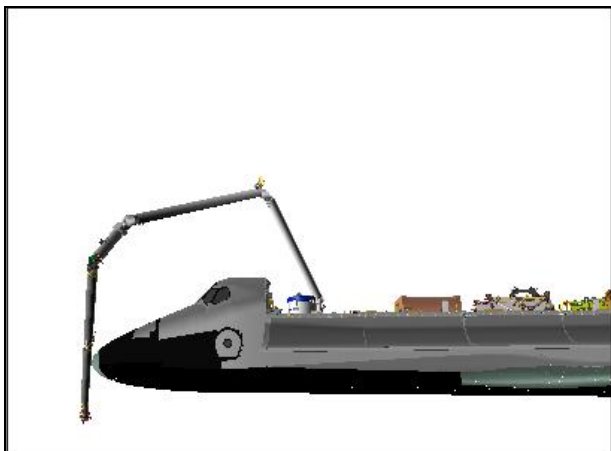

**PORT**

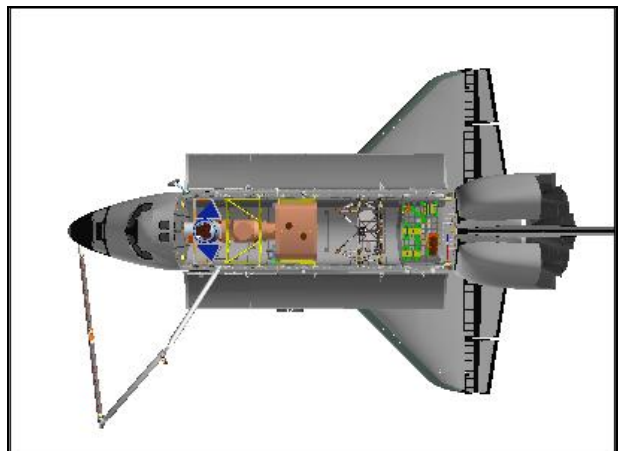

**OVERHEAD**

NOSE CAP IDC RCC SURVEY – Pause Pt 157

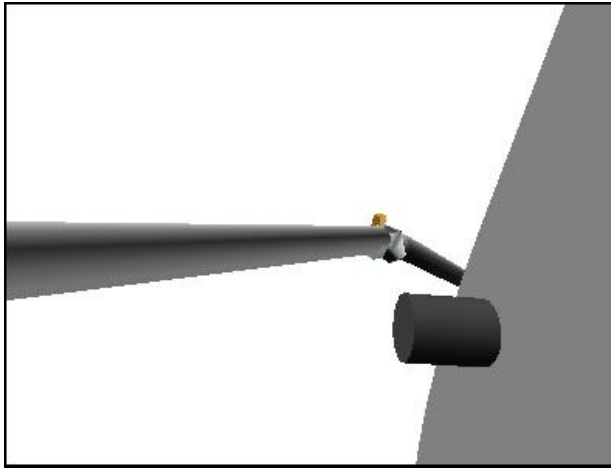

**CCTV A (95,10)**

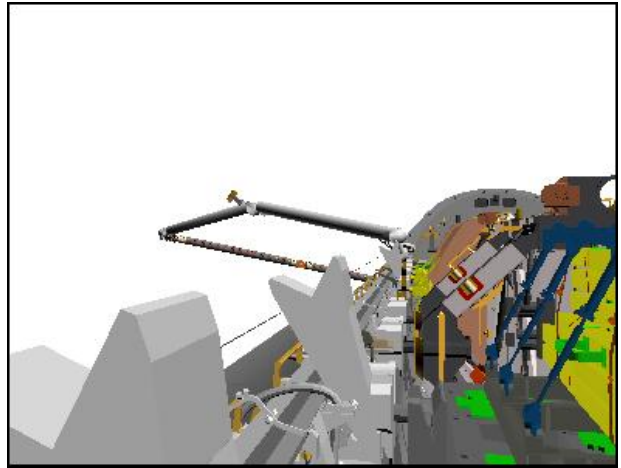

**CCTV B (-10,0)**

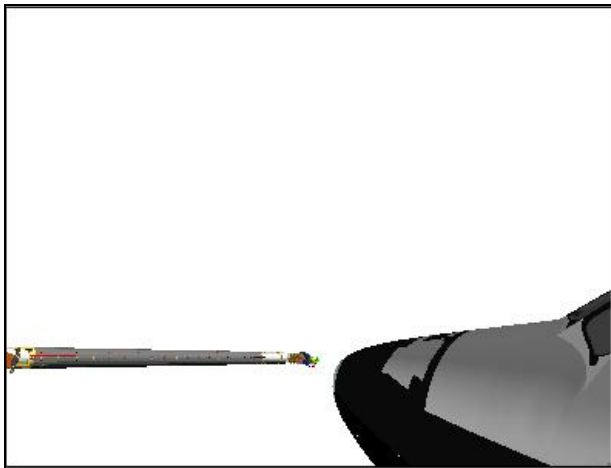

**ELBOW (90,-60)**

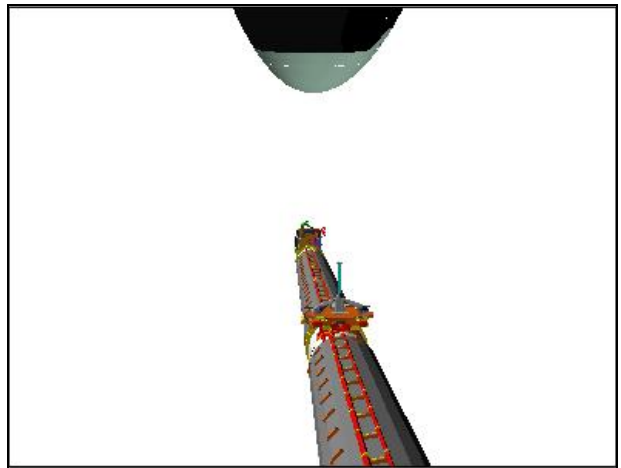

**RSC**



**PORT**

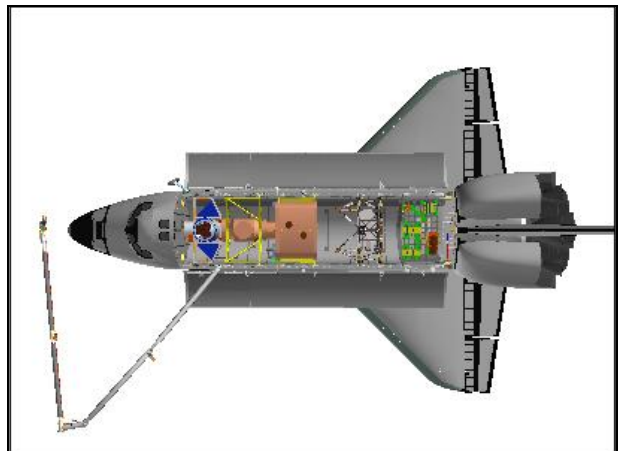

**OVERHEAD**

NOSE CAP IDC RCC SURVEY – Pause Pt 158

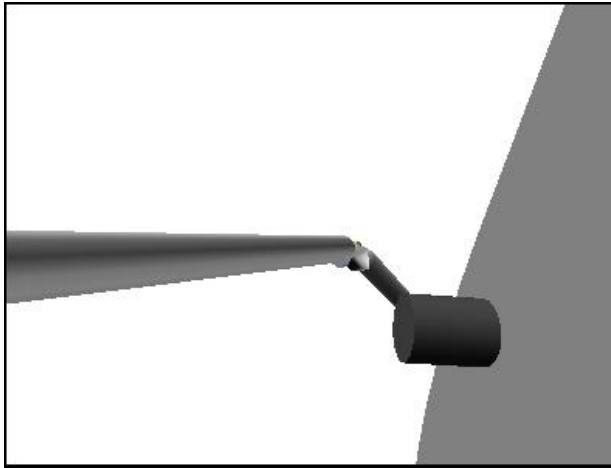

**CCTV A (95,10)**

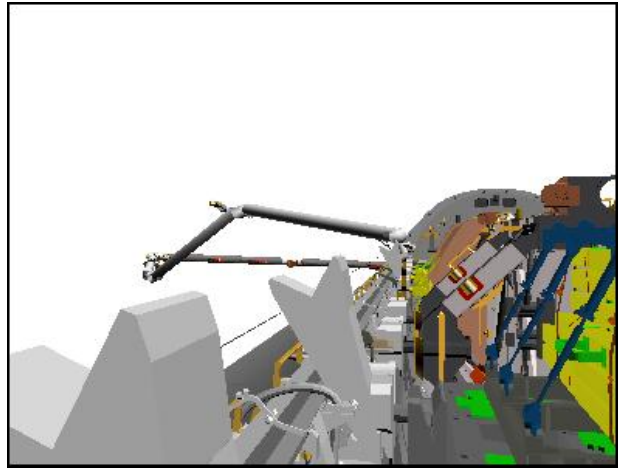

**CCTV B (-10,0)**

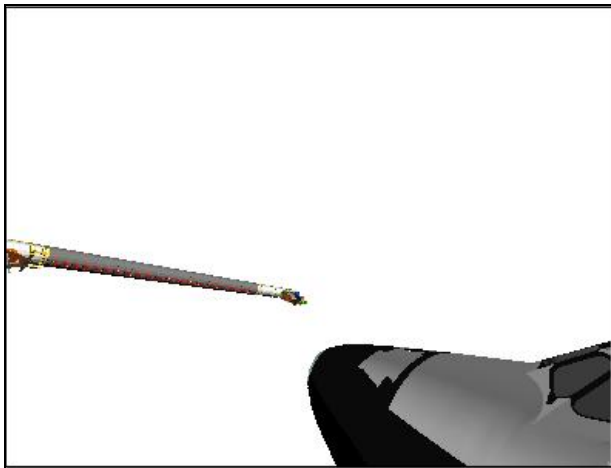

**ELBOW (90,-60)**

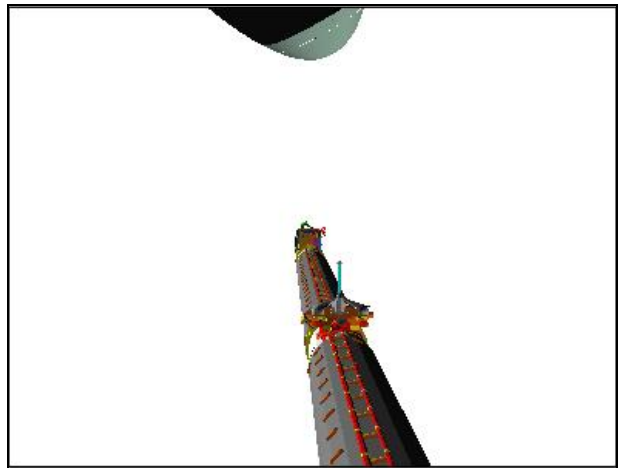

**RSC**

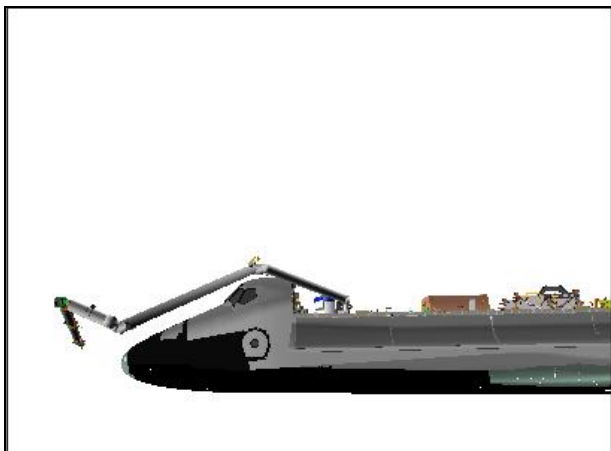

**PORT**

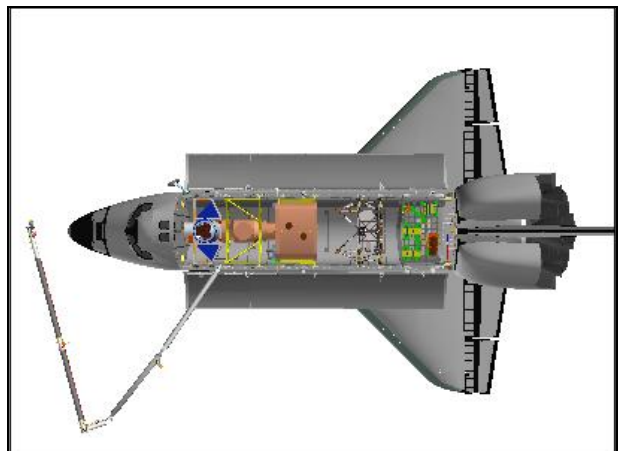

**OVERHEAD**

NOSE CAP IDC RCC SURVEY – Pause Pt 159

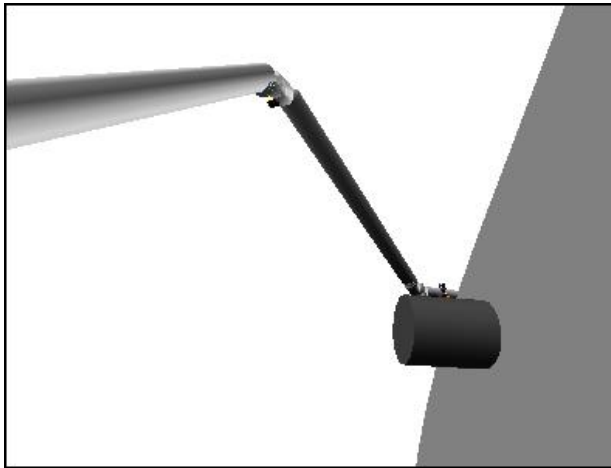

**CCTV A (95,10)**

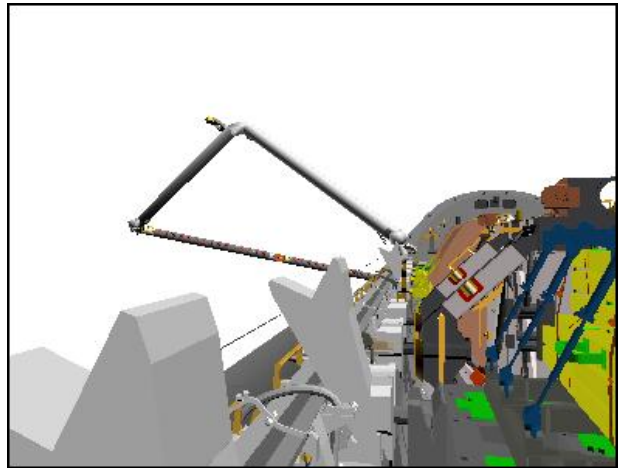

**CCTV B (-10,0)**

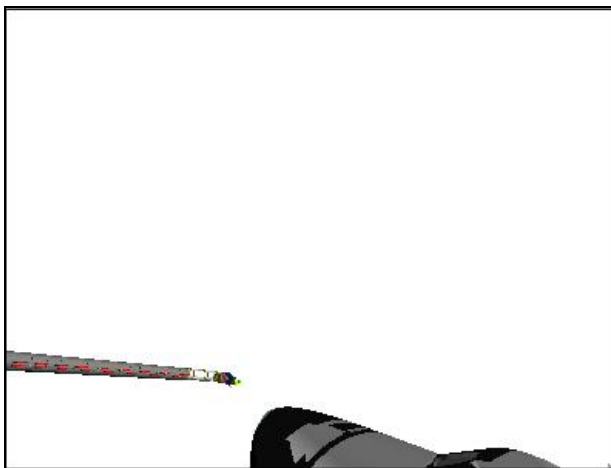

**ELBOW (90,-60)**

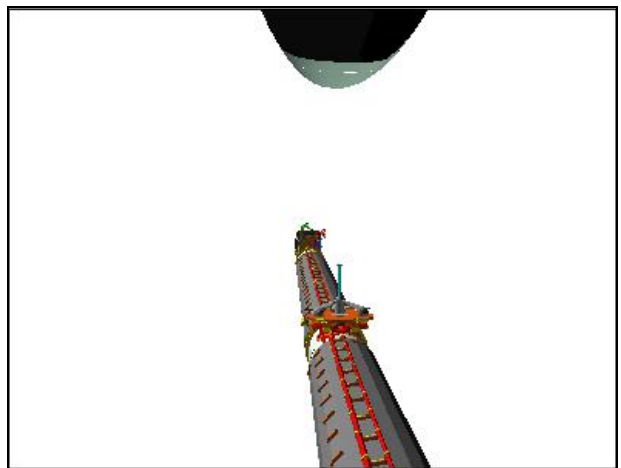

**RSC**

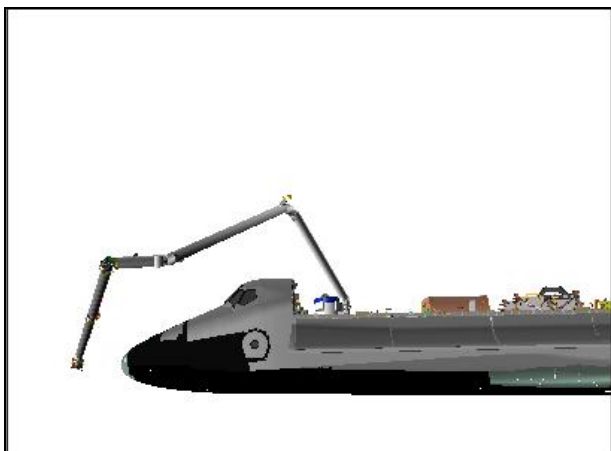

**PORT**

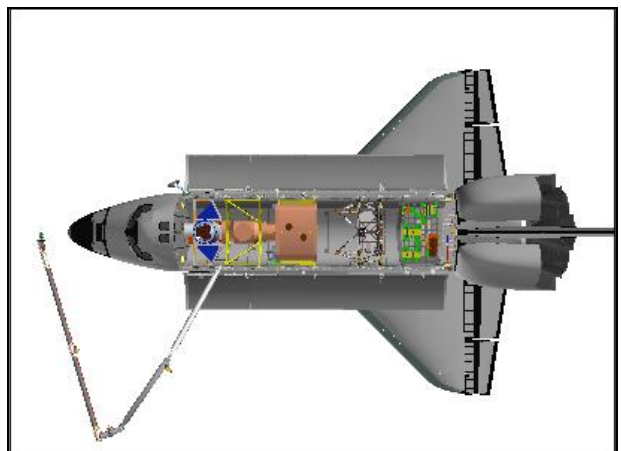

**OVERHEAD**

NOSE CAP IDC RCC SURVEY – Pause Pt 161

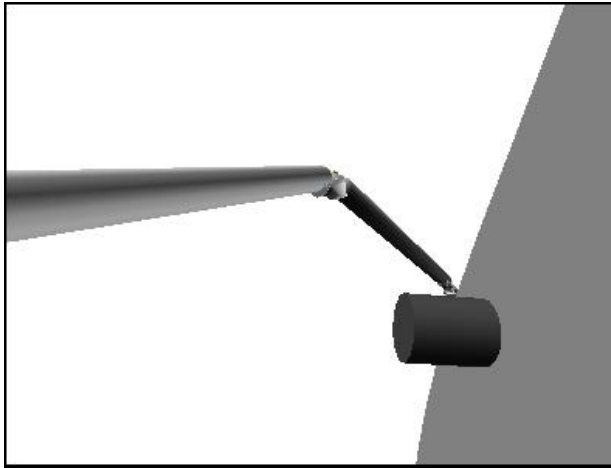

CCTV A (95,10)

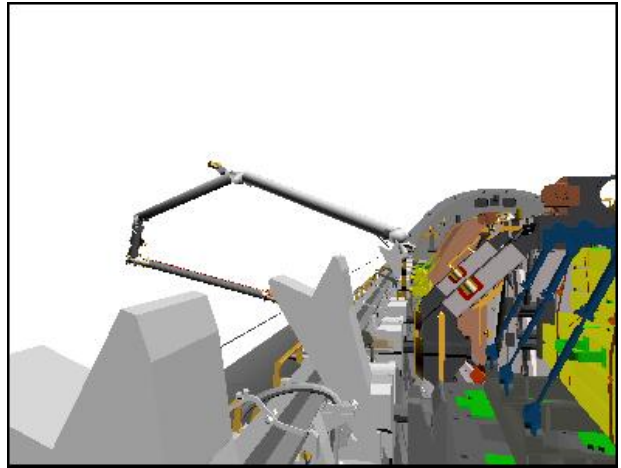

CCTV B (-10,0)

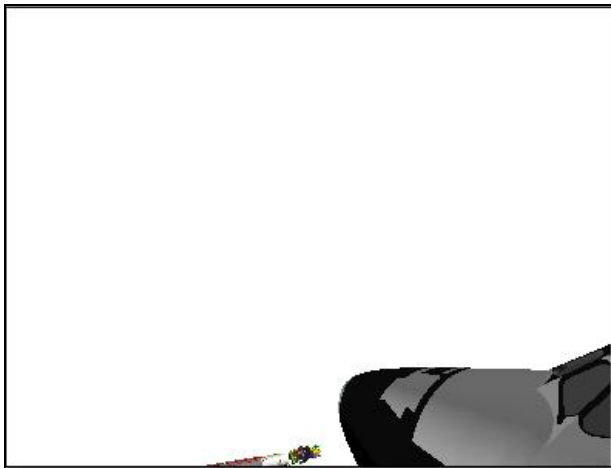

ELBOW (90,-60)



RSC

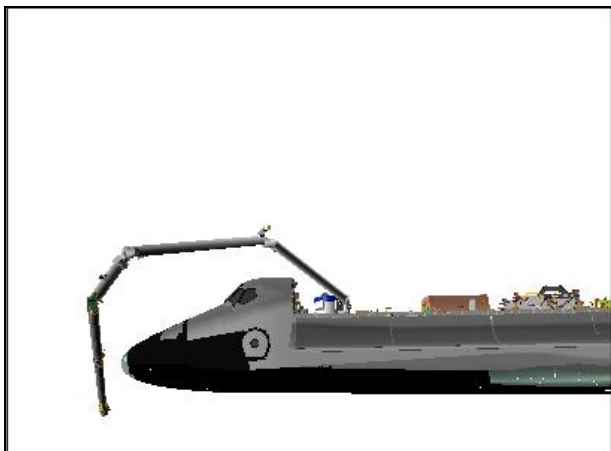

PORT

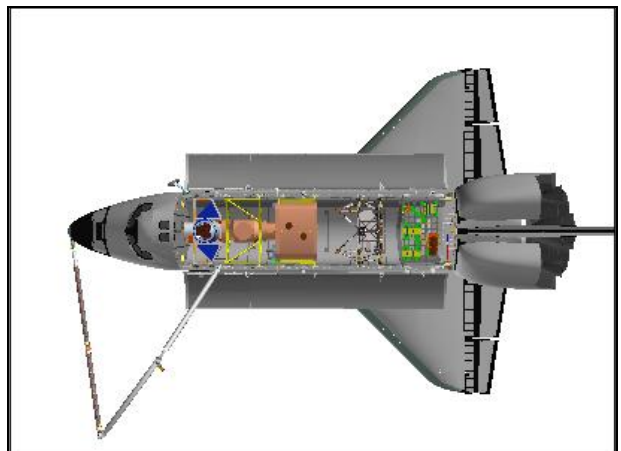

OVERHEAD



NOSE CAP IDC RCC SURVEY – Pause Pt 162

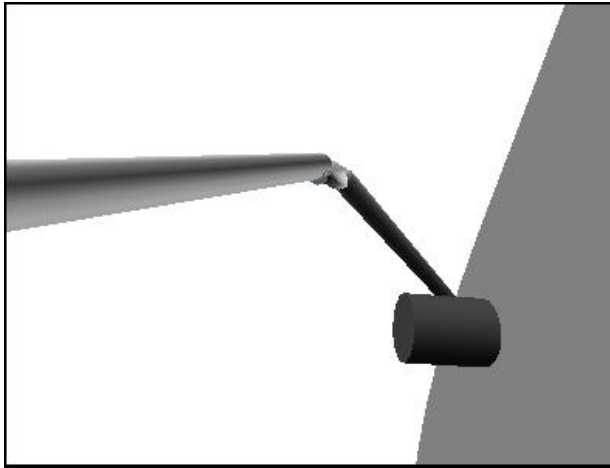

CCTV A (95,10)

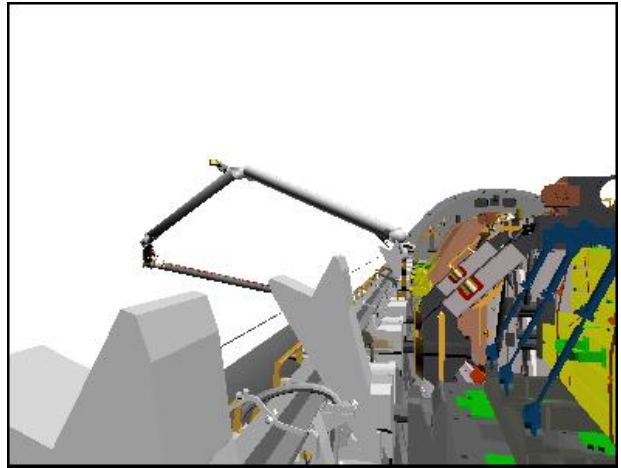

CCTV B (-10,0)

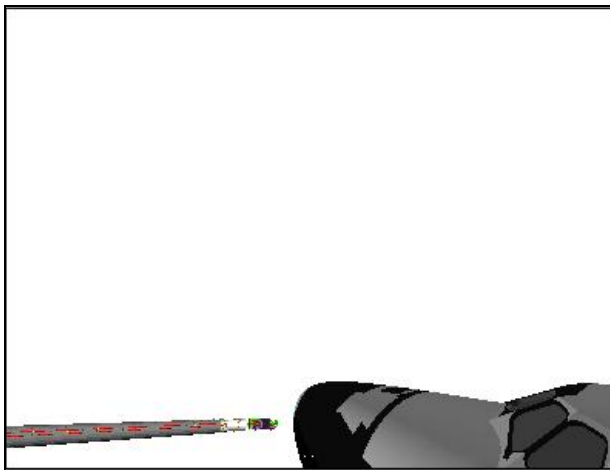

ELBOW (90,-60)

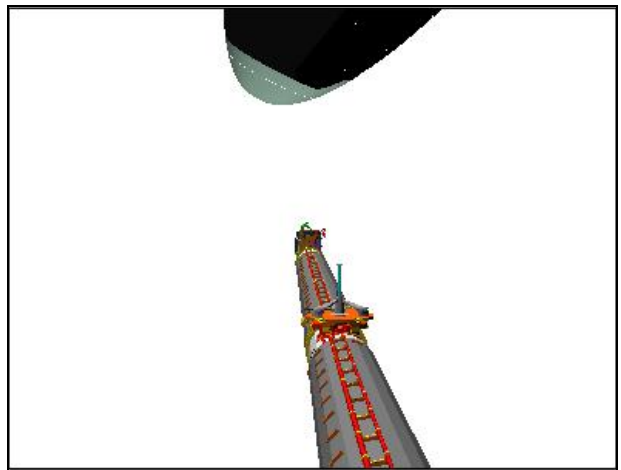

RSC



PORT

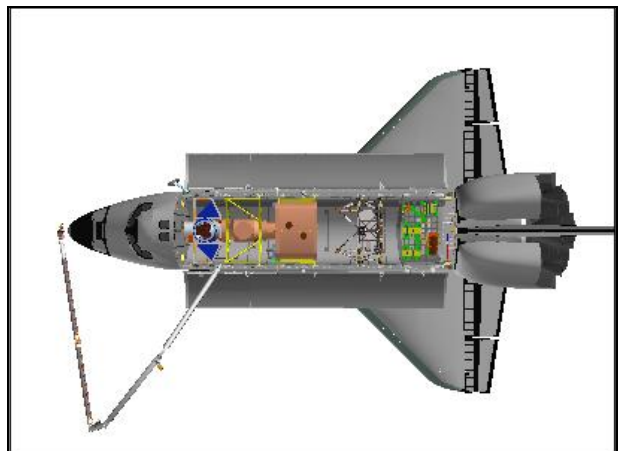

OVERHEAD

NOSE CAP IDC RCC SURVEY – Pause Pt 163

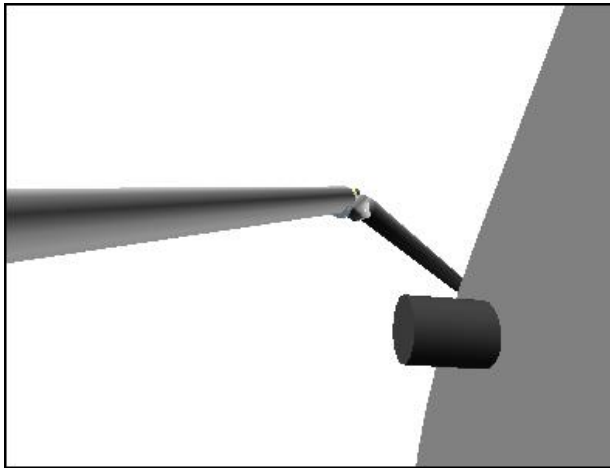

CCTV A (95,10)

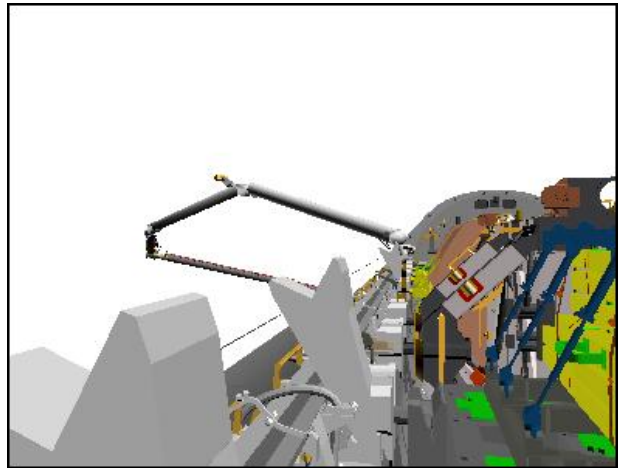

CCTV B (-10,0)

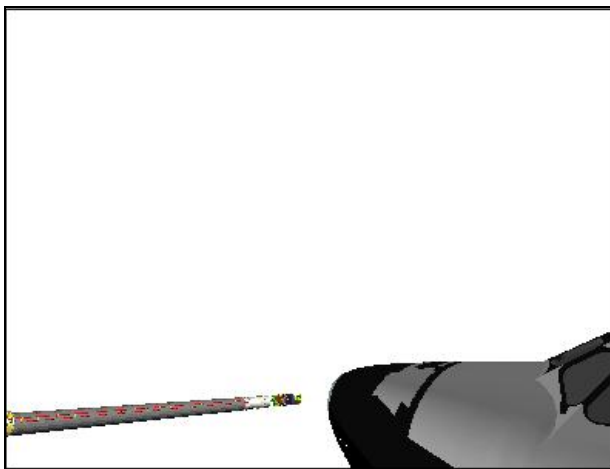

ELBOW (90,-60)

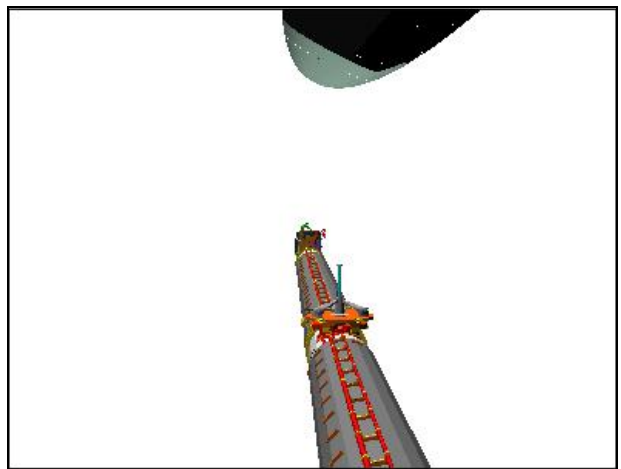

RSC

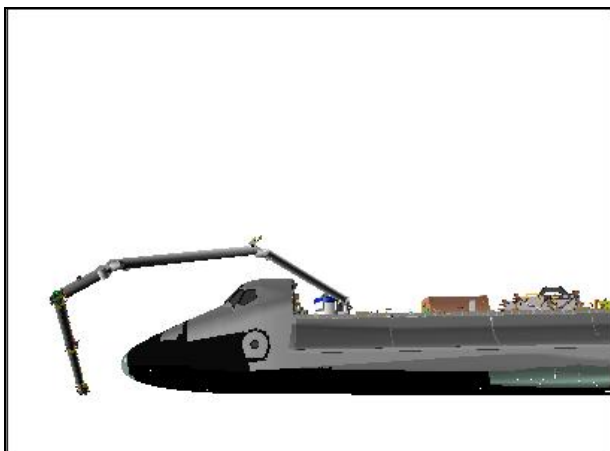

PORT

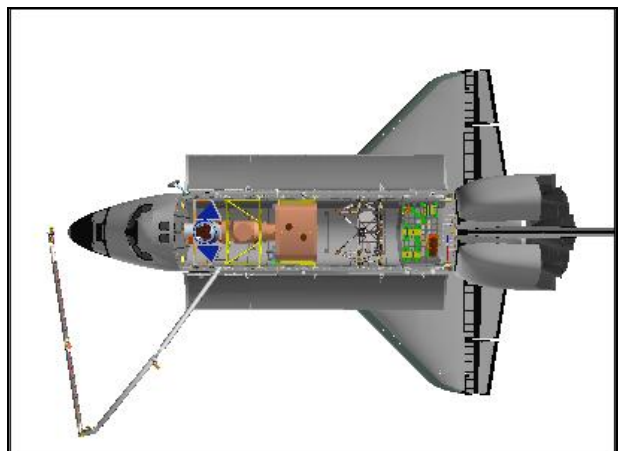

OVERHEAD

NOSE CAP IDC RCC SURVEY – Pause Pt 164

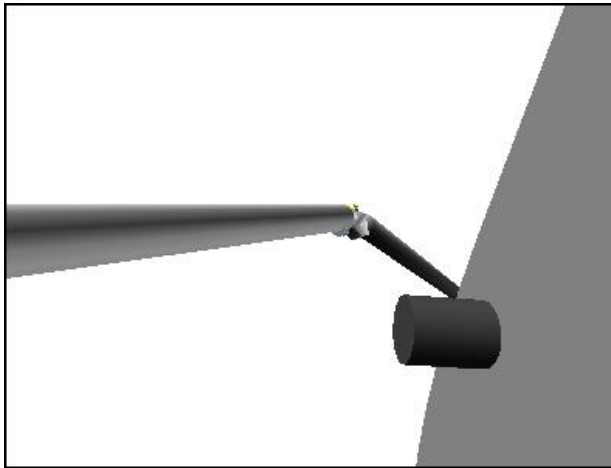

**CCTV A (95,10)**

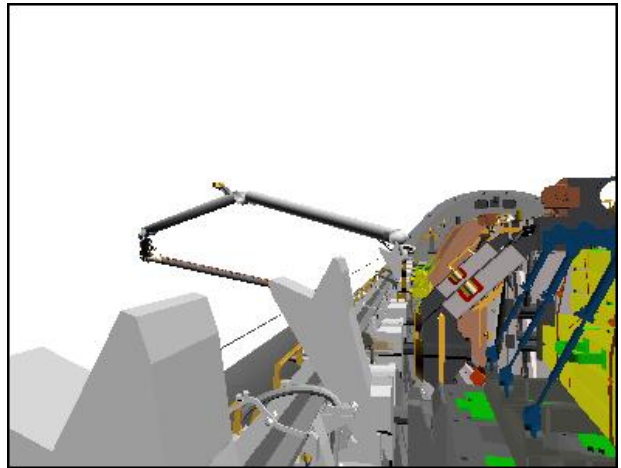

**CCTV B (-10,0)**

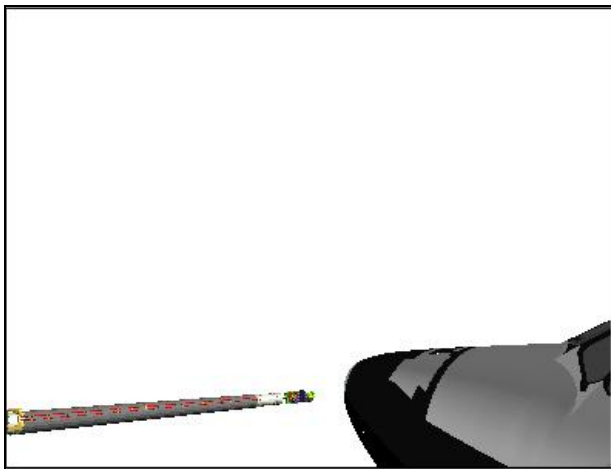

**ELBOW (90,-60)**

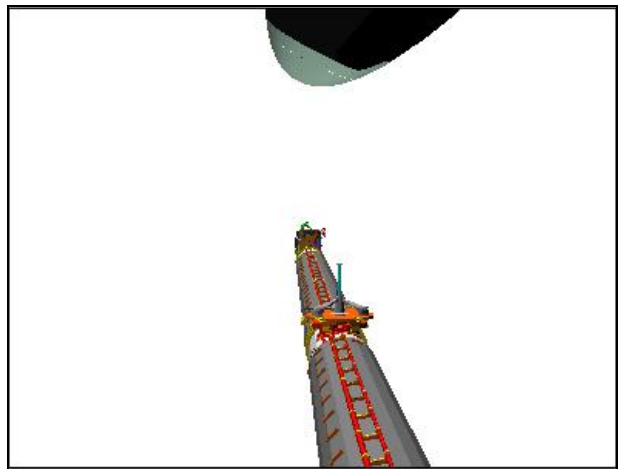

**RSC**



**PORT**

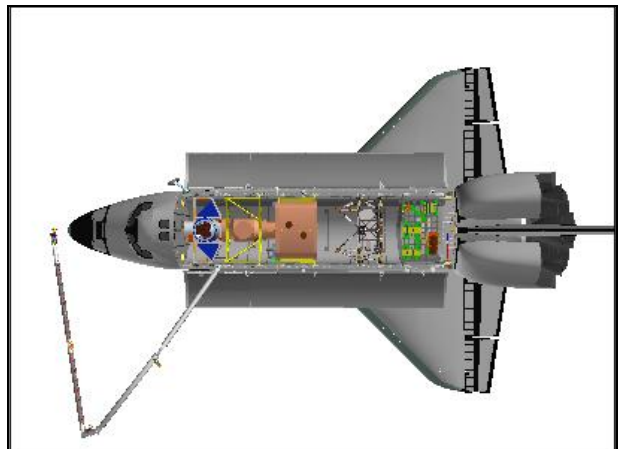

**OVERHEAD**

# OBSS IDC RCC SURVEY CAMERA VIEWS – PORT

PORT IDC RCC SURVEY – Pause Pt 165

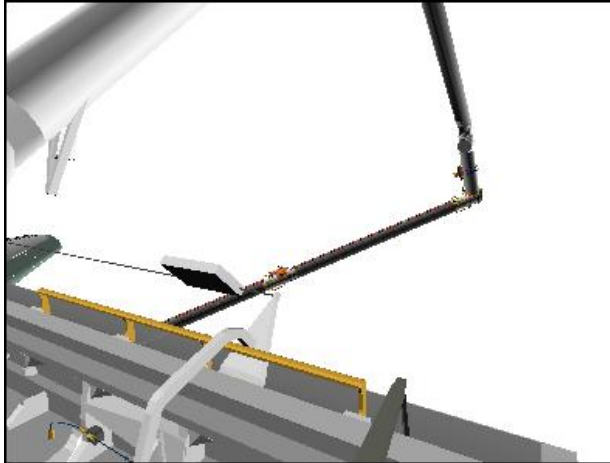

CCTV A (60,-10)

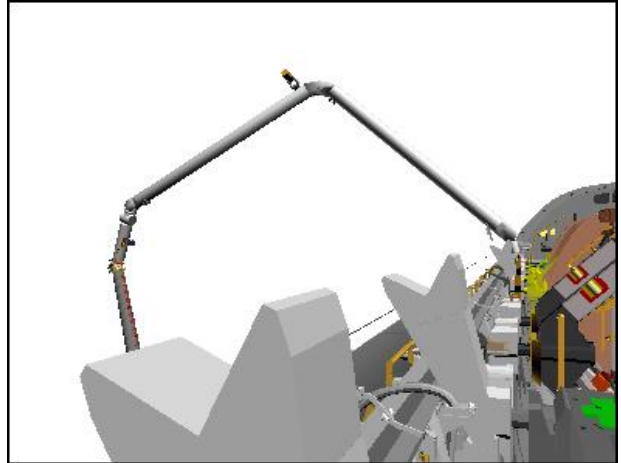

CCTV B (-20,0)

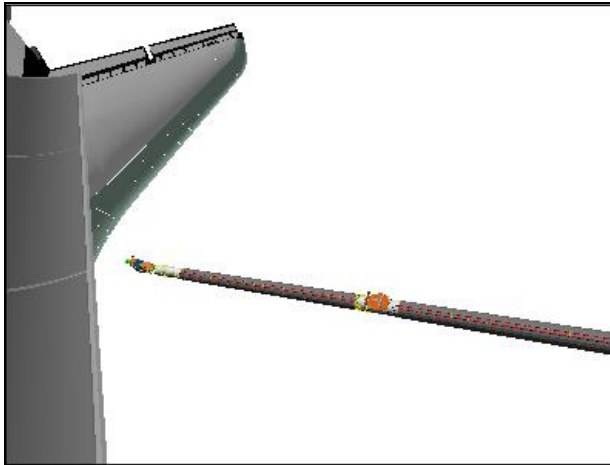

ELBOW (-60,0)

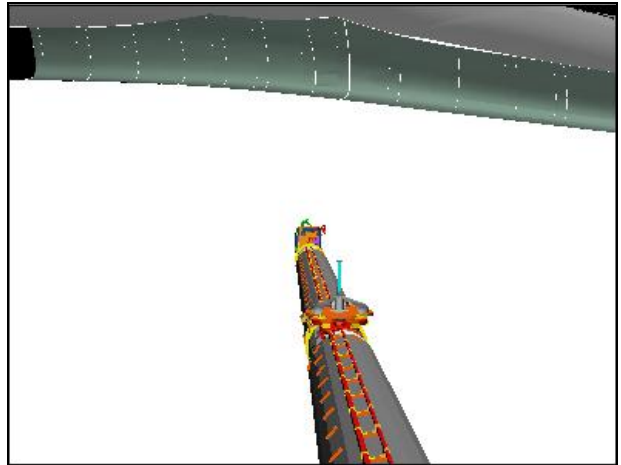

RSC

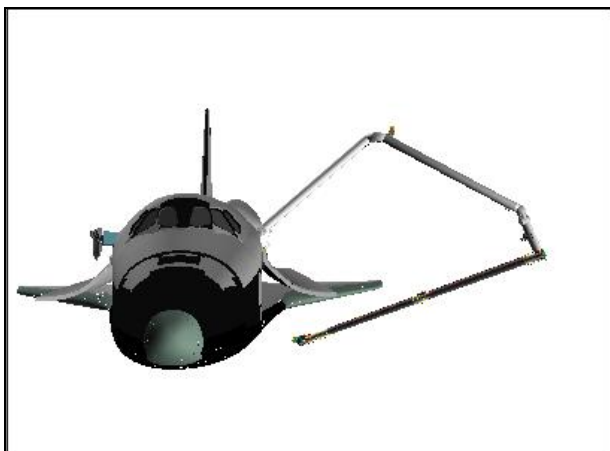

FRONT

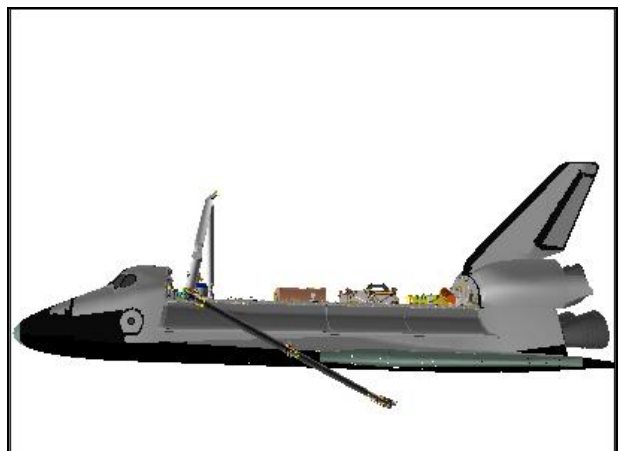

PORT

PORT IDC RCC SURVEY – Pause Pt 167

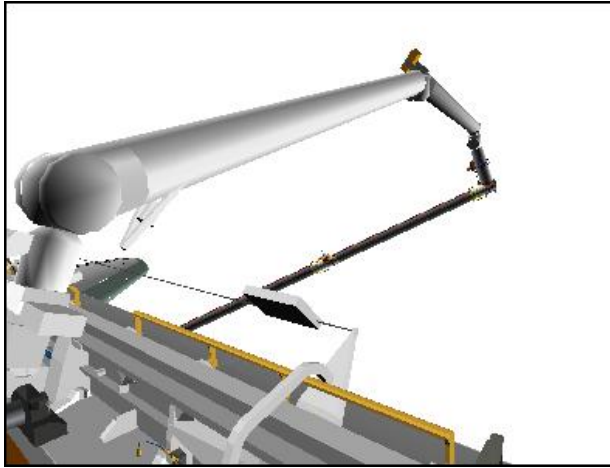

CCTV A (50,-6)

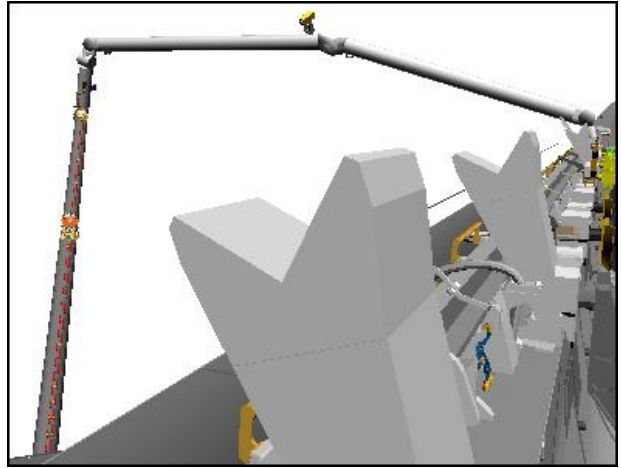

CCTV B (-26,-11)

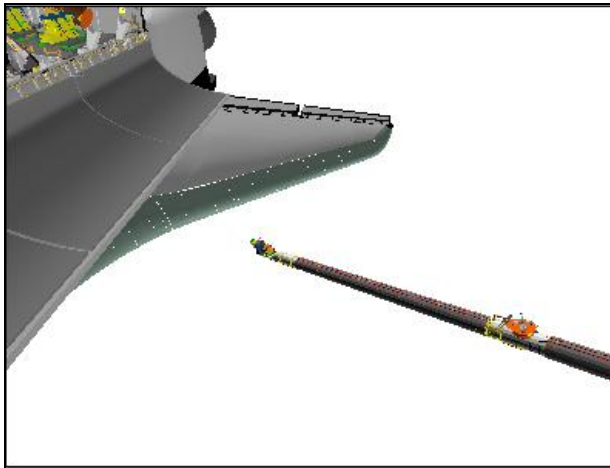

ELBOW (-83,4)

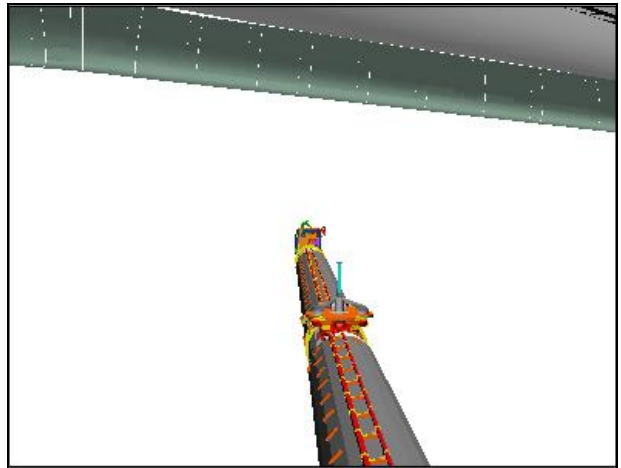

RSC

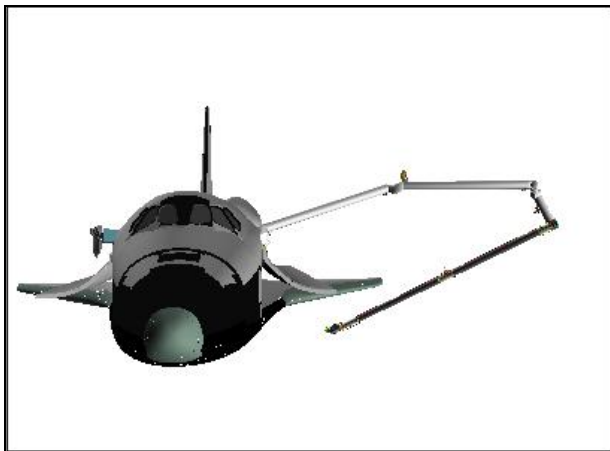

FRONT

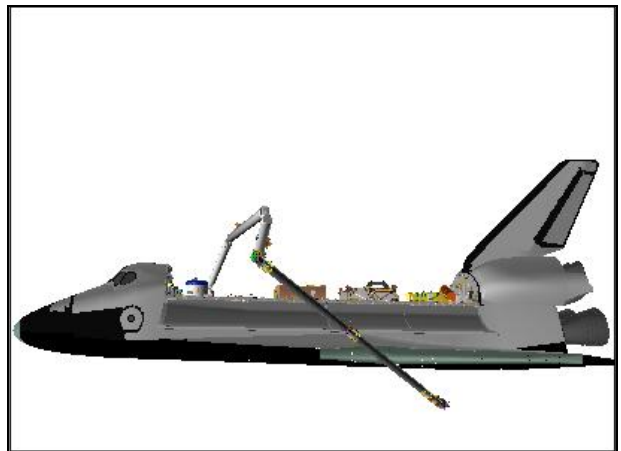

PORT

PORT IDC RCC SURVEY – Pause Pt 168

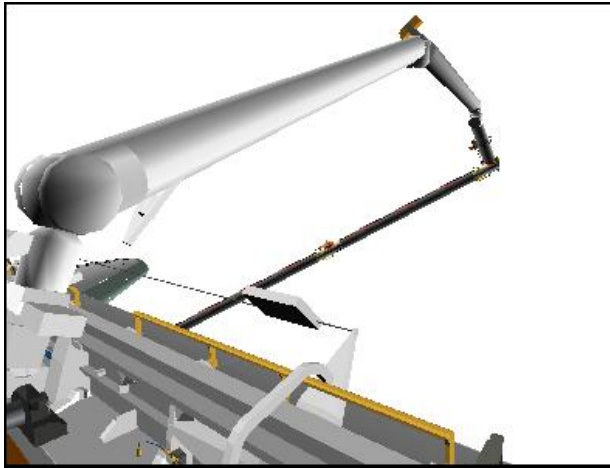

CCTV A (50,-6)

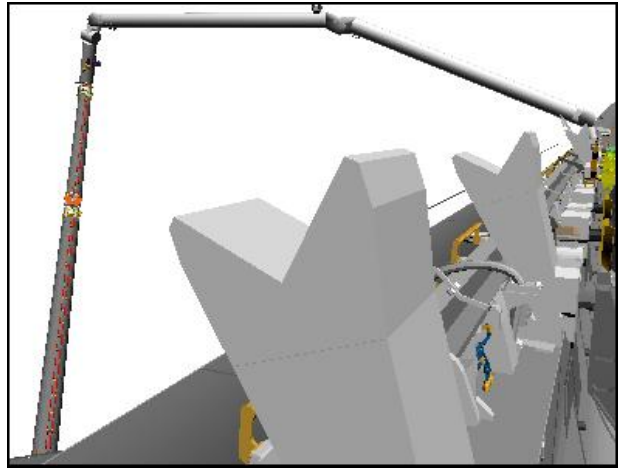

CCTV B (-26,-11)

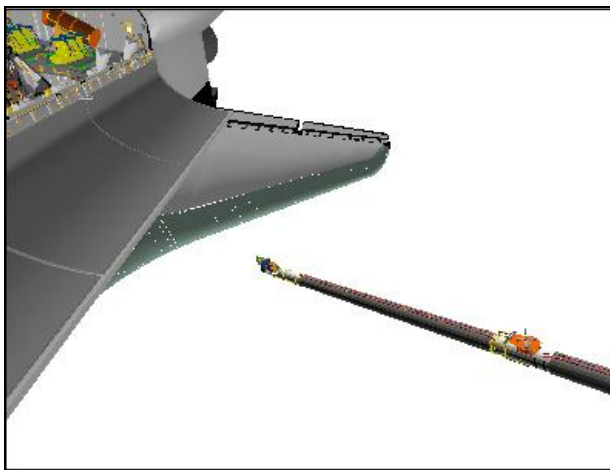

ELBOW (-83,4)

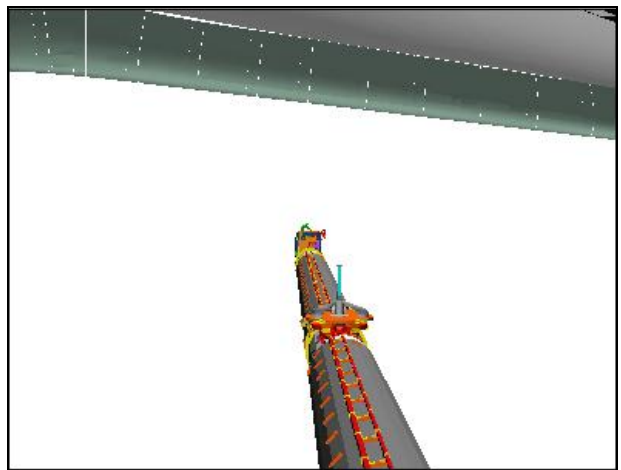

RSC

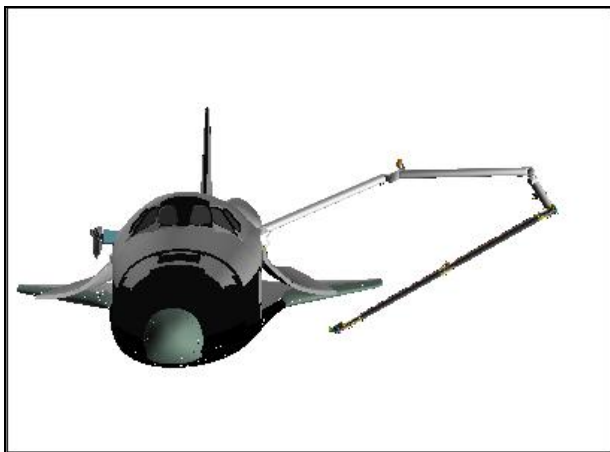

FRONT

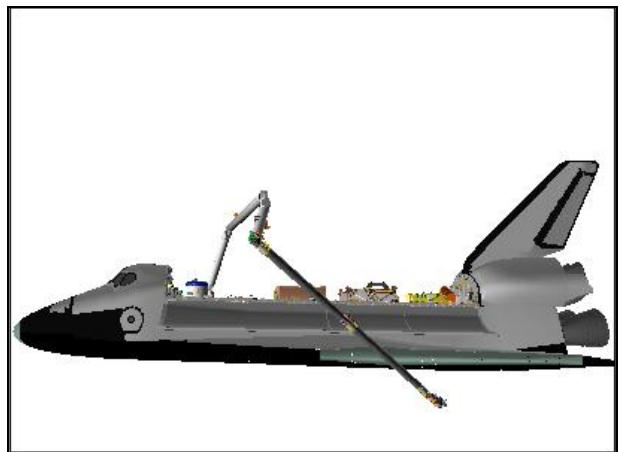

PORT

PORT IDC RCC SURVEY – Pause Pt 170

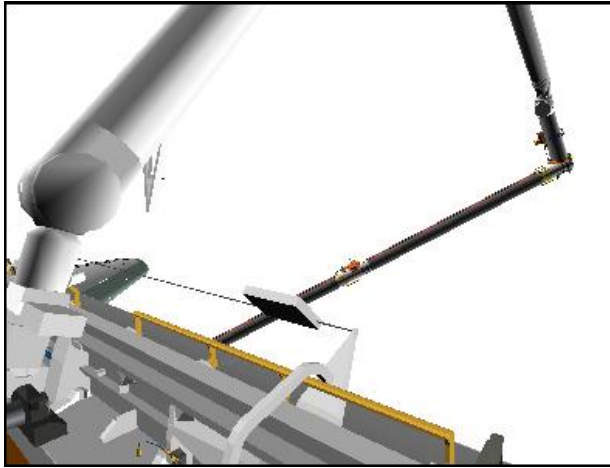

CCTV A (50,-6)

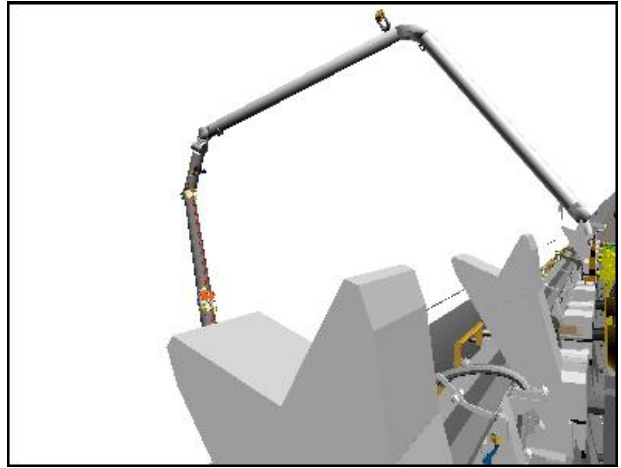

CCTV B (-26,-2)

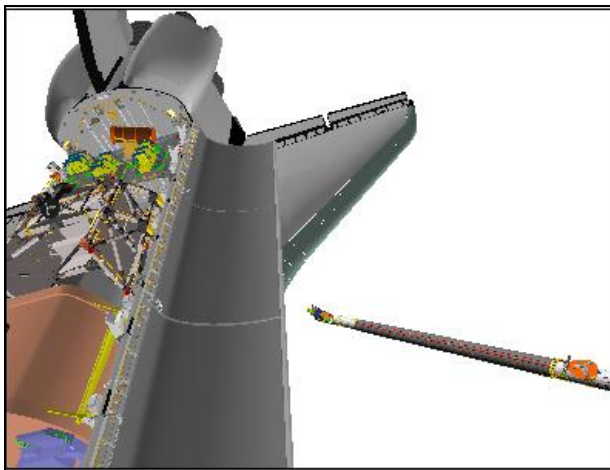

ELBOW (-83,4)

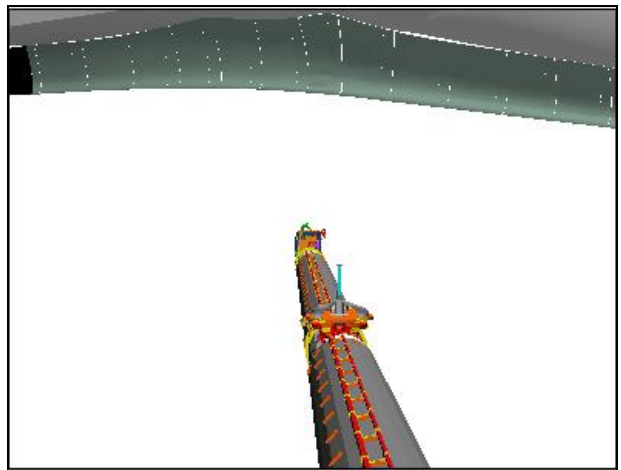

RSC

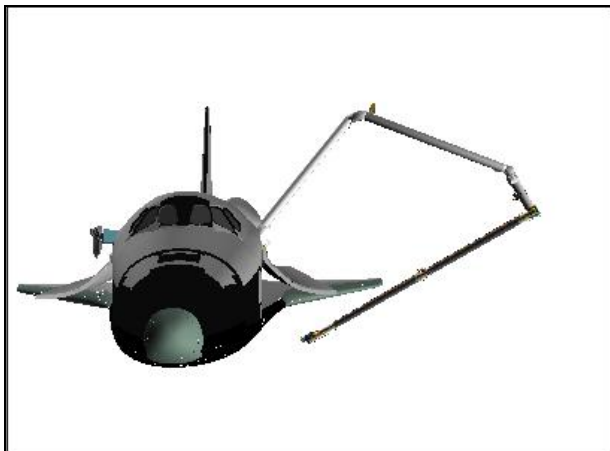

FRONT

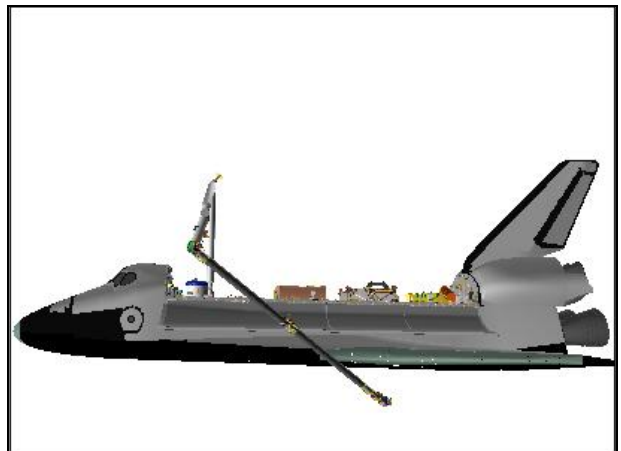

PORT

PORT IDC RCC SURVEY – Pause Pt 171

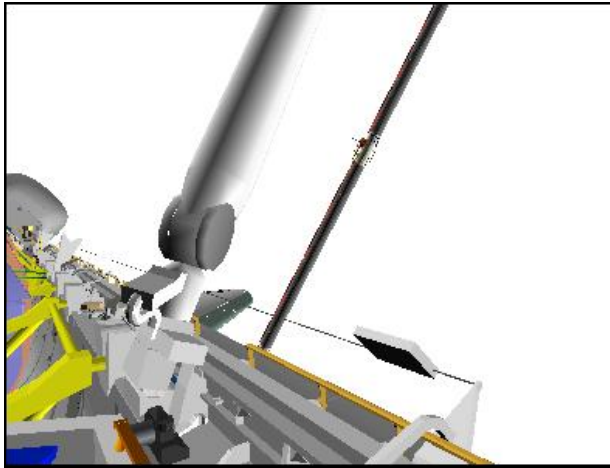

CCTV A (36,-1)

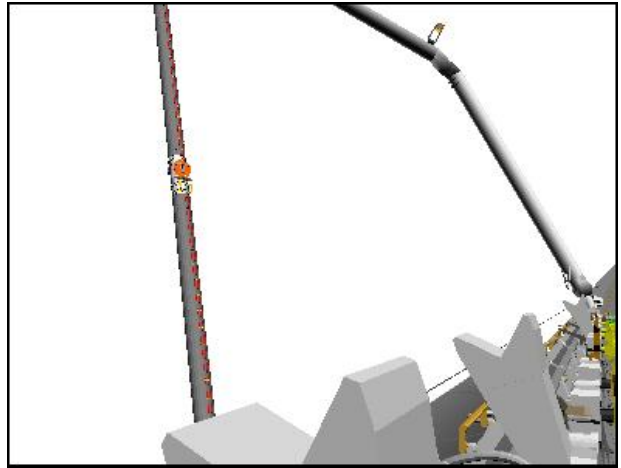

CCTV B (-26,5)

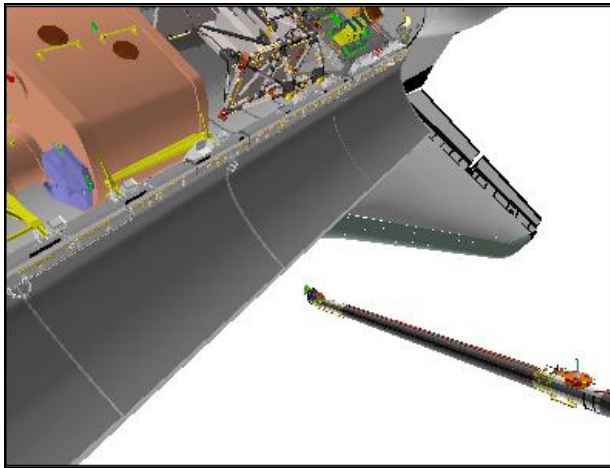

ELBOW (-93,-31)

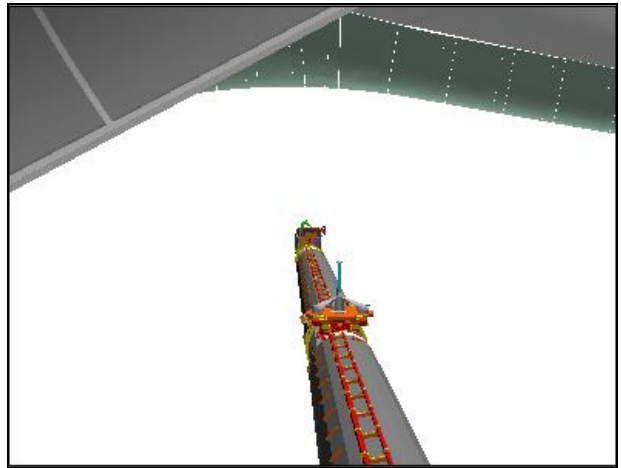

RSC

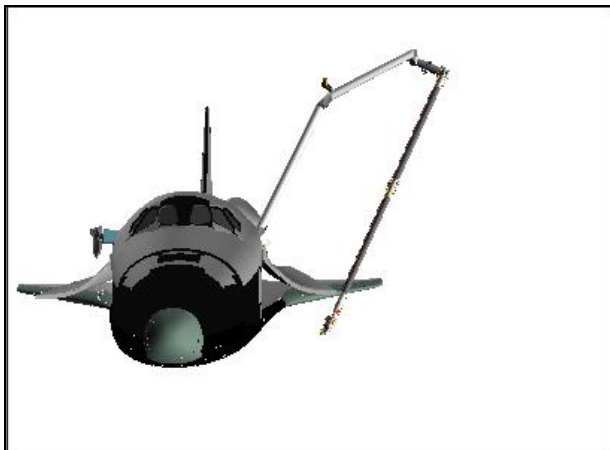

FRONT

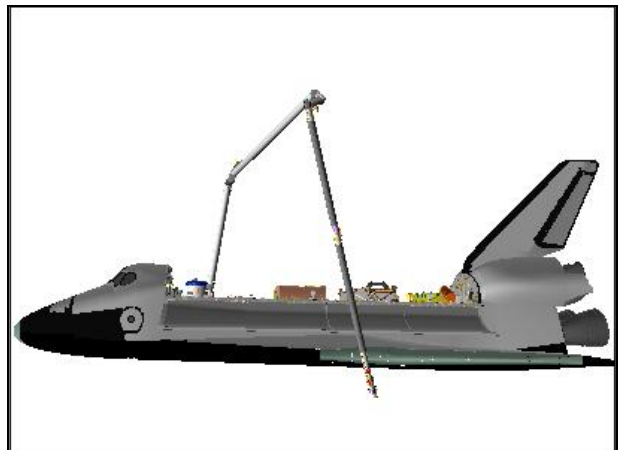

PORT



PORT IDC RCC SURVEY – Pause Pt 174

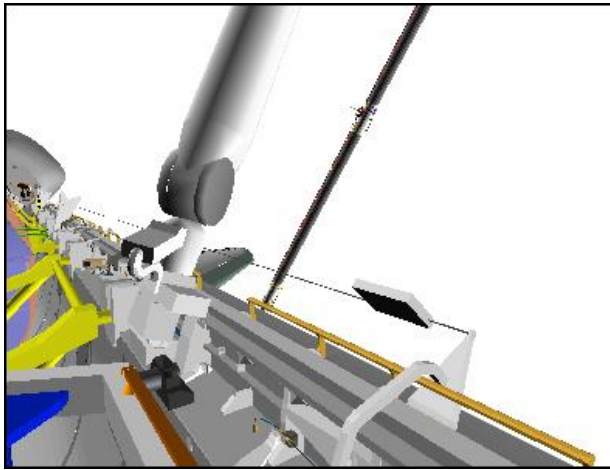

**CCTV A (36,-7)**

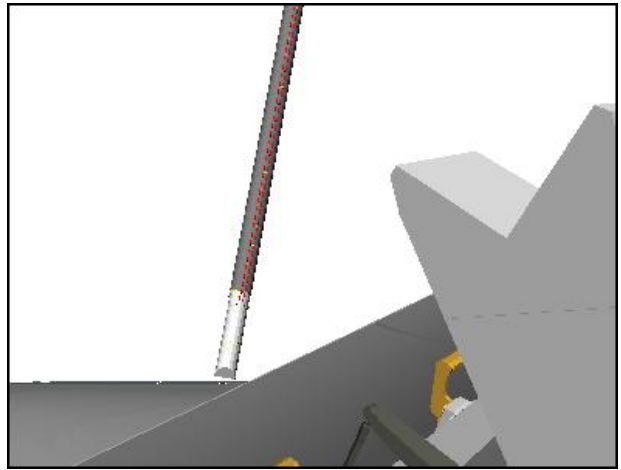

**CCTV B (-43,-15)**

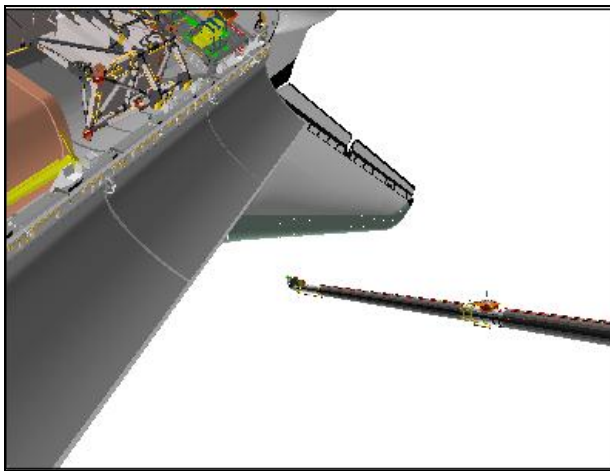

**ELBOW (-73,-31)**

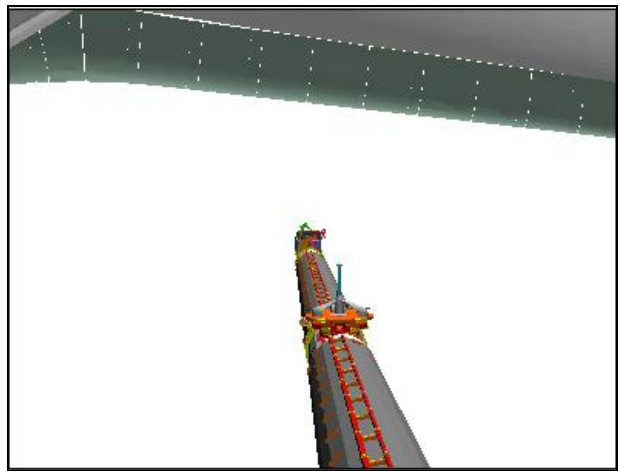

**RSC**

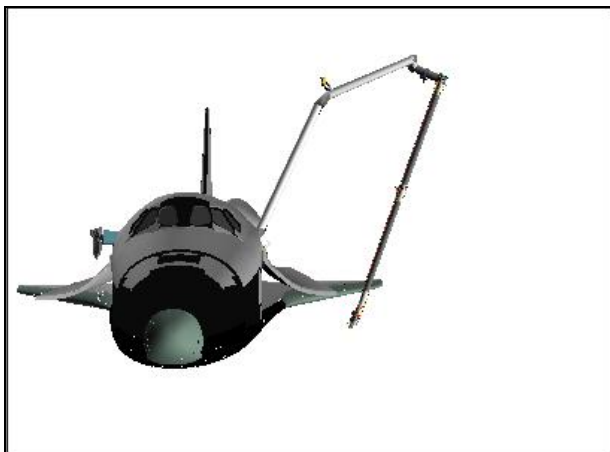

**FRONT**

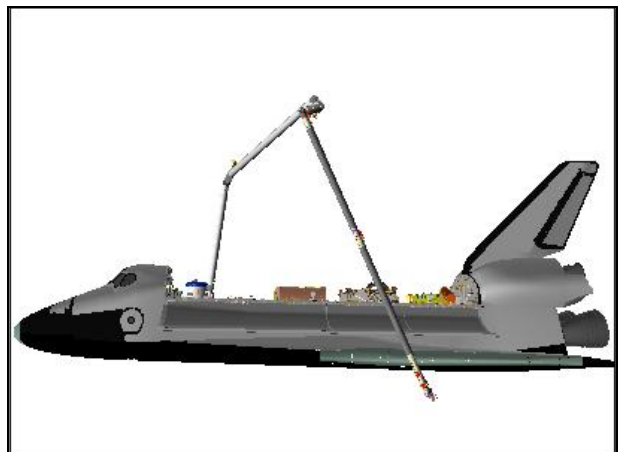

**PORT**

PORT IDC RCC SURVEY – Pause Pt 177

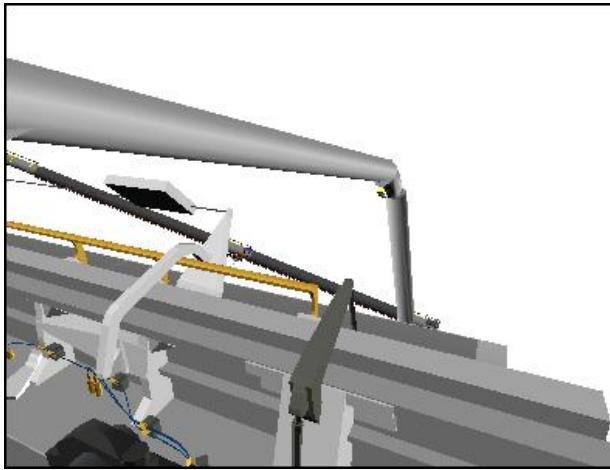

CCTV A (66,-21)



CCTV B (-53,-15)

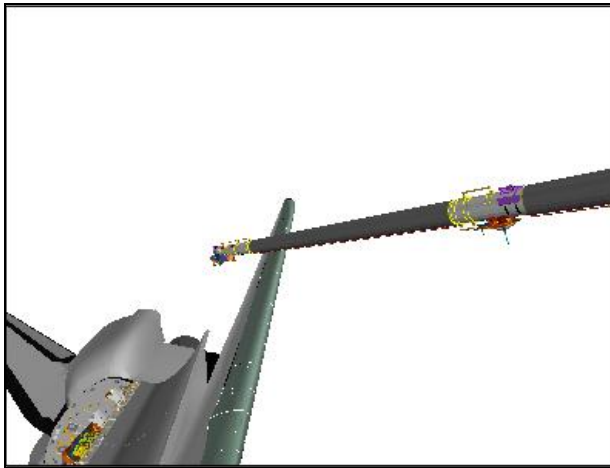

ELBOW (-83,39)

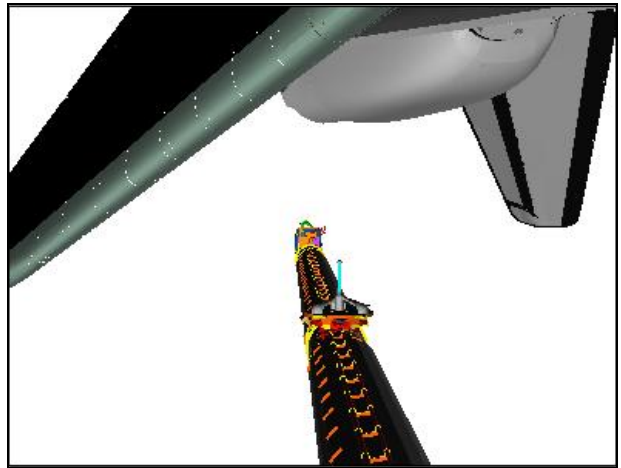

RSC



PORT

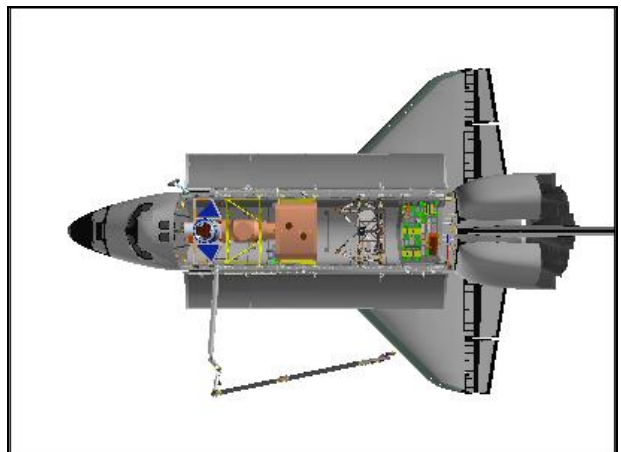

OVERHEAD

PORT IDC RCC SURVEY – Pause Pt 179

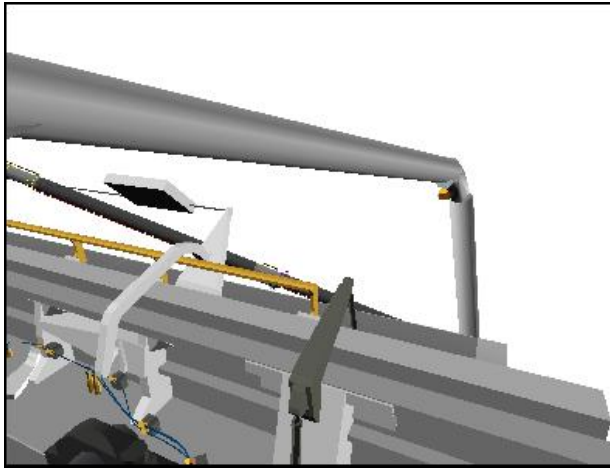

**CCTV A (66,-21)**



**CCTV B (-53,-15)**

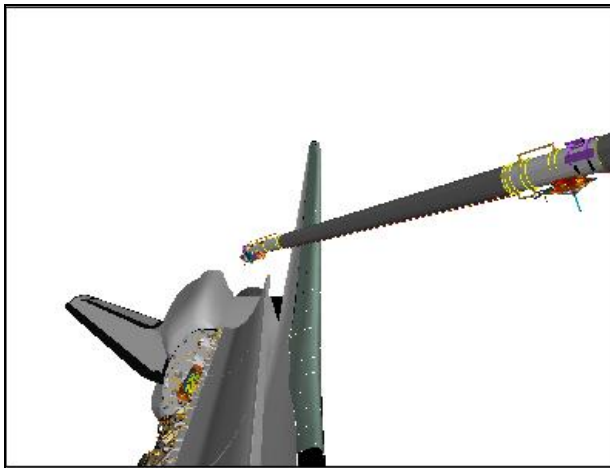

**ELBOW (-95,23)**

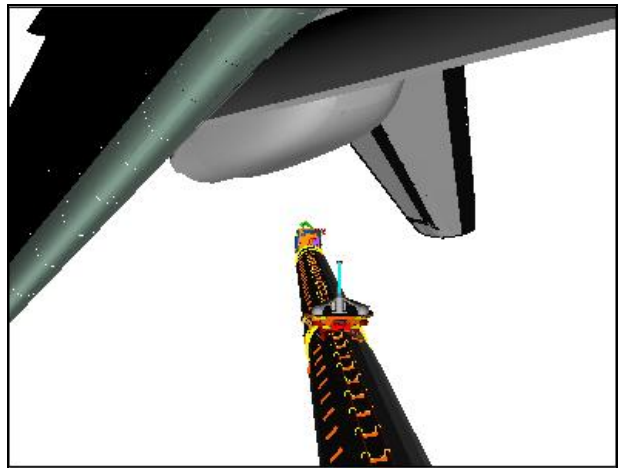

**RSC**



**PORT**

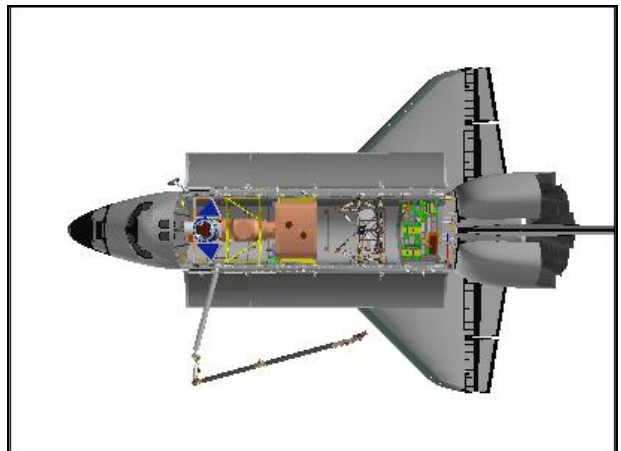

**OVERHEAD**

PORT IDC RCC SURVEY – Pause Pt 180

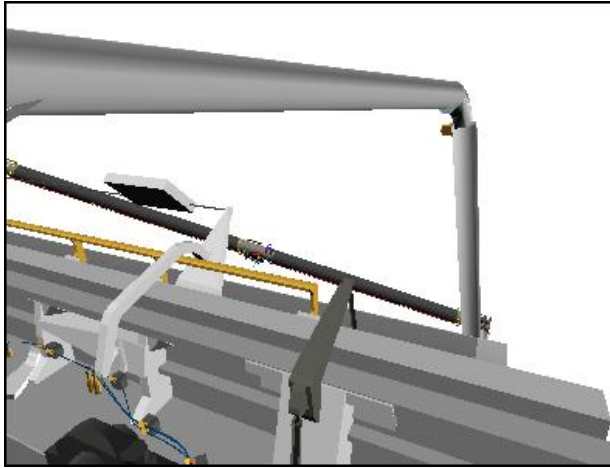

CCTV A (66,-21)



CCTV B (-53,-15)

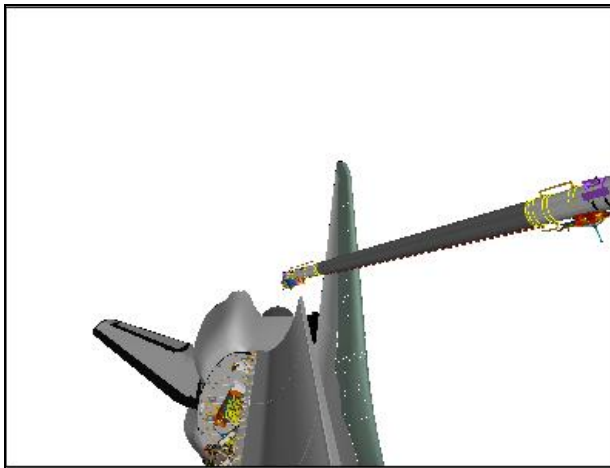

ELBOW (-95,25)

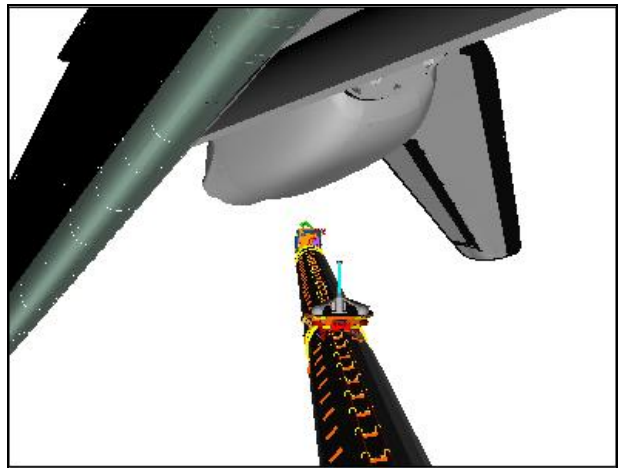

RSC



PORT

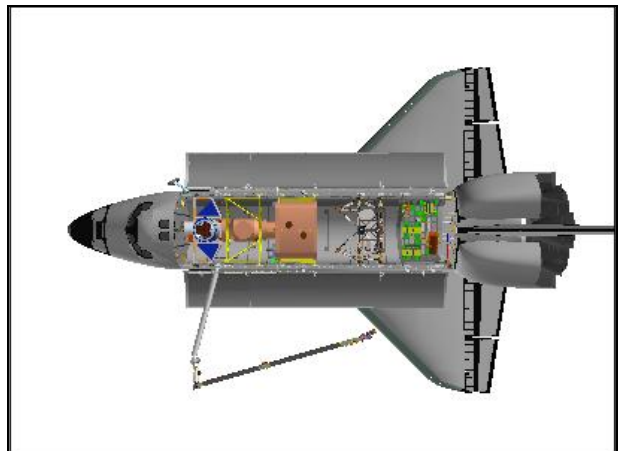

OVERHEAD

PORT IDC RCC SURVEY – Pause Pt 182

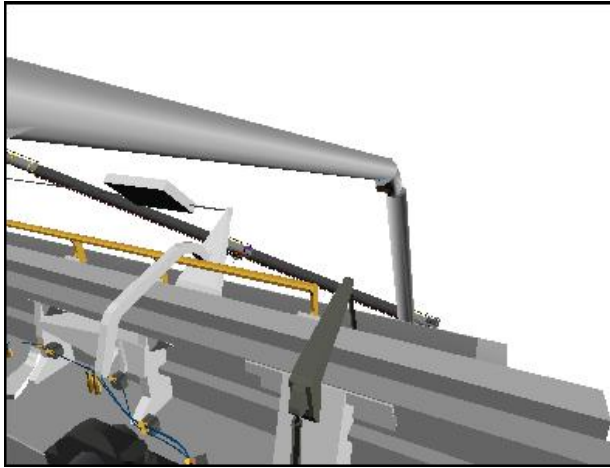

CCTV A (66,-21)



CCTV B (-53,-15)

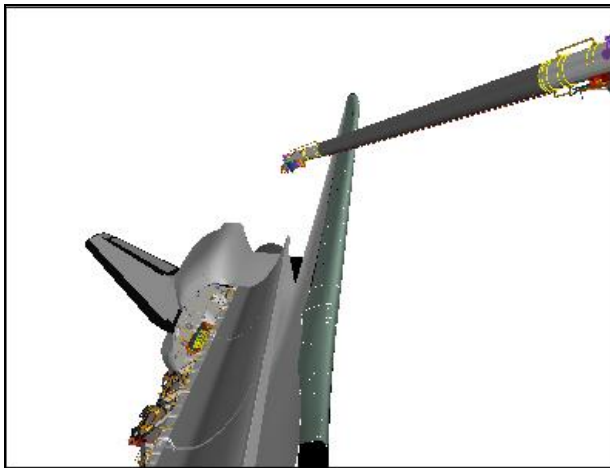

ELBOW (-95,25)

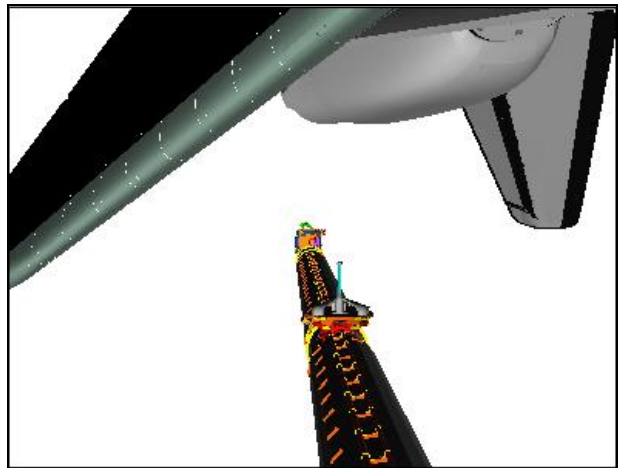

RSC

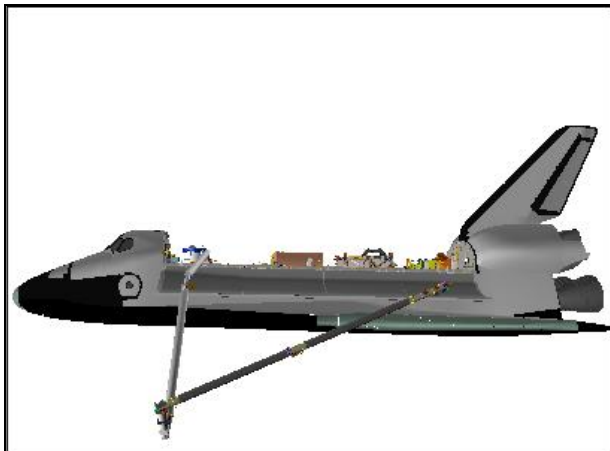

PORT

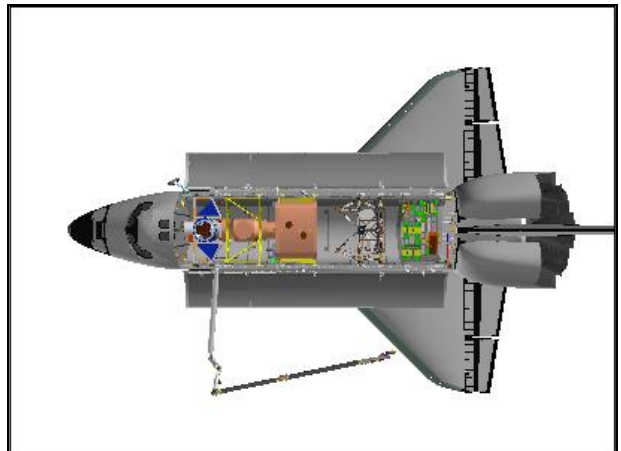

OVERHEAD

This Page Intentionally Blank

OBSS REFERENCE DATA

OBSS JOINT ANGLES VS POR COORDINATES .....	FS 11-2
AUTO SEQUENCES .....	FS 11-6
COORDINATE SYSTEM – PL ID 1 .....	FS 11-16
2 .....	FS 11-17
3 .....	FS 11-18
5 (UPLINK).....	FS 11-19
GO/NO-GO CRITERIA .....	FS 11-20
ATTITUDE CONTROL CONSTRAINTS .....	FS 11-21
SRMS EE CAM SURVEYS JOINT ANGLES VS POR COORDINATES.....	FS 11-22
CREW CABIN SURVEY AUTO SEQUENCES.....	FS 11-23
RCC WING SURVEY COORDINATE SYSTEM – PL ID 5 (UPLINK) .....	FS 11-24

**OBSS  
REF DATA**

## OBSS JOINT ANGLES VS POR COORDINATES

### OBSS PRE-GRAPPLE

SY	SP	EP	WP	WY	WR
-90.0	+87.6	-129.5	-57.5	0.0	+110.4

X	Y	Z	PITCH	YAW	ROLL	PL ID
-680	+96	-513	270	350	1	0
-680	+95	-495	0	0	340	1
-998	+95	-505	0	0	10	2
-1271	+92	-510	0	0	10	3

### OBSS GRAPPLE/BERTH (Expected Values)

SY	SP	EP	WP	WY	WR
-90.0	+76.5	-134.6	-40.9	0.0	+110.0

X	Y	Z	PITCH	YAW	ROLL	PL ID
-680	+106	-454	270	350	1	0
-680	+105	-435	0	0	341	1
-998	+108	-446	0	0	11	2
-1271	+106	-451	0	0	11	3

### OBSS HOVER

SY	SP	EP	WP	WY	WR
-89.8	+80.0	-123.3	-55.2	-0.5	+109.8

X	Y	Z	PITCH	YAW	ROLL	PL ID
-680	+127	-514	270	349	0	0
-680	+126	-496	0	0	341	1
-998	+129	-504	0	0	11	2
-1271	+128	-506	0	0	11	3

### FLAT FIELD START

SY	SP	EP	WP	WY	WR
-89.6	+44.5	-84.6	-45.4	0.0	+109.6

X	Y	Z	PITCH	YAW	ROLL	PL ID
-682	+300	-508	270	336	1	0
-682	+303	-490	0	0	354	1
-1001	+303	-501	0	0	24	2
-1273	+300	-505	0	0	24	3

### OBSS SJ PRE-GRAPPLE

SY	SP	EP	WP	WY	WR
-90.0	+87.9	-129.8	-57.0	0.0	+110.0

X	Y	Z	PITCH	YAW	ROLL	PL ID
-680	+96	-513	270	349	1	0
-680	+94	-495	0	0	341	1
-998	+97	-506	0	0	11	2
-1271	+95	-510	0	0	11	3

OBSS  
REF DATA



## STBD LDRI ACAS START

SY	SP	EP	WP	WY	WR
-126.0	+38.1	-54.2	-16.7	+25.9	+166.4

X	Y	Z	PITCH	YAW	ROLL	PL ID
-389	+294	-631	242	281	11	0
-385	+310	-625	322	2	49	1
-639	+291	-434	322	2	79	2
-854	+276	-266	322	2	79	3

## NOSE CAP LDRI ACAS START

SY	SP	EP	WP	WY	WR
+156.6	+48.8	-19.1	-47.9	-9.1	+162.6

X	Y	Z	PITCH	YAW	ROLL	PL ID
-244	-396	-666	210	23	295	0
-233	-405	-655	260	303	285	1
-208	-132	-492	260	303	315	2
-187	+98	-348	260	303	315	3

## NOSE JET CLEAR POSN

SY	SP	EP	WP	WY	WR
+128.8	+30.3	-28.5	-2.0	+35.0	0.0

X	Y	Z	PITCH	YAW	ROLL	PL ID
-303	-547	-434	186	15	140	0
-285	-548	-435	83	39	170	1
-325	-748	-680	83	39	200	2
-355	-916	-892	83	39	200	3

## PORT LDRI ACAS START

SY	SP	EP	WP	WY	WR
+138.8	+24.6	-61.2	+36.9	-67.4	-74.2

X	Y	Z	PITCH	YAW	ROLL	PL ID
-340	-433	-265	315	63	314	0
-346	-450	-264	2	341	259	1
-643	-336	-272	2	341	289	2
-899	-243	-284	2	341	289	3

## STBD IDC ACAS START

SY	SP	EP	WP	WY	WR
-13.2	+71.3	-76.1	+103.5	-64.8	+280.8

X	Y	Z	PITCH	YAW	ROLL	PL ID
-1016	-71	-734	111	317	274	0
-1007	-60	-744	286	313	56	1
-1074	+168	-532	286	313	86	2
-1126	+365	-350	286	313	86	3
-1123	+334	-374	292	43	266	5

NOSE CAP IDC 1 ACAS START

SY	SP	EP	WP	WY	WR
-125.3	+127.0	-109.0	+31.6	-31.3	+242.7

X	Y	Z	PITCH	YAW	ROLL	PL ID
-564	-117	-808	138	4	350	0
-551	-123	-819	227	349	326	1
-347	-58	-583	227	349	356	2
-169	-7	-383	227	349	356	3
-198	-11	-408	318	356	191	5

NOSE CAP IDC 2 ACAS START

SY	SP	EP	WP	WY	WR
+128.3	+137.2	-118.5	+12.7	+13.1	+155.8

X	Y	Z	PITCH	YAW	ROLL	PL ID
-581	-309	-700	156	41	324	0
-570	-323	-702	220	333	283	1
-359	-170	-519	220	333	313	2
-177	-45	-359	220	333	313	3
-205	-57	-383	336	319	217	5

PORT IDC ACAS START

SY	SP	EP	WP	WY	WR
+91.2	+60.1	-68.1	-41.3	+6.8	-116.8

X	Y	Z	PITCH	YAW	ROLL	PL ID
-663	-578	-412	262	21	318	0
-664	-588	-397	334	321	302	1
-882	-378	-296	333	320	332	2
-1072	-204	-206	334	321	332	3
-1043	-224	-223	82	339	223	5

OBSS PRE-GRAPPLE AT HANDOFF

SY	SP	EP	WP	WY	WR
-33.3	+80.0	-90.0	-77.3	+23.8	-39.8

X	Y	Z	PITCH	YAW	ROLL	PL ID
-966	-1	-625	285	0	271	0
-975	-1	-610	45	270	0	1
-967	+317	-621	15	270	0	2
-967	+590	-628	15	270	0	3

\*  
\*  
\*

\*display singularity

OBSS HANDOFF (Expected Values)

SY	SP	EP	WP	WY	WR
-28.4	+75.5	-98.1	-62.5	+23.6	-45.1

X	Y	Z	PITCH	YAW	ROLL	PL ID
-984	-1	-558	285	0	271	0
-993	-1	-543	45	270	0	1
-986	+318	-554	15	270	0	2
-986	+590	-561	15	270	0	3

\*  
\*  
\*

\*display singularity

OBSS JETTISON

SY	SP	EP	WP	WY	WR
-22.5	+40.0	-25.0	+5.0	0.0	0.0

X	Y	Z	PITCH	YAW	ROLL	PL ID
-1172	-3	-758	27	347	7	0
-1188	-3	-765	116	7	343	1
-1042	-37	-1046	116	7	13	2
-922	-69	-1289	116	7	13	3

OBSS JETTISON WITH MPM

SY	SP	EP	WP	WY	WR
-29.5	+66.7	-68.5	+26.8	+18.9	-9.9

X	Y	Z	PITCH	YAW	ROLL	PL ID
-1078	-1	-754	25	0	1	0
-1094	-5	-761	115	0	330	1
-950	0	-1045	115	0	0	2
-830	-2	-1290	115	0	0	3

## OBSS AUTO SEQUENCES

### OBSS LDRI RCC SURVEY – STBD (PL ID 3)

Auto Seq ID	Auto posn	X/ SY	Y/ SP	Z/ EP	PITCH/ WP	YAW/ WY	ROLL/ WR	Pause
1	1	-854	+276	-266	322	2	79	P
		-126.0	+38.1	-54.2	-16.7	+25.9	+166.4	
1	2	-941	+276	-261	322	2	73	
		-116.2	+49.3	-73.4	-10.6	+12.9	+161.9	
1	3	-1021	+282	-277	322	359	82	
		-107.6	+61.5	-89.7	+2.7	+10.2	+155.2	
1	4	-1228	+486	-281	326	354	69	
		-81.3	+23.0	-39.2	-19.8	-23.5	+135.5	
1	5	-1255	+502	-281	326	352	67	P
		-77.8	+22.1	-37.2	-23.0	-28.8	+131.8	
1	6	-1255	+502	-220	346	352	67	
		-87.2	+6.0	-61.2	+14.4	-14.8	+118.2	
1	7	-1358	+477	-220	346	347	16	P
		-71.2	+13.6	-64.0	-48.2	-15.1	+81.9	
1	8	-1316	+463	-220	346	347	16	
		-76.3	+18.3	-73.9	-41.6	-15.8	+87.2	
1	9	-1294	+464	-222	346	347	19	
		-79.3	+19.6	-76.6	-36.5	-17.1	+91.1	
1	10	-1061	+218	-201	334	12	22	
		-105.5	+27.8	-69.2	-39.9	-18.0	+147.3	
1	11	-1004	+200	-205	332	20	27	
		-107.1	+10.3	-36.1	-52.7	-13.6	+157.7	
1	12	-930	+220	-225	323	19	54	P
		-110.5	+9.7	-18.2	-49.6	+2.6	+167.7	
1	13	-1012	+246	-228	325	14	55	
		-105.0	+27.9	-52.3	-30.2	-1.0	+158.6	
1	14	-1016	+245	-221	309	13	38	
		-89.4	+26.9	-27.7	-64.2	-32.0	+153.2	
1	15	-1252	+472	-233	337	343	30	
		-78.0	+38.5	-88.8	-32.9	-30.3	+94.0	
1	16	-1281	+497	-240	338	341	38	
		-73.3	+36.6	-87.6	-26.6	-33.8	+90.8	
1	17	-1335	+540	-282	336	335	71	P
		-60.7	+40.2	-87.7	+3.1	-53.8	+104.2	
1	18	-1279	+527	-325	325	351	93	
		-76.3	+12.9	-16.5	-8.8	-19.0	+142.7	
1	19	-1227	+502	-300	329	344	74	
		-78.9	+45.3	-79.4	+6.0	-31.6	+132.0	
1	20	-1031	+303	-290	321	356	76	
		-104.2	+65.3	-89.6	-3.1	+0.8	+154.3	
1	21	-1002	+276	-288	329	8	85	
		-112.7	+35.4	-62.8	-3.4	+24.1	+153.1	
1	22	-915	+271	-282	311	10	81	P
		-106.3	+26.5	-20.3	-40.1	+13.3	+168.8	
1	23	-906	+285	-304	294	359	84	P
		-90.9	+52.8	-37.4	-36.5	-5.1	+176.2	
1	24	-733	+285	-299	289	357	84	
		-107.2	+48.7	-27.1	-40.4	+9.6	+186.5	

OBSS LDRI RCC SURVEY – STBD (PL ID 3) (Cont)

Auto Seq ID	Auto posn	X/ SY	Y/ SP	Z/ EP	PITCH/ WP	YAW/ WY	ROLL/ WR	Pause
1	25	-686	+288	-320	276	354	86	
		-96.8	+51.1	-20.0	-45.0	+2.0	+195.7	
1	26	-562	+299	-343	266	350	87	P
		-100.7	+54.1	-19.5	-43.9	+8.3	+205.7	
1	27	-563	+286	-369	266	343	86	
		-103.2	+75.8	-45.1	-33.0	+10.3	+204.4	
1	28	-678	+286	-373	270	339	86	
		-89.2	+88.1	-59.3	-27.2	-4.8	+200.0	
1	29	-906	+284	-379	294	332	98	
		-84.2	+112.0	-91.7	-10.8	-9.3	+179.9	
1	30	-963	+284	-381	295	322	87	
		-41.1	+124.3	-105.8	+14.5	-63.6	+205.1	
1	31	-1028	+291	-372	302	322	94	
		-36.1	+125.2	-114.6	+28.0	-65.0	+205.9	
1	32	-1051	+299	-359	302	322	92	P
		-32.1	+119.9	-115.1	+41.1	-69.9	+213.7	
1	33	-1047	+290	-358	291	336	83	P
		-50.6	+87.2	-69.6	-16.4	-54.4	+181.0	
1	34	-1235	+453	-381	300	316	97	
		-28.1	+62.8	-68.6	+67.0	-64.2	+231.1	
1	35	-1259	+495	-367	308	333	99	
		-54.4	+51.8	-52.6	+11.2	-44.0	+172.4	
1	36	-1280	+499	-373	305	329	97	
		-46.8	+46.5	-41.7	+12.4	-53.3	+181.9	
1	37	-1325	+515	-370	311	334	101	P
		-52.2	+36.7	-31.6	+5.6	-45.4	+170.0	
1	38	-1347	+480	-395	314	332	103	P
		-47.5	+48.4	-48.5	+15.7	-50.5	+172.2	
1	39	-1303	+474	-393	312	336	98	
		-54.4	+47.5	-42.6	+0.7	-45.1	+165.0	
1	40	-1282	+467	-390	312	337	94	
		-56.7	+50.7	-46.9	-2.9	-45.3	+161.5	
1	41	-1270	+448	-392	311	336	99	
		-55.5	+57.9	-56.3	+4.8	-42.7	+166.4	
1	42	-1077	+264	-408	305	335	94	
		-62.0	+106.0	-88.2	-13.3	-38.6	+170.2	
1	43	-1029	+272	-400	298	347	76	
		-73.5	+70.1	-41.0	-46.1	-34.3	+166.2	
1	44	-1002	+285	-385	305	355	72	
		-89.5	+57.1	-35.0	-48.2	-17.9	+163.0	
1	45	-970	+290	-365	316	4	65	
		-103.8	+30.9	-13.3	-56.7	-3.7	+161.1	
1	46	-875	+288	-365	322	1	69	P
		-120.8	+32.5	-23.7	-45.8	+12.8	+164.7	

OBSS LDRI RCC SURVEY – NOSE CAP (PL ID 3)

Auto Seq ID	Auto posn	X/ SY	Y/ SP	Z/ EP	PITCH/ WP	YAW/ WY	ROLL/ WR	Pause
2	47	-187	+98	-348	260	303	315	P
		+156.6	+48.8	-19.1	-47.9	-9.1	+162.7	
2	48	-160	+58	-371	221	302	274	
		+136.3	+81.8	-80.6	-18.5	-0.5	+149.6	
2	49	-177	+71	-381	227	305	291	P
		+139.9	+91.1	-85.3	-12.6	+2.2	+152.6	
2	50	-185	+27	-425	191	297	287	
		+118.0	+67.6	-87.8	+39.6	+38.0	+120.9	
2	51	-181	+27	-403	154	289	281	P
		+122.9	+15.3	-35.5	+72.8	+34.9	+87.0	
2	52	-182	+7	-414	146	296	273	
		+118.8	+14.5	-45.0	+80.9	+31.0	+83.3	
2	53	-177	+31	-385	220	296	348	
		+127.1	+57.0	-64.0	+66.4	+43.6	+106.8	
2	54	-184	-26	-423	148	309	281	
		+110.0	+18.5	-69.3	+103.9	+22.2	+78.6	
2	55	-170	-65	-369	173	327	275	
		+87.0	+52.1	-124.3	+103.1	+34.4	+96.8	
2	56	-148	-12	-332	169	306	250	P
		+110.3	+39.8	-86.1	+46.6	+33.9	+119.3	
2	57	-155	+38	-300	233	297	309	P
		+134.8	+56.5	-59.7	+0.2	+22.2	+150.9	
2	58	-183	+70	-273	184	282	237	
		+128.7	+19.6	-32.9	-20.0	+22.4	+147.3	
2	59	-209	+27	-228	238	298	266	P
		+133.5	+56.2	-60.2	-32.4	-10.8	+157.6	
2	60	-236	0	-234	217	287	242	P
		+123.1	+25.5	-25.2	-48.5	+2.0	+159.0	
2	61	-235	-35	-244	238	298	267	
		+126.5	+48.5	-40.8	-42.8	-4.4	+161.9	
2	62	-232	-67	-249	222	312	257	P
		+113.5	+82.9	-88.2	-18.1	+1.4	+157.5	
2	63	-191	-58	-267	234	322	268	P
		+138.2	+97.2	-85.8	-26.2	-27.4	+159.0	
2	64	-168	-13	-270	214	303	256	
		+122.6	+66.1	-78.5	-13.9	+3.9	+151.1	
2	65	-161	-40	-287	231	317	283	
		+135.4	+90.3	-83.6	-13.4	-8.7	+159.2	
2	66	-166	-60	-348	189	326	271	P
		+89.3	+89.9	-134.7	+59.6	+34.4	+119.9	
2	67	-179	-70	-381	185	316	280	P
		+96.4	+71.7	-109.3	+63.5	+38.5	+111.1	
2	68	-182	-84	-305	221	320	274	P
		+118.3	+98.2	-94.2	-9.3	+3.9	+154.1	

OBSS LDRI RCC SURVEY – PORT (PL ID 3)

Auto Seq ID	Auto posn	X/ SY	Y/ SP	Z/ EP	PITCH/ WP	YAW/ WY	ROLL/ WR	Pause
3	69	-899	-243	-284	2	341	289	P
		+138.8	+24.6	-61.2	+36.9	-67.4	-74.2	
3	70	-958	-253	-278	2	341	293	
		+132.6	+32.0	-75.1	+35.2	-60.7	-81.4	
3	71	-1023	-277	-267	0	353	308	
		+137.2	+46.0	-105.8	+30.5	-49.2	-95.4	
3	72	-1057	-310	-267	0	356	307	
		+132.8	+48.4	-112.0	+39.0	-43.5	-88.9	
3	73	-1186	-442	-272	0	359	309	
		+104.6	+53.8	-108.0	+34.1	-14.5	-75.6	
3	74	-1265	-509	-274	0	350	309	
		+90.5	+36.5	-61.6	+5.1	-8.3	-76.5	
3	75	-1324	-523	-274	0	348	315	P
		+83.6	+27.0	-40.2	-12.7	-2.7	-75.7	
3	76	-1345	-496	-232	345	352	262	P
		+77.7	+52.1	-81.0	+53.7	+1.4	-89.2	
3	77	-1268	-456	-230	345	352	262	
		+88.0	+59.4	-96.4	+62.1	-7.9	-84.8	
3	78	-1175	-357	-219	345	345	262	
		+101.6	+58.8	-101.1	+67.7	-27.1	-78.2	
3	79	-1134	-315	-218	345	345	262	
		+109.9	+60.7	-108.7	+75.7	-34.5	-73.9	
3	80	-1097	-277	-214	345	345	262	
		+118.3	+60.1	-113.1	+83.9	-41.8	-68.6	
3	81	-1061	-238	-210	345	345	262	
		+127.4	+57.8	-115.3	+93.5	-49.4	-61.5	
3	82	-998	-216	-214	345	345	259	
		+138.2	+51.6	-106.7	+105.8	-56.4	-45.3	
3	83	-972	-211	-216	345	345	259	
		+141.7	+49.1	-101.8	+107.8	-58.5	-40.2	
3	84	-935	-206	-219	345	345	259	
		+145.8	+44.9	-93.5	+109.7	-60.7	-33.2	
3	85	-906	-204	-220	345	345	259	P
		+148.4	+40.9	-85.9	+110.2	-61.9	-28.4	
3	86	-898	-214	-230	347	348	259	P
		+151.6	+37.4	-83.2	+112.5	-60.5	-24.5	
3	87	-979	-231	-226	347	348	259	
		+142.8	+47.3	-102.3	+109.1	-56.1	-39.1	
3	88	-1034	-262	-231	347	348	259	
		+133.0	+54.0	-109.7	+100.1	-49.7	-51.4	
3	89	-1110	-338	-234	347	348	259	
		+115.4	+57.6	-106.2	+82.6	-35.9	-66.5	
3	90	-1183	-406	-238	353	356	254	
		+105.4	+47.4	-108.3	+97.8	-18.3	-66.4	
3	91	-1244	-467	-242	354	356	254	
		+94.2	+43.7	-95.2	+86.8	-8.9	-72.3	
3	92	-1312	-504	-245	359	0	254	
		+83.9	+33.3	-88.5	+90.8	+4.7	-74.5	
3	93	-1343	-511	-246	359	0	254	P
		+79.6	+32.4	-85.3	+88.9	+8.1	-77.0	

OBSS LDRI RCC SURVEY – PORT (PL ID 3) (Cont)

Auto Seq ID	Auto posn	X/ SY	Y/ SP	Z/ EP	PITCH/ WP	YAW/ WY	ROLL/ WR	Pause
3	94	-1323	-537	-315	346	348	282	P
		+80.9	+49.1	-50.2	+5.9	+0.6	-87.1	
3	95	-1244	-513	-305	353	357	287	
		+93.4	+63.0	-95.3	+34.6	-4.2	-77.4	
3	96	-1176	-450	-298	352	2	290	
		+107.4	+76.4	-122.8	+46.3	-12.9	-76.9	
3	97	-1106	-380	-295	352	4	291	
		+129.7	+77.1	-134.2	+56.0	-33.1	-76.8	
3	98	-1023	-300	-288	354	357	289	
		+143.2	+59.7	-116.9	+57.7	-54.0	-76.3	
3	99	-989	-275	-294	350	350	282	
		+141.9	+62.4	-105.9	+54.8	-59.0	-73.1	
3	100	-965	-263	-294	350	350	282	
		+145.7	+59.5	-102.4	+55.6	-62.7	-71.4	
3	101	-933	-253	-289	358	347	283	
		+143.2	+37.8	-83.6	+59.1	-64.9	-64.1	
3	102	-887	-248	-287	4	341	282	P
		+138.7	+16.1	-50.9	+54.8	-67.1	-54.1	
3	103	-887	-285	-287	4	341	282	
		+135.8	+11.3	-38.1	+44.8	-64.3	-56.4	
3	104	-897	-285	-331	2	336	302	P
		+131.8	+25.2	-40.2	-13.0	-60.8	-101.1	
3	105	-910	-285	-330	2	340	302	
		+134.6	+32.1	-56.2	-2.8	-60.3	-98.7	
3	106	-926	-285	-325	1	340	298	
		+133.5	+35.2	-62.3	+8.1	-60.4	-92.4	
3	107	-950	-287	-335	359	340	292	
		+132.0	+42.7	-71.3	+20.8	-59.9	-84.2	
3	108	-978	-289	-352	357	345	287	
		+135.7	+55.0	-89.7	+37.0	-59.1	-75.7	
3	109	-1020	-286	-332	350	350	297	
		+138.4	+76.6	-109.9	+18.9	-51.8	-94.3	
3	110	-1074	-329	-341	342	1	292	
		+144.5	+110.9	-131.3	+18.5	-47.0	-87.9	
3	111	-1148	-401	-346	340	357	289	
		+111.3	+106.5	-115.8	+9.9	-17.6	-89.7	
3	112	-1229	-475	-357	333	359	289	
		+82.7	+103.5	-95.1	-6.4	+14.9	-96.3	
3	113	-1280	-503	-363	327	1	285	
		+63.2	+97.6	-79.2	-9.6	+35.4	-106.0	
3	114	-1328	-517	-364	327	1	285	P
		+55.8	+89.2	-69.8	-9.5	+42.7	-107.5	
3	115	-1338	-476	-389	345	357	254	P
		+74.7	+86.1	-101.8	+49.9	+5.8	-92.3	
3	116	-1283	-453	-391	343	350	243	
		+85.0	+78.6	-87.6	+51.5	-12.6	-84.7	



OBSS LDRI RCC SURVEY – PORT (PL ID 3) (Cont)

Auto Seq ID	Auto posn	X/ SY	Y/ SP	Z/ EP	PITCH/ WP	YAW/ WY	ROLL/ WR	Pause
3	117	-1166	-340	-392	343	350	243	
		+110.2	+97.3	-115.5	+67.9	-30.3	-65.2	
3	118	-1113	-285	-388	342	337	239	
		+109.8	+80.0	-93.2	+69.6	-41.1	-56.1	
3	119	-1071	-284	-378	352	332	270	
		+112.1	+61.9	-80.6	+39.3	-48.8	-70.4	
3	120	-1050	-279	-387	357	332	272	
		+114.9	+55.2	-78.4	+45.7	-51.5	-63.9	
3	121	-985	-279	-386	1	331	281	<b>P</b>
		+120.7	+42.9	-62.9	+32.8	-58.9	-67.5	

Starboard RCC Pnl 7-11 IDC Scans (IDC PL ID 5)

Auto Seq ID	Auto posn	X/ SY	Y/ SP	Z/ EP	PITCH/ WP	YAW/ WY	ROLL/ WR	Pause
6	130	-1123	+334	-374	292	43	266	<b>P</b>
		-13.2	+71.3	-76.1	+103.5	-64.8	+280.8	
6	131	-1057	+284	-369	295	47	261	
		-15.0	+83.1	-81.5	+96.2	-70.4	+282.4	
6	132	-1023	+276	-377	297	49	258	<b>P</b>
		-19.5	+88.5	-82.8	+79.9	-72.9	+270.7	
6	133	-992	+304	-342	328	58	254	<b>P</b>
		-76.9	+123.4	-126.1	+1.9	-40.0	+162.5	
6	134	-1104	+361	-348	310	52	272	<b>P</b>
		-43.6	+106.8	-127.4	+49.8	-67.4	+187.6	
6	135	-1080	+347	-285	14	46	219	<b>P</b>
		-68.3	+96.6	-119.2	-27.9	-59.1	+119.2	
6	136	-1044	+304	-282	23	55	201	
		-82.9	+80.9	-98.0	-20.6	-37.5	+146.5	
6	137	-1016	+297	-289	15	65	202	<b>P</b>
		-82.9	+77.1	-87.7	-17.4	-30.6	+157.9	
6	138	-1023	+275	-253	58	44	173	
		-100.3	+46.8	-76.5	-27.2	-16.9	+149.9	
6	139	-1029	+235	-222	76	24	169	<b>P</b>
		-111.4	+22.4	-72.4	-30.1	-10.2	+148.7	
6	140	-1119	+323	-229	75	23	178	<b>P</b>
		-101.1	+21.5	-76.3	-28.5	-13.1	+129.4	
6	141	-1128	+311	-224	74	23	178	<b>P</b>
		-100.1	+23.1	-80.3	-26.0	-13.3	+128.7	
6	142	-1033	+222	-212	75	23	166	<b>P</b>
		-108.7	+20.8	-68.9	-33.5	-12.1	+149.1	

Nose Cap RCC 1 IDC Scans (IDC PL ID 5)

Auto Seq ID	Auto posn	X/ SY	Y/ SP	Z/ EP	PITCH/ WP	YAW/ WY	ROLL/ WR	Pause
7	143	-198	-11	-408	318	356	191	P
		-125.3	+127.0	-109.0	+31.6	-31.3	+242.7	
7	144	-198	+21	-403	319	7	178	
		-107.0	+100.2	-99.7	+46.6	-37.8	+265.2	
7	145	-202	+56	-380	332	32	141	
		-98.8	+38.7	-61.1	+37.1	-39.9	+280.1	
7	146	-209	+81	-342	354	52	116	
		-92.9	+29.2	-68.7	+25.0	-34.9	+272.4	
7	147	-239	+77	-271	58	46	63	P
		-92.6	+13.8	-54.2	-17.7	-20.1	+253.6	
7	148	-224	+70	-279	58	46	63	P
		-94.5	+16.3	-56.8	-17.0	-19.1	+255.2	
7	149	-191	+73	-344	19	52	94	P
		-97.0	+21.7	-56.0	+2.8	-29.5	+266.8	

Nose Cap RCC 2 IDC Scans (IDC PL ID 5)

Auto Seq ID	Auto posn	X/ SY	Y/ SP	Z/ EP	PITCH/ WP	YAW/ WY	ROLL/ WR	Pause
8	150	-205	-57	-383	336	319	217	P
		+128.3	+137.2	-118.5	+12.7	+13.1	+155.8	
8	151	-204	-76	-337	6	314	259	
		+102.4	+89.3	-114.8	+37.5	+31.7	+132.7	
8	152	-213	-65	-293	40	326	272	
		+117.7	+69.3	-79.6	-8.2	+13.7	+152.8	
8	153	-235	-50	-256	62	339	275	P
		+124.7	+36.3	-33.4	-43.8	+0.8	+159.6	
8	154	-234	-22	-253	61	332	272	P
		+129.8	+57.2	-60.6	-31.7	-6.7	+159.3	
8	155	-195	-2	-277	35	349	281	
		+123.3	+11.7	-24.2	-19.3	+28.1	+144.4	
8	156	-183	-4	-299	31	349	281	
		+124.5	+8.6	-16.6	-20.3	+29.9	+141.4	
8	157	-168	+1	-331	5	348	259	P
		+132.6	+24.0	-16.3	-8.3	+34.5	+141.4	
8	158	-163	-12	-382	336	346	261	P
		+126.9	+24.3	-31.2	+44.1	+40.6	+107.7	
8	159	-173	-41	-348	5	337	260	P
		+123.4	+50.3	-58.7	+12.4	+33.3	+137.7	
8	160	-182	-47	-317	19	336	264	
		+123.3	+47.8	-54.6	-2.4	+27.3	+146.0	
8	161	-219	-44	-264	62	339	275	P
		+126.7	+34.6	-29.4	-46.2	-0.7	+158.3	
8	162	-196	-21	-284	33	341	267	P
		+127.4	+36.2	-39.4	-20.3	+19.9	+152.8	
8	163	-175	-25	-302	33	341	267	P
		+129.4	+30.9	-26.3	-27.8	+18.1	+151.9	
8	164	-180	-33	-297	33	341	267	P
		+128.3	+28.6	-22.6	-29.4	+19.1	+152.4	

Port RCC Pnls 7-11 IDC Scans (IDC PL ID 5)

Auto Seq ID	Auto posn	X/ SY	Y/ SP	Z/ EP	PITCH/ WP	YAW/ WY	ROLL/ WR	Pause
9	165	-1043	-224	-223	82	339	223	P
		+91.2	+60.1	-68.1	-41.3	+6.8	-116.8	
9	166	-1064	-233	-219	82	339	223	
		+88.4	+57.6	-64.5	-42.7	+8.7	-114.6	
9	167	-1131	-308	-228	78	336	222	P
		+78.7	+36.7	-16.4	-68.7	+18.8	-108.3	
9	168	-1123	-315	-234	76	334	221	P
		+78.6	+41.8	-20.3	-67.9	+20.8	-108.7	
9	169	-1057	-250	-226	76	334	221	
		+86.3	+67.3	-66.2	-45.7	+15.3	-114.6	
9	170	-1032	-239	-227	76	334	221	P
		+90.0	+70.2	-70.7	-43.5	+12.7	-117.2	
9	171	-1008	-268	-262	44	311	213	P
		+43.5	+79.4	-38.7	-76.3	+72.1	-112.3	
9	172	-1028	-284	-258	44	311	213	
		+43.2	+70.6	-26.5	-80.3	+72.4	-111.7	
9	173	-1054	-306	-258	42	312	206	
		+43.3	+77.8	-37.9	-78.7	+73.7	-103.8	
9	174	-1098	-339	-265	41	315	198	P
		+44.1	+81.2	-43.5	-85.4	+74.1	-88.1	
9	175	-1033	-343	-265	41	315	198	
		+55.9	+92.3	-56.6	-64.0	+64.6	-108.8	
9	176	-1030	-343	-361	115	315	198	
		+118.6	+41.7	-88.0	+15.8	-43.1	-84.6	
9	177	-1124	-349	-359	273	312	336	P
		+96.6	+5.7	-57.3	+112.8	-1.2	-38.0	
9	178	-1070	-312	-352	265	305	329	
		+104.5	+6.9	-63.0	+111.7	-11.3	-31.1	
9	179	-1047	-297	-364	264	304	326	P
		+106.5	+6.0	-62.4	+111.4	-13.2	-27.5	
9	180	-1070	-292	-370	259	304	325	P
		+106.0	+16.4	-74.8	+113.7	-15.6	-31.0	
9	181	-1148	-348	-375	273	312	335	
		+92.9	+8.2	-59.7	+112.8	+0.5	-40.2	
9	182	-1124	-349	-359	273	312	336	P
		+96.6	+5.7	-57.3	+112.8	-1.2	-38.0	

OBSS LDRI RCC SURVEY – STARBOARD DOCKED 1 (PL ID 3)

Auto Seq ID	Auto posn	X/ SY	Y/ SP	Z/ EP	PITCH/ WP	YAW/ WY	ROLL/ WR	Pause
6	130	-940	+291	-363	271	329	66	P
		-32.8	+77.7	-57.7	+32.4	-77.2	-113.9	
6	131	-971	+287	-376	270	322	61	
		-19.5	+70.3	-50.9	+103.6	-70.6	-44.6	
6	132	-1031	+293	-377	270	322	63	P
		-17.4	+48.4	-17.6	+91.9	-70.4	-44.4	
6	133	-1009	+265	-407	273	308	100	P
		+5.3	+85.0	-78.2	+77.3	-57.3	-74.0	
6	134	-1168	+384	-383	274	305	101	P
		-6.5	+46.2	-41.3	+64.0	-51.5	-93.0	
6	135	-1192	+352	-388	311	306	151	P
		-3.9	+91.9	-116.4	+83.2	-32.0	-116.2	
6	136	-1273	+431	-388	311	306	152	
		-15.2	+70.0	-96.2	+79.2	-24.9	-127.2	
6	137	-1294	+446	-388	311	306	152	
		-16.4	+64.5	-89.7	+77.7	-24.1	-128.2	
6	138	-1346	+459	-389	311	306	152	P
		-16.1	+52.6	-72.3	+72.3	-24.3	-127.9	
6	139	-1311	+539	-436	311	306	152	
		-29.0	+53.5	-69.7	+65.2	-16.1	-138.6	
6	140	-1309	+531	-343	294	308	105	P
		-21.5	+17.6	-10.5	+60.0	-52.8	-115.3	
6	141	-1266	+504	-355	286	302	106	
		-14.6	+24.2	-23.3	+69.2	-47.1	-102.8	
6	142	-1169	+406	-352	278	301	99	
		-4.0	+48.6	-59.4	+92.6	-49.6	-82.9	
6	143	-1067	+335	-336	265	310	80	P
		-4.1	+53.9	-53.0	+94.3	-59.1	-64.5	
6	144	-1069	+320	-334	273	328	79	P
		-25.8	+55.6	-35.5	+22.6	-72.6	-123.8	
6	145	-966	+289	-368	265	326	79	P
		-23.0	+68.2	-47.0	+25.8	-69.2	-113.0	
6	146	-976	+300	-358	268	327	80	
		-26.4	+71.1	-52.3	+20.3	-68.1	-123.3	
6	147	-1047	+331	-284	291	331	83	P
		-44.3	+95.0	-97.7	+14.0	-61.9	-170.6	
6	148	-1230	+505	-291	296	328	85	P
		-43.0	+44.5	-46.6	+19.4	-64.2	-169.8	
6	149	-1275	+528	-297	322	335	31	P
		-62.4	+40.7	-54.3	-84.5	-47.7	+72.6	
6	150	-1340	+549	-296	322	335	31	P
		-57.0	+18.7	-16.4	-106.1	-46.7	+64.8	
6	151	-1284	+690	-278	324	321	32	
		-56.7	+17.0	-30.6	-97.6	-50.0	+46.2	
6	152	-1325	+510	-165	317	341	23	P
		-56.8	+15.4	-27.2	-99.8	-43.4	+66.6	
6	153	-1265	+472	-213	317	341	23	
		-61.7	+37.9	-56.0	-88.9	-45.0	+73.1	
6	154	-1066	+298	-212	291	354	34	
		-61.1	+41.8	-30.1	-101.1	-65.5	+111.3	

OBSS LDRI RCC SURVEY – STARBOARD DOCKED 1 (PL ID 3) (Cont)

Auto Seq ID	Auto posn	X/ SY	Y/ SP	Z/ EP	PITCH/ WP	YAW/ WY	ROLL/ WR	Pause
6	155	-1053	+298	-210	290	354	34	P
		-61.5	+42.5	-31.1	-99.7	-66.4	+113.0	

OBSS LDRI RCC SURVEY – STARBOARD DOCKED 2 (PL ID 3)

Auto Seq ID	Auto posn	X/ SY	Y/ SP	Z/ EP	PITCH/ WP	YAW/ WY	ROLL/ WR	Pause
7	156	-903	+183	-212	31	278	24	P
		+67.7	+34.1	-89.1	-17.4	-0.6	-131.7	
7	157	-1008	+201	-214	15	291	357	
		+71.0	+34.6	-103.9	+4.3	-10.3	-120.6	
7	158	-1062	+224	-214	15	291	357	
		+60.6	+32.8	-102.5	+6.1	-5.9	-111.2	
7	159	-1111	+262	-208	11	298	345	P
		+58.0	+29.1	-116.0	+32.0	-7.2	-101.3	
7	160	-1028	+280	-238	18	298	7	P
		+70.9	+29.6	-122.4	+21.8	-6.0	-114.5	
7	161	-1007	+255	-238	18	299	9	
		+79.1	+30.9	-120.4	+16.1	-7.1	-121.5	
7	162	-924	+228	-241	21	302	14	P
		+103.1	+26.9	-112.9	+5.6	-11.5	-143.0	
7	163	-892	+222	-235	15	301	11	P
		+109.5	+33.9	-115.2	+2.5	-9.8	-149.3	
7	164	-903	+241	-246	67	288	61	P
		+65.7	+14.9	-84.2	-14.6	-4.8	-128.7	
7	165	-1008	+276	-246	67	288	61	P
		+49.0	+9.6	-73.3	-19.0	-2.9	-112.0	
7	166	-1044	+306	-248	67	288	61	P
		+42.1	+7.3	-70.3	-19.4	-2.0	-105.2	

# OBSS COORDINATE SYSTEM – PL ID 1

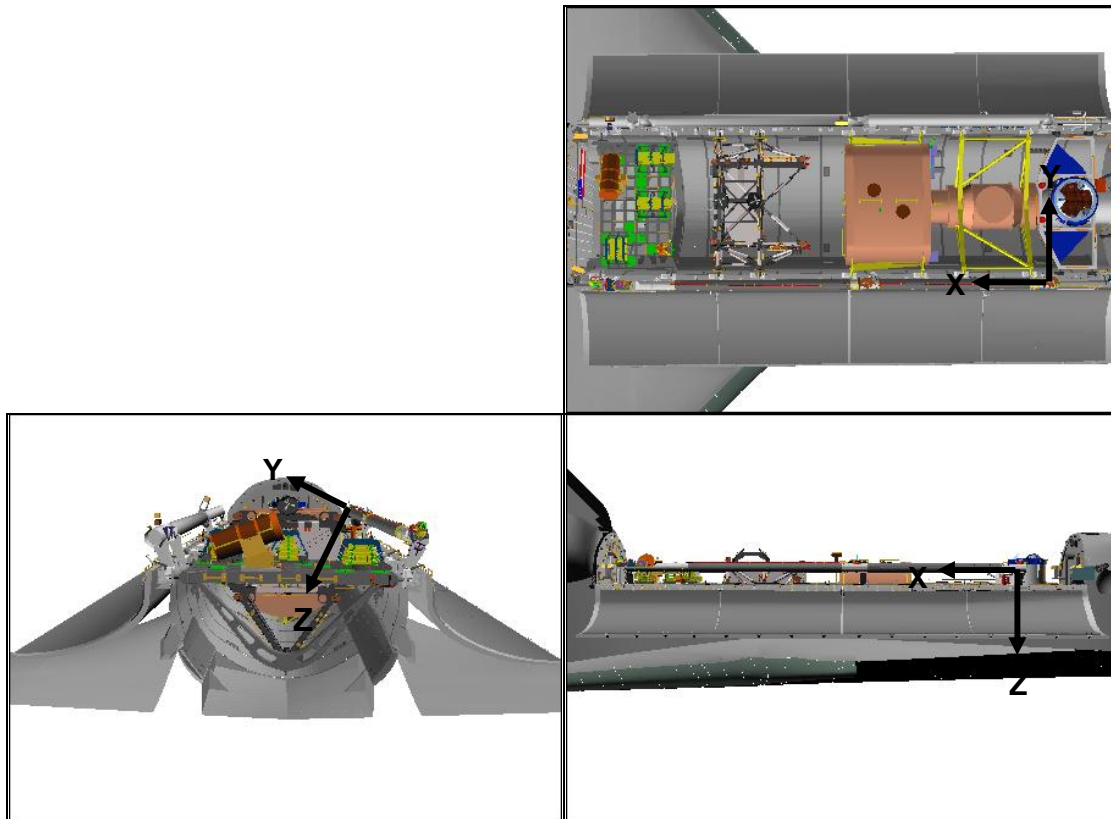

POR: POR at OBSS fwd striker bar. Aligned with MPMs

PURPOSE: OBSS unberth/berth

RATES: COARSE VERN  
TRANS LIM ft/sec 0.20 0.10  
ROT LIM deg/sec 0.88 0.08  
Joint coarse and vern rates are set equal

## OBSS COORDINATE SYSTEM – PL ID 2

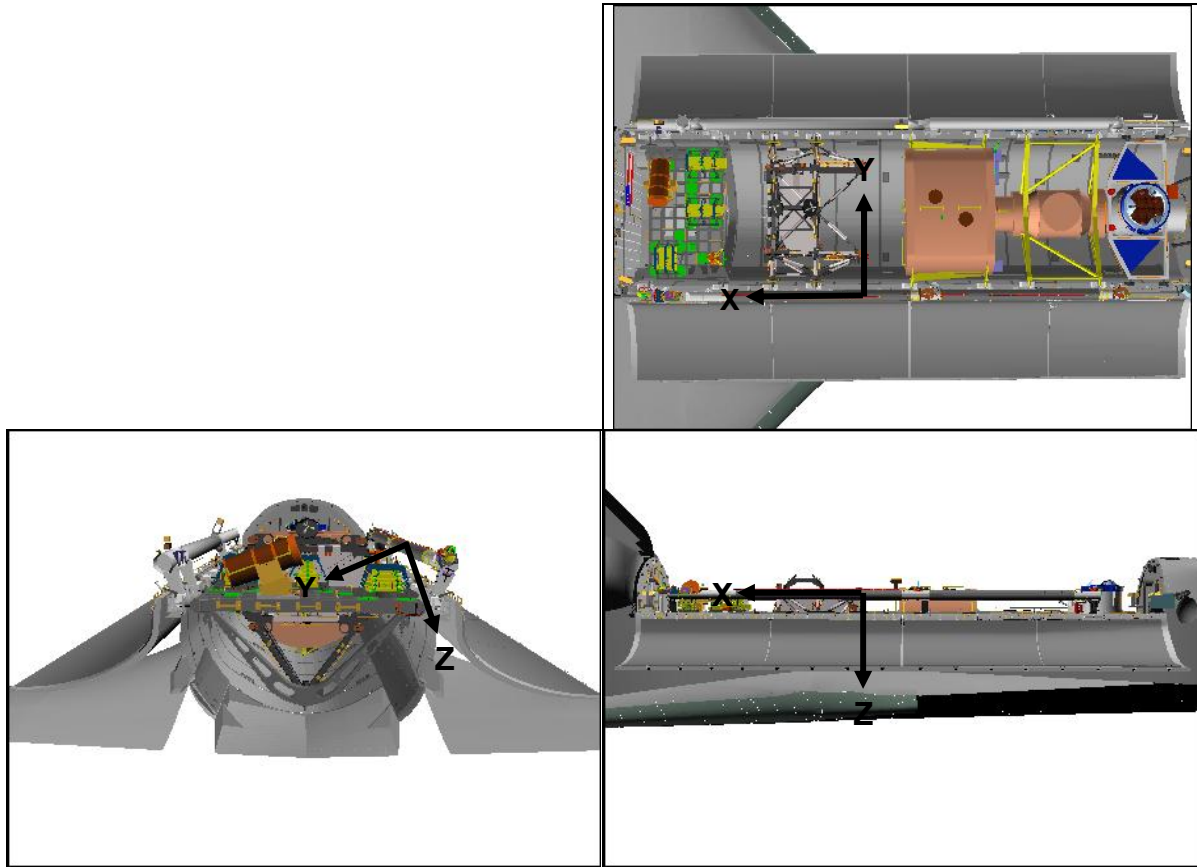

POR: POR at OBSS center of mass

PURPOSE: Large, non-survey boom maneuvers

RATES:	COARSE	VERN
TRANS LIM ft/sec	0.70	0.23
ROT LIM deg/sec	2.64	0.88

Joint coarse and vern rates are set equal

# OBSS COORDINATE SYSTEM – PL ID 3

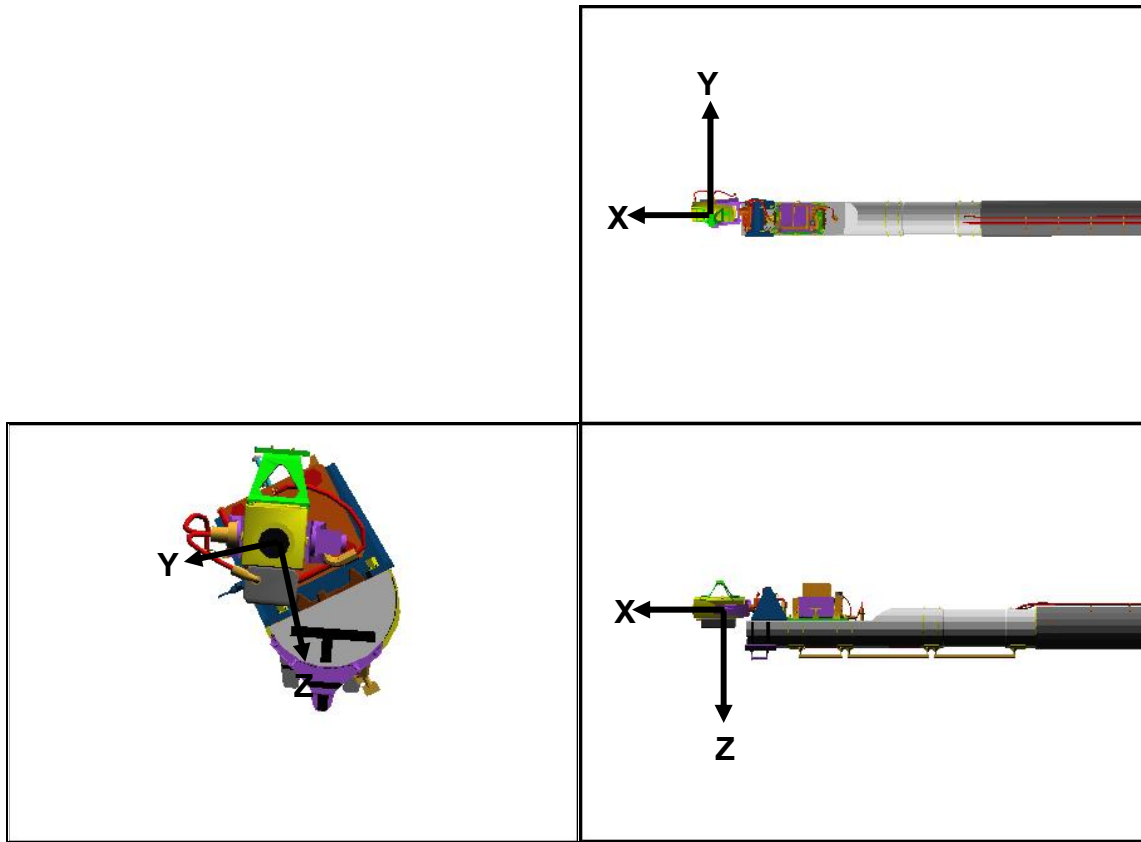

POR: POR at OBSS ITVC/LDRI PTU Pivot

PURPOSE: OBSS Surveys using LDRI

RATES: COARSE VERN  
TRANS LIM ft/sec 0.23 0.01  
ROT LIM deg/sec 2.64 0.88  
Joint coarse and vern rates are set equal



# OBSS IDC COORDINATE SYSTEM – PL ID 5 (UPLINK)

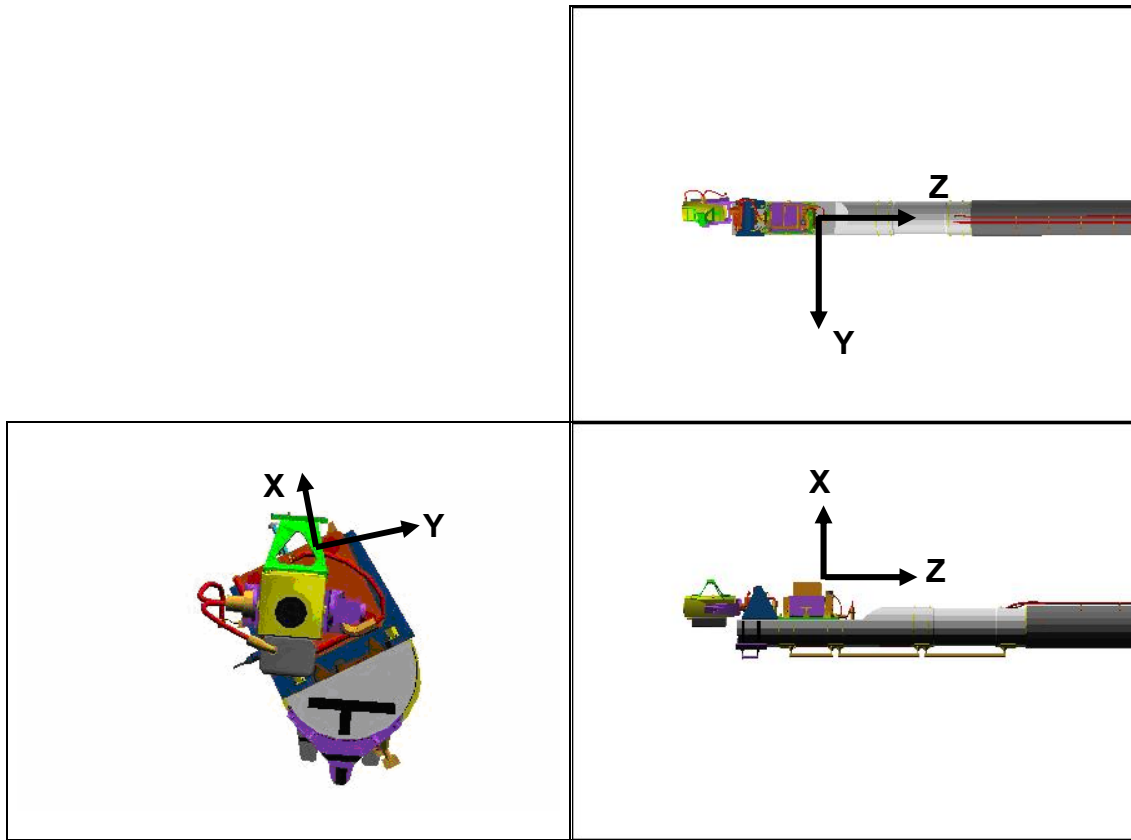

POR: POR at IDC Eyepoint

PURPOSE: OBSS Surveys using IDC

RATES: COARSE VERN  
TRANS LIM ft/sec 0.23 0.20  
ROT LIM deg/sec 2.64 0.88  
Joint coarse and vern rates are set equal

## OBSS GO/NO-GO CRITERIA

	CONTINUE OPERATIONS IF:					FLT RULE REF
	DAMAGE DETECT GRAPPLE UNBERTH	DAMAGE DETECT SURVEY	DAMAGE ASSESS/REPAIR GRAPPLE (HANDOFF) (HIGH PRIORITY)	CONTINUE DAMAGE ASSESS/REPAIR (HIGH PRIORITY)	ENTRY	
A. STBD MPM STOW MOTORS (2)	2 ↓ [1]	2 ↓ [1]	2 ↓ [1]	2 ↓ [1]		{A12-72}
B. STBD MPM (3) STOWED INDICATIONS (6)					[2]	{A12-72}
C. STBD MPM (3) DEP INDICATIONS (6)	FORWARD 1 ↓	FORWARD 1 ↓	FORWARD 1 ↓	FORWARD 1 ↓		{A12-72}
D. STBD MRL LAT CAP (3)	1 ↓ [6]	3 ↓ [6]	3 ↓ [7]	3 ↓ [7]	0 ↓ [6]	{A12-73}
E. STBD JETTISON (2)	1 ↓ [10]	1 ↓ [10]	1 ↓	1 ↓		{A12-183}
F. PORT MPM STOW MOTORS (2)	2 ↓ [1]	2 ↓ [1]	2 ↓ [1]	2 ↓ [1]		{A12-72}
G. PORT MPM (4) DEP INDICATIONS (8)	SHOULDER 1 ↓	SHOULDER 1 ↓	SHOULDER 1 ↓	SHOULDER 1 ↓		{A12-72}
H. PORT MRL LAT CAP (3)	[8]	[8]	[9]	[9]		{A12-73}
I. PORT JETTISON (2)	1 ↓ [10]	1 ↓ [10]	1 ↓	1 ↓		{A12-181}
J. AUTO MODE (1)			1 ↓	1 ↓		
K. MANUAL AUG MODE (1)			2 ↓ [3]	3 ↓ [3]		{A12-111}
L. DIRECT MODE (1)	1 ↓	1 ↓				{A12-111}
M. SINGLE MODE (1)						
N. BACKUP MODE (1)	0 ↓	0 ↓	0 ↓			{A12-111}
O. BRAKES (6)	0 ↓	0 ↓	0 ↓	0 ↓		{A12-115}
P. AUTO BRAKES (1)	0 ↓ [4]	0 ↓ [4]	0 ↓ [4]	0 ↓ [4]		{A12-116}
Q. CAPTURE & RIGIDIZE (2)	1 ↓		1 ↓			{A12-161}
R. DERIGIDIZE (2)	1 ↓	1 ↓	2 ↓	2 ↓		{A12-161}
S. RELEASE (2)	1 ↓ [1]	1 ↓ [1]	3 ↓ [1]	3 ↓ [1]		{A12-161}
T. BACKUP RELEASE (1)	0 ↓ [1]	0 ↓ [1]				{A12-161}
U. SRMS THERMAL	REQUIRED	REQUIRED	REQUIRED	REQUIRED		{A12-3}
V. SENSOR THERMAL	REQUIRED	REQUIRED	REQUIRED[5]	REQUIRED[5]		{A12-11}

### NOTES:

- [1] EVA CAPABILITY EXISTS FOR THE FOLLOWING CONTINGENCIES:  
 – MPM DEPLOY/STOW  
 – SRMS STRAPDOWN  
 – OBSS BERTHING  
 – GRAPPLE FIXTURE (GF) RELEASE
- [2] ONE AT THE FORWARD AND ONE AT EITHER THE MID OR AFT PEDESTAL IS REQUIRED
- [3] ONE OF MANUAL, SINGLE, DIRECT, OR BACKUP REQUIRED FOR POSITIONING FOR DAMAGE ASSESSMENT/REPAIR AND JETTISON
- [4] COMPUTER-SUPPORTED MODES UNAVAILABLE WITH LOSS OF AUTOBRAKES, BUT OPERATIONS IN DIRECT AND BACKUP CAN CONTINUE WITH THE LOSS OF AUTOBRAKES
- [5] SENSOR THERMAL NOT REQUIRED FOR REPAIR OR HANDOFF FOR SSRMS CLEARANCES
- [6] THREE MRLs LATCHED REQUIRED FOR ENTRY. TWO MRLs LATCHED REQUIRED FOR DOCK/UNDOCK (ONE OF WHICH MUST BE THE FWD MRL) OR OBSS LEFT ON SRMS DURING DOCK/UNDOCK. GO IF THERE IS A CONFIRMED CAPABILITY TO DOCK AND UNDOCK WITH THE OBSS ON THE SRMS.
- [7] WITH THREE MRLs FAILED, BOOM JETTISON OR CONTINGENCY STOW ON ISS WILL BE REQUIRED
- [8] CONTINUE OPERATIONS IF ONE FAILURE WILL NOT RESULT IN THE INABILITY TO LATCH AT LEAST TWO MRLs
- [9] CONTINUE OPERATIONS EVEN IF ONE FAILURE WILL RESULT IN THE INABILITY TO LATCH AT LEAST TWO MRLs (ASSUMES CURRENTLY HAVE TWO-LATCH CAPABILITY). EVA CAPABILITY REQUIRED
- [10] SYSTEM REDUNDANCY OR JETTISON REDUNDANCY IFM REQUIRED

# OBSS ATTITUDE CONTROL CONSTRAINTS

ATTITUDE CONTROL & OPS [1] [3] [4] [5]  OBSS CONFIG [2]		STS ATTITUDE CONTROL		ISS ATTITUDE CONTROL [7]			OPERATIONS [8]				
		VRCS	PRCS	CMG-TA [6]		THRUSTERS ONLY	CREW EXERCISE (ISOLATED OR UN-ISOLATED)	EVA OPS	REBOOST (STS, SM, PROG) [7] [11]	UNDOCK-ING (STS/RS) [9] [10]	DOCK-ING (STS/RS) [9] [10]
				MOM MGMT OR ATT HOLD	DESAT REQU EST						
OBSS SRMS OPS	OBSS AT UNDOCK POSITION	A12	B12, LO Z	TBD	TBD	TBD	TBD	TBD	OK	OK	OK
	OBSS AT HANDOFF POSITION	A12	B12, LO Z	TBD	TBD	TBD	TBD	TBD	TBD	TBD	TBD
	OBSS MNVR TO HANDOFF POSITION	A12	B12, LO Z	TBD	TBD	TBD	OK	OK	NOT OK	NOT OK	NOT OK
	IN DOCKED SURVEY POSITIONS	A12	B12, LO Z	TBD	TBD	TBD	TBD	TBD	OK	NOT OK	NOT OK
	MANEUVER TO OBSS DOCKED SURVEY POSITIONS	A12	B12, LO Z	TBD	TBD	TBD	TBD	TBD	NOT OK	NOT OK	NOT OK
AFTER OBSS LATCHING		A12	B12, LO Z	OK	ENA	OK	OK	OK	OK	OK	OK

**NOTES:**

- [1] KEY:  – ACS OR OPS ALLOWED.  – ACS OR OPS NOT ALLOWED  – NOT ANALYZED
- [2] SSRMS/OBSS POSITIONS DEFINED IN REF DATA
- [3] REFERENCE CSA-SS-MOA-ULF1.1-003-REV A
- [4] CONSTRAINTS APPLY TO BOTH BRAKES ON AND POSITION HOLD UNLESS OTHERWISE NOTED
- [5] SINGLE PULSE MODE FOR CMG-TA
- [6] REFERENCE RULE {B12-105}, SSRMS ATTITUDE CONTROL CONSTRAINTS FOR ISS [HC] [RC], FOR USE OF AUTOMATIC ATTITUDE CONTROL IN UNPLANNED CONTINGENCY
- [7] SHUTTLE REBOOST (CONFIG 1-4), SM AND PROGRESS REBOOST
- [8] DOCKING AND UNDOCKING VEHICLES INCLUDE ORBITER, SOYUZ, AND PROGRESS
- [9] CONSTRAINTS APPLY TO ISS ATTITUDE HOLD AND MANEUVERS
- [10] REFERENCE RULE {TBD}, CONTINGENCY SRMS/OBSS DAP CONSTRAINTS
- [11] SM OR PROGRESS MAIN ENGINE REBOOST NOT PERMITTED

## SRMS EE CAM SURVEYS JOINT ANGLES VS POR COORDINATES

### STBD CREW CABIN SURVEY

SY	SP	EP	WP	WY	WR
-134.9	+17.2	-57.5	-112.6	-59.5	+228.2

X	Y	Z	PITCH	YAW	ROLL	PLID
-351	+180	-411	241	53	123	0

### PORT CREW CABIN SURVEY

SY	SP	EP	WP	WY	WR
+65.9	+53.3	-94.3	-99.6	-36.5	+216.5

X	Y	Z	PITCH	YAW	ROLL	PLID
-840	-364	-333	324	291	323	0

## SRMS EE CAM CREW CABIN SURVEY AUTO SEQUENCES

### Stbd Crew Cabin Survey (PL ID 0)

Auto Seq ID	Auto posn	X/ SY	Y/ SP	Z/ EP	PITCH/ WP	YAW/ WY	ROLL/ WR	Pause
4	122	-351	+180	-411	241	53	123	P
		-134.9	+17.2	-57.5	-112.6	-59.5	+228.2	
4	123	-484	+230	-465	255	48	103	P
		-116.2	+28.3	-69.7	-112.7	-33.9	+212.2	
4	124	-351	+180	-411	241	53	123	P
		-134.9	+17.2	-57.5	-112.6	-59.5	+228.2	
4	125	-548	+266	-478	270	38	45	P
		-107.7	+28.3	-66.4	-108.1	-14.9	+164.2	

### Port Crew Cabin Survey (PL ID 0)

Auto Seq ID	Auto posn	X/ SY	Y/ SP	Z/ EP	PITCH/ WP	YAW/ WY	ROLL/ WR	Pause
5	126	-840	-364	-333	324	291	323	P
		+65.9	+53.3	-94.3	-99.6	-36.5	+216.5	
5	127	-517	-304	-275	19	279	23	
		+120.1	+39.4	-95.6	-106.2	+20.4	+194.7	
5	128	-294	-244	-331	242	275	270	P
		+150.4	+30.7	-64.5	-102.0	+54.5	+190.0	
5	129	-518	-252	-385	300	281	348	P
		+129.3	+69.9	-118.8	-97.8	+28.5	+227.4	

**SRMS EE RCC WING SURVEY COORDINATE SYSTEM – PL ID 5 (UPLINK)**

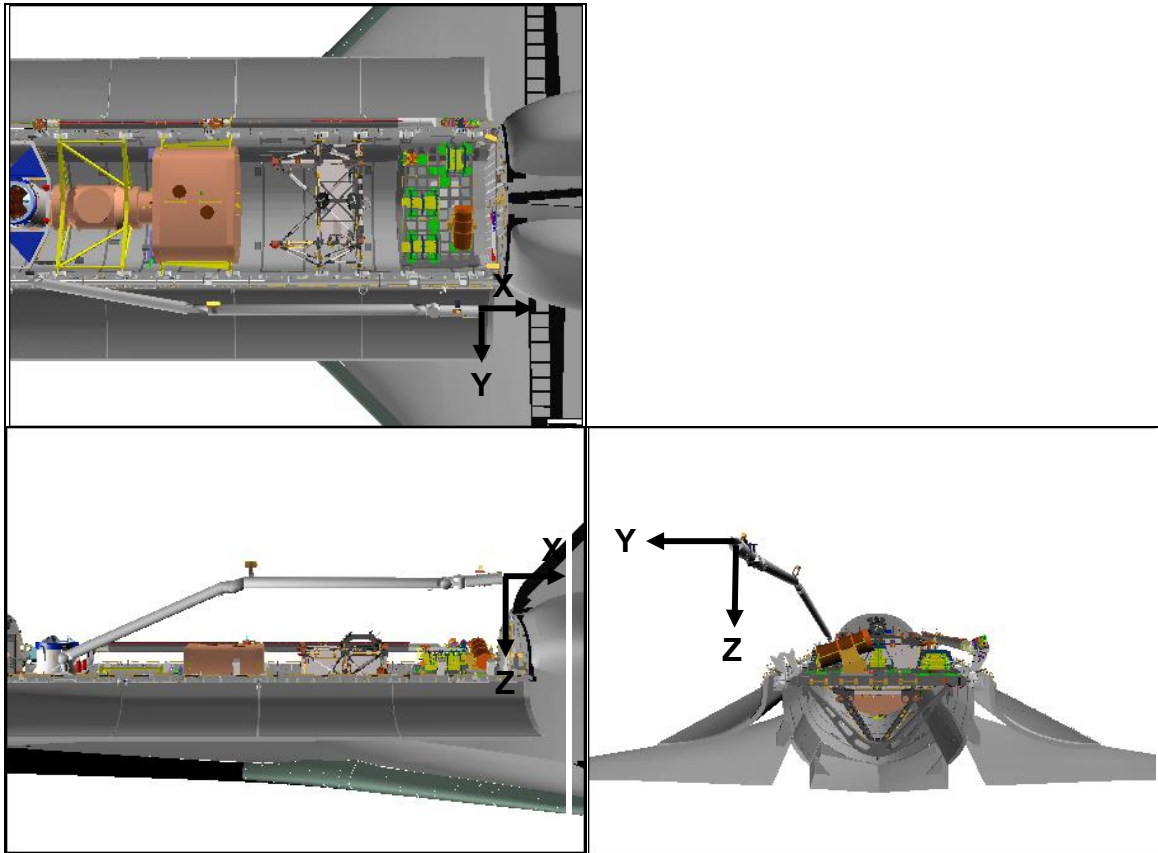

POR: POR at center of EE

PURPOSE: RCC WING SURVEY using SRMS EE Camera

RATES:	COARSE	VERN
TRANS LIM ft/sec	0.61	0.04
ROT LIM deg/sec	4.76	4.76

CUE CARD CONFIGURATION

P5 SJ GRAPPLE WRIST CCTV OVERLAY .....	FS CC 12-3
UNGRAPPLE WRIST CCTV OVERLAY .....	FS CC 12-4
OBSS SJ GRAPPLE AT HANDOFF OVERLAY .....	FS CC 12-5
UNGRAPPLE AT HANDOFF OVERLAY .....	FS CC 12-6
LDRI SCAN PATTERN CUE CARD – STBD & PORT .....	FS CC 12-7
– NOSE CAP .....	FS CC 12-8
IDC SCAN PATTERN CUE CARD – STBD & PORT .....	FS CC 12-9
– NOSE CAP .....	FS CC 12-10
LDRI SCAN PATTERN CUE CARD – STBD DOCKED .....	FS CC 12-11 I

CUE CARD  
CONFIG

This Page Intentionally Blank



Fabricate as transparency

ZOOM 34.0 HFOV  
FOCUS 5.0 FT  
EYEPOINT APPROX 18 IN

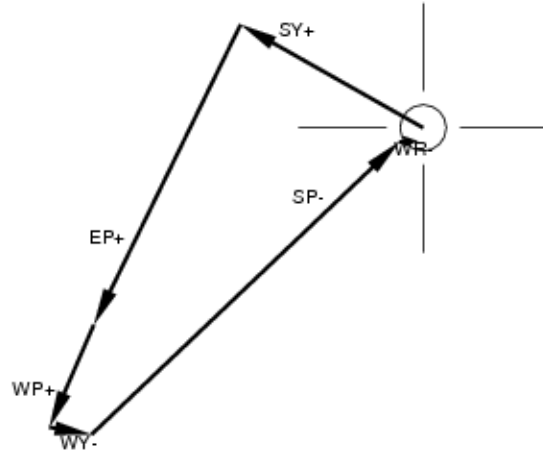

P5 SJ GRAPPLE WRIST CCTV OVERLAY

PDRS-7a/116/O/A

(reduced copy)

FS CC 12-3

PDRS/116/FIN

Fabricate as transparency

ZOOM 34.0 HFOV  
FOCUS 5.0 FT  
EYEPOINT APPROX 18 IN

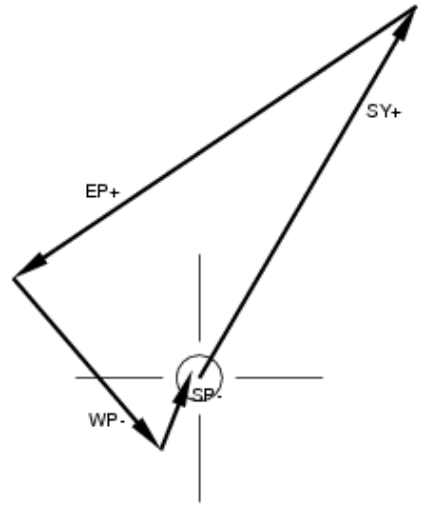

P5 SJ UNGRAPPLE WRIST CCTV OVERLAY

PDRS-8a/116/O/A

(reduced copy)  
FS CC 12-4

PDRS/116/FIN

Fabricate as transparency

ZOOM 34.0 HFOV  
FOCUS 5.0 FT  
EYEPOINT APPROX 18 IN



WR-

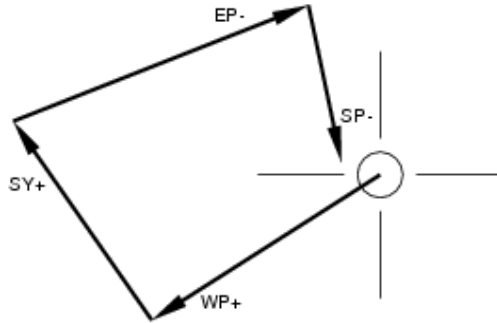

OBSS SJ GRAPPLE AT HANDOFF OVERLAY

PDRS-9a/116/O/A

(reduced copy)

FS CC 12-5

PDRS/116/FIN

Fabricate as transparency

ZOOM 34.0 HFOV  
FOCUS 5.0 FT  
EYEPOINT APPROX 18 IN

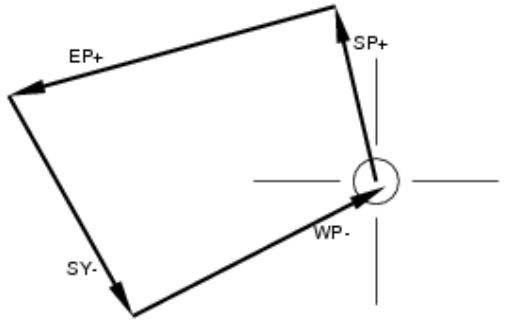

OBSS SJ UNGRAPPLE AT HANDOFF OVERLAY

PDRS-10a/116/O/A

(reduced copy)  
FS CC 12-6

PDRS/116/FIN

TOP

HOOK  
VELCRO

### OBSS LDRI SCAN PATTERN CUE CARD – STBD & PORT

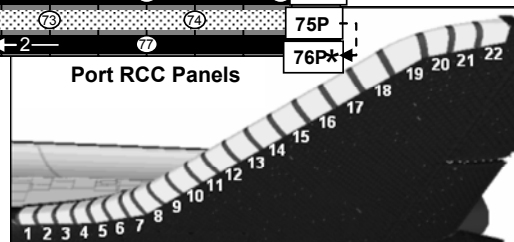
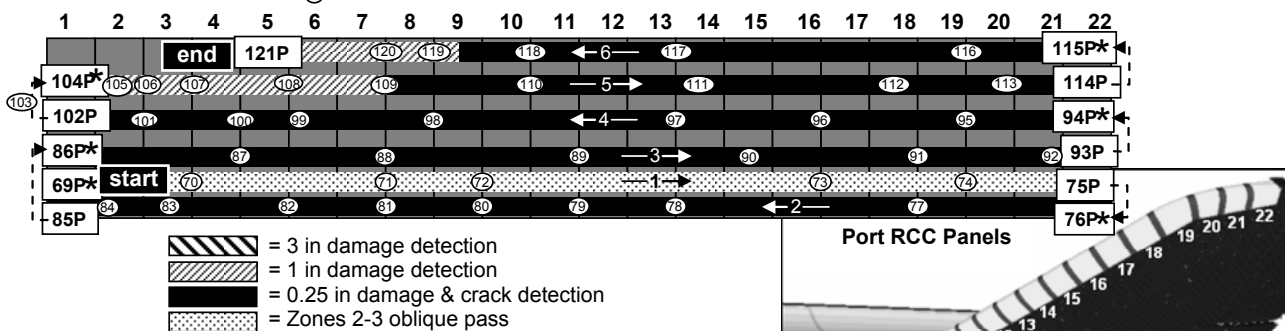
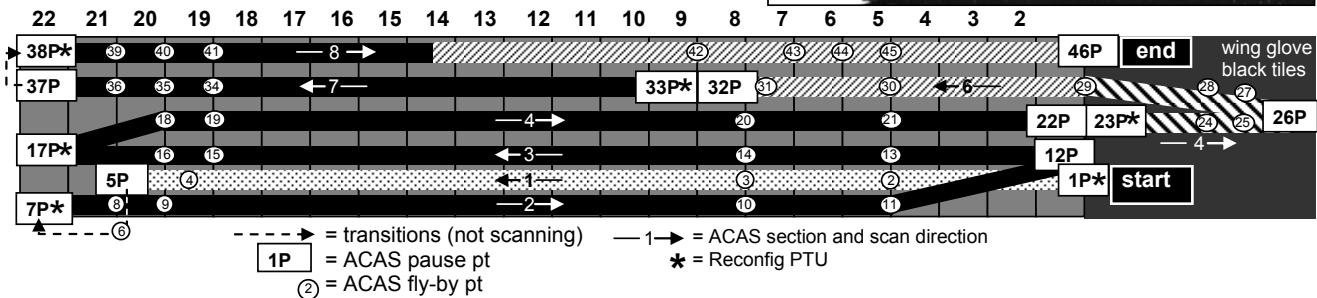
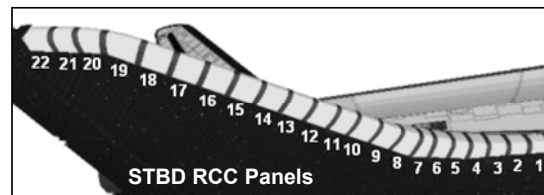

PDRS-11a/116/O/A

FS CC 12-7  
(reduced copy)

PDRS/116/FIN

TOP  
 Back of 'OBSS LDRI SCAN PATTERN CUE CARD – STBD & PORT'

HOOK  
 VELCRO

OBSS LDRI SCAN PATTERN CUE CARD – NOSE CAP

# LDRI

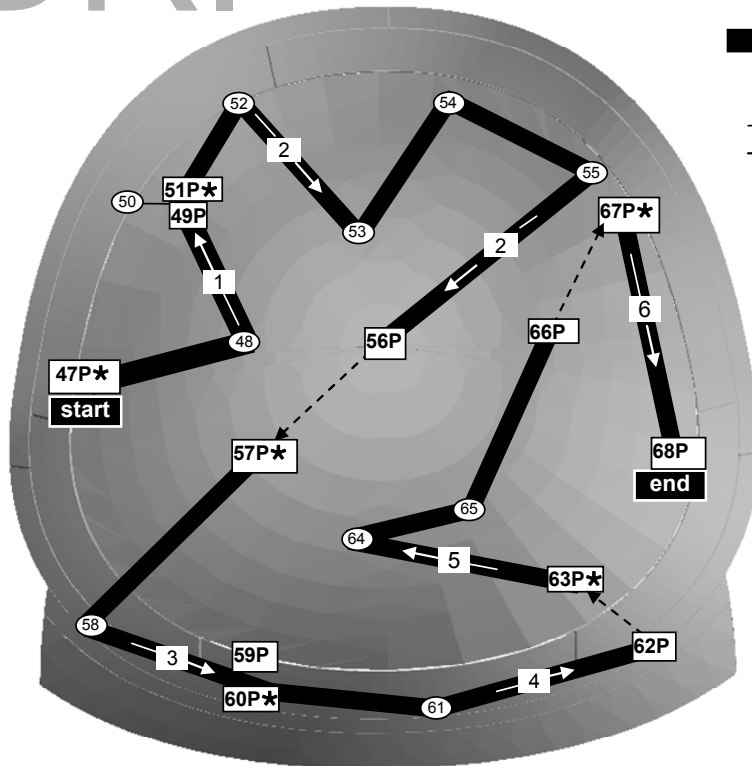

- █** = 0.25 in damage criteria
- 1P** = ACAS pause pt
- ②** = ACAS fly-by pt
- 1 →** = ACAS section & scan direction
- - - - -** = non-scan transitions
- \*** = Reconfig PTU

(reduced copy)

FS CC 12-8

PDRS/116/FIN

PDRS-11b/116/O/B



TOP  
Back of 'OBSS IDC SCAN PATTERN CUE CARD – STBD & PORT'

HOOK  
VELCRO

OBSS IDC SCAN PATTERN CUE CARD – NOSE CAP

# IDC

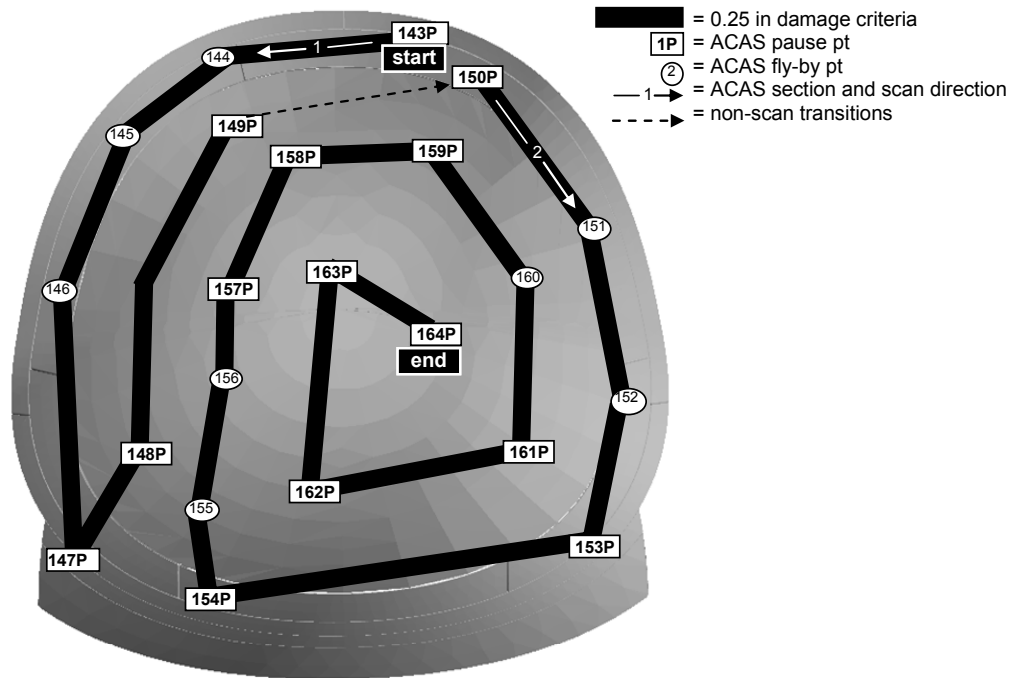

(reduced copy)  
FS CC 12-10

PDRS/116/FIN

PDRS-12b/116/O/A



TOP

HOOK  
VELCRO

OBSS LDRI SCAN PATTERN CUE CARD – STBD DOCKED

LDRI

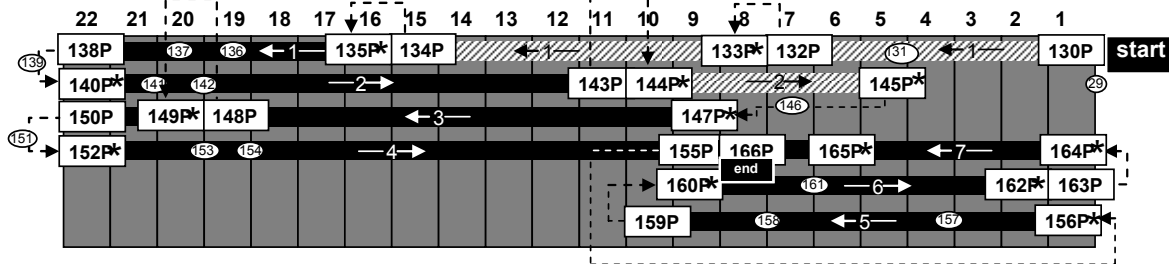
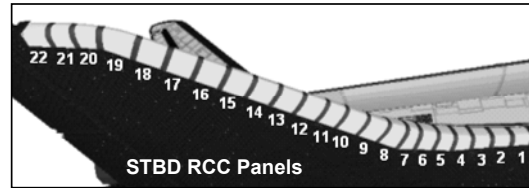
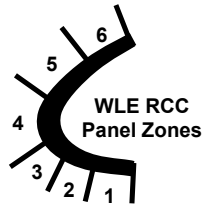

- > = transitions (not scanning)
- 1P = ACAS pause pt
- Ⓜ = ACAS fly-by pt
- 1 → = ACAS section and scan direction
- \* = Reconfig PTU

- = 1 in damage detection
- = 0.25 in damage & crack detection

PDRS-13a/116/O/B

FS CC 12-11

(reduced copy)

PDRS/116/FIN

TOP  
Back of 'OBSS LDRI SCAN PATTERN CUE CARD - STBD DOCKED'

HOOK  
VELCRO



PDRS-13b/116/O/B



(reduced copy)

FS CC 12-12

PDRS/116/FIN



# PDRS CHECKLIST

STS  
116