

PDRS Operations Checklist

STS-120 Flight Supplement

**Mission Operations Directorate
EVA, Robotics, & Crew Systems
Operations Division**

**Final, Rev A
October 5, 2007**

National Aeronautics and
Space Administration

Lyndon B. Johnson Space Center
Houston, Texas

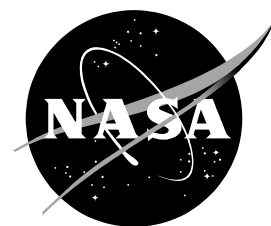

MISSION OPERATIONS DIRECTORATE

**PDRS OPERATIONS CHECKLIST
STS-120 FLIGHT SUPPLEMENT**

FINAL, REVISION A
October 5, 2007

PREPARED BY:

Frank D. Jurgens
Book Manager

APPROVED BY:

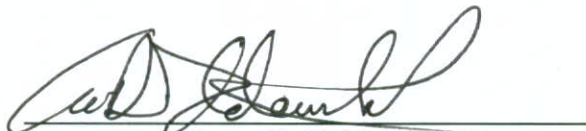
Aaron D. Goldenthal
Lead, Shuttle and Exploration Robotics
Operations Group

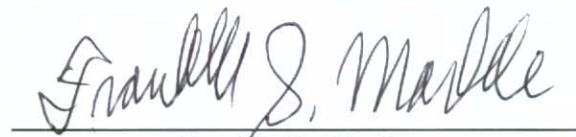
Franklin S. Markle
Chief, Robotics Operations Branch

This document is under the configuration control of the Crew Procedures Control Board (CPCB). All proposed changes must be submitted via FDF Workflow Crew Procedure Change Request (CR) to DO3/FDF Manager.

Additional distribution of this book, for official use only, may be requested in writing to DO3/PMO Administrator. The request must include justification and requester's name, organization, position, and phone number. Contractor requests are made through the NASA or DOD organization supported. Deletions, reduction in quantity, or change of address may be submitted to DO3/FDF Management Office, 281-244-1184.

Incorporates the following:	
482#:	PDRS FS-0025 PDRS FS-0026 PDRS FS-0027 PDRS FS-0028 PDRS FS-0029 PDRS FS-0030 PDRS FS-0031

AREAS OF TECHNICAL RESPONSIBILITY

Book Manager

DX22/F. Jurgens

281-244-5448

PDRS OPERATIONS CHECKLIST
 STS-120 FLIGHT SUPPLEMENT

LIST OF EFFECTIVE PAGES

FINAL 05/15/07
 REV A 10/05/07

Sign Off	*	120/FIN A	FS 2-26	120/FIN A
FS ii	*	120/FIN A	FS 2-27	120/FIN A
FS iii	*	120/FIN A	FS 2-28	120/FIN A
FS iv	*	120/FIN A	FS 2-29	120/FIN A
FS v		120/FIN A	FS 2-30	120/FIN A
FS vi		120/FIN A	FS 3-1	120/FIN A
FS 1-1		120/FIN A	FS 3-2	120/FIN A
FS 1-2		120/FIN A	FS 4-1	120/FIN A
FS 1-3		120/FIN A	FS 4-2	120/FIN A
FS 1-4		120/FIN A	FS 4-3	120/FIN A
FS 1-5		120/FIN A	FS 4-4	120/FIN A
FS 1-6		120/FIN A	FS 4-5	120/FIN A
FS 1-7		120/FIN A	FS 4-6	120/FIN A
FS 1-8		120/FIN A	FS 4-7	120/FIN A
FS 1-9		120/FIN A	FS 4-8	120/FIN A
FS 1-10		120/FIN A	FS 4-9	120/FIN A
FS 1-11		120/FIN A	FS 4-10	120/FIN A
FS 1-12		120/FIN A	FS 5-1	120/FIN A
FS 1-13		120/FIN A	FS 5-2	120/FIN A
FS 1-14		120/FIN A	FS 5-3	120/FIN A
FS 2-1		120/FIN A	FS 5-4	120/FIN A
FS 2-2		120/FIN A	FS 5-5	120/FIN A
FS 2-3		120/FIN A	FS 5-6	120/FIN A
FS 2-4		120/FIN A	FS 5-7	120/FIN A
FS 2-5		120/FIN A	FS 5-8	120/FIN A
FS 2-6		120/FIN A	FS 5-9	120/FIN A
FS 2-7		120/FIN A	FS 5-10	120/FIN A
FS 2-8		120/FIN A	FS 5-11	120/FIN A
FS 2-9		120/FIN A	FS 5-12	120/FIN A
FS 2-10		120/FIN A	FS 5-13	120/FIN A
FS 2-11		120/FIN A	FS 5-14	120/FIN A
FS 2-12		120/FIN A	FS 5-15	120/FIN A
FS 2-13		120/FIN A	FS 5-16	120/FIN A
FS 2-14		120/FIN A	FS 5-17	120/FIN A
FS 2-15		120/FIN A	FS 5-18	120/FIN A
FS 2-16		120/FIN A	FS 6-1	120/FIN A
FS 2-17		120/FIN A	FS 6-2	120/FIN A
FS 2-18		120/FIN A	FS 6-3	120/FIN A
FS 2-19		120/FIN A	FS 6-4	120/FIN A
FS 2-20		120/FIN A	FS 7-1	120/FIN A
FS 2-21		120/FIN A	FS 7-2	120/FIN A
FS 2-22		120/FIN A	FS 7-3	120/FIN A
FS 2-23		120/FIN A	FS 7-4	120/FIN A
FS 2-24		120/FIN A	FS 7-5	120/FIN A
FS 2-25		120/FIN A	FS 7-6	120/FIN A

* – Omit from flight book

FS 7-7	120/FIN A	FS 9-4	120/FIN A
FS 7-8	120/FIN A	FS 9-5	120/FIN A
FS 8-1	120/FIN A	FS 9-6	120/FIN A
FS 8-2	120/FIN A	FS 10-1	* 120/FIN A
FS 8-3	120/FIN A	FS CC 10-2	* 120/FIN A
FS 8-4	120/FIN A	FS CC 10-3	* 120/FIN A
FS 8-5	120/FIN A	FS CC 10-4	* 120/FIN A
FS 8-6	120/FIN A	FS CC 10-5	* 120/FIN A
FS 9-1	120/FIN A	FS 10-6	* 120/FIN A
FS 9-2	120/FIN A		
FS 9-3	120/FIN A		

PDRS CUE CARDS

<u>Title</u>	<u>Ref. Page</u>	<u>Card No.</u>
OBSS SJ GRAPPLE AT HANDOFF OVERLAY	FS CC 10-2	PDRS-9a/120/O/B
UNGRAPPLE AT HANDOFF OVERLAY	FS CC 10-3	PDRS-10a/120/O/B
P6 SJ GRAPPLE WRIST CCTV	FS CC 10-4	PDRS-11a/120/O/A
UNGRAPPLE WRIST CCTV	FS CC 10-5	PDRS-12a/120/O/A

* – Omit from flight book

<u>CONTENTS</u>	<u>PAGE</u>
<u>OBSS HANDOFF</u>	FS 1-1
<u>VERIFY UPLINKS</u>	FS 1-2
<u>OBSS HANDOFF FROM SSRMS TO SRMS</u>	FS 1-4
<u>SRMS TO SSRMS</u>	FS 1-10
 <u>OBSS CONTINGENCY</u>	 FS 2-1
<u>OBSS SJ HANDOFF FROM SSRMS TO SRMS</u>	FS 2-2
<u>SRMS TO SSRMS</u>	FS 2-17
 <u>OBSS REFERENCE DATA</u>	 FS 3-1
<u>OBSS JOINT ANGLES VS POR COORDINATES</u>	FS 3-2
 <u>P6 NOMINAL</u>	 FS 4-1
<u>P6 HANDOFF FROM SSRMS TO SRMS</u>	FS 4-2
<u>SRMS TO SSRMS</u>	FS 4-5
<u>INSTALL VIEWING</u>	FS 4-8
 <u>P6 CONTINGENCY</u>	 FS 5-1
<u>P6 SJ HANDOFF FROM SSRMS TO SRMS</u>	FS 5-2
<u>SRMS TO SSRMS</u>	FS 5-10
 <u>P6 REFERENCE DATA</u>	 FS 6-1
<u>P6 JOINT ANGLES VS POR COORDINATES</u>	FS 6-2
<u>COORDINATE SYSTEM – PL ID 3</u>	FS 6-3
 <u>EVA 3</u>	 FS 7-1
<u>EVA 3 SUPPORT</u>	FS 7-2
 <u>EVA 3 CONTINGENCY</u>	 FS 8-1
<u>EVA 3 CONTINGENCY MBSU SUPPORT</u>	FS 8-2
 <u>EVA 3 REFERENCE DATA</u>	 FS 9-1
<u>EVA 3 JOINT ANGLES VS POR COORDINATES</u>	FS 9-2
<u>COORDINATE SYSTEM – PL ID 4</u>	FS 9-4
<u>– PL ID 5</u>	FS 9-5
 <u>CUE CARD CONFIGURATION</u>	 FS 10-1

This Page Intentionally Blank

OBSS HANDOFF

VERIFY UPLINKS.....	FS 1-2
OBSS HANDOFF FROM SSRMS TO SRMS	FS 1-4
SRMS TO SSRMS	FS 1-10

**OBSS
HANDOFF**

VERIFY UPLINKS

OBSS
HANDOFF

1. CHECK PL ID 1

SM 94 PDRS CONTROL

PL ID – ITEM 3 +1 EXEC

	X	Y	Z	PITCH	YAW	ROLL	PL ID
√	-1279	-151	-553	95	359	328	1
	SY	SP	EP	WP	WY	WR	
√	0.0	+25.0	-25.0	+5.0	0.0	0.0	

2. CHECK PL ID 2

SM 94 PDRS CONTROL

PL ID – ITEM 3 +2 EXEC

	X	Y	Z	PITCH	YAW	ROLL	PL ID
√	-1216	-141	-1141	95	359	358	2

3. CHECK AUTOSEQUENCES 1, 2, AND 3 START POINTS

SM 94 PDRS CONTROL

√PL ID, ITEM 3: 2

AUTO 1 – ITEM 13 +1 +2 +3 EXEC

BRAKES – OFF (tb-OFF)

MODE – AUTO 1, ENTER

SM 94 PDRS CONTROL

√START PT, ITEM 17: 1

MODE – AUTO 2, ENTER

SM 94 PDRS CONTROL

√START PT, ITEM 17: 54

MODE – AUTO 3, ENTER

SM 94 PDRS CONTROL

√START PT, ITEM 17: 58

BRAKES – ON (tb-ON)

4. CHECK AUTOSEQUENCES 4, 5, AND 6 START POINTS

SM 94 PDRS CONTROL

√PL ID, ITEM 3: 2

AUTO 1 – ITEM 13 +4 +5 +6 EXEC

BRAKES – OFF (tb-OFF)

MODE – AUTO 1, ENTER

SM 94 PDRS CONTROL

√START PT, ITEM 17: 90

MODE – AUTO 2, ENTER

SM 94 PDRS CONTROL

√START PT, ITEM 17: 95

MODE – AUTO 3, ENTER

SM 94 PDRS CONTROL

√START PT, ITEM 17: 145

BRAKES – ON (tb-ON)

5. CHECK PL ID 3

SM 94 PDRS CONTROL

PL ID – ITEM 3 +3 EXEC

√

X	Y	Z	PITCH	YAW	ROLL	PL ID
-1308	-108	-632	274	1	2	3

6. CHECK PL ID 4

SM 94 PDRS CONTROL

PL ID – ITEM 3 +4 EXEC

√

X	Y	Z	PITCH	YAW	ROLL	PL ID
-1236	-94	-466	306	36	237	4

7. CHECK PL ID 5

SM 94 PDRS CONTROL

PL ID – ITEM 3 +5 EXEC

√

X	Y	Z	PITCH	YAW	ROLL	PL ID
-1244	-130	-506	306	36	237	5

8. RESET TO PL ID 0

SM 94 PDRS CONTROL

PL ID – ITEM 3 +0 EXEC

√

X	Y	Z	PITCH	YAW	ROLL	PL ID
-1261	-146	-551	5	2	0	0

OBSS HANDOFF FROM SSRMS TO SRMS

1. SETUP

SM 94 PDRS CONTROL

√PL ID, ITEM 3: 0

√INIT ID, ITEM 24: 0

A7U CCTV – config as reqd

2. PRE-GRAPPLE MNVR

On SSRMS Operator GO for mnvr to OBSS PRE-GRAPPLE AT HANDOFF posn,

RHC RATE – as reqd (VERN within 10 ft)

BRAKES – OFF (tb-OFF)

MODE – ORB UNL, ENTER

Mnvr to OBSS PRE-GRAPPLE AT HANDOFF posn:

X	Y	Z	PITCH	YAW	ROLL	PL ID
-1015	-362	-688	284	0	270	0
SY	SP	EP	WP	WY	WR	
+23.5	+63.5	-29.6	-102.9	+11.5	-98.6	

BRAKES – ON (tb-ON)

Notify SSRMS Operator that SRMS at OBSS PRE-GRAPPLE AT HANDOFF posn

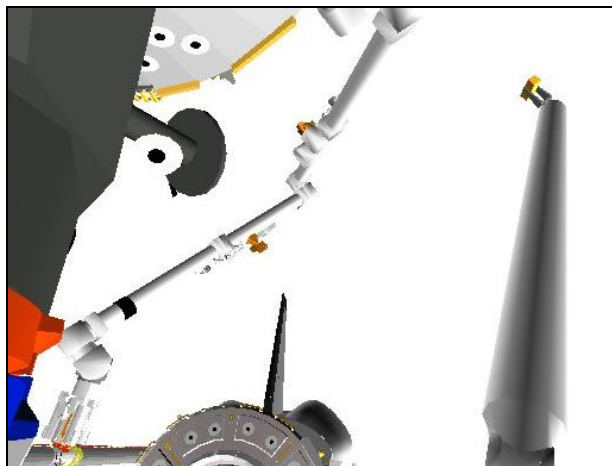

CCTV A (0,28)

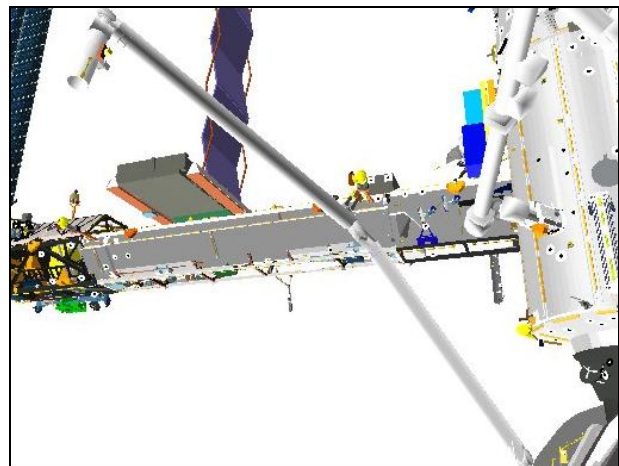

CCTV B (-20,20)

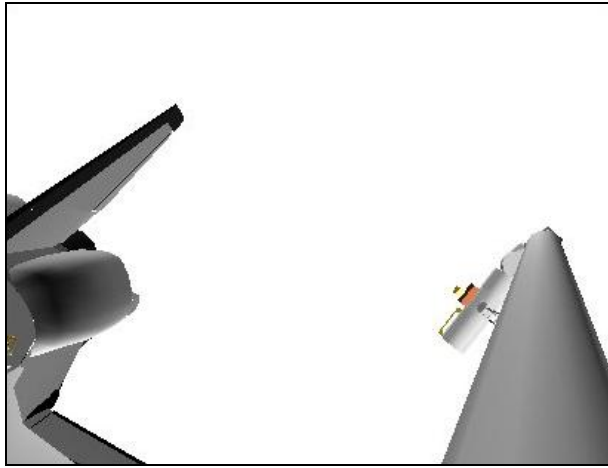

ELBOW (-30,-5)

3. CONFIGURE POWER

CAUTION
 SPEE power must be applied within 90 min
 to prevent sensor package damage

On SSRMS Operator GO to release STBD MRLs,
 STBD RMS HTR A,B (two) – OFF

- A6U EVENT TIMER MODE – UP
 CNTL – START
- MA73C:C cb MCA PWR AC3 3Φ MID 2 – op
 √AC2 3Φ MID 2 – op
- MA73C:D √AC3 3Φ MID 4 – op
- R13L PL BAY MECH PWR SYS (two) – ON

4. STBD MRL RELEASE

SM 94 PDRS CONTROL

RMS STBD – ITEM 2 EXEC (*)
 √STBD AFT, MID, FWD REL (six) = 0

NOTE

Expect single motor drive time for MRL release

STBD RMS RETEN LAT – REL (tb-REL) (18 sec max)
 – OFF

If motor drive time > 18 sec, √MCC

SM 94 PDRS CONTROL

√STBD AFT, MID, FWD REL (six) = 1

5. RECONFIGURE POWER

- R13L PL BAY MECH PWR SYS (two) – OFF
- MA73C:C cb MCA PWR AC3 3Φ MID 2 – cl
 √AC2 3Φ MID 2 – op
- MA73C:D √AC3 3Φ MID 4 – op

Give SSRMS Operator GO for OBSS Unberth
Monitor RFL Status

After OBSS Unberth,
SM 94 PDRS CONTROL
RMS PORT – ITEM 1 EXEC (*)

- A7U 6. SETUP FOR GRAPPLE
CCTV – config for grapple
– install PDRS TARGET OVERLAY FOR CTVM
– RMS WRIST, ZOOM: 34.0 HFOV
FOCUS: 5 ft
Maintain eyepoint approx 18 in when using grapple overlay

R12(OBSS) √SPEE PWR – OFF
A15 APCU 2 CONV – OFF

SM 179 POWER TRANSFER
√PTU 2 APCU OUT VOLTS: <10V

A15 APCU 2 OUTPUT – OFF

- RHC 7. OBSS GRAPPLE AT HANDOFF POSN
On SSRMS Operator GO for SRMS OBSS GRAPPLE posn,
RATE – VERN (RATE MIN tb-ON)
BRAKES – OFF (tb-OFF)
MODE – END EFF, ENTER

Mnvr to grapple envelope

CAUTION
Monitor EE tb timing to prevent EE motor burnout

EE MODE – AUTO
CAPTURE sw – depress (mom)

√	RIGID	CLOSE	CAPTURE	<u>CRITICAL TIMES (28 sec total):</u> CAPTURE tb – gray, then CLOSE tb – gray, 3 sec max, then RIGID tb – gray, 25 sec max
	<input type="checkbox"/>	<input type="checkbox"/>	<input type="checkbox"/>	
	DERIGID	OPEN	EXTEND	
	<input type="checkbox"/>	<input type="checkbox"/>	<input type="checkbox"/>	

EE MODE – OFF

- | | | |
|---|--|---|
| * | If manual capture required: | * |
| * | EE MODE – MAN | * |
| * | CAPTURE sw – depress (hold until CLOSE tb-gray, 3 sec max) | * |
| * | MAN CONTR – RIGID (hold until RIGID tb-gray, 25 sec max) | * |
| * | MODE – OFF | * |

MODE – TEST, ENTER
Wait 5 sec

BRAKES – ON (tb-ON)

SM 94 PDRS CONTROL

PL ID – ITEM 3 +2 EXEC
 INIT ID – ITEM 24 +2 EXEC

Expected OBSS HANDOFF posn:

	X	Y	Z	PITCH	YAW	ROLL	PL ID
√	-1029	+229	-614	284	270	270	2
	SY	SP	EP	WP	WY	WR	
√	+25.8	+66.3	-49.0	-85.9	+10.7	-100.7	

* display singularity

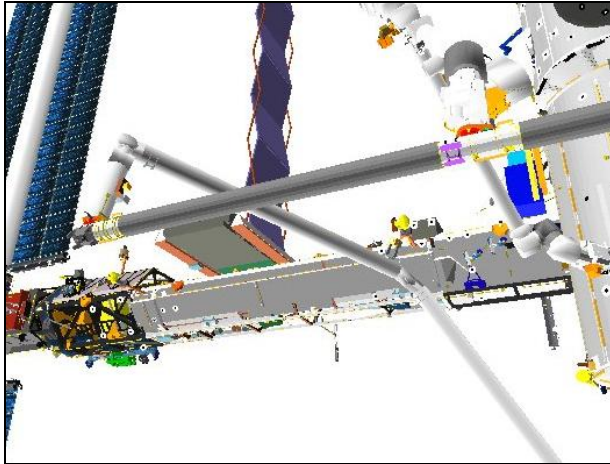

CCTV B (-25,25)

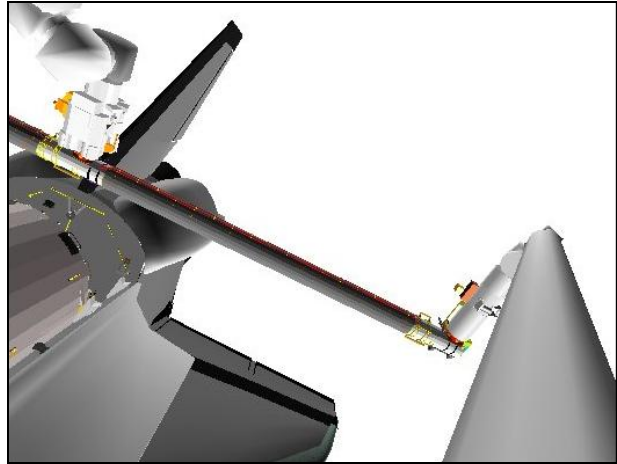

ELBOW (-30,-5)

- R12(OBSS) RSC PWR – OFF, ON
 SPEE PWR – ON
- A6U EVENT TIMER CNTL – STOP
- A15 √PTU 2 tb – ON
 APCU 2 OUTPUT – ON
 CONV – ON

SM 179 POWER TRANSFER

- √PTU 2 APCU OUT VOLTS: 123V to 126V
- √OUTPUT – ON

Give SSRMS Operator GO for OBSS Ungripple

Review GENERIC END EFFECTOR CUE CARD – ISS/SHUTTLE DOCKED OPS

8. MNVR TO NODE 2 VIEWING

- On SSRMS Operator GO for mnvr to NODE 2 VIEWING posn,
- RHC RATE – as required (VERN within 10 ft)
- BRAKES – OFF (tb-OFF)
- MODE – SINGLE, ENTER

Mnvr to NODE 2 VIEWING posn:

HANDOFF
 1: SY +
 2: EP +
 3: WR +
 4: WY -
 5: SP -
 6: WP +
 7: SY +
 NODE 2
 VIEW

SY	SP	EP	WP	WY	WR		
+25.8	+66.3	-49.0	-85.9	+10.7	-100.7		
+35.0							
		-22.8					
					+15.0		
				-0.5			
	+36.7						
			-2.0				
+85.0							
+85.0	+36.7	-22.8	-2.0	-0.5	+15.0		
X	Y	Z	PITCH	YAW	ROLL	PL ID	
-767	-775	-1068	86	7	276	2	

BRAKES – ON (tb-ON)
 MODE – not DIRECT
 PARAM – PORT TEMP
 JOINT – CRIT TEMP

Give SSRMS Operator GO for mnvr to EVA 1 SETUP posn

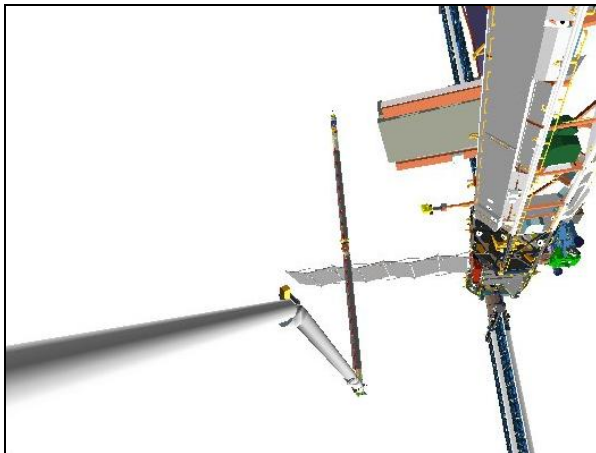

CCTV A (70,25)

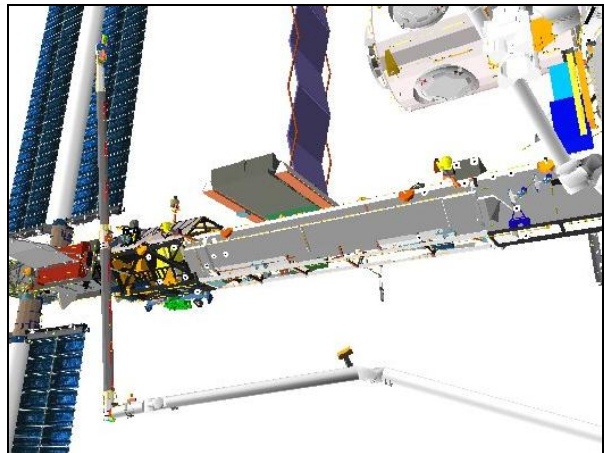

CCTV B (-30,20)

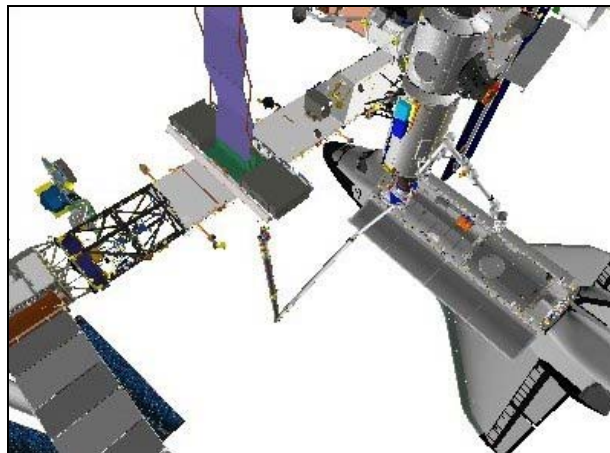

BIRD'S EYE

9. RECONFIG PTU

Perform ACTIVATION (LDRI/ITVC Cue Card, P/TV), steps 1, 3, 4, and 5

Perform LCC ACTIVATION (LCS Cue Card, P/TV), step 2 only

Perform LCC DEACTIVATION (LCS Cue Card, P/TV), step 1 only

A7U

VIDEO OUT MON2 pb – push
IN PL2(VPU) pb – push

CAMR CMD PAN/TILT – HI RATE
PAN – L (to hard stop)
TILT – UP (to hard stop)
PAN/TILT – RESET
PAN: +70 (right)
TILT: -68 (dn)
ZOOM – IN (full in)

VIDEO OUT MUX 1 L pb – push (MIDDECK It on)
LDRI MODE 1 pb – push (ITVC video)
VIDEO OUT – as desired (not MUX 1 L)

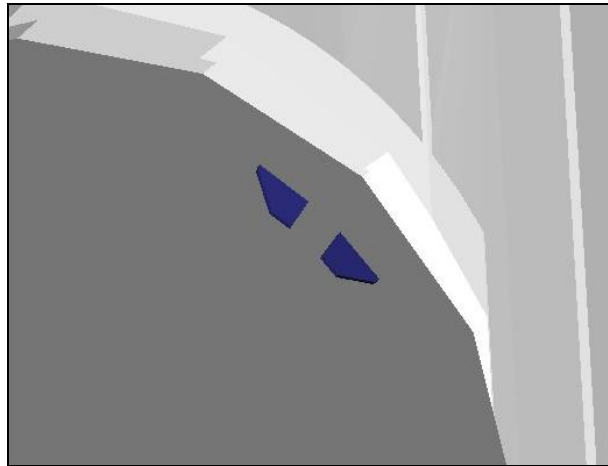

OBSS ITVC (70,-68)

OBSS HANDOFF FROM SRMS TO SSRMS

1. SETUP

SM 94 PDRS CONTROL

√PL ID, ITEM 3: 2

√INIT ID, ITEM 24: 2

A7U CCTV – config as reqd

Review GENERIC END EFFECTOR CUE CARD – ISS/SHUTTLE DOCKED OPS

2. MANEUVER TO OBSS HANDOFF

RHC On SSRMS Operator GO for mnvr to OBSS HANDOFF posn,
 RATE – as reqd (VERN within 10 ft)
 BRAKES – OFF (tb-OFF)
 MODE – SINGLE, ENTER

Mnvr to OBSS HANDOFF posn:

	SY	SP	EP	WP	WY	WR	
NODE 2 VIEW	+85.0	+36.7	-22.8	-2.0	-0.5	+15.0	
1: SY –	+35.0						
2: WP –				-85.9			
3: SP +		+66.3					
4: WY +					+10.7		
5: WR –						-100.7	
6: EP –			-49.0				
7: SY –	+25.8						
HANDOFF POSN	+25.8	+66.3	-49.0	-85.9	+10.7	-100.7	
	X	Y	Z	PITCH	YAW	ROLL	PL ID
	-1029	+229	-614	284	270	270	2

* display singularity

BRAKES – ON (tb-ON)

Give SSRMS Operator GO for OBSS Grapple

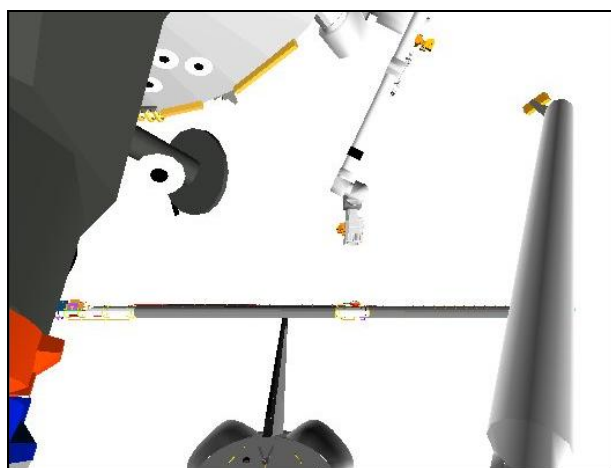

CCTV A (0,30)

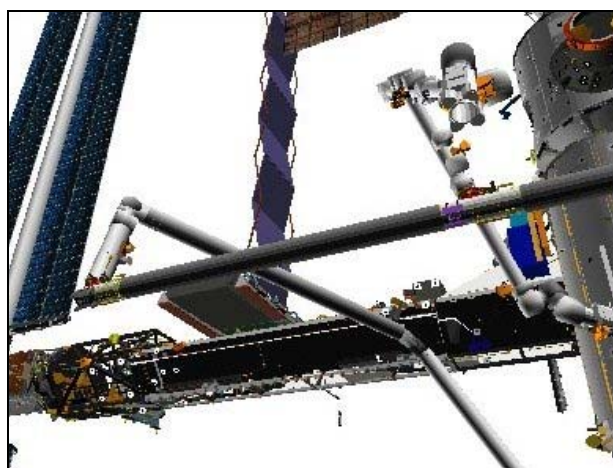

CCTV B (-25,30)



ELBOW (-30,0)

3. STOW PTU

A7U

On SSRMS Operator GO for OBSS Ungrapple,
 VIDEO OUT MON2 pb – push
 IN PL2(VPU) pb – push

CAMR CMD PAN/TILT – HI RATE

PAN – L (to hard stop)

TILT – UP (to hard stop)

PAN/TILT – RESET, HI RATE (LO within 10°)

PAN: +108 (right)

TILT: -175 (down)

Perform LCH DEACTIVATION (LCS Cue Card, P/TV)

CAUTION

STBD RMS HTR power must be applied within
 90 min to prevent sensor package damage

Perform DEACTIVATION (LDRI/ITVC Cue Card, P/TV)

4. OBSS UNGRAPPLE

A7U

CCTV – config for ungrapple
 – RMS WRIST, ZOOM: 34.0 HFOV
 FOCUS: 5 ft

NOTE

CONTR ERR It and 'S96 PDRS CNTL' msg may
 occur due to Consistency/Envelope Check error

RHC

RATE – COARSE (RATE MIN tb-OFF)

SM 94 PDRS CONTROL

AUTO BRAKE INH – ITEM 10 EXEC (*)

BRAKES – OFF (tb-OFF)
 MODE – TEST, ENTER
 Wait 5 sec

BRAKES – ON (tb-ON)







SM 94 PDRS CONTROL
 AUTO BRAKE ENA – ITEM 9 EXEC (*)
 PL ID – ITEM 3 +0 EXEC
 INIT ID – ITEM 24 +0 EXEC

RHC RATE – VERN (RATE MIN tb-ON)
 BRAKES – OFF (tb-OFF)
 MODE – END EFF, ENTER

CAUTION
 Monitor EE tb timing to prevent EE motor burnout

EE MODE – AUTO
 RELEASE sw – depress (mom)

When OPEN tb – gray, mnvr arm clear of grapple pin

√	RIGID 	CLOSE 	CAPTURE 	<u>CRITICAL TIMES (28 sec total):</u> DERIGID tb – gray, 5 sec max, then OPEN tb – gray, 3 sec max, then EXTEND tb – gray, 20 sec max
	DERIGID 	OPEN 	EXTEND 	

EE MODE – OFF

- * If manual release reqd: *
- * EE MODE – MAN *
- * MAN CONTR – DERIGID (hold until DERIGID tb-gray, 5 sec max) *
- * RELEASE sw – depress (hold until OPEN tb-gray, 3 sec max) *
- * Mnvr arm clear of grapple pin, then *
- * EE MAN CONTR – DERIGID (hold until EXTEND tb-gray, 20 sec max) *
- * MODE – OFF *

RHC 5. MNVR TO OBSS PRE-GRAPPLE AT HANDOFF
 RATE – VERN (RATE MIN tb-ON)
 MODE – as desired

Mnvr to OBSS PRE-GRAPPLE AT HANDOFF posn:

X	Y	Z	PITCH	YAW	ROLL	PL ID
-1015	-362	-688	284	0	270	0
SY	SP	EP	WP	WY	WR	
+23.5	+63.5	-29.6	-102.9	+11.5	-98.6	

BRAKES – ON (tb-ON)
 MODE – not DIRECT
 JOINT – CRIT TEMP

If using Shuttle attitude control and attitude maintenance required:
 Configure DAP per RMS DAPs, then perform RATE DAMPING (ORB OPS FS, REBOOST/DAP; DOCKED DAP REFERENCE)

Give SSRMS Operator GO for OBSS Berth

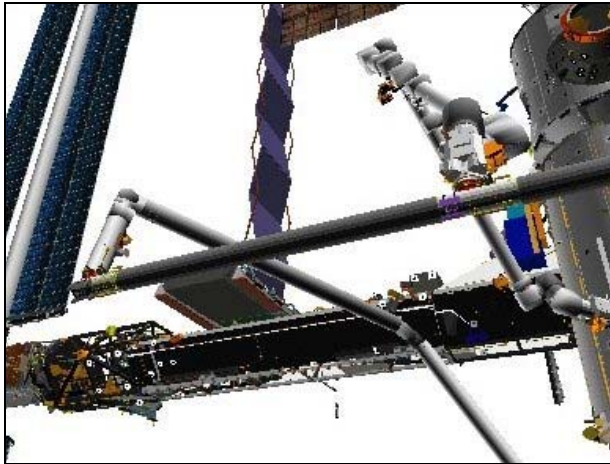

CCTV B (-25,30)

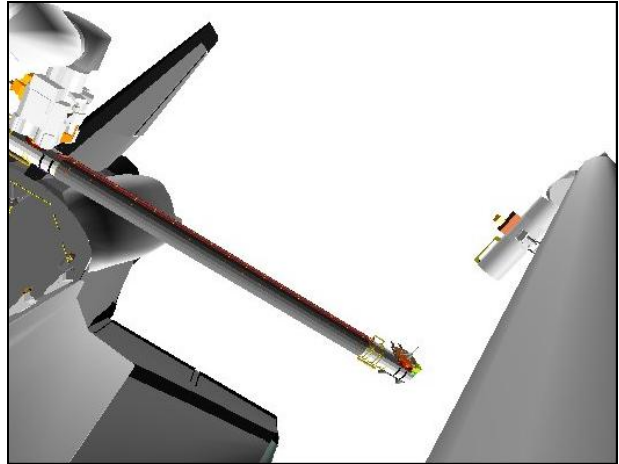

ELBOW (-35,-15)

6. CONFIGURE CIRCUIT BREAKERS

- MA73C:C cb MCA PWR AC3 3Φ MID 2 – op
- √AC2 3Φ MID 2 – op
- MA73C:D √AC3 3Φ MID 4 – op

7. CONFIGURE FOR MONITORING

On SSRMS notification to watch for STBD RMS RFLs,
SM 94 PDRS CONTROL
 RMS STBD – ITEM 2 EXEC (*)

Notify SSRMS operator when STBD RMS R-F-L tb (three) – gray

8. STBD MRL LATCH

On SSRMS Operator GO to latch STBD MRLs to Topological Capture,
 √STBD RMS R-F-L tb (three) – gray

SM 94 PDRS CONTROL

√STBD AFT, MID, FWD LAT (six) = 0

R13L PL BAY MECH PWR SYS (two) – ON

NOTE

Expect single motor drive time for MRL latching (18 sec max).
 The following STBD RMS RETEN LAT – OFF and PL BAY
 MECH PWR SYS (two) – OFF actions are to be performed simo

Verify AOS for latching to Topological Capture

STBD RMS RETEN LAT – LAT 6 sec only (tb-bp)
 – OFF

R13L PL BAY MECH PWR SYS (two) – OFF

Give SSRMS Operator GO to Limp All SSRMS Joints and Derigidize

R13L On SSRMS Operator GO to complete STBD MRL latching,
PL BAY MECH PWR SYS (two) – ON

STBD RMS RETEN LAT – LAT (tb-LAT) (12 sec max)
– OFF

9. RECONFIGURE POWER
R13L PL BAY MECH PWR SYS (two) – OFF

STBD RMS HTR A,B (two) – AUTO

A6U EVENT TIMER CNTL – STOP

SM 94 PDRS CONTROL

√STBD AFT, MID, FWD LAT (six) = 1
RMS PORT – ITEM 1 EXEC (*)

MA73C:C cb MCA PWR AC3 3Φ MID 2 – cl
√AC2 3Φ MID 2 – op

MA73C:D √AC3 3Φ MID 4 – op

Give SSRMS Operator GO for OBSS Ungrapple

10. MNVR TO PRE-CRADLE

RHC On SSRMS Operator GO for mnvr to PRE-CRADLE posn,
RATE – as reqd (VERN within 10 ft)
BRAKES – OFF (tb-OFF)
MODE – SINGLE, ENTER

Mnvr to PRE-CRADLE posn:

	SY	SP	EP	WP	WY	WR	
PRE-GRAPPLE	+23.5	+63.5	-29.6	-102.9	+11.5	-98.6	
1: WR +						0.0	
2: WY -					0.0		
3: WP +				+5.0			
4: SP -		+25.0					
5: EP +			-25.0				
6: SY -	0.0						
PRE-CRADLE	0.0	+25.0	-25.0	+5.0	0.0	0.0	
	X	Y	Z	PITCH	YAW	ROLL	PL ID
	-1261	-146	-551	5	2	0	0

BRAKES – ON (tb-ON)
MODE – not DIRECT
PARAM – PORT TEMP
JOINT – CRIT TEMP

Give SSRMS Operator GO for mnvr to MBS PDGF3 Pre-grapple

OBSS CONTINGENCY

OBSS SJ HANDOFF FROM SSRMS TO SRMS.....	FS 2-2
SRMS TO SSRMS.....	FS 2-17

OBSS
CONTINGENCY

OBSS SJ HANDOFF FROM SSRMS TO SRMS

1. SETUP

If SINGLE MODE available:

SM 94 PDRS CONTROL

√PL ID, ITEM 3: 0

√INIT ID, ITEM 24: 0

A7U

CCTV – config as reqd

– perform PAN/TILT RESET for PLB cameras

ZOOM – full OUT

2. SJ OBSS PRE-GRAPPLE AT HANDOFF MANEUVER

On SSRMS Operator GO for mnvr to OBSS PRE-GRAPPLE AT HANDOFF posn,

If SINGLE MODE available:

RHC

RATE – as reqd (VERN within 10 ft)

BRAKES – OFF (tb-OFF)

MODE – best available

Mnvr to OBSS PRE-GRAPPLE AT HANDOFF posn:

	SY	SP	EP	WP	WY	WR	
PRE-CRADLE	0.0	+25.0	-25.0	+5.0	0.0	0.0	
1: SY +	+23.5						
2: SP +		+63.5					
3: EP –			-29.6				
4: WP –				-102.9			
5: WY +					+11.5		
6: WR –						-98.6	
OBSS PRE-GRAPPLE AT HAND-OFF	+23.5	+63.5	-29.6	-102.9	+11.5	-98.6	
	X	Y	Z	PITCH	YAW	ROLL	PL ID
	-1015	-362	-688	284	0	270	0

BRAKES – ON (tb-ON)

MODE – not DIRECT

JOINT – CRIT TEMP

Notify SSRMS Operator that SRMS at OBSS PRE-GRAPPLE AT HANDOFF posn

OBSS CONTINGENCY

Start:
Pre-Cradle

Step 1:
Drive SY (+) from 0.0° to +23.5°

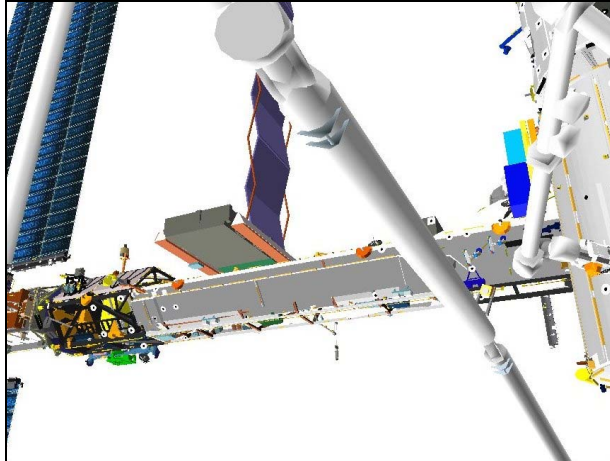

CCTV B (-25,25)

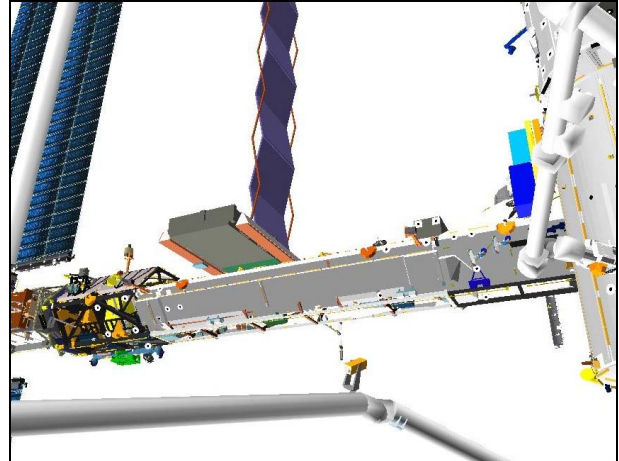

CCTV B (-25,25)

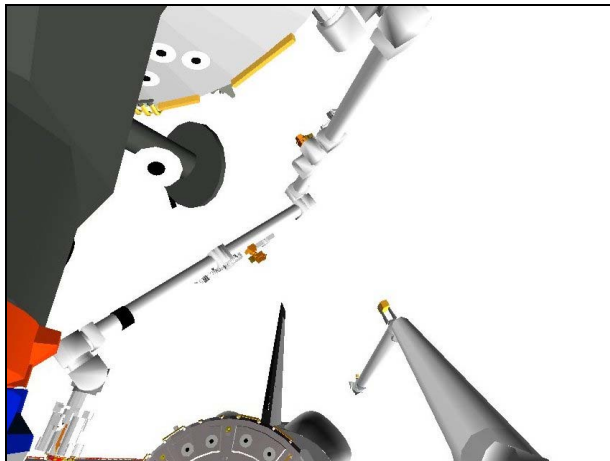

CCTV A (0,30)

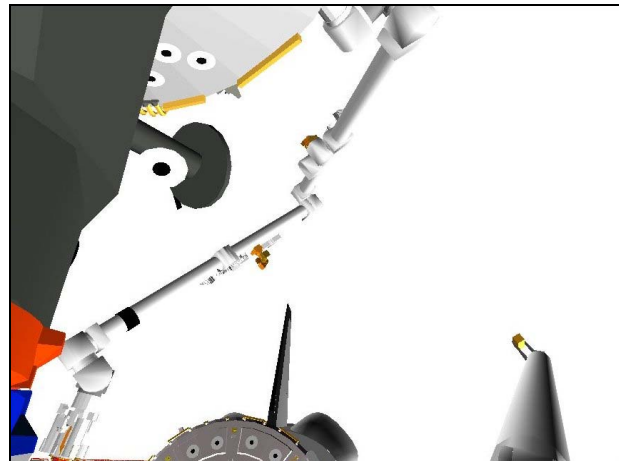

CCTV A (0,30)

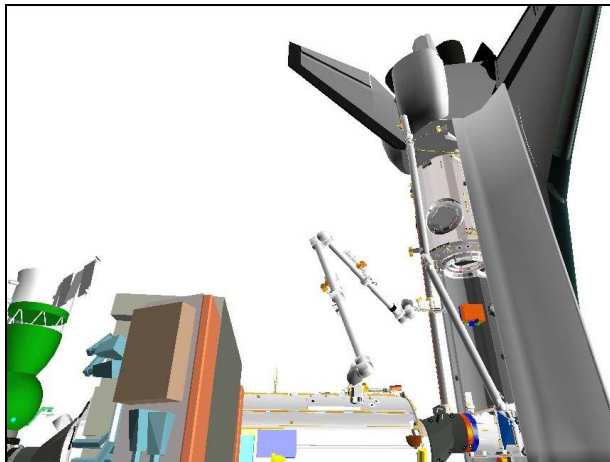

P1 LOOB (95,30)

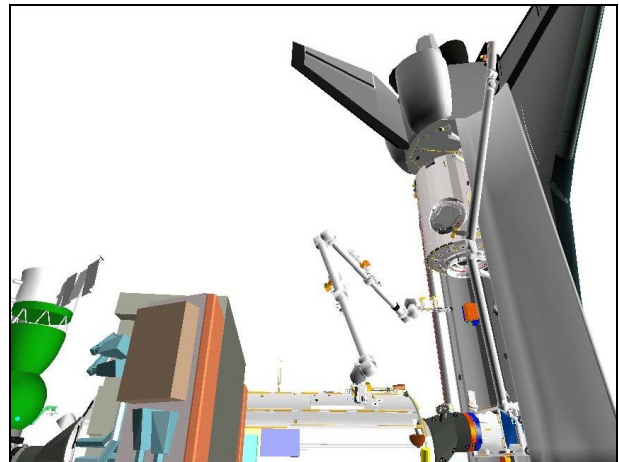

P1 LOOB (95,30)

Step 2:
Drive SP (+) from +25.0° to +63.5°

Step 3:
Drive EP (-) from -25.0° to -29.6°

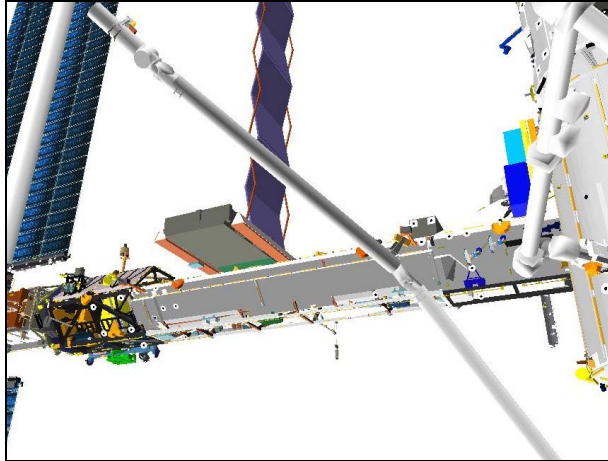

CCTV B (-25,25)

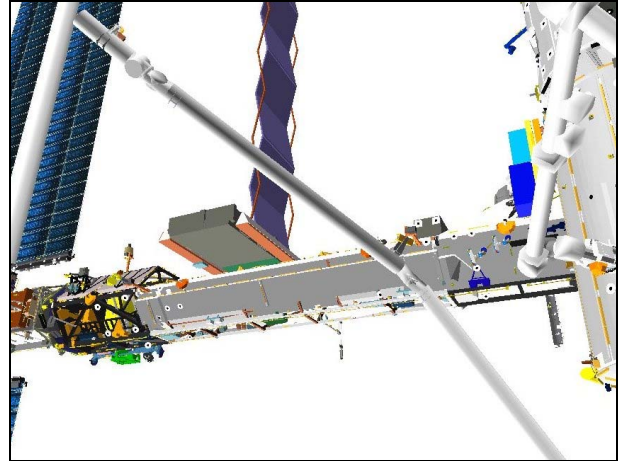

CCTV B (-25,25)

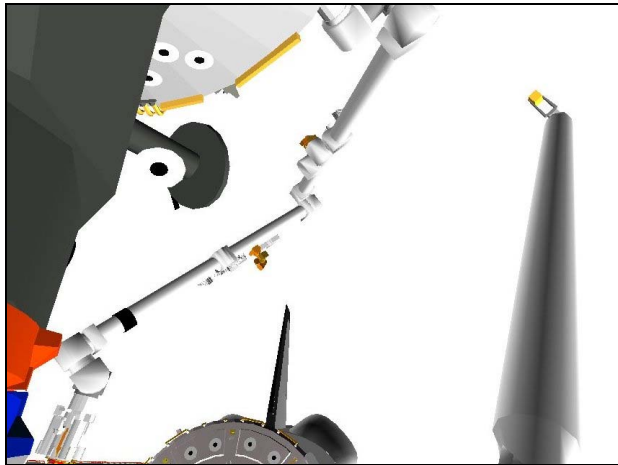

CCTV A (0,30)

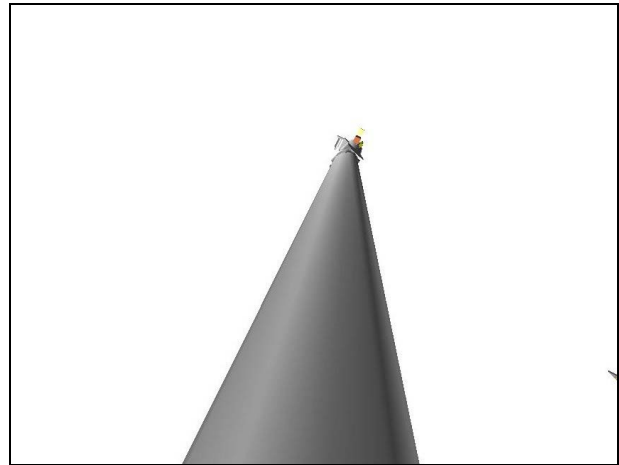

ELBOW (-5,-15)

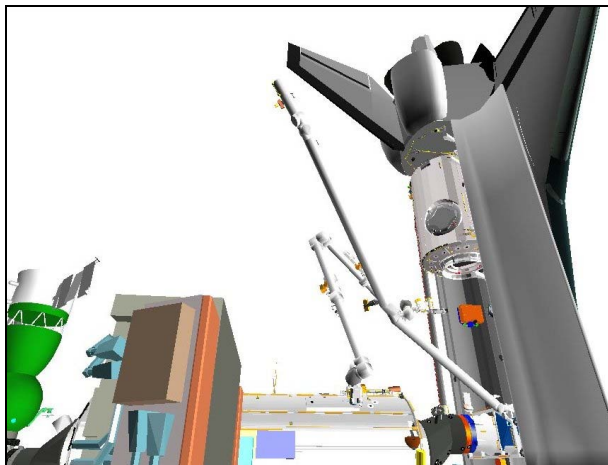

P1 LOOB (95,30)

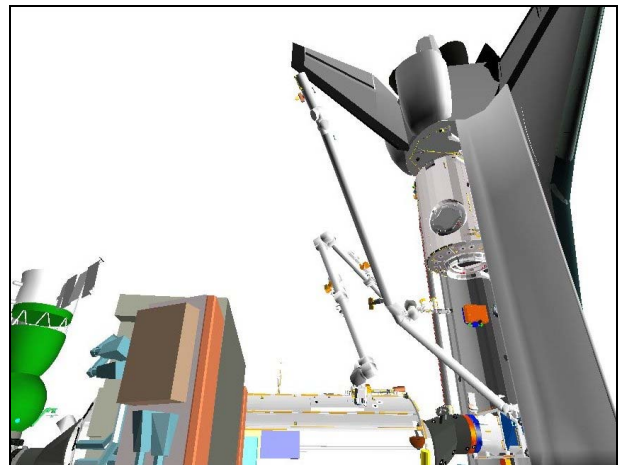

P1 LOOB (95,30)

Step 4:
Drive WP (-) from +5.0° to -102.9°

Step 5:
Drive WY (+) from 0.0° to +11.5°

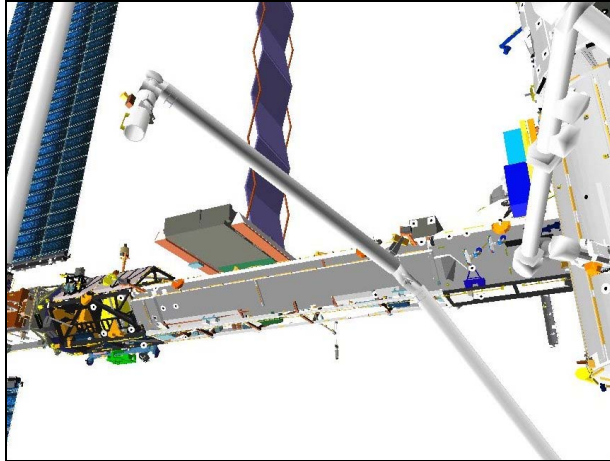

CCTV B (-25,25)

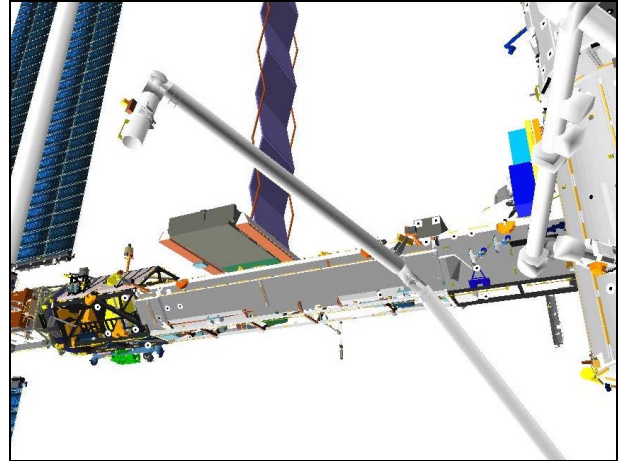

CCTV B (-25,25)

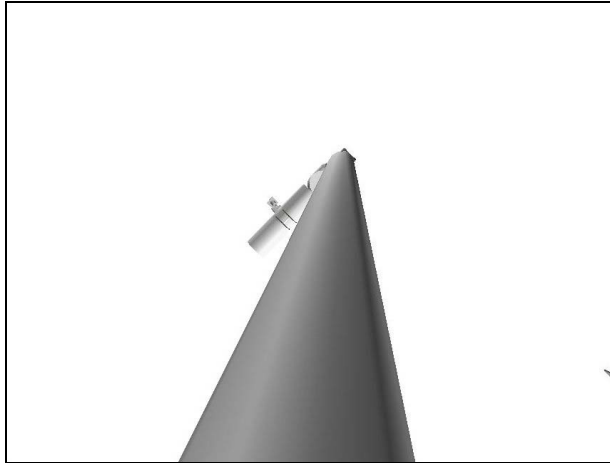

ELBOW (-5,-15)

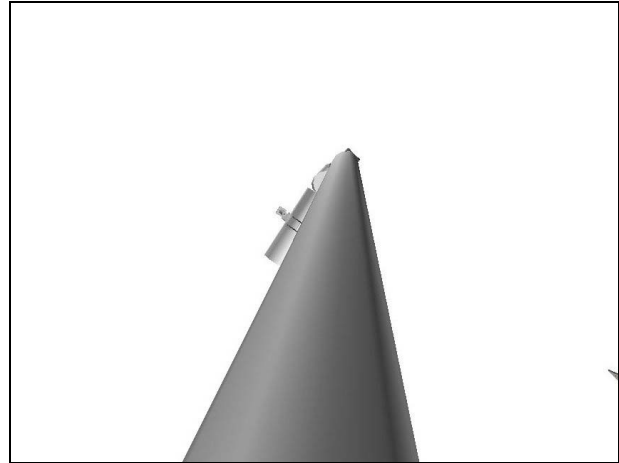

ELBOW (-5,-15)

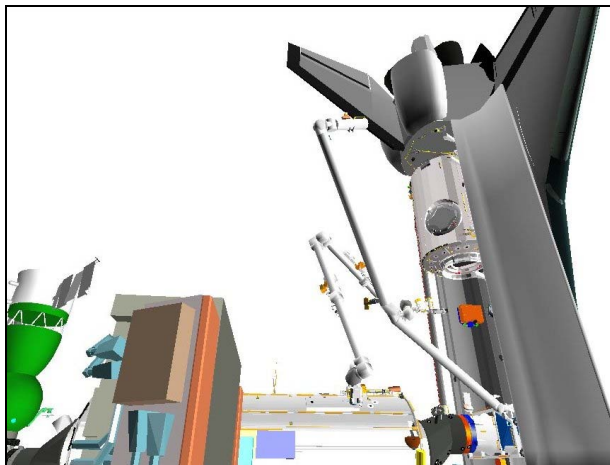

P1 LOOB (95,30)

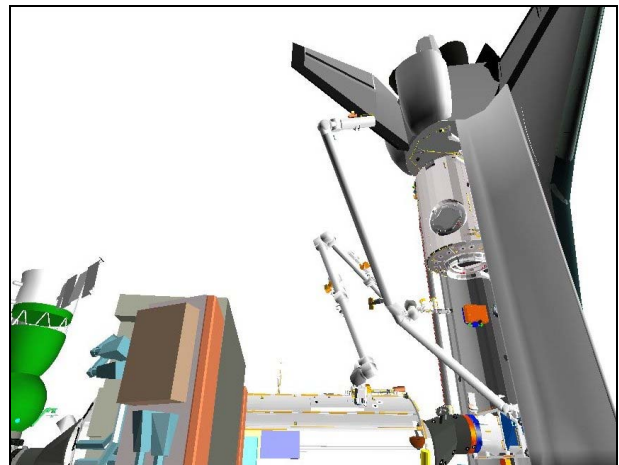

P1 LOOB (95,30)

Step 6:

Drive WR (-) from 0.0° to -98.6°

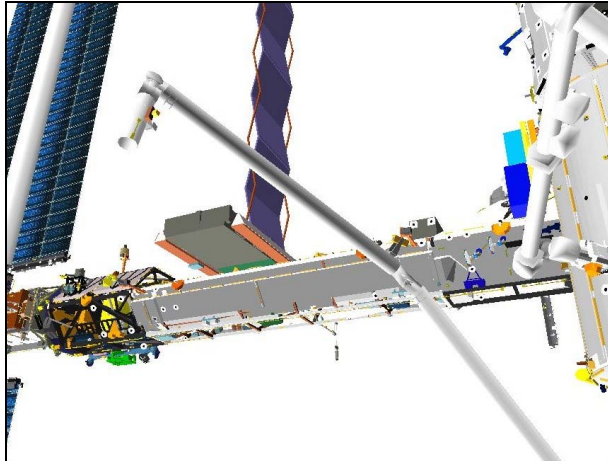

CCTV B (-25,25)

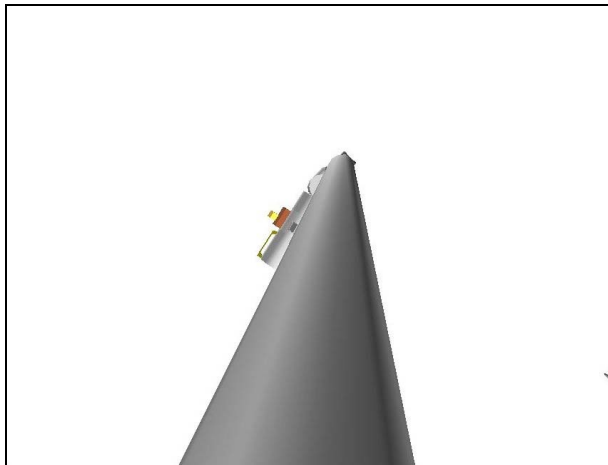

ELBOW (-5,-15)

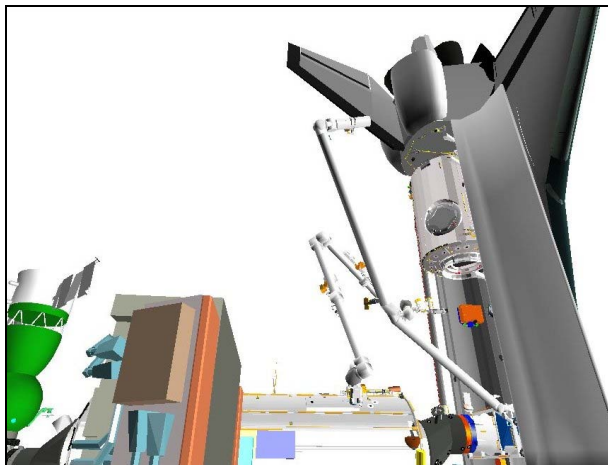

P1 LOOB (95,30)

3. CONFIGURE POWER

CAUTION
SPEE power must be applied within 90 min
to prevent sensor package damage

On SSRMS Operator GO to release STBD MRLs,
STBD RMS HTR A,B (two) – OFF

A6U EVENT TIMER MODE – UP
 CNTL – START

MA73C:C cb MCA PWR AC3 3Φ MID 2 – op
 √AC2 3Φ MID 2 – op
 :D √AC3 3Φ MID 4 – op

R13L PL BAY MECH PWR SYS (two) – ON

4. STBD MRL RELEASE

SM 94 PDRS CONTROL
RMS STBD – ITEM 2 EXEC (*)
√STBD AFT, MID, FWD REL (six) = 0

NOTE
Expect single motor drive time for MRL release

STBD RMS RETEN LAT – REL (tb-REL) (18 sec max)
– OFF
If motor drive time > 18 sec, √MCC

SM 94 PDRS CONTROL
√STBD AFT, MID, FWD REL (six) = 1

5. RECONFIGURE POWER

R13L PL BAY MECH PWR SYS (two) – OFF

MA73C:C cb MCA PWR AC3 3Φ MID 2 – cl
 √AC2 3Φ MID 2 – op
 :D √AC3 3Φ MID 4 – op

Give SSRMS Operator GO for OBSS Unberth
Monitor RFL Status

After OBSS Unberth,
SM 94 PDRS CONTROL
RMS PORT – ITEM 1 EXEC (*)

6. SETUP FOR GRAPPLE

A7U CCTV – config for grapple
 – install PDRS TARGET OVERLAY FOR CTVM
 – RMS WRIST, ZOOM: 34.0 HFOV
 FOCUS: 5 ft
Maintain eyepoint approx 18 in when using grapple overlay

R12(OBSS) √SPEE PWR – OFF
A15 APCU 2 CONV – OFF

SM 179 POWER TRANSFER

√PTU 2 APCU OUT VOLTS: <10V

A15 APCU 2 OUTPUT – OFF

7. SJ OBSS GRAPPLE AT HANDOFF

On SSRMS Operator GO for SRMS OBSS Grapple,
If SINGLE MODE available:

RHC RATE – VERN (RATE MIN tb-ON)
BRAKES – OFF (tb-OFF)

MODE – best available

Drive joints per OBSS SJ HANDOFF SRMS GRAPPLE WRIST CCTV OVERLAY
and diagram until EE within grapple envelope

CAUTION

Monitor EE tb timing to prevent EE motor burnout

EE MODE – AUTO

CAPTURE sw – depress (mom)

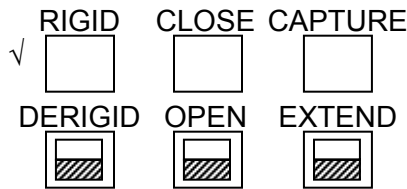

CRITICAL TIMES (28 sec total):

CAPTURE tb – gray, then
CLOSE tb – gray, 3 sec max, then
RIGID tb – gray, 25 sec max

EE MODE – OFF

- * If manual capture required: *
- * EE MODE – MAN *
- * CAPTURE sw – depress (hold until CLOSE tb-gray, 3 sec max) *
- * MAN CONTR – RIGID (hold until RIGID tb-gray, 25 sec max) *
- * MODE – OFF *

If TEST mode available,
MODE – TEST, ENTER
Wait 5 sec

BRAKES – ON (tb-ON)
MODE – not DIRECT
JOINT – CRIT TEMP

OBSS SJ GRAPPLE AT HANDOFF OVERLAY

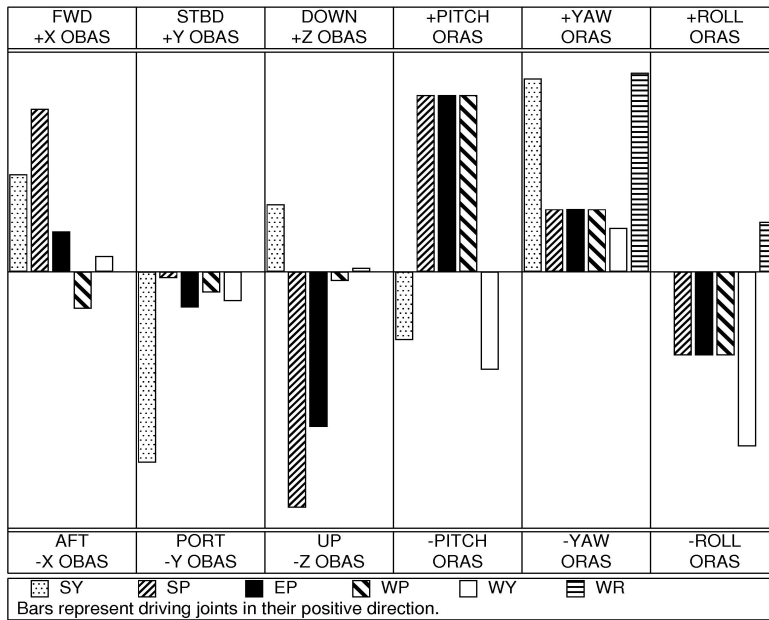

To get:	Drive:	To get:	Drive:	Driving:	Results In:	Driving:	Results In:
+X (fwd)	+SP, +SY	+PITCH	+WP, +EP	+SY	-Y (port), +YAW	+WP	-X (aft), +PITCH
+Y (stbd)	-SY	+YAW	+WR, +SY	+SP	-Z (up), +PITCH	+WY	-Y (port), -ROLL
+Z (down)	-SP, -EP	+ROLL	-WY, -WP	+EP	-Z (up), +PITCH	+WR	+YAW

ΔSY	ΔSP	ΔEP	ΔWP	ΔWY	ΔWR
+2.3	+2.8	-19.4	+17.0	-0.8	-2.1

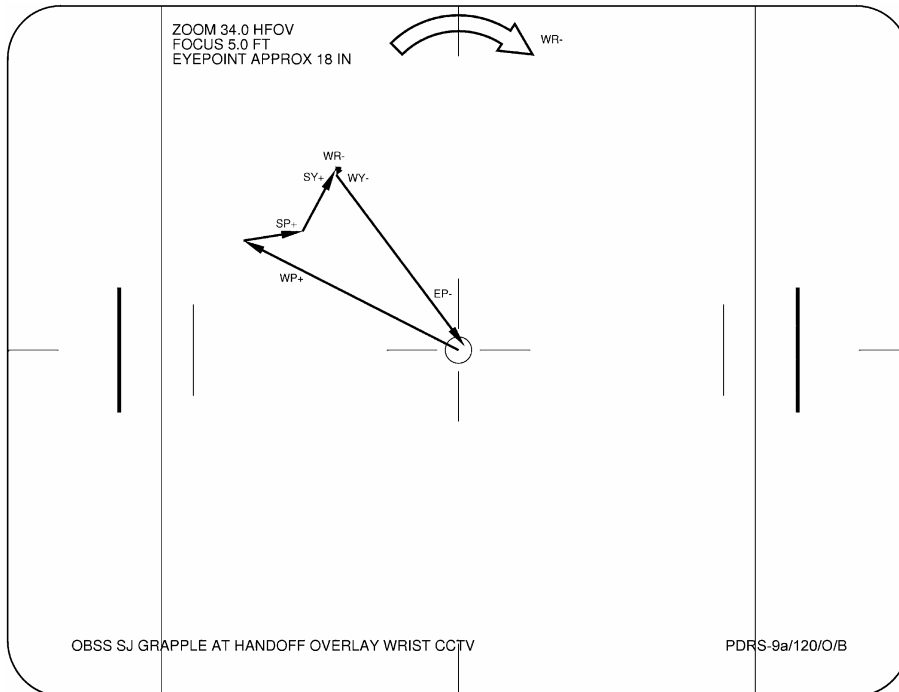

If SINGLE MODE available:

SM 94 PDRS CONTROL

PL ID – ITEM 3 +2 EXEC

INIT ID – ITEM 24 +2 EXEC

Expected OBSS HANDOFF posn:

X	Y	Z	PITCH	YAW	ROLL	PL ID
-1029	+229	-614	284	270	270	2
SY	SP	EP	WP	WY	WR	
+25.8	+66.3	-49.0	-85.9	+10.7	-100.7	

* display singularity

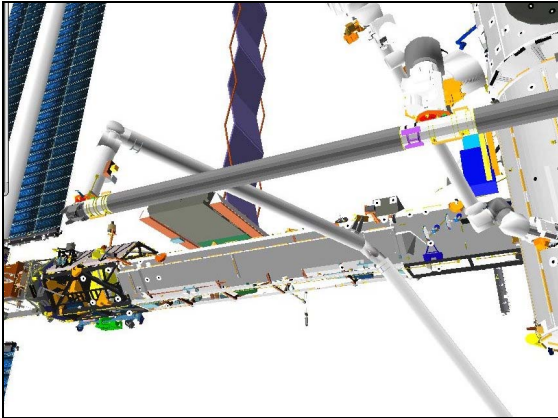

CCTV B (-25,25)

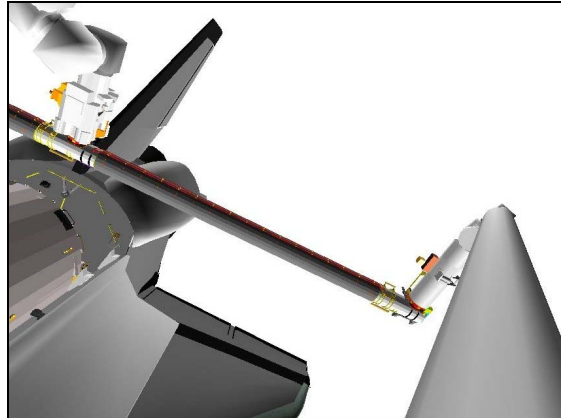

ELBOW (-5,-15)

- R12(OBSS) RSC PWR – OFF, ON
SPEE PWR – ON
- A6U EVENT TIMER CNTL – STOP
- A15 √PTU 2 tb – ON
APCU 2 OUTPUT – ON
CONV – ON

SM 179 POWER TRANSFER

- √PTU 2 APCU OUT VOLTS: 123V to 126V
- √OUTPUT – ON

Give SSRMS Operator GO for OBSS Ungrapple

Review GENERIC END EFFECTOR CUE CARD – ISS/SHUTTLE DOCKED OPS

8. MNVR TO NODE 2 VIEWING

On SSRMS Operator GO for mnvr to NODE 2 VIEWING posn,

If SINGLE MODE available:

- RHC RATE – as desired (VERN within 10 ft)
- BRAKES – OFF (tb-OFF)

MODE – best available

Mnvr to NODE 2 VIEWING posn:

	SY	SP	EP	WP	WY	WR	
HANDOFF	+25.8	+66.3	-49.0	-85.9	+10.7	-100.7	
1: SY +	+35.0						
2: EP +			-22.8				
3: WR +						+15.0	
4: WY -					-0.5		
5: SP -		+36.7					
6: WP +				-2.0			
7: SY +	+85.0						
NODE 2 VIEW	+85.0	+36.7	-22.8	-2.0	-0.5	+15.0	
	X	Y	Z	PITCH	YAW	ROLL	PL ID
	-767	-775	-1068	86	7	276	2

BRAKES – ON (tb-ON)
 MODE – not DIRECT
 PARAM – PORT TEMP
 JOINT – CRIT TEMP

Give SSRMS Operator GO for mnvr to EVA 1 SETUP posn

Start:
OBSS Handoff

Step 1:
Drive SY (+) from +25.8° to +35.0°

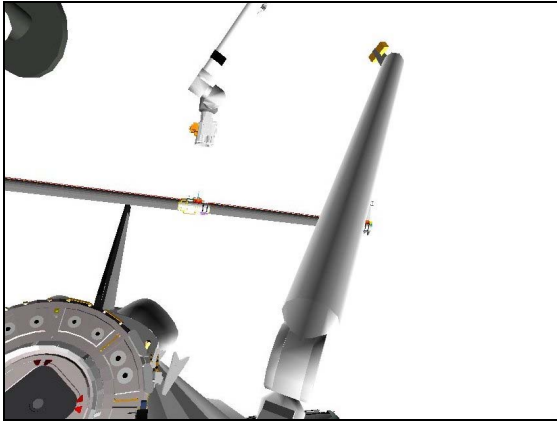

CCTV A (20,20)

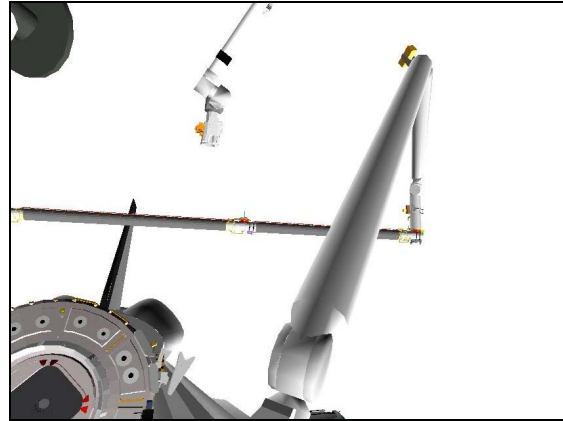

CCTV A (20,20)

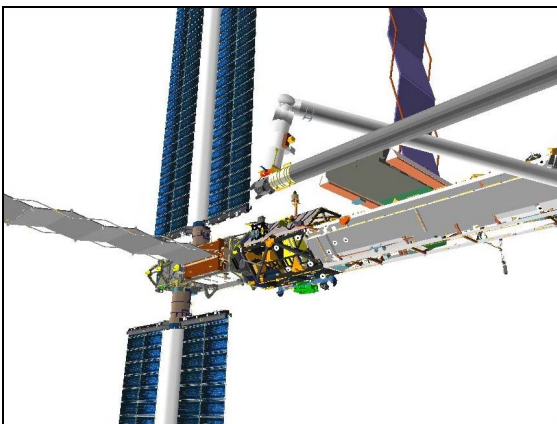

CCTV B (-45,20)

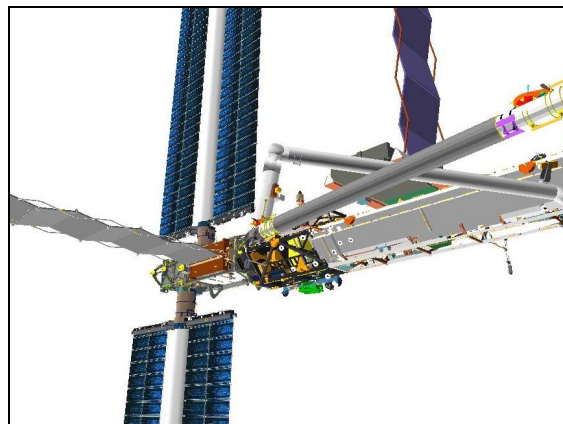

CCTV B (-45,20)

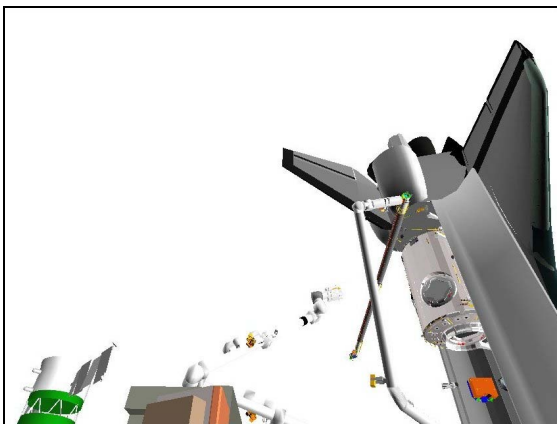

P1 LOOB (90,45)

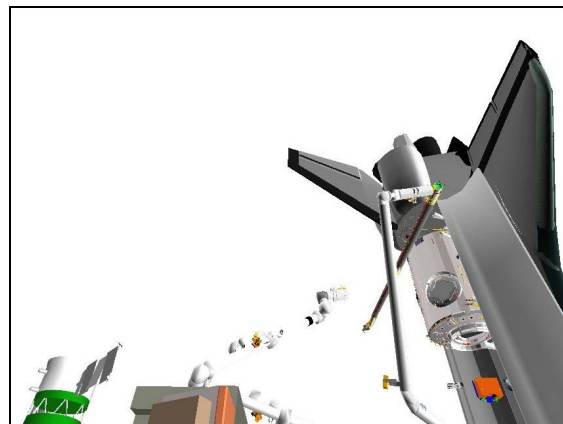

P1 LOOB (90,45)

Step 2:

Drive EP (+) from -49.0° to -22.8°

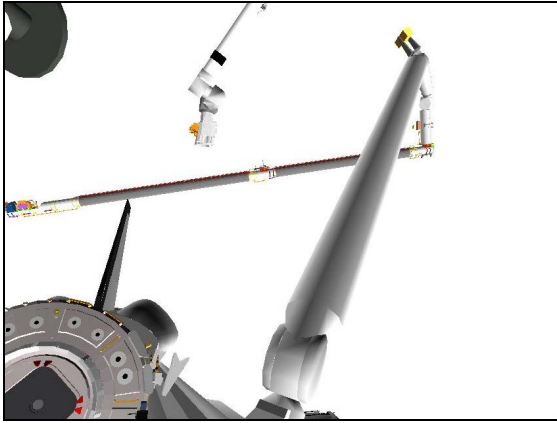

CCTV A (20,20)

Step 3:

Drive WR (+) from -100.7° to $+15^\circ$

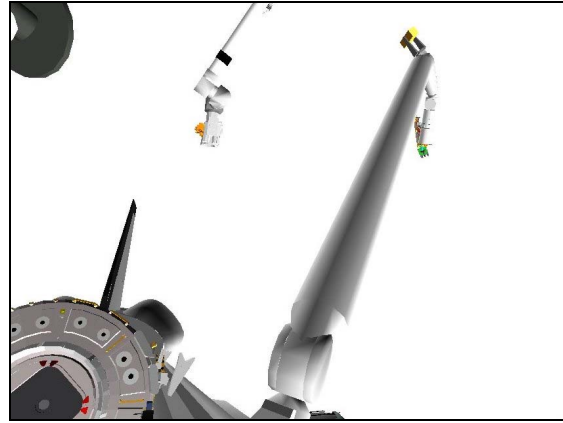

CCTV A (20,20)

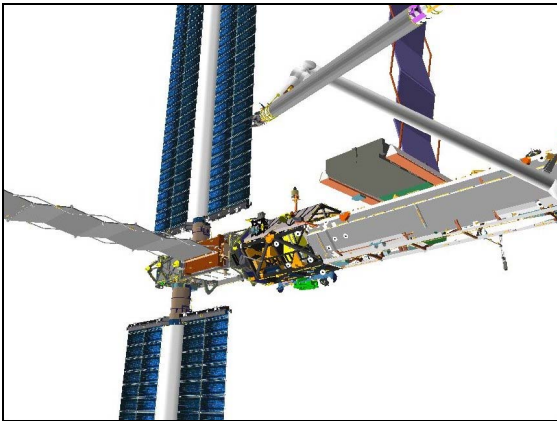

CCTV B (-45,20)

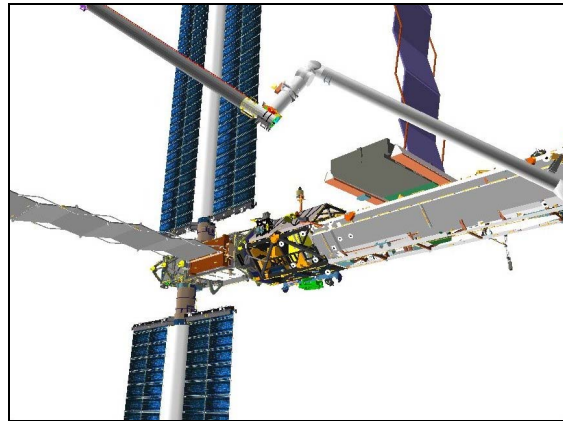

CCTV B (-45,20)

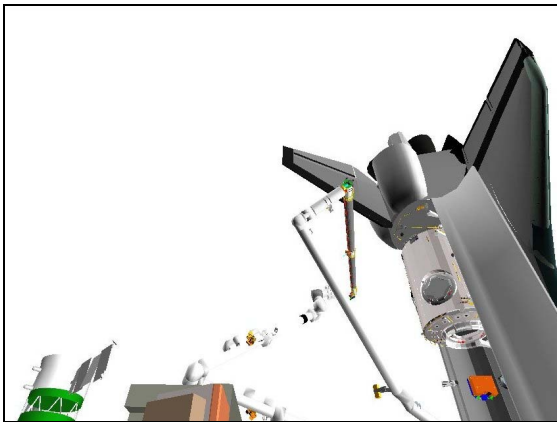

P1 LOOB (90,45)

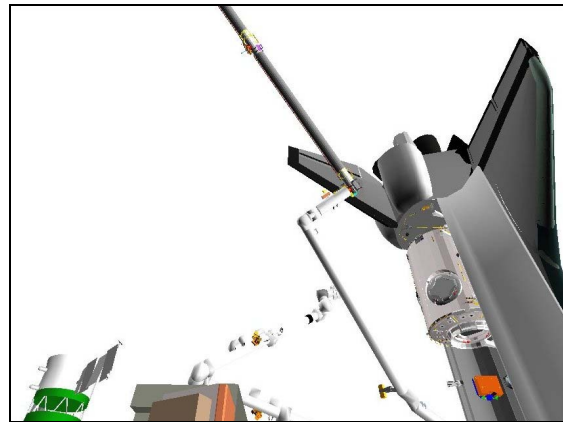

P1 LOOB (90,45)

Step 4:

Drive WY (-) from $+10.7^\circ$ to -0.5°

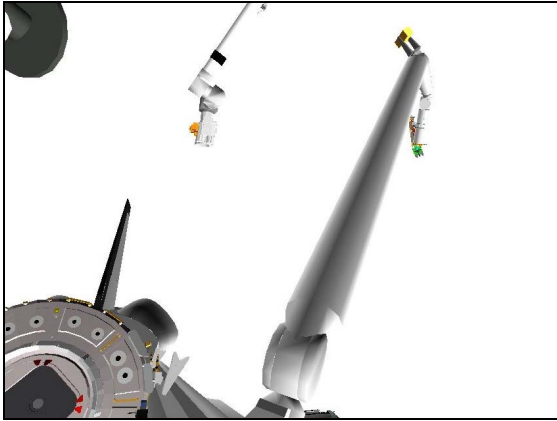

CCTV A (20,20)

Step 5:

Drive SP (-) from $+66.3^\circ$ to $+36.7^\circ$



CCTV A (20,20)

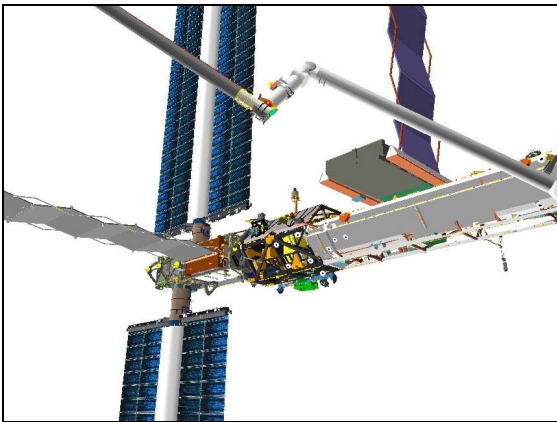

CCTV B (-45,20)

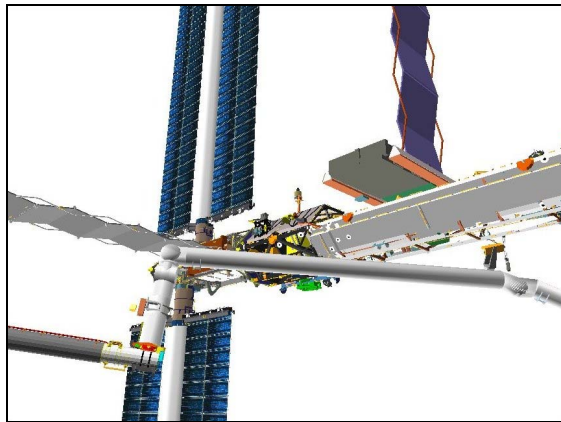

CCTV B (-45,20)

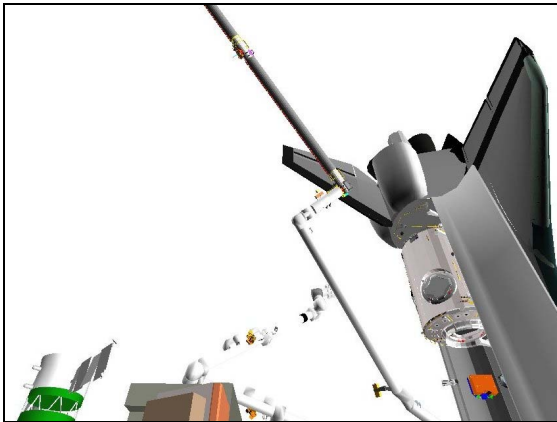

P1 LOOB (90,45)

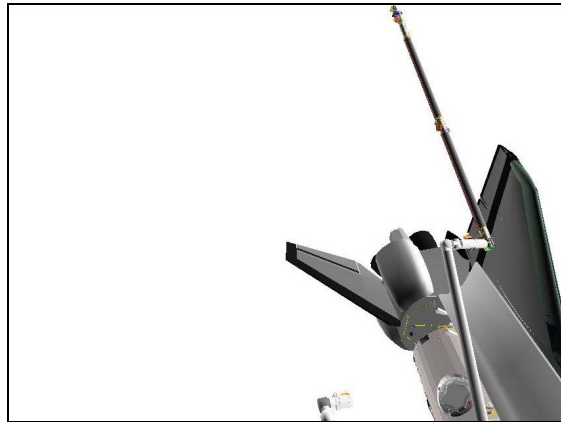

P1 LOOB (90,60)

Step 6:

Drive WP (+) from -85.9° to -2.0°



CCTV A (20,20)

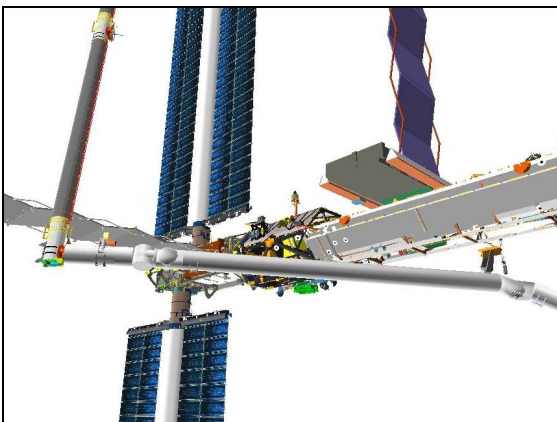

CCTV B (-45,20)

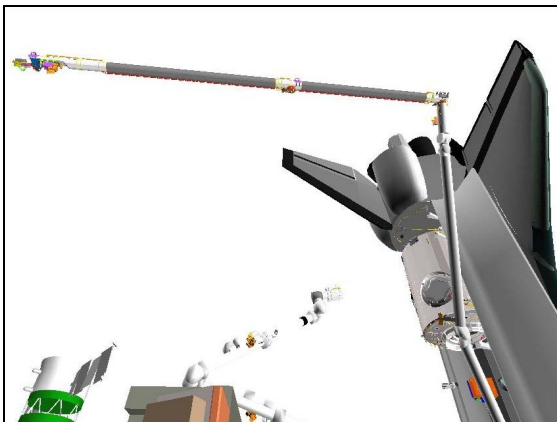

P1 LOOB (90,45)

Step 7:

Drive SY (+) from $+35.0^\circ$ to $+85.0^\circ$

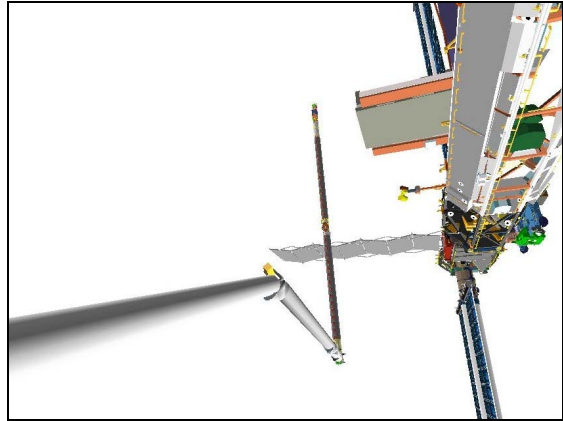

CCTV A (70,25)

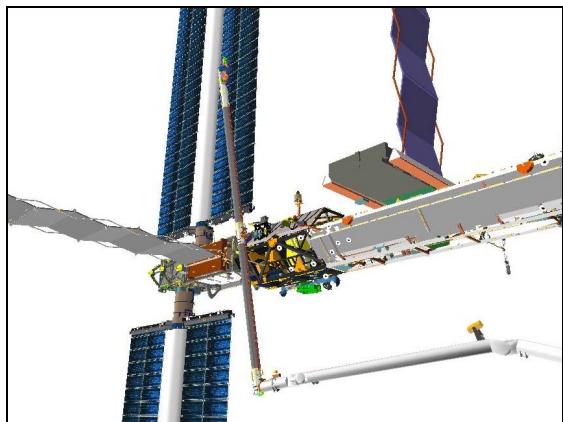

CCTV B (-45,20)

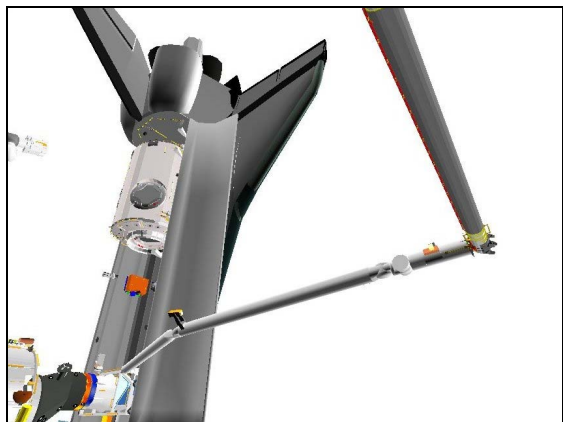

P1 LOOB (140,30)

9. RECONFIG PTU

Perform ACTIVATION (LDRI/ITVC Cue Card, P/TV), steps 1, 3, 4, and 5

Perform LCC ACTIVATION (LCS Cue Card, P/TV), step 2 only

Perform LCC DEACTIVATION (LCS Cue Card, P/TV), step 1 only

A7U

VIDEO OUT MON2 pb – push
IN PL2(VPU) pb – push

CAMR CMD PAN/TILT – HI RATE
PAN – L (to hard stop)
TILT – UP (to hard stop)
PAN/TILT – RESET
PAN: +70 (right)
TILT: -68 (dn)
ZOOM – IN (full in)

VIDEO OUT MUX 1 L pb – push (MIDDECK It on)
LDRI MODE 1 pb – push (ITVC video)
VIDEO OUT – as desired (not MUX 1 L)

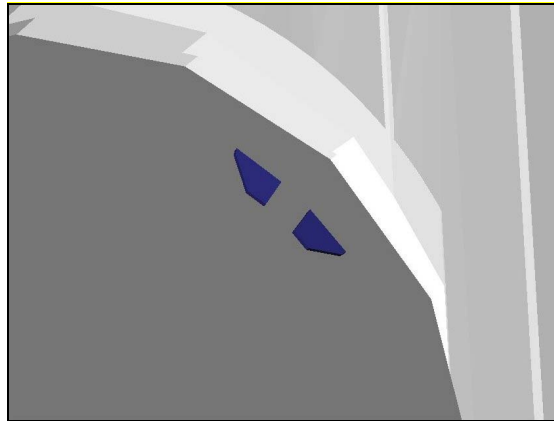

ITVC (70,-68)

OBSS SJ HANDOFF FROM SRMS TO SSRMS

1. SETUP

If SINGLE MODE available:

SM 94 PDRS CONTROL

√PL ID, ITEM 3: 2

√INIT ID, ITEM 24: 2

A7U

CCTV – config as reqd

– perform PAN/TILT RESET for PLB cameras

Review GENERIC END EFFECTOR CUE CARD – ISS/SHUTTLE DOCKED OPS

2. MANEUVER TO OBSS HANDOFF

On SSRMS Operator GO for mnvr to OBSS HANDOFF posn,

If SINGLE MODE available:

RHC

RATE – as reqd (VERN within 10 ft)

BRAKES – OFF (tb-OFF)

MODE – best available

Mnvr to OBSS HANDOFF posn:

	SY	SP	EP	WP	WY	WR	
NODE 2 VIEW	+85.0	+36.7	-22.8	-2.0	-0.5	+15.0	
1: SY –	+35.0						
2: WP –				-85.9			
3: SP +		+66.3					
4: WY +					+10.7		
5: WR –						-100.7	
6: EP –			-49.0				
7: SY –	+25.8						
HANDOFF POSN	+25.8	+66.3	-49.0	-85.9	+10.7	-100.7	
	X	Y	Z	PITCH	YAW	ROLL	PL ID
	-1029	+229	-614	284	270	270	2

* display singularity

BRAKES – ON (tb-ON)

MODE – not DIRECT

JOINT – CRIT TEMP

Give SSRMS Operator GO for OBSS Grapple

Start:
NODE 2 VIEW

Step 1:
Drive SY (-) from +85.0° to +35.0°

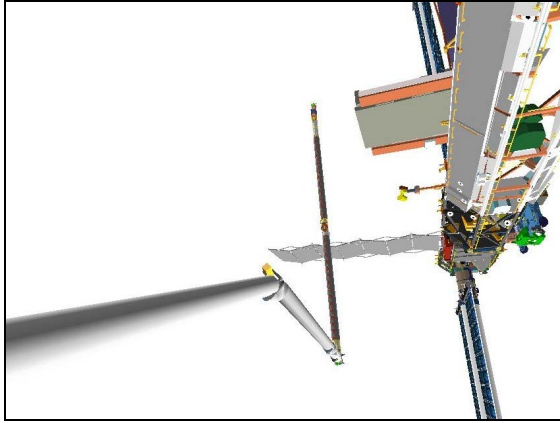

CCTV A (70,20)



CCTV A (20,20)

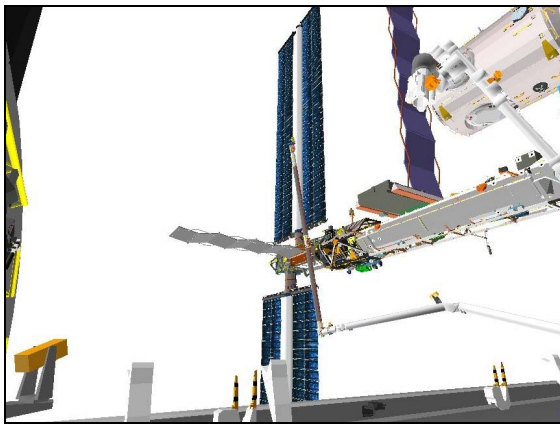

CCTV C (-60,20)

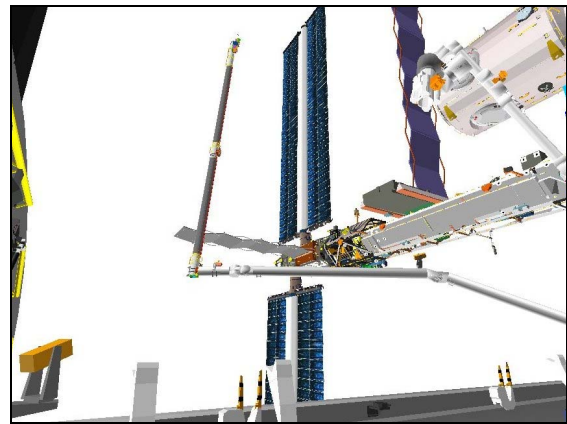

CCTV C (-60,20)

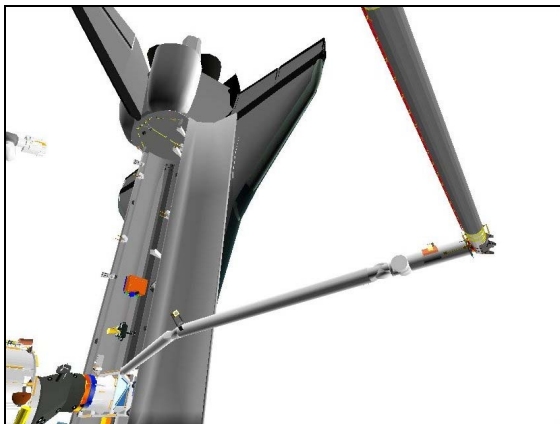

P1 LOOB (140,30)

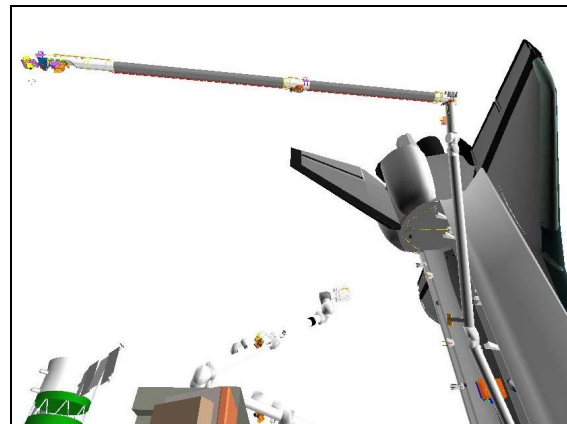

P1 LOOB (90,45)

Step 2:

Drive WP (-) from -2.0° to -85.9°



CCTV A (20,20)

Step 3:

Drive SP (+) from $+36.7^{\circ}$ to $+66.3^{\circ}$

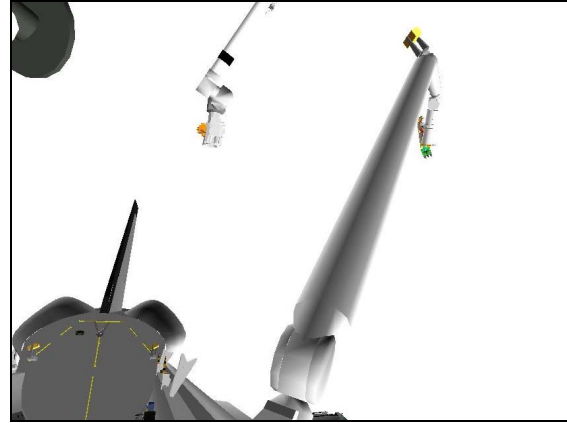

CCTV A (20,20)

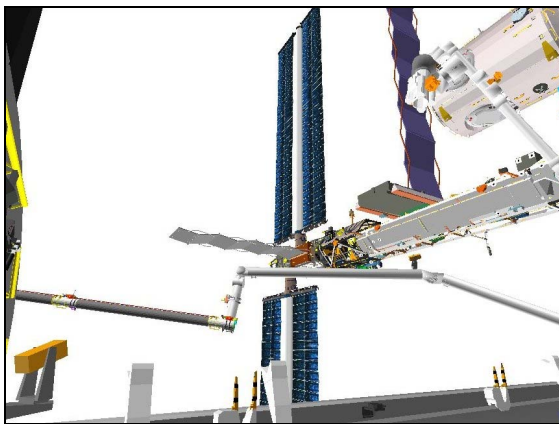

CCTV C (-60,20)

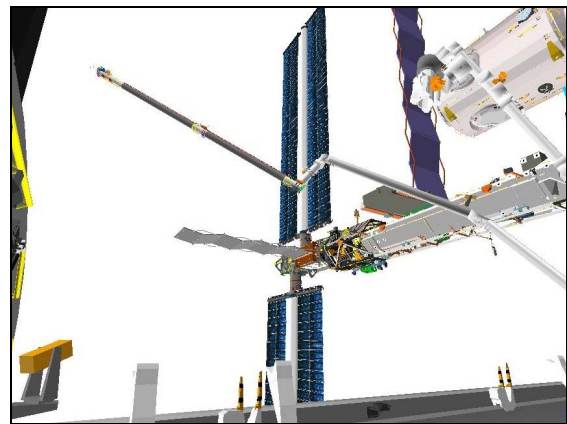

CCTV C (-60,20)



P1 LOOB (90,60)

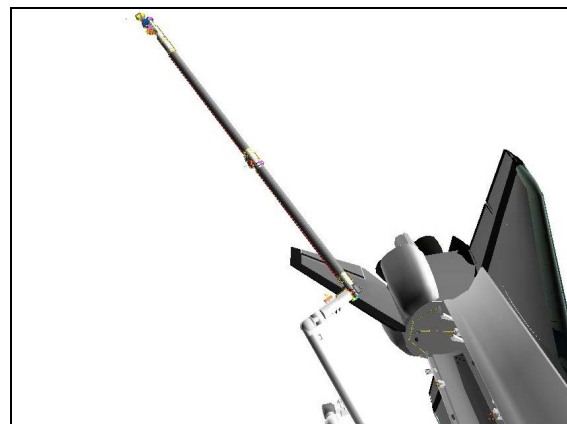

P1 LOOB (90,60)

Step 4:
Drive WY (+) from -0.5° to $+10.7^\circ$

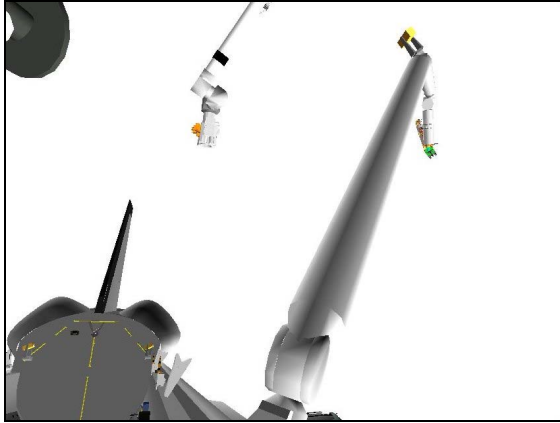

CCTV A (20,20)

Step 5:
Drive WR (-) from $+15.0^\circ$ to -100.7°

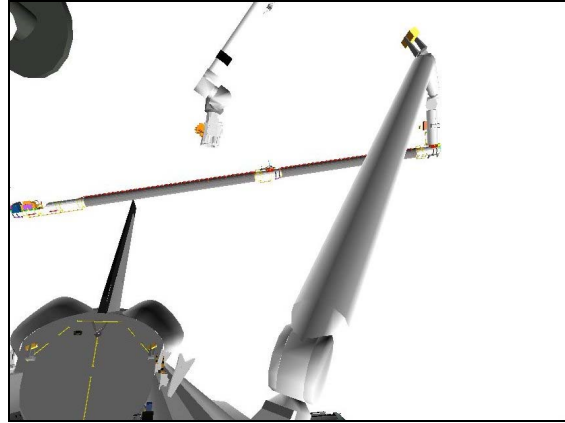

CCTV A (20,20)

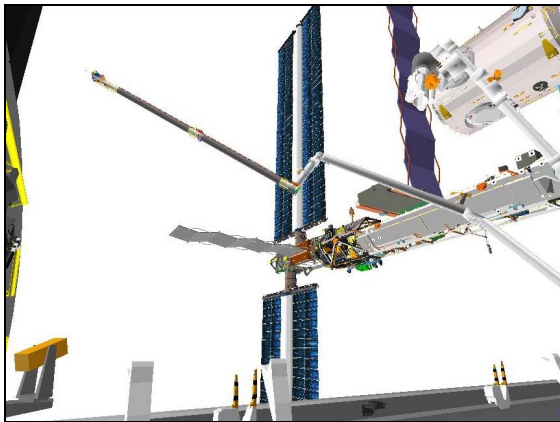

CCTV C (-60,20)

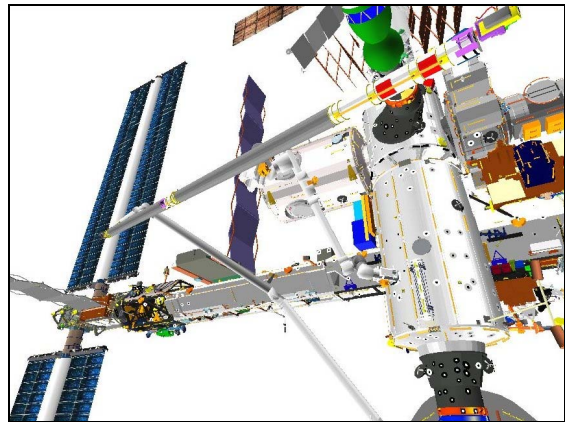

CCTV C (-30,30)



P1 LOOB (95,35)



P1 LOOB (95,35)

Step 6:

Drive EP (-) from -22.8° to -49.0°



CCTV A (20,20)

Step 7:

Drive SY (-) from $+35.0^\circ$ to $+25.8^\circ$



CCTV A (20,20)

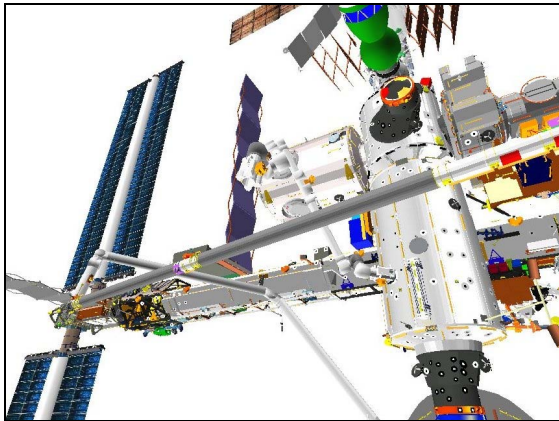

CCTV C (-30,30)

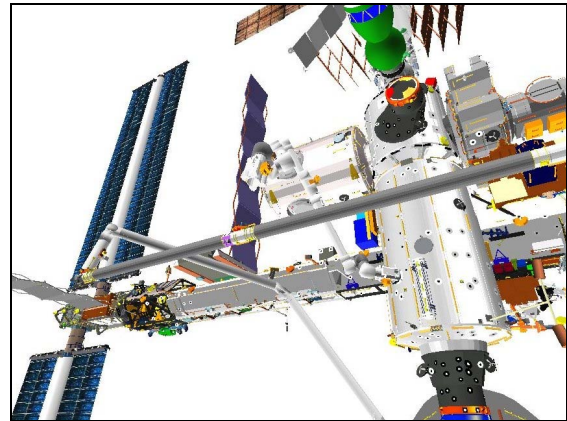

CCTV C (-30,30)



P1 LOOB (95,35)



P1 LOOB (95,35)

3. STOW PTU

A7U On SSRMS Operator GO for OBSS Ungrapple,
VIDEO OUT MON2 pb – push
IN PL2(VPU) pb – push

CAMR CMD PAN/TILT – HI RATE
PAN – L (to hard stop)
TILT – UP (to hard stop)
PAN/TILT – RESET
PAN: +108 (right)
TILT: -175 (down)

Perform LCH DEACTIVATION (LCS Cue Card, P/TV)

CAUTION
STBD RMS HTR power must be applied within
90 min to prevent sensor package damage

Perform DEACTIVATION (LDRI/ITVC Cue Card, P/TV)

4. OBSS UNGRAPPLE

A7U CCTV – config for ungrapple
– RMS WRIST, ZOOM: 34.0 HFOV
FOCUS: 5 ft

NOTE

CONTR ERR It and 'S96 PDRS CNTL' msg may
occur due to Consistency/Envelope Check error

If TEST MODE available:

RHC RATE – COARSE (RATE MIN tb-OFF)

SM 94 PDRS CONTROL
AUTO BRAKE INH – ITEM 10 EXEC (*)

BRAKES – OFF (tb-OFF)
MODE – TEST, ENTER
Wait 5 sec

BRAKES – ON (tb-ON)

SM 94 PDRS CONTROL
AUTO BRAKE ENA – ITEM 9 EXEC (*)

If SINGLE MODE available:

RHC SM 94 PDRS CONTROL
PL ID – ITEM 3 +0 EXEC
INIT ID – ITEM 24 +0 EXEC

RATE – VERN (RATE MIN tb-ON)
BRAKES – OFF (tb-OFF)

MODE – best available

CAUTION
Monitor EE tb timing to prevent EE motor burnout

EE MODE – MAN
MAN CONTR – DERIGID (hold until DERIGID tb-gray, 5 sec max)
RELEASE sw – depress (hold until OPEN tb-gray, 3 sec max)

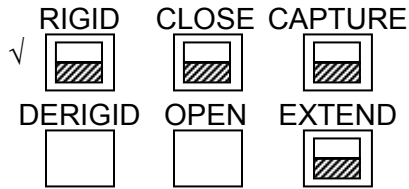

5. SJ MNVR TO OBSS PRE-GRAPPLE
Drive joints per OBSS SJ HANDOFF SRMS UNGRAPPLE WRIST CCTV OVERLAY and diagram until SRMS at OBSS PRE-GRAPPLE posn

EE MAN CONTR – DERIGID (hold until EXTEND tb-gray, 20 sec max)
MODE – OFF

√POS/ATT and Joint Angles at OBSS PRE-GRAPPLE AT HANDOFF posn:

X	Y	Z	PITCH	YAW	ROLL	PL ID
-1015	-362	-688	284	0	270	0
SY	SP	EP	WP	WY	WR	
+23.5	+63.5	-29.6	-102.9	+11.5	-98.6	

BRAKES – ON (tb-ON)
MODE – not DIRECT
JOINT – CRIT TEMP

If using Shuttle attitude control and attitude maintenance required:
Configure DAP per RMS DAPs, then perform RATE DAMPING (ORB OPS FS, REBOOST/DAP; DOCKED DAP REFERENCE)

Give SSRMS Operator GO for OBSS Berth

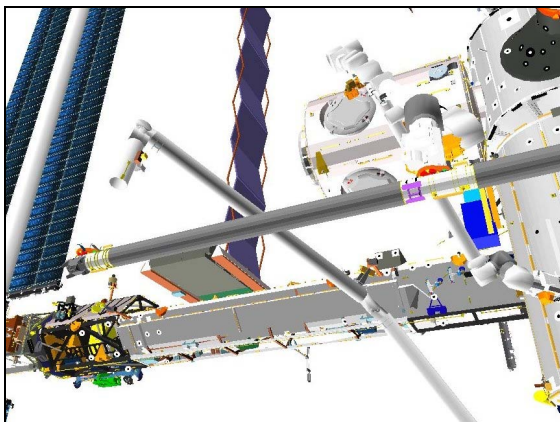

CCTV B (-25,30)

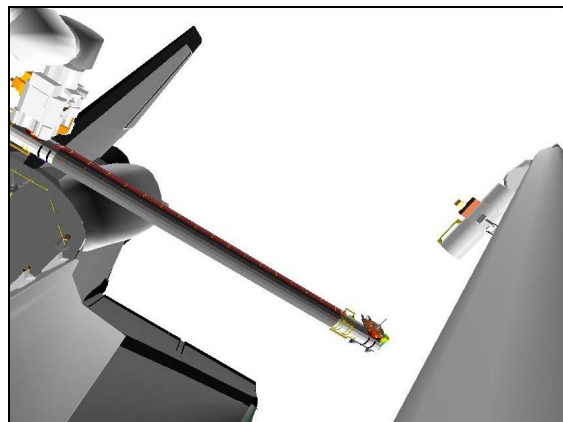

ELBOW (-35,-15)

OBSS SJ UNGRAPPLE AT HANDOFF OVERLAY

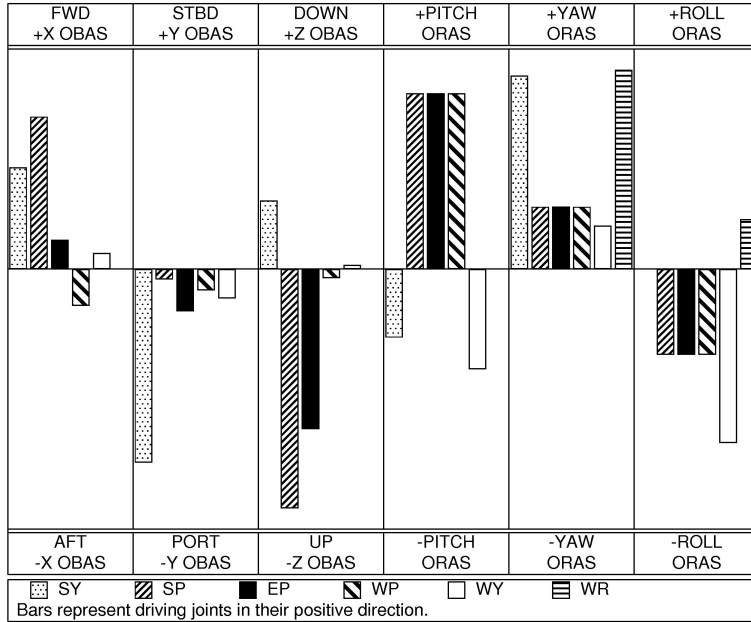

To get:	Drive:	To get:	Drive:	Driving:	Results In:	Driving:	Results In:
+X (fwd)	+SP, +SY	+PITCH	+WP, +EP	+SY	-Y (port), +YAW	+WP	-X (aft), +PITCH
+Y (stbd)	-SY	+YAW	+WR, +SY	+SP	-Z (up), +PITCH	+WY	-Y (port), -ROLL
+Z (down)	-SP, -EP	+ROLL	-WY, -WP	+EP	-Z (up), +PITCH	+WR	+YAW

ΔSY	ΔSP	ΔEP	ΔWP	ΔWY	ΔWR
-2.3	-2.8	+19.4	-17.0	+0.8	+2.1

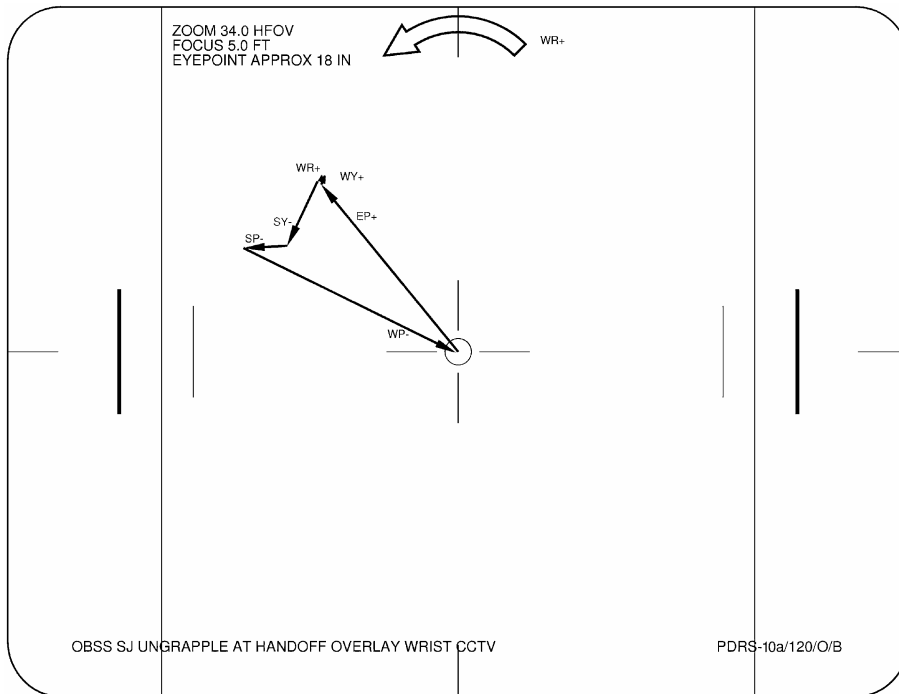

6. CONFIGURE CIRCUIT BREAKERS

MA73C:C cb MCA PWR AC3 3Φ MID 2 – op
 √AC2 3Φ MID 2 – op
:D √AC3 3Φ MID 4 – op

7. CONFIGURE FOR MONITORING

On SSRMS notification to watch for STBD RMS RFLs,

SM 94 PDRS CONTROL

RMS STBD – ITEM 2 EXEC (*)

Notify SSRMS operator when STBD RMS R-F-L tb (three) – gray

8. STBD MRL LATCH

On SSRMS Operator GO to latch STBD MRLs to Topological Capture,

√STBD RMS R-F-L tb (three) – gray

SM 94 PDRS CONTROL

√STBD AFT, MID, FWD LAT (six) = 0

R13L PL BAY MECH PWR SYS (two) – ON

NOTE

Expect single motor drive time for MRL latching (18 sec max).

The following STBD RMS RETEN LAT – OFF and PL BAY
MECH PWR SYS (two) – OFF actions are to be performed simo

Verify AOS for latching to Topological Capture

STBD RMS RETEN LAT – LAT 6 sec only (tb-bp)
– OFF

R13L PL BAY MECH PWR SYS (two) – OFF

Give SSRMS Operator GO to Limp All SSRMS Joints and Derigidize

R13L On SSRMS Operator GO to complete STBD MRL latching,
 PL BAY MECH PWR SYS (two) – ON

STBD RMS RETEN LAT – LAT (tb-LAT) (12 sec max)
– OFF

9. RECONFIGURE POWER

R13L PL BAY MECH PWR SYS (two) – OFF

STBD RMS HTR A,B (two) – AUTO

A6U EVENT TIMER CNTL – STOP

SM 94 PDRS CONTROL

√STBD AFT, MID, FWD LAT (six) = 1
RMS PORT – ITEM 1 EXEC (*)

MA73C:C cb MCA PWR AC3 3Φ MID 2 – cl
 √AC2 3Φ MID 2 – op
:D √AC3 3Φ MID 4 – op

Give SSRMS Operator GO for OBSS Ungripple

10. MNVR TO PRE-CRADLE

On SSRMS Operator GO for mnvr to PRE-CRADLE,

If SINGLE MODE available:

RHC

RATE – as reqd (VERN within 10 ft)

BRAKES – OFF (tb-OFF)

MODE – best available

Mnvr to PRE-CRADLE posn:

	SY	SP	EP	WP	WY	WR	
PRE-GRAPPLE	+23.5	+63.5	-29.6	-102.9	+11.5	-98.6	
1: WR +						0.0	
2: WY -					0.0		
3: WP +				+5.0			
4: SP -		+25.0					
5: EP +			-25.0				
6: SY -	0.0						
PRE-CRADLE	0.0	+25.0	-25.0	+5.0	0.0	0.0	
	X	Y	Z	PITCH	YAW	ROLL	PL ID
	-1261	-146	-551	5	2	0	0

BRAKES – ON (tb-ON)

MODE – not DIRECT

PARAM – PORT TEMP

JOINT – CRIT TEMP

Give SSRMS Operator GO for mnvr to MBS PDGF 3 Pre-grapple

Start:
OBSS Handoff

Step 1:
Drive WR (+) from -98.6° to 0.0°

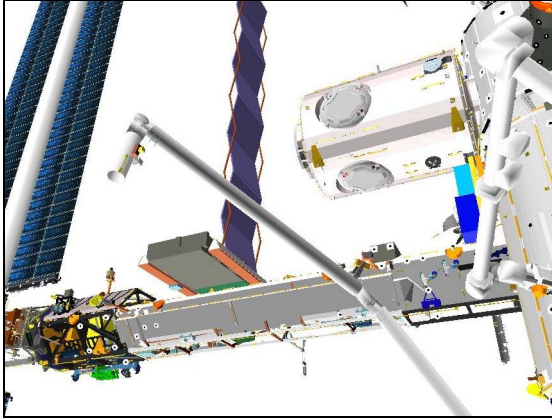

CCTV B (-25,30)

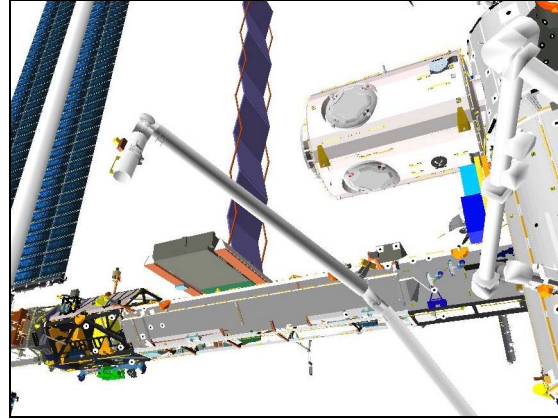

CCTV B (-25,30)

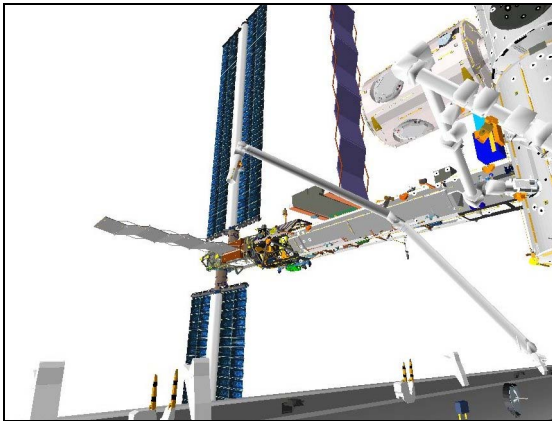

CCTV C (-50,20)

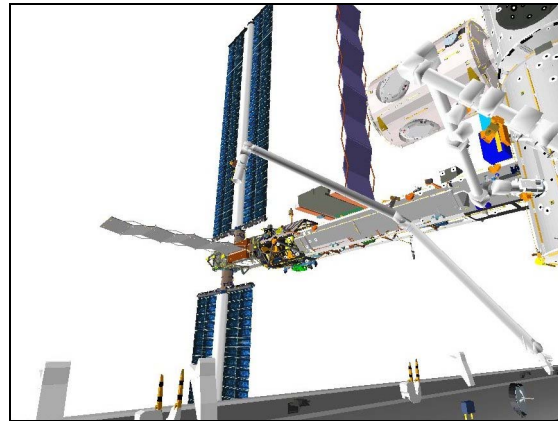

CCTV C (-50,20)



P1 LOOB (95,30)



P1 LOOB (95,30)

Step 2:

Drive WY (-) from $+11.5^\circ$ to 0.0°

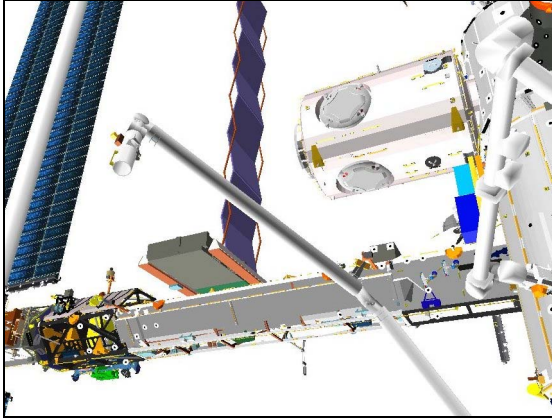

CCTV B (-25,30)

Step 3:

Drive WP (+) from -102.9° to $+5.0^\circ$

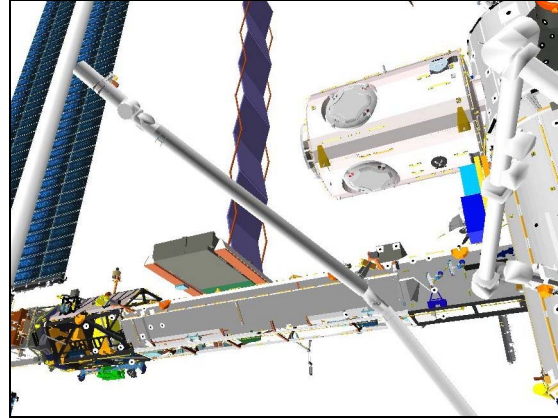

CCTV B (-25,30)

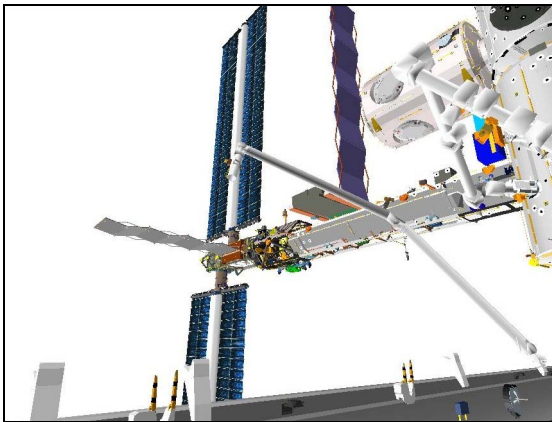

CCTV C (-50,20)

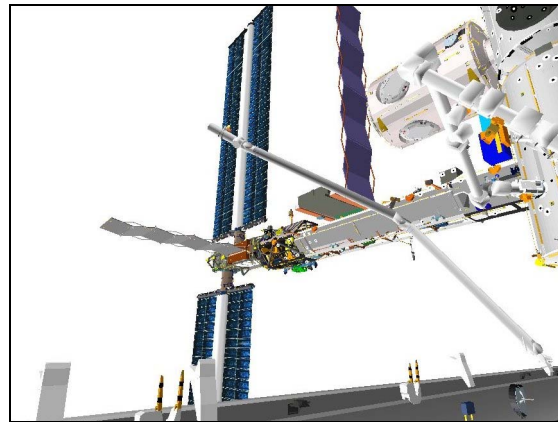

CCTV C (-50,20)



P1 LOOB (95,30)

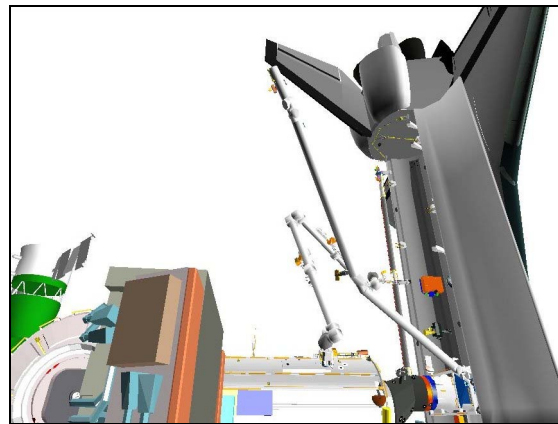

P1 LOOB (95,30)

Step 4:

Drive SP (-) from +63.5° to +25.0°

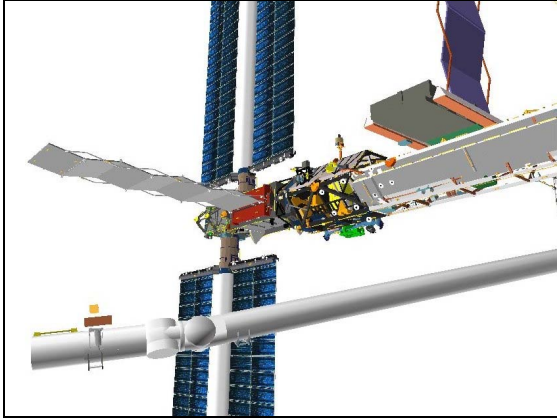

CCTV B (-50,15)

Step 5:

Drive EP (+) from -29.6° to -25.0°

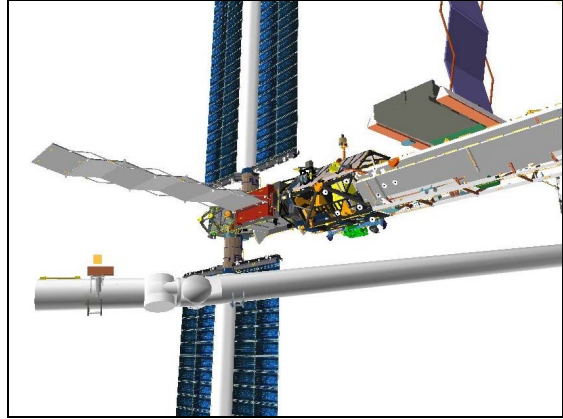

CCTV B (-50,15)

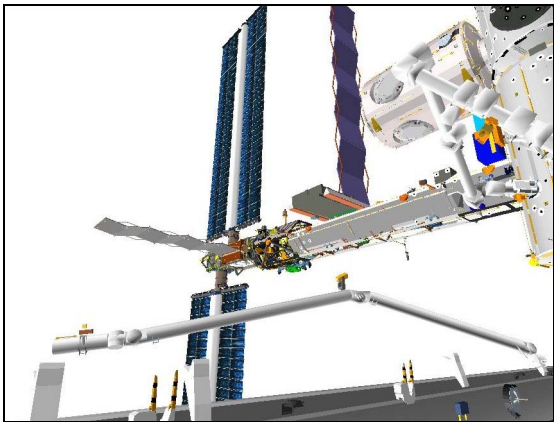

CCTV C (-50,20)

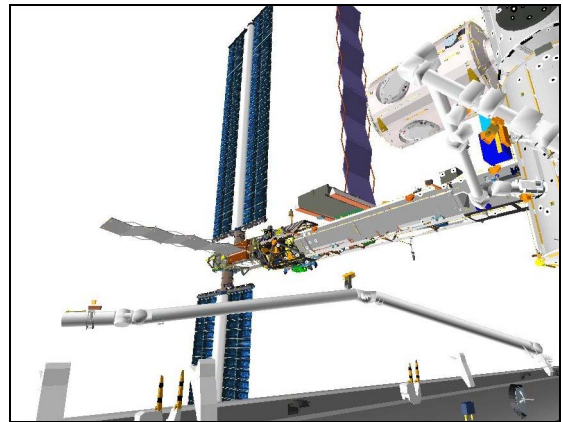

CCTV C (-50,20)



P1 LOOB (95,30)



P1 LOOB (95,30)

Step 6:

Drive SY (-) from +23.5° to 0.0°

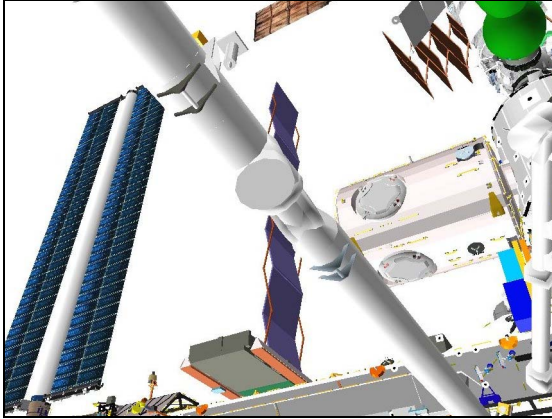

CCTV B (-30,40)

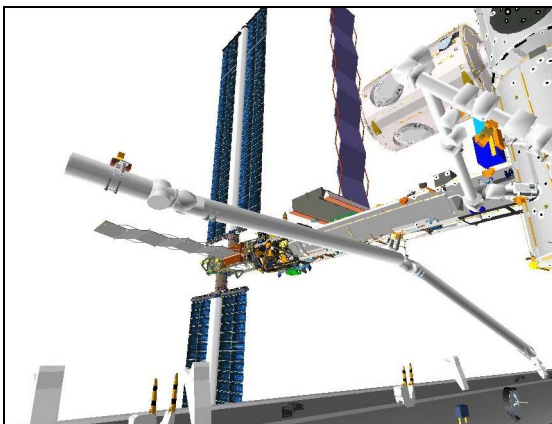

CCTV C (-50,20)



P1 LOOB (95,30)

OBSS REFERENCE DATA

OBSS JOINT ANGLES VS POR COORDINATES FS 3-2

OBSS
REF DATA

OBSS JOINT ANGLES VS POR COORDINATES

OBSS PRE-GRAPPLE AT HANDOFF

X	Y	Z	PITCH	YAW	ROLL	PL ID
-1012	+229	-685	284	270	270	2
-1015	-362	-688	284	0	270	0
SY	SP	EP	WP	WY	WR	
+23.5	+63.5	-29.6	-102.9	+11.5	-98.6	

* display singularity

OBSS HANDOFF

X	Y	Z	PITCH	YAW	ROLL	PL ID
-1029	+229	-614	284	270	270	2
-1032	-362	-618	284	360	270	
SY	SP	EP	WP	WY	WR	
+25.8	+66.3	-49.0	-85.9	+10.7	-100.7	

* display singularity

NODE 2 VIEWING

X	Y	Z	PITCH	YAW	ROLL	PL ID
-767	-775	-1068	86	7	276	2
-728	-698	-483	305	81	51	0
SY	SP	EP	WP	WY	WR	
+85.0	+36.7	-22.8	-2.0	-0.5	+15.0	

OBSS
REF DATA

P6 NOMINAL

P6 HANDOFF FROM SSRMS TO SRMS	FS 4-2
SRMS TO SSRMS	FS 4-5
INSTALL VIEWING	FS 4-8

P6
NOMINAL

P6 HANDOFF FROM SSRMS TO SRMS

1. SRMS MNVR TO P6 PRE-GRAPPLE POSN

SM 94 PDRS CONTROL

√PL ID, ITEM 3: 0

√INIT ID, ITEM 24: 0

MON 1	A
MON 2	B(EE)
DNLK	P1 LOOB

RATE – as required (VERN within 10 ft)

BRAKES – OFF (tb-OFF)

MODE – SINGLE, ENTER

Mnvr to P6 PRE-GRAPPLE posn:

	SY	SP	EP	WP	WY	WR	
PRE-CRADLE	0.0	+25.0	-25.0	+5.0	0.0	0.0	
1: SP +		+55.1					
2: SY +	+95.3						
3: WP –				-48.7			
4: WY +					+16.7		
5: WR –						-71.5	
6: EP –			-70.4				
P6 PRE-GRAPPLE	+95.3	+55.1	-70.4	-48.7	+16.7	-71.5	
	X	Y	Z	PITCH	YAW	ROLL	PL ID
	-622	-552	-362	251	5	6	0

BRAKES – ON (tb-ON)

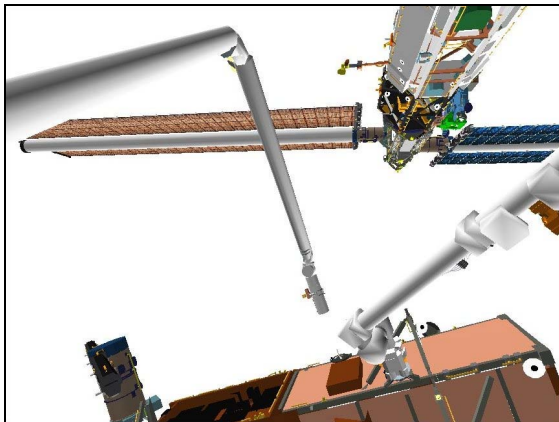

CCTV A (80,5)

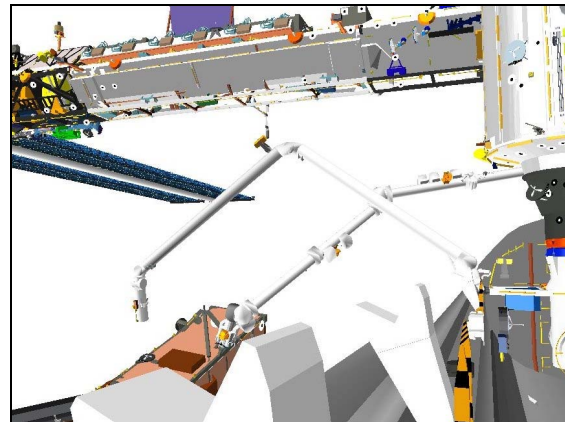

CCTV B (-20,5)

P6
NOMINAL

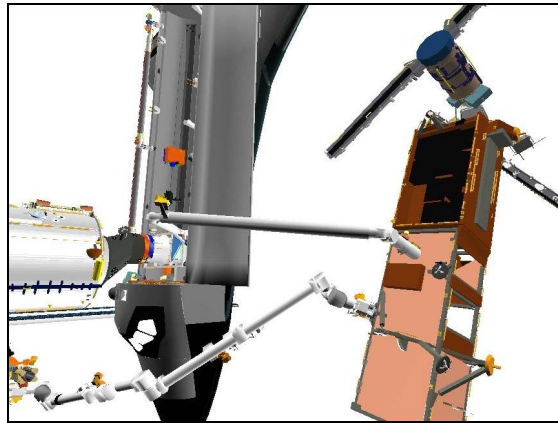

P1 LOOB (135,10)

2. ATTITUDE CONTROL CONFIGURATION

PCS

MSS: SSRMS: Thrusters: Thruster Controls for MSS Ops

Verify 'Desat Request:' – Inh

If using shuttle attitude control:
DAP: FREE

3. P6 GRAPPLE

A7U

- CCTV – config for grapple
- install PDRS TARGET OVERLAY FOR CTVM
- RMS WRIST, zoom 34.0 HFOV
focus 5 ft

Maintain eyepoint approx 18 in when using grapple overlay

Notify SSRMS Operator, going in for P6 Grapple

- RATE – VERN (RATE MIN tb-ON)
- BRAKES – OFF (tb-OFF)
- MODE – END EFF, ENTER

Mnvr to grapple envelope

CAUTION
Monitor EE tb timing to prevent EE motor burnout

EE MODE – AUTO
CAPTURE sw – depress (mom)

√	RIGID <input type="checkbox"/>	CLOSE <input type="checkbox"/>	CAPTURE <input type="checkbox"/>
	DERIGID <input type="checkbox"/>	OPEN <input type="checkbox"/>	EXTEND <input type="checkbox"/>

CRITICAL TIMES (28 sec total):
 CAPTURE tb – gray, then
 CLOSE tb – gray, 3 sec max, then
 RIGID tb – gray, 25 sec max

- * If manual grapple reqd: *
- * EE MODE – MAN *
- * CAPTURE sw – depress (hold until CLOSE tb-gray, *
- * 3 sec max) *
- * MAN CONTR – RIGID (hold until RIGID tb-gray, *
- * 25 sec max) *

EE MODE – OFF
 BRAKES – ON (tb-ON)

SM 94 PDRS CONTROL

PL ID – ITEM 3 +3 EXEC
 INIT ID – ITEM 24 +3 EXEC

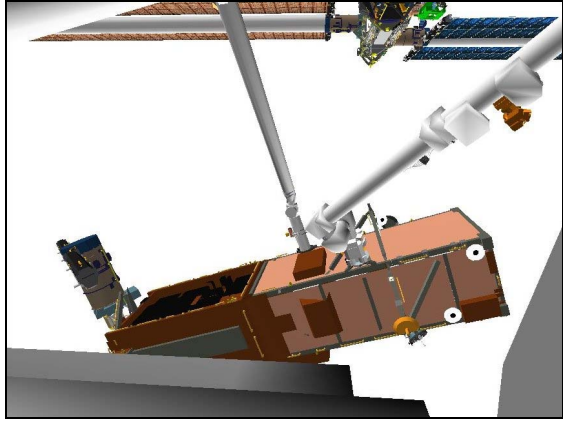

CCTV A (85,-10)

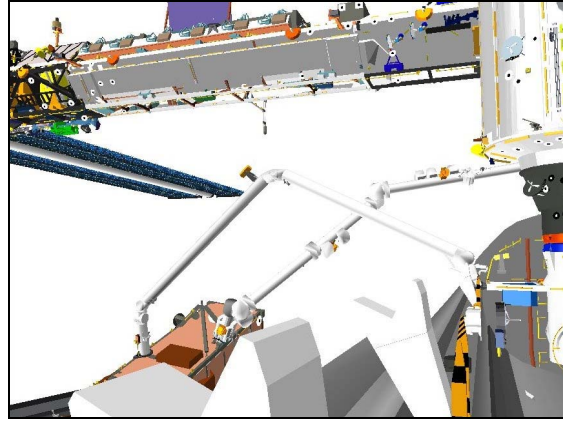

CCTV B (-20,5)

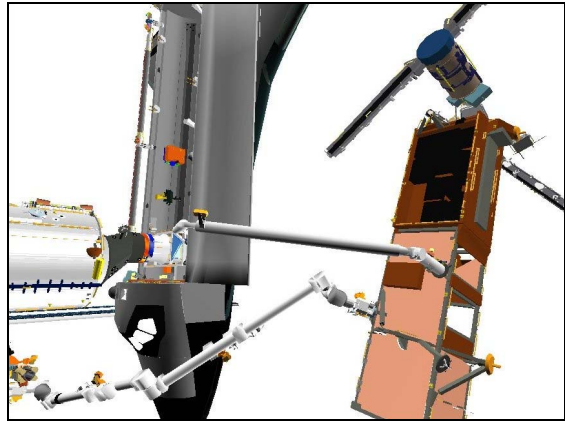

P1 LOOB (135,10)

Record POS/ATT and Joint Angles:

X	Y	Z	PITCH	YAW	ROLL	PL ID
						3
SY	SP	EP	WP	WY	WR	
Expected +97.4	+45.3	-65.7	-43.1	+15.7	-73.6	

A8U
 MODE – not DIRECT (It off)
 PARAM – PORT TEMP
 JOINT – CRIT TEMP

Give SSRMS Operator GO to Ungrapple P6

Review GENERIC END EFFECTOR CUE CARD – ISS/SHUTTLE DOCKED OPS

P6 HANDOFF FROM SRMS TO SSRMS

1. SETUP

MON 1	A (SSRMS Base Elb)
MON 2	EE (B)
DNLK	P1 LOOB

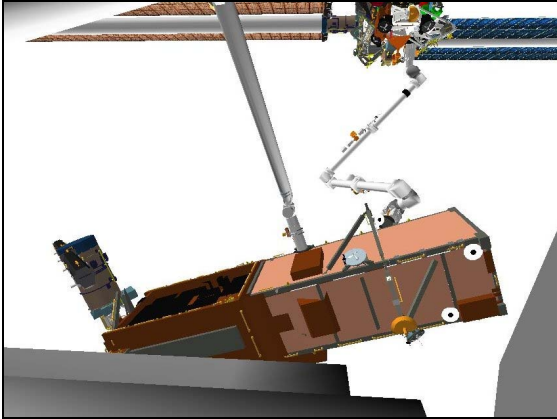

CCTV A (85,-10)

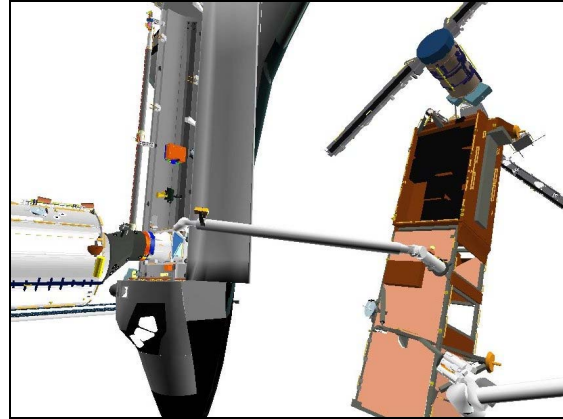

P1 LOOB (135,10)

2. P6 UNGRAPPLE

On SSRMS Operator GO to Ungrapple P6 and maneuver to PRE-CRADLE,

SM 94 PDRS CONTROL

PL ID – ITEM 3 +0 EXEC

INIT ID – ITEM 24 +0 EXEC

NOTE

CONTR ERR It and 'S96 PDRS CNTL' msg may occur due to Consistency/Envelope Check error

THC RATE – COARSE (RATE MIN tb-OFF)

SM 94 PDRS CONTROL

AUTO BRAKE INH – ITEM 10 EXEC (*)

A8U BRAKES – OFF (tb-OFF)

MODE – TEST, ENTER
Wait 5 sec

BRAKES – ON (tb-ON)

SM 94 PDRS CONTROL

AUTO BRAKE ENA – ITEM 9 EXEC (*)

RATE – VERN (RATE MIN tb-ON)
BRAKES – OFF (tb-OFF)
MODE – END EFF, ENTER

CAUTION

Monitor EE tb timing to prevent EE motor burnout

NOTE

When OPEN tb-gray, mnvr arm clear of GF

EE MODE – AUTO

RELEASE sw – depress (mom)

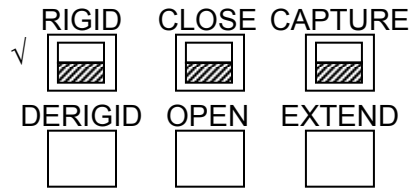

CRITICAL TIMES (28 sec total):

DERIGID tb – gray, 5 sec max, then

OPEN tb – gray, 3 sec max, then

EXTEND tb – gray, 20 sec max

EE MODE – OFF

- * If manual release reqd: *
- * EE MODE – MAN *
- * MAN CONTR – DERIGID (hold until DERIGID tb-gray, *
- 5 sec max) *
- * RELEASE sw – depress (hold until OPEN tb-gray, *
- 3 sec max) *
- * Mnvr arm clear, then *
- * EE MAN CONTR – DERIGID (hold until EXTEND tb-gray, *
- 20 sec max) *
- * MODE – OFF *

THC/RHC

Mnvr to UNGRAPPLE BACKOFF posn:

X	Y	Z	PITCH	YAW	ROLL	PL ID
-622	-552	-362	251	5	6	0
SY	SP	EP	WP	WY	WR	
+95.3	+55.1	-70.4	-48.7	+16.7	-71.5	

BRAKES – ON (tb-ON)

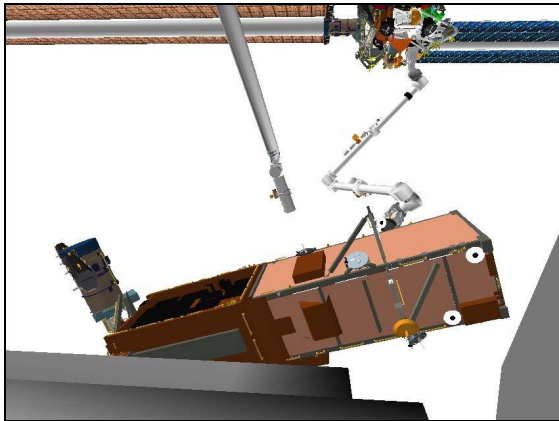

CCTV A (85,-10)

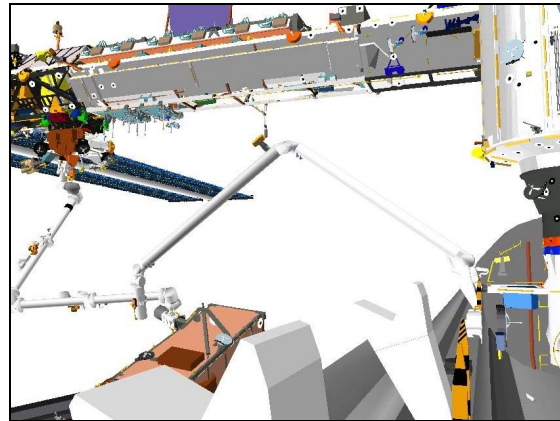

CCTV B (-20,5)

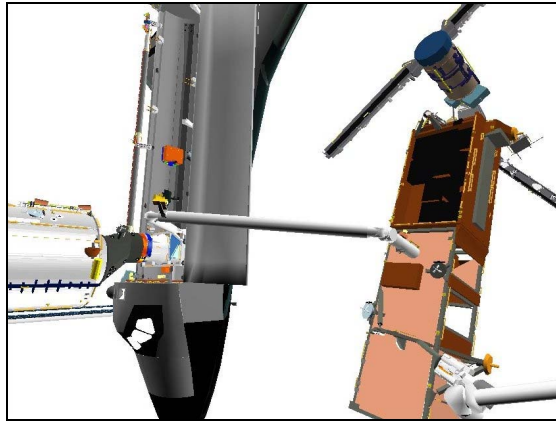

P1 LOOB (135,10)

If using shuttle attitude control and attitude maintenance required:
 Configure DAP per RMS DAPs, then perform RATE DAMPING (ORB OPS FS, REBOOST/DAP; DOCKED DAP REFERENCE)

Notify SSRMS Operator, P6 Ungrapple complete

3. SJ MNVR TO PRE-CRADLE

RATE – as reqd (VERN within 10 ft)

BRAKES – OFF (tb-OFF)

MODE – SINGLE, ENTER

Mnvr to PRE-CRADLE posn:

	SY	SP	EP	WP	WY	WR	
UNGRPL	+95.3	+55.1	-70.4	-48.7	+16.7	-71.5	
BACKOFF			-25.0				
1: EP +				+5.0			
2: WP +					0.0		
3: WY –						0.0	
4: WR +							
5: SY –	0.0						
6: SP –		+25.0					
PRE-CRADLE	0.0	+25.0	-25.0	+5.0	0.0	0.0	
	X	Y	Z	PITCH	YAW	ROLL	PL ID
	-1261	-146	-551	5	2	0	0

BRAKES – ON (tb-ON)

√MODE – not DIRECT

PARAM – PORT TEMP

JOINT – CRIT TEMP

P6 INSTALL VIEWING

1. SETUP

SM 94 PDRS CONTROL

√PL ID, ITEM 3: 0

√INIT ID, ITEM 24: 0

MON 1	A
MON 2	Elbow (EE)
DNLK	P1 LOOB (MBS Mast)

2. MNVR TO P6 INSTALL VIEWING POSN

On SSRMS Operator GO, maneuver to P6 INSTALL VIEWING position

A8U

RATE – as required (VERN within 10 ft)

BRAKES – OFF (tb-OFF)

MODE – SINGLE, ENTER

Mnvr to P6 INSTALL VIEWING posn:

	SY	SP	EP	WP	WY	WR	
PRE-CRADLE	0.0	+25.0	-25.0	+5.0	0.0	0.0	
1: WP +				+96.4			
2: WY +					+8.2		
3: WR +						+22.9	
4: SY +	+94.8						
5: SP –		+16.7					
6: EP –			-63.4				
P6 INSTALL VIEW	+94.8	+16.7	-63.4	+96.4	+8.2	+22.9	
	X	Y	Z	PITCH	YAW	ROLL	PL ID
	-631	-537	-213	111	57	252	0

BRAKES – ON (tb-ON)

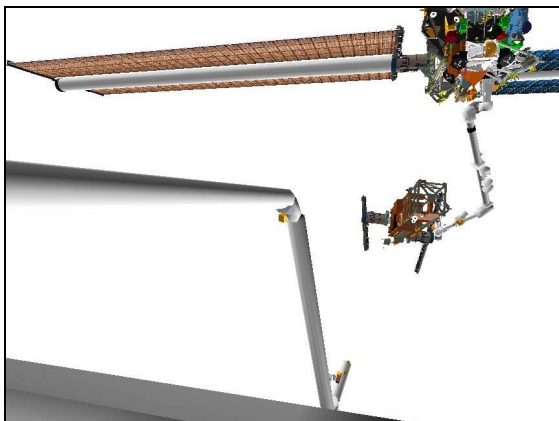

CCTV A (75,-5)

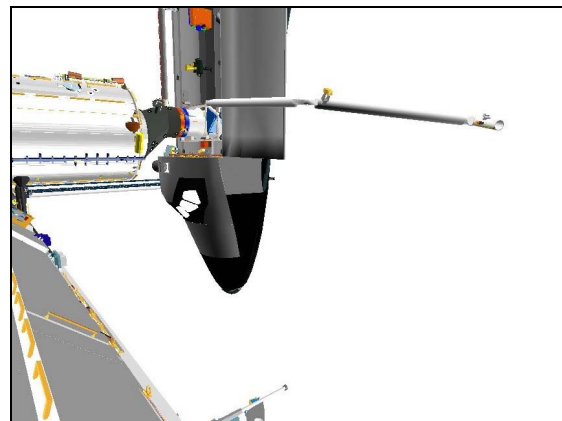

P1 LOOB (130,-10)

√MODE – not DIRECT (It off)

PARAM – PORT TEMP

JOINT – CRIT TEMP

Give SSRMS Operator GO for P6 Install

3. CONFIG CAMERAS FOR VIEWING

MON 1	EE (Elbow)
MON 2	A

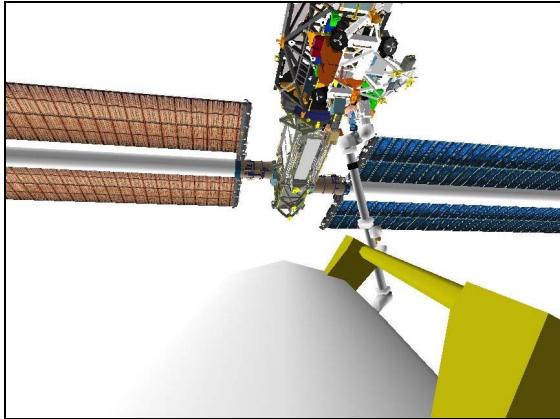

EE

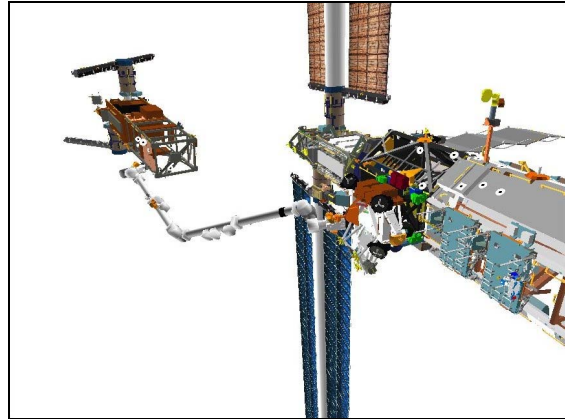

ELBOW (80,25)

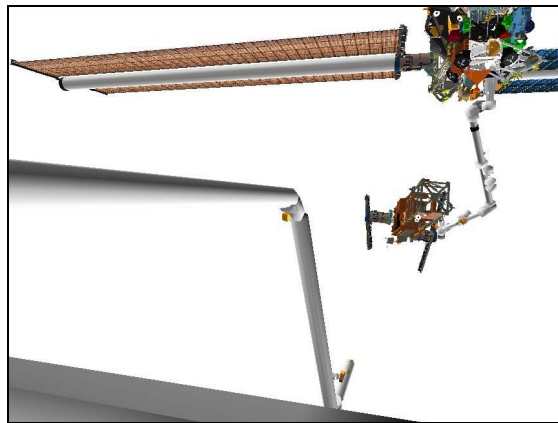

CCTV A (75,-5)

This Page Intentionally Blank

P6 CONTINGENCY

P6 SJ HANDOFF FROM SSRMS TO SRMS FS 5-2
SRMS TO SSRMS FS 5-10

P6 SJ HANDOFF FROM SSRMS TO SRMS

- A7U 1. SJ MNVR TO PRE-GRAPPLE POSN
CCTV – perform PAN/TILT RESET

SM 94 PDRS CONTROL

- √PL ID, ITEM 3: 0
- √INIT ID, ITEM 24: 0

MON 1	A
MON 2	B (EE)
DNLK	P1 LOOB

RATE – as required (VERN within 10 ft)
BRAKES – OFF (tb-OFF)
MODE – best available

Mnvr to P6 PRE-GRAPPLE posn (reference pictures as reqd):

	SY	SP	EP	WP	WY	WR	
PRE-CRADLE	0.0	+25.0	-25.0	+5.0	0.0	0.0	
1: SP +		+55.1					
2: SY +	+95.3						
3: WP –				-48.7			
4: WY +					+16.7		
5: WR –						-71.5	
6: EP –			-70.4				
P6 PRE-GRAPPLE	+95.3	+55.1	-70.4	-48.7	+16.7	-71.5	
	X	Y	Z	PITCH	YAW	ROLL	PL ID
	-622	-552	-362	251	5	6	0

BRAKES – ON (tb-ON)

Start:
Pre-cradle

Step 1:
Drive SP (+) 25.0 to 55.1

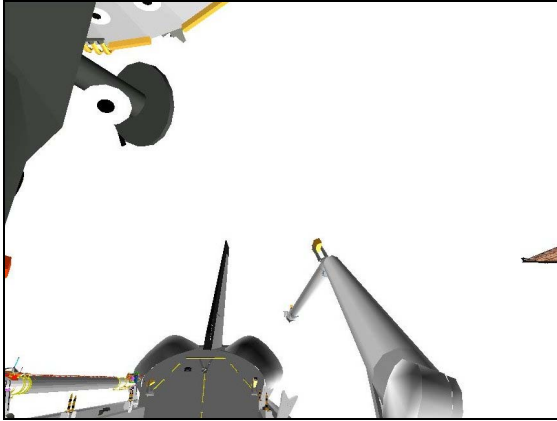

CCTV A (5,25)

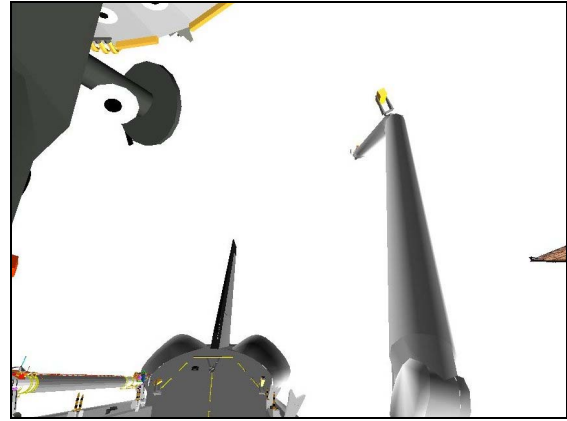

CCTV A (5,25)

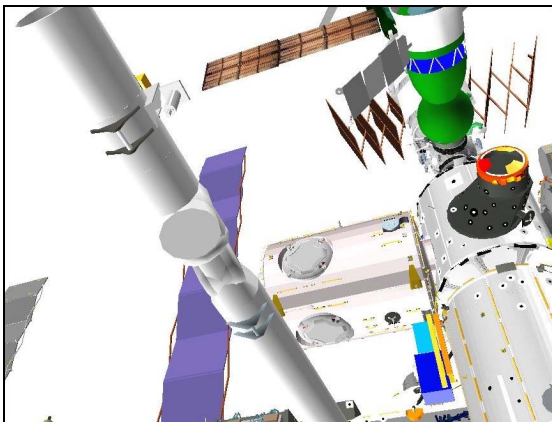

CCTV B (-20,45)

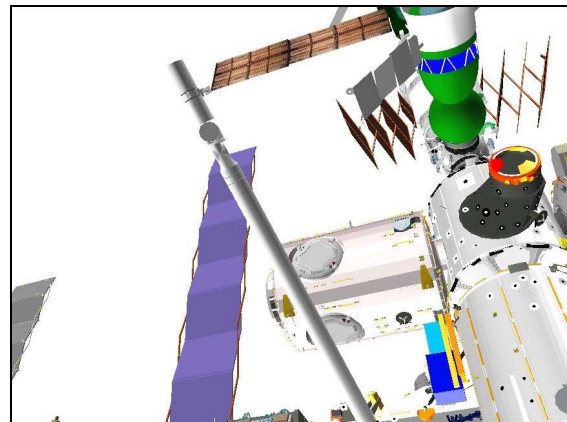

CCTV B (-20,45)



P1 LOOB (125,30)



P1 LOOB (125, 30)

Step 2:
Drive SY (+) for 0.0 to +95.3

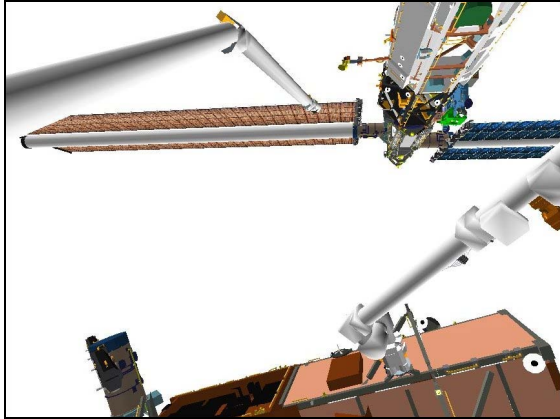

CCTV A (80,5)

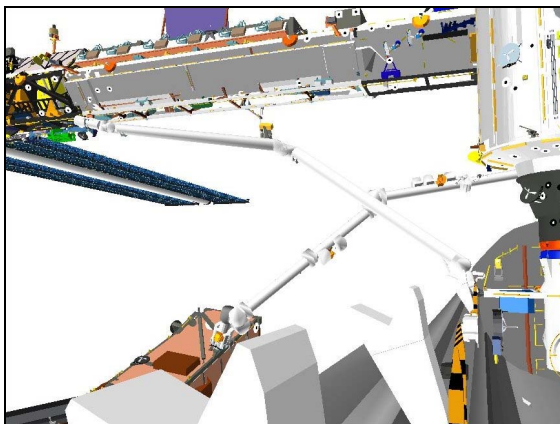

CCTV B (-20,5)

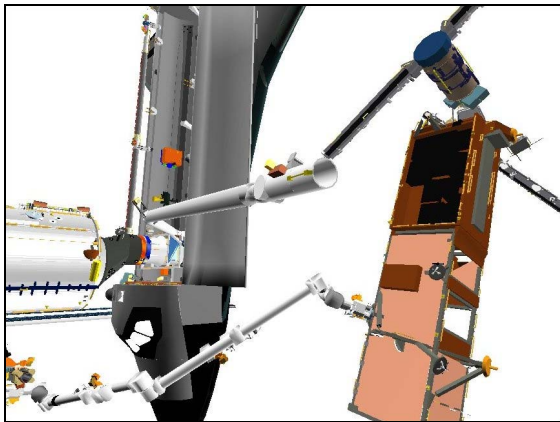

P1 LOOB (135,10)

Step 3:
Drive WP (-) from +5.0 to -48.7

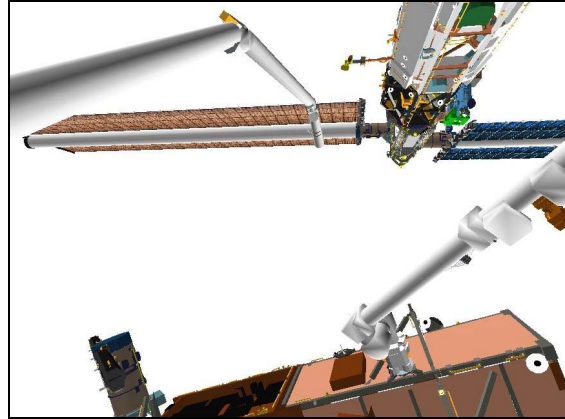

CCTV A (80,5)

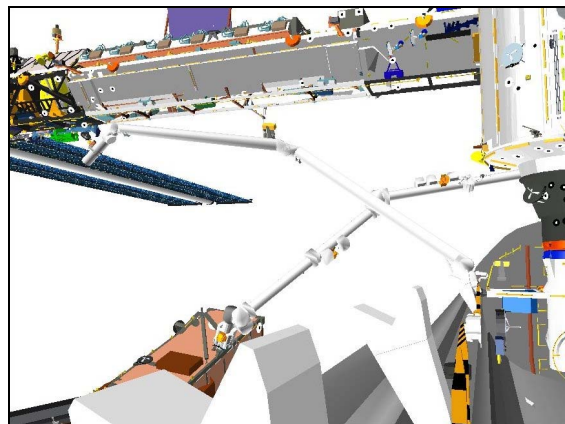

CCTV B (-20,5)

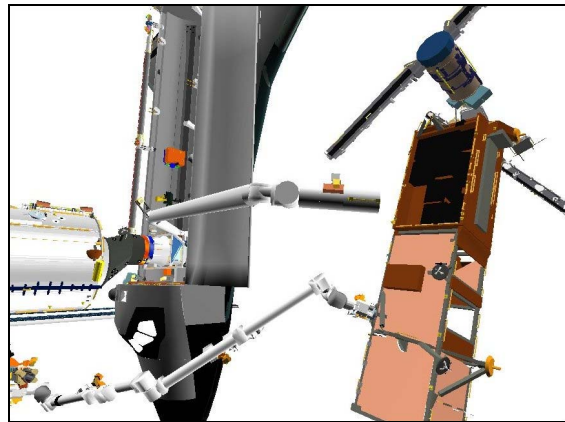

P1 LOOB (135,10)

Step 4:
Drive WY (+) for 0.0 to +16.7

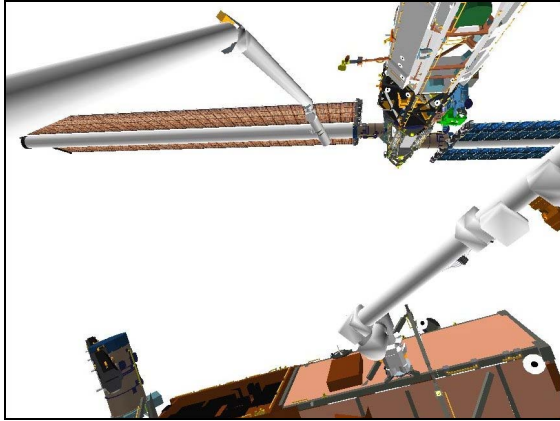

CCTV A (80,5)

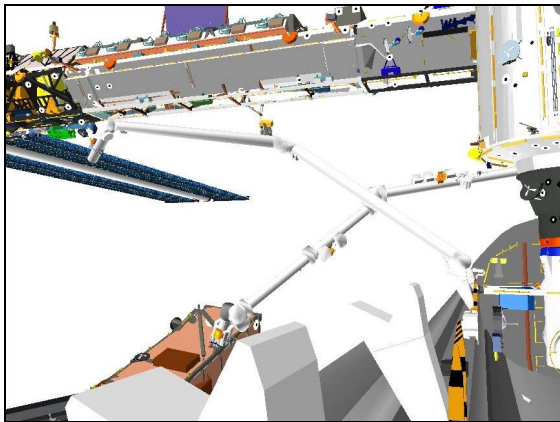

CCTV B (-20,5)

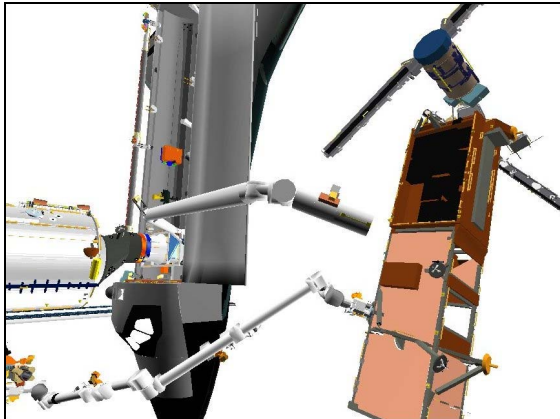

P1 LOOB (135,10)

Step 5:
Drive WR (-) from 0.0 to -71.5

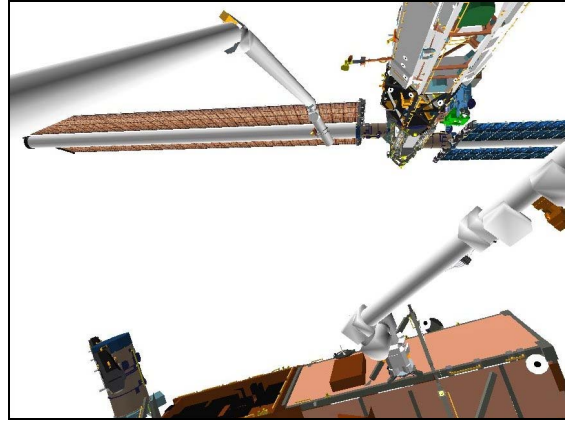

CCTV A (80,5)

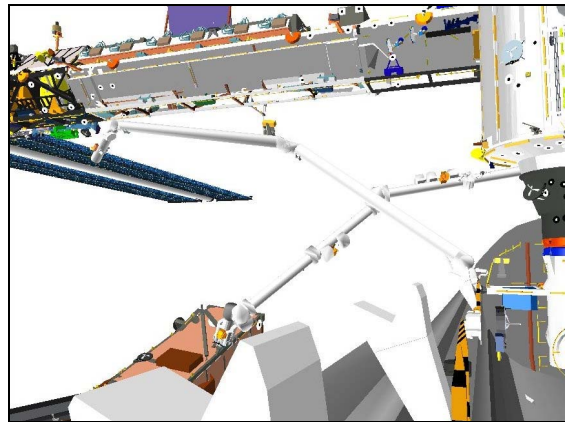

CCTV B (-20,5)

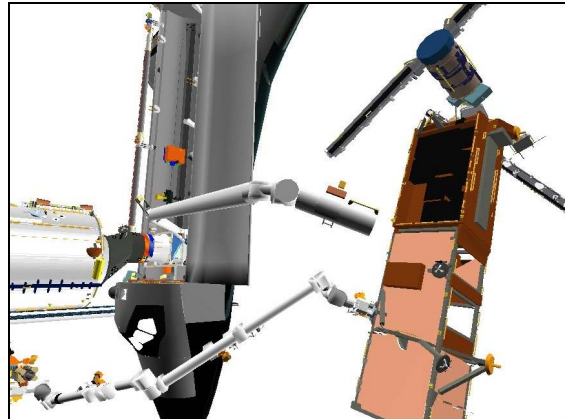

P1 LOOB (135,10)

Step 6:
Drive EP (-) from -25.0 to -70.4

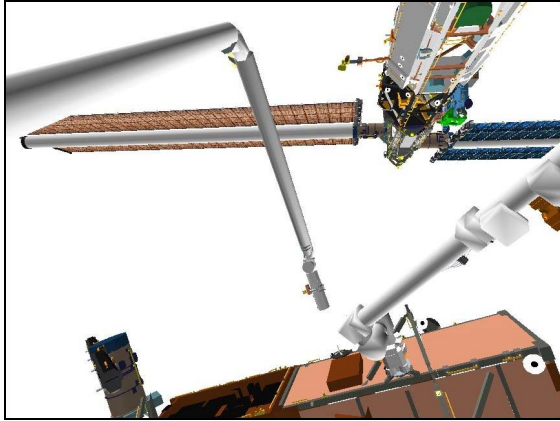

CCTV A (80,5)

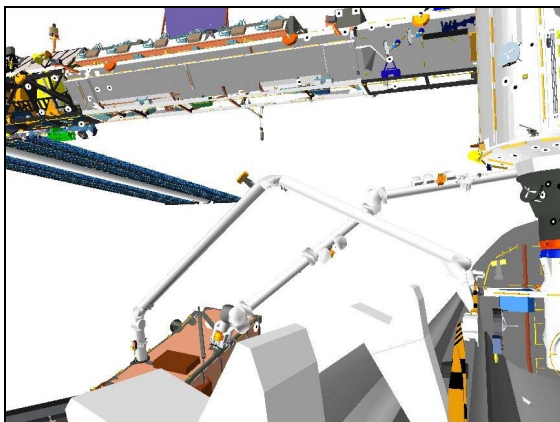

CCTV B (-20,5)

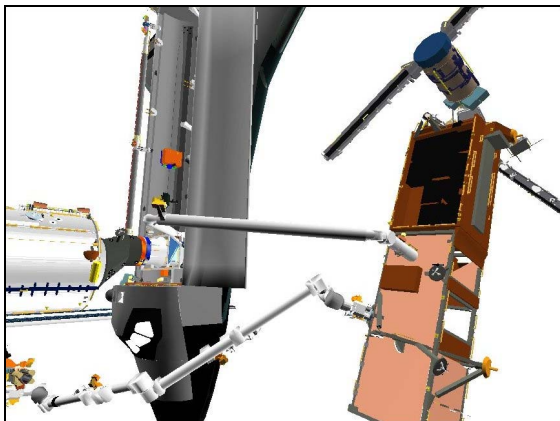

P1 LOOB (135,10)

2. ATTITUDE CONTROL CONFIGURATION

PCS

MSS: SSRMS: Thrusters:

Thruster Controls for MSS Ops

Verify 'Desat Request:' – Inh

If using shuttle attitude control:
DAP: FREE

3. SJ MNVR TO P6 GRAPPLE

A7U

- CCTV – config for grapple
 - install PDRS TARGET OVERLAY FOR CTVM
 - RMS WRIST, zoom 34.0 HFOV
focus 5 ft
 - fully zoom out for SJ pictures

Maintain eyepoint ~18 in when using grapple overlay

MON 1	A
MON 2	B (EE)
DNLK	P1 LOOB

Notify SSRMS operator going in for P6 Grapple

RATE – VERN (RATE MIN tb-ON)
BRAKES – OFF (tb-OFF)
MODE – best available

Drive joints per P6 SJ GRAPPLE WRIST CCTV OVERLAY and diagram until EE
within grapple envelope

P6 SJ GRAPPLE

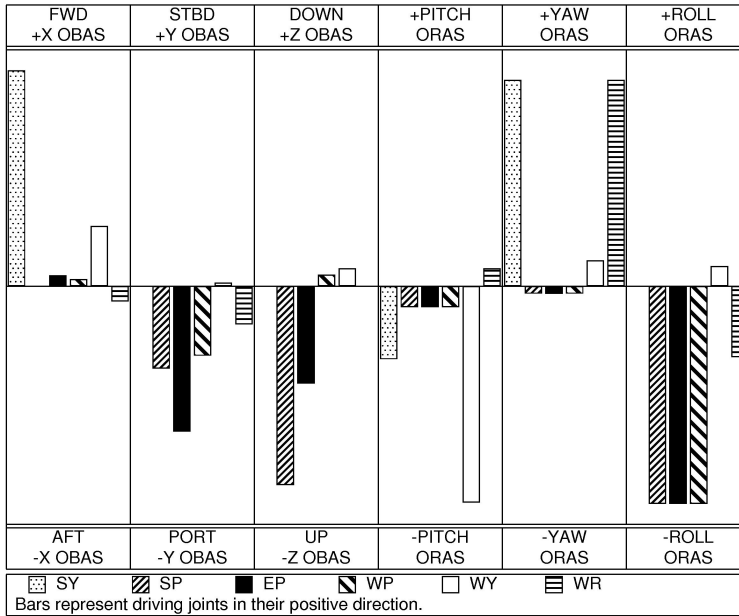

To get:	Drive:
+X (fwd)	+SY
+Y (stbd)	-EP, -WP
+Z (down)	-SP, -EP

To get:	Drive:
+PITCH	-WY
+YAW	+WR, +SY
+ROLL	-WP, -EP

Driving:	Results In:
+SY	+X (fwd), +YAW
+SP	-Z (up), -ROLL
+EP	-Y (port), -ROLL

Driving:	Results In:
+WP	-Y (port), -ROLL
+WY	+X (fwd), -PITCH
+WR	-Y (port), +YAW

ΔSY	ΔSP	ΔEP	ΔWP	ΔWY	ΔWR
+2.1	-9.8	+4.7	+5.6	-1.0	-2.1

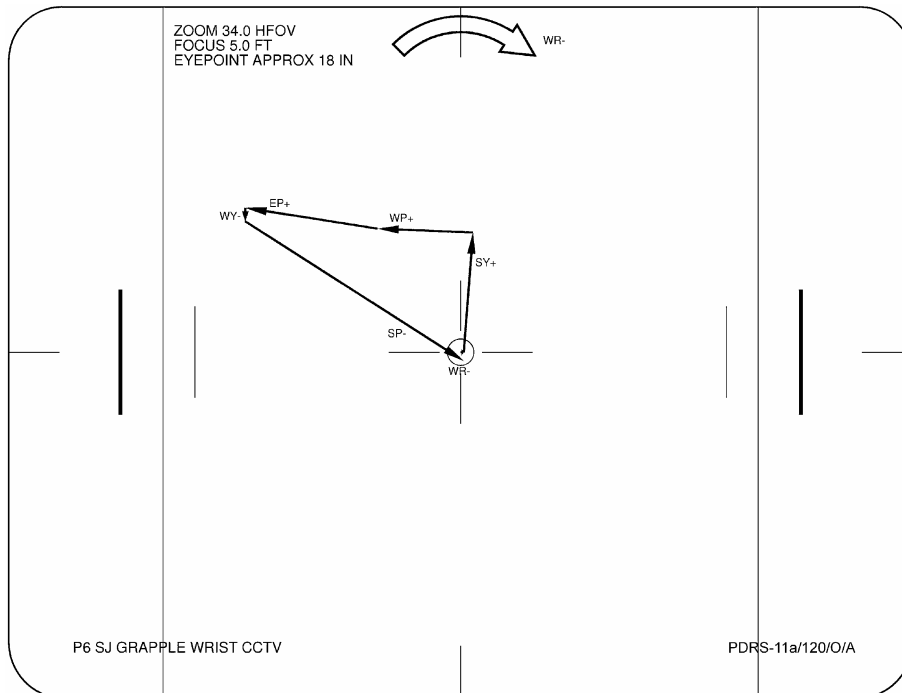

4. P6 GRAPPLE

CAUTION
Monitor EE tb timing to prevent EE motor burnout

EE MODE – AUTO (if available)
CAPTURE sw – depress (mom)

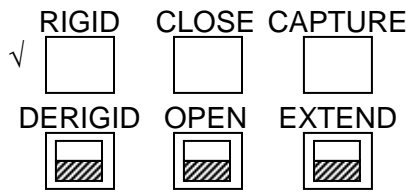

CRITICAL TIMES (28 sec total):
CAPTURE tb – gray, then
CLOSE tb – gray, 3 sec max, then
RIGID tb – gray, 25 sec max

- | | |
|---|---|
| * If manual grapple reqd: | * |
| * EE MODE – MAN | * |
| * CAPTURE sw – depress (hold until CLOSE tb-gray, | * |
| 3 sec max) | * |
| * MAN CONTR – RIGID (hold until RIGID tb-gray, | * |
| 25 sec max) | * |

EE MODE – OFF
BRAKES – ON (tb-ON)

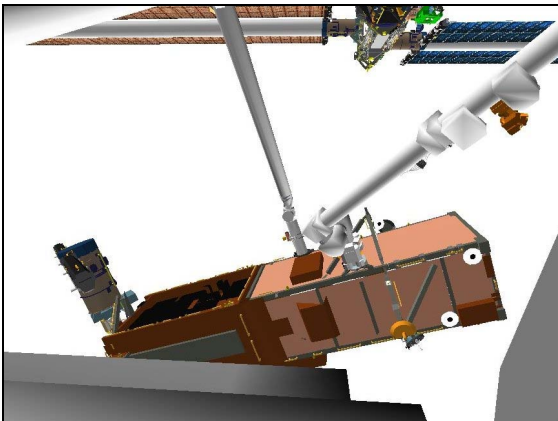

CCTV A (85,-10)

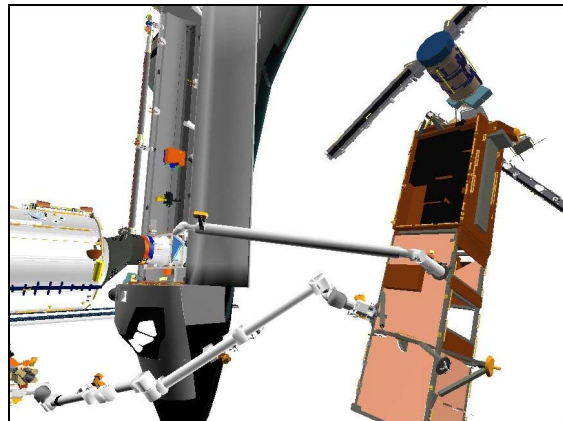

P1 LOOB (135,10)

SM 94 PDRS CONTROL
PL ID, ITEM 3 +3 EXEC
INIT ID, ITEM 24 +3 EXEC

Record POS/ATT and Joint Angles:

	X	Y	Z	PITCH	YAW	ROLL	PL ID
							3
	SY	SP	EP	WP	WY	WR	
Expected	+97.4	+45.3	-65.7	-43.1	+15.7	-73.6	

A8U
MODE – not DIRECT (It off)
PARAM – PORT TEMP
JOINT – CRIT TEMP

Give SSRMS Operator GO to Ungrapple P6

Review GENERIC END EFFECTOR CUE CARD – ISS/SHUTTLE DOCKED OPS

P6 SJ HANDOFF FROM SRMS TO SSRMS

1. SETUP
A7U CCTV – RMS WRIST, zoom 34.0 HFOV
focus 5 ft

MON 1	A (SSRMS Base Elb)
MON 2	EE (B)
DNLK	P1 LOOB

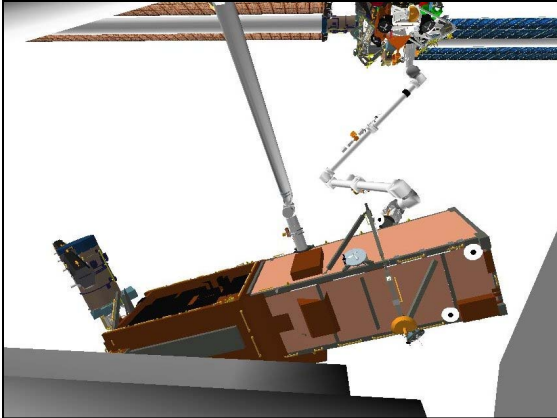

CCTV A (85,-10)

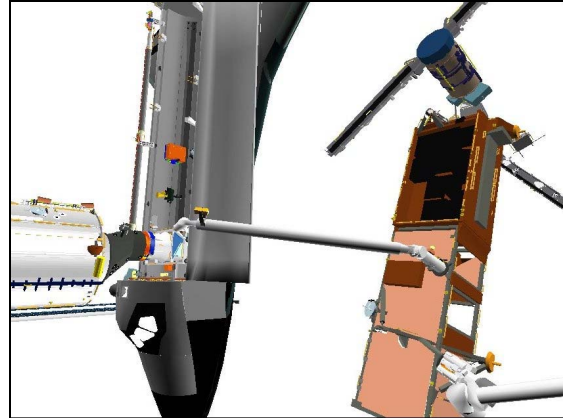

P1 LOOB (135,10)

2. P6 UNGRAPPLE
On SSRMS Operator GO to Ungrapple P6 and maneuver to PRE-CRADLE

NOTE

If SINGLE MODE available, CONTR ERR It and 'S96 PDRS CNTL' msg may occur due to Consistency/Envelope Check error

RATE – COARSE (RATE MIN tb-OFF)

SM 94 PDRS CONTROL

AUTO BRAKE INH – ITEM 10 EXEC (*)

BRAKES – OFF (tb-OFF)

MODE – TEST, ENTER

Wait 5 sec

BRAKES – ON (tb-ON)

SM 94 PDRS CONTROL

AUTO BRAKE ENA – ITEM 9 EXEC (*)

PL ID – ITEM 3 +0 EXEC

INIT ID – ITEM 24 +0 EXEC

RATE – VERN (RATE MIN tb-ON)

BRAKES – OFF (tb-OFF)

MODE – best available

CAUTION

Monitor EE tb timing to prevent EE motor burnout

SM 169 PDRS STATUS

EE MODE – MAN

MAN CONTR – DERIG (hold until DERIGID tb-gray, 5 sec max)

RELEASE sw – depress (hold until OPEN tb-gray, 3 sec max)

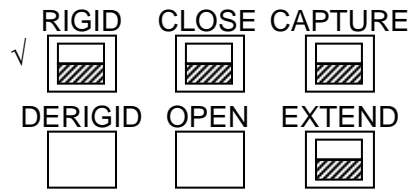

CRITICAL TIMES (8 sec total):

DERIGID tb – gray, 5 sec max, then

OPEN tb – gray, 3 sec max

3. MNVR ARM CLEAR OF P6

Drive joints per P6 SJ UNGRAPPLE WRIST CCTV OVERLAY until EE clear of grapple fixture

P6 SJ UNGRAPPLE

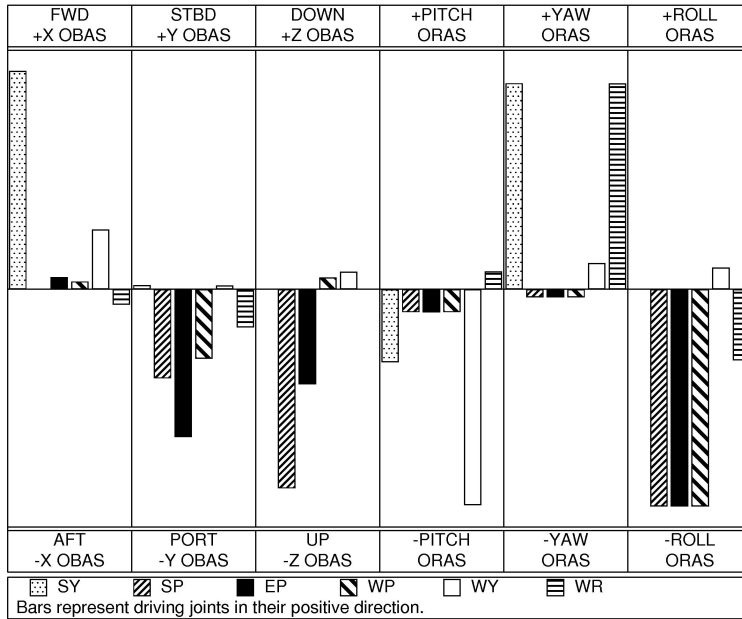

To get:	Drive:	To get:	Drive:	Driving:	Results In:	Driving:	Results In:
+X (fwd)	+SY	+PITCH	-WY	+SY	+X (fwd), +YAW	+WP	-Y (port), -ROLL
+Y (stbd)	-EP, -WP	+YAW	+WR, +SY	+SP	-Z (up), -ROLL	+WY	+X (fwd), -PITCH
+Z (down)	-SP, -EP	+ROLL	-WP, -EP	+EP	-Y (port), -ROLL	+WR	-Y (port), +YAW

ΔSY	ΔSP	ΔEP	ΔWP	ΔWY	ΔWR
-2.1	+9.8	-4.7	-5.6	+1.0	+2.1

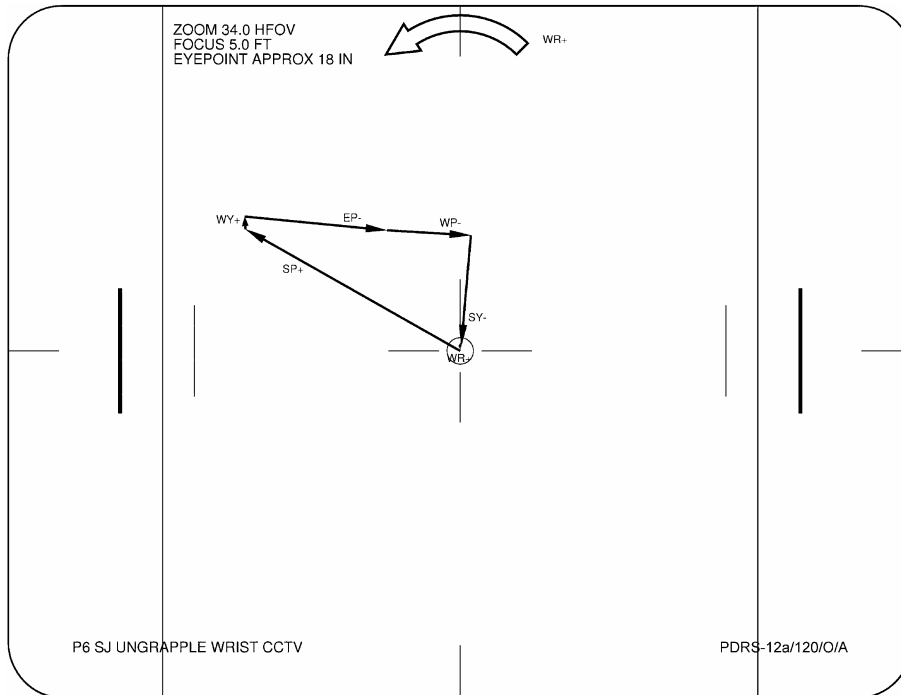

EE MAN CONTR – DERIG (hold until EXTEND tb-gray, 20 sec max)
MODE – OFF

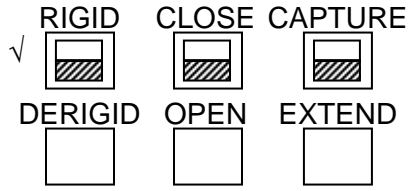

CRITICAL TIMES (20 sec total):
EXTEND tb – gray, 20 sec max

BRAKES – ON (tb-ON)
✓MODE – not DIRECT

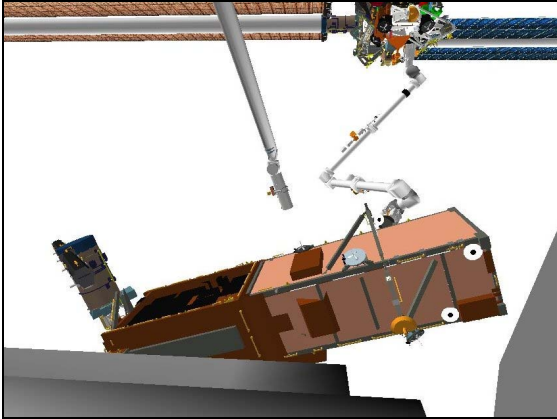

CCTV A (85,-10)

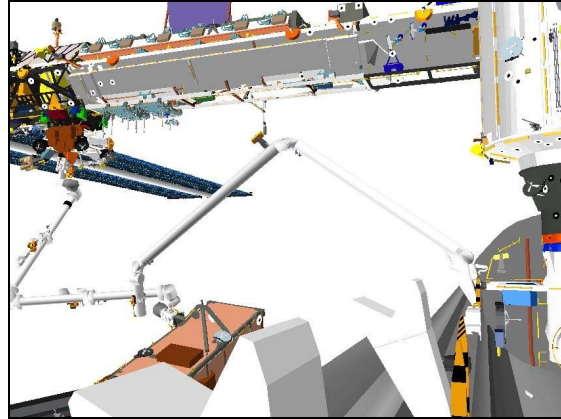

CCTV B (-20,5)

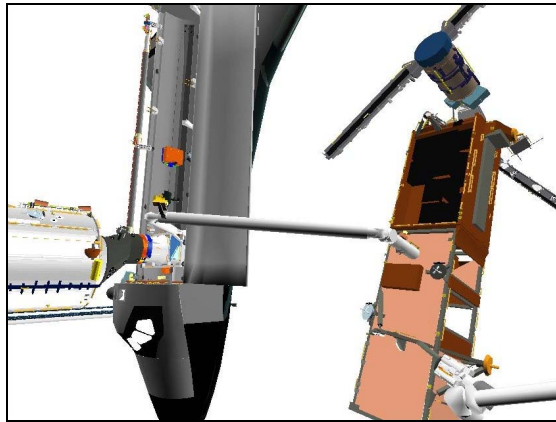

P1 LOOB (135,10)

If using shuttle attitude control and attitude maintenance required:
Configure DAP per RMS DAPs, then perform RATE DAMPING (ORB OPS FS,
REBOOST/DAP; DOCKED DAP REFERENCE)

Notify SSRMS Operator P6 Ungrapple complete

4. SJ MNVR TO PRE-CRADLE
 RATE – as required (VERN within 10 ft)
 BRAKES – OFF (tb-OFF)
 MODE – best available

Mnvr to PRE-CRADLE posn (reference pictures as reqd):

	SY	SP	EP	WP	WY	WR	
UNGRPL BACKOFF	+95.3	+55.1	-70.4	-48.7	16.7	-71.5	
1: EP +			-25.0				
2: WP +				+5.0			
3: WY –					0.0		
4: WR +						0.0	
5: SY –	0.0						
6: SP –		+25.0					
PRE-CRADLE	0.0	+25.0	-25.0	+5.0	0.0	0.0	
	X	Y	Z	PITCH	YAW	ROLL	PL ID
	-1261	-146	-551	5	2	0	0

- BRAKES – ON (tb-ON)
 √MODE – not DIRECT
 PARAM – PORT TEMP
 JOINT – CRIT TEMP

Step 1:
Drive EP (+) from -70.4 to -25.0

Step 2:
Drive WP (+) from -48.7 to +5.0

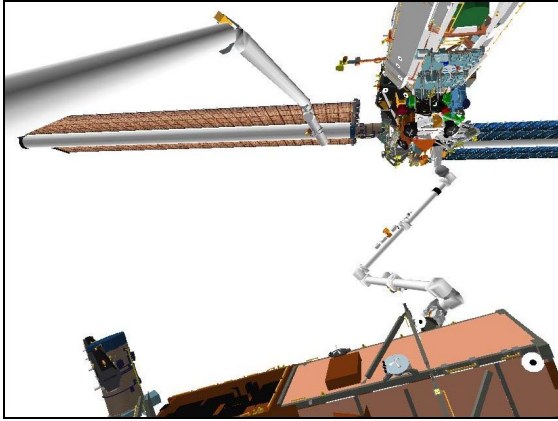

CCTV A (80,5)

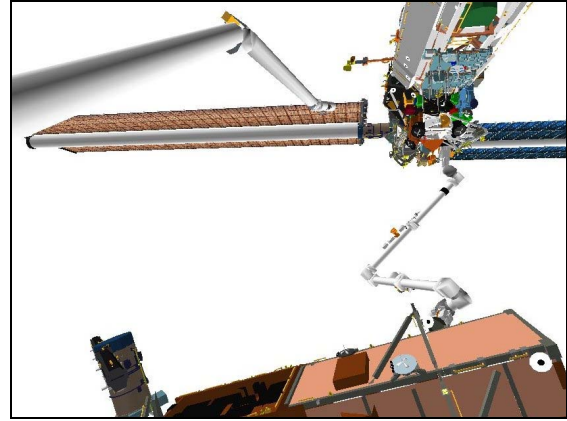

CCTV A (80,5)

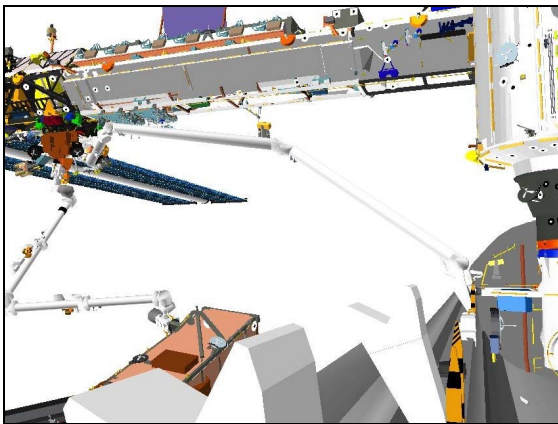

CCTV B (-20,5)

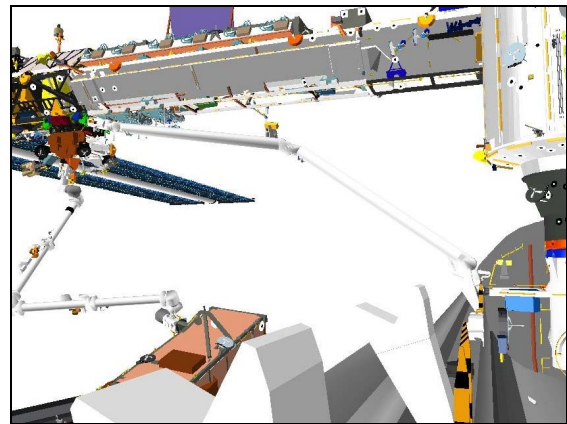

CCTV B (-20,5)

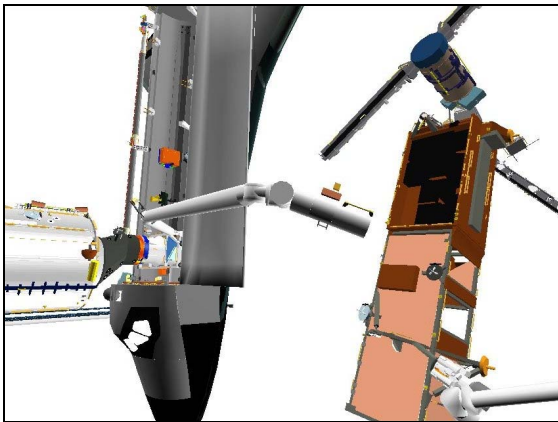

P1 LOOB (135,10)

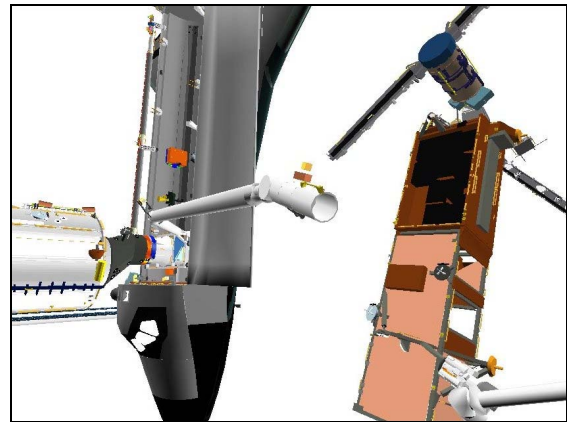

P1 LOOB (135,10)

Step 3:
Drive WY (-) from +16.7 to 0.0

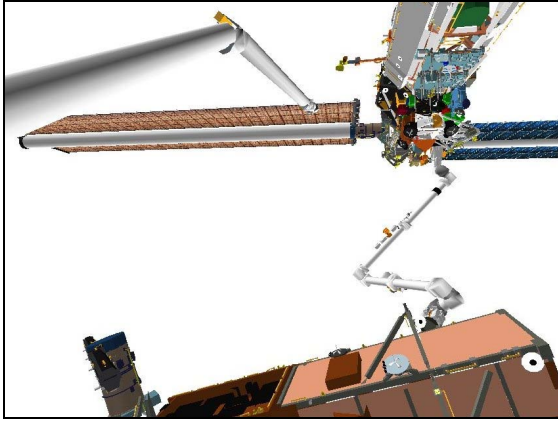

CCTV A (80,5)

Step 4:
Drive WR (+) from -71.5 to 0.0

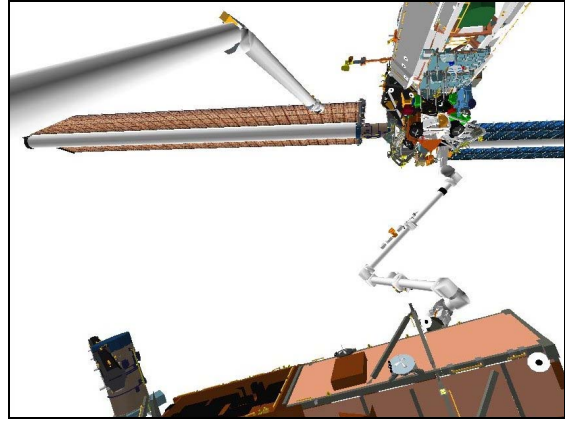

CCTV A (80,5)

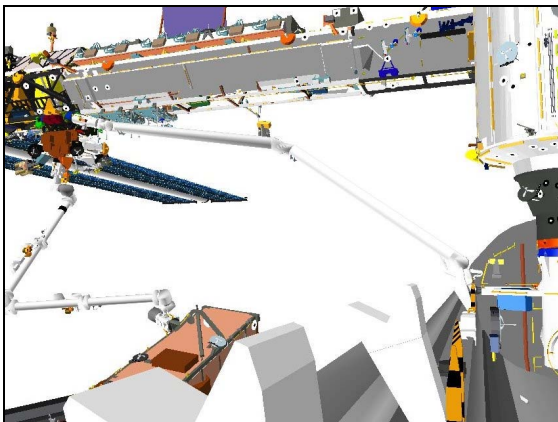

CCTV B (-20,5)

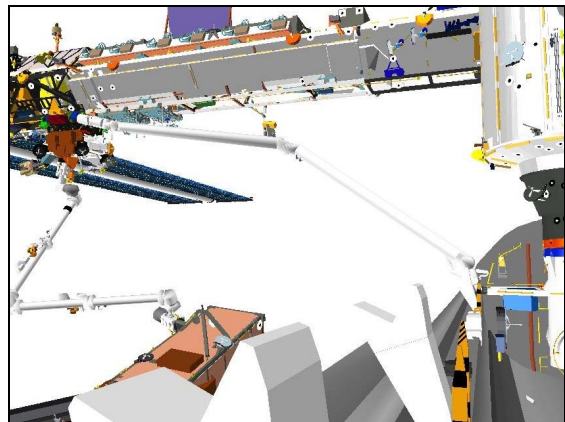

CCTV B (-20,5)

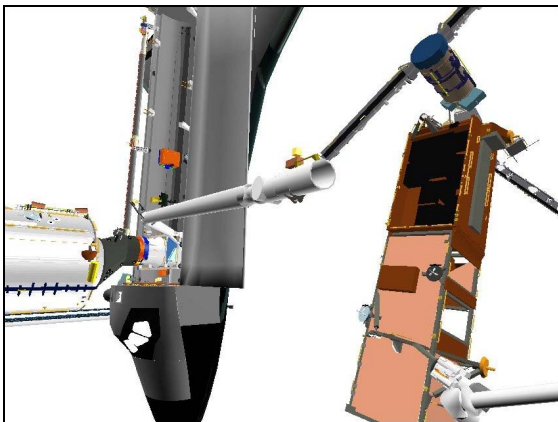

P1 LOOB (135,10)

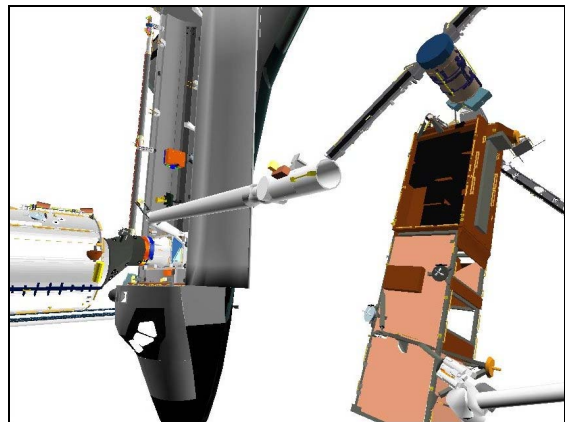

P1 LOOB (135,10)

Step 5:
Drive SY (-) from +95.3 to 0.0

Step 6:
Drive SP (-) from +55.1 to +25.0

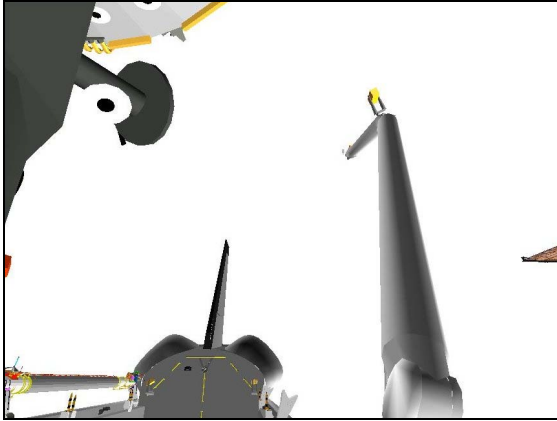

CCTV A (5,25)

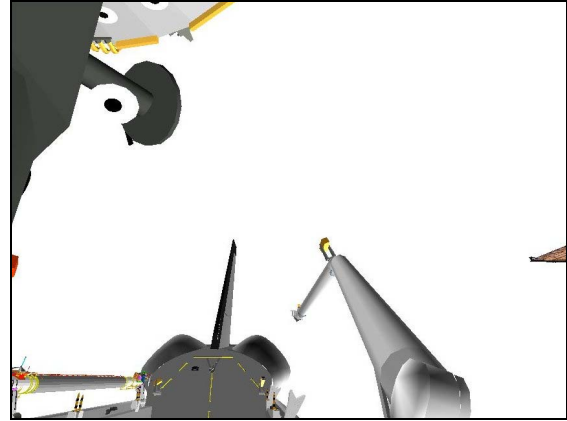

CCTV A (5,25)

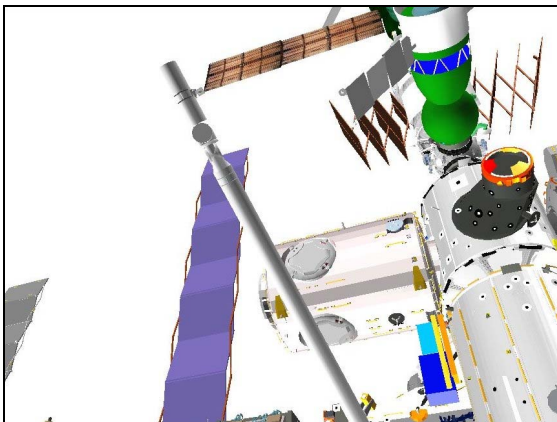

CCTV B (-20,45)

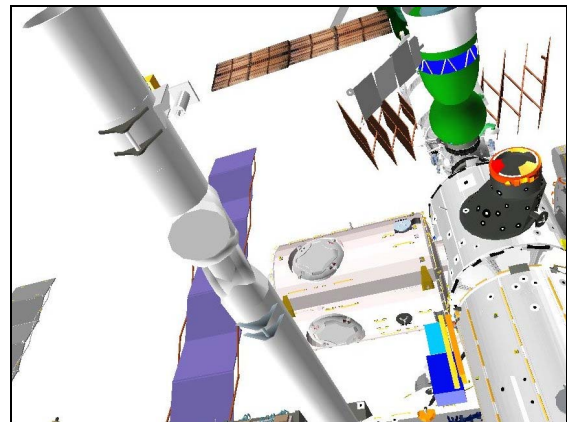

CCTV B (-20,45)

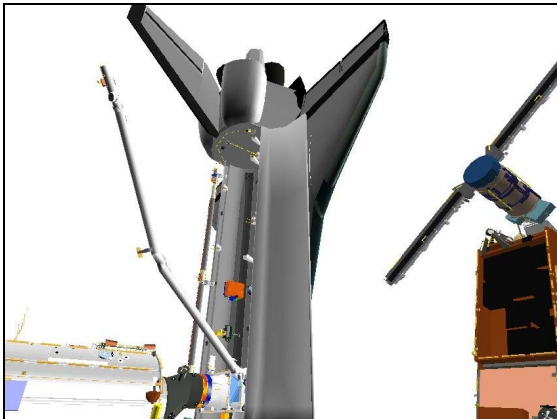

P1 LOOB (125,30)



P1 LOOB (125,30)

This Page Intentionally Blank

P6 REFERENCE DATA

P6 JOINT ANGLES VS POR COORDINATES.....	FS 6-2
COORDINATE SYSTEM – PL ID 3.....	FS 6-3

P6
REF DATA

P6 JOINT ANGLES VS POR COORDINATES

P6 HANDOFF

X	Y	Z	PITCH	YAW	ROLL	PL ID
-661	-530	-229	161	355	5	3
-603	-557	-306	251	5	6	0
SY	SP	EP	WP	WY	WR	
+97.4	+45.3	-65.7	-43.1	+15.7	-73.6	

PRE-GRAPPLE/UNGRAPPLE

X	Y	Z	PITCH	YAW	ROLL	PL ID
-680	-525	-285	161	355	5	3
-622	-552	-362	251	5	6	0
SY	SP	EP	WP	WY	WR	
+95.3	+55.1	-70.4	-48.7	+16.7	-71.5	

P6 INSTALL VIEWING

X	Y	Z	PITCH	YAW	ROLL	PL ID
-660	-549	-308	269	30	102	3
-631	-537	-213	111	57	252	0
SY	SP	EP	WP	WY	WR	
+94.8	+16.7	-63.4	+96.4	+8.2	+22.9	

P6
REF DATA

P6 COORDINATE SYSTEM – PL ID 3

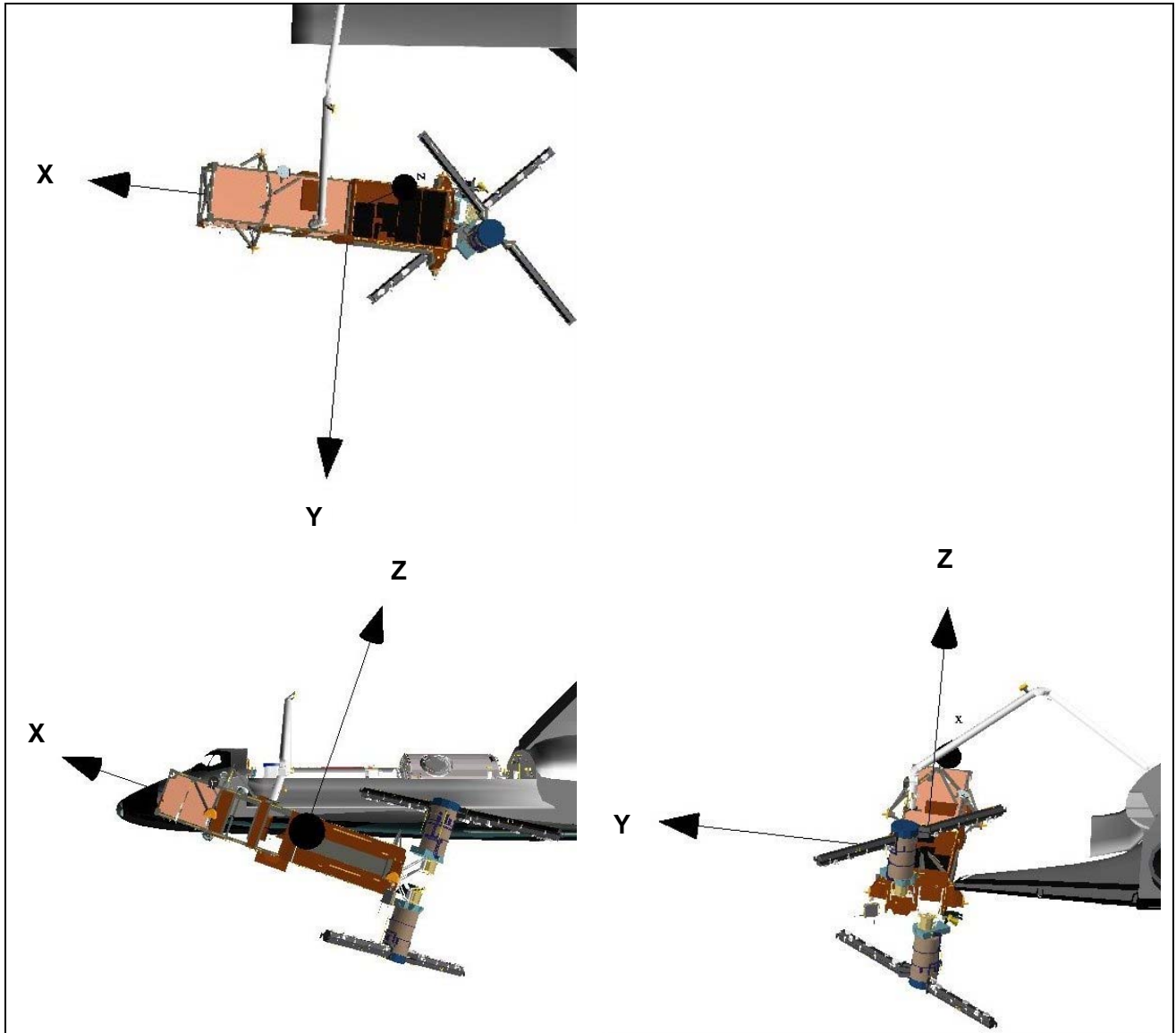

POR: At P6 axial center, centered between trunions (shown in P6 handoff position)

PURPOSE: P6 Handoff

RATES:	<u>COARSE</u>	<u>VERN</u>
TRANS LIM ft/sec:	0.15	0.10
ROT LIM deg/sec:	0.50	0.16

This Page Intentionally Blank

EVA 3

EVA 3 SUPPORT FS 7-2

EVA 3

EVA 3 SUPPORT

1. SETUP

SM 94 PDRS CONTROL

√ PL ID, ITEM 3: 0

√ INIT ID, ITEM 24: 0

MON 1	A (P1LOOB)
MON 2	B (C)
DWNLNK	RMS ELBOW

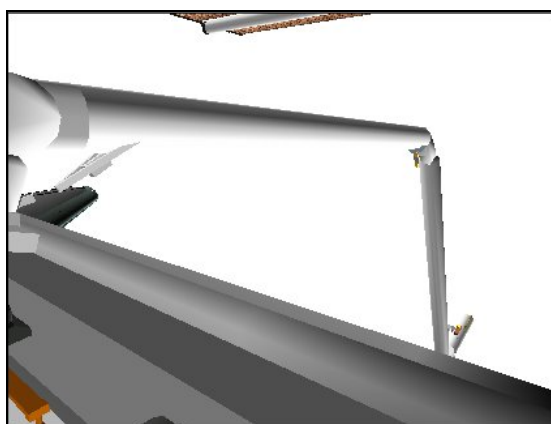

CCTV A (55,-15)

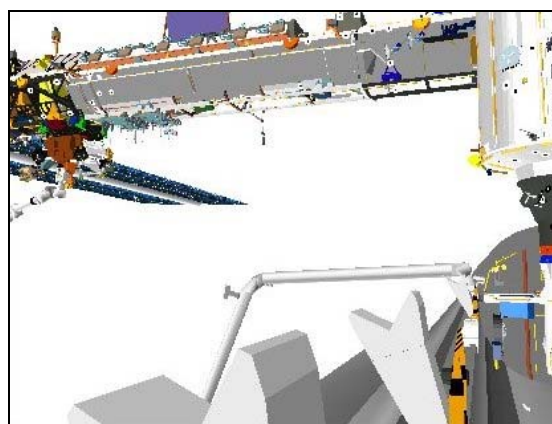

CCTV B (-20,5)

	X	Y	Z	PITCH	YAW	ROLL	PL ID
√	-631	-537	-213	111	57	252	0
	SY	SP	EP	WP	WY	WR	
√	+94.8	+16.7	-63.4	+96.4	+8.2	+22.9	

2. APFR INSTALL

RHC

On SSRMS Operator GO for maneuver to APFR INSTALL position:

RATE – as reqd (VERN within 10 ft)

BRAKES – OFF (tb-OFF)

MODE – SINGLE, ENTER

Mnvr to APFR INSTALL posn:

	SY	SP	EP	WP	WY	WR	
P6 VIEW	+94.8	+16.7	-63.4	+96.4	+8.2	+22.9	
1: SP +		+60.0					
2: SY -	-15.0						
3: WR +						+123.5	
4: WY -					-27.0		
5: WP -				-60.1			
6: EP -			-89.8				
7: SP +		+112.2					
8: SY -	-64.7						
APFR INSTALL	-64.7	+112.2	-89.8	-60.1	-27.0	+123.5	
	X	Y	Z	PITCH	YAW	ROLL	PL ID
	-750	-13	-802	245	285	5	0
	-707	-31	-894	195	343	178	4

EVA 3

BRAKES – ON (tb-ON)

Notify IV/EVA, “SRMS ready for APFR Install”

SM 94 PDRS CONTROL

PL ID – ITEM 3 +4 EXEC

INIT ID – ITEM 24 +4 EXEC

SM 95 PDRS OVERRIDE

LOADED RATE, ITEM 14 EXEC (*)

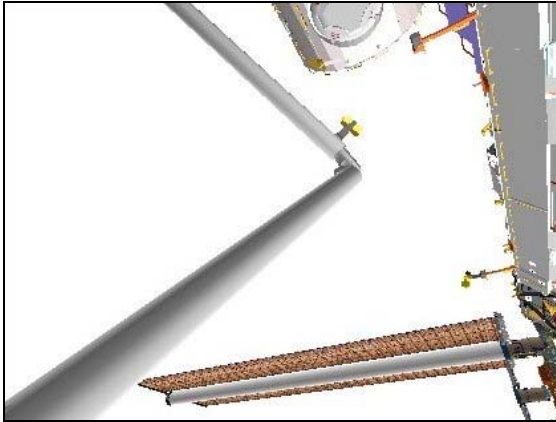

CCTV A (60,40)

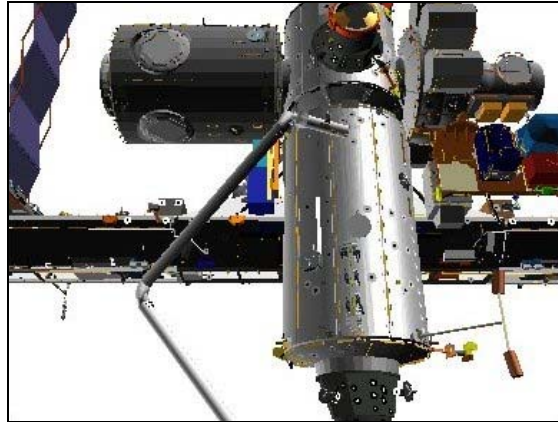

CCTV B (0,25)

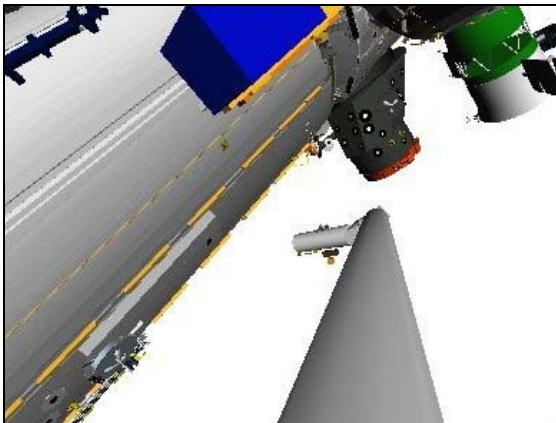

ELBOW (-15,-5)

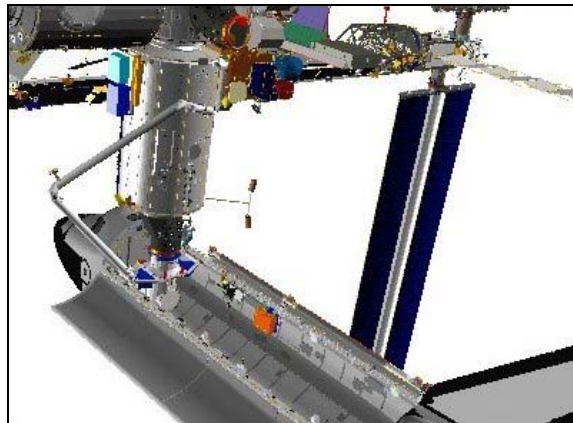

BIRD'S EYE

3. APFR INGRESS

When APFR install complete and on EVA GO for GCA to APFR ingress:

BRAKES – OFF (tb-OFF)

MODE – ORB LD, ENTER

GCA per EVA call to APFR INGRESS posn (record actual): (APFR: 4/II/F/6)

	X	Y	Z	PITCH	YAW	ROLL	PL ID
Expected	-707	-31	-894	195	343	178	4
	SY	SP	EP	WP	WY	WR	
Expected	-64.7	+112.2	-89.8	-60.1	-27.0	+123.5	

BRAKES – ON (tb-ON)

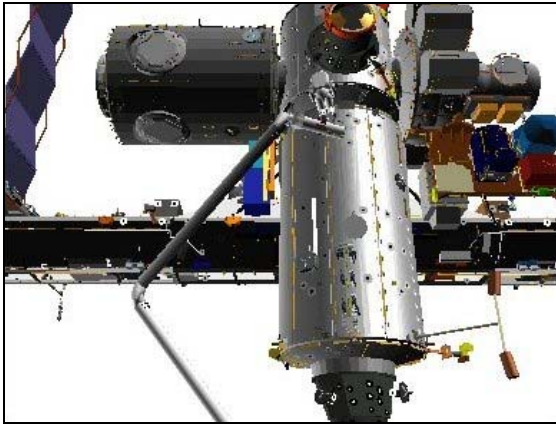

CCTV B (0,25)

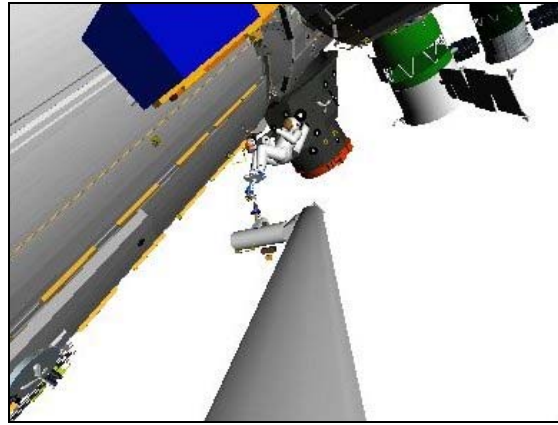

ELBOW (-5,-5)

4. MBSU RETRIEVAL

When APFR ingress complete and on EVA GO for mnvr to MBSU retrieval:

BRAKES – OFF (tb-OFF)

MODE – as desired

Mnvr to MBSU RETRIEVAL SETUP posn (within 2"/1°): (APFR: 4/II/F/6)

X	Y	Z	PITCH	YAW	ROLL	PL ID
-888	+66	-461	266	331	268	4
SY	SP	EP	WP	WY	WR	
-22.9	+76.7	-142.7	+30.2	+27.2	+87.8	

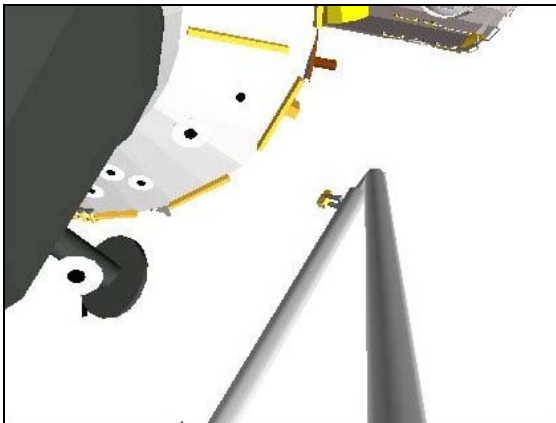

CCTV A (10,50)

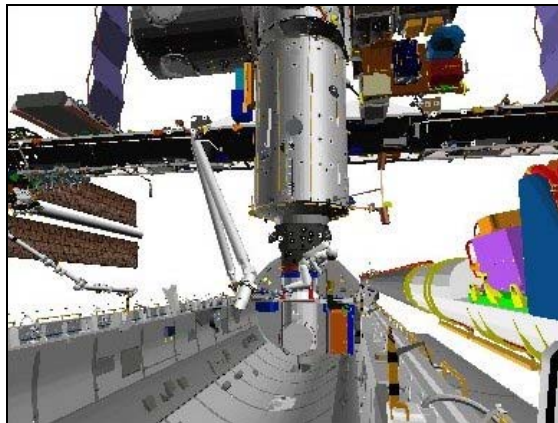

CCTV C (-10,10)

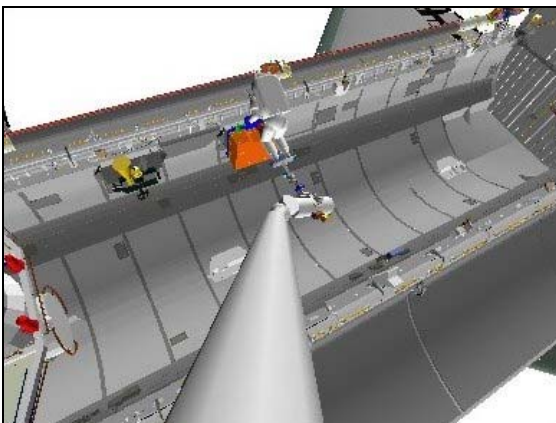

ELBOW (0,5)

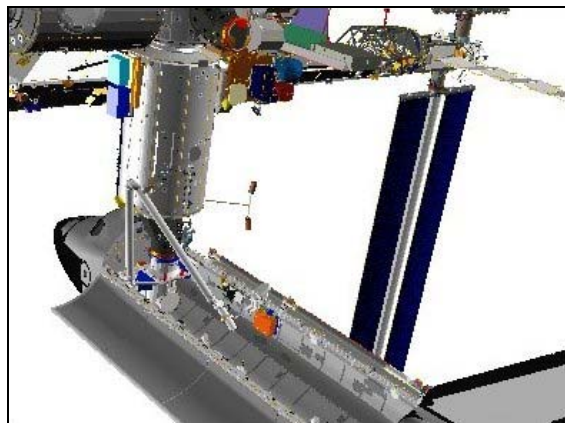

BIRD'S EYE

On EVA GO for GCA:

GCA per EVA call to MBSU RETRIEVAL posn: (APFR: 4/II/F/6)

	X	Y	Z	PITCH	YAW	ROLL	PL ID
Expected	-888	+66	-433	266	331	268	4
	SY	SP	EP	WP	WY	WR	
Expected	-20.3	+68.2	-142.8	+39.5	+25.1	+86.1	

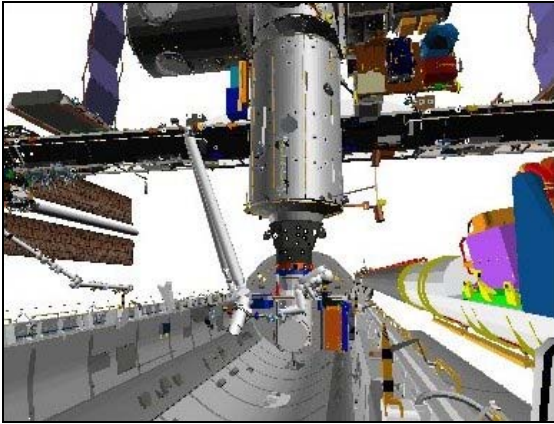

CCTV C (-10,10)



ELBOW (0,5)

When MBSU removal complete and on EVA GO for GCA:

GCA per EVA call to MBSU Starboard Sill Clearance

5. MBSU HANDOFF

When MBSU clear of starboard sill and on EVA GO for MBSU handoff:

Mnvr to MBSU HANDOFF SETUP posn (within 2"/1°) (APFR: 4/II/F/6)

X	Y	Z	PITCH	YAW	ROLL	PL ID
-739	+143	-785	238	355	180	4
SY	SP	EP	WP	WY	WR	
-64.1	+78.1	-79.3	-46.0	-17.6	+77.0	

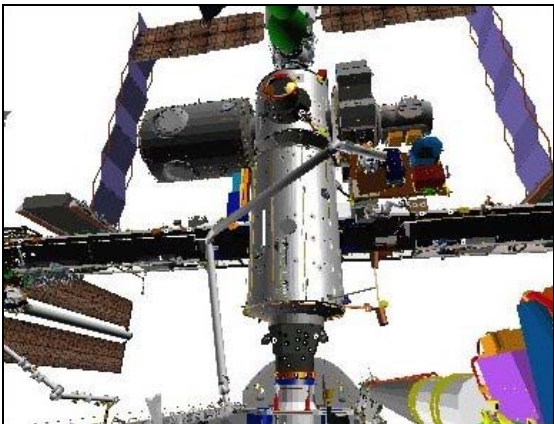

CCTV C (-10,25)

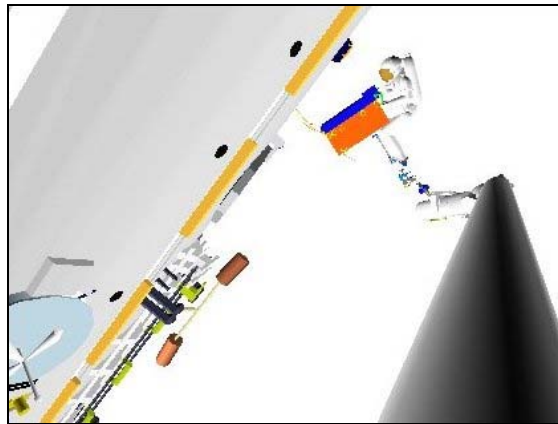

ELBOW (-30,-10)

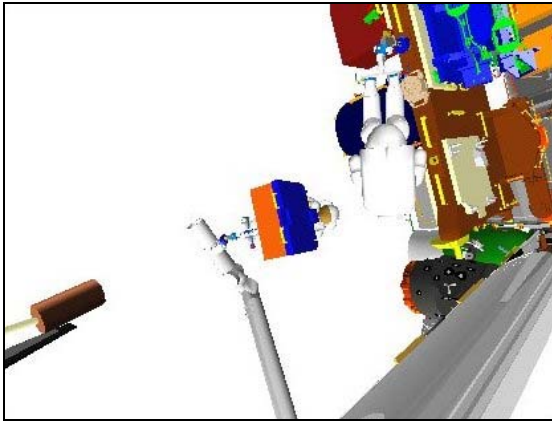

US LAB (45,-15)

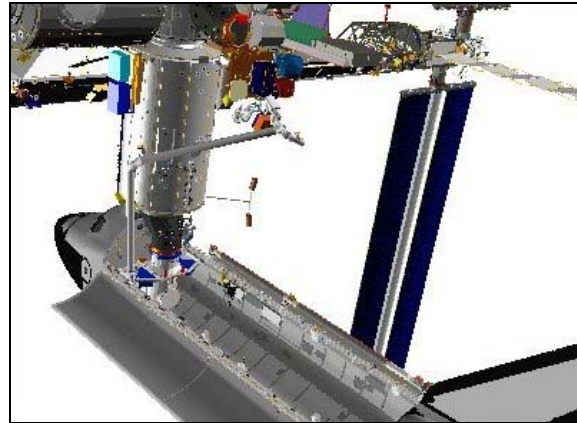

BIRD'S EYE

CAUTION

Monitor clearance between SRMS Lower Boom and US Lab Handrails with RMS Elbow camera

- If X = -688 (PL ID 4) clearance is 24"
- If X = -675 (PL ID 4) clearance is 18"

On EVA GO for GCA:

GCA per EVA call to MBSU HANDOFF posn: (APFR: 4/II/F/6)

	X	Y	Z	PITCH	YAW	ROLL	PL ID
Expected	-704	+144	-784	238	355	180	4
	SY	SP	EP	WP	WY	WR	
Expected	-69.6	+81.4	-83.3	-44.2	-13.8	+81.1	

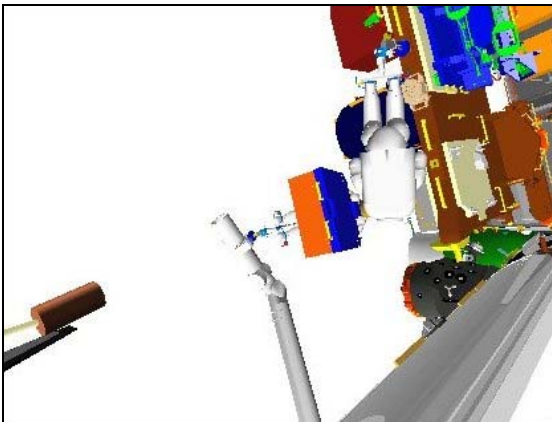

US LAB (45,-15)

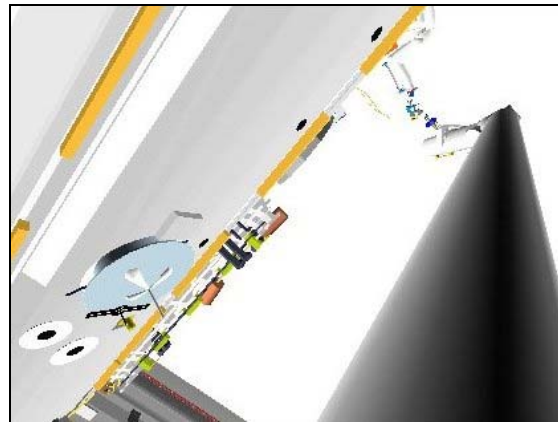

ELBOW (-30,-20)

When MBSU handoff complete and on EVA GO for GCA:

GCA per EVA call to MBSU Install Support Position

6. APFR EGRESS

When MBSU install complete and on EVA GO for APFR egress:

Mnvr to APFR EGRESS SETUP posn (within 2"/1°): (APFR: 4/II/F/6)

X	Y	Z	PITCH	YAW	ROLL	PL ID
-743	-31	-894	195	343	178	4
SY	SP	EP	WP	WY	WR	
-55.1	+108.2	-86.7	-62.4	-34.3	+116.5	

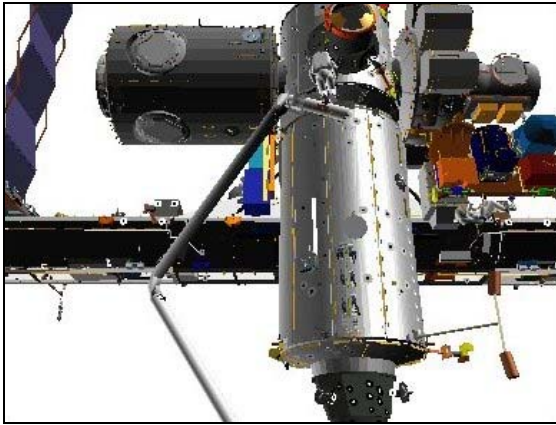

CCTV B (0,25)

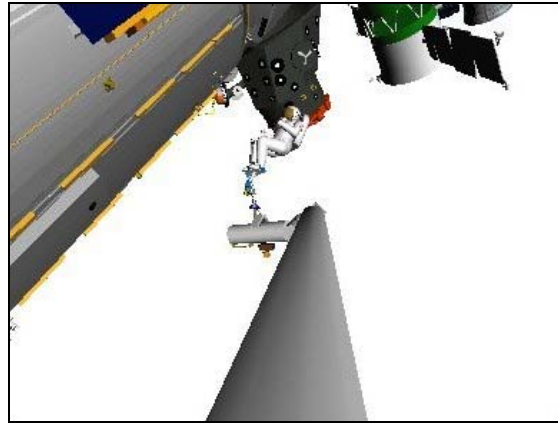

ELBOW (-5,-5)

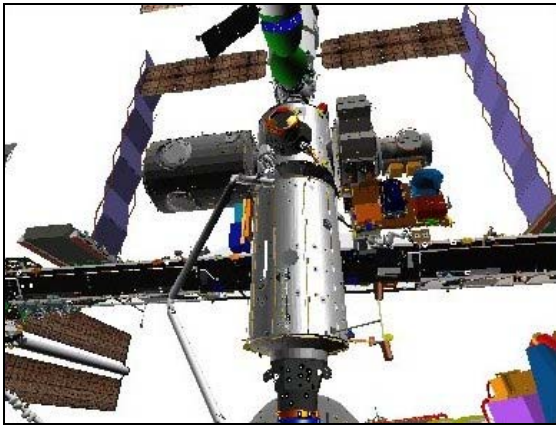

CCTV C (-10,30)

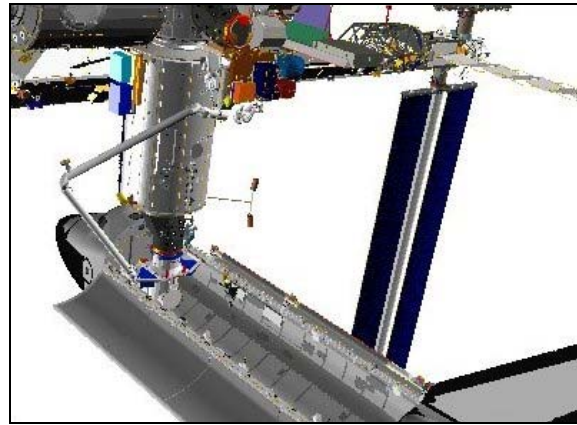

BIRD'S EYE

On EVA GO for GCA:

GCA per EVA call to APFR EGRESS posn: (APFR: 4/II/F/6)

	X	Y	Z	PITCH	YAW	ROLL	PL ID
Expected	-707	-31	-894	195	343	178	4
	SY	SP	EP	WP	WY	WR	
Expected	-64.7	+112.2	-89.8	-60.1	-27.0	+123.5	

BRAKES – ON (tb-ON)

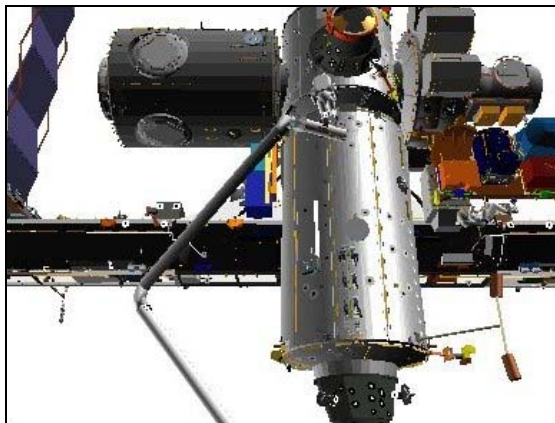

CCTV B (0,25)

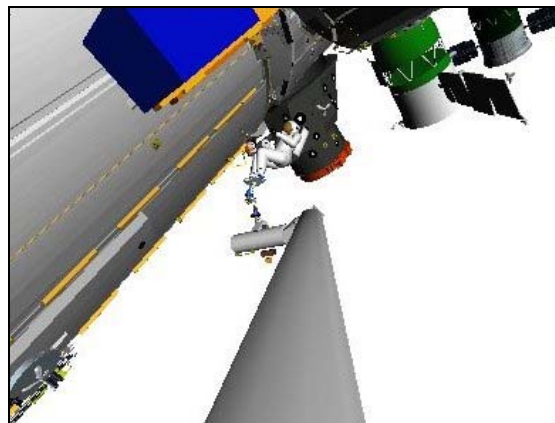

ELBOW (-5,-5)

7. APFR REMOVAL

When APFR Egress complete and on EVA GO for GCA:

BRAKES – OFF (tb-OFF)
 MODE – ORB LD, ENTER

GCA per EVA call to APFR REMOVAL posn: (APFR: 4/II/F/6)

	X	Y	Z	PITCH	YAW	ROLL	PL ID
Expected	-707	-31	-894	195	343	178	4
Expected	-750	-13	-802	245	285	5	0
	SY	SP	EP	WP	WY	WR	
Expected	-64.7	+112.2	-89.8	-60.1	-27.0	+123.5	

BRAKES – ON (tb-ON)

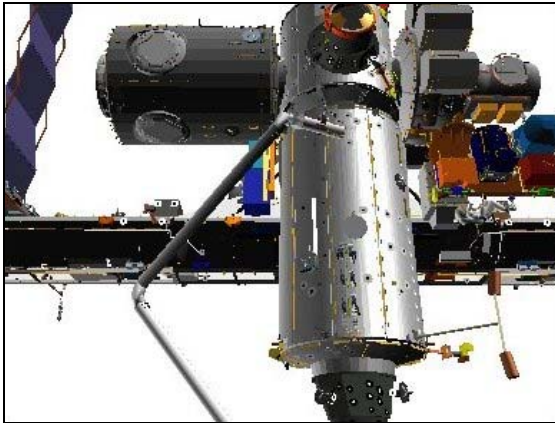

CCTV B (0,25)

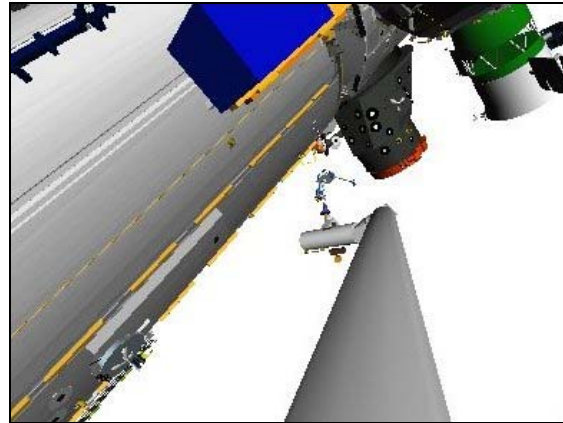

ELBOW (-15,-5)

8. MANEUVER TO PRE-CRADLE

When APFR removal complete and on EVA GO for mnvr to PRE-CRADLE:

SM 94 PDRS CONTROL

PL ID – ITEM 3 +0 EXEC
 INIT ID – ITEM 24 +0 EXEC

SM 95 PDRS OVERRIDE

LOADED RATE, ITEM 14 EXEC ()

RHC

RATE – as reqd (VERN within 10 ft)
 BRAKES – OFF (tb-OFF)
 MODE – as desired

Mnvr to PRE-CRADLE (within 2"/1°):

X	Y	Z	PITCH	YAW	ROLL	PL ID
-1261	-146	-551	5	2	0	0
SY	SP	EP	WP	WY	WR	
0.0	+25.0	-25.0	+5.0	0.0	0.0	

BRAKES – ON (tb-ON)
 MODE – not DIRECT (lt off)
 PARAM – PORT TEMP
 JOINT – CRIT TEMP

EVA 3 CONTINGENCY

I

EVA 3 CONTINGENCY MBSU SUPPORT FS 8-2

**EVA 3
CONTINGENCY**

EVA 3 CONTINGENCY MBSU SUPPORT

1. MANEUVER TO RECONFIGURATION POSITION

On EVA GO for maneuver to contingency rebolting:

Mnvr to MBSU CLEARANCE posn (within 2"/1°): (APFR: 4/II/F/6)

X	Y	Z	PITCH	YAW	ROLL	PL ID
-888	+40	-433	266	331	268	4
SY	SP	EP	WP	WY	WR	
-13.2	+71.9	-144.8	+39.4	+19.3	+81.8	

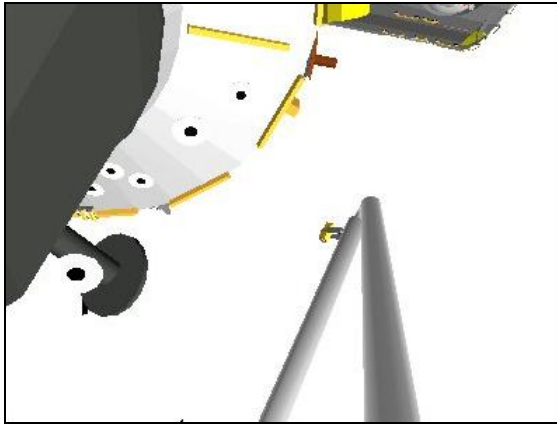

CCTV A (10,50)

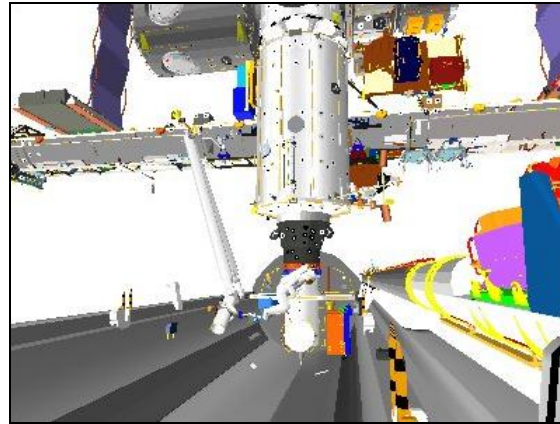

CCTV C (-10,10)



ELBOW (0,5)

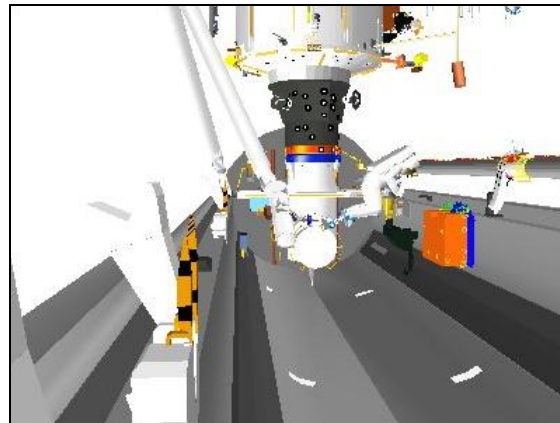

CCTV B (5,-5)

2. RECONFIGURE FOR MBSU REBOLTING

Mnvr to REBOLTING SETUP posn (APFR 4/II/F/6)

X	Y	Z	PITCH	YAW	ROLL	PL ID
-888	+40	-433	180	292	268	4
SY	SP	EP	WP	WY	WR	
-30.0	+83.5	-146.3	-44.4	-11.0	+162.5	

EVA 3 CONTINGENCY

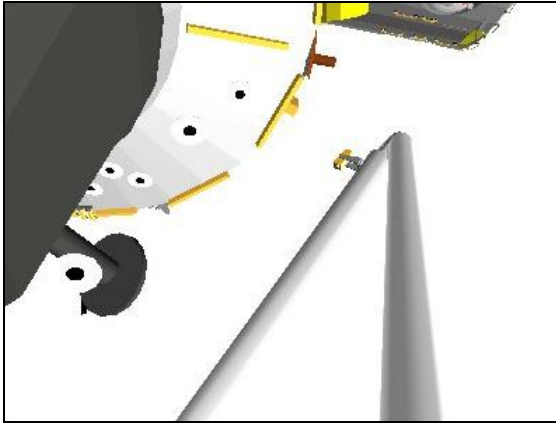

CCTV A (10,50)

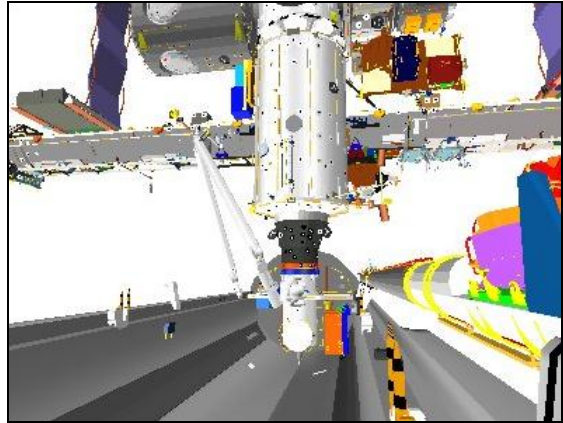

CCTV C (-10,10)

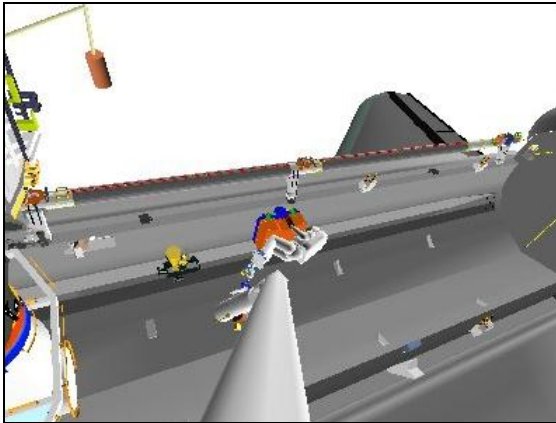

ELBOW (0,5)

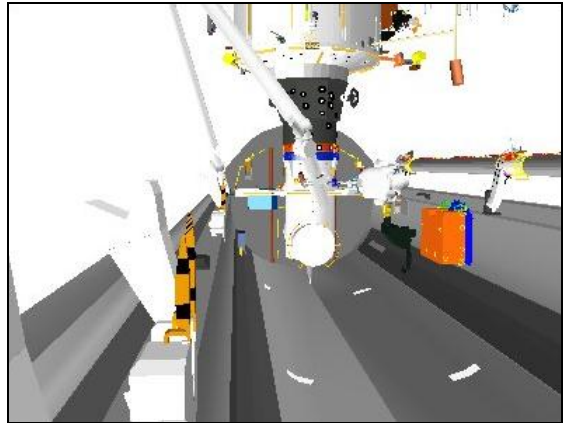

CCTV B (5,-5)

On EVA GO for GCA:

GCA per EVA call to MBSU REBOLTING posn

(APFR 4/III/F/6)

	X	Y	Z	PITCH	YAW	ROLL	PL ID
Expected	-888	+50	-374	180	292	268	4
	SY	SP	EP	WP	WY	WR	
Expected	-26.8	+62.7	-145.3	-25.1	-10.0	+159.3	

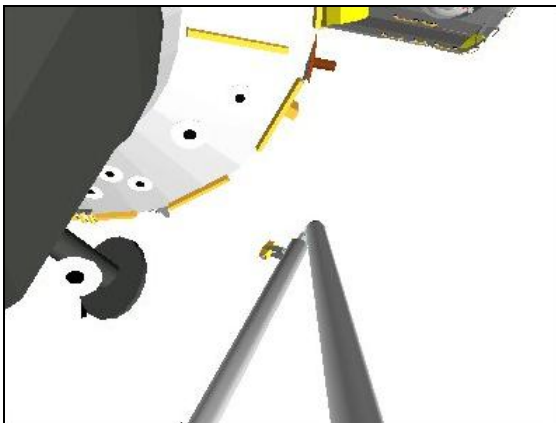

CCTV A (10,50)

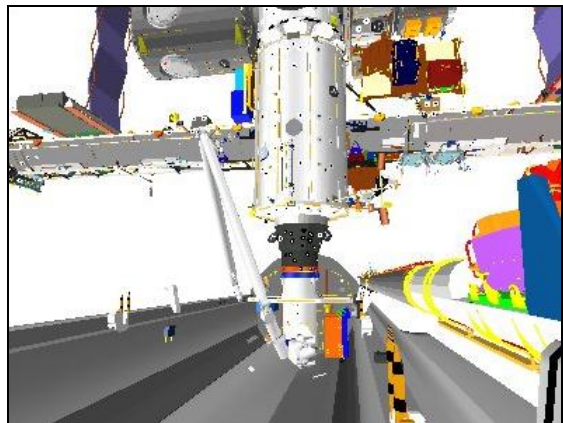

CCTV C (-10,10)

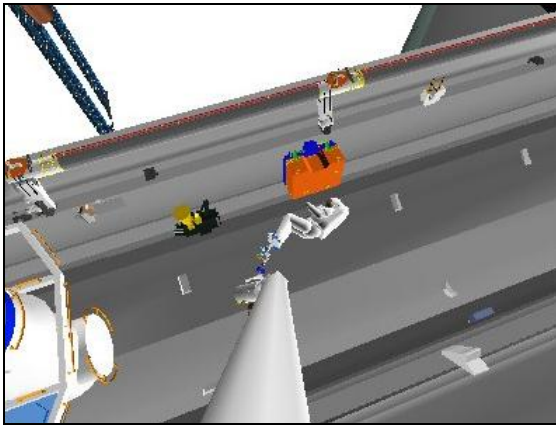

ELBOW (0,5)

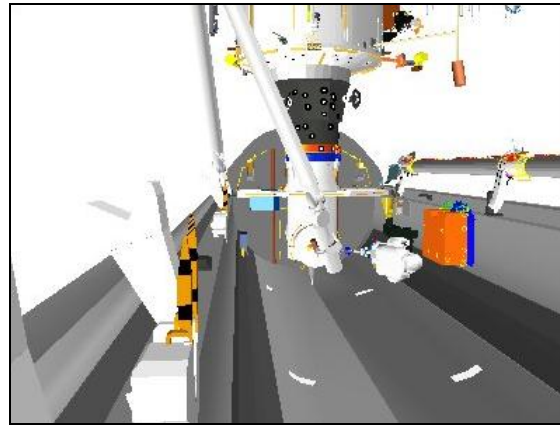

CCTV B (5,-5)

3. APFR EGRESS

When MBSU Rebolting complete and on EVA GO for APFR egress:

Mnvr to APFR EGRESS SETUP posn (within 2"/1°): (APFR: 4/II/F/6)

X	Y	Z	PITCH	YAW	ROLL	PL ID
-743	-31	-894	195	343	178	4
SY	SP	EP	WP	WY	WR	
-55.1	+108.2	-86.7	-62.4	-34.3	+116.5	

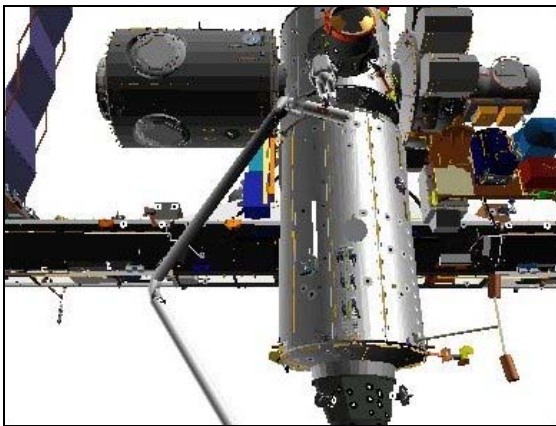

CCTV B (0,25)

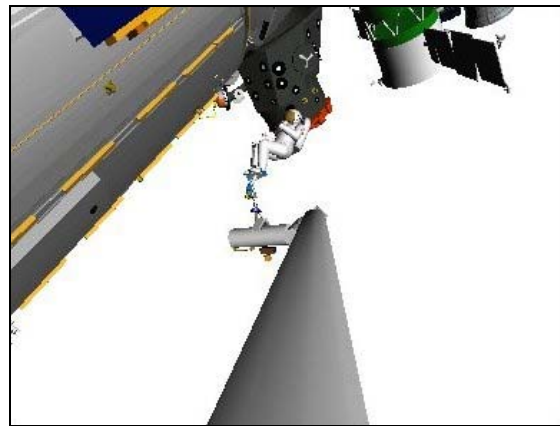

ELBOW (-5,-5)

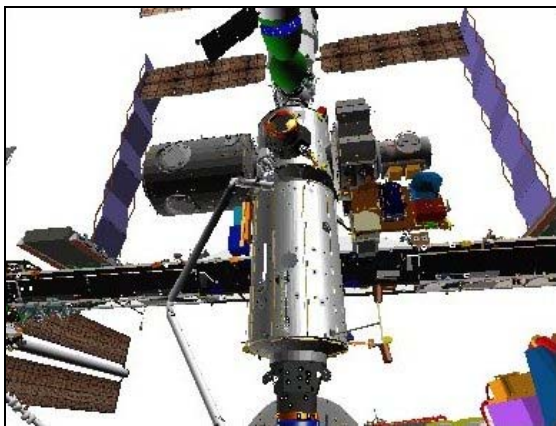

CCTV C (-10,30)

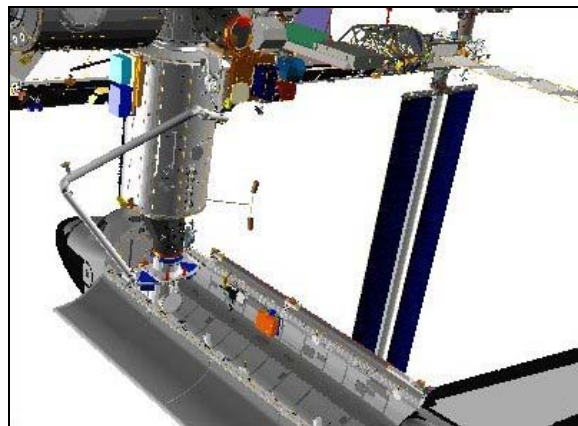

BIRD'S EYE

On EVA GO for GCA:

GCA per EVA call to APFR EGRESS posn: (APFR: 4/II/F/6)

	X	Y	Z	PITCH	YAW	ROLL	PL ID
Expected	-707	-31	-894	195	343	178	4
	SY	SP	EP	WP	WY	WR	
Expected	-64.7	+112.2	-89.8	-60.1	-27.0	+123.5	

BRAKES – ON (tb-ON)

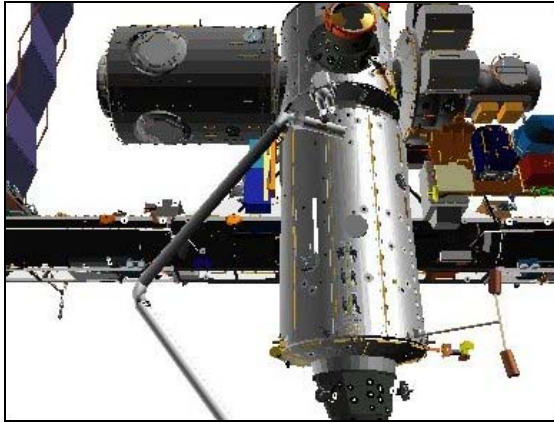

CCTV B (0,25)

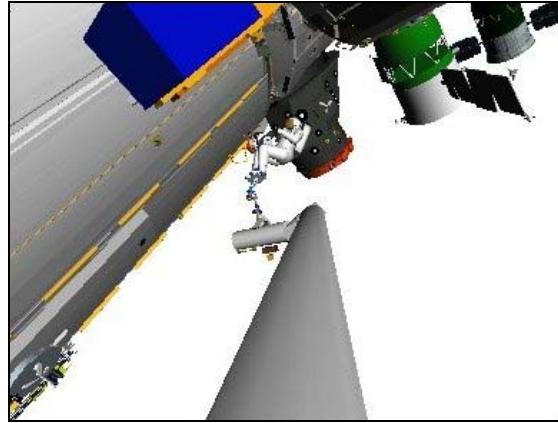

CCTV ELBOW (-5,-5)

4. APFR REMOVAL

When APFR Egress complete and on EVA GO for GCA:

BRAKES – OFF (tb-OFF)

MODE – ORB LD, ENTER

GCA per EVA call to APFR REMOVAL posn: (APFR: 4/II/F/6)

	X	Y	Z	PITCH	YAW	ROLL	PL ID
Expected	-707	-31	-894	195	343	178	4
Expected	-750	-13	-802	245	285	5	0
	SY	SP	EP	WP	WY	WR	
Expected	-64.7	+112.2	-89.8	-60.1	-27.0	+123.5	

BRAKES – ON (tb-ON)

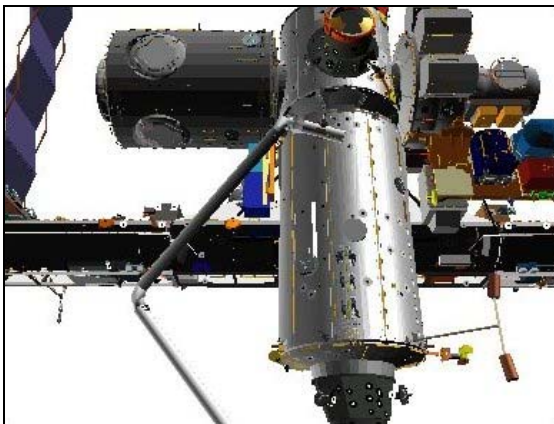

CCTV B (0,25)

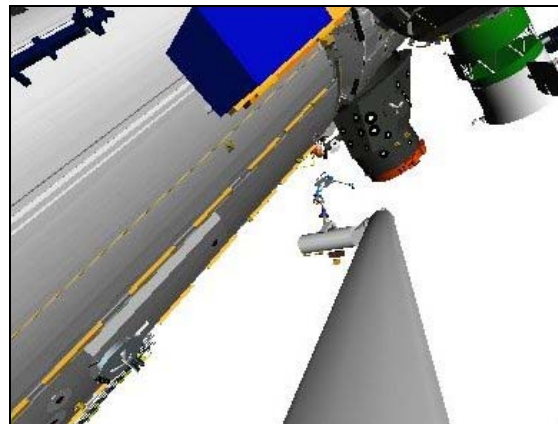

ELBOW (-15,-5)

5. MANEUVER TO PRE-CRADLE

When APFR removal complete and on EVA GO for mnvr to PRE-CRADLE:

SM 94 PDRS CONTROL

PL ID – ITEM 3 +0 EXEC

INIT ID – ITEM 24 +0 EXEC

SM 95 PDRS OVERRIDE

LOADED RATE, ITEM 14 EXEC ()

RHC

RATE – as reqd (VERN within 10 ft)

BRAKES – OFF (tb-OFF)

MODE – as desired

Mnvr to PRE-CRADLE (within 2"/1°):

X	Y	Z	PITCH	YAW	ROLL	PL ID
-1261	-146	-551	5	2	0	0
SY	SP	EP	WP	WY	WR	
0.0	+25.0	-25.0	+5.0	0.0	0.0	

BRAKES – ON (tb-ON)

MODE – not DIRECT (lt off)

PARAM – PORT TEMP

JOINT – CRIT TEMP

EVA 3 REFERENCE DATA

EVA 3 JOINT ANGLES VS POR COORDINATES..... FS 9-2
COORDINATE SYSTEM – PL ID 4..... FS 9-4
– PL ID 5..... FS 9-5

EVA 3
REF DATA

EVA 3 JOINT ANGLES VS POR COORDINATES

APFR INSTALL

X	Y	Z	PITCH	YAW	ROLL	PL ID
-707	-31	-894	195	343	178	4
-721	-29	-842	195	343	178	5
-750	-13	-802	245	285	5	0
SY	SP	EP	WP	WY	WR	
-64.7	+112.2	-89.8	-60.1	-27.0	+123.5	

APFR INGRESS

X	Y	Z	PITCH	YAW	ROLL	PL ID
-707	-31	-894	195	343	178	4
-721	-29	-842	195	343	178	5
-750	-13	-802	245	285	5	0
SY	SP	EP	WP	WY	WR	
-64.7	+112.2	-89.8	-60.1	-27.0	+123.5	

MBSU RETRIEVE SETUP

X	Y	Z	PITCH	YAW	ROLL	PL ID
-888	+66	-461	266	331	268	4
-888	+19	-435	266	331	268	5
-908	-27	-422	328	358	72	0
SY	SP	EP	WP	WY	WR	
-22.9	+76.7	-142.7	+30.2	+27.2	+87.8	

MBSU RETRIEVE

X	Y	Z	PITCH	YAW	ROLL	PL ID
-888	+66	-433	266	331	268	4
-888	+19	-407	266	331	268	5
-908	-27	-394	327	358	72	0
SY	SP	EP	WP	WY	WR	
-20.3	+68.2	-142.8	+39.5	+25.1	+86.1	

MBSU HANDOFF SETUP

X	Y	Z	PITCH	YAW	ROLL	PL ID
-739	+143	-785	238	355	180	4
-785	+143	-757	238	355	180	5
-832	+161	-744	272	295	348	0
SY	SP	EP	WP	WY	WR	
-64.1	+78.1	-79.3	-46.0	-17.6	+77.0	

MBSU HANDOFF

X	Y	Z	PITCH	YAW	ROLL	PL ID
-704	+144	-784	238	355	180	4
-750	+144	-756	238	355	180	5
-797	+161	-744	272	295	348	0
SY	SP	EP	WP	WY	WR	
-69.6	+81.4	-83.3	-44.2	-13.8	+81.1	

EVA 3
REF DATA

APFR EGRESS SETUP

X	Y	Z	PITCH	YAW	ROLL	PL ID
-743	-31	-894	195	343	178	4
-758	-29	-842	195	343	178	5
-787	-13	-803	246	285	6	0
SY	SP	EP	WP	WY	WR	
-55.1	+108.2	-86.7	-62.4	-34.3	+116.5	

APFR EGRESS

X	Y	Z	PITCH	YAW	ROLL	PL ID
-707	-31	-894	195	343	178	4
-721	-29	-842	195	343	178	5
-750	-13	-802	245	285	5	0
SY	SP	EP	WP	WY	WR	
-64.7	+112.2	-89.8	-60.1	-27.0	+123.5	

APFR REMOVAL

X	Y	Z	PITCH	YAW	ROLL	PL ID
-707	-31	-894	195	343	178	4
-721	-29	-842	195	343	178	5
-750	-13	-802	245	285	5	0
SY	SP	EP	WP	WY	WR	
-64.7	+112.2	-89.8	-60.1	-27.0	+123.5	

MBSU CLEARANCE

X	Y	Z	PITCH	YAW	ROLL	PL ID
-888	+40	-433	266	331	268	4
-888	-7	-407	266	331	268	5
-908	-53	-394	327	358	72	0
SY	SP	EP	WP	WY	WR	
-13.2	+71.9	-144.8	+39.4	+19.3	+81.8	

REBOLTING SETUP

X	Y	Z	PITCH	YAW	ROLL	PL ID
-888	+40	-433	180	292	268	4
-838	+19	-431	180	292	268	5
-800	-9	-411	249	341	107	0
SY	SP	EP	WP	WY	WR	
-30.0	+83.5	-146.3	-44.4	-11.0	+162.5	

MBSU REBOLTING

X	Y	Z	PITCH	YAW	ROLL	PL ID
-888	+50	-374	180	292	268	4
-838	+29	-372	180	292	268	5
-800	+1	-352	249	341	107	0
SY	SP	EP	WP	WY	WR	
-26.8	+62.7	-145.3	-25.1	-10.0	+159.3	

EVA 3 COORDINATE SYSTEM – PL ID 4

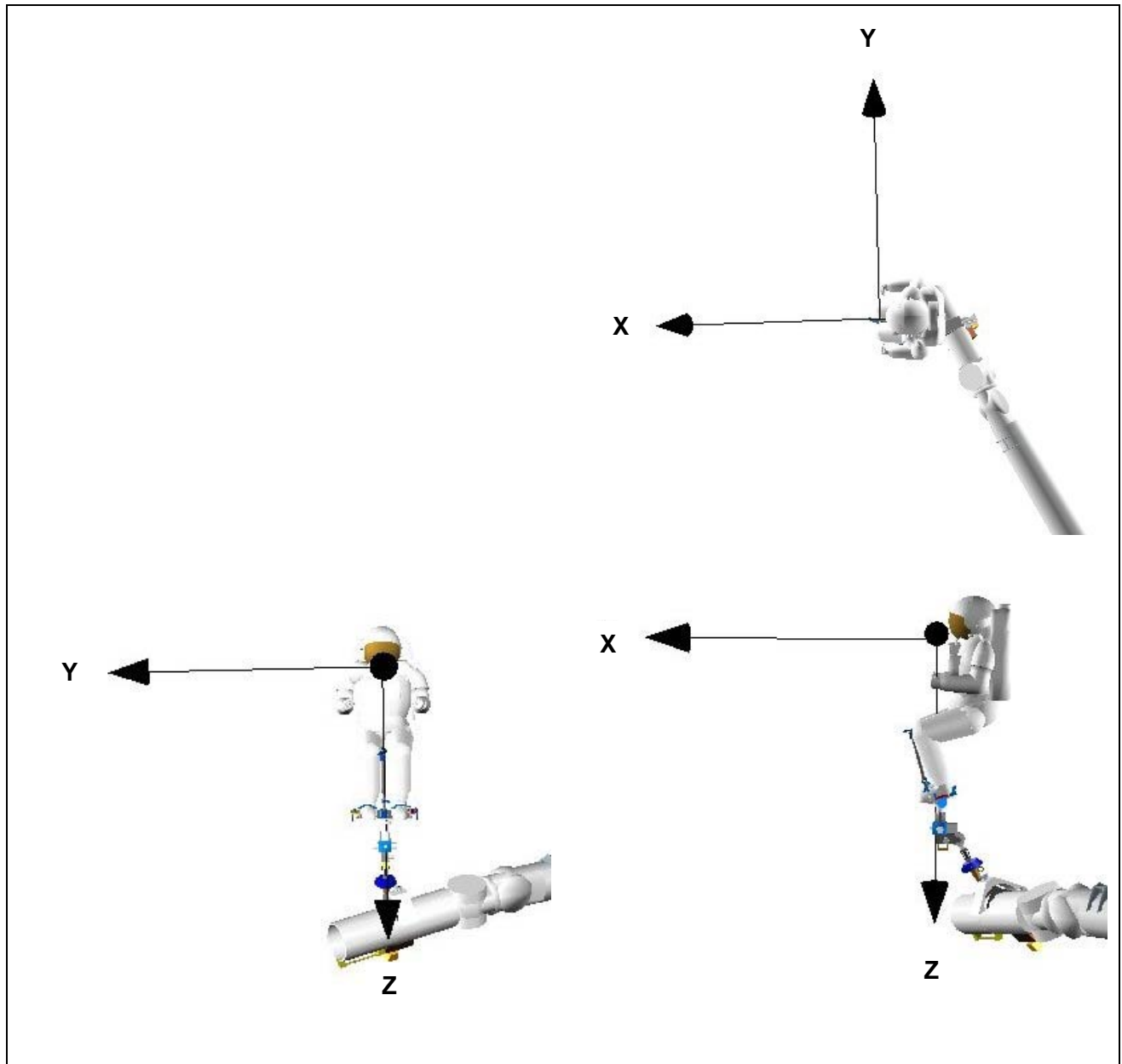

POR: At EVA's chest (EVA in APFR set at 4/II/F/6)

PURPOSE: EVA Operations

RATES:	<u>COARSE</u>	<u>VERN</u>
TRANS LIM ft/sec:	0.77	0.25
ROT LIM deg/sec:	2.79	0.92

EVA 3 COORDINATE SYSTEM – PL ID 5

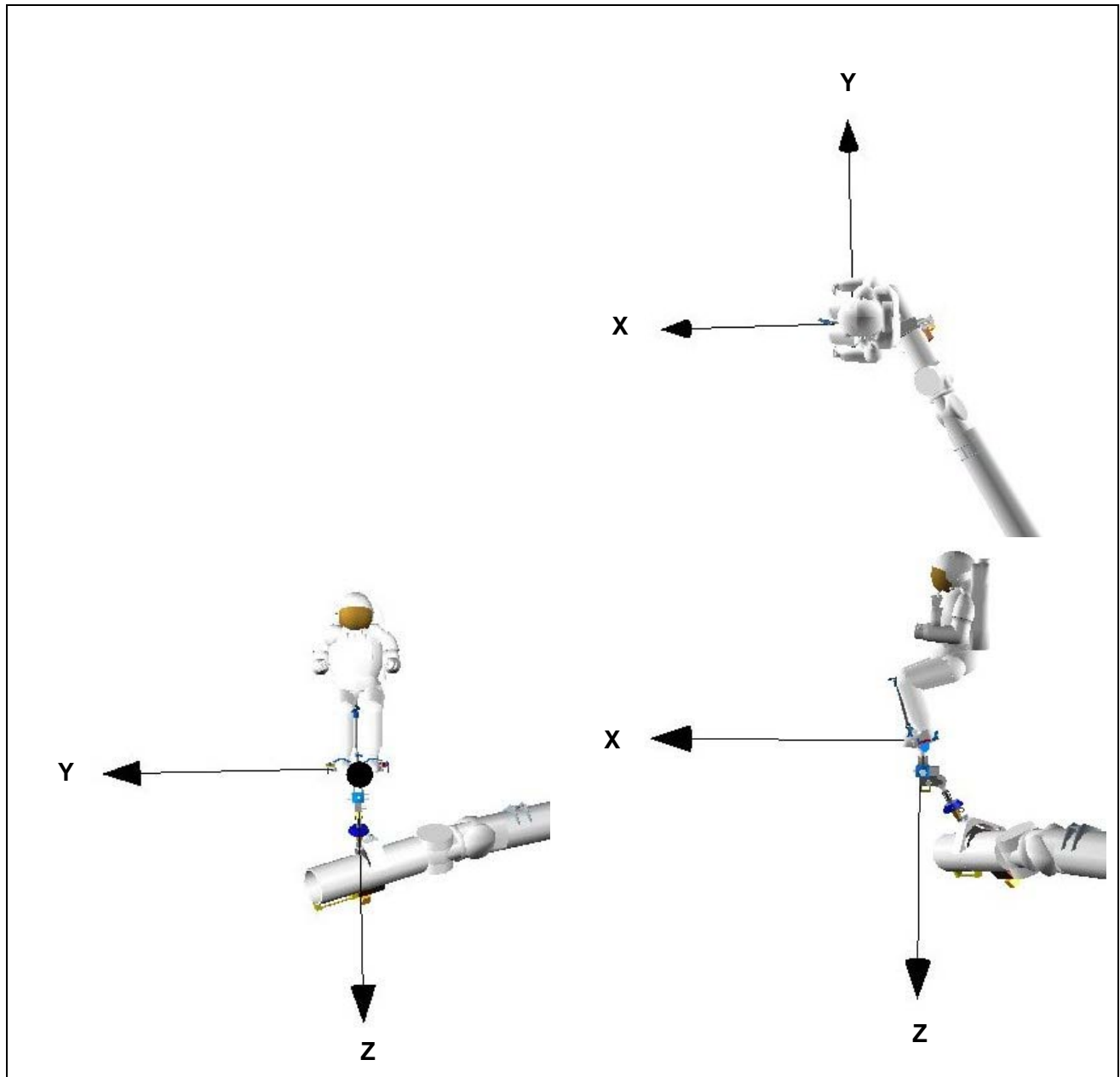

POR: At EVA's feet (EVA in APFR set at 4/II/F/6)

PURPOSE: EVA Operations

RATES:	<u>COARSE</u>	<u>VERN</u>
TRANS LIM ft/sec:	0.77	0.25
ROT LIM deg/sec:	2.79	0.92

This Page Intentionally Blank

CUE CARD CONFIGURATION

CUE CARD CONFIGURATION

Fabricate as transparency

ZOOM 34.0 HFOV
FOCUS 5.0 FT
EYEPOINT APPROX 18 IN



WR-

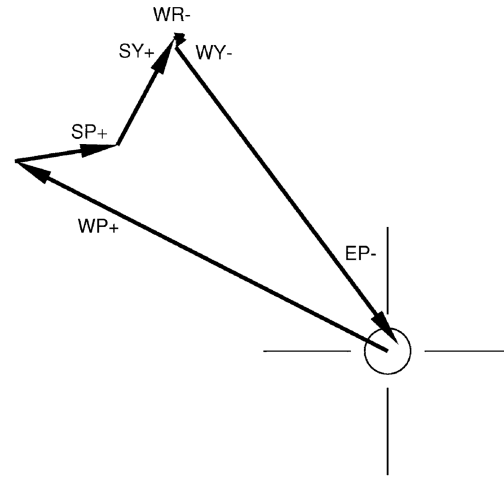

OBSS SJ GRAPPLE AT HANDOFF OVERLAY WRIST CCTV

PDRS-9a/120/O/B

(reduced copy)

FS CC 10-2

PDRS/120/FIN A

Fabricate as transparency

ZOOM 34.0 HFOV
FOCUS 5.0 FT
EYEPOINT APPROX 18 IN

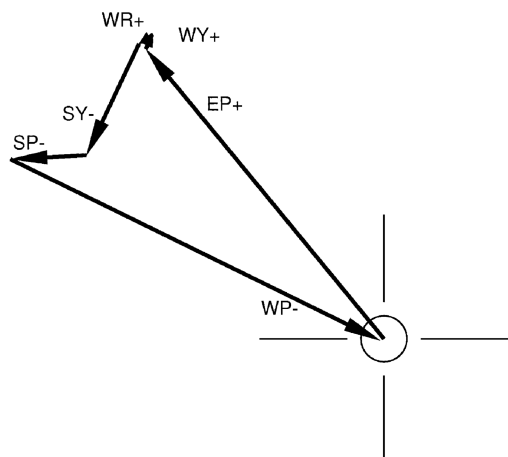

OBSS SJ UNGRAPPLE AT HANDOFF OVERLAY WRIST CCTV

PDRS-10a/120/O/B

(reduced copy)

FS CC 10-3

PDRS/120/FIN A

Fabricate as transparency

ZOOM 34.0 HFOV
FOCUS 5.0 FT
EYEPOINT APPROX 18 IN

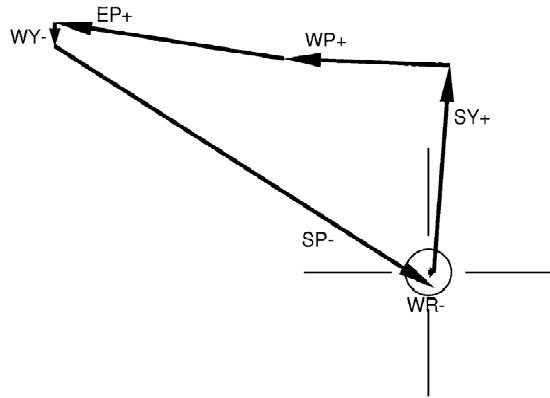

P6 SJ GRAPPLE WRIST CCTV

PDRS-11a/120/O/A

(reduced copy)

FS CC 10-4

PDRS/120/FIN A

Fabricate as transparency

ZOOM 34.0 HFOV
FOCUS 5.0 FT
EYEPOINT APPROX 18 IN



WR+

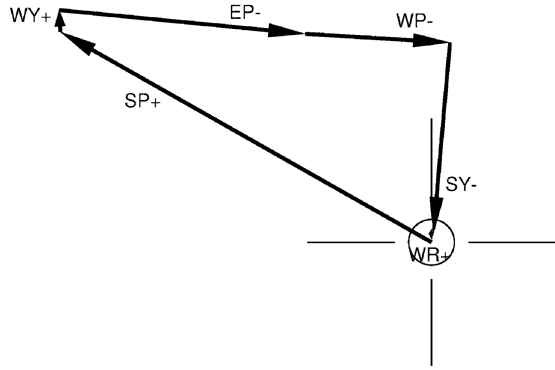

P6 SJ UNGRAPPLE WRIST CCTV

PDRS-12a/120/O/A

(reduced copy)

FS CC 10-5

PDRS/120/FIN A

This Page Intentionally Blank



PDRS OPS C/L

**STS
120**