

# PDRS Operations Checklist

## STS-120 Flight Supplement

---

**Mission Operations Directorate  
EVA, Robotics, & Crew Systems  
Operations Division**

**Final  
May 15, 2007**

National Aeronautics and  
Space Administration

**Lyndon B. Johnson Space Center**  
Houston, Texas

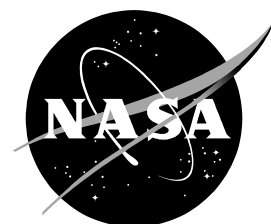

<b>SMS FDF CHANGE NOTIFICATION</b>		<b>SIM PACK</b>		DATE INITIATED 5/18/07	DATE RECEIVED (PMO) 05/18/07
BOOK TITLE STS-120 PDRS FS		BK ISSUE (Ed, Rev, PCN) FIN		SIM PACK NUMBER SIM-186	
Change is for flights (Also give SMS load if load dependent): STS-120				SMS UNIQUE? <input type="checkbox"/> YES <input checked="" type="checkbox"/> NO	DEVELOPMENTAL? <input checked="" type="checkbox"/> YES <input type="checkbox"/> NO
FABRICATED ITEM CHANGE? <input checked="" type="checkbox"/> NONE <input type="checkbox"/> CUE CARDS <input type="checkbox"/> TRANSPARENCIES <input type="checkbox"/> Other _____					
INSTRUCTIONS TO USER: Replace Section 1 Replace FS 2-7 through FS 2-12 Replace Section 3					
AUTHORITY FOR CHANGE* (Approved 482 numbers, approved issue at print shop, supervisors deem mandatory, etc.): Required for integrated training. Corrects problems identified since FOR and incorporates crew comments.					
*Refer to Crew Procedures Management Plan					
OTHER AFFECTED FDF BOOKS				Are all SIM PACKS submitted? <input type="checkbox"/> YES <input type="checkbox"/> NO	
IMPLEMENTATION REQUIREMENTS		<input type="checkbox"/> Limited Distribution (List in comments)	<input type="checkbox"/> NO EARLIER THAN _____ (Date and/or Sim ID)		
			<input checked="" type="checkbox"/> NO LATER THAN 5/30/07 (Date and/or Sim ID)		
BOOK MGR (Signature/Date) <i>Frank Dwyer</i> 5/18/07		SUPERVISOR (if required, Signature/Date) <i>[Signature]</i> 5/18/07		FDF COORD or FDF MGR (Signature/Date) <i>Renee U.M. Ross</i> 05/18/07	
COMMENTS:					

MISSION OPERATIONS DIRECTORATE

**PDRS OPERATIONS CHECKLIST  
STS-120 FLIGHT SUPPLEMENT**

FINAL  
May 15, 2007

PREPARED BY:

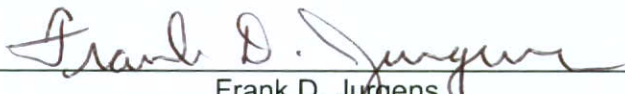
  
Frank D. Jurgens  
Book Manager

APPROVED BY:

  
Aaron D. Goldenthal  
Lead, Shuttle and Exploration Robotics  
Operations Group

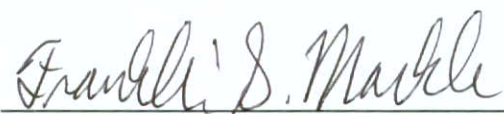
  
Franklin S. Markle  
Chief, Robotics Operations Branch

This document is under the configuration control of the Crew Procedures Control Board (CPCB). All proposed changes must be submitted via FDF Workflow Crew Procedure Change Request (CR) to DO3/FDF Manager.

Additional distribution of this book, for official use only, may be requested in writing to DO3/PMO Administrator. The request must include justification and requester's name, organization, position, and phone number. Contractor requests are made through the NASA or DOD organization supported. Deletions, reduction in quantity, or change of address may be submitted to DO3/FDF Management Office, 281-244-1184.

Incorporates the following:	
482#:	PDRS FS-0016 PDRS FS-0019

AREAS OF TECHNICAL RESPONSIBILITY

Book Manager

DX22/F. Jurgens

281-244-5448



PDRS OPERATIONS CHECKLIST  
 STS-120 FLIGHT SUPPLEMENT

**LIST OF EFFECTIVE PAGES**

FINAL 05/15/07

Sign Off .....	*	120/FIN	FS 2-27 .....	120/FIN
FS ii .....	*	120/FIN	FS 2-28 .....	120/FIN
FS iii .....	*	120/FIN	FS 2-29 .....	120/FIN
FS iv .....	*	120/FIN	FS 2-30 .....	120/FIN
FS v .....		120/FIN	FS 3-1 .....	120/FIN
FS vi .....		120/FIN	FS 3-2 .....	120/FIN
FS 1-1 .....		120/FIN	FS 4-1 .....	120/FIN
FS 1-2 .....		120/FIN	FS 4-2 .....	120/FIN
FS 1-3 .....		120/FIN	FS 4-3 .....	120/FIN
FS 1-4 .....		120/FIN	FS 4-4 .....	120/FIN
FS 1-5 .....		120/FIN	FS 4-5 .....	120/FIN
FS 1-6 .....		120/FIN	FS 4-6 .....	120/FIN
FS 1-7 .....		120/FIN	FS 4-7 .....	120/FIN
FS 1-8 .....		120/FIN	FS 4-8 .....	120/FIN
FS 1-9 .....		120/FIN	FS 4-9 .....	120/FIN
FS 1-10 .....		120/FIN	FS 4-10 .....	120/FIN
FS 1-11 .....		120/FIN	FS 5-1 .....	120/FIN
FS 1-12 .....		120/FIN	FS 5-2 .....	120/FIN
FS 1-13 .....		120/FIN	FS 5-3 .....	120/FIN
FS 1-14 .....		120/FIN	FS 5-4 .....	120/FIN
FS 2-1 .....		120/FIN	FS 5-5 .....	120/FIN
FS 2-2 .....		120/FIN	FS 5-6 .....	120/FIN
FS 2-3 .....		120/FIN	FS 5-7 .....	120/FIN
FS 2-4 .....		120/FIN	FS 5-8 .....	120/FIN
FS 2-5 .....		120/FIN	FS 5-9 .....	120/FIN
FS 2-6 .....		120/FIN	FS 5-10 .....	120/FIN
FS 2-7 .....		120/FIN	FS 5-11 .....	120/FIN
FS 2-8 .....		120/FIN	FS 5-12 .....	120/FIN
FS 2-9 .....		120/FIN	FS 5-13 .....	120/FIN
FS 2-10 .....		120/FIN	FS 5-14 .....	120/FIN
FS 2-11 .....		120/FIN	FS 5-15 .....	120/FIN
FS 2-12 .....		120/FIN	FS 5-16 .....	120/FIN
FS 2-13 .....		120/FIN	FS 5-17 .....	120/FIN
FS 2-14 .....		120/FIN	FS 5-18 .....	120/FIN
FS 2-15 .....		120/FIN	FS 6-1 .....	120/FIN
FS 2-16 .....		120/FIN	FS 6-2 .....	120/FIN
FS 2-17 .....		120/FIN	FS 6-3 .....	120/FIN
FS 2-18 .....		120/FIN	FS 6-4 .....	120/FIN
FS 2-19 .....		120/FIN	FS 7-1 .....	120/FIN
FS 2-20 .....		120/FIN	FS 7-2 .....	120/FIN
FS 2-21 .....		120/FIN	FS 7-3 .....	120/FIN
FS 2-22 .....		120/FIN	FS 7-4 .....	120/FIN
FS 2-23 .....		120/FIN	FS 7-5 .....	120/FIN
FS 2-24 .....		120/FIN	FS 7-6 .....	120/FIN
FS 2-25 .....		120/FIN	FS 7-7 .....	120/FIN
FS 2-26 .....		120/FIN	FS 7-8 .....	120/FIN

\* – Omit from flight book

FS 7-9 .....	120/FIN
FS 7-10 .....	120/FIN
FS 8-1 .....	120/FIN
FS 8-2 .....	120/FIN
FS 8-3 .....	120/FIN
FS 8-4 .....	120/FIN
FS 8-5 .....	120/FIN
FS 8-6 .....	120/FIN
FS 9-1 .....	* 120/FIN
FS CC 9-2 .....	* 120/FIN
FS CC 9-3 .....	* 120/FIN
FS CC 9-4 .....	* 120/FIN
FS CC 9-5 .....	* 120/FIN
FS 9-6 .....	* 120/FIN

PDRS CUE CARDS

<u>Title</u>	<u>Ref. Page</u>	<u>Card No.</u>
OBSS SJ GRAPPLE AT HANDOFF OVERLAY .....	FS CC 9-2	PDRS-9a/120/O/B
UNGRAPPLE AT HANDOFF OVERLAY....	FS CC 9-3	PDRS-10a/120/O/B
P6 SJ GRAPPLE WRIST CCTV .....	FS CC 9-4	PDRS-11a/120/O/A
UNGRAPPLE WRIST CCTV .....	FS CC 9-5	PDRS-12a/120/O/A

\* – Omit from flight book

<u>CONTENTS</u>	<u>PAGE</u>
<u>OBSS HANDOFF</u> .....	FS 1-1
<u>VERIFY UPLINKS</u> .....	FS 1-2
<u>OBSS HANDOFF FROM SSRMS TO SRMS</u> .....	FS 1-4
<u>SRMS TO SSRMS</u> .....	FS 1-9
<u>OBSS CONTINGENCY</u> .....	FS 2-1
<u>OBSS SJ HANDOFF FROM SSRMS TO SRMS</u> .....	FS 2-2
<u>SRMS TO SSRMS</u> .....	FS 2-17
<u>OBSS REFERENCE DATA</u> .....	FS 3-1
<u>OBSS JOINT ANGLES VS POR COORDINATES</u> .....	FS 3-2
<u>P6 NOMINAL</u> .....	FS 4-1
<u>P6 HANDOFF FROM SSRMS TO SRMS</u> .....	FS 4-2
<u>SRMS TO SSRMS</u> .....	FS 4-5
<u>INSTALL VIEWING</u> .....	FS 4-8
<u>P6 CONTINGENCY</u> .....	FS 5-1
<u>P6 SJ HANDOFF FROM SSRMS TO SRMS</u> .....	FS 5-2
<u>SRMS TO SSRMS</u> .....	FS 5-10
<u>P6 REFERENCE DATA</u> .....	FS 6-1
<u>P6 JOINT ANGLES VS POR COORDINATES</u> .....	FS 6-2
<u>COORDINATE SYSTEM – PL ID 3</u> .....	FS 6-3
<u>EVA 3</u> .....	FS 7-1
<u>EVA 3 SUPPORT</u> .....	FS 7-2
<u>EVA 3 REFERENCE DATA</u> .....	FS 8-1
<u>EVA 3 JOINT ANGLES VS POR COORDINATES</u> .....	FS 8-2
<u>COORDINATE SYSTEM – PL ID 4</u> .....	FS 8-4
<u>– PL ID 5</u> .....	FS 8-5
<u>CUE CARD CONFIGURATION</u> .....	FS 9-1

This Page Intentionally Blank

OBSS HANDOFF

I

VERIFY UPLINKS.....	FS 1-2
OBSS HANDOFF FROM SSRMS TO SRMS .....	FS 1-4
SRMS TO SSRMS .....	FS 1-10 I

**OBSS  
HANDOFF**

## VERIFY UPLINKS

OBSS  
HANDOFF

### 1. CHECK PL ID 1

SM 94 PDRS CONTROL

PL ID – ITEM 3 +1 EXEC

	X	Y	Z	PITCH	YAW	ROLL	PL ID
√	-1279	-151	-553	95	359	328	1
	SY	SP	EP	WP	WY	WR	
√	0.0	+25.0	-25.0	+5.0	0.0	0.0	

### 2. CHECK PL ID 2

SM 94 PDRS CONTROL

PL ID – ITEM 3 +2 EXEC

	X	Y	Z	PITCH	YAW	ROLL	PL ID
√	-1216	-141	-1141	95	359	358	2

### 3. CHECK AUTOSEQUENCES 1, 2, AND 3 START POINTS

SM 94 PDRS CONTROL

√PL ID, ITEM 3: 2

AUTO 1 – ITEM 13 +1 +2 +3 EXEC

BRAKES – OFF (tb-OFF)

MODE – AUTO 1, ENTER

SM 94 PDRS CONTROL

√START PT, ITEM 17: 1

MODE – AUTO 2, ENTER

SM 94 PDRS CONTROL

√START PT, ITEM 17: 54

MODE – AUTO 3, ENTER

SM 94 PDRS CONTROL

√START PT, ITEM 17: 58

BRAKES – ON (tb-ON)

### 4. CHECK AUTOSEQUENCES 4, 5, AND 6 START POINTS

SM 94 PDRS CONTROL

√PL ID, ITEM 3: 2

AUTO 1 – ITEM 13 +4 +5 +6 EXEC

BRAKES – OFF (tb-OFF)

MODE – AUTO 1, ENTER

SM 94 PDRS CONTROL

√START PT, ITEM 17: 90

MODE – AUTO 2, ENTER

SM 94 PDRS CONTROL

√START PT, ITEM 17: 95

MODE – AUTO 3, ENTER

SM 94 PDRS CONTROL

√START PT, ITEM 17: 145

BRAKES – ON (tb-ON)

5. CHECK PL ID 3

SM 94 PDRS CONTROL

PL ID – ITEM 3 +3 EXEC

√

X	Y	Z	PITCH	YAW	ROLL	PL ID
-1308	-108	-632	274	1	2	3

6. CHECK PL ID 4

SM 94 PDRS CONTROL

PL ID – ITEM 3 +4 EXEC

√

X	Y	Z	PITCH	YAW	ROLL	PL ID
-1236	-94	-466	306	36	237	4

7. CHECK PL ID 5

SM 94 PDRS CONTROL

PL ID – ITEM 3 +5 EXEC

√

X	Y	Z	PITCH	YAW	ROLL	PL ID
-1244	-130	-506	306	36	237	5

8. RESET TO PL ID 0

SM 94 PDRS CONTROL

PL ID – ITEM 3 +0 EXEC

√

X	Y	Z	PITCH	YAW	ROLL	PL ID
-1261	-146	-551	5	2	0	0



## OBSS HANDOFF FROM SSRMS TO SRMS

### 1. SETUP

SM 94 PDRS CONTROL

√PL ID, ITEM 3: 0

√INIT ID, ITEM 24: 0

A7U CCTV – config as reqd

### 2. PRE-GRAPPLE MNVR

On SSRMS Operator GO for mnvr to OBSS PRE-GRAPPLE AT HANDOFF posn,

RHC RATE – as reqd (VERN within 10 ft)

BRAKES – OFF (tb-OFF)

MODE – ORB UNL, ENTER

Mnvr to OBSS PRE-GRAPPLE AT HANDOFF posn:

X	Y	Z	PITCH	YAW	ROLL	PL ID
-1015	-362	-688	284	0	270	0
SY	SP	EP	WP	WY	WR	
+23.5	+63.5	-29.6	-102.9	+11.5	-98.6	

BRAKES – ON (tb-ON)

Notify SSRMS Operator that SRMS at OBSS PRE-GRAPPLE AT HANDOFF posn

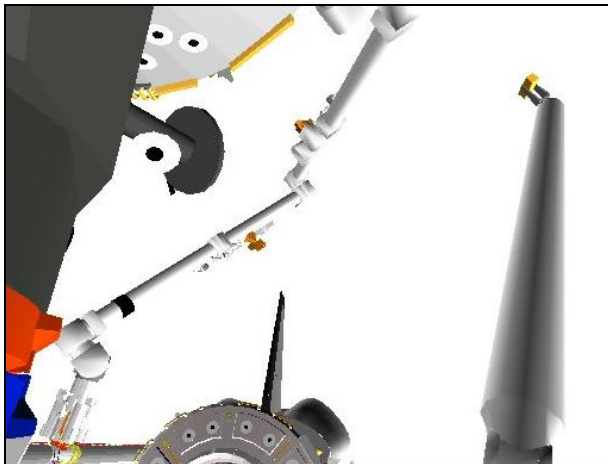

CCTV A (0,28)

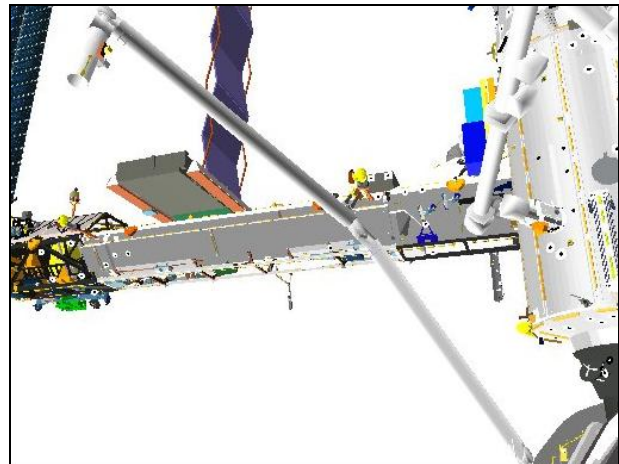

CCTV B (-20,20)

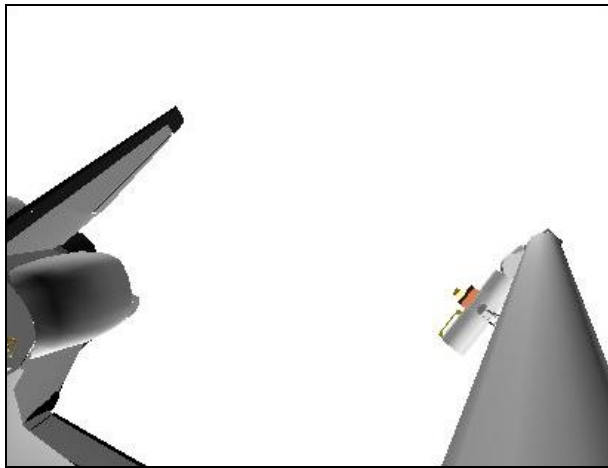

**ELBOW (-30,-5)**

3. CONFIGURE POWER

CAUTION  
SPEE power must be applied within 90 min  
to prevent sensor package damage

On SSRMS Operator GO to release STBD MRLs,  
STBD RMS HTR A,B (two) – OFF

- A6U           EVENT TIMER MODE – UP  
                  CNTL – START
- MA73C:C       cb MCA PWR AC3 3Φ MID 2 – op  
                  √AC2 3Φ MID 2 – op
- MA73C:D       √AC3 3Φ MID 4 – op
- R13L          PL BAY MECH PWR SYS (two) – ON

4. STBD MRL RELEASE

SM 94 PDRS CONTROL  
RMS STBD – ITEM 2 EXEC (\*)  
√STBD AFT, MID, FWD REL (six) = 0

NOTE  
Expect single motor drive time for MRL release

STBD RMS RETEN LAT – REL (tb-REL) (18 sec max)  
– OFF

If motor drive time > 18 sec, √MCC

SM 94 PDRS CONTROL  
√STBD AFT, MID, FWD REL (six) = 1

5. RECONFIGURE POWER

- R13L          PL BAY MECH PWR SYS (two) – OFF
- MA73C:C       cb MCA PWR AC3 3Φ MID 2 – cl  
                  √AC2 3Φ MID 2 – op
- MA73C:D       √AC3 3Φ MID 4 – op

Give SSRMS Operator GO for OBSS Unberth  
Monitor RFL Status

After OBSS Unberth,

**SM 94 PDRS CONTROL**

RMS PORT – ITEM 1 EXEC (\*)

- A7U 6. SETUP FOR GRAPPLE  
CCTV – config for grapple  
– install PDRS TARGET OVERLAY FOR CTVM  
– RMS WRIST, ZOOM: 34.0 HFOV  
FOCUS: 5 ft  
Maintain eyepoint approx 18 in when using grapple overlay

R12(OBSS) √SPEE PWR – OFF  
A15 APCU 2 CONV - OFF

**SM 179 POWER TRANSFER**

√PTU 2 APCU OUT VOLTS: <10V

A15 APCU 2 OUTPUT - OFF

- RHC 7. OBSS GRAPPLE AT HANDOFF POSN  
On SSRMS Operator GO for SRMS OBSS GRAPPLE posn,  
RATE – VERN (RATE MIN tb-ON)  
BRAKES – OFF (tb-OFF)  
MODE – END EFF, ENTER

Mnvr to grapple envelope

**CAUTION**  
Monitor EE tb timing to prevent EE motor burnout

EE MODE – AUTO  
CAPTURE sw – depress (mom)

√	RIGID	CLOSE	CAPTURE
	<input type="checkbox"/>	<input type="checkbox"/>	<input type="checkbox"/>
	DERIGID	OPEN	EXTEND
	<input checked="" type="checkbox"/>	<input checked="" type="checkbox"/>	<input checked="" type="checkbox"/>

CRITICAL TIMES (28 sec total):  
CAPTURE tb – gray, then  
CLOSE tb – gray, 3 sec max, then  
RIGID tb – gray, 25 sec max

EE MODE – OFF

- |   |                                                            |   |
|---|------------------------------------------------------------|---|
| * | If manual capture required:                                | * |
| * | EE MODE – MAN                                              | * |
| * | CAPTURE sw – depress (hold until CLOSE tb-gray, 3 sec max) | * |
| * | MAN CONTR – RIGID (hold until RIGID tb-gray, 25 sec max)   | * |
| * | MODE – OFF                                                 | * |

MODE – TEST, ENTER  
Wait 5 sec

BRAKES – ON (tb-ON)

**SM 94 PDRS CONTROL**

PL ID – ITEM 3 +2 EXEC

INIT ID – ITEM 24 +2 EXEC

Expected OBSS HANDOFF posn:

X	Y	Z	PITCH	YAW	ROLL	PL ID
-1029	+229	-614	284	270	270	2
SY	SP	EP	WP	WY	WR	
+25.8	+66.3	-49.0	-85.9	+10.7	-100.7	

\* display singularity

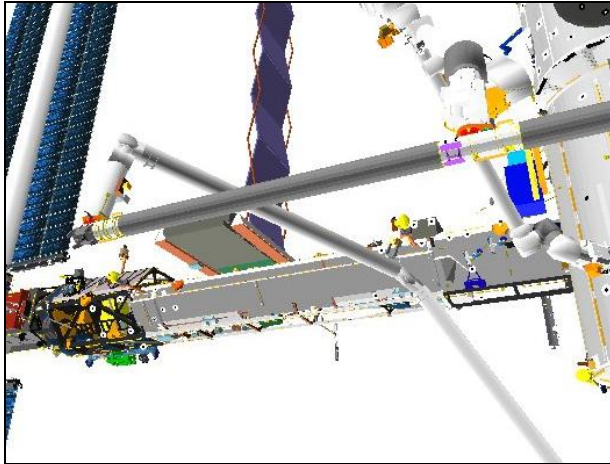

**CCTV B (-25,25)**

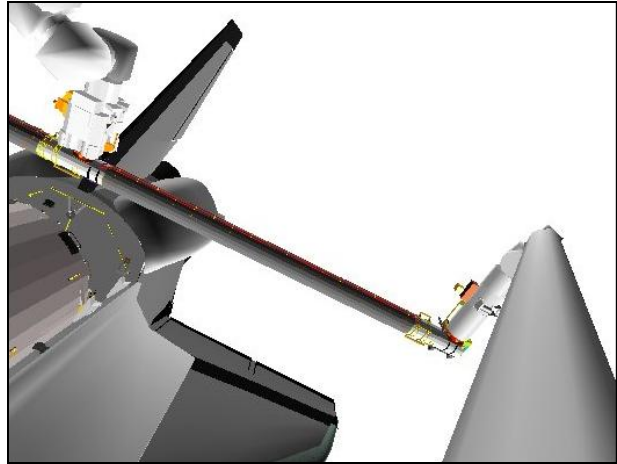

**ELBOW (-30,-5)**

R12(OBSS) RSC PWR – OFF, ON

Perform ACTIVATION (LDRI/ITVC Cue Card, PHOTO/TV)

Perform LCH ACTIVATION (LCS Cue Card, PHOTO/TV)

Perform LCC ACTIVATION (LCS Cue Card, PHOTO/TV), steps 1 and 2

Give SSRMS Operator GO for OBSS Ungrapple

Review GENERIC END EFFECTOR CUE CARD – ISS/SHUTTLE DOCKED OPS

8. MNVR TO NODE 2 VIEWING

RHC

On SSRMS Operator GO for mnvr to NODE 2 VIEWING posn,

RATE – as required (VERN within 10 ft)

BRAKES – OFF (tb-OFF)

MODE – SINGLE, ENTER

Mnvr to NODE 2 VIEWING posn:

HANDOFF

- 1: SY +
  - 2: EP +
  - 3: WR +
  - 4: WY -
  - 5: SP -
  - 6: WP +
  - 7: SY +
- NODE 2  
VIEW

SY	SP	EP	WP	WY	WR	
+25.8	+66.3	-49.0	-85.9	+10.7	-100.7	
+35.0						
		-22.8				
					+15.0	
				-0.5		
	+36.7					
			-2.0			
+85.0						
+85.0	+36.7	-22.8	-2.0	-0.5	+15.0	
X	Y	Z	PITCH	YAW	ROLL	PL ID
-767	-775	-1068	86	7	276	2

- BRAKES – ON (tb-ON)
- MODE – not DIRECT
- PARAM – PORT TEMP
- JOINT – CRIT TEMP

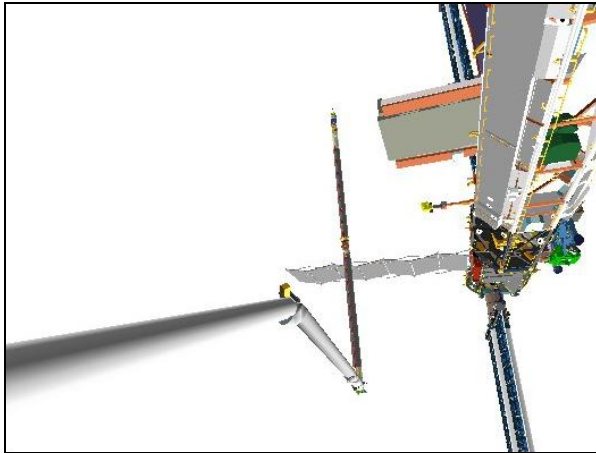

CCTV A (70,25)

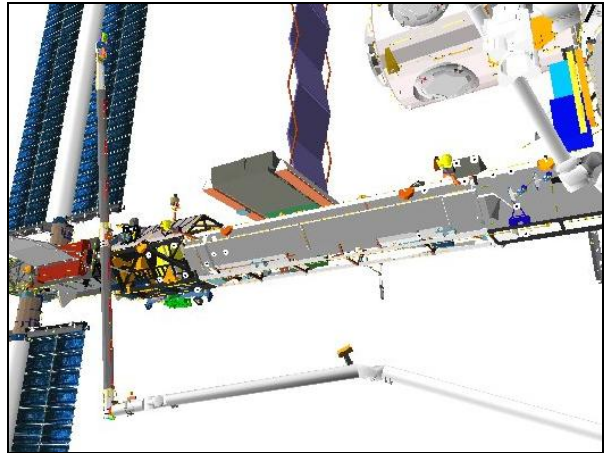

CCTV B (-30,20)

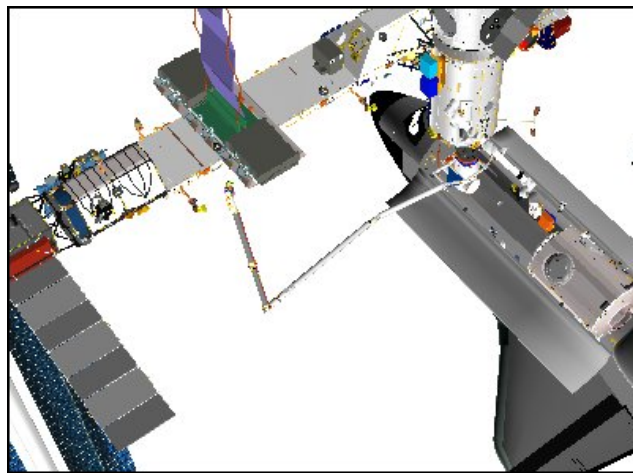

BIRD'S EYE

A7U 9. RECONFIG PTU  
VIDEO OUT MON2 pb – push  
IN PL2(VPU) pb – push

CAMR CMD PAN/TILT – HI RATE  
PAN – L (to hard stop)  
TILT – UP (to hard stop)  
PAN/TILT – RESET  
PAN: +70 (right)  
TILT: -68 (dn)  
ZOOM – IN (full in)

VIDEO OUT MUX 1 L pb – push (MIDDECK It on)  
LDR1 MODE 2 pb – push (ITVC video)

Give SSRMS Operator GO for mnvr to EVA 1 SETUP posn

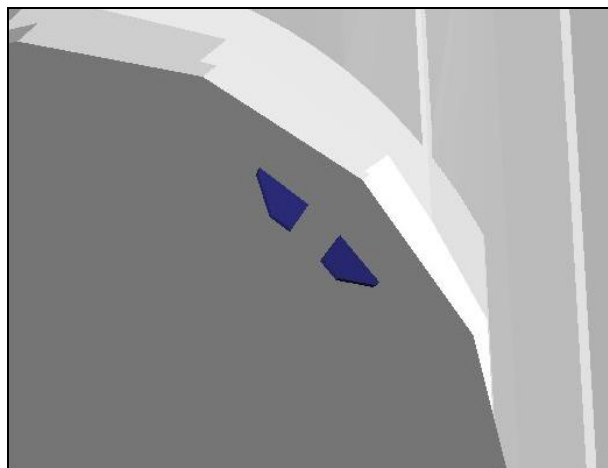

**OBSS ITVC (70,-68)**

# OBSS HANDOFF FROM SRMS TO SSRMS

## 1. SETUP

SM 94 PDRS CONTROL

√PL ID, ITEM 3: 2

√INIT ID, ITEM 24: 2

A7U CCTV – config as reqd

Review GENERIC END EFFECTOR CUE CARD – ISS/SHUTTLE DOCKED OPS

## 2. MANEUVER TO OBSS HANDOFF

RHC On SSRMS Operator GO for mnvr to OBSS HANDOFF posn,  
 RATE – as reqd (VERN within 10 ft)  
 BRAKES – OFF (tb-OFF)  
 MODE – SINGLE, ENTER

Mnvr to OBSS HANDOFF posn:

	SY	SP	EP	WP	WY	WR	
NODE 2 VIEW	+85.0	+36.7	-22.8	-2.0	-0.5	+15.0	
1: SY –	+35.0						
2: WP –				-85.9			
3: SP +		+66.3					
4: WY +					+10.7		
5: WR –						-100.7	
6: EP –			-49.0				
7: SY –	+25.8						
HANDOFF POSN	+25.8	+66.3	-49.0	-85.9	+10.7	-100.7	
	X	Y	Z	PITCH	YAW	ROLL	PL ID
	-1029	+229	-614	284	270	270	2

\* display singularity

BRAKES – ON (tb-ON)

Give SSRMS Operator GO for OBSS Grapple

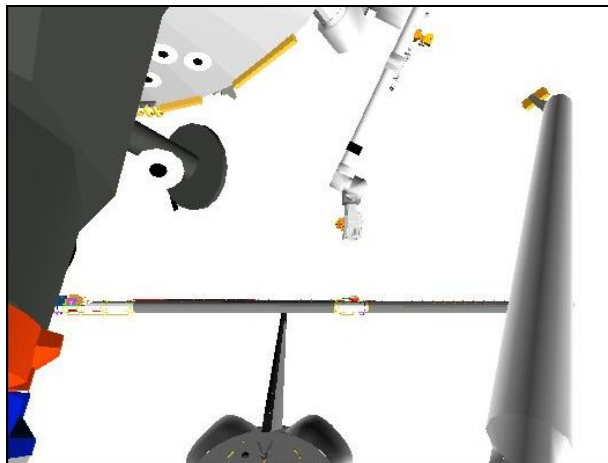

CCTV A (0,30)

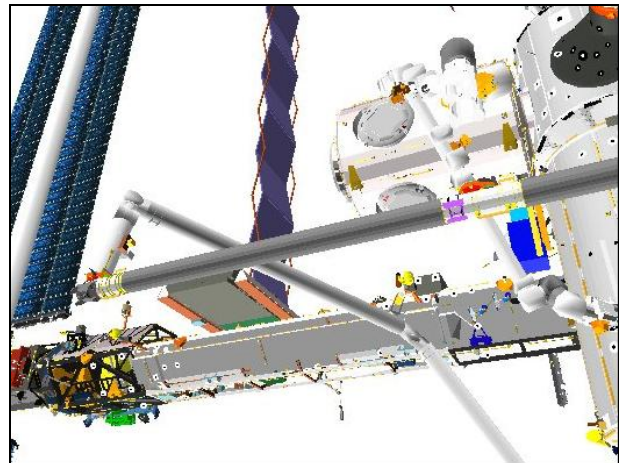

CCTV B (-25,30)



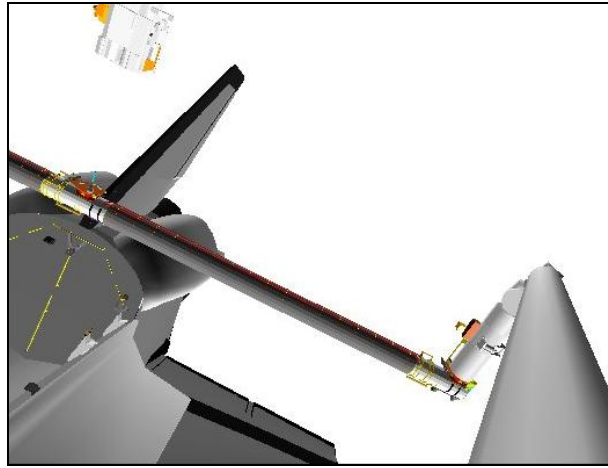

**ELBOW (-30,0)**

3. STOW PTU

A7U

On SSRMS Operator GO for OBSS Ungrapple,  
 VIDEO OUT MON2 pb – push  
 IN PL2(VPU) pb – push

CAMR CMD PAN/TILT – HI RATE

PAN – L (to hard stop)

TILT – UP (to hard stop)

PAN/TILT – RESET, HI RATE (LO within 10°)

PAN: +108 (right)

TILT: -175 (down)

Perform LCC DEACTIVATION (LCS Cue Card, PHOTO/TV)

Perform LCH DEACTIVATION (LCS Cue Card, PHOTO/TV)

**CAUTION**

STBD RMS HTR power must be applied within  
 90 min to prevent sensor package damage

Perform DEACTIVATION (LDRI/ITVC Cue Card, PHOTO/TV)

4. OBSS UNGRAPPLE

A7U

CCTV – config for ungrapple

– RMS WRIST, ZOOM: 34.0 HFOV

FOCUS: 5 ft

**NOTE**

CONTR ERR It and 'S96 PDRS CNTL' msg may  
 occur due to Consistency/Envelope Check error

RHC

RATE – COARSE (RATE MIN tb-OFF)

**SM 94 PDRS CONTROL**

AUTO BRAKE INH – ITEM 10 EXEC (\*)

BRAKES – OFF (tb-OFF)  
 MODE – TEST, ENTER  
 Wait 5 sec

BRAKES – ON (tb-ON)







**SM 94 PDRS CONTROL**  
 AUTO BRAKE ENA – ITEM 9 EXEC (\*)  
 PL ID – ITEM 3 +0 EXEC  
 INIT ID – ITEM 24 +0 EXEC

RHC RATE – VERN (RATE MIN tb-ON)  
 BRAKES – OFF (tb-OFF)  
 MODE – END EFF, ENTER

**CAUTION**  
 Monitor EE tb timing to prevent EE motor burnout

EE MODE – AUTO  
 RELEASE sw – depress (mom)

When OPEN tb – gray, mnvr arm clear of grapple pin

√	RIGID 	CLOSE 	CAPTURE 	<u>CRITICAL TIMES (28 sec total):</u> DERIGID tb – gray, 5 sec max, then OPEN tb – gray, 3 sec max, then EXTEND tb – gray, 20 sec max
	DERIGID 	OPEN 	EXTEND 	

EE MODE – OFF

- \* If manual release reqd: \*
- \* EE MODE – MAN \*
- \* MAN CONTR – DERIGID (hold until DERIGID tb-gray, 5 sec max) \*
- \* RELEASE sw – depress (hold until OPEN tb-gray, 3 sec max) \*
- \* Mnvr arm clear of grapple pin, then \*
- \* EE MAN CONTR – DERIGID (hold until EXTEND tb-gray, 20 sec max) \*
- \* MODE – OFF \*

RHC 5. MNVR TO OBSS PRE-GRAPPLE AT HANDOFF  
 RATE – VERN (RATE MIN tb-ON)  
 MODE – as desired

Mnvr to OBSS PRE-GRAPPLE AT HANDOFF posn:

X	Y	Z	PITCH	YAW	ROLL	PL ID
-1015	-362	-688	284	0	270	0
SY	SP	EP	WP	WY	WR	
+23.5	+63.5	-29.6	-102.9	+11.5	-98.6	

BRAKES – ON (tb-ON)  
 MODE – not DIRECT  
 JOINT – CRIT TEMP

If using Shuttle attitude control and attitude maintenance required:  
Configure DAP per RMS DAPs, then perform RATE DAMPING (ORB OPS FS,  
REBOOST/DAP; DOCKED DAP REFERENCE)

Give SSRMS Operator GO for OBSS Berth

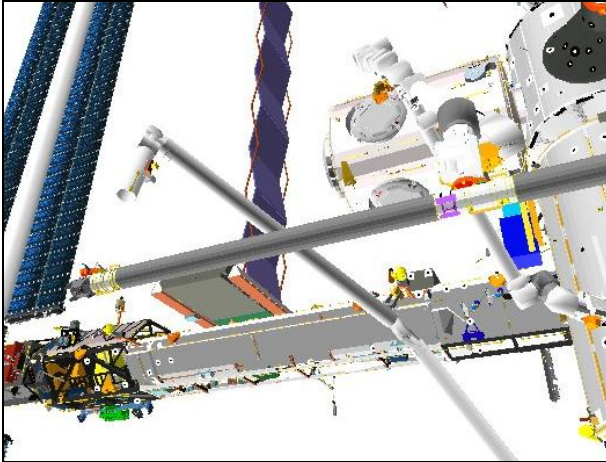

**CCTV B (-25,30)**

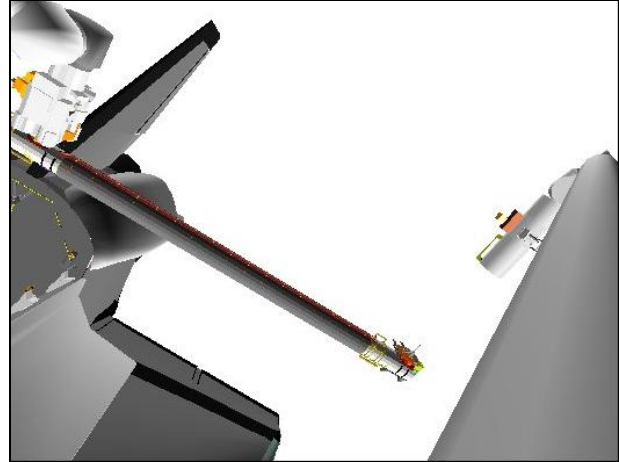

**ELBOW (-35,-15)**

6. CONFIGURE CIRCUIT BREAKERS

MA73C:C     cb MCA PWR AC3 3 $\Phi$  MID 2 – op  
                    √AC2 3 $\Phi$  MID 2 – op  
MA73C:D     √AC3 3 $\Phi$  MID 4 – op

7. CONFIGURE FOR MONITORING

On SSRMS notification to watch for STBD RMS RFLs,  
SM 94 PDRS CONTROL  
RMS STBD – ITEM 2 EXEC (\*)

Notify SSRMS operator when STBD RMS R-F-L tb (three) – gray

8. STBD MRL LATCH

On SSRMS Operator GO to latch STBD MRLs to Topological Capture,  
√STBD RMS R-F-L tb (three) – gray

SM 94 PDRS CONTROL  
√STBD AFT, MID, FWD LAT (six) = 0

R13L        PL BAY MECH PWR SYS (two) – ON

NOTE

Expect single motor drive time for MRL latching (18 sec max).  
The following STBD RMS RETEN LAT – OFF and PL BAY  
MECH PWR SYS (two) – OFF actions are to be performed simo

Verify AOS for latching to Topological Capture

STBD RMS RETEN LAT – LAT 6 sec only (tb-bp)  
– OFF

R13L        PL BAY MECH PWR SYS (two) – OFF

Give SSRMS Operator GO to Limp All SSRMS Joints and Derigidize

R13L On SSRMS Operator GO to complete STBD MRL latching,  
PL BAY MECH PWR SYS (two) – ON

STBD RMS RETEN LAT – LAT (tb-LAT) (12 sec max)  
– OFF

9. RECONFIGURE POWER  
R13L PL BAY MECH PWR SYS (two) – OFF

STBD RMS HTR A,B (two) – AUTO

A6U EVENT TIMER CNTL – STOP

SM 94 PDRS CONTROL

√STBD AFT, MID, FWD LAT (six) = 1  
RMS PORT – ITEM 1 EXEC (\*)

MA73C:C cb MCA PWR AC3 3Φ MID 2 – cl  
√AC2 3Φ MID 2 – op

MA73C:D √AC3 3Φ MID 4 – op

Give SSRMS Operator GO for OBSS Ungrapple

10. MNVR TO PRE-CRADLE

RHC On SSRMS Operator GO for mnvr to PRE-CRADLE posn,  
RATE – as reqd (VERN within 10 ft)  
BRAKES – OFF (tb-OFF)  
MODE – SINGLE, ENTER

Mnvr to PRE-CRADLE posn:

	SY	SP	EP	WP	WY	WR	
PRE-GRAPPLE	+23.5	+63.5	-29.6	-102.9	+11.5	-98.6	
1: WR +						0.0	
2: WY -					0.0		
3: WP +				+5.0			
4: SP -		+25.0					
5: EP +			-25.0				
6: SY -	0.0						
PRE-CRADLE	0.0	+25.0	-25.0	+5.0	0.0	0.0	
	X	Y	Z	PITCH	YAW	ROLL	PL ID
	-1261	-146	-551	5	2	0	0

BRAKES – ON (tb-ON)  
MODE – not DIRECT  
PARAM – PORT TEMP  
JOINT – CRIT TEMP

Give SSRMS Operator GO for mnvr to MBS PDGF3 Pre-grapple

OBSS CONTINGENCY

OBSS SJ HANDOFF FROM SSRMS TO SRMS.....	FS 2-2
SRMS TO SSRMS.....	FS 2-17

OBSS  
CONTINGENCY

# OBSS SJ HANDOFF FROM SSRMS TO SRMS

## 1. SETUP

If SINGLE MODE available:

**SM 94 PDRS CONTROL**

√PL ID, ITEM 3: 0

√INIT ID, ITEM 24: 0

A7U

CCTV – config as reqd  
 – perform PAN/TILT RESET for PLB cameras  
 ZOOM – full OUT

## 2. SJ OBSS PRE-GRAPPLE AT HANDOFF MANEUVER

On SSRMS Operator GO for mnvr to OBSS PRE-GRAPPLE AT HANDOFF posn,

If SINGLE MODE available:

RHC

RATE – as reqd (VERN within 10 ft)  
 BRAKES – OFF (tb-OFF)

MODE – best available

Mnvr to OBSS PRE-GRAPPLE AT HANDOFF posn:

	SY	SP	EP	WP	WY	WR	
PRE-CRADLE	0.0	+25.0	-25.0	+5.0	0.0	0.0	
1: SY +	+23.5						
2: SP +		+63.5					
3: EP –			-29.6				
4: WP –				-102.9			
5: WY +					+11.5		
6: WR –						-98.6	
OBSS PRE-GRAPPLE AT HAND-OFF	+23.5	+63.5	-29.6	-102.9	+11.5	-98.6	
	X	Y	Z	PITCH	YAW	ROLL	PL ID
	-1015	-362	-688	284	0	270	0

BRAKES – ON (tb-ON)

MODE – not DIRECT

JOINT – CRIT TEMP

Notify SSRMS Operator that SRMS at OBSS PRE-GRAPPLE AT HANDOFF posn

OBSS CONTINGENCY

Start:  
Pre-Cradle

Step 1:  
Drive SY (+) from 0.0° to +23.5°

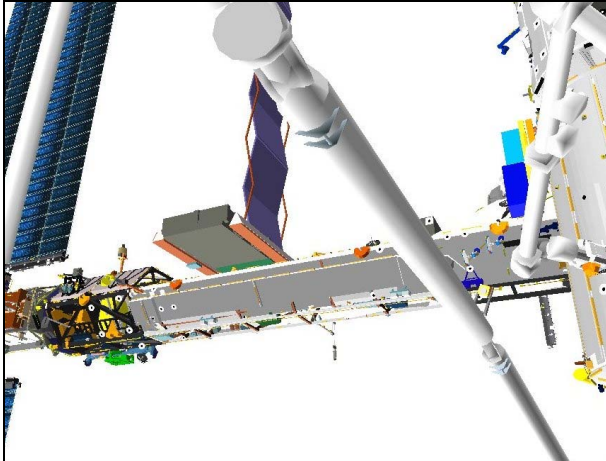

**CCTV B (-25,25)**

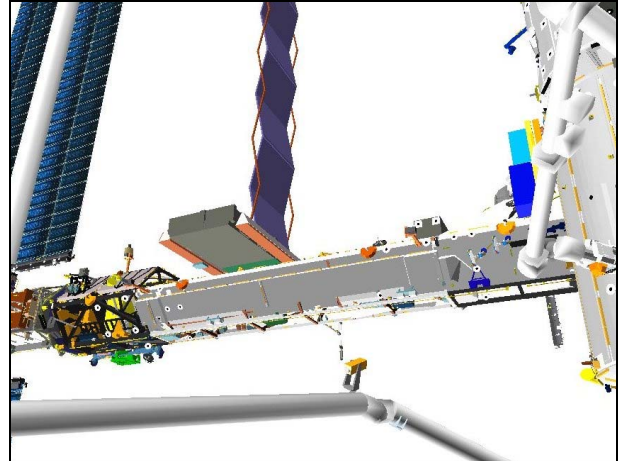

**CCTV B (-25,25)**

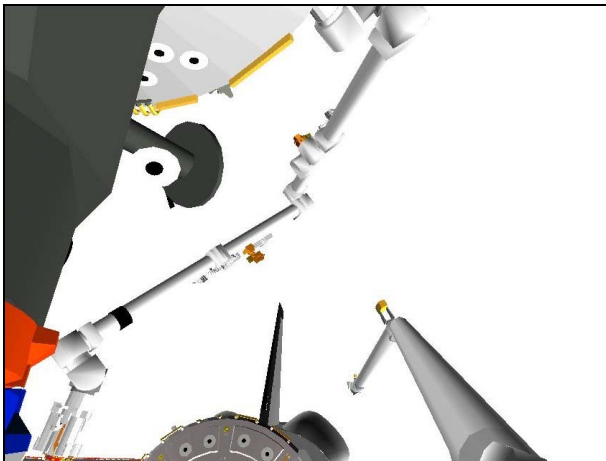

**CCTV A (0,30)**

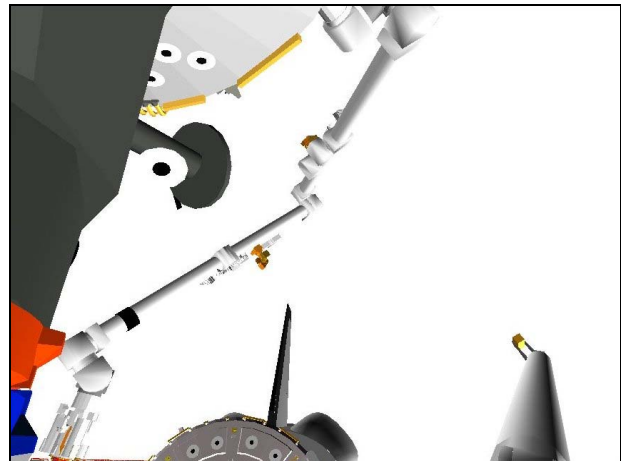

**CCTV A (0,30)**

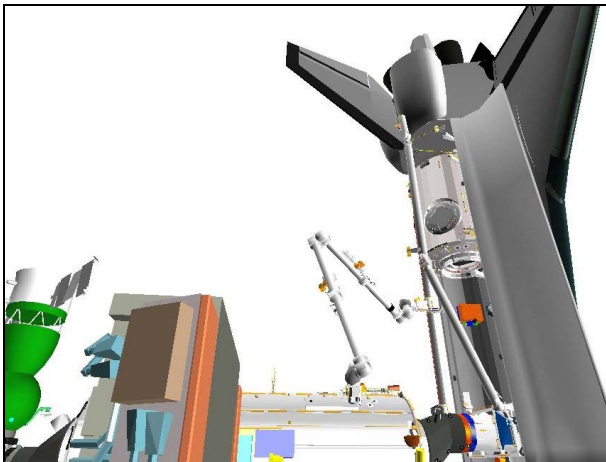

**P1 LOOB (95,30)**

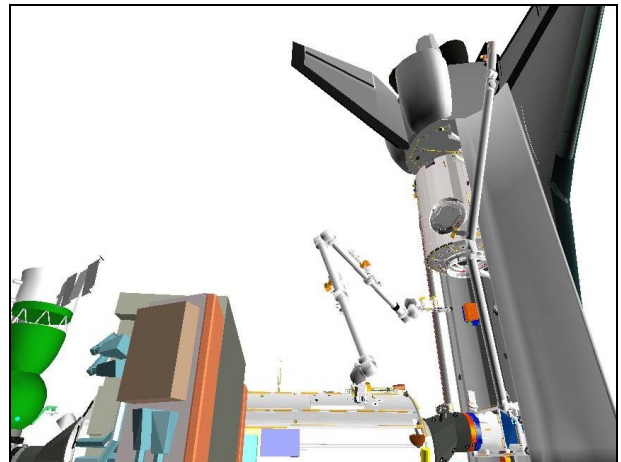

**P1 LOOB (95,30)**



Step 2:

Drive SP (+) from  $+25.0^\circ$  to  $+63.5^\circ$

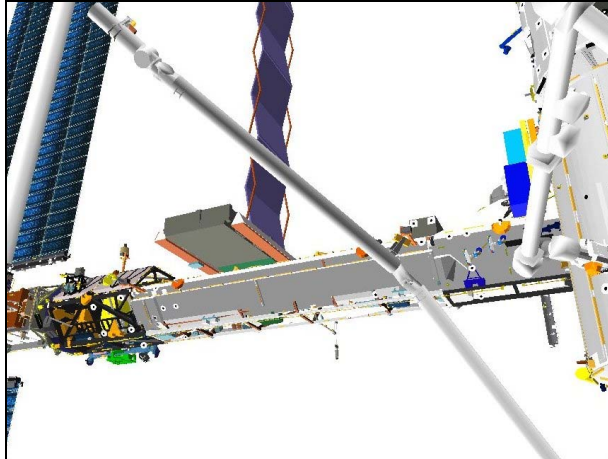

**CCTV B (-25,25)**

Step 3:

Drive EP (-) from  $-25.0^\circ$  to  $-29.6^\circ$

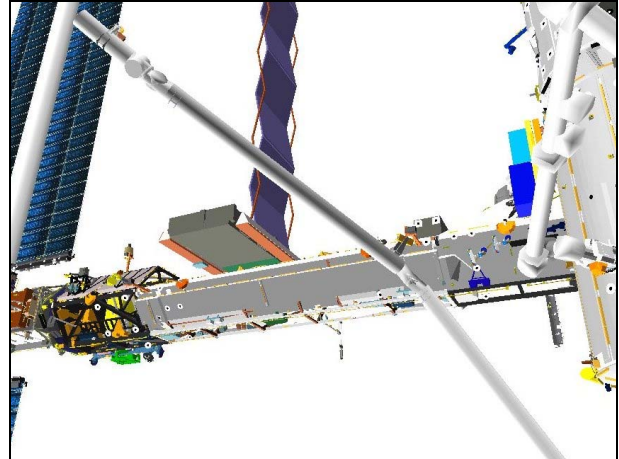

**CCTV B (-25,25)**

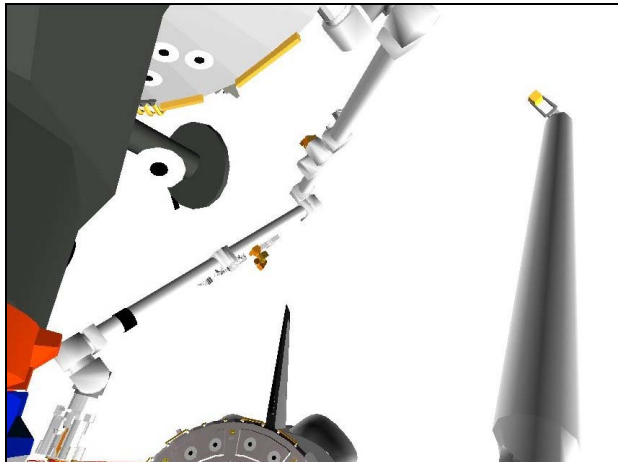

**CCTV A (0,30)**

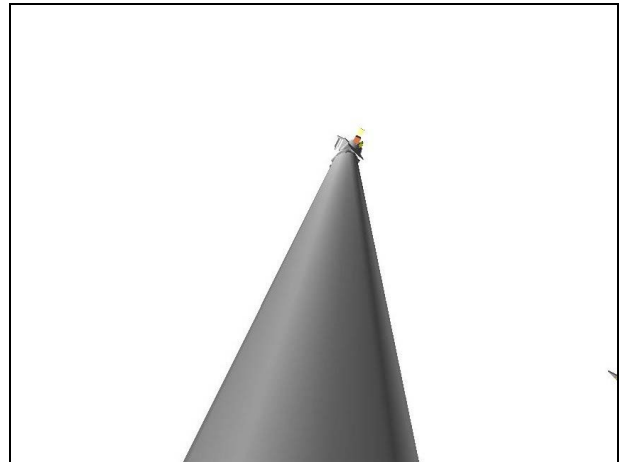

**ELBOW (-5,-15)**

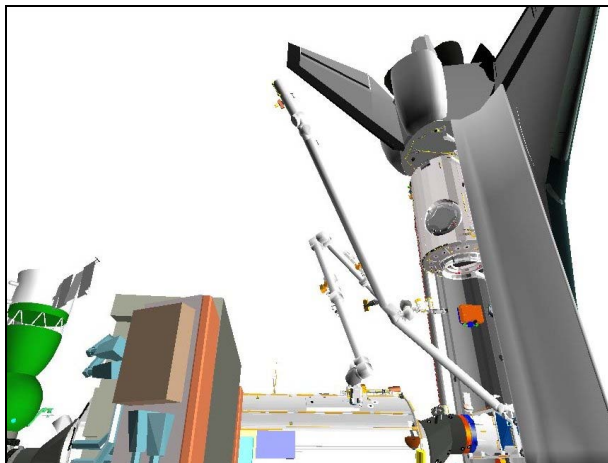

**P1 LOOB (95,30)**

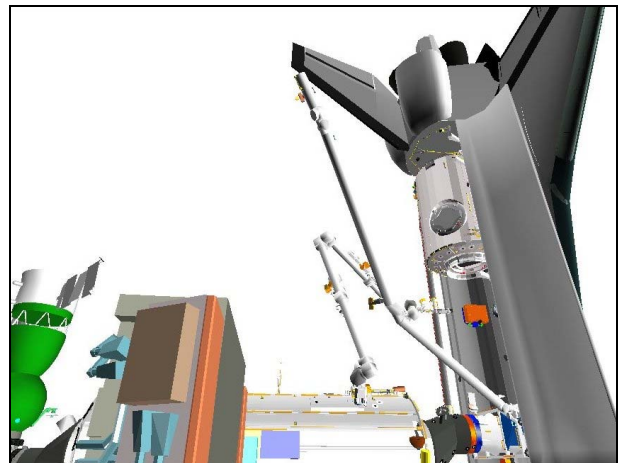

**P1 LOOB (95,30)**

Step 4:  
Drive WP (-) from +5.0° to -102.9°

Step 5:  
Drive WY (+) from 0.0° to +11.5°

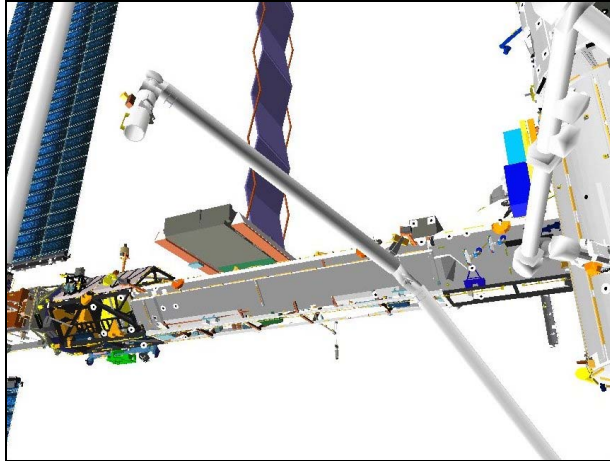

**CCTV B (-25,25)**

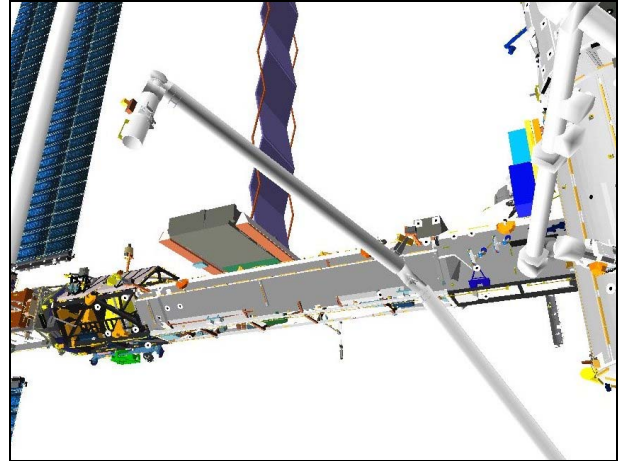

**CCTV B (-25,25)**

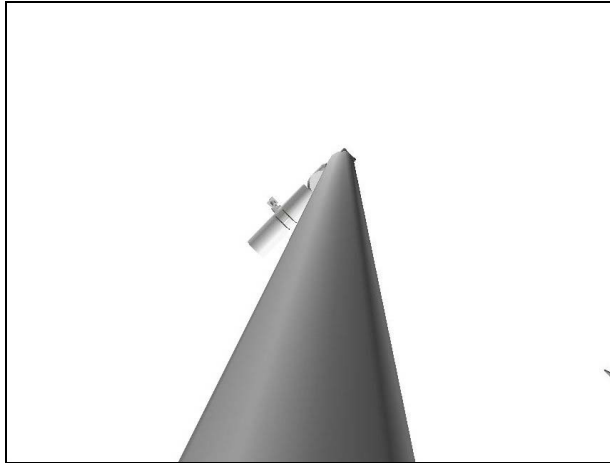

**ELBOW (-5,-15)**

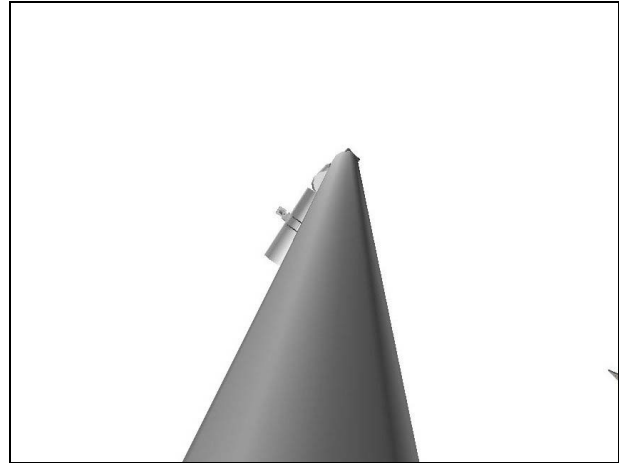

**ELBOW (-5,-15)**

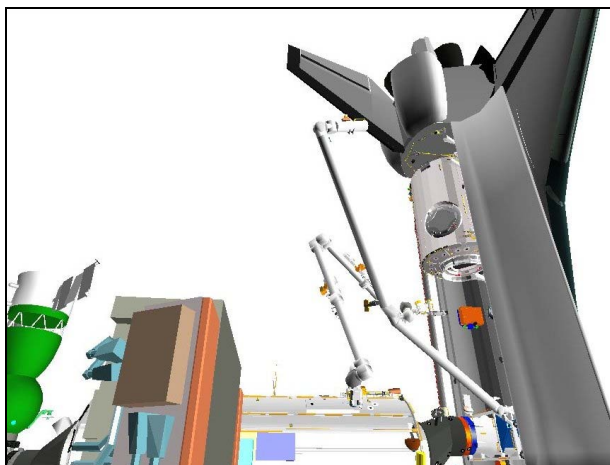

**P1 LOOB (95,30)**

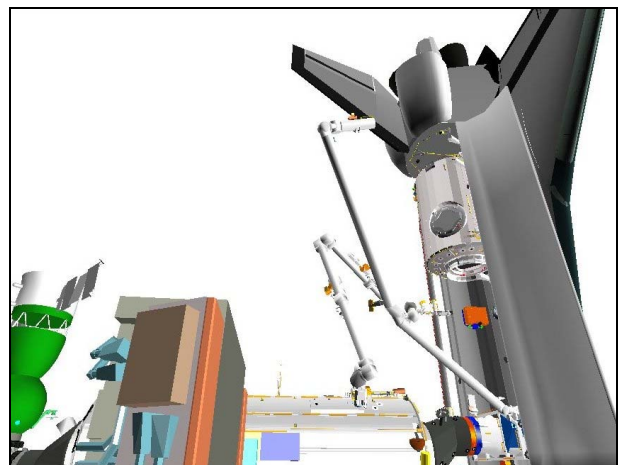

**P1 LOOB (95,30)**

Step 6:

Drive WR (-) from 0.0° to -98.6°

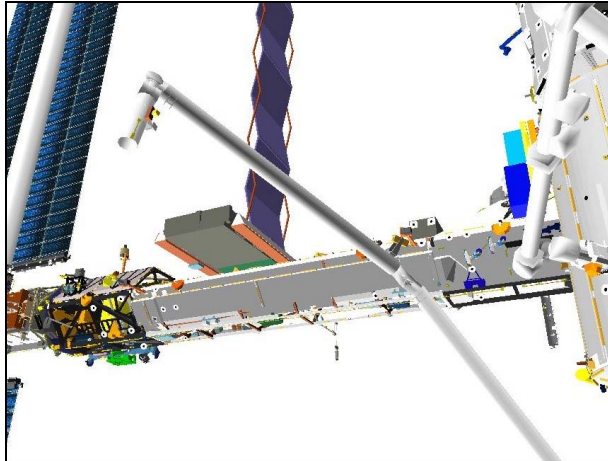

**CCTV B (-25,25)**

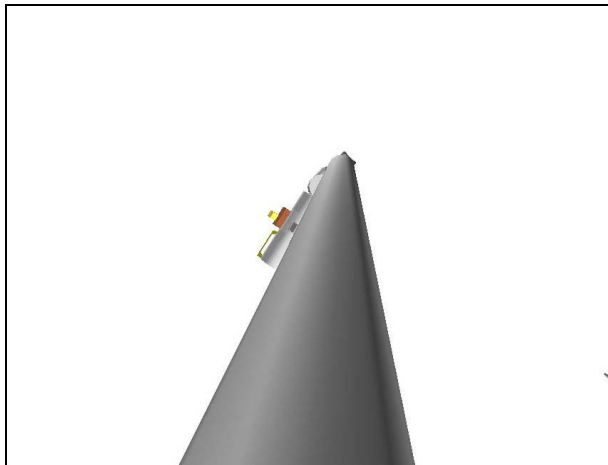

**ELBOW (-5,-15)**

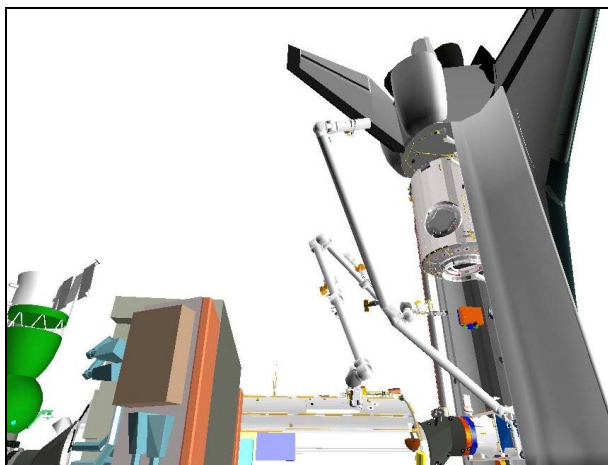

**P1 LOOB (95,30)**

3. CONFIGURE POWER

CAUTION  
SPEE power must be applied within 90 min  
to prevent sensor package damage

On SSRMS Operator GO to release STBD MRLs,  
STBD RMS HTR A,B (two) – OFF

A6U           EVENT TIMER MODE – UP  
                  CNTL – START

MA73C:C      cb MCA PWR AC3 3Φ MID 2 – op  
                  √AC2 3Φ MID 2 – op  
          :D       √AC3 3Φ MID 4 – op

R13L           PL BAY MECH PWR SYS (two) – ON

4. STBD MRL RELEASE

SM 94 PDRS CONTROL  
RMS STBD – ITEM 2 EXEC (\*)  
√STBD AFT, MID, FWD REL (six) = 0

NOTE  
Expect single motor drive time for MRL release

STBD RMS RETEN LAT – REL (tb-REL) (18 sec max)  
– OFF  
If motor drive time > 18 sec, √MCC

SM 94 PDRS CONTROL  
√STBD AFT, MID, FWD REL (six) = 1

5. RECONFIGURE POWER

R13L           PL BAY MECH PWR SYS (two) – OFF

MA73C:C      cb MCA PWR AC3 3Φ MID 2 – cl  
                  √AC2 3Φ MID 2 – op  
          :D       √AC3 3Φ MID 4 – op

Give SSRMS Operator GO for OBSS Unberth  
Monitor RFL Status

After OBSS Unberth,  
SM 94 PDRS CONTROL  
RMS PORT – ITEM 1 EXEC (\*)

6. SETUP FOR GRAPPLE

A7U           CCTV – config for grapple  
                  – install PDRS TARGET OVERLAY FOR CTVM  
                  – RMS WRIST, ZOOM: 34.0 HFOV  
                  FOCUS: 5 ft  
Maintain eyepoint approx 18 in when using grapple overlay

R12(OBSS) √SPEE PWR – OFF  
A15 APCU 2 CONV - OFF

**SM 179 POWER TRANSFER**

√PTU 2 APCU OUT VOLTS: <10V

A15 APCU 2 OUTPUT - OFF

7. SJ OBSS GRAPPLE AT HANDOFF

On SSRMS Operator GO for SRMS OBSS Grapple,

If SINGLE MODE available:

RHC RATE – VERN (RATE MIN tb-ON)  
BRAKES – OFF (tb-OFF)

MODE – best available

Drive joints per OBSS SJ HANDOFF SRMS GRAPPLE WRIST CCTV OVERLAY  
and diagram until EE within grapple envelope

**CAUTION**

Monitor EE tb timing to prevent EE motor burnout

EE MODE – AUTO

CAPTURE sw – depress (mom)

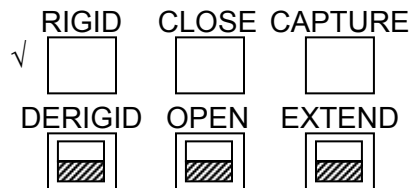

CRITICAL TIMES (28 sec total):

CAPTURE tb – gray, then  
CLOSE tb – gray, 3 sec max, then  
RIGID tb – gray, 25 sec max

EE MODE – OFF

- \* If manual capture required: \*
- \* EE MODE – MAN \*
- \* CAPTURE sw – depress (hold until CLOSE tb-gray, 3 sec max) \*
- \* MAN CONTR – RIGID (hold until RIGID tb-gray, 25 sec max) \*
- \* MODE – OFF \*

If TEST mode available,  
MODE – TEST, ENTER  
Wait 5 sec

BRAKES – ON (tb-ON)  
MODE – not DIRECT  
JOINT – CRIT TEMP

### OBSS SJ GRAPPLE AT HANDOFF OVERLAY

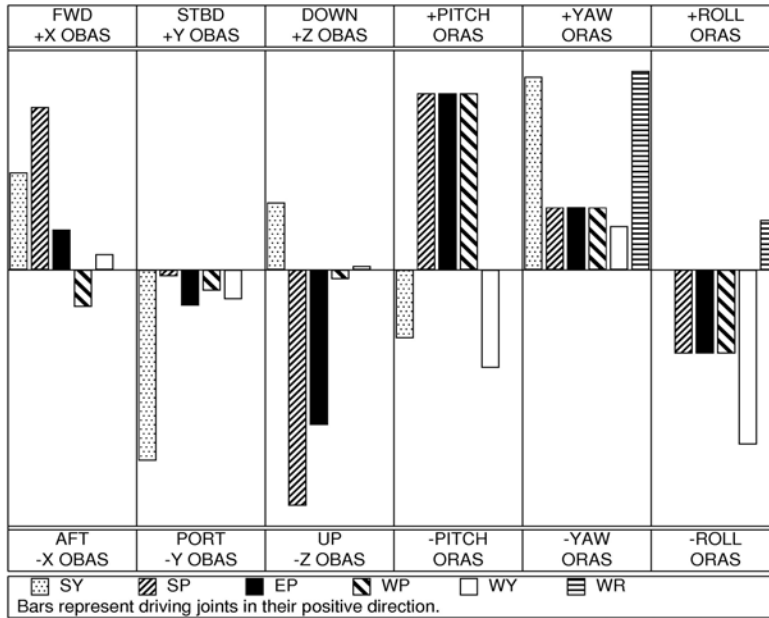

To get:	Drive:	To get:	Drive:	Driving:	Results In:	Driving:	Results In:
+X (fwd)	+SP, +SY	+PITCH	+WP, +EP	+SY	-Y (port), +YAW	+WP	-X (aft), +PITCH
+Y (stbd)	-SY	+YAW	+WR, +SY	+SP	-Z (up), +PITCH	+WY	-Y (port), -ROLL
+Z (down)	-SP, -EP	+ROLL	-WY, -WP	+EP	-Z (up), +PITCH	+WR	+YAW

$\Delta SY$	$\Delta SP$	$\Delta EP$	$\Delta WP$	$\Delta WY$	$\Delta WR$
+2.3	+2.8	-19.4	+17.0	-0.8	-2.1

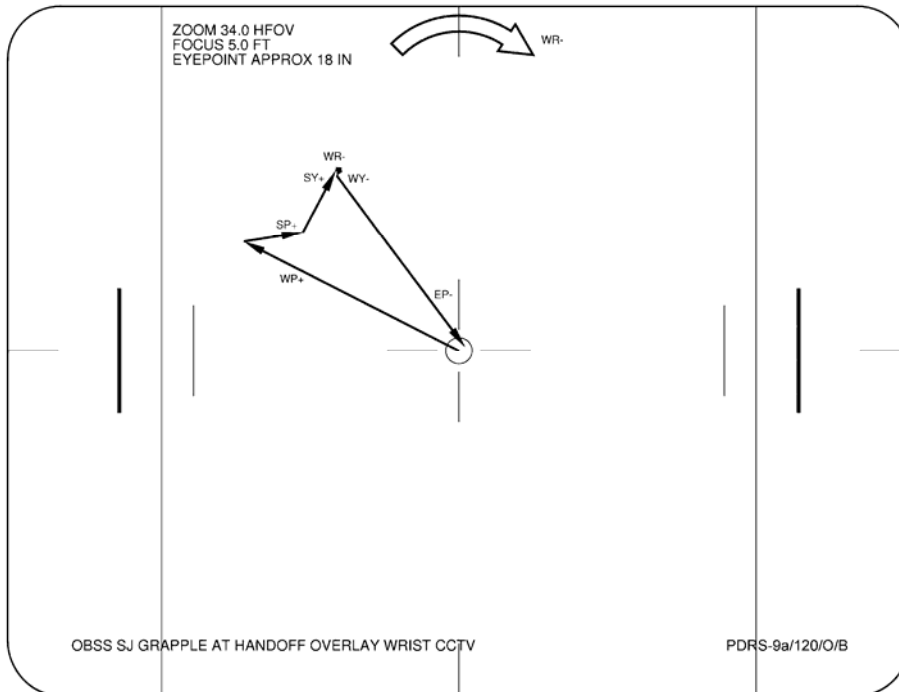

If SINGLE MODE available:

**SM 94 PDRS CONTROL**

PL ID – ITEM 3 +2 EXEC

INIT ID – ITEM 24 +2 EXEC

Expected OBSS HANDOFF posn:

X	Y	Z	PITCH	YAW	ROLL	PL ID
-1029	+229	-614	284	270	270	2
SY	SP	EP	WP	WY	WR	
+25.8	+66.3	-49.0	-85.9	+10.7	-100.7	

\* display singularity

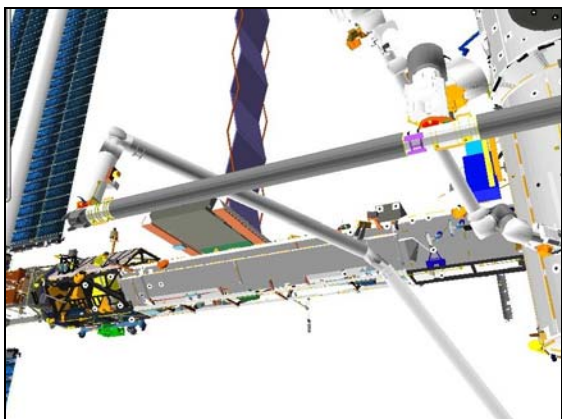

**CCTV B (-25,25)**

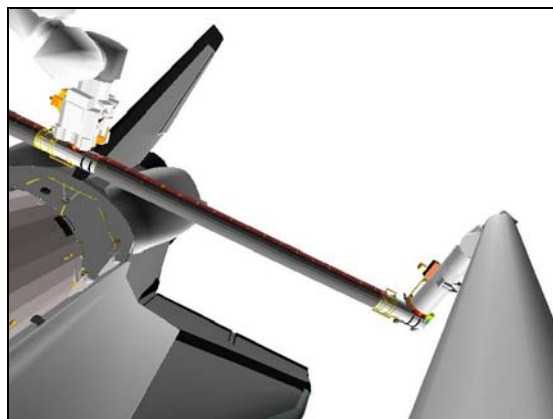

**ELBOW (-5,-15)**

R12(OBSS) RSC PWR – OFF, ON

Perform ACTIVATION (LDRI/ITVC Cue Card, PHOTO/TV)

Perform LCH ACTIVATION (LCS Cue Card, PHOTO/TV)

Perform LCC ACTIVATION (LCS Cue Card, PHOTO/TV), steps 1 and 2

Give SSRMS Operator GO for OBSS Ungrapple

Review GENERIC END EFFECTOR CUE CARD – ISS/SHUTTLE DOCKED OPS

8. MNVR TO NODE 2 VIEWING

On SSRMS Operator GO for mnvr to NODE 2 VIEWING posn,

If SINGLE MODE available:

RHC

RATE – as desired (VERN within 10 ft)

BRAKES – OFF (tb-OFF)

MODE – best available



Mnvr to NODE 2 VIEWING posn:

	SY	SP	EP	WP	WY	WR	
HANDOFF	+25.8	+66.3	-49.0	-85.9	+10.7	-100.7	
1: SY +	+35.0						
2: EP +			-22.8				
3: WR +						+15.0	
4: WY -					-0.5		
5: SP -		+36.7					
6: WP +				-2.0			
7: SY +	+85.0						
NODE 2 VIEW	+85.0	+36.7	-22.8	-2.0	-0.5	+15.0	
	X	Y	Z	PITCH	YAW	ROLL	PL ID
	-767	-775	-1068	86	7	276	2

BRAKES – ON (tb-ON)  
 MODE – not DIRECT  
 PARAM – PORT TEMP  
 JOINT – CRIT TEMP

Start:  
OBSS Handoff

Step 1:  
Drive SY (+) from +25.8° to +35.0°

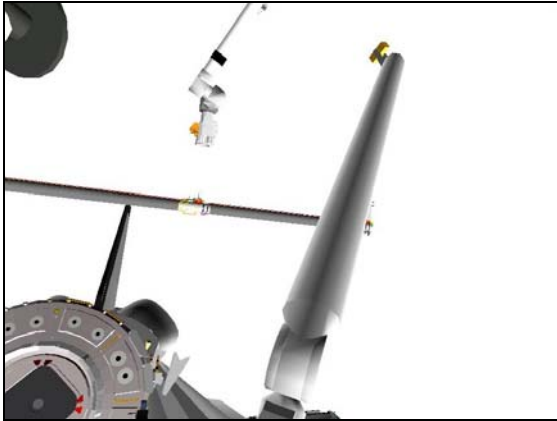

**CCTV A (20,20)**

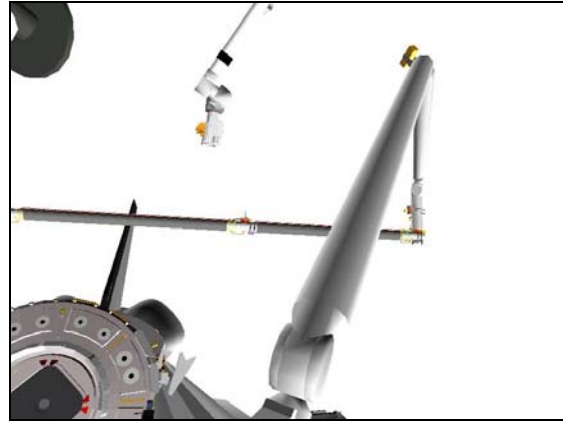

**CCTV A (20,20)**

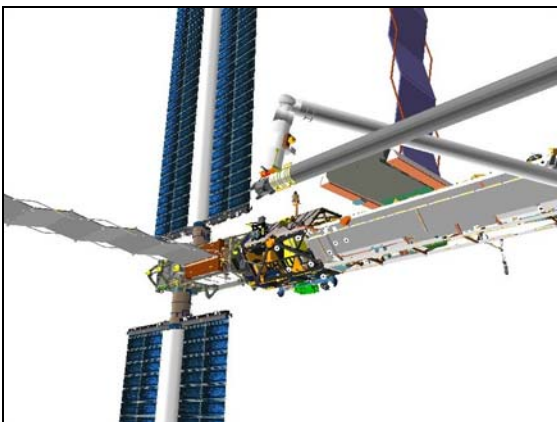

**CCTV B (-45,20)**

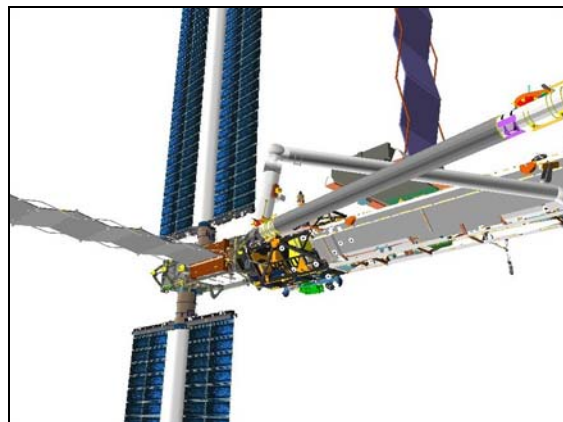

**CCTV B (-45,20)**

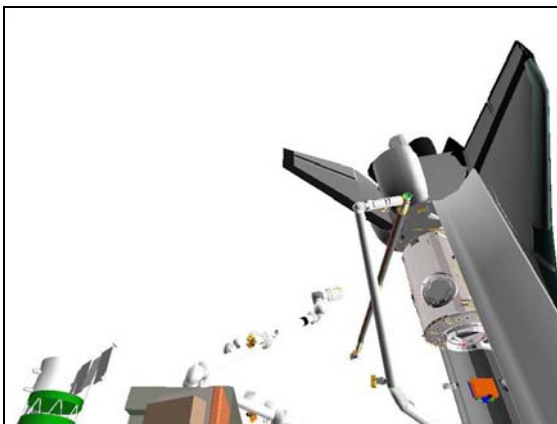

**P1 LOOB (90,45)**

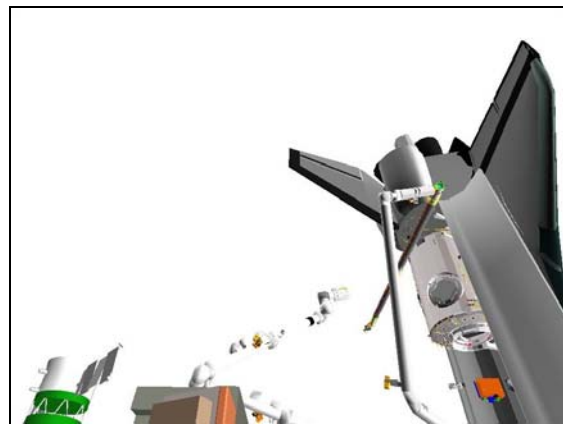

**P1 LOOB (90,45)**

Step 2:

Drive EP (+) from  $-49.0^\circ$  to  $-22.8^\circ$

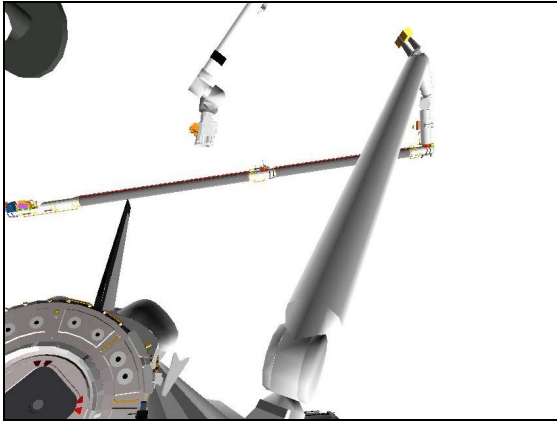

**CCTV A (20,20)**

Step 3:

Drive WR (+) from  $-100.7^\circ$  to  $+15^\circ$

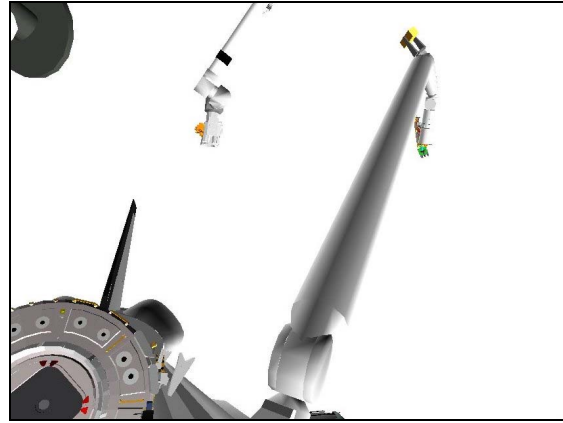

**CCTV A (20,20)**

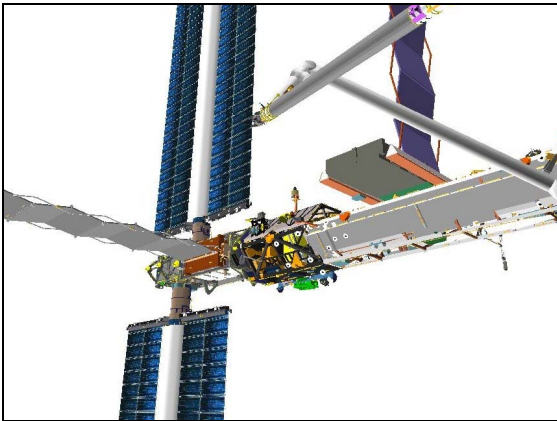

**CCTV B (-45,20)**

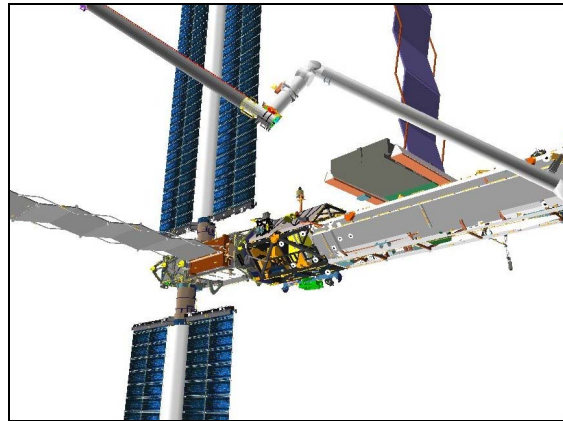

**CCTV B (-45,20)**

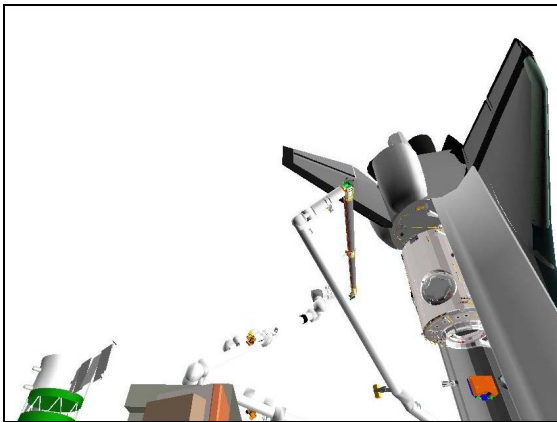

**P1 LOOB (90,45)**

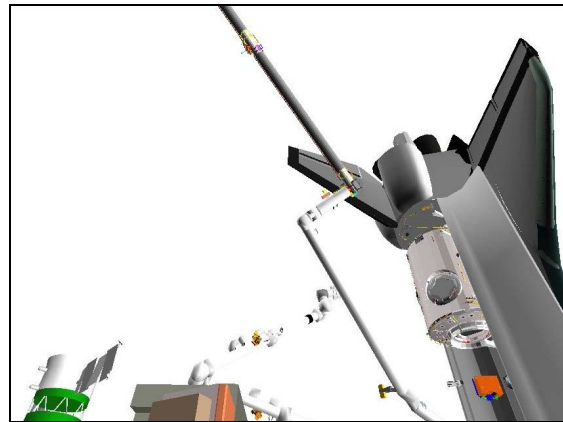

**P1 LOOB (90,45)**

Step 4:

Drive WY (-) from  $+10.7^\circ$  to  $-0.5^\circ$

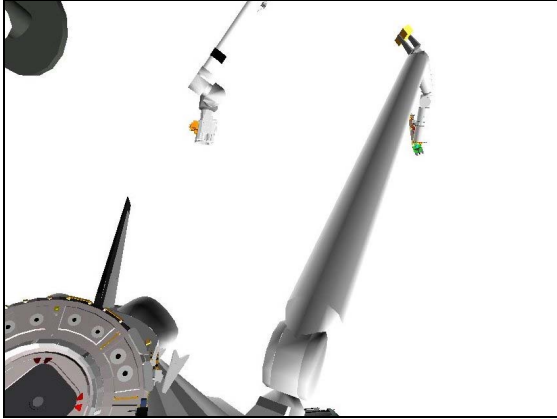

**CCTV A (20,20)**

Step 5:

Drive SP (-) from  $+66.3^\circ$  to  $+36.7^\circ$

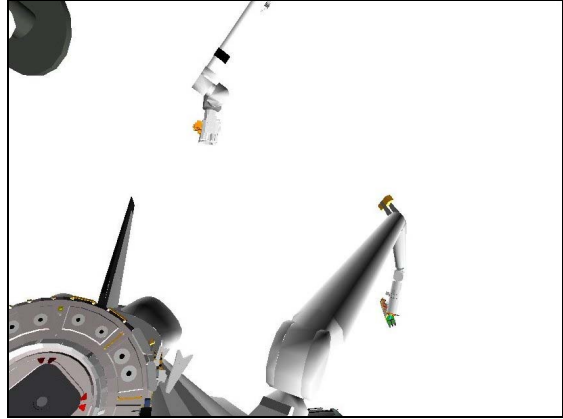

**CCTV A (20,20)**

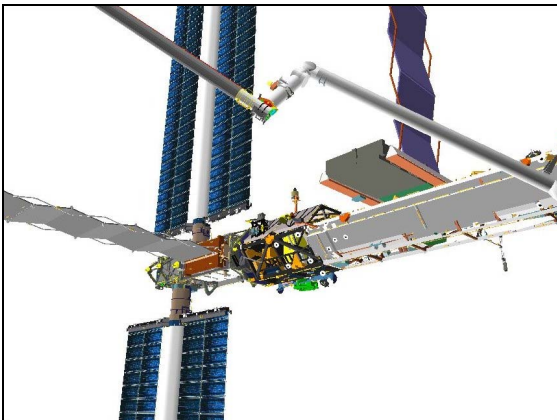

**CCTV B (-45,20)**

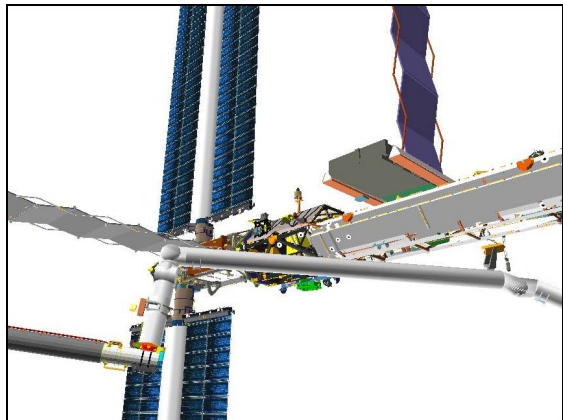

**CCTV B (-45,20)**

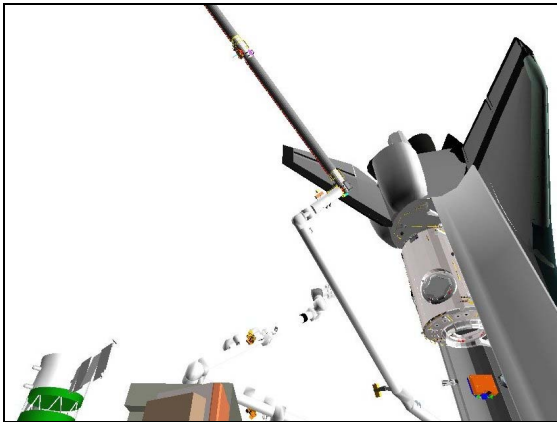

**P1 LOOB (90,45)**

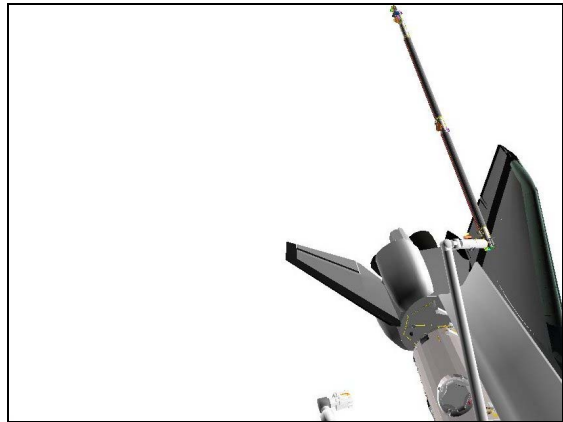

**P1 LOOB (90,60)**

Step 6:

Drive WP (+) from  $-85.9^\circ$  to  $-2.0^\circ$



**CCTV A (20,20)**

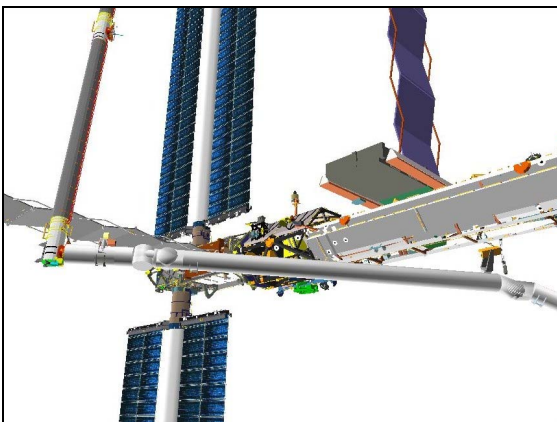

**CCTV B (-45,20)**

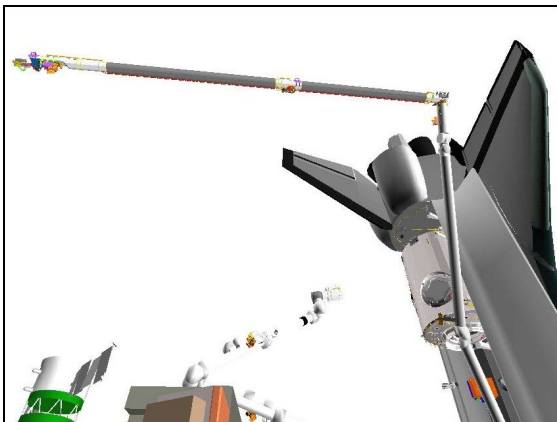

**P1 LOOB (90,45)**

Step 7:

Drive SY (+) from  $+35.0^\circ$  to  $+85.0^\circ$

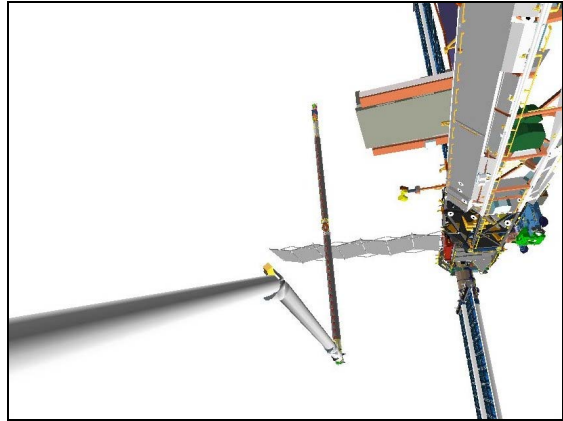

**CCTV A (70,25)**

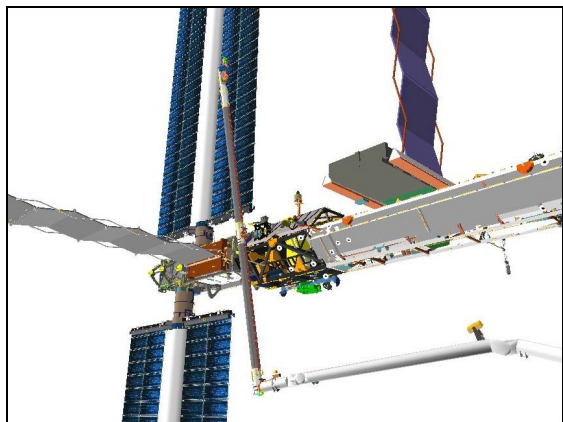

**CCTV B (-45,20)**

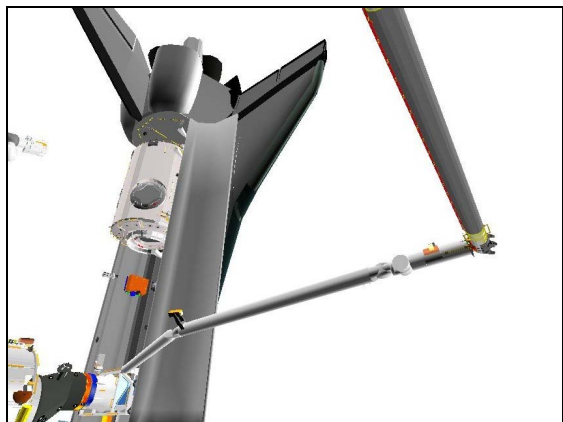

**P1 LOOB (140,30)**

A7U 9. RECONFIG PTU  
VIDEO OUT MON2 pb – push  
IN PL2(VPU) pb – push

CAMR CMD PAN/TILT – HI RATE  
PAN – L (to hard stop)  
TILT – UP (to hard stop)  
PAN/TILT – RESET  
PAN: +70 (right)  
TILT: -68 (dn)  
ZOOM – IN (full in)

VIDEO OUT MUX 1 L pb – push (MIDDECK It on)  
LDR1 MODE 2 pb – push (ITVC video)

Give SSRMS Operator GO for mnvr to EVA 1 SETUP posn

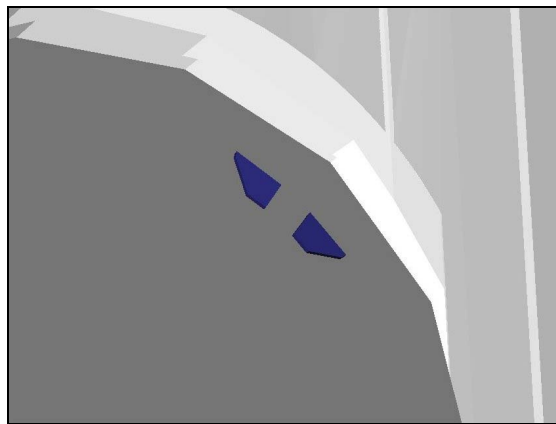

**ITVC (70,-68)**

# OBSS SJ HANDOFF FROM SRMS TO SSRMS

## 1. SETUP

If SINGLE MODE available:

SM 94 PDRS CONTROL

√PL ID, ITEM 3: 2

√INIT ID, ITEM 24: 2

A7U

CCTV – config as reqd

– perform PAN/TILT RESET for PLB cameras

Review GENERIC END EFFECTOR CUE CARD – ISS/SHUTTLE DOCKED OPS

## 2. MANEUVER TO OBSS HANDOFF

On SSRMS Operator GO for mnvr to OBSS HANDOFF posn,

If SINGLE MODE available:

RHC

RATE – as reqd (VERN within 10 ft)

BRAKES – OFF (tb-OFF)

MODE – best available

Mnvr to OBSS HANDOFF posn:

	SY	SP	EP	WP	WY	WR	
NODE 2 VIEW	+85.0	+36.7	-22.8	-2.0	-0.5	+15.0	
1: SY –	+35.0						
2: WP –				-85.9			
3: SP +		+66.3					
4: WY +					+10.7		
5: WR –						-100.7	
6: EP –			-49.0				
7: SY –	+25.8						
HANDOFF POSN	+25.8	+66.3	-49.0	-85.9	+10.7	-100.7	
	X	Y	Z	PITCH	YAW	ROLL	PL ID
	-1031	-44	-610	284	270	270	2

\* display singularity

BRAKES – ON (tb-ON)

MODE – not DIRECT

JOINT – CRIT TEMP

Give SSRMS Operator GO for OBSS Grapple

Start:  
NODE 2 VIEW

Step 1:  
Drive SY (-) from +85.0° to +35.0°

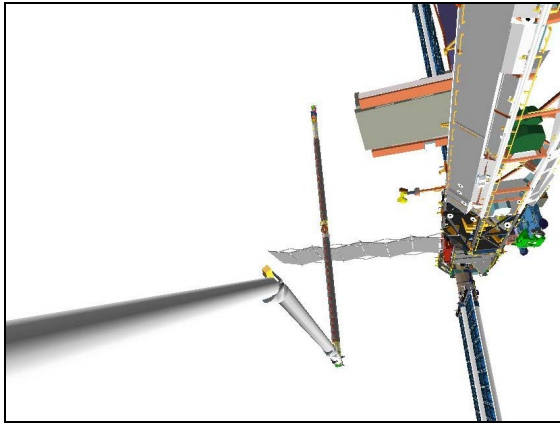

**CCTV A (70,20)**

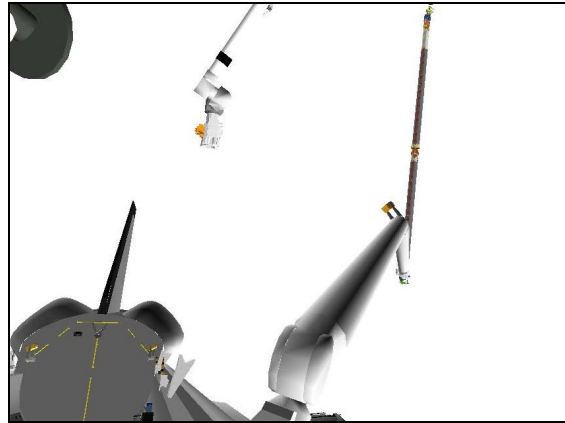

**CCTV A (20,20)**

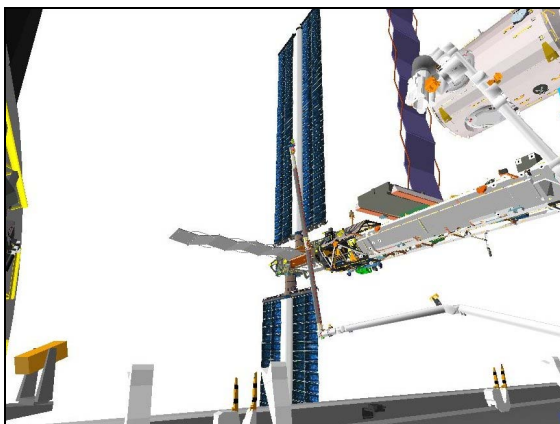

**CCTV C (-60,20)**

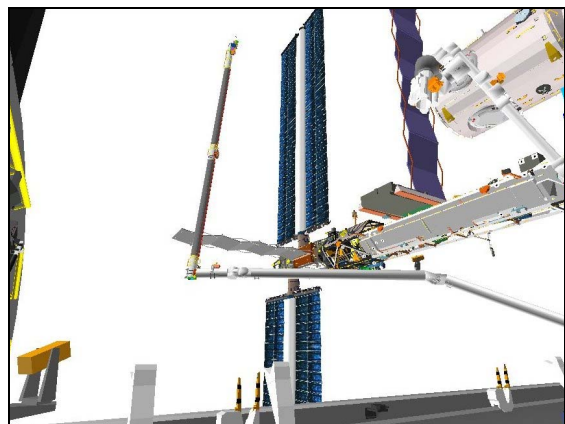

**CCTV C (-60,20)**

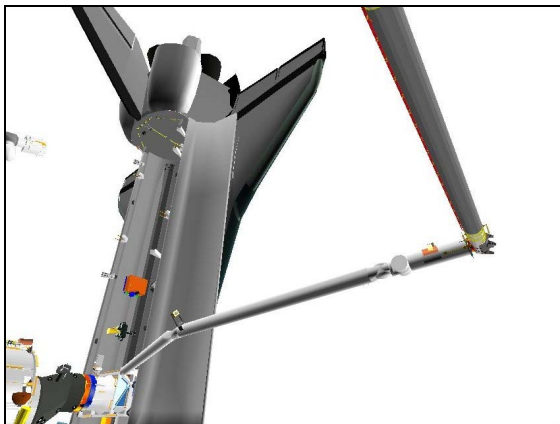

**P1 LOOB (140,30)**

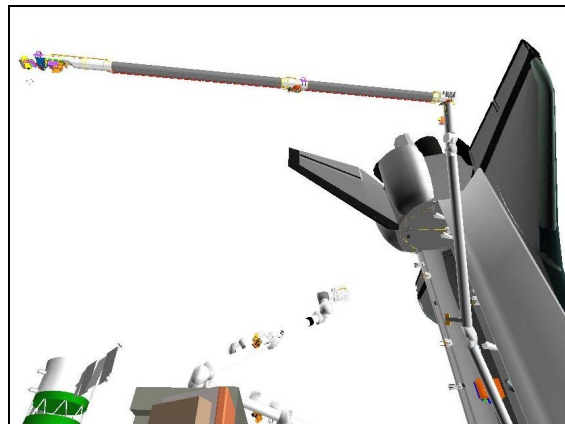

**P1 LOOB (90,45)**



Step 2:

Drive WP (-) from  $-2.0^\circ$  to  $-85.9^\circ$



**CCTV A (20,20)**

Step 3:

Drive SP (+) from  $+36.7^\circ$  to  $+66.3^\circ$

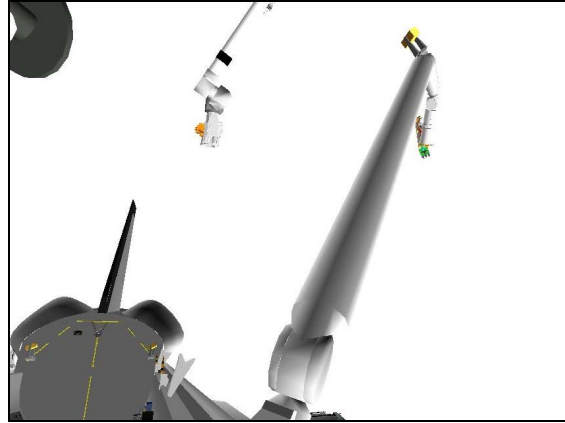

**CCTV A (20,20)**

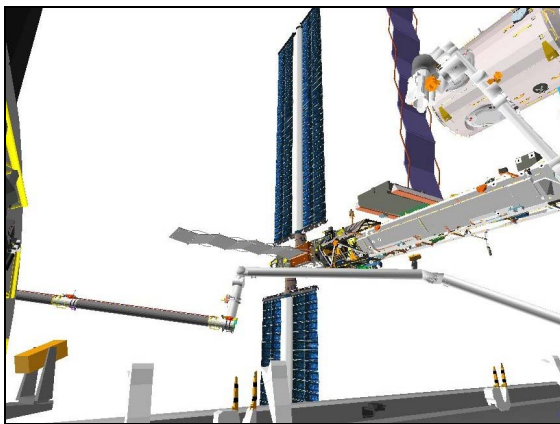

**CCTV C (-60,20)**

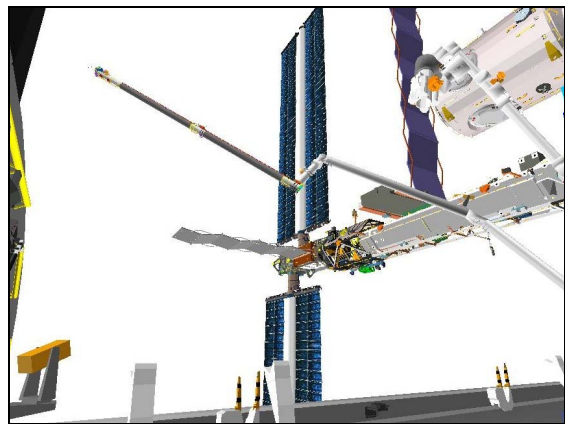

**CCTV C (-60,20)**



**P1 LOOB (90,60)**

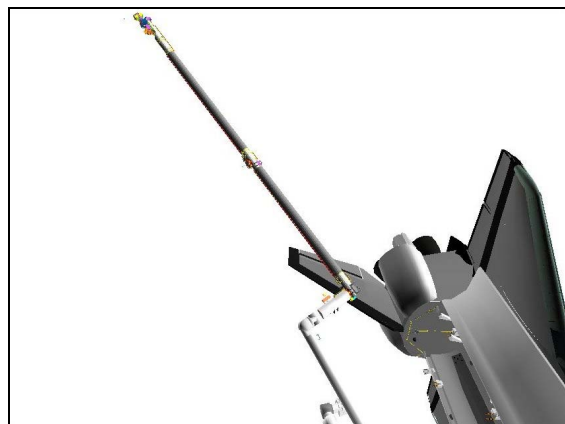

**P1 LOOB (90,60)**

Step 4:  
Drive WY (+) from  $-0.5^{\circ}$  to  $+10.7^{\circ}$

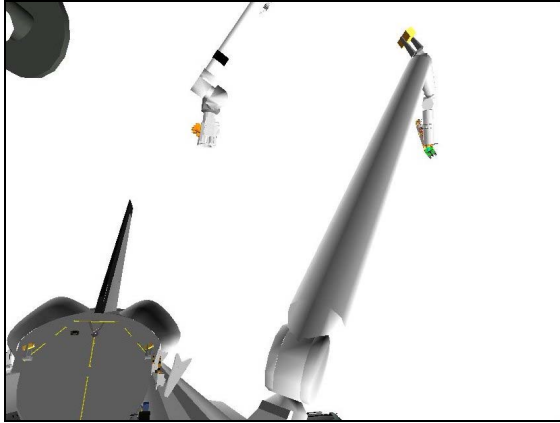

**CCTV A (20,20)**

Step 5:  
Drive WR (-) from  $+15.0^{\circ}$  to  $-100.7^{\circ}$

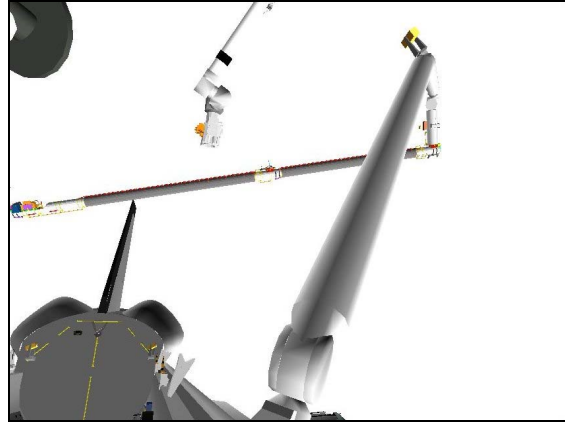

**CCTV A (20,20)**



**CCTV C (-60,20)**

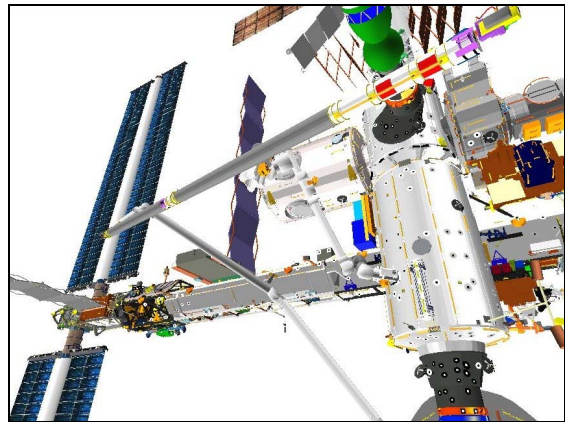

**CCTV C (-30,30)**



**P1 LOOB (95,35)**



**P1 LOOB (95,35)**

Step 6:

Drive EP (-) from  $-22.8^\circ$  to  $-49.0^\circ$

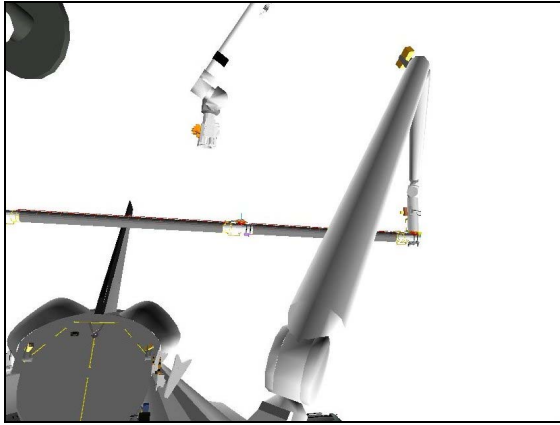

**CCTV A (20,20)**

Step 7:

Drive SY (-) from  $+35.0^\circ$  to  $+25.8^\circ$

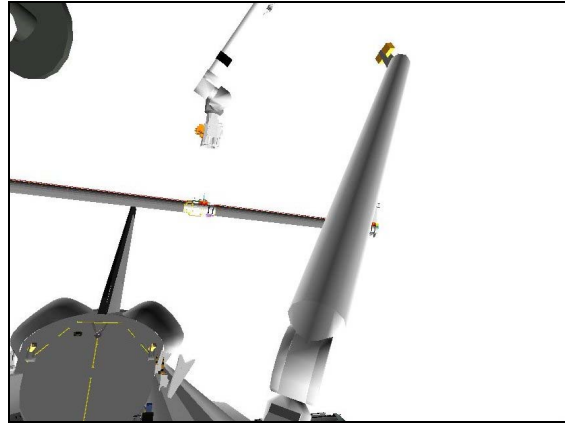

**CCTV A (20,20)**

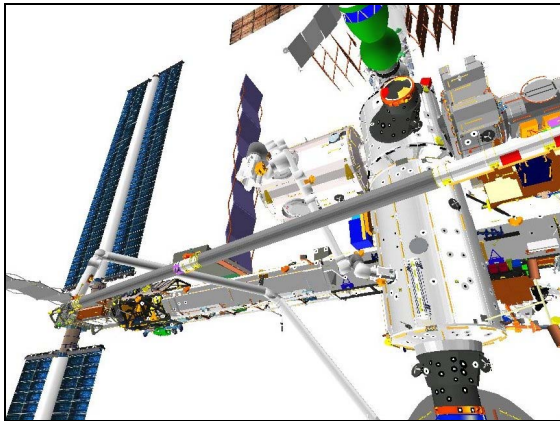

**CCTV C (-30,30)**

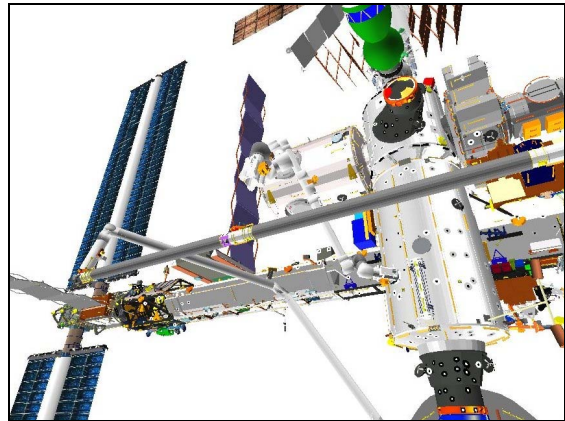

**CCTV C (-30,30)**



**P1 LOOB (95,35)**



**P1 LOOB (95,35)**

3. STOW PTU

A7U On SSRMS Operator GO for OBSS Ungrapple,  
VIDEO OUT MON2 pb – push  
IN PL2(VPU) pb – push

CAMR CMD PAN/TILT – HI RATE  
PAN – L (to hard stop)  
TILT – UP (to hard stop)  
PAN/TILT – RESET  
PAN: +108 (right)  
TILT: -175 (down)

Perform LCC DEACTIVATION (LCS Cue Card, PHOTO/TV)  
Perform LCH DEACTIVATION (LCS Cue Card, PHOTO/TV)

CAUTION  
STBD RMS HTR power must be applied within  
90 min to prevent sensor package damage

Perform DEACTIVATION (LDRI/ITVC Cue Card, PHOTO/TV)

4. OBSS UNGRAPPLE

A7U CCTV – config for ungrapple  
– RMS WRIST, ZOOM: 34.0 HFOV  
FOCUS: 5 ft

NOTE  
CONTR ERR It and 'S96 PDRS CNTL' msg may  
occur due to Consistency/Envelope Check error

If TEST MODE available:

RHC RATE – COARSE (RATE MIN tb-OFF)  
  
SM 94 PDRS CONTROL  
AUTO BRAKE INH – ITEM 10 EXEC (\*)  
  
BRAKES – OFF (tb-OFF)  
MODE – TEST, ENTER  
Wait 5 sec  
  
BRAKES – ON (tb-ON)  
  
SM 94 PDRS CONTROL  
AUTO BRAKE ENA – ITEM 9 EXEC (\*)

If SINGLE MODE available:

RHC SM 94 PDRS CONTROL  
PL ID – ITEM 3 +0 EXEC  
INIT ID – ITEM 24 +0 EXEC  
  
RATE – VERN (RATE MIN tb-ON)  
BRAKES – OFF (tb-OFF)

MODE – best available

**CAUTION**  
Monitor EE tb timing to prevent EE motor burnout

EE MODE – MAN

MAN CONTR – DERIGID (hold until DERIGID tb-gray, 5 sec max)

RELEASE sw – depress (hold until OPEN tb-gray, 3 sec max)

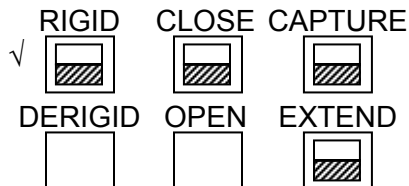

5. SJ MNVR TO OBSS PRE-GRAPPLE

Drive joints per OBSS SJ HANDOFF SRMS UNGRAPPLE WRIST CCTV OVERLAY and diagram until SRMS at OBSS PRE-GRAPPLE posn

EE MAN CONTR – DERIGID (hold until EXTEND tb-gray, 20 sec max)  
MODE – OFF

√POS/ATT and Joint Angles at OBSS PRE-GRAPPLE AT HANDOFF posn:

X	Y	Z	PITCH	YAW	ROLL	PL ID
-1015	-362	-688	284	0	270	0
SY	SP	EP	WP	WY	WR	
+23.5	+63.5	-29.6	-102.9	+11.5	-98.6	

BRAKES – ON (tb-ON)

MODE – not DIRECT

JOINT – CRIT TEMP

If using Shuttle attitude control and attitude maintenance required:

Configure DAP per RMS DAPs, then perform RATE DAMPING (ORB OPS FS, REBOOST/DAP; DOCKED DAP REFERENCE)

Give SSRMS Operator GO for OBSS Berth

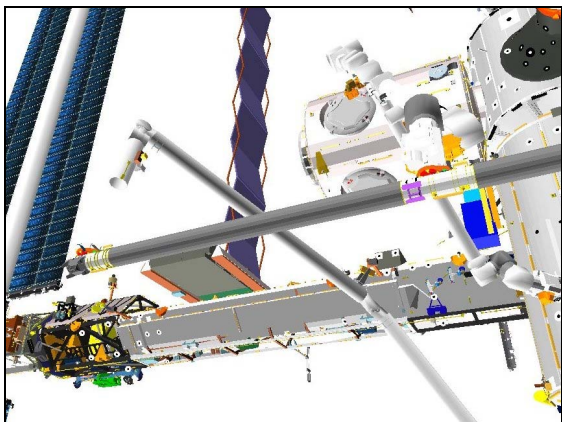

**CCTV B (-25,30)**

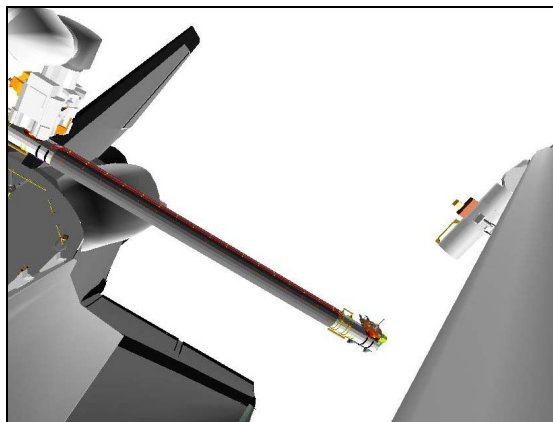

**ELBOW (-35,-15)**

### OBSS SJ UNGRAPPLE AT HANDOFF OVERLAY

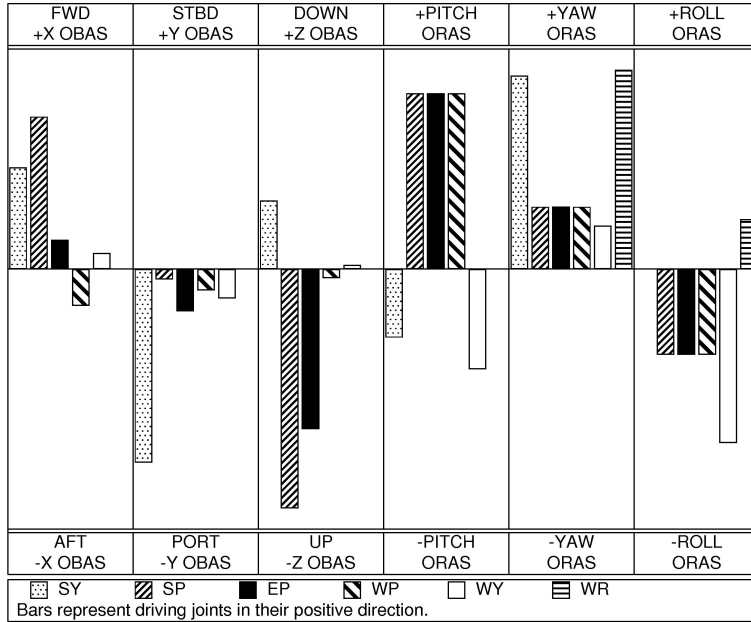

To get:	Drive:	To get:	Drive:	Driving:	Results In:	Driving:	Results In:
+X (fwd)	+SP, +SY	+PITCH	+WP, +EP	+SY	-Y (port), +YAW	+WP	-X (aft), +PITCH
+Y (stbd)	-SY	+YAW	+WR, +SY	+SP	-Z (up), +PITCH	+WY	-Y (port), -ROLL
+Z (down)	-SP, -EP	+ROLL	-WY, -WP	+EP	-Z (up), +PITCH	+WR	+YAW

$\Delta SY$	$\Delta SP$	$\Delta EP$	$\Delta WP$	$\Delta WY$	$\Delta WR$
-2.3	-2.8	+19.4	-17.0	+0.8	+2.1

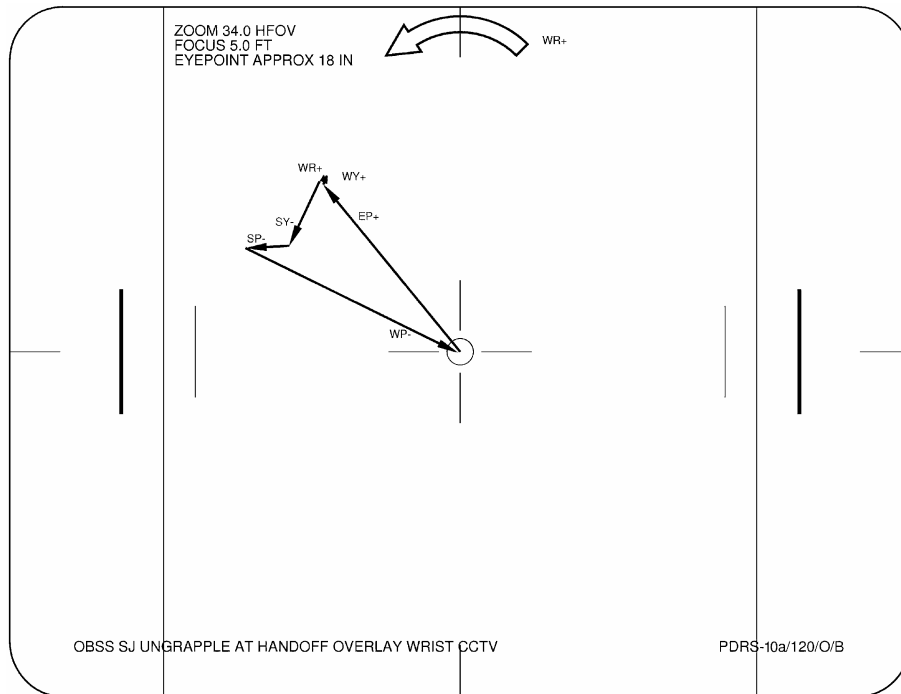

6. CONFIGURE CIRCUIT BREAKERS

MA73C:C      cb MCA PWR AC3 3Φ MID 2 – op  
                  √AC2 3Φ MID 2 – op  
:D               √AC3 3Φ MID 4 – op

7. CONFIGURE FOR MONITORING

On SSRMS notification to watch for STBD RMS RFLs,

SM 94 PDRS CONTROL

RMS STBD – ITEM 2 EXEC (\*)

Notify SSRMS operator when STBD RMS R-F-L tb (three) – gray

8. STBD MRL LATCH

On SSRMS Operator GO to latch STBD MRLs to Topological Capture,

√STBD RMS R-F-L tb (three) – gray

SM 94 PDRS CONTROL

√STBD AFT, MID, FWD LAT (six) = 0

R13L            PL BAY MECH PWR SYS (two) – ON

NOTE

Expect single motor drive time for MRL latching (18 sec max).

The following STBD RMS RETEN LAT – OFF and PL BAY  
MECH PWR SYS (two) – OFF actions are to be performed simo

Verify AOS for latching to Topological Capture

STBD RMS RETEN LAT – LAT (6 sec only, tb-bp)  
– OFF

R13L            PL BAY MECH PWR SYS (two) – OFF

Give SSRMS Operator GO to Limp All SSRMS Joints and Derigidize

R13L            On SSRMS Operator GO to complete STBD MRL latching,  
                  PL BAY MECH PWR SYS (two) – ON

STBD RMS RETEN LAT – LAT (tb-LAT) (12 sec max)  
– OFF

9. RECONFIGURE POWER

R13L            PL BAY MECH PWR SYS (two) – OFF

STBD RMS HTR A,B (two) – AUTO

A6U            EVENT TIMER CNTL – STOP

SM 94 PDRS CONTROL

√STBD AFT, MID, FWD LAT (six) = 1  
RMS PORT – ITEM 1 EXEC (\*)

MA73C:C      cb MCA PWR AC3 3Φ MID 2 – cl  
                  √AC2 3Φ MID 2 – op  
:D               √AC3 3Φ MID 4 – op

Give SSRMS Operator GO for OBSS Ungrapple

10. MNVR TO PRE-CRADLE

On SSRMS Operator GO for mnvr to PRE-CRADLE,

If SINGLE MODE available:

RHC

RATE – as reqd (VERN within 10 ft)

BRAKES – OFF (tb-OFF)

MODE – best available

Mnvr to PRE-CRADLE posn:

	SY	SP	EP	WP	WY	WR	
PRE-GRAPPLE	+23.5	+63.5	-29.6	-102.9	+11.5	-98.6	
1: WR +						0.0	
2: WY -					0.0		
3: WP +				+5.0			
4: SP -		+25.0					
5: EP +			-25.0				
6: SY -	0.0						
PRE-CRADLE	0.0	+25.0	-25.0	+5.0	0.0	0.0	
	X	Y	Z	PITCH	YAW	ROLL	PL ID
	-1261	-146	-551	5	2	0	0

BRAKES – ON (tb-ON)

MODE – not DIRECT

PARAM – PORT TEMP

JOINT – CRIT TEMP

Give SSRMS Operator GO for mnvr to MBS PDGF 3 Pre-grapple



Start:  
OBSS Handoff

Step 1:  
Drive WR (+) from  $-98.6^\circ$  to  $0.0^\circ$

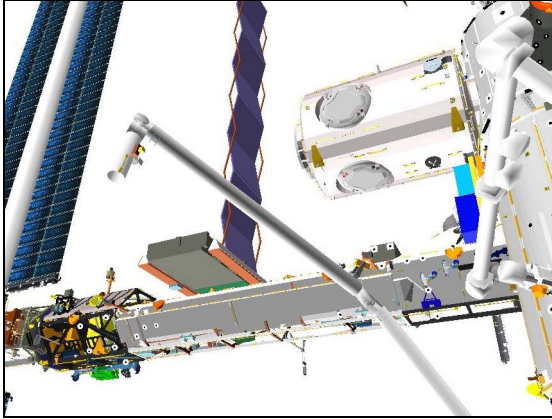

**CCTV B (-25,30)**

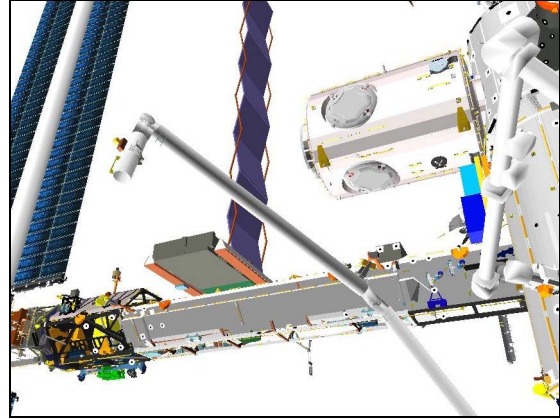

**CCTV B (-25,30)**

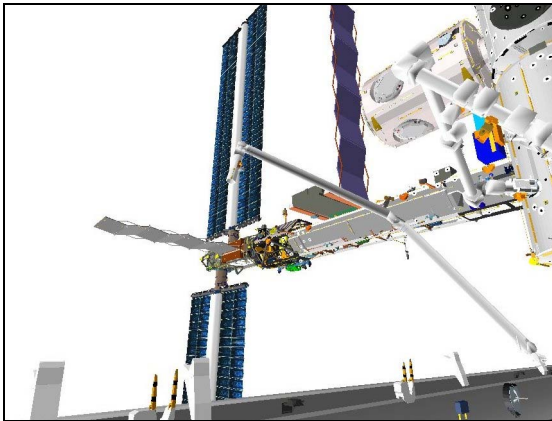

**CCTV C (-50,20)**

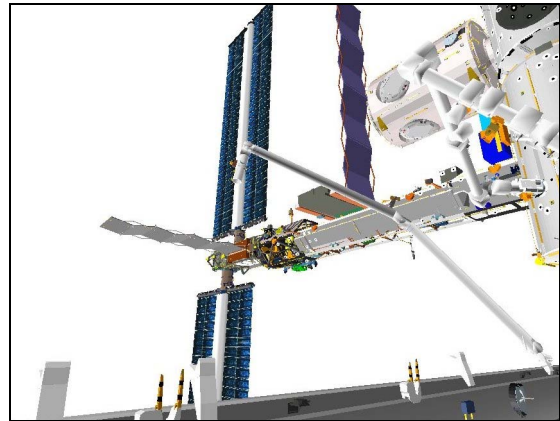

**CCTV C (-50,20)**



**P1 LOOB (95,30)**

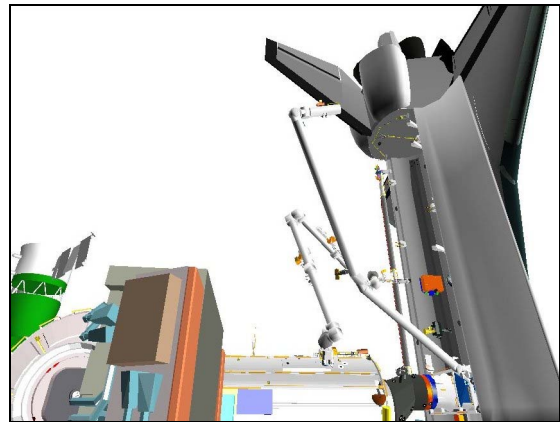

**P1 LOOB (95,30)**

Step 2:

Drive WY (-) from  $+11.5^\circ$  to  $0.0^\circ$

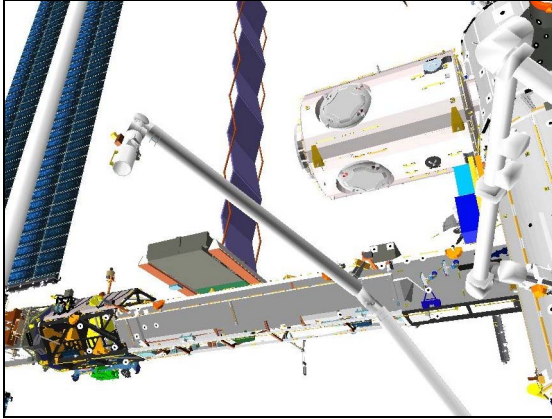

**CCTV B (-25,30)**

Step 3:

Drive WP (+) from  $-102.9^\circ$  to  $+5.0^\circ$

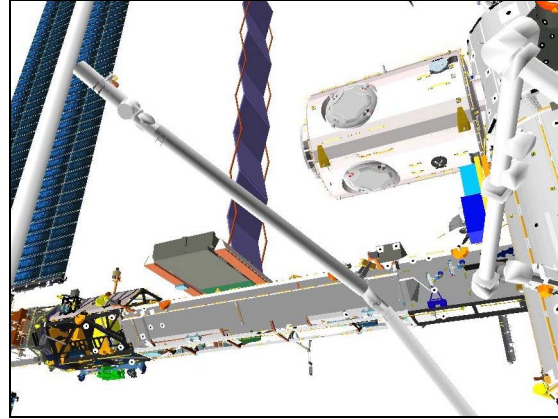

**CCTV B (-25,30)**

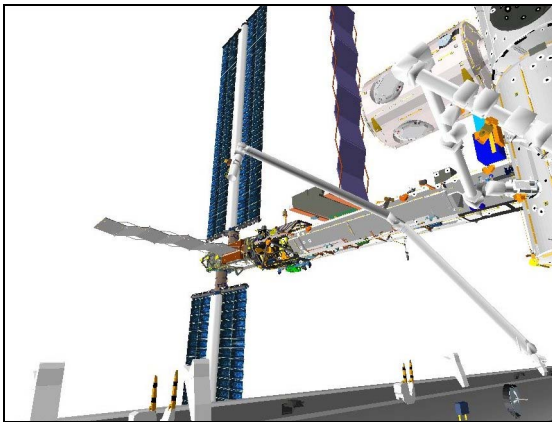

**CCTV C (-50,20)**

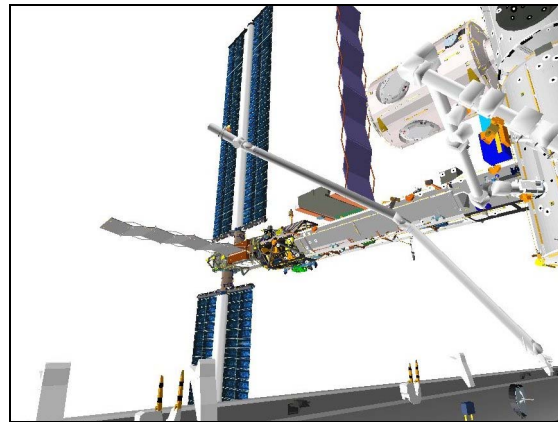

**CCTV C (-50,20)**



**P1 LOOB (95,30)**

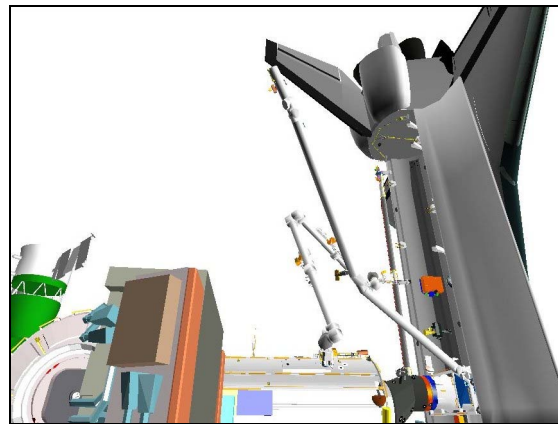

**P1 LOOB (95,30)**

Step 4:

Drive SP (-) from +63.5° to +25.0°

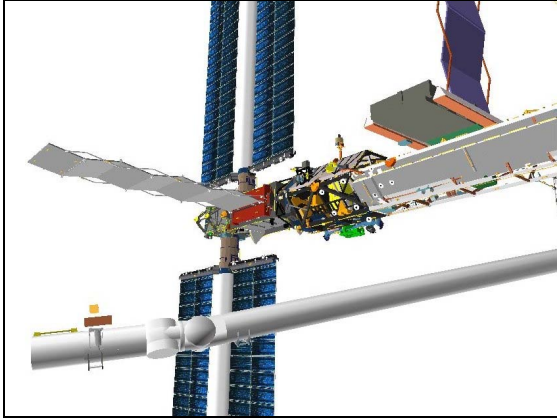

**CCTV B (-50,15)**

Step 5:

Drive EP (+) from -29.6° to -25.0°

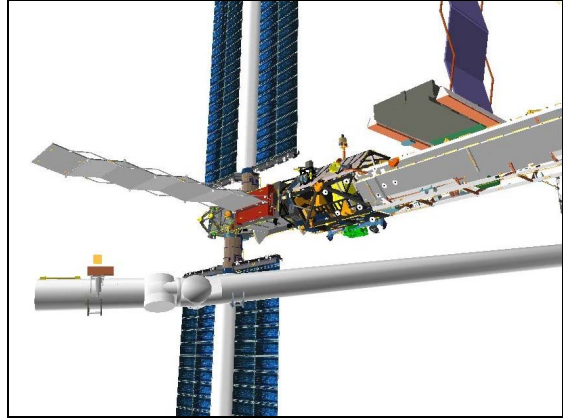

**CCTV B (-50,15)**

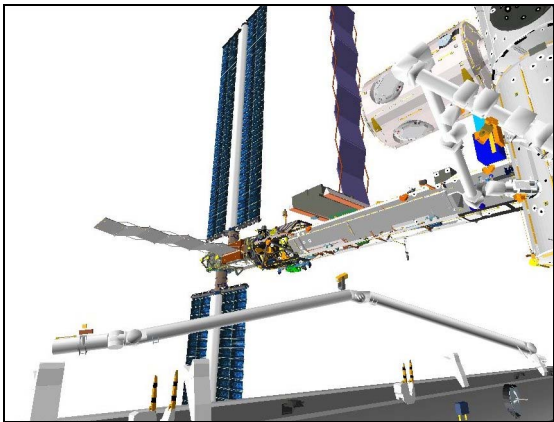

**CCTV C (-50,20)**

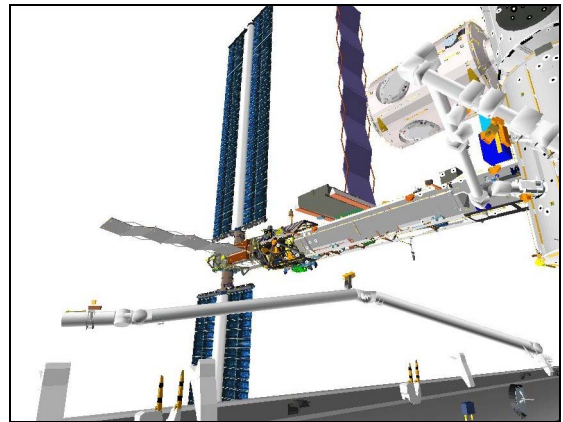

**CCTV C (-50,20)**

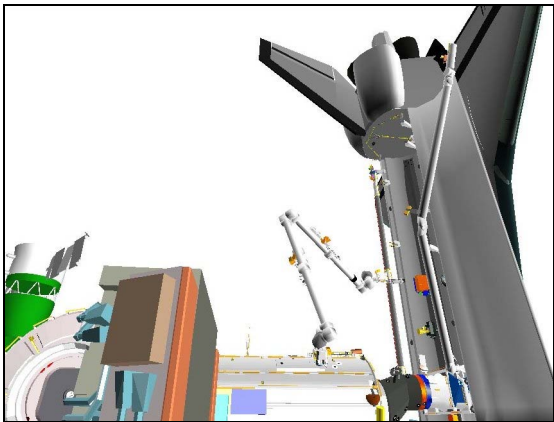

**P1 LOOB (95,30)**



**P1 LOOB (95,30)**

Step 6:

Drive SY (-) from +23.5° to 0.0°

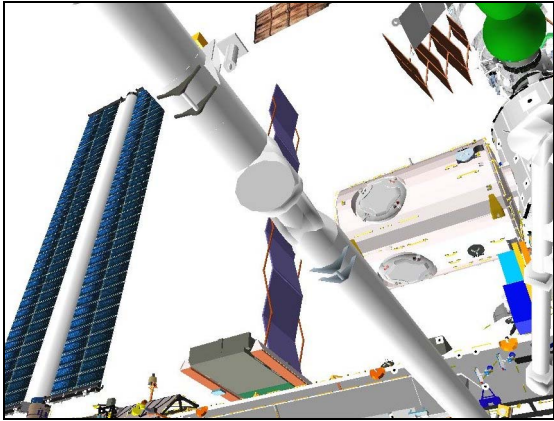

**CCTV B (-30,40)**

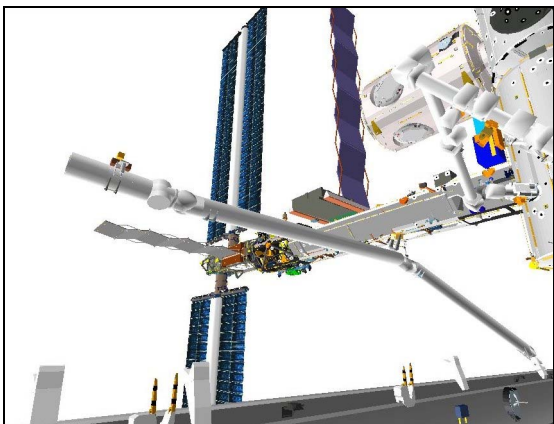

**CCTV C (-50,20)**

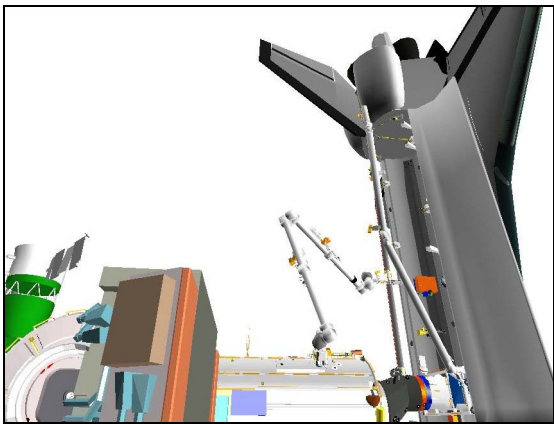

**P1 LOOB (95,30)**

OBSS REFERENCE DATA

OBSS JOINT ANGLES VS POR COORDINATES ..... FS 3-2

OBSS  
REF DATA

## OBSS JOINT ANGLES VS POR COORDINATES

### OBSS PRE-GRAPPLE AT HANDOFF

X	Y	Z	PITCH	YAW	ROLL	PL ID
-1012	+229	-685	284	270	270	2
-1015	-362	-688	284	0	270	0
SY	SP	EP	WP	WY	WR	
+23.5	+63.5	-29.6	-102.9	+11.5	-98.6	

\* display singularity

### OBSS HANDOFF

X	Y	Z	PITCH	YAW	ROLL	PL ID
-1029	+229	-614	284	270	270	2
-1032	-362	-618	284	360	270	
SY	SP	EP	WP	WY	WR	
+25.8	+66.3	-49.0	-85.9	+10.7	-100.7	

\* display singularity

### NODE 2 VIEWING

X	Y	Z	PITCH	YAW	ROLL	PL ID
-767	-775	-1068	86	7	276	2
-728	-698	-483	305	81	51	0
SY	SP	EP	WP	WY	WR	
+85.0	+36.7	-22.8	-2.0	-0.5	+15.0	

OBSS  
REF DATA

P6 NOMINAL

P6 HANDOFF FROM SSRMS TO SRMS .....	FS 4-2
SRMS TO SSRMS .....	FS 4-5
INSTALL VIEWING .....	FS 4-8

P6  
NOMINAL

# P6 HANDOFF FROM SSRMS TO SRMS

## 1. SRMS MNVR TO P6 PRE-GRAPPLE POSN

SM 94 PDRS CONTROL

√PL ID, ITEM 3: 0

√INIT ID, ITEM 24: 0

MON 1	A
MON 2	B(EE)
DNLK	P1 LOOB

RATE – as required (VERN within 10 ft)

BRAKES – OFF (tb-OFF)

MODE – SINGLE, ENTER

Mnvr to P6 PRE-GRAPPLE posn:

	SY	SP	EP	WP	WY	WR	
PRE-CRADLE	0.0	+25.0	-25.0	+5.0	0.0	0.0	
1: SP +		+55.1					
2: SY +	+95.3						
3: WP –				-48.7			
4: WY +					+16.7		
5: WR –						-71.5	
6: EP –			-70.4				
P6 PRE-GRAPPLE	+95.3	+55.1	-70.4	-48.7	+16.7	-71.5	
	X	Y	Z	PITCH	YAW	ROLL	PL ID
	-622	-552	-362	251	5	6	0

BRAKES – ON (tb-ON)

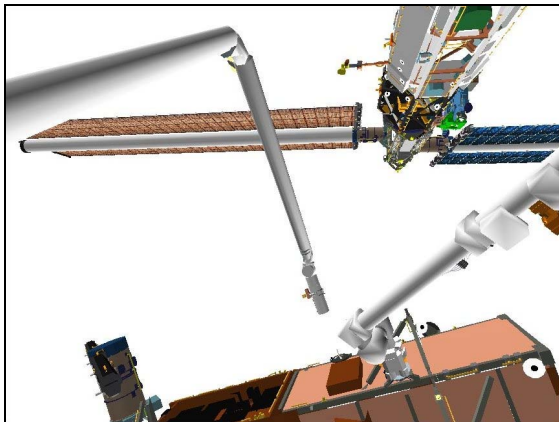

CCTV A (80,5)

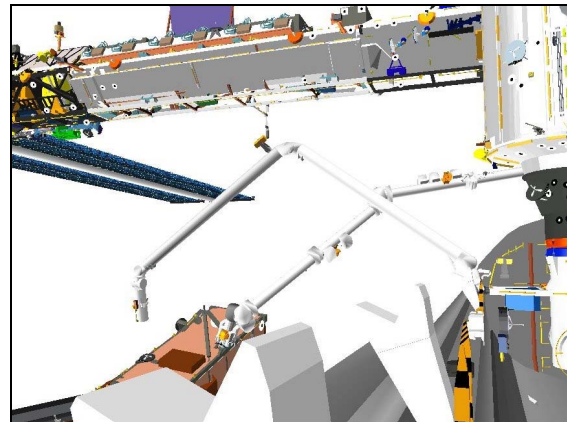

CCTV B (-20,5)

P6  
NOMINAL



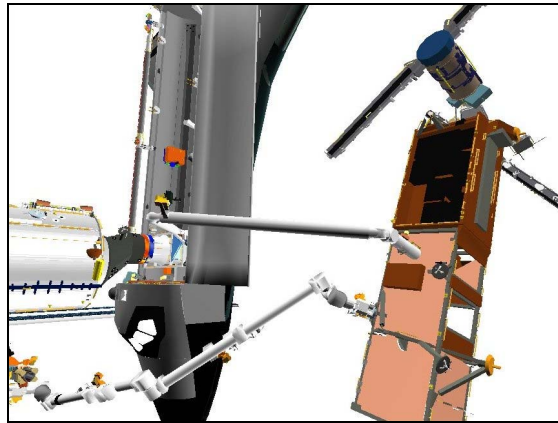

**P1 LOOB (135,10)**

2. ATTITUDE CONTROL CONFIGURATION

PCS

MSS: SSRMS: Thrusters: Thruster Controls for MSS Ops

Verify 'Desat Request:' – Inh

If using shuttle attitude control:  
DAP: FREE

3. P6 GRAPPLE

A7U

CCTV – config for grapple  
– install PDRS TARGET OVERLAY FOR CTVM  
– RMS WRIST, zoom 34.0 HFOV  
focus 5 ft

Maintain eyepoint approx 18 in when using grapple overlay

Notify SSRMS Operator, going in for P6 Grapple

RATE – VERN (RATE MIN tb-ON)  
BRAKES – OFF (tb-OFF)  
MODE – END EFF, ENTER

Mnvr to grapple envelope

**CAUTION**  
Monitor EE tb timing to prevent EE motor burnout

EE MODE – AUTO  
CAPTURE sw – depress (mom)

√	RIGID <input type="checkbox"/>	CLOSE <input type="checkbox"/>	CAPTURE <input type="checkbox"/>
	<input type="checkbox"/>	<input type="checkbox"/>	<input type="checkbox"/>
	DERIGID <input type="checkbox"/>	OPEN <input type="checkbox"/>	EXTEND <input type="checkbox"/>
	<input type="checkbox"/>	<input type="checkbox"/>	<input type="checkbox"/>

CRITICAL TIMES (28 sec total):  
CAPTURE tb – gray, then  
CLOSE tb – gray, 3 sec max, then  
RIGID tb – gray, 25 sec max

- \* If manual grapple reqd: \*
- \* EE MODE – MAN \*
- \* CAPTURE sw – depress (hold until CLOSE tb-gray, \*
- 3 sec max) \*
- \* MAN CONTR – RIGID (hold until RIGID tb-gray, \*
- 25 sec max) \*

EE MODE – OFF  
 BRAKES – ON (tb-ON)

**SM 94 PDRS CONTROL**

PL ID – ITEM 3 +3 EXEC  
 INIT ID – ITEM 24 +3 EXEC

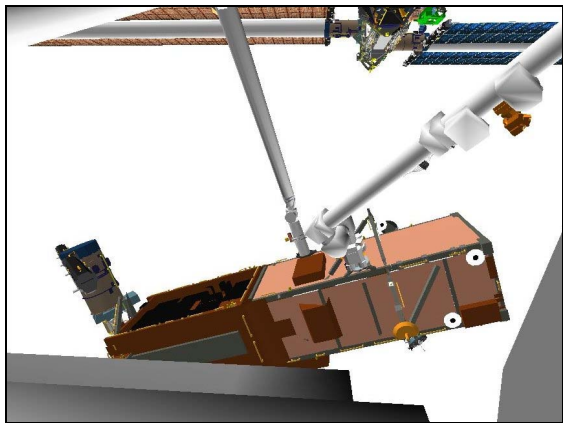

**CCTV A (85,-10)**

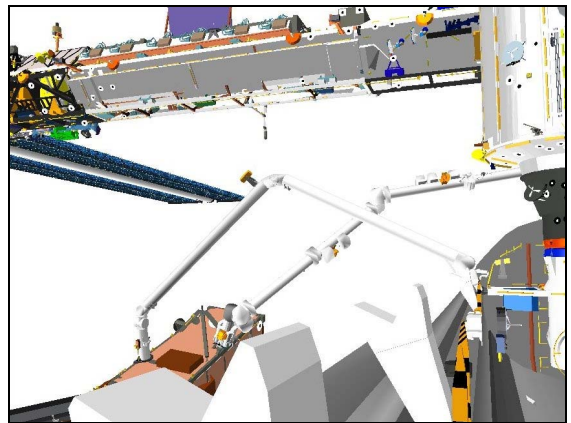

**CCTV B (-20,5)**

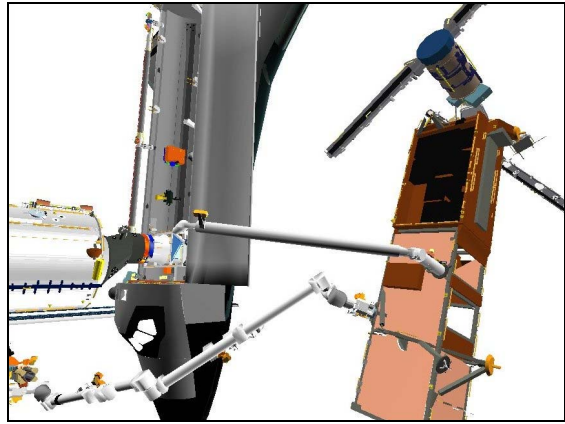

**P1 LOOB (135,10)**

Record POS/ATT and Joint Angles:

X	Y	Z	PITCH	YAW	ROLL	PL ID
						3
SY	SP	EP	WP	WY	WR	
Expected +97.4	+45.3	-65.7	-43.1	+15.7	-73.6	

A8U  
 MODE – not DIRECT (It off)  
 PARAM – PORT TEMP  
 JOINT – CRIT TEMP

Give SSRMS Operator GO to Ungrapple P6

Review GENERIC END EFFECTOR CUE CARD – ISS/SHUTTLE DOCKED OPS

## P6 HANDOFF FROM SRMS TO SSRMS

### 1. SETUP

MON 1	A (SSRMS Base Elb)
MON 2	EE (B)
DNLK	P1 LOOB

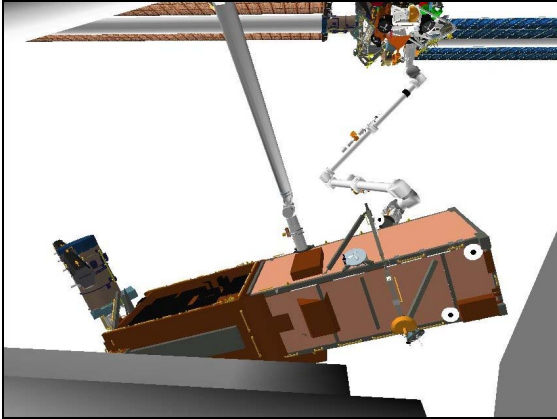

**CCTV A (85,-10)**

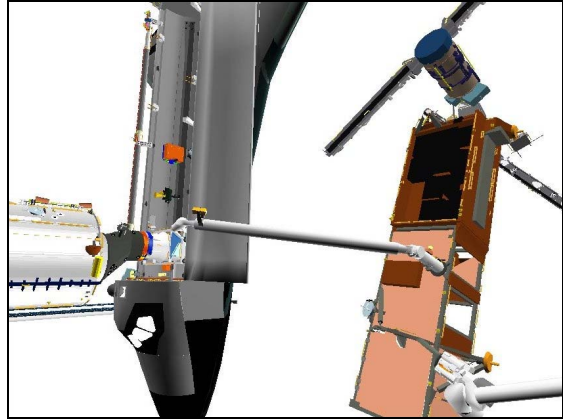

**P1 LOOB (135,10)**

### 2. P6 UNGRAPPLE

On SSRMS Operator GO to Ungrapple P6 and maneuver to PRE-CRADLE,

**SM 94 PDRS CONTROL**

PL ID – ITEM 3 +0 EXEC

INIT ID – ITEM 24 +0 EXEC

#### NOTE

CONTR ERR It and 'S96 PDRS CNTL' msg may occur due to Consistency/Envelope Check error

THC RATE – COARSE (RATE MIN tb-OFF)

**SM 94 PDRS CONTROL**

AUTO BRAKE INH – ITEM 10 EXEC (\*)

A8U BRAKES – OFF (tb-OFF)

MODE – TEST, ENTER  
Wait 5 sec

BRAKES – ON (tb-ON)

**SM 94 PDRS CONTROL**

AUTO BRAKE ENA – ITEM 9 EXEC (\*)

RATE – VERN (RATE MIN tb-ON)  
BRAKES – OFF (tb-OFF)  
MODE – END EFF, ENTER

#### CAUTION

Monitor EE tb timing to prevent EE motor burnout

**NOTE**

When OPEN tb-gray, mnvr arm clear of GF

EE MODE – AUTO

RELEASE sw – depress (mom)

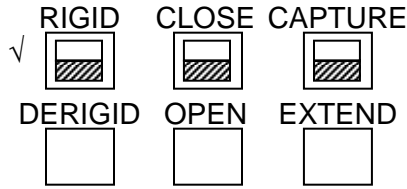

**CRITICAL TIMES (28 sec total):**

DERIGID tb – gray, 5 sec max, then

OPEN tb – gray, 3 sec max, then

EXTEND tb – gray, 20 sec max

EE MODE – OFF

- |                                                      |   |
|------------------------------------------------------|---|
| * If manual release reqd:                            | * |
| * EE MODE – MAN                                      | * |
| * MAN CONTR – DERIGID (hold until DERIGID tb-gray,   | * |
| * 5 sec max)                                         | * |
| * RELEASE sw – depress (hold until OPEN tb-gray,     | * |
| * 3 sec max)                                         | * |
| * Mnvr arm clear, then                               | * |
| * EE MAN CONTR – DERIGID (hold until EXTEND tb-gray, | * |
| * 20 sec max)                                        | * |
| * MODE – OFF                                         | * |

THC/RHC

Mnvr to UNGRAPPLE BACKOFF posn:

X	Y	Z	PITCH	YAW	ROLL	PL ID
-622	-552	-362	251	5	6	0
SY	SP	EP	WP	WY	WR	
+95.3	+55.1	-70.4	-48.7	+16.7	-71.5	

BRAKES – ON (tb-ON)

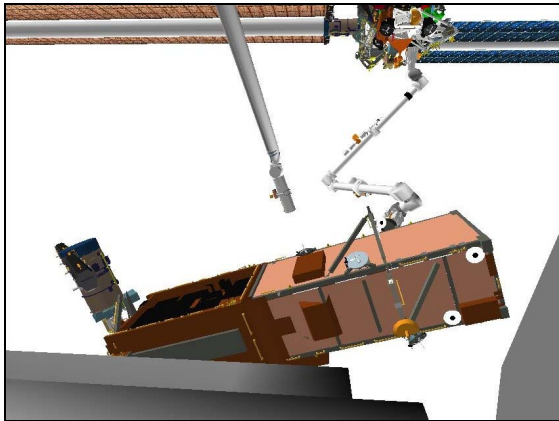

**CCTV A (85,-10)**

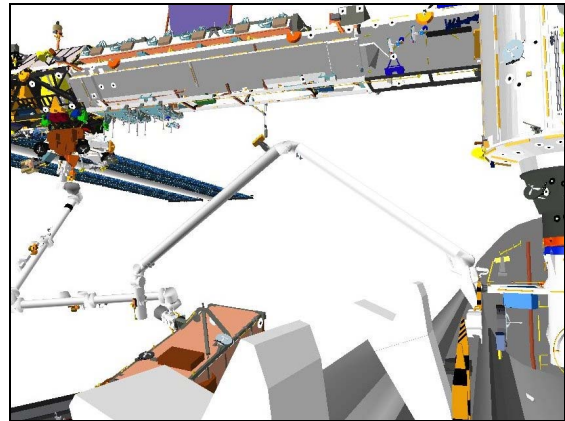

**CCTV B (-20,5)**

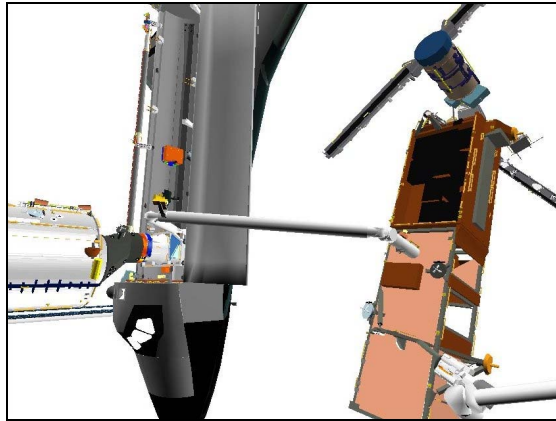

**P1 LOOB (135,10)**

If using shuttle attitude control and attitude maintenance required:  
 Configure DAP per RMS DAPs, then perform RATE DAMPING (ORB OPS FS, REBOOST/DAP; DOCKED DAP REFERENCE)

When in attitude,  
 DAP: FREE

Notify SSRMS Operator, P6 Ungrapple complete

3. SJ MNVR TO PRE-CRADLE

RATE – as reqd (VERN within 10 ft)

BRAKES – OFF (tb-OFF)

MODE – SINGLE, ENTER

Mnvr to PRE-CRADLE posn:

	SY	SP	EP	WP	WY	WR	
UNGRPL	+95.3	+55.1	-70.4	-48.7	+16.7	-71.5	
BACKOFF			-25.0				
1: EP +				+5.0			
2: WP +					0.0		
3: WY –						0.0	
4: WR +							
5: SY –	0.0						
6: SP –		+25.0					
PRE-CRADLE	0.0	+25.0	-25.0	+5.0	0.0	0.0	
	X	Y	Z	PITCH	YAW	ROLL	PL ID
	-1261	-146	-551	5	2	0	0

BRAKES – ON (tb-ON)

√MODE – not DIRECT

PARAM – PORT TEMP

JOINT – CRIT TEMP

## P6 INSTALL VIEWING

### 1. SETUP

SM 94 PDRS CONTROL

√PL ID, ITEM 3: 0

√INIT ID, ITEM 24: 0

MON 1	A
MON 2	Elbow (EE)
DNLK	P1 LOOB (MBS Mast)

### 2. MNVR TO P6 INSTALL VIEWING POSN

On SSRMS Operator GO, maneuver to P6 INSTALL VIEWING position

A8U

RATE – as required (VERN within 10 ft)

BRAKES – OFF (tb-OFF)

MODE – SINGLE, ENTER

Mnvr to P6 INSTALL VIEWING posn:

	SY	SP	EP	WP	WY	WR	
PRE-CRADLE	0.0	+25.0	-25.0	+5.0	0.0	0.0	
1: WP +				+96.4			
2: WY +					+8.2		
3: WR +						+22.9	
4: SY +	+94.8						
5: SP –		+16.7					
6: EP –			-63.4				
P6 INSTALL VIEW	+94.8	+16.7	-63.4	+96.4	+8.2	+22.9	
	X	Y	Z	PITCH	YAW	ROLL	PL ID
	-631	-537	-213	111	57	252	0

BRAKES – ON (tb-ON)

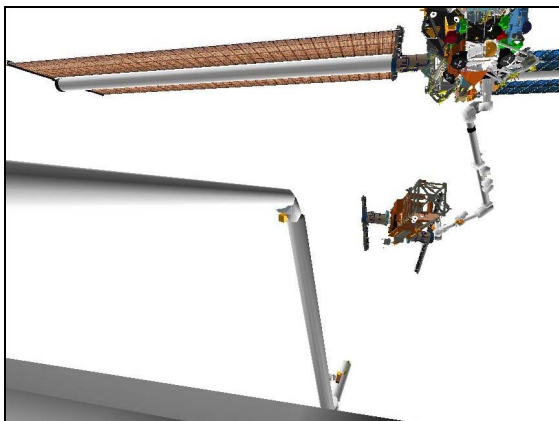

**CCTV A (75,-5)**

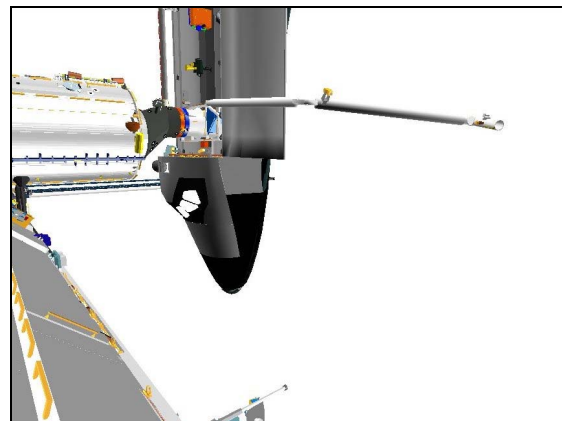

**P1 LOOB (130,-10)**

√MODE – not DIRECT (It off)

PARAM – PORT TEMP

JOINT – CRIT TEMP

Give SSRMS Operator GO for P6 Install

3. CONFIG CAMERAS FOR VIEWING

MON 1	EE (Elbow)
MON 2	A

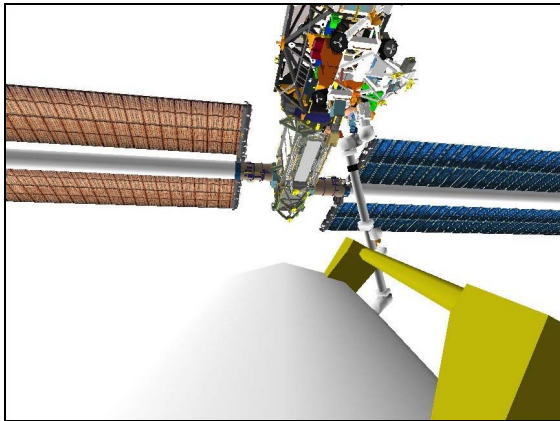

**EE**

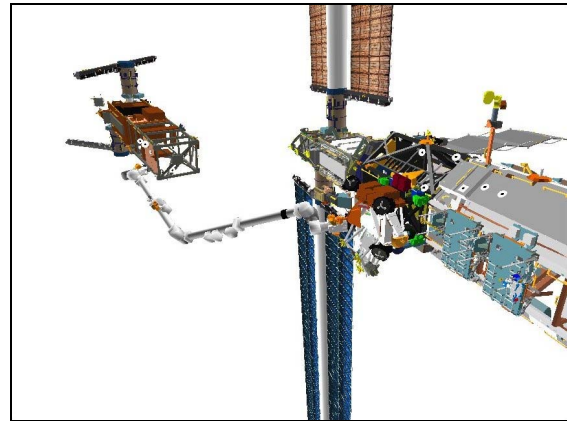

**ELBOW (80,25)**

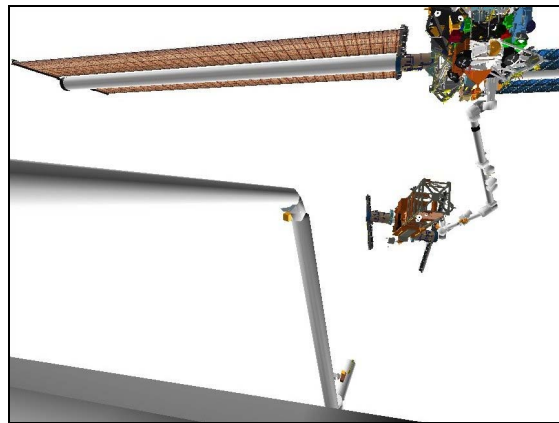

**CCTV A (75,-5)**

This Page Intentionally Blank



P6 CONTINGENCY

P6 SJ HANDOFF FROM SSRMS TO SRMS .....	FS 5-2
SRMS TO SSRMS .....	FS 5-10

# P6 SJ HANDOFF FROM SSRMS TO SRMS

- A7U 1. SJ MNVR TO PRE-GRAPPLE POSN  
CCTV – perform PAN/TILT RESET

SM 94 PDRS CONTROL

- √PL ID, ITEM 3: 0
- √INIT ID, ITEM 24: 0

MON 1	A
MON 2	B (EE)
DNLK	P1 LOOB

RATE – as required (VERN within 10 ft)  
BRAKES – OFF (tb-OFF)  
MODE – best available

Mnvr to P6 PRE-GRAPPLE posn (reference pictures as reqd):

	SY	SP	EP	WP	WY	WR	
PRE-CRADLE	0.0	+25.0	-25.0	+5.0	0.0	0.0	
1: SP +		+55.1					
2: SY +	+95.3						
3: WP –				-48.7			
4: WY +					+16.7		
5: WR –						-71.5	
6: EP –			-70.4				
P6 PRE-GRAPPLE	+95.3	+55.1	-70.4	-48.7	+16.7	-71.5	
	X	Y	Z	PITCH	YAW	ROLL	PL ID
	-622	-552	-362	251	5	6	0

BRAKES – ON (tb-ON)

Start:  
Pre-cradle

Step 1:  
Drive SP (+) 25.0 to 55.1

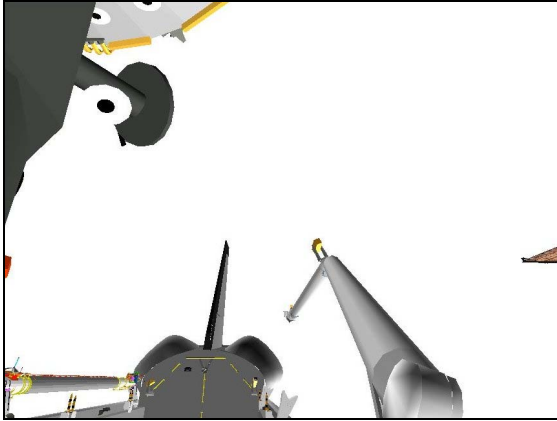

**CCTV A (5,25)**

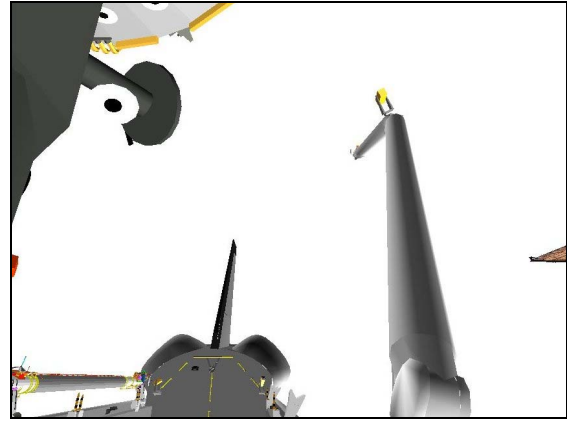

**CCTV A (5,25)**

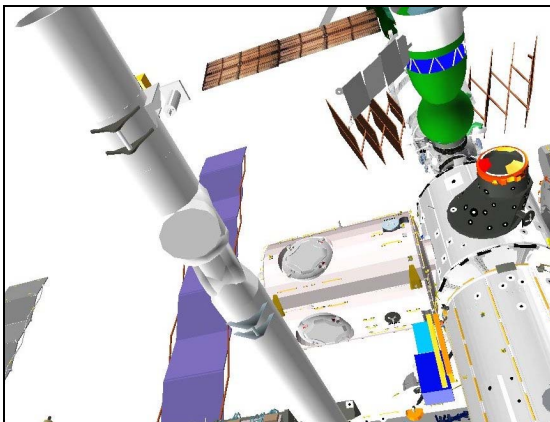

**CCTV B (-20,45)**

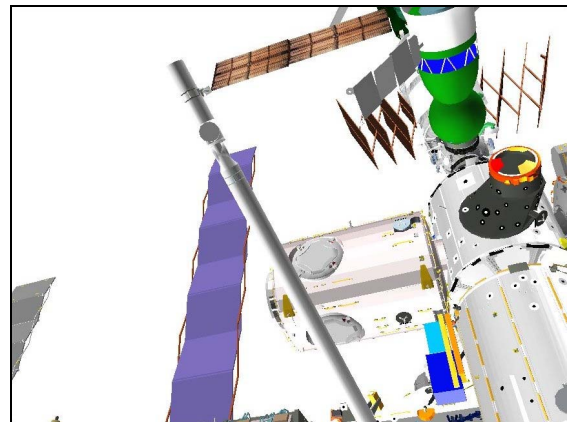

**CCTV B (-20,45)**



**P1 LOOB (125,30)**



**P1 LOOB (125, 30)**

Step 2:  
Drive SY (+) for 0.0 to +95.3

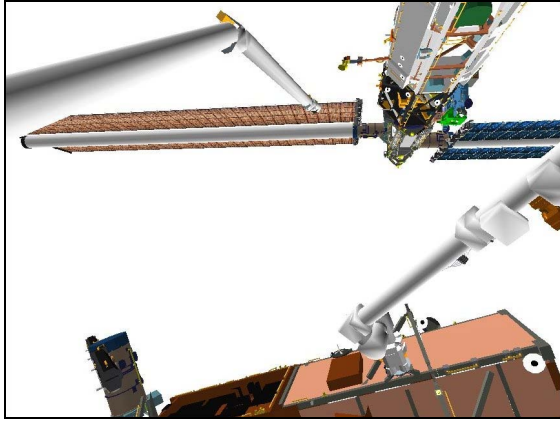

**CCTV A (80,5)**

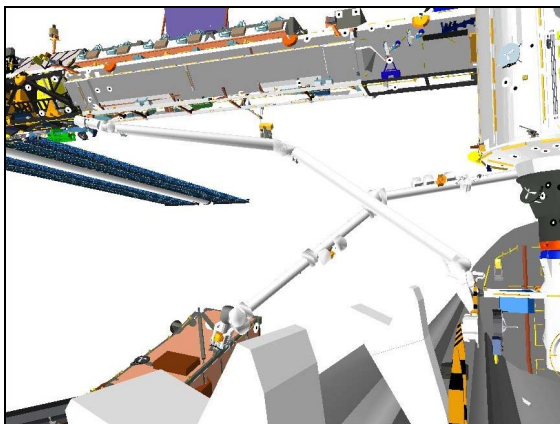

**CCTV B (-20,5)**

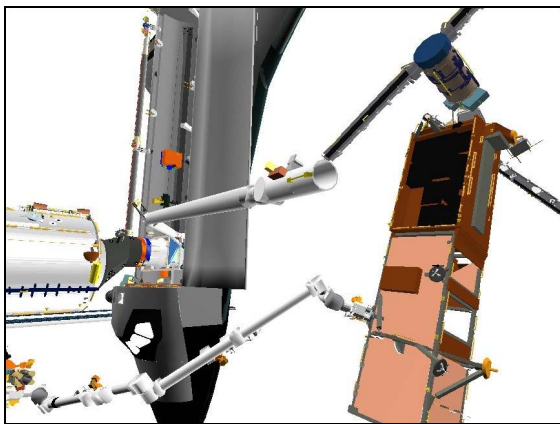

**P1 LOOB (135,10)**

Step 3:  
Drive WP (-) from +5.0 to -48.7

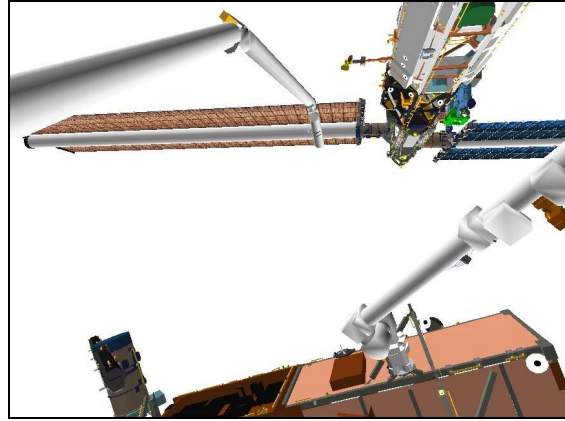

**CCTV A (80,5)**

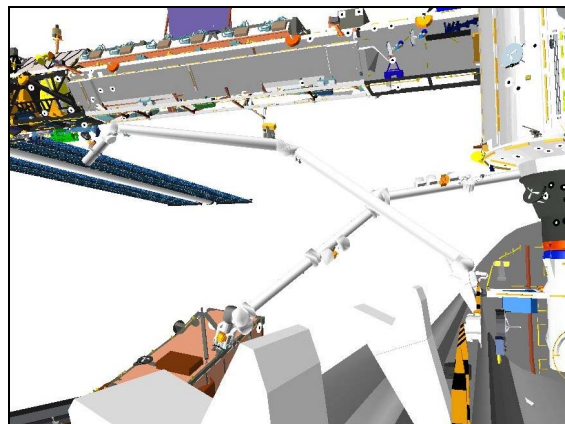

**CCTV B (-20,5)**

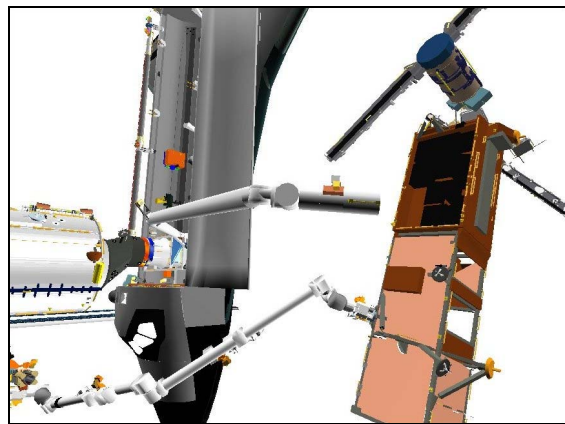

**P1 LOOB (135,10)**

Step 4:  
Drive WY (+) for 0.0 to +16.7

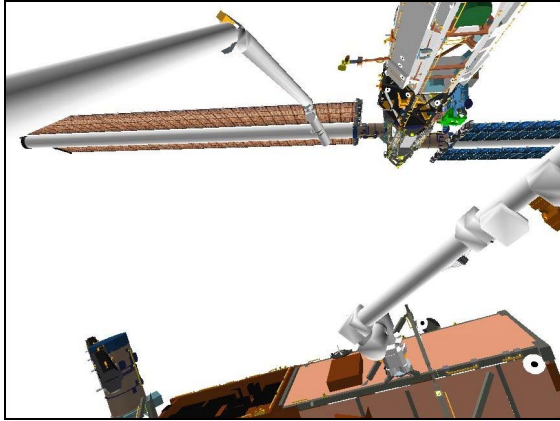

**CCTV A (80,5)**

Step 5:  
Drive WR (-) from 0.0 to -71.5

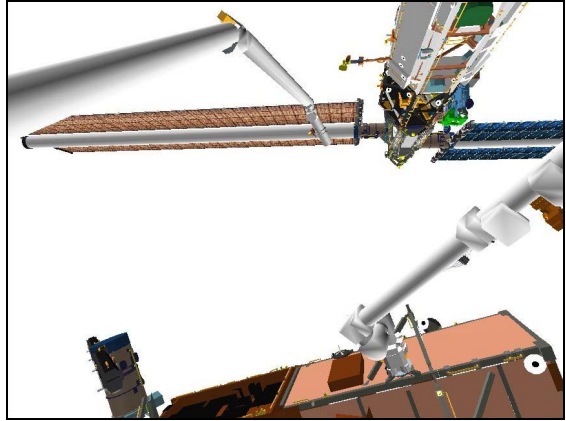

**CCTV A (80,5)**

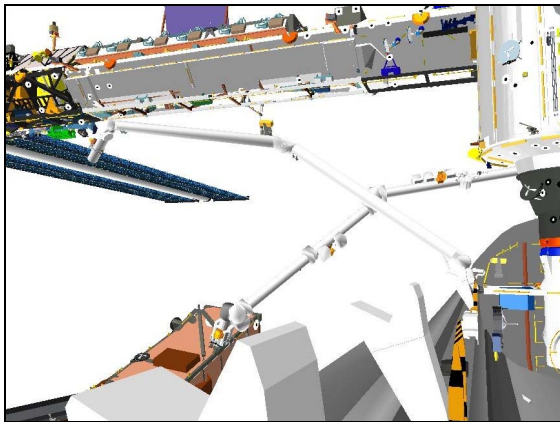

**CCTV B (-20,5)**

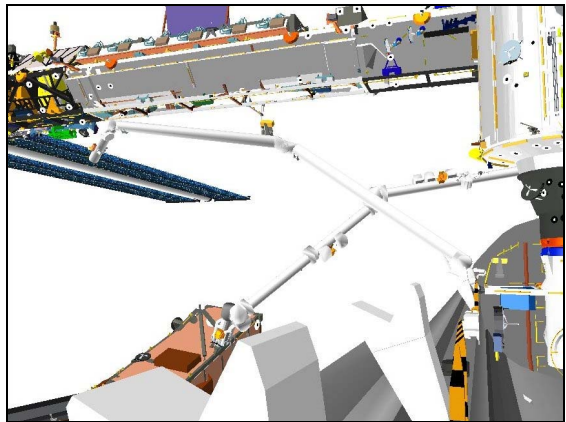

**CCTV B (-20,5)**

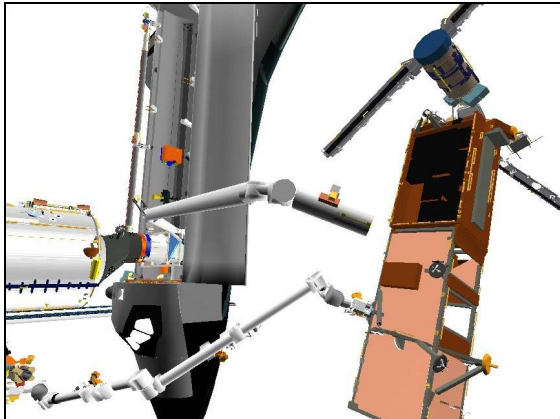

**P1 LOOB (135,10)**

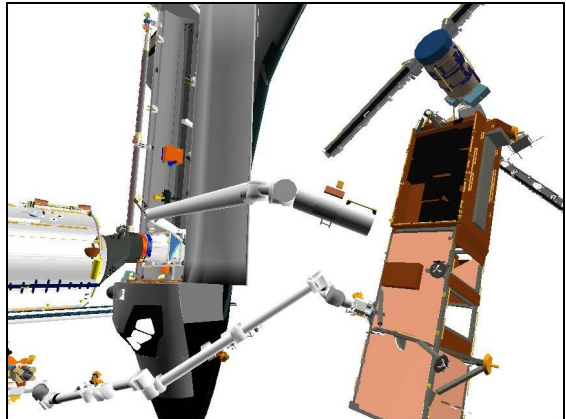

**P1 LOOB (135,10)**

Step 6:  
Drive EP (-) from -25.0 to -70.4

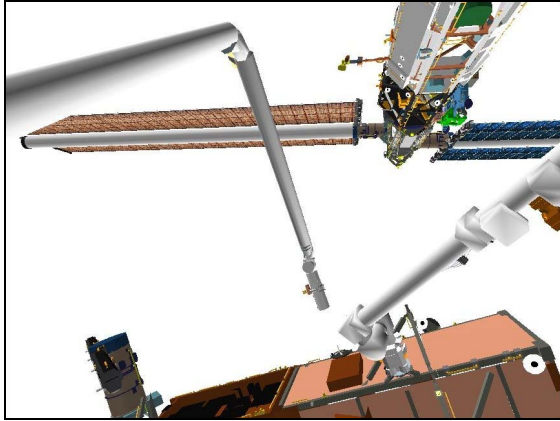

**CCTV A (80,5)**

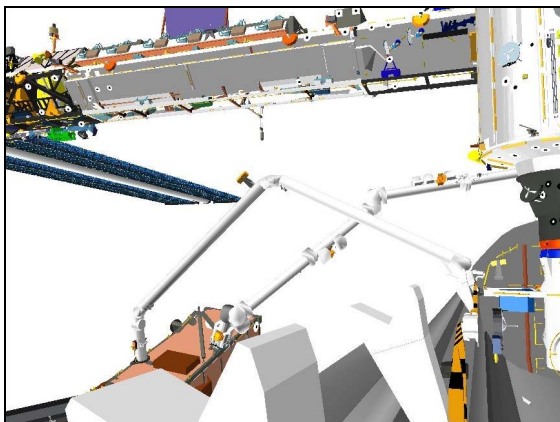

**CCTV B (-20,5)**

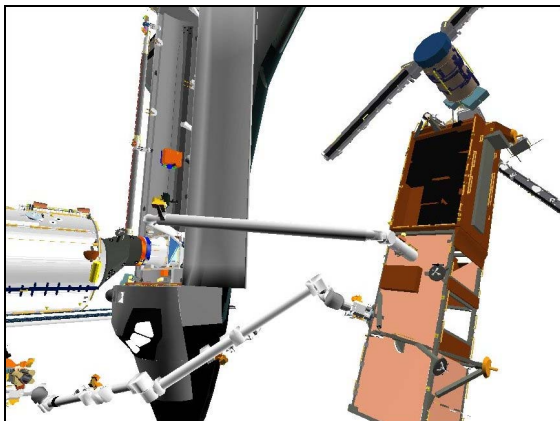

**P1 LOOB (135,10)**

2. ATTITUDE CONTROL CONFIGURATION

PCS

MSS: SSRMS: Thrusters: 

Thruster Controls for MSS Ops
-------------------------------

Verify 'Desat Request:' – Inh

If using shuttle attitude control:

DAP: FREE

3. SJ MNVR TO P6 GRAPPLE

A7U

CCTV – config for grapple

– install PDRS TARGET OVERLAY FOR CTVM

– RMS WRIST, zoom 34.0 HFOV

focus 5 ft

– fully zoom out for SJ pictures

Maintain eyepoint ~18 in when using grapple overlay

MON 1	A
MON 2	B (EE)
DNLK	P1 LOOB

Notify SSRMS operator going in for P6 Grapple

RATE – VERN (RATE MIN tb-ON)

BRAKES – OFF (tb-OFF)

MODE – best available

Drive joints per P6 SJ GRAPPLE WRIST CCTV OVERLAY and diagram until EE within grapple envelope

### P6 SJ GRAPPLE

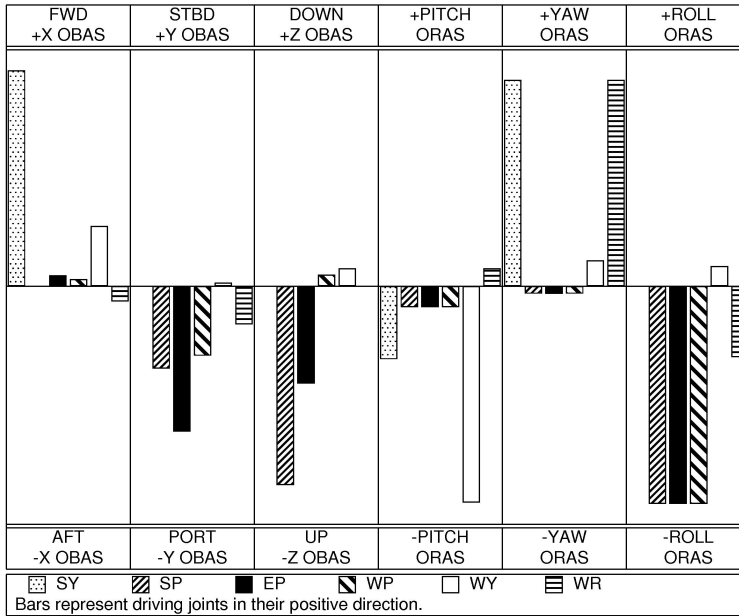

To get:	Drive:
+X (fwd)	+SY
+Y (stbd)	-EP, -WP
+Z (down)	-SP, -EP

To get:	Drive:
+PITCH	-WY
+YAW	+WR, +SY
+ROLL	-WP, -EP

Driving:	Results In:
+SY	+X (fwd), +YAW
+SP	-Z (up), -ROLL
+EP	-Y (port), -ROLL

Driving:	Results In:
+WP	-Y (port), -ROLL
+WY	+X (fwd), -PITCH
+WR	-Y (port), +YAW

$\Delta SY$	$\Delta SP$	$\Delta EP$	$\Delta WP$	$\Delta WY$	$\Delta WR$
+2.1	-9.8	+4.7	+5.6	-1.0	-2.1

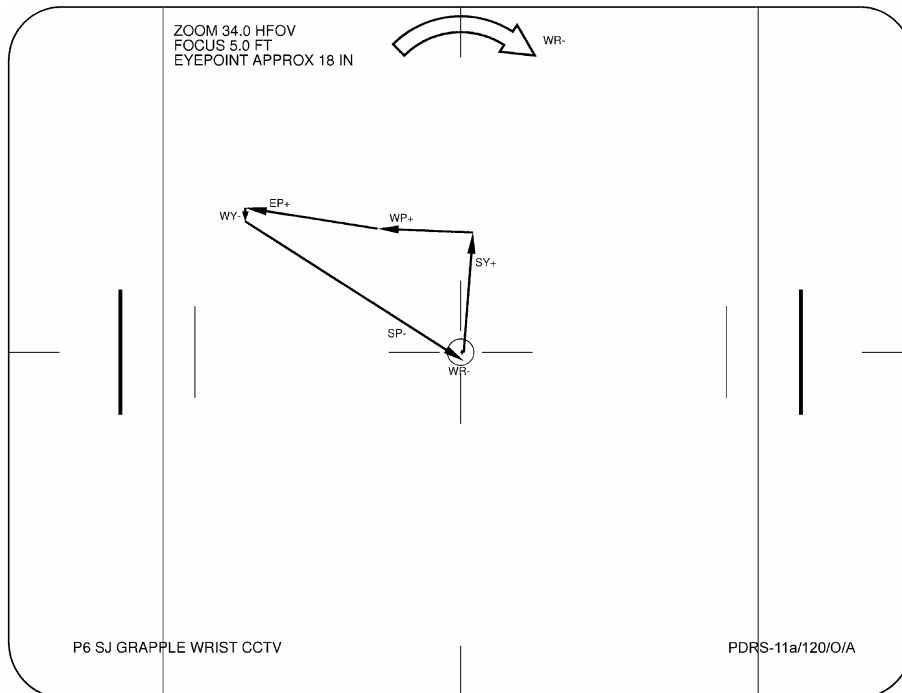



4. P6 GRAPPLE

**CAUTION**  
Monitor EE tb timing to prevent EE motor burnout

EE MODE – AUTO (if available)  
CAPTURE sw – depress (mom)

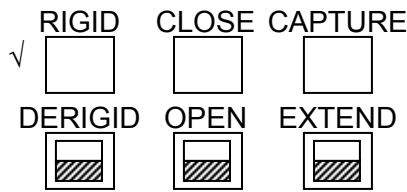

CRITICAL TIMES (28 sec total):  
CAPTURE tb – gray, then  
CLOSE tb – gray, 3 sec max, then  
RIGID tb – gray, 25 sec max

- \* If manual grapple reqd: \*
- \* EE MODE – MAN \*
- \* CAPTURE sw – depress (hold until CLOSE tb-gray, \*
- 3 sec max) \*
- \* MAN CONTR – RIGID (hold until RIGID tb-gray, \*
- 25 sec max) \*

EE MODE – OFF  
BRAKES – ON (tb-ON)

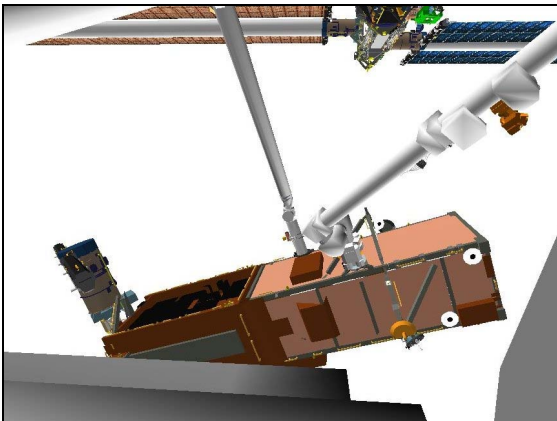

**CCTV A (85,-10)**

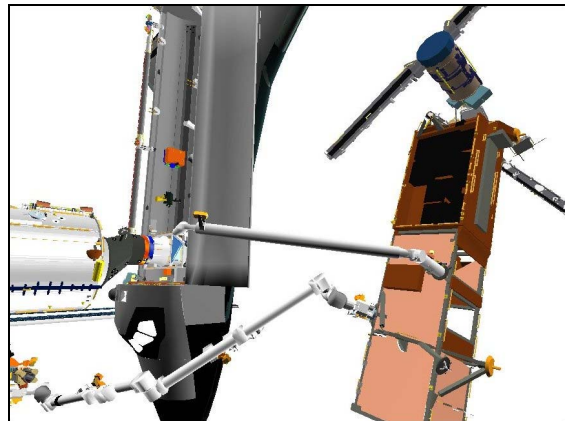

**P1 LOOB (135,10)**

**SM 94 PDRS CONTROL**  
PL ID, ITEM 3 +3 EXEC  
INIT ID, ITEM 24 +3 EXEC

Record POS/ATT and Joint Angles:

	X	Y	Z	PITCH	YAW	ROLL	PL ID
							3
	SY	SP	EP	WP	WY	WR	
Expected	+97.4	+45.3	-65.7	-43.1	+15.7	-73.6	

A8U  
MODE – not DIRECT (It off)  
PARAM – PORT TEMP  
JOINT – CRIT TEMP

Give SSRMS Operator GO to Ungrapple P6

Review GENERIC END EFFECTOR CUE CARD – ISS/SHUTTLE DOCKED OPS

## P6 SJ HANDOFF FROM SRMS TO SSRMS

1. SETUP  
A7U CCTV – RMS WRIST, zoom 34.0 HFOV  
focus 5 ft

MON 1	A (SSRMS Base Elb)
MON 2	EE (B)
DNLK	P1 LOOB

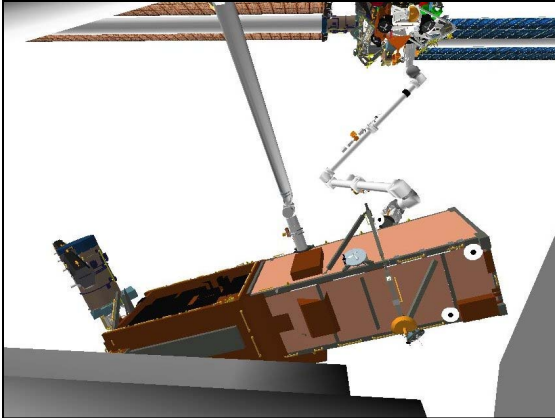

**CCTV A (85,-10)**



**P1 LOOB (135,10)**

2. P6 UNGRAPPLE  
On SSRMS Operator GO to Ungrapple P6 and maneuver to PRE-CRADLE

### NOTE

If SINGLE MODE available, CONTR ERR It and 'S96 PDRS CNTL' msg may occur due to Consistency/Envelope Check error

RATE – COARSE (RATE MIN tb-OFF)

**SM 94 PDRS CONTROL**

AUTO BRAKE INH – ITEM 10 EXEC (\*)

BRAKES – OFF (tb-OFF)

MODE – TEST, ENTER

Wait 5 sec

BRAKES – ON (tb-ON)

**SM 94 PDRS CONTROL**

AUTO BRAKE ENA – ITEM 9 EXEC (\*)

PL ID – ITEM 3 +0 EXEC

INIT ID – ITEM 24 +0 EXEC

RATE – VERN (RATE MIN tb-ON)

BRAKES – OFF (tb-OFF)

MODE – best available

### CAUTION

Monitor EE tb timing to prevent EE motor burnout

SM 169 PDRS STATUS

EE MODE – MAN

MAN CONTR – DERIG (hold until DERIGID tb-gray, 5 sec max)

RELEASE sw – depress (hold until OPEN tb-gray, 3 sec max)

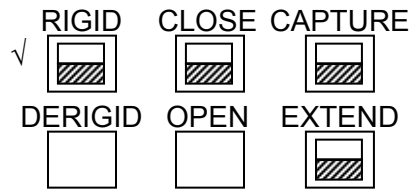

CRITICAL TIMES (8 sec total):

DERIGID tb – gray, 5 sec max, then

OPEN tb – gray, 3 sec max

3. MNVR ARM CLEAR OF P6

Drive joints per P6 SJ UNGRAPPLE WRIST CCTV OVERLAY until EE clear of grapple fixture

### P6 SJ UNGRAPPLE

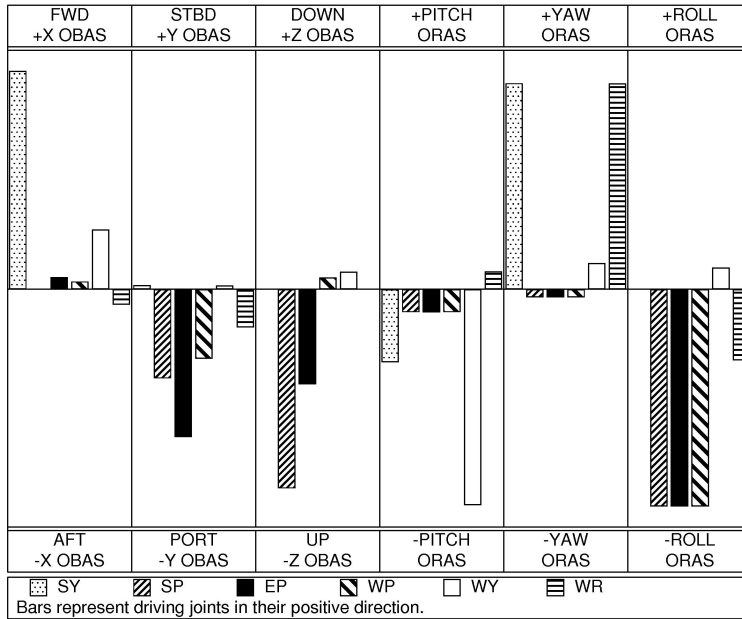

To get:	Drive:
+X (fwd)	+SY
+Y (stbd)	-EP, -WP
+Z (down)	-SP, -EP

To get:	Drive:
+PITCH	-WY
+YAW	+WR, +SY
+ROLL	-WP, -EP

Driving:	Results In:
+SY	+X (fwd), +YAW
+SP	-Z (up), -ROLL
+EP	-Y (port), -ROLL

Driving:	Results In:
+WP	-Y (port), -ROLL
+WY	+X (fwd), -PITCH
+WR	-Y (port), +YAW

$\Delta SY$	$\Delta SP$	$\Delta EP$	$\Delta WP$	$\Delta WY$	$\Delta WR$
-2.1	+9.8	-4.7	-5.6	+1.0	+2.1

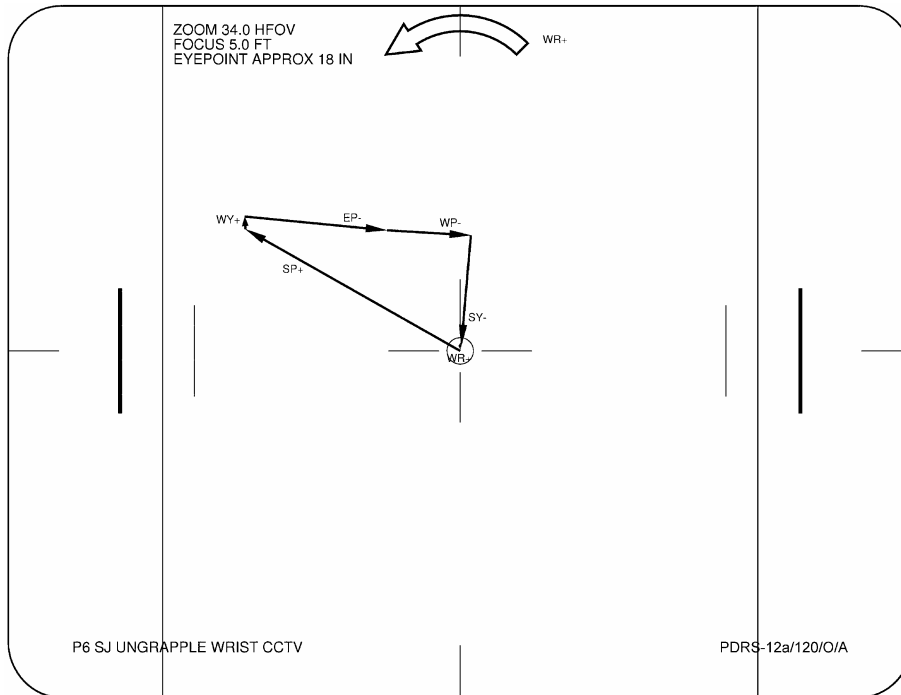

EE MAN CONTR – DERIG (hold until EXTEND tb-gray, 20 sec max)  
MODE – OFF

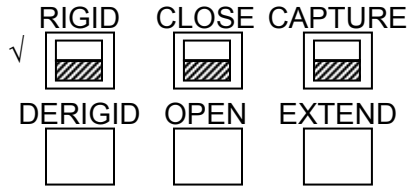

CRITICAL TIMES (20 sec total):  
EXTEND tb – gray, 20 sec max

BRAKES – ON (tb-ON)  
✓MODE – not DIRECT

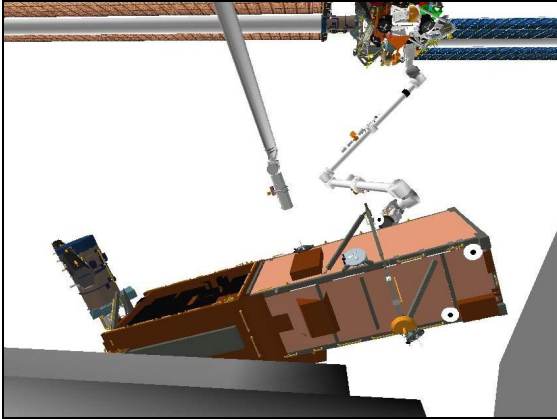

**CCTV A (85,-10)**

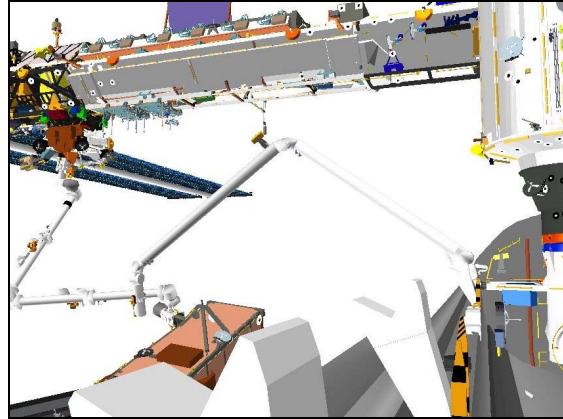

**CCTV B (-20,5)**

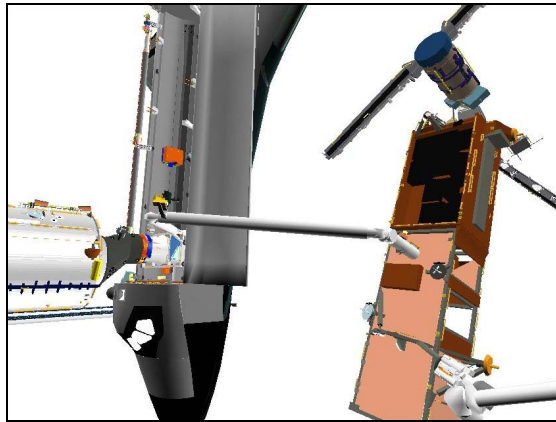

**P1 LOOB (135,10)**

If using shuttle attitude control and attitude maintenance required:  
Configure DAP per RMS DAPs, then perform RATE DAMPING (ORB OPS FS,  
REBOOST/DAP; DOCKED DAP REFERENCE)

When in attitude,  
DAP: FREE

Notify SSRMS Operator P6 Ungrapple complete

4. SJ MNVR TO PRE-CRADLE  
 RATE – as required (VERN within 10 ft)  
 BRAKES – OFF (tb-OFF)  
 MODE – best available

Mnvr to PRE-CRADLE posn (reference pictures as reqd):

	SY	SP	EP	WP	WY	WR	
UNGRPL	+95.3	+55.1	-70.4	-48.7	16.7	-71.5	
BACKOFF			-25.0				
1: EP +				+5.0			
2: WP +					0.0		
3: WY –						0.0	
4: WR +							
5: SY –	0.0						
6: SP –		+25.0					
PRE-CRADLE	0.0	+25.0	-25.0	+5.0	0.0	0.0	
	X	Y	Z	PITCH	YAW	ROLL	PL ID
	-1261	-146	-551	5	2	0	0

- BRAKES – ON (tb-ON)  
 √MODE – not DIRECT  
 PARAM – PORT TEMP  
 JOINT – CRIT TEMP

Step 1:  
Drive EP (+) from -70.4 to -25.0

Step 2:  
Drive WP (+) from -48.7 to +5.0

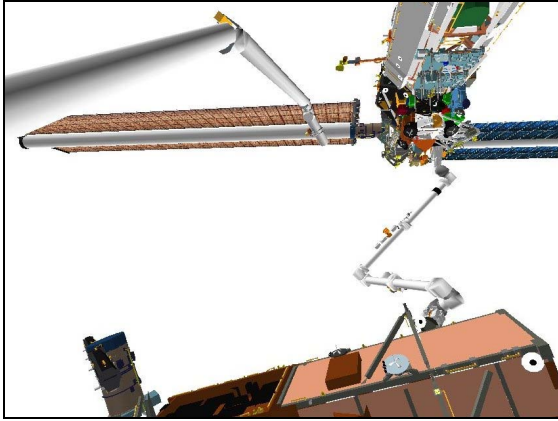

**CCTV A (80,5)**

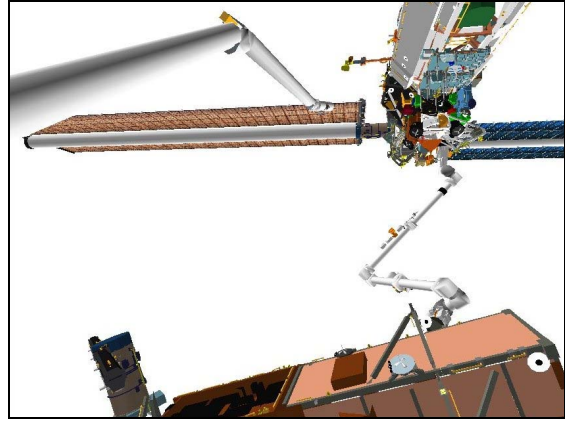

**CCTV A (80,5)**

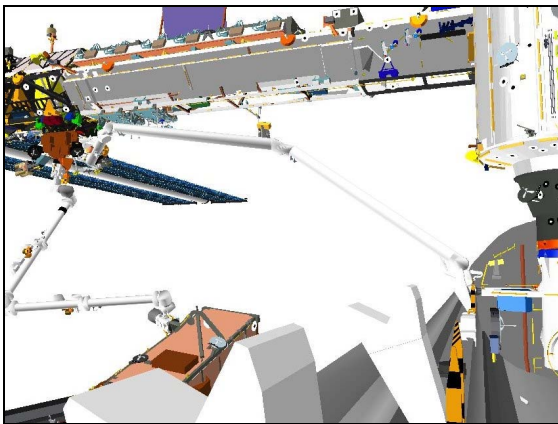

**CCTV B (-20,5)**

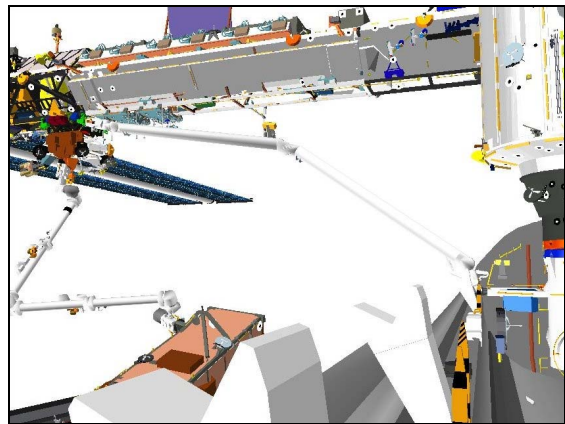

**CCTV B (-20,5)**

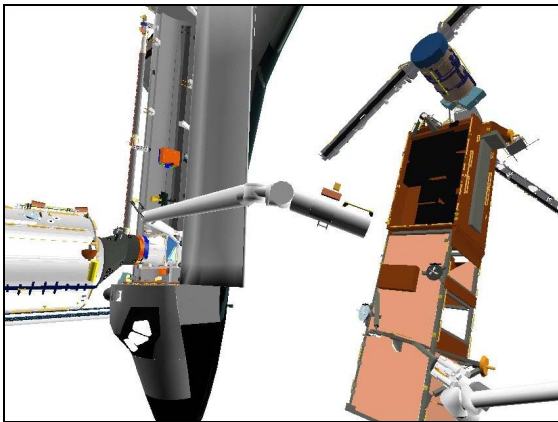

**P1 LOOB (135,10)**

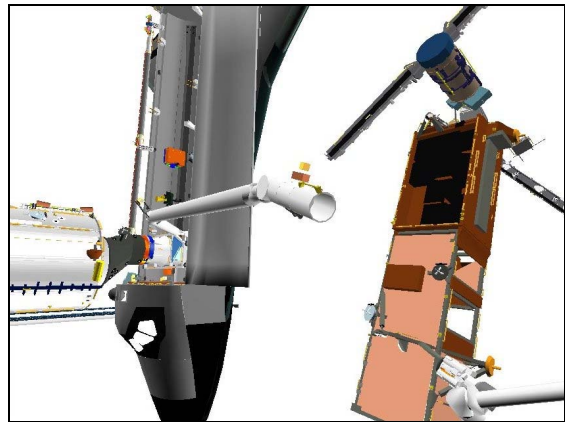

**P1 LOOB (135,10)**



Step 3:  
Drive WY (-) from +16.7 to 0.0

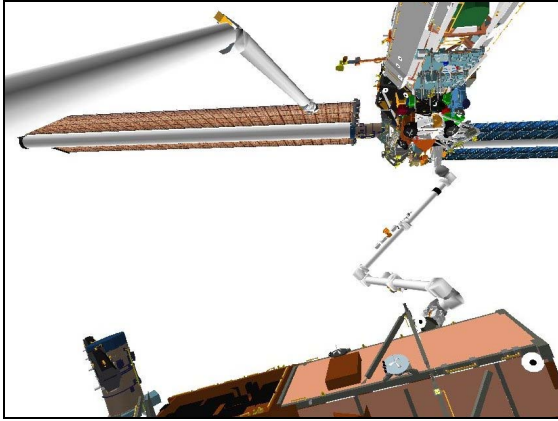

**CCTV A (80,5)**

Step 4:  
Drive WR (+) from -71.5 to 0.0

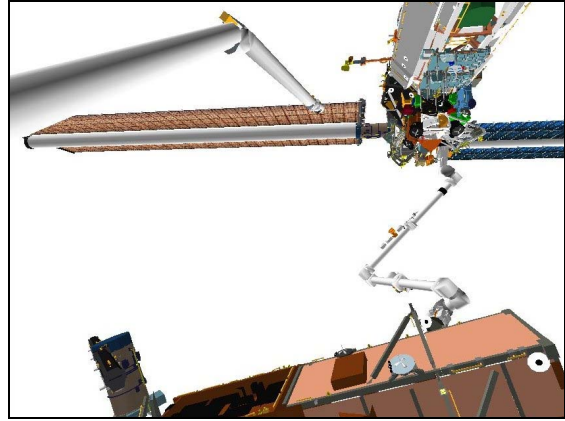

**CCTV A (80,5)**

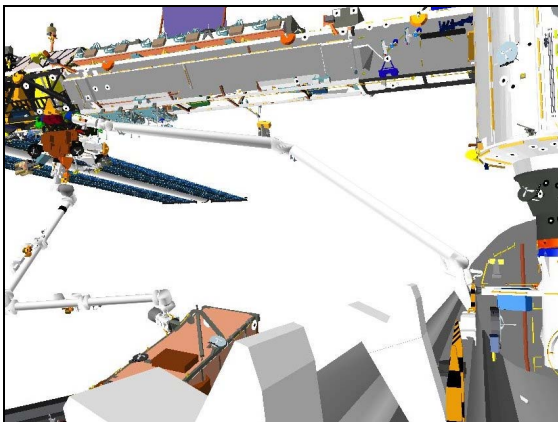

**CCTV B (-20,5)**

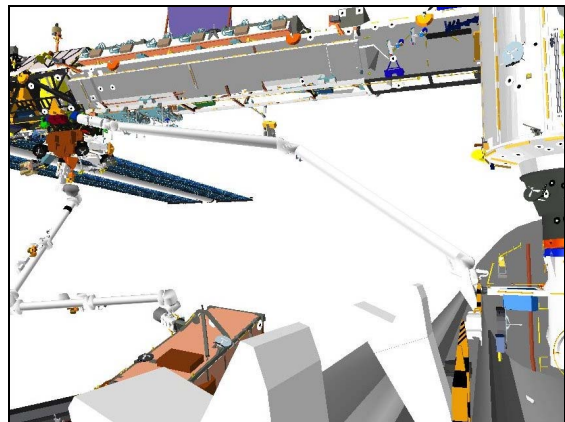

**CCTV B (-20,5)**

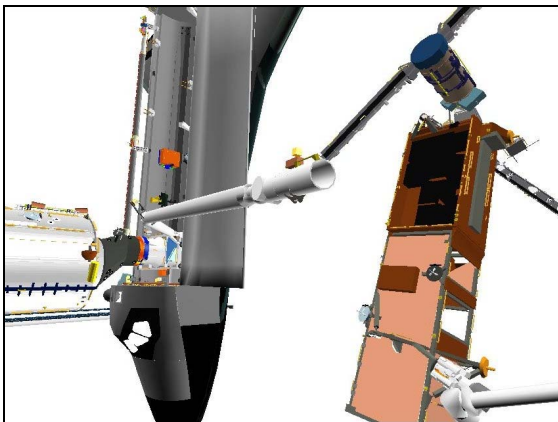

**P1 LOOB (135,10)**

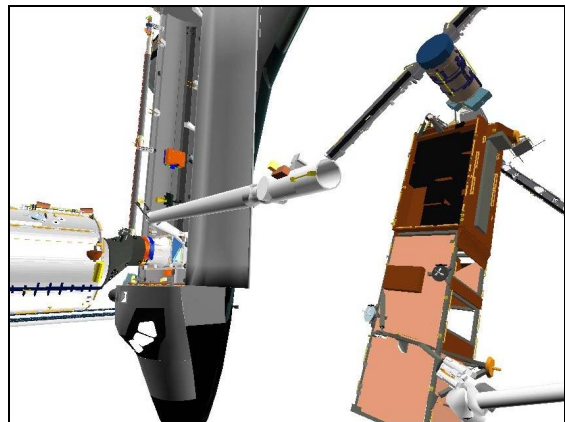

**P1 LOOB (135,10)**



Step 5:  
Drive SY (-) from +95.3 to 0.0

Step 6:  
Drive SP (-) from +55.1 to +25.0

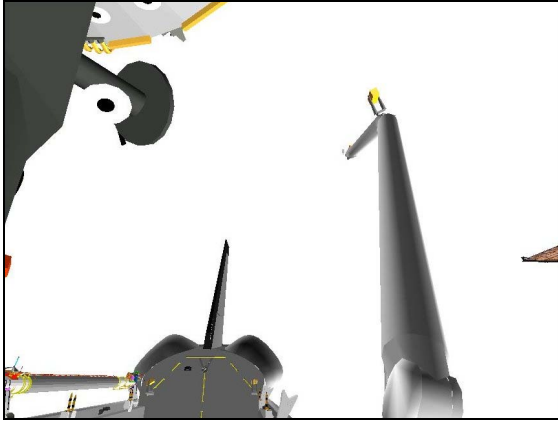

**CCTV A (5,25)**

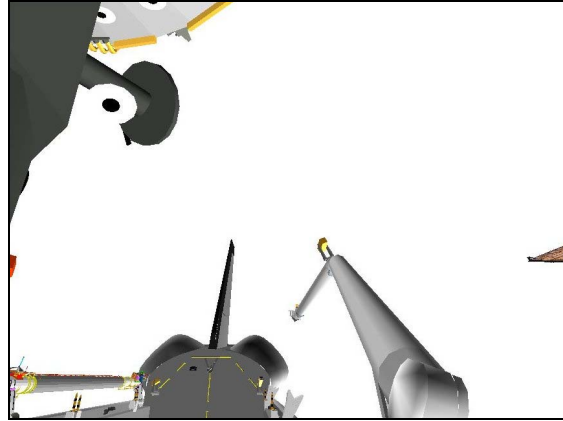

**CCTV A (5,25)**

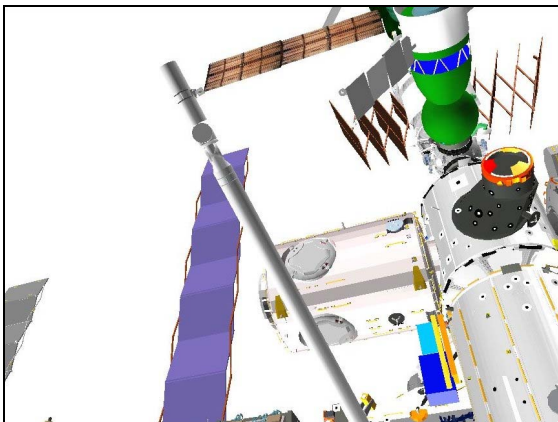

**CCTV B (-20,45)**

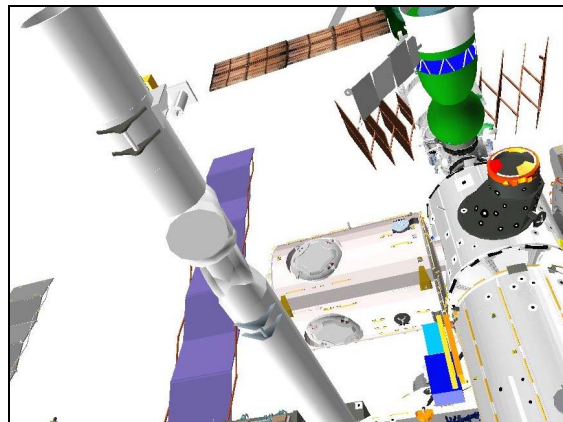

**CCTV B (-20,45)**

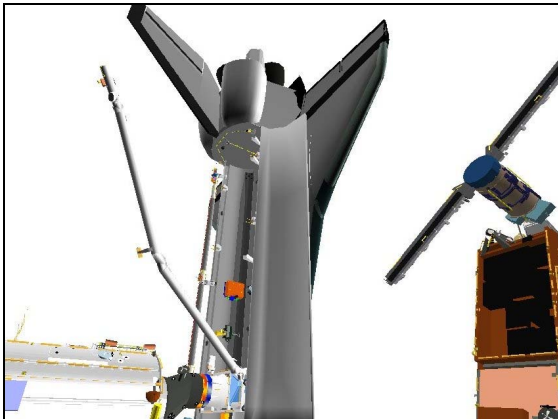

**P1 LOOB (125,30)**



**P1 LOOB (125,30)**

This Page Intentionally Blank

P6 REFERENCE DATA

P6 JOINT ANGLES VS POR COORDINATES..... FS 6-2  
COORDINATE SYSTEM – PL ID 3..... FS 6-3

P6  
REF DATA

## P6 JOINT ANGLES VS POR COORDINATES

### P6 HANDOFF

X	Y	Z	PITCH	YAW	ROLL	PL ID
-661	-530	-229	161	355	5	3
-603	-557	-306	251	5	6	0
SY	SP	EP	WP	WY	WR	
+97.4	+45.3	-65.7	-43.1	+15.7	-73.6	

### PRE-GRAPPLE/UNGRAPPLE

X	Y	Z	PITCH	YAW	ROLL	PL ID
-680	-525	-285	161	355	5	3
-622	-552	-362	251	5	6	0
SY	SP	EP	WP	WY	WR	
+95.3	+55.1	-70.4	-48.7	+16.7	-71.5	

### P6 INSTALL VIEWING

X	Y	Z	PITCH	YAW	ROLL	PL ID
-660	-549	-308	269	30	102	3
-631	-537	-213	111	57	252	0
SY	SP	EP	WP	WY	WR	
+94.8	+16.7	-63.4	+96.4	+8.2	+22.9	

P6  
REF DATA

# P6 COORDINATE SYSTEM – PL ID 3

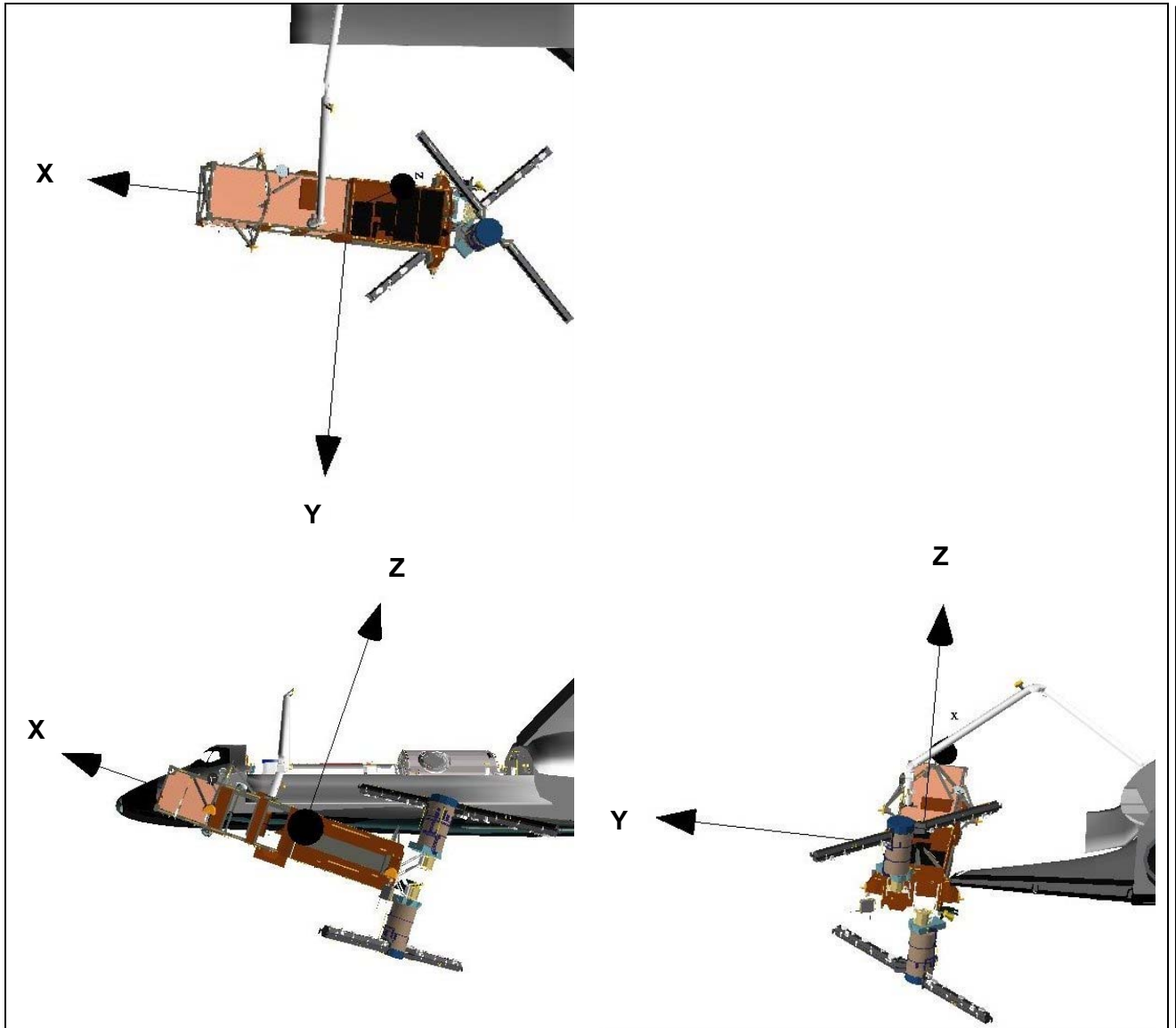

POR: At P6 axial center, centered between trunions (shown in P6 handoff position)

PURPOSE: P6 Handoff

RATES:	<u>COARSE</u>	<u>VERN</u>
TRANS LIM ft/sec:	0.15	0.10
ROT LIM deg/sec:	0.50	0.16

This Page Intentionally Blank

EVA 3

EVA 3 SUPPORT ..... FS 7-2

EVA 3

# EVA 3 SUPPORT

## 1. SETUP

SM 94 PDRS CONTROL

√ PL ID, ITEM 3: 0

√ INIT ID, ITEM 24: 0

MON 1	A (P1LOOB)
MON 2	B (C)
DWNLNK	RMS ELBOW

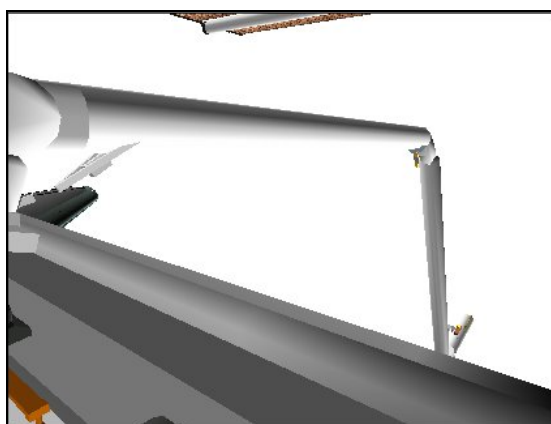

**CCTV A (55,-15)**



**CCTV B (-20,5)**

√	X	Y	Z	PITCH	YAW	ROLL	PL ID
	-631	-537	-213	111	57	252	0
√	SY	SP	EP	WP	WY	WR	
	+94.8	+16.7	-63.4	+96.4	+8.2	+22.9	

## 2. APFR INSTALL SETUP

RHC

On SSRMS Operator GO for maneuver to APFR INSTALL SETUP position:

RATE – as reqd (VERN within 10 ft)

BRAKES – OFF (tb-OFF)

MODE – SINGLE, ENTER

Mnvr to APFR INSTALL SETUP posn:

P6 VIEW

- 1: SP +
- 2: SY -
- 3: WR +
- 4: WY -
- 5: WP -
- 6: EP -
- 7: SP +
- 8: SY -

	SY	SP	EP	WP	WY	WR
	+94.8	+16.7	-63.4	+96.4	+8.2	+22.9
		+60.0				
	-15.0					
						+121.2
					-29.7	
				-60.8		
			-88.9			
		+111.0				
	-61.3					

APFR SETUP

	SY	SP	EP	WP	WY	WR	
	-61.3	+111.0	-88.9	-60.8	-29.7	+121.2	
	X	Y	Z	PITCH	YAW	ROLL	PL ID
	-762	-13	-802	245	285	5	0

BRAKES – ON (tb-ON)

Notify IV/EVA, "SRMS ready for APFR Install"

EVA 3



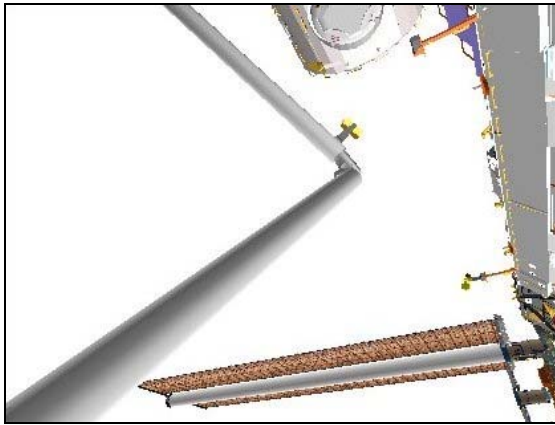

**CCTV A (60,40)**

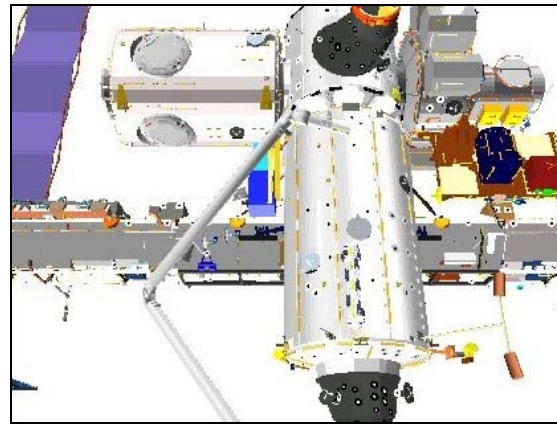

**CCTV B (0,25)**

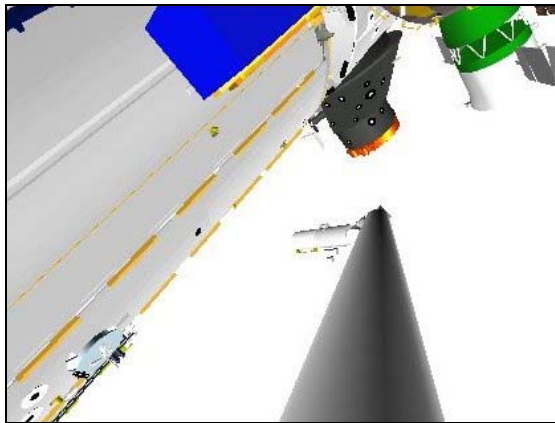

**RMS ELBOW (-15,-5)**

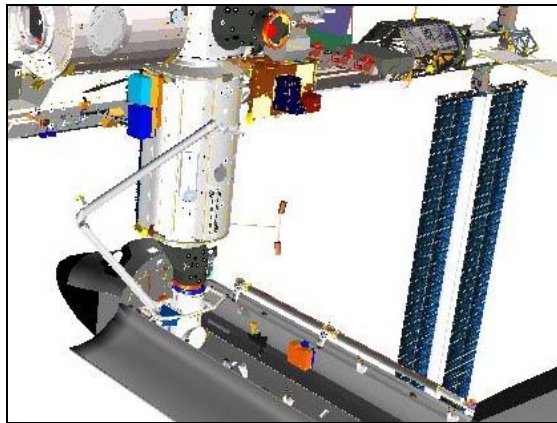

**BIRD'S EYE**

3. APFR INSTALL

RHC

On EVA GO for GCA to APFR install:

- RATE – VERN (RATE MIN tb-ON)
- BRAKES – OFF (tb-OFF)
- MODE – ORB UNL, ENTER

GCA per EVA call to APFR INSTALL posn (record actual): (APFR: 4/II/F/6)

	X	Y	Z	PITCH	YAW	ROLL	PL ID
Expected	-738	-13	-802	245	285	5	0
Expected	-695	-31	-894	195	343	178	4
	SY	SP	EP	WP	WY	WR	
Expected	-68.3	+113.3	-90.5	-59.3	-24.2	+126.0	

BRAKES – ON (tb-ON)

**SM 94 PDRS CONTROL**

PL ID – ITEM 3 +4 EXEC  
INIT ID – ITEM 24 +4 EXEC

**SM 95 PDRS OVERRIDE**

LOADED RATE, ITEM 14 EXEC (\*)

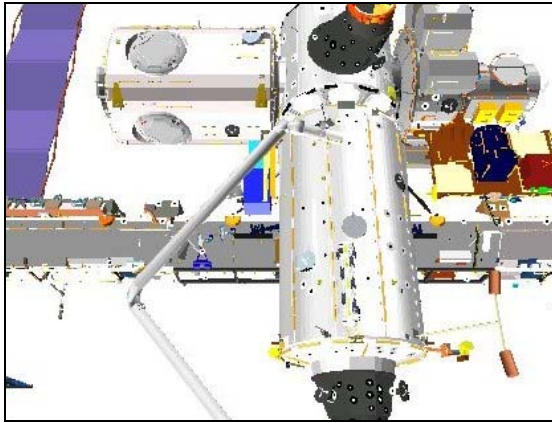

**CCTV B (0,25)**

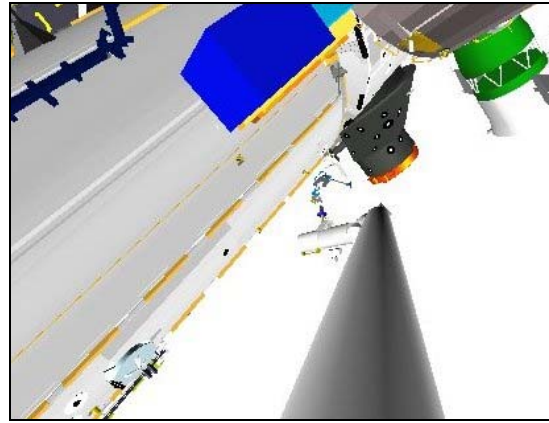

**RMS ELBOW (-15,-5)**

**4. APFR INGRESS**

When APFR install complete and on EVA GO for GCA to APFR ingress:

BRAKES – OFF (tb-OFF)

MODE – ORB LD, ENTER

GCA per EVA call to APFR INGRESS posn (record actual): (APFR: 4/II/F/6)

	X	Y	Z	PITCH	YAW	ROLL	PL ID
Expected	-719	-31	-894	195	343	178	4
	SY	SP	EP	WP	WY	WR	
Expected	-61.3	+111.0	-88.9	-60.8	-29.7	+121.2	

BRAKES – ON (tb-ON)

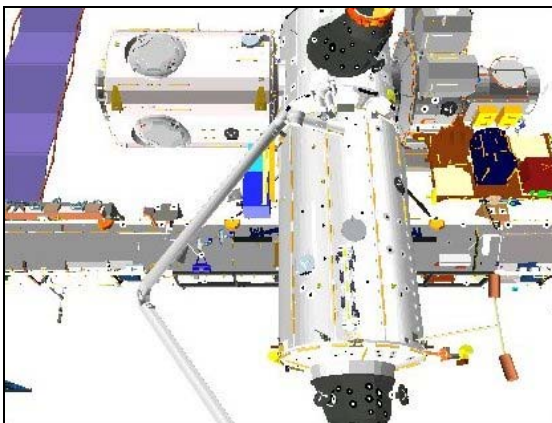

**CCTV B (0,25)**

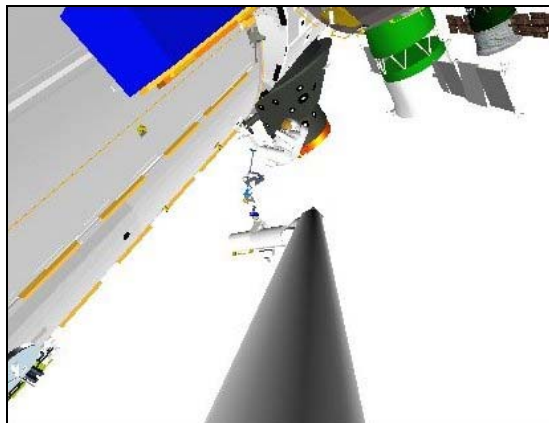

**RMS ELBOW (-5,-5)**

**5. MBSU RETRIEVAL**

When APFR ingress complete and on EVA GO for mnvr to MBSU retrieval:

BRAKES – OFF (tb-OFF)

MODE – as desired

Mnvr to MBSU RETRIEVAL SETUP posn (within 2"/1°): (APFR: 4/II/F/6)

X	Y	Z	PITCH	YAW	ROLL	PL ID
-888	66	-461	266	331	268	4
SY	SP	EP	WP	WY	WR	
-22.9	+76.7	-142.7	+30.2	+27.2	+87.8	

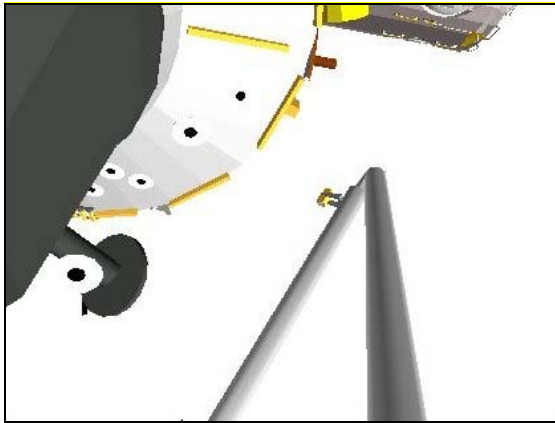

**CCTV A (10,50)**

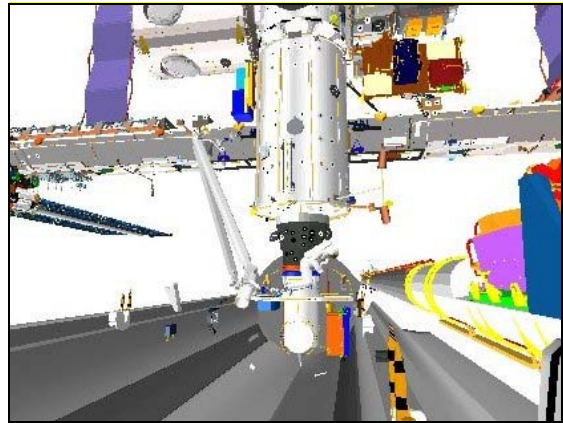

**CCTV C (-10,10)**

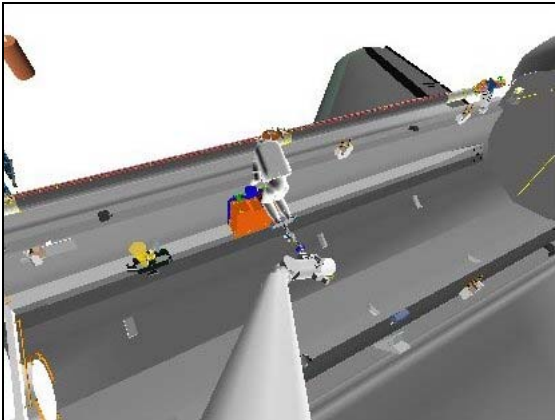

**RMS ELBOW (0,5)**

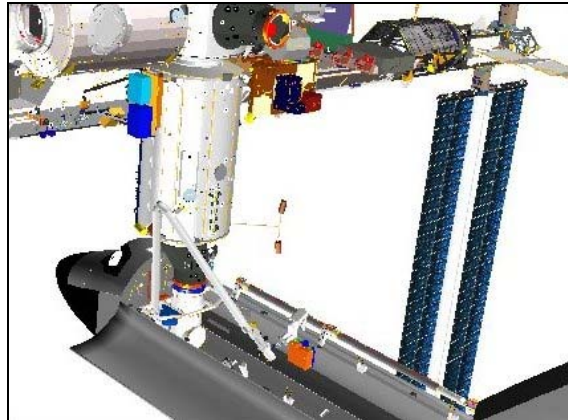

**BIRD'S EYE**

On EVA GO for GCA:

GCA per EVA call to MBSU RETRIEVAL posn: (APFR: 4/II/F/6)

	X	Y	Z	PITCH	YAW	ROLL	PL ID
Expected	-888	66	-433	266	331	268	4
	SY	SP	EP	WP	WY	WR	
Expected	-20.3	+68.2	-142.8	+39.5	+25.1	+86.1	

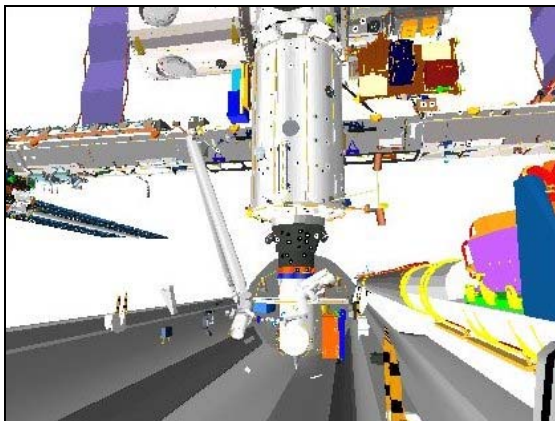

**CCTV C (-10,10)**



**RMS ELBOW (0,5)**

When MBSU removal complete and on EVA GO for GCA:

GCA per EVA call to MBSU Starboard Sill Clearance



6. MBSU HANDOFF

When MBSU clear of starboard sill and on EVA GO for MBSU handoff:

Mnvr to MBSU HANDOFF SETUP posn (within 2"/1°) (APFR: 4/II/F/6)

X	Y	Z	PITCH	YAW	ROLL	PL ID
-739	143	-785	238	355	180	4
SY	SP	EP	WP	WY	WR	
-64.1	+78.1	-79.3	-46.0	-17.6	+77.0	

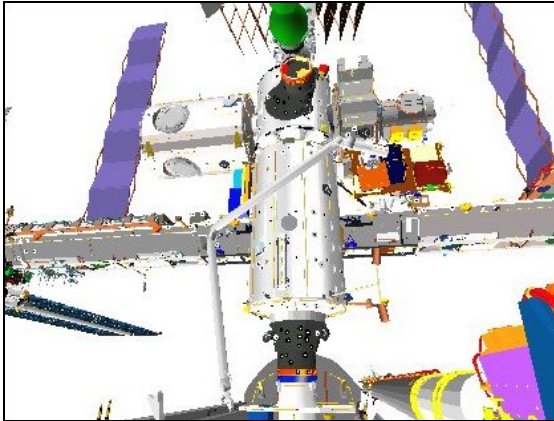

**CCTV C (-10,25)**

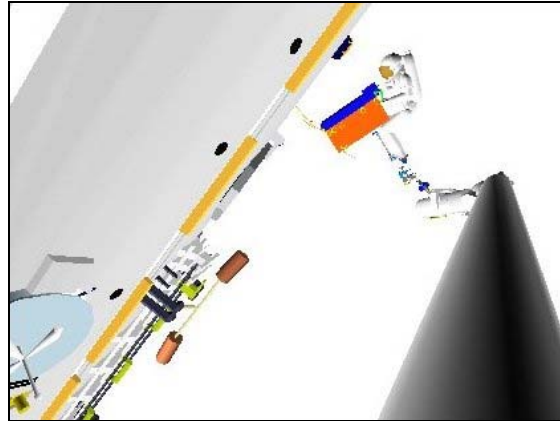

**RMS ELBOW (-30,-10)**

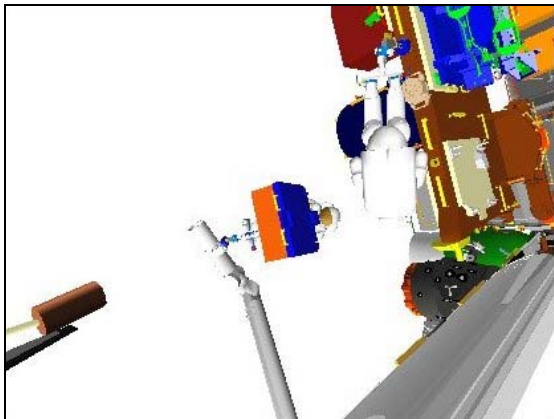

**US LAB (45,-15)**

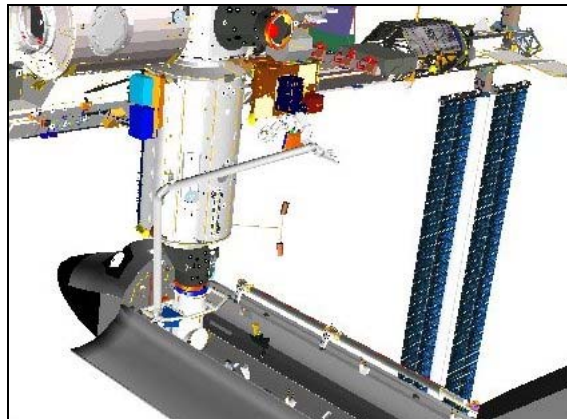

**BIRD'S EYE**

On EVA GO for GCA:

GCA per EVA call to MBSU HANDOFF posn: (APFR: 4/II/F/6)

	X	Y	Z	PITCH	YAW	ROLL	PL ID
Expected	-704	144	-784	238	355	180	4
	SY	SP	EP	WP	WY	WR	
Expected	-69.6	+81.4	-83.3	-44.2	-13.8	+81.1	

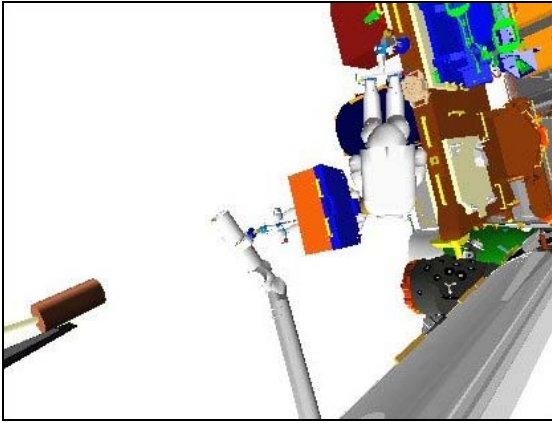

**US LAB (45,-15)**

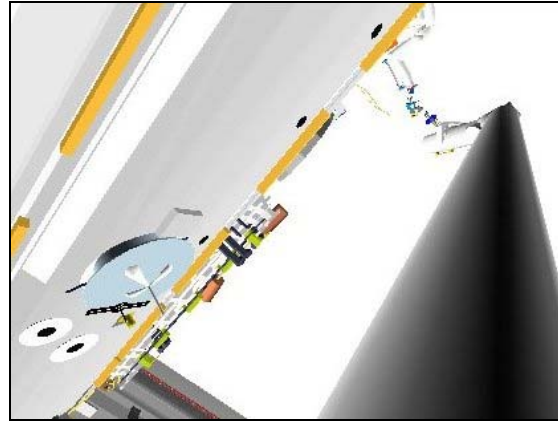

**RMS ELBOW (-30,-20)**

When MBSU handoff complete and on EVA GO for GCA:  
GCA per EVA call to MBSU Install Support Position

**CAUTION**

Monitor clearance between SRMS Lower Boom and US Lab. When X = -685 (PL ID 4) clearance between Lower Boom and US Lab will be 24"

**7. APFR EGRESS**

When MBSU install complete and on EVA GO for APFR egress:

Mnvr to APFR EGRESS SETUP posn (within 2"/1°): (APFR: 4/II/F/6)

X	Y	Z	PITCH	YAW	ROLL	PL ID
-743	-31	-894	195	343	178	4
SY	SP	EP	WP	WY	WR	
-55.1	+108.2	-86.7	-62.4	-34.3	+116.5	

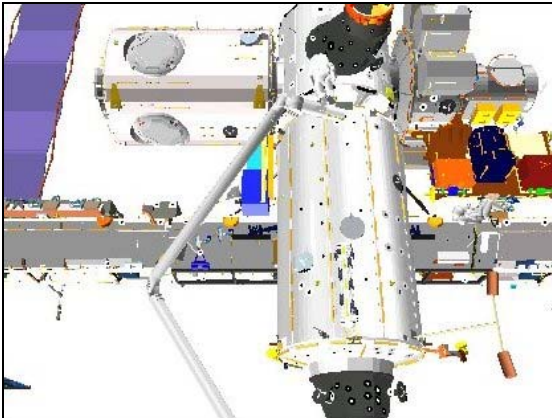

**CCTV B (0,25)**

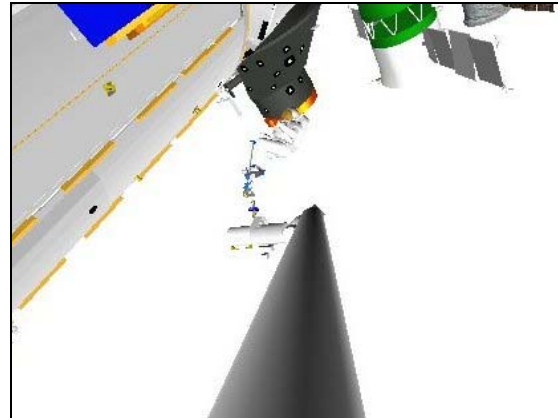

**RMS ELBOW (-5,-5)**

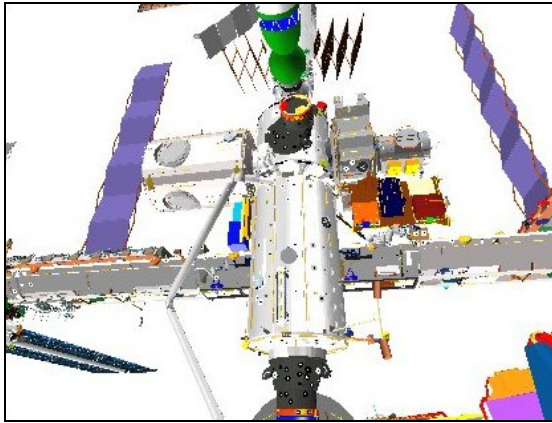

**CCTV C (-10,30)**

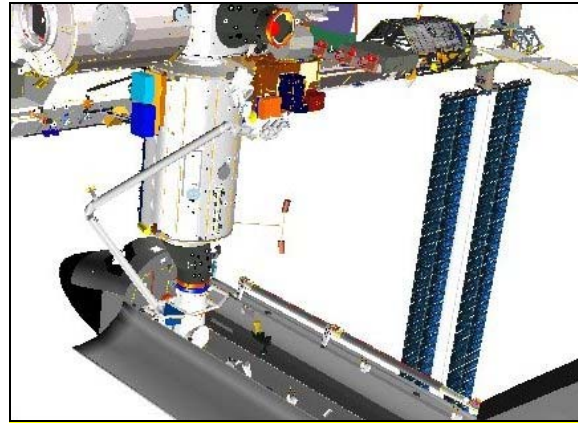

**BIRD'S EYE**

On EVA GO for GCA:

GCA per EVA call to APFR EGRESS posn: (APFR: 4/II/F/6)

	X	Y	Z	PITCH	YAW	ROLL	PL ID
Expected	-719	-31	-894	195	343	178	4
	SY	SP	EP	WP	WY	WR	
Expected	-61.3	+111.0	-88.9	-60.8	-29.7	+121.2	

**BRAKES – ON (tb-ON)**

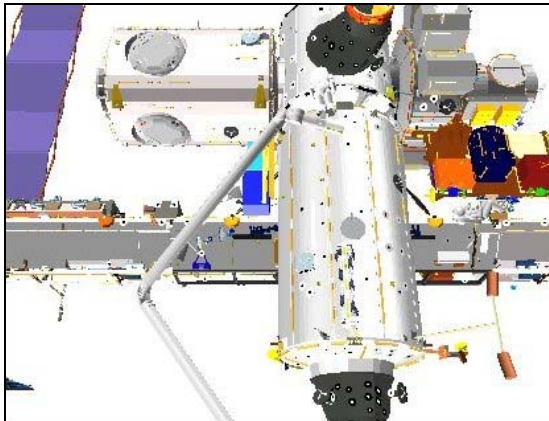

**CCTV B (0,25)**

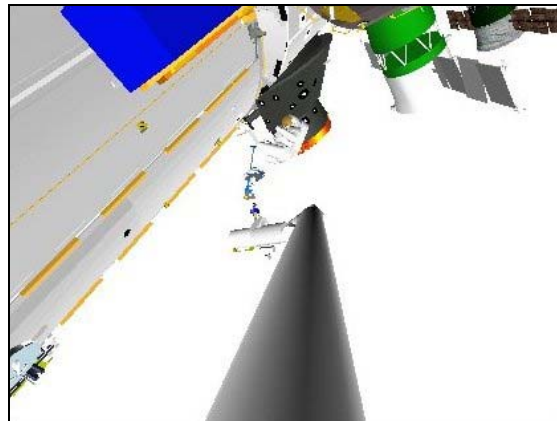

**RMS ELBOW (-5,-5)**

**8. APFR REMOVAL**

When APFR Egress complete and on EVA GO for GCA:

**BRAKES – OFF (tb-OFF)**

**MODE – ORB LD, ENTER**

GCA per EVA call to APFR REMOVAL posn: (APFR: 4/II/F/6)

	X	Y	Z	PITCH	YAW	ROLL	PL ID
Expected	-695	-31	-894	195	343	178	4
Expected	-738	-13	-802	245	285	5	0
	SY	SP	EP	WP	WY	WR	
Expected	-68.3	+113.3	-90.5	-59.3	-24.2	+126.0	

**BRAKES – ON (tb-ON)**

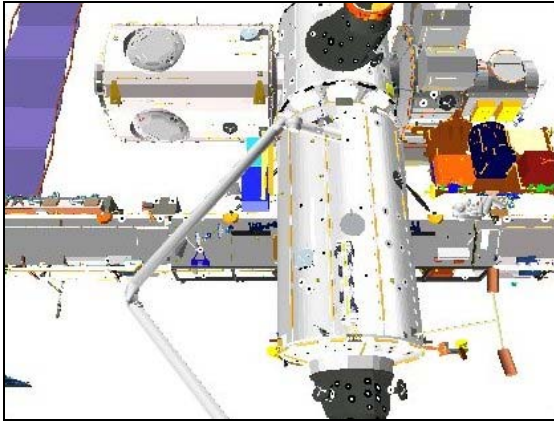

**CCTV B (0,25)**

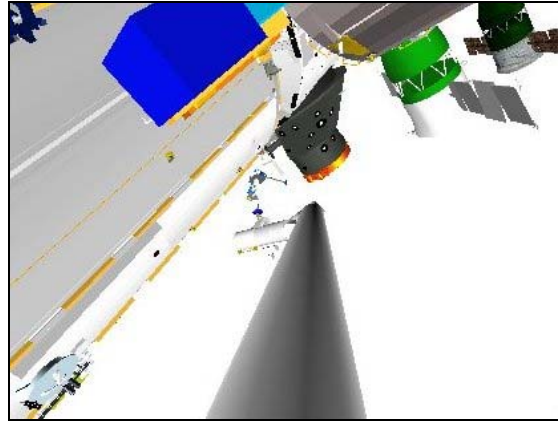

**RMS ELBOW (-15,-5)**

9. MANEUVER TO PRE-CRADLE

When APFR removal complete and on EVA GO for mnvr to PRE-CRADLE:

**SM 94 PDRS CONTROL**

PL ID – ITEM 3 +0 EXEC

INIT ID – ITEM 24 +0 EXEC

**SM 95 PDRS OVERRIDE**

LOADED RATE, ITEM 14 EXEC ()

RHC

RATE – as reqd (VERN within 10 ft)

BRAKES – OFF (tb-OFF)

MODE – as desired

Mnvr to PRE-CRADLE (within 2"/1°):

X	Y	Z	PITCH	YAW	ROLL	PL ID
-1261	-146	-551	5	2	0	0
SY	SP	EP	WP	WY	WR	
0.0	+25.0	-25.0	+5.0	0.0	0.0	

BRAKES – ON (tb-ON)

MODE – not DIRECT (lt off)

PARAM – PORT TEMP

JOINT – CRIT TEMP

This Page Intentionally Blank



EVA 3 REFERENCE DATA

EVA 3 JOINT ANGLES VS POR COORDINATES ..... FS 8-2  
COORDINATE SYSTEM – PL ID 4 ..... FS 8-4  
– PL ID 5 ..... FS 8-5

EVA 3  
REF DATA

## EVA 3 JOINT ANGLES VS POR COORDINATES

### APFR INSTALL SETUP

X	Y	Z	PITCH	YAW	ROLL	PL ID
-719	-31	-894	195	343	178	4
-734	-29	-842	195	343	178	5
-762	-13	-802	245	285	5	0
SY	SP	EP	WP	WY	WR	
-61.3	+111.0	-88.9	-60.8	-29.7	+121.2	

### APFR INSTALL

X	Y	Z	PITCH	YAW	ROLL	PL ID
-695	-31	-894	195	343	178	4
-710	-29	-842	195	343	178	5
-738	-13	-802	245	285	5	0
SY	SP	EP	WP	WY	WR	
-68.3	+113.3	-90.5	-59.3	-24.2	+126.0	

### APFR INGRESS

X	Y	Z	PITCH	YAW	ROLL	PL ID
-719	-31	-894	195	343	178	4
-734	-29	-842	195	343	178	5
-762	-13	-802	245	285	5	0
SY	SP	EP	WP	WY	WR	
-61.3	+111.0	-88.9	-60.8	-29.7	+121.2	

### MBSU RETRIEVE SETUP

X	Y	Z	PITCH	YAW	ROLL	PL ID
-888	+66	-461	266	331	268	4
-888	+19	-435	266	331	268	5
-908	-27	-422	328	358	72	0
SY	SP	EP	WP	WY	WR	
-22.9	+76.7	-142.7	+30.2	+27.2	+87.8	

### MBSU RETRIEVE

X	Y	Z	PITCH	YAW	ROLL	PL ID
-888	+66	-433	266	331	268	4
-888	+19	-407	266	331	268	5
-908	-27	-394	327	358	72	0
SY	SP	EP	WP	WY	WR	
-20.3	+68.2	-142.8	+39.5	+25.1	+86.1	

### MBSU HANDOFF SETUP

X	Y	Z	PITCH	YAW	ROLL	PL ID
-739	143	-785	238	355	180	4
-785	143	-757	238	355	180	5
-832	161	-744	272	295	348	0
SY	SP	EP	WP	WY	WR	
-64.1	+78.1	-79.3	-46.0	-17.6	+77.0	

EVA 3  
REF DATA

MBSU HANDOFF

X	Y	Z	PITCH	YAW	ROLL	PL ID
-704	144	-784	238	355	180	4
-750	144	-756	238	355	180	5
-797	161	-744	272	295	348	0
SY	SP	EP	WP	WY	WR	
-69.6	+81.4	-83.3	-44.2	-13.8	+81.1	

APFR EGRESS SETUP

X	Y	Z	PITCH	YAW	ROLL	PL ID
-743	-31	-894	195	343	178	4
-758	-29	-842	195	343	178	5
-787	-13	-803	246	285	6	0
SY	SP	EP	WP	WY	WR	
-55.1	+108.2	-86.7	-62.4	-34.3	+116.5	

APFR EGRESS

X	Y	Z	PITCH	YAW	ROLL	PL ID
-719	-31	-894	195	343	178	4
-734	-29	-842	195	343	178	5
-762	-13	-802	245	285	5	0
SY	SP	EP	WP	WY	WR	
-61.3	+111.0	-88.9	-60.8	-29.7	+121.2	

APFR REMOVAL

X	Y	Z	PITCH	YAW	ROLL	PL ID
-695	-31	-894	195	343	178	4
-710	-29	-842	195	343	178	5
-738	-13	-802	245	285	5	0
SY	SP	EP	WP	WY	WR	
-68.3	+113.3	-90.5	-59.3	-24.2	+126.0	

**EVA 3 COORDINATE SYSTEM – PL ID 4**

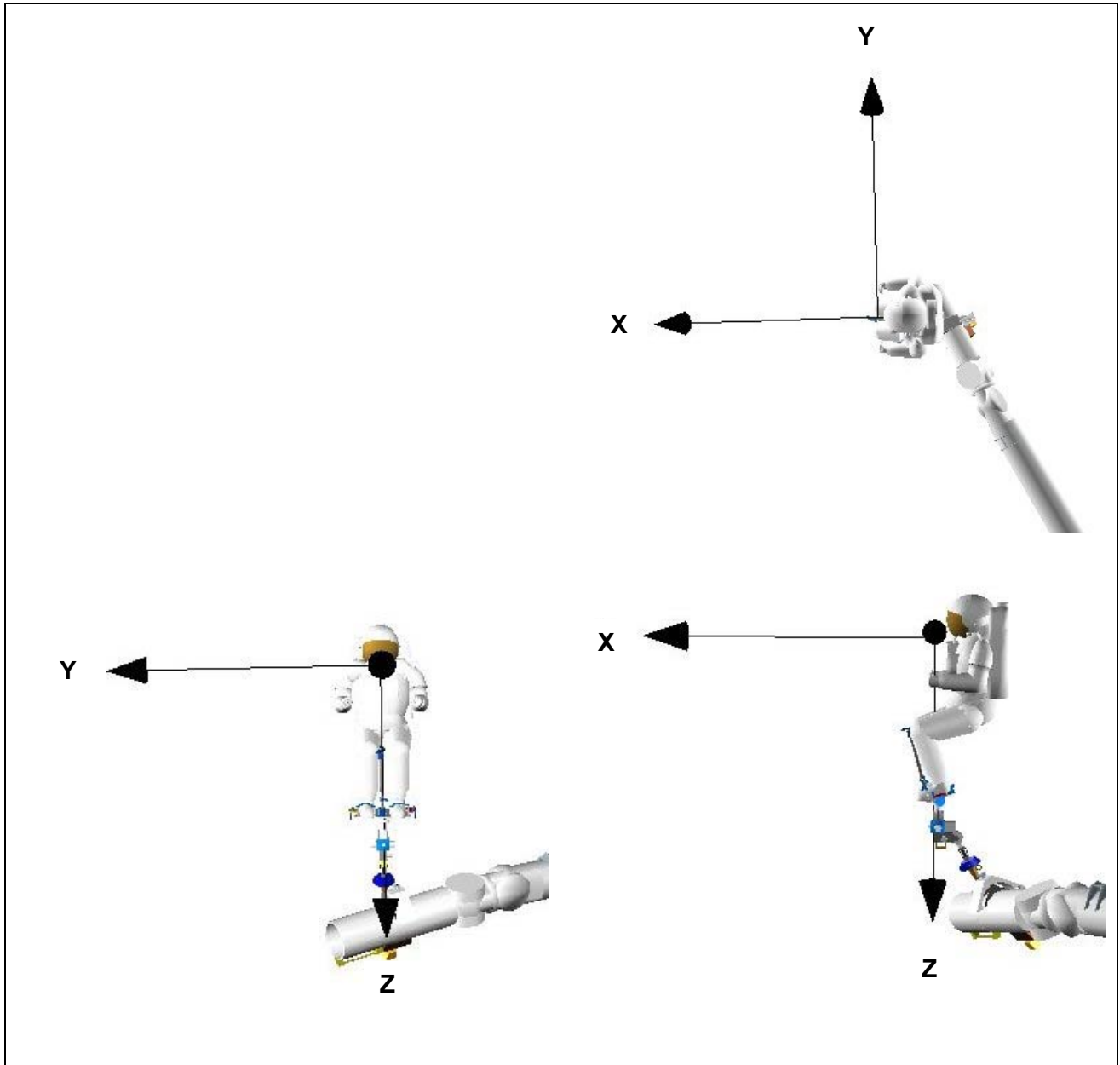

POR: At EVA's chest (EVA in APFR set at 4/II/F/6)

PURPOSE: EVA Operations

RATES:	<u>COARSE</u>	<u>VERN</u>
TRANS LIM ft/sec:	0.77	0.25
ROT LIM deg/sec:	2.79	0.92

# EVA 3 COORDINATE SYSTEM – PL ID 5

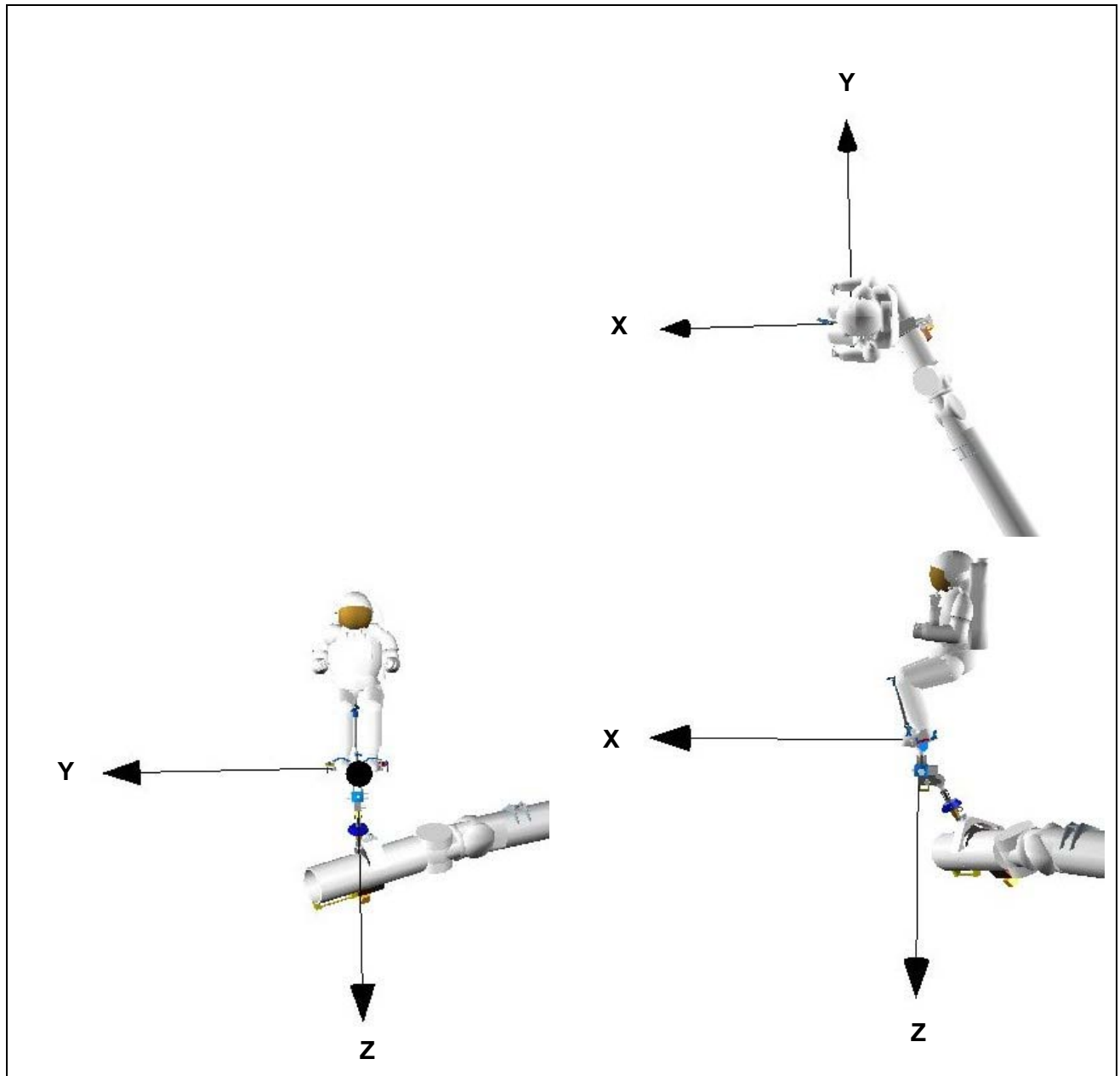

POR: At EVA's feet (EVA in APFR set at 4/III/F/6)

PURPOSE: EVA Operations

RATES:	<u>COARSE</u>	<u>VERN</u>
TRANS LIM ft/sec:	0.77	0.25
ROT LIM deg/sec:	2.79	0.92

This Page Intentionally Blank

CUE CARD CONFIGURATION

CUE CARD  
CONFIGURATION

# CUE CARD CONFIGURATION

Fabricate as transparency

ZOOM 34.0 HFOV  
FOCUS 5.0 FT  
EYEPOINT APPROX 18 IN

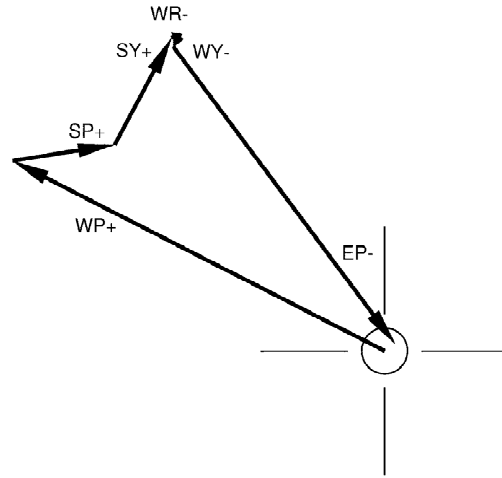

OBSS SJ GRAPPLE AT HANDOFF OVERLAY WRIST CCTV

PDRS-9a/120/O/B

(reduced copy)

FS CC 9-2

PDRS/120/FIN



Fabricate as transparency

ZOOM 34.0 HFOV  
FOCUS 5.0 FT  
EYEPOINT APPROX 18 IN

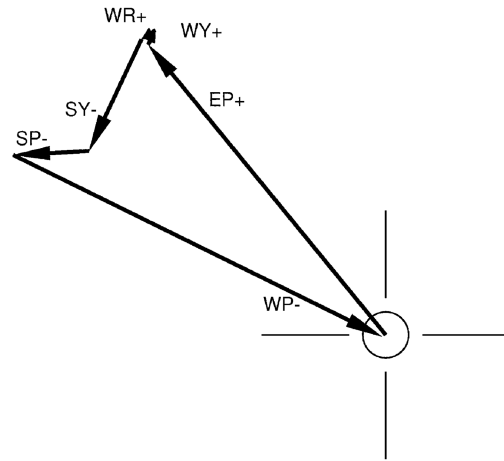

OBSS SJ UNGRAPPLE AT HANDOFF OVERLAY WRIST CCTV

PDRS-10a/120/O/B

(reduced copy)

FS CC 9-3

PDRS/120/FIN

Fabricate as transparency

ZOOM 34.0 HFOV  
FOCUS 5.0 FT  
EYEPOINT APPROX 18 IN

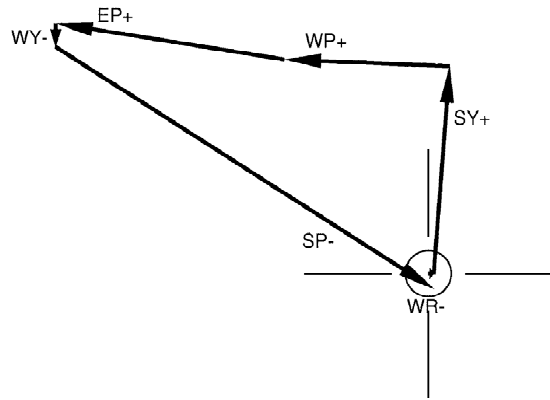
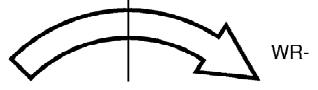

P6 SJ GRAPPLE WRIST CCTV

PDRS-11a/120/O/A

(reduced copy)

FS CC 9-4

PDRS/120/FIN

Fabricate as transparency

ZOOM 34.0 HFOV  
FOCUS 5.0 FT  
EYEPOINT APPROX 18 IN

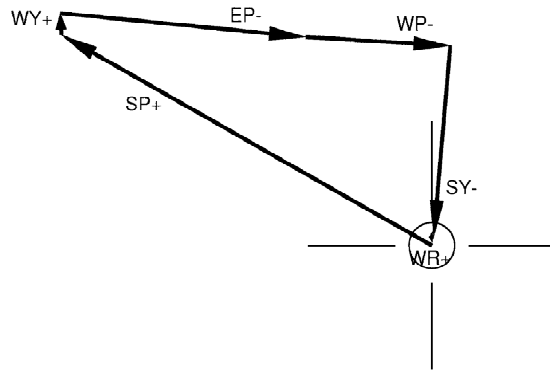

P6 SJ UNGRAPPLE WRIST CCTV

PDRS-12a/120/O/A

(reduced copy)

FS CC 9-5

PDRS/120/FIN

This Page Intentionally Blank



**PDRS OPS C/L**

**STS  
120**