

PDRS Operations Checklist

STS-126 Flight Supplement

**Mission Operations Directorate
EVA, Robotics, & Crew Systems
Operations Division**

**Final
August 22, 2008**

National Aeronautics and
Space Administration

Lyndon B. Johnson Space Center
Houston, Texas

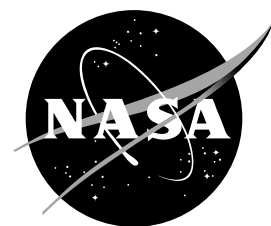

PDRS OPS CHECKLIST 126 FLT SUPPL

FINAL (Aug 22, 2008)

PCN-1 (Oct 24, 2008) Sheet 1 of 1

List of Implemented Change Requests (482s):

PDRS FS-0101
PDRS FS-0102A

Incorporate the following:

1. Replace FS iii thru FS vi
2. Replace FS 1-1 and FS 1-2, FS 1-13 thru FS 1-20
After FS 1-20, add FS 1-21 and FS 1-22
3. Replace FS 2-17 and FS 2-18
4. Replace FS 3-1 and FS 3-2

Prepared by:

Book Manager

Approved by:

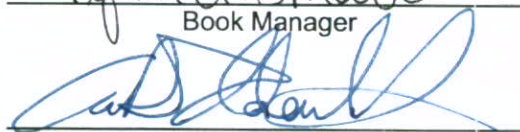
Lead, Shuttle and Exploration Robotics
Operations Group

Accepted by:

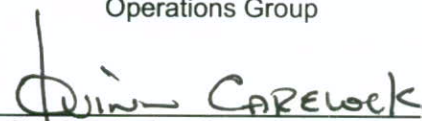
Chief, Robotics Operations Branch

Encl: 20 pages

File this PCN immediately behind the front cover as a permanent record

MISSION OPERATIONS DIRECTORATE

**PDRS OPERATIONS CHECKLIST
STS-126 FLIGHT SUPPLEMENT**

FINAL
August 22, 2008

PREPARED BY:



Tifanie A. Smart
Book Manager

APPROVED BY:



Aaron D. Goldenthal
Lead, Shuttle and Exploration Robotics
Operations Group



Quinn L. Carelock
Chief, Robotics Operations Branch

This document is under the configuration control of the Crew Procedures Control Board (CPCB). All proposed changes must be submitted via FDF Workflow Crew Procedure Change Request (CR) to DO3/FDF Manager.

Additional distribution of this book, for official use only, may be requested in writing to DO3/PMO Administrator. The request must include justification and requester's name, organization, position, and phone number. Contractor requests are made through the NASA or DOD organization supported. Deletions, reduction in quantity, or change of address may be submitted to DO3/FDF Management Office, 281-244-1184.

Incorporates the following:	
482#:	PDRS_FS-0073 PDRS_FS-0074 PDRS_FS-0093

AREAS OF TECHNICAL RESPONSIBILITY

Book Manager

DX22/T. Smart

281-483-6386

PDRS OPERATIONS CHECKLIST
 STS-126 FLIGHT SUPPLEMENT

LIST OF EFFECTIVE PAGES

FINAL 08/22/08
 PCN-1 10/24/08

Sign Off	*	126/FIN	FS 2-18	126/FIN 1
FS ii	*	126/FIN	FS 2-19	126/FIN
FS iii	*	126/FIN 1	FS 2-20	126/FIN
FS iv	*	126/FIN	FS 2-21	126/FIN
FS v		126/FIN 1	FS 2-22	126/FIN
FS vi		126/FIN	FS 2-23	126/FIN
FS 1-1		126/FIN 1	FS 2-24	126/FIN
FS 1-2		126/FIN	FS 2-25	126/FIN
FS 1-3		126/FIN	FS 2-26	126/FIN
FS 1-4		126/FIN	FS 2-27	126/FIN
FS 1-5		126/FIN	FS 2-28	126/FIN
FS 1-6		126/FIN	FS 2-29	126/FIN
FS 1-7		126/FIN	FS 2-30	126/FIN
FS 1-8		126/FIN	FS 2-31	126/FIN
FS 1-9		126/FIN	FS 2-32	126/FIN
FS 1-10		126/FIN	FS 2-33	126/FIN
FS 1-11		126/FIN	FS 2-34	126/FIN
FS 1-12		126/FIN	FS 2-35	126/FIN
FS 1-13		126/FIN	FS 2-36	126/FIN
FS 1-14		126/FIN 1	FS 2-37	126/FIN
FS 1-15		126/FIN 1	FS 2-38	126/FIN
FS 1-16		126/FIN 1	FS 2-39	126/FIN
FS 1-17		126/FIN 1	FS 2-40	126/FIN
FS 1-18		126/FIN 1	FS 3-1	126/FIN
FS 1-19		126/FIN 1	FS 3-2	126/FIN 1
FS 1-20		126/FIN 1	FS 4-1	* 126/FIN
FS 1-21		126/FIN 1	FS CC 4-2	* 126/FIN
FS 1-22		126/FIN 1	FS CC 4-3	* 126/FIN
FS 2-1		126/FIN	FS CC 4-4	* 126/FIN
FS 2-2		126/FIN		
FS 2-3		126/FIN		
FS 2-4		126/FIN		
FS 2-5		126/FIN		
FS 2-6		126/FIN		
FS 2-7		126/FIN		
FS 2-8		126/FIN		
FS 2-9		126/FIN		
FS 2-10		126/FIN		
FS 2-11		126/FIN		
FS 2-12		126/FIN		
FS 2-13		126/FIN		
FS 2-14		126/FIN		
FS 2-15		126/FIN		
FS 2-16		126/FIN		
FS 2-17		126/FIN		

* – Omit from flight book

PDRS CUE CARDS

<u>Title</u>	<u>Ref. Page</u>	<u>Card No.</u>
OBSS SJ GRAPPLE AT HANDOFF	FS CC 4-2	PDRS-9a/126/O/A
OBSS SJ UNGRAPPLE AT HANDOFF	FS CC 4-3	PDRS-10a/126/O/A
OVERLAY FOR ROEU PL SEL POSITION	FS CC 4-4	PDRS-11a/126/O/A

<u>CONTENTS</u>	<u>PAGE</u>
<u>OBSS NOMINAL</u>	FS 1-1
OBSS HANDOFF FROM SSRMS TO SRMS	FS 1-2
SRMS TO SSRMS	FS 1-8
MNVR TO STBD SARJ CLEANING	FS 1-14
FROM STBD SARJ CLEANING TO MPLM VIEWING	FS 1-16
TO UNDOCK	FS 1-17
FLAT FIELD.....	FS 1-19
 <u>OBSS CONTINGENCY</u>	 FS 2-1
OBSS SJ HANDOFF FROM SSRMS TO SRMS	FS 2-2
SRMS TO SSRMS	FS 2-19
MNVR FROM MPLM VIEWING TO STBD WING	FS 2-37
STBD WING TO MPLM VIEWING	FS 2-39
 <u>REFERENCE DATA</u>	 FS 3-1
OBSS HANDOFF JOINT ANGLES VS POR COORDINATES	FS 3-2
 <u>CUE CARD CONFIGURATION</u>	 FS 4-1

This Page Intentionally Blank

OBSS NOMINAL

OBSS HANDOFF FROM SSRMS TO SRMS	FS 1-2
SRMS TO SSRMS	FS 1-8
MNVR TO STBD SARJ CLEANING	FS 1-14
FROM STBD SARJ CLEANING TO MPLM VIEWING	FS 1-16
TO UNDOCK	FS 1-17
FLAT FIELD	FS 1-19

**OBSS
NOMINAL**

OBSS HANDOFF FROM SSRMS TO SRMS

OBSS
NOMINAL

1. SETUP

SM 94 PDRS CONTROL

√PL ID, ITEM 3: 0

√INIT ID, ITEM 24: 0

Verify at PRE-CRADLE posn:

X	Y	Z	PITCH	YAW	ROLL	PL ID
-1261	-146	-551	5	2	0	0
SY	SP	EP	WP	WY	WR	
0.0	+25.0	-25.0	+5.0	0.0	0.0	

R12

√Green Jumper – ISS

MON 1	BASE ELBOW
MON 2	B
DNLK	ELBOW (EE)
DTV	A

2. MNVR TO OBSS PRE-GRAPPLE AT HANDOFF

Verify SSRMS at Stage Park posn

RHC

RATE – as reqd (VERN within 10 ft)

BRAKES – OFF (tb-OFF)

MODE – as desired (OCAS Valid)

Maneuver to OBSS PRE-GRAPPLE AT HANDOFF posn:

X	Y	Z	PITCH	YAW	ROLL	PL ID
-1047	-360	-658	284	0	270	0
SY	SP	EP	WP	WY	WR	
+22.7	+57.5	-27.4	-99.3	+11.8	-97.9	

BRAKES – ON (tb-ON)

Notify SSRMS Operator that SRMS at OBSS Pre-Grapple at Handoff posn

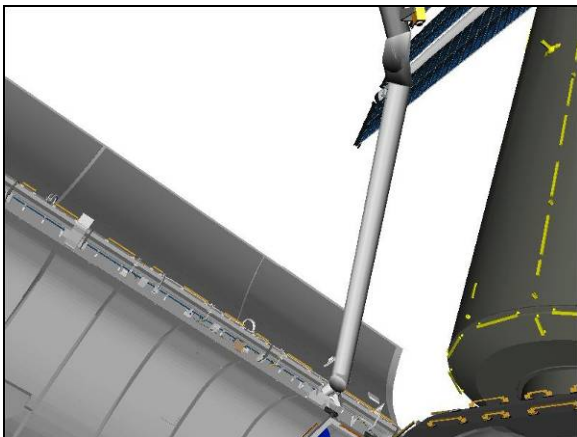

BASE ELBOW (-40,10)

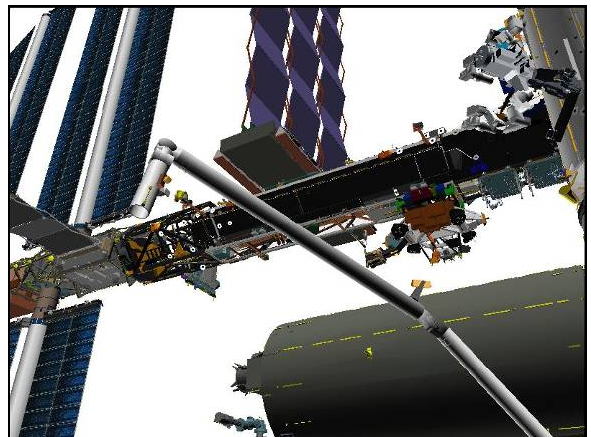

CCTV B (-30,30)

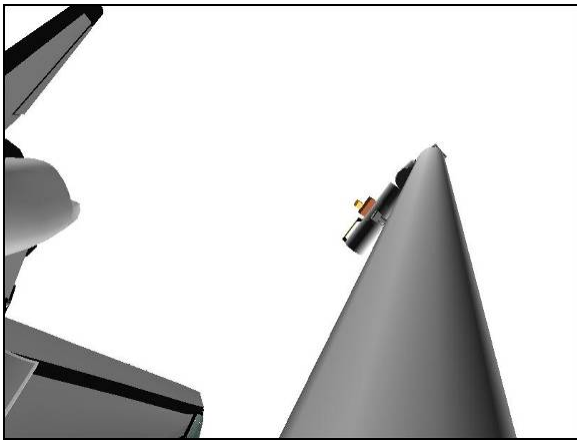

ELBOW (-20,-15)

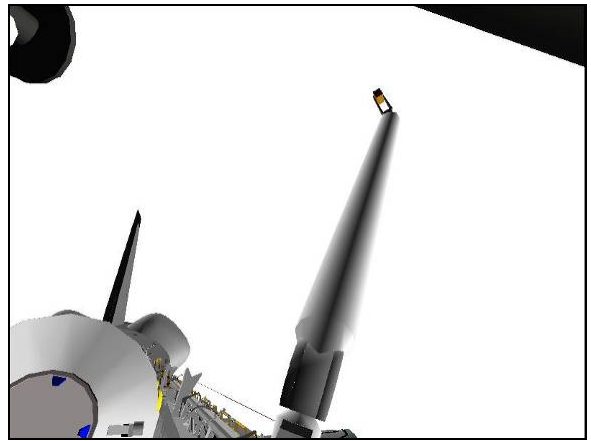

CCTV A (20,20)

3. CONFIGURE POWER

CAUTION
 SPEE power must be applied within 90 min
 to prevent sensor package damage

On SSRMS Operator GO to deactivate STBD heaters,
 STBD RMS HTR A,B (two) – OFF

- A6U EVENT TIMER MODE – UP
 CNTL – START
- MA73C:C cb MCA PWR AC3 3Φ MID 2 – op
 √AC2 3Φ MID 2 – op
- MA73C:D √AC3 3Φ MID 4 – op
- R13L PL BAY MECH PWR SYS (two) – ON

4. STBD MRL RELEASE

SM 94 PDRS CONTROL

 RMS STBD – ITEM 2 EXEC (*)
 √STBD AFT, MID, FWD REL (six) = 0

NOTE
 Expect single motor drive time for MRL release

STBD RMS RETEN LAT – REL (tb-REL) (18 sec max)
 – OFF

If motor drive time > 18 sec, √MCC

SM 94 PDRS CONTROL

 √STBD AFT, MID, FWD REL (six) = 1

5. RECONFIGURE POWER

- R13L PL BAY MECH PWR SYS (two) – OFF
- MA73C:C cb MCA PWR AC3 3Φ MID 2 – cl
 √AC2 3Φ MID 2 – op
- MA73C:D √AC3 3Φ MID 4 – op

Give SSRMS Operator GO for OBSS Unberth and SSRMS mnvr to Handoff
Monitor RFL Status

After OBSS Unberth,

SM 94 PDRS CONTROL

RMS PORT – ITEM 1 EXEC (*)

- A7U 6. SETUP FOR GRAPPLE
CCTV – config for grapple
– install PDRS TARGET OVERLAY FOR CTVM
– RMS WRIST, ZOOM: 34.0 HFOV
FOCUS: 5 ft

Maintain eyepoint approx 18 in when using grapple overlay

MON 1	BASE ELBOW
MON 2	B
DNLK	EE (ELBOW)
DTV	A

- R12(OBSS) √SPEE PWR – OFF
A15 √APCU 2 OUTPUT – OFF

- RHC 7. OBSS GRAPPLE AT HANDOFF POSN
On SSRMS Operator GO for SRMS OBSS Grapple,
RATE – VERN (RATE MIN tb-ON)
BRAKES – OFF (tb-OFF)
MODE – END EFF, ENTER

Mnvr to grapple envelope

CAUTION
Monitor EE tb timing to prevent EE motor burnout

EE MODE – AUTO
CAPTURE sw – depress (mom)

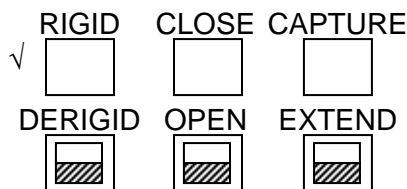

CRITICAL TIMES (28 sec total):

CAPTURE tb – gray, then
CLOSE tb – gray, 3 sec max, then
RIGID tb – gray, 25 sec max

EE MODE – OFF

- * If manual capture required: *
- * EE MODE – MAN *
- * CAPTURE sw – depress (hold until CLOSE tb-gray, 3 sec max) *
- * MAN CONTR – RIGID (hold until RIGID tb-gray, 25 sec max) *
- * MODE – OFF *

MODE – TEST, ENTER
Wait 5 sec

BRAKES – ON (tb-ON)

SM 94 PDRS CONTROL

PL ID – ITEM 3 +2 EXEC

INIT ID – ITEM 24 +2 EXEC

Expected OBSS HANDOFF posn:

X	Y	Z	PITCH	YAW	ROLL	PL ID
-1059	+231	-597	284	270	270	2
SY	SP	EP	WP	WY	WR	
+24.5	+59.0	-42.1	-85.9	+11.2	-99.4	

*Display singularity

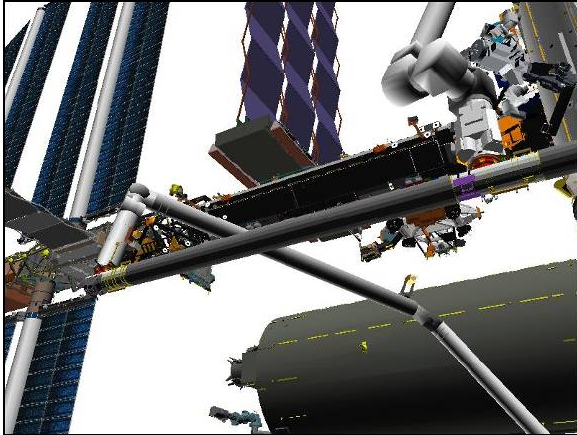

CCTV B (-30,30)

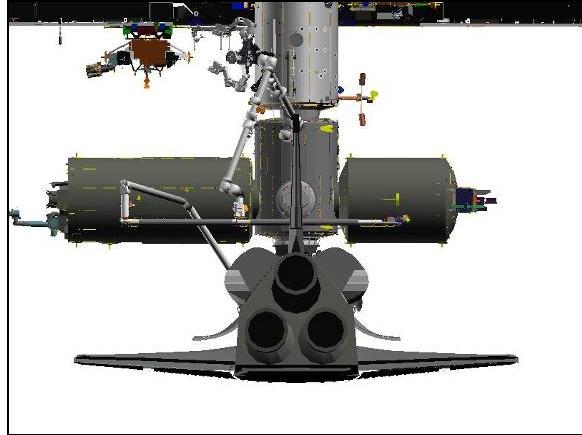

BIRD'S EYE

Perform ACTIVATION (LDRI/ITVC Cue Card, P/TV)

Perform LCH ACTIVATION (LCS Cue Card, P/TV)

Review GENERIC END EFFECTOR CUE CARD – ISS/SHUTTLE DOCKED OPS

Give SSRMS Operator GO for OBSS ungrapple

Perform LCC ACTIVATION (LCS Cue Card, P/TV)

Perform LCC DEACTIVATION (LCS Cue Card, P/TV), steps 1 and 2

8. RECONFIG PTU

R12
A7U

Green Jumper – LDRI/ITVC

DTV ← PL2

CAMR CMD PAN/TILT – HI RATE

PAN – L (to hard stop)

TILT – UP (to hard stop)

PAN/TILT – RESET, HI RATE (LO within 10°)

PAN: +140 (right)

TILT: -55 (dn)

MUX 1 L ← MIDDECK

LDRI MODE 2 pb – push (ITVC video)

VIDEO OUT – as desired (not DTV)

√VIDEO IN – not PL2

9. SINGLE JOINT MNVR TO MPLM VIEWING

On SSRMS Operator GO for OBSS mnvr to MPLM VIEWING

MON 1	ELBOW
MON 2	B
DNLK	A
DTV	ITVC

NOTE

During first WR Single Joint mnvr, OBSS will be 48 inches from SSRMS Tip LEE.

During SY Single Joint mnvr, SRMS Upper Boom will be 54 inches from JEM-PM

RHC RATE – as reqd (VERN within 10 ft)
 BRAKES – OFF (tb-OFF)
 MODE – SINGLE, ENTER

Mnvr to MPLM VIEWING posn:

	SY	SP	EP	WP	WY	WR	
OBSS Handoff	+24.5	+59.0	-42.1	-85.9	+11.2	-99.4	
1: WR +						-75.0	
2: WY –					0.0		
3: WP +				-60.0			
4: EP +			-23.0				
5: WP +				0.0			
6: SP –		+49.0					
7: SY +	+62.5						
8: SP –		+25.0					
9: WR +						-21.9	
10: WY –					-13.2		
MPLM Viewing	+62.5	+25.0	-23.0	0.0	-13.2	-21.9	
	X	Y	Z	PITCH	YAW	ROLL	PL ID
	-1252	-520	-889	60	349	312	2

BRAKES – ON (tb-ON)
 MODE – not DIRECT (lt off)
 PARAM – PORT TEMP
 JOINT – CRIT TEMP

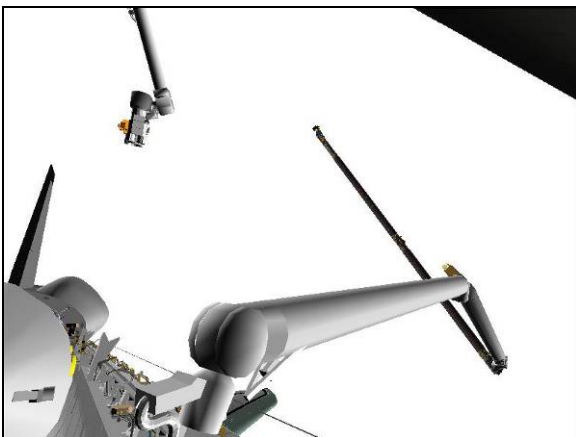

CCTV A (30,15)

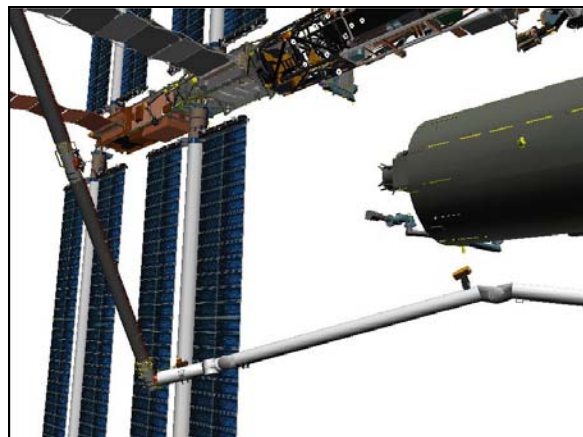

CCTV B (-45,10)

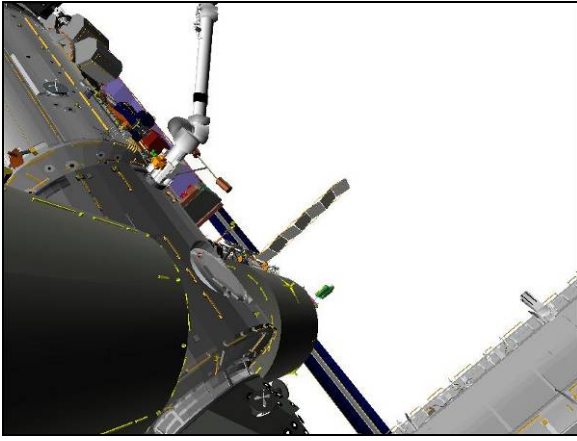

ELBOW (-165,20)

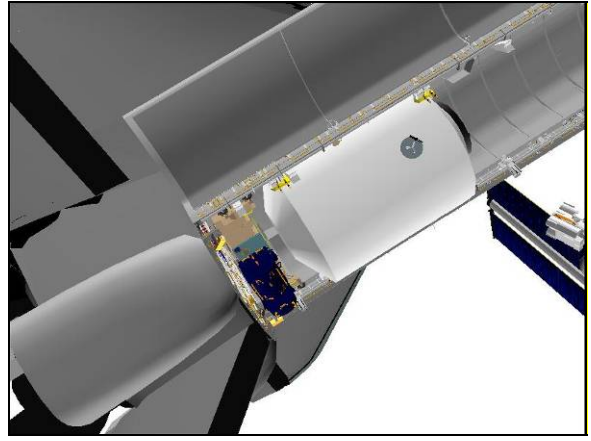

OBSS ITVC (140,-55)

OBSS HANDOFF FROM SRMS TO SSRMS

1. SETUP

SM 94 PDRS CONTROL

√ PL ID, ITEM 3: 2

√ INIT ID, ITEM 24: 2

Verify at MPLM VIEWING posn:

	X	Y	Z	PITCH	YAW	ROLL	PL ID
√	-1252	-520	-889	60	349	312	2
	SY	SP	EP	WP	WY	WR	
√	+62.5	+25.0	-23.0	0.0	-13.2	-21.9	

R12

√ Green Jumper – ISS

MON 1	BASE ELBOW
MON 2	B
DNLK	ELBOW (EE)
DTV	A

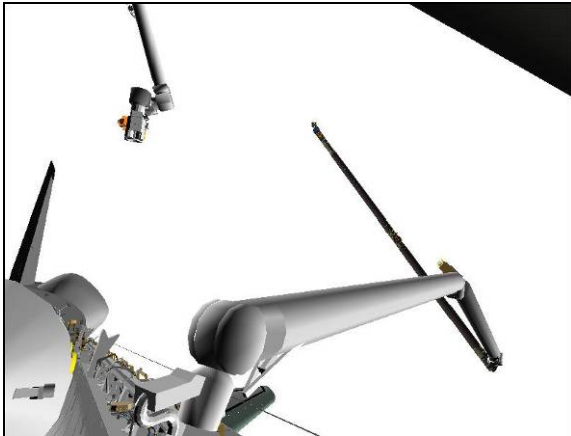

CCTV A (30,15)

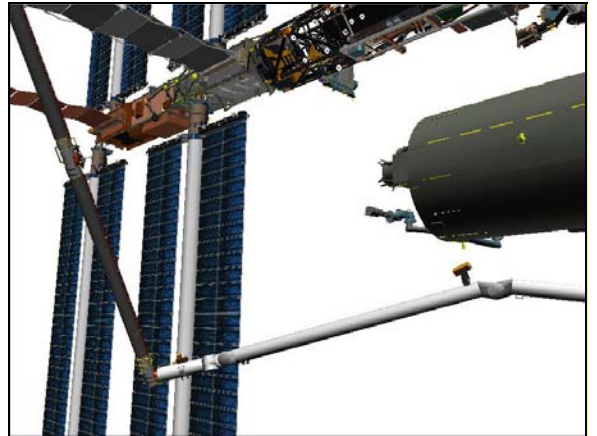

CCTV B (-45,10)

Review GENERIC END EFFECTOR CUE CARD – ISS/SHUTTLE DOCKED OPS

2. SINGLE JOINT MNVR TO OBSS HANDOFF

Verify SSRMS at OBSS PRE-GRAPPLE posn

NOTE

During first SP Single Joint mnvr, SRMS Upper Boom will be 54 inches from JEM-PM.

During second WR Single Joint mnvr, OBSS will be 48 inches from SSRMS Tip LEE

RHC

RATE – as reqd (VERN within 10 ft)

BRAKES – OFF (tb-OFF)

MODE – SINGLE, ENTER

Mnvr to OBSS HANDOFF posn:

	SY	SP	EP	WP	WY	WR	
MPLM Viewing	+62.5	+25.0	-23.0	0.0	-13.2	-21.9	
1: WY +					0.0		
2: WR -						-75.0	
3: SP +		+49.0					
4: SY -	+24.5						
5: SP +		+59.0					
6: WP -				-60.0			
7: EP -			-42.1				
8: WP -				-85.9			
9: WY +					+11.2		
10: WR -						-99.4	
OBSS Handoff	+24.5	+59.0	-42.1	-85.9	+11.2	-99.4	
	X	Y	Z	PITCH	YAW	ROLL	PL ID
	-1059	+231	-597	284	270	270	2 *

*Display singularity

BRAKES – ON (tb-ON)



CCTV A (10,30)

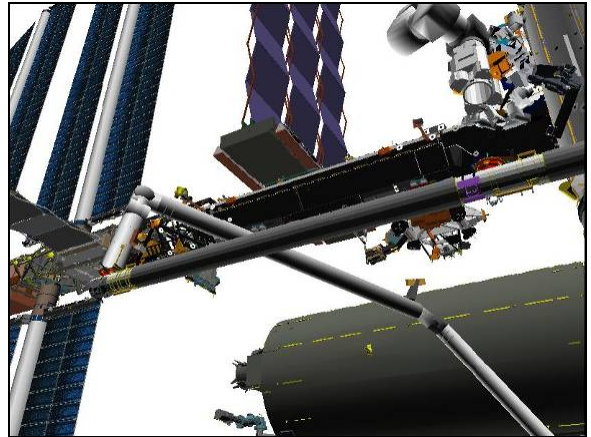

CCTV B (-30,30)

Give SSRMS Operator GO for OBSS grapple

3. STOW PTU

R12 (VPU) Green Jumper – LDRI/ITVC

A7U VID DNLK MON 1 pb – push
IN PL2(VPU) pb – push

CAMR CMD PAN/TILT – HI RATE
PAN – L (to hard stop)
TILT – UP (to hard stop)
PAN/TILT – RESET
PAN: +108 (right)
TILT: -175 (down)

R12 (VPU) Green Jumper – ISS

On SSRMS Operator GO for OBSS ungrapple

CAUTION
STBD RMS HTR power must be applied within 90 min
to prevent sensor package damage

Perform LCC DEACTIVATION (LCS Cue Card, P/TV)
Perform LCH DEACTIVATION (LCS Cue Card, P/TV)
Perform DEACTIVATION (LDRI/ITVC Cue Card, P/TV)

4. OBSS UNGRAPPLE

A7U

CCTV – config for ungrapple
– RMS WRIST, ZOOM: 34.0 HFOV
FOCUS: 5 ft

NOTE

CONTR ERR It and 'S96 PDRS CNTL' msg may
occur due to Consistency/Envelope Check error

RHC

RATE – COARSE (RATE MIN tb-OFF)

SM 94 PDRS CONTROL

AUTO BRAKE INH – ITEM 10 EXEC (*)

BRAKES – OFF (tb-OFF)
MODE – TEST, ENTER
Wait 5 sec

BRAKES – ON (tb-ON)

SM 94 PDRS CONTROL

AUTO BRAKE ENA – ITEM 9 EXEC (*)
PL ID – ITEM 3 +0 EXEC
INIT ID – ITEM 24 +0 EXEC

RHC

RATE – VERN (RATE MIN tb-ON)
BRAKES – OFF (tb-OFF)
MODE – END EFF, ENTER

CAUTION
Monitor EE tb timing to prevent EE motor burnout

EE MODE – AUTO
RELEASE sw – depress (mom)

When OPEN tb – gray, mnvr arm clear of grapple pin

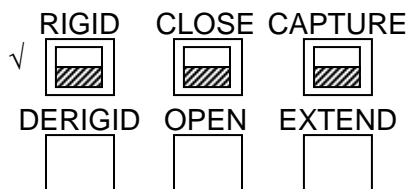

CRITICAL TIMES (28 sec total):
DERIGID tb – gray, 5 sec max, then
OPEN tb – gray, 3 sec max, then
EXTEND tb – gray, 20 sec max

EE MODE – OFF

- * If manual release reqd: *
- * EE MODE – MAN *
- * MAN CONTR – DERIGID (hold until DERIGID tb-gray, 5 sec max) *
- * RELEASE sw – depress (hold until OPEN tb-gray, 3 sec max) *
- * Mnvr arm clear of grapple pin, then *
- * EE MAN CONTR – DERIGID (hold until EXTEND tb-gray, 20 sec max) *
- * MODE – OFF *

Mnvr to OBSS BACKOFF posn:

X	Y	Z	PITCH	YAW	ROLL	PL ID
-1047	-360	-658	284	0	270	0
SY	SP	EP	WP	WY	WR	
+22.7	+57.5	-27.4	-99.3	+11.8	-97.9	

- BRAKES – ON (tb-ON)
- MODE – not DIRECT (lt off)
- PARAM – PORT TEMP
- JOINT – CRIT TEMP

If using Shuttle attitude control and attitude maintenance required:
 Configure DAP per RMS DAPs, then perform RATE DAMPING (ORB OPS FS,
REBOOST/DAP; DOCKED DAP REFERENCE)

Give SSRMS Operator GO for OBSS Berth Sequence

5. CONFIGURE CIRCUIT BREAKERS

- MA73C:C cb MCA PWR AC3 3Φ MID 2 – op
- √AC2 3Φ MID 2 – op
- MA73C:D √AC3 3Φ MID 4 – op

6. CONFIGURE FOR MONITORING

On SSRMS notification to watch for STBD RMS RFLs,
SM 94 PDRS CONTROL
 RMS STBD – ITEM 2 EXEC (*)

Notify SSRMS operator when STBD RMS R-F-L tb (three) – gray

7. STBD MRL LATCH

On SSRMS Operator GO to latch STBD MRLs to Topological Capture,
 √STBD RMS R-F-L tb (three) – gray

SM 94 PDRS CONTROL

√STBD AFT, MID, FWD LAT (six) = 0

R13L PL BAY MECH PWR SYS (two) – ON

NOTE

Expect single motor drive time for MRL latching (18 sec max).
 The following STBD RMS RETEN LAT – OFF and PL BAY
 MECH PWR SYS (two) – OFF actions are to be performed simo

Verify AOS for latching to Topological Capture

STBD RMS RETEN LAT – LAT 6 sec only (tb-bp)
 – OFF

R13L PL BAY MECH PWR SYS (two) – OFF

Give SSRMS Operator GO to Limp All SSRMS Joints and Derigidize

R13L On SSRMS Operator GO to complete STBD MRL latching,
PL BAY MECH PWR SYS (two) – ON

STBD RMS RETEN LAT – LAT (tb-LAT) (12 sec max)
– OFF

8. RECONFIGURE POWER
PL BAY MECH PWR SYS (two) – OFF

STBD RMS HTR A,B (two) – AUTO

A6U EVENT TIMER CNTL – STOP

SM 94 PDRS CONTROL

√STBD AFT, MID, FWD LAT (six) = 1
RMS PORT – ITEM 1 EXEC (*)

MA73C:C cb MCA PWR AC3 3Φ MID 2 – cl
√AC2 3Φ MID 2 – op

MA73C:D √AC3 3Φ MID 4 – op

Give SSRMS Operator GO for OBSS ungrapple

9. MNVR TO PRE-CRADLE
Verify SSRMS at Berthed OBSS Backoff or Overnight Park posn

DNLK MON 1	B (C)
DTV MON 2	A (ELBOW)

SM 94 PDRS CONTROL

END POS – ITEM 18 -1 2 6 1 -1 4 6 -5 5 1 EXEC

ATT – ITEM 21 +5 +2 +0 EXEC

CMD CK – ITEM 25 EXEC (GOOD)

RHC RATE – as reqd (VERN within 10 ft)
BRAKES – OFF (tb-OFF)
MODE – OPR CMD, ENTER (READY lt on)

AUTO SEQ – PROCEED (IN PROG lt on)

When AUTO SEQ IN PROG lt – off:

Verify at PRE-CRADLE posn:

	X	Y	Z	PITCH	YAW	ROLL	PL ID
√	-1261	-146	-551	5	2	0	0
	SY	SP	EP	WP	WY	WR	
√	0.0	+25.0	-25.0	+5.0	0.0	0.0	

BRAKES – ON (tb-ON)

MODE – not DIRECT (lt off)

PARAM – PORT TEMP

JOINT – CRIT TEMP

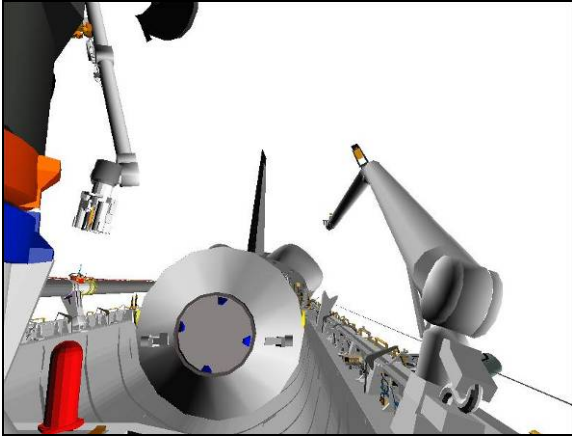

CCTV A (0,10)

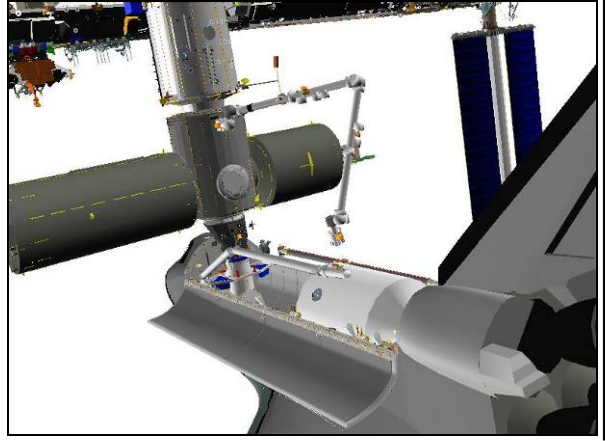

BIRD'S EYE

OBSS MNVR TO STBD SARJ CLEANING

I

1. SETUP

SM 94 PDRS CONTROL

√ PL ID, ITEM 3: 2

√ INIT ID, ITEM 24: 2

Verify at MPLM VIEWING posn:

	X	Y	Z	PITCH	YAW	ROLL	PL ID
√	-1252	-520	-889	60	349	312	2
	SY	SP	EP	WP	WY	WR	
√	+62.5	+25.0	-23.0	0.0	-13.2	-21.9	

R12

√ Green Jumper – ISS

MON 1	P1 LOOB
MON 2	B
DNLK	ELBOW
DTV	A

RHC

2. OBSS MNVR TO STBD SARJ CLEANING

RATE – as reqd (VERN within 10 ft)

BRAKES – OFF (tb-OFF)

MODE – SINGLE, ENTER

Mnvr to STBD SARJ CLEANING posn:

	SY	SP	EP	WP	WY	WR	
MPLM Viewing	+62.5	+25.0	-23.0	0.0	-13.2	-21.9	
1: WP –				-90.0			
2: EP –			-50.0				
3: WR +						+30.0	
STBD SARJ	+62.5	+25.0	-50.0	-90.0	-13.2	+30.0	
	X	Y	Z	PITCH	YAW	ROLL	PL ID
	-1050	-842	+183	290	41	78	2

BRAKES – ON (tb-ON)

MODE – not DIRECT (lt off)

PARAM – PORT TEMP

JOINT – CRIT TEMP

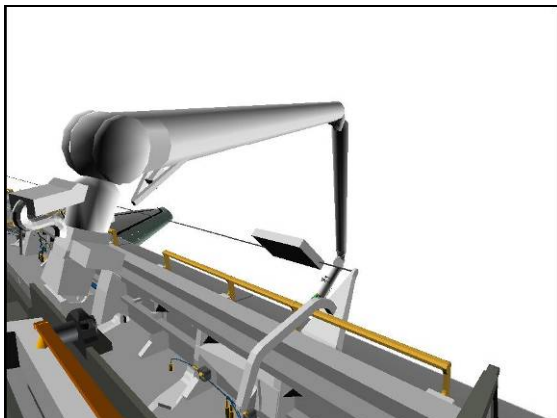

CCTV A (45,-10)



P1 LOOB (150,30)

R12
A7U

3. RECONFIG PTU
Green Jumper – LDRI/ITVC
DTV ← PL2

CAMR CMD PAN/TILT – HI RATE
PAN – L (to hard stop)
TILT – UP (to hard stop)
PAN/TILT – RESET, HI RATE (LO within 10°)
PAN: +100
TILT: -150

VIDEO OUT – as desired (not DTV)
√VIDEO IN – not PL2

OBSS MNVR FROM STBD SARJ CLEANING TO MPLM VIEWING

1. SETUP

SM 94 PDRS CONTROL

√ PL ID, ITEM 3: 2

√ INIT ID, ITEM 24: 2

Verify at STBD SARJ CLEANING posn:

	X	Y	Z	PITCH	YAW	ROLL	PL ID
√	-1050	-842	+183	290	41	78	2
	SY	SP	EP	WP	WY	WR	
√	+62.5	+25.0	-50.0	-90.0	-13.2	+30.0	

R12

√ Green Jumper – ISS

MON 1	P1 LOOB
MON 2	B
DNLK	ELBOW
DTV	A

2. OBSS MNVR TO MPLM VIEWING

RHC

RATE – as reqd (VERN within 10 ft)

BRAKES – OFF (tb-OFF)

MODE – SINGLE, ENTER

Mnvr to MPLM VIEWING posn:

	SY	SP	EP	WP	WY	WR	
STBD SARJ	+62.5	+25.0	-50.0	-90.0	-13.2	+30.0	
1: WR –						-21.9	
2: EP +			-23.0				
3: WP +				0.0			
MPLM Viewing	+62.5	+25.0	-23.0	0.0	-13.2	-21.9	
	X	Y	Z	PITCH	YAW	ROLL	PL ID
	-1252	-520	-889	60	349	312	2

BRAKES – ON (tb-ON)

MODE – not DIRECT (lt off)

PARAM – PORT TEMP

JOINT – CRIT TEMP



CCTV A (30,5)

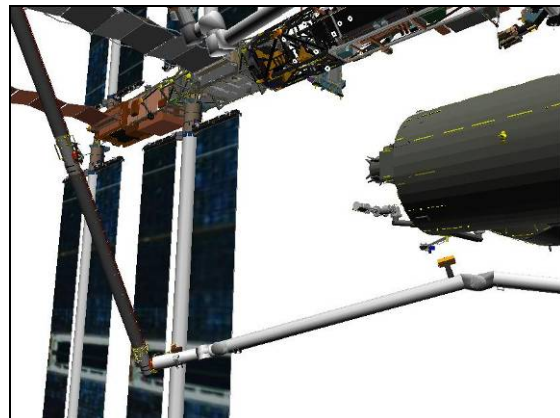

CCTV B (-45,10)

OBSS MNVR TO UNDOCK

1. SETUP

SM 94 PDRS CONTROL

√ PL ID, ITEM 3: 2

√ INIT ID, ITEM 24: 2

Verify at MPLM VIEWING posn:

	X	Y	Z	PITCH	YAW	ROLL	PL ID
√	-1252	-520	-889	60	349	312	2
	SY	SP	EP	WP	WY	WR	
√	+62.5	+25.0	-23.0	0.0	-13.2	-21.9	

R12

√ Green Jumper – ISS

MON 1	BASE ELBOW (S1 LOOB)
MON 2	B
DNLK	ELBOW
DTV	A

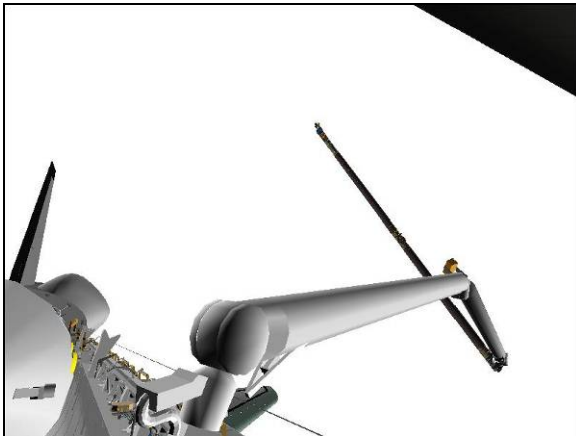

CCTV A (30,15)

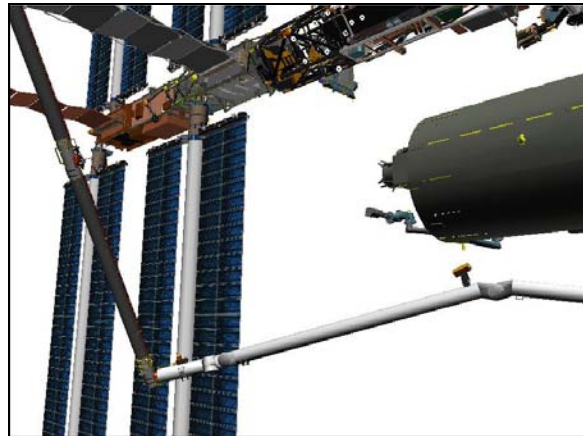

CCTV B (-45,10)

2. OBSS MNVR TO UNDOCK

On SSRMS Operator GO for SRMS mnvr to undock,

BRAKES – OFF (tb-OFF)

MODE – SINGLE, ENTER

NOTE

During first SP Single Joint mnvr, SRMS Upper Boom will be 54 inches from JEM-PM.

During second SP Single Joint mnvr, SRMS Upper Boom will be 40 inches from JEM-PM

Mnvr to UNDOCK posn:

	SY	SP	EP	WP	WY	WR	
MPLM Viewing	+62.5	+25.0	-23.0	0.0	-13.2	-21.9	
1: WY +					0.0		
2: WR -						-75.0	
3: SP +		+49.0					
4: SY -	+25.8						
5: SP +		+66.3					
6: EP -			-49.0				
7: WP -				-85.9			
8: WY +					+10.7		
9: WR -						-100.7	
Undock	+25.8	+66.3	-49.0	-85.9	+10.7	-100.7	
	X	Y	Z	PITCH	YAW	ROLL	PL ID
	-1029	+229	-614	14	270	0	2

*Display singularity

BRAKES – ON (tb-ON)
 MODE – not DIRECT (lt off)
 PARAM – PORT TEMP
 JOINT – CRIT TEMP

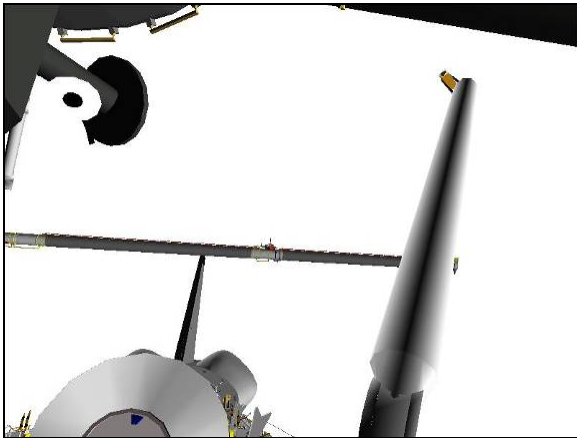

CCTV A (10,25)

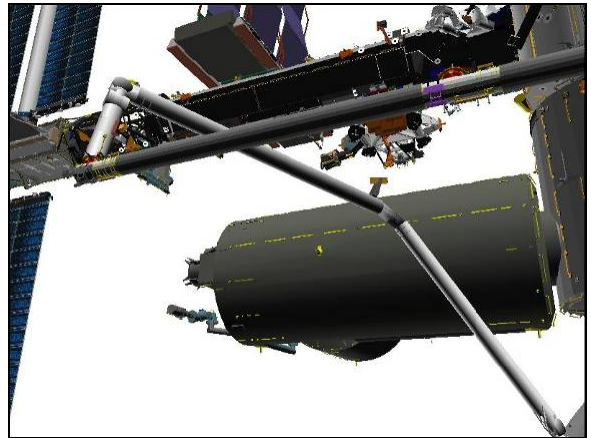

CCTV B (-25,20)

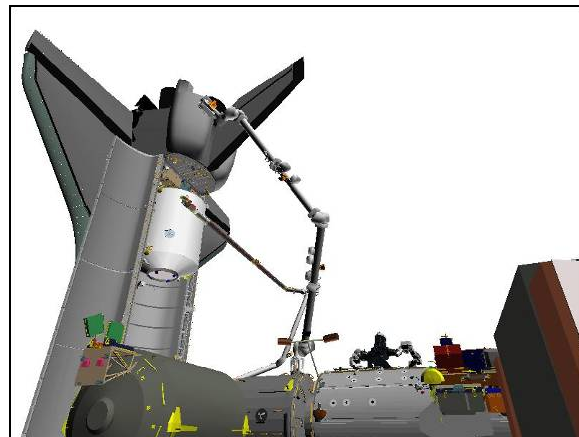

S1 LOOB (70,30)

OBSS MNVR TO FLAT FIELD

WARNING
For UNDOCKED ops only

1. SETUP

SM 94 PDRS CONTROL

- √ PL ID, ITEM 3: 2
- √ INIT ID, ITEM 24: 2

Verify at UNDOCK posn:

	X	Y	Z	PITCH	YAW	ROLL	PL ID	
√	-1029	+229	-614	14	270	0	2	*
	SY	SP	EP	WP	WY	WR		
√	+25.8	+66.3	-49.0	-85.9	+10.7	-100.7		

*Display singularity

MON 1	D
MON 2	B (A)
DNLK	C
DTV	ELBOW

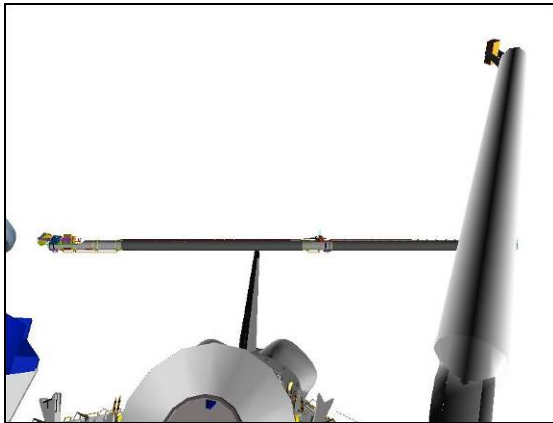

CCTV A (0,25)

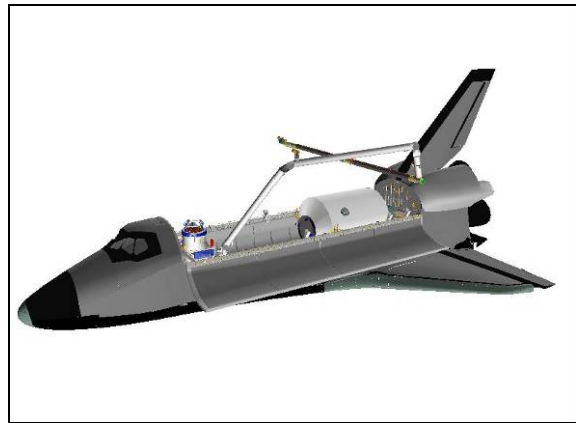

BIRD'S EYE

2. MNVR TO INTERMEDIATE

SM 94 PDRS CONTROL

- END POS – ITEM 18 -8 0 0 +5 0 0 -2 5 0 EXEC
- ATT – ITEM 21 +2 8 1 +3 3 3 +9 5 EXEC
- CMD CK – ITEM 25 EXEC (GOOD)

RHC

- RATE – as reqd (VERN within 10 ft)
- BRAKES – OFF (tb-OFF)
- MODE – OPR CMD, ENTER (READY lt on)

AUTO SEQ – PROCEED (IN PROG lt on)

- When AUTO SEQ IN PROG lt – off:
- BRAKES – ON (tb-ON)

Verify at INTERMEDIATE posn:

X	Y	Z	PITCH	YAW	ROLL	PL ID
-800	+500	-250	281	333	95	2
SY	SP	EP	WP	WY	WR	
-86.6	+72.8	-85.9	+21.1	-3.3	-169.2	

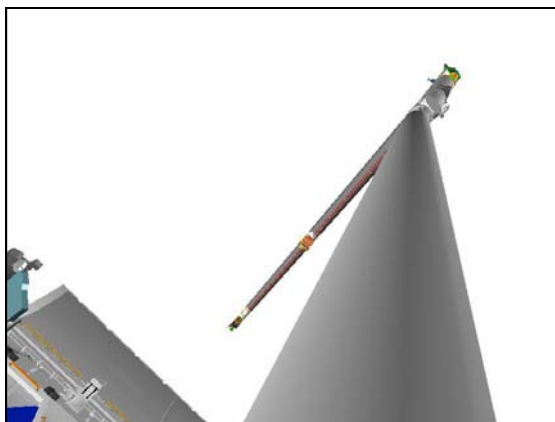

ELBOW (-20,-20)



BIRD'S EYE

3. MNVR TO FLAT FIELD

RHC
 RATE – as reqd (VERN within 10 ft)
 BRAKES – OFF (tb-OFF)
 MODE – SINGLE, ENTER

Mnvr to FLAT FIELD posn:

	SY	SP	EP	WP	WY	WR	
	-86.6	+72.8	-85.9	+21.1	-3.3	-169.2	
INTERM							
1: WR –							-249.9
2: SY –	-90.1						
3: WY +					0.0		
4: WP –				-57.6			
5: EP +			-65.8				
6: SP –		+25.0					
FLAT FIELD	-90.1	+25.0	-65.8	-57.6	0.0		-249.9
	X	Y	Z	PITCH	YAW	ROLL	PL ID
	-1270	+350	-445	0	0	11	2

BRAKES – ON (tb-ON)
 MODE – not DIRECT (lt off)

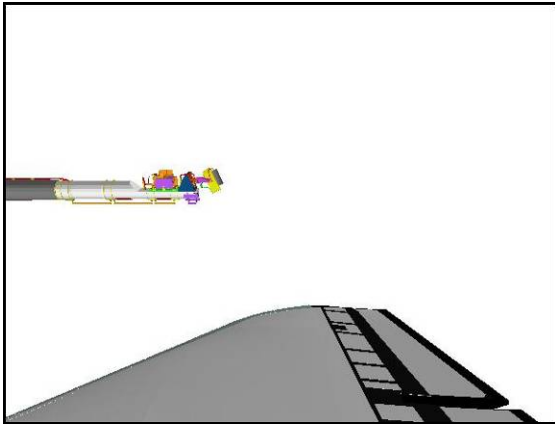

CCTV C (95,-5)

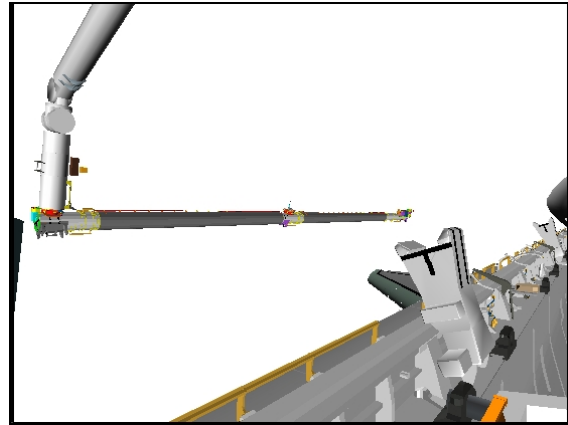

CCTV D (-40,0)

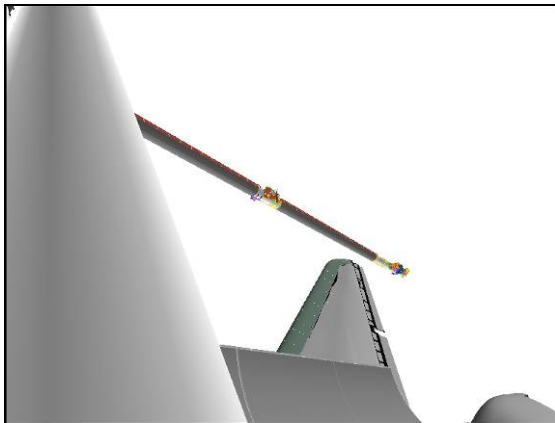

ELBOW (25,-40)

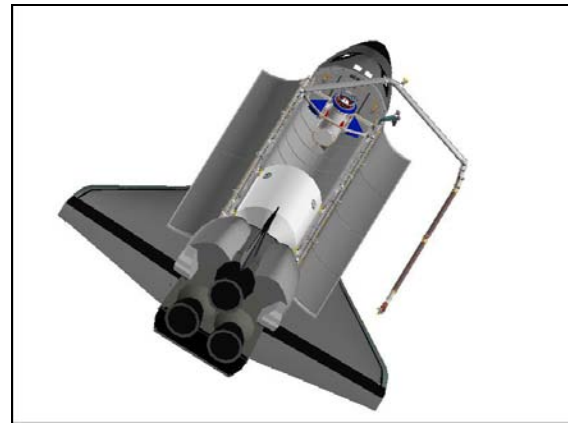

BIRD'S EYE

4. SETUP FOR STBD SURVEY

SM 94 PDRS CONTROL

AUTO MODES – ITEM 13 +1 +2 +3 +4 EXEC

For survey scan pattern, refer to OBSS SCAN PATTERN CUE CARDS – STBD & PORT, AND WING GLOVE AND CREW CABIN

Perform ACTIVATION (LDRI/ITVC Cue Card, P/TV) steps 1, 3, 4, and 5

A15 APCU 2 CONV – OFF
Wait 10 sec
APCU 2 CONV – ON

Perform LCC ACTIVATION (LCS Cue Card, P/TV)
Perform IDC SOFTWARE ACTIVATION (IDC Cue Card, P/TV) steps 1 and 2

A7U MUX 1 L ← MIDDECK
LDRI MODE 6 pb – lit (flickering LDRI video)
√DTV ← PL2

CAMR CMD PAN/TILT – HI RATE
PAN – L (to hard stop)
TILT – UP (to hard stop)
PAN/TILT – RESET, HI RATE (LO within 10°)
PAN: +103 (right)
TILT: -260 (dn)

VIDEO OUT – as desired (not DTV)
√VIDEO IN – not PL2

L10(VTR) REC pb – push, hold
PLAY pb – push, simo (red ●)

Go to OBSS LDRI/IDC RCC SURVEY – STBD (OBSS OPERATIONS), step 3.
Reference 7-9 for procedure Notes

OBSS CONTINGENCY

OBSS SJ HANDOFF FROM SSRMS TO SRMS.....	FS 2-2
SRMS TO SSRMS.....	FS 2-19
MNVR FROM MPLM VIEWING TO STBD WING.....	FS 2-37
STBD WING TO MPLM VIEWING.....	FS 2-39

OBSS
CONTINGENCY

OBSS SJ HANDOFF FROM SSRMS TO SRMS

1. SETUP

SM 94 PDRS CONTROL

√PL ID, ITEM 3: 0

√INIT ID, ITEM 24: 0

A7U CCTV – config as reqd
 – perform PAN/TILT RESET for PLB cameras
 ZOOM – full OUT

R12 √Green Jumper – ISS

MON 1	BASE ELBOW
MON 2	B
DNLK	ELBOW (EE)
DTV	A

2. SINGLE JOINT MANUEVER TO OBSS PRE-GRAPPLE AT HANDOFF

Verify SSRMS at Stage Park posn

If SINGLE mode available:

RHC RATE – as reqd (VERN within 10 ft)
 BRAKES – OFF (tb-OFF)

MODE – best available

Mnvr to OBSS PRE-GRAPPLE AT HANDOFF posn:

	SY	SP	EP	WP	WY	WR	
Pre-Cradle	0.0	+25.0	-25.0	+5.0	0.0	0.0	
1: SP +		+57.5					
2: WP –				-99.3			
3: WY +					+11.8		
4: WR –						-97.9	
5: EP –			-27.4				
6: SY +	+22.7						
OBSS Pre-Grapple at Handoff	+22.7	+57.5	-27.4	-99.3	+11.8	-97.9	
	X	Y	Z	PITCH	YAW	ROLL	PL ID
	-1047	-360	-658	284	0	270	0

BRAKES – ON (tb-ON)
 MODE – not DIRECT
 JOINT – CRIT TEMP

OBSS CONTINGENCY

Start:
Pre-Cradle

Step 1:
Drive SP (+) from +25.0° to +57.5°

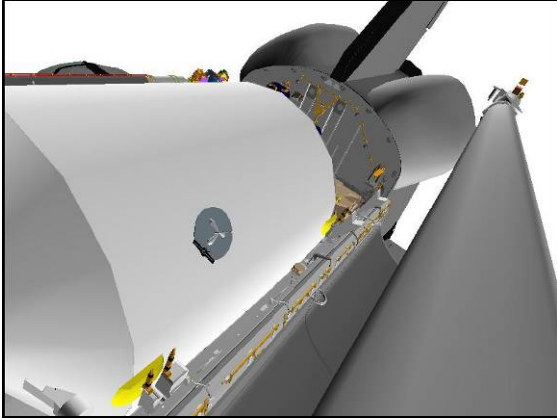

ELBOW (-30,-20)

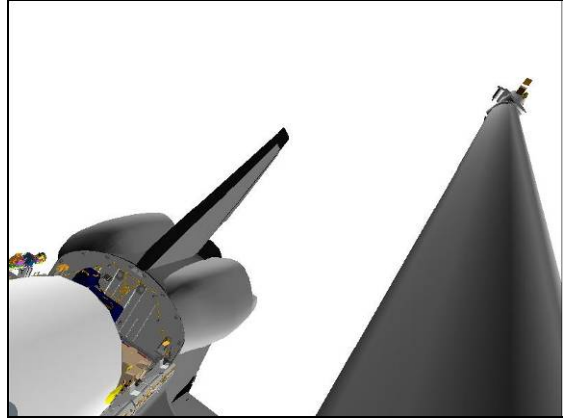

ELBOW (-30,-20)

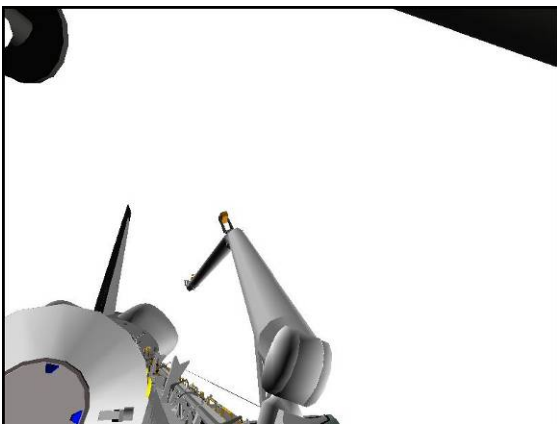

CCTV A (-20,20)

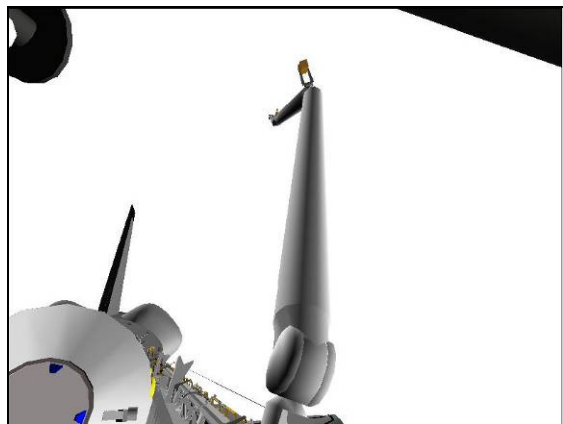

CCTV A (-20,20)

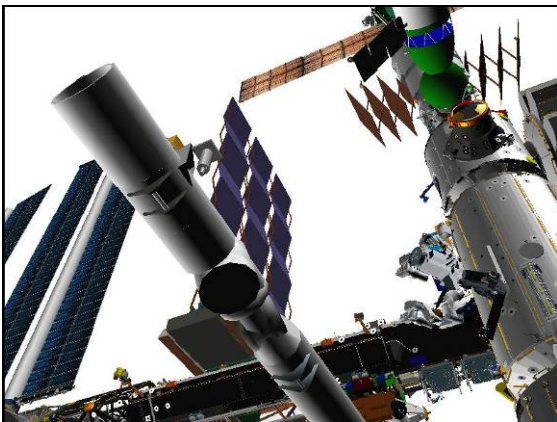

CCTV B (-25,50)

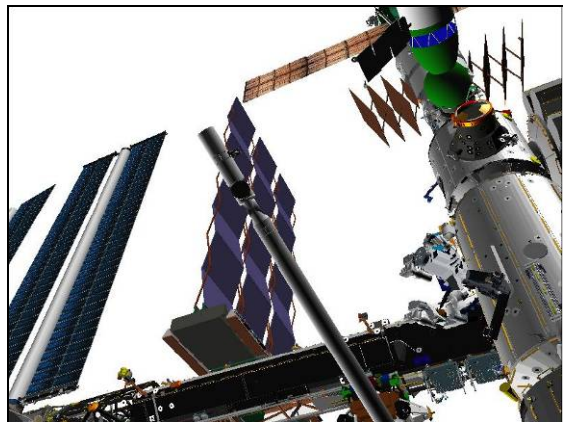

CCTV B (-25,50)

Step 2:
Drive WP (-) from $+5.0^\circ$ to -99.3°

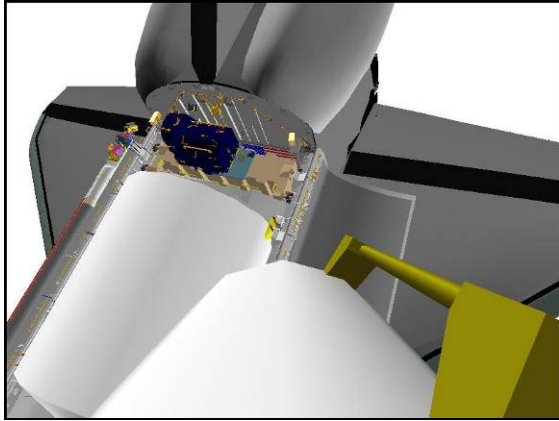

EE

Step 3:
Drive WY (+) from 0.0° to $+11.8^\circ$

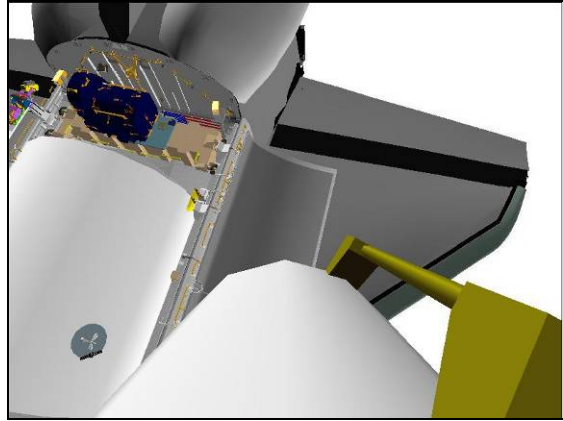

EE

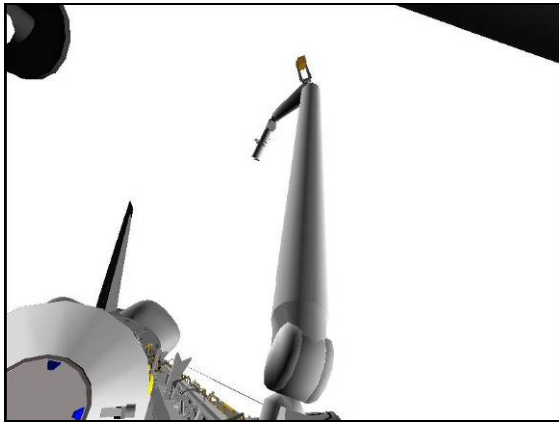

CCTV A (20,20)

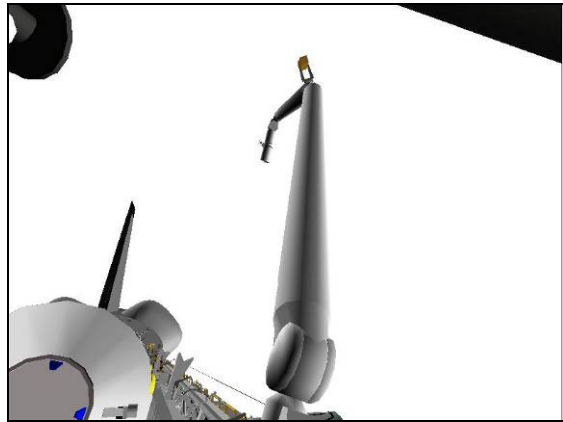

CCTV A (20,20)

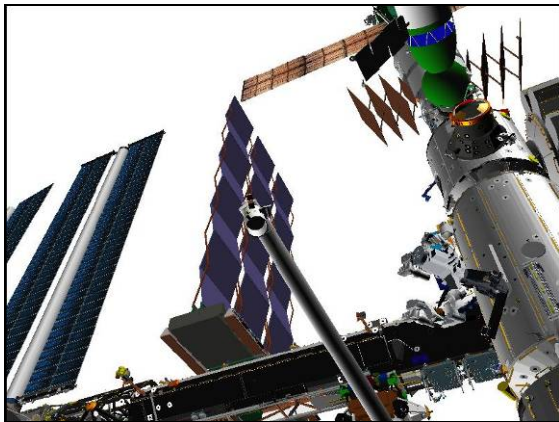

CCTV B (-25,50)

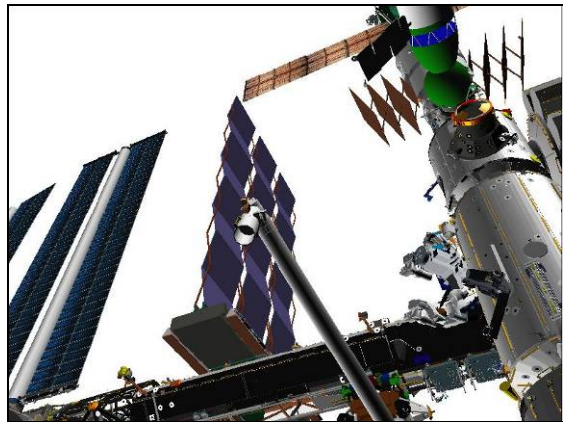

CCTV B (-25,50)

Step 4:

Drive WR (-) from 0.0° to -97.9°

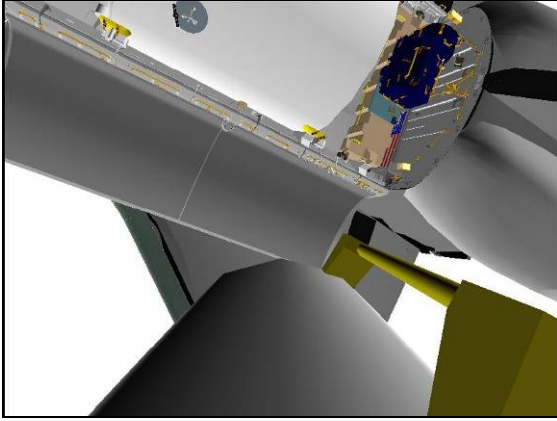

EE

Step 5:

Drive EP (-) from -25.0° to -27.4°

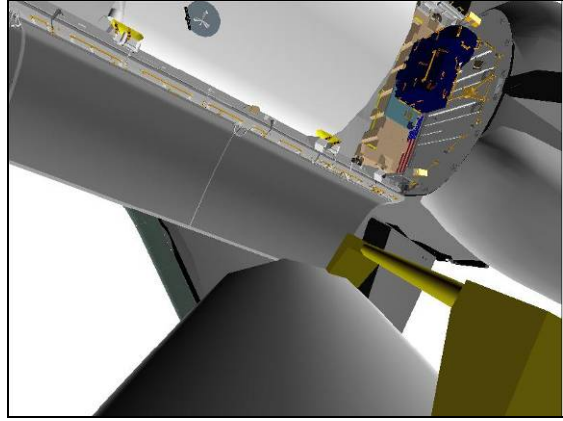

EE

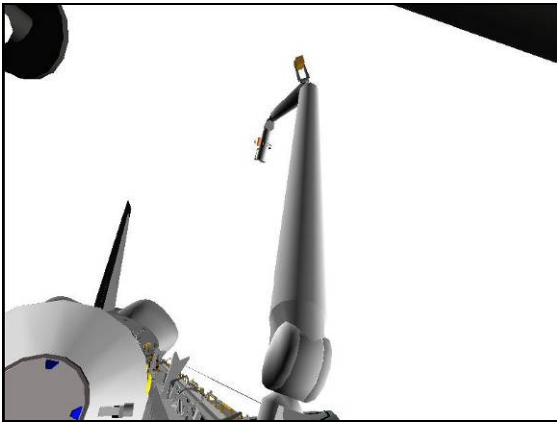

CCTV A (20,20)

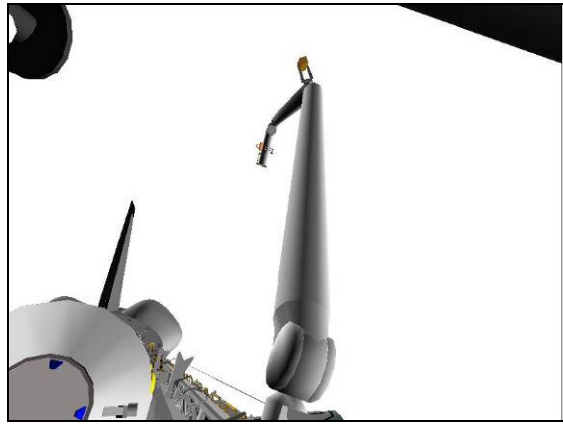

CCTV A (20,20)

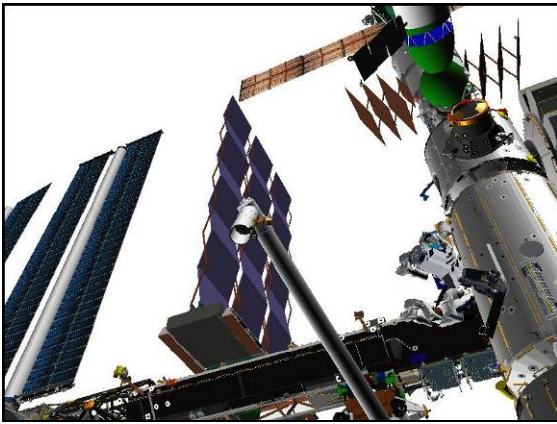

CCTV B (-25,50)

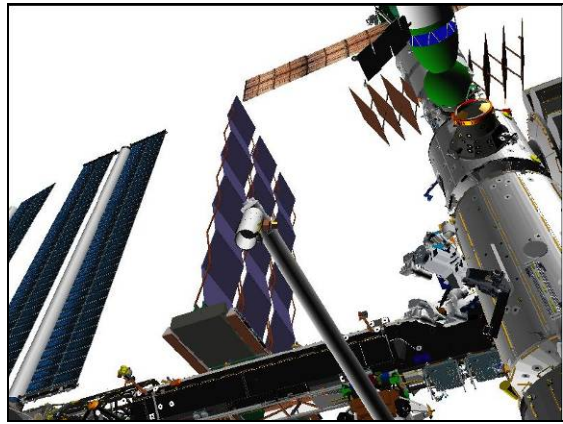

CCTV B (-25,50)

Step 6:

Drive SY (+) from 0.0° to +22.7°

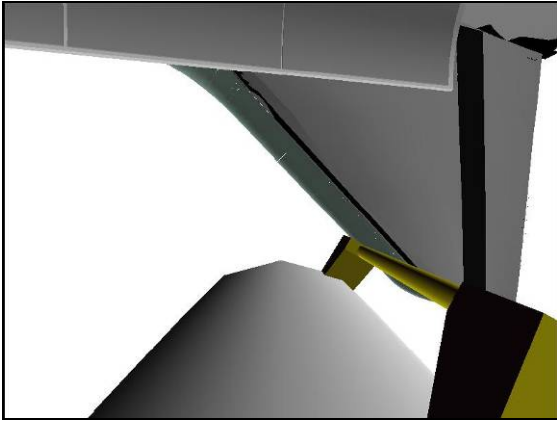

EE

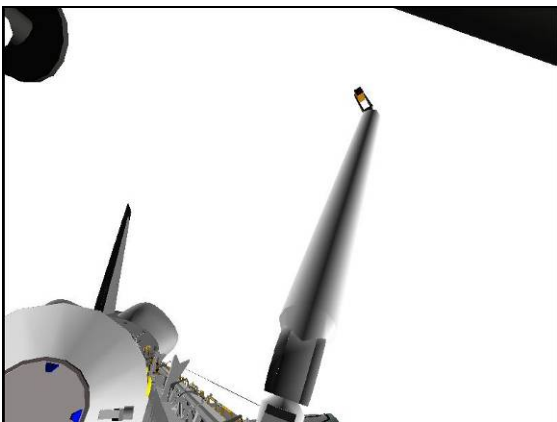

CCTV A (20,20)

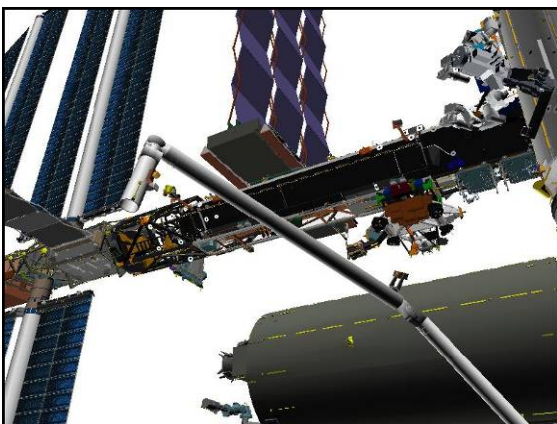

CCTV B (-30,30)

Notify SSRMS Operator that SRMS at OBSS Pre-Grapple at Handoff posn

3. CONFIGURE POWER

<p><u>CAUTION</u> SPEE power must be applied within 90 min to prevent sensor package damage</p>

On SSRMS Operator GO to deactivate STBD heaters,
STBD RMS HTR A,B (two) – OFF

- A6U EVENT TIMER MODE – UP
 CNTL – START
- MA73C:C cb MCA PWR AC3 3Φ MID 2 – op
 √AC2 3Φ MID 2 – op
- MA73C:D √AC3 3Φ MID 4 – op
- R13L PL BAY MECH PWR SYS (two) – ON

4. STBD MRL RELEASE

<p>SM 94 PDRS CONTROL</p>

RMS STBD – ITEM 2 EXEC (*)
√STBD AFT, MID, FWD REL (six) = 0

NOTE
Expect single motor drive time for MRL release

STBD RMS RETEN LAT – REL (tb-REL) (18 sec max)
– OFF

If motor drive time > 18 sec, √MCC

<p>SM 94 PDRS CONTROL</p>

√STBD AFT, MID, FWD REL (six) = 1

5. RECONFIGURE POWER

- R13L PL BAY MECH PWR SYS (two) – OFF
- MA73C:C cb MCA PWR AC3 3Φ MID 2 – cl
 √AC2 3Φ MID 2 – op
- MA73C:D √AC3 3Φ MID 4 – op

Give SSRMS Operator GO for OBSS Unberth and SSRMS mnvr to Handoff
Monitor RFL Status

After OBSS Unberth,

<p>SM 94 PDRS CONTROL</p>

RMS PORT – ITEM 1 EXEC (*)

6. SETUP FOR GRAPPLE

MON 1	B
MON 2	A
DNLK	EE (ELBOW)
DTV	S1 LOOB

A7U CCTV – config for grapple
 – install OBSS SJ GRAPPLE AT HANDOFF OVERLAY
 – RMS WRIST, ZOOM: 34.0 HFOV
 FOCUS: 5 ft
 Maintain eyepoint approx 18 in when using grapple overlay

R12(OBSS) √SPEE PWR – OFF
 A15 √APCU 2 OUTPUT – OFF

7. OBSS SJ GRAPPLE AT HANDOFF POSN
 On SSRMS Operator GO for SRMS OBSS grapple

RHC If SINGLE mode available:
 RATE – VERN (RATE MIN tb-ON)
 BRAKES – OFF (tb-OFF)

MODE – best available

Drive joints per OBSS SJ GRAPPLE AT HANDOFF OVERLAY and diagram until EE within grapple envelope

CAUTION
 Monitor EE tb timing to prevent EE motor burnout

EE MODE – AUTO
 CAPTURE sw – depress (mom)

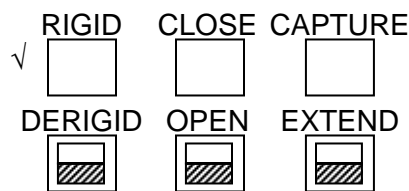

CRITICAL TIMES (28 sec total):
 CAPTURE tb – gray, then
 CLOSE tb – gray, 3 sec max, then
 RIGID tb – gray, 25 sec max

EE MODE – OFF

- * If manual capture required: *
- * EE MODE – MAN *
- * CAPTURE sw – depress (hold until CLOSE tb-gray, 3 sec max) *
- * MAN CONTR – RIGID (hold until RIGID tb-gray, 25 sec max) *
- * MODE – OFF *

If TEST mode available:
 MODE – TEST, ENTER
 Wait 5 sec

BRAKES – ON (tb-ON)
 MODE – not DIRECT (lt off)
 JOINT – CRIT TEMP

OBSS SJ GRAPPLE AT HANDOFF

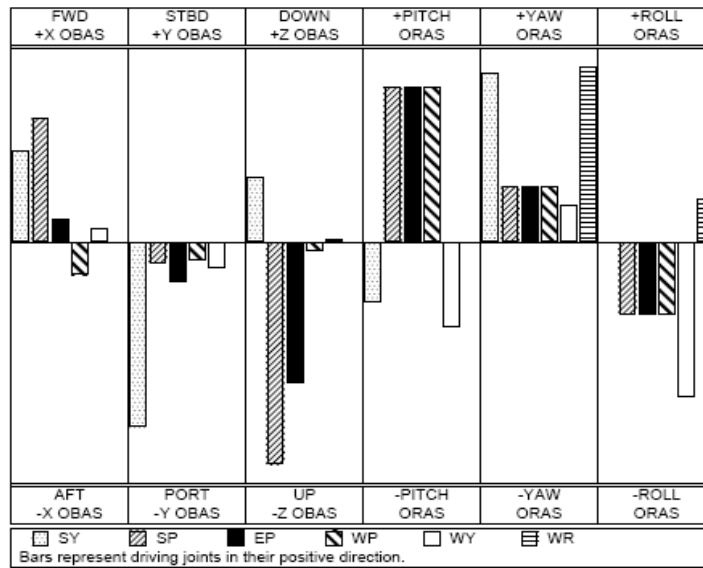

To get:	Drive:	To get:	Drive:	Driving:	Results In:	Driving:	Results In:
+X (fwd)	+SP, +SY	+PITCH	+WP, +EP	+SY	-Y (port), +YAW	+WP	-X (aft), +PITCH
+Y (stbd)	-SY	+YAW	+WR, +SY	+SP	-Z (up), +PITCH	+WY	-Y (port), -ROLL
+Z (down)	-SP, -EP	+ROLL	-WY, -WP	+EP	-Z (up), +PITCH	+WR	+YAW

ΔSY	ΔSP	ΔEP	ΔWP	ΔWY	ΔWR
+1.8	+1.9	-15.4	+13.9	-0.7	-1.7

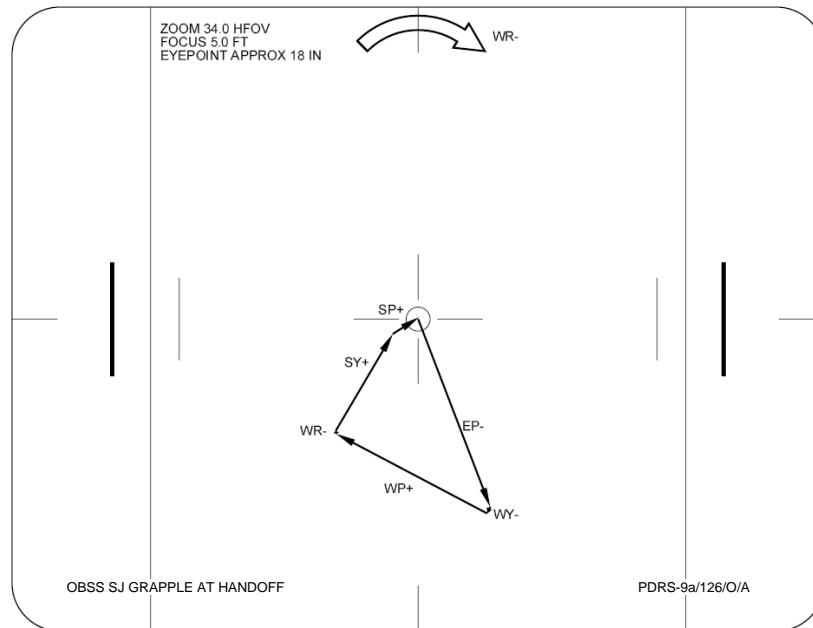

If SINGLE mode available:

SM 94 PDRS CONTROL

PL ID – ITEM 3 +2 EXEC

INIT ID – ITEM 24 +2 EXEC

Expected OBSS HANDOFF posn:

X	Y	Z	PITCH	YAW	ROLL	PL ID
-1059	+231	-597	284	270	270	2
SY	SP	EP	WP	WY	WR	
+24.5	+59.0	-42.1	-85.9	+11.2	-99.4	

*Display singularity

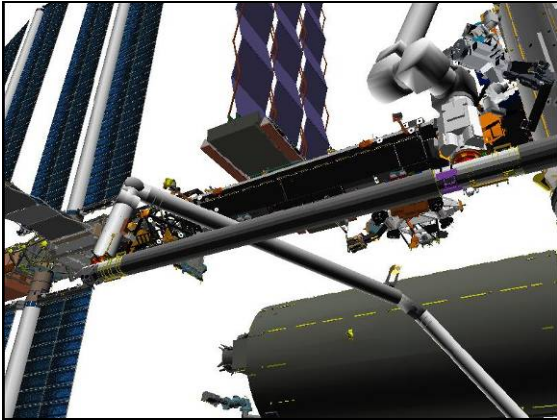

CCTV B (-30,30)

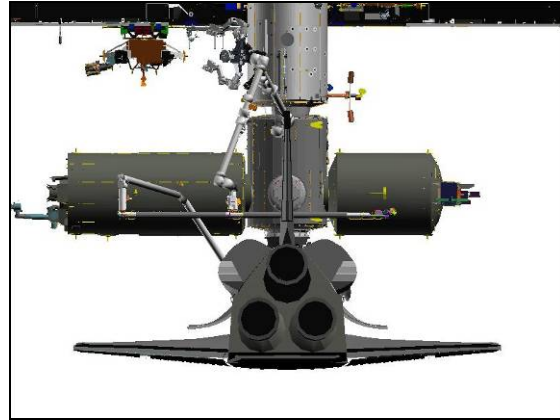

BIRD'S EYE

Perform ACTIVATION (LDRI/ITVC Cue Card, P/TV)

Perform LCH ACTIVATION (LCS Cue Card, P/TV)

Review GENERIC END EFFECTOR CUE CARD – ISS/SHUTTLE DOCKED OPS

Give SSRMS Operator GO for OBSS ungrapple

Perform LCC ACTIVATION (LCS Cue Card, P/TV)

Perform LCC DEACTIVATION (LCS Cue Card, P/TV), steps 1 and 2

R12
A7U
8. RECONFIG PTU
Green Jumper – LDRI/ITVC
DTV ← PL2

CAMR CMD PAN/TILT – HI RATE

PAN – L (to hard stop)

TILT – UP (to hard stop)

PAN/TILT – RESET, HI RATE (LO within 10°)

PAN: +85 (right)

TILT: -37 (dn)

MUX 1 L ← MIDDECK

LDRI MODE 2 pb – push (ITVC video)

VIDEO OUT – as desired (not DTV)

√VIDEO IN – not PL2

9. SINGLE JOINT MNVR TO MPLM VIEWING

On SSRMS Operator GO for OBSS mnvr to MPLM VIEWING

R12

Green Jumper – ISS

MON 1	S1 LOOB
MON 2	B
DNLK	A
DTV	ELBOW

NOTE

During first WR Single Joint mnvr the OBSS will be 48 inches from the SSRMS Tip LEE.

During SY Single Joint mnvr the SRMS Upper Boom will be 54 inches from the JEM-PM

RHC

If SINGLE mode available:

RATE – as reqd (VERN within 10 ft)

BRAKES – OFF (tb-OFF)

MODE – best available

Mnvr to MPLM VIEWING posn:

	SY	SP	EP	WP	WY	WR	
OBSS Handoff	+24.5	+59.0	-42.1	-85.9	+11.2	-99.4	
1: WR +						-75.0	
2: WY –					0.0		
3: WP +				-60.0			
4: EP +			-23.0				
5: WP +				0.0			
6: SP –		+49.0					
7: SY +	+62.5						
8: SP –		+25.0					
9: WR +						-21.9	
10: WY –					-13.2		
MPLM Viewing	+62.5	+25.0	-23.0	0.0	-13.2	-21.9	
	X	Y	Z	PITCH	YAW	ROLL	PL ID
	-1252	-520	-889	60	349	312	2

BRAKES – ON (tb-ON)

MODE – not DIRECT (lt off)

PARAM – PORT TEMP

JOINT – CRIT TEMP

Start:
OBSS Handoff

Step 1:
Drive WR (+) from -99.4° to -75.0°

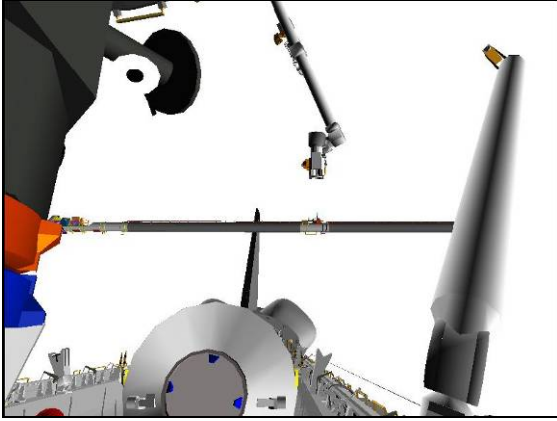

CCTV A (0,20)

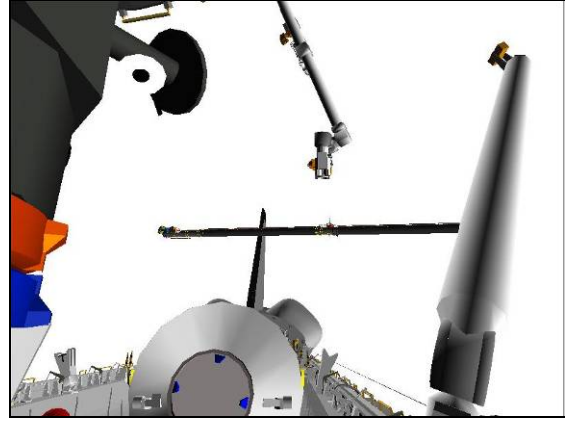

CCTV A (0,20)

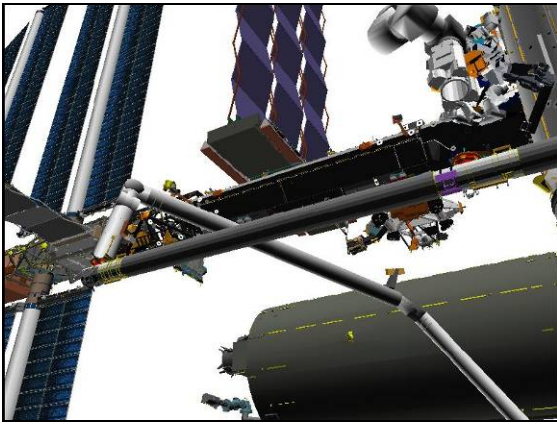

CCTV B (-30,30)

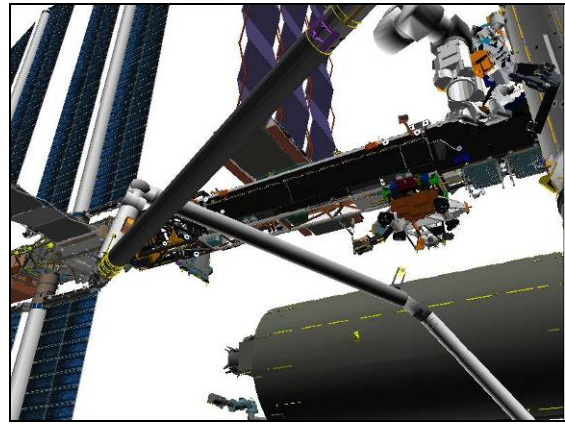

CCTV B (-30,30)

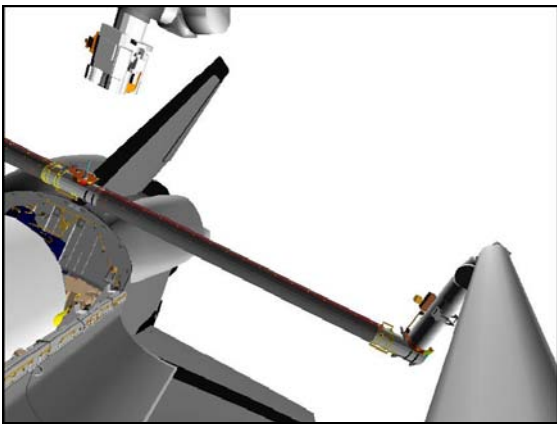

ELBOW (-30,0)



ELBOW (-30,0)

Step 2:

Drive WY (-) from $+11.2^\circ$ to 0.0°

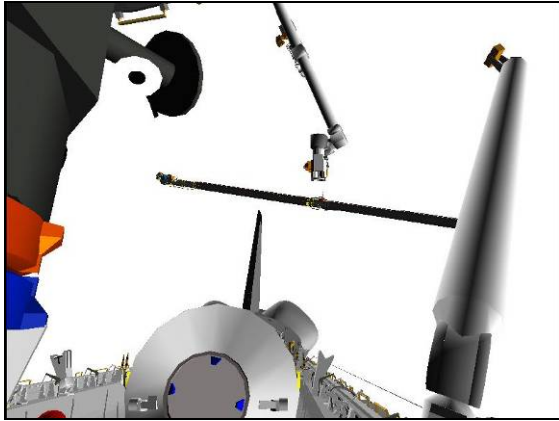

CCTV A (0,20)

Step 3:

Drive WP (+) from -85.9° to -60.0°

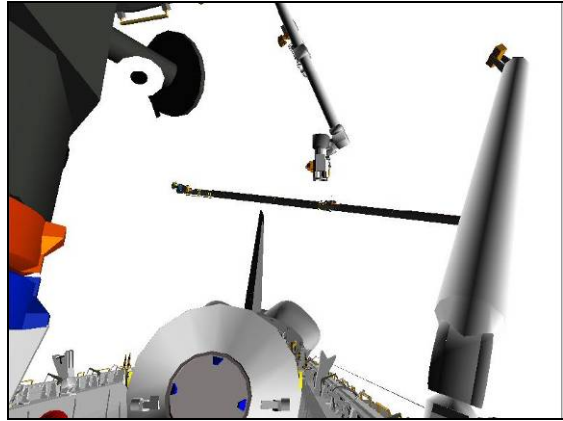

CCTV A (0,20)

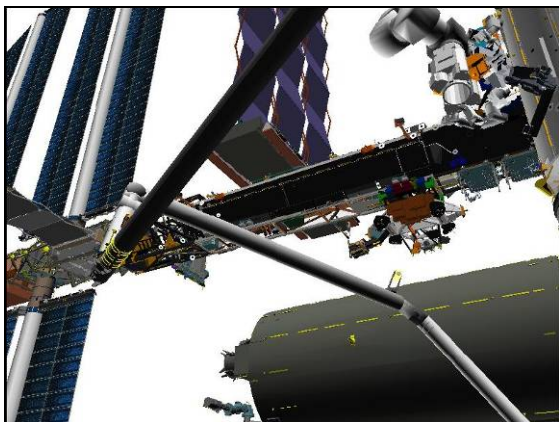

CCTV B (-30,30)

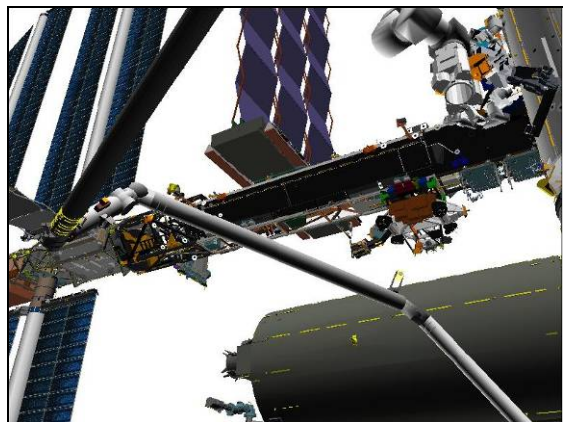

CCTV B (-30,30)

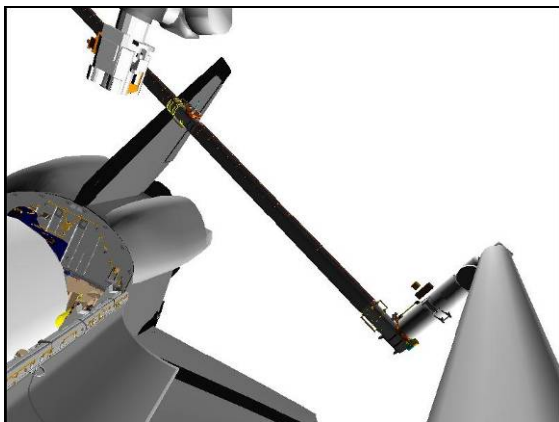

ELBOW (-30,0)



ELBOW (-30,0)

Step 4:

Drive EP (+) from -42.1° to -23.0°



CCTV A (0,20)

Step 5:

Drive WP (+) from -60.0° to 0.0°

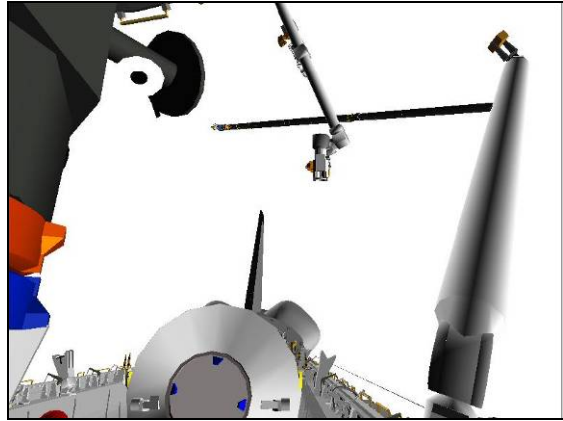

CCTV A (0,20)

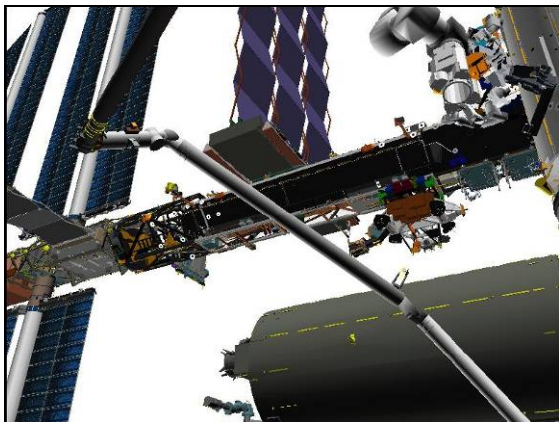

CCTV B (-30,30)

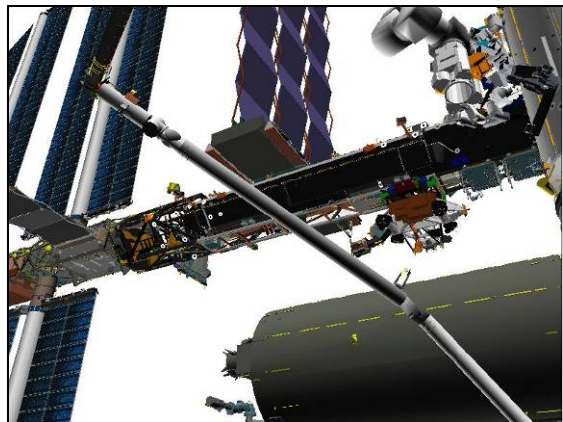

CCTV B (-30,30)

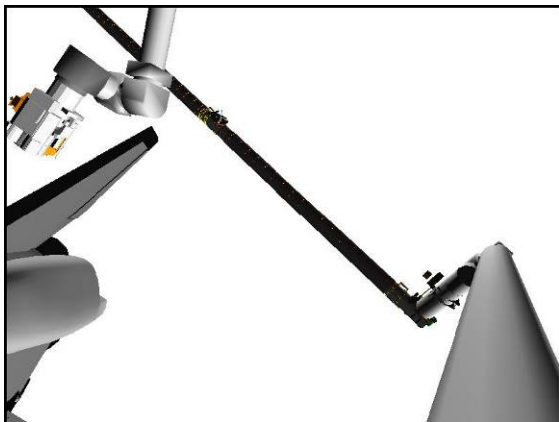

ELBOW (-30,0)

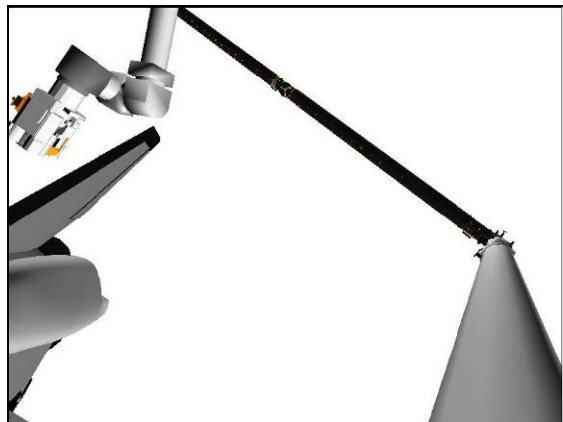

ELBOW (-30,0)

Step 6:

Drive SP (-) from +59.0° to +49.0°

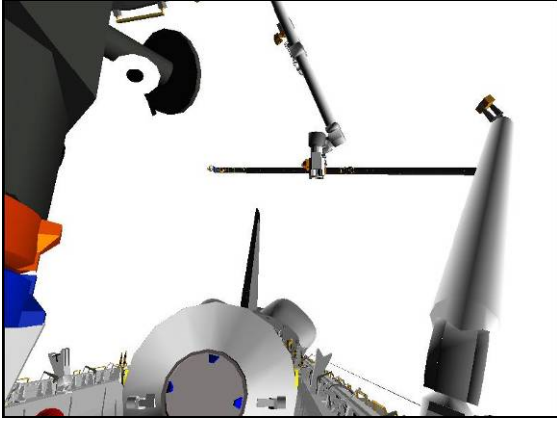

CCTV A (0,20)

Step 7:

Drive SY (+) from +24.5° to +62.5°

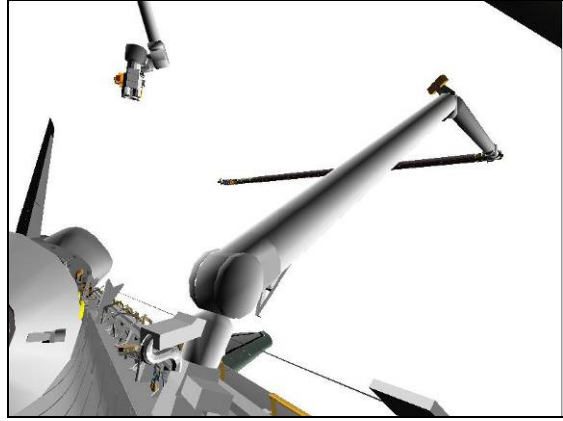

CCTV A (30,10)

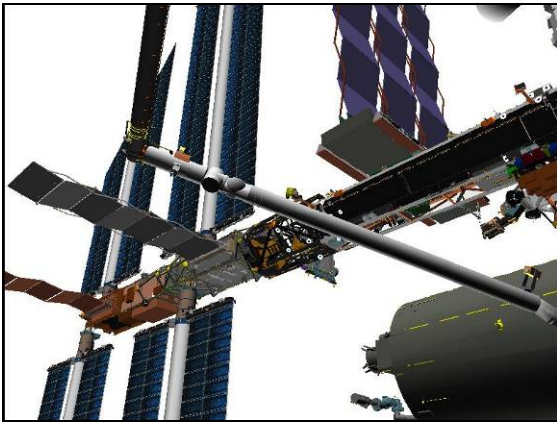

CCTV B (-45,30)

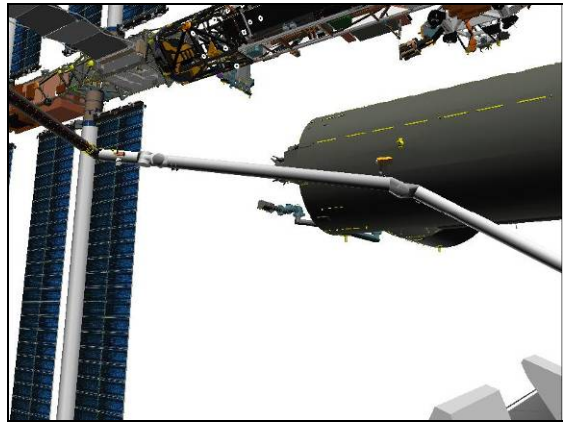

CCTV B (-35,10)

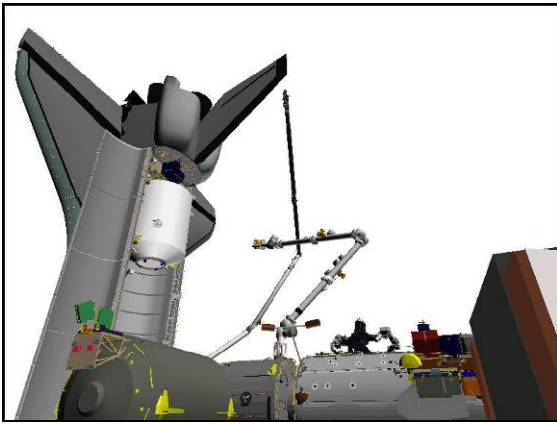

S1 LOOB (70,30)

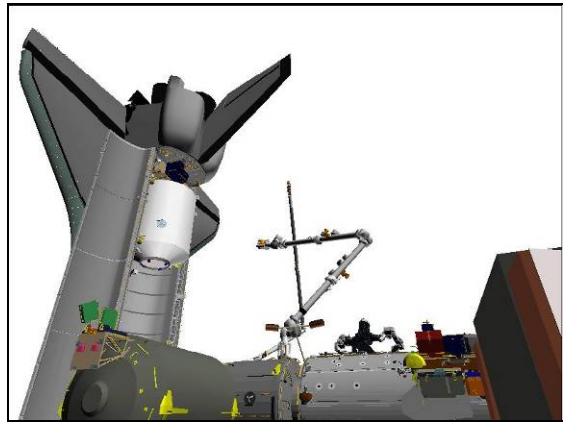

S1 LOOB (70,30)

Step 8:
Drive SP (-) from +49.0° to +25.0°

Step 9:
Drive WR (+) from -75.0° to -21.9°

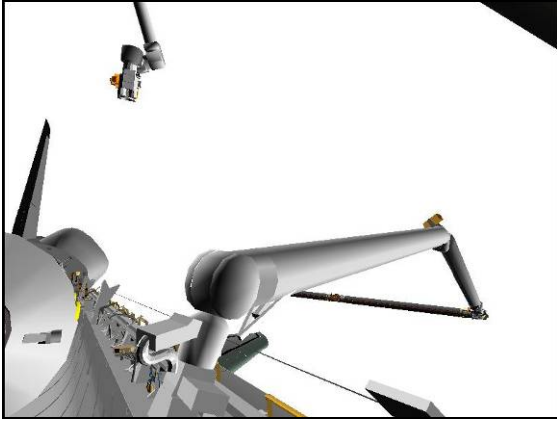

CCTV A (30,10)

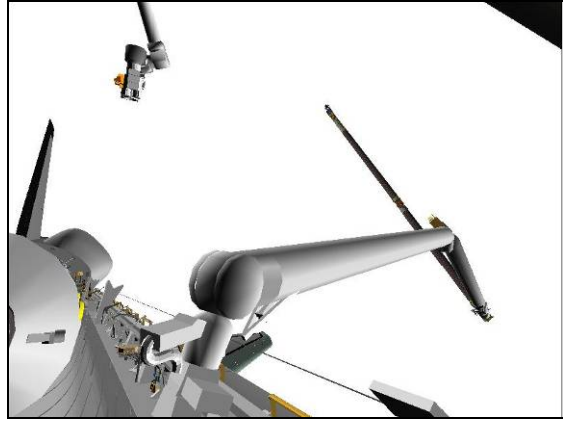

CCTV A (30,10)

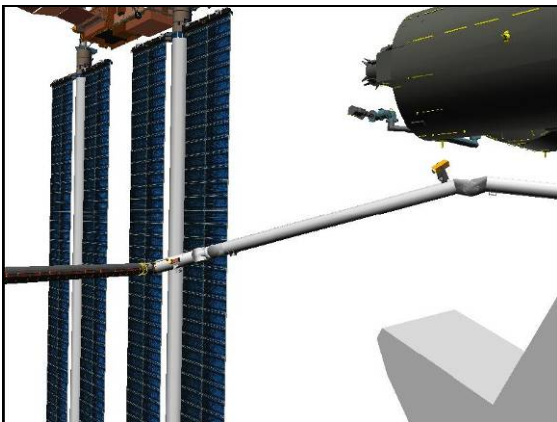

CCTV B (-45,0)

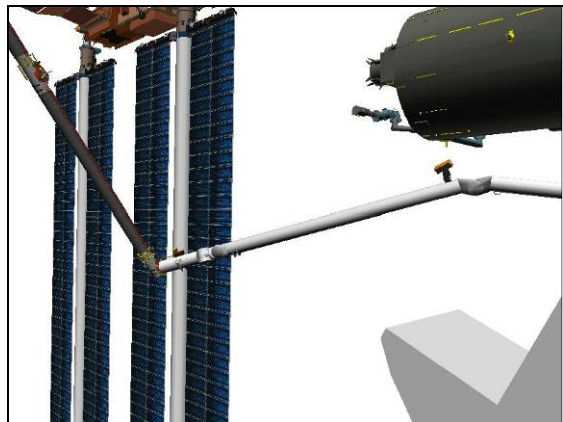

CCTV B (-45,0)

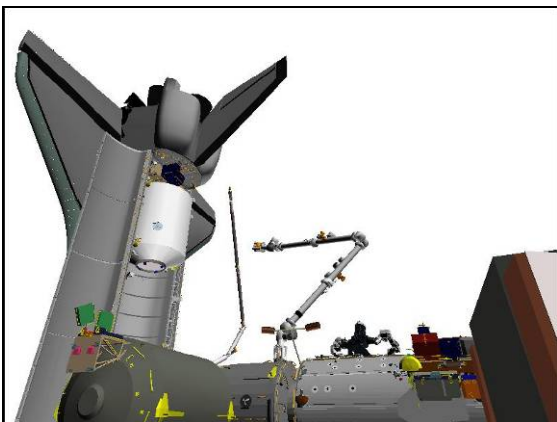

S1 LOOB (70,30)



S1 LOOB (70,30)

Step 10:

Drive WY (-) from 0.0° to -13.2°



CCTV A (30,10)

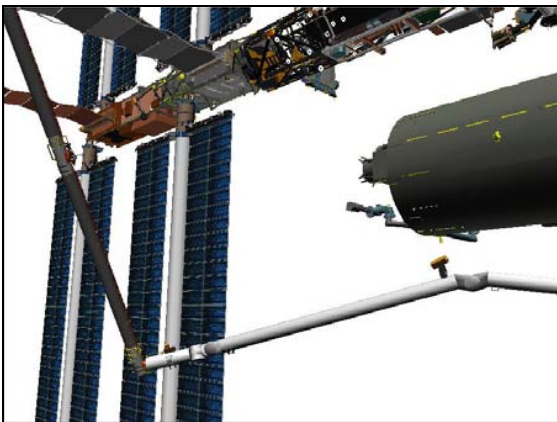

CCTV B (-45,10)

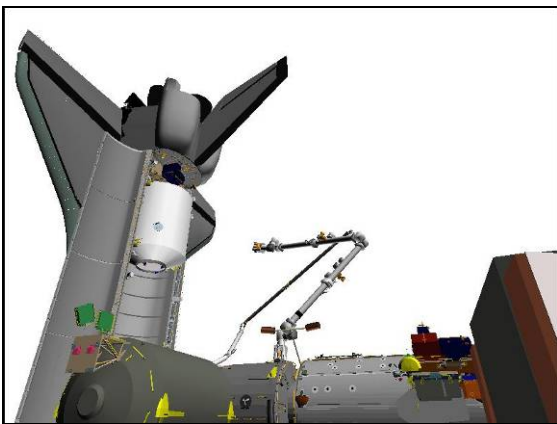

S1 LOOB (70,30)

Expected MPLM VIEWING posn:

	X	Y	Z	PITCH	YAW	ROLL	PL ID
√	-1252	-520	-889	60	349	312	2
	SY	SP	EP	WP	WY	WR	
√	+62.5	+25.0	-23.0	0.0	-13.2	-21.9	

R12 (VPU) Green Jumper – LDRI/ITVC

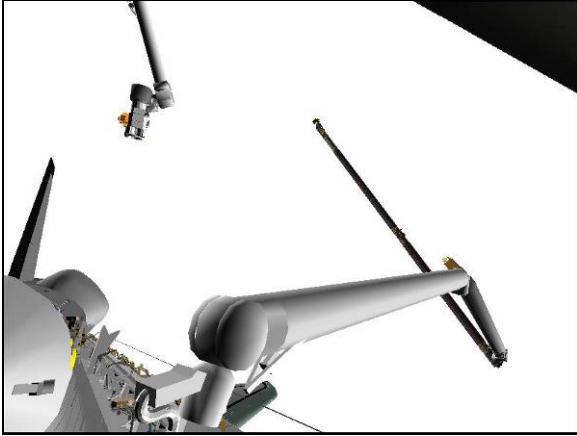

CCTV A (30,15)

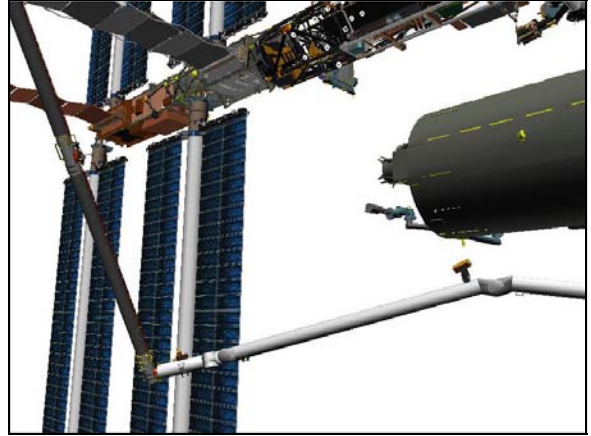

CCTV B (-45,10)

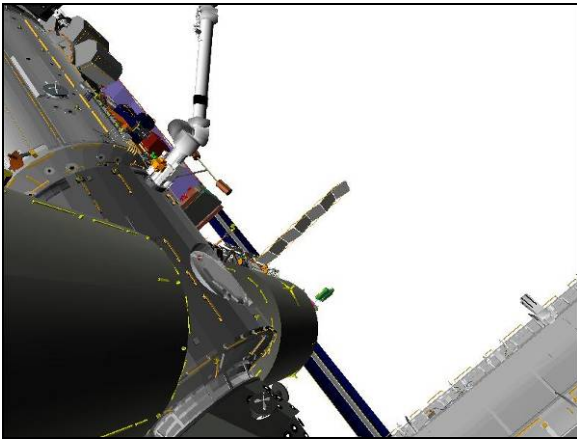

ELBOW (-165,20)

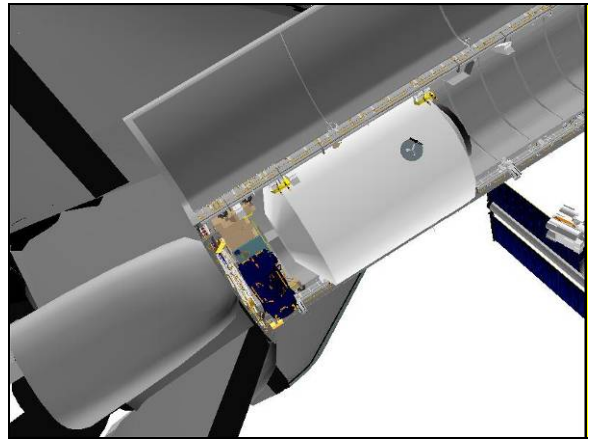

OBSS ITVC (140,-55)

OBSS SJ HANDOFF FROM SRMS TO SSRMS

1. SETUP

SM 94 PDRS CONTROL

√PL ID, ITEM 3: 2

√INIT ID, ITEM 24: 2

A7U CCTV – config as reqd
 – perform PAN/TILT RESET for PLB cameras
 ZOOM – full OUT

R12 √Green Jumper – ISS

MON 1	S1 LOOB
MON 2	B
DNLK	ELBOW
DTV	A

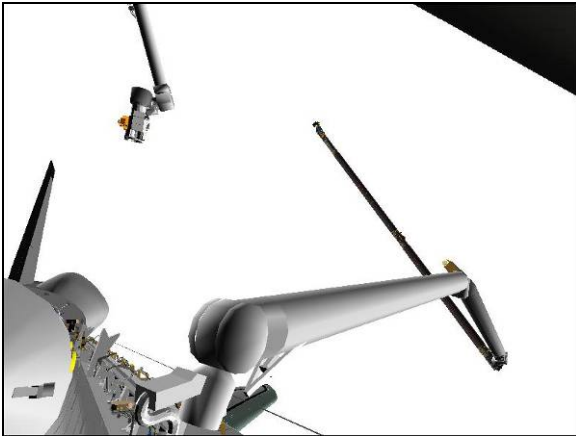

CCTV A (30,15)

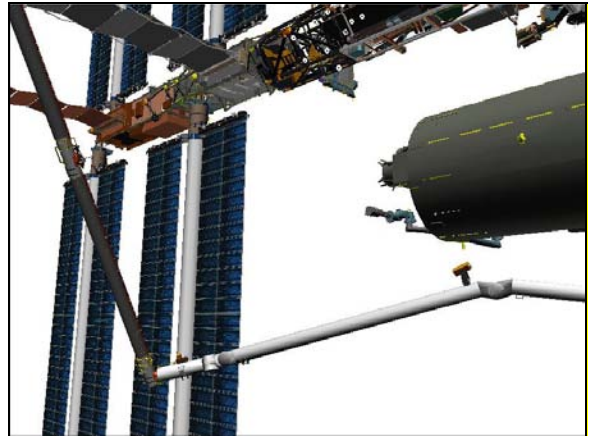

CCTV B (-45,10)

Review GENERIC END EFFECTOR CUE CARD – ISS/SHUTTLE DOCKED OPS

2. SINGLE JOINT MNVR TO OBSS HANDOFF

On SSRMS Operator GO for mnvr to OBSS HANDOFF

NOTE

During first SP Single Joint mnvr the SRMS Upper Boom will be 54 inches from the JEM-PM.

During second WR Single Joint mnvr the OBSS will be 48 inches from the SSRMS Tip LEE

RHC If SINGLE mode available:
 RATE – as reqd (VERN within 10 ft)
 BRAKES – OFF (tb-OFF)

MODE – best available

Mnvr to OBSS HANDOFF posn:

	SY	SP	EP	WP	WY	WR	
MPLM Viewing	+62.5	+25.0	-23.0	0.0	-13.2	-21.9	
1: WY +					0.0		
2: WR -						-75.0	
3: SP +		+49.0					
4: SY -	+24.5						
5: SP +		+59.0					
6: WP -				-60.0			
7: EP -			-42.1				
8: WP -				-85.9			
9: WY +					+11.2		
10: WR -						-99.4	
OBSS Handoff	+24.5	+59.0	-42.1	-85.9	+11.2	-99.4	
	X	Y	Z	PITCH	YAW	ROLL	PL ID
	-1059	+231	-597	284	270	270	2

*Display singularity

BRAKES – ON (tb-ON)
 MODE – not DIRECT (lt off)
 JOINT – CRIT TEMP

Give SSRMS Operator GO for OBSS grapple

Start:
MPLM Viewing

Step 1:
Drive WY (+) from -13.2° to 0.0°

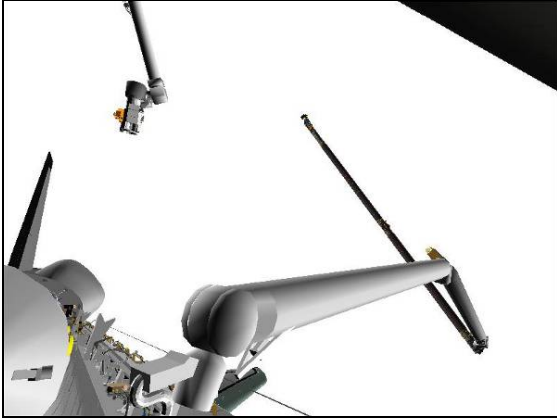

CCTV A (30,15)

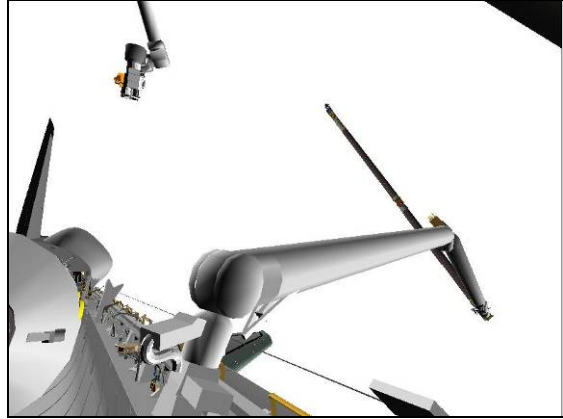

CCTV A (30,10)

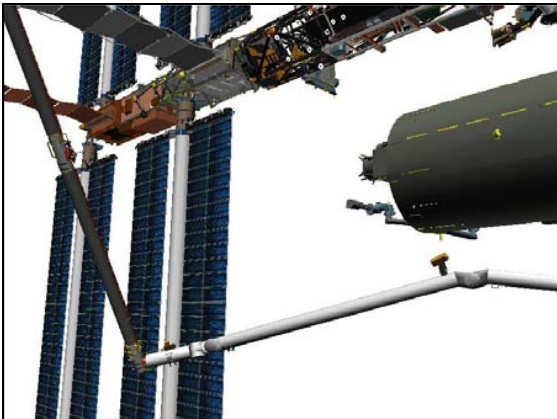

CCTV B (-45,10)

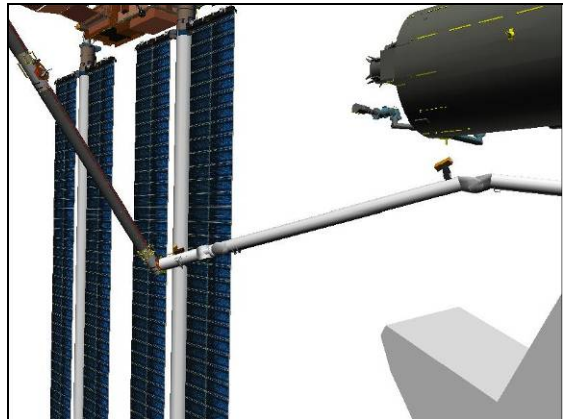

CCTV B (-45,0)

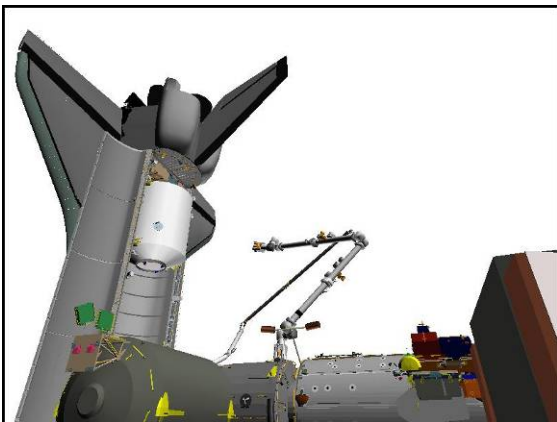

S1 LOOB (70,30)

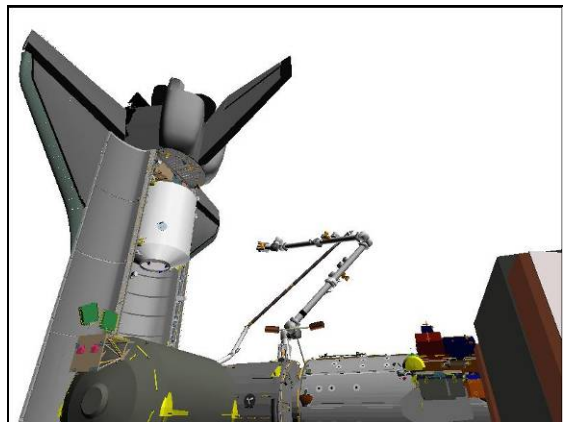

S1 LOOB (70,30)

Step 2:

Drive WR (-) from -21.9° to -75.0°

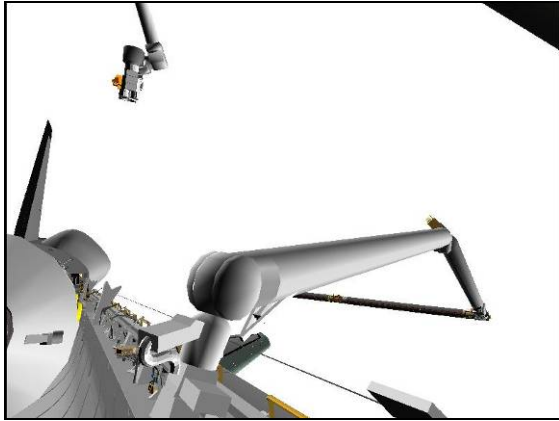

CCTV A (30,10)

Step 3:

Drive SP (+) from $+25.0^\circ$ to $+49.0^\circ$

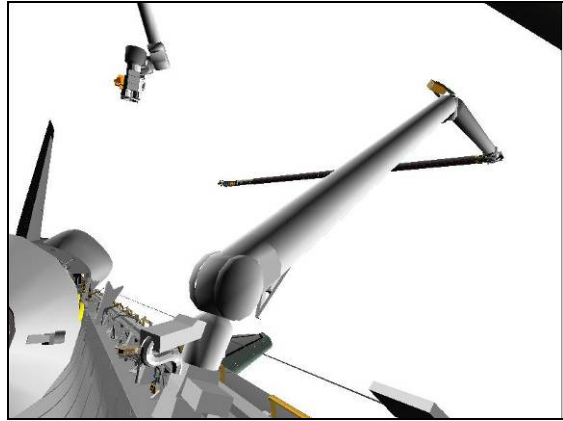

CCTV A (30,10)

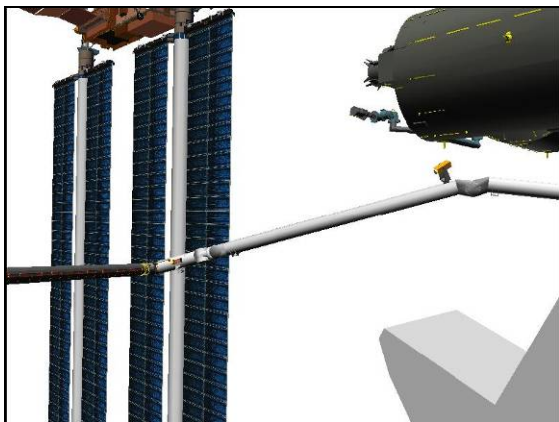

CCTV B (-45,0)

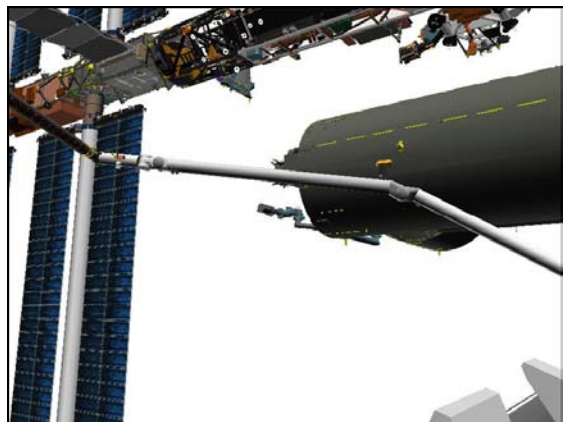

CCTV B (-35,10)



S1 LOOB (70,30)

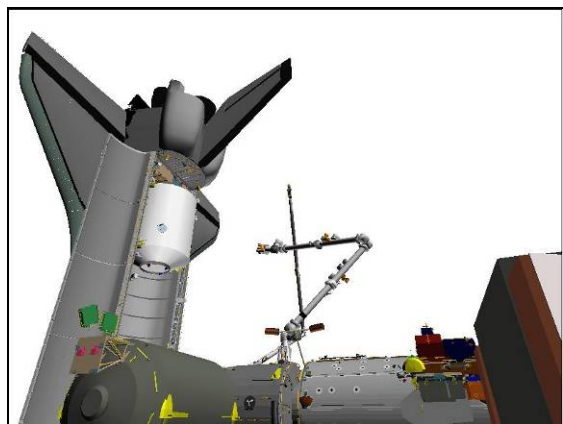

S1 LOOB (70,30)

Step 4:

Drive SY (-) from +62.5° to +24.5°

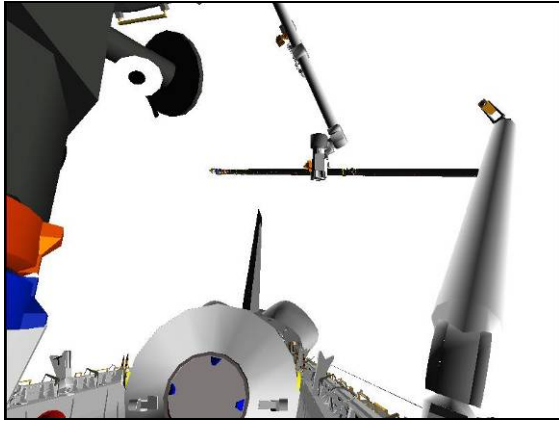

CCTV A (0,20)

Step 5:

Drive SP (+) from +49.0° to +59.0°



CCTV A (0,20)

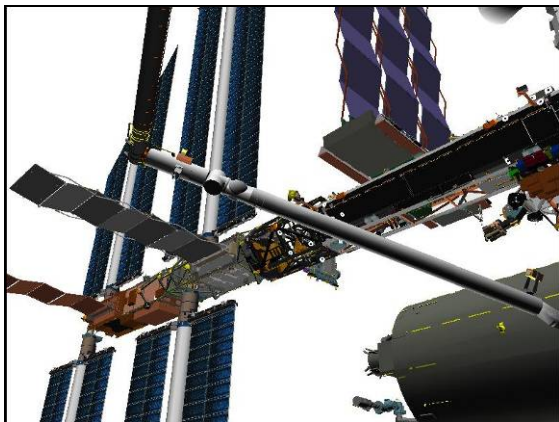

CCTV B (-45,30)

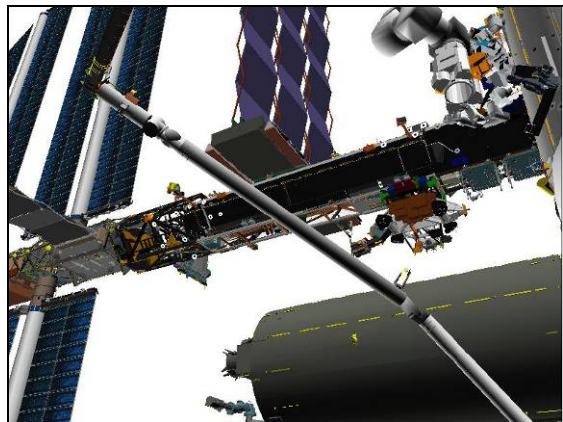

CCTV B (-30,30)

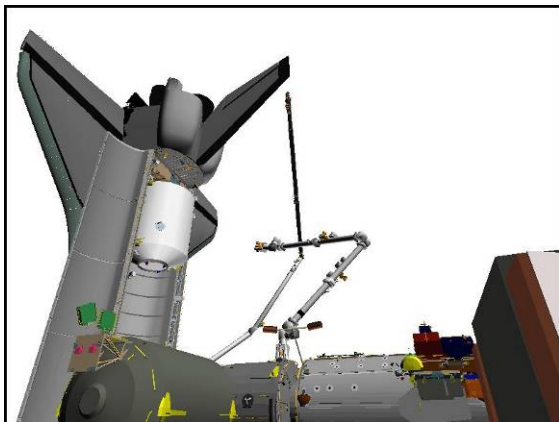

S1 LOOB (70,30)

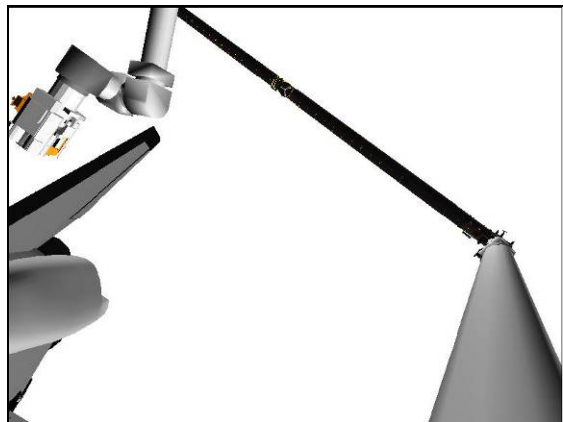

ELBOW (-30,0)

Step 6:

Drive WP (-) from 0.0° to -60.0°

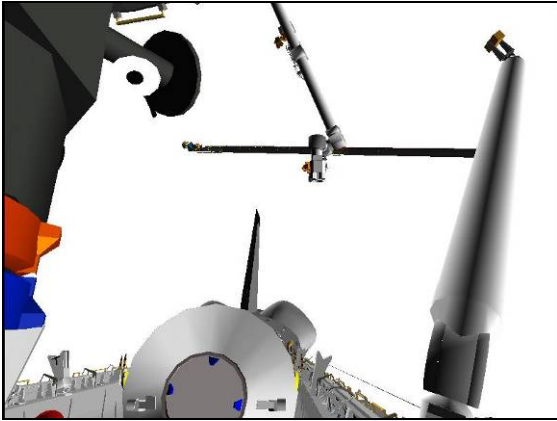

CCTV A (0,20)

Step 7:

Drive EP (-) from -23.0° to -42.1°

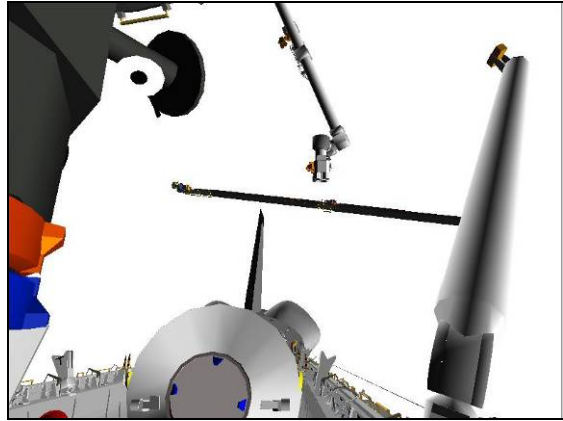

CCTV A (0,20)

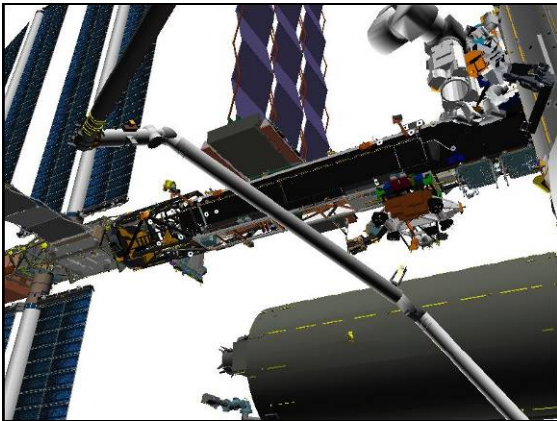

CCTV B (-30,30)

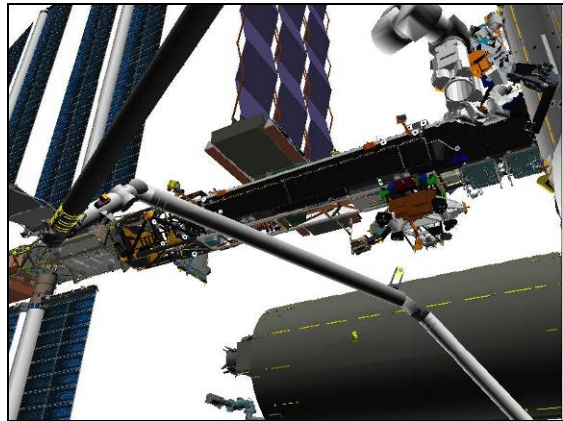

CCTV B (-30,30)

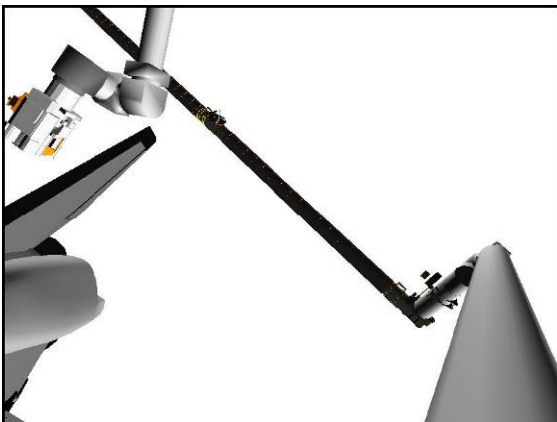

ELBOW (-30,0)



ELBOW (-30,0)

Step 8:

Drive WP (-) from -60.0° to -85.9°

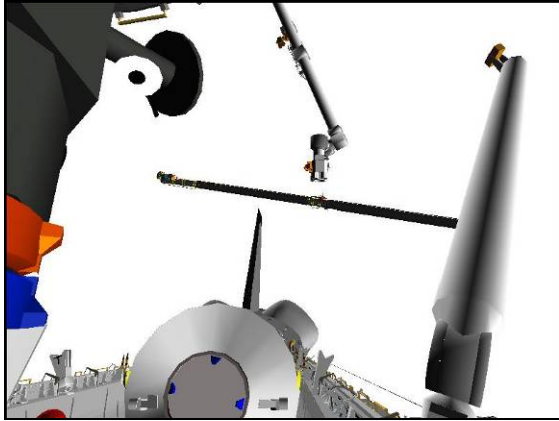

CCTV A (0,20)

Step 9:

Drive WY (+) from 0.0° to $+11.2^\circ$

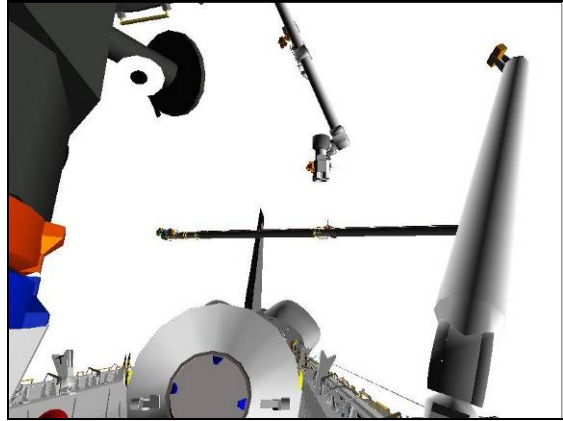

CCTV A (0,20)

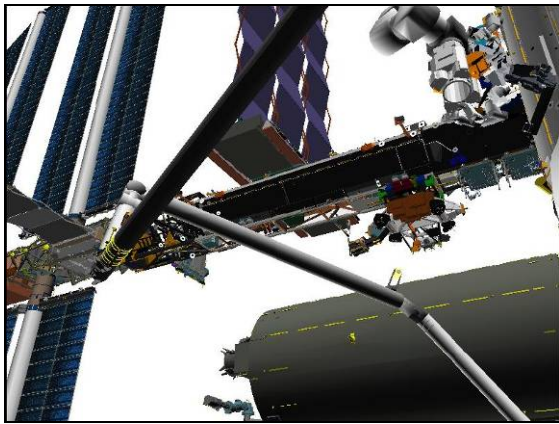

CCTV B (-30,30)

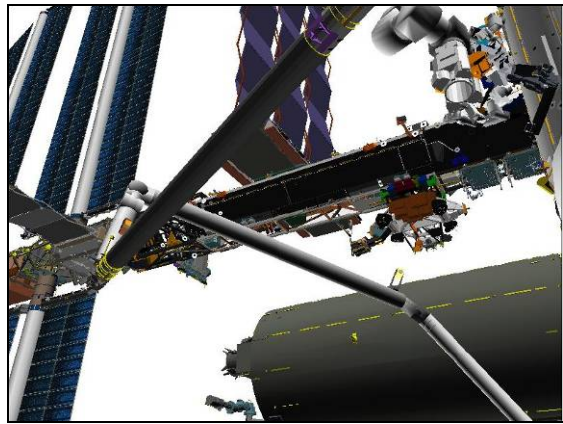

CCTV B (-30,30)

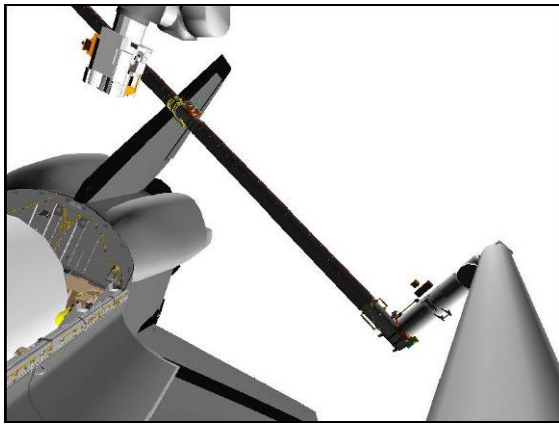

ELBOW (-30,0)

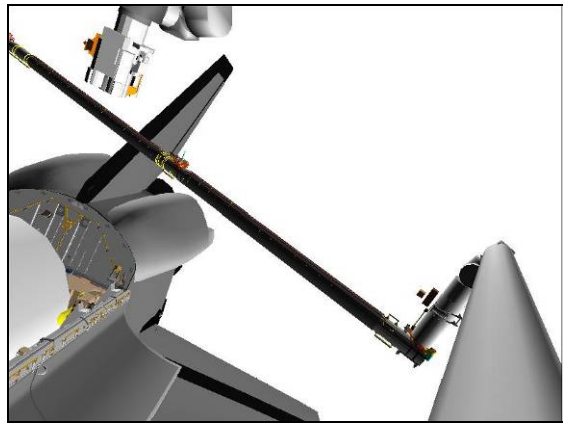

ELBOW (-30,0)

Step 10:

Drive WR (-) from -75.0° to -99.4°

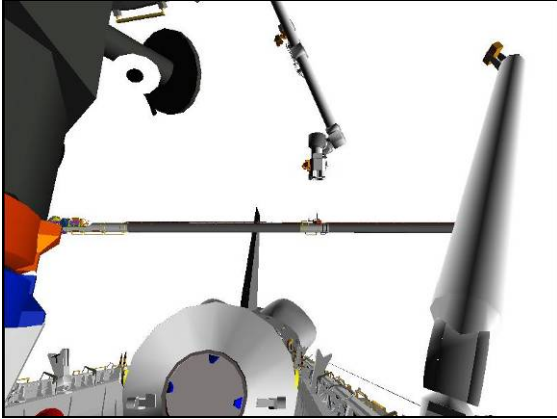

CCTV A (0,20)

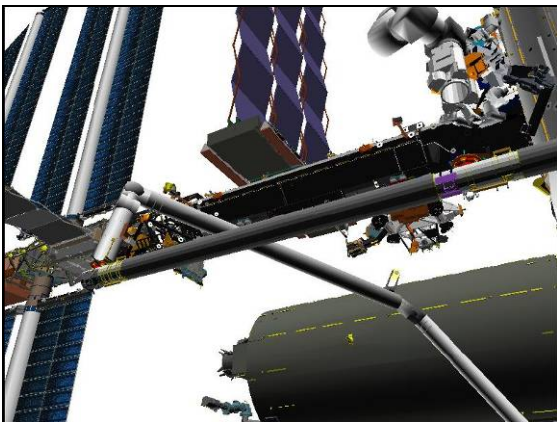

CCTV B (-30,30)

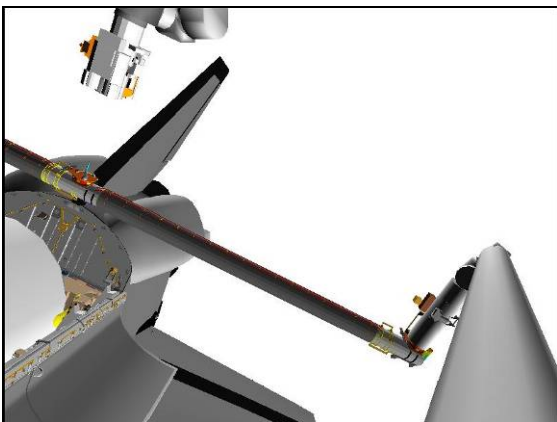

ELBOW (-30,0)

3. STOW PTU
R12 (VPU) Green Jumper – LDRI/ITVC

A7U VID DNLK MON 1 pb – push
IN PL2(VPU) pb – push

CAMR CMD PAN/TILT – HI RATE
PAN – L (to hard stop)
TILT – UP (to hard stop)
PAN/TILT – RESET
PAN: +108 (right)
TILT: -175 (down)

R12 (VPU) Green Jumper – ISS

On SSRMS Operator GO for OBSS ungrapple

<p><u>CAUTION</u> STBD RMS HTR power must be applied within 90 min to prevent sensor package damage</p>

Perform LCC DEACTIVATION (LCS Cue Card, P/TV)
Perform LCH DEACTIVATION (LCS Cue Card, P/TV)
Perform DEACTIVATION (LDRI/ITVC Cue Card, P/TV)

4. OBSS UNGRAPPLE
A7U CCTV – config for ungrapple
– RMS WRIST, ZOOM: 34.0 HFOV
FOCUS: 5 ft

RHC If SINGLE MODE available:
RATE – COARSE (RATE MIN tb-OFF)

<p><u>SM 94 PDRS CONTROL</u> AUTO BRAKE INH – ITEM 10 EXEC (*)</p>
--

BRAKES – OFF (tb-OFF)
MODE – TEST, ENTER
Wait 5 sec

BRAKES – ON (tb-ON)

<p><u>SM 94 PDRS CONTROL</u> AUTO BRAKE ENA – ITEM 9 EXEC (*) PL ID – ITEM 3 +0 EXEC INIT ID – ITEM 24 +0 EXEC</p>
--

RATE – as reqd (VERN within 10 ft)
BRAKES – OFF (tb-OFF)

MODE – best available

<p><u>CAUTION</u> Monitor EE tb timing to prevent EE motor burnout</p>
--

EE MODE – MAN

MAN CONTR – DERIGID (hold until DERIGID tb-gray, 5 sec max)

RELEASE sw – depress (hold until OPEN tb-gray, 3 sec max)

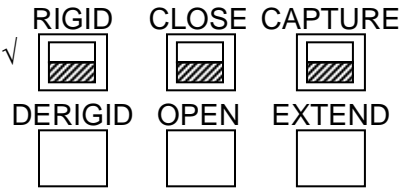

CRITICAL TIMES (8 sec total):
 DERIGID tb – gray, 5 sec max, then
 OPEN tb – gray, 3 sec max, then

Drive joints per OBSS SJ UNGRAPPLE AT HANDOFF overlay until EE clear of grapple fixture

OBSS SJ UNGRAPPLE AT HANDOFF

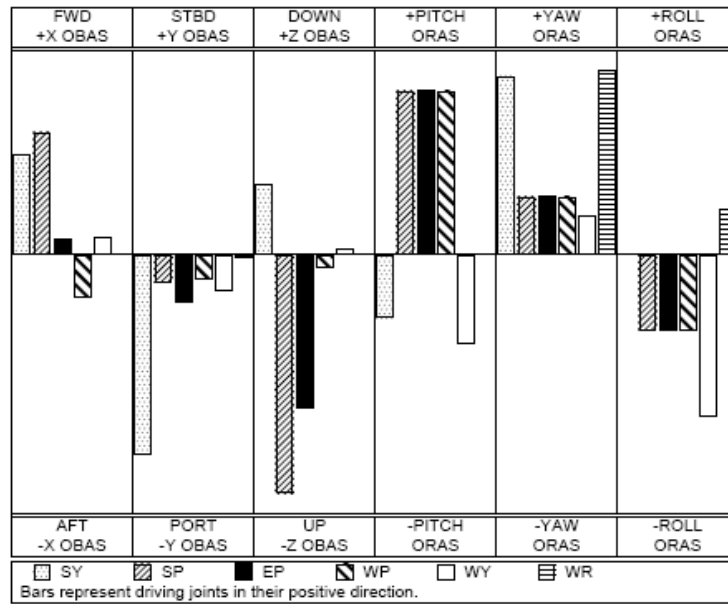

To get:	Drive:	To get:	Drive:	Driving:	Results In:	Driving:	Results In:
+X (fwd)	+SP, +SY	+PITCH	+WP, +EP	+SY	-Y (port), +YAW	+WP	-X (aft), +PITCH
+Y (stbd)	-SY	+YAW	+WR, +SY	+SP	-Z (up), +PITCH	+WY	-Y (port), -ROLL
+Z (down)	-SP, -EP	+ROLL	-WY, -WP	+EP	-Z (up), +PITCH	+WR	+YAW

ΔSY	ΔSP	ΔEP	ΔWP	ΔWY	ΔWR
-1.8	-1.9	+15.4	-13.9	+0.6	+1.7

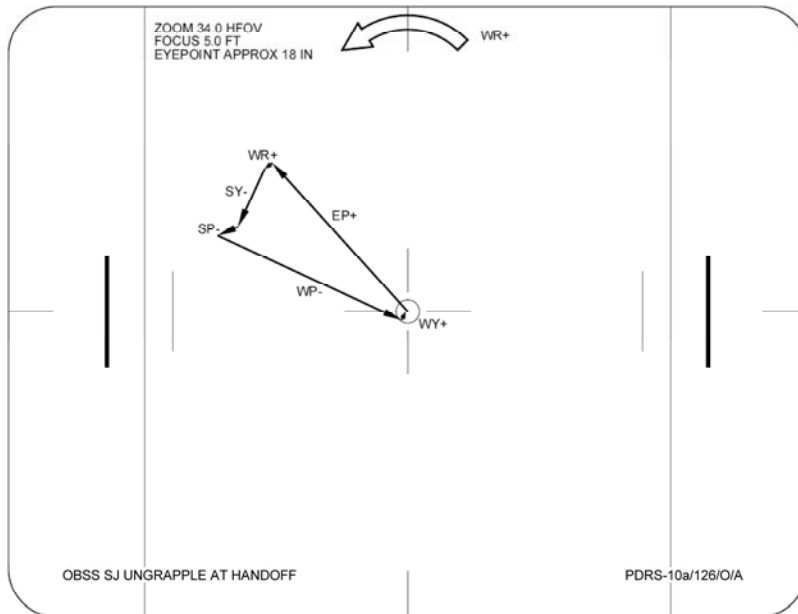

EE MAN CONTR – DERIG (hold until EXTEND tb-gray, 20 sec max)
 MODE – OFF

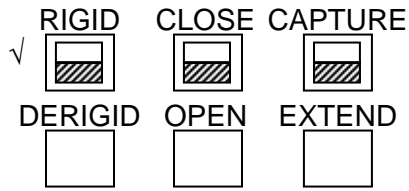

CRITICAL TIMES (20 sec total):
 EXTEND tb – gray, 20 sec max

Mnvr to OBSS BACKOFF posn:

X	Y	Z	PITCH	YAW	ROLL	PL ID
-1047	-360	-658	284	0	270	0
SY	SP	EP	WP	WY	WR	
+22.7	+57.5	-27.4	-99.3	+11.8	-97.9	

If SINGLE MODE available:
 BRAKES – ON (tb-ON)

MODE – not DIRECT
 JOINT – CRIT TEMP

If using Shuttle attitude control and attitude maintenance required:
 Configure DAP per RMS DAPs, then perform RATE DAMPING (ORB OPS FS,
REBOOST/DAP; DOCKED DAP REFERENCE)

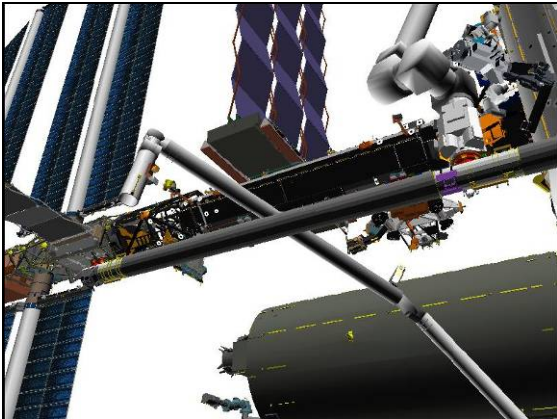

CCTV B (-30,30)

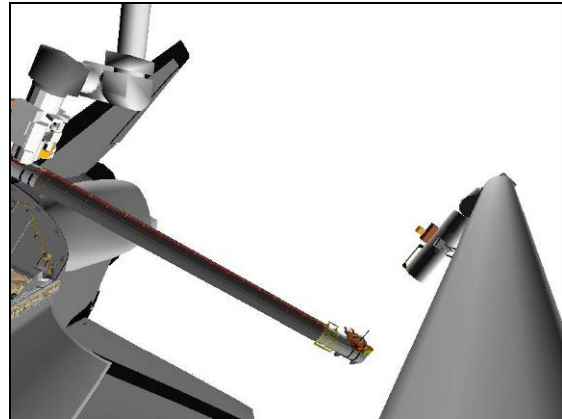

ELBOW (-30,-10)

Give SSRMS Operator GO for OBSS Berth Sequence

5. CONFIGURE CIRCUIT BREAKERS

MA73C:C cb MCA PWR AC3 3Φ MID 2 – op

 √AC2 3Φ MID 2 – op

MA73C:D √AC3 3Φ MID 4 – op

6. CONFIGURE FOR MONITORING

On SSRMS notification to watch for STBD RMS RFLs,

SM 94 PDRS CONTROL

RMS STBD – ITEM 2 EXEC (*)

Notify SSRMS operator when STBD RMS R-F-L tb (three) – gray

7. STBD MRL LATCH

On SSRMS Operator GO to latch STBD MRLs to Topological Capture,

√STBD RMS R-F-L tb (three) – gray

SM 94 PDRS CONTROL

√STBD AFT, MID, FWD LAT (six) = 0

R13L PL BAY MECH PWR SYS (two) – ON

NOTE

Expect single motor drive time for MRL latching (18 sec max).

The following STBD RMS RETEN LAT – OFF and PL BAY

MECH PWR SYS (two) – OFF actions are to be performed simo

Verify AOS for latching to Topological Capture – OFF

R13L PL BAY MECH PWR SYS (two) – OFF

Give SSRMS Operator GO to Limp All SSRMS Joints and Derigidize

R13L On SSRMS Operator GO to complete STBD MRL latching,

PL BAY MECH PWR SYS (two) – ON

STBD RMS RETEN LAT – LAT (tb-LAT) (12 sec max)

– OFF

8. RECONFIGURE POWER

R13L PL BAY MECH PWR SYS (two) – OFF

STBD RMS HTR A,B (two) – AUTO

A6U EVENT TIMER CNTL – STOP

SM 94 PDRS CONTROL

√STBD AFT, MID, FWD LAT (six) = 1

RMS PORT – ITEM 1 EXEC (*)

MA73C:C cb MCA PWR AC3 3Φ MID 2 – cl

 √AC2 3Φ MID 2 – op

MA73C:D √AC3 3Φ MID 4 – op

Give SSRMS Operator GO for OBSS ungrapple

9. MNVR TO PRE-CRADLE

Verify SSRMS is at Berthed OBSS Backoff or Overnight Park posn and on SSRMS Operator GO for mnvr to Pre-Cradle

MON 1	A
MON 2	B
DNLK	EE (ELBOW)
DTV	C

If SINGLE MODE available:

RATE – as reqd (VERN within 10 ft)

BRAKES – OFF (tb-OFF)

Mnvr to PRE-CRADLE posn:

	SY	SP	EP	WP	WY	WR	
OBSS Backoff	+22.7	+57.5	-27.4	-99.3	+11.8	-97.9	
1: SY –	0.0						
2: EP +			-25.0				
3: WR +						0.0	
4: WY –					0.0		
5: WP +				+5.0			
6: SP –		+25.0					
Pre-Cradle	0.0	+25.0	-25.0	+5.0	0.0	0.0	
	X	Y	Z	PITCH	YAW	ROLL	PL ID
	-1261	-146	-551	5	2	0	0

If SINGLE MODE available:

BRAKES – ON (tb-ON)

MODE – not DIRECT

PARAM – PORT TEMP

JOINT – CRIT TEMP

Start:
OBSS Handoff

Step 1:
Drive SY (-) from $+22.7^\circ$ to 0.0°

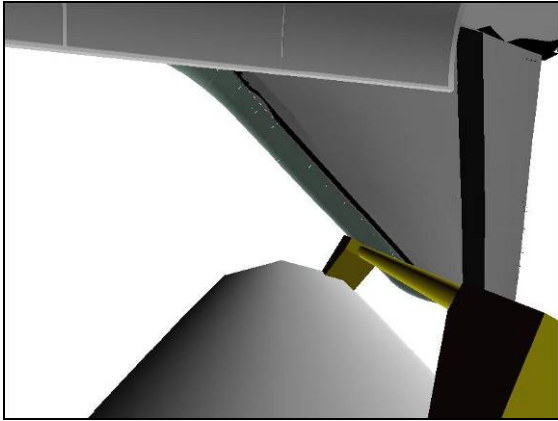

EE

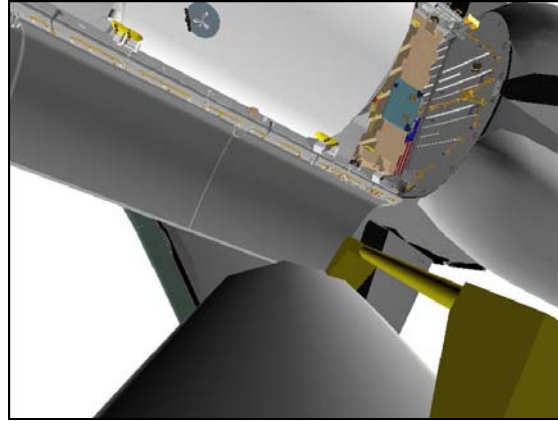

EE

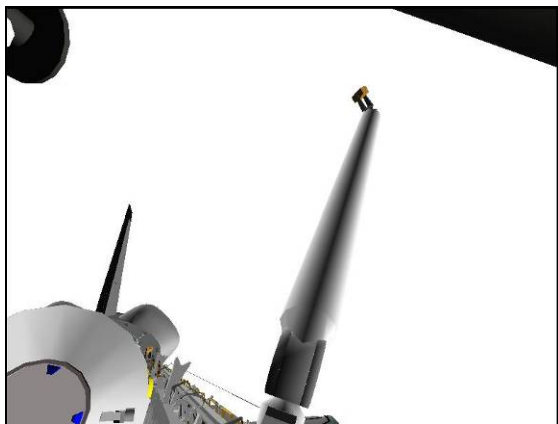

CCTV A (20,20)

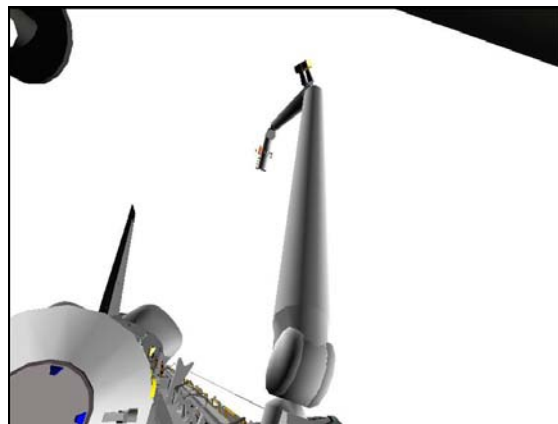

CCTV A (20,20)

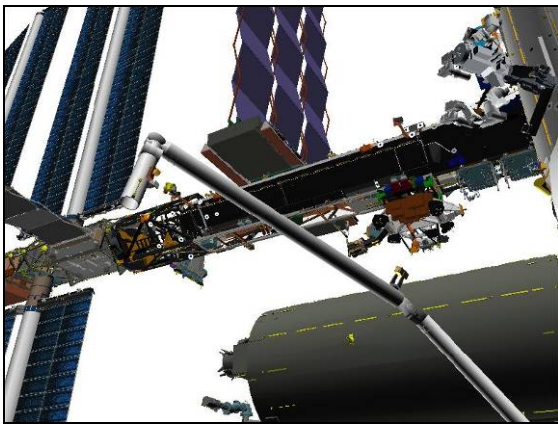

CCTV B (-30,30)

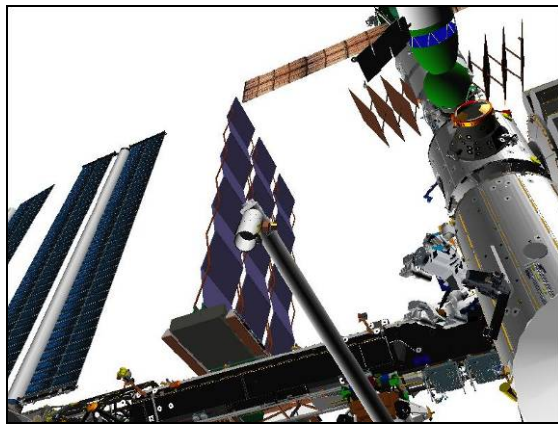

CCTV B (-25,50)

Step 2:

Drive EP (+) from -27.4° to -25.0°

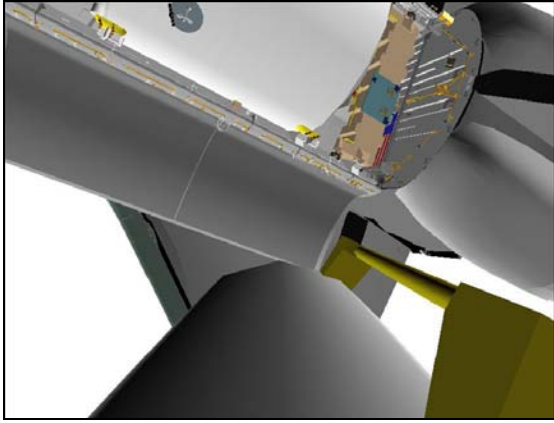

EE

Step 3:

Drive WR (+) from -97.9° to 0.0°

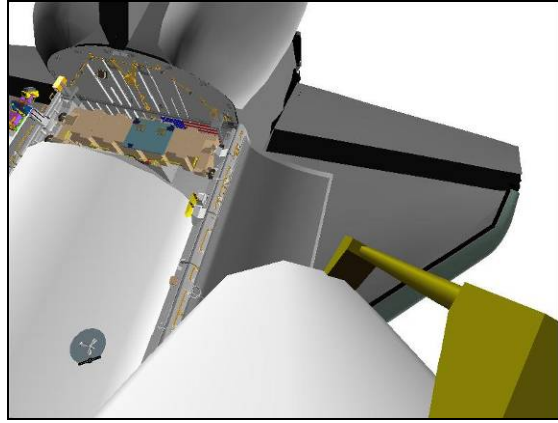

EE

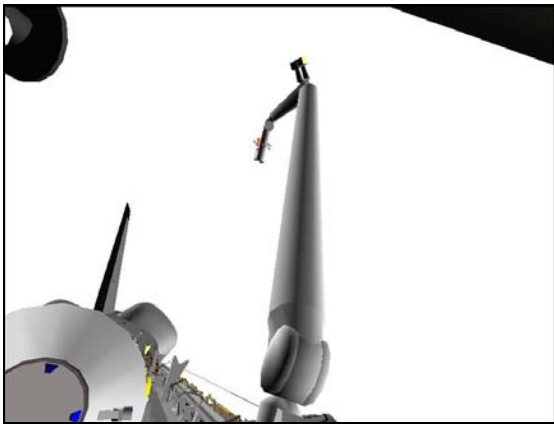

CCTV A (20,20)

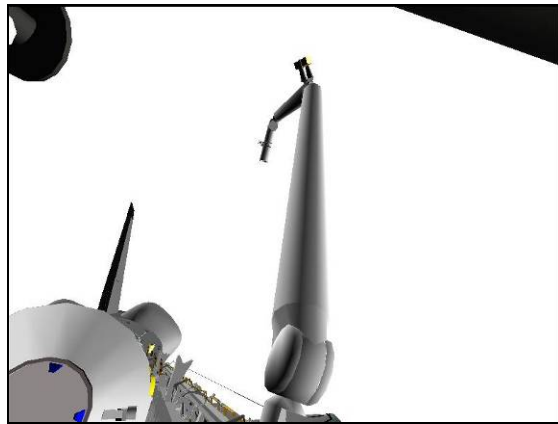

CCTV A (20,20)

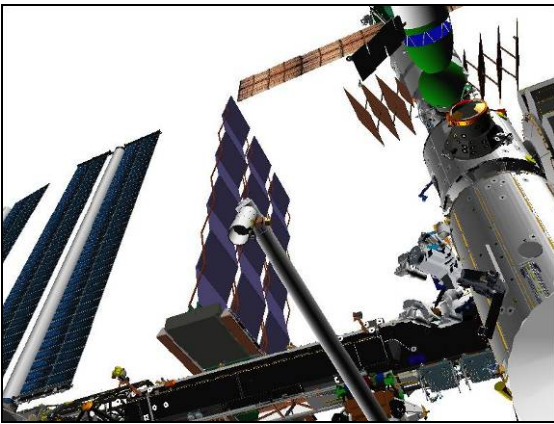

CCTV B (-25,50)

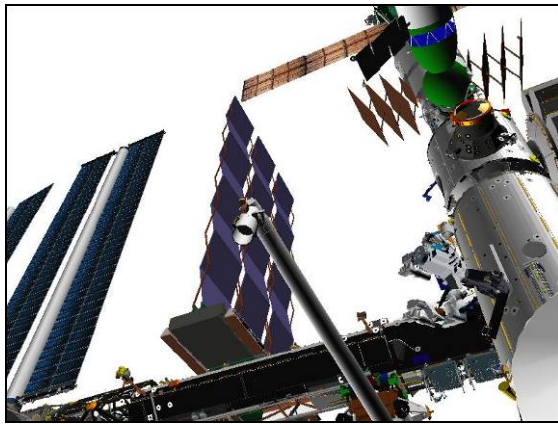

CCTV B (-25,50)

Step 4:
Drive WY (-) from +11.8° to 0.0°

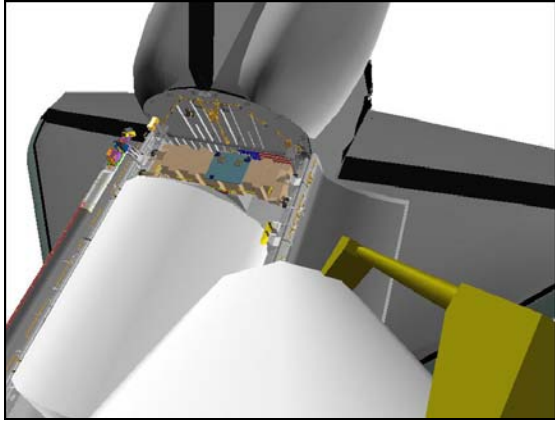

EE

Step 5:
Drive WP (+) from -99.3° to +5.0°

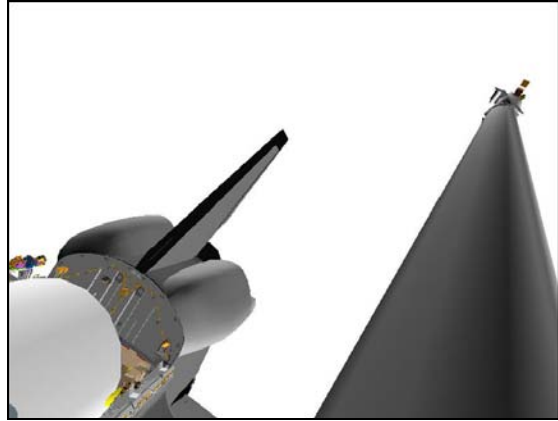

ELBOW (-30,-20)

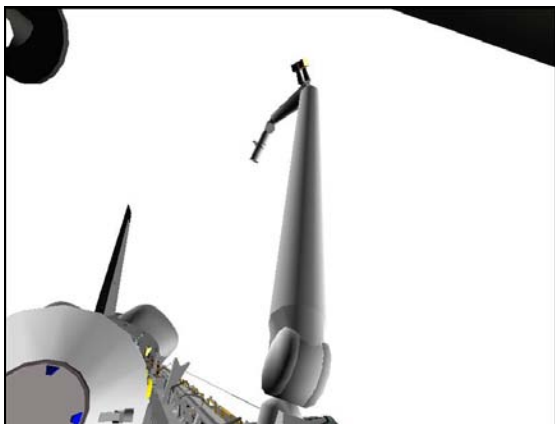

CCTV A (20,20)

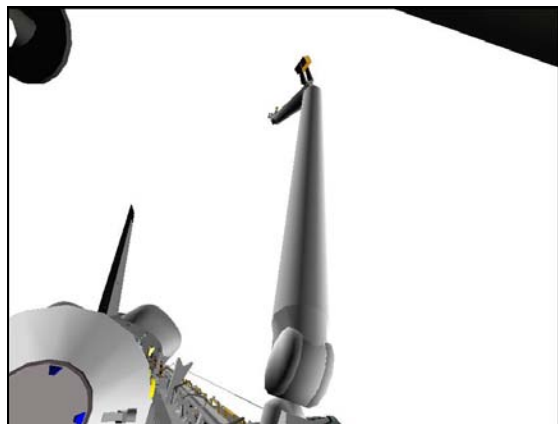

CCTV A (20,20)

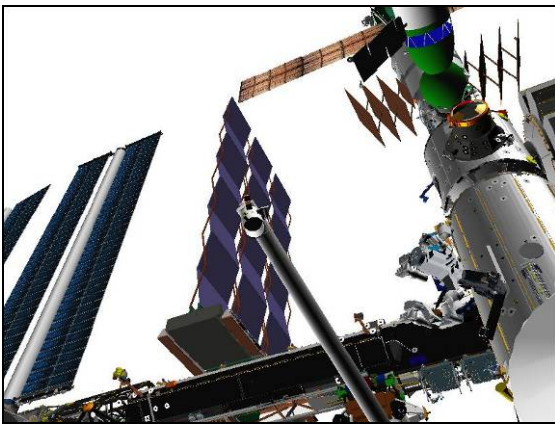

CCTV B (-25,50)

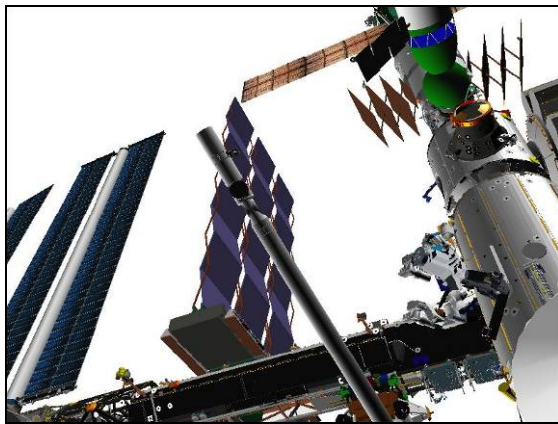

CCTV B (-25,50)

Step 6:

Drive SP (-) from +57.5° to +25.0°



ELBOW (-30,-20)

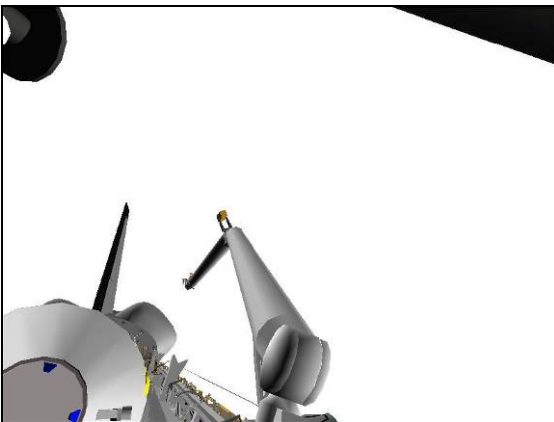

CCTV A (20,20)

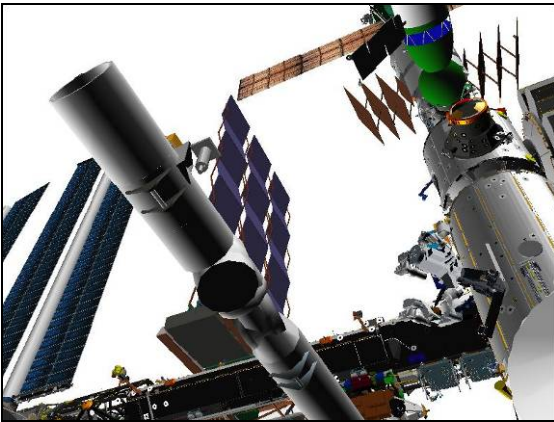

CCTV B (-25,50)

OBSS MNVR FROM MPLM VIEWING TO STBD WING

I

1. SETUP

SM 94 PDRS CONTROL

√ PL ID, ITEM 3: 2

√ INIT ID, ITEM 24: 2

Verify at MPLM VIEWING posn:

	X	Y	Z	PITCH	YAW	ROLL	PL ID
√	-1252	-520	-889	60	349	312	2
	SY	SP	EP	WP	WY	WR	
√	+62.5	+25.0	-23.0	0.0	-13.2	-21.9	

R12

√ Green Jumper – ISS

MON 1	D (C)
MON 2	B (A)
DNLK	ELBOW
DTV	TIP ELBOW (RSC)

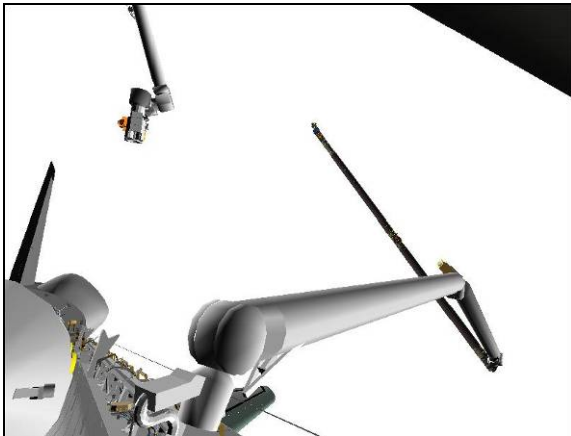

CCTV A (30,15)

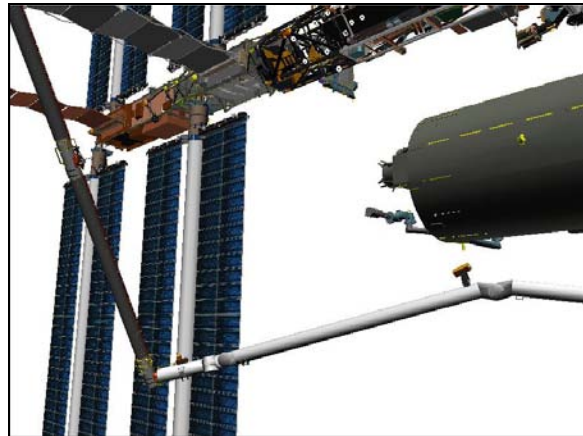

CCTV B (-45,10)

2. OBSS MNVR TO STBD WING

On SSRMS Operator GO for SRMS mnvr to STBD WING,

BRAKES – OFF (tb-OFF)

MODE – SINGLE, ENTER

Mnvr to STBD WING posn:

	SY	SP	EP	WP	WY	WR	
MPLM Viewing	+62.5	+25.0	-23.0	0.0	-13.2	-21.9	
1: WR +						+10.0	
2: SY -	-50.0						
3: SP -		+5.4					
4: WY +					-5.0		
5: SY -	-70.0						
6: WP -				-55.0			
7: EP -			-58.0				
8: WR +						+75.0	
STBD WING	-70.0	+5.4	-58.0	-55.0	-5.0	+75.0	
	X	Y	Z	PITCH	YAW	ROLL	PL ID
	-1371	+506	-222	351	344	5	2

BRAKES – ON (tb-ON)
 MODE – not DIRECT (lt off)
 PARAM – PORT TEMP
 JOINT – CRIT TEMP

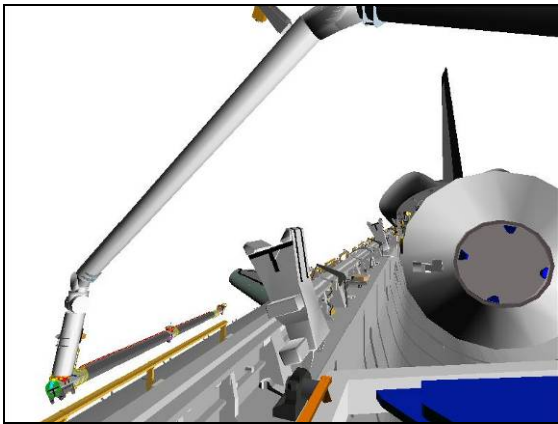

CCTV D (-20,0)

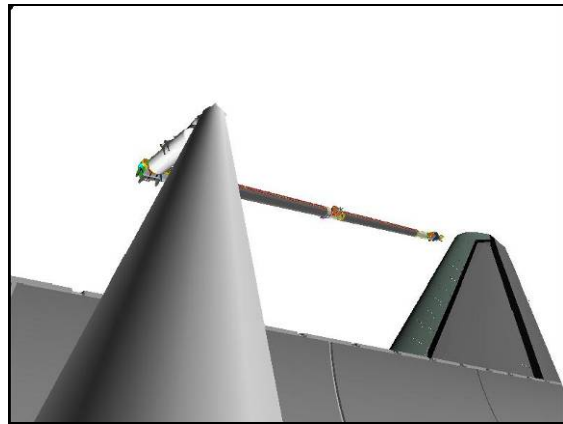

ELBOW (10,-20)

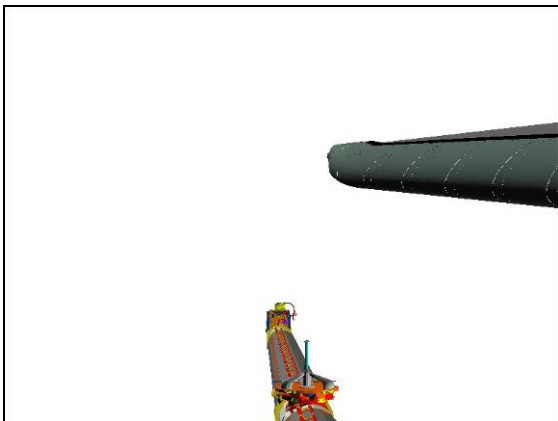

RSC

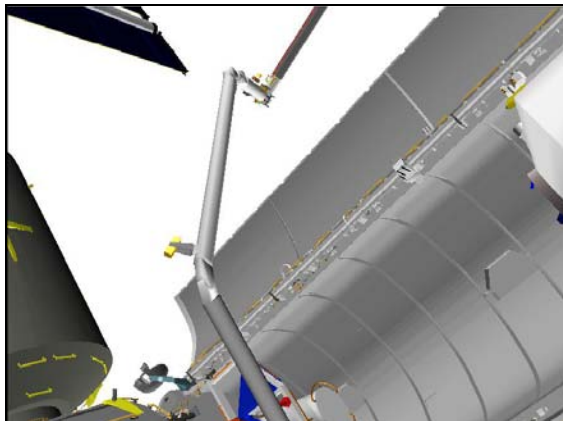

TIP ELBOW (-60,20)

OBSS MNVR FROM STBD WING TO MPLM VIEWING

I

1. SETUP

SM 94 PDRS CONTROL

√ PL ID, ITEM 3: 2

√ INIT ID, ITEM 24: 2

Verify at STBD WING posn:

	X	Y	Z	PITCH	YAW	ROLL	PL ID
√	-1371	+506	-222	351	344	5	2
	SY	SP	EP	WP	WY	WR	
√	-70.0	+5.4	-58.0	-55.0	-5.0	+75.0	

R12

√ Green Jumper – ISS

MON 1	D (C)
MON 2	B (A)
DNLK	ELBOW
DTV	TIP ELBOW (RSC)

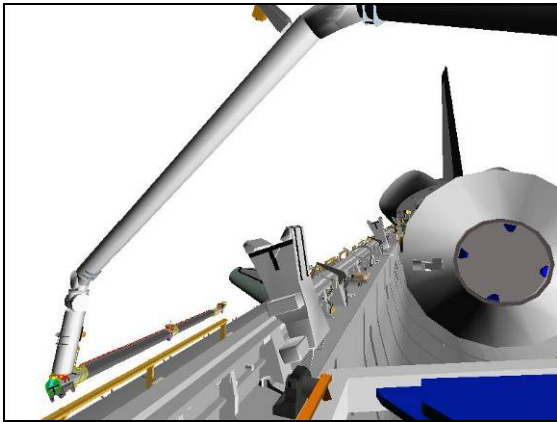

CCTV D (-20,0)

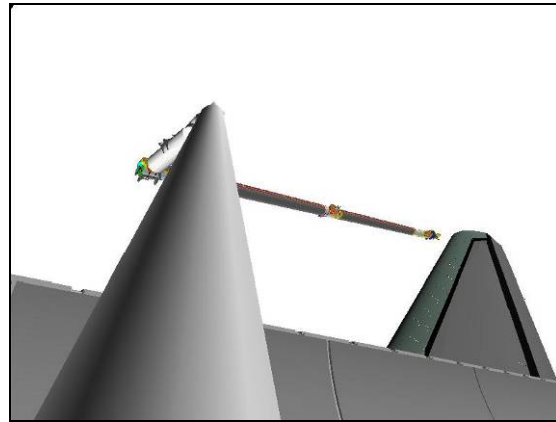

ELBOW (10,-20)

2. OBSS MNVR TO MPLM VIEWING

On SSRMS Operator GO for SRMS mnvr to MPLM Viewing,

BRAKES – OFF (tb-OFF)

MODE – SINGLE, ENTER

Mnvr to MPLM Viewing posn:

	SY	SP	EP	WP	WY	WR	
STBD WING	-70.0	+5.4	-58.0	-55.0	-5.0	+75.0	
1: WR -						+10.0	
2: EP +			-23.0				
3: WP +				0.0			
4: SY +	-50.0						
5: WY -					-13.2		
6: SP +		+25.0					
7: SY +	+62.5						
8: WR -						-21.9	
MPLM Viewing	+62.5	+25.0	-23.0	0.0	-13.2	-21.9	
	X	Y	Z	PITCH	YAW	ROLL	PL ID
	-1252	-520	-889	60	349	312	2

BRAKES – ON (tb-ON)
 MODE – not DIRECT (lt off)
 PARAM – PORT TEMP
 JOINT – CRIT TEMP

R12 (VPU) Green Jumper – LDRI/ITVC

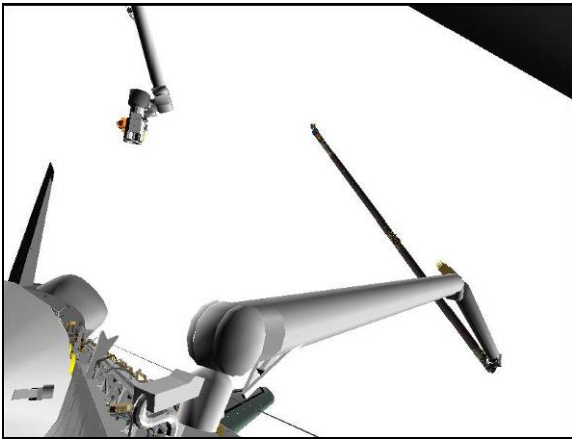

CCTV A (30,15)

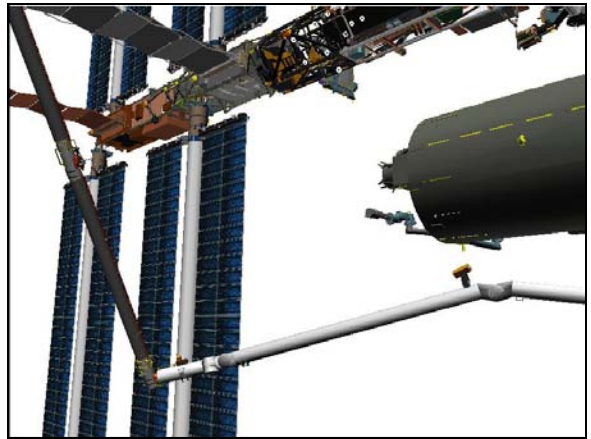

CCTV B (-45,10)

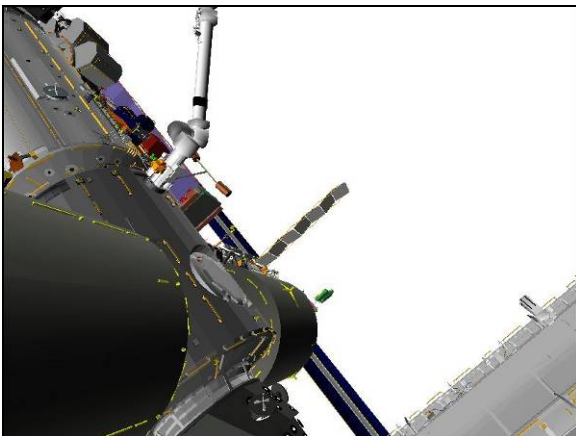

ELBOW (-165,20)

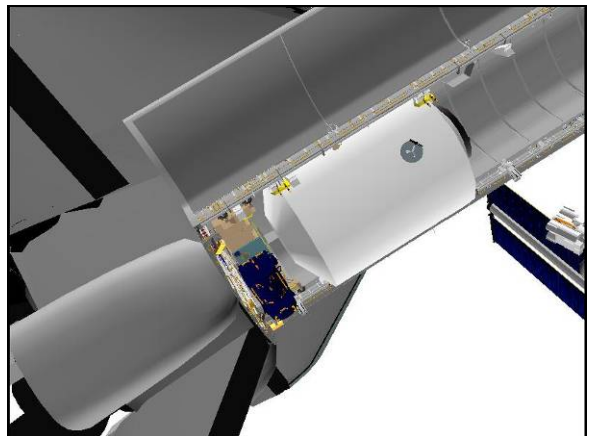

OBSS ITVC (140,-55)

REFERENCE DATA

OBSS HANDOFF JOINT ANGLES VS POR COORDINATES..... FS 3-2

REFERENCE
DATA

OBSS HANDOFF JOINT ANGLES VS POR COORDINATES

OBSS PRE-GRAPPLE AT HANDOFF/BACKOFF posn:

X	Y	Z	PITCH	YAW	ROLL	PL ID
-1047	-360	-658	284	0	270	0
-1043	+231	-655	284	270	270	2
SY	SP	EP	WP	WY	WR	
+22.7	+57.5	-27.4	-99.3	+11.8	-97.9	

OBSS HANDOFF posn:

X	Y	Z	PITCH	YAW	ROLL	PL ID
-1062	-360	-600	284	0	270	0
-1059	+231	-597	284	270	270	2
SY	SP	EP	WP	WY	WR	
+24.5	+59.0	-42.1	-85.9	+11.2	-99.4	

*Display singularity

MPLM VIEWING posn:

X	Y	Z	PITCH	YAW	ROLL	PL ID
-959	-627	-387	341	47	345	0
-1252	-520	-889	60	349	312	2
SY	SP	EP	WP	WY	WR	
+62.5	+25.0	-23.0	0.0	-13.2	-21.9	

STBD SARJ CLEANING posn:

X	Y	Z	PITCH	YAW	ROLL	PL ID
-1050	-842	+183	290	41	78	2
SY	SP	EP	WP	WY	WR	
+62.5	+25.0	-50.0	-90.0	-13.2	+30.0	

STBD WING posn:

X	Y	Z	PITCH	YAW	ROLL	PL ID
-812	+340	-317	259	356	344	0
-1371	+506	-222	351	344	5	2
SY	SP	EP	WP	WY	WR	
-70.0	+5.4	-58.0	-55.0	-5.0	+75.0	

OBSS UNDOCK posn:

X	Y	Z	PITCH	YAW	ROLL	PL ID
-1032	-362	-618	284	0	270	0
-1029	+229	-614	14	270	0	2
SY	SP	EP	WP	WY	WR	
+25.8	+66.3	-49.0	-85.9	+10.7	-100.7	

*Display singularity

FLAT FIELD posn:

X	Y	Z	PITCH	YAW	ROLL	PL ID
-679	+351	-448	270	349	1	0
-1270	+350	-445	0	0	11	2
SY	SP	EP	WP	WY	WR	
-90.1	+25.0	-65.8	-57.6	0.0	-249.9	

REFERENCE
DATA

CUE CARD CONFIGURATION

OBSS SJ GRAPPLE AT HANDOFF	FS CC 4-2
UNGRAPPLE AT HANDOFF.....	FS CC 4-3
OVERLAY FOR ROEU PL SEL POSITION.....	FS CC 4-4

CUE CARD
CONFIGURATION

CUE CARD CONFIGURATION

Fabricate as transparency

ZOOM 34.0 HFOV
FOCUS 5.0 FT
EYEPOINT APPROX 18 IN

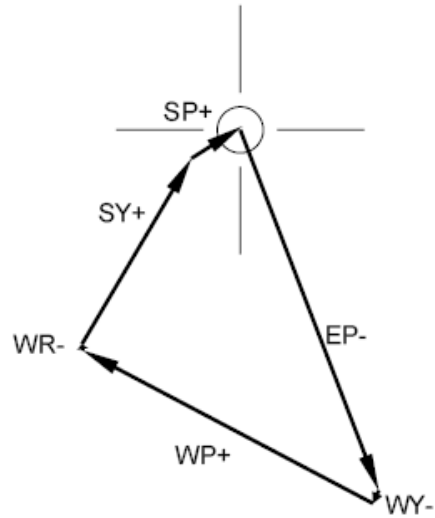

OBSS SJ GRAPPLE AT HANDOFF

PDRS-9a/126/O/A

(reduced copy)

FS CC 4-2

PDRS/126/FIN

Fabricate as transparency

ZOOM 34.0 HFOV
FOCUS 5.0 FT
EYEPOINT APPROX 18 IN



WR+

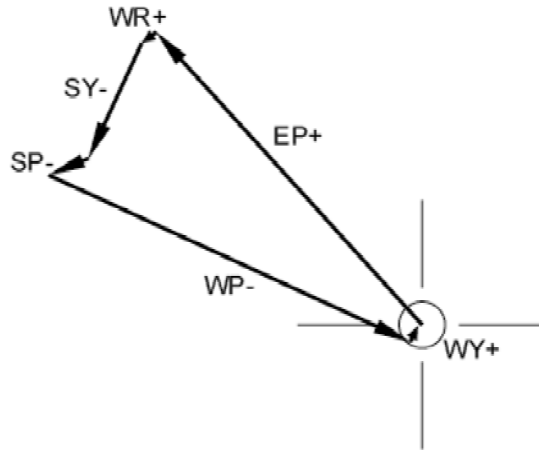

OBSS SJ UNGRAPPLE AT HANDOFF

PDRS-10a/126/O/A

(reduced copy)

FS CC 4-3

PDRS/126/FIN

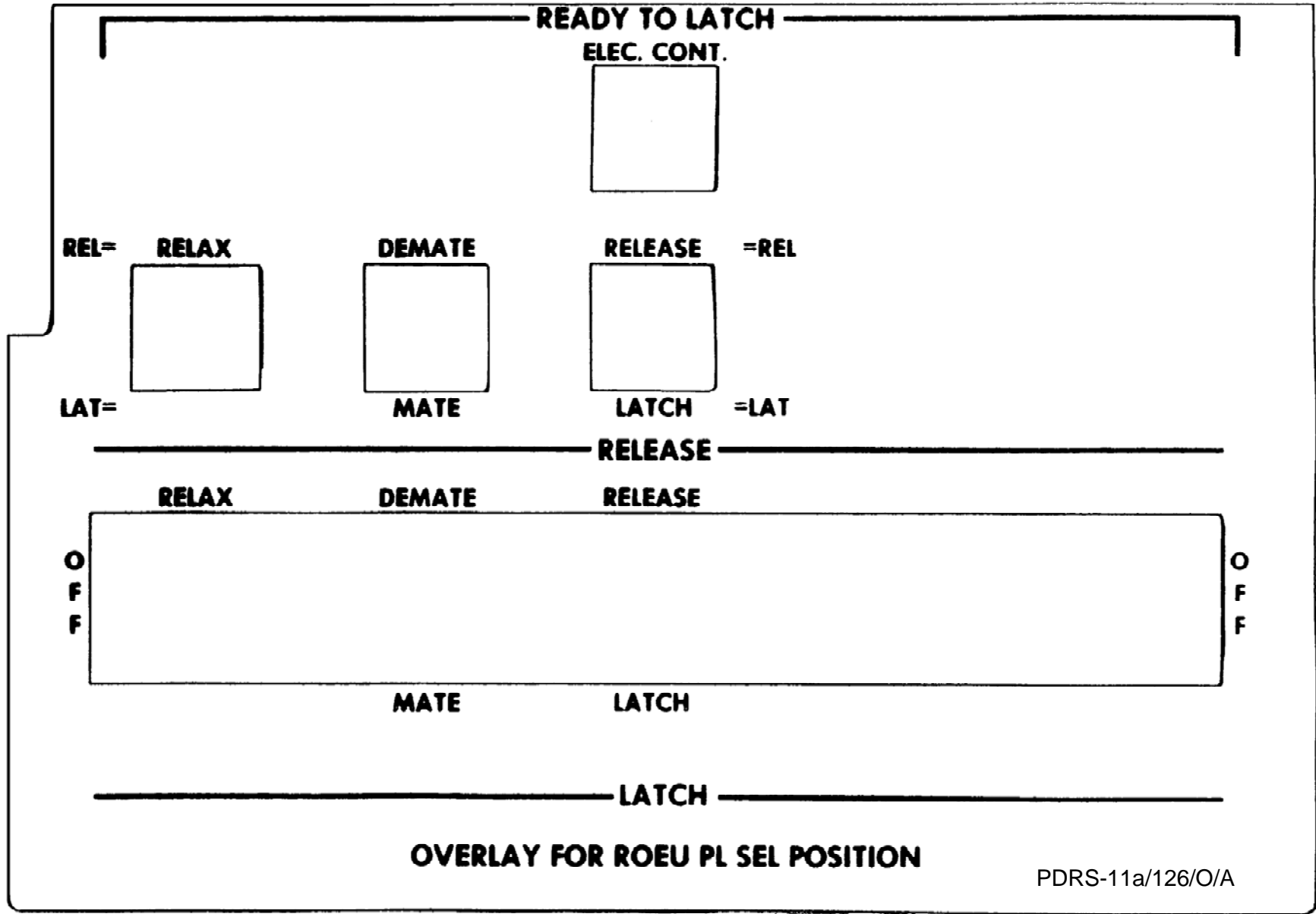



PDRS OPS C/L

**STS
126**