

# PDRS Operations Checklist

## STS-127 Flight Supplement

---

**Mission Operations Directorate  
EVA, Robotics, & Crew Systems  
Operations Division**

**Final  
January 9, 2009**

National Aeronautics and  
Space Administration

**Lyndon B. Johnson Space Center**  
Houston, Texas

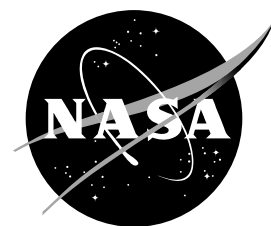

<b>SMS FDF CHANGE NOTIFICATION</b>		<b>SIM PACK</b>		DATE INITIATED 4/13/09	DATE RECEIVED (PMO) 4/14/09
BOOK TITLE  STS-127 PDRS FS		BK ISSUE (Ed, Rev, PCN) Final		SIM PACK NUMBER  SIM-206	
Change is for flights (Also give SMS load if load dependent): STS-127			SMS UNIQUE? <input checked="" type="checkbox"/> YES <input type="checkbox"/> NO		DEVELOPMENTAL? <input type="checkbox"/> YES <input checked="" type="checkbox"/> NO
FABRICATED ITEM CHANGE? <input checked="" type="checkbox"/> NONE <input type="checkbox"/> CUE CARDS <input type="checkbox"/> TRANSPARENCIES <input type="checkbox"/> Other _____					
INSTRUCTIONS TO USER:  This is a simpack for the STS-127/2JA FD4,5 long sim scheduled for 4/21/09.  Incorporate the following. Replace FS 1-3 through 1-12.					
AUTHORITY FOR CHANGE* (Approved 482 numbers, approved issue at print shop, supervisors deem mandatory, etc.): Supervisor deems mandatory					
*Refer to Crew Procedures Management Plan					
OTHER AFFECTED FDF BOOKS			Are all SIM PACKS submitted? <input checked="" type="checkbox"/> YES <input type="checkbox"/> NO		
IMPLEMENTATION REQUIREMENTS		<input type="checkbox"/> Limited Distribution (List in comments)		<input type="checkbox"/> NO EARLIER THAN _____ (Date and/or Sim ID)	
				<input checked="" type="checkbox"/> NO LATER THAN <u>4/20/09</u> (Date and/or Sim ID)	
BOOK MGR (Signature/Date) <i>Debra L. Klee 4/13/09</i>		SUPERVISOR (If required, Signature/Date) <i>Paul Reisman 4/13/09</i>		FDF COORD or FDF MGR (Signature/Date) <i>Renee M. R. 4/14/09</i>	
COMMENTS:					

MISSION OPERATIONS DIRECTORATE

**PDRS OPERATIONS CHECKLIST  
STS-127 FLIGHT SUPPLEMENT**

FINAL  
January 9, 2009

PREPARED BY:



---

Debra L. Klein  
Book Manager

APPROVED BY:



---

Aaron D. Goldenthal  
Lead, Shuttle and Exploration Robotics  
Operations Group

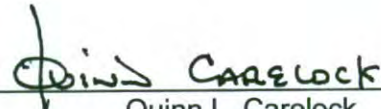

---

Quinn L. Carelock  
Chief, Robotics Operations Branch

This document is under the configuration control of the Crew Procedures Control Board (CPCB). All proposed changes must be submitted via FDF Workflow Crew Procedure Change Request (CR) to DO3/FDF Manager.

Additional distribution of this book, for official use only, may be requested in writing to DO3/PMO Administrator. The request must include justification and requester's name, organization, position, and phone number. Contractor requests are made through the NASA or DOD organization supported. Deletions, reduction in quantity, or change of address may be submitted to DO3/FDF Management Office, 281-244-1184.

Incorporates the following:	
482#:	PDRS_FS-0120 PDRS_FS-0121

AREAS OF TECHNICAL RESPONSIBILITY

Book Manager

DX22/D. Klein

281-483-9413

PDRS OPERATIONS CHECKLIST  
 STS-127 FLIGHT SUPPLEMENT

**LIST OF EFFECTIVE PAGES**

FINAL 01/09/09

Sign Off .....	*	127/FIN	FS 3-1 .....	127/FIN
FS ii .....	*	127/FIN	FS 3-2 .....	127/FIN
FS iii .....	*	127/FIN	FS 3-3 .....	⊗ 127/FIN
FS iv .....	*	127/FIN	FS 3-4 .....	⊗ 127/FIN
FS v .....		127/FIN	FS 3-5 .....	127/FIN
FS vi .....		127/FIN	FS 3-6 .....	127/FIN
FS vii .....		127/FIN	FS 3-7 .....	127/FIN
FS viii .....		127/FIN	FS 3-8 .....	⊗ 127/FIN
FS 1-1 .....		127/FIN	FS 3-9 .....	127/FIN
FS 1-2 .....	⊗	127/FIN	FS 3-10 .....	127/FIN
FS 1-3 .....		127/FIN	FS 3-11 .....	⊗ 127/FIN
FS 1-4 .....	⊗	127/FIN	FS 3-12 .....	127/FIN
FS 1-5 .....	⊗	127/FIN	FS 3-13 .....	127/FIN
FS 1-6 .....		127/FIN	FS 3-14 .....	⊗ 127/FIN
FS 1-7 .....	⊗	127/FIN	FS 3-15 .....	127/FIN
FS 1-8 .....		127/FIN	FS 3-16 .....	⊗ 127/FIN
FS 1-9 .....	⊗	127/FIN	FS 3-17 .....	⊗ 127/FIN
FS 1-10 .....	⊗	127/FIN	FS 3-18 .....	⊗ 127/FIN
FS 1-11 .....	⊗	127/FIN	FS 3-19 .....	127/FIN
FS 1-12 .....		127/FIN	FS 3-20 .....	⊗ 127/FIN
FS 2-1 .....		127/FIN	FS 3-21 .....	⊗ 127/FIN
FS 2-2 .....	⊗	127/FIN	FS 3-22 .....	⊗ 127/FIN
FS 2-3 .....		127/FIN	FS 3-23 .....	127/FIN
FS 2-4 .....	⊗	127/FIN	FS 3-24 .....	127/FIN
FS 2-5 .....		127/FIN	FS 3-25 .....	127/FIN
FS 2-6 .....	⊗	127/FIN	FS 3-26 .....	127/FIN
FS 2-7 .....	⊗	127/FIN	FS 4-1 .....	127/FIN
FS 2-8 .....		127/FIN	FS 4-2 .....	127/FIN
FS 2-9 .....	⊗	127/FIN	FS 4-3 .....	127/FIN
FS 2-10 .....	⊗	127/FIN	FS 4-4 .....	⊗ 127/FIN
FS 2-11 .....	⊗	127/FIN	FS 4-5 .....	127/FIN
FS 2-12 .....		127/FIN	FS 4-6 .....	127/FIN
FS 2-13 .....	⊗	127/FIN	FS 4-7 .....	⊗ 127/FIN
FS 2-14 .....		127/FIN	FS 4-8 .....	127/FIN
FS 2-15 .....	⊗	127/FIN	FS 5-1 .....	127/FIN
FS 2-16 .....		127/FIN	FS 5-2 .....	127/FIN
FS 2-17 .....	⊗	127/FIN	FS 5-3 .....	⊗ 127/FIN
FS 2-18 .....		127/FIN	FS 5-4 .....	127/FIN
FS 2-19 .....	⊗	127/FIN	FS 5-5 .....	⊗ 127/FIN
FS 2-20 .....	⊗	127/FIN	FS 5-6 .....	127/FIN
FS 2-21 .....	⊗	127/FIN	FS 5-7 .....	⊗ 127/FIN
FS 2-22 .....	⊗	127/FIN	FS 5-8 .....	127/FIN
FS 2-23 .....		127/FIN	FS 5-9 .....	⊗ 127/FIN
FS 2-24 .....		127/FIN	FS 5-10 .....	127/FIN
FS 2-25 .....	⊗	127/FIN	FS 5-11 .....	127/FIN
FS 2-26 .....		127/FIN	FS 5-12 .....	127/FIN

\* – Omit from flight book

⊗ – Flight copies of this page contain color

FS 5-13	⊗	127/FIN	FS 7-9		127/FIN
FS 5-14	⊗	127/FIN	FS 7-10	⊗	127/FIN
FS 5-15		127/FIN	FS 7-11		127/FIN
FS 5-16	⊗	127/FIN	FS 7-12	⊗	127/FIN
FS 5-17	⊗	127/FIN	FS 7-13		127/FIN
FS 5-18	⊗	127/FIN	FS 7-14	⊗	127/FIN
FS 5-19	⊗	127/FIN	FS 7-15	⊗	127/FIN
FS 5-20		127/FIN	FS 7-16	⊗	127/FIN
FS 5-21		127/FIN	FS 7-17		127/FIN
FS 5-22		127/FIN	FS 7-18	⊗	127/FIN
FS 5-23	⊗	127/FIN	FS 7-19	⊗	127/FIN
FS 5-24		127/FIN	FS 7-20	⊗	127/FIN
FS 5-25		127/FIN	FS 7-21	⊗	127/FIN
FS 5-26		127/FIN	FS 7-22		127/FIN
FS 5-27		127/FIN	FS 7-23		127/FIN
FS 5-28	⊗	127/FIN	FS 7-24	⊗	127/FIN
FS 5-29		127/FIN	FS 7-25		127/FIN
FS 5-30		127/FIN	FS 7-26		127/FIN
FS 6-1		127/FIN	FS 7-27		127/FIN
FS 6-2		127/FIN	FS 7-28	⊗	127/FIN
FS 6-3	⊗	127/FIN	FS 7-29		127/FIN
FS 6-4	⊗	127/FIN	FS 7-30	⊗	127/FIN
FS 6-5	⊗	127/FIN	FS 7-31	⊗	127/FIN
FS 6-6	⊗	127/FIN	FS 7-32	⊗	127/FIN
FS 6-7		127/FIN	FS 7-33	⊗	127/FIN
FS 6-8	⊗	127/FIN	FS 7-34		127/FIN
FS 6-9		127/FIN	FS 7-35	⊗	127/FIN
FS 6-10		127/FIN	FS 7-36	⊗	127/FIN
FS 6-11	⊗	127/FIN	FS 7-37	⊗	127/FIN
FS 6-12		127/FIN	FS 7-38		127/FIN
FS 6-13	⊗	127/FIN	FS 7-39		127/FIN
FS 6-14	⊗	127/FIN	FS 7-40		127/FIN
FS 6-15	⊗	127/FIN	FS 7-41		127/FIN
FS 6-16	⊗	127/FIN	FS 7-42	⊗	127/FIN
FS 6-17		127/FIN	FS 7-43		127/FIN
FS 6-18		127/FIN	FS 7-44	⊗	127/FIN
FS 6-19		127/FIN	FS 7-45	⊗	127/FIN
FS 6-20	⊗	127/FIN	FS 7-46	⊗	127/FIN
FS 6-21		127/FIN	FS 7-47	⊗	127/FIN
FS 6-22	⊗	127/FIN	FS 7-48		127/FIN
FS 6-23	⊗	127/FIN	FS 8-1		127/FIN
FS 6-24	⊗	127/FIN	FS 8-2		127/FIN
FS 6-25	⊗	127/FIN	FS 8-3	⊗	127/FIN
FS 6-26		127/FIN	FS 8-4	⊗	127/FIN
FS 7-1		127/FIN	FS 8-5	⊗	127/FIN
FS 7-2		127/FIN	FS 8-6	⊗	127/FIN
FS 7-3	⊗	127/FIN	FS 8-7		127/FIN
FS 7-4	⊗	127/FIN	FS 8-8		127/FIN
FS 7-5	⊗	127/FIN	FS 8-9	⊗	127/FIN
FS 7-6	⊗	127/FIN	FS 8-10		127/FIN
FS 7-7		127/FIN	FS 8-11	⊗	127/FIN
FS 7-8		127/FIN	FS 8-12		127/FIN

⊗ – Flight copies of this page contain color

FS 8-13 .....	127/FIN	FS 9-13.....	127/FIN
FS 8-14 .....	⊗ 127/FIN	FS 9-14.....	127/FIN
FS 8-15 .....	⊗ 127/FIN	FS 10-1.....*	127/FIN
FS 8-16 .....	⊗ 127/FIN	FS CC 10-2.....*	127/FIN
FS 8-17 .....	⊗ 127/FIN	FS CC 10-3.....*	127/FIN
FS 8-18 .....	⊗ 127/FIN	FS CC 10-4.....*	127/FIN
FS 8-19 .....	127/FIN	FS CC 10-5.....*	127/FIN
FS 8-20 .....	127/FIN	FS CC 10-6.....*	127/FIN
FS 8-21 .....	127/FIN	FS CC 10-7.....*	127/FIN
FS 8-22 .....	127/FIN	FS CC 10-8.....*	127/FIN
FS 8-23 .....	⊗ 127/FIN	FS CC 10-9.....*	127/FIN
FS 8-24 .....	⊗ 127/FIN	FS CC 10-10.....*	127/FIN
FS 8-25 .....	⊗ 127/FIN	FS CC 10-11.....*	127/FIN
FS 8-26 .....	⊗ 127/FIN	FS CC 10-12.....*	127/FIN
FS 8-27 .....	⊗ 127/FIN	FS CC 10-13.....*	127/FIN
FS 8-28 .....	127/FIN	FS CC 10-14.....*	127/FIN
FS 8-29 .....	⊗ 127/FIN		
FS 8-30 .....	⊗ 127/FIN		
FS 8-31 .....	⊗ 127/FIN		
FS 8-32 .....	⊗ 127/FIN		
FS 8-33 .....	127/FIN		
FS 8-34 .....	127/FIN		
FS 8-35 .....	⊗ 127/FIN		
FS 8-36 .....	127/FIN		
FS 8-37 .....	127/FIN		
FS 8-38 .....	⊗ 127/FIN		
FS 8-39 .....	⊗ 127/FIN		
FS 8-40 .....	⊗ 127/FIN		
FS 8-41 .....	⊗ 127/FIN		
FS 8-42 .....	⊗ 127/FIN		
FS 8-43 .....	127/FIN		
FS 8-44 .....	127/FIN		
FS 8-45 .....	127/FIN		
FS 8-46 .....	⊗ 127/FIN		
FS 8-47 .....	127/FIN		
FS 8-48 .....	⊗ 127/FIN		
FS 8-49 .....	⊗ 127/FIN		
FS 8-50 .....	⊗ 127/FIN		
FS 8-51 .....	⊗ 127/FIN		
FS 8-52 .....	127/FIN		
FS 9-1 .....	127/FIN		
FS 9-2 .....	127/FIN		
FS 9-3 .....	127/FIN		
FS 9-4 .....	⊗ 127/FIN		
FS 9-5 .....	127/FIN		
FS 9-6 .....	127/FIN		
FS 9-7 .....	⊗ 127/FIN		
FS 9-8 .....	⊗ 127/FIN		
FS 9-9 .....	127/FIN		
FS 9-10 .....	127/FIN		
FS 9-11 .....	⊗ 127/FIN		
FS 9-12 .....	⊗ 127/FIN		

⊗ – Flight copies of this page contain color

\* – Omit from flight book

PDRS CUE CARDS

<u>Title</u>	<u>Ref. Page</u>	<u>Card No.</u>
OVERLAY FOR ROEU PL SEL POSITION.....	FS CC 10-2	PDRS 9a/127/O/A
JEF SJ GRAPPLE AT HANDOFF 1 WRIST CCTV OVERLAY .....	FS CC 10-3	PDRS-10a/127/O/B
JEF SJ UNGRAPPLE AT HANDOFF 2 WRIST CCTV OVERLAY .....	FS CC 10-4	PDRS-11a/127/O/B
ICC SJ GRAPPLE IN PLB WRIST CCTV OVERLAY .....	FS CC 10-5	PDRS-12a/127/O/B
ICC SJ UNGRAPPLE AT HANDOFF WRIST CCTV OVERLAY .....	FS CC 10-6	PDRS-13a/127/O/B
ICC SJ GRAPPLE AT HANDOFF WRIST CCTV OVERLAY .....	FS CC 10-7	PDRS-14a/127/O/B
ICC SJ UNGRAPPLE IN PLB WRIST CCTV OVERLAY .....	FS CC 10-8	PDRS-15a/127/O/B
JLE SJ GRAPPLE IN PLB WRIST CCTV OVERLAY .....	FS CC 10-9	PDRS-16a/127/O/B
JLE SJ UNGRAPPLE AT HANDOFF WRIST CCTV OVERLAY .....	FS CC 10-10	PDRS-17a/127/O/B
JLE SJ GRAPPLE AT HANDBACK WRIST CCTV OVERLAY .....	FS CC 10-11	PDRS-18a/127/O/B
JLE SJ UNGRAPPLE IN PLB WRIST CCTV OVERLAY .....	FS CC 10-12	PDRS-19a/127/O/B
OBSS SJ GRAPPLE AT HANDOFF .....	FS CC 10-13	PDRS-20a/127/O/B
OBSS SJ UNGRAPPLE AT HANDOFF .....	FS CC 10-14	PDRS-21a/127/O/B



CONTENTS

	<u>PAGE</u>
<u>JEF NOMINAL</u> .....	FS 1-1
JEF UNBERTH CLEAR .....	FS 1-2
GRAPPLE .....	FS 1-3
HANDOFF TO SSRMS .....	FS 1-6
UNGRAPPLE .....	FS 1-8
<u>ICC NOMINAL</u> .....	FS 2-1
ICC GRAPPLE IN PLB .....	FS 2-2
UNBERTH .....	FS 2-5
HANDOFF TO SSRMS .....	FS 2-8
UNGRAPPLE .....	FS 2-12
BATTERY R&R VIEWING TO ICC PRE-GRAPPLE .....	FS 2-14
ICC GRAPPLE FROM SSRMS .....	FS 2-16
BERTH IN PLB .....	FS 2-18
<u>JLE NOMINAL</u> .....	FS 3-1
JLE GRAPPLE IN PLB .....	FS 3-2
UNBERTH .....	FS 3-5
HANDOFF TO SSRMS .....	FS 3-9
UNGRAPPLE .....	FS 3-12
GRAPPLE FROM SSRMS .....	FS 3-15
BERTH IN PLB .....	FS 3-19
<u>VIEWING SUPPORT</u> .....	FS 4-1
JEF INSTALL VIEWING TO PRE-CRADLE .....	FS 4-2
ICC BACKOFF TO EVA 2 VIEWING .....	FS 4-3
JLE INSTALL VIEWING TO BATTERY R&R VIEWING .....	FS 4-6
<u>OBSS</u> .....	FS 5-1
OBSS GRAPPLE FROM SSRMS .....	FS 5-2
HANDOFF TO SSRMS .....	FS 5-7
MNVR TO FLAT FIELD .....	FS 5-12
SJ OBSS GRAPPLE FROM SSRMS .....	FS 5-15
HANDOFF TO SSRMS .....	FS 5-25
<u>JEF OFF-NOMINAL</u> .....	FS 6-1
SJ JEF UNBERTH CLEAR .....	FS 6-2
GRAPPLE .....	FS 6-7
HANDOFF TO SSRMS .....	FS 6-12
UNGRAPPLE .....	FS 6-17
<u>ICC OFF-NOMINAL</u> .....	FS 7-1
SJ ICC GRAPPLE IN PLB .....	FS 7-2
UNBERTH .....	FS 7-11
HANDOFF TO SSRMS .....	FS 7-17
UNGRAPPLE .....	FS 7-22
GRAPPLE FROM SSRMS .....	FS 7-25
BERTH IN PLB .....	FS 7-29
<u>JLE OFF-NOMINAL</u> .....	FS 8-1
SJ JLE GRAPPLE IN PLB .....	FS 8-2
UNBERTH .....	FS 8-10
HANDOFF TO SSRMS .....	FS 8-12
UNGRAPPLE .....	FS 8-19
GRAPPLE FROM SSRMS .....	FS 8-28
BERTH IN PLB .....	FS 8-36

<u>REFERENCE DATA</u> .....	FS 9-1
JEF JOINT ANGLES VS POR COORDINATES .....	FS 9-2
COORDINATE SYSTEM – PL ID 3 .....	FS 9-4
JLE JOINT ANGLES VS POR COORDINATES .....	FS 9-5
COORDINATE SYSTEM – PL ID 4 .....	FS 9-7
PRLA CONFIGURATION .....	FS 9-8
ICC JOINT ANGLES VS POR COORDINATES .....	FS 9-9
COORDINATE SYSTEM – PL ID 5 .....	FS 9-11
PRLA CONFIGURATION .....	FS 9-12
OBSS JOINT ANGLES VS POR COORDINATES .....	FS 9-13
<u>CUE CARD CONFIGURATION</u> .....	FS 10-1

JEF NOMINAL

JEF UNBERTH CLEAR .....	FS 1-2
GRAPPLE.....	FS 1-3
HANDOFF TO SSRMS .....	FS 1-6
UNGRAPPLE .....	FS 1-8

**JEF  
NOMINAL**

# JEF UNBERTH CLEAR

JEF  
NOMINAL

## 1. SETUP

DNLK (72)	A
DTV (SSC 2)	Elbow
MON 1 (SSC 1)	C
MON 2 (71)	P1 LOOB

**SM 94 PDRS CONTROL**

- √ PL ID, ITEM 3: 0
- √ INIT ID, ITEM 24: 0

## 2. MNVR TO JEF UNBERTH CLEAR

### NOTE

Minimum clearance between SRMS Upper Boom and JPM is 42 inches at JEF Unberth Clear posn. Monitor with Camera A

RHC

- RATE – as reqd (VERN within 10 ft)
- BRAKES – OFF (tb-OFF)
- MODE – as desired (OCAS valid from Pre-cradle)

Mnvr to JEF UNBERTH CLEAR posn: (01:05)

X	Y	Z	PITCH	YAW	ROLL	PL ID
-1061	-412	-606	316	24	254	0
SY	SP	EP	WP	WY	WR	
+30.0	+65.2	-53.6	-39.4	+11.0	-121.0	

- BRAKES – ON (tb-ON)
- √ MODE – not DIRECT (lt off)

- PARAM – PORT TEMP
- JOINT – CRIT TEMP

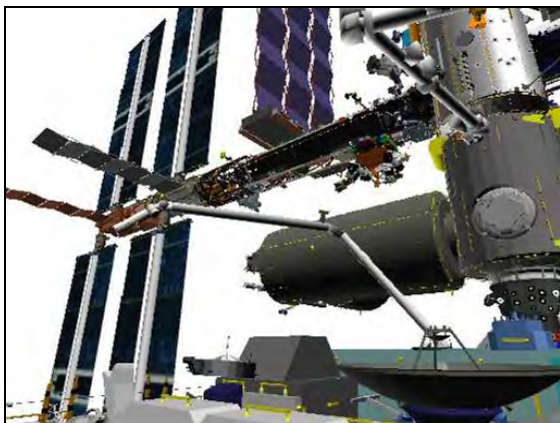

**CCTV C (-40,20)**

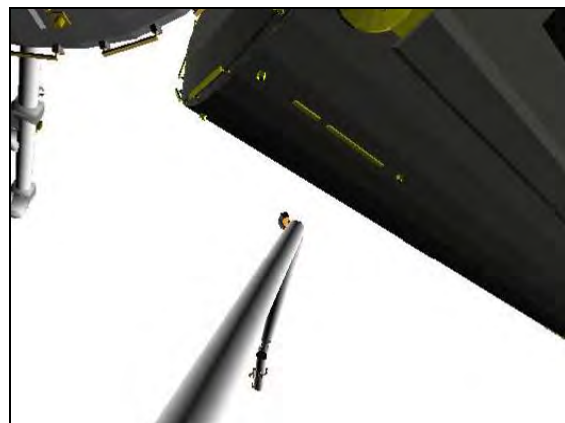

**CCTV A (40,40)**

# JEF GRAPPLE

- A7U 1. SETUP  
 CCTV – configure for JEF grapple  
 – RMS WRIST, ZOOM: 34.0 HFOV  
 FOCUS: 5 ft  
 Maintain eyepoint ~18 in when using grapple overlay

DNLK (72)	C
DTV (SSC 2)	Elbow (EE)
MON 1 (SSC 1)	A
MON 2 (71)	Tip Elbow (Base Elbow)

SM 94 PDRS CONTROL

- √ PL ID, ITEM 3: 0
- √ INIT ID, ITEM 24: 0

Verify at JEF UNBERTH CLEAR posn:

	X	Y	Z	PITCH	YAW	ROLL	PL ID
√	-1061	-412	-606	316	24	254	0
	SY	SP	EP	WP	WY	WR	
√	+30.0	+65.2	-53.6	-39.4	+11.0	-121.0	

## 2. MNVR TO PRE-GRAPPLE

Verify SSRMS at JEF Handoff 1 posn with Brakes ON and SSRMS operator GO for SRMS JEF grapple

### NOTE

Minimum clearance between EE and JEM Small Fine Arm Stowage Equipment (SSE) is 35 inches during maneuver to Pre-grapple and increases to 44 inches at Pre-grapple. Monitor with Base Elbow Camera.

Minimum clearance between SRMS Upper Boom and JPM is 42 inches at JEF Unberth Clear and increases to 46 inches at Pre-grapple. Monitor with Camera A

- RHC RATE – VERN (RATE MIN tb-ON)  
 BRAKES – OFF (tb-OFF)  
 MODE – SINGLE, ENTER

Mnvr to JEF PRE-GRAPPLE posn:

	SY	SP	EP	WP	WY	WR	
	+30.0	+65.2	-53.6	-39.4	+11.0	-121.0	
	+12.0						
	+12.0	+65.2	-53.6	-39.4	+11.0	-121.0	
	X	Y	Z	PITCH	YAW	ROLL	PL ID
	-1114	-290	-649	326	11	243	0

Clear  
 1: SY –  
 Pre-grapple

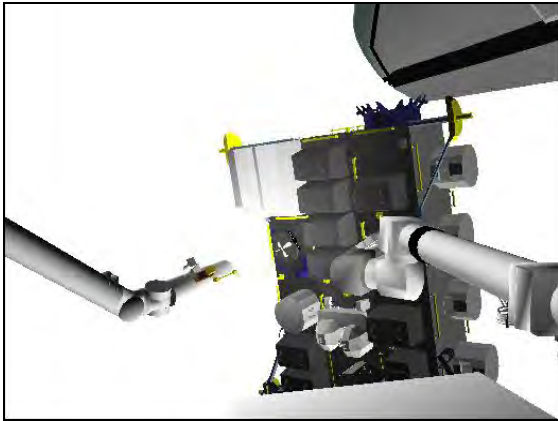

**BASE ELBOW (105,-5)**

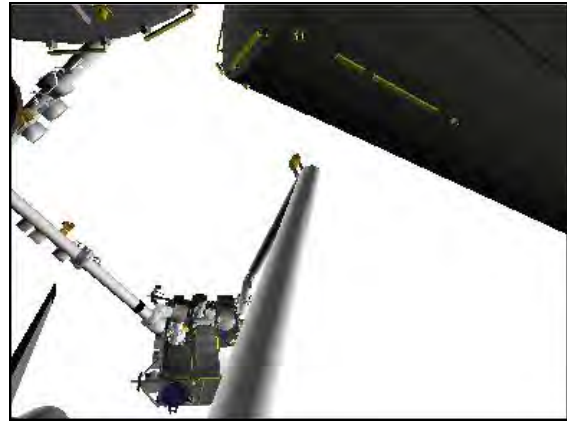

**CCTV A (30,35)**

3. JEF GRAPPLE

NOTE

Minimum clearance between RSC and SSE is 14 inches at grapple posn. Monitor with Base Elbow Camera

RHC

RATE – VERN (RATE MIN tb-ON)  
MODE – END EFF, ENTER

Mnvr to grapple envelope

CAUTION  
Monitor EE tb timing to prevent EE motor burnout

SM 169 PDRS STATUS

EE MODE – AUTO  
CAPTURE sw – depress (mom)

√	RIGID <input type="checkbox"/>	CLOSE <input type="checkbox"/>	CAPTURE <input type="checkbox"/>
	DERIGID <input checked="" type="checkbox"/>	OPEN <input checked="" type="checkbox"/>	EXTEND <input checked="" type="checkbox"/>

CRITICAL TIMES (28 sec total):

CAPTURE tb – gray, then  
CLOSE tb – gray, 3 sec max, then  
RIGID tb – gray, 25 sec max

- \* If manual grapple reqd: \*
- \* EE MODE – MAN \*
- \* CAPTURE sw – depress (hold until CLOSE tb-gray, 3 sec max) \*
- \* MAN CONTR – RIGID (hold until RIGID tb-gray, 25 sec max) \*

EE MODE – OFF

MODE – TEST, ENTER  
Wait 5 sec

BRAKES – ON (tb-ON)

SM 94 PDRS CONTROL

PL ID – ITEM 3 +3 EXEC  
INIT ID – ITEM 24 +3 EXEC

Expected JEF HANDOFF 1 posn:

	X	Y	Z	PITCH	YAW	ROLL	PL ID
√	-1187	-258	-628	236	358	191	3
	SY	SP	EP	WP	WY	WR	
√	+13.4	+50.3	-37.1	-41.1	+9.6	-121.5	

Notify SSRMS operator JEF grapple complete with SRMS Brakes ON;  
SSRMS GO for JEF ungrapple

Review GENERIC END EFFECTOR CUE CARD – ISS/SHUTTLE DOCKED OPS

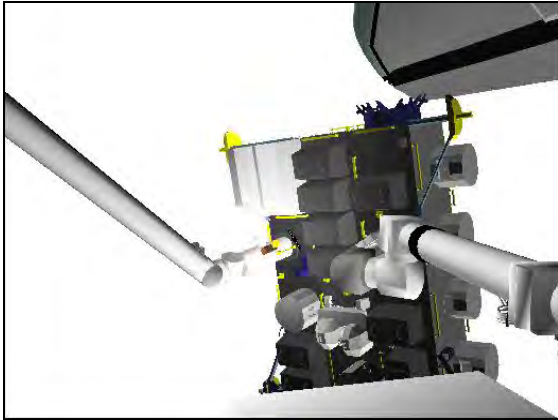

**BASE ELBOW (105,-5)**

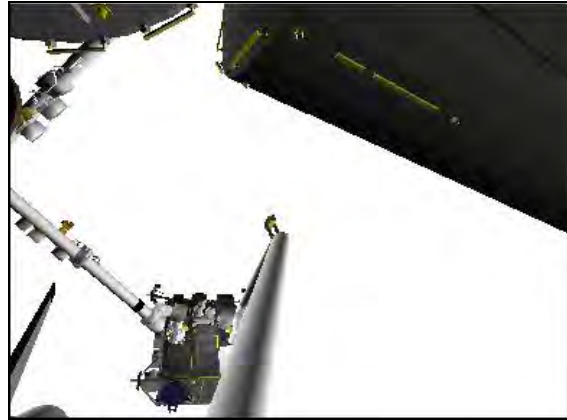

**CCTV A (30,35)**



**CCTV C (-60,30)**

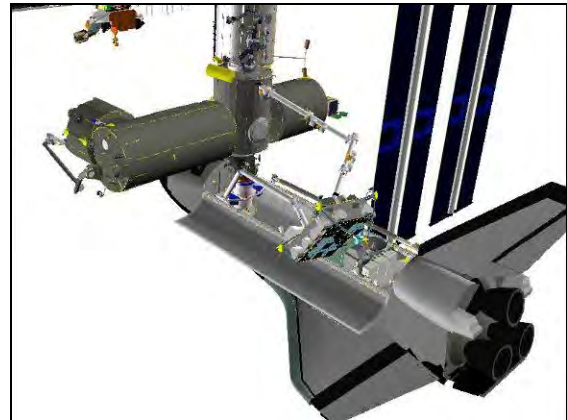

**BIRD'S EYE**

# JEF HANDOFF TO SSRMS

## NOTE

Simo arm motion allowed once SSRMS at PDGF 3 Pre-grapple Setup (trajectory & clearances have been verified).

When performing dual arm ops, communication with SSRMS operator must be maintained and ISS cameras should not be used for SRMS ops

### 1. SETUP

Verify JEMRMS at JEF INSTALL VIEWING posn:

SY	SP	EP	WP	WY	WR
-66.0	+133.3	-99.8	-123.5	0.0	+66.0

DNLK (72)	A
DTV (SSC 2)	Elbow
MON 1 (SSC 1)	B
MON 2 (71)	as required

SM 94 PDRS CONTROL

√ PL ID, ITEM 3: 3

√ INIT ID, ITEM 24: 3

AUTO 1 – ITEM 13 +Z EXEC

END POS – ITEM 18 -1 1 8 7 -2 5 8 -6 2 8 EXEC

ATT – ITEM 21 +2 3 6 +3 5 8 +1 9 1 EXEC

CMD CK – ITEM 25 EXEC (GOOD)

### 2. ACAS TO HANDOFF 2

Verify SSRMS at PDGF 3 Pre-grapple Setup and SSRMS operator GO for SRMS mnvr to JEF Handoff 2

## NOTE

Minimum clearance between SRMS and JPM is 57 inches during mnvr to point 155. Monitor with Cameras A and B

- \* If using Shuttle attitude control and attitude maintenance reqd: \*
- \* DAP: LVLH \*
- \* When rates damped: \*
- \* DAP: FREE > 2 sec \*
- \* DAP: AUTO \*
- \* When in attitude and rates damped: \*
- \* DAP: FREE \*

RHC

RATE – VERN (RATE MIN tb-ON)

BRAKES – OFF (tb-OFF)

MODE – OPR CMD, ENTER (READY It on)

AUTO SEQ – PROCEED (IN PROG It on)

-----  
 After PROCEED, if motion no longer apparent but POR is within  
 1 in/1 deg and IN PROG It - on:  
 -----  
 AUTO SEQ – STOP  
 -----



When AUTO SEQ IN PROG It – off:  
 MODE – AUTO 1, ENTER (READY It on)

**SM 94 PDRS CONTROL**

√START PT, ITEM 17: 148

**SM 169 PDRS STATUS**

Monitor ACAS status

AUTO SEQ – PROCEED (IN PROG It on)

(23:00)

Auto Pos #	X/ SY	Y/ SP	Z/ EP	PITCH/ WP	YAW/ WY	ROLL/ WR	PL ID
148	-1187	-258	-628	236	358	191	3
	+13.4	+50.3	-37.1	-41.1	+9.6	-121.5	
149	-1152	-311	-628	236	358	191	3
	+21.0	+55.5	-41.5	-41.3	+2.9	-125.5	
150	-1140	-392	-540	247	335	196	3
	+33.2	+50.9	-51.4	-21.4	-7.3	-105.5	
151	-1018	-565	-371	297	299	237	3
	+58.0	+29.6	-43.7	-1.6	-24.7	-63.1	
152	-653	-676	-279	359	335	305	3
	+94.2	+21.8	-39.1	-1.7	-23.5	-27.4	
153	-483	-645	-290	354	350	306	3
	+111.1	+21.7	-38.8	-2.0	-24.5	-27.8	
154	-325	-546	-289	350	8	313	3
	+128.9	+21.7	-44.5	-1.3	-23.3	-27.4	
155	-224	-300	-329	204	62	73	3
	+146.0	+20.3	-53.9	+11.9	+56.0	+16.2	

When AUTO SEQ IN PROG It – off:

BRAKES – ON (tb-ON)

√MODE – not DIRECT (It off)

- \* If using Shuttle attitude control and attitude maintenance reqd: \*
- \* DAP: LVLH \*
- \* When rates damped: \*
- \* DAP: FREE > 2 sec \*
- \* DAP: AUTO \*

Notify SSRMS operator that SRMS at JEF Handoff 2 posn with Brakes ON;  
 GO for SSRMS Node 2 ungrapple and JEF grapple

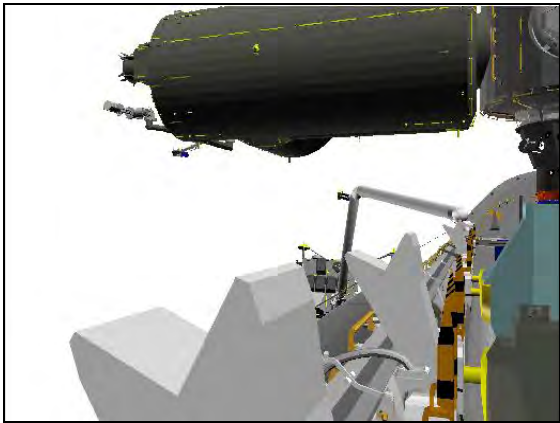

**CCTV B (-20,0)**

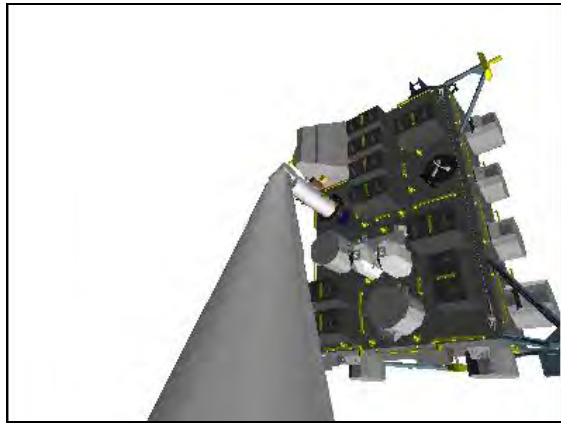

**ELBOW (0,-10)**

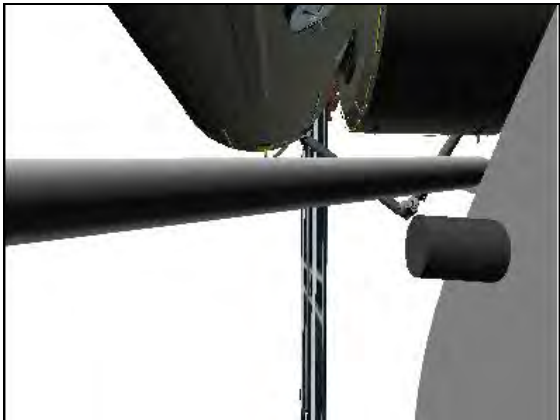

**CCTV A (90,5)**

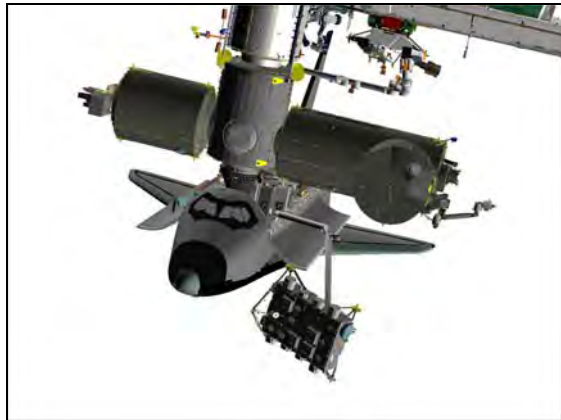

**BIRD'S EYE**

## JEF UNGRAPPLE

- A7U 1. SETUP  
 CCTV – configure for ungrapple  
 – RMS WRIST, ZOOM: 34.0 HFOV  
 FOCUS: 5 ft

DNLK (72)	S1 LOOB
DTV (SSC 2)	EE (Elbow)
MON 1 (SSC 1)	B
MON 2 (71)	A

SM 94 PDRS CONTROL  
 PL ID – ITEM 3 +0 EXEC  
 INIT ID – ITEM 24 +0 EXEC

Verify at HANDOFF 2 posn:

	X	Y	Z	PITCH	YAW	ROLL	PL ID
√	-224	-316	-280	184	334	142	0
	SY	SP	EP	WP	WY	WR	
√	+146.0	+20.3	-53.9	+11.9	+56.0	+16.2	

2. JEF UNGRAPPLE  
 Verify SSRMS grapple complete with Brakes ON and SSRMS operator GO for SRMS JEF ungrapple

### NOTE

Minimum clearance between RSC and SSE is 14 inches when grappled and increases during backoff. Monitor with JEM Ext-Fwd Camera.

Minimum clearance between SRMS Upper Boom and JPM is 57 inches at Backoff posn. Monitor with Cameras A and B.

CONTRL ERR It and 'S96 PDRS CNTL' msg may occur due to Consistency/Envelope Check error

RHC RATE – COARSE (RATE MIN tb-OFF)

SM 94 PDRS CONTROL  
 AUTO BRAKE INH – ITEM 10 EXEC (\*)

BRAKES – OFF (tb-OFF)

MODE – TEST, ENTER  
 Wait 5 sec

BRAKES – ON (tb-ON)

SM 94 PDRS CONTROL  
 AUTO BRAKE ENA – ITEM 9 EXEC (\*)

RHC

RATE – VERN (RATE MIN tb-ON)  
BRAKES – OFF (tb-OFF)  
MODE – END EFF, ENTER

**CAUTION**  
Monitor EE tb timing to prevent EE motor burnout

EE MODE – AUTO  
RELEASE sw – depress (mom)

**NOTE**  
When OPEN tb – gray, mnvr arm clear of grapple pin

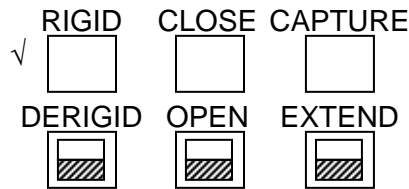

**CRITICAL TIMES (28 sec total):**  
DERIGID tb – gray, 5 sec max, then  
OPEN tb – gray, 3 sec max, then  
EXTEND tb – gray, 20 sec max

EE MODE – OFF

- \* If manual release reqd: \*
- \* EE MODE – MAN \*
- \* MAN CONTR – DERIGID (hold until DERIGID tb-gray, 5 sec max) \*
- \* RELEASE sw – depress (hold until OPEN tb-gray, 3 sec max) \*
- \* \*
- \* Mnvr clear of grapple pin \*
- \* EE MAN CONTR – DERIGID (hold until EXTEND tb-gray, 20 sec max) \*
- \* MODE – OFF \*

Mnvr to JEF HANDOFF 2 BACKOFF posn:

X	Y	Z	PITCH	YAW	ROLL	PL ID
-278	-343	-284	184	334	142	0
SY	SP	EP	WP	WY	WR	
+139.8	+28.6	-67.1	+12.7	+61.7	+20.1	

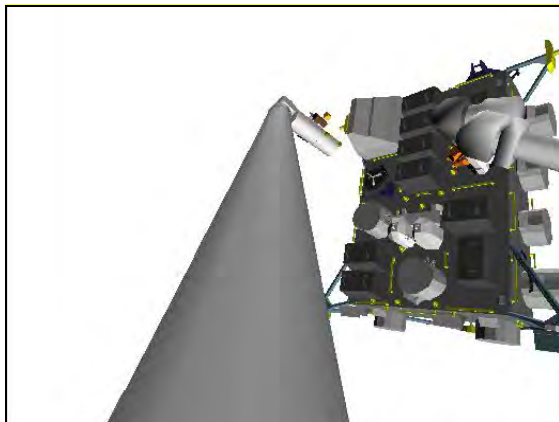

**ELBOW (0,-20)**

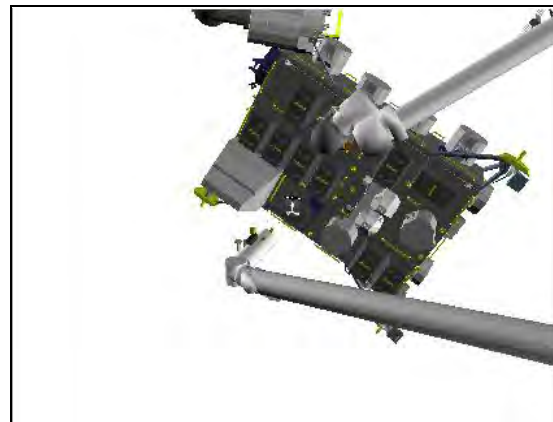

**JEM EXT-FWD (125,50)**

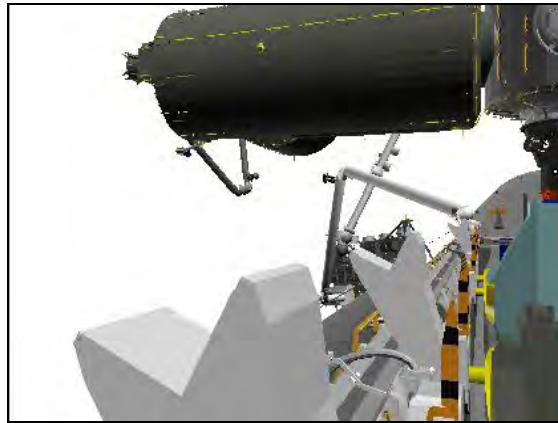

**CCTV B (-20,0)**

3. MNVR TO INSTALL VIEWING

NOTE

Minimum clearance between SRMS and JPM is 39 inches during OCAS (at X = -651) and increases to 44 inches at JEF Install Viewing. Monitor with Cameras A and B

RHC      √RATE    – VERN (RATE MIN tb-ON)  
           √BRAKES – OFF (tb-OFF)  
           MODE    – SINGLE, ENTER

Mnvr to OCAS START posn:

	SY	SP	EP	WP	WY	WR	
JEF Backoff	+139.8	+28.6	-67.1	+12.7	+61.7	+20.1	
1: SY –	+100.0						
OCAS Start	+100.0	+28.6	-67.1	+12.7	+61.7	+20.1	
	X	Y	Z	PITCH	YAW	ROLL	PL ID
	-547	-526	-220	197	11	135	0

BRAKES – ON (tb-ON)

SM 94 PDRS CONTROL

END POS – ITEM 18 -6 8 8 -5 4 5 -2 5 0 EXEC

ATT – ITEM 21 +2 7 8 +8 3 +8 3 EXEC

CMD CK – ITEM 25 EXEC (GOOD)

BRAKES – OFF (tb-OFF)

MODE – OPR CMD, ENTER (READY lt on)

AUTO SEQ – PROCEED (IN PROG lt on)

When AUTO SEQ IN PROG lt – off:

BRAKES – ON (tb-ON)

JEF INSTALL VIEWING posn:

(00:35)

	X	Y	Z	PITCH	YAW	ROLL	PL ID
√	-688	-545	-250	278	83	83	0
	SY	SP	EP	WP	WY	WR	
√	+89.0	+36.0	-82.0	+58.0	0.0	+20.1	

\*Approaching display singularity

√MODE – not DIRECT (lt off)

PARAM – PORT TEMP

JOINT – CRIT TEMP

Notify SSRMS operator that SRMS at JEF Install Viewing posn with Brakes ON;  
GO for SSRMS mnvr to JEF Pre-install

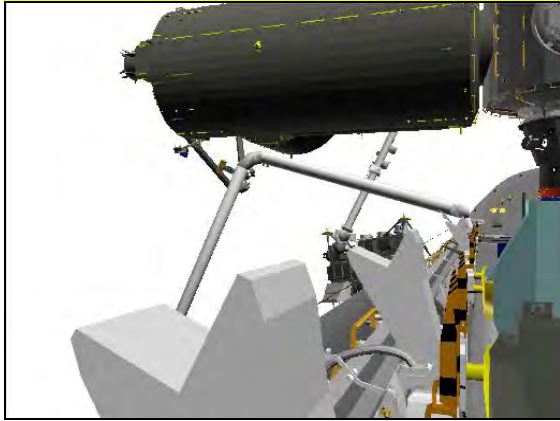

**CCTV B (-20,0)**



**CCTV A (70,0)**

4. CONFIGURE CAMERAS FOR VIEWING

Configure cameras as shown for JEF install viewing support

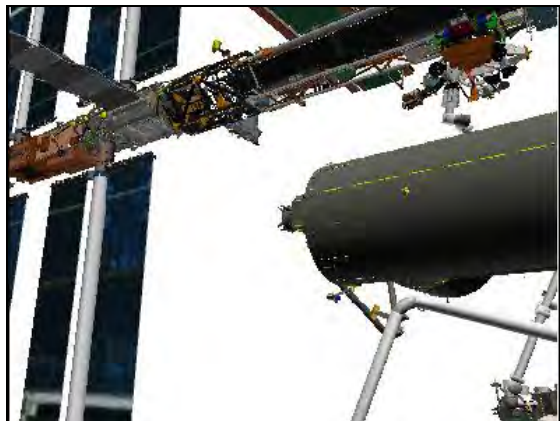

**CCTV B (-36,15)**

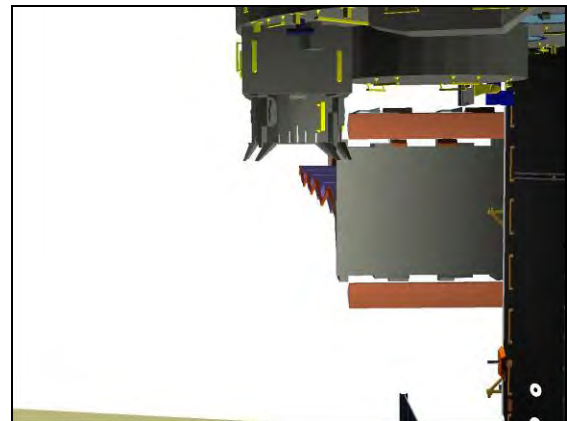

**RSC**

ICC NOMINAL

ICC GRAPPLE IN PLB .....	FS 2-2
UNBERTH .....	FS 2-5
HANDOFF TO SSRMS.....	FS 2-8
UNGRAPPLE.....	FS 2-12
BATTERY R&R VIEWING TO ICC PRE-GRAPPLE .....	FS 2-14
ICC GRAPPLE FROM SSRMS .....	FS 2-16
BERTH IN PLB .....	FS 2-18

ICC  
NOMINAL

# ICC GRAPPLE IN PLB

## 1. SETUP

**CAUTION**  
Aft Payload Bay Flood Lights must be OFF until ICC at Low Hover posn

DNLK (72)	B
DTV (SSC 2)	C
MON 1 (SSC 1)	A (Elbow)
MON 2 (71)	P1 LOOB (JEM EXT-FWD)

SM 94 PDRS CONTROL

- √PL ID, ITEM 3: 0
- √INIT ID, ITEM 24: 0

## 2. MNVR TO ICC PRE-GRAPPLE

### NOTE

If Focused Inspection performed, SSRMS is on Node 2 PDGF at MBS PDGF 3 Pre-grapple posn. Otherwise, SSRMS is on MBS PDGF 3 at MT Translate Stow posn

Verify SSRMS posn is as expected and SSRMS operator GO for ICC Unberth

RHC

- RATE – VERN (RATE MIN tb-ON)
- BRAKES – OFF (tb-OFF)
- MODE – as desired (OCAS valid from Pre-cradle or OBSS Backoff)

Mnvr to ICC PRE-GRAPPLE: (01:00)

X	Y	Z	PITCH	YAW	ROLL	PL ID
-1168	-46	-516	275	0	202	0
SY	SP	EP	WP	WY	WR	
-11.8	+31.9	-35.4	-85.4	+20.0	-128.2	

- BRAKES – ON (tb-ON)
- √MODE – not DIRECT (lt off)

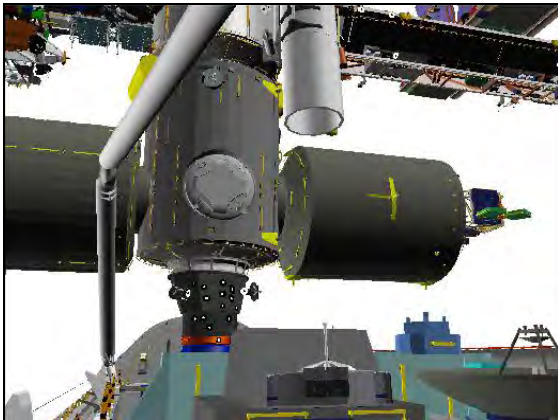

**CCTV B (15,15)**

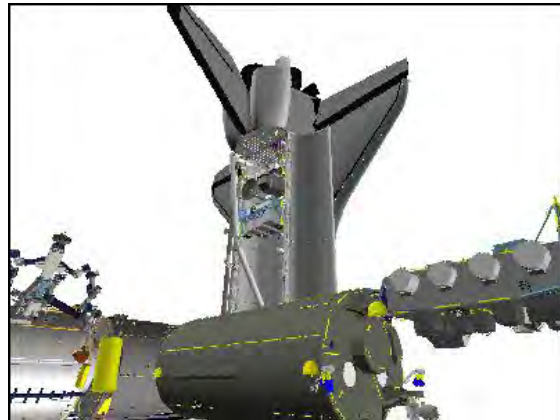

**P1 LOOB (135,25)**

ICC  
NOMINAL



3. ICC GRAPPLE

A7U

CCTV – configure for grapple  
 – RMS WRIST, ZOOM: 34.0 HFOV  
 FOCUS: 5 ft

Maintain eyepoint ~18 in when using grapple overlay

DNLK (72)	EE
DTV (SSC 2)	C (B)
MON 1 (SSC 1)	A
MON 2 (71)	P1 LOOB (JEM EXT-FWD)

RHC

RATE – VERN (RATE MIN tb-ON)  
 BRAKES – OFF (tb-OFF)  
 MODE – END EFF, ENTER

Mnvr to grapple envelope

CAUTION  
 Monitor EE tb timing to prevent EE motor burnout

SM 169 PDRS STATUS

EE MODE – AUTO  
 CAPTURE sw – depress (mom)

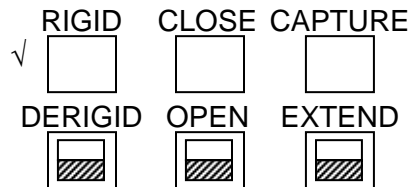

CRITICAL TIMES (28 sec total):

CAPTURE tb – gray, then  
 CLOSE tb – gray, 3 sec max, then  
 RIGID tb – gray, 25 sec max

- \* If manual grapple reqd: \*
- \* EE MODE – MAN \*
- \* CAPTURE sw – depress (hold until CLOSE tb-gray, 3 sec max) \*
- \* MAN CONTR – RIGID (hold until RIGID tb-gray, 25 sec max) \*

EE MODE – OFF  
 BRAKES – ON (tb-ON)

SM 94 PDRS CONTROL

PL ID – ITEM 3 +5 EXEC  
 INIT ID – ITEM 24 +5 EXEC

Record POS/ATT and Joint Angles:

	X	Y	Z	PITCH	YAW	ROLL	PL ID
							5
Expected	-1197	0	-414	180	0	180	5
	SY	SP	EP	WP	WY	WR	
Expected	-9.0	+27.8	-42.1	-73.6	+20.0	-131.2	

Record POS/ATT and Joint Angles in ICC BERTH IN PLB

Review GENERIC END EFFECTOR CUE CARD – ISS/SHUTTLE DOCKED OPS

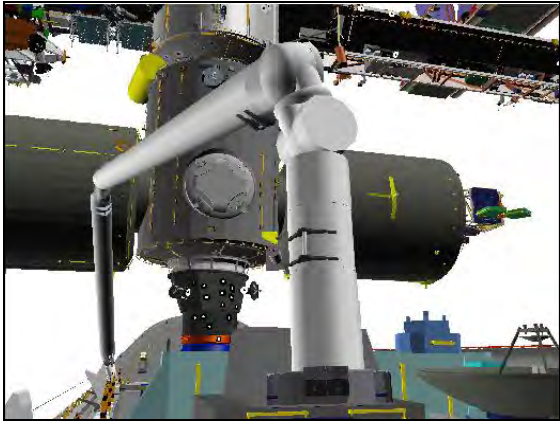

**CCTV B (15,15)**

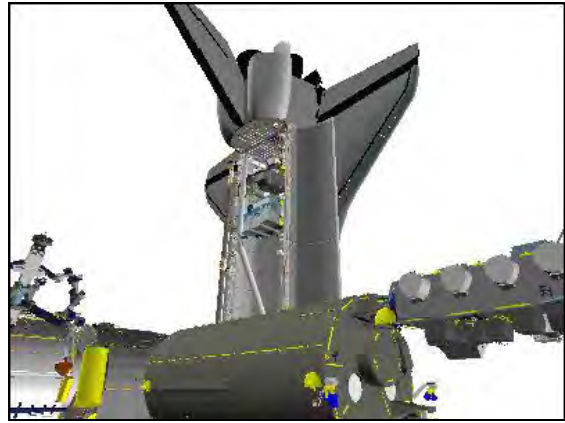

**P1 LOOB (135,25)**

# ICC UNBERTH

I

## 1. SETUP

DNLK (72)	B/C Mux
DTV (SSC 2)	D (Elbow)
MON 1 (SSC 1)	A
MON 2 (71)	Lab (Keel 1)

### SM 94 PDRS CONTROL

- √PL ID, ITEM 3: 5
- √INIT ID, ITEM 24: 5

√BRAKES – ON (tb-ON)

PCS MSS: SSRMS: Thrusters: Thruster Controls for MSS Ops

Verify 'Desat Request:' Inhibit

- \* If using Shuttle attitude control, verify in attitude; \*
- \* DAP: FREE \*

Notify SSRMS operator ICC unberth in work

## 2. ACTIVATE LATCHES

### NOTE

When MCA LOGIC switches taken OFF, KU will mode to standby. MPM and MRL tbs – bp

MA73C:A MCA LOGIC MNC MID 2 – OFF  
:B MNB MID 4 – OFF

A6U √PL RETEN LAT (five) – OFF  
PL SEL – 3  
LOGIC PWR SYS 1,2 (two) – ON  
R13L BAY MECH PWR SYS 1,2 (two) – ON

### SM 97 PL RETENTION

- √PL SEL 3 RDY-FOR-LAT 1,2,3,4,5 (ten) – 1
- √LAT 1,2,3,4,5 (ten) – 1

- \* If any REL msw shows '1', expect \*
- \* single motor time (60 sec) \*

## 3. AKA RELEASE

A6U √PL RETEN LAT 5 tb – LAT  
√RDY 5 tb – gray

Note single motor times (> 30 sec)

PL RETEN LAT 5 – REL (tb-REL), 60 sec max  
– OFF

4. PRLA RELEASE

√PL RETEN LAT 1,2,3,4 (four) tb – LAT  
 √RDY 1,2,3,4 (four) tb – gray

Note single motor times (> 30 sec)

PL RETEN LAT 1,2 (two) – REL (tb-REL), 60 sec max  
 – OFF  
 3,4 (two) – REL (tb-REL), 60 sec max  
 – OFF

5. DEACTIVATE LATCHES

PL RETEN LOGIC PWR SYS 1,2 (two) – OFF

R13L PL BAY MECH PWR SYS 1,2 (two) – OFF

MA73C:A MCA LOGIC MNC MID 2 – ON  
 :B MNB MID 4 – ON

6. MNVR TO ICC PITCH

NOTE

Minimum clearance between stbd trunnions and OBSS during unberth is expected to be 4 inches at approximately Rel = 41 (Z = -445). Monitor with Lab Camera

RHC RATE – VERN (RATE MIN tb-ON)  
 BRAKES – OFF (tb-OFF)  
 MODE – ORB LD, ENTER

Mnvr ICC up until Z = -486 (THC up)

√PL RETEN RDY 1,2,3,4 tb (four) – bp

ICC PITCH posn:

X	Y	Z	PITCH	YAW	ROLL	PL ID
-1197	0	-486	180	0	180	5
SY	SP	EP	WP	WY	WR	
-11.7	+29.1	-30.3	-87.7	+20.1	-128.3	

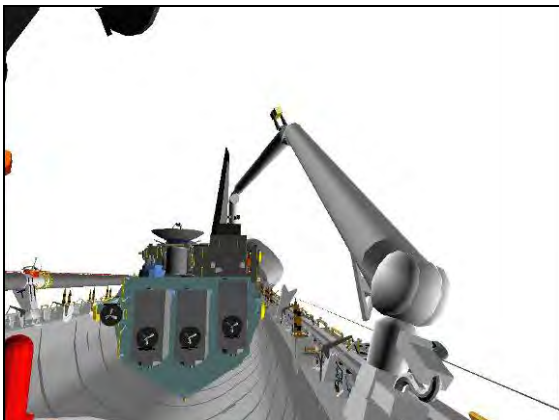

CCTV A (-5,10)

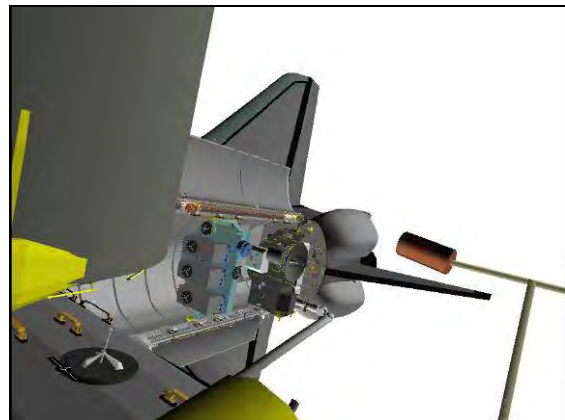

LAB (-35,-20)

7. MNVR TO ICC LOW HOVER

NOTE

Minimum clearance between ORUs on ICC and JLE is 53 inches. Monitor with Elbow and Lab Cameras

Mnvr ICC +PITCH (RHC back) and -Z (THC up) to ICC LOW HOVER posn:

X	Y	Z	PITCH	YAW	ROLL	PL ID
-1197	0	-600	205	0	180	5
SY	SP	EP	WP	WY	WR	
-16.3	+41.1	-33.3	-71.7	+24.7	-133.8	

BRAKES – ON (tb-ON)

√MODE – not DIRECT (lt off)

- \* If using Shuttle attitude control and attitude maintenance reqd: \*
- \* DAP: LVLH \*
- \* When rates damped \*
- \* DAP: FREE > 2 sec \*
- \* DAP: AUTO \*
- \* When in attitude and rates damped: \*
- \* DAP: FREE \*

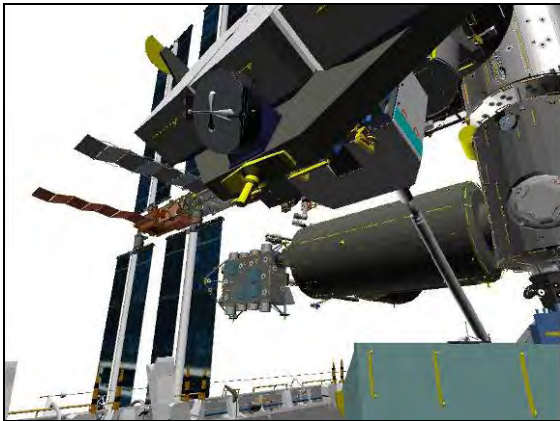

CCTV C (-45,20)

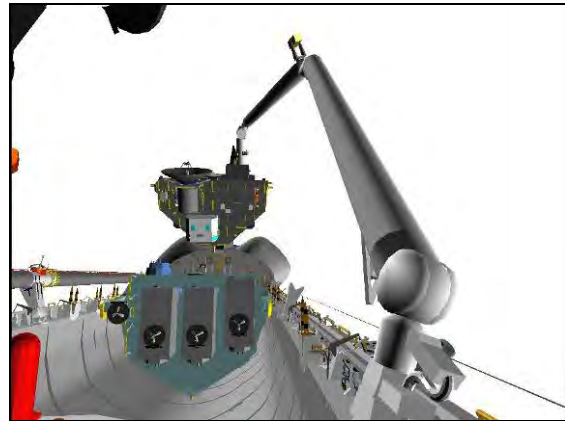

CCTV A (5,10)

# ICC HANDOFF TO SSRMS

I

## 1. SETUP

Verify JEMRMS at JEF INSTALL VIEWING:

SY	SP	EP	WP	WY	WR
-66.0	+133.3	-99.8	-123.5	0.0	+66.0

DNLK (72)	B
DTV (SSC 2)	A
MON 1 (SSC 1)	Elbow
MON 2 (71)	P1 LOOB (JEM EXT-FWD)

SM 94 PDRS CONTROL

√ PL ID, ITEM 3: 5

√ INIT ID, ITEM 24: 5

Verify at ICC LOW HOVER posn:

X	Y	Z	PITCH	YAW	ROLL	PL ID
√ -1197	0	-600	205	0	180	5
SY	SP	EP	WP	WY	WR	
√ -16.3	+41.1	-33.3	-71.7	+24.7	-133.8	

## 2. MNVR TO ICC PORT

### NOTE

Minimum clearance between ICC and port sill hardware is 53 inches. Monitor with Cameras A and B

RHC

RATE – VERN (RATE MIN tb-ON)

BRAKES – OFF (tb-OFF)

MODE – ORB LD, ENTER

Mnvr ICC port until Y = -180 (THC right)

ICC PORT posn:

X	Y	Z	PITCH	YAW	ROLL	PL ID
√ -1197	-180	-600	205	0	180	5
SY	SP	EP	WP	WY	WR	
√ +4.6	+43.1	-24.2	-76.4	+14.4	-153.0	

BRAKES – ON (tb-ON)

- \* If using Shuttle attitude control and attitude maintenance reqd: \*
- \* DAP: LVLH \*
- \* When rates damped: \*
- \* DAP: FREE > 2 sec \*
- \* DAP: AUTO \*
- \* When in attitude and rates damped: \*
- \* DAP: FREE \*

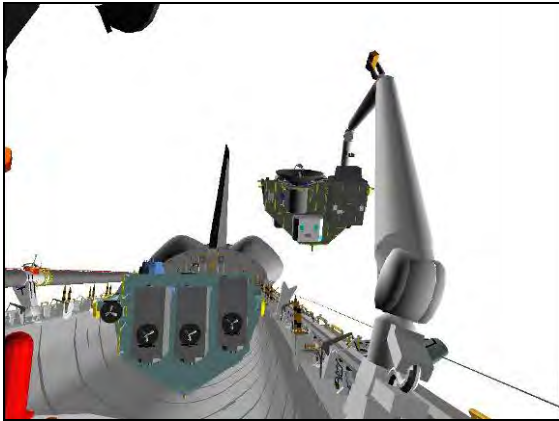

**CCTV A (5,10)**

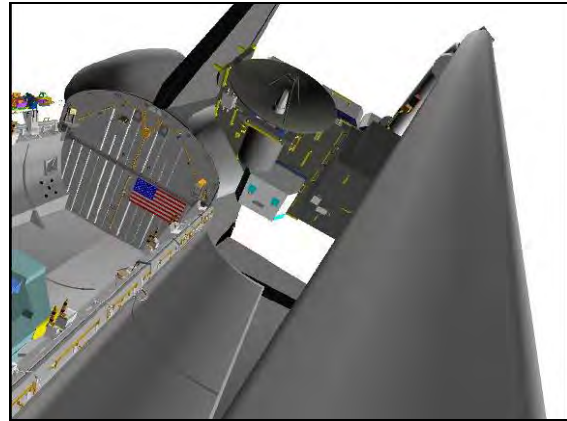

**ELBOW (-25,-30)**

3. OCAS TO ICC INTERMEDIATE POSN

NOTE

Minimum clearance between SRMS Upper Boom and JPM is 41 inches (at approx. Y = -362) during OCAS. Monitor with Camera A.

Monitor clearance from ICC to PLBD and ICC to Port RCC with Elbow Camera

SM 94 PDRS CONTROL

END POS – ITEM 18 -9 6 4 -6 3 4 -3 1 9 EXEC  
 ATT – ITEM 21 +2 4 0 +3 3 6 +2 9 3 EXEC  
 CMD CK – ITEM 25 EXEC (GOOD)

RHC

√RATE – VERN (RATE MIN tb-ON)  
 BRAKES – OFF (tb-OFF)  
 MODE – OPR CMD, ENTER (READY It on)

AUTO SEQ – PROCEED (IN PROG It on)

When AUTO SEQ IN PROG It – off:

Verify at ICC INTERMEDIATE posn: (08:50)

	X	Y	Z	PITCH	YAW	ROLL	PL ID
√	-964	-634	-319	240	336	293	5
	SY	SP	EP	WP	WY	WR	
√	+57.0	+22.0	-35.0	+40.0	+60.0	-190.0	

- \* If using Shuttle attitude control and attitude maintenance reqd: \*
- \* BRAKES – ON (tb-ON) \*
- \* \*
- \* DAP: LVLH \*
- \* When rates damped: \*
- \* DAP: FREE > 2 sec \*
- \* DAP: AUTO \*
- \* When in attitude and rates damped: \*
- \* DAP: FREE \*
- \* \*
- \* BRAKES – OFF (tb-OFF) \*

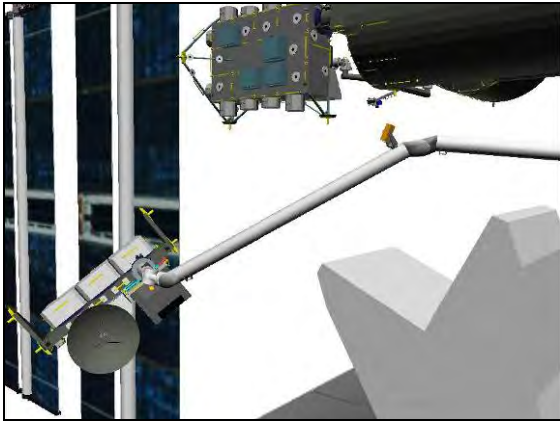

**CCTV B (-40,-5)**

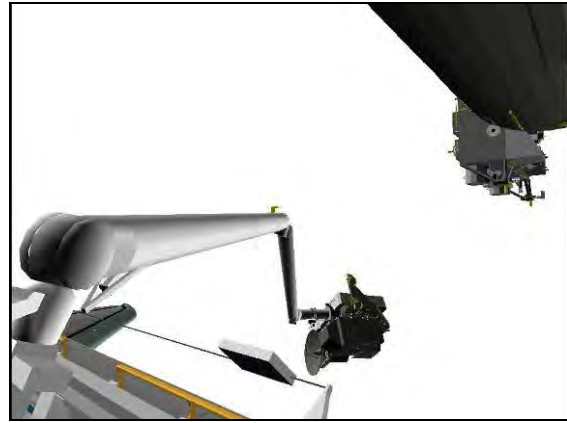

**CCTV A (80,5)**

RHC

4. MNVR TO HANDOFF POSN

√RATE – VERN (RATE MIN tb-ON)  
 MODE – SINGLE, ENTER

Mnvr to ICC HANDOFF posn:

Intermediate  
 1: SY +  
 2: WP +  
 Handoff

SY	SP	EP	WP	WY	WR	
+57.0	+22.0	-35.0	+40.0	+60.0	-190.0	
+97.0						
			+80.0			
+97.0	+22.0	-35.0	+80.0	+60.0	-190.0	
X	Y	Z	PITCH	YAW	ROLL	PL ID
-557	-671	-366	250	357	347	5

BRAKES – ON (tb-ON)  
 √MODE – not DIRECT (It off)

If remaining at ICC HANDOFF overnight,  
 PARAM – PORT TEMP  
 JOINT – CRIT TEMP, then >>

- \* If using Shuttle attitude control and attitude maintenance reqd: \*
- \* DAP: LVLH \*
- \* When rates damped: \*
- \* DAP: FREE > 2 sec \*
- \* DAP: AUTO \*

Notify SSRMS operator that SRMS at ICC Handoff with Brakes ON;  
 GO for SSRMS ICC grapple



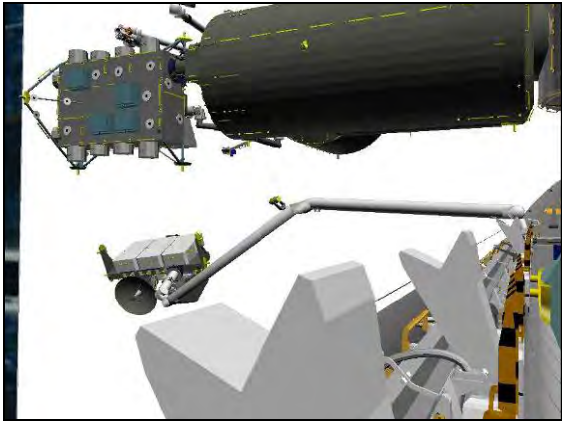

**CCTV B (-25,0)**

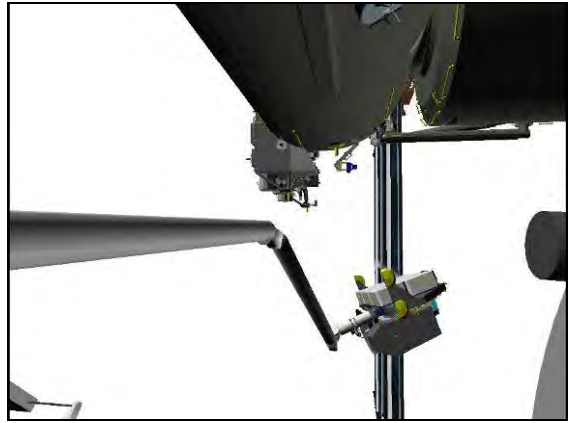

**CCTV A (50,5)**

# ICC UNGRAPPLE

I

- A7U 1. SETUP  
CCTV – configure for ungrapple  
– RMS WRIST, ZOOM: 34.0 HFOV  
FOCUS: 5 ft

DNLK (72)	EE (Elbow)
DTV (SSC 2)	A
MON 1 (SSC 1)	B
MON 2 (71)	JEM EXT-FWD (P1 LOOB)

SM 94 PDRS CONTROL  
PL ID – ITEM 3 +0 EXEC  
INIT ID – ITEM 24 +0 EXEC

2. ICC UNGRAPPLE  
Verify SSRMS grapple complete with Brakes ON and SSRMS operator GO for SRMS ICC ungrapple

### NOTE

CONTRL ERR It and 'S96 PDRS CNTL' msg may occur due to Consistency/Envelope Check error

- RHC RATE – COARSE (RATE MIN tb-OFF)

SM 94 PDRS CONTROL  
AUTO BRAKE INH – ITEM 10 EXEC (\*)

BRAKES – OFF (tb-OFF)

MODE – TEST, ENTER  
Wait 5 sec

BRAKES – ON (tb-ON)

SM 94 PDRS CONTROL  
AUTO BRAKE ENA – ITEM 9 EXEC (\*)

- RHC RATE – VERN (RATE MIN tb-ON)  
BRAKES – OFF (tb-OFF)  
MODE – END EFF, ENTER

CAUTION  
Monitor EE tb timing to prevent EE motor burnout

EE MODE – AUTO  
RELEASE sw – depress (mom)

### NOTE

When OPEN tb – gray, mnvr arm clear of grapple pin

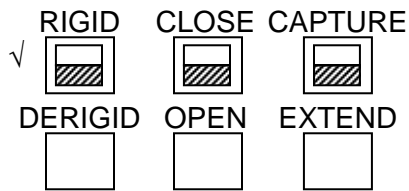

CRITICAL TIMES (28 sec total):  
 DERIGID tb – gray, 5 sec max, then  
 OPEN tb – gray, 3 sec max, then  
 EXTEND tb – gray, 20 sec max

EE MODE – OFF

- \* If manual release reqd: \*
- \* EE MODE – MAN \*
- \* MAN CONTR – DERIGID (hold until DERIGID tb-gray, 5 sec max) \*
- \* RELEASE sw – depress (hold until OPEN tb-gray, 3 sec max) \*
- \* \*
- \* Mnvr clear of grapple pin \*
- \* EE MAN CONTR – DERIGD (hold until EXTEND tb-gray, 20 sec max) \*
- \* MODE – OFF \*

NOTE

Backoff is 72 inches from ICC to improve clearances  
 for SSRMS manuever

Mnvr to ICC BACKOFF posn:

X	Y	Z	PITCH	YAW	ROLL	PL ID
-631	-601	-313	155	14	19	0
SY	SP	EP	WP	WY	WR	
+89.9	+20.9	-40.4	+98.7	+62.0	-204.6	

BRAKES – ON (tb-ON)  
 √MODE – not DIRECT (lt off)

Notify SSRMS operator that SRMS is ungrappled and clear with Brakes ON;  
 SSRMS GO to mnvr ICC

PARAM – PORT TEMP  
 JOINT – CRIT TEMP



CCTV A (80,5)

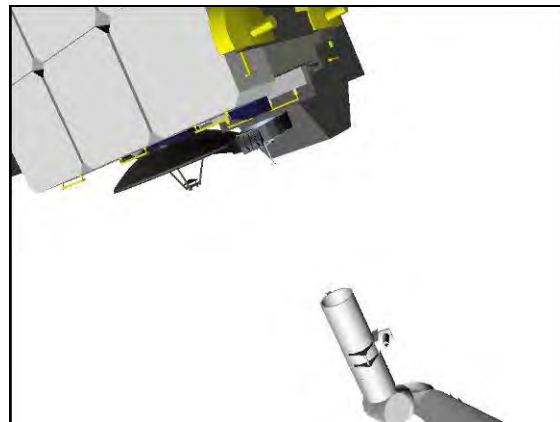

JEM EXT-FWD (60,0)

# BATTERY R&R VIEWING TO ICC PRE-GRAPPLE

I

## 1. SETUP

DNLK (72)	B
DTV (SSC 2)	A
MON 1 (SSC 1)	Elbow
MON 2 (71)	JEM EXT-FWD

SM 94 PDRS CONTROL

- √ PL ID, ITEM 3: 0
- √ INIT ID, ITEM 24: 0

Verify at BATTERY R&R VIEWING:

√	X	Y	Z	PITCH	YAW	ROLL	PL ID
	-544	-581	-289	104	48	242	0
	SY	SP	EP	WP	WY	WR	
√	+105.0	+20.9	-51.6	+90.0	+2.0	+15.0	

## 2. MNVR TO PRE-GRAPPLE

Verify SSRMS at P6 Clear posn and SSRMS operator GO for SRMS mnvr to ICC Pre-grapple

RHC

- RATE – as reqd (VERN within 10 ft)
- BRAKES – OFF (tb-OFF)
- MODE – as desired (OCAS valid from Battery R&R Viewing)

Mnvr to ICC PRE-GRAPPLE posn (suggested SJ sequence):

	SY	SP	EP	WP	WY	WR	
R&R Viewing	+105.0	+20.9	-51.6	+90.0	+2.0	+15.0	
1: WR –						-204.6	
2: WY +					+62.0		
3: WP +				+98.7			
4: EP +			-40.4				
5: SY –	+89.9						
Pre-grapple	+89.9	+20.9	-40.4	+98.7	+62.0	-204.6	
	X	Y	Z	PITCH	YAW	ROLL	PL ID
	-631	-601	-313	155	14	19	0

BRAKES – ON (tb-ON)

Notify SSRMS operator that SRMS at ICC Pre-grapple with Brakes ON;  
GO for SSRMS to maneuver to ICC Handoff

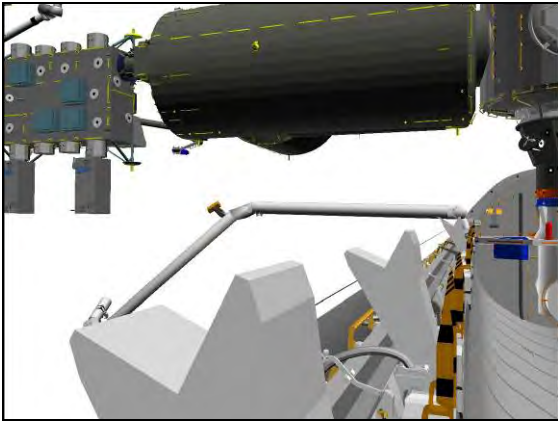

**CCTV B (-20,0)**

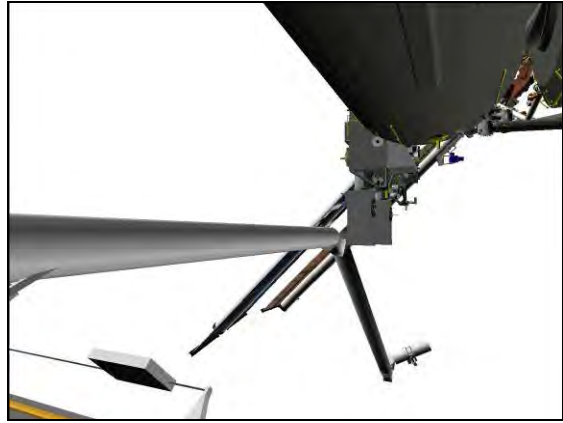

**CCTV A (65,5)**

# ICC GRAPPLE FROM SSRMS

I

- A7U
- SETUP FOR GRAPPLE  
 CCTV – configure for grapple  
 – RMS WRIST, ZOOM: 34.0 HFOV  
 FOCUS: 5 ft  
 Maintain eyepoint ~18 in when using grapple overlay

DNLK (72)	EE
DTV (SSC 2)	A
MON 1 (SSC 1)	B
MON 2 (71)	JEM EXT-FWD (P1 LOOB)

Verify at ICC PRE-GRAPPLE:

X	Y	Z	PITCH	YAW	ROLL	PL ID
√ -631	-601	-313	155	14	19	0
SY	SP	EP	WP	WY	WR	
√ +89.9	+20.9	-40.4	+98.7	+62.0	-204.6	

- ICC GRAPPLE  
 Verify SSRMS at ICC Handoff posn with Brakes ON and SSRMS operator GO for SRMS ICC grapple

- RHC
- RATE – VERN (RATE MIN tb-ON)  
 BRAKES – OFF (tb-OFF)  
 MODE – END EFF, ENTER

Mnvr to grapple envelope

**CAUTION**  
 Monitor EE tb timing to prevent EE motor burnout

SM 169 PDRS STATUS

EE MODE – AUTO  
 CAPTURE sw – depress (mom)

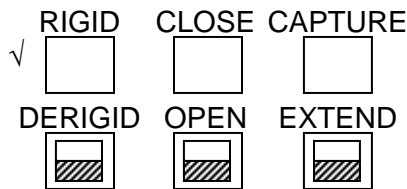

CRITICAL TIMES (28 sec total):  
 CAPTURE tb – gray, then  
 CLOSE tb – gray, 3 sec max, then  
 RIGID tb – gray, 25 sec max

- \* If manual grapple reqd: \*
- \* EE MODE – MAN \*
- \* CAPTURE sw – depress (hold until CLOSE tb-gray, 3 sec max) \*
- \* MAN CONTR – RIGID (hold until RIGID tb-gray, 25 sec max) \*

EE MODE – OFF

MODE – TEST, ENTER  
 Wait 5 sec

BRAKES – ON (tb-ON)

**SM 94 PDRS CONTROL**

PL ID – ITEM 3 +5 EXEC

INIT ID – ITEM 24 +5 EXEC

Expected ICC HANDOFF posn:

	X	Y	Z	PITCH	YAW	ROLL	PL ID
√	-556	-670	-367	250	357	347	5
	SY	SP	EP	WP	WY	WR	
√	+97.0	+22.0	-35.0	+80.0	+60.0	-190.0	

Notify SSRMS operator that SRMS grapple complete with Brakes ON;  
GO for ICC ungrapple

Review GENERIC END EFFECTOR CUE CARD – ISS/SHUTTLE DOCKED OPS

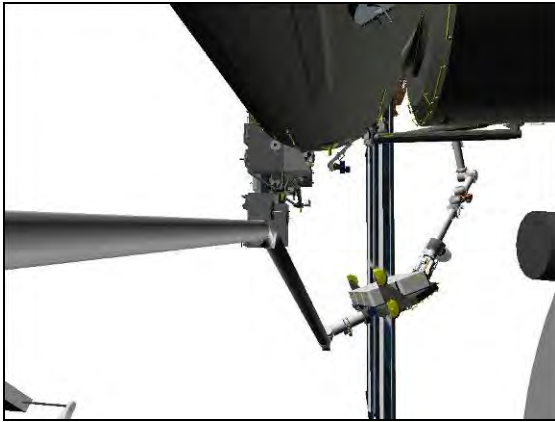

**CCTV A (80,5)**

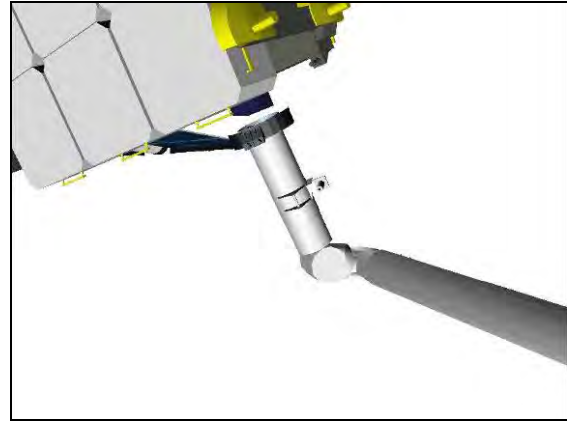

**JEM EXT-FWD (60,0)**

# ICC BERTH IN PLB

I

## 1. SETUP

DNLK (72)	Elbow
DTV (SSC 2)	A
MON 1 (SSC 1)	B (C)
MON 2 (71)	P1 LOOB (JEM EXT-FWD)

**SM 94 PDRS CONTROL**

- √ PL ID, ITEM 3: 5
- √ INIT ID, ITEM 24: 5

Verify at ICC HANDOFF posn:

√	X	Y	Z	PITCH	YAW	ROLL	PL ID
	-556	-670	-367	250	357	347	5
	SY	SP	EP	WP	WY	WR	
√	+97.0	+22.0	-35.0	+80.0	+60.0	-190.0	

## 2. MNVR TO INTERMEDIATE POSN

Verify SSRMS is ungrappled, clear, and SSRMS operator GO for ICC Berth

- \* If using Shuttle attitude control and attitude maintenance reqd: \*
- \* DAP: LVLH \*
- \* When rates damped: \*
- \* DAP: FREE > 2 sec \*
- \* DAP: AUTO \*
- \* When in attitude and rates damped: \*
- \* DAP: FREE \*

- RHC      √ RATE    – VERN (RATE MIN tb-ON)  
 BRAKES – OFF (tb-OFF)  
 MODE    – SINGLE, ENTER

Mnvr to ICC INTERMEDIATE posn:

	SY	SP	EP	WP	WY	WR	
Handoff	+97.0	+22.0	-35.0	+80.0	+60.0	-190.0	
1: WP –				+40.0			
2: SY –	+57.0						
Intermediate	+57.0	+22.0	-35.0	+40.0	+60.0	-190.0	
	X	Y	Z	PITCH	YAW	ROLL	PL ID
	-964	-634	-319	240	336	293	5

BRAKES – ON (tb-ON)

- \* If using Shuttle attitude control and attitude maintenance reqd: \*
- \* DAP: LVLH \*
- \* When rates damped: \*
- \* DAP: FREE > 2 sec \*
- \* DAP: AUTO \*
- \* When in attitude and rates damped: \*
- \* DAP: FREE \*



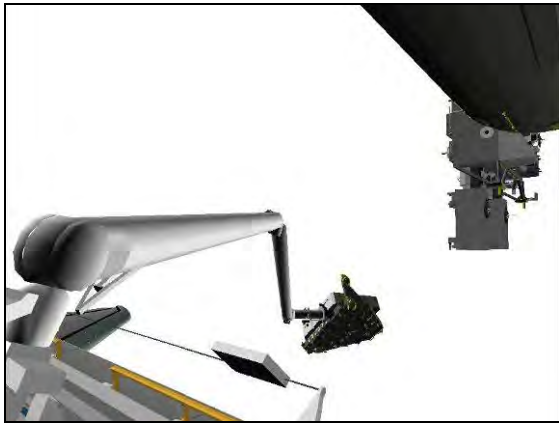

**CCTV A (50,5)**

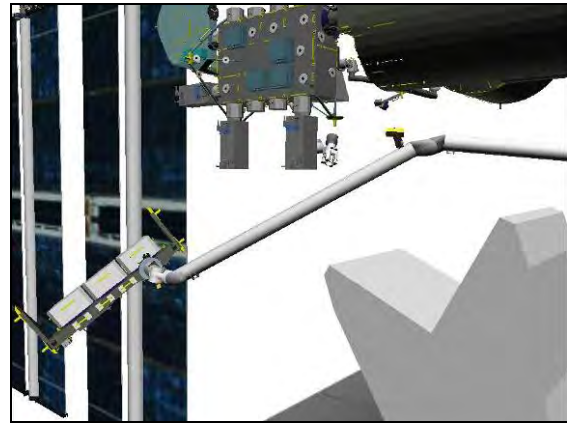

**CCTV B (-40,-5)**

3. MNVR TO ICC PORT

NOTE

Minimum clearance between SRMS Upper Boom and JPM is 41 inches (at approx Y = -362) during OCAS. Monitor with Camera A.

Monitor clearance from ICC to PLBD and ICC to Port RCC with Elbow Camera

SM 94 PDRS CONTROL

END POS – ITEM 18 -1 1 9 7 -1 8 0 -6 0 0 EXEC

ATT – ITEM 21 +2 0 5 +0 +1 8 0 EXEC

CMD CK – ITEM 25 EXEC (GOOD)

RHC

√RATE – VERN (RATE MIN tb-ON)  
 BRAKES – OFF (tb-OFF)  
 MODE – OPR CMD, ENTER (READY It on)

AUTO SEQ – PROCEED (IN PROG It on)

When AUTO SEQ IN PROG It – off:

Verify at ICC PORT posn: (08:50)

	X	Y	Z	PITCH	YAW	ROLL	PL ID
√	-1197	-180	-600	205	0	180	5
	SY	SP	EP	WP	WY	WR	
√	+4.6	+43.1	-24.2	-76.4	+14.4	-153.0	

- \* If using Shuttle attitude control and attitude maintenance reqd: \*
- \* BRAKES – ON (tb-ON) \*
- \* \*
- \* DAP: LVLH \*
- \* When rates damped: \*
- \* DAP: FREE > 2 sec \*
- \* DAP: AUTO \*
- \* When in attitude and rates damped: \*
- \* DAP: FREE \*
- \* \*
- \* BRAKES – OFF (tb-OFF) \*

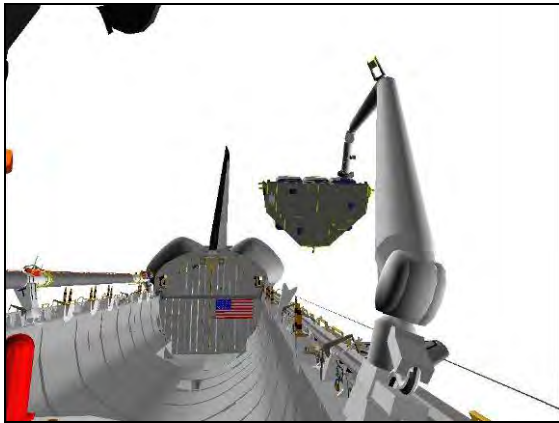

**CCTV A (5,10)**

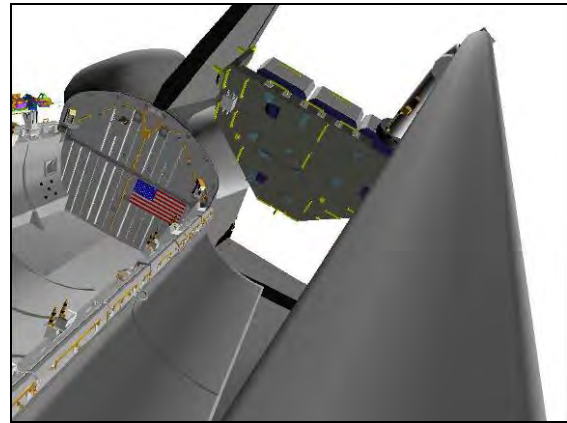

**ELBOW (-25,-30)**

**4. MNVR TO LOW HOVER**

**NOTE**

Minimum clearance between ICC and port sill hardware is 53 inches. Monitor with Cameras B(C) and A

RHC      √RATE – VERN (RATE MIN tb-ON)  
           MODE – ORB LD, ENTER

Mnvr stbd until Y = 0 (THC left)

ICC LOW HOVER posn:

	X	Y	Z	PITCH	YAW	ROLL	PL ID
√	-1197	0	-600	205	0	180	5
	SY	SP	EP	WP	WY	WR	
√	-16.3	+41.1	-33.3	-71.7	+24.7	-133.8	

**BRAKES – ON (tb-ON)**

- \* If using Shuttle attitude control and attitude maintenance reqd: \*
- \*     DAP: LVLH \*
- \*     When rates damped: \*
- \*         DAP: FREE > 2 sec \*
- \*         DAP: AUTO \*
- \*     When in attitude and rates damped: \*
- \*         DAP: FREE \*

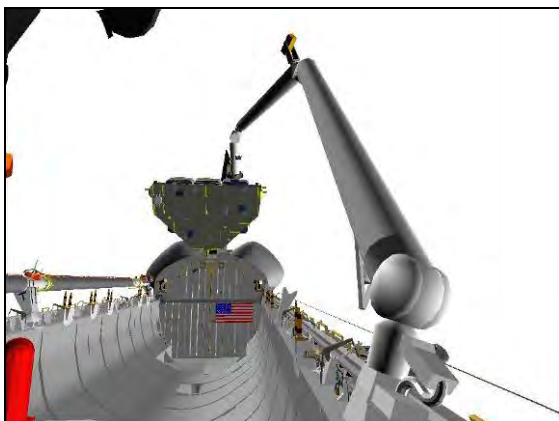

**CCTV A (5,10)**

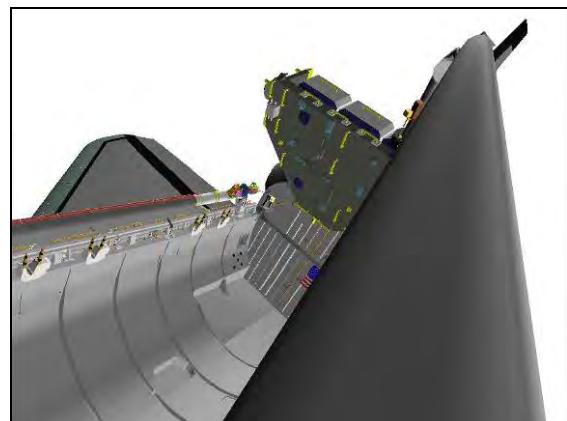

**ELBOW (-25,-30)**

5. MNVR TO ICC PITCH

DNLK (72)	B/C Mux
DTV (SSC 2)	Lab (Keel 1)
MON 1 (SSC 1)	D (C)
MON 2 (71)	A (Elbow)

NOTE

Minimum clearance between ICC and OBSS is 17 inches at ICC PITCH posn. Monitor with Camera C or D.

If JLE in PLB, monitor clearance between ICC and JLE with Elbow Camera

If KEEL 1 view required:

SSP 2

√cb CB2 – cl

√KEEL 1 PWR (ICC) – ON

Cycle KEEL 1 ILL. PWR (ICC) for desired illum

PCS

MSS: SSRMS: Thrusters: Thruster Controls for MSS Ops

Verify 'Desat Request:' Inhibit

\* If using Shuttle attitude control, verify in attitude: \*

\* DAP: FREE \*

RHC

√RATE – VERN (RATE MIN tb-ON)

BRAKES – OFF (tb-OFF)

MODE – ORB LD, ENTER

Mnvr to ICC +Z (THC down) and -PITCH (RHC fwd) to ICC PITCH posn:

X	Y	Z	PITCH	YAW	ROLL	PL ID
-1197	0	-486	180	0	180	5
SY	SP	EP	WP	WY	WR	
-11.7	+29.1	-30.3	-87.7	+20.1	-128.3	

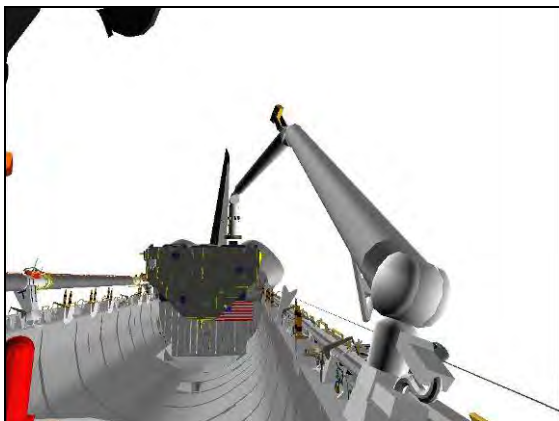

**CCTV A (5,10)**

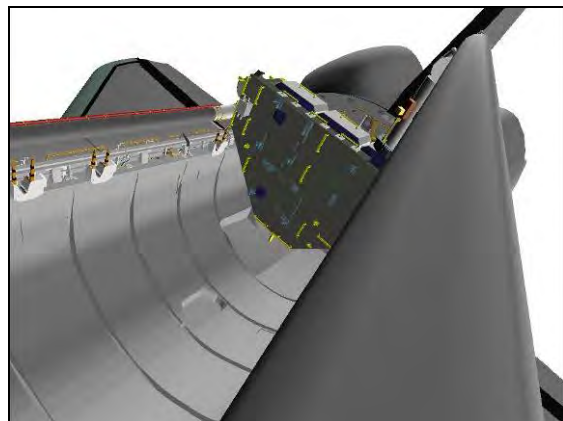

**ELBOW (-25,-30)**

6. ICC BERTH IN PLB

NOTE

Minimum clearance between stbd trunnions and OBSS during berth is expected to be 4 inches at approximately Rel = 31 (Z = -445).  
Monitor with Lab Camera

A6U PL RETEN PL SEL – 3

RHC √RATE – VERN (RATE MIN tb-ON)  
√MODE – ORB LD, ENTER

Mnvr ICC down (THC down) to BERTH posn (Z = -414 expected)

ICC BERTH posn (insert data from ICC UNBERTH):

	X	Y	Z	PITCH	YAW	ROLL	PL ID
							5
Expected	-1197	0	-414	180	0	180	5
	SY	SP	EP	WP	WY	WR	
Expected	-9.0	+27.8	-42.1	-73.6	+20.0	-131.2	

√PL RETEN RDY 1,2,3,4 tb (four) – gray

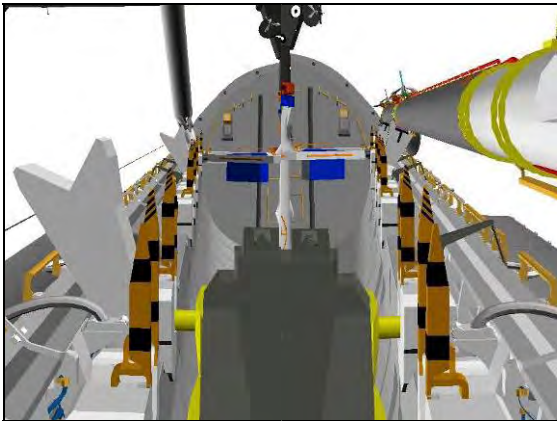

**MUX B/C**

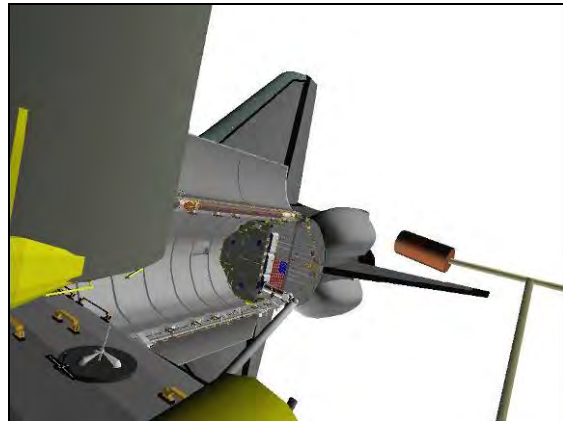

**LAB (-35,-25)**

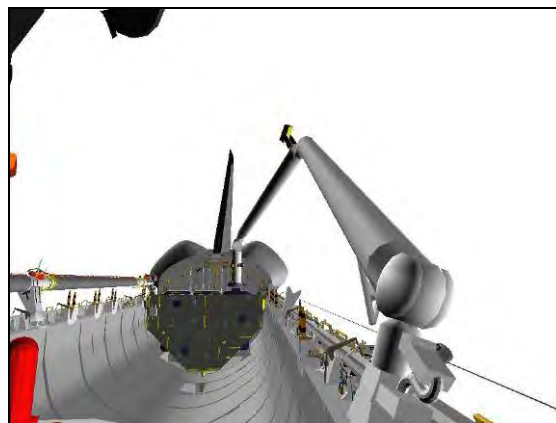

**CCTV A (5,10)**

7. ACTIVATE LATCHES

NOTE

When LOGIC switches taken OFF, KU will mode to standby.  
MPM and MRL tbs – bp

MA73C:A MCA LOGIC MNC MID 2 – OFF  
B MNB MID 4 – OFF

A6U √PL RETEN LAT (five) – OFF  
√PL SEL – 3  
LOGIC PWR SYS 1,2 (two) – ON

R13L BAY MECH PWR SYS 1,2 (two) – ON

SM 97 PL RETENTION

√PL SEL 3 RDY-FOR-LAT 1,2,3,4 (eight) – 1  
√LAT 1,2,3,4,5 (ten) – 0

- \* If any LAT msw shows '1', drive latch for \*
- \* single motor time (60 sec) \*

8. AKA LATCH

A6U √PL RETEN LAT 5 tb – REL  
√RDY 5 tb – bp

Note single motor times (> 30 sec)

PL RETEN LAT 5 – LAT (tb-LAT), 60 sec max  
– OFF  
√RDY 5 tb – gray

- \* If any PL RETEN RDY tb – bp or any RDY-FOR-LAT – 0, \*
- \* √MCC for GO to perform following: \*
- \* \*
- \* A6U PL RETEN LAT 5 – REL (tb-REL), 60 sec max \*
- \* PL RETEN LAT 5 – OFF \*
- \* \*
- \* Mnv r to ICC BERTH posn (until PL RETEN RDY \*
- \* 1,2,3,4 (four) tb – gray) \*
- \* \*
- \* Repeat step 8 \*

9. PRLA LATCH

A6U √PL RETEN LAT 1,2,3,4 (four) tb – REL  
√RDY 1,2,3,4 (four) tb – gray

Note single motor times (> 30 sec)

PL RETEN LAT 1,2 (two) – LAT (tb-LAT), 60 sec max  
– OFF  
3,4 (two) – LAT (tb-LAT), 60 sec max  
– OFF

BRAKES – ON (tb-ON)

- \* If using Shuttle attitude control: \*
- \*     DAP: LVLH                             \*
- \*     When rates damped:                 \*
- \*         DAP: FREE > 2 sec             \*
- \*         DAP: AUTO                       \*

10. DEACTIVATE LATCHES  
 PL RETEN LOGIC PWR SYS 1,2 (two) – OFF

R13L           PL BAY MECH PWR SYS 1,2 (two) – OFF

MA73C:A       MCA LOGIC MNC MID 2 – ON  
 B                             MNB MID 4 – ON

11. ICC RELEASE

A7U           CCTV – configure for ungrapple  
                   – RMS WRIST, zoom 34.0 HFOV  
                                   focus 5 ft

SM 94 PDRS CONTROL

  
 PL ID – ITEM 3 +0 EXEC  
 INIT ID – ITEM 24 +0 EXEC

RHC           √RATE     – VERN (RATE MIN tb-ON)  
                   BRAKES – OFF (tb-OFF)  
                   MODE     – END EFF, ENTER

NOTE

When OPEN tb – gray, mnvr arm clear of GF

EE MODE – AUTO  
 RELEASE sw – depress (mom)

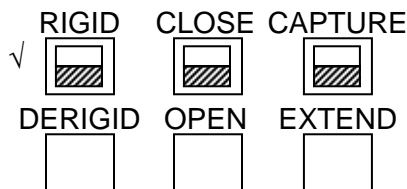

CRITICAL TIMES (28 sec total):  
 DERIGID tb – gray, 5 sec max, then  
 OPEN tb     – gray, 3 sec max, then  
 EXTEND tb – gray, 20 sec max

EE MODE – OFF

- \* If manual release reqd: \*
- \*     EE MODE                     – MAN                     \*
- \*         MAN CONTR – DERIGID (hold until DERIGID tb-gray, 5 sec max) \*
- \*         RELEASE sw – depress (hold until OPEN tb-gray, 3 sec max) \*
- \*                                     \*                                     \*
- \*     Mnvr clear of grapple pin                             \*
- \*     EE MAN CONTR – DERIGID (hold until EXTEND tb-gray, 20 sec max) \*
- \*         MODE                     – OFF                     \*

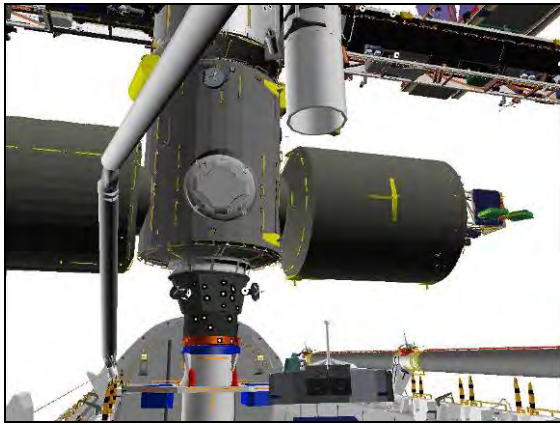

**CCTV B (15,15)**

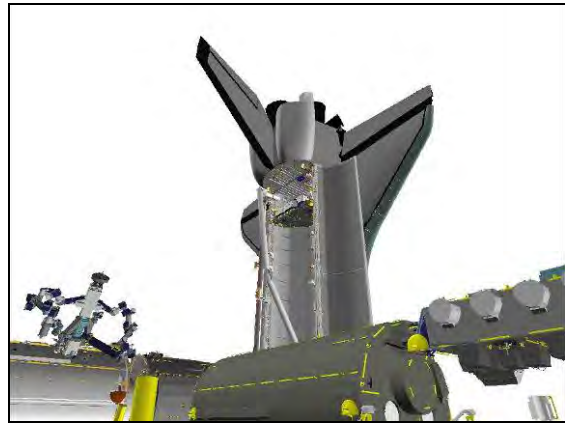

**P1 LOOB (130,30)**

RHC

12. MNVR TO PRE-CRADLE

RATE – as reqd (VERN within 10 ft)

MODE – as desired (OCAS valid if backed off > 5 ft)

Mnvr to PRE-CRADLE:

(01:00)

X	Y	Z	PITCH	YAW	ROLL	PL ID
-1261	-146	-551	5	2	0	0
SY	SP	EP	WP	WY	WR	
0.0	+25.0	-25.0	+5.0	0.0	0.0	

BRAKES – ON (tb-ON)

MODE – not DIRECT (lt off)

PARAM – PORT TEMP

JOINT – CRIT TEMP

This Page Intentionally Blank



JLE NOMINAL

JLE GRAPPLE IN PLB .....	FS 3-2
UNBERTH .....	FS 3-5
HANDOFF TO SSRMS.....	FS 3-9
UNGRAPPLE.....	FS 3-12
GRAPPLE FROM SSRMS .....	FS 3-15
BERTH IN PLB .....	FS 3-19

JLE  
NOMINAL

# JLE GRAPPLE IN PLB

## 1. SETUP

Verify SSRMS at FD6 Overnight Park posn:

SR	SY	SP	EP	WP	WY	WR
+213.7	-3.2	-101.1	+136.1	-165.1	-174.7	+140.1

DNLK (72)	Elbow
DTV (SSC 2)	B (C)
MON 1 (SSC 1)	A
MON 2 (71)	P1 LOOB

SM 94 PDRS CONTROL

√ PL ID, ITEM 3: 0

√ INIT ID, ITEM 24: 0

Verify SRMS at EVA 2 VIEWING posn:

X	Y	Z	PITCH	YAW	ROLL	PL ID
-355	-489	-328	93	33	357	0
SY	SP	EP	WP	WY	WR	
+130.0	+15.0	-40.4	+103.0	-7.0	-213.0	

## 2. MNVR TO JLE PRE-GRAPPLE IN PLB POSN

### NOTE

Monitor clearance between SRMS Upper Boom and JPM with Camera A

RHC

RATE – as reqd (VERN within 10 ft)

BRAKES – OFF (tb-OFF)

MODE – SINGLE, ENTER

Mnvr to JLE PRE-GRAPPLE SETUP posn:

EVA 2 View  
1: WR +  
2: SY -  
Pre-grapple  
Setup

SY	SP	EP	WP	WY	WR	
+130.0	+15.0	-40.4	+103.0	-7.0	-213.0	
					-48.2	
+65.0						
+65.0	+15.0	-40.4	+103.0	-7.0	-48.2	
X	Y	Z	PITCH	YAW	ROLL	PL ID
-903	-551	-308	77	27	233	0

MODE – ORB UNL, ENTER

Mnvr to JLE PRE-GRAPPLE posn:

X	Y	Z	PITCH	YAW	ROLL	PL ID
-1057	0	-510	270	0	270	0
SY	SP	EP	WP	WY	WR	
-20.6	+55.0	-78.7	-73.4	+18.2	-48.2	

JLE  
NOMINAL

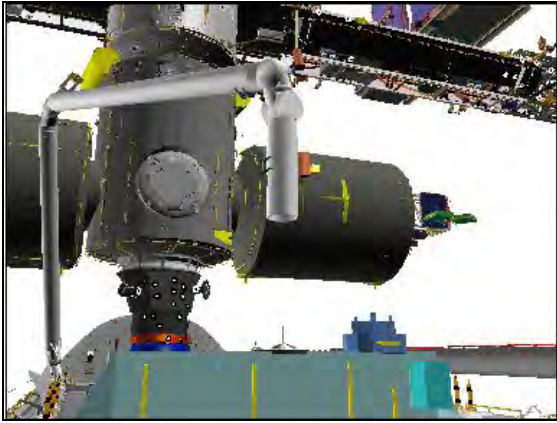

**CCTV B (20,15)**

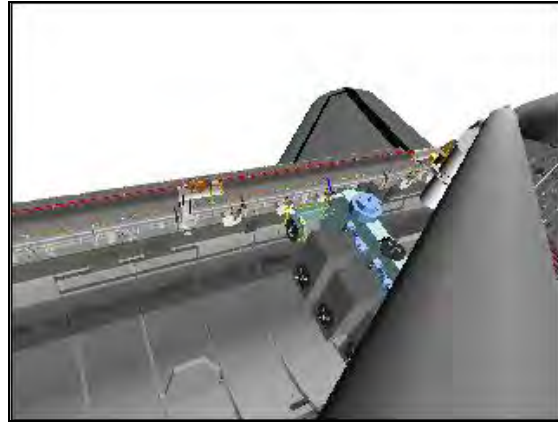

**ELBOW (-30,-20)**

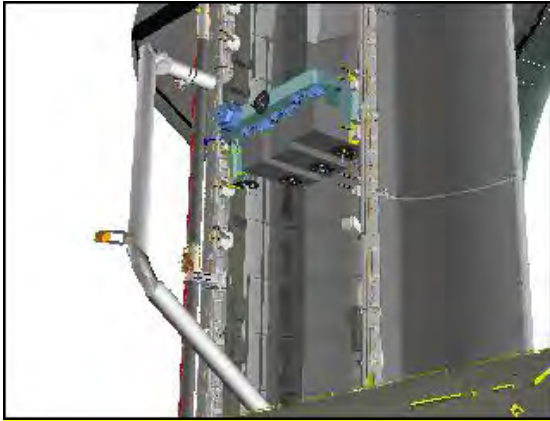

**P1 LOOB (130,20) (FL: 18)**



**CCTV A (0,40)**

**3. JLE GRAPPLE IN PLB**

DNLK (72)	EE
DTV (SSC 2)	B (C)
MON 1 (SSC 1)	A
MON 2 (71)	P1 LOOB

A7U

CCTV – configure for grapple  
 – RMS WRIST, zoom 34.0 HFOV  
 focus 5 ft

Maintain eyepoint ~18 in when using grapple overlay

RATE – VERN (RATE MIN tb-ON)  
 MODE – END EFF, ENTER

Mnvr to grapple envelope

<b>CAUTION</b> Monitor EE tb timing to prevent EE motor burnout
--

<b>SM 169 PDRS STATUS</b>
---------------------------

EE MODE – AUTO  
 CAPTURE sw – depress (mom)

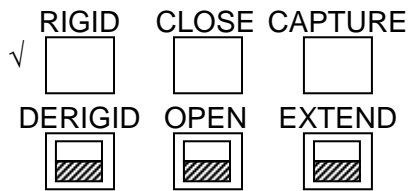

CRITICAL TIMES (28 sec total):

CAPTURE tb – gray, then  
 CLOSE tb – gray, 3 sec max, then  
 RIGID tb – gray, 25 sec max

- \* If manual grapple reqd: \*
- \* EE MODE – MAN \*
- \* CAPTURE sw – depress (hold until CLOSE tb-gray, 3 sec max) \*
- \* MAN CONTR – RIGID (hold until RIGID tb-gray, 25 sec max) \*

EE MODE – OFF  
 BRAKES – ON (tb-ON)

**SM 94 PDRS CONTROL**  
 PL ID – ITEM 3 +4 EXEC  
 INIT ID – ITEM 24 +4 EXEC

Record POS/ATT and Joint Angles:

	X	Y	Z	PITCH	YAW	ROLL	PL ID
							4
Expected	-1034	0	-414	180	0	180	4
	SY	SP	EP	WP	WY	WR	
Expected	-17.9	+50.3	-84.2	-62.3	+18.5	-51.1	

Record POS/ATT and Joint Angles in JLE BERTH IN PLB (JLE NOMINAL)

Review GENERIC END EFFECTOR CUE CARD – ISS/SHUTTLE DOCKED OPS

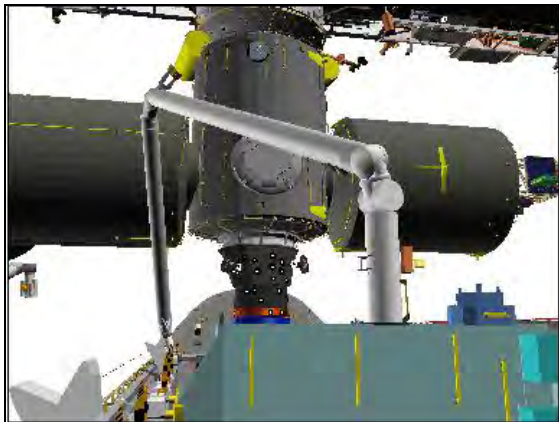

**CCTV B (10,12)**



**CCTV A (0,30)**

# JLE UNBERTH

I

## 1. SETUP

A7U CCTV – configure for unberth

DNLK (72)	Keel 2 → A
DTV (SSC 2)	Mux D/A → Elbow
MON 1 (SSC 1)	B
MON 2 (71)	Lab

### SM 94 PDRS CONTROL

√PL ID, ITEM 3: 4

√INIT ID, ITEM 24: 4

√BRAKES – ON (tb-ON)

PCS MSS: SSRMS: Thrusters: Thruster Controls for MSS Ops

Verify 'Desat Request' Inhibit

- \* If using Shuttle attitude control, verify in attitude; \*
- \* then DAP: FREE \*

√SSIPC, EFU latch open and ready for JLE unberth/install

Notify SSRMS Operator JLE Unberth in work

## 2. ROEU

A7U CCTV – configure for ROEU demate

### 2.1 Deadface ROEU

SSP 2 JLE HTR #1 – OFF (tb-bp)  
ICS-EF HTR #2 – OFF (tb-bp)  
SEDA-AP HTR #3 – OFF (tb-bp)  
MAXI HTR #4 – OFF (tb-bp)  
HTR 1-2 – DSBL (tb-bp)  
HTR 3-4 – DSBL (tb-bp)

A6U Install ROEU A6U PANEL OVERLAY

√PL RETEN LAT (five) – OFF  
PL SEL – 1

### PL 221 ELM-ES LATCH

CRT √RDY-FOR-LAT 1,2,3,4 (eight) – 1  
√LAT 1,2,3,4 (four) – 1

A6U PL RETEN PL SEL – 2

### SM 97 PL RETENTION

CRT √REL 2,3 (four) – 0

- \* If LATCH 2,3 REL msw shows 1, \*
- \* drive latch for single motor time \*

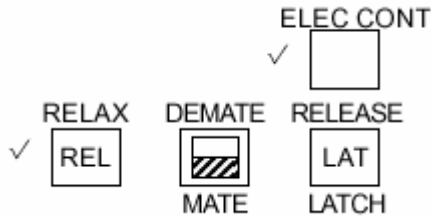

2.2 Activate ROEU

NOTE

When MCA LOGIC switches taken OFF, KU will mode to standby. MPM and MRL tbs – bp

MA73C:A MCA LOGIC MNC MID 2 – OFF  
:B MNB MID 4 – OFF

A6U PL RETEN LOGIC PWR SYS 1,2 (two) – ON  
R13L BAY MECH PWR SYS 1,2 (two) – ON

2.3 Release Latches

Note single motor time (> 20 sec)

A6U RELEASE/LATCH – REL (tb-REL), 40 sec max  
– OFF

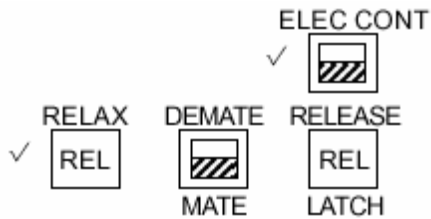

2.4 Demate ROEU

Note single motor time (> 18 sec)

A6U DEMATE/MATE – DEMATE (tb-REL), 36 sec max  
– OFF

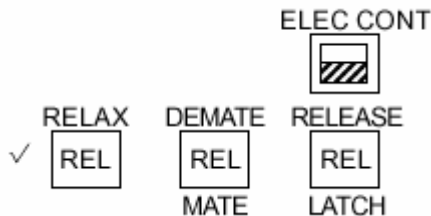

3. AKA RELEASE

CRT PL 221 ELM-ES LATCH  
√RDY-FOR-LAT AKA (two) – 1  
√LAT AKA (two) – 1

- \* If any rel msw shows '1', expect \*
- \* single motor time (60 sec) \*

A6U           √PL RETEN LAT 5 tb – LAT  
                  √RDY 5 tb – gray

Note single motor times (> 30 sec)

PL RETEN LAT 5 – REL (tb-REL), 60 sec max  
                  – OFF

A6U           4. PRLA RELEASE  
                  PL RETEN PL SEL – 1  
                  √LAT 4,5 (two) tb – LAT  
                  √RDY 4,5 (two) tb – gray

Note single motor times (> 30 sec)

PL RETEN LAT 4 – REL (tb-REL), 60 sec max  
                  – OFF  
                  5 – REL (tb-REL), 60 sec max  
                  – OFF

R13L           5. DEACTIVATE LATCHES  
                  PL RETEN LOGIC PWR SYS 1,2 (two) – OFF  
                  BAY MECH PWR SYS 1,2 (two)     – OFF

MA73C:A       MCA LOGIC MNC MID 2 – ON  
                  :B                   MNB MID 4 – ON

6. MNVR TO JLE LOW HOVER POSN

NOTE

Minimum clearance between stbd trunnions and OBSS during unberth is expected to be 4 inches at approximate Rel = 142 (Z = -444). Monitor with Lab Camera.

Minimum clearance between SRMS Upper Boom and JPM is 54 inches at Low Hover. Monitor with Camera A

RHC           √RATE     – VERN (RATE MIN tb-ON)  
                  BRAKES – OFF (tb-OFF)  
                  MODE     – ORB LD, ENTER

Mnvr JLE up until Z = -586 (THC up)

A6U           √PL RETEN RDY 1,2,3,4 tb (four) – bp

JLE LOW HOVER posn:

	X	Y	Z	PITCH	YAW	ROLL	PL ID
√	-1034	0	-586	180	0	180	4
	SY	SP	EP	WP	WY	WR	
√	-25.4	+56.6	-58.9	-96.4	+17.5	-43.2	

BRAKES – ON (tb-ON)

- \* If using Shuttle attitude control and attitude maintenance reqd: \*
- \* DAP: LVLH \*
- \* When rates damped: \*
- \* DAP: FREE > 2 sec \*
- \* DAP: AUTO \*
- \* When in attitude and rates damped: \*
- \* DAP: FREE \*



**CCTV A (-5,30)**

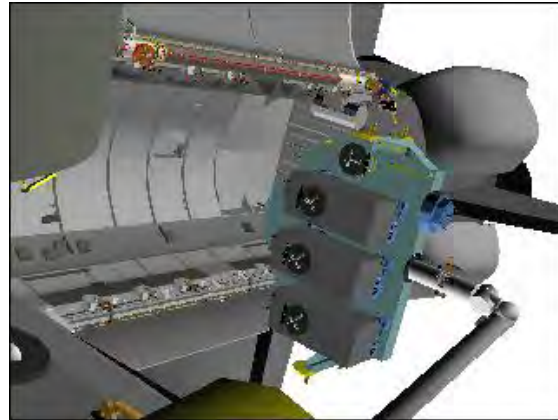

**LAB (-40,-30) (FL: 12)**



# JLE HANDOFF TO SSRMS

I

## 1. MNVR TO JLE PORT POSN

Verify JEMRMS at JLE INSTALL VIEWING posn:

SY	SP	EP	WP	WY	WR
-7.0	+70.0	-115.0	-40.0	0.0	+7.0

DNLK (72)	Elbow
DTV (SSC 2)	A
MON 1 (SSC 1)	B (C)
MON 2 (71)	P1 LOOB

RHC

√RATE – VERN (RATE MIN tb-ON)

BRAKES – OFF (tb-OFF)

MODE – ORB LD, ENTER

### NOTE

Minimum clearance between SRMS Upper Boom and JPM is 38 inches at JLE Port. Monitor with Camera A.

Minimum clearance between keel trunnions and port sill is 35 inches, expected at Rel = 63 (Y=-93). Monitor with Camera B

Mnvr JLE port until Y = -156 (THC right)

JLE PORT posn:

√	X	Y	Z	PITCH	YAW	ROLL	PL ID
	-1034	-156	-586	180	0	180	4
√	SY	SP	EP	WP	WY	WR	
	-4.9	+67.2	-63.3	-95.6	+19.4	-64.8	

BRAKES – ON (tb-ON)

- \* If using Shuttle attitude control and attitude maintenance reqd: \*
- \* DAP: LVLH \*
- \* When rates damped: \*
- \* DAP: FREE > 2 sec \*
- \* DAP: AUTO \*
- \* When in attitude and rates damped: \*
- \* DAP: FREE \*

## 2. MNVR TO JLE INTERMEDIATE POSN

### NOTE

Minimum clearance between SRMS Upper Boom and JPM is 38 inches during OCAS. Monitor with Camera A

SM 94 PDRS CONTROL

END POS – ITEM 18 -9 3 7 -6 1 6 -3 5 1 EXEC

ATT – ITEM 21 +1 0 6 +9 +2 4 3 EXEC

CMD CK – ITEM 25 EXEC (GOOD)

RHC

√RATE – VERN (RATE MIN tb-ON)

BRAKES – OFF (tb-OFF)

MODE – OPR CMD, ENTER (READY It on)

After PROCEED, if motion no longer apparent but POR is within  
1 in/1 deg and IN PROG It – on:  
AUTO SEQ – STOP

AUTO SEQ – PROCEED (IN PROG It on)

When AUTO SEQ IN PROG It – off:

Verify at JLE INTERMEDIATE posn: (07:15)

√	X	Y	Z	PITCH	YAW	ROLL	PL ID
	-937	-616	-351	106	9	243	4
	SY	SP	EP	WP	WY	WR	
√	+55.0	+23.6	-33.6	+15.4	+58.9	-235.6	

- \* If using Shuttle attitude control and attitude maintenance reqd: \*
- \* BRAKES – ON (tb-ON) \*
- \* \*
- \* DAP: LVLH \*
- \* When rates damped: \*
- \* DAP: FREE > 2 sec \*
- \* DAP: AUTO \*
- \* When in attitude and rates damped: \*
- \* DAP: FREE \*
- \* \*
- \* BRAKES – OFF (tb-OFF) \*

3. MNVR TO JLE HANDOFF TO SSRMS POSN

RHC √RATE – VERN (RATE MIN tb-ON)  
MODE – SINGLE, ENTER

Mnvr to JLE HANDOFF TO SSRMS posn:

Intermediate 1: SY + Handoff	SY	SP	EP	WP	WY	WR	
	+55.0	+23.6	-33.6	+15.4	+58.9	-235.6	
	+137.7						
	+137.7	+23.6	-33.6	+15.4	+58.9	-235.6	
	X	Y	Z	PITCH	YAW	ROLL	PL ID
	-206	-437	-414	82	2	165	4

BRAKES – ON (tb-ON)

- \* If using Shuttle attitude control and attitude maintenance reqd: \*
- \* DAP: LVLH \*
- \* When rates damped: \*
- \* DAP: FREE > 2 sec \*
- \* DAP: AUTO \*
- \* When in attitude and rates damped: \*
- \* DAP: FREE \*

Notify SSRMS operator that SRMS at JLE Handoff posn with Brakes ON;  
GO for SSRMS JLE Grapple



**CCTV B (-15,0)**

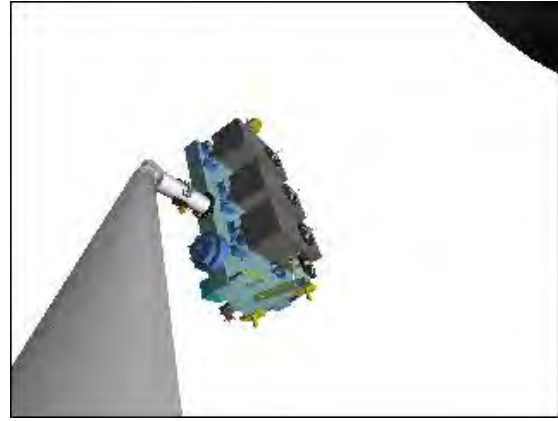

**ELBOW (20,-10)**

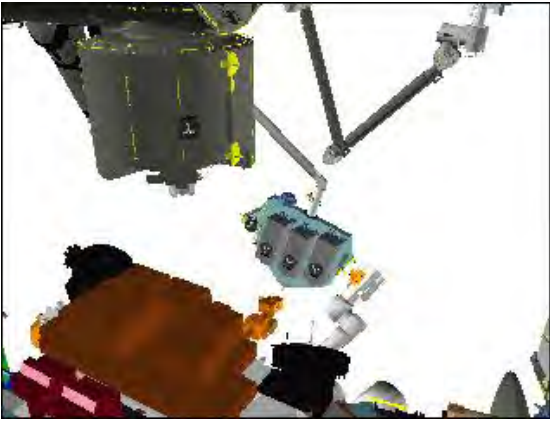

**P1 LOOB (150,-25) (FL: 8)**

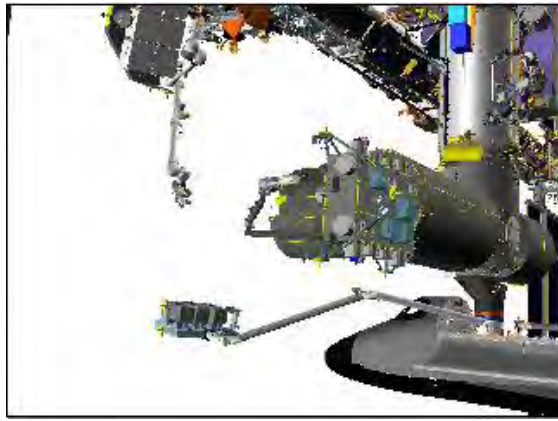

**BIRD'S EYE**

# JLE UNGRAPPLE

I

- A7U 1. SETUP  
CCTV – configure for ungrapple  
– RMS WRIST, zoom 34.0 HFOV  
focus 5 ft

DNLK (72)	EE (Elbow)
DTV (SSC 2)	Tip Elbow
MON 1 (SSC 1)	A
MON 2 (71)	B (C)

SM 94 PDRS CONTROL  
PL ID – ITEM 3 +0 EXEC  
INIT ID – ITEM 24 +0 EXEC

2. JLE UNGRAPPLE  
Verify SSRMS Grapple complete with Brakes ON and SSRMS Operator GO for SRMS JLE Ungrapple

### NOTE

CONTRL ERR It and 'S96 PDRS CNTL' msg may occur due to Consistency/Envelope Check error

- RHC RATE – COARSE (RATE MIN tb-OFF)

SM 94 PDRS CONTROL  
AUTO BRAKE INH – ITEM 10 EXEC (\*)

BRAKES – OFF (tb-OFF)

MODE – TEST, ENTER  
Wait 5 sec

BRAKES – ON (tb-ON)

SM 94 PDRS CONTROL  
AUTO BRAKE ENA – ITEM 9 EXEC (\*)

- RHC RATE – VERN (RATE MIN tb-ON)  
BRAKES – OFF (tb-OFF)  
MODE – END EFF, ENTER

CAUTION  
Monitor EE tb timing to prevent EE motor burnout

SM 169 PDRS STATUS  
EE MODE – AUTO  
RELEASE sw – depress (mom)

When OPEN tb – gray, mnvr arm clear of grapple pin

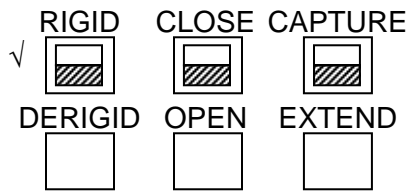

CRITICAL TIMES (28 sec total):  
 DERIGID tb – gray, 5 sec max, then  
 OPEN tb – gray, 3 sec max, then  
 EXTEND tb – gray, 20 sec max

EE MODE – OFF

- \* If manual release required: \*
- \* EE MODE – MAN \*
- \* MAN CONTR – DERIGID (hold until DERIGID tb-gray, 5 sec max) \*
- \* RELEASE sw – depress (hold until OPEN tb-gray, 3 sec max) \*
- \* \*
- \* Mnv r arm clear, then \*
- \* EE MAN CONTR – DERIGID (hold until EXTEND tb-gray, 20 sec max) \*
- \* MODE – OFF \*

NOTE

Minimum clearance between SRMS Upper Boom and JPM is 42 inches at JLE Clearance posn. Monitor with Cameras A and B

Mnv r to JLE CLEARANCE posn:

X	Y	Z	PITCH	YAW	ROLL	PL ID
-295	-460	-378	172	345	269	0
SY	SP	EP	WP	WY	WR	
+131.8	+33.1	-51.6	+25.1	+64.8	-236.9	

3. MNVR TO VIEWING POSN

DNLK (72)	A
DTV (SSC 2)	B
MON 1 (SSC 1)	Elbow (EE)
MON 2 (71)	P1 LOOB

NOTE

Minimum clearance between SRMS Upper Boom and JPM is 32 inches. Monitor with Camera A

RHC

RATE – as reqd (VERN within 10 ft)  
 MODE – SINGLE, ENTER

Mnv r to OCAS START posn:

	SY	SP	EP	WP	WY	WR	
Clearance	+131.8	+33.1	-51.6	+25.1	+64.8	-236.9	
1: SY –	+70.0						
2: WR +						-215.0	
OCAS Start	+70.0	+33.1	-51.6	+25.1	+64.8	-215.0	
	X	Y	Z	PITCH	YAW	ROLL	PL ID
	-810	-604	-327	195	43	287	0

BRAKES – ON (tb-ON)

**SM 94 PDRS CONTROL**

END POS – ITEM 18 -8 3 7 -5 9 4 -5 5 5 EXEC  
ATT – ITEM 21 +1 5 0 +4 0 +1 3 2 EXEC  
CMD CK – ITEM 25 EXEC (GOOD)

RHC       √RATE     – VERN (RATE MIN tb-ON)  
          BRAKES – OFF (tb-OFF)  
          MODE    – OPR CMD, ENTER (READY It on)

After PROCEED, if motion no longer apparent but POR is within  
1 in/1 deg and IN PROG It – on:  
AUTO SEQ – STOP

AUTO SEQ – PROCEED (IN PROG It on)

When AUTO SEQ IN PROG It – off:  
BRAKES – ON (tb-ON)

JLE INSTALL VIEWING posn: (00:50)

	X	Y	Z	PITCH	YAW	ROLL	PL ID
√	-837	-594	-555	150	40	132	0
	SY	SP	EP	WP	WY	WR	
√	+63.7	+52.3	-49.2	+73.5	+53.5	-105.6	

PARAM – PORT TEMP  
JOINT – CRIT TEMP

Notify SSRMS operator that SRMS at JLE Install Viewing posn and SSRMS GO  
for JLE Install

4. CONFIGURE CAMERAS FOR VIEWING

Configure cameras as shown for JLE install viewing support

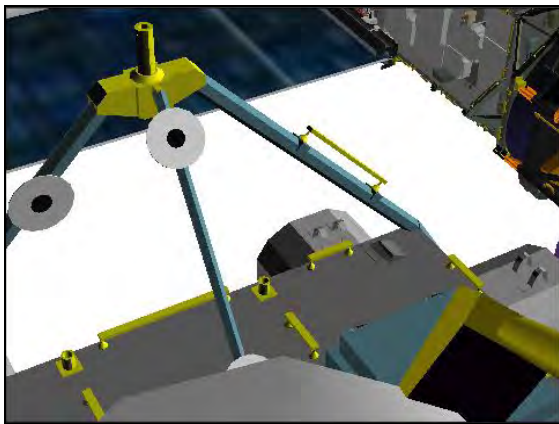

**EE (HFOV: 30.0)**

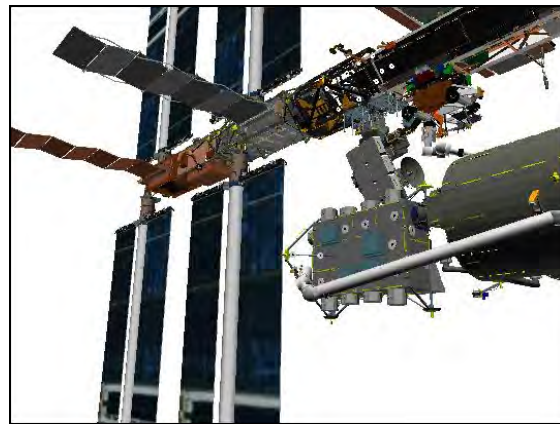

**CCTV B (-50,15)**

# JLE GRAPPLE FROM SSRMS

## 1. SETUP

Verify JEMRMS at STOWED posn:

SY	SP	EP	WP	WY	WR
0.0	+90.0	-149.0	-31.0	0.0	0.0

Verify SSRMS at JLE HANDBACK posn and SSRMS operator GO for SRMS grapple:

SR	SY	SP	EP	WP	WY	WR
-76.0	+1.7	-25.4	-39.3	-130.2	-171.7	+50.1

DNLK (72)	Elbow (EE)
DTV (SSC 2)	A
MON 1 (SSC 1)	B
MON 2 (71)	P1 LOOB (JEM EXT-FWD)

**SM 94 PDRS CONTROL**

√ PL ID, ITEM 3: 0

√ INIT ID, ITEM 24: 0

Verify SRMS at PRE-CRADLE posn:

X	Y	Z	PITCH	YAW	ROLL	PL ID
-1261	-146	-551	5	2	0	0
SY	SP	EP	WP	WY	WR	
0.0	+25.0	-25.0	+5.0	0.0	0.0	

## 2. MNVR TO JLE HANDBACK PRE-GRAPPLE

### NOTE

Monitor clearance between SRMS Upper Boom and JPM using Camera A

RHC

RATE – as reqd (VERN within 10 ft)

BRAKES – OFF (tb-OFF)

MODE – SINGLE, ENTER

Mnvr to HANDBACK PRE-GRAPPLE SETUP posn:

	SY	SP	EP	WP	WY	WR	
	0.0	+25.0	-25.0	+5.0	0.0	0.0	
Pre-cradle	+25.0						
1: SY +							
2: WR –						-75.0	
Setup	+25.0	+25.0	-25.0	+5.0	0.0	-75.0	
	X	Y	Z	PITCH	YAW	ROLL	PL ID
	-1207	-378	-469	356	25	284	0

BRAKES – ON (tb-ON)

**SM 94 PDRS CONTROL**

END POS – ITEM 18 -6 4 0 -6 1 9 -3 2 2 EXEC

ATT – ITEM 21 +1 8 6 +2 6 +2 7 0 EXEC

CMD CK – ITEM 25 EXEC (GOOD)





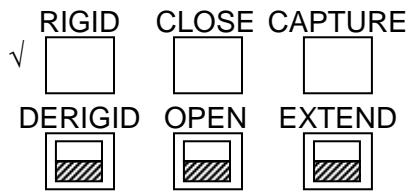

CRITICAL TIMES (28 sec total):  
 CAPTURE tb – gray, then  
 CLOSE tb – gray, 3 sec max, then  
 RIGID tb – gray, 25 sec max

- \* If manual grapple reqd: \*
- \* EE MODE – MAN \*
- \* CAPTURE sw – depress (hold until CLOSE tb-gray, 3 sec max) \*
- \* MAN CONTR – RIGID (hold until RIGID tb-gray, 25 sec max) \*

EE MODE – OFF

MODE – TEST, ENTER

Wait 5 sec

BRAKES – ON (tb-ON)

SM 94 PDRS CONTROL

PL ID – ITEM 3 +4 EXEC

INIT ID – ITEM 24 +4 EXEC

Expected JLE HANDBACK posn:

X	Y	Z	PITCH	YAW	ROLL	PL ID
✓ -552	-660	-334	96	0	206	4
	SY	SP	EP	WP	WY	WR
✓ +94.7	+23.6	-33.6	+15.4	+58.9	-235.6	

Notify SSRMS operator SRMS Grapple complete with Brakes ON;  
 GO for SSRMS JLE Ungrangle

Review GENERIC END EFFECTOR CUE CARD – ISS/SHUTTLE DOCKED OPS

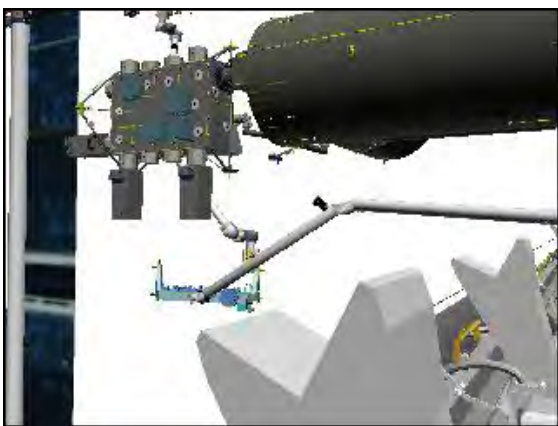

**CCTV B (-30,0)**

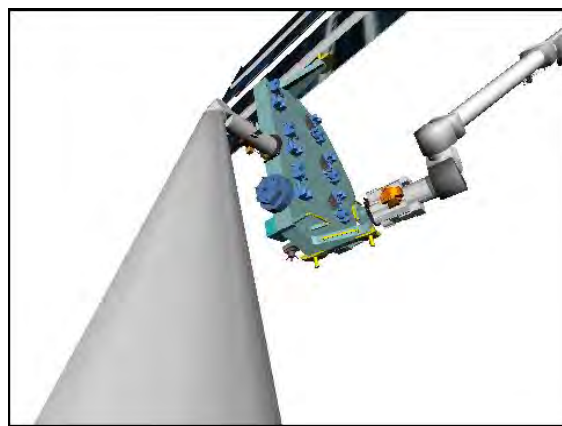

**ELBOW (10,-20)**

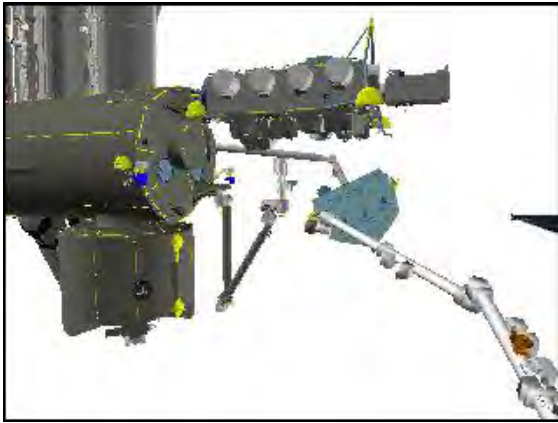

**P1 LOOB (161,-5)**

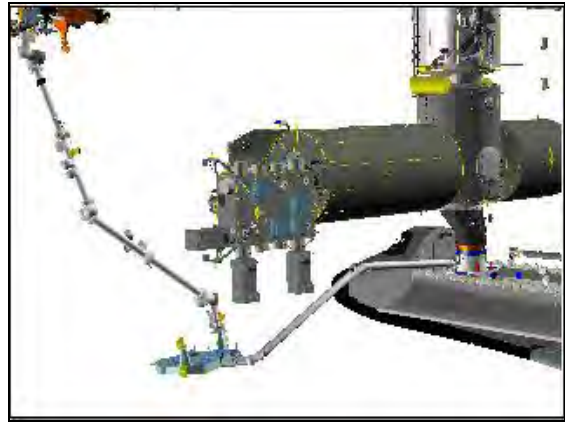

**BIRD'S EYE**

# JLE BERTH IN PLB

I

## 1. MNVR TO JLE INTERMEDIATE POSN

DNLK (72)	Elbow
DTV (SSC 2)	A
MON 1 (SSC 1)	B
MON 2 (71)	P1 LOOB

**SM 94 PDRS CONTROL**

- √ PL ID, ITEM 3: 4
- √ INIT ID, ITEM 24: 4

Verify SRMS at JLE HANDBACK posn:

X	Y	Z	PITCH	YAW	ROLL	PL ID
√ -552	-660	-334	96	0	206	4
√ SY	SP	EP	WP	WY	WR	
+94.7	+23.6	-33.6	+15.4	+58.9	-235.6	

Verify SSRMS at FD11 Park posn and SSRMS operator GO for JLE Berth

- \* If using Shuttle attitude control and attitude maintenance reqd: \*
- \* DAP: LVLH \*
- \* When rates damped: \*
- \* DAP: FREE > 2 sec \*
- \* DAP: AUTO \*
- \* When in attitude and rates damped: \*
- \* DAP: FREE \*

RHC RATE – VERN (RATE MIN tb-ON)  
 BRAKES – OFF (tb-OFF)  
 MODE – SINGLE, ENTER

Mnvr to JLE INTERMEDIATE posn:

Handback  
 1: SY –  
 Intermediate

SY	SP	EP	WP	WY	WR	
+94.7	+23.6	-33.6	+15.4	+58.9	-235.6	
+55.0						
+55.0	+23.6	-33.6	+15.4	+58.9	-235.6	
X	Y	Z	PITCH	YAW	ROLL	PL ID
-937	-616	-351	106	9	243	4

BRAKES – ON (tb-ON)

- \* If using Shuttle attitude control and attitude maintenance reqd: \*
- \* DAP: LVLH \*
- \* When rates damped: \*
- \* DAP: FREE > 2 sec \*
- \* DAP: AUTO \*
- \* When in attitude and rates damped: \*
- \* DAP: FREE \*

2. MNVR TO JLE PORT

NOTE

Minimum clearance between SRMS Upper Boom and JPM is 38 inches (at approx. X = -1030) during OCAS. Monitor with Camera A

SM 94 PDRS CONTROL

END POS – ITEM 18 -1 0 3 4 -1 5 6 -5 8 6 EXEC  
 ATT – ITEM 21 +1 8 0 +0 +1 8 0 EXEC  
 CMD CK – ITEM 25 EXEC (GOOD)

RHC

RATE – VERN (RATE MIN tb-ON)  
 BRAKES – OFF (tb-OFF)  
 MODE – OPR CMD, ENTER (READY It on)

After PROCEED, if motion no longer apparent but POR is within 1 in/1 deg and IN PROG It – on:  
 AUTO SEQ – STOP

AUTO SEQ – PROCEED (IN PROG It on)

When AUTO SEQ IN PROG It – off:  
 BRAKES – ON (tb-ON)

JLE PORT posn:

(07:20)

	X	Y	Z	PITCH	YAW	ROLL	PL ID
√	-1034	-156	-586	180	0	180	4
	SY	SP	EP	WP	WY	WR	
√	-4.9	+67.2	-63.3	-95.6	+19.4	-64.8	

- \* If using Shuttle attitude control and attitude maintenance reqd: \*
- \* DAP: LVLH \*
- \* When rates damped: \*
- \* DAP: FREE > 2 sec \*
- \* DAP: AUTO \*
- \* When in attitude and rates damped: \*
- \* DAP: FREE \*

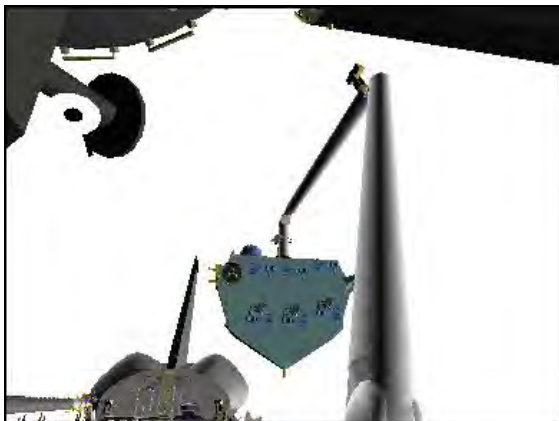

CCTV A (10,27)



P1 LOOB (130,23)

3. MNVR TO JLE LOW HOVER

DNLK (72)	Elbow → Keel 2
DTV (SSC 2)	A
MON 1 (SSC 1)	B
MON 2 (71)	Lab

NOTE

Minimum clearance between Keel trunnions and port sill is 35 inches, expected at Rel = 63 (Y=-93).  
Monitor with Camera B

RHC RATE – VERN (RATE MIN tb-ON)  
BRAKES – OFF (tb-OFF)  
MODE – ORB LD, ENTER

Mnvr JLE stbd until Y = 0 (THC left)

JLE LOW HOVER posn:

X	Y	Z	PITCH	YAW	ROLL	PL ID
-1034	0	-586	180	0	180	4
SY	SP	EP	WP	WY	WR	
-25.4	+56.6	-58.9	-96.4	+17.5	-43.2	

BRAKES – ON (tb-ON)

- \* If using Shuttle attitude control and attitude maintenance reqd: \*
- \* DAP: LVLH \*
- \* When rates damped: \*
- \* DAP: FREE > 2 sec \*
- \* DAP: AUTO \*
- \* When in attitude and rates damped: \*
- \* DAP: FREE \*



CCTV A (-5,30)

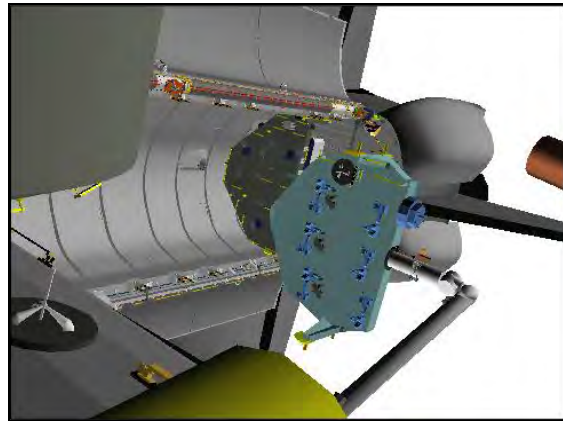

LAB (-40,-30)

4. BERTH JLE IN PLB

DNLK (72)	Keel 2
DTV (SSC 2)	Mux D/A
MON 1 (SSC 1)	C
MON 2 (71)	Lab

**NOTE**

Minimum clearance between stbd trunnions and OBSS during unberth is expected to be 4 inches at approximate Rel = 142 (Z = -444). Monitor with Lab Camera

PCS MSS: SSRMS: Thrusters: **Thruster Controls for MSS Ops**

Verify 'Desat Request:' Inhibit

A6U PL RETEN PL SEL – 1

**PL 221 ELM-ES LATCH**

CRT √RDY-FOR-LAT 1,2,3,4 (eight) – 0

RHC RATE – VERN (RATE MIN tb-ON)  
BRAKES – OFF (tb-OFF)  
MODE – ORB LD, ENTER

Mnvr JLE down (THC down) to BERTH posn (Z = -414 expected)

JLE BERTH posn (insert data from JLE GRAPPLE IN PLB):

	X	Y	Z	PITCH	YAW	ROLL	PL ID
							4
Expected	-1034	0	-414	180	0	180	4
	SY	SP	EP	WP	WY	WR	
Expected	-17.9	+50.3	-84.2	-62.3	+18.5	-51.1	

√PL RETEN RDY 4,5 tb (two) – gray

**PL 221 ELM-ES LATCH**

CRT √RDY-FOR-LAT 1,2,3,4 (eight) – 1

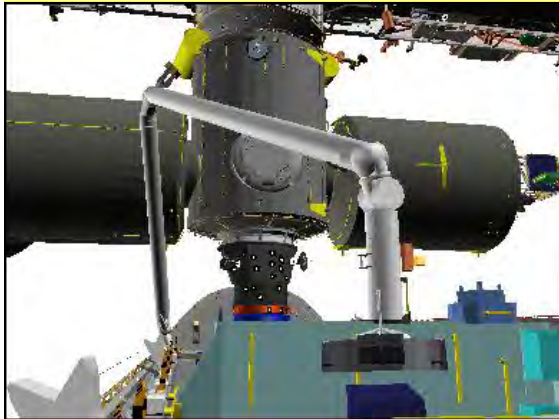

**CCTV B (20,15)**

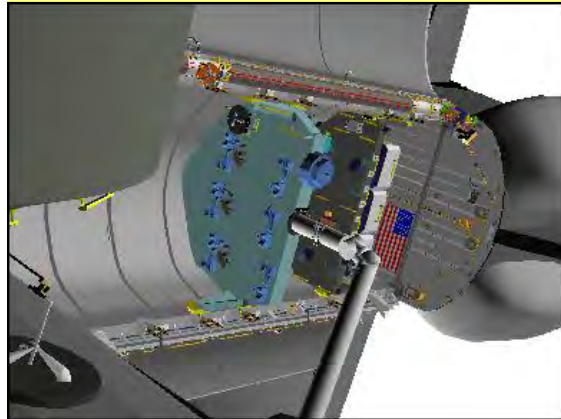

**LAB (-45,-28)**

**5. ACTIVATE LATCHES**

**NOTE**

When LOGIC switches taken OFF, KU will mode to standby. MPM and MRL tbs – bp

MA73C:A MCA LOGIC MNC MID 2 – OFF  
:B MNB MID 4 – OFF

A6U √PL RETEN LAT(five) – OFF  
PL SEL – 2  
LOGIC PWR SYS (1,2) – ON  
BAY MECH PWR SYS (1,2) – ON

6. AKA LATCH

A6U √PL RETEN LAT 5 tb – REL

CRT √LAT AKA (two) – 0

\* If any lat msw shows '1', expect \*  
\* single motor time (60 sec) \*

Note single motor times (> 30 sec)

PL RETEN LAT 5 – LAT (tb-LAT), 60 sec max  
– OFF  
√RDY 5 tb – gray

PL RETEN PL SEL – 1  
√RDY 4,5 (two) tb – gray

CRT √RDY-FOR-LAT 1,2,3,4 (eight) – 1  
√LAT 1,2,3,4 (four) – 0

\* If any lat msw shows '1', expect \*  
\* single motor time (60 sec) \*

\* If any PL RETEN RDY tb – bp or any RDY-FOR-LAT – 0, \*  
\* √MCC for GO to perform following: \*

\* A6U PL RETEN PL SEL – 2 \*

\* Note single motor drive times (> 30 sec) \*

\* PL RETEN LAT 5 – REL (tb-REL), 60 sec max \*  
\* – OFF \*

\* PL RETEN PL SEL – 1 \*

\* Maneuver to JLE BERTH posn (until \*  
\* RDY-FOR-LAT 1,2,3,4 (eight) – 1) \*

\* A6U PL RETEN PL SEL – 2 \*

\* Repeat step 6 \*

7. PRLA LATCH

A6U √PL RETEN LAT 4, 5 (two) tb – REL

Note single motor times (> 30 sec)

PL RETEN LAT 4 – LAT (tb-LAT), 60 sec max  
 – OFF  
 5 – LAT (tb-LAT), 60 sec max  
 – OFF

BRAKES – ON (tb-ON)

\* If using Shuttle attitude control: \*  
 \* DAP: LVLH \*  
 \* When rates damped: \*  
 \* DAP: FREE > 2 sec \*  
 \* DAP: AUTO \*

8. DEACTIVATE LATCHES

R13L PL RETEN LOGIC PWR SYS (1,2) – OFF  
 BAY MECH PWR SYS (1,2) – OFF

MA73C:A MCA LOGIC MNC MID 2 – ON  
 :B MNB MID 4 – ON

9. JLE UNGRAPPLE SETUP

A7U CCTV – RMS WRIST, zoom 34.0 HFOV  
 focus 5 ft

DNLK (72)	EE (Elbow)
DTV (SSC 2)	B (C)
MON 1 (SSC 1)	A
MON 2 (71)	P1 LOOB

SM 94 PDRS CONTROL  
 PL ID – ITEM 3 +0 EXEC  
 INIT ID – ITEM 24 +0 EXEC

10. JLE UNGRAPPLE







RATE – VERN (RATE MIN tb-ON)  
 BRAKES – OFF (tb-OFF)  
 MODE – END EFF, ENTER

<u>CAUTION</u>
Monitor EE tb timing to prevent EE motor burnout

NOTE

When OPEN tb – gray, mnvr arm clear of GF

EE MODE – AUTO  
 RELEASE sw – depress (mom)

✓	RIGID 	CLOSE 	CAPTURE 
	DERIGID 	OPEN 	EXTEND 

CRITICAL TIMES (28 sec total):  
 DERIGID tb – gray, 5 sec max, then  
 OPEN tb – gray, 3 sec max, then  
 EXTEND tb – gray, 20 sec max

EE MODE – OFF



- \* If manual release required: \*
- \* EE MODE – MAN \*
- \* MAN CONTR – DERIGID (hold until DERIGID tb-gray, 5 sec max) \*
- \* RELEASE sw – depress (hold until OPEN tb-gray, 3 sec max) \*
- \* \*
- \* Mnv r arm clear, then \*
- \* EE MAN CONTR – DERIGID (hold until EXTEND tb-gray, 20 sec max) \*
- \* MODE – OFF \*

- RHC 11. MNVR TO PRE-CRADLE  
 √RATE – VERN (RATE MIN tb-ON)  
 MODE – as desired (OCAS valid if backed off > 5 ft)

Mnv r to PRE-CRADLE: (00:50)

	X	Y	Z	PITCH	YAW	ROLL	PL ID
√	-1261	-146	-551	5	2	0	0
	SY	SP	EP	WP	WY	WR	
√	0.0	+25.0	-25.0	+5.0	0.0	0.0	

- BRAKES – ON (tb-ON)
- √MODE – not DIRECT (lt off)

- PARAM – PORT TEMP
- JOINT – CRIT TEMP

This Page Intentionally Blank

VIEWING SUPPORT

I

JEF INSTALL VIEWING TO PRE-CRADLE .....	FS 4-2
ICC BACKOFF TO EVA 2 VIEWING .....	FS 4-3
JLE INSTALL VIEWING TO BATTERY R&R VIEWING .....	FS 4-6

VIEWING  
SUPPORT

# JEF INSTALL VIEWING TO PRE-CRADLE

I

## 1. SETUP

Verify JEF Install complete and SSRMS operator GO for SRMS mnvr to Pre-cradle

DNLK (72)	Elbow
DTV (SSC 2)	B
MON 1 (SSC 1)	A
MON 2 (71)	JEM EXT-FWD (P1 LOIB)

**SM 94 PDRS CONTROL**

- √PL ID, ITEM 3: 0
- √INIT ID, ITEM 24: 0

Verify SRMS at JEF INSTALL VIEWING posn:

	X	Y	Z	PITCH	YAW	ROLL	PL ID
√	-688	-545	-250	278	83	83	0
	SY	SP	EP	WP	WY	WR	
√	+89.0	+36.0	-82.0	+58.0	0.0	+20.1	

## 2. MNVR TO PRE-CRADLE

RHC

RATE – as reqd (VERN within 10 ft)  
 BRAKES – OFF (tb-OFF)  
 MODE – SINGLE

Mnvr to PRE-CRADLE posn:

	SY	SP	EP	WP	WY	WR	
JEF Viewing	+89.0	+36.0	-82.0	+58.0	0.0	+20.1	
1: SP –		+25.0					
2: EP +			-25.0				
3: WR –						0.0	
4: WP –				+5.0			
5: SY –	0.0						
Pre-cradle	0.0	+25.0	-25.0	+5.0	0.0	0.0	
	X	Y	Z	PITCH	YAW	ROLL	PL ID
	-1261	-146	-551	5	2	0	0

BRAKES – ON (tb-ON)  
 √MODE – not DIRECT (lt off)

PARAM – PORT TEMP  
 JOINT – CRIT TEMP

VIEWING  
SUPPORT

# ICC BACKOFF TO EVA 2 VIEWING

I

## 1. SETUP

Verify JEMRMS at JEF Install Viewing posn:

SY	SP	EP	WP	WY	WR
-65.0	+135.0	-100.0	-125.0	0.0	+65.0

### NOTE

If Focused Inspection performed, JEMRMS at JLE Install Viewing posn

DNLK (72)	A
DTV (SSC 2)	B
MON 1 (SSC 1)	Elbow
MON 2 (71)	JEM EXT-FWD (P1 LOOB)

### SM 94 PDRS CONTROL

- √ PL ID, ITEM 3: 0
- √ INIT ID, ITEM 24: 0

Verify SRMS at ICC BACKOFF posn:

X	Y	Z	PITCH	YAW	ROLL	PL ID
-631	-601	-313	155	14	19	0
SY	SP	EP	WP	WY	WR	
+89.9	+20.9	-40.4	+98.7	+62.0	-204.6	

## 2. MNVR TO EVA 2 VIEWING

Verify SSRMS at ICC Clear posn and SSRMS operator GO for SRMS mnvr to EVA 2 Viewing

- RHC
- RATE – as reqd (VERN within 10 ft)
  - BRAKES – OFF (tb-OFF)
  - MODE – as desired (OCAS valid)

### NOTE

Minimum clearance between SRMS Upper Boom and JPM is 64 inches during OCAS. Monitor with Cameras A and B.

OCAS duration is 1 minute when flown in Vern rates

Mnvr to EVA 2 VIEWING posn (suggested SJ sequence):

	SY	SP	EP	WP	WY	WR	
ICC Backoff	+89.9	+20.9	-40.4	+98.7	+62.0	-204.6	
1: SY +	+130.0						
2: SP –		+15.0					
3: WP +				+103.0			
4: WY –					-7.0		
5: WR –						-213.0	
EVA2 Viewing	+130.0	+15.0	-40.4	+103.0	-7.0	-213.0	
	X	Y	Z	PITCH	YAW	ROLL	PL ID
	-355	-489	-328	93	33	357	0

- BRKES – ON (tb-ON)
- √ MODE – not DIRECT (lt off)

PARAM – PORT TEMP  
JOINT – CRIT TEMP

Notify SSRMS operator that SRMS at EVA 2 Viewing posn; GO for SSRMS mnvr to EVA Prep 1 posn

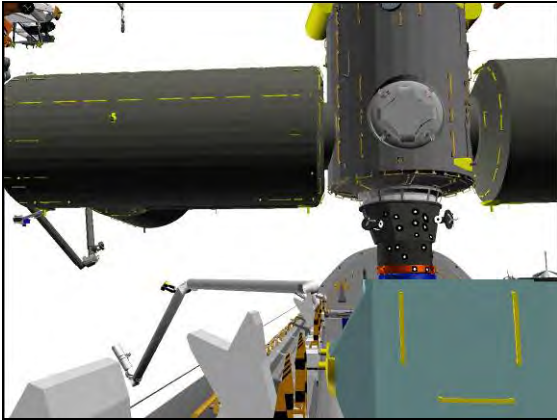

**CCTV B (-5,5)**

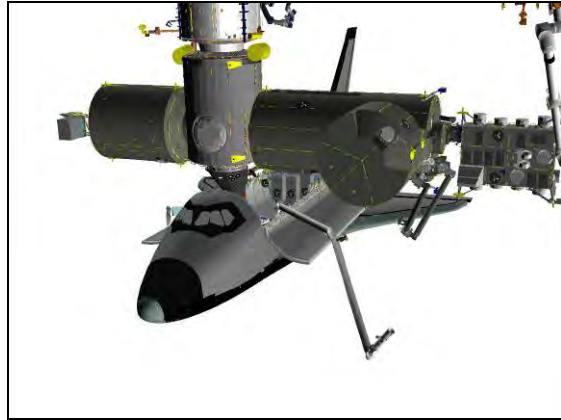

**BIRD'S EYE**

3. CONFIGURE CAMERAS

Configure cameras as shown to support EVA 2

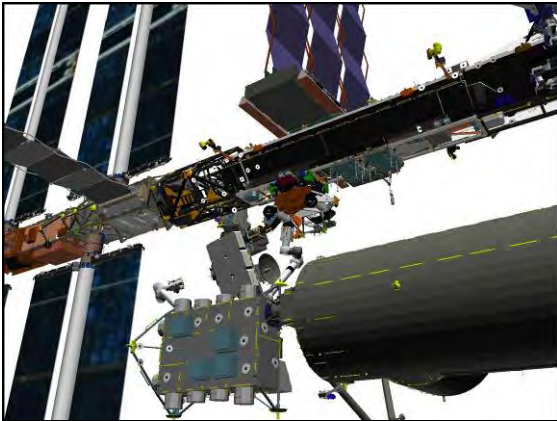

**CCTV B (-35,25)**

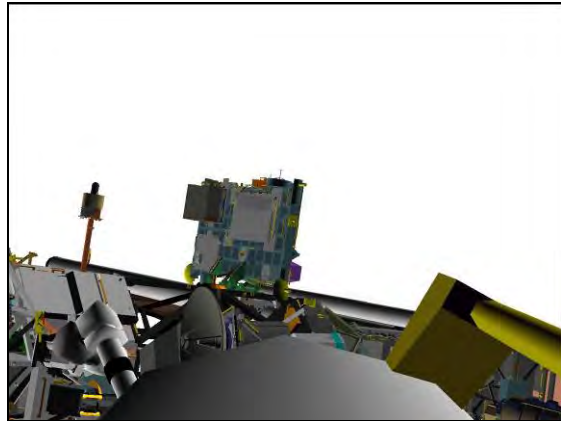

**EE (HFOV: 34.0)**

4. ADJUST SRMS CAMERA VIEW (OPTIONAL)

If SSRMS operator requires adjustment to SRMS EE view during EVA 2,

RHC

RATE – VERN (tb-MIN)  
BRAKES – OFF (tb-OFF)  
MODE – END EFF, ENTER

NOTE

Monitor clearance between SRMS and JPM with Cameras A and C (B). Coordinate video routing with SSRMS operator to avoid interfering with orbiter views on SSCs or Ch 71/72

Mnvr as required per SSRMS operator GCA

BRAKES – ON (tb-ON)

Repeat as required

When EVA/SSRMS activities complete:

√MCC if mnvr back to EVA 2 VIEWING posn required

√BRAKES – ON (tb-on)

√MODE – not direct

√PARAM – PORT TEMP

√JOINT – CRIT TEMP

# JLE INSTALL VIEWING TO BATTERY R&R VIEWING

I

## 1. SETUP

Verify JEMRMS at JLE INSTALL VIEWING posn:

SY	SP	EP	WP	WY	WR
-7.0	+70.0	-115.0	-40.0	0.0	+7.0

DNLK (72)	Elbow
DTV (SSC 2)	B
MON 1 (SSC 1)	A
MON 2 (71)	JEM EXT-FWD

SM 94 PDRS CONTROL

√PL ID, ITEM 3: 0

√INIT ID, ITEM 24: 0

Verify SRMS at JLE INSTALL VIEWING posn:

X	Y	Z	PITCH	YAW	ROLL	PL ID
-837	-594	-555	150	40	132	0
SY	SP	EP	WP	WY	WR	
+63.7	+52.3	-49.2	+73.5	+53.5	-105.6	

## 2. MNVR TO BATTERY R&R VIEWING

Verify SSRMS at Translate Stow posn and SSRMS operator GO for SRMS mnvr to Battery R&R Viewing

### NOTE

Minimum clearance between SRMS Upper Boom and JPM is 38 inches at JLE Install Viewing posn and increases during maneuver. Monitor with Camera A

RHC RATE – VERN (RATE MIN tb-ON)  
 BRAKES – OFF (tb-OFF)  
 MODE – SINGLE

Mnvr to BATTERY R&R VIEWING posn:

	SY	SP	EP	WP	WY	WR	
JLE Viewing	+63.7	+52.3	-49.2	+77.1	+53.5	-105.6	
1: SP –		+20.9					
2: SY +	+105.0						
3: EP –			-51.6				
4: WP +				+90.0			
5: WY –					+2.0		
6: WR +						+15.0	
R&R Viewing	+105.0	+20.9	-51.6	+90.0	+2.0	+15.0	
	X	Y	Z	PITCH	YAW	ROLL	PL ID
	-544	-581	-289	104	48	242	0

BRAKES – ON (tb-ON)

√MODE – not DIRECT (lt off)

PARAM – PORT TEMP  
 JOINT – CRIT TEMP



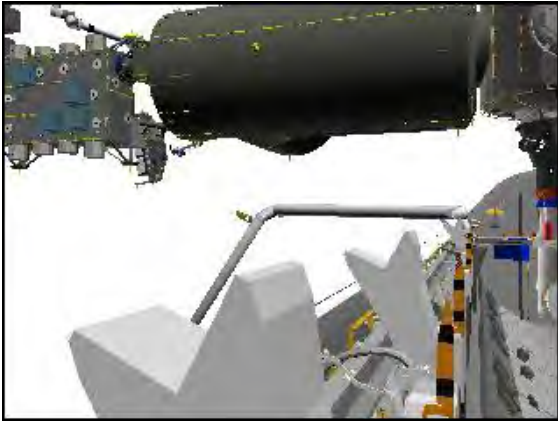

**CCTV B (-20,0)**

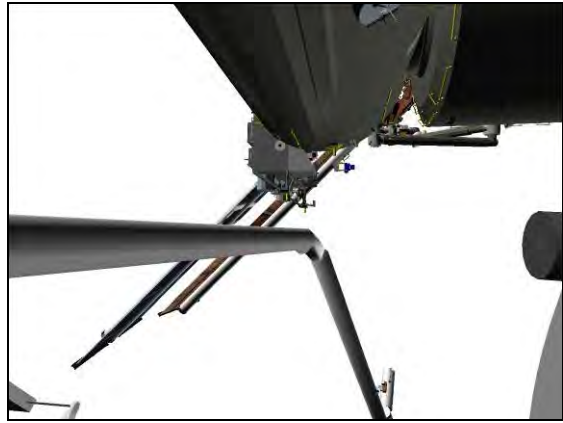

**CCTV A (80,5)**

3. CONFIGURE CAMERAS FOR VIEWING  
Configure cameras as required for Battery R&R Viewing

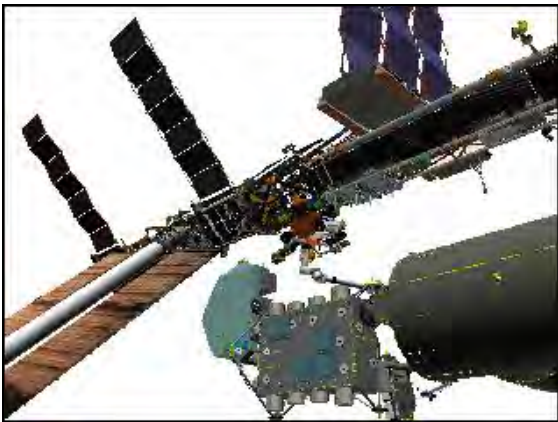

**CCTV B (-45,25)**



**ELBOW (72,22)**



**EE (HFOV: 34.0)**

This Page Intentionally Blank

OBSS

OBSS GRAPPLE FROM SSRMS.....	FS 5-2
HANDOFF TO SSRMS.....	FS 5-7
MNVR TO FLAT FIELD .....	FS 5-12
SJ OBSS GRAPPLE FROM SSRMS .....	FS 5-15
HANDOFF TO SSRMS.....	FS 5-25

# OBSS GRAPPLE FROM SSRMS

I

## 1. SETUP

### NOTE

Assumed starting position is Pre-cradle

Verify SSRMS at OBSS BERTHED PRE-GRAPPLE posn:

SR	SY	SP	EP	WP	WY	WR
+74.6	+217.4	-161.0	-112.7	-162.3	-158.0	+210.6

R12

√Green Jumper – ISS

DNLK (72)	A (D)
DTV	Elbow (EE)
MON 1	B
MON 2 (71)	P1 LOOB

SM 94 PDRS CONTROL

√PL ID, ITEM 3: 0

√INIT ID, ITEM 24: 0

## 2. MNVR TO OBSS HANDOFF PRE-GRAPPLE

### NOTE

Clearance between SRMS Upper Boom and JPM is 45 inches at OBSS Handoff Pre-grapple posn. Monitor with Camera A

RHC

RATE – as reqd (VERN within 10 ft)

BRAKES – OFF (tb-OFF)

MODE – as desired (OCAS valid from Pre-cradle)

Mnvr to OBSS HANDOFF PRE-GRAPPLE posn:

X	Y	Z	PITCH	YAW	ROLL	PL ID
-1018	-362	-676	284	0	270	0
SY	SP	EP	WP	WY	WR	
+24.0	+64.8	-34.4	-99.4	+11.3	-99.0	

BRAKES – ON (tb-ON)

Notify SSRMS Operator that SRMS at OBSS Handoff Pre-Grapple posn;  
SSRMS GO for OBSS Grapple

OBSS



NOTE

Expect single motor drive time for MRL release

STBD RMS RETEN LAT – REL (tb-REL) (18 sec max)  
– OFF

If motor drive time > 18 sec, √MCC

SM 94 PDRS CONTROL

√STBD AFT, MID, FWD REL (six) = 1

5. RECONFIGURE POWER

R13L PL BAY MECH PWR SYS (two) – OFF

MA73C:C cb MCA PWR AC3 3Φ MID 2 – cl  
√AC2 3Φ MID 2 – op

MA73C:D √AC3 3Φ MID 4 – op

Give SSRMS Operator GO for OBSS Unberth and mnvr to Handoff

Monitor RFL Status

After OBSS Unberth,

SM 94 PDRS CONTROL

RMS PORT – ITEM 1 EXEC (\*)

6. SETUP FOR GRAPPLE

A7U CCTV – configure for grapple  
– RMS WRIST, ZOOM: 34.0 HFOV  
FOCUS: 5 ft

Maintain eyepoint approx 18 in when using grapple overlay

R12(OBSS) √SPEE PWR – OFF

A15 √APCU 2 OUTPUT – OFF

7. OBSS GRAPPLE AT HANDOFF POSN

RHC On SSRMS Operator GO for SRMS OBSS Grapple,  
RATE – VERN (RATE MIN tb-ON)  
BRAKES – OFF (tb-OFF)  
MODE – END EFF, ENTER

Mnvr to grapple envelope

CAUTION  
Monitor EE tb timing to prevent EE motor burnout

EE MODE – AUTO

CAPTURE sw – depress (mom)

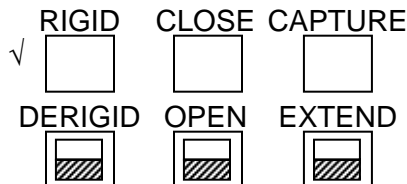

CRITICAL TIMES (28 sec total):

CAPTURE tb – gray, then  
CLOSE tb – gray, 3 sec max, then  
RIGID tb – gray, 25 sec max

EE MODE – OFF

- \* If manual capture required: \*
- \* EE MODE – MAN \*
- \* CAPTURE sw – depress (hold until CLOSE tb-gray, 3 sec max) \*
- \* MAN CONTR – RIGID (hold until RIGID tb-gray, 25 sec max) \*
- \* MODE – OFF \*

MODE – TEST, ENTER

Wait 5 sec

BRAKES – ON (tb-ON)

**SM 94 PDRS CONTROL**

PL ID – ITEM 3 +2 EXEC

INIT ID – ITEM 24 +2 EXEC

Expected OBSS HANDOFF posn:

	X	Y	Z	PITCH	YAW	ROLL	PL ID	
							2	
√	-1029	+229	-614	284	270	270	2	*
	SY	SP	EP	WP	WY	WR		
√	+25.8	+66.3	-49.0	-85.9	+10.7	-100.7		

\*Display singularity

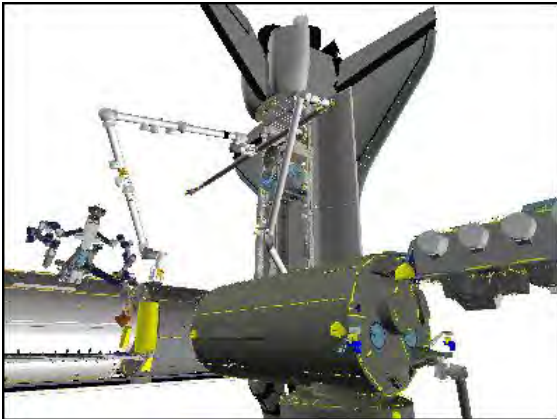

**P1 LOOB (130,20)**

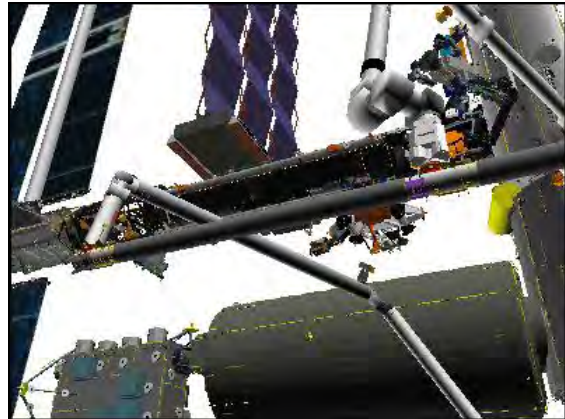

**CCTV B (-25,30)**

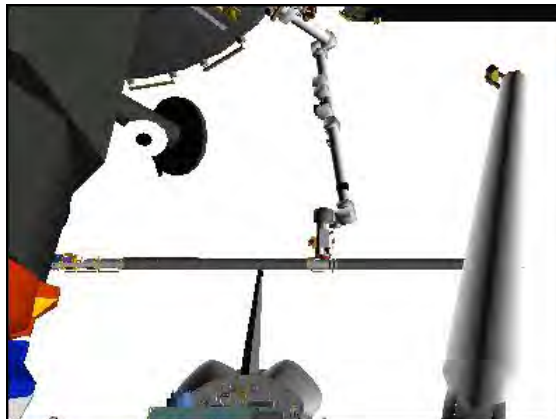

**CCTV A (0,28)**

R12

Green Jumper – LDRI/ITVC

Perform ACTIVATION (LDRI/ITVC Cue Card, P/TV)

Perform LCH ACTIVATION (LCS Cue Card, P/TV)

Give SSRMS Operator GO for OBSS ungrapple

Perform LCC ACTIVATION (LCS Cue Card, P/TV)

Perform LCC DEACTIVATION (LCS Cue Card, P/TV), steps 1 and 2

Review GENERIC END EFFECTOR CUE CARD – ISS/SHUTTLE DOCKED OPS

A7U

8. RECONFIGURE PTU

DTV ← PL2

CAMR CMD PAN/TILT – HI RATE

PAN – L (to hard stop)

TILT – UP (to hard stop)

PAN/TILT – RESET, HI RATE (LO within 10°)

PAN: +85 (right)

TILT: -57 (down)

MUX 1 L ← MIDDECK

LDRI MODE 2 pb – push (ITVC video)

VIDEO OUT – as desired (not DTV)

√VIDEO IN – not PL2

R12

Green Jumper – ISS



# OBSS HANDOFF TO SSRMS

## 1. SETUP

DNLK (72)	A
DTV	Elbow (EE)
MON 1	B (C)
MON 2 (71)	P1 LOOB

**SM 94 PDRS CONTROL**

√PL ID, ITEM 3: 2

√INIT ID, ITEM 24: 2

Verify SRMS at OBSS HANDOFF posn:

	X	Y	Z	PITCH	YAW	ROLL	PL ID	
√	-1029	+229	-614	284	270	270	2	*
	SY	SP	EP	WP	WY	WR		
√	+25.8	+66.3	-49.0	-85.9	+10.7	-100.7		

\*Display singularity

Notify SSRMS operator that SRMS at OBSS Handoff with Brakes ON;  
GO for SSRMS OBSS grapple

Review GENERIC END EFFECTOR CUE CARD – ISS/SHUTTLE DOCKED OPS

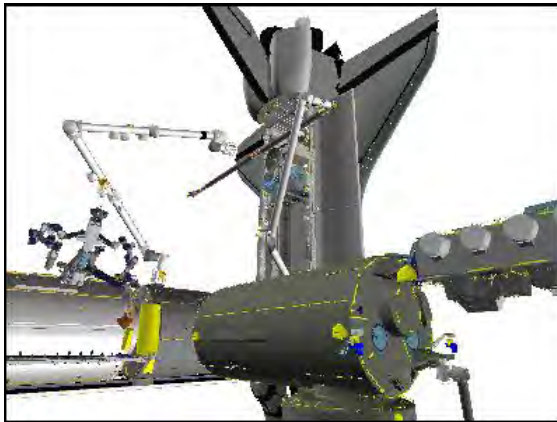

**P1 LOOB (130,20)**

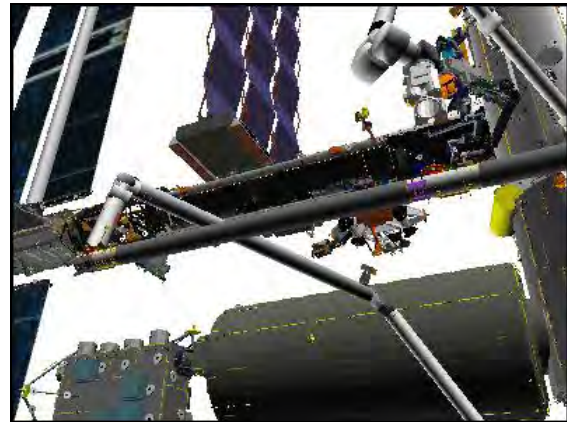

**CCTV B (-25,30)**

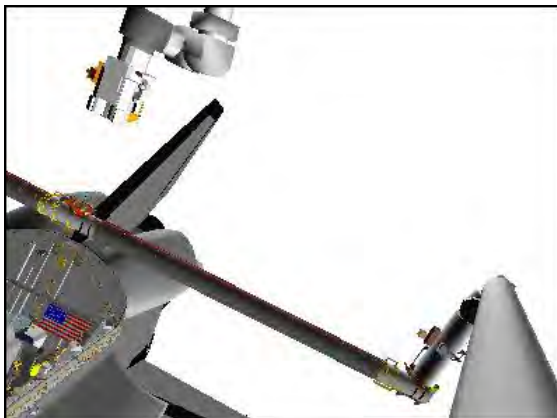

**ELBOW (-30,0)**



**CCTV A (0,28)**

2. STOW PTU  
R12 (VPU) Green Jumper – LDRI/ITVC

A7U DTV ← PL2

CAMR CMD PAN/TILT – HI RATE  
PAN – L (to hard stop)  
TILT – UP (to hard stop)  
PAN/TILT – RESET  
PAN: +108 (right)  
TILT: -175 (down)

R12 (VPU) Green Jumper – ISS

On SSRMS Operator GO for SRMS OBSS ungrapple,

<p><u>CAUTION</u> STBD RMS HTR power must be applied within 90 min to prevent sensor package damage</p>
---

Perform LCC DEACTIVATION (LCS Cue Card, P/TV)  
Perform LCH DEACTIVATION (LCS Cue Card, P/TV)  
Perform DEACTIVATION (LDRI/ITVC Cue Card, P/TV)

3. OBSS UNGRAPPLE  
A7U CCTV – configure for ungrapple  
– RMS WRIST, ZOOM: 34.0 HFOV  
FOCUS: 5 ft

NOTE  
CONTR ERR It and 'S96 PDRS CNTL' msg may  
occur due to Consistency/Envelope Check error

RHC RATE – COARSE (RATE MIN tb-OFF)

<p><u>SM 94 PDRS CONTROL</u></p>
----------------------------------

AUTO BRAKE INH – ITEM 10 EXEC (\*)

BRAKES – OFF (tb-OFF)  
MODE – TEST, ENTER  
Wait 5 sec

BRAKES – ON (tb-ON)

<p><u>SM 94 PDRS CONTROL</u></p>
----------------------------------

AUTO BRAKE ENA – ITEM 9 EXEC (\*)

PL ID – ITEM 3 +0 EXEC  
INIT ID – ITEM 24 +0 EXEC

RHC RATE – VERN (RATE MIN tb-ON)  
BRAKES – OFF (tb-OFF)  
MODE – END EFF, ENTER

**CAUTION**  
Monitor EE tb timing to prevent EE motor burnout

EE MODE – AUTO  
RELEASE sw – depress (mom)

When OPEN tb – gray, mnvr arm clear of grapple pin

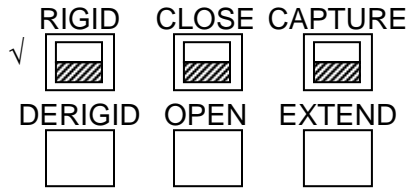

CRITICAL TIMES (28 sec total):  
DERIGID tb – gray, 5 sec max, then  
OPEN tb – gray, 3 sec max, then  
EXTEND tb – gray, 20 sec max

EE MODE – OFF

- \* If manual release reqd: \*
- \* EE MODE – MAN \*
- \* MAN CONTR – DERIGID (hold until DERIGID tb-gray, 5 sec max) \*
- \* RELEASE sw – depress (hold until OPEN tb-gray, 3 sec max) \*
- \* Mnvr arm clear of grapple pin, then \*
- \* EE MAN CONTR – DERIGID (hold until EXTEND tb-gray, 20 sec max) \*
- \* MODE – OFF \*

Mnvr to OBSS BACKOFF posn:

X	Y	Z	PITCH	YAW	ROLL	PL ID
-1018	-362	-676	284	0	270	0
SY	SP	EP	WP	WY	WR	
+24.0	+64.8	-34.4	-99.4	+11.3	-99.0	

BRAKES – ON (tb-ON)

- \* If using Shuttle attitude control and attitude maintenance reqd: \*
- \* DAP: LVLH \*
- \* When rates damped: \*
- \* DAP: FREE > 2 sec \*
- \* DAP: AUTO \*

Notify SSRMS operator that SRMS at OBSS Backoff with Brakes ON;  
GO for SSRMS OBSS Berth

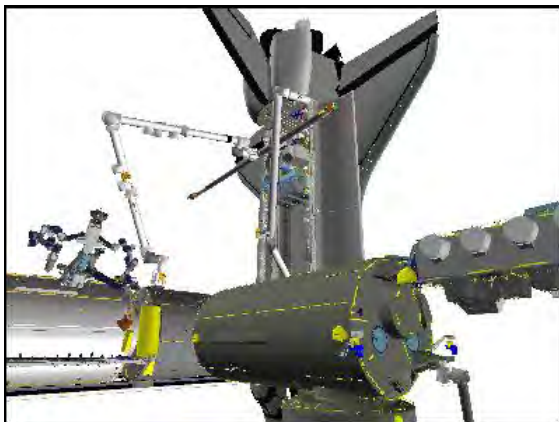

**P1 LOOB (130,20)**

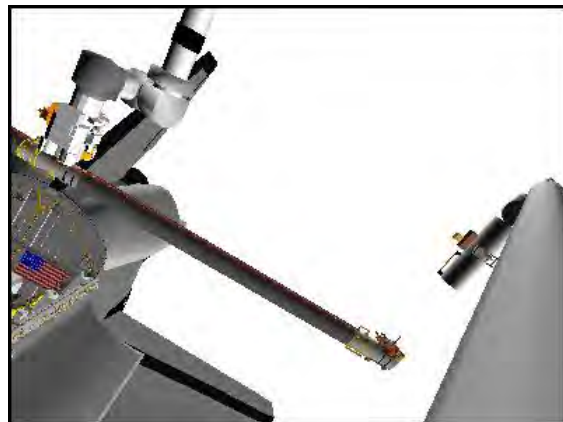

**ELBOW (-35,-10)**



7. RECONFIGURE POWER  
R13L PL BAY MECH PWR SYS (two) – OFF

STBD RMS HTR A,B (two) – AUTO

A6U EVENT TIMER CNTL – STOP

SM 94 PDRS CONTROL

√STBD AFT, MID, FWD LAT (six) = 1  
RMS PORT – ITEM 1 EXEC (\*)

MA73C:C cb MCA PWR AC3 3Φ MID 2 – cl

√AC2 3Φ MID 2 – op

MA73C:D √AC3 3Φ MID 4 – op

Give SSRMS Operator GO for OBSS ungrapple

# OBSS MNVR TO FLAT FIELD

I

<b>WARNING</b> For UNDOCKED ops only
---

## 1. SETUP

DNLK	A
DTV	Elbow
MON 1	B
MON 2	D (C)

**SM 94 PDRS CONTROL**

- √ PL ID, ITEM 3: 2
- √ INIT ID, ITEM 24: 2
- AUTO MODES – ITEM 13 + 8 EXEC

Verify at OBSS UNDOCK posn:

	X	Y	Z	PITCH	YAW	ROLL	PL ID	
√	-1029	+229	-614	284	270	270	2	*
	SY	SP	EP	WP	WY	WR		
√	+25.8	+66.3	-49.0	-85.9	+10.7	-100.7		

\*Display singularity

- RHC
- ## 2. ACAS TO STBD SURVEY START
- RATE – COARSE (RATE MIN tb-OFF)
  - BRAKES – OFF (tb-OFF)
  - MODE – AUTO 1, ENTER

- \* If unable to enter AUTO mode (no AUTO READY lt): \*
- \* √POR and adjust as reqd \*



- √ START PT, ITEM 17: 156

**SM 169 PDRS STATUS**

Monitor ACAS progress

AUTO SEQ – PROCEED (IN PROG It on)

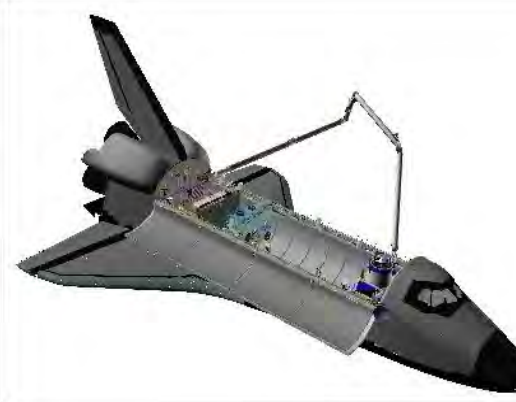
(11:00)

Pt	X	Y	Z	Pitch	Yaw	Roll	•
<b>156P</b>	<b>-1029</b>	<b>+229</b>	<b>-614</b>	<b>284</b>	<b>270</b>	<b>270</b>	
157	-800	+500	-250	281	333	95	
158	-1130	+350	-400	325	336	30	
<b>159P</b>	<b>-1270</b>	<b>+350</b>	<b>-445</b>	<b>0</b>	<b>0</b>	<b>11</b>	

When AUTO SEQ IN PROG It – off:  
BRAKES – ON (tb-ON)

Verify at FLAT FIELD posn:

	X	Y	Z	PITCH	YAW	ROLL	PL ID
√	-1270	+350	-445	0	0	11	2
	SY	SP	EP	WP	WY	WR	
√	-90.1	+25.0	-65.8	-57.6	0.0	-249.9	

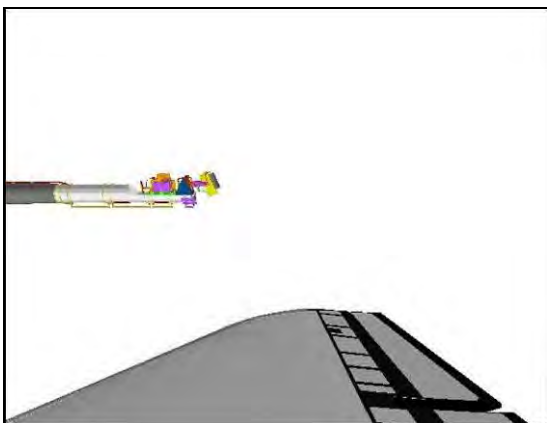

CCTV C (95,-5)

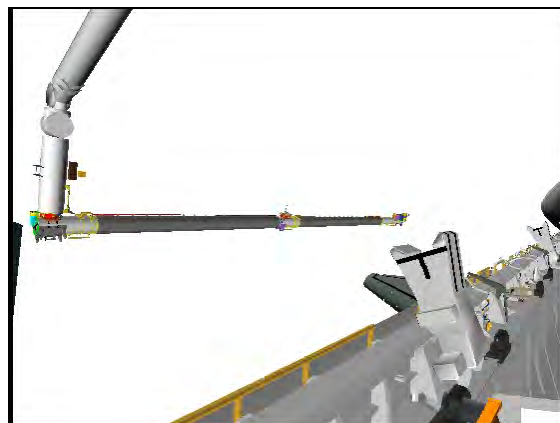

CCTV D (-40,0)

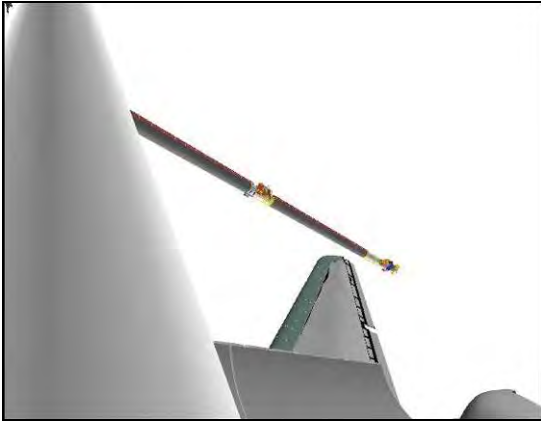

**ELBOW (25,-40)**



**BIRD'S EYE**

3. SETUP FOR STBD SURVEY

SM 94 PDRS CONTROL

AUTO MODES – ITEM 13 +1 +2 +3 +4 EXEC

For survey scan pattern, refer to OBSS SCAN PATTERN CUE CARDS – STBD & PORT, AND WING GLOVE & CREW CABIN

Perform ACTIVATION (LDRI/ITVC Cue Card, P/TV) steps 1, 3, 4, and 5

A15 APCU 2 CONV – OFF  
Wait 10 sec  
APCU 2 CONV – ON

Perform LCC ACTIVATION (LCS, Cue Card, P/TV)  
Perform IDC SOFTWARE ACTIVATION (IDC, Cue Card, P/TV) steps 1 and 2

A7U MUX 1 L ← MIDDECK  
LDRI MODE 6 pb – push (flickering LDRI video)  
DTV ← PL2

CAMR CMD PAN/TILT – HI RATE  
PAN – L (to hard stop)  
TILT – UP (to hard stop)  
PAN/TILT – RESET, HI RATE (LO within 10°)  
PAN: +103 (right)  
TILT: -260 (down)

VIDEO OUT – as desired (not DTV)  
√VIDEO IN – not PL2

L10(VTR) REC pb – push, hold  
PLAY pb – push, simo (red ●)

Go to OBSS LDRI/IDC RCC SURVEY – STBD (OBSS OPERATIONS), step 3.  
Reference procedure notes prior to beginning surveys



# SJ OBSS GRAPPLE FROM SSRMS

I

## 1. SETUP

Verify SSRMS at OBSS BERTHED PRE-GRAPPLE posn:

SR	SY	SP	EP	WP	WY	WR
+74.6	+217.4	-161.0	-112.7	-162.3	-158.0	+210.6

R12

√Green Jumper – ISS

DNLK (72)	A (D)
DTV	Elbow (EE)
MON 1	B
MON 2 (71)	P1 LOOB

**SM 94 PDRS CONTROL**

√PL ID, ITEM 3: 0

√INIT ID, ITEM 24: 0

A7U

CCTV – configure as reqd  
 – perform PAN/TILT RESET for PLB cameras  
 ZOOM – full OUT

## 2. SINGLE JOINT MANEUVER TO OBSS HANDOFF PRE-GRAPPLE

### NOTE

Clearance between SRMS Upper Boom and JPM is 45 inches after SP mnvr. Monitor with Camera A

If SINGLE mode available:

RHC

RATE – as reqd (VERN within 10 ft)  
 BRAKES – OFF (tb-OFF)

MODE – best available

Mnvr to OBSS HANDOFF PRE-GRAPPLE posn:

	SY	SP	EP	WP	WY	WR	
Pre-cradle	0.0	+25.0	-25.0	+5.0	0.0	0.0	
1: SP +		+64.8					
2: WP –				-99.4			
3: WY +					+11.3		
4: WR –						-99.0	
5: EP –			-34.4				
6: SY +	+24.0						
OBSS Handoff Pre-Grapple	+24.0	+64.8	-34.4	-99.4	+11.3	-99.0	
	X	Y	Z	PITCH	YAW	ROLL	PL ID
	-1018	-362	-676	284	0	270	0

BRAKES – ON (tb-ON)  
 MODE – not DIRECT  
 JOINT – CRIT TEMP

Notify SSRMS Operator that SRMS at OBSS Handoff Pre-Grapple posn;  
 SSRMS GO for OBSS Grapple

Start:  
Pre-cradle

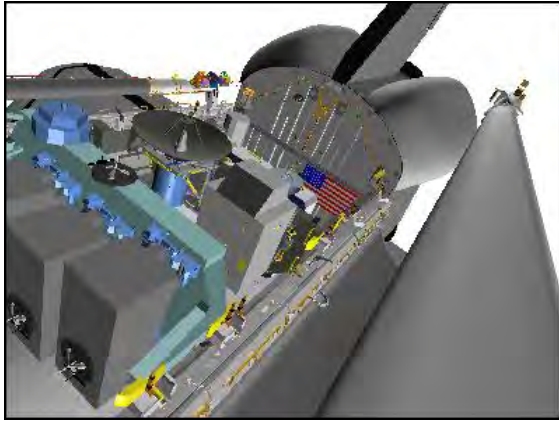

**ELBOW (-30,-20)**

Step 1:  
Drive SP+ (for 39.8°)  
from +25.0 to +64.8

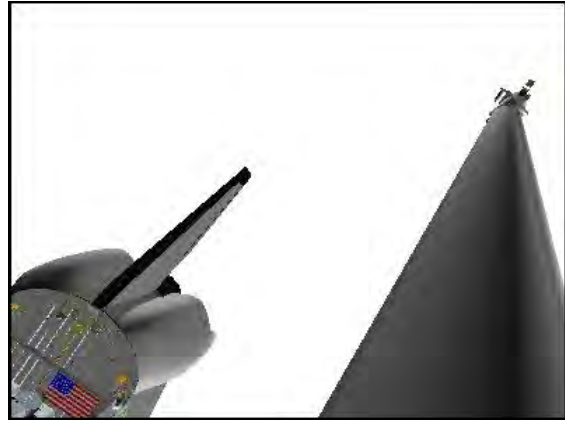

**ELBOW (-30,-20)**



**CCTV A (0,28)**



**CCTV A (0,28)**

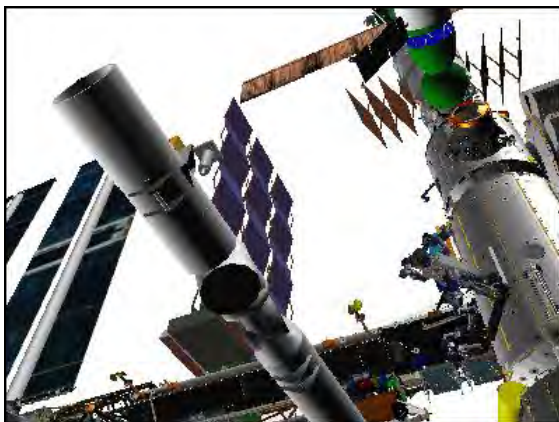

**CCTV B (-25,50)**

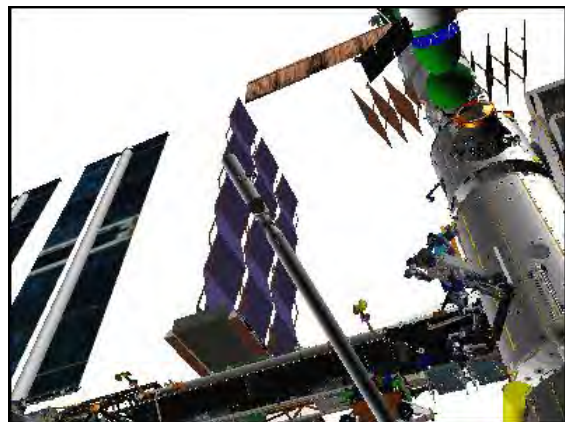

**CCTV B (-25,50)**

Step 2:

Drive WP- (for 104.4°)  
from +5.0 to -99.4

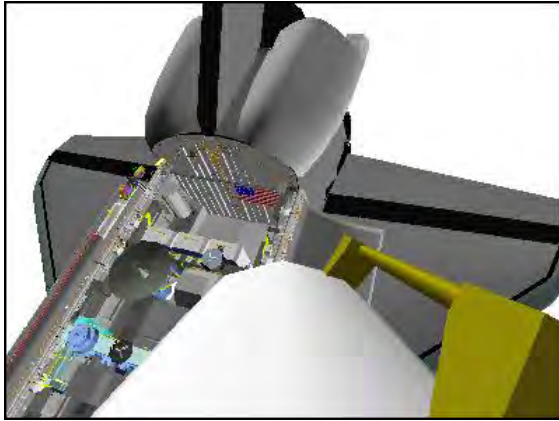

EE

Step 3:

Drive WY+ (for 11.3°)  
from 0.0 to +11.3

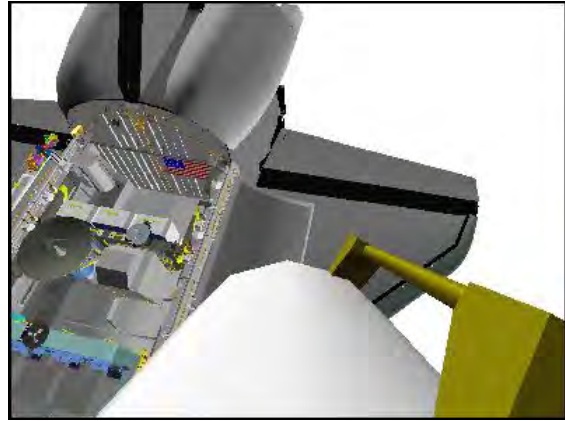

EE



CCTV A (0,28)



CCTV A (0,28)

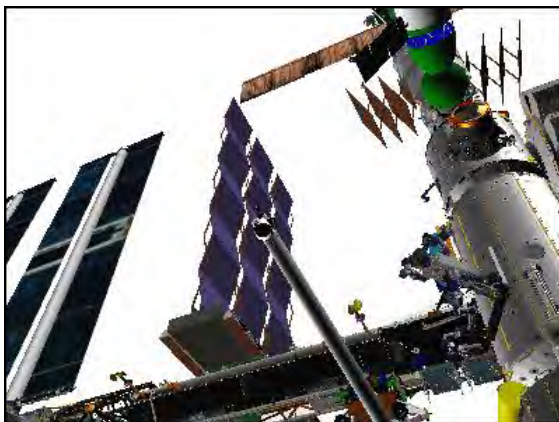

CCTV B (-25,50)

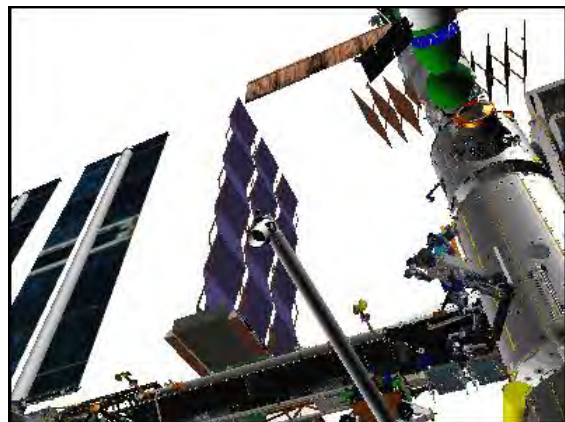

CCTV B (-25,50)

Step 4:

Drive WR- (for 99.0°)  
from 0.0 to -99.0

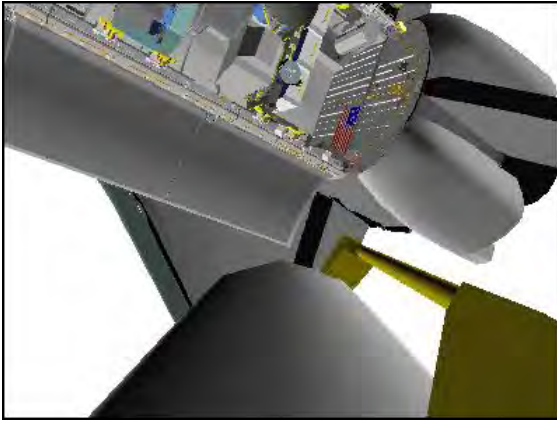

EE

Step 5:

Drive EP- (for 9.4°)  
from -25.0 to -34.4

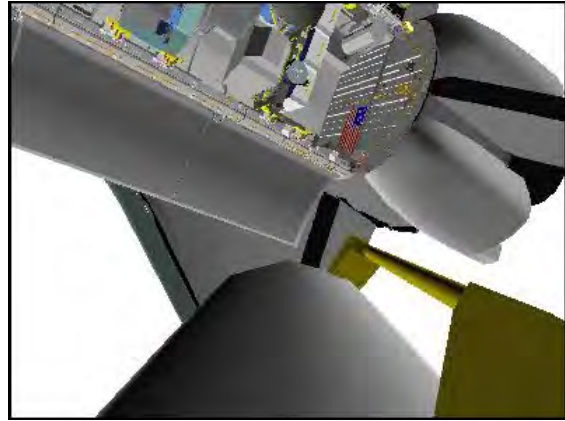

EE



CCTV A (0,28)



CCTV A (0,28)

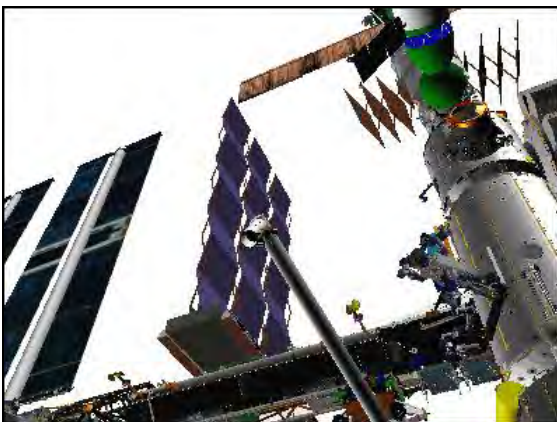

CCTV B (-25,50)

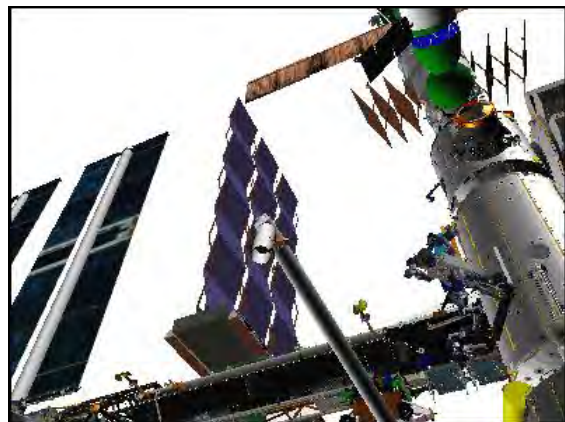

CCTV B (-25,50)

Step 6:

Drive SY+ (for 24.0°)  
from 0.0 to +24.0



**EE**



**CCTV A (0,28)**

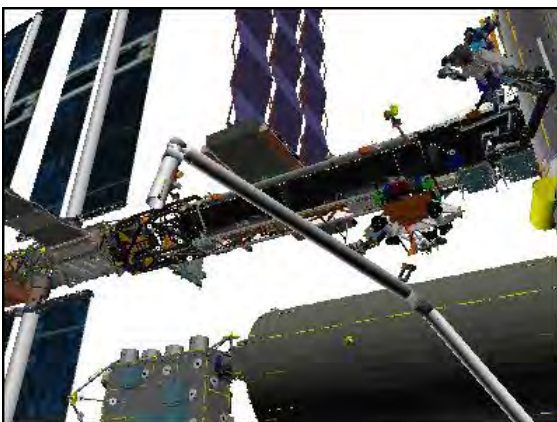

**CCTV B (-30,30)**



3. CONFIGURE POWER

CAUTION  
SPEE power must be applied within 90 min  
to prevent sensor package damage

On SSRMS Operator GO to release stbd MRLs,  
STBD RMS HTR A,B (two) – OFF

- A6U           EVENT TIMER MODE – UP  
                  CNTL – START
- MA73C:C       cb MCA PWR AC3 3Φ MID 2 – op  
                  √AC2 3Φ MID 2 – op
- MA73C:D       √AC3 3Φ MID 4 – op
- R13L           PL BAY MECH PWR SYS (two) – ON

4. STBD MRL RELEASE

SM 94 PDRS CONTROL

RMS STBD – ITEM 2 EXEC (\*)  
√STBD AFT, MID, FWD REL (six) = 0

NOTE  
Expect single motor drive time for MRL release

STBD RMS RETEN LAT – REL (tb-REL) (18 sec max)  
– OFF  
If motor drive time > 18 sec, √MCC

SM 94 PDRS CONTROL

√STBD AFT, MID, FWD REL (six) = 1

5. RECONFIGURE POWER

- R13L           PL BAY MECH PWR SYS (two) – OFF
- MA73C:C       cb MCA PWR AC3 3Φ MID 2 – cl  
                  √AC2 3Φ MID 2 – op
- MA73C:D       √AC3 3Φ MID 4 – op

Give SSRMS Operator GO for OBSS Unberth and SSRMS mnvr to Handoff

Monitor RFL Status

After OBSS Unberth,  
SM 94 PDRS CONTROL  
RMS PORT – ITEM 1 EXEC (\*)

6. SETUP FOR GRAPPLE

- A7U           CCTV – configure for grapple  
                  – install OBSS SJ GRAPPLE AT HANDOFF OVERLAY  
                  – RMS WRIST, ZOOM: 34.0 HFOV  
                  FOCUS: 5 ft
- Maintain eyepoint approx 18 in when using grapple overlay

R12(OBSS) √SPEE PWR – OFF  
A15 √APCU 2 OUTPUT – OFF

7. OBSS SJ GRAPPLE AT HANDOFF POSN

On SSRMS Operator GO for SRMS OBSS grapple,  
if SINGLE mode available:







RHC RATE – VERN (RATE MIN tb-ON)  
BRAKES – OFF (tb-OFF)

MODE – best available

Drive joints per OBSS SJ GRAPPLE AT HANDOFF OVERLAY and diagram until  
EE within grapple envelope

<u>CAUTION</u> Monitor EE tb timing to prevent EE motor burnout
--

EE MODE – AUTO  
CAPTURE sw – depress (mom)

√	RIGID	CLOSE	CAPTURE	<u>CRITICAL TIMES (28 sec total):</u> CAPTURE tb – gray, then CLOSE tb – gray, 3 sec max, then RIGID tb – gray, 25 sec max
				
	DERIGID	OPEN	EXTEND	
				

EE MODE – OFF

* If manual capture required:	*
* EE MODE – MAN	*
* CAPTURE sw – depress (hold until CLOSE tb-gray, 3 sec max)	*
* MAN CONTR – RIGID (hold until RIGID tb-gray, 25 sec max)	*
* MODE – OFF	*

If TEST mode available,  
MODE – TEST, ENTER  
Wait 5 sec

BRAKES – ON (tb-ON)  
MODE – not DIRECT (It off)

PARAM – PORT TEMP  
JOINT – CRIT TEMP

OBSS SJ GRAPPLE AT HANDOFF

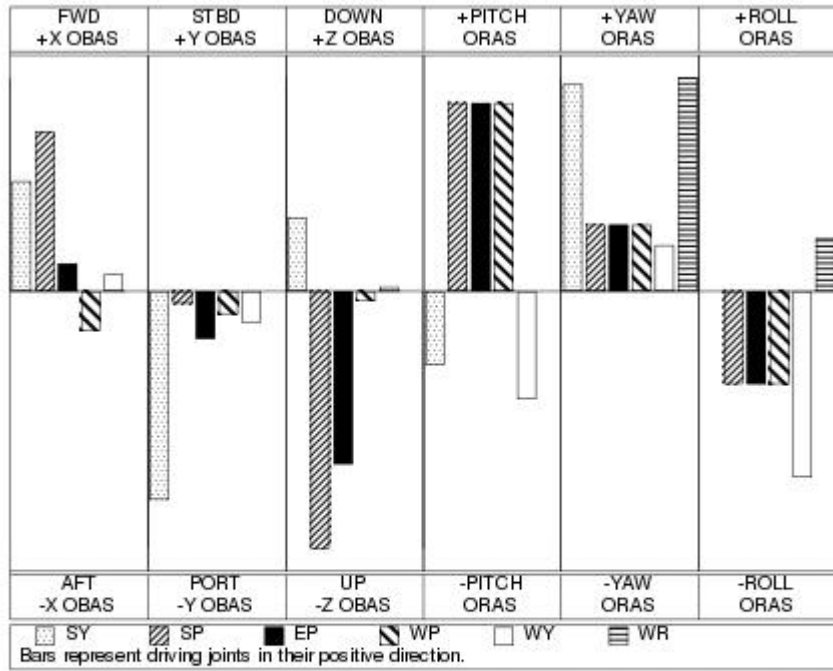

To get:	Drive:	To get:	Drive:	Driving:	Results in:	Driving:	Results in:
+X (fwd)	+SP, +SY, -WP, +EP	+PITCH	+WP, +EP	+SY	-Y (port), +YAW	+WP	-X (aft), +PITCH
+Y (stbd)	-SY	+YAW	+WR, +SY	+SP	-Z (up), +PITCH	+WY	-Y (port), -ROLL
+Z (down)	-SP, EP	+ROLL	-WY, -WP	+EP	-Z (up), +PITCH	+WR	+YAW

$\Delta SY$	$\Delta SP$	$\Delta EP$	$\Delta WP$	$\Delta WY$	$\Delta WR$
+1.8	+1.5	-14.6	+13.5	-0.6	-1.7

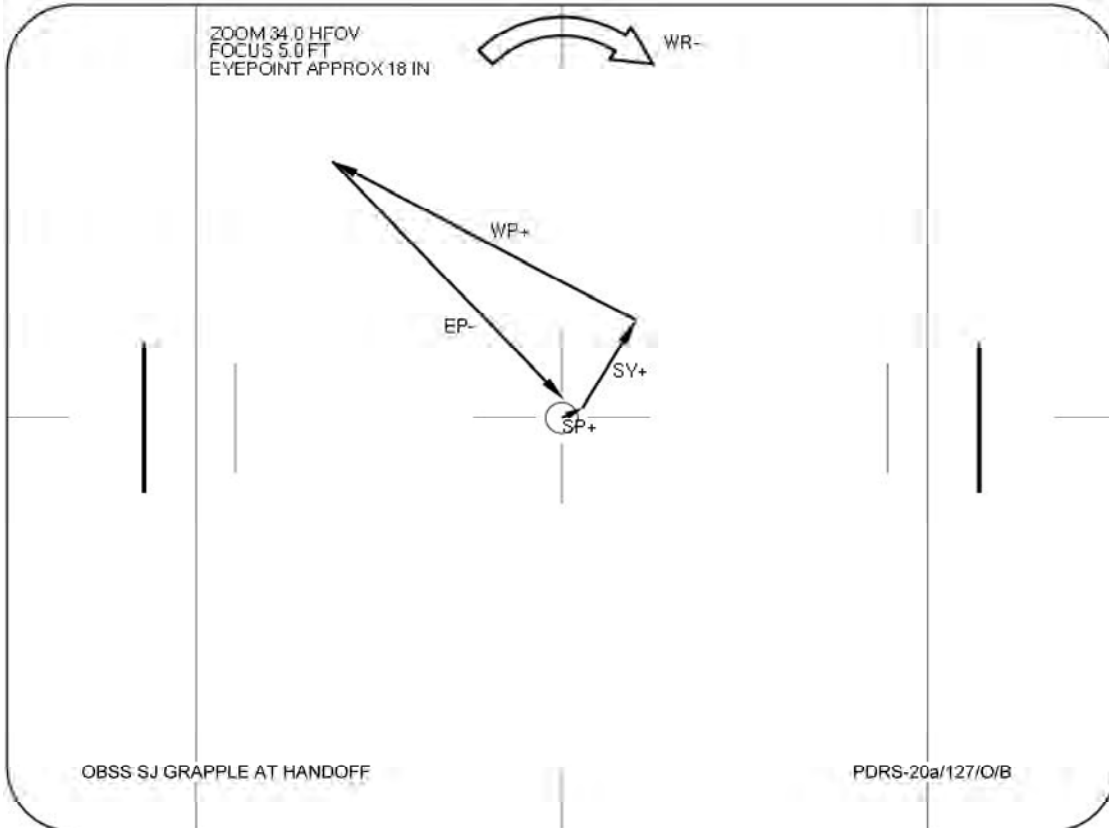



**SM 94 PDRS CONTROL**

PL ID – ITEM 3 +2 EXEC

INIT ID – ITEM 24 +2 EXEC

Expected OBSS HANDOFF posn:

	X	Y	Z	PITCH	YAW	ROLL	PL ID
							2
√	-1029	+229	-614	284	270	270	2
	SY	SP	EP	WP	WY	WR	
√	+25.8	+66.3	-49.0	-85.9	+10.7	-100.7	

\*Display singularity

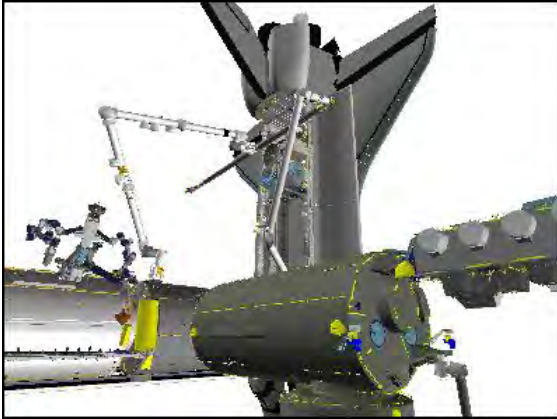

**P1 LOOB (130,20)**

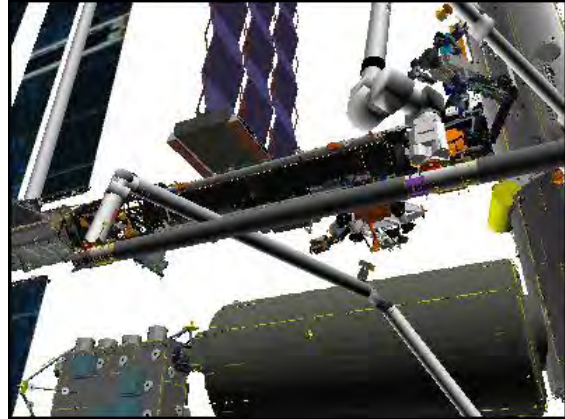

**CCTV B (-25,30)**



**CCTV A (0,28)**

R12

Green Jumper – LDRI/ITVC

Perform ACTIVATION (LDRI/ITVC Cue Card, P/TV)

Perform LCH ACTIVATION (LCS Cue Card, P/TV)

Give SSRMS Operator GO for OBSS ungrapple

Perform LCC ACTIVATION (LCS Cue Card, P/TV)

Perform LCC DEACTIVATION (LCS Cue Card, P/TV), steps 1 and 2

Review GENERIC END EFFECTOR CUE CARD – ISS/SHUTTLE DOCKED OPS

A7U 8. RECONFIGURE PTU  
DTV ← PL2

CAMR CMD PAN/TILT – HI RATE  
PAN – L (to hard stop)  
TILT – UP (to hard stop)  
PAN/TILT – RESET, HI RATE (LO within 10°)  
PAN: +85 (right)  
TILT: -57 (down)

MUX 1 L ← MIDDECK  
LDRI MODE 2 pb – push (ITVC video)  
VIDEO OUT – as desired (not DTV)  
√VIDEO IN – not PL2

R12 Green Jumper – ISS

# SJ OBSS HANDOFF TO SSRMS

I

## 1. SETUP

A7U CCTV – configure as reqd  
 – perform PAN/TILT RESET for PLB cameras  
 ZOOM – full OUT

R12 √Green Jumper – ISS

DNLK (72)	A
DTV	Elbow (EE)
MON 1	B (C)
MON 2 (71)	P1 LOOB

### SM 94 PDRS CONTROL

√PL ID, ITEM 3: 2  
 √INIT ID, ITEM 24: 2

Verify SRMS at OBSS HANDOFF posn:

X	Y	Z	PITCH	YAW	ROLL	PL ID
-1029	+229	-614	284	270	270	2
SY	SP	EP	WP	WY	WR	
+25.8	+66.3	-49.0	-85.9	+10.7	-100.7	

\*Display singularity

Notify SSRMS operator that SRMS at OBSS Handoff with Brakes ON;  
 GO for SSRMS OBSS grapple

Review GENERIC END EFFECTOR CUE CARD – ISS/SHUTTLE DOCKED OPS

## 2. STOW PTU

R12 (VPU) Green Jumper – LDRI/ITVC

A7U VID DNLK MON 1 pb – push  
 IN PL2(VPU) pb – push

CAMR CMD PAN/TILT – HI RATE  
 PAN – L (to hard stop)  
 TILT – UP (to hard stop)  
 PAN/TILT – RESET  
 PAN: +108 (right)  
 TILT: -175 (down)

R12 (VPU) Green Jumper – ISS

On SSRMS Operator GO for OBSS ungrapple,

<b><u>CAUTION</u></b> STBD RMS HTR power must be applied within 90 min to prevent sensor package damage
---

Perform LCC DEACTIVATION (LCS Cue Card, P/TV)  
 Perform LCH DEACTIVATION (LCS Cue Card, P/TV)  
 Perform DEACTIVATION (LDRI/ITVC Cue Card, P/TV)

- A7U 3. OBSS UNGRAPPLE  
 CCTV – configure for ungrapple  
 – RMS WRIST, ZOOM: 34.0 HFOV  
 FOCUS: 5 ft

NOTE

CONTR ERR It and 'S96 PDRS CNTL' msg may occur due to Consistency/Envelope Check error

- RHC If SINGLE mode available:  
 RATE – COARSE (RATE MIN tb-OFF)

SM 94 PDRS CONTROL

AUTO BRAKE INH – ITEM 10 EXEC (\*)

BRAKES – OFF (tb-OFF)  
 MODE – TEST, ENTER  
 Wait 5 sec

BRAKES – ON (tb-ON)

SM 94 PDRS CONTROL

AUTO BRAKE ENA – ITEM 9 EXEC (\*)

PL ID – ITEM 3 +0 EXEC  
 INIT ID – ITEM 24 +0 EXEC

RATE – VERN (RATE MIN tb-ON)  
 BRAKES – OFF (tb-OFF)

MODE – best available

CAUTION

Monitor EE tb timing to prevent EE motor burnout

EE MODE – MAN

MAN CONTR – DERIGID (hold until DERIGID tb-gray, 5 sec max)

RELEASE sw – depress (hold until OPEN tb-gray, 3 sec max)

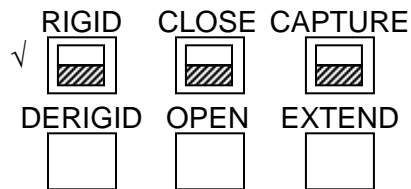

CRITICAL TIMES (8 sec total):

DERIGID tb – gray, 5 sec max, then

OPEN tb – gray, 3 sec max, then

Drive joints per OBSS SJ UNGRAPPLE AT HANDOFF overlay and diagram until EE clear of grapple pin

OBSS SJ UNGRAPPLE AT HANDOFF

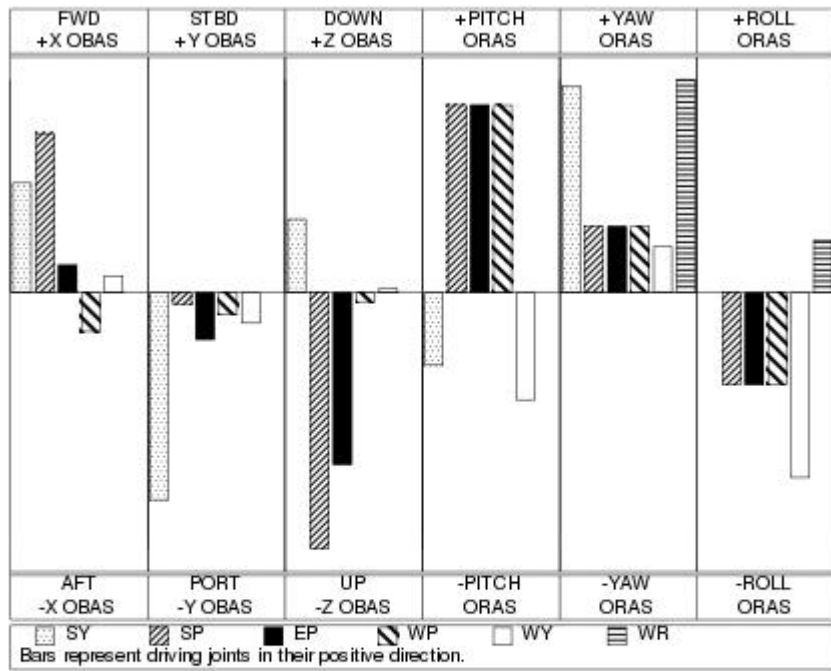

To get:	Drive:	To get:	Drive:	Driving:	Results in:	Driving:	Results in:
+X (fwd)	+EP, -WP, +SY, +SP	+PITCH	+WP, +EP	+SY	-Y (port), +YAW	+WP	-X (aft), +PITCH
+Y (stbd)	-SY	+YAW	+WR, +SY	+SP	-Z (up), +PITCH	+WY	-Y (port), -ROLL
+Z (down)	-SP, EP	+ROLL	-WY, -WP	+EP	-Z (up), +PITCH	+WR	+YAW

$\Delta SY$	$\Delta SP$	$\Delta EP$	$\Delta WP$	$\Delta WY$	$\Delta WR$
-1.8	-1.5	+14.6	-13.5	+0.6	+1.7

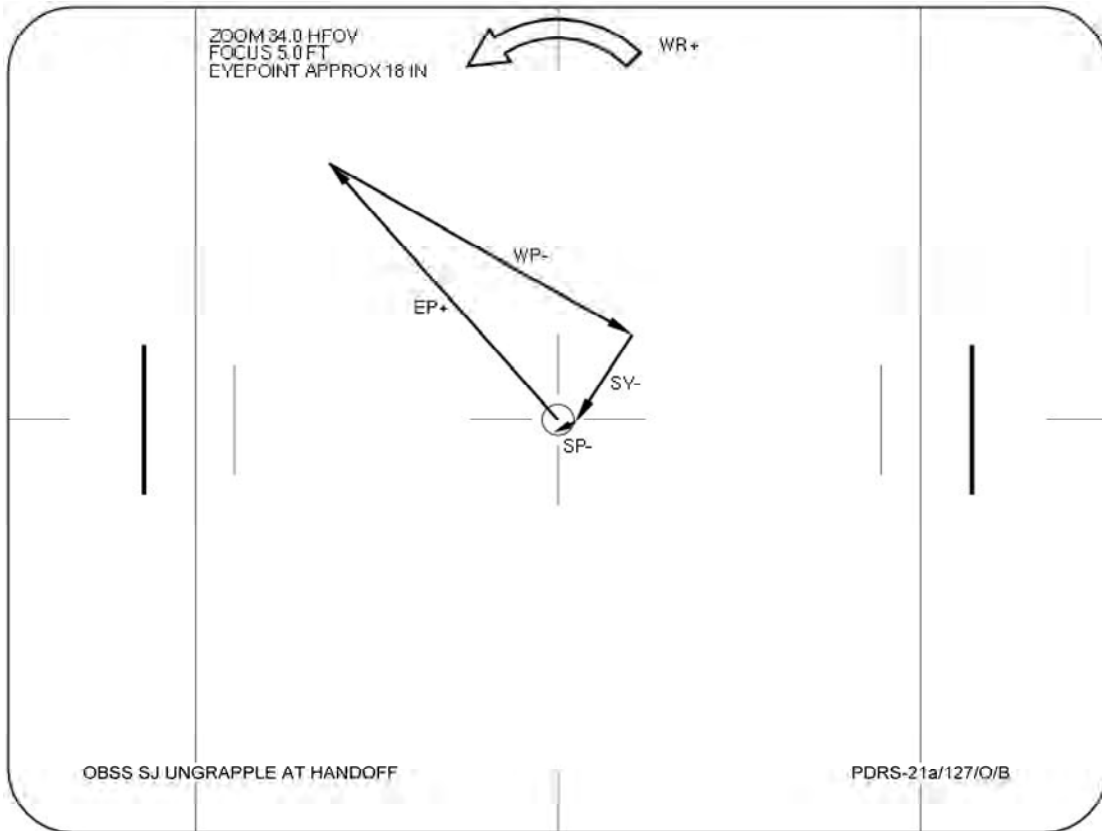

EE MAN CONTR – DERIG (hold until EXTEND tb-gray, 20 sec max)  
 MODE – OFF

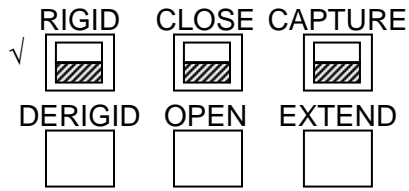

CRITICAL TIMES (20 sec total):  
 EXTEND tb – gray, 20 sec max

Mnvr to OBSS BACKOFF posn:

X	Y	Z	PITCH	YAW	ROLL	PL ID
-1018	-362	-676	284	0	270	0
SY	SP	EP	WP	WY	WR	
+24.0	+64.8	-34.4	-99.4	+11.3	-99.0	

BRAKES – ON (tb-ON)  
 MODE – not DIRECT  
 JOINT – CRIT TEMP

- \* If using Shuttle attitude control and attitude maintenance reqd: \*
- \* DAP: LVLH \*
- \* When rates damped: \*
- \* DAP: FREE > 2 sec \*
- \* DAP: AUTO \*

Notify SSRMS operator that SRMS at OBSS Backoff with Brakes ON;  
 GO for SSRMS OBSS Berth

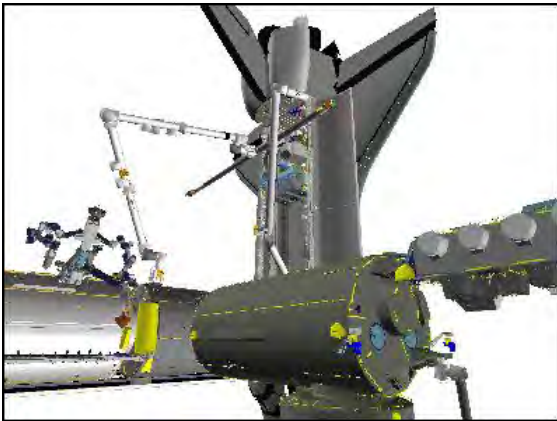

**P1 LOOB (130,20)**

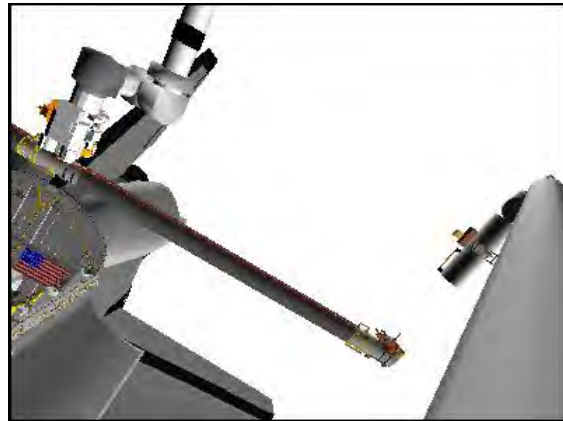

**ELBOW (-35,-10)**

4. CONFIGURE CIRCUIT BREAKERS  
 MA73C:C    cb MCA PWR AC3 3Φ MID 2 – op  
                   ✓AC2 3Φ MID 2 – op  
 MA73C:D    ✓AC3 3Φ MID 4 – op

5. CONFIGURE FOR MONITORING  
 On SSRMS notification to watch for stbd RMS RFLs,  
SM 94 PDRS CONTROL  
 RMS STBD – ITEM 2 EXEC (\*)

Notify SSRMS operator when STBD RMS R-F-L tb (three) – gray

6. STBD MRL LATCH

On SSRMS Operator GO to latch stbd MRLs to Topological Capture,  
√STBD RMS R-F-L tb (three) – gray

SM 94 PDRS CONTROL

√STBD AFT, MID, FWD LAT (six) = 0

R13L PL BAY MECH PWR SYS (two) – ON

NOTE

Expect single motor drive time for MRL latching (18 sec max).  
The following STBD RMS RETEN LAT – OFF and PL BAY  
MECH PWR SYS (two) – OFF actions are to be performed simo

Verify AOS for latching to Topological Capture

STBD RMS RETEN LAT – LAT 6 sec only (tb-bp)  
– OFF

R13L PL BAY MECH PWR SYS (two) – OFF

Give SSRMS Operator GO to Limp All SSRMS Joints and Derigidize

R13L On SSRMS Operator GO to complete stbd MRL latching,  
PL BAY MECH PWR SYS (two) – ON

STBD RMS RETEN LAT – LAT (tb-LAT) (12 sec max)  
– OFF

7. RECONFIGURE POWER

R13L PL BAY MECH PWR SYS (two) – OFF

STBD RMS HTR A,B (two) – AUTO

A6U EVENT TIMER CNTL – STOP

SM 94 PDRS CONTROL

√STBD AFT, MID, FWD LAT (six) = 1  
RMS PORT – ITEM 1 EXEC (\*)

MA73C:C cb MCA PWR AC3 3Φ MID 2 – cl

√AC2 3Φ MID 2 – op

MA73C:D √AC3 3Φ MID 4 – op

Give SSRMS Operator GO for OBSS ungrapple

This Page Intentionally Blank



JEF OFF-NOMINAL

I

SJ JEF UNBERTH CLEAR .....	FS 6-2
GRAPPLE.....	FS 6-7
HANDOFF TO SSRMS .....	FS 6-12
UNGRAPPLE .....	FS 6-17

JEF  
OFF-NOMINAL

# SJ JEF UNBERTH CLEAR

JEF  
OFF-NOMINAL

- A7U 1. SETUP  
 CCTV – perform PAN/TILT RESET on PLB cameras  
 – fully zoom out for SJ pictures

DNLK (72)	C
DTV (SSC 2)	Elbow → A
MON1 (SSC 1)	B
MON2 (71)	P1 LOOB

SM 94 PDRS CONTROL

- √PL ID, ITEM 3: 0
- √INIT ID, ITEM 24: 0

## 2. MNVR TO UNBERTH CLEAR

### NOTE

Clearance between SRMS Upper Boom and JPM is 42 inches at JEF Unberth Clear posn. Monitor with Camera A

- RHC If SINGLE mode available:  
 RATE – as reqd (VERN within 10 ft)  
 BRAKES – OFF (tb-OFF)

MODE – best available

Mnvr to JEF UNBERTH CLEAR posn:

	SY	SP	EP	WP	WY	WR	
Pre-cradle	0.0	+25.0	-25.0	+5.0	0.0	0.0	
1: WR –						-121.0	
2: WY +					+11.0		
3: WP –				-39.4			
4: SY +	+30.0						
5: SP +		+65.2					
6: EP –			-53.6				
Clear	+30.0	+65.2	-53.6	-39.4	+11.0	-121.0	
	X	Y	Z	PITCH	YAW	ROLL	PL ID
	-1061	-412	-606	316	24	254	0

- BRAKES – ON (tb-ON)
- MODE – not DIRECT (lt off)

- PARAM – PORT TEMP
- JOINT – CRIT TEMP

Start:  
Pre-cradle

Step 1:  
Drive WR- (for 121.0°)  
from 0.0 to -121.0

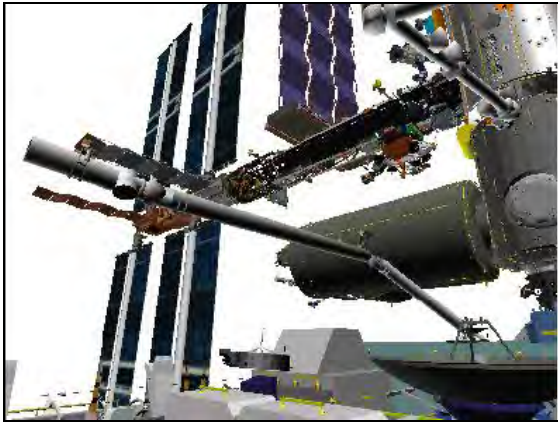

**CCTV C (-45,20)**

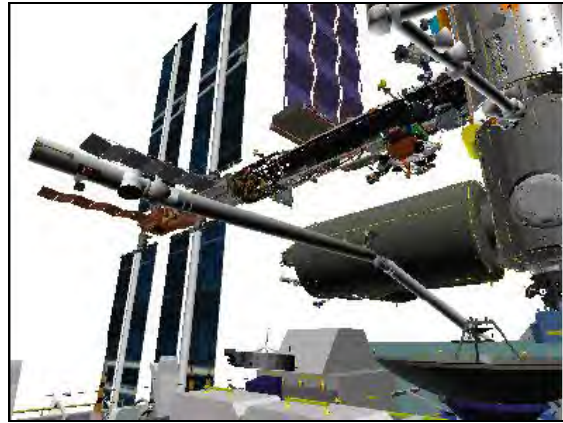

**CCTV C (-45,20)**

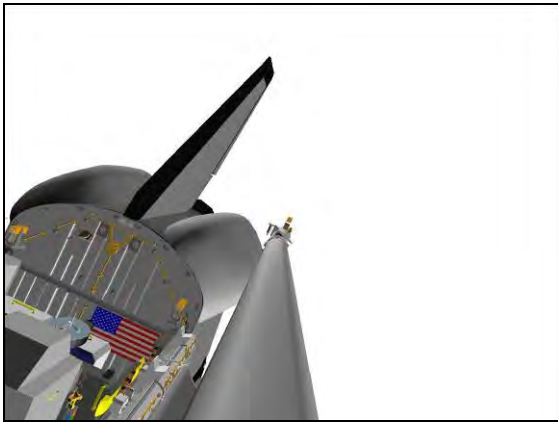

**ELBOW (0,0)**

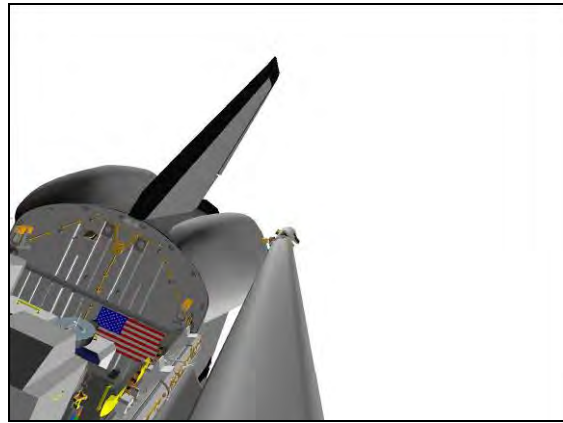

**ELBOW (0,0)**



**CCTV B (-60,50)**



**CCTV B (-60,50)**

Step 2:

Drive WY+ (for 11.0°)  
from 0.0 to +11.0

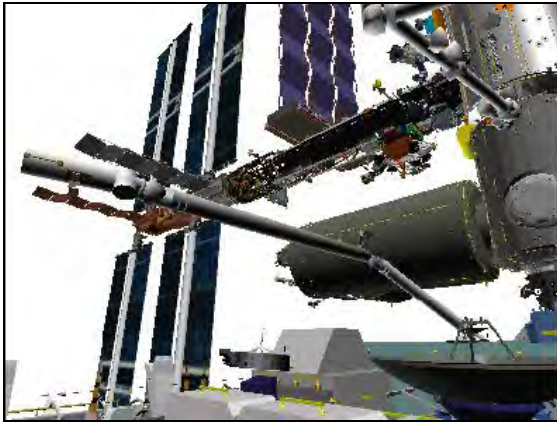

**CCTV C (-45,20)**

Step 3:

Drive WP- (for 44.4°)  
from +5.0 to -39.4

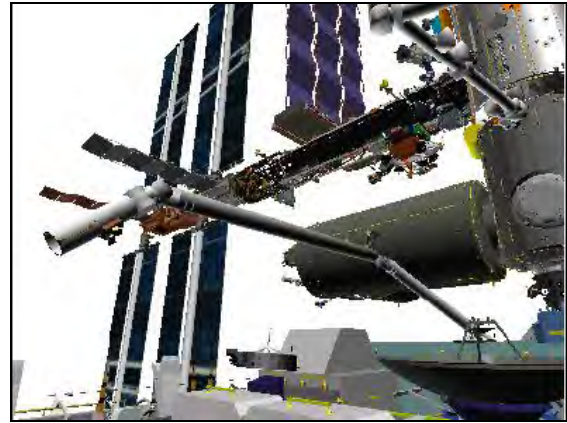

**CCTV C (-45,20)**

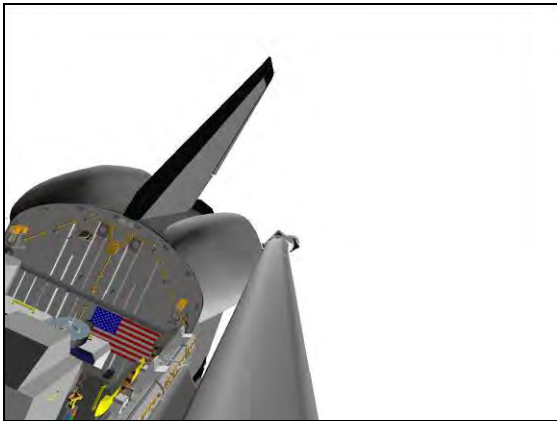

**ELBOW (0,0)**

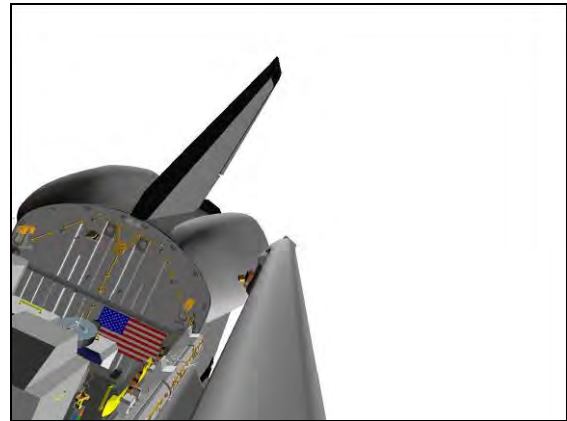

**ELBOW (0,0)**



**CCTV B (-60,50)**



**CCTV B (-60,50)**

Step 4:

Drive SY+ (for 30.0°)  
from 0.0 to +30.0

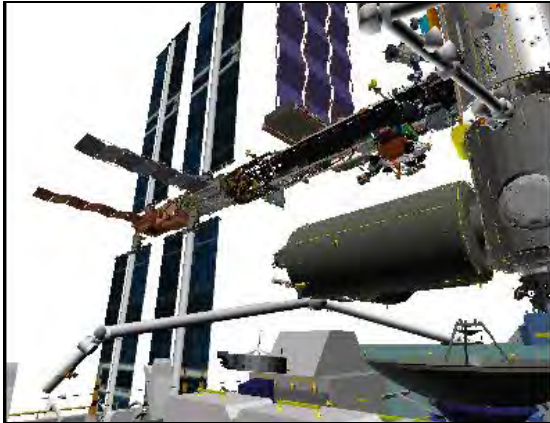

**CCTV C (-45,20)**

Step 5:

Drive SP+ (for 40.2°)  
from +25.0 to +65.2

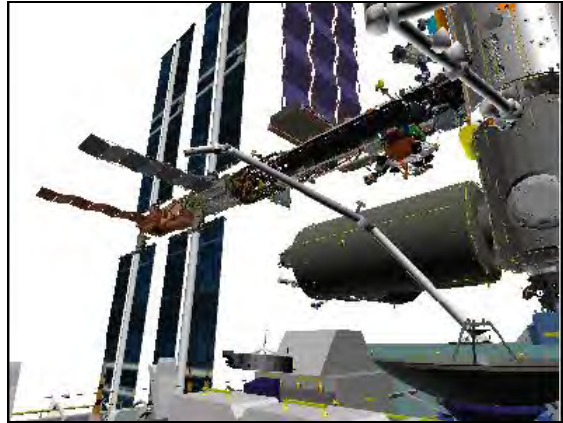

**CCTV C (-45,20)**



**CCTV A (5,30)**



**CCTV A (5,30)**



**CCTV B (-27,10)**

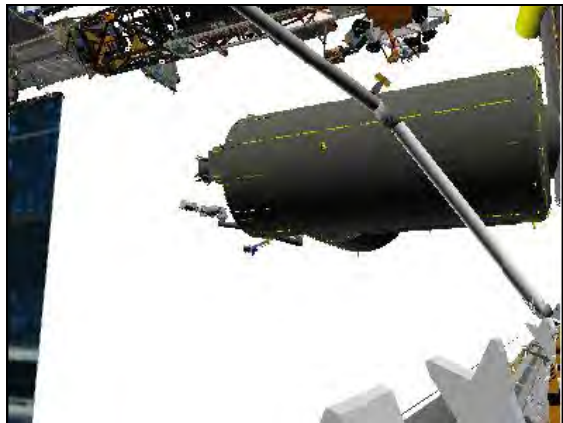

**CCTV B (-27,10)**



Step 6:

Drive EP- (for 28.6°)  
from -25.0 to -53.6

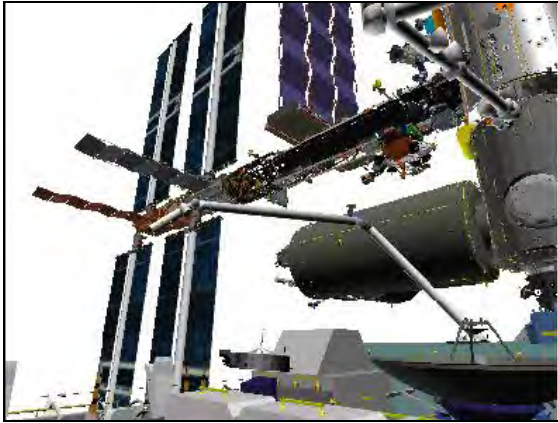

**CCTV C (-45,20)**



**CCTV A (5,30)**



**CCTV B (-27,10)**

# SJ JEF GRAPPLE

1. SETUP  
 A7U CCTV – configure for JEF grapple  
 – install JEF SJ GRAPPLE AT HANDOFF 1 WRIST CCTV OVERLAY  
 – RMS WRIST, ZOOM: 34.0 HFOV  
 FOCUS: 5 ft

Maintain eyepoint ~18 in when using grapple overlay

DNLK (72)	EE (Elbow)
DTV (SSC 2)	Base Elbow (Tip Elbow)
MON 1 (SSC 1)	A
MON 2 (71)	C

SM 94 PDRS CONTROL

- √ PL ID, ITEM 3: 0  
 √ INIT ID, ITEM 24: 0

Verify at JEF UNBERTH CLEAR posn:

X	Y	Z	PITCH	YAW	ROLL	PL ID
-1061	-412	-606	316	24	254	0
SY	SP	EP	WP	WY	WR	
+30.0	+65.2	-53.6	-39.4	+11.0	-121.0	

## 2. MNVR TO PRE-GRAPPLE

Verify SSRMS at JEF Handoff 1 posn with Brakes ON and SSRMS operator GO for SRMS JEF grapple

### NOTE

Minimum clearance between EE and JEM Small Fine Arm Stowage Equipment (SSE) is 35 inches during maneuver to Pre-grapple and increases to 44 inches at Pre-grapple. Monitor with SSRMS Base Elbow Camera.

Clearance between SRMS Upper Boom and JPM is 42 inches at JEF Unberth Clear and increases to 46 inches at Pre-grapple. Monitor with Camera A

- RHC If SINGLE mode available:  
 RATE – VERN (RATE MIN tb-ON)  
 BRAKES – OFF (tb-OFF)

MODE – best available

Mnvr to JEF PRE-GRAPPLE posn:

SY	SP	EP	WP	WY	WR	
+30.0	+65.2	-53.6	-39.4	+11.0	-121.0	
+12.0						
+12.0	+65.2	-53.6	-39.4	+11.0	-121.0	
X	Y	Z	PITCH	YAW	ROLL	PL ID
-1114	-290	-649	326	11	243	0

Clear  
 1: SY –  
 Pre-Grapple

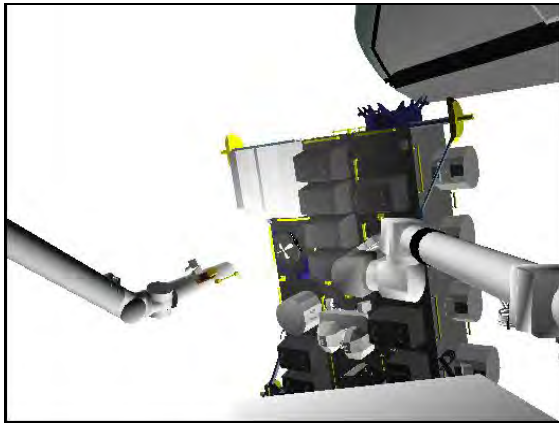

**BASE ELBOW (105,-5)**



**CCTV A (30,35)**

3. SJ MNVR TO JEF GRAPPLE

NOTE

Clearance between RSC and SSE is 14 inches at grapple posn.  
Monitor with Base Elbow Camera

RHC

√RATE – VERN (RATE MIN tb-ON)  
MODE – best available

Drive joints per JEF SJ GRAPPLE AT HANDOFF 1 WRIST CCTV OVERLAY  
and histogram until EE within grapple envelope



### JEF SJ GRAPPLE AT HANDOFF 1

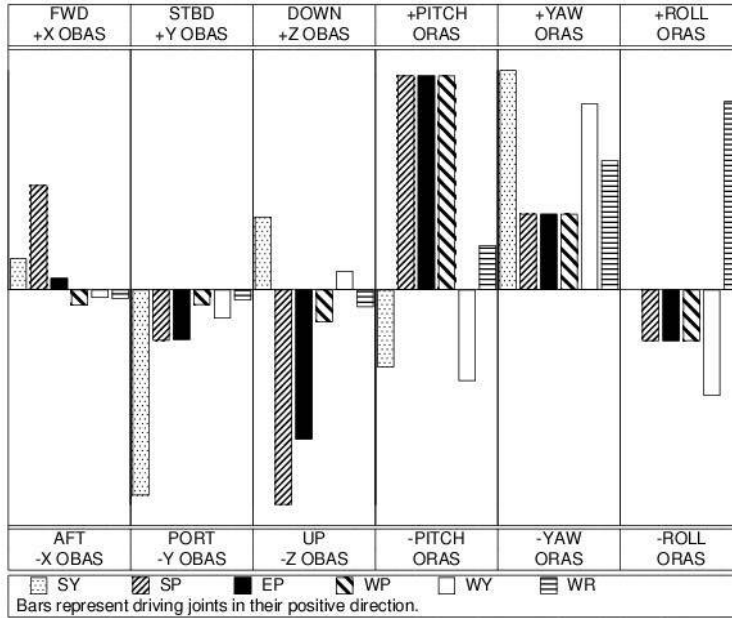

To get:	Drive:	To get:	Drive:
+X (fwd)	+SP	+PITCH	+WP, +EP
+Y (stbd)	-SY	+YAW	+WY, +SY
+Z (down)	-SP, -EP	+ROLL	+WR, -WY

Driving:	Results In:	Driving:	Results In:
+SY	-Y (port), +YAW	+WP	-Z (up), +PITCH
+SP	-Z (up), +PITCH	+WY	-Y (port), +YAW
+EP	-Z (up), +PITCH	+WR	-Z (up), +ROLL

$\Delta SY$	$\Delta SP$	$\Delta EP$	$\Delta WP$	$\Delta WY$	$\Delta WR$
+1.4	-14.9	+16.5	-1.7	-1.4	-0.5

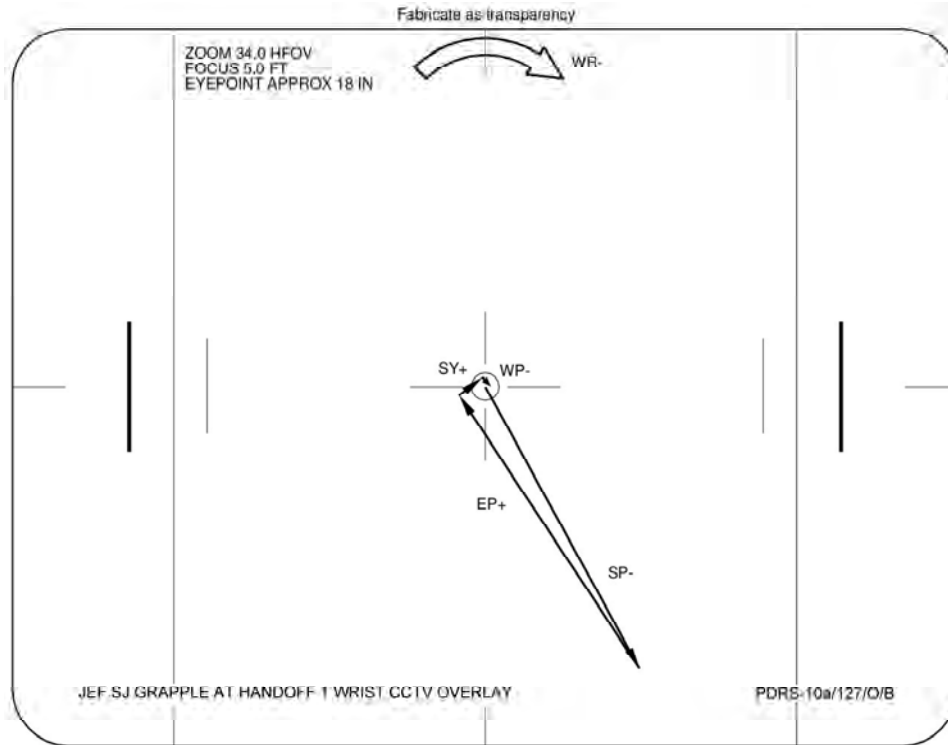

4. JEF GRAPPLE

**CAUTION**  
Monitor EE tb timing to prevent EE motor burnout

**SM 169 PDRS STATUS**

EE MODE – AUTO

CAPTURE sw – depress (mom)

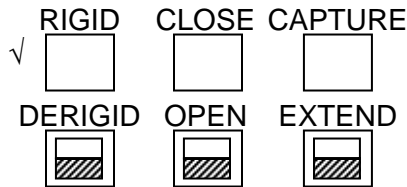

CRITICAL TIMES (28 sec total):

CAPTURE tb – gray, then  
CLOSE tb – gray, 3 sec max, then  
RIGID tb – gray, 25 sec max

- \* If manual grapple reqd: \*
- \* EE MODE – MAN \*
- \* CAPTURE sw – depress (hold until CLOSE tb-gray, 3 sec max) \*
- \* MAN CONTR – RIGID (hold until RIGID tb-gray, 25 sec max) \*
- \* MODE – OFF \*

EE MODE – OFF

If SINGLE mode available:

MODE – TEST, ENTER

Wait 5 sec

BRAKES – ON (tb-ON)

MODE – not DIRECT (lt off)

**SM 94 PDRS CONTROL**

PL ID – ITEM 3 +3 EXEC

INIT ID – ITEM 24 +3 EXEC

Expected JEF HANDOFF 1 posn:

	X	Y	Z	PITCH	YAW	ROLL	PL ID
√	-1187	-258	-628	236	357	191	3
	SY	SP	EP	WP	WY	WR	
√	+13.4	+50.3	-37.1	-41.1	+9.6	-121.5	

Notify SSRMS operator JEF grapple complete with SRMS Brakes ON;  
SSRMS GO for JEF ungrapple

Review GENERIC END EFFECTOR CUE CARD – ISS/SHUTTLE DOCKED OPS

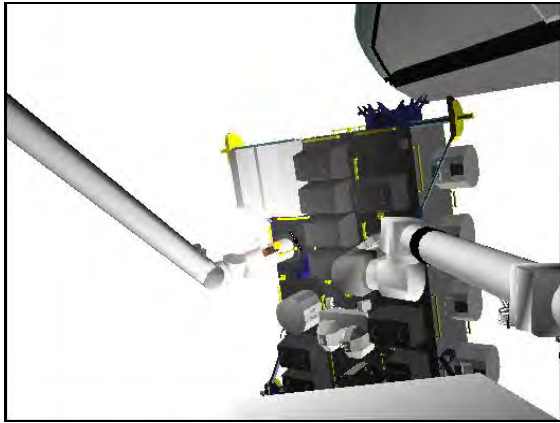

**BASE ELBOW (105,-5)**

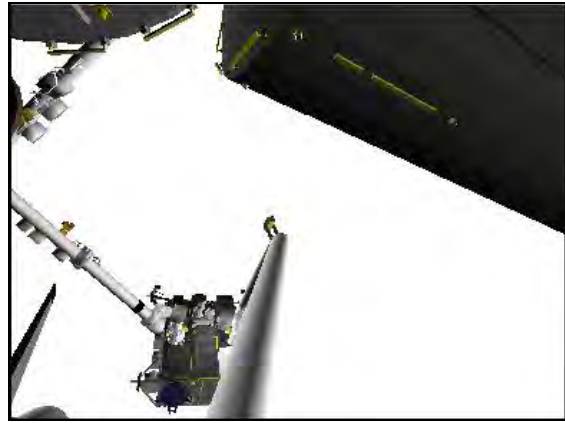

**CCTV A (30,35)**



**CCTV C (-60,30)**

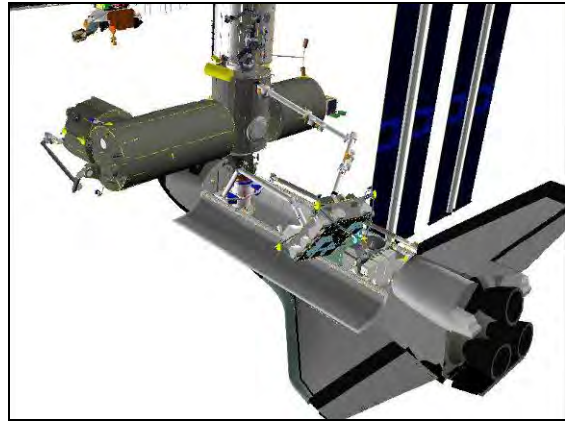

**BIRD'S EYE**

# SJ JEF HANDOFF TO SSRMS

## 1. SETUP

Verify JEMRMS at JEF INSTALL VIEWING:

SY	SP	EP	WP	WY	WR
-66.0	+133.3	-99.8	-123.5	0.0	+66.0

A7U

CCTV – fully zoom out for SJ pictures

DNLK (72)	Elbow
DTV (SSC 2)	B
MON 1 (SSC 1)	A
MON 2 (71)	P1 LOOB (JEF EXT-FWD)

SM 94 PDRS CONTROL

√PL ID, ITEM 3: 3

√INIT ID, ITEM 24: 3

## 2. SJ MNVR TO HANDOFF

Verify SSRMS grappled to PDGF 3 with Brakes ON and SSRMS operator GO for SRMS mnvr to JEF Handoff 2

RHC

If SINGLE mode available:

RATE – as reqd (VERN within 10 ft)

BRAKES – OFF (tb-OFF)

MODE – best available

Mnvr to HANDOFF 2 posn:

	SY	SP	EP	WP	WY	WR	
Handoff 1	+13.4	+50.3	-37.1	-41.1	+9.6	-121.5	
1: SY +	+45.0						
2: WR +						+16.2	
3: WY +					+56.0		
4: WP +				+11.9			
5: EP –			-53.9				
6: SP –		+20.3					
7: SY +	+146.0						
Handoff 2	+146.0	+20.3	-53.9	+11.9	+56.0	+16.2	
	X	Y	Z	PITCH	YAW	ROLL	PL ID
	-224	-300	-329	204	62	73	3

BRAKES – ON (tb-ON)

MODE – not DIRECT (lt off)

- \* If using Shuttle attitude control and attitude maintenance reqd: \*
- \* DAP: LVLH \*
- \* When rates damped: \*
- \* DAP: FREE > 2 sec \*
- \* DAP: AUTO \*
- \* When in attitude and rates damped: \*
- \* DAP: FREE \*

Notify SSRMS operator that SRMS at JEF Handoff 2 posn with Brakes ON;  
GO for SSRMS Node 2 ungrapple and JEF grapple

Start:  
Handoff 1

Step 1:  
Drive SY+ (for 31.6°)  
from +13.4 to +45.0

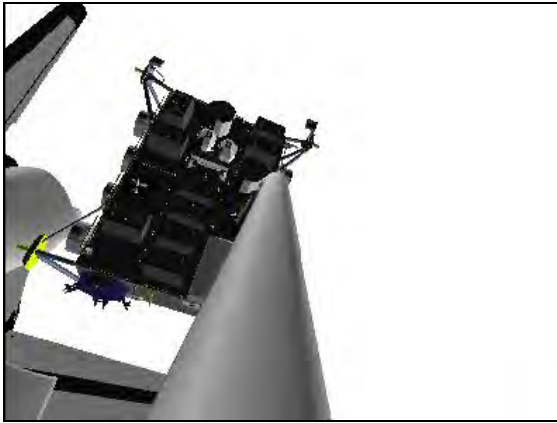

**ELBOW (0,-10)**

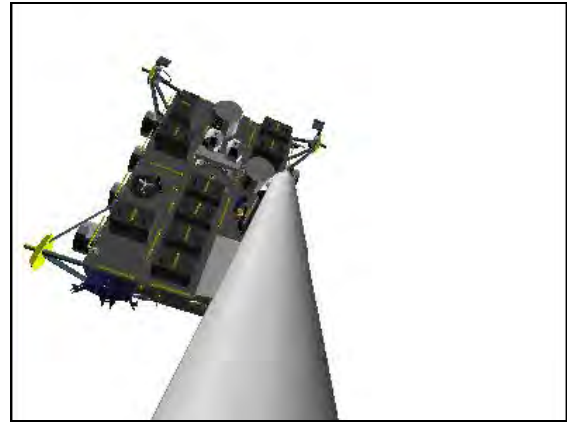

**ELBOW (0,-10)**

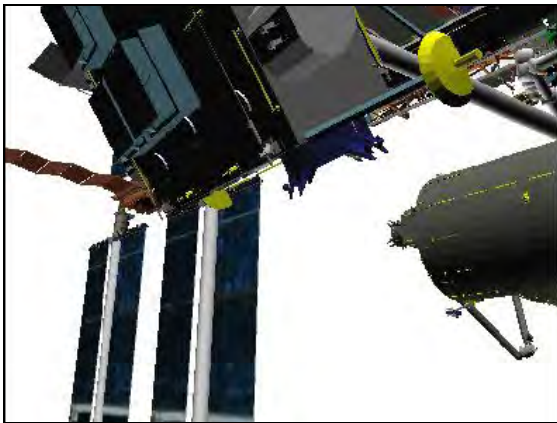

**CCTV B (-48,17)**

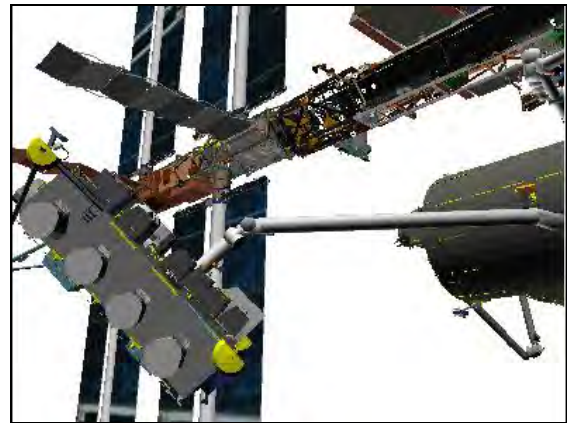

**CCTV B (-48,17)**

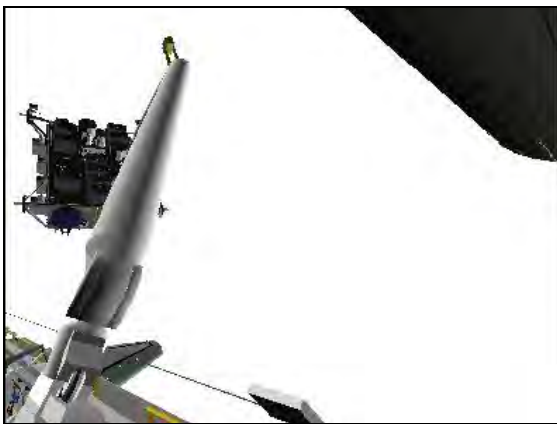

**CCTV A (45,10)**

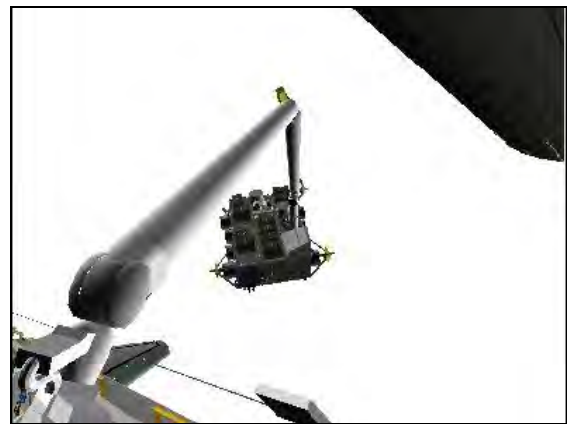

**CCTV A (45,10)**

Step 2:

Drive WR+ (for 137.7°)  
from -121.5 to +16.2

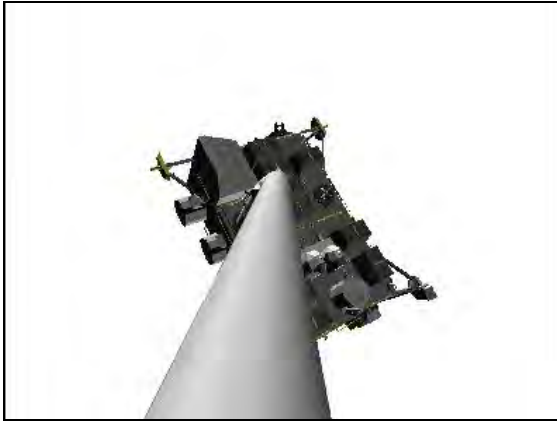

**ELBOW (0,-10)**

Step 3:

Drive WY+ (for 46.4°)  
from +9.6 to +56.0

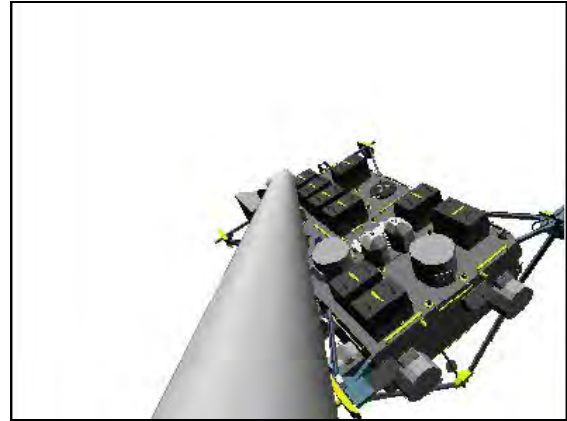

**ELBOW (0,-10)**



**CCTV B (-48,17)**



**CCTV B (-48,17)**

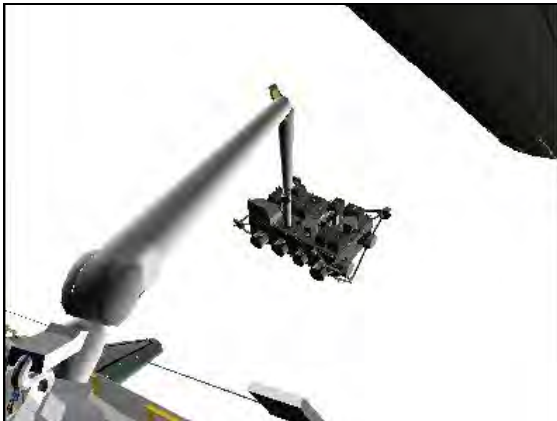

**CCTV A (45,10)**



**CCTV A (45,10)**



Step 4:

Drive WP+ (for 53.0°)  
from -41.1 to +11.9

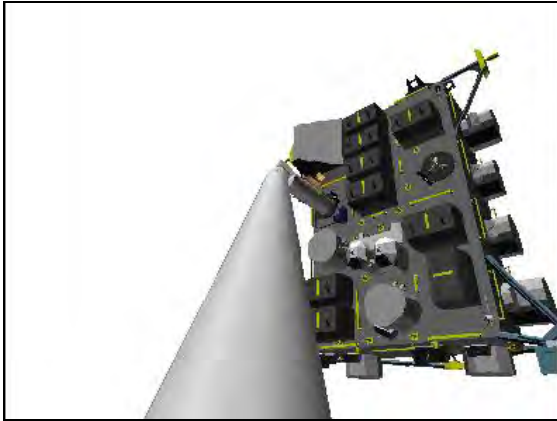

**ELBOW (0,-10)**

Step 5:

Drive EP- (for 16.8°)  
from -37.1 to -53.9

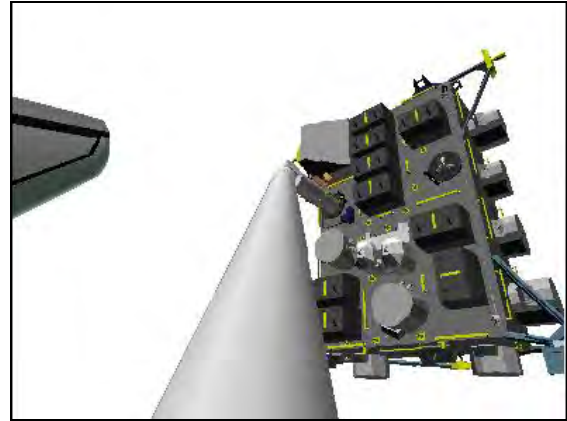

**ELBOW (0,-10)**

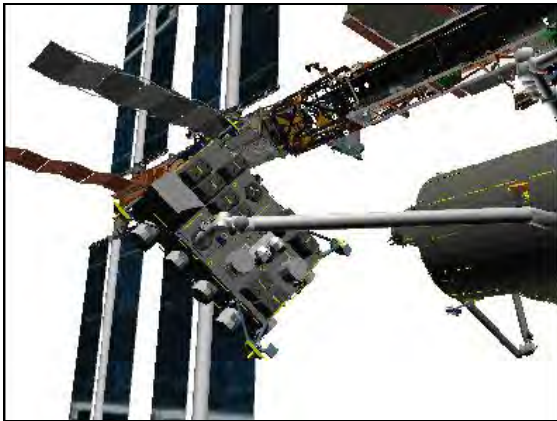

**CCTV B (-48,17)**



**CCTV B (-48,17)**

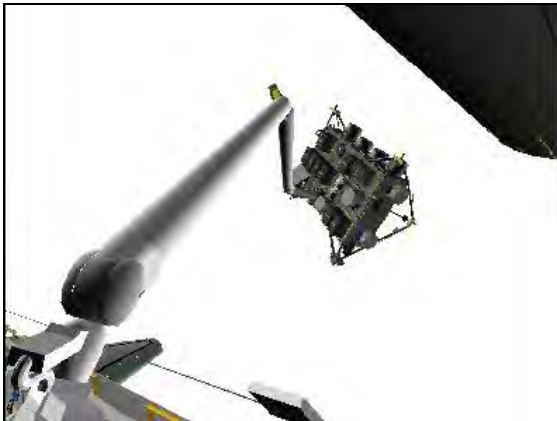

**CCTV A (45,10)**

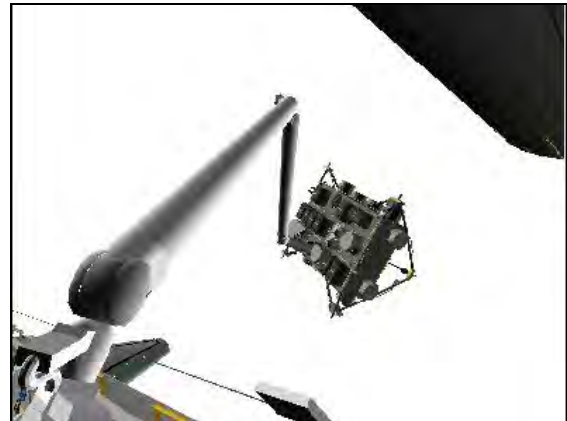

**CCTV A (45,10)**

Step 6:

Drive SP- (for 30.0°)  
from +50.3 to +20.3

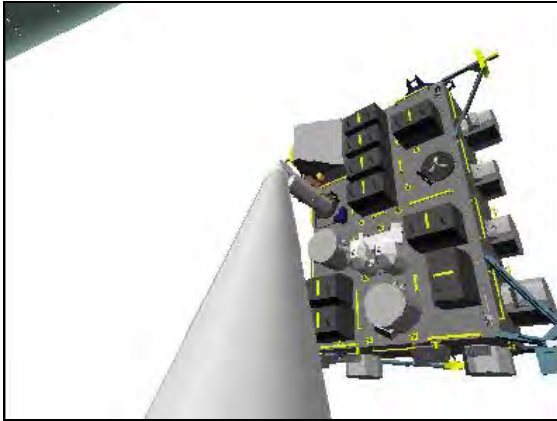

**ELBOW (0,-10)**

Step 7:

Drive SY+ (for 101.0°)  
from +45.0 to +146.0

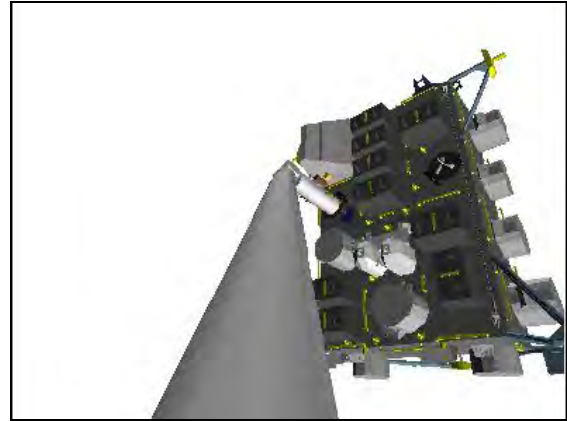

**ELBOW (0,-10)**



**CCTV B (-25,-7)**

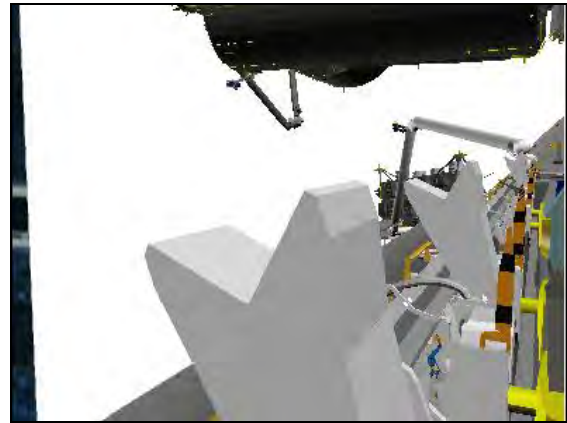

**CCTV B (-25,-7)**



**CCTV A (50,5)**

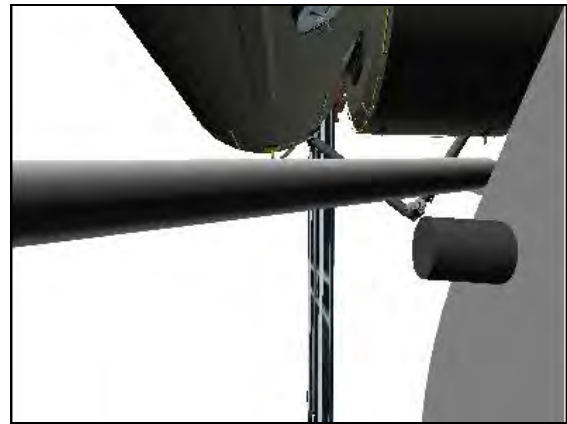

**CCTV A (90,5)**



## SJ JEF UNGRAPPLE

- A7U 1. SETUP  
 CCTV – configure for JEF grapple  
 – install JEF SJ UNGRAPPLE AT HANDOFF 2 WRIST CCTV OVERLAY  
 – RMS WRIST, ZOOM: 34.0 HFOV  
 FOCUS: 5 ft

DNLK (72)	EE (Elbow)
DTV (SSC 2)	B (C)
MON 1 (SSC 1)	A (D)
MON 2 (71)	JEM EXT-FWD (JEM RMS Elbow)

SM 94 PDRS CONTROL  
 PL ID – ITEM 3 +0 EXEC  
 INIT ID – ITEM 24 +0 EXEC

Verify at HANDOFF 2 posn:

	X	Y	Z	PITCH	YAW	ROLL	PL ID
√	-224	-316	-280	184	334	142	0
	SY	SP	EP	WP	WY	WR	
√	+146.0	+20.3	-53.9	+11.9	+56.0	+16.2	

2. JEF UNGRAPPLE  
 Verify SSRMS grapple complete with brakes ON and SSRMS operator GO for SRMS JEF ungrapple

### NOTE

Clearance between RSC and SSE is 15 inches when grappled. Monitor with JEM Ext-Fwd Camera.

Minimum clearance between SRMS Upper Boom and JPM is 57 inches at Backoff posn. Monitor with Camera B or JEM Ext-Fwd Camera

If SINGLE mode available:

NOTE

CONTRL ERR It and 'S96 PDRS CNTL' msg may occur due to Consistency/Envelope Check error

RATE – COARSE (RATE MIN tb-OFF)

SM 94 PDRS CONTROL

AUTO BRAKE INH – ITEM 10 EXEC (\*)

BRAKES – OFF (tb-OFF)

MODE – TEST, ENTER

Wait 5 sec

BRAKES – ON (tb-ON)

SM 94 PDRS CONTROL

AUTO BRAKE ENA – ITEM 9 EXEC (\*)

RHC

RATE – VERN (RATE MIN tb-ON)

BRAKES – OFF (tb-OFF)

MODE – best available

EE MODE – MAN

MAN CONTR – DERIGID (hold until DERIGID tb-gray, 5 sec max)

RELEASE sw – depress (hold until OPEN tb-gray, 3 sec max)

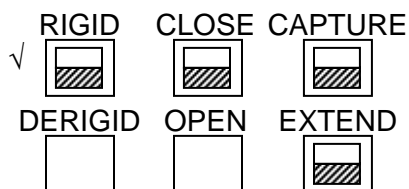

CRITICAL TIMES (28 sec total):

DERIGID tb – gray, 5 sec max, then

OPEN tb – gray, 3 sec max, then

3. MNVR CLEAR OF JEF

Drive joints per JEF SJ UNGRAPPLE AT HANDOFF 2 WRIST CCTV OVERLAY and histogram until EE clear of JEF

### JEF SJ UNGRAPPLE AT HANDOFF 2

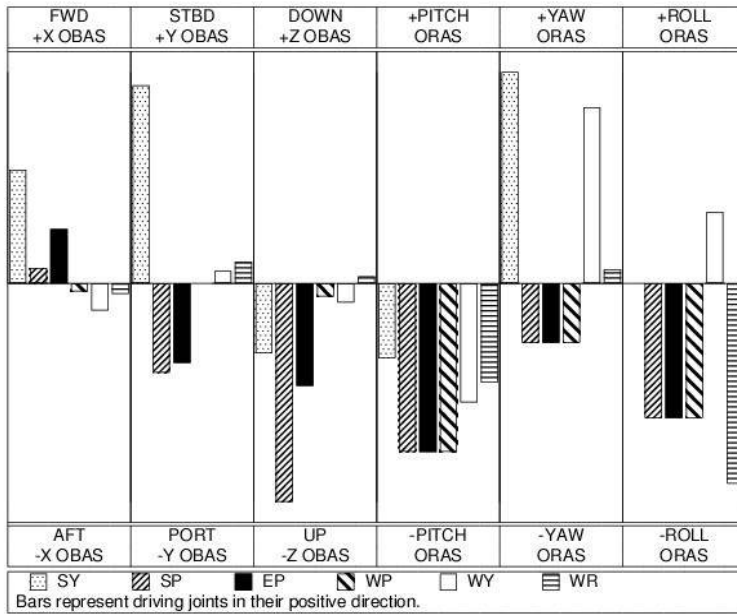

<b>To get:</b>	<b>Drive:</b>	<b>To get:</b>	<b>Drive:</b>	<b>Driving:</b>	<b>Results In:</b>	<b>Driving:</b>	<b>Results In:</b>
+X (fwd)	+SY, +EP	+PITCH	-WP, -EP	+SY	+Y (stbd), +YAW	+WP	-Z (up), -PITCH
+Y (stbd)	+SY, -EP	+YAW	+WY, +SY	+SP	-Z (up), -PITCH	+WY	-X (aft), +YAW
+Z (down)	-SP, -EP	+ROLL	-WR, -WP	+EP	-Z (up), -PITCH	+WR	+Y (stbd), -ROLL

$\Delta SY$	$\Delta SP$	$\Delta EP$	$\Delta WP$	$\Delta WY$	$\Delta WR$
-6.2	+8.3	-13.2	+0.8	+5.7	+4.8

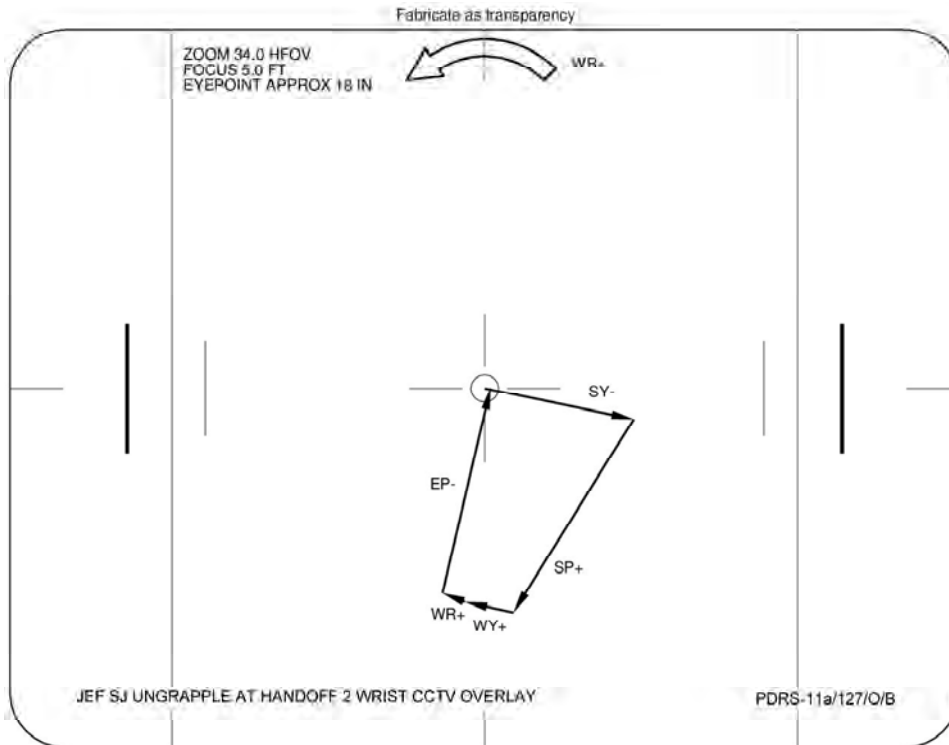

EE MAN CONTR – DERIGID (hold until EXTEND tb-gray, 20 sec max)  
 MODE – OFF

✓	RIGID <input checked="" type="checkbox"/>	CLOSE <input checked="" type="checkbox"/>	CAPTURE <input checked="" type="checkbox"/>
	DERIGID <input type="checkbox"/>	OPEN <input type="checkbox"/>	EXTEND <input type="checkbox"/>

CRITICAL TIMES (20 sec total):  
 EXTEND tb – gray, 20 sec max

Mnvr to JEF HANDOFF 2 BACKOFF posn:

X	Y	Z	PITCH	YAW	ROLL	PL ID
-278	-343	-284	184	334	142	0
SY	SP	EP	WP	WY	WR	
+139.8	+28.6	-67.1	+12.7	+61.7	+20.1	

BRAKES – ON (tb-ON)  
 MODE – not DIRECT (lt off)

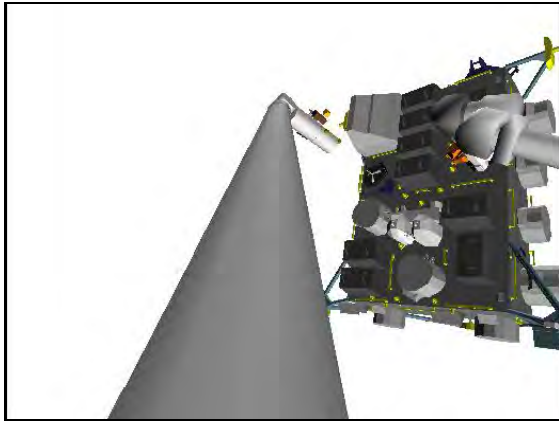

**ELBOW (0,-20)**

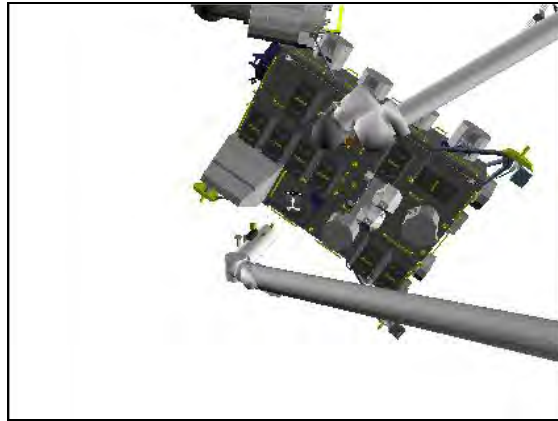

**JEM EXT-FWD (125,50)**

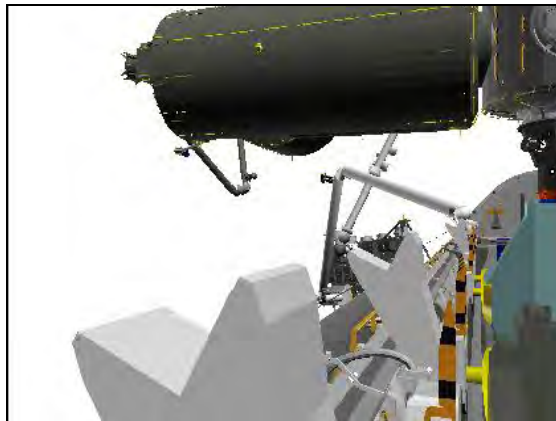

**CCTV B (-20,0)**

- A7U 4. MNVR TO JEF INSTALL VIEWING  
CCTV – fully zoom out for SJ pictures

DNLK (72)	Elbow → RSC
DTV (SSC 2)	B
MON 1 (SSC 1)	A
MON 2 (71)	JEM EXT-FWD

- RHC If SINGLE mode available:  
RATE – as reqd (VERN within 10 ft)  
BRAKES – OFF (tb-OFF)

MODE – best available

Mnvr to JEF INSTALL VIEWING posn:

	SY	SP	EP	WP	WY	WR	
Backoff	+139.8	+28.6	-67.1	+12.7	+61.7	+20.1	
1: SY –	+89.0						
2: WY –					0.0		
3: WP +				+58.0			
4: EP –			-82.0				
5: SP +		+36.0					
Viewing	+89.0	+36.0	-82.0	+58.0	0.0	+20.1	
	X	Y	Z	PITCH	YAW	ROLL	PL ID
	-688	-545	-250	278	83	83	0

\*Approaching display singularity

BRAKES – ON (tb-ON)  
MODE – not DIRECT

PARAM – PORT TEMP  
JOINT – CRIT TEMP

Notify SSRMS operator that SRMS at JEF Install Viewing posn with Brakes ON;  
GO for SSRMS mnvr to JEF Pre-install

Start:  
JEF Handoff 2 Backoff

Step 1:  
Drive SY- (for 50.8°)  
from +139.8 to +89.0

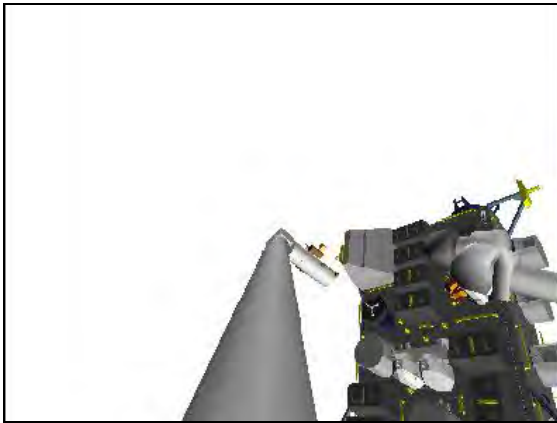

**ELBOW (0,0)**



**ELBOW (0,0)**

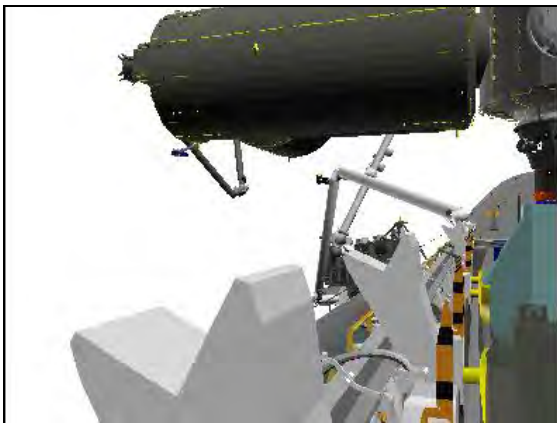

**CCTV B (-20,0)**

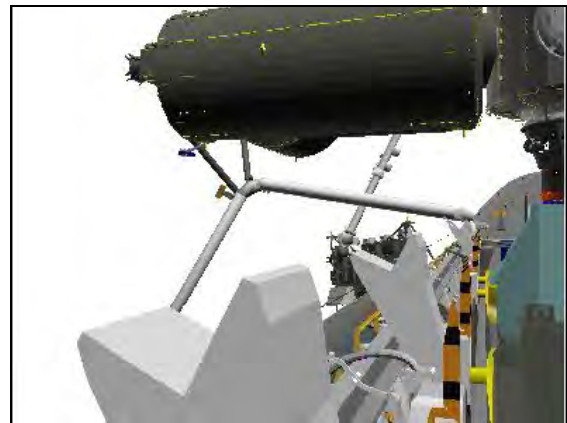

**CCTV B (-20,0)**

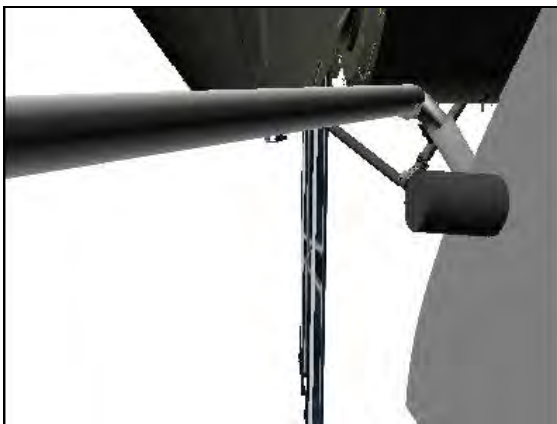

**CCTV A (90,0)**



**CCTV A (90,0)**

Step 2:

Drive WY- (for 61.7°)  
from +61.7 to 0.0



**ELBOW (0,0)**

Step 3:

Drive WP+ (for 45.3°)  
from +12.7 to +58.0



**ELBOW (0,0)**

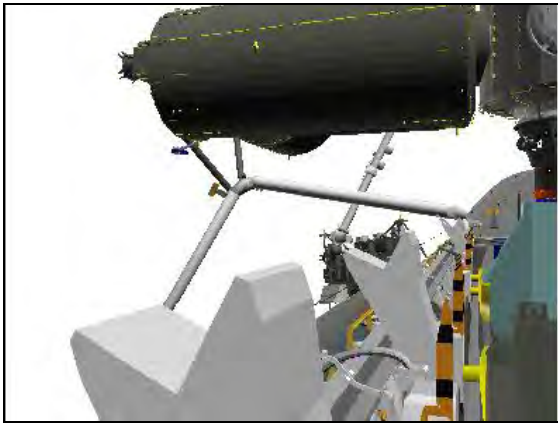

**CCTV B (-20,0)**

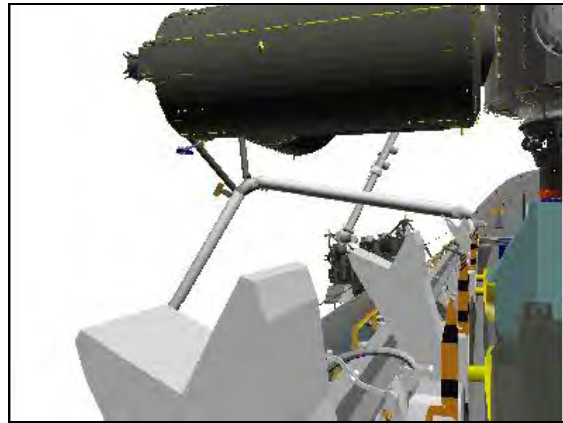

**CCTV B (-20,0)**



**CCTV A (90,0)**



**CCTV A (90,0)**

Step 4:

Drive EP- (for 20.3°)  
from -67.1 to -82.0



RSC

Step 5:

Drive SP+ (for 7.4°)  
from +28.6 to +36.0

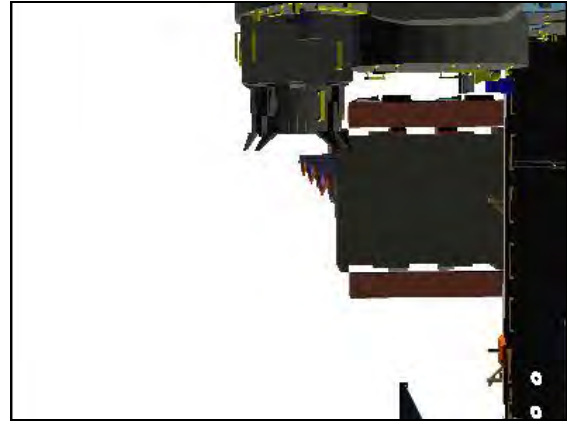

RSC

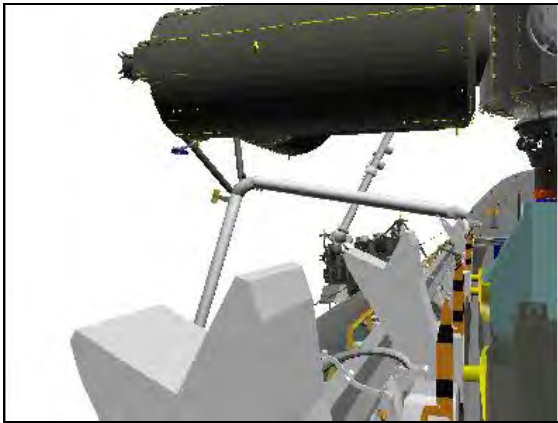

CCTV B (-20,0)

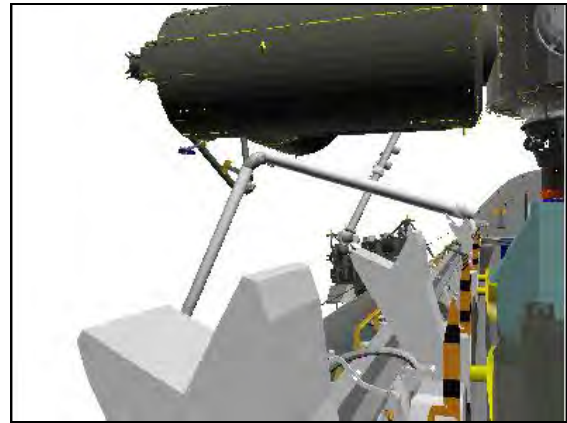

CCTV B (-20,0)



CCTV A (90,0)

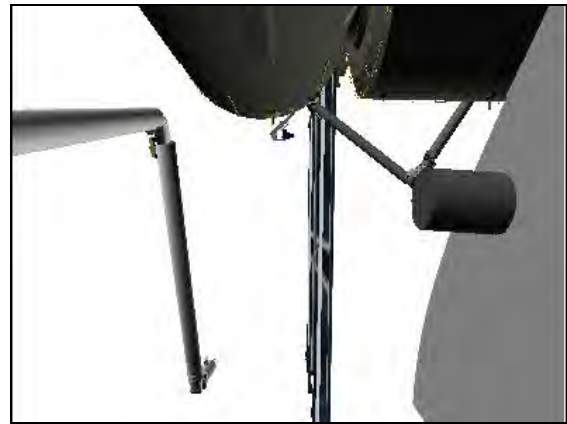

CCTV A (90,0)



5. CONFIGURE CAMERAS FOR VIEWING

Configure cameras as shown for JEF install viewing support

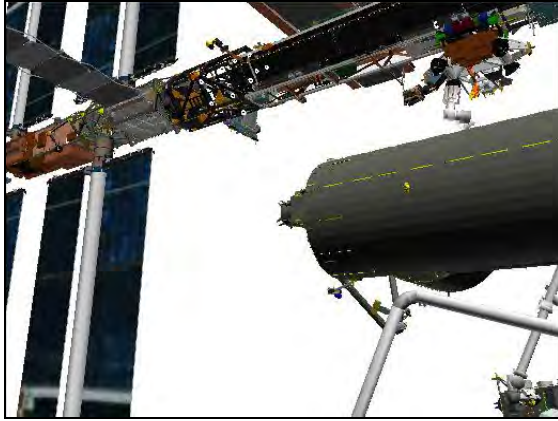

**CCTV B (-36,15)**

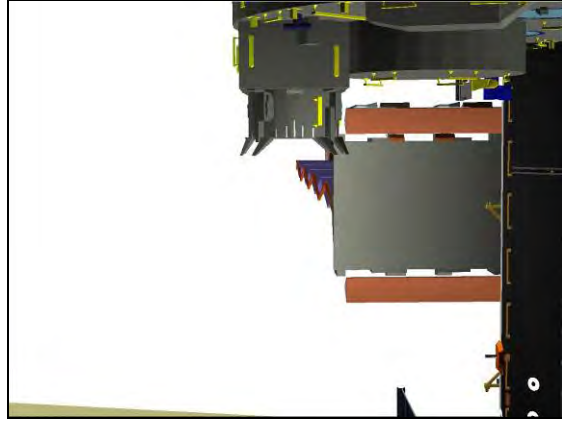

**RSC**

This Page Intentionally Blank

ICC OFF-NOMINAL

I

SJ ICC GRAPPLE IN PLB .....	FS 7-2
UNBERTH .....	FS 7-11
HANDOFF TO SSRMS .....	FS 7-17
UNGRAPPLE .....	FS 7-22
GRAPPLE FROM SSRMS .....	FS 7-25
BERTH IN PLB .....	FS 7-29

ICC  
OFF-NOMINAL

# SJ ICC GRAPPLE IN PLB

## 1. SETUP

**CAUTION**  
Aft Payload Bay Flood Lights must be OFF until ICC at Hover posn

A7U CCTV – perform PAN/TILT RESET on PLB cameras  
– fully zoom out for SJ pictures

DNLK (72)	Elbow (EE)
DTV (SSC 2)	C
MON 1 (SSC 1)	A
MON 2 (71)	P1 LOOB (JEM EXT-FWD)

SM 94 PDRS CONTROL

√PL ID, ITEM 3: 0  
√INIT ID, ITEM 24: 0

## 2. MNVR TO PRE-GRAPPLE

### NOTE

If Focused Inspection performed, SSRMS is on Node 2 PDGF at MBS PDGF 3 Pre-grapple posn. Otherwise, SSRMS is on MBS PDGF 3 at MT Translate Stow posn.

Assumed SRMS starting posn is Pre-cradle, but SJ sequence also valid if starting from OBSS Backoff posn

Verify SSRMS posn and SSRMS operator GO for ICC Unberth

RHC If SINGLE mode available:  
RATE – as reqd (VERN within 10 ft)  
BRAKES – OFF (tb-OFF)

MODE – best available

Mnvr to ICC PRE-GRAPPLE posn:

	SY	SP	EP	WP	WY	WR	
Pre-cradle	0.0	+25.0	-25.0	+5.0	0.0	0.0	
1: SY –	-11.4						
2: SP +		+31.5					
3: WR –						-128.7	
4: WY +					+20.0		
5: WP –				-83.2			
6: EP –			-37.1				
Pre-grapple	-11.4	+31.5	-37.1	-83.2	+20.0	-128.7	
	X	Y	Z	PITCH	YAW	ROLL	PL ID
	-1169	-45	-504	275	0	202	0

BRAKES – ON (tb-ON)  
MODE – not DIRECT (lt off)

ICC OFF-NOMINAL

Start:  
Pre-cradle

Step 1:  
Drive SY- (for 11.4°)  
from 0.0 to -11.4

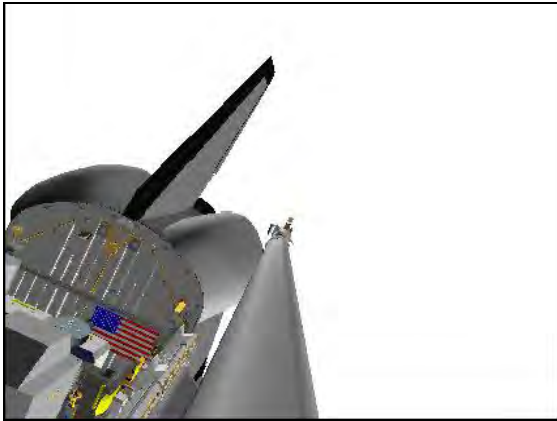

**ELBOW (0,0)**

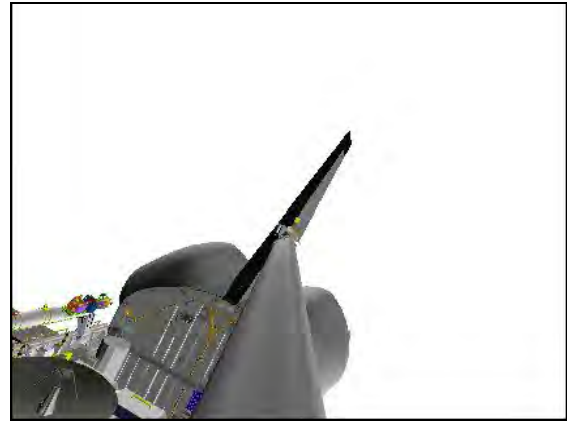

**ELBOW (0,0)**

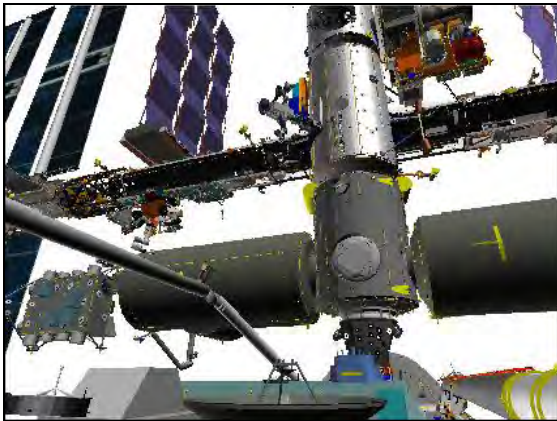

**CCTV C (-20,25)**

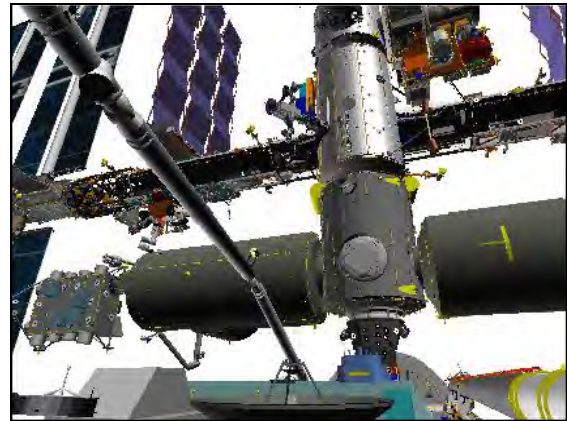

**CCTV C (-20,25)**



**CCTV A (0,0)**

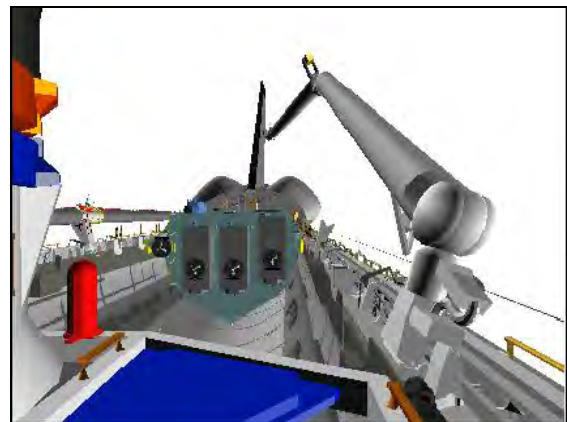

**CCTV A (0,0)**

Step 2:

Drive SP+ (for 6.5°)  
from +25.0 to +31.5



**ELBOW (0,0)**

Step 3:

Drive WR- (for 128.7°)  
from 0.0 to -128.7

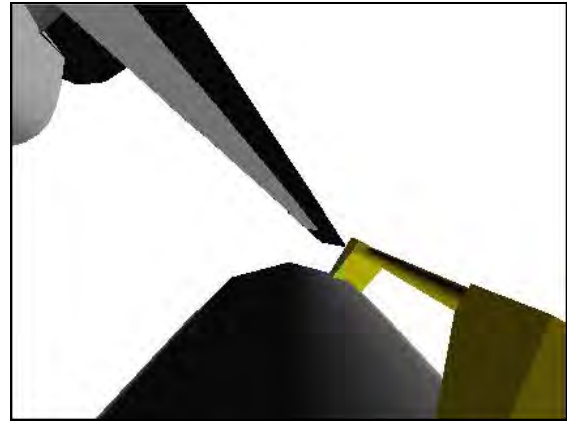

**EE**

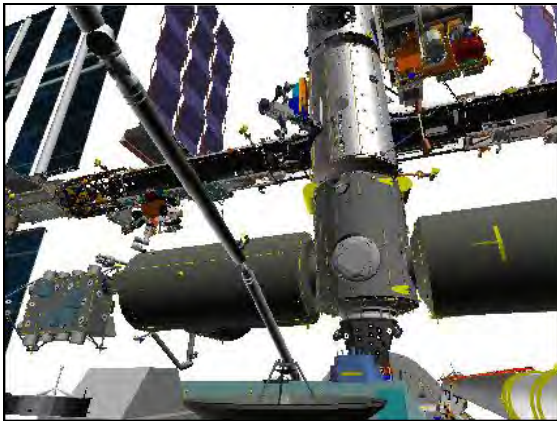

**CCTV C (-20,25)**

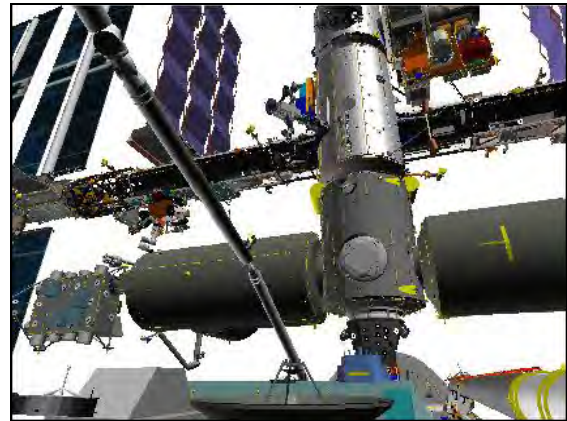

**CCTV C (-20,25)**



**CCTV A (0,0)**

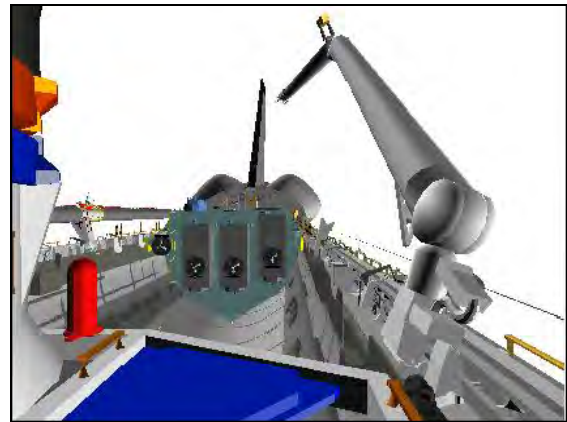

**CCTV A (0,0)**

Step 4:

Drive WY+ (for 20.0°)  
from 0.0 to +20.0

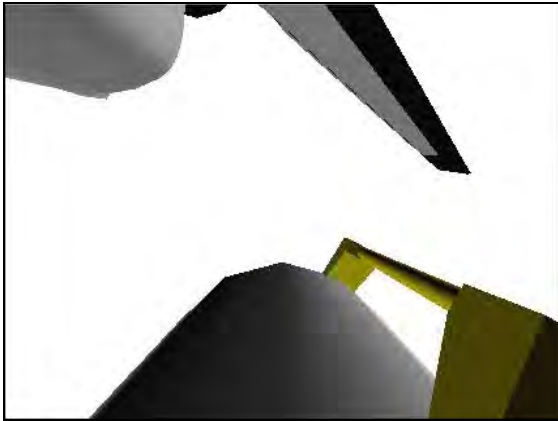

EE

Step 5:

Drive WP- (for 88.2°)  
from +5.0 to -83.2

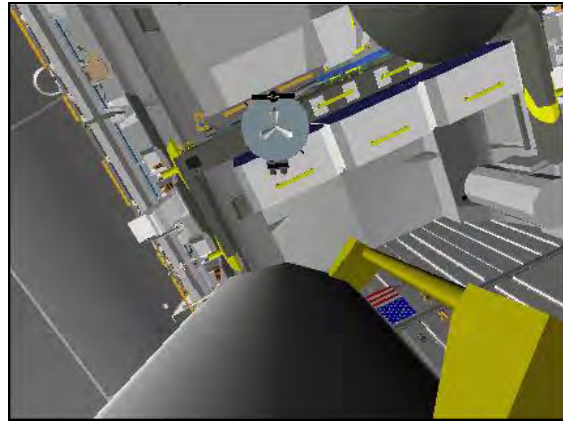

EE

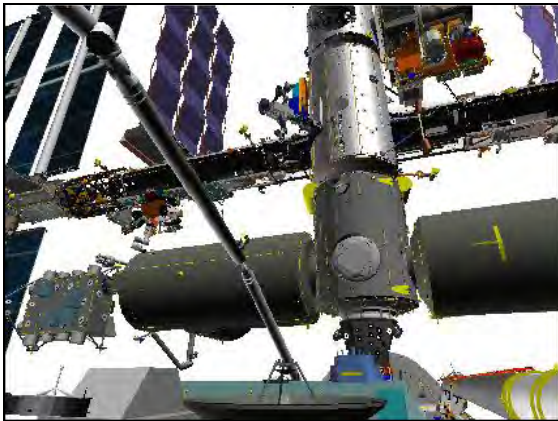

CCTV C (-20,25)

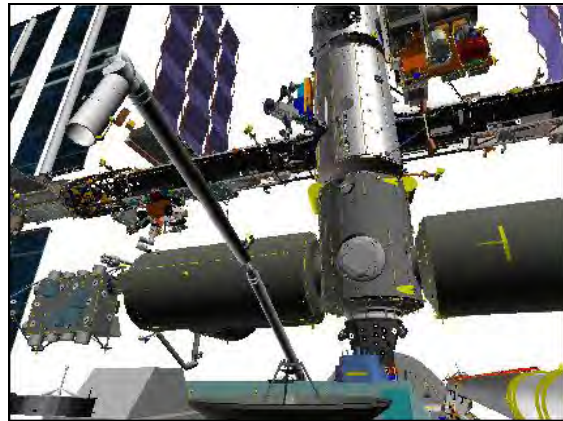

CCTV C (-20,25)



CCTV A (0,0)

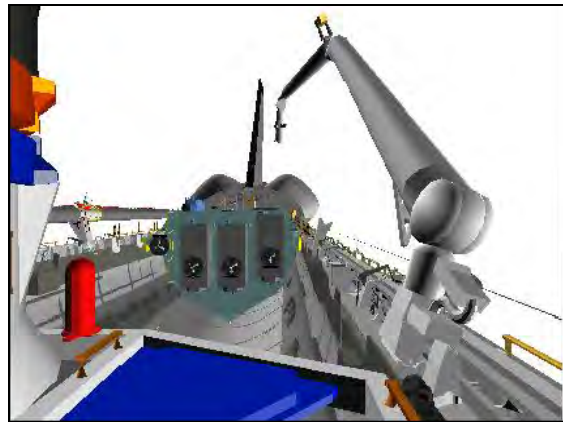

CCTV A (0,0)



Step 6:

Drive EP- (for 12.1°)  
from -25.0 to -37.1



**EE**

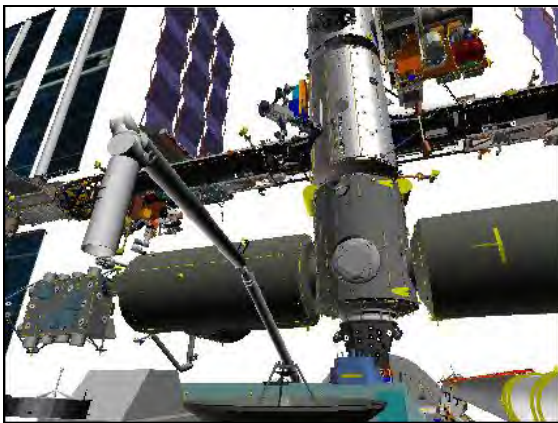

**CCTV C (-20,25)**



**CCTV A (0,0)**



- A7U 3. SJ MNVR TO ICC GRAPPLE  
 CCTV – configure for grapple  
 – install ICC SJ GRAPPLE IN PLB WRIST CCTV OVERLAY  
 – RMS WRIST, ZOOM: 34.0 HFOV  
 FOCUS: 5 ft  
 Maintain eyepoint ~18 in when using grapple overlay

DNLK (72)	EE
DTV (SSC 2)	C (B)
MON 1 (SSC 1)	A
MON 2 (71)	P1 LOOB (JEM EXT-FWD)

- RHC If SINGLE mode available:  
 RATE – VERN (RATE MIN tb-ON)  
 BRAKES – OFF (tb-OFF)

MODE – best available

Drive joints per ICC SJ GRAPPLE IN PLB WRIST CCTV OVERLAY and histogram until EE within grapple envelope

### ICC SJ GRAPPLE IN PLB

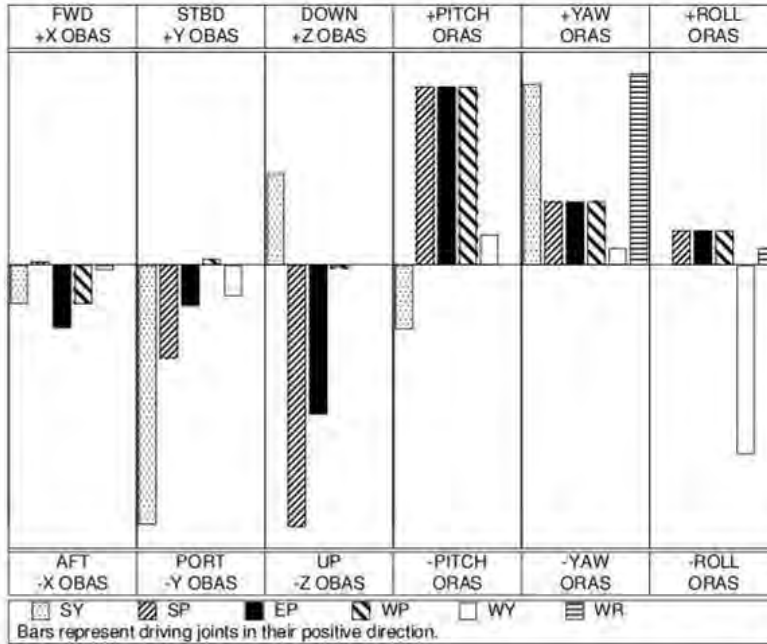

To get:	Drive:	To get:	Drive:	Driving:	Results In:	Driving:	Results In:
+X (fwd)	-EP, -WP	+PITCH	+WP, +EP	+SY	-Y (port), +YAW	+WP	-X (aft), +PITCH
+Y (stbd)	-SY	+YAW	+WR	+SP	-Z (up), +PITCH	+WY	-Y (port), -ROLL
+Z (down)	-SP, -EP	+ROLL	-WY	+EP	-Z (up), +PITCH	+WR	+YAW

$\Delta SY$	$\Delta SP$	$\Delta EP$	$\Delta WP$	$\Delta WY$	$\Delta WR$
+2.4	-3.7	-5.0	+9.6	+0.0	-2.5

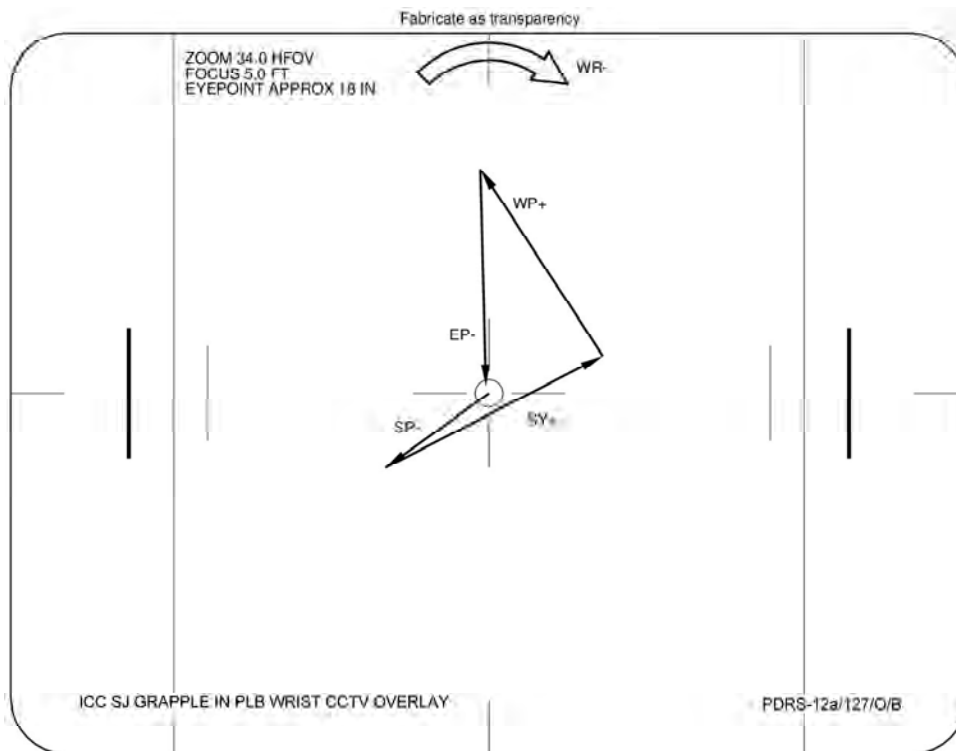

4. ICC GRAPPLE

**CAUTION**  
Monitor EE tb timing to prevent EE motor burnout

**SM 169 PDRS STATUS**

EE MODE – AUTO (if available)  
CAPTURE sw – depress (mom)

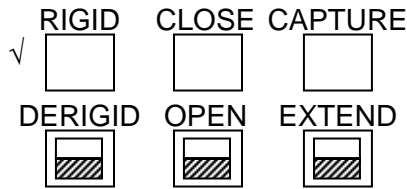

CRITICAL TIMES (28 sec total):

CAPTURE tb – gray, then  
CLOSE tb – gray, 3 sec max, then  
RIGID tb – gray, 25 sec max

- \* If manual grapple reqd: \*
- \* EE MODE – MAN \*
- \* CAPTURE sw – depress (hold until CLOSE tb-gray, 3 sec max) \*
- \* MAN CONTR – RIGID (hold until RIGID tb-gray, 25 sec max) \*

EE MODE – OFF

BRAKES – ON (tb-ON)  
MODE – not DIRECT (It off)

**SM 94 PDRS CONTROL**

PL ID – ITEM 3 +5 EXEC  
INIT ID – ITEM 24 +5 EXEC

Record POS/ATT and Joint Angles:

	X	Y	Z	PITCH	YAW	ROLL	PL ID
							5
Expected	-1197	0	-414	180	0	180	5
	SY	SP	EP	WP	WY	WR	
Expected	-9.0	+27.8	-42.1	-73.6	+20.0	-131.2	

Record POS/ATT and Joint Angles in SJ ICC BERTH IN PLB (ICC OFF-NOMINAL)

Review GENERIC END EFFECTOR CUE CARD – ISS/SHUTTLE DOCKED OPS

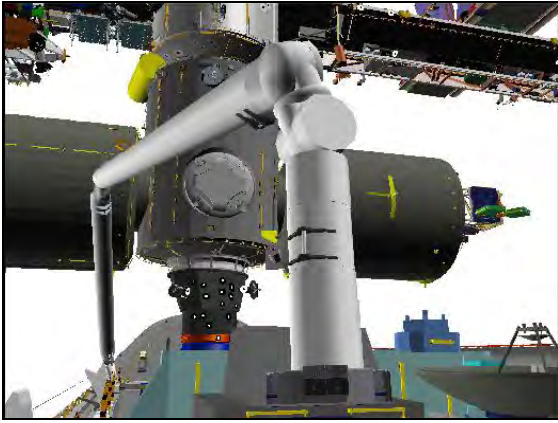

**CCTV B (15,15)**

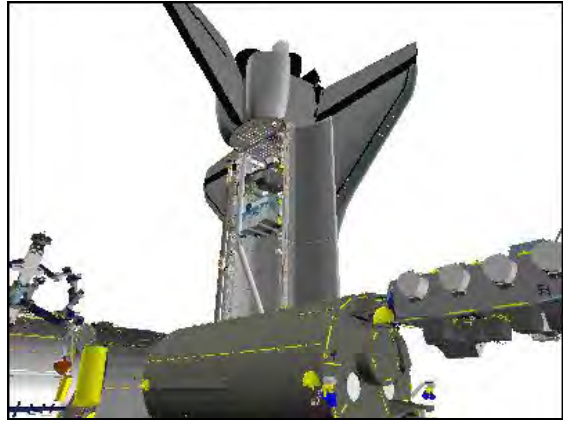

**P1 LOOB (135,25)**

## SJ ICC UNBERTH

- SETUP  
Perform ICC UNBERTH (ICC NOMINAL), steps 1 through 5

- SJ MNVR TO TOP OF V-GUIDES

If SINGLE mode available:

RHC      RATE      – VERN (RATE MIN tb-ON)  
            BRAKES – OFF (tb-OFF)

MODE – best available

Mnvr ICC up until unconstrained

√PL RETEN RDY 1,2,3,4 tb (four) – bp

Drive joints per ICC UNBERTH table and histogram until trunnions at top of V-guides

ICC SJ TOP OF V-GUIDES

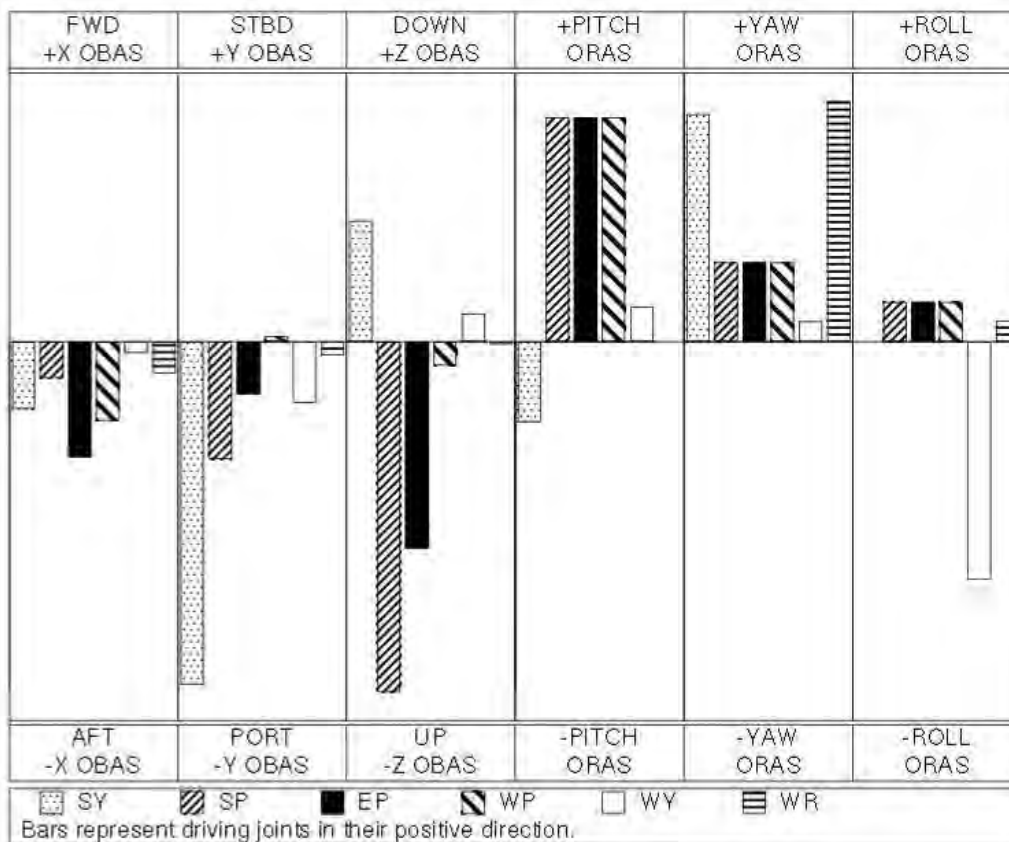

To get:	Drive:	To get:	Drive:
+X (fwd)	-EP, -WP	+PITCH	+WP, +EP
+Y (stbd)	-SY	+YAW	+WR, +SY
+Z (down)	-SP, -EP	+ROLL	-WY

Driving:	Results In:	Driving:	Results In:
+SY	-Y (port), +YAW	+WP	-X (aft), +PITCH
+SP	-Z (up), +PITCH	+WY	-Y (port), -ROLL
+EP	-Z (up), +PITCH	+WR	-X (aft), +YAW

SUGGESTED JOINT ORDER  
SP+, WP-, SY-, EP+, WR+ as req

$\Delta SY$	$\Delta SP$	$\Delta EP$	$\Delta WP$	$\Delta WY$	$\Delta WR$
-1.0	+1.2	+3.0	-4.5	+0.0	+1.0

z	SY	SP	EP	WP	WY	WR
-414	-9.0	+27.8	-42.0	-73.6	+20.0	-131.2
-416	-9.1	+27.9	-41.8	-74.0	+20.0	-131.1
-418	-9.2	+28.0	-41.6	-74.3	+20.0	-131.1
-420	-9.2	+28.1	-41.4	-74.6	+20.0	-131.0
-422	-9.3	+28.2	-41.2	-75.0	+20.0	-130.9
-424	-9.4	+28.3	-41.0	-75.3	+20.0	-130.8
-426	-9.5	+28.4	-40.8	-75.7	+20.0	-130.7
-428	-9.5	+28.5	-40.5	-76.0	+20.0	-130.7
-430	-9.6	+28.5	-40.3	-76.4	+20.0	-130.6
-432	-9.7	+28.6	-40.1	-76.7	+20.0	-130.5
-434	-9.8	+28.7	-39.8	-77.1	+20.0	-130.4
-436	-9.8	+28.8	-39.6	-77.5	+20.0	-130.3
-438	-9.9	+28.9	-39.3	-77.8	+20.0	-130.2
-440	-10.0	+28.9	-39.0	-78.2	+20.0	-130.2

BRAKES – ON (tb-ON)  
MODE – not DIRECT (lt off)

ICC TOP OF V-GUIDES

	X	Y	Z	PITCH	YAW	ROLL	PL ID
√	-1197	0	-440	180	0	180	5
	SY	SP	EP	WP	WY	WR	
√	-10	+28.9	-39.0	-78.2	+20.0	-130.2	

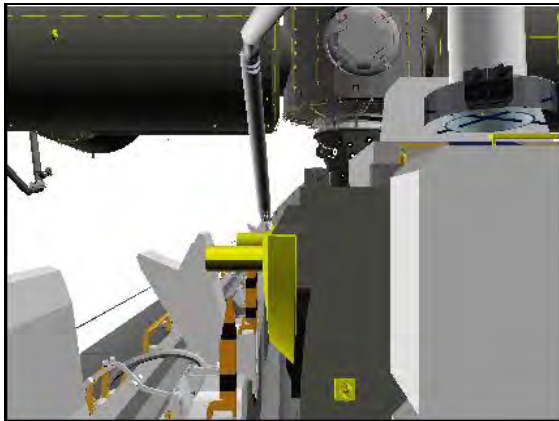

CCTV B (0,0)

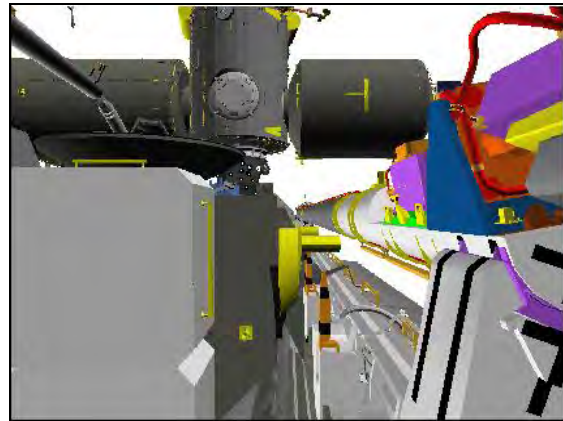

CCTV C (0,0)

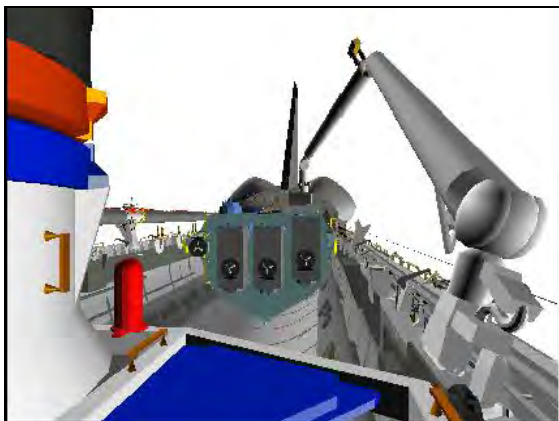

CCTV A (-5,0)

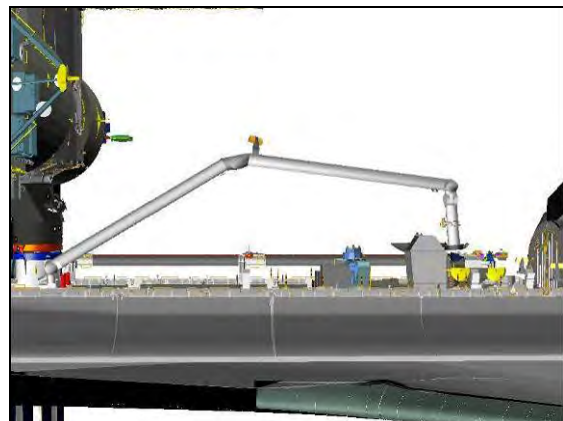

PORT

3. MNVR TO ICC SJ HOVER

R12

√Green Jumper – ISS

A7U

CCTV – fully zoom out for SJ pictures

DNLK (72)	B
DTV (SSC 2)	C (A)
MON 1 (SSC 1)	Elbow
MON 2 (71)	Lab (P1 LOIB)

NOTE

SJ sequence designed to maximize clearance to OBSS. Monitor clearance between Port Trunnions and V-guides with Camera B and clearance between Stbd Trunnions and OBSS with Camera C.

Line 1: 2 inches to Port V-guides, 7 inches to OBSS

Line 2: 3 inches to Port V-guides, 8 inches to OBSS

Line 3: 3 inches to Port V-guides, 14 inches to OBSS

Line 4: 4 inches to Port V-guides, 14 inches to OBSS

RHC

If SINGLE mode available:

RATE – as reqd (VERN within 10 ft)

BRAKES – OFF (tb-OFF)

MODE – best available

Mnvr to ICC SJ HOVER posn:

	SY	SP	EP	WP	WY	WR	
Top V-Guide	-10.0	+28.9	-39.0	-78.2	+20.0	-130.2	
1: SP +		+30.0					
2: WY –					+19.0		
3: SP +		+31.0					
4: WY –					+16.0		
5: SP +		+50.0					
SJ Hover	-10.0	+50.0	-39.0	-78.2	+16.0	-130.2	
	X	Y	Z	PITCH	YAW	ROLL	PL ID
	-1175	+62	-623	199	353	174	5

BRAKES – ON (tb-ON)

MODE – not DIRECT (lt off)

A7U

Configure PLB Flood Lights as required



Start:  
Top of V-Guides

Step 1:  
Drive SP+ (for 1.1°)  
from +28.9 to +30.0

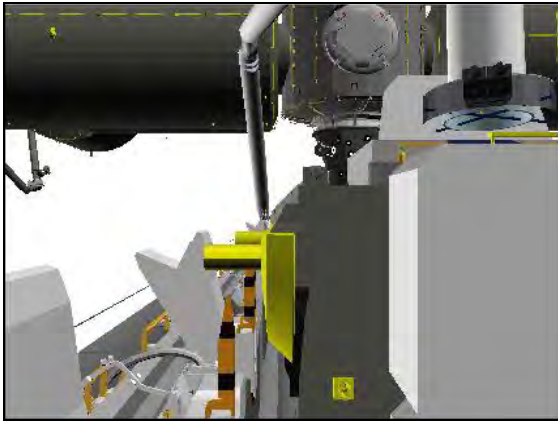

**CCTV B (0,0)**

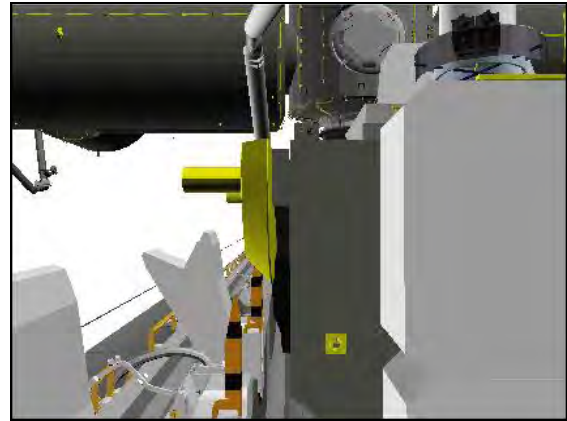

**CCTV B (0,0)**

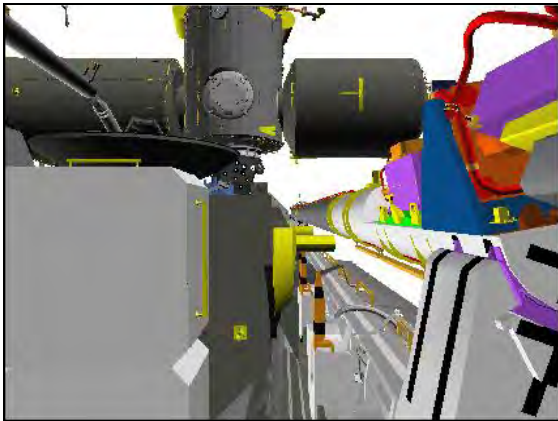

**CCTV C (0,0)**

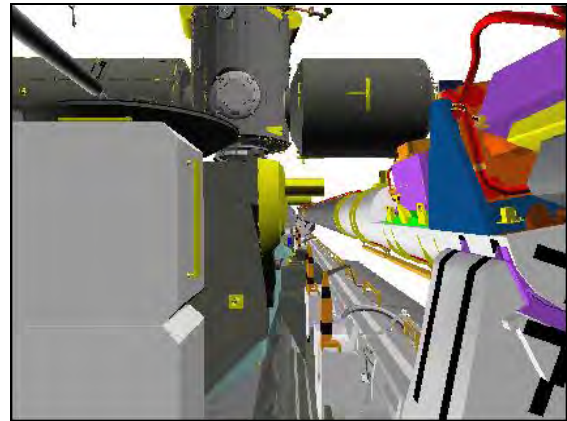

**CCTV C (0,0)**

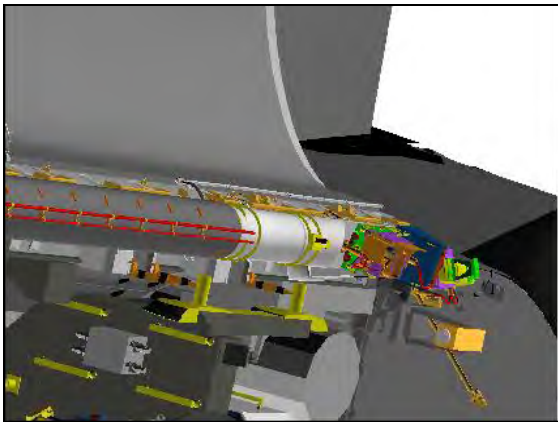

**LAB (-35,-20)**  
FL: 49mm

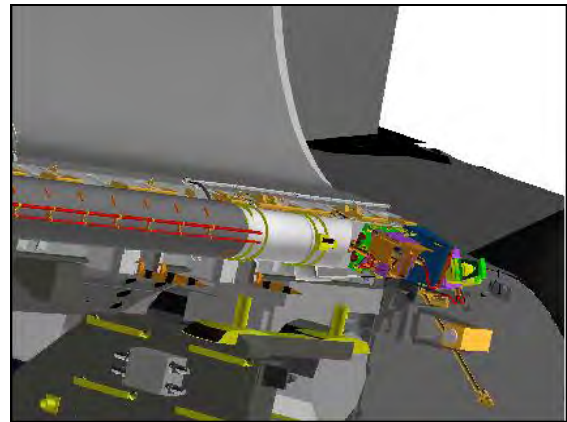

**LAB (-35,-20)**  
FL: 49mm



Step 2:

Drive WY- (for 1.0°)  
from +20.0 to +19.0

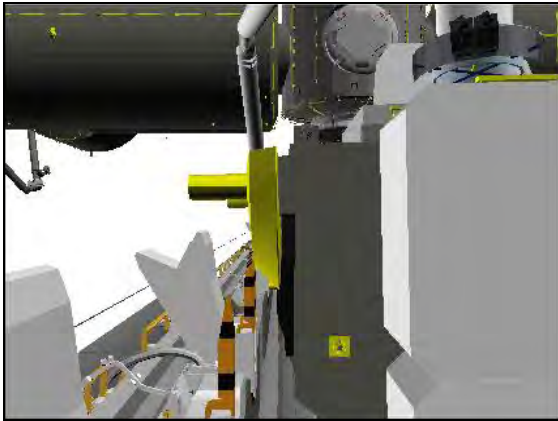

**CCTV B (0,0)**

Step 3:

Drive SP+ (for 1.0°)  
from +30.0 to +31.0

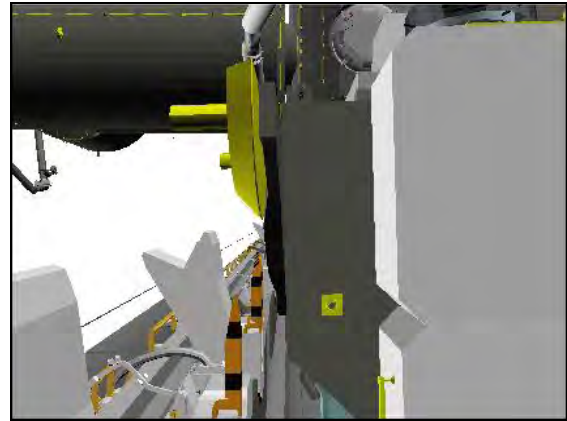

**CCTV B (0,0)**

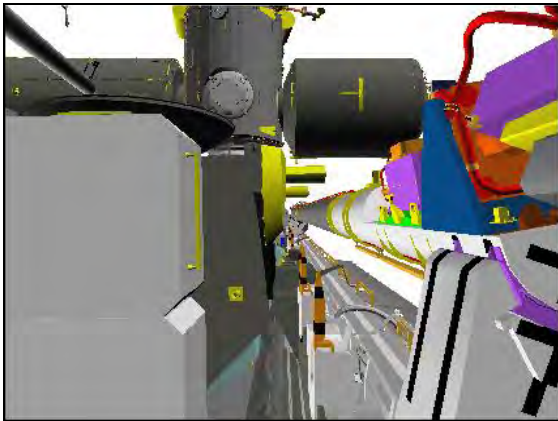

**CCTV C (0,0)**

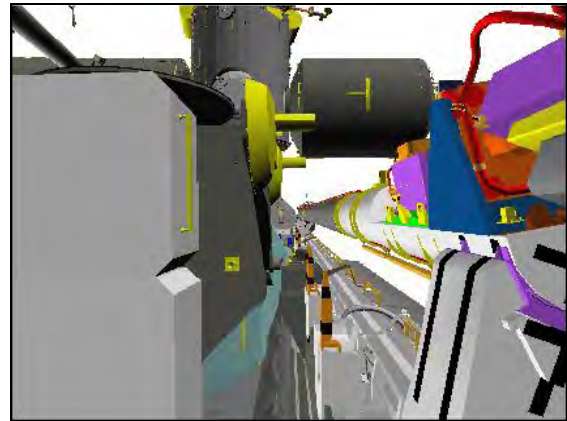

**CCTV C (0,0)**



**LAB (-35,-20)**  
FL: 49mm

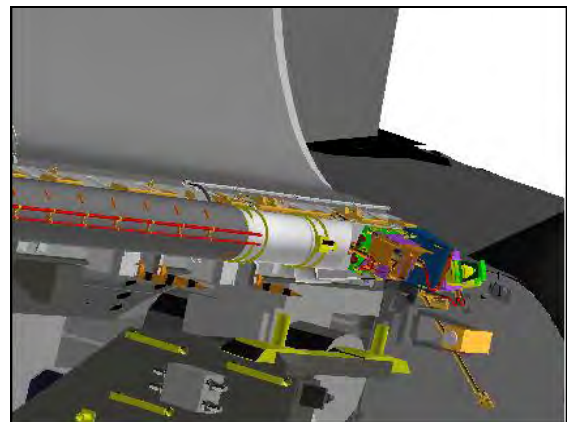

**LAB (-35,-20)**  
FL: 49mm

Step 4:

Drive WY- (for 3.0°)  
from +19.0 to +16.0

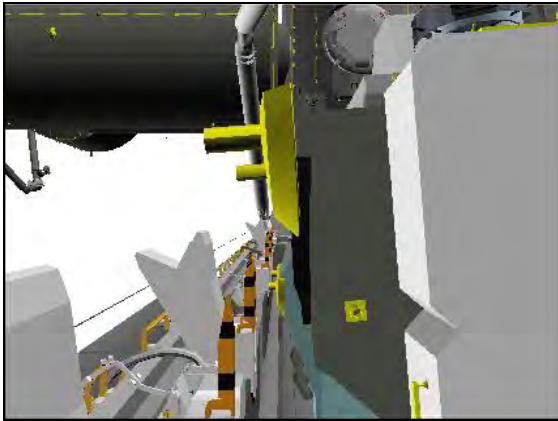

**CCTV B (0,0)**

Step 5:

Drive SP+ (for 19.0°)  
from +31.0 to +50.0

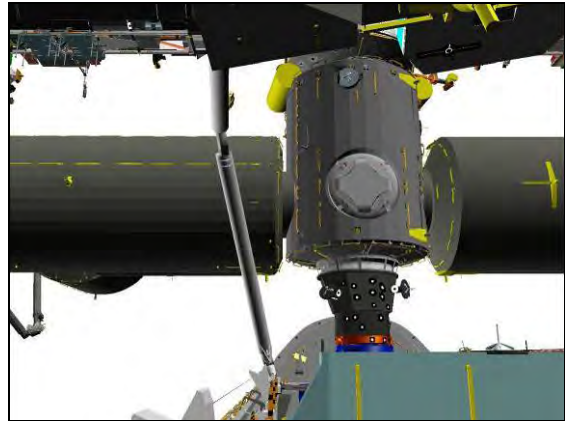

**CCTV B (0,15)**

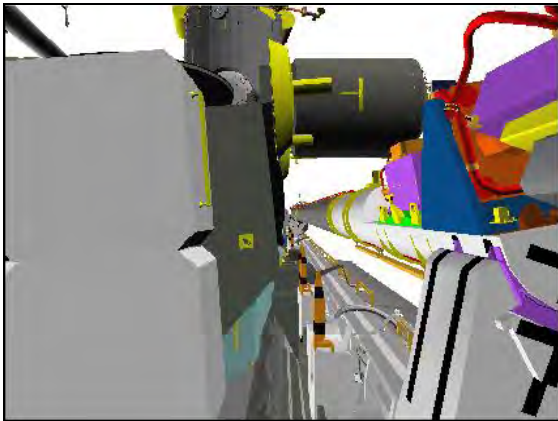

**CCTV C (0,0)**

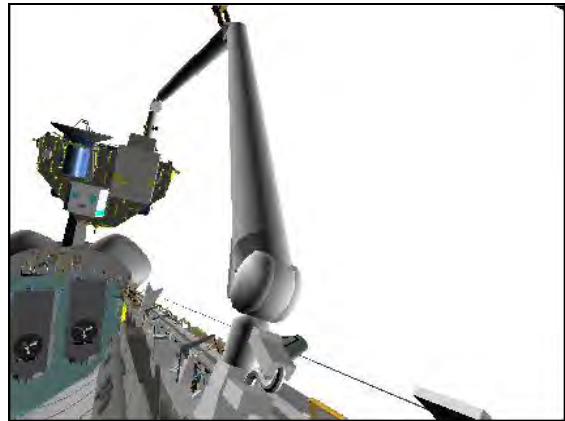

**CCTV A (25,10)**

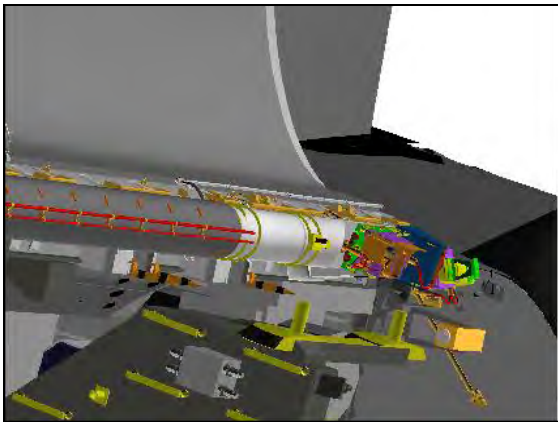

**LAB (-35,-20)**  
FL: 49mm



**ELBOW (-15,-10)**

# SJ ICC HANDOFF TO SSRMS

## 1. SJ MNVR TO ICC HANDOFF

Verify JEMRMS at JEF INSTALL VIEWING:

SY	SP	EP	WP	WY	WR
-65.0	+135.0	-100.0	-125.0	0.0	+65.0

A7U

CCTV – fully zoom out for SJ pictures

DNLK (72)	B
DTV (SSC 2)	A
MON 1 (SSC 1)	Elbow
MON 2 (71)	P1 LOOB (P1 LOIB)

RHC

If SINGLE mode available:

RATE – as reqd (VERN within 10 ft)

BRAKES – OFF (tb-OFF)

MODE – best available

Mnvr to ICC HANDOFF posn:

	SY	SP	EP	WP	WY	WR	
SJ Hover	-10.0	+50.0	-39.0	-78.2	+16.0	-130.2	
1: SY +	+35.0						
2: WR –						-190.0	
3: WY +					+60.0		
4: WP +				+80.0			
5: EP +			-35.0				
6: SP –		+22.0					
7: SY +	+97.0						
ICC Handoff	+97.0	+22.0	-35.0	+80.0	+60.0	-190.0	
	X	Y	Z	PITCH	YAW	ROLL	PL ID
	-556	-670	-367	250	357	347	5

BRAKES – ON (tb-ON)

MODE – not DIRECT (lt off)

If remaining at ICC HANDOFF overnight,

PARAM – PORT TEMP

JOINT – CRIT TEMP, then >>

- \* If using Shuttle attitude control and attitude maintenance reqd: \*
- \* DAP: LVLH \*
- \* When rates damped: \*
- \* DAP: FREE > 2 sec \*
- \* DAP: AUTO \*

Notify SSRMS operator that SRMS at ICC Handoff with Brakes ON;  
GO for SSRMS ICC grapple

Start:  
Hover

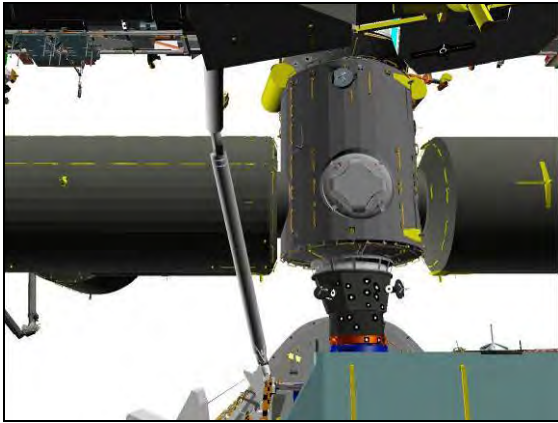

**CCTV B (0,15)**

Step 1:  
Drive SY+ (for 45.0°)  
from -10.0 to +35.0

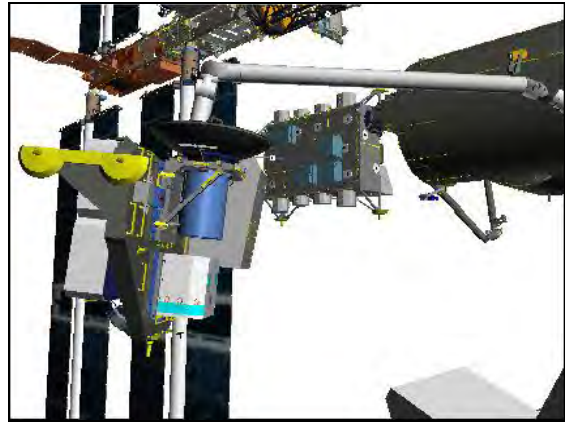

**CCTV B (-45,5)**

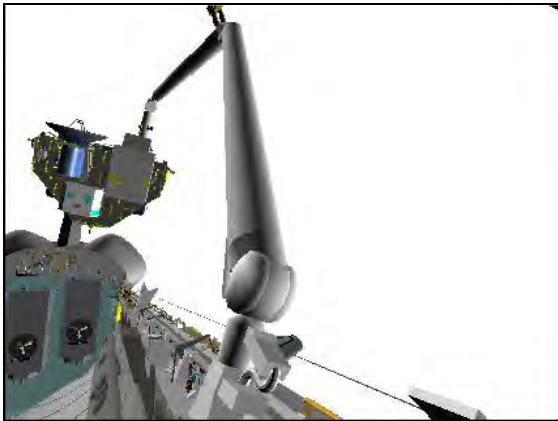

**CCTV A (25,10)**

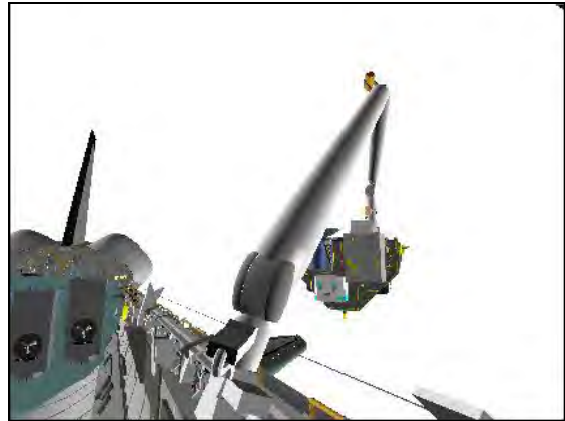

**CCTV A (25,10)**



**ELBOW (-15,-10)**

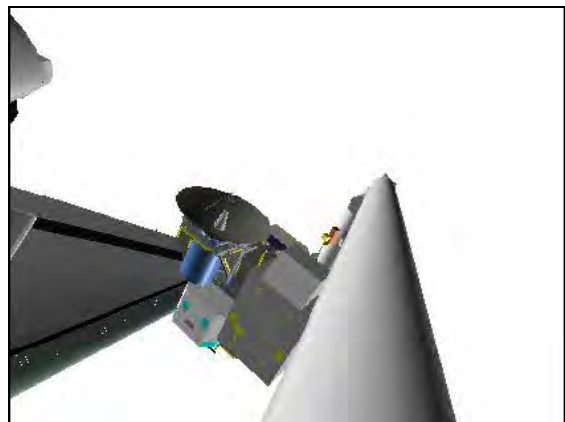

**ELBOW (-15,-10)**



Step 2:

Drive WR- (for 59.8°)  
from -130.2 to -190.0

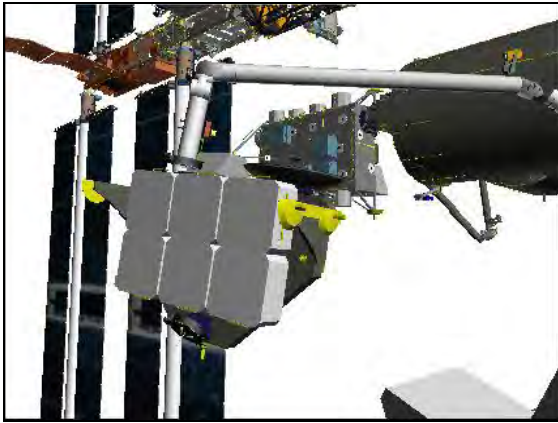

**CCTV B (-45,5)**

Step 3:

Drive WY+ (for 44.0°)  
from +16.0 to +60.0

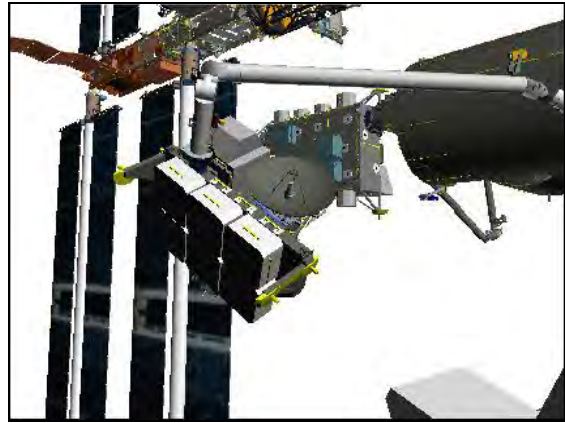

**CCTV B (-45,5)**

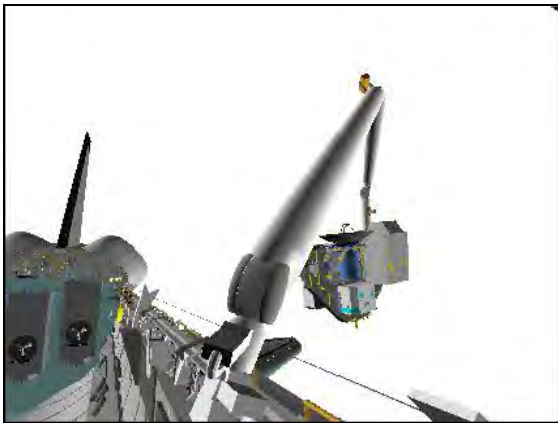

**CCTV A (25,10)**

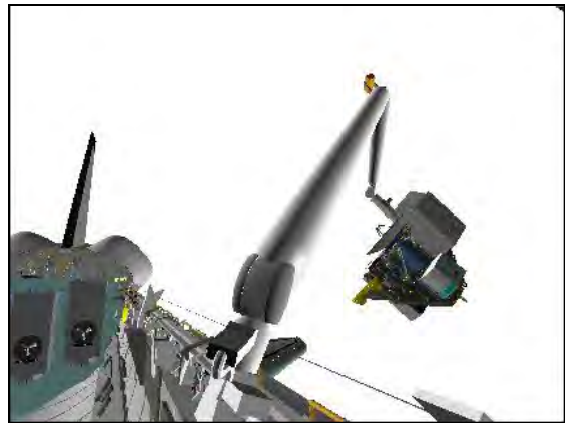

**CCTV A (25,10)**

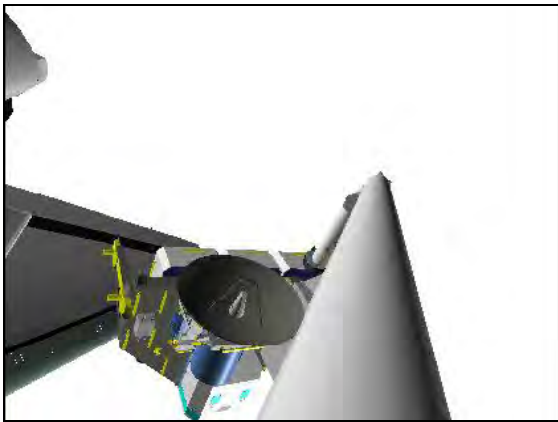

**ELBOW (-15,-10)**

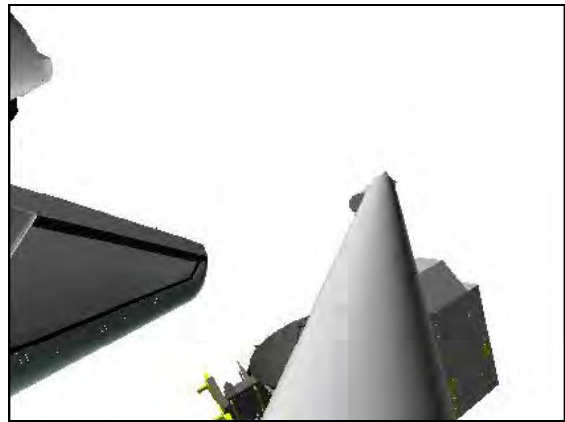

**ELBOW (-15,-10)**

Step 4:

Drive WP+ (for 158.2°)  
from -78.2 to +80.0

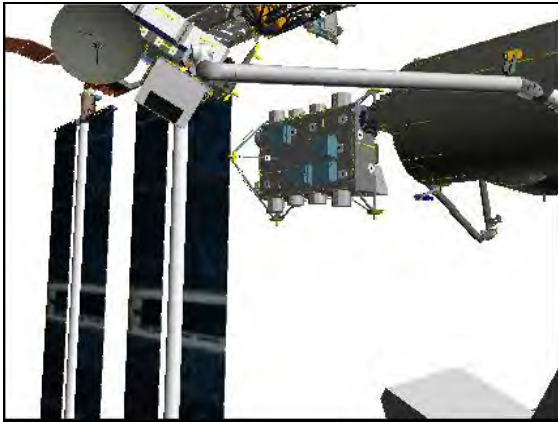

**CCTV B (-45,5)**

Step 5:

Drive EP+ (for 4.0°)  
from -39.0 to -35.0

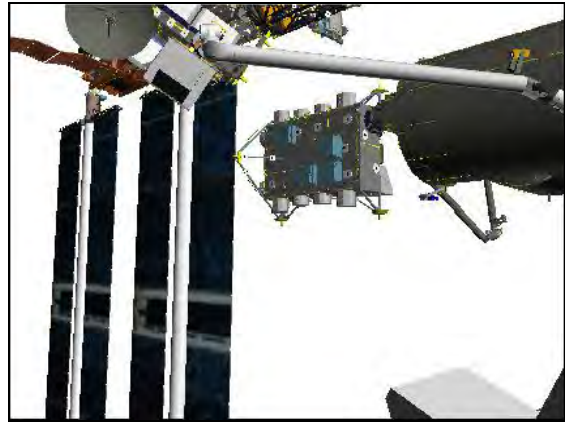

**CCTV B (-45,5)**

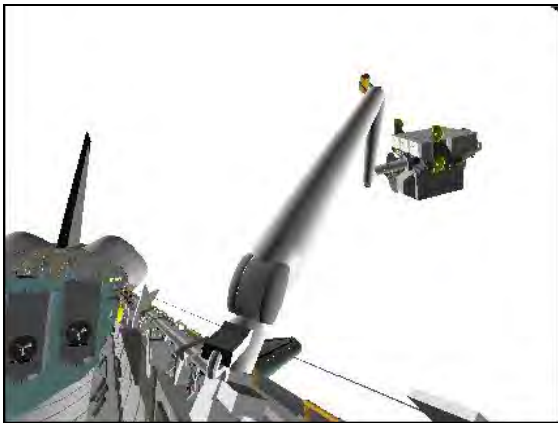

**CCTV A (25,10)**

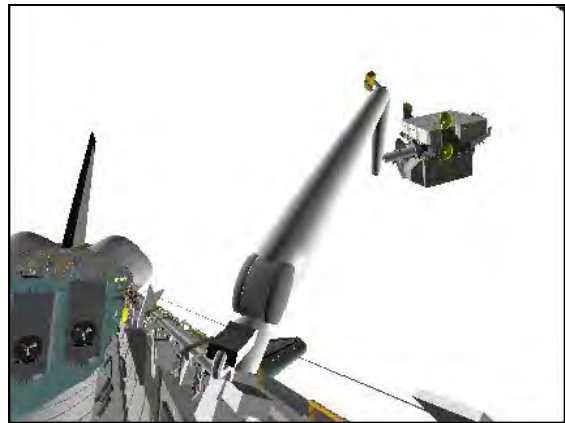

**CCTV A (25,10)**

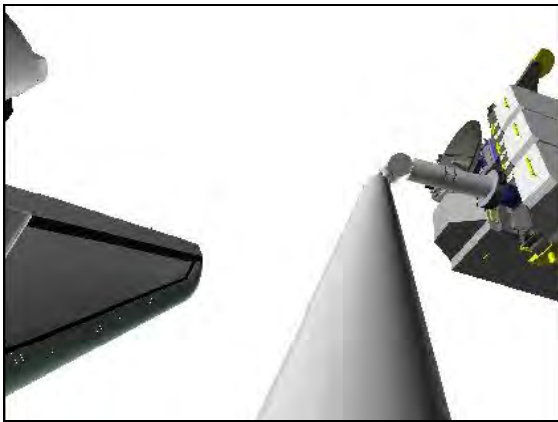

**ELBOW (-15,-10)**

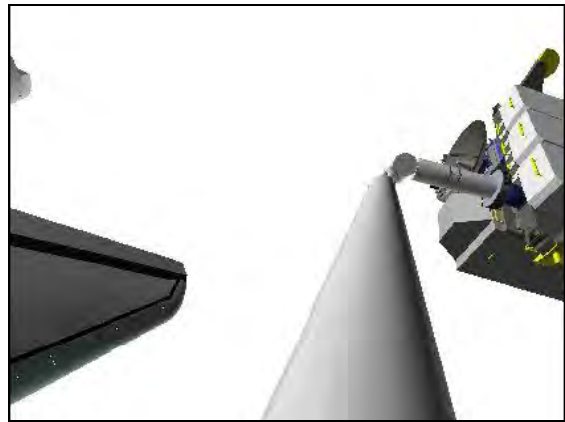

**ELBOW (-15,-10)**

Step 6:

Drive SP- (for 28.0°)  
from +50.0 to +22.0

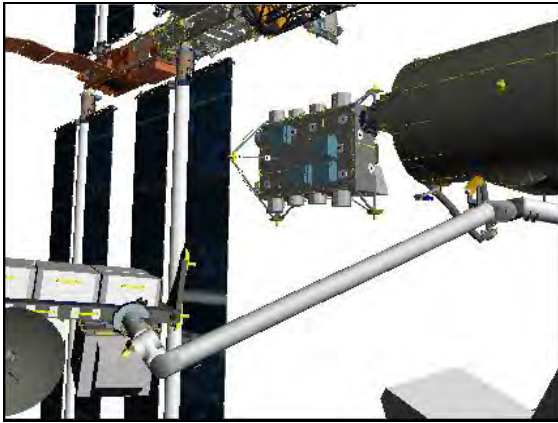

**CCTV B (-45,5)**

Step 7:

Drive SY+ (for 72.0°)  
from +25.0 to +97.0

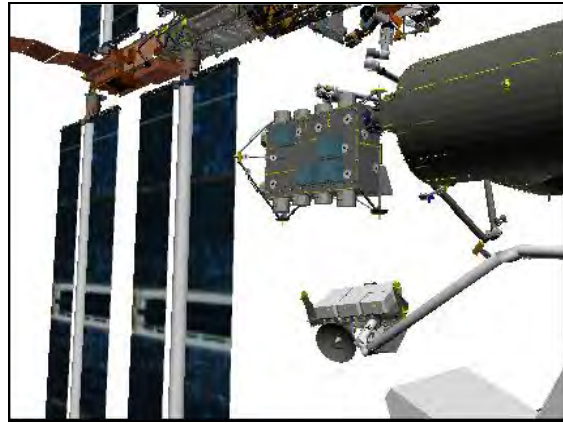

**CCTV B (-45,5)**



**CCTV A (25,10)**



**CCTV A (85,0)**



**ELBOW (-15,-10)**

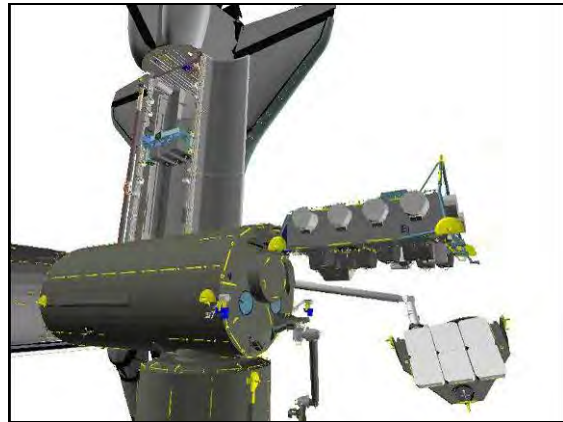

**P1 LOOB (150,-15)**

## SJ ICC UNGRAPPLE

- A7U 1. SETUP  
CCTV – configure for ungrapple  
– install ICC SJ UNGRAPPLE AT HANDOFF WRIST CCTV OVERLAY  
– RMS WRIST, ZOOM: 34.0 HFOV  
FOCUS: 5 ft

DNLK (72)	EE
DTV (SSC 2)	A
MON 1 (SSC 1)	B (C)
MON 2 (71)	JEM EXT-FWD (P1 LOOB)

SM 94 PDRS CONTROL  
PL ID – ITEM 3 +0 EXEC  
INIT ID – ITEM 24 +0 EXEC

2. ICC UNGRAPPLE  
Verify SSRMS grapple complete with Brakes ON and SSRMS operator GO for SRMS ICC ungrapple

If SINGLE mode available:

### NOTE

CONTRL ERR It and 'S96 PDRS CNTL' msg may occur due to Consistency/Envelope Check error

RHC RATE – COARSE (RATE MIN tb-OFF)

SM 94 PDRS CONTROL  
AUTO BRAKE INH – ITEM 10 EXEC (\*)

BRAKES – OFF (tb-OFF)

MODE – TEST, ENTER  
Wait 5 sec

BRAKES – ON (tb-ON)

SM 94 PDRS CONTROL  
AUTO BRAKE ENA – ITEM 9 EXEC (\*)

RHC RATE – VERN (RATE MIN tb-ON)  
BRAKES – OFF (tb-OFF)

MODE – best available

CAUTION  
Monitor EE tb timing to prevent EE motor burnout

EE MODE – MAN  
MAN CONTR – DERIGID (hold until DERIGID tb-gray, 5 sec max)  
RELEASE sw – depress (hold until OPEN tb-gray, 3 sec max)



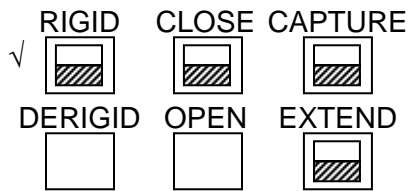

**CRITICAL TIMES (8 sec total):**  
 DERIGID tb – gray, 5 sec max, then  
 OPEN tb – gray, 3 sec max, then

3. MNVR CLEAR OF ICC

Drive joints per ICC SJ UNGRAPPLE AT HANDOFF WRIST CCTV OVERLAY  
 and histogram until EE clear of grapple fixture

ICC SJ UNGRAPPLE AT HANDOFF

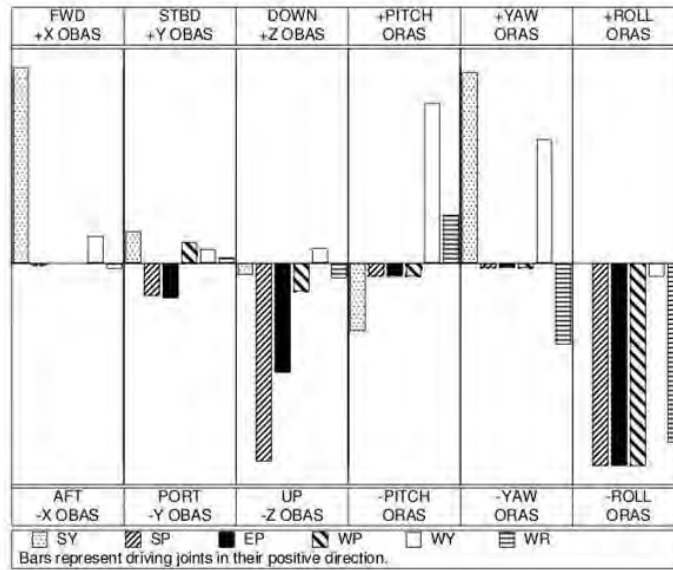

To get:	Drive:	To get:	Drive:	Driving:	Results In:	Driving:	Results In:
+X (fwd)	+SY	+PITCH	+WY	+SY	+X (fwd), +YAW	+WP	-Z (up), -ROLL
+Y (stbd)	-EP, -SP	+YAW	+SY, +WY	+SP	-Z (up), -ROLL	+WY	+X (fwd), +PITCH
+Z (down)	-SP, -EP	+ROLL	-WP, -EP	+EP	-Z (up), -ROLL	+WR	-Z (up), -ROLL

$\Delta SY$	$\Delta SP$	$\Delta EP$	$\Delta WP$	$\Delta WY$	$\Delta WR$
-6.1	-0.0	-5.8	+16.0	+2.2	-12.1

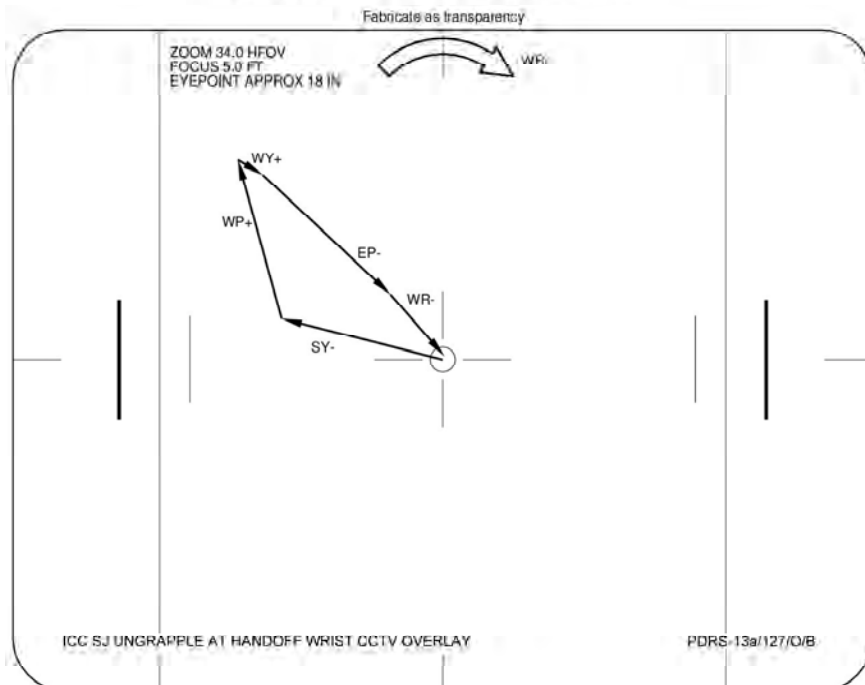

EE MAN CONTR – DERIGID (hold until EXTEND tb-gray, 20 sec max)  
 MODE – OFF

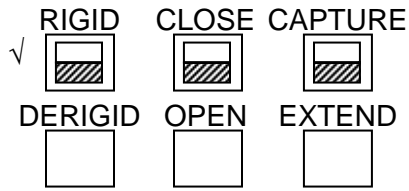

CRITICAL TIMES (20 sec total):  
 EXTEND tb – gray, 20 sec max

**NOTE**

Backoff is 72 inches from ICC to improve clearances for SSRMS maneuver

Mnvr to ICC BACKOFF posn:

X	Y	Z	PITCH	YAW	ROLL	PL ID
-631	-601	-313	155	14	19	0
SY	SP	EP	WP	WY	WR	
+89.9	+20.9	-40.4	+98.7	+62.0	-204.6	

BRAKES – ON (tb-ON)  
 MODE – not DIRECT (lt off)

Notify SSRMS operator that SRMS is ungrappled and clear with Brakes ON,  
 SSRMS GO to mnvr ICC

PARAM – PORT TEMP  
 JOINT – CRIT TEMP

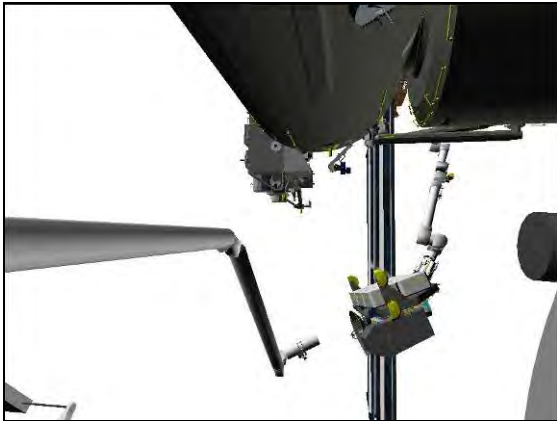

**CCTV A (80,5)**

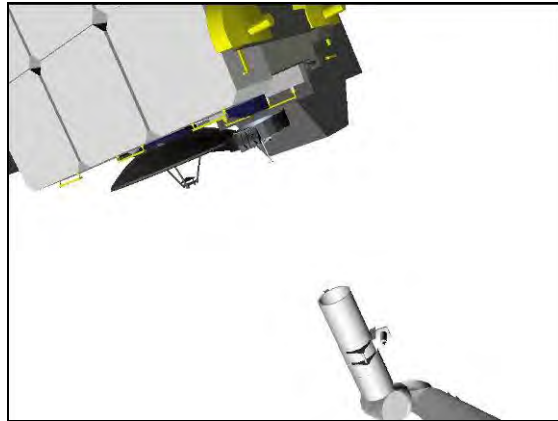

**JEM EXT-FWD (60,0)**

# SJ ICC GRAPPLE FROM SSRMS

## NOTE

Procedure assumes BATTERY R&R VIEWING TO ICC PRE-GRAPPLE (ICC NOMINAL) has been performed and SRMS at ICC Pre-grapple posn

- A7U
1. MNVR TO ICC GRAPPLE  
 CCTV – configure for grapple  
 – install ICC SJ GRAPPLE AT HANDOFF WRIST CCTV OVERLAY  
 – RMS WRIST, ZOOM: 34.0 HFOV  
     FOCUS: 5 ft  
 Maintain eyepoint ~18 in when using grapple overlay

DNLK (72)	EE
DTV (SSC 2)	A
MON 1 (SSC 1)	B
MON 2 (71)	JEM EXT-FWD (P1 LOOB)

Verify at ICC PRE-GRAPPLE:

X	Y	Z	PITCH	YAW	ROLL	PL ID
√ -631	-601	-313	155	14	19	0
√ SY	SP	EP	WP	WY	WR	
+89.9	+20.9	-40.4	+98.7	+62.0	-204.6	

2. MNVR TO ICC GRAPPLE  
 Verify SSRMS at ICC Handoff posn with Brakes ON and SSRMS operator GO for SRMS ICC grapple

RHC

If SINGLE mode available:  
 RATE – VERN (RATE MIN tb-ON)  
 BRAKES – OFF (tb-OFF)

MODE – best available

Drive joints per ICC SJ GRAPPLE AT HANDOFF WRIST CCTV OVERLAY and histogram until EE within grapple envelope

### ICC SJ GRAPPLE AT HANDOFF

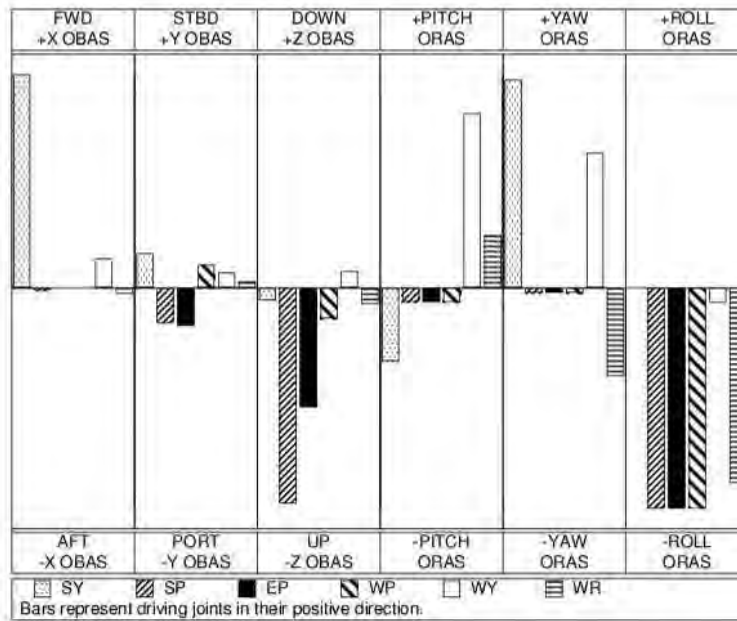

To get:	Drive:	To get:	Drive:
+X (fwd)	+SY	+PITCH	+WY
+Y (stbd)	-EP, -SP	+YAW	+SY, +WY
+Z (down)	-SP, -EP	+ROLL	-WP, -EP

Driving:	Results In:	Driving:	Results In:
+SY	+X (fwd), +YAW	+WP	-Z (up), -ROLL
+SP	-Z (up), -ROLL	+WY	+X (fwd), +PITCH
+EP	-Z (up), -ROLL	+WR	-Z (up), -ROLL

$\Delta SY$	$\Delta SP$	$\Delta EP$	$\Delta WP$	$\Delta WY$	$\Delta WR$
+6.1	+0.0	+5.8	-16.0	-2.2	+12.1

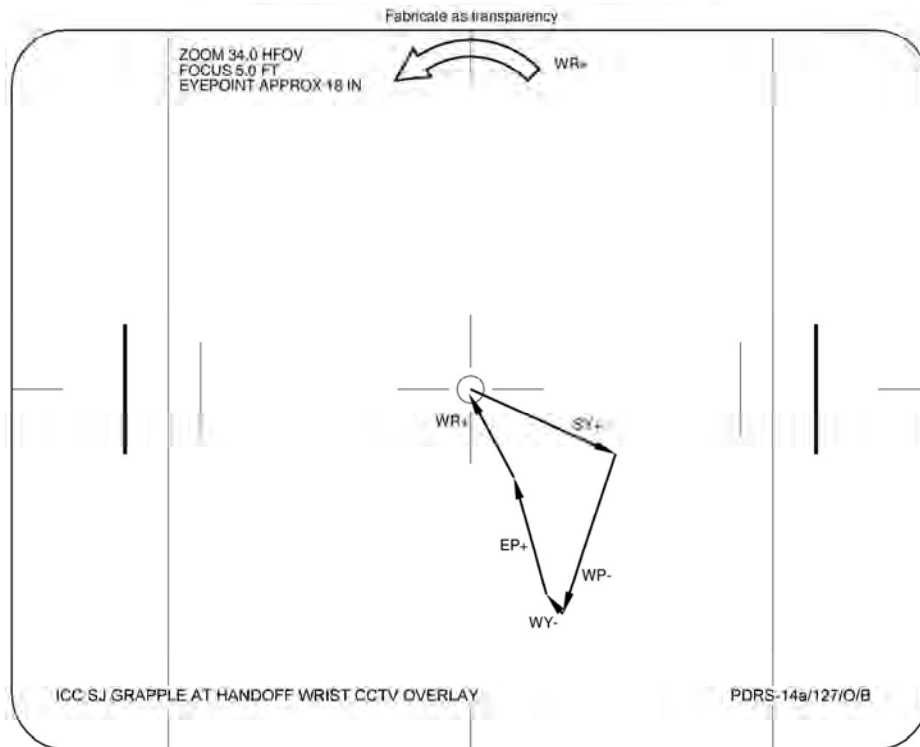

3. ICC GRAPPLE

**CAUTION**  
Monitor EE tb timing to prevent EE motor burnout

**SM 169 PDRS STATUS**

EE MODE – AUTO

CAPTURE sw – depress (mom)

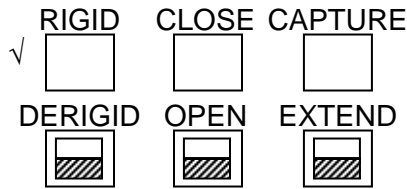

CRITICAL TIMES (28 sec total):

CAPTURE tb – gray, then  
CLOSE tb – gray, 3 sec max, then  
RIGID tb – gray, 25 sec max

- \* If manual grapple reqd: \*
- \* EE MODE – MAN \*
- \* EE CAPTURE sw – depress (hold until CLOSE tb-gray, 3 sec max) \*
- \* EE MAN CONTR – RIGID (hold until RIGID tb-gray, 25 sec max) \*

EE MODE – OFF

If SINGLE mode available:

MODE – TEST, ENTER

Wait 5 sec

BRAKES – ON (tb-ON)

MODE – not DIRECT (lt off)

**SM 94 PDRS CONTROL**

PL ID – ITEM 3 +5 EXEC

INIT ID – ITEM 24 +5 EXEC

Expected ICC HANDOFF posn:

√	X	Y	Z	PITCH	YAW	ROLL	PL ID
	-557	-671	367	250	357	347	5
	SY	SP	EP	WP	WY	WR	
√	+97.0	+22.0	-35.0	+80.0	+60.0	-190.0	

Notify SSRMS operator that SRMS grapple complete with Brakes ON;

GO for ICC ungrapple

Review GENERIC END EFFECTOR CUE CARD – ISS/SHUTTLE DOCKED OPS

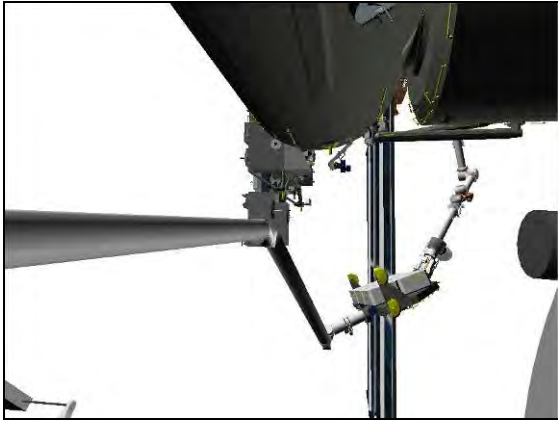

**CCTV A (80,5)**

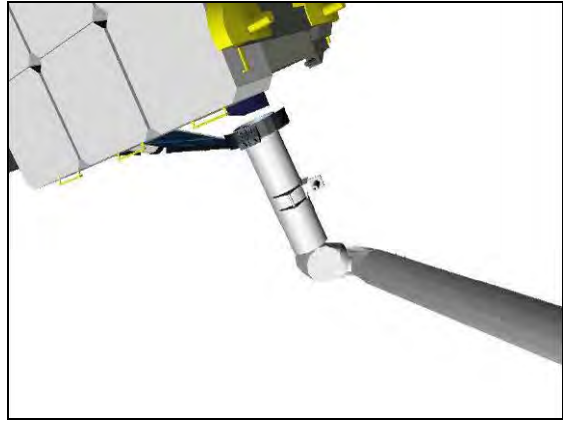

**JEM EXT-FWD (60,0)**

# SJ ICC BERTH IN PLB

1. SETUP  
 A7U CCTV – perform PAN/TILT reset on PLB cameras  
 – fully zoom out for SJ pictures

DNLK (72)	B
DTV (SSC 2)	A
MON 1 (SSC 1)	Elbow
MON 2 (71)	P1 LOOB

**SM 94 PDRS CONTROL**

- √ PL ID, ITEM 3: 5
- √ INIT ID, ITEM 24: 5

Verify at ICC HANDOFF posn:

	X	Y	Z	PITCH	YAW	ROLL	PL ID
√	-556	-670	-367	250	357	347	5
	SY	SP	EP	WP	WY	WR	
√	+97.0	+22.0	-35.0	+80.0	+60.0	-190.0	

2. MNVR TO ICC SJ HOVER

Verify SSRMS is ungrappled, clear, and SSRMS operator GO for ICC Berth

- \* If using Shuttle attitude control and attitude maintenance reqd: \*
- \* DAP: LVLH \*
- \* When rates damped: \*
- \* DAP: FREE > 2 sec \*
- \* DAP: AUTO \*
- \* When in attitude and rates damped: \*
- \* DAP: FREE \*

- RHC If SINGLE mode available:  
 RATE – as reqd (VERN within 10 ft)  
 BRAKES – OFF (tb-OFF)

MODE – best available

Mnvr to ICC SJ HOVER posn:

	SY	SP	EP	WP	WY	WR	
Handoff	+97.0	+22.0	-35.0	+80.0	+60.0	-190.0	
1: EP –			-39.0				
2: SY –	+55.0						
3: WR +						-130.2	
4: WY –					+16.0		
5: WP –				-78.2			
6: SP +		+50.0					
7: SY –	-10.0						
SJ Hover	-10.0	+50.0	-39.0	-78.2	+16.0	-130.2	
	X	Y	Z	PITCH	YAW	ROLL	PL ID
	-1175	+62	-623	199	353	174	5

- BRAKES – ON (tb-ON)
- MODE – not DIRECT (lt off)

Start:  
Handoff

Step 1:  
Drive EP- (for 4.0°)  
from -35.0 to -39.0

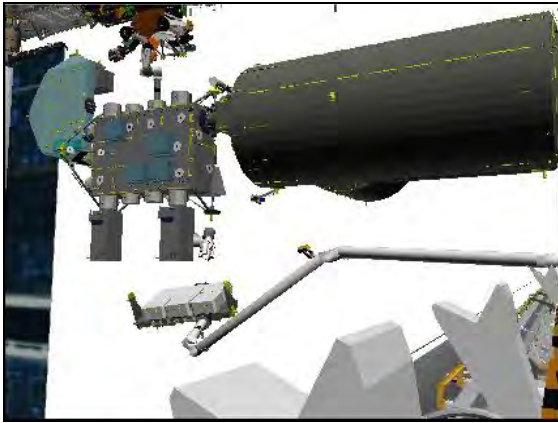

**CCTV B (-28,5)**

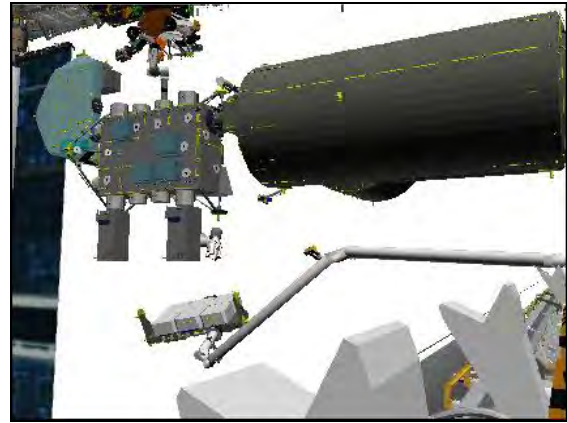

**CCTV B (-28,5)**



**CCTV A (85,0)**



**CCTV A (85,0)**

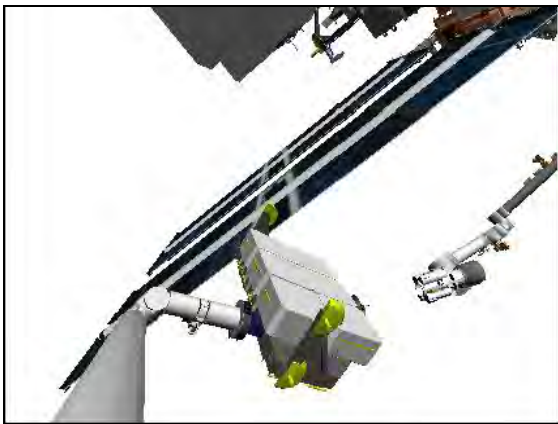

**ELBOW (20,10)**

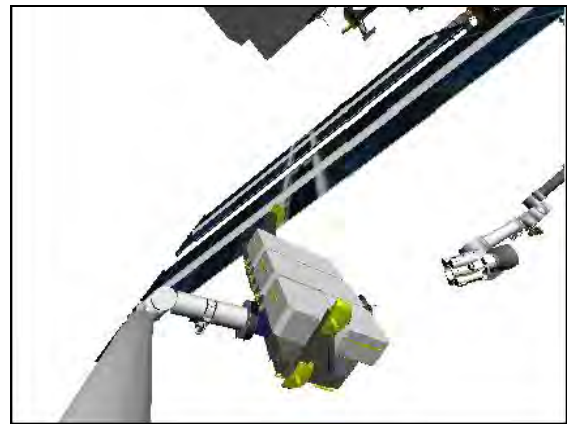

**ELBOW (20,10)**



Step 2:

Drive SY- (for 42.0°)  
from +97.0 to +55.0

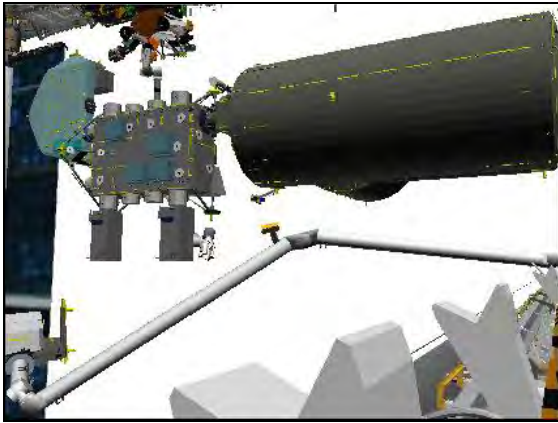

**CCTV B (-28,5)**

Step 3:

Drive WR+ (for 59.8°)  
from -190.0 to -130.2

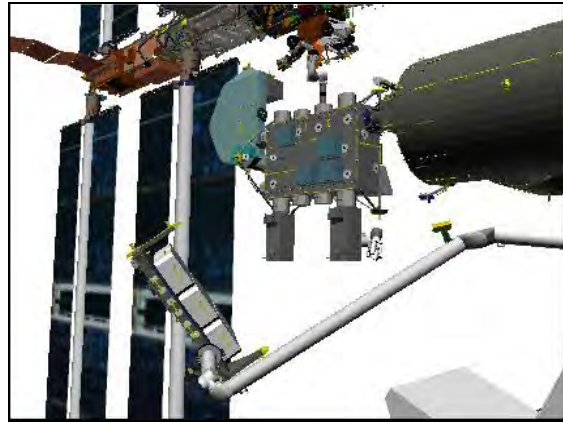

**CCTV B (-45,5)**

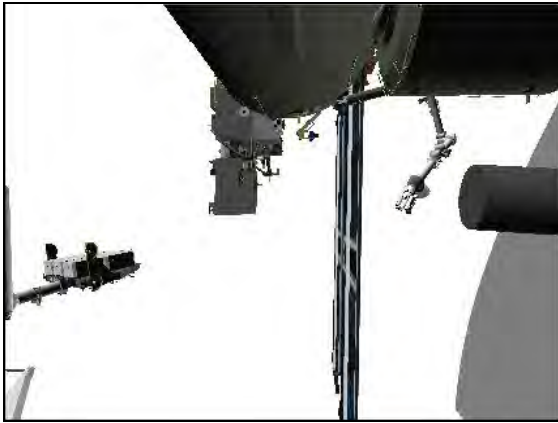

**CCTV A (85,0)**

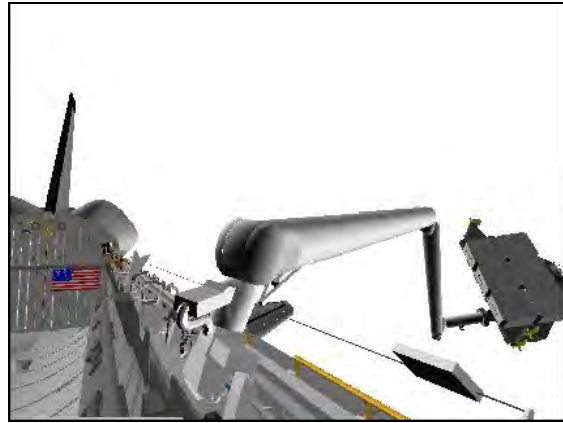

**CCTV A (27,5)**

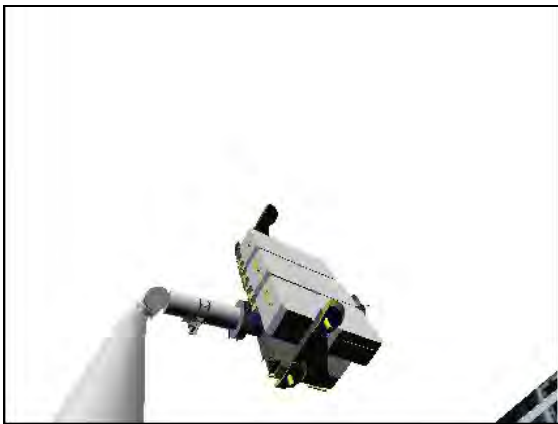

**ELBOW (20,10)**

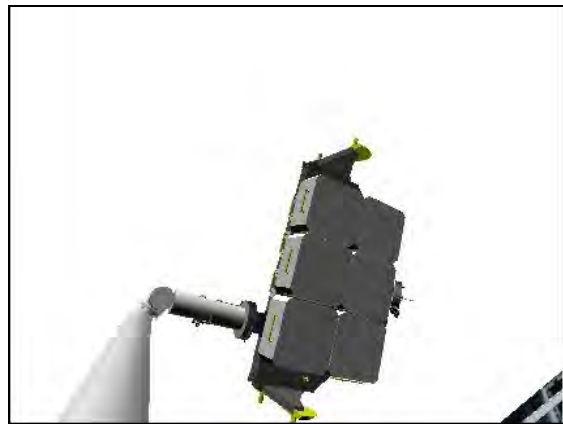

**ELBOW (20,10)**

Step 4:

Drive WY- (for  $44.0^\circ$ )  
from +60.0 to +16.0

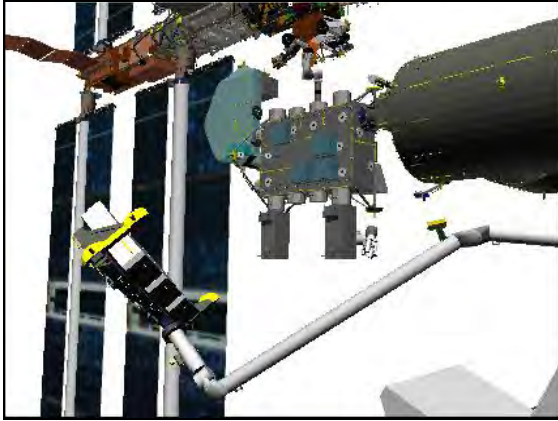

**CCTV B (-45,5)**

Step 5:

Drive WP- (for  $158.2^\circ$ )  
from +80.0 to -78.2

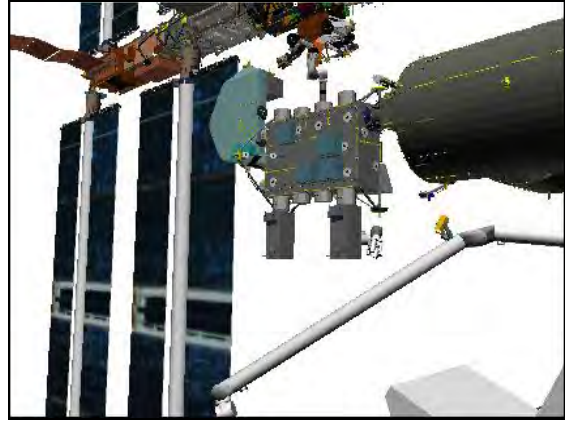

**CCTV B (-45,5)**

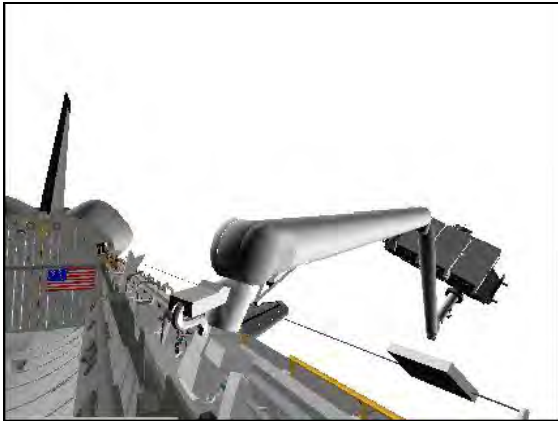

**CCTV A (27,5)**

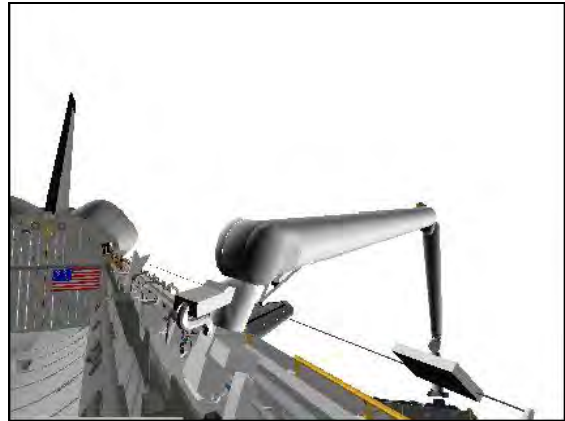

**CCTV A (27,5)**

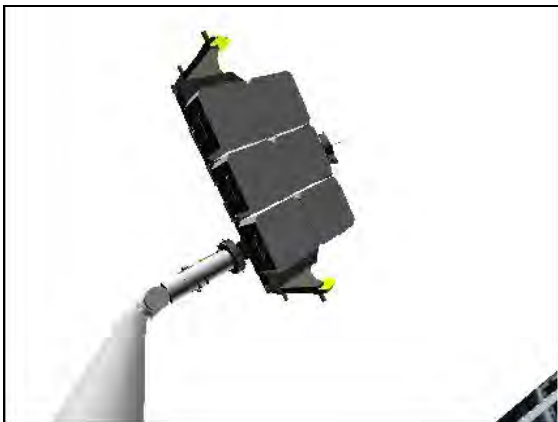

**ELBOW (20,10)**

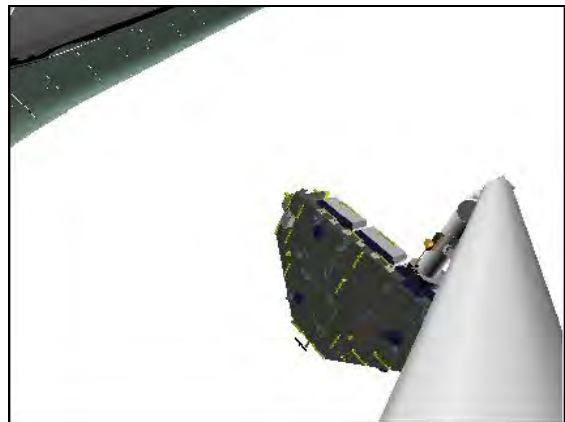

**ELBOW (-30,-10)**

Step 6:

Drive SP+ (for 28.0°)  
from +22.0 to +50.0

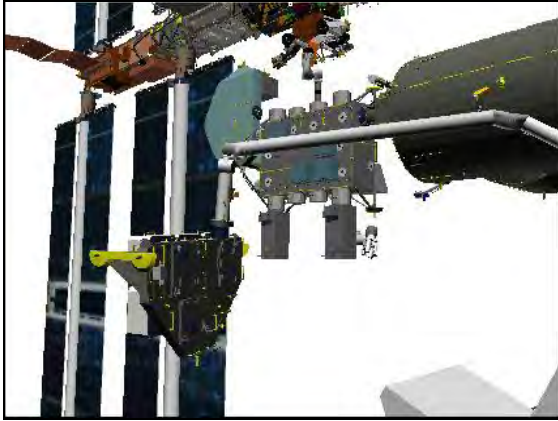

**CCTV B (-45,5)**

Step 7:

Drive SY- (for 65.0°)  
from +55.0 to -10.0

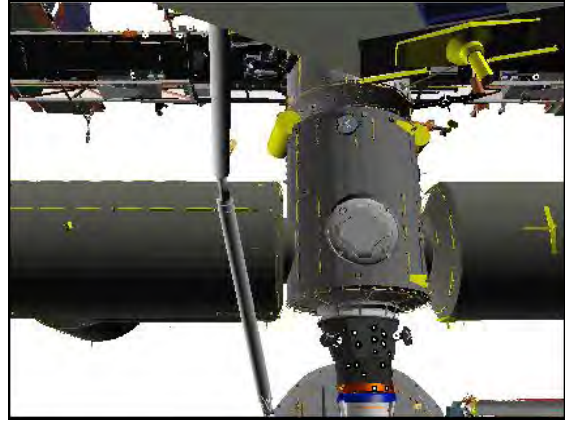

**CCTV B (0,20)**



**CCTV A (27,5)**

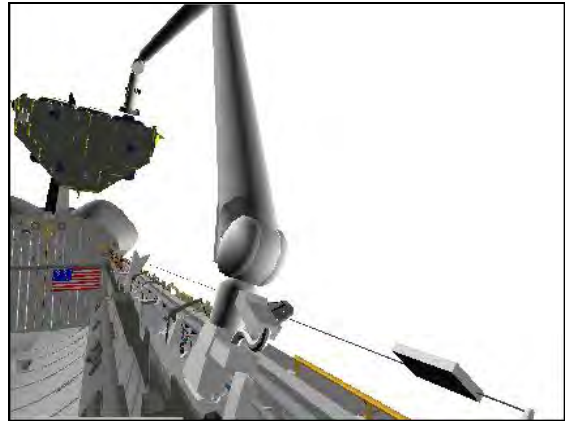

**CCTV A (27,5)**



**ELBOW (-30,-10)**

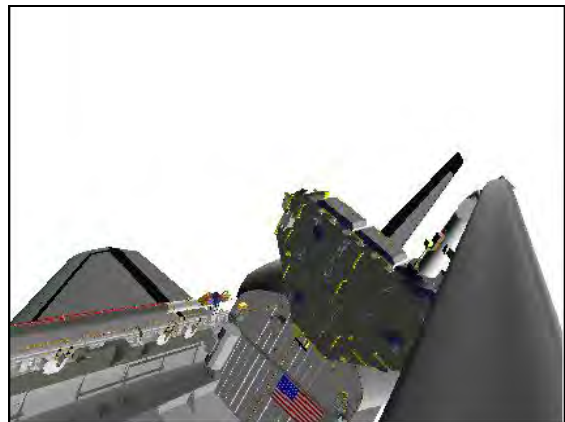

**ELBOW (-30,-10)**

A7U 3. MNVR TO V-GUIDES  
 CCTV – fully zoom out for SJ pictures

DNLK (72)	B
DTV (SSC 2)	C
MON 1 (SSC 1)	Elbow
MON 2 (71)	Lab

PCS MSS: SSRMS: Thrusters: Thruster Controls for MSS Ops

Verify 'Desat Request' Inhibit

- \* If using Shuttle attitude control, verify in attitude; \*
- \* then DAP: FREE \*

NOTE

SJ sequence designed to maximize clearance to OBSS. Monitor clearance between Port Trunnions and V-guides with Camera B and clearance between Stbd Trunnions and OBSS with Camera C.

- Line 2: 4 inches to Port V-guides, 14 inches to OBSS
- Line 3: 3 inches to Port V-guides, 14 inches to OBSS
- Line 4: 3 inches to Port V-guides, 8 inches to OBSS
- Line 5: 2 inches to Port V-guides, 7 inches to OBSS

RHC If SINGLE mode available:  
 RATE – VERN (RATE MIN tb-ON)  
 BRAKES – OFF (tb-OFF)

MODE – best available

Mnvr to TOP OF V-GUIDES posn:

	SY	SP	EP	WP	WY	WR	
Hover	-10.0	+50.0	-39.0	-78.2	+16.0	-310.2	
1: SP –		+31.0					
2: WY +					+19.0		
3: SP –		+30.0					
4: WY +					+20.0		
5: SP –		+28.9					
Top V-guides	-10.0	+28.9	-39.0	-78.2	+20.0	-310.2	
	X	Y	Z	PITCH	YAW	ROLL	PL ID
	-1197	0	-440	180	0	180	5

BRAKES – ON (tb-ON)  
 MODE – not DIRECT (lt off)



Start:  
Hover

Step 1:  
Drive SP- (for 19.0°)  
from +50.0 to +31.0

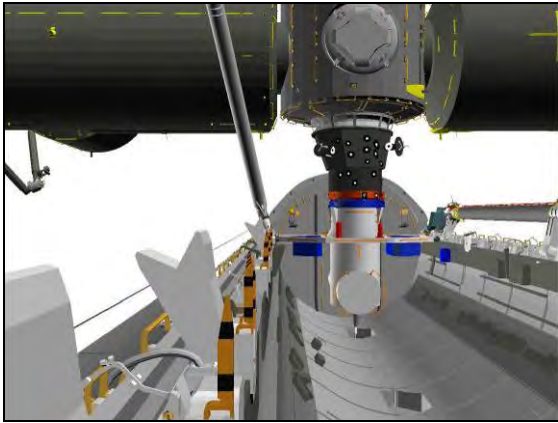

**CCTV B (0,0)**

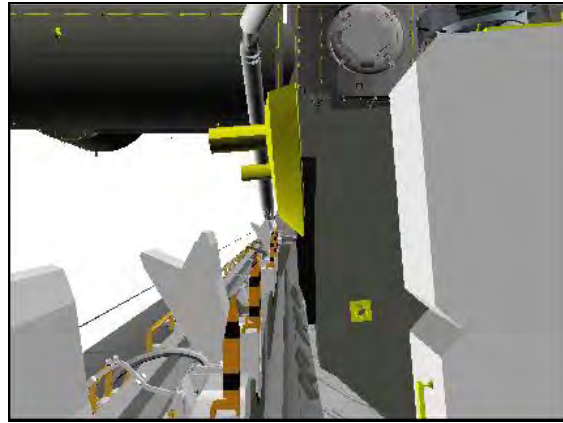

**CCTV B (0,0)**

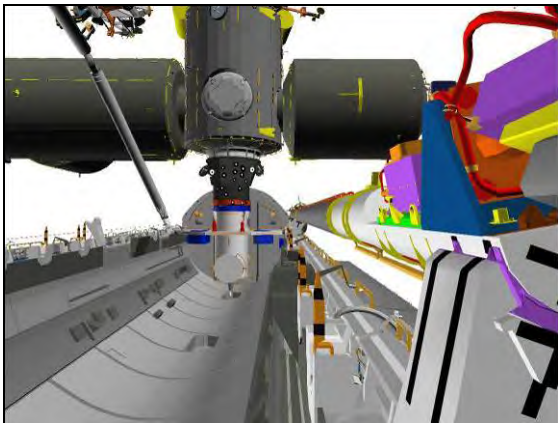

**CCTV C (0,0)**

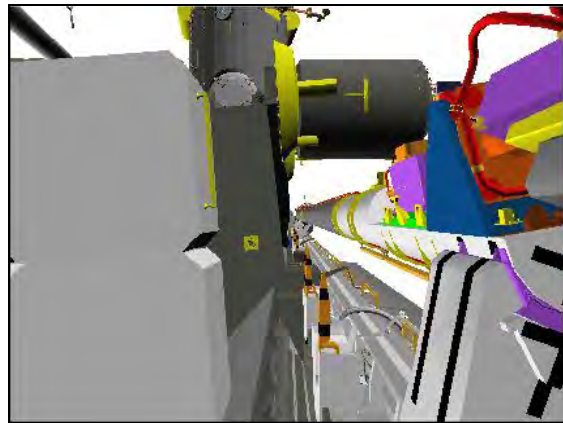

**CCTV C (0,0)**

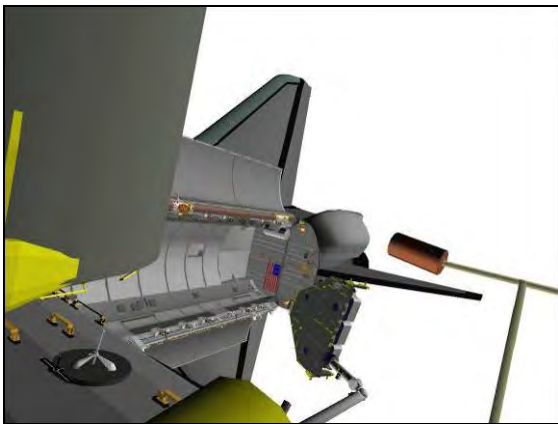

**LAB (-35,-20)**

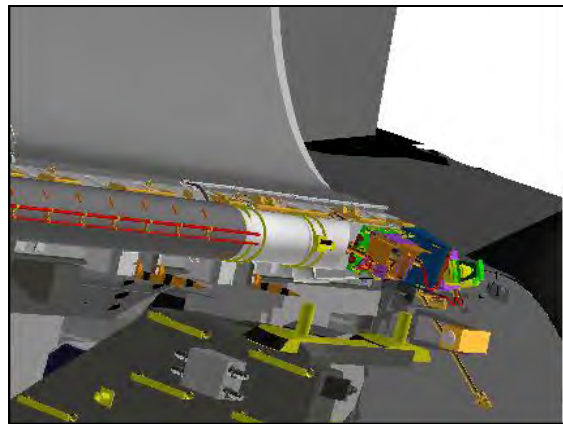

**LAB (-35,-20)**  
**FL = 39mm**

Step 3:

Drive WY+ (for 5.0°)  
from +16.0 to +19.0

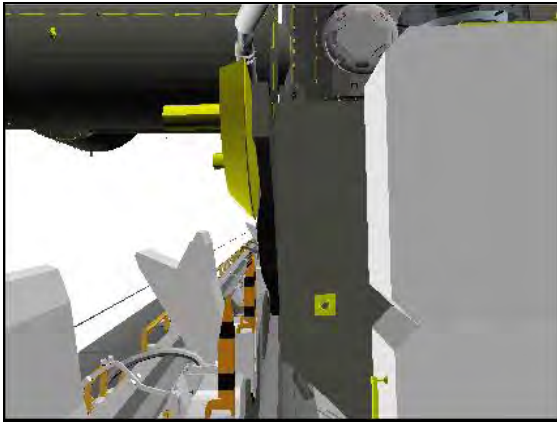

**CCTV B (0,0)**



**CCTV C (0,0)**

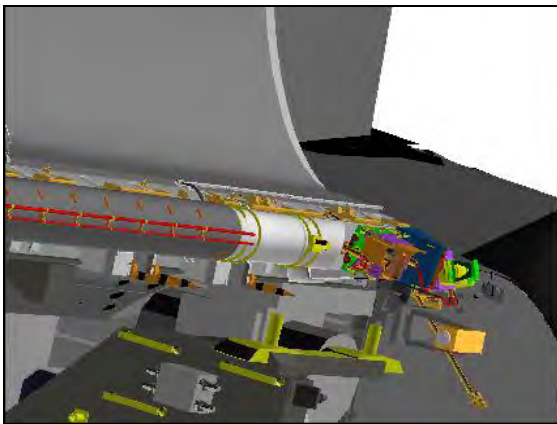

**LAB (-35,-20)  
FL = 39mm**

Step 4:

Drive SP- (for 1.0°)  
from +31.0 to +30.0

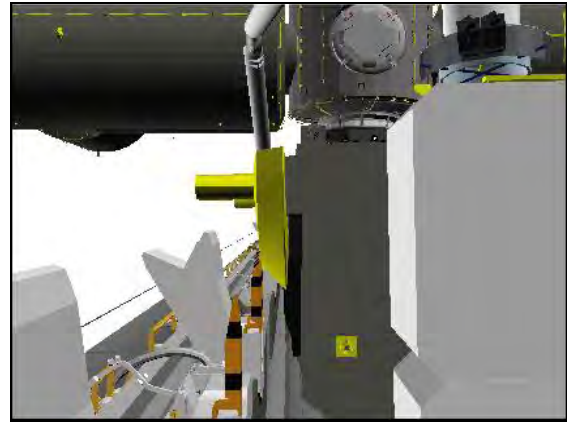

**CCTV B (0,0)**

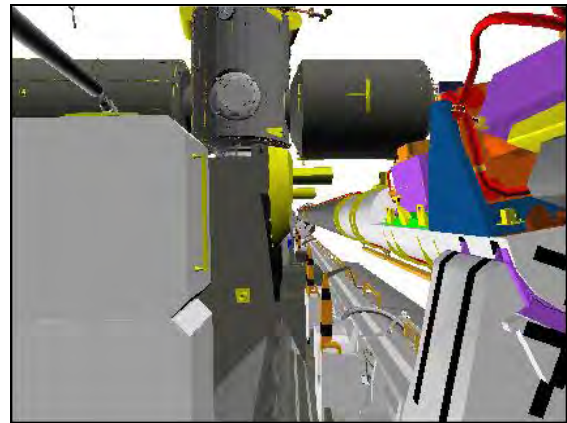

**CCTV C (0,0)**

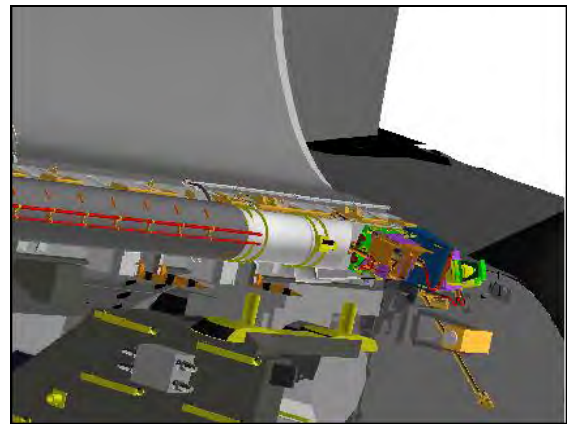

**LAB (-35,-20)  
FL = 39mm**

Step 5:

Drive WY+ (for 1.0°)  
from +19.0 to +20.0

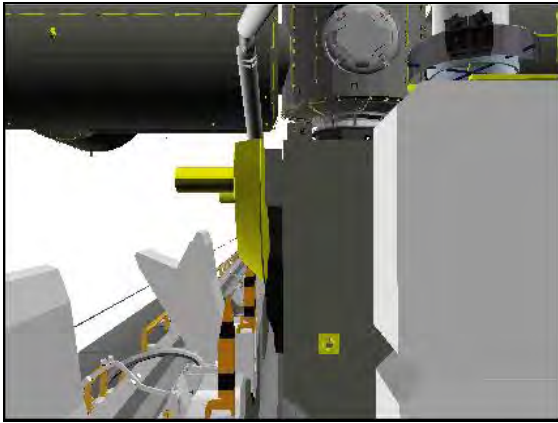

**CCTV B (0,0)**

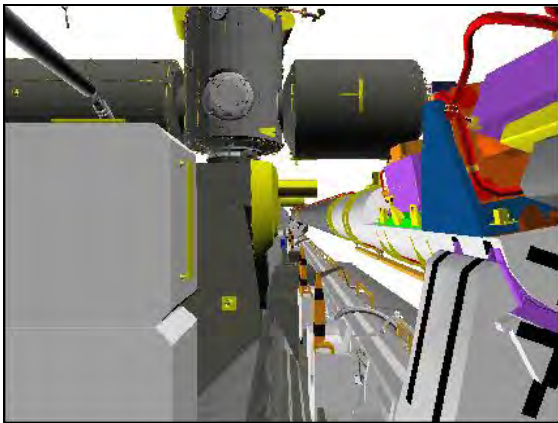

**CCTV C (0,0)**

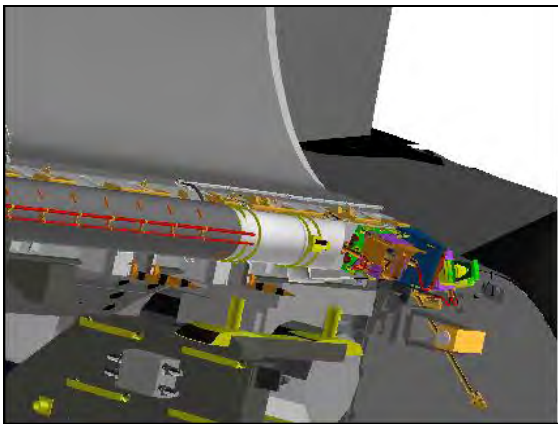

**LAB (-35,-20)**  
**FL = 39mm**

Step 6:

Drive SP- (for 1.1°)  
from +30.0 to +28.9

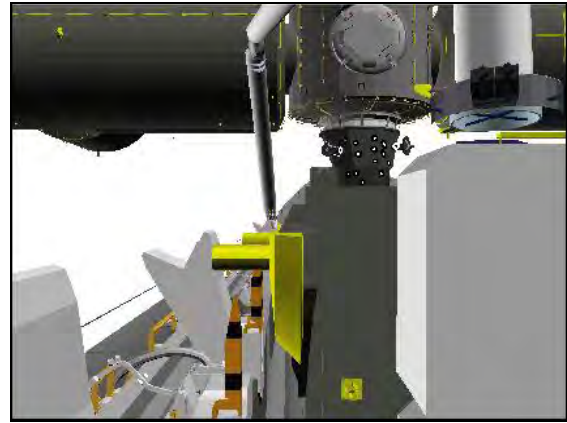

**CCTV B (0,0)**

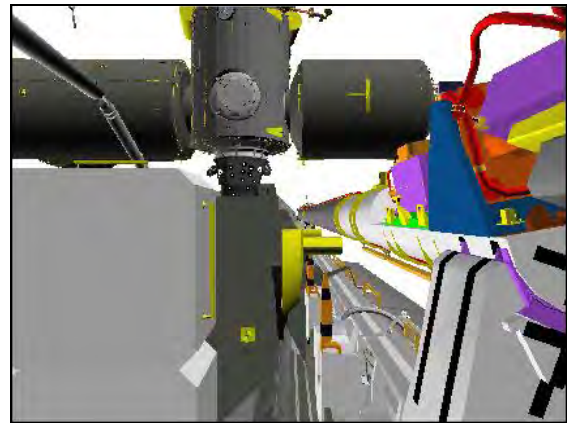

**CCTV C (0,0)**

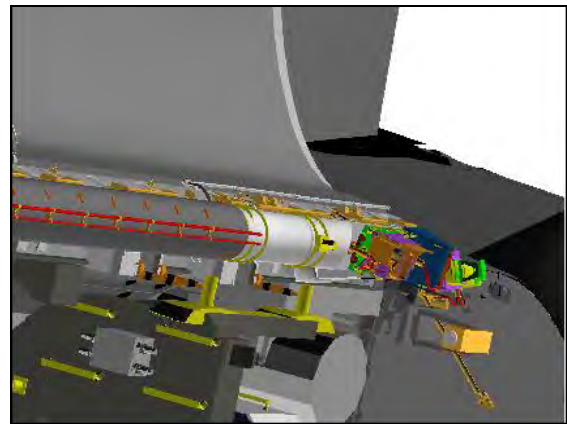

**LAB (-35,-20)**  
**FL = 39mm**



A7U 4. SJ ICC BERTH IN PLB  
CCTV – configure for berthing

DNLK (72)	B/C Mux
DTV (SSC 2)	Keel 1
MON 1 (SSC 1)	D
MON 2 (71)	A (Elbow)

A6U PL RETEN PL SEL – 3

RHC If SINGLE mode available:  
RATE – VERN (RATE MIN tb-ON)  
BRAKES – OFF (tb-OFF)

MODE – best available

Drive joints per ICC BERTH table and histogram to ICC BERTH posn

ICC BERTH posn (insert data from (SJ) ICC UNBERTH):

	X	Y	Z	PITCH	YAW	ROLL	PL ID
							5
Expected	-1197	0	-414	180	0	180	5
	SY	SP	EP	WP	WY	WR	
Expected	-9.0	+27.8	-42.1	-73.6	+20.0	-131.2	

√PL RETEN RDY 1,2,3,4 tb (four) – gray



## SJ ICC BERTH

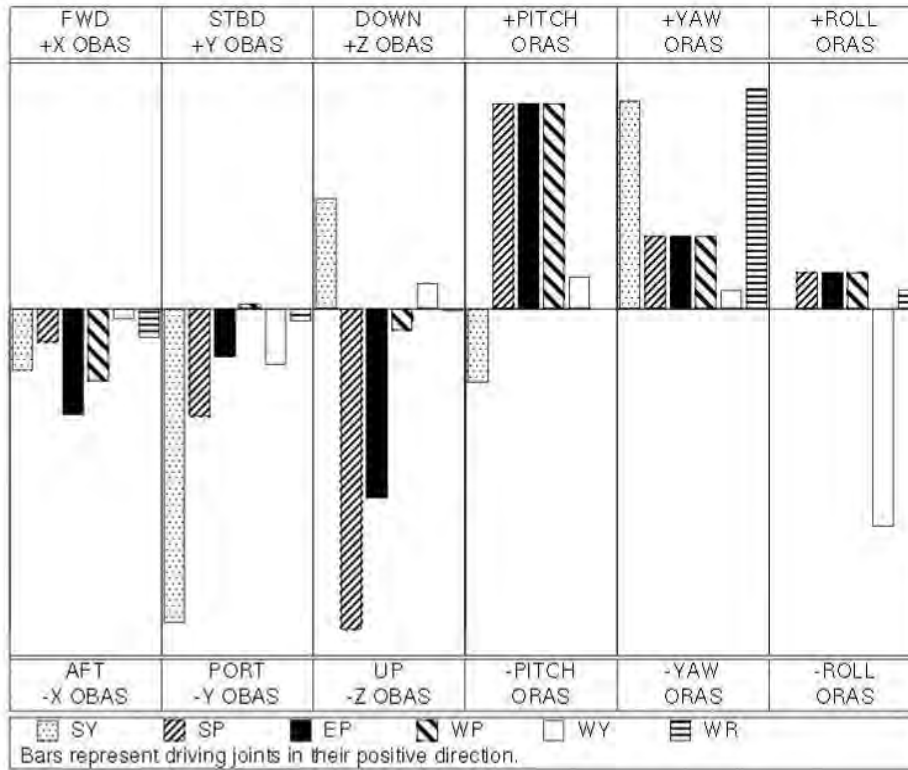

To get:	Drive:	To get:	Drive:	Driving:	Results In:	Driving:	Results In:
+X (fwd)	-EP, -WP	+PITCH	+WP, +EP	+SY	-Y (port), +YAW	+WP	-X (aft), +PITCH
+Y (stbd)	-SY	+YAW	+WR, +SY	+SP	-Z (up), +PITCH	+WY	-Y (port), -ROLL
+Z (down)	-SP, -EP	+ROLL	-WY	+EP	-Z (up), +PITCH	+WR	-X (aft), +YAW

### SUGGESTED JOINT ORDER SP-, WP+, SY-, EP-, WR- as req

$\Delta SY$	$\Delta SP$	$\Delta EP$	$\Delta WP$	$\Delta WY$	$\Delta WR$
+1.0	-1.2	-3.0	+4.5	-0.0	-1.0

z	SY	SP	EP	WP	WY	WR
-440	-10.0	+28.9	-39.0	-78.2	+20.0	-130.2
-438	-9.9	+28.9	-39.3	-77.8	+20.0	-130.2
-436	-9.8	+28.8	-39.6	-77.5	+20.0	-130.3
-434	-9.8	+28.7	-39.8	-77.1	+20.0	-130.4
-432	-9.7	+28.6	-40.1	-76.7	+20.0	-130.5
-430	-9.6	+28.5	-40.3	-76.4	+20.0	-130.6
-428	-9.5	+28.5	-40.5	-76.0	+20.0	-130.7
-426	-9.5	+28.4	-40.8	-75.7	+20.0	-130.7
-424	-9.4	+28.3	-41.0	-75.3	+20.0	-130.8
-422	-9.3	+28.2	-41.2	-75.0	+20.0	-130.9
-420	-9.2	+28.1	-41.4	-74.6	+20.0	-131.0
-418	-9.2	+28.0	-41.6	-74.3	+20.0	-131.1
-416	-9.1	+27.9	-41.8	-74.0	+20.0	-131.1
-414	-9.0	+27.8	-42.0	-73.6	+20.0	-131.2

5. CLOSE PRLAS  
 Perform ICC BERTH IN PLB (ICC NOMINAL) steps 7 through 10

√BRAKES – ON (tb-ON)  
 √MODE – not DIRECT (lt off)

A7U

6. SJ ICC RELEASE  
 CCTV – configure for ungrapple  
 – install ICC SJ UNGRAPPLE IN PLB WRIST CCTV OVERLAY  
 – RMS WRIST, ZOOM: 34.0 HFOV  
 FOCUS: 5 ft

DNLK (72)	EE
DTV (SSC 2)	A
MON 1 (SSC 1)	B (C)
MON 2 (71)	P1 LOOB







SM 94 PDRS CONTROL  
 PL ID – ITEM 3 +0 EXEC  
 INIT ID – ITEM 24 +0 EXEC

RHC If SINGLE mode available:  
 RATE – VERN (RATE MIN tb-ON)  
 BRAKES – OFF (tb-OFF)

MODE – best available

CAUTION  
 Monitor EE tb timing to prevent EE motor burnout

EE MODE – MAN  
 MAN CONTR – DERIGID (hold until DERIGID tb-gray, 5 sec max)  
 RELEASE sw – depress (hold until OPEN tb-gray, 3 sec max)

<p>√  RIGID</p> <p> DERIGID</p>	<p> CLOSE</p> <p> OPEN</p>	<p> CAPTURE</p> <p> EXTEND</p>	<p><u>CRITICAL TIMES (8 sec total):</u>          DERIGID tb – gray, 5 sec max, then          OPEN tb – gray, 3 sec max, then</p>
---	--	--	--

7. MNVR CLEAR OF ICC  
 Drive joints per ICC SJ UNGRAPPLE IN PLB WRIST CCTV OVERLAY and histogram until EE clear of grapple fixture

### ICC SJ UNGRAPPLE IN PLB

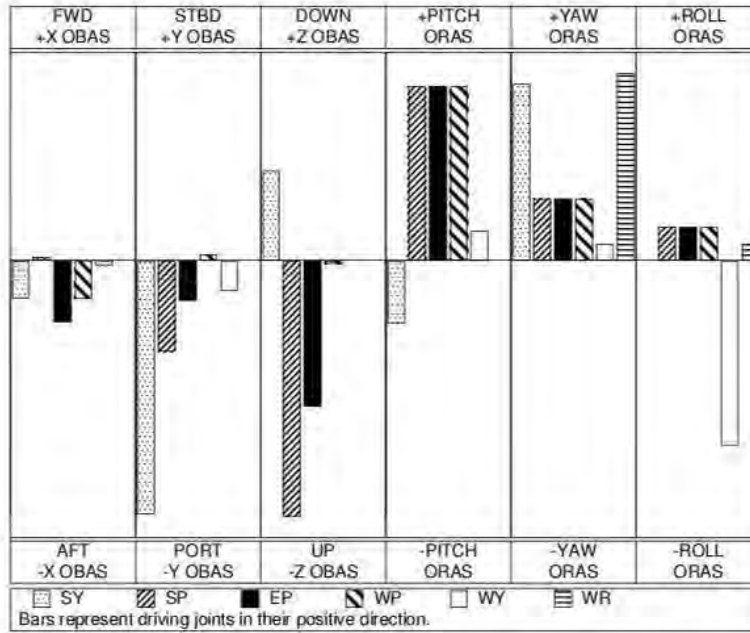

To get:	Drive:
+X (fwd)	-EP, -WP
+Y (stbd)	-SY
+Z (down)	-SP, -EP

To get:	Drive:
+PITCH	+WP, +EP
+YAW	+WR
+ROLL	-WY

Driving:	Results In:
+SY	-Y (port), +YAW
+SP	-Z (up), +PITCH
+EP	-Z (up), +PITCH

Driving:	Results In:
+WP	-X (aft), +PITCH
+WY	-Y (port), -ROLL
+WR	+YAW

$\Delta SY$	$\Delta SP$	$\Delta EP$	$\Delta WP$	$\Delta WY$	$\Delta WR$
-2.4	+3.7	+5.0	-9.6	-0.0	+2.5

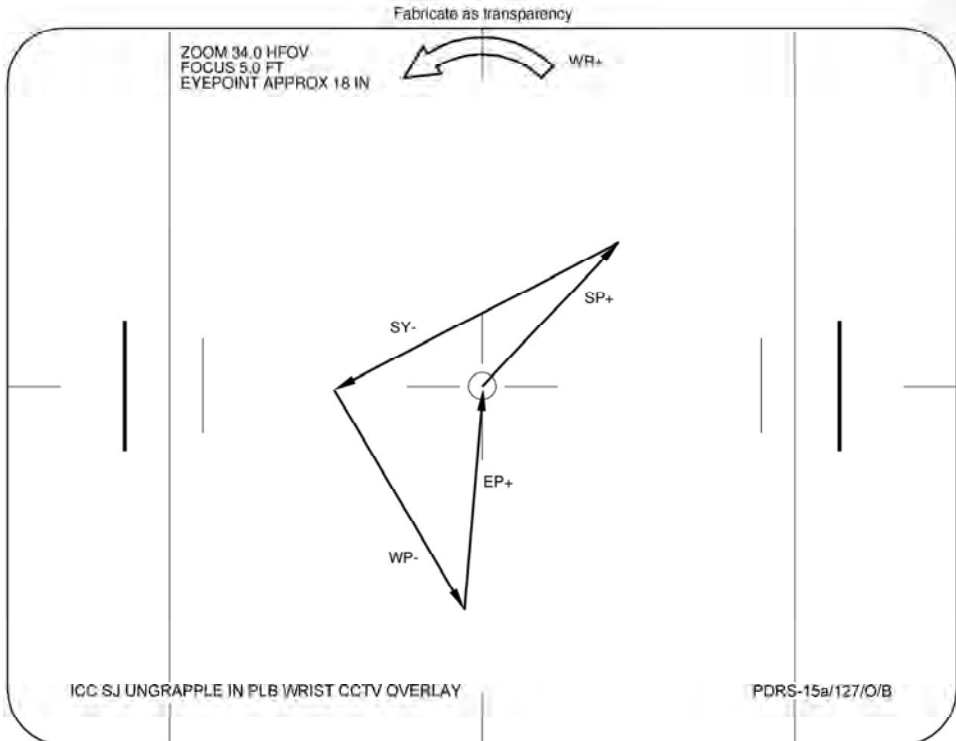

**CAUTION**  
Monitor EE tb timing to prevent EE motor burnout

EE MAN CONTR – DERIGID (hold until EXTEND tb-gray, 20 sec max)  
MODE – OFF

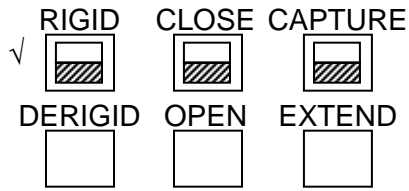

CRITICAL TIMES (20 sec total):  
EXTEND tb – gray, 20 sec max

Mnvr to ICC BACKOFF:

X	Y	Z	PITCH	YAW	ROLL	PL ID
-1169	-45	-504	275	0	202	0
SY	SP	EP	WP	WY	WR	
-11.4	+31.5	-37.1	-83.2	+20.0	-128.7	

BRAKES – ON (tb-ON)  
MODE – not DIRECT (lt off)

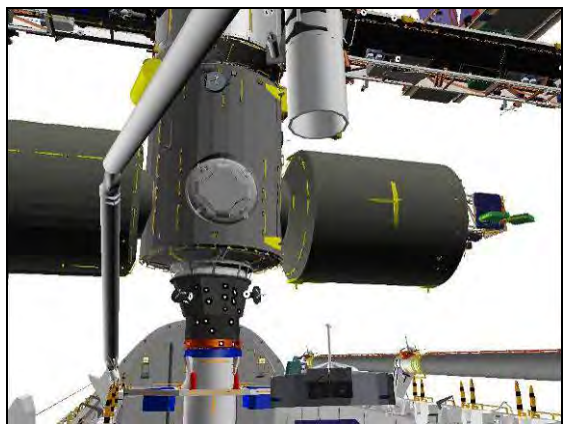

**CCTV B (15,15)**

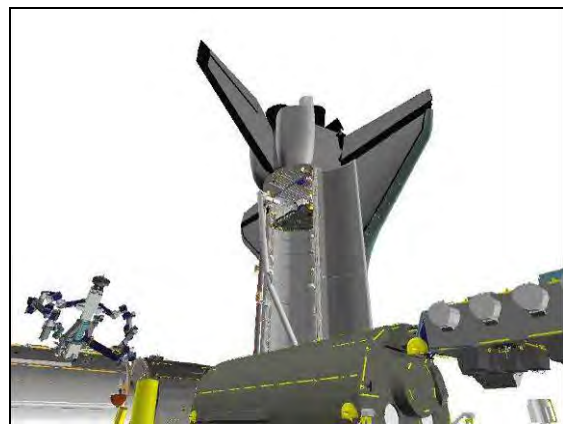

**P1LOOB (130,30)**

8. MNVR TO PRE-CRADLE

A7U CCTV – fully zoom out cameras for SJ pictures

DNLK (72)	B
DTV (SSC 2)	C
MON 1 (SSC 1)	A
MON 2 (71)	Elbow

RHC If SINGLE mode available:  
RATE – as reqd (VERN within 10 ft)  
BRAKES – OFF (tb-OFF)

MODE – best available

Mnvr to PRE-CRADLE:

	SY	SP	EP	WP	WY	WR	
ICC Backoff	-11.4	+31.5	-37.1	-83.2	+20.0	-128.7	
1: EP +			-25.0				
2: WP +				+5.0			
3: WY -					0.0		
4: WR +						0.0	
5: SY +	0.0						
6: SP -		+25.0					
Pre-cradle	0.0	+25.0	-25.0	+5.0	0.0	0.0	
	X	Y	Z	PITCH	YAW	ROLL	PL ID
	-1261	-146	-551	5	2	0	0

BRAKES – ON (tb-ON)  
 MODE – not DIRECT (lt off)

PARAM – PORT TEMP  
 JOINT – CRIT TEMP

Start:  
ICC Backoff

Step 1:  
Drive EP+ (for 12.1°)  
from -37.1 to -25.0

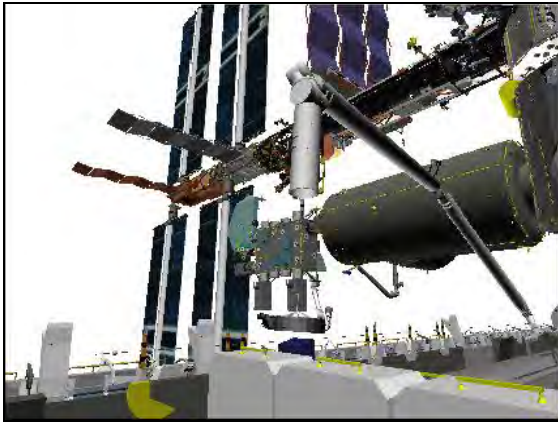

**CCTV C (-50,15)**

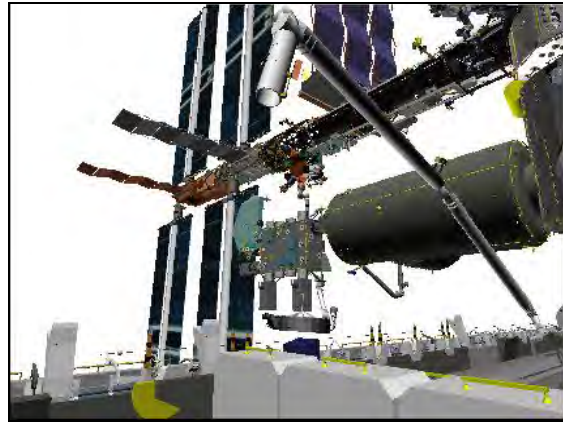

**CCTV C (-50,15)**

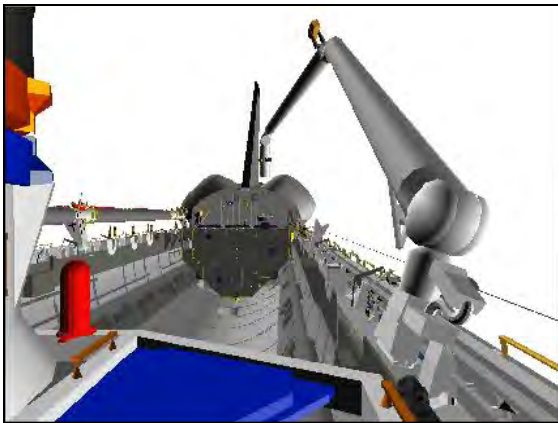

**CCTV A (0,0)**



**CCTV A (0,0)**

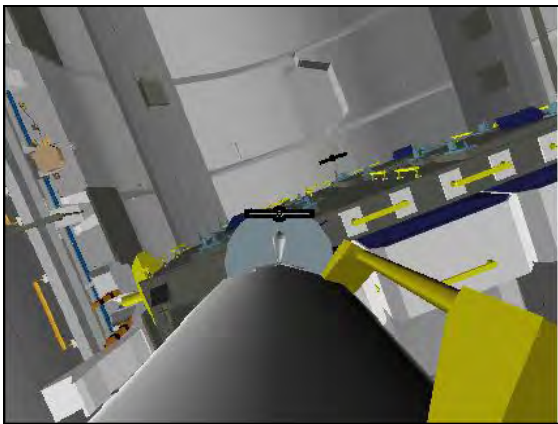

**EE**

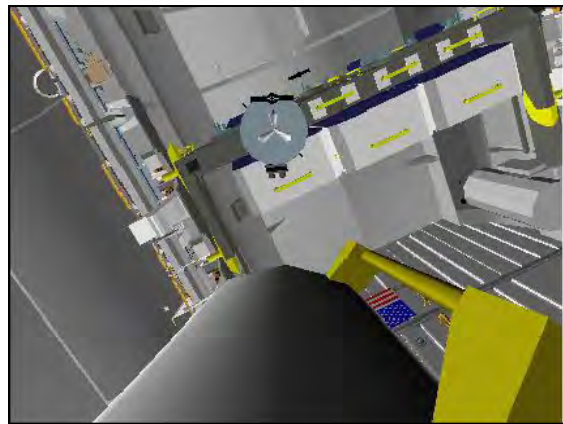

**EE**



Step 2:

Drive WP+ (for  $88.2^\circ$ )  
from -83.2 to +5.0

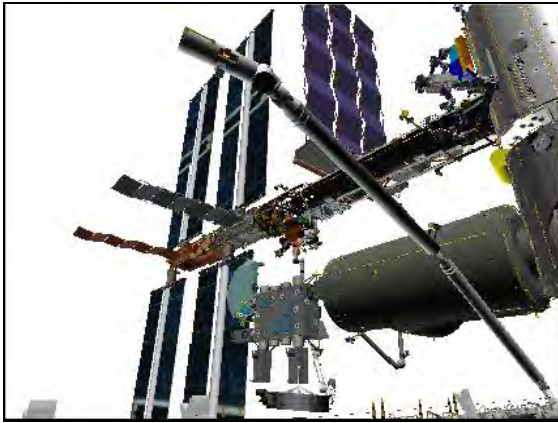

**CCTV C (-50,25)**

Step 3:

Drive WY- (for  $20.0^\circ$ )  
from +20.0 to 0.0

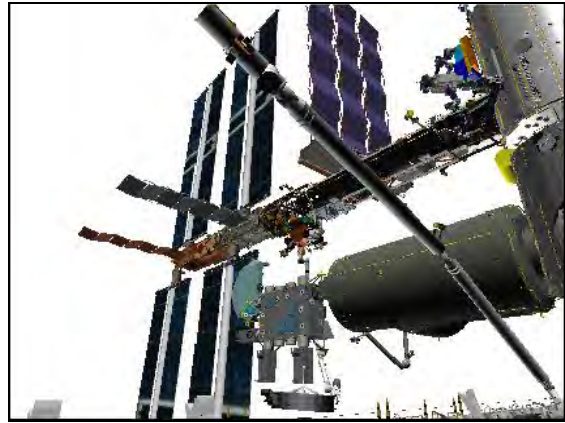

**CCTV C (-50,25)**



**CCTV A (0,0)**



**CCTV A (0,0)**

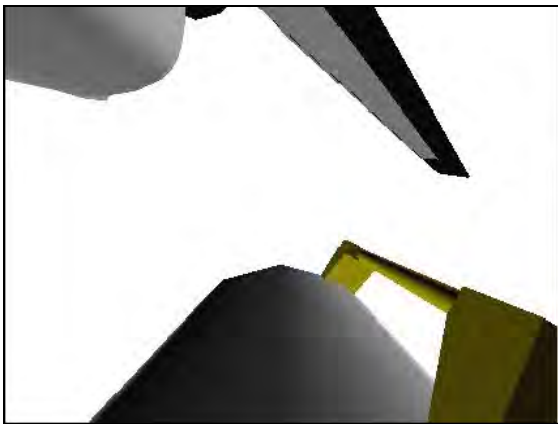

**EE**

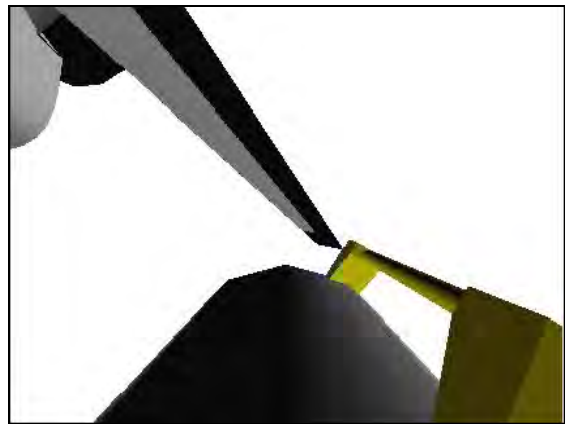

**EE**

Step 4:

Drive WR+ (for 128.7°)  
from -128.7 to 0.0

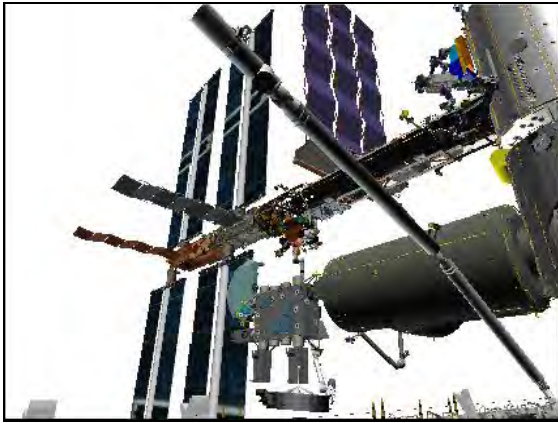

**CCTV C (-50,25)**

Step 5:

Drive SY+ (for 11.4°)  
from -11.4 to 0.0

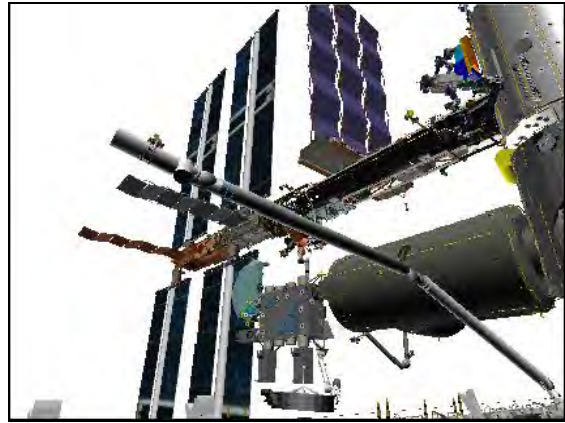

**CCTV C (-50,25)**



**CCTV A (0,0)**



**CCTV A (0,0)**

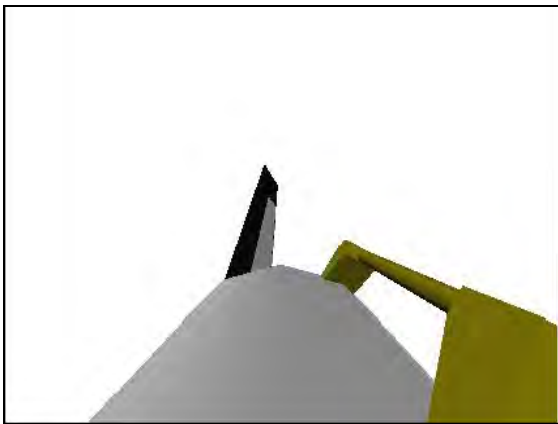

**EE**

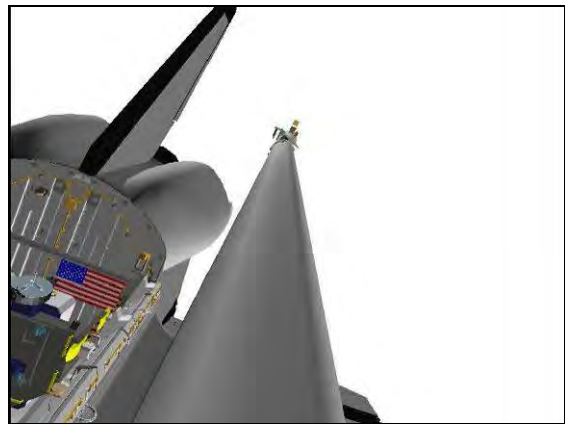

**ELBOW (0,-15)**



Step 6:

Drive SP- (for 6.5°)  
from +31.5 to +25.0

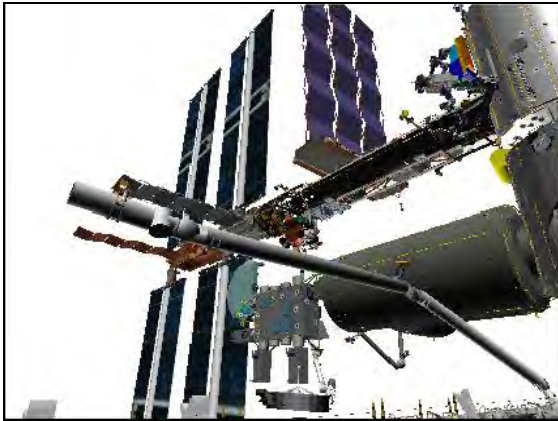

**CCTV C (-50,25)**



**CCTV A (0,0)**

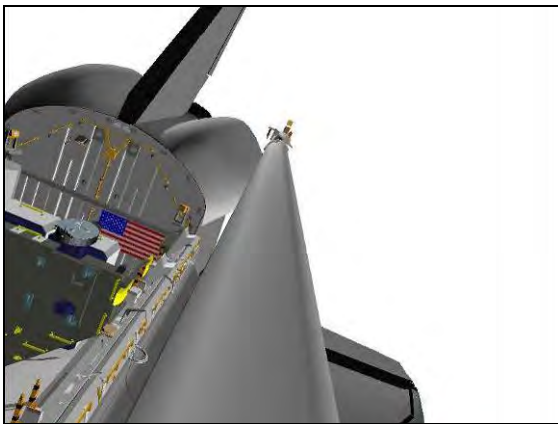

**ELBOW (0,-15)**

This Page Intentionally Blank

JLE OFF-NOMINAL

I

SJ JLE GRAPPLE IN PLB .....	FS 8-2
UNBERTH .....	FS 8-10
HANDOFF TO SSRMS .....	FS 8-12
UNGRAPPLE .....	FS 8-19
GRAPPLE FROM SSRMS .....	FS 8-28
BERTH IN PLB .....	FS 8-36

JLE  
OFF-NOMINAL

# SJ JLE GRAPPLE IN PLB

## 1. SETUP

Verify SSRMS at FD6 Overnight Park posn:

SR	SY	SP	EP	WP	WY	WR
+213.7	-3.2	-101.1	+136.1	-165.1	-174.7	+140.1

DNLK (72)	Elbow
DTV (SSC 2)	B (C)
MON 1 (SSC 1)	A
MON 2 (71)	P1 LOOB

SM 94 PDRS CONTROL

√ PL ID, ITEM 3: 0

√ INIT ID, ITEM 24: 0

Verify SRMS at EVA 2 VIEWING posn:

X	Y	Z	PITCH	YAW	ROLL	PL ID
-355	-489	-328	93	33	357	0
SY	SP	EP	WP	WY	WR	
+130.0	+15.0	-40.4	+103.0	-7.0	-213.0	

## 2. MNVR TO JLE PRE-GRAPPLE IN PLB POSN

### NOTE

Clearance between SRMS Upper Boom and JPM is 60 inches at Pre-grapple. Monitor with Camera A

If SINGLE mode available:

RATE – as reqd (VERN within 10 ft)

BRAKES – OFF (tb-OFF)

MODE – best available

Mnvr to JLE PRE-GRAPPLE posn:

	SY	SP	EP	WP	WY	WR	
EVA 2 View	+130.0	+15.0	-40.4	+103.0	-7.0	-213.0	
1: SY -	+45.0						
2: SP +		+55.0					
3: WY +					+18.2		
4: WP -				-73.4			
5: WR +						-48.2	
6: SY -	-20.6						
7: EP -			-78.7				
Pre-grapple	-20.6	+55.0	-78.7	-73.4	+18.2	-48.2	
	X	Y	Z	PITCH	YAW	ROLL	PL ID
	-1057	0	-510	270	0	270	0

JLE  
OFF-NOMINAL

RHC

Start:  
EVA 2 Viewing

Step 1:  
Drive SY- (for 85.0°)  
from +130.0 to +45.0

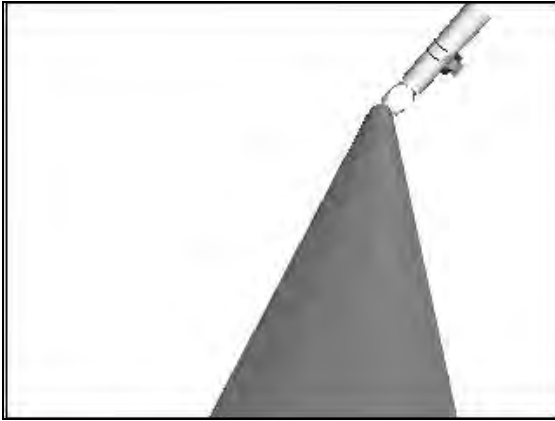

**ELBOW (-15,-20)**

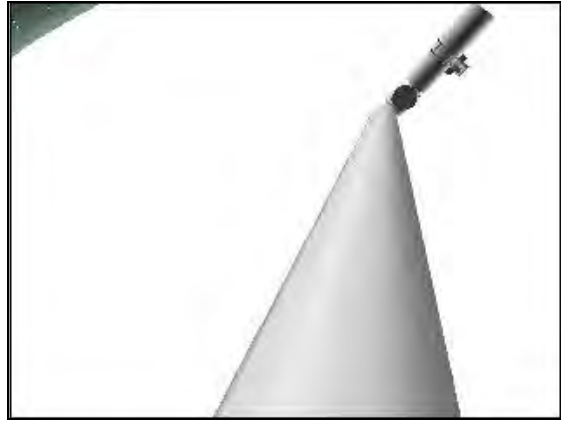

**ELBOW (-15,-20)**



**CCTV A (15,25)**



**CCTV A (15,25)**

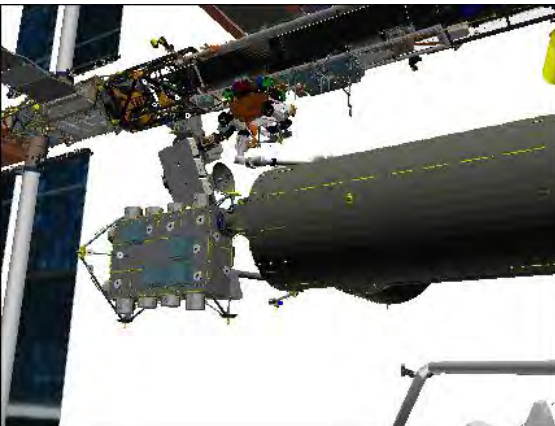

**CCTV B (-30,15)**

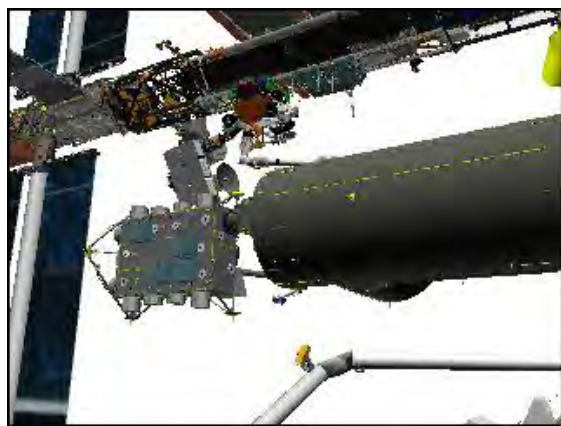

**CCTV B (-30,15)**

Step 2:

Drive SP+ (for 40.0°)  
from +15.0 to +55.0

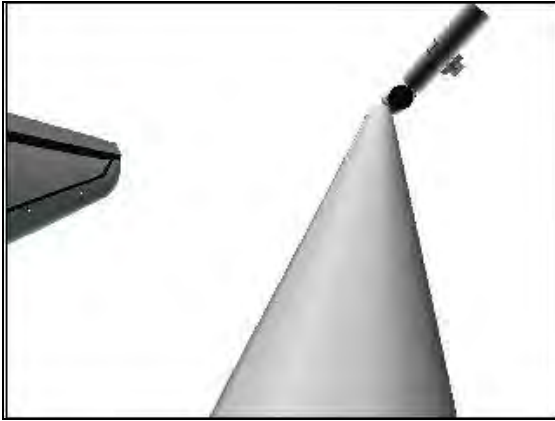

**ELBOW (-15,-20)**

Step 3:

Drive WY+ (for 25.2°)  
from -7.0 to +18.2

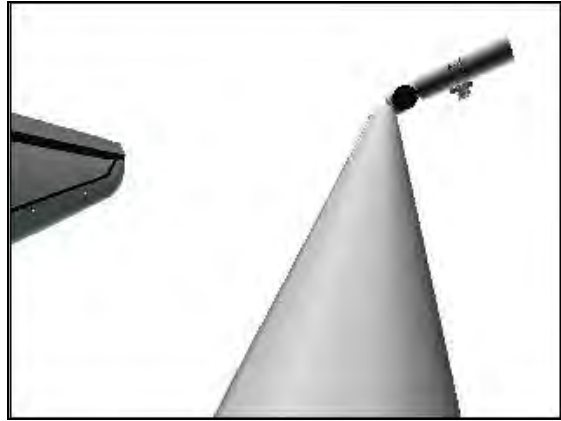

**ELBOW (-15,-20)**



**CCTV A (15,25)**



**CCTV A (15,25)**



**CCTV B (-30,15)**



**CCTV B (-30,15)**

Step 4:

Drive WP- (for 176.4°)  
from +103.0 to -73.4

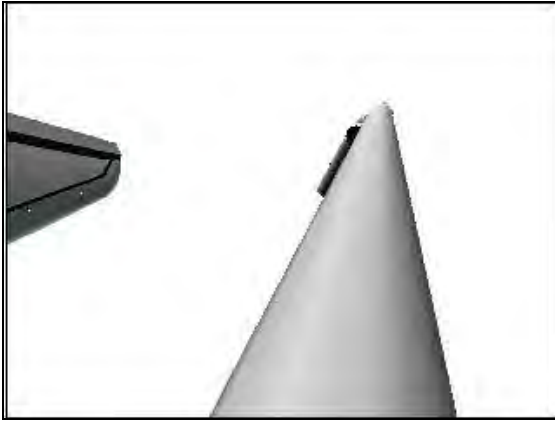

**ELBOW (-15,-20)**

Step 5:

Drive WR+ (for 164.8°)  
from -213.0 to -48.2

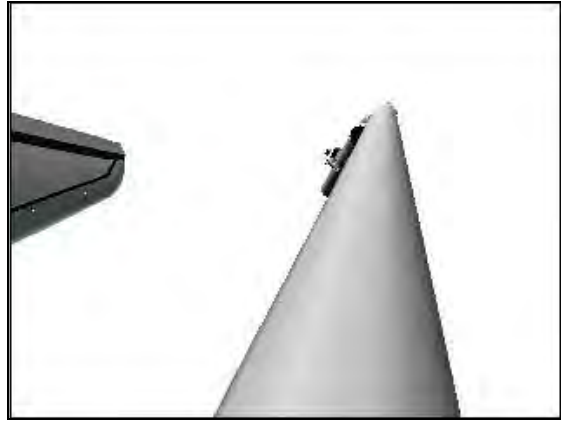

**ELBOW (-15,-20)**



**CCTV A (15,25)**



**CCTV A (15,25)**



**CCTV B (-30,15)**



**CCTV B (-30,15)**



Step 6:

Drive SY- (for 65.6°)  
from +45.0 to -20.6

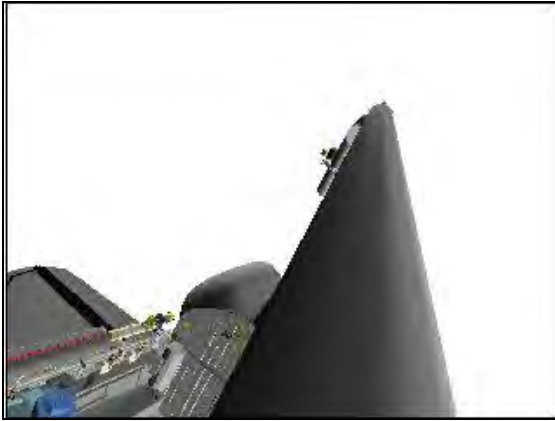

**ELBOW (-15,-20)**

Step 7:

Drive EP- (for 38.3°)  
from -40.4 to -78.7

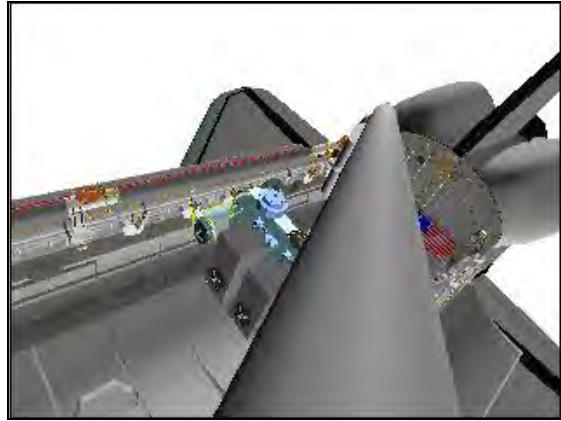

**ELBOW (-15,-20)**



**CCTV A (15,25)**



**CCTV A (15,25)**

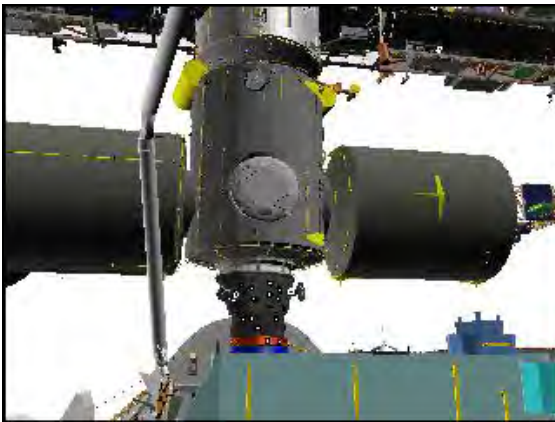

**CCTV B (10,15)**

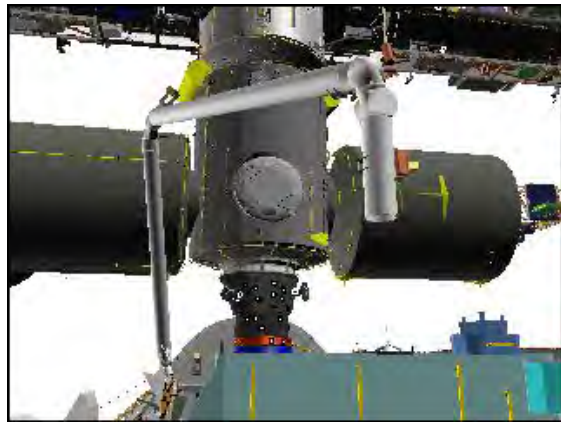

**CCTV B (10,15)**



3. SJ MNVR TO JLE GRAPPLE IN PLB

DNLK (72)	EE
DTV (SSC 2)	B (C)
MON 1 (SSC 1)	A
MON 2 (71)	P1 LOOB

A7U

CCTV – configure for grapple  
– install JLE SJ GRAPPLE IN PLB WRIST CCTV OVERLAY  
– RMS WRIST, zoom 34.0 HFOV  
focus 5 ft  
Maintain eyepoint ~18 in when using grapple overlay

RHC

If SINGLE mode available:  
RATE – VERN (RATE MIN tb-ON)  
BRAKES – OFF (tb-OFF)

MODE – best available

Drive joints per JLE SJ GRAPPLE IN PLB WRIST CCTV OVERLAY and histogram until EE within grapple envelope

### JLE SJ GRAPPLE IN PLB

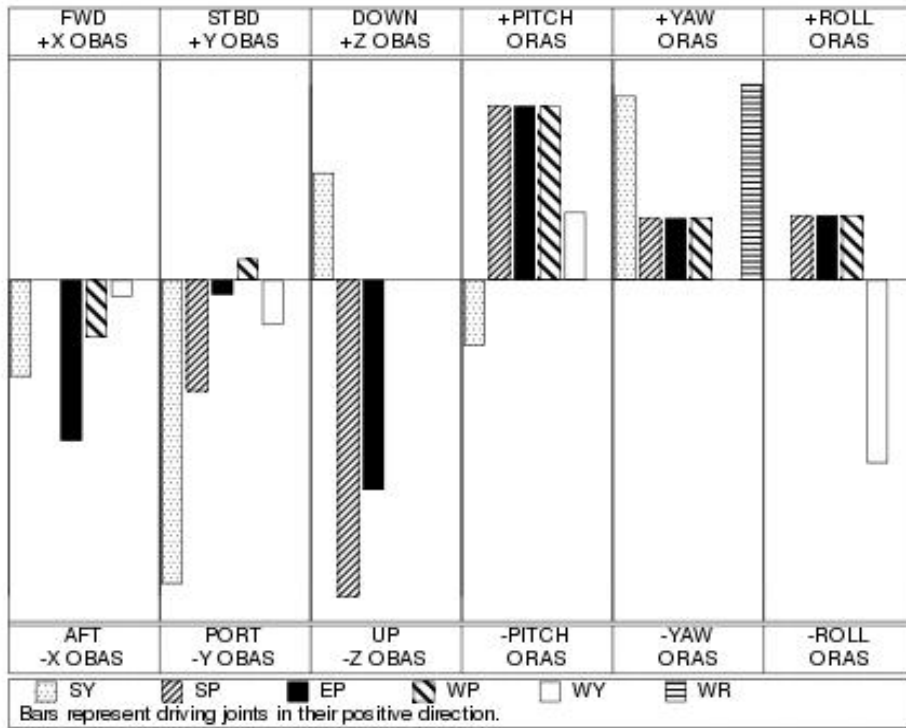

To get:	Drive:	To get:	Drive:
+X (fwd)	-EP, -SY	+PITCH	+WP, +EP
+Y (stbd)	-SY	+YAW	+WR
+Z (down)	-SP, -EP	+ROLL	-WY

Driving:	Results in:	Driving:	Results in:
+SY	-Y (port), +YAW	+WP	-X (aft), +PITCH
+SP	-Z (up), +PITCH	+WY	-Y (port), -ROLL
+EP	-Z (up), +PITCH	+WR	+YAW

$\Delta SY$	$\Delta SP$	$\Delta EP$	$\Delta WP$	$\Delta WY$	$\Delta WR$
+2.7	-4.7	-5.5	+11.1	+0.3	-2.9

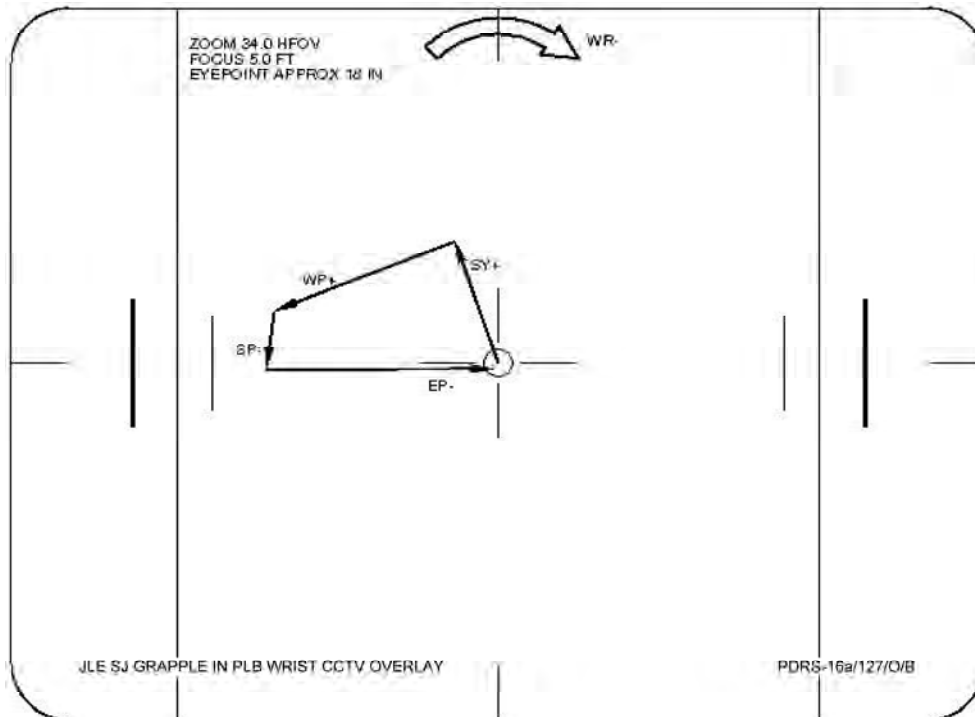

4. JLE GRAPPLE IN PLB

**CAUTION**  
Monitor EE tb timing to prevent EE motor burnout

**SM 169 PDRS STATUS**

EE MODE – AUTO  
CAPTURE sw – depress (mom)

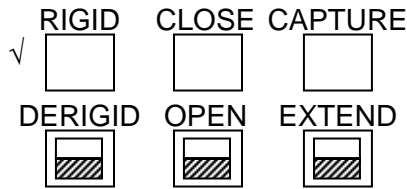

CRITICAL TIMES (28 sec total):  
CAPTURE tb – gray, then  
CLOSE tb – gray, 3 sec max, then  
RIGID tb – gray, 25 sec max

- \* If manual grapple reqd: \*
- \* EE MODE – MAN \*
- \* CAPTURE sw – depress (hold until CLOSE tb-gray, 3 sec max) \*
- \* MAN CONTR – RIGID (hold until RIGID tb-gray, 25 sec max) \*

EE MODE – OFF

BRAKES – ON (tb-ON)  
MODE – not DIRECT (lt off)

**SM 94 PDRS CONTROL**

PL ID – ITEM 3 +4 EXEC  
INIT ID – ITEM 24 +4 EXEC

Record POS/ATT and Joint Angles:

	X	Y	Z	PITCH	YAW	ROLL	PL ID
							4
Expected	-1034	0	-414	180	0	180	4
	SY	SP	EP	WP	WY	WR	
Expected	-17.9	+50.3	-84.2	-62.3	+18.5	-51.1	

Record POS/ATT and Joint Angles in SJ JLE BERTH IN PLB

Review GENERIC END EFFECTOR CUE CARD – ISS/SHUTTLE DOCKED OPS

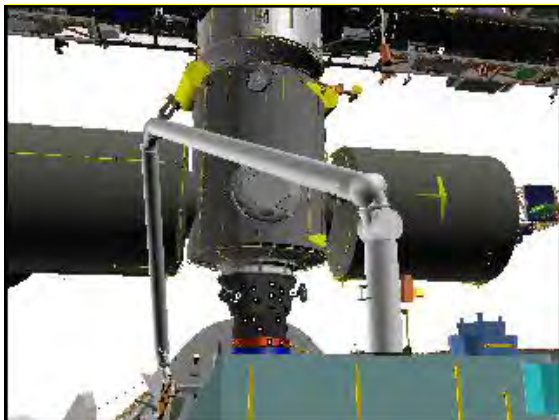

**CCTV B (10,15)**



**CCTV A (0,30)**

# SJ JLE UNBERTH

1. SETUP  
Perform JLE UNBERTH (JLE NOMINAL), steps 1 through 5

2. SJ MNVR TO TOP OF V-GUIDES

If SINGLE mode available:

RHC           RATE       – VERN (RATE MIN tb-ON)  
               BRAKES   – OFF (tb-OFF)

MODE – best available

Mnvr JLE up until unconstrained

A6U           √PL RETEN RDY 1,2,3,4 tb (four) – bp

Drive joints per JLE UNBERTH Table and Histogram until trunnions at top of V-guides

JLE SJ TOP OF V-GUIDES

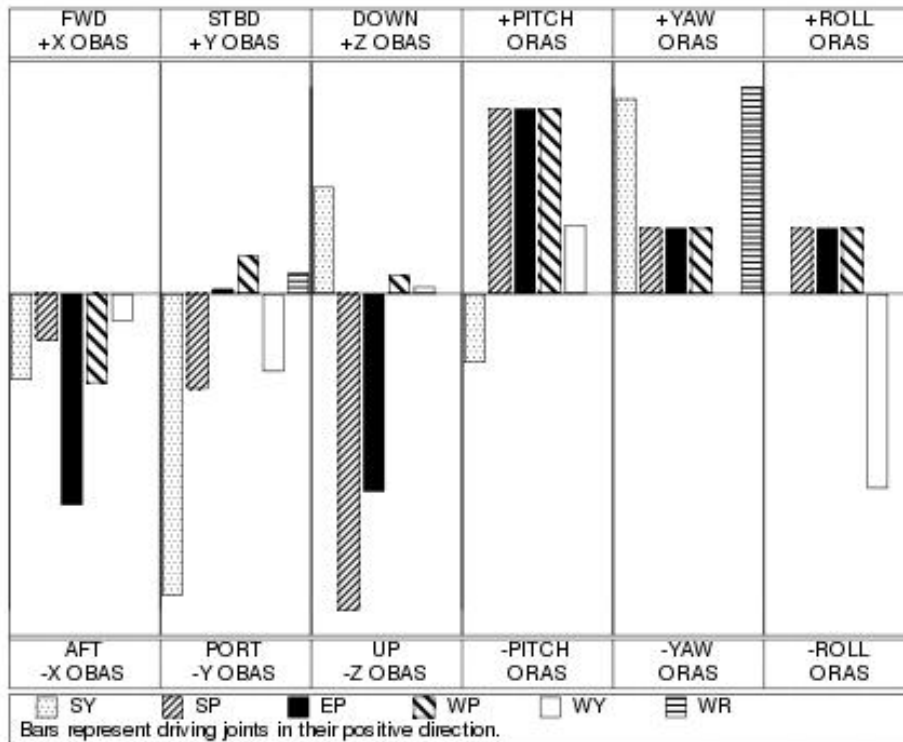

To get:	Drive:	To get:	Drive:
+X (fwd)	-EP, -WP	+PITCH	+WP, +EP
+Y (stbd)	-SY	+YAW	+WR
+Z (down)	-SP, -EP	+ROLL	-WY

Driving:	Results In:	Driving:	Results In:
+SY	-Y (port), +YAW	+WP	-X (aft), +PITCH
+SP	-Z (up), +PITCH	+WY	-Y (port), -ROLL
+EP	-X (aft), +PITCH	+WR	+Y (stbd), +YAW

**SUGGESTED JOINT ORDER**  
SP+, WP-, SY-, EP+, WR+ as req

$\Delta SY$	$\Delta SP$	$\Delta EP$	$\Delta WP$	$\Delta WY$	$\Delta WR$
-1.0	+2.0	+1.7	-4.0	-0.1	+1.1

z	SY	SP	EP	WP	WY	WR
-414	-17.9	+50.3	-84.2	-62.3	+18.5	-51.1
-416	-18.0	+50.5	-84.1	-62.7	+18.5	-51.0
-418	-18.1	+50.7	-83.9	-63.0	+18.5	-50.9
-420	-18.2	+50.9	-83.8	-63.4	+18.5	-50.8
-422	-18.3	+51.1	-83.6	-63.8	+18.5	-50.7
-424	-18.4	+51.3	-83.5	-64.1	+18.5	-50.6
-426	-18.5	+51.4	-83.3	-64.5	+18.5	-50.5
-428	-18.6	+51.6	-83.2	-64.8	+18.5	-50.4
-430	-18.6	+51.8	-83.0	-65.2	+18.4	-50.3
-432	-18.7	+52.0	-82.9	-65.6	+18.4	-50.2
-434	-18.8	+52.1	-82.7	-65.9	+18.4	-50.1
-436	-18.9	+52.3	-82.5	-66.3	+18.4	-50.0

BRAKES – ON (tb-ON)  
MODE – not DIRECT

JLE TOP OF V-GUIDES

	X	Y	Z	PITCH	YAW	ROLL	PL ID
√	-1034	0	-436	180	0	180	4
	SY	SP	EP	WP	WY	WR	
√	-18.9	+52.3	-82.5	-66.3	+18.3	-50.0	



CCTV B (0,5)

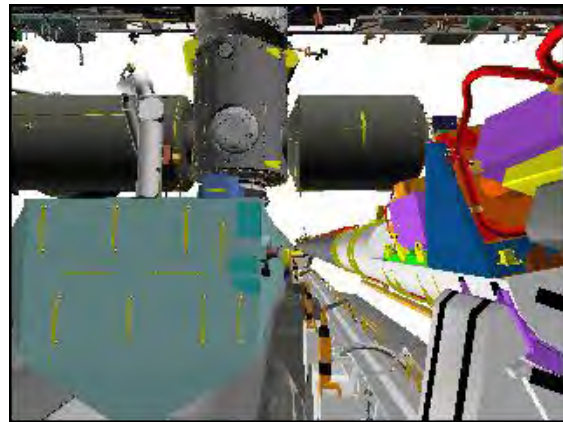

CCTV C (0,5)



CCTV A (0,20)



PORT

# SJ JLE HANDOFF TO SSRMS

## 1. SJ MNVR TO JLE HANDOFF POSN

Verify JEMRMS at JLE INSTALL VIEWING posn:

SY	SP	EP	WP	WY	WR
-7.0	+70.0	-115.0	-40.0	0.0	+7.0

R12

√Green Jumper – ISS

DNLK (72)	Elbow
DTV (SSC 2)	Lab
MON 1 (SSC 1)	C
MON 2 (71)	Mux D/A

### NOTE

Minimum clearance between Port Trunnions and V-guides is 5 inches. Monitor with Camera A. Minimum clearance between Stbd Trunnions and OBSS is 6 inches and increases during maneuver. Monitor with Camera D.

After Line 1, minimum clearance between SRMS Upper Boom and JPM is 34 inches. Monitor with Camera A. Monitor clearance between JLE and Orbiter Aft with Camera C

RHC

If SINGLE mode available:

RATE – as reqd (VERN within 10 ft)

BRAKES – OFF (tb-OFF)

MODE – best available

Mnvr to JLE HANDOFF posn:

	SY	SP	EP	WP	WY	WR	
Top V-Guides	-18.9	+52.3	-82.5	-66.3	+18.3	-50.0	
1: SP +		+67.0					
2: WP +				+15.4			
3: SY +	+35.0						
4: WR –						-235.6	
5: WY +					+58.9		
6: EP +			-33.6				
7: SP –		+23.6					
8: SY +	+137.7						
Handoff	+137.7	+23.6	-33.6	+15.4	+58.9	-235.6	
	X	Y	Z	PITCH	YAW	ROLL	PL ID
	-206	-437	-414	82	2	165	4

BRAKES – ON (tb-ON)

MODE – not DIRECT (lt off)

- \* If using Shuttle attitude control and attitude maintenance reqd: \*
- \* DAP: LVLH \*
- \* When rates damped: \*
- \* DAP: FREE > 2 sec \*
- \* DAP: AUTO \*
- \* When in attitude and rates damped: \*
- \* DAP: FREE \*

Notify SSRMS operator that SRMS at JLE HANDOFF posn with Brakes ON;  
GO for SSRMS JLE Grapple



Start:  
Top of V-Guides

Step 1:  
Drive SP+ (for 14.4°)  
from +52.6 to +67.0

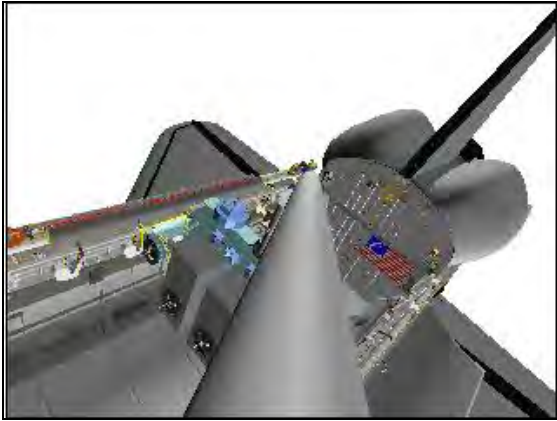

**ELBOW (-5,-10)**

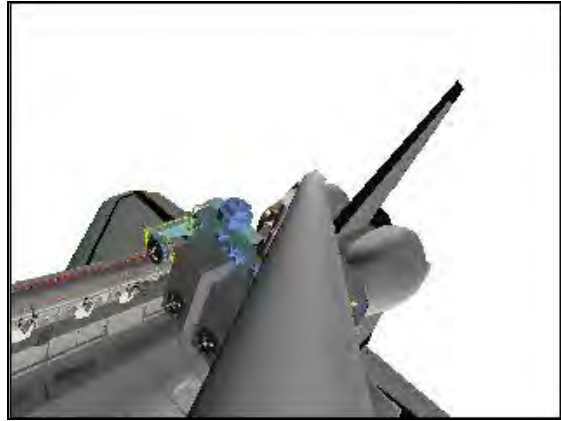

**ELBOW (-5,-10)**



**CCTV A (0,28)**



**CCTV A (0,28)**



**CCTV C (-50,35)**

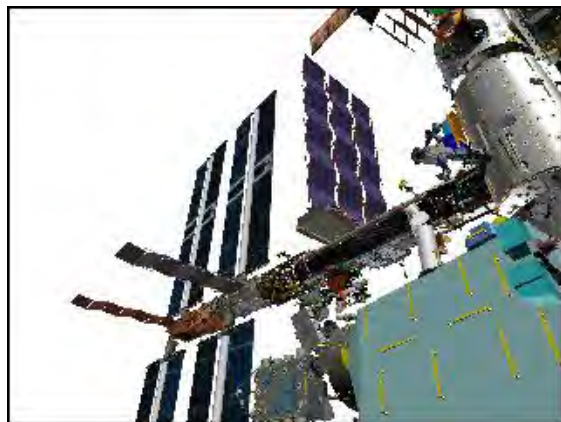

**CCTV C (-50,35)**



Step 2:

Drive WP+ (for 82.4°)  
from -67.0 to +15.4

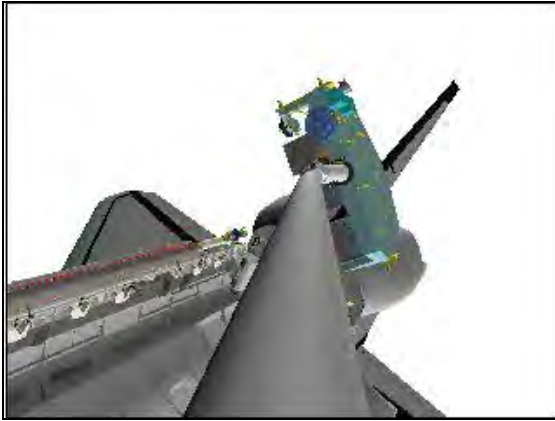

**ELBOW (-5,-10)**

Step 3:

Drive SY+ (for 54.1°)  
from -19.1 to +35.0

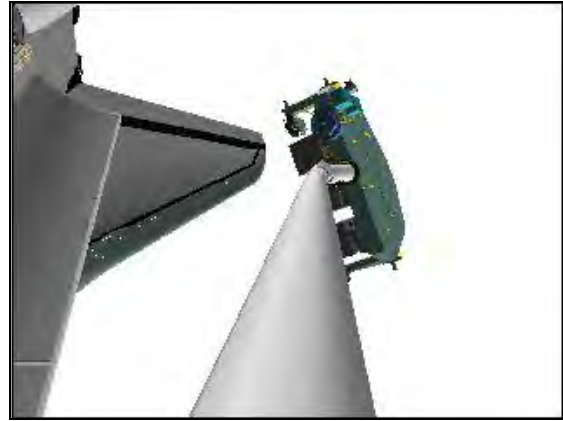

**ELBOW (-5,-10)**



**CCTV A (0,28)**



**CCTV A (35,20)**

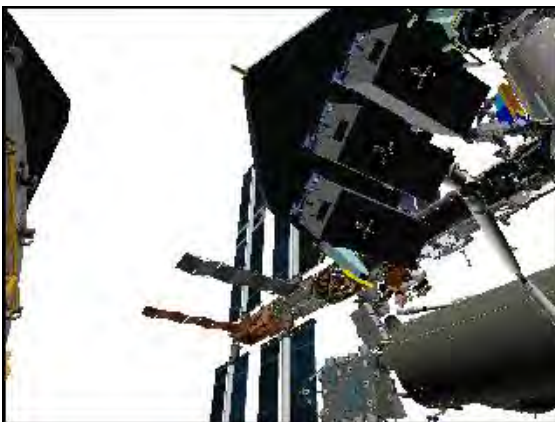

**CCTV C (-60,35)**



**CCTV B (-45,20)**

Step 4:

Drive WR- (for 185.8°)  
from -49.8 to -235.6

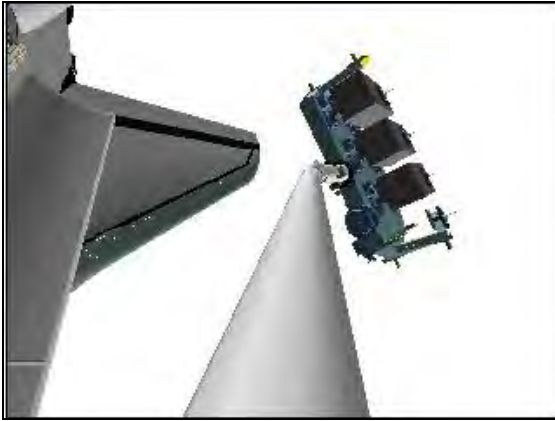

**ELBOW (-5,-10)**

Step 5:

Drive WY+ (for 40.5°)  
from +18.4 to +58.9

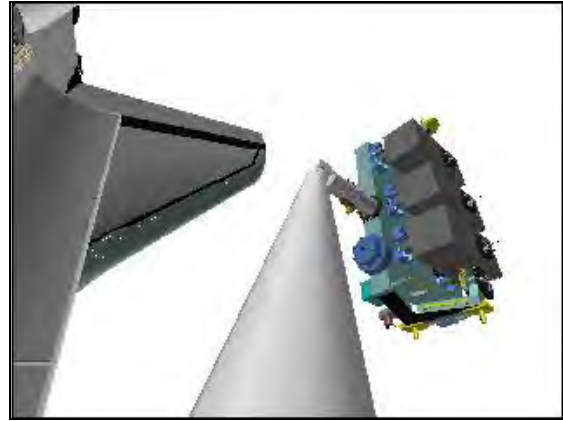

**ELBOW (-5,-10)**



**CCTV A (35,20)**



**CCTV A (35,20)**



**CCTV B (-45,20)**



**CCTV B (-45,20)**

Step 6:

Drive EP+ (for 48.6°)  
from -82.2 to -33.6

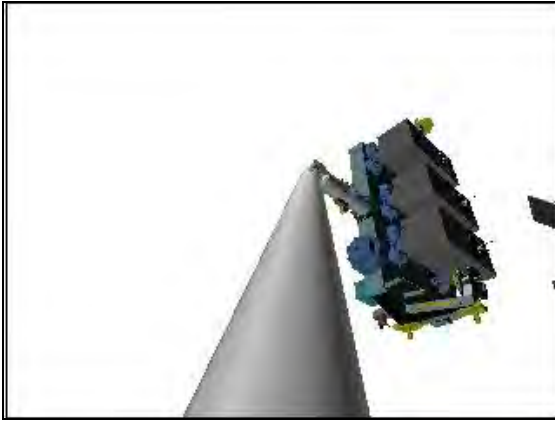

**ELBOW (-5,-10)**

Step 7:

Drive SP- (for 43.4°)  
from +67.0 to +23.6

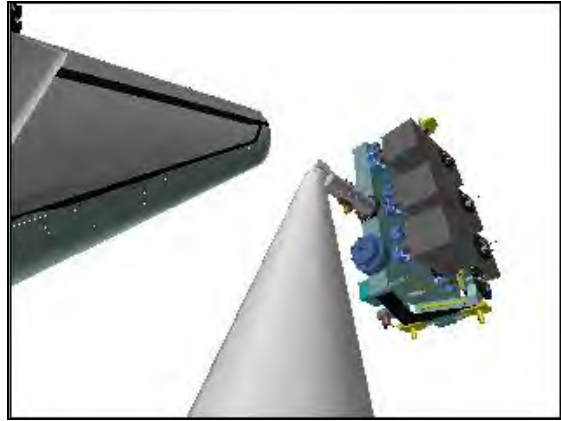

**ELBOW (-5,-10)**



**CCTV A (35,20)**



**CCTV A (35,20)**



**CCTV B (-45,20)**

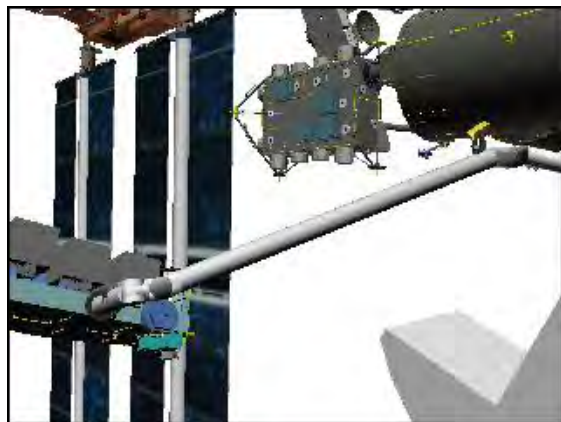

**CCTV B (-45,0)**

Step 8:

Drive SY+ (for 102.7°)  
from +35.0 to +137.7

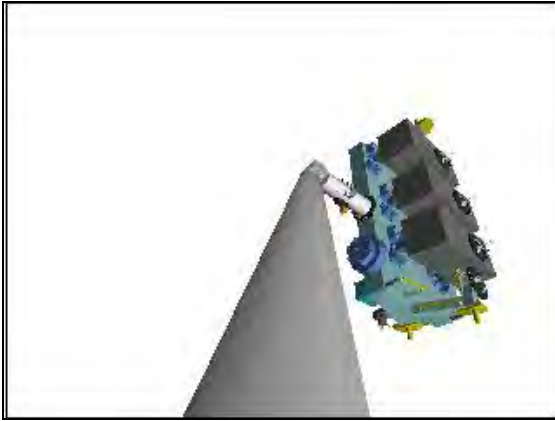

**ELBOW (-5,-10)**



**CCTV A (85,20)**



**CCTV B (-35,0)**

## SJ JLE UNGRAPPLE

- A7U 1. SETUP  
CCTV – configure for ungrapple  
– install JLE SJ UNGRAPPLE AT HANDOFF WRIST CCTV OVERLAY  
– RMS WRIST, zoom 34.0 HFOV  
focus 5 ft

DNLK (72)	EE (Elbow)
DTV (SSC 2)	Tip Elbow
MON 1 (SSC 1)	A
MON 2 (71)	B (C)

SM 94 PDRS CONTROL  
PL ID – ITEM 3 +0 EXEC  
INIT ID – ITEM 24 +0 EXEC

2. JLE UNGRAPPLE  
Verify SSRMS Grapple complete with Brakes ON and SSRMS Operator GO for SRMS JLE Ungrapple

If SINGLE mode available:

### NOTE

CONTRL ERR It and 'S96 PDRS CNTL' msg may occur due to Consistency/Envelope Check error

RHC RATE – COARSE (RATE MIN tb-OFF)

SM 94 PDRS CONTROL  
AUTO BRAKE INH – ITEM 10 EXEC (\*)

BRAKES – OFF (tb-OFF)

MODE – TEST, ENTER  
Wait 5 sec

BRAKES – ON (tb-ON)

SM 94 PDRS CONTROL  
AUTO BRAKE ENA – ITEM 9 EXEC (\*)

RHC RATE – VERN (RATE MIN tb-ON)  
BRAKES – OFF (tb-OFF)

MODE – best available

### CAUTION

Monitor EE tb timing to prevent EE motor burnout

EE MODE – MAN  
MAN CONTR – DERIGID (hold until DERIGID tb-gray, 5 sec max)  
RELEASE sw – depress (hold until OPEN tb-gray, 3 sec max)



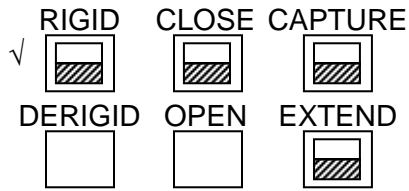

**CRITICAL TIMES (8 sec total):**  
 DERIGID tb – gray, 5 sec max, then  
 OPEN tb – gray, 3 sec max, then

3. MNVR CLEAR OF JLE

Drive joints per JLE SJ UNGRAPPLE AT HANDOFF WRIST CCTV OVERLAY  
 and histogram until EE clear of grapple fixture

JLE SJ UNGRAPPLE AT HANDOFF

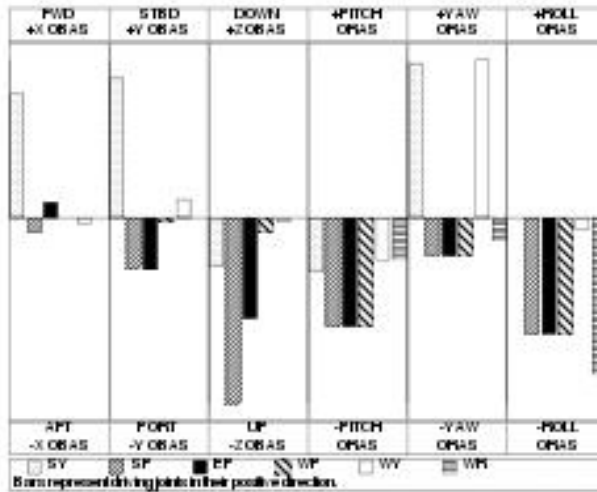

To get:	Drive:	To get:	Drive:	Driving:	Results In:	Driving:	Results In:
+X (fwd)	+SY	+PITCH	-WP, -EP	+SY	+Y (stbd), +YAW	+WP	-Z (up), -ROLL
+Y (stbd)	+SY, -EP	+YAW	+WY, +SY	+SP	-Z (up), -ROLL	+WY	+Y (stbd), +YAW
+Z (down)	-SP, -EP	+ROLL	-WR, -WP	+EP	-Z (up), -ROLL	+WR	-ROLL

$\Delta SY$	$\Delta SP$	$\Delta EP$	$\Delta WP$	$\Delta WY$	$\Delta WR$
-5.9	+8.5	-18.0	+8.7	+5.9	-1.3

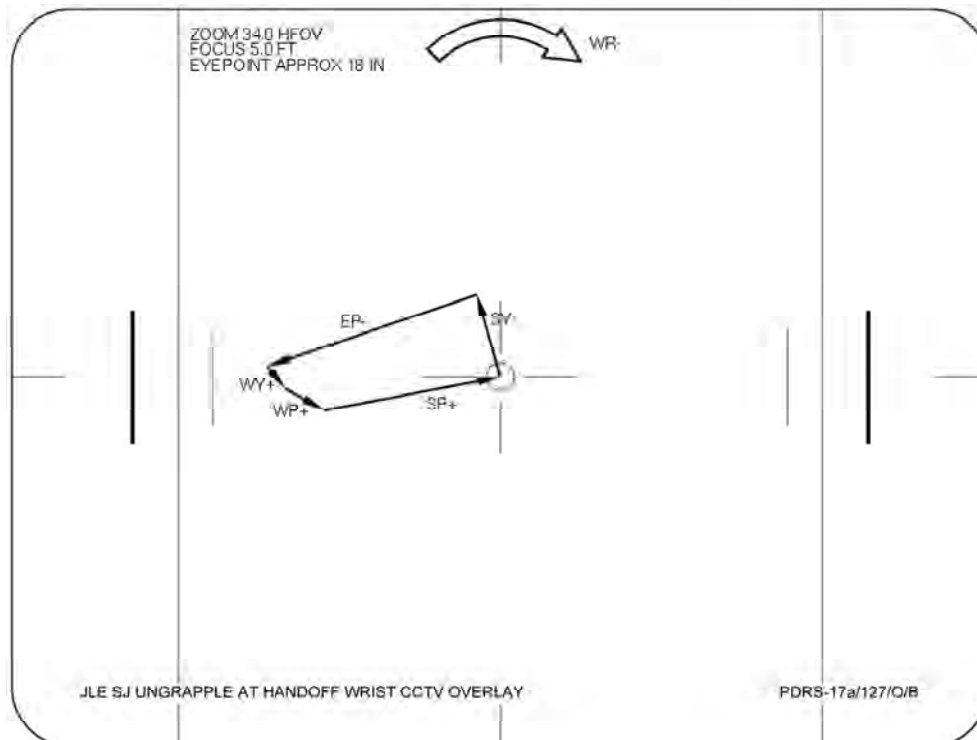

EE MAN CONTR – DERIGID (hold until EXTEND tb-gray, 20 sec max)  
 MODE – OFF

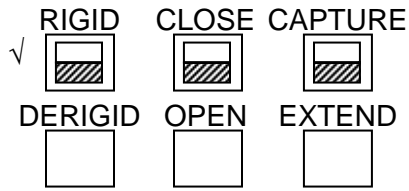

CRITICAL TIMES (20 sec total):  
 EXTEND tb – gray, 20 sec max

NOTE

Minimum clearance between SRMS Upper Boom and JPM is 42 inches at JLE Clearance posn. Monitor with Cameras A and B

Mnvr to JLE CLEARANCE posn:

X	Y	Z	PITCH	YAW	ROLL	PL ID
-295	-460	-378	172	345	269	0
SY	SP	EP	WP	WY	WR	
+131.8	+33.1	-51.6	+25.1	+64.8	-236.9	

4. MNVR TO VIEWING POSN

DNLK (72)	A
DTV (SSC 2)	B
MON 1 (SSC 1)	Elbow (EE)
MON 2 (71)	P1 LOOB

NOTE

Minimum clearance between SRMS Upper Boom and JPM is 32 inches at line 1. Monitor with Camera A

RHC If SINGLE mode available:  
 RATE – as reqd (VERN within 10 ft)  
 BRAKES – OFF (tb-OFF)

MODE – best available

Mnvr to JLE INSTALL VIEWING posn:

	SY	SP	EP	WP	WY	WR	
Clearance	+131.8	+33.1	-51.6	+25.1	+64.8	-236.9	
1: SY –	+63.7						
2: SP +		+52.3					
3: EP +			-49.2				
4: WP +				+77.1			
5: WY –					+53.5		
6: WR +						-105.6	
Install View	+63.7	+52.3	-49.2	+77.1	+53.5	-105.6	
	X	Y	Z	PITCH	YAW	ROLL	PL ID
	-837	-594	-555	150	40	132	0

BRAKES – ON (tb-ON)  
MODE – not DIRECT (lt off)

PARAM – PORT TEMP  
JOINT – CRIT TEMP

Notify SSRMS operator that SRMS at JLE Install Viewing posn and SSRMS GO  
for JLE Install



Start:  
JLE Clearance

Step 1:  
Drive SY- (for 68.1°)  
from +131.8 to +63.7

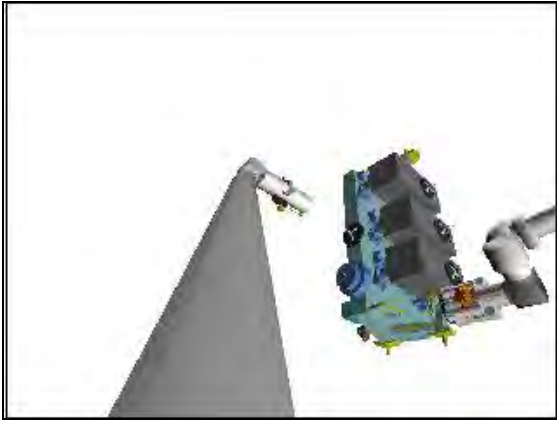

**ELBOW (5,-10)**



**ELBOW (5,-10)**



**CCTV A (85,10)**

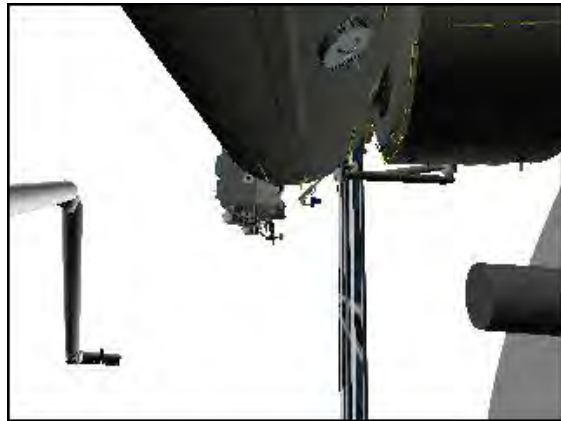

**CCTV A (85,10)**



**CCTV B (-35,0)**

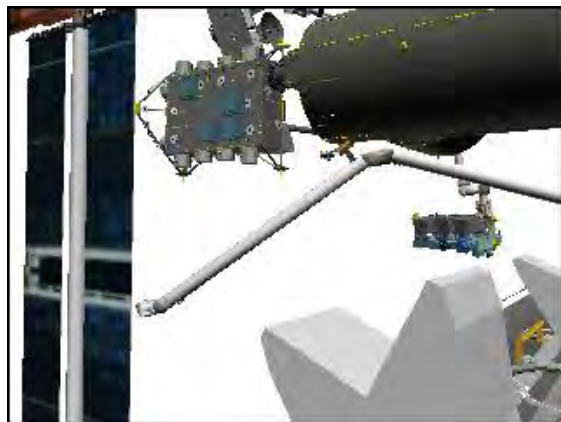

**CCTV B (-35,0)**

Step 2:

Drive SP+ (for  $19.2^\circ$ )  
from +33.1 to +52.3

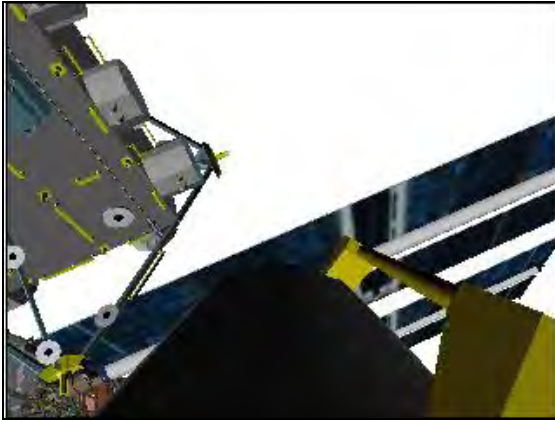

EE

Step 3:

Drive EP+ (for  $2.4^\circ$ )  
from -51.6 to -49.2

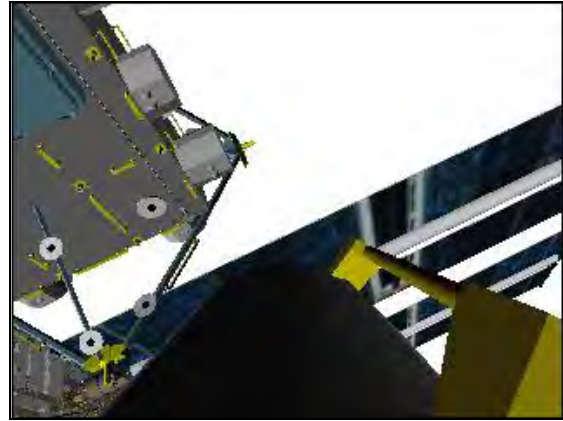

EE



CCTV A (85,10)



CCTV A (85,10)



CCTV B (-35,0)



CCTV B (-35,0)

Step 4:

Drive WP+ (for 52.0°)  
from +25.1 to +77.1

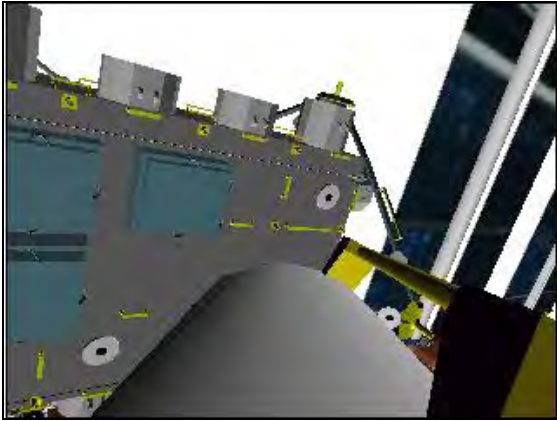

EE

Step 5:

Drive WY- (for 11.3°)  
from +64.8 to +53.5

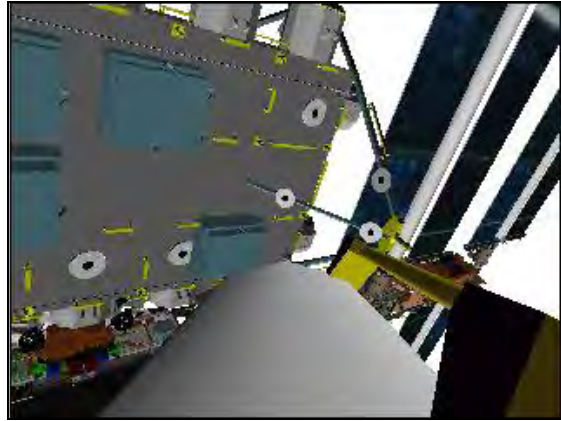

EE



CCTV A (85,10)



CCTV A (85,10)

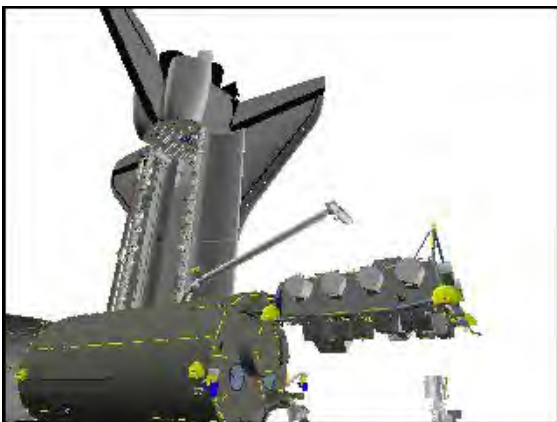

P1 LOOB (150,25)

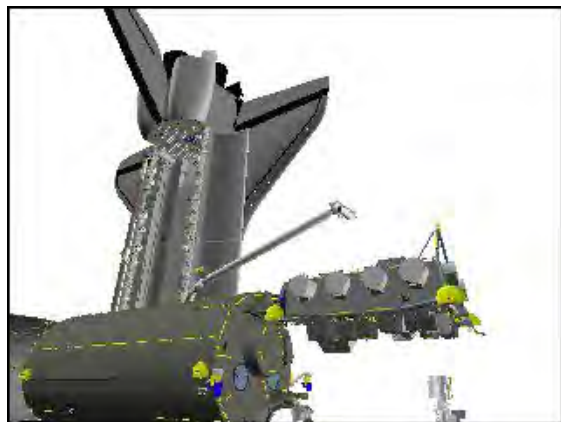

P1 LOOB (150,25)

Step 6:

Drive WR+ (for 131.3°)  
from -236.9 to -105.6

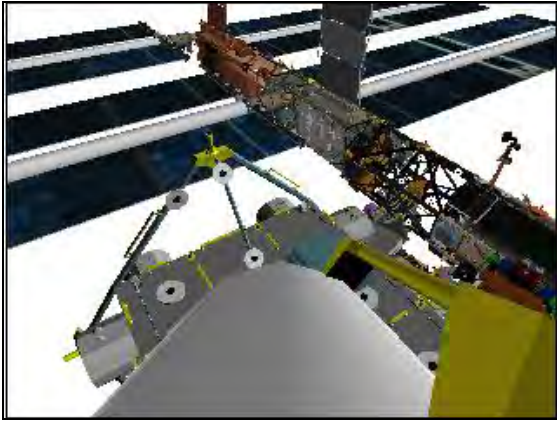

**EE**



**CCTV A (85,10)**

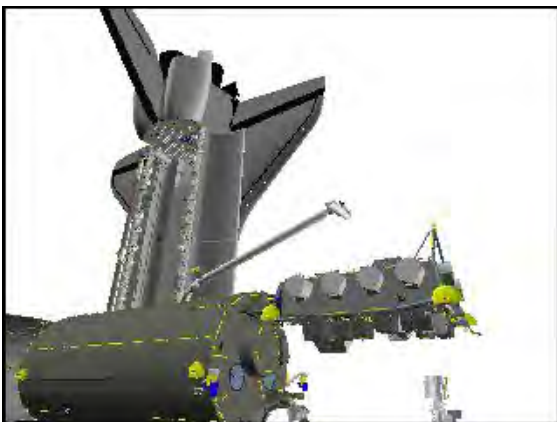

**P1 LOOB (150,25)**



5. CONFIGURE CAMERAS FOR VIEWING

Configure cameras as shown for JLE install viewing support

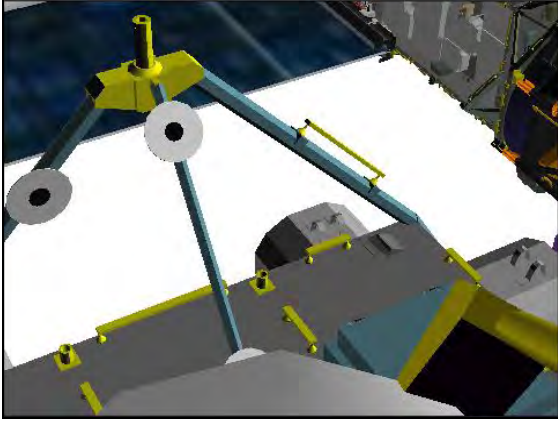

**EE (HFOV: 30.0)**

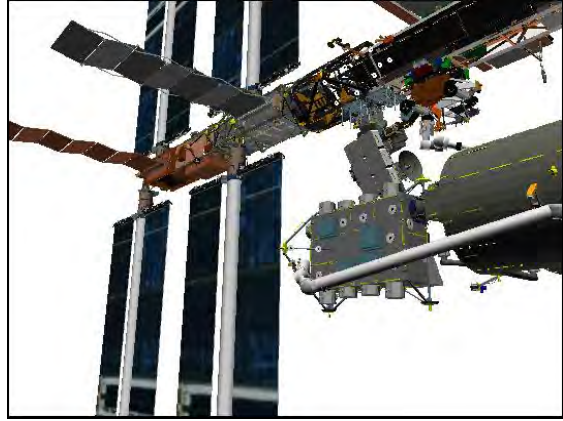

**CCTV B (-50,15)**

# SJ JLE GRAPPLE FROM SSRMS

## 1. SETUP

Verify JEMRMS at STOWED posn:

SY	SP	EP	WP	WY	WR
0.0	+90.0	-149.0	-31.0	0.0	0.0

Verify SSRMS at JLE HANDBACK posn and SSRMS operator GO for SRMS grapple:

SR	SY	SP	EP	WP	WY	WR
-76.0	+1.7	-25.4	-39.3	-130.2	-171.7	+50.1

DNLK (72)	Elbow (EE)
DTV (SSC 2)	A
MON 1 (SSC 1)	B
MON 2 (71)	P1 LOOB (JEM EXT-FWD)

SM 94 PDRS CONTROL

√ PL ID, ITEM 3: 0

√ INIT ID, ITEM 24: 0

Verify SRMS at PRE-CRADLE posn:

X	Y	Z	PITCH	YAW	ROLL	PL ID
-1261	-146	-551	5	2	0	0
SY	SP	EP	WP	WY	WR	
0.0	+25.0	-25.0	+5.0	0.0	0.0	

## 2. SJ MNVR TO JLE HANDBACK PRE-GRAPPLE

If SINGLE mode available:

RHC

RATE – as reqd (VERN within 10 ft)

BRAKES – OFF (tb-OFF)

MODE – best available

Mnvr to JLE HANDBACK PRE-GRAPPLE posn:

	SY	SP	EP	WP	WY	WR	
Pre-cradle	0.0	+25.0	-25.0	+5.0	0.0	0.0	
1: WP +				+25.2			
2: WY +					+64.5		
3: WR –						-236.4	
4: SY +	+88.8						
5: EP –			-51.3				
6: SP +		+32.9					
Pre-grapple	+88.8	+32.9	-51.3	+25.2	+64.5	-236.4	
X	Y	Z	PITCH	YAW	ROLL	PL ID	
-640	-619	-322	186	26	270	0	

BRAKES – ON (tb-ON)

MODE – not DIRECT (lt off)

Start:  
Pre-cradle

Step 1:  
Drive WP+ (for 20.2°)  
from +5.0 to +25.2



**ELBOW (15,-15)**



**ELBOW (15,-15)**

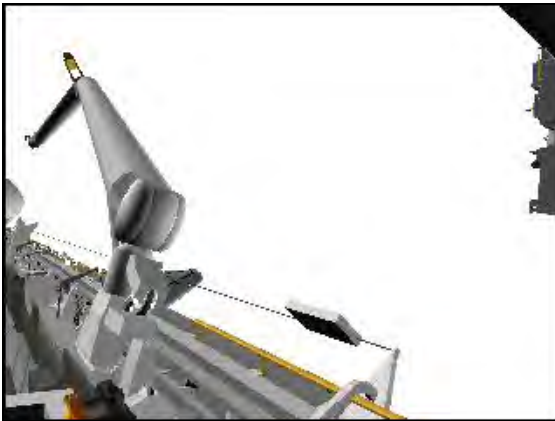

**CCTV A (40,0)**

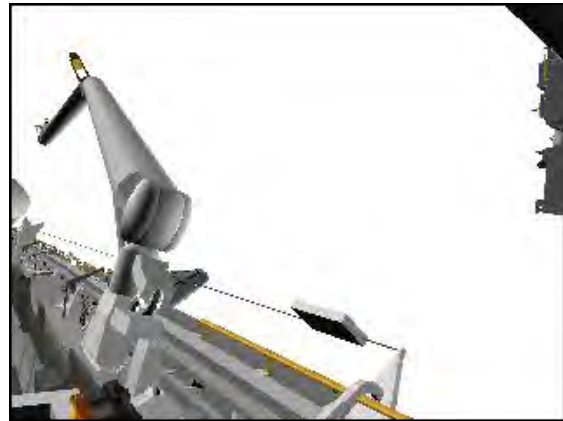

**CCTV A (40,0)**



**CCTV B (-35,40)**



**CCTV B (-35,40)**

Step 2:

Drive WY+ (for  $64.5^\circ$ )  
from +0.0 to +64.5



**ELBOW (15,-15)**

Step 3:

Drive WR- (for  $236.4^\circ$ )  
from +0.0 to -236.4



**ELBOW (15,-15)**

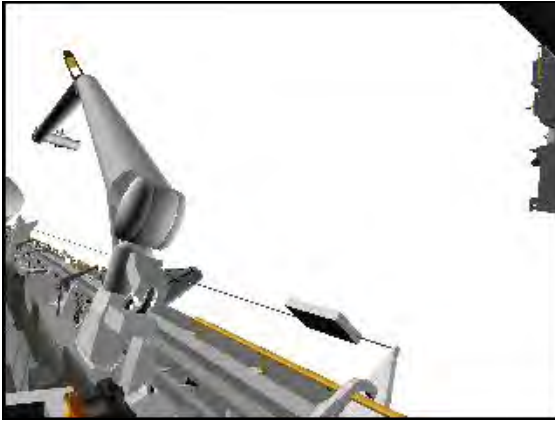

**CCTV A (40,0)**

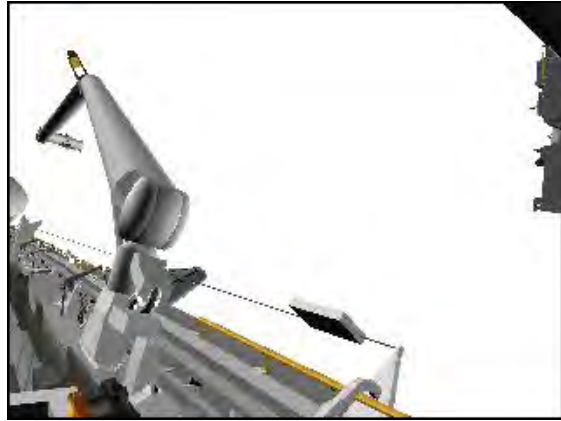

**CCTV A (40,0)**



**CCTV B (-35,40)**



**CCTV B (-35,40)**



Step 4:

Drive SY+ (for 88.8°)  
from +0.0 to +88.8



**ELBOW (15,-15)**

Step 5:

Drive EP- (for 26.3°)  
from -25.0 to -51.3



**ELBOW (15,-15)**

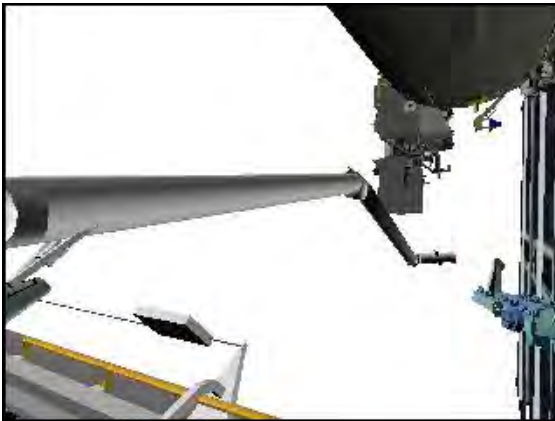

**CCTV A (60,0)**



**CCTV A (60,0)**



**CCTV B (-35,0)**



**CCTV B (-35,0)**

Step 6:

Drive SP+ (for 7.9°)  
from +25.0 to +32.9



**ELBOW (15,-15)**



**CCTV A (60,0)**

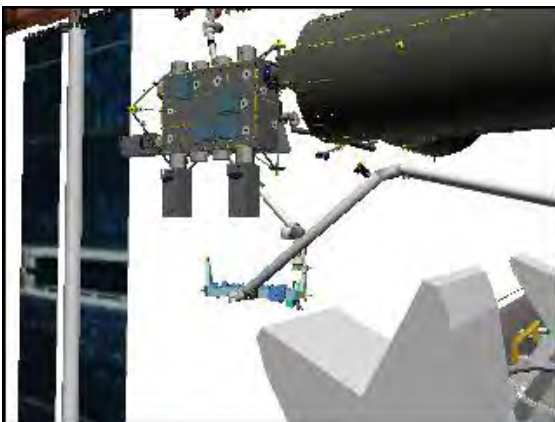

**CCTV B (-35,0)**

3. MNVR TO JLE GRAPPLE

A7U

CCTV – configure for grapple

– install JLE SJ GRAPPLE AT HANDBACK WRIST CCTV OVERLAY

– RMS WRIST, zoom 34.0 HFOV

focus 5 ft

Maintain eyepoint ~18 in when using grapple overlay

RHC

If SINGLE mode available:

RATE – VERN (RATE MIN tb-ON)

BRAKES – OFF (tb-OFF)

MODE – best available

Drive joints per JLE SJ GRAPPLE AT HANDBACK WRIST CCTV OVERLAY and histogram until EE within grapple envelope

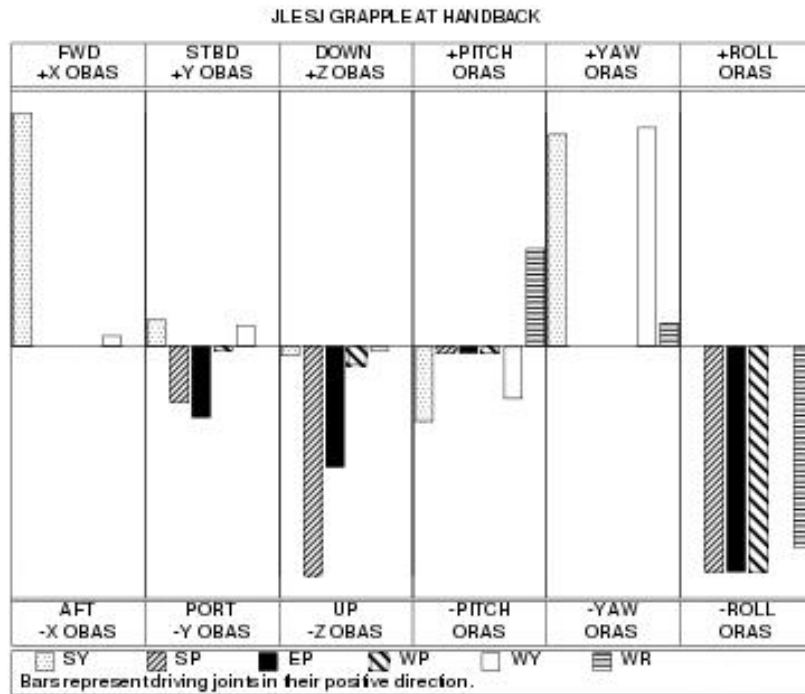

To get:	Drive:	To get:	Drive:	Driving:	Results in:	Driving:	Results in:
+X (fwd)	+SY	+PITCH	+WR, -SY	+SY	+X (fwd), +YAW	+WP	-Z (up), +ROLL
+Y (stbd)	EP, -SP	+YAW	+WY, +SY	+SP	-Z (up), +ROLL	+WY	+Y (stbd), +YAW
+Z (down)	-SP, EP	+ROLL	-WP, -WR	+EP	-Z (up), +ROLL	+WR	+ROLL

ΔSY	ΔSP	ΔEP	ΔWP	ΔWY	ΔWR
+5.9	-9.3	+17.7	-9.8	-5.6	+0.8

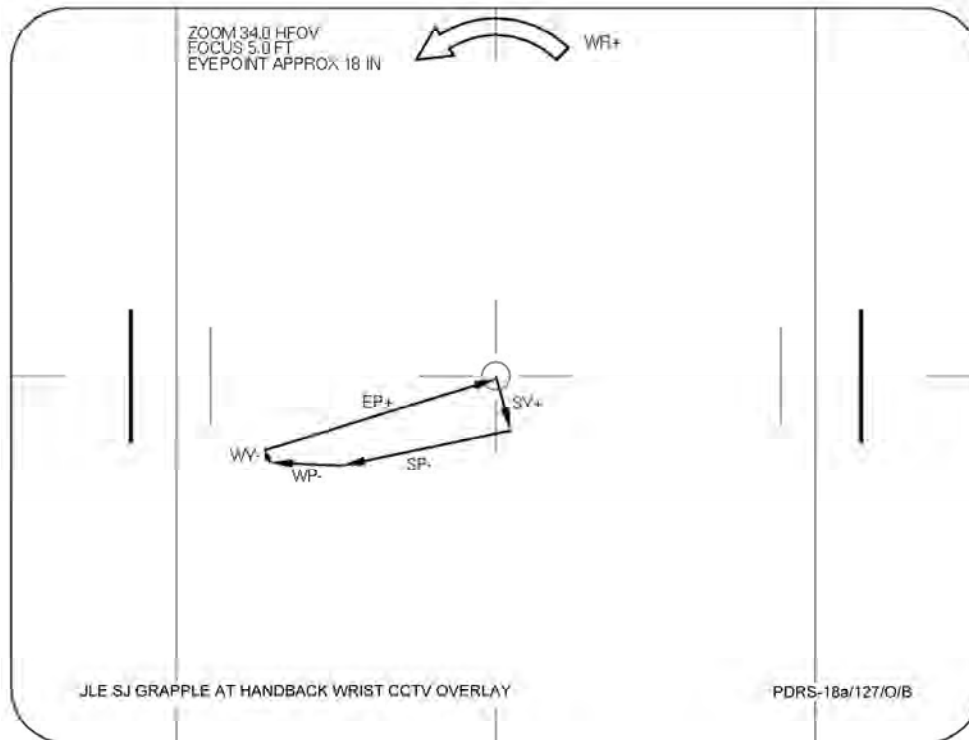

#### 4. JLE GRAPPLE

**CAUTION**  
Monitor EE tb timing to prevent EE motor burnout

**SM 169 PDRS STATUS**

EE MODE – AUTO  
CAPTURE sw – depress (mom)

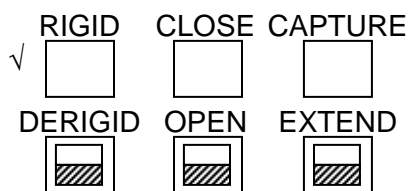

CRITICAL TIMES (28 sec total):  
CAPTURE tb – gray, then  
CLOSE tb – gray, 3 sec max, then  
RIGID tb – gray, 25 sec max

- \* If manual grapple reqd: \*
- \* EE MODE – MAN \*
- \* CAPTURE sw – depress (hold until CLOSE tb-gray, 3 sec max) \*
- \* MAN CONTR – RIGID (hold until RIGID tb-gray, 25 sec max) \*

EE MODE – OFF

If SINGLE mode available:  
MODE – TEST, ENTER  
Wait 5 sec

BRAKES – ON (tb-ON)  
MODE – not DIRECT (It off)

**SM 94 PDRS CONTROL**

PL ID – ITEM 3 +4 EXEC  
INIT ID – ITEM 24 +4 EXEC

Expected JLE HANDOFF posn:

	X	Y	Z	PITCH	YAW	ROLL	PL ID
√	-552	-660	-334	96	0	206	4
	SY	SP	EP	WP	WY	WR	
√	+94.7	+23.6	-33.6	+15.4	+58.9	-235.6	

Notify SSRMS operator, SRMS Grapple complete with Brakes ON;  
GO for SSRMS JLE Ungrangle

Review GENERIC END EFFECTOR CUE CARD – ISS/SHUTTLE DOCKED OPS



**CCTV B (-30,0)**

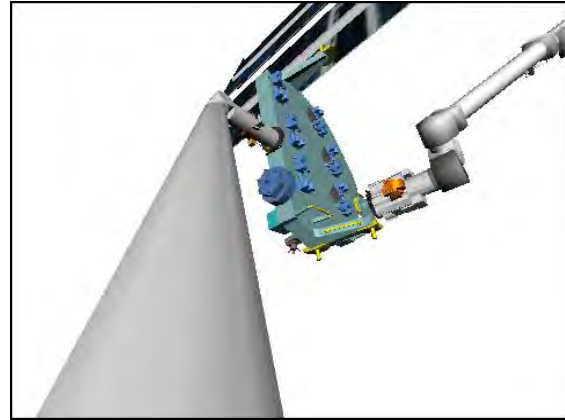

**ELBOW (10,-20)**

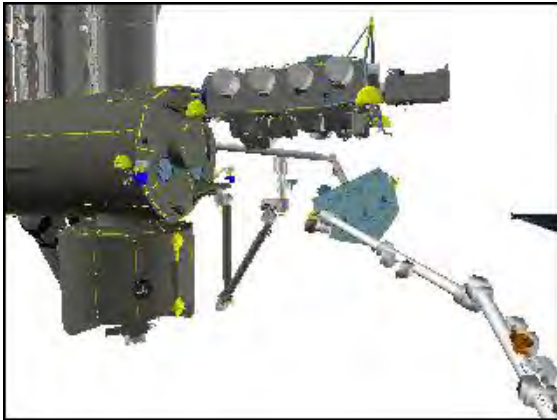

**P1 LOOB (161,-5)**

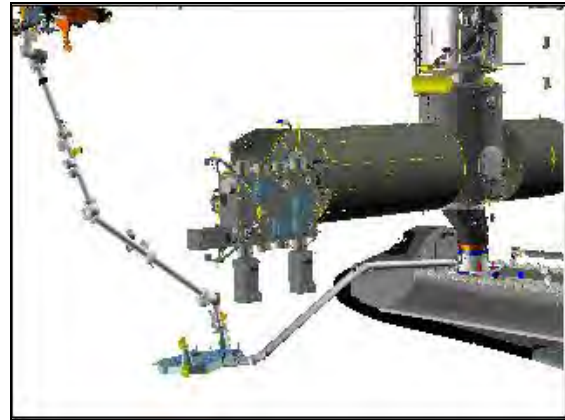

**BIRD'S EYE**

# SJ JLE BERTH IN PLB

## 1. SETUP

DNLK (72)	Elbow
DTV (SSC 2)	A
MON 1 (SSC 1)	B (C)
MON 2 (71)	Lab

**SM 94 PDRS CONTROL**

- √ PL ID, ITEM 3: 4
- √ INIT ID, ITEM 24: 4

Verify SRMS at JLE HANDOFF posn:

X	Y	Z	PITCH	YAW	ROLL	PL ID
√ -552	-660	-334	96	0	206	4
	SY	SP	EP	WP	WY	WR
√ +94.7	+23.6	-33.6	+15.4	+58.9	-235.6	

## 2. MNVR TO TOP OF V-GUIDES

Verify SSRMS at FD11 Park posn and SSRMS operator GO for JLE Berth

- \* If using Shuttle attitude control and attitude maintenance reqd: \*
- \* DAP: LVLH \*
- \* When rates damped: \*
- \* DAP: FREE > 2 sec \*
- \* DAP: AUTO \*
- \* When in attitude and rates damped: \*
- \* DAP: FREE \*

PCS

MSS: SSRMS: Thrusters: **Thruster Controls for MSS Ops**

Verify 'Desat Request' Inhibit

### NOTE

Minimum clearance between Port Trunnions and V-guides is 5 inches. Monitor with Camera B. Minimum clearance between Stbd Trunnions and OBSS is 6 inches. Monitor with Camera C.

Minimum clearance between SRMS Upper Boom and JPM is 34 inches. Monitor with Camera A.

Monitor clearance between JLE and Orbiter Aft with Camera C

RHC

- If SINGLE mode available:
- RATE – as reqd (VERN within 10 ft)
  - BRAKES – OFF (tb-OFF)

MODE – best available

Mnvr to Top of V-guides posn:

	SY	SP	EP	WP	WY	WR	
Handoff	+94.7	+23.6	-33.6	+15.4	+58.9	-235.6	
1: SY -	+35.0						
2: SP +		+67.0					
3: EP -			-82.5				
4: WY -					+18.3		
5: WR +						-50.0	
6: SY -	-18.9						
7: WP -				-66.3			
8: SP -		+52.3					
Top V-Guides	-18.9	+52.3	-82.5	-66.3	+18.3	-50.0	
	X	Y	Z	PITCH	YAW	ROLL	PL ID
	-1034	0	-436	180	0	180	4

BRAKES – ON (tb-ON)

MODE – not DIRECT (lt off)



Start:  
JLE Handoff

Step 1:  
Drive SY- (for 59.7°)  
from +94.7 to +35.0



**ELBOW (15,-15)**

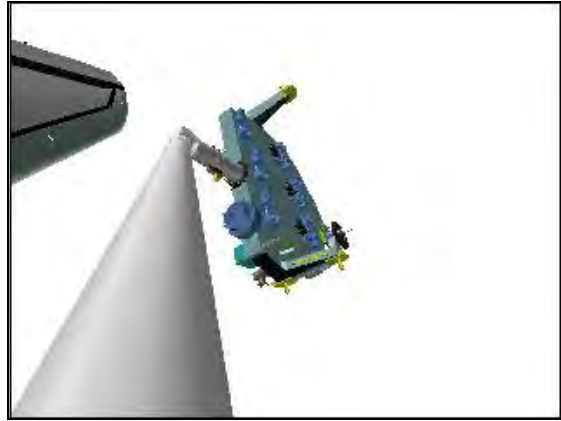

**ELBOW (15,-15)**

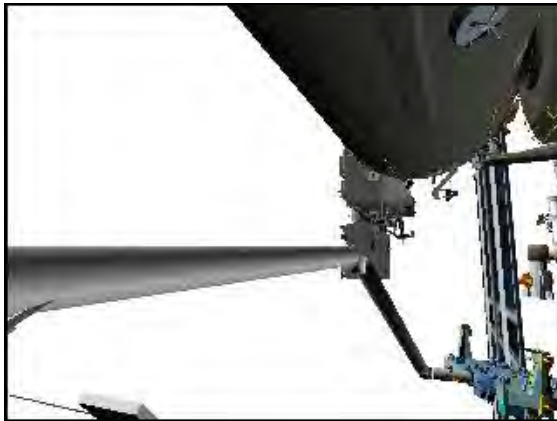

**CCTV A (65,10)**

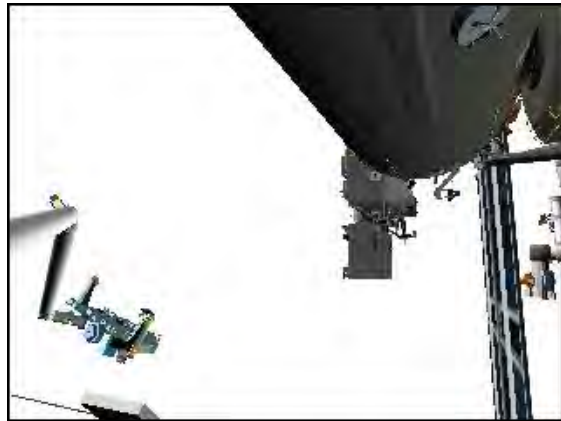

**CCTV A (65,10)**



**CCTV B (-35,0)**



**CCTV B (-35,0)**

Step 2:

Drive SP+ (for 43.4°)  
from +23.6 to +67.0

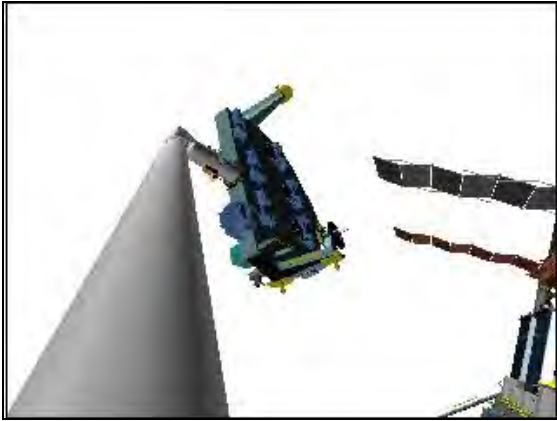

**ELBOW (15,-15)**

Step 3:

Drive EP- (for 48.6°)  
from -33.6 to -82.2

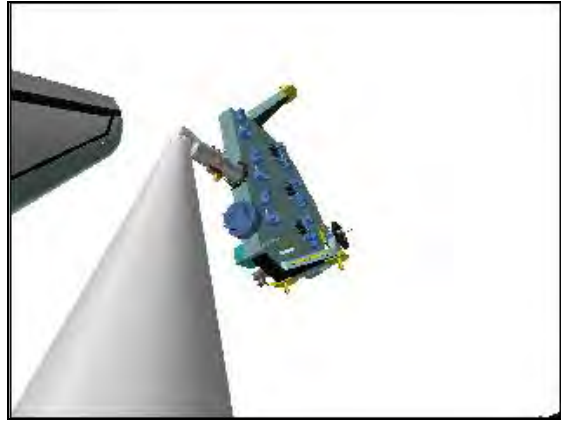

**ELBOW (15,-15)**



**CCTV A (35,20)**



**CCTV A (35,20)**



**CCTV B (-45,20)**



**CCTV B (-45,20)**

Step 4:

Drive WY- (for 40.5°)  
from +58.9 to +18.4

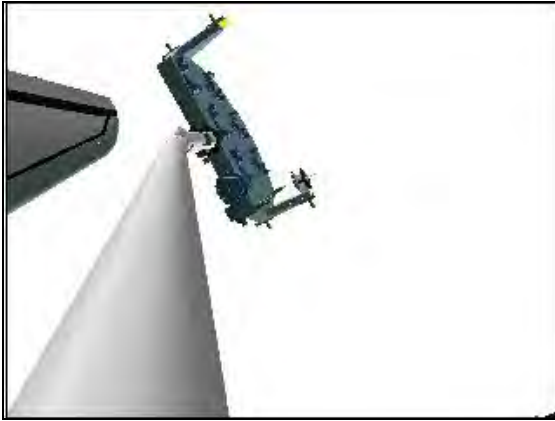

**ELBOW (15,-15)**

Step 5:

Drive WR+ (for 185.8°)  
from -235.6 to -49.8



**ELBOW (15,-15)**



**CCTV A (35,20)**



**CCTV A (35,20)**



**CCTV B (-45,20)**



**CCTV B (-45,20)**



Step 6:

Drive SY- (for  $54.1^\circ$ )  
from +35.0 to -19.1

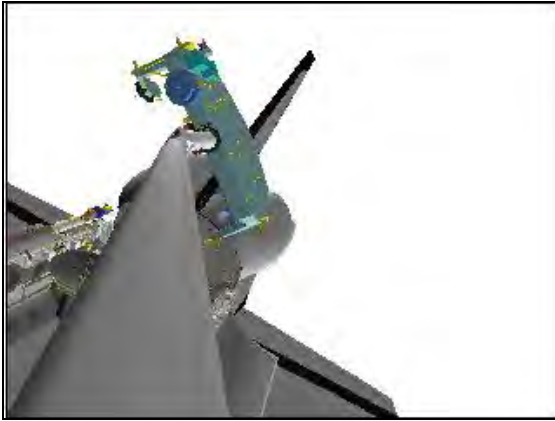

**ELBOW (15,-15)**

Step 7:

Drive WP- (for  $82.4^\circ$ )  
from +15.4 to -67.0



**ELBOW (15,-15)**

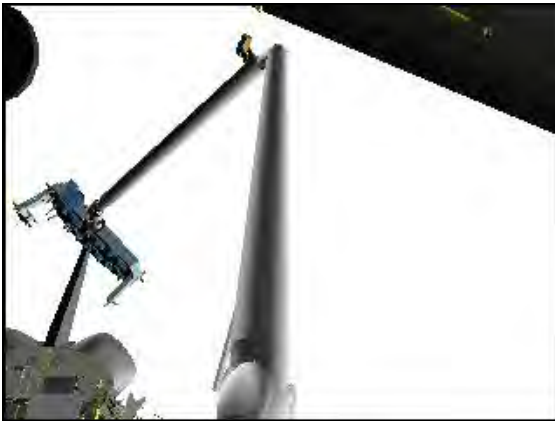

**CCTV A (25,25)**



**CCTV A (0,28)**

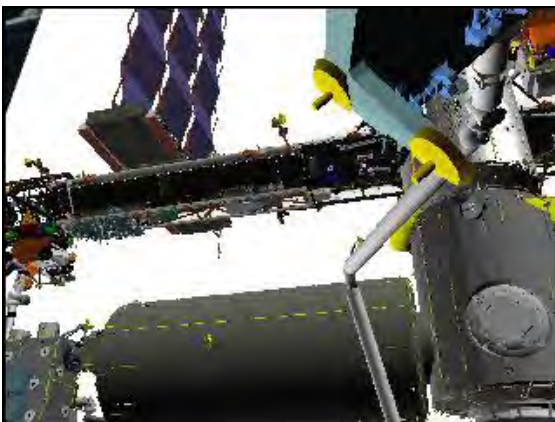

**CCTV B (-15,30)**

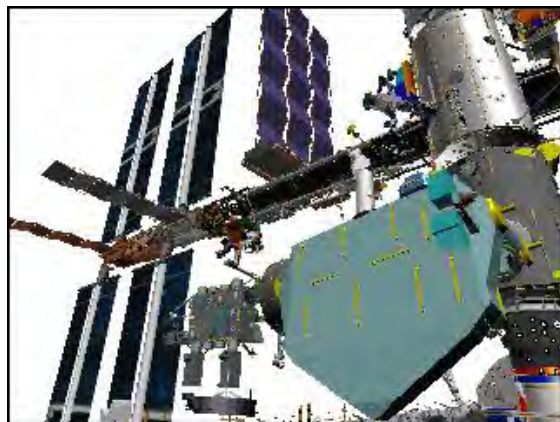

**CCTV C (-40,25)**

Step 8:

Drive SP- (for 14.4°)  
from +67.0 to +52.6

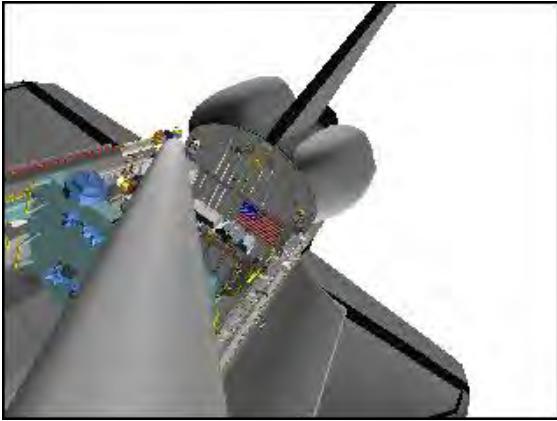

**ELBOW (15,-15)**



**CCTV A (0,28)**

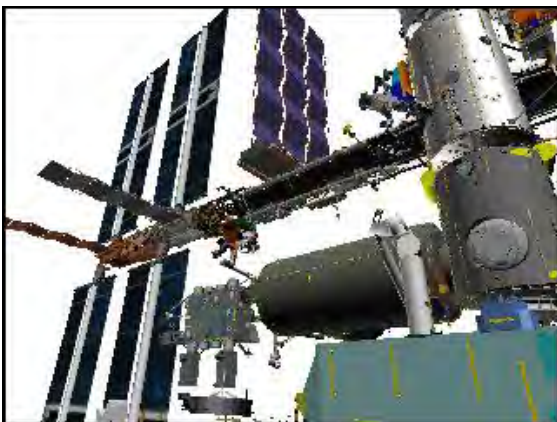

**CCTV C (-40,25)**

3. SJ BERTH JLE IN PLB

DNLK (72)	Keel 2
DTV (SSC 2)	Mux D/A
MON 1 (SSC 1)	C
MON 2 (71)	Lab

PCS MSS: SSRMS: Thrusters: 

Thruster Controls for MSS Ops
-------------------------------

Verify 'Desat Request:' Inhibit

A6U PL RETEN PL SEL – 1

PL 221 ELM-ES LATCH
---------------------

CRT  $\sqrt$ RDY-FOR-LAT 1,2,3,4 (eight) – 0

RHC If SINGLE mode available:  
 RATE – VERN (RATE MIN tb-ON)  
 BRAKES – OFF (tb-OFF)

MODE – best available

Drive joints per JLE BERTH table and histogram to JLE BERTH posn

JLE BERTH posn (insert data from (SJ) JLE GRAPPLE IN PLB):

	X	Y	Z	PITCH	YAW	ROLL	PL ID
							4
Expected	-1034	0	-414	180	0	180	4
	SY	SP	EP	WP	WY	WR	
Expected	-17.9	+50.3	-84.2	-62.3	+18.5	-51.1	

A6U  $\sqrt$ PL RETEN RDY 4,5 tb (two) – gray

PL 221 ELM-ES LATCH
---------------------

CRT  $\sqrt$ RDY-FOR-LAT 1,2,3,4 (eight) – 1

### SJ JLE BERTH

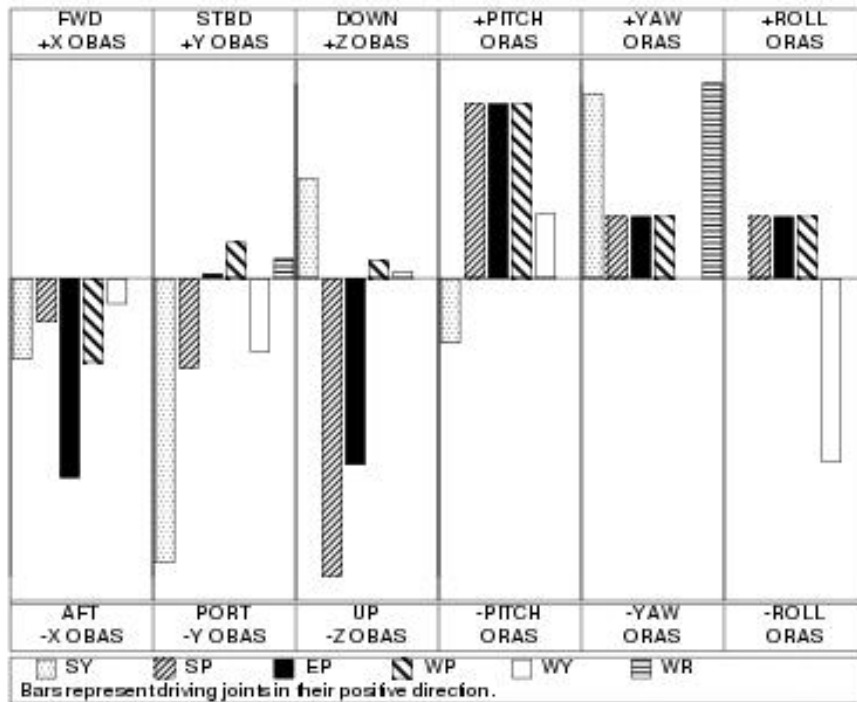

To get:	Drive:	To get:	Drive:	Driving:	Results In:	Driving:	Results In:
+X (fwd)	-EP, -WP	+PITCH	+WP, +EP	+SY	-Y (port), +YAW	+WP	-X (aft), +PITCH
+Y (stbd)	-SY	+YAW	+WR	+SP	-Z (up), +PITCH	+WY	-Y (port), -ROLL
+Z (down)	-SP, -EP	+ROLL	-WY	+EP	-X (aft), +PITCH	+WR	+Y (stbd), +YAW

### SUGGESTED JOINT ORDER SP-, WP+, SY+, EP-, WR- as req

ΔSY	ΔSP	ΔEP	ΔWP	ΔWY	ΔWR
+1.0	-2.0	-1.7	+4.0	+0.2	-1.1

z	SY	SP	EP	WP	WY	WR
-436	-18.9	+52.3	-82.5	-66.3	+18.3	-50.0
-434	-18.8	+52.1	-82.7	-65.9	+18.3	-50.1
-432	-18.7	+52.0	-82.8	-65.6	+18.3	-50.2
-430	-18.6	+51.8	-83.0	-65.2	+18.4	-50.3
-428	-18.5	+51.6	-83.2	-64.8	+18.4	-50.4
-426	-18.4	+51.4	-83.3	-64.5	+18.4	-50.5
-424	-18.4	+51.3	-83.5	-64.1	+18.4	-50.6
-422	-18.3	+51.1	-83.6	-63.8	+18.4	-50.7
-420	-18.2	+50.9	-83.8	-63.4	+18.4	-50.8
-418	-18.1	+50.7	-83.9	-63.0	+18.5	-50.9
-416	-18.0	+50.5	-84.1	-62.7	+18.5	-51.0
-414	-17.9	+50.3	-84.2	-62.3	+18.5	-51.1

4. LATCH PRLAS AND AKA  
Perform JLE BERTH IN PLB (JLE NOMINAL) steps 5 through 8
5. SJ JLE UNGRAPPLE  
If SINGLE mode available:  
    √BRAKES – ON (tb-ON)  
  
    √MODE – not DIRECT (It off)

A7U

CCTV – configure for ungrapple

- install JLE SJ UNGRAPPLE IN PLB WRIST CCTV OVERLAY
- RMS WRIST, zoom 34.0 HFOV  
focus 5 ft

DNLK (72)	EE (Elbow)
DTV (SSC 2)	B (C)
MON 1 (SSC 1)	A
MON 2 (71)	P1 LOOB

**SM 94 PDRS CONTROL**

PL ID – ITEM 3 +0 EXEC  
INIT ID – ITEM 24 +0 EXEC

RHC

If SINGLE mode available:

- RATE – VERN (RATE MIN tb-ON)
- BRAKES – OFF (tb-OFF)

MODE – best available

- EE MODE – MAN
- MAN CONTR – DERIGID (hold until DERIGID tb-gray, 5 sec max)
- RELEASE sw – depress (hold until OPEN tb-gray, 3 sec max)

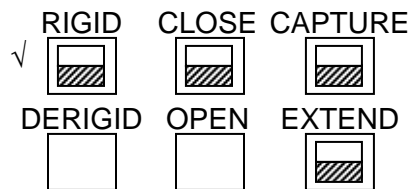

CRITICAL TIMES (8 sec total):

- DERIGID tb – gray, 5 sec max, then
- OPEN tb – gray, 3 sec max, then

6. MNVR CLEAR OF JLE

Drive joints per JLE SJ UNGRAPPLE IN PLB WRIST CCTV OVERLAY and histogram until EE clear of grapple fixture

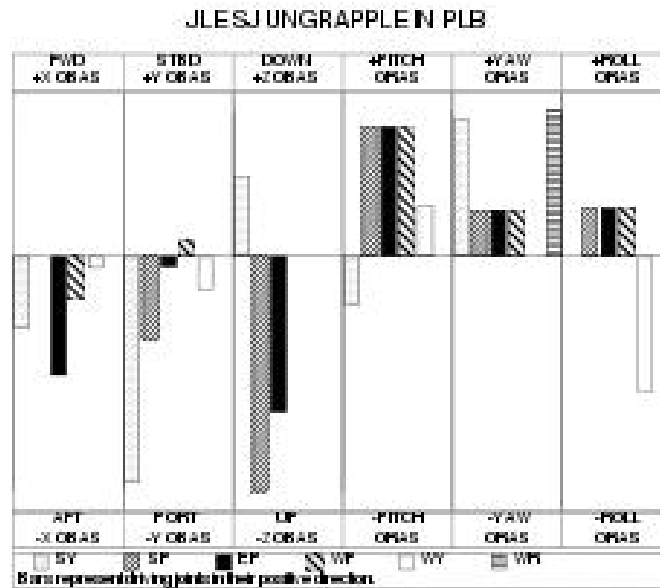

To get:	Drive:	To get:	Drive:	Driving:	Results In:	Driving:	Results In:
+X (fwd)	-EP, -SY	+PITCH	+WP, +EP	+SY	-Y (port), +YAW	+WP	-X (aft), +PITCH
+Y (stbd)	-SY	+YAW	+WR	+SP	-Z (up), +PITCH	+WY	-Y (port), -ROLL
+Z (down)	-SP, -EP	+ROLL	-WY	+EP	-Z (up), +PITCH	+WR	+YAW

$\Delta SY$	$\Delta SP$	$\Delta EP$	$\Delta WP$	$\Delta WY$	$\Delta WR$
-2.7	+4.7	+8.5	-11.1	-0.3	+2.9



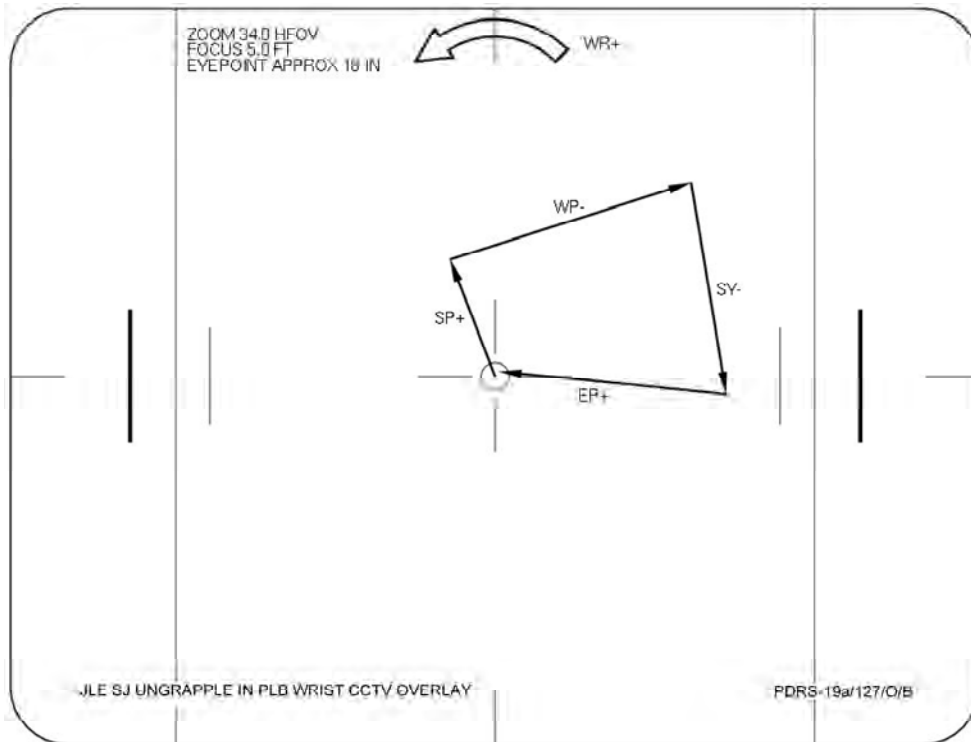

**CAUTION**  
Monitor EE tb timing to prevent EE motor burnout

EE MAN CONTR – DERIGID (hold until EXTEND tb-gray, 20 sec max)  
MODE – OFF

✓	RIGID <input checked="" type="checkbox"/>	CLOSE <input checked="" type="checkbox"/>	CAPTURE <input checked="" type="checkbox"/>
	DERIGID <input type="checkbox"/>	OPEN <input type="checkbox"/>	EXTEND <input type="checkbox"/>

CRITICAL TIMES (20 sec total):  
EXTEND tb – gray, 20 sec max

Mnvr to JLE CLEARANCE:

X	Y	Z	PITCH	YAW	ROLL	PL ID
-1057	0	-510	270	0	270	0
SY	SP	EP	WP	WY	WR	
-20.6	+55.0	-78.7	-73.4	+18.2	-48.2	



**CCTV A (0,28)**

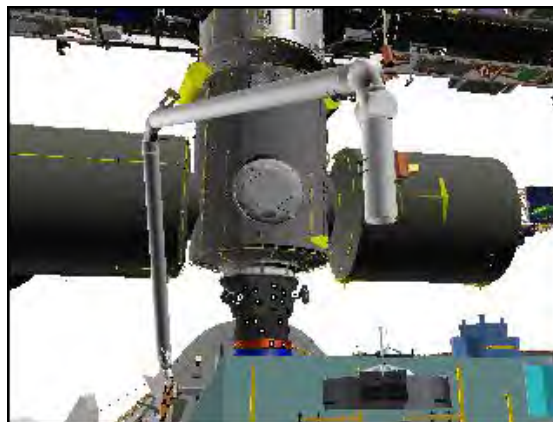

**CCTV B (10,15)**

7. MNVR TO PRE-CRADLE

If SINGLE mode available:

RHC           RATE    – as reqd (VERN within 10 ft)  
               √BRAKES – OFF (tb-OFF)

MODE – best available

Mnvr to PRE-CRADLE posn:

	SY	SP	EP	WP	WY	WR	
JLE Clearance	-20.6	+55.0	-78.7	-73.4	+18.2	-48.2	
1: WP +				+5.0			
2: WY –					0.0		
3: WR +						0.0	
4: EP +			-25.0				
5: SY +	0.0						
6: SP –		+25.0					
Pre-cradle	0.0	+25.0	-25.0	+5.0	0.0	0.0	
	X	Y	Z	PITCH	YAW	ROLL	PL ID
	-1261	+146	-551	5	2	0	0

BRAKES – ON (tb-ON)

MODE – not DIRECT (lt off)

PARAM – PORT TEMP

JOINT – CRIT TEMP

Start:  
JLE Clearance

Step 1:  
Drive WP+ (for 78.4°)  
from -73.4 to +5.0

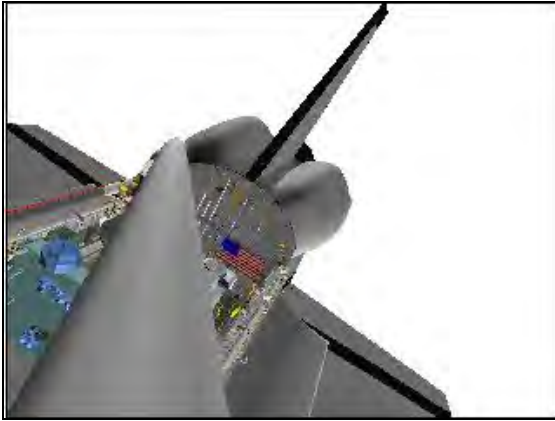

**ELBOW (15,-15)**

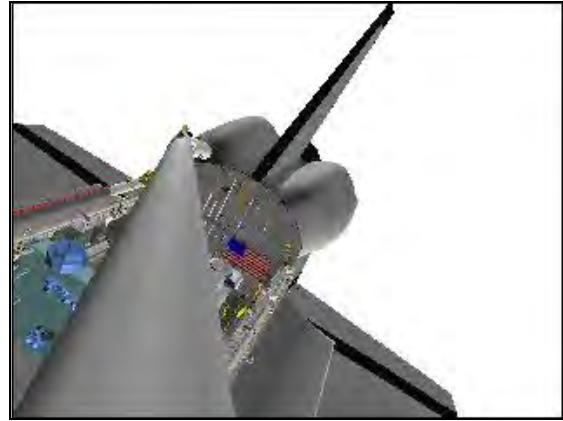

**ELBOW (15,-15)**



**CCTV A (0,28)**



**CCTV A (0,28)**

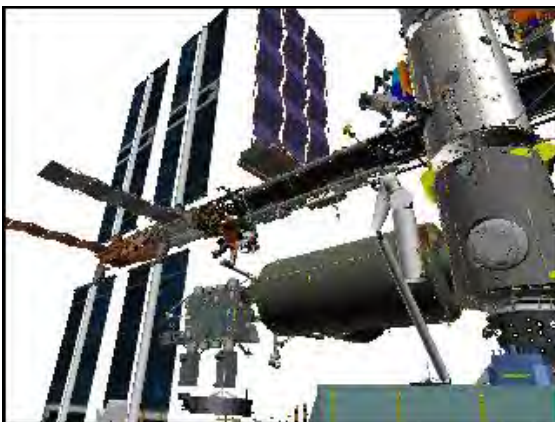

**CCTV C (-40,25)**

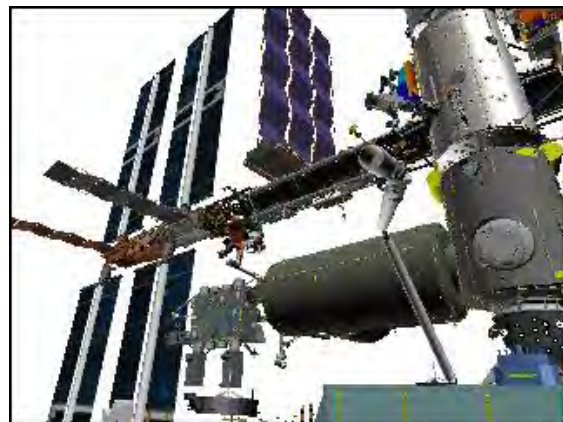

**CCTV C (-40,25)**

Step 2:

Drive WY- (for 18.2°)  
from +18.2 to +0.0

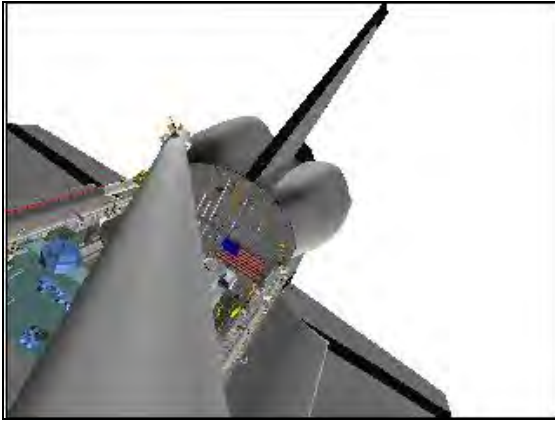

**ELBOW (15,-15)**

Step 3:

Drive WR+ (for 48.2°)  
from -48.2 to +0.0

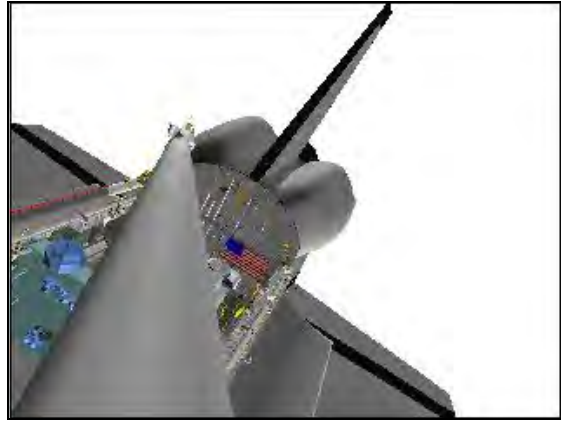

**ELBOW (15,-15)**



**CCTV A (0,28)**



**CCTV A (0,28)**

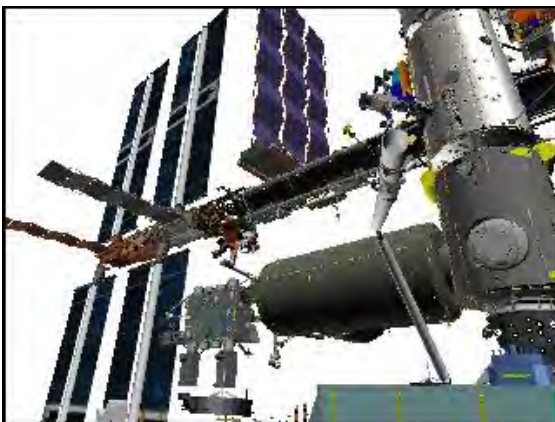

**CCTV C (-40,25)**

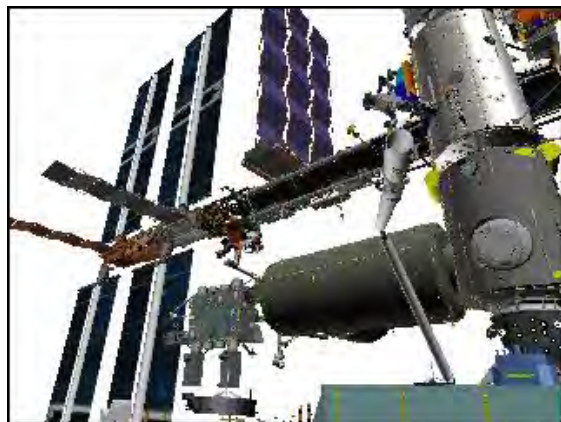

**CCTV C (-40,25)**

Step 4:

Drive EP+ (for 53.7°)  
from -78.7 to -25.0

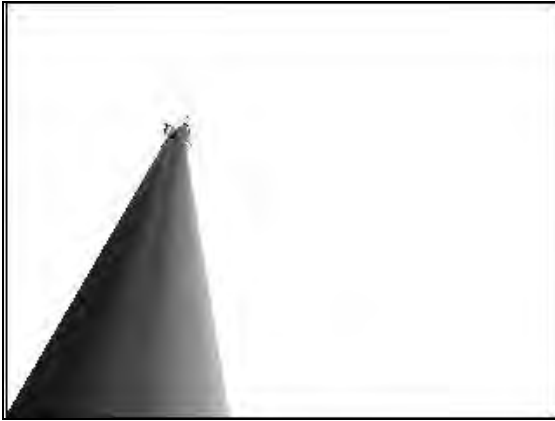

**ELBOW (15,-15)**

Step 5:

Drive SY+ (for 20.6°)  
from -20.6 to 0.0



**ELBOW (15,-15)**



**CCTV A (0,28)**



**CCTV A (0,28)**

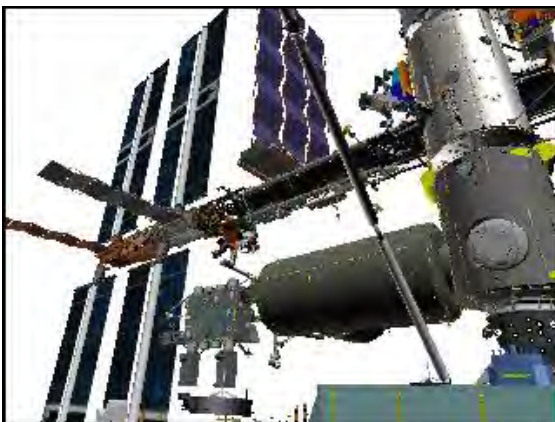

**CCTV C (-40,25)**

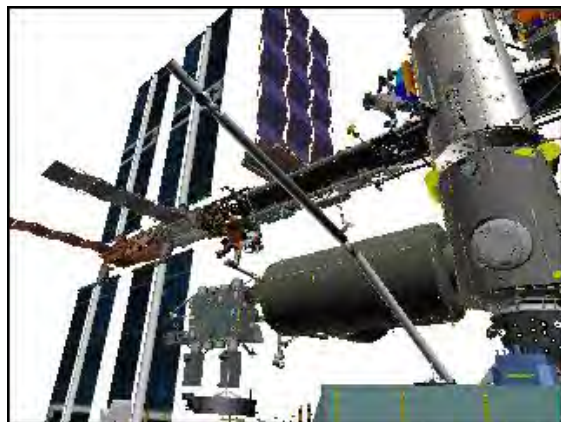

**CCTV C (-40,25)**



Step 6:

Drive SP- (for 30°)  
from +55.0 to +25.0



**ELBOW (15,-15)**



**CCTV A (0,28)**

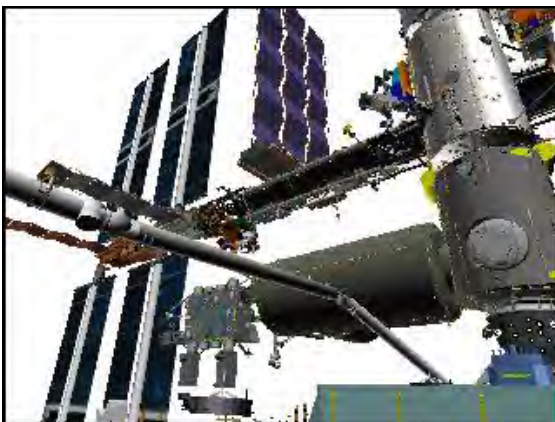

**CCTV C (-40,25)**

This Page Intentionally Blank



REFERENCE DATA

JEF JOINT ANGLES VS POR COORDINATES.....	FS 9-2
COORDINATE SYSTEM – PL ID 3.....	FS 9-4
JLE JOINT ANGLES VS POR COORDINATES.....	FS 9-5
COORDINATE SYSTEM – PL ID 4.....	FS 9-7
PRLA CONFIGURATION.....	FS 9-8
ICC JOINT ANGLES VS POR COORDINATES.....	FS 9-9
COORDINATE SYSTEM – PL ID 5.....	FS 9-11
PRLA CONFIGURATION.....	FS 9-12
OBSS JOINT ANGLES VS POR COORDINATES.....	FS 9-13

**REFERENCE  
DATA**

## JEF JOINT ANGLES VS POR COORDINATES

### JEF UNBERTH CLEAR

X	Y	Z	PITCH	YAW	ROLL	PL ID
-1061	-412	-606	316	24	254	0
SY	SP	EP	WP	WY	WR	
+30.0	+65.2	-53.6	-39.4	+11.0	-121.0	

### JEF PRE-GRAPPLE

X	Y	Z	PITCH	YAW	ROLL	PL ID
-1114	-290	-649	326	11	243	0
SY	SP	EP	WP	WY	WR	
+12.0	+65.2	-53.6	-39.4	+11.0	-121.0	

### JEF HANDOFF 1

X	Y	Z	PITCH	YAW	ROLL	PL ID
-1163	-300	-615	326	11	243	0
<b>-1187</b>	<b>-258</b>	<b>-628</b>	<b>236</b>	<b>357</b>	<b>191</b>	<b>3</b>
SY	SP	EP	WP	WY	WR	
+13.4	+50.3	-37.1	-41.1	+9.6	-121.5	

### Auto Sequence to HANDOFF 2

Auto Pos #	X/ SY	Y/ SP	Z/ EP	PITCH/ WP	YAW/ WY	ROLL/ WR	PL ID
148	-1187	-258	-628	236	358	191	3
	+13.4	+50.3	-37.1	-41.1	+9.6	-121.5	
149	-1152	-311	-628	236	358	191	3
	+21.0	+55.5	-41.5	-41.3	+2.9	-125.5	
150	-1140	-392	-540	247	335	196	3
	+33.2	+50.9	-51.4	-21.4	-7.3	-105.5	
151	-1018	-565	-371	297	299	237	3
	+58.0	+29.6	-43.7	-1.6	-24.7	-63.1	
152	-653	-676	-279	359	335	305	3
	+94.2	+21.8	-39.1	-1.7	-23.5	-27.4	
153	-483	-645	-290	354	350	306	3
	+111.1	+21.7	-38.8	-2.0	-24.5	-27.8	
154	-325	-546	-289	350	8	313	3
	+128.9	+21.7	-44.5	-1.3	-23.3	-27.4	
155	-224	-300	-329	204	62	73	3
	+146.0	+20.3	-53.9	+11.9	+56.0	+16.2	

### JEF HANDOFF 2

X	Y	Z	PITCH	YAW	ROLL	PL ID
-224	-316	-280	184	334	142	0
<b>-224</b>	<b>-300</b>	<b>-329</b>	<b>204</b>	<b>62</b>	<b>73</b>	<b>3</b>
SY	SP	EP	WP	WY	WR	
+146.0	+20.3	-53.9	+11.9	+56.0	+16.2	

### JEF HANDOFF 2 BACKOFF

X	Y	Z	PITCH	YAW	ROLL	PL ID
-278	-343	-284	184	334	142	0
SY	SP	EP	WP	WY	WR	
+139.8	+28.6	-67.1	+12.7	+61.7	+20.1	

REFERENCE DATA

JEF INSTALL VIEWING

X	Y	Z	PITCH	YAW	ROLL	PL ID
-688	-545	-250	278	83	83	0
SY	SP	EP	WP	WY	WR	
+89.0	+36.0	-82.0	+58.0	0.0	+20.1	

\*

\*Approaching display singularity

# JEF COORDINATE SYSTEM – PL ID 3

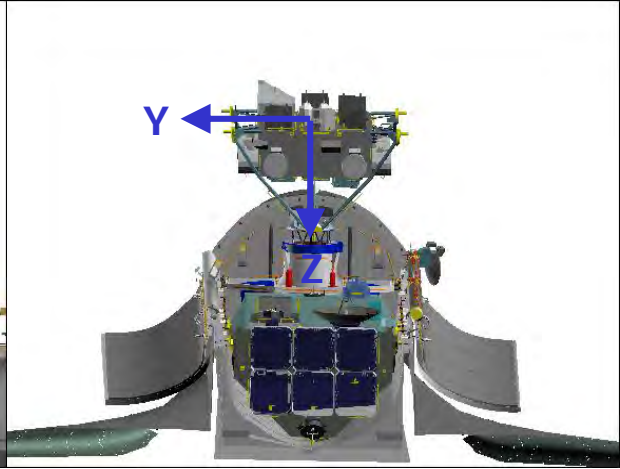
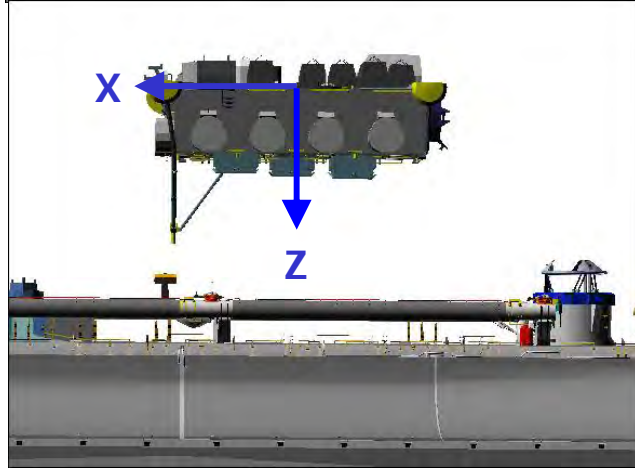
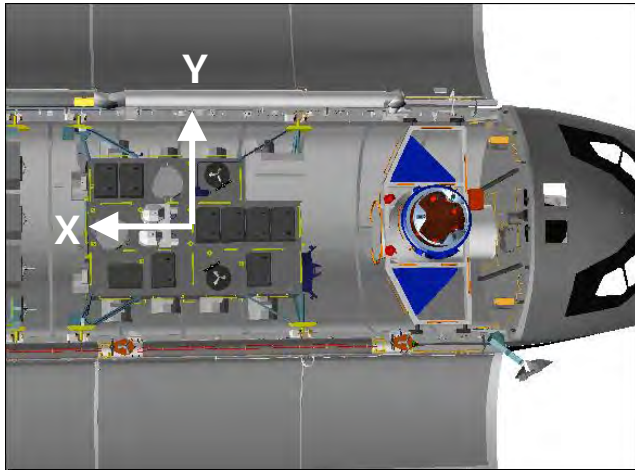

POR: Centered at trunnion level, aligned with ORAS

PURPOSE: JEF Handoff

RATES:	<u>COARSE</u>	<u>VERN</u>
TRANS LIM ft/sec	0.28	0.10
ROT LIM deg/sec	1.07	0.35

JOINT RATES:	<u>COARSE</u>	<u>VERN</u>
SHOULDER LIM deg/sec	0.51	0.17
ELBOW LIM deg/sec	0.72	0.24
WRIST LIM deg/sec	1.07	0.35

## JLE JOINT ANGLES VS POR COORDINATES

### JLE PRE-GRAPPLE IN PLB

X	Y	Z	PITCH	YAW	ROLL	PL ID
-1057	0	-510	270	0	270	0
<b>SY</b>	<b>SP</b>	<b>EP</b>	<b>WP</b>	<b>WY</b>	<b>WR</b>	
-20.6	+55.0	-78.7	-73.4	+18.2	-48.2	

### JLE GRAPPLE/BERTH IN PLB

X	Y	Z	PITCH	YAW	ROLL	PL ID
-1057	0	-450	270	0	270	0
<b>-1034</b>	<b>0</b>	<b>-414</b>	<b>180</b>	<b>0</b>	<b>180</b>	<b>4</b>
<b>SY</b>	<b>SP</b>	<b>EP</b>	<b>WP</b>	<b>WY</b>	<b>WR</b>	
-17.9	+50.3	-84.2	-62.3	+18.5	-51.1	

### JLE LOW HOVER

X	Y	Z	PITCH	YAW	ROLL	PL ID
-1057	0	-621	270	0	270	0
<b>-1034</b>	<b>0</b>	<b>-586</b>	<b>180</b>	<b>0</b>	<b>180</b>	<b>4</b>
<b>SY</b>	<b>SP</b>	<b>EP</b>	<b>WP</b>	<b>WY</b>	<b>WR</b>	
-25.4	+56.6	-58.9	-96.4	+17.5	-43.2	

### JLE PORT

X	Y	Z	PITCH	YAW	ROLL	PL ID
-1057	-156	-622	270	0	270	0
<b>-1034</b>	<b>-156</b>	<b>-586</b>	<b>180</b>	<b>0</b>	<b>180</b>	<b>4</b>
<b>SY</b>	<b>SP</b>	<b>EP</b>	<b>WP</b>	<b>WY</b>	<b>WR</b>	
-4.9	+67.2	-63.3	-95.6	+19.4	-64.8	

### JLE INTERMEDIATE

X	Y	Z	PITCH	YAW	ROLL	PL ID
-958	-581	-338	212	61	252	0
<b>-937</b>	<b>-616</b>	<b>-351</b>	<b>106</b>	<b>9</b>	<b>243</b>	<b>4</b>
<b>SY</b>	<b>SP</b>	<b>EP</b>	<b>WP</b>	<b>WY</b>	<b>WR</b>	
+55.0	+23.6	-33.6	+15.4	+58.9	-235.6	

### JLE HANDOFF TO SSRMS

X	Y	Z	PITCH	YAW	ROLL	PL ID
-238	-445	-386	172	345	269	0
<b>-206</b>	<b>-437</b>	<b>-414</b>	<b>82</b>	<b>2</b>	<b>165</b>	<b>4</b>
<b>SY</b>	<b>SP</b>	<b>EP</b>	<b>WP</b>	<b>WY</b>	<b>WR</b>	
+137.7	+23.6	-33.6	+15.4	+58.9	-235.6	

### JLE CLEARANCE

X	Y	Z	PITCH	YAW	ROLL	PL ID
-295	-460	-378	172	345	269	0
<b>SY</b>	<b>SP</b>	<b>EP</b>	<b>WP</b>	<b>WY</b>	<b>WR</b>	
+131.8	+33.1	-51.6	+25.1	+64.8	-236.9	

### OCAS START

X	Y	Z	PITCH	YAW	ROLL	PL ID
-810	-604	-327	195	43	287	0
<b>SY</b>	<b>SP</b>	<b>EP</b>	<b>WP</b>	<b>WY</b>	<b>WR</b>	
+70.0	+33.1	-51.6	+25.1	+64.8	-215.0	

JLE INSTALL VIEWING

X	Y	Z	PITCH	YAW	ROLL	PL ID
-837	-594	-555	150	40	132	0
SY	SP	EP	WP	WY	WR	
+63.7	+52.3	-49.2	+73.5	+53.5	-105.6	

JLE HANDBACK PRE-GRAPPLE

X	Y	Z	PITCH	YAW	ROLL	PL ID
-640	-619	-322	186	26	270	0
SY	SP	EP	WP	WY	WR	
+88.8	+32.9	-51.3	+25.2	+64.5	-236.4	

JLE HANDBACK FROM SSRMS

X	Y	Z	PITCH	YAW	ROLL	PL ID
-586	-644	-316	187	26	269	0
<b>-552</b>	<b>-660</b>	<b>-334</b>	<b>96</b>	<b>0</b>	<b>206</b>	<b>4</b>
SY	SP	EP	WP	WY	WR	
+94.7	+23.6	-33.6	+15.4	+58.9	-235.6	

## JLE COORDINATE SYSTEM – PL ID 4

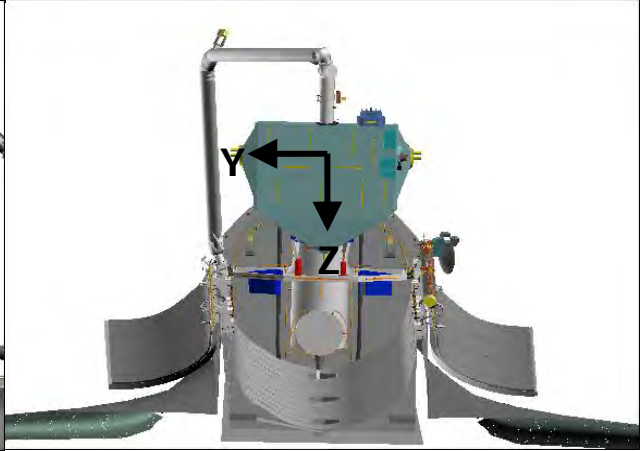
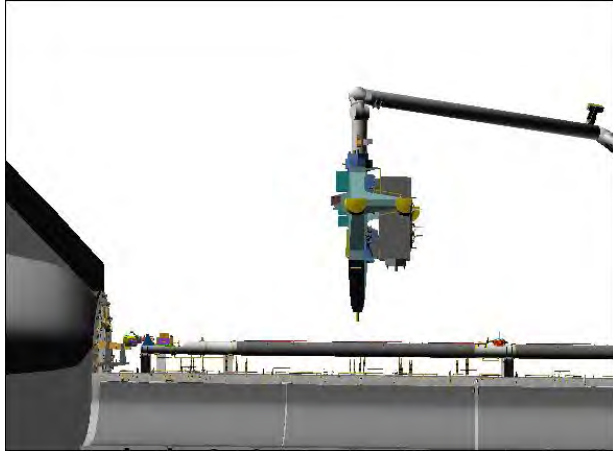
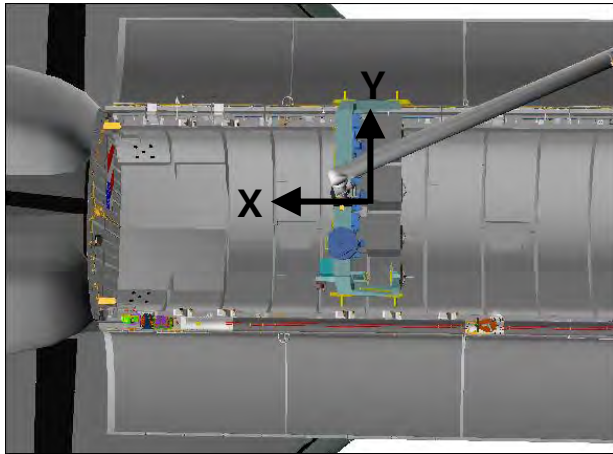

POR: Centered at trunnion level, aligned with ORAS

PURPOSE: JLE Unberth, Handoff, and Reberth

RATES:	<u>COARSE</u>	<u>VERN</u>
TRANS LIM ft/sec	0.32	0.10
ROT LIM deg/sec	1.27	0.42

JOINT RATES:	<u>COARSE</u>	<u>VERN</u>
SHOULDER LIM deg/sec	0.61	0.2
ELBOW LIM deg/sec	0.85	0.28
WRIST LIM deg/sec	1.27	0.42



# JLE PRLA CONFIGURATION

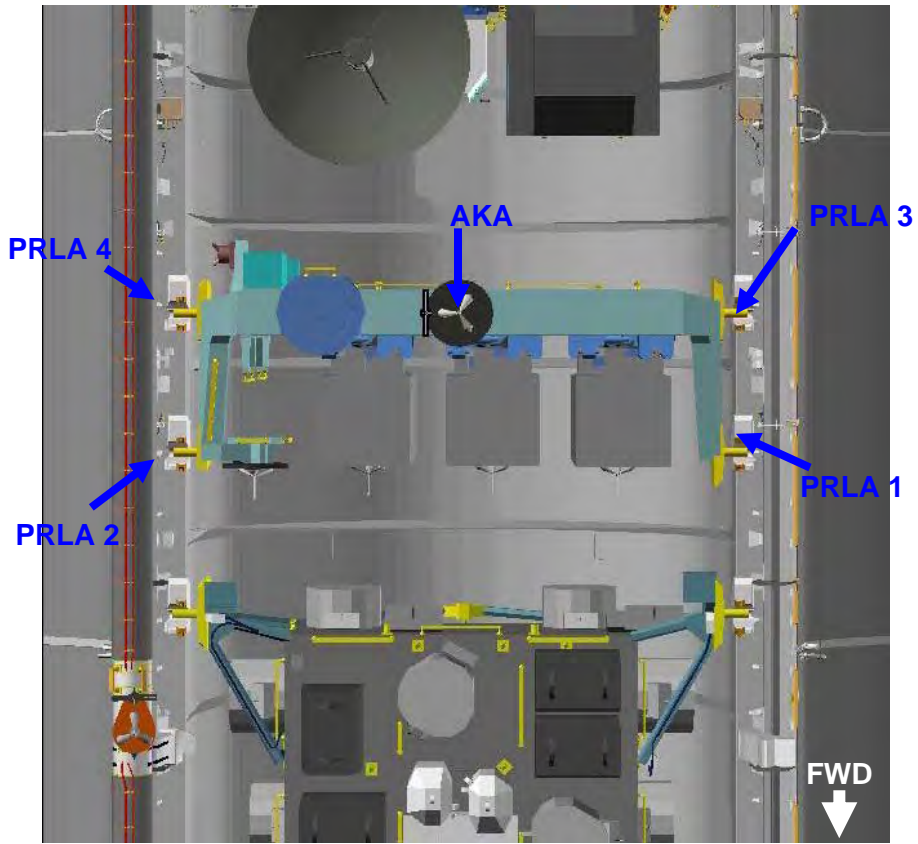

SEQUENCE	PL SEL	RELEASE	LATCH
AKA	2	5	5
PRLA 1,4	1	LATCH 4	LATCH 4
PRLA 2,3	1	LATCH 5	LATCH 5

## ICC JOINT ANGLES VS POR COORDINATES

### ICC PRE-GRAPPLE IN PLB

X	Y	Z	PITCH	YAW	ROLL	PL ID
-1168	-46	-516	275	0	202	0
SY	SP	EP	WP	WY	WR	
-11.8	+31.9	-35.4	-85.4	+20.0	-128.2	

### ICC GRAPPLE/BERTH IN PLB

X	Y	Z	PITCH	YAW	ROLL	PL ID
-1175	-45	-444	275	0	202	0
<b>-1197</b>	<b>0</b>	<b>-414</b>	<b>180</b>	<b>0</b>	<b>180</b>	<b>5</b>
SY	SP	EP	WP	WY	WR	
-9.0	+27.8	-42.1	-73.6	+20.0	-131.2	

### ICC PITCH

X	Y	Z	PITCH	YAW	ROLL	PL ID
-1175	-45	-516	275	0	202	0
<b>-1197</b>	<b>0</b>	<b>-486</b>	<b>180</b>	<b>0</b>	<b>180</b>	<b>5</b>
SY	SP	EP	WP	WY	WR	
-11.7	+29.1	-30.3	-87.7	+20.1	-128.3	

### ICC LOW HOVER

X	Y	Z	PITCH	YAW	ROLL	PL ID
-1164	-45	-618	300	0	202	0
<b>-1197</b>	<b>0</b>	<b>-600</b>	<b>205</b>	<b>0</b>	<b>180</b>	<b>5</b>
SY	SP	EP	WP	WY	WR	
-16.3	+41.1	-33.3	-71.7	+24.7	-133.8	

### ICC PORT

X	Y	Z	PITCH	YAW	ROLL	PL ID
-1164	-225	-618	300	0	202	0
<b>-1197</b>	<b>-180</b>	<b>-600</b>	<b>205</b>	<b>0</b>	<b>180</b>	<b>5</b>
SY	SP	EP	WP	WY	WR	
+4.6	+43.1	-24.2	-76.4	+14.4	-153.0	

### ICC INTERMEDIATE

X	Y	Z	PITCH	YAW	ROLL	PL ID
-937	-584	-332	188	61	338	0
<b>-964</b>	<b>-634</b>	<b>-319</b>	<b>240</b>	<b>336</b>	<b>293</b>	<b>5</b>
SY	SP	EP	WP	WY	WR	
+57.0	+22.0	-35.0	+40.0	+60.0	-190.0	

### ICC HANDOFF

X	Y	Z	PITCH	YAW	ROLL	PL ID
-567	-619	-343	155	14	19	0
<b>-557</b>	<b>-671</b>	<b>-366</b>	<b>250</b>	<b>357</b>	<b>347</b>	<b>5</b>
SY	SP	EP	WP	WY	WR	
+97.0	+22.0	-35.0	+80.0	+60.0	-190.0	

### ICC BACKOFF

X	Y	Z	PITCH	YAW	ROLL	PL ID
-631	-601	-313	155	14	19	0
SY	SP	EP	WP	WY	WR	
+89.9	+20.9	-40.4	+98.7	+62.0	-204.6	

ICC PRE-GRAPPLE AT HANDOFF

X	Y	Z	PITCH	YAW	ROLL	PL ID
-631	-601	-313	155	14	19	0
SY	SP	EP	WP	WY	WR	
+89.9	+20.9	-40.4	+98.7	+62.0	-204.6	

EVA 2 VIEWING

X	Y	Z	PITCH	YAW	ROLL	PL ID
-355	-489	-328	93	33	357	0
SY	SP	EP	WP	WY	WR	
+130.0	+15.0	-40.4	+103.0	-7.0	-213.0	

BATTERY R&R VIEWING

X	Y	Z	PITCH	YAW	ROLL	PL ID
-544	-581	-289	104	48	242	0
SY	SP	EP	WP	WY	WR	
+105.0	+20.9	-51.6	+90.0	+2.0	+15.0	

# ICC COORDINATE SYSTEM – PL ID 5

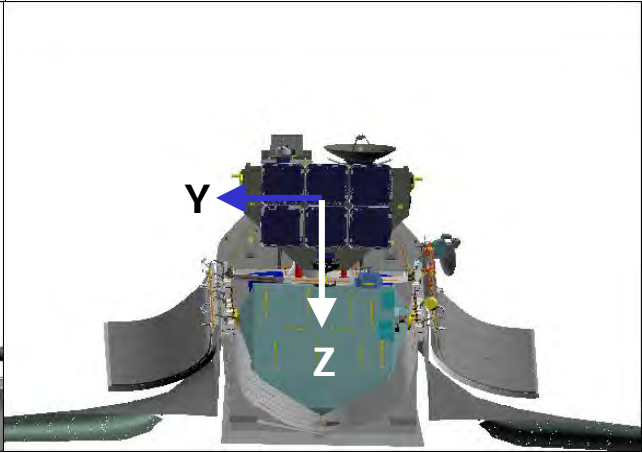
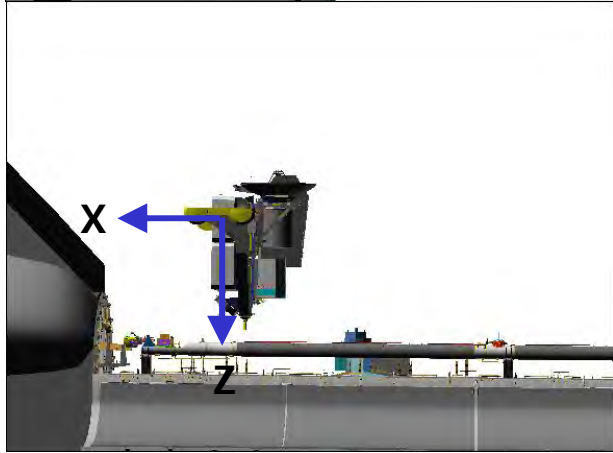
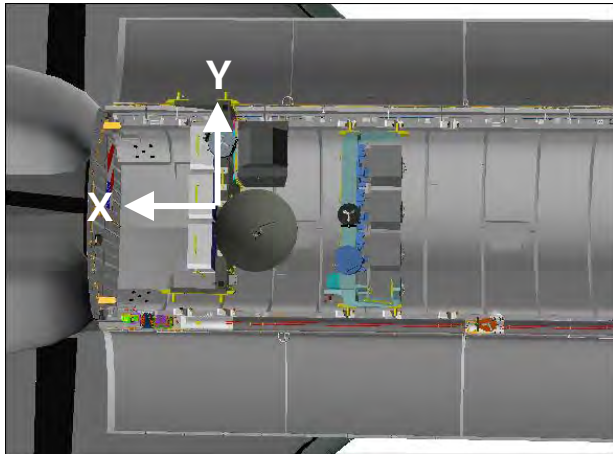

POR: Centered at trunnion level, aligned with ORAS

PURPOSE: ICC Unberth, Handoff, and Reberth

RATES:	<u>COARSE</u>	<u>VERN</u>
TRANS LIM ft/sec	0.26	0.10
ROT LIM deg/sec	1.01	0.33

JOINT RATES:	<u>COARSE</u>	<u>VERN</u>
SHOULDER LIM deg/sec	0.48	0.16
ELBOW LIM deg/sec	0.68	0.22
WRIST LIM deg/sec	1.01	0.33

# ICC PRLA CONFIGURATION

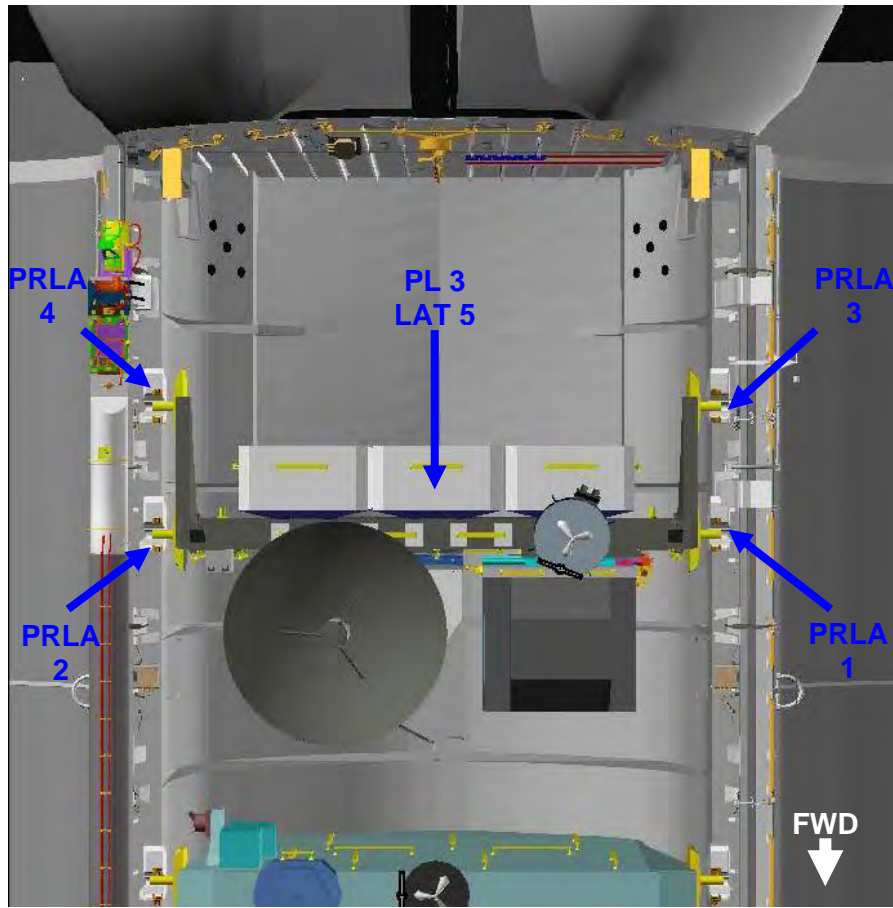

SEQUENCE	PL SEL	RELEASE	LATCH
AKA	3	5	5
PRLA	3	1,2 (fwd)	3,4 (aft)
PRLA	3	3,4 (aft)	1,2 (fwd)

## OBSS JOINT ANGLES VS POR COORDINATES

### OBSS HANDOFF PRE-GRAPPLE/OBSS BACKOFF

X	Y	Z	PITCH	YAW	ROLL	PL ID
<b>-1018</b>	<b>-362</b>	<b>-676</b>	<b>284</b>	<b>0</b>	<b>270</b>	<b>0</b>
-1015	+229	-673	284	270	270	2
SY	SP	EP	WP	WY	WR	
+24.0	+64.8	-34.4	-99.4	+11.3	-99.0	

\*Display singularity

### OBSS HANDOFF/UNDOCK

X	Y	Z	PITCH	YAW	ROLL	PL ID
-1032	-362	-618	284	0	270	0
-1041	-362	-602	284	270	270	1
<b>-1029</b>	<b>+229</b>	<b>-614</b>	<b>284</b>	<b>270</b>	<b>270</b>	<b>2</b>
SY	SP	EP	WP	WY	WR	
+25.8	+66.3	-49.0	-85.9	+10.7	-100.7	

\*Display singularity

### Auto Sequence to FLAT FIELDS

Auto Pos #	X/ SY	Y/ SP	Z/ EP	PITCH/ WP	YAW/ WY	ROLL/ WR	PL ID
156	-1029	+229	-614	284	270	270	2
	+26.1	+67.7	-51.2	-85.0	+10.6	-100.6	
157	-800	+500	-250	281	333	95	2
	-86.7	+72.7	-86.0	+21.2	-3.3	-169.3	
158	-1130	+350	-400	325	336	30	2
	-80.4	+90.4	-94.6	-76.3	-43.9	+97.2	
159	-1270	+350	-445	0	0	11	2
	-90.1	+25.0	-65.8	-57.6	0.0	-249.9	

This Page Intentionally Blank



CUE CARD CONFIGURATION

OVERLAY FOR ROEU PL SEL POSITION.....	FS CC 10-2
JEF SJ GRAPPLE AT HANDOFF 1 WRIST CCTV OVERLAY .....	FS CC 10-3
UNGRAPPLE AT HANDOFF 2 WRIST CCTV OVERLAY .....	FS CC 10-4
ICC SJ GRAPPLE IN PLB WRIST CCTV OVERLAY .....	FS CC 10-5
UNGRAPPLE AT HANDOFF WRIST CCTV OVERLAY .....	FS CC 10-6
GRAPPLE AT HANDOFF WRIST CCTV OVERLAY .....	FS CC 10-7
UNGRAPPLE IN PLB WRIST CCTV OVERLAY .....	FS CC 10-8
JLE SJ GRAPPLE IN PLB WRIST CCTV OVERLAY .....	FS CC 10-9
UNGRAPPLE AT HANDOFF WRIST CCTV OVERLAY .....	FS CC 10-10
GRAPPLE AT HANDBACK WRIST CCTV OVERLAY .....	FS CC 10-11
UNGRAPPLE IN PLB WRIST CCTV OVERLAY .....	FS CC 10-12
OBSS SJ GRAPPLE AT HANDOFF .....	FS CC 10-13
UNGRAPPLE AT HANDOFF .....	FS CC 10-14

CUE CARD  
CONFIGURATION

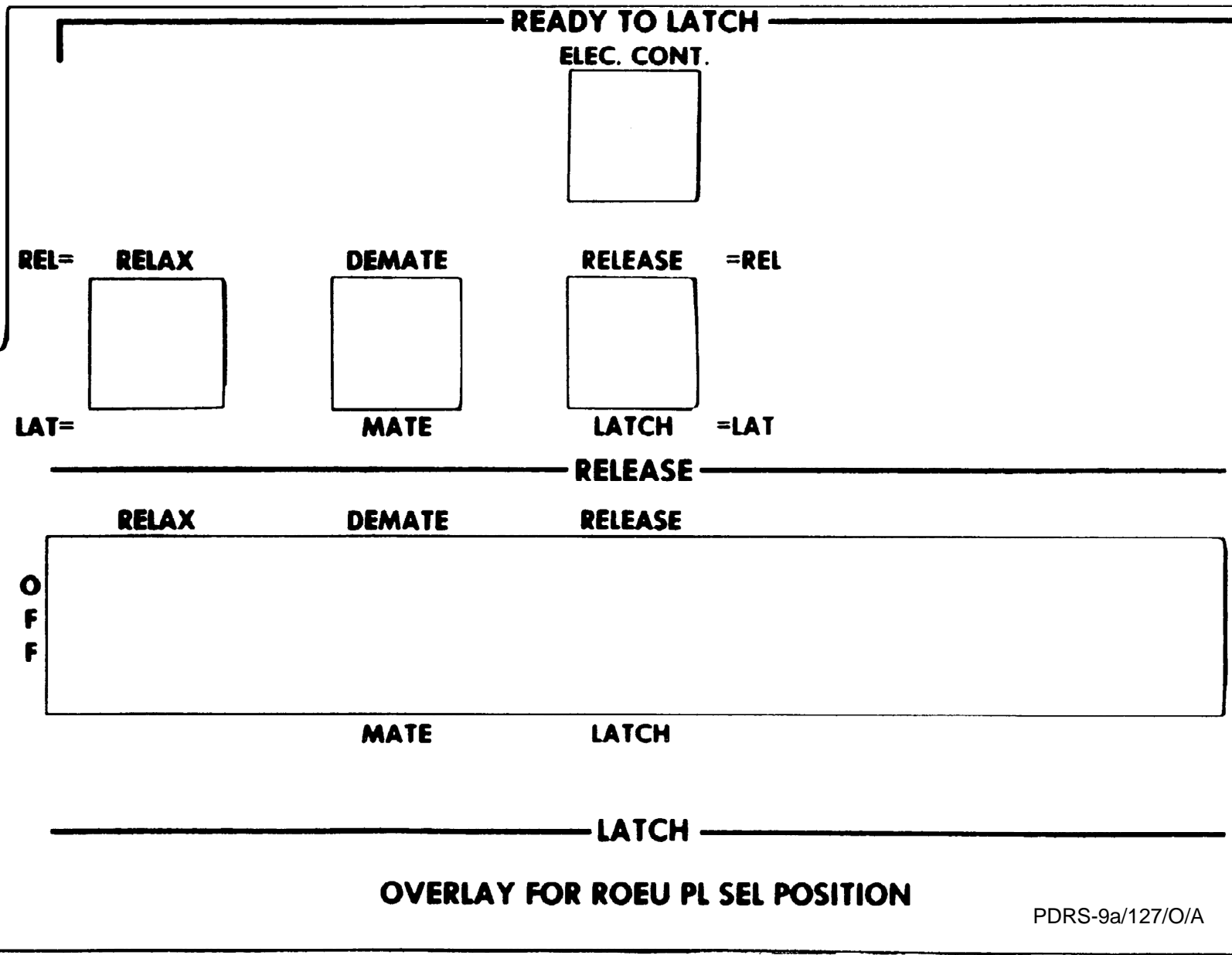

FS CC 10-2

(reduced copy)

PDRS/127/FIN

OVERLAY FOR ROEU PL SEL POSITION

PDRS-9a/127/O/A

Fabricate as transparency

ZOOM 34.0 HFOV  
FOCUS 5.0 FT  
EYEPOINT APPROX 18 IN



WR-

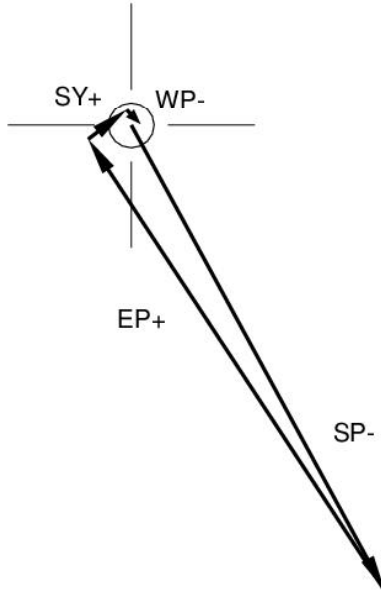

SY+

WP-

EP+

SP-

JEF SJ GRAPPLE AT HANDOFF 1 WRIST CCTV OVERLAY

PDRS-10a/127/O/B

(reduced copy)

FS CC 10-3

PDRS/127/FIN

Fabricate as transparency

ZOOM 34.0 HFOV  
FOCUS 5.0 FT  
EYEPOINT APPROX 18 IN

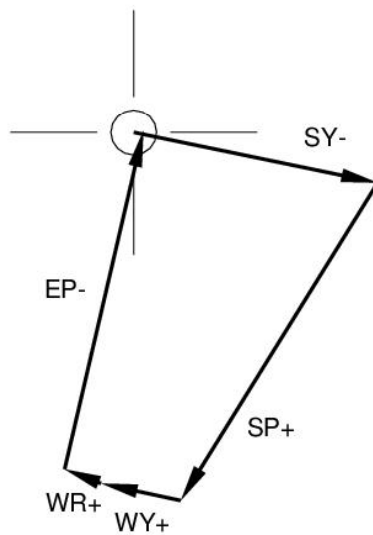

JEF SJ UNGRAPPLE AT HANDOFF 2 WRIST CCTV OVERLAY

PDRS-11a/127/O/B

(reduced copy)

FS CC 10-4

PDRS/127/FIN

I

Fabricate as transparency

ZOOM 34.0 HFOV  
FOCUS 5.0 FT  
EYEPOINT APPROX 18 IN



WR-

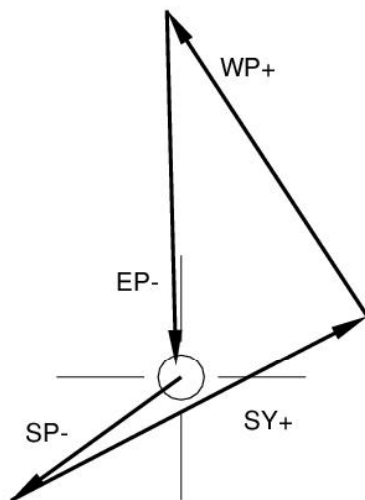

ICC SJ GRAPPLE IN PLB WRIST CCTV OVERLAY

PDRS-12a/127/O/B

(reduced copy)

FS CC 10-5

PDRS/127/FIN

I

Fabricate as transparency

ZOOM 34.0 HFOV  
FOCUS 5.0 FT  
EYEPOINT APPROX 18 IN

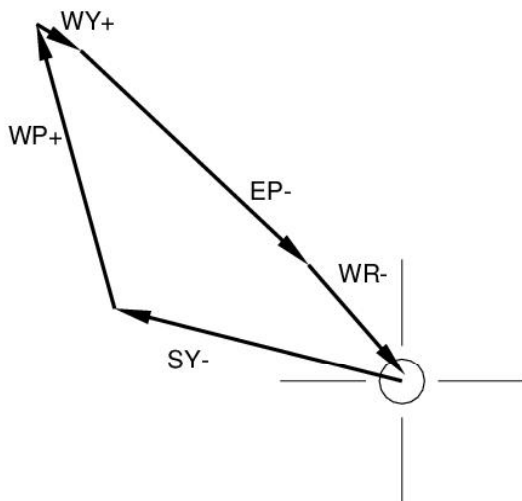

ICC SJ UNGRAPPLE AT HANDOFF WRIST CCTV OVERLAY

PDRS-13a/127/O/B

(reduced copy)

FS CC 10-6

PDRS/127/FIN

Fabricate as transparency

ZOOM 34.0 HFOV  
FOCUS 5.0 FT  
EYEPOINT APPROX 18 IN

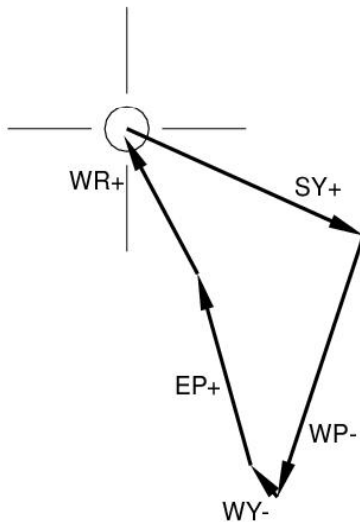

ICC SJ GRAPPLE AT HANDOFF WRIST CCTV OVERLAY

PDRS-14a/127/O/B

(reduced copy)

FS CC 10-7

PDRS/127/FIN

|

Fabricate as transparency

ZOOM 34.0 HFOV  
FOCUS 5.0 FT  
EYEPOINT APPROX 18 IN

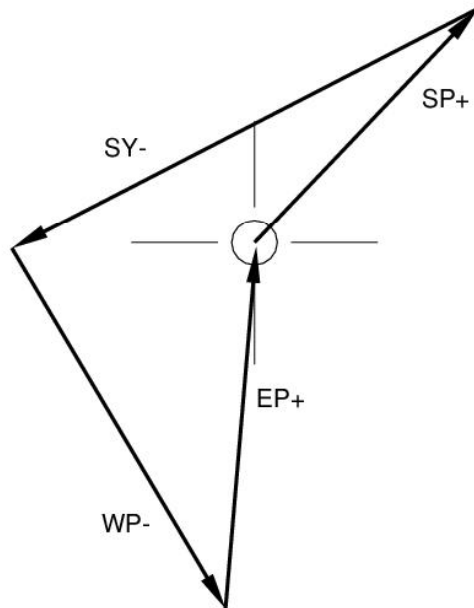

ICC SJ UNGRAPPLE IN PLB WRIST CCTV OVERLAY

PDRS-15a/127/O/B

I

(reduced copy)

FS CC 10-8

PDRS/127/FIN



Fabricate as transparency

ZOOM 34.0 HFOV  
FOCUS 5.0 FT  
EYEPOINT APPROX 18 IN



WR-

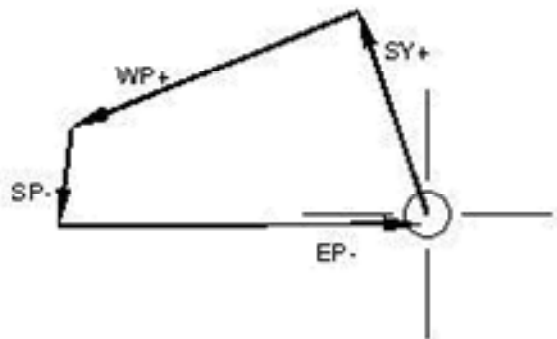

JLE SJ GRAPPLE IN PLB WRIST CCTV OVERLAY

PDRS-16a/127/O/B

(reduced copy)

FS CC 10-9

PDRS/127/FIN

Fabricate as transparency

ZOOM 34.0 HFOV  
FOCUS 5.0 FT  
EYEPOINT APPROX 18 IN



WR-

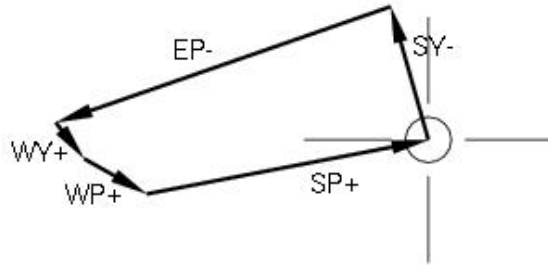

JLE SJ UNGRAPPLE AT HANDOFF WRIST CCTV OVERLAY

PDRS-17a/127/O/B

I

(reduced copy)

FS CC 10-10

PDRS/127/FIN

Fabricate as transparency

ZOOM 34.0 HFOV  
FOCUS 5.0 FT  
EYEPOINT APPROX 18 IN



WR+

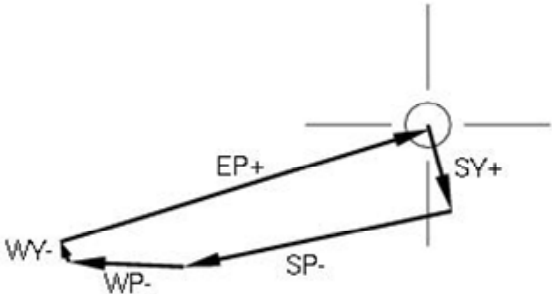

JLE SJ GRAPPLE AT HANDBACK WRIST CCTV OVERLAY

PDRS-18a/127/O/B

I

(reduced copy)

FS CC 10-11

PDRS/127/FIN

Fabricate as transparency

ZOOM 34.0 HFOV  
FOCUS 5.0 FT  
EYEPOINT APPROX 18 IN

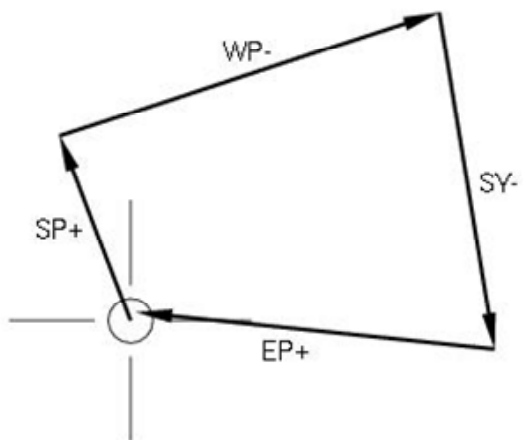

JLE SJ UNGRAPPLE IN PLB WRIST CCTV OVERLAY

PDRS-19a/127/O/B

I

(reduced copy)  
FS CC 10-12

PDRS/127/FIN

Fabricate as transparency

ZOOM 34.0 HFOV  
FOCUS 5.0 FT  
EYEPOINT APPROX 18 IN



WR-

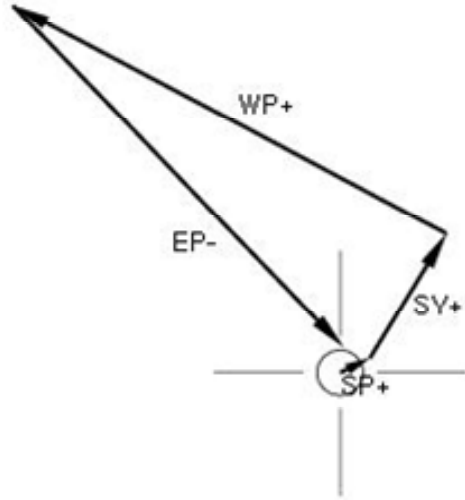

OBSS SJ GRAPPLE AT HANDOFF

PDRS-20a/127/O/B

I

(reduced copy)  
FS CC 10-13

PDRS/127/FIN

Fabricate as transparency

ZOOM 34.0 HFOV  
FOCUS 5.0 FT  
EYEPOINT APPROX 18 IN



WR+

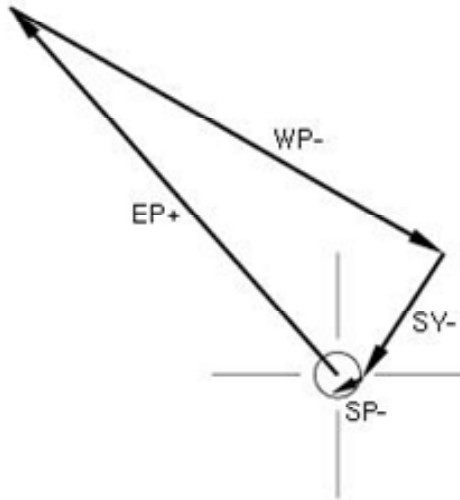

OBSS SJ UNGRAPPLE AT HANDOFF

PDRS-21a/127/O/B

I

(reduced copy)  
FS CC 10-14

PDRS/127/FIN



**PDRS OPS C/L**

**STS  
127**