

# PDRS Operations Checklist

## STS-128 Flight Supplement

---

**Mission Operations Directorate  
EVA, Robotics, & Crew Systems  
Operations Division**

**Final, Rev A  
July 30, 2009**

National Aeronautics and  
Space Administration

**Lyndon B. Johnson Space Center**  
Houston, Texas

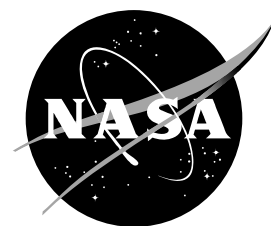



MISSION OPERATIONS DIRECTORATE

**PDRS OPERATIONS CHECKLIST  
STS-128 FLIGHT SUPPLEMENT**

FINAL, REVISION A  
July 30, 2009

PREPARED BY:

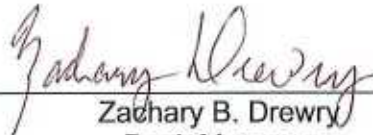
  
\_\_\_\_\_  
Zachary B. Drewry  
Book Manager

APPROVED BY:

  
\_\_\_\_\_  
Aaron D. Goldenthal  
Lead, Shuttle and Exploration Robotics  
Operations Group

  
\_\_\_\_\_  
Quinn L. Carelock  
Chief, Robotics Operations Branch

This document is under the configuration control of the Crew Procedures Control Board (CPCB). All proposed changes must be submitted via Change Request Workflow (CRW) to DO3/FDF Manager.

Additional distribution of this book, for official use only, may be requested in writing to DO3/PMO Administrator. The request must include justification and requester's name, organization, position, and phone number. Contractor requests are made through the NASA or DOD organization supported. Deletions, reduction in quantity, or change of address may be submitted to DO3/FDF Management Office, 281-244-1184.

| Incorporates the following: |  |
|-----------------------------|--|
| 482#:                       | PDRS FS-00145<br>PDRS FS-00146<br>PDRS FS-00147<br>PDRS FS-00148 |

AREAS OF TECHNICAL RESPONSIBILITY

|                      |                  |              |
|----------------------|------------------|--------------|
| Book Manager         | DX25/Z. Drewry   | 281-244-7726 |
| RMS Analysis         | DX24/D. Westman  | 281-244-0040 |
| RMS Training         | DX25/L. Bigoness | 281-244-9009 |
| PRLA/ROEU Procedures | DX42/L. Slovey   | 281-483-1685 |
| DAP Procedures       | DS62/D. Shafer   | 281-244-0143 |
| OBSS Procedures      | DX46/P. Reichert | 281-483-1827 |



PDRS OPERATIONS CHECKLIST  
 STS-128 FLIGHT SUPPLEMENT

**LIST OF EFFECTIVE PAGES**

FINAL 04/17/09  
 REV A 07/30/09

|                |   |           |                |   |           |
|----------------|---|-----------|----------------|---|-----------|
| Sign Off ..... | * | 128/FIN A | FS 2-25.....   | ⊗ | 128/FIN A |
| ii.....        | * | 128/FIN A | FS 2-26.....   | ⊗ | 128/FIN A |
| iii.....       | * | 128/FIN A | FS 2-27.....   | ⊗ | 128/FIN A |
| iv.....        | * | 128/FIN A | FS 2-28.....   | ⊗ | 128/FIN A |
| v .....        |   | 128/FIN A | FS 2-29.....   | ⊗ | 128/FIN A |
| vi.....        |   | 128/FIN A | FS 2-30.....   |   | 128/FIN A |
| FS 1-1 .....   |   | 128/FIN A | FS 2-31.....   | ⊗ | 128/FIN A |
| FS 1-2 .....   |   | 128/FIN A | FS 2-32.....   | ⊗ | 128/FIN A |
| FS 1-3 .....   | ⊗ | 128/FIN A | FS 2-33.....   | ⊗ | 128/FIN A |
| FS 1-4 .....   |   | 128/FIN A | FS 2-34.....   | ⊗ | 128/FIN A |
| FS 1-5 .....   |   | 128/FIN A | FS 2-35.....   | ⊗ | 128/FIN A |
| FS 1-6 .....   | ⊗ | 128/FIN A | FS 2-36.....   | ⊗ | 128/FIN A |
| FS 1-7 .....   | ⊗ | 128/FIN A | FS 2-37.....   |   | 128/FIN A |
| FS 1-8 .....   | ⊗ | 128/FIN A | FS 2-38.....   |   | 128/FIN A |
| FS 1-9 .....   | ⊗ | 128/FIN A | FS 2-39.....   |   | 128/FIN A |
| FS 1-10 .....  | ⊗ | 128/FIN A | FS 2-40.....   | ⊗ | 128/FIN A |
| FS 1-11 .....  |   | 128/FIN A | FS 2-41.....   |   | 128/FIN A |
| FS 1-12 .....  | ⊗ | 128/FIN A | FS 2-42.....   |   | 128/FIN A |
| FS 1-13 .....  |   | 128/FIN A | FS 2-43.....   | ⊗ | 128/FIN A |
| FS 1-14 .....  |   | 128/FIN A | FS 2-44.....   | ⊗ | 128/FIN A |
| FS 2-1 .....   |   | 128/FIN A | FS 2-45.....   | ⊗ | 128/FIN A |
| FS 2-2 .....   | ⊗ | 128/FIN A | FS 2-46.....   | ⊗ | 128/FIN A |
| FS 2-3 .....   | ⊗ | 128/FIN A | FS 2-47.....   |   | 128/FIN A |
| FS 2-4 .....   |   | 128/FIN A | FS 2-48.....   | ⊗ | 128/FIN A |
| FS 2-5 .....   |   | 128/FIN A | FS 2-49.....   | ⊗ | 128/FIN A |
| FS 2-6 .....   |   | 128/FIN A | FS 2-50.....   | ⊗ | 128/FIN A |
| FS 2-7 .....   | ⊗ | 128/FIN A | FS 2-51.....   | ⊗ | 128/FIN A |
| FS 2-8 .....   | ⊗ | 128/FIN A | FS 2-52.....   |   | 128/FIN A |
| FS 2-9 .....   | ⊗ | 128/FIN A | FS 2-53.....   | ⊗ | 128/FIN A |
| FS 2-10 .....  | ⊗ | 128/FIN A | FS 2-54.....   | ⊗ | 128/FIN A |
| FS 2-11 .....  | ⊗ | 128/FIN A | FS 2-55.....   | ⊗ | 128/FIN A |
| FS 2-12 .....  |   | 128/FIN A | FS 2-56.....   | ⊗ | 128/FIN A |
| FS 2-13 .....  | ⊗ | 128/FIN A | FS 3-1.....    |   | 128/FIN A |
| FS 2-14 .....  | ⊗ | 128/FIN A | FS 3-2.....    |   | 128/FIN A |
| FS 2-15 .....  | ⊗ | 128/FIN A | FS 3-3.....    |   | 128/FIN A |
| FS 2-16 .....  | ⊗ | 128/FIN A | FS 3-4.....    |   | 128/FIN A |
| FS 2-17 .....  |   | 128/FIN A | FS 4-1.....    | * | 128/FIN A |
| FS 2-18 .....  |   | 128/FIN A | FS CC 4-2..... | * | 128/FIN A |
| FS 2-19 .....  |   | 128/FIN A | FS CC 4-3..... | * | 128/FIN A |
| FS 2-20 .....  | ⊗ | 128/FIN A | FS CC 4-4..... | * | 128/FIN A |
| FS 2-21 .....  |   | 128/FIN A |                |   |           |
| FS 2-22 .....  | ⊗ | 128/FIN A |                |   |           |
| FS 2-23 .....  | ⊗ | 128/FIN A |                |   |           |
| FS 2-24 .....  | ⊗ | 128/FIN A |                |   |           |

\* – Omit from flight book  
 ⊗ – Flight copies of this page contain color

PDRS CUE CARDS

| <u>Title</u>                          | <u>Ref. Page</u> | <u>Card No.</u>  |
|---------------------------------------|------------------|------------------|
| OBSS SJ GRAPPLE AT HANDOFF .....      | FS CC 4-2        | PDRS-9a/128/O/A  |
| OBSS SJ UNGRAPPLE AT HANDOFF .....    | FS CC 4-3        | PDRS-10a/128/O/A |
| OVERLAY FOR ROEU PL SEL POSITION..... | FS CC 4-4        | PDRS-11a/128/O/A |

| <u>CONTENTS</u>                                    | <u>PAGE</u> |
|--|-------------|
| <u>OBSS NOMINAL</u> .....                          | FS 1-1      |
| OBSS HANDOFF FROM SSRMS TO SRMS .....              | FS 1-2      |
| MNVR TO UNDOCK .....                               | FS 1-9      |
| FLAT FIELD.....                                    | FS 1-11     |
| <br><u>OBSS CONTINGENCY</u> .....                  | <br>FS 2-1  |
| OBSS HANDOFF FROM SRMS TO SSRMS .....              | FS 2-2      |
| MNVR TO CONTINGENCY UNDOCK.....                    | FS 2-8      |
| CONT UNDOCK TO NOM UNDOCK .....                    | FS 2-10     |
| SJ HANDOFF FROM SSRMS TO SRMS .....                | FS 2-12     |
| SRMS TO SSRMS .....                                | FS 2-29     |
| MNVR TO UNDOCK.....                                | FS 2-47     |
| OBSS HOVER.....                                    | FS 2-52     |
| <br><u>REFERENCE DATA</u> .....                    | <br>FS 3-1  |
| OBSS HANDOFF JOINT ANGLES VS POR COORDINATES ..... | FS 3-2      |
| AUTOSEQUENCE .....                                 | FS 3-4      |
| <br><u>CUE CARD CONFIGURATION</u> .....            | <br>FS 4-1  |

This Page Intentionally Blank

OBSS NOMINAL

|                                      |         |
|--------------------------------------|---------|
| OBSS HANDOFF FROM SSRMS TO SRMS..... | FS 1-2  |
| MNVR TO UNDOCK.....                  | FS 1-9  |
| FLAT FIELD .....                     | FS 1-11 |

**OBSS  
NOMINAL**

# OBSS HANDOFF FROM SSRMS TO SRMS

OBSS  
NOMINAL

## 1. SETUP

SM 94 PDRS CONTROL

√PL ID, ITEM 3: 0

√INIT ID, ITEM 24: 0

Verify at PRE-CRADLE posn:

| X     | Y     | Z     | PITCH | YAW | ROLL | PL ID |
|-------|-------|-------|-------|-----|------|-------|
| -1261 | -146  | -551  | 5     | 2   | 0    | 0     |
| SY    | SP    | EP    | WP    | WY  | WR   |       |
| 0.0   | +25.0 | -25.0 | +5.0  | 0.0 | 0.0  |       |

R12

√Green Jumper – ISS

|       |            |
|-------|------------|
| MON 1 | P1 LOOB    |
| MON 2 | B          |
| DNLK  | ELBOW (EE) |
| DTV   | A          |

## 2. MNVR TO OBSS PRE-GRAPPLE AT HANDOFF

Verify SSRMS at Stage Park posn

SM 94 PDRS CONTROL

END POS – ITEM 18 -1 0 4 7 -3 6 0 -6 5 8 EXEC

ATT – ITEM 21 +2 8 4 +0 +2 7 0 EXEC

CMD CK – ITEM 25 EXEC (GOOD)

RHC

RATE – as reqd (VERN within 10 ft)

BRAKES – OFF (tb-OFF)

MODE – OPR CMD, ENTER

AUTO SEQ – PROCEED (IN PROG It on)

When AUTO SEQ IN PROG It – off:

BRAKES – ON (tb-ON)

OBSS PRE-GRAPPLE AT HANDOFF posn:

| X     | Y     | Z     | PITCH | YAW   | ROLL  | PL ID |
|-------|-------|-------|-------|-------|-------|-------|
| -1047 | -360  | -658  | 284   | 0     | 270   | 0     |
| SY    | SP    | EP    | WP    | WY    | WR    |       |
| +22.7 | +57.5 | -27.4 | -99.3 | +11.8 | -97.9 |       |

Notify SSRMS Operator that SRMS at OBSS Pre-Grapple at Handoff posn

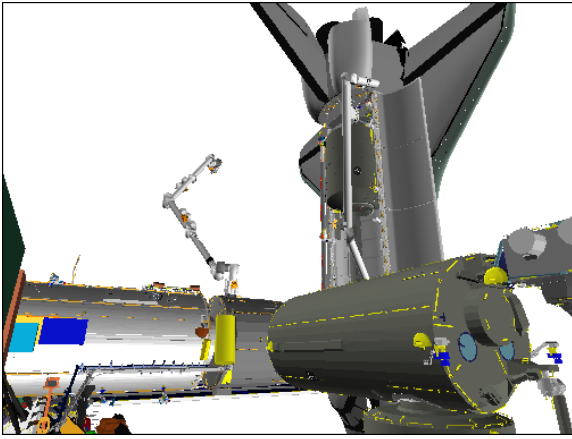

**P1 LOOB (120,20)**

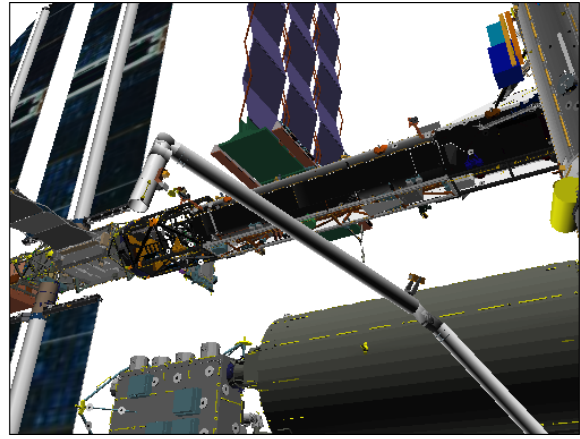

**CCTV B (-30,30)**

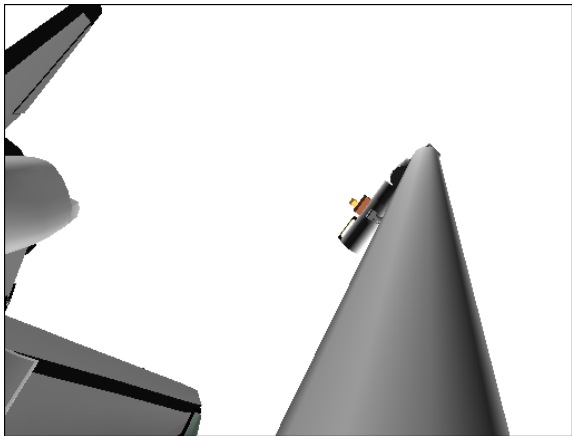

**ELBOW (-20,-15)**



**CCTV A (20,20)**

3. CONFIGURE POWER

**CAUTION**  
 SPEE power must be applied within 90 min  
 to prevent sensor package damage

On SSRMS Operator GO to release STBD MRLs,  
 STBD RMS HTR A,B (two) – OFF

- |         |  |
|---------|--|
| A6U     | EVENT TIMER MODE – UP<br>CNTL – START              |
| MA73C:C | cb MCA PWR AC3 3Φ MID 2 – op<br>√AC2 3Φ MID 2 – op |
| MA73C:D | √AC3 3Φ MID 4 – op                                 |
| R13L    | PL BAY MECH PWR SYS (two) – ON                     |

4. STBD MRL RELEASE

SM 94 PDRS CONTROL

RMS STBD – ITEM 2 EXEC (\*)  
√STBD AFT, MID, FWD REL (six) = 0

NOTE

Expect single motor drive time for MRL release

STBD RMS RETEN LAT – REL (tb-REL) (18 sec max)  
– OFF

If motor drive time > 18 sec, √MCC

SM 94 PDRS CONTROL

√STBD AFT, MID, FWD REL (six) = 1

5. RECONFIGURE POWER

R13L PL BAY MECH PWR SYS (two) – OFF

MA73C:C cb MCA PWR AC3 3Φ MID 2 – cl  
√AC2 3Φ MID 2 – op

MA73C:D √AC3 3Φ MID 4 – op

Give SSRMS Operator GO for OBSS Unberth and SSRMS mnvr to Handoff  
Monitor RFL Status

After OBSS Unberth,

SM 94 PDRS CONTROL

RMS PORT – ITEM 1 EXEC (\*)

6. SETUP FOR GRAPPLE

A7U CCTV – config for grapple  
– install PDRS TARGET OVERLAY FOR CTVM  
– RMS WRIST, ZOOM: 34.0 HFOV  
FOCUS: 5 ft

Maintain eyepoint approx 18 in when using grapple overlay

|       |            |
|-------|------------|
| MON 1 | BASE ELBOW |
| MON 2 | B          |
| DNLK  | EE (ELBOW) |
| DTV   | A          |

R12(OBSS) √SPEE PWR – OFF  
A15 √APCU 2 OUTPUT – OFF



7. OBSS GRAPPLE AT HANDOFF POSN

RHC

On SSRMS Operator GO for SRMS OBSS Grapple,

RATE – VERN (RATE MIN tb-ON)

BRAKES – OFF (tb-OFF)

MODE – END EFF, ENTER

Mnvr to grapple envelope

CAUTION  
Monitor EE tb timing to prevent EE motor burnout

EE MODE – AUTO

CAPTURE sw – depress (mom)

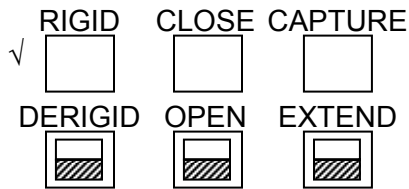

CRITICAL TIMES (28 sec total):

CAPTURE tb – gray, then

CLOSE tb – gray, 3 sec max, then

RIGID tb – gray, 25 sec max

EE MODE – OFF

- \* If manual capture required: \*
- \* EE MODE – MAN \*
- \* CAPTURE sw – depress (hold until CLOSE tb-gray, 3 sec max) \*
- \* MAN CONTR – RIGID (hold until RIGID tb-gray, 25 sec max) \*
- \* MODE – OFF \*

MODE – TEST, ENTER

Wait 5 sec

BRAKES – ON (tb-ON)

SM 94 PDRS CONTROL  
PL ID – ITEM 3 +1 EXEC  
INIT ID – ITEM 24 +1 EXEC

Expected OBSS HANDOFF posn:

|   |       |       |       |       |       |       |       |   |
|---|-------|-------|-------|-------|-------|-------|-------|---|
|   | X     | Y     | Z     | PITCH | YAW   | ROLL  | PL ID |   |
| √ | -1070 | -360  | -584  | 44    | 270   | 0     | 1     | * |
|   | SY    | SP    | EP    | WP    | WY    | WR    |       |   |
| √ | +24.5 | +59.0 | -42.1 | -85.9 | +11.2 | -99.4 |       |   |

\*Display singularity

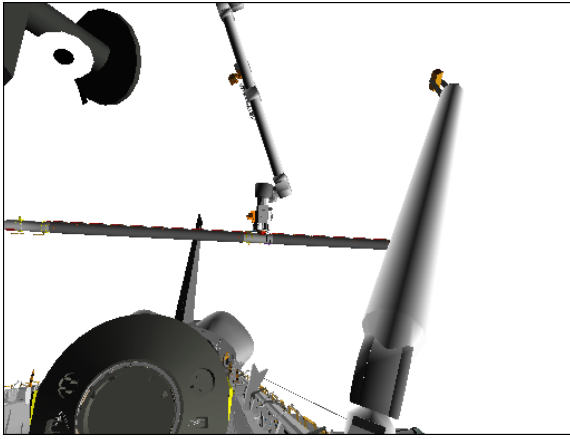

**CCTV A (10,20)**

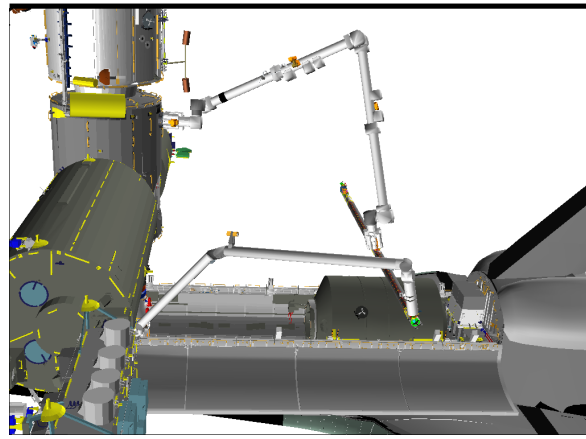

**BIRD'S EYE**

Perform ACTIVATION (LDRI/ITVC Cue Card, P/TV)

Perform LCH ACTIVATION (LCS Cue Card, P/TV)

Review GENERIC END EFFECTOR CUE CARD – ISS/SHUTTLE DOCKED OPS

Give SSRMS Operator GO for OBSS ungrapple

Perform LCC ACTIVATION (LCS Cue Card, P/TV)

Perform LCC DEACTIVATION (LCS Cue Card, P/TV), steps 1 and 2

- R12 8. MNVR TO MPLM VIEWING  
 √Green Jumper – ISS

|       |         |
|-------|---------|
| MON 1 | S1 LOOB |
| MON 2 | B       |
| DNLK  | RSC     |
| DTV   | A       |

SM 94 PDRS CONTROL

END POS – ITEM 18 -9 6 7 -6 4 3 -3 8 6 EXEC

ATT – ITEM 21 +6 0 +3 4 9 +2 8 2 EXEC

CMD CK – ITEM 25 EXEC (GOOD)

On SSRMS Operator GO for OBSS mnvr to MPLM VIEWING

- RHC RATE – as reqd (VERN within 10 ft)  
 BRAKES – OFF (tb-OFF)  
 MODE – SINGLE, ENTER

Mnvr to INTERMEDIATE posn:

|   |       |       |       |       |       |       |       |
|---|-------|-------|-------|-------|-------|-------|-------|
| OBSS Handoff<br>1: WR +<br>Intermediate | SY    | SP    | EP    | WP    | WY    | WR    |       |
|   | +24.5 | +59.0 | -42.1 | -85.9 | +11.2 | -99.4 |       |
|   |       |       |       |       |       | -87.8 |       |
|   | +24.5 | +59.0 | -42.1 | -85.9 | +11.2 | -87.8 |       |
|   | X     | Y     | Z     | PITCH | YAW   | ROLL  | PL ID |
|   | -1070 | -361  | -584  | 14    | 281   | 330   | 1     |

MODE – OPR CMD, ENTER (READY It on)

AUTO SEQ – PROCEED (IN PROG It on)

When AUTO SEQ IN PROG It – off:  
BRAKES – ON (tb-ON)

MPLM VIEWING posn:

(02:30)

|   | X     | Y     | Z     | PITCH | YAW   | ROLL  | PL ID |
|---|-------|-------|-------|-------|-------|-------|-------|
| √ | -967  | -643  | -386  | 60    | 349   | 282   | 1     |
|   | SY    | SP    | EP    | WP    | WY    | WR    |       |
| √ | +62.5 | +25.0 | -23.0 | 0.0   | -13.2 | -21.9 |       |

√MODE – not DIRECT (It off)

PARAM – PORT TEMP  
JOINT – CRIT TEMP

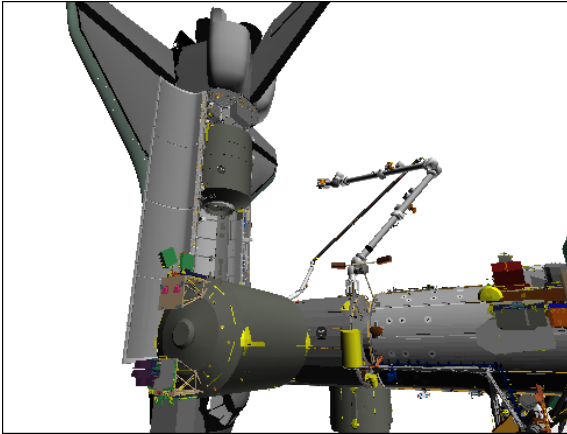

**S1 LOOB (60,20)**

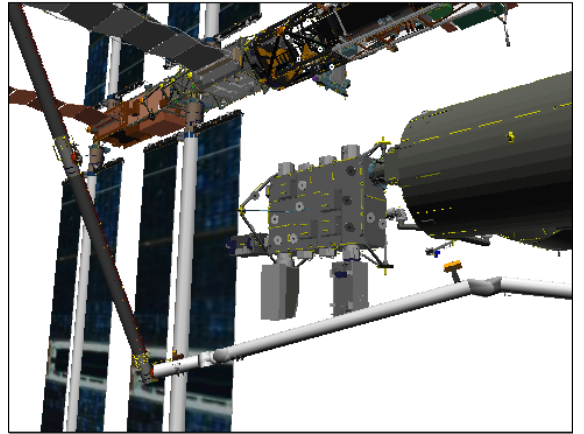

**CCTV B (-45,10)**

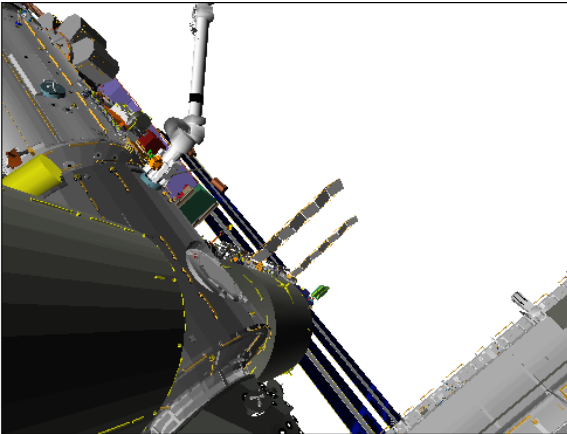

**ELBOW (-165,20)**

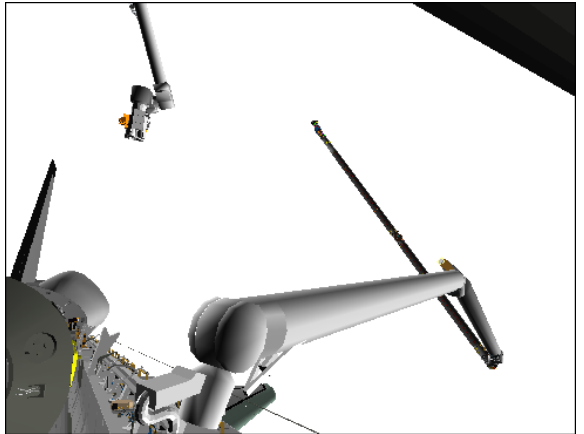

**CCTV A (30,15)**

9. RECONFIG PTU

R12  
A7U  
Green Jumper – LDRI/ITVC  
DTV ← PL2

CAMR CMD PAN/TILT – HI RATE

PAN – L (to hard stop)

TILT – UP (to hard stop)

PAN/TILT – RESET, HI RATE (LO within 10°)

PAN: +130 (right)

TILT: -60 (dn)

MUX 1 L ← MIDDECK  
LDRI MODE 2 pb – push (ITVC video)  
VIDEO OUT – as desired (not DTV)  
√VIDEO IN – not PL2

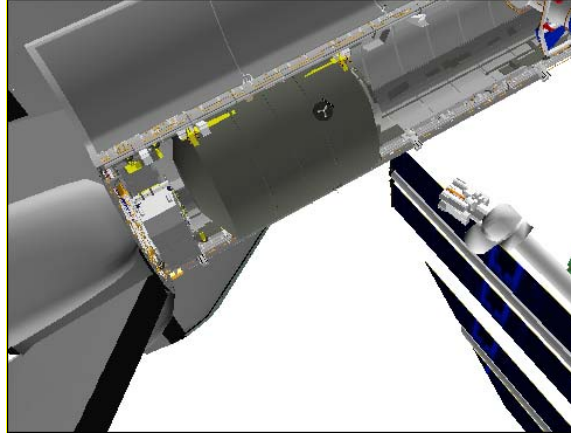

**OBSS ITVC (130,-60)**

# OBSS MNVR TO UNDOCK

## 1. SETUP

SM 94 PDRS CONTROL

√ PL ID, ITEM 3: 1

√ INIT ID, ITEM 24: 1

Verify at MPLM VIEWING posn:

|   | X     | Y     | Z     | PITCH | YAW   | ROLL  | PL ID |
|---|-------|-------|-------|-------|-------|-------|-------|
| √ | -967  | -643  | -386  | 60    | 349   | 282   | 1     |
|   | SY    | SP    | EP    | WP    | WY    | WR    |       |
| √ | +62.5 | +25.0 | -23.0 | 0.0   | -13.2 | -21.9 |       |

R12

√ Green Jumper – ISS

|       |         |
|-------|---------|
| MON 1 | P1 LOOB |
| MON 2 | B       |
| DNLK  | RSC     |
| DTV   | A       |

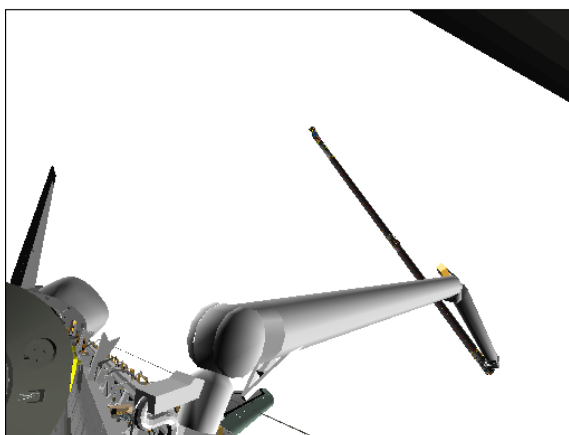

CCTV A (30,15)

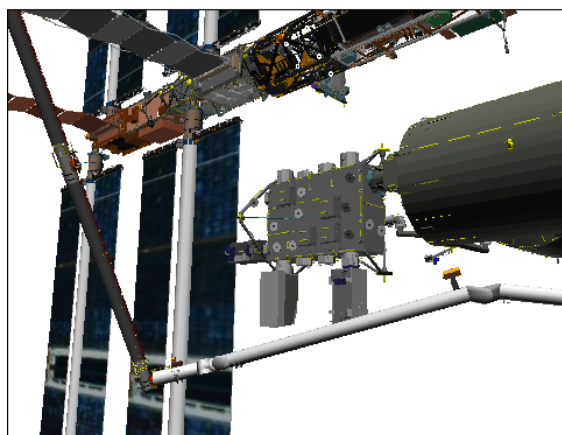

CCTV B (-45,10)

## 2. OBSS MNVR TO UNDOCK

SM 94 PDRS CONTROL

END POS – ITEM 18 -1 0 4 1 -3 6 2 -6 0 2 EXEC

ATT – ITEM 21 +4 4 +2 7 0 +0 EXEC

CMD CK – ITEM 25 EXEC (GOOD)

RHC

RATE – as reqd (VERN within 10 ft)

BRAKES – OFF (tb-OFF)

MODE – OPR CMD, ENTER (READY It on)

AUTO SEQ – PROCEED (IN PROG It on)

When AUTO SEQ IN PROG It – off:

BRAKES – ON (tb-ON)

UNDOCK posn: (02:30)

|   | X     | Y     | Z     | PITCH | YAW   | ROLL   | PL ID |
|---|-------|-------|-------|-------|-------|--------|-------|
| √ | -1041 | -362  | -602  | 44    | 270   | 0      | 1     |
|   | SY    | SP    | EP    | WP    | WY    | WR     |       |
| √ | +25.8 | +66.3 | -49.0 | -85.9 | +10.7 | -100.7 |       |

\*Display singularity

√MODE – not DIRECT (It off)  
 PARAM – PORT TEMP  
 JOINT – CRIT TEMP

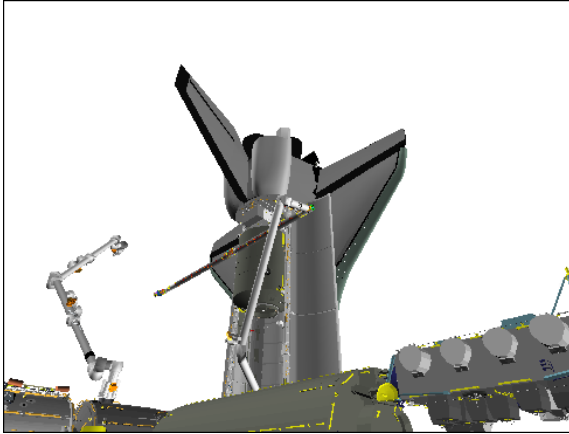

P1 LOOB (135,35)

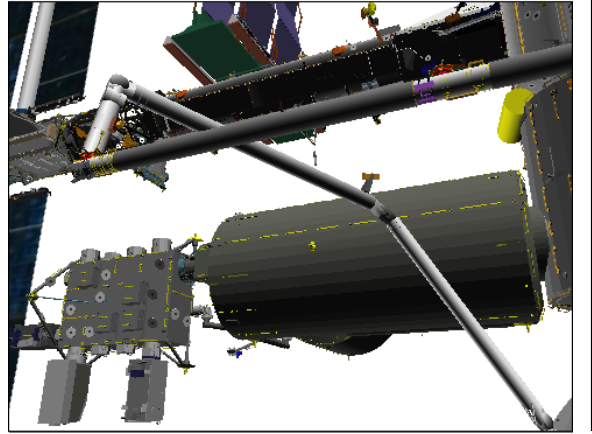

CCTV B (-25,20)

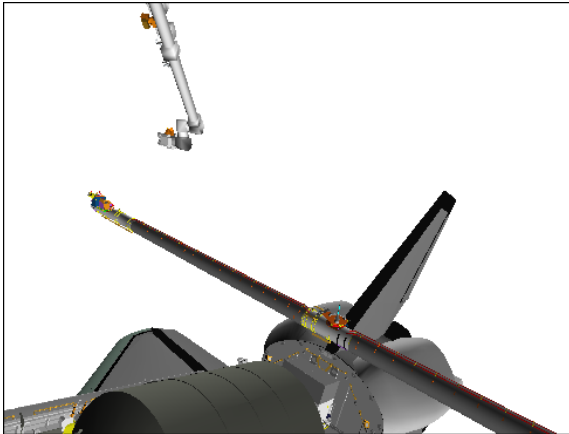

ELBOW (-65,20)

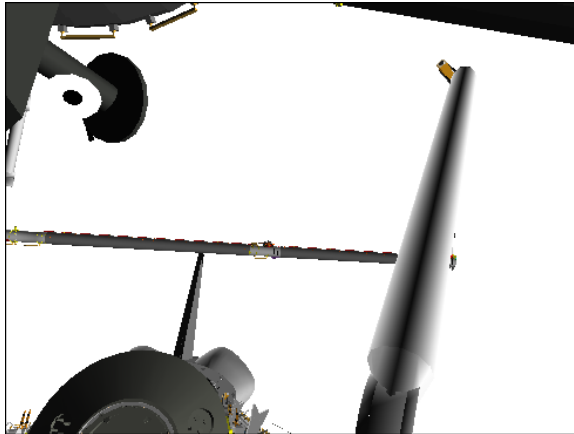

CCTV A (10,25)

# OBSS MNVR TO FLAT FIELD

**WARNING**  
For UNDOCKED ops only

## 1. SETUP

**SM 94 PDRS CONTROL**

PL ID – ITEM 3 +2 EXEC  
 INIT ID – ITEM 24 +2 EXEC  
 AUTO MODES – ITEM 13 +7 EXEC

|       |       |
|-------|-------|
| MON 1 | C     |
| MON 2 | D     |
| DNLK  | ELBOW |
| DTV   | A (B) |

## 2. MNVR TO FLAT FIELD START

**SM 94 PDRS CONTROL**

END POS – ITEM 18 -1 0 2 9 +2 2 9 -6 1 4 EXEC  
 ATT – ITEM 21 +1 4 +2 7 0 +0 EXEC  
 CMD CK – ITEM 25 EXEC (GOOD)

RHC

RATE – COARSE (RATE MIN tb-OFF)  
 BRAKES – OFF (tb-OFF)  
 MODE – OPR CMD, ENTER (READY It on)

AUTO SEQ – PROCEED (IN PROG It on)

ACAS START posn:

|   | X     | Y     | Z     | PITCH | YAW   | ROLL   | PL ID |
|---|-------|-------|-------|-------|-------|--------|-------|
| √ | -1029 | +229  | -614  | 14    | 270   | 0      | 2     |
|   | SY    | SP    | EP    | WP    | WY    | WR     |       |
| √ | +26.1 | +67.7 | -51.2 | +85.0 | +10.6 | -100.6 |       |

When AUTO SEQ IN PROG It – off:

MODE – AUTO 1, ENTER (READY It on)

**SM 94 PDRS CONTROL**

√START PT, ITEM 17: 148

**SM 169 PDRS STATUS**

Monitor ACAS progress

AUTO SEQ – PROCEED (IN PROG It on)

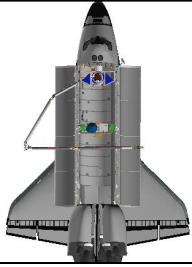
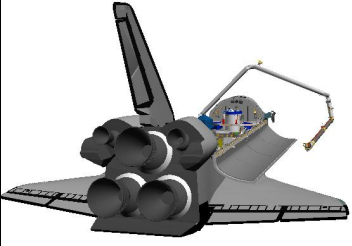
| Pt   | X            | Y           | Z           | PITCH     | YAW         | ROLL      |   |
|------|--------------|-------------|-------------|-----------|-------------|-----------|---|
| 148P | <b>-1029</b> | <b>+229</b> | <b>-614</b> | <b>14</b> | <b>270*</b> | <b>0</b>  |  |
| 149  | -800         | +500        | -250        | 281       | 333         | 95        |   |
| 150  | -1130        | +350        | -400        | 325       | 336         | 30        |   |
| 151P | <b>-1270</b> | <b>+350</b> | <b>-445</b> | <b>0</b>  | <b>0</b>    | <b>11</b> |  |

\*Display singularity

When AUTO SEQ IN PROG It – off:  
BRAKES – ON (tb-ON)

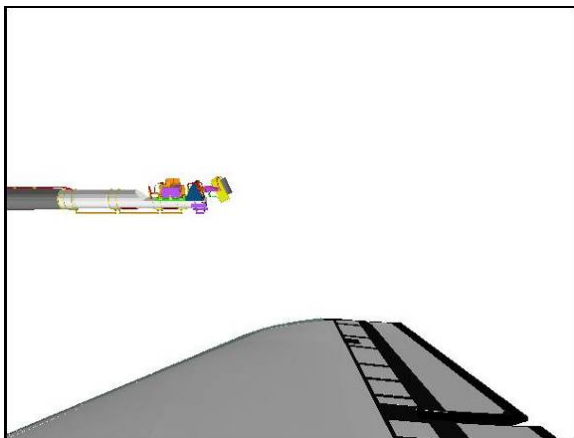

CCTV C (95,-5)

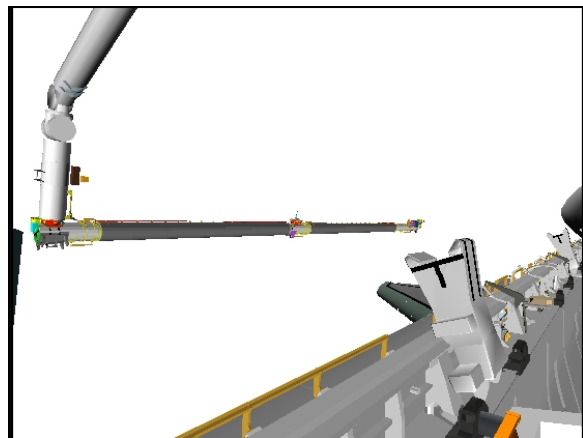

CCTV D (-40,0)

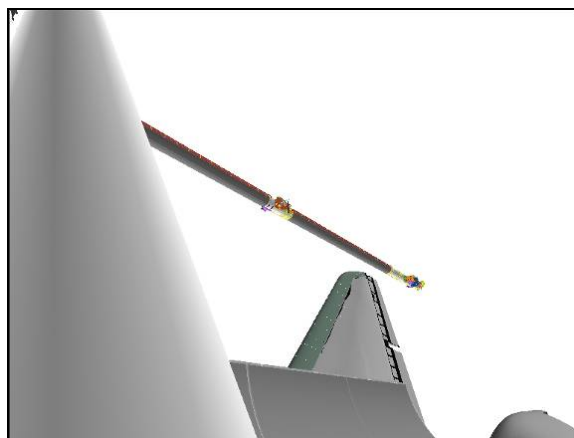

ELBOW (25,-40)

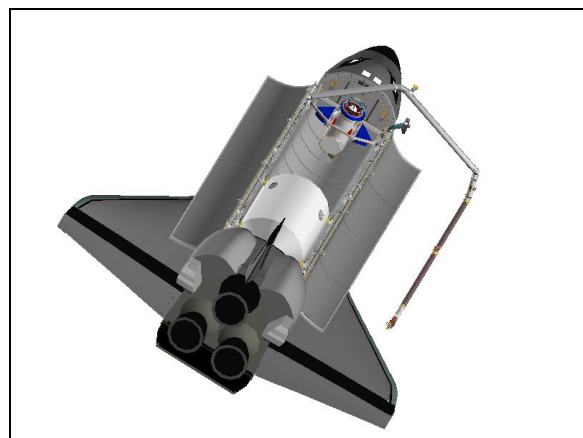

BIRD'S EYE



3. SETUP FOR STBD SURVEY

SM 94 PDRS CONTROL

AUTO MODES – ITEM 13 +1 +2 +3 +4 EXEC

For survey scan pattern, refer to OBSS SCAN PATTERN CUE CARDS – STBD & PORT, AND WING GLOVE AND CREW CABIN

Perform ACTIVATION (LDRI/ITVC Cue Card, P/TV) steps 1, 3, 4, and 5

A15 APCU 2 CONV – OFF  
Wait 10 sec  
APCU 2 CONV – ON

Perform LCC ACTIVATION (LCS Cue Card, P/TV)  
Perform IDC SOFTWARE ACTIVATION (IDC Cue Card, P/TV) steps 1 and 2

A7U MUX 1 L ← MIDDECK  
LDRI MODE 6 pb – push (flickering LDRI video)  
√DTV ← PL2

CAMR CMD PAN/TILT – HI RATE  
PAN – L (to hard stop)  
TILT – UP (to hard stop)  
PAN/TILT – RESET, HI RATE (LO within 10°)  
PAN: +103 (right)  
TILT: -260 (dn)

VIDEO OUT – as desired (not DTV)  
√VIDEO IN – not PL2

L10(VTR) REC pb – push, hold  
PLAY pb – push, simo (red ●)

Go to OBSS LDRI/IDC RCC SURVEY – STBD (OBSS OPERATIONS), step 5 |  
Reference 7-9 for procedure Notes

This Page Intentionally Blank

OBSS CONTINGENCY

|                                       |         |
|---------------------------------------|---------|
| OBSS HANDOFF FROM SRMS TO SSRMS ..... | FS 2-2  |
| MNVR TO CONTINGENCY UNDOCK .....      | FS 2-8  |
| CONT UNDOCK TO NOM UNDOCK.....        | FS 2-10 |
| SJ HANDOFF FROM SSRMS TO SRMS.....    | FS 2-12 |
| SRMS TO SSRMS.....                    | FS 2-29 |
| MNVR TO UNDOCK.....                   | FS 2-47 |
| OBSS HOVER .....                      | FS 2-52 |

OBSS  
CONTINGENCY

# OBSS HANDOFF FROM SRMS TO SSRMS

## 1. SETUP

SM 94 PDRS CONTROL

√ PL ID, ITEM 3: 1

√ INIT ID, ITEM 24: 1

Verify at MPLM VIEWING posn:

|   | X     | Y     | Z     | PITCH | YAW   | ROLL  | PL ID |
|---|-------|-------|-------|-------|-------|-------|-------|
| √ | -967  | -643  | -386  | 60    | 349   | 282   | 1     |
|   | SY    | SP    | EP    | WP    | WY    | WR    |       |
| √ | +62.5 | +25.0 | -23.0 | 0.0   | -13.2 | -21.9 |       |

R12

√ Green Jumper – ISS

|       |         |
|-------|---------|
| MON 1 | S1 LOOB |
| MON 2 | B       |
| DNLK  | RSC     |
| DTV   | A       |

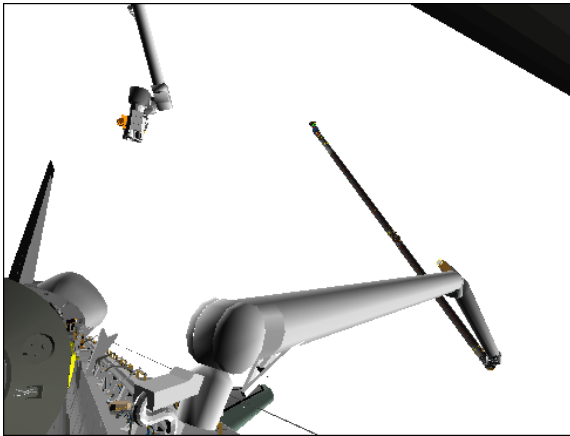

CCTV A (30,15)

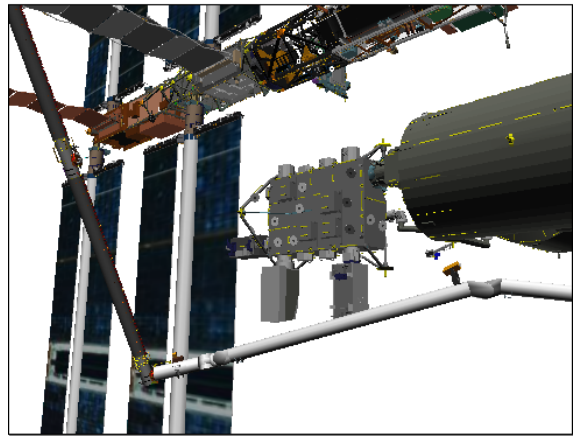

CCTV B (-45,10)

Review GENERIC END EFFECTOR CUE CARD – ISS/SHUTTLE DOCKED OPS

## 2. MNVR TO OBSS HANDOFF

SM 94 PDRS CONTROL

END POS – ITEM 18 -1 0 7 0 -3 6 1 -5 8 4 EXEC

ATT – ITEM 21 +1 4 +2 8 1 +3 3 0 EXEC

CMD CK – ITEM 25 EXEC (GOOD)

On SSRMS Operator GO for mnvr to OBSS HANDOFF

RHC

RATE – as reqd (VERN within 10 ft)

BRAKES – OFF (tb-OFF)

MODE – OPR CMD, ENTER (READY It on)

AUTO SEQ – PROCEED (IN PROG It on)

OBSS CONTINGENCY

When AUTO SEQ IN PROG It – off

INTERMEDIATE posn: (02:30)

|   | X     | Y     | Z     | PITCH | YAW   | ROLL  | PL ID |
|---|-------|-------|-------|-------|-------|-------|-------|
| √ | -1070 | -361  | -584  | 14    | 281   | 330   | 1     |
|   | SY    | SP    | EP    | WP    | WY    | WR    |       |
| √ | +24.5 | +59.0 | -42.1 | -85.9 | +11.2 | -87.8 |       |

MODE – SINGLE, ENTER

Mnvr to OBSS HANDOFF posn:

|              | SY    | SP    | EP    | WP    | WY    | WR    |       |
|--------------|-------|-------|-------|-------|-------|-------|-------|
| Intermediate | +24.5 | +59.0 | -42.1 | -85.9 | +11.2 | -87.8 |       |
| 1: WR -      |       |       |       |       |       | -99.4 |       |
| OBSS Handoff | +24.5 | +59.0 | -42.1 | -85.9 | +11.2 | -99.4 |       |
|              | X     | Y     | Z     | PITCH | YAW   | ROLL  | PL ID |
|              | -1070 | -360  | -584  | 44    | 270   | 0     | 1     |

\*Display singularity

BRAKES – ON (tb-ON)

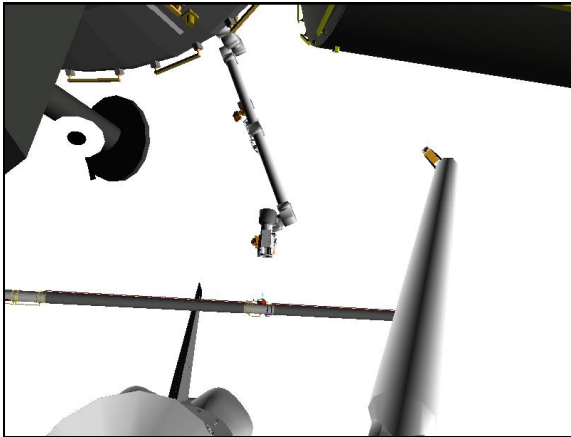

CCTV A (10,30)

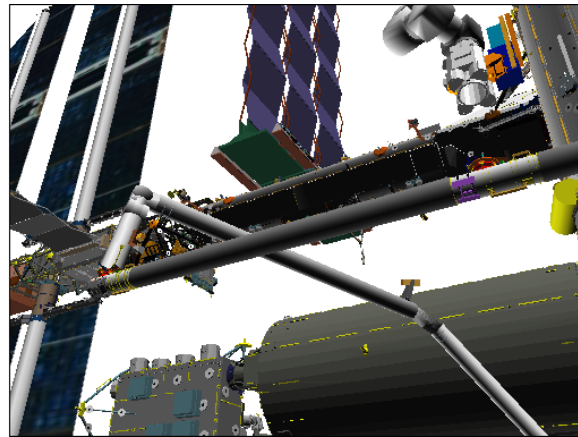

CCTV B (-30,30)

Give SSRMS Operator GO for OBSS grapple

3. STOW PTU

R12 (VPU) Green Jumper – LDRI/ITVC

A7U VID OUT DTV pb – push  
IN PL2(VPU) pb – push

CAMR CMD PAN/TILT – HI RATE

PAN – L (to hard stop)  
TILT – UP (to hard stop)  
PAN/TILT – RESET  
PAN: +108 (right)  
TILT: -175 (down)

R12 (VPU) Green Jumper – ISS

On SSRMS Operator GO for OBSS ungrapple

CAUTION  
STBD RMS HTR power must be applied within 90 min  
to prevent sensor package damage

Perform LCC DEACTIVATION (LCS Cue Card, P/TV)  
Perform LCH DEACTIVATION (LCS Cue Card, P/TV)  
Perform DEACTIVATION (LDRI/ITVC Cue Card, P/TV)

4. OBSS UNGRAPPLE

A7U

CCTV – config for ungrapple  
– RMS WRIST, ZOOM: 34.0 HFOV  
FOCUS: 5 ft

NOTE

CONTR ERR It and 'S96 PDRS CNTL' msg may  
occur due to Consistency/Envelope Check error

RHC

RATE – COARSE (RATE MIN tb-OFF)

SM 94 PDRS CONTROL

  
AUTO BRAKE INH – ITEM 10 EXEC (\*)

BRAKES – OFF (tb-OFF)  
MODE – TEST, ENTER  
Wait 5 sec

BRAKES – ON (tb-ON)

SM 94 PDRS CONTROL

  
AUTO BRAKE ENA – ITEM 9 EXEC (\*)  
PL ID – ITEM 3 +0 EXEC  
INIT ID – ITEM 24 +0 EXEC

RHC

RATE – VERN (RATE MIN tb-ON)  
BRAKES – OFF (tb-OFF)  
MODE – END EFF, ENTER

CAUTION  
Monitor EE tb timing to prevent EE motor burnout

EE MODE – AUTO  
RELEASE sw – depress (mom)

When OPEN tb – gray, mnvr arm clear of grapple pin

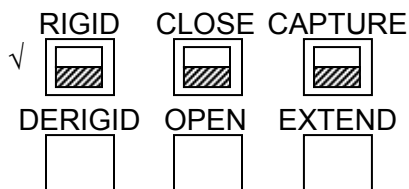

CRITICAL TIMES (28 sec total):  
DERIGID tb – gray, 5 sec max, then  
OPEN tb – gray, 3 sec max, then  
EXTEND tb – gray, 20 sec max

EE MODE – OFF

- \* If manual release reqd: \*
- \* EE MODE – MAN \*
- \* MAN CONTR – DERIGID (hold until DERIGID tb-gray, 5 sec max) \*
- \* RELEASE sw – depress (hold until OPEN tb-gray, 3 sec max) \*
- \* Mnvr arm clear of grapple pin, then \*
- \* EE MAN CONTR – DERIGID (hold until EXTEND tb-gray, 20 sec max) \*
- \* MODE – OFF \*

Mnvr to OBSS BACKOFF posn:

| X     | Y     | Z     | PITCH | YAW   | ROLL  | PL ID |
|-------|-------|-------|-------|-------|-------|-------|
| -1047 | -360  | -658  | 284   | 0     | 270   | 0     |
| SY    | SP    | EP    | WP    | WY    | WR    |       |
| +22.7 | +57.5 | -27.4 | -99.3 | +11.8 | -97.9 |       |

BRAKES – ON (tb-ON)  
 MODE – not DIRECT (It off)  
 PARAM – PORT TEMP  
 JOINT – CRIT TEMP

- \* If using Shuttle attitude control and attitude maintenance reqd: \*
- \* DAP: LVLH \*
- \* When rates damped: \*
- \* DAP: FREE > 2 sec \*
- \* DAP: AUTO \*

Give SSRMS Operator GO for OBSS Berth Sequence

5. CONFIGURE CIRCUIT BREAKERS  
 MA73C:C cb MCA PWR AC3 3Φ MID 2 – op  
                   √AC2 3Φ MID 2 – op  
 MA73C:D           √AC3 3Φ MID 4 – op

6. CONFIGURE FOR MONITORING  
 On SSRMS notification to watch for STBD RMS RFLs,  
 SM 94 PDRS CONTROL  
 RMS STBD – ITEM 2 EXEC (\*)

Notify SSRMS operator when STBD RMS R-F-L tb (three) – gray

7. STBD MRL LATCH  
 On SSRMS Operator GO to latch STBD MRLs to Topological Capture,  
 √STBD RMS R-F-L tb (three) – gray

SM 94 PDRS CONTROL  
 √STBD AFT, MID, FWD LAT (six) = 0

R13L PL BAY MECH PWR SYS (two) – ON

NOTE

Expect single motor drive time for MRL latching (18 sec max).  
 The following STBD RMS RETEN LAT – OFF and PL BAY  
 MECH PWR SYS (two) – OFF actions are to be performed simo

Verify AOS for latching to Topological Capture

STBD RMS RETEN LAT – LAT 6 sec only (tb-bp)  
 – OFF

R13L PL BAY MECH PWR SYS (two) – OFF  
 Give SSRMS Operator GO to Limp All SSRMS Joints and Derigidize

R13L On SSRMS Operator GO to complete STBD MRL latching,  
 PL BAY MECH PWR SYS (two) – ON

STBD RMS RETEN LAT – LAT (tb-LAT) (12 sec max)  
 – OFF

8. RECONFIGURE POWER  
 PL BAY MECH PWR SYS (two) – OFF

STBD RMS HTR A,B (two) – AUTO

A6U EVENT TIMER CNTL – STOP

SM 94 PDRS CONTROL

√STBD AFT, MID, FWD LAT (six) = 1  
 RMS PORT – ITEM 1 EXEC (\*)

MA73C:C cb MCA PWR AC3 3Φ MID 2 – cl  
 √AC2 3Φ MID 2 – op

MA73C:D √AC3 3Φ MID 4 – op

Give SSRMS Operator GO for OBSS ungrapple

9. MNVR TO PRE-CRADLE  
 Verify SSRMS at Berthed OBSS Backoff or Overnight Park posn

|       |         |
|-------|---------|
| MON 1 | P1 LOOB |
| MON 2 | B       |
| DNLK  | ELBOW   |
| DTV   | A       |

SM 94 PDRS CONTROL

END POS – ITEM 18 -1 2 6 1 -1 4 6 -5 5 1 EXEC  
 ATT – ITEM 21 +5 +2 +0 EXEC  
 CMD CK – ITEM 25 EXEC (GOOD)

RHC RATE – as reqd (VERN within 10 ft)  
 BRAKES – OFF (tb-OFF)  
 MODE – OPR CMD, ENTER (READY lt on)

AUTO SEQ – PROCEED (IN PROG lt on)

When AUTO SEQ IN PROG lt – off:  
 Verify at PRE-CRADLE posn:

|   |       |       |       |       |     |      |       |
|---|-------|-------|-------|-------|-----|------|-------|
|   | X     | Y     | Z     | PITCH | YAW | ROLL | PL ID |
| √ | -1261 | -146  | -551  | 5     | 2   | 0    | 0     |
|   | SY    | SP    | EP    | WP    | WY  | WR   |       |
| √ | 0.0   | +25.0 | -25.0 | +5.0  | 0.0 | 0.0  |       |



BRAKES – ON (tb-ON)  
MODE – not DIRECT (lt off)  
PARAM – PORT TEMP  
JOINT – CRIT TEMP

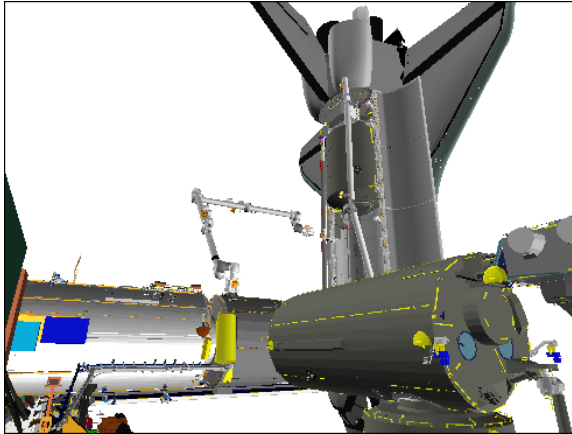

**P1 LOOB (120,20)**

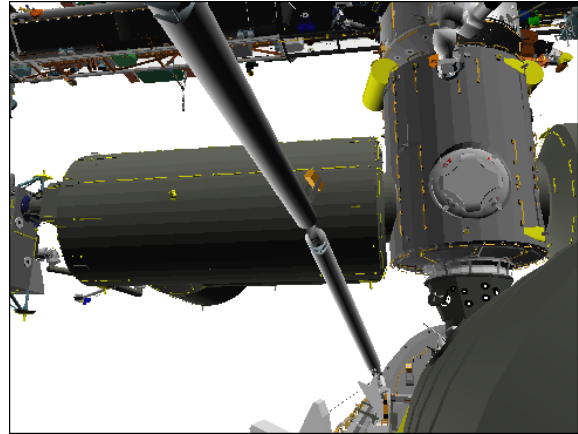

**CCTV B (-10,15)**

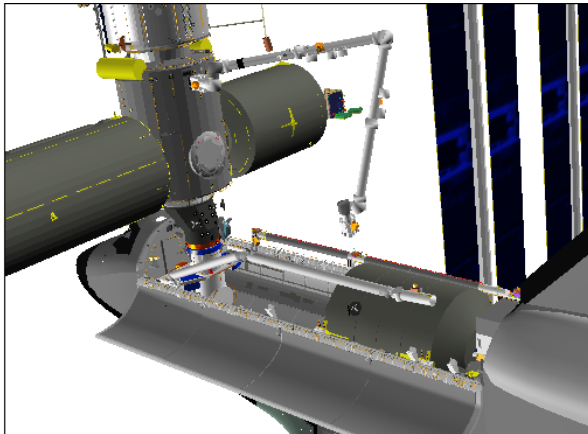

**BIRD'S EYE**

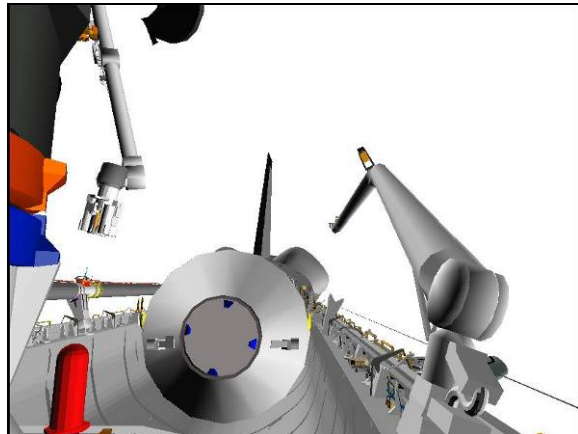

**CCTV A (0,10)**

# OBSS MNVR TO CONTINGENCY UNDOCK

## 1. SETUP

SM 94 PDRS CONTROL

√ PL ID, ITEM 3: 1

√ INIT ID, ITEM 24: 1

Verify at MPLM VIEWING posn:

|   | X     | Y     | Z     | PITCH | YAW   | ROLL  | PL ID |
|---|-------|-------|-------|-------|-------|-------|-------|
| √ | -967  | -643  | -386  | 60    | 349   | 282   | 1     |
|   | SY    | SP    | EP    | WP    | WY    | WR    |       |
| √ | +62.5 | +25.0 | -23.0 | 0.0   | -13.2 | -21.9 |       |

R12

√ Green Jumper – ISS

|       |         |
|-------|---------|
| MON 1 | P1 LOOB |
| MON 2 | A       |
| DNLK  | ELBOW   |
| DTV   | B       |

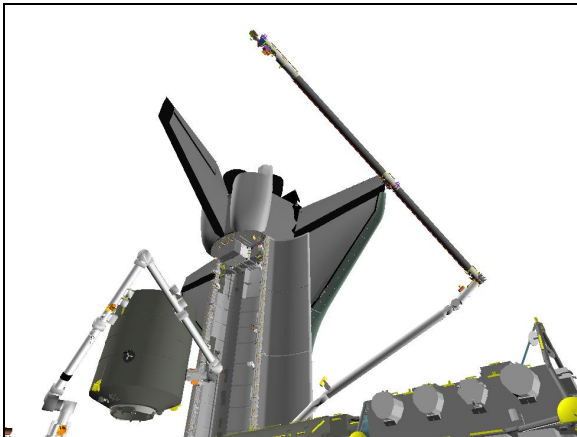

P1 LOOB (140,40)

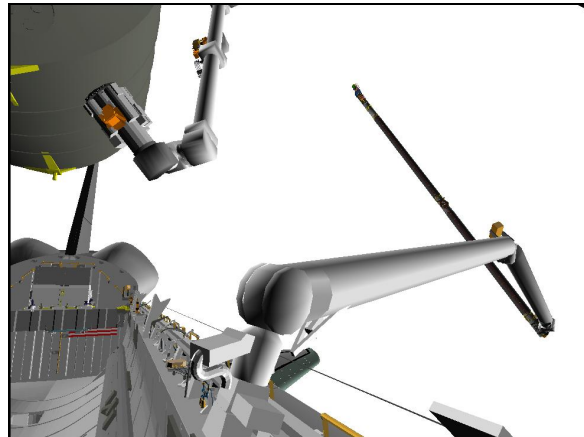

CCTV A (25,10)



ELBOW (-30,15)

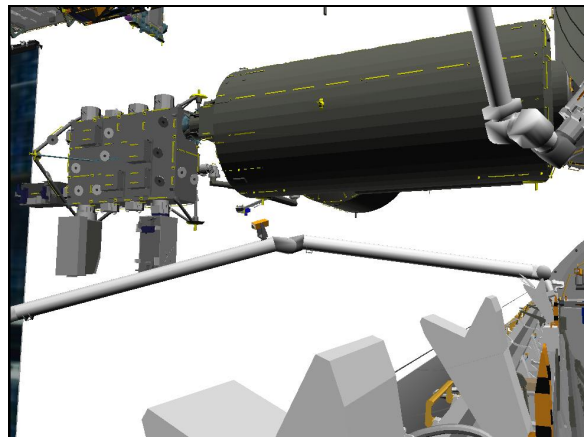

CCTV B (-25,5)

## 2. MNVR TO OBSS CONTINGENCY UNDOCK POSN

SM 94 PDRS CONTROL

END POS – ITEM 18 -1 1 3 1 -4 9 6 -5 8 6 EXEC

ATT – ITEM 21 +6 2 +3 2 4 +2 8 2 EXEC

CMD CK – ITEM 25 EXEC (GOOD)

RHC

RATE – VERN (RATE MIN tb-ON)

BRAKES – OFF (tb-OFF)  
 MODE – OPR CMD, ENTER (READY It on)

AUTO SEQ – PROCEED (IN PROG It on)

When AUTO SEQ IN PROG It – off:  
 BRAKES – ON (tb-ON)  
 MODE – not DIRECT (It off)

OBSS CONTINGENCY UNDOCK posn:

|   | X     | Y     | Z     | PITCH | YAW  | ROLL  | PL ID |
|---|-------|-------|-------|-------|------|-------|-------|
| √ | -1131 | -496  | -586  | 62    | 324  | 282   | 1     |
|   | SY    | SP    | EP    | WP    | WY   | WR    |       |
| √ | +35.0 | +38.7 | -22.8 | -0.5  | -0.3 | -40.0 |       |

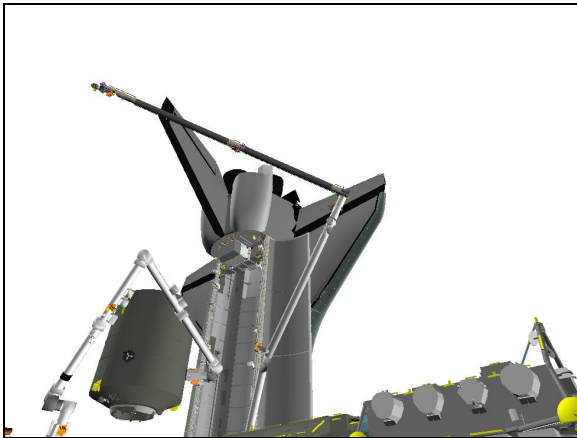

**P1 LOOB (140,40)**

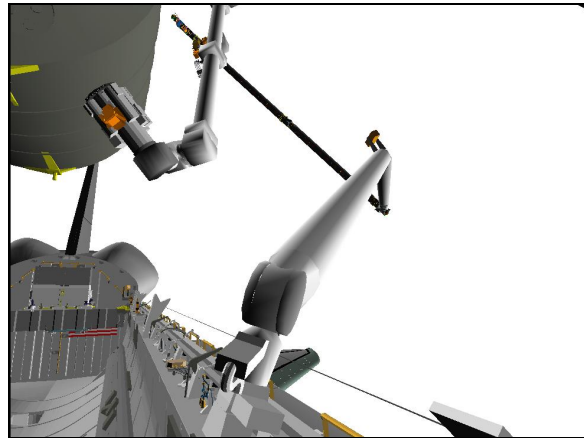

**CCTV A (25,10)**

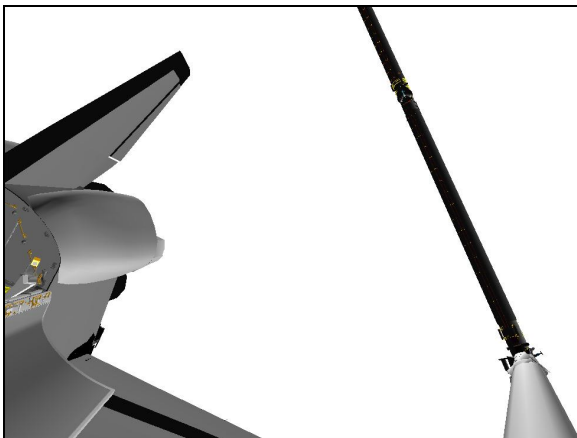

**ELBOW (-30,15)**

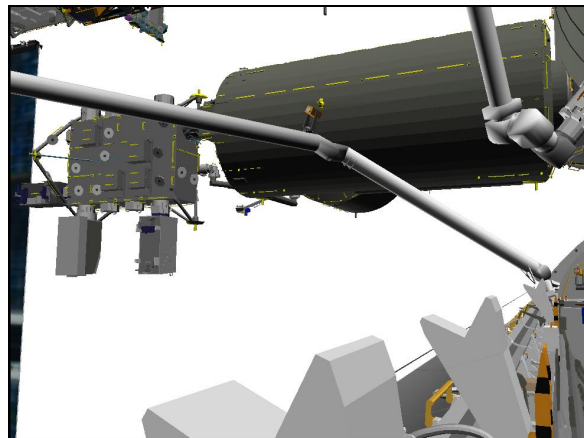

**CCTV B (-25,5)**

PARAM – PORT TEMP  
 JOINT – CRIT TEMP

# OBSS MNVR CONT UNDOCK TO NOM UNDOCK

## 1. SETUP

SM 94 PDRS CONTROL

√ PL ID, ITEM 3: 1

√ INIT ID, ITEM 24: 1

Verify at OBSS CONTINGENCY UNDOCK posn:

|   | X     | Y     | Z     | PITCH | YAW  | ROLL  | PL ID |
|---|-------|-------|-------|-------|------|-------|-------|
| √ | -1131 | -496  | -586  | 62    | 324  | 282   | 1     |
|   | SY    | SP    | EP    | WP    | WY   | WR    |       |
| √ | +35.0 | +38.7 | -22.8 | -0.5  | -0.3 | -40.0 |       |

|       |       |
|-------|-------|
| MON 1 | A     |
| MON 2 | D     |
| DNLK  | B     |
| DTV   | ELBOW |



CCTV A (5,10)

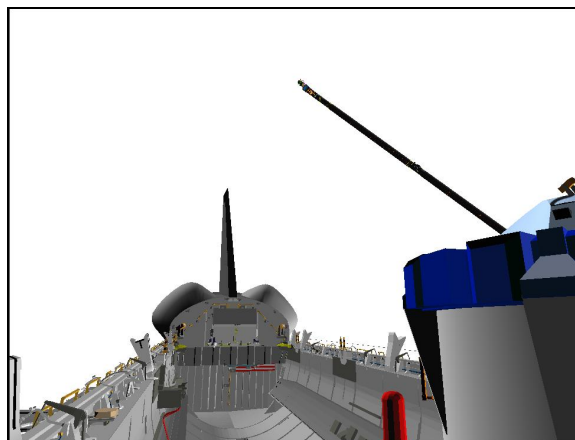

CCTV D (15,15)

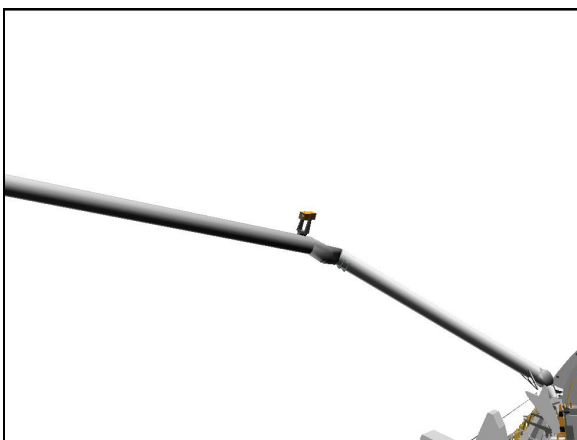

CCTV B (-25,15)

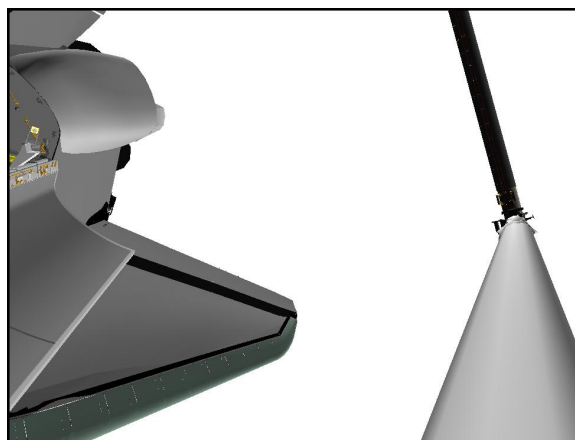

ELBOW (-30,5)

## 2. MNVR TO NOMINAL UNDOCK POSN

SM 94 PDRS CONTROL

END POS – ITEM 18 -1 0 4 1 -3 6 2 -6 0 2 EXEC

ATT – ITEM 21 +4 4 +2 7 0 +0 EXEC

CMD CK – ITEM 25 EXEC (GOOD)

RHC

RATE – VERN (RATE MIN tb-ON)

BRAKES – OFF (tb-OFF)  
 MODE – OPR CMD, ENTER (READY It on)

AUTO SEQ – PROCEED (IN PROG It on)

When AUTO SEQ IN PROG It – off:  
 BRAKES – ON (tb-ON)  
 MODE – not DIRECT (It off)

UNDOCK posn:

|   | X     | Y     | Z     | PITCH | YAW   | ROLL   | PL ID |   |
|---|-------|-------|-------|-------|-------|--------|-------|---|
| √ | -1041 | -362  | -602  | 44    | 270   | 0      | 1     | * |
|   | SY    | SP    | EP    | WP    | WY    | WR     |       |   |
| √ | +25.8 | +66.3 | -49.0 | -85.9 | +10.7 | -100.7 |       |   |

\*Display singularity



**CCTV A (5,10)**

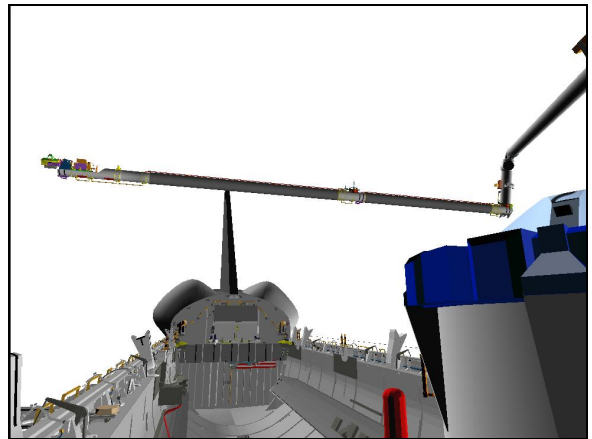

**CCTV D (15,15)**



**CCTV B (-25,15)**

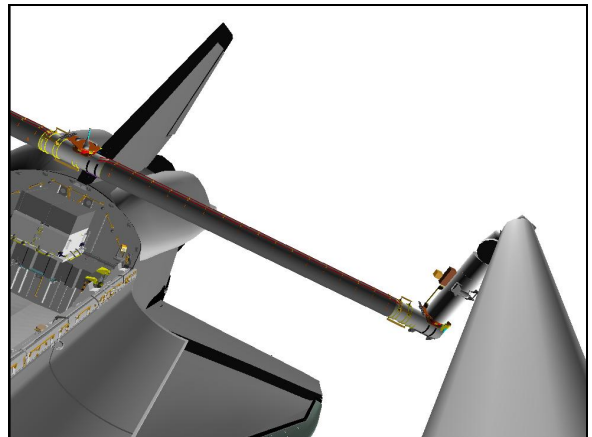

**ELBOW (-30,5)**

PARAM – PORT TEMP  
 JOINT – CRIT TEMP

# OBSS SJ HANDOFF FROM SSRMS TO SRMS

## 1. SETUP

SM 94 PDRS CONTROL

√PL ID, ITEM 3: 0

√INIT ID, ITEM 24: 0

A7U CCTV – config as reqd  
 – perform PAN/TILT RESET for PLB cameras  
 ZOOM – full OUT

R12 √Green Jumper – ISS

|       |            |
|-------|------------|
| MON 1 | P1 LOOB    |
| MON 2 | B          |
| DNLK  | ELBOW (EE) |
| DTV   | A          |

## 2. SINGLE JOINT MANUEVER TO OBSS PRE-GRAPPLE AT HANDOFF

Verify SSRMS at Stage Park posn

If SINGLE mode available:

RHC RATE – as reqd (VERN within 10 ft)  
 BRAKES – OFF (tb-OFF)

MODE – best available

Mnvr to OBSS PRE-GRAPPLE AT HANDOFF posn:

|                                   |       |       |       |       |       |       |       |
|-----------------------------------|-------|-------|-------|-------|-------|-------|-------|
|                                   | SY    | SP    | EP    | WP    | WY    | WR    |       |
| Pre-Cradle                        | 0.0   | +25.0 | -25.0 | +5.0  | 0.0   | 0.0   |       |
| 1: SP +                           |       | +57.5 |       |       |       |       |       |
| 2: WP –                           |       |       |       | -99.3 |       |       |       |
| 3: WY +                           |       |       |       |       | +11.8 |       |       |
| 4: WR –                           |       |       |       |       |       | -97.9 |       |
| 5: EP –                           |       |       | -27.4 |       |       |       |       |
| 6: SY +                           | +22.7 |       |       |       |       |       |       |
| OBSS<br>Pre-Grapple at<br>Handoff | +22.7 | +57.5 | -27.4 | -99.3 | +11.8 | -97.9 |       |
|                                   | X     | Y     | Z     | PITCH | YAW   | ROLL  | PL ID |
|                                   | -1047 | -360  | -658  | 284   | 0     | 270   | 0     |

BRAKES – ON (tb-ON)  
 MODE – not DIRECT  
 JOINT – CRIT TEMP

Start:  
Pre-Cradle

Step 1:  
Drive SP (+) from +25.0° to +57.5°



**CCTV A (20,20)**



**CCTV A (20,20)**

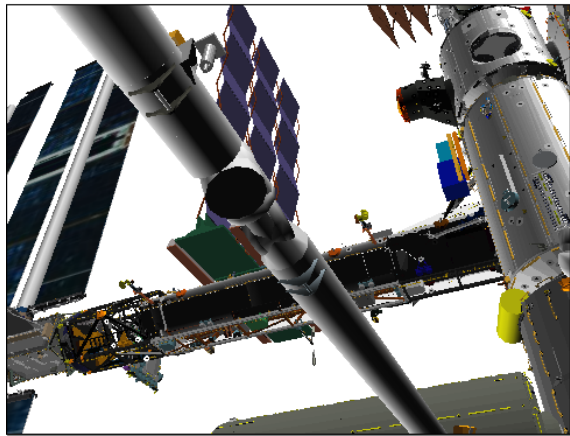

**CCTV B (-25,40)**

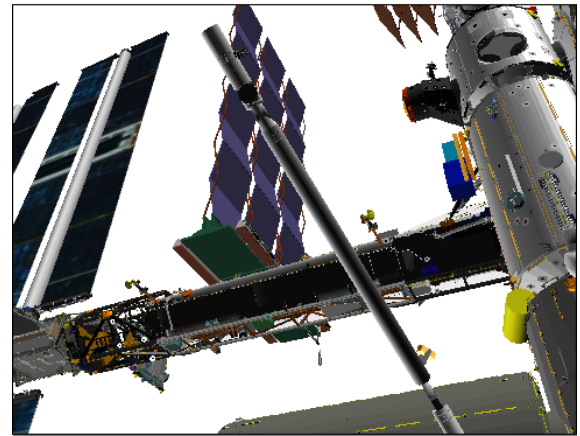

**CCTV B (-25,40)**



**ELBOW (-30,-20)**

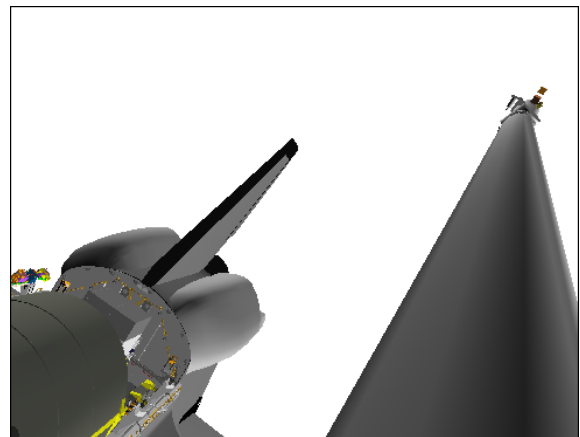

**ELBOW (-30,-20)**



Step 2:

Drive WP (-) from  $+5.0^\circ$  to  $-99.3^\circ$



**CCTV A (20,20)**

Step 3:

Drive WY (+) from  $0.0^\circ$  to  $+11.8^\circ$



**CCTV A (20,20)**

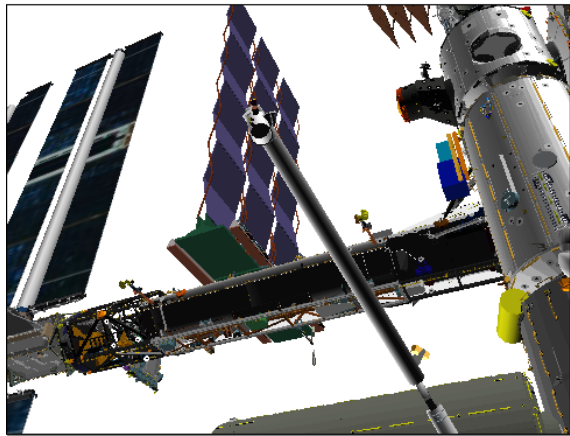

**CCTV B (-25,40)**

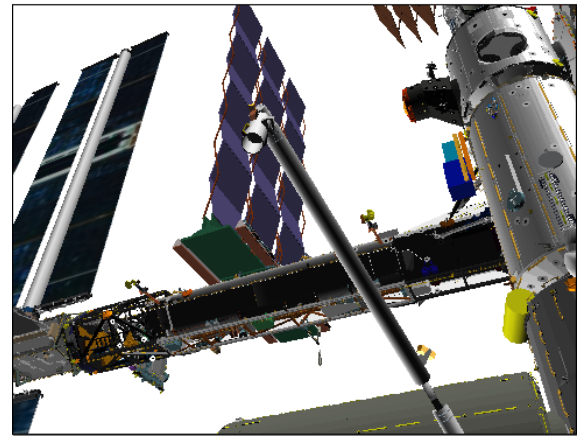

**CCTV B (-25,40)**

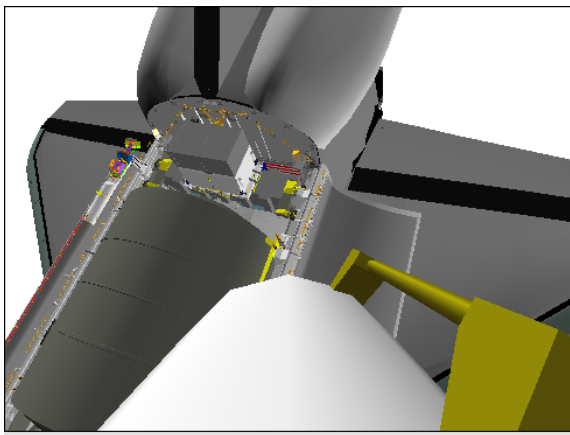

**EE**

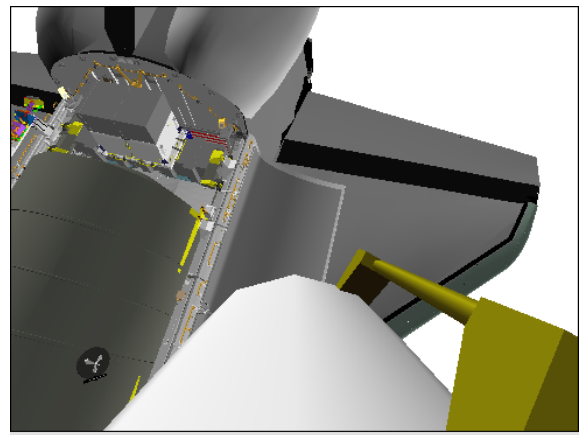

**EE**



Step 4:

Drive WR (-) from 0.0° to -97.9°



**CCTV A (20,20)**

Step 5:

Drive EP (-) from -25.0° to -27.4°

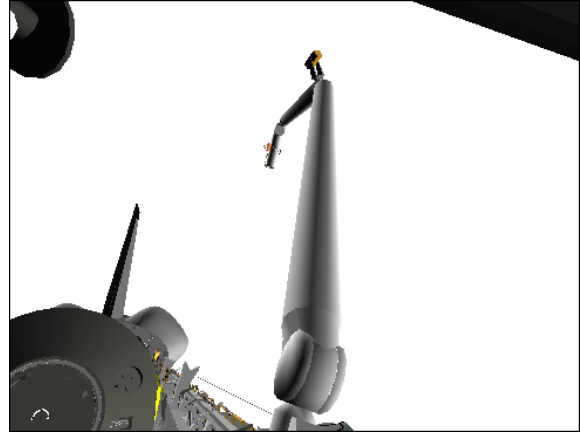

**CCTV A (20,20)**

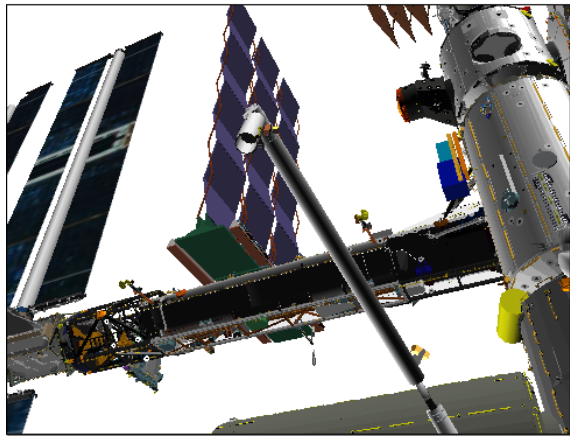

**CCTV B (-25,40)**

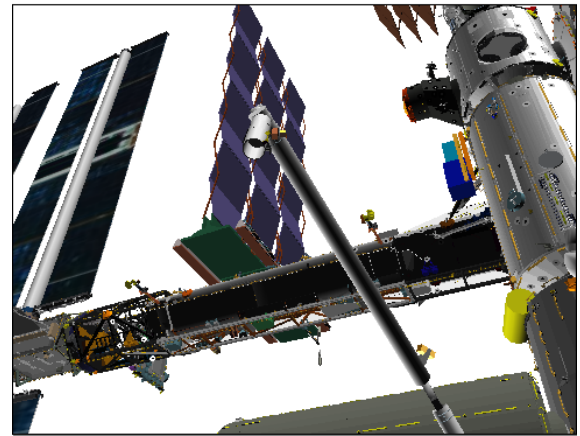

**CCTV B (-25,40)**

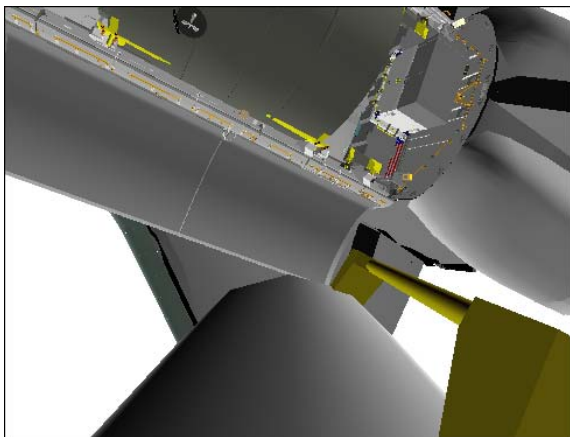

**EE**

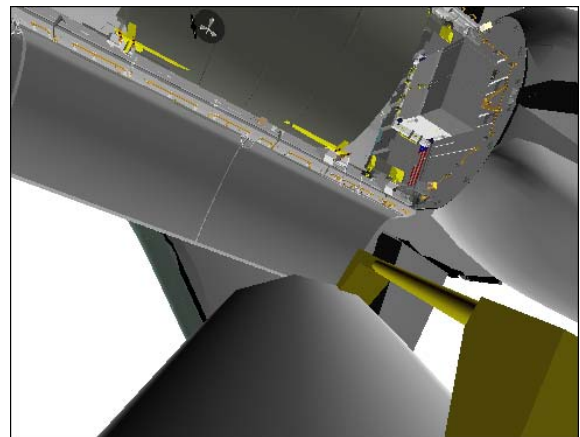

**EE**

Step 6:

Drive SY (+) from 0.0° to +22.7°



**CCTV A (20,20)**

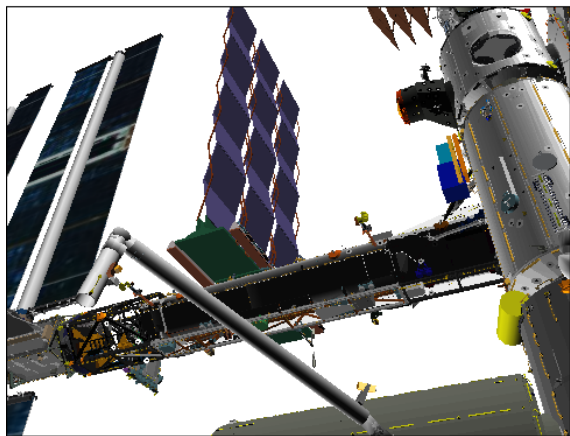

**CCTV B (-25,40)**

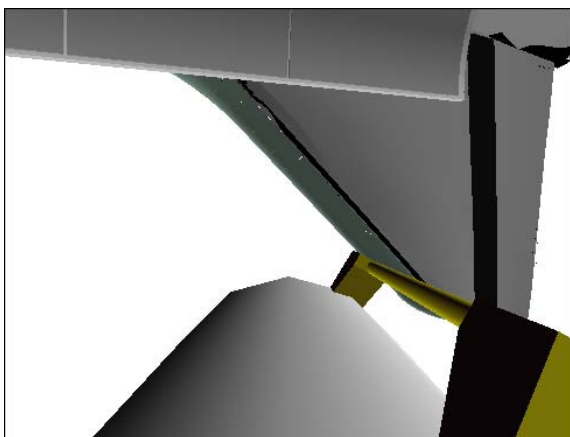

**EE**

Notify SSRMS Operator that SRMS at OBSS Pre-Grapple at Handoff posn

3. CONFIGURE POWER

CAUTION  
SPEE power must be applied within 90 min  
to prevent sensor package damage

On SSRMS Operator GO to release STBD MRLs,  
STBD RMS HTR A,B (two) – OFF

A6U           EVENT TIMER MODE – UP  
                  CNTL – START

MA73C:C      cb MCA PWR AC3 3Φ MID 2 – op  
                  √AC2 3Φ MID 2 – op

MA73C:D      √AC3 3Φ MID 4 – op

R13L          PL BAY MECH PWR SYS (two) – ON

4. STBD MRL RELEASE

SM 94 PDRS CONTROL

RMS STBD – ITEM 2 EXEC (\*)  
√STBD AFT, MID, FWD REL (six) = 0

NOTE  
Expect single motor drive time for MRL release

STBD RMS RETEN LAT – REL (tb-REL) (18 sec max)  
– OFF

If motor drive time > 18 sec, √MCC

SM 94 PDRS CONTROL

√STBD AFT, MID, FWD REL (six) = 1

5. RECONFIGURE POWER

R13L          PL BAY MECH PWR SYS (two) – OFF

MA73C:C      cb MCA PWR AC3 3Φ MID 2 – cl  
                  √AC2 3Φ MID 2 – op

MA73C:D      √AC3 3Φ MID 4 – op

Give SSRMS Operator GO for OBSS Unberth and SSRMS mnvr to Handoff  
Monitor RFL Status

After OBSS Unberth,  
style="text-align: center;">SM 94 PDRS CONTROL  
RMS PORT – ITEM 1 EXEC (\*)

- A7U 6. SETUP FOR GRAPPLE  
 CCTV – config for grapple  
 – install OBSS SJ GRAPPLE AT HANDOFF OVERLAY  
 – RMS WRIST, ZOOM: 34.0 HFOV  
 FOCUS: 5 ft  
 Maintain eyepoint approx 18 in when using grapple overlay

|       |            |
|-------|------------|
| MON 1 | BASE ELBOW |
| MON 2 | B          |
| DNLK  | EE (ELBOW) |
| DTV   | A          |

R12(OBSS) √SPEE PWR – OFF  
 A15 √APCU 2 OUTPUT – OFF

7. OBSS SJ GRAPPLE AT HANDOFF POSN  
 On SSRMS Operator GO for SRMS OBSS grapple

RHC If SINGLE mode available:  
 RATE – VERN (RATE MIN tb-ON)  
 BRAKES – OFF (tb-OFF)

MODE – best available

Drive joints per OBSS SJ GRAPPLE AT HANDOFF OVERLAY and diagram until EE within grapple envelope

CAUTION  
 Monitor EE tb timing to prevent EE motor burnout

EE MODE – AUTO  
 CAPTURE sw – depress (mom)

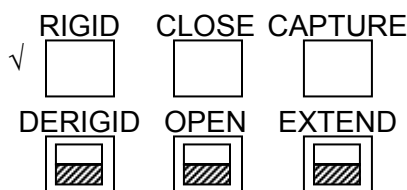

CRITICAL TIMES (28 sec total):  
 CAPTURE tb – gray, then  
 CLOSE tb – gray, 3 sec max, then  
 RIGID tb – gray, 25 sec max

EE MODE – OFF

- \* If manual capture required: \*
- \* EE MODE – MAN \*
- \* CAPTURE sw – depress (hold until CLOSE tb-gray, 3 sec max) \*
- \* MAN CONTR – RIGID (hold until RIGID tb-gray, 25 sec max) \*
- \* MODE – OFF \*

If TEST mode available:  
 MODE – TEST, ENTER  
 Wait 5 sec

BRAKES – ON (tb-ON)  
 MODE – not DIRECT (It off)  
 JOINT – CRIT TEMP

### OBSS SJ GRAPPLE AT HANDOFF

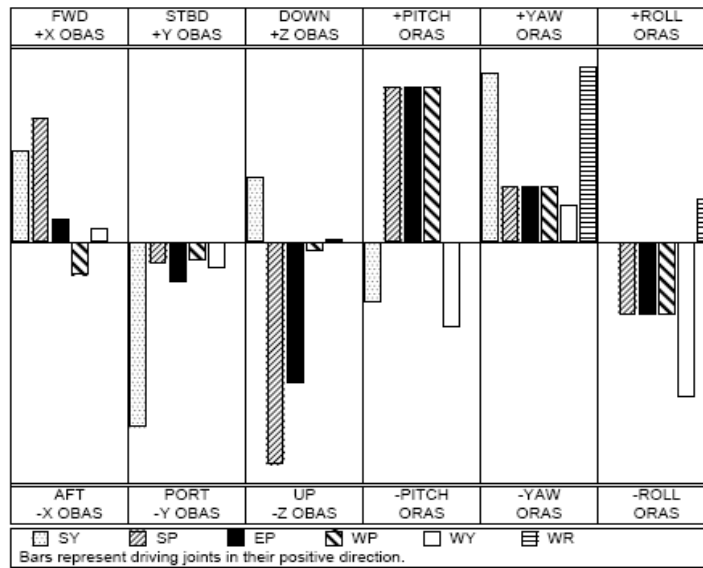

|           |          |         |          |          |                 |          |                  |
|-----------|----------|---------|----------|----------|-----------------|----------|------------------|
| To get:   | Drive:   | To get: | Drive:   | Driving: | Results In:     | Driving: | Results In:      |
| +X (fwd)  | +SP, +SY | +PITCH  | +WP, +EP | +SY      | -Y (port), +YAW | +WP      | -X (aft), +PITCH |
| +Y (stbd) | -SY      | +YAW    | +WR, +SY | +SP      | -Z (up), +PITCH | +WY      | -Y (port), -ROLL |
| +Z (down) | -SP, -EP | +ROLL   | -WY, -WP | +EP      | -Z (up), +PITCH | +WR      | +YAW             |

|             |             |             |             |             |             |
|-------------|-------------|-------------|-------------|-------------|-------------|
| $\Delta SY$ | $\Delta SP$ | $\Delta EP$ | $\Delta WP$ | $\Delta WY$ | $\Delta WR$ |
| +1.8        | +1.9        | -15.4       | +13.9       | -0.7        | -1.7        |

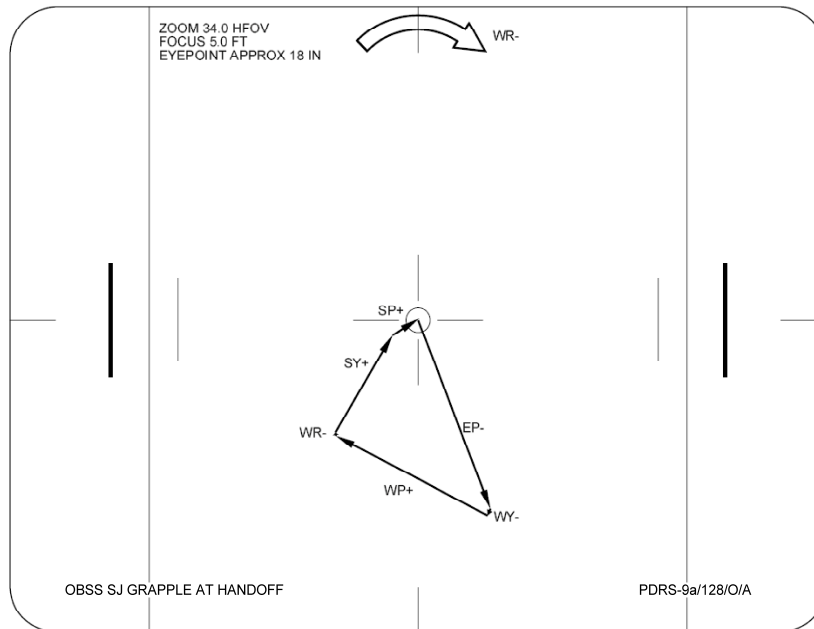

If SINGLE mode available:

**SM 94 PDRS CONTROL**

PL ID – ITEM 3 +2 EXEC

INIT ID – ITEM 24 +2 EXEC

Expected OBSS HANDOFF posn:

| X     | Y     | Z     | PITCH | YAW   | ROLL  | PL ID |
|-------|-------|-------|-------|-------|-------|-------|
| -1059 | +231  | -597  | 14    | 270   | 0     | 2     |
| SY    | SP    | EP    | WP    | WY    | WR    |       |
| +24.5 | +59.0 | -42.1 | -85.9 | +11.2 | -99.4 |       |

\*Display singularity

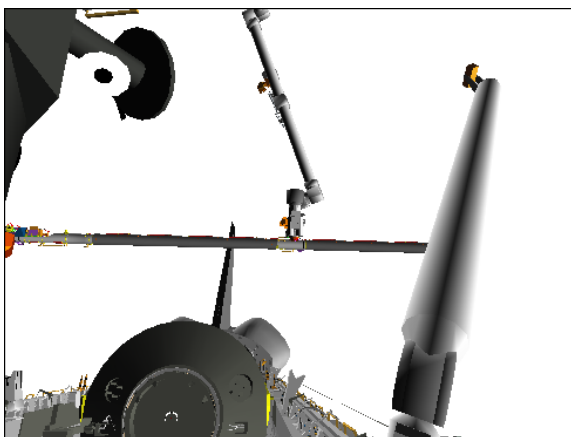

**CCTV A (5,20)**

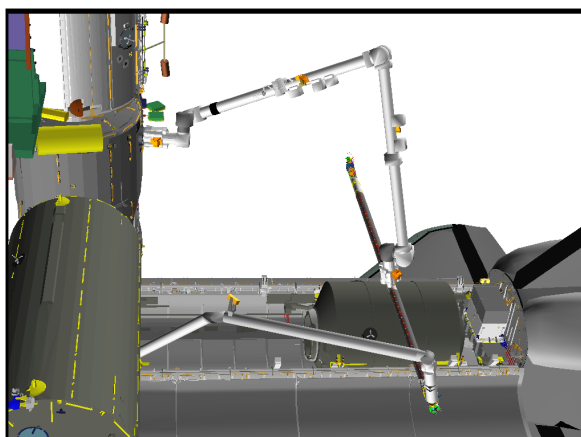

**BIRD'S EYE**

Perform ACTIVATION (LDRI/ITVC Cue Card, P/TV)

Perform LCH ACTIVATION (LCS Cue Card, P/TV)

Review GENERIC END EFFECTOR CUE CARD – ISS/SHUTTLE DOCKED OPS

Give SSRMS Operator GO for OBSS ungrapple

Perform LCC ACTIVATION (LCS Cue Card, P/TV)

Perform LCC DEACTIVATION (LCS Cue Card, P/TV), steps 1 and 2

8. SINGLE JOINT MNVR TO MPLM VIEWING

On SSRMS Operator GO for OBSS mnvr to MPLM VIEWING

R12

√Green Jumper – ISS

|       |         |
|-------|---------|
| MON 1 | S1 LOOB |
| MON 2 | B       |
| DNLK  | ELBOW   |
| DTV   | A       |

RHC

If SINGLE mode available:

RATE – as reqd (VERN within 10 ft)

BRAKES – OFF (tb-OFF)

MODE – best available

Mnvr to MPLM VIEWING posn:

|              | SY    | SP    | EP    | WP    | WY    | WR    |       |
|--------------|-------|-------|-------|-------|-------|-------|-------|
| OBSS Handoff | +24.5 | +59.0 | -42.1 | -85.9 | +11.2 | -99.4 |       |
| 1: WR +      |       |       |       |       |       | -75.0 |       |
| 2: WY -      |       |       |       |       | 0.0   |       |       |
| 3: WP +      |       |       |       | -60.0 |       |       |       |
| 4: EP +      |       |       | -23.0 |       |       |       |       |
| 5: WP +      |       |       |       | 0.0   |       |       |       |
| 6: SP -      |       | +49.0 |       |       |       |       |       |
| 7: SY +      | +62.5 |       |       |       |       |       |       |
| 8: SP -      |       | +25.0 |       |       |       |       |       |
| 9: WR +      |       |       |       |       |       | -21.9 |       |
| 10: WY -     |       |       |       |       | -13.2 |       |       |
| MPLM Viewing | +62.5 | +25.0 | -23.0 | 0.0   | -13.2 | -21.9 |       |
|              | X     | Y     | Z     | PITCH | YAW   | ROLL  | PL ID |
|              | -1252 | -520  | -889  | 60    | 349   | 312   | 2     |

BRAKES – ON (tb-ON)  
 MODE – not DIRECT (lt off)  
 PARAM – PORT TEMP  
 JOINT – CRIT TEMP

Start:  
OBSS Handoff

Step 1:  
Drive WR (+) from  $-99.4^\circ$  to  $-75.0^\circ$

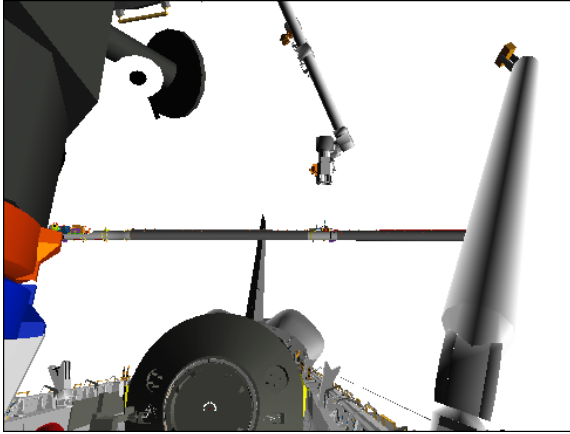

**CCTV A (0,20)**

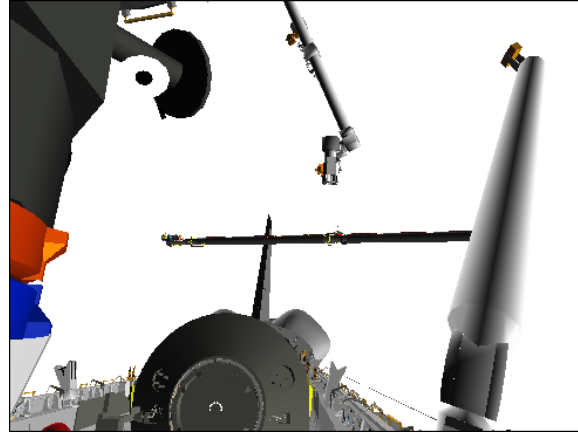

**CCTV A (0,20)**

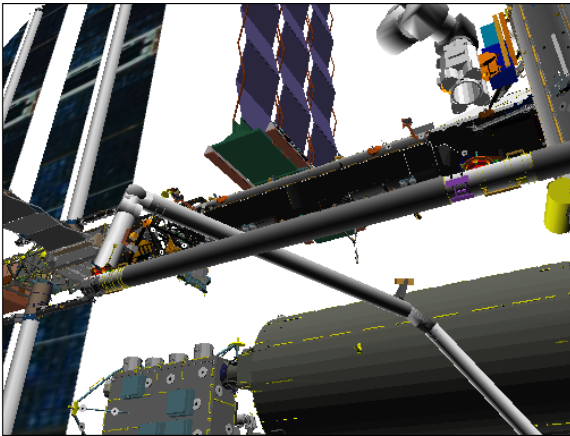

**CCTV B (-30,30)**

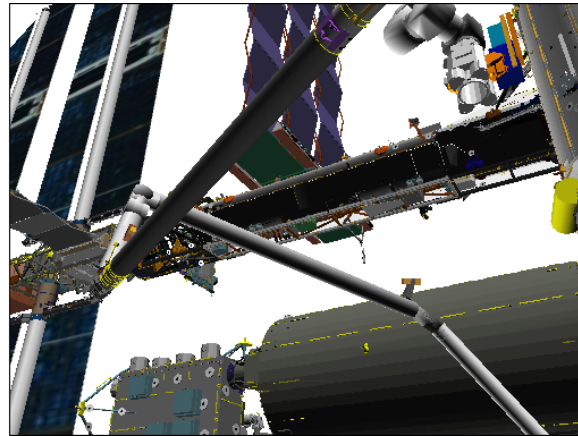

**CCTV B (-30,30)**

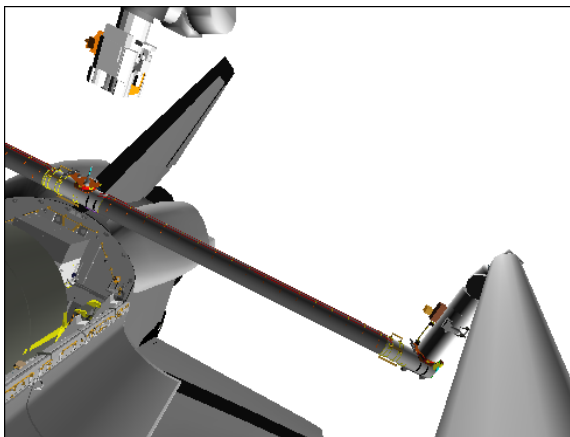

**ELBOW (-30,0)**

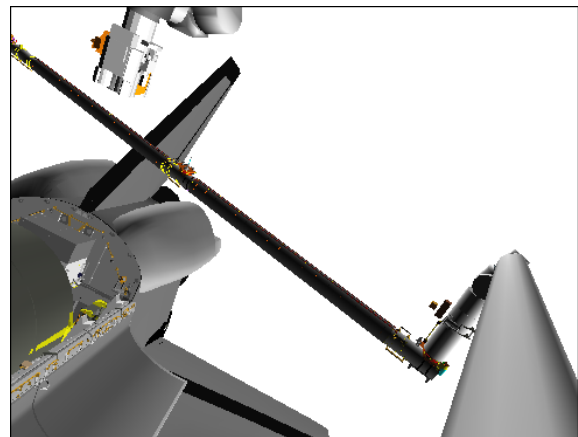

**ELBOW (-30,0)**



Step 2:  
Drive WY (-) from +11.2° to 0.0°

Step 3:  
Drive WP (+) from -85.9° to -60.0°

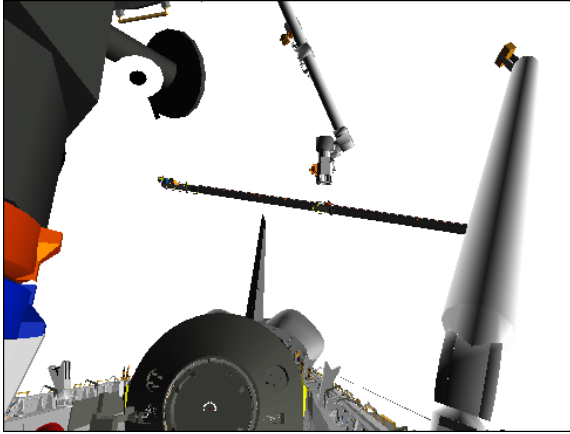

**CCTV A (0,20)**

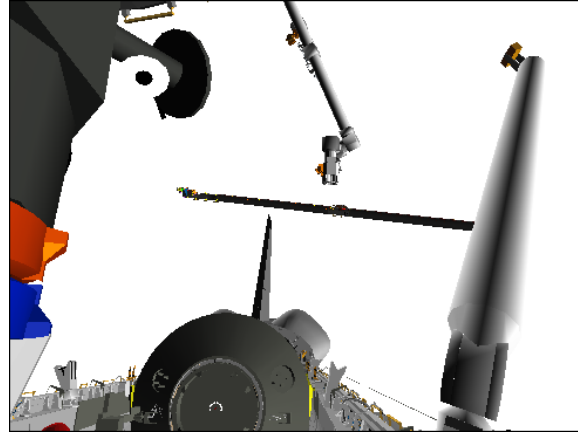

**CCTV A (0,20)**

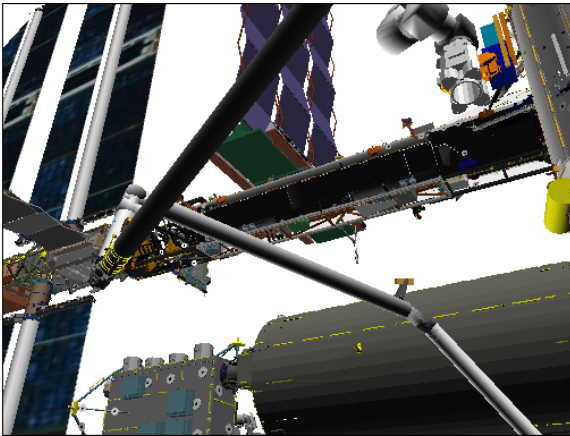

**CCTV B (-30,30)**

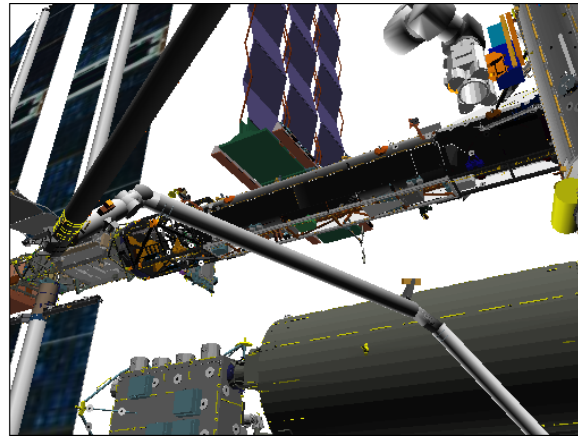

**CCTV B (-30,30)**

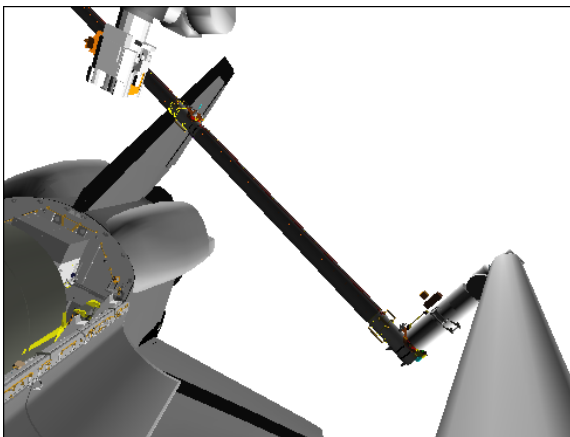

**ELBOW (-30,0)**

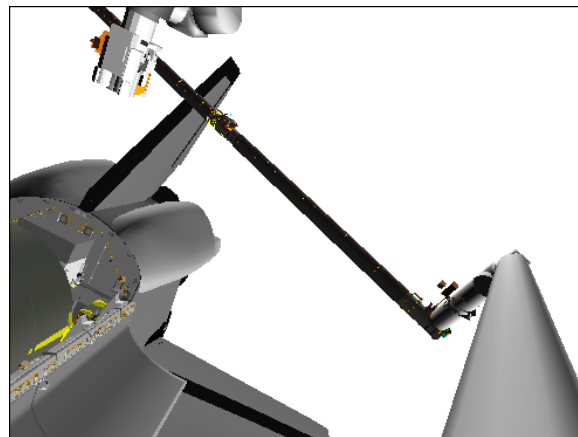

**ELBOW (-30,0)**

Step 4:

Drive EP (+) from  $-42.1^\circ$  to  $-23.0^\circ$

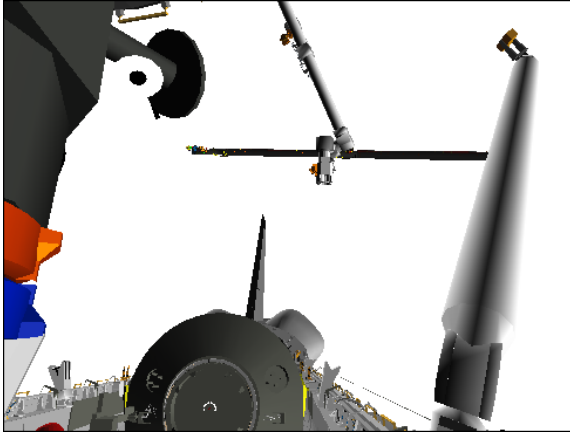

**CCTV A (0,20)**

Step 5:

Drive WP (+) from  $-60.0^\circ$  to  $0.0^\circ$

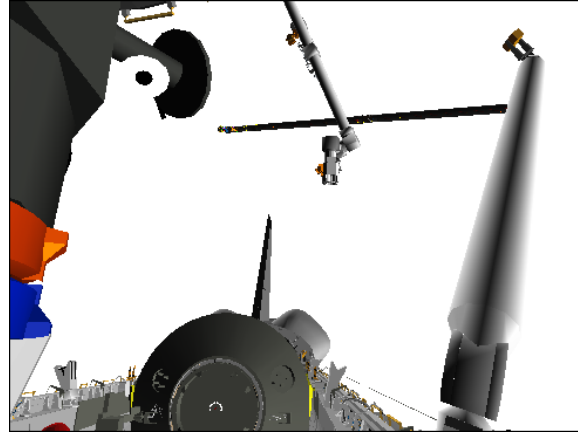

**CCTV A (0,20)**

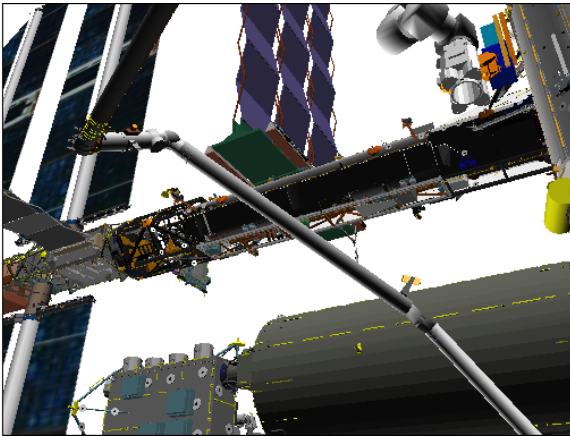

**CCTV B (-30,30)**

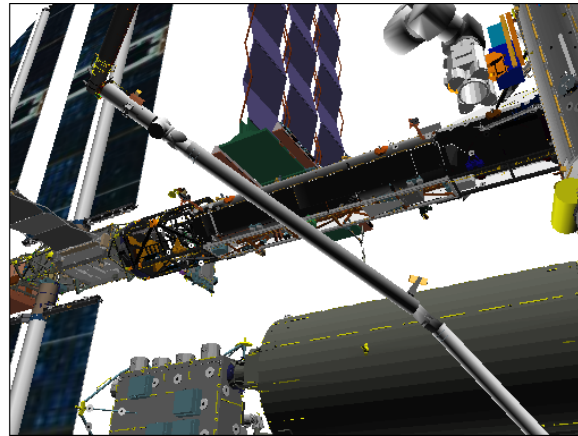

**CCTV B (-30,30)**

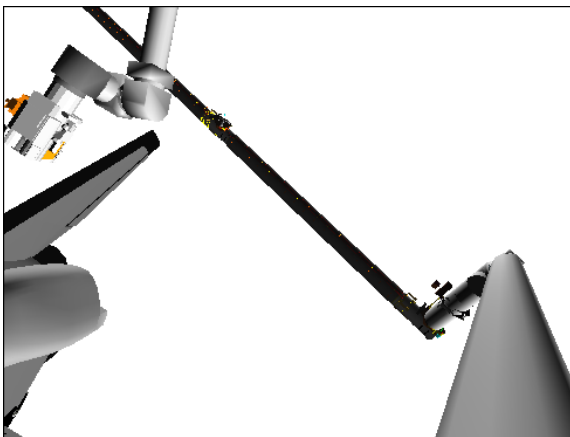

**ELBOW (-30,0)**

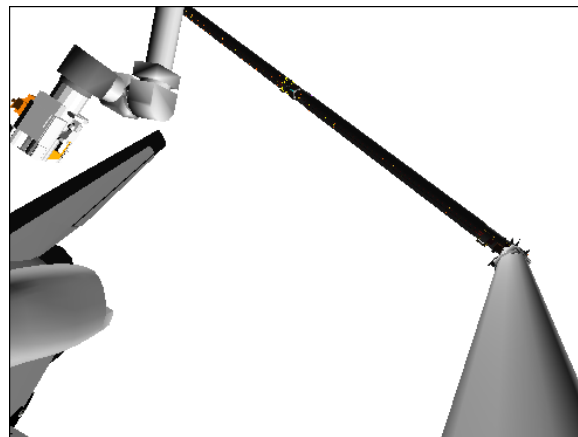

**ELBOW (-30,0)**

Step 6:

Drive SP (-) from +59.0° to +49.0°

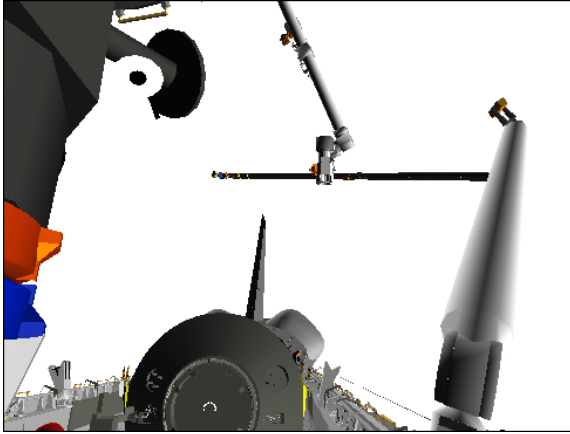

**CCTV A (0,20)**

Step 7:

Drive SY (+) from +24.5° to +62.5°



**CCTV A (30,10)**

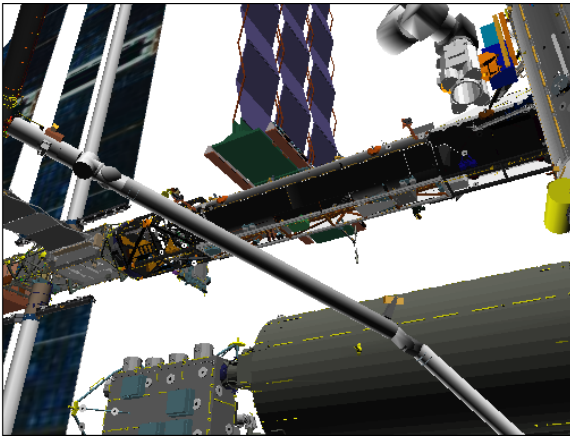

**CCTV B (-30,30)**

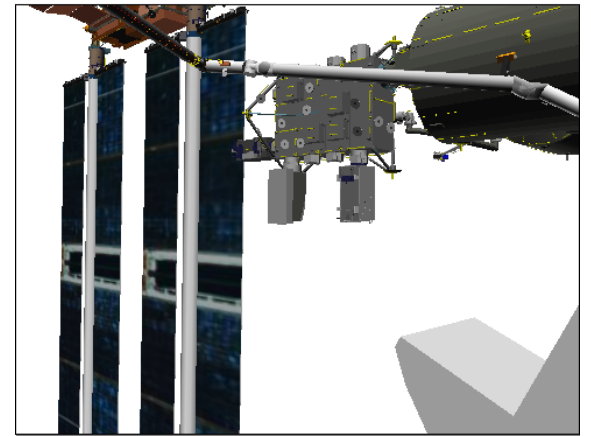

**CCTV B (-45,0)**

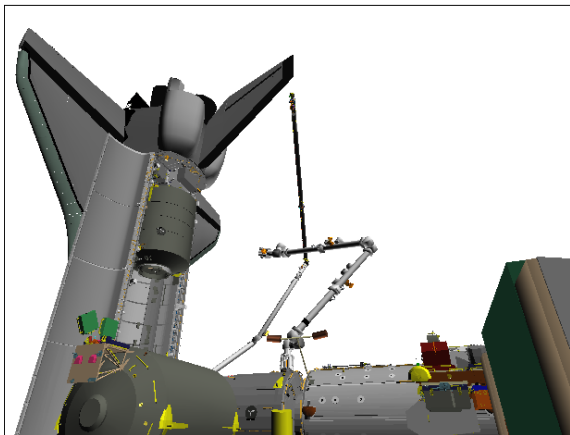

**S1 LOOB (70,30)**



**S1 LOOB (70,30)**

Step 8:

Drive SP (-) from +49.0° to +25.0°

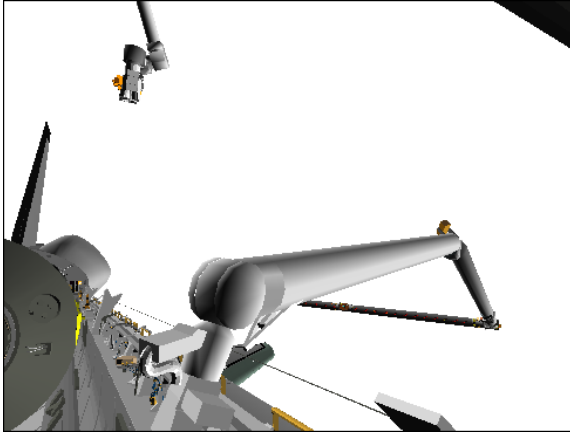

**CCTV A (30,10)**

Step 9:

Drive WR (+) from -75.0° to -21.9°

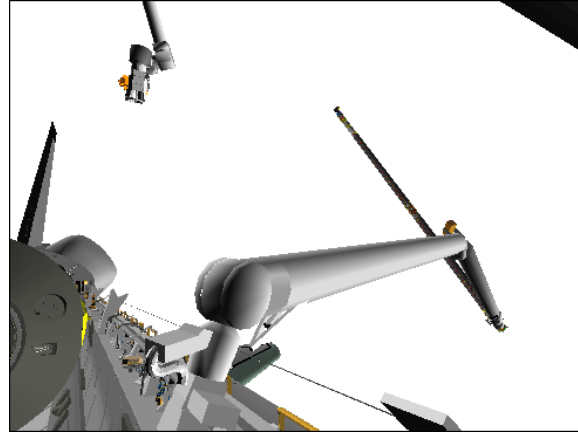

**CCTV A (30,10)**

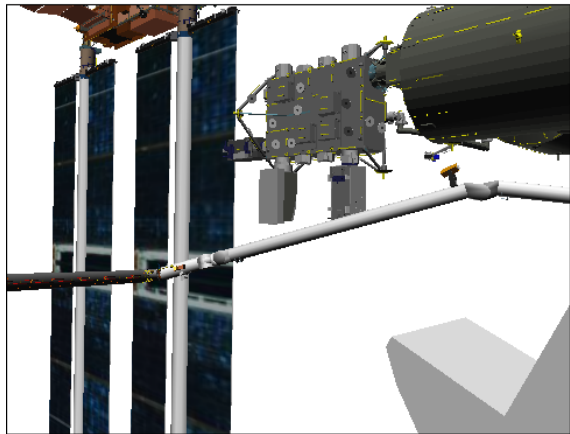

**CCTV B (-45,0)**

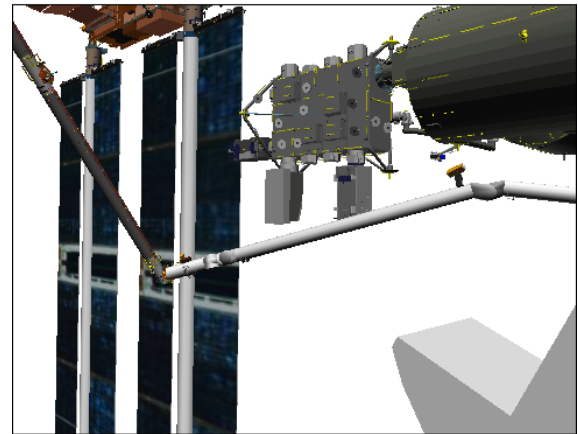

**CCTV B (-45,0)**

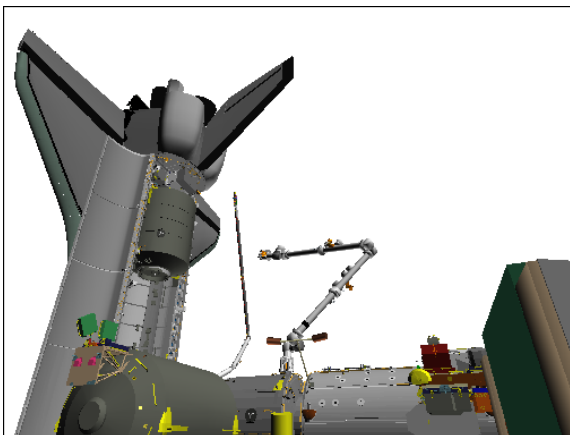

**S1 LOOB (70,30)**



**S1 LOOB (70,30)**

Step 10:

Drive WY (-) from 0.0° to -13.2°

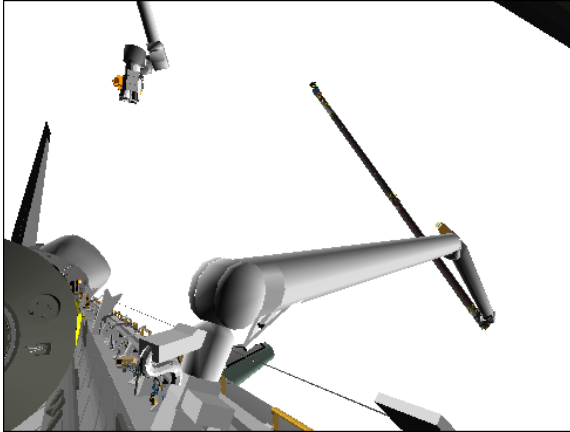

**CCTV A (30,10)**

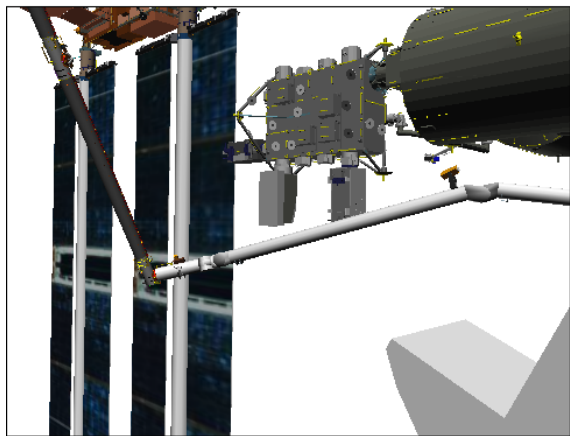

**CCTV B (-45,0)**

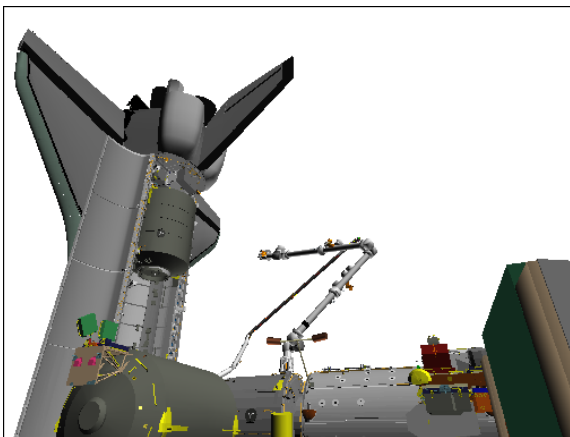

**S1 LOOB (70,30)**

Expected MPLM VIEWING posn:

|   | X     | Y     | Z     | PITCH | YAW   | ROLL  | PL ID |
|---|-------|-------|-------|-------|-------|-------|-------|
| √ | -1252 | -520  | -889  | 60    | 349   | 312   | 2     |
|   | SY    | SP    | EP    | WP    | WY    | WR    |       |
| √ | +62.5 | +25.0 | -23.0 | 0.0   | -13.2 | -21.9 |       |

R12  
A7U

9. RECONFIG PTU

Green Jumper – LDRI/ITVC

DTV ← PL2

CAMR CMD PAN/TILT – HI RATE

PAN – L (to hard stop)

TILT – UP (to hard stop)

PAN/TILT – RESET, HI RATE (LO within 10°)

PAN: +130 (right)

TILT: -60 (down)

MUX 1 L ← MIDDECK

LDRI MODE 2 pb – push (ITVC video)

VIDEO OUT – as desired (not DTV)

√VIDEO IN – not PL2

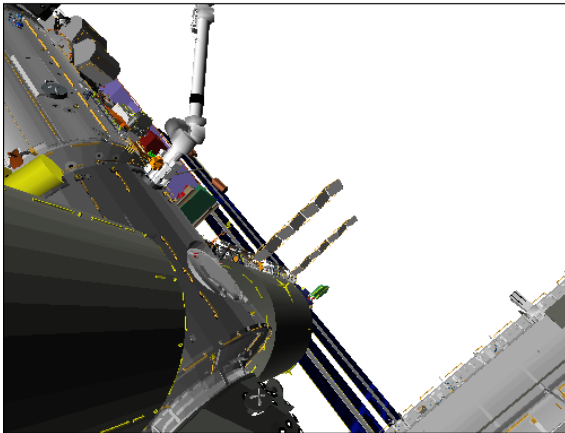

**ELBOW (-165,20)**

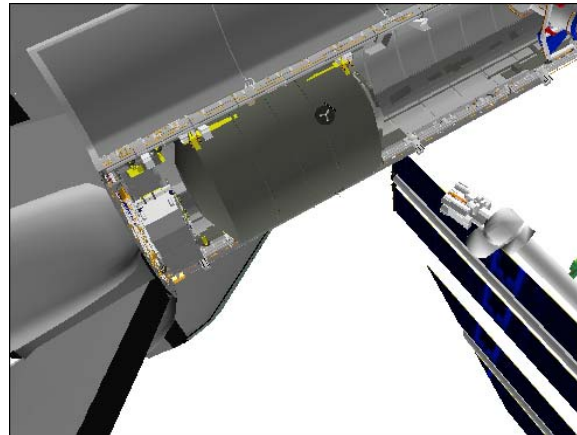

**OBSS ITVC (130,-60)**

# OBSS SJ HANDOFF FROM SRMS TO SSRMS

## 1. SETUP

If digitals available:

**SM 94 PDRS CONTROL**

√PL ID, ITEM 3: 2

√INIT ID, ITEM 24: 2

A7U            CCTV – config as reqd  
                  – perform PAN/TILT RESET for PLB cameras  
ZOOM – full OUT

R12            √Green Jumper – ISS

|       |        |
|-------|--------|
| MON 1 | D(RSC) |
| MON 2 | B      |
| DNLK  | ELBOW  |
| DTV   | A      |

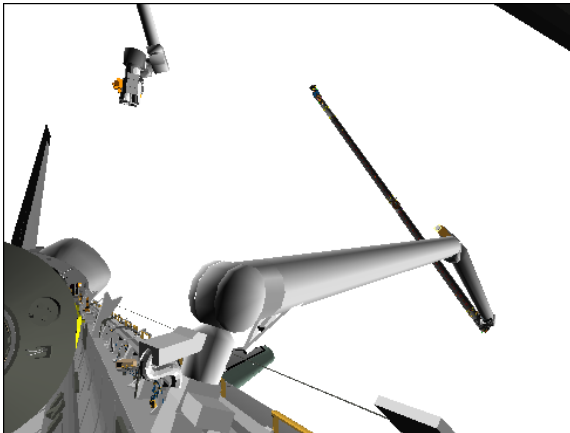

**CCTV A (30,10)**

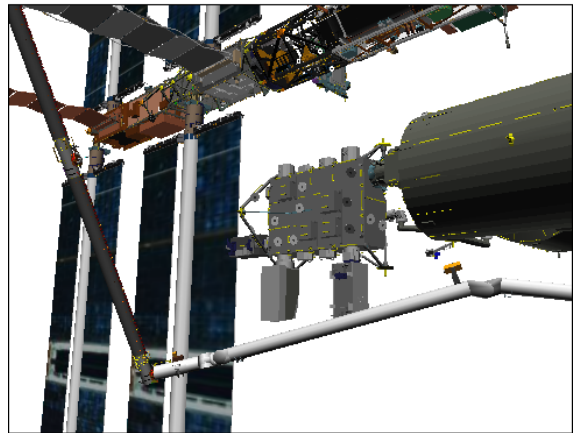

**CCTV B (-45,10)**

Review GENERIC END EFFECTOR CUE CARD – ISS/SHUTTLE DOCKED OPS

## 2. SINGLE JOINT MNVR TO OBSS HANDOFF

On SSRMS Operator GO for mnvr to OBSS HANDOFF

If SINGLE mode available:

RHC            RATE        – as reqd (VERN within 10 ft)  
                  BRAKES – OFF (tb-OFF)

MODE – best available

Mnvr to OBSS HANDOFF posn:

|              | SY    | SP    | EP    | WP    | WY    | WR    |       |
|--------------|-------|-------|-------|-------|-------|-------|-------|
| MPLM Viewing | +62.5 | +25.0 | -23.0 | 0.0   | -13.2 | -21.9 |       |
| 1: WY +      |       |       |       |       | 0.0   |       |       |
| 2: WR -      |       |       |       |       |       | -75.0 |       |
| 3: SP +      |       | +49.0 |       |       |       |       |       |
| 4: SY -      | +24.5 |       |       |       |       |       |       |
| 5: SP +      |       | +59.0 |       |       |       |       |       |
| 6: WP -      |       |       |       | -60.0 |       |       |       |
| 7: EP -      |       |       | -42.1 |       |       |       |       |
| 8: WP -      |       |       |       | -85.9 |       |       |       |
| 9: WY +      |       |       |       |       | +11.2 |       |       |
| 10: WR -     |       |       |       |       |       | -99.4 |       |
| OBSS Handoff | +24.5 | +59.0 | -42.1 | -85.9 | +11.2 | -99.4 |       |
|              | X     | Y     | Z     | PITCH | YAW   | ROLL  | PL ID |
|              | -1059 | +231  | -597  | 284   | 270   | 270   | 2     |

\*Display singularity

BRAKES – ON (tb-ON)  
 MODE – not DIRECT (It off)  
 JOINT – CRIT TEMP

Give SSRMS Operator GO for OBSS grapple



Start:  
MPLM Viewing

Step 1:  
Drive WY (+) from  $-13.2^{\circ}$  to  $0.0^{\circ}$

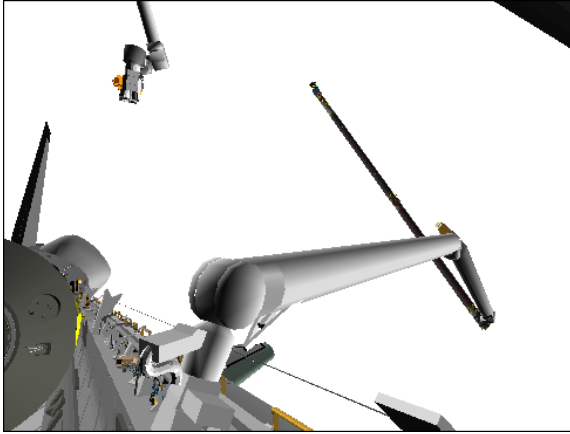

**CCTV A (30,10)**

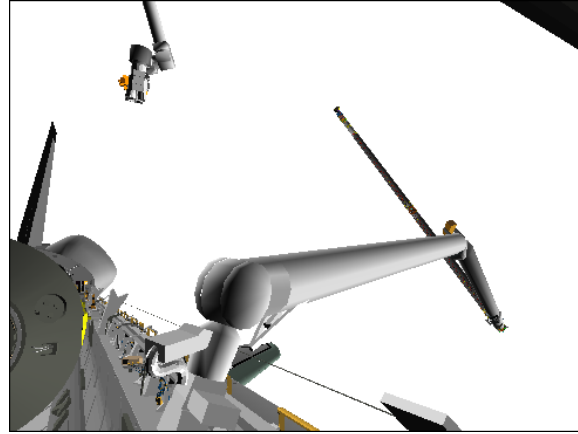

**CCTV A (30,10)**

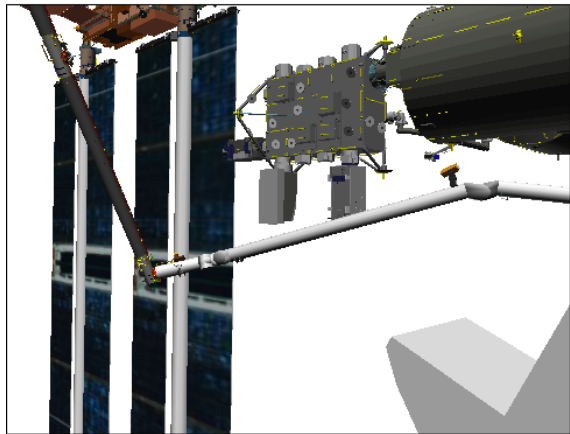

**CCTV B (-45,0)**

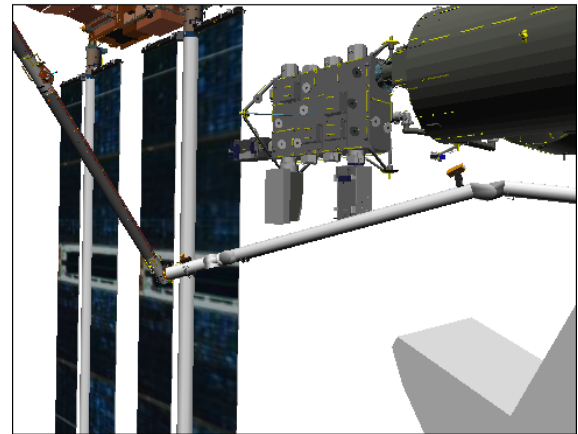

**CCTV B (-45,0)**

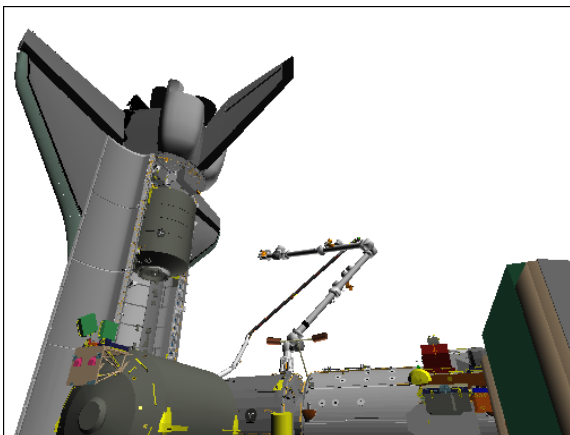

**S1 LOOB (70,30)**



**S1 LOOB (70,30)**

Step 2:

Drive WR (-) from  $-21.9^\circ$  to  $-75.0^\circ$

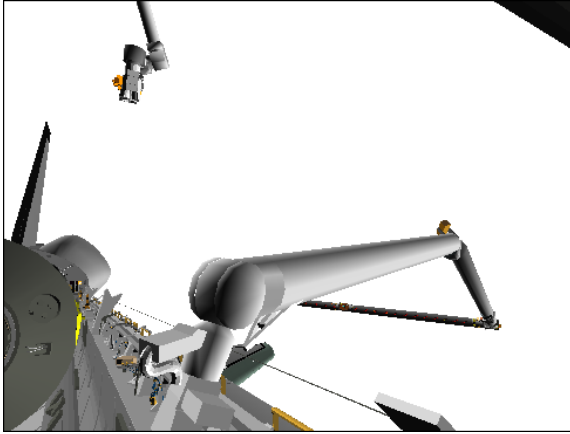

**CCTV A (30,10)**

Step 3:

Drive SP (+) from  $+25.0^\circ$  to  $+49.0^\circ$

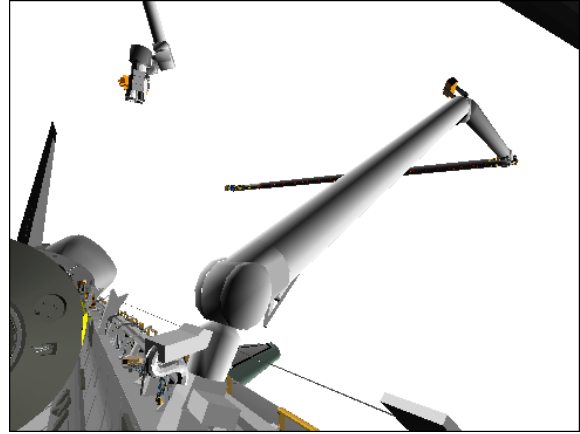

**CCTV A (30,10)**

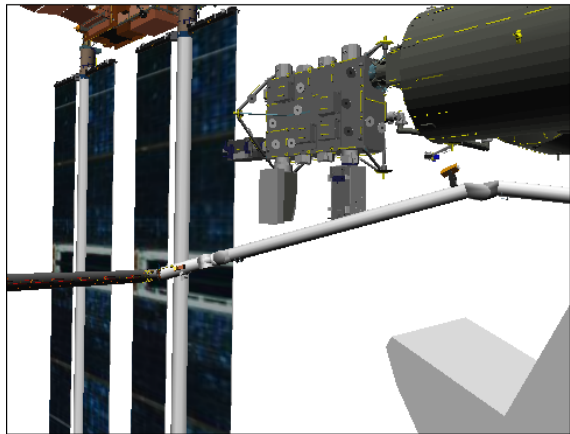

**CCTV B (-45,0)**

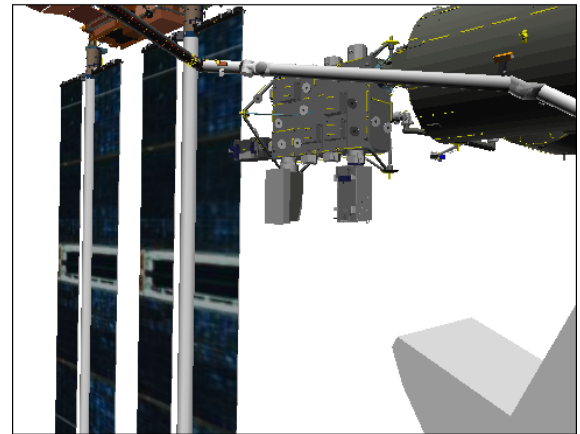

**CCTV B (-45,0)**

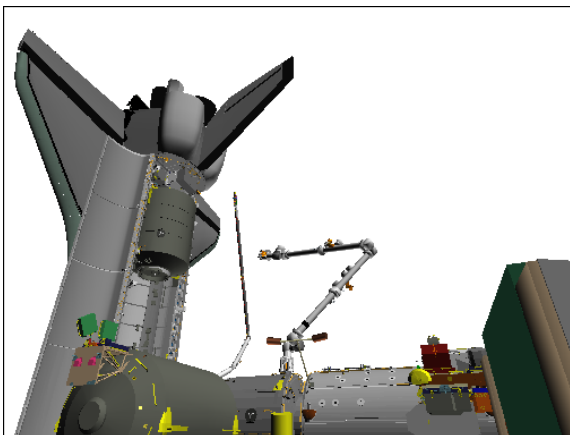

**S1 LOOB (70,30)**



**S1 LOOB (70,30)**

Step 4:

Drive SY (-) from +62.5° to +24.5°

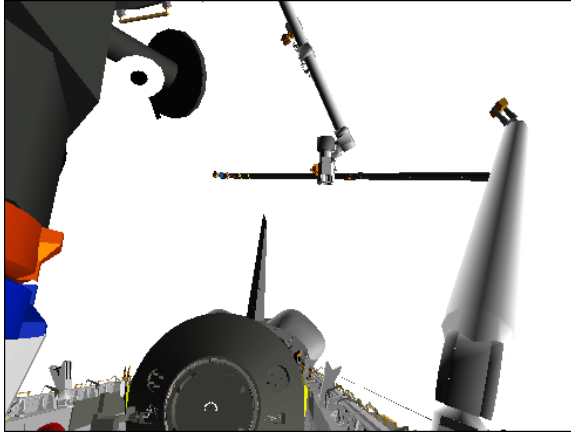

**CCTV A (0,20)**

Step 5:

Drive SP (+) from +49.0° to +59.0°

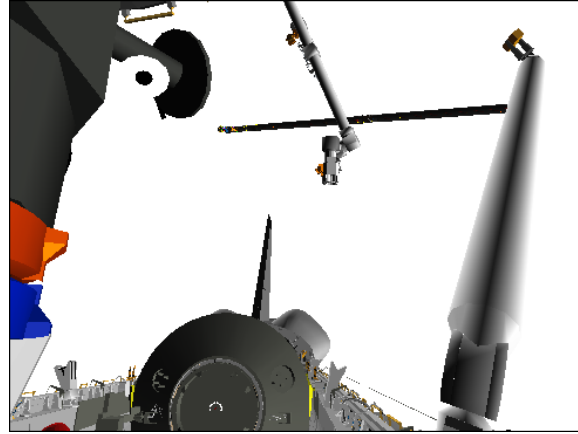

**CCTV A (0,20)**

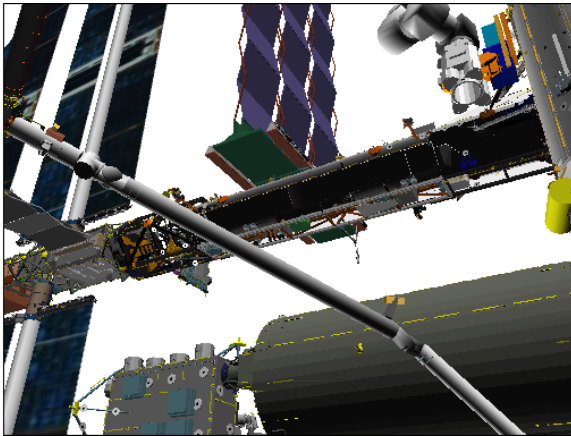

**CCTV B (-30,30)**

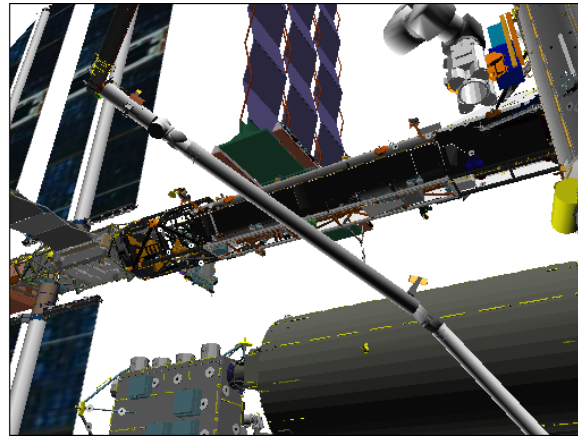

**CCTV B (-30,30)**



**S1 LOOB (70,30)**

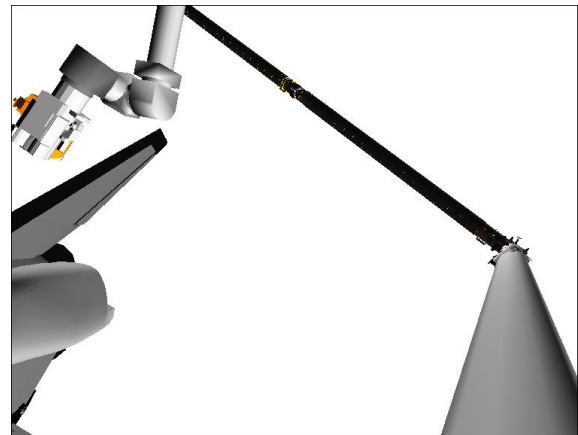

**ELBOW (-30,0)**

Step 6:

Drive WP (-) from  $0.0^\circ$  to  $-60.0^\circ$

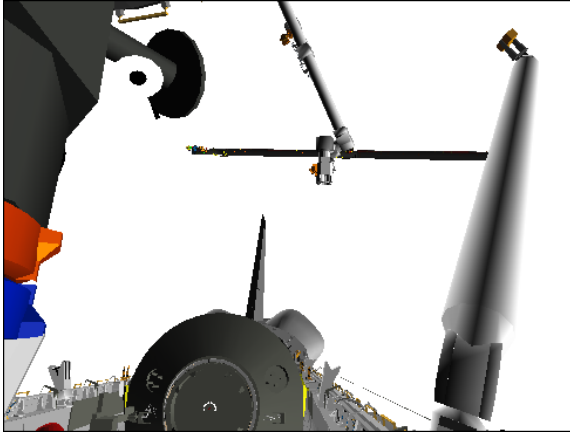

**CCTV A (0,20)**

Step 7:

Drive EP (-) from  $-23.0^\circ$  to  $-42.1^\circ$

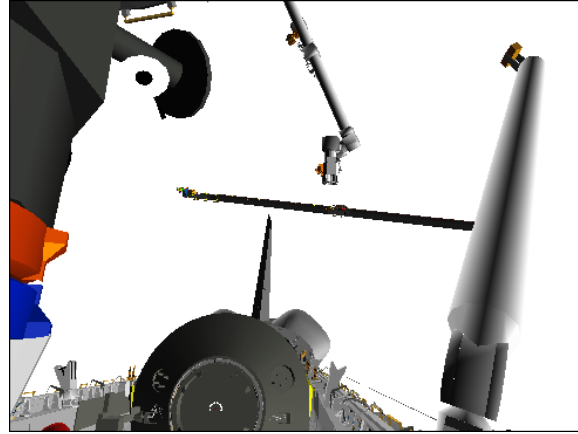

**CCTV A (0,20)**

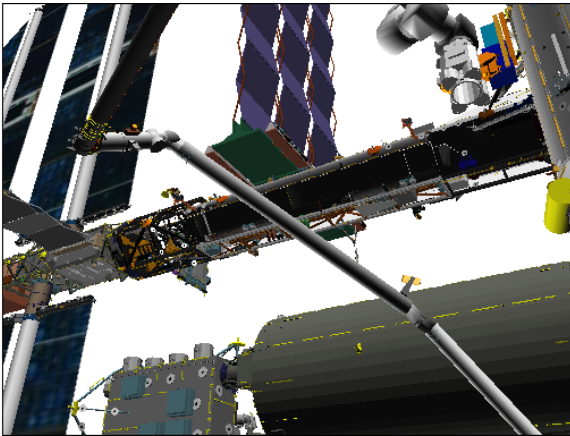

**CCTV B (-30,30)**

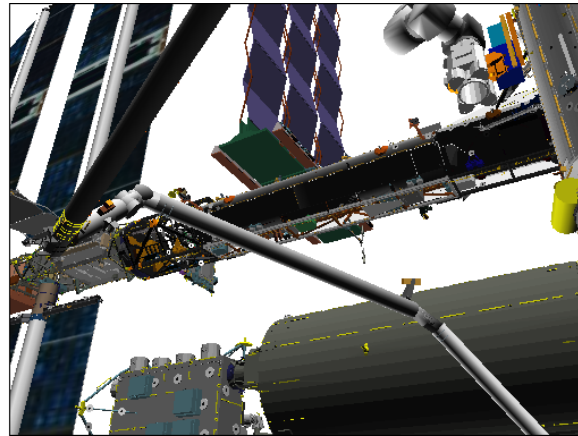

**CCTV B (-30,30)**

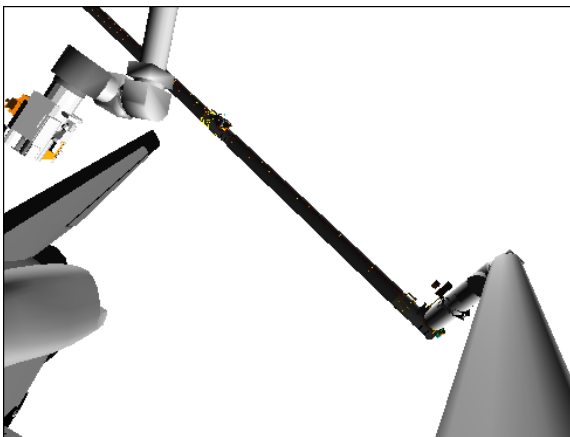

**ELBOW (-30,0)**

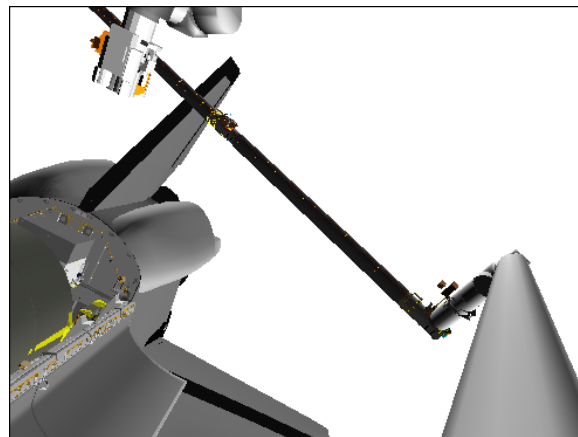

**ELBOW (-30,0)**

Step 8:

Drive WP (-) from  $-60.0^\circ$  to  $-85.9^\circ$

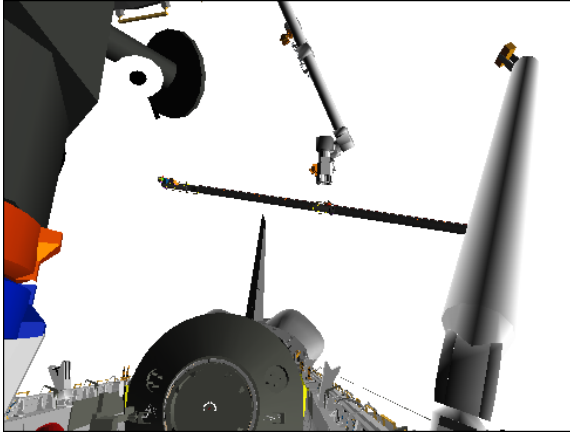

**CCTV A (0,20)**

Step 9:

Drive WY (+) from  $0.0^\circ$  to  $+11.2^\circ$

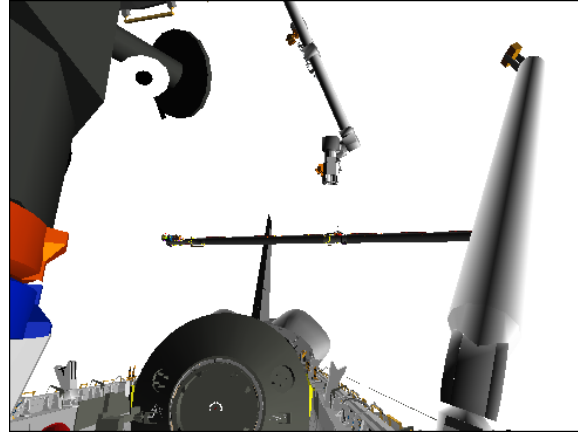

**CCTV A (0,20)**

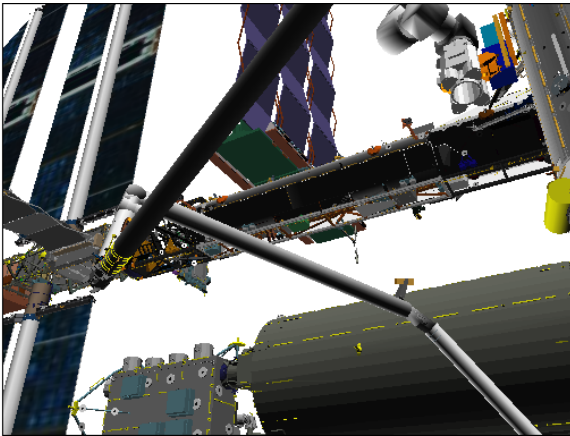

**CCTV B (-30,30)**

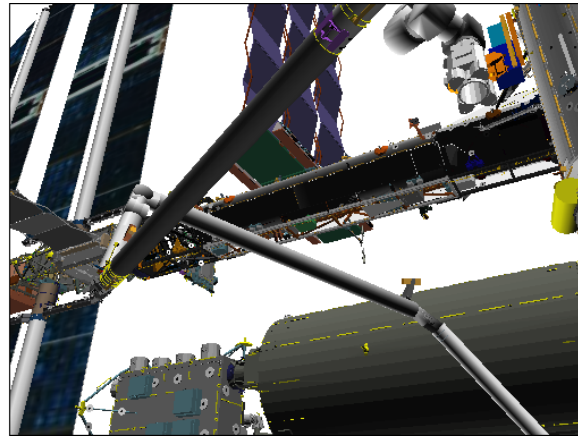

**CCTV B (-30,30)**

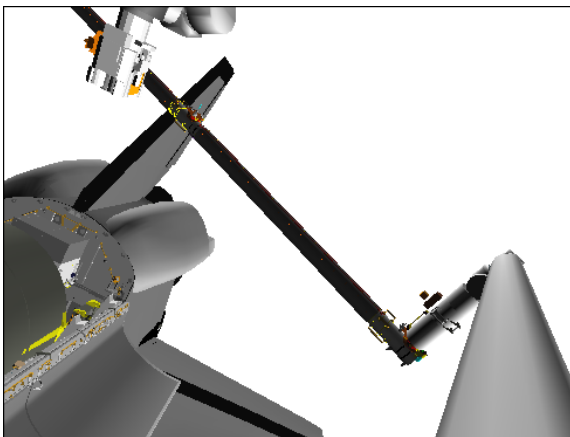

**ELBOW (-30,0)**

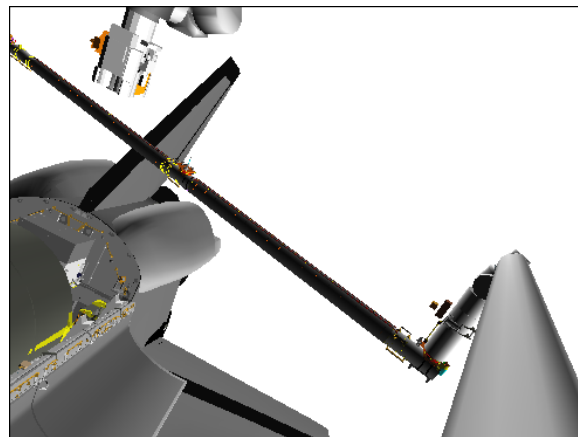

**ELBOW (-30,0)**

Step 10:

Drive WR (-) from  $-75.0^\circ$  to  $-99.4^\circ$

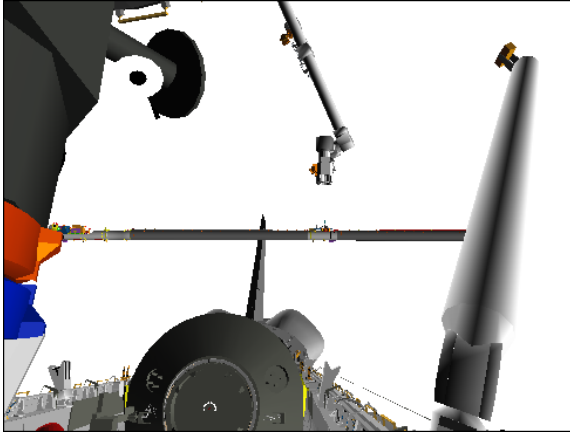

**CCTV A (0,20)**

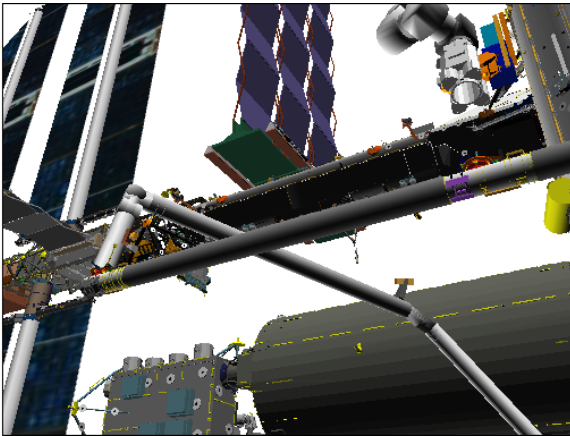

**CCTV B (-30,30)**

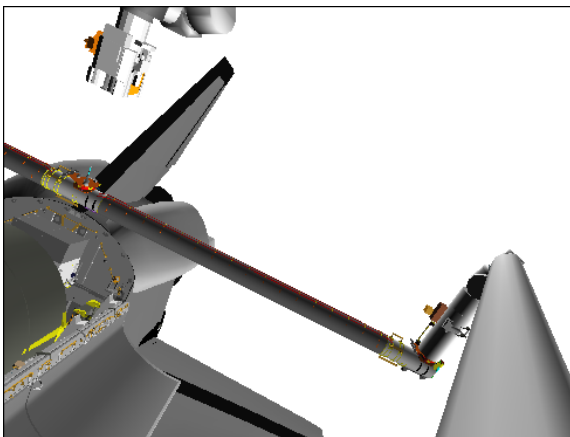

**ELBOW (-30,0)**

3. STOW PTU  
R12 (VPU) Green Jumper – LDRI/ITVC

A7U VID OUT DTV pb – push  
IN PL2(VPU) pb – push

CAMR CMD PAN/TILT – HI RATE  
PAN – L (to hard stop)  
TILT – UP (to hard stop)  
PAN/TILT – RESET  
PAN: +108 (right)  
TILT: -175 (down)

R12 (VPU) Green Jumper – ISS

On SSRMS Operator GO for OBSS ungrapple

|   |
|---|
| <p><u>CAUTION</u><br/>STBD RMS HTR power must be applied within 90 min<br/>to prevent sensor package damage</p> |
|---|

Perform LCC DEACTIVATION (LCS Cue Card, P/TV)  
Perform LCH DEACTIVATION (LCS Cue Card, P/TV)  
Perform DEACTIVATION (LDRI/ITVC Cue Card, P/TV)

4. OBSS UNGRAPPLE  
A7U CCTV – config for ungrapple  
– RMS WRIST, ZOOM: 34.0 HFOV  
FOCUS: 5 ft

If digitals available:

|  |
|--|
| <p>SM 94 PDRS CONTROL<br/>PL ID – ITEM 3 +0 EXEC<br/>INIT ID – ITEM 24 +0 EXEC</p> |
|--|

If SINGLE MODE available:

NOTE

CONTR ERR It and 'S96 PDRS CNTL' msg may occur due to Consistency/Envelope Check error

RHC RATE – COARSE (RATE MIN tb-OFF)

|   |
|---|
| <p>SM 94 PDRS CONTROL<br/>AUTO BRAKE INH – ITEM 10 EXEC (*)</p> |
|---|

BRAKES – OFF (tb-OFF)  
MODE – TEST, ENTER  
Wait 5 sec

BRAKES – ON (tb-ON)

|  |
|--|
| <p>SM 94 PDRS CONTROL<br/>AUTO BRAKE ENA – ITEM 9 EXEC (*)</p> |
|--|

RATE – as reqd (VERN within 10 ft)  
BRAKES – OFF (tb-OFF)







MODE – best available

|  |
|--|
| <b>CAUTION</b><br>Monitor EE tb timing to prevent EE motor burnout |
|--|

EE MODE – MAN

MAN CONTR – DERIGID (hold until DERIGID tb-gray, 5 sec max)

RELEASE sw – depress (hold until OPEN tb-gray, 3 sec max)

|   |   |   |   |   |
|---|---|---|---|---|
|   | <u>RIGID</u>  | <u>CLOSE</u>  | <u>CAPTURE</u>  | <u>CRITICAL TIMES (8 sec total):</u><br>DERIGID tb – gray, 5 sec max, then<br>OPEN tb – gray, 3 sec max, then |
| √ |  |  |  |   |
|   | <u>DERIGID</u>  | <u>OPEN</u>   | <u>EXTEND</u>   |   |
|   |  |  |  |   |

Drive joints per OBSS SJ UNGRAPPLE AT HANDOFF overlay until EE clear of grapple fixture



# OBSS SJ UNGRAPPLE AT HANDOFF

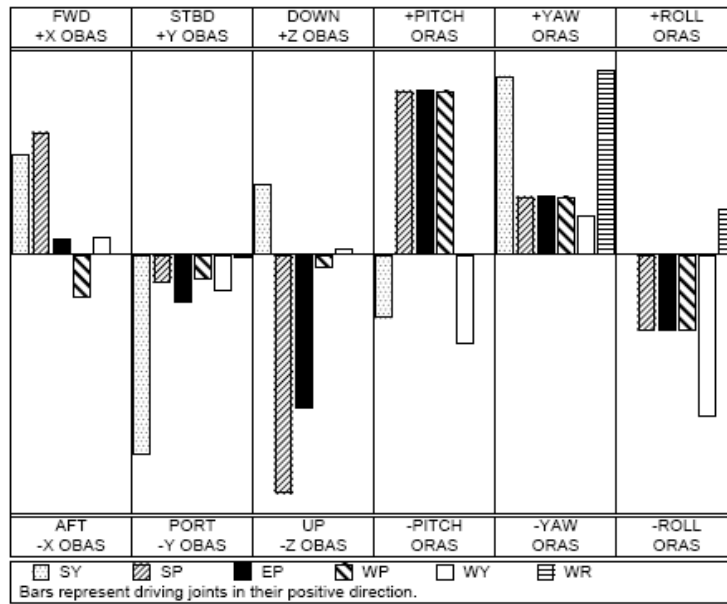

| To get:   | Drive:   | To get: | Drive:   | Driving: | Results In:     | Driving: | Results In:      |
|-----------|----------|---------|----------|----------|-----------------|----------|------------------|
| +X (fwd)  | +SP, +SY | +PITCH  | +WP, +EP | +SY      | -Y (port), +YAW | +WP      | -X (aft), +PITCH |
| +Y (stbd) | -SY      | +YAW    | +WR, +SY | +SP      | -Z (up), +PITCH | +WY      | -Y (port), -ROLL |
| +Z (down) | -SP, -EP | +ROLL   | -WY, -WP | +EP      | -Z (up), +PITCH | +WR      | +YAW             |

| $\Delta SY$ | $\Delta SP$ | $\Delta EP$ | $\Delta WP$ | $\Delta WY$ | $\Delta WR$ |
|-------------|-------------|-------------|-------------|-------------|-------------|
| -1.8        | -1.9        | +15.4       | -13.9       | +0.6        | +1.7        |

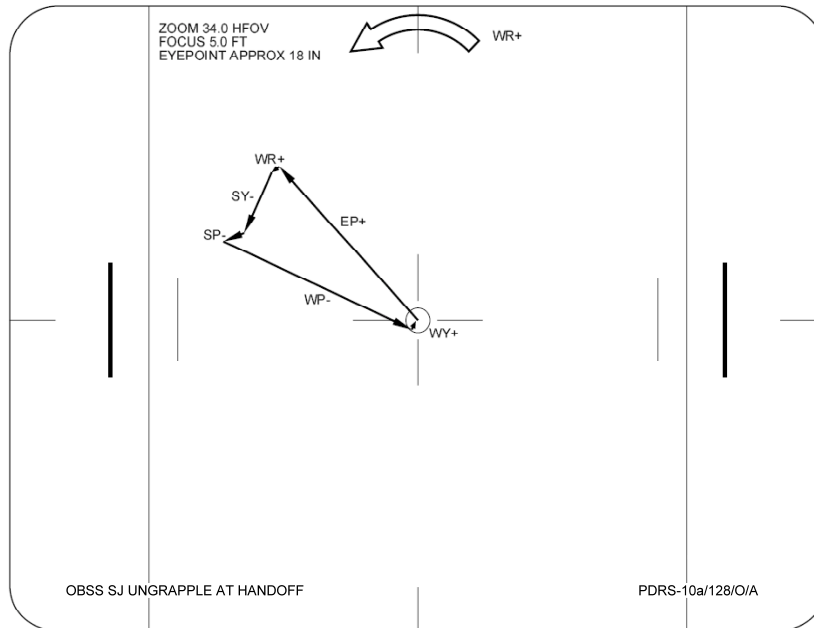

EE MAN CONTR – DERIG (hold until EXTEND tb-gray, 20 sec max)  
 MODE – OFF

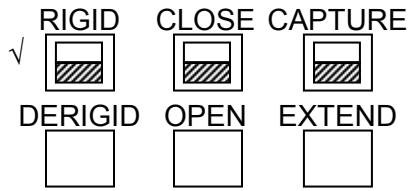

CRITICAL TIMES (20 sec total):  
 EXTEND tb – gray, 20 sec max

Mnvr to OBSS BACKOFF posn:

| X     | Y     | Z     | PITCH | YAW   | ROLL  | PL ID |
|-------|-------|-------|-------|-------|-------|-------|
| -1047 | -360  | -658  | 284   | 0     | 270   | 0     |
| SY    | SP    | EP    | WP    | WY    | WR    |       |
| +22.7 | +57.5 | -27.4 | -99.3 | +11.8 | -97.9 |       |

If SINGLE MODE available:  
 BRAKES – ON (tb-ON)

MODE – not DIRECT  
 JOINT – CRIT TEMP

- \* If using Shuttle attitude control and attitude maintenance reqd: \*
- \*     DAP: LVLH \*
- \*     When rates damped: \*
- \*         DAP: FREE > 2 sec \*
- \*         DAP: AUTO \*

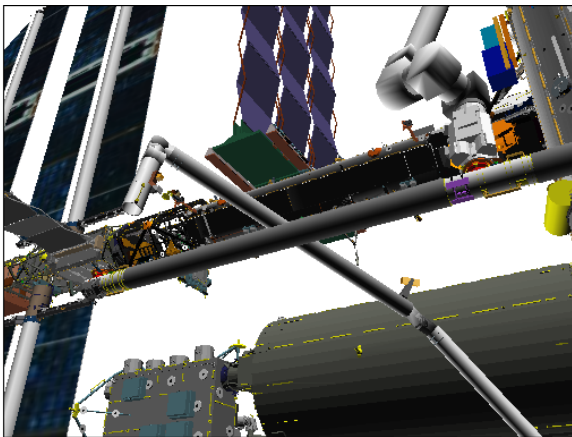

**CCTV B (-30,30)**

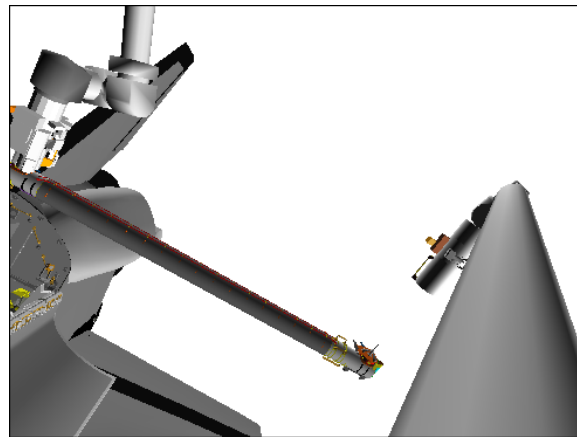

**ELBOW (-30,-10)**

Give SSRMS Operator GO for OBSS Berth Sequence

5. CONFIGURE CIRCUIT BREAKERS  
 MA73C:C    cb MCA PWR AC3 3Φ MID 2 – op  
                   √AC2 3Φ MID 2 – op  
 MA73C:D    √AC3 3Φ MID 4 – op

6. CONFIGURE FOR MONITORING  
 On SSRMS notification to watch for STBD RMS RFLs,  
 SM 94 PDRS CONTROL  
 RMS STBD – ITEM 2 EXEC (\*)

Notify SSRMS operator when STBD RMS R-F-L tb (three) – gray

7. STBD MRL LATCH

On SSRMS Operator GO to latch STBD MRLs to Topological Capture,  
√STBD RMS R-F-L tb (three) – gray

SM 94 PDRS CONTROL

√STBD AFT, MID, FWD LAT (six) = 0

R13L PL BAY MECH PWR SYS (two) – ON

NOTE

Expect single motor drive time for MRL latching (18 sec max).  
The following STBD RMS RETEN LAT – OFF and PL BAY  
MECH PWR SYS (two) – OFF actions are to be performed simo

Verify AOS for latching to Topological Capture

STBD RMS RETEN LAT – LAT 6 sec only (tb-bp)  
– OFF

R13L PL BAY MECH PWR SYS (two) – OFF

Give SSRMS Operator GO to Limp All SSRMS Joints and Derigidize

R13L On SSRMS Operator GO to complete STBD MRL latching,  
PL BAY MECH PWR SYS (two) – ON

STBD RMS RETEN LAT – LAT (tb-LAT) (12 sec max)  
– OFF

8. RECONFIGURE POWER

R13L PL BAY MECH PWR SYS (two) – OFF

STBD RMS HTR A,B (two) – AUTO

A6U EVENT TIMER CNTL – STOP

SM 94 PDRS CONTROL

√STBD AFT, MID, FWD LAT (six) = 1  
RMS PORT – ITEM 1 EXEC (\*)

MA73C:C cb MCA PWR AC3 3Φ MID 2 – cl

√AC2 3Φ MID 2 – op

MA73C:D √AC3 3Φ MID 4 – op

Give SSRMS Operator GO for OBSS ungrapple

9. MNVR TO PRE-CRADLE

Verify SSRMS is at Berthed OBSS Backoff or Overnight Park posn and on SSRMS Operator GO for mnvr to Pre-Cradle

|       |            |
|-------|------------|
| MON 1 | A          |
| MON 2 | B          |
| DNLK  | EE (ELBOW) |
| DTV   | C          |

If SINGLE MODE available:

RATE – as reqd (VERN within 10 ft)

BRAKES – OFF (tb-OFF)

MODE – Best Available

Mnvr to PRE-CRADLE posn:

|              | SY    | SP    | EP    | WP    | WY    | WR    |       |
|--------------|-------|-------|-------|-------|-------|-------|-------|
| OBSS Backoff | +22.7 | +57.5 | -27.4 | -99.3 | +11.8 | -97.9 |       |
| 1: SY –      | 0.0   |       |       |       |       |       |       |
| 2: EP +      |       |       | -25.0 |       |       |       |       |
| 3: WR +      |       |       |       |       |       | 0.0   |       |
| 4: WY –      |       |       |       |       | 0.0   |       |       |
| 5: WP +      |       |       |       | +5.0  |       |       |       |
| 6: SP –      |       | +25.0 |       |       |       |       |       |
| Pre-Cradle   | 0.0   | +25.0 | -25.0 | +5.0  | 0.0   | 0.0   |       |
|              | X     | Y     | Z     | PITCH | YAW   | ROLL  | PL ID |
|              | -1261 | -146  | -551  | 5     | 2     | 0     | 0     |

If SINGLE MODE available:

BRAKES – ON (tb-ON)

MODE – not DIRECT

PARAM – PORT TEMP

JOINT – CRIT TEMP

Start:  
OBSS Backoff

Step 1:  
Drive SY (-) from +22.7° to 0.0°



**CCTV A (20,20)**



**CCTV A (20,20)**

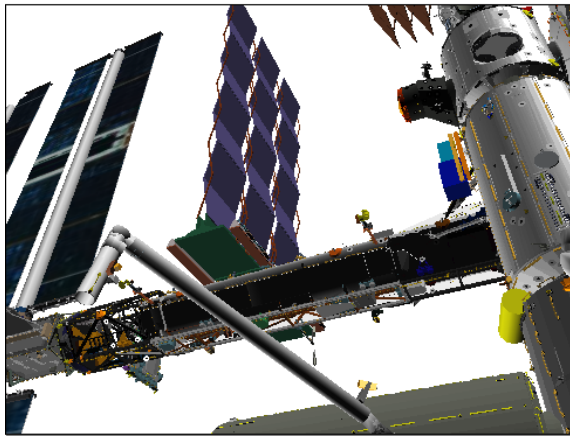

**CCTV B (-25,40)**

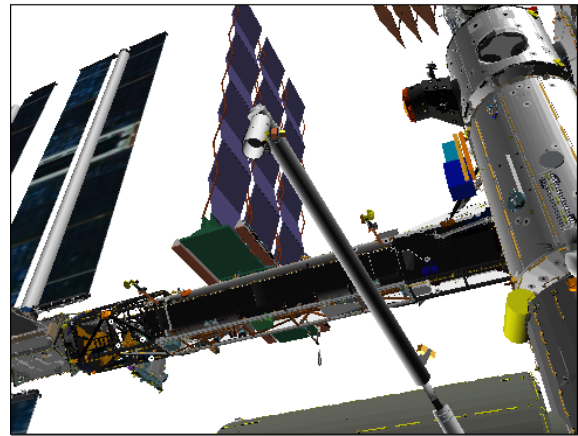

**CCTV B (-25,40)**

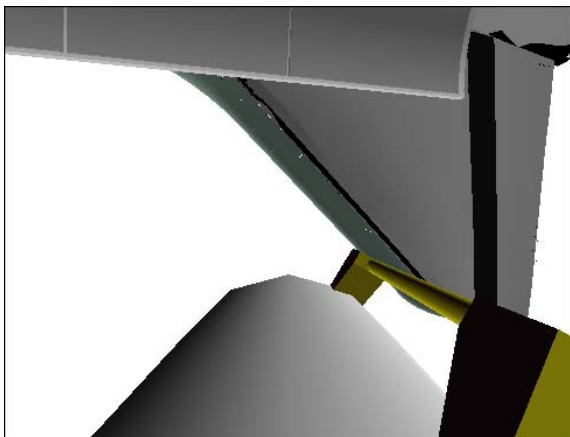

**EE**

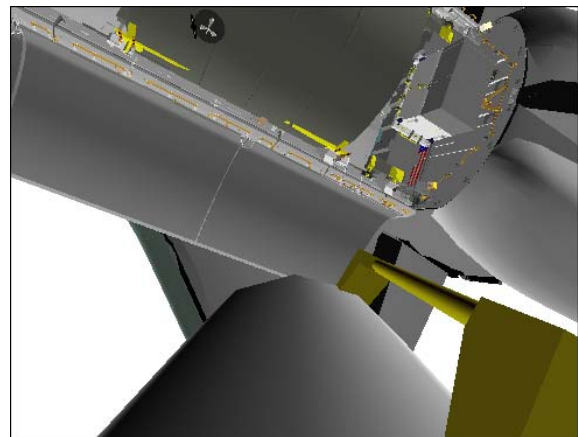

**EE**

Step 2:

Drive EP (+) from  $-27.4^\circ$  to  $-25.0^\circ$



**CCTV A (20,20)**

Step 3:

Drive WR (+) from  $-97.9^\circ$  to  $0.0^\circ$



**CCTV A (20,20)**

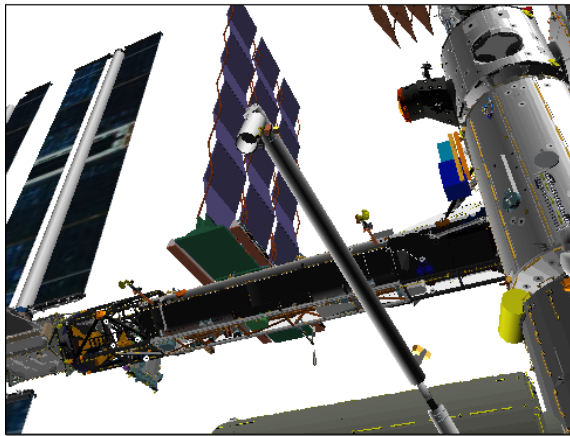

**CCTV B (-25,40)**

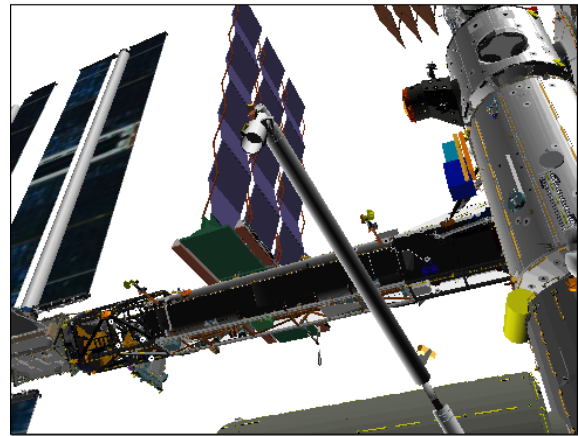

**CCTV B (-25,40)**

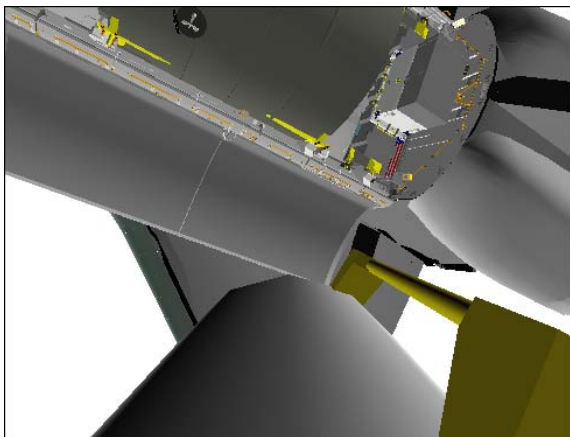

**EE**

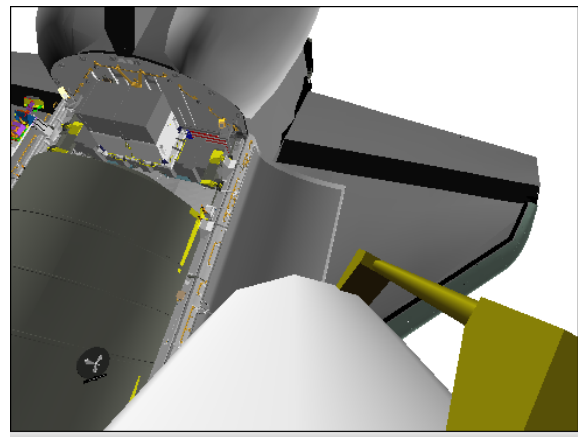

**EE**

Step 4:  
Drive WY (-) from +11.8° to 0.0°



**CCTV A (20,20)**

Step 5:  
Drive WP (+) from -99.3° to +5.0°



**CCTV A (20,20)**

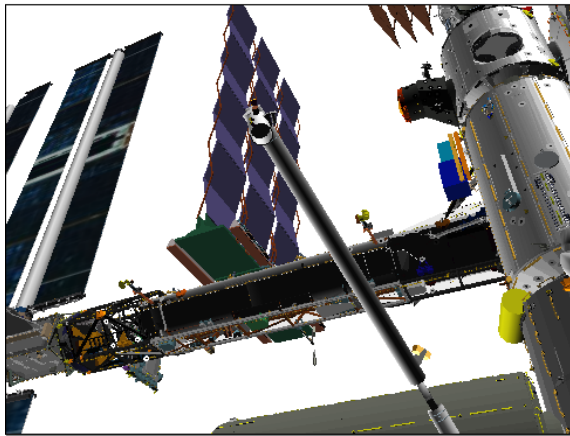

**CCTV B (-25,40)**

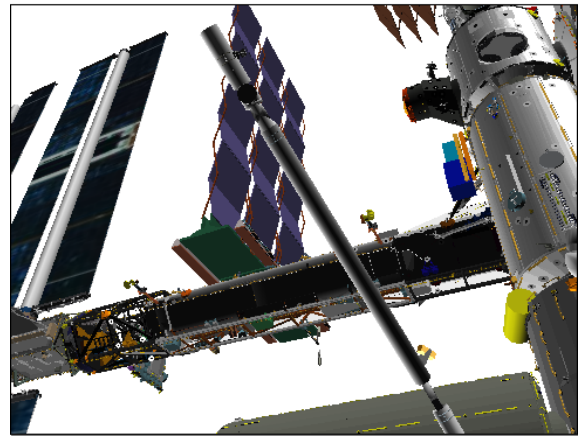

**CCTV B (-25,40)**

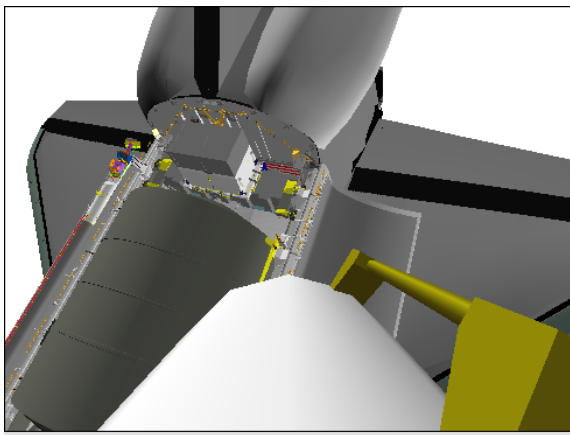

**EE**

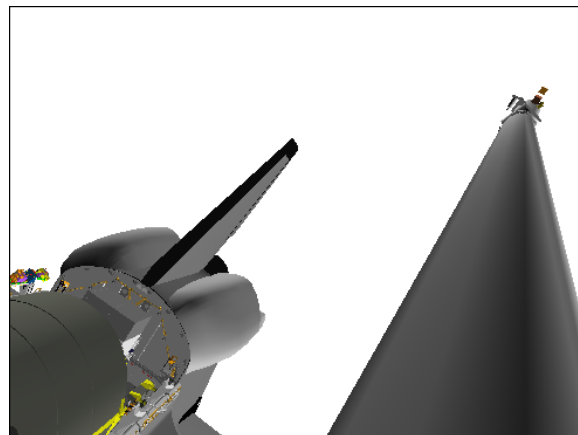

**ELBOW (-30,-20)**

Step 6:

Drive SP (-) from +57.5° to +25.0°



**CCTV A (20,20)**

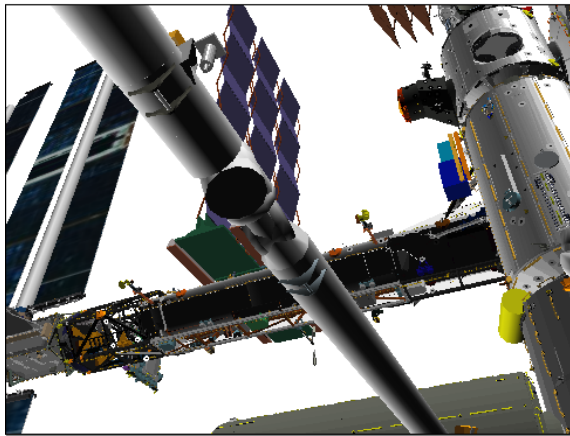

**CCTV B (-25,40)**

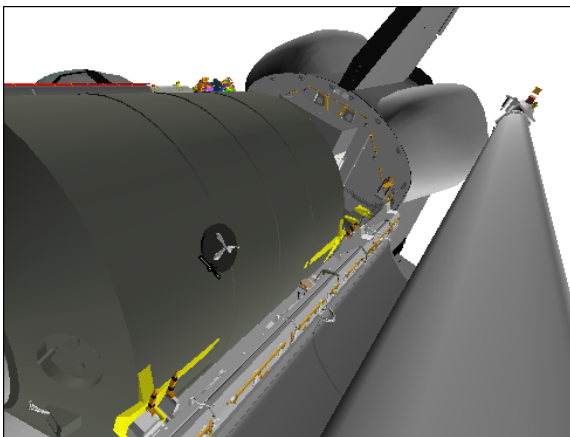

**ELBOW (-30,-20)**



# OBSS SJ MNVR TO UNDOCK

I

## 1. SETUP

|       |             |
|-------|-------------|
| MON 1 | P1 LOOB     |
| MON 2 | B           |
| DNLK  | ELBOW (RSC) |
| DTV   | A           |

If digitals available:

SM 94 PDRS CONTROL

√PL ID, ITEM 3: 1

√INIT ID, ITEM 24: 1

Verify at MPLM VIEWING posn:

|   |       |       |       |       |       |       |       |
|---|-------|-------|-------|-------|-------|-------|-------|
|   | X     | Y     | Z     | PITCH | YAW   | ROLL  | PL ID |
| √ | -967  | -643  | -386  | 60    | 349   | 282   | 1     |
|   | SY    | SP    | EP    | WP    | WY    | WR    |       |
| √ | +62.5 | +25.0 | -23.0 | 0.0   | -13.2 | -21.9 |       |

R12

√Green Jumper – ISS

## 2. OBSS MANEUVER TO UNDOCK

If SINGLE MODE available:

RHC

RATE – as reqd (VERN within 10 ft)

BRAKES – OFF (tb-OFF)

MODE – best available

SM 169 PDRS STATUS

Mnvr to UNDOCK posn:

|              |       |       |       |       |       |        |       |
|--------------|-------|-------|-------|-------|-------|--------|-------|
|              | SY    | SP    | EP    | WP    | WY    | WR     |       |
| MPLM Viewing | +62.5 | +25.0 | -23.0 | 0.0   | -13.2 | -21.9  |       |
| 1: SY –      | +25.8 |       |       |       |       |        |       |
| 2: WP –      |       |       |       | -85.9 |       |        |       |
| 3: SP +      |       | +66.3 |       |       |       |        |       |
| 4: WY +      |       |       |       |       | +10.7 |        |       |
| 5: WR –      |       |       |       |       |       | -100.7 |       |
| 6: EP –      |       |       | -49.0 |       |       |        |       |
| Undock       | +25.8 | +66.3 | -49.0 | -85.9 | +10.7 | -100.7 |       |
|              | X     | Y     | Z     | PITCH | YAW   | ROLL   | PL ID |
|              | -1041 | +362  | -603  | 288   | 270   | 244    | 1     |

\*Display singularity

If SINGLE MODE available:

BRAKES – ON (tb-ON)

MODE – not DIRECT (lt off)

PARAM – PORT TEMP

JOINT – CRIT TEMP

Step :  
MPLM Viewing Position

Step 1:  
Drive SY (-) from +62.5 to +25.8



**CCTV A (30,20)**

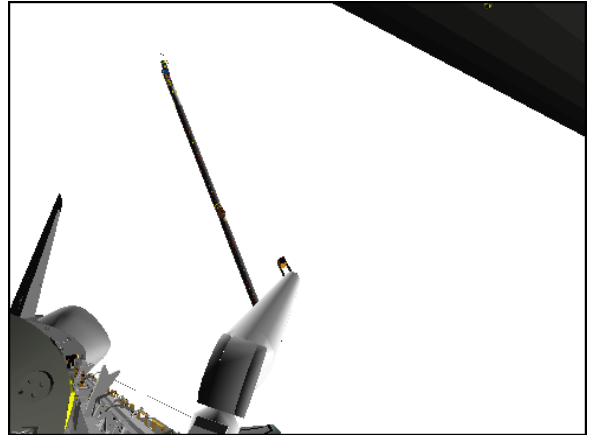

**CCTV A (30,20)**

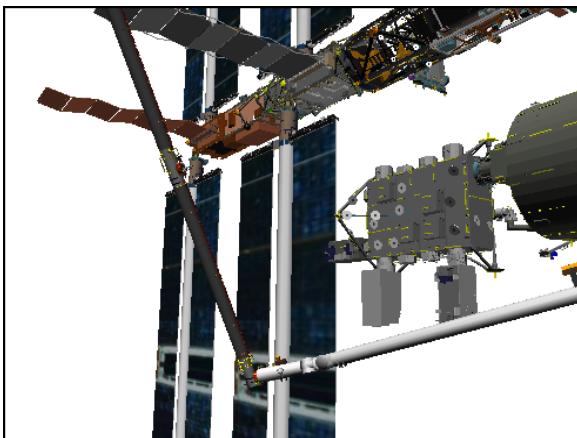

**CCTV B (-55,10)**

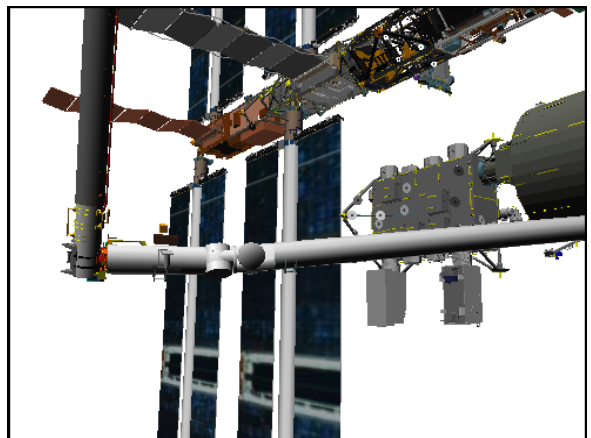

**CCTV B (-55,10)**

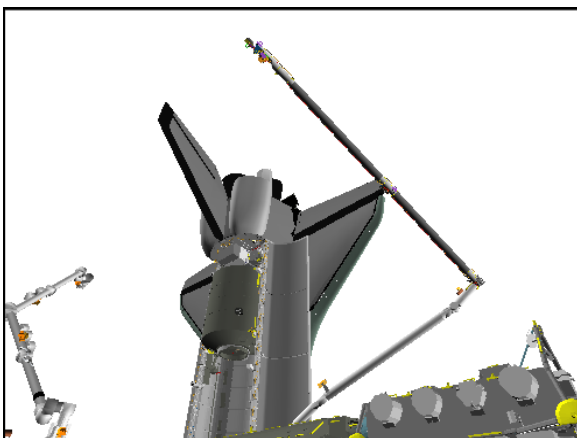

**P1 LOOB (140,40)**

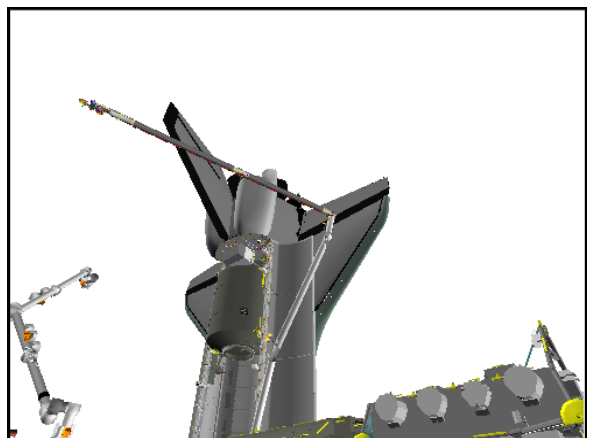

**P1 LOOB (140,40)**

Step 2:  
Drive WP (-) from 0.0 to -85.9

Step 3:  
Drive SP (+) from +25.0 to +66.3



**CCTV A (30,20)**

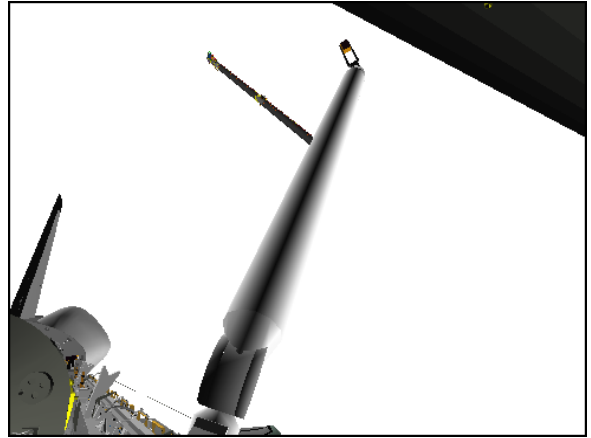

**CCTV A (30,20)**

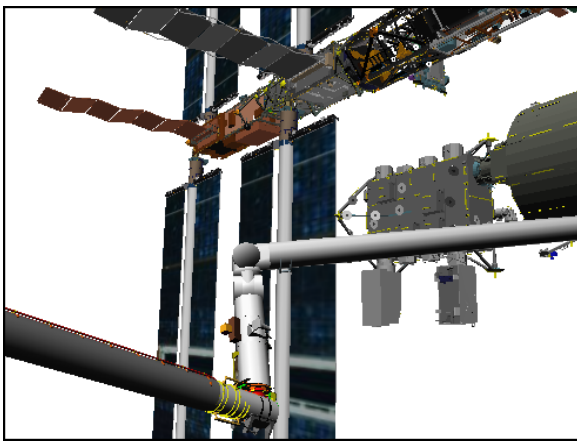

**CCTV B (-55,10)**

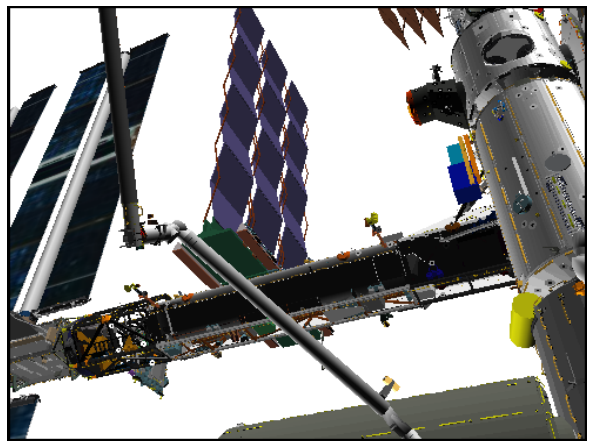

**CCTV B (-25,40)**

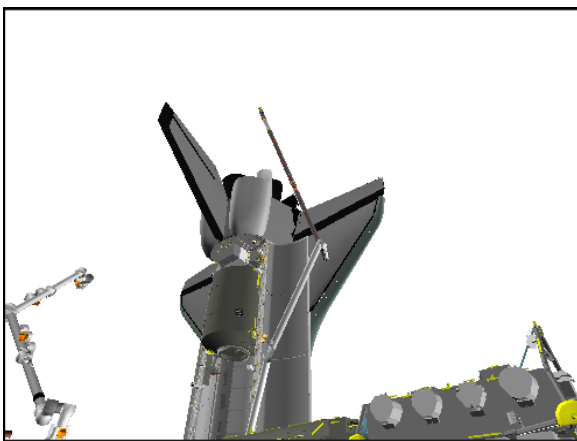

**P1 LOOB (140,40)**

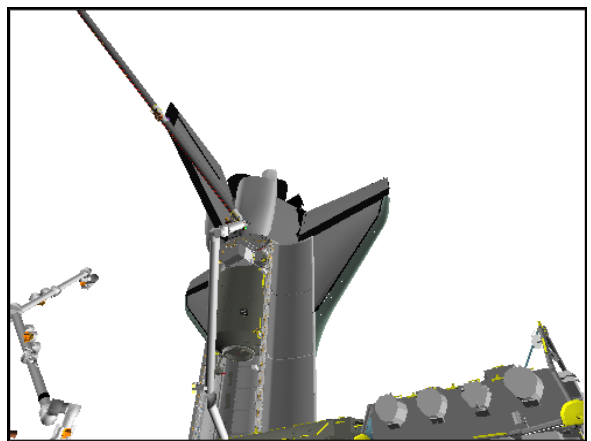

**P1 LOOB (140,40)**

Step 4:  
Drive WY (+) from -13.2 to +10.7

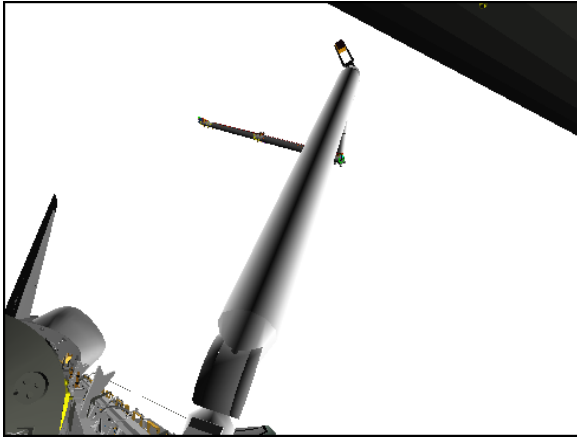

**CCTV A (30,20)**

Step 5:  
Drive WR (-) from -21.9 to -100.7

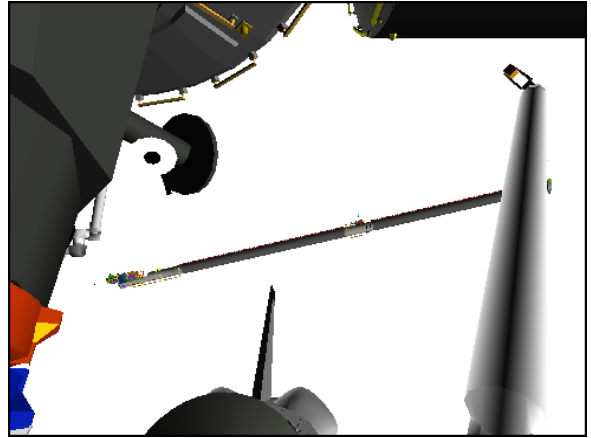

**CCTV A (0,30)**

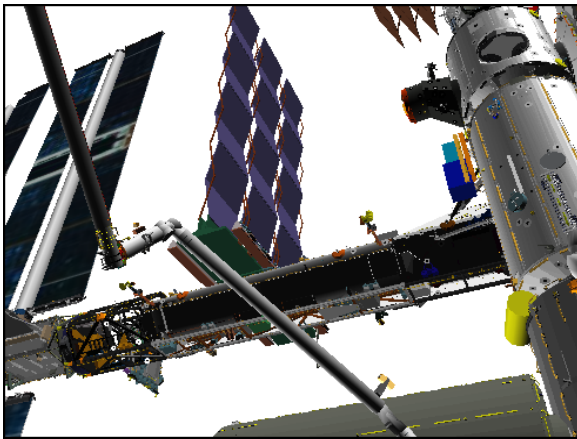

**CCTV B (-25,40)**

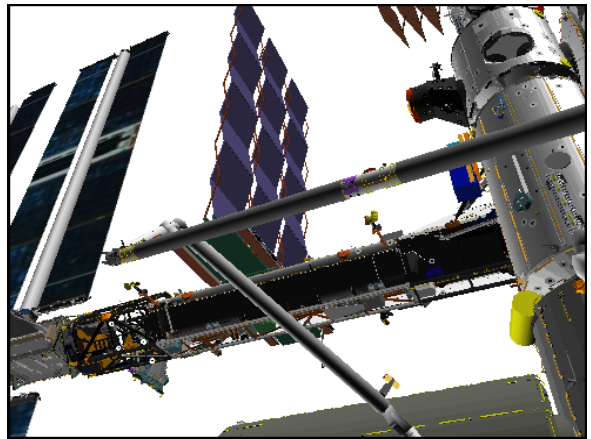

**CCTV B (-25,40)**

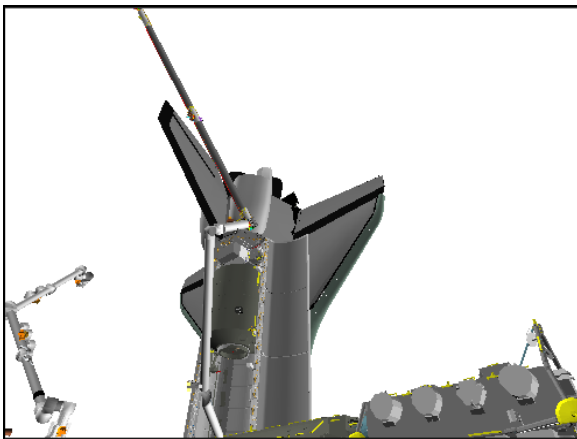

**P1 LOOB (140,40)**

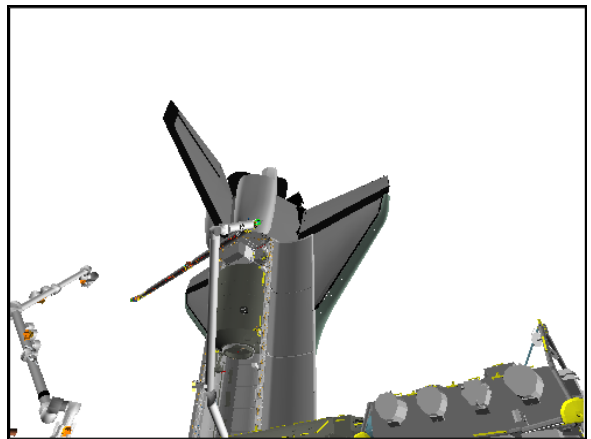

**P1 LOOB (140,40)**

Step 6:  
Drive EP (-) from -23.0 to -49.0

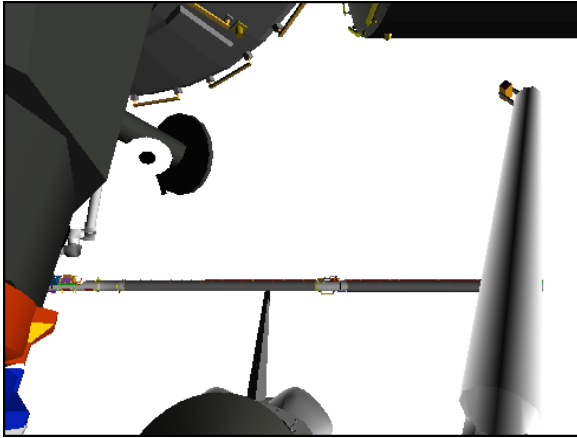

**CCTV A (0,30)**

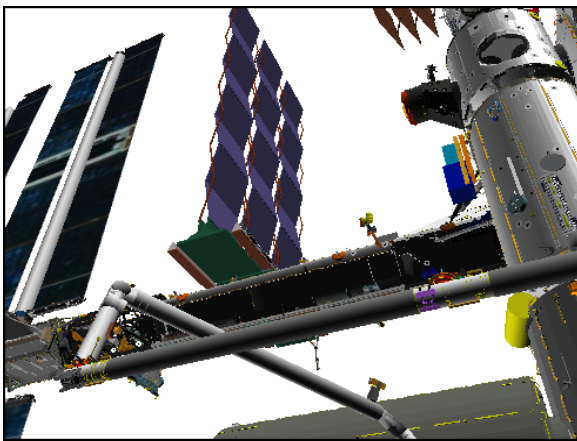

**CCTV B (-25,40)**

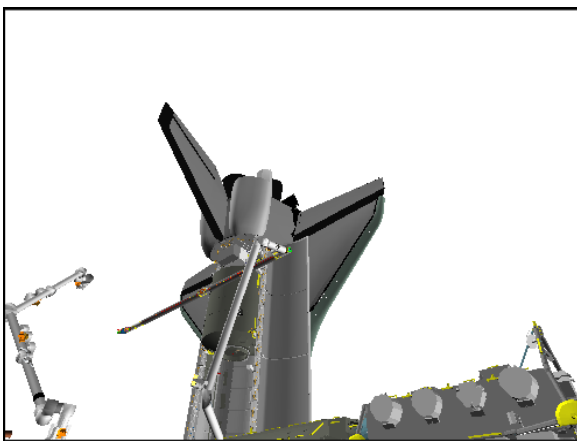

**P1 LOOB (140,40)**

# OBSS SJ MNVR TO OBSS HOVER

I

## 1. SETUP

|       |       |
|-------|-------|
| MON 1 | D     |
| MON 2 | A     |
| DNLK  | ELBOW |
| DTV   | B     |

If digitals available:

SM 94 PDRS CONTROL

√ PL ID, ITEM 3: 1

√ INIT ID, ITEM 24: 1

Verify at OBSS UNDOCK posn:

| X       | Y     | Z     | PITCH | YAW   | ROLL   | PL ID |
|---------|-------|-------|-------|-------|--------|-------|
| √ -1041 | -362  | -602  | 25    | 270   | 341    | 1     |
| √ SY    | SP    | EP    | WP    | WY    | WR     |       |
| +25.8   | +66.3 | -49.0 | -85.9 | +10.7 | -100.7 |       |

\*Display singularity

## 2. SINGLE TO OBSS HOVER

### NOTE

When SY joint is driving, minimum clearance between OBSS ITVC and orbiter tail is 95 inches. At the end of this single joint sequence, the OBSS ITVC is 66 inches from the starboard OMS pod

If SINGLE MODE available:

RHC

RATE – as reqd (VERN within 10 ft)

BRAKES – OFF (tb-OFF)

MODE – best available

Mnvr to OBSS HOVER posn:

|            | SY    | SP    | EP     | WP    | WY    | WR     |       |
|------------|-------|-------|--------|-------|-------|--------|-------|
| Undocking  | +25.8 | +66.3 | -49.0  | -85.9 | +10.7 | -100.7 |       |
| 1: WY –    |       |       |        |       | 0.0   |        |       |
| 2: WP +    |       |       |        | -59.8 |       |        |       |
| 3: WR +    |       |       |        |       |       | +110.0 |       |
| 4: SY –    | -90.0 |       |        |       |       |        |       |
| 5: SP +    |       | +80.2 |        |       |       |        |       |
| 6: EP –    |       |       | -118.8 |       |       |        |       |
| OBSS Hover | -90.0 | +80.2 | -118.8 | -59.8 | 0.0   | +110.0 |       |
|            | X     | Y     | Z      | PITCH | YAW   | ROLL   | PL ID |
|            | -680  | +133  | -517   | 0     | 0     | 341    | 1     |

If SINGLE MODE available:

BRAKES – ON (tb-ON)

MODE – not DIRECT (lt off)

PARAM – PORT TEMP

JOINT – CRIT TEMP

If berthing OBSS, perform OBSS SJ BERTH (PDRS, OBSS OPS)

Start:  
Undocking Position

Step 1:  
Drive WY (-) from +10.7 to 0.0



CCTV A (0,25)



CCTV A (0,25)



CCTV B (-20,20)



CCTV B (-20,20)

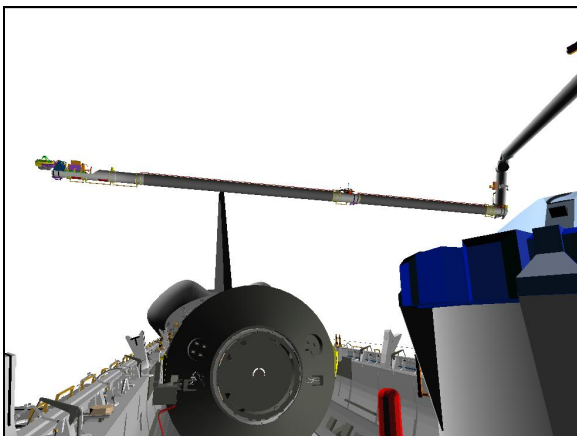

CCTV D (15,15)

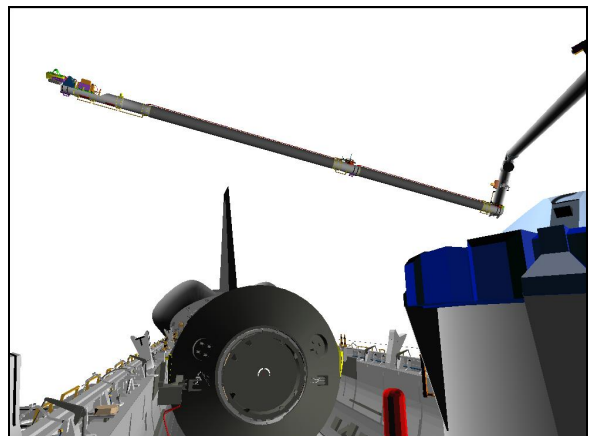

CCTV D (15,15)

Step 2:  
Drive WP (+) from -85.9 to -59.8

Step 3:  
Drive WR (+) from -100.7 to +110.0



**CCTV A (0,25)**

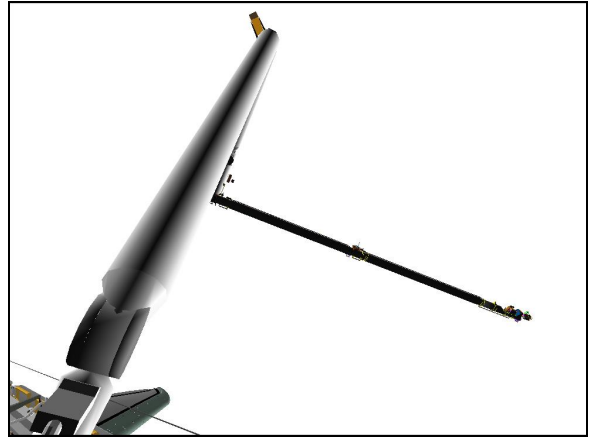

**CCTV A (45,15)**



**CCTV B (-25,20)**

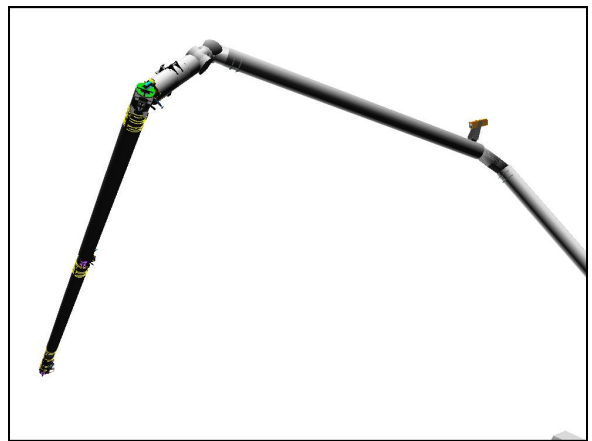

**CCTV B (-35,15)**

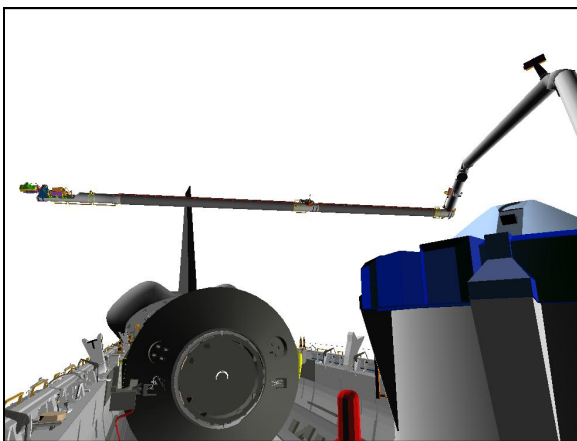

**CCTV D (20,15)**

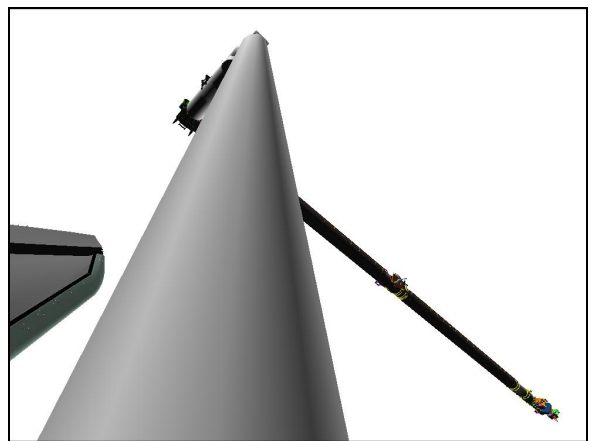

**ELBOW (5,-30)**



Step 4:  
Drive SY (-) from +25.8 to -90

Step 5:  
Drive SP (+) from +66.3 to +80.2

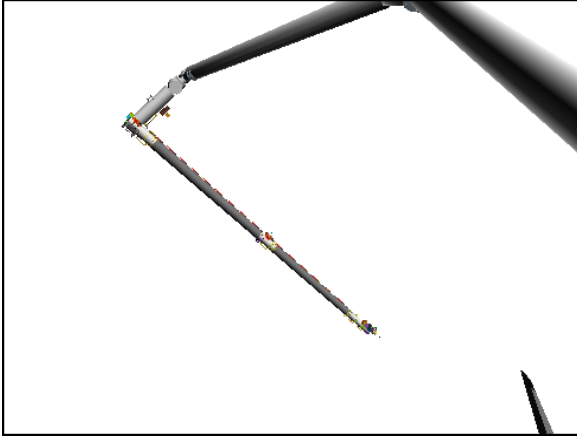

**CCTV A (-35,45)**



**CCTV A (-35,45)**

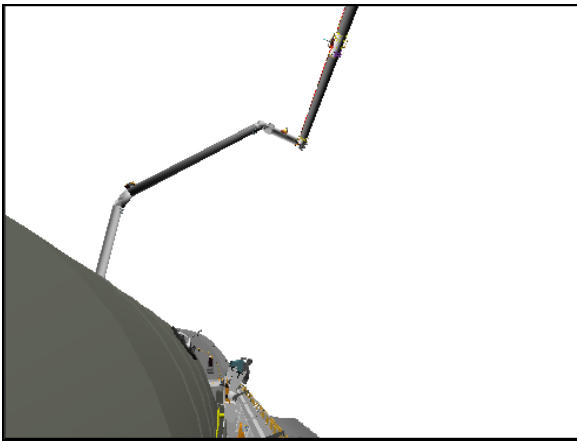

**CCTV C (10,20)**

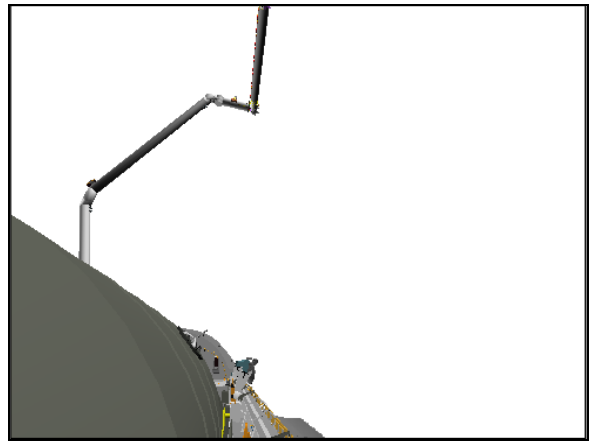

**CCTV C (10,20)**

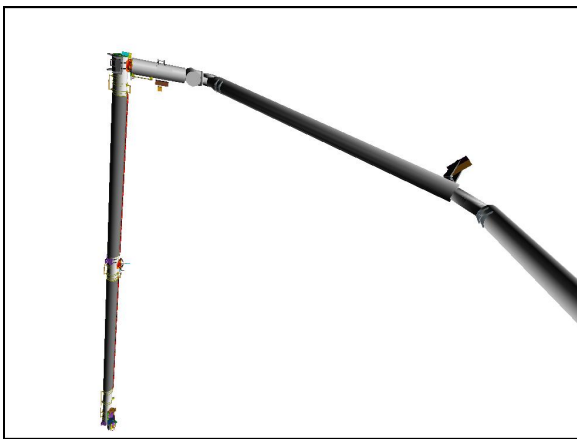

**CCTV D (15,60)**



**CCTV D (15,60)**

Step 6:  
Drive EP (-) from -49.0 to -118.8

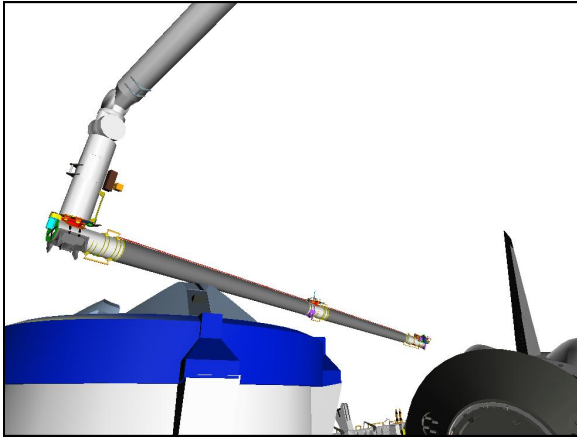

**CCTV A (35,25)**

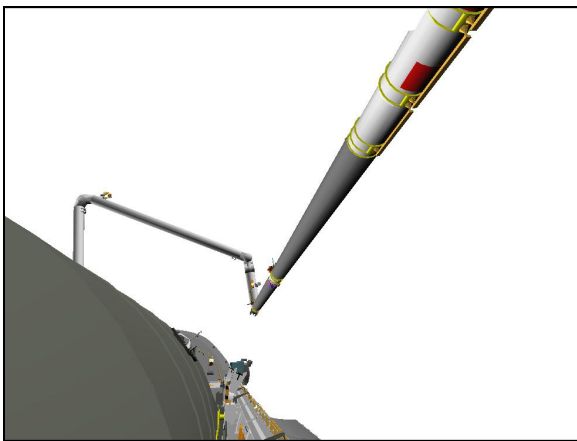

**CCTV C (10,20)**

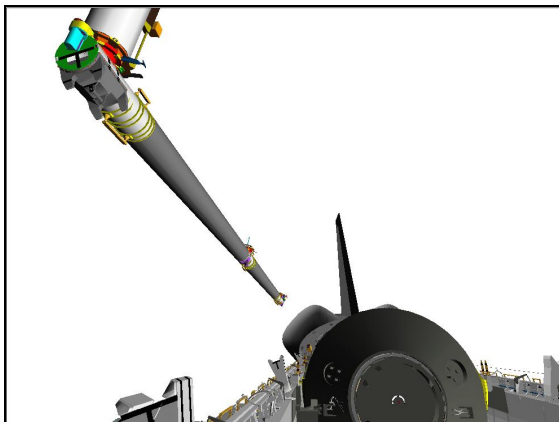

**CCTV D (5,20)**

REFERENCE DATA

OBSS HANDOFF JOINT ANGLES VS POR COORDINATES..... FS 3-2  
AUTOSEQUENCE..... FS 3-4

REFERENCE  
DATA

## OBSS HANDOFF JOINT ANGLES VS POR COORDINATES

OBSS PRE-GRAPPLE AT HANDOFF/BACKOFF posn:

| X     | Y     | Z     | PITCH | YAW   | ROLL  | PL ID |
|-------|-------|-------|-------|-------|-------|-------|
| -1047 | -360  | -658  | 284   | 0     | 270   | 0     |
| -1056 | -360  | -642  | 44    | 270   | 0     | 1     |
| -1043 | +231  | -655  | 14    | 270   | 0     | 2     |
| SY    | SP    | EP    | WP    | WY    | WR    |       |
| +22.7 | +57.5 | -27.4 | -99.3 | +11.8 | -97.9 |       |

\*Display singularity

OBSS HANDOFF posn:

| X     | Y     | Z     | PITCH | YAW   | ROLL  | PL ID |
|-------|-------|-------|-------|-------|-------|-------|
| -1062 | -360  | -600  | 284   | 0     | 270   | 0     |
| -1070 | -360  | -584  | 44    | 270   | 0     | 1     |
| -1059 | +231  | -597  | 14    | 270   | 0     | 2     |
| SY    | SP    | EP    | WP    | WY    | WR    |       |
| +24.5 | +59.0 | -42.1 | -85.9 | +11.2 | -99.4 |       |

\*Display singularity

INTERMEDIATE posn:

| X     | Y     | Z     | PITCH | YAW   | ROLL  | PL ID |
|-------|-------|-------|-------|-------|-------|-------|
| -1062 | -360  | -600  | 284   | 0     | 282   | 0     |
| -1070 | -361  | -584  | 14    | 281   | 330   | 1     |
| -1174 | +219  | -626  | 14    | 281   | 0     | 2     |
| SY    | SP    | EP    | WP    | WY    | WR    |       |
| +24.5 | +59.0 | -42.1 | -85.9 | +11.2 | -87.8 |       |

MPLM VIEWING posn:

| X     | Y     | Z     | PITCH | YAW   | ROLL  | PL ID |
|-------|-------|-------|-------|-------|-------|-------|
| -959  | -627  | -387  | 341   | 47    | 345   | 0     |
| -967  | -643  | -386  | 60    | 349   | 282   | 1     |
| -1252 | -520  | -889  | 60    | 349   | 312   | 2     |
| SY    | SP    | EP    | WP    | WY    | WR    |       |
| +62.5 | +25.0 | -23.0 | 0.0   | -13.2 | -21.9 |       |

OBSS UNDOCK posn:

| X     | Y     | Z     | PITCH | YAW   | ROLL   | PL ID |
|-------|-------|-------|-------|-------|--------|-------|
| -1032 | -362  | -618  | 284   | 0     | 270    | 0     |
| -1041 | -362  | -602  | 44    | 270   | 0      | 1     |
| -1029 | +229  | -614  | 14    | 270   | 0      | 2     |
| SY    | SP    | EP    | WP    | WY    | WR     |       |
| +25.8 | +66.3 | -49.0 | -85.9 | +10.7 | -100.7 |       |

\*Display singularity

FLAT FIELD posn:

| X     | Y     | Z     | PITCH | YAW | ROLL   | PL ID |
|-------|-------|-------|-------|-----|--------|-------|
| -679  | +351  | -448  | 270   | 349 | 1      | 0     |
| -679  | +349  | -430  | 0     | 0   | 341    | 1     |
| -1270 | +350  | -445  | 0     | 0   | 11     | 2     |
| SY    | SP    | EP    | WP    | WY  | WR     |       |
| -90.1 | +25.0 | -65.8 | -57.6 | 0.0 | -249.9 |       |

REFERENCE  
DATA

OBSS CONTINGENCY UNDOCK posn:

| X     | Y     | Z     | PITCH | YAW  | ROLL  | PL ID |
|-------|-------|-------|-------|------|-------|-------|
| -1119 | -483  | -582  | 5     | 37   | 313   | 0     |
| -1131 | -496  | -586  | 62    | 324  | 282   | 1     |
| -1348 | -141  | -1006 | 62    | 324  | 312   | 2     |
| SY    | SP    | EP    | WP    | WY   | WR    |       |
| +35.0 | +38.7 | -22.8 | -0.5  | -0.3 | -40.0 |       |

## OBSS AUTOSEQUENCE

| Auto Seq ID | Auto posn | X/ SY | Y/ SP | Z/ EP | PITCH/ WP | YAW/ WY | ROLL/ WR | Pause    |
|-------------|-----------|-------|-------|-------|-----------|---------|----------|----------|
| 7           | 148       | -1029 | +229  | -614  | 14        | 270     | 0        | <b>P</b> |
|             |           | +26.1 | +67.7 | -51.2 | -85.0     | +10.6   | -100.6   |          |
| 7           | 149       | -800  | +500  | -250  | 281       | 333     | 95       |          |
|             |           | -86.7 | +72.7 | -86.0 | +21.2     | -3.3    | -169.3   |          |
| 7           | 150       | -1130 | +350  | -400  | 325       | 336     | 30       |          |
|             |           | -80.4 | +90.4 | -94.6 | -76.3     | -43.9   | +97.2    |          |
| 7           | 151       | -1270 | +350  | -445  | 0         | 0       | 11       | <b>P</b> |
|             |           | -90.1 | +25.0 | -65.8 | -57.6     | 0.0     | -249.9   |          |

CUE CARD CONFIGURATION

|                                       |           |
|---------------------------------------|-----------|
| OBSS SJ GRAPPLE AT HANDOFF .....      | FS CC 4-2 |
| UNGRAPPLE AT HANDOFF.....             | FS CC 4-3 |
| OVERLAY FOR ROEU PL SEL POSITION..... | FS CC 4-4 |

CUE CARD  
CONFIG

# CUE CARD CONFIG

Fabricate as transparency

ZOOM 34.0 HFOV  
FOCUS 5.0 FT  
EYEPOINT APPROX 18 IN

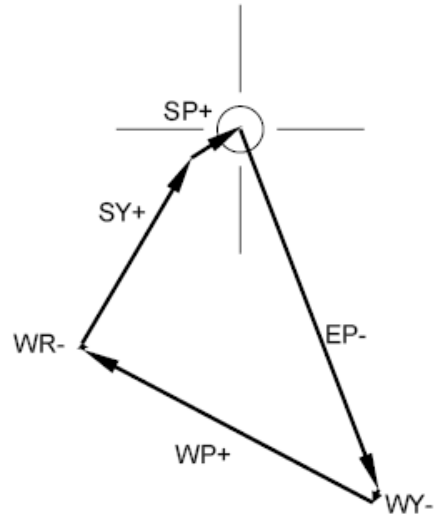

OBSS SJ GRAPPLE AT HANDOFF

PDRS-9a/128/O/A

(reduced copy)

FS CC 4-2

PDRS/128/FIN A



Fabricate as transparency

ZOOM 34.0 HFOV  
FOCUS 5.0 FT  
EYEPOINT APPROX 18 IN



WR+

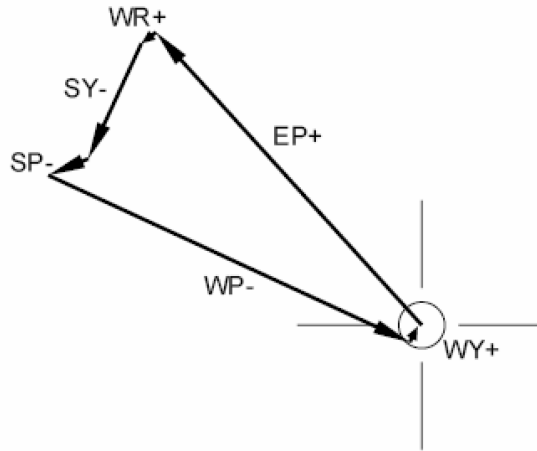

OBSS SJ UNGRAPPLE AT HANDOFF

PDRS-10a/128/O/A

(reduced copy)

FS CC 4-3

PDRS/128/FIN A

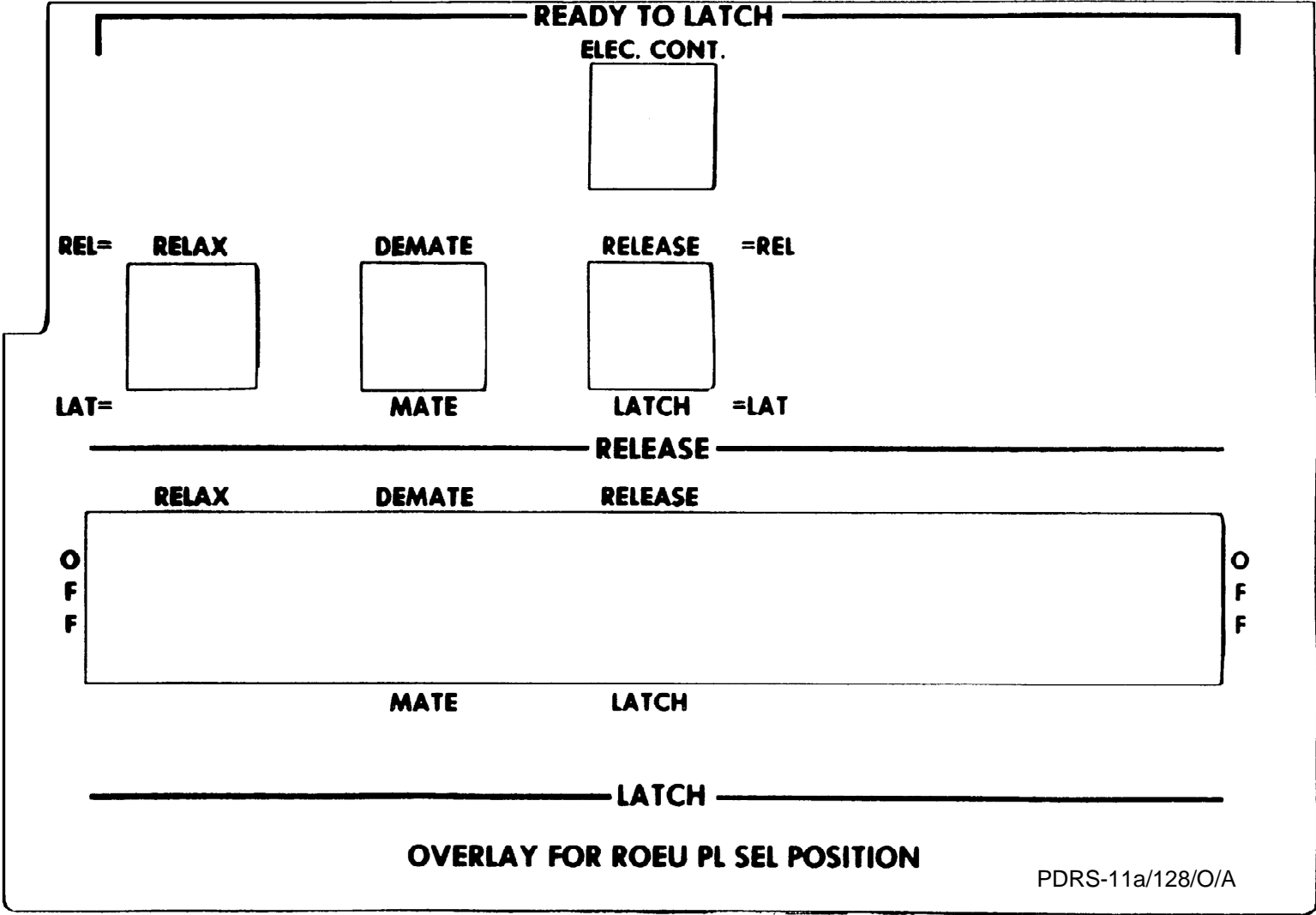

FS CC 4-4

PDRS/128/FIN A



**PDRS OPS C/L**

**STS  
128**