

PDRS Operations Checklist

STS-129 Flight Supplement

**Mission Operations Directorate
EVA, Robotics, & Crew Systems
Operations Division**

**Final
October 26, 2009**

National Aeronautics and
Space Administration

Lyndon B. Johnson Space Center
Houston, Texas

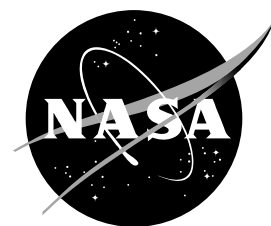

MISSION OPERATIONS DIRECTORATE

**PDRS OPERATIONS CHECKLIST
STS-129 FLIGHT SUPPLEMENT**

FINAL
October 26, 2009

PREPARED BY:

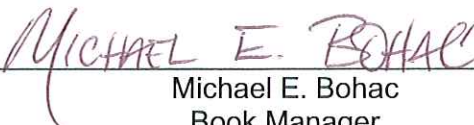

Michael E. Bohac
Book Manager

APPROVED BY:



Aaron D. Goldenthal
Lead, Shuttle and Exploration Robotics
Operations Group

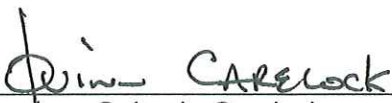

Quinn L. Carelock
Chief, Robotics Operations Branch

This document is under the configuration control of the Crew Procedures Control Board (CPCB). All proposed changes must be submitted via Change Request Workflow (CRW) to DO3/FDF Manager.

Additional distribution of this book, for official use only, may be requested in writing to DO3/PMO Administrator. The request must include justification and requester's name, organization, position, and phone number. Contractor requests are made through the NASA or DOD organization supported. Deletions, reduction in quantity, or change of address may be submitted to DO3/FDF Management Office, 281-244-1184.

Incorporates the following:	
482#:	PDRS FS-00150 PDRS FS-00151 PDRS FS-00152 PDRS FS-00153 PDRS FS-00154

AREAS OF TECHNICAL RESPONSIBILITY

Book Manager

DX22/M. Bohac

281-483-4926

PDRS OPERATIONS CHECKLIST
 STS-129 FLIGHT SUPPLEMENT

LIST OF EFFECTIVE PAGES

FINAL 10/26/09

Sign Off	*	129/FIN	FS 2-13.....	⊗	129/FIN
FS ii	*	129/FIN	FS 2-14.....	⊗	129/FIN
FS iii	*	129/FIN	FS 2-15.....		129/FIN
FS iv	*	129/FIN	FS 2-16.....		129/FIN
FS v		129/FIN	FS 2-17.....	⊗	129/FIN
FS vi		129/FIN	FS 2-18.....		129/FIN
FS 1-1		129/FIN	FS 2-19.....	⊗	129/FIN
FS 1-2		129/FIN	FS 2-20.....	⊗	129/FIN
FS 1-3	⊗	129/FIN	FS 2-21.....	⊗	129/FIN
FS 1-4		129/FIN	FS 2-22.....		129/FIN
FS 1-5	⊗	129/FIN	FS 2-23.....		129/FIN
FS 1-6		129/FIN	FS 2-24.....	⊗	129/FIN
FS 1-7		129/FIN	FS 2-25.....		129/FIN
FS 1-8		129/FIN	FS 2-26.....		129/FIN
FS 1-9	⊗	129/FIN	FS 2-27.....	⊗	129/FIN
FS 1-10	⊗	129/FIN	FS 2-28.....		129/FIN
FS 1-11	⊗	129/FIN	FS 2-29.....	⊗	129/FIN
FS 1-12		129/FIN	FS 2-30.....	⊗	129/FIN
FS 1-13		129/FIN	FS 2-31.....	⊗	129/FIN
FS 1-14	⊗	129/FIN	FS 2-32.....	⊗	129/FIN
FS 1-15		129/FIN	FS 2-33.....		129/FIN
FS 1-16	⊗	129/FIN	FS 2-34.....		129/FIN
FS 1-17	⊗	129/FIN	FS 2-35.....	⊗	129/FIN
FS 1-18		129/FIN	FS 2-36.....		129/FIN
FS 1-19		129/FIN	FS 2-37.....	⊗	129/FIN
FS 1-20		129/FIN	FS 2-38.....	⊗	129/FIN
FS 1-21	⊗	129/FIN	FS 2-39.....	⊗	129/FIN
FS 1-22	⊗	129/FIN	FS 2-40.....	⊗	129/FIN
FS 1-23	⊗	129/FIN	FS 3-1.....		129/FIN
FS 1-24		129/FIN	FS 3-2.....		129/FIN
FS 1-25	⊗	129/FIN	FS 3-3.....	⊗	129/FIN
FS 1-26	⊗	129/FIN	FS 3-4.....		129/FIN
FS 1-27	⊗	129/FIN	FS 3-5.....	⊗	129/FIN
FS 1-28		129/FIN	FS 3-6.....	⊗	129/FIN
FS 2-1		129/FIN	FS 3-7.....	⊗	129/FIN
FS 2-2		129/FIN	FS 3-8.....	⊗	129/FIN
FS 2-3	⊗	129/FIN	FS 3-9.....		129/FIN
FS 2-4	⊗	129/FIN	FS 3-10.....		129/FIN
FS 2-5	⊗	129/FIN	FS 3-11.....	⊗	129/FIN
FS 2-6		129/FIN	FS 3-12.....		129/FIN
FS 2-7		129/FIN	FS 3-13.....		129/FIN
FS 2-8	⊗	129/FIN	FS 3-14.....	⊗	129/FIN
FS 2-9		129/FIN	FS 4-1.....		129/FIN
FS 2-10	⊗	129/FIN	FS 4-2.....		129/FIN
FS 2-11		129/FIN	FS 4-3.....	⊗	129/FIN
FS 2-12	⊗	129/FIN	FS 4-4.....	⊗	129/FIN

* – Omit from flight book

⊗ – Flight copies of this page contain color

FS 4-5	⊗ 129/FIN	FS 5-1	129/FIN
FS 4-6	129/FIN	FS 5-2	129/FIN
FS 4-7	129/FIN	FS 5-3	⊗ 129/FIN
FS 4-8	129/FIN	FS 5-4	⊗ 129/FIN
FS 4-9	⊗ 129/FIN	FS 5-5	129/FIN
FS 4-10	129/FIN	FS 5-6	129/FIN
FS 4-11	⊗ 129/FIN	FS 5-7	⊗ 129/FIN
FS 4-12	129/FIN	FS 5-8	⊗ 129/FIN
FS 4-13	⊗ 129/FIN	FS 5-9	129/FIN
FS 4-14	129/FIN	FS 5-10	129/FIN
FS 4-15	129/FIN	FS 6-1	*
FS 4-16	⊗ 129/FIN	FS CC 6-2	*
FS 4-17	129/FIN	FS CC 6-3	*
FS 4-18	129/FIN	FS CC 6-4	*
FS 4-19	129/FIN	FS CC 6-5	*
FS 4-20	⊗ 129/FIN	FS CC 6-6	*
FS 4-21	⊗ 129/FIN	FS CC 6-7	*
FS 4-22	⊗ 129/FIN	FS 6-8	*

PDRS CUE CARDS

<u>Title</u>	<u>Ref. Page</u>	<u>Card No.</u>
ELC-1 SJ GRAPPLE WRIST CCTV OVERLAY	FS CC 6-2	PDRS-9a/129/O/B
UNGRAPPLE WRIST CCTV OVERLAY	FS CC 6-3	PDRS-10a/129/O/B
ELC-2 SJ GRAPPLE WRIST CCTV OVERLAY	FS CC 6-4	PDRS-11a/129/O/B
UNGRAPPLE WRIST CCTV OVERLAY	FS CC 6-5	PDRS-12a/129/O/B
OBSS SJ GRAPPLE AT HANDOFF OVERLAY	FS CC 6-6	PDRS-13a/129/O/B
UNGRAPPLE AT HANDOFF OVERLAY....	FS CC 6-7	PDRS-14a/129/O/B

⊗ – Flight copies of this page contain color

* – Omit from flight book

<u>CONTENTS</u>	<u>PAGE</u>
<u>ELC NOMINAL OPS</u>	FS 1-1
ELC-1 GRAPPLE	FS 1-3
UNBERTH.....	FS 1-6
UNGRAPPLE	FS 1-12
ELC-2 GRAPPLE	FS 1-15
UNBERTH.....	FS 1-18
UNGRAPPLE	FS 1-24
 <u>ELC OFF-NOMINAL OPS</u>	 FS 2-1
ELC-1 SJ GRAPPLE	FS 2-2
UNBERTH	FS 2-9
HANDOFF	FS 2-11
UNGRAPPLE.....	FS 2-15
ELC-2 SJ GRAPPLE	FS 2-18
UNBERTH	FS 2-25
HANDOFF	FS 2-28
UNGRAPPLE.....	FS 2-33
 <u>OBSS NOMINAL</u>	 FS 3-1
OBSS HANDOFF FROM SSRMS (NODE 2) TO SRMS	FS 3-2
MANEUVER TO OBSS CLEARANCE POSN.....	FS 3-6
HANDOFF FROM SRMS TO SSRMS (NODE 2)	FS 3-8
MNVR FROM OBSS PRE-GRAPPLE TO PRE-CRADLE POSN	FS 3-13
 <u>OBSS OFF-NOMINAL</u>	 FS 4-1
OBSS SJ HANDOFF FROM SSRMS (NODE 2) TO SRMS	FS 4-2
MANEUVER TO OBSS CLEARANCE POSN.....	FS 4-10
HANDOFF FROM SRMS TO SSRMS (NODE 2)	FS 4-12
MNVR FROM OBSS PRE-GRAPPLE TO PRE-CRADLE POSN	FS 4-19
 <u>REFERENCE DATA</u>	 FS 5-1
ELC-1 JOINT ANGLES VS POR COORDINATES	FS 5-2
COORDINATE SYSTEM – PL ID 3	FS 5-3
PRLA CONFIGURATION	FS 5-4
ELC-2 JOINT ANGLES VS POR COORDINATES	FS 5-5
COORDINATE SYSTEM – PL ID 4	FS 5-7
PRLA CONFIGURATION	FS 5-8
OBSS JOINT ANGLES VS POR COORDINATES	FS 5-9
 <u>CUE CARD CONFIGURATION</u>	 FS 6-1

This Page Intentionally Blank

ELC NOMINAL OPS

ELC-1 GRAPPLE	FS 1-3
UNBERTH	FS 1-6
UNGRAPPLE	FS 1-12
ELC-2 GRAPPLE	FS 1-15
UNBERTH	FS 1-18
UNGRAPPLE	FS 1-24

**ELC
NOMINAL OPS**

This Page Intentionally Blank

ELC-1 GRAPPLE

1. ELC-1 PRE-GRAPPLE

Mon 1	A
Mon 2	C
Dwnlnk	D

SM 94 PDRS CONTROL

√PL ID, ITEM 3: 0

√INIT ID, ITEM 24: 0

√SRMS at OBSS PRE-GRAPPLE posn:

X	Y	Z	PITCH	YAW	ROLL	PL ID
-680	+96	-513	270	350	1	0
SY	SP	EP	WP	WY	WR	
-90.0	+87.6	-129.5	-57.5	0.0	+110.4	

RHC

RATE – VERN (RATE MIN tb-ON)

BRAKES – OFF (tb-OFF)

MODE – as desired

Maneuver to ELC-1 PRE-GRAPPLE posn (within 1"/1°):

X	Y	Z	PITCH	YAW	ROLL	PL ID
-1029	+15	-545	270	0	181	0
SY	SP	EP	WP	WY	WR	
-25.6	+60.6	-81.1	-78.3	+17.7	+227.3	



CCTV A (0,20)



CCTV B (10,10)

2. ELC-1 GRAPPLE

A7U

Mon 1	A(D)
Mon 2	B(C)
Dwnlnk	EE

CCTV – config for grapple

– install PDRS TARGET OVERLAY FOR CTVM

– RMS WRIST, zoom 34.0 HFOV

focus 5 ft

Maintain eyepoint ~18 in when using grapple overlay

RATE – VERN (RATE MIN tb-ON)
 BRAKES – OFF (tb-OFF)
 MODE – END EFF, ENTER

Mnvr to grapple envelope

CAUTION
 Monitor EE tb timing to prevent EE motor burnout

SM 169 PDRS STATUS

EE MODE – AUTO
 CAPTURE sw – depress (mom)

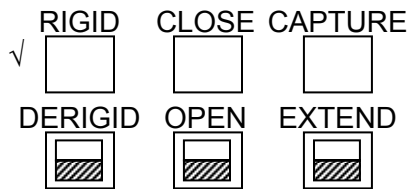

CRITICAL TIMES (28 sec total):
 CAPTURE tb – gray, then
 CLOSE tb – gray, 3 sec max, then
 RIGID tb – gray, 25 sec max

- * If manual grapple reqd: *
- * EE MODE – MAN *
- * CAPTURE sw – depress (hold until CLOSE tb-gray, 3 sec max) *
- * MAN CONTR – RIGID (hold until RIGID tb-gray, 25 sec max) *

EE MODE – OFF
 BRAKES – ON (tb-ON)

PARAM – PORT TEMP
 JOINT – CRIT TEMP

SM 94 PDRS CONTROL

PL ID – ITEM 3 +3 EXEC
 INIT ID – ITEM 24 +3 EXEC

Record POS/ATT and Joint Angles:

	X	Y	Z	PITCH	YAW	ROLL	PL ID
							3
Expected	-945	0	-414	0	0	0	3
	SY	SP	EP	WP	WY	WR	
Expected	-21.6	+54.3	-90.9	-60.8	+18.1	+222.7	

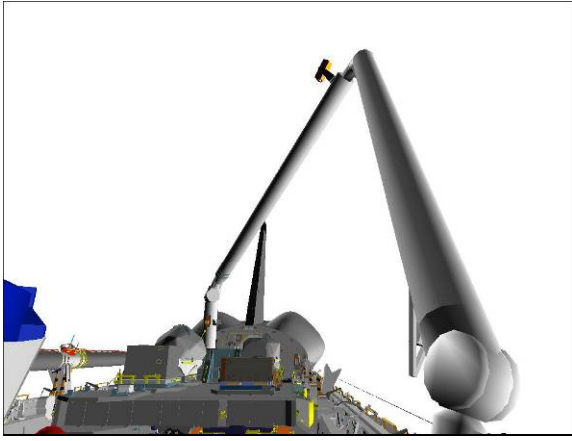

CCTV A (0,20)

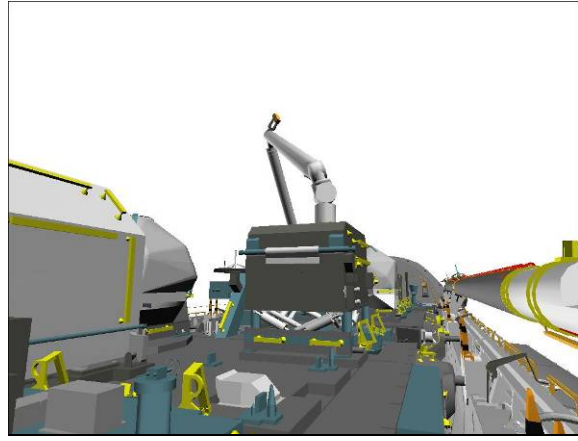

CCTV B (-20,10)

ELC-1 UNBERTH

I

- A7U 1. SETUP
CCTV – config for unberth

Mon 1	B
Mon 2	S1 LOOB
DwnInk	Elbow(A)
DTV	Mux A & D

Review GENERIC END EFFECTOR CUE CARD – ISS/SHUTTLE DOCKED OPS

SM 94 PDRS CONTROL

- √PL ID, ITEM 3: 3
√INIT ID, ITEM 24: 3

√BRAKES – ON (tb-ON)

PCS MSS: SSRMS: Thrusters: Thruster Controls for MSS Ops

Verify 'Desat Request:' – Inh

- * If using Shuttle attitude control, verify in attitude; *
- * then DAP: FREE *

Notify SSRMS Operator that ELC-1 Unberth is in work

2. ROEU RELEASE
2.1 Deadfacing ROEU

NOTE

When LOGIC switches taken OFF, KU will mode to standby.
MPM and MRL tbs – bp

MA73C:A MCA LOGIC MNC MID 2 – OFF
:B MNB MID 4 – OFF

NOTE

Expect 'S200 APCU 1(2) TRIP' msgs

R1 PL PRI MNC – OFF (tb-OFF)
√MNB,FC3 (two) – ctr (tb-OFF)

A6U √ROEU A6U PANEL OVERLAY installed

√PL RETEN LAT (five) – OFF
PL SEL – 2

SM 97 PL RETENTION

CRT √REL 1,2 (four): 0

- * If LATCH 1,2 REL msw shows 1, *
- * drive latch for single motor time *

A6U

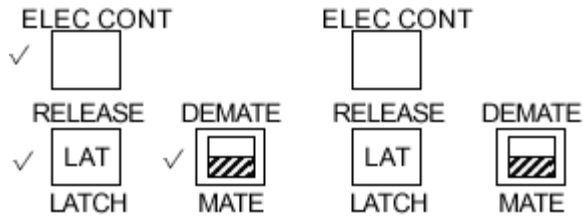

2.2 Activating ROEU

R13L

PL RETEN LOGIC PWR SYS 1,2 (two) – ON
BAY MECH PWR SYS 1,2 (two) – ON

2.3 Releasing Latches

Note single motor time (> 20 sec)

A6U

ELC-1 RELEASE/LATCH – REL (tb-REL), 40 sec max
– OFF

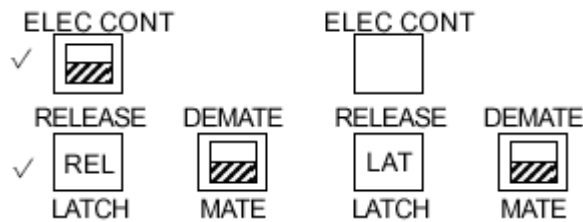

2.4 Demating ROEU

Note single motor time (> 18 sec)

ELC-1 DEMATE/MATE – DEMATE (tb-REL), 36 sec max
– OFF

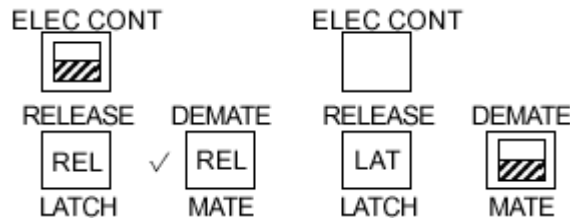

2.5 Deactivating ROEU

R13L

PL RETEN LOGIC PWR SYS 1,2 (two) – OFF
BAY MECH PWR SYS 1,2 (two) – OFF

A6U

Remove ROEU A6U PANEL OVERLAY

3. ACTIVATE LATCHES

√PL RETEN LAT(five) – OFF
PL SEL – 1

R13L BAY MECH PWR SYS 1,2 (two) – ON
A6U RETEN LOGIC PWR SYS 1,2 (two) – ON

CRT

√PL SEL 1 RDY-FOR-LAT 1,2,3,4 (eight): 1
√LAT 1,2,3,4 (eight): 1

- * If any rel msw shows '1', *
- * expect single motor time (60 sec) *

4. PRLA RELEASE
 A6U √PL RETEN LAT 1,2,3,4 (four) tb – LAT
 √RDY 1,2,3,4 (four) tb – gray

Note single motor times (> 30 sec)

PL RETEN LAT 1,2 (two) – REL (tb-REL), 60 sec max
 – OFF
 3,4 (two) – REL (tb-REL), 60 sec max
 – OFF

5. DEACTIVATE LATCHES
 R13L PL RETEN LOGIC PWR SYS 1,2 (two) – OFF
 BAY MECH PWR SYS 1,2 (two) – OFF

R1 PL PRI MNC – ON (tb-ON)

MA73C:A MCA LOGIC MNC MID 2 – ON
 :B MNB MID 4 – ON

6. MNVR TO ELC-1 HOVER POSN

NOTE

Monitor clearances between STBD trunnions and OBSS during unberth. Minimum clearance of approximately 3.4 inches expected

RATE – VERN (RATE MIN tb-ON)
 BRAKES – OFF (tb-OFF)
 MODE – ORB LD, ENTER

Mnvr ELC-1 up until Z = -582

- A6U √PL RETEN RDY 1,2,3,4 tb (four) – bp

NOTE

Maximum allowable translational rate in the V-guides is 0.023 ft/sec

Mnvr to ELC-1 HOVER posn:

X	Y	Z	PITCH	YAW	ROLL	PL ID
-945	0	-582	0	0	0	3
SY	SP	EP	WP	WY	WR	
-29.1	+61.4	-66.8	-94.3	+17.0	+230.4	

BRAKES – ON (tb-ON)

- * If using Shuttle attitude control and attitude maintenance reqd: *
- * DAP: LVLH *
- * When rates damped *
- * DAP: FREE > 2 sec *
- * DAP: AUTO *
- * When in attitude and rates damped: *
- * DAP: FREE *

7. MNVR TO ELC-1 INTERMEDIATE POSN

Mon 1	B
Mon 2	C
DwnInk	A
DTV	S1 LOOB

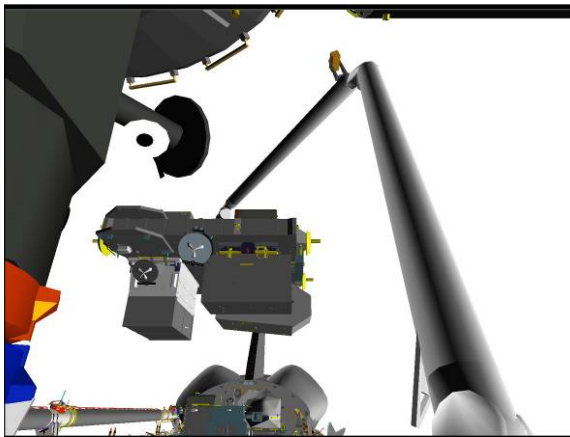

CCTV A (0,30)

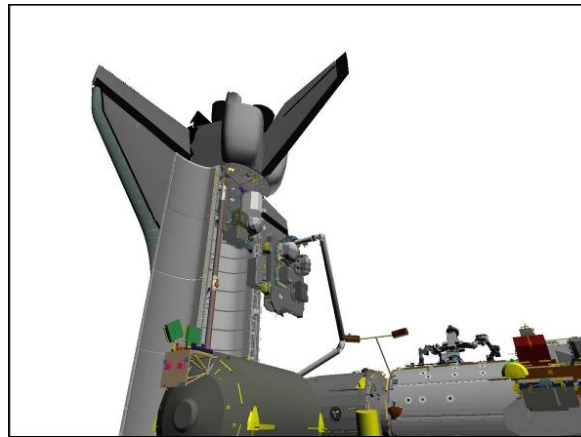

S1 LOOB (60,30)

SM 94 PDRS CONTROL
 END POS – ITEM 18 (-) 1 1 0 (-) 3 5 0 (-) 6 5 0 EXEC
 ATT – ITEM 21 +3 5 0 +3 0 0 +3 0 0 EXEC
 CMD CK – ITEM 25 EXEC (GOOD)

SM 94 PDRS CONTROL
 POR DISPLAY: ITEM 30 EXEC (REL)

RHC RATE – as reqd (VERN within 10 ft)

NOTE

COARSE rates are allowed once POR Y position value reaches -190 inches (REL: +160)

BRAKES – OFF (tb-OFF)
 MODE – OPR CMD, ENTER (READY It on)

┌ After PROCEED, if motion no longer apparent but POR is within ┐
 ┌ 1 in/1 deg and IN PROG It – on: ┐
 └ AUTO SEQ – STOP ┘

AUTO SEQ – PROCEED (IN PROG It on)

When AUTO SEQ IN PROG It – off:
 BRAKES – ON (tb-ON)

ELC-1 INTERMEDIATE posn: ~6 min

	X	Y	Z	PITCH	YAW	ROLL	PL ID
√	-1110	-350	-650	350	300	300	3
	SY	SP	EP	WP	WY	WR	
√	+4.8	+64.2	-53.0	-43.5	+34.0	+105.1	

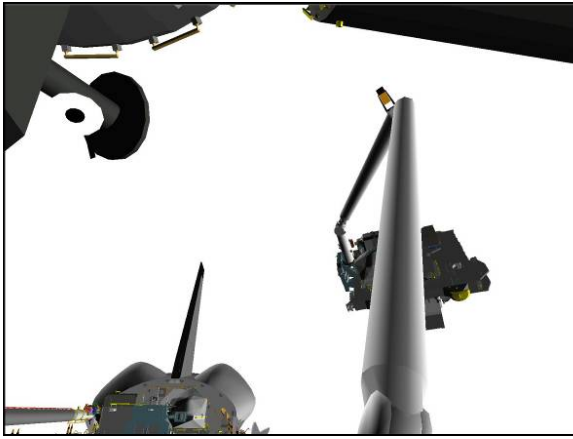

CCTV A (10,27)

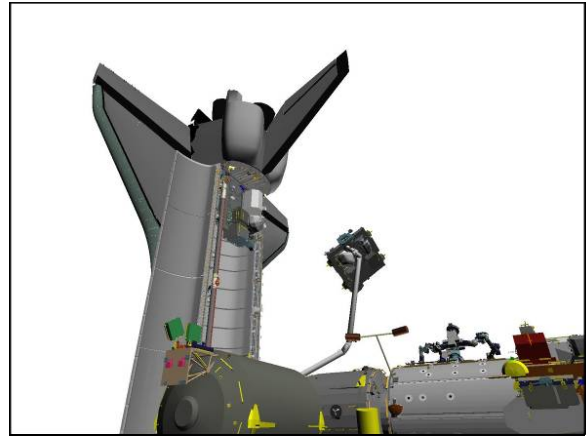

S1 LOOB (60,30)

- * If using Shuttle attitude control and attitude maintenance reqd: *
- * DAP: LVLH *
- * When rates damped *
- * DAP: FREE > 2 sec *
- * DAP: AUTO *
- * When in attitude and rates damped: *
- * DAP: FREE *

8. MNVR TO ELC-1 HANDOFF POSN

Mon 1	A
Mon 2	B
DwnInk	P1 LOOB
DTV	Elbow

SM 94 PDRS CONTROL

END POS – ITEM 18 (-) 9 3 9 (-) 5 8 1 (-) 7 2 8 EXEC
 ATT – ITEM 21 +2 8 6 +3 5 6 +2 9 1 EXEC
 CMD CK – ITEM 25 EXEC (GOOD)

RHC

RATE – as reqd (VERN within 10 ft)

NOTE

COARSE rates are allowed until POR Y position value reaches -543 inches (REL: +38)

BRAKES – OFF (tb-OFF)

MODE – OPR CMD, ENTER (READY It on)

After PROCEED, if motion no longer apparent but POR is within 1 in/1 deg and IN PROG It – on:
 AUTO SEQ – STOP

AUTO SEQ – PROCEED (IN PROG It on)

When AUTO SEQ IN PROG It – off:

BRAKES – ON (tb-ON)

ELC-1 HANDOFF posn:

~5:15 min

X	Y	Z	PITCH	YAW	ROLL	PL ID
-939	-581	-728	286	356	291	3
SY	SP	EP	WP	WY	WR	
+42.7	+58.2	-36.2	-0.2	+65.0	+20.3	

SM 94 PDRS CONTROL

POR DISPLAY: ITEM 30 EXEC (ORB)

- * If using Shuttle attitude control and attitude maintenance reqd: *
- * DAP: LVLH *
- * When rates damped *
- * DAP: FREE > 2 sec *
- * DAP: AUTO *

Give SSRMS Operator GO for ELC-1 Grapple Mnvr

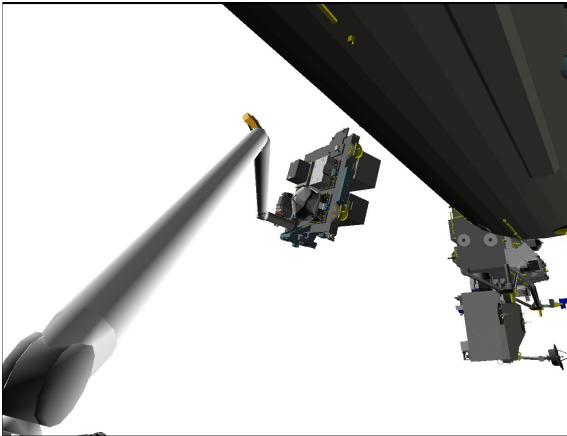

CCTV A (50,20)

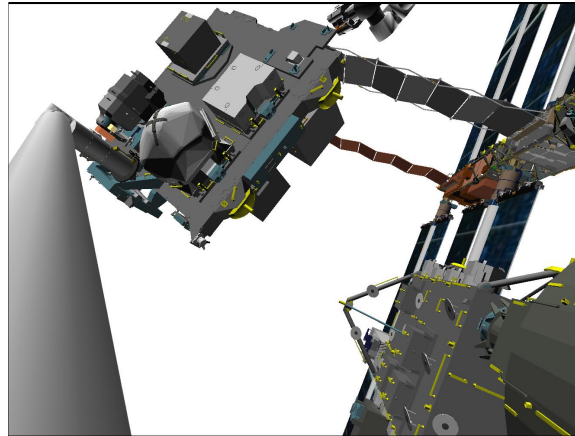

ELBOW (30,-20)

ELC-1 UNGRAPPLE

I

1. SETUP

A7U

Mon 1	A
Dwnlnk	EE
Mon 2	B
DTV	C

CCTV – RMS WRIST, zoom 34.0 HFOV
focus 5 ft

SM 94 PDRS CONTROL

PL ID – ITEM 3 +0 EXEC
INIT ID – ITEM 24 +0 EXEC

2. ELC-1 UNGRAPPLE

On SSRMS Operator GO for ELC-1 Ungrapple

NOTE

CONTR ERR It and 'S96 PDRS CNTL' msg may occur due to Consistency/Envelope Check error

RATE – COARSE (RATE MIN tb-OFF)

SM 94 PDRS CONTROL

AUTO BRAKE INH – ITEM 10 EXEC (*)

BRAKES – OFF (tb-OFF)

MODE – TEST, ENTER

Wait 5 sec

BRAKES – ON (tb-ON)

SM 94 PDRS CONTROL

AUTO BRAKE ENA – ITEM 9 EXEC (*)

RATE – VERN (RATE MIN tb-ON)

BRAKES – OFF (tb-OFF)

MODE – END EFF, ENTER

CAUTION

Monitor EE tb timing to prevent EE motor burnout

SM 169 PDRS STATUS

EE MODE – AUTO

RELEASE sw – depress (mom)

Mnvr clear of grapple pin

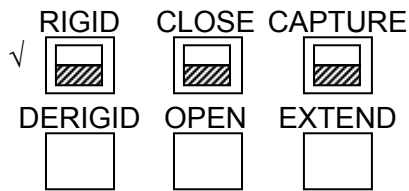

CRITICAL TIMES (28 sec total):
 DERIGID tb – gray, 5 sec max, then
 OPEN tb – gray, 3 sec max, then
 EXTEND tb – gray, 20 sec max

EE MODE – OFF

- * If manual release required: *
- * EE MODE – MAN *
- * MAN CONTR – DERIGID (hold until DERIGID tb-gray, 5 sec max) *
- * RELEASE sw – depress (hold until OPEN tb-gray, 3 sec max) *
- * *
- * Mnvr arm clear, then *
- * EE MAN CONTR – DERIGID (hold until EXTEND tb-gray, 20 sec max) *
- * MODE – OFF *

NOTE

Drive to ELC-1 BACKOFF posn through WY SINGULARITY

Mnvr to ELC-1 BACKOFF posn:

X	Y	Z	PITCH	YAW	ROLL	PL ID
-1002	-419	-670	207	69	169	0
SY	SP	EP	WP	WY	WR	
+26.0	+68.7	-57.2	+42.1	+78.8	-12.9	

Mon 1	A
Mon 2	B
DwnInk	Elbow

MODE – SINGLE, ENTER

Mnvr to SINGULARITY AVOIDANCE posn:

ELC-1
Backoff
1: WY –
Singularity
Avoidance

SY	SP	EP	WP	WY	WR	
+26.0	+68.7	-57.2	+42.1	+78.8	-12.9	
				+74.0		
+26.0	+68.7	-57.2	+42.1	+74.0	-12.9	
X	Y	Z	PITCH	YAW	ROLL	PL ID
-1004	-421	-674	201	73	175	0

BRAKES – ON (tb-ON)

√MODE – not DIRECT (It off)

PARAM – PORT TEMP

JOINT – CRIT TEMP

Give SSRMS Operator GO for ELC-1 Mnvr to Install

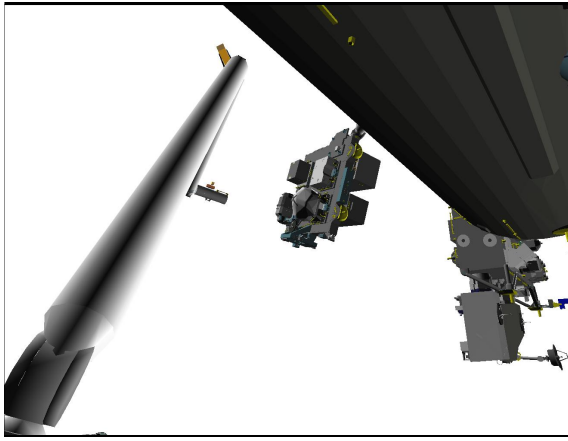

CCTV A (50,20)

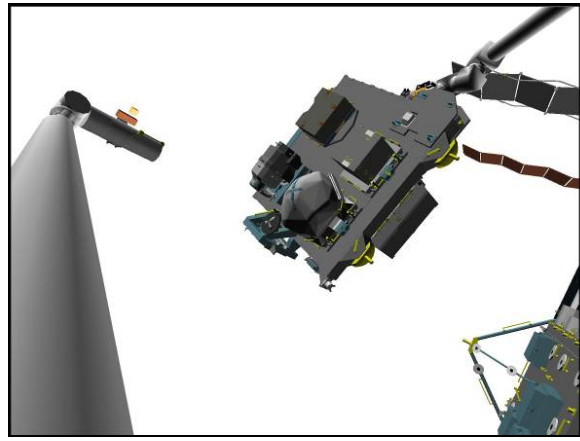

ELBOW (30,-20)

ELC-2 GRAPPLE

1. ELC-2 PRE-GRAPPLE

Mon 1	A
Mon 2	B
Dwnlnk	S1 LOOB
DTV	C

SM 94 PDRS CONTROL

√ PL ID, ITEM 3: 0

√ INIT ID, ITEM 24: 0

√ SRMS at SINGULARITY AVOIDANCE posn:

X	Y	Z	PITCH	YAW	ROLL	PL ID
-1004	-421	-674	201	73	175	0
SY	SP	EP	WP	WY	WR	
+26.0	+68.7	-57.2	+42.1	+74.0	-12.9	

RHC RATE – VERN (RATE MIN tb-ON)
BRAKES – OFF (tb-OFF)

MODE – SINGLE, ENTER

Mnvr to INTERMEDIATE PRE-GRAPPLE posn:

Singularity
Avoidance
1: SP –
Intermediate
Pre-grapple

SY	SP	EP	WP	WY	WR	
+26.0	+68.7	-57.2	+42.1	+74.0	-12.9	
	+55.0					
+26.0	+55.0	-57.2	+42.1	+74.0	-12.9	
X	Y	Z	PITCH	YAW	ROLL	PL ID
-1063	-414	-569	213	74	150	0

BRAKES – ON (tb-ON)

SM 94 PDRS CONTROL

END POS – ITEM 18 (-) 1 1 0 5 (-) 1 5 (-) 5 4 5 EXEC

ATT – ITEM 21 + 2 7 0 + 0 + 0 EXEC

CMD CK – ITEM 25 EXEC (GOOD)

SM 94 PDRS CONTROL

POR DISPLAY: ITEM 30 EXEC (REL)

RHC RATE – as reqd (VERN within 10 ft)
BRAKES – OFF (tb-OFF)
MODE – OPR CMD, ENTER (READY It on)

AUTO SEQ – PROCEED (IN PROG It on)

When AUTO SEQ IN PROG It – off:

BRAKES – ON (tb-ON)

SM 94 PDRS CONTROL

POR DISPLAY: ITEM 30 EXEC (ORB)

ELC-2 PRE-GRAPPLE posn:

~1 min

√	X	Y	Z	PITCH	YAW	ROLL	PL ID
	-1105	-15	-545	270	0	0	0
√	SY	SP	EP	WP	WY	WR	
	-18.1	+47.1	-57.7	-85.6	+18.6	+38.7	

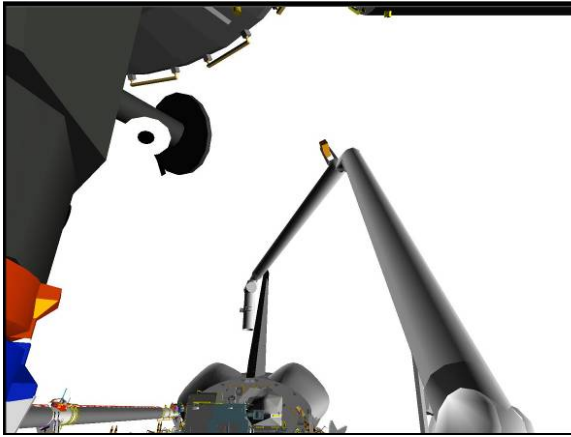

CCTV A (0,27)

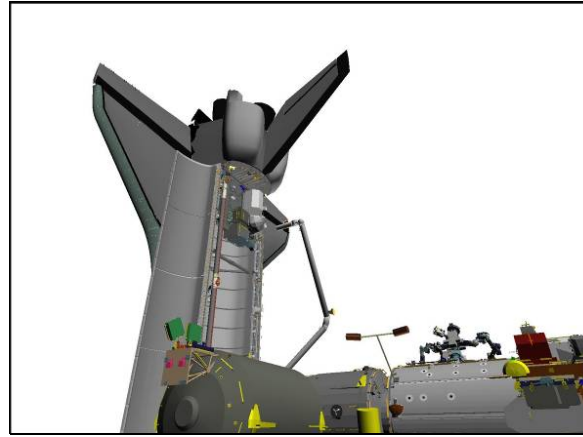

S1 LOOB (60,30)

2. ELC-2 GRAPPLE

A7U

Mon 1	A(D)
Mon 2	EE
Dwnlnk	S1 LOOB
DTV	C(B)

CCTV – config for grapple

- install PDRS TARGET OVERLAY FOR CTVM
- RMS WRIST, zoom 34.0 HFOV
focus 5 ft

Maintain eyepoint ~18 in when using grapple overlay

- RATE – VERN (RATE MIN tb-ON)
- BRAKES – OFF (tb-OFF)
- MODE – END EFF, ENTER

Mnvr to grapple envelope

CAUTION
Monitor EE tb timing to prevent EE motor burnout

SM 169 PDRS STATUS

EE MODE – AUTO

CAPTURE sw – depress (mom)

RIGID	CLOSE	CAPTURE
√ <input type="checkbox"/>	<input type="checkbox"/>	<input type="checkbox"/>
DERIGID	OPEN	EXTEND
<input type="checkbox"/>	<input type="checkbox"/>	<input type="checkbox"/>

CRITICAL TIMES (28 sec total):

- CAPTURE tb – gray, then
- CLOSE tb – gray, 3 sec max, then
- RIGID tb – gray, 25 sec max

- * If manual grapple reqd: *
- * EE MODE – MAN *
- * CAPTURE sw – depress (hold until CLOSE tb-gray, 3 sec max) *
- * MAN CONTR – RIGID (hold until RIGID tb-gray, 25 sec max) *

EE MODE – OFF
 BRAKES – ON (tb-ON)

SM 94 PDRS CONTROL
 PL ID – ITEM 3 +4 EXEC
 INIT ID – ITEM 24 +4 EXEC

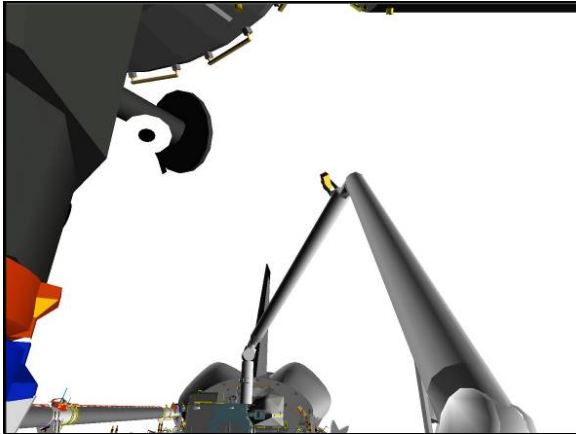

CCTV A (0,27)

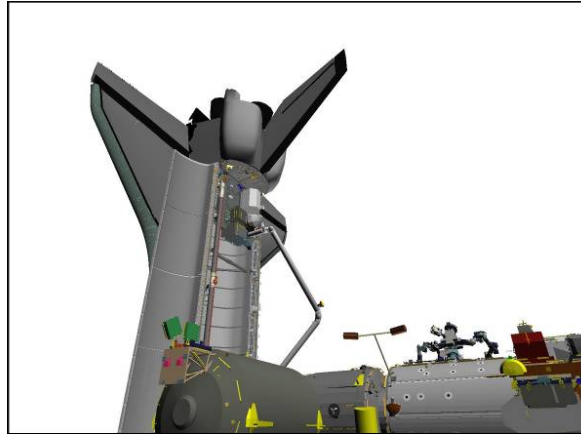

S1 LOOB (60,30)

Record POS/ATT and Joint Angles:

	X	Y	Z	PITCH	YAW	ROLL	PL ID
							4
Expected	-1189	0	-414	0	0	0	4
	SY	SP	EP	WP	WY	WR	
Expected	-14.5	+42.7	-68.7	-69.1	+18.8	+35.3	

Review GENERIC END EFFECTOR CUE CARD – ISS/SHUTTLE DOCKED OPS

ELC-2 UNBERTH

I

- A7U 1. SETUP
CCTV – config for unberth

Mon 1	B
Mon 2	Elbow
DwnInk	Lab Stbd Zenith
DTV	Mux A & D

SM 94 PDRS CONTROL

- √PL ID, ITEM 3: 4
- √INIT ID, ITEM 24: 4
- √BRAKES – ON (tb-ON)

PCS MSS: SSRMS: Thrusters: **Thruster Controls for MSS Ops**

Verify 'Desat Request:' – Inh

- * If using Shuttle attitude control, verify in attitude; *
- * then DAP: FREE *

Notify SSRMS operator that ELC-2 Unberth is in work

2. ROEU RELEASE
2.1 Deadfacing ROEU

NOTE

When LOGIC switches taken OFF, KU will mode to standby.
MPM and MRL tbs – bp

MA73C:A MCA LOGIC MNC MID 2 – OFF
:B MNB MID 4 – OFF

NOTE

Expect 'S200 APCU 1(2) TRIP' msgs

R1 PL PRI MNC – OFF (tb-OFF)
√MNB,FC3 (two) – ctr (tb-OFF)

A6U Install ROEU A6U PANEL OVERLAY

- √PL RETEN LAT (five) – OFF
- PL SEL – 2

SM 97 PL RETENTION

CRT √REL 3,4 (four): 0

- * If LATCH 3,4 REL msw shows 1, *
- * drive latch for single motor time *

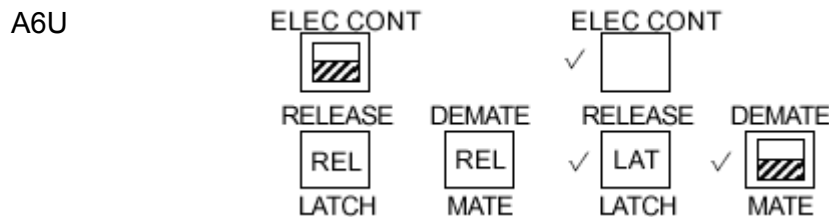

A6U
R13L

2.2 Activating ROEU
 PL RETEN LOGIC PWR SYS 1,2 (two) – ON
 BAY MECH PWR SYS 1,2 (two) – ON

2.3 Releasing Latches
 Note single motor time (> 20 sec)

A6U

ELC-2 RELEASE/LATCH – REL (tb-REL), 40 sec max
 – OFF

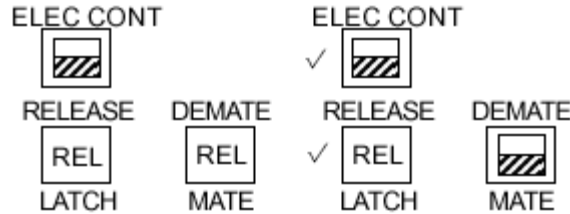

2.4 Demating ROEU
 Note single motor time (> 18 sec)

ELC-2 DEMATE/MATE – DEMATE (tb-REL), 36 sec max
 – OFF

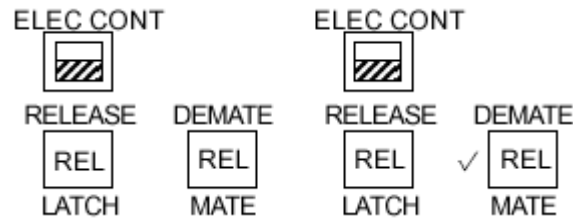

2.5 Deactivating ROEU
 PL RETEN LOGIC PWR SYS 1,2 (two) – OFF
 BAY MECH PWR SYS 1,2 (two) – OFF

R13L

A6U

Remove ROEU A6U PANEL OVERLAY

3. ACTIVATE LATCHES

√PL RETEN LAT(five) – OFF
 PL SEL – 3

R13L BAY MECH PWR SYS 1,2 (two) – ON
 A6U RETEN LOGIC PWR SYS 1,2 (two) – ON

CRT √PL SEL 3 RDY-FOR-LAT 1,2,3,4 (eight): 1
 √LAT 1,2,3,4 (eight): 1

- * If any rel msw shows '1', *
- * expect single motor time (60 sec) *

- A6U 4. PRLA RELEASE
 √PL RETEN LAT 1,2,3,4 (four) tb – LAT
 √RDY 1,2,3,4 (four) tb – gray

Note single motor times (> 30 sec)

PL RETEN LAT 1,2 (two) – REL (tb-REL), 60 sec max
 – OFF
 3,4 (two) – REL (tb-REL), 60 sec max
 – OFF

- R13L 5. DEACTIVATE LATCHES
 PL RETEN LOGIC PWR SYS 1,2 (two) – OFF
 BAY MECH PWR SYS 1,2 (two) – OFF

MA73C:A MCA LOGIC MNC MID 2 – ON
 :B MNB MID 4 – ON

6. MNVR TO ELC-2 HOVER POSN

CAUTION

Monitor clearances between STBD trunnions and OBSS during unberth with LAB CAM and LAB window. Minimum clearance of approximately 2.8 inches expected. Also, monitor clearance between aft bulkhead and PVGF which is a minimum of 10.6 inches with CCTV B and C

RATE – VERN (RATE MIN tb-ON)
 BRAKES – OFF (tb-OFF)
 MODE – ORB LD, ENTER

Mnvr ELC-2 up until Z = -570

- A6U √PL RETEN RDY 1,2,3,4 tb (four) – bp

NOTE

Maximum allowable translational rate in the V-guides is 0.023 ft/sec

Mnvr to ELC-2 HOVER posn

X	Y	Z	PITCH	YAW	ROLL	PL ID
-1189	0	-570	0	0	0	4
SY	SP	EP	WP	WY	WR	
-20.7	+45.5	-42.5	-100.2	+18.2	+42.0	

BRAKES – ON (tb-ON)

- * If using Shuttle attitude control and attitude maintenance reqd: *
- * DAP: LVLH *
- * When rates damped *
- * DAP: FREE > 2 sec *
- * DAP: AUTO *
- * When in attitude and rates damped: *
- * DAP: FREE *

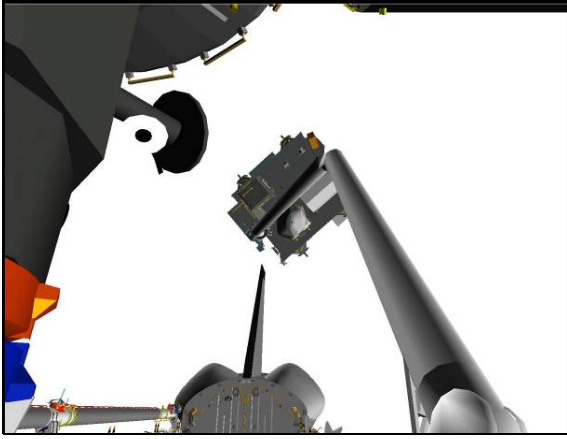

CCTV A (0,27)

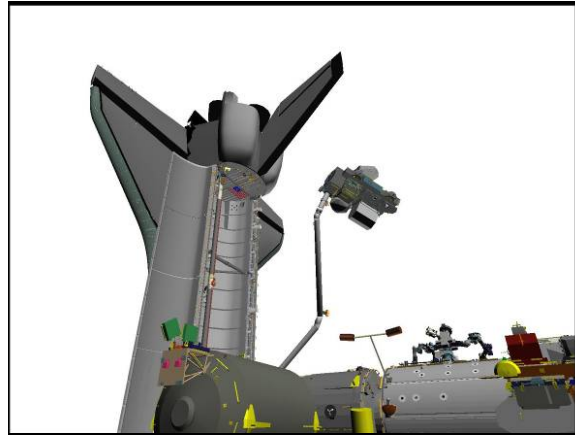

S1 LOOB (60,30)

8. MNVR TO ELC-2 HANDOFF POSN

Mon 1	A(Elbow)
Mon 2	D
DwnInk	S1 LOOB
DTV	B

SM 94 PDRS CONTROL

END POS – ITEM 18 (-) 9 0 0 (+) 3 7 5 (-) 7 6 0 EXEC
 ATT – ITEM 21 +1 9 7 +3 1 8 +3 3 EXEC
 CMD CK – ITEM 25 EXEC (GOOD)

SM 94 PDRS CONTROL

POR DISPLAY: ITEM 30 EXEC (REL)

RHC

RATE – as reqd (VERN within 10 ft)

NOTE

COARSE rates are allowed until POR Y position value reaches +311 inches (REL: -64). Monitor clearance between Node 2 and upper boom with Elbow Cam or SSRMS Tip Elbow

BRAKES – OFF (tb-OFF)

MODE – OPR CMD, ENTER (READY lt on)

┌ After PROCEED, if motion no longer apparent but POR is within ┌
 ┌ 1 in/1 deg and IN PROG lt – on: ┌
 ┌ AUTO SEQ – STOP ┌

AUTO SEQ – PROCEED (IN PROG lt on)

When AUTO SEQ IN PROG lt – off:

BRAKES – ON (tb-ON)

SM 94 PDRS CONTROL

POR DISPLAY: ITEM 30 EXEC (ORB)

ELC-2 HANDOFF posn:

~8 min

	X	Y	Z	PITCH	YAW	ROLL	PL ID
√	-900	+375	-760	197	318	33	4
	SY	SP	EP	WP	WY	WR	
√	-59.5	+29.3	-35.0	+54.0	-15.0	-91.8	

- * If using Shuttle attitude control and attitude maintenance reqd: *
- * DAP: LVLH *
- * When rates damped *
- * DAP: FREE > 2 sec *
- * DAP: AUTO *

Give SSRMS Operator GO for ELC-2 Grapple Mnv

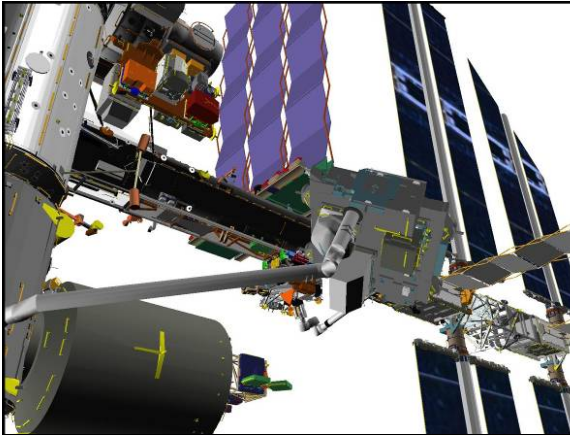

CCTV B (40,30)

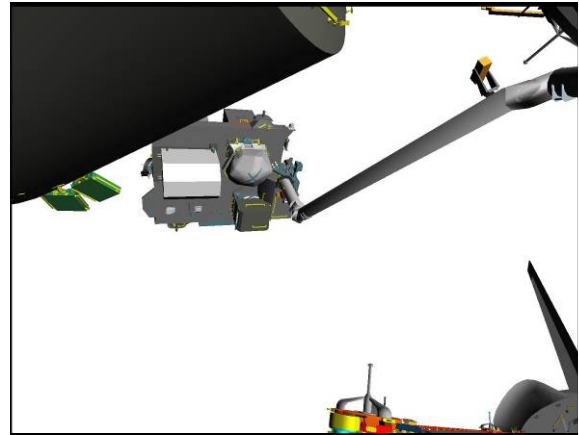

CCTV D (-30,30)

ELC-2 UNGRAPPLE

I

- A7U 1. SETUP
 CCTV – RMS WRIST, zoom 34.0 HFOV
 focus 5 ft

Mon 1	A
Mon 2	EE
Dwnlnk	D
DTV	B

SM 94 PDRS CONTROL
 PL ID – ITEM 3 +0 EXEC
 INIT ID – ITEM 24 +0 EXEC

2. ELC-2 UNGRAPPLE
On SSRMS Operator GO for ELC-2 Ungrapple

NOTE

CONTR ERR It and 'S96 PDRS CNTL' msg may occur due to Consistency/Envelope Check error

RATE – COARSE (RATE MIN tb-OFF)

SM 94 PDRS CONTROL
 AUTO BRAKE INH – ITEM 10 EXEC (*)

BRAKES – OFF (tb-OFF)

MODE – TEST, ENTER
 Wait 5 sec

BRAKES – ON (tb-ON)

SM 94 PDRS CONTROL
 AUTO BRAKE ENA – ITEM 9 EXEC (*)

RATE – VERN (RATE MIN tb-ON)
 BRAKES – OFF (tb-OFF)
 MODE – END EFF, ENTER

CAUTION
 Monitor EE tb timing to prevent EE motor burnout

SM 169 PDRS STATUS
 EE MODE – AUTO
 RELEASE sw – depress (mom)

Mnvr clear of grapple pin

RIGID <input checked="" type="checkbox"/>	CLOSE <input type="checkbox"/>	CAPTURE <input type="checkbox"/>
DERIGID <input type="checkbox"/>	OPEN <input type="checkbox"/>	EXTEND <input type="checkbox"/>

CRITICAL TIMES (28 sec total):
 DERIGID tb – gray, 5 sec max, then
 OPEN tb – gray, 3 sec max, then
 EXTEND tb – gray, 20 sec max

EE MODE – OFF

- * If manual release required: *
- * EE MODE – MAN *
- * MAN CONTR – DERIGID (hold until DERIGID tb-gray, 5 sec max) *
- * RELEASE sw – depress (hold until OPEN tb-gray, 3 sec max) *
- * *
- * Mnv'r arm clear, then *
- * EE MAN CONTR – DERIGID (hold until EXTEND tb-gray, 20 sec max) *
- * MODE – OFF *

Mnv'r to ELC-2 BACKOFF posn:

X	Y	Z	PITCH	YAW	ROLL	PL ID
-932	+244	-637	83	336	313	0
SY	SP	EP	WP	WY	WR	
-55.5	+42.0	-76.7	+83.8	-17.3	-88.8	

BRAKES – ON (tb-ON)

Give SSRMS Operator GO for ELC-2 Intermediate JOCAS

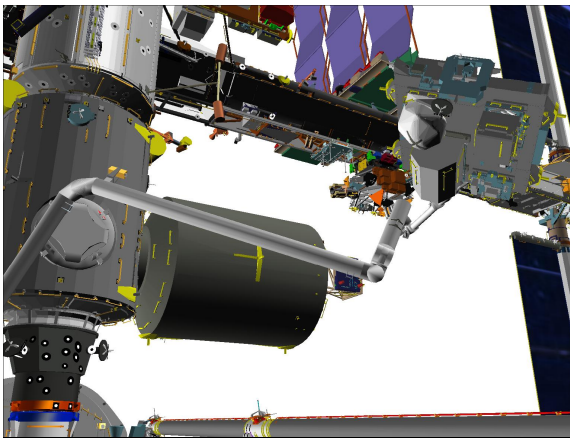

CCTV B (30,20)

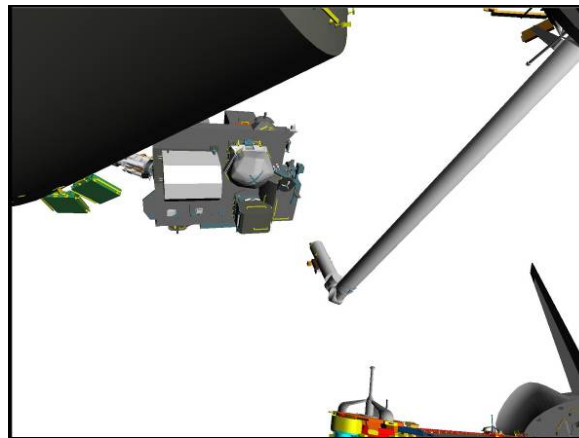

CCTV D (-30,30)

3. MNVR TO PRE-CRADLE POSN

Mon 1	A
Mon 2	B
Dwnlnk	D

SM 94 PDRS CONTROL

END POS – ITEM 18 (-)1 2 6 1 (-)1 4 6 (-)5 5 1 EXEC

ATT – ITEM 21 +5 +2 +0 EXEC

CMD CK – ITEM 25 EXEC (GOOD)

RHC

RATE – as reqd (VERN within 10 ft)

On SSRMS Operator GO for ELC-2 Install Viewing

BRAKES – OFF (tb-OFF)

MODE – OPR CMD, ENTER (READY It on)

After PROCEED, if motion no longer apparent but POR is within
 1 in/1 deg and IN PROG It – on:
 AUTO SEQ – STOP

AUTO SEQ – PROCEED (IN PROG It on)

When AUTO SEQ IN PROG It – off:

BRAKES – ON (tb-ON)

PRE-CRADLE posn:

~1.5 min

	X	Y	Z	PITCH	YAW	ROLL	PL ID
√	-1261	-146	-551	5	2	0	0
	SY	SP	EP	WP	WY	WR	
√	+0.0	+25.0	-25.0	+5.0	+0.0	+0.0	

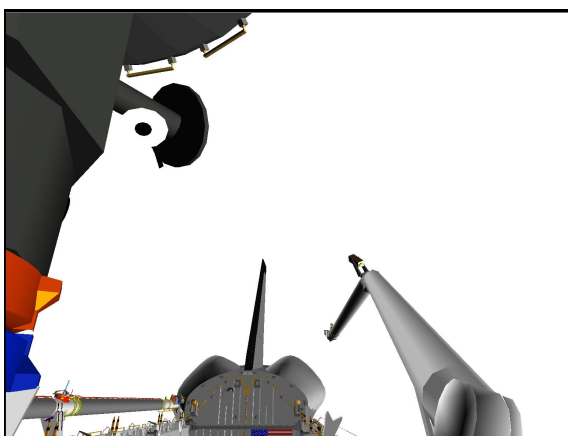

CCTV (0,25)

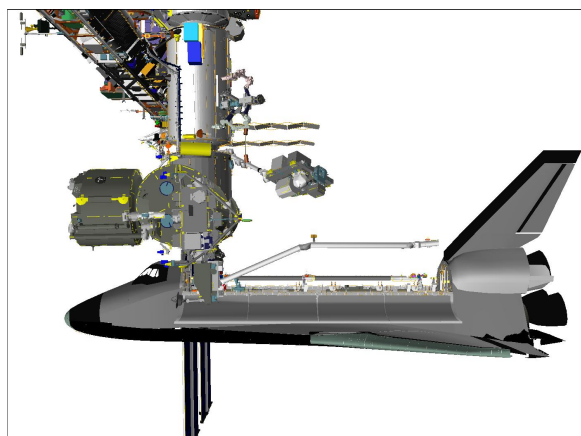

PORT

4. MNVR TO ELC-2 INSTALL VIEWING POSN

Mon 1	A
Mon 2	B
Dwnlnk	Elbow

RHC

RATE – as reqd (VERN within 10 ft)

BRAKES – OFF (tb-OFF)

MODE – SINGLE, ENTER

NOTE

Clearance between SRMS Upper Boom and JEM reduces to 53 inches.
 Use B, ELB CAM and PORT windows to monitor clearance. Expect
 WY SINGULARITY. Final position is near SY singularity

Mnvr to ELC-2 INSTALL VIEWING posn:

	SY	SP	EP	WP	WY	WR	
Pre-cradle	0.0	+25.0	-25.0	+5.0	0.0	0.0	
1: SP -		+20.0					
2: SY +	+174.5						
3: WP -				-27.9			
4: WY +					+106.0		
5: SP +		+25.0					
ELC-2 Install Viewing	+174.5	+25.0	-25.0	-27.9	+106.0	0.0	
	X	Y	Z	PITCH	YAW	ROLL	PL ID
	-166	-139	-546	72	298	26	0

- BRAKES – ON (tb-ON)
- √MODE – not DIRECT (lt off)
- PARAM – PORT TEMP
- JOINT – CRIT TEMP

Give SSRMS Operator GO to Mnvr to ELC-2 Install

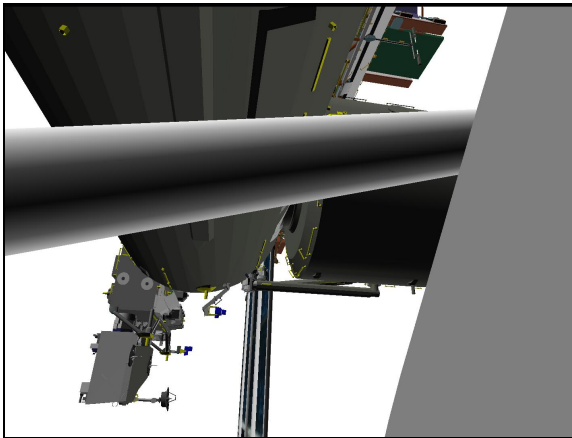

CCTV A (100,25)

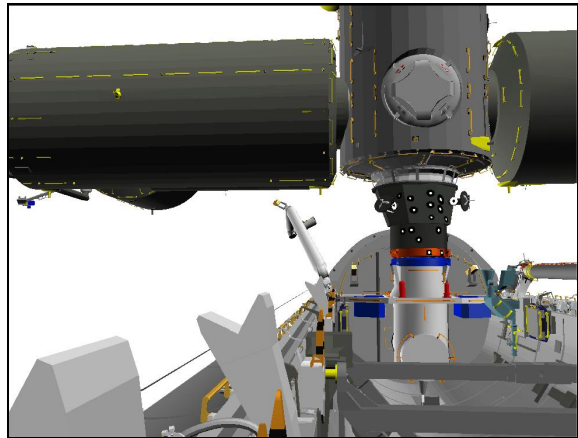

CCTV B (-5,5)

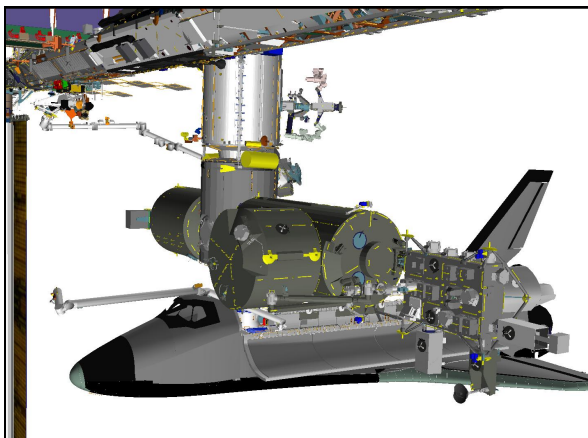

BIRD'S EYE

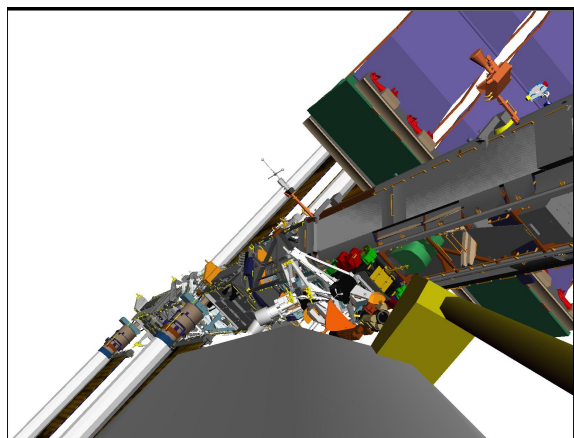

EE

5. MNVR TO PRE-CRADLE

Mon 1	A
DwnInk	B
Mon 2	Elbow

On SSRMS GO to Mnvr to Pre-cradle

RHC RATE – as reqd (VERN within 10 ft)
 BRAKES – OFF (tb-OFF)
 MODE – SINGLE, ENTER

NOTE

Clearance between SRMS Upper Boom and JEM starts at 53 inches and increases. Use B, ELB CAM and PORT windows to monitor clearance. Expect WY SINGULARITY. Starting position is near SY singularity

Mnvr to PRE-CRADLE posn:

ELC-2
 Install Viewing
 1: SP –
 2: WP +
 3: WY –
 4: SY –
 5: SP +
 Pre-cradle

SY	SP	EP	WP	WY	WR	
+174.5	+25.0	-25.0	-27.9	+106.0	0.0	
	+20.0					
			+5.0			
				0.0		
0.0						
	+25.0					
0.0	+25.0	-25.0	+5.0	0.0	0.0	
X	Y	Z	PITCH	YAW	ROLL	PL ID
-1261	-146	-551	5	2	0	0

BRAKES – ON (tb-ON)
 ✓MODE – not DIRECT (It off)
 PARAM – PORT TEMP
 JOINT – CRIT TEMP

ELC OFF-NOMINAL OPS

ELC-1 SJ GRAPPLE.....	FS 2-2
UNBERTH	FS 2-9
HANDOFF	FS 2-11
UNGRAPPLE	FS 2-15
ELC-2 SJ GRAPPLE.....	FS 2-18
UNBERTH	FS 2-25
HANDOFF	FS 2-28
UNGRAPPLE	FS 2-33

ELC
OFF-NOM OPS

ELC-1 SJ GRAPPLE

- A7U 1. ELC-1 MNVR TO PRE-GRAPPLE
 CCTV – perform PAN/TILT RESET
 – fully zoom out for SJ pictures

SM 94 PDRS CONTROL

- √PL ID, ITEM 3: 0
- √INIT ID, ITEM 24: 0

Mon 1	S1 LOOB
Dwnlnk	B(EE)
Mon 2	C
DTV	A(D)

RATE – as required (VERN within 10 ft)
 BRAKES – OFF (tb-OFF)
 MODE – best available

Mnvr to ELC-1 PREGRAPPLE posn:

	SY	SP	EP	WP	WY	WR	
Pre-cradle	0.0	+25.0	-25.0	+5.0	0.0	0.0	
1: SY –	-25.6						
2: SP +		+60.6					
3: EP –			-81.1				
4: WP –				-78.3			
5: WY +					+17.7		
6: WR +						+227.3	
ELC-1 Pregrapple	-25.6	+60.6	-81.1	-78.3	+17.7	+227.3	
	X	Y	Z	PITCH	YAW	ROLL	PL ID
	-1029	+15	-545	270	0	181	0

BRAKES – ON (tb-ON)
 MODE – not DIRECT

ELC
OFF-NOM OPS

Step 1:
Drive SY-
From 0 to -25.6

Step 2:
Drive SP+
From +25.0 to +60.6



CCTV A (-10,30)

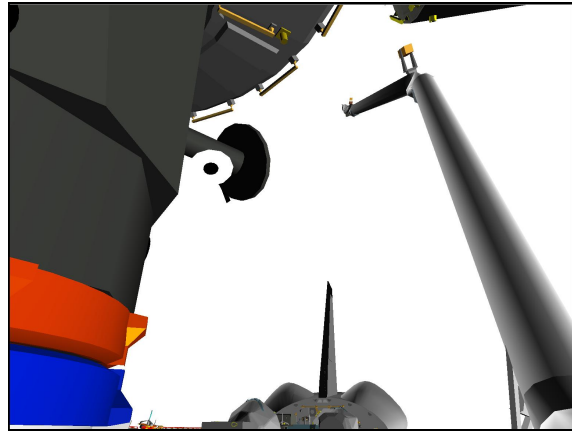

CCTV A (-10,30)

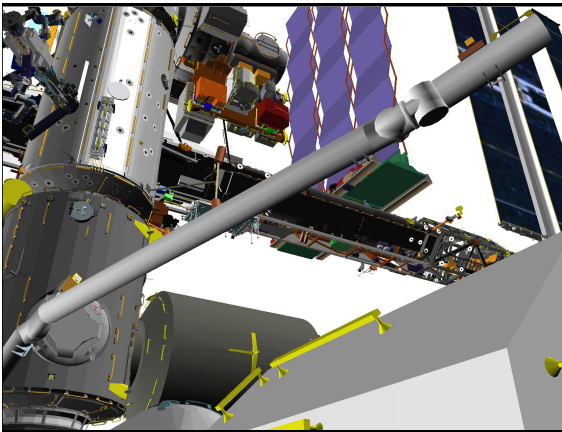

CCTV B (30,30)

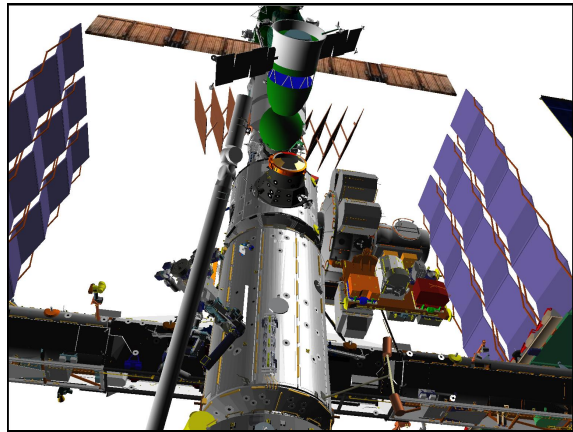

CCTV B (10,50)

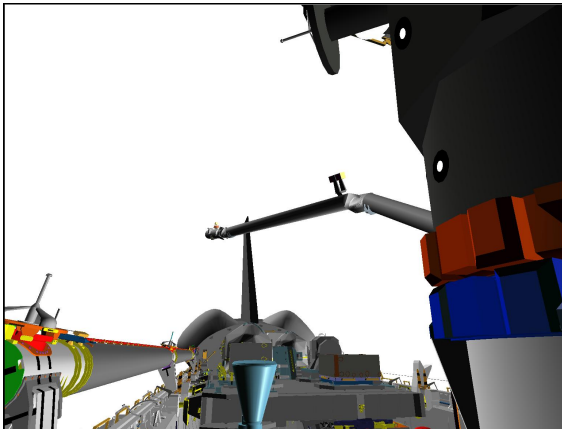

CCTV D (10,20)

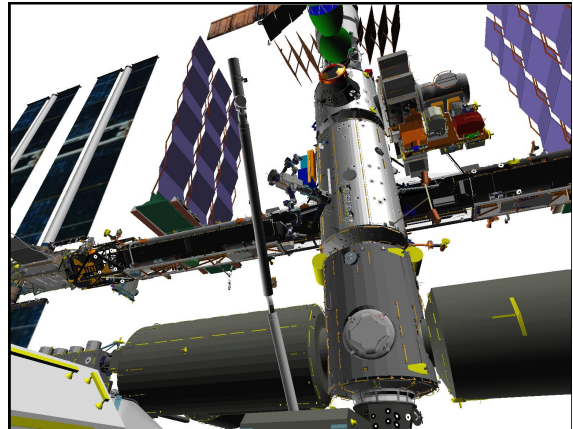

CCTV C (-20,35)

Step 3:
Drive EP-
From -25.0 to -81.1

Step 4:
Drive WP-
From +5.0 to -78.3



CCTV A (-10,30)



CCTV A (-10,30)

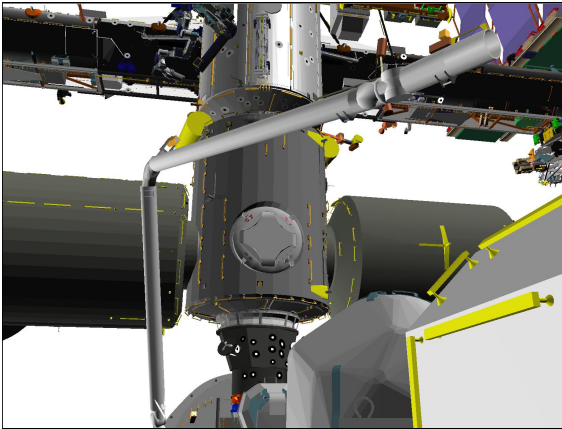

CCTV B (20,20)

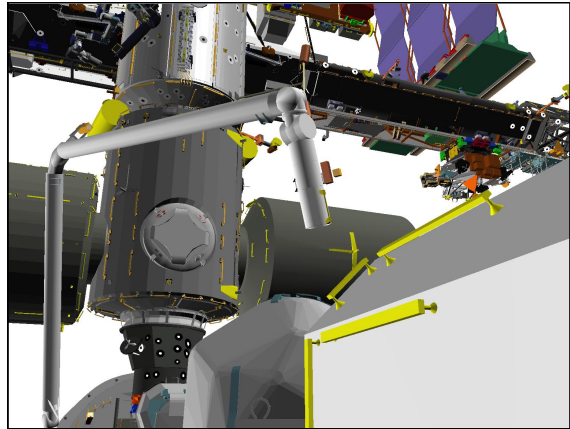

CCTV B (20,20)

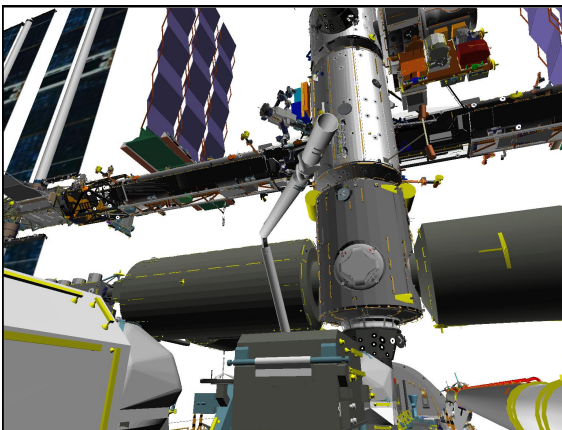

CCTV C (-20,25)

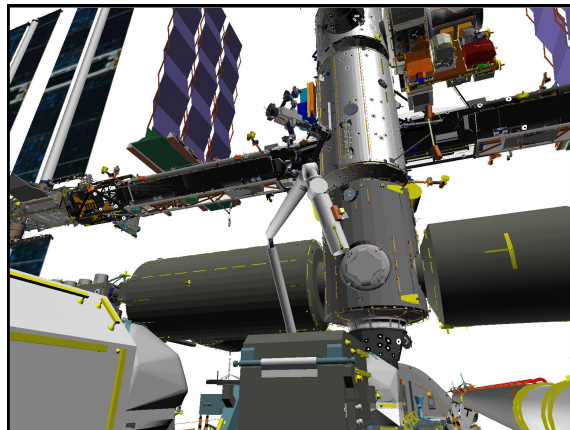

CCTV C (-20,25)

Step 5:
Drive WY+
From 0.0 to +17.7



CCTV A (-10,30)

Step 6:
Drive WR+
From 0.0 to +227.3



CCTV A (-10,30)

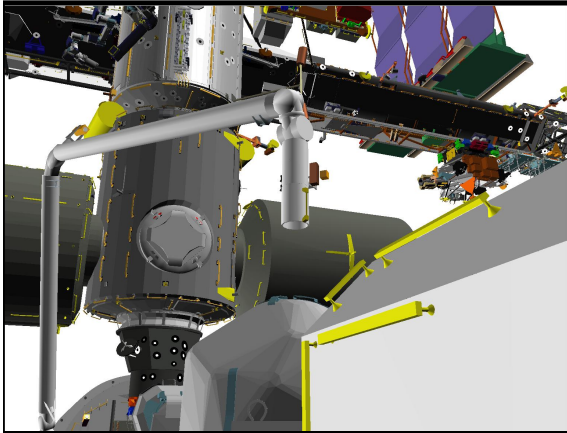

CCTV B (20,20)

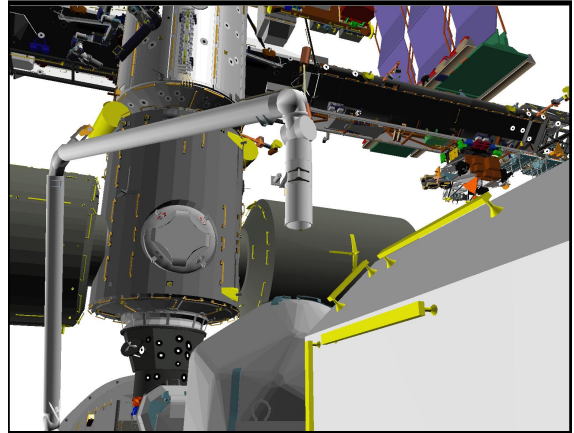

CCTV B (20,20)

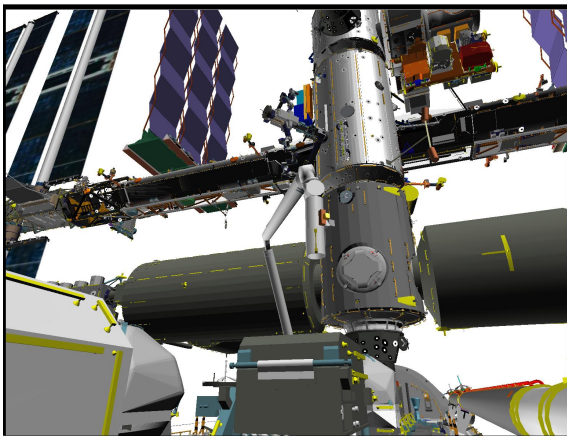

CCTV C (-20,25)

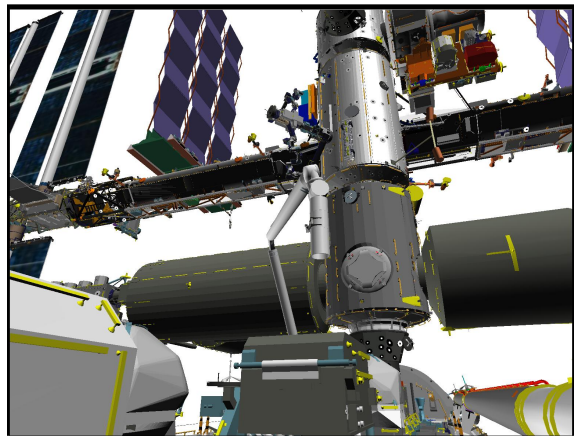

CCTV C (-20,25)

A7U

2. SJ MNVR TO ELC-1 GRAPPLE

CCTV – config for grapple

– install PDRS TARGET OVERLAY FOR CTVM

– RMS WRIST, ZOOM 34.0 HFOV

FOCUS 5 ft

Maintain eyepoint ~18 in when using grapple overlay

Mon 1	S1 LOOB
DwnInk	EE
Mon 2	A(C)
DTV	D

RATE – VERN (RATE MIN tb-ON)

BRAKES – OFF (tb-OFF)

MODE – best available

Drive joints per ELC-1 SJ GRAPPLE WRIST CCTV OVERLAY and diagram until EE within grapple envelope

ELC-1 SJ GRAPPLE

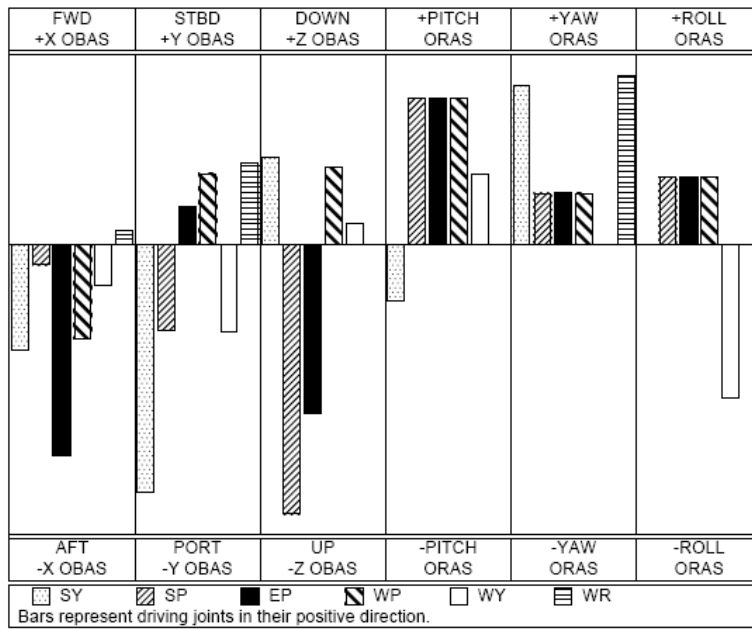

To get:	Drive:	To get:	Drive:	Driving:	Results In:	Driving:	Results In:
+X (fwd)	-EP, -WP	+PITCH	+WP, +EP	+SY	-Y (port), +YAW	+WP	-X (aft), +PITCH
+Y (stbd)	-SY, +WR	+YAW	+WR, +SY	+SP	-Z (up), +PITCH	+WY	-Y (port), -ROLL
+Z (down)	-SP, -EP	+ROLL	-WY, +WP	+EP	-X (aft), +PITCH	+WR	+Y (stbd), +YAW

ΔSY	ΔSP	ΔEP	ΔWP	ΔWY	ΔWR
+4.1	-6.4	-9.7	+17.4	+0.6	-4.3

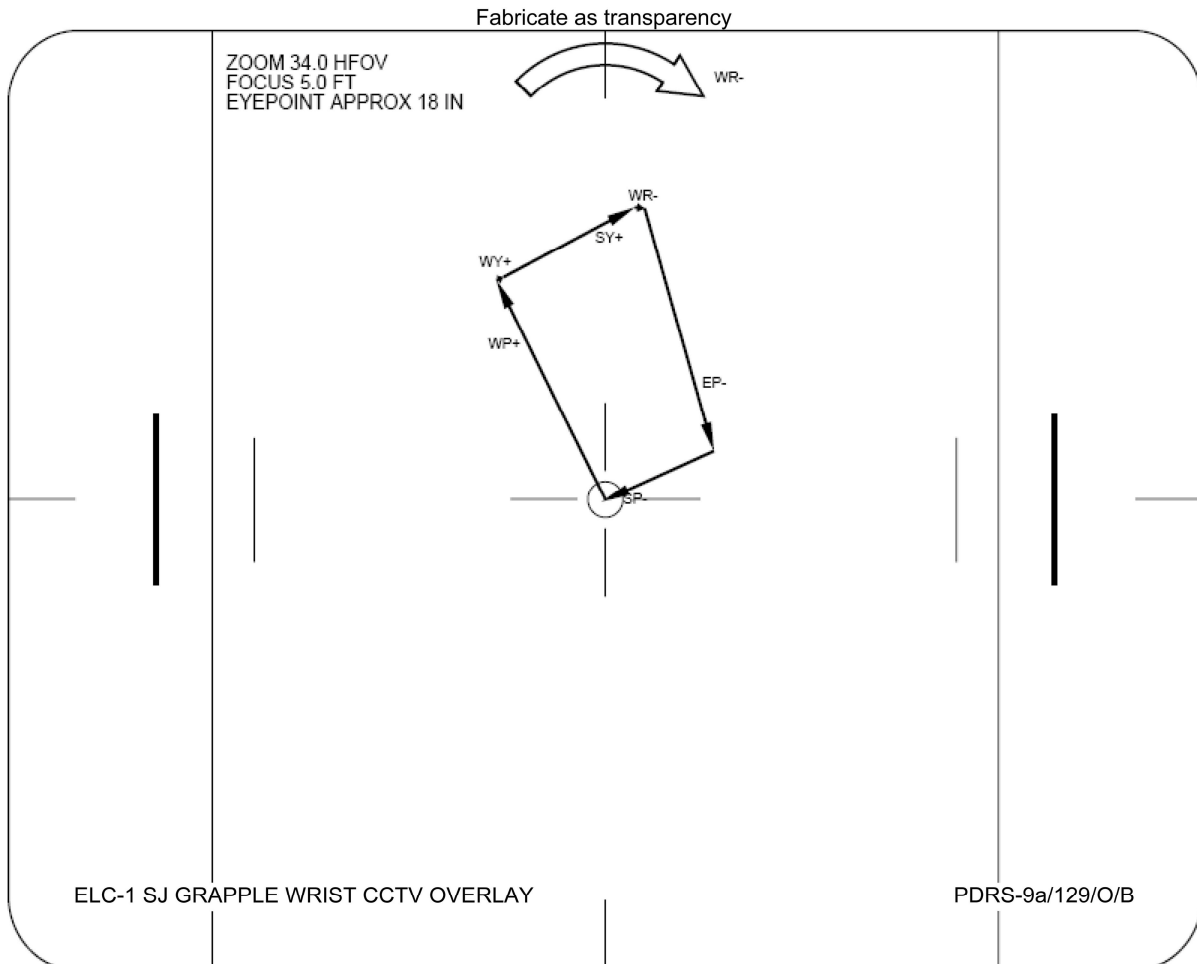

3. ELC-1 GRAPPLE

CAUTION
Monitor EE tb timing to prevent EE motor burnout

EE MODE – AUTO (if available)
CAPTURE sw – depress (mom)

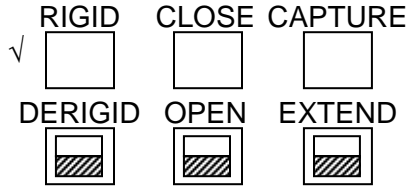

CRITICAL TIMES (28 sec total):
CAPTURE tb – gray, then
CLOSE tb – gray, 3 sec max, then
RIGID tb – gray, 25 sec max

- * If manual grapple reqd: *
- * EE MODE – MAN *
- * CAPTURE sw – depress (hold until CLOSE tb-gray, 3 sec max) *
- * MAN CONTR – RIGID (hold until RIGID tb-gray, 25 sec max) *

EE MODE – OFF

BRAKES – ON (tb-ON)
MODE – not DIRECT



CCTV A (-10,30)

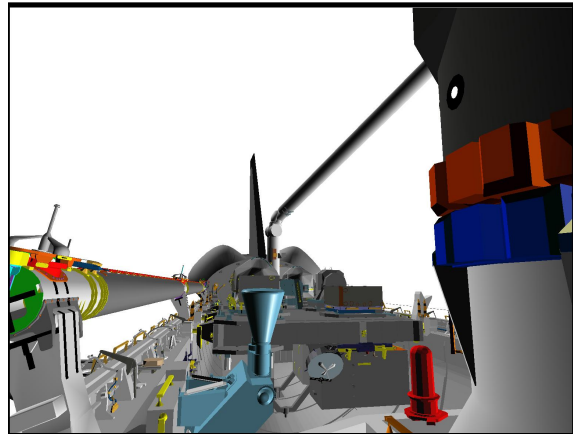

CCTV D (10,20)

SM 94 PDRS CONTROL
PL ID – ITEM 3 +3 EXEC
INIT ID – ITEM 24 +3 EXEC

Record POS/ATT and Joint Angles:

	X	Y	Z	PITCH	YAW	ROLL	PL ID
							3
Expected	-945	0	-414	0	0	0	
	SY	SP	EP	WP	WY	WR	
Expected	-21.6	+54.3	-90.9	-60.8	+18.1	+222.7	

Review GENERIC END EFFECTOR CUE CARD – ISS/SHUTTLE DOCKED OPS

ELC-1 SJ UNBERTH

1. SETUP
Perform ELC-1 UNBERTH, steps 1-5 (ELC NOMINAL OPS)
2. SJ MNVR TO CLEAR OF V-GUIDES
RATE – as required (VERN within 10 ft)
BRAKES – OFF (tb-OFF)
MODE – best available

Drive joints per ELC-1 SJ TOP OF V-GUIDES histogram until ELC-1 trunnions at top of V-guides (Z = -485)

ELC-1 SJ UNBERTH

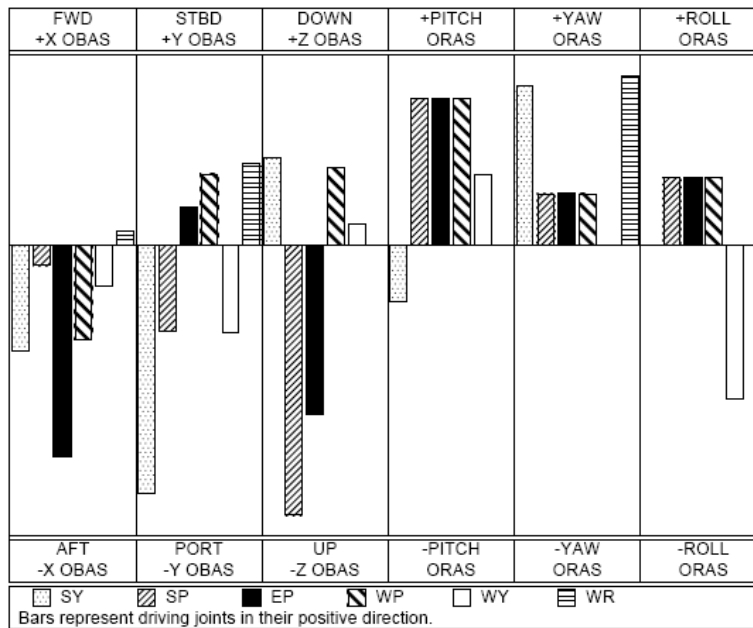

To get:	Drive:	To get:	Drive:
+X (fwd)	-EP, -WP	+PITCH	+WP, +EP
+Y (stbd)	-SY, +WR	+YAW	+WR, +SY
+Z (down)	-SP, -EP	+ROLL	-WY, +WP

Driving:	Results In:	Driving:	Results In:
+SY	-Y (port), +YAW	+WP	-X (aft), +PITCH
+SP	-Z (up), +PITCH	+WY	-Y (port), -ROLL
+EP	-X (aft), +PITCH	+WR	+Y (stbd), +YAW

ΔSY	ΔSP	ΔEP	ΔWP	ΔWY	ΔWR
-4.1	+6.4	+9.7	-17.4	-0.6	+4.3

z	SY	SP	EP	WP	WY	WR
-414	-21.6	+54.3	-90.9	-60.8	+18.1	-137.3
-430	-22.3	+55.8	-89.7	-63.8	+18.0	-136.5
-480	-24.6	+59.5	-84.5	-73.4	+17.7	-134.1
-504	-25.7	+60.7	-81.2	-78.2	+17.5	-133.0

SUGGESTED JOINT ORDER

SP+, EP+, WR+, SY-, WY-, WP- as reqd

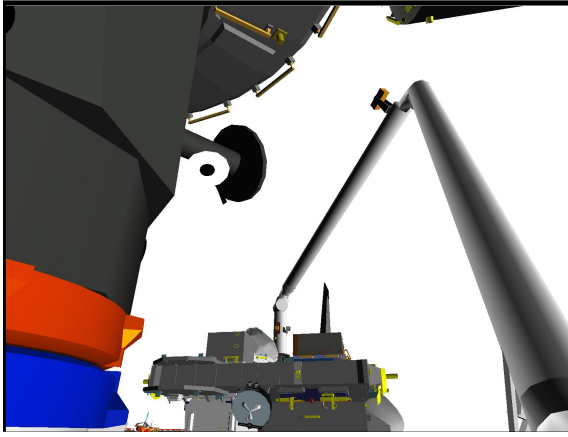

CCTV A (-10,30)

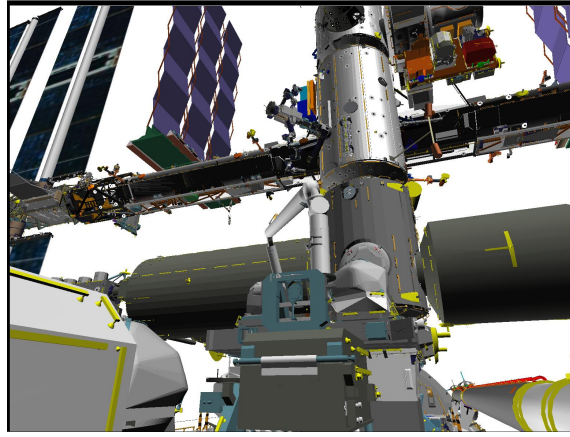

CCTV C (20,25)

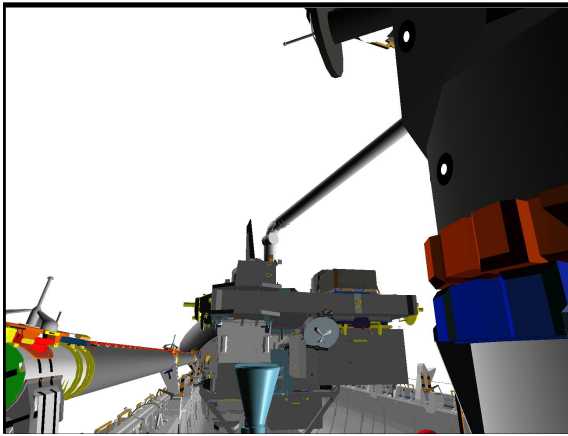

CCTV D (10,20)

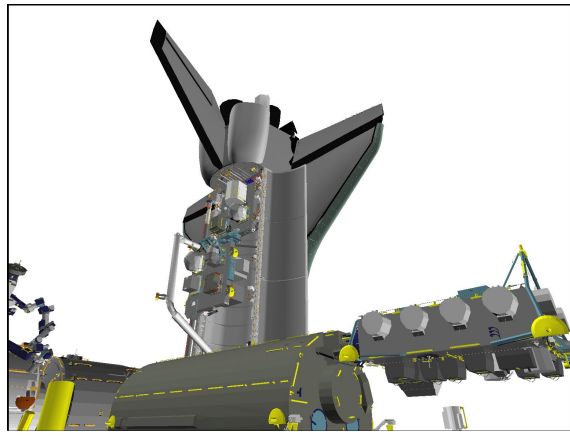

P1 LOOB (140,30)

ELC-1 SJ HANDOFF

1. SJ MNVR TO ELC-1 HANDOFF POSN

Mon 1	P1 LOOB
Dwnlnk	Elbow
Mon 2	A
DTV	B(C)

RATE – as reqd (VERN within 10 ft)
 BRAKES – OFF (tb-OFF)
 MODE – best available

Mnvr to ELC-1 HANDOFF posn:

	SY	SP	EP	WP	WY	WR	
ELC-1 Hover Posn	-24.8	+59.8	-83.9	-74.4	+17.6	+226.1	
1: EP +			-36.2				
2: WR –						+20.3	
3: WP +				-0.2			
4: WY +					+65.0		
5: SP –		+58.2					
6: SY +	+42.7						
ELC-1 Handoff Posn	+42.7	+58.2	-36.2	-0.2	+65.0	+20.3	
	X	Y	Z	PITCH	YAW	ROLL	PL ID
	-939	-581	-728	286	356	291	3

BRAKES – ON (tb-ON)
 √MODE – not DIRECT

- * If using Shuttle attitude control and attitude maintenance reqd: *
- * DAP: LVLH *
- * When rates damped *
- * DAP: FREE > 2 sec *
- * DAP: AUTO *

**Notify SSRMS Operator, SRMS is in ELC-1 Handoff position with brakes on.
 GO for ELC-1 GRAPPLE MANEUVER**

Step 1:
Drive EP+
From -83.9 to -36.2

Step 2:
Drive WR-
From +226.1 to +20.3



CCTV A (-10,30)



CCTV A (-10,30)

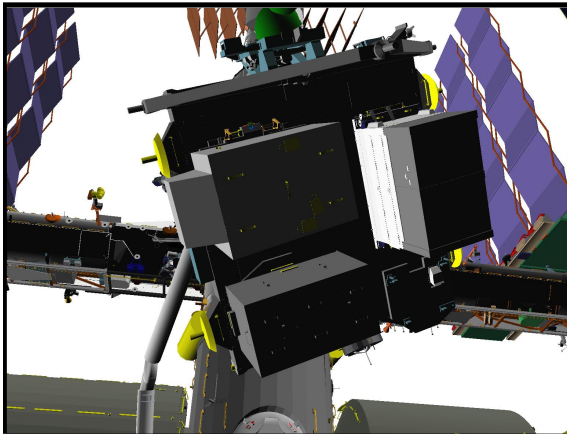

CCTV B (10,40)

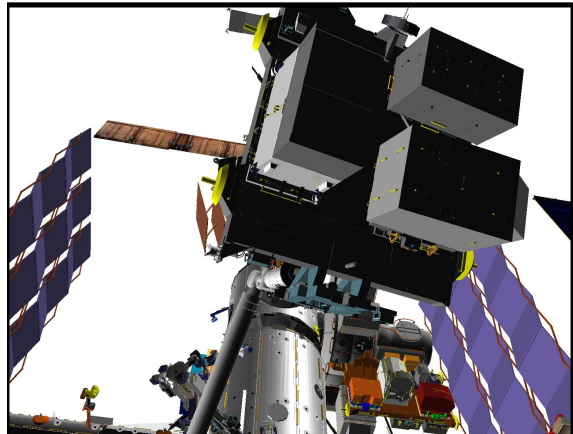

CCTV B (10,40)

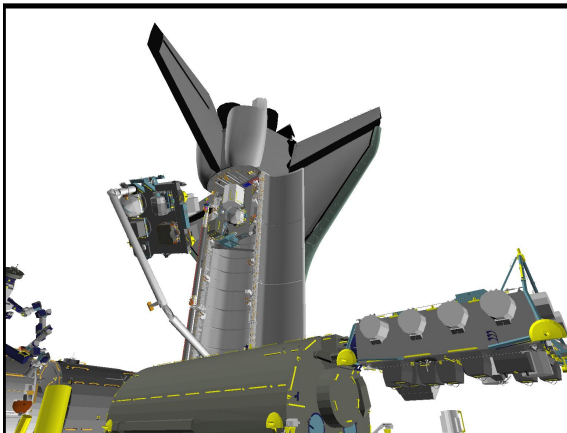

P1 LOOB (140,30)

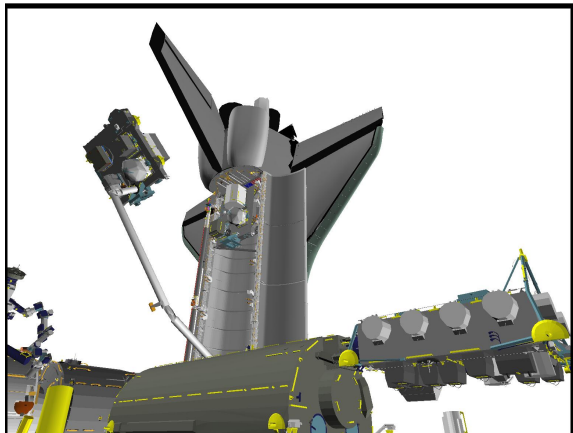

P1 LOOB (140,30)

Step 3:
Drive WP+
From -74.4 to -0.2



CCTV A (-10,30)

Step 4:
Drive WY+
From +17.6 to +65.0



CCTV A (-10,30)

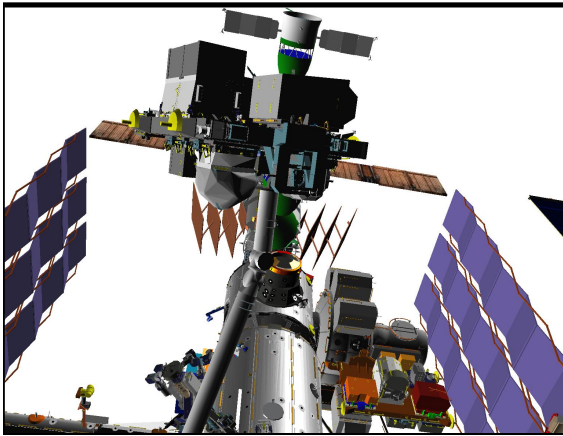

CCTV B (10,40)

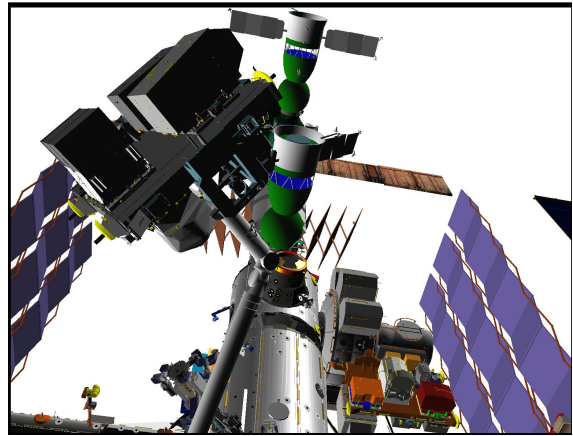

CCTV B (10,40)

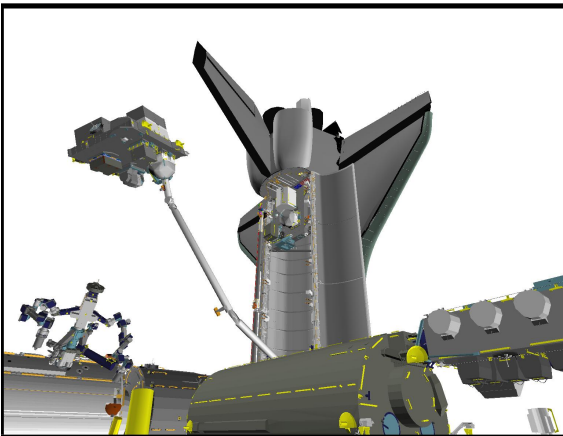

P1 LOOB (130,30)

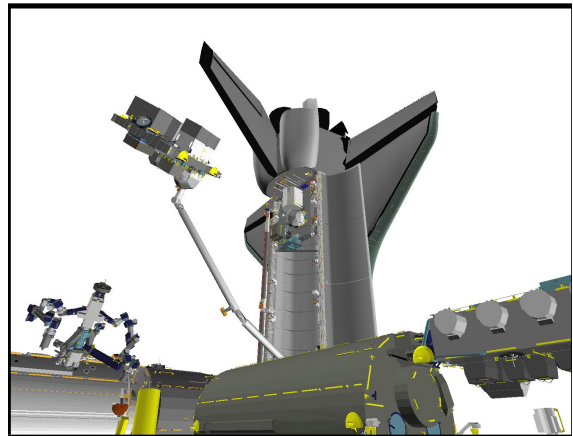

P1 LOOB (130,30)

Step 5:
Drive SP-
From +59.8 to +58.2



CCTV A (-10,30)

Step 6:
Drive SY+
From -24.8 to +42.7

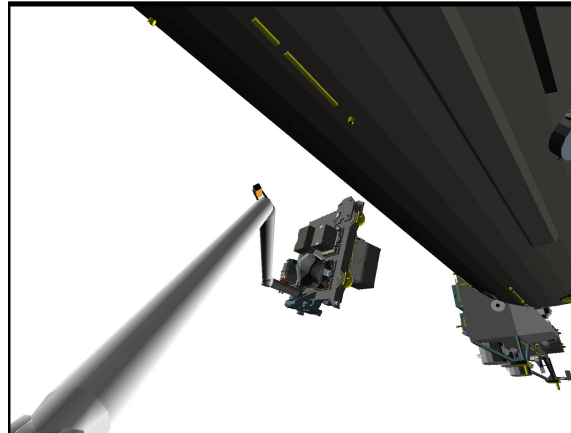

CCTV A (50,30)

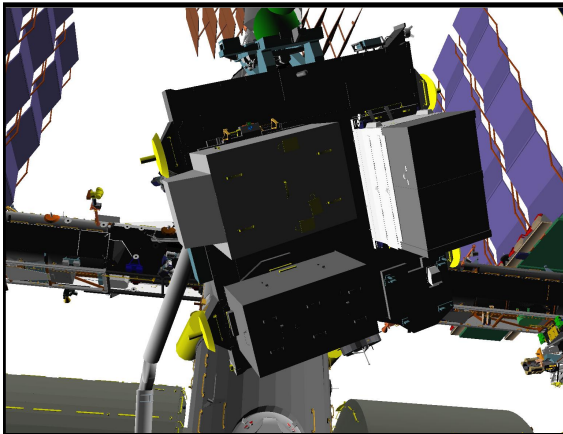

CCTV B (10,60)

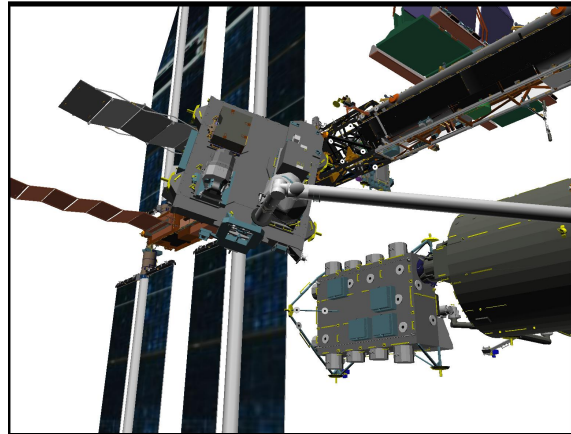

CCTV B (-50,20)

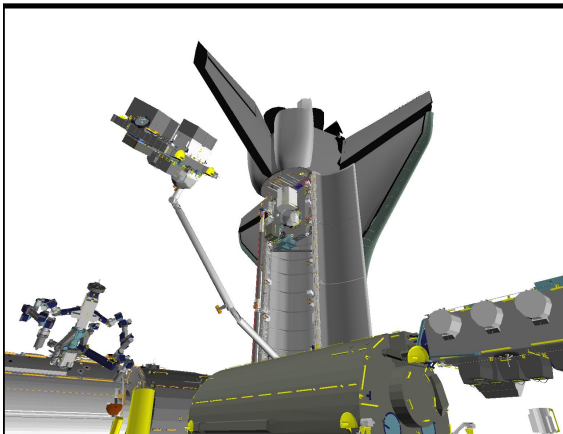

P1 LOOB (130,30)

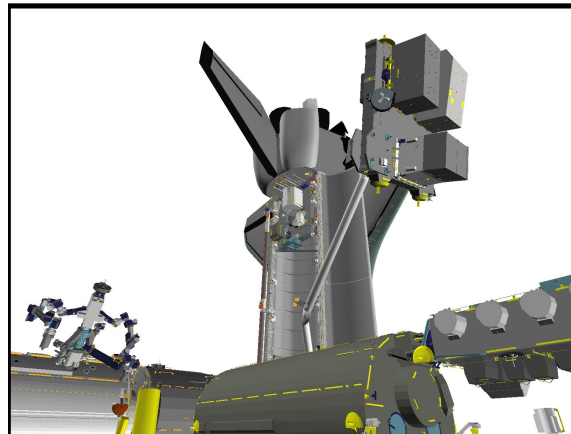

P1 LOOB (130,30)

ELC-1 SJ UNGRAPPLE

- A7U 1. SETUP
 CCTV – RMS WRIST, ZOOM 34.0 HFOV
 FOCUS 5 ft

Mon 1	P1 LOOB
DwnInk	EE
Mon 2	A
DTV	C

2. ELC-1 UNGRAPPLE
On SSRMS Operator GO for Ungrapple, ELC-1 Grapple complete and brakes on

If SINGLE MODE available:

NOTE

CONTR ERR It and 'S96 PDRS CNTL' msg may occur due to Consistency/Envelope Check error

RATE – COARSE (RATE MIN tb-OFF)

SM 94 PDRS CONTROL

AUTO BRAKE INH – ITEM 10 EXEC (*)

BRAKES – OFF (tb-OFF)

MODE – TEST, ENTER

Wait 5 sec

BRAKES – ON (tb-ON)

SM 94 PDRS CONTROL

AUTO BRAKE ENA – ITEM 9 EXEC (*)

PL ID – ITEM 3 +0 EXEC

INIT ID – ITEM 24 +0 EXEC

RATE – VERN (RATE MIN tb-ON)

BRAKES – OFF (tb-OFF)

MODE – best available

CAUTION

Monitor EE tb timing to prevent EE motor burnout

NOTE

SRMS must back away at least 120 inches.

Expect 'WY Reach Limit' warning

SM 169 PDRS STATUS

EE MODE – MAN

MAN CONTR – DERIG (hold until DERIGID tb-gray, 5 sec max)

RELEASE sw – depress (hold until OPEN tb-gray, 3 sec max)

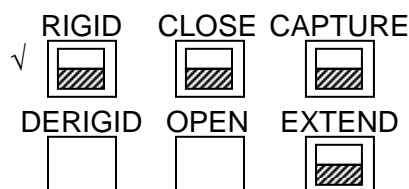

CRITICAL TIMES (8 sec total):

DERIGID tb – gray, 5 sec max, then

OPEN tb – gray, 3 sec max

3. MNVR ARM CLEAR OF ELC-1

Drive joints per ELC-1 SJ UNGRAPPLE WRIST CCTV OVERLAY until EE clear of grapple fixture

ELC-1 SJ UNGRAPPLE

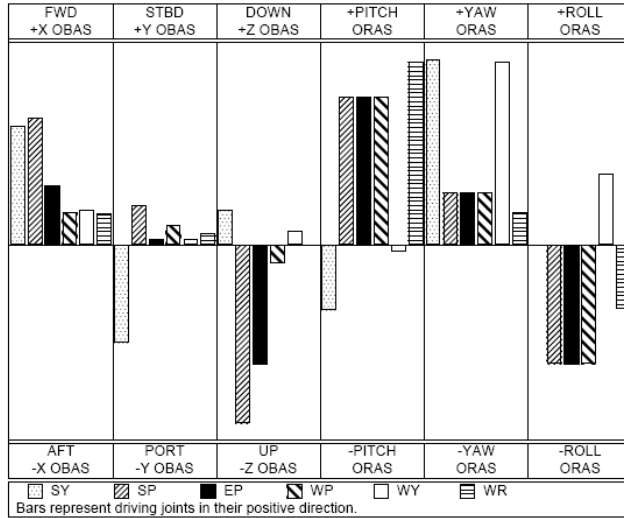

To get:	Drive:	To get:	Drive:	Driving:	Results In:	Driving:	Results In:
+X (fwd)	+SY, +SP	+PITCH	+WR, +WP	+SY	+X (fwd), +YAW	+WP	+X (fwd), +PITCH
+Y (stbd)	-SY, +SP	+YAW	+WY, +SY	+SP	-Z (up), +PITCH	+WY	+X (fwd), +YAW
+Z (down)	-SP, -EP	+ROLL	-WP, -EP	+EP	-Z (up), +PITCH	+WR	+X (fwd), +PITCH

ΔSY	ΔSP	ΔEP	ΔWP	ΔWY	ΔWR
-11.2	+9.2	-17.2	+23.0	+9.9	-16.0

Fabricate as transparency

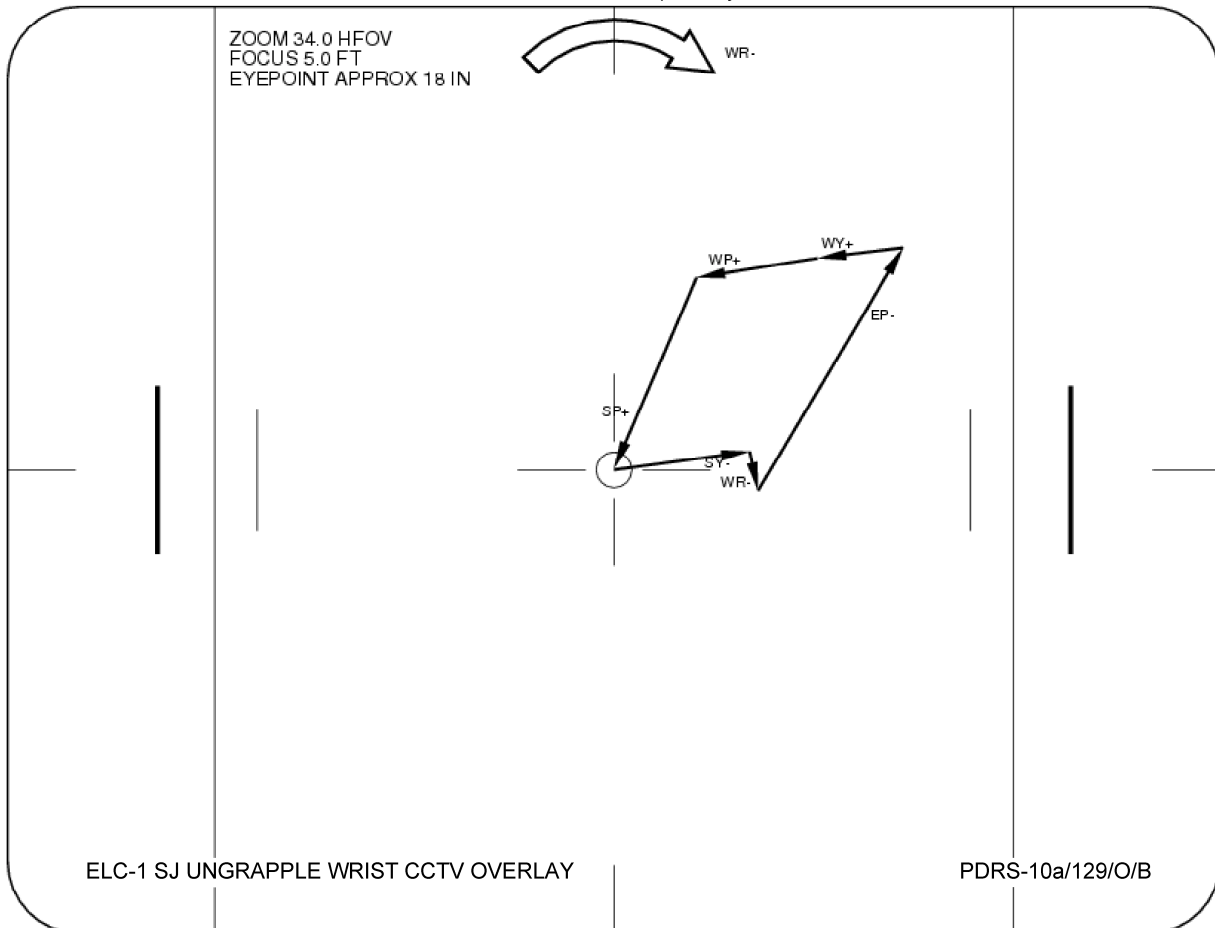

ELC-1 SJ UNGRAPPLE WRIST CCTV OVERLAY

PDRS-10a/129/O/B

EE MAN CONTR – DERIG (hold until EXTEND tb-gray, 20 sec max)
MODE – OFF

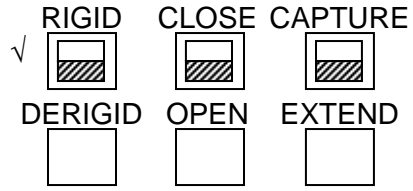

CRITICAL TIMES (20 sec total):
EXTEND tb – gray, 20 sec max

BRAKES – ON (tb-ON)
√MODE – not DIRECT

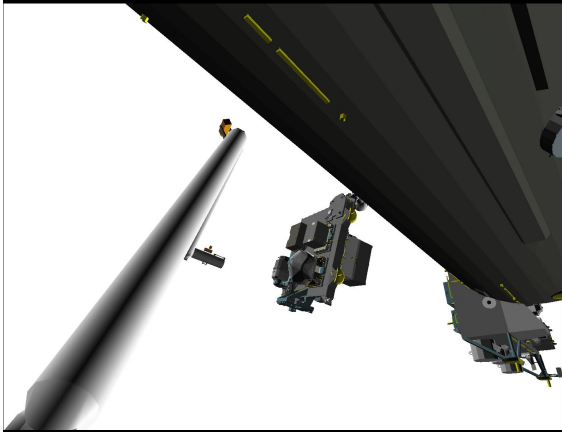

CCTV A (50,30)

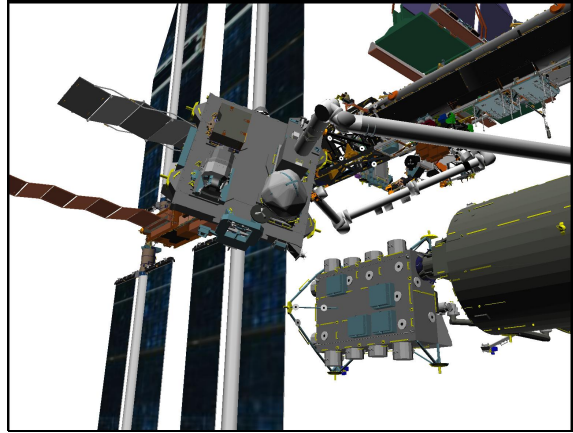

CCTV B (-50,20)

ELC-2 SJ GRAPPLE

- A7U 1. ELC-2 MNVR TO PRE-GRAPPLE
 CCTV – perform PAN/TILT RESET
 – fully zoom out for SJ pictures

SM 94 PDRS CONTROL

- √PL ID, ITEM 3: 0
 √INIT ID, ITEM 24: 0

Mon 1	S1 LOOB
Dwnlnk	Elbow(EE)
Mon 2	C
DTV	A(D)

RATE – as required (VERN within 10 ft)
 BRAKES – OFF (tb-OFF)
 MODE – best available

Mnvr to ELC-2 PRE-GRAPPLE posn:

	SY	SP	EP	WP	WY	WR	
Pre-cradle	0.0	+25.0	-25.0	+5.0	0.0	0.0	
1: SY –	-18.1						
2: SP +		+47.1					
3: EP –			-57.7				
4: WP –				-85.6			
5: WY +					+18.6		
6: WR +						+38.7	
ELC-2	-18.1	+47.1	-57.7	-85.6	+18.6	+38.7	
Pre-grapple	X	Y	Z	PITCH	YAW	ROLL	PL ID
	-1105	-15	-545	270	0	0	0

BRAKES – ON (tb-ON)
 MODE – not DIRECT

Step 1:
Drive SY-
From 0.0 to -18.1

Step 2:
Drive SP+
From +25.0 to +47.1

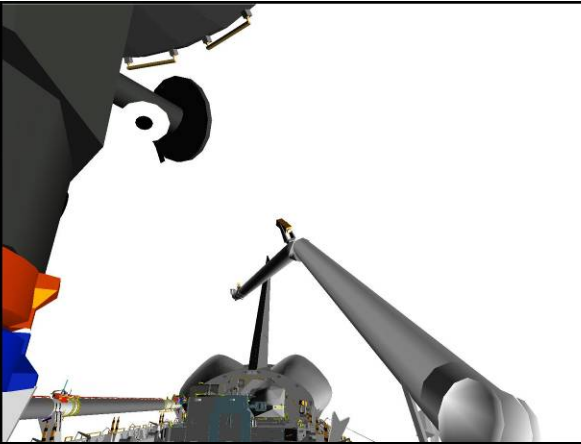

CCTV A (0,25)

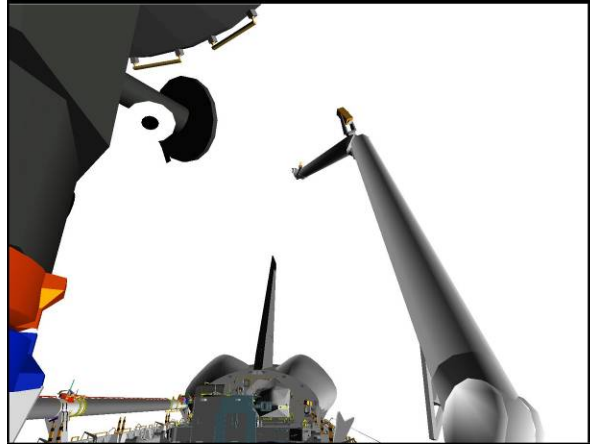

CCTV A (0,25)

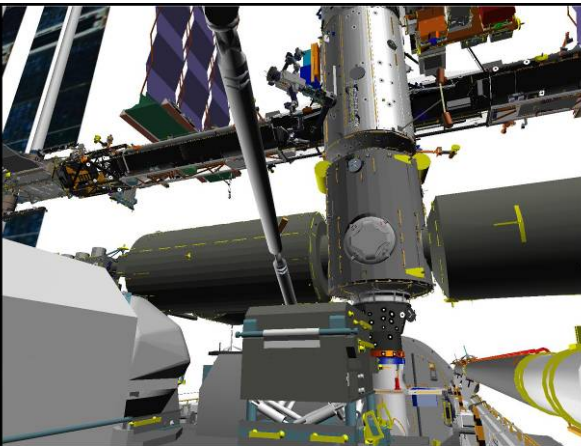

CCTV C (-20,20)

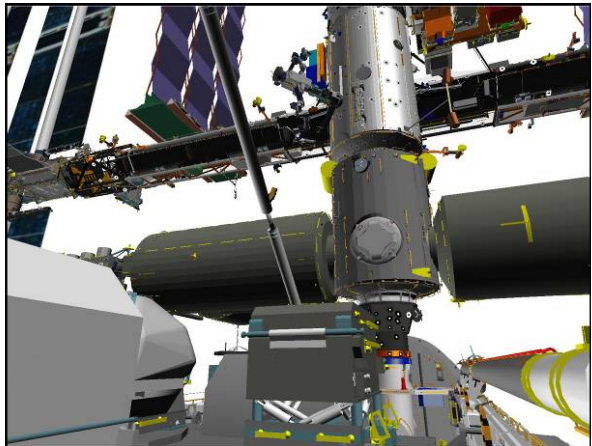

CCTV C (-20,20)

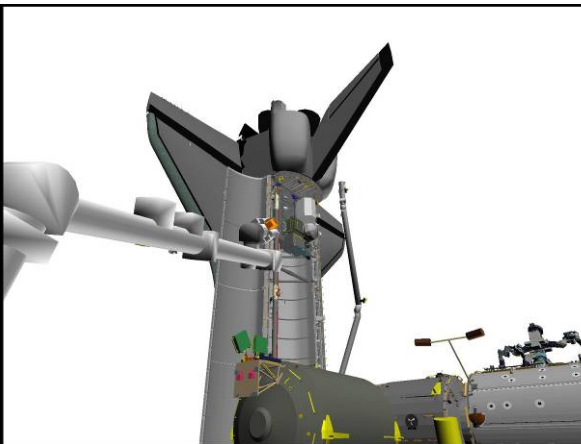

S1 LOOB (50,30)

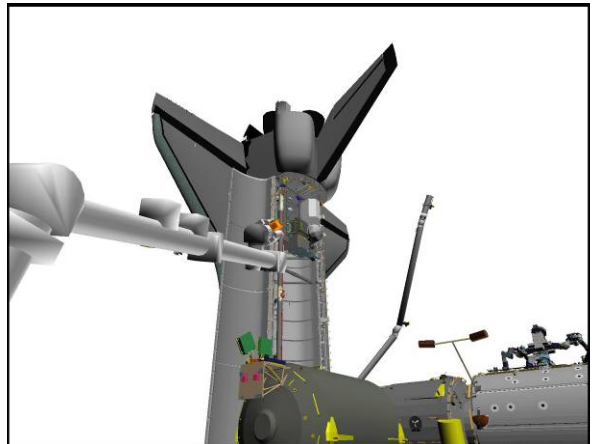

S1 LOOB (50,30)

Step 3:
Drive EP-
From -25.0 to -57.7

Step 4:
Drive WP-
From +5.0 to -85.6

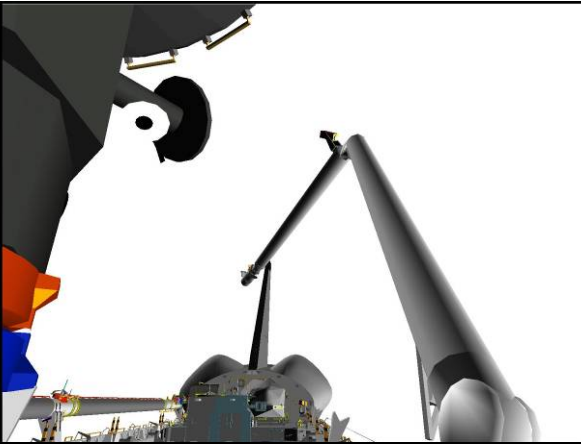

CCTV A (0,25)

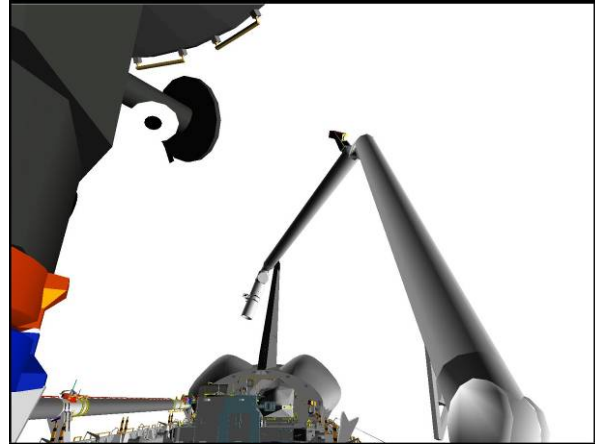

CCTV A (0,25)

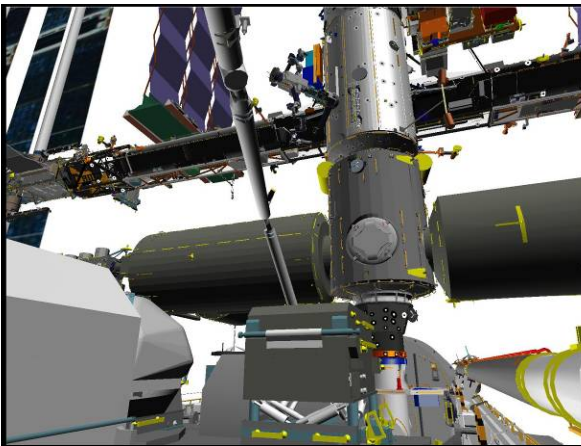

CCTV C (-20,20)

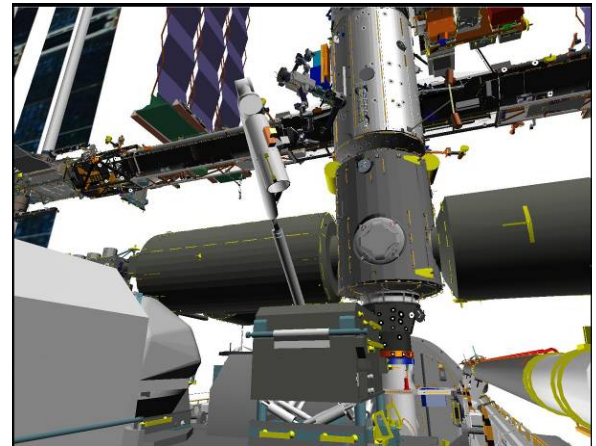

CCTV C (-20,20)

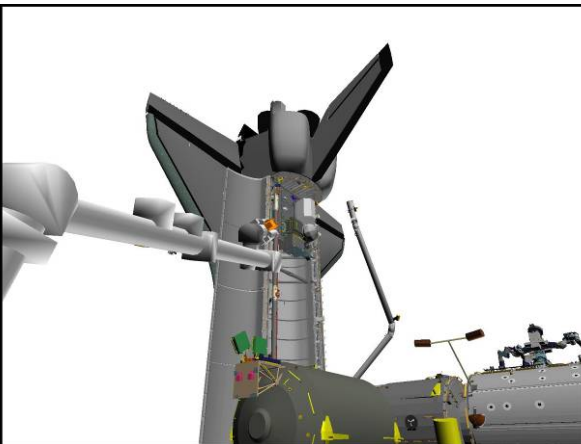

S1 LOOB (50,30)

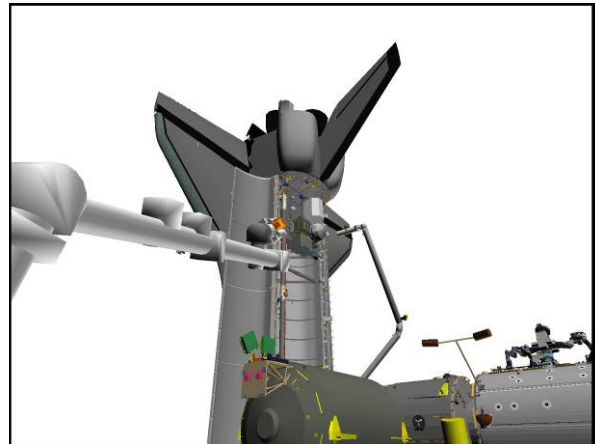

S1 LOOB (50,30)

Step 5:
Drive WY+
From 0.0 to +18.6

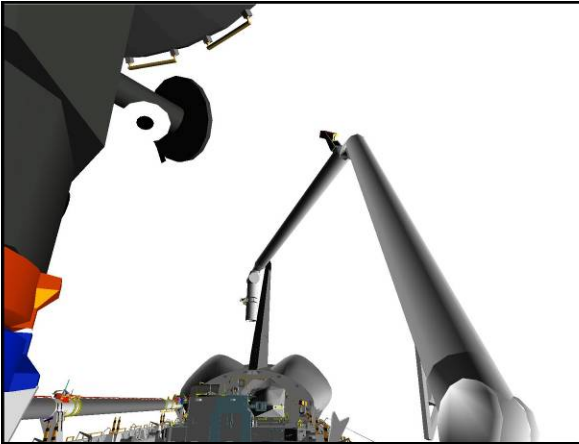

CCTV A (0,25)

Step 6:
Drive WR+
From 0.0 to +38.7

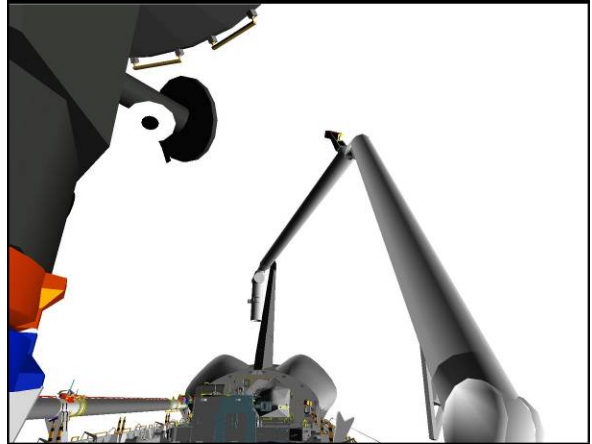

CCTV A (0,25)

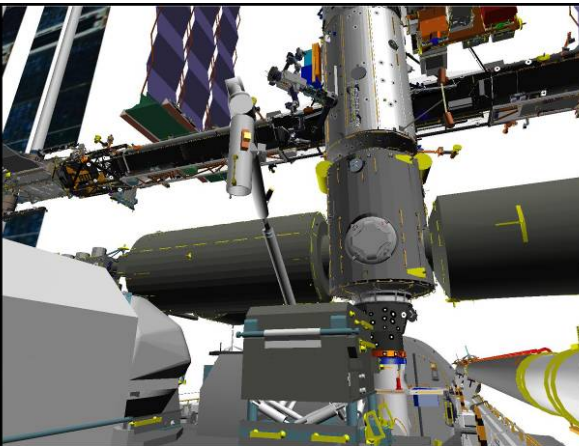

CCTV C (-20,20)

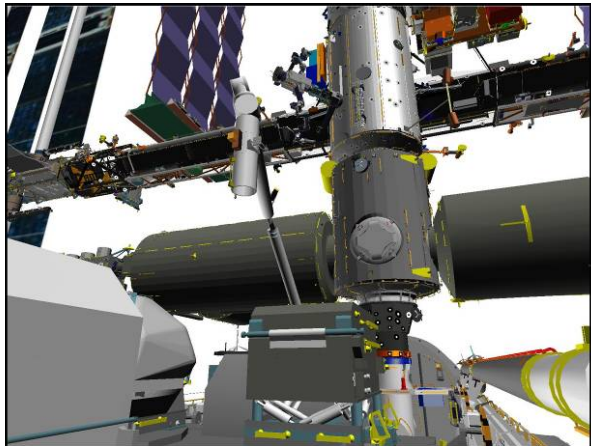

CCTV C (-20,20)

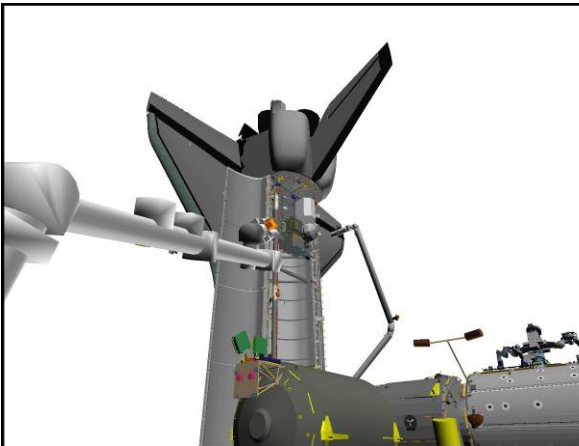

S1 LOOB (50,30)

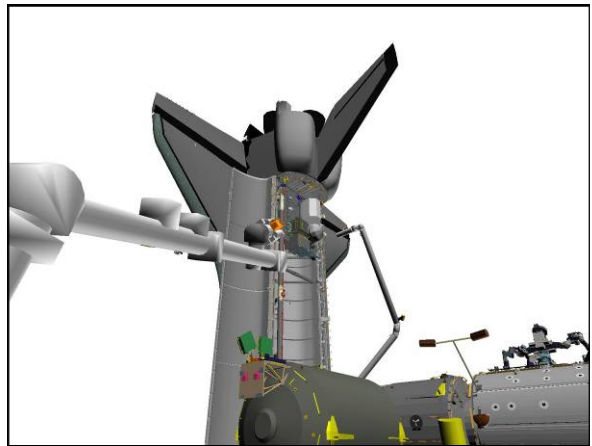

S1 LOOB (50,30)

A7U

2. SJ MNVR TO ELC-2 GRAPPLE

CCTV – config for grapple

– install PDRS TARGET OVERLAY FOR CTVM

– RMS WRIST, zoom 34.0 HFOV

focus 5 ft

Maintain eyepoint ~18 in when using grapple overlay

Mon 1	S1 LOOB
DwnInk	EE
Mon 2	C
DTV	D

RATE – VERN (RATE MIN tb-ON)

BRAKES – OFF (tb-OFF)

MODE – best available

Drive joints per ELC-2 SJ GRAPPLE WRIST CCTV OVERLAY and diagram until EE within grapple envelope

ELC-2 SJ GRAPPLE

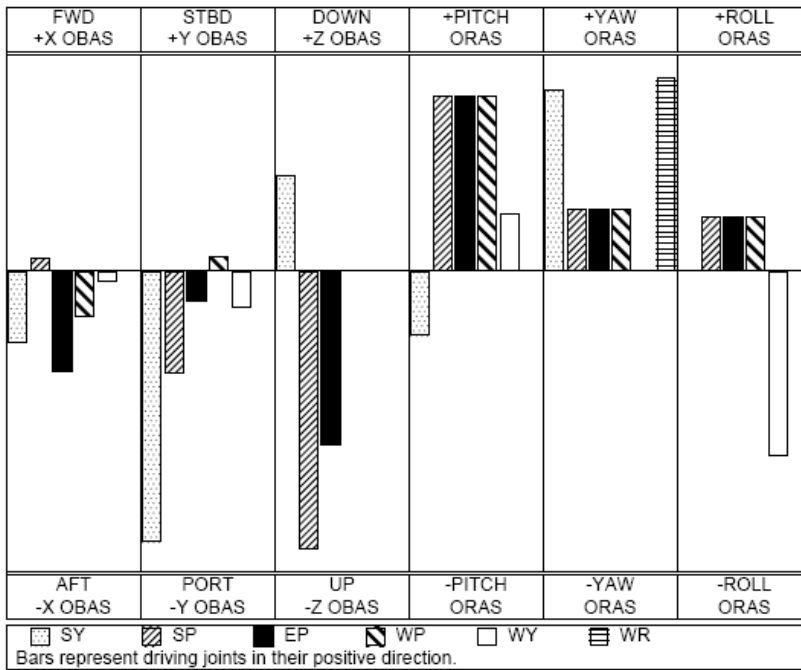

To get:	Drive:	To get:	Drive:
+X (fwd)	-EP, -SY	+PITCH	+WP, +EP
+Y (stbd)	-SY, -SP	+YAW	+WR
+Z (down)	-SP, -EP	+ROLL	-WY

Driving:	Results In:	Driving:	Results In:
+SY	-Y (port), +YAW	+WP	-X (aft), +PITCH
+SP	-Z (up), +PITCH	+WY	-Y (port), -ROLL
+EP	-Z (up), +PITCH	+WR	+YAW

ΔSY	ΔSP	ΔEP	ΔWP	ΔWY	ΔWR
+3.6	-4.3	-11.1	+16.3	+0.2	-3.3

Fabricate as transparency

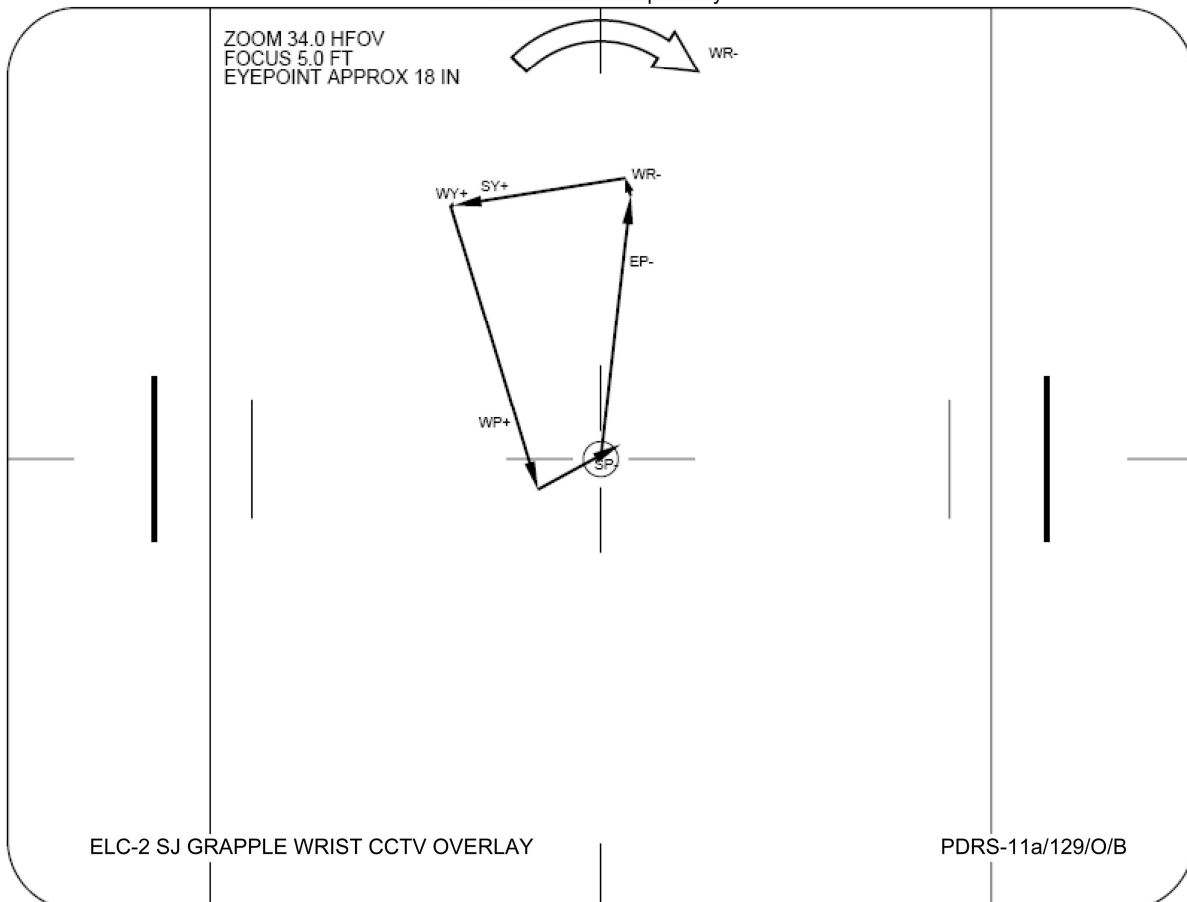

3. ELC-2 GRAPPLE

CAUTION
Monitor EE tb timing to prevent EE motor burnout

EE MODE – AUTO (if available)
CAPTURE sw – depress (mom)

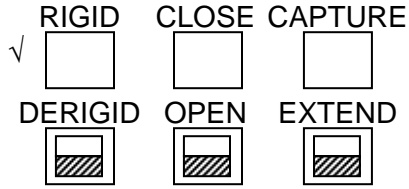

CRITICAL TIMES (28 sec total):
CAPTURE tb – gray, then
CLOSE tb – gray, 3 sec max, then
RIGID tb – gray, 25 sec max

- * If manual grapple reqd: *
- * EE MODE – MAN *
- * CAPTURE sw – depress (hold until CLOSE tb-gray, 3 sec max) *
- * MAN CONTR – RIGID (hold until RIGID tb-gray, 25 sec max) *

EE MODE – OFF

BRAKES – ON (tb-ON)
MODE – not DIRECT

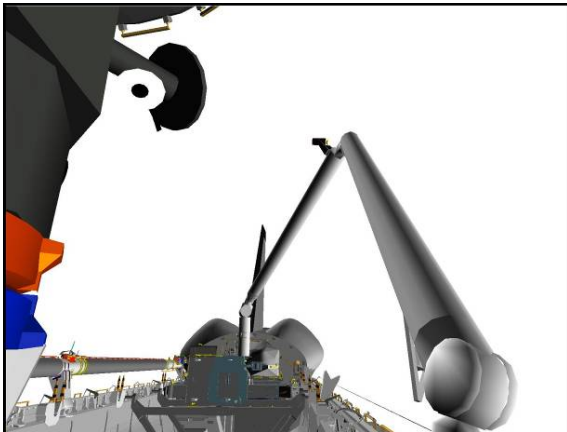

CCTV A (0,20)

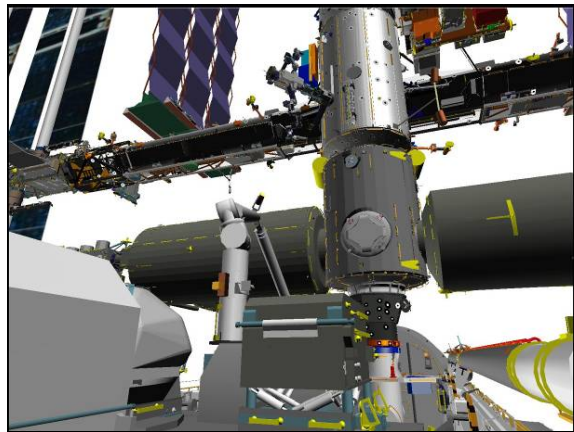

CCTV C (-20,20)

SM 94 PDRS CONTROL

PL ID – ITEM 3 +4 EXEC
INIT ID – ITEM 24 +4 EXEC

Record POS/ATT and Joint Angles:

	X	Y	Z	PITCH	YAW	ROLL	PL ID
							4
Expected	-1189	0	-414	0	0	0	
	SY	SP	EP	WP	WY	WR	
Expected	-14.5	+42.7	-68.7	-69.1	+18.8	+35.3	

Review GENERIC END EFFECTOR CUE CARD – ISS/SHUTTLE DOCKED OPS

ELC-2 SJ UNBERTH

1. SETUP
Perform ELC-2 UNBERTH, steps 1-5 (ELC NOMINAL OPS)

NOTE

Use camera B(C) to monitor clearance
between ELC-2 PVGF and aft bulkhead.

Drive until visible clearance between aft port
22 ELC V guide and PM on ELC-2 shroud

2. SJ MNVR TO CLEAR OF V-GUIDES
RATE – as required (VERN within 10 ft)
BRAKES – OFF (tb-OFF)
MODE – best available

Drive joints per ELC-2 SJ TOP OF V-GUIDES histogram until ELC-2 trunnions at
top of V-guides (Z = -490)

ELC-2 SJ UNBERTH

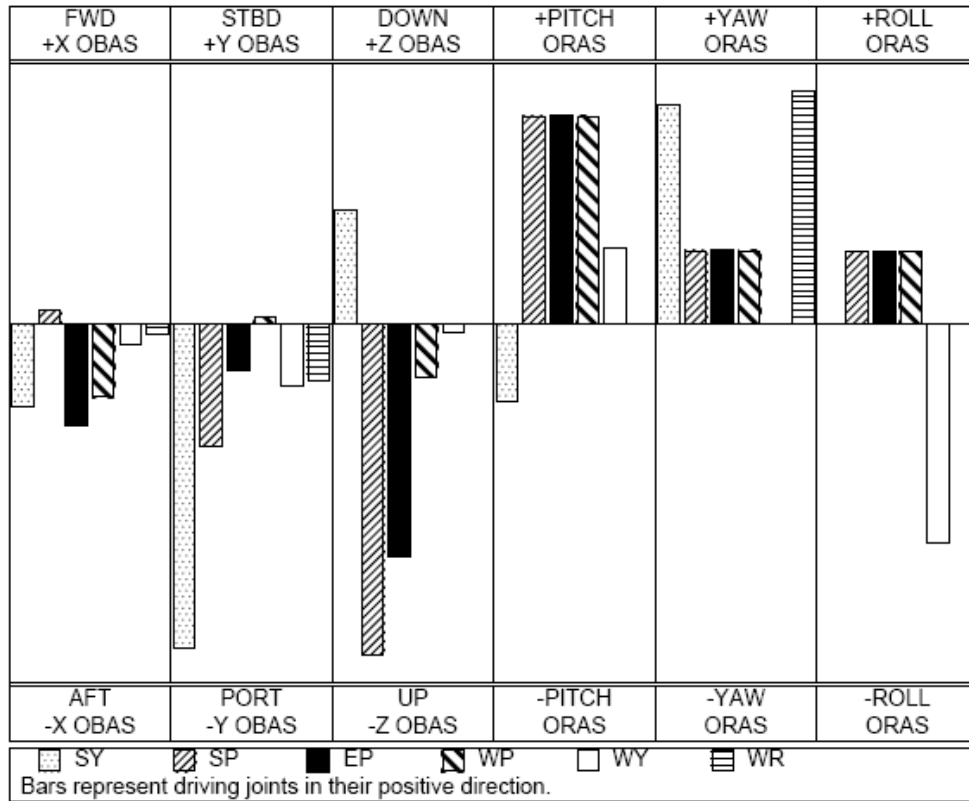

To get:	Drive:	To get:	Drive:	Driving:	Results In:	Driving:	Results In:
+X (fwd)	-EP, -WP	+PITCH	+WP, +EP	+SY	-Y (port), +YAW	+WP	-X (aft), +PITCH
+Y (stbd)	-SY, -SP	+YAW	+WR, +SY	+SP	-Z (up), +PITCH	+WY	-Y (port), -ROLL
+Z (down)	-SP, -EP	+ROLL	-WY	+EP	-Z (up), +PITCH	+WR	-Y (port), +YAW

ΔSY	ΔSP	ΔEP	ΔWP	ΔWY	ΔWR
-7.5	-0.5	+37.8	-39.8	-0.8	+7.9

z	SY	SP	EP	WP	WY	WR
-414	-14.5	+42.7	-68.7	-69.1	+18.8	+35.3
-433	-15.3	+44.1	-67.1	-72.4	+18.7	+36.1
-581	-21.3	+44.5	-38.5	-103.4	+18.1	+42.4
-600	-22.0	+42.2	-30.9	-108.9	+18.0	+43.2

SUGGESTED JOINT ORDER
 EP+, WP-, SY+, WR+, WY-, SP- as reqd

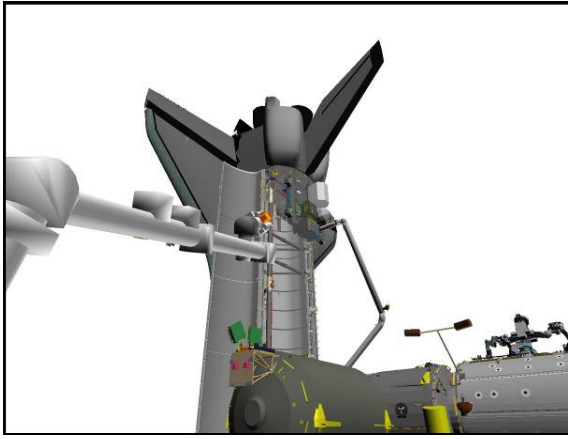

S1 LOOB (50,30)

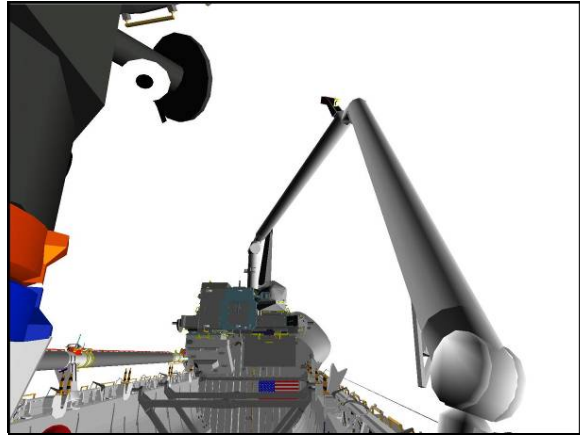

CCTV A (0,20)

ELC-2 SJ HANDOFF

1. SJ MNVR TO ELC-2 HANDOFF POSN

Mon 1	S1 LOOB
Dwnlnk	A
Mon 2	D
DTV	B(C)

RATE – as reqd (VERN within 10 ft)
 BRAKES – OFF (tb-OFF)
 MODE – best available

Mnvr to ELC-2 HANDOFF posn:

ELC-2
 Hover Posn
 1: SP +
 2: EP +
 3: WP +
 4: WY –
 5: WR –
 6: SP –
 7: SY –

	SY	SP	EP	WP	WY	WR	
	-17.6	+46.7	-59.9	-82.9	+18.5	+38.6	
		+60.0					
			-35.1				
				+53.9			
					-14.6		
						-92.0	
		+29.5					
	-59.5						
ELC-2 Handoff Posn	-59.5	+29.5	-35.1	+53.9	-14.6	-92.0	
	X	Y	Z	PITCH	YAW	ROLL	PL ID
	-900	+375	-760	197	318	33	4

BRAKES – ON (tb-ON)
 √MODE – not DIRECT

- * If using Shuttle attitude control and attitude maintenance reqd: *
- * DAP: LVLH *
- * When rates damped *
- * DAP: FREE > 2 sec *
- * DAP: AUTO *

**Notify SSRMS Operator, SRMS is in ELC-2 Handoff position with brakes on.
 GO for ELC-2 Grapple maneuver**

Step 1:
Drive SP+
From +46.7 to +60.0

Step 2:
Drive EP+
From -59.9 to -35.1

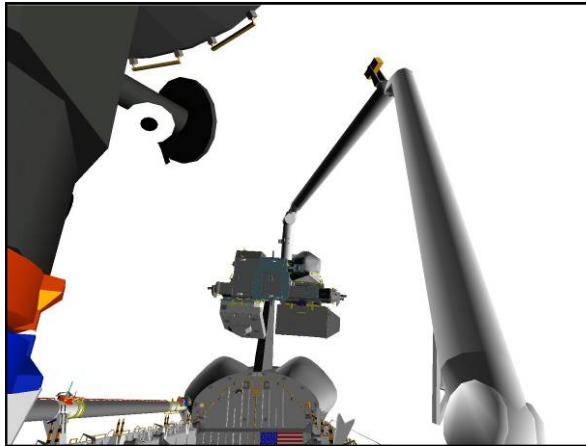

CCTV A (0,25)

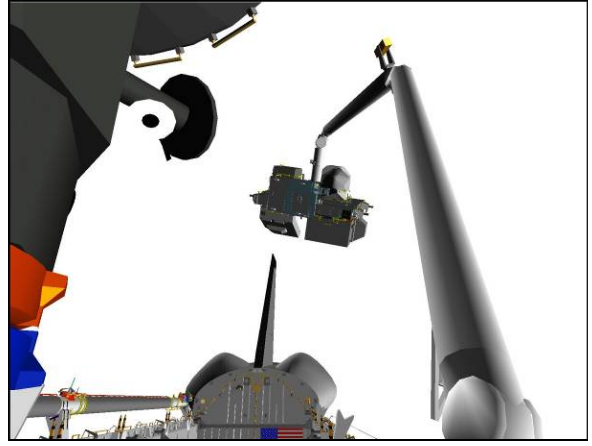

CCTV A (0,25)



CCTV D (0,20)



CCTV D (0,20)

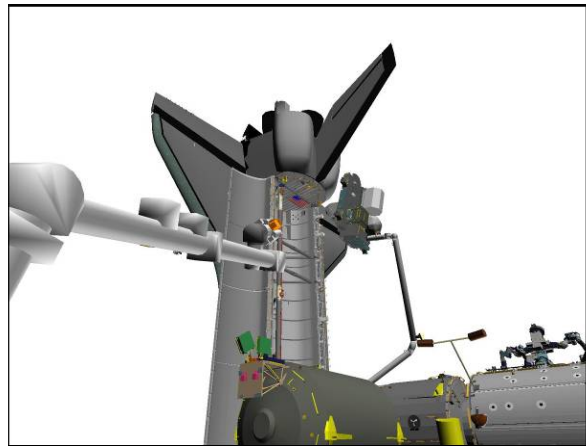

S1 LOOB (50,30)

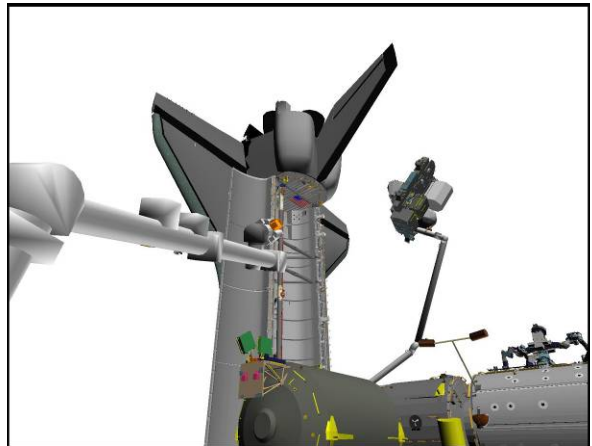

S1 LOOB (50,30)

Step 3:
Drive WP+
From -82.9 to +53.9

Step 4:
Drive WY-
From +18.5 to -14.6

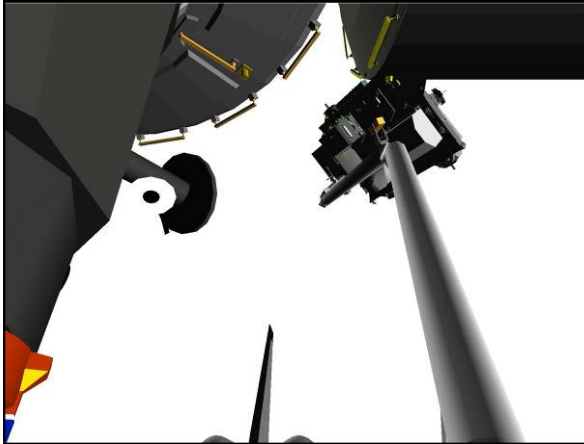

CCTV A (0,35)

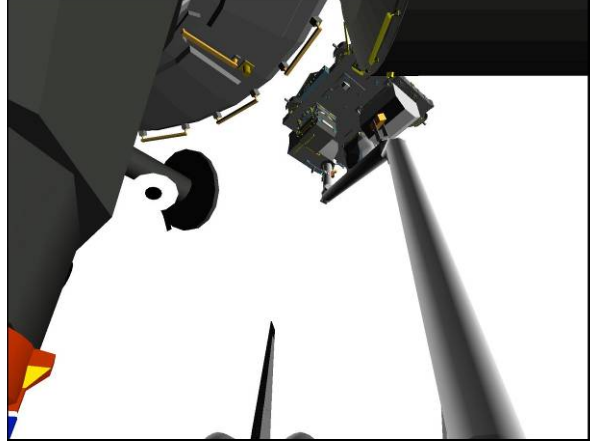

CCTV A (0,35)

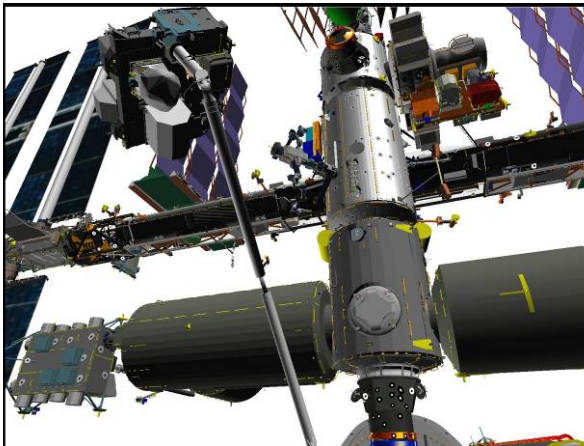

CCTV C (-20,30)

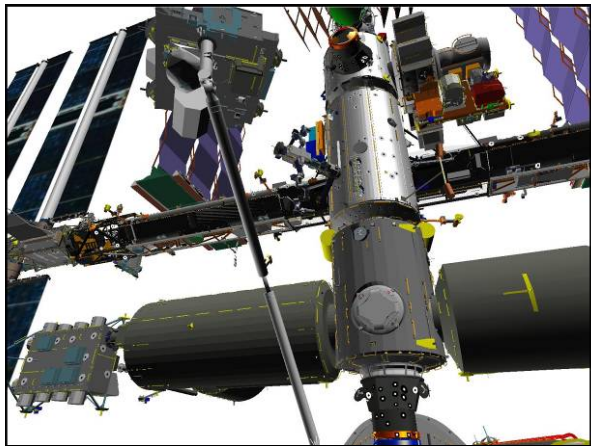

CCTV C (-20,30)



S1 LOOB (50,30)

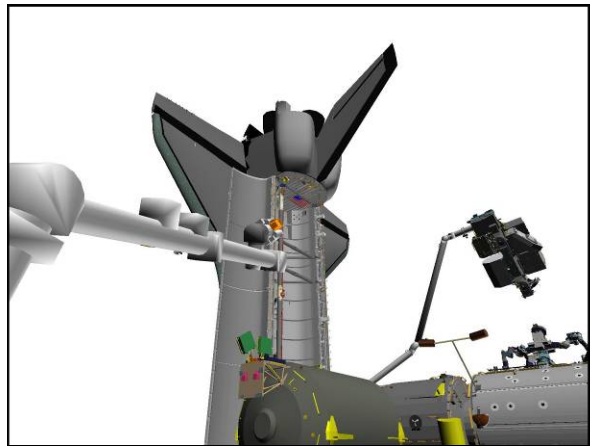

S1 LOOB (50,30)

Step 5:
Drive WR-
From +38.6 to -92.0

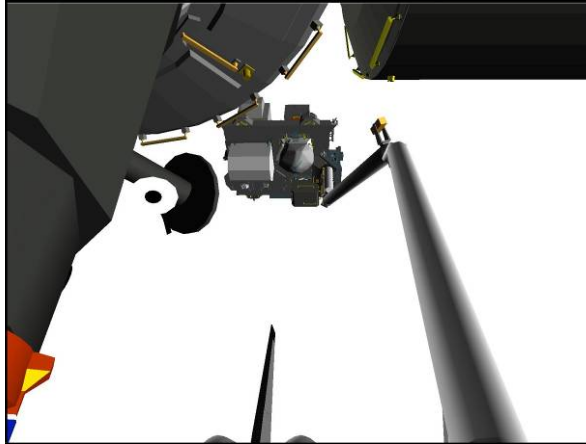

CCTV A (0,35)

Step 6:
Drive SP-
From +60.0 to +29.5

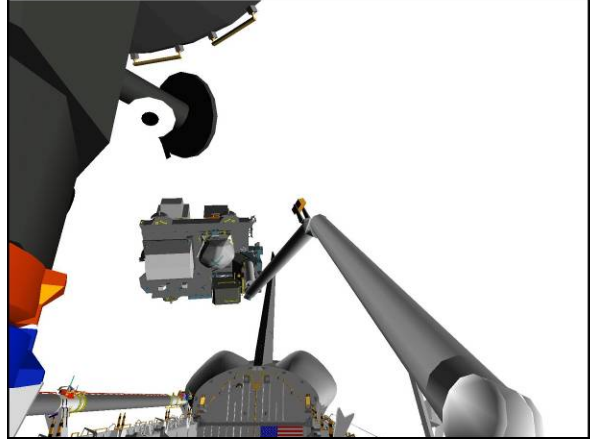

CCTV A (0,25)

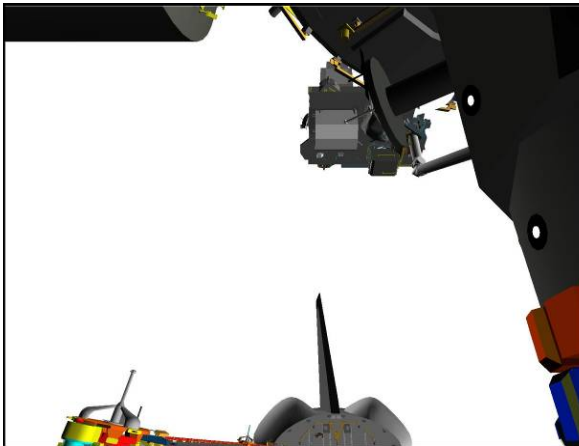

CCTV D (0,30)



CCTV D (0,30)

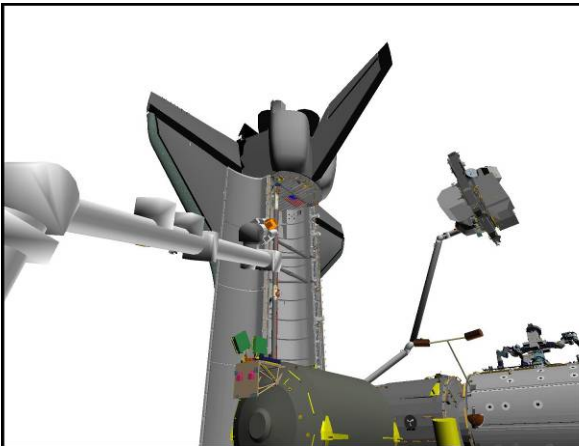

S1 LOOB (50,30)

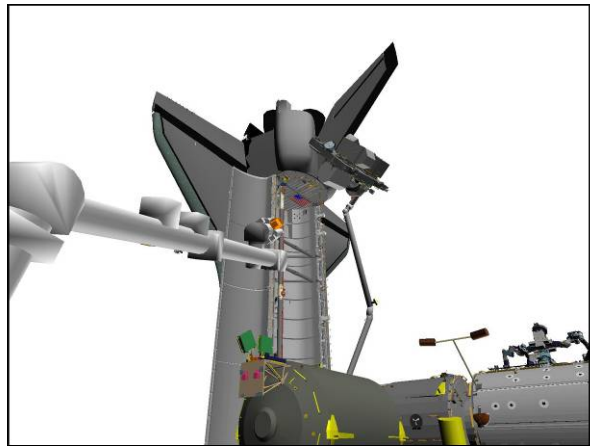

S1 LOOB (50,30)

Step 7:
Drive SY-
From -17.6 to -59.5

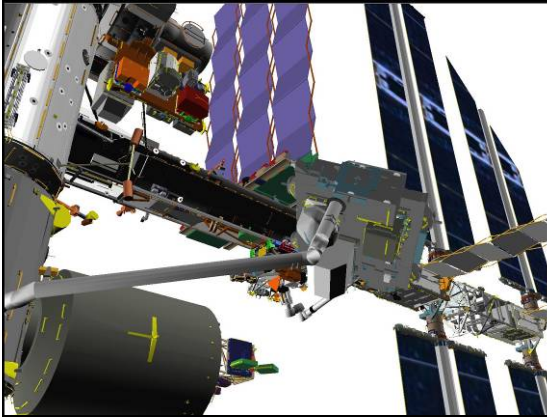

CCTV B (40,30)



CCTV D (-20,30)

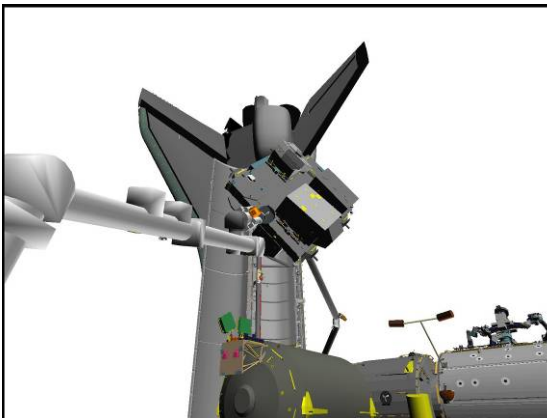

S1 LOOB (50,30)

ELC-2 SJ UNGRAPPLE

- A7U 1. SETUP
 CCTV – RMS WRIST, zoom 34.0 HFOV
 focus 5 ft

Mon 1	S1 LOOB
DwnInk	EE
Mon 2	D
DTV	B

2. ELC-2 UNGRAPPLE
On SSRMS Operator GO for Ungrapple, ELC-2 Grapple complete and brakes on

If SINGLE MODE available:

NOTE

CONTR ERR It and 'S96 PDRS CNTL' msg may occur due to Consistency/Envelope Check error

RATE – COARSE (RATE MIN tb-OFF)

SM 94 PDRS CONTROL

AUTO BRAKE INH – ITEM 10 EXEC (*)

BRAKES – OFF (tb-OFF)

MODE – TEST, ENTER

Wait 5 sec

BRAKES – ON (tb-ON)

SM 94 PDRS CONTROL

AUTO BRAKE ENA – ITEM 9 EXEC (*)

PL ID – ITEM 3 +0 EXEC

INIT ID – ITEM 24 +0 EXEC

RATE – VERN (RATE MIN tb-ON)

BRAKES – OFF (tb-OFF)

MODE – best available

CAUTION

Monitor EE tb timing to prevent EE motor burnout

NOTE

SRMS must back away at least 120 inches

SM 169 PDRS STATUS

EE MODE – MAN

MAN CONTR – DERIG (hold until DERIGID tb-gray, 5 sec max)

RELEASE sw – depress (hold until OPEN tb-gray, 3 sec max)

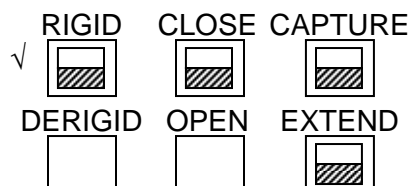

CRITICAL TIMES (8 sec total):

DERIGID tb – gray, 5 sec max, then

OPEN tb – gray, 3 sec max

3. MNVR ARM CLEAR OF ELC-2

Drive joints per ELC-2 SJ UNGRAPPLE WRIST CCTV OVERLAY until EE clear of grapple fixture

ELC-2 SJ UNGRAPPLE

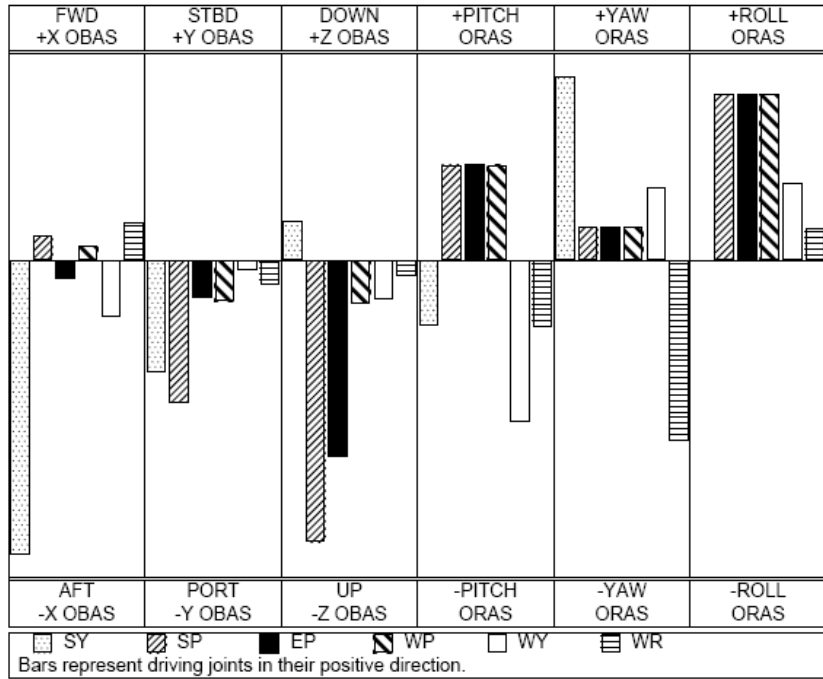

To get:	Drive:	To get:	Drive:
+X (fwd)	-SY	+PITCH	-WY, +WP
+Y (stbd)	-SP, -SY	+YAW	-WR, +SY
+Z (down)	-SP, -EP	+ROLL	+WP, +EP

Driving:	Results In:	Driving:	Results In:
+SY	-X (aft), +YAW	+WP	-Z (up), +ROLL
+SP	-Z (up), +ROLL	+WY	-X (aft), -PITCH
+EP	-Z (up), +ROLL	+WR	+X (fwd), -YAW

ΔSY	ΔSP	ΔEP	ΔWP	ΔWY	ΔWR
+2.8	+9.2	-37.4	+28.6	-1.8	+2.2

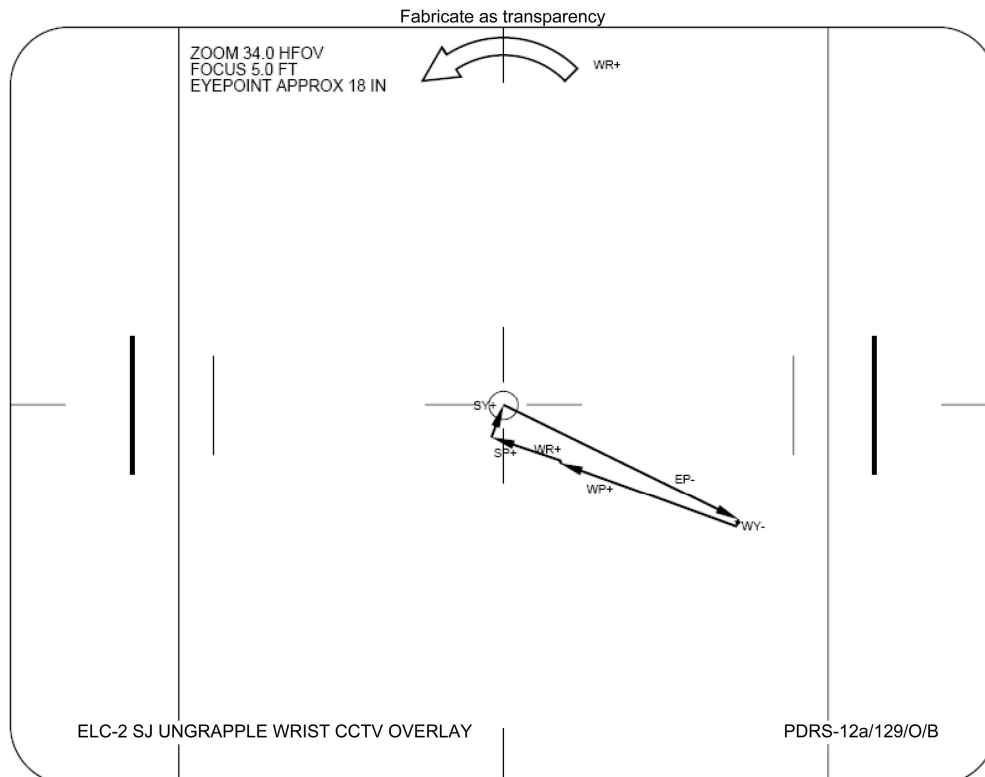

EE MAN CONTR – DERIG (hold until EXTEND tb-gray, 20 sec max)
 MODE – OFF

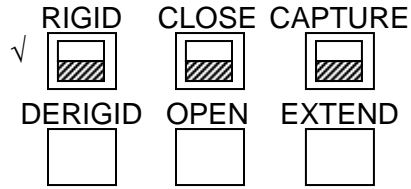

CRITICAL TIMES (20 sec total):
 EXTEND tb – gray, 20 sec max

BRAKES – ON (tb-ON)
 ✓MODE – not DIRECT

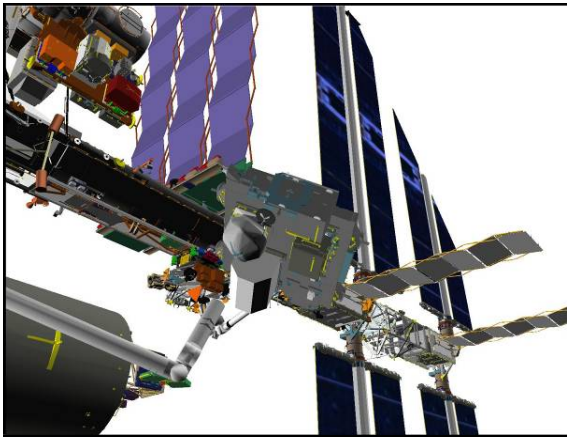

CCTV B (40,30)

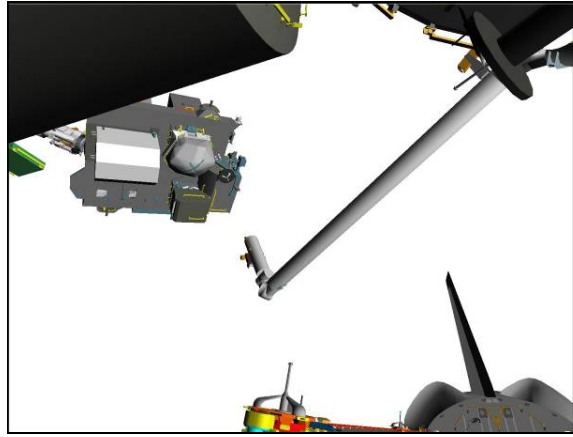

CCTV D (-20,30)

4. SRMS MNVR TO PRE-CRADLE

Mon 1	P1 LOOB
DwnInk	Elbow
Mon 2	D(A)
DTV	B(C)

RATE – as required (VERN within 10 ft)
 BRAKES – OFF (tb-OFF)
 MODE – best available

Mnvr to PRE-CRADLE posn:

	SY	SP	EP	WP	WY	WR	
ELC-2 Backoff Posn	-55.5	+42.0	-76.7	+83.8	-17.3	-88.8	
1: SY +	-40.0						
2: EP +			-25.0				
3: SY +	0.0						
4: SP –		+25.0					
5: WP –				+5.0			
6: WY +					0.0		
7: WR +						0.0	
Pre-cradle	0.0	+25.0	-25.0	+5.0	0.0	0.0	
	X	Y	Z	PITCH	YAW	ROLL	PL ID
	-1261	-146	-551	5	2	0	0

If ELC-2 Install Viewing required, perform ELC-2 UNGRAPPLE, step 4
(ELC NOMINAL OPS)

BRAKES – ON (tb-ON)
MODE – not DIRECT
PARAM – PORT TEMP
JOINT – CRIT TEMP

Step 1:
Drive SY+
From -55.5 to -40.0

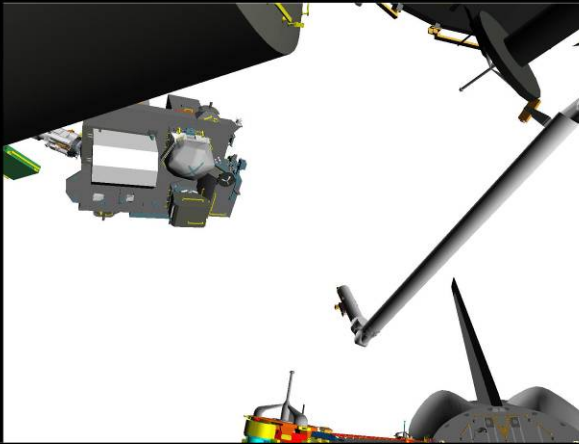

CCTV D (-20,30)

Step 2:
Drive EP+
From -76.7 to -25.0

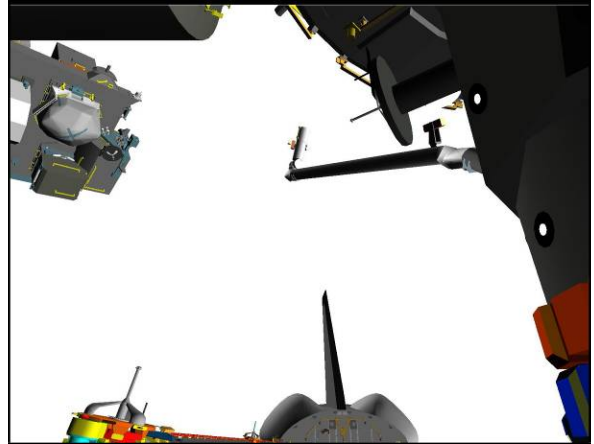

CCTV D (0,30)

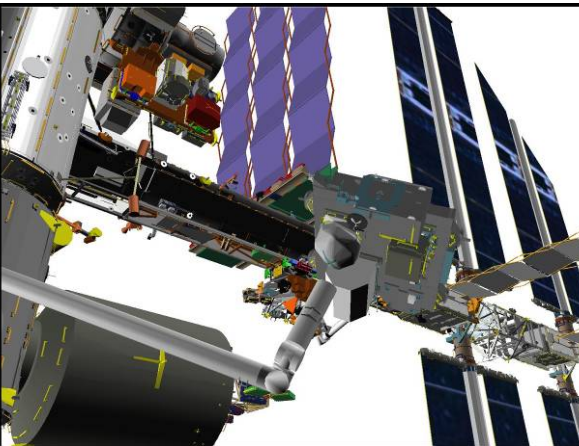

CCTV B (40,30)

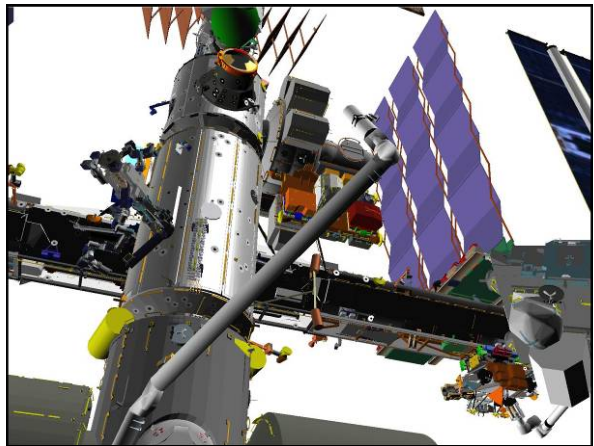

CCTV B (20,40)

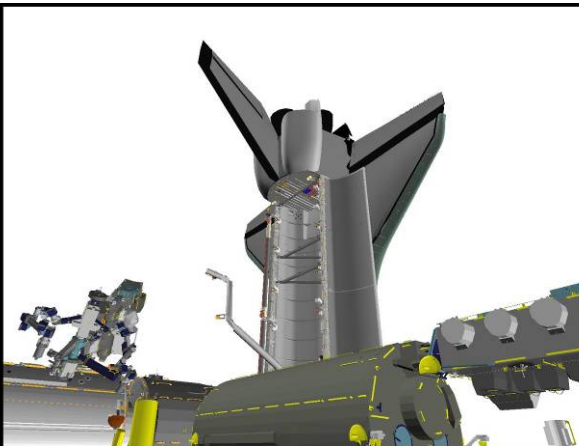

P1 LOOB (130,30)

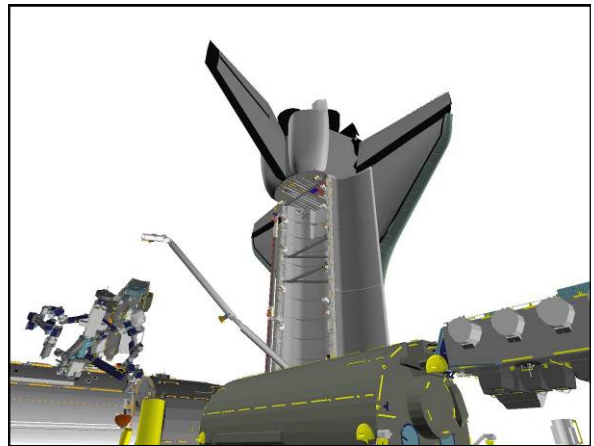

P1 LOOB (130,30)

Step 3:
Drive SY+
From -40.0 to +0.0

Step 4:
Drive SP-
From +42.0 to +25.0



CCTV A (0,25)



CCTV A (0,25)



CCTV C (-40,20)

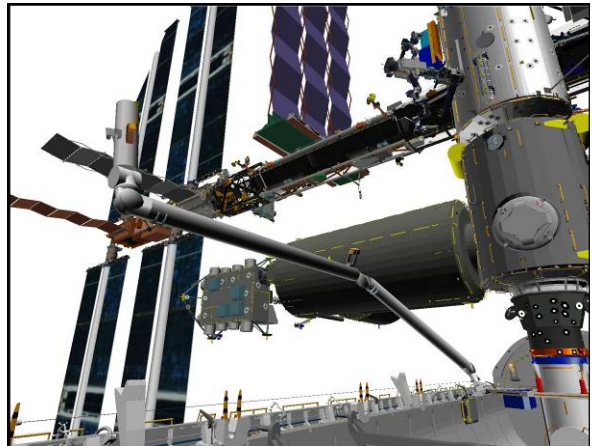

CCTV C (-40,20)

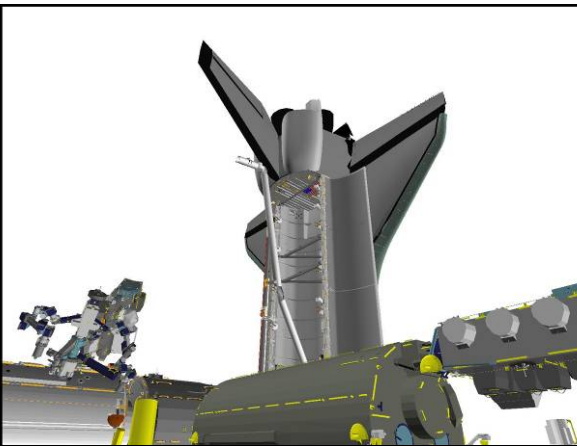

P1 LOOB (130,30)

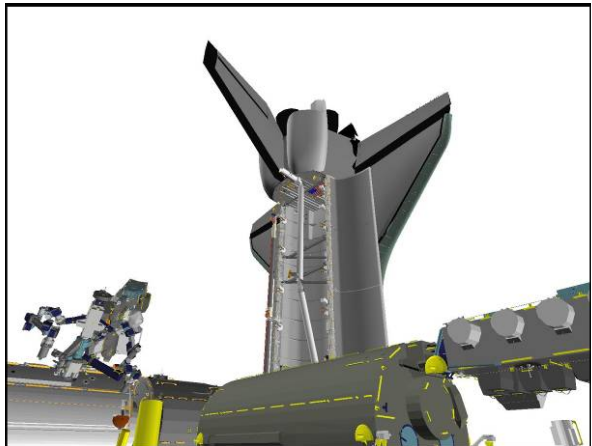

P1 LOOB (130,30)

Step 5:
Drive WP-
From +83.8 to +5.0

Step 6:
Drive WY+
From -17.3 to 0.0



CCTV A (0,25)

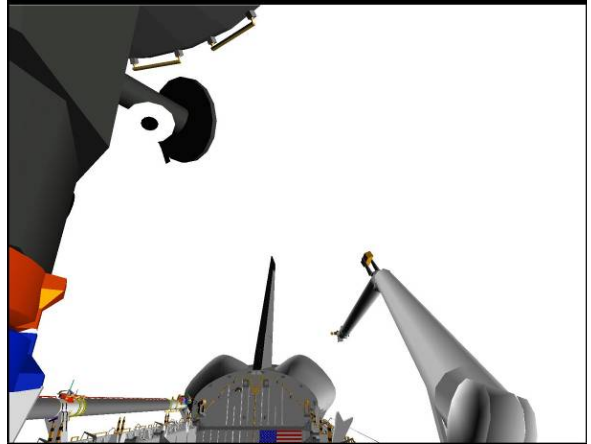

CCTV A (0,25)

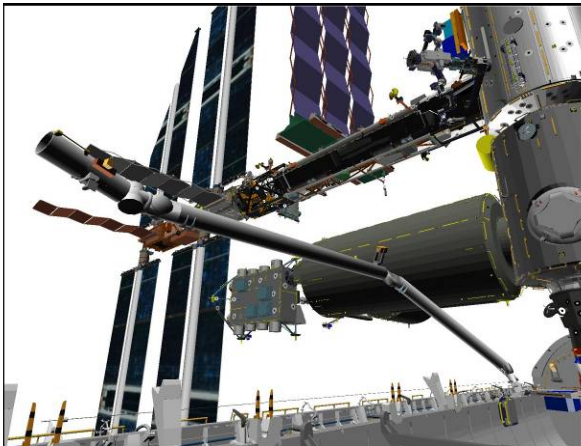

CCTV C (-45,20)

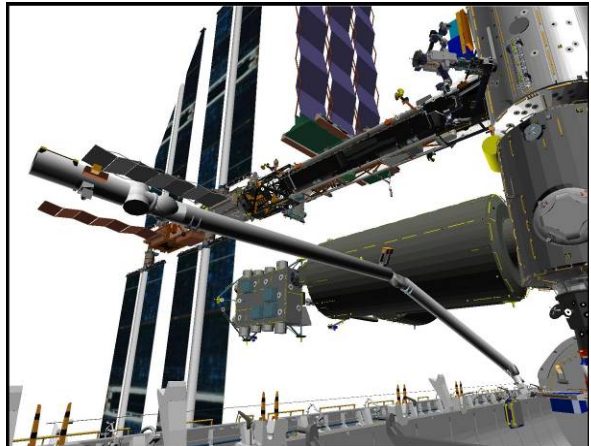

CCTV C (-45,20)

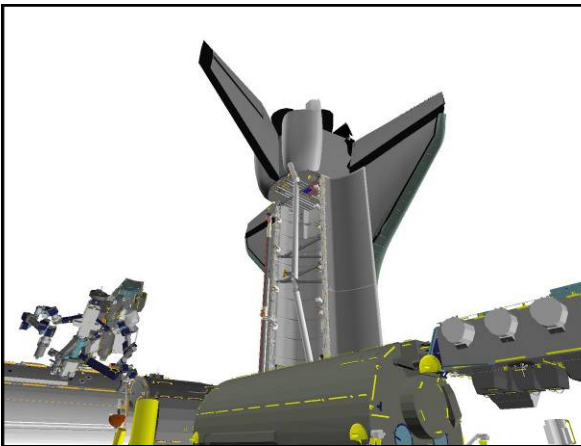

P1 LOOB (130,30)

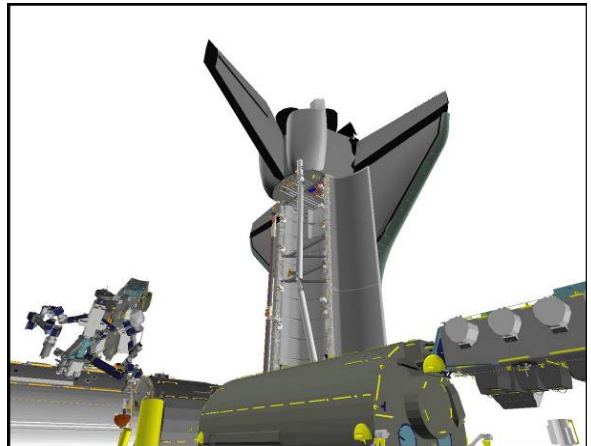

P1 LOOB (130,30)

Step 7:
Drive WR+
From -88.8 to 0.0



CCTV A (0,25)

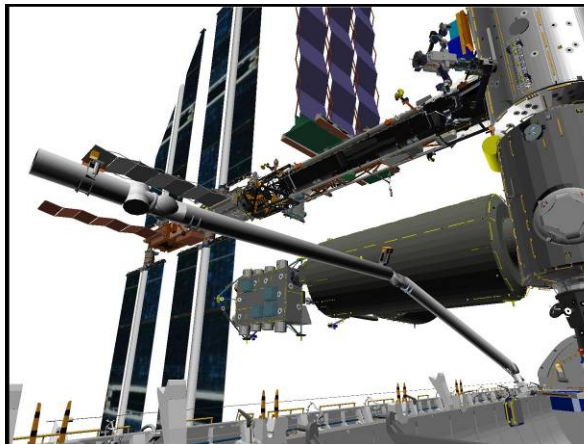

CCTV C (-45,20)

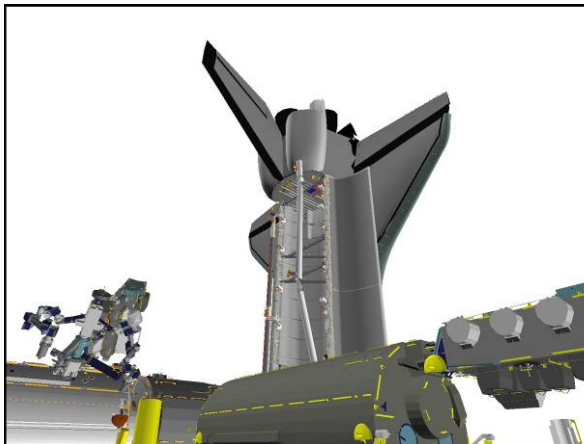

P1 LOOB (130,30)

OBSS NOMINAL

OBSS HANDOFF FROM SSRMS (NODE 2) TO SRMS	FS 3-2
MANEUVER TO OBSS CLEARANCE POSN	FS 3-6
HANDOFF FROM SRMS TO SSRMS (NODE 2).....	FS 3-8
MNVR FROM OBSS PRE-GRAPPLE TO PRE-CRADLE POSN	FS 3-13

**OBSS
NOMINAL**

OBSS HANDOFF FROM SSRMS (NODE 2) TO SRMS

NOTE

Assumed starting posn is SINGULARITY AVOIDANCE

1. SETUP

SM 94 PDRS CONTROL

√ PL ID, ITEM 3: 0

√ INIT ID, ITEM 24: 0

V10/L	P1 LOOB
V10/R	A
MON 1	Elbow
MON 2	C

2. PRE-GRAPPLE MNVR

RHC

RATE – as reqd (VERN within 10 ft)

BRAKES – OFF (tb-OFF)

MODE – SINGLE, ENTER

Mnvr to INTERMEDIATE posn:

Singularity
Avoidance
1: WP –
2: WY –
Intermediate

SY	SP	EP	WP	WY	WR	
+26.0	+68.7	-57.2	+42.1	+74.0	-12.9	
			-50.0			
				+25.0		
+26.0	+68.7	-57.2	-50.0	+25.0	-12.9	
X	Y	Z	PITCH	YAW	ROLL	PL ID
-1048	-386	-612	301	28	3	0

OBSS
NOMINAL

SM 94 PDRS CONTROL

END POS – ITEM 18 (-)1 0 1 5 (-)3 6 2 (-)6 8 8 EXEC

ATT – ITEM 21 +2 8 4 +0 +2 7 0 EXEC

CMD CK – ITEM 25 EXEC (GOOD)

MODE – OPR CMD, ENTER (READY It on)

After PROCEED, if motion no longer apparent but POR is within
1 in/1 deg and IN PROG It – on:

AUTO SEQ – STOP

AUTO SEQ – PROCEED (IN PROG It on)

When AUTO SEQ IN PROG It – off:

BRAKES – ON (tb-ON)

OBSS PRE-GRAPPLE AT HANDOFF posn:

~ 1 min

X	Y	Z	PITCH	YAW	ROLL	PL ID
-1015	-362	-688	284	0	270	0
SY	SP	EP	WP	WY	WR	
+23.5	+63.5	-29.6	-102.9	+11.5	-98.6	

PARAM – PORT TEMP

JOINT – CRIT TEMP

**Notify SSRMS Operator that SRMS at OBSS PRE-GRAPPLE AT HANDOFF
posn**



CCTV A (10,25)

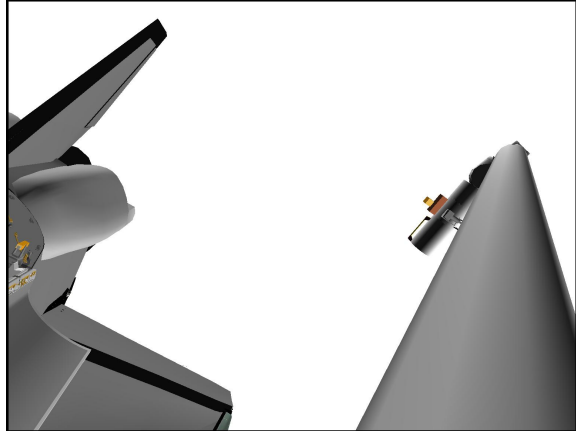

ELBOW (-30,-15)

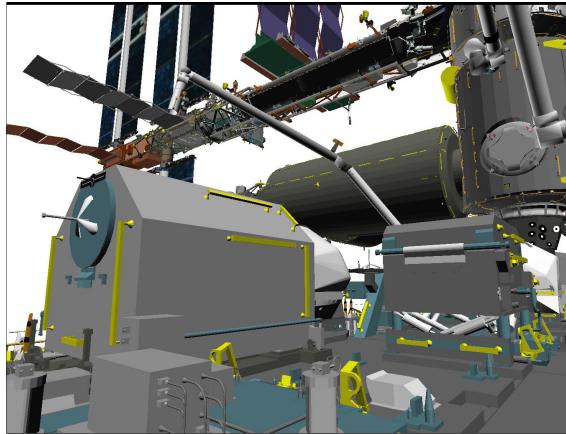

CCTV C (-45,10)

3. CONFIGURE POWER

CAUTION
SPEE power must be applied within 90 min
to prevent sensor package damage

On SSRMS Operator GO to release STBD MRLs

STBD RMS HTR A,B (two) – OFF

A6U EVENT TIMER MODE – UP
 CNTL – START

MA73C:C cb MCA PWR AC3 3Φ MID 2 – op
 √AC2 3Φ MID 2 – op
:D √AC3 3Φ MID 4 – op

R13L PL BAY MECH PWR SYS (two) – ON

4. STBD MRL RELEASE

SM 94 PDRS CONTROL
RMS STBD – ITEM 2 EXEC (*)
√STBD AFT, MID, FWD REL (six) = 0

NOTE

Expect single motor drive time for MRL release

STBD RMS RETEN LAT – REL (tb-REL) (18 sec max)
– OFF

If motor drive time > 18 sec, √MCC

SM 94 PDRS CONTROL

√STBD AFT, MID, FWD REL (six) = 1

5. RECONFIGURE POWER

R13L PL BAY MECH PWR SYS (two) – OFF

MA73C:C cb MCA PWR AC3 3Φ MID 2 – cl
√AC2 3Φ MID 2 – op
:D √AC3 3Φ MID 4 – op

Give SSRMS Operator GO for OBSS Unberth
Monitor RFL Status

After OBSS Unberth,

SM 94 PDRS CONTROL

RMS PORT – ITEM 1 EXEC (*)

6. SETUP FOR GRAPPLE

V10/L	P1 LOOB
V10/R	A
MON 1	EE
MON 2	C

A7U CCTV – config for grapple
– install PDRS TARGET OVERLAY FOR CTVM
– RMS WRIST, ZOOM: 34.0 HFOV
FOCUS: 5 ft
Maintain eyepoint approx 18 in when using grapple overlay

R12(OBSS) √SPEE PWR – OFF
A15 √APCU 1,2 CONV (two) – OFF
√OUTPUT (two) – OFF

7. OBSS GRAPPLE AT HANDOFF

RHC On SSRMS Operator GO for OBSS grapple,
RATE – VERN (RATE MIN tb-ON)
BRAKES – OFF (tb-OFF)
MODE – END EFF, ENTER

Mnvr to grapple envelope

CAUTION

Monitor EE tb timing to prevent EE motor burnout

SM 169 PDRS STATUS

EE MODE – AUTO

CAPTURE sw – depress (mom)

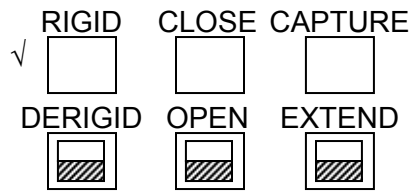

CRITICAL TIMES (28 sec total):

CAPTURE tb – gray, then
 CLOSE tb – gray, 3 sec max, then
 RIGID tb – gray, 25 sec max

EE MODE – OFF

MODE – TEST, ENTER

Wait 5 sec

BRAKES – ON (tb-ON)

MODE – not DIRECT

SM 94 PDRS CONTROL

PL ID – ITEM 3 +2 EXEC

INIT ID – ITEM 24 +2 EXEC

Expected OBSS HANDOFF posn:

X	Y	Z	PITCH	YAW	ROLL	PL ID
-1029	+229	-614	14	270*	0	2
SY	SP	EP	WP	WY	WR	
+25.8	+66.3	-49.0	-85.9	+10.7	-100.7	

*Display singularity

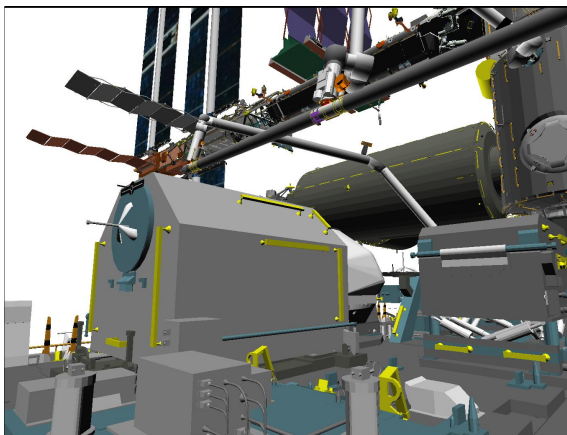

CCTV C (-45,10)

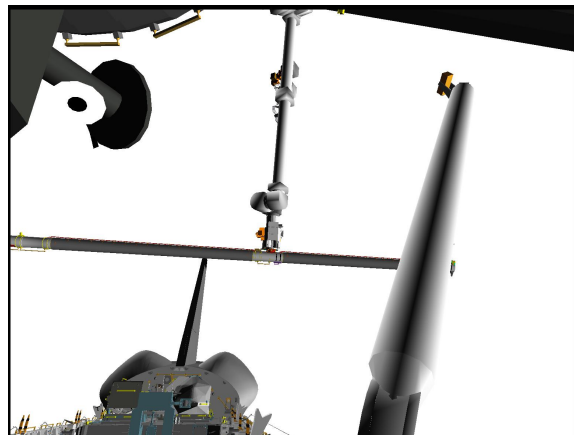

CCTV A (10,25)

Perform ACTIVATION (LDRI/ITVC Cue Card, PHOTO/TV)

Perform LCH ACTIVATION (LCS Cue Card, PHOTO/TV)

**Notify SSRMS Operator SRMS OBSS grapple complete and Brakes On,
 GO for OBSS RELEASE**

Perform LCC ACTIVATION (LCS Cue Card, PHOTO/TV)

Review GENERIC END EFFECTOR CUE CARD – ISS/SHUTTLE DOCKED OPS

OBSS MANEUVER TO OBSS CLEARANCE POSN

NOTE

Assumed starting posn is OBSS Handoff

1. SETUP

On SSRMS Operator GO for mnvr to OBSS CLEARANCE posn

SM 94 PDRS CONTROL

√PL ID, ITEM 3: 2

√INIT ID, ITEM 24: 2

R12

Green Jumper – ISS

V10/L	P1 LOOB
V10/R	A
MON 1	Elbow
MON 2	C(B)

RHC

2. MNVR TO OBSS CLEARANCE POSN

RATE – as reqd (VERN within 10 ft)

BRAKES – OFF (tb-OFF)

MODE – SINGLE, ENTER

Mnvr to OBSS CLEARANCE posn:

OBSS
Handoff
1: WR +
OBSS
Clearance

SY	SP	EP	WP	WY	WR	
+25.8	+66.3	-49.0	-85.9	+10.7	-100.7	
					-70.0	
+25.8	+66.3	-49.0	-85.9	+10.7	-70.0	
X	Y	Z	PITCH	YAW	ROLL	PL ID
-1323	+148	-688	14	300	0	2

BRAKES – ON (tb-ON)

Notify SSRMS Operator SRMS at OBSS CLEARANCE posn, GO for mnvr to FOCUSED INSPECTION VIEWING posn

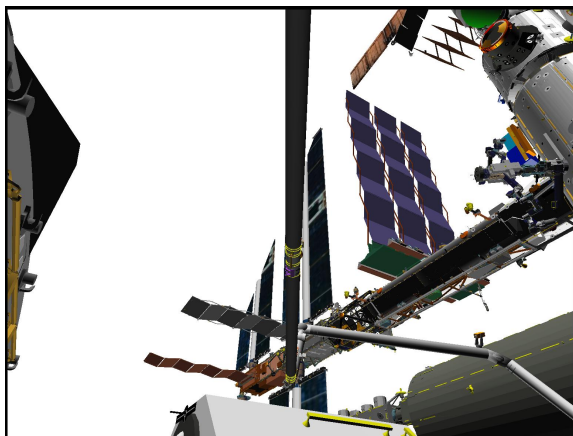

CCTV C (-60,40)

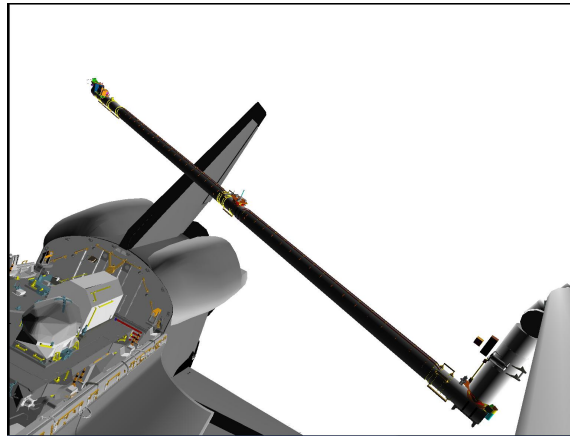

ELBOW (-35,5)

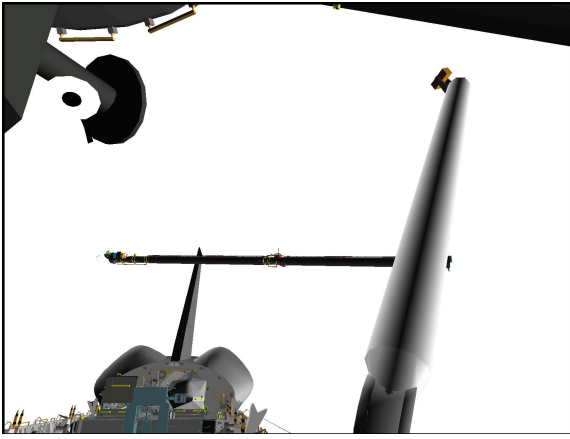

CCTV A (10,25)

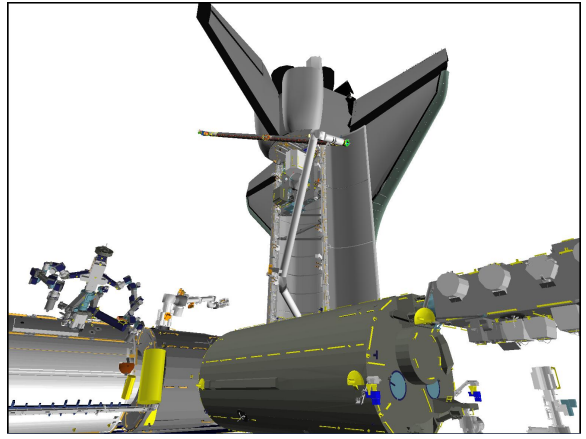

P1 LOOB (130,25)

OBSS HANDOFF FROM SRMS TO SSRMS (NODE 2)

NOTE

Assumed starting posn is OBSS Clearance

- SETUP
On SSRMS Operator GO for mnvr to OBSS HANDOFF posn

SM 94 PDRS CONTROL

√PL ID, ITEM 3: 2

√INIT ID, ITEM 24: 2

R12 Green Jumper – ISS

V10/L	P1 LOOB
V10/R	A
MON 1	Elbow
MON 2	C

- RHC
- MNVR TO OBSS HANDOFF POSN
RATE – as reqd (VERN within 10 ft)
BRAKES – OFF (tb-OFF)
MODE – SINGLE, ENTER

Mnvr to OBSS HANDOFF posn:

OBSS
Clearance
1: WR –
OBSS
Handoff

SY	SP	EP	WP	WY	WR	
+25.8	+66.3	-49.0	-85.9	+10.7	-70.0	
					-100.7	
+25.8	+66.3	-49.0	-85.9	+10.7	-100.7	
X	Y	Z	PITCH	YAW	ROLL	PL ID
-1029	+229	-614	14	270*	0	2

*Display singularity

BRAKES – ON (tb-ON)

Notify SSRMS Operator SRMS at OBSS HANDOFF posn, GO for OBSS Grapple

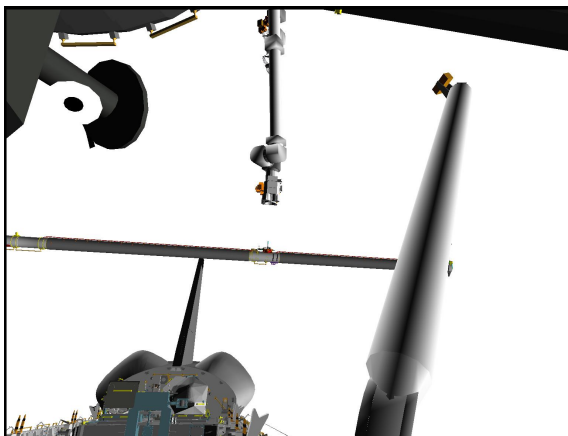

CCTV A (10,25)

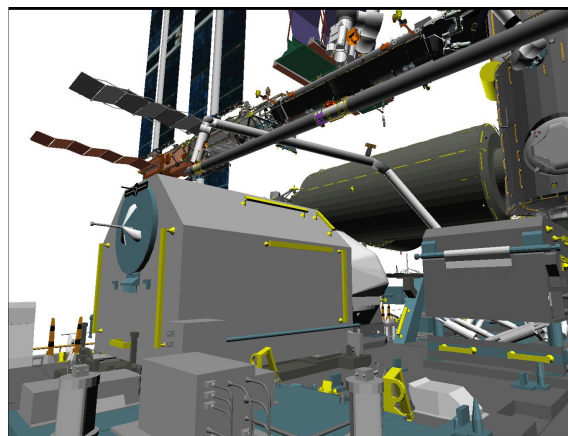

CCTV C (-45,10)

R12 3. STOW PTU
Green Jumper – LDRI/ITVC

A7U DTV ← PL2

CAMR CMD PAN/TILT – HI RATE
PAN – L (to hard stop)
TILT – UP (to hard stop)
PAN/TILT – RESET, HI RATE (LO within 10°)
PAN: +108 (right)
TILT: -175 (down)

On SSRMS Operator GO for OBSS Release

<u>CAUTION</u> STBD RMS HTR power must be applied within 90 min to prevent sensor package damage
--

Perform LCC DEACTIVATION (LCS Cue Card, PHOTO/TV)
Perform LCH DEACTIVATION (LCS Cue Card, PHOTO/TV)

Perform DEACTIVATION (LDRI/ITVC Cue Card, PHOTO/TV)

R12 4. OBSS UNGRAPPLE
Green Jumper – ISS

V10/L	P1 LOOB
V10/R	A
MON 1	EE→Elbow
MON 2	C

A7U CCTV – config for ungrapple
– RMS WRIST, ZOOM: 34.0 HFOV
FOCUS: 5 ft

NOTE
CONTR ERR It and 'S96 PDRS CNTL' msg may
occur due to Consistency/Envelope Check error

RHC RATE – COARSE (RATE MIN tb-OFF)

<u>SM 94 PDRS CONTROL</u>

AUTO BRAKE INH – ITEM 10 EXEC (*)

BRAKES – OFF (tb-OFF)
MODE – TEST, ENTER
Wait 5 sec

BRAKES – ON (tb-ON)

SM 94 PDRS CONTROL

AUTO BRAKE ENA – ITEM 9 EXEC (*)
PL ID – ITEM 3 +0 EXEC
INIT ID – ITEM 24 +0 EXEC

RHC RATE – VERN (RATE MIN tb-ON)
BRAKES – OFF (tb-OFF)
MODE – END EFF, ENTER

CAUTION
Monitor EE tb timing to prevent EE motor burnout

SM 169 PDRS STATUS

EE MODE – AUTO
RELEASE sw – depress (mom)

When OPEN tb – gray, mnvr arm clear of grapple pin

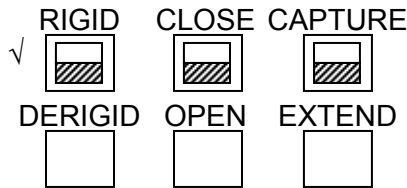

CRITICAL TIMES (28 sec total):
DERIGID tb – gray, 5 sec max, then
OPEN tb – gray, 3 sec max, then
EXTEND tb – gray, 20 sec max

EE MODE – OFF

- * If manual release reqd: *
- * EE MODE – MAN *
- * MAN CONTR – DERIGID (hold until DERIGID tb-gray, 5 sec max) *
- * RELEASE sw – depress (hold until OPEN tb-gray, 3 sec max) *
- * Mnvr arm clear of grapple pin, then *
- * EE MAN CONTR – DERIGID (hold until EXTEND tb-gray, 20 sec max) *
- * MODE – OFF *

Mnvr to OBSS PRE-GRAPPLE AT HANDOFF posn:

X	Y	Z	PITCH	YAW	ROLL	PL ID
-1015	-362	-688	284	0	270	0
SY	SP	EP	WP	WY	WR	
+23.5	+63.5	-29.6	-102.9	+11.5	-98.6	

BRAKES – ON (tb-ON)
MODE – not DIRECT

Give SSRMS Operator GO for OBSS Berth

- * If using Shuttle attitude control and attitude maintenance reqd: *
- * DAP: LVLH *
- * When rates damped *
- * DAP: FREE > 2 sec *
- * DAP: AUTO *
- * When in attitude and rates damped: *
- * DAP: FREE *

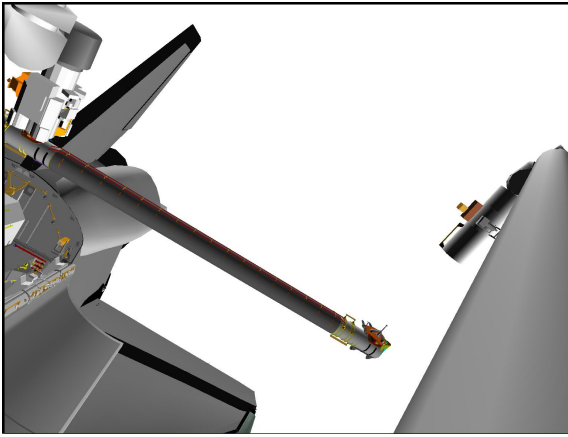

ELBOW (-35,-15)

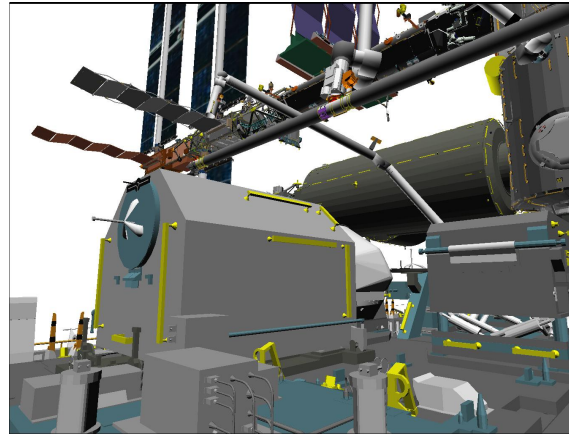

CCTV C (-45,10)

5. CONFIGURE CIRCUIT BREAKERS
 MA73C:C cb MCA PWR AC3 3Φ MID 2 – op
 √AC2 3Φ MID 2 – op
 :D √AC3 3Φ MID 4 – op

6. CONFIGURE FOR MONITORING
On SSRMS notification to watch for STBD RMS RFLs,
SM 94 PDRS CONTROL
 RMS STBD – ITEM 2 EXEC (*)

Notify SSRMS operator when STBD RMS R-F-L tb (three) – gray

7. STBD MRL LATCH
On SSRMS Operator GO to latch STBD MRLs to Topological Capture,
 √STBD RMS R-F-L tb (three) – gray

SM 94 PDRS CONTROL
 √STBD AFT, MID, FWD LAT (six) = 0

R13L PL BAY MECH PWR SYS (two) – ON

NOTE

Expect single motor drive time for MRL latching (18 sec max).
 The following STBD RMS RETEN LAT – OFF and PL BAY
 MECH PWR SYS (two) – OFF actions are to be performed simo

Verify AOS for latching to Topological Capture

STBD RMS RETEN LAT – LAT 6 sec only (tb-bp)
 – OFF

R13L PL BAY MECH PWR SYS (two) – OFF

Give SSRMS Operator GO to Limp All SSRMS Joints and Derigidize

R13L **On SSRMS Operator GO to complete STBD MRL latching,**
 PL BAY MECH PWR SYS (two) – ON

STBD RMS RETEN LAT – LAT (tb-LAT) (12 sec max)
 – OFF

8. RECONFIGURE POWER
R13L PL BAY MECH PWR SYS (two) – OFF

STBD RMS HTR A,B (two) – AUTO

A6U EVENT TIMER CNTL – STOP

SM 94 PDRS CONTROL

√STBD AFT, MID, FWD LAT (six) = 1
RMS PORT – ITEM 1 EXEC (*)

MA73C:C cb MCA PWR AC3 3Φ MID 2 – cl

√AC2 3Φ MID 2 – op

:D √AC3 3Φ MID 4 – op

Give SSRMS Operator GO for OBSS Release

MNVR FROM OBSS PRE-GRAPPLE TO PRE-CRADLE POSN

1. SETUP

SM 94 PDRS CONTROL

√ PL ID, ITEM 3: 0

√ INIT ID, ITEM 24: 0

V10/L	P1 LOOB
V10/R	A
MON 1	Elbow
MON 2	C

Verify at OBSS PRE-GRAPPLE AT HANDOFF posn:

X	Y	Z	PITCH	YAW	ROLL	PL ID
-1015	-362	-688	284	0	270	0
SY	SP	EP	WP	WY	WR	
+23.5	+63.5	-29.6	-102.9	+11.5	-98.6	

2. MNVR TO PRE-CRADLE POSN

On SSRMS Operator GO for maneuver to Pre-cradle posn

SM 94 PDRS CONTROL

END POS – ITEM 18 (-)1 2 6 1 (-)1 4 6 (-)5 5 1 EXEC

ATT – ITEM 21 +5 +2 +0 EXEC

CMD CK – ITEM 25 EXEC (GOOD)

RHC

RATE – as reqd (VERN within 10 ft)

BRAKES – OFF (tb-OFF)

MODE – OPR CMD, ENTER (READY lt on)

AUTO SEQ – PROCEED (IN PROG lt on)

When AUTO SEQ IN PROG lt – off:

BRAKES – ON (tb-ON)

PRE-CRADLE posn:

~1 min

X	Y	Z	PITCH	YAW	ROLL	PL ID
√ -1261	-146	-551	5	2	0	0
SY	SP	EP	WP	WY	WR	
√ 0.0	+25.0	-25.0	+5.0	0.0	0.0	

PARAM – PORT TEMP

JOINT – CRIT TEMP

Notify SSRMS Operator that SRMS at Pre-cradle posn

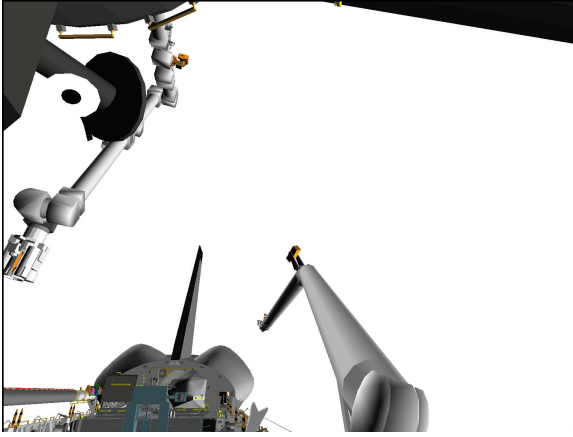

CCTV A (10,25)

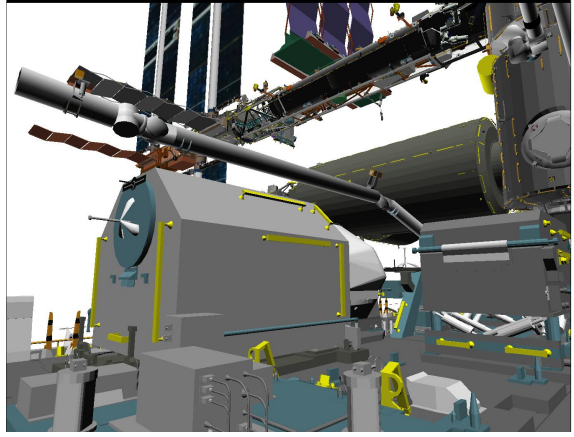

CCTV C (-45,10)

OBSS OFF-NOMINAL

OBSS SJ HANDOFF FROM SSRMS (NODE 2) TO SRMS	FS 4-2
MANEUVER TO OBSS CLEARANCE POSN	FS 4-10
HANDOFF FROM SRMS TO SSRMS (NODE 2).....	FS 4-12
MNVR FROM OBSS PRE-GRAPPLE TO PRE-CRADLE POSN	FS 4-19

**OBSS
OFF-NOMINAL**

OBSS SJ HANDOFF FROM SSRMS (NODE 2) TO SRMS

1. SETUP

SM 94 PDRS CONTROL

√PL ID, ITEM 3: 0

√INIT ID, ITEM 24: 0

A7U

CCTV – config as reqd
 – perform PAN/TILT RESET for PLB cameras
 ZOOM – full OUT

V10/L	P1 LOOB
V10/R	A
MON 1	Elbow
MON 2	C

2. SJ OBSS PRE-GRAPPLE MANEUVER

If SINGLE mode available:

RHC

RATE – as reqd (VERN within 10 ft)
 BRAKES – OFF (tb-OFF)

MODE – best available

Mnvr to OBSS PRE-GRAPPLE AT HANDOFF posn:

	SY	SP	EP	WP	WY	WR	
Singularity Avoidance	+26.0	+68.7	-57.2	+42.1	+74.0	-12.9	
1: EP +			-29.6				
2: SY -	+23.5						
3: SP -		+63.5					
4: WP -				-102.9			
5: WY -					+11.5		
6: WR -						-98.6	
OBSS Pre-Grapple	+23.5	+63.5	-29.6	-102.9	+11.5	-98.6	
	X	Y	Z	PITCH	YAW	ROLL	PL ID
	-1015	-362	-688	284	0	270	0

If SINGLE mode available:
 BRAKES – ON (tb-ON)

MODE – not DIRECT

PARAM – PORT TEMP
 JOINT – CRIT TEMP

Notify SSRMS Operator that SRMS at OBSS PRE-GRAPPLE AT HANDOFF posn

OBSS OFF-NOMINAL

Step 1:
Drive EP+
From -57.2 to -29.6



CCTV A (10,25)

Step 2:
Drive SY-
From +26.0 to +23.5



CCTV A (10,25)

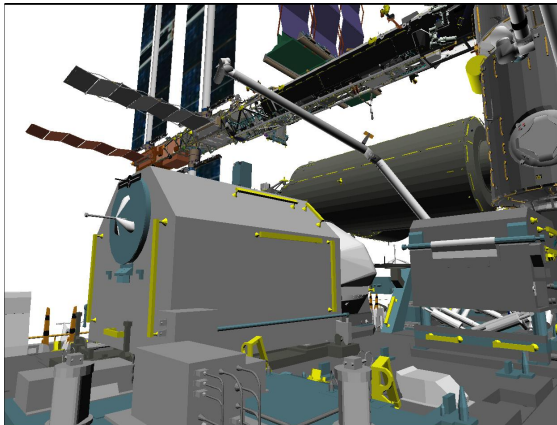

CCTV C (-45,10)

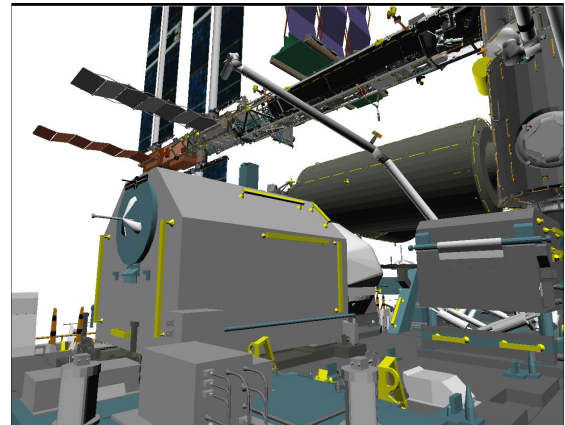

CCTV C (-45,10)

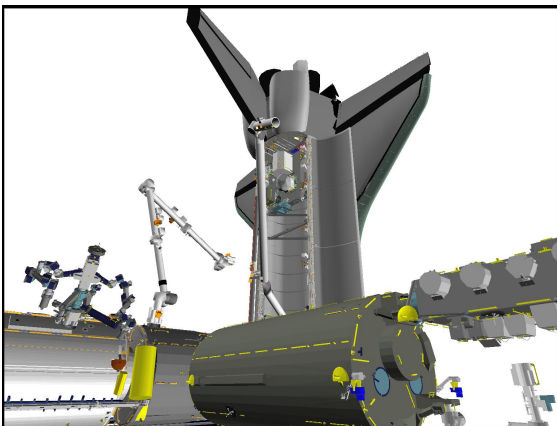

P1 LOOB (130,25)

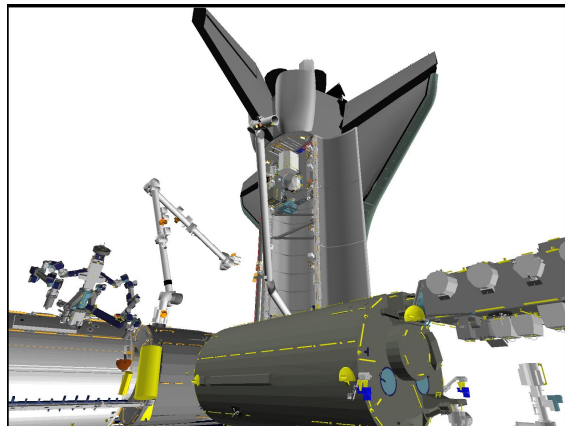

P1 LOOB (130,25)

Step 3:
Drive SP-
From +68.7 to +63.5

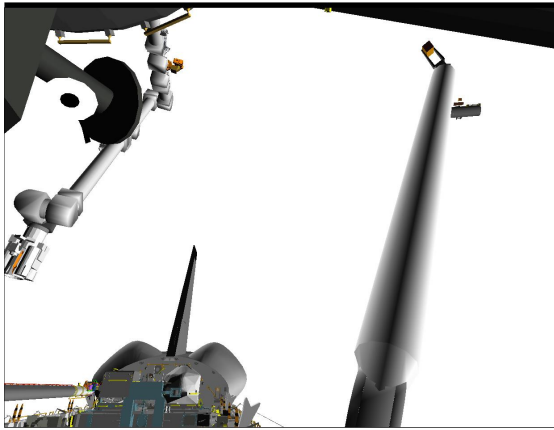

CCTV A (10,25)

Step 4:
Drive WP-
From +42.1 to -102.9

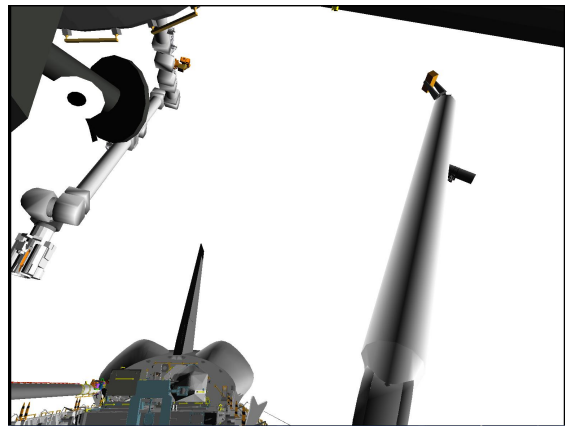

CCTV A (10,25)

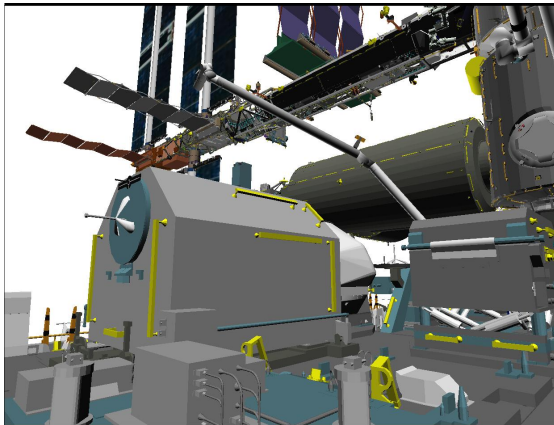

CCTV C (-45,10)

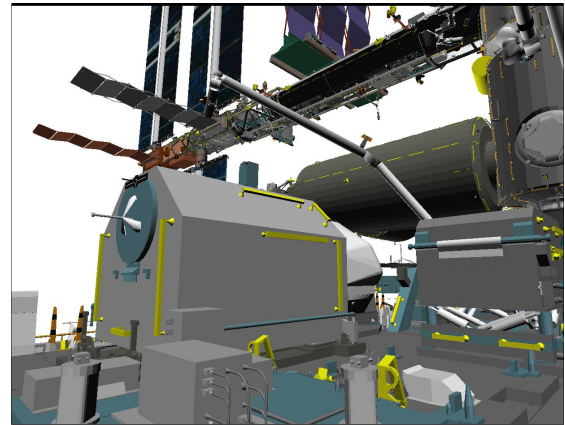

CCTV C (-45,10)

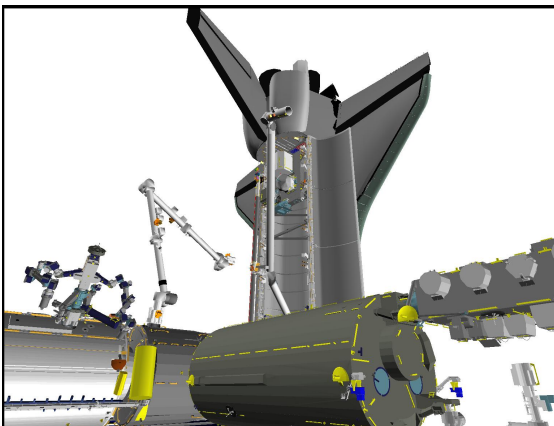

P1 LOOB (130,25)

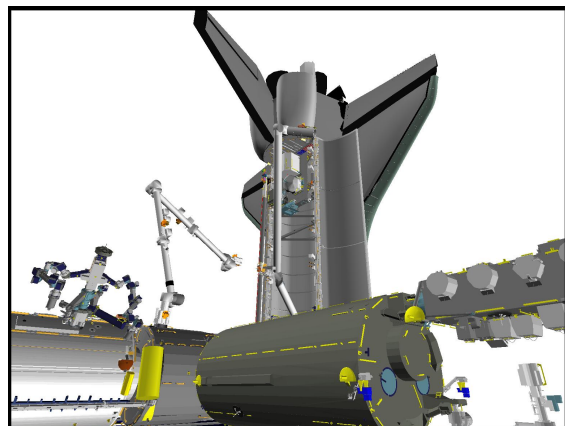

P1 LOOB (130,25)

Step 5:
Drive WY-
From +74.0 to +11.5

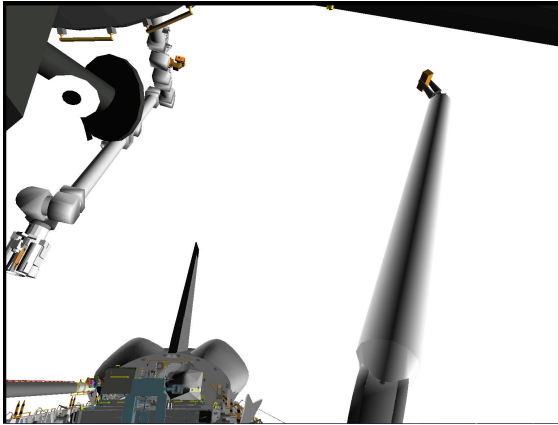

CCTV A (10,25)

Step 6:
Drive WR-
From -12.9 to -98.6

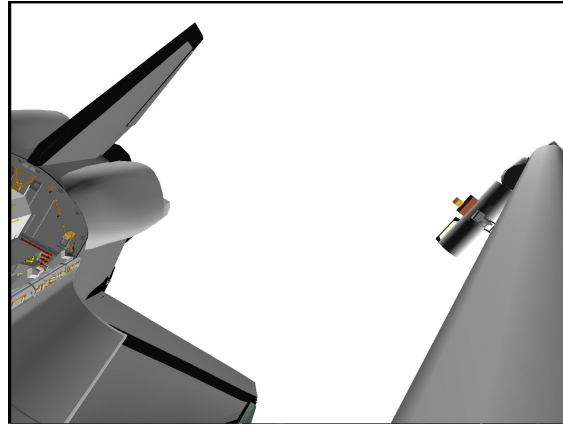

ELBOW (-35,-15)

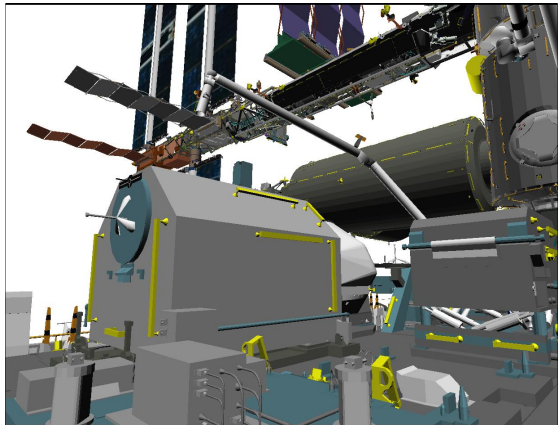

CCTV C (-45,10)

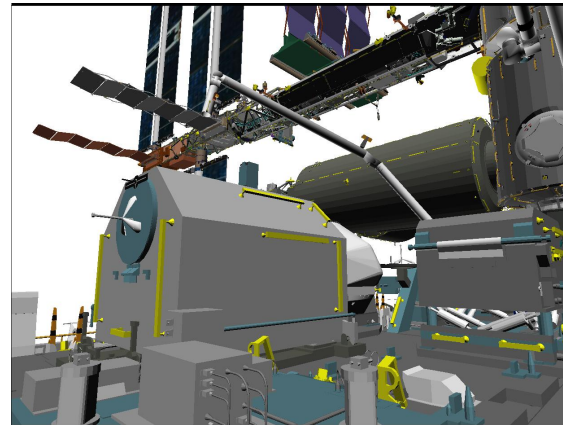

CCTV C (-45,10)

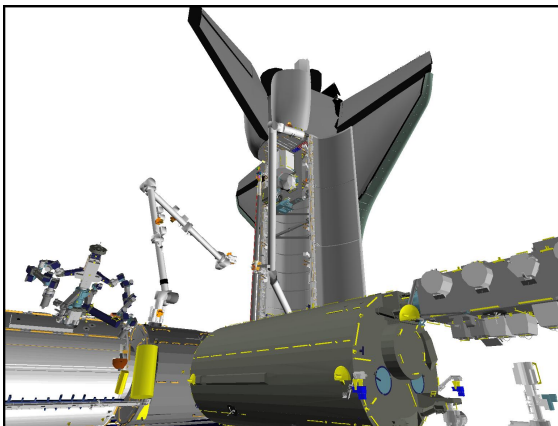

P1 LOOB (130,25)

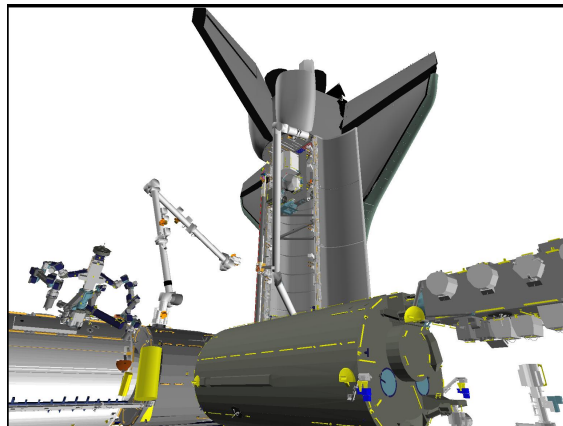

P1 LOOB (130,25)

3. CONFIGURE POWER

CAUTION
SPEE power must be applied within 90 min
to prevent sensor package damage

On SSRMS Operator GO to Release STBD MRLs

STBD RMS HTR A,B (two) – OFF

A6U EVENT TIMER MODE – UP
 CNTL – START

MA73C:C cb MCA PWR AC3 3Φ MID 2 – op
 √AC2 3Φ MID 2 – op
:D √AC3 3Φ MID 4 – op

R13L PL BAY MECH PWR SYS (two) – ON

4. STBD MRL RELEASE

SM 94 PDRS CONTROL
RMS STBD – ITEM 2 EXEC (*)
√STBD AFT, MID, FWD REL (six) = 0

NOTE
Expect single motor drive time for MRL release

STBD RMS RETEN LAT – REL (tb-REL) (18 sec max)
– OFF

If motor drive time > 18 sec, √MCC

SM 94 PDRS CONTROL
√STBD AFT, MID, FWD REL (six) = 1

5. RECONFIGURE POWER

R13L PL BAY MECH PWR SYS (two) – OFF

MA73C:C cb MCA PWR AC3 3Φ MID 2 – cl
 √AC2 3Φ MID 2 – op
:D √AC3 3Φ MID 4 – op

Give SSRMS Operator GO for OBSS Unberth
Monitor RFL Status

After OBSS Unberth,
SM 94 PDRS CONTROL
RMS PORT – ITEM 1 EXEC (*)

6. SETUP FOR GRAPPLE

V10/L	P1 LOOB
V10/R	A
MON 1	EE
MON 2	C

A7U CCTV – config for grapple
 – install OBSS SJ GRAPPLE AT HANDOFF OVERLAY
 – RMS WRIST, ZOOM: 34.0 HFOV
 FOCUS: 5 ft
 Maintain eyepoint approx 18 in when using grapple overlay

R12(OBSS) √SPEE PWR – OFF
 A15 √APCU 1,2 CONV (two) – OFF (tb-bp)
 A15 √OUTPUT (two) – OFF (tb-bp)

7. SJ OBSS GRAPPLE AT HANDOFF

On SSRMS Operator GO for OBSS grapple,

If SINGLE mode available:

RHC RATE – VERN (RATE MIN tb-ON)
 BRAKES – OFF (tb-OFF)

MODE – best available

Drive joints per OBSS SJ GRAPPLE AT HANDOFF OVERLAY and diagram until EE within grapple envelope

CAUTION
 Monitor EE tb timing to prevent EE motor burnout

SM 169 PDRS STATUS

EE MODE – AUTO
 CAPTURE sw – depress (mom)

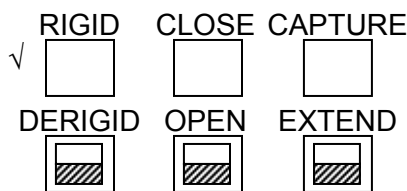

CRITICAL TIMES (28 sec total):
 CAPTURE tb – gray, then
 CLOSE tb – gray, 3 sec max, then
 RIGID tb – gray, 25 sec max

EE MODE – OFF

- * If manual capture required: *
- * EE MODE – MAN *
- * CAPTURE sw – depress (hold until CLOSE tb-gray, 3 sec max) *
- * MAN CONTR – RIGID (hold until RIGID tb-gray, 25 sec max) *
- * MODE – OFF *

If TEST mode available,
 MODE – TEST, ENTER
 Wait 5 sec

If SINGLE mode available:
 BRAKES – ON (tb-ON)

MODE – not DIRECT

OBSS SJ GRAPPLE AT HANDOFF OVERLAY

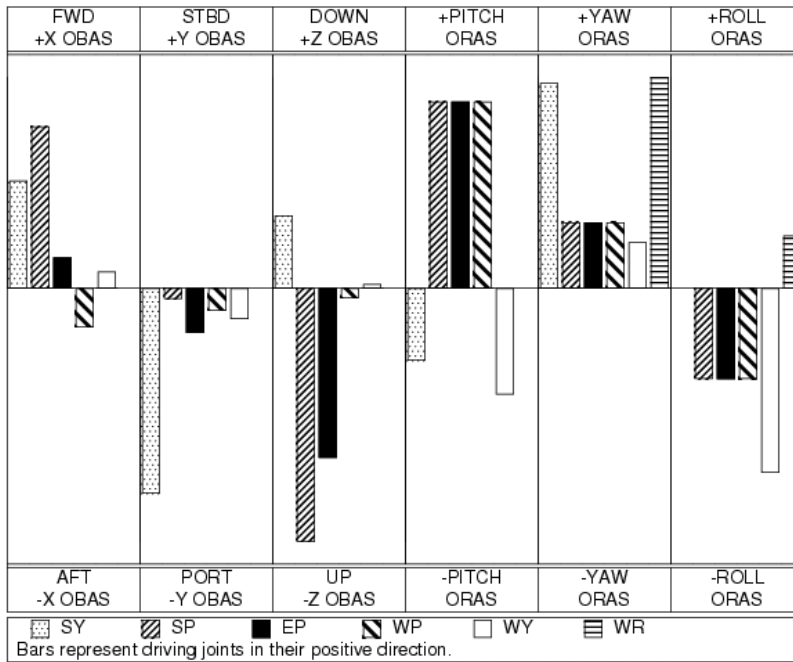

To get:	Drive:	To get:	Drive:	Driving:	Results In:	Driving:	Results In:
+X (fwd)	+SP, +SY	+PITCH	+WP, +EP	+SY	-Y (port), +YAW	+WP	-X (aft), +PITCH
+Y (stbd)	-SY	+YAW	+WR, +SY	+SP	-Z (up), +PITCH	+WY	-Y (port), -ROLL
+Z (down)	-SP, -EP	+ROLL	-WY, -WP	+EP	-Z (up), +PITCH	+WR	+YAW

ΔSY	ΔSP	ΔEP	ΔWP	ΔWY	ΔWR
+2.3	+2.8	-19.4	+17.0	-0.8	-2.1

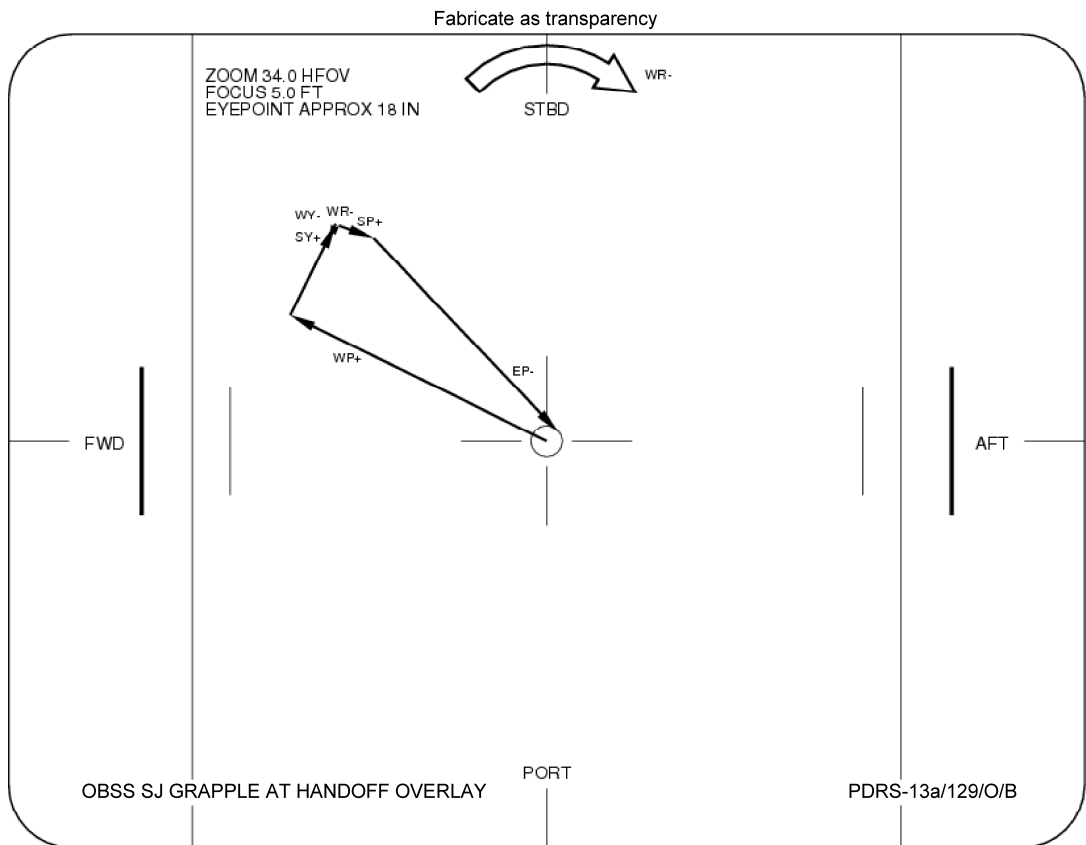

If SINGLE mode available:

SM 94 PDRS CONTROL

PL ID – ITEM 3 +2 EXEC

INIT ID – ITEM 24 +2 EXEC

Expected OBSS HANDOFF posn:

	X	Y	Z	PITCH	YAW	ROLL	PL ID
√	-1029	+229	-614	14	270*	0	2
	SY	SP	EP	WP	WY	WR	
√	+25.8	+66.3	-49.0	-85.9	+10.7	-100.7	

*Display singularity

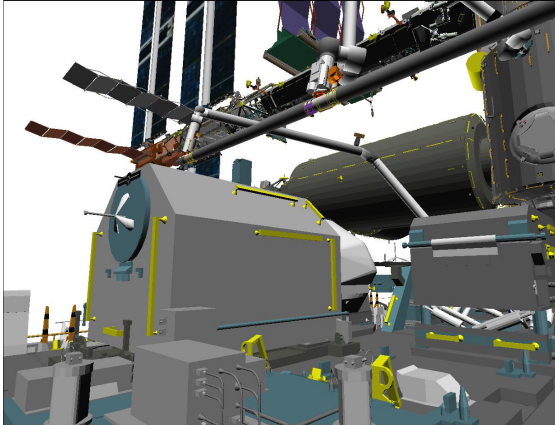

CCTV C (-45,10)



CCTV A (10,25)

Perform ACTIVATION (LDRI/ITVC Cue Card, PHOTO/TV)

Perform LCH ACTIVATION (LCS Cue Card, PHOTO/TV)

Review GENERIC END EFFECTOR CUE CARD – ISS/SHUTTLE DOCKED OPS

**Notify SSRMS Operator SRMS OBSS grapple complete and Brakes On,
GO for OBSS RELEASE**

Perform LCC ACTIVATION (LCS Cue Card, PHOTO/TV)

OBSS SJ MANEUVER TO OBSS CLEARANCE POSN

NOTE

Assumed starting posn is OBSS Handoff

- SETUP
On SSRMS Operator GO for mnvr to OBSS CLEARANCE posn

R12 Green Jumper – ISS

V10/L	P1 LOOB
V10/R	A
MON 1	Elbow
MON 2	C(B)

- MNVR TO OBSS CLEARANCE POSN

If SINGLE mode available:

RHC RATE – as reqd (VERN within 10 ft)
BRAKES – OFF (tb-OFF)

MODE – best available

Mnvr to OBSS CLEARANCE posn:

OBSS
Handoff
1: WR +
OBSS
Clearance

SY	SP	EP	WP	WY	WR	
+25.8	+66.3	-49.0	-85.9	+10.7	-100.7	
					-70.0	
+25.8	+66.3	-49.0	-85.9	+10.7	-70.0	
X	Y	Z	PITCH	YAW	ROLL	PL ID
-1323	+148	-688	14	300	0	2

If SINGLE mode available:

BRAKES – ON (tb-ON)

MODE – not DIRECT

Notify SSRMS Operator SRMS at OBSS CLEARANCE posn, GO for mnvr to
FOCUSED INSPECTION VIEWING posn

Step 1:
Drive WR+
From -100.7 to -70.0

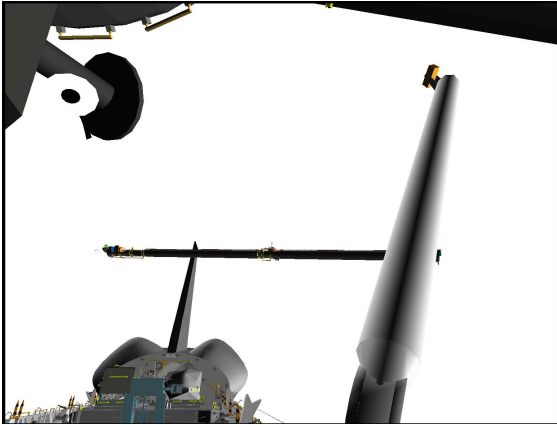

CCTV A (10,25)

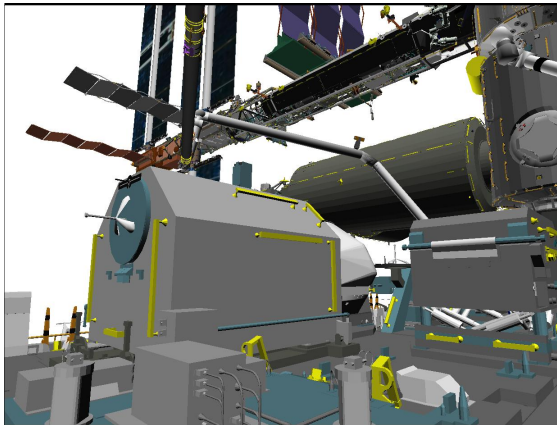

CCTV C (-45,10)

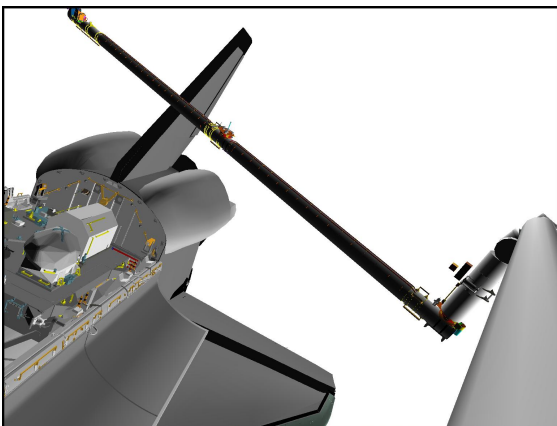

ELBOW (-35,5)

OBSS SJ HANDOFF FROM SRMS TO SSRMS (NODE 2)

NOTE

Assumed starting posn is OBSS Clearance

1. SETUP

On SSRMS Operator GO for mnvr to OBSS HANDOFF posn

SM 94 PDRS CONTROL

√PL ID, ITEM 3: 2

√INIT ID, ITEM 24: 2

R12

Green Jumper – ISS

V10/L	P1 LOOB
V10/R	A
MON 1	Elbow
MON 2	C

2. SJ MNVR TO OBSS HANDOFF POSN

If SINGLE mode available:

RHC

RATE – as reqd (VERN within 10 ft)

BRAKES – OFF (tb-OFF)

MODE – best available

Mnvr to OBSS HANDOFF posn:

OBSS
Clearance
1: WR –
OBSS
Handoff

SY	SP	EP	WP	WY	WR	
+25.8	+66.3	-49.0	-85.9	+10.7	-70.0	
					-100.7	
+25.8	+66.3	-49.0	-85.9	+10.7	-100.7	
X	Y	Z	PITCH	YAW	ROLL	PL ID
-1029	+229	-614	14	270*	0	2

*Display singularity

If SINGLE mode available:

BRAKES – ON (tb-ON)

MODE – not DIRECT

Notify SSRMS Operator SRMS at OBSS HANDOFF posn, GO for OBSS Grapple

Step 1:
Drive WR-
From -70.0 to -100.7

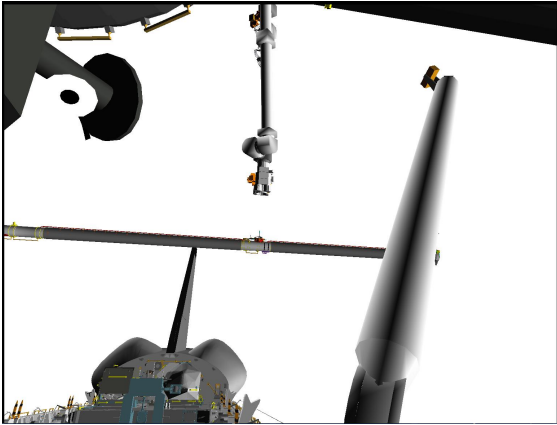

CCTV A (10,25)

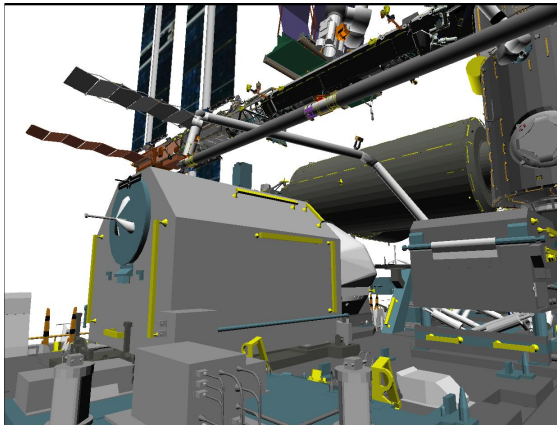

CCTV C (-45,10)

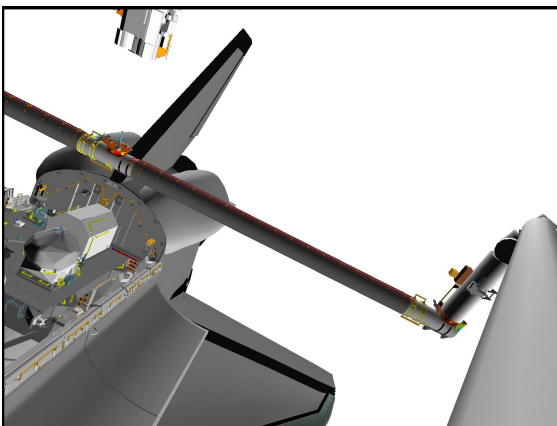

ELBOW (-35,-5)

R12 3. STOW PTU
Green Jumper – LDRI/ITVC

A7U DTV ← PL2

CAMR CMD PAN/TILT – HI RATE
PAN – L (to hard stop)
TILT – UP (to hard stop)
PAN/TILT – RESET, HI RATE (LO within 10°)
PAN: +108 (right)
TILT: -175 (down)

On SSRMS Operator GO for OBSS Release

<u>CAUTION</u> STBD RMS HTR power must be applied within 90 min to prevent sensor package damage
--

Perform LCC DEACTIVATION (LCS Cue Card, PHOTO/TV)
Perform LCH DEACTIVATION (LCS Cue Card, PHOTO/TV)
Perform DEACTIVATION (LDRI/ITVC Cue Card, PHOTO/TV)

R12 4. OBSS UNGRAPPLE
Green Jumper – ISS

V10/L	P1 LOOB
V10/R	A
MON 1	EE → Elbow
MON 2	C

A7U CCTV – config for ungrapple
– RMS WRIST, ZOOM: 34.0 HFOV
FOCUS: 5 ft

NOTE
CONTR ERR It and 'S96 PDRS CNTL' msg may
occur due to Consistency/Envelope Check error

RHC If TEST MODE available:
RATE – COARSE (RATE MIN tb-OFF)

SM 94 PDRS CONTROL

AUTO BRAKE INH – ITEM 10 EXEC (*)

BRAKES – OFF (tb-OFF)
MODE – TEST, ENTER
Wait 5 sec

BRAKES – ON (tb-ON)

SM 94 PDRS CONTROL

AUTO BRAKE ENA – ITEM 9 EXEC (*)

↑
If SINGLE MODE available:

SM 94 PDRS CONTROL
 PL ID – ITEM 3 +0 EXEC
 INIT ID – ITEM 24 +0 EXEC



















RHC RATE – VERN (RATE MIN tb-ON)
 BRAKES – OFF (tb-OFF)

MODE – best available

CAUTION
 Monitor EE tb timing to prevent EE motor burnout

SM 169 PDRS STATUS



















EE MODE – MAN
 MAN CONTR – DERIGID (hold until DERIGID tb-gray, 5 sec max)
 RELEASE sw – depress (hold until OPEN tb-gray, 3 sec max)

<p>✓</p> <table border="0"> <tr> <td>RIGID </td> <td>CLOSE </td> <td>CAPTURE </td> </tr> <tr> <td>DERIGID </td> <td>OPEN </td> <td>EXTEND </td> </tr> </table>	RIGID 	CLOSE 	CAPTURE 	DERIGID 	OPEN 	EXTEND 	<p><u>CRITICAL TIMES (8 sec total):</u> DERIGID tb – gray, 5 sec max, then OPEN tb – gray, 3 sec max</p>
RIGID 	CLOSE 	CAPTURE 					
DERIGID 	OPEN 	EXTEND 					

EE MODE – OFF

Drive joints per OBSS SJ HANDOFF SRMS UNGRAPPLE WRIST CCTV OVERLAY and diagram until SRMS at OBSS PRE-GRAPPLE posn

EE MODE – MAN
 MAN CONTR – DERIGID (hold until EXTEND tb-gray, 20 sec max)
 MODE – OFF

<p>✓</p> <table border="0"> <tr> <td>RIGID </td> <td>CLOSE </td> <td>CAPTURE </td> </tr> <tr> <td>DERIGID </td> <td>OPEN </td> <td>EXTEND </td> </tr> </table>	RIGID 	CLOSE 	CAPTURE 	DERIGID 	OPEN 	EXTEND 	<p><u>CRITICAL TIMES (20 sec total):</u> EXTEND tb – gray, 20 sec max</p>
RIGID 	CLOSE 	CAPTURE 					
DERIGID 	OPEN 	EXTEND 					

OBSS PRE-GRAPPLE AT HANDOFF posn:

X	Y	Z	PITCH	YAW	ROLL	PL ID
-1015	-362	-688	284	0	270	0
SY	SP	EP	WP	WY	WR	
+23.5	+63.5	-29.6	-102.9	+11.5	-98.6	

If SINGLE mode available:
 BRAKES – ON (tb-ON)

MODE – not DIRECT

Give SSRMS Operator GO for OBSS Berth

If using Shuttle attitude control and attitude maintenance required:
Configure DAP per RMS DAPs, then perform RATE DAMPING (ORB OPS FS,
REBOOST/DAP; DOCKED DAP REFERENCE)

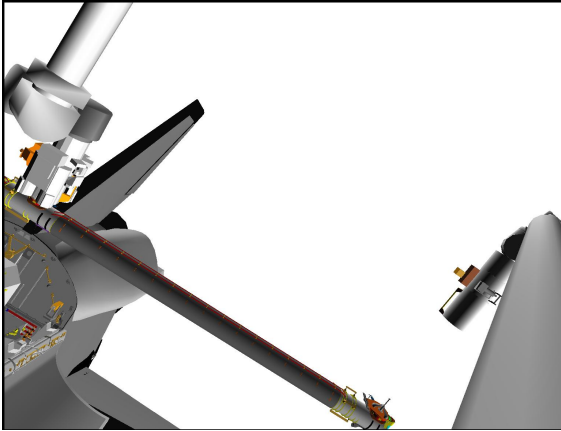

ELBOW (-35,-5)

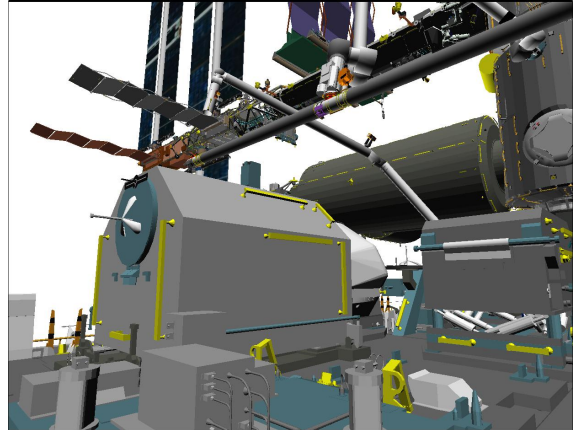

CCTV C (-45,10)

OBSS SJ UNGRAPPLE AT HANDOFF OVERLAY

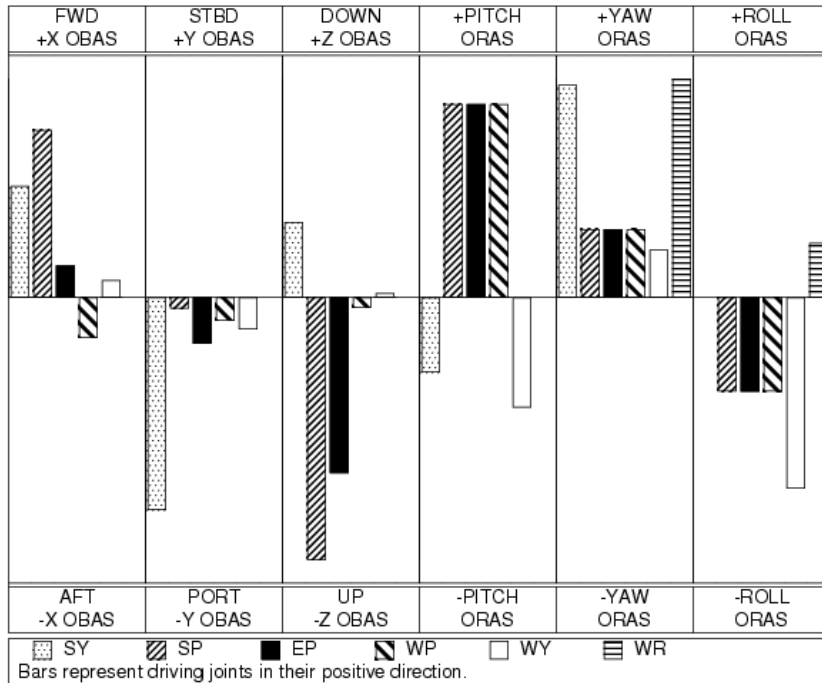

To get:	Drive:	To get:	Drive:	Driving:	Results In:	Driving:	Results In:
+X (fwd)	+SP, +SY	+PITCH	+WP, +EP	+SY	-Y (port), +YAW	+WP	-X (aft), +PITCH
+Y (stbd)	-SY	+YAW	+WR, +SY	+SP	-Z (up), +PITCH	+WY	-Y (port), -ROLL
+Z (down)	-SP, -EP	+ROLL	-WY, -WP	+EP	-Z (up), +PITCH	+WR	+YAW

ΔSY	ΔSP	ΔEP	ΔWP	ΔWY	ΔWR
-2.3	-2.8	+19.4	-17.0	+0.8	+2.1

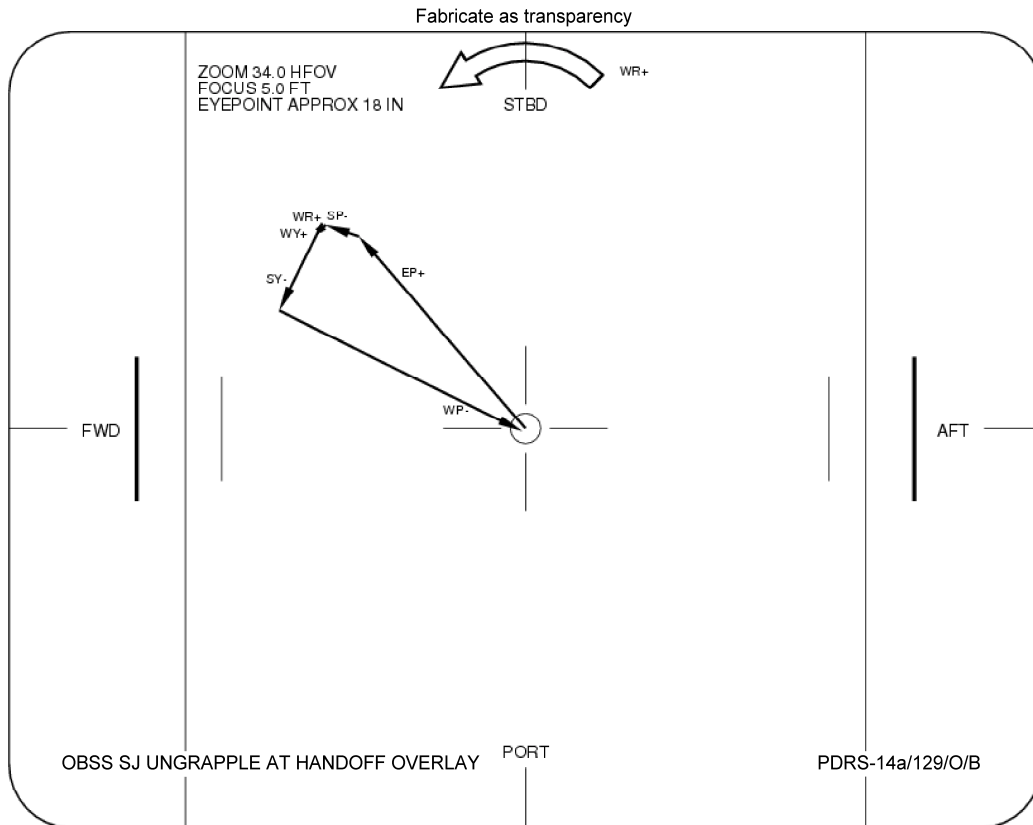

5. CONFIGURE CIRCUIT BREAKERS
MA73C:C cb MCA PWR AC3 3Φ MID 2 – op
 √AC2 3Φ MID 2 – op
:D √AC3 3Φ MID 4 – op

6. CONFIGURE FOR MONITORING
On SSRMS notification to watch for STBD RMS RFLs,
SM 94 PDRS CONTROL
RMS STBD – ITEM 2 EXEC (*)

Notify SSRMS operator when STBD RMS R-F-L tb (three) – gray

7. STBD MRL LATCH
On SSRMS Operator GO to latch STBD MRLs to Topological Capture,
√STBD RMS R-F-L tb (three) – gray

SM 94 PDRS CONTROL
√STBD AFT, MID, FWD LAT (six) = 0

R13L PL BAY MECH PWR SYS (two) – ON

NOTE

Expect single motor drive time for MRL latching (18 sec max).
The following STBD RMS RETEN LAT – OFF and PL BAY
MECH PWR SYS (two) – OFF actions are to be performed simo

Verify AOS for latching to Topological Capture

STBD RMS RETEN LAT – LAT 6 sec only (tb-bp)
– OFF

R13L PL BAY MECH PWR SYS (two) – OFF

Give SSRMS Operator GO to Limp All SSRMS Joints and Derigidize

R13L **On SSRMS Operator GO to complete STBD MRL latching,**
PL BAY MECH PWR SYS (two) – ON

STBD RMS RETEN LAT – LAT (tb-LAT) (12 sec max)
– OFF

8. RECONFIGURE POWER
R13L PL BAY MECH PWR SYS (two) – OFF

STBD RMS HTR A,B (two) – AUTO

A6U EVENT TIMER CNTL – STOP

SM 94 PDRS CONTROL
√STBD AFT, MID, FWD LAT (six) = 1
RMS PORT – ITEM 1 EXEC (*)

MA73C:C cb MCA PWR AC3 3Φ MID 2 – cl
 √AC2 3Φ MID 2 – op
:D √AC3 3Φ MID 4 – op

Give SSRMS Operator GO for OBSS Release

MNVR FROM OBSS PRE-GRAPPLE TO PRE-CRADLE POSN

- SETUP
On SSRMS Operator GO for mnvr to PRE-CRADLE

SM 94 PDRS CONTROL

- √PL ID, ITEM 3: 0
- √INIT ID, ITEM 24: 0

V10/L	P1 LOOB
V10/R	A
MON 1	Elbow
MON 2	C

- MNVR TO PRE-CRADLE POSN

If SINGLE MODE available:

RHC RATE – as reqd (VERN within 10 ft)
 BRAKES – OFF (tb-OFF)

MODE – best available

Mnvr to PRE-CRADLE posn:

	SY	SP	EP	WP	WY	WR	
OBSS	+23.5	+63.5	-29.6	-102.9	+11.5	-98.6	
Pre-Grapple							
1: WR +						0.0	
2: WY –					0.0		
3: WP +				+5.0			
4: EP +			-25.0				
5: SP –		+25.0					
6: SY –	0.0						
Pre-Cradle	0.0	+25.0	-25.0	+5.0	0.0	0.0	
	X	Y	Z	PITCH	YAW	ROLL	PL ID
	-1261	-146	-551	5	2	0	0

If SINGLE mode available:
 BRAKES – ON (tb-ON)

MODE – not DIRECT

PARAM – PORT TEMP
 JOINT – CRIT TEMP

Step 1:
Drive WR+
From -98.6 to 0.0

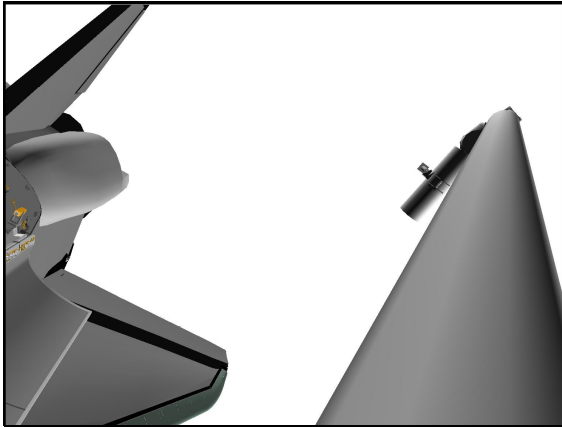

ELBOW (-30,-20)

Step 2:
Drive WY-
From +11.5 to 0.0

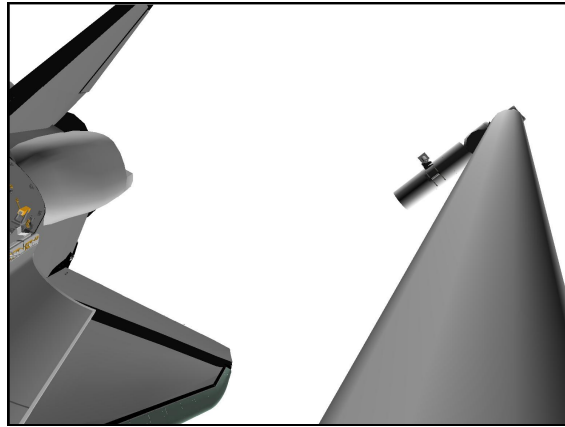

ELBOW (-30,-20)

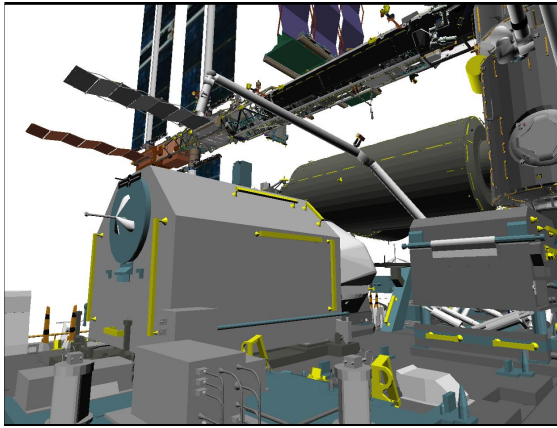

CCTV C (-45,10)

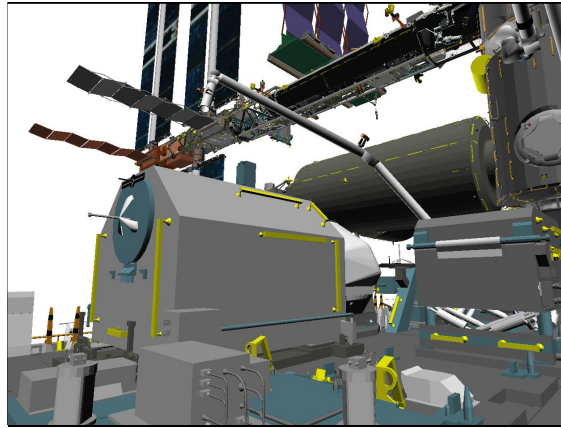

CCTV C (-45,10)

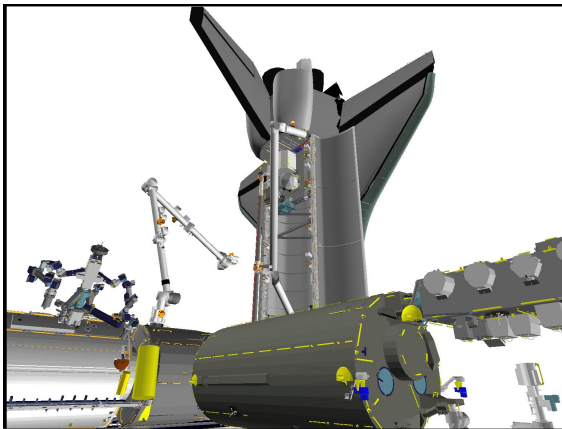

P1 LOOB (130,25)

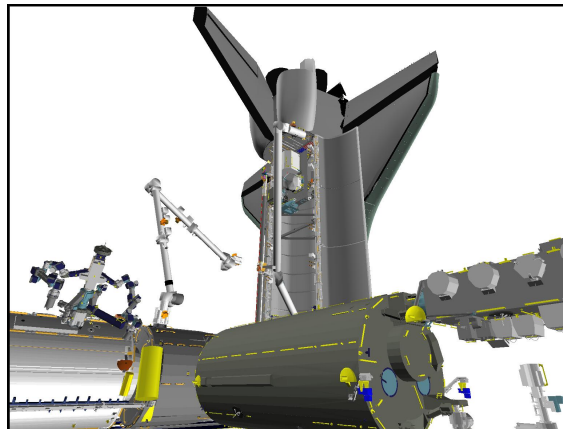

P1 LOOB (130,25)

Step 3:
Drive WP+
From -102.9 to +5.0

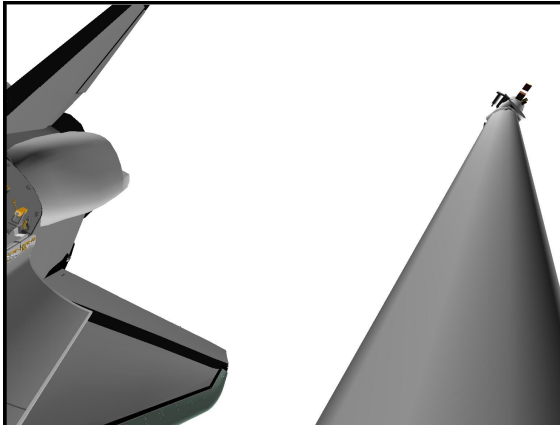

ELBOW (-30,-20)

Step 4:
Drive EP+
From -29.6 to -25.0



CCTV A (10,25)

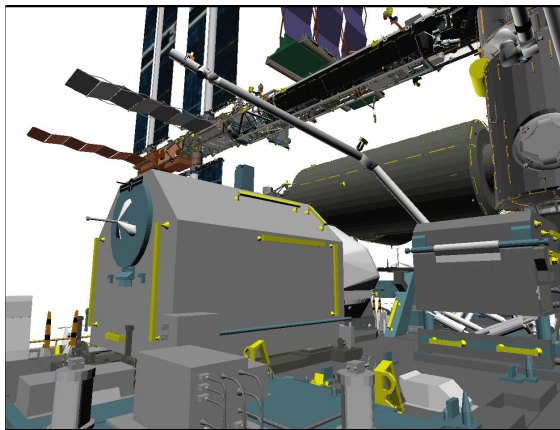

CCTV C (-45,10)

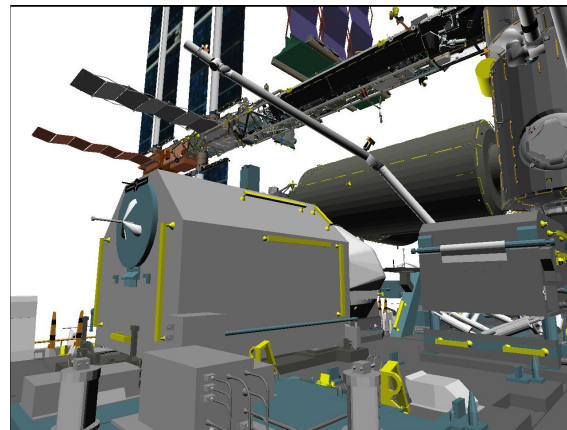

CCTV C (-45,10)

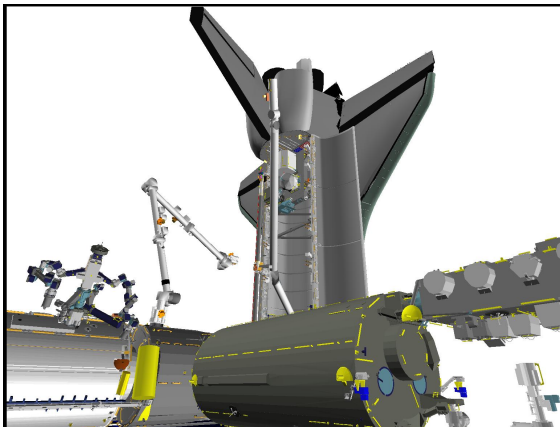

P1 LOOB (130,25)

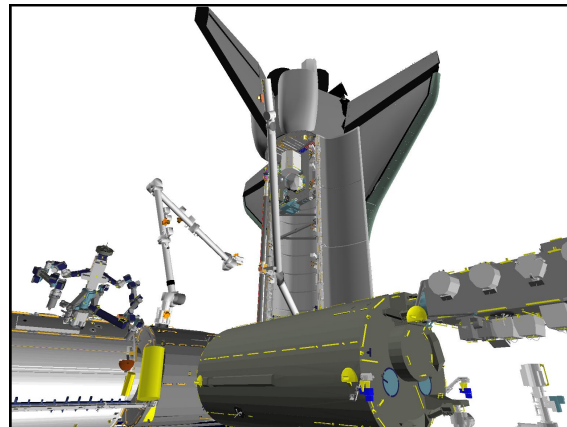

P1 LOOB (130,25)

Step 5:
Drive SP-
From +63.5 to +25.0

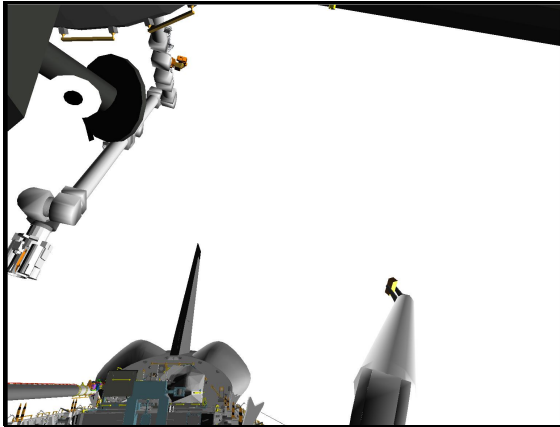

CCTV A (10,25)

Step 6:
Drive SY-
From +23.5 to 0.0

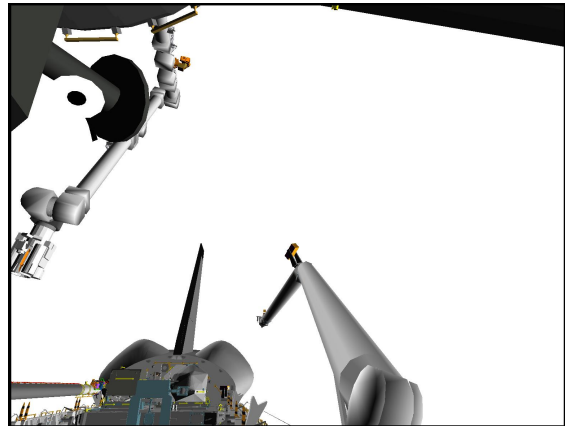

CCTV A (10,25)

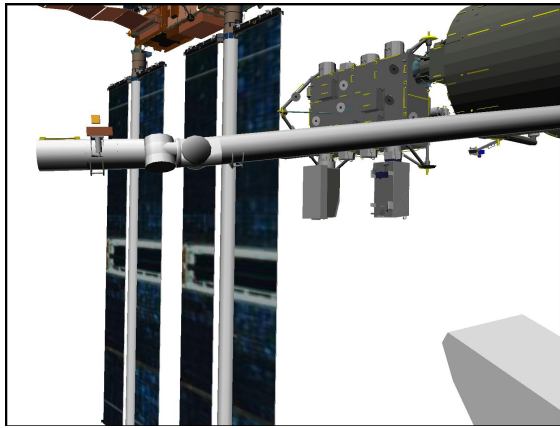

CCTV B (-50,0)

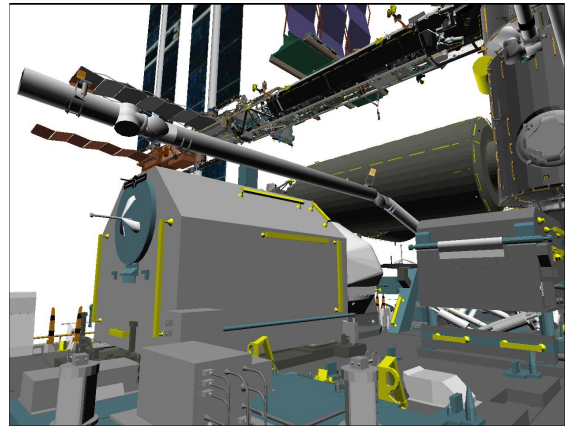

CCTV C (-45,10)

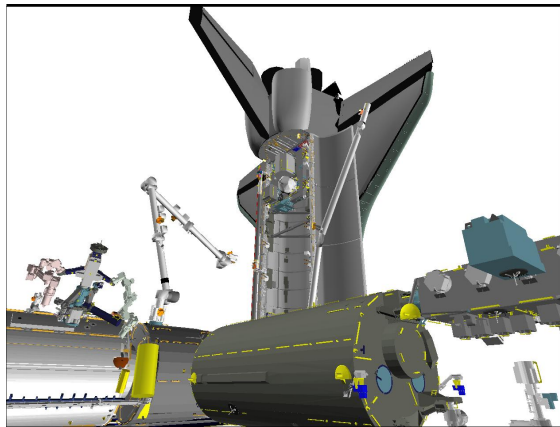

P1 LOOB (130,25)

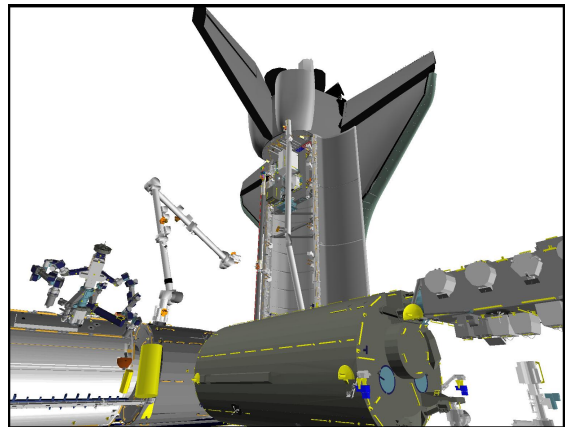

P1 LOOB (130,25)

REFERENCE DATA

I

ELC-1 JOINT ANGLES VS POR COORDINATES	FS 5-2
COORDINATE SYSTEM – PL ID 3	FS 5-3
PRLA CONFIGURATION	FS 5-4
ELC-2 JOINT ANGLES VS POR COORDINATES	FS 5-5
COORDINATE SYSTEM – PL ID 4	FS 5-7
PRLA CONFIGURATION	FS 5-8
OBSS JOINT ANGLES VS POR COORDINATES	FS 5-9

REFERENCE
DATA

ELC-1 JOINT ANGLES VS POR COORDINATES

ELC-1 PRE-GRAPPLE

X	Y	Z	PITCH	YAW	ROLL	PL ID
-1029	+15	-545	270	0	181	0
SY	SP	EP	WP	WY	WR	
-25.6	+60.6	-81.1	-78.3	+17.7	+227.3	

ELC-1 GRAPPLE

X	Y	Z	PITCH	YAW	ROLL	PL ID
-1029	+15	-455	270	0	180	0
-945	0	-414	0	0	0	3
SY	SP	EP	WP	WY	WR	
-21.6	+54.3	-90.9	-60.8	+18.1	+222.7	

ELC-1 HOVER

X	Y	Z	PITCH	YAW	ROLL	PL ID
-945	0	-582	0	0	0	3
SY	SP	EP	WP	WY	WR	
-29.1	+61.4	-66.8	-94.3	+17.0	+230.4	

ELC-1 INTERMEDIATE

X	Y	Z	PITCH	YAW	ROLL	PL ID
-1110	-350	-650	350	300	300	3
SY	SP	EP	WP	WY	WR	
+4.8	+64.2	-53.0	-43.5	+34.0	+105.1	

ELC-1 HANDOFF

X	Y	Z	PITCH	YAW	ROLL	PL ID
-939	-581	-728	286	356	291	3
SY	SP	EP	WP	WY	WR	
+42.7	+58.2	-36.2	-0.2	+65.0	+20.3	

ELC-1 BACKOFF

X	Y	Z	PITCH	YAW	ROLL	PL ID
-1002	-419	-670	207	69	169	0
SY	SP	EP	WP	WY	WR	
+26.0	+68.7	-57.2	+42.1	+78.8	-12.9	

SINGULARITY AVOIDANCE

X	Y	Z	PITCH	YAW	ROLL	PL ID
-1004	-421	-674	201	73	175	0
SY	SP	EP	WP	WY	WR	
+26.0	+68.7	-57.2	+42.1	+74.0	-12.9	

ELC-1 COORDINATE SYSTEM – PL ID 3

POR: at trunnion level and aligned w/ ORAS

PURPOSE: ELC-1 unberth and handoff

POR RATES:	COARSE	VERN
TRANS LIM ft/sec	0.23	0.10
ROT LIM deg/sec	0.82	0.27

JOINT RATES:	COARSE	VERN
SHOULDER LIM deg/sec	0.40	0.13
ELBOW LIM deg/sec	0.55	0.18
WRIST LIM deg/sec	0.82	0.27

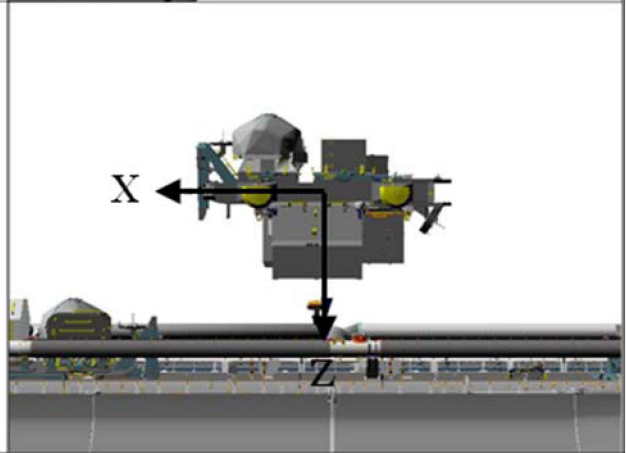
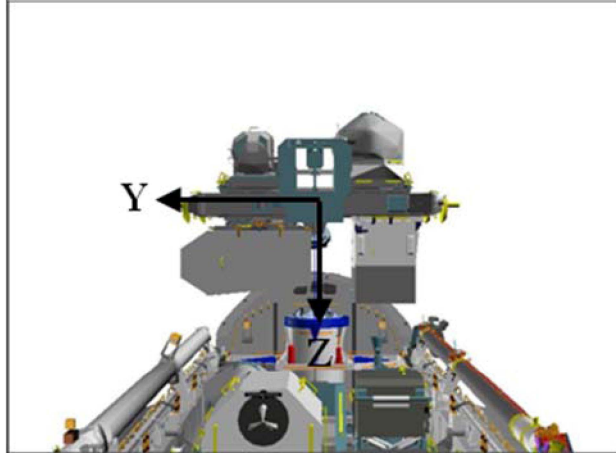
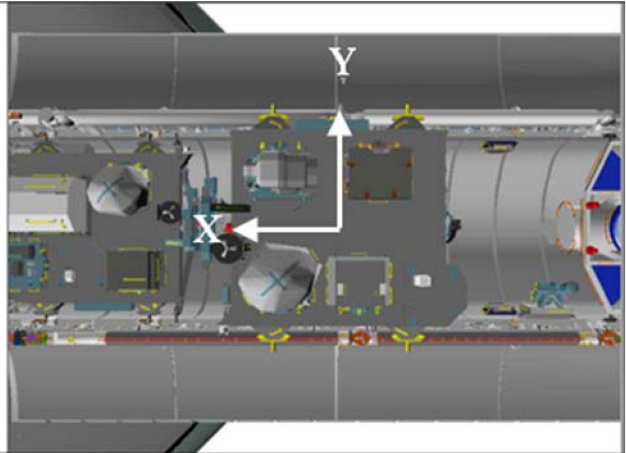

ELC-1 PRLA CONFIGURATION

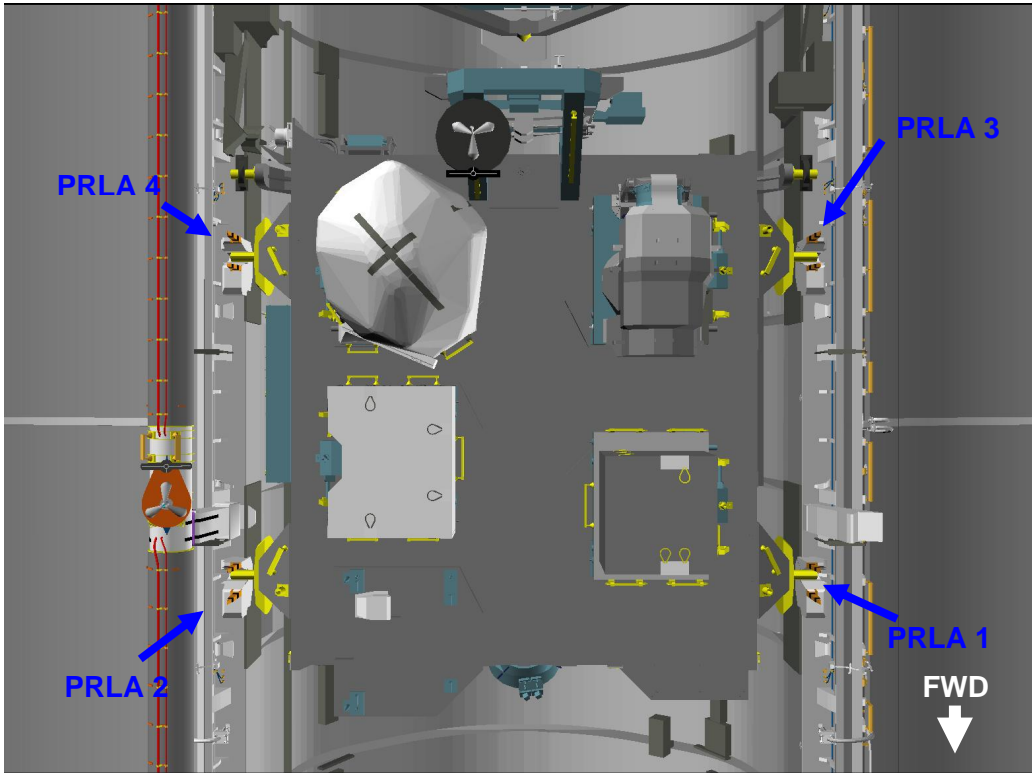

SEQUENCE	PL SEL	RELEASE	LATCH
PRLA 1,2	1	1,2 (fwd)	3,4 (aft)
PRLA 3,4	1	3,4 (aft)	1,2 (fwd)

ELC-2 JOINT ANGLES VS POR COORDINATES

INTERMEDIATE PRE-GRAPPLE

X	Y	Z	PITCH	YAW	ROLL	PL ID
-1063	-414	-569	213	74	150	0
SY	SP	EP	WP	WY	WR	
+26.0	+55.0	-57.2	+42.1	+74.0	-12.9	

ELC-2 PRE-GRAPPLE

X	Y	Z	PITCH	YAW	ROLL	PL ID
-1105	-15	-545	270	0	0	0
SY	SP	EP	WP	WY	WR	
-18.1	+47.1	-57.7	-85.6	+18.6	+38.7	

ELC-2 GRAPPLE

X	Y	Z	PITCH	YAW	ROLL	PL ID
-1105	-15	-455	270	0	0	0
-1189	0	-414	0	0	0	4
SY	SP	EP	WP	WY	WR	
-14.5	+42.7	-68.7	-69.1	+18.8	+35.3	

ELC-2 HOVER

X	Y	Z	PITCH	YAW	ROLL	PL ID
-1189	0	-570	0	0	0	4
SY	SP	EP	WP	WY	WR	
-20.7	+45.5	-42.5	-100.2	+18.2	+42.0	

ELC-2 INTERMEDIATE

X	Y	Z	PITCH	YAW	ROLL	PL ID
-1174	-85	-790	125	48	347	4
SY	SP	EP	WP	WY	WR	
-20.7	+45.5	-42.5	+25.0	+18.2	+42.0	

ELC-2 HANDOFF

X	Y	Z	PITCH	YAW	ROLL	PL ID
-900	+375	-760	197	318	33	4
SY	SP	EP	WP	WY	WR	
-59.5	+29.3	-35.0	+54.0	-15.0	-91.8	

ELC-2 BACKOFF

X	Y	Z	PITCH	YAW	ROLL	PL ID
-932	+244	-637	83	336	313	0
SY	SP	EP	WP	WY	WR	
-55.5	+42.0	-76.7	+83.8	-17.3	-88.8	

PRE-CRADLE

X	Y	Z	PITCH	YAW	ROLL	PL ID
-1261	-146	-551	5	2	0	0
SY	SP	EP	WP	WY	WR	
+0.0	+25.0	-25.0	+5.0	+0.0	+0.0	

ELC-2 INSTALL VIEWING

X	Y	Z	PITCH	YAW	ROLL	PL ID
-166	-139	-546	72	298	26	0
SY	SP	EP	WP	WY	WR	
+174.5	+25.0	-25.0	-27.9	+106.0	0.0	

ELC-2 COORDINATE SYSTEM – PL ID 4

<p>POR: at trunnion level and aligned w/ORAS</p> <p>PURPOSE: ELC-2 unberth and handoff</p> <p>POR RATES:</p> <table border="1"> <thead> <tr> <th></th> <th>COARSE</th> <th>VERN</th> </tr> </thead> <tbody> <tr> <td>TRANS LIM ft/sec</td> <td>0.23</td> <td>0.10</td> </tr> <tr> <td>ROT LIM deg/sec</td> <td>0.82</td> <td>0.27</td> </tr> </tbody> </table> <p>JOINT RATES:</p> <table border="1"> <thead> <tr> <th></th> <th>COARSE</th> <th>VERN</th> </tr> </thead> <tbody> <tr> <td>SHOULDER LIM deg/sec</td> <td>0.40</td> <td>0.13</td> </tr> <tr> <td>ELBOW LIM deg/sec</td> <td>0.56</td> <td>0.19</td> </tr> <tr> <td>WRIST LIM deg/sec</td> <td>0.82</td> <td>0.27</td> </tr> </tbody> </table>				COARSE	VERN	TRANS LIM ft/sec	0.23	0.10	ROT LIM deg/sec	0.82	0.27		COARSE	VERN	SHOULDER LIM deg/sec	0.40	0.13	ELBOW LIM deg/sec	0.56	0.19	WRIST LIM deg/sec	0.82	0.27	<p>A 3D cutaway view of the ELC-2 coordinate system. The X-axis points to the left, and the Y-axis points upwards. The view shows the internal structure of the system, including various components and wiring.</p>		
	COARSE	VERN																								
TRANS LIM ft/sec	0.23	0.10																								
ROT LIM deg/sec	0.82	0.27																								
	COARSE	VERN																								
SHOULDER LIM deg/sec	0.40	0.13																								
ELBOW LIM deg/sec	0.56	0.19																								
WRIST LIM deg/sec	0.82	0.27																								
<p>A 3D view of the ELC-2 coordinate system. The Y-axis points to the left, and the Z-axis points downwards. The view shows the external structure of the system.</p>			<p>A 3D view of the ELC-2 coordinate system. The X-axis points to the left, and the Z-axis points downwards. The view shows the external structure of the system.</p>																							

ELC-2 PRLA CONFIGURATION

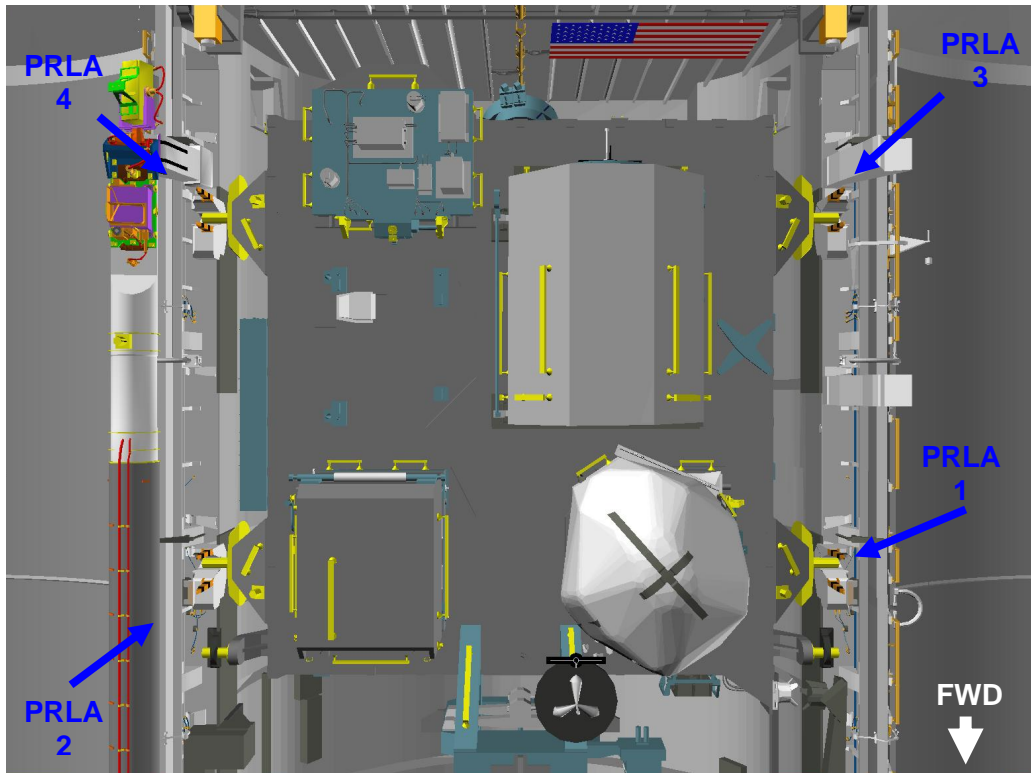

SEQUENCE	PL SEL	RELEASE	LATCH
PRLA 1,2	3	1,2 (fwd)	3,4 (aft)
PRLA 3,4	3	3,4 (aft)	1,2 (fwd)

OBSS JOINT ANGLES VS POR COORDINATES

OBSS PRE-GRAPPLE AT HANDOFF

X	Y	Z	PITCH	YAW	ROLL	PL ID
-1015	-362	-688	284	0	270	0
-1012	+229	-685	284	270	270	2
SY	SP	EP	WP	WY	WR	
+23.5	+63.5	-29.6	-102.9	+11.5	-98.6	

OBSS HANDOFF

X	Y	Z	PITCH	YAW	ROLL	PL ID
-1032	-362	-618	284	0	270	0
-1029	+229	-614	14	270*	0	2
SY	SP	EP	WP	WY	WR	
+25.8	+66.3	-49.0	-85.9	+10.7	-100.7	

*Display singularity

This Page Intentionally Blank

CUE CARD CONFIGURATION

Fabricate as transparency

ZOOM 34.0 HFOV
FOCUS 5.0 FT
EYEPOINT APPROX 18 IN

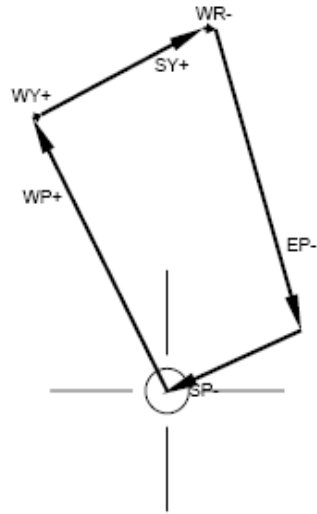

ELC-1 SJ GRAPPLE WRIST CCTV OVERLAY

PDRS-9a/129/O/B

|

(reduced copy)

FS CC 6-2

PDRS/129/FIN

Fabricate as transparency

ZOOM 34.0 HFOV
FOCUS 5.0 FT
EYEPOINT APPROX 18 IN



WR-

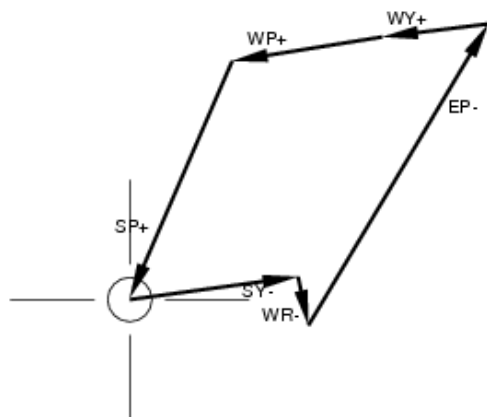

ELC-1 SJ UNGRAPPLE WRIST CCTV OVERLAY

PDRS-10a/129/O/B

I

(reduced copy)

FS CC 6-3

PDRS/129/FIN

Fabricate as transparency

ZOOM 34.0 HFOV
FOCUS 5.0 FT
EYEPOINT APPROX 18 IN

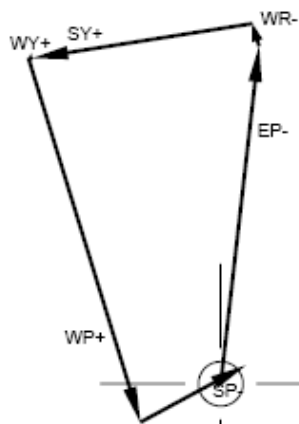

ELC-2 SJ GRAPPLE WRIST CCTV OVERLAY

PDRS-11a/129/O/B

I

(reduced copy)

FS CC 6-4

PDRS/129/FIN

Fabricate as transparency

ZOOM 34.0 HFOV
FOCUS 5.0 FT
EYEPOINT APPROX 18 IN

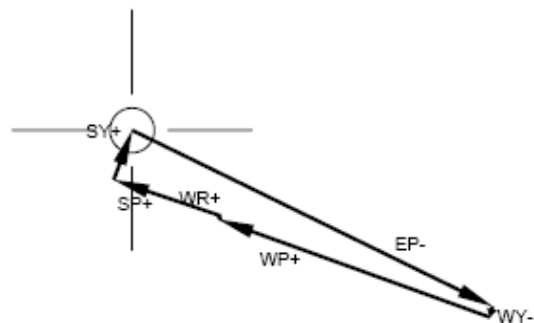

ELC-2 SJ UNGRAPPLE WRIST CCTV OVERLAY

PDRS-12a/129/O/B

(reduced copy)

FS CC 6-5

PDRS/129/FIN

Fabricate as transparency

ZOOM 34.0 HFOV
FOCUS 5.0 FT
EYEPOINT APPROX 18 IN

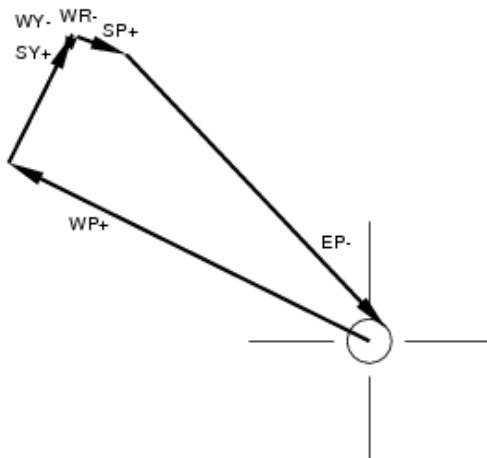

FWD

AFT

OBSS SJ GRAPPLE AT HANDOFF OVERLAY

PORT

PDRS-13a/129/O/B

(reduced copy)

FS CC 6-6

PDRS/129/FIN

Fabricate as transparency

ZOOM 34.0 HFOV
FOCUS 5.0 FT
EYEPOINT APPROX 18 IN

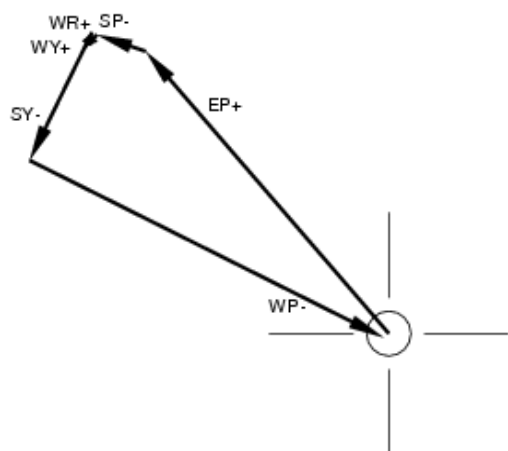

FWD

AFT

OBSS SJ UNGRAPPLE AT HANDOFF OVERLAY

PORT

PDRS-14a/129/O/B

I

(reduced copy)

FS CC 6-7

PDRS/129/FIN

This Page Intentionally Blank



PDRS OPS C/L

**STS
129**