

PDRS Operations Checklist

STS-131 Flight Supplement

**Mission Operations Directorate
EVA, Robotics, & Crew Systems
Operations Division**

**Final
November 30, 2009**

National Aeronautics and
Space Administration

Lyndon B. Johnson Space Center
Houston, Texas

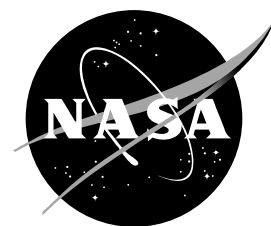

PDRS OPS CHECKLIST 131 FLT SUPPL

FINAL (Nov 30, 2009)

PCN-1 (Mar 10, 2010) Sheet 1 of 1

List of Implemented Change Requests (482s):

PDRS FS-00169
PDRS FS-00170
PDRS FS-00171
PDRS FS-00177

Incorporate the following:

1. Replace FS iii and FS iv
2. Replace FS 1-1 thru FS 1-8, FS 1-11 and FS 1-12, FS 1-15 and FS 1-16
After FS 1-16, add FS 1-16a and FS 1-16b
Replace FS 1-19 and FS 1-20
3. Replace FS 2-13 and FS 2-14, FS 2-17 thru FS 2-22, FS 2-29 and FS 2-30,
FS 2-65 and FS 2-66, FS 2-73 and FS 2-74
4. Replace FS 3-3 and FS 3-4

Prepared by:

Book Manager

Approved by:

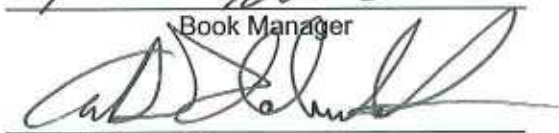
Lead, Shuttle and Exploration Robotics
Operations Group

Accepted by:

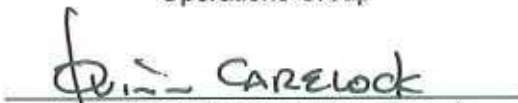
Chief, Robotics Operations Branch

Encl: 34 pages

File this PCN immediately behind the front cover as a permanent record

MISSION OPERATIONS DIRECTORATE

**PDRS OPERATIONS CHECKLIST
STS-131 FLIGHT SUPPLEMENT**

FINAL
November 30, 2009

PREPARED BY:



Robert J. Scheid
Book Manager

APPROVED BY:

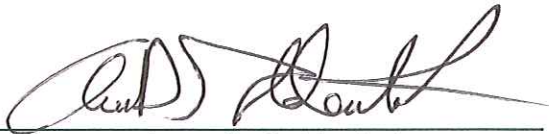

Aaron D. Goldenthal
Lead, Shuttle and Exploration Robotics
Operations Group



Quinn L. Carelock
Chief, Robotics Operations Branch

This document is under the configuration control of the Crew Procedures Control Board (CPCB). All proposed changes must be submitted via Change Request Workflow (CRW) to DO3/FDF Manager.

Additional distribution of this book, for official use only, may be requested in writing to DO3/PMO Administrator. The request must include justification and requester's name, organization, position, and phone number. Contractor requests are made through the NASA or DOD organization supported. Deletions, reduction in quantity, or change of address may be submitted to DO3/FDF Management Office, 281-244-1184.

Incorporates the following:		
482#:	PDRS FS-00155	PDRS FS-00158
	PDRS FS-00156	PDRS FS-00159
	PDRS FS-00157	PDRS FS-00160

AREAS OF TECHNICAL RESPONSIBILITY

Book Manager

DX22/R. Scheid

281-483-0795

PDRS OPERATIONS CHECKLIST
 STS-131 FLIGHT SUPPLEMENT

LIST OF EFFECTIVE PAGES

	FINAL PCN-1	11/30/09 03/10/10
Sign Off.....	* 131/FIN	FS 2-19..... 131/FIN 1
FS ii.....	* 131/FIN	FS 2-20..... 131/FIN
FS iii.....	* 131/FIN 1	FS 2-21..... ⊗ 131/FIN 1
FS iv.....	* 131/FIN 1	FS 2-22..... 131/FIN
FS v.....	131/FIN	FS 2-23..... ⊗ 131/FIN
FS vi.....	131/FIN	FS 2-24..... ⊗ 131/FIN
FS 1-1.....	131/FIN	FS 2-25..... ⊗ 131/FIN
FS 1-2.....	131/FIN 1	FS 2-26..... ⊗ 131/FIN
FS 1-3.....	⊗ 131/FIN	FS 2-27..... ⊗ 131/FIN
FS 1-4.....	131/FIN 1	FS 2-28..... ⊗ 131/FIN
FS 1-5.....	131/FIN 1	FS 2-29..... ⊗ 131/FIN 1
FS 1-6.....	⊗ 131/FIN 1	FS 2-30..... ⊗ 131/FIN
FS 1-7.....	⊗ 131/FIN 1	FS 2-31..... 131/FIN
FS 1-8.....	⊗ 131/FIN 1	FS 2-32..... ⊗ 131/FIN
FS 1-9.....	⊗ 131/FIN	FS 2-33..... ⊗ 131/FIN
FS 1-10.....	⊗ 131/FIN	FS 2-34..... ⊗ 131/FIN
FS 1-11.....	⊗ 131/FIN	FS 2-35..... ⊗ 131/FIN
FS 1-12.....	⊗ 131/FIN 1	FS 2-36..... ⊗ 131/FIN
FS 1-13.....	⊗ 131/FIN	FS 2-37..... ⊗ 131/FIN
FS 1-14.....	⊗ 131/FIN	FS 2-38..... 131/FIN
FS 1-15.....	⊗ 131/FIN	FS 2-39..... 131/FIN
FS 1-16.....	⊗ 131/FIN 1	FS 2-40..... 131/FIN
FS 1-16a.....	⊗ 131/FIN 1	FS 2-41..... ⊗ 131/FIN
FS 1-16b.....	131/FIN 1	FS 2-42..... 131/FIN
FS 1-17.....	⊗ 131/FIN	FS 2-43..... 131/FIN
FS 1-18.....	⊗ 131/FIN	FS 2-44..... ⊗ 131/FIN
FS 1-19.....	131/FIN 1	FS 2-45..... ⊗ 131/FIN
FS 1-20.....	⊗ 131/FIN	FS 2-46..... ⊗ 131/FIN
FS 1-21.....	131/FIN	FS 2-47..... ⊗ 131/FIN
FS 1-22.....	131/FIN	FS 2-48..... 131/FIN
FS 2-1.....	131/FIN	FS 2-49..... ⊗ 131/FIN
FS 2-2.....	131/FIN	FS 2-50..... ⊗ 131/FIN
FS 2-3.....	⊗ 131/FIN	FS 2-51..... ⊗ 131/FIN
FS 2-4.....	⊗ 131/FIN	FS 2-52..... ⊗ 131/FIN
FS 2-5.....	131/FIN	FS 2-53..... 131/FIN
FS 2-6.....	131/FIN	FS 2-54..... ⊗ 131/FIN
FS 2-7.....	131/FIN	FS 2-55..... ⊗ 131/FIN
FS 2-8.....	⊗ 131/FIN	FS 2-56..... ⊗ 131/FIN
FS 2-9.....	⊗ 131/FIN	FS 2-57..... ⊗ 131/FIN
FS 2-10.....	⊗ 131/FIN	FS 2-58..... 131/FIN
FS 2-11.....	⊗ 131/FIN	FS 2-59..... 131/FIN
FS 2-12.....	⊗ 131/FIN	FS 2-60..... ⊗ 131/FIN
FS 2-13.....	131/FIN 1	FS 2-61..... ⊗ 131/FIN
FS 2-14.....	⊗ 131/FIN	FS 2-62..... ⊗ 131/FIN
FS 2-15.....	⊗ 131/FIN	FS 2-63..... ⊗ 131/FIN
FS 2-16.....	⊗ 131/FIN	FS 2-64..... ⊗ 131/FIN
FS 2-17.....	⊗ 131/FIN	FS 2-65..... ⊗ 131/FIN 1
FS 2-18.....	131/FIN 1	FS 2-66..... 131/FIN

* – Omit from flight book

⊗ – Flight copies of this page contain color

FS 2-67	131/FIN
FS 2-68	⊗ 131/FIN
FS 2-69	⊗ 131/FIN
FS 2-70	⊗ 131/FIN
FS 2-71	⊗ 131/FIN
FS 2-72	⊗ 131/FIN
FS 2-73	⊗ 131/FIN 1
FS 2-74	131/FIN
FS 3-1	131/FIN
FS 3-2	131/FIN
FS 3-3	131/FIN 1
FS 3-4	131/FIN 1
FS 4-1	* 131/FIN
FS CC 4-2	* 131/FIN
FS CC 4-3	* 131/FIN
FS CC 4-4	* 131/FIN

PDRS CUE CARDS

<u>Title</u>	<u>Ref. Page</u>	<u>Card No.</u>
OBSS SJ GRAPPLE AT HANDOFF	FS CC 4-2	PDRS-9a/131/O/A
OBSS SJ UNGRAPPLE AT HANDOFF	FS CC 4-3	PDRS-10a/131/O/A
OVERLAY FOR ROEU PL SEL POSITION.....	FS CC 4-4	PDRS-11a/131/O/A

⊗ – Flight copies of this page contain color

* – Omit from flight book

<u>CONTENTS</u>	<u>PAGE</u>
<u>OBSS NOMINAL</u>	FS 1-1
OBSS HANDOFF FROM SSRMS TO SRMS	FS 1-2
MNVR TO EVA 2 VIEWING POSITION.....	FS 1-9
MPLM VIEWING POSITION.....	FS 1-13
UNDOCK.....	FS 1-17
FLAT FIELD.....	FS 1-19
 <u>OBSS CONTINGENCY</u>	 FS 2-1
OBSS HANDOFF FROM SRMS TO SSRMS	FS 2-3
MNVR TO CONTINGENCY UNDOCK.....	FS 2-9
CONT UNDOCK TO NOM UNDOCK	FS 2-11
SJ HANDOFF FROM SSRMS TO SRMS	FS 2-13
SRMS TO SSRMS.....	FS 2-30
MNVR TO UNDOCK.....	FS 2-48
OBSS HOVER.....	FS 2-53
SJ MNVR TO EVA 2 VIEWING POSITION.....	FS 2-58
MPLM VIEWING POSITION	FS 2-66
 <u>REFERENCE DATA</u>	 FS 3-1
OBSS JOINT ANGLES VS POR COORDINATES	FS 3-2
AUTOSEQUENCE	FS 3-4
 <u>CUE CARD CONFIGURATION</u>	 FS 4-1

This Page Intentionally Blank

OBSS NOMINAL

I

OBSS HANDOFF FROM SSRMS TO SRMS	FS 1-2
MNVR TO EVA 2 VIEWING POSITION	FS 1-9
MPLM VIEWING POSITION	FS 1-13
UNDOCK.....	FS 1-17
FLAT FIELD	FS 1-19

**OBSS
NOMINAL**

OBSS HANDOFF FROM SSRMS TO SRMS

OBSS
NOMINAL

1. SETUP

SM 94 PDRS CONTROL

√ PL ID, ITEM 3: 0

√ INIT ID, ITEM 24: 0

Verify at PRECRADLE posn:

X	Y	Z	PITCH	YAW	ROLL	PL ID
-1261	-146	-551	5	2	0	0
SY	SP	EP	WP	WY	WR	
0.0	+25.0	-25.0	+5.0	0.0	0.0	

R12(VPU) √ Green Jumper – ISS

MON 1	D
MON 2	B (P1 LOOB)
DNLK	A
DTV	ELBOW (EE)

2. MNVR TO OBSS PRE-GRAPPLE AT HANDOFF

√ MCC to verify SSRMS at Stage Park posn

SM 94 PDRS CONTROL

END POS – ITEM 18 -1 0 4 7 -3 6 0 -6 5 8 EXEC

ATT – ITEM 21 +2 8 4 +0 +2 7 0 EXEC

CMD CK – ITEM 25 EXEC (GOOD)

RHC

RATE – as reqd (VERN within 10 ft)

BRAKES – OFF (tb-OFF)

MODE – OPR CMD, ENTER

AUTO SEQ – PROCEED (IN PROG It on)

When AUTO SEQ IN PROG It – off:

BRAKES – ON (tb-ON)

OBSS PRE-GRAPPLE AT HANDOFF posn:

X	Y	Z	PITCH	YAW	ROLL	PL ID
√ -1047	-360	-658	284	0	270	0
SY	SP	EP	WP	WY	WR	
√ +22.7	+57.5	-27.4	-99.3	+11.8	-97.9	

**Notify SSRMS Operator that SRMS at OBSS Pre-Grapple at Handoff posn,
GO for OBSS Grapple**

MUX 1 L ← D (-20, 0, HFOV 55°)

MUX 1 R ← C (25, -5, HFOV 70°)

DNLK ← MUX 1

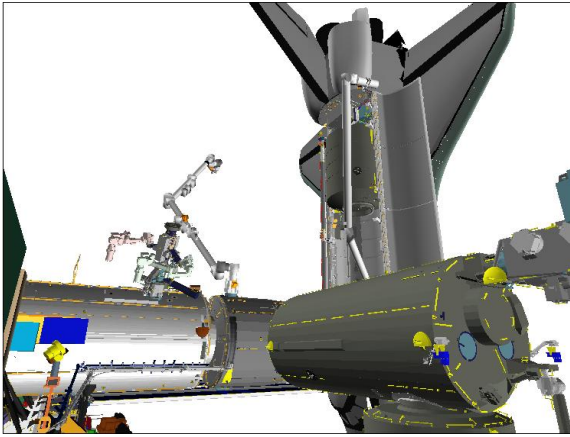

P1 LOOB (120,20)

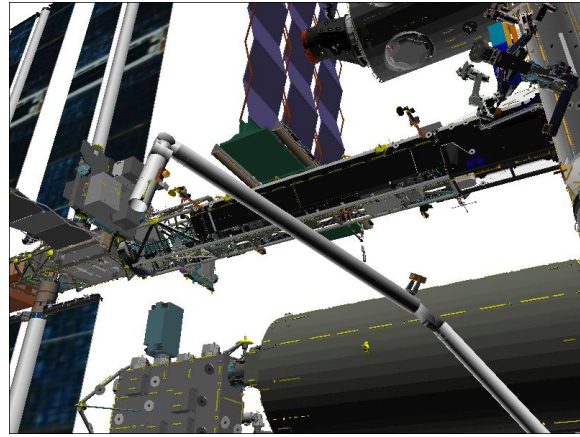

CCTV B (-30,30)

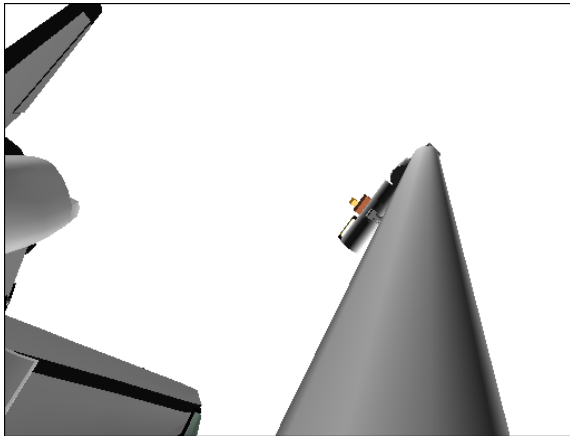

ELBOW (-20,-15)



CCTV A (20,20)

3. CONFIGURE POWER

CAUTION
 SPEE power must be applied within 90 min
 to prevent sensor package damage

**On SSRMS Operator GO to release STBD MRLs,
 STBD RMS HTR A,B (two) – OFF**

- | | |
|---------|--|
| A6U | EVENT TIMER MODE – UP
CNTL – START |
| MA73C:C | cb MCA PWR AC3 3Φ MID 2 – op
√AC2 3Φ MID 2 – op |
| MA73C:D | √AC3 3Φ MID 4 – op |
| R13L | PL BAY MECH PWR SYS (two) – ON |

4. STBD MRL RELEASE

SM 94 PDRS CONTROL

RMS STBD – ITEM 2 EXEC (*)
√STBD AFT, MID, FWD REL (six) = 0

NOTE

Expect single motor drive time for MRL release

STBD RMS RETEN LAT – REL (tb-REL) (18 sec max)
– OFF

If motor drive time > 18 sec, √MCC

SM 94 PDRS CONTROL

√STBD AFT, MID, FWD REL (six) = 1

5. RECONFIGURE POWER

R13L PL BAY MECH PWR SYS (two) – OFF

MA73C:C cb MCA PWR AC3 3Φ MID 2 – cl
√AC2 3Φ MID 2 – op

MA73C:D √AC3 3Φ MID 4 – op

Give SSRMS Operator GO for OBSS Unberth

Monitor R-F-L Status

After OBSS Unberth,

SM 94 PDRS CONTROL

RMS PORT – ITEM 1 EXEC (*)

6. SETUP FOR GRAPPLE

A7U CCTV – config for grapple
– install PDRS TARGET OVERLAY FOR CTVM
– RMS WRIST, ZOOM: 34.0 HFOV
FOCUS: 5 ft

Maintain eyepoint approx 18 in when using grapple overlay

MON 1	BASE ELBOW
MON 2	B
DNLK	EE (ELBOW)
DTV	A

R12(OBSS) √SPEE PWR – OFF
A15 √APCU 2 OUTPUT – OFF

7. OBSS GRAPPLE AT HANDOFF POSN

RHC

On SSRMS Operator GO for OBSS Grapple,

RATE – VERN (RATE MIN tb-ON)

BRAKES – OFF (tb-OFF)

MODE – END EFF, ENTER

Mnvr to grapple envelope

CAUTION
Monitor EE tb timing to prevent EE motor burnout

EE MODE – AUTO

CAPTURE sw – depress (mom)

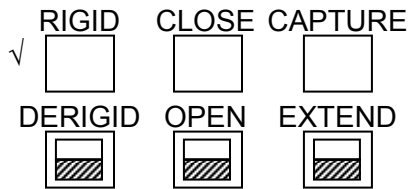

CRITICAL TIMES (28 sec total):

CAPTURE tb – gray, then

CLOSE tb – gray, 3 sec max, then

RIGID tb – gray, 25 sec max

EE MODE – OFF

- * If manual capture required: *
- * EE MODE – MAN *
- * CAPTURE sw – depress (hold until CLOSE tb-gray, 3 sec max) *
- * MAN CONTR – RIGID (hold until RIGID tb-gray, 25 sec max) *
- * MODE – OFF *

MODE – TEST, ENTER

Wait 5 sec

BRAKES – ON (tb-ON)

SM 94 PDRS CONTROL
PL ID – ITEM 3 +1 EXEC
INIT ID – ITEM 24 +1 EXEC

Expected OBSS HANDOFF posn:

	X	Y	Z	PITCH	YAW	ROLL	PL ID	
√	-1070	-360	-584	44	270	0	1	*
	SY	SP	EP	WP	WY	WR		
√	+24.5	+59.0	-42.1	-85.9	+11.2	-99.4		

*Display singularity

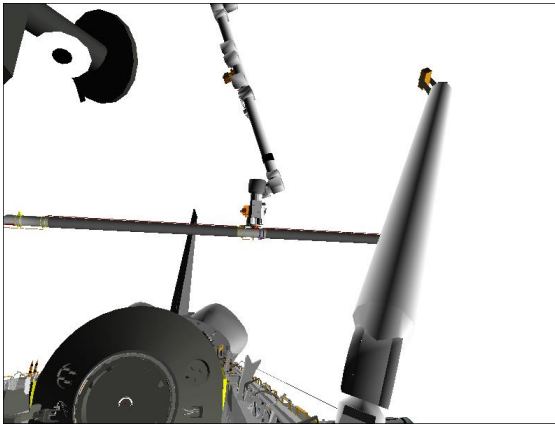

CCTV A (10,20)

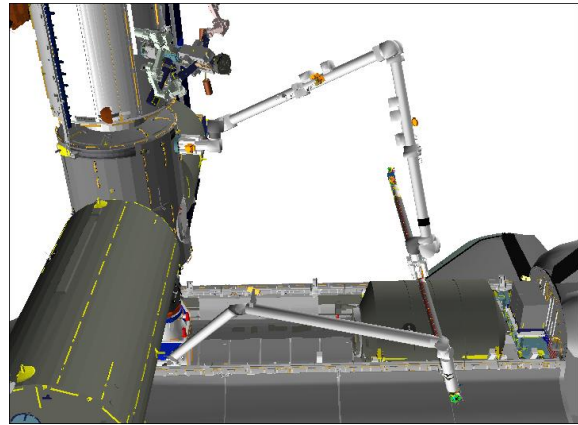

BIRD'S EYE

Review GENERIC END EFFECTOR CUE CARD – ISS/SHUTTLE DOCKED OPS

Give SSRMS Operator GO for OBSS ungrapple

- Perform ACTIVATION (LDRI/ITVC Cue Card, P/TV)
- Perform LCH ACTIVATION (LCS Cue Card, P/TV)
- Perform LCC ACTIVATION (LCS Cue Card, P/TV), step 2
- Perform LCC DEACTIVATION (LCS Cue Card, P/TV), step 1

8. MNVR TO MPLM VIEWING

R12(VPU) ✓Green Jumper – ISS

MON 1	S1 LOOB
MON 2	B
DNLK	RSC
DTV	A

SM 94 PDRS CONTROL

END POS – ITEM 18 -9 6 7 -6 4 3 -3 8 6 EXEC
 ATT – ITEM 21 +6 0 +3 4 9 +2 8 2 EXEC
 CMD CK – ITEM 25 EXEC (GOOD)

On SSRMS Operator GO for mnvr to MPLM VIEWING

RHC RATE – as reqd (VERN within 10 ft)
 BRAKES – OFF (tb-OFF)
 MODE – SINGLE, ENTER

SM 169 PDRS STATUS

Mnvr to OBSS HANDOFF INTERMEDIATE posn:

	SY	SP	EP	WP	WY	WR	
OBSS HANDOFF	+24.5	+59.0	-42.1	-85.9	+11.2	-99.4	
1: WR +						-87.8	
OBSS HANDOFF INTERMEDIATE	+24.5	+59.0	-42.1	-85.9	+11.2	-87.8	
	X	Y	Z	PITCH	YAW	ROLL	PL ID
	-1070	-361	-584	14	281	330	1

MODE – OPR CMD, ENTER (READY lt on)

AUTO SEQ – PROCEED (IN PROG It on)

When AUTO SEQ IN PROG It – off:
BRAKES – ON (tb-ON)

MPLM VIEWING posn: (02:30)

	X	Y	Z	PITCH	YAW	ROLL	PL ID
√	-967	-643	-386	60	349	282	1
	SY	SP	EP	WP	WY	WR	
√	+62.5	+25.0	-23.0	0.0	-13.2	-21.9	

√MODE – not DIRECT (It off)

PARAM – PORT TEMP
JOINT – CRIT TEMP

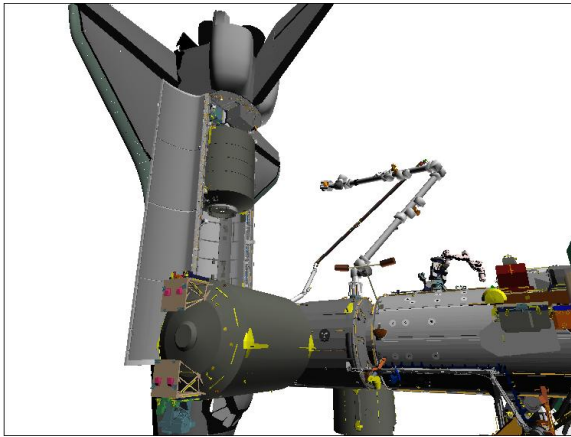

S1 LOOB (60,20)

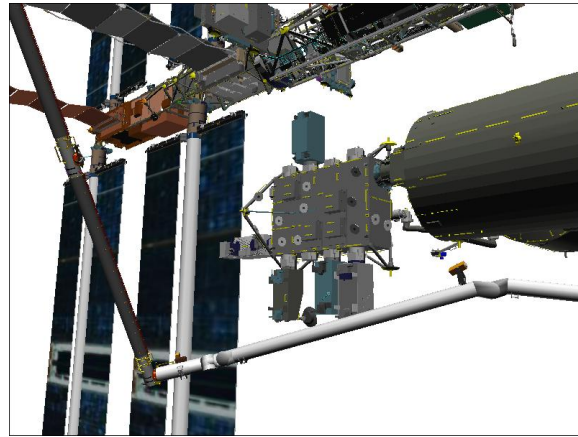

CCTV B (-45,10)

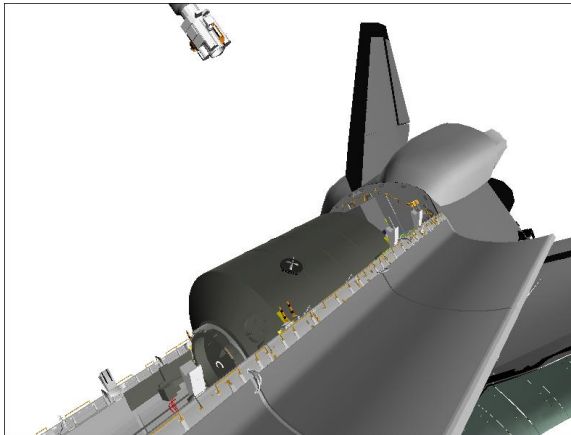

ELBOW (-110,30)

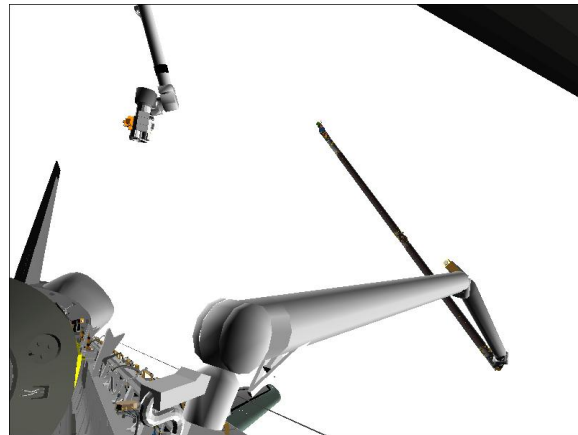

CCTV A (30,15)

9. CONFIGURE CAMERAS FOR MPLM INSTALL

R12(VPU)
A7U

Green Jumper – LDRI/ITVC
DTV ← PL2

CAMR CMD PAN/TILT – HI RATE

PAN – L (to hard stop)

TILT – UP (to hard stop)

PAN/TILT – RESET, HI RATE (LO within 10°)

PAN: +130 (right)

TILT: -60 (down)

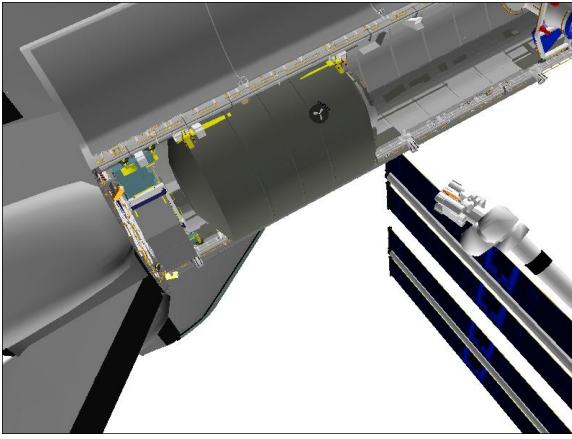

OBSS ITVC (130,-60)

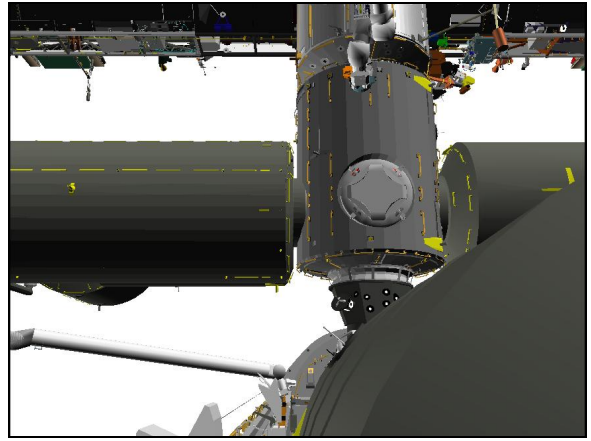

CCTV B (0,15)

MUX 1 L ← MIDDECK
LDRI MODE 2 pb – push (ITVC video)
VIDEO OUT – as desired (not DTV)
√VIDEO IN – not PL2

OBSS MNVR TO EVA 2 VIEWING POSITION

1. SETUP

NOTE

This procedure assumes the SSRMS is at the FD6 Overnight Park position on MBS PDGF1

SM 94 PDRS CONTROL

√ PL ID, ITEM 3: 1

√ INIT ID, ITEM 24: 1

Verify at MPLM VIEWING posn:

	X	Y	Z	PITCH	YAW	ROLL	PL ID
√	-967	-643	-386	60	349	282	1
	SY	SP	EP	WP	WY	WR	
√	+62.5	+25.0	-23.0	0.0	-13.2	-21.9	

R12(VPU) √ Green Jumper – LDRI/ITVC

MON 1	A
MON 2	OBSS ITVC (P1 LOOB)
DNLK	B
DTV	ELBOW (RSC)

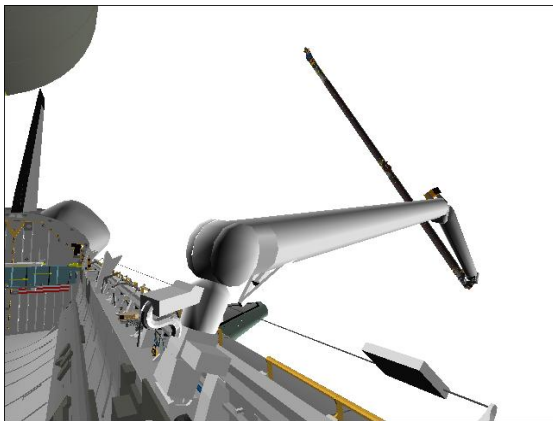

CCTV A (30,5)

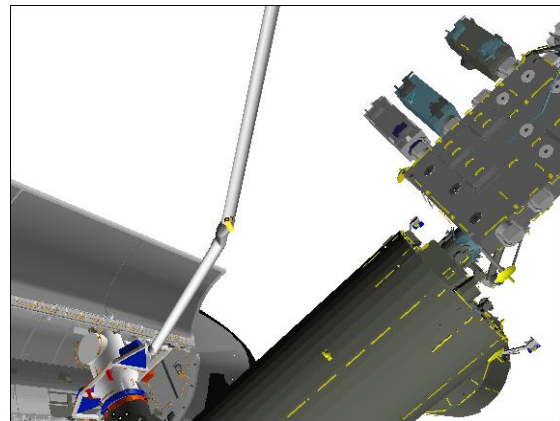

OBSS ITVC (75,-25)

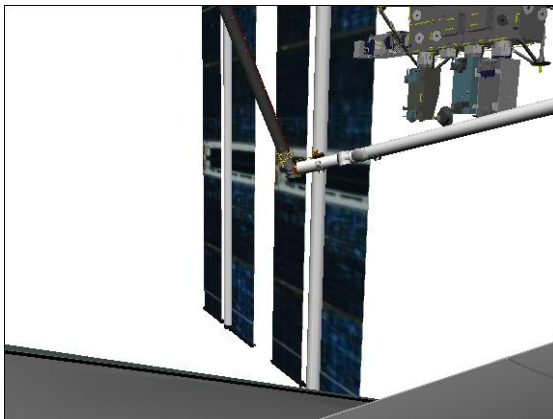

CCTV B (-60,-10)



ELBOW (-30,20)

2. SINGLE JOINT TO INTERMEDIATE POSN

NOTE

At SY = +88, clearance between tip boom and MAXI is 58 inches. Monitor clearance with Elbow camera.

At SY = +105, minimum clearance between OBSS and ICS-EF Antenna KOZ is 36 inches. Monitor clearance with camera B or RSC.

At SY = +108, clearance between OBSS and JEM-SEDA antenna is 36 inches. Monitor clearance with RSC.

Minimum clearance between OBSS and SAW 4A is 68 inches at SY = +119

RHC RATE – as reqd (VERN within 10 ft)
 BRAKES – OFF (tb-OFF)
 MODE – SINGLE, ENTER

SM 169 PDRS STATUS

Mnvr to EVA 2 INTERMEDIATE posn:

	SY	SP	EP	WP	WY	WR	
MPLM VIEWING	+62.5	+25.0	-23.0	0.0	-13.2	-21.9	
1: WP –				-32.0			
2: WY –					-25.3		
3: SP –		+20.0					
4: SY +	+130.0						
EVA 2 INTERMEDIATE	+130.0	+20.0	-23.0	-32.0	-25.3	-21.9	
	X	Y	Z	PITCH	YAW	ROLL	PL ID
	-323	-558	-312	58	50	256	1

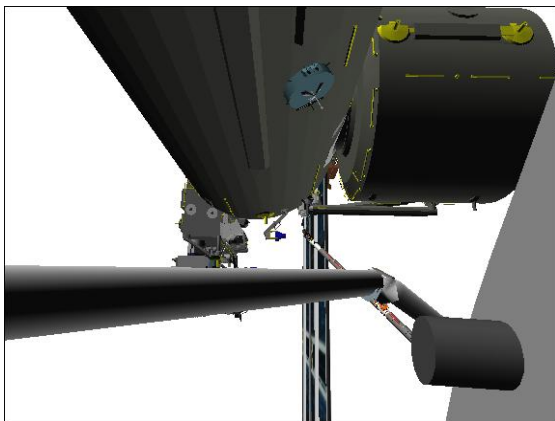

CCTV A (90,15)

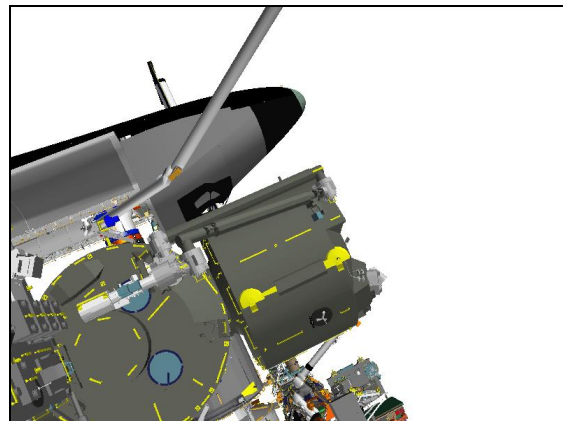

OBSS ITVC (85,-25)

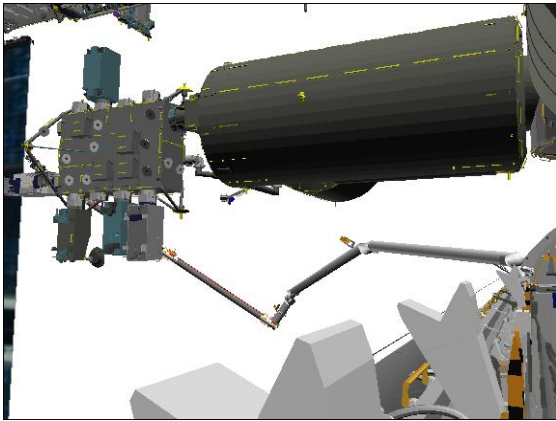

CCTV B (-25,5)



ELBOW (20,20)

3. OCAS TO EVA 2 VIEWING POSN

NOTE

At SY = +146, clearance between base boom and JPM PDGF is 26 inches. Monitor clearance with camera A,B or Elbow

SM 94 PDRS CONTROL

END POS – ITEM 18 -1 3 9 -3 7 1 -5 0 8 EXEC
 ATT – ITEM 21 +1 3 1 +3 4 4 +1 9 0 EXEC
 CMD CK – ITEM 25 EXEC (GOOD)

RHC

RATE – VERN (RATE MIN tb-ON)

MODE – OPR CMD, ENTER (READY It on)

SM 169 PDRS STATUS

┌ After PROCEED, if motion no longer apparent but POR is within ┐
 ┌ 1 in/1 deg and IN PROG It – on: ┐
 └ AUTO SEQ – STOP ┘

AUTO SEQ – PROCEED (IN PROG It on)

When AUTO SEQ IN PROG It – off:
 BRAKES – ON (tb-ON)

EVA 2 VIEWING posn: (02:15)

	X	Y	Z	PITCH	YAW	ROLL	PL ID
√	-139	-371	-508	131	344	190	1
	SY	SP	EP	WP	WY	WR	
√	+160.0	+24.3	-11.6	-21.8	-25.3	+69.3	

√MODE – not DIRECT (It off)

PARAM – PORT TEMP
 JOINT – CRIT TEMP

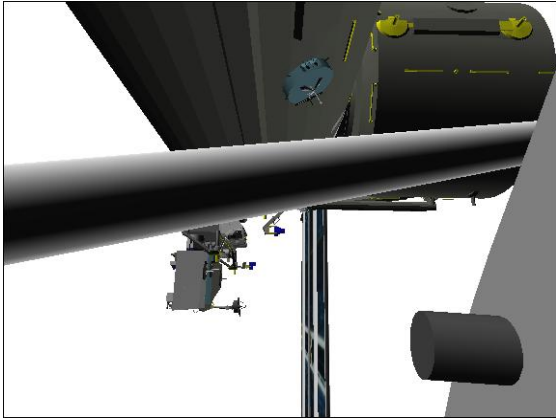

CCTV A (90,15)

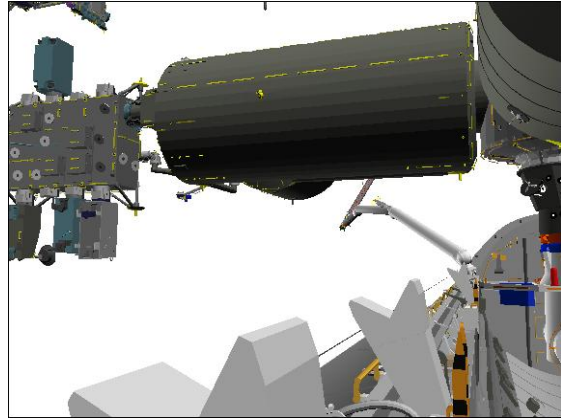

CCTV B (-20,5)

A7U

4. CAMERA SETUP FOR EVA 2

DTV ← PL2

CAMR CMD PAN/TILT – HI RATE

PAN – L (to hard stop)

TILT – UP (to hard stop)

PAN/TILT – RESET

PAN: +65 (right)

TILT: -65 (down)

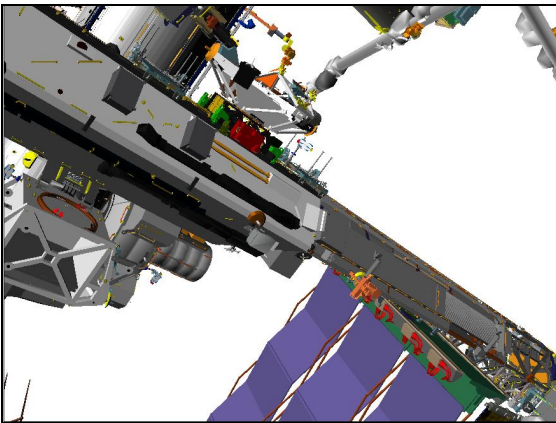

OBSS ITVC (75,-70)

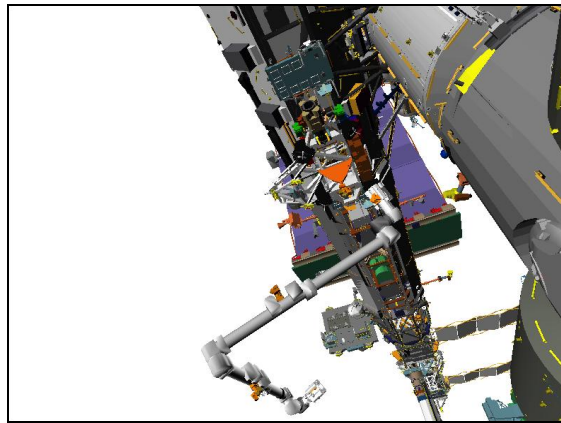

ELBOW (90,-20)

MUX 1 L ← MIDDECK

LDRI MODE 2 pb – push (ITVC video)

VIDEO OUT – as desired (not DTV)

√VIDEO IN – not PL2

OBSS MNVR TO MPLM VIEWING POSITION

1. SETUP

NOTE

This procedure assumes the SSRMS is at the FD7 Overnight Park position on MBS PDGF1

SM 94 PDRS CONTROL

√ PL ID, ITEM 3: 1

√ INIT ID, ITEM 24: 1

Verify at EVA 2 VIEWING posn:

X	Y	Z	PITCH	YAW	ROLL	PL ID
-139	-371	-508	131	344	190	1
SY	SP	EP	WP	WY	WR	
+160.0	+24.3	-11.6	-21.8	-25.3	+69.3	

R12(VPU) √ Green Jumper – LDRI/ITVC

MON 1	A
MON 2	OBSS ITVC (P1 LOOB)
DNLK	B
DTV	ELBOW (RSC)

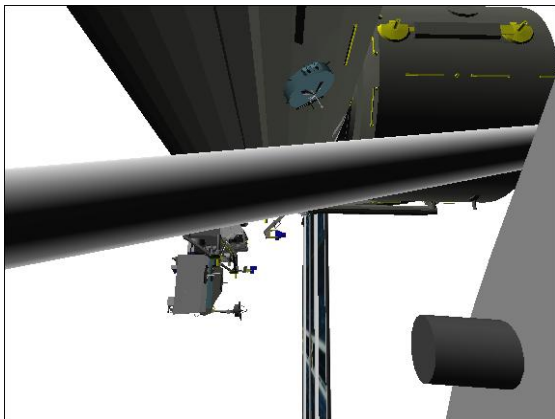

CCTV A (90,15)

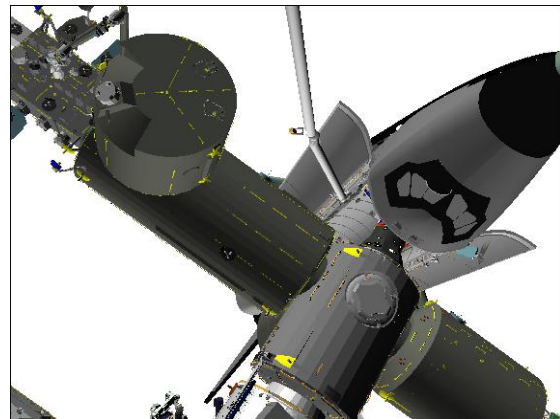

OBSS ITVC (85,-25)

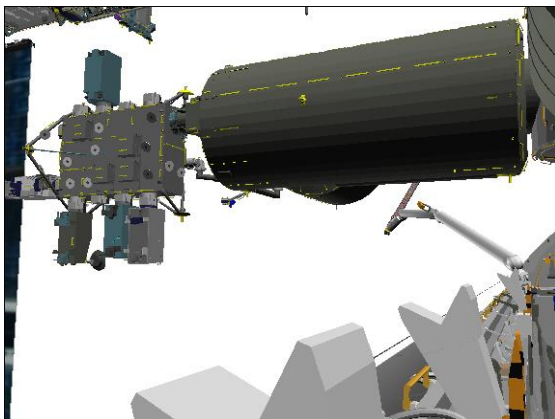

CCTV B (-25,5)

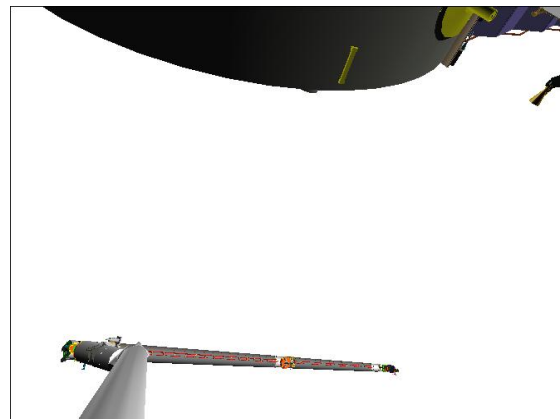

ELBOW (20,15)

2. OCAS TO INTERMEDIATE POSN

NOTE

At SY = +146, clearance between base boom and JPM PDGF is 26 inches. Monitor clearance with camera A,B or Elbow.

At end of OCAS, minimum distance between OBSS and P4 SAW will be no less than 89 inches

SM 94 PDRS CONTROL

END POS – ITEM 18 -3 2 3 -5 5 8 -3 1 2 EXEC
 ATT – ITEM 21 +5 8 +5 0 +2 5 6 EXEC
 CMD CK – ITEM 25 EXEC (GOOD)

RHC

RATE – VERN (RATE MIN tb-ON)

BRAKES – OFF (tb-OFF)

MODE – OPR CMD, ENTER (READY It on)

SM 169 PDRS STATUS

After PROCEED, if motion no longer apparent but POR is within 1 in/1 deg and IN PROG It – on:
 AUTO SEQ – STOP

AUTO SEQ – PROCEED (IN PROG It on)

When AUTO SEQ IN PROG It – off:

BRAKES – ON (tb-ON)

EVA 2 INTERMEDIATE posn:

(02:15)

	X	Y	Z	PITCH	YAW	ROLL	PL ID
√	-323	-558	-312	58	50	256	1
	SY	SP	EP	WP	WY	WR	
√	+130.0	+20.0	-23.0	-32.0	-25.3	-21.9	

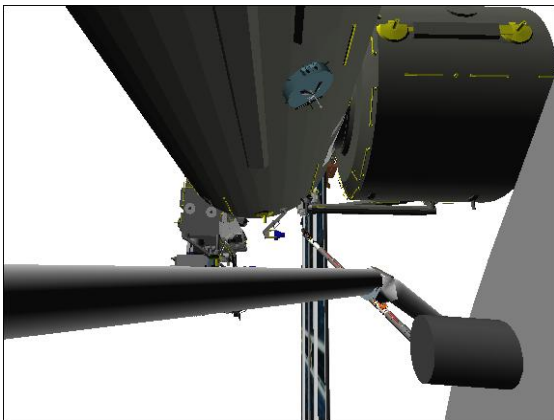

CCTV A (90,15)

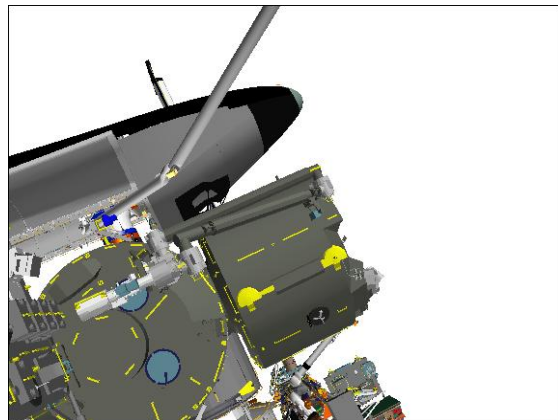

OBSS ITVC (85,-25)

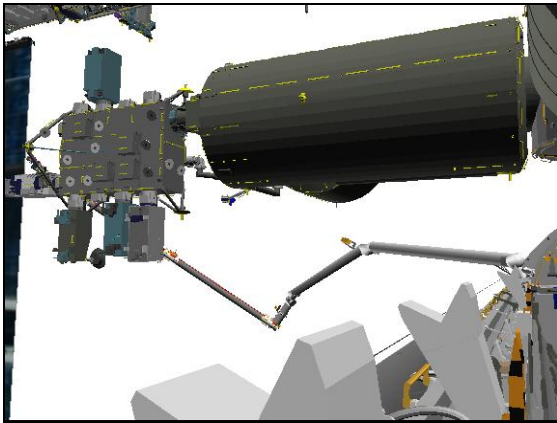

CCTV B (-25,5)



ELBOW (20,15)

3. SINGLE JOINT TO MPLM VIEWING POSN

NOTE

Minimum clearance between OBSS and SAW 4A is 68 inches at SY = +119.

At SY = +108, clearance between OBSS and JEM-SEDA antenna is 36 inches. Monitor clearance with RSC.

At SY = +105, clearance between OBSS and ICS-EF Antenna KOZ is 36 inches. Monitor clearance with camera B or RSC.

At SY = +88, clearance between tip boom and MAXI is 58 inches. Monitor clearance with Elbow camera

RHC RATE – as reqd (VERN within 10 ft)
 BRAKES – OFF (tb-OFF)
 MODE – SINGLE, ENTER

SM 169 PDRS STATUS

Mnvr to MPLM VIEWING posn (within 2"/1°):

	SY	SP	EP	WP	WY	WR	
EVA 2 INTERMEDIATE	+130.0	+20.0	-23.0	-32.0	-25.3	-21.9	
1: SY -	+62.5						
2: SP +		+25.0					
3: WY +					-13.2		
4: WP +				0.0			
MPLM VIEWING	+62.5	+25.0	-23.0	0.0	-13.2	-21.9	
	X	Y	Z	PITCH	YAW	ROLL	PL ID
	-967	-643	-386	60	349	282	1

BRAKES – ON (tb-ON)
 ✓MODE – not DIRECT (lt off)
 PARAM – PORT TEMP
 JOINT – CRIT TEMP

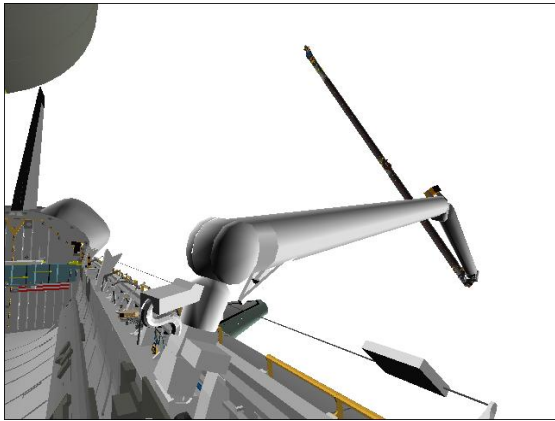

CCTV A (30,5)

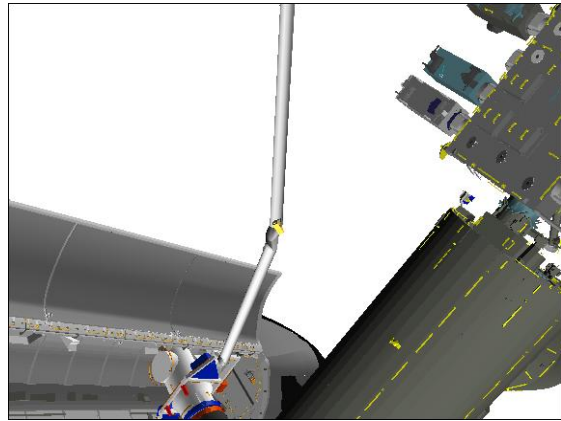

OBSS ITVC (85,-25)

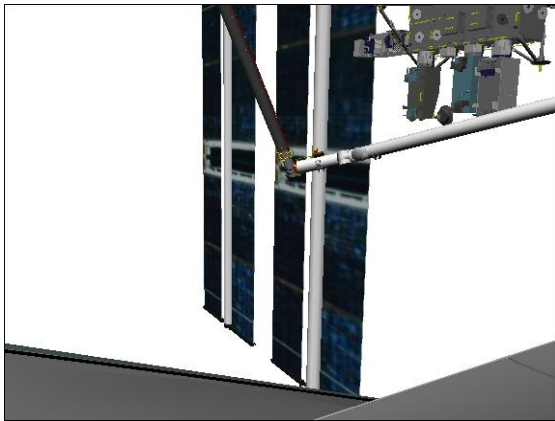

CCTV B (-60,-10)



ELBOW (-30,20)

A7U

4. CONFIGURE CAMERAS FOR MPLM UNINSTALL
DTV ← PL2

CAMR CMD PAN/TILT – HI RATE
 PAN – L (to hard stop)
 TILT – UP (to hard stop)
 PAN/TILT – RESET
 PAN: +130 (right)
 TILT: -60 (down)

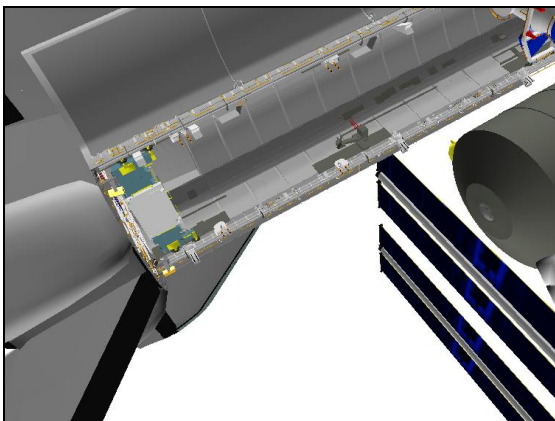

OBSS ITVC (130,-60)

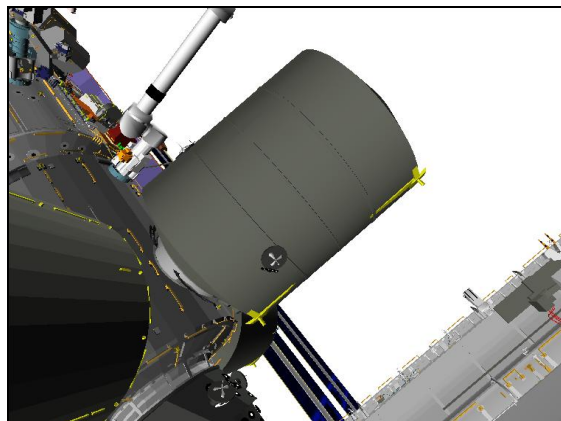

ELBOW (160,-20)

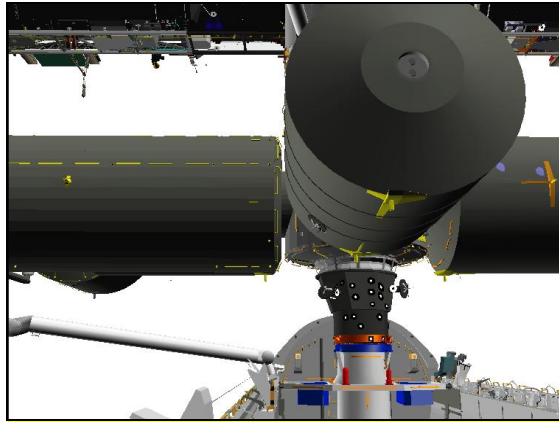

CCTV B (0,15)

MUX 1 L ← MIDDECK
LDRI MODE 2 pb – push (ITVC video)
VIDEO OUT – as desired (not DTV)
√VIDEO IN – not PL2

This Page Intentionally Blank

OBSS MNVR TO UNDOCK

1. SETUP

SM 94 PDRS CONTROL

√ PL ID, ITEM 3: 1

√ INIT ID, ITEM 24: 1

Verify at MPLM VIEWING posn:

	X	Y	Z	PITCH	YAW	ROLL	PL ID
√	-967	-643	-386	60	349	282	1
	SY	SP	EP	WP	WY	WR	
√	+62.5	+25.0	-23.0	0.0	-13.2	-21.9	

R12(VPU) √ Green Jumper – ISS

MON 1	P1 LOOB
MON 2	B
DNLK	RSC
DTV	A

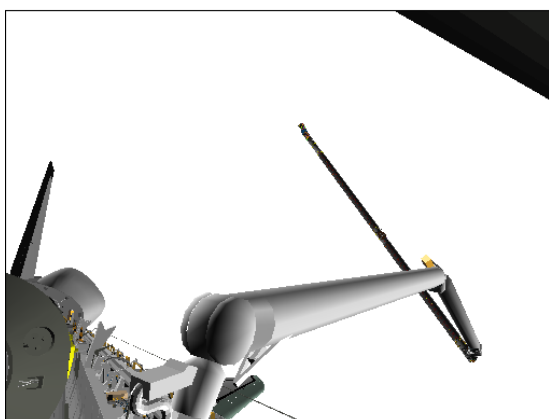

CCTV A (30,15)

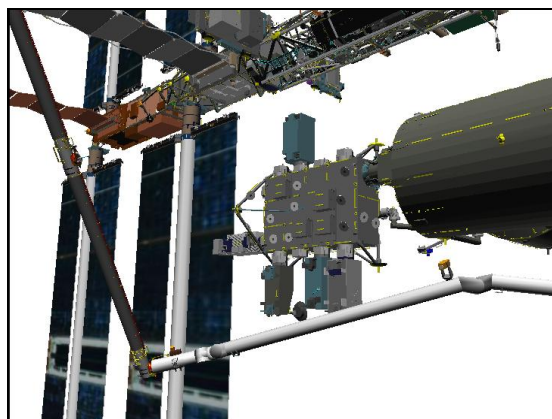

CCTV B (-45,10)

2. OBSS MNVR TO UNDOCK

SM 94 PDRS CONTROL

END POS – ITEM 18 -1 0 4 1 -3 6 2 -6 0 2 EXEC

ATT – ITEM 21 +4 4 +2 7 0 +0 EXEC

CMD CK – ITEM 25 EXEC (GOOD)

RHC

RATE – as reqd (VERN within 10 ft)

BRAKES – OFF (tb-OFF)

MODE – OPR CMD, ENTER (READY It on)

AUTO SEQ – PROCEED (IN PROG It on)

When AUTO SEQ IN PROG It – off:

BRAKES – ON (tb-ON)

OBSS UNDOCK posn:

(02:30)

	X	Y	Z	PITCH	YAW	ROLL	PL ID
√	-1041	-362	-602	44	270	0	1
	SY	SP	EP	WP	WY	WR	
√	+25.8	+66.3	-49.0	-85.9	+10.7	-100.7	

*Display singularity

√MODE – not DIRECT (It off)
 PARAM – PORT TEMP
 JOINT – CRIT TEMP

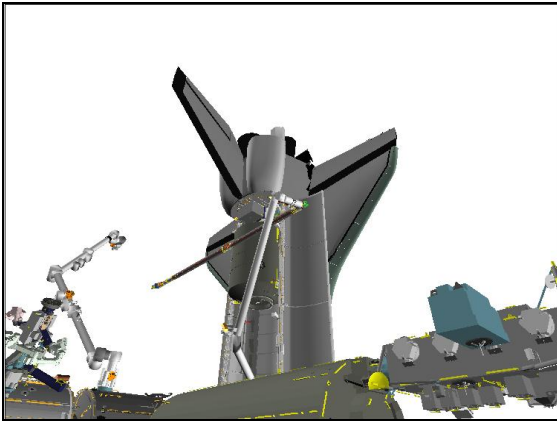

P1 LOOB (135,35)

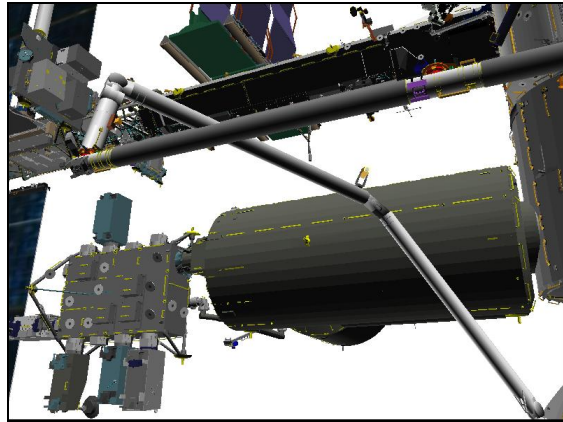

CCTV B (-25,20)

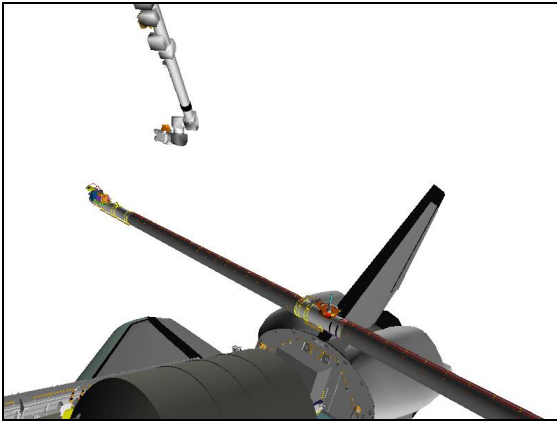

ELBOW (-65,20)

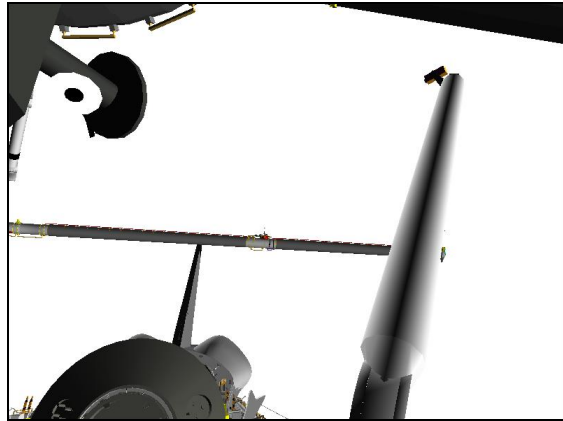

CCTV A (10,25)

OBSS MNVR TO FLAT FIELD

WARNING
 For UNDOCKED ops only

1. SETUP

SM 94 PDRS CONTROL

PL ID – ITEM 3 +2 EXEC
 INIT ID – ITEM 24 +2 EXEC
 AUTO MODES – ITEM 13 +7 EXEC

Verify at OBSS UNDOCK posn:

	X	Y	Z	PITCH	YAW	ROLL	PL ID
√	-1029	+229	-614	14	270	0	2
	SY	SP	EP	WP	WY	WR	
√	+25.8	+66.3	-49.0	-85.9	+10.7	-100.7	

*Display singularity

MON 1	C
MON 2	D
DNLK	ELBOW
DTV	A (B)

2. MNVR TO FLAT FIELD START

SM 94 PDRS CONTROL

END POS – ITEM 18 -1 0 2 9 +2 2 9 -6 1 4 EXEC
 ATT – ITEM 21 +2 8 4 +2 7 0 +0 EXEC
 CMD CK – ITEM 25 EXEC (GOOD)

RHC

RATE – COARSE (RATE MIN tb-OFF)
 BRAKES – OFF (tb-OFF)
 MODE – OPR CMD, ENTER (READY It on)

AUTO SEQ – PROCEED (IN PROG It on)

ACAS START posn:

	X	Y	Z	PITCH	YAW	ROLL	PL ID
√	-1029	+229	-614	284	270	270	2
	SY	SP	EP	WP	WY	WR	
√	+26.1	+67.7	-51.2	-85.0	+10.6	-100.6	

*Display singularity

When AUTO SEQ IN PROG It – off:
 MODE – AUTO 1, ENTER (READY It on)

SM 94 PDRS CONTROL

√START PT, ITEM 17: 148

SM 169 PDRS STATUS

Monitor ACAS progress

AUTO SEQ – PROCEED (IN PROG It on)

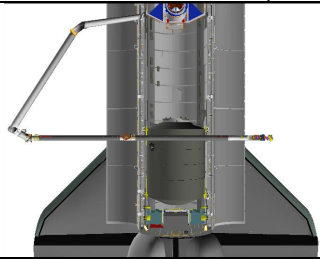
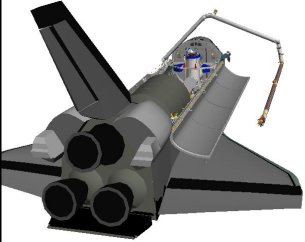
Pt	X	Y	Z	PITCH	YAW	ROLL	
148P	-1029	+229	-614	284	270*	270	
149	-800	+500	-250	281	333	95	
150	-1130	+350	-400	325	336	30	
151P	-1270	+350	-445	0	0	11	

*Display singularity

When AUTO SEQ IN PROG It – off:
BRAKES – ON (tb-ON)

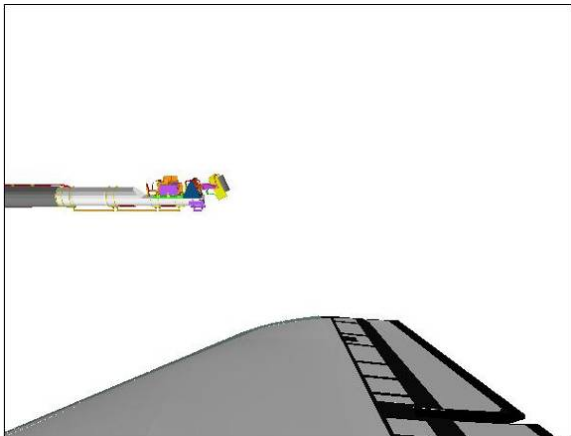

CCTV C (95,-5)

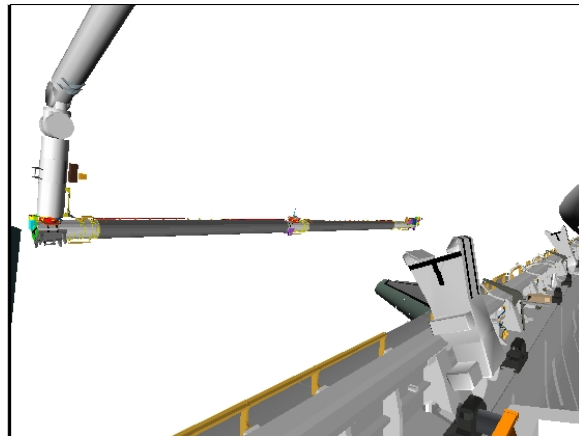

CCTV D (-40,0)

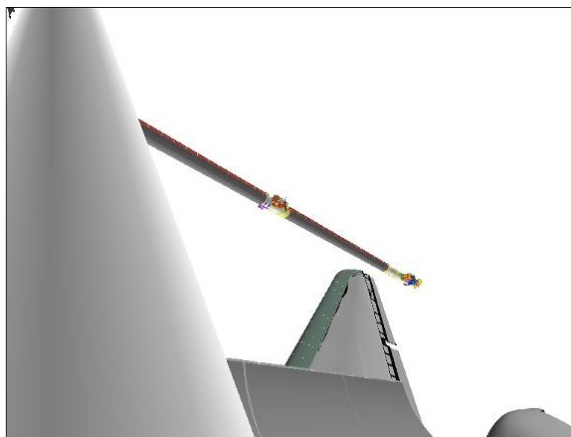

ELBOW (25,-40)

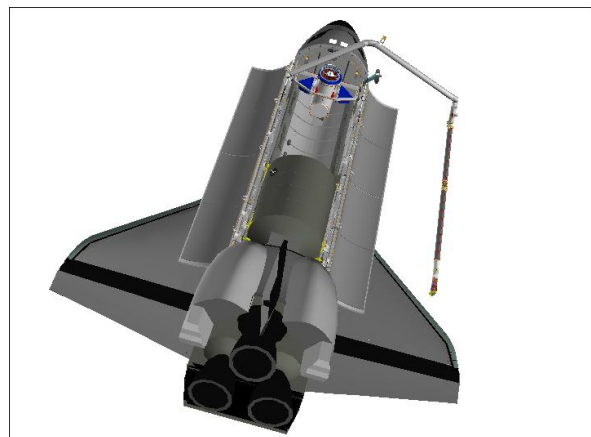

BIRD'S EYE

3. SETUP FOR STBD SURVEY

SM 94 PDRS CONTROL

AUTO MODES – ITEM 13 +1 +2 +3 +4 EXEC

For survey scan pattern, refer to OBSS SCAN PATTERN CUE CARDS – STBD & PORT, AND WING GLOVE AND CREW CABIN

Perform ACTIVATION (LDRI/ITVC Cue Card, P/TV) steps 1, 3, 4, and 5

A15 APCU 2 CONV – OFF
Wait 10 sec
APCU 2 CONV – ON

Perform LCC ACTIVATION (LCS Cue Card, P/TV)
Perform IDC SOFTWARE ACTIVATION (IDC Cue Card, P/TV) steps 1 and 2

A7U MUX 1 L ← MIDDECK
LDRI MODE 6 pb – push (flickering LDRI video)
√DTV ← PL2

CAMR CMD PAN/TILT – HI RATE
PAN – L (to hard stop)
TILT – UP (to hard stop)
PAN/TILT – RESET, HI RATE (LO within 10°)
PAN: +103 (right)
TILT: -260 (down)

VIDEO OUT – as desired (not DTV)
√VIDEO IN – not PL2

L10(VTR) REC pb – push, hold
PLAY pb – push, simo (red ●)

BRAKES – OFF (tb-OFF)

Go to OBSS LDRI/IDC RCC SURVEY – STBD (OBSS OPERATIONS), step 5
Reference 7-9 for procedure Notes

This Page Intentionally Blank

OBSS CONTINGENCY

I

OBSS HANDOFF FROM SRMS TO SSRMS	FS 2-3
MNVR TO CONTINGENCY UNDOCK	FS 2-9
CONT UNDOCK TO NOM UNDOCK.....	FS 2-11
SJ HANDOFF FROM SSRMS TO SRMS.....	FS 2-13
SRMS TO SSRMS.....	FS 2-30
MNVR TO UNDOCK.....	FS 2-48
OBSS HOVER	FS 2-53
SJ MNVR TO EVA 2 VIEWING POSITION	FS 2-58
MPLM VIEWING POSITION	FS 2-66

**OBSS
CONTINGENCY**

This Page Intentionally Blank

OBSS HANDOFF FROM SRMS TO SSRMS

1. SETUP

SM 94 PDRS CONTROL

√ PL ID, ITEM 3: 1

√ INIT ID, ITEM 24: 1

Verify at MPLM VIEWING posn:

	X	Y	Z	PITCH	YAW	ROLL	PL ID
√	-967	-643	-386	60	349	282	1
	SY	SP	EP	WP	WY	WR	
√	+62.5	+25.0	-23.0	0.0	-13.2	-21.9	

R12(VPU) √ Green Jumper – ISS

MON 1	S1 LOOB
MON 2	B
DNLK	RSC
DTV	A

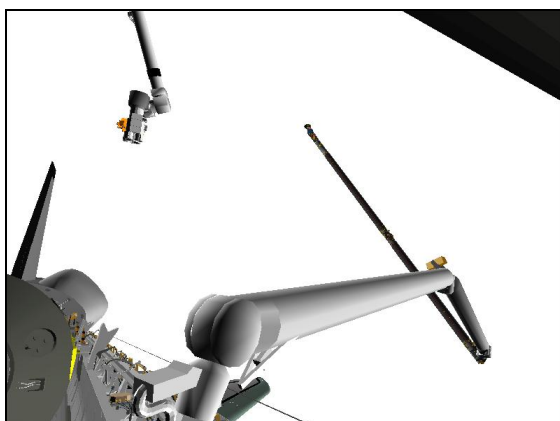

CCTV A (30,15)

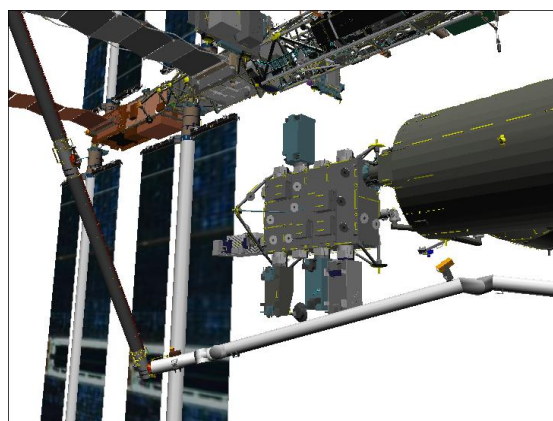

CCTV B (-45,10)

Review GENERIC END EFFECTOR CUE CARD – ISS/SHUTTLE DOCKED OPS

2. MNVR TO OBSS HANDOFF

SM 94 PDRS CONTROL

END POS – ITEM 18 -1 0 7 0 -3 6 1 -5 8 4 EXEC

ATT – ITEM 21 +1 4 +2 8 1 +3 3 0 EXEC

CMD CK – ITEM 25 EXEC (GOOD)

On SSRMS Operator GO for mnvr to OBSS HANDOFF

RHC

RATE – as reqd (VERN within 10 ft)

BRAKES – OFF (tb-OFF)

MODE – OPR CMD, ENTER (READY It on)

AUTO SEQ – PROCEED (IN PROG It on)

When AUTO SEQ IN PROG It – off

OBSS HANDOFF INTERMEDIATE posn: (02:30)

	X	Y	Z	PITCH	YAW	ROLL	PL ID
√	-1070	-361	-584	14	281	330	1
	SY	SP	EP	WP	WY	WR	
√	+24.5	+59.0	-42.1	-85.9	+11.2	-87.8	

MODE – SINGLE, ENTER

Mnvr to OBSS HANDOFF posn:

	SY	SP	EP	WP	WY	WR	
OBSS HANDOFF INTERMEDIATE	+24.5	+59.0	-42.1	-85.9	+11.2	-87.8	
1: WR –						-99.4	
OBSS HANDOFF	+24.5	+59.0	-42.1	-85.9	+11.2	-99.4	
	X	Y	Z	PITCH	YAW	ROLL	PL ID
	-1070	-360	-584	44	270	0	1

*Display singularity

BRAKES – ON (tb-ON)



CCTV A (10,30)

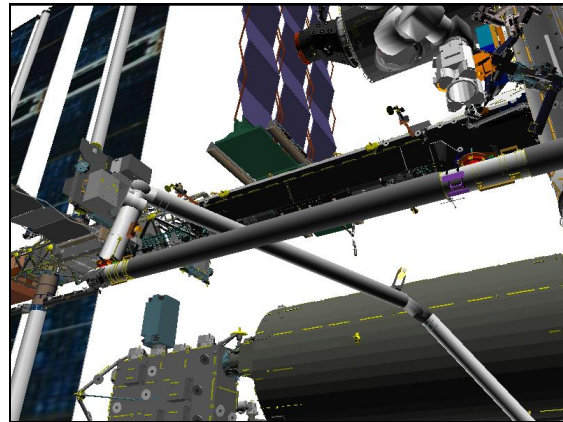

CCTV B (-30,30)

Give SSRMS Operator GO for OBSS grapple

3. STOW PTU

R12(VPU) Green Jumper – LDRI/ITVC

A7U DTV ← PL2

CAMR CMD PAN/TILT – HI RATE

PAN – L (to hard stop)

TILT – UP (to hard stop)

PAN/TILT – RESET

PAN: +108 (right)

TILT: -175 (down)

R12(VPU) Green Jumper – ISS

On SSRMS Operator GO for OBSS ungrapple

CAUTION
STBD RMS HTR power must be applied within 90 min
to prevent sensor package damage

Perform LCC DEACTIVATION (LCS Cue Card, P/TV)
Perform LCH DEACTIVATION (LCS Cue Card, P/TV)
Perform DEACTIVATION (LDRI/ITVC Cue Card, P/TV)

4. OBSS UNGRAPPLE

A7U CCTV – config for ungrapple
– RMS WRIST, ZOOM: 34.0 HFOV
FOCUS: 5 ft

NOTE

CONTR ERR It and 'S96 PDRS CNTL' msg may
occur due to Consistency/Envelope Check error

RHC RATE – COARSE (RATE MIN tb-OFF)

SM 94 PDRS CONTROL

AUTO BRAKE INH – ITEM 10 EXEC (*)

BRAKES – OFF (tb-OFF)
MODE – TEST, ENTER
Wait 5 sec

BRAKES – ON (tb-ON)

SM 94 PDRS CONTROL

AUTO BRAKE ENA – ITEM 9 EXEC (*)
PL ID – ITEM 3 +0 EXEC
INIT ID – ITEM 24 +0 EXEC

RHC RATE – VERN (RATE MIN tb-ON)
BRAKES – OFF (tb-OFF)
MODE – END EFF, ENTER

CAUTION
Monitor EE tb timing to prevent EE motor burnout

EE MODE – AUTO
RELEASE sw – depress (mom)

When OPEN tb – gray, mnvr arm clear of grapple pin

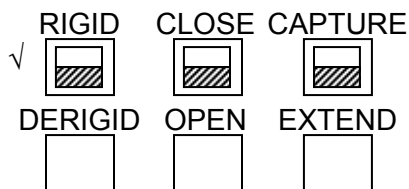

CRITICAL TIMES (28 sec total):
DERIGID tb – gray, 5 sec max, then
OPEN tb – gray, 3 sec max, then
EXTEND tb – gray, 20 sec max

EE MODE – OFF

STBD RMS RETEN LAT – LAT 6 sec only (tb-bp)
– OFF

R13L PL BAY MECH PWR SYS (two) – OFF
Give SSRMS Operator GO to Limp All SSRMS Joints and Derigidize

R13L **On SSRMS Operator GO to complete STBD MRL latching,**
PL BAY MECH PWR SYS (two) – ON

STBD RMS RETEN LAT – LAT (tb-LAT) (12 sec max)
– OFF

8. RECONFIGURE POWER
PL BAY MECH PWR SYS (two) – OFF

STBD RMS HTR A,B (two) – AUTO

A6U EVENT TIMER CNTL – STOP

SM 94 PDRS CONTROL

√STBD AFT, MID, FWD LAT (six) = 1
RMS PORT – ITEM 1 EXEC (*)

MA73C:C cb MCA PWR AC3 3Φ MID 2 – cl
√AC2 3Φ MID 2 – op

MA73C:D √AC3 3Φ MID 4 – op

Give SSRMS Operator GO for OBSS ungrapple

9. MNVR TO PRECRADLE
Verify SSRMS at Berthed OBSS Backoff or Overnight Park posn

MON 1	P1 LOOB
MON 2	B
DNLK	ELBOW
DTV	A

SM 94 PDRS CONTROL

END POS – ITEM 18 -1 2 6 1 -1 4 6 -5 5 1 EXEC

ATT – ITEM 21 +5 +2 +0 EXEC

CMD CK – ITEM 25 EXEC (GOOD)

RHC RATE – as reqd (VERN within 10 ft)
BRAKES – OFF (tb-OFF)
MODE – OPR CMD, ENTER (READY lt on)

AUTO SEQ – PROCEED (IN PROG lt on)

When AUTO SEQ IN PROG lt – off:

Verify at PRECRADLE posn:

√	X	Y	Z	PITCH	YAW	ROLL	PL ID
	-1261	-146	-551	5	2	0	0
	SY	SP	EP	WP	WY	WR	
√	0.0	+25.0	-25.0	+5.0	0.0	0.0	

BRAKES – ON (tb-ON)
MODE – not DIRECT (lt off)
PARAM – PORT TEMP
JOINT – CRIT TEMP

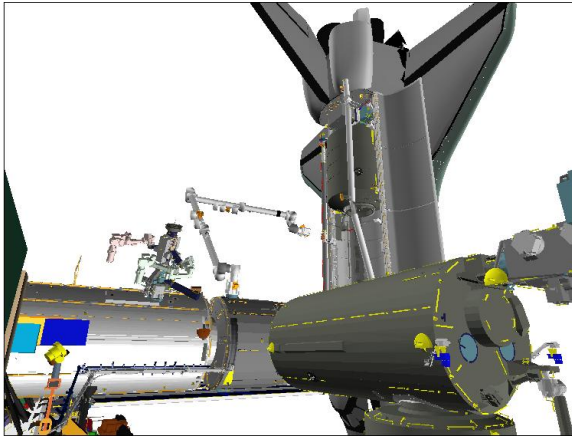

P1 LOOB (120,20)



CCTV B (-10,15)

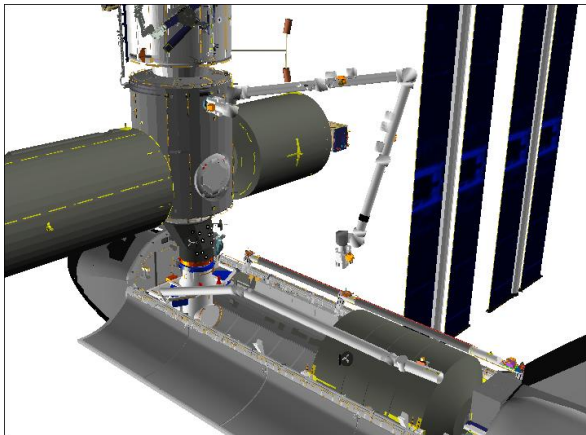

BIRD'S EYE

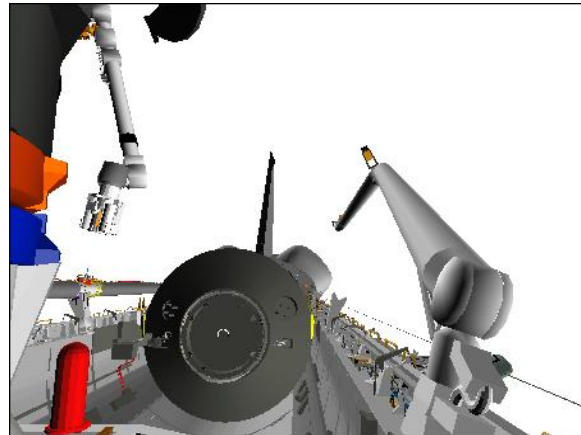

CCTV A (0,10)

OBSS MNVR TO CONTINGENCY UNDOCK

1. SETUP

SM 94 PDRS CONTROL

√ PL ID, ITEM 3: 1

√ INIT ID, ITEM 24: 1

Verify at MPLM VIEWING posn:

	X	Y	Z	PITCH	YAW	ROLL	PL ID
√	-967	-643	-386	60	349	282	1
	SY	SP	EP	WP	WY	WR	
√	+62.5	+25.0	-23.0	0.0	-13.2	-21.9	

R12(VPU) √ Green Jumper – ISS

MON 1	P1 LOOB
MON 2	A
DNLK	ELBOW
DTV	B



P1 LOOB (140,40)

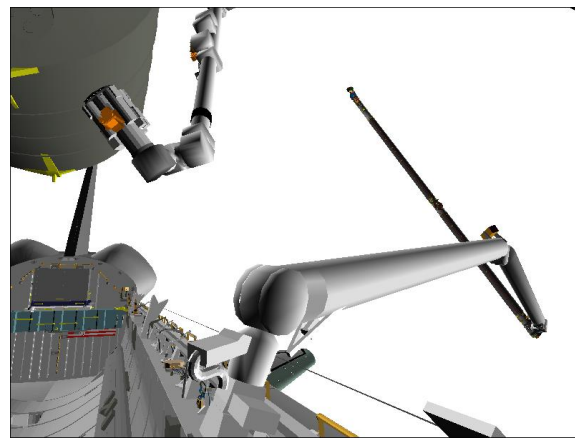

CCTV A (25,10)

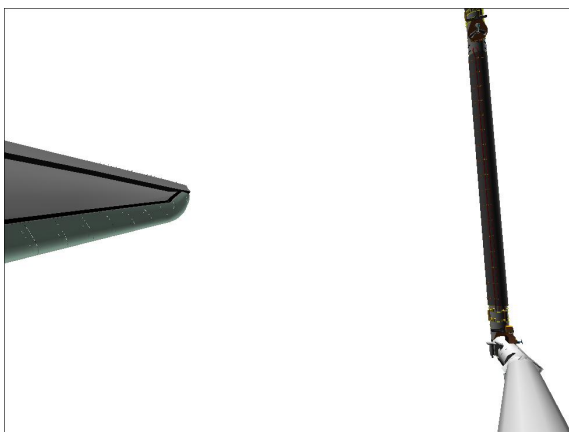

ELBOW (-30,15)

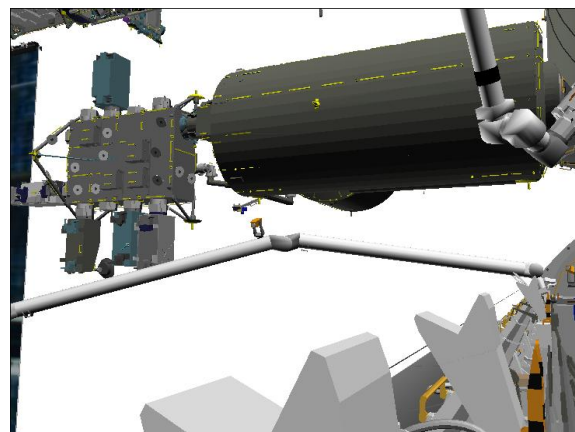

CCTV B (-25,5)

2. MNVR TO OBSS CONTINGENCY UNDOCK POSN

SM 94 PDRS CONTROL

END POS – ITEM 18 -1 1 3 1 -4 9 6 -5 8 6 EXEC

ATT – ITEM 21 +6 2 +3 2 4 +2 8 2 EXEC

CMD CK – ITEM 25 EXEC (GOOD)

RHC

RATE – VERN (RATE MIN tb-ON)
BRAKES – OFF (tb-OFF)
MODE – OPR CMD, ENTER (READY It on)

AUTO SEQ – PROCEED (IN PROG It on)

When AUTO SEQ IN PROG It – off:
BRAKES – ON (tb-ON)

OBSS CONTINGENCY UNDOCK posn:

	X	Y	Z	PITCH	YAW	ROLL	PL ID
√	-1131	-496	-586	62	324	282	1
	SY	SP	EP	WP	WY	WR	
√	+35.0	+38.7	-22.8	-0.5	-0.3	-40.0	

MODE – not DIRECT (It off)
PARAM – PORT TEMP
JOINT – CRIT TEMP

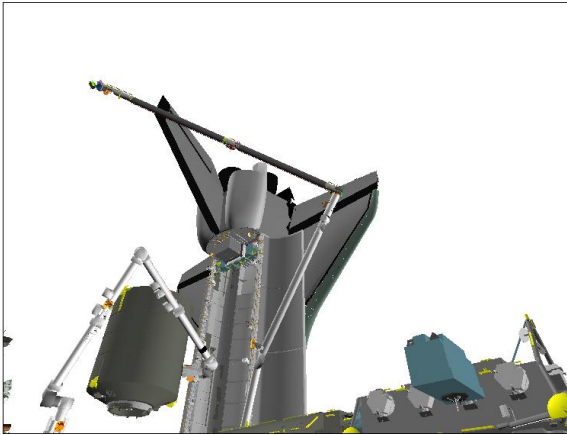

P1 LOOB (140,40)

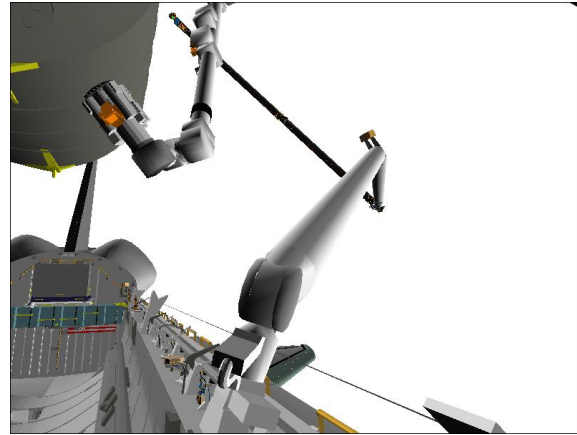

CCTV A (25,10)

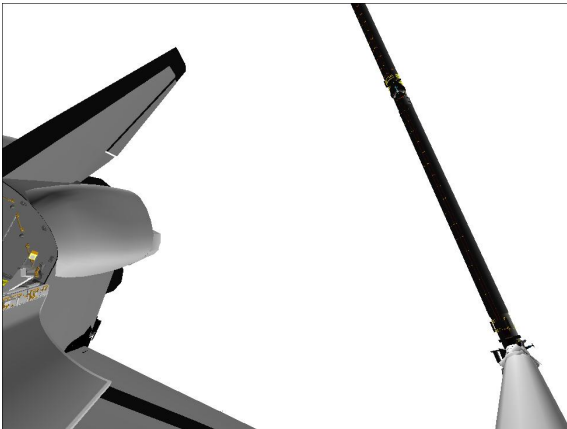

ELBOW (-30,15)

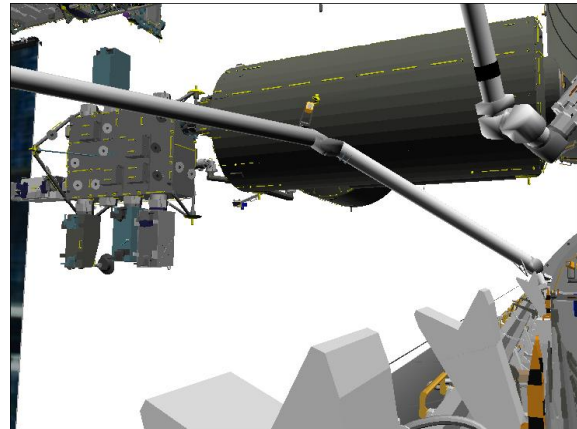

CCTV B (-25,5)

OBSS MNVR CONT UNDOCK TO NOM UNDOCK

1. SETUP

SM 94 PDRS CONTROL

√ PL ID, ITEM 3: 1

√ INIT ID, ITEM 24: 1

Verify at OBSS CONTINGENCY UNDOCK posn:

	X	Y	Z	PITCH	YAW	ROLL	PL ID
√	-1131	-496	-586	62	324	282	1
	SY	SP	EP	WP	WY	WR	
√	+35.0	+38.7	-22.8	-0.5	-0.3	-40.0	

MON 1	A
MON 2	D
DNLK	B
DTV	ELBOW



CCTV A (5,10)

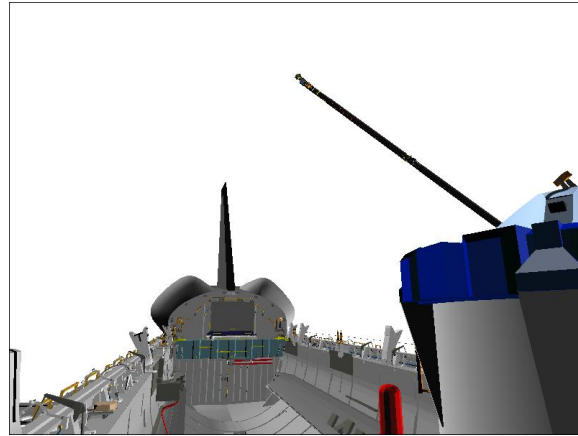

CCTV D (15,15)

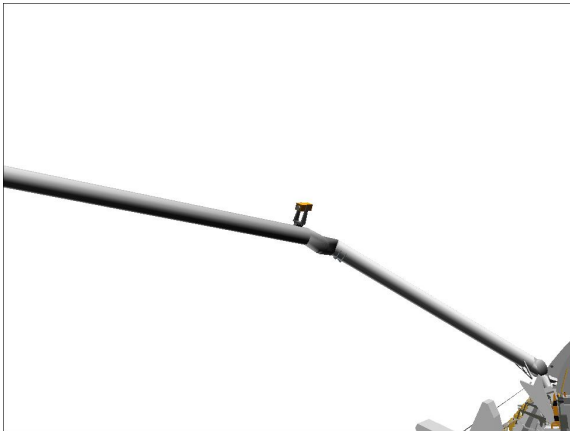

CCTV B (-25,15)

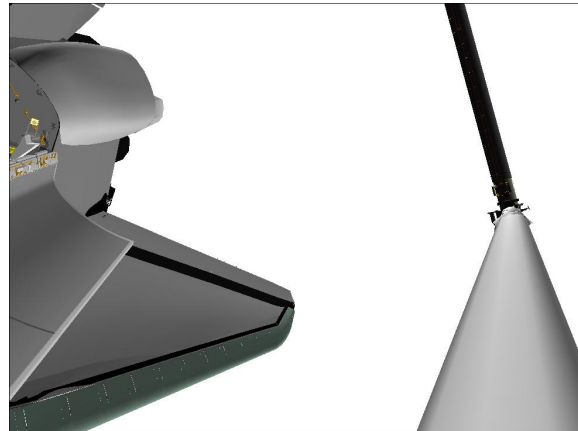

ELBOW (-30,-5)

2. MNVR TO NOMINAL UNDOCK POSN

SM 94 PDRS CONTROL

END POS – ITEM 18 -1 0 4 1 -3 6 2 -6 0 2 EXEC

ATT – ITEM 21 +4 4 +2 7 0 +0 EXEC

CMD CK – ITEM 25 EXEC (GOOD)

RHC

RATE – VERN (RATE MIN tb-ON)
BRAKES – OFF (tb-OFF)
MODE – OPR CMD, ENTER (READY It on)

AUTO SEQ – PROCEED (IN PROG It on)

When AUTO SEQ IN PROG It – off:
BRAKES – ON (tb-ON)

OBSS UNDOCK posn:

	X	Y	Z	PITCH	YAW	ROLL	PL ID	*
√	-1041	-362	-602	44	270	0	1	
	SY	SP	EP	WP	WY	WR		
√	+25.8	+66.3	-49.0	-85.9	+10.7	-100.7		

*Display singularity

MODE – not DIRECT (It off)
PARAM – PORT TEMP
JOINT – CRIT TEMP



CCTV A (5,10)

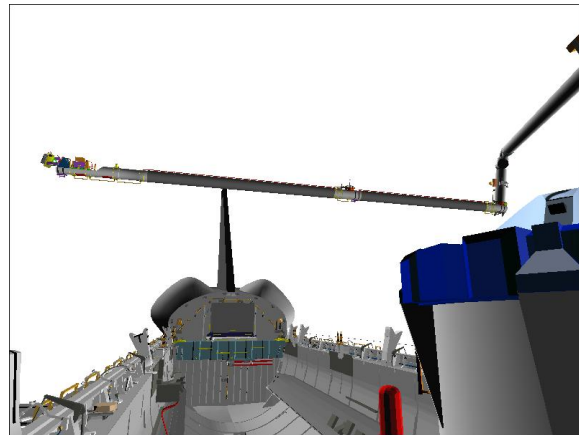

CCTV D (15,15)



CCTV B (-25,15)

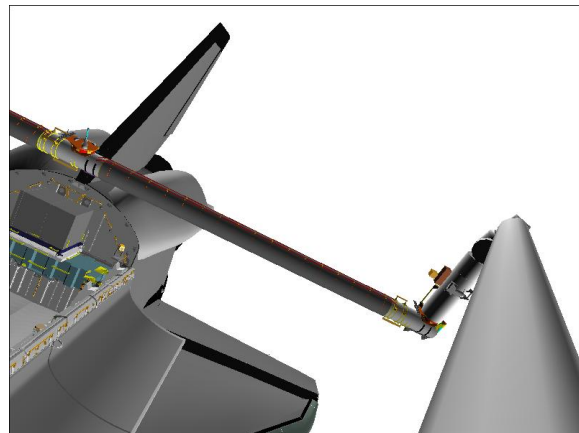

ELBOW (-30,5)

OBSS SJ HANDOFF FROM SSRMS TO SRMS

1. SETUP

SM 94 PDRS CONTROL

√PL ID, ITEM 3: 0

√INIT ID, ITEM 24: 0

A7U CCTV – config as reqd
 – perform PAN/TILT RESET for PLB cameras
 ZOOM – full OUT

R12(VPU) √Green Jumper – ISS

MON 1	D
MON 2	B (P1 LOOB)
DNLK	A
DTV	ELBOW (EE)

2. SINGLE JOINT MANUEVER TO OBSS PRE-GRAPPLE AT HANDOFF

√MCC to verify SSRMS at Stage Park posn

RHC If SINGLE mode available:
 RATE – as reqd (VERN within 10 ft)
 BRAKES – OFF (tb-OFF)

MODE – best available

Mnvr to OBSS PRE-GRAPPLE AT HANDOFF posn:

	SY	SP	EP	WP	WY	WR	
PRECRADLE	0.0	+25.0	-25.0	+5.0	0.0	0.0	
1: SP +		+57.5					
2: WP –				-99.3			
3: WY +					+11.8		
4: WR –						-97.9	
5: EP –			-27.4				
6: SY +	+22.7						
OBSS PRE-GRAPPLE AT HANDOFF	+22.7	+57.5	-27.4	-99.3	+11.8	-97.9	
	X	Y	Z	PITCH	YAW	ROLL	PL ID
	-1047	-360	-658	284	0	270	0

BRAKES – ON (tb-ON)
 MODE – not DIRECT
 PARAM – PORT TEMP
 JOINT – CRIT TEMP

**Notify SSRMS Operator that SRMS at OBSS Pre-Grapple at Handoff posn,
 GO for OBSS Grapple**

MUX 1 L ← D (-20, 0, HFOV 55°)
 MUX 1 R ← C (25, -5, HFOV 70°)
 DNLK ← MUX 1

Start:
PRECRADLE

Step 1:
Drive SP (+) from +25.0 to +57.5



CCTV A (20,20)



CCTV A (20,20)

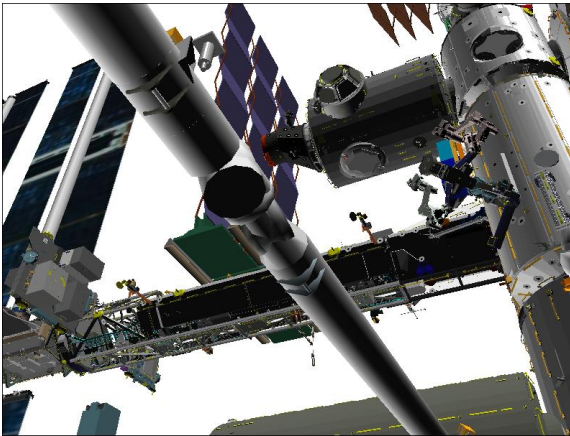

CCTV B (-25,40)

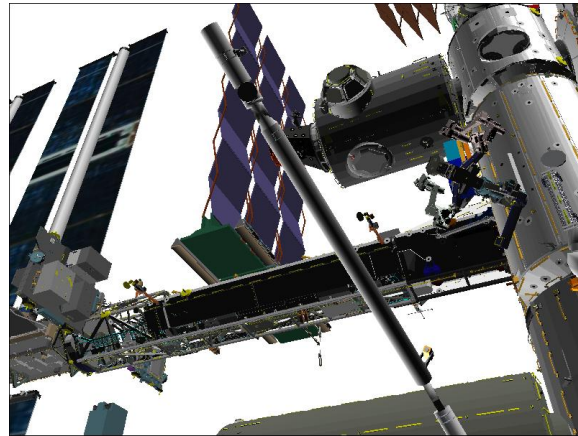

CCTV B (-25,40)

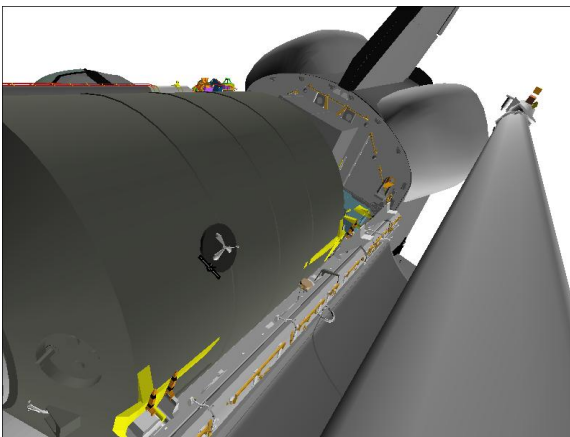

ELBOW (-30,-20)

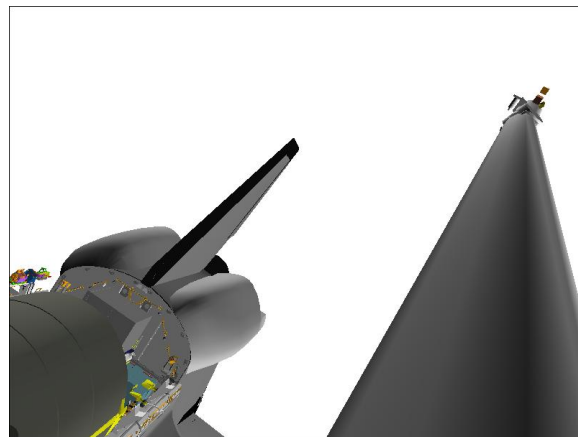

ELBOW (-30,-20)

Step 2:
Drive WP (-) from +5.0 to -99.3



CCTV A (20,20)

Step 3:
Drive WY (+) from 0.0 to +11.8



CCTV A (20,20)

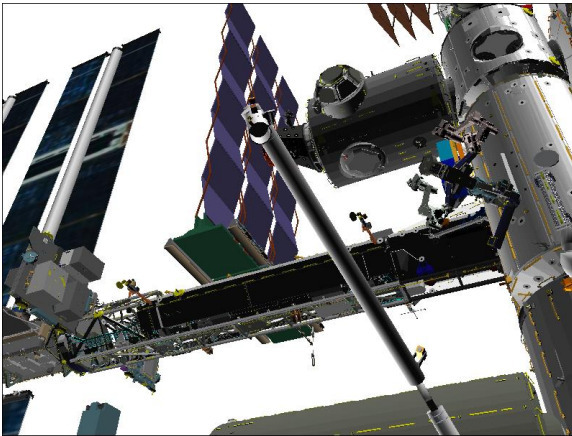

CCTV B (-25,40)

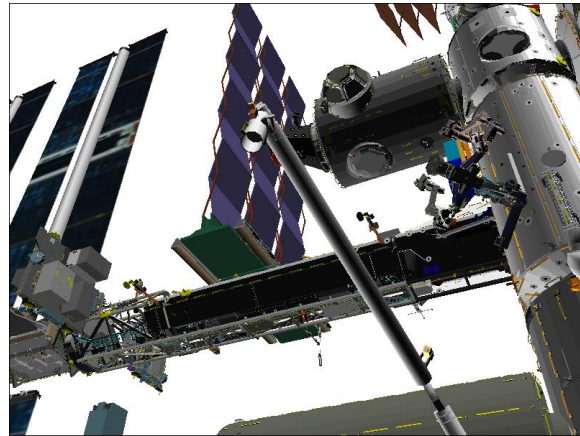

CCTV B (-25,40)

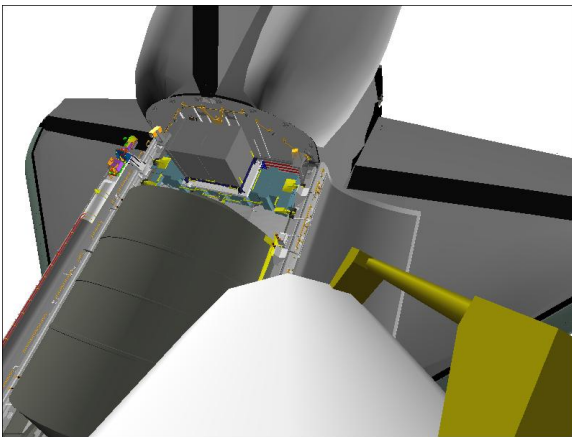

EE

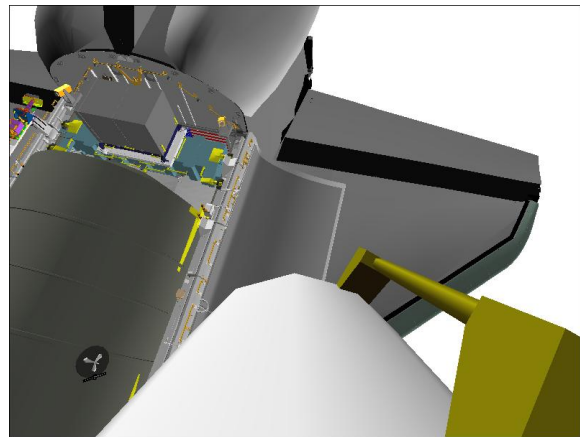

EE

Step 4:
Drive WR (-) from 0.0 to -97.9



CCTV A (20,20)

Step 5:
Drive EP (-) from -25.0 to -27.4



CCTV A (20,20)

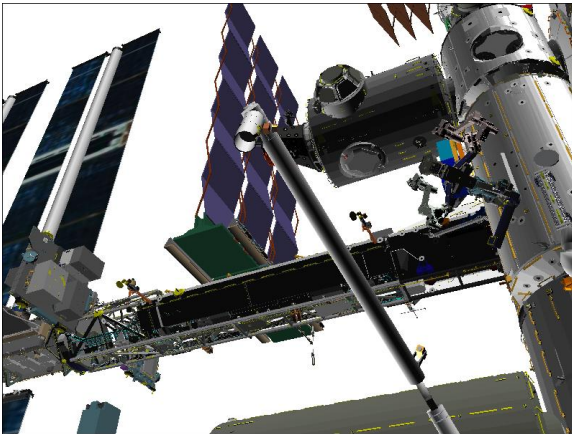

CCTV B (-25,40)

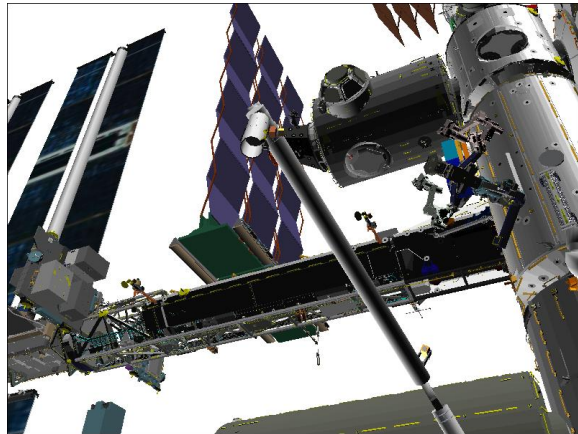

CCTV B (-25,40)

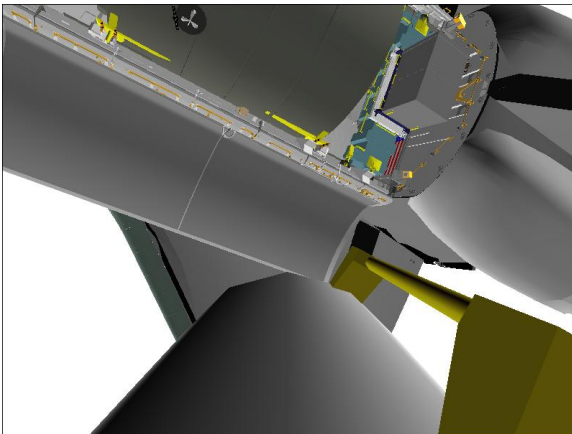

EE

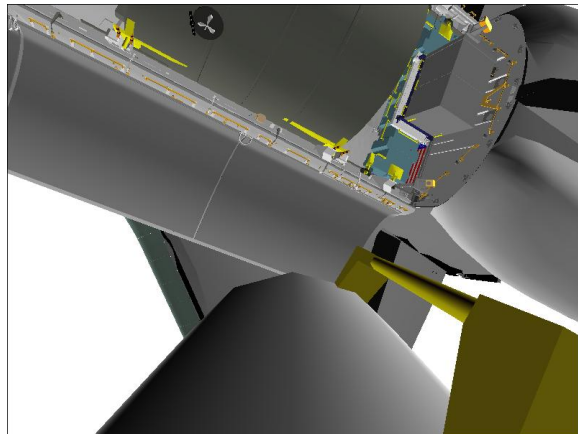

EE

Step 6:
Drive SY (+) from 0.0 to +22.7



CCTV A (20,20)

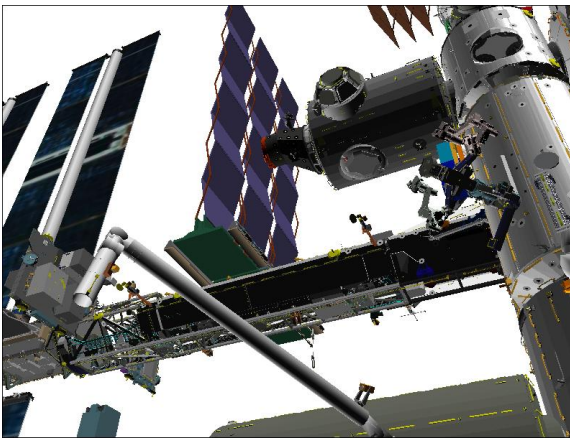

CCTV B (-25,40)

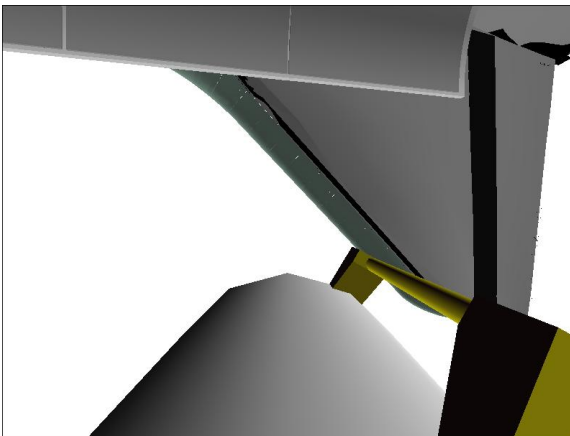

EE

3. CONFIGURE POWER

CAUTION
SPEE power must be applied within 90 min
to prevent sensor package damage

**On SSRMS Operator GO to release STBD MRLs,
STBD RMS HTR A,B (two) – OFF**

A6U EVENT TIMER MODE – UP
 CNTL – START

MA73C:C cb MCA PWR AC3 3Φ MID 2 – op
 √AC2 3Φ MID 2 – op

MA73C:D √AC3 3Φ MID 4 – op

R13L PL BAY MECH PWR SYS (two) – ON

4. STBD MRL RELEASE

SM 94 PDRS CONTROL

RMS STBD – ITEM 2 EXEC (*)
√STBD AFT, MID, FWD REL (six) = 0

NOTE
Expect single motor drive time for MRL release

STBD RMS RETEN LAT – REL (tb-REL) (18 sec max)
– OFF

If motor drive time > 18 sec, √MCC

SM 94 PDRS CONTROL

√STBD AFT, MID, FWD REL (six) = 1

5. RECONFIGURE POWER

R13L PL BAY MECH PWR SYS (two) – OFF

MA73C:C cb MCA PWR AC3 3Φ MID 2 – cl
 √AC2 3Φ MID 2 – op

MA73C:D √AC3 3Φ MID 4 – op

Give SSRMS Operator GO for OBSS Unberth

Monitor R-F-L Status

After OBSS Unberth,
SM 94 PDRS CONTROL
RMS PORT – ITEM 1 EXEC (*)

- A7U 6. SETUP FOR GRAPPLE
 CCTV – config for grapple
 – install OBSS SJ GRAPPLE AT HANDOFF OVERLAY
 – RMS WRIST, ZOOM: 34.0 HFOV
 FOCUS: 5 ft
 Maintain eyepoint approx 18 in when using grapple overlay

MON 1	BASE ELBOW
MON 2	B
DNLK	EE (ELBOW)
DTV	A

- R12(OBSS) √SPEE PWR – OFF
 A15 √APCU 2 OUTPUT – OFF

7. OBSS SJ GRAPPLE AT HANDOFF POSN
On SSRMS Operator GO for OBSS grapple

- RHC If SINGLE mode available:
 RATE – VERN (RATE MIN tb-ON)
 BRAKES – OFF (tb-OFF)

MODE – best available

Drive joints per OBSS SJ GRAPPLE AT HANDOFF OVERLAY and diagram until EE within grapple envelope

CAUTION
 Monitor EE tb timing to prevent EE motor burnout

EE MODE – AUTO
 CAPTURE sw – depress (mom)

<p>√ RIGID</p> <div style="border: 1px solid black; width: 40px; height: 40px; margin: 5px auto;"></div> <p>DERIGID</p> <div style="border: 1px solid black; width: 40px; height: 40px; margin: 5px auto; background-color: #cccccc;"></div>	<p>CLOSE</p> <div style="border: 1px solid black; width: 40px; height: 40px; margin: 5px auto;"></div> <p>OPEN</p> <div style="border: 1px solid black; width: 40px; height: 40px; margin: 5px auto; background-color: #cccccc;"></div>	<p>CAPTURE</p> <div style="border: 1px solid black; width: 40px; height: 40px; margin: 5px auto;"></div> <p>EXTEND</p> <div style="border: 1px solid black; width: 40px; height: 40px; margin: 5px auto; background-color: #cccccc;"></div>	<p>CRITICAL TIMES (28 sec total): CAPTURE tb – gray, then CLOSE tb – gray, 3 sec max, then RIGID tb – gray, 25 sec max</p>
--	---	---	--

EE MODE – OFF

- * If manual capture required: *
- * EE MODE – MAN *
- * CAPTURE sw – depress (hold until CLOSE tb-gray, 3 sec max) *
- * MAN CONTR – RIGID (hold until RIGID tb-gray, 25 sec max) *
- * MODE – OFF *

If TEST mode available:
 MODE – TEST, ENTER
 Wait 5 sec

BRAKES – ON (tb-ON)
 MODE – not DIRECT (It off)
 JOINT – CRIT TEMP

OBSS SJ GRAPPLE AT HANDOFF

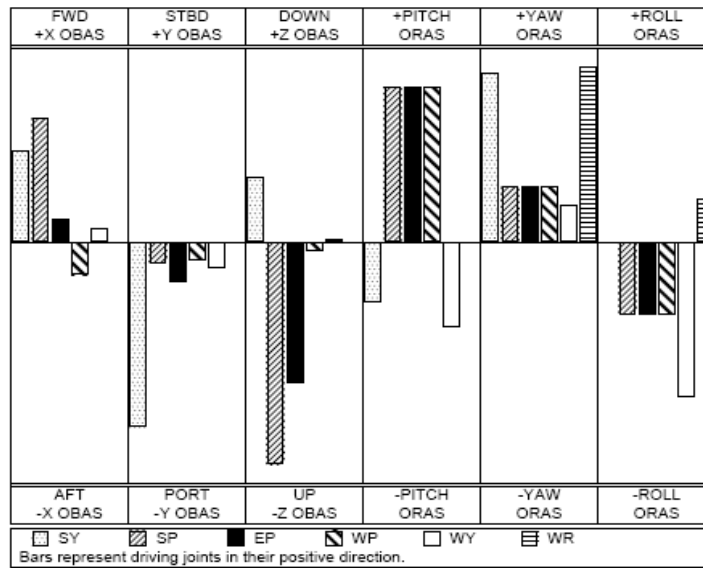

To get:	Drive:	To get:	Drive:	Driving:	Results In:	Driving:	Results In:
+X (fwd)	+SP, +SY	+PITCH	+WP, +EP	+SY	-Y (port), +YAW	+WP	-X (aft), +PITCH
+Y (stbd)	-SY	+YAW	+WR, +SY	+SP	-Z (up), +PITCH	+WY	-Y (port), -ROLL
+Z (down)	-SP, -EP	+ROLL	-WY, -WP	+EP	-Z (up), +PITCH	+WR	+YAW

ΔSY	ΔSP	ΔEP	ΔWP	ΔWY	ΔWR
+1.8	+1.9	-15.4	+13.9	-0.7	-1.7

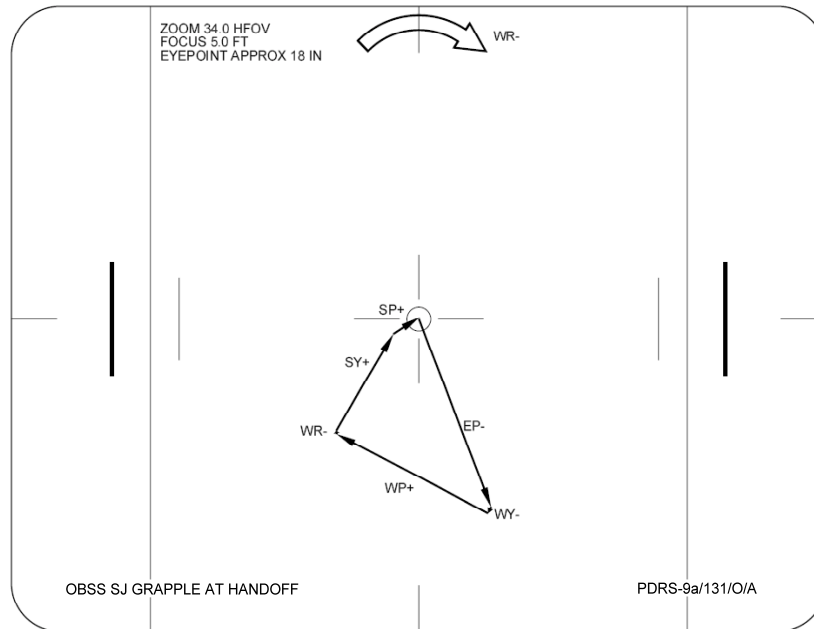

If digitals available:

SM 94 PDRS CONTROL

PL ID – ITEM 3 +2 EXEC

INIT ID – ITEM 24 +2 EXEC

Expected OBSS HANDOFF posn:

X	Y	Z	PITCH	YAW	ROLL	PL ID
-1059	+231	-597	14	270	0	2
SY	SP	EP	WP	WY	WR	
+24.5	+59.0	-42.1	-85.9	+11.2	-99.4	

*Display singularity

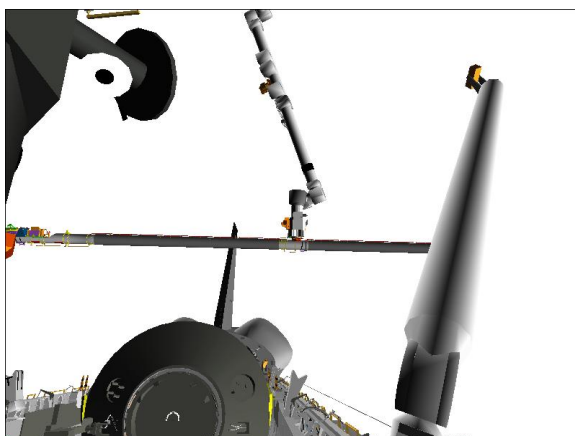

CCTV A (5,20)

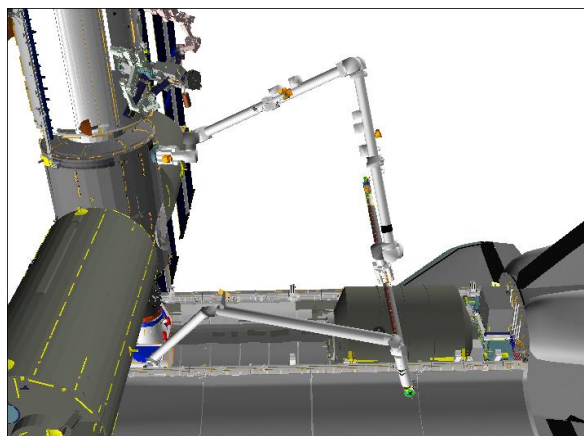

BIRD'S EYE

Review GENERIC END EFFECTOR CUE CARD – ISS/SHUTTLE DOCKED OPS

Give SSRMS Operator GO for OBSS ungrapple

Perform ACTIVATION (LDRI/ITVC Cue Card, P/TV)

Perform LCH ACTIVATION (LCS Cue Card, P/TV)

Perform LCC ACTIVATION (LCS Cue Card, P/TV), step 2

Perform LCC DEACTIVATION (LCS Cue Card, P/TV), step 1

8. SINGLE JOINT MNVR TO MPLM VIEWING

On SSRMS Operator GO for mnvr to MPLM VIEWING

R12(VPU) √Green Jumper – ISS

MON 1	S1 LOOB
MON 2	B
DNLK	ELBOW
DTV	A

RHC

If SINGLE mode available:

RATE – as reqd (VERN within 10 ft)

BRAKES – OFF (tb-OFF)

MODE – best available

Mnvr to MPLM VIEWING posn:

OBSS
HANDOFF

- 1: WR +
- 2: WY -
- 3: WP +
- 4: EP +
- 5: WP +
- 6: SP -
- 7: SY +
- 8: SP -
- 9: WR +
- 10: WY -

MPLM
VIEWING

SY	SP	EP	WP	WY	WR	
+24.5	+59.0	-42.1	-85.9	+11.2	-99.4	
					-75.0	
				0.0		
			-60.0			
		-23.0				
			0.0			
	+49.0					
+62.5						
	+25.0					
					-21.9	
				-13.2		
+62.5	+25.0	-23.0	0.0	-13.2	-21.9	
X	Y	Z	PITCH	YAW	ROLL	PL ID
-1252	-520	-889	60	349	312	2

- BRAKES – ON (tb-ON)
- MODE – not DIRECT (It off)
- PARAM – PORT TEMP
- JOINT – CRIT TEMP

Start:
OBSS HANDOFF posn

Step 1:
Drive WR (+) from -99.4 to -75.0

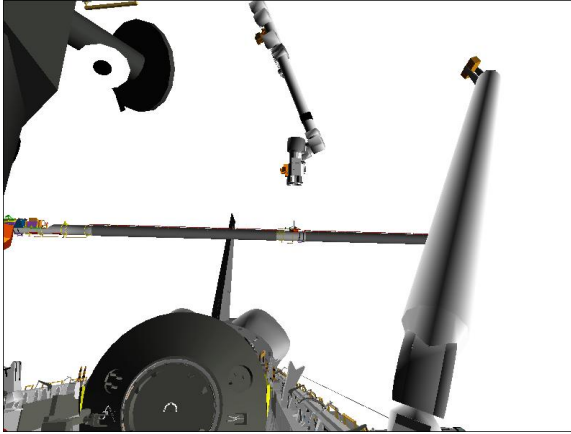

CCTV A (5,20)



CCTV A (5,20)

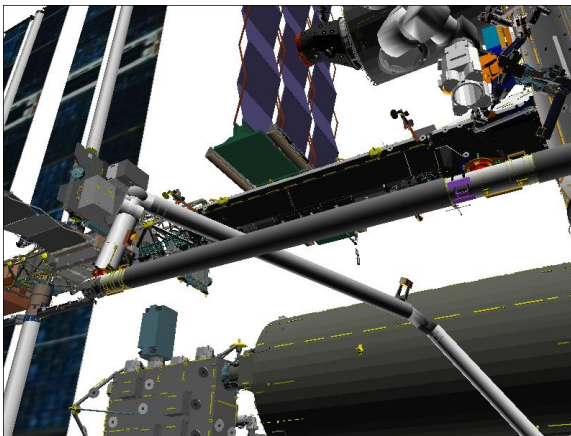

CCTV B (-30,30)

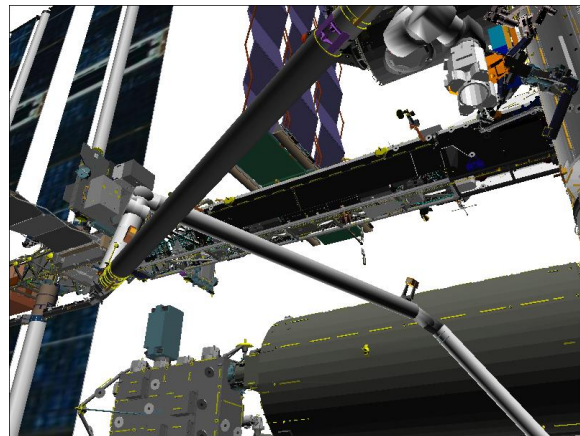

CCTV B (-30,30)

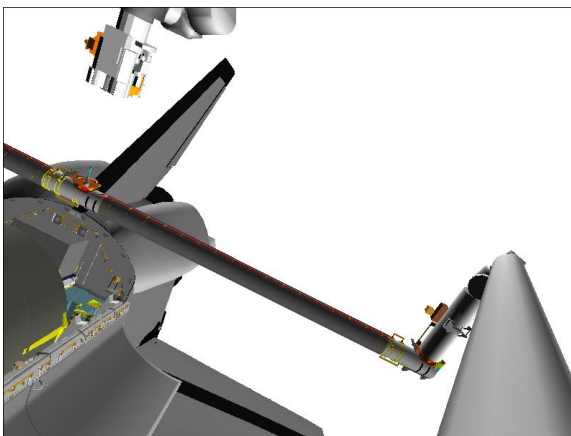

ELBOW (-30,0)

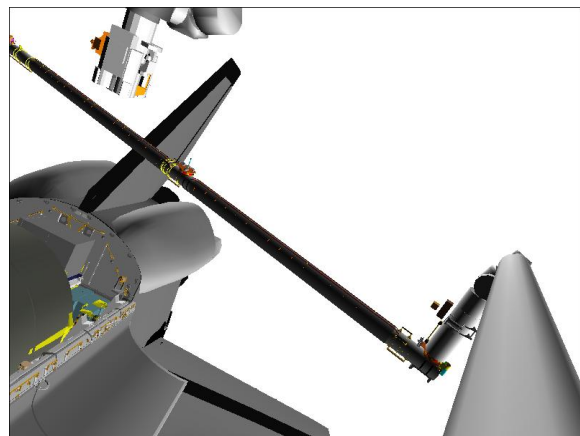

ELBOW (-30,0)

Step 2:
Drive WY (-) from +11.2 to 0.0



CCTV A (5,20)

Step 3:
Drive WP (+) from -85.9 to -60.0



CCTV A (5,20)

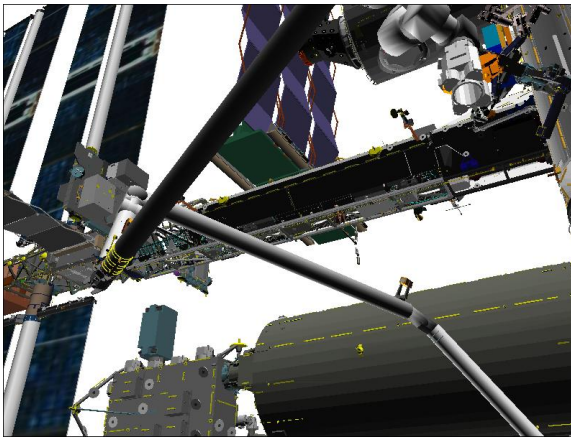

CCTV B (-30,30)

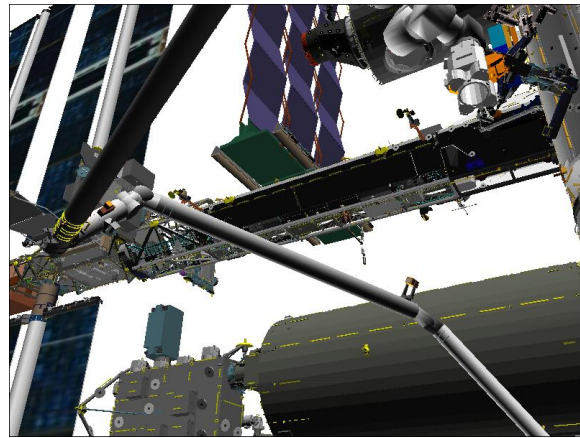

CCTV B (-30,30)

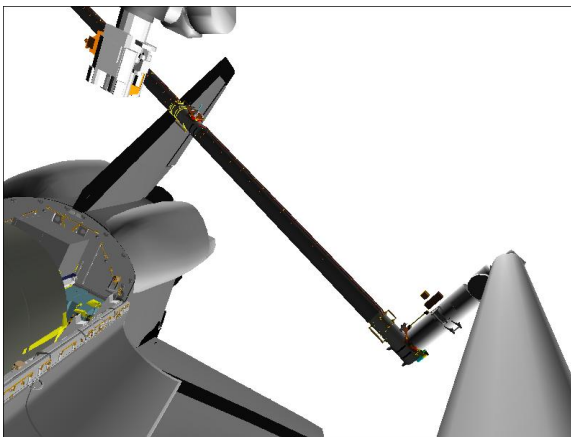

ELBOW (-30,0)



ELBOW (-30,0)

Step 4:
Drive EP (+) from -42.1 to -23.0

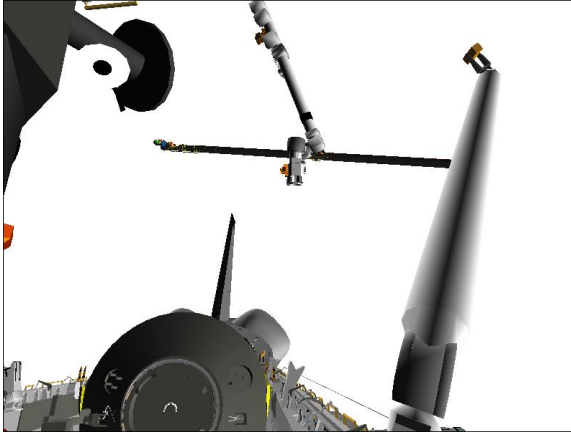

CCTV A (5,20)

Step 5:
Drive WP (+) from -60.0 to 0.0



CCTV A (5,20)

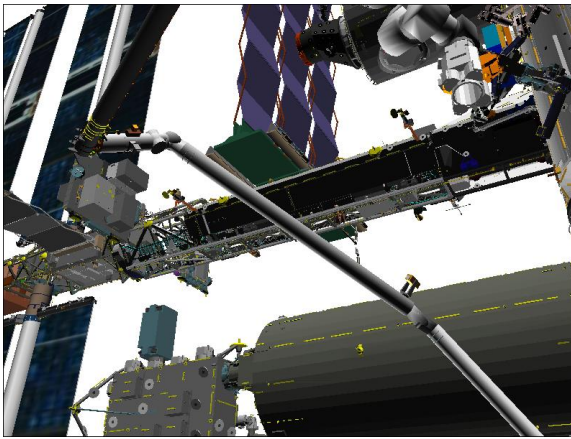

CCTV B (-30,30)

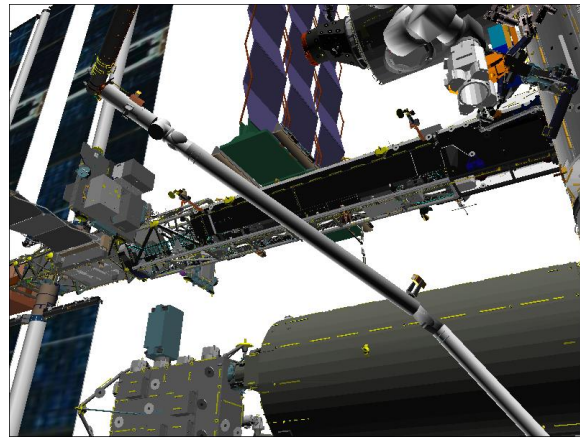

CCTV B (-30,30)

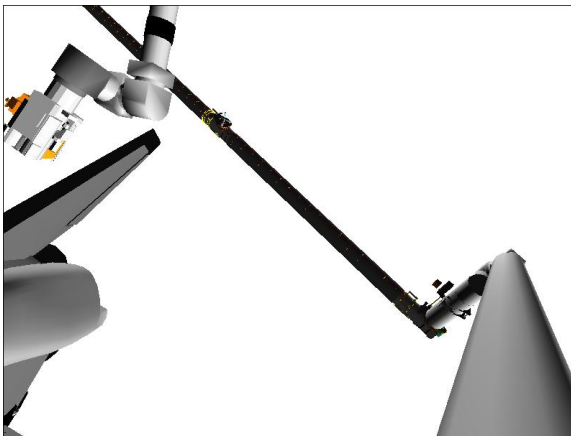

ELBOW (-30,0)

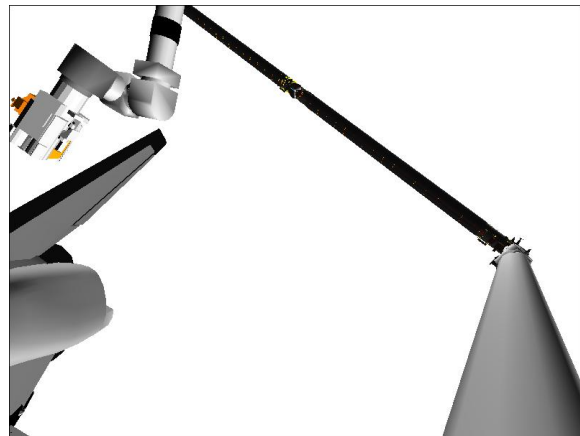

ELBOW (-30,0)

Step 6:
Drive SP (-) from +59.0 to +49.0

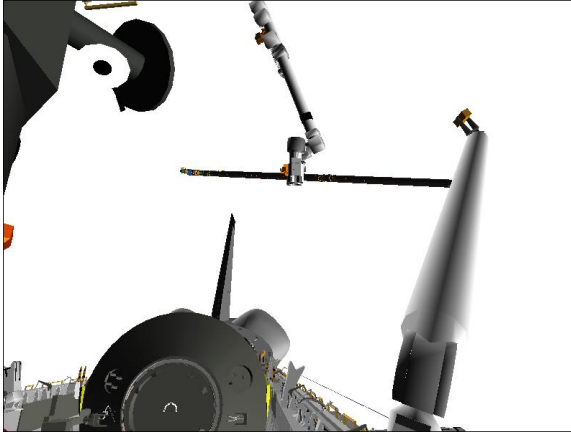

CCTV A (5,20)

Step 7:
Drive SY (+) from +24.5 to +62.5



CCTV A (30,10)

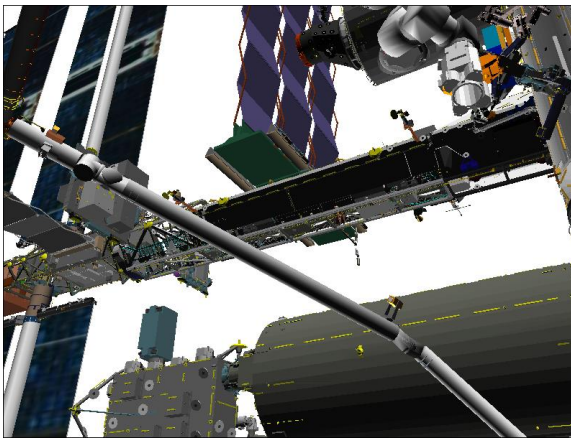

CCTV B (-30,30)

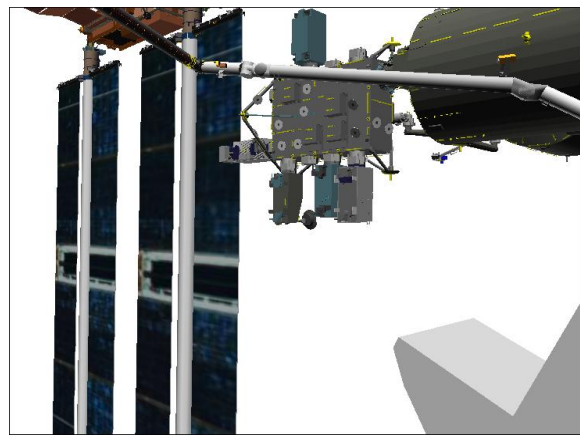

CCTV B (-45,0)

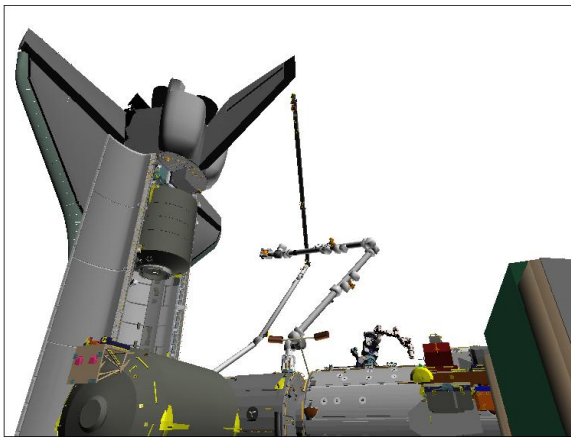

S1 LOOB (70,30)



S1 LOOB (70,30)

Step 8:
Drive SP (-) from +49.0 to +25.0

Step 9:
Drive WR (+) from -75.0 to -21.9

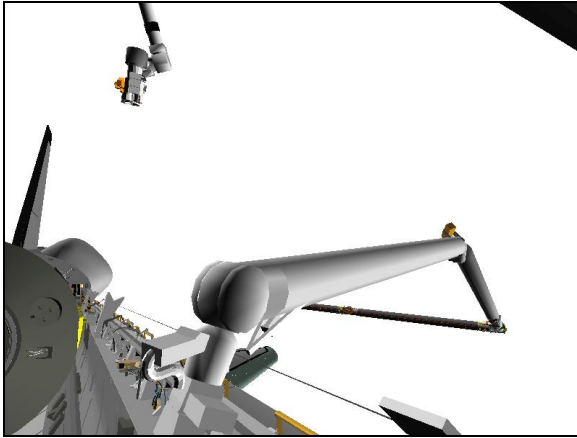

CCTV A (30,10)

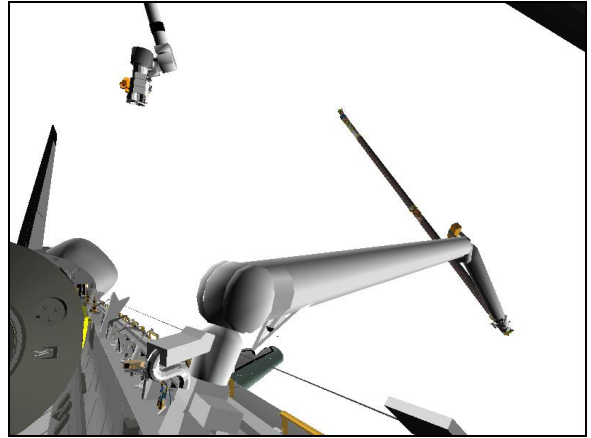

CCTV A (30,10)

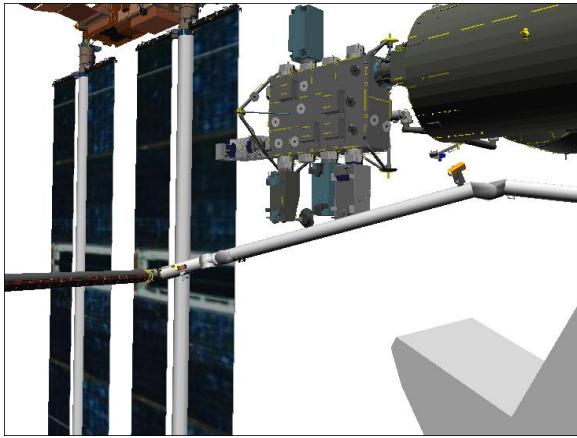

CCTV B (-45,0)

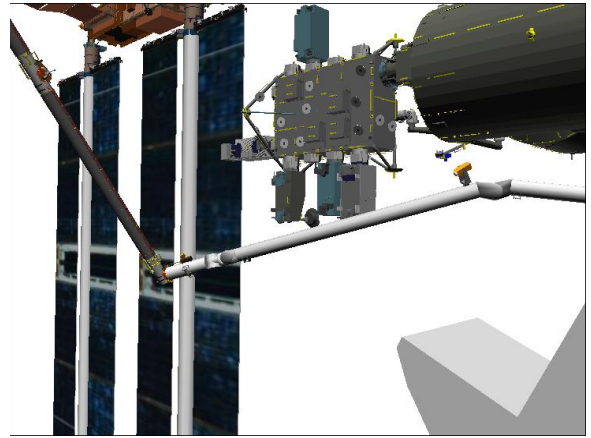

CCTV B (-45,0)

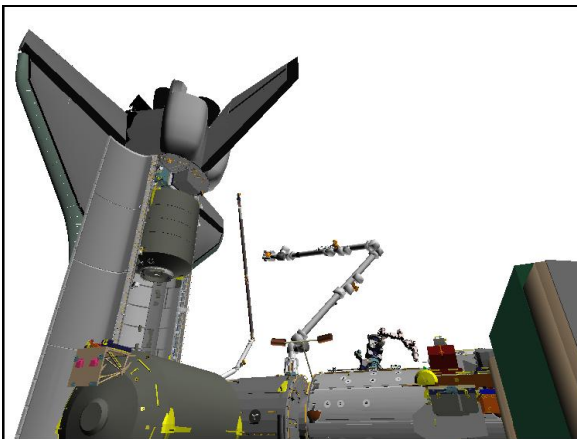

S1 LOOB (70,30)



S1 LOOB (70,30)

Step 10:
Drive WY (-) from 0.0 to -13.2

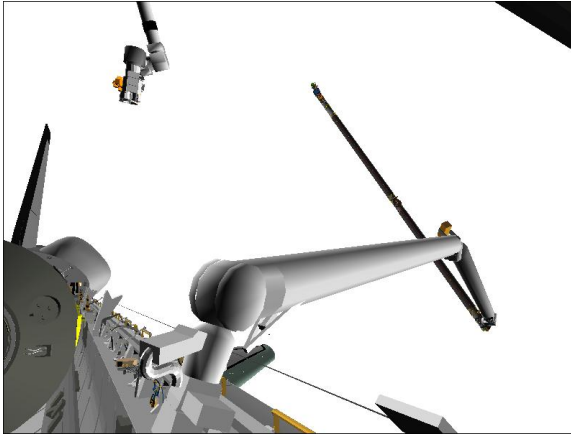

CCTV A (30,10)

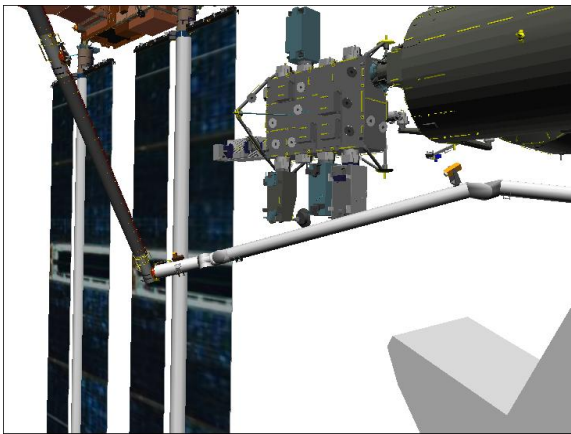

CCTV B (-45,0)



S1 LOOB (70,30)

MPLM VIEWING posn:

	X	Y	Z	PITCH	YAW	ROLL	PL ID
√	-1252	-520	-889	60	349	312	2
	SY	SP	EP	WP	WY	WR	
√	+62.5	+25.0	-23.0	0.0	-13.2	-21.9	

9. CONFIGURE CAMERAS FOR MPLM INSTALL

R12(VPU)
A7U

Green Jumper – LDRI/ITVC
DTV ← PL2

CAMR CMD PAN/TILT – HI RATE

PAN – L (to hard stop)

TILT – UP (to hard stop)

PAN/TILT – RESET, HI RATE (LO within 10°)

PAN: +130 (right)

TILT: -60 (down)

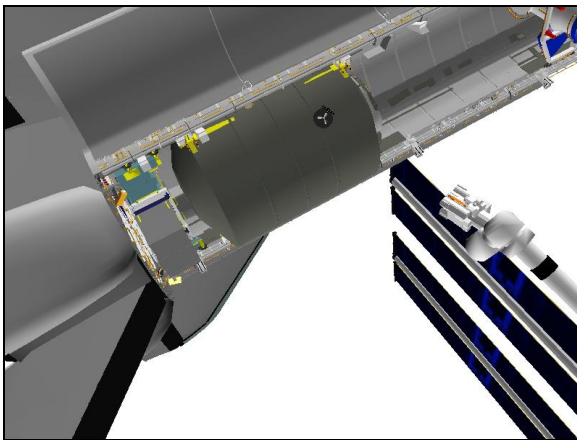

OBSS ITVC (130,-60)

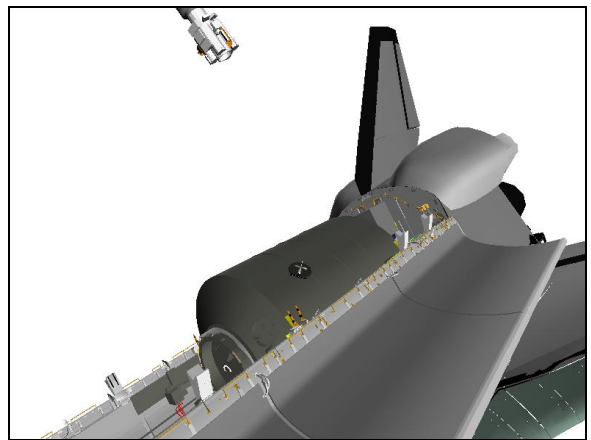

ELBOW (-110,30)

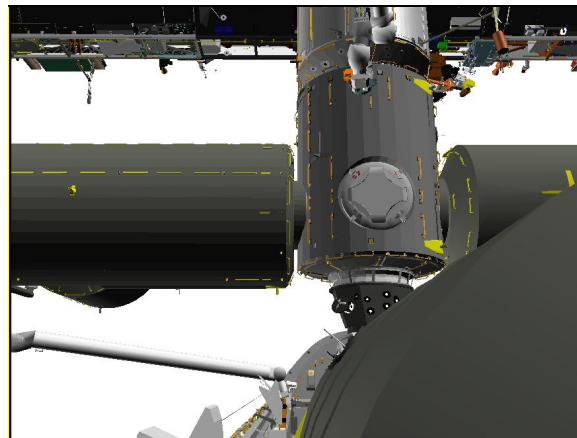

CCTV B (0,15)

MUX 1 L ← MIDDECK

LDRI MODE 2 pb – push (ITVC video)

VIDEO OUT – as desired (not DTV)

√VIDEO IN – not PL2

OBSS SJ HANDOFF FROM SRMS TO SSRMS

1. SETUP

If digitals available:

SM 94 PDRS CONTROL

√PL ID, ITEM 3: 2

√INIT ID, ITEM 24: 2

Verify at MPLM VIEWING posn:

	X	Y	Z	PITCH	YAW	ROLL	PL ID
√	-1252	-520	-889	60	349	312	2
	SY	SP	EP	WP	WY	WR	
√	+62.5	+25.0	-23.0	0.0	-13.2	-21.9	

A7U

CCTV – config as reqd

– perform PAN/TILT RESET for PLB cameras

ZOOM – full OUT

R12(VPU)

√Green Jumper – ISS

MON 1	S1 LOOB
MON 2	B
DNLK	ELBOW
DTV	A

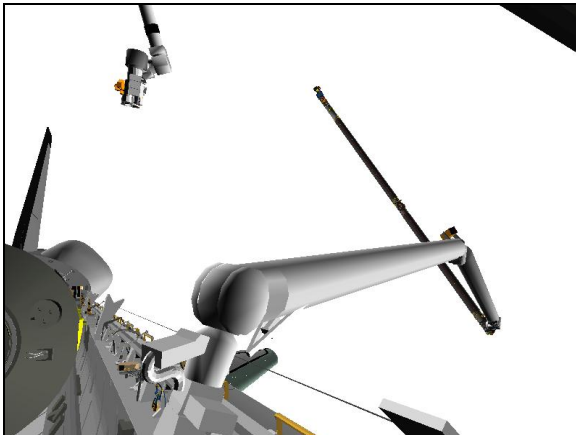

CCTV A (30,10)

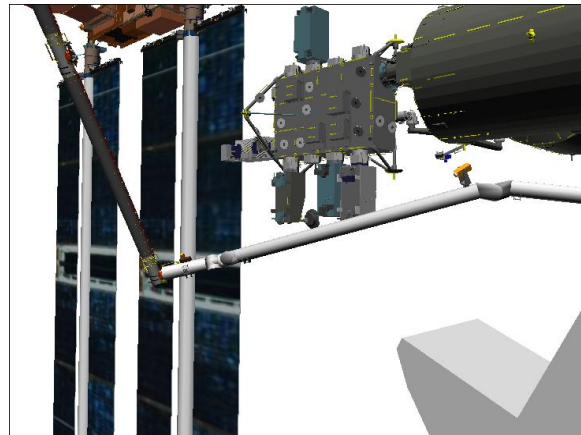

CCTV B (-45,0)

Review GENERIC END EFFECTOR CUE CARD – ISS/SHUTTLE DOCKED OPS

2. SINGLE JOINT MNVR TO OBSS HANDOFF

On SSRMS Operator GO for mnvr to OBSS HANDOFF

If SINGLE mode available:

RHC

RATE – as reqd (VERN within 10 ft)

BRAKES – OFF (tb-OFF)

MODE – best available

Mnvr to OBSS HANDOFF posn:

MPLM
VIEWING
1: WY +
2: WR -
3: SP +
4: SY -
5: SP +
6: WP -
7: EP -
8: WP -
9: WY +
10: WR -
OBSS
HANDOFF

SY	SP	EP	WP	WY	WR	
+62.5	+25.0	-23.0	0.0	-13.2	-21.9	
				0.0		
					-75.0	
	+49.0					
+24.5						
	+59.0					
			-60.0			
		-42.1				
			-85.9			
				+11.2		
					-99.4	
+24.5	+59.0	-42.1	-85.9	+11.2	-99.4	
X	Y	Z	PITCH	YAW	ROLL	PL ID
-1059	+231	-597	14	270	0	2

*Display singularity

BRAKES – ON (tb-ON)
MODE – not DIRECT (lt off)
JOINT – CRIT TEMP

Give SSRMS Operator GO for OBSS grapple

Start:
MPLM VIEWING posn

Step 1:
Drive WY (+) from -13.2 to 0.0

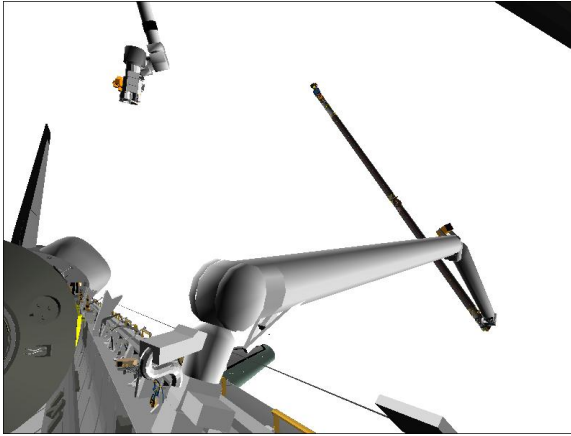

CCTV A (30,10)

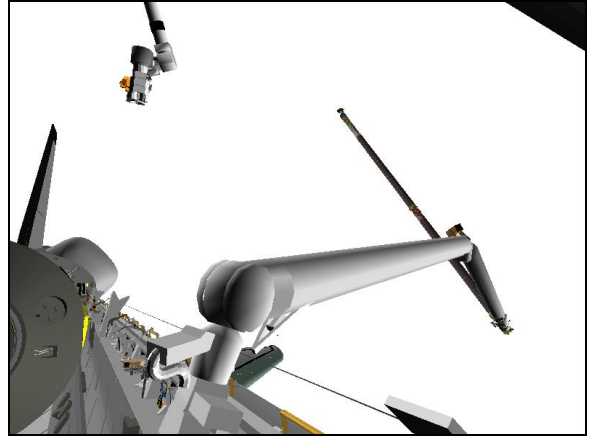

CCTV A (30,10)

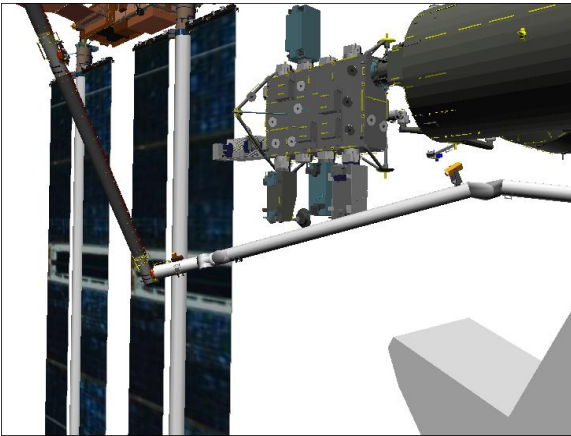

CCTV B (-45,0)

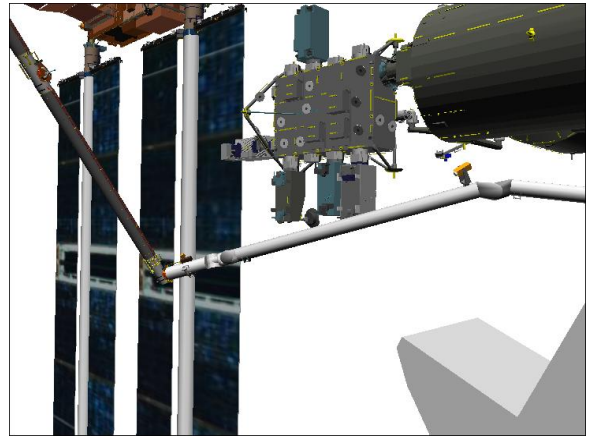

CCTV B (-45,0)

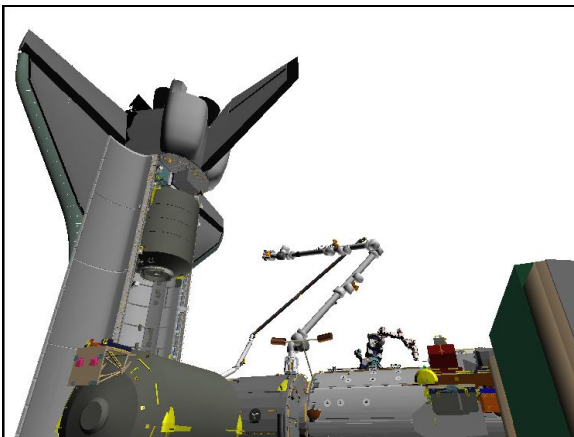

S1 LOOB (70,30)

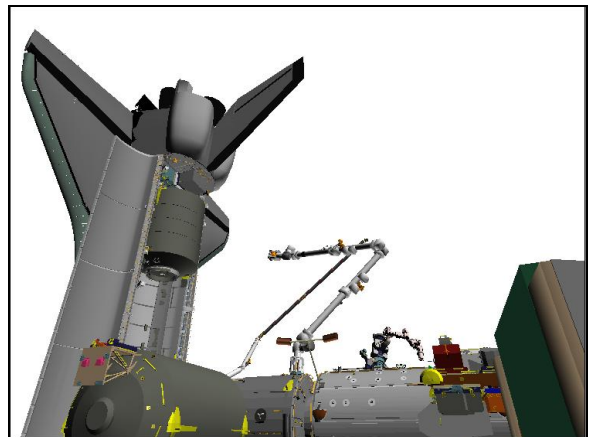

S1 LOOB (70,30)

Step 2:
Drive WR (-) from -21.9 to -75.0

Step 3:
Drive SP (+) from +25.0 to +49.0

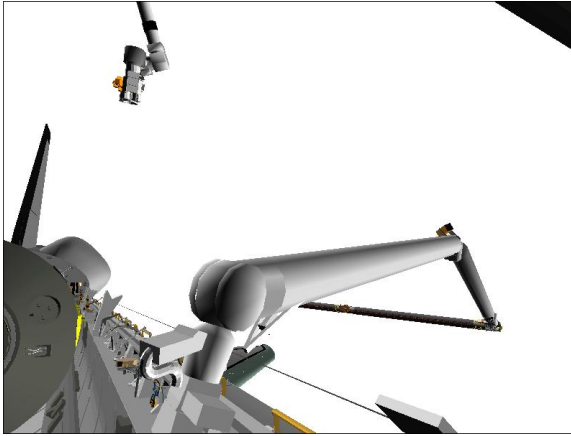

CCTV A (30,10)

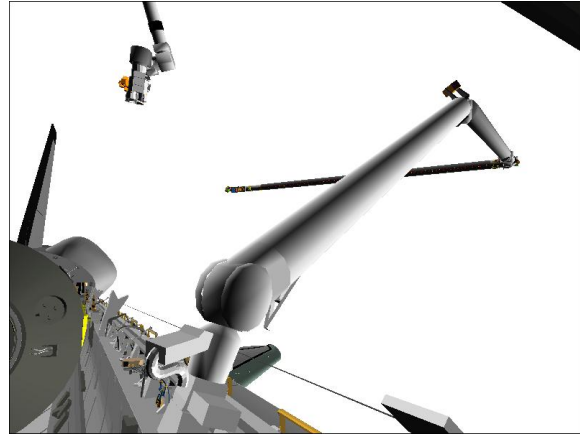

CCTV A (30,10)

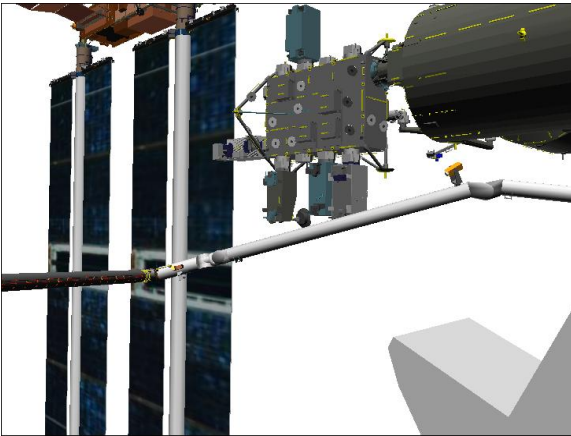

CCTV B (-45,0)

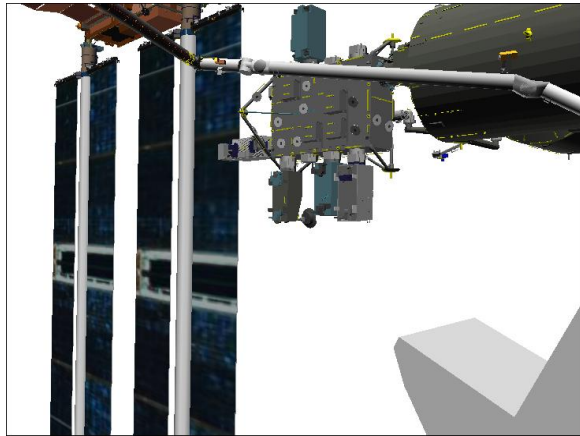

CCTV B (-45,0)

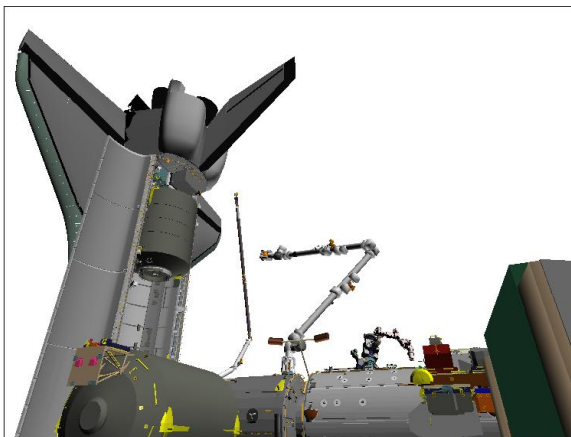

S1 LOOB (70,30)



S1 LOOB (70,30)

Step 4:
Drive SY (-) from +62.5 to +24.5

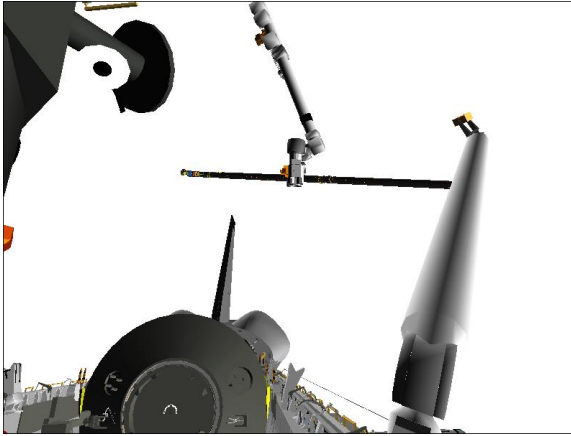

CCTV A (5,20)

Step 5:
Drive SP (+) from +49.0 to +59.0



CCTV A (5,20)

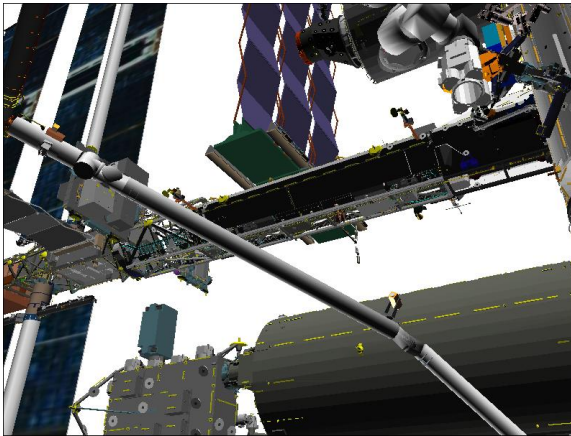

CCTV B (-30,30)

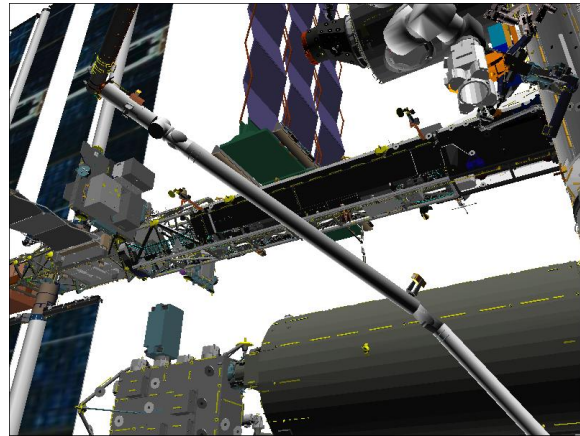

CCTV B (-30,30)



S1 LOOB (70,30)

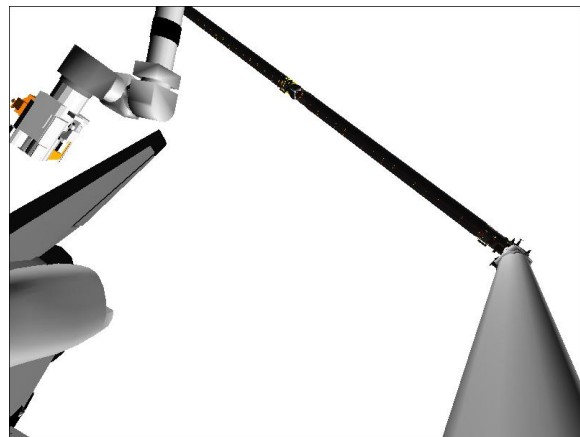

ELBOW (-30,0)

Step 6:
Drive WP (-) from 0.0 to -60.0

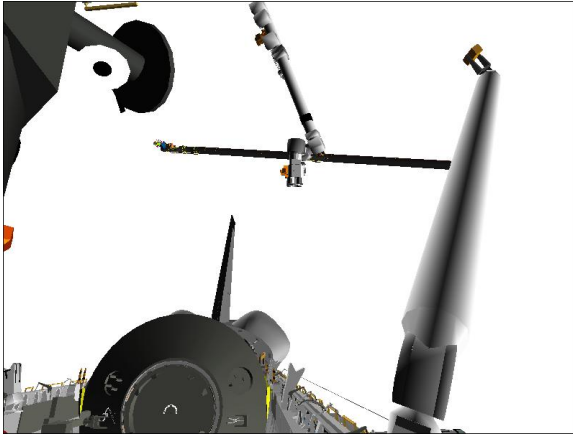

CCTV A (5,20)

Step 7:
Drive EP (-) from -23.0 to -42.1



CCTV A (5,20)

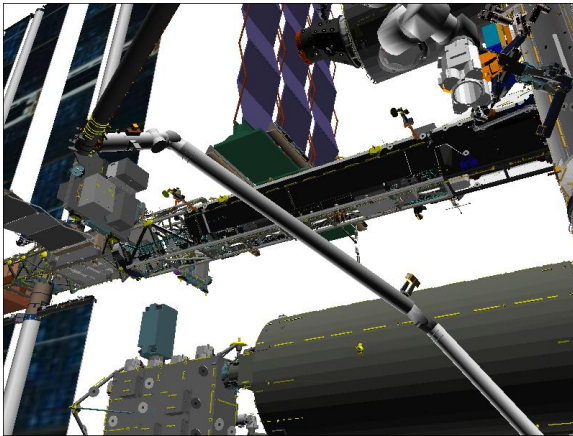

CCTV B (-30,30)

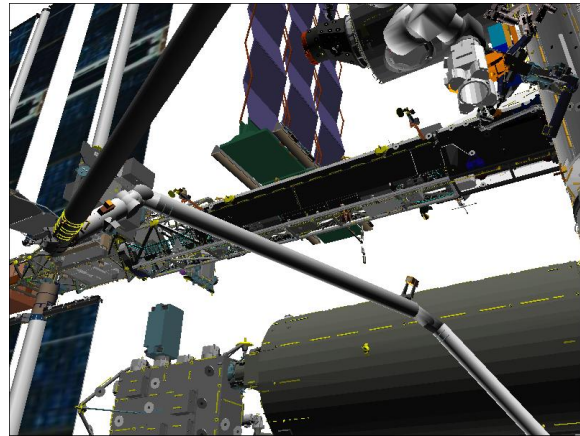

CCTV B (-30,30)

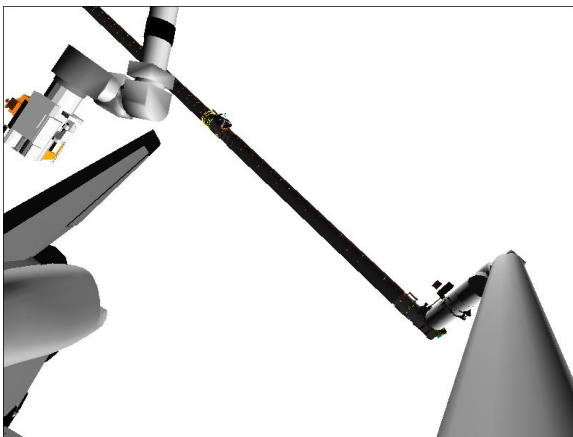

ELBOW (-30,0)



ELBOW (-30,0)

Step 8:
Drive WP (-) from -60.0 to -85.9



CCTV A (5,20)

Step 9:
Drive WY (+) from 0.0 to +11.2



CCTV A (5,20)

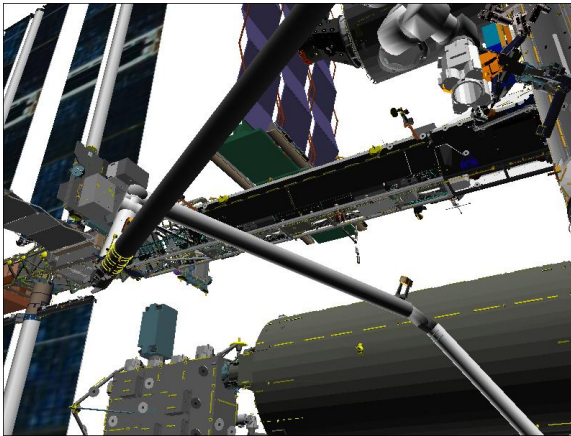

CCTV B (-30,30)

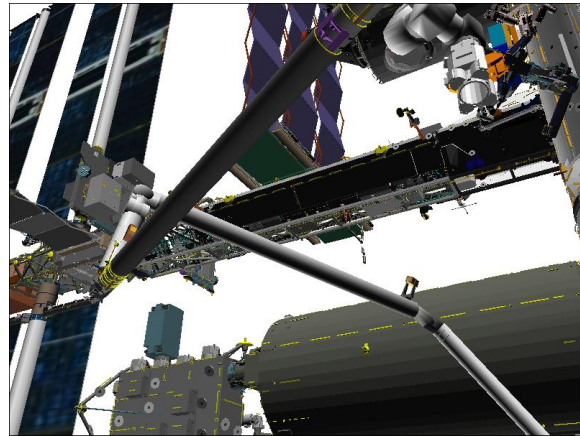

CCTV B (-30,30)

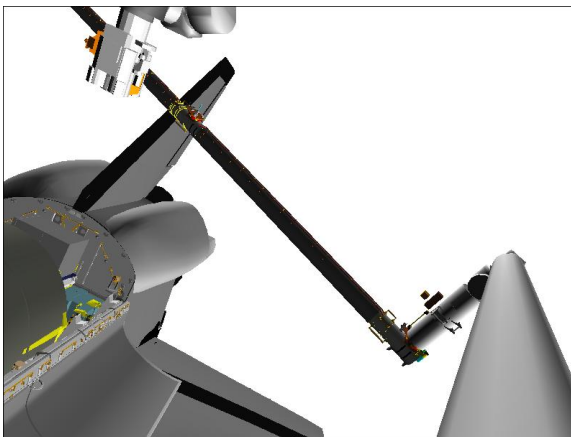

ELBOW (-30,0)



ELBOW (-30,0)

Step 10:
Drive WR (-) from -75.0 to -99.4

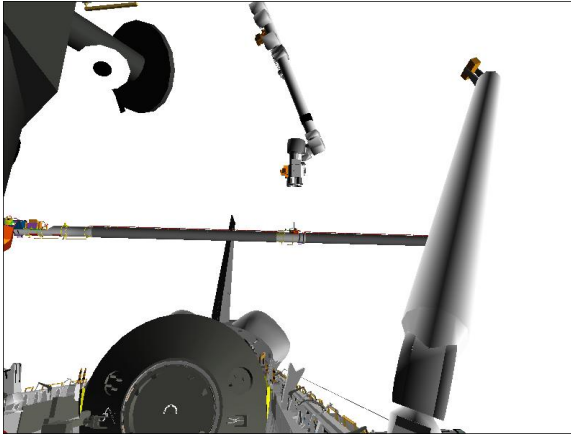

CCTV A (5,20)

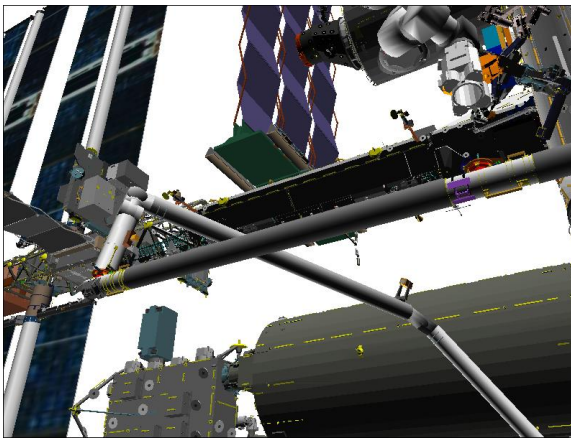

CCTV B (-30,30)

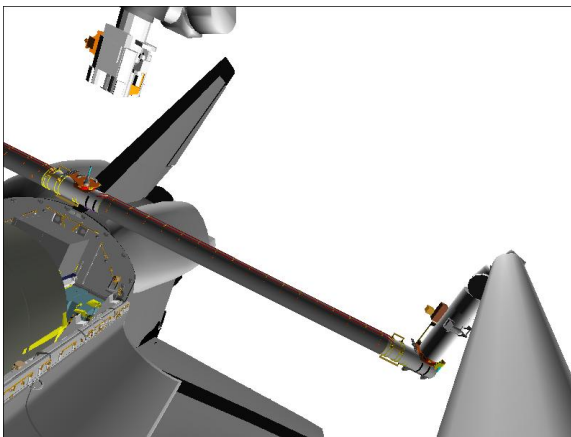

ELBOW (-30,0)

3. STOW PTU
R12(VPU) Green Jumper – LDRI/ITVC

A7U DTV ← PL2

CAMR CMD PAN/TILT – HI RATE
PAN – L (to hard stop)
TILT – UP (to hard stop)
PAN/TILT – RESET
PAN: +108 (right)
TILT: -175 (down)

R12(VPU) Green Jumper – ISS

On SSRMS Operator GO for OBSS ungrapple

<p><u>CAUTION</u> STBD RMS HTR power must be applied within 90 min to prevent sensor package damage</p>

Perform LCC DEACTIVATION (LCS Cue Card, P/TV)
Perform LCH DEACTIVATION (LCS Cue Card, P/TV)
Perform DEACTIVATION (LDRI/ITVC Cue Card, P/TV)

4. OBSS UNGRAPPLE
A7U CCTV – config for ungrapple
– RMS WRIST, ZOOM: 34.0 HFOV
FOCUS: 5 ft

If digitals available:

<p>SM 94 PDRS CONTROL PL ID – ITEM 3 +0 EXEC INIT ID – ITEM 24 +0 EXEC</p>
--

If SINGLE mode available:

NOTE

CONTR ERR It and 'S96 PDRS CNTL' msg may
occur due to Consistency/Envelope Check error

RHC RATE – COARSE (RATE MIN tb-OFF)

<p>SM 94 PDRS CONTROL AUTO BRAKE INH – ITEM 10 EXEC (*)</p>

BRAKES – OFF (tb-OFF)
MODE – TEST, ENTER
Wait 5 sec

BRAKES – ON (tb-ON)

<p>SM 94 PDRS CONTROL AUTO BRAKE ENA – ITEM 9 EXEC (*)</p>
--

RATE – as reqd (VERN within 10 ft)
BRAKES – OFF (tb-OFF)







MODE – best available

CAUTION Monitor EE tb timing to prevent EE motor burnout
--

EE MODE – MAN

MAN CONTR – DERIGID (hold until DERIGID tb-gray, 5 sec max)

RELEASE sw – depress (hold until OPEN tb-gray, 3 sec max)

	<u>RIGID</u>	<u>CLOSE</u>	<u>CAPTURE</u>	<u>CRITICAL TIMES (8 sec total):</u> DERIGID tb – gray, 5 sec max, then OPEN tb – gray, 3 sec max, then
√				
	<u>DERIGID</u>	<u>OPEN</u>	<u>EXTEND</u>	
				

Drive joints per OBSS SJ UNGRAPPLE AT HANDOFF overlay until EE clear of grapple fixture

OBSS SJ UNGRAPPLE AT HANDOFF

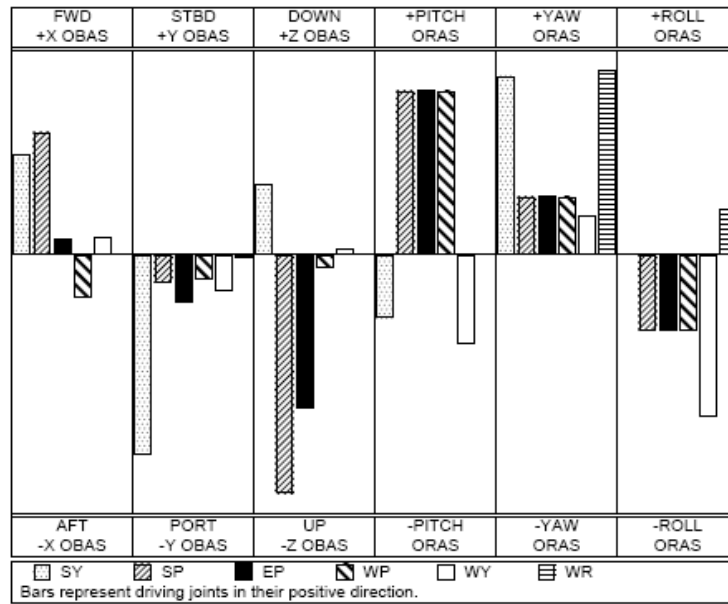

To get:	Drive:	To get:	Drive:	Driving:	Results In:	Driving:	Results In:
+X (fwd)	+SP, +SY	+PITCH	+WP, +EP	+SY	-Y (port), +YAW	+WP	-X (aft), +PITCH
+Y (stbd)	-SY	+YAW	+WR, +SY	+SP	-Z (up), +PITCH	+WY	-Y (port), -ROLL
+Z (down)	-SP, -EP	+ROLL	-WY, -WP	+EP	-Z (up), +PITCH	+WR	+YAW

ΔSY	ΔSP	ΔEP	ΔWP	ΔWY	ΔWR
-1.8	-1.9	+15.4	-13.9	+0.6	+1.7

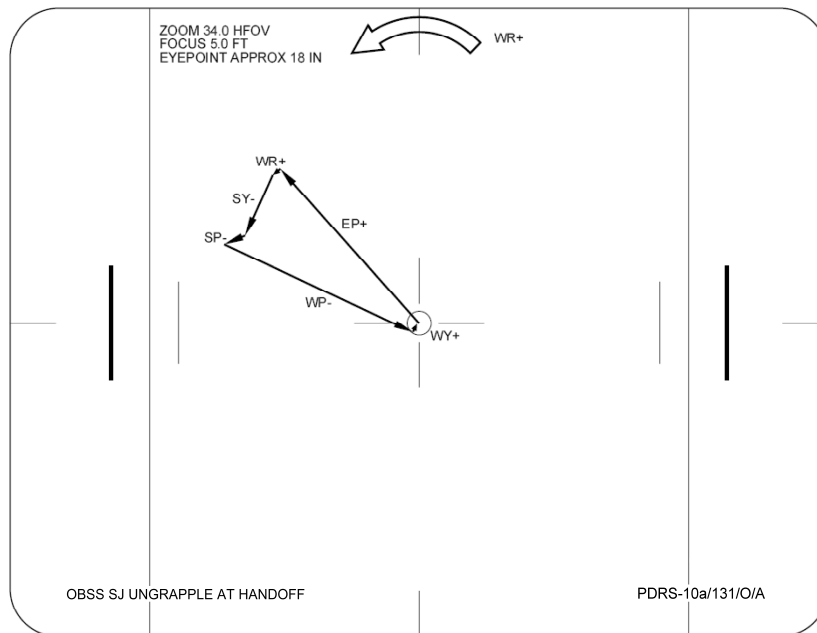

EE MAN CONTR – DERIG (hold until EXTEND tb-gray, 20 sec max)
 MODE – OFF

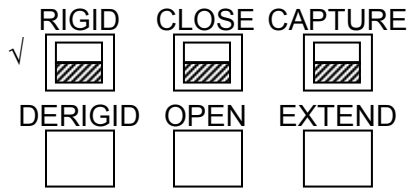

CRITICAL TIMES (20 sec total):
 EXTEND tb – gray, 20 sec max

Mnvr to OBSS BACKOFF posn:

X	Y	Z	PITCH	YAW	ROLL	PL ID
-1047	-360	-658	284	0	270	0
SY	SP	EP	WP	WY	WR	
+22.7	+57.5	-27.4	-99.3	+11.8	-97.9	

BRAKES – ON (tb-ON)
 MODE – not DIRECT
 JOINT – CRIT TEMP

- * If using Shuttle attitude control and attitude maintenance reqd: *
- * DAP: LVLH *
- * When rates damped: *
- * DAP: FREE > 2 sec *
- * DAP: AUTO *

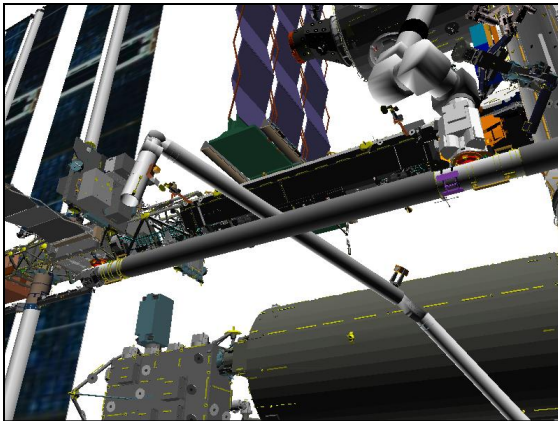

CCTV B (-30,30)

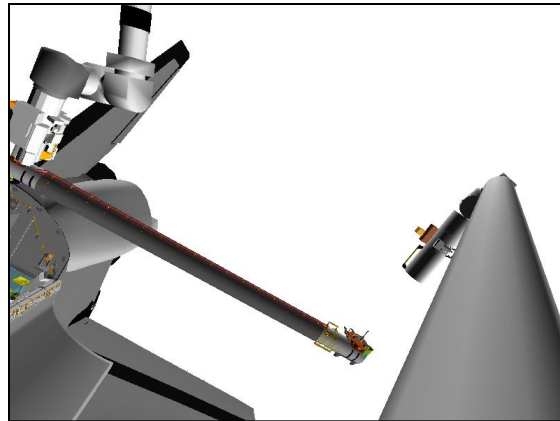

ELBOW (-30,-10)

Give SSRMS Operator GO for OBSS Berth Sequence

5. CONFIGURE CIRCUIT BREAKERS
 MA73C:C cb MCA PWR AC3 3Φ MID 2 – op
 √AC2 3Φ MID 2 – op
 MA73C:D √AC3 3Φ MID 4 – op

6. CONFIGURE FOR MONITORING
On SSRMS notification to watch for STBD RMS R-F-Ls,
SM 94 PDRS CONTROL
 RMS STBD – ITEM 2 EXEC (*)

Notify SSRMS operator when STBD RMS R-F-L tb (three) – gray

7. STBD MRL LATCH
On SSRMS Operator GO to latch STBD MRLs to Topological Capture,
√STBD RMS R-F-L tb (three) – gray

SM 94 PDRS CONTROL

√STBD AFT, MID, FWD LAT (six) = 0

R13L PL BAY MECH PWR SYS (two) – ON

NOTE

Expect single motor drive time for MRL latching (18 sec max).
The following STBD RMS RETEN LAT – OFF and PL BAY
MECH PWR SYS (two) – OFF actions are to be performed simo

Verify AOS for latching to Topological Capture

STBD RMS RETEN LAT – LAT 6 sec only (tb-bp)
– OFF

R13L PL BAY MECH PWR SYS (two) – OFF

Give SSRMS Operator GO to Limp All SSRMS Joints and Derigidize

R13L **On SSRMS Operator GO to complete STBD MRL latching,**
PL BAY MECH PWR SYS (two) – ON

STBD RMS RETEN LAT – LAT (tb-LAT) (12 sec max)
– OFF

8. RECONFIGURE POWER

R13L PL BAY MECH PWR SYS (two) – OFF

STBD RMS HTR A,B (two) – AUTO

A6U EVENT TIMER CNTL – STOP

SM 94 PDRS CONTROL

√STBD AFT, MID, FWD LAT (six) = 1
RMS PORT – ITEM 1 EXEC (*)

MA73C:C cb MCA PWR AC3 3Φ MID 2 – cl

√AC2 3Φ MID 2 – op

MA73C:D √AC3 3Φ MID 4 – op

Give SSRMS Operator GO for OBSS ungrapple

9. MNVR TO PRECRADLE

Verify SSRMS is at Berthed OBSS Backoff or Overnight Park posn and on SSRMS Operator GO for mnvr to PreCradle

MON 1	P1 LOOB
MON 2	B
DNLK	EE (ELBOW)
DTV	A

If SINGLE mode available:

RATE – as reqd (VERN within 10 ft)

BRAKES – OFF (tb-OFF)

MODE – best available

Mnvr to PRECRADLE posn:

	SY	SP	EP	WP	WY	WR	
	+22.7	+57.5	-27.4	-99.3	+11.8	-97.9	
OBSS	0.0						
BACKOFF			-25.0				
1: SY -							
2: EP +						0.0	
3: WR +					0.0		
4: WY -				+5.0			
5: WP +		+25.0					
6: SP -							
PRECRADLE	0.0	+25.0	-25.0	+5.0	0.0	0.0	
	X	Y	Z	PITCH	YAW	ROLL	PL ID
	-1261	-146	-551	5	2	0	0

BRAKES – ON (tb-ON)

MODE – not DIRECT

PARAM – PORT TEMP

JOINT – CRIT TEMP

Start:
OBSS BACKOFF posn

Step 1:
Drive SY (-) from +22.7 to 0.0



CCTV A (20,20)



CCTV A (20,20)

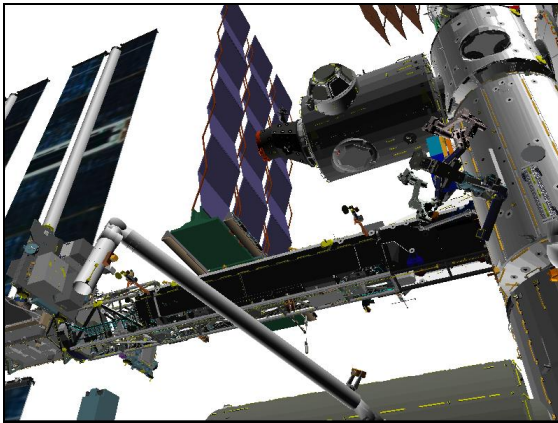

CCTV B (-25,40)

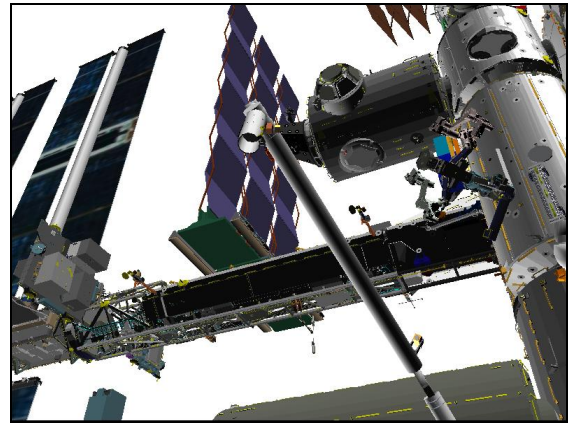

CCTV B (-25,40)

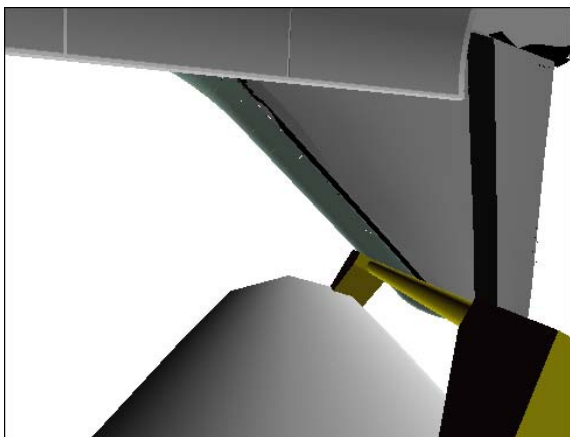

EE

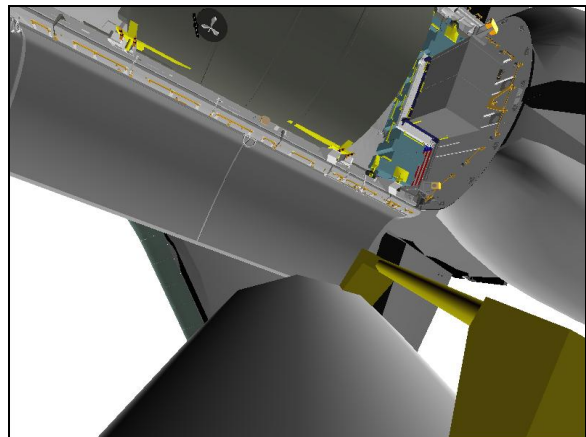

EE

Step 2:
Drive EP (+) from -27.4 to -25.0

Step 3:
Drive WR (+) from -97.9 to 0.0



CCTV A (20,20)



CCTV A (20,20)

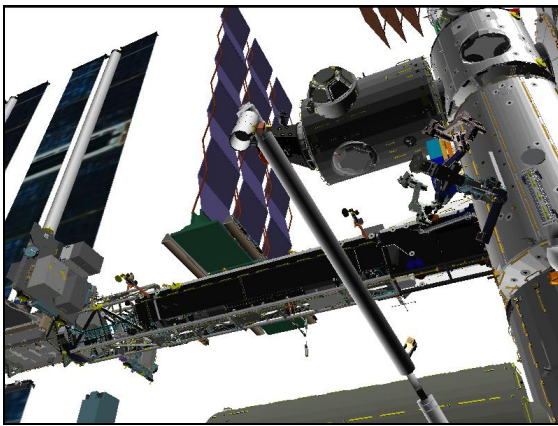

CCTV B (-25,40)

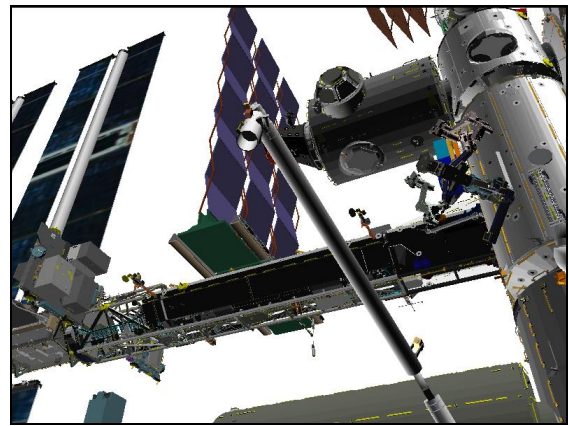

CCTV B (-25,40)

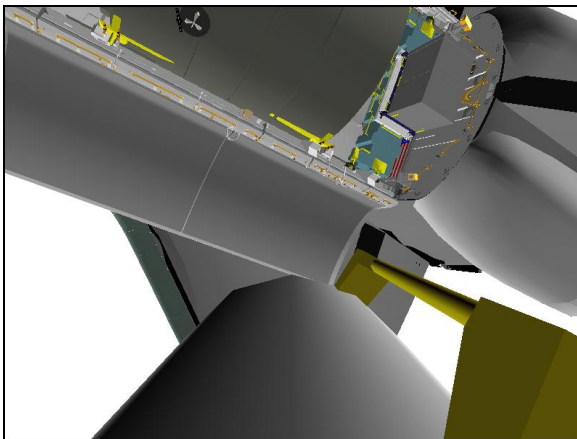

EE

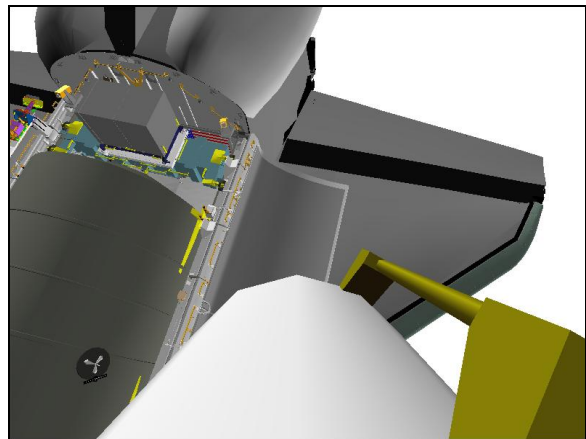

EE

Step 4:
Drive WY (-) from +11.8 to 0.0



CCTV A (20,20)

Step 5:
Drive WP (+) from -99.3 to +5.0



CCTV A (20,20)

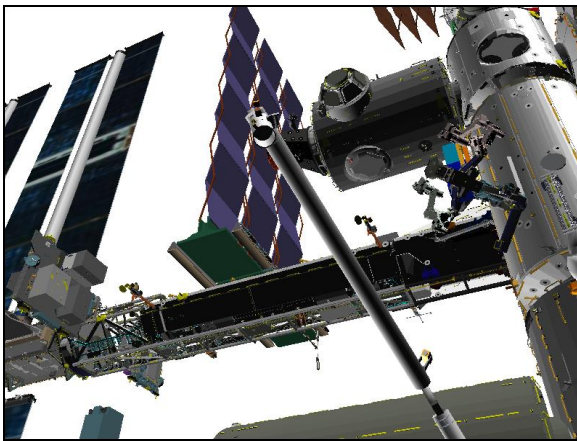

CCTV B (-25,40)

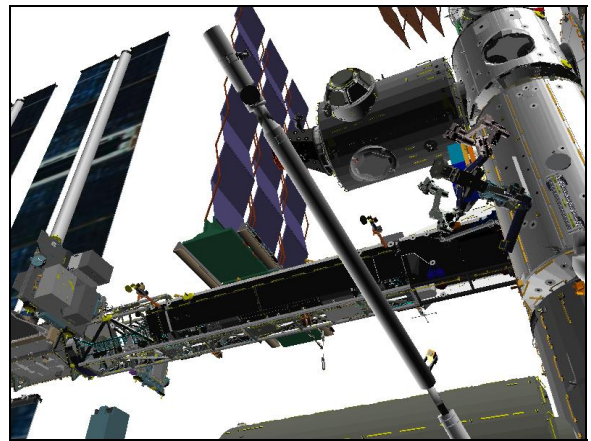

CCTV B (-25,40)

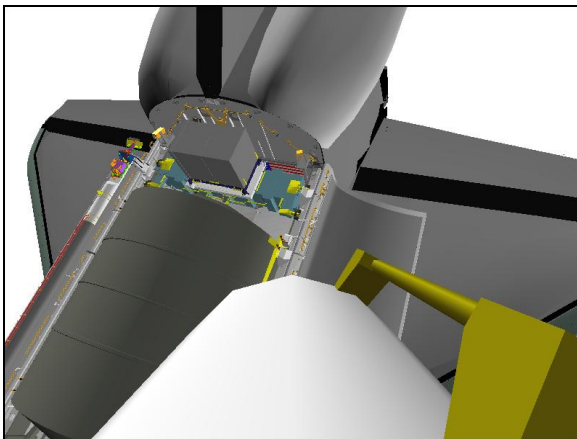

EE

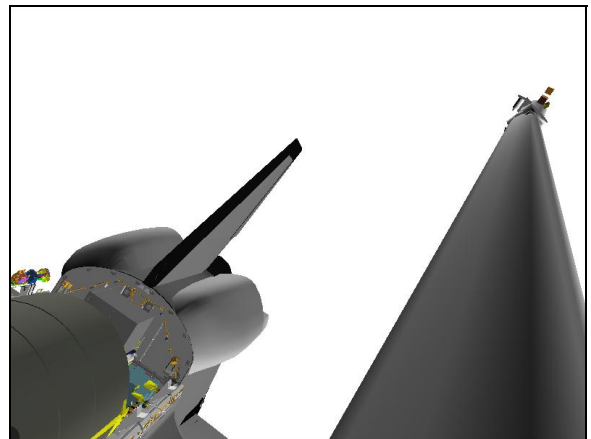

ELBOW (-30,-20)

Step 6:
Drive SP (-) from +57.5 to +25.0



CCTV A (20,20)

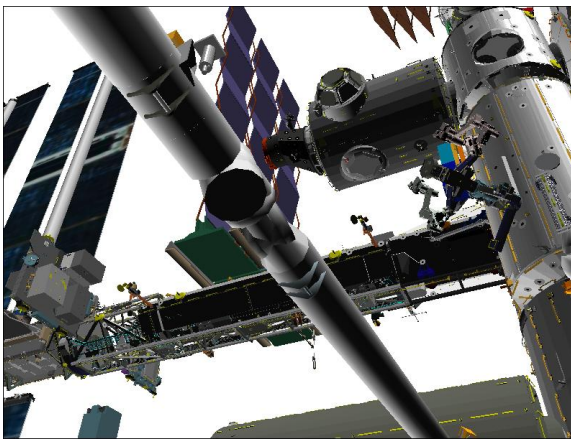

CCTV B (-25,40)

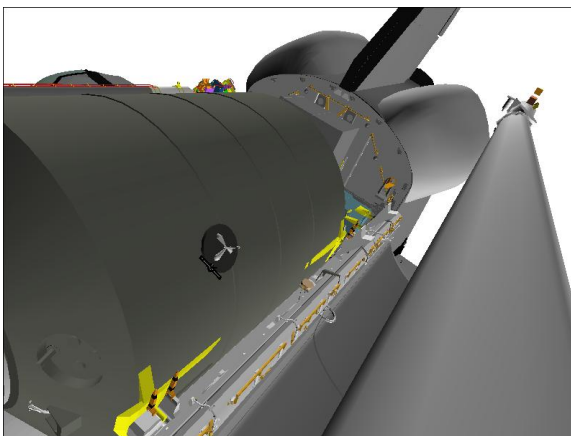

ELBOW (-30,-20)

OBSS SJ MNVR TO UNDOCK

1. SETUP

If digitals available:

SM 94 PDRS CONTROL

√PL ID, ITEM 3: 1

√INIT ID, ITEM 24: 1

Verify at MPLM VIEWING posn:

	X	Y	Z	PITCH	YAW	ROLL	PL ID
√	-967	-643	-386	60	349	282	1
	SY	SP	EP	WP	WY	WR	
√	+62.5	+25.0	-23.0	0.0	-13.2	-21.9	

A7U

CCTV – config as reqd

– perform PAN/TILT RESET for PLB cameras

ZOOM – full OUT

R12(VPU)

√Green Jumper – ISS

MON 1	P1 LOOB
MON 2	B
DNLK	ELBOW (RSC)
DTV	A

2. OBSS MNVR TO UNDOCK

If SINGLE mode available:

RHC

RATE – as reqd (VERN within 10 ft)

BRAKES – OFF (tb-OFF)

MODE – best available

SM 169 PDRS STATUS

Mnvr to OBSS UNDOCK posn:

	SY	SP	EP	WP	WY	WR	
MPLM VIEWING	+62.5	+25.0	-23.0	0.0	-13.2	-21.9	
1: SY –	+25.8						
2: WP –				-85.9			
3: SP +		+66.3					
4: WY +					+10.7		
5: WR –						-100.7	
6: EP –			-49.0				
OBSS UNDOCK	+25.8	+66.3	-49.0	-85.9	+10.7	-100.7	
	X	Y	Z	PITCH	YAW	ROLL	PL ID
	-1041	-362	-602	44	270	0	1

*Display singularity

BRAKES – ON (tb-ON)

MODE – not DIRECT (lt off)

PARAM – PORT TEMP

JOINT – CRIT TEMP

Start:
MPLM VIEWING posn

Step 1:
Drive SY (-) from +62.5 to +25.8

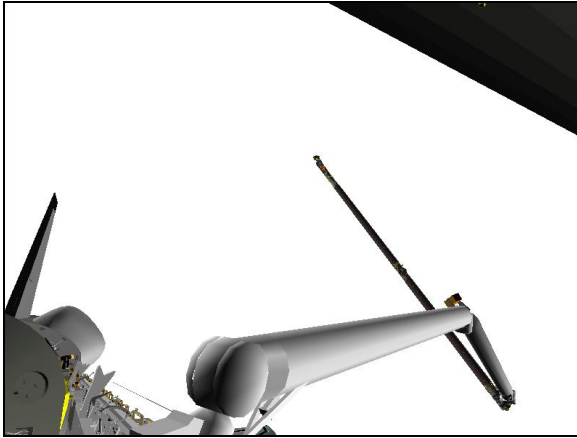

CCTV A (30,20)



CCTV A (30,20)

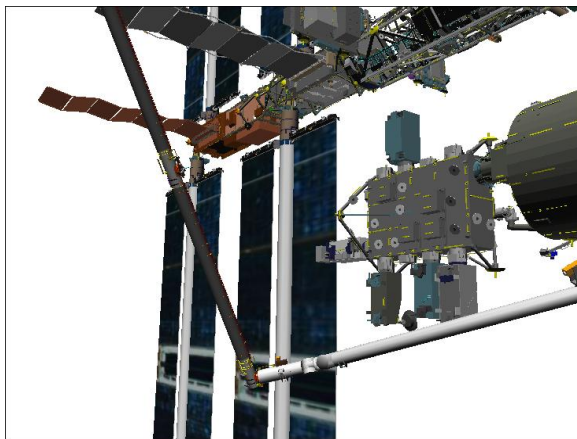

CCTV B (-55,10)

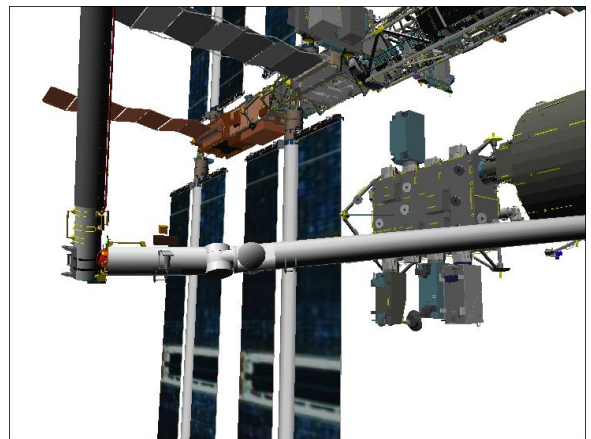

CCTV B (-55,10)

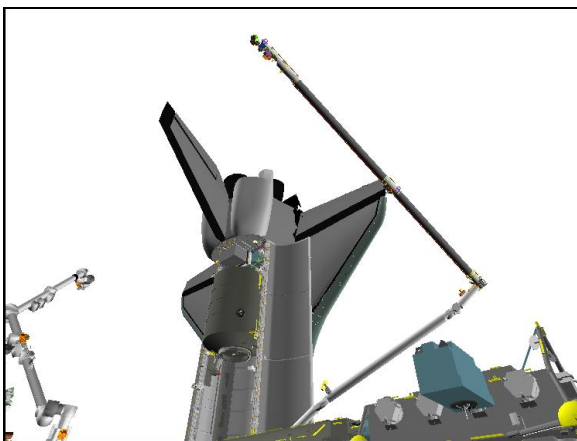

P1 LOOB (140,40)

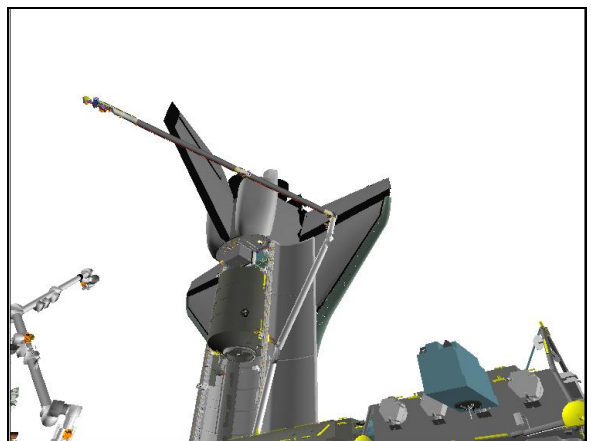

P1 LOOB (140,40)

Step 2:
Drive WP (-) from 0.0 to -85.9

Step 3:
Drive SP (+) from +25.0 to +66.3



CCTV A (30,20)

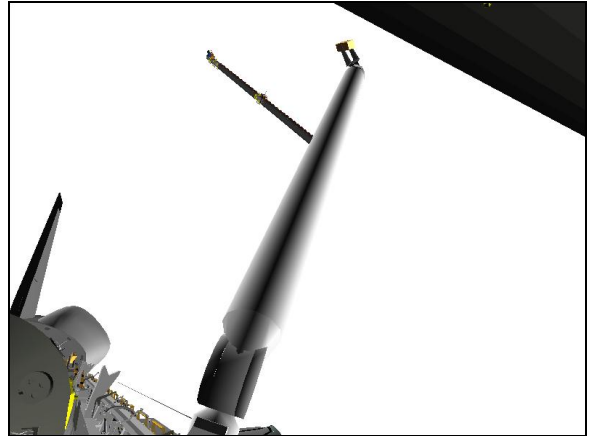

CCTV A (30,20)

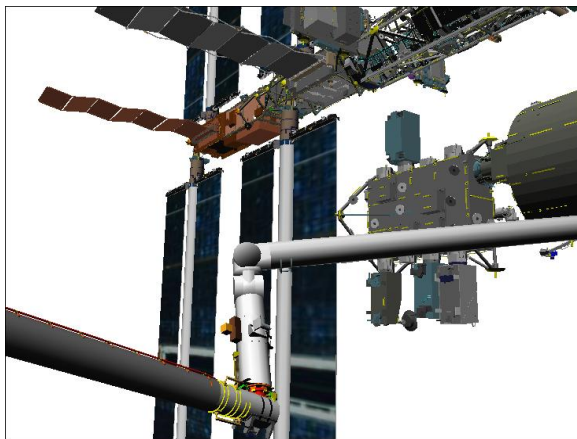

CCTV B (-55,10)

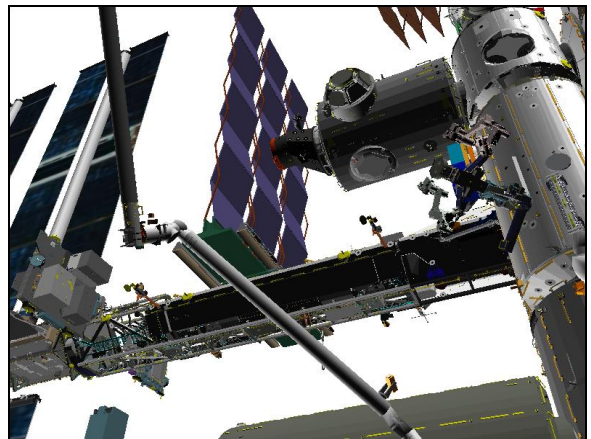

CCTV B (-25,40)

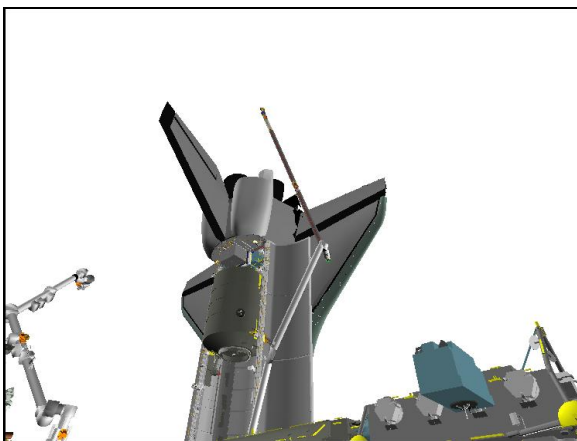

P1 LOOB (140,40)

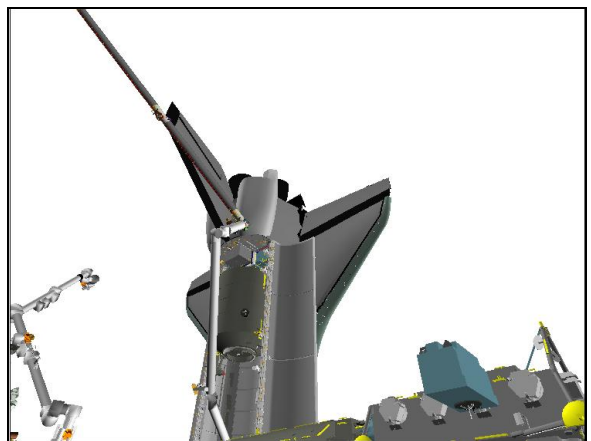

P1 LOOB (140,40)

Step 4:
Drive WY (+) from -13.2 to +10.7



CCTV A (30,20)

Step 5:
Drive WR (-) from -21.9 to -100.7

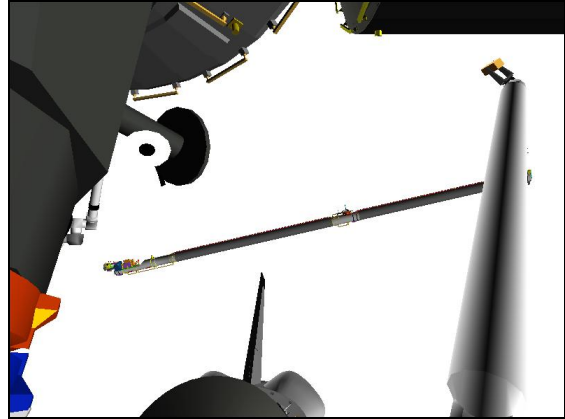

CCTV A (0,30)

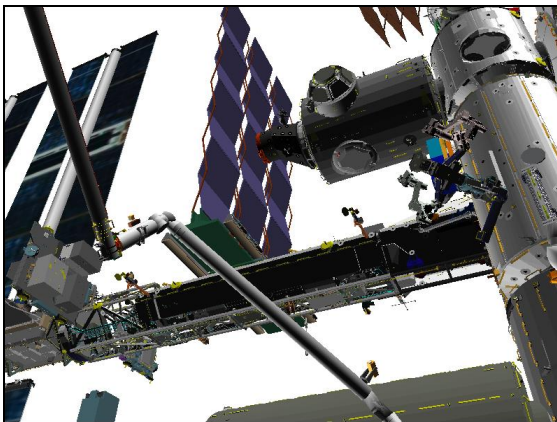

CCTV B (-25,40)

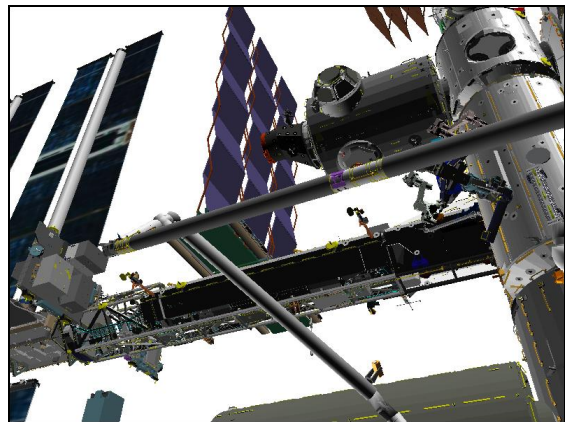

CCTV B (-25,40)

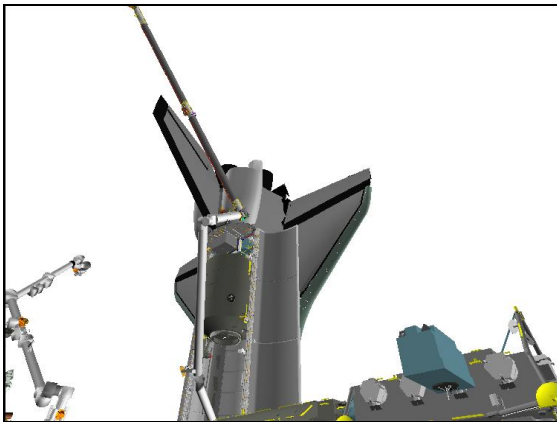

P1 LOOB (140,40)

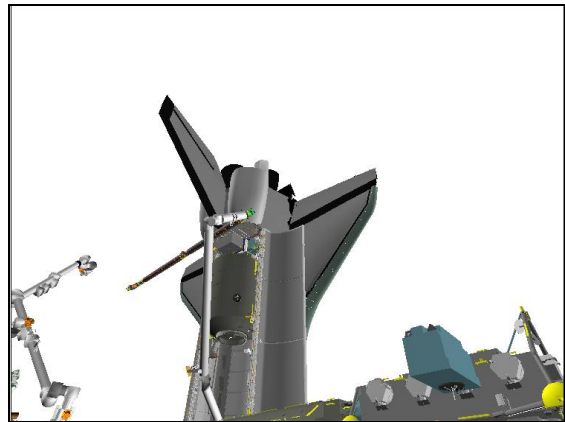

P1 LOOB (140,40)

Step 6:
Drive EP (-) from -23.0 to -49.0

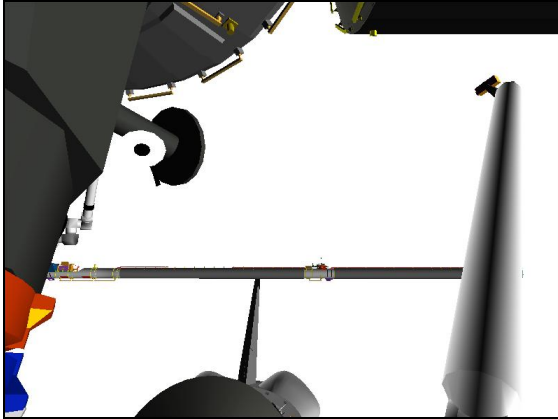

CCTV A (0,30)

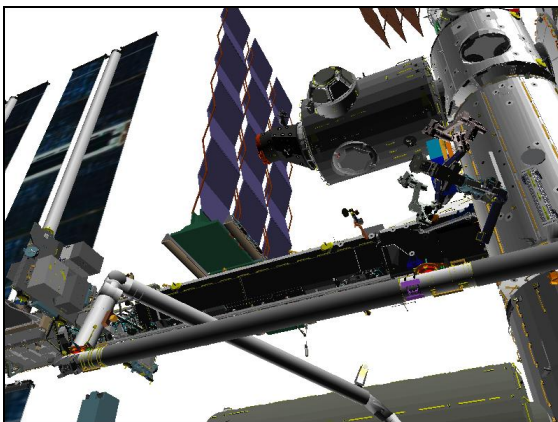

CCTV B (-25,40)

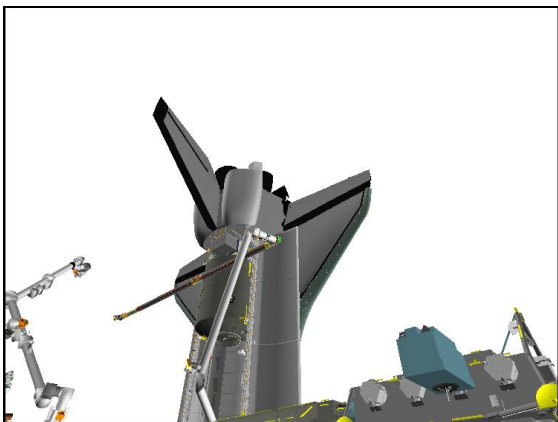

P1 LOOB (140,40)

OBSS SJ MNVR TO OBSS HOVER

1. SETUP

If digitals available:

SM 94 PDRS CONTROL

√ PL ID, ITEM 3: 1

√ INIT ID, ITEM 24: 1

Verify at OBSS UNDOCK posn:

	X	Y	Z	PITCH	YAW	ROLL	PL ID
√	-1041	-362	-602	44	270	0	1
	SY	SP	EP	WP	WY	WR	
√	+25.8	+66.3	-49.0	-85.9	+10.7	-100.7	

*Display singularity

A7U

CCTV – config as reqd

– perform PAN/TILT RESET for PLB cameras

ZOOM – full OUT

MON 1	D
MON 2	A
DNLK	ELBOW (C)
DTV	B

2. SINGLE TO OBSS HOVER

NOTE

When SY joint is driving, minimum clearance between OBSS ITVC and orbiter tail is 95 inches. At the end of this single joint sequence, the OBSS ITVC is 66 inches from the starboard OMS pod

If SINGLE mode available:

RHC

RATE – as reqd (VERN within 10 ft)

BRAKES – OFF (tb-OFF)

MODE – best available

Mnvr to OBSS HOVER posn:

	SY	SP	EP	WP	WY	WR	
OBSS UNDOCK	+25.8	+66.3	-49.0	-85.9	+10.7	-100.7	
1: WY –					0.0		
2: WP +				-59.8			
3: WR +						+110.0	
4: SY –	-90.0						
5: SP +		+80.2					
6: EP –			-118.8				
OBSS HOVER	-90.0	+80.2	-118.8	-59.8	0.0	+110.0	
	X	Y	Z	PITCH	YAW	ROLL	PL ID
	-680	+133	-517	0	0	341	1

BRAKES – ON (tb-ON)

MODE – not DIRECT (It off)

PARAM – PORT TEMP

JOINT – CRIT TEMP

If berthing OBSS, perform OBSS SJ BERTH (PDRS, OBSS OPS)

Start:
OBSS UNDOCK posn

Step 1:
Drive WY (-) from +10.7 to 0.0

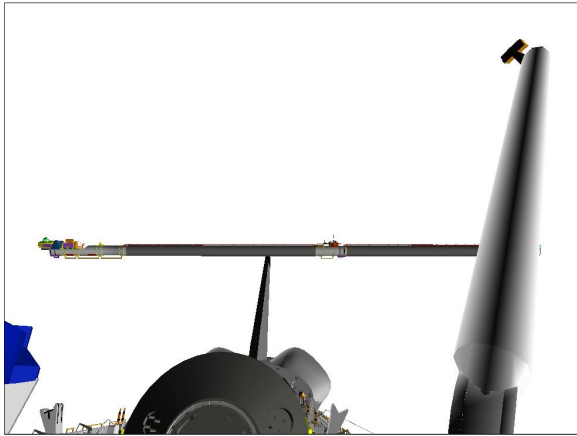

CCTV A (0,25)



CCTV A (0,25)



CCTV B (-20,20)



CCTV B (-20,20)

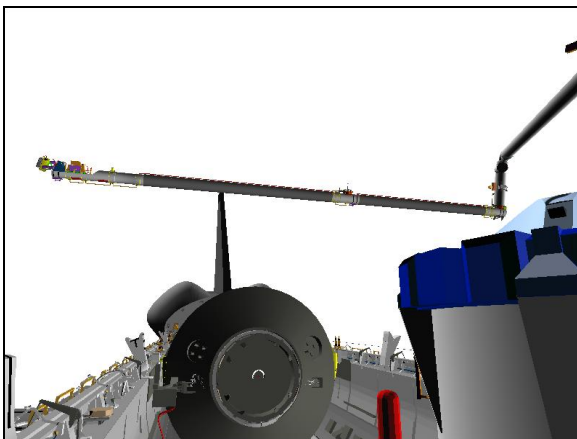

CCTV D (15,15)

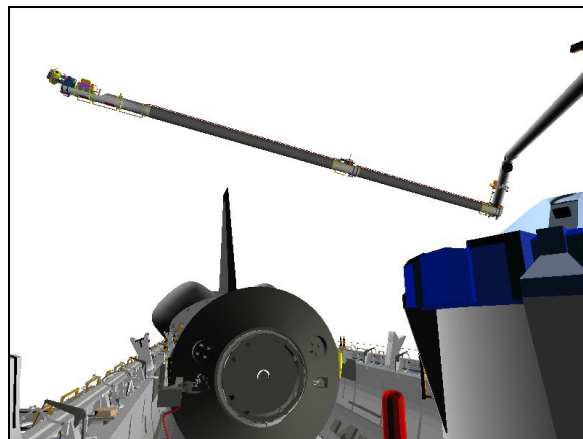

CCTV D (15,15)

Step 2:
Drive WP (+) from -85.9 to -59.8

Step 3:
Drive WR (+) from -100.7 to +110.0



CCTV A (0,25)



CCTV A (45,15)



CCTV B (-25,20)



CCTV B (-35,15)

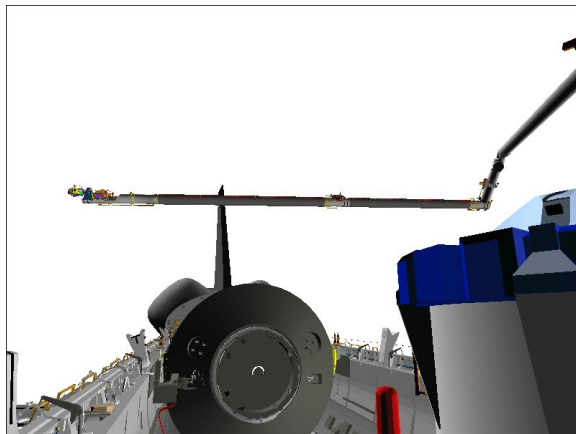

CCTV D (15,15)



ELBOW (5,-30)

Step 4:
Drive SY (-) from +25.8 to -90.0

Step 5:
Drive SP (+) from +66.3 to +80.2

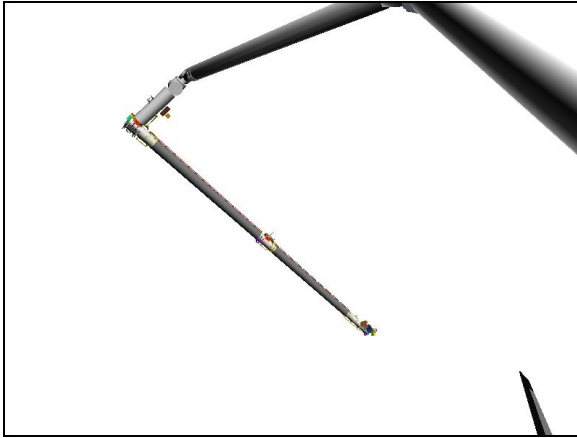

CCTV A (-35,45)



CCTV A (-35,45)

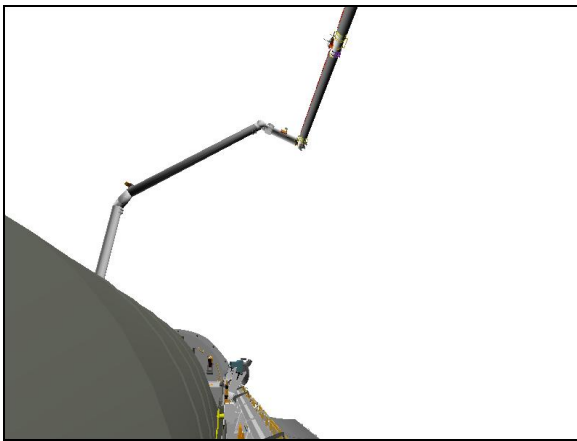

CCTV C (10,20)

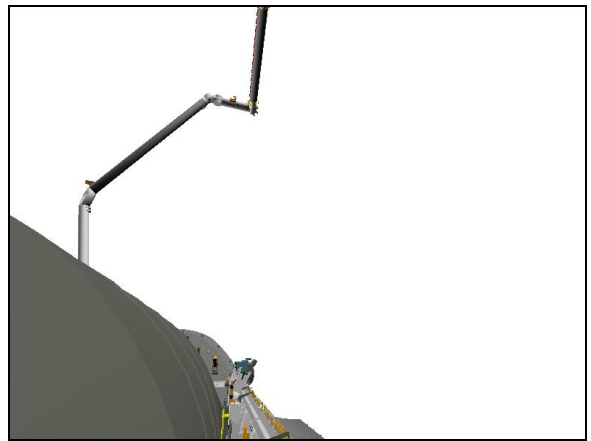

CCTV C (10,20)



CCTV D (15,60)



CCTV D (15,60)

Step 6:
Drive EP (-) from -49.0 to -118.8

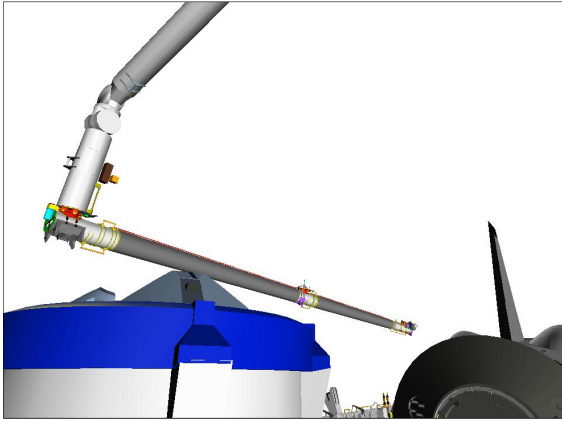

CCTV A (-35,25)

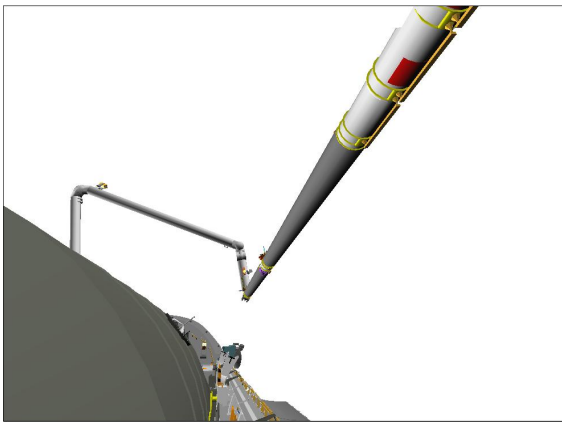

CCTV C (10,20)

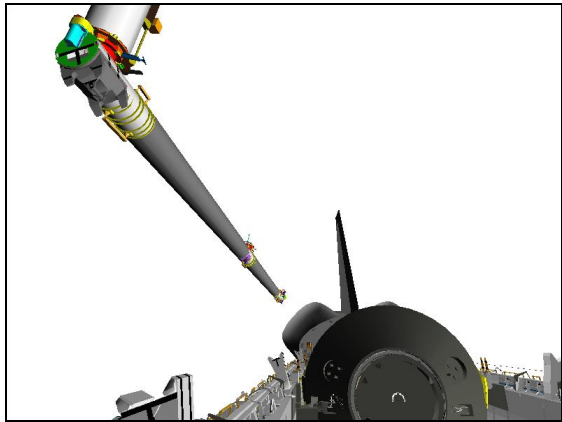

CCTV D (-5,20)

SJ MNVR TO EVA 2 VIEWING POSITION

1. SETUP

NOTE

This procedure assumes the SSRMS is at the FD6 Overnight Park position on MBS PDGF1

If digitals available:

SM 94 PDRS CONTROL

PL ID, ITEM 3: 1

INIT ID, ITEM 24: 1

Verify in MPLM VIEWING posn:

	X	Y	Z	PITCH	YAW	ROLL	PL ID
√	-967	-643	-386	60	349	282	1
	SY	SP	EP	WP	WY	WR	
√	+62.5	+25.0	-23.0	0.0	-13.2	-21.9	

A7U

CCTV – config as reqd
 – perform PAN/TILT RESET for PLB cameras
 ZOOM – full OUT

R12(VPU)

√Green Jumper – LDRI/ITVC

MON 1	A
MON 2	OBSS ITVC (P1 LOOB)
DTV	B
DNLK	ELBOW (RSC)

2. SINGLE JOINT MNVR TO EVA 2 VIEWING POSN

NOTE

At SY = +88, clearance between SRMS tip boom and MAXI is 58 inches. Monitor with Elbow camera.

At SY = +105, clearance between OBSS and ICS-EF Antenna KOZ is 36 inches. Monitor with camera B and RSC.

At SY = +108, clearance between OBSS and JEM-SEDA antenna is 36 inches. Monitor clearance with RSC.

Minimum clearance between OBSS and SAW 4A is 68 inches at SY = +119

If SINGLE mode available:

BRAKES – OFF (tb-OFF)

RHC

RATE – as reqd (VERN within 10 ft)

MODE – best available

SM 169 PDRS STATUS

Mnvr to EVA 2 VIEWING posn:

MPLM
VIEWING
1: WP -
2: WY -
3: SP -
4: SY +
5: WR +
6: SP +
7: WP +
8: EP +
EVA 2
VIEWING

SY	SP	EP	WP	WY	WR	
+62.5	+25.0	-23.0	0.0	-13.2	-21.9	
			-32.0			
	+20.0			-25.3		
+160.0						
					+69.3	
	+24.3					
			-21.8			
		-11.6				
+160.0	+24.3	-11.6	-21.8	-25.3	+69.3	
X	Y	Z	PITCH	YAW	ROLL	PL ID
-139	-371	-508	131	344	190	1

BRAKES - ON (tb-ON)
 MODE - not DIRECT (lt off)
 PARAM - PORT TEMP
 JOINT SEL - CRIT TEMP

Start:
MPLM VIEWING posn

Step 1:
Drive WP (-) from 0.0 to -32.0



CCTV A (30,5)



CCTV A (30,5)

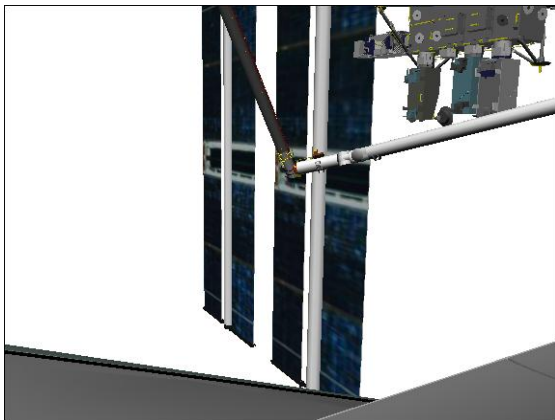

CCTV B (-60,-10)

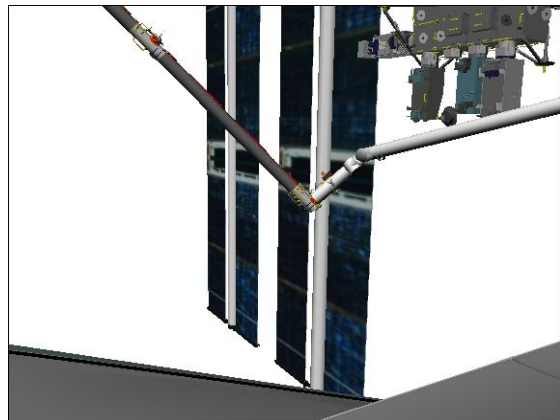

CCTV B (-60,-10)



ELBOW (-30,20)

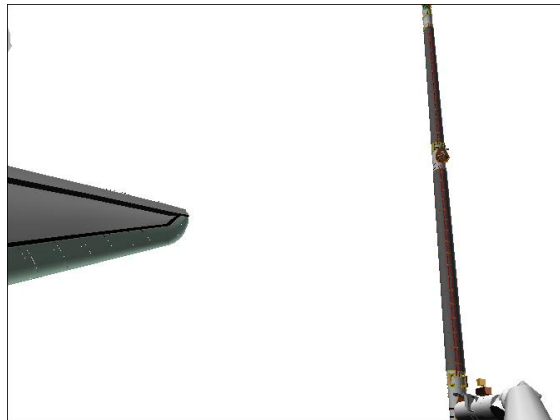

ELBOW (-30,20)

Step 2:
Drive WY (-) from -13.2 to -25.3

Step 3:
Drive SP (-) from +25.0 to +20.0



CCTV A (30,5)

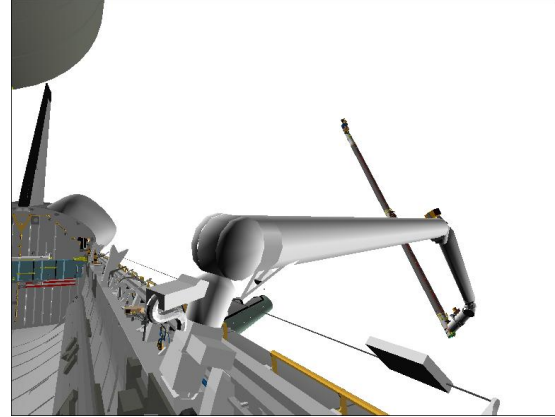

CCTV A (30,5)

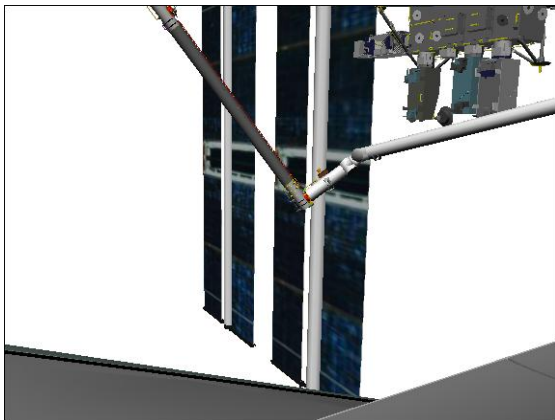

CCTV B (-60,-10)

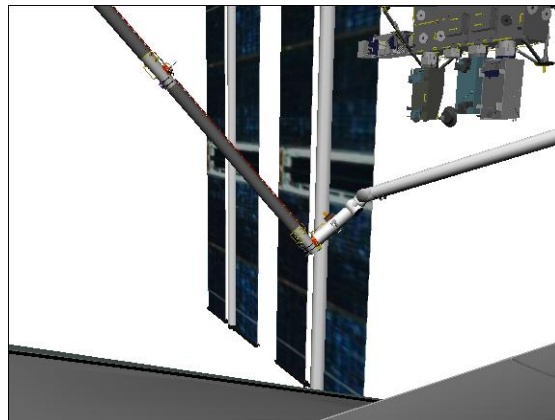

CCTV B (-60,-10)



ELBOW (-30,20)



ELBOW (-30,20)

Step 4:

Drive SY (+) from +62.5 to +160.0

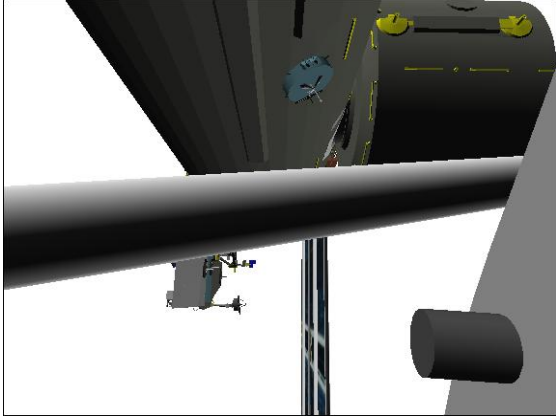

CCTV A (90,15)

Step 5:

Drive WR (+) from -21.9 to +69.3

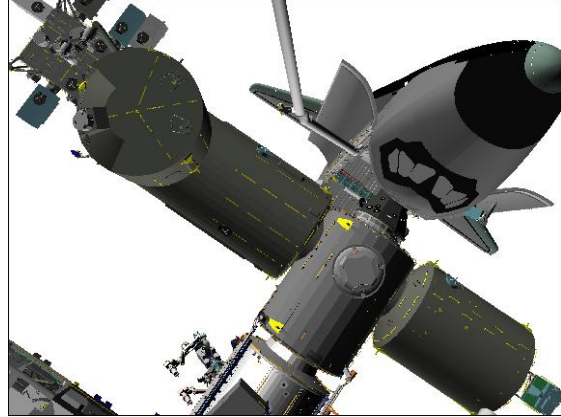

OBSS ITVC (75,-25)

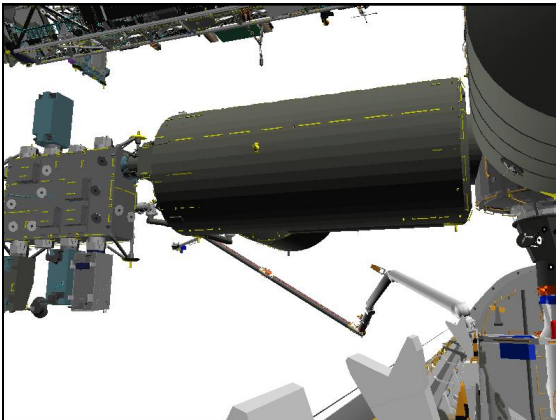

CCTV B (-20,10)

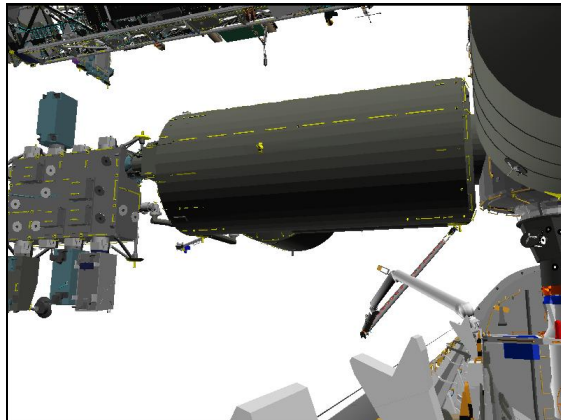

CCTV B (-20,10)



ELBOW (20,40)

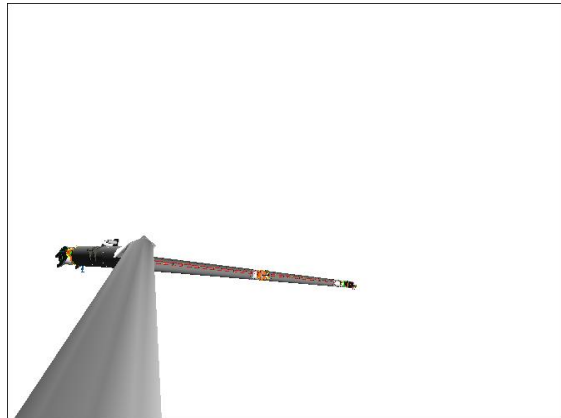

ELBOW (20,0)

Step 6:
Drive SP (+) from +20.0 to +24.3

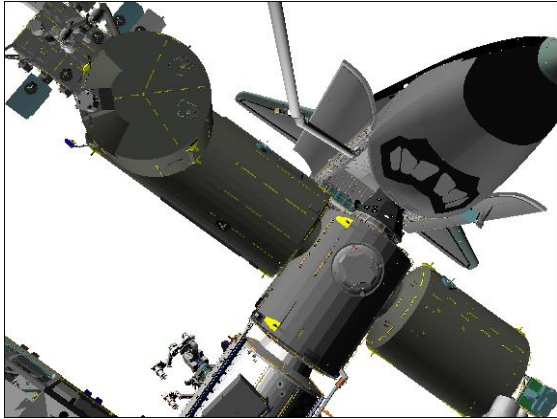

OBSS ITVC (75,-25)

Step 7:
Drive WP (+) from -32.0 to -21.8

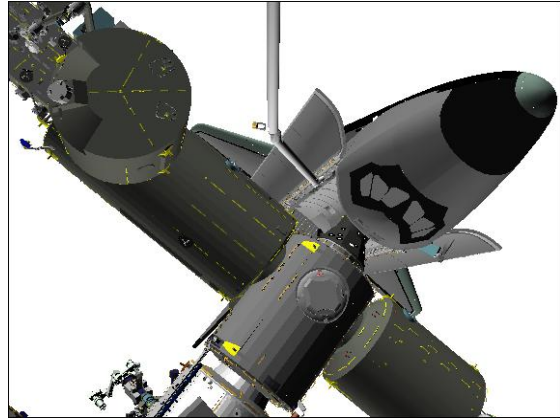

OBSS ITVC (75,-25)

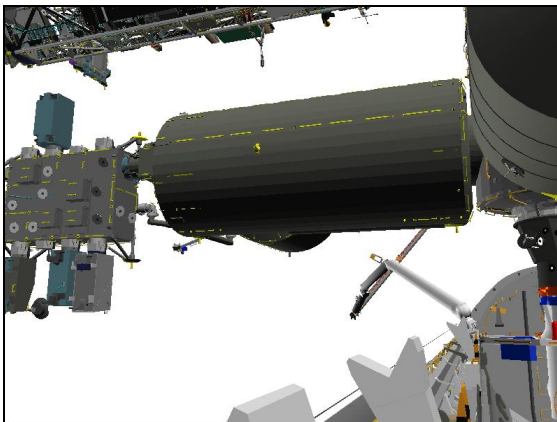

CCTV B (-20,10)

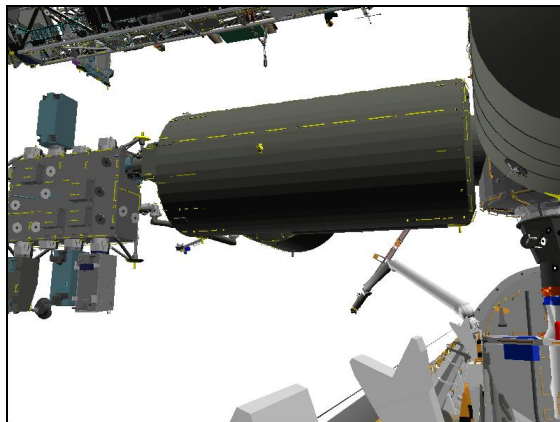

CCTV B (-20,10)

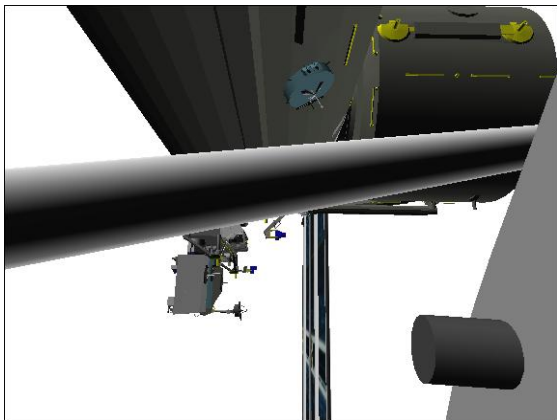

CCTV A (90,15)

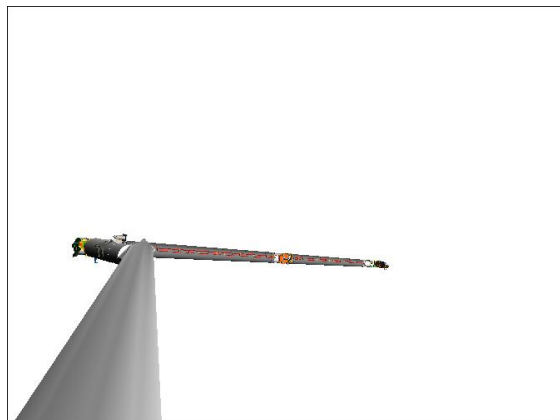

ELBOW (20,0)

Step 8:
Drive EP (+) from -23.0 to -11.6

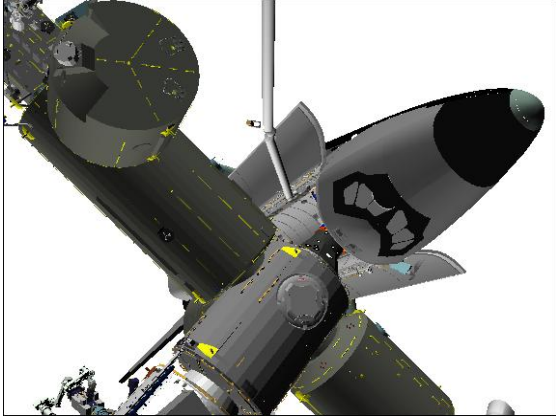

OBSS ITVC (75,-25)

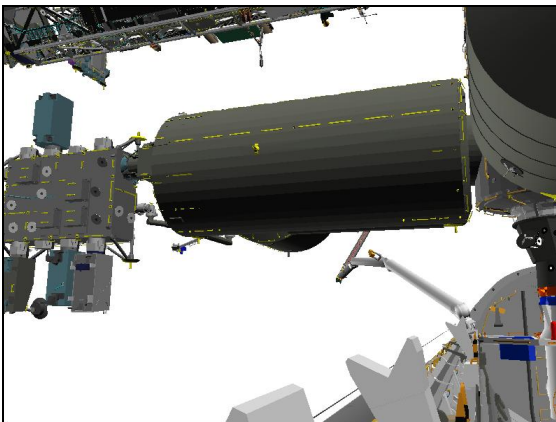

CCTV B (-20,10)



ELBOW (25,10)

A7U

3. CONFIGURE CAMERAS FOR EVA 2 VIEWING

DTV ← PL2

CAMR CMD PAN/TILT – HI RATE

PAN – L (to hard stop)

TILT – UP (to hard stop)

PAN/TILT – RESET

PAN: +65 (right)

TILT: -65 (down)

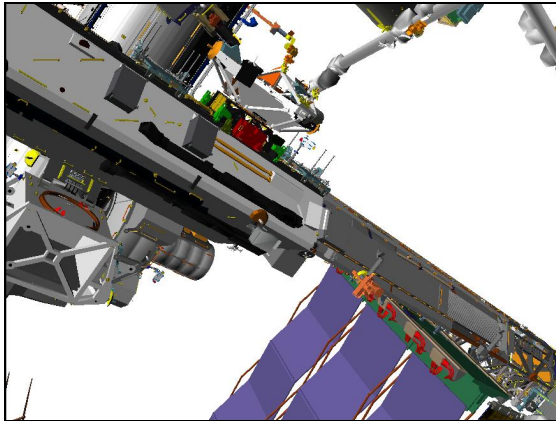

OBSS ITVC (75,-70)

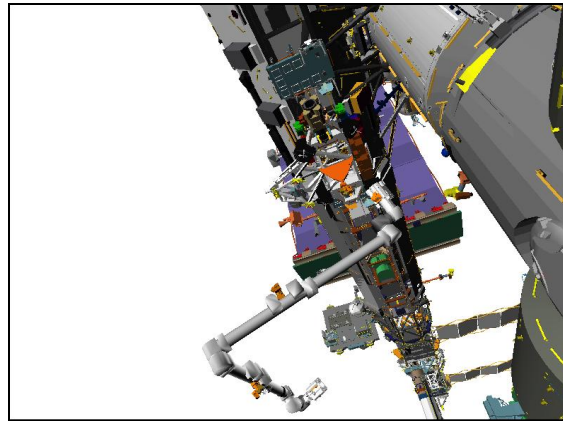

ELBOW (90,-20)

MUX 1 L ← MIDDECK

LDRI MODE 2 pb – push (ITVC video)

VIDEO OUT – as desired (not DTV)

√VIDEO IN – not PL2

SJ MNVR TO MPLM VIEWING POSITION

1. SETUP

NOTE

This procedure assumes the SSRMS is at the FD7 Overnight Park position on MBS PDGF1

If digitals available:

SM 94 PDRS CONTROL

PL ID, ITEM 3: 1

INIT ID, ITEM 24: 1

Verify in EVA 2 VIEWING posn:

	X	Y	Z	PITCH	YAW	ROLL	PL ID
√	-139	-371	-508	131	344	190	1
	SY	SP	EP	WP	WY	WR	
√	+160.0	+24.3	-11.6	-21.8	-25.3	+69.3	

A7U

CCTV – config as reqd
 – perform PAN/TILT RESET for PLB cameras
 ZOOM – full OUT

R12(VPU) √Green Jumper – LDRI/ITVC

MON 1	A
MON 2	OBSS ITVC (P1 LOOB)
DTV	B
DNLK	ELBOW (RSC)

2. SINGLE JOINT MNVR TO MPLM VIEWING POSN

NOTE

Minimum clearance between OBSS and SAW 4A is 68 inches at SY = +119.

At SY = +108, clearance between OBSS and JEM-SEDA antenna is 36 inches. Monitor clearance with RSC.

At SY = +105, clearance between OBSS and ICS-EF Antenna KOZ is 36 inches. Monitor with camera B and RSC.

At SY = +88, clearance between SRMS tip boom and MAXI is 58 inches. Monitor with Elbow camera

If SINGLE mode available:

BRAKES – OFF (tb-OFF)

RHC

RATE – as reqd (VERN within 10 ft)

MODE – best available

SM 169 PDRS STATUS

Mnvr to MPLM VIEWING posn:

EVA 2
VIEWING

- 1: EP -
- 2: WP -
- 3: SP -
- 4: WR -
- 5: SY -
- 6: SP +
- 7: WY +
- 8: WP +

MPLM
VIEWING

SY	SP	EP	WP	WY	WR	
+160.0	+24.3	-11.6	-21.8	-25.3	+69.3	
		-23.0				
			-32.0			
	+20.0					
					-21.9	
+62.5						
	+25.0					
				-13.2		
			0.0			
+62.5	+25.0	-23.0	0.0	-13.2	-21.9	
X	Y	Z	PITCH	YAW	ROLL	PL ID
-967	-643	-386	60	349	282	1

BRAKES - ON (tb-ON)
 MODE - not DIRECT (It off)
 PARAM - PORT TEMP
 JOINT SEL - CRIT TEMP

Start:
EVA 2 VIEWING posn

Step 1:
Drive EP (-) from -11.6 to -23.0

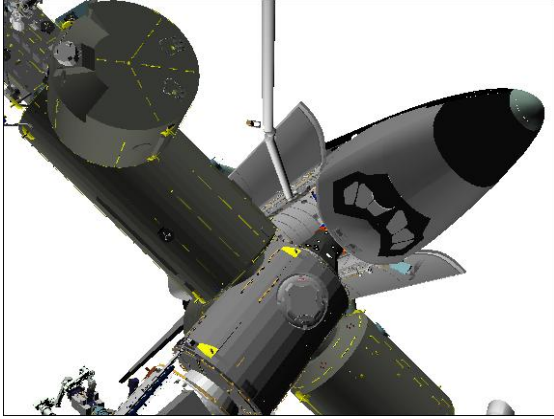

OBSS ITVC (75,-25)

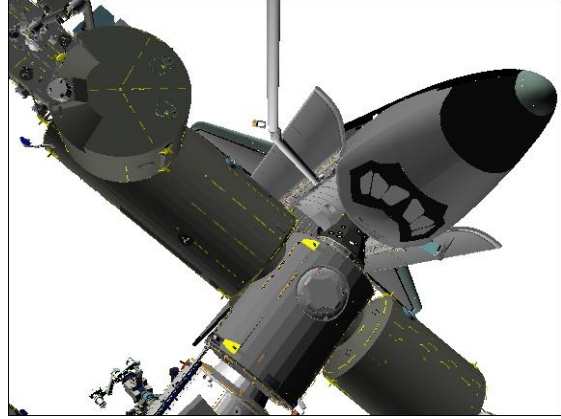

OBSS ITVC (75,-25)

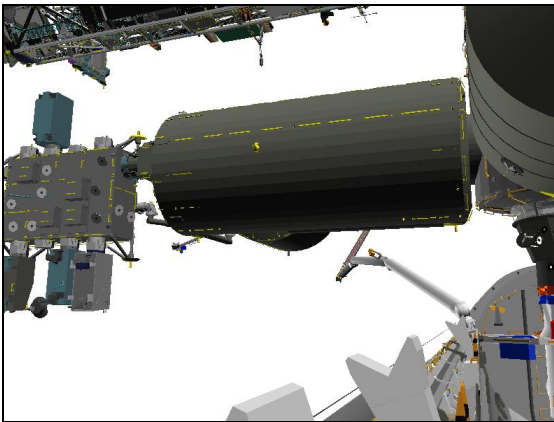

CCTV B (-20,10)

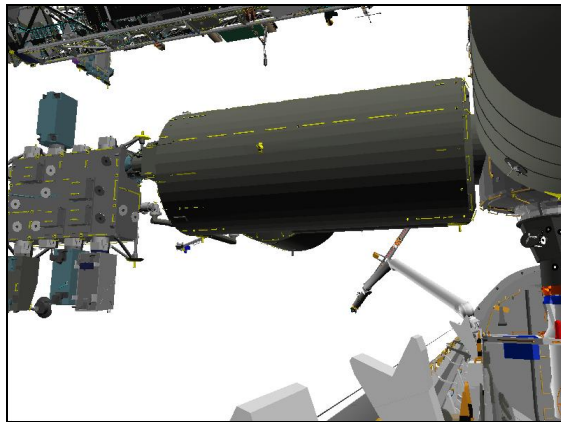

CCTV B (-20,10)



ELBOW (25,10)



ELBOW (25,10)

Step 2:

Drive WP (-) from -21.8 to -32.0

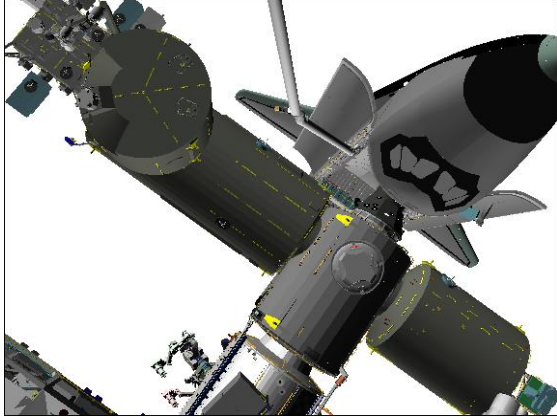

OBSS ITVC (75,-25)

Step 3:

Drive SP (-) from +24.3 to +20.0

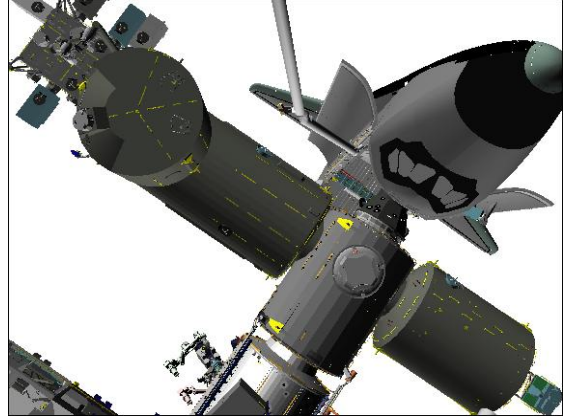

OBSS ITVC (75,-25)

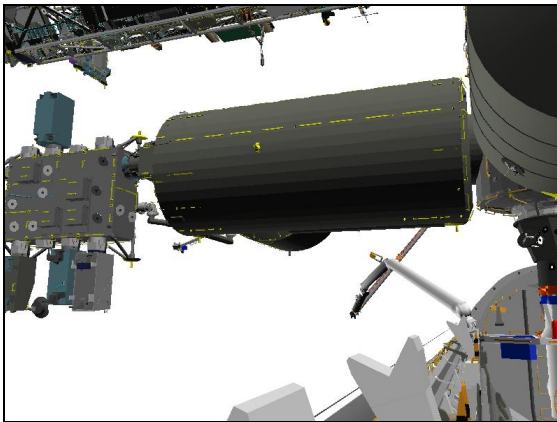

CCTV B (-20,10)

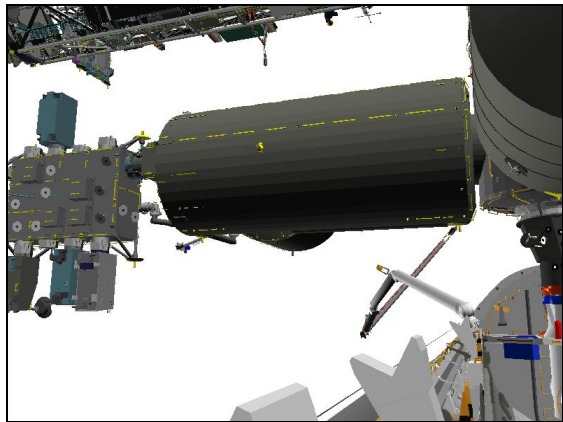

CCTV B (-20,10)

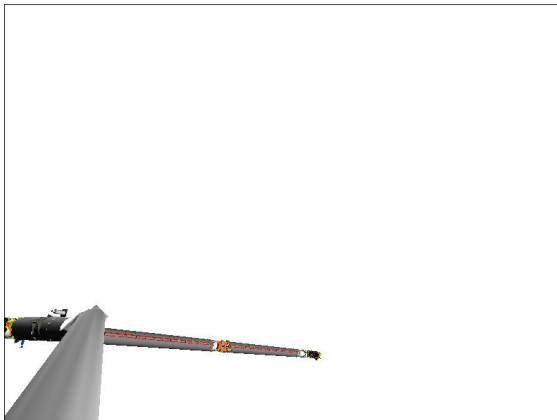

ELBOW (25,10)

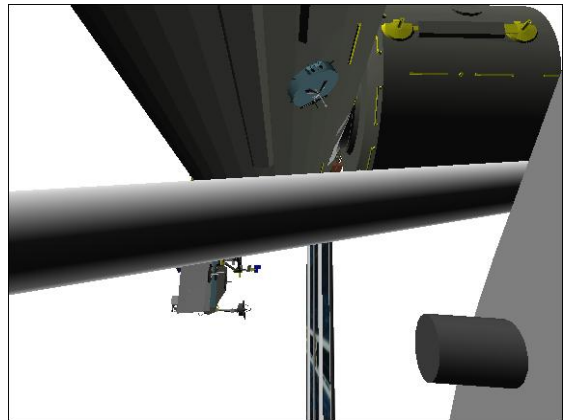

CCTV A (90,15)

Step 4:
Drive WR (-) from +69.3 to -21.9

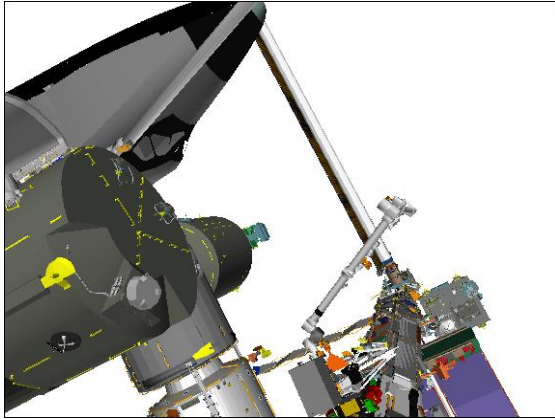

OBSS ITVC (75,-25)

Step 5:
Drive SY (-) from +160.0 to +62.5

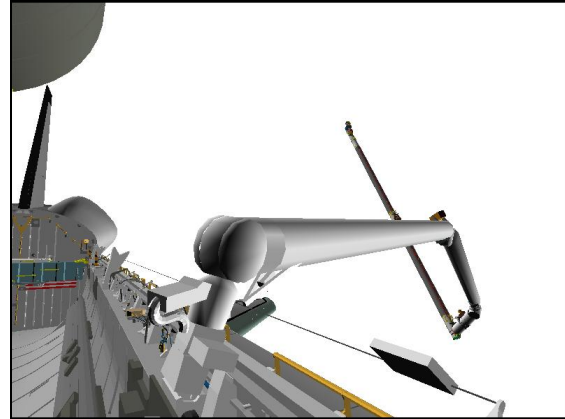

CCTV A (30,5)

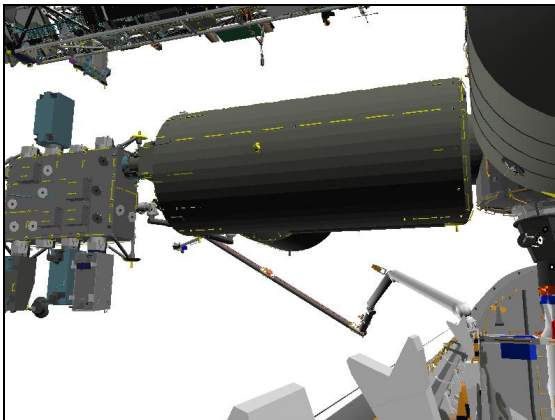

CCTV B (-20,10)

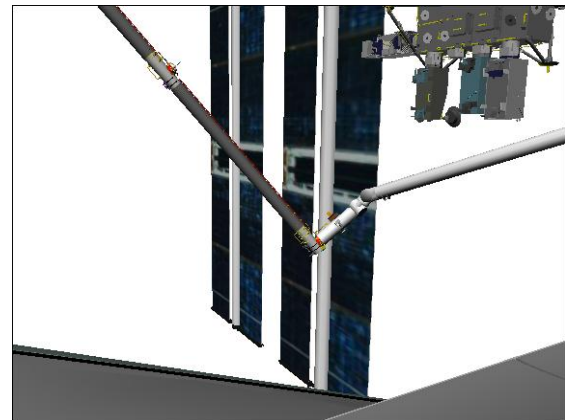

CCTV B (-60,-10)

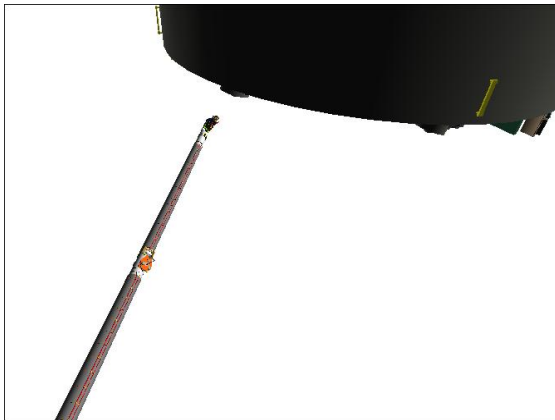

ELBOW (20,40)



ELBOW (-30,20)

Step 6:
Drive SP (+) from +20.0 to +25.0

Step 7:
Drive WY (+) from -25.3 to -13.2



CCTV A (30,5)



CCTV A (30,5)

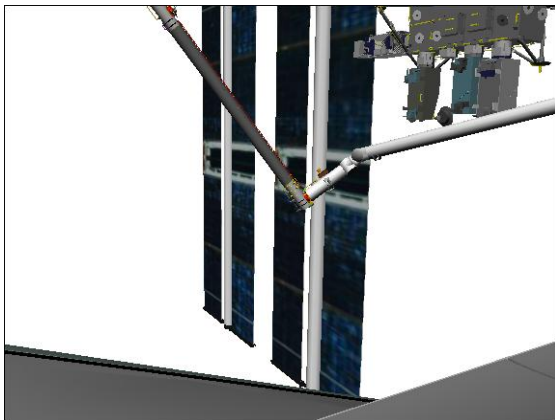

CCTV B (-60,-10)

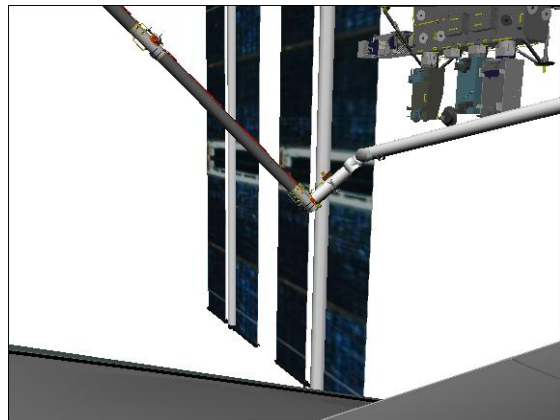

CCTV B (-60,-10)



ELBOW (-30,20)

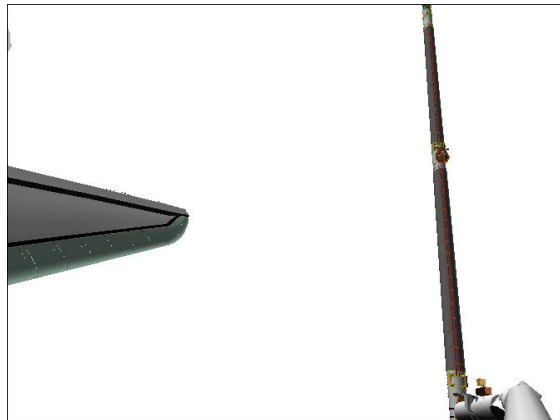

ELBOW (-30,20)

Step 8:
Drive WP (+) from -32.0 to 0.0

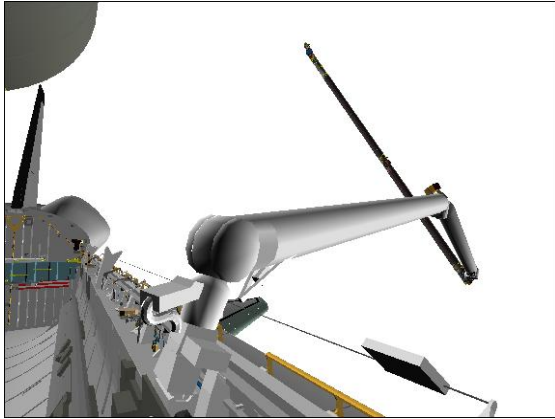

CCTV A (30,5)

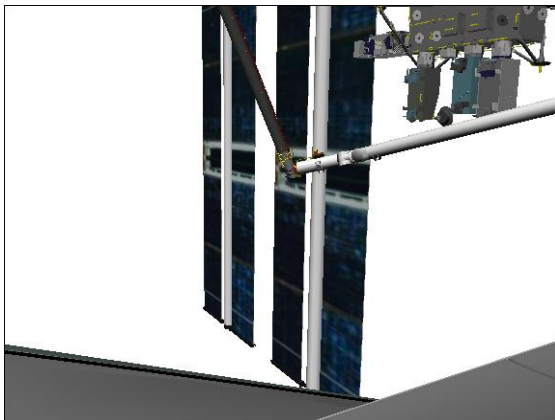

CCTV B (-60,-10)



ELBOW (-30,20)

A7U

3. CONFIGURE CAMERAS FOR MPLM VIEWING

DTV ← PL2

CAMR CMD PAN/TILT – HI RATE

PAN – L (to hard stop)

TILT – UP (to hard stop)

PAN/TILT – RESET

PAN: +130 (right)

TILT: -60 (down)

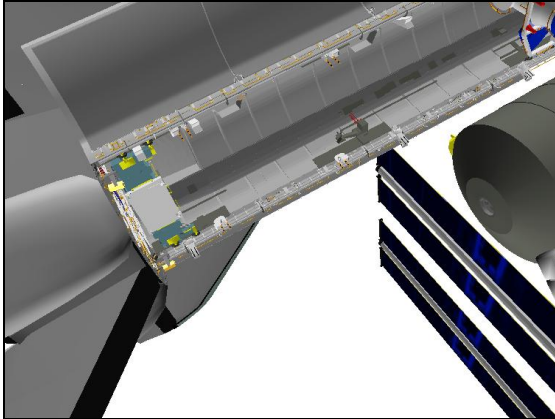

OBSS ITVC (130,-60)

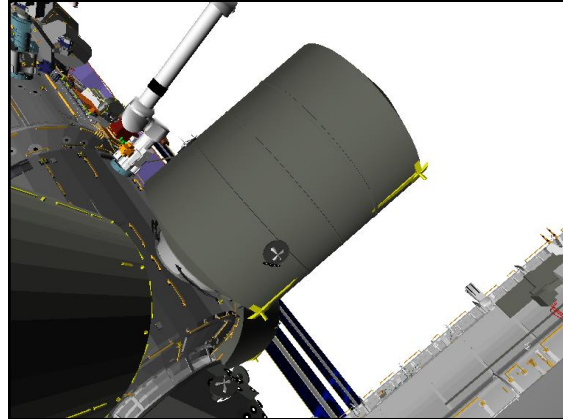

ELBOW (-160,20)

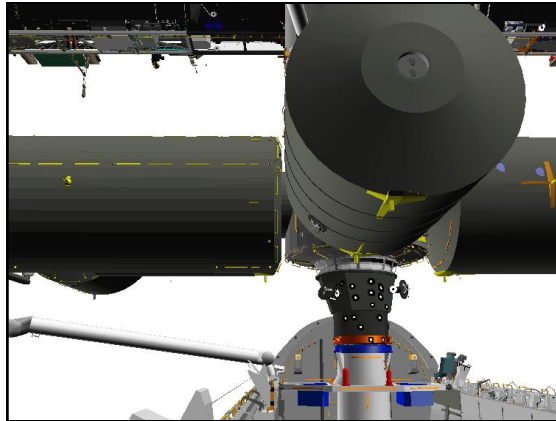

CCTV B (0,15)

MUX 1 L ← MIDDECK

LDR1 MODE 2 pb – push (ITVC video)

VIDEO OUT – as desired (not DTV)

√VIDEO IN – not PL2

This Page Intentionally Blank

REFERENCE DATA

OBSS JOINT ANGLES VS POR COORDINATES	FS 3-2
AUTOSEQUENCE	FS 3-4

REFERENCE
DATA

OBSS JOINT ANGLES VS POR COORDINATES

OBSS PRE-GRAPPLE AT HANDOFF/BACKOFF posn:

X	Y	Z	PITCH	YAW	ROLL	PL ID
-1047	-360	-658	284	0	270	0
-1056	-360	-642	44	270	0	1
-1043	+231	-655	14	270	0	2
SY	SP	EP	WP	WY	WR	
+22.7	+57.5	-27.4	-99.3	+11.8	-97.9	

*Display singularity

OBSS HANDOFF posn:

X	Y	Z	PITCH	YAW	ROLL	PL ID
-1062	-360	-600	284	0	270	0
-1070	-360	-584	44	270	0	1
-1059	+231	-597	14	270	0	2
SY	SP	EP	WP	WY	WR	
+24.5	+59.0	-42.1	-85.9	+11.2	-99.4	

*Display singularity

OBSS HANDOFF INTERMEDIATE posn:

X	Y	Z	PITCH	YAW	ROLL	PL ID
-1062	-360	-600	284	0	282	0
-1070	-361	-584	14	281	330	1
-1174	+219	-626	14	281	0	2
SY	SP	EP	WP	WY	WR	
+24.5	+59.0	-42.1	-85.9	+11.2	-87.8	

MPLM VIEWING posn:

X	Y	Z	PITCH	YAW	ROLL	PL ID
-959	-627	-387	341	47	345	0
-967	-643	-386	60	349	282	1
-1252	-520	-889	60	349	312	2
SY	SP	EP	WP	WY	WR	
+62.5	+25.0	-23.0	0.0	-13.2	-21.9	

EVA 2 INTERMEDIATE posn:

X	Y	Z	PITCH	YAW	ROLL	PL ID
-330	-546	-324	259	38	77	0
-323	-558	-312	58	50	256	1
-528	-1000	-647	58	50	286	2
SY	SP	EP	WP	WY	WR	
+130.0	+20.0	-23.0	-32.0	-25.3	-21.9	

EVA 2 VIEWING posn:

X	Y	Z	PITCH	YAW	ROLL	PL ID
-153	-364	-518	208	38	201	0
-139	-371	-508	131	344	190	1
+223	-203	-944	131	344	220	2
SY	SP	EP	WP	WY	WR	
+160.0	+24.3	-11.6	-21.8	-25.3	+69.3	

REFERENCE
DATA

OBSS UNDOCK posn:

X	Y	Z	PITCH	YAW	ROLL	PL ID
-1032	-362	-618	284	0	270	0
-1041	-362	-602	44	270	0	1
-1029	+229	-614	284	270	270	2
SY	SP	EP	WP	WY	WR	
+25.8	+66.3	-49.0	-85.9	+10.7	-100.7	

*
*

*Display singularity

OBSS HOVER posn:

X	Y	Z	PITCH	YAW	ROLL	PL ID
-680	+135	-535	270	349	1	0
-680	+133	-517	0	0	341	1
-1271	+134	-532	0	0	11	2
SY	SP	EP	WP	WY	WR	
-90.0	+80.2	-118.8	-59.8	0.0	+110.0	

FLAT FIELD posn:

X	Y	Z	PITCH	YAW	ROLL	PL ID
-679	+351	-448	270	349	1	0
-679	+349	-430	0	0	341	1
-1270	+350	-445	0	0	11	2
SY	SP	EP	WP	WY	WR	
-90.1	+25.0	-65.8	-57.6	0.0	-249.9	

OBSS CONTINGENCY UNDOCK posn:

X	Y	Z	PITCH	YAW	ROLL	PL ID
-1119	-483	-582	5	37	313	0
-1131	-496	-586	62	324	282	1
-1348	-141	-1006	62	324	312	2
SY	SP	EP	WP	WY	WR	
+35.0	+38.7	-22.8	-0.5	-0.3	-40.0	

OBSS AUTOSEQUENCE

Auto Seq ID	Auto posn	X/ SY	Y/ SP	Z/ EP	PITCH/ WP	YAW/ WY	ROLL/ WR	Pause
7	148	-1029	+229	-614	284	270	270	P
		+26.1	+67.7	-51.2	-85.0	+10.6	-100.6	
7	149	-800	+500	-250	281	333	95	
		-86.7	+72.7	-86.0	+21.2	-3.3	-169.3	
7	150	-1130	+350	-400	325	336	30	
		-80.4	+90.4	-94.6	-76.3	-43.9	-262.8	
7	151	-1270	+350	-445	0	0	11	P
		-90.1	+25.0	-65.8	-57.6	0.0	-249.9	

I

CUE CARD CONFIGURATION

OBSS SJ GRAPPLE AT HANDOFF	FS CC 4-2
UNGRAPPLE AT HANDOFF.....	FS CC 4-3
OVERLAY FOR ROEU PL SEL POSITION.....	FS CC 4-4

CUE CARD
CONFIG

CUE CARD CONFIG

Fabricate as transparency

ZOOM 34.0 HFOV
FOCUS 5.0 FT
EYEPOINT APPROX 18 IN

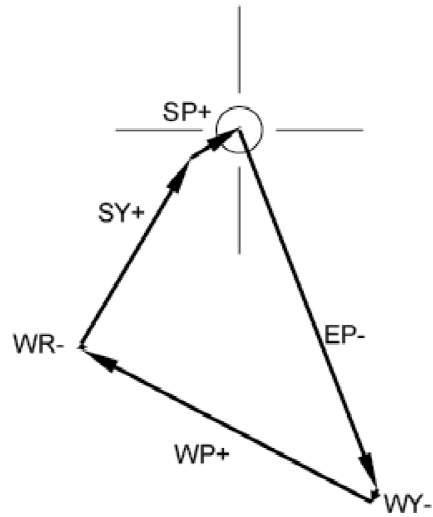

OBSS SJ GRAPPLE AT HANDOFF

PDRS-9a/131/O/A

(reduced copy)

FS CC 4-2

PDRS/131/FIN

Fabricate as transparency

ZOOM 34.0 HFOV
FOCUS 5.0 FT
EYEPOINT APPROX 18 IN

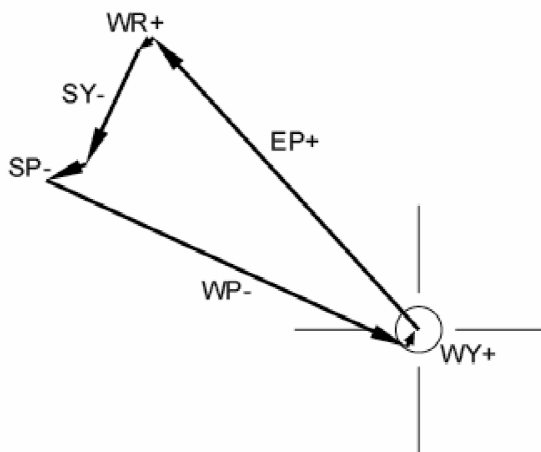

OBSS SJ UNGRAPPLE AT HANDOFF

PDRS-10a/131/O/A

(reduced copy)

FS CC 4-3

PDRS/131/FIN

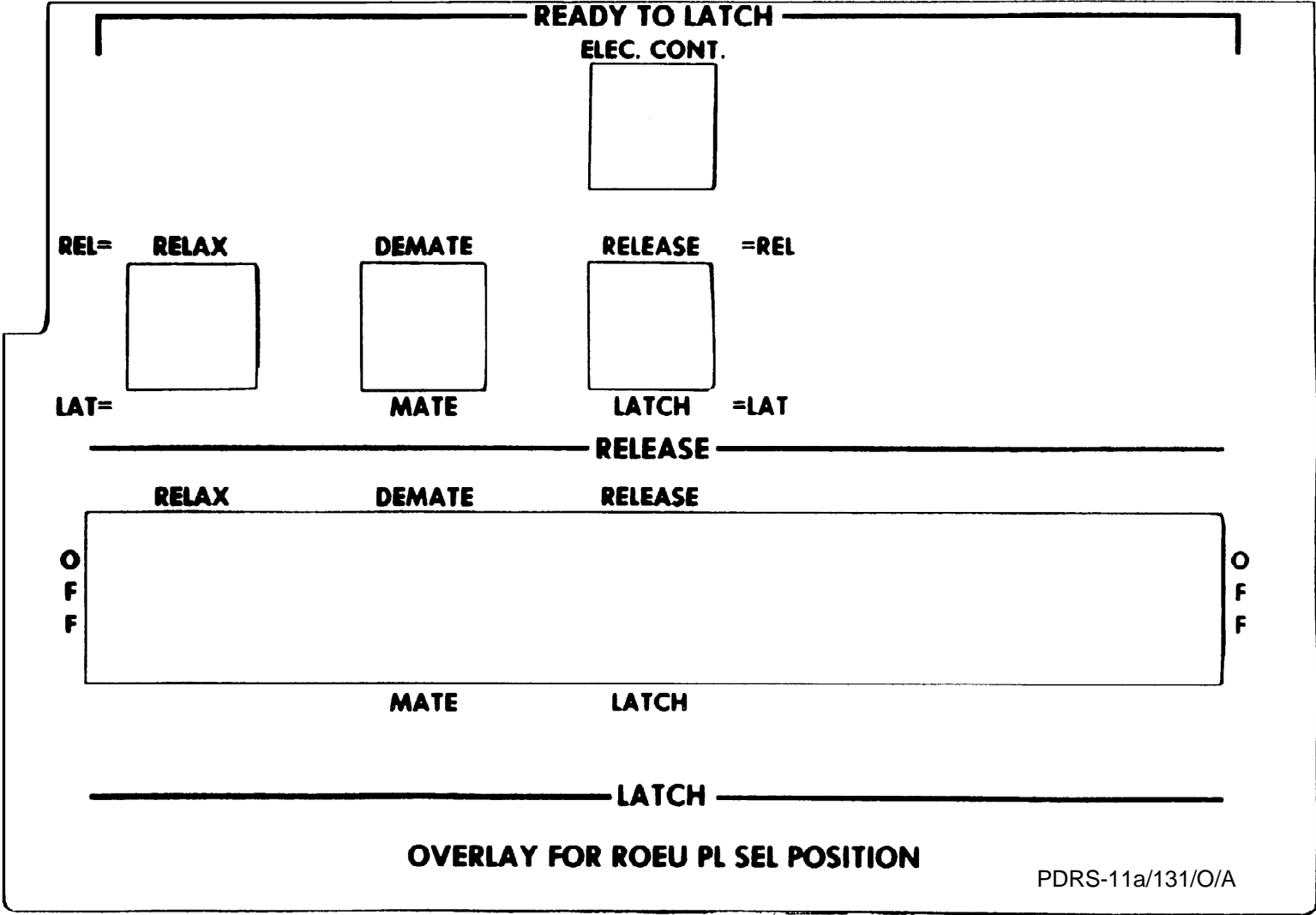

FS CC 4-4

PDRS/131/FIN

Space Shuttle Program
FLIGHT DATA FILE

JSC-48040-131
FINAL



PDRS OPS C/L

**STS
131**