

Payload Operations Checklist

STS-125

**Mission Operations Directorate
Operations Division**

**Final, Rev C
April 17, 2009**

National Aeronautics and
Space Administration

Lyndon B. Johnson Space Center
Houston, Texas

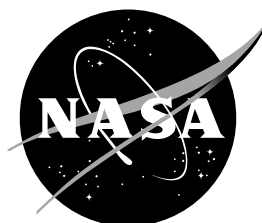

MISSION OPERATIONS DIRECTORATE

**PAYLOAD OPERATIONS CHECKLIST
STS-125**

FINAL, REVISION C
April 17, 2009

PREPARED BY:



Renee' M. Ross
Publication Manager

APPROVED BY:



Todd M. Batten
Technical Lead, Cargo Support
Planning Group



Roger A. Galpin
Chief, Cargo Integration and
Operations Branch



Kimberly Johnson
Manager, Flight Procedures



Mike Hurt
Flight Data File Manager

This document is under the configuration control of the Crew Procedures Control Board (CPCB). All proposed changes must be submitted via Change Request Workflow (CRW) to DO3/FDF Manager.

Additional distribution of this book, for official use only, may be requested in writing to DO3/PMO Administrator. The request must include justification and requester's name, organization, position, and phone number. Contractor requests are made through the NASA or DOD organization supported. Deletions, reduction in quantity, or change of address may be submitted to DO3/FDF Management Office, 281-244-1184.

Incorporates the following:			
482#:	PL OPS-1802A	PL OPS-1807	PL OPS-1812
	PL OPS-1803B	PL OPS-1808	PL OPS-1813
	PL OPS-1804	PL OPS-1809	PL OPS-1815
	PL OPS-1805	PL OPS-1810	PL OPS-1816
	PL OPS-1806	PL OPS-1811	

AREAS OF TECHNICAL RESPONSIBILITY

Publication Manager	DO35/R. Ross	281-244-1104
Alternate Publication Manager	DO35/T. Vaughan	281-483-4180
Payloads	DO5/T. Batten	281-244-0201

PAYLOAD OPERATIONS CHECKLIST
STS-125

LIST OF EFFECTIVE PAGES

FINAL 03/19/08
REV C 04/17/09

Sign Off	*	125/FIN C	3-9	125/FIN C
ii.....	*	125/FIN C	3-10	125/FIN C
iii.....	*	125/FIN C	3-11	125/FIN C
iv.....	*	125/FIN C	3-12	† 125/FIN C
v		125/FIN C	3-13	125/FIN C
vi.....		125/FIN C	3-14	125/FIN C
1-1		125/FIN C	3-15	125/FIN C
1-2		125/FIN C	3-16	125/FIN C
1-3		125/FIN C	3-17	125/FIN C
1-4		125/FIN C	3-18	125/FIN C
1-5		125/FIN C	3-19	125/FIN C
1-6		125/FIN C	3-20	125/FIN C
1-7		125/FIN C	4-1	125/FIN C
1-8		125/FIN C	4-2	125/FIN C
1-9		125/FIN C	4-3	125/FIN C
1-10		125/FIN C	4-4	125/FIN C
1-11		125/FIN C	4-5	125/FIN C
1-12		125/FIN C	4-6	125/FIN C
1-13		125/FIN C	4-7	125/FIN C
1-14		125/FIN C	4-8	125/FIN C
1-15		125/FIN C	4-9	125/FIN C
1-16		125/FIN C	4-10	125/FIN C
1-17		125/FIN C	5-1	125/FIN C
1-18		125/FIN C	5-2	125/FIN C
1-19		125/FIN C	5-3	125/FIN C
1-20		125/FIN C	5-4	125/FIN C
1-21		125/FIN C	5-5	125/FIN C
1-22		125/FIN C	5-6	125/FIN C
2-1		125/FIN C	5-7	125/FIN C
2-2		125/FIN C	5-8	125/FIN C
2-3		125/FIN C	5-9	125/FIN C
2-4		125/FIN C	5-10	125/FIN C
2-5		125/FIN C	5-11	125/FIN C
2-6		125/FIN C	5-12	125/FIN C
2-7		125/FIN C	5-13	125/FIN C
2-8		125/FIN C	5-14	125/FIN C
2-9		125/FIN C	5-15	125/FIN C
2-10		125/FIN C	5-16	125/FIN C
3-1		125/FIN C	5-17	125/FIN C
3-2		125/FIN C	5-18	125/FIN C
3-3		125/FIN C	5-19	125/FIN C
3-4	†	125/FIN C	5-20	125/FIN C
3-5		125/FIN C	5-21	125/FIN C
3-6		125/FIN C	5-22	125/FIN C
3-7		125/FIN C	5-23	125/FIN C
3-8		125/FIN C	5-24	125/FIN C

* – Omit from flight book
† – Color page in flight book

5-25	125/FIN C	7-1	125/FIN C
5-26	125/FIN C	7-2	125/FIN C
5-27	125/FIN C	7-3	125/FIN C
5-28	125/FIN C	7-4	125/FIN C
5-29	125/FIN C	8-1	125/FIN C
5-30	125/FIN C	8-2	125/FIN C
6-1	125/FIN C	9-1	125/FIN C
6-2	125/FIN C	9-2	125/FIN C
6-3 †	125/FIN C	10-1	* 125/FIN C
6-4	125/FIN C	CC 10-2	* † 125/FIN C
6-5	125/FIN C	CC 10-3	* 125/FIN C
6-6 †	125/FIN C	10-4	* 125/FIN C
6-7	125/FIN C		
6-8	125/FIN C		

PAYLOAD OPS CUE CARDS

<u>Title</u>	<u>Ref. Page</u>	<u>Card No.</u>
BIT SYNC ASSEMBLY (Front)	CC 10-2	PL OPS-1a/125/O/C
(Back).....	CC 10-3	PL OPS-1b/125/O/A

* – Omit from flight book
† – Color page in flight book

CONTENTS

	<u>PAGE</u>
<u>SSE ACT/FSS PREP</u>	1-1
SSE ACTIVATION	1-2
HST BSA INSTALL AND CONFIG	1-8
SSE CHECKOUT	1-9
FSS PREP FOR BERTHING	1-17
RNS ON-ORBIT CHECKOUT	1-20
<u>RETRIEVAL OPERATIONS</u>	2-1
PI CONFIG	2-2
LATCH AND MATE HST	2-3
ACTIVATE HST EXTERNAL PWR	2-10
<u>IN-BAY OPERATIONS</u>	3-1
SINGLE (DUAL) SA SLEW	3-2
ROTATE HST	3-3
PIVOT HST	3-7
HGA DEPLOYMENT	3-11
UNBERTH BSA CONFIG	3-13
FSS STOW WITH BSP INSTALLED	3-14
ACTIVATE HST ESS BUS INTERNAL PWR	3-17
SSE DEACT	3-18
<u>ORU/ORI OPERATIONS</u>	4-1
DEADFACE WFPC2	4-2
BAY 3 BATT PREP FOR REMOVAL	4-3
DEADFACE RSU/ECU	4-4
BAY 2 BATT PREP FOR REMOVAL	4-5
DEADFACE COSTAR	4-6
DEADFACE ACS	4-7
DEADFACE STIS	4-8
DEADFACE FGS-2	4-9
<u>CONTINGENCY OPERATIONS</u>	5-1
FSS STOW WITHOUT BSP	5-2
HST JETTISON FOR RAPID SAFE	5-5
SLIC JETTISON	5-10
ORUC JETTISON	5-12
ENABLE RNDZ NAV	5-14
POST REL RADAR ACQUISITION	5-14
POST REL RR NAV	5-14
BSP MECHANISM CHECKOUT	5-15
SSE CHECKOUT WITH FAILED MULE FMDM-A	5-16
EVA HARDWARE JETTISON	5-19
RAPID SAFING WITHOUT HST	5-24
RNS PWRDN	5-26
CONFIGURE PRIME COMM STRING FOR HST BSA	5-27
CONFIGURE PRIME COMM STRING FOR PSP-BYPASS (TURN-AROUND PLUG)	5-28
ENABLE RNS OP HTRS	5-29
<u>NATIONAL LAB PATHFINDER (NLP)</u>	6-1
NLP ACTIVATION	6-2
NLP TERMINATION	6-5

<u>DEORBIT PREP</u>	7-1
PAYLOAD DEACT	7-2
PAYLOAD ENTRY SW LIST/VERIF	7-2
PAYLOAD REACT	7-3
<u>HST QUICK RESPONSE</u>	8-1
SA SLEW (INADVERTENT)	8-2
<u>REFERENCE DATA</u>	9-1
DPC ON/OFF INDEX NUMBERS	9-2
<u>CUE CARD CONFIGURATION</u>	10-1

SSE ACT/FSS PREP

SSE ACTIVATION 1-2
HST BSA INSTALL AND CONFIG 1-8
SSE CHECKOUT..... 1-9
FSS PREP FOR BERTHING 1-17
RNS ON-ORBIT CHECKOUT..... 1-20

**SSE ACT/
FSS PREP**

SSE ACTIVATION

SSE ACT/
FSS PREP

- R1 1. PRIMARY PAYLOAD ACT
 √PL PRI MNC tb – ON
 √CAB – MNA
- L12U 2. FSS AND MULE FMDM-B PWR ON
 cb FSS/ORUC A SIDE PWR – cl
- FSS FMDM-B PWR – ON (tb-gray)
- * If FSS FMDM-B PWR tb – bp, cycle sw *
 - * If still no joy, continue *
- L11U cb MULE B SIDE PWR – cl
- MULE FMDM-B PWR – ON (tb-gray)
- * If MULE FMDM-B PWR tb – bp, cycle sw *
 - * If still no joy, continue *

SM 211 SSE OVERVIEW
 SM I/O RESET

- * If FSS FMDM-B PWR or MULE FMDM-B PWR tb – bp and 'I/O *
- * ERROR FLEX' msg, FMDM failed: *
- L12U * FSS FMDM-B PWR – OFF (tb-bp) *
- * FMDM-A PWR – ON (tb-gray) *
- L11U * MULE FMDM-B PWR – OFF (tb-bp) *
- * FMDM-A PWR – ON (tb-gray) *
- * *
- * SM 1 DPS UTILITY *
- * PORT ASSIGN STRING PL 1/2 SEC – ITEM 24 EXEC (*) *
- * If 'I/O ERROR FLEX' msg, go to *
- * 1.4a 'I/O ERROR FLEX' (PL SYS, SSE) *
- * If 'BCE BYP FLEX' msg, go to 1.4b 'BCE *
- * BYP FLEX' (PL SYS, SSE) *

3. VERIFY SSE STATUS

NOTE

Notify MCC of any parameter not in range, continue

SM 211 SSE OVERVIEW

- √PCU – blank/blank
- √CCTV ENA OFF – *
- √PWR OFF – *
- √COPE A HTR ZONE 1&2,3 (two) – (no *)
- √B HTR ZONE 1&2,3 (two) – (no *)
- √RNS ENA STAT – (no *)
- √AMPS: ≤ 0.6

POWER

√FSS EPDSU 1/2 AMPS (two):	< 3.0
√FMDM A/B AMPS:	< 0.15/0.5 to 1.1
√HTR	– blank/blank
√HTR P1/P2 AMPS (two):	< 0.4
√R1/R2 AMPS (two):	< 0.4
√CCTV HTR AMPS:	< 0.10
√ORUC	– blank/blank
√AMPS (two):	< 0.4
√MULE FMDM A/B AMPS:	< 0.15/0.7 to 1.3
√HTR	– (no *)
√HTR AMPS:	< 0.4
√COPE 1A/2A AMPS (two):	< 0.4
√1B&2B AMPS:	< 0.4
√3A/3B AMPS (two):	< 0.4
√SLIC EPDSU AMPS:	0.5 to 2.7
√FSS VOLTS (two):	24.0 to 32.0
√SLIC VOLTS (two):	24.0 to 32.0
√MULE VOLTS:	24.0 to 32.0

DPC

√DPC 1-12 (twelve):	– (no *)
√VOLTS (twelve):	< 0.5
√AMPS (twelve):	< 0.5

THERMAL

√FSS EPDSU TEMP (two):	-20 to 50 degC
√FMDM TEMP:	-3 to 55 degC (active FMDM only)
√PCU TEMP (two):	-20 to 50 degC
√IPCU TEMP:	-30 to 50 degC
√AMSB TEMP:	-20 to 50 degC
√MULE PDSU TEMP:	-20 to 50 degC
√FMDM TEMP:	-3 to 55 degC (active FMDM only)
√SLIC EPDSU TEMP (two):	-20 to 50 degC

4. FSS HEATER ACT

L12U FSS HTR PWR – PRI (tb-gray)

- * If tb – bp, cycle sw *
- * If still no joy, continue *

CRT √POWER FSS HTR – 1/2

- * If POWER FSS HTR NOT 1/2, go to 1.1a POWER *
- * FSS HTR NOT 1/2 (S211) (PL SYS, SSE) *

√POWER FSS HTR P1,P2 AMPS (two): ≤ 0.4

CRT * If POWER FSS HTR P1 AMPS: > 14 or POWER FSS HTR P2 *
 * AMPS: > 11, expect FDA, then *
 L12U * FSS HTR PWR – OFF (tb-bp), √MCC *
 * If POWER FSS HTR P1 AMPS: 0.4 to 14 or POWER FSS HTR P2 *
 * AMPS: 0.4 to 11, then *
 * notify MCC, continue *

L12U CCTV HTR PWR – ON (tb-gray)
 * If CCTV HTR PWR tb – bp, cycle sw *
 * If no joy, continue *

CRT √POWER FSS CCTV HTR AMPS: ≤ 0.9
 * If POWER FSS CCTV HTR AMPS: > 0.9, *
 L12U * CCTV HTR PWR – OFF (tb-bp), continue *

5. ORUC HTR ACT

L12U ORUC POWER CONTR A – ON (tb-gray)
 CONTR B – ON (tb-gray)
 * If either tb – bp, *
 * cycle sw *
 * If still no joy, continue *

CRT √POWER ORUC – A/B
 √AMPS (two): < 30
 √THERMAL ORUC PRJU TEMP (two): -20 to 50 degC

CRT * If POWER ORUC A or B AMPS > 30: expect FDA, then *
 L12U * ORUC POWER CONTR A or B – OFF (tb-bp) *
 * √MCC *

CRT * If POWER ORUC not A/B and associated tb – bp: *
 * ORUC A or B side failed *
 L12U * ORUC POWER CONTR A or B – OFF (tb-bp) *
 * Continue with loss of redundancy *
 * If POWER ORUC not A/B and associated tb – gray: *
 * Possible monitor failure *
 * Continue ops *

6. MULE/RNS SURVIVAL HEATER ACT

L11U SURV HTR B PWR – ON (tb-gray)
 * If SURV HTR PWR tb – bp, *
 * cycle sw *
 * If still no joy, continue *

CRT √POWER MULE HTR – *

- * If POWER MULE HTR NOT *, go to *
- * 1.1b POWER MULE HTR NOT * *
- * (S211) (PL SYS, SSE) *

√POWER MULE HTR AMPS: ≤ 0.5

L11U * If POWER MULE HTR AMPS: > 13, expect FDA, then *
* SURV HTR B PWR – OFF *
* √PWR tb – bp *
* √MCC *
* If POWER MULE HTR AMPS 0.5 to 13, then notify MCC, *
* continue *

L11U 7. MULE COPE HEATER ACT
MULE COPE HTR B PWR – ON (tb-gray)

- * If MULE COPE HTR B PWR tb – bp, *
- * cycle sw *
- * If still no joy: *
- * MULE COPE HTR B PWR – OFF (tb-bp) *
- * A PWR – ON (tb-gray) *

CRT √COPE B HTR ZONE 1&2,3 (two) – *
√POWER MULE COPE 1A/2A AMPS (two): ≤ 0.4
 √1B&2B AMPS: ≤ 6.0
 √3A/3B AMPS: ≤ 0.4/≤ 3.5

L11U * If POWER MULE COPE B AMPS not as expected: *
* expect FDA, then *
* MULE COPE HTR B PWR – OFF (tb-bp), *
* √MCC *
* If POWER MULE COPE A AMPS not as expected, *
* then notify MCC, continue *

L12L 8. SLIC PWR ON
cb SLIC A-SIDE PWR ENA – cl
SLIC B-SIDE PWR ENA – ON

9. WSIPE HTR A ON
WSIPE HTR A PWR – ON (tb-UP)

- * If WSIPE HTR A PWR tb – bp, cycle sw *
- * If still no joy: *
- * WSIPE HTR A PWR – OFF (tb-bp) *
- * B PWR – ON (tb-UP) *

CRT √POWER SLIC EPDSU AMPS: ≤ 9

L12L * If POWER SLIC EPDSU AMPS: > 9, *
* WSIPE HTR A PWR – OFF (tb-bp) *
* √MCC *

L12L 10. BPA STBD HTR B PWR ON
 BPA STBD HTR B PWR – ON (tb-gray)

- * If BPA STBD HTR B PWR tb – bp, *
- * cycle sw *
- * If still no joy: *
- * BPA STBD HTR B PWR – OFF (tb-bp) *
- * A PWR – ON (tb-gray) *

CRT $\sqrt{\text{POWER SLIC EPDSU AMPS: } \leq 11}$

- * If POWER SLIC EPDSU AMPS: > 11, *
- * BPA STBD HTR B PWR – OFF (tb-bp) *
- * $\sqrt{\text{MCC}}$ *

L12L

L12L 11. BPA PORT HTR A ON
 BPA PORT HTR A PWR – ON (tb-gray)

- * If BPA PORT HTR A PWR tb – bp, *
- * cycle sw *
- * If still no joy: *
- * BPA PORT HTR A PWR – OFF (tb-bp) *
- * B PWR – ON (tb-gray) *

CRT $\sqrt{\text{POWER SLIC EPDSU AMPS: } \leq 13}$

- * If POWER SLIC EPDSU AMPS: > 13, *
- * BPA PORT HTR A PWR – OFF (tb-bp), *
- * $\sqrt{\text{MCC}}$ *

L12L

L12L 12. SLIC EPDSU HTR PWR B ON
 SLIC EPDSU HTR PWR – B ON (tb-gray)

- * If SLIC EPDSU HTR PWR tb – bp, cycle sw *
- * If still no joy: *
- * SLIC EPDSU HTR PWR – OFF (tb-bp) *
- * – A ON (tb-gray) *

CRT $\sqrt{\text{POWER SLIC EPDSU AMPS: } \leq 16}$

- * If POWER SLIC EPDSU AMPS: > 16, *
- * SLIC EPDSU HTR PWR – OFF (tb-bp) *
- * $\sqrt{\text{MCC}}$ *

L12L

L11U 13. RNS PWR ENA
 RNS PWR – ENA (tb-gray)

- * If RNS PWR (tb-bp), *
- * cycle sw *
- * If still no joy, continue *

CRT $\sqrt{\text{RNS AMPS: } \leq 1.0}$

- * If RNS AMPS: > 1.0 *
- * RNS PWR – DIS (tb-bp), *
- * $\sqrt{\text{MCC}}$ *

L11U

14. VERIFY MECHANISM STATUS

SM 212 SSE MECH/BPA/RNS

- √AMSB OFF – *
- √AMSB AC AMPS: < 0.20
- √AMSB TEMP: -20 to 50 degC
- √MECH – blank
 - √PIVOT LO TACH: < 0.25 deg/min
 - √ROTATOR TACH: < 0.9 deg/min

15. VERIFY BATT PLATE TEMPERATURE

- √BATT PLATE TEMP PORT-FWD: -20.0 to 50.0 degC
 - √PORT-AFT: -20.0 to 50.0 degC
 - √STBD-FWD: -20.0 to 50.0 degC
 - √STBD-AFT: -20.0 to 50.0 degC

16. VERIFY RNS STATUS

- √RNS ICE VOLTS: 24.0 to 32.0
 - √TEMP: -20.0 to 50.0 degC
- √RNS OP HTR OFF – *
 - √AMPS: < 0.4
- √RNS SP-CUBE OFF – *
 - √AMPS: < 0.4
- √RNS SENSORS OFF – *
 - √AMPS: < 0.4

17. RNS TM ACTIVATION

SM 212 SSE MECH/BPA/RNS

RNS TM ON – ITEM 25 EXEC

√RNS AMPS: ≤ 1.3

- * If RNS AMPS > 1.3, *
- * record value and turn OFF TM: *
- * RNS TM OFF – ITEM 26 EXEC *
- * √MCC *

√RNS FRM CNT: INCR

- * If RNS FRM CNT not incrementing, *
- * RNS TM OFF – ITEM 26 EXEC *
- * RNS TM ON – ITEM 25 EXEC *
- * If still no joy, √MCC *

√RNS MSM1 OFF – *

√MSM2 OFF – *

Notify MCC, SSE ACTIVATION complete; report any anomalies

HST BSA INSTALL AND CONFIG

1. UNSTOW BSA AND CABLES
MA16D Remove BSA SN 001F from storage locker
BSA √POWER – OFF
MO13Q √DC UTIL PWR MNB – OFF

2. VERIFY CONNECTORS DEADFACED FOR BSA INSTALLATION
L12L √PSP BY-PASS – DISABLE

3. CONFIGURE PDIP1 PI CONNECTORS
L12L Remove: HST PI 1(2) Turn-around Plug
Connect: BSA 14 foot data cable to PDIP1 HST PI 1(2)
BSA Connect: BSA 14 foot data cable to BSA data port
Connect: BSA power cable to BSA power port

4. CONFIGURE BSA FRONT PANEL
RATE SW – up 32k
POLARITY – Norm
WATCHDOG – Dis

5. BSA POWERUP AND LED VERIFICATION
MO13Q DC UTIL PWR MNB – ON

BSA POWER – ON
√All LEDs illuminate for 4 sec

* If pwr to BSA fails (PWR LED not illuminated): *
* Check pwr cable connection *
* If pwr cable connection OK, *
* √MCC *
* POWER – OFF (wait 5 sec) *
* POWER – ON *
* If no joy, √MCC *

- After LED check:
√POWER (four) – Green
√SEARCH – Yellow
√SIGNAL LOSS – Red

* If PWR/SEARCH/SIGNAL LOSS *
* do not match this pattern, √MCC *

- Velcro BSA to desired location, install BSA Cue Card to exterior of BSA

6. BSA PWR OFF
BSA POWER – OFF

Notify MCC, HST BSA INSTALL AND CONFIG complete

SSE CHECKOUT

1. SSP INTERFACE CHECKS

SM 211 SSE OVERVIEW

PCU ON – ITEM 1 EXEC (*)
√PCU – P/S
√DPC 1-12 (twelve): – *
 √VOLTS (twelve): 33.7 to 35.5
 √AMPS (twelve): ≤ 0.5

- * If any DPC 1-12 (twelve) AMPS: > 0.5, turn off affected DPC *
- * DPC OFF – ITEM 24 +X X EXEC (no *) *
- * (Refer to DPC ON/OFF INDEX NUMBERS (REFERENCE DATA)), *
- * √MCC *
- * If any other param(s) not in range, record MET and off nominal *
- * DPC values; notify MCC *
- * Continue *

NOTE

If any parameters out of limits, note and continue

L12U cb SPACE TEL SW PWR – cl
 ESS/MN SW ENA – ON (tb-gray)
 MAIN BUS EXT PWR – ON (expect no tb)
√IPC U RLY CL tb – gray
 MAIN BUS EXT PWR – OFF
√IPC U RLY CL tb – bp
 ESS/MN SW ENA – OFF (tb-bp)
 RSU SURV HTR PWR – ON (tb-gray)
 – OFF (tb-bp)
 FHST SHUTTER – CLOSE (tb-gray)
 – OPEN (tb-bp)

CRT PCU OFF – ITEM 2 EXEC (*)
√PCU – blank/blank
√DPC 1-12 (twelve) – (no *)

L12U FSS PCU PWR CONTR A – ON
CRT √DPC 1-12 (twelve) – *

L12U FSS PCU PWR CONTR A – OFF
CRT √DPC 1-12 (twelve) – (no *)

L12U FSS PCU PWR CONTR B – ON
CRT √DPC 1-12 (twelve) – *

L12U FSS PCU PWR CONTR B – OFF
CRT √DPC 1-12 (twelve) – (no *)

2. FSS CCTV CHECK

CCTV ENA ON – ITEM 3 EXEC (*)
PWR ON – ITEM 5 EXEC (*)

- * If CCTV ENA ON does not indicate ‘*’, *
- * re-exec ITEM 3. If still no ‘*’, continue *

- * If CCTV PWR ON does not indicate ‘*’, *
- * re-exec ITEM 5. If still no ‘*’, attempt to *
- * display Camr image on monitor. If no *
- * image, √MCC *

R12 (VPU) √Green Jumper – FSS
 √VPU PWR – ON (LED on)

A7U VID OUT MON 1(2) pb – push
 IN PL2 pb – push
 √FSS Camr Placard installed
 ALC AVG pb – push
 GAMMA NORM pb – push

Mon 1(2) √FSS Camr Image to verify Camr operational

CRT CCTV PWR OFF – ITEM 6 EXEC (*)
 * If CCTV PWR OFF not ‘*’, *
 * do not perform CCTV ENA – OFF *
 * Proceed to step 3 *

Wait 15 sec,
 CCTV ENA OFF – ITEM 4 EXEC (*)

3. FSS AMSB CHECKOUT

A6U √PL RETEN LAT 1,2 (two) – OFF
 √LOGIC PWR SYS 1,2 (two) – OFF
 √PL SEL – 1

R13L √PL BAY MECH PWR SYS 1,2 (two) – OFF

SM 212 SSE MECH/BPA/RNS

AMSB ON – ITEM 7 EXEC (B)

* If AMSB ON – blank, *
 * record and continue *

√AMSB AC AMPS: < 0.20
 √MECH – blank
 √SEL (ITEMS 9-19) (eleven) – (no *)
 √STAT (ITEMS 9-19) (eleven) – blank
 √PIVOT LO TACH: < 0.25 deg/min
 √ROTATOR TACH: < 0.9 deg/min
 √O/R DIS (ITEM 22) – *

* If any parameter out of limit, √MCC *

Perform following ITEM entries and checks per table

NOTE

SEL field should show ‘*’ only for MECHANISM selected. For any parameters not as expected, do not deselect; contact MCC

ITEM EXEC	MECHANISM	SEL	STAT	AMSB DC AMPS	MECH	SM 97 PL SEL 1, LAT/REL LATCH 2
9	DLOCK	9 – *	ENG	0.035-0.125	B	01/00
Expect ‘S212 AMSB DC AMPS’ msg						
21	O/R ENA (*)	9 – *	RDY	0.130-0.230		00/00
11	PIVOT LO	11 – *	DN	0.035-0.125	B	00/01
Expect ‘S212 AMSB DC AMPS’ msg						
21	O/R ENA (*)	11 – *	RDY	0.130-0.230		00/00
22	O/R DIS (*)	11 – *	DN	0.035-0.125	B	00/01
12	ROTATOR	12 – *	RDY	0.035-0.125		00/00
14	B LAT 1	14 – *	OP	0.035-0.125	B	00/01
15	B LAT 2	15 – *	OP	0.035-0.125	B	00/01
16	B LAT 3	16 – *	OP	0.035-0.125	B	00/01
17	UMB MN	17 – *	REL	0.035-0.125	B	00/01
18	UMB B/U	18 – *	MAT	0.035-0.125	B	01/00
19	BSP	19 – *	SET	0.035-0.125	B	01/00
20	DESEL	9-19 blank		< 0.035		00/00

4. B SIDE UMBILICAL TEST

CAUTION

Operating the umbilical in a stalled condition for greater than 30 sec may result in damage to unit. An umbilical stall condition is indicated by AMSB AC AMPS > 0.6 and no mechanism motion

Perform FSS UMBILICAL SURVEY (PDRS OPS FS, PHOTO SURVEYS)

CCTV Monitor UMB MN operations

A6U PL RETEN LOGIC PWR SYS 2 – ON

R13L PL BAY MECH PWR SYS 2 – ON

CRT MECH UMB MN SEL – ITEM 17 EXEC (* REL)
√AMSB DC AMPS: 0.035 to 0.125
√MECH – steady B

A6U PL RETEN LAT 2 – LAT

CRT √MECH – flashing B
√AMSB AC AMPS: 0.6 to 1.1
√MECH UMB MN STAT – RDY

* If stall condition observed (AMSB AC AMPS *
* > 0.6 and no mechanism motion): *
* PL RETEN LAT 2(1) – OFF *
* √MCC *

Wait 8 sec

A6U √MECH UMB MN STAT – MAT
PL RETEN LAT 2 – OFF

CRT √MECH – steady B

CCTV Visually verify UMB in mated posn

A6U PL RETEN LAT 2 – REL

CRT √MECH – flashing B
√AMSB AC AMPS: 0.6 to 1.1
√MECH UMB MN STAT – RDY

* If stall condition observed (AMSB AC AMPS *
* > 0.6 and no mechanism motion): *
* PL RETEN LAT 2(1) – OFF *
* √MCC *

Wait 8 sec

√MECH UMB MN STAT – REL

A6U PL RETEN LAT 2 – OFF

CRT √MECH – steady B
 CCTV Visually verify UMB in released posn
 CRT MECH DESEL – ITEM 20 EXEC (√ITEMS 9-19 (eleven) – (no *))
 √AMSB DC AMPS: < 0.035
 OFF – ITEM 8 EXEC (*)

R13L PL BAY MECH PWR SYS 2 – OFF
 A6U RETEN LOGIC PWR SYS 2 – OFF

Notify MCC of any anomalies in SSE CHECKOUT prior to next step

5. SSE SWAP TO A SIDE

L12U FSS FMDM-A PWR – ON (tb-gray)

- * If FSS FMDM-A PWR tb – bp, *
- * cycle sw *
- * If still no joy, continue *

SM 211 SSE OVERVIEW

√POWER FSS FMDM A/B AMPS (two): 0.5 to 1.1

L11U MULE FMDM-A PWR – ON (tb-gray)

- * If MULE FMDM-A PWR tb – bp, *
- * cycle sw *
- * If still no joy, continue *

CRT √POWER MULE FMDM A/B AMPS (two): 0.7 to 1.3

SM1 DPS UTILITY

PORT ASSIGN STRING PL 1/2 SEC – ITEM 24 EXEC (*)

- * If FSS FMDM-A PWR tb – bp and accompanied by *
- * 'I/O ERROR FLEX' msg, FSS FMDM-A failed: *
- * PORT ASSIGN STRING PL 1/2 PRI – ITEM 23 EXEC (*), *
- L12U * FSS FMDM-A PWR – OFF (tb-bp) *
- L11U * MULE FMDM-A PWR – OFF (tb-bp) *
- * √MCC *
- * If MULE FMDM-A PWR tb – bp and accompanied by *
- * 'I/O ERROR FLEX' msg, MULE FMDM-A failed. MULE *
- * FMDM-A PWR – OFF (tb-bp). Go to SSE CHECKOUT *
- * WITH FAILED MULE FMDM-A (CONTINGENCY OPERATIONS) *

L11U 6. MULE/RNS SURVIVAL A HEATER ACT
 SURV HTR A PWR – ON
 B PWR – OFF
 √PWR tb – gray

- * If SURV HTR PWR tb – bp, *
- * cycle SURV HTR A PWR sw *
- * If still no joy, continue *

SM 211 SSE OVERVIEW

√POWER MULE HTR – *

- * If POWER MULE HTR not *, *
- * go to 1.1b POWER MULE HTR *
- * NOT * (S211) (PL SYS, SSE) *

√POWER MULE HTR AMPS: ≤ 0.5

L11U * If POWER MULE HTR AMPS: > 13, expect FDA, then *

* SURV HTR A PWR – OFF *

* √PWR tb – bp *

* √MCC *

* If POWER MULE HTR AMPS 0.5 to 13, *

* then notify MCC, continue *

L11U 7. MULE COPE-A HEATER ACT
 MULE COPE HTR A PWR – ON (tb-gray)

- * If MULE COPE HTR A PWR *
- * tb – bp, cycle sw *
- * If still no joy, continue *

CRT √COPE A HTR ZONE 1&2,3 (two) – *

√POWER MULE COPE 1A/2A AMPS (two): ≤ 3.5
 √1B&2B AMPS: ≤ 6.0
 √3A/3B AMPS (two): ≤ 3.5

L11U * If any MULE COPE AMPS not as expected, *

* expect FDA, then *

* MULE COPE HTR A PWR – OFF (tb-bp), *

* proceed to step 8 *

L11U MULE COPE HTR B PWR – OFF (tb-bp)

8. VERIFY SSE STATUS

NOTE

If any parameter not in range, do not perform step 9; notify MCC

CRT √PCU – blank/blank
 √PCU OFF – *
 √CCTV ENA OFF – *
 √PWR OFF – *

✓COPE A HTR ZONE 1&2,3 (two) – *
 ✓B HTR ZONE 1&2,3 (two) – blank
 ✓RNS ENA STAT – *
 ✓AMPS: ≤ 1.0

POWER

✓FSS EPDSU 1/2 AMPS (two): < 3.0
 ✓FMDM A/B AMPS (two): 0.5 to 1.1
 ✓HTR – 1/2
 ✓HTR P1/P2 AMPS (two): < 0.4
 ✓R1/R2 AMPS (two): < 0.4
 ✓CCTV HTR AMPS: < 0.9
 ✓ORUC – A/B
 ✓AMPS (two): < 30.0
 ✓MULE FMDM A/B AMPS (two): 0.7 to 1.3
 ✓HTR – *
 ✓HTR AMPS: ≤ 0.5
 ✓COPE 1A/2A AMPS (two): < 3.5
 ✓1B&2B AMPS: < 0.4
 ✓3A/3B AMPS: < 3.5/< 0.4
 ✓SLIC EPDSU AMPS: < 16
 ✓FSS VOLTS (two): 24.0 to 32.0
 ✓SLIC VOLTS (two): 24.0 to 32.0
 ✓MULE VOLTS: 24.0 to 32.0

DPC

✓DPC 1-12 (twelve) – (no *)
 ✓VOLTS (twelve): < 0.5
 ✓AMPS (twelve): < 0.5

THERMAL

✓FSS EPDSU TEMP (two): -20 to 50 degC
 ✓FMDM TEMP (two): -3 to 55 degC
 ✓PCU TEMP (two): -20 to 50 degC
 ✓IPCU TEMP: -30 to 50 degC
 ✓AMSB TEMP: -20 to 50 degC
 ✓ORUC PRJU TEMP (two): -20 to 50 degC
 ✓MULE PDSU TEMP: -20 to 50 degC
 ✓FMDM TEMP (two): -3 to 55 degC
 ✓SLIC EPDSU TEMP (two): -20 to 50 degC

9. FMDM-B PWRDN

NOTE

RNS TM will turn off on next step,
 expect RNS PDI data to be invalid

- L11U MULE FMDM-B PWR – OFF (tb-bp)
 * If tb – gray, note and continue *
- L12U FSS FMDM-B PWR – OFF (tb-bp)
 * If tb – gray, note and continue *
- CRT ✓POWER FSS FMDM A/B AMPS: 0.5 to 1.1/< 0.15
 ✓MULE FMDM A/B AMPS: 0.7 to 1.3/< 0.15

10. FSS PCU CHECKOUT

PCU ON – ITEM 1 EXEC (*)

√PCU – P/S

√DPC 1-12 (twelve) – *

√VOLTS (twelve): 33.7 to 35.5

√AMPS (twelve): ≤ 0.5

* If DPC 1-12 (twelve) AMPS > 0.5, *

* PCU OFF – ITEM 2 EXEC(*) *

* √MCC *

PCU OFF – ITEM 2 EXEC (*)

√PCU – blank/blank

√DPC 1-12 (twelve) – (no *)

11. REACTIVATE RNS TM

SM 212 SSE MECH/BPA/RNS

RNS TM ON – ITEM 25 EXEC

√RNS AMPS: ≤ 1.3

* If RNS AMPS > 1.3, record value and turn OFF TM: *

* RNS TM OFF – ITEM 26 EXEC *

* √MCC *

√RNS FRM CNT: INCR

* If RNS FRM CNT not incrementing, *

* RNS TM OFF – ITEM 26 EXEC *

* RNS TM ON – ITEM 25 EXEC *

* If still no joy, √MCC *

√RNS MSM1 OFF – *

√MSM2 OFF – *

12. VERIFY MECH STATUS

√AMSB OFF – *

√AC AMPS: < 0.20

√TEMP: -20 to 50 degC

√MECH – blank

√PIVOT LO TACH: < 0.25 deg/min

√ROTATOR TACH: < 0.9 deg/min

13. AMSB CHECKOUT SIDE A

A6U

√PL RETEN LAT 1,2 (two) – OFF

√LOGIC PWR SYS 1,2 (two) – OFF

√PL SEL – 1

R13L

√PL BAY MECH PWR SYS 1,2 (two) – OFF

CRT

AMSB ON – ITEM 7 EXEC (A)

* If AMSB ON – blank, *

* record and continue *

√AMSB AC AMPS: < 0.20

√MECH – blank

√SEL (ITEMS 9-19) (eleven) – (no *)

√STAT (ITEMS 9-19) (eleven) – blank

√PIVOT LO TACH: < 0.25 deg/min

√ROTATOR TACH: < 0.9 deg/min

√O/R DIS (ITEM 22) – *

* If any parameter out of limit, *

* √MCC *

Perform following ITEM entries and checks per table

NOTE

SEL field should show ‘*’ only for MECHANISM selected. For any parameters not as expected, do not deselect; contact MCC

ITEM EXEC	MECHANISM	SEL	STAT	AMSB DC AMPS	MECH	SM 97 PL SEL 1, LAT/REL LATCH 1
9	DLOCK	9 – *	ENG	0.035-0.125	A	10/00
Expect ‘S212 AMSB DC AMPS’ msg						
21	O/R ENA(*)	9 – *	RDY	0.130-0.230		00/00
11	PIVOT LO	11 – *	DN	0.035-0.125	A	00/10
Expect ‘S212 AMSB DC AMPS’ msg						
21	O/R ENA (*)	11 – *	RDY	0.130-0.230		00/00
22	O/R DIS (*)	11 – *	DN	0.035-0.125	A	00/10
12	ROTATOR	12 – *	RDY	0.035-0.125		00/00
14	B LAT 1	14 – *	OP	0.035-0.125	A	00/10
15	B LAT 2	15 – *	OP	0.035-0.125	A	00/10
16	B LAT 3	16 – *	OP	0.035-0.125	A	00/10
17	UMB MN	17 – *	REL	0.035-0.125	A	00/10
18	UMB B/U	18 – *	MAT	0.035-0.125	A	10/00
19	BSP	19 – *	SET	0.035-0.125	A	10/00
20	DESEL	9-19 blank		< 0.035		00/00

AMSB OFF – ITEM 8 EXEC (*)

Notify MCC, SSE CHECKOUT complete; report any anomalies

FSS PREP FOR BERTHING

1. FSS AMSB PWR ON

A6U √PL RETEN LAT 1,2 (two) – OFF
 √LOGIC PWR SYS 2(1) – OFF
 √PL SEL – 1
 LOGIC PWR SYS 1(2) – ON

SM 212 SSE MECH/BPA/RNS
AMSB ON – ITEM 7 EXEC (A(B))

* If AMSB ON – blank, *
* record and continue *

√MECH – blank
√SEL (ITEMS 9-19) (eleven) – (no *)
√STAT (ITEMS 9-19) (eleven) – blank
√O/R DIS (ITEM 22) – *

* If any param not as expected, √MCC *

R13L PL BAY MECH PWR SYS 1(2) – ON

2. BAPS DOWNLOCK RELEASE

CAUTION
Operating the downlock in a stalled condition for greater than 30 sec may result in damage to unit. A stalled condition is indicated by AMSB AC AMPS > 1.0 and no mechanism motion

CCTV Configure CCTV to monitor downlock ops, P/TV03 FSS OPS (PHOTO/TV FS, SCENES)

CRT MECH DLOCK SEL – ITEM 9 EXEC (* ENG)

* If MECH DLOCK STAT – *, then EOT sw failed: *
* O/R ENA – ITEM 21 EXEC (*) and continue *
* operation of downlock until observed clear of *
* BAPS pin or 20 sec max *
* Expect '212 AMSB DC AMPS' msg *
* Expect no MECH – A(B) and PL RETEN LAT 1 *
* tb-bp indications below *
* If MECH DLOCK STAT – RDY, continue *

√AMSB DC AMPS: 0.035 to 0.125
√MECH – steady A(B)

A6U √PL RETEN LAT 1 tb – LAT (A side only)
 1(2) – REL (tb-bp)

CRT √MECH – flashing A(B)
√AMSB AC AMPS: 1.0 to 2.5
√MECH DLOCK STAT – RDY

* If MECH DLOCK STAT – ENG, then BOT sw failed, *
* continue *
* Expect '*' *

- * If stall condition observed at any time during *
- * mechanism operations (AMSB AC AMPS > 1.0 *
- * and no mechanism motion) immediately perform: *
- * PL RETEN LAT 1(2) – OFF *
- * √MCC *

Wait 24 sec

√MECH DLOCK STAT – DIS

- A6U
- * If DLOCK STAT – RDY after 30 total sec: *
 - * PL RETEN LAT 1(2) – OFF *
 - * Perform 1.3a PRIMARY MOTOR FAILS TO *
 - * DRIVE MECHANISM (PL SYS, SSE) *

A6U √PL RETEN LAT 1 tb – REL (A side only)
1(2) – OFF

CRT √MECH – steady A(B)

CCTV Visually verify DLOCK clear of BAPS pin

3. PIVOT BAPS UP FOR BERTHING

CAUTION
 Operating the pivoter in a stalled condition for greater than 30 sec may result in damage to unit. A stalled condition is indicated by AMSB AC AMPS > 0.3 and no mechanism motion

CCTV Configure CCTV to monitor pivot ops, P/TV03 FSS OPS (PHOTO/TV FS, SCENES)

CRT MECH PIVOT LO SEL – ITEM 11 EXEC (* DN)

- * If MECH PIVOT LO STAT – *, EOT sw failed: *
- * MECH DESEL – ITEM 20 EXEC (ITEM 11 – (no *)) *
- * Perform SSE SSR-1 FMDM SWAP A→B(B→A) *
- * (PL SYS, SSE) and repeat step 3 for alt side *
- * If MECH PIVOT LO STAT – RDY, continue *

√AMSB DC AMPS: 0.035 to 0.125

√MECH – steady A(B)

A6U √PL RETEN LAT 1 tb – REL (A side only)
1(2) – LAT (tb-bp)

Start Timer

CRT √MECH – flashing A(B)
√AMSB AC AMPS: 0.3 to 0.7
√MECH PIVOT LO STAT – RDY

- * If MECH PIVOT LO STAT – DN, BOT sw failed, *
- * continue *
- * Expect '*' in 23.8 min *

CCTV Visually verify BAPS motion, monitor performance

CRT √MECH PIVOT LO TACH: > 2.5 deg/min

A6U * If FDA 'S212 PVT STALL' received, *
* PL RETEN LAT 1(2) – OFF, *
* perform 1.3e 'S212 PVT(ROT) STALL' *
* (PL SYS, SSE) *

* If MECH PIVOT LO TACH: < 0.25 deg/min and *
* AMSB AC AMPS: < 0.2, PL RETEN LAT 1(2) – OFF, *
* perform 1.3a 'PRIMARY MOTOR FAILS TO DRIVE *
* MECHANISM' (PL SYS, SSE) *

CRT √MECH PIVOT LO STAT – UP

A6U √PL RETEN LAT 1 tb – LAT (A side only)
1(2) – OFF

Stop Timer
Record pivot time _____:_____

CRT √MECH – steady A(B)

CCTV Visually verify BAPS properly positioned

Notify MCC of pivot duration

CRT 4. AMSB PWRDN
MECH DESEL – ITEM 20 EXEC (ITEMS 9-19 (eleven) – (no *))

* If any MECH SEL – *, do not turn AMSB – OFF; *
* notify MCC, continue *

√AMSB DC AMPS: < 0.035
OFF – ITEM 8 EXEC (*)

R13L PL BAY MECH PWR SYS 1(2) – OFF

A6U PL RETEN LOGIC PWR SYS 1(2) – OFF

Notify MCC, FSS PREP FOR BERTHING complete; report any deviation

RNS ON-ORBIT CHECKOUT

CAUTION

Do not proceed without MCC GO. Potential hardware damage if activated outside of operational temperature

On MCC GO:

1. RNS OPS ACTIVATION

SM 212 SSE MECH/BPA/RNS

RNS OPS ON – ITEM 37 EXEC

√RNS AMPS: 2.8 to 13.0

√RNS MSM1 ON – *
√MSM2 ON – *
√OP HTR ON – *
√AMPS: < 8.5
√SP-CUBE ON – *
√AMPS: 1.0 to 2.0
√SENSORS ON – *
√AMPS: 0.8 to 1.8

Start timer

2. RNS DATA RECORD

NOTE

Wait for MSM hard drives to be powered sequentially

Wait 2.5 min

L11U RNS CAM REC – START (tb-UP)

* If RNS CAM REC (tb-bp), *
* note and continue *

RNS GPS REC – START (tb-UP)

* If RNS GPS REC (tb-bp), *
* note and continue *

NOTE

Ground will acquire RNS data for 30 sec

Wait 30 sec

RNS CAM REC – STOP (tb-bp)
GPS REC – STOP (tb-bp)

3. RNS OPS DEACTIVATION

SM 212 SSE MECH/BPA/RNS

RNS OPS OFF – ITEM 38 EXEC

√RNS AMPS:	≤ 1.3
√MSM1 OFF	– *
√MSM2 OFF	– *
√OP HTR OFF	– *
√AMPS:	< 0.4
√SP-CUBE OFF	– *
√AMPS:	< 0.4
√SENSORS OFF	– *
√AMPS:	< 0.4

Notify MCC, RNS ON-ORBIT CHECKOUT complete; report any anomalies

This Page Intentionally Blank

RETRIEVAL OPERATIONS

PI CONFIG..... 2-2
LATCH AND MATE HST 2-3
ACTIVATE HST EXTERNAL PWR..... 2-10

RETRIEVAL
OPERATIONS

PI CONFIG

1. √PDI CONFIG

SM 62 PCMMU/PL COMM

√TFL: 206

√PDI config 768

DECOM	INPUT	FMT	SOURCE
1	1(2)	10	4 kbps A Normal
2	1(2)	18	32 kbps INV T
3	4	28	4 kbps RNS
4	1(2)	19	32 kbps T Normal
5-FPM	(510)		

2. CONFIG PL COMM

- √cb SW PWR – cl
- L12L PSP BY-PASS – ENABLE
- A1U SIGNAL STRENGTH – S-BAND PL
- A1L
 - √S-BD PL CNTL – CMD
 - √ANT POLAR – L CIRC
 - √XMTR PWR – LO
 - √PWR SYS – 1(2)
 - √PSP CMD OUTPUT – PL UMB
 - √MOD – OFF
 - CH SEL INTRG 1,2 tw (six) – 701,701
 - PWR SEL – BOTH

3. BSA PWR ON POWER – ON

- √POWER (four) – Green
- √SEARCH – Yellow
- √SIGNAL LOSS – Red

4. VERIFY BSA CONFIG SETUP

- √RATE SW – up 32k
- √POLARITY – Norm
- √WATCHDOG – Dis
- RESET pb – push

Notify MCC, "BSA is configured for RNDZ"

NOTE

Step 5 will occur after HST Berth

5. POST BERTH BSA CONFIG

- BSA
 - RATE SW – ctr (AUTO led – Green)
 - WATCHDOG – En
 - RESET pb – push
- √SYNC – Frame – Green

LATCH AND MATE HST

WARNING

Operation of two FSS mechanisms may result in HST collision with orbiter

For any SM ALERT during FSS ops:

A6U PL RETEN LAT 1,2 (two) – OFF
R13 PL BAY MECH PWR SYS 1,2 (two) – OFF
√MCC

CAUTION

Operating a berthing latch in a stalled condition for greater than 30 sec may result in damage to unit. A stalled condition is indicated by AMSB AC AMPS > 1.0 and no mechanism motion

1. AMSB PWR ON

A6U √PL RETEN LAT 1,2 (two) – OFF
√LOGIC PWR SYS 1(2) – OFF
√PL SEL – 1
LOGIC PWR SYS 1(2) – ON

SM 212 SSE MECH/BPA/RNS

AMSB ON – ITEM 7 EXEC (A(B))

* If AMSB ON – blank, continue *

√MECH – blank
√SEL (ITEMS 9-19) (eleven) – (no *)
√STAT (ITEMS 9-19) (eleven) – blank
√O/R DIS (ITEM 22) – *

* If any param not as expected, AMSB OFF – ITEM 8 EXEC *
* (*), and perform SSE SSR-1 FMDM SWAP A→B(B→A) *
* (PL SYS, SSE), then proceed to step 2 on alt side *

R13L PL BAY MECH PWR SYS 1(2) – ON
Go to HST BERTH, step 4 (PDRS OPS FS, NOMINAL HST RETRIEVAL)
or SJ HST BERTH, step 6 (PDRS OPS FS, OFF-NOMINAL HST RETRIEVAL)

2. BERTH LAT 2 PARTIAL CLOSURE

CCTV Verify with RMS operator that HST is in latch posn
Perform P/TV04 HST RETRIEVE/BERTH, OPS, HST BERTH, LATCHING
(PHOTO/TV FS, SCENES)
CAMR B(C) √Berth latch 2 align and monitor operations
Start VTR

√DAP: FREE

CRT MECH B LAT 2 SEL – ITEM 15 EXEC (* OP)

- * If MECH B LAT 2 STAT – * and visually observed open, *
- * then EOT sw failed: *
- * MECH DESEL – ITEM 20 EXEC (ITEMS 9-19 (eleven) – (no *)) *
- * Perform SSE SSR-1 FMDM SWAP A→B(B→A) (PL SYS, SSE) *
- * and complete steps 2-9 on alt side *
- * If MECH B LAT 2 STAT – RDY, continue *

√AMSB DC AMPS: 0.035 to 0.125

√MECH – steady A(B)

A6U √PL RETEN LAT 1 tb – REL (A side only)
1(2) – LAT (tb-bp), drive to cage ~8 sec

CRT √MECH – flashing A(B)
√AMSB AC AMPS: 1.0 to 2.5

A6U * If stall condition observed (AMSB AC AMPS *
* > 1.0 and no mechanism motion): *
* PL RETEN LAT 1(2) – OFF *
* √MCC *

A6U PL RETEN LAT 1(2) – OFF

CRT √MECH B LAT 2 STAT – RDY
√MECH – blank

CCTV √Latch 2 cages berthing pin

* If latch not caging berthing pin, perform *
* 1.3a PRIMARY MOTOR FAILS TO *
* DRIVE MECHANISM (PL SYS, SSE) *

3. BERTH LAT 1 PARTIAL CLOSURE

CCTV √Berth LAT 1 align and monitor operations
CAMR C(D)

CRT MECH B LAT 1 SEL – ITEM 14 EXEC (* OP)

- * If MECH B LAT 1 STAT – * and visually observed open, *
- * then EOT sw failed: *
- * MECH DESEL – ITEM 20 EXEC (ITEMS 9-19 (eleven) – (no *)) *
- * Perform SSE SSR-1 FMDM SWAP A→B(B→A) (PL SYS, SSE) *
- * and complete steps 3-9 on alt side *
- * If MECH B LAT 1 STAT – RDY, continue *

√AMSB DC AMPS: 0.035 to 0.125

√MECH – steady A(B)

A6U √PL RETEN LAT 1 tb – REL (A side only)
1(2) – LAT (tb-bp), drive to cage ~8 sec

CRT √MECH – flashing A(B)
√AMSB AC AMPS: 1.0 to 2.5

- * If stall condition observed (AMSB AC AMPS *
- * > 1.0 and no mechanism motion): *
- * PL RETEN LAT 1(2) – OFF *
- * √MCC *

A6U PL RETEN LAT 1(2) – OFF

CRT √MECH B LAT 1 STAT – RDY
√MECH – blank

CCTV √Latch 1 cages berthing pin

- * If latch not caging berthing pin, perform *
- * 1.3a PRIMARY MOTOR FAILS TO *
- * DRIVE MECHANISM (PL SYS, SSE) *

Go to HST BERTH, step 6 (PDRS OPS FS, NOMINAL HST RETRIEVAL)
or SJ HST BERTH, step 8 (PDRS OPS FS, OFF-NOMINAL HST RETRIEVAL)

4. BERTH LAT 3 COMPLETE CLOSURE

Verify with RMS operator that RMS in TEST MODE

CCTV √Latch 3 align and monitor operations
CAMR B

CRT MECH B LAT 3 SEL – ITEM 16 EXEC (*OP)

- * If MECH B LAT 3 STAT – * and visually observed open, then EOT *
- * sw failed: *
- * MECH DESEL – ITEM 20 EXEC (ITEMS 9-19 (eleven – (no *))) *
- * Perform SSE SSR-1 FMDM SWAP A→B(B→A) (PL SYS, SSE) *
- * and complete steps 4-9 on alt side *
- * If MECH B LAT 3 STAT – RDY, continue *

√AMSB DC AMPS: 0.035 to 0.125
√MECH – steady A(B)

A6U √PL RETEN LAT 1 tb – REL (A side only)
1(2) – LAT (tb-bp)

CRT √MECH – flashing A(B)
√AMSB AC AMPS: 1.0 to 2.5
√MECH B LAT 3 STAT – RDY

A6U * If stall condition observed (AMSB AC AMPS *
* > 1.0 and no mechanism motion): *
* PL RETEN LAT 1(2) – OFF *
* √MCC *

- * If MECH B LAT 3 STAT – OP and motion observed, *
- * BOT sw failed. Continue and expect ‘*’ *

CRT Wait 15 sec,
√MECH B LAT 3 STAT – CL

A6U * If MECH B LAT 3 STAT – OP or RDY after 30 total sec: *
* PL RETEN LAT 1(2) – OFF *
* Perform 1.3a PRIMARY MOTOR FAILS TO DRIVE *
* MECHANISM (PL SYS, SSE) *

A6U √PL RETEN LAT 1 tb – LAT (A side only)
1(2) – OFF

CRT √MECH – steady A(B)

CCTV √Latch 3 completely closed

5. BERTH LAT 2 COMPLETE CLOSURE

CCTV Monitor Latch 2 closure operations
CAMR B(C)

CRT MECH B LAT 2 SEL – ITEM 15 EXEC (* RDY)

√AMSB DC AMPS: 0.035 to 0.125
√MECH – blank

A6U PL RETEN LAT 1(2) – LAT

CRT √MECH – flashing A(B)
√AMSB AC AMPS: 1.0 to 2.5
√MECH B LAT 2 STAT – RDY

A6U * If stall condition observed (AMSB AC *
* AMPS > 1.0 and no mechanism motion): *
* PL RETEN LAT 1(2) – OFF *
* √MCC *

* If MECH B LAT 2 STAT – OP, BOT sw *
* failed. Continue and expect (*) *

Wait 7 sec,
√MECH B LAT 2 STAT – CL

A6U * If MECH B LAT 2 STAT – RDY after 15 total sec: *
* PL RETEN LAT 1(2) – OFF *
* Perform 1.3a PRIMARY MOTOR FAILS TO *
* DRIVE MECHANISM (PL SYS, SSE) *

A6U √PL RETEN LAT 1 tb – LAT (A side only)
1(2) – OFF

CRT √MECH – steady A(B)

CCTV √Latch 2 completely closed

6. BERTH LAT 1 COMPLETE CLOSURE

CCTV Monitor Latch 1 closure operations
CAMR B(C),D

CRT MECH B LAT 1 SEL – ITEM 14 EXEC (* RDY)

√AMSB DC AMPS: 0.035 to 0.125
√MECH – blank

A6U PL RETEN LAT 1(2) – LAT

CRT √MECH – flashing A(B)
√AMSB AC AMPS: 1.0 to 2.5
√MECH B LAT 1 STAT – RDY

A6U * If stall condition observed (AMSB AC *
* AMPS > 1.0 and no mechanism motion): *
* PL RETEN LAT 1(2) – OFF *
* √MCC *

* If MECH B LAT 1 STAT – OP, BOT sw *
* failed. Continue and expect ‘*’ *

Wait 7 sec,
√MECH B LAT 1 STAT – CL

A6U * If MECH B LAT 1 STAT – RDY after 15 total sec: *
* PL RETEN LAT 1(2) – OFF *
* Perform 1.3a PRIMARY MOTOR FAILS TO *
* DRIVE MECHANISM (PL SYS, SSE) *

√PL RETEN LAT 1 tb – LAT (A side only)
1(2) – OFF

CRT √MECH – steady A(B)

CCTV √Latch 1 completely closed
CAMR B(C),D

CCTV Perform P/TV04 HST RETRIEVE/BERTH, DEACTIVATION (PHOTO/TV FS,
SCENES)

Notify MCC, MECH B LAT ops complete. Ready for ungrapple
RMS return to HST BERTH, step 6 (PDRS OPS FS, NOMINAL HST RETRIEVAL)
or SJ HST BERTH, step 8 (PDRS OPS FS, OFF-NOMINAL HST RETRIEVAL)

7. UMBILICAL DEADFACE VERIFICATION

SM 211 SSE OVERVIEW

√PCU – blank/blank
√DPC 1-12 (twelve) – (no *)

L12U √FHST SHUTTER – OPEN (tb-bp)
√RSU SURV HTR PWR – OFF (tb-bp)
√ESS/MN SW ENA – OFF (tb-bp)
√SSM WK LTS – OFF

8. MAIN UMBILICAL MATE

CAUTION

Operating the umbilical in a stalled condition for greater than 30 sec may result in damage to unit. A stalled condition is indicated by AMSB AC AMPS > 0.6 and no mechanism motion

CCTV Monitor UMB operations
CAMR A,B

CCTV Perform P/TV04 HST RETRIEVE/BERTH, OPS, HST/FSS UMBILICAL MATE
(PHOTO/TV FS, SCENES)

SM 212 SSE MECH/BPA/RNS

On MCC GO:

MECH UMB MN SEL – ITEM 17 EXEC (* REL)

- * If MECH UMB MN STAT – *: *
- * MECH DESEL – ITEM 20 EXEC (ITEMS 9-19 (eleven) – (no *)) *
- * Perform SSE SSR-1 FMDM SWAP A→B(B→A) (PL SYS, SSE) *
- * and complete steps 8,9 on alt side *
- * If MECH UMB MN – RDY, continue *

√AMSB DC AMPS: 0.035 to 0.125

√MECH – steady A(B)

A6U √PL RETEN LAT 1 tb – REL (A side only)
1(2) – LAT (tb-bp)

CRT √MECH – flashing A(B)
√AMSB AC AMPS: 0.6 to 1.2
√MECH UMB MN STAT – RDY

- * If stall condition observed (AMSB AC AMPS *
- * > 0.6 and no mechanism motion): *
- * PL RETEN LAT 1(2) – OFF *
- * √MCC *

Wait 8 sec,

√MECH UMB MN STAT – MAT

A6U * If MECH UMB MAT STAT – RDY or REL after 30 total sec: *

- * PL RETEN LAT 1(2) – OFF *
- * Perform 1.3a PRIMARY MOTOR FAILS TO DRIVE *
- * MECHANISM (PL SYS, SSE) *

√PL RETEN LAT 1 tb – LAT (A side only)
1(2) – OFF

CRT √MECH – steady A(B)

CCTV Visually verify UMB mated

L12U √MN BUS PWR ON tb – gray
√ESS BUS INT PWR tb – UP

SM 210 HST SYS

√UMB SG V INT MN BUS > 26

√ESS BUS > 26

- * If either tb – bp or any UMB SG V ≤ 26, *
- * √MCC *

9. AMSB PWRDN

SM 212 SSE MECH/BPA/RNS

DESEL – ITEM 20 EXEC (√ITEMS 9-19 (eleven) – (no *))

- * If any MECH SEL – *, do not turn *
- * AMSB OFF; notify MCC, continue *

√AMSB DC AMPS: < 0.035
OFF – ITEM 8 EXEC (*)

A6U PL RETEN LOGIC PWR SYS 1(2) – OFF

R13L PL BAY MECH PWR SYS 1(2) – OFF

Notify MCC, LATCH AND MATE HST complete; report any anomalies

ACTIVATE HST EXTERNAL PWR

1. SETUP

L12U √cb SPACE TEL SW PWR – cl
 FHST SHUTTER – CLOSE (remains bp)
 SM 210 HST SYS
 √TLM COUNT – incr
 √EPS INT ESS BUS A,B,C – * * *

SM 211 SSE OVERVIEW
PCU ON – ITEM 1 EXEC (*)

L12U * If 'PDI DECOM FAIL' msg accompanied by MN *
 * BUS PWR ON tb – bp, notify MCC and hold *

CRT √PCU – P/S
 √DPC 1-12 (twelve) – *
 √VOLTS (twelve): 33.7 to 35.5
 √AMPS (twelve): ≤ 0.5

* If any DPC 1-12 (twelve) AMPS: > 0.5, turn off *
* affected DPC, DPC OFF – ITEM 24 +X X EXEC (*) *
* (DPC ON/OFF INDEX NUMBERS (REFERENCE DATA)), *
* √MCC *
* If any other param(s) not in range, record MET and *
* off nominal DPC values, notify MCC *

L12U √FHST SHUTTER tb – gray

2. EXTERNAL PWR ACTIVATION

On MCC GO:

ESS/MN SW ENA – ON (tb-gray)
MAIN BUS EXT PWR – ON (tb-gray)
√IPCU RLY CL tb – gray

* If any tb – bp, notify MCC, continue *
* If both MAIN BUS EXT PWR and IPCU RLY CL tb – bp, *
* cycle MAIN BUS EXT PWR sw (up only) *
* If no joy, √MCC *

CRT √DPC 1-12 VOLTS (twelve): 33.7 to 35.3
 √AMPS (twelve): 2 to 7

L12U ESS BUS EXT PWR – ON (tb-UP)

SM 210 HST SYS

√UMB SG V EXT MN BUS > 30
 √ESS BUS > 30

3. INT ESS PWR OFF

On MCC GO:

L12U ESS BUS INT PWR – OFF (tb-bp)
 ESS/MN SW ENA – OFF (tb-bp)

Notify MCC, ACTIVATE HST EXTERNAL PWR complete; report any anomalies

IN-BAY OPERATIONS

SINGLE (DUAL) SA SLEW.....	3-2
ROTATE HST	3-3
PIVOT HST	3-7
HGA DEPLOYMENT	3-11
UNBERTH BSA CONFIG	3-13
FSS STOW WITH BSP INSTALLED	3-14
ACTIVATE HST ESS BUS INTERNAL PWR	3-17
SSE DEACT.....	3-18

SINGLE (DUAL) SA SLEW

1. SETUP
 Set up CCTVs to monitor SA slew
 CCTV Perform P/TV03 FSS OPS, OPS, #3 SA SLEWS (PHOTO/TV FS,
 CAMR A,D SCENES)

Perform following only if VRCS available:

√In ATT
 DAP: B11/AUTO/VERN

SM 210 HST SYS

√SOLAR ARRAY SLEW – blank,blank

Inform MCC ready for SINGLE (DUAL) SA SLEW

2. STOCC INITIATE SLEW

- * For any observed uncontrolled SA motion, or if unable to go *
- * free drift on time: *
- * SM 210 HST SYS *
- * SOLAR ARRAY SADE OFF – ITEM 9 +9 9 EXEC (OFF) *
- * Notify MCC *

On MCC call:
 DAP: FREE

STOCC CMD ± WING SLEW

NOTE

Expect 'S210 SADE WING' msg in ~30 sec

Visually verify SAs slewing

CRT √SOLAR ARRAY SLEW – +OP -OP one (or both) flash

SA MNVR SIZE (deg)	SLEW TIME (Motor Op, mm:ss)
15	08:32
20	09:10
30	10:16
45	11:37
60	12:45
90	14:38
100	15:11
105	15:28
180	18:54

On MCC call:
 DAP: B11/AUTO/VERN(ALT)

- * If no comm 2 min after SOLAR ARRAY SLEW *
- * +OP -OP not flashing: *
- * DAP: B11/AUTO/VERN(ALT) *

ROTATE HST

WARNING

Operation of two FSS mechanisms may result in HST collision with orbiter

For any SM ALERT during FSS ops:

A6U PL RETEN LAT 1,2 (two) – OFF
R13 PL BAY MECH PWR SYS 1,2 (two) – OFF
√MCC

CAUTION

Operating the rotator in a stalled condition for greater than 30 sec may result in damage to unit. A stalled condition is indicated by AMSB AC AMPS > 0.3 and no mechanism motion

1. FSS AMSB PWR ON

A6U √PL RETEN LAT 1,2 (two) – OFF
√LOGIC PWR SYS 2(1) – OFF
√PL SEL – 1
LOGIC PWR SYS 1(2) – ON

SM 212 SSE MECH/BPA/RNS

AMSB ON – ITEM 7 EXEC (A(B))

√MECH – blank
√SEL (ITEMS 9-19) (eleven) – (no *)
√STAT (ITEMS 9-19) (eleven) – blank
√O/R DIS (ITEM 22) – *

- * If any param not as expected, √MCC *
- * If rotation reqd to continue EVA, AMSB OFF – ITEM 8 *
- * EXEC (*), perform SSE SSR-1 FMDM SWAP *
- * A→B(B→A) (PL SYS, SSE) and proceed to step 2 *

R13L PL BAY MECH PWR SYS 1(2) – ON

2. HST ROTATION

Check HST solar arrays in safe posn for planned rotation:

SM 210 HST SYS

SolarArray Clearance With Orbiter Tail

Keep Out Zones Include 24 Inch Envelope Around Orbiter Tail And ± 3 Degree Slew Angle

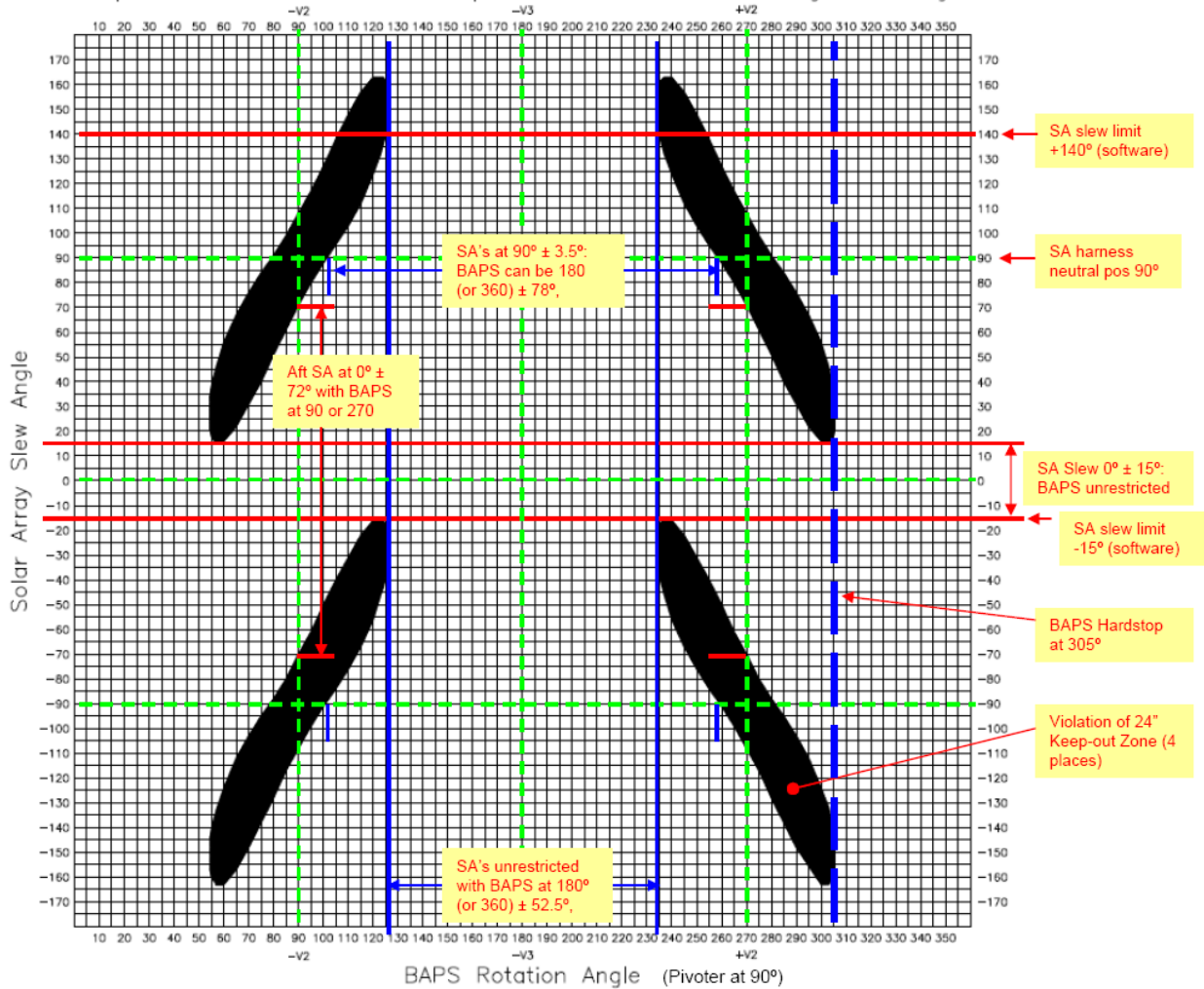

If in a configuration not identified, \sqrt{MCC}

CCTV Perform P/TV03 FSS OPS, OPS (PHOTO/TV FS, SCENES)
 CAMR B(D), Monitor HST posn during rotation
 ELBOW

SM 212 SSE MECH/BPA/RNS
 MECH ROTATOR SEL – ITEM 12 EXEC (*RDY)

- * If ROTATOR STAT – CCW or CW and visually *
- * verified not at EOT, then EOT sw failed: *
- * O/R ENA – ITEM 21 EXEC (*), continue *

\sqrt{AMSB} DC AMPS: 0.035 to 0.125

Mnvr to reqd posn:

NOTE

Rotator hardstop located at HST 300° posn (+/- 5°)

FSS ROTATOR POSN CORRELATION				
POSN TO → FROM ↓	B (-V3) HST 180°	-V2 HST 90°	+V2 HST 270°	(+V3) HST 0°
B (-V3) HST 180°		06:05 LAT	06:05 REL	12:11 LAT
-V2 HST 90°	06:05 REL		12:11 REL	06:05 LAT
+V2 HST 270°	06:05 LAT	12:11 LAT		18:16 LAT
(+V3) HST 0°	12:11 REL	06:05 REL	18:16 REL	

Times based on 14.8 deg/min actual run time during previous missions

NOTE: Table contains duration of motion in mm:ss, REL LAT switch posn

A6U PL RETEN LAT 1(2) – REL or LAT (tb-bp) as reqd

CRT √MECH – flashing A(B)
√ROTATOR STAT – RDY

CCTV √Rotator posn visually
CAMR B(D)

CRT √ROTATOR TACH: > 10 deg/min
√AMSB AC AMPS: 0.3 to 0.7

A6U * If FDA 'S212 ROT STALL' received, *

* PL RETEN LAT 1(2) – OFF, perform 1.3e 'S212 *

* PVT(ROT) STALL' (PL SYS, SSE) *

* *

* If ROTATE TACH: < 0.9 deg/min and AMSB AC *

* AMPS: < 0.2, PL RETEN LAT 1(2) – OFF, *

* perform 1.3a PRIMARY MOTOR FAILS TO *

* DRIVE MECHANISM (PL SYS, SSE) *

A6U Once at target position,
PL RETEN LAT 1(2) – OFF

CRT √MECH – blank

3. AMSB PWRDN

DESEL – ITEM 20 EXEC (MECH SEL, ITEMS 9-19 (eleven) – (no *))

- * If any MECH SEL – *, do not turn AMSB – OFF; *
- * notify MCC. Continue *

√AMSB DC AMPS: < 0.035
OFF – ITEM 8 EXEC (*)

A6U PL RETEN LOGIC PWR SYS 1(2) – OFF

R13L PL BAY MECH PWR SYS 1(2) – OFF

Report to MCC when complete; report any anomalies

PIVOT HST

<u>WARNING</u>
Operation of two FSS mechanisms may result in HST collision with orbiter
For any SM ALERT during FSS ops: A6U PL RETEN LAT 1,2 (two) – OFF R13 PL BAY MECH PWR SYS 1,2 (two) – OFF √MCC
Do not pivot up with BSP latch engaged

1. FSS AMSB PWR ON

A6U √PL RETEN LAT 1,2 (two) – OFF
√LOGIC PWR SYS 2(1) – OFF
√PL SEL – 1
LOGIC PWR SYS 1(2) – ON

<u>SM 212 SSE MECH/BPA/RNS</u>

AMSB ON – ITEM 7 EXEC (A(B))

√MECH – blank
√SEL (ITEMS 9-19) (eleven) – (no *)
√STAT (ITEMS 9-19) (eleven) – blank
√O/R DIS (ITEM 22) – *

- * If any param not as expected, √MCC *
- * If pivot reqd to continue EVA, AMSB OFF – ITEM 8 *
- * EXEC (*), perform SSE SSR-1 FMDM SWAP *
- * A→B(B→A) (PL SYS, SSE) and proceed to step 2 *

R13L PL BAY MECH PWR SYS 1(2) – ON

2. BSP LATCH RELEASE

If pivoting up from 43.8°, continue; else, go to step 3
CRT MECH BSP SEL – ITEM 19 EXEC (*)
√STAT – SET
√AMSB DC AMPS: 0.035 to 0.125
√MECH – steady A(B)

A6U PL RETEN LAT 1(2) – REL, wait 4 sec, OFF
CRT √MECH BSP STAT – REL
√MECH BSP – DIS *

- * If MECH BSP STAT not REL and MECH BSP DIS *, continue *
- * If MECH BSP STAT REL and MECH BSP DIS A, DIS B, continue *
- * Else, perform 1.3b BSP FAILS TO DISENGAGE (PL SYS, SSE) *

3. BSP LATCH SET VERIFICATION

If pivoting down to 43.8°, continue; else, go to step 4
MECH BSP SEL – ITEM 19 EXEC (*)
√AMSB DC AMPS: 0.035 to 0.125
√MECH BSP STAT – SET

- * If MECH BSP STAT not SET, √MCC *

√MECH BSP – blank/blank/blank

- * If MECH BSP not blank, record and assume switch failed *
- * Ignore affected status and continue *

4. HST PIVOT

WARNING

With HST attached and HGA Booms Stowed do not pivot below 70° without notifying MCC. Could violate HST HGA pointing constraints

CAUTION

Operating the pivoter in a stalled condition for greater than than 30 sec may result in damage to unit. A stalled condition is indicated by AMSB AC AMPS > 0.3 and no mechanism motion

CCTV Monitor HST posn during pivot, verify envelope clear of obstructions

CCTV Perform P/TV03 FSS OPS, OPS (PHOTO/TV FS, SCENES)
CAMR B(D),
ELBOW

Verify BSP PIP pins removed

NOTE

When pivoting from 90 (without BSP installed) or 0, expect MECH PIVOT LO SEL – ITEM 11 EXEC (*UP or *DN), respectively

CRT MECH PIVOT LO SEL – ITEM 11 EXEC (* RDY)
√AMSB DC AMPS: 0.035 to 0.125

Maneuver to reqd posn

FSS PIVOTER POSN CHANGES TIME CORRELATION					
POSN TO → FROM ↓	0°	43.8°	75°	85°	90°
0°		11:35 LAT	19:50 LAT	22:29 LAT	23:48 LAT
43.8°	11:35 REL		08:15 LAT	10:54 LAT	12:13 LAT
75°	19:50 REL	08:15 REL		02:39 LAT	03:58 LAT
85°	22:29 REL	10:54 REL	02:39 REL		01:19 LAT
90°	23:48 REL	12:13 REL	03:58 REL	01:19 REL	

Times based on 3.8 deg/min actual run time during previous missions

NOTE: Duration displayed in mm:ss

Start Timer

NOTE

With BSP installed, pivoter will stall when reaching 43.8° or 90° posn and FDA will annunciate 15 sec later. 15 sec stall is reqd to preload BSP

A6U PL RETEN LAT 1(2) – REL for pivot dn or LAT for pivot up as reqd

CRT √MECH – flashing A(B)

CCTV Visually verify BAPS motion
CAMR B(D),
ELBOW

CRT √MECH PIVOT LO TACH: > 2.5 deg/min
√AMSB AC AMPS: 0.3 to 0.7

A6U * If unexpected 'S212 PVT STALL' msg received *
* PL RETEN LAT 1(2) – OFF, perform *
* 1.3e 'S212 PVT(ROT) STALL' (PL SYS, SSE) *

* If MECH PIVOT LO TACH: < 0.25 deg/min and AMSB AC AMPS: *
* < 0.2, PL RETEN 1(2) – OFF, perform 1.3a PRIMARY MOTOR *
* FAIL TO DRIVE MECHANISM (PL SYS, SSE) *

A6U If pivoting to 43.8°:
Expect 'S212 PVT STALL' msg
PL RETEN LAT 1(2) – OFF
Stop Timer

CRT √MECH BSP – RET *, ENG *

* If MECH BSP – ENG *, continue; *
* else, perform 1.3d BSP FAILS TO ENGAGE *
* (PL SYS, SSE) *

A6U If pivoting to 90°:
Expect 'S212 PVT STALL' msg
PL RETEN LAT 1(2) – OFF
Stop Timer

CCTV If pivoting to any intermediate posn:
At expected pivot completion time:
Visually confirm pivoter posn
CAMR B(D),
ELBOW

A6U PL RETEN LAT 1(2) – OFF
Stop Timer

CRT √MECH – blank

5. BSP LATCH RESET

If pivoted up from 43.8°, continue; else, go to step 6

MECH BSP SEL – ITEM 19 EXEC (*)

√AMSB DC AMPS: 0.035 to 0.125

√MECH – steady A(B)

A6U PL RETEN LAT 1(2) – LAT, wait 4 sec, OFF

CRT √MECH BSP STAT – SET

* If MECH BSP STAT – * or L/A, √MCC *

6. AMSB PWRDN

MECH DESEL – ITEM 20 EXEC (ITEMS 9-19 (eleven) – (no *))

* If any MECH SEL – *, do not turn *

* AMSB OFF; notify MCC. Continue *

√AMSB DC AMPS: < 0.035

OFF – ITEM 8 EXEC (*)

A6U PL RETEN LOGIC PWR SYS 1(2) – OFF

R13L PL BAY MECH PWR SYS 1(2) – OFF

Notify MCC, PIVOT HST complete; report any anomalies

HGA DEPLOYMENT

- CCTV 1. SETUP
Set up CCTVs to monitor HGA deployment (P/TV08 HST RELEASE, OPS, HGA DEPLOY (PHOTO/TV FS, SCENES))

Perform following only if VRCS available:

√In ATT

DAP: B11/AUTO/VERN

NOTE

Expect MCC call immediately prior to commanded mechanism operations

SM 210 HST SYS

√TLM COUNT – incr

√HGA +V3,-V3 HNG (two) – STWD

√LAT (two) – REL

WARNING

√Within 45 deg of $\pm V2$ FWD for crew safety.

If not within 45 deg of $\pm V2$ FWD, call MCC

Inform MCC ready for HGA deployment

2. HGA DEPLOYMENT

NOTE

HGA deployment nominally performed simo. HGA mast deploy takes ~8 min. Mast deploy speed will vary during deployment

On MCC call:

DAP: FREE

- STOCC Command \pm HGA HNG – DPLY

SM 210 HST SYS

√HGA +V3,-V3 HNG (two) – TRAN

Visually verify both HGA masts deploying

Note posn of HGA dish upon clearing latches

√HGA +V3,-V3 HNG (two) – DPLY

On MCC call:

DAP: B11/AUTO/VERN(ALT)

- * If no comm 2 min after HGA Deploy *
- * HGA +V3,-V3 HNG (two) – DPLY: *
- * DAP: B11/AUTO/VERN(ALT) *

3. HGA SLEW TO 0,0 POSITION

NOTE

HGA slew nominally performed simo. HGA slew takes ~15 min

STOCC Command HGA slew to 0,0 (straight out)

4. HGA SLEW TO STRUCTURAL CLEARANCE POSITION

NOTE

HGA slew nominally performed simo. HGA slew takes ~15 min

STOCC Command HGA slew to RMS/tail clearance posn

Visually verify both HGA dishes in the RMS/tail clearance posn

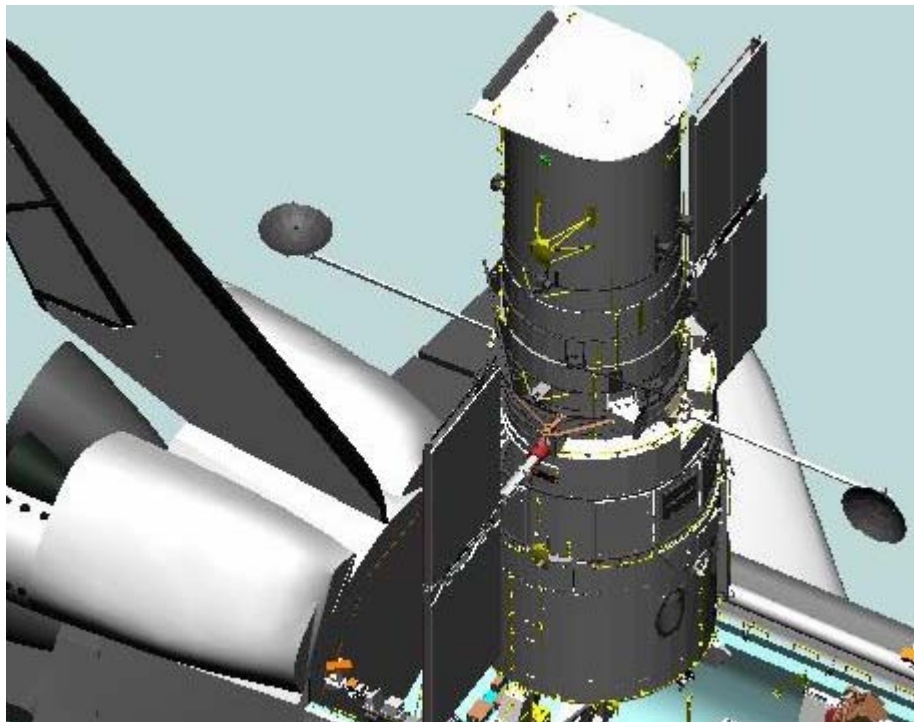

UNBERTH BSA CONFIG

1. CONFIGURE BSA
BSA RATE SW – up (√32k led – Green)
WATCHDOG – Dis
RESET pb – push

√SYNC – Frame – Green

NOTE
Step 2 and subs will occur after Sep burn
2. POWER OFF BSA
On MCC GO:
BSA POWER – OFF
3. DISABLE PSP-BYPASS
L12L PSP BY-PASS – DISABLE
4. CONFIGURE PDIP1 PI CONNECTORS
L12L Disconnect BSA 14 foot data cable from HST PI 1(2)
Re-install HST PI 1(2) Turn-Around Plug
5. DISCONNECT BSA CABLE
MO13Q DC UTIL PWR MNB – OFF
BSA Disconnect BSA power cable from BSA power port
Disconnect BSA data cable from BSA data port
6. STOW HST BSA AND DATA CABLE
MA16D Stow BSA

Notify MCC, HST BSA stowage complete
7. CONFIG PL COMM
A1U SIG STR – S-BD PM

A1L √S-BD PL CNTL – CMD
√ANT POLAR – L CIRC
√XMTR PWR – LO
√PWR SYS – 1
√PSP CMD OUTPUT – PL UMB
√PL MOD – OFF
CH SEL INTRG 1,2 tw (six) – 910,910
PL PWR SEL – PSP
CNTL – PNL
wait 5 sec
CMD

A1R S-BAND FM POWER – 1

FSS STOW WITH BSP INSTALLED

CAUTION

Operating the pivoter or rotator in a stalled condition for greater than 30 sec may result in damage to unit. A stalled condition is indicated by AMSB AC AMPS > 0.3 and no mechanism motion

1. FSS AMSB PWR ON

A6U √PL RETEN LAT 1,2 (two) – OFF
 √LOGIC PWR SYS 2(1) – OFF
 √PL SEL – 1
 LOGIC PWR SYS 1(2) – ON

SM 212 SSE MECH/BPA/RNS

AMSB ON – ITEM 7 EXEC A(B)

√MECH – blank
 √SEL (ITEMS 9-19) (eleven) – (no *)
 √STAT (ITEMS 9-19) (eleven) – blank
 √O/R DIS (ITEM 22) – *

- * If any param not as expected, √MCC *
- * If pivot reqd to continue EVA, AMSB OFF – ITEM 8 EXEC (*), *
- * perform SSE SSR-1 FMDM SWAP A→B(B→A) (PL SYS, SSE) *
- * and proceed to step 2 on alt side *

R13L PL BAY MECH PWR SYS 1(2) – ON

2. ROTATE BAPS

CCTV Perform P/TV03 FSS OPS, OPS, FSS CONFIG FOR LANDING
 (PHOTO/TV FS, SCENES)

CRT MECH ROTATOR SEL – ITEM 12 EXEC (* RDY)

- * If ROTATOR STAT – CCW or CW and visually *
- * verified not at EOT, then EOT sw failed: *
- * O/R ENA – ITEM 21 EXEC (*), continue *

A6U √AMSB DC AMPS: 0.035 to 0.125
 PL RETEN LAT 1(2) – REL or LAT as reqd
 Rotate until berthing latch 1 or 3 aligns with fixed target

CRT √MECH – flashing A(B)
 √ROTATOR TACH: > 10 deg/min
 √AMSB AC AMPS: 0.3 to 0.7
 √ROTATOR STAT – RDY

- * If FDA 'S212 ROT STALL' received, PL RETEN *
- * LAT 1(2) – OFF, perform 1.3e 'S212 PVT(ROT) *
- * STALL' (PL SYS, SSE) *

A6U * If ROTATE TACH: < 0.9 deg/min and AMSB AC *- * AMPS: < 0.2, PL RETEN LAT 1(2) – OFF, *
- * perform 1.3a PRIMARY MOTOR FAILS TO *
- * DRIVE MECHANISM (PL SYS, SSE) *

√Rotator posn visually (Berthing latch aligned with fixed target)

A6U PL RETEN LAT 1(2) – OFF
CRT √MECH – blank

3. BSP LATCH SET VERIFICATION

MECH BSP SEL – ITEM 19 EXEC (*)

√AMSB DC AMPS: 0.035 to 0.125

√MECH BSP STAT – SET

* If MECH BSP STAT not SET, √MCC *

√MECH BSP – blank/blank/blank

* If MECH BSP not blank, record and assume switch failed *

* Ignore affected status and continue *

Verify BSP PIP pins removed

4. MECH PIVOT DOWN TO 43.8°

CAUTION

Operating the pivoter in a stalled condition for greater than 30 sec may result in damage to unit. A stalled condition is indicated by AMSB AC AMPS > 0.3 and no mechanism motion

CRT MECH PIVOT LO SEL – ITEM 11 EXEC (* RDY)
√AMSB DC AMPS: 0.035 to 0.125

NOTE

With BSP installed, pivoter will stall when reaching 43.8° posn (~12 min 13 sec) and 'S212 PVT STALL' FDA will annunciate 15 sec later. 15 sec stall is reqd to preload BSP

A6U PL RETEN LAT 1(2) – REL for approximately 12:13 (wait for FDA)

CRT √MECH – flashing A(B)

CCTV Visually verify BAPS motion
CAMR A,B

CRT √MECH PIVOT LO TACH: > 2.5 deg/min
√AMSB AC AMPS: 0.3 to 0.6

* If unexpected 'S212 PVT STALL' msg received, *

* PL RETEN LAT 1(2) – OFF, perform 1.3e *

* 'S212 PVT(ROT) STALL' (PL SYS, SSE) *

A6U * If MECH PIVOT LO TACH: < 0.25 deg/min and *
* AMSB AC AMPS: < 0.2, PL RETEN LAT 1(2) – *
* OFF, perform 1.3a PRIMARY MOTOR FAILS *
* TO DRIVE MECHANISM (PL SYS, SSE) *

A6U Expect 'S212 PVT STALL' msg:
 PL RETEN LAT 1(2) – OFF

CRT √MECH BSP – RET *, ENG *

 * If MECH BSP – ENG*, continue; *

 * else, perform 1.3d BSP FAILS TO ENGAGE * *

 * (PL SYS, SSE) *

CRT √MECH – blank

5. AMSB PWRDN
 MECH DESEL – ITEM 20 EXEC (ITEMS 9-19 (eleven) – (no *))

 √AMSB DC AMPS: < 0.035
 OFF – ITEM 8 EXEC (*)

A6U PL RETEN PL SEL – MON
 LOGIC PWR SYS 1(2) – OFF

R13L PL BAY MECH PWR SYS 1(2) – OFF

 Notify MCC when complete; report any anomalies

ACTIVATE HST ESS BUS INTERNAL PWR

1. PRECHECKS

SM 210 HST SYS

√TLM COUNT – incr

√EPS INT ESS BUS ABC (three) – no ***

L12U √cb SPACE TEL SW PWR – cl

2. CONNECT BATTERIES TO ESS BUS

On MCC GO:

ESS/MN SW ENA – ON (tb-gray)

ESS BUS INT PWR – ON (tb-UP)

- * If ESS BUS INT PWR tb-bp, *
- * Perform 2.1a ESS BUS INT PWR tb-bp *
- * WHEN SHOULD BE tb-UP (WHEN CMDED) *
- * (PL SYS, HST) *

SM 210 HST SYS

√EPS INT ESS BUS ABC – ***

- * If INT ESS BUS ABC not ***, √MCC *

L12U ESS/MN SW ENA – OFF (tb-bp)

Notify MCC, ACTIVATE HST ESS BUS INTERNAL PWR complete

SSE DEACT

NOTE

If any tb – gray, note and continue

- L12L 1. DEACT SLIC HTRS
WSIPE HTR A(B) PWR – OFF (tb-bp)
BPA STBD HTR B(A) PWR – OFF (tb-bp)
BPA PORT HTR A(B) PWR – OFF (tb-bp)
SLIC EPDSU HTR PWR – OFF (tb-bp)

SM 211 SSE OVERVIEW

√POWER SLIC EPDSU AMPS: 0.5 to 2.7

- L12L 2. SLIC PWR OFF
SLIC B-SIDE PWR ENA – OFF
cb SLIC A-SIDE PWR ENA – op

- L12U 3. DEACT CCTV HTR
CCTV HTR PWR – OFF (tb-bp)

4. DEACT ORUC PWR
ORUC PWR CONTR A – OFF (tb-bp)
B – OFF (tb-bp)

SM 211 SSE OVERVIEW

√POWER ORUC – blank/blank

√AMPS (two): < 0.4

5. DEACT FSS HTRS
FSS HTR PWR – OFF (tb-bp)

CRT √POWER FSS HTR P1/P2 AMPS (two): < 0.4
√R1/R2 AMPS (two): < 0.4

- L11U 6. DEACT MULE/RNS HTRS
SURV HTR A(B) PWR – OFF
√PWR tb – bp

CRT √POWER MULE HTR AMPS: < 0.4

L11U MULE COPE HTR A(B) PWR – OFF (tb-bp)

CRT √POWER MULE COPE 1A/2A AMPS (two): < 0.4
√1B&2B AMPS: < 0.4
√3A/3B AMPS (two): < 0.4

- L11U 7. RNS PWR DISABLE
RNS PWR – DIS (tb-bp)

8. MULE FMDM PWR OFF

NOTE

Expect 'I/O ERROR FLEX' msg

L11U MULE FMDM-A(B) PWR – OFF (tb-bp)
cb MULE B SIDE PWR – op

9. FSS FMDM PWR OFF

NOTE

Expect 'I/O ERROR FLEX' msg

L12U FSS FMDM-A(B) PWR – OFF (tb-bp)

cb FSS/ORUC A SIDE PWR – op
√cb SPACE TEL SW PWR – op

10. PAYLOAD BUS DEACT

R1 PL PRI MNC – OFF (tb-OFF)

Notify MCC, SSE DEACT complete; report any anomalies

This Page Intentionally Blank

ORU/ORI OPERATIONS

DEADFACE WFPC2..... 4-2
BAY 3 BATT PREP FOR REMOVAL..... 4-3
DEADFACE RSU/ECU 4-4
BAY 2 BATT PREP FOR REMOVAL..... 4-5
DEADFACE COSTAR 4-6
DEADFACE ACS 4-7
DEADFACE STIS 4-8
DEADFACE FGS-2..... 4-9

DEADFACE WFPC2

SM 210 HST SYS

√PSP ENA (ITEM 1) – 1

√TLM COUNT – incr

√RCVR 2(1) LOCK – *

Log CMD CT: _____

√ORU/ORI WFPC2 – ON

ORU/ORI WFPC2 OFF – ITEM 10 +9 8 EXEC

– ITEM 10 +9 9 EXEC

√ORU/ORI WFPC2 – OFF

Log CMD CT: _____

MET: ___/___:___:___

- * If ORU/ORI WFPC2 ON, command not received. *
- * Reverify comm config and re-exec command *
- * If still no joy, √MCC *

Notify EVA crewmembers, ready for WFC3 changeout

BAY 3 BATT PREP FOR REMOVAL

SM 213 HST BATT

√TLM COUNT – incr

√PSP ENA (ITEM 1) – 1

√RCVR 2(1) LOCK – *

Log CMD CT: _____

√BATT TRIM 4-6,EE (four) – (no *)

√BYPASS 4-6 (three) – (no *)

√CURR 4-6 (three): -0.2 to +0.6

* If any parameters not as expected, √MCC *

BATT DEACT BAY 3 – ITEM 4 +9 7 (96) EXEC

√SA SECT BAY 3 – OFF

√DISCHG BAY 3 – OFF

* If any parameters not as expected, command not received. *

* Attempt alt CDI cmd: *

* BATT DEACT BAY 3 ITEM 4 +9 6 (97) EXEC *

* √SA SECT BAY 3 – OFF *

* √DISCHG BAY 3 – OFF *

* If still no joy, √MCC *

BATT DEACT BAY 3 – ITEM 4 +9 9 (98) EXEC

√PRI HTR BAY 3 – OFF

√VIK BAY 3 – OFF

√BATT TRIM 4-6,EE (four) – *(INVALID STATE; DUE TO CT BUS OFF)

√BATT 4-6 PRESS (three): < +70.0

√4-6 CURR (three): < -24.0

* If any parameters not as expected, command not received. Attempt alt *

* CDI cmd: *

* BATT DEACT BAY 3 ITEM 4 +9 8 (99) EXEC *

* √PRI HTR BAY 3 – OFF *

* √VIK BAY 3 – OFF *

*

* √BATT TRIM 4-6,EE (four) – *(INVALID STATE; DUE TO CT BUS OFF) *

* √BATT 4-6 PRESS (three): < +70.0 *

* √4-6 CURR (three): < -24.0 *

* If still no joy, √MCC *

√BATT 4 VOLTS at least 0.5 volts below DIODE BUS B VOLTS

√5 VOLTS at least 0.5 volts below DIODE BUS C VOLTS

√6 VOLTS at least 0.5 volts below DIODE BUS C VOLTS

Notify EVA crewmembers, BAY 3 BATTERIES ready for changeout

NOTE

Expect: BATT DISCHG BAY 3 – ON when
first battery P1 connector is demated

DEADFACE RSU/ECU

SM 210 HST SYS

√PSP ENA (ITEM 1) – 1

√TLM COUNT – incr

√RCVR 2(1) LOCK – *

Log CMD CT: _____

L12U √RSU SURV HTR PWR – OFF (tb-bp)

CRT √RSU STAT 1,2,3 (three) – ON

√MAMP 1,2,3 (three): 84-168

1 OFF – ITEM 15 +9 9 EXEC

2 OFF – ITEM 16 +9 9 EXEC

3 OFF – ITEM 17 +9 9 EXEC

√MAMP 1,2,3 (three): ≤ 20

√STAT 1,2,3 (three) – OFF

Log CMD CT: _____

MET: ____/____:____

- * If RSU STAT ON or MAMPs > 20, command not received. *
- * Reverify comm config and re-exec command *
- * If still no joy, √MCC *

When MAMPs < 20 for 10 min (spindown complete), notify EVA crewmembers
RSU ready for changeout

BAY 2 BATT PREP FOR REMOVAL

SM 213 HST BATT

√TLM COUNT – incr

√PSP ENA (ITEM 1) – 1

√RCVR 2(1) LOCK – *

Log CMD CT: _____

√BATT TRIM 1-3,EE (four) – (no *)

√BYPASS 1-3 (three) – (no *)

√CURR 1-3 (three): -0.2 to +0.6

* If any parameters not as expected, √MCC *

BATT DEACT BAY 2 – ITEM 3 +9 7 (96) EXEC

√SA SECT BAY 2 – OFF

√DISCHG BAY 2 – OFF

* If any parameters not as expected, command not received. *

* Attempt alt CDI cmd: *

* BATT DEACT BAY 2 ITEM 3 +9 6 (97) EXEC *

* √SA SECT BAY 2 – OFF *

* √DISCHG BAY 2 – OFF *

* If still no joy, √MCC *

BATT DEACT BAY 2 – ITEM 3 +9 9 (98) EXEC

√PRI HTR BAY 2 – OFF

√VIK BAY 2 – OFF

√BATT TRIM 1-3,EE (four) – * (INVALID STATE; DUE TO CT BUS OFF)

√BATT 1-3 PRESS (three): < +70.0

√1-3 CURR (three): < -24.0

* If any parameters not as expected, command not received. Attempt alt *

* CDI cmd: *

* BATT DEACT BAY 2 ITEM 3 +9 8 (99) EXEC *

* √PRI HTR BAY 2 – OFF *

* √VIK BAY 2 – OFF *

*

* √BATT TRIM 1-3,EE (four) – * (INVALID STATE; DUE TO CT BUS OFF) *

* √BATT 1-3 PRESS (three): < +70.0 *

* √1-3 CURR (three): < -24.0 *

* If still no joy, √MCC *

√BATT 1 VOLTS at least 0.5 volts below DIODE BUS A VOLTS

√2 VOLTS at least 0.5 volts below DIODE BUS A VOLTS

√3 VOLTS at least 0.5 volts below DIODE BUS B VOLTS

Notify EVA crewmembers, BAY 2 BATTERIES ready for changeout

NOTE

Expect: BATT DISCHG BAY 2 – ON when
first battery P1 connector is demated

DEADFACE COSTAR

SM 210 HST SYS

√PSP ENA (ITEM 1) – 1
√TLM COUNT – incr
√RCVR 2(1) LOCK – *
Log CMD CT: _____

√ORU/ORI COSTAR – ON
ORU/ORI COSTAR OFF – ITEM 11 +9 7 EXEC
– ITEM 11 +9 8 EXEC
– ITEM 11 +9 9 EXEC

√ORU/ORI COSTAR – OFF

Log CMD CT: _____
MET: ___/___:___:___

- * If ORU/ORI COSTAR ON, command(s) not received. *
- * Reverify comm config and re-exec command *
- * If still no joy, √MCC *

Notify EVA crewmembers, ready for COS install

DEADFACE ACS

SM 210 HST SYS

√PSP ENA (ITEM 1) – 1

√TLM COUNT – incr

√RCVR 2(1) LOCK – *

Log CMD CT: _____

√ORU/ORI ACS – ON

ORU/ORI ACS OFF – ITEM 13 +96 EXEC

– ITEM 13 +97 EXEC

– ITEM 13 +98 EXEC

– ITEM 13 +99 EXEC

√ORU/ORI ACS – OFF

Log CMD CT: _____

MET: ___/___:___:___

* If ORU/ORI ACS ON, command(s) not received. *

* Reverify comm config and re-exec command *

* If still no joy, √MCC *

Notify EVA crewmembers, ready for ACS Repair

DEADFACE STIS

SM 210 HST SYS

√PSP ENA (ITEM 1) – 1

√TLM COUNT – incr

√RCVR 2(1) LOCK – *

Log CMD CT: _____

√ORU/ORI STIS – ON

ORU/ORI STIS OFF – ITEM 12 +9 7 EXEC

– ITEM 12 +9 8 EXEC

– ITEM 12 +9 9 EXEC

√ORU/ORI STIS – OFF

Log CMD CT: _____

MET: ___/___:___:___

- * If ORU/ORI STIS ON, command(s) not received. *
- * Reverify comm config and re-exec command *
- * If still no joy, √MCC *

Notify EVA crewmembers, ready for STIS repair

DEADFACE FGS-2

SM 210 HST SYS

√PSP ENA (ITEM 1) – 1
√TLM COUNT – incr
√RCVR 2(1) LOCK – *
Log CMD CT: _____

CRT

√FGS EPT V > 5.0
√FGS 2 BUS 2 – *
√FGS 2 V > 14.0
FGS 2 OFF – ITEM 20 +9 8 EXEC
– ITEM 20 +9 9 EXEC

√FGS EPT V < 5.0
√FGS 2 BUS 2 – (no *)
√FGS 2 V < 14.0
√FGS AME 2 V < 1.0

Log CMD CT: _____
MET: ___/___:___:___

- * If FGS EPT V > 5.0, FGS 2 V > 14.0, FGS AME 2 V > 1.0 *
- * or FGS 2 BUS 2 *, command not received. Reverify *
- * comm config and re-exec command *
- * If still no joy, √MCC *

Notify EVA crewmembers, FGS-2 ready for changeout

This Page Intentionally Blank

CONTINGENCY OPERATIONS

FSS STOW WITHOUT BSP	5-2
HST JETTISON FOR RAPID SAFE	5-5
SLIC JETTISON.....	5-10
ORUC JETTISON.....	5-12
ENABLE RNDZ NAV	5-14
POST REL RADAR ACQUISITION	5-14
POST REL RR NAV.....	5-14
BSP MECHANISM CHECKOUT.....	5-15
SSE CHECKOUT WITH FAILED MULE FMDM-A.....	5-16
EVA HARDWARE JETTISON	5-19
RAPID SAFING WITHOUT HST.....	5-24
RNS PWRDN.....	5-26
CONFIGURE PRIME COMM STRING FOR HST BSA.....	5-27
CONFIGURE PRIME COMM STRING FOR PSP-BYPASS (TURN-AROUND PLUG)....	5-28
ENABLE RNS OP HTRS	5-29

FSS STOW WITHOUT BSP

1. FSS AMSB PWR ON

A6U √PL RETEN LAT 1,2 (two) – OFF
 √LOGIC PWR SYS 2(1) – OFF
 √PL SEL – 1
 LOGIC PWR SYS 1(2) – ON

SM 212 SSE MECH/BPA/RNS

AMSB ON – ITEM 7 EXEC (A(B))

√MECH – blank
 √SEL (ITEMS 9-19) (eleven) – (no *)
 √STAT (ITEMS 9-19) (eleven) – blank
 √O/R DIS (ITEM 22) – *

R13L PL BAY MECH PWR SYS 1(2) – ON

2. BAPS PIVOT DOWN FOR STOW

CAUTION

Operating the pivoter in a stalled condition for greater than 30 sec may result in damage to unit. A stalled condition is indicated by **AMSB AC AMPS > 0.3** and no mechanism motion

CCTV Perform P/TV03 FSS OPS, OPS, FSS CONFIG FOR LANDING
 (PHOTO/TV FS, SCENES)

CRT MECH PIVOT LO SEL – ITEM 11 EXEC (* UP)

- * If MECH PIVOT LO STAT – *, EOT sw failed: *
- * MECH DESEL – ITEM 20 EXEC (ITEMS 9-19 (eleven) – (no *)) *
- * Perform SSE SSR-1 FMDM SWAP A→B(B→A) *
- * (PL SYS, SSE) and continue on alt side *
- * If MECH PIVOT LO STAT – RDY, continue *

√AMSB DC AMPS: 0.035 to 0.125
 √MECH – steady A(B)

A6U √PL RETEN LAT 1 tb – LAT (A side only)
 1(2) – REL (tb-bp)

CRT √MECH – flashing A(B)
 √PIVOT LO TACH: > 2.5 deg/min
 √AMSB AC AMPS: 0.3 to 0.7
 √MECH PIVOT LO STAT – RDY

- * If MECH PIVOT LO STAT – UP, EOT sw *
- * failed, continue *
- * Expect ‘*’ in 23.8 min *

CCTV Visually verify BAPS motion; monitor performance
 CAMR
 A,B,C

**CONTINGENCY
 OPERATIONS**

- A6U * If FDA 'S212 PVT STALL' received, *
- * PL RETEN LAT 1(2) – OFF, perform 1.3e 'S212 *
- * PVT(ROT) STALL' (PL SYS, SSE) *

- * If MECH PIVOT LO TACH: < 0.25 deg/min and *
- * AMSB AMPS: < 0.2, PL RETEN LAT 1(2) – *
- * OFF, perform 1.3a PRIMARY MOTOR FAILS *
- * TO DRIVE MECHANISM (PL SYS, SSE) *

Wait 23.8 min

- CRT √MECH PIVOT LO STAT – DN
- A6U √PL RETEN LAT 1 tb – REL (A side only)
- 1(2) – OFF
- CRT √MECH – steady A(B)
- Visually verify BAPS properly positioned

3. DOWNLOCK INSERTION

CAUTION

Operating the downlock in a stalled condition for greater than 30 sec may result in damage to unit. A stalled condition is indicated by AMSB AC AMPS > 1.0 and no mechanism motion

WARNING

The downlock engagement is required for landing if SCM is on FSS

MECH DLOCK SEL – ITEM 9 EXEC (* DIS)

- * If MECH DLOCK STAT – *, then EOT sw failed: *
- * DESEL – ITEM 20 EXEC (ITEM 9 – (no *)) *
- * Perform SSE SSR-1 FMDM SWAP A→B(B→A) *
- * (PL SYS, SSE) and continue on alt side *
- * If MECH DLOCK STAT – RDY, continue *

- √AMSB DC AMPS: 0.035 to 0.125
- √MECH – steady A(B)

- A6U √PL RETEN LAT 1 tb – REL (A side only)
- 1(2) – LAT (tb-bp)

- CRT √MECH – flashing A(B)
- √AMSB AC AMPS: 1.0 to 2.5
- √MECH DLOCK STAT – RDY

- A6U * If stall condition observed (AMSB AC AMPS > 1.0 *
- * and no mechanism motion): *
- * PL RETEN LAT 1,2 (two) – OFF *
- * √MCC *

- * If MECH DLOCK STAT – DIS, continue *
- * Expect '*' *

Wait 24 sec,
√MECH DLOCK STAT – ENG

A6U * If MECH DLOCK STAT – RDY after 30 total sec: *
* PL RETEN LAT 1(2) – OFF *
* Perform 1.3a PRIMARY MOTOR FAILS TO *
* DRIVE MECHANISM (PL SYS, SSE) *

A6U √MECH DLOCK STAT – ENG
√PL RETEN LAT 1 tb – LAT (A side only)
1(2) – OFF

CRT √MECH – steady A(B)
Visually verify DOWNLOCK engaged

4. AMSB PWRDN

SM 212 SSE MECH/BPA/RNS

MECH DESEL – ITEM 20 EXEC (ITEMS 9-19 (eleven) – (no *))

√AMSB DC AMPS: < 0.035
OFF – ITEM 8 EXEC (*)

A6U PL RETEN PL SEL – MON
LOGIC PWR SYS 1(2) – OFF

R13L PL BAY MECH PWR SYS 1(2) – OFF

Notify MCC, FSS STOWED

HST JETTISON FOR RAPID SAFE

1. CHECK PL BAY CONFIG
If EVA:
 - √BSP PIP pin removed prior to EV crew ingress
 - √RMS/OBSS clear of payload envelope

2. DAP/TIMER SETUP
DAP: A10/INRTL/VERN(ALT), LO Z

O14, Pri RJD LOGIC, DRIVER (sixteen) – ON
O15, √cb MNA,C DDU AFT (two) – cl
O16

SM 2 TIME

F7,A4 Set CRT and Event Timers counting down to SEP 1
MET ____/____:____:____

- 10:00
A6U 3. ADI SETUP
ADI ATT – LVLH
ERR – MED
RATE – LO
SENSE: – Z

4. ACTIVATE LOGIC AND MECH POWER
√PL RETEN LAT 1,2 (two) – OFF
LOGIC PWR SYS 1,2 (two) – ON
√PL SEL – 1

R13 PL BAY MECH PWR SYS 1,2 (two) – ON

SM 212 SSE MECH/BPA/RNS

AMSB ON – ITEM 7 EXEC (A(B))

5. PIVOT HST
Perform this step only if pivoter not at 90°; else, go to step 6

MECH PIVOT LO SEL – ITEM 11 EXEC (* RDY)

A6U PL RETEN LAT 1(2) – LAT

CRT √MECH – flashing A(B)

Pivot to 90°

A6U PL RETEN LAT 1(2) – OFF

- L12U 6. DEADFACE UMBILICAL
ESS/MN SW ENA – ON (tb-gray)
ESS BUS INT PWR – ON (tb-UP)
EXT PWR – OFF (tb-bp)
MAIN BUS EXT PWR – OFF (tb-bp)
FHST SHUTTER – OPEN (tb-bp)

CRT 7. DISCONNECT UMBILICAL
 A6U MECH UMB MN SEL – ITEM 17 EXEC (* MAT)
 PL RETEN LAT 1(2) – REL

CRT √MECH UMB MN STAT – RDY (wait 8 sec)
 √STAT – REL

A6U PL RETEN LAT 1(2) – OFF

A4 8. FINAL SETUP
 Set Event Timer to count up from SEP 1 TIG

GNC UNIV PTG
 √RATES: < 0.1 deg/sec

-:02:00 DAP: A/FREE/VERN(PRI)

GNC 20 DAP CONFIG
 Change DAP A,B to A1,B1

-01:00 9. OPEN BERTHING LATCHES

NOTE
 Perform SEP 1 BURN ASAP once LATCH 2
 open and verified clear

SM 212 SSE MECH/BPA/RNS
 MECH B LAT 3 SEL – ITEM 16 EXEC (* CL)

A6U PL RETEN LAT 1(2) – REL

CRT √MECH B LAT 3 STAT – RDY (wait 15 sec)
 √3 STAT – OP

A6U PL RETEN LAT 1(2) – OFF

CRT MECH B LAT 1 SEL – ITEM 14 EXEC (* CL)

A6U PL RETEN LAT 1(2) – REL

CRT √MECH B LAT 1 STAT – RDY (wait 15 sec)
 √1 STAT – OP

A6U PL RETEN LAT 1(2) – OFF

CRT MECH B LAT 2 SEL – ITEM 15 EXEC (* CL)

A6U PL RETEN LAT 1(2) – REL

CRT √MECH B LAT 2 STAT – RDY (wait 15 sec)
 √2 STAT – OP

A6U PL RETEN LAT 1(2) – OFF

Visually verify LATCHES open and umbilical clear

10. HST TO SUN POINT

NOTE

Expect 'PDI DECOM FAIL' msg

SM 210 HST SYS

- PCS MODE – ITEM 7 +9 5 EXEC
- ITEM 7 +9 6 EXEC
- ITEM 7 +9 7 EXEC

11. SEP 1 BURN

A6U

√SENSE: -Z
FLT CNTLR PWR – ON

√DAP: A1/FREE/VERN(PRI)
DAP TRANS: PULSE/PULSE/PULSE, LO Z

If OMS or RCS propellant leak,
DAP: NORM Z

+ :00:00

AFT THC: +Z (out) 1 pulse (0.1 fps)
When HST clear of latches,
DAP: A1/INRTL/VERN(PRI)

If LO Z:
AFT THC +Z (out) 9 pulses (0.9 fps)
If NORM Z:
AFT THC +Z (out) 7 pulses (0.7 fps)

Record MET ____/____:____:____

NOTE

Perform steps 15,16 in parallel with steps 12,13

12. PERFORM OUT-OF-PLANE MNVR

CRT

GNC UNIV PTG

CNCL – ITEM 21 EXEC
GNC, OPS 202 PRO

GNC ORBIT MNVR EXEC

RCS SEL – ITEM 4 EXEC (*)

Set TIG to current time + 2:00 (+3:00 if NORM Z)

TGT PEG 7 ΔV_x – ITEM 19 +0 EXEC
7 ΔV_y – ITEM 20 +2 EXEC
ΔV_z – ITEM 21 +0 EXEC

LOAD – ITEM 22 EXEC
TIMER – ITEM 23 EXEC

√VGOZ: ≥ 0

- * If VGO Z < 0: *
- * TGT PEG 7 ΔV_y – ITEM 20 (-2) EXEC *
- * LOAD – ITEM 22 EXEC *
- * TIMER – ITEM 23 EXEC *
- * √VGOZ: ≥ 0 *

Do not mnvr to burn att

A6U At TIG, deflect THC to null VGOs

13. PERFORM FINAL SEP

CRT GNC ORBIT MNVR EXEC
 √RCS SEL – ITEM 4 EXEC (*)

If ΔV_y (step 12) +2:
 TV ROLL – ITEM 5 +2 7 0 EXEC

If ΔV_y (step 12) -2:
 TV ROLL – ITEM 5 +0 9 0 EXEC

Set TIG to TIG from step 12 +15:00
 TGT PEG 7 ΔV_x – ITEM 19 +3 EXEC
 ΔV_y – ITEM 20 +0 EXEC
 ΔV_z – ITEM 21 +0 EXEC

LOAD – ITEM 22 EXEC
 TIMER – ITEM 23 EXEC
 DAP: A/AUTO/PRI

At TIG-8:00,
 MNVR – ITEM 27 EXEC (*)

A6U At TIG, deflect THC to null VGOs
 FLT CNTLR PWR – OFF

14. RADAR NAV (IF DESIRED)
 ENABLE RNDZ NAV, 5-15
 POST REL RADAR ACQUISITION, 5-15
 RR NAV, 5-15

15. ROTATOR (SINGLE MOTOR DRIVE)
 If B/L 1 or 3 aligned with fixed target, go to step 16

NOTE
 Rotate to align berthing latch 1 or 3 to fixed target.
 If hardstop encountered, reverse direction

SM 212 SSE MECH/BPA/RNS
 MECH ROTATOR SEL – ITEM 12 EXEC (* RDY)

A6U PL RETEN LAT 1(2) – REL (cw) or LAT (ccw) as reqd

CRT √MECH – flashing A(B)
 Complete maneuver to reqd posn

CCTV When rotator in posn:
 A6U PL RETEN LAT 1(2) – OFF

If BSP not installed, go to RAPID SAFING WITHOUT HST, steps 4 thru 8

16. START PIVOT DN (DUAL MOTOR DRIVE)

SM 212 SSE MECH/BPA/RNS

MECH BSP SEL – ITEM 19 EXEC (* SET)

MECH PIVOT LO SEL – ITEM 11 EXEC (* RDY)

A6U PL RETEN LAT 1(2) – REL
L12U FSS FMDM-B(A) – ON

SM 1 DPS UTILITY

PORT ASSIGN STRING PL 1/2 PRI(SEC) – ITEM 23(24) EXEC (*)

SM 212 SSE MECH/BPA/RNS

AMSB PWR ON – ITEM 7 EXEC (*)

MECH PIVOT LO SEL – ITEM 11 EXEC (* RDY)

A6U PL RETEN LAT 2(1) – REL
CRT √MECH – flashing A,B
After MECH BSP – RET (not blank)/ENG (not blank) status
received (06:06):
PL RETEN LAT 1,2 (two) – OFF

17. VERIFY BSP ENGAGED

CRT √MECH BSP – RET (not blank)/ENG (not blank)

18. CLOSEOUT

A6U √PL RETEN LAT 1,2 (two) – OFF
LOGIC PWR SYS 1,2 (two) – OFF
PL SEL – MON
R13L PL BAY MECH PWR SYS 1,2 (two) – OFF

19. SSE RAPID DEACT

NOTE

Expect 'I/O ERROR FLEX' msg

R1 PL PRI MNC – OFF (tb-OFF)

SLIC JETTISON

1. PRE-REL CONFIG
 - √RMS/OBSS MPMs deployed
 - √Elbow Camr stowed
 - √HST deployed
 - √FSS stowed for landing
 - Perform SSE DEACT, (IN-BAY OPERATIONS)
 - PL CAB – OFF
- R1
- A6U
2. AFT STATION CONFIG FOR RELEASE
 - ADI ATT – LVLH
 - ERR – MED
 - RATE – LO
 - SENSE: -Z
3. RJD HEALTH STATUS
 - √MCC to verify comm
 - DAP: FREE
 - RJDA 1A L2/R2 MANF DRIVER – OFF
 - RJD MANF L5/F5/R5 DRIVER – OFF
 - Pri RJD LOGIC (eight) – ON
 - √MCC FOR GO TO POWER UP Vern AND Pri DRIVERS
 - RJD MANF L5/F5/R5 DRIVER – ON
 - Wait 5 sec,
 - DAP: AUTO
 - O14:F, Pri RJD DRIVER (eight) – ON
 - O15:F, √cb MNA,C DDU AFT (two) – cl
 - O16:F
 - A1U
 - √CNTL – CMD
 - √KU BD PWR – ON
 - MODE – RDR PASSIVE
 - RADAR OUTPUT – LO
 - sel – GPC
 - SIG STR – KU
 - SLEW RATE – as reqd
 - A2
 - DIGI-DIS SEL – R/RDOT
 - √X-PNTR SCALE – X1
 - Install -Z COAS
4. MNVR TO BACKAWAY JETTISON ATT
 - √DAP A1,B1 loaded
 - | |
|--------------|
| GNC UNIV PTG |
|--------------|
 - TGT ID: 2
 - BODY VECT: 2
 - OM: 180
 - TRK – ITEM 19 EXEC (CUR - *)
 - ERR TOT – ITEM 23 EXEC (*)
 - DAP: A/AUTO/VERN, no LO Z

5. ENABLE RNDZ NAV
ENABLE RNDZ NAV, 5-14

6. LATCH REL
EV crewmember cuts carrier umbilicals and RF bond straps

On EV call:

GNC UNIV PTG

√RATES < 0.1 deg/sec

DAP: A/FREE/VERN(PRI)

GNC 33 REL NAV

ORB TO TGT – ITEM 10 EXEC

EV crewmember opens passive latches per CARRIER PASSIVE LATCH
RELEASE (EVA FS, HST CONTINGENCIES)

Verify EVA crewmembers clear of SLIC

A6U PL RETEN PL SEL – 3
LOGIC PWR SYS 1,2 (two) – ON
R13L PL BAY MECH PWR SYS 1,2 (two) – ON
A6U RETEN LAT 5 – REL (tb-bp)

After ~30 sec (60 sec max):

√PL RETEN LAT 5 tb – REL

LAT 5 – OFF

R13L PL BAY MECH PWR SYS 1,2 (two) – OFF
A6U RETEN LOGIC PWR SYS 1,2 (two) – OFF
PL SEL – MON

00:00:00 7. SEP 1 BURN

A6U

√SENSE: -Z

FLT CNTLR PWR – ON

On EV call:

AFT THC: +Z (out) 1 pulse (0.1 fps)

When separation confirmed,

AFT THC: +Z (out) 4 pulses (0.4 fps)

√VZ ~0.5 fps

00:01:00 8. SEP 2 BURN (RETROGRADE)

A6U

AFT THC: +Z (out) 15 pulses (1.5 fps)

FLT CNTLR PWR – OFF

DAP: A/INRTL/VERN

9. RADAR NAV (if desired)
POST REL RADAR ACQUISITION, 5-14
RR NAV, 5-14

ORUC JETTISON

1. PRE-REL CONFIG
 - √RMS/OBSS MPMs deployed
 - √Elbow Camr stowed
 - √HST deployed
 - √FSS stowed for landing
 - SSP2 ICBC3D PWR – OFF (tb-bp)
 - Perform SSE DEACT, (IN-BAY OPERATIONS)
 - R1 PL CAB – OFF
 - AFT MNB – OFF

2. AFT STATION CONFIG FOR RELEASE
 - A6U ADI ATT – LVLH
 - ERR – MED
 - RATE – LO
 - SENSE: – Z

3. RJD HEALTH STATUS
 - √MCC to verify comm

 - DAP: FREE
 - O14:F, RJDA 1A L2/R2 MANF DRIVER – OFF
 - O15:F, RJD MANF L5/F5/R5 DRIVER – OFF
 - O16:F Pri RJD LOGIC (eight) – ON

 - √MCC FOR GO TO POWER UP Vern AND Pri DRIVERS
 - RJD MANF L5/F5/R5 DRIVER – ON
 - Wait 5 sec,
 - DAP: AUTO

 - O14:F, Pri RJD DRIVER (eight) – ON
 - O15:F, √cb MNA,C DDU AFT (two) – cl
 - O16:F
 - A1U √CNTL – CMD
 - √KU BD PWR – ON
 - MODE – RDR PASSIVE
 - RADAR OUTPUT – LO
 - sel – GPC
 - SIG STR – KU
 - SLEW RATE – as reqd

- A2 DIGI-DIS SEL – R/RDOT
- √X-PNTR SCALE – X1

- Install -Z COAS

 4. MNVR TO BACKAWAY JETTISON ATT
 - √DAP A1,B1 loaded

 - | |
|--------------|
| GNC UNIV PTG |
|--------------|
 - TGT ID: 2
 - BODY VECT: 2
 - OM: 180
 - TRK – ITEM 19 EXEC (CUR - *)
 - ERR TOT – ITEM 23 EXEC (*)
 - DAP: A/AUTO/VERN, no LO Z

5. ENABLE RNDZ NAV
ENABLE RNDZ NAV, 5-14

6. LATCH REL
EV crew cuts carrier umbilicals and RF bond straps

On EV call:

GNC UNIV PTG

√Rates < 0.1 deg/sec

DAP: A/FREE/VERN(PRI)

GNC 33 REL NAV

ORB TO TGT – ITEM 10 EXEC

EV crewmember opens passive latches per CARRIER PASSIVE LATCH
RELEASE (EVA FS, HST CONTINGENCIES)

Verify EVA crewmembers clear of ORUC

A6U PL RETEN PL SEL – 2
LOGIC PWR SYS 1,2 (two) – ON
R13L PL BAY MECH PWR SYS 1,2 (two) – ON
A6U RETEN LAT 4 – REL (tb-bp)

After ~30 sec (60 sec max):

√PL RETEN LAT 4 tb – REL

LAT 4 – OFF

R13L PL BAY MECH PWR SYS 1,2 (two) – OFF
RETEN LOGIC PWR SYS 1,2 (two) – OFF
PL SEL – MON

00:00:00 7. SEP 1 BURN

A6U

√SENSE: -Z

FLT CNTLR PWR – ON

On EV call:

AFT THC: +Z (out) 1 pulse (0.1 fps)

When separation confirmed,

AFT THC: +Z (out) 4 pulses (0.4 fps)

√VZ ~0.5 fps

+00:01:00 8. SEP 2 BURN (RETROGRADE)

A6U

AFT THC: +Z (out) 15 pulses (1.5 fps)

FLT CNTLR PWR – OFF

DAP: A/INRTL/VERN

9. RADAR NAV (if desired)
POST REL RADAR ACQUISITION, 5-14
RR NAV, 5-14

ENABLE RNDZ NAV

√MCC for target vector onboard
GNC 33 REL NAV
RNDZ NAV ENA – ITEM 1 EXEC (*)
√SV SEL, ITEM 4 – (PROP)
√INH RNG, ITEM 18 – (*)
RDOT, ITEM 21 – (*)
Angles, ITEM 24 – (*)
RR – ITEM 13 EXEC (*)

POST REL RADAR ACQUISITION

GNC 33 REL NAV
KU ANT ENA – ITEM 2 EXEC (*)
GNC I/O RESET

A2 √DIGI-DIS SEL – R/RDOT

SM ANTENNA
RDR RNG MIN – ITEM 17 EXEC (*)
A1U √KU BD RDR OUTPUT – LO
√sel – GPC
√MODE – RDR PASSIVE
CNTL – PNL (wait 3 sec)
PWR – ON

* If no lock within 2 min: *

* KU sel – AUTO TRACK *

* √EL, AZ angles < 30 deg (as seen in *

COAS) *

* SLEW – as reqd (as seen in COAS) *

* KU SEARCH – SEARCH (tb-gray) *

* Repeat slew and search as reqd *

* If acquisition not successful, √MCC *

POST REL RR NAV

A1U √KU TRACK tb – gray
GNC 33 REL NAV
√RR – ITEM 13 (*)

IF RATIO > 1.0
FORCE 3 MARKS
If RATIO still > 1.0 call MCC

AUTO RNG – ITEM 17 EXEC
RDOT – ITEM 20 EXEC
Angles – ITEM 23 EXEC

When updates small and stable,
SV SEL – ITEM 4 EXEC (FLTR)

SM ANTENNA
RDR RNG AUTO – ITEM 16 EXEC (*)

When R > 400 ft,
KU RDR OUTPUT – HI

BSP MECHANISM CHECKOUT

1. FSS AMSB PWR ON

A6U √PL RETEN LAT 1,2 (two) – OFF
 √LOGIC PWR SYS 2(1) – OFF
 √PL SEL – 1
 LOGIC PWR SYS 1(2) – ON

SM 212 SSE MECH/BPA/RNS

AMSB ON – ITEM 7 EXEC (A(B))
 √MECH – blank
 √SEL (ITEMS 9-19) (eleven) – (no *)
 √STAT (ITEMS 9-19) (eleven) – blank
 √O/R DIS (ITEM 22) – *

R13L PL BAY MECH PWR SYS 1(2) – ON

2. BSP REL

CRT If MECH BSP DIS A, DIS B or DIS *, √MCC
 MECH BSP SEL – ITEM 19 EXEC (*)
 √AMSB DC AMPS: 0.035 to 0.125
 √MECH – steady A(B)
 √BSP STAT – SET
 A6U PL RETEN LAT 1(2) – REL, wait 4 sec, then OFF
 CRT √MECH BSP STAT – REL

* If MECH BSP STAT not REL: *
 * Perform 1.3a PRIMARY MOTOR FAILS *
 * TO DRIVE MECHANISM (PL SYS, SSE) *

3. BSP SET

On MCC GO:
 A6U PL RETEN LAT 1(2) – LAT, wait 4 sec, then OFF
 CRT √MECH BSP STAT – SET

* If MECH BSP STAT not SET: *
 * Perform 1.3a PRIMARY MOTOR FAILS *
 * TO DRIVE MECHANISM (PL SYS, SSE) *

4. AMSB PWRDN

CRT MECH DESEL – ITEM 20 EXEC (MECH SEL ITEMS 9-19 (eleven) – (no *))

* If any MECH SEL – *, do not turn *
 * AMSB OFF; notify MCC, continue *

√AMSB DC AMPS: < 0.035
 OFF – ITEM 8 EXEC (*)
 A6U PL RETEN LOGIC PWR SYS 1(2) – OFF
 R13L BAY MECH PWR SYS 1(2) – OFF

Notify MCC BSP MECHANISM CHECKOUT complete; report any anomalies

SSE CHECKOUT WITH FAILED MULE FMDM-A

L11U 1. MULE/RNS SURVIVAL HEATER C/O

SURV HTR A PWR – ON

B PWR – OFF

√PWR tb – gray

B PWR – ON

A PWR – OFF

√PWR tb – gray

- * If SURV HTR PWR tb – bp, *
- * cycle SURV HTR A PWR sw *
- * If still no joy, continue *

2. MULE COPE A HEATER C/O

MULE COPE HTR A PWR – ON (tb-gray)

- * If MULE COPE HTR A PWR tb – bp, *
- * cycle sw *
- * If still no joy, continue *

MULE COPE HTR A PWR – OFF (tb-bp)

3. VERIFY SSE STATUS

NOTE

If any parameter not in range, notify MCC

SM 211 SSE OVERVIEW

√PCU – blank/blank

√PCU OFF – *

√CCTV ENA OFF – *

√PWR OFF – *

POWER

√FSS EPDSU 1/2 AMPS (two): < 3.0

√FMDM A/B AMPS (two): 0.5 to 1.1

√HTR – 1/2

√HTR P1/P2 AMPS (two): < 0.4

√R1/R2 AMPS (two): < 0.4

√CCTV HTR AMPS: < 0.9

√ORUC – A/B

√AMPS (two): < 30

√SLIC EPDSU AMPS: < 16

√FSS VOLTS (two): 24.0 to 32.0

√SLIC VOLTS (two): 24.0 to 32.0

√DPC 1-12 (twelve) – (no *)

√VOLTS (twelve): < 0.5

√AMPS (twelve): < 0.5

THERMAL

- √FSS EPDSU TEMP (two): -20 to 50 degC
- √FMDM TEMP (two): -3 to 55 degC
- √PCU TEMP (two): -20 to 50 degC
- √PCU TEMP: -30 to 50 degC
- √AMSB TEMP: -20 to 50 degC
- √ORUC PRJU TEMP (two): -20 to 50 degC
- √SLIC EPDSU TEMP (two): -20 to 50 degC

4. AMSB CHECKOUT SIDE A

SM 212 SSE MECH/BPA/RNS

- √AMSB OFF - *
- √AMSB AC AMPS: < 0.20
- √AMSB TEMP: -20 to 50 degC
- √MECH - blank
- √PIVOT LO TACH: < 0.25 deg/min
- √ROTATOR TACH: < 0.9 deg/min

- A6U √PL RETEN LAT 1,2 (two) – OFF
 - √LOGIC PWR SYS 1,2 (two) – OFF
 - √PL SEL - 1

- R13L √PL BAY MECH PWR SYS 1,2 (two) – OFF

- CRT AMSB ON – ITEM 7 EXEC (A)

- * If AMSB ON – blank, *
- * record and continue *

- √AMSB AC AMPS: < 0.20
- √MECH - blank
- √SEL (ITEMS 9-19) (eleven) – (no *)
- √STAT (ITEMS 9-19) (eleven) – blank
- √PIVOT LO TACH: < 0.25 deg/min
- √ROTATOR TACH: < 0.9 deg/min
- √O/R DIS (ITEM 22) - *

- * If any parameter out of limit, √MCC *

Perform following ITEM ENTRIES and checks per table

NOTE

SEL field should show ‘*’ for only MECHANISM selected.
For any parameters not as expected, do not deselect;
contact MCC

ITEM EXEC	MECHANISM	SEL	STAT	AMSB DC AMPS	MECH	SM 97 PL SEL 1, LAT/REL LATCH 1
9	DLOCK	9 – *	ENG	0.035-0.125	A	10/00
Expect 'S212 AMSB DC AMPS' msg						
21	O/R ENA(*)	9 – *	RDY	0.130-0.230		00/00
11	PIVOT LO	11 – *	DN	0.035-0.125	A	00/10
Expect 'S212 AMSB DC AMPS' msg						
21	O/R ENA (*)	11 – *	RDY	0.130-0.230		00/00
22	O/R DIS (*)	11 – *	DN	0.035-0.125	A	00/10
12	ROTATOR	12 – *	RDY	0.035-0.125		00/00
14	B LAT 1	14 – *	OP	0.035-0.125	A	00/10
15	B LAT 2	15 – *	OP	0.035-0.125	A	00/10
16	B LAT 3	16 – *	OP	0.035-0.125	A	00/10
17	UMB MN	17 – *	REL	0.035-0.125	A	00/10
18	UMB B/U	18 – *	MAT	0.035-0.125	A	10/00
19	BSP	19 – *	SET	0.035-0.125	A	10/00
20	DESEL	9-19 blank		< 0.035		00/00

AMSB OFF – ITEM 8 EXEC (*)

5. FSS PCU CHECKOUT

SM 211 SSE OVERVIEW

PCU ON – ITEM 1 EXEC (*)

√PCU – P/S

√DPC 1-12 (twelve) – *

√VOLTS (twelve): 33.7 to 35.5

√AMPS (twelve): ≤ 0.5

* If any DPC 1-12 AMPS (twelve): > 0.5, *

* PCU OFF – ITEM 2 EXEC (*), *

* √MCC *

PCU OFF – ITEM 2 EXEC (*)

√PCU – blank/blank

√DPC 1-12 (twelve) – (no *)

6. FSS FMDM-A PWRDN

SM 1 DPS UTILITY

PORT ASSIGN STRING PL 1/2 PRI – ITEM 23 EXEC (*)

FSS FMDM-A PWR – OFF (tb-bp)

* If tb – gray, note and continue *

SM 211 SSE OVERVIEW

√POWER FSS FMDM A/B AMPS: < 0.15/0.5 to 1.1

Notify MCC, SSE CHECKOUT WITH FAILED MULE FMDM-A complete; report any anomalies

L12U

EVA HARDWARE JETTISON

1. CONFIG HST
 Pivot FSS to 90° and rotate as reqd:
 Perform PIVOT HST (IN-BAY OPERATIONS)
 Perform ROTATE HST (IN-BAY OPERATIONS)
 √MCC (SA slew may be reqd)
 √BSP pinned
2. ACQUIRE FAILED ORU
 Configure orbiter lighting as reqd to support night jettison
 Unstow HHL

MS √VTR recording

SM 94 PDRS CONTROL

- √PL ID, ITEM 3: 3
- √INIT ID, ITEM 24: 3

RHC RATE – as reqd (VERN within 10 ft)
 A8U BRAKES – OFF (tb-OFF)
 MODE – ORB LD, ENTER

MS/EV If acquiring other failed hardware,
 mnvr as reqd to grasp failed ORU

- CDR/PLT 3. ORBITER MNVR TO JETTISON ATTITUDE
 O14,O15, cb DDU (six) – cl
 O16:E

O14,O15, PRI RJD DRIVER, LOGIC (sixteen) – ON
 O16:F

√DAP: A10/AUTO/VERN(ALT)

GNC UNIV PTG

TRK OPTION:
 TGT ID +2
 BODY VECTOR +2
 √P +180.0
 √Y +0.0
 OM +0.0
 TRK – ITEM 19 EXEC (CUR – *)

4. RMS MNVR TO JETTISON POSN

4a. If jettisoning hardware:
 RHC RATE – as reqd (VERN within 10 ft)
 A8U BRAKES – OFF (tb-OFF)
 MODE – ORB LD, ENTER

Mnvr to HARDWARE JETTISON posn:

X	Y	Z	PITCH	YAW	ROLL	PL ID
-760	+63	-750	2	288	0	3
-762	+63	-698	2	288	0	4
-755	+42	-690	2	288	180	0
SY	SP	EP	WP	WY	WR	
-71.3	+117.8	-123.4	-12.2	+0.2	-168.0	

DAP: FREE as reqd to maintain control of jettison hardware

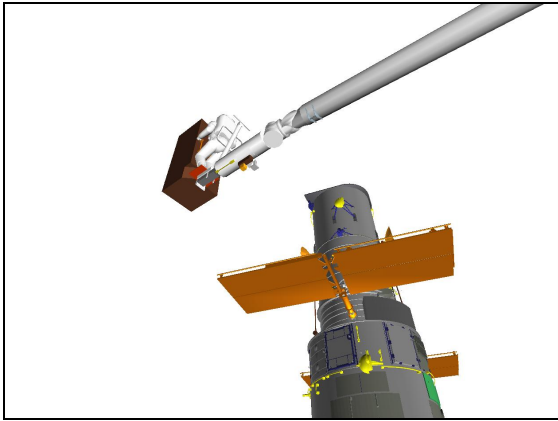

CCTV A (-20,45)

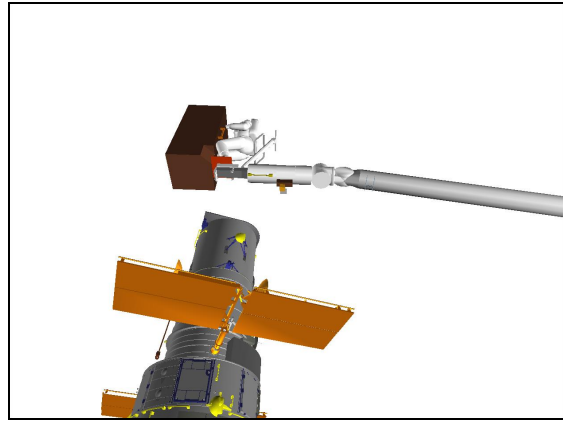

CCTV D (20,50)

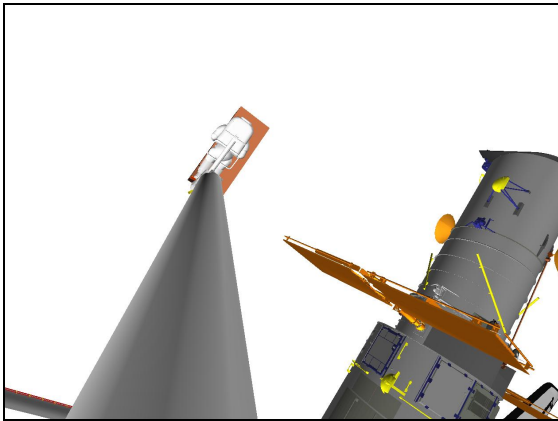

ELBOW (10,-10)

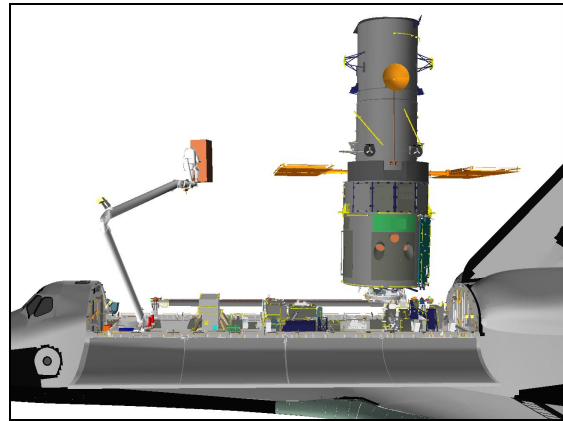

PORT

4b. If jettisoning MFR:

RHC
A8U

SM 94 PDRS CONTROL

PL ID - ITEM 3 +0 EXEC
INIT ID - ITEM 24 +0 EXEC

RATE - as reqd (VERN within 10 ft)
BRAKES - OFF (tb-OFF)
MODE - ORB UNL, ENTER

Mnvr to **HARDWARE JETTISON** posn:

X	Y	Z	PITCH	YAW	ROLL	PL ID
-755	+42	-690	2	288	180	0
-760	+63	-750	2	288	0	3
-762	+63	-698	2	288	0	4
SY	SP	EP	WP	WY	WR	
-71.3	+117.8	-123.4	-12.2	+0.2	-168.0	

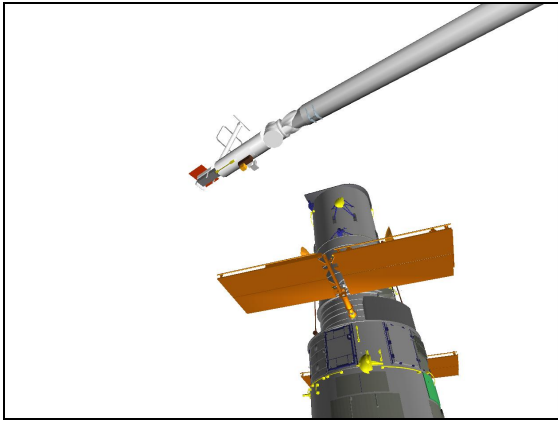

CCTV A (-20,45)

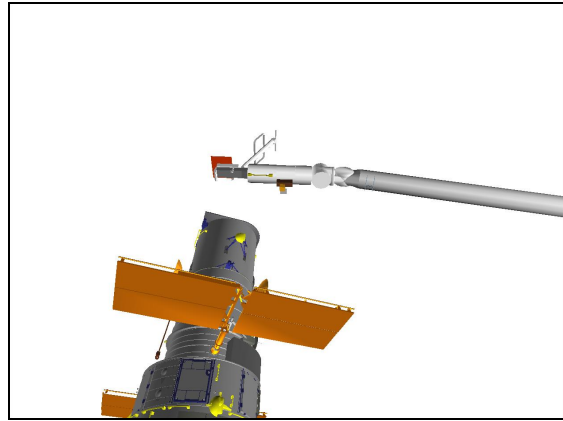

CCTV D (20,50)

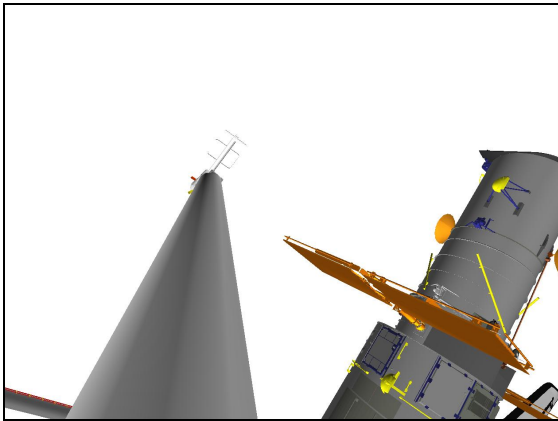

ELBOW (10,-10)

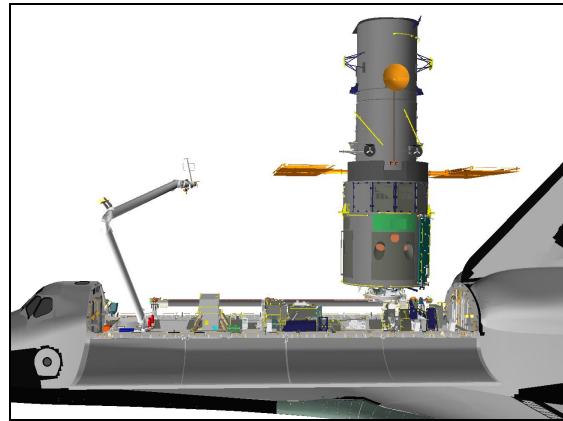

PORT

5. PREP FOR RELEASE

GNC 20 DAP CONFIG

REBOOST CFG – ITEM 8 +4 EXEC

INTVL – ITEM 9 +5.1 2 EXEC

GNC UNIV PTG

Set start time to current time:

START TIME – ITEM 1 + ___ + ___ + ___ + ___ EXEC

When RMS/EV stable at jettison position:

DAP: A/AUTO/VERN(ALT)

√DAP TRANS: PULSE/PULSE/PULSE, LO Z

6. HARDWARE RELEASE

When in jettison attitude with rates damped:

√MCC GO for release

DAP: FREE

6a. If jettisoning hardware:

RHC
A8

√RATE – COARSE (RATE MIN tb-OFF)

√BRAKES – OFF (tb-OFF)

√MODE – ORB LD, ENTER

EV

√Tether released

Release Hardware

MS

Mnvr RMS EV 5 ft (minimum) clear of jettisoned hardware

Maintain 5 ft clearance to structure during reboost

BRAKES – ON (tb-ON)

RHC
A8

6b. If jettisoning MFR:







- √RATE – COARSE (RATE MIN tb-OFF)
- √BRAKES – OFF (tb-OFF)
- MODE – END EFF, ENTER

CAUTION
Monitor EE tb timing to prevent EE motor burnout

EE MODE – AUTO
RELEASE sw – depress (mom)

NOTE

When OPEN tb – gray, mnvr arm clear of grapple pin

	RIGID	CLOSE	CAPTURE	<u>CRITICAL TIMES (28 sec total)</u>
√				DERIGID tb – gray, 5 sec max, then
	DERIGID	OPEN	EXTEND	OPEN tb – gray, 3 sec max, then
				EXTEND tb – gray, 20 sec max

EE MODE – OFF

Mnvr RMS 5 ft (minimum) clear of jettisoned MFR
Maintain 5 ft clearance to structure during reboost

- * If manual release reqd: *
- * EE MODE – MAN *
- * MAN CONTR – DERIGID (hold until DERIGID tb-gray, *
- 5 sec max) *
- * RELEASE sw – depress (hold until OPEN tb-gray, *
- 3 sec max) *
- * Mnvr arm clear, then *
- * EE MAN CONTR – DERIGID (hold until EXTEND tb-gray, *
- 20 sec max) *
- * MODE – OFF *

BRAKES – ON (tb-ON)

7. REBOOST

GNC UNIV PTG

Set DURATION to 0:01:31.0
RBST – ITEM 25 EXEC (CUR – *)

NOTE

Reboost firings will start 14 sec after ITEM 25. Reboost
can be aborted with an ITEM 26 on UNIV PTG

Report HHL Range, Rdot to MCC

8. POST-REBOOST CLEANUP

When reboost cmplt:

DAP: A/LVLH/VERN(ALT)

O14,O15,
O16:E

cb DDU (six) – op

O14,O15,
O16:F

PRI RJD DRIVER,LOGIC (sixteen) – as reqd

Return to FLIGHT PLAN attitude

RAPID SAFING WITHOUT HST

1. √PL BAY CONFIG

If EVA:

√BSP PIP pin removed prior to EV crew ingress

√RMS/OBSS clear of payload envelope

2. ACTIVATE LOGIC AND MECH POWER

Perform this step only if FSS not stowed for entry; else, go to step 7

A6U √PL RETEN LAT 1,2 (two) – OFF
LOGIC PWR SYS 1,2 (two) – ON
√PL SEL – 1

R13L PL BAY MECH PWR SYS 1,2 (two) – ON

SM 212 SSE MECH/BPA/RNS

AMSB PWR ON – ITEM 7 EXEC (A(B))

3. ROTATE (SINGLE MOTOR DRIVE)

Perform this step only if BSP installed and B/L not aligned with fixed target (+V3 FWD); else, go to step 4

NOTE

Rotate to align closest berthing latch to fixed target.
If hardstop encountered, reverse direction

MECH ROTATOR SEL – ITEM 12 EXEC (* RDY)

A6U PL RETEN LAT 1(2) – REL (cw) or LAT (ccw) as reqd

CRT √MECH – flashing A(B)
Complete rotation to reqd posn

CCTV When rotator in posn:
A6U PL RETEN LAT 1(2) – OFF

4. PIVOT DOWN (DUAL MOTOR DRIVE)

SM 212 SSE MECH/BPA/RNS

MECH BSP SEL – ITEM 19 EXEC (* SET)

MECH PIVOT LO SEL – ITEM 11 EXEC (* RDY or UP)

A6U PL RETEN LAT 1(2) – REL
L12U FSS FMDM-B(A) – ON

SM 1 DPS UTILITY

PORT ASSIGN STRING PL 1/2 PRI(SEC) – ITEM 23(24) EXEC (*)

SM 212 SSE MECH/BPA/RNS

AMSB PWR ON – ITEM 7 EXEC (*)

MECH PIVOT LO SEL – ITEM 11 EXEC (* RDY)

A6U PL RETEN LAT 2(1) – REL
CRT √MECH – flashing A,B

If BSP installed, go to step 5, else complete pivot to 0°
A6U √MECH PIVOT LO STAT – (* DN)
PL RETEN LAT 1,2 (two) – OFF

5. VERIFY BSP ENGAGED

If BSP not installed proceed to step 6

A6U After MECH BSP – RET/ENG status received,
PL RETEN LAT 1,2 (two) – OFF
CRT √MECH BSP – RET (not blank)/ENG (not blank)

Proceed to step 7 (Downlock not required with BAPS post installed)

6. ENGAGE DOWNLOCK

If SCM not installed proceed to step 7

<u>WARNING</u> The downlock engagement is required for landing if SCM is on FSS Failure to operate correct side may result in pivoter motion (pivoter is still selected on alternate side)
--

SM 212 SSE MECH/BPA/RNS

CRT MECH DLOCK SEL – ITEM 9 EXEC (* DIS)

A6U PL RETEN LOGIC PWR SYS 1(2) – OFF
R13L PL BAY MECH PWR SYS 1(2) – OFF

A6U PL RETEN LAT 2(1) – LAT

CRT After MECH DLOCK STAT – ENG status received,
A6U PL RETEN LAT 2(1) – OFF

7. CLOSEOUT

NOTE

If downlock engaged, SYS 1(2) will be off

A6U PL RETEN LOGIC PWR SYS 1,2 (two) – OFF
PL SEL – MON
R13L BAY MECH PWR SYS 1,2 (two) – OFF

8. SSE RAPID DEACT

NOTE

Expect 'I/O ERROR FLEX' msg

R1 PL PRI MNC – OFF (tb-OFF)

CONFIGURE PRIME COMM STRING FOR HST BSA

NOTE

Possible 'S62 PDI DECOM FAIL' msg

1. DEADFACE PI CONNECTOR
PSP BY-PASS – DISABLE
L12L
2. CONFIGURE PDIP1 PI CONNECTORS
Remove Turn-Around Plug from HST PI 1(2)
Connect BSA data cable to HST PI 1(2)
L12L
3. BSA PWR ON
POWER – ON
WATCHDOG RESET pb – push
√POWER (four) – Green
BSA
4. ENABLE PSP-BYPASS
PSP BY-PASS – ENABLE
√SYNC – Frame – Green
L12L
BSA

Notify MCC "HST BSA installation on prime COMM string complete"

CONFIGURE PRIME COMM STRING FOR PSP-BYPASS (TURN-AROUND PLUG)

NOTE

Possible 'S62 PDI DECOM FAIL' msg

- | | |
|------|--|
| BSA | 1. <u>BSA PWR OFF</u>
POWER – OFF |
| L12L | 2. <u>DEADFACE PI CONNECTOR</u>
PSP BY-PASS – DISABLE |
| L12L | 3. <u>CONFIGURE PDIP1 PI CONNECTORS</u>
Disconnect BSA data cable from HST PI 1(2)
Install Turn-Around Plug on HST PI 1(2) |
| L12L | 4. <u>ENABLE PSP BYPASS</u>
PSP BY-PASS – ENABLE |

Notify MCC "HST prime COMM string configured for PSP-BYPASS"

ENABLE RNS OP HTRS

SM 212 SSE MECH/BPA/RNS

On MCC GO:

RNS OP HTR ON – ITEM 27 EXEC (*)

* If RNS OP HTR ON – (no *) *
* record and continue *

√RNS OP HTR AMPS < 8.5

* If RNS OP HTR ON > 8.5, *
* expect FDA then, *
* RNS OP HTR OFF – ITEM 28 EXEC (*) *
* Notify MCC *

This Page Intentionally Blank

NATIONAL LAB PATHFINDER (NLP)

NLP ACTIVATION 6-2
NLP TERMINATION 6-5

NLP

NLP ACTIVATION

OBJECTIVE:

Up to fourteen Group Activation Packs (GAPs) containing microbial experiments will be activated, one at a time, for the National Lab Pathfinder (NLP) - Vaccine-1C payload. The loaded Glass Barrel will be inspected for any signs of leakage both before and after activation. During activation, microbes will be injected into the growth media chamber so that growth may occur.

LOCATION:

MA16G

PARTS:

- NLP-Vaccine-1C/Stowage Foam
- Group Activation Packs (GAPs)
- Hand Crank
- Ziplock Bag (if required, use for leakage control.)

1. Check Flight Plan Detail Page for which GAPs to activate. Record information in Table 1 in Step 2.1

MA16G 2. [ACTIVATING NLP-VACCINE-1C EXPERIMENT](#)

- 2.1 Record MET Activation Start Time in Table 1.

NOTE

All GAPs listed in Execute Package Detail Page should be activated within one hour timeframe for optimum science return.

Table 1.

GAP(s)	Activation Start MET	Activation Stop MET

WARNING

GAP cannot be processed if external leakage is evident. GAP will remain in sealed Ziplock Bag.

- 2.2 Remove one GAP listed in Table 1 from foam.
- 2.3 Verify visually:
No leakage from GAP.
No fluid outside of the upper and lower seals within the Glass Barrel (Figure 1).

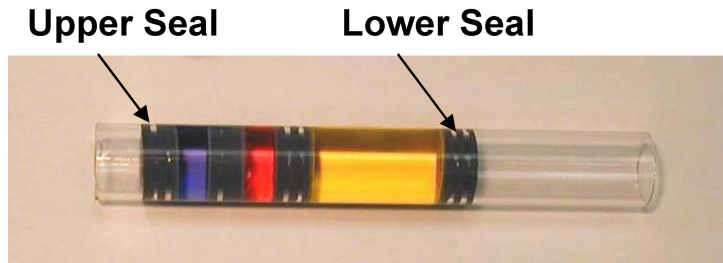

Figure 1. - Loaded Glass Barrel.

- * If any external leakage is evident
- * | Immediately seal GAP in Ziplock Bag, stow.
- * | Report to **MCC** GAP number.
- * |
- * If any leakage is evident in more than two loaded Glass Barrels
- * | Immediately seal GAP in Ziplock Bag, stow.
- * | Report to **MCC** Glass Barrel and GAP number(s).
- * |
- * If any leakage is evident in two or fewer loaded Glass Barrel(s)
- * | Complete step 2, then seal GAP in Ziplock Bag, stow.
- * | Report to **MCC** Glass Barrel and GAP number(s).

- 2.4 Unstow Hand Crank and attach to GAP.
Slowly rotate the Hand Crank ↻ until lower edge of pressure plate aligns with lower edge of the first mark labeled “ACTIVATION” on the side of GAP housing.
- 2.5 Detach Hand Crank.
- 2.6 Shake GAP firmly by accelerating in a back and forth motion along the lengthwise axis of the GAP four times.
- 2.7 Verify visually:
No leakage from GAP.
No fluid outside of the upper and lower seals within the Glass Barrel (Figure 1).

* If any leakage from GAP or leakage within the
* | loaded Glass Barrel(s) is evident
* | Immediately seal GAP in Ziplock Bag, stow.
* | Report to **MCC** GAP number.

- 2.8 Restow GAP in original foam location.
- 2.9 Repeat steps 2.2 to 2.8 until all GAPs identified in Table 1 are activated.
- 2.10 Record MET Activation Stop in Table 1.
- 2.11 Restow Hand Crank in original foam location.
- 3. Report to **MCC** METs recorded in Table 1.

NLP TERMINATION

OBJECTIVE:

Up to fourteen Group Activation Packs (GAPs) containing microbial experiments will be terminated, one at a time, for the National Lab Pathfinder (NLP) - Vaccine-1C payload. The loaded Glass Barrels will be inspected for any signs of leakage both before and after the termination. During termination, reagent will be injected into the growth chamber to stop the growth.

LOCATION:

MA16G

PARTS:

NLP-Vaccine-1C/Stowage Foam
Group Activation Packs (GAPs)
Hand Crank
Ziplock Bag (if required, use for leakage control)

1. Check Flight Plan Detail Page for which GAPs to terminate. Record information in Table 1 in Step 2.1.

MA16G 2. [TERMINATING NLP-VACCINE-1C EXPERIMENT](#)

- 2.1 Record MET Termination Start in Table 1.

<u>NOTE</u> All GAPs listed in Execute Package Detail Page should be terminated within one hour timeframe for optimum science return.

Table 1.

GAPs	Termination Start MET	Termination Stop MET

WARNING
GAP cannot be processed if external leakage is evident. GAP will remain in sealed Ziplock Bag.

- 2.2 Remove one GAP listed in Table 1 from foam.
- 2.3 Verify visually:
No leakage from GAP.
No fluid outside of the upper and lower seals within the Glass Barrel
(Figure 1).

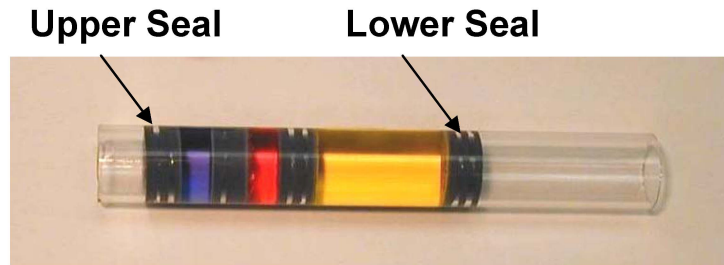

Figure 1. - Loaded Glass Barrel.

- * If any external leakage is evident
- * | Immediately seal GAP in Ziplock Bag, stow.
- * | Report to **MCC** GAP number.
- * |
- * If any leakage is evident in more than two loaded Glass Barrels
- * | Immediately seal GAP in Ziplock Bag, stow.
- * | Report to **MCC** Glass Barrel and GAP number(s).
- * |
- * If any leakage is evident in two or fewer loaded Glass Barrel(s)
- * | Complete step 2, then seal GAP in Ziplock Bag, stow.
- * | Report to **MCC** Glass Barrel and GAP number(s).

- 2.4 Unstow Hand Crank and attach to GAP.
Slowly rotate the Hand Crank ↻ until lower edge of pressure plate aligns with lower edge of the first mark labeled "TERMINATION" on the side of GAP housing.
- 2.5 Detach Hand Crank.
- 2.6 Shake GAP firmly by accelerating in a back and forth motion along the lengthwise axis of the GAP four times.
- 2.7 Verify visually:
No leakage from GAP.
No fluid outside of the upper and lower seals within the Glass Barrel
(Figure 1).

* If any leakage from GAP or leakage within the
* | loaded Glass Barrel(s) is evident
* | Immediately seal GAP in Ziplock Bag, stow.
* | Report to **MCC** GAP number.

2.8 Restow GAP in original foam location.

2.9 Repeat steps 2.2 to 2.8 until all GAPs identified in Table 1 are terminated.

2.10 Record MET Termination Stop in Table 1.

2.11 Restow Hand Crank in original foam location.

3. Report to **MCC** METs recorded in Table 1.

This Page Intentionally Blank

DEORBIT PREP

PAYLOAD DEACT 7-2
PAYLOAD ENTRY SW LIST/VERIF 7-2
PAYLOAD REACT 7-3

DEORBIT
PREP

PAYLOAD DEACT

R1 PL CAB – OFF
AFT MNB – OFF

PAYLOAD ENTRY SW LIST/VERIF

R1 √PL CAB – OFF
√PRI MNC,MNB,FC3 (three) – ctr (tb-OFF)
√AUX – ON
√AFT MNB – OFF
√MNC – OFF

A6U √PL RETEN LAT 1,2 (two) – OFF (tb-bp)
√PL SEL – MON
√LOGIC PWR SYS 1,2 (two) – OFF

R13L √PL BAY MECH PWR SYS 1,2 (two) – OFF

L12U (SSP-1) (FSS/ORUC)
√FSS PCU PWR CONTR A,B (two) – OFF
√ORUC PWR CONTR A,B (two) – OFF (tb-bp)
√CCTV HTR PWR – OFF (tb-bp)
√FSS FMDM-A,B PWR (two) – OFF (tb-bp)
√HTR PWR – OFF (tb-bp)
√cb FSS/ORUC A SIDE PWR – op
PDIP1 PWR 2/Ku BAND RLY – op

(TELESCOPE)
√ESS BUS EXT PWR – ctr (tb-bp)
√INT PWR – ctr (tb-bp)
√FHST SHUTTER – OPEN (tb-bp)
√RSU SURV HTR PWR – OFF (tb-bp)
√MN BUS INT PWR – ctr
√PWR ON tb – bp
√ESS/MN SW ENA – OFF (tb-bp)
√IPCU RLY CL tb – bp
√MAIN BUS EXT PWR – ctr (tb-bp)
√SSM WK LTS – OFF
√cb SPACE TEL SW PWR – op
PDIP1 PWR 1 – op

L12L (SSP-2) (APCU/PSP BY-PASS/ICBC3D)
√APCU 1 CONV – OFF (tb-bp)
√OUTPUT RLY – OPEN (tb-bp)
√2 CONV – OFF (tb-bp)
√OUTPUT RLY – OPEN (tb-bp)
√PSP BY-PASS – DISABLE
√ICBC3D PWR – OFF (tb-bp)
√EMER RUN – OFF (tb-bp)
cb SW PWR – op
PDIP2 PWR 2 – op

DEORBIT
PREP

(SLIC)
 √WSIPE HTR A,B PWR (two) – ctr (tb-bp)
 √BPA PORT HTR A,B PWR (two) – OFF (tb-bp)
 √SLIC B SIDE PWR ENA – OFF
 √BPA STBD HTR A,B PWR (two) – OFF (tb-bp)
 √SLIC EPDSU HTR PWR – OFF (tb-bp)
 √cb SLIC A SIDE PWR ENA – op
 PDIP 2 PWR 1 – op

L12L (PDIP 1)
 √Ku BAND RATE – LO
 √DC PWR 1,2 (two) – OFF

L11U (PDIP 2)
 √DC PWR 1,2 (two) – OFF

(SSP-3)
 HTR/ILLUM PWR – OFF
 √KEEL CAM ENABLE – OFF
 cb KEEL CAM SW – op
 √CB2 – op

(MULE/RNS)
 √RNS GPS REC – ctr (tb-bp)
 √CAM REC – ctr (tb-bp)
 √MULE FMDM-A,B PWR (two) – OFF (tb-bp)
 √SURV HTR A,B PWR (two) – OFF
 √PWR tb – bp
 √RNS PWR – DIS (tb-bp)
 √MULE COPE HTR A,B PWR (two) – OFF (tb-bp)
 √cb MULE B SIDE PWR – op
 KEEL CAM PWR – op

MO13Q √DC UTIL PWR MNB – OFF

PAYLOAD REACT

R1 PL CAB – MNA
 PRI MNC – ON (tb-ON)

SM1 DPS UTILITY

PORT ASSIGN STRING PL 1/2 PRI – ITEM 23 EXEC (*)
 Perform SSE ACTIVATION (SSE ACT/FSS PREP)

This Page Intentionally Blank

HST QUICK RESPONSE

SA SLEW (INADVERTENT) 8-2

HST
QUICK RESPONSE

SA SLEW (INADVERTENT)

SM 210 HST SYS

SOLAR ARRAY SADE OFF – ITEM 9 +9 9 EXEC (OFF)
Notify MCC

HST
QUICK RESPONSE

REFERENCE DATA

DPC ON/OFF INDEX NUMBERS..... 9-2

REFERENCE
DATA

DPC ON/OFF INDEX NUMBERS

SM 211 SSE OVERVIEW

	DPC ON – ITEM 23 + <u>x</u> <u>x</u>	DPC OFF – ITEM 24 + <u>x</u> <u>x</u>
DPC	X X	X X
1	01	71
2	02	72
3	03	73
4	04	74
5	05	75
6	06	76
7	07	77
8	08	78
9	09	79
10	10	80
11	11	81
12	12	82

CUE CARD CONFIGURATION

CUE CARD
CONFIG

TOP

HOOK
VELCRO

HOOK
VELCRO

BIT SYNC ASSEMBLY

BSA MANUAL MODE
RNDZ/UNBERTH CONFIG

BSA AUTOMATIC MODE
HST BERTHED CONFIG

CONFIGURE BSA
BSA RATE SW – up (√32k LED – Green) BSA
WATCHDOG – DIS
RESET pb – push

CONFIGURE BSA
BSA RATE SW – ctr (√AUTO LED – Green)
WATCHDOG – EN
RESET pb – push

√POWER LEDs (four) – Green
√SYNC FRAME – Green

√POWER LEDs (four) – Green
√SYNC FRAME – Green

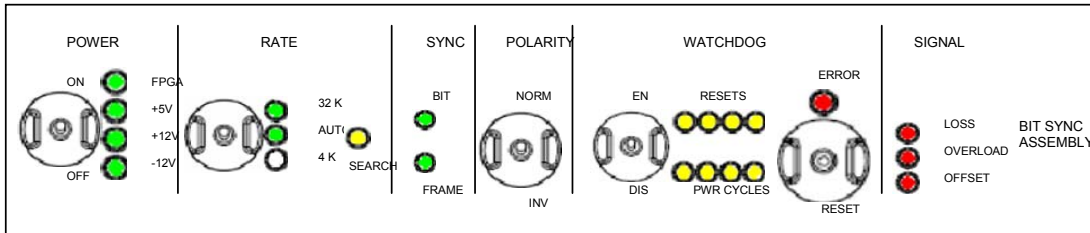

POWER – All four LEDs must be lit green for proper operation
 RATE – 32k, indicates the data rate being processed is the standard HST T (F, H, J) data at 32 kbps
 AUTO, indicates the BSA will automatically process either 32 kbps or 4 kbps
 4k, indicates the data rate being processed is HST M, A, or D data at 4 kbps
 SEARCH – If lit, indicates loss of signal (At 4K rate, expect yellow SEARCH LED to flicker on and off, result of less than ideal signal integrity from PI in 4K data rate)
 SYNC – BIT, indicates a proper HST bit sync is being processed
 FRAME, indicates a proper HST FRAME sync is detected and being processed
 POLARITY – Used if SYNC BIT is achieved, but no PDI DECOM lock is detected
 NORM – biases the outgoing telemetry polarity to the incoming telemetry polarity
 INV – inverts the outgoing data stream polarity
 WATCHDOG – EN, performs automatic Single Event Upset correction
 DIS, inhibits automatic Single Event Upset correction
 RESETS – Displays in binary the number of WATCHDOG resets performed (Left MSB)
 PWR CYCLES – Displays in binary the number of POWER CYCLES the BSA has executed (Left MSB)
 ERROR – BSA has experienced multiple uncorrectable errors that the WATCHDOG can't recover. RESET Req'd
 SIGNAL – LOSS, OVERLOAD, or OFFSET indicate a problem with the incoming PI – HST Bit Stream

PL OPS-1a/125/O/C

HOOK
VELCRO

HOOK
VELCRO

CUE CARD
CONFIG

(reduced copy)

TOP
BACK OF 'BIT SYNC ASSEMBLY'

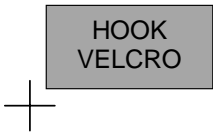
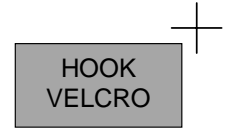
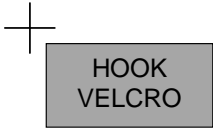

PL OPS-1b/125/O/A

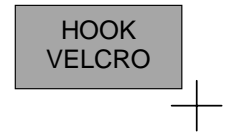

(reduced copy)

This Page Intentionally Blank



PAYLOAD OPS CHECKLIST

STS
125