

Photo/TV Checklist

STS-134 Flight Supplement

**Mission Operations Directorate
Operations Division**

**Final, Rev A
October 4, 2010**

National Aeronautics and
Space Administration

Lyndon B. Johnson Space Center
Houston, Texas

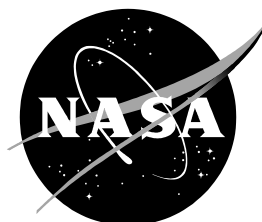

PHOTO/TV C/L, STS-134 Flt Suppl

FINAL, REV A (Oct 4, 2010)

PCN-3 (Mar 21, 2011) Sheet 1 of 1

List of Implemented Change Requests (482s):



P/TV_FS-0140

P/TV_FS-0145

Incorporate the following:

1. Replace FS iii and FS iv, FS vii and FS viii
2. Replace FS 1-9 and FS 1-10, FS 1-19 and FS 1-20, FS 1-29 and FS 1-30, FS 1-37 and FS 1-38, FS 1-41 thru FS 1-50, FS 1-55 thru FS 1-58, FS 1-65 and FS 1-66, FS 1-73 thru FS 1-76
3. Replace FS 2-21 and FS 2-22, FS 2-27 thru FS 2-30
4. Replace FS CC 3-7 thru FS CC 3-12

Prepared by:

Mission Lead
Publication Manager

Approved by:

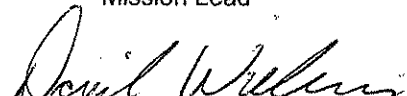
Lead, Shuttle Photo/TV Group
Manager, Flight Procedures

Accepted by:

FDF Manager

Encl: 44 pages

File this PCN immediately behind the front cover as a permanent record

PHOTO/TV C/L, STS-134 Flt Suppl

FINAL, REV A (Oct 4, 2010)

PCN-2 (Feb 7, 2011) Sheet 1 of 1

List of Implemented Change Requests (482s):

P/TV_FS-0138

Incorporate the following:

1. Replace FS iii and FS iv, FS vii and FS viii
2. Replace FS 1-3 and FS 1-4, FS 1-7 and FS 1-8, FS 1-17 and FS 1-18, FS 1-27 and FS 1-28, FS 1-71 thru FS 1-78
3. Replace FS 2-23 and FS 2-24
4. Replace FS CC 3-15 and FS CC 3-16, FS CC 3-19 and FS CC 3-20

Prepared by:

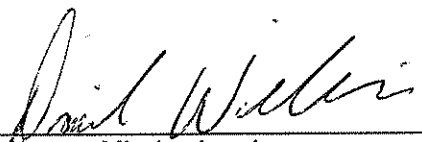
Mission Lead
Publication Manager

Approved by:

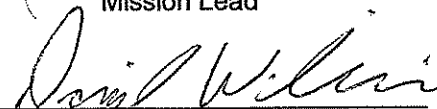
Lead, Shuttle Photo/TV Group
Manager, Flight Procedures

Accepted by:

FDF Manager

Encl: 26 pages

File this PCN immediately behind the front cover as a permanent record

PHOTO/TV C/L, STS-134 Flt Suppl

FINAL, REV A (Oct 4, 2010)

PCN-1 (Dec 7, 2010) Sheet 1 of 1

List of Implemented Change Requests (482s):

P/TV_FS-0137

Incorporate the following:

1. Replace FS iii and FS iv
2. Replace FS 1-5 thru FS 1-8, FS 1-13 thru FS 1-32, FS 1-35 thru FS 1-38, FS 1-41 thru FS 1-50, FS 1-53 thru FS 1-58, FS 1-63 thru FS 1-68, FS 1-71 thru FS 1-74
3. Replace FS 2-1 and FS 2-2
After FS 2-8, add FS 2-8a and FS 2-8b (2 pages)

Prepared by:

Mission Lead
Publication Manager

Approved by:

Lead, Shuttle Photo/TV Group
Manager, Flight Procedures

Accepted by:

FDF Manager

Encl: 60 pages

File this PCN immediately behind the front cover as a permanent record

MISSION OPERATIONS DIRECTORATE

**PHOTO/TV CHECKLIST
STS-134 FLIGHT SUPPLEMENT**

FINAL, REVISION A
October 4, 2010

PREPARED BY:

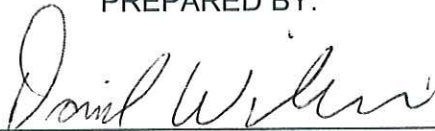

David L. Williams
Mission Lead

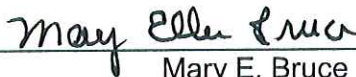

Mary E. Bruce
Publication Manager

APPROVED BY:



David L. Williams
Technical Lead, Shuttle Photo/TV Group



Kimberly Johnson
Manager, Flight Procedures

ACCEPTED BY:



FDF Manager

This document is under the configuration control of the Crew Procedures Control Board (CPCB). All proposed changes must be submitted via Change Request Workflow (CRW) to DO3/FDF Manager.

Additional distribution of this book, for official use only, may be requested in writing to DO3/PMO Administrator. The request must include justification and requester's name, organization, position, and phone number. Contractor requests are made through the NASA or DOD organization supported. Deletions, reduction in quantity, or change of address may be submitted to DO3/FDF Management Office, 281-244-1184.

Incorporates the following:	
482#:	P/TV_FS-0134 P/TV_FS-0135A

AREAS OF TECHNICAL RESPONSIBILITY

Publication Manager	DO35/M. Bruce	281-483-6083
Alternate Publication Manager	DO35/L. Giles	281-244-9068
Mission Lead	DX46/D. Williams	281-244-7882
Backup Mission Lead	DX46/P. Richert	281-483-1827
Technical Lead, Shuttle Photo/TV Group	DX46/D. Williams	281-244-7882

PHOTO/TV CHECKLIST
STS-134 FLIGHT SUPPLEMENT

LIST OF EFFECTIVE PAGES

FINAL	04/16/10	PCN-3	03/21/11
REV A	10/04/10		
PCN-1	12/07/10		
PCN-2	02/07/11		

Sign Off.....*	134/FIN A	FS 1-37.....	134/FIN A,3
FS ii.....*	134/FIN A	FS 1-38.....	134/FIN A
FS iii.....*	134/FIN A,3	FS 1-39.....	134/FIN A
FS iv.....*	134/FIN A,3	FS 1-40.....⊗	134/FIN A
FS v.....*	134/FIN A	FS 1-41.....⊗	134/FIN A
FS vi.....*	134/FIN A	FS 1-42.....	134/FIN A,3
FS vii.....*	134/FIN A,3	FS 1-43.....	134/FIN A,3
FS viii.....*	134/FIN A	FS 1-44.....	134/FIN A,1
FS ix.....	134/FIN A	FS 1-45.....	134/FIN A,3
FS x.....	134/FIN A	FS 1-46.....	134/FIN A
1-i.....	generic	FS 1-47.....	134/FIN A
1-ii.....	generic	FS 1-48.....⊗	134/FIN A,3
FS 1-1.....	134/FIN A	FS 1-49.....	134/FIN A,1
FS 1-2.....	134/FIN A	FS 1-50.....	134/FIN A,3
FS 1-3.....	134/FIN A	FS 1-51.....	134/FIN A
FS 1-4.....⊗	134/FIN A,2	FS 1-52.....⊗	134/FIN A
FS 1-5.....	134/FIN A,1	FS 1-53.....	134/FIN A,1
FS 1-6.....	134/FIN A	FS 1-54.....	134/FIN A
FS 1-7.....	134/FIN A	FS 1-55.....	134/FIN A
FS 1-8.....	134/FIN A,2	FS 1-56.....	134/FIN A,3
FS 1-9.....	134/FIN A	FS 1-57.....	134/FIN A
FS 1-10.....	134/FIN A,3	FS 1-58.....	134/FIN A,3
FS 1-11.....	134/FIN A	FS 1-59.....	134/FIN A
FS 1-12.....	134/FIN A	FS 1-60.....	134/FIN A
FS 1-13.....	134/FIN A	FS 1-61.....	134/FIN A
FS 1-14.....⊗	134/FIN A,1	FS 1-62.....	134/FIN A
FS 1-15.....	134/FIN A,1	FS 1-63.....	134/FIN A,1
FS 1-16.....	134/FIN A	FS 1-64.....⊗	134/FIN A,1
FS 1-17.....	134/FIN A,1	FS 1-65.....⊗	134/FIN A,3
FS 1-18.....	134/FIN A,2	FS 1-66.....	134/FIN A
FS 1-19.....	134/FIN A,3	FS 1-67.....	134/FIN A,1
FS 1-20.....	134/FIN A,1	FS 1-68.....	134/FIN A
FS 1-21.....	134/FIN A,1	FS 1-69.....	134/FIN A
FS 1-22.....	134/FIN A	FS 1-70.....	134/FIN A
FS 1-23.....	134/FIN A	FS 1-71.....	134/FIN A,2
FS 1-24.....⊗	134/FIN A,1	FS 1-72.....	134/FIN A,1
FS 1-25.....	134/FIN A,1	FS 1-73.....	134/FIN A,3
FS 1-26.....	134/FIN A	FS 1-74.....	134/FIN A,1
FS 1-27.....	134/FIN A,1	FS 1-75.....	134/FIN A
FS 1-28.....	134/FIN A,2	FS 1-76.....⊗	134/FIN A,3
FS 1-29.....	134/FIN A,3	FS 1-77.....⊗	134/FIN A,2
FS 1-30.....	134/FIN A,1	FS 1-78.....⊗	134/FIN A,2
FS 1-31.....	134/FIN A,1	FS 2-1.....	134/FIN A,1
FS 1-32.....	134/FIN A	FS 2-2.....	134/FIN A
FS 1-33.....	134/FIN A	FS 2-3.....	134/FIN A
FS 1-34.....⊗	134/FIN A	FS 2-4.....	134/FIN A
FS 1-35.....	134/FIN A	FS 2-5.....	134/FIN A
FS 1-36.....	134/FIN A,1	FS 2-6.....	134/FIN A

* – Omit from flight book

⊗ – Flight copies of this page contain color

FS 2-7	134/FIN A	FS CC 3-17.....	⊗ 134/FIN A
FS 2-8	134/FIN A	FS CC 3-18.....	⊗ 134/FIN A
FS 2-8a	⊗ 134/FIN A,1	FS CC 3-19.....	⊗ 134/FIN A
FS 2-8b	134/FIN A,1	FS CC 3-20.....	⊗ 134/FIN A,2
FS 2-9	134/FIN A	FS CC 3-21.....	134/FIN A
FS 2-10	134/FIN A	FS CC 3-22.....	⊗ 134/FIN A
FS 2-11	134/FIN A	FS CC 3-23.....	⊗ 134/FIN A
FS 2-12	⊗ 134/FIN A	FS CC 3-24.....	134/FIN A
FS 2-13	134/FIN A	FS CC 3-25.....	134/FIN A
FS 2-14	134/FIN A	FS CC 3-26.....	⊗ 134/FIN A
FS 2-15	134/FIN A	FS CC 3-27.....	134/FIN A
FS 2-16	134/FIN A	FS CC 3-28.....	134/FIN A
FS 2-17	134/FIN A	FS 3-29 (4 pgs).....	Δ 134/FIN A
FS 2-18	134/FIN A	FS 3-30 (4 pgs).....	Δ 134/FIN A
FS 2-19	134/FIN A	4-i.....	generic
FS 2-20	134/FIN A	4-ii.....	generic
FS 2-21	134/FIN A	4-1	† generic
FS 2-22	⊗ 134/FIN A,3	4-2	† generic
FS 2-23	134/FIN A,2	4-3	† generic
FS 2-24	134/FIN A	4-4	† generic
FS 2-25	134/FIN A	4-5	†⊗ generic
FS 2-26	⊗ 134/FIN A	4-6	†⊗ generic
FS 2-27	134/FIN A	4-7	†⊗ generic
FS 2-28	134/FIN A,3	4-8	† generic
FS 2-29	134/FIN A,3	4-9	† generic
FS 2-30	134/FIN A	4-10	† generic
FS 2-31	134/FIN A	4-11	† generic
FS 2-32	134/FIN A	4-12	† generic
FS 2-33	⊗ 134/FIN A	4-13	† generic
FS 2-34	134/FIN A	4-14	† generic
FS 2-35	134/FIN A	4-15	† generic
FS 2-36	134/FIN A	4-16	† generic
FS 2-37	134/FIN A	4-17	† generic
FS 2-38	⊗ 134/FIN A	4-18	† generic
FS 2-39	⊗ 134/FIN A	4-19	† generic
FS 2-40	⊗ 134/FIN A	4-20	† generic
FS 2-41	⊗ 134/FIN A	4-21	† generic
FS 2-42	134/FIN A	4-22	†⊗ generic
FS 2-43	134/FIN A	4-23	†⊗ generic
FS 2-44	134/FIN A	4-24	†⊗ generic
FS 3-1	134/FIN A	4-25	†⊗ generic
FS 3-2	134/FIN A	4-26	†⊗ generic
FS CC 3-3.....	134/FIN A	4-27	†⊗ generic
FS CC 3-4.....	134/FIN A	4-28	†⊗ generic
FS CC 3-5.....	134/FIN A	4-29	† generic
FS CC 3-6.....	⊗ 134/FIN A	4-30	† generic
FS CC 3-7.....	134/FIN A	4-31	† generic
FS CC 3-8.....	134/FIN A,3	4-32	† generic
FS CC 3-9.....	134/FIN A	4-33	† generic
FS CC 3-10.....	134/FIN A,3	4-34	† generic
FS CC 3-11.....	134/FIN A,3	4-35	† generic
FS CC 3-12.....	134/FIN A	4-36	† generic
FS CC 3-13.....	⊗ 134/FIN A	4-37	† generic
FS CC 3-14.....	134/FIN A	4-38	† generic
FS CC 3-15.....	134/FIN A	5-1	† generic
FS CC 3-16.....	⊗ 134/FIN A,2	5-2	† generic
		5-3	† generic
		5-4	† generic

⊗ – Flight copies of this page contain color
Δ – Replace with blue K-10 card stock in flight book only
† – May be replaced with CD in flight book only

5-5	† generic	7-18a	† generic
5-6	† generic	7-18b	† generic
5-7	†⊗generic	7-19	† generic
5-8	†⊗generic	7-20	† generic
5-9	†⊗generic	7-21	† generic
5-10	† generic	7-22	† generic
5-11	† generic	7-23	†⊗generic
5-12	† generic	7-24	†⊗generic
5-13	†⊗generic	8-1	† generic
5-14	†⊗generic	8-2	† generic
5-15	†⊗generic	8-3	† generic
5-16	†⊗generic	8-4	† generic
5-17	† generic	8-5	† generic
5-18	† generic	8-6	† generic
5-19	† generic	9-1	† generic
5-20	† generic	9-2	† generic
5-21	† generic	9-3	†⊗generic
5-22	† generic	9-4	†⊗generic
5-23	† generic	10-1	† generic
5-24	† generic	10-2	† generic
6-1	† generic	10-3	† generic
6-2	† generic	10-4	† generic
6-3	† generic	10-5	† generic
6-4	† generic	10-6	†⊗generic
6-5	†⊗generic	10-7	† generic
6-6	†⊗generic	10-8	† generic
6-7	† generic	10-9	† generic
6-8	† generic	10-10	† generic
6-9	† generic	10-11	† generic
6-10	† generic	10-12	† generic
6-11	† generic	10-13	† generic
6-12	† generic	10-14	† generic
6-13	† generic	10-15	† generic
6-14	† generic	10-16	† generic
6-15	† generic	10-17	† generic
6-16	† generic	10-18	† generic
6-17	† generic	10-19	† generic
6-18	† generic	10-20	† generic
7-1	† generic	10-21	† generic
7-2	† generic	10-22	† generic
7-3	† generic	10-23	† generic
7-4	† generic	10-24	† generic
7-5	† generic	10-25	† generic
7-6	† generic	10-26	† generic
7-7	†⊗generic	11-1	† generic
7-8	† generic	11-2	† generic
7-9	† generic	11-3	† generic
7-10	† generic	11-4	† generic
7-11	† generic	11-5	† generic
7-12	† generic	11-6	† generic
7-13	† generic	11-7	† generic
7-14	† generic	11-8	† generic
7-15	†⊗generic	11-9	† generic
7-16	† generic	11-10	† generic
7-17	† generic	11-11	†⊗generic
7-18	† generic	11-12	† generic

† – May be replaced with CD in flight book only

⊗ – Flight copies of this page contain color

12-1	†	generic	16-3	†	generic
12-2	†	generic	16-4	†	generic
12-3	†	generic	16-5	†	generic
12-4	†	generic	16-6	†	generic
12-5	†	generic	17-1	†	generic
12-6	†	generic	17-2	†	generic
12-7	†	generic	18-1	†	generic
12-8	†	generic	18-2	†	generic
12-9	†	generic	18-3	†	generic
12-10	†	generic	18-4	†	generic
12-11	†	generic	18-5	†	generic
12-12	†	generic	18-6	†	generic
12-12a	†	generic	19-1	†	generic
12-12b	†	generic	19-2	†	generic
12-13	†	generic	19-3	†	generic
12-14	†⊗	generic	19-4	†	generic
12-15	†	generic	19-5	†	generic
12-16	†	generic	19-6	†	generic
12-17	†	generic	19-7	†	generic
12-18	†	generic	19-8	†	generic
12-19	†	generic	19-9	†	generic
12-20	†	generic	19-10	†	generic
13-1	†	generic	19-11	†	generic
13-2	†	generic	19-12	†	generic
13-3	†	generic	20-1	†	generic
13-4	†⊗	generic	20-2	†	generic
13-5	†⊗	generic	20-3	†	generic
13-6	†⊗	generic	20-4	†	generic
13-7	†⊗	generic	20-5	†	generic
13-8	†⊗	generic	20-6	†	generic
13-9	†	generic	20-7	†	generic
13-10	†	generic	20-8	†	generic
13-11	†	generic	20-9	†	generic
13-12	†	generic	20-10	†	generic
14-1	†	generic	20-11	†	generic
14-2	†	generic	20-12	†	generic
14-3	†	generic	20-13	†	generic
14-4	†	generic	20-14	†	generic
15-1	†	generic	20-15	†⊗	generic
15-2	†	generic	20-16	†	generic
15-3	†	generic	20-17	†	generic
15-4	†	generic	20-18	†⊗	generic
15-5	†	generic	20-19	†	generic
15-6	†	generic	20-20	†	generic
15-7	†	generic	20-21	†	generic
15-8	†	generic	20-22	†	generic
15-9	†	generic	21-1	†	generic
15-10	†	generic	21-2	†	generic
15-11	†	generic			
15-12	†	generic			
15-13	†	generic			
15-14	†	generic			
15-15	†	generic			
15-16	†	generic			
16-1	†	generic			
16-2	†	generic			

† – May be replaced with CD in flight book only

⊗ – Flight copies of this page contain color

PHOTO/TV CUE CARDS

	<u>Title</u>	<u>Ref. Page</u>	<u>Card No.</u>
TV			
	(Front).....	FS CC 3-3	P/TV-1a/134/O/A
	(Back).....	FS CC 3-4	P/TV-1b/134/O/A
ANALOG PLAYBACK			
	(Front).....	FS CC 3-5	P/TV-2a/134/O/A
	(Back).....	FS CC 3-6	P/TV-2b/134/O/A
ET PHOTO			
	(Front).....	FS CC 3-7	P/TV-3a/134/O/A
	(Back).....	FS CC 3-7	P/TV-3b/134/O/A
MEDIA ALLOCATIONS			
	(Front).....	FS CC 3-8	P/TV-4a/134/O/C
	(Back).....	FS CC 3-9	P/TV-4b/134/O/A
WVS			
	(Front).....	FS CC 3-10	P/TV-5a/134/O/B
	(Back).....	FS CC 3-11	P/TV-5b/134/O/C
PLBD VTR RECORDING			
	(Front).....	FS CC 3-12	P/TV-6a/134/O/A
	(Back).....	FS CC 3-13	P/TV-6b/134/O/A
LDRI/ITVC			
	(Front).....	FS CC 3-14	P/TV-7a/134/O/A
	(Back).....	FS CC 3-15	P/TV-7b/134/O/A
LCS			
	(Front).....	FS CC 3-16	P/TV-8a/134/O/C
	(Back).....	FS CC 3-17	P/TV-8b/134/O/C
IDC			
	(Front).....	FS CC 3-18	P/TV-9a/134/O/C
	(Back).....	FS CC 3-19	P/TV-9b/134/O/C
VIDEO SETUP			
	(Front).....	FS CC 3-20	P/TV-10a/134/O/D
	(Back).....	FS CC 3-21	P/TV-10b/134/O/A
D2Xs SETUP			
	(Front).....	FS CC 3-22	P/TV-11a/134/O/A
	(Back).....	FS CC 3-23	P/TV-11b/134/O/A
LDRI/ITVC A7 PLACARD			
	(Front).....	FS CC 3-24	P/TV-12a/134/O/A
	(Back).....	FS CC 3-24	P/TV-12b/134/O/A
DIGITAL PLAYBACK			
	(Front).....	FS CC 3-25	P/TV-13a/134/O/A
	(Back).....	FS CC 3-26	P/TV-13b/134/O/B
G1 CC SETUP CUE CARD			
	(Front).....	FS CC 3-27	P/TV-17a/134/O/A
	(Back).....	FS CC 3-28	P/TV-17b/134/O/A

This Page Intentionally Blank

TABLE OF CONTENTS

PAGE

FLIGHT SPECIFIC

<u>SCENES</u>	FS 1-1
P/TV01 VIDEO SETUP	FS 1-4
P/TV02 DOCK.....	FS 1-14
P/TV03 UNDOCK.....	FS 1-24
P/TV04 INGRESS/EGRESS	FS 1-34
P/TV05 ISS INTERNAL OPS (HC)	FS 1-40
P/TV06 ROBOTICS OPERATIONS	FS 1-48
P/TV07 EVA	FS 1-52
P/TV08 EXTERNAL SURVEY	FS 1-60
P/TV09 MIDDECK PAYLOADS	FS 1-70
P/TV10 STORMM.....	FS 1-76
 <u>REFERENCED PROCEDURES</u>	 FS 2-1
 <u>CUE CARD CONFIGURATION</u>	 FS 3-1

GENERIC

<u>NIKON D2Xs</u>	4-1
<u>D2Xs EVA CAMR</u>	5-1
<u>EVA IR CAMR</u>	6-1
<u>CANON G1</u>	7-1
<u>SONY V10</u>	8-1
<u>PORTABLE MONITORS</u>	9-1
<u>CCTV</u>	10-1
<u>CENTERLINE (C/L) CAMR</u>	11-1
<u>DTV</u>	12-1
<u>BPSMU</u>	13-1
<u>MINI-CAM</u>	14-1
<u>WIRELESS VIDEO SYSTEM (WVS)</u>	15-1
<u>SEQUENTIAL STILL VIDEO (SSV)</u>	16-1
<u>BINOCULARS</u>	17-1
<u>FIBERSCOPE</u>	18-1
<u>LASER DYNAMIC RANGE IMAGER (LDRI)</u>	19-1
<u>LASER CAMR SYSTEM (LCS)/INTEGRATED SENSOR INSPECTION SYSTEM</u> <u>DIGITAL CAMR (IDC)</u>	20-1
<u>BATTS & FUSES</u>	21-1

This Page Intentionally Blank

SCENES

	<u>PAGE</u>
P/TV01 VIDEO SETUP.....	FS 1-4
P/TV02 DOCK	FS 1-14
P/TV03 UNDOCK	FS 1-24
P/TV04 INGRESS/EGRESS.....	FS 1-34
P/TV05 ISS INTERNAL OPS (HC).....	FS 1-40
P/TV06 ROBOTICS OPERATIONS	FS 1-48
P/TV07 EVA.....	FS 1-52
P/TV08 EXTERNAL SURVEY	FS 1-60
P/TV09 MIDDECK PAYLOADS.....	FS 1-70
P/TV10 STORRM	FS 1-76

This Page Intentionally Blank

This Page Intentionally Blank

P/TV01 VIDEO SETUP

P/TV01 VIDEO SETUP

H/W SUMMARY

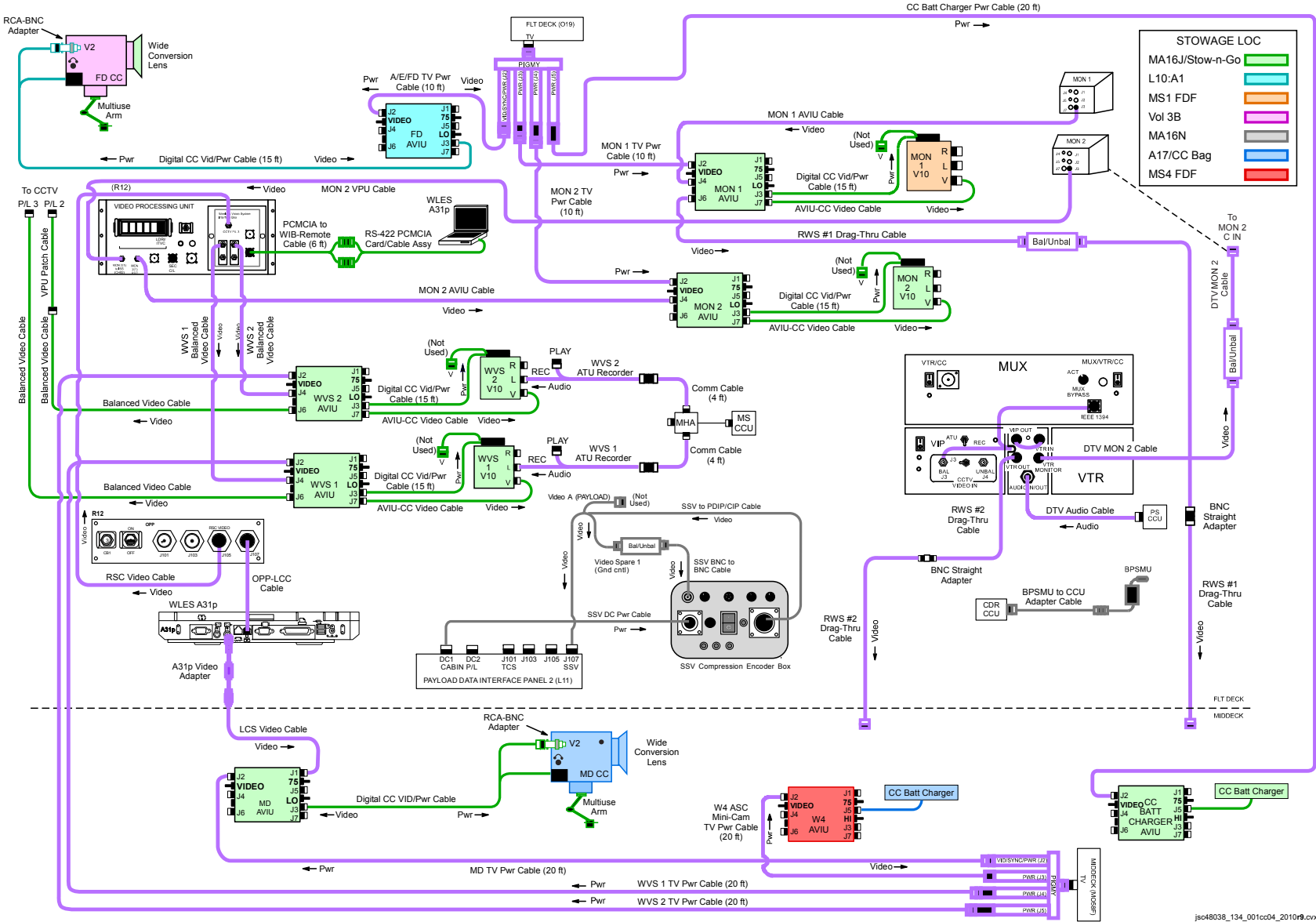

P/TV01 VIDEO SETUP (Continued)

SETUP

NOTE

Steps 1-7 minimum rqmt for OBSS RCC Inspection

1. Perform ACTIVATION, OPERATION (Cue Card, TV) as reqd
 2. Perform DTV Setup
- O19 2a. Deconfig ASCENT AVIU |
 TV PWR – OFF
- L10:A1 Unstow AVIU and disconnect following cables:
 ASC/ENT/FD TV Pwr Cable from J2
 AVIU Adapter Cable from J5
 ASC/ENT FD V10 Cable from J1
 Temp stow AVIU for use on Flight Deck |
- L10 (MUX) 2b. Config Panels |
 ✓VTR/CC PWR – on (LED on)
 If dnk:
 MUX/VTR/CC PWR – on (LED on)
 ✓MUX BYPASS – ACT
- (VIP) ✓ATU – REC
 ✓CCTV VIDEO IN – J3
 ✓PWR – on (LED on)
- (VTR) ✓ON/STANDBY LED – green
 ✓Switches set to White Dot (seven)
 ✓COUNTER SELECT – COUNTER (TC)
- MON 1 2c. Config MON 1,2 |
 MON 2 SOURCE – DNLK
 Connect DTV MON 2 Cbl to C-IN
 SOURCE – C
- A15 2d. Config Audio |
 L9 (PS ATU) Connect DTV Audio Cable to PS CCU
 ✓PWR – AUD
 ✓A/G1 – RCV, VOL – 5
 ✓OTHER LOOPS – OFF
 ✓MODE – PTT/PTT

P/TV01 VIDEO SETUP (Continued)

SETUP (Continued)

3. Perform MON 1,2 V10 Setup

MA16J Remove MON 1,2 Desk Assy Hardware from Stow-n-Go CTB

O19 TV PWR – OFF

Config MON 1,2 V10s and Cables per H/W SUMMARY, FS 1-4

Retrieve MON 1 V10 from MS1 Saddlebag

Connect:

MON 1,2 Digital CC Vid/Pwr Cables to MON 1,2 V10s

MON 1,2 AVIU-CC Video Cables to MON 1,2 V10s

Multiuse Brkt to desk

RWS #1 Drag-Thru Cable to MON 1 AVIU J6

MON 1 AVIU Cable to MON 1 AVIU J4

MON 2 AVIU Cable to MON 2 AVIU J4

MON 1,2 TV PWR Cable to MON 1,2 AVIU J2

Multiuse Brkt to wall

AVIU (MON 1,2) √SYNC/VIDEO – VIDEO

√HI-Z/75 – 75

√PWR SELECT – LO

R12 (VPU) VPU PWR – ON (LED on)

O19 TV PWR – ON

V10 (MON 1,2) PWR – ON

DISPLAY pb – toggle to display tape counter

√Tape installed

4. √RSC Video Cable connected between R12/OPP-RSC Video (J105) and R12/WIB-CCTV PL3

P/TV01 VIDEO SETUP (Continued)

SETUP (Continued)

5. Perform Analog Camcorder Setup for FD,MD

O19,MO58F TV PWR – OFF
Config G1 CCs per H/W SUMMARY, FS 1-4, as reqd

AVIU (FD,MD) SYNC/VIDEO – VIDEO
HI-Z/75 – 75
PWR SELECT – LO

O19,MO58F TV PWR – ON

CC (FD,MD) Install Wide Conversion lens
√ND FILTER – OFF
√OUTPUT – CAM
√... -
√STANDBY/LOCK – STANDBY
PWR dial – “green”
√Tape installed
√Viewfinder (LCD) displays “green” •||
Install Audio Muting Plug (optional)
Install Multiuse Brkt

6. Perform LCS Cable Connections per H/W SUMMARY, FS 1-4, as reqd

Middeck AVIU (MD) Connect MD TV Pwr Cable to MD AVIU J2
Connect end of LCS Video Cable to MD AVIU J1
√HI-Z/75 – 75

Flt Deck Connect other end of LCS Video Cable (A31p Video Adapter) to A31p Video Out port via PGSC Usage Chart
Connect OPP-LCC Cable to A31p RJ45 Ethernet port via PGSC Usage Chart

P/TV01 VIDEO SETUP (Continued)

SETUP (Continued)

7. Perform SSV Setup

MF710

Unstow:

- SSV Compression Encoder Box
- SSV BNC-BNC Cable
- SSV to PDIP/CIP Cable
- SSV DC Pwr Cable
- Bal/Unbal Xfmr

Config SSV H/W per H/W SUMMARY, FS 1-4

NOTE

Video Spare 1 controlled by MCC instead of pnl A7

L12 (SSP 2)
L11 (PDIP 2)

√cb PDIP 2 PWR 1 – cl
DC PWR 1 – ON

SSV

Config SSV settings

IN SEL – NTSC

Mode – 3

OUTRATE – 3

SSV Pwr – on

√Pwr LED illum

√ENC DATA LED flickering

√FRM DATA LED flickering

√FILL FRM pulsing

Inform MCC when SSV SETUP complete

8. Perform HDTV Setup for handheld ET Video Downlink

L10:A1

Unstow MPC

- White Brick

- MPC-DTV MUX Cbl (Fiber Optic)

- MPC-G1 Cbl (Firewire)

Config H/W per HD DIGITAL VIA CC PLAYBACK diagram on back of DIGITAL PLAYBACK Cue Card

P/TV01 VIDEO SETUP (Continued)

SETUP (Continued)

9. Perform WVS Setup

a. Activate WVS System

A7 WIRELESS VID HTR – ON
PWR – ON

MO58F TV PWR – OFF

b. Remove WVS Hardware from Stow-n-Go CTB

Config WVS 1,2 V10s and Cables per H/W SUMMARY, FS 1-4

Connect:

WVS 1,2 Digital CC Vid/Pwr Cables to WVS 1,2 V10s

WVS 1,2 AVIU-CC Vid Cables to WVS 1,2 V10s

Multiuse Brkt to desk

Pre-routed WVS 1,2 Balanced Video Cables from R12/VPU XCVR 1,2 BAL to WVS 1,2 AVIU J4

Pre-routed WVS TV Pwr Cables to WVS 1,2 AVIU J2

Balanced Video Cables stowed on WVS Stow-n-Go desk to WVS 1,2 AVIU J6

ATU Recorder Cables to left (white) port per H/W SUMMARY, FS 1-4

Multiuse Brkt to wall

PCMCIA-to-WIB Remote Cable to R12/WIB J701

RS-422 PCMCIA Card/Cable Assy and PCMCIA-to-WIB Remote Cable to bottom PCMCIA slot on A31p per

PGSC Usage Chart

AVIU (WVS 1,2) √SYNC/VIDEO – VIDEO
√HI-Z/75 – 75
√PWR SELECT – LO

MO58F V10 (two)
V10 (WVS 1,2) TV PWR – ON
PWR – ON
√Tape installed
√WVS Test Pattern displayed (color bars w/“No WVS Video”)
PWR – OFF

P/TV01 VIDEO SETUP (Continued)

SETUP (Continued)

9. Perform WVS Setup (Continued)

c. WVS PGSC Prep

PGSC

PGSC Pwrup and Application Opening

√Pwr – ON

Sel Shuttle Apps icon

Sel WVS icon

Sel 'No' at 'Restore To Previous Settings:' window

If 'Comm Port Configuration' error displayed:

Remove Quatech RS-422 Card

Sel 'Start' > 'Shut Down' > 'Shut Down' > 'OK'

Reinstall Quatech RS-422 Card in bottom PCMCIA slot

Pwr – ON

Sel Shuttle Apps icon

Sel WVS icon

RF Camera page will appear

Application Setup

If 'Static XCVR' ('Bad ID Received', 'Temp Alert', 'Temp Caution') alert msg:

| Perform ALERT MSG TROUBLESHOOTING (Cue Card, WVS)

If 'Static RF Camera' alert msg:

Disregard

Sel 'File' → 'Assign Camera ID'

Verify following:

Camr Address	S/N	In Use	Label
18	1007	1	EV1
20	1006	1	EV2

If Camr IDs not correct:

Sel 'Delete Entry' until all deleted

Perform CAMR ID ASSIGNMENT (Cue Card, WVS) as reqd

When complete, sel 'OK'

P/TV01 VIDEO SETUP (Concluded)

SETUP (Concluded)

9. Perform WVS Setup (Concluded)

d. PWRDN

Sel 'File' → 'Exit'
WIRELESS VID PWR – OFF
HTR – OFF

A7

MF710 10. Unstow, set up BPSMU w/BPSMU to CCU Adapter Cable at CDR CCU
Connect BPSMU Batt

A17/CC BAG 11. Unstow, connect CC Batt Charger to W4 AVIU J5 port

MA16J/
Stow-N-Go BAG 12. Unstow, connect CC Batt Charger, AVIU to TV Power Cable

This Page Intentionally Blank

This Page Intentionally Blank

P/TV02 DOCK

P/TV02 DOCK

H/W SUMMARY

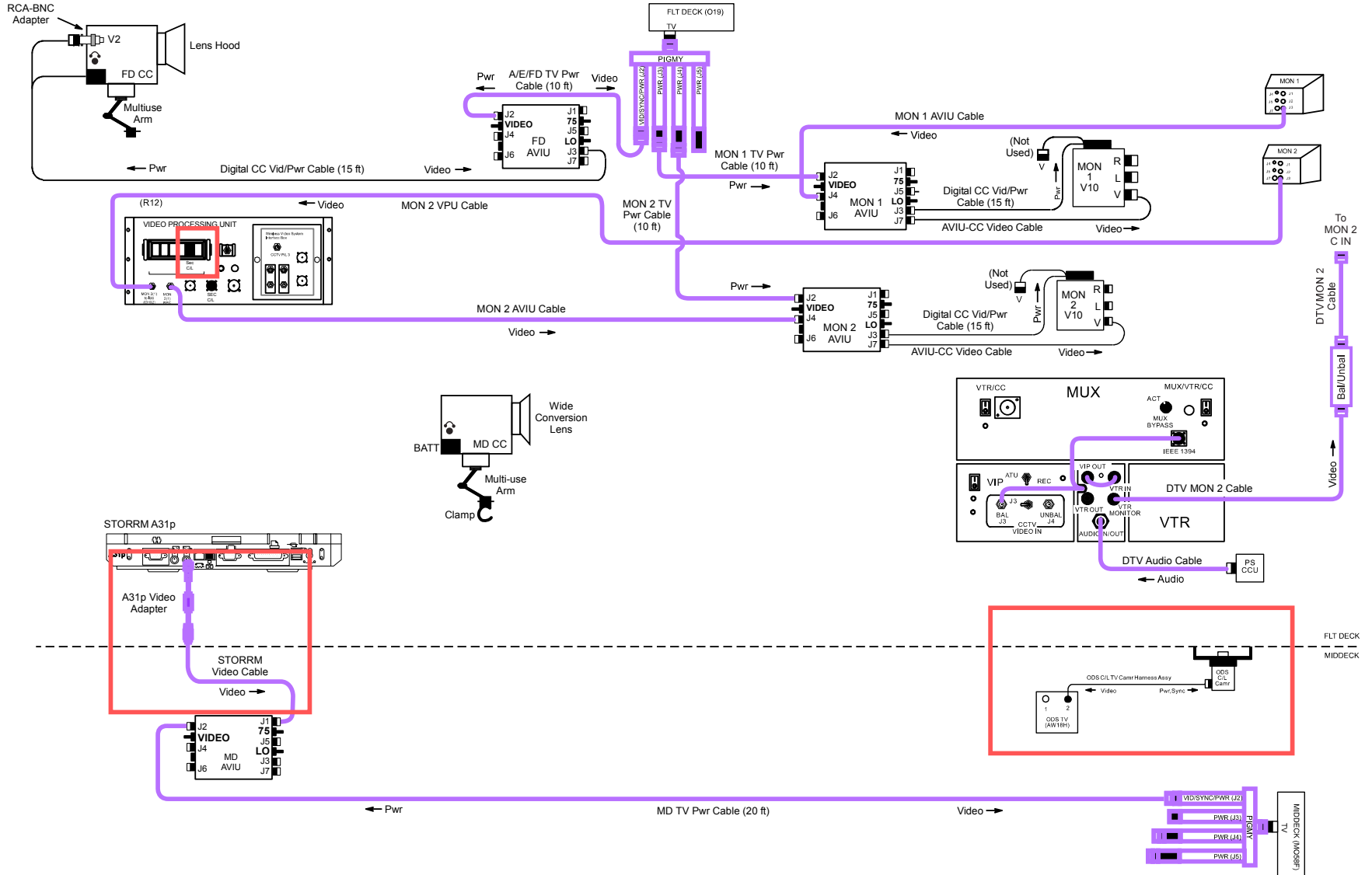

jsc48038_134_002r5.cvx

P/TV02 DOCK (Continued)

SCENE SYNOPSIS

Scene contains procedures for obtaining video, still photos of ISS rndz, docking

SETUP

1. Perform ACTIVATION, OPERATION (Cue Card, TV) as reqd
2. Perform D3s PROGRAM w/FLASH for in-cabin imagery

D3s

Lens – 14-24mm

Aperture – N/A

Body Focus Mode – S

√Batt installed

√Flash Card installed

Pwr – ON

Top LCD:

√Batt

√Frames remaining sufficient

Exp Comp () – 0.0

Exp Mode – P

Meter – Matrix ()

Diopter – Adjust

Frame Rate – S

√BKT disabled – 0 F

Rear LCD:

√ISO – 200

√QUAL – RAW

√WB – 0,A

AF Area Mode – [[]]

√Focus Area – Center

√Focus Selector Lock – L

SB-800 Flash Settings:

ON/OFF pb – ON

√Diffuser Dome installed

√MODE –  TTL BL

√Exp Comp – 0 EV

Tilt – 45° (Direct)

P/TV02 DOCK (Continued)

SETUP (Continued)

3. Perform D2Xs MANUAL for docking/external imagery

Remove ovhd window shields

SB-800 Flash Settings:
ON/OFF pb – OFF

Lens – 400mm(80-200mm)

If 400mm:

| Focus Limit – ∞ -6m
| Lens Focus Mode – A

If 80-200mm:

Focus Limit – full
Lens Focus Mode – A

Aperture – Min, locked

Body Focus Mode – S

√Batt installed

√Flash Card installed

Pwr – ON

Top LCD:

√Batt

√Frames remaining sufficient

Exp Comp () – 0.0

Exp Mode – M:

SS – 500

f/stop – 8

Meter – Matrix ()

Diopter – Adjust

Frame Rate – S

√BKT disabled – 0 F

Rear LCD:

√ISO – 100

√QUAL – RAW

√WB – 0,A

AF Area Mode – [[]]

√Focus Area – Center

√Focus Selector Lock – L

P/TV02 DOCK (Continued)

SETUP (Continued)

4. Perform Hardware Verification for V10s, FD CC, DTV

- O19 √TV PWR – ON
- R12 (VPU) √VPU PWR – ON (LED on)
 √Green Jumper – SEC C/L
 √SEC C/L Cap installed
- V10
(MON 1,2) PWR – ON

 √Tape installed
 DISPLAY pb – Toggle to display tape counter
- CC For in-cabin views:
 √Wide Conversion lens installed
 √ND FILTER – OFF
 √OUTPUT – CAM
 √..-
 √STANDBY/LOCK – STANDBY
 PWR dial – “green”
 √Tape installed
 Open LCD:
 √“green” •|| displayed
 Install Audio Muting Plug (optional)
- For external sun-lit ISS views from G1 in W8:
 Remove Wide Conversion lens
 Install lens hood
 Install Batt
 √ND FILTER – OFF
 AF/M – M
 AGC – OFF
 GAIN – L
 √OUTPUT – CAM
 √AWB – ON
 √..-
 √STANDBY/LOCK – STANDBY
 PWR dial – M
 √Tape installed

P/TV02 DOCK (Continued)

SETUP (Concluded)

4. Perform Hardware Verification for V10s, FD CC, DTV (Concluded)

Open LCD:

√“green” •|| displayed

SS – 1/500

√GAIN – 0dB

f/stop – F8.0

√FOCUS – M ∞

MON 2
L10 (MUX)

√SOURCE – PNL

VTR/CC PWR – on (LED on)

If dnlk, MUX/VTR/CC PWR – on (LED on)

(VIP) PWR – on (LED on)

(VTR) ON/STANDBY LED – green

√Tape installed

P/TV02 DOCK (Continued)

OPS

√	Item # Track #	Rqmts	Still Imagery	Video			Notes
				PLB	CC	Drnk	
	1. ULF6-18	PAO Coverage	<u>D3s (Interior)</u> 14-24mm If exterior: Flash ON/OFF – OFF	As desired	<u>G1</u> Tape installed	LIVE (if avail)	Plan for end of day crew choice video,DCS
	2. ULF6-3	Rendezvous <ul style="list-style-type: none"> • Overall • Closeup • Damage • Deterioration 	<u>D2Xs (Exterior)</u> 400mm(80-200mm) Flash ON/OFF – OFF	<u>A(B,C,D), ELB</u>	<u>G1</u> As desired		Map ISS surfaces w/30% overlap
	3. ULF6-3	Approach,Dock <ul style="list-style-type: none"> • PMA2 Docking Target • PMA2 Mating Surfaces • PMA2 TCS Planar and Hemispherical Retro Reflectors 	<u>D2Xs (Exterior)</u> 400mm(80-200mm) Flash ON/OFF – OFF	<u>C/L</u> Per RNDZ <u>A(D)</u> Per RNDZ <u>C(B)</u> Docking view	<u>G1</u> As desired		Rcd C/L Camr video thru hard dock on DTV Continually √focus sharpness

P/TV02 DOCK (Continued)

OPS (Continued)

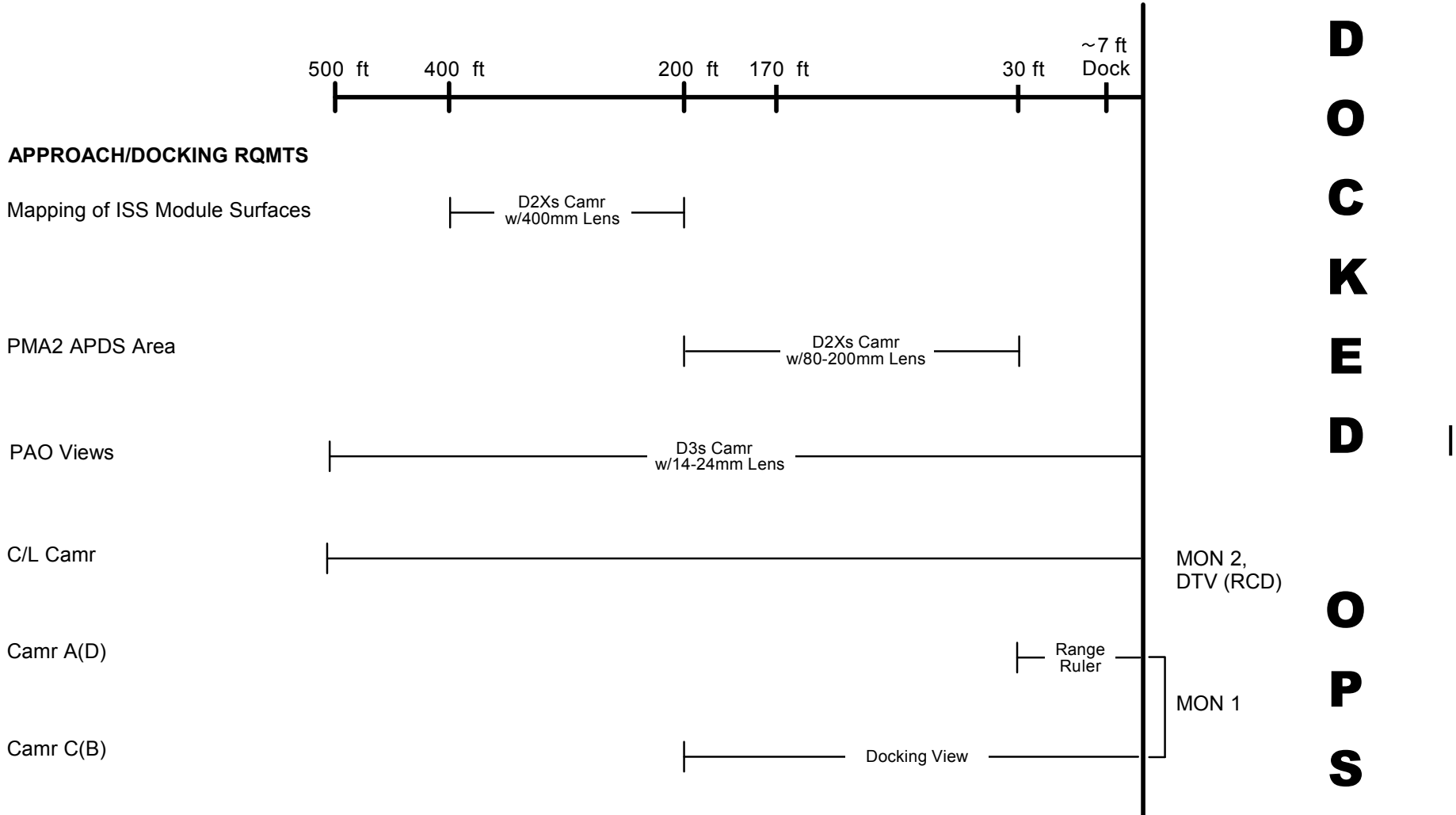

jsc48038_134_003r1.cvx

P/TV02 DOCK (Concluded)

OPS (Concluded)

If OPS temporarily suspended, perform DEACTIVATION as reqd
If OPS completed, go to DEACTIVATION

DEACTIVATION

1. D2Xs,D3s
 - √Exp Mode – P
 - Pwr – OFF
 - √Flash ON/OFF – ON

2. TV System
 - R12 (VPU) √Green Jumper – SEC C/L
 - √SEC C/L Cap installed
 - √VPU PWR – ON (LED on)
 - A7 VID OUT MON 1 pb – push
 - IN PL2(VPU) pb – push
 - L12 (SSP 2) CAMR CMD IRIS – CL
 - C/L CAM PWR – OFF
 - ODS Remove, stow C/L camr, Harness Assy, Bridge
 - Go to DEACTIVATION (Cue Card, TV) as reqd

3. G1
 - PWR dial – “green”
 - Install Wide Conversion Lens

This Page Intentionally Blank

This Page Intentionally Blank

P/TV03 UNDOCK (Continued)

SCENE SYNOPSIS

Scene contains procedures for obtaining video, still photos of ISS undocking, flyaround

SETUP

1. Perform ACTIVATION, OPERATION (Cue Card, TV) as reqd
2. Perform D3s PROGRAM w/FLASH for in-cabin imagery

D3s

Lens – 14-24mm

Aperture – N/A

Body Focus Mode – S

√Batt installed

√Flash Card installed

Pwr – ON

Top LCD:

√Batt

√Frames remaining sufficient

Exp Comp () – 0.0

Exp Mode – P

Meter – Matrix ()

Diopter – Adjust

Frame Rate – S

√BKT disabled – 0 F

Rear LCD:

√ISO – 200

√QUAL – RAW

√WB – 0,A

AF Area Mode – [[]]

√Focus Area – Center

√Focus Selector Lock – L

SB-800 Flash Settings:

ON/OFF pb – ON

√Diffuser Dome installed

√MODE –  TTL 

√Exp Comp – 0 EV

Tilt – 45° (Direct)

P/TV03 UNDOCK (Continued)

SETUP (Continued)

3. Perform D2Xs MANUAL for undocking/external imagery

Remove ovhd window shields

SB-800 Flash Settings:
ON/OFF pb – OFF

Lens – 400mm(80-200mm)

If 400mm:

| Focus Limit – ∞ -6m
| Lens Focus Mode – A

If 80-200mm:

Focus Limit – full
Lens Focus Mode – A

Aperture – Min, locked

Body Focus Mode – S

√Batt installed

√Flash Card installed

Pwr – ON

Top LCD:

√Batt

√Frames remaining sufficient

Exp Comp () – 0.0

Exp Mode – M:

SS – 500

f/stop – 8

Meter – Matrix ()

Diopter – Adjust

Frame Rate – S

√BKT disabled – 0 F

Rear LCD:

√ISO – 100

√QUAL – RAW

√WB – 0,A

AF Area Mode – [[]]

√Focus Area – Center

√Focus Selector Lock – L

P/TV03 UNDOCK (Continued)

SETUP (Continued)

4. Perform Hardware Verification for V10s, FD CC, DTV

- O19 √TV PWR – ON
- R12 (VPU) √VPU PWR – ON (LED on)
 √Green Jumper – SEC C/L
 √SEC C/L Cap installed
- V10
(MON 1,2) PWR – ON
 √Tape installed
 DISPLAY pb – Toggle to display tape counter
- CC For in-cabin views:
 √Wide Conversion lens installed
 √ND FILTER – OFF
 √OUTPUT – CAM
 √..-
 √STANDBY/LOCK – STANDBY
 PWR dial – “green”
 √Tape installed
 Open LCD:
 √“green” •|| displayed
 Install Audio Muting Plug (optional)
- For external sun-lit ISS views from G1 in W8:
 Remove Wide Conversion lens
 Install lens hood
 Install Batt
 √ND FILTER – OFF
 AF/M – M
 AGC – OFF
 GAIN – L
 √OUTPUT – CAM
 √AWB – ON
 √..-
 √STANDBY/LOCK – STANDBY
 PWR dial – M
 √Tape installed

P/TV03 UNDOCK (Continued)

SETUP (Concluded)

4. Perform Hardware Verification for V10s, FD CC, DTV (Concluded)

Open LCD:

√“green” •|| displayed

SS – 1/500

√GAIN – 0dB

f/stop – F8.0

√FOCUS – M ∞

MON 2
L10 (MUX)

√SOURCE – PNL

VTR/CC PWR – on (LED on)

If dnk, MUX/VTR/CC PWR – on (LED on)

(VIP)

PWR – on (LED on)

(VTR)

ON/STANDBY LED – green

√Tape installed

P/TV03 UNDOCK (Continued)

OPS

√	Item # Track #	Rqmts	Still Imagery	Video			Notes
				PLB	CC	Dnlk	
	1. ULF6-18	PAO Coverage	<u>D3s (Interior)</u> 14-24mm If exterior: Flash ON/OFF – OFF	As desired	<u>G1</u> Tape installed	LIVE (if avail)	Plan for end of day crew choice video,DCS
	2. ULF6-2 ULF6-3	Undock and Flyaround <ul style="list-style-type: none"> • PMA-2 Docking Tgt/Mating Surfaces • PMA-2 TCS Planar, Hemispherical Retro Reflectors • Surfaces • Solar Panels • Handrails • SM Thrusters on Zenith, near aft end • Trusses including rads/baseplates and SAWs (in/outboard SABB insulation degradation) • SOLAR on Columbus EPF • MISSE-8 on ELC2 on S3 • AMS on S3 	<u>D2Xs (Exterior)</u> 80-200mm(400mm) Flash ON/OFF – OFF	<u>A(C,D)</u> Per RNDZ <u>C/L</u> Docking tgt and PAO view	<u>G1</u> Tape installed	LIVE (if avail)	Map ISS surfaces w/30% overlap

P/TV03 UNDOCK (Continued)

OPS (Continued)

**D
O
C
K
E
D

O
P
S**

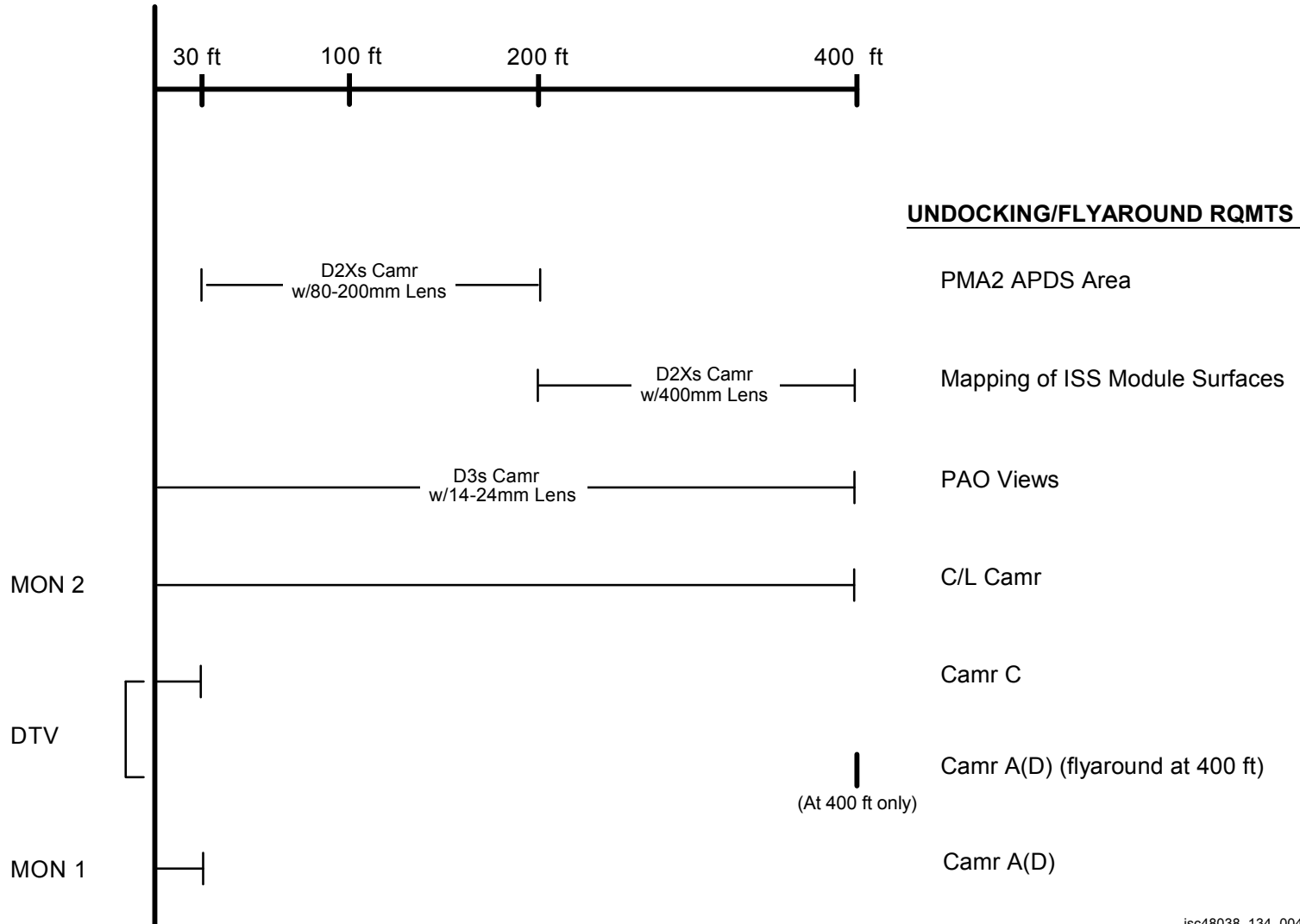

jsc48038_134_004r1.cvx

P/TV03 UNDOCK (Concluded)

OPS (Concluded)

If OPS temporarily suspended, perform DEACTIVATION as reqd
If OPS completed, go to DEACTIVATION

DEACTIVATION

1. D2Xs,D3s
 - √Exp Mode – P
 - Pwr – OFF
 - √Flash ON/OFF – ON

2. TV System
 - R12 (VPU) √Green Jumper – SEC C/L
 - √SEC C/L Cap installed
 - √VPU PWR – ON (LED ON)
 - A7U VID OUT MON 1 pb – push
 - IN PL2(VPU) pb – push
 - L12 (SSP 2) CAMR CMD IRIS – CL
 - C/L CAM PWR – OFF
 - ODS Remove, stow C/L Camr, Harness Assy
 - Go to DEACTIVATION (Cue Card, TV) as reqd

3. G1
 - √PWR dial – “green”
 - Install Wide Conversion Lens

This Page Intentionally Blank

This Page Intentionally Blank

P/TV04 INGRESS/EGRESS

H/W SUMMARY

INGRESS TV CONFIG

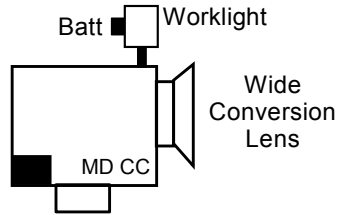

(R12)

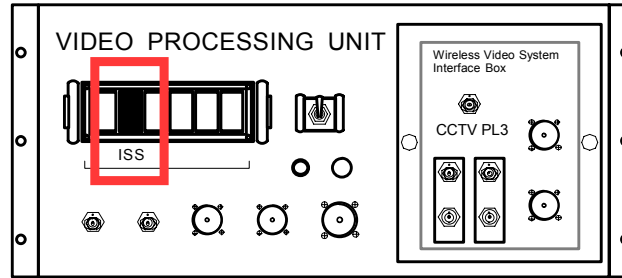

jsc48038_131_005r1.cvx

P/TV04 INGRESS/EGRESS (Continued)

SCENE SYNOPSIS

Scene contains procedures for documenting ISS ingress/egress w/video and still photos

SETUP



1. Config ISS Video |
R12 (VPU) Perform ACTIVATION (Cue Card, TV) for DNLK OPS of ISS signal as reqd
Green Jumper – ISS
√VPU PWR – ON
A7 VID OUT DNLK pb – push
IN PL2(VPU) pb – push
 2. Perform Ingress Camcorder Setup |
Obtain two Batts, one for CC and one spare
Install Batt
CC Install Wide Conversion lens
√ND FILTER – OFF
√OUTPUT – CAM
√... -
√STANDBY/LOCK – STANDBY
PWR dial – “green”
√Tape installed
√Viewfinder (LCD) displays “green” •||
Install Audio Muting Plug (optional)
Install Multiuse Brkt
- CAUTION**
Due to temp constraints, worklights at full
pwr for 60 min; 90% pwr for unlimited time
- Worklights Install fresh Batts
Mount light on CC
PWR – as reqd

P/TV04 INGRESS/EGRESS (Continued)

SETUP (Concluded)

3. Perform D2Xs(D3s) PROGRAM w/FLASH



D2Xs

Lens – 12-24mm
√Aperture – Min, locked
Body Focus Mode – S
√Batt installed
√Flash Card installed
Pwr – ON
Top LCD:
√Batt
√Frames remaining sufficient
Exp Comp () – 0.0
Exp Mode – P
Meter – Matrix ()
Diopter – Adjust
Frame Rate – S
√BKT disabled – 0 F
Rear LCD:
√ISO – 100
√QUAL – RAW
√WB – 0,A
AF Area Mode – [[]]
√Focus Area – Center
√Focus Selector Lock – L

SB-800 Flash Settings:

√Diffuser Dome installed
ON/OFF pb – ON
√MODE –  TTL [B]
√Exp Comp – 0 EV
Tilt – 45° (Direct)

D3s

Lens – 14-24mm
√Aperture – N/A
Body Focus Mode – S
√Batt installed
√Flash Card installed
Pwr – ON
Top LCD:
√Batt
√Frames remaining sufficient
Exp Comp () – 0.0
Exp Mode – P
Meter – Matrix ()
Diopter – Adjust
Frame Rate – S
√BKT disabled – 0 F
Rear LCD:
√ISO – 200
√QUAL – RAW
√WB – 0,A
AF Area Mode – [[]]
√Focus Area – Center
√Focus Selector Lock – L

SB-800 Flash Settings:

√Diffuser Dome installed
ON/OFF pb – ON
√MODE –  TTL [B]
√Exp Comp – 0 EV
Tilt – 45° (Direct)

P/TV04 INGRESS/EGRESS (Concluded)

OPS

√	Item # Track #	Rqmts	Still Imagery	Video			Notes
				PLB	CC	Dnlk	
	1. ULF6-18	Hatch Opening, Ingress Hatch Close, Egress	<u>D2Xs(D3s)</u> 12-24mm(14-24mm)		<u>G1</u>	LIVE (if avail)	

I

If OPS temporarily suspended, perform DEACTIVATION as reqd
 If OPS completed, go to DEACTIVATION

DEACTIVATION

1. D2Xs,D3s
Pwr – OFF
2. TV System
Go to DEACTIVATION (Cue Card, TV) as reqd

This Page Intentionally Blank

This Page Intentionally Blank

P/TV05 ISS INTERNAL OPS

H/W SUMMARY

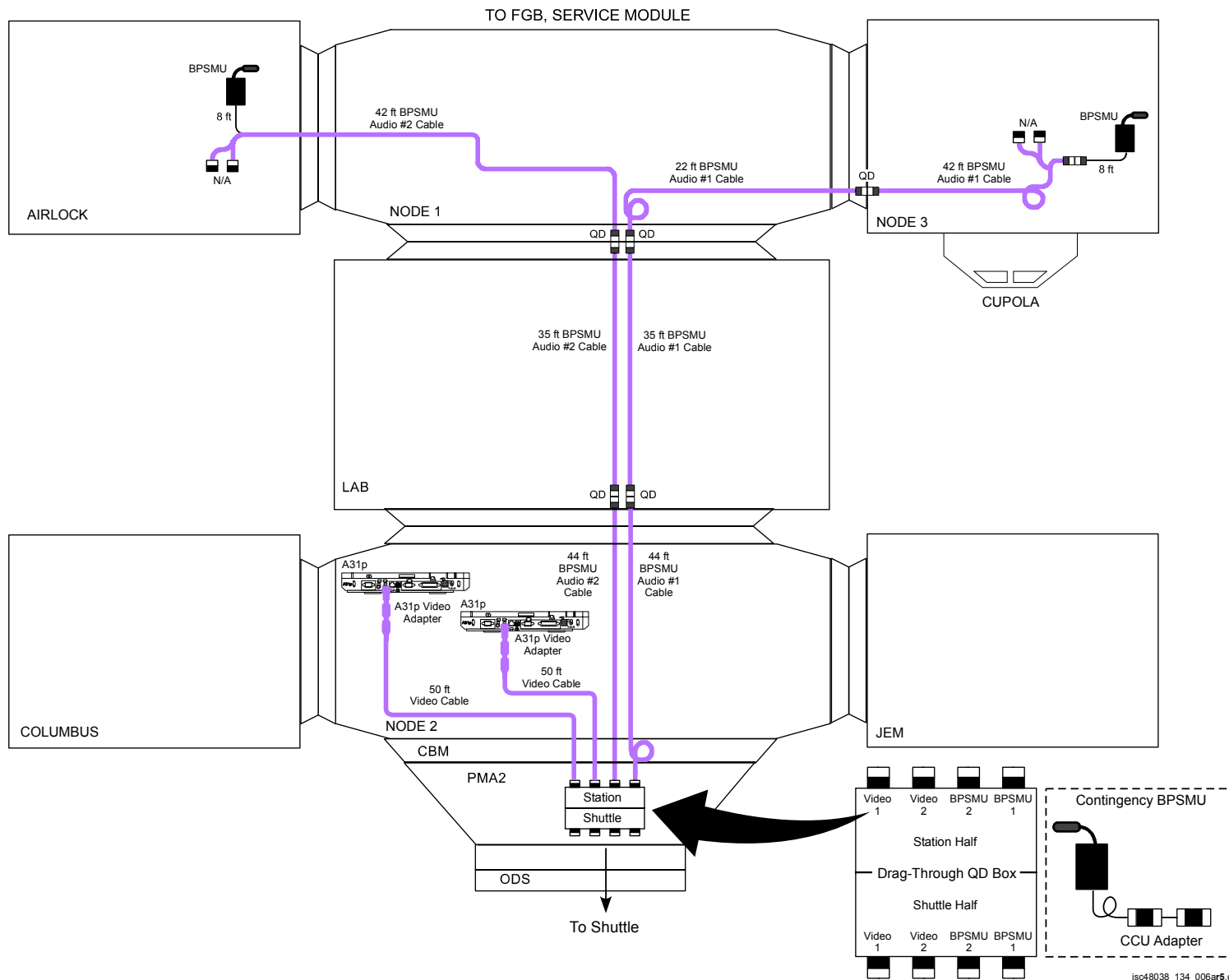

P/TV05 ISS INTERNAL OPS (Continued)

H/W SUMMARY (Concluded)

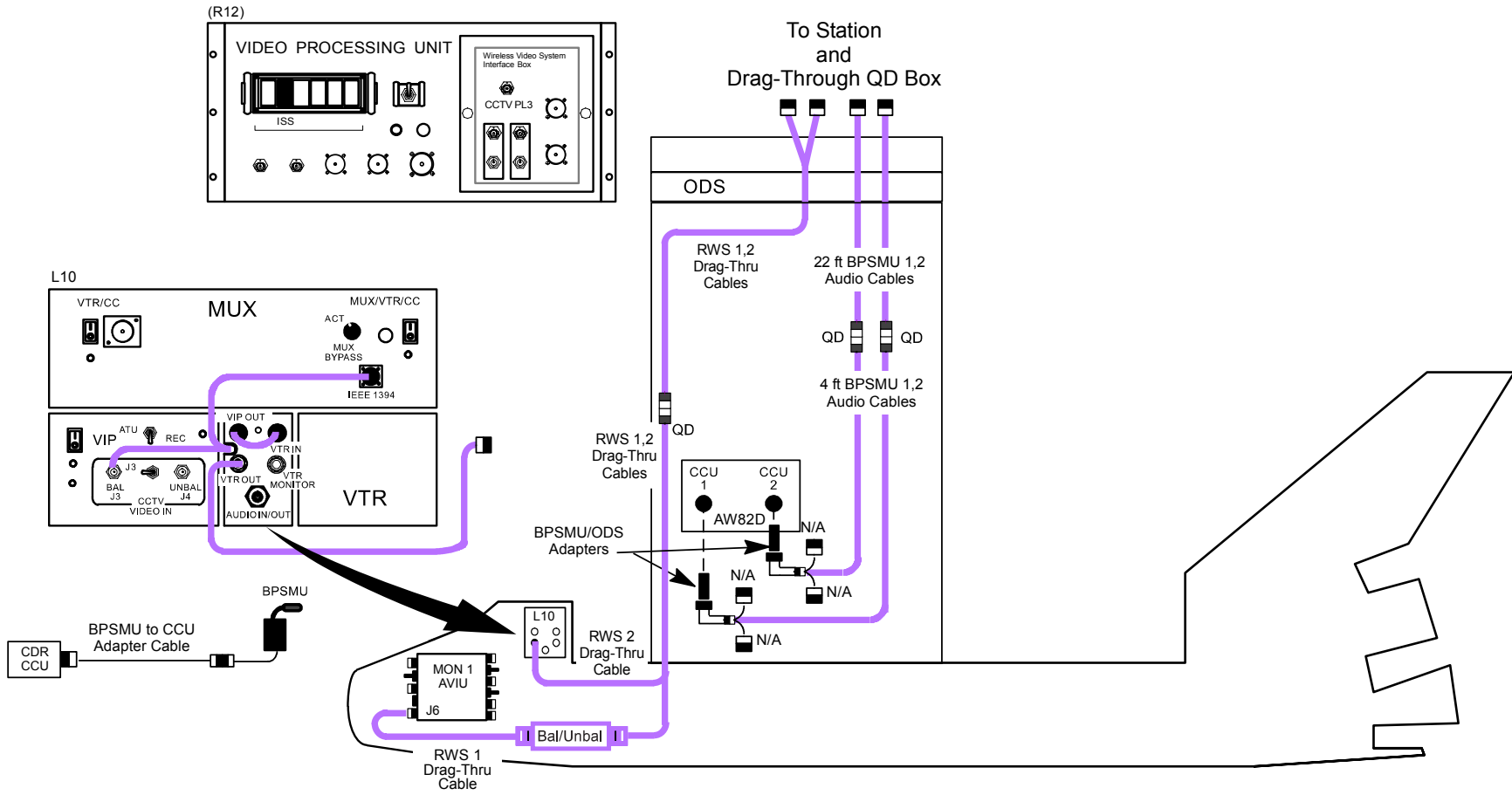

jsc48038_134_006br2.cvx

P/TV05 ISS INTERNAL OPS (Continued)

SCENE SYNOPSIS

Scene contains procedures for setup, documenting ISS internal ops (surveys, PAO events, logistics, transfers, closeouts) w/video,still photos

SETUP

WARNING

Locate QDs at hatches for ease in locating,disconnecting during hatch closure.
Route,restrain cables to prevent loose cable lengths which could entrap crew

BPSMU AND RWS CABLES

1. Config H/W per H/W SUMMARY, FS 1-40 and FS 1-41

ISS PMA

Retrieve contingency BPSMU, connect internal battery, temp stow in PMA for contingency use

MON 1,2
(Stow-n-Go)
L10:A1

Config RWS Vid Cables:

√RWS 1 Drag-Thru Cable connected to MON 1 AVIU J6

√RWS 2 Drag-Thru Cable connected to DTV VTR OUT connector

ODS/PMA2
AW82D

Config BPSMU and RWS Cables:

Connect orbiter RWS 1,2 Cables to Drag-Through QD Box

Connect BPSMU Cables to orbiter A/L CCU 1,2 and Drag-Through QD Box

Config A/L ATU per Comm Plan

P/TV05 ISS INTERNAL OPS (Continued)

SETUP (Continued)

PAO EVENT

1. Config VPU

R12 (VPU) √Green Jumper – ISS
 √VPU PWR – ON (LED on)

2. Config Shuttle Video

A7 VID OUT DNLK pb – push
 IN PL2(VPU) pb – push



P/TV05 ISS INTERNAL OPS (Continued)

SETUP (Concluded)

STILL CAMR



1. Perform D2Xs(D3s) PROGRAM w/FLASH

D2s

- Lens – 12-24mm
- √Aperture – Min, locked
- Body Focus Mode – S
- √Batt installed
- √Flash Card installed
- Pwr – ON
- Top LCD:
 - √Batt
 - √Frames remaining sufficient
- Exp Comp () – 0.0
- Exp Mode – P
- Meter – Matrix ()
- Diopter – Adjust
- Frame Rate – S
- √BKT disabled – 0 F
- Rear LCD:
 - √ISO – 100
 - √QUAL – RAW
 - √WB – 0,A
- AF Area Mode – [[]]
- √Focus Area – Center
- √Focus Selector Lock – L

- SB-800 Flash Settings:
 - √Diffuser Dome installed
 - ON/OFF pb – ON
 - √MODE –  TTL BL
 - √Exp Comp – 0 EV
 - Tilt – 45° (Direct)

D3s

- Lens – 14-24mm
- √Aperture – N/A
- Body Focus Mode – S
- √Batt installed
- √Flash Card installed
- Pwr – ON
- Top LCD:
 - √Batt
 - √Frames remaining sufficient
- Exp Comp () – 0.0
- Exp Mode – P
- Meter – Matrix ()
- Diopter – Adjust
- Frame Rate – S
- √BKT disabled – 0 F
- Rear LCD:
 - √ISO – 200
 - √QUAL – RAW
 - √WB – 0,A
- AF Area Mode – [[]]
- √Focus Area – Center
- √Focus Selector Lock – L

- SB-800 Flash Settings:
 - √Diffuser Dome installed
 - ON/OFF pb – ON
 - √MODE –  TTL BL
 - √Exp Comp – 0 EV
 - Tilt – 45° (Direct)

P/TV05 ISS INTERNAL OPS (Continued)

OPS

√	Item # Track #	Rqmts	Still Imagery	Video			Notes
				PLB	CC	Dnlk	
	1. ULF6-18	General ISS IVA Activity <ul style="list-style-type: none"> • PAO Scenes of Interest • Crew Photo 	<u>D2Xs(D3s)</u> 12-24mm(14-24mm) For Crew Photo: Perform D2Xs CREW PHOTO (Cue Card, <u>D2Xs</u> <u>SETUP</u>)		<u>ISS G1</u>	LIVE (if avail)	Plan for end of day crew choice video

If OPS temporarily suspended, perform DEACTIVATION as reqd
 If OPS completed, go to DEACTIVATION

DEACTIVATION

1. D2Xs,D3s
Pwr – OFF
2. Drag-Through QD Box
Disconnect:
RWS Cables (two) from orbiter side Video 1,2 ports. Stow cables on orbiter
BPSMU Cables from orbiter side BPSMU 1,2 and ODS CCU ports; stow cables on orbiter
Transfer Drag-Through QD Box and remaining attached cables to ISS
3. TV System
Go to DEACTIVATION (Cue Card, TV) as reqd

This Page Intentionally Blank

This Page Intentionally Blank

P/TV06 ROBOTICS OPERATIONS

H/W SUMMARY

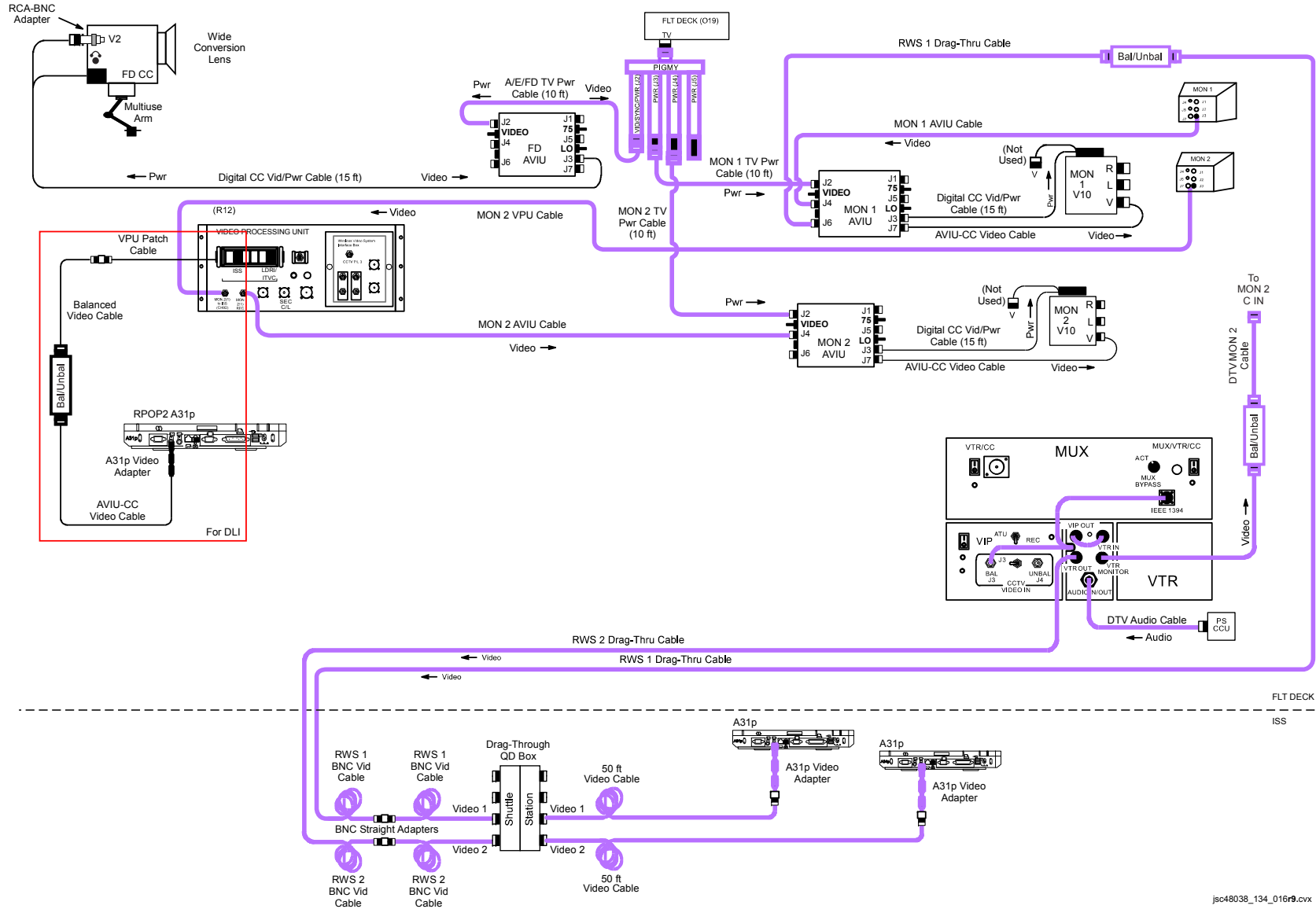

jsc48038_134_016r9.cvx

P/TV06 ROBOTICS OPERATIONS (Continued)

SCENE SYNOPSIS

Scene contains procedures for obtaining video of SSRMS activities

SETUP

1. Perform ACTIVATION, OPERATION (Cue Card, TV) as reqd
2. Perform Hardware Verification for V10s, FD CC, DTV

O19	√TV PWR – ON
R12 (VPU)	√VPU PWR – ON (LED on) Green Jumper – ISS (LDRI/ITVC for DLI)
	√Drag-Thru Cables configured as reqd
A17/DTV Bag	Unstow VPU Repeater Ziploc Bag, connect Cbl String between VPU “FROM ISS” to WLE “VIDEO IN” per diagram on FS 1-48. Launch Video Overlay from Shuttle Apps to see video on WLE A31p
V10 (MON 1,2)	PWR – ON √Tape installed DISPLAY pb – Toggle to display tape counter
CC	√Wide Conversion lens installed √ND FILTER – OFF √OUTPUT – CAM √ <input type="checkbox"/> .. <input type="checkbox"/> - <input type="checkbox"/> √STANDBY/LOCK – STANDBY PWR dial – “green” <input type="checkbox"/> √Tape installed √Viewfinder (LCD) displays “green” • Install Audio Muting Plug (optional) Install Multiuse Brkt
MON 1	SOURCE – DNLK
MON 2	SOURCE – C
L10 (MUX)	VTR/CC PWR – on (LED on) If dnk, MUX/VTR/CC PWR – on (LED on)
(VIP)	PWR – on (LED on)
(VTR)	ON/STANDBY LED – green √Tape installed

P/TV06 ROBOTICS OPERATIONS (Concluded)

OPS

√	Item # Track #	Rqmts	Still Imagery	Video			Notes	
			DCS	PLB	CC	Dnlk		
	1. ULF6-18	PAO Coverage	<u>D2Xs(D3s)</u> 12-24mm(14-24mm) If exterior: Flash ON/OFF – OFF	As desired	<u>G1</u> Tape installed		LIVE (if avail)	Plan for end of day crew choice video,DCS
	2. ULF6-13 ULF6-14	ELC-3 XFER to ISS <ul style="list-style-type: none"> • SRMS Grapple,Release • ROEU Disconnect • PRLA,Keel Latch Release • Unberth,Hover • Positioning MnvrS for Hand-off to SSRMS • ELC-3 Install • SSRMS Release 		Per SODF: ROBO FS			LIVE (if avail)	
	3. ULF6-15	AMS XFER to ISS <ul style="list-style-type: none"> • Unberth • SRMS to SSRMS Hand-off • Installation on S3 	<u>D2Xs(D3s)</u> As reqd	Per SODF: ROBO FS			LIVE (if avail)	

If OPS temporarily suspended, perform DEACTIVATION as reqd
 If OPS completed, go to DEACTIVATION

DEACTIVATION

1. TV System
Go to DEACTIVATION (Cue Card, TV) as reqd

This Page Intentionally Blank

P/TV07 EVA

P/TV07 EVA

H/W SUMMARY

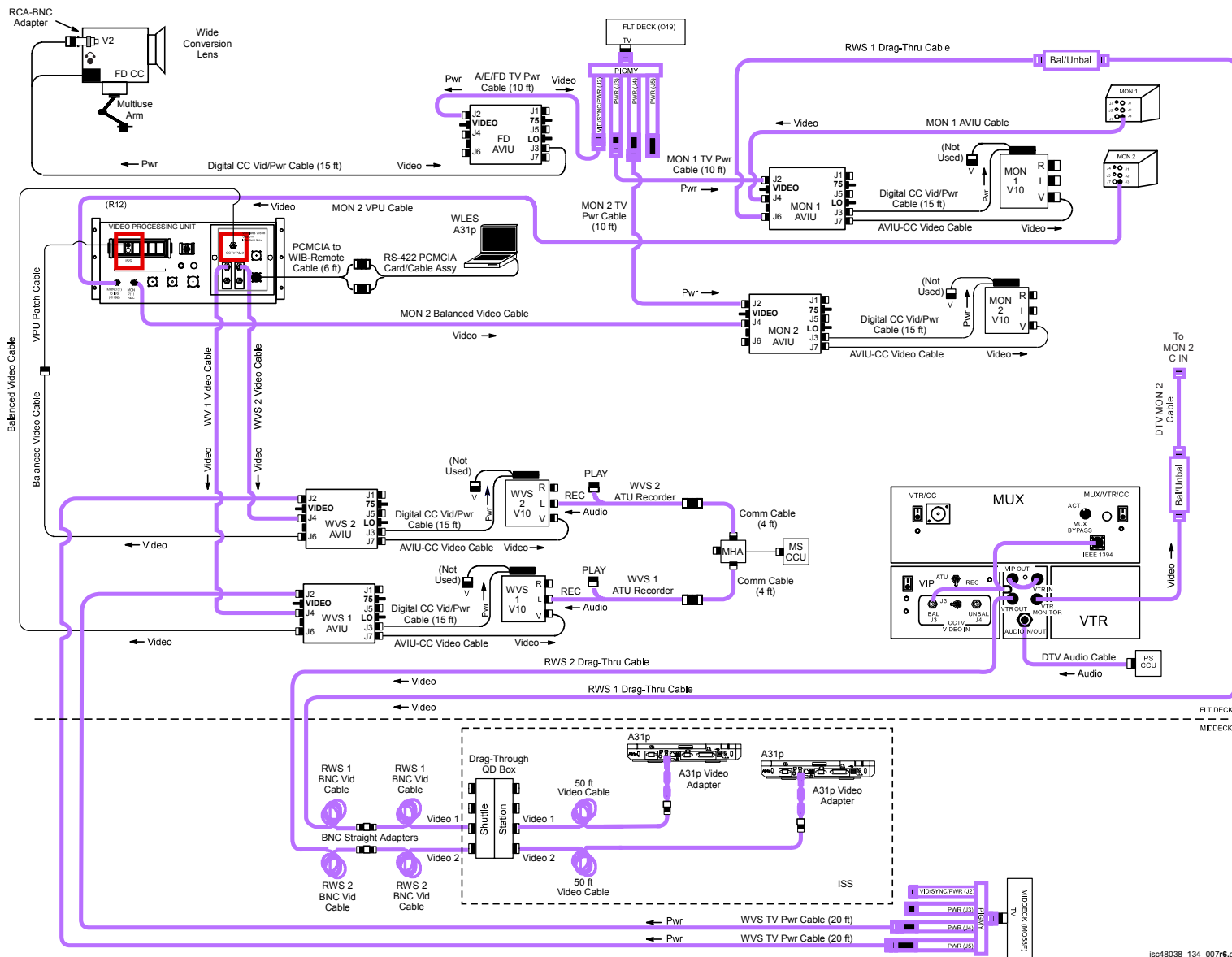

jsc48038_134_007r6.cvx

P/TV07 EVA (Continued)

SCENE SYNOPSIS



Scene contains procedures for documenting ISS EVA and IVA ops w/video, still photos

SETUP



FOR ALL EVAs:

1. Perform ACTIVATION, OPERATION (Cue Card, TV) as reqd
2. Perform D2Xs(D3s) PROGRAM w/FLASH

D2Xs

Lens – 12-24mm
√Aperture – Min, locked
Body Focus Mode – S
√Batt installed
√Flash Card installed
Pwr – ON
Top LCD:
√Batt
√Frames remaining sufficient
Exp Comp () – 0.0
Exp Mode – P
Meter – Matrix ()
Diopter – Adjust
Frame Rate – S
√BKT disabled – 0 F
Rear LCD:
√ISO – 100
√QUAL – RAW
√WB – 0,A
AF Area Mode – [[]]
√Focus Area – Center
√Focus Selector Lock – L
SB-800 Flash Settings:
√Diffuser Dome installed
ON/OFF pb – ON
√MODE –  TTL [B]
√Exp Comp – 0 EV
Tilt – 45° (Direct)

D3s

Lens – 14-24mm
√Aperture – N/A
Body Focus Mode – S
√Batt installed
√Flash Card installed
Pwr – ON
Top LCD:
√Batt
√Frames remaining sufficient
Exp Comp () – 0.0
Exp Mode – P
Meter – Matrix ()
Diopter – Adjust
Frame Rate – S
√BKT disabled – 0 F
Rear LCD:
√ISO – 200
√QUAL – RAW
√WB – 0,A
AF Area Mode – [[]]
√Focus Area – Center
√Focus Selector Lock – L
SB-800 Flash Settings:
√Diffuser Dome installed
ON/OFF pb – ON
√MODE –  TTL [B]
√Exp Comp – 0 EV
Tilt – 45° (Direct)

P/TV07 EVA (Continued)

SETUP (Continued)

3. Perform Hardware Verification for V10s, FD CC, DTV

- | | | |
|--|--|--|
| O19,MO58F | √TV PWR – ON | |
| R12 (VPU) | √VPU PWR – ON (LED on)
Connect WVS1 Balanced Video Cable to WIB CCTV PL3
WVS2 Balanced Video Cable to VPU to PL2 | |
| V10
(MON 1,2,
WVS 1,2) | PWR – ON
√Tape installed
DISPLAY pb – Toggle to display tape counter | |
| CC | Install Wide Conversion lens
√ND FILTER – OFF
√OUTPUT – CAM
√ <input type="checkbox"/> .. <input type="checkbox"/> - <input type="checkbox"/>
√STANDBY/LOCK – STANDBY
PWR dial – “green” <input type="checkbox"/>
√Tape installed
√Viewfinder (LCD) displays “green” •
Install Audio Muting Plug (optional)
Install Multiuse Brkt | |
| MON 2
L10 (MUX)

(VIP)
(VTR) | SOURCE – C
VTR/CC PWR – on (LED on)
If dnlk, MUX/VTR/CC PWR – on (LED on)
PWR – on (LED on)
ON/STANDBY LED – green
√Tape installed | |

P/TV07 EVA (Continued)

SETUP (Concluded)

4. Config WVS and PGSC

A7 a. Activate WVS System
√WIRELESS VID HTR – ON
PWR – ON

PGSC b. WVS PGSC Prep
PGSC Pwrup and Application Opening
Pwr – ON
Sel Shuttle Apps icon
Sel WVS icon
Sel 'No' at 'Restore To Previous Settings' window
If 'Comm Port Configuration' error displayed:
Remove Quatech RS-422 Card
Sel 'Start'> 'Shut Down'> 'Shut Down'> 'OK'
Reinstall Quatech RS-422 Card
Pwr – ON
Sel Shuttle Apps icon
Sel WVS icon
RF Camera page will appear

NOTE

During EVA prep, EMU TV assy will be pwr'd

Application Setup

Select Page – XCVR
Transceiver 1(2) CMD Power – ON (green CMD PWR:LVL- "ON:Min")
RF Camera 1 – One EVA crewmember (green "ON")
RF Camera 2 – Other EVA crewmember (green "ON")
If alert msg, perform ALERT MSG TROUBLESHOOTING (Cue Card, WVS)
Select Page – RF CAMERA
Near middle of RF Camera page, sel 'Advanced Controls'
When Post-A/L Depress:
For center lens on each RF Camr Assy:
Lens Iris Cntl – op(cl) until good video on V10(MON)

R10 (MS ATU) c. Config Audio
√PWR – AUD/TONE
√A/G 1 – T/R, VOL – 2
√ICOMA – T/R, VOL – 2
√OTHER LOOPS – OFF
√MODE – PTT/PTT
A11 √CNTRL – NORM
√MSCCU PWR – ON

P/TV07 EVA (Continued)

OPS

√	Item # Track #	Rqmts	Still Imagery	Video			Notes
				PLB	CC	Dnlk	
	1. ULF6-18	PAO Coverage	IVA D2Xs(D3s) 12-24mm(14-24mm) If exterior: Flash ON/OFF – OFF	As desired <u>WVS</u>	G1 As desired	LIVE (if avail)	Plan for end of day crew choice video, DCS stills
	2. ULF6-4	Thermal Cover Closeout Imagery <ul style="list-style-type: none"> All areas where thermal covers were altered during EVA 	<u>EVA D2Xs</u> per EVA C/L	<u>PLB Camrs</u> As desired <u>WVS</u>	G1 As available	LIVE (if avail)	
	3. ULF6-6	MISSE-7 Retrieval Video Photos <ul style="list-style-type: none"> Photos of all four PEC surfaces, perp to tray surface, prior to closeout Photos of ExPA/FSE from diff angles to verify electrical harnesses are undamaged Video of retrieval of MISSE-7 from ELC-2 	<u>EVA D2Xs</u> per EVA C/L	<u>PLB Camrs</u> As desired <u>WVS</u>		LIVE (if avail)	
	4. ULF6-7	MISSE-8 PEC, ORMatE-III Install, Deploy on ELC-2 <ul style="list-style-type: none"> Photos of the two PEC surfaces, perp to tray surfaces, after installation, deploy Photos of ExPA/FSE from diff angles to verify electrical harnesses are undamaged Photos of the two ORMatE-III R/W, perp to tray surfaces, after installation Video of installation, deployment 	<u>EVA D2Xs</u> per EVA C/L	<u>PLB Camrs</u> As reqd <u>WVS</u>		LIVE (if avail)	

P/TV07 EVA (Continued)

OPS (Continued)

√	Item # Track #	Rqmts	Still Imagery	Video			Notes
				PLB	CC	Drnk	
	5. ULF6-5	<u>EVA Closeouts</u> a. Retrieve MISSE PECs 7A,B from ELC-2 b. Install, deploy MISSE-8 on ELC-2 c. Install, deploy MISSE-8 ORMatE-III on ELC-2 d. Xfer EIBA, stow in OSE on S0/S1 e. Perform Port SARS lube f. Connect P1-P6 lines, recharge P6, temp stow P3-P4 line g. Install ET VCG Wedge h. Retrieve P6 PDGF i. Remove EFGF, install adapter plate/PDGF on IBA j. Route FGB PDGF 1553 Data Cbl k. Lube SPDM LEE l. Install Radiator Grapple Bar beams m. Final stow of P3/P4	<u>EVA D2Xs</u> per EVA C/L	<u>PLB Camrs</u> As desired <u>WVS</u>		LIVE (if avail)	

P/TV07 EVA (Concluded)

OPS (Concluded)

√	Item # Track #	Rqmts	Still Imagery	Video			Notes
				PLB	CC	Dnlk	
	6. ULF6-8	<u>External Payloads</u> <ul style="list-style-type: none"> • Imagery of the following external payloads as opportunities allow: <ol style="list-style-type: none"> a. MISSE-8 on ELC-2 on S3 truss b. SOLAR on Columbus EPF c. AMS on S3 truss 	<u>EVA D2Xs(D3s)</u> per EVA C/L	<u>PLB Camrs</u> As desired <u>WVS</u> <u>SSRMS Camrs</u>			Take imagery via any 1 of 3 methods: <ul style="list-style-type: none"> • EVA still camr • WVS • SSRMS Camrs
	7. ULF6-20 ULF6-21 ULF6-22 ULF6-23	<u>STP-H3 Post Installation Surveys</u> <ol style="list-style-type: none"> a. Photos of CANARY front face focused on central window b. Photos of VADER <ol style="list-style-type: none"> 1. Entire face (12 x 12 in) 2. Quad VED (4 x 4 in) 3. Entire back (12 x 12 in) c. Photos of DISC lens d. Photos of MHTEX radiator (37 x 24 in) 	<u>EVA D2Xs</u> per EVA C/L				14 in minimum focus distance reqd May req multiple pictures to capture entire area

If OPS temporarily suspended, perform DEACTIVATION as reqd
 If OPS completed, go to DEACTIVATION

DEACTIVATION

1. IVA D2Xs,D3s
 Pwr – OFF
 √Flash ON/OFF – ON
 Download images
2. TV System
 Perform PWRDN (Cue Card, WVS)
 Go to DEACTIVATION (Cue Card, TV) as reqd

This Page Intentionally Blank

**P/TV08
EXT SURVEY**

P/TV08 EXTERNAL SURVEY

SCENE SYNOPSIS

Scene contains procedures for documenting STS,ISS external structures w/still photos during general survey activities

SETUP

1. D2Xs Camr Configuration for OMS Pod Survey

Remove aft window shields

If Sunlit OMS Pod, config D2Xs Manual Mode:

SB-800 Flash Settings:
ON/OFF pb – OFF

Lens – 80-200mm at 200mm

Focus Limit – full

Lens Focus Mode – A

Aperture – Min,locked

Body Focus Mode – S

√Batt installed

Install Empty Card

Pwr – ON

Top LCD:

√Batt

√Frames remaining sufficient

Exp Comp () – 0.0

Exp Mode – M:

SS – 1000

f/stop – F8

Meter – Matrix ()

Diopter – Adjust

Frame Rate – S

√BKT disabled – 0 F

Rear LCD:

√ISO – 100

√QUAL – RAW

√WB – 0,A

AF Area Mode – [[]]

√Focus Area – Center

√Focus Selector Lock – L

~

P/TV08 EXTERNAL SURVEY (Continued)

SETUP (Continued)

1. D2Xs Camr Configuration for OMS Pod Survey (Concluded)

↑
If Earthshine OMS Pod, config D2Xs Program Mode:

SB-800 Flash Settings:
ON/OFF pb – OFF

Lens – 80-200mm at 200mm

Focus Limit – full

Lens Focus Mode – A

√Aperture – Min, locked

Body Focus Mode – S

√Batt installed

Install Empty Card

Pwr – ON

Top LCD:

√Batt

√Frames remaining sufficient

Exp Comp () – 0.0

Exp Mode – P

Meter – Matrix )

Diopter – Adjust

Frame Rate – S

√BKT disabled – 0 F

Rear LCD:

√ISO – 100

√QUAL – RAW

√WB – 0,A

AF Area Mode – [[]]

√Focus Area – Center

√Focus Selector Lock – L

P/TV08 EXTERNAL SURVEY (Continued)

SETUP (Continued)

2. D2Xs Camr Config for ISS Still Survey (D2Xs Shutter Priority Mode)

SB-800 Flash Settings:
ON/OFF pb – OFF

Lens – 50mm(80-200mm @ 200mm)

If 80-200mm:

Focus Limit – full

Lens Focus Mode – A

√Aperture – Min, locked

Body Focus Mode – S

√Batt installed

√Flash Card installed

Pwr – ON

Top LCD:

√Batt

√Frames remaining sufficient

Exp Comp () – 0.0

Exp Mode – S:

SS – 500

Meter – Matrix ()

Diopter – Adjust

Frame Rate – S

√BKT disabled – 0 F

Rear LCD:

√ISO – 100

√QUAL – RAW

√WB – 0,A

AF Area Mode – [[]]

√Focus Area – Center

√Focus Selector Lock – L

P/TV08 EXTERNAL SURVEY (Continued)

SETUP (Continued)

3. SEITE(SIMPLEX) OMS Burn Photography
- 3a. Remove window shields prior to setup
- 3b. Perform ACTIVATION, OPERATION (Cue Card, TV) as reqd
- 3c. D3s Camr Config for SEITE(SIMPLEX) (D3s Shutter Priority Mode)

SB-800 Flash Settings:
ON/OFF pb – OFF

Lens – 28mm

√Aperture – Min, locked

Lens Focus Mode – M

√Batt installed

√Flash Card installed

Pwr – ON

Top LCD:

√Batt

√Frames remaining sufficient

Exp Comp () – 0.0

Exp Mode – S:

SS – 500

Meter – Matrix ()

Diopter – Adjust

Frame Rate – CH

√BKT disabled – 0 F

Rear LCD:

√ISO – 200

√QUAL – RAW

√WB – 0,A

AF Area Mode – [[]]

√Focus Area – Center

√Focus Selector Lock – L

P/TV08 EXTERNAL SURVEY (Continued)

SETUP (Concluded)

3c. D3s Camr Config for SEITE(SIMPLEX) (D3s Shutter Priority Mode) (Concluded)

Accessory Equipment:

- Shutter Release Cable – install
- Multiuse Base – install in W9/10
- Multiuse Brkt – install on Base

Technique:

- Frame image per picture at right
- Focus on OMS pod
- Body Focus Mode – M



3d. Perform Hardware Verification for DTV

- L10 (MUX) VTR/CC PWR – on (LED on)
- (VIP) √ATU – REC
√CCTV VIDEO IN – J3
PWR – on (LED on, DATA FLOW flashes twice)
- (VTR) √ON/STANDBY LED – green
√Switches set to white dot (seven)
√COUNTER SELECT – COUNTER (TC)
√Tape installed (tape icon LED on)
- Set GMT:
DISPLAY SELECT – MENU
↓ pb – ETC, EXEC pb – push
↓ pb – CLOCK SET, EXEC pb – push
Use ↓, ↑, EXEC to set Y,M,D,hr,min to GMT
DISPLAY SELECT – DATA
- L9 If Audio desired:
PS AUD PWR – AUD
Desired Loops – RCV, Vol tw 5
Other Loops – OFF
- A7 VID OUT DTV pb – push
VID IN pb – A(D)
- L10 (VTR) REC pb – push, hold
PLAY pb – push, simo (red dot displayed)

P/TV08 EXTERNAL SURVEY (Continued)

OPS

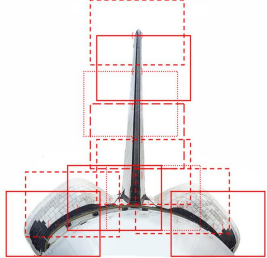
√	Item # Track #	Rqmts	Still Imagery	Video			Notes
				PLB	CC	Dnlk	
	1.	<u>OMS Pod Survey</u> <ul style="list-style-type: none"> •√No shadows on OMS pod tiles • Remove window shields • 50 percent overlap mapping of both OMS pods and vertical stabilizer w/emphasis on Black Tile areas • Repeat thru other window 	<u>D3s</u> 80-200mm @ 200mm				Download images to MCC once complete 
	2. ULF6-10	<u>ISS Still Survey</u> <ul style="list-style-type: none"> • Surfaces • Solar Panels • Handrails • MISSE-8 on ELC2 on S3 • AMS on S3 	<u>D2Xs</u> 28-70mm @ 50mm (80-200mm @ 200mm)				Map ISS surfaces w/30% overlap from all Flt Deck windows Document during orbital day; shoot MISSE-8, AMS from W6
	3.	<u>SEITE(SIMPLEX)</u> <ul style="list-style-type: none"> • Initiate photo sequence 1 sec prior to burn • Start DTV VTR 5 min prior to burn 	<u>D3s</u> 28mm	<u>A(D)</u>		LIVE (if avail)	√Focus set on OMS pod
	4.	<u>AMS in PLB</u> <ul style="list-style-type: none"> • General shots of AMS in PLB w/o ELC in PLB 	<u>D2Xs(D3s)</u> As reqd				Suggest shooting from cupola

P/TV08 EXTERNAL SURVEY (Continued)

OPS (Continued)

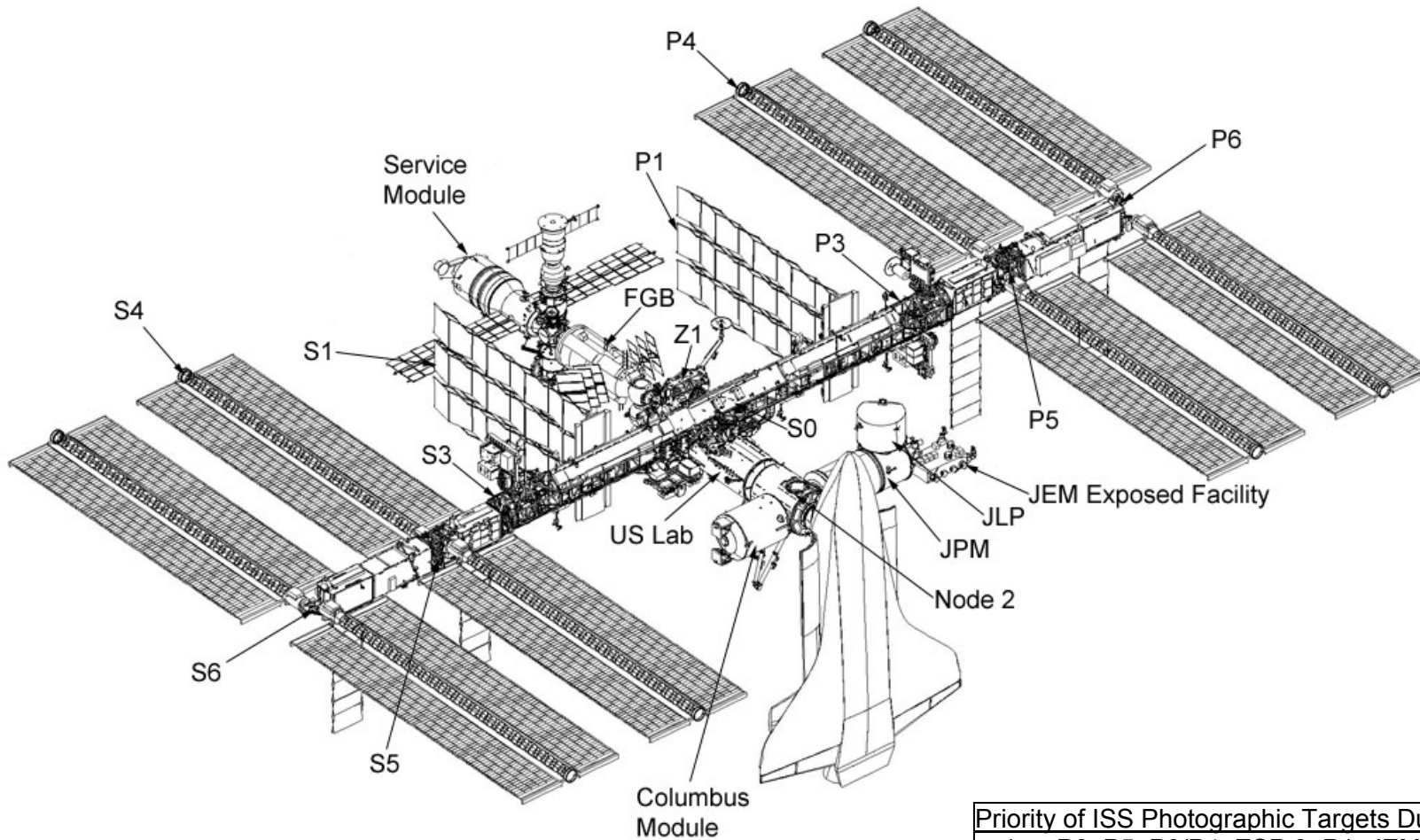

Priority of ISS Photographic Targets During Docked Phase:	
1.	P6, P5, P3/P4, ESP 3, P1, JEM, JLP, Columbus, S0, S1, S3/S4, S5, S6, Solar Arrays – W1, W6 (special emphasis on newly installed components)
2.	Node 2, Columbus, JEM, JLP – W7, W8
3.	PMA2 – W9, W10

P/TV08 EXTERNAL SURVEY (Concluded)

OPS (Concluded)

If OPS temporarily suspended, perform DEACTIVATION as reqd
If OPS completed, go to DEACTIVATION

DEACTIVATION

1. D2Xs,D3s
 - √Lens Focus Mode – A
 - √Exp Mode – P
 - Frame Rate – S
 - Flash ON/OFF – ON

2. TV System
 - Remove, mark tape for SEITE(SIMPLEX)
 - Go to DEACTIVATION (Cue Card, TV) as reqd

This Page Intentionally Blank

This Page Intentionally Blank

**P/TV09
MIDDECK PL**

P/TV09 MIDDECK PAYLOADS

H/W SUMMARY

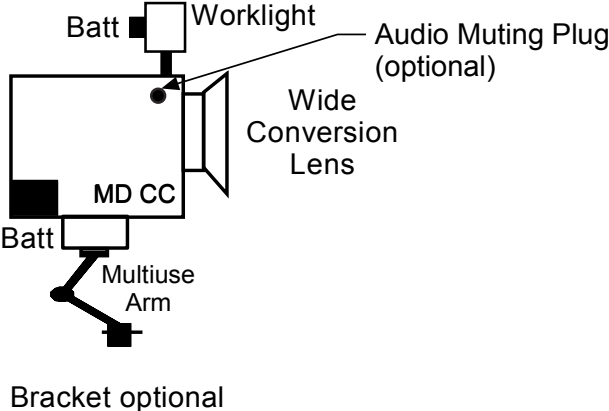

jsc48038_134_017r1.cvx

P/TV09 MIDDECK PAYLOADS (Continued)

SCENE SYNOPSIS

Scene contains procedures for obtaining in-cabin photo-documentation conducted within orbiter/ISS of GLACIER

SETUP

1. Perform Camcorder Setup for MD per H/W SUMMARY, 1-70, as reqd

CC

- √Batt installed
- Install Wide Conversion lens
- √ND FILTER – OFF
- √OUTPUT – CAM
- √..-
- √STANDBY/LOCK – STANDBY
- PWR dial – “green”
- √Tape installed
- √Viewfinder (LCD) displays “green” •||
- Install Audio Muting Plug (optional)
- Install Multiuse Brkt, Clamp as reqd

CAUTION

Due to temp constraints, worklights at full
pwr for 60 min; 90% pwr for unlimited time

Worklight

- Install fresh Batts
- Mount light on CC
- PWR – as reqd

P/TV09 MIDDECK PAYLOADS (Continued)

SETUP (Concluded)

2. Perform D2Xs(D3s) PROGRAM w/FLASH

D2s

Lens – 12-24mm

Aperture – Min, locked

Body Focus Mode – S

√Batt installed

√Flash Card installed

Pwr – ON

Top LCD

√Batt

√Frames remaining sufficient

Exp Comp (☑) – 0.0

Exp Mode – P

Meter – Matrix (☼)

Diopter – Adjust

Frame Rate – S

√BKT disabled – 0 F

Rear LCD

√ISO – 100

√QUAL – RAW

√WB – 0,A

AF Area Mode – [[]]

√Focus Area – Center

√Focus Selector Lock – L

SB-800 Flash Settings

√Diffuser Dome installed

ON/OFF pb – ON

√MODE –  TTL BL

√Exp Comp – 0 EV

Tilt – 45° (Direct)

D3s

Lens – 14-24mm

Aperture – N/A

Body Focus Mode – S

√Batt installed

√Flash Card installed

Pwr – ON

Top LCD

√Batt

√Frames remaining sufficient

Exp Comp (☑) – 0.0

Exp Mode – P

Meter – Matrix (☼)

Diopter – Adjust

Frame Rate – S

√BKT disabled – 0 F

Rear LCD

√ISO – 200

√QUAL – RAW

√WB – 0,A

AF Area Mode – [[]]

√Focus Area – Center

√Focus Selector Lock – L

SB-800 Flash Settings

√Diffuser Dome installed

ON/OFF pb – ON

√MODE –  TTL BL

√Exp Comp – 0 EV

Tilt – 45° (Direct)

P/TV09 MIDDECK PAYLOADS (Continued)

OPS

√	Item # Track #	Rqmts	Still Imagery	Video			Notes
			DCS	PLB	CC	Dnlk	
	1.	GLACIER Video, Still Photography <ul style="list-style-type: none"> • Wide-angle video, photos showing crew interaction • Medium-angle video, photos showing stowage location • Closeup video, photos of front panel after activation for gnd verification 	<u>D2Xs(D3s)</u> 12-24mm (14-24mm)		<u>G1</u>	LIVE desired within 12 hrs	
	2.	IFOAM Photography <ul style="list-style-type: none"> • Photo of IFOAM deployed in the middeck 	<u>D2Xs(D3s)</u> 12-24mm (14-24mm)				
	3.	IENOS Photography <ul style="list-style-type: none"> • Two (2) photos of each deployed IENOS (3) 	<u>D2Xs(D3s)</u> 12-24mm (14-24mm)				
	4.	BIOKIS Photography <ul style="list-style-type: none"> • Photo of BIOKIS 002 deployed in the middeck 	<u>D2Xs(D3s)</u> 12-24mm (14-24mm)				
	5.	IAPE Video <ul style="list-style-type: none"> • Videotape all three deployed experiment sessions 			<u>G1</u>		Prefer hand-held
	6.	VIABLE ISS Photography <ul style="list-style-type: none"> • Setup: Photograph each individual bag and all bags together • Post-Bag closure, photograph each bag and all bags together 	<u>D2Xs(D3s)</u> 12-24mm (14-24mm)				
	7.	Cube Lab Video <ul style="list-style-type: none"> • Videotape crew performing Cube Lab Module sortie ops 			<u>G1</u>		

If OPS temporarily suspended, perform DEACTIVATION as reqd
 If OPS completed, go to DEACTIVATION

P/TV09 MIDDECK PAYLOADS (Concluded)

DEACTIVATION

- | | |
|-----------|-------------------|
| Worklight | 1. PWR – OFF |
| CC | Remove, mark tape |
| | PWR dial – OFF |

This Page Intentionally Blank

P/TV10 STORRM

SCENE SYNOPSIS

Scene contains procedures for obtaining in-cabin photogrammetry of DTO-703 STORRM

SETUP

- STORRM PGSC 1. Unstow STORRM fiducial scales
IFM Locker 2. Unstow Kapton tape
3. Perform Setup using D2Xs Camera body (SN **1025**) and 17-35mm lens (SN **1016**)

Lens – 17-35mm

Tape zoom ring @ 35mm

Aperture – Min, locked

Body Focus Mode – S

√Batt installed

Install empty card

Pwr – ON

Top LCD

√Batt

√Frames remaining sufficient

Exp Comp (☑) – 0.0

Exp Mode – A

f/stop – 16

Meter – Matrix (☼)

Diopter – Adjust

Frame Rate – S

√BKT disabled – 0 F

Rear LCD

√ISO – 100

√QUAL – RAW

√WB – 0,A

AF Area Mode – []

√Focus Area – Center

√Focus Selector Lock – L

SB-800 Flash Settings

√Diffuser Dome installed

ON/OFF pb – ON

√MODE – [] [TTL] [BL]

√Exp Comp – 0 EV

Tilt – 45° (Direct)

P/TV10 STORRM (Continued)

SETUP (Concluded)

4. Tape scale on docking target using Kapton tape in two places per diagram; Do not cover fiducials

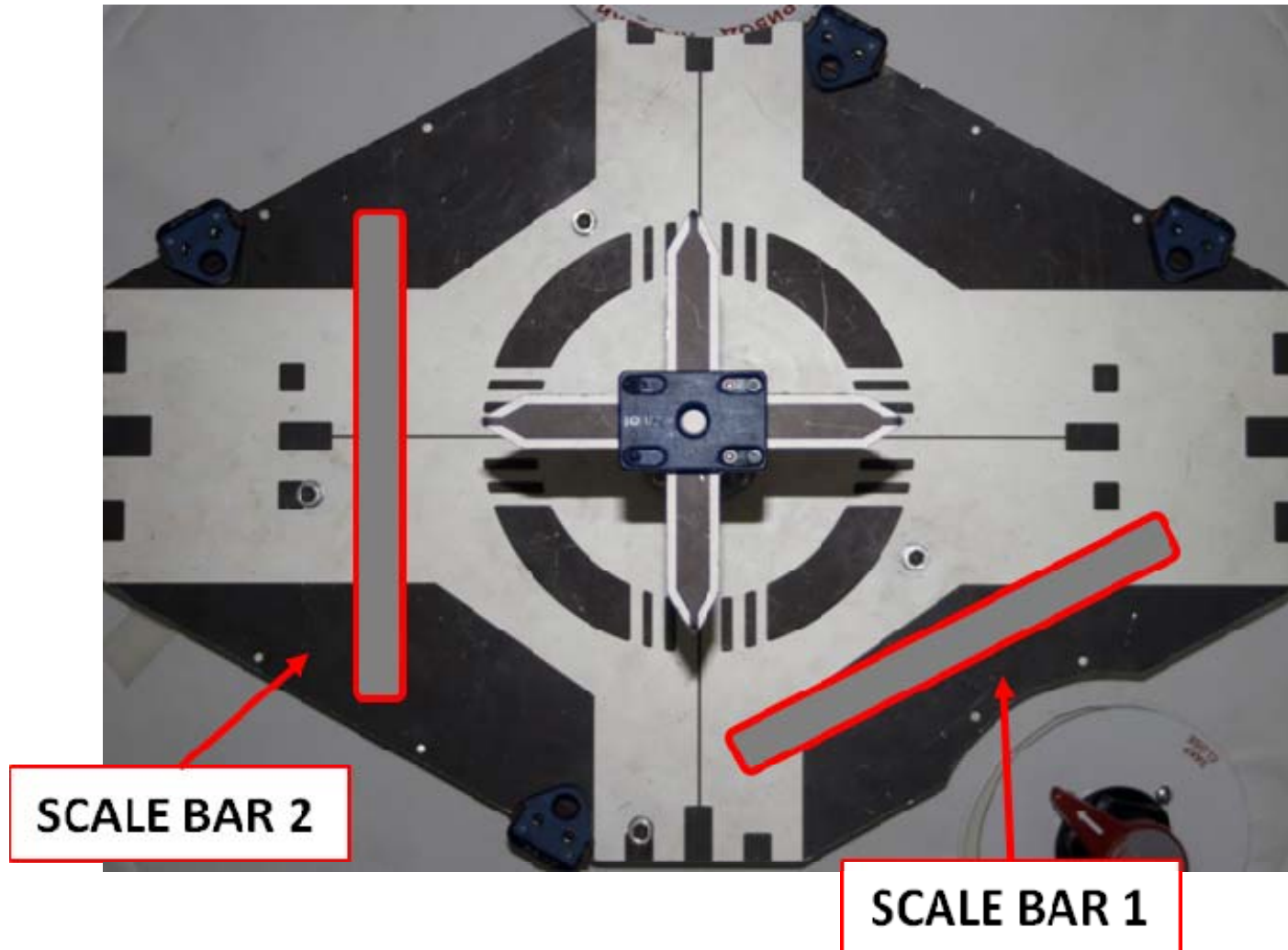

P/TV10 STORRM (Concluded)

OPS

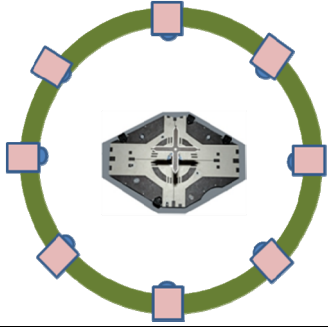
√	Item # Track #	Rqmts	Still Imagery	Video			Notes
			DCS	PLB	CC	Dnlk	
	1.	STORRM, Still Photography <ul style="list-style-type: none"> • 8 Images around the ODS perimeter at 45° intervals • 1 Image of center standoff target 	D2Xs 35mm				All images at no less than 4 ft (use plane of ODS Hatch) Focus on standoff cross base for each image Center each image on docking target Verify targets and entire scale visible in each photo Maintain flash radially inward Dnlk images immediately following capture
	2.	Repeat step 1					

If OPS temporarily suspended, perform DEACTIVATION as reqd
 If OPS completed, go to DEACTIVATION

DEACTIVATION

1. Remove scales from docking target – stow on STORRM PGSC
2. D2Xs
 - √Exp Mode – P
 - Pwr – OFF
 - √Flash ON/OFF – ON

REFERENCED PROCEDURES

	<u>PAGE</u>
<u>CENTERLINE (C/L) CAMR</u>	
C/L CAMR INSTALL	FS 2-4
<u>DTV</u>	
VTR CLOCK SET	FS 2-8
AVI VIDEO CAPTURE	FS 2-8a
<u>D2Xs</u>	
DATE/TIME SET	FS 2-10
<u>CANON G1</u>	
ANALOG (SD DTV) CC REC,DNLK	FS 2-12
HD CC DNLK	FS 2-14
<u>FCS CHECKOUT CAMR SETUP</u>	
SETUP	FS 2-18
DEACTIVATION	FS 2-20
<u>MINI-CAM</u>	
ENTRY VIDEO SETUP	FS 2-22
<u>LASER CAMR SYSTEM (LCS)/INTEGRATED SENSOR INSPECTION SYSTEM DIGITAL CAMR (IDC)</u>	
LCS/IDC (HEATER ONLY MODE)/(OPERATIONAL PWR MODE) DATA AND PWR INTERFACES	FS 2-26
<u>D3s</u>	
SPECIFICATIONS	FS 2-28
LENS DATA	FS 2-29
NOMENCLATURE	FS 2-31
NOMINAL SETUP	FS 2-38
DATE/TIME SET	FS 2-42
DELETING SINGLE IMAGES	FS 2-42
ADDING .WAV FILES TO AN IMAGE	FS 2-42
DELETING .WAV FILE FROM AN IMAGE	FS 2-43
.WAV FILE PLAYBACK	FS 2-43

This Page Intentionally Blank

This Page Intentionally Blank

C/L CAMR

CENTERLINE (C/L) CAMR

C/L CAMR INSTALL

1. ODS C/L Camr Config
- L12 (SSP 2) ✓C/L CAM PWR – OFF
- R12 (VPU) ✓SEC C/L Cap installed
 ✓Green Jumper – SEC C/L
 ✓VPU PWR – ON (LED on)
- ML60B Unstow PRI C/L Camr, PRI C/L TV Camr Harness Assy

NOTE

When connecting ODS C/L TV Camr Harness Assy, ✓pins to socket connection

- ODS ✓ODS C/L Camr Brkt mounted securely
 Mount PRI C/L Camr to ODS C/L Camr Brkt
 ✓Flex Duct attached to Camr brkt
 Config cable per dwg at right
- C/L Camr ✓SSF/STS sw – STS
- L12 (SSP 1) ✓cb SW PWR 1 – cl
 (SSP 2) C/L CAM PWR – SEC ON
- A6L LT VEST PORT,STBD – ON as reqd
 Perform ACTIVATION (Cue Card, TV) as reqd
- A7 VID OUT MON 1(2) pb – push
 IN PL2(VPU) pb – push
 ALC pb – push
 AVG pb – push

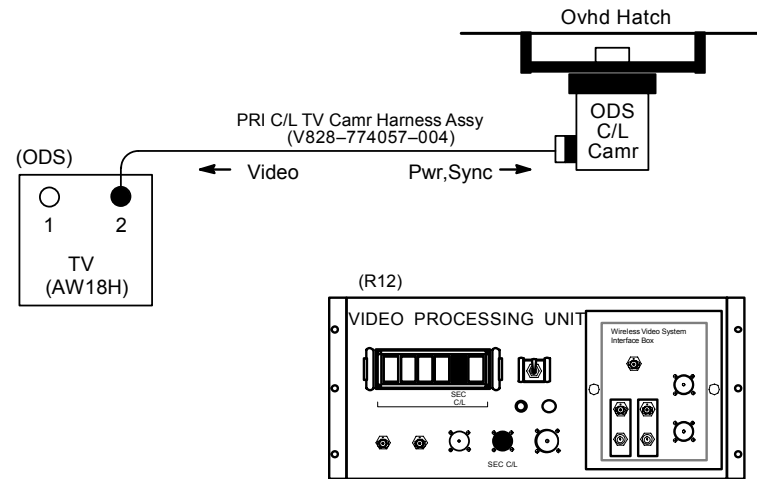

jsc48037_048r2.cvx

CENTERLINE (C/L) CAMR (Continued)

C/L CAMR INSTALL (Continued)

2. Camr Position Verification

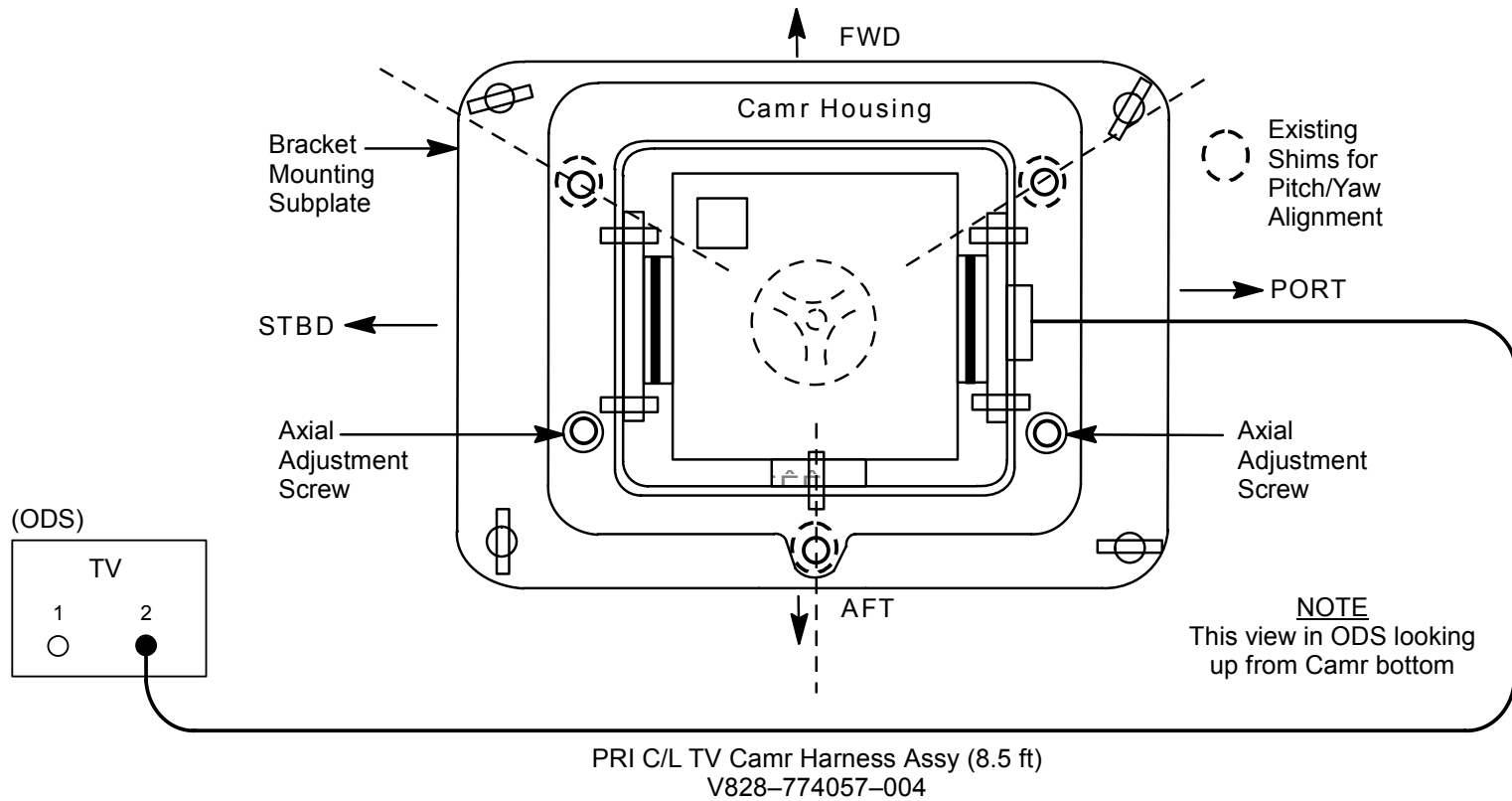

jsc48037_049r2.cvx

CENTERLINE (C/L) CAMR (Concluded)

C/L CAMR INSTALL (Concluded)

MON 1(2) 3. ODS C/L Camr Alignment Check
LDATA – ON
CDATA – GRN
XHAIR – GRN

A7 Zoom to $10^\circ \pm 0.5^\circ$
Focus to see Xhair target

NOTE

Green xhairs on monitor may move off center in calibration target when zooming in,out. Xhair will be closest to center at full zoom in position

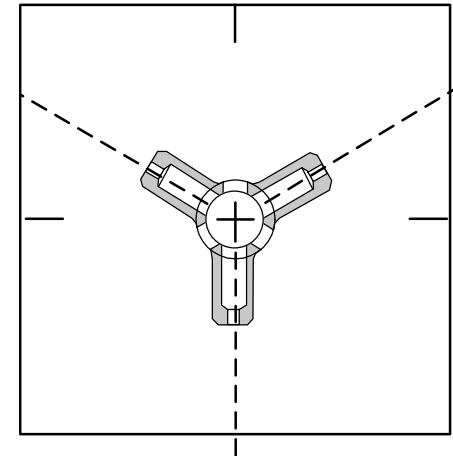

MON 1(2) ✓ Vertical xhairs coincide w/vertical alignment wire and are parallel. If xhair marks overlay each other, no yaw(axial) alignment needed (see dwg above)

✓ Intersection of monitor vertical, horizontal xhair falls within target circular opening from $\sim 10\text{-}40^\circ$ zoom range of Camr

Report results of both alignment verifications (at 10° and 40°) to MCC

A7 4. Deactivation
L12 (SSP 2) CAMR CMD IRIS – CL
C/L CAM PWR – OFF
Go to DEACTIVATION (Cue Card, TV) as reqd

A6L LT VEST PORT,STBD – OFF as reqd

This Page Intentionally Blank

DTV

DTV

VTR CLOCK SET

1. Activate VTR

R1 √PL AUX – ON

L10 (MUX) VTR/CC PWR – on (LED on)
(VTR) √ON/STANDBY LED – green

2. Set VTR clock to GMT

DISPLAY SELECT – MENU

↓ pb – ETC, EXEC pb – push

↓ pb – CLOCK SET, EXEC pb – push

Use ↑,↓,EXEC to set Y,M,D,hr,min to GMT

DISPLAY SELECT – DATA

3. Deactivate VTR,VIP as reqd

(VIP) ON/STANDBY pb – push (red LED on)
 PWR – off (LED off)

DTV (Continued)

AVI VIDEO CAPTURE

NOTE

This procedure assumes A31p laptop is configured for pwr and running

1. Unstow:
A17 (DTV bag) DTV IEEE 1394 4-PIN to CIRC FEMALE CABLE (SDZ16103651-801)
2. VTR/CC PWR – on (LED on)
√ON/STANDBY LED – green
3. Configure hardware per Diagram

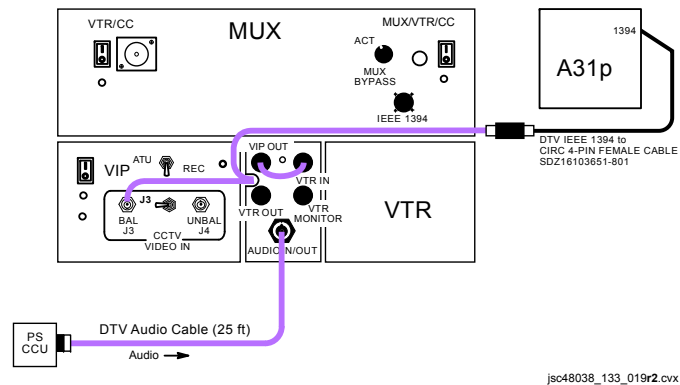

4. √PGSC Pwr – on
If 'Digital Video Device' appears:
Sel 'Take no action'
Sel 'Always perform the selected action'
Sel 'OK'
5. Close all applications

DTV (Concluded)

AVI VIDEO CAPTURE (Concluded)

- L10 (VTR)
6. Sel Shuttle Apps > Image Processing > AVI Capture
If 'Error! No Firewire video capture device found. Please verify a device is connected and rerun the application' appears:
Sel 'OK'
√DTV IEEE 1394 4-Pin to CIRC FEMALE CABLE connected to A31P
√ON/STANDBY LED – green
Restart application > Double-click 'AVI_Cap.exe'
 7. √Video displayed in 'Shuttle DV Capture'
 8. Under 'Save Size':
√'Current size: 250MB'
 9. Recording actions are documented in PDRS OPS

DEACTIVATION

1. Close Software (click X)
2. Disconnect DTV IEEE 4-Pin to CIRC FEMALE CABLE from A31p
3. Disconnect DTV IEEE 4-Pin to CIRC FEMALE CABLE from IEEE 4-Pin to CIRC MALE CABLE
4. Connect IEEE 4-Pin to CIRC MALE CABLE to MUX IEEE 1394 port
5. Return to nominal ops

This Page Intentionally Blank

D2Xs

D2Xs

DATE/TIME SET

1. MENU pb – press
2. Navigate pad – sel Menu icon **Y** setup menu
 - press (right)
 - sel WORLD TIME (up,down)
 - press (right)
 - sel DATE (up,down)
 - press (right)
3. Set TIME/DATE to GMT
 - Navigate pad – sel desired field (left,right)
 - sel desired setting (up,down)
4. ENTER pb – press
5. MENU pb – press twice

This Page Intentionally Blank

CANON G1

ANALOG (SD DTV) CC REC.DNLK

Config H/W per dwg at right

AVIU SYNC/VIDEO – VIDEO
 HI-Z/75 – 75
 PWR SELECT – LO

O19(MO58F) √TV PWR – ON

CC √Wide Conversion lens installed
 √ND FILTER – OFF
 Install Audio Muting Plug (optional)
 √OUTPUT – CAM
 √A/V1/V2 – V2
 √ [] .. [] - []
 √STANDBY/LOCK – STANDBY
 PWR dial – “green” []
 If rec to tape:
 Tape – Install
 √Viewfinder (LCD) displays “green” •||
 Mount w/Multiuse Brkt, Clamp as reqd

CAUTION
 Due to temp constraints, worklights at full pwr for 60 min; 90% pwr for unlimited time

Worklights Install fresh Batts
 Mount light(s) w/brkts (Velcro/tape)
 PWR – as reqd

Cabin Lts Flt Deck – ON
 Lts in FOV – OFF as reqd
 Lt Shades – install as reqd
 Window Shades – install as reqd

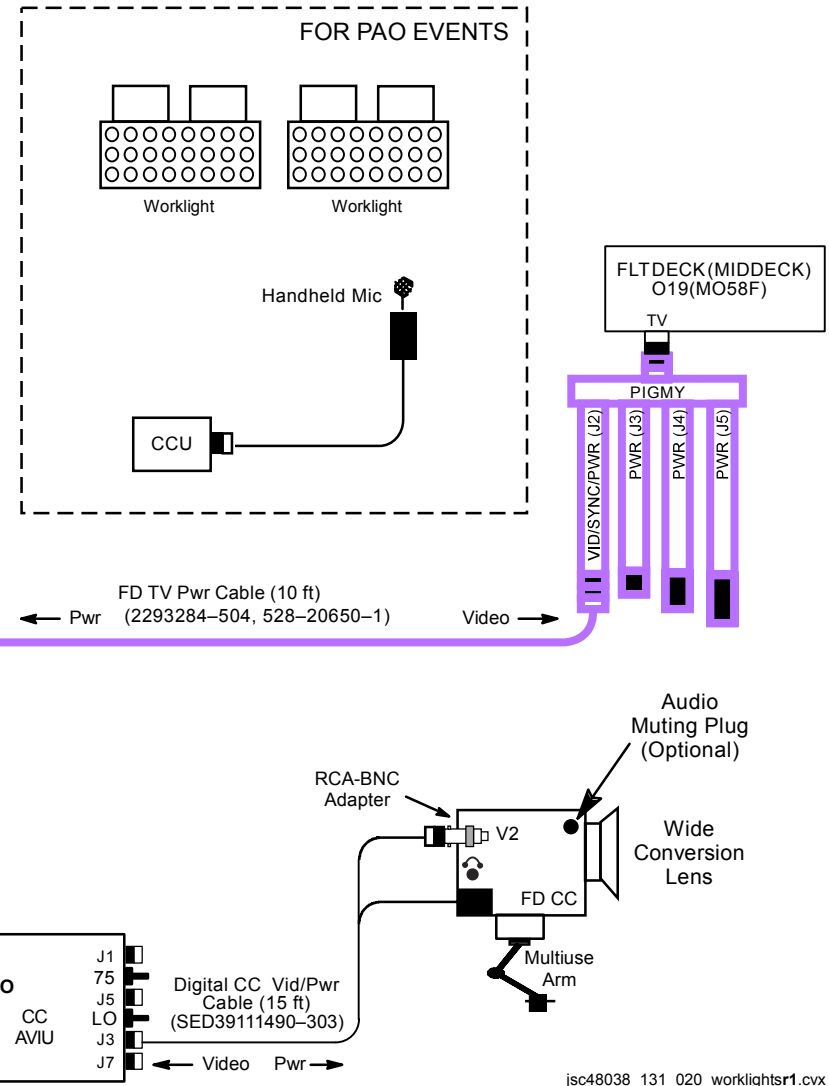

jsc48038_131_020_worklightsr1.cvx

CANON G1 (Continued)

ANALOG (SD DTV) CC REC.DNLK (Concluded)

CC √Scene composition
 Adjust Camr angle for best framing

CCU CCU PWR – ON

ATU PWR – AUD
 A/G 1(2) – T/R
 All Other Loops – OFF
 XMIT/ICOM MODE SEL – PTT/PTT
 MSTR SPKR VOL SEL – as reqd

A7 When ready for dnlk:
 √TV DNLK – ENA
 PWR CNTL – PNL
 CONTR UNIT – MNA(B)
 CNTL – CMD (wait 10 sec for system initialization)

 If Analog, on MCC GO:
 | VID OUT DNLK pb – push
 | IN FLT DECK(MIDDECK) pb – push
 If SD DTV, on MCC GO:

L10 √Cables connected
(MUX) MUX/VTR/CC PWR – on (LED on)
 √MUX BYPASS – ACT
(VIP) PWR – on (LED on, DATA FLOW LED flashes twice)
(VTR) √ON/STANDBY LED – green
 √INPUT SELECT – VIDEO

A7 VID OUT DTV pb – push
 IN FLT DECK(MIDDECK) pb – push

L10 (MUX) √CH 3 DATA LED – on

 When dnlk complete:
CC PWR dial – OFF
Worklights PWR – off
L10 (MUX) MUX/VTR/CC PWR – off (LED off)

 Go to DEACTIVATION (Cue Card, TV) as reqd

CANON G1 (Continued)

HD CC DNLK



Notify MCC, configuring for HD TV dnlk

Config H/W per dwg at right

CC For cable strain relief attach MPC-to-G1 Cable Velcro strap to CC strap

AVIU SYNC/VIDEO – VIDEO
HI-Z/75 – 75
PWR SELECT – LO

O19 ✓TV PWR – ON

CC ✓Wide Conversion Lens installed
Install LAV MIC
✓ND FILTER – OFF
✓OUTPUT – CAM
✓ - 
✓STANDBY/LOCK – STANDBY
PWR dial – “green” 
If rec to tape:
TAPE – INSTALL
✓VIEWFINDER (LED) displays “green” •||
Mount w/Multiuse Brkt, Clamp as reqd

L10 (MUX) ✓MUX/VTR/CC PWR – on (LED on)
✓MUX BYPASS – ACT
✓CH 0,1 RATE SEL – 1
✓2 RATE SEL – 8

(VTR) ON/STBY pb – push (LED red)
(VIP) PWR – off (LED off)

O19 DC UTIL PWR MNA – ON
MPC PWR DC PWR SPLY PWR SW1 – ON

MPC PWR SPLY PWR SW1
MPC PWR – ON (HDV, TAXI, 5V, 3V green LEDs on)

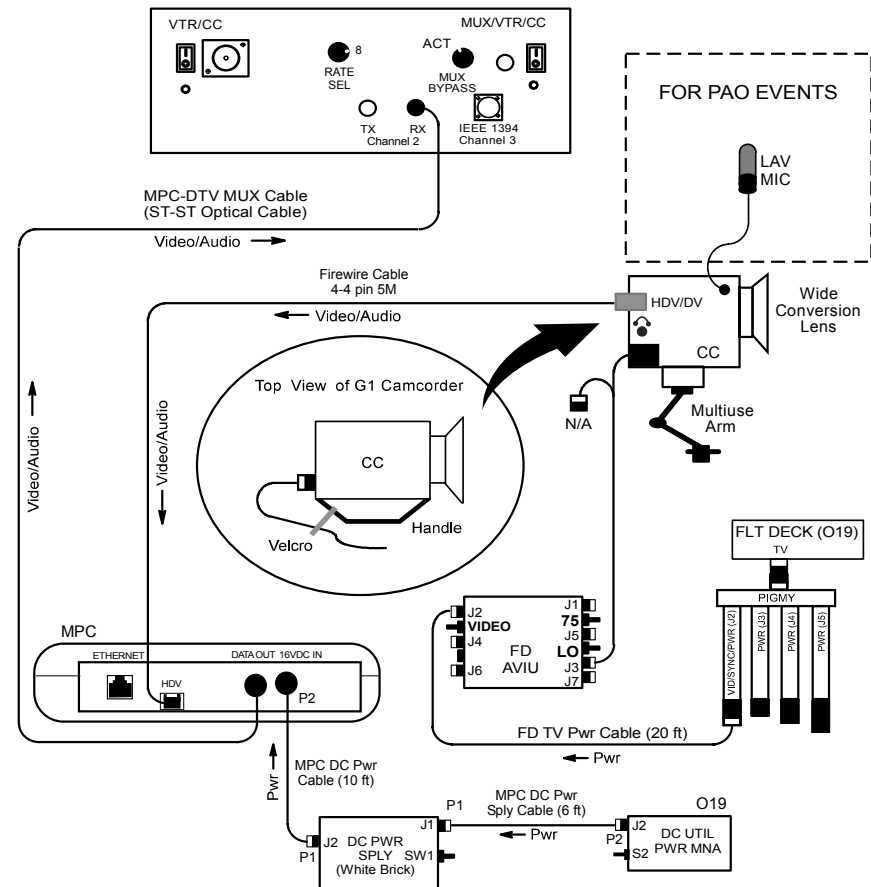
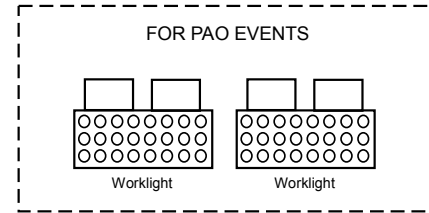

jsc48038_134_021r2.cvx

CANON G1 (Continued)

HD CC DNLK (Continued)

L10 (MUX) ✓CH 2 F/O OK, DATA LEDs on

CAUTION

Due to temp constraints, worklights at full
pwr for 60 min; 90% pwr for unlimited time

Worklights Install fresh Batts
Mount light(s) w/brkts (Velcro/tape)
PWR – as reqd

Cabin Lts Flt Deck – ON
Lts in FOV – OFF as reqd
Lt Shades – install as reqd
Window Shades – install as reqd

CC ✓Scene composition

Adjust Camr angle for best framing

LAV MIC PWR – ON (talk), OFF (listen)

✓MCC if Black video and color bars reqd
If reqd:
 PWR dial – Av
 Aperture – close
 ✓Av CLOSE displayed on top left of LCD
 AGC – OFF
 ✓GAIN sw – L
 ✓±0dB displayed on LCD
 OUTPUT – BARS

When MCC says done w/bars:
 OUTPUT – CAM

When MCC says done w/black screen test:
 PWR dial – “green”

CANON G1 (Concluded)

HD CC DNLK (Concluded)

CC	When dnlk complete: PWR dial – OFF
Worklights	PWR – OFF
O19	TV PWR – OFF as reqd
MPC	PWR – OFF
PWR SPLY	DC PWR SPLY PWR SW1 – OFF
O19	DC UTIL PWR MNA – OFF
L10 (MUX)	MUX/VTR/CC PWR – off (LED off)
(VIP)	PWR – on (LED on, DATA FLOW LED flashes twice)
(VTR)	ON/STANDBY pb – push (LED green)

Notify MCC, returned to SD DTV dnlk

Go to DEACTIVATION (Cue Card, TV) as reqd

This Page Intentionally Blank

FCS CHECKOUT CAMR SETUP

SCENE SYNOPSIS

The following camera and camcorder settings will be used to photodocument items that may be liberated from the Orbiter during FCS C/O. Images and video should be downlinked if time and assets are available

SETUP

1. D2Xs

Lens – 400mm

NOTE

If auto focus unachievable:
Lens Focus Mode – M

SB-800 Flash Settings:
ON/OFF pb – OFF

Aperture – Min, locked
Lens Focus Limit – ∞ -6m
Lens Focus Mode – A
Body Focus Mode – S

√Batt installed

√Flash Card installed

Pwr – ON

Top LCD:

√Batt

√Frames remaining sufficient

Exp Comp – 0.0

Exp Mode – M:

SS – 500

f/stop – f/8

Meter – Matrix

Diopter – Adjust

Frame Rate – S

√BKT disabled – 0 F

FCS CHECKOUT CAMR SETUP (Continued)

SETUP (Concluded)

1. D2Xs (Concluded) |

Rear LCD:

√ISO – 100

√QUAL – RAW

√WB – 0,A

AF Area Mode – [[]]

√Focus Area – Center

√Focus Selector Lock – L

2. G1 CC |

Remove Wide Conversion Lens

Install Batt

√ND FILTER – OFF

AF/M – M

AGC – OFF

GAIN – L

√OUTPUT – CAM

√AWB – ON

√..-

√STANDBY/LOCK – STANDBY

PWR dial – M

√Tape installed

Open LCD:

√'green' ●|| displayed

SS – 1/500

√GAIN – 0dB

f/stop – F8.0

√FOCUS – M ∞

FCS CHECKOUT CAMR SETUP (Concluded)

DEACTIVATION

1. D2Xs
Lens focus mode – A
EXP Mode – P
Pwr – OFF

2. G1
Install Wide Conversion Lens
AF/M – AF
AGC – ON
Pwr dial – OFF
Remove Batt
Connect Dig/CC Vid Pwr Cable
PWR dial – 'green'
Place G1 on brkt

This Page Intentionally Blank

FS 2-21

P/TV/134/FIN A

MINI-CAM

MINI-CAM

MINI-CAM

ENTRY VIDEO SETUP

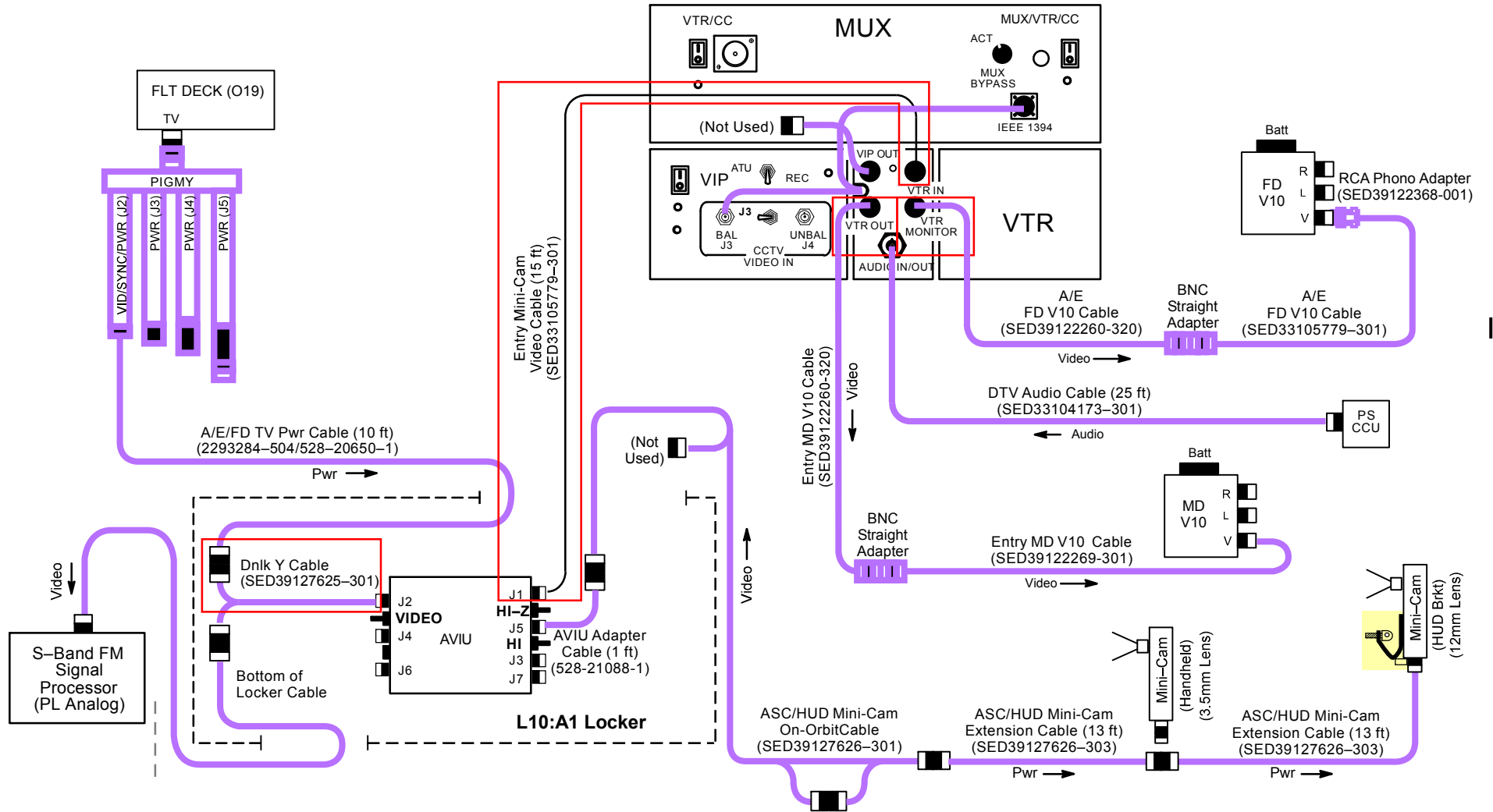

jsc48038_134_008r3.cvx

MINI-CAM (Continued)

ENTRY VIDEO SETUP (Continued)

1. Remove "Entry" Ziplock bag from DTV Bag
2. Config Mini-Cam, VTR for Audio, Video Recording
Config H/W per dwg, FS 2-22
 - a. Config HUD Mini-Cam w/12mm Lens
Using two (2) captive screws, attach HUD Brkt to installation holes for protective cover w/ HUD Brkt tab pointing up
Attach Tie Wrap thru holes on captive screws to prevent screw from coming loose; cut off extra length on Tie Wrap
Attach Mini-Cam Extension Cable to Mini-Cam

12mm Lens Focus – ∞ (Just off hard-stop)
 Aperture – f/5.6 for daylight landing, 1.4 for night landing

Velcro Mini-Cam w/12mm Lens to HUD Brkt. (Top of white Velcro on front of Camr should be at top edge of HUD Brkt.
Only yellow Velcro should be visible above HUD Brkt)
 - b. Config in-cabin Mini-Cam w/3.5mm Lens

3.5mm Lens Aperture – f/1.8
 - c. Config additional Mini-Cam H/W

L10:A1 AVIU
 SYNC/VIDEO – VIDEO
 HI-Z/75 – HI-Z
 PWR SELECT – HI

O19 √TV PWR – ON

PS ATU Config audio as reqd for entry audio

L10 (MUX)
 (VTR) VTR/CC PWR – on (LED on)
 √ON/STANDBY LED – green

MINI-CAM (Concluded)

ENTRY VIDEO SETUP (Concluded)

Acquire four (4) V10 Li-ION batts

NOTE

One Batt will be used on V10 for system c/o. Second Batt is spare. Batt will be removed after c/o and used for Entry

- V10 (FD,MD) Install fresh Batt
PWR – ON
√HUD 12mm Lens/Mini-Cam producing good video
- Change config to in-cabin 3.5mm Lens/Mini-Cam
√In-cabin 3.5mm Lens/Mini-Cam producing good video
√MD Camera view
- PWR – OFF
- L10 (VTR)
(MUX)
(VIP) ON/STANDBY pb – push (red LED off)
VTR/CC PWR – off (LED off)
√PWR – OFF
- O19 TV PWR – OFF

NOTE

TV, VTR pwr will be re-enabled per ENT AFT FLT DECK CONFIG 15 (DEORB, NOMINAL DEORBIT PREP); recording will be initiated via ENTRY C/L

Start w/3.5mm Lens/Mini-Cam video in-cabin and reconfig for 12mm Lens/Mini-Cam when exterior scene available

When exterior avail:

Focus – Adjust per V10

Aperture – Adjust per V10

If needed, turn down brightness on HUD display

Turn off V10 when not needed

This Page Intentionally Blank

LCS/IDC

LASER CAMR SYSTEM (LCS)/INTEGRATED SENSOR INSPECTION SYSTEM DIGITAL CAMR (IDC)

LCS/IDC (HEATER ONLY MODE)/(OPERATIONAL PWR MODE) DATA AND PWR INTERFACES

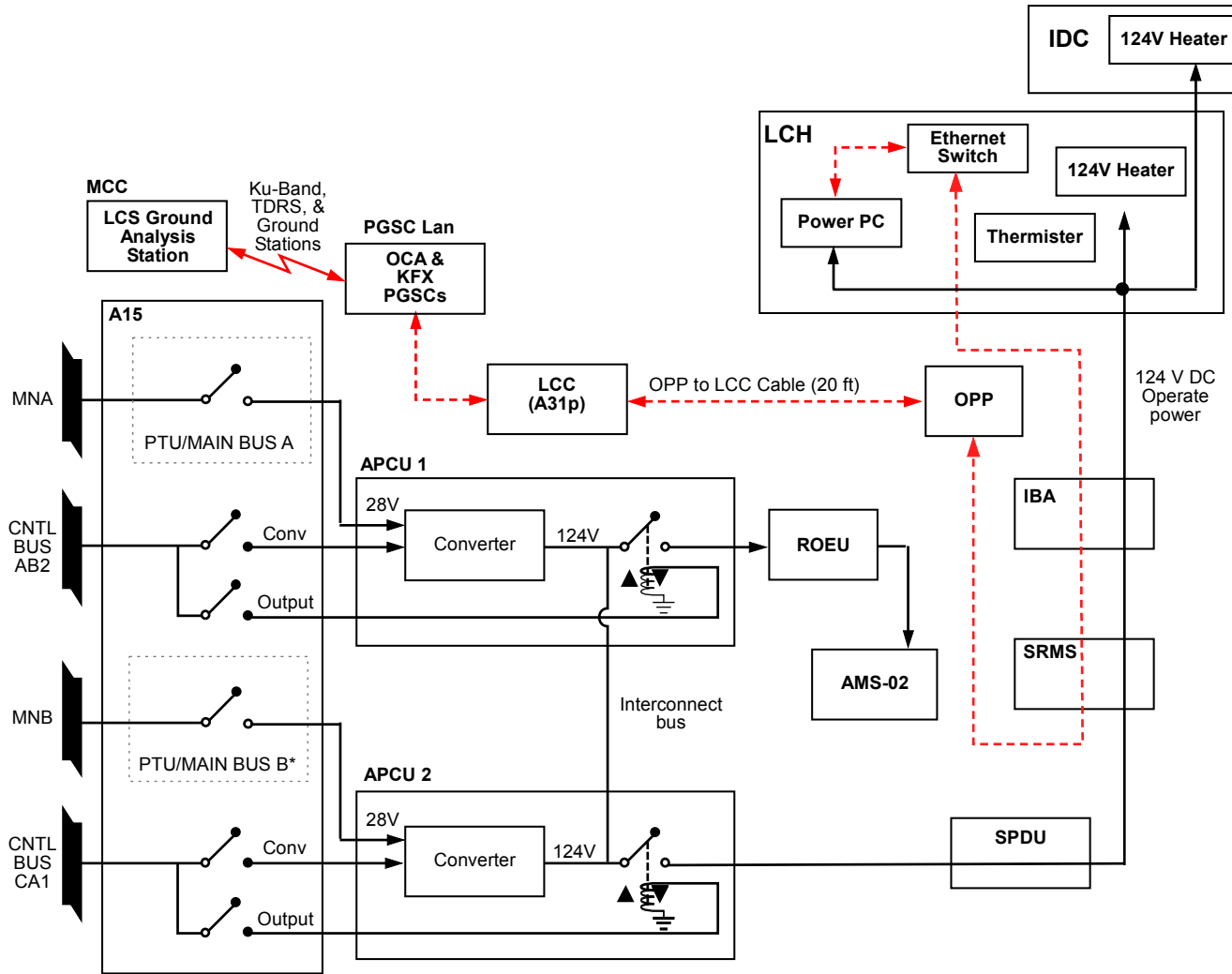

*See PTU 2/MAIN BUS B for detailed system dwg

jsc48038_134_134cr2.cvx

This Page Intentionally Blank

D3s

D3s

SPECIFICATIONS

CAMR BODY

CMOS SENSOR SIZE: 36mm x 23.9mm (DX MODE 24mm x 16mm)

PIXEL COUNT: 4256 x 2832 (12.1 million pixels)

FRAME/CARD: ~300/4 GB EVA Flash Card

RAW FILE SIZE: ~14 MB compressed lossless (14-bit)

EXPOSURE CONTROL: Auto (program, shutter priority, aperture priority), Manual

METER PATTERN: 3D Color Matrix II, Center Weighted, Spot

EXPOSURE COMP: ± 5 EV RANGE in full, 1/2 or 1/3 EV steps

SHUTTER:

Program & Aperture Priority – 1/8000 thru 30 sec (virtually stepless)

Manual & Shutter Priority – 1/8000 thru 30 sec (full, 1/3 or 1/2) stop increments, 250x, and Bulb (manual only)

ISO Setting: 200 to 12,800; H-0.3, H-0.5, H-0.7, H-1.0, H-2.0, H-3.0, L-0.3, L-0.7, and L-1.0 available (H-3.0 = 102,400 ISO)

FRAME RATE: Single continuous up to 9 frames/sec (up to 11 frames/sec in DX MODE)

Burst Rate: 41 raw images

MOVIE MODE SIZES: 1280 x 720/24 fps, 640 x 420/24 fps, 320 x 260/24 fps

MOVIE FORMAT: AVI

MOVIE COMPRESSION: Motion JPEG

MOVIE ISO: 200-12,800

MOVIE RECORDING TIME: 5 min max in 1280 x 720, 20 min max in other movie modes

MOVIE FILE SIZE: Max 2 GB

CAMERA INTERFACES: USB, audio/video, HDMI, Microphone, 10-pin remote

CAMR BATT: Li-ION EN-EL4A

CAMR BATT VOLTAGE: 11.1VDC

CAMR WEIGHT: 3.2 lb (w/Batt & Memory Card)

FLASH

SB-800

BATT: 4AA

BATT LIFETIME: 200+ images

WEIGHT: w/o Batts – .77 lb

SYNC FLASH CONTROL: Master, Remote

D3s (Continued)

LENS DATA

Lens	Aperture Range (f/stop)	Approximate Field of View (FOV)			Approx Minimum Focus Distance (ft)	Weight (lb)	Filter Size	M-A Switch
		Horizontal	Vertical	Diagonal				
10.5mm DXG	f/2.8-f/22	–	–	180°	0.5	0.7	Rear	
12-24mm DXG	f/4.0-f/22	89°-53°	66°-36°	100°-61°	1.0	1.0	77mm	Yes
14mm	f/2.8-f/22	104°	81°	114°	0.7	1.5	Rear	Yes
14-24mm G	f/2.8-f/22	104°-74°	81°-53°	114°-84°	0.7	2.2	None	Yes
16mm	f/2.8-f/22	97°	74°	107°	0.9	0.6	Rear	
17-35mm	f/2.8-f/22	93°-54°	70°-38°	104°-63°	1.0	1.6	77mm	Yes
24-70mm	f/2.8-f/22	74°-29°	53°-19°	84°-34°	1.2	2.0	77mm	Yes
17-55mm	f/2.8-f/22	70°-24°	50°-16°	80°-29°	1.3	1.7	77mm	Yes
20-35mm	f/2.8-f/22	61°-37°	43°-25°	71°-44°	1.7	1.3	77mm	Yes
24-85mm	f/2.8(4)-f/22	53°-16°	36°-11°	61°-19°	1.6	1.2	72mm	Yes
28mm	f/2.8-f/22	46°	31°	54°	1.2	0.5	52mm	
28mm	f/1.4-f/16	46°	31°	54°	1.1	1.2	72mm	Yes
28-70mm	f/2.8-f/22	46°-19°	31°-13°	54°-23°	2.3 (1.5 ft macro)	1.9	77mm	Yes
35mm	f/2-f/22	54°	38°	63°	0.9	0.5	52mm	
35-70mm	f/2.8-f/22	54°-29°	38°-19°	63°-34°	2.0 (0.9 ft macro)	1.5	62mm	
50mm	f/1.4-f/16	40°	27°	47°	1.5	0.5	52mm	
60mm Micro	f/2.8-f/32	33°	23°	40°	0.7	1.0	62mm	Yes
80-200mm	f/2.8-f/22	25°-10°	17°-7°	30°-12°	6	2.9	77mm	Yes
85mm	f/1.8-f/16	24°	16°	29°	3.0	1.2	62mm	

D3s (Continued)

LENS DATA (Concluded)

Lens	Aperture Range (f/stop)	Approximate Field of View (FOV)			Approx Minimum Focus Distance (ft)	Weight (lb)	Filter Size	M-A Switch
		Horizontal	Vertical	Diagonal				
105mm Micro	f/2.8-f/32	20°	13°	23°	1.0	1.2	52mm	Yes
180mm	f/2.8-f/22	11°	8°	14°	5.0	1.7	72mm	Yes
400mm	f/2.8-f/22	5.2°	3.4°	6.2°	12.5	10.6	52mm	Yes
400mm w/2X Teleconverter (800mm) TC-20E	f/5.6-f/45	2.6°	1.7°	3.1°	12.5	11.3	52mm	Yes

D3s (Continued)

NOMENCLATURE

CAMR – FRONT

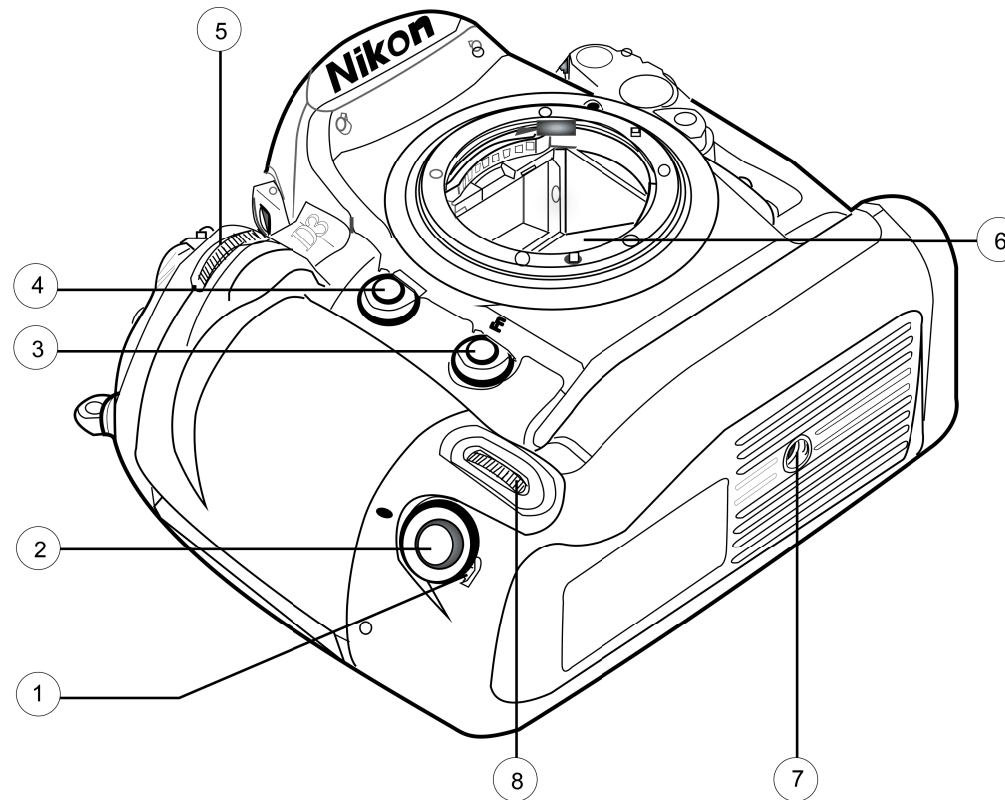

Nikon D3s Camera Front

- | | | | |
|---|---|---|--------------------------------------|
| 1 | sw Shutter-release Lock (vertical shooting) | 5 | Sub-command Dial |
| 2 | pb Shutter-release (vertical shooting) | 6 | Mirror |
| 3 | pb Fn | 7 | 1/4-20 Socket |
| 4 | pb Depth-of-field Preview | 8 | Sub-command Dial (vertical shooting) |

jsc48038_131_152r1.cvx



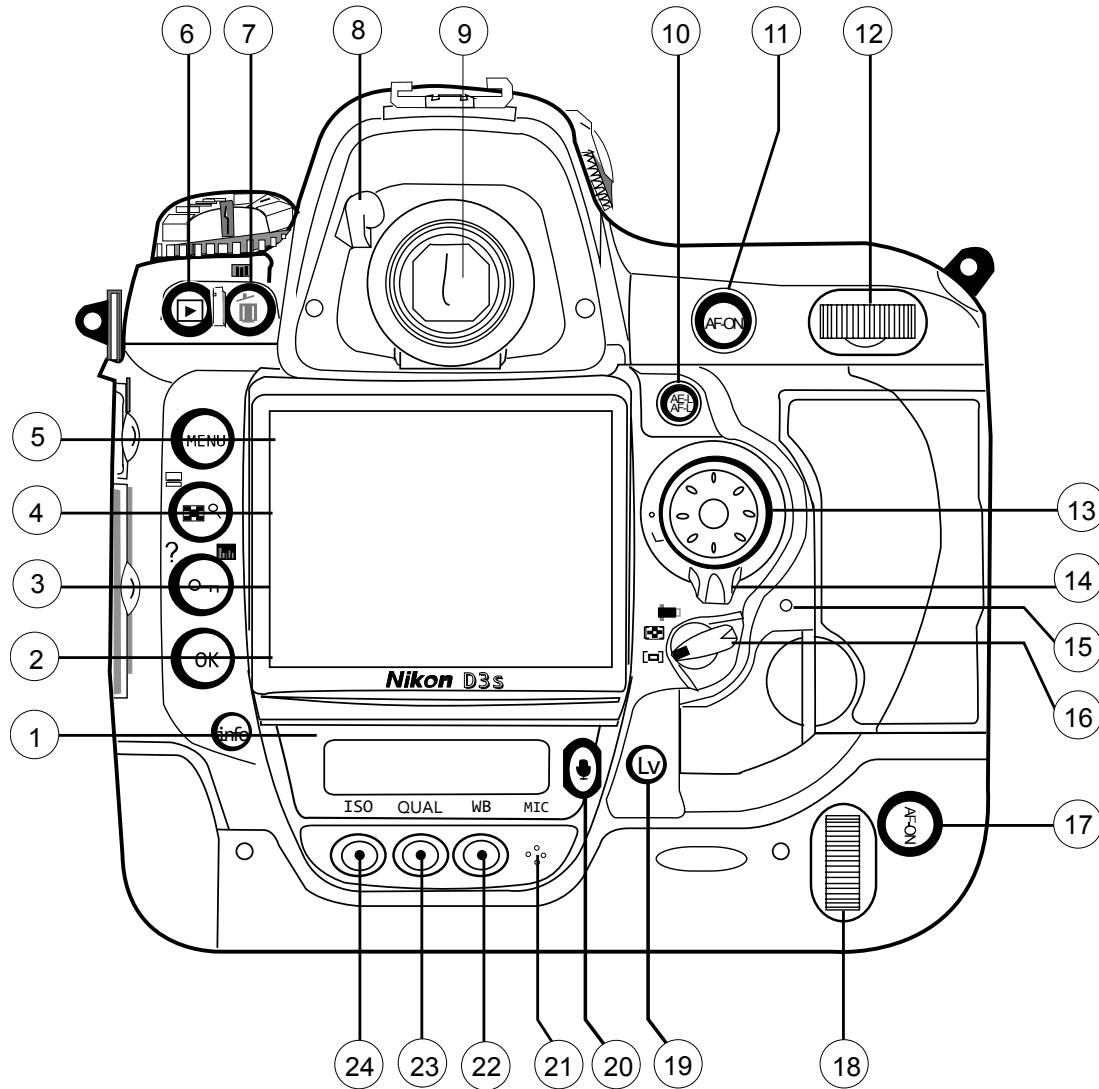

D3s (Continued)

NOMENCLATURE (Continued)

CAMR – BACK



Nikon D3s Camera Back



- | | |
|---|---|
| 1 pb info | 13 Navigate Pad |
| 2 pb OK | 14 Focus Selector Lock |
| 3 pb Protect  | 15 Memory Card Busy Lamp |
| 4 pb Thumbnail/Zoom  | 16 AF-Area Mode Selector |
| 5 pb MENU | 17 pb AF-ON (vertical shooting) |
| 6 pb Playback  | 18 Main Command Dial (vertical shooting) |
| 7 pb Delete  | 19 pb Live View |
| 8 Eyepiece Shutter Lever | 20 pb Microphone  |
| 9 Viewfinder Eyepiece | 21 Microphone |
| 10 pb AE/AF Lock | 22 pb White Balance |
| 11 pb AF-ON | 23 pb QUAL (image quality/size) |
| 12 Main Command Dial | 24 pb ISO Sensitivity |

D3s (Continued)

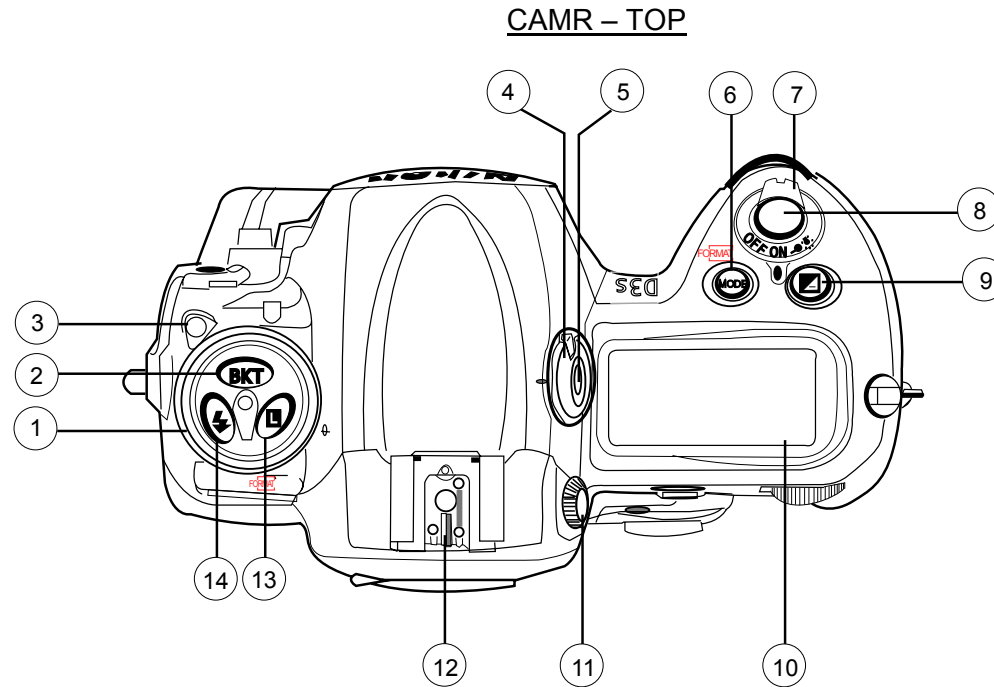
NOMENCLATURE (Continued)



Nikon D3s Camera Top

- | | | | |
|---|---------------------------------|---|--|
| ① | Shooting mode dial | ⑧ | pb Shutter-release |
| ② | pb Bracketing (BKT) | ⑨ | pb Exposure compensation  |
| ③ | Shooting mode dial lock release | ⑩ | Top LCD |
| ④ | Metering selector | ⑪ | Diopter adjustment knob |
| ⑤ | pb Metering selector lock | ⑫ | Accessory shoe |
| ⑥ | pb Exposure mode (MODE) | ⑬ | pb Lock |
| ⑦ | sw Power | ⑭ | pb Flash Mode  |

jsc48038_131_154r1.cvx

D3s (Continued)

NOMENCLATURE (Continued)

CAMR – LEFT SIDE

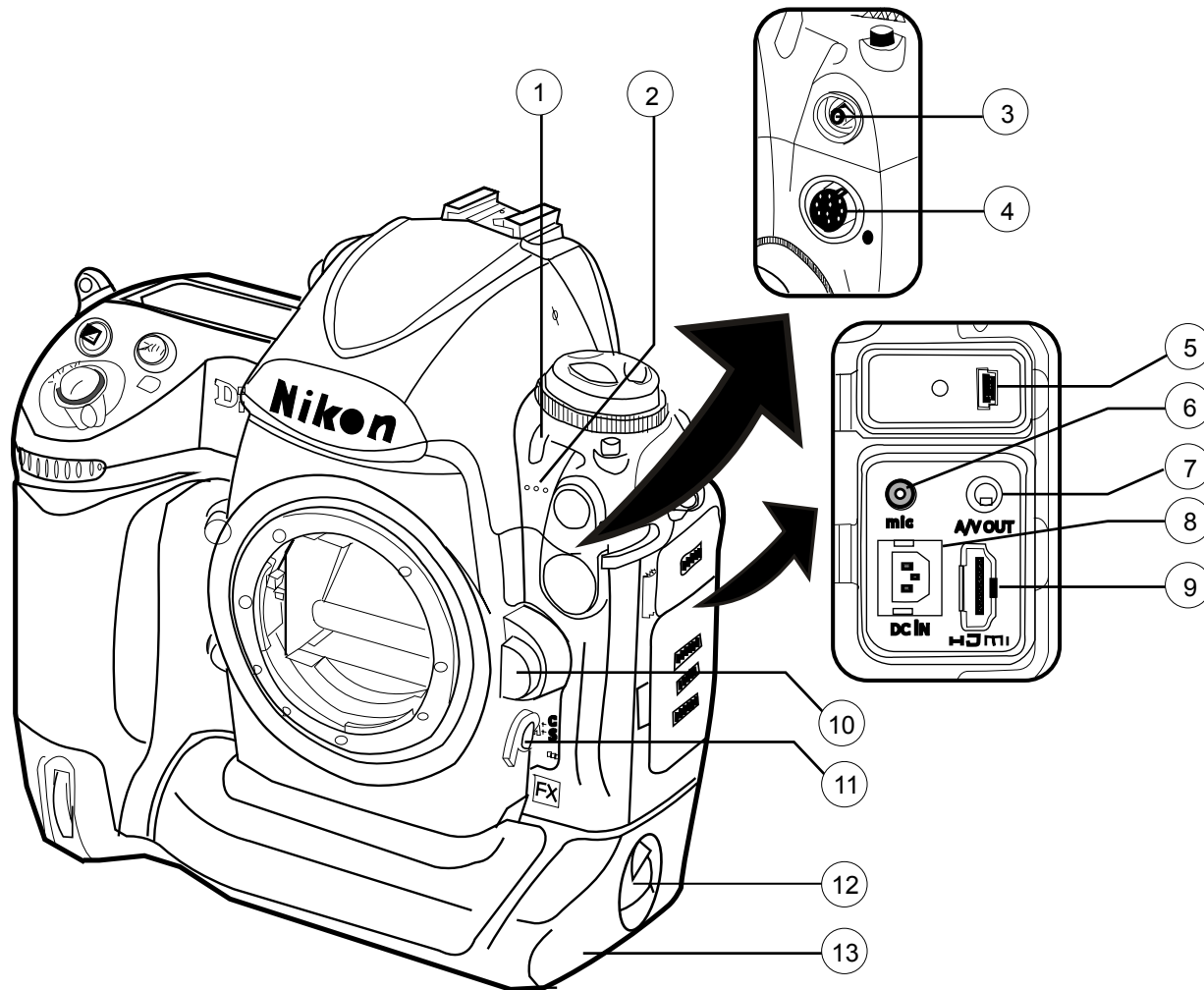

- ① Self-timer Lamp
- ② Microphone (for movies)
- ③ Flash Sync Terminal
- ④ Ten-pin Remote Terminal
- ⑤ USB Connector
- ⑥ Microphone Port
- ⑦ Audio/Video (A/V) Connector
- ⑧ DC-IN Connector for optional AC Adapter EH-6
- ⑨ HDMI Connector
- ⑩ Lens Release Button
- ⑪ Focus-mode Selector
- ⑫ Battery Door Latch
- ⑬ Battery Door

Nikon D3s Camera Left Front

D3s (Continued)

NOMENCLATURE (Continued)

CAMR – TOP CONTROL PANEL

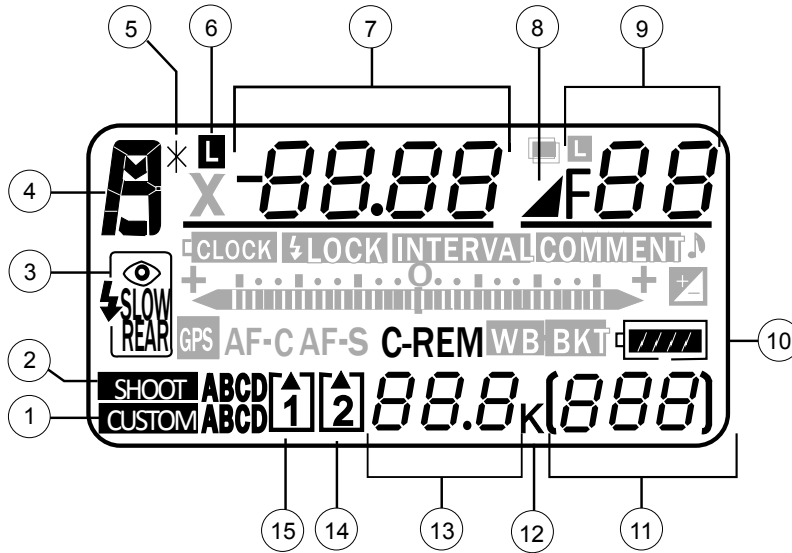

Nikon D3s Camera Top Control Panel - 1

- | | |
|------------------------------|--|
| ① Custom settings bank | ⑨ Aperture (f/number) |
| ② Shooting menu bank | ⑩ Battery indicator |
| ③ Flash mode | ⑪ Frame count |
| ④ Exposure mode | ⑫ "K" (indicates memory remains for over 1000 exposures) |
| ⑤ Flexible program indicator | ⑬ Number of exposures remaining |
| ⑥ Shutter-speed lock icon | ⑭ Memory card indicator (slot 2) |
| ⑦ Shutter speed | ⑮ Memory card indicator (slot 1) |
| ⑧ Aperture delta | |

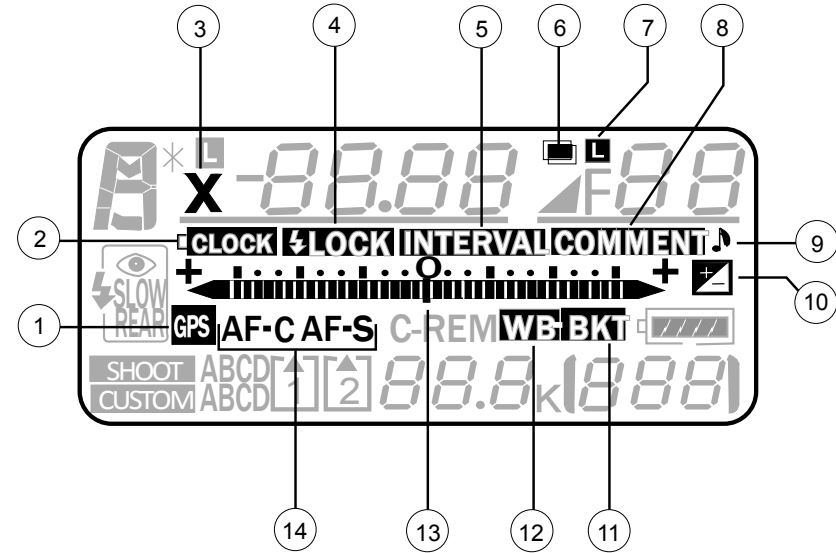

Nikon D3s Camera Top Control Panel - 2

- | | |
|-------------------------------|---|
| ① GPS connection indicator | ⑧ Image comment indicator |
| ② Clock battery indicator | ⑨ "Beep" indicator |
| ③ Flash sync indicator | ⑩ Exposure compensation indicator |
| ④ FV lock indicator | ⑪ Exposure and flash bracketing indicator |
| ⑤ Interval timer indicator | ⑫ White balance bracketing indicator |
| ⑥ Multiple exposure indicator | ⑬ Electronic analog exposure display |
| ⑦ Aperture lock icon | ⑭ Focus mode indicator |

jsc48038_131_156r1.cvx

D3s (Continued)

NOMENCLATURE (Continued)

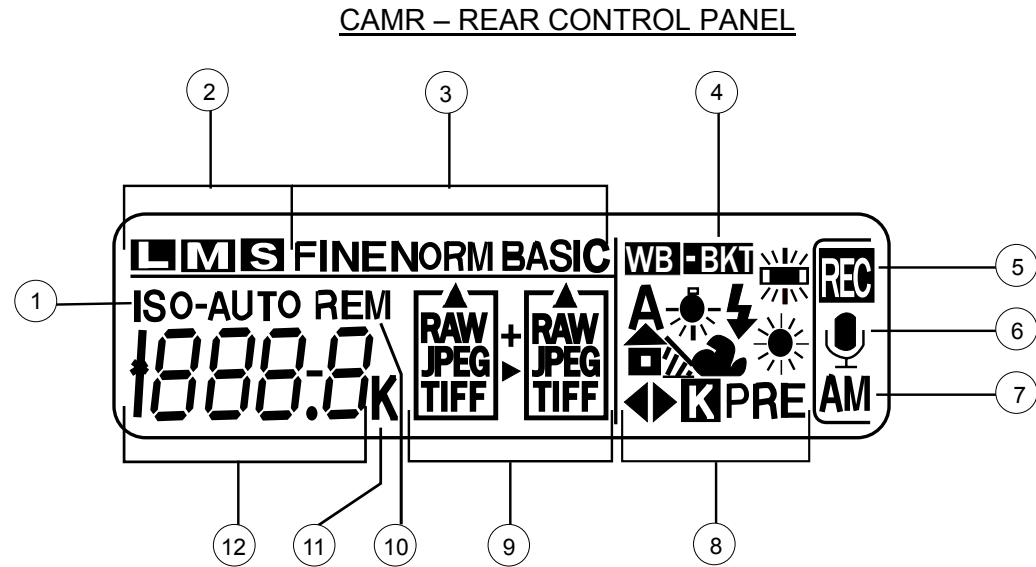

Nikon D3 Camera Back Panel

- | | | | |
|---|--|---|--|
| ① | ISO sensitivity indicator | ⑦ | Voice memo recording mode |
| ② | Image size (JPEG and TIFF images) | ⑧ | White balance |
| ③ | Image quality (JPEG images) | ⑨ | Memory card slot indicators |
| ④ | White-balance bracketing indicator | ⑩ | "Remaining" indicator |
| ⑤ | Voice memo recording indicator (shooting mode) | ⑪ | "K" (indicates memory remains for over 1000 exposures) |
| ⑥ | Voice memo status indicator | ⑫ | ISO sensitivity |

jsc48038_131_157r1.cvx

D3s (Continued)

NOMENCLATURE (Continued)

VIEWFINDER DISPLAY – LOWER BAR

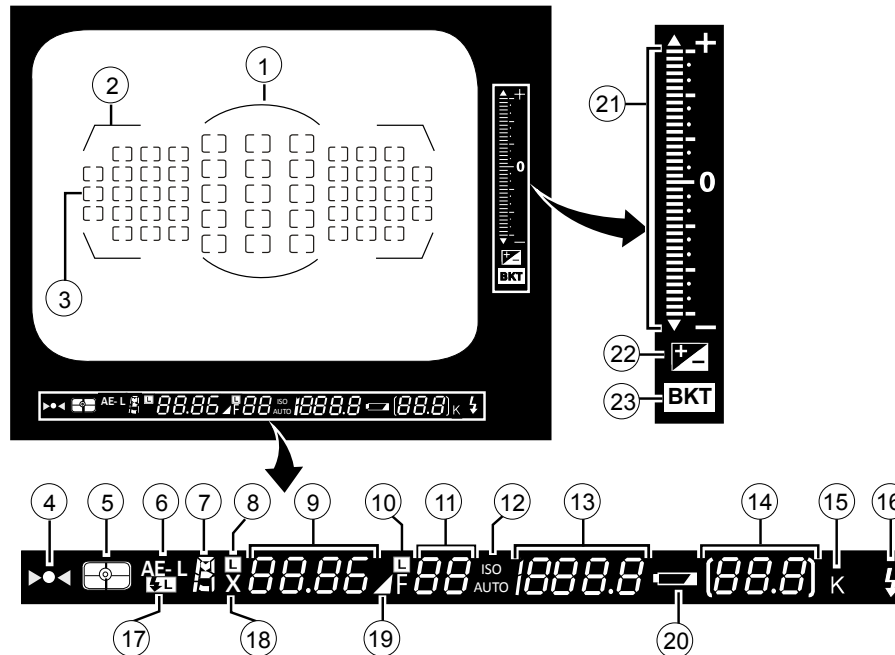

- ① 12-mm Reference circle for Center-weighted Metering
- ② AF Area Brackets
- ③ Focus Points
Spot Metering Targets
- ④ Focus Indicator (▶▶◀◀)
- ⑤ Metering (☉)
- ⑥ Autoexposure (AE) Lock
- ⑦ Exposure Mode (M)
- ⑧ Shutter Speed Lock Icon (L)
- ⑨ Shutter Speed

- ⑩ Aperture Lock Icon (L)
- ⑪ Aperture (f-number)
Aperture (number of stops)
- ⑫ ISO Sensitivity Indicator (ISO AUTO)
- Auto ISO Sensitivity Indicator
- ⑬ ISO Sensitivity
- ⑭ Frame Count
Number of exposures remaining
Number of shots remaining before
memory buffer fills
Preset White Balance Recording Indicator
Exposure Compensation Value
PC Mode Indicator

- ⑮ "K" (Appears when memory
remains for over 1000
exposures)
- ⑯ Flash-ready Indicator* (⚡)
- ⑰ FV Lock Indicator (L)
- ⑱ Flash Sync Indicator (X)
- ⑲ Aperture Stop Indicator (M)

* Displayed when an optional flash unit is attached.
The flash-ready indicator lights when the flash is charged.



- ⑳ Battery Indicator (🔋)
- ㉑ Exposure Indicator
Exposure Compensation Display
Tilt Indicator
- ㉒ Exposure Compensation
Indicator (±)
- ㉓ Exposure and Flash Bracketing
Indicator (BKT)



jsc48038_134_158r4.cvx

D3s (Continued)



NOMINAL SETUP

D3s PROGRAM w/FLASH

Lens – as reqd
Aperture – Min, locked
Body Focus Mode – S
√Batt installed
√Flash Card installed
Pwr – ON
Top LCD
√Batt
√Frames remaining sufficient
Exp Comp () – 0.0
Exp Mode – P
Meter – Matrix ()
Diopter – Adjust
Frame Rate – S
√BKT disabled – 0 F
Rear LCD
√ISO – 200
√QUAL – RAW
√WB – 0,A
AF Area Mode – [[]]
Info pb – press
Focus Selector Lock – • (unlocked)
Navigate Pad, Center – press
Focus Selector Lock – L

SB-800 Flash Settings
√Diffuser Dome installed
ON/OFF pb – ON
√MODE –  TTL  BL
√Exp Comp – 0 EV
Tilt – 45° (Direct)

D3s SHUTTER PRIORITY (EARTH OBS)

Lens – as reqd
Aperture – Min, locked
Body Focus Mode – S
√Batt installed
√Flash Card installed
Pwr – ON
Top LCD
√Batt
√Frames remaining sufficient
Exp Comp () – 0.0
Exp Mode – S
SS – 500
Meter – Matrix ()
Diopter – Adjust
Frame Rate – S
√BKT disabled – 0 F
Rear LCD
√ISO – 200
√QUAL – RAW
√WB – 0,A
AF Area Mode – [[]]
Info pb – press
Focus Selector Lock – • (unlocked)
Navigate Pad, Center – press
Focus Selector Lock – L



SB-800 Flash Settings
ON/OFF pb – OFF

D3s (Continued)

NOMINAL SETUP (Continued)



D3s MANUAL (SUNLIT OBJECT)

SB-800 Flash Settings
ON/OFF pb – OFF

Lens – as reqd
Aperture – Min, locked
Body Focus Mode – S
√Batt installed
√Flash Card installed
Pwr – ON
Top LCD
√Batt
√Frames remaining sufficient
Exp Comp () – 0.0
Exp Mode – M
SS – 1000
f/stop – f8
Meter – Matrix ()
Diopter – Adjust
Frame Rate – S
√BKT disabled – 0 F
Rear LCD
√ISO – 200
√QUAL – RAW
√WB – 0,A
AF Area Mode – [[]]
Info pb – press
Focus Selector Lock – • (unlocked)
Navigate Pad, Center – press
Focus Selector Lock – L

D3s AURORA/AIRGLOW

Lens – as reqd

Lens Focus Mode – A
Aperture – Min, locked
Body Focus Mode – S
√Batt installed
√Flash Card installed
Pwr – ON
Top LCD
√Batt
√Frames remaining sufficient
Exp Comp () – 0.0
Exp Mode – M
SS – 3"
f/stop – maximum (smallest number)
Meter – Matrix ()
Diopter – Adjust
√BKT disabled – 0 F
Rear LCD
√ISO – 3,200
√QUAL – RAW
√WB – 0,A
AF Area Mode – [[]]
Info pb – press
Focus Selector Lock – • (unlocked)
Navigate Pad, Center – press
Focus Selector Lock – L

SB-800 Flash Settings
ON/OFF pb – OFF

Technique

1. Dim cabin lights
2. Use dark clothing to shield window
3. Focus, Frame, Fire

D3s (Continued)

NOMINAL SETUP (Continued)

D3s CITY LIGHTS

Lens – as reqd

Lens Focus Mode – A
Aperture – Min, locked
Body Focus Mode – S
√Batt installed
√Flash Card installed
Pwr – ON
Top LCD
√Batt
√Frames remaining sufficient
Exp Comp () – 0.0

Exp Mode – M

SS – 2

f/stop – maximum (smallest number)

Meter – Matrix ()
Diopter – Adjust
√BKT disabled – 0 F
Rear LCD

ISO – 6,400

√QUAL – RAW
√WB – 0,A

AF Area Mode – [[]]

Info pb – press
Focus Selector Lock – • (unlocked)
Navigate Pad, Center – press
Focus Selector Lock – L

SB-800 Flash Settings

ON/OFF pb – OFF

Accessory Equipment

Shutter Release Cable – Install
Multiuse Brkt, Clamp – Install

Technique

1. Dim cabin lights
2. Use dark clothing to shield window
3. Focus, Frame, Fire

D3s STARS

Lens – as reqd

Lens Focus Mode – A
Aperture – Min, locked
Body Focus Mode – S
√Batt installed
√Flash Card installed
Pwr – ON
Top LCD
√Batt
√Frames remaining sufficient
Exp Comp () – 0.0

Exp Mode – M

SS – 4"

f/stop – maximum (smallest number)

Meter – Matrix ()
Diopter – Adjust
√BKT disabled – 0 F
Rear LCD

ISO – 9,000

√QUAL – RAW
√WB – 0,A

AF Area Mode – [[]]

Info pb – press
Focus Selector Lock – • (unlocked)
Navigate Pad, Center – press
Focus Selector Lock – L

SB-800 Flash Settings

ON/OFF pb – OFF

Accessory Equipment

Shutter Release Cable – Install
Multiuse Brkt, Clamp – Install

Technique

1. Dim cabin lights
2. Use dark clothing to shield window
3. Focus, Frame, Fire

D3s (Continued)

NOMINAL SETUP (Concluded)

D3s LIGHTNING

Lens – as reqd

Lens Focus Mode – A
Aperture – Min, locked
Body Focus Mode – S
√Batt installed
√Flash Card installed
Pwr – ON
Top LCD
√Batt
√Frames remaining sufficient
Exp Comp () – 0.0

Exp Mode – M

SS – 2"
f/stop – maximum (smallest number)
Meter – Matrix ()
Diopter – Adjust
Frame Rate – S
√BKT disabled – 0 F
Rear LCD
ISO – 400
√QUAL – RAW
√WB – 0,A
AF Area Mode – [[]]
Info pb – press
Focus Selector Lock – • (unlocked)
Navigate Pad, Center – press
Focus Selector Lock – L

SB-800 Flash Settings

ON/OFF pb – OFF

Accessory Equipment

Shutter Release Cable – Install
Multiuse Brkt, Clamp – Install as reqd

Technique

1. Fire Camr repeatedly. Luck reqd

IN-CABIN EXISTING LIGHT

Lens – as reqd

Lens Focus Mode – A
Aperture – Min, locked
Body Focus Mode – S
√Batt installed
√Flash Card installed
Pwr – ON
Top LCD
√Batt
√Frames remaining sufficient
Exp Comp () – 0.0

Exp Mode – A

f/stop – f4
Meter – Matrix ()
Diopter – Adjust
Frame Rate – S
√BKT disabled – 0 F
Rear LCD
ISO – 3,200
√QUAL – RAW
√WB – 0,A
AF Area Mode – [[]]
Info pb – press
Focus Selector Lock – • (unlocked)
Navigate Pad, Center – press
Focus Selector Lock – L
SB-800 Flash Settings
ON/OFF pb – OFF

Technique



1. √Light falling on front of subject
2. √SS fast enough for lens focal length, subject movement

D3s (Continued)





DATE/TIME SET

1. MENU pb – press
Set TIME ZONE
2. Navigate pad – sel menu icon  SETUP MENU
 - press (right)
 - sel TIME ZONE and DATE (up,down)
 - press (right)
 - sel TIME ZONE (up,down)
 - press (right)
 - sel LONDON, CASABLANCA (left,right)
 - OK pb – press
3. Set DATE/TIME to GMT
Navigate pad – sel DATE and TIME (up,down)
 - sel desired field (left,right)
 - sel desired setting (up,down)
4. OK pb – press
5. MENU pb – press twice

DELETING SINGLE IMAGES



1. PLAYBACK  pb – press
2. Navigate pad – sel image (left,right)
3. DELETE  pb – press twice to delete

ADDING .WAV FILES TO AN IMAGE



1. PLAYBACK  pb – press
2. Navigate pad – sel image (left,right)
3. MICROPHONE  pb – press, hold (✓microphone icon  appears on upper left of rear LCD)
4. Talk to MIC
5. ✓Music Note icon  appears in upper left image

D3s (Concluded)

DELETING .WAV FILE FROM AN IMAGE

1. PLAYBACK  pb – press
2. Navigate pad – sel image (left,right)
3. DELETE  pb – press
4. Sel – Sound only
5. DELETE  pb – press

.WAV FILE PLAYBACK

1. PLAYBACK  pb – press
2. Navigate pad – sel image w/music note  (left,right)
3. MICROPHONE  pb – press

This Page Intentionally Blank

CUE CARD CONFIGURATION

	<u>PAGE</u>
TV	FS CC 3-3
ANALOG PLAYBACK.....	FS CC 3-5
ET PHOTO	FS CC 3-7
MEDIA ALLOCATIONS	FS CC 3-8
WVS.....	FS CC 3-10
PLBD VTR RECORDING	FS CC 3-12
LDRI/ITVC	FS CC 3-14
LCS.....	FS CC 3-16
IDC.....	FS CC 3-18
VIDEO SETUP.....	FS CC 3-20
D2Xs SETUP	FS CC 3-22
LDRI/ITVC A7 PLACARD.....	FS CC 3-24
DIGITAL PLAYBACK.....	FS CC 3-25
G1 CC SETUP	FS CC 3-27

CUE CARDS

This Page Intentionally Blank

HOOK
VELCRO

TV

ACTIVATION

A3 MON 1(2) PWR – ON (LED ON)
 A7 √TV DNLK – ENA
 PWR CONTR UNIT – MNA(B)
 CNTL – PNL, wait 10 sec for system initialization, CMD

OPERATION**Auto Ops (Auto Exposure)**

A7 √MCC has commanded sync config
 TV CAMR PWR A(B,C,D,RMS) – ON (tb-ON)
 VID OUT MON 1(2) pb – push
 IN pb – as reqd
 If CTVC:
 ALC pb – push
 AVG pb – push
 If ITVC:
 If MAN GAIN pb not illuminated:
 TV CAMR PWR A(B,C,D,RMS) – OFF, wait 10 sec, ON
 Repeat until MAN GAIN pb illuminated
 LT LEVEL pb – push
 DAY(NIGHT) pb – push
 ALC pb – push
 AVG pb – push

Dnlk Ops

Coordinate dnk and sync config w/MCC
 Config audio as reqd

A7 If analog, on MCC GO:
 VID OUT DNLK pb – push
 IN pb – as reqd
 If DTV, on MCC GO:
 √Cables connected
 L10 (MUX) MUX/VTR/CC PWR – on (LED on)
 √MUX BYPASS – ACT
 (VIP) PWR – on (LED on, DATA FLOW LED flashes twice)
 (VTR) √ON/STANDBY LED – green
 √INPUT SELECT – VIDEO
 A7 VID OUT DTV pb – push
 IN pb – as reqd

L10 (MUX) √DATA FLOW LED – on
 √CH 3 DATA LED – on

DEACTIVATION

If Illuminator ON:
 Refer to Illuminator Ops and perform Illuminator OFF

A7 PORT RMS CAMR – WRIST
 TV CAMR PWR A(B,C,D,RMS) – OFF (tb-OFF), wait 10 sec
 PORT RMS CAMR – ELBOW
 TV CAMR PWR RMS – ON (tb-on), wait 10 sec, OFF (tb-OFF)
 PWR CNTL – PNL
 CONTR UNIT – OFF
 CNTL – CMD

A3 MON 1,2 PWR – OFF

If DTV:
 L10 (VTR) ON/STANDBY pb – push (red LED on)
 (VIP) PWR – off (LED off)
 (MUX) MUX/VTR/CC PWR – off (LED off)
 VTR/CC PWR – off (LED off)

Manual Ops – CTVC/ITVC (Manual Exposure)

CAUTION
 DO NOT LEAVE CAMRS UNATTENDED IN MANUAL
 MODE. DIRECT SUNLIGHT WILL DAMAGE CAMRS

Manual Exposure ON

A7 MAN GAIN pb – push
 0(+12,+24) dB pb – push
 CAMR CMD IRIS – OP,CL

Return to Auto Exposure

ALC pb – push
 AVG pb – push

MUX Ops

NOTE
 Although dnk/red is in color, MON
 will display MUX in B&W

A7 VID OUT MON pb – as reqd
 IN MUX 1(2) pb – push
 OUT MUX 1(2) L pb – push
 IN pb – As reqd
 OUT MUX 1(2) R pb – push
 IN pb – as reqd

For RSC ops:
 Go to LDR/ITVC Cue Card

P/TV-1a/134/O/A

(reduced copy)

FS CC 3-3

P/TV/134/FIN A

HOOK
VELCRO

ANALOG PLAYBACK

ANALOG VIA CC

NOTE

Analog Playback from CC only possible for CC Video recordings

ACTIVATION

CC Setup per diagram (back of cue card)
 A7 Perform ACTIVATION (Cue Card, TV), as reqd
 O19 √TV PWR – ON

AVIU SYNC/VIDEO – VIDEO
 HI-Z/75 – 75
 PWR SELECT – LO

CC PWR – VTR/PLAY
 √A/V1/V2 – V2

OPERATIONSPLBK or DNLK VIDEO

CC Install tape, if reqd

If audio reqd:
 CCU If MHA, COMM PWR – ON
 ATU PWR – AUD
 Desired Loops – T/R
 Other Loops – RCV(OFF)
 XMIT/ICOM Mode – VOX/VOX
 VOX SENS – MAX

CC Speaker Vol Max

A7 VID OUT MON pb – as reqd
 IN FLT DECK(MIDDECK) pb – push

CC VTR pb – REW(FF) to cue tape

If Dnlk

A7 √MCC has commanded async config
 √TV DNLK – ENA
 VID OUT DNLK pb – push
 IN FLT DECK(MIDDECK) pb – push

CC PLAY pb – push (green ► displayed)

If PLBK(DNLK) complete:
 | STOP pb – push
 If CC ops complete, go to DEACTIVATION

DEACTIVATION

CC Remove, mark, stow tape as reqd
 PWR – OFF

ATU Reconfig as desired

O19 TV PWR – OFF, as reqd
 Go to DEACTIVATION (Cue Card, TV), as reqd

ANALOG VIA VTR

ACTIVATION

Setup per diagram (back of cue card)
 Disconnect CC Video input from AVIU J3
 Perform ACTIVATION (Cue Card, TV) as reqd
 O19 √TV PWR – ON

AVIU SYNC/VIDEO – VIDEO
 HI-Z/75 – 75
 PWR SELECT – LO

L10 (MUX) √VTR/CC PWR – on (LED on)
 (VTR) √ON/STANDBY LED – green

OPERATIONSPLBK or DNLK VIDEO

L10 (VTR) Install tape if reqd
 √DISPLAY SELECT – DATA

(VIP) If audio reqd:
 PWR – on (LED on, DATA FLOW LED
 flashes twice)

CCU ATU – PBK/KEY MIC (Amber LED on)
 If MHA, COMM PWR – ON
 PWR – AUD
 Desired Loops – T/R
 Other Loops – OFF
 XMIT/ICOM Mode – VOX/VOX
 VOX SENS – MAX

A7 VID OUT Desired MON pb – push
 IN FLT DECK pb – push

L10 (VTR) REW(FF),PLAY,PAUSE pb – push as reqd to
 cue tape

If Dnlk

A7 √MCC has commanded async config
 √TV DNLK – ENA
 VID OUT DNLK pb – push
 IN FLT DECK pb – push

L10 (VTR) PLAY pb – push (green • displayed)

If PLBK(DNLK) complete:
 | STOP pb – push
 If VTR ops complete, go to DEACTIVATION

DEACTIVATION

Connect CC video input to AVIU J3
 L10 (VTR) Remove, mark, stow tape as reqd
 ATU Reconfig as desired
 O19 TV PWR – OFF, as reqd
 Go to DEACTIVATION (Cue Card, TV) as reqd

P/TV-2a/134/O/A

(reduced copy)

FS CC 3-5

P/TV/134/FIN A

TOP
BACK OF 'ANALOG PLAYBACK'

HOOK
VELCRO

ANALOG VIA CC PLAYBACK

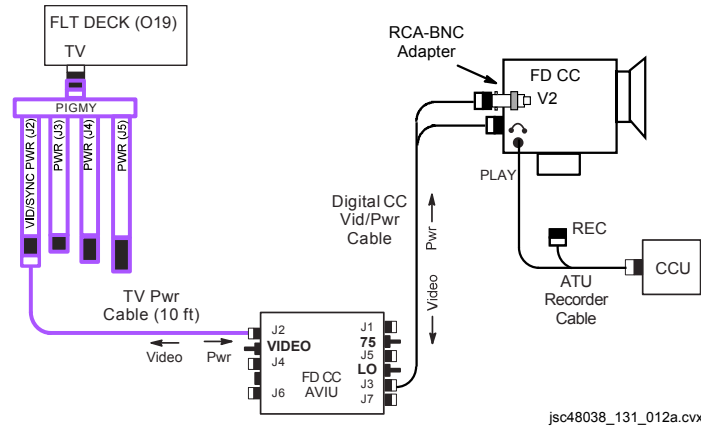

jsc48038_131_012a.cvx

ANALOG VIA VTR PLAYBACK

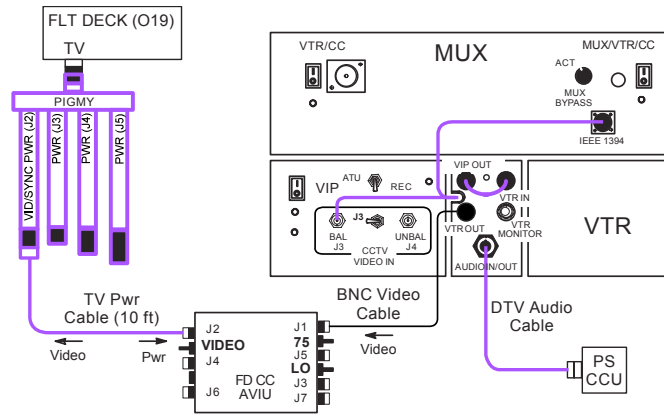

jsc48038_131_012b.cvx

P/TV-2b/134/O/A

(reduced copy)
FS CC 3-6

P/TV/134/FIN A

TOP

HOOK
VELCRO

ET PHOTO

D2Xs D2Xs

LENS SETTINGS:

- √APERTURE – MIN, LOCKED
- √LENS FOCUS MODE – A

CAMR SETTINGS

PWR – ON
TOP LCD:

- √BATT
- √EXP MODE – M
- √SS – 1000
- √F/STOP – 8

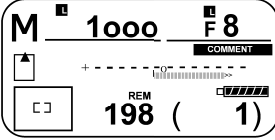

DIOPTR – ADJUST
√FRAME RATE – S
√BODY FOCUS MODE-S

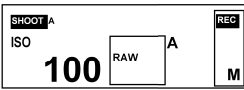

REAR LCD:

- √ISO – 100
- √QUAL – RAW

CRITICAL FOCUS REQD EACH FRAME

P/TV-3a/134/O/A

TOP
BACK OF 'ET PHOTO'

HOOK
VELCRO

ET PHOTO

G1 CC G1 CC

LENS CAP – REMOVE
INSTALL MUTING PLUG

- √ND FILTER – OFF
- √AF/M – M
- √AGC – OFF
- √GAIN – L
- √OUTPUT – CAM
- √AWB – ON
- √POWER dial – M
- √LOCK (handle) – off (aft)
- STANDBY/LOCK – STANDBY

OPEN LCD

- √BATT SUFFICIENT
- √EXP MODE – M
- √SS – 1/1000
- √GAIN – ±0dB
- √F/STOP – F8.0
- √FOCUS MODE – MF ∞

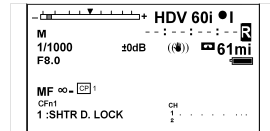

ZOOM – WIDE TO FIND TANK, THEN TIGHT

START RECORDING

- √LCD DISPLAYS RED DOT

P/TV-3b/134/O/A

TOP

MEDIA ALLOCATIONS											
DVCAM						3 hr/tape					
						15	14	13	12	11	
10	9	8	7	6	5	4	3	2	1		
MINI DVCAM						40 min/tape					
						226	225	224	223	222	221
220	219	218	217	216	215	214	213	212	211		
210	209	208	207	206	205	204	203	202	201		
200	199	198	197	196	195	194	193	192	191		
190	189	188	187	186	185	184	183	182	181		
180	179	178	177	176	175	174	173	172	171		
170	169	168	167	166	165	164	163	162	161		
160	159	158	157	156	155	154	153	152	151		
150	149	148	147	146	145	144	143	142	141		
140	139	138	137	136	135	134	133	132	131		
130	129	128	127	126	125	124	123	122	121		
120	119	118	117	116	115	114	113	112	111		
110	109	108	107	106	105	104	103	102	101		
100	99	98	97	96	95	94	93	92	91		
90	89	88	87	86	85	84	83	82	81		
80	79	78	77	76	75	74	73	72	71		
70	69	68	67	66	65	64	63	62	61		
60	59	58	57	56	55	54	53	52	51		
50	49	48	47	46	45	44	43	42	41		
40	39	38	37	36	35	34	33	32	31		
30	29	28	27	26	25	24	23	22	21		
20	19	18	17	16	15	14	13	12	11		
10	9	8	7	6	5	4	3	2	1		
MEMORY CARD						4GB/card					
50	49	48	47	46	45	44	43	42	41		
40	39	38	37	36	35	34	33	32	31		
30	29	28	27	26	25	24	23	22	21		
20	19	18	17	16	15	14	13	12	11		
10	9	8	7	6	5	4	3	2	1		

P/TV-4a/134/O/C

(reduced copy)

FS CC 3-8

P/TV/134/FIN A,3

TOP
BACK OF 'MEDIA ALLOCATIONS'



HOOK
VELCRO

P/TV-4b/134/O/A



(reduced copy)
FS CC 3-9

P/TV/134/FIN A

TOP

HOOK
VELCRO

HOOK
VELCRO

WVS

CAMR ADJUSTMENTS

ADJUST BRIGHTNESS

Course Adjustment

PGSC Select Page – RF Camera
Lens Iris Control – cl(op)

Fine Adjustment

PGSC Select Page – RF Camera
Electronic Shutter – Manual
Brightness – Dec(Inc)
(# to right: 100 = brightest; 0 = darkest)

DARK SUBJECT

PGSC Select Page – RF Camera
√Advanced Controls displayed
Automatic Gain Control – Enabled
(Disabled preferred)

PWRDN

PGSC For all lens (three) on each RF Camera Assy:
Lens Iris Control – Close until view black

V10 Sel RF Camr 1,2 – None (black “OFF”)
√Test Pattern displayed (color bars w/“No WVS
Video”)

PGSC Select Page – XCVR
Transceiver 1(2) CMD Pwr – Off
(black CMD PWR:LVL-“OFF:Min”)
Sel File → Exit

V10 STOP pb – push
Mark, stow tapes
PWR – OFF

A7 WIRELESS VID PWR – OFF
HTR – OFF

VIDEO SIGNAL PROBLEMS

For problem EMU TV:
EMU EMU TV Pwr pb – push (no LED), wait 10 sec, push
(green LED)

If no joy:
PGSC √Select Page – XCVR
√Advanced Controls displayed
For XCVR w/Video problem: IF – Narrow

If still no joy:
A7 WIRELESS VID PWR – OFF, wait 10 sec, ON

If still no joy:
PGSC For XCVR w/video problem: IF – Wide
For XCVR w/good video: Sel RF Camr – None (black ‘OFF’)
If video acceptable, other EMU TV interfering w/signal
Alternately sel EMU TVs to acquire video

If still no joy:
For XCVR with good video:
Sel RF Camr – reselect original EVA crewmember
For XCVR w/video problem: Antenna – Manual
Sel desired antenna

If still no joy:
For XCVR w/video problem: Antenna – Auto
√MCC

COMMANDING PROBLEM (UHF)

If commanding of WVS not visually seen:
PGSC Select Page – XCVR
Sel Transceiver 2(1) CMD Pwr – On
(green CMD PWR:LVL-“ON:Min”)

ANTENNA LOCATIONS

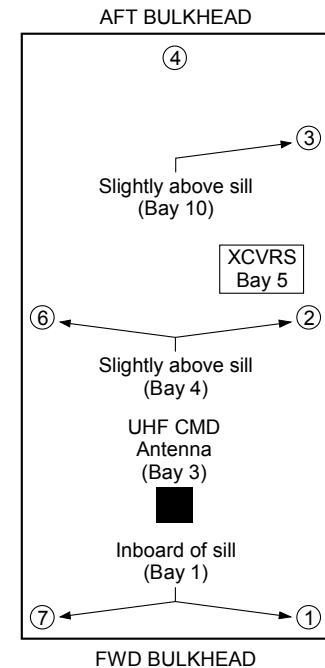

jsc48038_134_022r2.cvx

P/TV-5a/134/O/B

(reduced copy)

FS CC 3-10

P/TV/134/FIN A,3

HOOK
VELCRO

HOOK
VELCRO

ALERT MSG TROUBLESHOOTING

STATIC XCVR

Condition: No comm between PGSC & PLB XCVR

- PGSC 1. √Cable connections between WIB and PGSC
- A7 2. WIRELESS VID PWR – OFF, wait 10 sec, ON
- If no joy:
- PGSC 3. Sel 'Start' > 'Shut Down' > 'Restart' > 'OK'
When reboot complete:
Sel Shuttle Apps icon > WVS icon
Sel 'Yes' at 'Restore To Previous Settings' window
RF Camera page will appear
- If still no joy:
- 4. √MCC

STATIC RF CAMERA

Condition: No telemetry and video received by PLB XCVR from EMU TV

- EMU 1. √EMU TV Pwr pb pushed (green LED)
- If no joy:
- PGSC 2. √Correct RF Camera selected via pulldown menu
√RF Camera (two) – ON (green "ON")
If not ON:
RF Camera (of static EMU TV) – sel "None" via pulldown menu, then sel original EMU TV
- If still no joy:
- 3. RF Camera 1(2) – sel 'None'
Perform CAMR ID ASSIGNMENT
Reattempt RF Camr selections
- If still no joy:
- 4. √CMD PWR:LVL – green "ON:Min" for XCVR 1(2)
If not ON:
Select Page – XCVR
Transceiver 1(2) CMD Power – On
(green CMD PWR:LVL - "ON:Min")
- If still no joy:
- EMU 5. EMU TV Pwr pb (of static EMU TV) – push (no LED), wait 10 sec, push (green LED)
- If still no joy:
- 6. √MCC

BAD ID RECEIVED

Condition: Mismatch between EMU TV Camera ID and software camera ID

- PGSC 1. Select Page – XCVR:
Transceiver 1(2) CMD Power – On (green CMD PWR:LVL - "ON:Min")
Sel RF Camera 1,2 – None
Sel File > Assign Camera ID
√Camera IDs match data under CAMR ID ASSIGNMENT
If not a match:
Highlight entry, then sel 'Delete Entry' option
Perform CAMR ID ASSIGNMENT
Sel RF Camera 1,2 – EVA crewmembers
- If still no joy:
- 2. √MCC

TEMP ALERT (blue text)

Condition: EMU TV -35 °C to -30 °C OR 80 °C to 85 °C range
PLB XCVR -40 °C to -35 °C OR 80 °C to 85 °C range

- Select Page – Telemetry
- Identify component w/temperature alert (blue text)
- √MCC

TEMP CAUTION (yellow text)

Condition: EMU TV < -35 °C OR > 85 °C
PLB XCVR < -40 °C OR > 85 °C

- Select Page – Telemetry
- Identify component w/temperature alert (yellow text)
- √MCC

CAMR ID ASSIGNMENT

Sel File → Assign Camr ID
√All EV crewmembers listed as options on pulldown 'Label' menu under CAMERA ID SETUP

If label entry reqd:
Type label into space next to "Add Label" icon
Sel "Add Label" icon to add to listing

Under CAMERA ID SETUP:
Camera Address – As reqd via left/right arrows
Serial Number – As reqd via left/right arrows
Label – As reqd via pulldown menu
"In Use" Box – Check via single click
Sel "Save Entry" icon to right of Camr ID table (top)
√Data entry visible in Camr ID table

Camr ID Data		
Camr Address	18	20
Serial Number	1007	1006
Label	EV1	EV2

Sel OK P/TV-5b/134/O/C

(reduced copy)

TOP

HOOK
VELCRO

PLBD VTR RECORDING

- L10 √VIP,VTR covers removed
- R1 √PL AUX – ON
- MA73C:E cb AC2 PL3Φ – cl

- L10 √Cables config'd per dwg (back of cue card)
(MUX) VTR/CC PWR – on (LED on)
- (VIP) √ATU – REC
 √CCTV VIDEO IN – J3
 PWR – on (LED on, DATA FLOW flashes twice)
- (VTR) √ON/STANDBY LED – green

 √Switches set to white dot (seven)

 √COUNTER SELECT – COUNTER (TC)

 √Tape installed (tape icon LED on)

 Set GMT:
 DISPLAY SELECT – MENU
 ↓ pb – ETC, EXEC pb – push
 ↓ pb – CLOCK SET, EXEC pb - push
 Use ↓, ↑,EXEC to set Y,M,D,hr,min to GMT
 DISPLAY SELECT – DATA
- L9 If Audio desired:
 PS AUD PWR – AUD
 Desired Loops – RCV, Vol tw 5
 Other Loops – OFF
- A7 VID OUT DTV pb – push
 IN pb – as reqd
- L10 REC pb – push, hold
(VTR) PLAY pb – push, simo (red dot displayed)

P/TV-6a/134/O/A

(reduced copy)

FS CC 3-12

P/TV/134/FIN A

TOP
BACK OF 'PLBD VTR RECORDING'

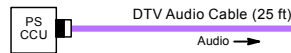
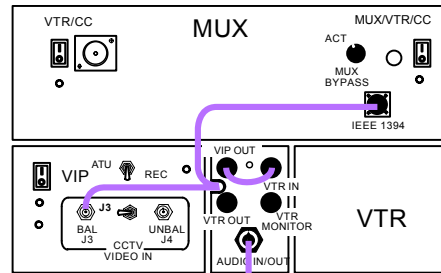
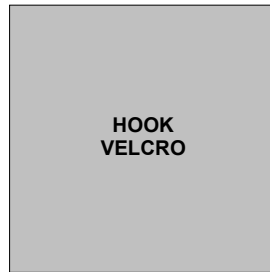

jsc48038_131_019r1.cvx

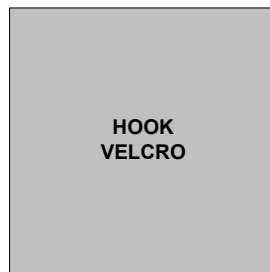

P/TV-6b/134/O/A

(reduced copy)
FS CC 3-13

P/TV/134/FIN A

HOOK
VELCRO

LDRI/ITVC

HOOK
VELCRO

ACTIVATION

- Config CCTV Sys
 - A7 √ACTIVATION (Cue Card, TV) performed
 - L10 (MUX) √MUX/VTR/CC PWR – on (LED on)
 - √Cabling from VTR MON port to MON 2 C-IN
 - R12 (VPU) √VPU PWR – ON (LED on)
 - √Green Jumper – LDRI/ITVC
 - √RSC vid cable connected to WIB CCTV PL/3
 - MON 1,2 L-DATA – ON
 - C-DATA – GRN
 - X-HAIR – GRN
 - MON 2 SOURCE – C
- Apply SPEE Pwr
 - R12 (OPP) √cb OBSS SW PWR – cl
 - √OBSS SW PWR – ON
 - (OBSS) SPEE PWR – ON
 - A6U EVENT TIMER CNTL – STOP
 - RESET
 - CNTL – START
 - (15 min LDRI calibration warmup)
- Config RSC Illum to HI
 - A7 VID OUT MON 1 pb – push
 - IN C pb – push
 - PAN/TILT – Adjust to see RSC Camr
 - R12 (OBSS) SPEE PWR – OFF, wait 10 sec, ON
 - MON 1 √RSC illum on HI (three rings)
- Enable ITVC
 - √MCC has commanded sync config
 - R12 (OBSS) ITVC ENA – ON
 - A7 VID OUT DTV pb – push
 - IN PL 2(VPU) pb – push
 - If MAN GAIN pb not illuminated:
 - R12 (OBSS) ITVC ENA – OFF, wait 10 sec, ON
 - Repeat until MAN GAIN pb illuminated
 - A7 LT LEVEL pb – push
 - DAY (NIGHT) pb – push
 - ALC pb – push
 - AVG pb – push
 - MON 2 √ITVC video displayed
- Turn LDRI Laser On
 - A7 VID OUT MUX 1 L pb – push
 - IN MIDDECK pb – push
 - LDRI MODE 2 pb – push
 - VID OUT DTV pb – push, to return to ITVC control

GENERAL LDRI CONTROL

- A7 VID OUT MUX 1 L pb – push
IN MIDDECK pb – push
- Mode 1 (default at pwrup)
- A7 LDRI MODE 1 pb – push
MON 2 √ITVC video displayed
- Mode 2
- A7 LDRI MODE 2 pb – push
MON 2 √ITVC video w/illum displayed
- Modes 3 (4,5,6)
- A7 LDRI MODE 3(4,5,6) pb – push
MON 2 √LDRI w/rounded corners displayed
- A7 CAMR CMD IRIS – OP,CL, as reqd

PAN/TILT OPS WITH LDRI ACTIVE

- NOTE
- When adjusting pan/tilt in Modes 3(4,5,6), ITVC FOCUS (ZOOM, IRIS) cntls functional
- A7 VID OUT MON 1 pb – push
IN PL2(VPU) pb – push
CAMR CMD PAN,TILT – as reqd
VID OUT MUX 1 L pb – push, to return to LDRI cntl

DEACTIVATION

- A7 VID OUT MUX 1 L pb – push
IN MIDDECK pb – lt on
LDRI MODE 1 pb – push
- R12 (OBSS) ITVC ENA – OFF, pause 10 sec
SPEE PWR – OFF
- A6U EVENT TIMER MODE – UP
CNTL – START

LDRI MODE SUMMARY

Mode 1 – Standby

- ITVC video
- LDRI in standby

Mode 2 – Illuminator

- ITVC video w/illum
- LDRI laser active, LDRI camera inactive

Mode 3 – 2D

- LDRI 2D video
- Similar to ITVC video

Mode 4 – 2D Gamma

- LDRI 2D video w/Gamma Black Stretch
- Similar to ITVC video

Mode 5 – 3D

- LDRI 3D video
- Flicker on MON

Mode 6 – 3D Gamma

- LDRI 3D video w/Gamma Black Stretch
- Flicker on MON

P/TV-7a/134/O/A

(reduced copy)

FS CC 3-14

P/TV/134/FIN A

TOP
BACK OF 'LDRI/ITVC'

HOOK
VELCRO

HOOK
VELCRO

RSC CAMR OPS

NOTE

Camr nominally pwr'd in Block 3 of
POST INSERT

R12 (OPP) cb OBSS SW PWR CB1 – cl
OBSS SW PWR – ON
(OBSS) RSC PWR – ON

RSC ILLUMINATOR OPS

NOTE

RSC illuminator OFF when SPEE PWR
sw initially taken to ON. A cycle of the
SPEE PWR sw takes RSC illuminator to
HIGH. Subsequent pwr cycles take
illuminator to MED, LOW, OFF and then
back to HIGH. Config may req alt Camr
view of RSC

R12 (OBSS) √SPEE PWR – ON
√RSC PWR – ON
ITVC ENA – OFF
A7 VID OUT MON 1 pb – push
IN A(B,C,D) pb – push
PAN,TILT – Adjust to see RSC Camr

NOTE

SPEE pwr cycle will reset LDRI/ITVC to
Mode 1 and reset the PTU angles

R12 (OBSS) SPEE PWR – OFF, wait 10 sec, ON
MON 1 √RSC illum on

To cycle thru illuminator modes:
R12 (OBSS) SPEE PWR – OFF, wait 10 sec, ON

Perform LDRI/ITVC ACTIVATION, step 4

Return to original LDRI/ITVC Mode, continue
OPS

CONTINGENCY LDRI CLEARANCE VIEW

NOTE

Do not apply RMS brakes

A8U AUTO SEQ – STOP (READY It on)

L10(VTR) STOP pb – push (no red ●)

A7 VID OUT MUX 1 L pb – push (MIDDECK It on)
LDRI MODE 3(4) pb – push (steady LDRI video)

VID OUT MON 1 pb – push
IN PL2(VPU) pb – push

Record PTU Pan _____ and Tilt _____

CAMR CMD PAN/TILT – HI RATE
PAN: 0 (left, to hard stop)
TILT: 0 (up, to hard stop)

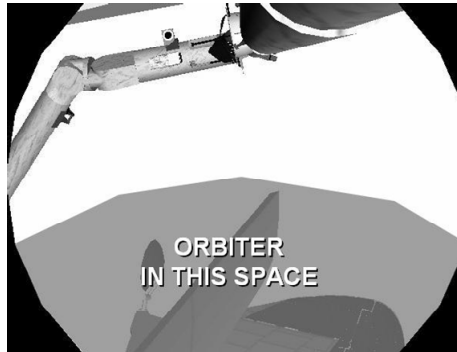

Note clearance thru LDRI FOV

Return PTU to Pan and Tilt values recorded above

VID OUT MUX 1 L pb – push (MIDDECK It on)
LDRI MODE 6 pb – push (flickering LDRI video)

VID OUT MON 1 pb – push
IN pb – as desired (not PL2)

L10(VTR) REC pb – push, hold
PLAY pb – push, simo (red dot)

A8U AUTO SEQ – PROCEED (IN PROG It on)

LDRI PAN/TILT RESET

Reset PTU

A7 VID OUT MON 1 pb – push
IN PL2(VPU) pb – push

CAMR CMD PAN/TILT – HI RATE
PAN – L (to hard stop)
TILT – UP (to hard stop)
PAN/TILT – RESET

SPEE PWR DEACT CLEANUP ACTIONS

Config RSC Illum to HI

R12 (OBSS) √SPEE PWR – OFF
ITVC ENA – OFF
RSC PWR – OFF, wait 10 sec, ON
SPEE PWR – ON, OFF, wait 10 sec, ON

Config ITVC

ITVC ENA – ON
A7 VID OUT DTV pb – push
IN PL2(VPU) pb – push
If MAN GAIN pb not illuminated:
R12 (OBSS) ITVC ENA – OFF, wait 10 sec, ON
Repeat until MAN GAIN pb illuminated
A7 LT LEVEL pb – push
DAY (NIGHT) pb – push
ALC pb – push
AVG pb – push

Reset PTU

A7 CAMR CMD PAN/TILT – HI RATE
PAN – L (to hard stop)
TILT – UP (to hard stop)
PAN/TILT – RESET
PAN and TILT ITVC to values needed for
Survey

Return LDRI to Mode 6

A7 VID OUT MUX 1 L pb – push
IN MIDDECK pb – push
LDRI MODE 6 pb – push
VID OUT DTV pb – push, to return to ITVC
control

P/TV-7b/134/O/A

(reduced copy)

FS CC 3-15

P/TV/134/FIN A

HOOK
VELCRO

TOP

LCS

HOOK
VELCRO

LCH ACTIVATION

Activate SSPTS APCU 2

- A15 If AMS-02 in PLB, on MCC GO:
APCU 1,2 CONV (two) – OFF
- SM 179 POWER TRANSFER**
√PTU 2 APCU OUT VOLTS: <10V
APCU 2 OUTPUT – ON
1,2 CONV (two simo) – ON

- A15 If AMS-02 not in PLB:
APCU 2 OUTPUT – ON
CONV – ON

LCC ACTIVATION

1. LCC Setup

√Hardware and cables configured per diagram below:

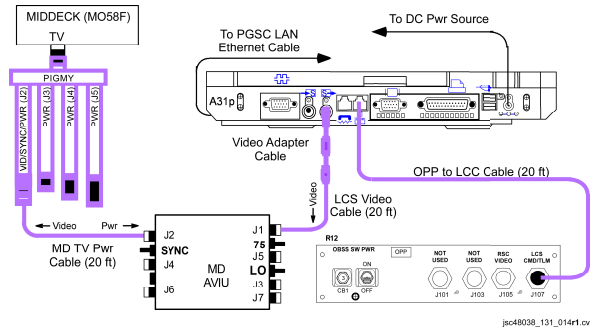

2. LCC Startup
A31p

- √PGSC Pwr – ON
√Yellow 'RJ-45 Port Configured for LCS Ops' displayed on desktop crew patch
If yellow text not displayed, perform TROUBLESHOOTING, Yellow 'RJ-45 Port Configured for LCS Ops' Not Displayed on Desktop Crew Patch
If 'LCS Camera Controller' minimized on desktop taskbar, maximize window
If not minimized, sel 'Shuttle Apps' > 'LCC' (wait 2-3 min from APCU CONV – ON for GUI Status)
√Laser off – blue
√Comm – green
If Laser off and Comm status not correct: √MCC

3. Verify LCC Desktop Video

- MO58F √TV PWR – ON
AVIU √HI-Z/75 – 75
PWR SELECT – LO
PWR – OFF
CC

(For SSPTS APCU 2 flights only)

3. Verify LCC Desktop Video (Concluded)

- A31p Minimize all programs
Right click on ATI icon on system tray
Sel 'Schemes'
Sel 'ENABLE DESKTOP DOWNLINK', 'ATI Property Page' displayed
Sel 'Yes'
Maximize program windows as desired
- A7 VID OUT MON1(2) pb – push
IN MIDDECK pb – push
- A3 √LCC desktop displayed on MON1(2)

- * If LCC Desktop not displayed *
* √MCC *

4. Verify GMT

- A31p √GMT on GUI lower right-hand side within 3 sec of SM-GPC GMT
- * If GMT not within 3 sec of SM GPC: *
* Sel 'Tools' > 'Set GMT' *
* Adjust GMT as reqd *
* Sel 'Apply' > 'OK' *

OPERATION

NOTE
PDRS OPS will call for appropriate scan steps on LCC.
MCC may have limited insight if desktop dnk avail

1. Load Database (if reqd)

- √MCC for desired LCS database
√'DB Name': Field on upper left-hand side of LCS GUI
- * If 'DB Name' incorrect: *
* Sel 'Load Database...' from File menu *
* Sel MCC desired database file *
* Sel 'OK' *

2. LCS System Status

LCS SYSTEM STATUS

Laser On/Off	Comm	LCS State
Laser ? (gray)	No Comm (yellow)	Unknown or Keep Alive Heater Only Mode (No LCC to LCH Network Connection)
Laser Off (blue)	Comm (green)	Configuration (Waiting for user command)
Laser On (green)	Comm (green)	Operational (Scan in progress)

While Scan in progress ('Scan Status' counter incrementing):
√Laser On – green
√Comm – green
√Scan Display – updating
√Temp – green
√Elec – green
Scan complete when 'Scan Status: Complete' displayed
If LCS system status out of config, perform appropriate TROUBLESHOOTING section of this cue card

P/TV-8a/134/O/C

(reduced copy)

HOOK
VELCRO

HOOK
VELCRO

LCC DEACTIVATION

NOTE

Shutting down LCC software also puts LCH in keep-alive heater mode. No LCH scans/insight or IDC ops available. APCU Converter pwr cycle reqd to reinitialize LCH for scanning and IDC ops

1. LCC Software Shutdown

- A31p Sel 'File' > 'Exit'
When 'Shutdown' dialog box opens:
√Shutdown LCH and Exit LCC Software' selected
Sel 'OK'
When 'Shutdown?' dialog box opens:
Sel 'OK'

2. A31p Screen Resolution Reset

- A31p Right click on ATI icon on system tray
Sel 'Schemes'
Sel 'DISABLE DESKTOP DOWNLINK, ATI Property Settings'
Sel 'Yes'
Arrange program windows as desired

LCH DEACTIVATION

CAUTION

Deactivating SSPTS APCU 2 will remove critical keep-alive pwr to LCH and IDC. Pwr must be reapplied within 105 min

1. Deactivate SSPTS APCU 2/LCH

- A15 If AMS-02 in PLB, on MCC GO:
APCU 1,2 CONV (two) – OFF
SM 179 POWER TRANSFER
√PTU 2 APCU OUT VOLTS: <10V
APCU 2 OUTPUT – OFF
1,2 CONV (two simo) – ON
If AMS-02 not in PLB:
APCU 2 CONV – OFF
√1 CONV – OFF
SM 179 POWER TRANSFER
√PTU 2 APCU OUT VOLTS: <10V
APCU 2 OUTPUT – OFF

(For SSPTS APCU 2 flights only)

TROUBLESHOOTING

Temp or Elec Status Yellow

- A31p Sel 'System' page
Report 'Elec' or 'Temp' values backlit in yellow to MCC

Comm Status Yellow and LAN2 Network cable unplugged (red X on A31p system tray)

NOTE

LCC GUI Comm status will be yellow and A31p Local Area Network status (w/red X on A31p system tray) cable unplugged tool tip will appear if LCH is in keep-alive heater mode

- A31p If unexpected red X w/Local Area Network Connection tool tip shown on A31p system tray:



- R12 √OPP to LCC Cable connected to LCS CMD/TLM(J107) port
A31p √OPP to LCC Cable connected to LCC RJ45 port
Exit LCC software and shut down Windows

- A15 On MCC GO:
APCU 1,2 CONV (two) – OFF
2 OUTPUT – OFF, wait 10 sec, ON
1,2 CONV (two simo) – ON

SM 179 POWER TRANSFER

- √PTU 2 APCU OUT VOLTS: 123V to 126V

- A31p LCC PGSC Pwr – ON
√A31p internal RJ45 Network Interface Card LED green
Perform LCC ACTIVATION, step 2
√Local Area Network Connection status icon (with red X) in Windows system tray not displayed
√MCC if LCC GUI Comm status still yellow

Message Area Entry

- Report LCC GUI message area log entry(ies) to MCC

Yellow 'RJ-45 Port Configured for LCS Ops' Not Displayed on Desktop Crew Patch

- A31p Sel 'Shuttle Apps' > 'Network Configuration' > 'LCS RJ-45 Network Setup'
Enter '1' in network window
Sel 'OK'
Sel 'OK' in LCS window
Allow 20 sec for program to execute
√Yellow text displayed on desktop
Resume LCS Ops

P/TV-8b/134/O/C

(reduced copy)

HOOK
VELCRO

HOOK
VELCRO

IDC ACTIVATION

1. LCC Setup
 - √Hardware configured per LCC ACTIVATION steps 1,2 (Cue Card, LCS)
 - A31p √PGSC Pwr – ON
2. IDC connectivity Check
 - A31p √A31p internal RJ45 Network Interface Card LED green
 - A15
 - If RJ45 Network Interface Card LED not green, on MCC GO:
 - APCU 1,2 CONV (two) – OFF
 - 2 OUTPUT – OFF, wait 10 sec, ON
 - 1,2 CONV (two simo) – ON
 - SM 179 POWER TRANSFER
 - √PTU 2 APCU OUT VOLTS: 123V to 126V

IDC SOFTWARE ACTIVATION

1. IDC Software Startup
 - A31p Sel 'Shuttle Apps' > 'IDC'
2. Verify GMT
 - A31p √GMT within 3 sec of SM-GPC GMT
 - * If GMT not within 3 sec: *
 - * Double click on GMT box on GUI *
 - * Adjust GMT as reqd *
 - * Sel 'OK' on MTU Time dialogue box *
3. IDC Pwr on and self test

CAUTION

Pwr off IDC when not imaging. Pointing IDC at Sun when pwr on will damage Camr

- A31p Sel 'Power On'
- √Black and White self-test image displayed
- √'Waiting for User Command' displayed
- * If red backlit error msg displayed: *
- * Perform appropriate TROUBLESHOOTING *
- * steps on this cue card *

OPERATION

NOTE

PDRS OPS will call for IDC image steps on LCC A31p. Limited MCC real-time insight avail if configured for desktop dnk

1. Configure LDRI Illumination
 - R12 (VPU) √Green Jumper – LDRI/ITVC
 - A7
 - VID OUT MUX 1L pb – push
 - IN MIDDECK pb – push
 - LDRI MODE 2 pb – push
 - VID OUT MON 1(2) pb – push
 - IN PL2 (VPU) pb – push
 - CAMR CMD PAN/TILT – HI RATE
 - PAN – L (to hard stop)
 - TILT – UP (to hard stop)
 - PAN/TILT – RESET
 - LO RATE within 10°
 - PAN: +85 (right)
 - TILT: -57 (down)

NOTE

If IDC GUI GMT does not update during Ops, an attempt to shut down/restart A31p should be made

2. Auto Exposure (AE) Ops
 - A31p √'Use AE' checked
 - Sel 'Scan Lo-Res'
 - Resize and posn AE box as reqd (pause 2 sec)
 - √MCC for AOI FOV
 - Sel 'Scan Hi-Res'
 - If Scanning w/no RMS Motion:
 - | Sel 'Stop Scan' after 30 sec
 - If scanning w/RMS motion:
 - Move box to maintain RCC in AE box (using keyboard arrows)
 - Sel 'Stop Scan' at pause point
 - √'Waiting for User Command' displayed
3. Scenario File Ops
 - A31p From Scenario File drop-list, sel appropriate lighting condition

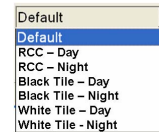

- Sel 'Acquire Set'
- √'Acquiring Set' displayed
- √'Waiting for User Command' displayed after set
- √MCC content w/data take

P/TV-9a/134/O/C

(For SSPTS APCU 2 flights only)

(reduced copy)

HOOK
VELCRO

HOOK
VELCRO

IDC DEACTIVATION

- IDC and Software Shutdown
A31p Sel 'Power off' on IDC GUI
IDC software > 'YES'
Close (X) IDC software > 'YES'
- A31p Screen Resolution Reset
A31p Right click on ATI icon on system tray
Sel 'Schemes'
Sel 'DISABLE DESKTOP DOWNLINK, ATI Property Settings'
Sel 'Yes'
Arrange program windows as desired

IDC HOT KEY COMMANDS

- | | |
|------------------------------------|-------------------------------|
| F5 – Toggle Summary View | F6 – Toggle Image Mode |
| F7 – Zoom In | F8 – Zoom Out |
| F9 – Reset Brightness and Contrast | F10 – Reset AE Box to Default |
| F11 – Toggle AE Box Visibility | F12 – Find AE Box |

IDC SOFTWARE ERROR MESSAGES

- Can't connect to LCH:** Perform TROUBLESHOOTING, steps 1,2
Condition: Possible heater only mode or Network failure
- lport probe failed:** Perform TROUBLESHOOTING, step 2
Condition: lport startup check failed
- lport not responding:** Perform TROUBLESHOOTING, step 2
Condition: lport connection lost
- Camera not responding:** Perform TROUBLESHOOTING, step 2
Condition: Camera connectivity lost
- Image acquisition failed:** Perform TROUBLESHOOTING, steps 1,2
Condition: Camera connectivity lost during imaging
- Network recovery failed:** Perform TROUBLESHOOTING, steps 1,2
Condition: LCH network switch connection lost
- Bad initialization file:** Perform TROUBLESHOOTING, step 3
Condition: Software will not launch due to severe ini file corruption

TROUBLESHOOTING

- LCC to LCH Connectivity Check
A31p If Local Area Network Connection (with red X) tool tip on system tray:



Reseat OPP to LCC Cable (20 ft) to LCC RJ45 port
√Local Area Network Connection Speed 10 mps
If no connection:
Perform LCH, LCC, and IDC Reset, step 2
Continue nominal ops

- LCH, LCC, and IDC Reset
A31p Exit IDC software and shut down Windows
√OPP to LCC Cable (20 ft) connected to LCC RJ45 port and LCS
CMD/TLM port

On MCC GO:
APCU 1,2 CONV (two) – OFF
2 OUTPUT – OFF, wait 10 sec, ON
1,2 CONV (two simo) – ON

SM 179 POWER TRANSFER
√PTU 2 APCU OUT VOLTS: 123V to 126V

A31p LCC PGSC Pwr – ON
√A31p internal RJ45 Network Interface Card LED green

Perform IDC SOFTWARE ACTIVATION
Continue nominal ops
- LCC Swap
A31p Exit IDC software and shut down Windows
Swap LCC with other A31p
Perform IDC Activation
Perform IDC Software Activation
Continue nominal ops

(For SSPTS APCU 2 flights only)

(reduced copy)

FS CC 3-19

P/TV-9b/134/O/C

P/TV/134/FIN A

TOP

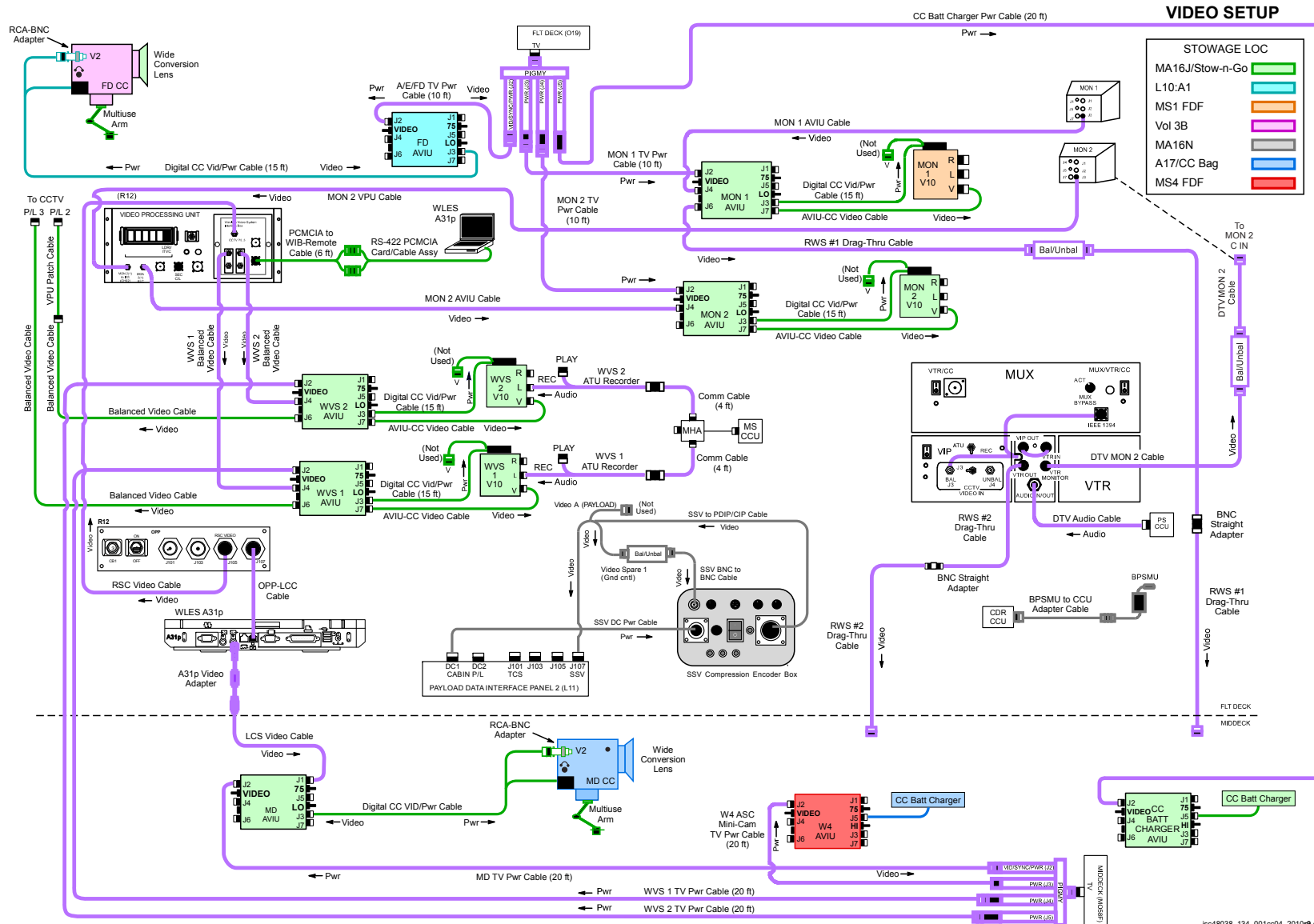

jsc48038_134_001cc04_2010@lcvx

P/TV-10a/134/O/D

(reduced copy)
FS CC 3-20

P/TV/134/FIN A,2

TOP
BACK OF 'VIDEO SETUP'

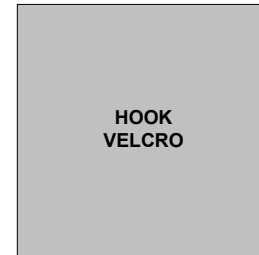
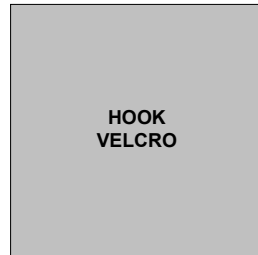
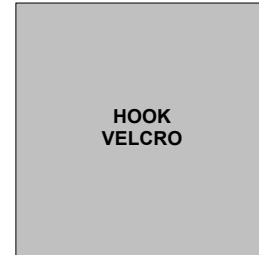
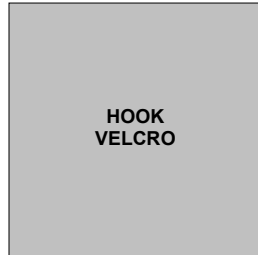

(reduced copy)
FS CC 3-21

P/TV-10b/134/O/A















P/TV/134/FIN A

TOP













D2Xs SETUP

HOOK
VELCRO

D2Xs PROGRAM In Cabin	D2Xs Aperture Priority	D2Xs Shutter Priority "Earth Obs"
<p>Lens – as reqd Aperture – Min, locked Body Focus Mode – S √Batt installed √Flash Card installed Pwr – ON Top LCD: √Batt √Frames remaining sufficient Exp Comp () – 0.0 Exp Mode – P Meter – Matrix () Diopter – Adjust Frame Rate – S √BKT disabled – 0 F Rear LCD: √ISO – 100 √QUAL – RAW √WB – 0,A AF Area Mode – [[]] √Focus Area – Center √Focus Selector Lock – L</p> <p>SB-800 Flash Settings: √Diffuser Dome installed ON/OFF pb – ON √MODE –    √Exp Comp – 0 EV Tilt – 45° (Direct)</p>	<p>Lens – as reqd Aperture – Min, locked Body Focus Mode – S √Batt installed √Flash Card installed Pwr – ON Top LCD: √Batt √Frames remaining sufficient Exp Comp () – 0.0 Exp Mode – A: f/stop – as reqd Meter – Matrix () Diopter – Adjust Frame Rate – S √BKT disabled – 0 F Rear LCD: √ISO – 100 √QUAL – RAW √WB – 0,A AF Area Mode – [[]] √Focus Area – Center √Focus Selector Lock – L</p> <p>SB-800 Flash Settings: √Diffuser Dome installed ON/OFF pb – ON √MODE –    √Exp Comp – 0 EV Tilt – 45° (Direct)</p>	<p>SB-800 Flash Settings: ON/OFF pb – OFF</p> <p>Lens – as reqd Aperture – Min, locked Body Focus Mode – S √Batt installed √Flash Card installed Pwr – ON Top LCD: √Batt √Frames remaining sufficient Exp Comp () – 0.0 Exp Mode – S: SS – 500 Meter – Matrix () Diopter – Adjust Frame Rate – S √BKT disabled – 0 F Rear LCD: √ISO – 100 √QUAL – RAW √WB – 0,A AF Area Mode – [[]] √Focus Area – Center √Focus Selector Lock – L</p>

TOP
BACK OF 'D2Xs'

HOOK
VELCRO

D2Xs MANUAL "SUNLIT OBJECTS"	D2Xs EXPOSURE MATCH "HERO SHOT"	D2Xs CREW PHOTO
<p>SB-800 Flash Settings: ON/OFF pb – OFF</p> <p>Lens – as reqd</p> <p>NOTE If auto focus unachievable: Lens Focus Mode – M</p> <p>Lens Focus Mode – A Aperture – Min, locked Body Focus Mode – S √Batt installed √Flash Card installed Pwr – ON Top LCD: √Batt √Frames remaining sufficient</p> <p>Exp Comp () – 0.0</p> <p>Exp Mode – M: SS – 500 f/stop – f/8</p> <p>Meter – Matrix () Diopter – Adjust Frame Rate – S √BKT disabled – 0 F</p> <p>Rear LCD: √ISO – 100 √QUAL – RAW √WB – 0,A</p> <p>AF Area Mode – [[]] √Focus Area – Center √Focus Selector Lock – L</p>	<p>Lens – 12-24mm @ 18mm Aperture – Min, locked Body Focus Mode – S √Batt installed √Flash Card installed Pwr – ON Top LCD: √Batt √Frames remaining sufficient</p> <p>Exp Comp () – 0.0 Exp Mode – P Meter – Matrix () Diopter – Adjust Frame Rate – S √BKT disabled – 0 F</p> <p>Rear LCD: √ISO – 100 √QUAL – RAW √WB – 0,A</p> <p>AF Area Mode – [[]] √Focus Area – Center √Focus Selector Lock – L</p> <p>SB-800 Flash Settings: √Diffuser Dome installed ON/OFF pb – ON</p> <p>√MODE –   </p> <p>√Exp Comp – 0 EV Tilt – 45° (Direct)</p> <p>Technique</p> <ol style="list-style-type: none"> 1. Fill FOV w/sunlit subject 2. Activate D2Xs Cam 3. Auto Exp Lock – Depress,hold Expect values such as 250,f/11 4. Focus, Frame, Fire 	<p>Lens – 17-35mm @ 17mm Aperture – Min, locked Body Focus Mode – S √Batt installed √Flash Card installed Pwr – ON Top LCD: √Batt √Frames remaining sufficient</p> <p>Exp Comp () – 0.0</p> <p>Exp Mode – A: f/stop – f/8</p> <p>Meter – Matrix () Diopter – Adjust Frame Rate – Selftimer</p> <p>√BKT disabled – 0 F</p> <p>Rear LCD: √ISO – 100 √QUAL – RAW √WB – 0,A</p> <p>AF Area Mode – [[]] √Focus Area – Center √Focus Selector Lock – L</p> <p>SB-800 Flash Settings: √Diffuser Dome installed ON/OFF pb – ON</p> <p>√MODE –   </p> <p>√Exp Comp – 0 EV Tilt – 45° (Direct)</p> <p>Accessory Equipment: Shutter Release Cable – Install Multiuse Brkt – Install Multiuse Brkt Clamp – Install as reqd</p> <p>Technique</p> <ol style="list-style-type: none"> 1. Focus on crewmember 2. Body Focus Mode – M 3. Frame, Fire

P/TV-11b/134/O/A

(reduced copy)

FS CC 3-23

P/TV/134/FIN A

TOP

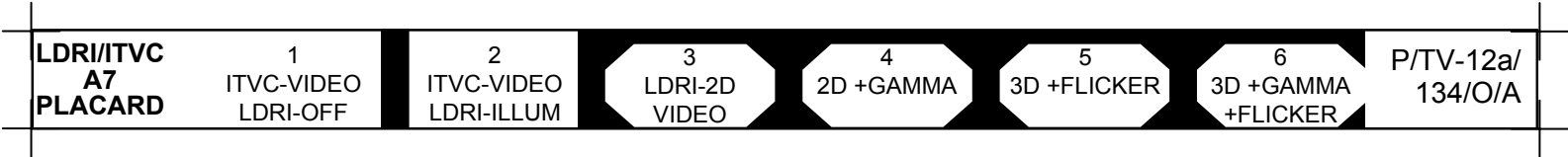

TOP
BACK OF 'LDRI/ITVC A7 PLACARD'

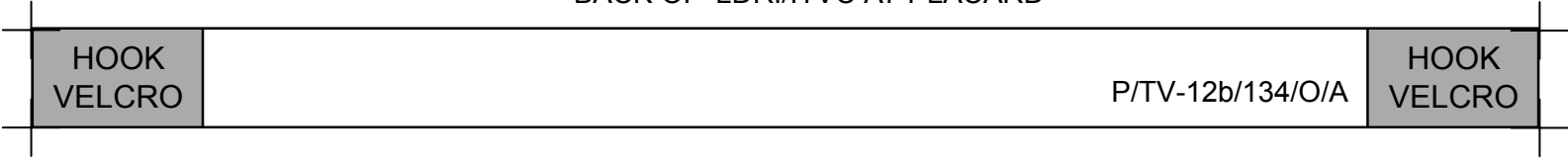

DIGITAL PLAYBACK**HD DIGITAL VIA CC**NOTE

Digital Playback from CC only possible for CC Video recordings

ACTIVATION

CC	Setup per diagram (back of cue card) For cable strain relief, attach MPC-to-G1 Cable Velcro strap to CC strap
AVIU	SYNC/VIDEO – VIDEO HI-Z/75 – 75 PWR SELECT – LO
O19	√TV PWR – ON
CC	PWR dial – VCR/PLAY

If DnK Notify MCC, configuring for HD TV dnk	
L10 (MUX)	√MUX/VTR/CC PWR – on (LED on) √MUX BYPASS – ACT √CH 0, 1 RATE SEL – 1 √2 RATE SEL – 8
(VTR) (VIP)	ON/STANDBY pb – push (LED red) PWR – off (LED off)
O19	DC UTIL PWR MNA – ON
MPC PWR SPLY	DC PWR SPLY PWR SW1 – ON
MPC	PWR – ON (5V,3V green LEDs on)
L10 (MUX)	√CH 2 F/O OK LED on

OPERATIONSPLBK or DNK VIDEO

CC	Install tape, if reqd VTR pb – REW(FF),PLAY,PAUSE to cue tape
----	--

If DnK	
MPC	√HDV, TAXI LEDs – on
L10 (MUX)	√CH 2 DATA LED – on

CC	PLAY pb – push (green ► displayed) If PLBK(DNK) complete: STOP pb – push If CC ops complete, go to DEACTIVATION
----	--

DEACTIVATION

CC	Remove, mark, stow tape as reqd PWR dial – OFF
O19	TV PWR – OFF, as reqd

If DnK	
MPC	PWR – OFF
MPC PWR SPLY	DC PWR SPLY PWR SW1 – OFF
O19	DC UTIL PWR MNA – OFF
L10 (MUX)	√VTR/CC PWR – on (LED on) MUX/VTR/CC PWR – off (LED off) PWR – on (LED on, DATA FLOW LED flashes twice)
(VIP)	ON/STANDBY pb – push (LED green)
(VTR)	ON/STANDBY pb – push (LED green)
Notify MCC, returned to SD TV dnk Go to DEACTIVATION (Cue Card, TV), as reqd	

HOOK
VELCRO**DIGITAL VIA VTR****ACTIVATION**

L10 (MUX) (VTR)	Setup per diagram (back of cue card) √VTR/CC PWR – on (LED on) √ON/STANDBY LED – green
--------------------	--

OPERATIONSPLBK or DNK VIDEO

L10 (VTR)	Install tape if reqd √DISPLAY SELECT – DATA
Remote	If Index Search reqd: √ID – VTR4 SEARCH MODE pb – push (INDEX SEARCH mode displayed) ◀▶ (▶▶) pb – push to move highlight bar to desired GMT start When VTR auto-cue complete, green • displayed: PAUSE pb – push If playback time not displayed on DSR-25 LCD cycle "DATA CODE" repeatedly until time displayed
L10 (VTR)	REW(FF),PLAY,PAUSE pb – push as reqd to cue tape

If DnK	
L10 (MUX)	MUX/VTR/CC PWR – on (LED on) √MUX BYPASS – ACT √CH 3 DATA LED – on

L10 (VTR)	PLAY pb – push (green • displayed)
-----------	------------------------------------

If PLBK(DNK) complete:
| STOP pb – push
If VTR ops complete, go to DEACTIVATION

DEACTIVATION

L10 (VTR)	Remove, mark, stow tape as reqd Go to DEACTIVATION (Cue Card, TV) as reqd
-----------	--

TOP
BACK OF 'DIGITAL PLAYBACK'

HOOK
VELCRO

HD DIGITAL VIA CC PLAYBACK

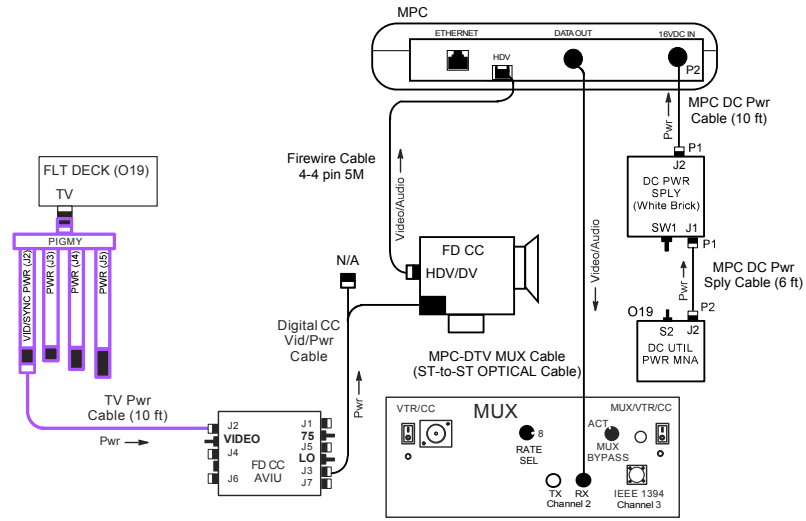

jsc48038_134_012er2.cvx

DIGITAL VIA VTR PLAYBACK

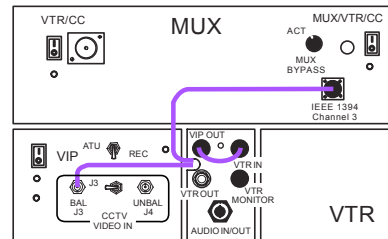

jsc48038_131_012d.cvx

P/TV-13b/134/O/B

TOP

G1 CC SETUP CUE CARD

HOOK
VELCRO

ASSUMPTION: G1 is powered by either direct or battery power

WELL LIT SCENE ("green" <input type="checkbox"/>)	SUN-LIT SCENE (M)	DIM-LIT SCENE (A)
<p>Install Wide Conversion Lens as reqd ND FILTER – OFF (per CC prompt) √OUTPUT – CAM √A/V1/V2 – V2 √<input type="checkbox"/>..<input type="checkbox"/><input type="checkbox"/>-<input type="checkbox"/><input type="checkbox"/> √STANDBY/LOCK – STANDBY PWR dial – "green" <input type="checkbox"/> Open LCD √Tape installed</p>	<p>Install Wide Conversion Lens as reqd √ND FILTER – OFF AF/M – AF(M) AGC – OFF GAIN – L √OUTPUT – CAM √AWB – ON √AUDIO LEVEL – A √A/V1/V2 – V2 √<input type="checkbox"/>..<input type="checkbox"/><input type="checkbox"/>-<input type="checkbox"/><input type="checkbox"/> √STANDBY/LOCK – STANDBY PWR dial – M Open LCD √Tape installed √GAIN – 0dB SS – 1/500 (Small Wheel) f/stop – F8.0 (Aft Ring) Adjust focus if AF/M – M (Fwd Ring)</p>	<p>Install Wide Conversion Lens as reqd √ND FILTER – OFF AF/M – AF AGC – OFF √OUTPUT – CAM √AWB – ON √AUDIO LEVEL – A √A/V1/V2 – V2 √<input type="checkbox"/>..<input type="checkbox"/><input type="checkbox"/>-<input type="checkbox"/><input type="checkbox"/> √STANDBY/LOCK – STANDBY PWR dial – A Open LCD √Tape installed √GAIN – L (M,H) per Scene</p>

P/TV-17a/134/O/A

(reduced copy)

FS CC 3-27

P/TV/134/FIN A

TOP
BACK OF 'G1 CC SETUP CUE CARD'

HOOK
VELCRO



(reduced copy)
FS CC 3-28

P/TV-17b/134/O/A



P/TV/134/FIN A

NOTE

Replace this page with four (4) sheets of blue
K-10 stock in crew copies only

NOTE

Replace this page with four (4) sheets of blue
K-10 stock in crew copies only

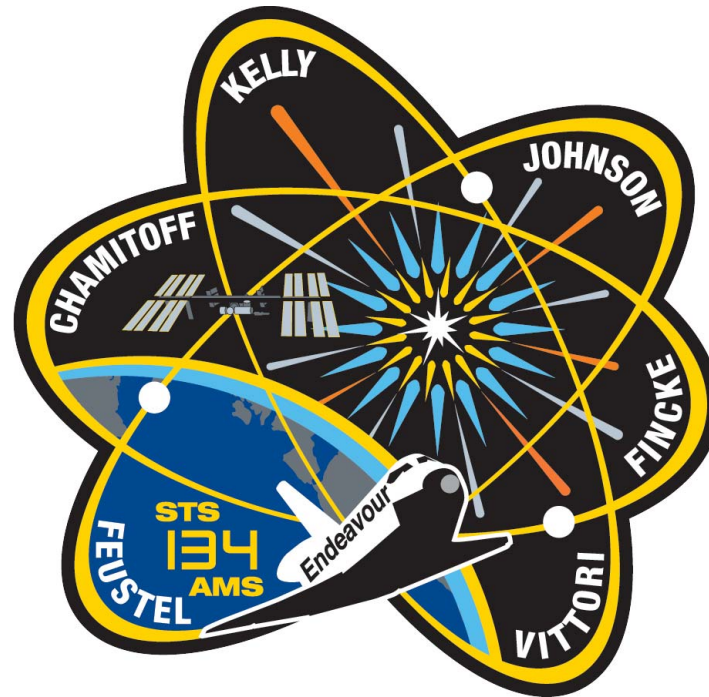

PHOTO/TV CHECKLIST

STS
134