

Reference Data

Mission Operations Directorate Operations Division

Generic, Rev I
May 15, 2009

NOTE

For STS-127 and subsequent flights

National Aeronautics and
Space Administration

Lyndon B. Johnson Space Center
Houston, Texas



Verify this is the correct version for the pending operation (training, simulation or flight).
Electronic copies of FDF books are available. URL: <http://mod.jsc.nasa.gov/do3/FDF/index.html>

REFERENCE DATA	GENERIC, Rev I (May 15, 2009)
-----------------------	--------------------------------------

PCN-2 (Oct 22, 2009) Sheet 1 of 1

List of Implemented Change Requests (482s):

EVA-01773

Incorporate the following:

1. Replace vii and viii
2. Replace 4-11 thru 4-14

NOTE For STS-129 and subsequent flights

Prepared by: *Lisa A. Giles*
Publication Manager

Approved by: *Timberly Johnson*
Manager, Flight Procedures

Accepted by: *Timberly Johnson for*
FDE Manager

Encl: 6 pages

File this PCN immediately behind the front cover as a permanent record

REFERENCE DATA

GENERIC, Rev I (May 15, 2009)

PCN-1 (July 9, 2009) Sheet 1 of 1

List of Implemented Change Requests (482s):

REF-01121

Incorporate the following:

1. Replace vii thru x
2. Replace 4-49 and 4-50

NOTE

For STS-128 and subsequent flights

Prepared by:



Publication Manager

Approved by:



Manager, Flight Procedures

Accepted by:



FDF Manager

Encl: 6 pages

File this PCN immediately behind the front cover as a permanent record

JSC-48041

MISSION OPERATIONS DIRECTORATE

REFERENCE DATA

GENERIC, REVISION I
May 15, 2009

PREPARED BY:



Lisa A. Giles
Publication Manager

APPROVED BY:

ACCEPTED BY:

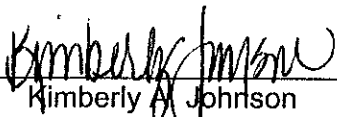

Kimberly A. Johnson
Manager, Flight
Procedures

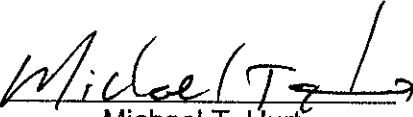

Michael T. Hurt
FDF Manager

This document is under the configuration control of the Crew Procedures Control Board (CPCB). All proposed changes must be submitted via Change Request Workflow (CRW) to DO3/FDF Manager.

Additional distribution of this book, for official use only, may be requested in writing to DO3/FDF Manager. The request must include justification and requester's name, organization, position, and phone number. Contractor requests are made through the NASA or DOD organization supported. Deletions, reduction in quantity, or change of address may be submitted to DO3/FDF Management Office, 281-244-1184.

REF/ALL/GEN I

Incorporates the following:
482#: REF-01120

AREAS OF TECHNICAL RESPONSIBILITY

Publication Manager	DO35/L. Giles	281-244-9068
Asst. Publication Manager	DO35/M. Crisp	281-483-5975
APU/HYD (MMACS)	DS421/K. McCluney	281-483-0867
DPS	DS211/C. Sherman	281-483-0831
ECLS (EECOM)	DS441/R. Jarvis	281-483-6808
GMEMs	MS311/C. Santiago	281-483-7150
GNC	DS621/D. Gruber	281-483-0709
IFM	DX44/J. Shimp	281-483-2581
MPS (Booster)	DS66/A. Park	281-244-7185
PROP (OMS/RCS)	DS66/P. Clarke	281-483-0877

NOTES

1. EPDC

The EPDC table includes CRITICAL equipment lost if a bus or sub bus is lost. Listed is hardware, switches, and instrumentation grouped under subheadings of (a) CRITICAL FUNCTIONS/EQUIPMENT LOST; (b) CRITICAL REDUNDANCY LOST; (c) INSTRUMENTATION/OTHER; and (d) OMS/RCS AFFECTED. For a complete listing of equipment lost, see BUS LOSS SSRs (MAL, EPS).

2. MDM

The MDM table includes a highly selective listing of input and output GPC parameters alerting the crew of I/O parameter (or contact) losses with element bypass failures of a specific MDM. Also included is a set of CRT displays which can be used to identify the loss of a specific OI DSC. The following I/O functions/displays have been excluded from the MDM tables:

Functions/displays lost during ascent (SRB, MPS, OMS crossfeed, ET/orbiter SEP cameras)

ET umbilical door and vent door functions

Loss of redundancy in the multi-redundant SM alert and C/W 'Backup C/W Alarm'

Loss of OMS-kit associated display functions

(Cont next page)

In the input and output columns, coded notation indicates the following:

A* or B* indicates dual redundancy – a two (A&B) contact (path) parameter. This is a convention for this publication. The actual designation of the contact could be numerical; i.e., 1 or 2 as examples.

BCE	GPC INPUT
B	FWD DAP AXES – A*

If MDM FF1 is lost:
FF1 FWD DAP AXES
A* contact is lost.
The dual redundant contact is indicated by B* on another MDM as shown below.

B	FWD DAP AXES – B*
---	-------------------

FWD DAP AXES B* contact is lost when MDM FF2 is lost.

1*, 2*, 3*, or 4* indicates triple or quad redundancy – a 3 or 4 contact (path) parameter.

BCE	GPC INPUT
B	AFT RHC – 1*

If MDM FF1 is lost:
Similar to A*(B*) in previous example.
Contact 1 lost but redundant contacts 2 & 3 or 2,3, & 4 are still available on other MDMs.

3. FAULT MESSAGES

With fault annunciation during ascent and entry, the crew should go directly to the appropriate PKT C/L contingency procedure. If on orbit and no PKT C/L procedure exists, the crew should go to the MAL book.

(Cont next page)

The 'MESSAGE' column of the Fault Messages notes the exact message annunciated on the display, and it can be driven by any of the 'CAUSES' stated. Only causes and fault messages resulting in flight situations requiring immediate response have PKT contingency procedures. For locating the specific procedure in the PKT, the appropriate system tab is lifted, exposing a complete array of contingency procedure titles on the ladder format. These ladder titles are at times more generic than the annunciated fault messages and/or the 'CAUSE' column drivers; in this case, the comment column is used to identify the PKT procedure.

4. C/W

The C/W and FDA table provides annunciation limits for the hardwired primary C/W and software backup C/W and Fault Detection and Annunciation (FDA). These tables are followed by SM TABLE MAINTENANCE and HARDWARE C/W procedures used for the manipulation (changing) of C/W parameters and annunciation limits if required. The C/W and FDA table provides a comprehensive alphabetical listing of limit-sensed parameters which can result in a Class 2 or 3 alarm, and also information which can be used by the crew to alter limits in order to eliminate nuisance alarms.

The table columns are organized as follows. The parameter name is consistent with the appropriate CRT display as much as possible. Footnotes attached to the parameter name indicate OPS and Major Mode (MM) availability and which Major Function (GNC or SM) of the Flight System (PASS, BFS, or both) is doing the limit sensing. All parameters are sensed by both PASS and BFS SM Major Functions unless otherwise specified. The C/W CH column gives the hardwired parameter number, matching the numbers on the status matrix panel R13. The H/W C/W columns present the low and high Primary C/W (hardwired) limits in volts DC (VDC). In the few cases where hardwired limits are not backed up by identical software limits, the value in engineering units (EU) is

(Cont next page)

printed below or to the side of the value in VDC in parentheses. The Software ID column gives the Parameter ID number to be used when altering parameter fault detection via Table Maintenance, PASS SM SPEC 60. Software IDs for BFS SM limits are also given, although at the present time there is no BFS equivalent to the Table Maintenance SPEC. GNC limit-sensed parameters cannot be changed except by memory read/write, and I-LOAD identification numbers are provided for them. The SPEC column provides the system-level SPEC or DISP number on which the parameter appears. The SM ALERT columns contain the low and high SM (Class 3) Alert limits in EU. The Backup C/W columns contain the low and high Backup C/W (Class 2) software limits in EU. The last column identifies precondition characteristics where applicable, and where possible it describes the circumstances which generate the bilevel change of state and subsequent alarm. In addition, there are a few notes describing unusual cases.

5. GPC Memory Data Locations

This section contains GPC Memory (GMEM) data used to access particular parameters with the orbiter GPCs.

REFERENCE DATA

LIST OF EFFECTIVE PAGES

GENERIC 10/15/87

REV I 05/15/09

PCN-1 07/09/09

PCN-2 10/22/09

Sign Off	*	ALL/GEN I	1-19	ALL/GEN I
ii	*	ALL/GEN I	1-20	ALL/GEN I
iii	*	ALL/GEN I	1-21	ALL/GEN I
iv	*	ALL/GEN I	1-22	ALL/GEN I
v	*	ALL/GEN I	1-23	ALL/GEN I
vi	*	ALL/GEN I	1-24	ALL/GEN I
vii	*	ALL/GEN I,2	1-25	ALL/GEN I
viii	*	ALL/GEN I,2	1-26	ALL/GEN I
ix	*	ALL/GEN I,1	1-27	ALL/GEN I
x	*	ALL/GEN I,1	1-28	ALL/GEN I
xi		ALL/GEN I	2-1	ALL/GEN I
xii		ALL/GEN I	2-2	ALL/GEN I
1-1		ALL/GEN I	2-3	ALL/GEN I
1-2		ALL/GEN I	2-4	ALL/GEN I
1-3		ALL/GEN I	2-5	ALL/GEN I
1-4		ALL/GEN I	2-6	ALL/GEN I
1-5		ALL/GEN I	2-7	ALL/GEN I
1-6		ALL/GEN I	2-8	ALL/GEN I
1-7		ALL/GEN I	2-9	ALL/GEN I
1-8		ALL/GEN I	2-10	ALL/GEN I
1-9		ALL/GEN I	2-11	ALL/GEN I
1-10		ALL/GEN I	2-12	ALL/GEN I
1-11		ALL/GEN I	2-13	ALL/GEN I
1-12		ALL/GEN I	2-14	ALL/GEN I
1-13		ALL/GEN I	2-15	ALL/GEN I
1-14		ALL/GEN I	2-16	ALL/GEN I
1-15		ALL/GEN I	2-17	ALL/GEN I
1-16		ALL/GEN I	2-18	ALL/GEN I
1-17		ALL/GEN I	2-19	ALL/GEN I
1-18		ALL/GEN I	2-20	ALL/GEN I

* – Omit from flight book

2-21.....	ALL/GEN I	3-35.....	ALL/GEN I
2-22.....	ALL/GEN I	3-36.....	ALL/GEN I
2-23.....	ALL/GEN I	3-37.....	ALL/GEN I
2-24.....	ALL/GEN I	3-38.....	ALL/GEN I
3-1.....	ALL/GEN I	3-39.....	ALL/GEN I
3-2.....	ALL/GEN I	3-40.....	ALL/GEN I
3-3.....	ALL/GEN I	3-41.....	ALL/GEN I
3-4.....	ALL/GEN I	3-42.....	ALL/GEN I
3-5.....	ALL/GEN I	3-43.....	ALL/GEN I
3-6.....	ALL/GEN I	3-44.....	ALL/GEN I
3-7.....	ALL/GEN I	4-1.....	ALL/GEN I
3-8.....	ALL/GEN I	4-2.....	ALL/GEN I
3-9.....	ALL/GEN I	4-3.....	ALL/GEN I
3-10.....	ALL/GEN I	4-4.....	ALL/GEN I
3-11.....	ALL/GEN I	4-5.....	ALL/GEN I
3-12.....	ALL/GEN I	4-6.....	ALL/GEN I
3-13.....	ALL/GEN I	4-7.....	ALL/GEN I
3-14.....	ALL/GEN I	4-8.....	ALL/GEN I
3-15.....	ALL/GEN I	4-9.....	ALL/GEN I
3-16.....	ALL/GEN I	4-10.....	ALL/GEN I
3-17.....	ALL/GEN I	4-11.....	ALL/GEN I
3-18.....	ALL/GEN I	4-12.....	ALL/GEN I,2
3-19.....	ALL/GEN I	4-13.....	ALL/GEN I
3-20.....	ALL/GEN I	4-14.....	ALL/GEN I,2
3-21.....	ALL/GEN I	4-15.....	ALL/GEN I
3-22.....	ALL/GEN I	4-16.....	ALL/GEN I
3-23.....	ALL/GEN I	4-17.....	ALL/GEN I
3-24.....	ALL/GEN I	4-18.....	ALL/GEN I
3-25.....	ALL/GEN I	4-19.....	ALL/GEN I
3-26.....	ALL/GEN I	4-20.....	ALL/GEN I
3-27.....	ALL/GEN I	4-21.....	ALL/GEN I
3-28.....	ALL/GEN I	4-22.....	ALL/GEN I
3-29.....	ALL/GEN I	4-23.....	ALL/GEN I
3-30.....	ALL/GEN I	4-24.....	ALL/GEN I
3-31.....	ALL/GEN I	4-25.....	ALL/GEN I
3-32.....	ALL/GEN I	4-26.....	ALL/GEN I
3-33.....	ALL/GEN I	4-27.....	ALL/GEN I
3-34.....	ALL/GEN I	4-28.....	ALL/GEN I

4-29.....	ALL/GEN I	5-3.....	ALL/GEN I
4-30.....	ALL/GEN I	5-4.....	ALL/GEN I
4-31.....	ALL/GEN I	5-5.....	ALL/GEN I
4-32.....	ALL/GEN I	5-6.....	ALL/GEN I
4-33.....	ALL/GEN I	6-1.....	ALL/GEN I
4-34.....	ALL/GEN I	6-2.....	ALL/GEN I
4-35.....	ALL/GEN I	6-3.....	ALL/GEN I
4-36.....	ALL/GEN I	6-4.....	ALL/GEN I
4-37.....	ALL/GEN I	7-1.....	ALL/GEN I
4-38.....	ALL/GEN I	7-2.....	ALL/GEN I
4-39.....	ALL/GEN I	7-3.....	ALL/GEN I
4-40.....	ALL/GEN I	7-4.....	ALL/GEN I
4-41.....	ALL/GEN I	7-5.....	ALL/GEN I
4-42.....	ALL/GEN I	7-6.....	ALL/GEN I
4-43.....	ALL/GEN I	7-7.....	ALL/GEN I
4-44.....	ALL/GEN I	7-8.....	ALL/GEN I
4-45.....	ALL/GEN I	7-9.....	ALL/GEN I
4-46.....	ALL/GEN I	7-10.....	ALL/GEN I
4-47.....	ALL/GEN I	7-11.....	ALL/GEN I
4-48.....	ALL/GEN I	7-12.....	ALL/GEN I
4-49.....	ALL/GEN I,1	7-13.....	ALL/GEN I
4-50.....	ALL/GEN I	7-14.....	ALL/GEN I
4-51.....	ALL/GEN I	7-15.....	ALL/GEN I
4-52.....	ALL/GEN I	7-16.....	ALL/GEN I
4-53.....	ALL/GEN I	7-17.....	ALL/GEN I
4-54.....	ALL/GEN I	7-18.....	ALL/GEN I
4-55.....	ALL/GEN I	7-19.....	ALL/GEN I
4-56.....	ALL/GEN I	7-20.....	ALL/GEN I
4-57.....	ALL/GEN I	7-21.....	ALL/GEN I
4-58.....	ALL/GEN I	7-22.....	ALL/GEN I
4-59.....	ALL/GEN I	7-23.....	ALL/GEN I
4-60.....	ALL/GEN I	7-24.....	ALL/GEN I
4-61.....	ALL/GEN I	7-25.....	ALL/GEN I
4-62.....	ALL/GEN I	7-26.....	ALL/GEN I
4-63.....	ALL/GEN I	7-27.....	ALL/GEN I
4-64.....	ALL/GEN I	7-28.....	ALL/GEN I
5-1.....	ALL/GEN I	7-29.....	ALL/GEN I
5-2.....	ALL/GEN I	7-30.....	ALL/GEN I
		7-31.....	ALL/GEN I
		7-32.....	ALL/GEN I

7-33..... ALL/GEN I
 7-34..... ALL/GEN I
 8-1.....* ALL/GEN I
 8-2.....* ALL/GEN I
 9-1.....* ALL/GEN I
 9-2.....* ALL/GEN I
 10-1.....* ALL/GEN I
 CC 10-2.....* ALL/GEN I
 CC 10-3.....* ALL/GEN I
 10-4.....* ALL/GEN I

REFERENCE DATA CUE CARDS

<u>Title</u>	<u>Ref. Page</u>	<u>Card No.</u>
MN C-DC UTILITY POWER MO63P		
(Front)	CC 10-2	REF-2a/O/A
(Back).....	CC 10-3	REF-2b/O/A

* – Omit from flight book

x

REF/ALL/GEN I,1

<u>CONTENTS</u>	<u>PAGE</u>
EPDC	1-1
CRITICAL EQUIPMENT LOST – MNA/AC1	1-4
MNB/AC2	1-8
MNC/AC3	1-12
CONTROL BUS AB	1-16
BC	1-19
CA	1-22
ESS BUSES	1-25
MDM.....	2-1
MDM FF1	2-2
FA1	2-3
FF2	2-4
FA2	2-5
FF3	2-6
FA3	2-7
FF4	2-8
FA4	2-9
PL1	2-10
PL2	2-11
OI DSC LOSS	2-12
NOTES	2-12
DISP 78 SM SYS SUMM 1 (PASS).....	2-13
(BFS)	2-14
79 SM SYS SUMM 2 (PASS).....	2-15
(BFS)	2-16
89 PRPLT THERMAL	2-17
19 GNC SYS SUMM 2	2-18
MDM/DCU/DSC LOSS	2-20
DISP 167 DOCKING STATUS	2-20
ADC DATA LOSS (MEDS only)	2-22
MEDS QUICK REFERENCE	2-24
FAULT MESSAGES.....	3-1
MEDS FAULT MESSAGES	3-41
CAUTION & WARNING	4-1
C/W POWER SUPPLY FAILURE	4-2
LIGHT PANEL	4-3
& FDA TABLE	4-4
HARDWARE C/W TABLE	4-54

CONTENTS (Cont)

PAGE

PRIMARY TO BACKUP C/W ANALOG PARAMETER CALIBRATION	4-55
SM & H/W FDA LIMIT MANAGEMENT PROCEDURES	4-61
GPC READ/WRITE PADS	5-1
NAV STARS.....	6-1
PROGRAM NOTES	7-1
CRT DISPLAYS	7-7
DPS (GENERAL)	7-19
ASCENT/ABORT	7-24
ON-ORBIT (OPS 2).....	7-30
DEORBIT/ENTRY (OPS 3/6)	7-32
CUE CARD LOCATION MAPS AND ORBITER PROCEDURAL DECALS.....	8-1
SHUTTLE SYSTEMS SCHEMATICS AND PHOTOGRAPHS	9-1
CUE CARD CONFIGURATION	10-1

EPDC

CRITICAL EQUIPMENT LOST – MNA/AC1	1-4
MNB/AC2	1-8
MNC/AC3	1-12
CONTROL BUS AB	1-16
BC	1-19
CA	1-22
ESS BUSES	1-25

EPDC

EPDC

This Page Intentionally Blank

The following decal scheme is used onboard the orbiter to identify the phase-related, nominal position of all circuit breakers:

cb COLOR CODE (Nominal Position)

- RED – OPEN ALL PHASES
- GREEN – OPEN ON-ORBIT
- YELLOW – OPEN ASCENT
- ORANGE – OPEN ORBIT AND ENTRY
- BLACK – CLOSED ALL PHASES

MNA

CRITICAL FUNCTIONS/EQUIP LOST

Functions or equipment lost during ASC/ENT which would require manual action be taken by crew

CRITICAL REDUNDANCY LOST

Loss of function or equipment with automatic redundancy. No action required by crew, but loss could be serious

INSTRUMENTATION/OTHER

A “catch-all” column containing items which do not belong in other categories

OMS/RCS AFFECTED

Loss of control of OMS/RCS systems (vlvs, sws, etc). Some OMS/RCS systems considered critical are listed in column 1

MNA

CRITICAL EQUIPMENT LOST – MNA/AC1

BUS LOST	CRITICAL FUNCTIONS/ EQUIPMENT LOST	CRITICAL REDUNDANCY LOST	INSTRUMENTATION/OTHER	OMS/RCS AFFECTED	
M N A	DA1		Cryo O2/H2 Tk 1/3 Htrs A		
	FPC1	IDP 1 MDU CRT 1 L HUD MMU 1 GPS 1(OV105)	LG Hyd Sys 1 Dpy Bk/Skid Pwr Redun NWS Hyd Sys 1	MCIU PDI Redundancy F RCS A Htrs	
	FLC1	F1 Manf Jets Bay 3 Agent Discharge			F RCS He P A (CL & GPC)
	FMC1	H2O Loop 1 Pump A	L Probe Mtr 1 Dpy Dsc 1 Fwd Vent Dr Mtr Redun	-Y S TRK SYS 1	F RCS Tk Isol 3/4/5 Manf Isol 1
	AC1 multi	FC1 Pumps Freon Pump 1A,2B H2O Loop 1 Pump A Av Bay Fan 1A,3B	L Probe Mtr 1 IMU Fan A PLBD Bikh Lat,C/L Lat,Stbd Dr Mtrs Redun ET Door C/L,L Lat,L Dr Mtrs Redun Rad Port/Stbd Lat,Pnl Mtrs Redun Fwd/Mid/Aft Vent Dr Mtrs Redun Ark/Tnl Fan A ^a	-Y S TRK SYS 1 Door Mtr Humidity Sep A RCS/OMS Prplt Qty RMS MRL Redun WCS Fan/Sep 1 PRLA Drive Mtrs (all) Redun	L,R OMS Tk Isol A L OMS Xfeed A L,R RCS Tk Isol 3/4/5 A Xfeed 3/4/5 Manf Isol 2 F RCS Tk Isol 3/4/5 Manf Isol 1
ΦA		FCL 1 Cntrl B Rad Byp vlv Mtr H2O Loop 2 Byp Cntrl C ME Ch A R ME Ch B Blr Cntrl 1B	H2O Loop 2 Instr RMS Shldr Brace Rel Cabin Temp Cntrl Sys 2 FC1 pH Snsr 1Φ of: WCS Fan/Sep 1		

^aDocking missions only

(Cont next page)

M N A	FPC1				
	AC1 multi				
	ΦB	Av Bay 2 Sig Condr	FCL 2 Cntr B Rad Byp vlv Mtr C ME Ch A R ME Ch B	RCS/OMS Prplt Qty Cabin Air Sig Condr Fwd Timers Hyd 1 Qty Snsr 1Φ of: WCS Fan/Sep 1	
	ΦC		C ME Ch A R ME Ch B Blr Cntr 3A	Hyd Pri Sw Vlv ind 1Φ of: WCS Fan/Sep 1	
	ML86B		Ku-Bd Jett Redun	WCS Fan Sep 1 Mtr Relay	
	APC4	ATVC Ch 2 SSME/SRB Isol Cap	APU Cntr Pwrs 1A,3B 1 Gbx GN2 Repress Vlv Hyd 1,3 Mn Pump Depress Redun	APU 3 Turbine Speed ind	
	APC1	L OMS Pri TVC R OMS Sec TVC		RCS/OMS Htrs L Pod A R Pod B Xfeed Lines A APU GG Inj H2O Htrs 1A,2A,3B	L,R RCS He P A (CL & GPC) L,R OMS He P/Vap Isol A (GPC OP) L,R OMS Eng vlv 1 Pos (=0) L Manf 5 Jets L RCS He P B (man OP)

(Cont next page)

CRITICAL EQUIPMENT LOST – MNA/AC1 (Cont)

BUS LOST	CRITICAL FUNCTIONS/ EQUIPMENT LOST	CRITICAL REDUNDANCY LOST	INSTRUMENTATION/OTHER	OMS/RCS AFFECTED	
M N A	APC4				
	ALC1	FES Cntrl Pri B Top L Noz Htr A NH3 Cntrl Pri A (GPC) Auto sw-over C Me He Isol A Top/Hi Load Duct Htrs A	FES H2O Fdln A(B) Htrs 1(2) L,R OMS Ign Path APU Fu Tk Vlvs 1A,3B GG/Fu Pump Htrs 1A,3B Tk/Fu Ln Htrs 1A,3B Blr Cntrl 1B,3A Hyd Bk Isol Vlv 1 Cntl (tb-OP)	L,R RCS Manf 2 Jet Htrs OMS Qty Gaging APU Lube Oil Htrs 1A,3B Hyd Circ Pump 1,3 MNA Pwrs Bdyflp A,Elvn A,Rud Spdbk A Htrs MPS/TVC Isol Vlv 1 Cntl (tb-CL) RCS/OMS Htrs Xfd Lines A	L,R RCS He P A (CL & GPC) L Manf 5 jets L OMS Eng P vlv Pos L RCS He P B (man OP) L,R OMS He P/Vap Isol A (GPC OP)
	AMC1		LG Extend Iso Vlv (tb-OP) LG Hyd Sys 1 Dpy NWS Hyd Sys 1 Aft Vent Dr Mtr Redun	*****GPC***** ET Door C/L,L Lat,L Dr Mtrs Redun	
	O14	TACAN 1(OV103,4) RA 1 MLS 1 AA 1 ADTA 1 Bay 3 Agent Discharge L ME Status Lts GPS 1 Pre Amps (Up/Lwr) (OV105)	Atm O2 Sys 1 Xovr vlv Atm P N2 Sys 1 Sply & Reg In sws FCL 1,2 Rad Flow Cntrl B O2/N2 Cntrl 1 Rad Isol Auto Contr NWS 1 GPS Pre Amps (Up/Lwr) (OV103)	PPO2 Snsr A L Ovrhd Cnsl Flood Fwd Mission Timer IMU Fan Snsr Smoke Det: L,R Flt Dk Av Bay 2A,3B -Z S TRK ACA 1 MNA Pwr O2/N2 Cntrl Sys 1 Aft Event Timer Cabin Vent Isol/Vent sws Tire Press inds Redun	
O14 & A8			RMS Pri Pwr	F1 Manf RJDs (if sw OFF)	

(Cont next page)

M N A	R14	MDU MFD 2 PLT 1 ADC 1A/2A UHF Pwr Amp MS ATU/CCU	GCIL Pwr Redun ACCU Data Word Redun	OS SU	
	A6 & A14			F RCS Jet 1 Htrs PRLA Drive Mtrs Redun	
	MPC1	O2 Sys 1 Sply sw (tb-CL) Top/Hi Load Duct Htrs A	FC H2O Ln and Rlf Htrs A Docking Sys Pwr Redun OIU 1 Pwr Redun	FC1 H2,O2 Flow Xdcrs FC3 Redun Reac Vlv Close (via pnl C3) RMS Pri Pwr Vest Dep Vlv Sys 1 Vent Vent Isol Hyd Bk A Htr	
	MMC1 MMC3	Auto PLBD Ops	PLBD C/L,Blkhd Lat,Stbd Dr Mtrs Redun Rad Port/Stbd Pnl Mtrs Redun Mid Vent Dr Mtrs Redun	RMS Redun MRL	

MNB

CRITICAL EQUIPMENT LOST – MNB/AC2

BUS LOST	CRITICAL FUNCTIONS/ EQUIPMENT LOST	CRITICAL REDUNDANCY LOST	INSTRUMENTATION/OTHER	OMS/RCS AFFECTED	
M N B	DA2		Cryo O2/H2 Tk 2/3/4 Htrs B Cryo O2/H2 Tk 2/3/4 Htrs A (if in AUTO)		
	FPC2	IDP 2 MDU CRT 2 MMU 2 GPS 2 (OV104,105)	NLG Hyd Sys 2 Dpy LG B/U Rel Sys 2 Bk/Skid Pwr Redun NWS Hyd Sys 2	F RCS B Htrs	
	FLC2	F2 Manf Jets S-Bd String 1 Bay 1 Agent Discharge cap	PL Intrg 1 PSP 1 LMG,NLG B/U Rel Sys 2	LMG/NLG UP and DN tb	F RCS He P B (CL & GPC) A (man OP)
	FMC2	H2O Loop 1 Pump B	L,R Probes Mtrs 2 Dpy Dsc 2 Fwd Vent Dr Mtrs Redun	-Y S Trk Sys 2 -Z S Trk Sys 1	F RCS Manf Isol 2 & TM
	AC2 multi	FC2 Pumps Av Bay Fan 1B,2A Freon Pump 1B H2O Loop 1 Pump 1B	Cabin Fan B L,R Probe Mtrs 2 IMU Fan B PLBD C/L,Blkhd Lat,Port/Stbd Dr Mtrs Redun ET Door C/L,L,R Lat, R Dr Mtrs Redun Ku-Bd Sto/Dpy Mtr Redun Rad Port/Stbd Lat Mtrs Redun Fwd/Mid/Aft Vent Dr Mtrs Redun Ark/Tnl Fan B ^a	RMS MPM, MRL Redun Cabin Temp Cntrl Sys 1 Humidity Sep B PRLA Drive Mtrs (all) Redun WCS Fan/Sep 2 -Y S Trk Sys 2 Door Mtr -Z S Trk Sys 1 Door Mtr L,R Seat AC2 Pwr	L,R OMS Xfeed B RCS Tk Isol 3/4/5 B Manf Isol 1 F RCS Manf Isol 2

^aDocking missions only

(Cont next page)

M N B	FPC2			
	AC2 multi			
	ΦA	Digital Television (DTV) Vertical Interval Processor (VIP)	L ME Ch A C ME Ch B LG Prox Snsr 2 LMG, NLG B/U Rel Sys 2 Blr Cntrl 1A	LMG & NLG UP & DN tb FC 2 pH Snsr Cabin Temp Cntrl Sys 1 1Φ of: WCS Fan/Sep 2
	ΦB	Av Bay 3 Sig Condr	FCL 1 Cntrl A Rad Byp Vlv Mtr A L ME Ch A C ME Ch B	Freon S/C AC2 Pwr Hyd 2 Qty Snsr 1Φ of: WCS Fan/Sep 2
	ΦC		L ME Ch A C ME Ch B FCL 1,2 Rad Isol Vlv Mtr A Blr Cntrl 2B	Hyd Sec Sw Vlv inds 1Φ of: WCS Fan/Sep 2
ML86B		RMS Jet Redun	WCS Sep Fan 2 Mtr Relay L,R Seat AC2 Pwr	

(Cont next page)

CRITICAL EQUIPMENT LOST – MNB/AC2 (Cont)

BUS LOST	CRITICAL FUNCTIONS/ EQUIPMENT LOST	CRITICAL REDUNDANCY LOST	INSTRUMENTATION/OTHER	OMS/RCS AFFECTED	
M N B	APC5	RGA 2 ATVC Ch 3 SSME/SRB Isol Cap	APU Cntrl Pwrs 1B,2A 2 Gbx GN2 Repress Vlv Hyd 1,2 Mn Pump Depress Redun	APU 1 Turbine Speed ind Freon Loop 1 Cldplate Flow Xdcr	
	APC2	L OMS Sec TVC ATVC Ch 4 SSME/SRB Isol Cap ASA Ch 4 Isol Cap		APU GG Inj H2O Htrs 1B,2B Aft PL MNB Bus Pwr Htrs L Pod B RCS/OMS Htrs R Pod A, Xfeed Lines B	L OMS He P/Vap Isol B (GPC OP) R OMS He P/Vap Isol A,B (man OP) R Manf 5 Jets L,R RCS He P A (man OP) R RCS He P B (CL & GPC) L OMS Eng vlv 2 Pos (=0)
	ALC2	Sec Flash Evap Cntrl Top L Noz Htr B R Noz Htr A Top/Hi Load Duct Htrs B L ME He Isol A	FES H2O Fdln Htrs 2 (except mid 2) L OMS Ignition Path APU Fu Tk Vlvs 1B,2A GG/Fu Pump Htrs 1B,2A Tk/Fu Ln Htrs 1B,2A Blr Cntrl 1A,2B Hyd Bk Isol Vlv 2 Cntl (tb-OP) NWS Hyd Sys 2 NLG Hyd Sys 2 Dpy	L,R RCS Manf 1 Jet Htrs OMS Qty Gaging for L Burn NH3 Cntrl B Sec – man sel APU Lube Oil Htrs 1B,2A Hyd Circ Pump 1,2 MNB Pwrs MPS/TVC Isol Vlv 2 Cntl (tb-CL) Bdyflp B,Elvn B, Rud Spdbk B Htrs RCS/OMS Htrs Xfd Lines B	L OMS He P/Vap Isol B (GPC OP) L,R RCS He P A (man OP) R Manf 5 Jets R RCS He P B (CL & GPC)
	AMC2		Aft Vent Dr Mtrs Redun	*****GPC***** ET Door C/L,L,R Lat, R Dr Mtrs Redun	

(Cont next page)

M N B	O15	TACAN 2(OV103,4) RA 2 MLS 2 AA 2 ADTA 2 Bay 1 Agent Discharge Cap C,R ME Status lts GPS 2 Pre Amps (Up/Lwr) (OV104,5)	FCL 1,2 Rad Flow Cntrl A Atm O2 Sys 2 Xovr Vlv Atm P N2 Sys 2 Sply & Reg In sws Drag Chute PLT Arm NWS 2	PPO2 Snsr B,C Fwd Event Timer L Seat/Ctr Cnsl Flood R Ovhd Cnsl Flood Av Bay Smoke Det 1B,3A -Y S Trk ACA 1,2,3 MNB Pwr dP/dT Snsr O2/N2 Cntrl Sys 2 Cabin Relief A sw Docking Sys Pwr Redun Tire Press inds Redun		
	O15 & A8			RMS B/U Pwr	F2 Manf RJDs (if sw OFF)	
	R14	Ku-A System (Comm & Radar) Ku-Bd Gimbal Lock MDU CDR 2 MFD 1 ADC 1B/2B VPU				
	A6 & A14			F RCS Jet 2,3 Htrs PRLA Drive Mtrs (all) Redun		
	MPC2	O2 Sys 2 Sply sw (tb-CL) Top/Hi Load Duct Htrs B Ku-A System (Comm & Radar) Ku-Bd Gimbal Lock OIU 2	Docking Sys Pwr Redun OIU 1 Pwr Redun	FC1 Redun Reac Vlv Close (via pnl C3) FC2 H2,O2 Flow Xdcrs RMS B/U Pwr Vest Dep Vlv Sys 2 Vent Vent Isol Hyd Bk B, Aft Fus A Htrs		
	MMC1 MMC2 MMC4	Auto PLBD Ops	PLBD C/L,Blkhd Lat,Port/Stbd Dr Mtrs Redun Rad Port/Stbd Pnl Dply Mtrs Redun Mid Vent Dr Mtrs Redun	RMS Redun MPM,MRL		

MNC

CRITICAL EQUIPMENT LOST – MNC/AC3

BUS LOST	CRITICAL FUNCTIONS/ EQUIPMENT LOST	CRITICAL REDUNDANCY LOST	INSTRUMENTATION/OTHER	OMS/RCS AFFECTED	
M N C	DA3		Cryo O2/H2 Tk 1 Htrs B 2,4 Htrs A Cryo O2/H2 Tk 1 Htrs A (if in AUTO)	PRIPL Bus MNC Pwr	
	FPC3	IDP 3,4 MDU CRT 3/4 R HUD Ku-Bd Gimbal Lock GPS 2(OV103) GPS 3(OV105)	LG B/U Rel Sys 1 Bk/Skid Pwr Redun	PDI Redun Ku-Bd Sys (Comm & Radar)	
	FLC3	F4 Manf Jets S-Bd String 2 Bay 2 Agent Discharge Cap	PL Intrg 2 PSP 2 RMG,NLG B/U Rel Sys 1	NWS Fail It NLG UP tb RMG UP & DN tb	F RCS He P B (man OP) F5 Manf Jets F RCS Manf Isol 5 & TM (Jets Lost)
	FMC3		R Probe Mtr 1 Dpy Dsc 1 Fwd Vent Dr Mtr Redun	-Z S Trk Sys 2	F RCS Tk Isol 1/2 Manf Isol 3/4 4 TM
	AC3 multi	FC3 Pumps Freon Pump 2A Av Bay Fans 2B,3A H2O Loop 2 Pmp Man ON	Cabin Fan A R Probe Mtr 1 IMU Fan C PLBD C/L,Blkhd Lat,Port Dr Mtrs Redun ET Door C/L,R Lat, L/R Dr Mtrs Redun Rad Port/Stbd Lat,Pnl Mtrs Redun Ku-Bd Sto/Dpy Mtr Redun Fwd/Mid/Aft Vent Dr Mtrs Redun	RMS MPM,MRL Redun L Seat AC3 Pwr IMU Fan S/C Hum Sep S/C -Z S Trk Sys 2 Door Mtr	L,R OMS Tk Isol B R OMS Xfeed A L,R RCS Tk Isol 1/2 F RCS Tk Isol 1/2 L,R RCS Xfeed 1/2 F,L,R RCS Manf Isol 3/4

(Cont next page)

M N C	FPC3				
	AC3 multi				
	ΦA	COAS	L ME Ch B R ME Ch A LG Prox Snsr 1 RMG,NLG B/U Rel Sys 1 Blr Cntrlr 2A	NLG UP tb RMG UP & DN tb H2O Loop 1 Instr Byr Cntrlr Hum Sep S/C FC 3 pH Snsr	
	ΦB	Av Bay 1 Sig Condr	FCL 2 Cntrlr A Rad Byp vlv Mtr R ME Ch A L ME Ch B	Freon S/C AC3 Pwr Hyd 3 Qty Snsr	
	ΦC		L ME Ch B R ME Ch A FCL 1,2 Rad Isol Vlv Mtr B Blr Cntrlr 3B		
	ML86B		RMS Jett Redun Ku-Bd Jett Redun	L,R Seat AC3 Pwr	
	APC6	ATVC Ch 1 SSME/SRB Isol cap	APU Cntrlr Pwrs 2B,3A 3 Gbx GN2 Repress Vlv Hyd 2,3 Mn Pump Depress Redun	APU 2 Turbine Speed ind Freon Loop 2 Cldplate Flow Xdcr	
	APC3	R OMS Pri TVC	APU Fu Tk Vlv 2B	APU GG Inj H2O Htr 3A RCS/OMS Htrs L,R Pod B Aft PL MNC Bus Pwr	L OMS He P/Vap Isol A,B (man OP) R OMS He P/Vap Isol B (GPC OP) R RCS He P B (man OP) R OMS Eng vlv 2 Pos (=0) L RCS He P B (CL & GPC) L,R RCS Manf Isol 5

(Cont next page)

CRITICAL EQUIPMENT LOST – MNC/AC3 (Cont)

BUS LOST	CRITICAL FUNCTIONS/ EQUIPMENT LOST	CRITICAL REDUNDANCY LOST	INSTRUMENTATION/OTHER	OMS/RCS AFFECTED	
M N C	APC6				
	ALC3	R ME He Isol A Flash Evap Cntrl Pri A Top R Noz Htr B	FES H2O FdIn B Htrs 1 (ex mid 2) R OMS Ignition Path APU Fu Tk Vlvs 2B,3A GG/Fu Pump Htrs 2B,3A Tk/Fu Ln Htrs 2B,3A Blr Cntrlrs 2A,3B Hyd Bk Isol Vlv 3 Cntl (tb-OP)	OMS Qty Gaging for R Brn L,R RCS Manf 3/4/5 Jet Htrs APU Lube Oil Htrs 2B,3A Hyd Circ Pump 2,3 MNC Pwr MPS/TVC Isol vlv 3 Cntl (tb-CL) NH3 Cntrlr B Pri Sec auto sw-over A Sec – man sel	R OMS He P/Vap Isol B (GPC OP) L RCS He P B (CL & GPC) R OMS Eng P vlv Pos RCS He P B (man OP) L,R RCS Manf Isol 5
	AMC3		Aft Vent Dr Mtr Redun	*****GPC***** ET Door C/L,R Lat, L/R Dr Mtrs Redun	
	O16	TACAN 3(OV103,4) MLS 3 ADTA 3,4 Bay 2 Agent Disch cap Atm P Cntrl O2 Emer sw GPS 3 Pre Amps (Up/Lwr) (OV105)	Drag Chute CDR Arm GPS Pre Amps (Up/Lwr) (OV103)	Smoke Det: Cabin Av Bay 1A,2B R Seat/Ctr Cnsl Flood Cabin Relief B sw OMS/RCS Qty Meter (pnl O3) ACA 2,3 MNC Pwr Aft Mission Timer	
	O16 RJD				F4 Manf RJDs (if F3 & F4/5 sw OFF)
	A6 & A14			F RCS Jet 4/5 Htrs	

(Cont next page)

M N C	R14	MDU CDR 1 PLT 2 AFD 1	GCIL Pwr Redun	Audio Center 2 Ku-A Sig Proc (Comm) PS ATU/CCU	
	MPC3	RGA 3	FC H2O Ln & Rlf Htrs B Docking Sys Pyro Pwr Redun	FC2 Redun Reac Vlv Close (via pnl C3) FC3 H2,O2 Flow Xdcrs Hyd Bk C, Aft Fus B Htrs	
	MMC2 MMC4	Auto PLBD Ops	PLBD C/L,Blkhd Lat,Port Dr Mtrs Redun Rad Port/Stbd Pnl Mtrs Redun Mid Vent Dr Mtrs Redun	RMS MPM,MRL Redun	

CNTL

CRITICAL EQUIPMENT LOST – CONTROL BUS AB

BUS LOST	CRITICAL FUNCTIONS/ EQUIPMENT LOST	CRITICAL REDUNDANCY LOST	INSTRUMENTATION/OTHER	OMS/RCS AFFECTED
CNTL AB1	IDP 1 MDU CRT 1 MMU 1 FES Pri B GPC cap C ME Shutdown pb Top/Hi Load Duct Htrs A L Pnl Trim Body Flap	L Probe Mtr 1 FC H2O Ln & Rif Htrs A L OMS Ignition Path APU GG/Fu Pump Htrs 1A,3B Tk/Fu Ln Htrs 1A,3B Fu Tk Vlv 1A Cntlr Pwr 1A 1 Gbx GN2 Repress Vlv Blr Cntlr 1B Hyd 1,3 Mn Pump Depress Redun PLBD C/L,Blkhd Lat,Stbd Dr Mtrs Redun Rad Port/Stbd Lat,Pnl Mtrs Redun LG B/U Rel Sys 2 NLG Hyd Sys 2 Dpy NWS Hyd Sys 2 COMSEC 1 & 2 Power Redundancy FCL 1,2 Cntlr B Rad Byp Vlv Mtr man cntl	APU GG Inj H2O Htrs 1A,2A Lube Oil Htr 1A 1 GG Bed T ind (APU running) 1 Gbx P ind (APU running) Hyd Circ Pump 1,3 MNA Pwr Bk A,Elvln A,Aft Fus A Htrs FES H2O Fdln B Htrs 1 RCS/OMS Htrs L Pod A F RCS A L,R RCS Manf 2 Jet Htrs RMS MRL Redun NWS Fail ind PRLA Drive Mtrs (all) Redun -Y S Trk Sys 1 Door Mtr *****man sw cap***** Atm P Cntlr O2 Sys 1 Sply FC1 STOP & Reac Vlvs FC3 Redun Reac Vlv Close (via pnl C3) Cryo O2/H2 Manf Vlv Tk 1 L ADI Att Ref Set cap Hyd Bk Isol Vlv 1 MPS/TVC Isol Vlv 1 ET Door C/L,L,R Lat, L Dr Mtrs Redun	F1 Manf RJDs (if sw OFF) L RCS Manf Isol 2 F RCS Manf Isol 1 *****man CL cap***** L,R RCS Xfeed 3/4/5 A OMS Tk Isol A Xfeed A F,L RCS He P A *****man OP & CL cap***** L RCS Tk Isol 3/4/5 A F RCS Tk Isol 3/4/5 R OMS He P Isol A Vap Isol 1,2

(Cont next page)

CNTL AB1 (Cont)			*****man ON cap***** NH3 SYS A SEC/ON CNTLR Cryo O2/H2 Tk 1 Htr B 3 Htr A	
CNTL AB2	L HUD MMU 2 F1 Manf Jets Top/Hi Load Duct Htrs A FES Cntrl Pri B ON H2O Loop 1 Pump A (ON) ATVC Ch 2 SSME Isol cap CDR sws Green Dot Top L Noz Htr B	L Probe Mtr L OMS Ignition Path APU GG/Fu Pump Htrs 1A Tk/Fu Ln Htrs 1A,3B Fu Tk Vlv 2B Blr Cntrl 1B Hyd 1,3 Mn Pump Depress Redun PLBD C/L,Blkhd Lat Mtrs Redun Rad Port/Stbd Lat, Pnl Mtrs Redun	APU GG Inj H2O Tk Htr A Hyd Circ Pump 1 MNA Pwr Rud Spdbk A Htr FES H2O Fdln A Htrs 1 RCS/OMS Htrs L Pod A F RCS A *****man sw cap***** Cryo O2/H2 Tk 1 Htr B Tk 3 Htr A Manf Vlv Tk 1 FC1 STOP, Reac Vlvs FC3 Redun Reac Vlv Close (via pnl C3) L ADI Att Ref Set cap Atm P Cntrl O2 Sys 1 Sply Hyd MPS/TVC Isol Vlv 1 LG Extend Iso Vlv ET Door C/L,L,R Lat,R Dr Mtrs Redun -Y S Trk Sys 1 Door Mtr Close cap *****man ON cap***** NH3 SYS B SEC/ON CNTLR	*****man sw cap***** L Manf 5 RJDs (if sw OFF) R RCS Manf Isol 2 *****man CL cap***** L,R RCS Xfeed 3/4/5 OMS Tk Isol A Xfeed A F RCS Tk Isol 3/4/5 (and man GPC CL ovrd) R RCS He P A *****man OP & CL cap***** R RCS Tk Isol 3/4/5 A **man OP,CL, & GPC cap** L,F RCS He P A

(Cont next page)

CRITICAL EQUIPMENT LOST – CONTROL BUS AB (Cont)

BUS LOST	CRITICAL FUNCTIONS/ EQUIPMENT LOST	CRITICAL REDUNDANCY LOST	INSTRUMENTATION/OTHER	OMS/RCS AFFECTED
CNTL AB3	Top/Hi Load Duct Htrs A Auto PLBD Ops H2O Loop 1 Pump A CDRs BFS Engage GPCs 1,2,4 – No Engage MPS Dump Seq Start sw	L Probe Mtr 1 Dpy Dsc 1 APU GG/Fu Pump Htrs 1B Tk/Fu Ln Htrs 1A,3B Cntlr Pwr 3B Fu Tk Vlv 3B Blr Cntrlrs 1A,3A PLBD C/L,Blkhd Lat,Stbd Dr Mtrs Redun Rad Port/Stbd Pnl Mtrs Redun Fwd/Mid/Aft Vent Dr Mtrs Redun LG Hyd Sys 1 Dpy NWS Hyd Sys 1 COMSEC 1 & 2 Power Redundancy	Hyd Circ Pump 1 MNB Pwr Bdyflp A Htr APU GG Inj H2O Htr 3B Lube Oil Htr 1B 3 Turbine Speed ind Rad Port/Stbd Pnl tbs RMS MRL Redun RCS/OMS Htrs Xfeed Ln A All Pnl C3 Man Mode pbs (18) -Y S Trk Sys 1 Door Mtr *****GPC***** ET Door C/L,L Lat, L Dr Mtrs Redun	F RCS Tk Isol 3/4/5 Manf Isol 1 **man OP,CL, & GPC cap** R RCS He P A

CRITICAL EQUIPMENT LOST – CONTROL BUS BC

BUS LOST	CRITICAL FUNCTIONS/ EQUIPMENT LOST	CRITICAL REDUNDANCY LOST	INSTRUMENTATION/OTHER	OMS/RCS AFFECTED
CNTL BC1	R HUD RGA 2 S-Bd String 1 Top L Noz Htr A L Pnl Trim L Body Flap Top/Hi Load Duct Htrs B GPS 2(OV103,4) C ME Shutdown pb	PSP 1 PL Intrg 1 F,L,R Manf 5 Jets L,R Probe Mtrs 2 FC H2O Ln & Rlf Htrs B APU GG/Fu Pump Htrs 1B,2A Tk/Fu Ln Htrs 1B,2A Cntlr Pwr 1B Fu Tk Vlv 1B Blr Cntlr 2B Hyd 1,2 Mn Pump Depress Redun PLBD C/L,Blkhd Lat,Port Dr Mtrs Redun Rad Port/Stbd Lat,Stbd Pnl Mtrs Redun Ku-Bd Sto/Dpy Mtr Redun LG B/U Rel Sys 2 NLG Hyd Sys 2 Dpy NWS Hyd Sys 2 Drag Chute CDR Dpy, Jett FCL 1 Cntlr A Rad Byp Vlv Mtr man cntl	APU Lube Oil Htr 2A GG Inj H2O Htrs 1B,2B 1 Turbine Speed ind Hyd Circ Pump 1,2 MNB Pwrs Bk B,Bdyflp B Htrs RCS/OMS Htrs L Pod B R Pod A F RCS B RMS MPM,MRL Redun L,R RCS Manf 1 Jet Htrs PDI Redun PRLA Drive Mtr (all) Redun -Y S Trk Sys 2 Door Mtr Close cap -Z S Trk Sys 1 Door Mtr FCL 2 Rad Byp Vlv Byp, Rad tb *****man sw cap***** Hyd Bk Isol Vlv 2 MPS/TVC Isol Vlv 2 Cryo O2/H2 Manf Vlv Tk 2 Tk 2,4 Htrs Atm P Cntl O2 Sys 2 Sply FC1 Redun Reac Vlv Close (via pnl C3) FC2 STOP, Reac Vlvs R ADI Att Ref Set cap	F2 Manf RJDs (if sw OFF) L RCS Manf Isol 1 F RCS Manf Isol 2 *****man CL cap***** L OMS Tk Isol B L,R OMS Xfeed B F,R RCS He P B ****man OP & CL cap**** L,R OMS He P/Vap Isol B L RCS Tk Isol 3/4/5 B

(Cont next page)

CNTL BC2	IDP 2 MDU CRT 2 S-Bd String 2 R Pnl Trim R Body Flap F2 Manf Jets PLT sws Green Dot ASA Ch 4 Isol cap Top/Hi Load Duct Htrs B L ME Shutdown pb H2O Loop 1 Pump B (ON) NH3 Cntrl B Pri	PSP 2 PL Intrg 2 F,L,R Manf 5 Jets L,R Probe Mtrs 2 APU GG/Fu Pump Htrs 2A Tk/Fu Ln Htrs 1B,2A Cntrl Pwr 2A Fu Tk Vlv 2B 2 Gbx GN2 Repress Vlv Blr Cntrl 2B Hyd 1,2 Mn Pump Depress Redun PLBD Blkhd Lat,Stbd Dr Mtrs Redun Rad Port/Stbd Lat,Stbd Pnl Mtrs Redun Ku-Bd Sto/Dpy Mtr Redun LG B/U Rel Sys 2 NLG Hyd Sys 2 Dpy NWS Hyd Sys 2 Drag Chute CDR Dpy, Jett	Freon Loop 1 Cldplate Flow Xdcr RCS/OMS Htrs L Pod B R Pod A F RCS B APU GG Inj H2O Tk Htr B APU 2 GG Bed T ind (APU running) APU 2 Gbx P ind (APU running) Hyd Circ Pump 2 MNB Pwr Elvn B Htr FES H2O Fdln A Htrs 2 PDI Redun RMS MPM,MRL Redun NH3 Cntrl B Sec Auto switchover Cryo O2/H2 Tk 2/4 Htrs A All Pnl A6 Man Mode pbs (18) PRLA Drive Mtr (all) Redun -Y S Trk Sys 2 Door Mtr -Z S Trk Sys 1 Door Mtr Close cap *****GPC***** Sec FES Cntrl (if GPC) *****man sw cap***** Hyd MPS/TVC Isol Vlv 2 Atm P Cntl O2 Sys 2 Sply Cryo O2/H2 Manf Vlv Tk 2 FC2 STOP, Reac Vlvs FC1 Redun Reac Vlv Close (via pnl C3) R ADI Att Ref Set cap	R RCS Manf Isol 1 *****man CL cap***** L OMS Tk Isol B L,R OMS Xfeed B *****man OP & CL cap***** R RCS Tk Isol 3/4/5 B **man OP,CL, & GPC cap** F,R RCS He P B
-----------------	--	---	--	---

(Cont next page)

CRITICAL EQUIPMENT LOST – CONTROL BUS BC (Cont)

BUS LOST	CRITICAL FUNCTIONS/ EQUIPMENT LOST	CRITICAL REDUNDANCY LOST	INSTRUMENTATION/OTHER	OMS/RCS AFFECTED
CNTL BC3	H2O Loop 1 Pump B ATVC Ch 3/4 SSME Isol cap R ME Shutdown pb Top R Noz Htr A MPS Dump Seq Start sw Sec FES Cntrl (if sw ON) Top/Hi Load Duct Htrs B Auto PLBD Ops	L,R Probe Mtrs 2 Dpy Dsc 2 APU GG/Fu Pump Htr 2B Tk/Fu Ln Htrs 1B,2A Fu Tk Vlv 3B Blr Cntrlrs 1A,2A PLBD C/L,Blkhd Lat,Port/Stbd Dr Mtrs Redun Rad Port/Stbd Pnl Dpy Mtrs Redun Fwd/Mid/Aft Vent Dr Mtrs Redun LG B/U Rel Sys 1	Hyd Rud Spdbk B Htr Rad Port Pnl tb RMS Redun RCS/OMS Htrs Xfeed Ln B All Pnl C3 Man Mode pbs (18) Smoke Det Circ Test NH3 Cntrl A Pri NH3 Cntrl A Sec Auto switchover -Y S Trk Sys 2 Door Mtr -Z S Trk Sys 1 Door Mtr *****man ON cap***** Cryo O2/H2 Tk 2,4 Htr B *****GPC***** ET Door C/L,L/R Lat,R Dr Mtrs Redun	F4/5 Manf RJDs (if sw OFF) F RCS Manf Isol 2

CRITICAL EQUIPMENT LOST – CONTROL BUS CA

BUS LOST	CRITICAL FUNCTIONS/ EQUIPMENT LOST	CRITICAL REDUNDANCY LOST	INSTRUMENTATION/OTHER	OMS/RCS AFFECTED
CNTL CA1	IDP 3 MDU CRT 3 RGA 3 Top R Noz Htr B Hi Load Duct Htrs C GPCs 3,5 No Engage cap PLTs BFS Engage cap FES Pri A GPC cap ATVC Ch 1 SSME Isol cap H2O Loop 2 GPC cap	R Probe Mtr 1 R OMS Ignition Path APU GG/Fu Pump Htrs 2B,3A Tk/Fu Ln Htrs 2B,3A Fu Tk Vlv 1B Blr Cntrl 3B Hyd Mn Pump Depress 2,3 Redun Bk/Skid Pwr Redun PLBD C/L,Port Blkhd Lat Mtrs Redun Rad Stbd Lat,Port Pnl Mtrs Redun Ku-Bd Sto/Dpy Mtr Redun NWS Hyd Sys 1 LG Hyd Sys 1 Dpy Drag Chute PLT Dpy, Jett FCL 2 Cntrl A Rad Byp Vlv Mtr man cntl	Freon Loop 2 Cldplate Flow Xdcr APU Lube Oil Htr 3A Hyd Circ Pump 2,3 MNC Pwr Bk C, Aft Fus B Htrs RMS MRL Redun FES H2O Fdln B Htrs 2 RCS/OMS Htrs R Pod B L,R RCS Manf 3 Jet Htrs -Z S Trk Sys 2 Door Mtr Top Evap Duct Htrs C Hi Load Duct Htrs C *****man sw cap***** FC2 Redun Reac Vlv Close (via pnl C3) FC3 STOP, Reac Vlvs A ADI Att Ref Set cap Hyd Bk Isol Vlv 3 MPS/TVC Isol Vlv 3 ET Door C/L,L/R Lat, L Dr Mtrs Redun *****man ON cap***** Cryo O2/H2 Tk 1 Htr A Tk 3 Htr B NH3 SYS B SEC/ON CNTLR	F3 Manf RJDs (if sw OFF) F,L RCS Manf Isol 3 R RCS Manf Isol 3/4 *****man OP & CL cap***** F RCS Tk Isol 1/2 L OMS He P/Vap Isol A *****man CL cap***** L,R RCS Tk Isol 1/2 Xfeed 1/2 R OMS Tk Isol B L RCS He P B L,F RCS Manf Isol 5

(Cont next page)

CNTL CA2	IDP 4 MDU CRT 4 R Pnl Trim Body Flap F3 Manf Jets L ME Shutdown pb FES Cntrl Pri A if sw ON	R Probe Mtr R OMS Ignition Path APU GG/Fu Pump Htr 3A Tk/Fu Ln Htrs 2B,3A Cntrl Pwr 2B Fu Tk Vlv 2A Blr Cntrl 3B Hyd 2,3 Mn Pump Depress Redun Bk/Skid Pwr Redun PLBD C/L,Stbd Blkhd Lat, Port Dr Mtrs Redun Rad Port Lat,Port Pnl Mtrs Redun Ku-Bd Sto/Dpy Mtr Redun LG B/U Rel Sys 1 Drag Chute PLT Dpy, Jett	APU GG Inj H2O Htr 3A 2 Turbine Speed ind Hyd Circ Pump 3 MNC Pwr Cryo O2/H2 Tk Htrs 1A,3B RCS/OMS Htrs R Pod B L,R RCS Manf 4 Jet Htrs RMS MPM Redun A ADI Sel (three) Att Ref Set All Pnl A6 Man Mode pb (18) -Z S Trk Sys 2 Door Mtr Close cap HI LOAD Duct IB/OB, Noz Htrs C Topping Duct FWD/AFT Htrs C *****man sw cap***** FC3 STOP, Reac Vlvs FC2 Redun Reac Vlv Close (via pnl C3) Hyd MPS/TVC Isol Vlv 3 ET Dr C/L,L/R Lat, R Dr Mtrs Redun *****man ON cap***** NH3 SYS A SEC/ON CNTLR	L,F RCS Manf Isol 4 ***man CL & GPC CL cap*** F RCS Tk Isol 1,2 *****man CL cap sw***** L,R RCS Tk Isol 1/2 Xfeed 1/2 R OMS Tk Isol B **man OP, CL, & GPC cap** L RCS He P B ****man OP & CL cap**** L,R,F RCS Manf Isol 5
-----------------	---	--	--	--

(Cont next page)

CRITICAL EQUIPMENT LOST – CONTROL BUS CA (Cont)

BUS LOST	CRITICAL FUNCTIONS/ EQUIPMENT LOST	CRITICAL REDUNDANCY LOST	INSTRUMENTATION/OTHER	OMS/RCS AFFECTED
CNTL CA3	F4 Manf Jets Auto PLBD Ops R ME Shutdown pb	R Probe Mtr 1 Dpy Dsc 1 APU GG/Fu Pump Htrs 3B Tk/Fu Ln Htrs 2B,3A Cntlr Pwr 3A Fu Tk Vlv 3A 3 Gbx GN2 Repress Vlv Blr Cntrs 2A,3A PLBD C/L,Blkhd Lat,Port Dr Mtrs Redun Rad Port/Stbd Pnl Mtrs Redun Fwd/Mid/Aft Vent Dr Mtrs Redun	APU Lube Oil Htrs 3B 1 GG Bed T ind (APU running) APU 1 Gbx P ind (APU running) Hyd Circ Pump 3 MNA Pwr Rad Port/Stbd Pnl tbs L,R RCS Manf 5 Jet Htrs Cryo O2/H2 Tk 2,4 Htrs B RMS Redun -Z S Trk Sys 2 Door Mtr HI LOAD Duct IB/OB, Noz Htrs C Topping Duct FWD/AFT Htrs C *****GPC***** ET Door C/L,R Lat,L/R Dr Mtr Redun	F RCS Tk Isol 1/2 Manf Isol 3/4 *****man OP & CL cap***** R RCS Manf Isol 5

CRITICAL EQUIPMENT LOST – ESS BUSES

BUS LOST	CRITICAL FUNCTIONS/ EQUIPMENT LOST	CRITICAL REDUNDANCY LOST	INSTRUMENTATION/OTHER	OMS/RCS AFFECTED
ESS 1 BC	DA1	GPS 1(OV105)	APU Fu Tk Vlv 1A	FC1/MNA & MNA Bus Tie tb
	MPC1	FC1 Cntrl (FC1 Pumps)		*****switches lost***** Cryo O2/H2 Manf Vlv Tk 1 FC1 Reac Vlvs (and tb)
	FP & LC1			*****switches lost***** Inv Pwr 1 (tb lost)
	FD	FC1 Cntrl (FC1 Pumps)	OIU 1 Pwr Redun	TACAN 1 Auto Self-Test (OV103,4) *****switches lost***** Inv Pwr 1, Inv/AC Bus 1 Cryo O2/H2 Tk 2,4 Htrs (test,reset) GPC 1,4 HALT,TERM cap
	O13 & R14	CDRs ATU/CCU All C/W annun lts (F7)	C/W Sys A Pwr Sply: Pnl lts/Functions (R13) Pri C/W Limit Sensing Smoke Detn A Siren Cryo O2(H2) Tk 1,2 Htrs AUTO LG ARM/DN Reset	Cryo O2/H2 Tk 2 Qty Xdcr AC1 Bus Snsr L Glrshld Flood Docking Sys Pwr Redun
	ML86B		Cryo O2(H2) Tk 3,4 Htrs AUTO	Cryo O2/H2 Tk 4 Qty Xdcr
APC4				

(Cont next page)

ESS

E S S 2 C A	DA2	GPS 2(OV105)	APU Fu Tk Vlv 2A	FC2/MNB & MNB Bus Tie tb	
	MPC2	FC2 Cntrl (FC2 Pumps)		*****switches lost***** Cryo O2/H2 Manf Vlv Tk 2 FC2 Reac Vlvs (and tb)	
	FP & LC2			*****switches lost***** Inv Pwr 2 (tb lost)	
	FD	FC2 Cntrl (FC2 Pumps) OIU 2	OIU 1 Pwr Redun	TACAN 2 Auto Self-Test (OV103,4) *****switches lost***** Inv Pwr 2, Inv/AC Bus 2 Cryo O2 Tk 1 Htrs (test,reset) GPC 2,5 HALT,TERM cap	
	O13 & R14	PLTs ATU/CCU Audio Center 1	ACCU Data Word Redun C/W Sys B Pwr Sply: B/U C/W Alarm annun It – on (cannot be reset) Sleep Sta Hdst Tones Smoke Detn B Siren Cryo O2(H2) Tk 1,2 Htrs AUTO	Cryo O2/H2 Tk 1 Qty Xdcr AC2 Bus Snsr R Glrshld Flood Docking Sys Pwr Redun	
	APC5				

(Cont next page)

CRITICAL EQUIPMENT LOST – ESS BUSES (Cont)

BUS LOST	CRITICAL FUNCTIONS/ EQUIPMENT LOST	CRITICAL REDUNDANCY LOST	INSTRUMENTATION/OTHER	OMS/RCS AFFECTED	
DA3	GPS 3(OV105)	APU Fu Tk Vlv 3A	FC3/MNC & MNC Bus Tie tb MNC/PRI PL tbs		
ESS 3 A B	MPC3	FC3 Cntr (FC3 Pumps)	*****switches lost***** FC3 Reac Vlvs (and tb)		
	FP & LC3		*****switches lost***** Inv Pwr 3 (tb lost)		
	FD	FC3 Cntr (FC3 Pumps) BFS Engage cap (Do not engage BFS)		TACAN 3 Auto Self-Test (OV103,4) *****switches lost***** Inv Pwr 3, Inv/AC Bus 3 Cryo O2 Tk 3 Htrs (test,reset) GPC 3 HALT,TERM cap	
	O13	CAM Status Matrix	Cryo O2(H2) Tk 3,4 Htrs AUTO	AC3 Bus Snsr Docking Sys Pyro Pwr Redun	
	ML86B			Cryo O2/H2 Tk 3 Qty Xdcr	
	APC6				



This Page Intentionally Blank



MDM

MDM FF1	2-2
FA1	2-3
FF2	2-4
FA2	2-5
FF3	2-6
FA3	2-7
FF4	2-8
FA4	2-9
PL1	2-10
PL2	2-11
OI DSC LOSS	2-12
NOTES	2-12
DISP 78 SM SYS SUMM 1 (PASS)	2-13
(BFS)	2-14
79 SM SYS SUMM 2 (PASS)	2-15
(BFS)	2-16
89 PRPLT THERMAL	2-17
19 GNC SYS SUMM 2	2-18
MDM/DCU/DSC LOSS	2-20
DISP 167 DOCKING STATUS	2-20
ADC DATA LOSS (MEDS only)	2-22
MEDS QUICK REFERENCE	2-24

MDM

MDM

FF1				
BCE	GPC INPUT		BCE	GPC INPUT
A	F RCS Ts & Ps MANF 1 P BFS QTY IMU 1 STATUS PNL F6 DISP SWs (eight)		ADTA GPS IMU MLS MTU NSP STKR TAC	ADTA 1 GPS 1(OV105) IMU 1 MLS 1 MTU ACCUM 1 NSP 1 -Z S TRK TACAN 1 RADAR ALT 1
				GPC OUTPUT
B	AA 1		AA TEST	
	F RCS MANF 1 JET RM		ADTA 1 TEST	
	L ADS DEPLOY DISC	- A*	F RCS He PRESS VLV A	
	RMG NO WOW	- 1*	MANF 1 JETS	
	CNTRLs/PBIs/SWs:		IMU 1	
	AFT DAP CNTL	- 3*	L OMS GMBL PRI SEL	
	RHC	- 1*	MLS 1 TEST	
	SENSE	- 1*	MTU UPDATE	- 1*
	THC	- 1*	NWS 1	
	C ME S/D PB (S/D INOP)		RADAR ALT 1 TEST	
			GPS 1(OV105)	
	FCS CH 1 ORIDE	- 2*	TACAN 1(OV103,4)	
	3 ORIDE	- 2*	-Z S TRK	
	4 ORIDE	- 3*	DISPLAYS:	
	ENTRY MODE	- 1*	C/W: L RCS (LK/TK P)	
	FWD DAP AXES	- A*	FWD DAP LIGHTS	
	CNTRL	- 1*	L FCS MODE LIGHTS:	
	THC	- 1*	BDY FLP AUTO	
	L ATT REF		P & R/Y AUTO	
	BDY FLP	- A*	SPD BRK AUTO	
	FCS MODE	- 1*	RCS COMMAND LIGHTS	- A*
	PNL TRIM	- A*	FWD,L,R RCS OXID QTY	
	RHC	- 1*	FWD,L RCS LOWEST QTY	
	TRIM INH	- A*	SPI: ELEVON POS	
	TRIM	- A*	SPD BRK POS	
	RUD PEDAL	- 1*	CMD	
	SBTC	- 1*	RUD POS	
	MAN	- 1*	OFF FLAG	
	MSTR RCS XFEED	- 1*		
	SEP, ET, & SRB	- 1*		
	NWS POS FDBK A	- 1*		

*In INPUT & OUTPUT columns, A(B) indicates dual redundancy; 1(2,3,4) indicates triple or quad redundancy

FA1		
BCE	GPC INPUT	
C	L,R OMS Ps RCS MANF 1 P L RCS Ts and Ps	
D	FCS CH 1 FDBK BYP IND	
	HYD 1 P	- 1*
	2 P	- 2*
	L OMS GMBL PRI FDBK	
	ARM	- B*
	ARM/PRESS	- B*
	L RCS MANF 5 JET RM	
	VLV STATUS	
	L,R RCS MANF 1 JET RM	
	RGA 1	
GPC OUTPUT		
	BDY FLP	- 1*
	FCS CH 1 CMD	
	HYD BRAKE ISOL VLV 1 OP CMD	
	MPS/TVC ISOL VLV 1 CMD	
	LG EXTEND ISOL VLV OP CMD	
	L OMS CNTL VLV 1	- B*
	GMBL PRI	
	He P/VAP ISOL VLV A	
	PURGE VLV 1	
	L RCS MANF 5 JETs	
	L,R RCS MANF 1 JET	
	He PRESS VLV A	
	TK ISOL VLV 1/2 CL	
	OP	- A*
	R OMS CNTL VLV 1	- B*
	RGA 1 - TEST	

FF2/FA2

*In INPUT and OUTPUT columns, A(B) indicates dual redundancy; 1(2,3,4) indicates triple or quad redundancy

FF2/FA2

FF2				
BCE	GPC INPUT		BCE	GPC INPUT
A	F RCS MANF 2 P IMU 2 STATUS PNL F8 DISP SWs (eight)		ADTA GPS IMU MLS MTU TAC	ADTA 2 GPS 2 IMU 2 MLS 2 MTU ACCUM 2 TACAN 2 RADAR ALT 2
			GPC OUTPUT	
B	AA 2		AA 2 TEST	
	F RCS MANF 2 JET RM	- A*	ADTA 2 TEST	
	R ADS DEPLOY DISC	- B*	F RCS MANF 2 JETS	
	NLG NO WOW	- 1*	GPS 2(ALL)	
	LMG NO WOW	- 1*	IMU 2	
	RMG NO WOW	- 2*	L OMS GMBL SEC SEL	
	CNTRLs/PBIs/SWs:		MLS 2 TEST	
	AFT SENSE	- 2*	MTU UPDATE	- 2*
	RHC (PITCH,YAW)	- 2*	NWS 1	
	THC	- 2*	RADAR ALT 2 TEST	
	C ME S/D PB (S/D INOP)		TACAN 2(OV103,4)	
	FCS CH 1 ORIDE	- 1*	DISPLAYS:	
	2 ORIDE	- 1*	L FCS MODE LIGHTS:	
	3 ORIDE	- 3*	BDY FLP MAN	
	ENTRY MODE	- 2*	P and R/Y CSS	
	FWD DAP AXES	- B*	SPD BRK MAN	
	CNTL	- 2*	SPI: AILERON POS	
	THC	- 2*	BDY FLP POS	
	L BDY FLP	- B*		
	FCS MODE	- 2*		
	ME S/D PB (S/D INOP)			
	PNL TRIM	- B*		
	RHC	- 2*		
	TRIM INH	- B*		
	TRIM	- B*		
	RUD PED	- 2*		
	SBTC	- 2*		
	MAN	- 2*		
	R ATT REF			
	FCS MODE	- 1*		
	RHC	- 1*		
	RUD PEDAL	- 1*		
	SBTC	- 1*		
	MAN	- 1*		
	MSTR RCS XFEED	- 2*		
	NWS POS FDBK B	- 2*		

*In INPUT and OUTPUT columns, A(B) indicates dual redundancy; 1(2,3,4) indicates triple or quad redundancy

FA2	
BCE	GPC INPUT
C	L,R OMS Ps RCS MANF 3 P R RCS Ts and Ps
D	FCS CH 2 FDBK BYP IND HYD 1 P - 2* 2 P - 1* L OMS GMBL SEC FDBK L,R RCS MANF 3 JET RM RGA 2 R OMS ARM - B* ARM/PRESS - B* RCS MANF 5 VLV (JET RM)
-	HYD 3P - 3*
GPC OUTPUT	
	BDY FLP - 2* FCS CH 2 CMD HYD BRAKE ISOL VLV 2 OP CMD MPS/TVC ISOL VLV 2 CMD L OMS CNTL VLV 2 - B* GMBL SEC He P/VAP ISOL VLV B PURGE VLV 2 R RCS MANF 5 JETS L,R RCS MANF 3 JETS He PRESS VLV B TK ISOL VLV 3/4/5 A R OMS CNTL VLV 2 - B* RGA 2 - TEST

FF3/FA3

*In INPUT and OUTPUT columns, A(B) indicates dual redundancy; 1(2,3,4) indicates triple or quad redundancy

FF3/FA3

FF3					
BCE	GPC INPUT		BCE	GPC INPUT	
A	F RCS Ts and Ps MANF 4 P BFS QTY IMU 3 STATUS PNL A6 DISP SWs (three)		ADTA GPS IMU MLS MTU NSP STKR TAC	ADTA 3 GPS 3(OV105) IMU 3 MLS 3 MTU ACCUM 3 NSP 2 -Y S TRK TACAN 3(OV103,4) RNDZ RADAR**	
	GPC OUTPUT				
B	AA 3 F RCS MANF 4 JET RM 5 JET RM VLV STATUS L ADS DEPLOY DISC - B* NLG NO WOW - A* LMG NO WOW - 2* RMG NO WOW - 3* CNTLRs/PBIs/SWs: AFT ATT REF DAP AXES - A* CNTL - 1* RHC - 3* SENSE - 3* THC - 3* FCS CH 1 ORIDE - 3* 2 ORIDE - 2* 4 ORIDE - 2* ENTRY MODE - 3* FWD DAP CNTL - 3* THC - 3* L FCS MODE - 3* ME S/D PB (S/D INOP) RHC - 3* RUD PEDAL - 3* SBTC - 3* MAN - 3* R BDY FLP - A* FCS MODE - 2* ME S/D PB (S/D INOP) PNL TRIM - A* RHC - 2* TRIM INH - A* TRIM - A* RUD PEDAL - 2* SBTC - 2* MAN - 2* MSTR RCS XFEED - 3* SEP, ET, and SRB - 3*		AA 3 TEST ADTA 3 TEST F RCS He PRESS VLV B MANF 4 JETS 5 JETS IMU 3 MLS 3 TEST MTU UPDATE - 3* R OMS GMBL SEC SEL -Y S TRK NWS 2 GPS 3(OV105) TACAN 3(OV103,4) DISPLAYS: AFT DAP LIGHTS C/W: ADTA FCS CH SAT FWD RCS (LK/TK P) R RCS (LK/TK P) IMU L OMS ENG L RHC OMS TVC RCS JET RGA/AA R OMS ENG R RHC FWD,L,R RCS FU QTY R RCS LOWEST QTY - B* RCS CMD LTS - B* R FCS MODE LIGHTS: BDY FLP AUTO P and R/Y AUTO SPD BRK AUTO		

*In INPUT and OUTPUT columns, A(B) indicates dual redundancy; 1(2,3,4) indicates triple or quad redundancy

**No BCE msg associated w/loss of RNDZ RADAR

FA3	
BCE	GPC INPUT
C	L OMS Ps BALL VLVs AFT QTY Pc (FDI) L,R RCS MANF 2 P L RCS BFS QTY
D	FCS CH 3 FDBK BYP IND HYD 2 P - 3* 3 P - 1* L OMS ARM - A* ARM/PRESS - A* N2 P VLV POS IND L,R RCS MANF 2 JET RM VLV STATUS R OMS GMBL SEC FDBK RGA 3
GPC OUTPUT	
	BDY FLP - 3* FCS CH 3 CMD HYD BRAKE ISOL VLV 3 OP CMD HYD MPS/TVC ISOL VLV 3 CMD L OMS CNTL VLV 2 - A* L,R RCS MANF 2 JETS TK ISOL VLV 1/2 CL OP - B* XFEED VLV 1/2 CL OP - A* 3/4/5 CL OP - A* R OMS CNTL VLV 1 - A* GMBL SEC He P/VAP ISOL VLV A PURGE VLV 1 RGA 3 TEST

FF4/FA4

*In INPUT and OUTPUT columns, A or B indicates dual redundancy; 1, 2, 3, or 4 indicates triple or quad redundancy

FF4				
BCE	GPC INPUT		BCE	GPC INPUT
A	F RCS MANF 3 P		ADTA	ADTA 4
				GPC OUTPUT
B	AA 4 F RCS MANF 3 JET RM R ADS DEPLOY DISC - B* LMG NO WOW - 3* CNTLRs/PBIs/SWs: AFT DAP AXES - B* CNTL - 2* RHC (ROLL) - 2* FCS CH 2 ORIDE - 3* 3 ORIDE - 1* 4 ORIDE - 1* ENTRY MODE - 4* R BDY FLP - B* FCS MODE - 3* ME S/D PB (S/D INOP) PNL TRIM - B* RHC - 3* TRIM INH - B* TRIM - B* RUD PEDAL - 3* SBTC - 3* MAN - 3* SEP, ET and SRB - 2* NWS POS FDBK C - 3*			AA 4 TEST ADTA 4 TEST F RCS MANF 3 JETS R OMS GMBL PRI SEL NWS 2 DISPLAYS: R FCS MODE LIGHTS: BDY FLP MAN P and R/Y CSS SPD BRK MAN NWS FAIL LIGHT (POSN ERROR)

*In INPUT and OUTPUT columns, A or B indicates dual redundancy; 1, 2, 3, or 4 indicates triple or quad redundancy

FF4/FA4

FA4	
BCE	GPC INPUT
C	R OMS Ps BALL VLVs Pc (FDI) L,R RCS MANF 4 P R RCS BFS QTY
D	FCS CH 4 FDBK BYP IND HYD 1 P - 3* 3 P - 2* L,R RCS MANF 4 JET RM R OMS GMBL PRI FDBK ARM - A* ARM/PRESS - A* RGA 4
GPC OUTPUT	
	FCS CH 4 CMD HYD MPS/TVI ISOL VLV 3 CMD L OMS CNTL VLV 1 - A* L,R RCS MANF 4 JETS TK ISOL VLV 3/4/5 B - B* XFEED VLV 1/2 CL OP - B* 3/4/5 CL OP - B* R OMS CNTL VLV 2 - A* GMBL PRI He P/VAP ISOL B PURGE VLV 2 RGA 4 - TEST

*In INPUT & OUTPUT columns, A or B indicates dual redundancy; 1, 2, 3, or 4 indicates triple or quad redundancy

PL1/PL2

PL1/PL2

PL1		
BCE	GPC INPUT	
PL	PLBD CENTER LATCHES	- A (13-16 B)*
	PL BAY DR sw	- 2,3*
	PORT AFT RDY TO LAT LATCHES	- 1,2*
	FWD RDY TO LAT LATCHES	- 1,2*
	DOOR	- A*
	STBD AFT RDY TO LAT LATCHES	- B*
	FWD RDY TO LAT LATCHES	- 1*
	DOOR	- A*
KU	KU-A COMM	- A*
GPC OUTPUT		
	FLASH EVAP CNTLR PRI B	
	FREON PUMP LOOP 2 B	
	FCL 1 RAD ISO VLV	
	FC 1 PURGE VLV	
	2 PURGE VLV	
	GCIL DECODER A	
	H2O LOOP 1 PMP A	
	B	
	HYD SYS 1 CIRC PMP	- A*
	2 CIRC PMP	- A*
	3 CIRC PMP	- A*
	NH3 BLR CNTLR PRI A	
	MMU 1 (RECORDER)	
	PLBD AC PWR ENA 1,3,4	
	CENTER LATCHES	- A (13-16 B)*
	PORT FWD & AFT LATCHES	- A*
	DOOR	- B*
	STBD FWD LATCHES	- A*
	AFT LATCHES	- B*
	DOOR	- A*
	S-BD FM ANT SW ELECT 1	
	PM ANT SW ELECT 1	
	PSP 1	
	KU-A COMM/RDR	
	DISPLAYS:	
	ABORT LIGHT	- A*
	PL BAY DR tb	- A*
	IF FLOWN:	
	APCU1 OUTPUT VOLTS HI RES	
	LO	
	CONV A TEMPS	- B*
	OUTPUT CURRENT	- B*
	TRIP STATUS	

*In INPUT & OUTPUT columns, A or B indicates dual redundancy; 1, 2, 3, or 4 indicates triple or quad redundancy

PL2		
BCE	GPC INPUT	
PL	FC PURGE SEQ START	
	PLBD CENTER LATCHES	- B (13-16 A)*
	PL BAY DR sw	- 1,4*
	PORT AFT RDY TO LAT	- 3*
	LATCHES	- B*
	FWD RDY TO LAT	- 3*
	LATCHES	- B*
	DOOR	- A*
	STBD AFT RDY TO LAT	- 2,3*
	LATCHES	- A*
	FWD RDY TO LAT	- 2,3*
	LATCHES	- B*
	DOOR	- B*
GPC OUTPUT		
	CCTV UPLINK COMMAND	
	FLASH EVAP CNTLR PRI A	
	SEC	
	FREON PUMP LOOP 1 B	
	FCL 2 RAD ISO VLV	
	FC O2/H2 PURGE HTR	
	3 PURGE VLV	
	GCIL DECODER B	
	H2O LOOP 2 PMP	
	HYD SYS 1 CIRC PMP	- B*
	2 CIRC PMP	- B*
	3 CIRC PMP	- B*
	NH3 BLR CNTLR PRI A	
	B	
	MMU 2 (RECORDER)	
	PLBD AC PWR ENA 2,5,6	
	CENTER LATCHES	- B (13-16 A)*
	PORT FWD & AFT LATCHES	- B*
	DOOR	- A*
	STBD FWD LATCHES	- B*
	AFT LATCHES	- A*
	DOOR	- B*
	S-BD FM ANT SW ELECT 2	
	PM ANT SW ELECT 2	
	PSP 2	
	DISPLAYS:	
	ABORT LIGHT	- B*
	APU FUEL QTY	
	H2O QTY	
	L & R BFC LIGHT	
	PL BAY DR tb	- B*
	IF FLOWN:	
	APCU2 OUTPUT VOLTS HI RES	
	LO	
	CONV A TEMPS	- B*
	OUTPUT CURRENT	- B*
	TRIP STATUS	

*In INPUT & OUTPUT columns, A or B indicates dual redundancy; 1, 2, 3, or 4 indicates triple or quad redundancy

OIDSC
LOSS

OI DSC LOSS

NOTES

1. Loss of signal conditioning will usually (but not always) cause display of an off-scale low value for that parameter. 'L's will be displayed adjacent to this value. The following displays are to be used as road maps to determine if a grouping of displayed off-scale low measurements is the result of the failure of an OI DSC.
2. The pwr controls for the OI DSCs are as follows:

DSC OF 1/4	O14:B cb MNA OI SIG CONDR OF 1/4 A
	O15:B cb MNB OI SIG CONDR OF 1/4 B
DSC OF 2/3	O15:B cb MNB OI SIG CONDR OF 2/3 A
	O16:B cb MNC OI SIG CONDR OF 2/3 B
DSC OM 1/2	O14:B cb MNA OI SIG CONDR OM 1/2 A
	O15:B cb MNB OI SIG CONDR OM 1/2 B
DSC OL 1/2	O17:C SIG CONDR OL 1/2
DSC OR 1/2	O17:C SIG CONDR OR 1/2
DSC OA 1/2/3	O17:D SIG CONDR OA 1/2/3
DSC OM 3	O15:B cb MNB OI SIG CONDR OM 3 A
	O16:B cb MNC OI SIG CONDR OM 3 B

OI DSC
LOSS

	1									2									3									4									5												
	1	2	3	4	5	6	7	8	9	1	2	3	4	5	6	7	8	9	0	1	2	3	4	5	6	7	8	9	0	1	2	3	4	5	6	7	8	9	0	1	2	3	4	5	6	7	8	9	0
1	XXXX/XXX/078									SM SYS SUMM 1									XX X									DDD/HH:MM:SS																					
2																												DDD/HH:MM:SS																					
3	SMOKE			1/A			2/B			DC VOLTS									1/A			2/B			3/C																								
4	CABIN			OF1						FC									OM1			OM2			OM2																								
5	L/R FD			OF3			OF2			MAIN									OM2			OM2			OM1																								
6	AV BAY 1			OF2			OF3			ESS									OM2			OM2			OM1																								
7				2			OF1			OF3			A									B			C																								
8				3			OF1			OF2			CNTL 1									OF1			OF2			OF3																					
9				CABIN						2									OF1			OF2			OF3																								
10	PRESS			OF2						3									OF1			OF2			OF3																								
1	dP/dT-EQ			OF3			±X.XXXS			AC																																							
2	O2 CONC			XX.XS						VOLT ΦA									OF1			OF2			OF3																								
3	PPO2			OF1			OF2			ΦB									OF1			OF2			OF3																								
4	FAN ΔP			OF1						ΦC									OF1			OF2			OF3																								
5	HX OUT T			OF1						AMPS ΦA									XX.XS			XX.XS			XX.XS																								
6	O2 FLOW			OF1			OF2			ΦB									XX.XS			XX.XS			XX.XS																								
7	N2 FLOW			OF1			OF2			ΦC									XX.XS			XX.XS			XX.XS																								
8	IMU FAN			AXS			BXS			CXS			FUEL CELL																																				
9	ΔV			FC1			FC2			FC3			AMPS									OM1			OM1			OM1																					
20	SS1			XXXS			XXXS			XXXS			REAC VLV									XXS			XXS			XXS																					
1	SS2			XXXS			XXXS			XXXS			STACK T									OM1			OM2			OM2																					
2	SS3			XXXS			XXXS			XXXS			EXIT T									OM1			OM2			OM2																					
3	TOTAL AMPS			XXXXS						COOL P									OM1			OM2			OM2																								
4				KW			XXS			PUMP									XXS			XXS			XXS																								
5																									(XX)																								
6																																																	

'L' suggests loss of Dedicated Signal Conditioner

P
A
S
S

	1									2									3									4									5								
	1	2	3	4	5	6	7	8	9	1	2	3	4	5	6	7	8	9	1	2	3	4	5	6	7	8	9	1	2	3	4	5	6	7	8	9	1	2	3	4	5	6	7	8	9
1	XXXX/XXX/078									SM SYS SUMM 1									XX X DDD/HH:MM:SS																										
2																			BFS DDD/HH:MM:SS																										
3	SMOKE			1/A			2/B			DC VOLTS									1/A			2/B			3/C																				
4	CABIN			OF1						FC									OM1			OM2			OM2																				
5	L/R FD			OF3			OF2			MAIN									OM2			OM2			OM1																				
6	AV BAY 1			OF2			OF3												A			B			C			A																	
7				2			OF1			OF3			CNTL 1									OF1			OF2			OF3																	
8				3			OF1			OF2												2			OF1			OF2			OF3														
9																			3			OF1			OF2			OF3																	
10	CABIN									ESS									OM2									OM2									OM1								
1	PRESS			OF2						AC																																			
2	dP/dT			OF3						VOLT									ΦA			OF1			OF2			OF3																	
3	BU/EQ			OF2(3)			OF2(3)			ΦB									OF1			OF2			OF3																				
4	PPO2			OF1			OF2			ΦC									OF1			OF2			OF3																				
5	FAN ΔP			OF1						AMPS									ΦA			XX.XS			XX.XS			XX.XS																	
6	HX OUT T			OF1						ΦB									XX.XS			XX.XS			XX.XS																				
7	O2 FLOW			OF1			OF2			ΦC									XX.XS			XX.XS			XX.XS																				
8	N2 FLOW			OF1			OF2			FUEL CELL pH									XXS			XXS			XXS																				
9	IMU FAN ΔP						X.XXS			AMPS									OM1			OM1			OM1																				
20	ΔV FC1			FC2			FC3			REAC VLV									XXS			XXS			XXS																				
1	SS1			XXXS			XXXS			STACK T									OM1			OM2			OM2																				
2	SS2			XXXS			XXXS			EXIT T									OM1			OM2			OM2																				
3	SS3			XXXS			XXXS			COOL P									OM1			OM2			OM2																				
4	TOTAL AMPS			XXXXS						PUMP									XXS			XXS			XXS																				
5	KW			XXS																																									
6																												(XX)																	

B
F
S

	1			2			3			4			5																											
	1	2	3	4	5	6	7	8	9	0	1	2	3	4	5	6	7	8	9	0	1	2	3	4	5	6	7	8	9	0	1	2	3	4	5	6	7	8	9	0
1	XXXX/XXX/079			SM			SYS			SUMM			2			XX			X			DDD/HH:MM:SS																		
2																			DDD/HH:MM:SS																					
3																																								
4	CRYO TK			1			2			3			4			5			MANF1			MANF2																		
5	H2 PRESS			XXXS			XXXS			XXXS			XXXS			XXXS			OM1			OM2																		
6	O2 PRESS			XXXXS			XXXXS			XXXXS			XXXXS			XXXXS			OM1			OM2																		
7	HTR T1			OM1			OM1			OM1			OM2			OF2																								
8	T2			OM2			OM2			OF3			OF3			OF3																								
9																																								
10	APU			1			2			3			HYD			1			2			3																		
1	TEMP EGT			OA1			OA2			OA3			PRESS			OA2			OA1			OA3																		
2	B/U EGT			OA2			OA3			OA1			RSVR T			OA1			OA2			OA3																		
3	OIL IN			OA1			OA2			OA3			P			OA1			OA2			OA3																		
4	OUT			OA2			OA3			OA1			QTY			OA1			OA2			OA3																		
5	SPEED %			OA1			OA2			OA3			W/B																											
6	FUEL QTY			XXXS			XXXS			XXXS			H2O QTY			XXXS			XXXS			XXXS																		
7	PMP LK P			OM3			OM3			OM3			BYP VLV			XXXS			XXXS			XXXS																		
8	OIL OUT P			OA1			OA2			OA3																														
9																																								
20	AV BAY			1			2			3			THERM CNTL			1			2																					
1	TEMP			OF2			OF3			OF1			H2O PUMP P			OF2			OF3																					
2	FAN ΔP			X.XXS			X.XXS			X.XXS			FREON FLOW			OF2			OF3																					
3													EVAP OUT T			OA2			OA3																					
4																																								
5																																								
6																																								

P
A
S
S

(XX)

	1									2									3									4									5								
	1	2	3	4	5	6	7	8	9	1	2	3	4	5	6	7	8	9	1	2	3	4	5	6	7	8	9	1	2	3	4	5	6	7	8	9	1	2	3	4	5	6	7	8	9
1	XXXX/XXX/079									SM SYS SUMM 2									XX X									DDD/HH:MM:SS																	
2																												BFS DDD/HH:MM:SS																	
3	CRYO TK			1			2			3			4			5			MANF1			MANF2																							
4	H2 PRESS			XXXS			XXXS			XXXS			XXXS			XXXS			OM1			OM2																							
5	O2 PRESS			XXXXS			XXXXS			XXXXS			XXXXS			XXXXS			OM1			OM2																							
6	HTR T1			OM1			OM1			OM1			OM2			OF2																													
7	T2			OM2			OM2			OF3			OF3			OF3																													
8	APU									1			2			3			HYD									1			2			3											
9	TEMP EGT			OA1			OA2			OA3			PRESS			OA2			OA1			OA3																							
10	B/U EGT			OA2			OA3			OA1			ACUM P			OM3			OM2			OM2																							
1	OIL IN			OA1			OA2			OA3			RSVR T			OA1			OA2			OA3																							
2	OUT			OA2			OA3			OA1																																			
3	GG BED			XXXS			XXXS			XXXS			QTY			OA1			OA2			OA3																							
4	INJ			OA1			OA2			OA3																																			
5	SPEED %			OA1			OA2			OA3			W/B																																
6	FUEL QTY			XXXS			XXXS			XXXS			H2O QTY			XXXS			XXXS			XXXS																							
7	PMP LK P			OM3			OM3			OM3			BYP VLV			XXXS			XXXS			XXXS																							
8	OIL OUT P			OA1			OA2			OA3																																			
9	FU TK VLV																																												
20	A T			OM3			OM3			OM3			THERM CNTL			1			2																										
1	B T			OM1			OM1			OM1			H2O PUMP P			OF2			OF3																										
2	AV BAY			1			2			3			FREON FLOW			OF2			OF3																										
3	TEMP			OF2			OF3			OF1			EVAP OUT T			OA2			OA3																										
4	FAN ΔP			X.XXS			X.XXS			X.XXS																																			
5																												(XX)																	
6																																													

B
F
S

	1									2									3									4									5																						
	1	2	3	4	5	6	7	8	9	1	2	3	4	5	6	7	8	9	0	1	2	3	4	5	6	7	8	9	0	1	2	3	4	5	6	7	8	9	0	1	2	3	4	5	6	7	8	9	0	1	2	3	4	5	6	7	8	9	0
1	XXXX/XXX/089									PRPLT									THERMAL									XX X									DDD/HH:MM:SS																						
2	POD									L									R																		DDD/HH:MM:SS																						
3	OMS TK									OX OL2									OR2																																								
4										FU OL1									OR1									OMS CRSFD									L R C																						
5	ENG I/F									OX OL1									OR1									XFD									OX OA1 OA2 OA3																						
6										FU OL2									OR2									GMBL									LN OA1 OA2																						
7										OX VLV									OL1									OR1									DRN									OX OA3 OA3													
8										FU INJ									OL1									OR1																															
9																																																											
10	WEB KEEL									1 OL2									OR2																																								
1										2 OL2									OR2																																								
2	Y									OB OL2									OR2																																								
3										UP OL1									OR1																																								
4	OX DRN PNL									1 OL1									OR1																																								
5										2 OL1									OR1									FWD RCS									FU OX																						
6	ENG COVER									OM1									OM2									LINE									T1 OF2 OF4																						
7	SERV PNL									OL2									OR2																		T2 OF4 OF2																						
8	GSE SERV PNL									OL2									OR2																																								
9	TEST HE/OX									1 OL1									OR1									AFT RCS									L R																						
20										2 OL2									OR2									MANF 1									OX OL1 OR1																						
1																												DRN PNL									1 OL2 OR2																						
2																																					2 OL2 OR2																						
3																												VERN PNL									1 OL2 OR2																						
4																																					2 OL2 OR2																						
5																																														(XX)													
6																																																											

	1									2									3									4									5																						
	1	2	3	4	5	6	7	8	9	1	2	3	4	5	6	7	8	9	0	1	2	3	4	5	6	7	8	9	0	1	2	3	4	5	6	7	8	9	0	1	2	3	4	5	6	7	8	9	0	1	2	3	4	5	6	7	8	9	0
1	XXXX/XXX/019									GNC SYS SUMM 2									XX X DDD/HH:MM:SS									BFS DDD/HH:MM:SS																															
2																																																											
3	OMS AFT QTY			L			R			OMS									L			R																																					
4				OXID XX.XS			XX.XS			TK P			HE			OL2			OR2																																								
5				FU XX.XS			XX.XS						OXID			OA2/OL2			OA1/OR2																																								
6	FU INJ T			OL1			OR1						FU			OL1			OR1																																								
7	RCS			OXID			FU			JET			ISOL			N2 TK P			OL1			OR1																																					
8	FWD			HE P			OF4			OF2						REG P			OL1			OR1																																					
9				TK P			OF2			OF4						P VLV			XXS			XXS																																					
10				QTY			OF2(4)			OF2(3,4)						ENG IN P																																											
11	MANF			1 P			OF4			OF4			XXX			XXS			OXID			OL1			OR1																																		
12				2 P			OF4			OF4			XXX			XXS			FU			OL2			OR2																																		
13				3 P			OF2			OF2			XXX			XXS			VLV 1			XXXS			XXXS																																		
14				4 P			OF2			OF2			XXX			XXS			2			XXXS			XXXS																																		
15				5						XXX			XXS																																														
16	AFT			HE P			OL2			OL1									HE P			OR2			OR1																																		
17	L			TK P			OL1			OA1/OL2									R TK P			OR1			OA2/OR2																																		
18				QTY			OL1(2)			OL1(2)									QTY			OR1(2)			OR1(2)																																		
19	MANF			1 P			OL1			OL1			XXX			XXS			1 P			OR1			OA1/OR1			XXX			XXS																												
20				2 P			OL1			OL1			XXX			XXS			2 P			OR1			OA2/OR1			XXX			XXS																												
21				3 P			OL2			OA2/OL2			XXX			XXS			3 P			OR2			OA2/OR2			XXX			XXS																												
22				4 P			OL2			OA1/OL2			XXX			XXS			4 P			OR2			OR2			XXX			XXS																												
23				5						XXX			XXS			5									XXX			XXS																															
24																																																											
25																																																											
26																																																											

Note: indicates parameters are driven and displayed on the BFS displays only

This Page Intentionally Blank

**MDM/DCU/
DSC LOSS**

	1	2	3	4	5
	1	2	3	4	5
1	XXXX/XXX/167 DOCKING STATUS XX X DDD/HH:MM:SS				
2	DDD/HH:MM:SS				
3	CONTACT OF3 ₁	CNTL PNL PWR OA3 ₂ /OA2 ₂ /OA2 ₂	CNTL CMD PWR OA3 ₁		
4	CAPTURE OA1 ₁	HTR/DCU PWR OA2 ₂ /OA2 ₂ /OA3 ₂	RNG DR BUS OF3 ₁ /OA3 ₁		
5	DAMPING OF3 ₁	APDS PWR OA3 ₂ /OA3 ₂ /OA3 ₂	HKS DR BUS OA3 ₁ /OA3 ₁		
6	RNG ALGN OF3 ₁	APDS CIRC PROT OA1 ₁	DAMPER BUS OA3 ₁ /OA3 ₁		
7	RING POS OA2 ₂ / OA2 ₂ / OA2 ₂	FIXER BUS OA3 ₁ /OA1 ₁			
8	DRV CMD OA1 ₁	PMA 2 / 3		OP / CL	
9	FIXERS OA1 ₁	HK1 CMD OF1 OF2 / OF1 OF2			
10	CLUTCH OA1 ₃ / OA2 ₄	IND OF1 OF2 / OF1 OF2			
1	PETAL POS 1 2 3	HK2 CMD OF1 OF2 / OF1 OF2			
2	RING OF1 ₂ OF2 ₂ OF2 ₂	IND OF1 OF2 / OF1 OF2			
3	BASE OF2 ₂ OF2 ₂ OF1 ₂	HK CLS			
4	UNDOCK CMLT OA1 ₂	1 / 3 5 OA1 ₃ 7 / 9 / 11 OA1 ₃			
5	RDY TO HOOK OA1 ₂	2 / 4 / 6 OA2 ₄ 8 / 10 / 12 OA2 ₄			
6	HK1 DRV CMD OA1 ₁	ODS INDIV HK CL		ODS CONN	
7	POS OF1 ₁	1 3 5 7 9 11		X3 OA2 ₄	
8	IND OA1 ₂ /OA1 ₂	OA1 ₃ OA1 ₃ OA1 ₃ OA1 ₃ OA1 ₃ OA1 ₃		X4 OA1 ₃	
9	HK2 DRV CMD OA1 ₁				
20	POS OF1 ₁	2 4 6 8 10 12			
1	IND OA2 ₂ /OA2 ₂	OA2 ₄ OA2 ₄ OA2 ₄ OA2 ₄ OA2 ₄ OA2 ₄			
2	CAP LAT CMD OA1 ₁	PYRO LOGIC PWR		OA3 ₂ /OA3 ₂ /OA3 ₂	
3	IND OA2 ₂ /OA2 ₂	PYRO CIRC PROT		OA1 ₁ / OA1 ₁	
4	MAN REL OA2 ₂	PYRO MNA 40 / 6 AMP		OA1 / OA1	
5	(X X)				
6					

Note: Subscript numbers indicate Data Collection Unit or DSC channelization: Subscript 1 for DCU 1, subscript 2 for DCU 2, subscript 3 for DSC OA1, and subscript 4 for DSC OA2. Parameters without a subscript are not processed by a DCU or DSC

MEDS ADC
DATA LOSS

This Page Intentionally Blank

ADC DATA LOSS (MEDS only)

ADC 1A,1B DATA LOSS

MEDS ADC
DATA LOSS

DATA PARAMETER		MSID	CH
SPI	Aileron Position	V72H5131C	2
	Body Flap Position	V72H5130C	1
	Left Inboard Elevon Position	V72H5110C	3
	Left Outboard Elevon Position	V72H5112C	4
	Right Inboard Elevon Position	V72H5120C	5
	Right Outboard Elevon Position	V72H5122C	6
	Rudder Position	V72H5100C	8
	Speed Brake Command Position	V72H5106C	10
	Speed Brake Position	V72H5105C	7
	Valid Flag (not currently used)	V72X8283C	9
OMS	Left Chamber Pressure	V43P4649C	26
	Left He Tank Pressure	V43P4121C	24
	Left N2 Tank Pressure	V43P4547C	25
	Right Chamber Pressure	V43P5649C	30
	Right He Tank Pressure	V43P5121C	28
	Right N2 Tank Pressure	V43P5547C	29
MPS	Center Engine Chamber Pressure	V72P0040C	11
	Center Engine He Regulator Pressure	V41P1154A	21
	Center Engine He Tank Pressure	V41P1150C	20
	Left Engine He Regulator Pressure	V41P1254A	16
	Left Engine He Tank Pressure	V41P1250C	15
	Left Engine Chamber Pressure	V72P0041C	12
	Right Engine Chamber Pressure	V72P0042C	13
	Right Engine He Regulator Pressure	V41P1354A	23
	Right Engine He Tank Pressure	V41P1350C	22
	LO2 Engine Manifold Pressure	V41P1533C	19
	LH2 Engine Manifold Pressure	V41P1433C	14
	PNEU He Tank Pressure	V41P1600A	17
	PNEU He Regulator Pressure	V41P1605A	18

ADC 2A,2B DATA LOSS

DATA PARAMETER		MSID	CH
APU	1 Fuel Pressure	V46P0100A	7
	2 Fuel Pressure	V46P0200A	12
	3 Fuel Pressure	V46P0300A	17
	1 Fuel Quantity	V72Q6001V	1
	2 Fuel Quantity	V72Q6002V	3
	3 Fuel Quantity	V72Q6003V	6
	1 H2O Quantity	V72Q6040V	2
	2 H2O Quantity	V72Q6042V	4
	3 H2O Quantity	V72Q6044V	5
	1 Oil In Temperature	V46T0150A	8
	2 Oil In Temperature	V46T0250A	13
	3 Oil In Temperature	V46T0350A	18
	Hydraulic	1 Pressure	V58P0114C
2 Pressure		V58P0214C	15
3 Pressure		V58P0314C	20
1 Reservoir Quantity		V58Q0102A	11
2 Reservoir Quantity		V58Q0202A	16
3 Reservoir Quantity		V58Q0302A	21

**MEDS
QREF**

**MEDS
QREF**

MEDS QUICK REFERENCE

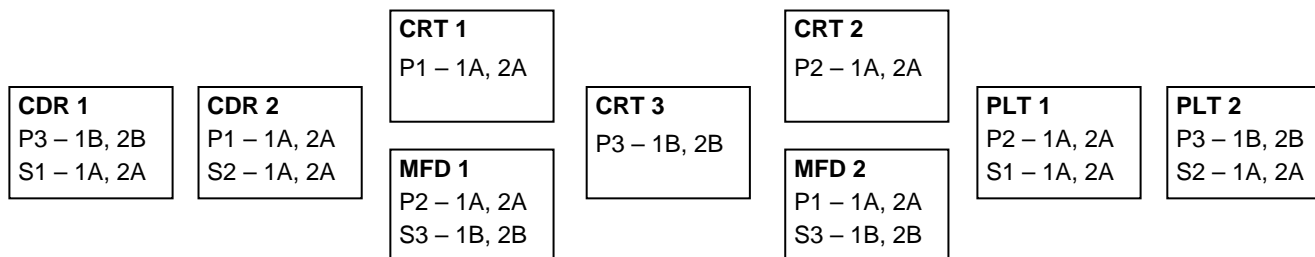

Legend:

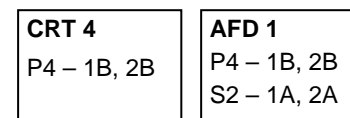
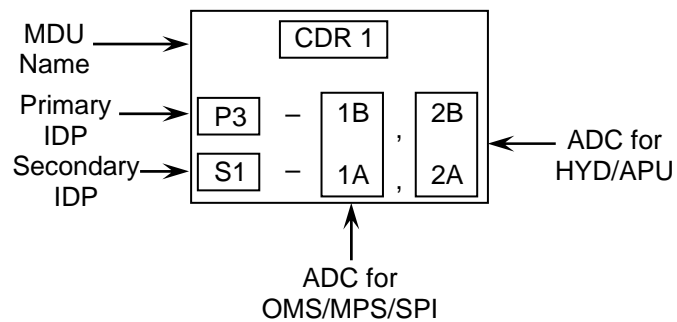

FAULT MESSAGES

3-1

REF/ALL/GEN I

**FAULT
MSG**

FAULT MSG

MESSAGE	OPS AVAIL		CAUSE	COMMENTS
	PASS	BFS		
S67 AC AMPS	1(2,3)	S2,4	• AC AMPS ↑	• ANY PHASE
S67 AC OVLD	1(2,3)	S2,4	• AC OVLD ↓	
SM1 AC OVLD 1(2,3)				
S67 AC VOLTS	1(2,3)	S2,4	• AC VOLTS ↑↓	• ANY PHASE
SM1 AC VOLTS 1(2,3)				
AERO DRIVE		G8	• SURFACE CMD/POS MISCOMPARE (I-LOAD)	• NO MAL • THRESHOLDS: ELEV = 5.8° RUD = 5.5° S/B = 10.9°
177 A/L H2O LCG LN	P1(2) T1(2)	S2,4 S2,4	• EXT A/L LCG SPLY P ↑↓ • EXT A/L H2O SPLY T ZN1(2) ↑↓ • EXT A/L LCG2 SPLY T ZN1(2) ↑↓ • EXT A/L QD PNL T ZN2 ↑↓	• QD PNL T ZN2 IS ACTUALLY O2 SPLY LN T ZN2
XFER	P	S2,4	• EXT A/L H2O XFER P ↑↓	
177 A/L STRUC	T	S2,4	• EXT A/L UPR BKHD T ↑↓ • EXT A/L LWR BKHD T ↑↓ • EXT A/L AFT STRUC T ↑↓	
177 A/L-VEST ANTENNA	DP	S2,4 S2,4	• AIRLOCK-VEST ΔP ↑↓ • QUAD ANT FAIL ↓	• MSG ONLY DURING AOS – CORRECTIVE ACTION BY MCC

MESSAGE		OPS AVAIL		CAUSE	COMMENTS
		PASS	BFS		
S67 APC/ALC	A(B,C)	S2,4		• AFT PCA V ↓	
S200 APCU 1(2) AMP	HIGH	S2		• APCU AMP ↑	• OV-104 ONLY
S200 APCU 1(2) TEMP	HIGH	S2		• APCU TEMP ↑↓	
S200 APCU 1(2)	TRIP	S2		• APCU TRIP ↑	
S200 APCU 1(2) VOLT	LMT	S2		• APCU VOLTS ↑↓	
S179 APCU1(2) IN	AMPS	S2,4		• APCU IN AMPS ↑	• OV-103 & OV-105 (SSPTS)
	UV	S2,4		• APCU TRIP IN UV (UNDER VOLT)	
S179 APCU1(2) OUT	AMPS	S2,4		• APCU OUT AMPS ↑	
	OC	S2,4		• APCU TRIP OUT OC (OVER CURRENT)	
	OV	S2,4		• APCU TRIP OUT OV (OVER VOLT)	
	UV	S2,4		• APCU TRIP OUT UV (UNDER VOLT)	
	VOLTS	S2,4		• APCU OUT VOLTS ↑↓	
S179 APCU1(2)	TEMP	S2,4		• APCU TEMP ↑↓	
SM2 APU 1(2,3)			SM	• APU TEMP OIL OUT ↑↓	
				• APU FUEL QTY ↓	
				• APU FUEL PUMP LK P ↑	
				• APU OIL OUT P ↑↓	• APU SPEED % > 40 + 10 SEC
APU 1(2,3) COOL DOWN			SM	• INJECTOR COOL DOWN COMPLETE	• APU OPER – INJ COOL + 3.5 MIN
S88 APU FU LN	1(2,3)	S2,4		• APU FUEL T TEST LN 1(2) ↑↓	
				• APU FUEL T FEED LN ↑↓	
				• APU FUEL T PUMP IN ↑↓	
				• APU FUEL T PUMP DRN LN 1(2) ↑↓	
S88 APU FU PMP	1(2,3)	S2,4		• APU FUEL T PUMP OUT ↑↓	
				• APU FUEL T PUMP BYP LN ↑↓	
				• APU FUEL T GG SPLY LN ↑↓	

┌

—

┐

—

This Page Intentionally Blank

—

└

3-4

REF/ALL/GEN I

—

└

MESSAGE		OPS AVAIL		CAUSE	COMMENTS
		PASS	BFS		
S86 APU FUEL	1(2,3)	S2,4		<ul style="list-style-type: none"> • APU FUEL QTY ↓ • APU FUEL TK P ↑↓ 	
S86 APU GBX P	1(2,3)	S2,4		<ul style="list-style-type: none"> • APU OIL OUT P ↑↓ • APU GBX P ↓ 	• NO MAL
T	1(2,3)	S2,4		<ul style="list-style-type: none"> • APU OIL OUT T ↑↓ • APU GBX BRG T ↑ 	• NO MAL
S88 APU H2O T	1(2,3)	S2,4		<ul style="list-style-type: none"> • H2O LN INJ ↑↓ 	
SM2 APU SPD HI 1(2,3)			SM	<ul style="list-style-type: none"> • APU SPEED % ↑ 	
SM2 APU SPD LO 1(2,3)			SM	<ul style="list-style-type: none"> • APU SPEED % ↓ 	
S86 APU TEMP	1(2,3)	S2,4		<ul style="list-style-type: none"> • APU B/U EGT ↑ • APU OIL T ↑ 	• NO MAL
SM2 APU TEMP 1(2,3)			SM	<ul style="list-style-type: none"> • APU TEMP OIL IN ↑ 	
S88 APU TANK T	1(2,3)	S2,4		<ul style="list-style-type: none"> • APU FUEL T TK SURF ↓ • APU FUEL T TK HTR ↑↓ 	
S66 AV BAY 1(2,3)	FAN	S2,4		<ul style="list-style-type: none"> • AV BAY 1(2,3) FAN ΔP ↑↓ 	
SM2 AV BAY FAN			SM		
S66 AV BAY 1(2,3)	TEMP	S2,4		<ul style="list-style-type: none"> • AV BAY 1(2,3) FAN AIR OUT T ↑ 	
SM2 AV BAY TEMP			SM		
BCE BYP	FLEX	S2,4		<ul style="list-style-type: none"> • BCE BYPASS ON FLEX/FLEX PAIR 	
BCE BYP	KU	S2,4		<ul style="list-style-type: none"> • PL 1 KU COMM/RADAR S10 FAIL 	<ul style="list-style-type: none"> • RADAR: GPC MODE NOT VALID UNLESS TRACKING, AUTO-TRACK MODE IS VALID • NO MAL
BCE BYP	MCIU	S2,4		<ul style="list-style-type: none"> • GPC DETECTED I/O LOSS WITH MCIU 	

B

MESSAGE		OPS AVAIL		CAUSE	COMMENTS
		PASS	BFS		
S62 BCE BYP	OA	S2,4		• OA1, OA2, OR OA3 MDM OR MDM CARD FAIL	
	OFA	S2,4		• OF1 OR OF2 MDM OR MDM CARD FAIL	
	OFB	S2,4		• OF3 OR OF4 MDM OR MDM CARD FAIL	
	PDI	S2,4		• PDI INTERFACE TO SM GPC FAIL	• MSG OCCURS AT SM OPS TRANSITION IF PDI POWER OFF
	PL	S2,4		• PDI SSC OR EXC INTERFACE TO PCMMU FAIL	• MSG OCCURS AT SM OPS TRANSITION IF PDI POWER OFF OR IF SPACELAB AND SSC OR EXC POWER OFF
	PSP 1(2)	S2,4		• PSP 1(2) TO PL 1(2) MDM SERIAL I/O FAIL	
BCE BYP	PL1(2)	S2,4		• BCE BYPASS ON PL BUSES	
BCE BYP	SCA	S2,4		• BCE BYPASS ON SCA	• NO MAL
BCE STRG 1	A	G1,2,3,6,8	G0,1,2,3,6	• ALL GPCs DETECTED PROBLEM RECEIVING DATA FROM INDICATED BCE ELEMENT OF STRING 1 AND HAVE BYPASSED THAT ELEMENT	• BFS PRE-ENGAGE MUST BE IN SYNC WITH (TRACKING) PASS TO ANNUNCIATE
	ADTA	G1,3,6,8	G0,1,3,6		
	B	G1,2,3,6,8	G0,1,3,6		
	C	G1,2,3,6,8	G0,1,3,6		

MESSAGE		OPS AVAIL		CAUSE	COMMENTS
		PASS	BFS		
BCE STRG 1 (Cont)	D	G1,2,3, 6,8	G0,1,3, 6	• ALL GPCs DETECTED PROBLEM RECEIVING DATA FROM INDICATED BCE ELEMENT OF STRING 1 AND HAVE BYPASSED THAT ELEMENT	• BFS PRE-ENGAGE MUST BE IN SYNC WITH (TRACKING) PASS TO ANNUNCIATE
	IMU	G1,2,3, 6,8	G0,1,3, 6		
	GPS	G1,2,3, 6, 8	G0,1,3, 6		
	MLS	G1,3,6, 8			
	MTU	G1,2,3, 6,8,0	G0,1,3, 6		
	NSP	G1,2,3, 6,8,0	G0,1,3, 6		
	STKR	G2,3,8			
	TAC	G1,3,6, 8	G0,1,3, 6	• ALL GPCs DETECTED PROBLEM RECEIVING DATA FROM INDICATED BCE ELEMENT OF STRING 1 AND HAVE BYPASSED THAT ELEMENT	• BFS PRE-ENGAGE MUST BE IN SYNC WITH (TRACKING) PASS TO ANNUNCIATE • RADAR ALTIMETER DATA LOST
	PASS		G0,1,3, 6	• BFS FAIL TO TRACK STRING 1	• NO MAL • I/O RESET MAY RESTORE PASS/BFS COMM
BCE STRG 2	A	G1,2,3, 6,8	G0,1,3, 6	• ALL GPCs DETECTED PROBLEM RECEIVING DATA FROM INDICATED BCE ELEMENT OF STRING 2 AND HAVE BYPASSED THAT ELEMENT	• BFS PRE-ENGAGE MUST BE IN SYNC WITH (TRACKING) PASS TO ANNUNCIATE
	ADTA	G1,3,6, 8	G0,1,3, 6		

MESSAGE	OPS AVAIL		CAUSE	COMMENTS	
	PASS	BFS			
BCE STRG 2 (Cont)	B	G1,2,3, 6,8	G0,1,3, 6	<ul style="list-style-type: none"> • ALL GPCs DETECTED PROBLEM RECEIVING DATA FROM INDICATED BCE ELEMENT OF STRING 2 AND HAVE BYPASSED THAT ELEMENT 	<ul style="list-style-type: none"> • BFS PRE-ENGAGE MUST BE IN SYNC WITH (TRACKING) PASS TO ANNUNCIATE
	C	G1,2,3, 6,8	G0,1,3, 6		
	D	G1,2,3, 6,8	G0,1,3, 6		
	IMU	G1,2,3, 6,8	G0,1,3, 6		
	GPS	G1,2,3, 6,8	G0,1,3, 6		
	MLS	G1,3,6, 8			
	MTU	G1,2,3, 6,8,0	G0,1,3, 6		
	TAC	G1,3,6, 8	G0,1,3, 6		
	PASS		G0,1,3, 6	<ul style="list-style-type: none"> • BFS FAIL TO TRACK STRING 2 	<ul style="list-style-type: none"> • NO MAL • I/O RESET MAY RESTORE PASS/BFS COMM
BCE STRG 3	A	G1,2,3, 6,8	G0,1,3, 6	<ul style="list-style-type: none"> • ALL GPCs DETECTED PROBLEM RECEIVING DATA FROM INDICATED BCE ELEMENT OF STRING 3 AND HAVE BYPASSED THAT ELEMENT 	<ul style="list-style-type: none"> • BFS PRE-ENGAGE MUST BE IN SYNC WITH (TRACKING) PASS TO ANNUNCIATE
	ADTA	G1,3,6, 8	G0,1,3, 6		

MESSAGE	OPS AVAIL		CAUSE	COMMENTS	
	PASS	BFS			
BCE STRG 3 (Cont)	B	G1,2,3, 6,8	G0,1,3, 6	<ul style="list-style-type: none"> ALL GPCs DETECTED PROBLEM RECEIVING DATA FROM INDICATED BCE ELEMENT OF STRING 3 AND HAVE BYPASSED THAT ELEMENT 	<ul style="list-style-type: none"> BFS PRE-ENGAGE MUST BE IN SYNC WITH (TRACKING) PASS TO ANNUNCIATE
	C	G1,2,3, 6,8	G0,1,3, 6		
	D	G1,2,3, 6,8	G0,1,3, 6		
	IMU	G1,2,3, 6,8	G0,1,3, 6		
	GPS	G1,2,3, 6,8	G0,1,3, 6		
	MLS	G1,3,6, 8			
	MTU	G1,2,3, 6,8,0	G0,1,3, 6		
	NSP	G1,2,3, 6,8,0	G0,1,3, 6		
	STKR	G2,3,8			
	PASS		G0,1,3, 6		

MESSAGE		OPS AVAIL		CAUSE	COMMENTS
		PASS	BFS		
BCE STRG 4	A	G1,2,3, 6,8	G0,1,3, 6	• ALL GPCs DETECTED PROBLEM RECEIVING DATA FROM INDICATED BCE ELEMENT OF STRING 4 AND HAVE BYPASSED THAT ELEMENT	• BFS PRE-ENGAGED MUST BE IN SYNC WITH (TRACKING) PASS TO ANNUNCIATE
	ADTA	G1,3,6, 8	G0,1,3, 6		
	B	G1,2,3, 6,8	G0,1,3, 6		
	C	G1,2,3, 6,8	G0,1,3, 6		
	D	G1,2,3, 6,8	G0,1,3, 6		
	PASS		G0,1,3, 6	• BFS FAIL TO TRACK STRING 4	• NO MAL • I/O RESET MAY RESTORE PASS/BFS COMM
BDY FLP SW	L(R)	G3,6		• BODY FLAP DN(UP) SW DISAGREE	• NO MAL • DEFAULT TO NO OUTPUT
BODY FLAP	CYCL	G1,3,6		• BODY FLAP LIMIT CYCLING BUT USABLE	• NO MAL
	FAIL	G1,3,6		• BODY FLAP STALLED OR RUNAWAY	
	HOLD	G1,3,6		• BODY FLAP ONE CH FAILED BUT USABLE	
SM0 BRAKE P 1/3 2/3			G0,1,3, 6	• BRAKE PRESS HYD SYS 1/3 L OB (L IB,R IB,R OB)↑	• PRESSURE >180 PSI IN BRAKES DRIVEN BY HYDRAULIC SYSTEM 1/3 • NO MAL
			G0,1,3, 6	• BRAKE PRESS HYD SYS 2/3 L OB (L IB,R IB,R OB)↑	• PRESSURE >180 PSI IN BRAKES DRIVEN BY HYDRAULIC SYSTEM 2/3 • NO MAL

MESSAGE		OPS AVAIL		CAUSE	COMMENTS
		PASS	BFS		
S66 CAB AIRLK	PRES	S2,4		• AIRLOCK P ↑↓	• ΔP AIRLOCK TO AMB (PL)
S66 CAB HX OUT	TEMP	S2,4		• CAB HX OUT T	• NO MAL (NO LIMITS)
S66 CAB H2O N2	P1(2)	S2,4		• H2O TK N2 P ↓	
S66 CAB N2 FLO	1(2)	S2,4		• N2 FLOW ↑	
SM1 CABIN N2			SM		
S66 CAB N2 QTY	1(2)	S2,4		• N2 SPLY QTY ↓	
S66 CAB N2 REG	P1(2)	S2,4		• N2 REG P ↑↓	
S66 CAB O2 EMR	SPLY	S2,4		• EMER O2 QTY AND REG P	• EMER O2 MSG ONLY WHEN EMER O2 TK MANIFESTED
S66 CAB O2 FLO	1(2)	S2,4		• O2 FLOW ↑	
SM1 CABIN O2			SM		
S66 CAB O2 REG	P 1(2)	S2,4		• O2 REG P ↑	
S66 CAB PPCO2		S2,4		• PPCO2 ↑	
S78 CABIN	DP/DT	S2,4		• CABIN PRESS RATE OF CHANGE ↓	
S66 CABIN	FAN	S2,4		• CABIN FAN ΔP ↑↓	
SM1 CABIN FAN			SM		
S66 CABIN	PRES	S2,4		• CAB P ↓↑	
SM1 CABIN PRES			SM		
S66 CABIN	TEMP	S2,4		• CAB T ↑	
S78 CABIN O2	CONC	S2,4		• O2 CONC ↑	• NO MAL
S66 CABIN PPO2	A(B,C)	S2,4		• PPO2 ↑↓	• NO MAL
SM1 CABIN PPO2			SM		
SM1 CABN DP/DT	BU		SM	• S/W CAB P RATE OF CHANGE COMP ↓	• NOT IN PRELAUNCH OPS 0

C

MESSAGE	OPS AVAIL		CAUSE	COMMENTS
	PASS	BFS		
S78 CABN DP/DT SM1 CABN DP/DT EQ	EQ	S2,4	• EQ CABIN PRESS RATE OF CHANGE ↓	
S60 CHECKPT FAIL		SM	• SM CHECKPOINT FAILED ON WRITE OR RESTORE DUE TO AN I/O FAILURE BETWEEN THE GPC AND MMU, OR MMU WAS OFF/BUSY	• ATTEMPT RECOVERY USING MMU MALS
CIRC PUMP		S2,4	• CIRC PUMP INHIBITED FROM OPERATING DUE TO ANOTHER CIRC PUMP RUNNING IN MANUAL MODE	• INHIBITS PUMP CYCLING FOR THERMAL CONTROL • NO MAL
S87 CIRC PMP P	1(2,3)	S2,4	• HYD CIRC PMP P ↑↓	
S67 CNTL BUS	V	S2,4	• DC CNTL VOLT ↓	
S67 CNTL RPC		S2,4	• DC CNTL BUS RPC = OFF	
SM1 CNTL RPC		SM		
S67 CM BUF BSY	CRT1(2,3,4)	S2,4	• DEU IPL REQUEST WHEN THE SM COMMON BUFFER IS CURRENTLY BUSY	• NO MAL • WAIT FOR CONTENDING OPERATION TO COMPLETE, THEN RETRY THE SM DEU IPL
SM1 CNTL/ESS V		SM	• DC VOLT CNTL ↓ • DC VOLT ESS ↓	

MESSAGE		OPS AVAIL		CAUSE	COMMENTS
		PASS	BFS		
S76 COMM CAM	TEMP	S2,4		• TV CAMERA OVERTEMP - YES ↓	• CAM TEMP MSG VALID ONLY WHEN CCTV IN SYNC MODE
PA1	TEMP	S2,4		• PWR AMP 1 TEMP ↑	
PA2	TEMP	S2,4		• PWR AMP 2 TEMP ↑	
S76 COMSEC 1	BITE	S2,4		• COMSEC XMIT AND/OR RCV FAILED	
S76 COMSEC 2	BITE	S2,4		• COMSEC XMIT AND/OR RCV FAILED	
CRT BITE	1(2,3,4)	ALL	ALL	• A BITE ERROR DETECTED IN INDICATED DEU	
SM2 CRYO H2 MANF			SM	• MANF P ↓	
PRES			SM	• TK CNTL P ↑↓	
SM2 CRYO O2 HTR			SM	• TK HTR T ↑	
MANF			SM	• MANF P ↓	
PRES			SM	• TK CNTL P ↑↓	
DAP DNMODE	RHC	G1,2,3,6,8		• RHC MOVEMENT BEYOND DETENT THRESHOLD WHILE DAP IN AUTO • DURING OPS 3 AND OPS 6, EFFECTIVE ABOVE MACH 2.0	• NO MAL • IF ENTRY/GRTLS DAP, RESELECT AUTO IF CSS NOT DESIRED • IF TRANS DAP, RESELECT AUTO AND RE-INITIATE MANEUVER IF DESIRED • IF ORBIT DAP, DAP AS REQD
DAP RECONF		G2,8		• DESELECTION OF ONE OR MORE VERNIER JETS	• NO MAL • IF USING PRI RCS, MSG INDICATES FAILURE OF VERN JET W/O DOWNMODING • IF USING VERN RCS, OR UPON TRANS FROM PRI TO VERN RCS, DAP WILL DOWNMODE TO FREE DRIFT

MESSAGE	OPS AVAIL		CAUSE	COMMENTS
	PASS	BFS		
SM1 DC VOLT FC 1(2,3)		SM	<ul style="list-style-type: none"> • FC VOLT ↑↓ 	
S69 DELTA AMPS 1(2,3)	S2,4		<ul style="list-style-type: none"> • FC ΔAMPS ↑↓ 	
>3 DEU	ALL		<ul style="list-style-type: none"> • TOO MANY DEUs IN COMMON SET 	<ul style="list-style-type: none"> • NO MAL
DISPLAY SW	A	G2,8	<ul style="list-style-type: none"> • AFT ADI ERROR/RATE SW • AFT ADI ATT SEL SW 	<ul style="list-style-type: none"> • NO MAL • MAY BE TRIGGERED BY COMM FAULT OR I/O RESET • MOVE APPROPRIATE SW TO GREEN DOT DEFAULT POS • AIR DATA/RADAR ALT SW NOT READ IN OPS 1,2 OR 8 FOR PASS
	L	G1,2,3,6,8	<ul style="list-style-type: none"> • LH ADI ERROR/RATE SW • LH ADI ATT SEL SW • LH AIR DATA SW • LH HSI MODE/SOURCE/TRAN SW • LH RADAR ALT SW 	
	R	G1,2,3,6,8	<ul style="list-style-type: none"> • RH ADI ERROR/RATE SW • RH ADI ATT SEL SW • RH AIR DATA SW • RH HSI MODE/SOURCE/TRAN SW • RH RADAR ALT SW 	
DK XMTR 1(2,3,4)		ALL	<ul style="list-style-type: none"> • BFS DK TRANSMITTER FAILED HIGH ON A PASS CONTROLLED CRT 	<ul style="list-style-type: none"> • NO MAL • BFS WILL DOWNMODE AFFECTED DK BUS – NO COMMAND/LISTEN CAPABILITY ON THAT BUS • ASSIGN BFS TO AFFECTED CRT TO RECOVER BFS COMMAND/LISTEN CAPABILITY • BFS IS STILL ENGAGEABLE WITH FULL CAPABILITY
S67 ESS BUS V 1BC(2CA,3AB)	S2,4		<ul style="list-style-type: none"> • DC VOLT ESS ↓ 	

MESSAGE		OPS AVAIL		CAUSE	COMMENTS
		PASS	BFS		
ET SEP	AUTO	G1,6		• ET SEP MODE SW FAIL	• NO MAL • SW DEFAULTS TO AUTO FOR RTLS AND TAL
	INH	G1,6	G1,6	• AUTO SEP INH G1 = BODY RATES & FDLN DISC VLVS G6 = BODY RATES, α AND β	• NO MAL • USE CUE CARDS FOR DISC VLVS
	MAN	G1		• ET SEP SW FAIL (RM)	• NO MAL • USE SPEC 51 OVERRIDE
S77 EVA-MMU T	PORT STBD	S2,4		• MMU/FSS TEMP OUT OF LIMITS	
S88 EVAP FDLN	TA(B)	S2,4		• FDLN FWD,MID,AFT, TOPPING, ACCUM LINE A(B) AND HI LOAD LINE A(B) T $\uparrow\downarrow$	• FES FEEDLINE TEMPS
S88 EVAP HI LD	TEMP	S2,4		• FES HI LOAD NOZ AND DUCT T $\uparrow\downarrow$	• HI LOAD IB/OB DUCT T AND NOZ T
S88 EVAP OUT T	1(2)	S2,4		• OUT T $\uparrow\downarrow$	
SM2 EVAP OUT T			SM		
S88 EVAP TOP	TEMP	S2,4		• FES TOPPING NOZ AND DUCT T \uparrow	• TOPPING EVAP L(R) FWD(AFT) DUCT T AND L(R) NOZ T
177 EXT A/L	PRES	S2,4		• EXT AIRLOCK P $\uparrow\downarrow$	
F RCS	JET		G1,3,6	• F JET MANF 1(2,3,4) FAIL ON/OFF	• NO FAIL LK DETECTION IN BFS
	DJET	G1,2,3,6,8		• F DOWN JET 1(2,3,4) FAIL ON/OFF/LK	• FAIL OFF DETECTION NOT PERFORMED IN MM101 & 102 FOR PASS
	FJET	G1,2,3,6,8		• F FWD JET 1(2,3) FAIL ON/OFF/LK	
	LJET	G1,2,3,6,8		• F LEFT JET 1(3,5) FAIL ON/OFF/LK	

F

MESSAGE		OPS AVAIL		CAUSE	COMMENTS
		PASS	BFS		
F RCS (Cont)	RJET	G1,2,3, 6,8		• F RIGHT JET 2(4,5) FAIL ON/OFF/LK	• FAIL OFF DETECTION NOT PERFORMED IN MM101 & 102 FOR PASS
	UJET	G1,2,3, 6,8		• F UP JET 1(2,3) FAIL ON/OFF/LK	
	He P	G2,8	G1,3,6	• F He (FU OR OX) TK P 2 LOW	• PKT C/L – RCS LEAK ISOL • OX/FU Δ QTY > 9.5%
	LEAK	G2,3,8	G1,3,6	• PROP/He LEAK	
	PVT	G2,3,8		• LOSS OF P OR T DATA FOR RCS QTY CALC	• NO MAL • QTY CALC SUSPENDE
TK P	G2,8	G1,3,6	• FWD RCS (FU OR OX) TK ULL PRESS HI/LOW	• QTY CALC SUSPENDE	
S69 FC AMPS SM1 FC AMPS 1(2,3)	1(2,3)	S2,4		• FC AMPS ↑ ↓	
			SM		
S69 FC COOL P SM1 FC COOL P 1(2,3)	1(2,3)	S2,4		• FC COOL P ↑ ↓	
			SM		
S69 FC DELTA V SM1 FC DELTA V 1(2,3)	1(2,3)	S2,4		• FC SUBSTACK ΔV > 150 MV	
			SM		
S69 FC EXIT T SM1 FC EXIT T 1(2,3)	1(2,3)	S2,4		• FC EXIT T ↑ ↓	
			SM		
S69 FC H2 FLOW	1(2,3)	S2,4		• FC H2 FLOW ↑	
S69 FC H2 PUMP	1(2,3)	S2,4		• FC H2 PUMP STATUS ↑ ↓	

MESSAGE		OPS AVAIL		CAUSE	COMMENTS
		PASS	BFS		
S69 FC H2O ALT PRI RLF HTR	1(2,3)	S2,4		• FC ALT H2O LN T ↑↓	• BOTH HTRS OFF OR BOTH HTRS INDICATING AUTO WILL ANNUNCIATE ALARM
	1(2,3)	S2,4		• FC H2O LN T ↑↓	
	1(2,3)	S2,4		• FC H2O RLF VLV T ↑↓	
	HTR	S2,4		• FC H2O RLF HTR STATUS A,B ↑↓	
	LINE	S2,4		• FC H2O RLF LN T ↑↓	
	NOZ	S2,4		• FC H2O RLF NOZ T A(B) ↑↓	
S69 FC O2 FLOW	1(2,3)	S2,4		• FC O2 FLOW ↑	
S69 FC PH	1(2,3)	S2,4		• FC PH – PH ↓	• PH > BILEVEL
SM1 FC PH 1(2,3)			SM	• FC PH HIGH	
S69 FC PRG LN	H2	S2,4		• FC H2 PURGE LN T 1(2) ↑	
	O2	S2,4		• FC O2 PURGE LN T ↑	
S69 FC PUMP	1(2,3)	S2,4		• FC COOL PUMP ΔP ↓	
SM1 FC PUMP 1(2,3)			SM		
FC PURGE	1(2,3)	S2,4		• FAILS FLOW CHECK AT PURGES AT END OF PURGE	• USE MAN FC PURGE PROC
	SEQ	S2,4		• LOSS OF PWR TO PURGE LN HTRS AFTER AUTO SEQ INIT OR LOSS OF SWITCH FUNCTION	• USE MAN FC PURGE PROC • SEQ FAIL FLAG TERMINATES AUTO PURGE SEQ
	TEMP	S2,4		• FC PURGE LINE TEMP TOO LOW TO PERFORM AUTO PURGE	• TERMINATES AUTO PURGE • USE MAN FC PURGE PROC
S69 FC REAC	1(2,3)	S2,4		• FC REAC ↓	• FC REAC VLV – CL
SM1 FC REAC 1(2,3)			SM		
S69 FC READY	1(2,3)	S2,4		• FC READY ↓	

MESSAGE		OPS AVAIL		CAUSE	COMMENTS
		PASS	BFS		
S69 FC STACK T	1(2,3)	S2,4		• FC STACK T ↑↓	
SM1 FC STACK T 1(2,3)			SM		
S69 FC VOLTS	1(2,3)	S2,4		• FC VOLT ↑↓	
FCS CH	1(2,3,4)	G1	G1	• SRB CHANNEL BYPASS	• NO MAL • ROCK & TILT ACT A(B,C,D) CH FAIL
		G1,3,6	G1,6	• MPS CHANNEL BYPASS	• NO MAL • MPS ENG PITCH(YAW) CH FAIL
		G1,3,6	G1,3,6	• AERO CHANNEL BYPASS	• NO MAL • ELEV (RUD,S/B) ACT CH FAIL
FCS SAT	POS	G3,6	G3,6	• L/R IB/OB ELEVON POSITION SATURATION	• NO MAL • ELEVON SAT (>+12 OR <-15 DEG)
	MOM	G3,6	G3,6	• L/R IB/OB PRI DELTA PRESS	• NO MAL • IN RTLS EXPECT HINGE MOM > 2400 PSI (80% SYS MAX)
S67 FPC/FLC	1(2,3)	S2,4		• FWD PCA V ↓	
S88 FREON FLOW	1(2)	S2,4		• FLOW ↓	• FCL ICH FLOW
SM2 FREON FLOW			SM		
S88 FREON QTY	1(2)	S2,4		• ACCUM QTY ↓	• FREON LOOP ACCUM QTY
S88 FREON RAD	T1(2)	S2,4		• CNTL OUT T 1(2) ↓	• RAD CONTROLLER OUT TEMP
S88 FRN AFT CP	1(2)	S2,4		• AFT CP FREON FLOW ↓	• AFT CP FLOW
S88 FRN PL HX	1(2)	S2,4		• PL HX FREON FLOW ↓	• PL HX FLOW
S86 FU TK VLV	1(2,3)	S2,4		• APU FUEL TK VLV A(B) T ↑↓	
SM2 FU TK VLV APU			SM	• APU FU TK VLV A(B) T ↑↓	

MESSAGE		OPS AVAIL		CAUSE	COMMENTS	
		PASS	BFS			
S76 GCIL	FAIL	S2,4		• GCIL CONFIG FAILED TO PNL		
S86 GG/FU PMP	1(2,3)	S2,4		• APU GG BED T ↑↓	• NO MAL	
S86 GPC	BITE	ALL	ALL	• S/W FORCED CLOSED PROCESS DUE TO GPC H/W (S/W) FAULT	• IN PASS	
				• BFS RESTART INDICATION	• IN BFS	
	CONF	ALL		• NBAT TGT GPCs NOT IN RUN OR NOT SPECIFIED	• NO MAL • PROCEDURAL ERROR OR SWITCH ERROR	
	SUM	1	ALL		• INDICATED GPC HAS FAILED	
		2	ALL			
3		ALL				
4		ALL				
	5	ALL		• GPC 5 HAS FAILED	• NO MAL	
GPC PWR			ALL	• PWR TRANSITIONS TO BFS GPC	• NO MAL • BFS WILL DISENGAGE • S/W DOES AUTO RESTART	
G55 GPS FAIL	1(2,3)	G1,2,3,6,8		• INDICATED GPS HAS FAILED	• NO BFS MSG • NO MAL	
G55 QA FL GPS	1(2,3)	G2,3,6,8		• INDICATED GPS HAS FAILED QA 1(3,4) CHECK	• NO BFS MSG • NO MAL	
S68 H2 CNTL P HTR T	1(2,3,4,5)	S2,4		• CNTL P ↑↓		
	1(2,3,4,5)	S2,4		• HTR T ↑		

MESSAGE		OPS AVAIL		CAUSE	COMMENTS
		PASS	BFS		
S68 H2 MANF TK P	PRES	S2,4		• MANF P ↓	
	VLV	S2,4		• MANF VLV = CL	
	1(2,3,4,5)	S2,4		• TK P ↑↓	
S69 H2O LN PH		S2,4		• H2O LINE PH ↓	• PH > 9 BILEVEL
S88 H2O LOOP 1(2)	FLOW	S2,4		• ICH FLOW ↓	• ACTIVE LOOP ONLY
	QTY	S2,4		• ACCUM QTY ↓↑	
	TEMP	S2,4		• PUMP OUT T ↑↓ • CAB HX IN T ↓ • ICH OUT T ↓	• H2O LOOP TEMPS
S88 H2O PUMP P SM2 H2O PUMP P	1(2)	S2,4		• P 1(2) ↑↓ OR ΔP 1(2) ↑↓	• ΔP HIGH ONLY FOR INACTIVE LOOP • ΔP HIGH OR LOW FOR ACTIVE LOOP
			SM		
HIGH G		G3,6		• HIGH G	• NO MAL
S66 HUMID SEP	A(B)	S2,4		• HUM SEP SPEED ↓	
SM2 HYD ACUM P 1(2,3)			SM	• HYD ACUM P ↓	
S86 HYD PRESS	1(2,3)	S2,4		• HYD B/U P ↓	• NO MAL
SM2 HYD PRES 1(2,3)			SM	• HYD PRESS ↓	
SM2 HYD QTY 1(2,3)			SM	• HYD RSVR QTY ↑↓	
S86 HYD RSVR Q	1(2,3)	S2,4		• HYD RSVR QTY ↑↓	
S86 HYD RSVR T SM2 HYD RSVR T 1(2,3)	1(2,3)	S2,4		• HYD RSVR T ↓↑	• NO MAL
			SM		

MESSAGE	OPS AVAIL		CAUSE	COMMENTS	
	PASS	BFS			
SM2 ILLEGAL ENTRY	ALL	ALL	<ul style="list-style-type: none"> ILLEGAL KYBD ENTRY WITH RESPECT TO OPS SELECT/ TRANSITION, DATA LOAD, INITIALIZATION, MEM RECONFIG, GPC ASSIGN, KYBD SYNTAX, FREEZE DRY LOAD, ETC 	<ul style="list-style-type: none"> NO MAL IF APPROPRIATE, KYBD INPUT SHOULD BE REENTERED 	
S66 IMU FAN SM1 CABIN IMU	DP	S2,4	<ul style="list-style-type: none"> IMU FAN ΔP ↑↓ 		
S66 IMU FN SPD	A(B,C)	S2,4	<ul style="list-style-type: none"> IMU FAN SPEED ↓ 		
I/O ERROR	CRT1	ALL	ALL	<ul style="list-style-type: none"> ERROR IN DEU 1(2,3,4) MSG (I/O OR CHECKSUM) 	
	CRT2	ALL	ALL		
	CRT3	ALL	ALL		
	CRT4	ALL	ALL		
	D/L	ALL		<ul style="list-style-type: none"> I/O ERROR ON DOWNLIST INTERFACE WITH PCMMU 	
	FA1	G1,2,3, 6,8	G0,1,3, 6	<ul style="list-style-type: none"> INPUT/OUTPUT ERROR ON INDICATED UNIT HAS BEEN DETECTED 	<ul style="list-style-type: none"> BFS PRE-ENGAGE MUST BE IN SYNC WITH (TRACKING) PASS TO ANNUNCIATE
	FA2	G1,2,3, 6,8	G0,1,3, 6		
	FA3	G1,2,3, 6,8	G0,1,3, 6		
	FA4	G1,2,3, 6,8	G0,1,3, 6		

MESSAGE		OPS AVAIL		CAUSE	COMMENTS
		PASS	BFS		
I/O ERROR (Cont)	FF1	G1,2,3, 6,8	G0,1,3, 6	• INPUT/OUTPUT ERROR ON INDICATED UNIT HAS BEEN DETECTED	• BFS PRE-ENGAGE MUST BE IN SYNC WITH (TRACKING) PASS TO ANNUNCIATE
	FF2	G1,2,3, 6,8	G0,1,3, 6		
	FF3	G1,2,3, 6,8	G0,1,3, 6		
	FF4	G1,2,3, 6,8	G0,1,3, 6		
	FLEX	S2,4	G0,1,3, 6	• I/O ERROR FLEX/FLEX PAIR	
	MMU 1(2)	ALL		<ul style="list-style-type: none"> • CHECK SUM ERROR OR I/O ERROR ON MMU TRANSACTION, OR GPC-GPC OL FAILURE • TFL FORMAT NOT FOUND IN BUFFER FOLLOWING RETRIEVAL FROM MMU • I/O ERROR DURING DEU 1(2,3,4) LOAD 	• MAY OCCUR WHILE EXPANDING REDUNDANT SET AS NEW GPC TAKES COMMAND OF MMU
	PCM	S2,4	SM	• I/O ERROR ON PCMMU	
PL1	S2,4	SM	• I/O ERROR ON PL BUS 1/2		
PL2	S2,4	SM			
IMU BITE/T	1(2,3)	G1,2,3, 6,8		• IMU 1,2,3 TEMP SAFE OR IMU BITE	<ul style="list-style-type: none"> • NO MAL • BITE PARAMETERS CAN BE MASKED VIA SPEC 21 • BFS USES ONLY IMU GOOD BIT • DAP DOWNMODES TO FREE FOR BITE IN SINGLE IMU CASE (OPS 2,8 ONLY)

MESSAGE		OPS AVAIL		CAUSE	COMMENTS
		PASS	BFS		
S211 ISS CW CAB	FIRE	S2		• ISS CABIN FIRE CW TONE ANNUNCIATION	
	PRES	S2		• ISS CABIN PRESS CW TONE ANNUNCIATION	
	CAU	CAUT	S2	• ISS EVENT CAUSING CAUTION TONE ANNUNCIATION	
	TOX	ATM	S2	• ISS TOXIC ATM CW TONE ANNUNCIATION	
	WAR	WARN	S2	• ISS EVENT CAUSING WARNING TONE ANNUNCIATION	
ITEM RJCT PSP		S2,4		• PCP CC CMD REJECTED DUE TO PSP CMD DATA TRANSMISSION IN PROGRESS	• NO MAL
S76 KU-GMBL A GMBL B GYRO XMTR	TEMP	S2,4		• KU GMBL A TEMP ↑	
	TEMP	S2,4		• KU GMBL B TEMP ↑	
	TEMP	S2,4		• KU GYRO TEMP ↑	
	TEMP	S2,4		• KU XMTR TEMP ↑	
L OMS	GMBL	G1,2,3	G1,3	• PITCH (YAW) CMD/FEEDBACK Δ2° FOR 3.8 SEC	• NO MAL
	PC	G1,2,3,6	G1,3,6	• ENG CHAMBER PRESS LOW	
	QTY	G1,2,3,6,8		• ENG FU OR OX TK LEVEL LOW	
	TEMP		G1,3	• ENG FU INJ T HI	
	TK P		G2,8	G1,3	
				G1,3,6	• He OR N2 TK P LOW • N2 REG P HI/LOW
	VLV	G2		• He P/VAP ISOL VLV MISMATCH	• NO MAL
S89 L OMS	TEMP	S2,4		• ENG FU INJ T HI/LOW	• NO MAL

MESSAGE	OPS AVAIL		CAUSE	COMMENTS	
	PASS	BFS			
S89 L RCS	JET		• LEFT JET MANF 1(2,3,4) FAIL ON/OFF	<ul style="list-style-type: none"> • NO FAIL LK DETECTION IN BFS • FAIL OFF DETECTION NOT PERFORMED IN MM101 & 102 FOR PASS 	
	AJET	G1,2,3,6,8	• L AFT JET 1(3) FAIL ON/OFF/LK		
	DJET	G1,2,3,6,8	• L DOWN JET 2(3,4,5) FAIL ON/OFF/LK		
	LJET	G1,2,3,6,8	• L LEFT JET 1(2,3,4,5) FAIL ON/OFF/LK		
	UJET	G1,2,3,6,8	• L UP JET 1(2,4) FAIL ON/OFF/LK		
	He P	G2,8	G1,3,6	• L RCS AFT He (FU OR OX) TK PRESS – 2 LOW	• PKT C/L – RCS LEAK ISOL
	LEAK	G2,3,8	G1,3,6	• PROP/He LEAK	• OX/FU ΔQTY > 9.5%
	PVT	G2,3,8		• LOSS OF P OR T DATA FOR RCS QTY CALC	• NO MAL
	TK P	G2,8	G1,2,3,6	• L RCS AFT (FU OR OX) TK ULL PRESS HI/LOW	• QTY CALC SUSPENDED
	XFEED	G1,3,6		• L RCS PROP TANK LOW PRESS	• FAILURE ON LEFT SIDE, AUTO XFEED FROM RIGHT
S67 MAIN BUS V	A(B,C)	S2,4	• MN VOLTS ↑↓		
SM1 MAIN BUS V A(B,C)		SM			

MESSAGE		OPS AVAIL		CAUSE	COMMENTS
		PASS	BFS		
SM1 MDM OUTPUT	FF1 2 3 <u>4</u> FA1 2 3 <u>4</u> PL1 2	ALL		• MDM RETURN WORD FAILURE (ON MDM OUTPUT)	
ME SHDN SW	C(L,R)	G1		• SW CONTACT DISAGREE	• NO MAL • SHUTDOWN FUNCTION OF SWITCH NO LONGER WORKS
S67 MPC	1(2,3)	S2,4		• MID PCA AMPS ↓	
MPS CMD	C(L,R)	G1,6	G1,6	• MPS C(L,R) CMD PATH FAIL	• NO MAL • REF A/E SYS CUE CARDS • BFS DOES NOT SUPPORT CMD PATH FAIL ANNUNCIATION PRE-ENGAGED

MESSAGE		OPS AVAIL		CAUSE	COMMENTS
		PASS	BFS		
MPS DATA	C(L,R)	G1,6	G1,6	• DATA PATH FAIL	• NO MAL • REF AESP CUE CARDS
MPS ELEC	C(L,R)	G1,6	G1,6	• ELECTRONIC LOCKUP MODE FAIL	• NO MAL • REF AESP CUE CARDS
MPS H2 OUT P	C(L,R)		G1,6	• PREMATURE SSME SHUTDOWN • MPS GH2 OUT P ↓	• NO MAL • REF AESP CUE CARDS
MPS HYD	C(L,R)	G1,6	G1,6	• HYD LOCKUP MODE FAIL	• NO MAL • REF AESP CUE CARDS
MPS He P	C(L,R)		G1,6	• MPS He TK P HI/LOW • HI LEAK RATE dP/dT	• NO MAL • REF AESP, ASC PKT
			G1,3,6	• INDICATED REG P HI/LOW	• NO MAL • REF AESP, ASC PKT, ENT PKT
MPS LH2/O2 MANF ULL			G1,6	• MPS LH2 ENG MANF P HI • MPS LOX ENG MANF P HI	• NO MAL • REF AESP CUE CARDS
			G1,6	• ET ULL P HI/LO	
MPS O2 OUT T	C(L,R)		G1,6	• PREMATURE SSME SHUTDOWN • MPS GO2 OUT T ↓	• NO MAL • REF AESP CUE CARDS
MPS PNEU ACUM REG TK			G1,6	• MPS PNEU ACUM PRESS LOW	• NO MAL • REF AESP CUE CARDS
			G1,3,6	• MPS PNEU REG PRESS HI/LOW	• NO MAL • REF AESP, ASC PKT, ENT PKT
			G1,6	• MPS PNEU TANK PRESS LOW	• NO MAL • REF AESP CUE CARDS

MESSAGE	OPS AVAIL		CAUSE	COMMENTS
	PASS	BFS		
NAV EDIT		G2	<ul style="list-style-type: none"> • RNDZ NAV EDIT 	<ul style="list-style-type: none"> • NO MAL
		G3,6	<ul style="list-style-type: none"> • DRAG H, ADTA, OR TACAN NAV EDIT 	<ul style="list-style-type: none"> • BFS DOES NOT SUPPORT MLS • NO MAL
	ALT	G3,6	<ul style="list-style-type: none"> • ADTA ALT DATA NOT PROCESSING < M2.5 • DRAG H DATA NOT PROCESSING 85.2K FT < H < 140K FT 	<ul style="list-style-type: none"> • NO MAL • MLS NAV EDIT MESSAGE (MLSNV) SEEN ONLY ON HUD
	GPS	G2,3,6,8	<ul style="list-style-type: none"> • SELECTED GPS STATE VECTOR EXCEEDED THRESHOLD • NO GPS VECTOR SELECTED < 140K FT 	
	TAC	G3,6	<ul style="list-style-type: none"> • SELECTED GPS STATE VECTOR EXCEEDED THRESHOLD • TACAN DATA NOT PROCESSING < 140K FT 	<ul style="list-style-type: none"> • NO MAL
NO UPDATE	GPS	G2,3,6,8	<ul style="list-style-type: none"> • NO GPS UPDATE TO SF 	<ul style="list-style-type: none"> • NO BFS MSG
S76 NSP 1	BITE	S2,4	<ul style="list-style-type: none"> • NSP A/G 1 OR 2 XMIT AND/OR RCV VOICE MUX FAILED 	
S76 NSP 2	BITE	S2,4	<ul style="list-style-type: none"> • NSP A/G 1 OR 2 XMIT AND/OR RCV VOICE MUX FAILED 	

MESSAGE		OPS AVAIL		CAUSE	COMMENTS
		PASS	BFS		
S68 O2 CNTL P	1(2,3,4,5)	S2,4		• CNTL P ↑↓	
HTR T	1(2,3,4,5)	S2,4		• HTR T ↑	
TRP	1(2,3,4,5)	S2,4		• HTR CUR SNSR = TRIP	
MANF	PRES	S2,4		• MANF P ↓	
	VLV	S2,4		• MANF VLV = CL	
TK P	1(2,3,4,5)	S2,4		• TK P ↑↓	
OFF/BUSY MMU	1(2)	ALL		• AN MMU TRANSACTION IS REQUESTED WHEN THE MMU IS OFF/BUSY, FAILED OFF, OR SELECTED FOR IPL	

MESSAGE		OPS AVAIL		CAUSE	COMMENTS
		PASS	BFS		
G23 OMS/RCS	QTY	G2		<ul style="list-style-type: none"> L(R) OMS TO RCS PROP TRANSFER EXCEEDS LIMIT 	<ul style="list-style-type: none"> NO MAL
OTT ST IN		G3,6	G3,6	<ul style="list-style-type: none"> INDICATED E/W LVL LESS THAN LVL REQD FOR OVHD APPROACH 	<ul style="list-style-type: none"> NO MAL MSG TERMINATES < 45 NM FROM LDG OR E/W LVL AGAIN MATCHES PROFILE
S179 OPCU-1(2) CH A(B)	AMPS	S2,4		<ul style="list-style-type: none"> OPCU OUT AMPS ↑ 	<ul style="list-style-type: none"> OV103 & OV105 (SSPTS)
	IOC	S2,4		<ul style="list-style-type: none"> OPCU TRIP IOC (INPUT OVER CURRENT) 	
	IUV	S2,4		<ul style="list-style-type: none"> OPCU TRIP IUV (INPUT UNDER VOLT) 	
	OOV	S2,4		<ul style="list-style-type: none"> OPCU TRIP OOV (OUTPUT OVER VOLT) 	
	OUV	S2,4		<ul style="list-style-type: none"> OPCU TRIP OUV (OUTPUT UNDER VOLT) 	
	TEMP	S2,4		<ul style="list-style-type: none"> OPCU TEMP ↑ 	
	VOLT	S2,4		<ul style="list-style-type: none"> OPCU OUT VOLT ↓ 	
S76 PA1 OUTPUT	LOW	S2,4		<ul style="list-style-type: none"> PWR AMP OUTPUT ↓ 	
S76 PA2 OUTPUT	LOW	S2,4		<ul style="list-style-type: none"> PWR AMP OUTPUT ↓ 	
PBD CONFIG		S2,4		<ul style="list-style-type: none"> PLBD OUT-OF-SEQUENCE CONFIG DETECTED 	<ul style="list-style-type: none"> CAUSES TERMINATION OF AUTO SEQUENCE
S63 PBD CONFIG			SM		
PBD SEQ FAIL		S2,4		<ul style="list-style-type: none"> PLBD ACTUATOR DOES NOT REACH END OF TRAVEL WITHIN SINGLE MOTOR DRIVE TIME 	<ul style="list-style-type: none"> CAUSES TERMINATION OF AUTO SEQUENCE
S63 PBD SEQ FAIL			SM		

MESSAGE	OPS AVAIL		CAUSE	COMMENTS
	PASS	BFS		
S62 PDI DECOM FAIL	S2,4		<ul style="list-style-type: none"> • DECOM 1 FMT ↑ • DECOM 2 FMT ↑ • DECOM 3 FMT ↑ • DECOM 4 FMT ↑ 	<ul style="list-style-type: none"> • MSG OCCURS IF DECOM FDA ENA AND PL TLM FAIL OR PDI DECOM FAILS • MSG ALSO OCCURS IF PL DEPLOYED, PI FAIL, OR PSP FAIL
S96 PDRS ABE	COMM	S2,4	<ul style="list-style-type: none"> • ABE/MCIU MISCOMPARE 	
	SY SP EP WP WY WR	S2,4	<ul style="list-style-type: none"> • SPA PWR (COMMUTATOR, MDA) FAIL • TACH/PHASE LOCK LOOP FAIL 	<ul style="list-style-type: none"> • AUTO BRAKES APPLIED
S96 PDRS CKCRT	D	S2,4	<ul style="list-style-type: none"> • D&C COMM FAIL 	<ul style="list-style-type: none"> • AUTO BRAKES APPLIED
	SY	S2,4	<ul style="list-style-type: none"> • TACH/ENCODER DATA FAIL • JOINT ENCODER FAIL 	<ul style="list-style-type: none"> • DNMODE TO IDLE IF IN AUTO MODE
	SP			
	EP			
	WP			
	WY			
	WR			
EE	S2,4		<ul style="list-style-type: none"> • EE CMDS ↓, EE FLAG ↓, EEEU FAIL ↓ 	
T CK	S2,4		<ul style="list-style-type: none"> • MCIU TEMP MONITOR CIRCUIT FAIL 	
FS	S2,4		<ul style="list-style-type: none"> • MCIU EXTERNAL FRAME SYNC BITE OR BITE VERIFICATION FAILURE 	
HC	S2,4		<ul style="list-style-type: none"> • RHC (THC) HARDOVER (ANY AXIS) • MCIU HC ↓ (MULTIPLEXER MISMATCH) 	<ul style="list-style-type: none"> • S/W DOWNMODE TO IDLE IF IN MANUAL (TEST)

MESSAGE		OPS AVAIL		CAUSE	COMMENTS
		PASS	BFS		
S96 PDRS CNTL	SY SP EP WP WY WR	S2,4		<ul style="list-style-type: none"> CONSISTENCY CK – JOINT RUNAWAY TACH DATA FAIL 	<ul style="list-style-type: none"> AUTO BRAKES APPLIED
PDRS CNTL	POR	S2,4		<ul style="list-style-type: none"> TRAJECTORY TRACKING ERROR DETECTION EXCEEDENCE 	<ul style="list-style-type: none"> AUTO BRAKES APPLIED
PDRS DERIG		S2,4		<ul style="list-style-type: none"> UNCOMMANDED DERIGIDIZE 	<ul style="list-style-type: none"> POSSIBLE EE STRUCT FAIL
S94 PDRS GPC		S2,4		<ul style="list-style-type: none"> MCIU-DETECTED GPC COMM FAIL 	<ul style="list-style-type: none"> MCIU SAFING COMMANDED S/W DNMODE TO 'SUSPEND'
S96 PDRS MCIU	MADC	S2,4		<ul style="list-style-type: none"> MADC REF VOLT TEST FAIL 	<ul style="list-style-type: none"> AUTO BRAKES APPLIED
	MCPC	S2,4		<ul style="list-style-type: none"> MCPC REF VOLT TEST FAIL 	<ul style="list-style-type: none"> AUTO BRAKES APPLIED
	ICF	S2,4		<ul style="list-style-type: none"> ICF FAIL 	<ul style="list-style-type: none"> AUTO BRAKES APPLIED (MAY NOT BE IND)
S96 PDRS RCH	SY SP EP WP WY WR	S2,4		<ul style="list-style-type: none"> JOINT EXCEEDS POS OR NEG RCH LIMIT 	<ul style="list-style-type: none"> APPROX 2° PRIOR TO S/W STOP APPROX 4° PRIOR TO HARDSTOP
PDRS REL		S2,4		<ul style="list-style-type: none"> UNCOMMANDED P/L RELEASE 	<ul style="list-style-type: none"> POSSIBLE EE STRUCT FAIL
PDRS SING	SY	S2,4		<ul style="list-style-type: none"> SY/WY WITHIN 3 FT OF COALIGNMENT 	<ul style="list-style-type: none"> LOSE ±Y DEG OF FREEDOM AT SINGULARITY
	EP	S2,4		<ul style="list-style-type: none"> EP > -7.6° 	<ul style="list-style-type: none"> LOSE -X DEG OF FREEDOM AT SINGULARITY
	WY	S2,4		<ul style="list-style-type: none"> WY WITHIN ±15° OF ±90° SING 	<ul style="list-style-type: none"> LOSE ROLL DEG OF FREEDOM AT SINGULARITY

MESSAGE		OPS AVAIL		CAUSE	COMMENTS
		PASS	BFS		
S96 PDRS SLIP	SY SP EP WP WY WR ALL	S2,4		<ul style="list-style-type: none"> JOINT SLIPPAGE WITH THE BRAKES ON AND NOT IN DIRECT MODE 	<ul style="list-style-type: none"> SLIPPAGE GREATER THAN 0.5° PER JOINT OR SUM OF 2.0° FOR ALL JOINTS
PDRS TEMP	PORT STBD	S2,4		<ul style="list-style-type: none"> JOINT/EE TEMP OUT OF LIMITS 	
PDRS TEST	BRK C/W NMI FS LOSS	S2,4		<ul style="list-style-type: none"> MCIU BITE VERIFICATION TEST FAILURE 	
S96 PDRS TEST	SPA	S2,4		<ul style="list-style-type: none"> SPA BITE VERIFICATION TEST FAILURE 	
S94 PDRS WR R		S2,4		<ul style="list-style-type: none"> PDRS WRIST ROLL RANGE CHECK FAILURE 	
PNL TRIM	L(R)	G3,6		<ul style="list-style-type: none"> LH(RH) +/- P/R/Y TRIM SW DISAGREE 	<ul style="list-style-type: none"> NO MAL
PROBES		G3,6		<ul style="list-style-type: none"> EITHER ADTA PROBE NOT DEPLOYED DURING 1 < M < 2.5 	<ul style="list-style-type: none"> NO MAL
S89 PRPLT THRM	OMS	S2,4		<ul style="list-style-type: none"> OX(FU) LN STRUCT T HI/LOW 	
	POD	S2,4		<ul style="list-style-type: none"> PROP AND STRUCT T HI/LOW 	
	RCS	S2,4		<ul style="list-style-type: none"> FWD AND L/R RCS STRUCT T HI/LOW 	

MESSAGE		OPS AVAIL		CAUSE	COMMENTS
		PASS	BFS		
R OMS	GMBL	G1,2,3	G1,3	• PITCH (YAW) CMD/FEEDBACK $\Delta 2^\circ$ FOR 3.8 SEC	• NO MAL
	PC	G1,2,3,6	G1,3,6	• ENG CHAMBER PRESS LOW	
	QTY	G1,2,3,6,8		• FU OR OX TK LEVEL LOW	
	TEMP		G1,3	• ENG FU INJ T HI	
	TK P	G2,8	G1,3	• FU OR OX TK ULLAGE P HI/LOW	
			G1,3,6	• He OR N2 TK P LOW • N2 REG P HI/LOW	
	VLV	G2	• OMS R POD He/P VAP ISOL VLV MISMATCH	• NO MAL	
S89 R OMS	TEMP	S2,4		• ENG FU INJ T HI/LOW	• NO MAL

R

MESSAGE	OPS AVAIL		CAUSE	COMMENTS	
	PASS	BFS			
R RCS	JET		• RIGHT JET MANF 1(2,3,4) FAIL ON/OFF	• NO FAIL LK DETECTION IN BFS • FAILED OFF DETECTION NOT PERFORMED IN MM101 & 102 FOR PASS	
	AJET	G1,2,3,6,8	• R AFT JET 1(3) FAIL ON/OFF/LK		
	DJET	G1,2,3,6,8	• R DOWN JET 2(3,4,5) FAIL ON/OFF/LK		
	RJET	G1,2,3,6,8	• R RIGHT JET 1(2,3,4,5) FAIL ON/OFF/LK		
	UJET	G1,2,3,6,8	• R UP JET 1(2,4) FAIL ON/OFF/LK		
	He P	G2,8	G1,3,6	• R RCS AFT He (FU OR OX) TK PRESS – 2 LOW	• PKT C/L – RCS LEAK ISOL
	LEAK	G2,3,8	G1,3,6	• PROP/He LEAK	• OX/FU ΔQTY > 9.5%
	PVT	G2,3,8		• LOSS OF P OR T DATA FOR RCS QTY CALC	• NO MAL • QTY CALC SUSPENDED
	TK P	G2,8	G1,3,6	• R RCS AFT (FU OR OX) TK ULL PRESS HI/LOW	
	XFEED	G1,3,6		• R RCS PROP TANK LOW PRESS	• FAILURE ON RIGHT SIDE, AUTO XFEED FROM LEFT
G23 RCS SYSTEM	F(L,R)	G2,8	• F(L,R) RCS FU OR OX TK TEMP		
		G2,8	• F(L,R) RCS FU OR OX TK OUT PRESS		
RCS PWR	FAIL	G1,2,3,6,8	• LOSS OF VLV LOGIC PWR TO MANF ISOL VLVs	• OMS/RCS VLVs WITH tb – bp STUCK IN CURRENT POSITION	

MESSAGE		OPS AVAIL		CAUSE	COMMENTS
		PASS	BFS		
RHC	A	G2,8		<ul style="list-style-type: none"> CHANNEL FAIL R(P,Y) DISAGREE 	<ul style="list-style-type: none"> NO MAL FAIL = SM ALERT RHC LOST FOR DISAGREE
	L	G1,2,3,6,8		<ul style="list-style-type: none"> CHANNEL FAIL R(P,Y) DISAGREE 	
	R	G1,2,3,6,8		<ul style="list-style-type: none"> CHANNEL FAIL R(P,Y) DISAGREE 	
G51 RL MODE SW		G3,6		<ul style="list-style-type: none"> ENTRY ROLL MODE SW FAIL 	<ul style="list-style-type: none"> NO MAL
RM DLMA	ADTA	G3,6		<ul style="list-style-type: none"> DELAYED ADTA DILEMMA FLAG 	<ul style="list-style-type: none"> NO MAL DES/SEL AVAILABLE CONDITION NOT RESET UNTIL DATA GOOD FLAG RETURNS TO VALID
	GPS	G2,3,6,8		<ul style="list-style-type: none"> QA4 DILEMMA GPS 1/2/3 	<ul style="list-style-type: none"> NO BFS MSG NO MAL DES/SEL AVAILABLE
	TAC	G3,6		<ul style="list-style-type: none"> DILEMMA 	<ul style="list-style-type: none"> NO MAL DES/SEL AVAILABLE
	IMU	G1,2,3,6,8		<ul style="list-style-type: none"> DILEMMA 	<ul style="list-style-type: none"> NO MAL DES/SEL AVAILABLE
	MLS	G3,6		<ul style="list-style-type: none"> EL, RNG, OR AZ DISAGREE 	<ul style="list-style-type: none"> NO MAL DES/SEL AVAILABLE OPS 8 ONLY PWR-OFF/CHANGE CHANNEL NO CRT DATA OPS 3: HSI MAY IDENTIFY BAD UNIT
	PRL	G1,3,6		<ul style="list-style-type: none"> HYD SYS 1(2,3) DISAGREE 	<ul style="list-style-type: none"> NO MAL ASC PKT, ENT PKT – HYD P LOW ORB PKT – HYD ACCUM (RSVR) P LOW
	MANF	G1,2,3,6,8		<ul style="list-style-type: none"> RCS MANF DILEMMA FLAG. MANF VLV STATUS SET 'CLOSE' 	

MESSAGE		OPS AVAIL		CAUSE	COMMENTS
		PASS	BFS		
RM FAIL	ACC	G1,3,6		• FAIL	• NO MAL • DES/SEL AVAILABLE
	ADTA	G3,6	G3,6	• FAIL	• NO MAL • DES/SEL AVAILABLE
	IMU	G1,2,3 6,8	G1,3,6	• FAIL • COMM FAULT CAUSES BFS RM FAIL	• NO MAL • DES/SEL AVAILABLE
	MLS	G3,6		• FAIL	• NO MAL • DES/SEL AVAILABLE OPS 8 ONLY • NO CRT DATA OPS 3
	RGA	G1,3,6		• FAIL	• NO MAL • DES/SEL AVAILABLE
	TAC	G3,6		• FAIL	• NO MAL • DES/SEL AVAILABLE
	XFER		G1,3,6	• BFS NOT RECEIVE STATE VECTOR OR REFSMAT	• NO MAL
G33 RNDZ RADAR		G2		• KU-BAND BREAKS TRACK WITH RADAR TARGET (GPC ANT STEERING MODE ONLY)	• NO MAL
ROLL REF		G3	G3	• REF ROLL STATUS FAIL	• NO MAL
S86 RSVR/ACC P	1(2,3)	S2,4		• HYD RSVR P ↓ • HYD ACCUM P ↓	
SBTC/THC	A	G2,8		• AFT THC POS/NEG X/Y/Z OUTPUT A/B/C FAIL • AFT THC POS/NEG X/Y/Z OUTPUT DISAGREE	• NO MAL
	L	G3,6		• L SBTC CMD A(B,C) FAIL • L SBTC CMD A(B,C) DISAGREE	

MESSAGE	OPS AVAIL		CAUSE	COMMENTS
	PASS	BFS		
SBTC/THC	L	G2,3,8	<ul style="list-style-type: none"> FWD THC POS/NEG X/Y/Z OUTPUT A/B/C FAIL FWD THC POS/NEG X/Y/Z OUTPUT DISAGREE 	<ul style="list-style-type: none"> NO MAL
	R	G3,6	<ul style="list-style-type: none"> R SBTC CMD A(B,C) FAIL R SBTC CMD A(B,C) DISAGREE 	
SEL AUTO		G2	<ul style="list-style-type: none"> UNIV PTG MNVR T-30 & NOT AUTO 	<ul style="list-style-type: none"> NO MAL
SENSE SW		G2	<ul style="list-style-type: none"> AFT SENSE SW DEFAULT 	<ul style="list-style-type: none"> NO MAL DEFAULT POS IS '-Z'
212 OIU TEMP		S2	ACTIVE OIU HAS PWR SUPPLY TEMP > 212° F	<ul style="list-style-type: none"> NO MAL
212 OIU CONV ERR		S2	ACTIVE OIU HAS ERROR CONVERTING FLOATING POINT VALUES FROM BUS CNTL UNIT	<ul style="list-style-type: none"> NO MAL
212 OIU AD1 NO LK		S2	AD1 CANNOT ACHIEVE SYNC WITH BC WITHIN 100 MS FRAMES	<ul style="list-style-type: none"> NO MAL
212 OIU AD2 NO LK		S2	AD2 CANNOT ACHIEVE SYNC WITH BC WITHIN 100 MS FRAMES	<ul style="list-style-type: none"> NO MAL
212 OIU AD3 NO LK		S2	AD3 CANNOT ACHIEVE SYNC WITH BC WITHIN 100 MS FRAMES	<ul style="list-style-type: none"> NO MAL
212 OIU AD4 NO LK		S2	AD4 CANNOT ACHIEVE SYNC WITH BC WITHIN 100 MS FRAMES	<ul style="list-style-type: none"> NO MAL
SM1 SMOKE ALRM		SM	<ul style="list-style-type: none"> ANY SMOKE CONC ↑ 	

MESSAGE	OPS AVAIL		CAUSE	COMMENTS	
	PASS	BFS			
SM1 SMOKE BAY	1A	S2,4		<ul style="list-style-type: none"> • AV BAY 1 SENSOR A CONC ↑ • AV BAY 1 SENSOR B CONC ↑ • AV BAY 2 SENSOR A CONC ↑ • AV BAY 2 SENSOR B CONC ↑ • AV BAY 3 SENSOR A CONC ↑ • AV BAY 3 SENSOR B CONC ↑ 	• NO MAL
	1B	S2,4			
	2A	S2,4			
	2B	S2,4			
	3A	S2,4			
	3B	S2,4			
SM1 SMOKE CAB	LFD	S2,4		<ul style="list-style-type: none"> • LEFT FLT DECK SMOKE CONC ↑ • RIGHT FLT DECK SMOKE CONC ↑ • RETURN AIR CAB HX SMOKE CONC ↑ 	• NO MAL
	RFD	S2,4			
	HX	S2,4			
SPD BRK		G3,6		<ul style="list-style-type: none"> • SPEED BRAKE POSITION > 20% FROM AUTO SCHEDULE DURING 0.95 < M < 9.8 	• NO MAL
S66 SPLY H2O	PRES	S2,4		<ul style="list-style-type: none"> • SUPPLY H2O IN P ↓↑ • SUPPLY QTY TK A(B,C,D) ↓ C(D) ↑ • SPLY DUMP LINE T ↑↓ • SPLY NOZ T A(B) ↑ 	
	QTY	S2,4			
	TEMP	S2,4			
SSME FAIL	C(L,R)	G1,6	G1,6	<ul style="list-style-type: none"> • PREMATURE ME SHUTDOWN 	• IN MM101, MSG ANNUNCIATED BY BFS ONLY
SSME REPOS FAIL		G3	G3	<ul style="list-style-type: none"> • MORE THAN ONE MPS/TVC ISOL VLV FAILED TO INDICATE OPEN • LESS THAN TWO APU/HYD SYSTEMS INDICATED GOOD 	<ul style="list-style-type: none"> • NO MAL • SSME REPOSITIONING FOR DRAG CHUTE DEPLOY IS NOT COMPLETE • MM304 AND 3.5 < MACH < 8

MESSAGE		OPS AVAIL		CAUSE	COMMENTS
		PASS	BFS		
SUMWORD ICC	1(2,3,4,5)	ALL		<ul style="list-style-type: none"> SUMWORD MISCOMPARE IN DATA FROM INDICATED GPC 	
SW TO MEP		G3,6	G3	<ul style="list-style-type: none"> MEP ALERT 	<ul style="list-style-type: none"> NO MAL
TFL LOAD FAIL		S2,4	ALL	<ul style="list-style-type: none"> READ COMPARE ERROR UNSUCCESSFUL LOAD 	<ul style="list-style-type: none"> NO MAL MAY BE RESULT OF GROUND UPLINK
TGT ΔT		G2		<ul style="list-style-type: none"> REQUESTED TRANSFER TIME CAUSED SINGULARITY IN TARGETING ALGORITHM 	
TGT EL ANG		G2		<ul style="list-style-type: none"> EXCEEDED MAX NUMBER OF ITERATIONS ON TPI TIG FOR GIVEN ELEVATION ANGLE 	<ul style="list-style-type: none"> NO MAL
TGT ITER		G2		<ul style="list-style-type: none"> LAMBERT TGT TRANSFER ANGLE NEAR SINGULARITY POINT PARABOLIC TRANSFER MAX NUMBER OF ITERATIONS 	
S87 THERMAL	HYD	S2,4		<ul style="list-style-type: none"> HYD HX OUT T 1(2,3) ↓ 	<ul style="list-style-type: none"> NO MAL
S87 THERMAL CNTL	1(2,3)	S2,4		<ul style="list-style-type: none"> LINE TEMPS ELEVON LOB ↑↓ LINE TEMPS ELEVON LIB ↑↓ LINE TEMPS ELEVON RIB ↑↓ LINE TEMPS ELEVON ROB ↑↓ LINE TEMPS RD/SB PDU ↑↓ LINE TEMPS RD/SB FUS ↑↓ LINE TEMPS BDYFLP PDU ↑↓ LINE TEMPS BDYFLP FUS ↑↓ 	<ul style="list-style-type: none"> NO MAL HYD CIRC PUMP NOT MAINTAINING HYD THERMAL ENVIR
SM0 THRM APU			SM	<ul style="list-style-type: none"> APU TEMP GG BED ↓ APU TEMP INJ ↓ 	<ul style="list-style-type: none"> AVAILABLE ON SM SYS SUMM 2
APU			SM	<ul style="list-style-type: none"> APU FUEL T TEST LN 1(2) ↑↓ APU FUEL T FEED LN ↑↓ APU FUEL T PUMP IN ↑↓ APU FUEL T PUMP DRN LN 1(2) ↑↓ APU FUEL T PUMP OUT ↑↓ APU FUEL T PUMP BYP LN ↑↓ APU FUEL T GG SPLY LN ↑↓ H2O LN INJ ↑↓ 	<ul style="list-style-type: none"> ONLY AVAILABLE IN PASS SM,S88

T

MESSAGE	OPS AVAIL		CAUSE	COMMENTS
	PASS	BFS		
SM0 THRM EVAP (Cont)		a	• FES NOZ, DUCT OR FDLN T ↑↓	• ONLY SELECTED DUCTS AND FDLN Ts ARE SENSED FOR STATUS
FRN		SM	• ACCUM QTY ↓ • RAD OUT T ↑↓	• NO ASC/ENT PKT
H2O		a	• H2O SPLY IN P ↑↓	
HYD		a	• H2O BLR T ↑↓	• NO MAL • ASC/ENT PKT – THERM HTR
PRPLT		a	• OMS OX DRAIN LN T • OMS POD RCS HOUSING • OMS RCS STRUCT T • OX ENG IN OR ENG FU FDLN T	
TIME	MTU	ALL	• AUTOMATIC TIME SOURCE CHANGE	
	MTU TONE	ALL	• TIME MGT TIME TONE	• NO MAL
SM0 TIRE PRESS		G3,6	• TIRE PRESS LEFT(RIGHT) MG IB(OB) ↓ • TIRE PRESS LEFT(RIGHT) NG ↓	• UNITS ARE IN PCM COUNTS, NOT PSIA • NO MAL
S66 VAC VNT NZ	TEMP	S2,4	• VACUUM VENT NOZ T	• NO MAL (NO LIMITS)
SM2 W/B QTY 1(2,3)		SM	• W/B H2O QTY ↓	
S66 WASTE H2O	PRES	S2,4	• WASTE LIQ P ↑↓	
	QTY	S2,4	• WASTE QTY ↑↓	• NO MAL FOR QTY HIGH
	TEMP	S2,4	• WASTE NOZ T ↑↓ • DUMPLINE T ↑↓	
S86 WSB P	1(2,3)	S2,4	• W/B N2 P ↓ • W/B REG P ↑↓	• NO MAL
Q	1(2,3)	S2,4	• W/B H2O QTY ↓	
T	1(2,3)	S2,4	• W/B TANK T ↑↓ • W/B BLR T ↑↓	• A AND B BLR CNTLRS USE SEPARATE TRANSDUCERS • NO MAL

^a MM104 to 106, ORB OPS 0, MM301 to 303

MEDS FAULT MESSAGES

MEDS messages will appear in all PASS/BFS OPS on all MDUs that are operating in DPS mode and controlled by the detecting ID. If no MDUs are in DPS mode MEDS message will appear on an MDU display, if it is being commanded by that MDU, in the following hierarchy for its corresponding IDP:

IDP1		IDP2		IDP3		IDP4	
Rank	MDU	Rank	MDU	Rank	MDU	Rank	MDU
1	CRT1	1	CRT2	1	CRT3	1	CRT4
2	CDR1	2	PLT2	2	PLT2	2	AFD1
3	CDR2	3	PLT1	3	MFD2		
4	MFD2	4	MFD1	4	MFD1		
5	PLT1	5	CDR2	5	CDR1		
		6	AFD1				

MEDS FAULTS

MESSAGE	CAUSE	COMMENTS ^a
BITE FAIL ADC1A (1B,2A,2B)	<ul style="list-style-type: none"> • ADC BITE ERROR • ADC PWR ON SELF-TEST 	<ul style="list-style-type: none"> • MEDS I/O ERROR XXXXX
MDU AFD(1) MDU CDR1(2) MDU CRT1(2,3,4) MDU MFD1(2) MDU PLT1(2)	<ul style="list-style-type: none"> • MDU BITE ERROR • MDU PWR ON SELF-TEST ERROR 	<ul style="list-style-type: none"> • MEDS I/O ERROR XXXX • PORT CHANGE XXXX
IDP1(2,3,4)	<ul style="list-style-type: none"> • IDP BITE ERROR • IDP H/W or S/W HALT • IDP PWR ON SELF-TEST ERROR 	<ul style="list-style-type: none"> • I/O ERROR CRTX • PORT CHANGE XXXX • CRT BITE XXXX
CHECKSUM FAIL IDP1(2,3,4)	<ul style="list-style-type: none"> • CHECKSUM ERROR AT PWR ON SELF-TEST FAIL OF A LIMITED PORTION OF EEPROM 	
MEDS I/O ERROR FAIL ADC1A(1B,2A,2B)	<ul style="list-style-type: none"> • COM ERROR ON 1553B DATA BUS (between IDP and ADC) • ADC PWR LOSS or FAILURE • ADC H/W or S/W FAILURE 	
MDU AFD1 MDU CRT1(2,3,4) MDU CDR1(2,3) MDU MFD1(2) MDU PLT1(2)	<ul style="list-style-type: none"> • MDU PWR LOSS or FAILURE • MDU H/W or S/W FAILURE • MDU S/W LOAD FAIL • COMM ERROR ON 1553 DATA BUS 	<ul style="list-style-type: none"> • PORT CHANGE XXXX
MDU IS AUTONOMOUS	<ul style="list-style-type: none"> • LOSS OF MDU INTERFACE VIA PRIMARY AND SECONDARY PORTS 	<ul style="list-style-type: none"> • MESSAGE APPEARS IN CENTER OF MDU • MEDS I/O ERROR XXXX
MDU OVERTEMP MDU AFD1 MDU CDR1(2) MDU CRT1(2,3,4) MDU MFD1(2) MDU PLT1(2)	<ul style="list-style-type: none"> • MDU TEMP SENSOR FAILURE • INSUFFICIENT COOLING 	

^aAll messages listed in comments column are possible and may not be annunciated

MESSAGE	CAUSE	COMMENTS ^a
OPERATOR REQUEST FAIL MDU AFD1 MDU CDR1(2) MDU CRT1(2,3,4) MDU MFD1(2) MDU PLT1(2)	<ul style="list-style-type: none"> • IDP OR MDU MEMORY LOAD ERROR • MDU MEMORY DUMP READ ERROR • MASS STORAGE UNIT (MSU) FILE PATCHING ERRORS • MASS STORAGE UNIT (MSU) or 1553B OPERATOR REQUEST ERROR 	
PORT CHANGE MDU AFD1 MDU CDR1(2,3) MDU CRT1(2,3,4) MDU MFD1(2) MDU PLT1(2)	<ul style="list-style-type: none"> • MDU PRI/SEC PORT MODE ERROR • IDP/MDU 1553 BUS ERROR • IDP FAILURE 	<ul style="list-style-type: none"> • AUTOMATIC MDU PORT CHANGE WILL CAUSE ANNUNCIATION OF MESSAGE
PROCESSOR FAIL ADC1A(2A,1B,2B)	<ul style="list-style-type: none"> • INTERNAL ADC PROCESSOR ERROR 	
MDU AFD(1) MDU CDR1(2) MDU CRT1(2,3,4) MDU MFD1(2) MDU PLT1(2)	<ul style="list-style-type: none"> • INTERNAL MDU PROCESSOR ERROR 	<ul style="list-style-type: none"> • PORT CHANGE XXXX
SOFTWARE FAIL IDP1(2,3,4)	<ul style="list-style-type: none"> • IDP S/W HALT 	<ul style="list-style-type: none"> • I/O ERROR CRTX

^aAll messages listed in comments column are possible and may not be annunciated



This Page Intentionally Blank



CAUTION & WARNING

C/W POWER SUPPLY FAILURE	4-2
LIGHT PANEL	4-3
& FDA TABLE	4-4
HARDWARE C/W TABLE	4-54
PRIMARY TO BACKUP C/W ANALOG PARAMETER CALIBRATION	4-55
SM & H/W FDA LIMIT MANAGEMENT PROCEDURES	4-61

C/W

C/W

C/W POWER SUPPLY FAILURE

Power Supply Lost	Crew Indication	Function/Equipment Lost	Redundancy Lost	Remaining Functions	Next Worst Failure
System A	-F7 Panel ¹ : Primary C/W light & all Annunciator Its ON except Backup C/W It	-F7 Panel ¹ Primary C/W light & all Annunciator Its -R13U/C3: Status lights and functions lost (Memory Read/Clear, Limit Set/Read, Param Inhibit/Enable, Trip/Inhibited Status) -All tones to bottom speaker of middeck speaker unit through the ACCU Bypass switch/system ²	-Smoke Detection A Siren (A lights still work on L1) -Lower Bulbs of MA pbis (Lamp test will illuminate all bulbs) -Pri (H/W) C/W limit sensing -C/W Tone feed into the ACCU (1 of 2 feeds) -Emergency Tones (Siren and Klaxon) to the Orbit Station top speaker	-F7 panel ¹ : Backup C/W light -Class 2 limit sensing through Backup C/W (Software) -C/W tones, MA lights, and Spec Msgs -All tones heard thru Orbit station (bottom speaker) and Middeck (Top and bottom speakers)	ESS2CA DA Reference MAL, EPS SSR 80 for expected Crew Indications for this failure. Loss of ESS2CA causes loss of ALL C/W tones, MA lights, and the FC ECU. Therefore an aural alarm would not be generated so that FC 2 could be shutdown within 9 minutes. Fault Summ Msgs should be closely monitored.
System B	-F7 Panel: Primary and Backup C/W Its - ON (Cannot reset Backup C/W)	-F7 Panel: Primary and Backup C/W Its -Sleep Station Headset tones ²	-Smoke Detection B Siren (B lights still work on L1) -Upper Bulbs of MA pbi (Lamp test will illuminate all bulbs) -C/W Tone feed into the ACCU (1 of 2 feeds) -Emergency Tones (Siren and Klaxon) to the Middeck top speaker	-F7 panel: All Annunciator lights (except B/U and Pri C/W lights) -C/W tones, MA lights, and Spec Msgs -All tones heard thru Orbit station (top & bottom speakers) and Middeck (bottom speaker)	ESS1BC DA Reference MAL, EPS SSR 70 for expected Crew Indications for this failure. Loss of ESS1BC causes loss of ALL C/W tones, MA lights, and the FC ECU. Therefore an aural alarm would not be generated so that FC 1 could be shutdown within 9 minutes. Fault Summ Msgs should be closely monitored.

¹ If Power Supply A lost due to ESS1BC O13 & R14 Bus loss, power to the F7 Matrix is lost. (All lights are extinguished at all times)

² Not normally configured – No impact

C/W LIGHT PANEL

O ₂ PRESS	H ₂ PRESS	FUEL CELL REAC (R)	FUEL CELL STACK TEMP	FUEL CELL PUMP
CABIN ATM (R)	O ₂ HEATER TEMP	MAIN BUS (R) UNDERVOLT	AC VOLTAGE	AC OVERLOAD
FREON LOOP	AV BAY/ CABIN AIR	IMU	FWD RCS (R)	RCS JET
H ₂ O LOOP	RGA/ACCEL	AIR DATA (R)	LEFT RCS (R)	RIGHT RCS (R)
—	LEFT RHC (R)	RIGHT/AFT RHC (R)	LEFT OMS (R)	RIGHT OMS (R)
PAYLOAD WARNING (R)	GPC	FCS (R) SATURATION	OMS KIT	OMS TVC (R)
PAYLOAD CAUTION	PRIMARY C/W	FCS CHANNEL	MPS (R)	—
BACKUP C/W ALARM (R)	APU TEMP	APU OVERSPEED	APU UNDERSPEED	HYD PRESS

(34V73A7A2)

C/W & FDA TABLE

PARAMETER NAME	C/W CH	H/W C/W		SOFTWARE ID	PASS SPEC	SM ALERT		B/U C/W		PRECONDITION (P) AND/OR BILEVEL STATE (BL)
		LOW	HIGH			LOW	HIGH	LOW	HIGH	
AC AMPS 1 ΦA^a				0761540	67		10.0			
ΦB^a				0761541	67		10.0			
ΦC^a				0761542	67		10.0			
2 ΦA^a				0761640	67		10.0			
ΦB^a				0761641	67		10.0			
ΦC^a				0761642	67		10.0			
3 ΦA^a				0761740	67		10.0			
ΦB^a				0761741	67		10.0			
ΦC^a				0761742	67		10.0			
OVLD 1			5.00	0761506	67			1		• > 14.5 AMPS FOR 10-20 SEC (BL)
2	73		5.00	0761606	67			1		
3	83		5.00	0761706	67			1		
V 1 ΦA	33		5.00	0761500	67			108.0	123.0	• PRI C/W AC OV-UV (BL)
ΦB	33		5.00	0761501	67			108.0	123.0	
ΦC	33		5.00	0761502	67			108.0	123.0	
V 2 ΦA	43		5.00	0761600	67			108.0	123.0	• PRI C/W AC OV-UV (BL)
ΦB	43		5.00	0761601	67			108.0	123.0	
ΦC	43		5.00	0761602	67			108.0	123.0	
V 3 ΦA	53		5.00	0761700	67			108.0	123.0	• PRI C/W AC OV-UV (BL)
ΦB	53		5.00	0761701	67			108.0	123.0	
ΦC	53		5.00	0761702	67			108.0	123.0	
ADTA	91		2.50							• NAV SENSOR FAIL (BL)

^aPASS only

PARAMETER NAME	C/W CH	H/W C/W		SOFTWARE ID	PASS SPEC	SM ALERT		B/U C/W		PRECONDITION (P) AND/OR BILEVEL STATE (BL)
		LOW	HIGH			LOW	HIGH	LOW	HIGH	
AFT RCS DRN PNL 1 L ^a				0422304	89	49.0	125.0			
R ^a				0423304	89	49.0	125.0			
2 L ^b				0422305	89	49.0	125.0			
R ^b				0423305	89	49.0	125.0			
MANF 1 OX L ^b				0422204	89	50.0	140.0			
R ^b				0423204	89	50.0	140.0			
VERN PNL 1 L ^a (PASS)				0434701	89	45.0	140.0			
(BFS)						45.0	150.0			
R ^a (PASS)				0435701	89	45.0	140.0			
(BFS)						45.0	150.0			
2 L ^a				0434711	89	45.0	140.0			
R ^a				0435711	89	45.0	140.0			
A/L-VEST ΔP				0640127	177					
APCU1 AMPS CONV A ^c				6509003	200		8.5			
CONV B ^c				6509004	200		8.5			
2 AMPS CONV A ^c				6509009	200		8.5			
CONV B ^c				6509011	200		8.5			
1 TEMP CONV A ^c				6509002	200	20	130			
CONV B ^c				6509005	200	20	130			
2 TEMP CONV A ^c				6509010	200	20	130			
CONV B ^c				6509012	200	20	130			
1 TRIP ^c				6509006	200		-4.4			
2 TRIP ^c				6509013	200		-4.4			
1 VOLT ^c				6509000	200	122	126.5			
2 VOLT ^c				6509008	200	122	126.5			

^aPASS OPS S2,4; BFS MM 104-106, 301-303, OPS 0

^bPASS only

^cOV-104 PASS only

PARAMETER NAME	C/W CH	H/W C/W		SOFTWARE ID	PASS SPEC	SM ALERT		B/U C/W		PRECONDITION (P) AND/OR BILEVEL STATE (BL)
		LOW	HIGH			LOW	HIGH	LOW	HIGH	
APCU1 IN AMPS ^d				0762401	179		85			<ul style="list-style-type: none"> • <23±0.5 v 250 mS (BL) • <23±0.5 v 250 mS (BL) • >14.8±0.1 AMPS 200 µS (BL) • >130.5±2.3 v 2.5 mS (BL) • <115±2.5 v 55.5 mS (BL) • Low Limit - APCU CONV ON (P) • >14.8±0.1 AMPS 200 µS (BL) • >130.5±2.3 V 2.5 mS (BL) • <115±2.5 v 55.5 mS (BL) • Low Limit - APCU CONV ON (P)
UV ^d				0762411	179	1				
2 IN AMPS ^d				0762501	179		85			
UV ^d				0762511	179	1				
1 OUT AMPS ^d				0762402	179		14.7			
OC ^d				0762413	179	1				
OV ^d				0762415	179	1				
UV ^d				0762414	179	1				
VOLT ^d				0762403	179	122	127			
2 OUT AMPS ^d				0762502	179		14.7			
OC ^d				0762513	179	1				
OV ^d				0762515	179	1				
UV ^d				0762514	179	1				
VOLT ^d				0762503	179	122	127			
1 TEMP ^d				0762404	179		169			
2 TEMP ^d				0762504	179		169			

^dOV-103 & OV-105 PASS only (SSPTS)

┌

—

┐

—

This Page Intentionally Blank

—

└

4-7

REF/ALL/GEN I

—

└

PARAMETER NAME	C/W CH	H/W C/W	SOFTWARE ID	PASS SPEC	SM ALERT	B/U C/W	PRECONDITION (P) AND/OR BILEVEL STATE (BL)
APU B/U EGT 1 ^a			0460140	86		1160.0	
2 ^a			0460240	86		1160.0	
3 ^a			0460340	86		1160.0	
FUEL PUMP LK P 1 ^b			0460190		25.0		
2 ^b			0460290		25.0		
3 ^b			0460390		25.0		
QTY 1 (PASS)			0726001	86	50.0		
(BFS)					20.0		
2 (PASS)			0726002	86	50.0		
(BFS)					20.0		
3 (PASS)			0726003	86	50.0		
(BFS)					20.0		
APU FUEL T FEED LN 1			0460104	88	45.0	120.0	
2			0460204	88	45.0	120.0	
3			0460304	88	45.0	120.0	
SPLY LN 1 (PASS)			0461171	88	60.0	200.0	
(BFS)						200.0	
2 (PASS)			0461271	88	60.0	200.0	
(BFS)						200.0	
3 (PASS)			0461371	88	60.0	200.0	
(BFS)						200.0	
PUMP BYP LN 1			0460128	88	60.0	200.0	
2			0460228	88	60.0	200.0	
3			0460328	88	60.0	200.0	
DRN LN 1 1			0460186	88	43.0	95.0	
2			0460286	88	43.0	95.0	
3			0460386	88	43.0	95.0	
2 1			0460170	88	43.0	140.0	
2			0460270	88	48.0	195.0	
3			0460370	88	43.0	140.0	

^aPASS only
^bBFS only

PARAMETER NAME	C/W CH	H/W C/W	SOFTWARE ID	PASS SPEC	SM ALERT	B/U C/W	PRECONDITION (P) AND/OR BILEVEL STATE (BL)
APU FUEL T PUMP IN 1			0460108	88	45.0 125.0		
2			0460208	88	45.0 125.0		
3			0460308	88	45.0 125.0		
OUT 1			0460112	88	50.0 210.0		
2			0460212	88	50.0 210.0		
3			0460312	88	50.0 210.0		
TEST LN 1 1			0460183	88	45.0 110.0		
2			0460283	88	45.0 110.0		
3			0460383	88	45.0 110.0		
2 1			0460184	88	45.0 150.0		
2			0460284	88	45.0 150.0		
3			0460384	88	45.0 150.0		
TK HTR 1 ^a			0460130	88	45.0 140.0		
2 ^a			0460230	88	45.0 140.0		
3 ^a			0460330	88	45.0 140.0		
SURF 1 ^a			0460102	88	45.0		
2 ^a			0460202	88	45.0		
3 ^a			0460302	88	45.0		
TK P 1 ^a			0460100	86	100.0 350.0		
2 ^a			0460200	86	100.0 350.0		
3 ^a			0460300	86	100.0 350.0		
VLV A T 1			0461175	86	45.0 140.0		
2			0461275	86	45.0 140.0		
3			0461375	86	45.0 140.0		
B T 1			0461173	86	45.0 140.0		
2			0461273	86	45.0 140.0		
3			0461373	86	45.0 140.0		

^aPASS only

PARAMETER NAME	C/W CH	H/W C/W		SOFTWARE ID	PASS SPEC	SM ALERT		B/U C/W		PRECONDITION (P) AND/OR BILEVEL STATE (BL)
		LOW	HIGH			LOW	HIGH	LOW	HIGH	
APU GBX BRG T 1 ^a				0460161	86		400.0			<ul style="list-style-type: none"> • ① GG/FU PMP HTRS – OFF OR APU CNTLR PWR – ON (P) • ② GG/FU PMP HTRS A OR B – ON AND APU CNTLR PWR – OFF (P) • SEE ① • SEE ② • SEE ① • SEE ② • APU 1 SPEED % > 40 (P) • APU 1 SPEED % < 40 (P) • APU 1 SPEED % > 40 (P) • APU 2 SPEED % > 40 (P) • APU 2 SPEED % < 40 (P) • APU 2 SPEED % > 40 (P) • APU 3 SPEED % > 40 (P) • APU 3 SPEED % < 40 (P) • APU 3 SPEED % > 40 (P)
2 ^a				0460261	86		400.0			
3 ^a				0460361	86		400.0			
N2 P 1 ^a				0460151	86	3.0				
2 ^a				0460251	86	3.0				
3 ^a				0460351	86	3.0				
APU GG BED T 1 (PASS)				0460122	86	100.0				
(PASS)						100.0	475.0			
2 (PASS)				0460222	86	100.0				
(PASS)						100.0	475.0			
3 (PASS)				0460322	86	100.0				
(PASS)						100.0	475.0			
H2O LN INJ T 1				0460501	88	40.0	110.0			
2				0460502	88	40.0	190.0			
3				0460503	88	40.0	110.0			
OIL OUT P 1 (PASS)				0460153	86	25.0	150.0			
(PASS)					86		150.0			
(BFS)						25.0	150.0			
2 (PASS)				0460253	86	25.0	150.0			
(PASS)					86		150.0			
(BFS)						25.0	150.0			
3 (PASS)				0460353	86	25.0	150.0			
(PASS)					86		150.0			
(BFS)						25.0	150.0			
T 1 (PASS)				0460154	86	40.0	305.0			
2 (PASS)				0460254	86	40.0	305.0			
3 (PASS)				0460354	86	40.0	305.0			

^aPASS only

PARAMETER NAME	C/W CH	H/W C/W		SOFTWARE ID	PASS SPEC	SM ALERT		B/U C/W		PRECONDITION (P) AND/OR BILEVEL STATE (BL)
		LOW	HIGH			LOW	HIGH	LOW	HIGH	
APU OIL T 1 (PASS)	38		2.90	0460150	86				290.0	<ul style="list-style-type: none"> • APU X SPEED % > 129 (BL) • ① APU OPER X – STRT/RUN & APU SPD SEL X – NORM (P) • ② APU OPER X – STRT/RUN (P) • ③ APU OPER X – INJ COOL FOR 3.5 MIN (CONTINUOUS) (P) • SEE ① • SEE ② • SEE ③ • SEE ① • SEE ② • SEE ③
2 (PASS)	48		2.90	0460250	86				290.0	
3 (PASS)	58		2.90	0460350	86				290.0	
OVERSPEED 1	68		5.00							
2	78		5.00							
3	88		5.00							
PUMP/VLV PMP T 1				0460192	86		210.0			
2				0460292	86		210.0			
3				0460392	86		210.0			
SPEED % 1 (BFS)				0460135			112.0			
						80.0		80.0	122.0	
2 (BFS)				0460235			112.0	80.0	122.0	
3 (BFS)				0460335		80.0	112.0	80.0	122.0	
						80.0		80.0	122.0	

PARAMETER NAME	C/W CH	H/W C/W		SOFTWARE ID	PASS SPEC	SM ALERT		B/U C/W		PRECONDITION (P) AND/OR BILEVEL STATE (BL)
		LOW	HIGH			LOW	HIGH	LOW	HIGH	
APU TEMP EGT 1 ^a	8		4.20	0460142						
2 ^a	18		4.20	0460242						
3 ^a	28		4.20	0460342						
GG BED 1 (BFS)				0460122		258.0				
2 (BFS)				0460222		258.0				
3 (BFS)				0460322		258.0				
INJ 1 ^c				0460174		258.0				
2 ^c				0460274		258.0				
3 ^c				0460374		258.0				
OIL IN 1 (BFS)	38		2.90	0460150				45.0	290.0	
2 (BFS)	48		2.90	0460250				45.0	290.0	
3 (BFS)	58		2.90	0460350				45.0	290.0	
OUT 1 (BFS)				0460154		40.0	305.0			
2 (BFS)				0460254		40.0	305.0			
3 (BFS)				0460354		40.0	305.0			
UNDERSPEED 1	98		5.00							• < 80% (BL)
2	108		5.00							
3	118		5.00							
AV BAY FAN ΔP 1				0612642	66	3.10	4.80			
2				0612647	66	2.50	4.60			
3				0612658	66	3.30	4.90			
3 ^b				0612658	66	6.10	7.70			
TEMP 1	84		4.25	0612645	66				130.0	
2	94		4.25	0612650	66				130.0	
3	104		4.25	0612661	66				130.0	

^a H/W C/W channels are inhibited

^b Upgraded AV BAY FAN

^c BFS only

PARAMETER NAME	C/W CH	H/W C/W		SOFTWARE ID	PASS SPEC	SM ALERT		B/U C/W		PRECONDITION (P) AND/OR BILEVEL STATE (BL)
		LOW	HIGH			LOW	HIGH	LOW	HIGH	
BRAKE PRESS HYD SYS 1/3 L OB ^a				0510724			180			<ul style="list-style-type: none"> • INHIBITED AFTER LANDING GEAR UPLOCK DISCRETES ARE OFF (0) (V51X0100X, 0200X) (P)
L IB ^a				0510726			180			
R IB ^a				0510746			180			
R OB ^a				0510744			180			
2/3 L OB ^a				0510722			180			
L IB ^a				0510728			180			
R IB ^a				0510742			180			
R OB ^a				0510748			180			

^aBFS only

C

PARAMETER NAME	C/W CH	H/W C/W		SOFTWARE ID	PASS SPEC	SM ALERT		B/U C/W		PRECONDITION (P) AND/OR BILEVEL STATE (BL)
		LOW	HIGH			LOW	HIGH			
CABIN AIRLOCK P ^a				0640101	66	13.8	15.7			<ul style="list-style-type: none"> • HIGH C/W DEFAULT VALUE 4.40 V (7.04 inches H2O) AND LOW C/W DEFAULT VALUE 1.75 V (2.80 inches H2O) • THIS VALUE IS TMBUD AT OPS 2 DEPENDING ON NUMBER OF TANKS FLOWN, LL = 150 (200) FOR 3(4) N2 TANKS/SYS
dP/dT ^a				0612401	78	-0.12				
dP/dT EQ				0924935	78					
EMER O2 REG P ^a				0612166	66					
FAN ΔP	74	2.60	4.25	0612556	66			4.2	6.8	
HX OUT T ^a	114		5.00	0612635	66					
H2O TK N2 P 1 ^a				0612307	66	13.0				
2 ^a				0612311	66	13.0				
N2 FLOW 1 ^b	54		4.90	0612553	66				4.9	
2 ^b	64		4.90	0612554	66				4.9	
QTY 1 ^a				0920315	66	100.0				
2 ^a				0920318	66	100.0				
REG P 1 ^a				0612310	66	150.0	260.0			
2 ^a				0612410	66	150.0	260.0			
O2 CONC ^a				0922104	78		25.9			
FLOW 1	14		4.90	0612105	66				4.9	
2	24		4.90	0612205	66				4.9	
REG P 1 ^a				0612115	66		145.0			
2 ^a				0612215	66		145.0			

^aPASS only

^bH/W and B/U C&W are inhibited on OV-104 prelaunch (Crew Pre-Ingress sw Reconfiguration)

PARAMETER NAME	C/W CH	H/W C/W		SOFTWARE ID	PASS SPEC	SM ALERT		B/U C/W		PRECONDITION (P) AND/OR BILEVEL STATE (BL)			
		LOW	HIGH			LOW	HIGH	LOW	HIGH				
CABIN P (PASS) (OV103) (OV104) (OV105) (BFS)	4	3.45	3.85 ^b	0612405	66	7.5		13.8	15.2	<ul style="list-style-type: none"> • LOW C/W DEFAULT VALUE 3.45 V AND HIGH C/W DEFAULT VALUE 3.80 V 			
PPCO2 ^a												13.8	15.35
PPO2 A (PASS) (BFS) (BFS)		34	2.70					3.60	0612540		66		7.6
B (PASS) (BFS) (BFS)	44		2.70	3.60	0612513	66	1.9		2.7 2.7 2.4	3.6 3.6 3.6	<ul style="list-style-type: none"> • POST-LANDING BFS TRANSITION TO OPS 0 (P) 		
C ^a				0612515	66								
T ^a				0612552	66		90.0						
CCTV CAM OVER-TEMP ^a				0740847	76	1				<ul style="list-style-type: none"> • CCTV CAMERA OUT OF TEMP (BL) 			
CIRC PUMP CONTROL LINE TEMPS													
BDYFLP FUS 1 ^a				0580184	87	-40.0	250.0						
2 ^a				0580269	87								
3 ^a				0580369	87								
PDU 1 ^a				0580169	87								
2 ^a				0580288	87	-40.0	250.0						
3 ^a				0580388	87	-40.0	250.0						

^aPASS only

^bCABIN P H/W C/W high limit set prelaunch (Crew Pre-Ingress sw Reconfiguration) to: (OV103) = 3.85 V/15.36 psia; (OV104) = 3.85 V/15.35 psia; (OV105) = 3.90 V/15.54 psia. POST Insertion, crew resets limits to those shown above

PARAMETER NAME	C/W CH	H/W C/W		SOFTWARE ID	PASS SPEC	SM ALERT		B/U C/W		PRECONDITION (P) AND/OR BILEVEL STATE (BL)
		LOW	HIGH			LOW	HIGH	LOW	HIGH	
CIRC PUMP CONTROL LINE TEMPS										
ELEVON LIB 1 ^a				0580157	87		250.0			
2 ^a				0580257	87	-40.0	250.0			
3 ^a				0580833	87		250.0			
LOB 1 ^a				0580193	87	-40.0	250.0			
2 ^a				0580883	87		250.0			
3 ^a				0580394	87	-40.0	250.0			
RIB 1 ^a				0580159	87		250.0			
2 ^a				0580933	87		250.0			
3 ^a				0580359	87	-40.0	250.0			
ROB 1 ^a				0580194	87	-40.0	250.0			
2 ^a				0580294	87	-40.0	250.0			
3 ^a				0580983	87		250.0			
L BRAKE FUS 2 ^a				0580292	87					
3 ^a				0580392	87					
WHL 2 ^a				0580841	87					
3 ^a				0580842	87					
MG L UPLK ^a				0580125	87					
MG R FUS ^a				0580129	87					
UPLK ^a				0580128	87					
NG MFUS 1 ^a				0580127	87					
2 ^a				0581143	87					
UPLK ^a				0580126	87					

^aPASS only

PARAMETER NAME	C/W CH	H/W C/W		SOFTWARE ID	PASS SPEC	SM ALERT		B/U C/W		PRECONDITION (P) AND/OR BILEVEL STATE (BL)
		LOW	HIGH			LOW	HIGH	LOW	HIGH	
CIRC PUMP CONTROL LINE TEMPS										
R BRAKE FUS 1 ^a				0580192	87					
2 ^a				0580296	87					
3 ^a				0580393	87					
WHL 1 ^a				0580846	87					
2 ^a				0580293	87					
3 ^a				0580845	87					
RD/SB FUS 1 ^a				0580198	87	-40.0	250.0			
2 ^a				0580298	87	-40.0	250.0			
3 ^a				0580384	87					
PDU 1 ^a				0581006	87	-40.0	250.0			
2 ^a				0580284	87	-40.0	250.0			
3 ^a				0580398	87	-40.0	250.0			
COMSEC 1 BITE				0745003	76	0				• NSP 1 RCV ENCRYPTED
2 BITE				0745004	76	0				• NSP 2 RCV ENCRYPTED

^aPASS only

PARAMETER NAME	C/W CH	H/W C/W		SOFTWARE ID	PASS SPEC	SM ALERT		B/U C/W		PRECONDITION (P) AND/OR BILEVEL STATE (BL)
		LOW	HIGH			LOW	HIGH	LOW	HIGH	
CRYO H2 CNTL P TK 1	50	0.25	4.65	0452110	68			153.0	293.8	
2	60	0.25	4.65	0452210	68			153.0	293.8	
3	70	0.25	4.65	0452310	68			153.0	293.8	
4	80	0.25	4.65	0452410	68			153.0	293.8	
5	90	0.25	4.65	0452510	68			153.0	293.8	
HTR T TK 1 ^a				0452107	68		210.0			
2 ^a				0452207	68		210.0			
3 ^a				0452307	68		210.0			
4 ^a				0452407	68		210.0			
5 ^a				0452507	68		210.0			
MANF P TK 1 (PASS)				0452140	68	150.0				
(BFS)						189.8				
2 (PASS)				0452145	68	150.0				
(BFS)						189.8				

^aPASS only

PARAMETER NAME	C/W CH	H/W C/W		SOFTWARE ID	PASS SPEC	SM ALERT		B/U C/W		PRECONDITION (P) AND/OR BILEVEL STATE (BL)
		LOW	HIGH			LOW	HIGH			
CRYO H2 MANF VLV TK 1 ^a TK P TK 1 ^a 2 ^a 3 ^a 4 ^a 5 ^a				0452141	68	0				<ul style="list-style-type: none"> VALVE CLOSED (BL) HTRS NOT IN AUTO (P)^b A OR B HEATER IN AUTO (P)^b
				0452146	68	0				
				0452100	68	165.0 189.8	283.0 283.0			
				0452200	68	165.0 189.8	283.0 283.0			
				0452300	68	165.0 189.8	283.0 283.0			
				0452400	68	165.0 189.8	283.0 283.0			
				0452500	68	165.0 189.8	283.0 283.0			

^aPASS only

^bAll tanks have same preconditioning

PARAMETER NAME	C/W CH	H/W C/W		SOFTWARE ID	PASS SPEC	SM ALERT		B/U C/W		PRECONDITION (P) AND/OR BILEVEL STATE (BL)
		LOW	HIGH			LOW	HIGH	LOW	HIGH	
CRYO O2 CNTL P TK 1	0	0.25	4.70	0451110	68			540.0	985.0	• EXCESSIVE HTR CURRENT (BL)
2	10	0.25	4.70	0451210	68			540.0	985.0	
3	20	0.25	4.70	0451310	68			540.0	985.0	
4	30	0.25	4.70	0451410	68			540.0	985.0	
5	40	0.25	4.70	0451510	68			540.0	985.0	
HTR CUR SNSR 1A 1 ^a				0451185	68	1				
2 ^a				0451285	68	1				
3 ^a				0451385	68	1				
4 ^a				0451485	68	1				
5 ^a				0451585	68	1				

^aPASS only

PARAMETER NAME	C/W CH	H/W C/W		SOFTWARE ID	PASS SPEC	SM ALERT		B/U C/W		PRECONDITION (P) AND/OR BILEVEL STATE (BL)
		LOW	HIGH			LOW	HIGH	LOW	HIGH	
CRYO O2 HTR CUR SNSR 1B	1 ^a			0451187	68	1				• EXCESSIVE HTR CURRENT (BL)
	2 ^a			0451287	68	1				
	3 ^a			0451387	68	1				
	4 ^a			0451487	68	1				
	5 ^a			0451587	68	1				
	6 ^a			0453187	168	1				
	7 ^a			0453287	168	1				
	8 ^a			0453387	168	1				
	9 ^a			0453487	168	1				
2A	1 ^a			0451186	68	1				• EXCESSIVE HTR CURRENT (BL)
	2 ^a			0451286	68	1				
	3 ^a			0451386	68	1				
	4 ^a			0451486	68	1				
	5 ^a			0451586	68	1				
	6 ^a			0453186	168	1				
	7 ^a			0453286	168	1				
	8 ^a			0453386	168	1				
	9 ^a			0453486	168	1				
2B	1 ^a			0451188	68	1				• EXCESSIVE HTR CURRENT (BL)
	2 ^a			0451288	68	1				
	3 ^a			0451388	68	1				
	4 ^a			0451488	68	1				
	5 ^a			0451588	68	1				
	6 ^a			0453188	168	1				
	7 ^a			0453288	168	1				
	8 ^a			0453388	168	1				
	9 ^a			0453488	168	1				

^aPASS only

PARAMETER NAME	C/W CH	H/W C/W		SOFTWARE ID	PASS SPEC	SM ALERT		B/U C/W		PRECONDITION (P) AND/OR BILEVEL STATE (BL)
		LOW	HIGH			LOW	HIGH	LOW	HIGH	
CRYO O2 HTR T 1 TK 1	1		4.30	0451107	68				349.0	
2	21		4.30	0451207	68				349.0	
3	41		4.30	0451307	68				349.0	
4	61		4.30	0451407	68				349.0	
5	81 ^a		4.30 ^a	0451507	68				349.0	
T 2 TK 1	11		4.30	0451109	68				349.0	
2	31		4.30	0451209	68				349.0	
3	51		4.30	0451309	68				349.0	
4	71		4.30	0451409	68				349.0	
5	b		b	0451509	68				349.0	
MANF P 1 (PASS)				0451140	68	200.0				
(BFS)						740.0				
2 (PASS)				0451145	68	200.0				
(BFS)						740.0				

^aTK 5 H/W C/W on OV105 only

^bMission and configuration dependent

PARAMETER NAME	C/W CH	H/W C/W		SOFTWARE ID	PASS SPEC	SM ALERT		B/U C/W		PRECONDITION (P) AND/OR BILEVEL STATE (BL)
		LOW	HIGH			LOW	HIGH	LOW	HIGH	
CRYO O2 MANF VLV 1 ^a				0451141	68	0				<ul style="list-style-type: none"> • VALVE CLOSED (BL)
TK P TK 1 ^a				0451146	68	0				
2 ^a				0451100	68	575.0	960.0			<ul style="list-style-type: none"> • HTRS NOT IN AUTO (P) • A OR B HTR IN AUTO (P)
3 ^a				0451200	68	740.0	960.0			
4 ^a				0451300	68	575.0	960.0			
5 ^a				0451400	68	740.0	960.0			
				0451500	68	575.0	960.0			
						740.0	960.0			<ul style="list-style-type: none"> • TK 5 HTR NOT IN AUTO (P) • TK 5 HTR IN AUTO (P)

^aPASS only

PARAMETER NAME	C/W CH	H/W C/W		SOFTWARE ID	PASS SPEC	SM ALERT		B/U C/W		PRECONDITION (P) AND/OR BILEVEL STATE (BL)
		LOW	HIGH			LOW	HIGH	LOW	HIGH	
DC AMPS MID PCA 1 ^a				0763085	67	1.0				<ul style="list-style-type: none"> • MID MCA 1 OP STAT 1 ACTIVE (P) • MID MCA 2 OP STAT 1 ACTIVE (P) • MID MCA 2 OP STAT 3 ACTIVE (P) • RPC OFF (BL)
2 ^a				0763086	67	1.0				
3 ^a				0763087	67	1.0				
RPC CNTL MNA AB1/CA1 ^a				0760124	67	0				
AB2/CA2 ^a				0760125	67	0				
AB3/CA3 ^a				0760126	67	0				
MNB AB1/BC1 ^a				0760224	67	0				
AB2/BC2 ^a				0760225	67	0				
AB3/BC3 ^a				0760226	67	0				
MNC BC1/CA1 ^a				0760324	67	0				
BC2/CA2 ^a				0760325	67	0				
BC3/CA3 ^a				0760326	67	0				
VOLT AFT PCA 4 ^a				0763091	67	26.2				
5 ^a				0763092	67	26.2				
6 ^a				0763093	67	26.2				
CNTL AB 1				0760120	67	24.5				
2				0760121	67	24.5				
3				0760122	67	24.5				
BC 1				0760220	67	24.5				
2				0760221	67	24.5				
3				0760222	67	24.5				
CA 1				0760320	67	24.5				
2				0760321	67	24.5				
3				0760322	67	24.5				

^aPASS only

PARAMETER NAME	C/W CH	H/W C/W		SOFTWARE ID	PASS SPEC	SM ALERT		B/U C/W		PRECONDITION (P) AND/OR BILEVEL STATE (BL)
		LOW	HIGH			LOW	HIGH	LOW	HIGH	
DC VOLT ESS 1BC				0760130	67	25.0				
2CA				0760230	67	25.0				
3AB				0760330	67	25.0				
FWD PCA 1 ^a				0763071	67	26.2				
2 ^a				0763072	67	26.2				
3 ^a				0763073	67	26.2				
DC VOLT MAIN A	3	3.30		0760100	67	27.0	32.0	26.4		
B	13	3.30		0760200	67	27.0	32.0	26.4		
C	23	3.30		0760300	67	27.0	32.0	26.4		

^aPASS only

E

PARAMETER NAME	C/W CH	H/W C/W		SOFTWARE ID	PASS SPEC	SM ALERT		B/U C/W		PRECONDITION (P) AND/OR BILEVEL STATE (BL)
		LOW	HIGH			LOW	HIGH	LOW	HIGH	
ELEV HINGE MOM (GNC) ^a				V97U6814C					80.0	
POS SAT HI (GNC) ^a				V97U6856C					12.0	
LO				V97U6857C				-15.0		
EMER dP/dT BU ^b				0980004		-0.12				
EVAP FDLN T ACCUM A ^c				0631892	88	50.0	150.0			
B ^c				0631894	88	50.0	150.0			
AFT A										
(PASS)				0631876	88	50.0	150.0			
(BFS) ^d						50.0	140.0			
AFT B										
(PASS)				0631877	88	50.0	150.0			
(BFS) ^d						50.0	140.0			
FWD A										
(PASS)				0631870	88	50.0	150.0			
(BFS) ^d						50.0	140.0			
FWD B										
(PASS)				0631871	88	50.0	150.0			
(BFS) ^d						50.0	140.0			
HI LOAD A ^c				0631895	88	50.0	OSH			
B ^c				0631896	88	50.0	OSH			
MID 1 A										
(PASS)				0631872	88	50.0	150.0			
(BFS) ^d						50.0	140.0			
MID 1 B										
(PASS)				0631873	88	50.0	150.0			
(BFS) ^d						50.0	140.0			

^a PASS OPS G3,6; BFS OPS 3,6

^b BFS only

^c PASS only

^d BFS only; MM104-106, 301-303, OPS 0

PARAMETER NAME	C/W CH	H/W C/W		SOFTWARE ID	PASS SPEC	SM ALERT		B/U C/W		PRECONDITION (P) AND/OR BILEVEL STATE (BL)
		LOW	HIGH			LOW	HIGH	LOW	HIGH	
EVAP FDLN T MID 2 A										
(PASS)				0631874	88	50.0	150.0			
(BFS) ^a						50.0	140.0			
MID 2 B										
(PASS)				0631875	88	50.0	150.0			
(BFS) ^a						50.0	140.0			
TOPPING A ^b				0631891	88	50.0	150.0			
B ^b				0631893	88	50.0	150.0			
TEMP HI LOAD INBD DUCT										
(PASS)				0631820	88	150.0	375.0			<ul style="list-style-type: none"> • ANY HI LOAD DUCT HTR ON (24 MIN DELAY) (P) • ALL HI LOAD DUCT HTRS OFF (P) • NO PRECOND IN BFS
(PASS)					88		375.0			
(BFS) ^a						150.0	375.0			
TEMP HI LOAD OUTBD DUCT										
(PASS)				0631821	88	150.0	330.0			<ul style="list-style-type: none"> • ANY HI LOAD DUCT HTR ON (15 MIN DELAY) (P) • ALL HI LOAD DUCT HTRS OFF (P) • NO PRECOND IN BFS
(PASS)					88		330.0			
(BFS) ^a						150.0	330.0			
NOZ										
(PASS)				0631890	88	100.0	350.0			<ul style="list-style-type: none"> • ANY HI LOAD DUCT HTR ON (38 MIN DELAY) (P) • ALL HI LOAD DUCT HTRS OFF (P) • NO PRECOND IN BFS
(PASS)					88		350.0			
(BFS) ^a						100.0	350.0			

^aBFS only; MM104-106, 301-303, OPS 0

^bPASS only

PARAMETER NAME	C/W CH	H/W C/W		SOFTWARE ID	PASS SPEC	SM ALERT		B/U C/W		PRECONDITION (P) AND/OR BILEVEL STATE (BL)
		LOW	HIGH			LOW	HIGH	LOW	HIGH	
EVAP TEMP TOPPING AFT ^a				0631802	88	100.0	330.0			
FWD ^a				0631801	88	100.0	330.0			
L DUCT ^b				0631800	88	50.0	245.0			
NOZ ^a				0631878	88	40.0	245.0			
R DUCT ^b				0631810	88	50.0	245.0			
NOZ ^a				0631879	88	40.0	245.0			
EXT AL H2O LINE PRESS LCG SPLY P1 ^b				0640170	177	---	---			
P2 ^b				0640171	177	---	---			
H2O XFER P ^b				0640173	177	---	---			
INT TEMP UPR BKHD T ^b				0640135	177	40	113			
LWR BKHD T ^b				0640136	177	40	113			
EXT TEMP AFT STRUC T ^b				0640137	177	40	113			
LINE TEMP H2O SPLY T ZN1 ^b				0640181	177	43	145			
ZN2 ^b				0640184	177	48	145			
LCG2 SPLY T ZN1 ^b				0640182	177	49	145			
ZN2 ^b				0640185	177	45	145			
O2 SPLY LN T ^b				0640186	177	---	---			
PRESS ^b				0640126	177	13.8	15.7			
FC ΔAMPS 1 ^b				0922142	69	-500 ^c	+500 ^c			
2 ^b				0922143	69	-500 ^c	+500 ^c			
3 ^b				0922144	69	-500 ^c	+500 ^c			
1				0450100	69	27.5	32.5			
2				0450200	69	27.5	32.5			
3				0450300	69	27.5	32.5			

^aPASS OPS S2,4; BFS MM104-106, 301-303, OPS 0

^bPASS only

^cTMBU value. Limit will be changed appropriately if needed

PARAMETER NAME	C/W CH	H/W C/W		SOFTWARE ID	PASS SPEC	SM ALERT		B/U C/W		PRECONDITION (P) AND/OR BILEVEL STATE (BL)
		LOW	HIGH			LOW	HIGH	LOW	HIGH	
FC 1 ΔV SS 1				0450102	69		150.0			• PUMP OFF OR ΔP < 2 PSI (BL)
2				0450103	69		150.0			
3				0450104	69		150.0			
2 ΔV SS 1				0450202	69		150.0			
2				0450203	69		150.0			
3				0450204	69		150.0			
3 ΔV SS 1				0450302	69		150.0			
2				0450303	69		150.0			
3				0450304	69		150.0			
AMPS 1 (PASS)				0450101	69	54.0	360.0			
(BFS)						54.0	410.0			
2 (PASS)				0450201	69	54.0	360.0			
(BFS)						54.0	410.0			
3 (PASS)				0450301	69	54.0	360.0			
(BFS)						54.0	410.0			
COOL P 1				0450147	69	50.0	75.0			
2				0450247	69	50.0	75.0			
3				0450347	69	50.0	75.0			
PUMP 1	92	4.80		0450143	69			0		
2	102	4.80		0450243	69			0		
3	112	4.80		0450343	69			0		
EXIT T 1				0450130	69	131.0	164.0			
2				0450230	69	131.0	164.0			
3				0450330	69	131.0	164.0			
FLOW H2 1 ^a				0450170	69		1.6			
2 ^a				0450270	69		1.6			
3 ^a				0450370	69		1.6			

^aPASS only

PARAMETER NAME	C/W CH	H/W C/W		SOFTWARE ID	PASS SPEC	SM ALERT		B/U C/W		PRECONDITION (P) AND/OR BILEVEL STATE (BL)
		LOW	HIGH			LOW	HIGH	LOW	HIGH	
FC FLOW O2 1 ^a				0450160	69		11.1			
2 ^a				0450260	69		11.1			
3 ^a				0450360	69		11.1			
H2 PUMP STATUS 1 ^a				0450114	69	0.2	0.8			
2 ^a				0450214	69	0.2	0.8			
3 ^a				0450314	69	0.2	0.8			
H2O ALT LN T 1 ^a				0450182	69	60.0	185.0			
2 ^a				0450282	69	60.0	185.0			
3 ^a				0450382	69	60.0	185.0			
LINE PH ^a				0450462	69	1				• HIGH PH (BL)
LN T 1 ^a				0450181	69	60.0	185.0			
2 ^a				0450281	69	60.0	185.0			
3 ^a				0450381	69	60.0	185.0			
H2O RLF HTRS A-AUTO	2			0450445	69	0				• H2O RLF HTRS B-AUTO = OFF (P) • H2O RLF HTRS B-AUTO = ON (P)
H2O RLF LINE T ^a				0450450	69	60.0	185.0			
NOZ T A ^a				0450455	69	150.0	425.0			
B ^a				0450456	69	150.0	425.0			
VLV T 1 ^a				0450412	69	60.0	185.0			
2 ^a				0450422	69	60.0	185.0			
3 ^a				0450432	69	60.0	185.0			
PH 1				0450410	69	1				• HIGH PH (BL)
2				0450420	69	1				
3				0450430	69	1				
PURGE LN H2 T1 ^a				0450699	69		380.0			
T2 ^a				0450700	69		380.0			
O2 T ^a				0450600	69		380.0			

^aPASS only

PARAMETER NAME	C/W CH	H/W C/W		SOFTWARE ID	PASS SPEC	SM ALERT		B/U C/W		PRECONDITION (P) AND/OR BILEVEL STATE (BL)		
		LOW	HIGH			LOW	HIGH	LOW	HIGH			
FC REAC H2 1	12	4.80		0452150	69			0		• VALVE CLOSED (BL)		
2	32	4.80		0452155	69			0				
3	52	4.80		0452160	69			0				
O2 1	2	4.80		0451150	69			0		• VALVE CLOSED (BL)		
2	22	4.80		0451155	69			0				
3	42	4.80		0451160	69			0				
READY 1 ^a				0450105	69	0				• (BL)		
2 ^a				0450205	69	0				• (BL)		
3 ^a				0450305	69	0				• (BL)		
STACK T 1 (PASS)	62	3.30	4.25	0450120	69	180.0	212.0	172.5	243.7	• ≤ 3.5 KW OUTPUT (P)		
(BFS)												
(PASS)					69	190.0	222.0					• 3.5< KW< 7.5 OUTPUT (P)
(BFS)												
(PASS)					69	198.0	238.0					• ≥ 7.5 KW OUTPUT (P)
STACK T 2 (PASS)	72	3.30	4.25	0450220	69	180.0	212.0	172.5	243.7	• ≤ 3.5 KW OUTPUT (P)		
(BFS)												
(PASS)					69	190.0	222.0					• 3.5< KW< 7.5 OUTPUT (P)
(BFS)												
(PASS)					69	198.0	238.0					• ≥ 7.5 KW OUTPUT (P)
3 (PASS)	82	3.30	4.25	0450320	69	180.0	212.0	172.5	243.7	• ≥ 3.5 KW OUTPUT (P)		
(BFS)												
(PASS)					69	190.0	222.0					• 3.5< KW< 7.5 OUTPUT (P)
(BFS)												
(PASS)					69	198.0	238.0					• ≥ 7.5 KW OUTPUT (P)

^aPASS only

PARAMETER NAME	C/W CH	H/W C/W		SOFTWARE ID	PASS SPEC	SM ALERT		B/U C/W		PRECONDITION (P) AND/OR BILEVEL STATE (BL)
		LOW	HIGH			LOW	HIGH	LOW	HIGH	
FCS CH BYPASS	111		2.50							<ul style="list-style-type: none"> • (BL) • (BL) • HIGH C/W DEFAULT VALUE 1.90 V (64.8 °F) • ASCENT • POST OMS 1 (TMBU), ENTRY • HIGH C/W DEFAULT VALUE 1.90 V (64.8 °F) • ASCENT • POST OMS 1 (TMBU), ENTRY • LOW C/W DEFAULT VALUE 1.00 V (1287 lb/hr) • FLOW PROP VLV – INTERCHANGER (P) • FLOW PROP VLV – PL HX • NO PRECOND IN BFS • LOW C/W DEFAULT VALUE 1.00 V (1287 lb/hr) • FLOW PROP VLV – INTERCHANGER (P) • FLOW PROP VLV – PL HX • NO PRECOND IN BFS
SATURATION	101		2.50							
FREON LOOP ACCUM QTY 1				0631130	88	12.0				
2				0631330	88	12.0				
AFT CP FLOW 1 ^a				0631105	88	200.0				
2 ^a				0631305	88	200.0				
EVAP OUT T 1 (PASS)	107	.35	1.9 ^b	0631207	88			32.0	65.0	
(BFS)								32.0	115.0	
2 (PASS)	117	.35	1.9 ^b	0631407	88			32.0	65.0	
(BFS)								32.0	115.0	
FREON FLOW 1 (PASS)	106	0.80		0631100	88	1950.0		1200.0		
(PASS)					88	1300.0				
(BFS)								1200.0		
2 (PASS)	116	0.80		0631300	88	1950.0		1200.0		
(PASS)					88	1300.0				
(BFS)								1200.0		

^aPASS only

^bEVAP OUT T H/W C/W high limits set to 4.3 V (115.2 °F) Prelaunch at crew pre-ingress sw reconfig and set back to 1.90 V (64.8 °F) Post Insertion

PARAMETER NAME	C/W CH	H/W C/W		SOFTWARE ID	PASS SPEC	SM ALERT		B/U C/W		PRECONDITION (P) AND/OR BILEVEL STATE (BL)
		LOW	HIGH			LOW	HIGH			
FREON LOOP PL HX FLOW 1 ^a				0631103	88	OSL 500.0				<ul style="list-style-type: none"> • ① FLOW PROP VLV – 1(2) INTERCHANGER (P) • ② FLOW PROP VLV – 1(2) PAYLOAD (P) • SEE ① • SEE ② • COMM CONTROL IS REVERTED TO PNL (BL) • (BL) • (BL) • (BL) • (BL) • (BL)
2 ^a				0631303	88	OSL 500.0				
RAD OUT T 1 (PASS) (BFS)				0631208	88	32.0 32.0	129.0			
2 (PASS) (BFS)				0631408	88	32.0 32.0	129.0			
FWD RCS LINE T1 FU ^a				0421306	89	46.0	105.0			
OX ^a				0421206	89	46.0	105.0			
T2 FU ^a				0421308	89	46.0	105.0			
OX ^a				0421208	89	46.0	105.0			
GCIL CONFIG ^a				0745052	76	0				
GPC 1	5		2.50							
2	15		2.50							
3	25		2.50							
4	35		2.50							
5	45		2.50							

^aPASS only

H

PARAMETER NAME	C/W CH	H/W C/W		SOFTWARE ID	PASS SPEC	SM ALERT		B/U C/W		PRECONDITION (P) AND/OR BILEVEL STATE (BL)
		LOW	HIGH			LOW	HIGH	LOW	HIGH	
H2O LOOP ACCUM QTY 1 ^a				0612610	88	20.0	80.0			<ul style="list-style-type: none"> • LOOP 1 PUMP SW – ON, OR SW – GPC AND EITHER 'PUMP ON' CMD ISSUED (P) • LOOP 1 PUMP SW – OFF (P) • LOOP 1 PUMP SW – GPC AND NEITHER 'PUMP ON' CMD PRESENT (P) • LOOP 2 PUMP SW – ON, OR SW – GPC AND 'PUMP ON' CMD ISSUED (P) • LOOP 2 PUMP SW – OFF, OR SW – GPC AND 'PUMP ON' CMD NOT PRESENT (P)
2 ^a				0612710	88	20.0	80.0			
CAB HX IN T 1 ^a				0612663	88	34.0				
2 ^a				0612665	88	34.0				
ICH FLOW 1 ^a				0612742	88	550.0				
2 ^a				0612722	88					
OUT T 1 ^a				0612744	88	35.0				
2 ^a				0612724	88	35.0				

^aPASS only

PARAMETER NAME	C/W CH	H/W C/W		SOFTWARE ID	PASS SPEC	SM ALERT		B/U C/W		PRECONDITION (P) AND/OR BILEVEL STATE (BL)
		LOW	HIGH			LOW	HIGH	LOW	HIGH	
H2O LOOP PUMP OUT P 1 (PASS)	105	0.65	2.65	0612600	88	50.0	75.0	19.5	79.5	<ul style="list-style-type: none"> • LOOP 1 PUMP SW – ON, OR SW – GPC AND EITHER 'PUMP ON' CMD ISSUED (P) • LOOP 1 PUMP SW – OFF (P) • LOOP 1 PUMP SW – GPC AND NEITHER 'PUMP ON' CMD PRESENT (P) • NO PRECOND IN BFS • LOOP 2 PUMP SW – ON OR SW – GPC AND 'PUMP ON' CMD ISSUED (P) • LOOP 2 PUMP SW – OFF, OR SW – GPC AND 'PUMP ON' CMD NOT PRESENT (P) • NO PRECOND IN BFS • LOOP 1 PUMP SW – ON, OR SW – GPC AND EITHER 'PUMP ON' CMD ISSUED (P) • LOOP 1 PUMP SW – OFF (P) • LOOP 1 PUMP SW – GPC AND NEITHER 'PUMP ON' CMD PRESENT (P)
(PASS)					88	20.0				
(PASS)					88	20.0				
(BFS)								19.5	79.5	
2 (PASS)	115	1.50	2.70	0612700	88	50.0	75.0	45.0	81.0	
(PASS)					88	20.0				
(BFS)								45.0	81.0	
$\Delta P 1^a$				0612605	88	33.0	46.0			
							5.0			
							5.0			

^aPASS only

PARAMETER NAME	C/W CH	H/W C/W		SOFTWARE ID	PASS SPEC	SM ALERT		B/U C/W		PRECONDITION (P) AND/OR BILEVEL STATE (BL)
		LOW	HIGH			LOW	HIGH	LOW	HIGH	
HYD ACCUM P 1 (PASS)				0580167	86	1930.0				<ul style="list-style-type: none"> • PUMP 1 ON (P) • PUMP 1 OFF (P) • PUMP 2 ON (P) • PUMP 2 OFF (P) • PUMP 3 ON (P) • PUMP 3 OFF (P)
ACUM P 1 (BFS)						1936.0				
2 (PASS)				0580267	86	1930.0				
(BFS)						1936.0				
3 (PASS)				0580367	86	1930.0				
(BFS)						1936.0				
B/U P 1 (PASS)				0580115	86			2400.0		
2 (PASS)				0580215	86			2400.0		
3 (PASS)				0580315	86			2400.0		
CIRC PMP P 1 ^a				0580137	87	100.0				
2 ^a				0580237	87	100.0	100.0			
3 ^a				0580337	87	100.0	100.0			
HX OUT T 1 ^a				0580120	87	0.0	100.0			
2 ^a				0580220	87	0.0				
3 ^a				0580320	87	0.0				
PRESS 1 ^b	99	3.00		0580114						
(BFS)				0580115				2400.0		
2 ^b	109	3.00		0580214						
(BFS)				0580215				2400.0		
3 ^b	119	3.00		0580314						
(BFS)				0580315				2400.0		
RSVR P 1 ^a				0580131	86	28.0				
2 ^a				0580231	86	28.0				
3 ^a				0580331	86	28.0				

^aPASS only

^bBFS only

PARAMETER NAME	C/W CH	H/W C/W		SOFTWARE ID	PASS SPEC	SM ALERT		B/U C/W		PRECONDITION (P) AND/OR BILEVEL STATE (BL)
		LOW	HIGH			LOW	HIGH			
HYD RSVR QTY 1				0580102	86	40.0	95.0			<ul style="list-style-type: none"> • (BL) • ① FAN X – ON OR ALL OTHER FANS – NOT ON (P); FAN X SPD NOT NORMAL (BL) • ② FAN X – NOT ON (P); FAN X SPD NORMAL • SEE ① • SEE ② • SEE ① • SEE ② • CW INDICATION (BL)
2				0580202	86	40.0	95.0			
3				0580302	86	40.0	95.0			
T 1				0580101	86	10.0	230.0			
2				0580201	86	10.0	230.0			
3				0580301	86	10.0	230.0			
IMU	103		2.50							
FAN A (PASS)				0612860	66	0				
(PASS)					66	1				
B (PASS)				0612861	66	0				
(PASS)					66	1				
C (PASS)				0612862	66	0				
(PASS)					66	1				
ΔP				0612869	66	3.7	4.95			
ISS C&W CAUT ^a				6790830	211			1		
FIRE ^a				6790803	211			1		
PRESS ^a				6790801	211			1		
TOX ATM ^a				6790802	211			1		
WARN ^a				6790831	211			1		
KU-BAND GMBL T A ^b				0742965	76		150.0			
B ^b				0742969	76		166.0			
GYRO T ^b				0742967	76		155.0			
XMTR T ^b				0742497	76		171.0			

^aISS flights only
^bPASS only

PARAMETER NAME	C/W CH	H/W C/W		SOFTWARE ID	PASS SPEC	SM ALERT		B/U C/W		PRECONDITION (P) AND/OR BILEVEL STATE (BL)
		LOW	HIGH			LOW	HIGH	LOW	HIGH	
LEFT RHC	100		2.50							• (BL)
MMU-FSS TEMP/FSS										
L TOGGLE VLV – PORT				0660752	77	-13.0	154.0			
STBD				0660762	77	-13.0	154.0			
R TOGGLE VLV – PORT				0660753	77	-13.0	154.0			
STBD				0660763	77	-13.0	154.0			
MMU-FSS TEMP/MMU										
CNTL ELECT – PORT				0660757	77	-13.0	148.0			
STBD				0660767	77	-13.0	148.0			
L GN2 TK BAR – PORT				0660756	77		150.0			
STBD				0660766	77		150.0			
R GN2 TK BAR – PORT				0660758	77		150.0			
STBD				0660768	77		150.0			
L TOGGLE VLV – PORT				0660754	77	-33.0	123.0			
STBD				0660764	77	-33.0	123.0			
R TOGGLE VLV – PORT				0660755	77	-33.0	123.0			
STBD				0660765	77	-33.0	123.0			

PARAMETER NAME	C/W CH	H/W C/W		SOFTWARE ID	PASS SPEC	SM ALERT		B/U C/W		PRECONDITION (P) AND/OR BILEVEL STATE (BL)
		LOW	HIGH			LOW	HIGH	LOW	HIGH	
MPS ET ULL P LH2 HI (GNC) ^a				V97U6783C			48.9			<ul style="list-style-type: none"> • LOW C/W DEFAULT VALUE 3.4 V (680 psia) AND HIGH C/W DEFAULT VALUE 4.05 V (810 psia)
LO				V97U6784C		28.0				
LO2 HI (GNC) ^a				V97U6785C			29.0			
LO				V97U6786C		0.0				
H2 OUT P C				V97U9601C		1050				
L				V97U9602C		1050				
R				V97U9603C		1050				
He dP/dT (GNC) ^a				V99U6943C			20.0			
REG P (GNC) ^{b,d}				V96U8499C		679.0	810.0			
C ^c	39									
(OV103)		3.30	4.00							
(OV104)		3.40	4.10							
(OV105)		3.45	4.10							
L ^c	49									
(OV103)		3.35	4.00							
(OV104)		3.40	4.05							
(OV105)		3.45	4.10							
R ^c	59									
(OV103)		3.40	4.05							
(OV104)		3.40	4.05							
(OV105)		3.35	4.00							
TK P (GNC) ^a				V97U6826C				1150.0		
C	9	1.15								
L	19	(1150)								
R	29	1.15								
L		(1150)								
R		1.15								
L		(1150)								

^aBFS only; OPS 1,6

^bBFS only; OPS 1,3,6

^cReg A only

^dMPS He REG P low and high limits set prelaunch (Crew Pre-Ingress sw Reconfiguration)

PARAMETER NAME	C/W CH	H/W C/W		SOFTWARE ID	PASS SPEC	SM ALERT		B/U C/W		PRECONDITION (P) AND/OR BILEVEL STATE (BL)
		LOW	HIGH			LOW	HIGH	LOW	HIGH	
MPS MANF P LH2	79		3.25 (65.0)	V97U6828C					65.0	
HI (GNC) ^a										
LO2	69		4.15 (249.0)	V97U6831C					249.0	
HI (GNC) ^a										
O2 OUT T C				V97U9605C		125				
L				V97U9606C		125				
R				V97U9607C		125				
PNEU P ACUM (GNC) ^a				V97U7680C		700				
REG (GNC) ^b				V97U6778C		700				
TK (GNC) ^a				V97U6777C			810			
TK (GNC) ^a				V97U6775C		3800				
NSP 1 BITE ^c				0745184	76	1				
2 BITE ^c				0745185	76	1				

^aBFS only; OPS 1,6

^bBFS only; OPS 1,3,6

^cPASS only

PARAMETER NAME	C/W CH	H/W C/W		SOFTWARE ID	PASS SPEC	SM ALERT		B/U C/W		PRECONDITION (P) AND/OR BILEVEL STATE (BL)
		LOW	HIGH			LOW	HIGH	LOW	HIGH	
OMS CRSFD DRN OX L ^a				0436236	89	50.0	100.0			
R ^a				0436237	89	50.0	110.0			
GMBL LN L ^b				0436218	89	50.0	100.0			
R ^b				0436219	89	50.0	90.0			
XFD OX C ^b				0436242	89	50.0	100.0			
L ^b				0436243	89	50.0	90.0			
R ^b				0436244	89	50.0	90.0			
OMS ENG L	27		2.50							• (BL)
R	57		2.50							• (BL)
N2 REG P HI (GNC) ^c				V97U6847C			434.0			
LO				V97U6848C		299.0				
TK P (GNC) ^c				V97U6846C		1200.0				
Pc (GNC) ^c (PASS)				V97U4208C				2.5		PASS IS IN VOLTS; BFS IS
(BFS)				V99U6942C				80.0		IN PERCENT
RCS QTY (GNC) ^d				V97U9826C			10,000			
TK P FU/OX HI (GNC) (PASS)				V97U6852C					284.0	
HI (BFS)				V97U9869C					288.0	
LO (BFS)				V97U6853C				234.0		
FU										
L	17	2.90	3.60							• HIGH C/W DEFAULT
		(232.0)	(288.0)							VALUE: 3.55 (284.0)
R	47	2.90	3.60							3.55 (284.0)
		(232.0)	(288.0)							

^a PASS OPS S2,4; BFS MM104-106, 301-303, OPS 0

^b PASS only

^c PASS only; OPS G2,8; BFS 1,3,6

^d PASS OPS G2

PARAMETER NAME	C/W CH	H/W C/W		SOFTWARE ID	PASS SPEC	SM ALERT		B/U C/W		PRECONDITION (P) AND/OR BILEVEL STATE (BL)
		LOW	HIGH			LOW	HIGH	LOW	HIGH	
OMS TK P He (GNC)				V97U6840C		1500.0				
OX										
L	7	2.90 (232.0)	3.60 (288.0)							• HIGH C/W DEFAULT VALUE 3.55 (284.0)
R	37	2.90 (232.0)	3.60 (288.0)							3.55 (284.0)
TVC	67		2.50							• (BL)
OPCU1 CH A AMPS ^b				0762405			75			
IOC ^b				0762416	1					• 22±1 AMPS 190 mS (BL)
IUV ^b				0762417	1					• 110 V 119 mS (BL)
OOV ^b				0762419	1					• >32 v 149 mS (BL)
OUV ^b				0762418	1					• 10 V 10.3 mS (BL)
TEMP ^b				0762409			187			
VOLT ^b				0762407	27					• OPCU CONV ON (P)
OPCU1 CH B AMPS ^b				0762406			75			
IOC ^b				0762420	1					• 22±1 AMPS 190 mS (BL)
IUV ^b				0762421	1					• 110 V 119 mS (BL)
OOV ^b				0762423	1					• >32 v 149 mS (BL)
OUV ^b				0762422	1					• 10 V 10.3 mS (BL)
TEMP ^b				0762410			187			
VOLT ^b				0762408	27					• OPCU CONV ON (P)
OPCU2 CH A AMPS ^b				0762505			75			
IOC ^b				0762516	1					• 22±1 AMPS 190 mS (BL)
IUV ^b				0762517	1					• 110 V 119 mS (BL)
OOV ^b				0762519	1					• >32 v 149 mS (BL)
OUV ^b				0762518	1					• 10 V 10.3 mS (BL)
TEMP ^b				0762509			187			
VOLT ^b				0762507	27					• OPCU CONV ON (P)

^bOV-103 & OV-105 PASS only (SSPTS)

PARAMETER NAME	C/W CH	H/W C/W		SOFTWARE ID	PASS SPEC	SM ALERT		B/U C/W		PRECONDITION (P) AND/OR BILEVEL STATE (BL)
		LOW	HIGH			LOW	HIGH	LOW	HIGH	
OPCU2 CH B AMPS ^b				0762506			75			<ul style="list-style-type: none"> • 22±1 AMPS 190 mS (BL) • 110 V 119 mS (BL) • >32 v 149 mS (BL) • 10 V 10.3 mS (BL) • OPCU CONV ON (P) • PA1 ON & TDRS/STDN HI (P) • PA ON & TDRS/STDN HI (P)
IOC ^b				0762520		1				
IUV ^b				0762521		1				
OOV ^b				0762523		1				
OUV ^b				0762522		1				
TEMP ^b				0762510			187			
VOLT ^b				0762508		27				
PA1 OUTPUT LOW ^a				0744512	76	60				
PA2 OUTPUT LOW ^a				0744513	76	60				
PA1 TEMP ^a				0744514	76		230			
PA2 TEMP ^a				0744515	76		230			

^aPASS only

^bOV-103 & OV-105 PASS only (SSPTS)

PARAMETER NAME	C/W CH	H/W C/W		SOFTWARE ID	PASS SPEC	SM ALERT		B/U C/W		PRECONDITION (P) AND/OR BILEVEL STATE (BL)
		LOW	HIGH			LOW	HIGH	LOW	HIGH	
PDI DECOM INPUT 1 ^a				0920106	62		0.00			<ul style="list-style-type: none"> • ① IF SPEC 62 DECOM X FDA ENA & IF ANY LOSS OF DATA STREAM LOCK X DETECTED (MASTER FRAME LOCK, WORD LOCK, OR BIT LOCK) (P) • ② IF SPEC 62 DECOM X FDA NOT ENA OR IF DATA STREAM LOCK X DETECTED (MASTER FRAME LOCK, WORD LOCK, AND BIT LOCK) (P) • SEE ① • SEE ② • SEE ① • SEE ② • SEE ① • SEE ② NOTE: SLIPPAGE GREATER THAN 0.5° PER JOINT OR SUM OF 2.0° FOR ALL JOINTS
				0920106	62	0.00	6.00			
2 ^a				0920107	62	0.00	0.00			
3 ^a				0920108	62		0.00			
4 ^a				0920109	62		0.00			
						0.00	6.00			
PDRS JOINT SLIP TOLERANCE VALUE				0986951			0.5			
	SY			0986952			0.5			
	SP			0986953			0.5			
	EP			0986954			0.5			
	WP			0986955			0.5			
	WY			0986956			0.5			
	WR			0986957			0.5			
	TOTAL						2.0			

^aPASS only

PARAMETER NAME	C/W CH	H/W C/W		SOFTWARE ID	PASS SPEC	SM ALERT		B/U C/W		PRECONDITION (P) AND/OR BILEVEL STATE (BL)
		LOW	HIGH			LOW	HIGH	LOW	HIGH	
PDRS PORT ABE 1(2) S HI				0966800			106.0			NOTE: PDRS LIMITS ARE MANAGED THRU THE CONSTANTS PORTION OF SM 60 TABLE MAINTENANCE
LO				0966817		1.0				
3 EP HI				0966801			106.0			
LO				0966818		1.0				
4(5) WP HI				0966802			106.0			
LO				0966819		1.0				
6 WR HI				0966803			106.0			
LO				0966820		1.0				
7 EE HI				0966804			144.0			
LO				0966821		1.0				
LED 1 SY HI				0966790			172.0			
LO				0966808		1.0				
2 SP HI				0966791			172.0			
LO				0966809		1.0				
3 EP HI				0966792			172.0			
LO				0966810		1.0				
4 WP HI				0966793			172.0			
LO				0966811		1.0				
5 WY HI				0966794			172.0			
LO				0966812		1.0				
6 WR HI				0966795			172.0			
LO				0966813		1.0				
7 EE HI				0966796			172.0			
LO				0966814		1.0				

PARAMETER NAME	C/W CH	H/W C/W		SOFTWARE ID	PASS SPEC	SM ALERT		B/U C/W		PRECONDITION (P) AND/OR BILEVEL STATE (BL)
		LOW	HIGH			LOW	HIGH	LOW	HIGH	
POD ENG COVER L ^a				0434720	89	45.0				
R ^a				0435720	89	45.0				
I/F FU L ^b				0434642	89	45.0	110.0			
R ^b				0435642	89	45.0	110.0			
INJ L ^a				0434643	89	36.0	260.0			
R ^a				0435643	89	36.0	260.0			
OX L ^b				0434216	89	45.0	110.0			
R ^b				0435216	89	45.0	110.0			
VLV L ^a				0434641	89	40.0	122.0			
R ^a				0435641	89	40.0	122.0			
SERV PNL L ^b				0434707	89	45.0	140.0			
R ^b				0435707	89	45.0	140.0			
GSE SERV PNL L ^a				0434706	89	45.0	120.0			
R ^a				0435706	89	45.0	120.0			
OMS TK FU L ^a				0434315	89	45.0	95.0			
R ^a				0435315	89	45.0	95.0			
OX L ^a				0434215	89	45.0	95.0			
R ^a				0435215	89	45.0	95.0			
OX DRN PNL 1 L ^b				0434704	89	45.0	110.0			
R ^b				0435704	89	45.0	110.0			
2 L ^b				0434705	89	45.0	110.0			
R ^b				0435705	89	45.0	110.0			

^aPASS only

^bPASS OPS S2,4: BFS MM104-106, 301-303, OPS 0

PARAMETER NAME	C/W CH	H/W C/W		SOFTWARE ID	PASS SPEC	SM ALERT		B/U C/W		PRECONDITION (P) AND/OR BILEVEL STATE (BL)
		LOW	HIGH			LOW	HIGH	LOW	HIGH	
POD TEST He/OX 1 L ^a				0434708	89	35.0	125.0			
R ^a				0435708	89	35.0	125.0			
2 L ^a				0434718	89	35.0	125.0			
R ^a				0435718	89	35.0	125.0			
WEB KEEL 1 L ^a				0434700	89	45.0	100.0			
R ^a				0435700	89	45.0	100.0			
2 L ^a				0434710	89	45.0	100.0			
R ^a				0435710	89	45.0	100.0			
Y OB L ^a				0434702	89	45.0	120.0			
R ^a				0435702	89	45.0	120.0			
UP L ^a				0434703	89	45.0	120.0			
R ^a				0435703	89	45.0	120.0			
RCS He TK P FU/OX (GNC)				V97U6864C		500.0				
JET	96		2.50							• (BL)
LEAK (GNC) ^b				V97U9807C					9.5	
LEAK/TK P F	26		2.50							• LEAK ALERT OR TANK
L	56		2.50							ULLAGE PRESSURE
R	86		2.50							(PARAMETERS 6,16/36,
TK OUT P FU/OX HI (GNC)				V97U6870C			300.0			46)
LO				V97U6871C		220.0				
TK P FU/OX HI (GNC)				V97U6876C					312.0	
LO				V97U6877C				200.0		

^aPASS only

^bPASS OPS G2,3,8: BFS OPS 1,3,6

PARAMETER NAME	C/W CH	H/W C/W		SOFTWARE ID	PASS SPEC	SM ALERT		B/U C/W		PRECONDITION (P) AND/OR BILEVEL STATE (BL)
		LOW	HIGH			LOW	HIGH	LOW	HIGH	
RCS TK P FU F	16	2.50 (200.0)	3.90 (312.0)							
L	46	2.50 (200.0)	3.90 (312.0)							
R	76	2.50 (200.0)	3.90 (312.0)							
OX F	6	2.50 (200.0)	3.90 (312.0)							
L	36	2.50 (200.0)	3.90 (312.0)							
R	66	2.50 (200.0)	3.90 (312.0)							
TK T FU/OX HI FWD (GNC) AFT LO				V97U6873C V97U8756C V97U6874C		50.0	100.0 100.0			
RGA/AA	93		2.50							• (BL)
RIGHT/AFT RHC	110		2.50							• (BL)
S-BAND ANT QUAD ^a				0921049		1				• VERIFICATION FAIL (BL) • GPC MODE ONLY (P)
SMOKE CONCEN LEFT FD				0620590					2	
RIGHT FD				0620591					2	
CABIN				0620595					2	
1A				0620618					2	
1B				0620619					2	
2A				0620608					2	
2B				0620609					2	
3A				0620628					2	
3B				0620629					2	

^aPASS only

PARAMETER NAME	C/W CH	H/W C/W		SOFTWARE ID	PASS SPEC	SM ALERT		B/U C/W		PRECONDITION (P) AND/OR BILEVEL STATE (BL)
		LOW	HIGH			LOW	HIGH	LOW	HIGH	
TIRE PRESS MG LEFT INBD 1 ^a				051P0571		50				<ul style="list-style-type: none"> ENABLED IF LG ARM SWITCH HAS NOT BEEN ACTIVATED (P)
2 ^a				051P0573		50				
OTBD 1 ^a				051P0570		50				
2 ^a				051P0572		50				
RIGHT INBD 1 ^a				051P0471		50				
2 ^a				051P0473		50				
OTBD 1 ^a				051P0470		50				
2 ^a				051P0472		50				
NG LEFT 1 ^a				051P0370		50				
2 ^a				051P0372		50				
RIGHT 1 ^a				051P0371		50				
2 ^a				051P0373		50				

^aBFS only; OPS 3,6

PARAMETER NAME	C/W CH	H/W C/W		SOFTWARE ID	PASS SPEC	SM ALERT		B/U C/W		PRECONDITION (P) AND/OR BILEVEL STATE (BL)
		LOW	HIGH			LOW	HIGH	LOW	HIGH	
WB BLR T A 1 ^a				0580162	86	40.0	185.0			<ul style="list-style-type: none"> • ① BLR CNTLR/HTR X – A PLUS 2 MIN DELAY (P) • ② BLR CNTLR/HTR X – OFF (P) • ③ BLR CNTLR/HTR X – B PLUS 2 MIN DELAY (P) • ④ BLR CNTLR/HTR X – OFF (P) • SEE ① • SEE ② • SEE ③ • SEE ④ • SEE ① • SEE ② • SEE ③ • SEE ④
B 1 ^a				0580163	86	40.0	185.0			
A 2 ^a				0580262	86	40.0	185.0			
B 2 ^a				0580263	86	40.0	185.0			
A 3 ^a				0580362	86	40.0	185.0			
B 3 ^a				0580363	86	40.0	185.0			
					86					
					86					
					86					
					86					
					86					
					86					

^aPASS only

W

PARAMETER NAME	C/W CH	H/W C/W		SOFTWARE ID	PASS SPEC	SM ALERT		B/U C/W		PRECONDITION (P) AND/OR BILEVEL STATE (BL)
		LOW	HIGH			LOW	HIGH			
W/B H2O QTY 1 (PASS)				0726040	86	60.0				<ul style="list-style-type: none"> • BLR CNTLR/HTR 1 – A OR B (P) • BLR CNTLR/HTR 1 – OFF (P) • BLR CNTLR/HTR 2 – A OR B (P) • BLR CNTLR/HTR 2 – OFF (P) • BLR CNTLR/HTR 3 – A OR B (P) • BLR CNTLR/HTR 3 – OFF (P) • ① BLR CNTLR/HTR X – A PLUS 5 MIN DELAY (P) • ② BLR CNTLR/HTR X – OFF (P) • SEE ① • SEE ② • SEE ① • SEE ②
(PASS)										
(BFS)						40.0				
2 (PASS)				0726042	86	60.0				
(PASS)										
(BFS)						40.0				
3 (PASS)				0726044	86	60.0				
(PASS)										
(BFS)						40.0				
N2 P 1 ^a				0580147	86	1800.0				
2 ^a				0580247	86	1800.0				
3 ^a				0580347	86	1800.0				
REG P 1 ^a				0580104	86	20.0	33.0			
2 ^a				0580204	86	20.0	33.0			
3 ^a				0580304	86	20.0	33.0			
W/B TANK T A 1 ^a				0580161	86	40.0	110.0			
2 ^a				0580261	86	40.0	110.0			
3 ^a				0580361	86	40.0	110.0			

^aPASS only

PARAMETER NAME	C/W CH	H/W C/W		SOFTWARE ID	PASS SPEC	SM ALERT		B/U C/W		PRECONDITION (P) AND/OR BILEVEL STATE (BL)
		LOW	HIGH			LOW	HIGH	LOW	HIGH	
W/B TANK T B 1 ^a				0580164	86	40.0	110.0			<ul style="list-style-type: none"> • ③ BLR CNTLR/HTR X – B PLUS 5 MIN DELAY (P) • ④ BLR CNTLR/HTR – OFF (P) • SEE ③ • SEE ④ • SEE ③ • SEE ④
2 ^a				0580264	86	40.0	110.0			
3 ^a				0580364	86	40.0	110.0			

^aPASS only

HARDWARE C/W TABLE

C/W CH	PARAMETER NAME	C/W CH	PARAMETER NAME	C/W CH	PARAMETER NAME	C/W CH	PARAMETER NAME	C/W CH	PARAMETER NAME
0	CRYO O2 P TK1	25	GPC 3	50	CRYO H2 P TK1	*75		100	L RHC
1	CRYO O2 HTR 1 TK1	26	RCS LEAK/TK P - F	51	CRYO O2 HTR 2 TK3	76	RCS TK P FU - R	101	FCS SATURATION
2	FC1 REAC O2	27	OMS ENG - L	52	FC3 REAC H2	*77		102	FC2 COOL PUMP
3	DC VOLT MAIN A	28	APU 3 EGT	53	AC3 VOLT (ΦA,B,C)	78	APU 2 OVERSPEED	103	IMU
4	CAB PRESS	29	MPS HE TK P - R	54	CAB N2 FLOW 1	79	MPS MANF P LH2	104	AV BAY 3 TEMP
5	GPC 1	30	CRYO O2 P TK4/5	*55		80	CRYO H2 P TK4/5	105	H2O LOOP 1 PUMP OUT P
6	RCS TK P OX - F	31	CRYO O2 HTR 2 TK2	56	RCS LEAK/TK P - L	81	CRYO O2 HTR 1 TK5	106	FREON LOOP 1 FREON FLOW
7	OMS TK P OX - L	32	FC2 REAC H2	57	OMS ENG - R	82	FC3 STACK T	107	FREON LOOP 1 EVAP OUT T
8	APU 1 EGT	33	AC1 VOLT (ΦA,B,C)	‡58	APU 3 OIL IN T	83	AC3 OVLD	108	APU 2 UNDERSPEED
9	MPS HE TK P - C	34	CAB PPO2 A	59	MPS HE REG P - R	84	AV BAY 1 TEMP	109	HYD 2 P
10	CRYO O2 P TK2	35	GPC 4	60	CRYO H2 P TK2	*85		110	R/AFT RHC
11	CRYO O2 HTR 2 TK1	36	RCS TK P OX - L	61	CRYO O2 HTR 1 TK4	86	RCS LEAK/TK P - R	111	FCS CH BYPASS
12	FC1 REAC H2	37	OMS TK P OX - R	62	FC1 STACK T	*87		112	FC3 COOL PUMP
13	DC VOLT MAIN B	‡38	APU 1 OIL IN T	63	AC1 OVLD	88	APU 3 OVERSPEED	*113	
14	CAB O2 FLOW 1	39	MPS HE REG P - C	64	CAB N2 FLOW 2	*89		114	CAB HX OUT T
15	GPC 2	40	CRYO O2 P TK5	*65		90	CRYO H2 P TK5	115	H2O LOOP 2 PUMP OUT P
16	RCS TK P FU - F	41	CRYO O2 HTR 1 TK3	66	RCS TK P OX - R	91	ADTA	116	FREON LOOP 2 FREON FLOW
17	OMS TK P FU - L	42	FC3 REAC O2	67	OMS TVC	92	FC1 COOL PUMP	117	FREON LOOP 2 EVAP OUT T
18	APU 2 EGT	43	AC2 VOLT (ΦA,B,C)	68	APU 1 OVERSPEED	93	RGAA	118	APU 3 UNDERSPEED
19	MPS HE TK P - L	44	CAB PPO2 B	69	MPS MANF P L O2	94	AV BAY 2 TEMP	119	HYD 3 P
20	CRYO O2 P TK3	45	GPC 5	70	CRYO H2 P TK3	95	PL WARNING		
21	CRYO O2 HTR 1 TK2	46	RCS TK P FU - L	71	CRYO O2 HTR 2 TK4	96	RCS JET		
22	FC2 REAC O2	47	OMS TK P FU - R	72	FC2 STACK T	97	PL CAUTION		
23	DC VOLT MAIN C	‡48	APU 2 OIL IN T	73	AC2 OVLD	98	APU 1 UNDERSPEED		
24	CAB O2 FLOW 2	49	MPS HE REG P - L	74	CAB FAN ΔP	99	HYD 1 P		

* Channel not used

‡ APU OIL IN T (BFS) = APU OIL T (PASS)

PRIMARY TO BACKUP C/W ANALOG PARAMETER CALIBRATION

①	②	③	④	⑤a	⑤b	⑤c	⑥	⑦	⑧	⑨	⑩	⑪	⑫	⑬	⑭	⑮	⑯	⑰
0.00	-417	-76.7	-3.1	-0.02	-0.04	-0.02	0	0	0	0	0	8	24.9	45	145	515	732	0
TO	TO	TO	TO	TO	TO	TO	TO	TO	TO	TO	TO	TO	TO	TO	TO	TO	TO	TO
5.00	468	298.1	496.8	19.96	19.95	19.93	8	40	100	150	300	1520	129.9	145	305	1015	2684	25
0.00	-417	-76.7	-3.1	-0.02	-0.04	-0.02	0.00	0.0	0	0.0	0	8	24.9	45	145.0	515	732	0.01
0.05	-408	-72.9	1.9	0.18	0.16	0.18	0.08	0.4	1	1.5	3	23	25.9	46	146.6	520	763	0.01
0.10	-399	-69.2	6.9	0.38	0.36	0.38	0.16	0.8	2	3.0	6	38	27.0	47	148.2	525	793	0.02
0.15	-390	-65.4	11.9	0.58	0.56	0.58	0.24	1.2	3	4.5	9	53	28.0	48	149.8	530	823	0.02
0.20	-381	-61.7	16.9	0.78	0.76	0.78	0.32	1.6	4	6.0	12	68	29.1	49	151.4	535	853	0.02
0.25	-373	-57.9	21.9	0.98	0.96	0.97	0.40	2.0	5	7.5	15	84	30.1	50	153.0	540	882	0.03
0.30	-364	-54.2	26.9	1.18	1.16	1.17	0.48	2.4	6	9.0	18	99	31.2	51	154.6	545	912	0.03
0.35	-355	-50.4	31.9	1.38	1.36	1.37	0.56	2.8	7	10.5	21	114	32.2	52	156.2	550	940	0.03
0.40	-346	-46.7	36.9	1.58	1.56	1.57	0.64	3.2	8	12.0	24	129	33.3	53	157.8	555	969	0.04
0.45	-337	-42.9	41.9	1.78	1.76	1.77	0.72	3.6	9	13.5	27	144	34.3	54	159.4	560	997	0.04
0.50	-328	-39.2	46.9	1.98	1.96	1.97	0.80	4.0	10	15.0	30	159	35.4	55	161.0	565	1025	0.05

- | | | | | | | |
|---|----------------------|--------------------|-----------------------|--|---------------------|--|
| <p>① C/W LIMIT VOLTS
O2 PP
GN2 FLOW
CAB O2 FLOW
X1000 = MPS
He TK P</p> | <p>② O2 TK HTR T</p> | <p>③ FCP STK T</p> | <p>④ APU OIL IN T</p> | <p>⑤ CABIN P
a OV103
b OV104
c OV105</p> | <p>⑥ CAB FAN ΔP</p> | <p>⑦ MAIN BUS VOLTS
X10 = OMS
TK ULL P
X10 = RCS
TK ULL P
X100 = HYD
SYS P</p> |
|---|----------------------|--------------------|-----------------------|--|---------------------|--|

0.55	-320	-35.4	51.9	2.18	2.16	2.17	0.88	4.4	11	16.5	33	174	36.4	56	162.6	570	1052	0.05
0.60	-311	-31.7	56.9	2.38	2.36	2.37	0.96	4.8	12	18.0	36	189	37.5	57	164.2	575	1080	0.05
0.65	-302	-27.9	61.9	2.58	2.56	2.57	1.04	5.2	13	19.5	39	205	38.5	58	165.8	580	1107	0.06
0.70	-293	-24.2	66.9	2.78	2.76	2.77	1.12	5.6	14	21.0	42	220	39.6	59	167.4	585	1133	0.06
0.75	-284	-20.4	71.9	2.98	2.96	2.97	1.20	6.0	15	22.5	45	235	40.6	60	169.0	590	1160	0.06
0.80	-275	-16.7	76.9	3.18	3.16	3.17	1.28	6.4	16	24.0	48	250	41.7	61	170.6	595	1186	0.07
0.85	-266	-12.9	81.9	3.38	3.36	3.37	1.36	6.8	17	25.5	51	265	42.7	62	172.2	600	1212	0.07
0.90	-258	-9.2	86.9	3.58	3.56	3.57	1.44	7.2	18	27.0	54	280	43.8	63	173.8	605	1237	0.07
0.95	-249	-5.5	91.9	3.78	3.76	3.77	1.52	7.6	19	28.5	57	295	44.8	64	175.4	610	1263	0.08
1.00	-240	-1.7	96.8	3.98	3.96	3.97	1.60	8.0	20	30.0	60	310	45.9	65	177.0	615	1287	0.08
1.05	-231	2.0	101.8	4.18	4.16	4.17	1.68	8.4	21	31.5	63	325	46.9	66	178.6	620	1312	0.08
1.10	-222	5.8	106.8	4.38	4.36	4.37	1.76	8.8	22	33.0	66	341	48.0	67	180.2	625	1337	0.09
1.15	-213	9.5	111.8	4.58	4.56	4.57	1.84	9.2	23	34.5	69	356	49.0	68	181.8	630	1361	0.09
1.20	-205	13.3	116.8	4.78	4.76	4.77	1.92	9.6	24	36.0	72	371	50.1	69	183.4	635	1385	0.09
1.25	-196	17.0	121.8	4.98	4.96	4.96	2.00	10.0	25	37.5	75	386	51.1	70	185.0	640	1408	0.10
1.30	-187	20.8	126.8	5.18	5.16	5.16	2.08	10.4	26	39.0	78	401	52.2	71	186.6	645	1432	0.10
1.35	-178	24.5	131.8	5.38	5.36	5.36	2.16	10.8	27	40.5	81	416	53.2	72	188.2	650	1455	0.10
1.40	-169	28.3	136.8	5.58	5.56	5.56	2.24	11.2	28	42.0	84	431	54.3	73	189.8	655	1478	0.11
1.45	-160	32.0	141.8	5.78	5.76	5.76	2.32	11.6	29	43.5	87	446	55.3	74	191.4	660	1501	0.11
1.50	-152	35.8	146.8	5.98	5.96	5.96	2.40	12.0	30	45.0	90	462	56.4	75	193.0	665	1523	0.12

- ⑧ MPS LH2 MANF P X10 = MPS He REG P
- ⑨ H2O LP PUMP P
- ⑩ MPS LO2 MANF P
- ⑪ APU EGT
- ⑫ FCL EVAP OUT T
- ⑬ AV BAY T CAB HX AIR OUT T
- ⑭ CRYO H2 PRESS
- ⑮ CRYO O2 PRESS
- ⑯ FCL FLOW
- ⑰ (OV-104 and OV-105 ONLY) CAB O2 FLOW 1,2 CAB N2 FLOW 1,2

①	②	③	④	⑤a	⑤b	⑤c	⑥	⑦	⑧	⑨	⑩	⑪	⑫	⑬	⑭	⑮	⑯	⑰
0.00 TO 5.00	-417 TO 468	-76.7 TO 298.1	-3.1 TO 496.8	-0.02 TO 19.96	-0.04 TO 19.95	-0.02 TO 19.93	0 TO 8	0 TO 40	0 TO 100	0 TO 150	0 TO 300	8 TO 1520	24.9 TO 129.9	45 TO 145	145 TO 305	515 TO 1015	732 TO 2684	0 TO 25
1.55	-143	39.5	151.8	6.18	6.16	6.16	2.48	12.4	31	46.5	93	477	57.4	76	194.6	670	1545	0.12
1.60	-134	43.3	156.8	6.38	6.36	6.36	2.56	12.8	32	48.0	96	492	58.5	77	196.2	675	1567	0.12
1.65	-125	47.0	161.8	6.58	6.56	6.56	2.64	13.2	33	49.5	99	507	59.5	78	197.8	680	1589	0.14
1.70	-116	50.8	166.8	6.77	6.76	6.76	2.72	13.6	34	51.0	102	522	60.6	79	199.4	685	1610	0.16
1.75	-107	54.5	171.8	6.97	6.96	6.96	2.80	14.0	35	52.5	105	537	61.6	80	201.0	690	1631	0.19
1.80	-98	58.3	176.8	7.17	7.16	7.16	2.88	14.4	36	54.0	108	552	62.7	81	202.6	695	1652	0.21
1.85	-90	62.0	181.8	7.37	7.36	7.36	2.96	14.8	37	55.5	111	567	63.7	82	204.2	700	1673	0.23
1.90	-81	65.7	186.8	7.57	7.56	7.56	3.04	15.2	38	57.0	114	582	64.8	83	205.8	705	1694	0.25
1.95	-72	69.5	191.8	7.77	7.76	7.76	3.12	15.6	39	58.5	117	598	65.8	84	207.4	710	1714	0.27
2.00	-63	73.2	196.8	7.97	7.96	7.96	3.20	16.0	40	60.0	120	613	66.9	85	209.0	715	1734	0.29
2.05	-54	77.0	201.8	8.17	8.16	8.16	3.28	16.4	41	61.5	123	628	67.9	86	210.6	720	1754	0.31
2.10	-45	80.7	206.8	8.37	8.36	8.36	3.36	16.8	42	63.0	126	643	69.0	87	212.2	725	1774	0.33
2.15	-37	84.5	211.8	8.57	8.56	8.56	3.44	17.2	43	64.5	129	658	70.0	88	213.8	730	1794	0.35
2.20	-28	88.2	216.8	8.77	8.76	8.76	3.52	17.6	44	66.0	132	673	71.1	89	215.4	735	1813	0.37
2.25	-19	92.0	221.8	8.97	8.96	8.96	3.60	18.0	45	67.5	135	688	72.1	90	217.0	740	1832	0.40
2.30	-10	95.7	226.8	9.17	9.16	9.16	3.68	18.4	46	69.0	138	703	73.2	91	218.6	745	1851	0.42
2.35	-1	99.5	231.8	9.37	9.36	9.36	3.76	18.8	47	70.5	141	719	74.2	92	220.2	750	1870	0.44
2.40	8	103.2	236.8	9.57	9.56	9.56	3.84	19.2	48	72.0	144	734	75.3	93	221.8	755	1889	0.46
2.45	16	107.0	241.8	9.77	9.76	9.76	3.92	19.6	49	73.5	147	749	76.3	94	223.4	760	1907	0.48
2.50	25	110.7	246.8	9.97	9.96	9.96	4.00	20.0	50	75.0	150	764	77.4	95	225.0	765	1925	0.50

① C/W LIMIT VOLTS O2 PP
GN2 FLOW
CAB O2 FLOW
X1000 = MPS
He TK P

② O2 TK HTR T

③ FCP STK T

④ APU OIL IN T

⑤ CABIN P
a OV103
b OV104
c OV105

⑥ CAB FAN ΔP

⑦ MAIN BUS VOLTS
X10 = OMS
TK ULL P
X10 = RCS
TK ULL P
X100 = HYD
SYS P

2.55	34	114.5	251.8	10.17	10.16	10.15	4.08	20.4	51	76.5	153	779	78.4	96	226.6	770	1943	0.56
2.60	43	118.2	256.8	10.37	10.36	10.35	4.16	20.8	52	78.0	156	794	79.5	97	228.2	775	1961	0.62
2.65	52	122.0	261.8	10.57	10.56	10.55	4.24	21.2	53	79.5	159	809	80.5	98	229.8	780	1979	0.68
2.70	61	125.7	266.8	10.77	10.76	10.75	4.32	21.6	54	81.0	162	824	81.6	99	231.4	785	1997	0.74
2.75	70	129.4	271.8	10.97	10.96	10.95	4.40	22.0	55	82.5	165	840	82.6	100	233.0	790	2014	0.80
2.80	78	133.2	276.8	11.17	11.16	11.15	4.48	22.4	56	84.0	168	855	83.7	101	234.6	795	2031	0.86
2.85	87	136.9	281.8	11.37	11.36	11.35	4.56	22.8	57	85.5	171	870	84.7	102	236.2	800	2048	0.92
2.90	96	140.7	286.8	11.57	11.56	11.55	4.64	23.2	58	87.0	174	885	85.8	103	237.8	805	2065	0.98
2.95	105	144.4	291.8	11.77	11.76	11.75	4.72	23.6	59	88.5	177	900	86.8	104	239.4	810	2082	1.04
3.00	114	148.2	296.8	11.97	11.95	11.95	4.80	24.0	60	90.0	180	915	87.9	105	241.0	815	2099	1.09
3.05	123	151.9	301.8	12.17	12.15	12.15	4.88	24.4	61	91.5	183	930	88.9	106	242.6	820	2115	1.21
3.10	131	155.7	306.8	12.37	12.35	12.35	4.96	24.8	62	93.0	186	945	90.0	107	244.2	825	2132	1.33
3.15	140	159.4	311.8	12.57	12.55	12.55	5.04	25.2	63	94.5	189	960	91.0	108	245.8	830	2148	1.45
3.20	149	163.2	316.8	12.77	12.75	12.75	5.12	25.6	64	96.0	192	976	92.1	109	247.4	835	2164	1.57
3.25	158	166.9	321.8	12.97	12.95	12.95	5.20	26.0	65	97.5	195	991	93.1	110	249.0	840	2180	1.69
3.30	167	170.7	326.8	13.17	13.15	13.14	5.28	26.4	66	99.0	198	1006	94.2	111	250.6	845	2196	1.81
3.35	176	174.4	331.8	13.37	13.35	13.34	5.36	26.8	67	100.5	201	1021	95.2	112	252.2	850	2212	1.93
3.40	185	178.2	336.8	13.56	13.55	13.54	5.44	27.2	68	102.0	204	1036	96.3	113	253.8	855	2227	2.05
3.45	193	181.9	341.8	13.76	13.75	13.74	5.52	27.6	69	103.5	207	1051	97.3	114	255.4	860	2243	2.23
3.50	202	185.7	346.8	13.96	13.95	13.94	5.60	28.0	70	105.0	210	1066	98.4	115	257.0	865	2258	2.42
3.55	211	189.4	351.8	14.16	14.15	14.14	5.68	28.4	71	106.5	213	1081	99.4	116	258.6	870	2273	2.61
3.60	220	193.2	356.8	14.36	14.35	14.34	5.76	28.8	72	108.0	216	1097	100.5	117	260.2	875	2289	2.80

⑧ MPS LH2 MANF P X10 = MPS He REG P ⑨ H2O LP PUMP P ⑩ MPS LO2 MANF P ⑪ APU EGT ⑫ FCL EVAP OUT T ⑬ AV BAY T CAB HX AIR OUT T

⑭ CRYO H2 PRESS

⑮ CRYO O2 PRESS

⑯ FCL FLOW

⑰ (OV-104 and OV-105 ONLY) CAB O2 FLOW 1,2 CAB N2 FLOW 1,2

①	②	③	④	⑤a	⑤b	⑤c	⑥	⑦	⑧	⑨	⑩	⑪	⑫	⑬	⑭	⑮	⑯	⑰
0.00 TO 5.00	-417 TO 468	-76.7 TO 298.1	-3.1 TO 496.8	-0.02 TO 19.96	-0.04 TO 19.95	-0.02 TO 19.93	0 TO 8	0 TO 40	0 TO 100	0 TO 150	0 TO 300	8 TO 1520	24.9 TO 129.9	45 TO 145	145 TO 305	515 TO 1015	732 TO 2684	0 TO 25
3.65	229	196.9	361.8	14.56	14.55	14.54	5.84	29.2	73	109.5	219	1112	101.5	118	261.8	880	2304	3.06
3.70	238	200.6	366.8	14.76	14.75	14.74	5.92	29.6	74	111.0	222	1127	102.6	119	263.4	885	2319	3.31
3.75	246	204.4	371.8	14.96	14.95	14.94	6.00	30.0	75	112.5	225	1142	103.6	120	265.0	890	2334	3.57
3.80	255	208.1	376.8	15.16	15.15	15.14	6.08	30.4	76	114.0	228	1157	104.7	121	266.6	895	2348	3.83
3.85	264	211.9	381.8	15.36	15.35	15.34	6.16	30.8	77	115.5	231	1172	105.7	122	268.2	900	2363	4.18
3.90	273	215.6	386.8	15.56	15.55	15.54	6.24	31.2	78	117.0	234	1187	106.8	123	269.8	905	2378	4.53
3.95	282	219.4	391.8	15.76	15.75	15.74	6.32	31.6	79	118.5	237	1202	107.8	124	271.4	910	2392	4.88
4.00	291	223.1	396.8	15.96	15.95	15.94	6.40	32.0	80	120.0	240	1217	108.9	125	273.0	915	2407	5.23
4.05	299	226.9	401.8	16.16	16.15	16.14	6.48	32.4	81	121.5	243	1233	109.9	126	274.6	920	2421	5.71
4.10	308	230.6	406.8	16.36	16.35	16.34	6.56	32.8	82	123.0	246	1248	111.0	127	276.2	925	2435	6.19
4.15	317	234.4	411.8	16.56	16.55	16.54	6.64	33.2	83	124.5	249	1263	112.0	128	277.8	930	2450	6.67
4.20	326	238.1	416.8	16.76	16.75	16.74	6.72	33.6	84	126.0	252	1278	113.1	129	279.4	935	2464	7.15
4.25	335	241.9	421.8	16.96	16.95	16.94	6.80	34.0	85	127.5	255	1293	114.1	130	281.0	940	2478	7.81
4.30	344	245.6	426.8	17.16	17.15	17.13	6.88	34.4	86	129.0	258	1308	115.2	131	282.6	945	2492	8.47
4.35	353	249.4	431.8	17.36	17.35	17.33	6.96	34.8	87	130.5	261	1323	116.2	132	284.2	950	2506	9.12
4.40	361	253.1	436.8	17.56	17.55	17.53	7.04	35.2	88	132.0	264	1338	117.3	133	285.8	955	2520	9.78
4.45	370	256.9	441.8	17.76	17.75	17.73	7.12	35.6	89	133.5	267	1354	118.3	134	287.4	960	2534	10.68
4.50	379	260.6	446.8	17.96	17.95	17.93	7.20	36.0	90	135.0	270	1369	119.4	135	289.0	965	2548	11.58

① C/W LIMIT VOLTS
O2 PP
GN2 FLOW
CAB O2 FLOW
X1000 = MPS
He TK P

② O2 TK HTR T

③ FCP STK T

④ APU OIL IN T

⑤ CABIN P
^aOV103
^bOV104
^cOV105

⑥ CAB FAN ΔP

⑦ MAIN BUS VOLTS
X10 = OMS
TK ULL P
X10 = RCS
TK ULL P
X100 = HYD
SYS P

4.55	388	264.4	451.8	18.16	18.15	18.13	7.28	66.4	91	136.5	273	1384	120.4	136	290.6	970	2561	12.48
4.60	397	268.1	456.8	18.36	18.35	18.33	7.36	36.8	92	138.0	276	1399	121.5	137	292.2	975	2575	13.37
4.65	406	271.8	461.8	18.56	18.55	18.53	7.44	37.2	93	139.5	279	1414	122.5	138	293.8	980	2589	14.60
4.70	414	275.6	466.8	18.76	18.75	18.73	7.52	37.6	94	141.0	282	1429	123.6	139	295.4	985	2602	15.83
4.75	423	279.3	471.8	18.96	18.95	18.93	7.60	38.0	95	142.5	285	1444	124.6	140	297.0	990	2616	17.06
4.80	432	283.1	476.8	19.16	19.15	19.13	7.68	38.4	96	144.0	288	1459	125.7	141	298.6	995	2630	18.29
4.85	441	286.8	481.8	19.36	19.35	19.33	7.76	38.8	97	145.5	291	1475	126.7	142	300.2	1000	2643	19.97
4.90	450	290.6	486.8	19.56	19.55	19.53	7.84	39.2	98	147.0	294	1490	127.8	143	301.8	1005	2657	21.64
4.95	459	294.3	491.8	19.76	19.75	19.73	7.92	39.6	99	148.5	297	1505	128.8	144	303.4	1010	2670	23.32
5.00	468	298.1	496.8	19.96	19.95	19.93	8.00	40.0	100	150.0	300	1520	129.9	145	305.0	1015	2684	25.00

⑧ MPS LH2 MANF P X10 = MPS He REG P
 ⑨ H2O LP PUMP P
 ⑩ MPS LO2 MANF P
 ⑪ APU EGT
 ⑫ FCL EVAP OUT T
 ⑬ AV BAY T CAB HX AIR OUT T

⑭ CRYO H2 PRESS
 ⑮ CRYO O2 PRESS
 ⑯ FCL FLOW
 ⑰ (OV-104 and OV-105 ONLY) CAB O2 FLOW 1,2 CAB N2 FLOW 1,2

FDA LIMIT CHANGE

SM 60 SM TABLE MAINT

- CRT
1. PARAM ID – ITEM 1 + _____ EXEC
 2. √Update of ID
 3. LIMITS – ITEM XX ± _____ EXEC
 4. √Update of LIMIT
 5. Notify MCC of CHANGED LIMIT(s)

FDA NOISE FILTER CHANGE

SM 60 SM TABLE MAINT

- CRT
1. PARAM ID – ITEM 1 + _____ EXEC
 2. √Update of ID
 3. FILTER – ITEM 8(13) + __ EXEC
 4. √Update of FILTER

FDA PARAM ANNUN INHIBIT

SM 60 SM TABLE MAINT

- CRT
1. PARAM ID – ITEM 1 + _____ EXEC
 2. √Update of ID
 3. INH – ITEM 10(15) EXEC
 4. √Update of INH
 5. Notify MCC of INHIBITED PARAMETER

CW &
FDA OPS

FDA PARAM ANNUN ENABLE

SM 60 SM TABLE MAINT

- CRT
1. PARAM ID – ITEM 1 + _____ EXEC
 2. √Update of ID
 3. ENA – ITEM 9(14) EXEC
 4. √Update of ENA

CONSTANT VALUE CHANGE

SM 60 SM TABLE MAINT

- CRT
1. CONSTANT ID – ITEM 16 + _____ EXEC
 2. √Update of ID
 3. VALUE – ITEM 17 + _____ EXEC
 4. √Update of CONSTANT VALUE

FDA ANNUN INHIBIT

SM 60 SM TABLE MAINT

- CRT
1. FDA INH – ITEM 20 EXEC
 2. √Update of INH
 3. Notify MCC that FDA INHIBITED

FDA ANNUN ENABLE

SM 60 SM TABLE MAINT

- CRT
1. FDA ENA – ITEM 19 EXEC
 2. √Update of ENA

C/W MEMORY READ/CLEAR

1. C/W Memory Read & Clear – Pnl F7 Annunciator
 - C3 √C/W MODE – NORM
 C/W MEM – READ, hold
 - F7 √C/W annunciator lts (parameters out-of-limits since
 C/W memory clear) – on
 - C3 C/W MEM – CLEAR
 - F7 √C/W annunciator lts – off
2. C/W Memory Read & Clear – Pnl R13 Status
 - R13U C/W MEM – READ, hold
 - √C/W STATUS lts (parameters out-of-limits since
 C/W memory clear) – on
 - C3 C/W MEM – CLEAR
 √STATUS lts – off
3. C/W Memory Clear
 - C3 C/W MEM – CLEAR
(R13U)

C/W PARAMETER INHIBIT/ENABLE

- R13U
1. C/W Parameter Inhibit
C/W PARAM SEL tw – desired parameter number (XXX)
PARAM – INH
PARAM STATUS – INH, hold
STATUS It (selected parameter) – on
PARAM SEL tw – 120 or greater
 2. C/W Parameter Enable
C/W PARAM SEL tw – desired parameter number (XXX)
PARAM – ENA
PARAM STATUS – INH, hold
STATUS It (selected parameter) – off
PARAM SEL tw – 120 or greater

C/W PARAMETER LIMIT READ/CHANGE

- R13U
1. C/W Parameter Limit Read
C/W PARAM SEL tw – desired parameter number (XXX)
LIMIT SET LIMIT – desired limit (UPPER or LOWER)
LIMIT SET FUNC – READ, hold
STATUS Its – read value (X.XX volts)
PARAM SEL tw – 120 or greater
 2. C/W Parameter Limit Change
C/W PARAM SEL tw – desired param number (XXX)
LIMIT SET VALUE tw – desired value (X.XX volts)
LIMIT SET LIMIT – desired limit (UPPER or LOWER)
LIMIT SET FUNC – SET, then READ, hold
STATUS Its – read value (X.XX volts)
PARAM SEL tw – 120 or greater



GPC READ/WRITE PADS



5-1

**GPC
R/W**

REF/ALL/GEN I



GPC R/W

GPC READ/WRITE	PASS	MAJOR FUNCTION	<input type="checkbox"/> GNC	<input type="checkbox"/> SM	<input type="checkbox"/> PL	OPS _____																				
OBJECTIVE:																										
<input type="checkbox"/> DATA 20 <input type="checkbox"/> BIT SET 22 <input type="checkbox"/> CODE 21 <input type="checkbox"/> BIT RST 23 26 ENG UNITS _____ _____ _____ <input type="checkbox"/> HEX 27 <div style="border: 1px solid black; display: inline-block; padding: 2px; margin: 5px 0;">0: GPC MEMORY</div>																										
ADD ID		INITIAL ACTUAL		DESIRED		FINAL ACTUAL																				
28	<table border="1" style="width: 100%; height: 20px;"><tr><td> </td><td> </td><td> </td><td> </td><td> </td></tr></table>						<table border="1" style="width: 100%; height: 20px;"><tr><td> </td><td> </td><td> </td><td> </td><td> </td></tr></table>							29	<table border="1" style="width: 100%; height: 20px;"><tr><td> </td><td> </td><td> </td><td> </td><td> </td></tr></table>						<table border="1" style="width: 100%; height: 20px;"><tr><td> </td><td> </td><td> </td><td> </td><td> </td></tr></table>					
30	<table border="1" style="width: 100%; height: 20px;"><tr><td> </td><td> </td><td> </td><td> </td><td> </td></tr></table>						<table border="1" style="width: 100%; height: 20px;"><tr><td> </td><td> </td><td> </td><td> </td><td> </td></tr></table>							31	<table border="1" style="width: 100%; height: 20px;"><tr><td> </td><td> </td><td> </td><td> </td><td> </td></tr></table>						<table border="1" style="width: 100%; height: 20px;"><tr><td> </td><td> </td><td> </td><td> </td><td> </td></tr></table>					
32	<table border="1" style="width: 100%; height: 20px;"><tr><td> </td><td> </td><td> </td><td> </td><td> </td></tr></table>						<table border="1" style="width: 100%; height: 20px;"><tr><td> </td><td> </td><td> </td><td> </td><td> </td></tr></table>							33	<table border="1" style="width: 100%; height: 20px;"><tr><td> </td><td> </td><td> </td><td> </td><td> </td></tr></table>						<table border="1" style="width: 100%; height: 20px;"><tr><td> </td><td> </td><td> </td><td> </td><td> </td></tr></table>					
34	<table border="1" style="width: 100%; height: 20px;"><tr><td> </td><td> </td><td> </td><td> </td><td> </td></tr></table>						<table border="1" style="width: 100%; height: 20px;"><tr><td> </td><td> </td><td> </td><td> </td><td> </td></tr></table>							35	<table border="1" style="width: 100%; height: 20px;"><tr><td> </td><td> </td><td> </td><td> </td><td> </td></tr></table>						<table border="1" style="width: 100%; height: 20px;"><tr><td> </td><td> </td><td> </td><td> </td><td> </td></tr></table>					
36	<table border="1" style="width: 100%; height: 20px;"><tr><td> </td><td> </td><td> </td><td> </td><td> </td></tr></table>						<table border="1" style="width: 100%; height: 20px;"><tr><td> </td><td> </td><td> </td><td> </td><td> </td></tr></table>							37	<table border="1" style="width: 100%; height: 20px;"><tr><td> </td><td> </td><td> </td><td> </td><td> </td></tr></table>						<table border="1" style="width: 100%; height: 20px;"><tr><td> </td><td> </td><td> </td><td> </td><td> </td></tr></table>					
38	<table border="1" style="width: 100%; height: 20px;"><tr><td> </td><td> </td><td> </td><td> </td><td> </td></tr></table>						<table border="1" style="width: 100%; height: 20px;"><tr><td> </td><td> </td><td> </td><td> </td><td> </td></tr></table>							39	<table border="1" style="width: 100%; height: 20px;"><tr><td> </td><td> </td><td> </td><td> </td><td> </td></tr></table>						<table border="1" style="width: 100%; height: 20px;"><tr><td> </td><td> </td><td> </td><td> </td><td> </td></tr></table>					
<input type="checkbox"/> SEQ ID 24 <input type="checkbox"/> WRITE 25																										
REMARKS:																										

GPC READ/WRITE	BFS	MAJOR FUNCTION	<input type="checkbox"/> GNC	<input type="checkbox"/> SM	OPS _____																			
OBJECTIVE:																								
<input type="checkbox"/> DATA 1 <input type="checkbox"/> BIT SET 3 <input type="checkbox"/> CODE 2 <input type="checkbox"/> BIT RST 4 7 ENG UNITS — — — <input type="checkbox"/> HEX 8																								
0: GPC MEMORY																								
ADD ID		INITIAL ACTUAL	DESIRED	FINAL ACTUAL																				
9	<table border="1" style="width: 100%; height: 20px;"><tr><td> </td><td> </td><td> </td><td> </td><td> </td></tr></table>						<table border="1" style="width: 100%; height: 20px;"><tr><td> </td><td> </td><td> </td><td> </td></tr></table>					10	<table border="1" style="width: 100%; height: 20px;"><tr><td> </td><td> </td><td> </td><td> </td><td> </td></tr></table>						<table border="1" style="width: 100%; height: 20px;"><tr><td> </td><td> </td><td> </td><td> </td><td> </td></tr></table>					
11	<table border="1" style="width: 100%; height: 20px;"><tr><td> </td><td> </td><td> </td><td> </td><td> </td></tr></table>						<table border="1" style="width: 100%; height: 20px;"><tr><td> </td><td> </td><td> </td><td> </td></tr></table>					12	<table border="1" style="width: 100%; height: 20px;"><tr><td> </td><td> </td><td> </td><td> </td><td> </td></tr></table>						<table border="1" style="width: 100%; height: 20px;"><tr><td> </td><td> </td><td> </td><td> </td><td> </td></tr></table>					
13	<table border="1" style="width: 100%; height: 20px;"><tr><td> </td><td> </td><td> </td><td> </td><td> </td></tr></table>						<table border="1" style="width: 100%; height: 20px;"><tr><td> </td><td> </td><td> </td><td> </td></tr></table>					14	<table border="1" style="width: 100%; height: 20px;"><tr><td> </td><td> </td><td> </td><td> </td><td> </td></tr></table>						<table border="1" style="width: 100%; height: 20px;"><tr><td> </td><td> </td><td> </td><td> </td><td> </td></tr></table>					
15	<table border="1" style="width: 100%; height: 20px;"><tr><td> </td><td> </td><td> </td><td> </td><td> </td></tr></table>						<table border="1" style="width: 100%; height: 20px;"><tr><td> </td><td> </td><td> </td><td> </td></tr></table>					16	<table border="1" style="width: 100%; height: 20px;"><tr><td> </td><td> </td><td> </td><td> </td><td> </td></tr></table>						<table border="1" style="width: 100%; height: 20px;"><tr><td> </td><td> </td><td> </td><td> </td><td> </td></tr></table>					
17	<table border="1" style="width: 100%; height: 20px;"><tr><td> </td><td> </td><td> </td><td> </td><td> </td></tr></table>						<table border="1" style="width: 100%; height: 20px;"><tr><td> </td><td> </td><td> </td><td> </td></tr></table>					18	<table border="1" style="width: 100%; height: 20px;"><tr><td> </td><td> </td><td> </td><td> </td><td> </td></tr></table>						<table border="1" style="width: 100%; height: 20px;"><tr><td> </td><td> </td><td> </td><td> </td><td> </td></tr></table>					
19	<table border="1" style="width: 100%; height: 20px;"><tr><td> </td><td> </td><td> </td><td> </td><td> </td></tr></table>						<table border="1" style="width: 100%; height: 20px;"><tr><td> </td><td> </td><td> </td><td> </td></tr></table>					20	<table border="1" style="width: 100%; height: 20px;"><tr><td> </td><td> </td><td> </td><td> </td><td> </td></tr></table>						<table border="1" style="width: 100%; height: 20px;"><tr><td> </td><td> </td><td> </td><td> </td><td> </td></tr></table>					
<input type="checkbox"/> SEQ ID 5 <input type="checkbox"/> WRITE 6																								
REMARKS:																								

GPC READ/WRITE	PASS	MAJOR FUNCTION	<input type="checkbox"/> GNC	<input type="checkbox"/> SM	<input type="checkbox"/> PL	OPS _____
----------------	------	----------------	------------------------------	-----------------------------	-----------------------------	-----------

OBJECTIVE:

<input type="checkbox"/> DATA 20	<input type="checkbox"/> BIT SET 22	<input type="checkbox"/> GPC MEMORY
<input type="checkbox"/> CODE 21	<input type="checkbox"/> BIT RST 23	
26 ENG UNITS _____		<input type="checkbox"/> HEX 27

ADD ID	INITIAL ACTUAL	DESIRED	FINAL ACTUAL
28		29	
30		31	
32		33	
34		35	
36		37	
38		39	

SEQ ID 24 WRITE 25

REMARKS:

GPC READ/WRITE	BFS	MAJOR FUNCTION	<input type="checkbox"/> GNC	<input type="checkbox"/> SM	OPS _____
----------------	-----	----------------	------------------------------	-----------------------------	-----------

OBJECTIVE:

<input type="checkbox"/> DATA 1	<input type="checkbox"/> BIT SET 3	<input type="checkbox"/> GPC MEMORY
<input type="checkbox"/> CODE 2	<input type="checkbox"/> BIT RST 4	
7 ENG UNITS — — —	<input type="checkbox"/> HEX 8	

ADD ID	INITIAL ACTUAL	DESIRED	FINAL ACTUAL								
9	<table border="1"><tr><td></td><td></td><td></td><td></td></tr></table>					10	<table border="1"><tr><td></td><td></td><td></td><td></td></tr></table>				
11	<table border="1"><tr><td></td><td></td><td></td><td></td></tr></table>					12	<table border="1"><tr><td></td><td></td><td></td><td></td></tr></table>				
13	<table border="1"><tr><td></td><td></td><td></td><td></td></tr></table>					14	<table border="1"><tr><td></td><td></td><td></td><td></td></tr></table>				
15	<table border="1"><tr><td></td><td></td><td></td><td></td></tr></table>					16	<table border="1"><tr><td></td><td></td><td></td><td></td></tr></table>				
17	<table border="1"><tr><td></td><td></td><td></td><td></td></tr></table>					18	<table border="1"><tr><td></td><td></td><td></td><td></td></tr></table>				
19	<table border="1"><tr><td></td><td></td><td></td><td></td></tr></table>					20	<table border="1"><tr><td></td><td></td><td></td><td></td></tr></table>				

<input type="checkbox"/> SEQ ID 5	<input type="checkbox"/> WRITE 6
-----------------------------------	----------------------------------

REMARKS:



This Page Intentionally Blank





NAV STARS

**NAV
STARS**



NAV STAR REFERENCE TABLE

- ⑤ Nav Star Mean of 1950 RA/DEC coordinates and magnitude data are provided for use with the onboard star charts. The names of the stars 61-110 have been omitted from the star charts for clarity.
- ⑥ The current RA and DEC of the orbiter's +X axis can be determined from the IMU M50 angles on SPEC 21. The Z angle is equal to the RA and the -Y angle is equal to the DEC. (Ref SPEC 21 description in the DPS Dictionary)
- ⑦ Mean of 1950 Pitch and Yaw angles are included to support two axis manual maneuvers for COAS IMU alignments. By placing either the CDRs or aft ADI in the inertial reference frame and using either the +X or -Z sense respectively, a manual maneuver can be flown to the given inertial Pitch and Yaw angles to center the star in either the +X or -Z COAS. These data emulate the technique of using the old Starball RELMAT.

Please note that no formal procedures exist to support this maneuver technique for COAS star acquisition.

NAV
STARS

NAV STAR REFERENCE TABLE

Star ID	Name	*** MEAN OF 1950 ***				
		RA	Dec	Pitch	Yaw	MAG
11	SIRIUS	101	-17	122	70	-1
12	CANOPUS	96	-53	94	37	-1
13	RIGEL	78	-8	35	75	0
14	VEGA	279	39	281	310	0
15	HADAR	210	-60	116	346	1
16	ACHERNAR	24	-57	60	13	0
17	ACRUX	186	-63	117	357	1
18	CAPELLA	78	46	281	43	0
19	SPICA	201	-11	168	340	1
20	ARCTURUS	213	19	203	329	0
21	PROCYON	114	5	193	65	0
22	ALTAIR	297	9	341	298	1
23	BETELGEUSE	88	7	284	82	0
24	BELLATRIX	81	6	326	79	2
25	REGULUS	151	12	194	28	1
26	FOMALHAUT	344	-30	31	346	1
27	DENEK	310	45	303	327	1
28	AL NA'IR	331	-47	51	341	2
29	ALKAID	206	50	233	343	2
30	ANTARES	247	-26	129	305	1
31	CASTOR	113	32	238	51	2
32	ALDEBARAN	68	16	322	63	1
33	PEACOCK	305	-57	69	334	2
34	MIAPLACIDUS	138	-70	106	14	2
35	NUNKI	283	-26	66	299	2
36	KAUS AUSTRALIS	275	-34	82	305	2
37	ALPHERATZ	1	29	331	1	2
38	NAVI	13	60	299	7	2
39	ALHENA	99	16	243	71	2
40	MIRFAK	50	50	299	30	2
41	DENEBOLA	177	15	195	3	2
42	ALPHECCA	233	27	220	314	2
43	RASALHAGUE	263	13	242	284	2
44	MERAK	165	57	238	8	2
45	POLARIS	27	89	271	0	2
46	PHECDA	178	54	234	1	2
47	GIENAH	183	-17	163	357	3
48	ZUBENESCHEMALI	229	-9	166	312	3
49	KOCHAB	223	74	258	349	2
50	AVIOR	125	-59	109	25	2
51	ATRIA	251	-69	97	340	2
52	HAMAL	31	23	333	28	2
53	MENKENT	211	-36	140	335	2
54	DIPHDA	10	-18	19	10	2
55	ALPHARD	141	-8	169	38	2
56	AL SUHAIL	137	-43	128	30	2
57	ACAMAR	44	-41	50	32	3
58	DENEB ALGEDI	326	-16	19	328	3
59	SCHEAT	345	28	331	347	2
60	ENIF	325	10	348	326	2

NAV STAR REFERENCE TABLE (Cont)

Star ID	Name	*** MEAN OF 1950 ***				
		RA	Dec	Pitch	Yaw	MAG
61	ALNILAM	83	-1	11	83	2
62	EL NATH	81	29	286	60	2
63	NAOS	120	-40	121	41	2
64	SAIPH	86	-10	70	80	2
65	ALIOTH	193	56	237	353	2
66	MENKALINAN	89	45	271	45	2
67	ETA CENTAURI	218	-42	131	333	2
68	REGOR	122	-47	116	35	2
69	ALGOL	46	41	309	33	2
70	MUHLIFAIN	190	-49	131	354	2
71	ZETA CENTAURI	208	-47	129	341	3
72	ALUDRA	111	-29	122	55	2
73	ACRAB	241	-20	144	305	3
74	THETA CARINAE	160	-64	115	8	3
75	ZETA OPHIUCHI	249	-10	153	294	3
76	EPSILON CENTAURI	204	-53	124	346	2
77	ALGENIB	3	15	345	3	3
78	GAMMA LUPI	233	-41	125	323	3
79	MARKAB	346	15	345	346	2
80	EPSILON PERSEI	59	40	302	41	3
81	PHACT	84	-34	82	56	3
82	SABIK	257	-16	129	290	2
83	THETA AURIGAE	89	37	271	53	3
84	ALPHA ARAE	262	-50	97	320	3
85	KAPPA VELORUM	140	-55	118	22	2
86	ALDERAMIN	319	62	292	342	2
87	ZOZCA	168	21	201	11	3
88	ZETA CAN. MAJ.	95	-30	98	60	3
89	ARNEB	83	-18	68	71	3
90	ZETA PERSEI	58	32	311	46	3
91	ALPHIRK	322	70	286	348	3
92	MIRACH	17	35	323	14	2
93	ICEN	199	-36	142	344	3
94	COR CAROLI	193	39	219	350	3
95	BETA GRUIS	340	-47	49	346	2
96	DELTA CYGNI	296	45	294	320	3
97	ALMACH	30	42	314	22	2
98	ZUBENELGENUBI	222	-16	159	320	3
99	GAMMA GRUIS	328	-38	42	335	3
100	GAMMA TRI. AUS.	229	-68	105	344	3
101	IZAR	221	27	214	325	3
102	ELTAMIN	269	51	269	322	2
103	ARICH	190	-1	179	350	3
104	ZETA AQUILAE	286	14	318	291	3
105	EPSILON CYGNI	311	34	314	321	2
106	ANKAA	6	-43	43	4	2
107	RHO PUPPIS	121	-24	139	51	3
108	BETA TRIANGULI	32	35	321	26	3
109	PI SAGITTARII	287	-21	53	297	3
110	ZETA HERCULIS	250	32	241	307	3

PROGRAM NOTES

CRT DISPLAYS	7-7
DPS (GENERAL)	7-19
ASCENT/ABORT	7-24
ON-ORBIT (OPS 2).....	7-30
DEORBIT/ENTRY (OPS 3/6).....	7-32

**PGM
NOTES**

PROGRAM NOTES

The notes in this section apply to PASS only unless otherwise indicated. Information in parentheses following each note indicates the applicable Software Discrepancy Report (DR XXXXX), BFS Discrepancy (BXXXXX), or Software Change Request (CR XXXXX). If no reference is given, the note describes an 'as is' peculiarity of the Data Processing System

PAGE

CRT DISPLAYS

GPC MEMORY	7-7
1. Mass Memory Pre-position Failure	7-7
2. Stale NBAT Data.....	7-7
3. Engineering Units Conversion Processing	7-7
4. G-MEM Item Initialization.....	7-7
5. Read/Write and Memory Dump	7-7
DPS UTILITY	7-8
1. MMU Assignments.....	7-8
TIME	7-8
1. Sign Convention for Item Entries	7-8
2. GMT Update on GPC Time.....	7-8
3. MTU Effects on GMT Updates.....	7-8
4. MTU Updates with FC Strings not in RS	7-9
XXXX MNVR YYYY	7-9
1. Bad OMS Engine ID.....	7-9
2. Targeting	7-9
3. Use of BOTH to Clear OMS Down Arrows	7-9
4. Stale OMS Trim Angle Data.....	7-9
5. Timer Countdown Terminated Unconditionally on MM301 Init or MNVR Target Item Update	7-10
6. Guidance Convergence Indications	7-10
7. Item Entries During RCS BURN	7-10
8. Unsupported AOA/ATO Requests in MM105 after OMS 2....	7-10
9. No Flashing 'LOAD' for BFS on Major Mode Transitions	7-10
10. No Burn Attitude for Yaw Near $\pm 90^\circ$	7-11
11. Attitude Maneuver to Unknown Attitude	7-11
12. TFF/REI Blanking.....	7-11
13. Actuator Deselection.....	7-11
14. Gimbal Drive Check	7-11
15. Abnormal OMS Termination/Keyboard Lockout	7-12

PGM
NOTES

OVERRIDE	7-12
1. Possible Contingency Dump Lockout for Second Dump Request Pre-MECO	7-12
2. OMS Propellant Dump Termination Via Arm/Press Switches.....	7-12
3. RCS Dump Status May Change to Inhibit in MM304 or 602.....	7-12
4. ET SEP Switch Default	7-13
UNIV PTG.....	7-13
1. Enable RNDZ NAV Before Target Tracking	7-13
2. Disable Target Tracking Before OPS Transition.....	7-13
GNC SYS SUMM 1.....	7-13
1. GNC SYS SUMM 1	7-13
IMU ALIGN	7-13
1. IMU Operate Mode Indication.....	7-13
2. Unexpected ILLEGAL ENTRY when Selecting IMU Alignment	7-13
S TRK/COAS CNTL.....	7-14
1. COAS ACCEPT Without Mark.....	7-14
2. COAS Operation from AFT Station in OPS 3	7-14
RM ORBIT	7-14
1. AFT THC Data Display	7-14
REL NAV	7-14
1. Noise in ΔV	7-14
VERT SIT 1.....	7-15
1. Alpha-Recovery/Nz-Hold Transition	7-15
HORIZ SIT	7-15
1. OVHD to STRT Toggle in MM101	7-15
FCS/DED DIS C/O.....	7-15
1. Run ADT Prior to SEC ACT CK.....	7-15
2. ADT Fault Annunciation.....	7-15
3. Actuator Bypass Down Arrows	7-15
SWITCH/SURF	7-16
1. FCS Channel Switch Comm Fault Status.....	7-16

CONTROLLERS.....	7-16
1. AFT THC Data Display	7-16
2. RHC Contact Deselection	7-16
ANTENNA.....	7-16
1. S-band Antenna Selection	7-16
PL BAY DOORS	7-16
1. PL Bay Door Auto Open Sequence (PASS)	7-16
2. PL Bay Door Talkback	7-16
3. BFS PL Bay Door Operation.....	7-17
SM TABLE MAINT.....	7-17
1. SPEC/TMBU Interlock	7-17
2. Limits for Discrete Parameters with Multiple Limit Sets.....	7-17
PCMMU/PL COMM	7-18
1. Item Entry Characteristics.....	7-18
2. Erroneous Format Load Indications.....	7-18
3. SM2 PDI Fault Message Interpretation.....	7-18
BFS MEMORY.....	7-18
1. DESIRED Field Not Blanking.....	7-18
BFS HORIZ SIT	7-18
1. BFS Horizontal Situation Display Predictors Incorrect	7-18
<u>DPS (GENERAL)</u>	
INITIAL PROGRAM LOADS (GPC and DEU).....	7-19
1. Invalid DEU IPL Requests	7-19
2. SM OPS 2/4 DEU IPL Failure Due to SM Common Buffer Busy.....	7-19
3. DEU Loaded by BFS.....	7-19
GPC/CRT MANAGEMENT.....	7-19
1. Potential FTS at New GPC Startup	7-19
2. DEU Control Loss with BFC CRT SEL Switch to OFF	7-20
3. RS Split and BFS Standalone.....	7-20
4. CRT Assignment Guidelines.....	7-20

OPS AND MAJOR MODE TRANSITIONS.....	7-21
1. OPS Transition Restrictions.....	7-21
2. OPS Transition with SPEC Request in Progress	7-21
3. Annunciation of FTS During OPS Transition	7-21
4. OPS Transition After MMU Powerup	7-21
5. CRT Assignments During OPS Transition.....	7-21
KEYBOARD/DISPLAY MANAGEMENT.....	7-22
1. PASS/BFS Item Entry Monitoring	7-22
2. System SPEC Availability	7-22
3. NBAT Updates and Stale Data	7-22
4. Consecutive I/O RESETs.....	7-22
5. Moving Switches to GPC Position	7-22
6. Simultaneous System SPEC Inputs	7-23
7. RESUME of SPEC on Failed DEU	7-23
8. I/O RESET with Failed MTU	7-23

ASCENT/ABORT

ASCENT (GENERAL).....	7-24
1. Erroneous Command Path Failure Annunciation (PASS and BFS)	7-24
2. RHC Status Not Displayed.....	7-24
3. Incorrect SSME Limit Control Commands Issued	7-24
4. Inappropriate Upmode to Auto After Fast Sep.....	7-24
5. Unexpected Roll Maneuver in MM103.....	7-25
RTLS (also see ABORT OMS DUMPS)	7-25
1. CSS Alpha Recovery/Nz Hold Transition in OPS 6.....	7-25
2. RTLS Delayed Guidance Convergence.....	7-25
ABORT OMS DUMPS (GENERAL)	7-27
1. OMS Propellant Dump Termination via ARM/PRESS Switches.....	7-27
2. Possible 2nd OMS Pre-MECO Dump Lockout	7-27
3. Abort OMS Dumps Inhibited Upon BFS Engagement.....	7-27
MM104/MM105.....	7-27
1. OMS Target Guidance Convergence	7-27
2. OMS 1 Attitude Errors Induced by MPS Dump.....	7-27
3. Engine Response to the ARM/PRESS Switch (in all MMs).....	7-28

ON-ORBIT (OPS 2)

- 1. OPS 2 OMS Burn ADI Guidance Error Requirement 7-30
- 2. Improper COAS Operation..... 7-30
- 3. Multiple Commands via a PSP 7-30
- 4. ADI Freeze at 90°/270° Yaw..... 7-30
- 5. VRCS Failure 7-30

DEORBIT/ENTRY (OPS 3/6)

- OPS 3/6 (GENERAL)..... 7-32
- 1. COAS Operation in OPS 3..... 7-32

- DEORBIT BURNS 7-32
- 1. Erroneous Attitude Displays for Yaw Near $\pm 90^\circ$ 7-32
- 2. Yaw Error Needle Sensitivity During Deorbit Burns 7-32
- 3. Pitch Error Needle Sensitivity During RCS Burns..... 7-32

- ENTRY 7-33
- 1. HAC Radius Position Uninitialized in MM304..... 7-33
- 2. BFS Horizontal Situation Display Predictors Incorrect 7-33

CRT DISPLAYS

GPC MEMORY

1. Mass Memory Pre-position Failure. When a mass memory pre-position failure occurs, SPEC 0 does not appear on the DEU where OPS request was made. During TAL abort (G1 to G3), if OPS 0 page is not displayed within 12 sec, a mass memory pre-position failure can be assumed. For other transitions, a 70-sec wait is required. An 'I/O ERROR MMU' message may appear on the Fault Summary Page (FSP) and CRT message lines when failure occurs (DR 25372)
2. Stale NBAT Data. If the MC # displayed (item 1) is the currently active MC, DEU selections (items 12,13,14,15) will not reflect any CRT reassignments that have occurred due to MF change or GPC/CRT entry

If G3 NBAT is not updated in OPS G1, the active G1 bus assignment is carried over at OPS G1 to G3 transition as the G3 bus assignment. After G1 to G3 transition, string/bus assignments displayed are stale data from the MC3 NBAT previously displayed in OPS G1. Selecting item 1+3 on SPEC 0 after transition to OPS G3 will update the display with the current G3 NBAT (DR 37506)

3. Engineering Units Conversion Processing. Processing of read/write information continues in the software even if GPC MEM SPEC is removed via RESUME. If improper engineering units conversion is requested, GPC errors may occur if SPEC is RESUMEd without first doing ITEM 27 EXEC to clear the read/conversion function
4. G-MEM Item Initialization. ADD ID and DESIRED columns are blanked at OPS transitions or fresh callup of SPEC 0, but not if SPEC 0 is active on another DEU or is underlying a DISP when it is called. A DEU equivalent G-MEM in the latter situation could produce an erroneous write to GPC memory. Reinitialization via item 20 should always be performed prior to DEU equivalent G-MEM writes
5. Read/Write and Memory Dump. When GPC MEMORY SPEC is called, READ/WRITE and MEMORY DUMP sections are initialized to DATA, HEX, and all other fields blank. If GPC MEMORY is being viewed as an OPS display and on another DEU driven by the same GPC or RS, GPC MEMORY SPEC is requested, both displays will be initialized to the default item selections previously described. In configurations where GPC MEMORY SPEC is available as the OPS display, view it as the OPS display by resuming any other SPEC or display on DEU when reinitialization

is not desired. Request SPEC 0 when reinitialization is desired (DR 37516)

DPS UTILITY

1. MMU Assignments. User selection of MMU assignments on DPS UTILITY SPEC from another GPC can interfere with proper operation of PL9 MM Utility (DR 37420)

TIME

1. Sign Convention for Item Entries. The sign of lowest non-zero item entry value determines the sign for entire field. Since S/W cannot interpret negative zero, the user should enter desired sign immediately preceding first non-zero entry (+ or -) or not use zero as the first digit in a series of entries to the items (DR 37504)
2. GMT Update on GPC Time. If GMT update is issued from either a redundant set GPC or nonredundant set GPC while on GPC time, there is a possibility that the redundant set GPC could perceive different time than nonredundant set GPC. This could lead to a common set fail-to-sync of nonredundant set GPC
3. MTU Effects on GMT Updates. When Greenwich mean time (GMT) update (item 32) is executed, there is an interval of up to 2 min before the update takes effect, as indicated by GMT Δ blanking on the display. The length of delay is a function of the master timing unit (MTU) hardware, which can be updated only at a whole minute. During the interval, while waiting for the update to take effect, some user actions such as keyboard inputs may cause unexpected results (e.g., a FAIL-TO-SYNC)

For GMT updates > 15 msec:

No user actions or keyboard inputs should be attempted until the update takes effect. This type of update will force reinitialization

For GMT updates < or = 15 msec:

Do not perform the following actions until the update takes effect:

- Addition of a GPC to the CS
- OPS transition request or mode recall
- I/O RESET
- I/O terminate switch change
- Accumulator select (DR 29284/DR 40620)

4. MTU Updates with FC Strings not in RS. If an MTU update or accumulator sync is performed with flight critical strings 1, 2, or 3 split between redundant set and nonredundant set GPCs, it is possible to have two computers issuing an MTU update. Effects on the MTU are unpredictable

XXXX MNVR YYYY

1. Bad OMS Engine ID. If a bad engine ID is uplinked as part of a target load, the maneuver display will default to RCS +X thrusters in OPS 3 and to an indeterminable selection in OPS 1. Proper engine ID uplink or crew item number entry will correct this problem (DR 38163U)
2. Targeting. If targeting is active in MM105 or 302 when PRO to MM106 or 303 occurs, target parameters will be displayed on the Coast MM display when they should be blank. In addition, for MM302 and 303 cases, the I-LOAD entry interface attitude will be overwritten by the targeting attitude and ADI error needles will reflect this new attitude. Manual entry of the entry interface attitude would resolve this last problem. In general, avoid any major mode transition except 301 to 302 while targeting is still computing burn numbers (DR 36015)

If transition to 301 from 303 occurs just after a state vector update (whole or delta) has been performed, target data entry rejection and CRT timer anomalies may be observed for several seconds while a targeting module finishes execution. When the module completes, item number entry will return to normal and the CRT timer will return to crew control (DR 36479)

In MM202, the rendezvous guidance option chosen by ORBIT TARGETING spec is displayed in text. Discrete (1) is set and 'LAMBERT' is displayed for this option. Discrete can be reset (0) by ground uplinking or crew retargeting to external ΔV (via this or the ORBIT TARGETING display) and 'EXT ΔV ' will be displayed

3. Use of BOTH to Clear OMS Down Arrows. If an engine indicates failure (down arrow) during a burn, subsequent to the burn the arrow cannot be cleared by selecting the BOTH item number. The down arrow will be automatically cleared by OMS RM at TIG-15 sec for a subsequent OMS burn regardless of engine selection (DR 55314)
4. Stale OMS Trim Angle Data. During maneuver operations in MM104 thru 106, 202, and 301 thru 303, OMS trim angles remain static during and after a burn until the next item entry or display recall. Perform an item entry or display recall to update OMS trim angles, repeating for each DEU (DR 39371)

5. Timer Countdown Terminated Unconditionally on MM301 Init or MNVR Target Item Update. Any CRT timer countdown initiated by the crew or software will be terminated upon entry to MM301 or upon update of a MNVR target item by keyboard or uplink. The crew may reinitiate countdown using items 22 (LOAD) and 23 (TIMER) (DR 37591)
6. Guidance Convergence Indications. Subsequent to execution of LOAD item number, only positive indication of guidance being unable to converge on a solution will be the display of zeroes for BURN ATT (blank or non-zero when converged) and TGT HA and HP (non-zero when converged) (DR 37573)
7. Item Entries During RCS BURN. During RCS maneuver, entries from the keyboard will be accepted by software. This is the case whether the maneuver was initially planned +4X or whether both OMS engines have failed during maneuver. If any target-set-related entry, except propellant to be depleted (i.e., trims, engine select, TIG, or targets), is made during maneuver, target solution values (i.e., TGO, VGOs, burn attitude, etc.) are blanked and a flashing LOAD appears.

The same applies for any such target entry prior to burn enable. Do not make target item entries (except for propellant to be depleted) during RCS maneuver. If an entry is inadvertently made, a new LOAD will be required to reestablish guidance solution. The TIG for LOAD must be in the future. Also, the THETA target must be adjusted if TIG is changed (in OPS 3 only) or an REI miss will result (DR 37564)

8. Unsupported AOA/ATO Requests in MM105 after OMS 2. If AOA or ATO abort is requested in MM105 following OMS 2 burn completion:
 - a. The AOA/ATO targeting function is not scheduled so MNVR target items are not automatically updated
 - b. When crew manually enters desired MNVR target (item 10-17), followed by LOAD item, ATO targeting is correct; however, AOA targeting is incorrect (it should be done in MM301)
 - c. For AOA, subsequent transition to MM106 causes MNVR title to be unreadable in MM106 (DR 45739)
9. No Flashing 'LOAD' for BFS on Major Mode Transitions. After transitioning from MM104 to MM105, MM104 to MM301, or MM106 to MM301, 'LOAD' will flash on the PASS maneuver display but not on the BFS maneuver display. Additionally, 'LOAD' will not flash for BFS OPS 0 to OPS 3 transition, but will flash on

the PASS maneuver display after OPS 2 to OPS 3 transition. The flashing 'LOAD' does not appear for BFS since there are no valid target data to be loaded. It will appear when an uplink or keyboard entry of target data is performed

For both PASS and BFS, 'LOAD' must be flashing before item 18 (PRPLT) on the maneuver display can be entered with a non-zero value. Because of the flashing 'LOAD' difference between PASS and BFS, a non-zero item 18 could be entered on a PASS keyboard and displayed on the PASS maneuver display while being rejected by BFS without an ILLEGAL ENTRY message (DR 108559/B20611, 45749)

10. No Burn Attitude for Yaw Near $\pm 90^\circ$. If PEG 4 or PEG 7 target solution results in a desired preburn yaw attitude near $\pm 90^\circ$, the desired BURN ATT will not be displayed on the MNVR display. This is a display problem only; guidance will still function normally and ADI error needles are still valid (DR 37585)
11. Attitude Maneuver to Unknown Attitude. If auto maneuver is in progress in OPS 2 and item 22 (LOAD) is entered, a new burn attitude will be computed and displayed; the vehicle, however, will continue to maneuver to the old burn attitude. Mode the DAP to any manual mode and back to auto to avoid confusion regarding the attitude to which the vehicle is maneuvering. The crew could also reexecute item 27 with DAP in auto (once burn attitude values are displayed) to begin the new maneuver (DR 48348)
12. TFF/REI Blanking. Maneuver display parameters TFF and REI are not computed for perigee altitudes above 55 nm (I-load) on any LOAD situation in OPS 3. These parameters are blanked on the display when this occurs and therefore, REI/TIG adjust (as called for in ASCENT C/L) is not possible. These parameters may therefore not be computed for AOAs with large MECO underspeeds (DR 37573)
13. Actuator Deselection. If both primary and secondary actuators are deselected, P and Y gimbal angles for that engine show a static display of the last valid gimbal data prior to OFF execution (item 32/33). Transition to OPS 3 in this case may result in erroneous gimbal data being displayed. Manually reselecting either primary or secondary gimbals will reinstate dynamic data (DR 37123)
14. Gimbal Drive Check. The GMBL CK item can be executed during an OMS burn and will cause check to be performed, overriding OMS TVC flight control commands (DR 37561)

15. Abnormal OMS Termination/Keyboard Lockout. Multiple failures during an OMS maneuver may lead to control problems and subsequent guidance divergence requiring manual OMS cutoff. Proper crew response is to terminate OMS thrust with the ARM PRESS switch. Absence of OMS cutoff commands (in software) causes keyboard lockout

If TGO stops counting down, the auto system probably will not achieve cutoff and proper crew response is a manual OMS cutoff

The chance of a keyboard lockout in this situation should be recognized and, if it results, the procedure for manual setting of cutoff commands should be used

In the case of a keyboard lockout, release is effected by OPS XXX PRO to the next OPS (MM104-105, 302-303). Note that MM105-106 terminates OMS burn capability in OPS 1 since MM106-105 is not permitted

OVERRIDE

1. Possible Contingency Dump Lockout for Second Dump Request Pre-MECO. In an abort situation which causes automatic Pre-MECO OMS dump (MM103), if an additional OMS dump is requested during the OMS engine purge process, the dump does not occur, and subsequent requests for contingency OMS dumping are not honored. The same contingency dump lockout can also occur in MM103 when requesting another crew-initiated contingency dump during purge process of a previous contingency dump. Therefore, contingency dumping should only be requested prior to completion of the original OMS dump or after OMS purge completion (DR 55217)
2. OMS Propellant Dump Termination Via Arm/Press Switches. If OMS ARM/PRESS switches are turned OFF during a contingency dump (MM102, 103, 601, 602), OMS RM will fail vote the OMS engines. Attempts to reactivate dump will also fail. Terminate dump sequence using item 8 rather than ARM/PRESS switches. MM104, MM201, or MM301 PRO allows OMS engines to fire again (DR 55306)
3. RCS Dump Status May Change to Inhibit in MM304 or 602. In MM304 or 602, when dump start initiation conditions are met, user may see forward and/or aft RCS DUMP STATUS (items 13 and 15) change from 'ENA' to 'INH'. This occurs if dump duration (I-LOAD or crew entry) is a negative number

Negative dump duration allows dump to remain enabled but not started. The crew may then start dump during TAL or RTLS by

entering only one item entry (entering a positive dump duration) instead of two items (dump duration and dump enable) (DR 101386)

4. ET SEP Switch Default. In OPS 1, if ET SEP switch defaults to 'MANUAL', ET SEP AUTO (item 38) is used to override the function back to AUTO. In OPS 6, default is to 'AUTO', so item 38 is not needed

UNIV PTG

1. Enable RNDZ NAV Before Target Tracking. Execution of the target tracking option (item 19) with TGT ID (item 8) = 1 when rendezvous navigation is not enabled will cause divide by zero GPC errors. RNDZ NAV (item 1, REL NAV display) must be enabled each time GNC OPS 2 is entered, before attempting to track another orbiting object (DR 53101)
2. Disable Target Tracking Before OPS Transition. Target tracking of another orbiting vehicle should be stopped via item 21 before executing OPS transition or mode recall, or the target state vector may be lost (DR 58374)

GNC SYS SUMM 1

1. GNC SYS SUMM 1. When an FCS channel switch is moved between AUTO and OVERRIDE positions, a momentary down arrow may appear on GNC SYS SUMM 1 for that channel. This occurs because switch is of the break-before-make variety causing momentary loss of power to ASA during switch movement

Although RHC LRU fault annunciation is possible in OPS 1, the RHC LRU status fields are blanked in OPS 1 preventing display of RHC failure, dilemma, or comm-fault status (DR 104639)

IMU ALIGN

1. IMU Operate Mode Indication. It is possible for the IMU LRU to be in operate mode (as indicated by OPER asterisk) but for the software to still be in an IMU STBY state. ACC and ANG data for that IMU will be indicating zeroes in this situation. Problem can be corrected by executing the OPER item number for that IMU (No DR)
2. Unexpected ILLEGAL ENTRY when Selecting IMU Alignment. If Bite Test 4 MDM initialization read is bypassed at OPS 2 or 3 transition, the output discrete that indicates IMU is 'In Operate' is set to zero. Any IMU to IMU alignment entry (item 16) with an IMU whose 'In Operate' output discrete is zero fails with an ILLEGAL

ENTRY. If this occurs, select item 4, 5, or 6 (OPERATE) to set 'In Operate' output discrete for the reference IMU and repeat alignment (DR 100520)

S TRK/COAS CNTL

1. COAS ACCEPT Without Mark. Current software makes no check to ensure a COAS mark has been taken as a condition for processing ACCEPT item selection. Therefore, erroneous data could go into the star table. This might only be apparent to the crew after second (valid) star is sighted and ANG DIF shows a significant error from the expected angular separation. If ACCEPT command is inadvertently entered without a mark, complete current processing by entering second ACCEPT command, reinitialize by entering a star table clear (item 20), and then perform the normal sight mode procedure (DR 35151)
2. COAS Operation from AFT Station in OPS 3. Marks from the aft station are not detected by flight software in OPS 3 because switch processing does not occur in OPS 3 for the aft station. COAS operations should only be performed at the forward station during OPS 3 (DR 35151)

RM ORBIT

1. AFT THC Data Display. Physical orientation (rotated 90 degrees clockwise) of AFT THC causes crew commands to be displayed as follows:

THC CMD	TX	TY	TZ
PUSH	+		
PULL	-		
DOWN		+	
UP		-	
STBD			+
PORT			-

REL NAV

1. Noise in ΔV . Flight data has shown that ΔV_X , ΔV_Y , and ΔV_Z accumulated velocities are extremely noisy and should not be used as an indication of orbiter ΔV . Use either R-dot or count THC pulses

VERT SIT 1

1. Alpha-Recovery/Nz-Hold Transition. Subphase transition from alpha-recovery to Nz-hold in MM602 requires one of the following conditions; either A or B:
 - A. Nz > approx 1.8G (I-load)
 - B. For intact abort only:
 - ALPHA > 35° (I-load) in guidance cycle, and
 - ALPHA < 35° in subsequent cycle

Furthermore, the pitch error needle on ADI displays:

- Alpha error during alpha-recovery subphase, and
- Nz error during Nz-hold subphase

Normally, Case A takes place and transition to Nz-hold subphase occurs automatically. Case B can be forced by CSS takeover

The crew should monitor VERT SIT 1 during MM602 and wait for display of an overbright Nz which appears when guidance transitions to Nz-hold phase (either case A or B). Pitch axis of the ADI error needle will display Nz error in Nz-hold subphase. The crew should not null Nz error manually for case B until Nz reaches 1.8G (BO7339A/DR 46515)

HORIZ SIT

1. OVHD to STRT Toggle in MM101. Item 6 cannot be used to toggle back to OVHD once STRT has been selected in MM101. The desired landing site can then be reselected (item 41), which will reset OVHD (DR 42650)

FCS/DED DIS C/O

1. Run ADT Prior to SEC ACT CK. The SURF DR (ADT) test should be run prior to SEC CK because SURF DR leaves surfaces far enough from hardstops to ensure valid SEC ACT CK (DR 35572)
2. ADT Fault Annunciation. An 'AERO DRIVE' fault message and associated down arrow are generated when SEC ACT CK (channel 1) is run. This is expected and can be cleared by MSG RESET on the MCDS keyboard (DR 46503)
3. Actuator Bypass Down Arrows. Actuator bypass down arrows will not appear as expected if more than two channels are bypassed before resetting. Bypassed channels should be reset before bypassing next channel (DR 44250)

SWITCH/SURF

1. FCS Channel Switch Comm Fault Status. In OPS 8 (only), comm faulted FCS channel switch contacts are not removed from contact selection filtering as they should be. If FF 1, 2, or 3 failures or 'BCE STRG 1 (2,3) B' bypasses occur, switch status should be closely monitored via SPEC and ground downlist to ensure erroneous OVERRIDE commands do not occur (DR 30526)

CONTROLLERS

1. AFT THC Data Display. Physical orientation (rotated 90° clockwise) of the AFT THC causes crew commands to be displayed as follows:

THC CMD	TX	TY	TZ
PUSH	+		
PULL	-		
DOWN		+	
UP		-	
STBD			+
PORT			-

2. RHC Contact Deselection. When RM automatically deselects an RHC channel, it places a down arrow by the axis that experienced the failure but not by the other two axes on that channel. An asterisk will appear under the 'DES' column for that channel to indicate all axes on that channel have been deselected

ANTENNA

1. S-band Antenna Selection. When using the ANTENNA S-BAND PM rotary switch (panel C3), allow at least 2 sec at each intermediate position

PL BAY DOORS

1. PL Bay Door Talkback. When BFS is taken to RUN, the payload bay door position indicator on panel R13 is initialized to barberpole, regardless of the true state of the doors. To show the true state, call BFS SM SPEC 63 (B08246)
2. BFS PL Bay Door Operation. PLBD operations cause unique handling of SPECs and displays in BFS. BFS operates as follows:
 - a. RESUME, MF switch, display, and SPEC requests operate per normal interaction of structures requirements when a PLBD OPEN or CLOSE sequence is not in progress

- b. RESUME, MF switch, display, and SPEC requests operate per normal interaction of structures requirements as long as there is more than one CRT with PLBD SPEC active
 - c. If only one CRT has PLBD SPEC active, RESUME of PLBD SPEC is illegal if either:
 - PBD SW BYPASS (item 14) is not selected and the PL BAY DR switch is not in STOP position, or
 - PBD SW BYPASS (item 14) is selected and the STOP item (item 16) is not selected
 - d. Change of MF is allowed while a PLBD OPEN or CLOSE sequence is in progress and the sequence will continue
 - e. PLBD OPEN or CLOSE sequence will continue if SPEC or display is called on top of the PLBD SPEC
 - f. SPEC may overlay PLBD SPEC, but if an OPEN or CLOSE sequence is in progress and that CRT is the only CRT with PLBD SPEC active, RESUME will return to PLBD SPEC (B03926)
3. BFS PL Bay Door Manual Item Entries May Cause Problem in Auto Mode. The PBD Auto sequence may operate out of order if it is preceded by the execution of a manual item entry that is out of the normal sequence order. If the auto sequence operates out of order, perform the following steps:
- a. Stop the auto sequence
 - b. Using manual mode correct the out of order condition
 - c. Reset the sequence to the proper latch/door group by manual item entry
 - d. Continue the sequence in either auto or manual. (B28716)

SM TABLE MAINT

1. SPEC/TMBU Interlock. Table maintenance block update (TMBU) via uplink and SPEC 60 are interlocked such that (a) TMBU loads are rejected if SPEC 60 is active and (b) if TMBU is in progress and SPEC 60 is called, all items will be 'ILLEGAL ENTRIES' (DR 37572)
2. Limits for Discrete Parameters with Multiple Limit Sets. The out-of-limit state for a discrete parameter will be a +0, +1, or +2 entered in item 2. The +2 state causes FDA to be bypassed. If the +2 state is entered for a discrete parameter with only one limit set, an 'ILLEGAL ENTRY' message will result

PCMMU/PL COMM

1. Item Entry Characteristics. If OPS transition is initiated while item 3 (SEL ID), 4 (LOAD) format load is in progress, the load will fail. If this occurs, reinitiate load via items 3, 4 (DR 37584)
2. Erroneous Format Load Indications. PCMMU and PDI formats loaded on G9 GPC (prelaunch) are not reflected on SM-driven SPEC 62. Power-cycling the PCMMU or PDI erases stored formats, but not SPEC 62 indications. SPEC 62 displayed formats are blanked after SM GPC is re-IPLed on orbit even though loads are not changed (No DR)
3. SM2 PDI Fault Message Interpretation. When PDI is powered in SM2, but a payload data stream is not being DECOMed, PDI fault annunciation may occur without PDI failure. Annunciations caused by payloads which are not in configuration for PDI data processing (deployed payloads, those for which lock has been lost, etc.) do not necessarily indicate PDI failure (DR 55302)

BFS MEMORY

1. DESIRED Field Not Blanking. Old data in DESIRED column of the READ/WRITE section will not blank when new addresses are entered into ADD ID columns. Always reselect mode (item 1 thru 4, or 7, or 8) to clear DESIRED column prior to entering new addresses

BFS HORIZ SIT

1. BFS Horizontal Situation Display Predictors Incorrect. During BFS MM304, if roll angle of 90° or more is performed below 200K feet, the 20-, 40-, and 60-sec predictors of the horizontal situation display will indicate a turn in the opposite direction. The crew should ignore HSD predictors when roll angle is greater than or equal to 90° (DR B08297)

DPS (GENERAL)

INITIAL PROGRAM LOADS (GPC and DEU)

1. Invalid DEU IPL Requests. A DEU IPL request using PASS is valid only in SM, PL9, or post-IPL OPS 0 and SM OPS 2/4. Requests made at any other time will result in unpredictable problems with that DEU. If a 'CM BUF BSY CRTX' fault message is annunciated, wait until the SM common buffer is no longer in use before attempting another DEU IPL request. If an invalid IPL request is made, deassign DEU and perform DEU re-IPL to recover DEU (DR 33643)
2. SM OPS 2/4 DEU IPL Failure Due to SM Common Buffer Busy. SM common buffer is utilized during DEU IPL and also by other processes running concurrently; buffer may be in use when DEU IPL is requested in SM 2/4. If buffer is in use, a 'CM BUF BSY CRTX' fault message will be annunciated by SM GPC, and the DEU IPL attempt will fail. The 'X' in 'CRTX' portion of fault message represents the number of CRT/DEU being IPLed. Operations which contend for the SM common buffer are: TFL loads, SM checkpoint/restore, orbiter mass memory read/write SPEC operations, and crew text uplinks (TUMMS). Should a 'CM BUF BSY CRTX' message be annunciated, wait for contending operation to complete before retrying DEU IPL (No DR)
3. DEU Loaded by BFS. A DEU that has been IPLed by BFS does not have the critical format background displays loaded into DEU to be usable to PASS. DEU must be re-IPLed by PASS (DR 37542)

DPS
(GEN)

GPC/CRT MANAGEMENT

1. Potential FTS at New GPC Startup. During ICC initialization of new GPC into a common set, the following DPS-related actions could cause resulting ICC data to be overlaid by initialization ICC data. This could lead to an FTS at common set formation or later at redundant set formation
 - a. Reassign GSE polling (ground initiated)
 - b. Downlist GPC switch
 - c. FC/PL string moding
 - d. DEU major function switch change
 - e. GPC/CRT key, BFC CRT select switch, BFS CRT display switch
 - f. OPS transitions
 - g. OPS mode recall
 - h. Redundant set to OPS 0
 - i. Moding another GPC from STBY to RUN or RUN to STBY

DPS
(GEN)

The above actions should not be performed during time span approximately 10 sec before moding GPC to RUN until 10 sec after placing mode switch to RUN or until output tb goes gray (DRs 42433, 46617, 30138a)

2. DEU Control Loss with BFC CRT SEL Switch to OFF. For a BFC CRT SEL switch change which requires PASS to resume control of a DEU, that DEU will not be picked up by PASS if the previous PASS commander is unable to assume command. On another PASS DEU, reassign dropped DEU to an active PASS GPC to regain DEU control (DR 37512)
3. RS Split and BFS Standalone. A 2 on 2 PASS redundant set split normally causes BFS to track the lower pair. However, if prior to the split, BFS experienced an I/O error due to BFS MIA receiver problem on a forward bus associated with lower pair, BFS will track higher pair. Upon execution of BFS I/O reset, BFS will attempt to reinitialize tracking on lowest pair. BFS will then downmode string with the faulty forward bus (MIA) and go standalone for lack of two strings to track. During PASS 2 on 2 set split, if BFS is tracking higher pair, do not attempt I/O reset to BFS until PASS restringing is complete (DR 101898/B28531)
4. CRT Assignment Guidelines
 - a. Prior to CRT reassignment, deassignment, major function change or power off, 'RESUME' CRT to release any SPEC so one of two allowable SPECS (per major function) will not be allocated to that CRT
 - b. Use PASS CS keyboard (not BFS or F-T-S keyboard). Note that BFS will DK listen to GPC/CRT keyboard entries
 - c. To move CRT from F-T-S GPC to CS GPC, deassign CRT with F-T-S keyboard, then reassign on PASS CS keyboard
 - d. Always ensure new GPC is available (running in CS) and new CRTs MF switch matches new GPCs MF (PL if OPS 0 GPC) prior to 'GPC/CRT XX EXEC'
 - e. Request for more than three CRTs to be assigned to common set will result in the fault message '> 3 DEU' in all OPS. There is no restriction on number of CRTs that can be assigned to BFS
 - f. The BFS CRT switch can only be used to assign a CRT to BFS (preengage) if the IPL source switch on panel O6 is in the 'OFF' position

- g. If new NBAT reassigns a CRT which is assigned to BFS via the BFC CRT switch, the new assignment will not be made until the BFC CRT switch turned off. At that time, the previous PASS commander will momentarily take that CRT until the new NBAT assignment is invoked. (If this switch left 'ON', PASS cannot see the new NBAT assignment) (No DR)

OPS AND MAJOR MODE TRANSITIONS

1. OPS Transition Restrictions. To ensure a successful OPS transition, numerous DPS-related actions should be avoided throughout duration of OPS transition. Perform no switch or keyboard action at all during OPS transitions (DR 15620)
2. OPS Transition with SPEC Request in Progress. If a currently active SPEC is requested on another DEU simultaneously with an OPS transition request, it is possible the OPS transition will fail. Therefore, if OPS transition is desired following a request to bring up SPEC on second DEU, wait several seconds for the underlying SPEC control segment to get canceled before keying in OPS XXX PRO (DR 52779)
3. Annunciation of FTS During OPS Transition. Computer annunciation matrix (CAM) lights and software fail votes are cleared as part of any OPS transition involving memory reconfiguration in a redundant set. If an FTS occurs, both message and CAM light annunciation will be generated but CAM lights (and associated down arrow for GPC STATUS on GNC SYS SUMM 1 and GPC/BUS STATUS displays) will subsequently be cleared after overlay (successful or unsuccessful) (DRs 55300, 100788)
4. OPS Transition After MMU Powerup. Failure to allow a tape-driven MMU to complete its initialization may result in retention of the old OPS configuration and an 'OFF/BUSY MMU' message (if other MMU is unavailable). Delay at least 34 sec before trying OPS transition after MMU powerup (DR 33749)
5. CRT Assignments During OPS Transition. Prior to OPS XXX PRO, use GPC/CRT key to add/delete any desired CRTs/IDPs (NBAT can only redistribute currently commanded CRTs). Ensure new NBAT not requesting more than three PASS CRTs (No DR)

KEYBOARD/DISPLAY MANAGEMENT

1. PASS/BFS Item Entry Monitoring. PASS and BFS keyboard item handling cannot be guaranteed to be identical. BFS may accept item entries illegal in PASS or may reject item entries legal in PASS. (BFS does not annunciate 'ILLEGAL ENTRY' when it rejects an item entered via DK listen.) The crew should monitor the BFS display to determine BFS response to each DK listen item entry (DR B03973)
2. System SPEC Availability. System SPECs are available under only one major function at a time. If a system SPEC is being viewed and the major function switch on that DEU is changed without first doing RESUME, then the SPEC cannot be requested again under the new major function switch setting. Therefore, perform RESUME before changing major function switch on DEU (DR 25396)
3. NBAT Updates and Stale Data. DEU assignment changes made via the MF switch, GPC/CRT entry, BFC/CRT DISPLAY switch, or BFC/CRT SEL switch do not update NBAT (items 12-15 on SPEC 0). Be aware that NBAT will reflect stale data. During OPS transition from G1 to G3, the active G1 NBAT shall be used by software to determine the G3 bus assignment table, but only if G3 NBAT has not been changed during OPS 1. If G3 NBAT is not updated in OPS 1, the active G1 bus assignment at the time of G1 to G3 transition is carried over to G3 as the active bus assignment, and G3 NBAT is updated accordingly. If, however, G3 NBAT is updated in OPS 1 (items 2 thru 19), the new G3 NBAT will be invoked at the time of G1 to G3 transition. The G3 NBAT was called up but not changed in OPS 1. For current G3 bus assignments, reselect ITEM 1+3 on SPEC 0 (CR 89592, DR 37506)
4. Consecutive I/O Resets. An I/O reset takes a minimum of 8 sec to complete. If subsequent I/O resets are requested before the first one is complete, an illegal entry error message will be issued. Therefore, consecutive I/O resets should be at least 10 sec apart (DR 31435)
5. Moving Switches to GPC Position. Multiposition cockpit switches in the GPC position store hardware commands in FSW output buffers and issue these commands via MDMs. The independent 'hardware' manual switch positions mode hardware without FSW having visibility into the mode change. Switching back to the GPC position after manual moding reconfigures the hardware back to the last FSW commanded position because FSW commands are not changed to reflect the 'hardware' command. Before returning any switch to GPC position, evaluate desirability of producing a

moding change to that hardware device. If moding is undesirable, verify with ground the software output command status to that device (DR 46513)

6. Simultaneous System SPEC Inputs. Most item entry data on system SPECs (GPC MEMORY, TIME, and DPS UTILITY) are ICCed between common set computers. If simultaneous item entries are made on system SPECs in different major functions, interference in the ICC messages between GPCs may result. If this occurs, item entries from one SPEC will be ICCed properly but those from the other SPEC will be filtered out and lost. Avoid simultaneous inputs from different common set GPCs of system SPEC item data (DR 37427)
7. RESUME of SPEC on Failed DEU. If a SPEC is active on a DEU that fails, capability to RESUME that SPEC by normal means is lost. SPEC may be called on another DEU; however the failed DEU SPEC is charged to the active MF as one of two SPECs that are allowed to be active at one time. SPEC may be canceled by doing an OPS transition or by uplink of DEU equivalent RESUME to the failed DEU if CRT has not been deassigned since failure (DR 37503)
8. I/O RESET with Failed MTU. After entering I/O RESET in a PASS with failed MTU, a message may appear on a BFS CRT indicating that BFS has downmoded a string(s). To reinstate that string(s) for BFS, do BFS I/O RESET after PASS I/O RESET processing complete (approximately 10 sec) (DR 35211)

ASCENT/
ABORT

ASCENT/ABORT

ASCENT (GENERAL)

ASCENT/
ABORT

1. Erroneous Command Path Failure Annunciation (PASS and BFS). GPC and MEC time base oscillators are not synchronized. When GPCs send a command to the controller, an acknowledgement which is present in the MEC engine vehicle data table (VDT) for only one 40-msec cycle is read by the GPCs. Because of the asynchronous operation, it is possible that an occasional VDT frame will be omitted. If the missed frame is one which contained command acknowledgement, failure is annunciated on the display message line, and the SSME amber light illuminated even though the engine received the command

Message line annunciation may not occur if subsequent command processed within 1.92 sec. The amber light will be extinguished on next good cycle of command accepted data. If command path failure occurs, crew will see a CRT message and SSME status amber light. If amber light extinguishes, then crew could assume command path failure was erroneous due to this DR condition. If failure is an engine throttling command, engine chamber pressure can be monitored for failure confirmation (DRs 37594, 106180/B22567)

2. RHC Status Not Displayed. Although RHC LRU fault annunciation is possible in OPS 1, RHC LRU status fields on the GNC SYS SUMM 1 display are blanked in OPS 1 preventing display of RHC failure, dilemma, or commfault status (DR 104639)
3. Incorrect SSME Limit Control Commands Issued. When engine failure occurs, software inhibits limit shutdown control capability on remaining two engines automatically. If SSME LIMIT SHUT DN switch changed from INHIBIT to AUTO position after engine has shut down or had DATA PATH FAIL, incorrect limit control commands will be issued and limits enabled. If switch taken to INHIBIT and it is desired to have limits inhibited, do not return switch to AUTO once it has been moved to inhibited position (DR 37678)
4. Inappropriate Upmode to Auto After Fast Sep. With implementation of single-engine auto contingency abort capability, flight control system will mode to AUTO after FAST SEP. Downmode to manual can only occur after ZERO_THRUST event and when RHC is out-of-detent. When RHC is returned to detent, FCS will mode to AUTO. This discrepancy adversely affects the three-engine-out RTLS contingency abort yellow procedure

5. Unexpected Roll Maneuver in MM103. If engine failure occurs in MM102 on missions that are inertially targeted or have high inclination with significant yaw steering, the PASS TAL droop logic may be activated in MM103. Droop logic modifies PEG thrust attitude in pitch to keep vehicle from drooping below minimum safe altitude. This causes PASS to command roll of up to 12° from heads down prior to aborting RTLS. Since BFS does not have this capability, there will be a difference between ADI attitude error needles and attitude error on the BFS Ascent TRAJ display. If 'DROOP' is overbright on the TRAJ display, be aware of possible attitude error difference. Once RTLS is declared, both PASS and BFS will command a heads-down attitude. Thus, the vehicle will roll back to wings level at a rate of 1 to 2°/sec. If BFS is engaged prior to declaring RTLS, the vehicle will also roll back to wings level (DR 105356)

RTLS (also see ABORT OMS Dumps)

1. CSS Alpha Recovery/Nz Hold Transition in OPS 6. In MM602, transition from alpha-recovery to Nz-hold subphase occurs when either Nz > approx 1.8G (I-load) or alpha > 35° for a guidance cycle and less than 35° in subsequent cycle. If the second condition occurs prematurely for BFS or PASS, erroneous pitch errors will be displayed on the ADI. Guidance will command an alpha > 50° to attempt to achieve target Nz. When during alpha recovery and guidance prematurely modes to the Nz-hold phase, the crew should ignore pitch errors and manually fly alpha = 50° until Nz = 1.8G. Guidance can then be used to fly the Nz-hold phase (DR 46515/B07339A)
2. RTLS Delayed Guidance Convergence. During second stage, the crew monitors the status of guidance convergence by the condition of the ADI error needles and PASS and BFS time to MECO (TMECO). When guidance is unconverged for five consecutive cycles (10 sec), the ADI error needles will stow. When guidance is converged for five consecutive cycles (10 sec), the error needles will unstow. At RTLS initialization, the ADI error needles are initialized unstowed and will be visible to the crew. Problems with guidance usually result in unreasonable or dynamic TMECO, while a good guidance solution will be stable and agree well in PASS and BFS

During RTLS second stage, the RTLS PPA solution is indicated by the GUID parameter on the RTLS TRAJ display. The GUID parameter will indicate 'INIT' during RTLS guidance initialization, 'INHB' if PPA solution is not converged, and a countdown value when a good solution computed. At PPA, the GUID parameter will indicate 'PPA'. Note that the PPA solution is a function of

guidance convergence. When guidance is unconverged, the PPA solution will indicate 'INHB'. However, it is common to have guidance converged without a PPA solution

If SSME fails early in first stage, delays in guidance convergence and a PPA solution may be seen when RTLS is selected in second stage. The ground and crew may notice any of the following scenarios:

- a. Guidance goes unconverged at RTLS selection. This may last approximately 30 sec
- b. Guidance goes unconverged after initial RTLS guidance convergence. This may last approximately 14 sec
- c. Delay in a PPA solution at RTLS selection. This may last approximately 45 sec
- d. Guidance convergence and a good PPA solution occur at different times in PASS and BFS. Differences of approximately 30 sec may be seen

The crew should be aware of these possible delays in guidance convergence and cross-check PASS and BFS guidance with the RTLS Unconverged Guidance Table. If significant differences from this table occur, then the crew should check with MCC or take over manually in a no-comm situation. It is important to remember that the RTLS fuel dissipation attitude is a function of velocity and altitude rate at engine out or SRB SEP. It should be good regardless of the status of the RTLS guidance parameters

Even though PASS and BFS may get solutions at different times, the final solution should be the same. An exception to this is if PASS or BFS have not been notified of the engine out. Delays in engine out recognition by GPC can significantly impact RTLS guidance performance (DR 105441, B27583/105429, 46520+)

ABORT OMS DUMPS (GENERAL)

1. OMS Propellant Dump Termination via ARM/PRESS Switches. If the OMS ARM/PRESS switches are turned off during a contingency dump (MM102, 103, 601, 602), OMS RM will fail vote the OMS engines. Attempts to reactivate dump will also fail. The (contingency) dump sequence should be terminated by item 8 on SPEC 51, not the ARM/PRESS switches. If RM has failed the OMS engines because of the switch taken to OFF, a PRO to MM104, MM201, or MM301 will allow OMS engines to be fired again (DR 55306)
2. Possible 2nd OMS Pre-MECO Dump Lockout. In an abort situation which causes automatic pre-MECO OMS dump (MM103), if an additional OMS dump is requested during the OMS engine purge process, the dump does not occur, and subsequent requests for contingency OMS dumping are not honored. The same contingency dump lockout can also occur in MM103 when requesting another crew-initiated contingency dump during purge process of a previous contingency dump. Therefore, contingency dumping should only be requested prior to completion of the original OMS dump or after OMS purge completion (DR 55217)
3. Abort OMS Dumps Inhibited Upon BFS Engagement. During any abort, if PASS fails prior to commanding the OMS engines ON, BFS goes standalone and is engaged after it sets its OMS ignition event, then the automatic OMS dump will be inhibited. If this scenario occurs, the crew should start OMS dump manually via the BFS override display (DR 108524/B22592)

MM104/MM105

1. OMS Target Guidance Convergence. In OPS 1 and 3, the only positive indication of guidance convergence after performing a target LOAD (ITEM 22 EXEC) is a nonzero target HA/HP. Time for guidance convergence is generally proportional to how far in the future TIG is. When a target LOAD is performed in PASS, guidance computation cannot be interrupted until convergence except by doing an OPS transition. (Note that this would not help in OPS 1 because, once moded out of OPS 1, return to OPS 1 is not possible.) This means that, if targets are wrong, loading them could tie up PASS for an indefinite period of time. Ensure OMS targets are correct before loading to preclude being locked out of PASS (DR 37573)
2. OMS 1 Attitude Errors Induced by MPS Dump. MPS dump started at OMS 1 ignition results in burn attitude errors because of the change in total body thrust vector. Guidance commands vehicle attitude based on sensed acceleration and operated correctly.

Expect up to 6° of transient error at ignition and about 1° of pitch and yaw error after stabilization during auto (DAP) OMS 1 burn. For a manual (CSS) OMS 1 burn, centering needles throughout burn will result in small burn residuals and minimal fuel wasting (DR 101774)

3. Engine Response to the ARM/PRESS Switch (in all MMs). OMS engine ARM/PRESS switch in the OFF position commands OMS cutoff. However, if this switch is moved from OFF to ARM or ARM/PRESS before OMS FDI detects a failure, engine attempts to return to steady state thrust conditions, possibly causing engine damage. If switch is inadvertently moved to OFF position during an OMS burn, no attempt should be made to recycle switch immediately back to ARM or ARM/PRESS. If it is recycled to ARM or ARM/PRESS, switch should be taken to OFF immediately to minimize the chance of engine damage (DR 37555)



This Page Intentionally Blank

**ON-ORBIT
(OPS 2)**



ON-ORBIT (OPS 2)

1. OPS 2 OMS Burn ADI Guidance Error Requirement. In OPS 2, ADI attitude error needles are not referenced to the PEG guidance solution unless AUTO MNVR is executed on the MM202 MANEUVER display. Before executing an MM202 OMS/RCS burn, perform AUTO MNVR (item 27) to reference ADI error needles to the guidance computed thrust solution (DR 46512)
2. Improper COAS Operation. Current software makes no check to ensure a COAS mark has been taken as a condition for processing an ACCEPT item selection. Therefore, erroneous data could go into the star table. This might only be apparent to the crew after a second (valid) star is sighted and the ANG DIF shows significant error from expected angular separation. If an ACCEPT command is inadvertently entered without a mark, complete current processing by entering second ACCEPT command, reinitialize by entering a star table clear (item 20), and then perform the normal sight mode procedure (DR 35151)
3. Multiple Commands via a PSP. Item entries for commands to a payload via PSP should be entered one at a time. When multiple commands are entered simultaneously, all commands except the first one will be rejected (No DR)
4. ADI Freeze at 90°/270° Yaw. Anytime the ADI YAW angle command is within 1.7° of 90° or 270°, the PITCH and ROLL axes of the ADI are frozen because of the indeterminate nature of PITCH and ROLL at high YAW angles. For example, if an ADI is in INRTL mode with YAW near zero, but vehicle attitude is such that in LVLH mode YAW would be 90°, the ball will freeze in the last PITCH and ROLL INRTL attitude if the ADI select switch is taken to LVLH. YAW will, however, read the correct attitude. Yawing the vehicle more than 1.7° away from 90° LVLH will unfreeze the ADI in this situation as will returning to INRTL mode (No DR)
5. VRCS Failure. If one or more vernier RCS jets fail with ORBIT DAP in VERN mode, the jet fire outputs to all vernier jet drivers are inhibited. However, DAP continues to compute required jet commands. The VERN PBI stays on and RCS command lights on F6 continue to reflect DAP or RHC command activity (No DR)



This Page Intentionally Blank

**DEORBIT/
ENTRY**



DEORBIT/ENTRY (OPS 3/6)

OPS 3/6 (GENERAL)

1. COAS Operation in OPS 3. In OPS 3, COAS switch processing does not occur for the aft station, so that marks from the aft station are not detected by flight software. In OPS 3, perform COAS operations from the forward station (DR 35151)

DEORBIT BURNS

1. Erroneous Attitude Displays for Yaw Near $\pm 90^\circ$. If a burn solution results in a yaw attitude near $\pm 90^\circ$, burn attitudes (R,P,Y) on the PASS Maneuver display are blanked and remain blanked during cyclic guidance. Additionally, if burn attitudes are displayed and yaw enters the $\pm 90^\circ$ region, the crew will see stale burn attitudes during cyclic guidance. The burn solution and ADI error needle readings are still good, and guidance will function as normal. In this scenario, the crew should use standard procedures to maneuver to attitude via the auto maneuver capability or by nulling the ADI error needles. Once the burn attitude is achieved, the ADI REF option can be used for attitude reference during the burn (DR 37585)

Pitch and roll axes of the ADI will freeze up if the ADI yaw angle is within 1.7° of 90° . This is due to the indeterminate nature of pitch and roll at high yaw angles. For example, if an ADI is in INRTL mode with YAW near zero, but vehicle attitude is such that in LVLH mode YAW would be 90° , the ball will freeze in the last PITCH and ROLL INRTL attitude if the ADI select switch is taken to LVLH. YAW will, however, read the correct attitude. Yawing the vehicle more than 1.7° away from 90° LVLH will unfreeze the ADI in this situation as will returning to INRTL mode (DR 106915)

2. Yaw Error Needle Sensitivity During Deorbit Burns. During OPS 3 deorbit burns with fuel wasting, the ADI yaw error needle will appear sensitive, especially when time-to-go (TTG) is small. Typically, the yaw error needle will diverge or jump suddenly near a TGO of 6 sec. In this scenario, the crew should not attempt to follow the yaw error needle near cutoff (DR 37559)
3. Pitch Error Needle Sensitivity During RCS Burns. During +X RCS maneuvers (OPS 1, 2, or 3) the ADI pitch error needle becomes very sensitive as time-to-go (TGO) gets small. Error needle jumps of several degrees can occur as TGO approaches 6 sec. In this scenario, the crew should not attempt to follow the pitch error needle near cutoff, since a divergent situation can be created (DR 37562)

DEORBIT/
ENTRY

ENTRY

1. HAC Radius Position Uninitialized in MM304. HAC is displayed with its center located on the extended runway centerline on SPEC 50 during MM304. This is due to the HAC radius not being calculated until TAEM, after which the displayed HAC position is correct (DR 50085)
2. BFS Horizontal Situation Display Predictors Incorrect. During BFS MM304, if a roll angle of 90° or more is performed below 200K ft, the 20-, 40-, and 60-sec predictors of the horizontal situation display will indicate a turn in the opposite direction. The crew should ignore the HSD predictors when the roll angle is greater than or equal to 90° (DR B08297)



This Page Intentionally Blank



┌ | | | ┌

CUE CARD LOCATION MAPS AND ORBITER PROCEDURAL DECALS

DECAL

Electronic reference materials previously provided in the Cue Cards and Procedural Decals Book (CUE CARD) have been incorporated into the Generic Reference Data Checklist. These materials are provided to the crew via the FDF Books CD. Ground users may view these materials via the FDF Status Sheets on the FDF web page or on the FDF File Server (JSC-MOD-FS3)

To view cue card location maps and orbiter procedural decals previously provided in the CUE CARD book, access the following URL:

\\Jsc-mod-fs3\FDF\Books\Current Published Documents\Generic\Reference Data\Cue Card Location Maps and Orbiter Procedural Decals

Users should select file "DECAL TOC.pdf" to access the linked Table of Contents

DECAL

NOTES

1. The cue card location maps provide the titles and generic stowage locations of cue card procedures which are deployed for various phases of flight. Cue cards listed as “not shown” on the location maps are stowed for launch.
2. The orbiter procedural decals published in this document are provided for ground reference only to document the configuration of procedural decals that are actually flown.

NOT FLOWN

8-2

REF/ALL/GEN I

SHUTTLE SYSTEMS SCHEMATICS AND PHOTOGRAPHS

Electronic reference materials previously provided in the Systems Data Book (SYS DATA) have been incorporated into the Generic Reference Data Checklist. These materials are provided to the crew via the FDF Books CD. Ground users may view these materials via the FDF Status Sheets on the FDF web page or on the FDF File Server (JSC-MOD-FS3)

To view shuttle system schematics from the Space Shuttle Systems Handbook (SSSH), access the following URL:

http://modspops.jsc.nasa.gov/mod/da3/MOD_Export_Control/default.aspx

Users should select "Export Controlled MOD Documents," then select "JSC-11174 SSSH" to access this document

To view shuttle system photographs previously provided in SYS DATA, access the following URL:

<\\Jsc-mod-fs3\FDF\Books\Current Published Documents\Generic\Reference Data\Shuttle Systems Photographs>

Users should select file "SYS TOC.pdf" to access the linked Table of Contents

SYS



SYS

This Page Intentionally Blank



NOT FLOWN

9-2

REF/ALL/GEN I





CUE
CARD

CUE CARD CONFIGURATION



NOT FLOWN

10-1

REF/ALL/GEN I



CUE
CARD

TOP

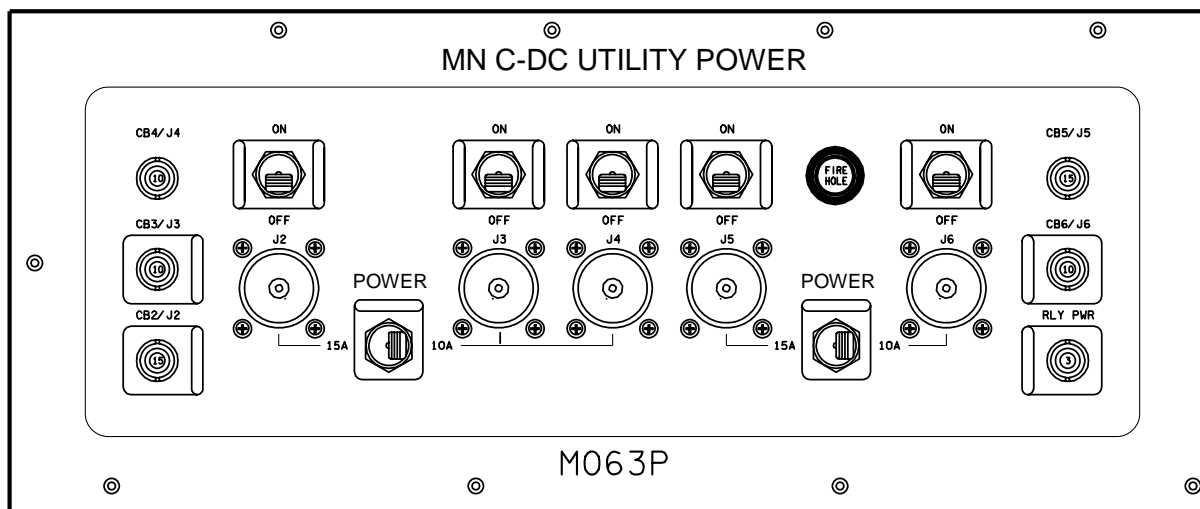

19409E_M063P. PNL 1

REF-2a/O/A

FAB USE ONLY

CC 10-2

REF/ALL/GEN I

(reduced copy)

TOP
BACK OF 'MN C-DC UTILITY POWER M063P'

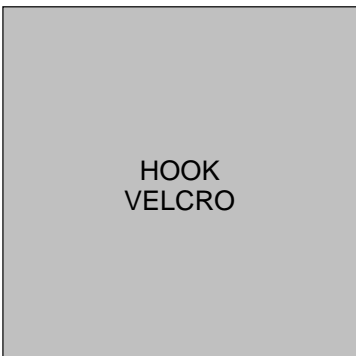

HOOK
VELCRO

FAB USE ONLY

(reduced copy)
CC 10-3

REF/ALL/GEN I

REF-2b/O/A



This Page Intentionally Blank



NOT FLOWN

10-4

REF/ALL/GEN I



Space Shuttle Program
FLIGHT DATA FILE

JSC-48041
GENERIC, REV I

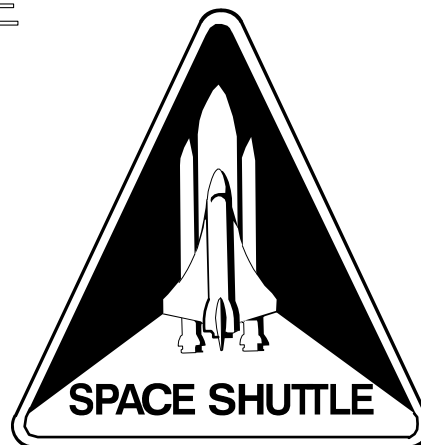

**REFERENCE
DATA**

**STS
ALL**

Flight Cover (trim bottom to expose tabs)