

National Space Transportation System Reference

Volume 2
Operations

September 1988

(NASA-TM-89765) NATIONAL SPACE
TRANSPORTATION SYSTEM REFERENCE. VOLUME 2:
OPERATIONS (NASA) 130 p. ORCL 220

N91-10100



Unclass
0304426

63/16

P-113

(

(

(

CONTENTS

SPACE SHUTTLE OVERVIEW	1	SPACE SHUTTLE INTEGRATION	
MISSION PREPARATION AND PRELAUNCH OPERATIONS		and ROLLOUT	30
MISSION PLANNING	4	Vehicle Assembly Building	30
Payload Integration Process Overview	4	Mobile Launcher Platforms	33
Cargo Integration and Manifest Development	5	Crawler Transporters	36
Shuttle Cargo Capability	6	Crawlerway	36
Payload Accommodations	7	COMPLEX 39 LAUNCH PAD FACILITIES	38
Small Payload Accommodations	9	Fixed Service Structure	38
Middeck Payload Accommodations	9	Orbiter Access Arm	38
Crew Related Services	10	External Tank Hydrogen Vent	
ASTRONAUT SELECTION AND TRAINING	12	Line & Access Arm	42
Pilot Astronauts	12	External Tank Gaseous Oxygen	
Mission Specialist Astronauts	12	Vent Arm	42
Payload Specialists	14	Emergency Exit System	42
Astronaut Training	14	Lightning Mast	44
Advanced Training	16	Rotating Service Structure	44
Shuttle Mission Simulator	16	Payload Changeout Room	44
SPACE SHUTTLE PROCESSING	23	Orbiter Midbody Umbilical Unit	44
Launch Processing System	23	Hypergolic Umbilical System	44
SRB Processing Facilities	23	OMS Pod Heaters	44
Assembly and Refurbishment Facility	23	Sound Suppression Water System	45
Rotation Processing Building		SRB Ignition Overpressure	
and Surge Facility	23	Suppression System	45
Orbiter Processing Facility	25	Main Engine Hydrogen Burnoff System	45
Orbiter Modification and		Pad Surface Flame Deflectors	45
Refurbishment Facility	25	Propellant Storage and Distribution	46
Logistics Facility	26	Launch Pad/Launch Processing	
		System Interface	46
		Launch Equipment Test Facility	46

CONTENTS

SPACE SHUTTLE CARGO PROCESSING	48	FLIGHT OPERATIONS	77
Multi-Use Support Equipment	48	Launch Abort Modes	78
Vertical Cargo Processing Facilities	52	On-Orbit Operations	82
Vertical Cargo Processing Operations	53	Maneuvering In Orbit	82
Horizontal Cargo Processing Facilities	54	LANDING, POSTLANDING AND SRB	
O&C Building Spacelab Facilities	54	RETRIEVAL OPERATIONS	84
Spacelab Processing and		LANDING OPERATIONS	84
Integration Operations	55	POSTLANDING OPERATIONS	86
Getaway Special Payloads	57	Recovery Convoy	86
Life Sciences Payloads	57	Recovery Convoy Operations	87
Department of Defense Payloads	58	SOLID ROCKET BOOSTER	
LAUNCH AND FLIGHT OPERATIONS	61	RETRIEVAL OPERATIONS	91
PRELAUNCH OPERATIONS	61	SRB Disassembly Operations	91
Prelaunch Propellant Loading	61	Parachute Refurbishment	92
Final Prelaunch Activities	61	SPACE SHUTTLE PROGRAM	
Launch Control Center	61	MANAGEMENT	95
Launch Countdown	63	NSTS ORGANIZATION	95
Launch Minus 3 Days	63	LAUNCH CONSTRAINT PROCEDURES	97
Launch Minus 2 Days	63	LAUNCH DECISION PROCESS	97
Launch Minus 1 Day	63	MANAGEMENT COMMUNICATIONS	98
Launch Day	64	SPACE SHUTTLE MISSION SUMMARIES	99
MISSION CONTROL CENTER	66	PROGRAM CHRONOLOGY	119
PAYLOAD OPERATIONS		GLOSSARY OF ACRONYMS,	
CONTROL CENTER	70	ABBREVIATIONS	127
SPACE TRACKING AND DATA		METRIC CONVERSION TABLE	131
ACQUISITION	72		
Ground Network	72		
Space Network	73		

SPACE SHUTTLE OVERVIEW

Flight hardware for the Space Shuttle is manufactured at many locations around the United States by NASA prime contractors and subcontractors.

In the case of the orbiter, the prime contractor is Rockwell International, Downey, Calif., and major components and subsystems for it are assembled at the firm's production plant at Palmdale, Calif. After an orbiter is built, it is flown to NASA's Kennedy Space Center (KSC) Fla., atop a specially-equipped Boeing-747 aircraft called the Shuttle Carrier Aircraft.

The Space Shuttle main engines are produced by the Rocketdyne Division of Rockwell International, Canoga Park, Calif. The engines are shipped to the KSC after they have undergone engine test firings on stands at NASA's John C. Stennis Space Center (formerly the National Space Technology Laboratories) near Bay St. Louis, Miss.

The Shuttle's huge external tank is built at NASA's Michoud Assembly Facility near New Orleans, La., by Martin Marietta Corp., Michoud Aerospace. The tanks are shipped to KSC by barge, arriving at the center's turn basin canal in the Launch Complex 39 area, where they are unloaded and moved to the Vehicle Assembly Building (VAB).

Several aerospace firms components for the Shuttle's solid rocket boosters (SRB). The solid propellant motors are built by the Wasatch Division of the Morton Thiokol Chemical Corp., Brigham City, Utah.

All other SRB components are produced by United Space Boosters, Inc., Huntsville, Ala. Booster stacking -- assembly of the entire solid rocket booster -- is performed by the Lockheed Space Operations Co., Titusville, Fla., the Shuttle processing contractor at KSC.

Processing flow procedures for new and reused Shuttle flight hardware are essentially similar. Differences in the procedures occur early in the pre-integration activity. For example, newly-produced orbiters usually undergo a period of powered-down processing to allow time to finish work that may not have been completed at the manufacturing plant, or to make modifications ordered after the orbiter leaves the plant. Also, during the initial flow processing of a new orbiter, the main engines and orbiter maneuvering system pods undergo checkouts before being installed.

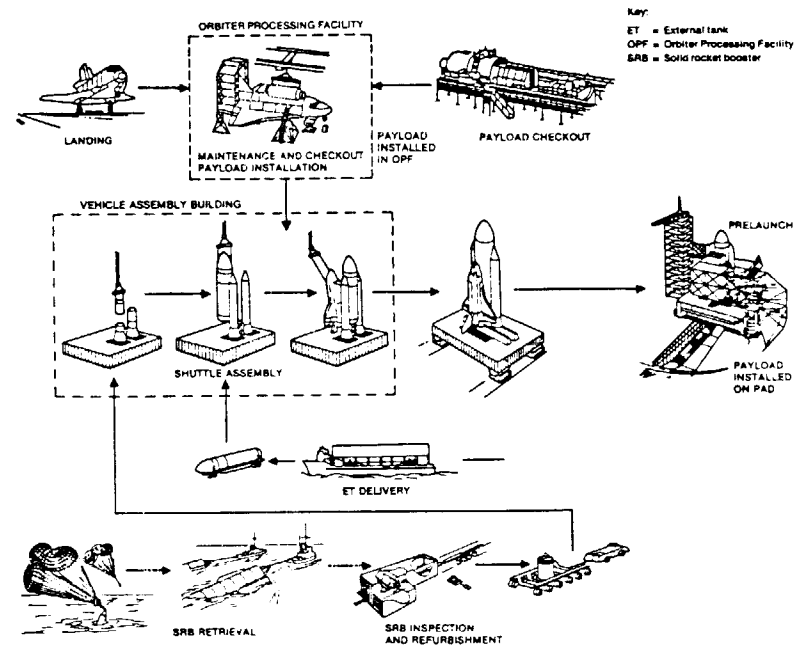

Space Shuttle Ground Operations.

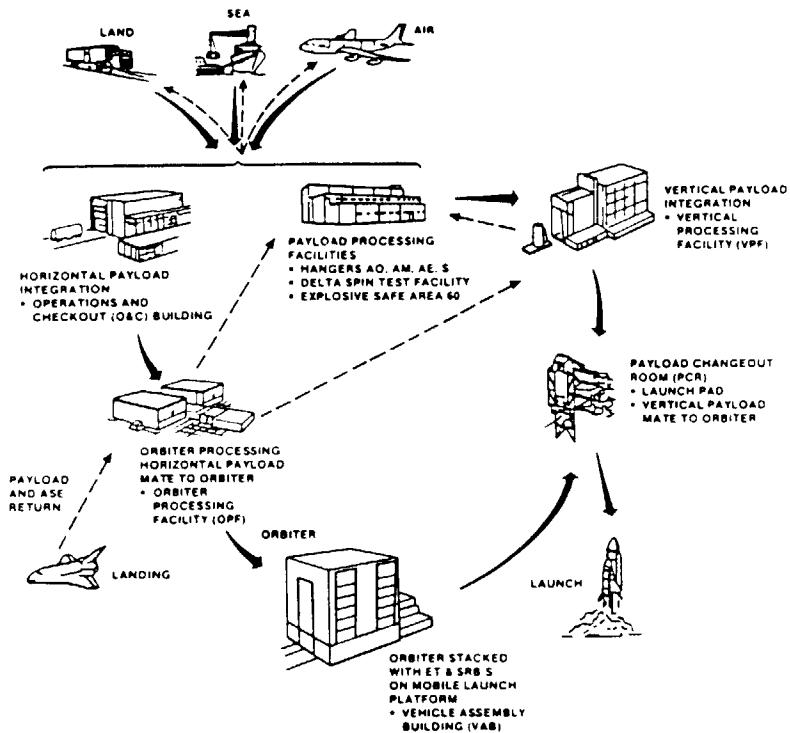

Payload processing; delivery to launch and landing.

Another requirement for new orbiters is that their main engines are test fired on the launch pad. Called the Flight Readiness Firing, the purpose of the test is to verify that the main propulsion system works the way it is designed to work.

For orbiters that have already flown, turnaround processing procedures include various post-flight deservicing and maintenance functions which are carried out in parallel with payload removal and the installation of equipment needed for the next mission.

If new flight hardware is called for, additional pre-launch tests are usually needed. For example, if new auxiliary power units

(APU) are installed, they must undergo "hot firings" to verify their operational readiness.

If changes are made in external tank design, the tank usually will usually require a tanking test in which it is loaded with liquid oxygen and hydrogen just as it is before launch. This is called a "confidence check" and determines the tank's ability to withstand the high pressures and super cold temperatures of the cryogenics.

After separate hardware checks and servicing of major flight elements are completed -- a process called stand-alone processing -- actual Shuttle vehicle integration starts with stacking of the SRBs on a Mobile Launcher Platform in one of the high bays of the VAB. Next, the external tank is moved from its VAB location and is mated with the SRBs.

The orbiter, having completed its pre-launch processing and after horizontally-integrated payloads have been installed, is towed from the Orbiter Processing Facility (OPF) to the VAB and hoisted into position alongside the SRBs and the external tank. It then is then attached to the external tank. The mating is then complete.

The mobile launcher concept was originally developed for the Apollo program. It permits the complete checkout of the vehicle in the enclosed protection of the VAB before moving the vehicle to the launch pad. This provides greater protection of flight hardware from the elements and allows for more systematic checkout processing using computer techniques. Thus, the Shuttle spends a relatively short time on the launch pad.

When the VAB pre-launch preparations are completed, the entire system -- the assembled Space Shuttle and the Mobile Launcher Platform -- is lifted by the Crawler Transporter and rolled slowly to the launch pad. The move takes about 6 hours.

At the pad, vertically integrated payloads are loaded into the payload bay. Then, propellant servicing and needed ordnance tasks are performed. Finally, the countdown gets underway, launch readiness is confirmed and launch takes place.

ORIGINAL PRICE IS OF POOR QUALITY

Only minutes following the launch, recovery crews, on station in the Atlantic Ocean off shore from the launch site, prepare to recover the spent SRBs thus beginning the process of vehicle turnaround. While the Shuttle is carrying out its mission in orbit, back on Earth the ground crews already are preparing for the next mission.

MISSION PREPARATION AND PRELAUNCH-OPERATIONS

MISSION PLANNING

As might be expected, crew training and planning for a particular Space Shuttle mission are closely intertwined. The key elements of mission planning outline specific crew activities and essential flight support functions. The effort, like astronaut training, is directed by NASA's Johnson Space Center (JSC), Houston, Mission Operations Directorate (MOD). The degree of thoroughness of this planning probably can best be described as mind boggling. Since crew activity planning is the analysis and development of when and what activities are to be performed on a specific mission, the end result is a minute-by-minute timeline of each crewmember's activities.

A second aspect of mission planning is operations support planning. This is a detailed analysis of flight requirements and ground flight control operations essential to support a proposed mission. One part of this activity includes reviewing flight controller documentation and up-dating it when flight requirements call for up-date. This comprehensive review includes numerous basic Space Shuttle operations documents including:

- Space Transportation System Flight Rules
- Console Handbooks
- Command Plans
- Communications and Data Plans
- Mission Control and Tracking Network Support Plans
- Systems Operating Procedures
- Operations and Maintenance Instructions
- Flight Control Operations Handbooks
- Flight Software Documentation

Other important flight planning work is done by the MOD's Flight Design and Dynamics Division. Here, a mission's flight

profile is developed, and flight analysis and the design and production of mission planning products is accomplished. Briefly, some of the major activities of this organization include:

- Assessment of a specific flight with particular emphasis on ascent performance.
- Flight design analysis leading development of flight design ground rules and constraints
- Commit-to-flight certification for flight readiness.
- Development of guidance, navigation and control software as well as products to reconfigure the Mission Control Center and the Shuttle Mission Simulators (SMSs) for specific flight operations.
- Trajectory, navigation and guidance design, as well as performance analyses for ascent, orbit shaping, separation and collision avoidance, payload deployment, rendezvous, proximity operations and descent and landing operations.
- Development of checklists for ascent, rendezvous proximity operations and crew descent procedures.
- Development of flight programs for the Shuttle Portable OnBoard Computer (SPOC) for flight.
- Preparation of operating procedures, console handbooks, flight mission rules and other operational documentation to support flight operations.

PAYLOAD INTEGRATION PROCESS OVERVIEW.

The first step in developing integration procedures for payloads belonging to a user organization -- a private or governmental organization -- is an administrative one in which the organization submits a Request for Flight Assignment Form 1628 to NASA

Headquarters in Washington, D.C. If the request is approved, there is set in motion a series of actions that ultimately lead to space flight. These actions include signing of a launch services agreement, development of a payload integration plan, preparation of engineering designs and analyses, safety analysis and flight readiness.

Finally, there is the actual Shuttle mission, spacecraft deployment or experiment activity, ending in data analysis and distribution.

The two most important phases of payload integration planning include the development of the formal agreements between the user and NASA and the implementation of these agreements. Other considerations involved in payload integration planning include safety reviews of all phases of the mission, such as payload design, flight operations, ground support equipment design and overall ground operations. These preparations are reviewed by a NASA safety panel working with the user to assess the complexity, technical maturity and hazard potential of a specific payload and mission plan.

CARGO INTEGRATION AND MANIFEST DEVELOPMENT. The integration procedures for a Shuttle payload begin with a preliminary flight assessment and continue through the requirements development phase with each user. After the preliminary launch and services agreements are signed, a series of cargo compatibility assessments are made. This information is presented to the user and NASA management at a formal meeting called the Cargo Integration Review.

Meanwhile, when to schedule a user's payload for flight is the responsibility of the Flight Assignment Working Group (FAWG) at JSC. The user's requirements are assessed and other payloads, with compatible orbital requirements and configurations, are placed on the launch manifest together, if space and weight constraints permit. This preliminary flight assessment manifest then is reviewed at KSC to permit development of a ground processing flow schedule to establish a realistic launch date for

These purely administrative activities continue after the preliminary flight assessment schedule is published. NASA then does a preliminary cargo engineering analysis to confirm that the proposed cargo elements are compatible with each other and the capabilities of the Shuttle system itself. These important analyses are based on information contained in the Payload Integration Plan (PIP) and its annexes. Cargo engineering and preliminary flight analyses must be ready early enough to permit completion of detailed hardware requirements for the mission. All of this information is evaluated at a Cargo Integration Review meeting. If it is agreed that all requirements have been met, final flight operations plans are then prepared.

Flight operations planning includes final flight design, any modifications needed in the Mission Control Center (MCC) or the user's Payload Operations Control Center (POCC), and detailed crew training programs. These items are then formally reviewed by the Flight Operations Review Board, still another level in the comprehensive process of getting ready for a mission.

Finally, the payloads or cargo for a specific mission undergo their final checkouts before launch. The user or owner of the payload is responsible for verifying the payload compatibility and functional interfaces before payload processing procedures start. NASA, on the other hand, is responsible for verifying the compatibility of the integrated cargo.

Just before a payload is installed in the Shuttle's payload bay, a Payload Readiness Review is held at KSC. This review, one of the last in a long process, assesses the readiness of the the Shuttle and the payload for what are called the "payload on-line integration activities."

The last major cargo/Shuttle review prior to launch is the Flight Readiness Review which verifies that all integration operations have been completed satisfactorily and gives final certification that the flight elements are ready to go.

SHUTTLE CARGO CAPABILITY. The allowable cargo weight for a Space Shuttle flight is a function of the various operational activities and the type of mission being conducted. The allowable cargo weight is constrained by either ascent performance or landing weight limits if a payload such as Spacelab is returned to Earth. It also may be affected by such other factors such as orbital altitude, orbital inclination, mission duration and rendezvous requirements.

Payload control weight is another term used for Shuttle cargo allowances. It includes the weight of the payload itself, plus any airborne support equipment and payload-unique hardware, as well as the weight of payload specialists, their personal equipment and provisions up to a limit of 490 pounds per individual. Payload weight control is an important item in the PIP, and increases only can be made by a specific agreement amending the original PIP.

Cargo weight is defined as the payload control weight plus the weight of the attached hardware used to secure the payload to the orbiter. Allowable cargo weight is determined by altitude and orbital inclination. For example, on a standard inclination of 28.45 degrees, maximum cargo weight capability in a circular orbit at an altitude of 100 nautical miles is about 55,000 lb. This capability decreases with altitude and falls to about 40,000 lb. in a 300-mile circular orbit. At the higher inclination of 57 degrees (also a standard inclination), cargo weight capability is 40,000 lb. in a 100-mile circular orbit. This decreases to slightly over 20,000 lb. in a 320-mile-high orbit. These weights are those for a nominal ascent for what is described as a "simple, short duration, satellite deploy mission."

The allowable cargo weight also is constrained by landing weight limits. For spacecraft deployment missions in which the payload or payloads remain in orbit, the orbiter abort landing weight limit is a constraining factor. Although nominal-end-of-mission landing weight applies to all flights, it is only a constraint consideration if a major portion of the payload is returned to Earth.

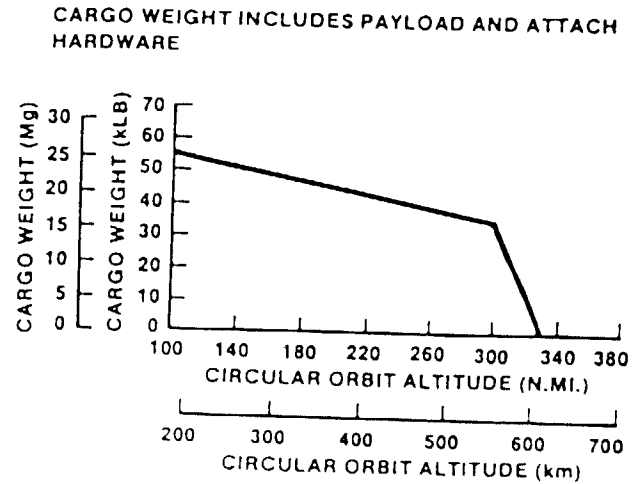

Cargo capability (28.45 degree inclination)

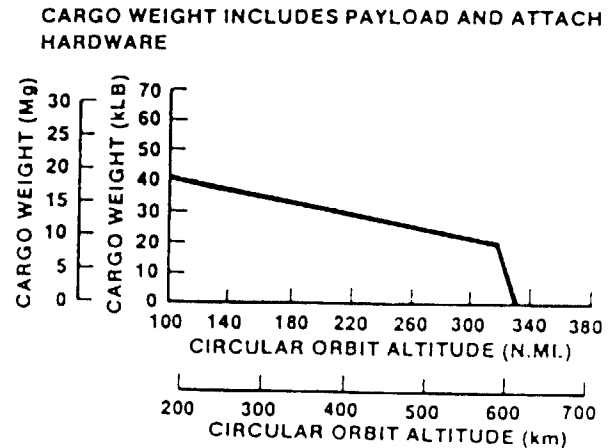

Cargo capability (57 degree inclination)

For orbiters Discovery (OV-103) and Atlantis (OV-104) and the unnamed OV-105 under construction, the abort landing weight constraints cannot exceed 50,500 lb. of allowable cargo on the so-called simple satellite deployment missions. For longer duration flights with attached payloads, the allowable cargo weight for end-

of-mission or abort situations is limited to 25,000 lb. For Columbia (OV-102), however, these allowable cargo weights are reduced by 8,400 lb.

In November 1987, NASA announced that the allowable end-of-mission total landing weight for Space Shuttle orbiters had been increased from the earlier limit of 211,000 lb. to 230,000 lb. The higher limit was attributed to an on-going structural analysis and additional review of forces encountered by the orbiter during maneuvers just before touch down. This new capability increases the performance capability between lift capacity to orbit and the allowable return weight during reentry and landing. Thus, the Shuttle will be able to carry a cumulative weight in excess of 100,000 lb. of additional cargo through 1993. This additional capability is expected to be an important factor in delivering materials for construction of the Space Station. Moreover, the new allowable landing weights are expected to aid in relieving the payload backlog which resulted from the STS 51-L Challenger accident.

PAYLOAD ACCOMMODATIONS. The Space Shuttle has three basic payload accommodation categories. These are dedicated, standard and middeck accommodations.

Dedicated payloads up the entire cargo-carrying capacity and services of the orbiter such as the the Spacelab and some Department of Defense payloads.

Standard payloads -- usually geosynchronous communications satellites -- are the primary type of cargo carried by the Shuttle. Normally, accommodations are available in the payload bay for up to four standard payloads per flight. Space is allocated based on specific requirements of a payload and load factors.

Middeck payloads-small, usually self-contained packages - are stored in compartments on the middeck. These are often manufacturing-in-space or small life sciences experiments.

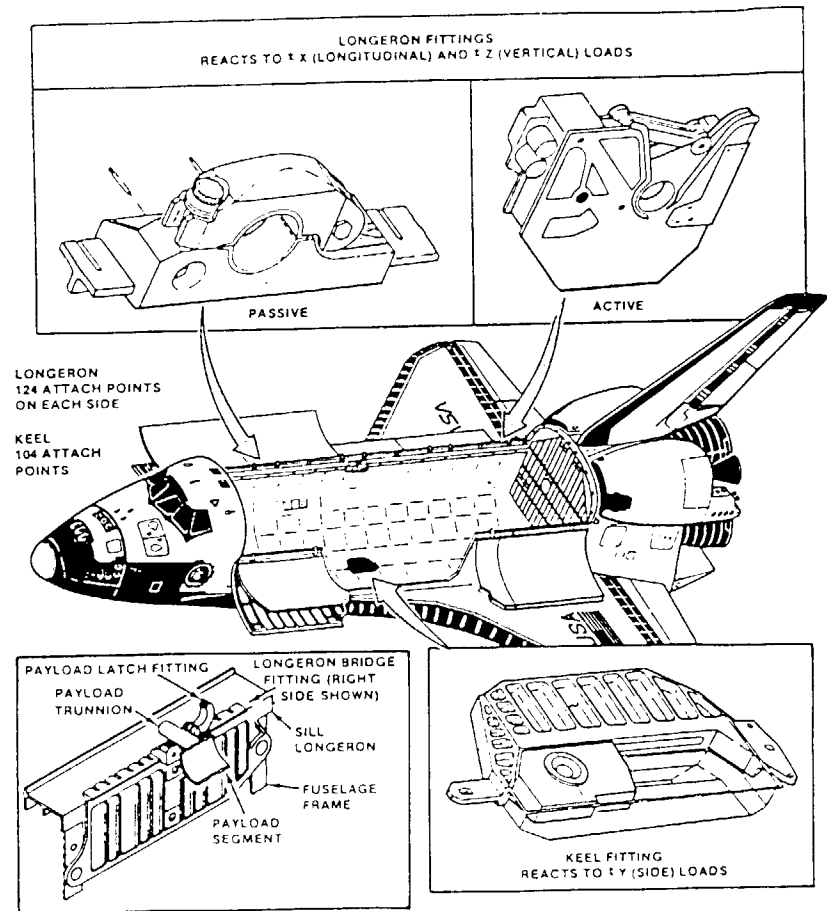

Attach fittings for payload

For standard-type payloads, the payload bay has structural support points along its length for payload mounting fixtures provided by the user. Payloads can be supported by attach fittings at 248 locations along both sides of the payload bay. There are 104 attach points along the payload bay floor at the orbiter's keel centerline. For deployable payloads, active fittings are used. The attachment provisions are adaptable to various payload designs and provide load reaction and strain isolation between the orbiter and

the payload itself. The most common attachment devices are known as the three- and five-point types.

The avionics services for standard payloads -- power, command and data services are provided through what is called a standard mixed cargo harness (SMCH). The harness consists of cables which are routed to a payload through wire trays located on either side of the payload bay. Cables on the right or starboard side of the payload bay area contain the electrical interfaces -- plugs -- while those on the left or port side provide signal and control interfaces. It is possible to access the SMCH from the cable trays at almost any location along the payload bay sides.

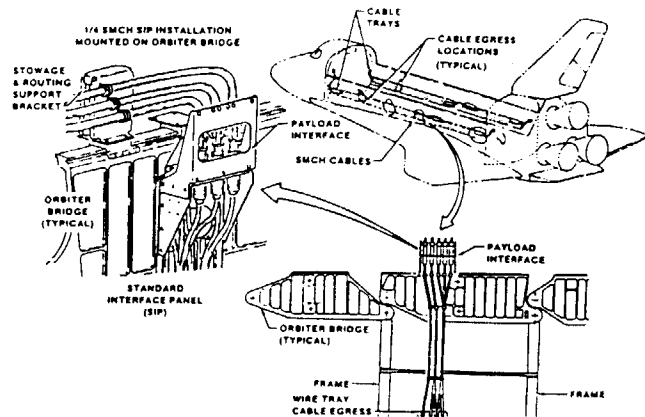

Standard Interface Panel Configuration

Electrical power from the orbiter to the payloads is distributed through the standard interface panel. A nominal of 28 volt direct current is available during ground operations, ascent, orbital operations, and descent. During prelaunch operations up to 250 watts of power is available to perform payload checkouts. During ascent or descent, the amount of continuous power available to payloads is 250 watts maximum. Higher power levels are available

for brief periods to facilitate payload checkout or to accommodate active operations, especially payload deployments.

A variety of command services are available for payloads either from the orbiter itself, the MCC or from the POCC. Ground-originated commands to payloads are relayed through the orbiter's communications system. If necessary, the flight crew can send payload commands, through the standard switch panel or by placing command instructions through the keyboard into the orbiter's avionics system.

Monitoring and processing payload data can be done on board the orbiter, through the MCC or the user POCC. Payload telemetry is funnelled through the orbiter's communications to the MCC or the POCC. Eventually, the operational Tracking and Data Relay Satellite System (TDRSS) -- the space network -- will make payload data available for practically an entire orbit which is not the case with ground tracking stations.

The standard payload data recording capability on board the orbiter includes three parallel tape recording channels, one analog and two digital. Ten-minute segments of recording time are available during ascent, payload deployment and descent.

Timing services for standard payloads include one mission elapsed time (MET) signal and two Greenwich Mean Time (GMT) signals in what is known as the interrange instrumentation Group-B (IRIG-B) modified code format.

The orbiter's thermal accommodations for payloads provide nominal thermal environments which meet the requirements of practically all standard payloads. During prelaunch and postlanding operations, the payload bay "purge" provides limited thermal conditioning. The actual thermal environment depends on a number of factors including the thermal interactions between the orbiter and the payloads. For mixed cargo payloads, the payload design must be compatible with standard purge and attitude requirements.

The pointing capability of the orbiter at an inertial attitude is a remarkable plus or minus one degree. For dedicated flights -- those with a single payload -- the selected attitude can be maintained as long as the thermal constraints of the orbiter itself are not exceeded. For mixed standard cargos, a given attitude cannot be maintained longer than the standard mixed cargo thermal criteria allow, unless specified in the payload integration plan.

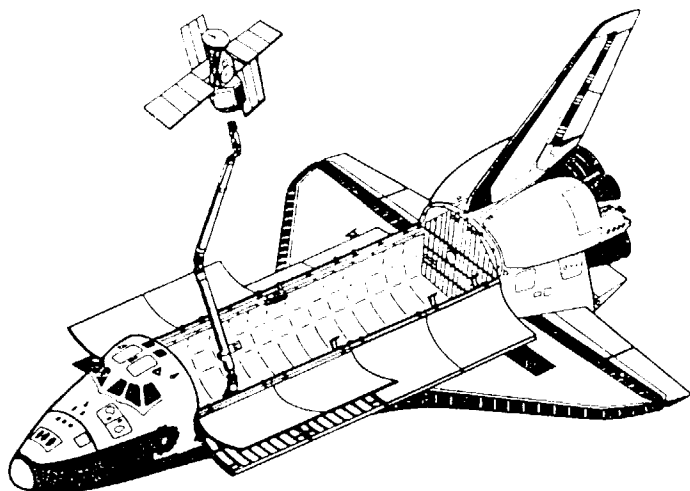

Remote Manipulator System Deploys Satellite from Payload Bay

SMALL PAYLOAD ACCOMMODATIONS. Small payloads mounted in the payload bay do not need the full range of accommodations required for large, standard payloads. Small payloads can be mounted in either a side-mounted or an across-the-bay configuration. In the side-mounted method, the payload is mounted on a side wall payload carrier. This only can be done on the right or starboard side of the payload bay. In the across-the-bay configuration, the payload is mounted on a structure provided by the payload user which is attached to an avionics outlet similar to the ones used by standard payloads.

The maximum electrical power available for small payloads, during pre-launch checkout and orbital operations, is 1,400 watts or

a nominal 28 volts of direct current. During high power use by other payloads on board -- especially during deployment of standard payloads -- electrical power for small payloads may be cut to 300 watts.

Small payloads can be commanded by limited discrete commands from the flight crew or by serial digital commands originating from user's POCC and relayed to the payload through the MCC. Command services are available on a time-shared basis with the orbiter and other payload operations.

Data processing and display is done on the orbiter and at the user's POCC. Telemetry data is made available at the user's POCC on a time-shared basis with other on board payloads.

The critically-important timing information for small payloads is available from one MET signal and through the IRIG-B in modified code format, similar to that available to standard payloads.

Small payload thermal conditions are those experienced in payload bay thermal environments. NASA recommends that small payloads be designed with a self-contained thermal control system and that the thermal attitude capability be essentially equivalent to that of the orbiter.

MIDDECK PAYLOAD ACCOMMODATIONS. In addition to the payload bay area, the Space Shuttle can accommodate small payloads in the middeck of the crew compartment. This location is ideal for payloads that require a pressurized crew cabin environment or must be operated directly by the crew. Another advantage of the middeck is that small payloads can be stowed on board shortly before launch and they can be removed quickly and easily after landing.

Middeck payloads are stored in small, 2-cubic-foot lockers. Each locker can hold up to 60 lb. of cargo. Moreover, trays with dividers can be installed to divide each locker into 16 compartments. Payload hardware that replaces one or more lockers

-- using standard locker mounting locations -- also can be accommodated.

Electrical power available for middeck payloads during on-orbit operations ranges up to 5 amps of nominal 28-volt direct current. Continuous power used by a middeck payload is limited to 115 watts for no more than 8 hours or no more than 200 watts peak for periods of 10 seconds or less. For middeck payloads that require electrical power, standard cables are available for routing power from utility outlets to the payload. The heat load from middeck experiments is dissipated into the crew compartment.

Command and monitoring of middeck payloads is limited to internal controls, displays and data collection capabilities built into the payloads. Remote Manipulator System

The remote manipulator system (RMS) is the Canadian-built mechanical arm component of the payload deployment and retrieval system (PDRS). It is used for payload deployment, retrieval, special handling operations and orbiter servicing activities. The arm is 50 ft., 3 in. long and is mounted along the left or port side of the payload bay, outside a 15-ft. diameter envelope reserved for cargo. The RMS has proven to be a versatile and invaluable instrument for Shuttle operations.

CREW RELATED SERVICES. To support payload missions, members of the flight crew can provide unique ancillary services in three specific areas. These are extravehicular activity (EVA), intravehicular activity (IVA) and in-flight maintenance (IFM).

Extravehicular activity refers to those activities during which crew members don pressurized space suits and life support systems, leave the orbiter cabin and perform various payload-related activities in the vacuum of space, frequently outside the payload bay -- becoming, in effect, human satellites. The requirements for performing EVAs are spelled out in the PIP.

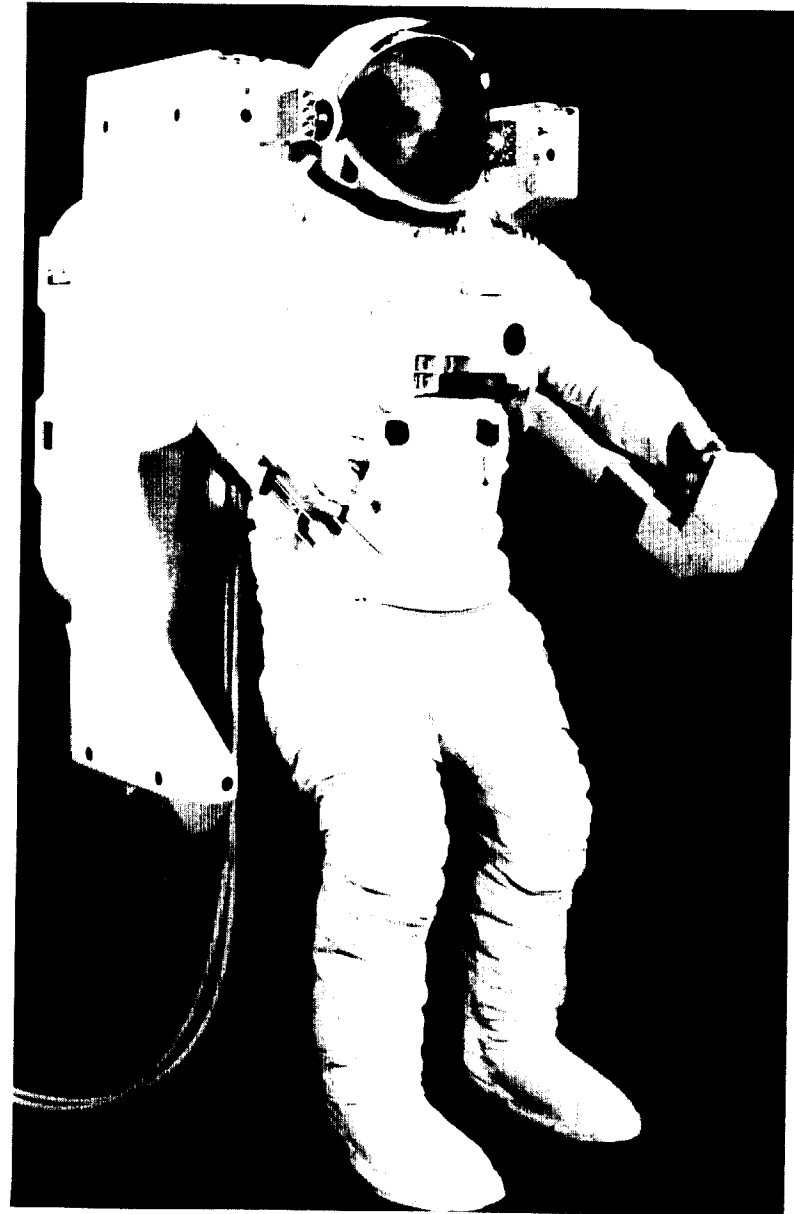

Manned Maneuvering Unit

ORIGINAL PAGE
BLACK AND WHITE PHOTOGRAPH

IVA includes all activities during which crew members dressed in space suits and using life support systems perform hands-on operations "internal to a customer-supplied crew module." The requirements for performing IVA also are specified in the PIP. (IVAs performed in the Spacelab do not require crew members to dress in space suits with life support systems.)

Finally, IFM is any off-normal, on-orbit maintenance or repair action conducted to repair a malfunctioning payload. In-flight maintenance procedures, for planned payload maintenance or repair, are developed before a flight and often involve EVA.

ASTRONAUT SELECTION AND TRAINING

The first group of astronauts -- known as the Mercury seven -- was selected by NASA in 1959. Since then 11 other groups of astronaut candidates have been selected. Through the end of 1987, there have been 172 graduates of the astronaut program.

With the advent of the Space Shuttle, the first astronaut candidates for that program -- 35 in all -- were selected in January 1978. They began training at JSC the following June. The group consisted of 20 mission specialists and 15 pilots and included six women and four members of minority groups. They completed their 1-year basic training program in August 1979.

Since then, four additional groups of pilots and mission specialists were selected to become members of the astronaut corps. They included 19 selected in July 1980, 17 in July 1984, 13 in August 1985 and 15 in June 1987. In addition, a new crew category, the payload specialist, was added to meet expanded capabilities of the Space Shuttle program.

The astronaut candidate program is an ongoing and NASA accepts applications from qualified individuals -- from both civilian and military walks of life -- on a continuing basis, selecting candidates as needed for the rigorous, 1-year training program directed by JSC. Upon completing the course, successful candidates become regular members of the astronaut corps. Usually they are eligible for a flight assignment about 1 year after completing the basic training program.

PILOT ASTRONAUTS. Early in the U.S. manned space program, jet aircraft and engineering training were prerequisites for selection as an astronaut. Today, scientific education and experience are equally important prerequisites in selecting both pilots and mission specialists.

Pilot astronauts play a key role in Shuttle flights, serving as either commanders or pilots. During flights, commanders are responsible for the vehicle, the crew, mission success and safety --

duties analogous to those of the captain of a ship. Shuttle commanders are assisted by pilot astronauts who are second in command and whose primary responsibilities involve controlling and operating the Shuttle. During flights, commanders and pilots usually assist in spacecraft deployment and retrieval operations using the RMS arm or other payload-unique equipment on board the Shuttle.

To be selected as a pilot astronaut candidate an applicant must meet a number of basic qualification requirements. A bachelor's degree in engineering, biological science, physical science or mathematics is required. A graduate degree is desired, although not essential. The applicant must have had at least 1,000 hours flying time in jet aircraft. Experience as a test pilot is desirable, but not required. All applicants -- pilots and missions specialists -- must be citizens of the United States.

Physically, an applicant must pass a strict physical examination and have a distant visual acuity no greater than 20/50 uncorrected, correctable to 20/20. Blood pressure, while sitting, must be no greater than 140 over 90. An applicant also must also be between 64" to 76" tall.

MISSION SPECIALIST ASTRONAUTS. Mission specialist astronauts, working closely with the commander and pilot, are responsible for coordinating on board operations involving crew activity planning, use and monitoring of the Shuttle's consumables (fuel, water, food, etc.), and conducting experiment and payload activities. They are required to have a detailed knowledge of Shuttle systems and the "operational characteristics, mission requirements and objectives and supporting systems for each of the experiments to be conducted on the assigned missions." Mission specialists perform on-board experiments, spacewalks (called extravehicular activity (EVA) and payload handling functions involving the RMS arm.



ORIGINAL PAGE
BLACK AND WHITE PHOTOGRAPH

Aerial view of Lyndon B. Johnson Space Center, Houston, Texas, with Clear Lake in the background.

The basic physical qualifications for selection as a mission specialist astronaut are the same as those for pilots, except that uncorrected visual acuity can be as high as 20/100, correctable to 20/20. A candidate's height can range from 60" to 76".

Academically, applicants must have a bachelor's degree in engineering, biological science, physical science or mathematics plus at least 3 years of related and progressively responsible professional experience. An advanced degree can be substituted for part or all of the experience requirement, 1 year for a master's degree and 3 years for a doctoral degree.

PAYLOAD SPECIALISTS. This newest category of Shuttle crew member, the payload specialist, is a professional in the physical or life sciences or a technician skilled in operating Shuttle-unique equipment. Selection of a payload specialist for a particular mission is made by the payload sponsor or customer. For NASA-sponsored spacecraft or experiments requiring a payload specialist, the specialist is nominated by an investigator working group and approved by NASA.

Payload specialists for major non-NASA payloads or experiments are selected by the sponsoring organization. payload specialists do not have to be U.S. citizens. However, they must meet strict NASA health and physical fitness standards.

In addition to intensive training for a specific mission assignment at a company plant, a university or government agency, the payload specialist also must take a comprehensive flight training course to become familiar with Shuttle systems, payload support equipment, crew operations, housekeeping techniques and emergency procedures. This training is conducted at JSC and other locations, as required. Payload specialist training may begin as much as 2 years before a flight.

Since the STS 51-L accident, the payload specialist program has been under review by NASA and a decision is pending on whether to continue with this special crew member category.

ASTRONAUT TRAINING. Astronaut training is highly specialized and requires the efforts of literally hundreds of persons and numerous facilities. It is conducted under the auspices of JSC's Mission Operations Directorate.

As manned space flight programs have become more sophisticated over the years so too has the complex and length training process needed to meet the demands of operating the Space Shuttle.

Initial training for new candidates consists of a series of short courses in aircraft safety, including instruction in ejection, parachute and survival to prepare them in the event their aircraft is disabled and they have to eject or make an emergency landing. Pilot and mission specialist astronauts are trained to fly T-38 high-performance jet aircraft, which are based at Ellington Field near JSC.

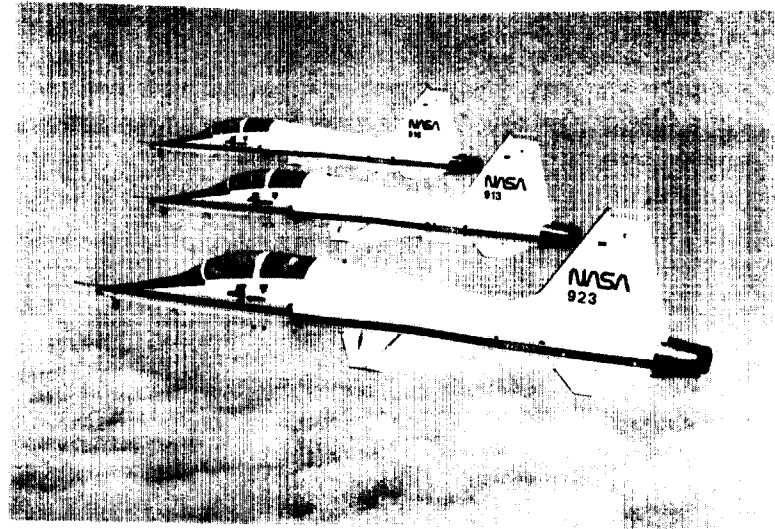

T-38 Training Aircraft

Flying these aircraft, pilot astronauts are able to maintain their flying skills and mission specialists are able to become familiar with high-performance jets.

In the formal academic areas, the novice astronauts are given a full range of basic science and technical courses, including mathematics, Earth resources, meteorology, guidance and navigation, astronomy, physics and computer sciences.

Basic knowledge of the Shuttle system, including payloads, is obtained through lectures, briefings, text books and flight operations manuals. Mockups of the orbiter flight and middecks, as well as the mid-body, including a full-scale payload bay, train future crew members in orbiter habitability, routine housekeeping and maintenance, waste management and stowage, television operations and extravehicular activities.

As training progresses, the student astronauts gain one-on-one experience in the single systems trainers (SST) located in Building 4 at JSC. The SSTs contain computer data bases with software allowing students to interact with controls and displays like those of a Shuttle crew station. Here they can develop work procedures and react to malfunction situations in a Shuttle-like environment.

Learning to function in a weightless or environment is simulated in aircraft and in an enormous "neutral buoyancy" water tank at JSC.

Aircraft weightless training is conducted in a modified KC-135 four-engine jet transport. Flying a parabolic course, the aircraft is able to create up to 30 seconds of weightlessness when flying a parabolic maneuver. During this rather brief period of time, astronauts can practice eating and drinking as well as use various kinds of Shuttle-type equipment. Training sessions in the KC-135 normally last from 1 to 2 hours, providing an exciting prelude to the sustained weightless experience of space flight.

Longer periods of weightlessness are possible in the neutral buoyancy tank, officially called the Weightless Environment Training Facility (WETF), in Building 29 at JSC. Here, a full-

scale mockup of the orbiter payload bay and airlock can be placed in the 25-foot-deep water tank permitting extended training periods for practicing EVA -- space walks -- by trainees wearing pressurized EVA suits.

The facility also is an essential tool for the design, testing and development of spacecraft and EVA crew equipment. In addition, it makes possible evaluation of payload bay body restraints and handholds, permits development of various crew procedures and, perhaps most importantly, helps determine an astronaut's EVA capabilities and workload limitations.

Other major operations training facilities at JSC include the Computer-Aided Instructional Trainer (CAIT) in Building 4, which fills the gap between textbook lessons and more complex trainers and simulators; the Crew Software Trainer (CST) used to demonstrate orbiter software capabilities before students go on to the SSTs; the Shuttle Mission Simulator (SMS) described earlier; the Orbiter Crew Compartment Trainer in Building 9A, used to train crew members for most of their on-orbit duties; as well as engineering mockups of orbiter work stations, the Spacelab and the remote manipulator system.

Most of these training facilities also are used by regular members of the astronaut corps to help them maintain proficiency in their areas of specialization.

Since the orbiter lands on a runway much like a high-performance aircraft, pilot astronauts use conventional and modified aircraft to simulate actual landings. In addition to the T-38 trainers, the four-engine KC-135 provides experience in handling large, heavy aircraft. Pilot astronauts also use a modified Grumman Gulfstream II, known as the Shuttle Training Aircraft (STA), which is configured to simulate the handling characteristics of the orbiter. It is used extensively for landing practice, particularly at the Ames-Dryden Flight Research Facility (DFRF) in California and at KSC's Shuttle Landing Facility.

ADVANCED TRAINING. Advanced training follows the 1-year basic training course for new astronauts. The Mission Operations Directorate's Flight and Systems Branches at JSC direct this advanced training which includes 16 different course curricula covering all Shuttle-related crew training requirements. The courses range from guidance, navigation and control systems to payload deployment and retrieval systems. This advanced training encompasses two specific types of instruction. These are system-related and phase-related training.

The bulk of system-related training is carried out in the various low and medium fidelity trainers and computer-aided instructional trainers at JSC. This approach permits self-paced, interactive programmed instruction for both initial and refresher systems training. Systems instructors provide one-on-one training by controlling simulator software, setting up staged malfunctions and letting the trainee solve them.

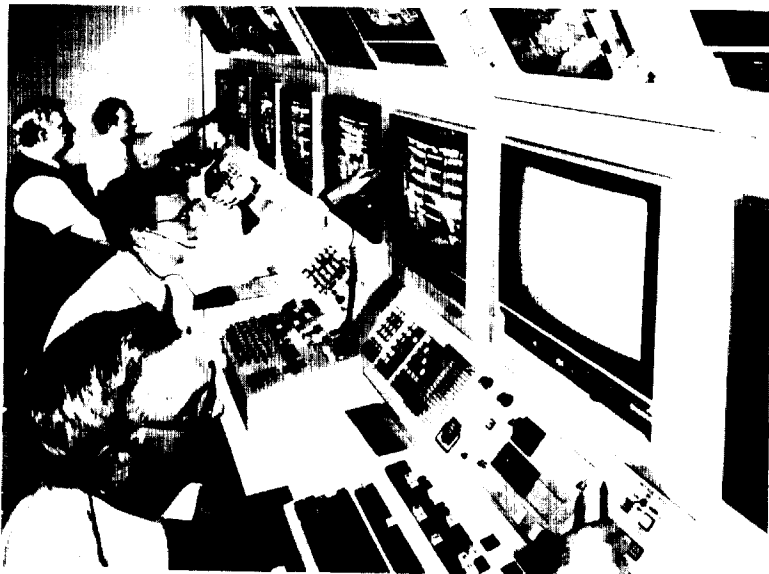

Mission Simulation and Training Facility

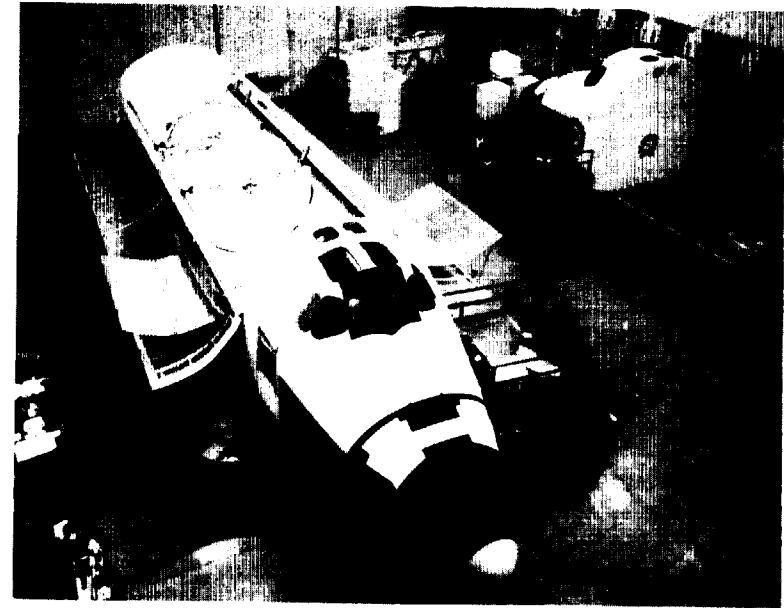

Space Shuttle Trainers

System training is designed to provide instruction in orbiter systems. It is not related to a specific mission or its cargo. It is designed to familiarize the trainee with a feel for what it's like to work and live in space. Generally, systems training is completed before an astronaut is assigned to a mission.

As its name implies, the second type of advanced training, phase-related training, concentrates on the specific skills an astronaut needs to perform successfully in space. This training is conducted in the SMS, which is the primary facility for training astronauts in all phases of a mission from liftoff to landing.

Phase-related training continues after a crew is assigned to a specific mission, normally about 7 months to 1 year before the scheduled launch date.

From this point on, crew training becomes more structured and is directed by a training management team. At any one time, there are nine structured Shuttle Mission Simulator teams operating at JSC. Each is assigned to a specific Shuttle flight. These specialized teams are responsible for directing the remaining advanced training needed for a specific flight. This includes what is described as "stand-alone training and flight-specific integrated and joint integrated training." It involves carefully developed scripts and scenarios for the mission. This intensive training is designed to permit the crew to operate as a closely integrated team, performing normal flight operations according to a flight timeline.

At about 10 weeks before a scheduled launch, the crew begins what are called "flight-specific integrated simulations, designed to provide a dynamic testing ground for mission rules and flight procedures." Just as during a real mission, the crew works at designated stations interacting with the flight control team who man their positions in the operationally-configured MCC.

These final pre-launch segments of training are called integrated and joint integrated simulations and normally include the payload users' operations control centers. Everything from EVA operations to interaction with the tracking networks can be simulated during these training sessions.

The integrated simulations are directed by a simulation supervisor, who is referred to as the "sim sup," assisted by a team of flight-specific instructors who direct and observe the simulations, evaluate crew and controller responses to malfunctions and other flight-unique situations. This final intensive training joint crew/flight controller effort is carried out in parallel with the complex and extensive activity called mission planning.

SHUTTLE MISSION SIMULATOR. The Shuttle Mission Simulator (SMS) is the primary system for training Space Shuttle crews. Located in Building 5 at JSC, it is described as the only high-fidelity simulator capable of training crews for all phases of a mission beginning at T-minus 30 minutes, including such

simulated events as launch, ascent, abort, orbit, rendezvous, docking, payload handling, undocking, deorbit, entry, approach, landing and rollout.

The unique simulator system can duplicate main engine and solid rocket booster performance, external tank and support equipment and interface with the MCC. The SMS construction was completed in 1977 at a cost of about \$100 million. The SMS, is operated for NASA by the Link Flight Simulation Division of The Singer Co., Binghamton, N.Y.

Major components of the SMS are two orbiter cockpits, one called the motion-base crew station (MBCS) and the other the fixed-base crew station (FBCS). Each is equipped with the identical controls, displays and consoles, of an actual orbiter. Although in many ways more complex, the crew station simulators are similar to the trainers used for commercial airline pilots.

The MBCS is configured for Shuttle commander and pilot positions. It operates with motion cues supplied by a modified 6-degree-of-freedom motion system providing motion simulation for all phases of a flight from launch to descent and landing. A special tilt frame provides a 90-degree upward tilt that simulates acceleration of liftoff and ascent.

The FBCS is configured for the commander, pilot, mission specialist and payload operations crew positions. While it does not simulate motion, it does have navigation, rendezvous, remote manipulator and payload accommodation systems configured to simulate specific payload activities planned for future missions. The FBCS is located on an elevated platform and it is entered through a hatch like the one on the orbiter. During long-duration mission simulations water and food are provided in the FBCS.

Visual simulations for the two training stations are provided by four independent digital image generation (DIG) systems. The DIG can display scenes for every phase of a Shuttle mission from pre-launch pad views to landing and rollout on the runway. The views are displayed in color in the six orbiter forward windows of

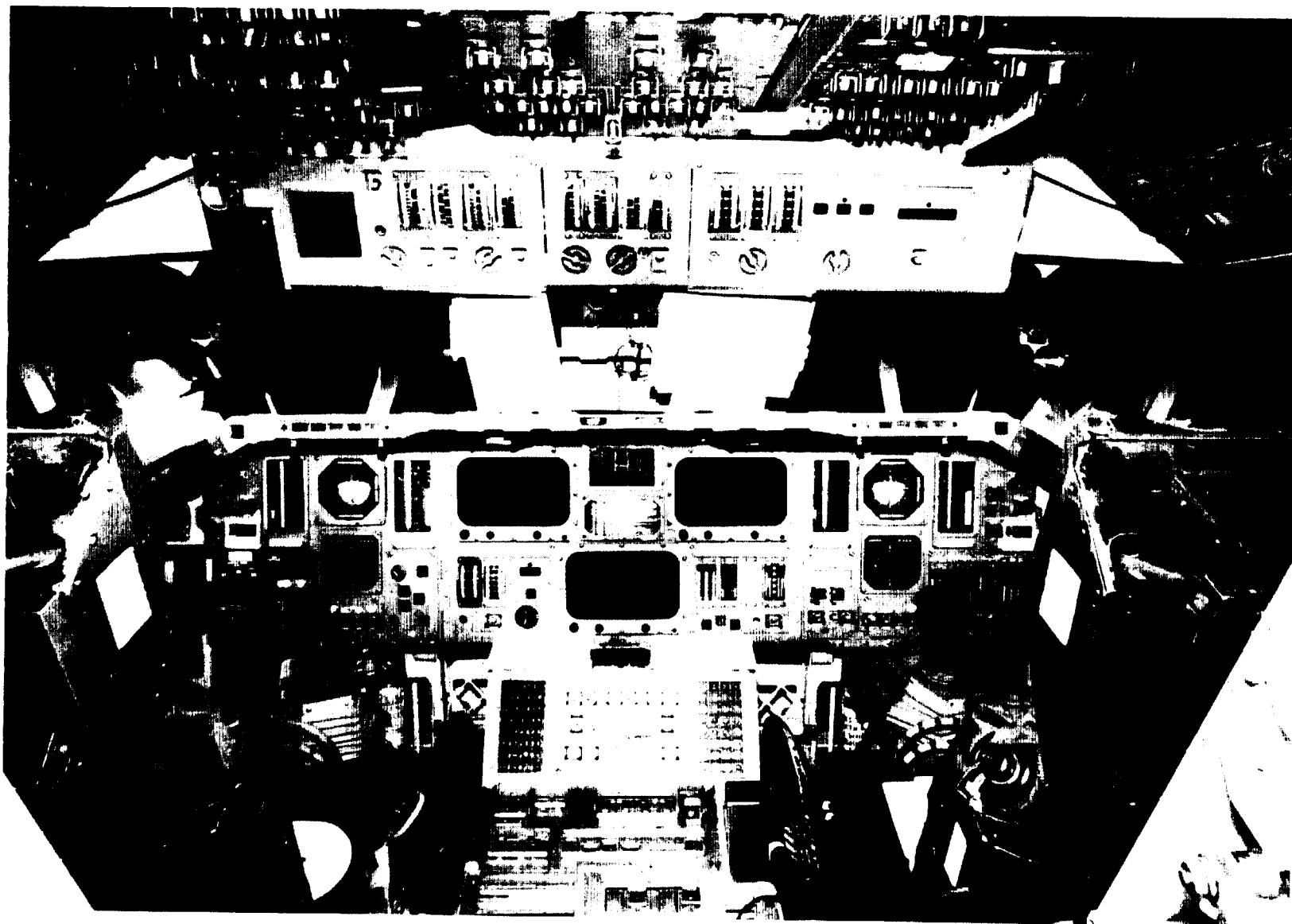

Cockpit of Shuttle Mission Simulator

the two stations, while the overhead and two aft windows have a green hue. The Earth, sun, moon and stars are included in these visual scenes. A closed circuit television display provides proper spatial ordering of moving objects for aft window and closed circuit TV fields of view. The closed circuit TV also permits viewing the payload through fixed cameras or through cameras mounted on remote manipulator arms. This is important for payload deployment and retrieval training.

Computer-generated sound simulations come from hidden loudspeakers which duplicate those experienced during an actual flight, including the onboard pumps, blowers, mechanical valves, aerodynamic vibrations, thruster firings, pyrotechnic explosions, gear deployment and runway touchdown.

SMS instructors at consoles act as devil's advocates in devising scenarios of systems failures or other circumstances to which astronaut crews and flight control teams must react. There are about 6,800 malfunction simulations that can be activated from the instructor consoles. Both SMS trainers can be used separately or in integrated simulations linked to flight control teams in the MCC.

Two independent computer facilities comprise the SMS computer system. Each has a Univac 110/40 host computer containing a majority of the mathematical modes used for simulated flights. Fourteen microcomputers perform data collection and transfer as well as other functions. There are two simulation interface devices (called SIDs) that communicate with flight computer systems. The flight computer systems, like those actually on the Shuttle, are five IBM AP 101s. Finally, four DIG computers and various input/output processors complete the basic SMS computer system.

The SMS can be interfaced with other simulators to duplicate various Shuttle missions. The European Space Agency's Spacelab Simulator (SLS), also in Building 5, is one of these.

The SMS design is modular which allows easy installation of update kits as well as specialized mission and payload simulation kits.

ASTRONAUT CANDIDATE

ASTRONAUT POOL

ASSIGNED CREW

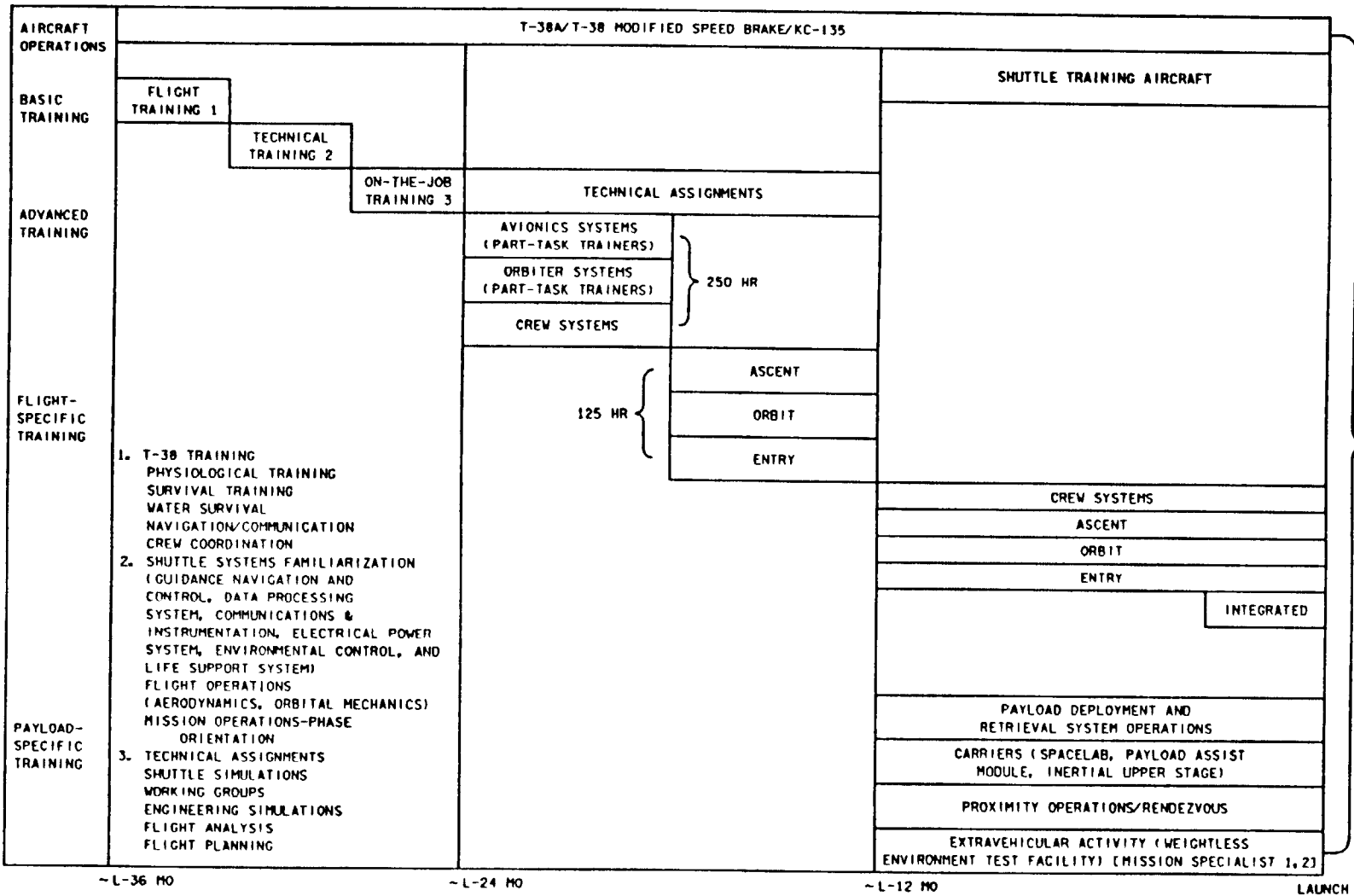

~ L-36 MO

~ L-24 MO

~ L-12 MO

LAUNCH

ORIGINAL PAGE IS OF POOR QUALITY

Typical Pilot Astronaut Training Program

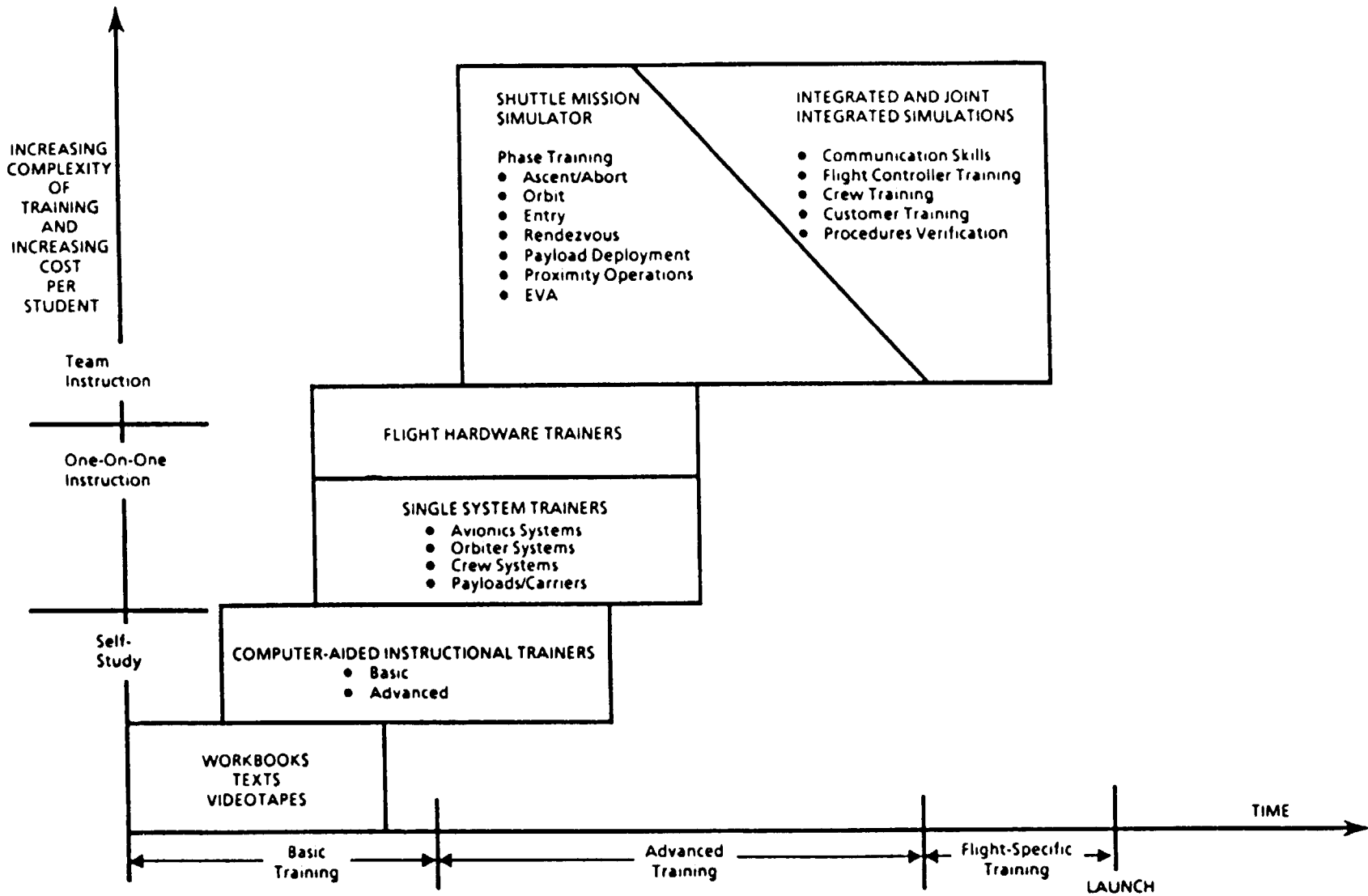

Astronaut Training, Building Block Approach

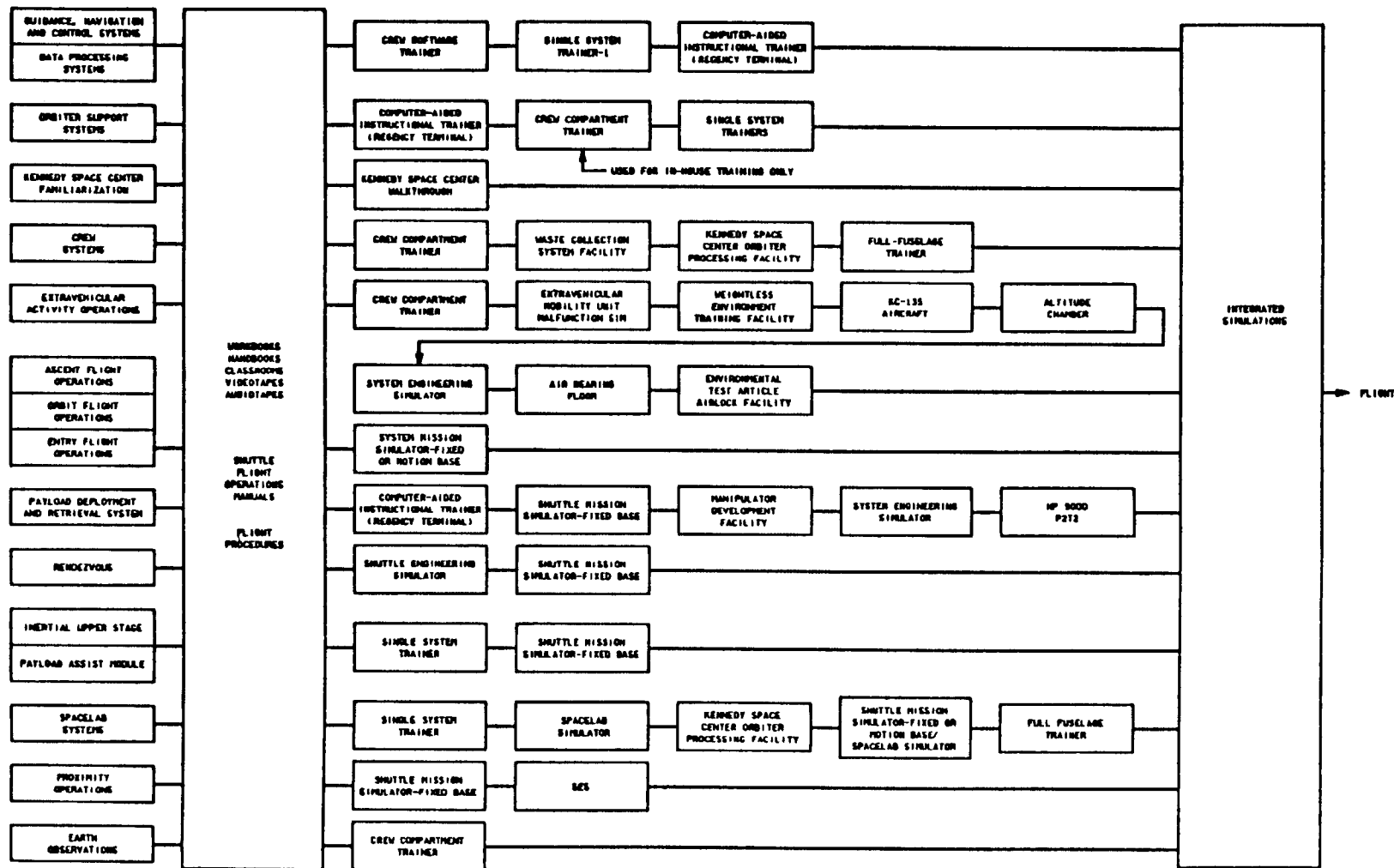

Training Facilities for Shuttle-related Courses

ORIGINAL PAGE IS
OF POOR QUALITY

SPACE SHUTTLE PROCESSING

LAUNCH PROCESSING SYSTEM. Space Shuttle processing, checkout and countdown procedures are more automated and streamlined than those of earlier manned space flight programs thanks to the Launch Processing System (LPS). This unique system automatically controls and performs much of the Shuttle processing from the arrival of individual components and their integration, to launch pad operations and, ultimately, the launch itself.

The LPS consists of three basic subsystems: the Central Data Subsystem (CDS) located on the second floor of the Launch Control Center (LCC), the Checkout, Control and Monitor Subsystem (CCMS) located in the firing rooms and the Record and Playback Subsystem (RPS).

The CDS consists of large-scale computers which store such vital data as test procedures, vehicle processing data, a master program library, historical data, pre- and post-test data analysis as well as other essential information. This information is automatically available to the smaller capacity computers of the CCMS.

Actual processing and launch of the Space Shuttle is controlled by the CCMS. These tasks are accomplished by using computer programs to monitor and record the pre-launch performance of all Shuttle electrical and mechanical systems. Command signals from the subsystem computer are sent to hundreds of components and test circuits. While a vehicle component is functioning, a sensor measures its performance and sends data back to the LPS. The data is compared against the checkout limits stored in the system's computer memory. Pre-determined measurements related to test requirements launch commit criteria and performance specifications are stored in the CCMS computers.

Finally, the RPS, mentioned above, records unprocessed Shuttle instrumentation data during test and launch countdowns.

This data can be played back for post-test analysis when firing room engineers are troubleshooting Shuttle or LPS problems.

RPS consists of tape records, telemetry demultiplexing equipment, chart recorders and computers to provide data reduction capabilities.

SOLID ROCKET BOOSTER PROCESSING FACILITIES. After a Space Shuttle launch, the expended solid rocket boosters (SRB) are parachuted into the Atlantic Ocean off shore from the Complex 39 launch site. The boosters are retrieved by recovery vessels and towed back to facilities on the Cape Canaveral Air Force Station (CCAFS) where they are taken apart and cleaned.

The empty propellant-carrying segments are taken then to booster processing facilities at Complex 39 where they are inspected, packed and shipped by rail to the Morton-Thiokol manufacturing plant in Utah for propellant reloading. The remaining SRB components are taken to an assembly and refurbishment facility several miles south of Complex 39 where they are reconditioned and readied for future Space Shuttle launches.

Assembly and Refurbishment Facility. The solid rocket Assembly and Refurbishment Facility consists of four main buildings on a 45-acre site south of the KSC Industrial Area. The site includes facilities for solid rocket processing and servicing and needed administrative offices.

SRB components including aft and forward skirts, frustums, nose caps, recovery systems, electronics and instrumentation as well as elements of the trust vector control system, are refurbished, assembled and tested here.

Rotation Processing and Surge Facility. The Rotation Processing Building (RPSF), located north of the VAB, is where

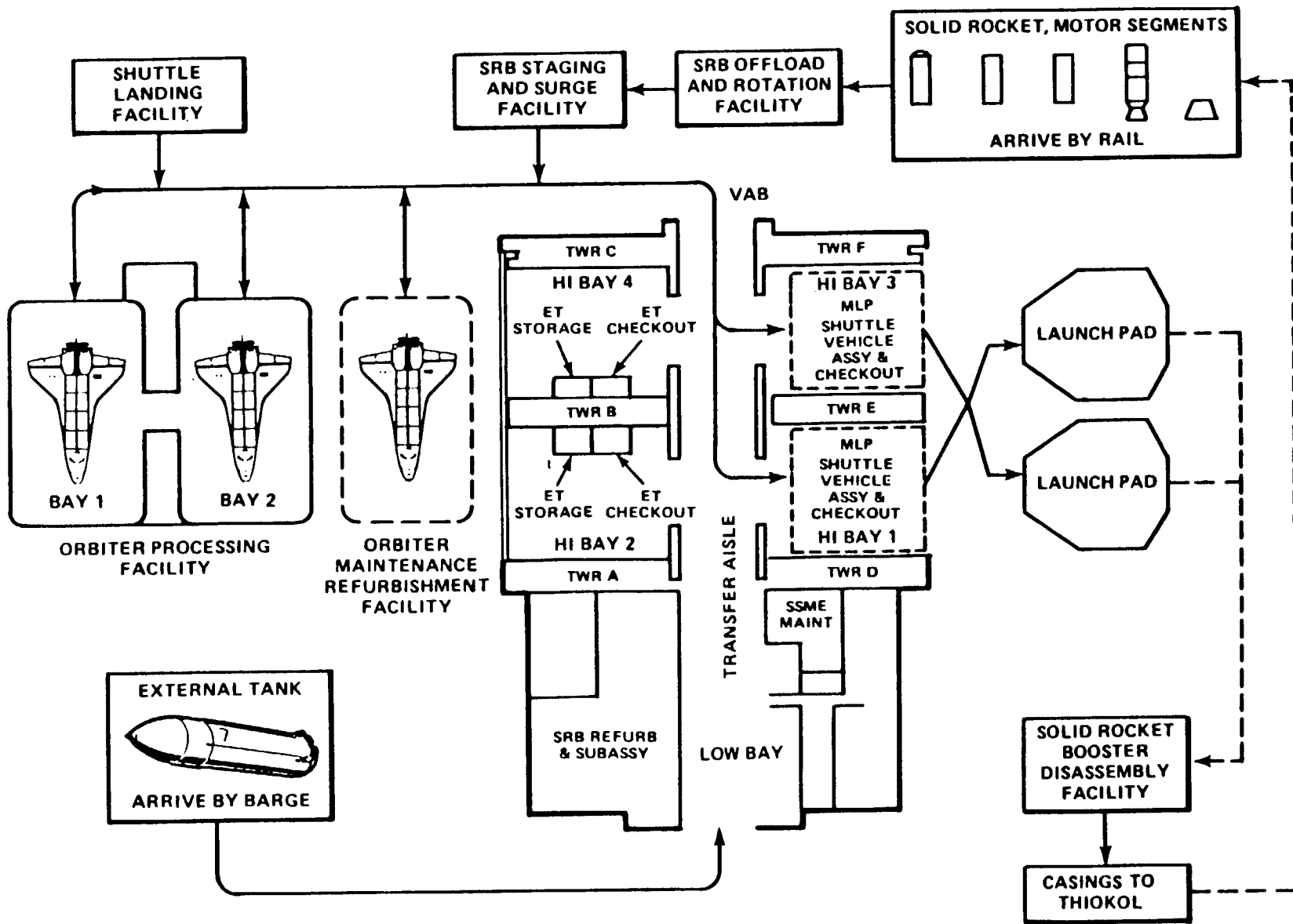

Shuttle Ground Processing Flow Diagram

new and reloaded SRB segments are received after being shipped by rail from the Morton-Thiokol's Utah plant. Completed aft skirt assemblies from the Assembly and Refurbishment Facility are integrated here with the SRB aft segments. The remaining SRB components are integrated with the booster stack surge building -- during final mating operations in the VAB.

The two Surge Buildings store SRB flight segments stored after they have been transferred from the nearby Rotation Processing Building. The segments remain there until they are moved to the VAB for integration with other flight-ready SRB components received from the Assembly and Refurbishment Facility.

ORBITER PROCESSING FACILITY. Between missions, Space Shuttle orbiters are prepared for flight in the Orbiter Processing Facility (OPF) which resembles modern aircraft maintenance hanger. The OPF is located west of the VAB. It can handle two orbiters at a time.

The OPF consists of two identical high bays connected by a low bay. Each high bay is 197 ft. long, 150 ft. wide and 95 ft. high. Each bay has two 30-ton bridge-type cranes and contains a complex series of platforms which surround the orbiter and permit work access. The high bays also have under-floor trench systems which contain electrical, electronic and communications instrumentation as well as outlets for gaseous nitrogen, oxygen and helium.

In addition, the high bay areas have emergency exhaust systems which are used in the event of a fuel spill in the area. Fire protection systems are located throughout the facility.

The low bay is 233 ft. long, 95 ft. wide and 25 ft. high. In addition to an office annex, it also contains electronic, mechanical and electrical support systems.

Orbiter payloads that must be processed in the horizontal attitude -- such as the Hubble Space Telescope and Spacelab -- are

loaded into the orbiter's payload bay in the OPF. Payloads that can be checked out and installed vertically are placed into the orbiter's payload bay at the launch pad.

Orbiter processing procedures are similar to procedures used by airlines for their aircraft maintenance programs.



Orbiter Processing Facility with VAB in background

ORBITER MODIFICATION AND REFURBISHMENT FACILITY. The Orbiter Modification and Refurbishment Facility (OMRF) is a 50,000 square-foot facility located northwest of the VAB. This facility, completed in the fall

of 1987, is used to perform extensive modification, rehabilitation and overhaul of orbiters. The OMRF permits extensive work on orbiters to be performed without disrupting routine operational flight processing of orbiters through the OPF.

The OMRF consists of a single high bay identical to those of the OPF. It is 95 ft. high and has a 2-story low bay area. It contains special work platforms, a 30-ton crane, storage and parts areas as well as office space. Initially, only non-hazardous work will be performed in the OMRF. However, eventually it will be equipped to perform hazardous operations such as hypergolic deservicing.

LOGISTICS FACILITY. The Logistics Facility is a 324,640 square-foot building located south of the VAB. It houses 190,000 Space Shuttle hardware parts, as well as about 500 NASA and contractor workers.

Perhaps the most unusual feature of the Logistics Facility is its state-of-the-art storage retrieval parts system which includes automated handling equipment designed to find and retrieve specific Shuttle parts as they are needed.

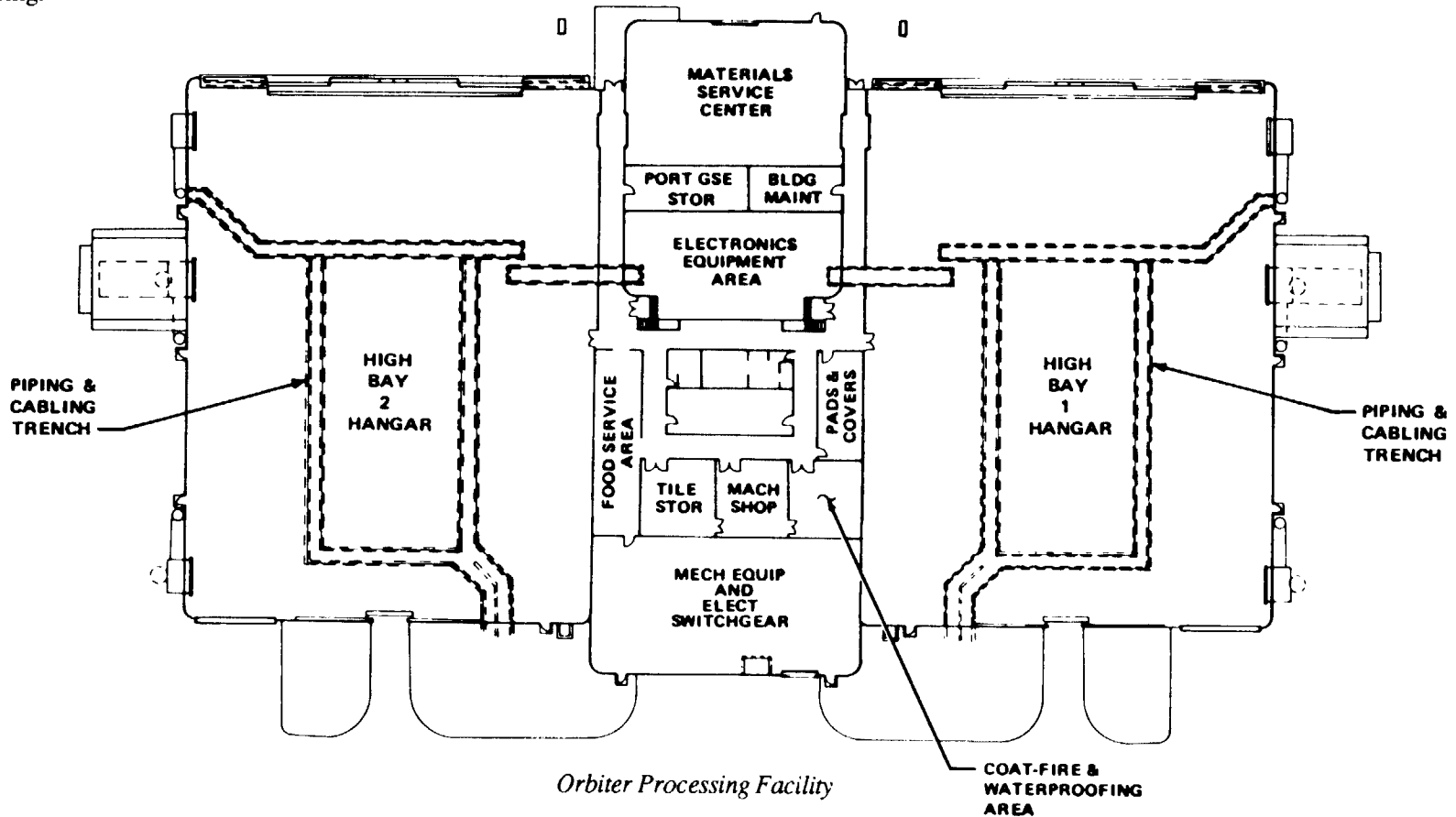

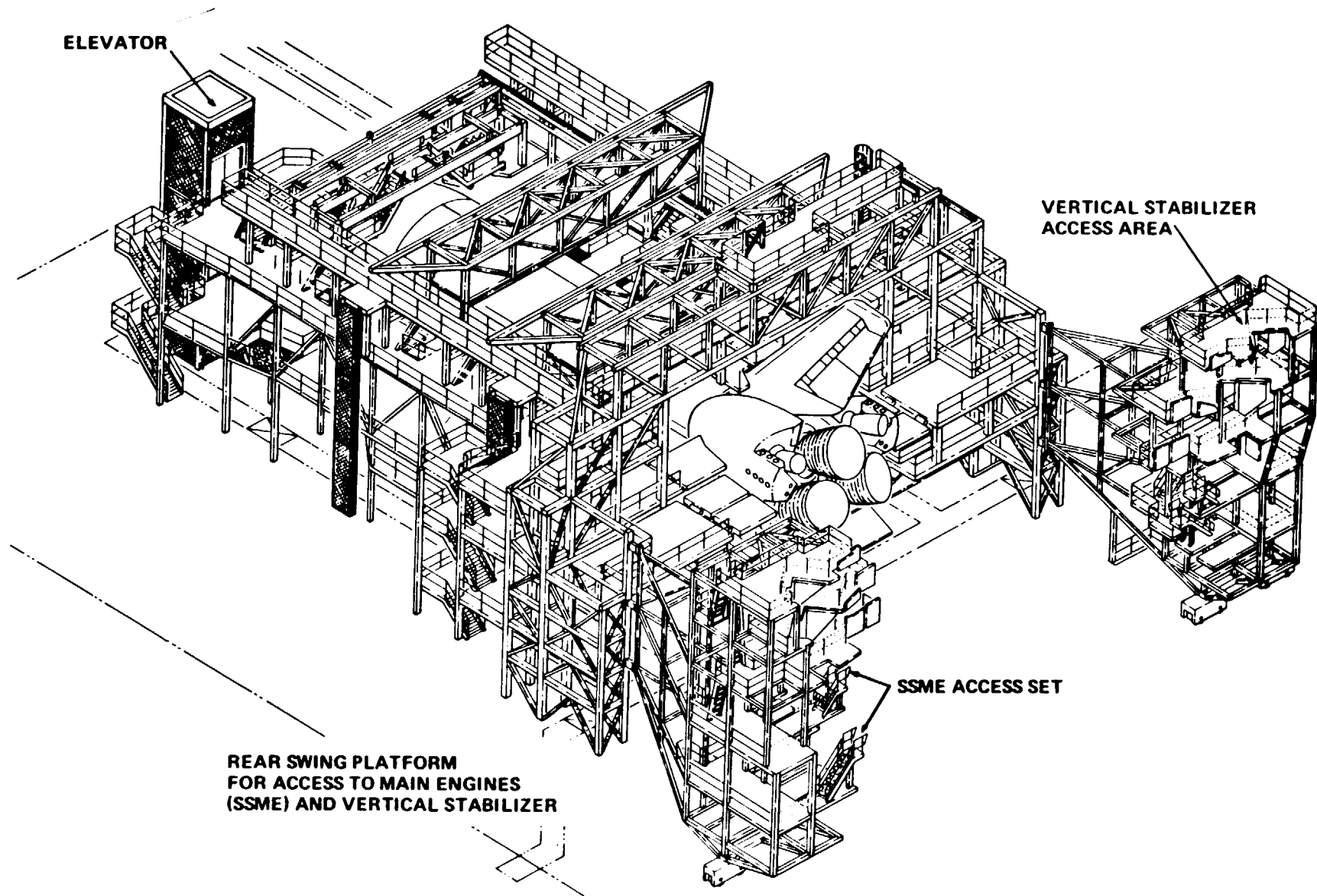

ELEVATOR

**VERTICAL STABILIZER
ACCESS AREA**

**REAR SWING PLATFORM
FOR ACCESS TO MAIN ENGINES
(SSME) AND VERTICAL STABILIZER**

SSME ACCESS SET

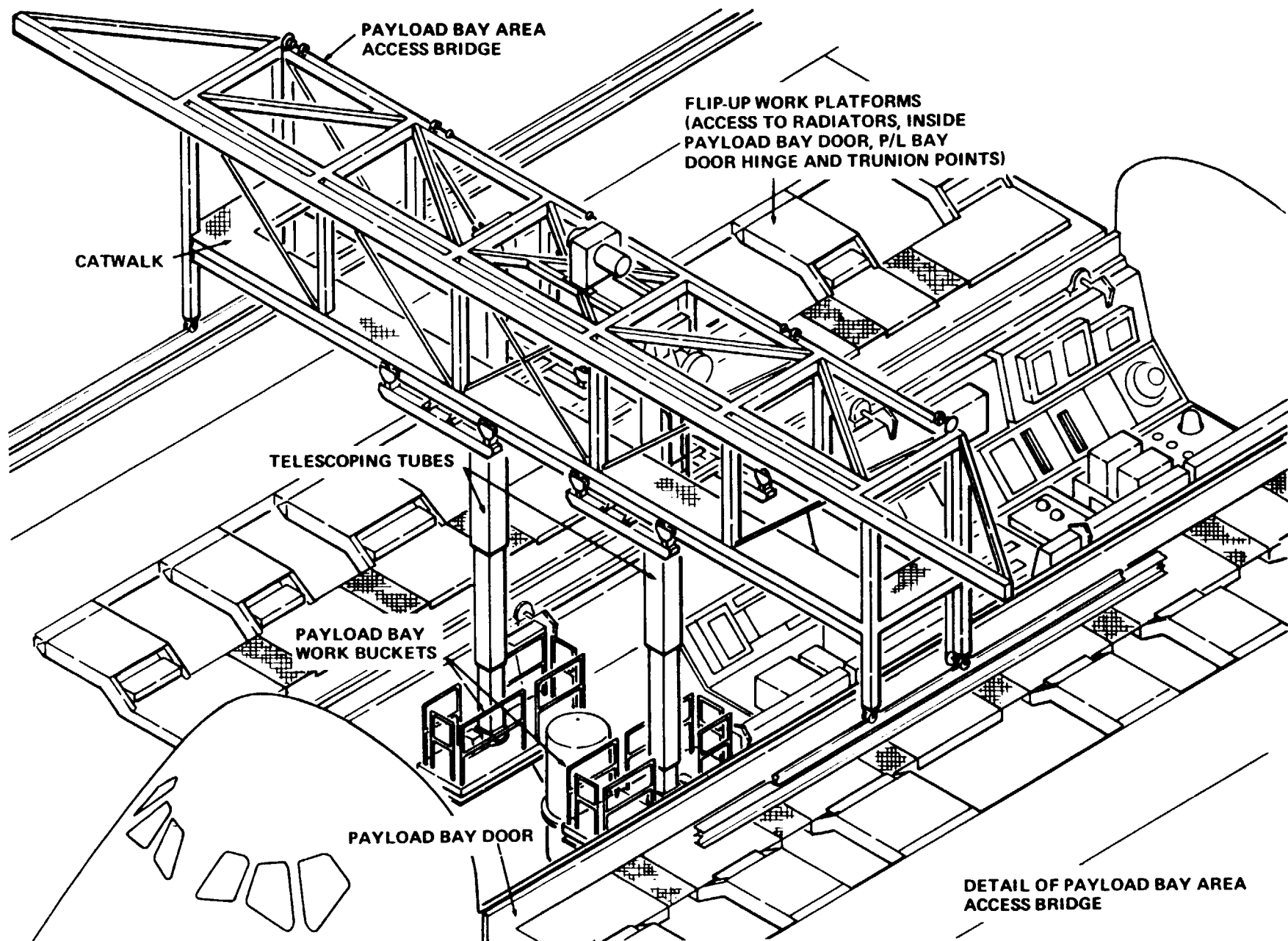

Orbiter Processing Facility Overhead Access Platforms

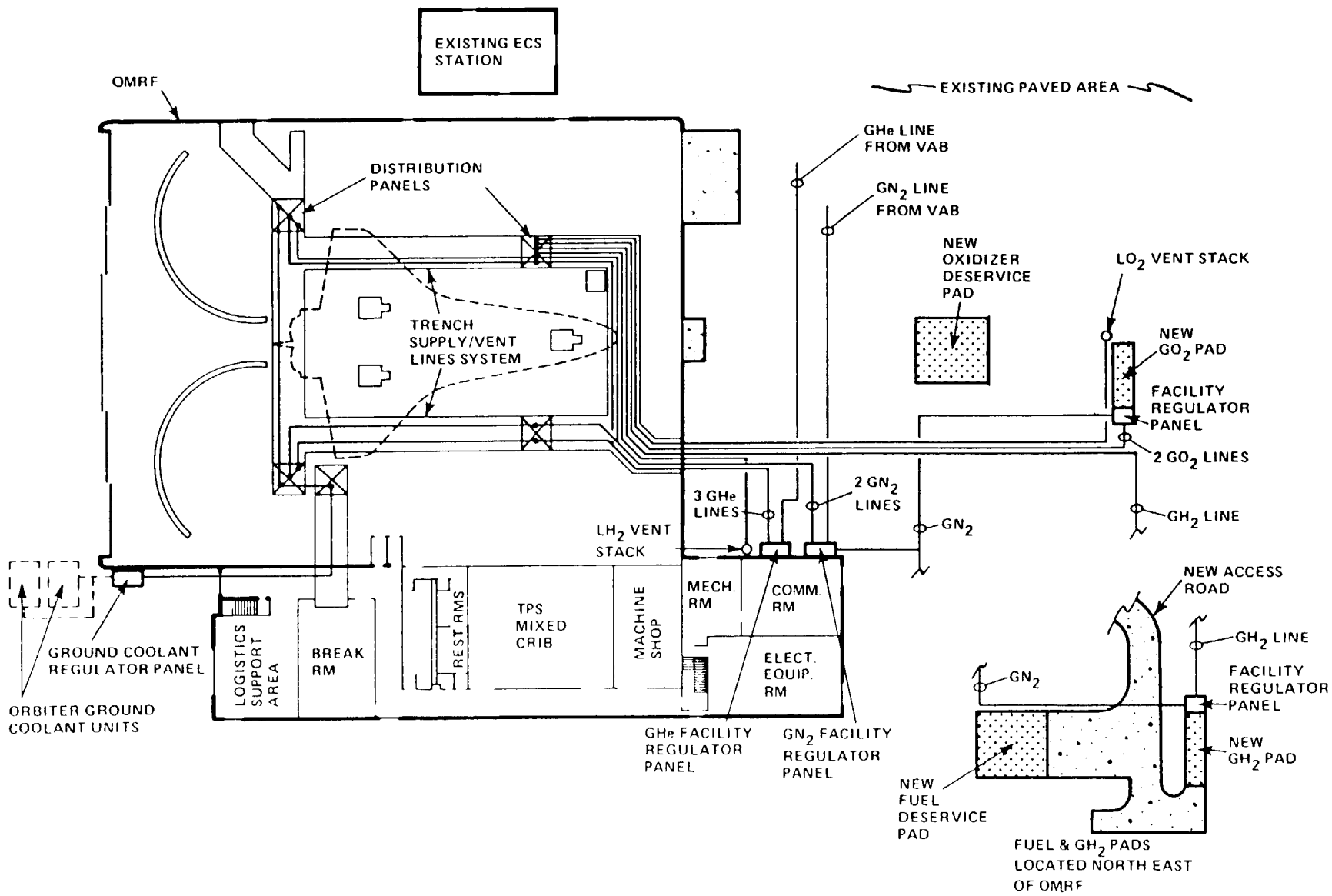

Orbiter Modification and Refurbishment Facility Floor Plan

SPACE SHUTTLE INTEGRATION & ROLLOUT

Space Shuttle components are brought together from various locations throughout the country and assembled at Launch Complex 39 (LC-39) facilities at the Kennedy Space Center. It is in these facilities that the components -- the orbiter, solid rocket booster and external tank -- are assembled into an integrated Space Shuttle vehicle, tested, rolled out to the launch pad and ultimately launched into space.

VEHICLE ASSEMBLY BUILDING. The VAB is the heart of operations at LC-39. It was originally built to assemble vertically the huge Saturn launch vehicles used for the Apollo, Skylab and the Apollo Soyuz Test Project programs. Its initial construction cost was \$117,000,000.

The VAB is one of the largest buildings in the world. It covers a ground area of 8 acres and has a volume of 129,428,000 cubic ft. By contrast, the Pentagon contains 77,025,000 cubic ft. of space. In overall volume, the VAB is exceeded only by the Boeing facility in Washington state where 747 jet aircraft are built.

The VAB is 525 ft. tall, 716 ft. long and 518 ft. wide. It is divided into a high bay area 525 ft. high and a low bay area which is 210 ft. high. A transfer aisle, which runs north and south, connects and transects the two bays thereby allowing the easy movement of Space Shuttle components.

There are four separate bays in the high bay area. The two located on the west side of the building -- called Bays 2 and 4 -- are used for storage and processing of the Shuttle's external tank. The two bays facing to the east -- Bays 1 and 3 -- are used for the vertical assembly of the Shuttle vehicles atop Mobile Launcher Platforms (MLP).

Movable work platforms, modified to fit the configuration of the Space Shuttle, provide access during the integration and pre-rollout preparations.

The low bay area is used for Shuttle main engine maintenance. It contains overhaul shops and serves as a holding area for the SRB forward assemblies and aft skirts.

During Shuttle integration operations, the SRB segments are transferred from the SRB Rotation Processing and Surge Facility (RPSF) to the VAB. They are hoisted onto the MLP in either High Bay 1 or 3 and the segments are individually mated to form two complete SRBs.

The external tanks, after arriving by barge from their assembly plant in Louisiana, are inspected and stored in either High Bay 2 or 4 until they are needed. Eventually the tanks are moved to the high bay where the SRBs already have been assembled. There the external tank is attached to the SRB stack.

The Shuttle orbiter, the last element to be mated, is towed from the OPF to the VAB transfer aisle where it is raised to a vertical position and mated to the external tank on the MLP to form the Space Shuttle vehicle.

When assembly and checkout of the vehicle are complete, a Crawler Transporter is moved into the high bay, picks up the MLP and the assembled Space Shuttle and then proceeds slowly to the launch pad.

The VAB's high bay door openings are 456 ft. high from ground to top. The lower door opening is 192 ft. wide and 114 ft. high with four door "leaves" that move horizontally. The upper door opening is 342 ft. high and 76 ft. wide and has seven door leaves that move vertically.

The building has more than 70 lifting devices, including two bridge cranes capable of lifting 250 tons.

The VAB is designed to withstand winds of up to 125 miles an hour. Its foundation rests on more than 4,200 open-end steel pipe

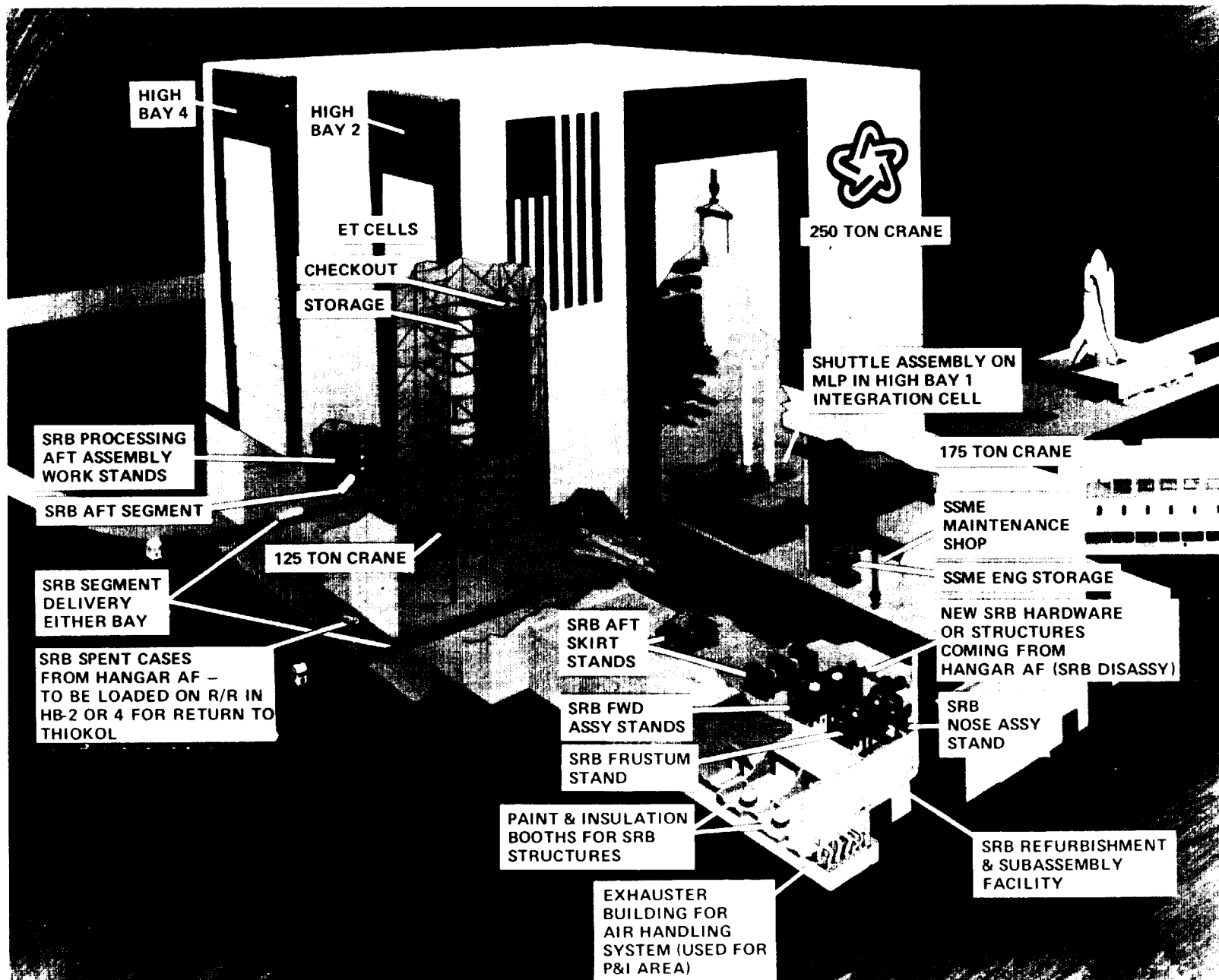

Vehicle Assembly Building cut away view

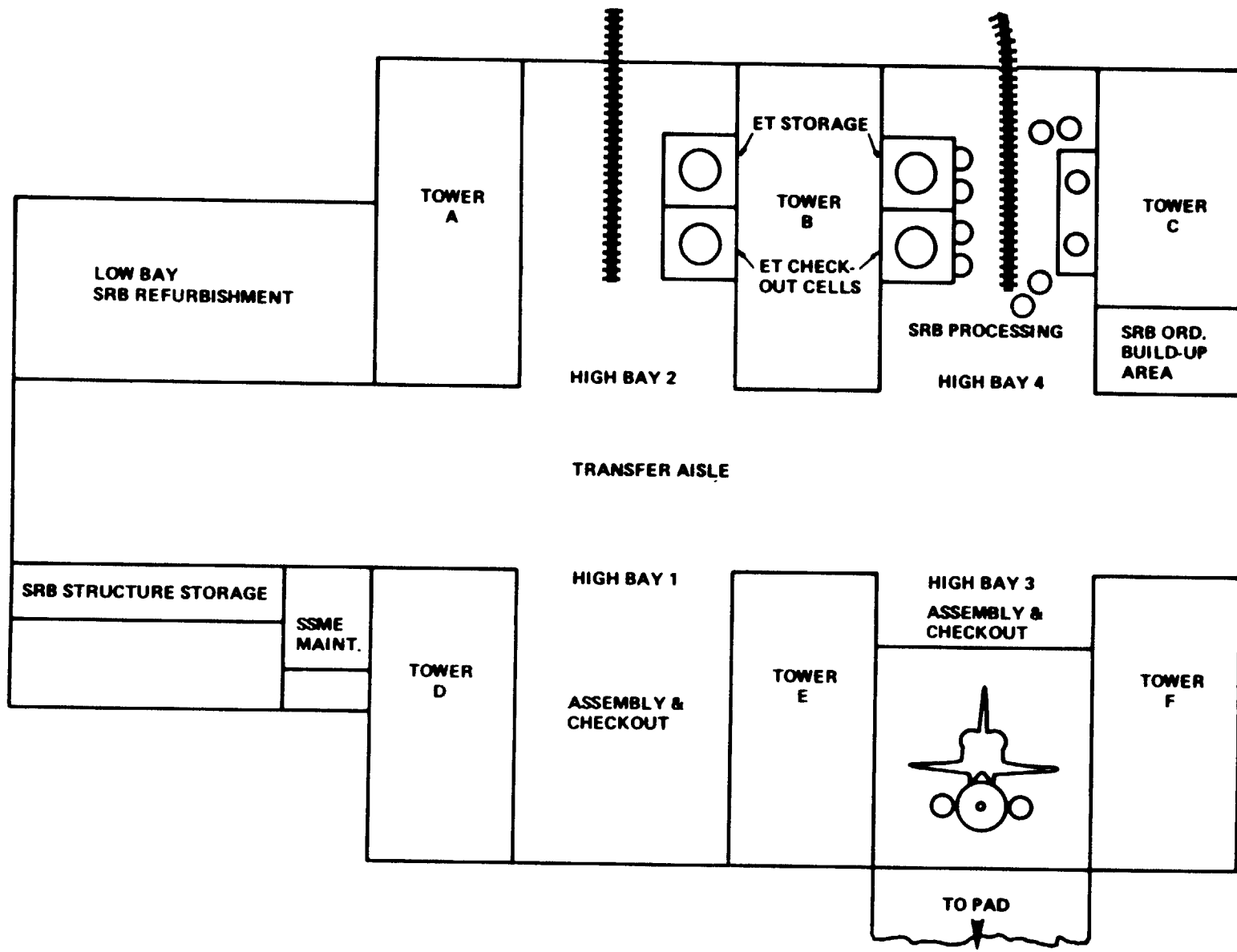

Vehicle Assembly Building Floor Plan

pilings which are 16 inches in diameter. The pilings were driven down into bedrock to a depth of 160 ft. -- a total of more than 127 miles of pilings.

A U.S. flag and the bicentennial emblem were painted on the south side of the VAB in 1976 for the nation's bicentennial observance. Over 6,000 gallons of paint were used. The large flag is 209 by 110 ft. in size and is visible at long distances.

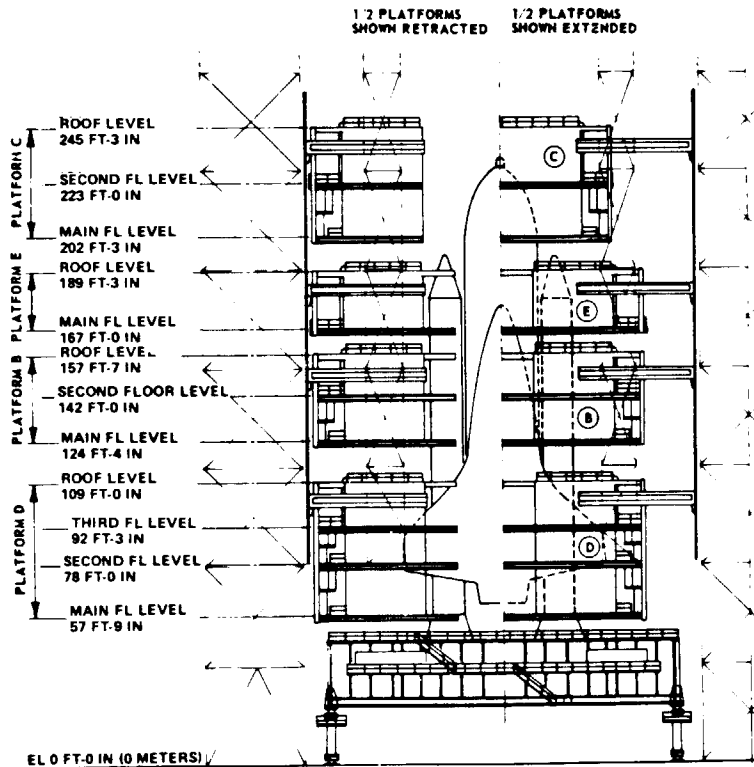

Vehicle Assembly Building Assembly and Checkout Bay Workstand - forward view

MOBILE LAUNCHER PLATFORMS. Mobile Launcher Platforms (MLP) are the transportable launch bases for the Space Shuttle vehicle. There are three MLPs at KSC. Like most of the major Shuttle-dedicated facilities, the MLPs were originally designed and used for the Apollo/Saturn program. Extensive modifications were necessary to adapt them for Shuttle operations.

The MLPs are impressive steel structures, 25 ft. high, 160 ft. long and 135 ft. wide. They weigh 8,230,000 pounds. At the launch pad, with a fueled Shuttle on their 6-inch-thick decks, they weigh 12,700,000 lb.

There are three exhaust openings in the main deck of an MLP. Two are for the exhaust of the SRBs at launch and the third, a center opening, is for the exhaust from the main engines. SRB exhaust holes are 42 ft. long and 20 ft. wide. The main engine hole is 34 ft. long and 31 ft. wide.

On each side of the main engine exhaust hole there are two large devices called Tail Service Masts. They are 15 ft. long, 9 ft. wide and rise 31 ft. above the MLP deck. Their function is to provide umbilical connections for liquid oxygen and liquid hydrogen lines to fuel the external tank from storage tanks adjacent to the launch pad. Other umbilical lines carry helium and nitrogen, as well as ground electrical power and connections for vehicle data and communications.

At launch, the umbilicals are pulled away from the orbiter and retracted into the masts where protective hoods rotate closed to protect the umbilicals from possible exhaust flame damage.

Another feature of the MLPs is the hydrogen burnoff system which consists of 5-foot-long booms suspended from each Tail Service Mast. Each boom contains four flare-like devices which burn off gas from a pre-ignition flow of liquid hydrogen through the main engines. This prevents a cloud of excess gaseous hydrogen from forming which could explode when the main engines are ignited at launch.

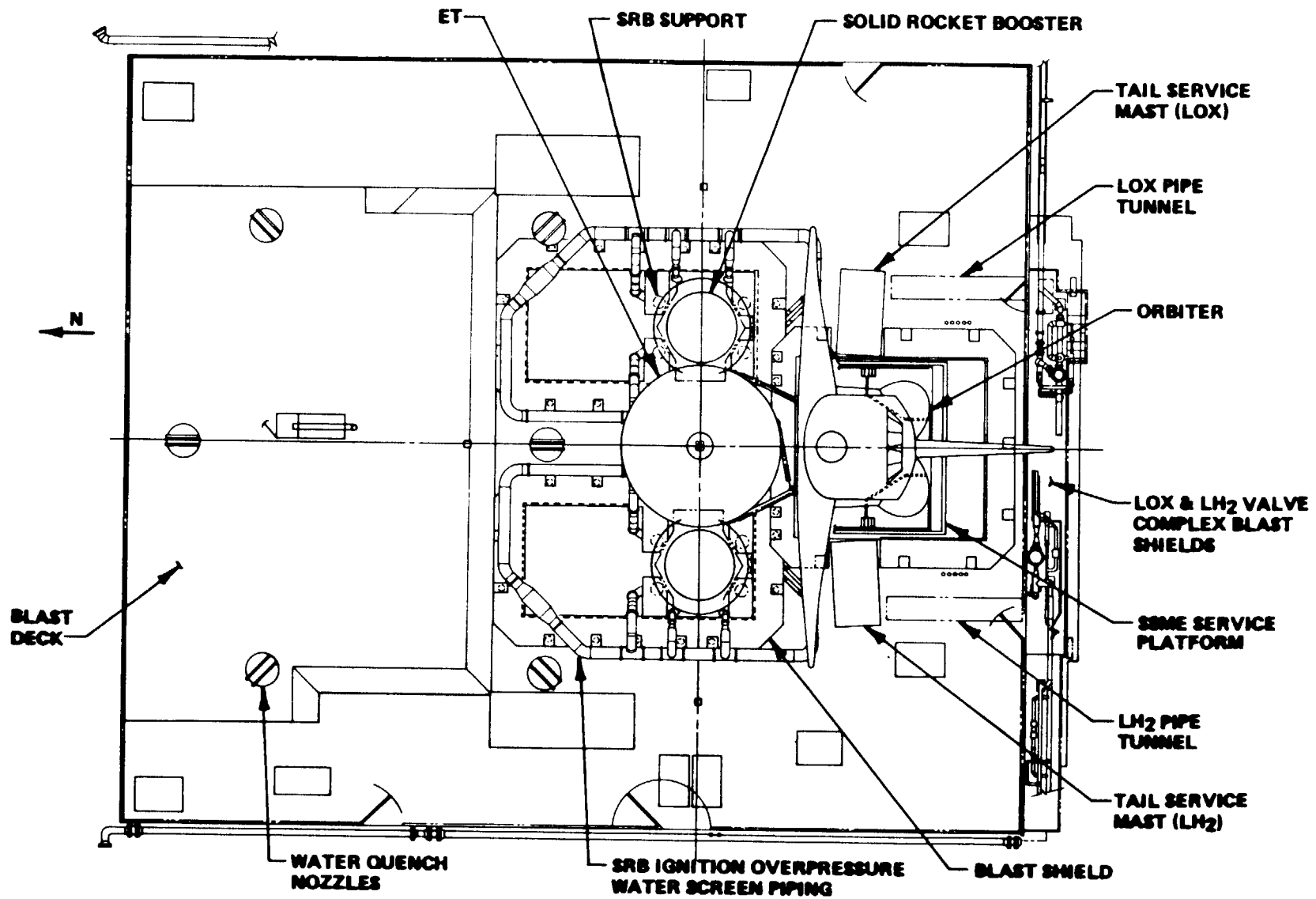

Mobile Launch Platform Floor Plan

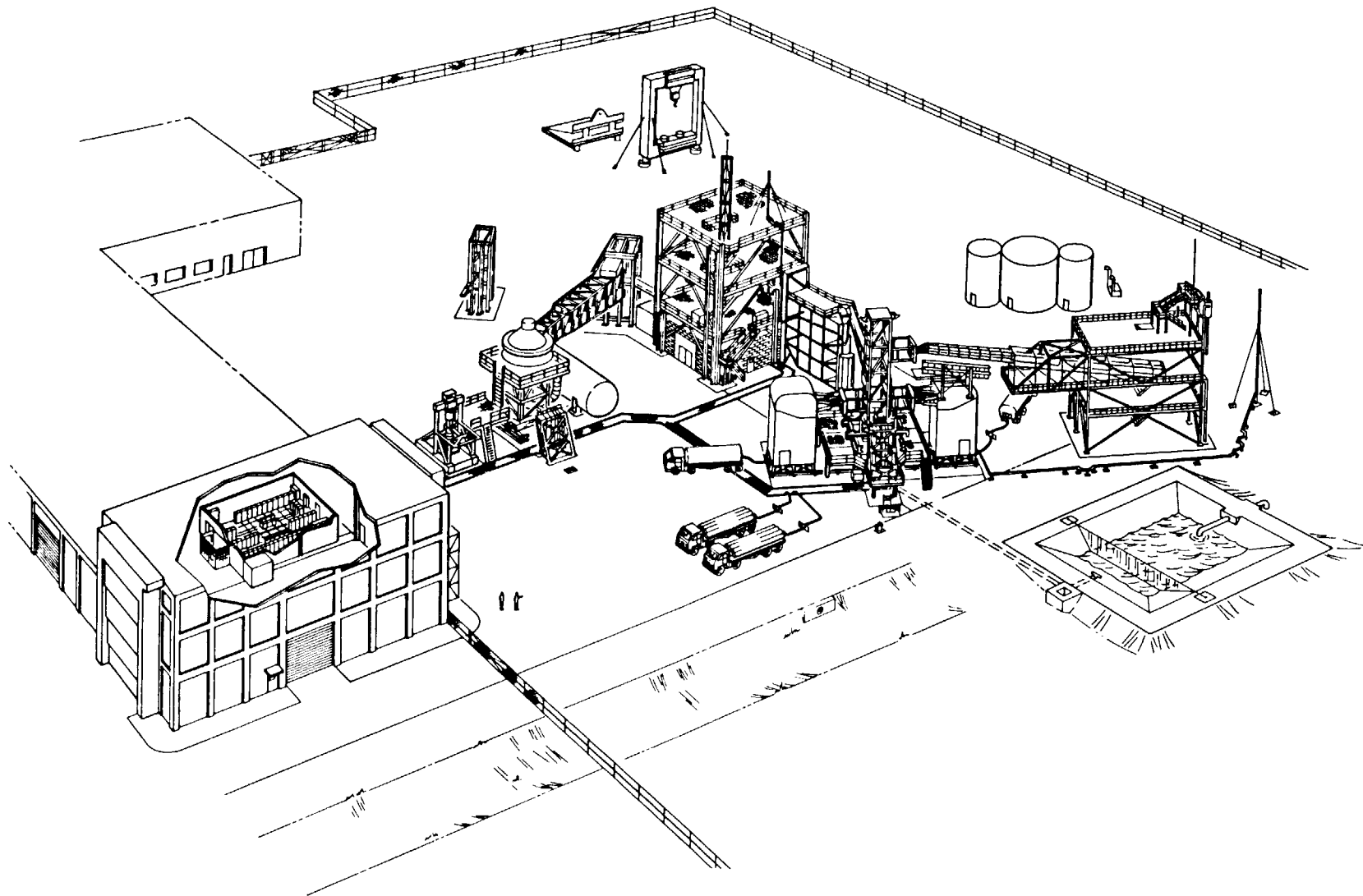

Launch Equipment Test Facility at Kennedy Space Center

The Space Shuttle vehicle is supported and held on the the MLP by eight attach posts, four on the aft skirt of each SRB. These fit into counterpart posts located in the platform's two SRB support wells. At launch, the Shuttle is freed by triggering explosive nuts which release the giant studs linking the SRB attach posts with the platform support posts.

Each MLP has two inner levels containing various rooms housing electrical test and propellant loading equipment.

At their parking locations north of the VAB, in the VAB and at the launch pads, the MLPs rest on six 22-foot-tall pedestals. Also, at the launch pad, four extensible columns are used to stiffen the MLP against rebound loads, should main engine cutoff occur during launch operations.

CRAWLER TRANSPORTERS. Fully assembled Space Shuttles mounted on MLPs, are moved from the VAB to the launch pad by enormous tracked vehicles called Crawler Transporters. These vehicles originally were used during the Apollo and Skylab programs and were modified for the Shuttle program, as were most of the major Shuttle facilities at KSC.

The flattop vehicles are about 20 ft. high, 131 ft. long and 114 ft. wide -- about the size of a baseball diamond. They weigh 6 million pounds unloaded and are said to be the largest vehicles of their type in the world. They move on four double-tracked crawlers, each of which is 10 ft. high and 41 ft. long. Each crawler track shoe weighs 1 ton. Unloaded the crawlers can move

at a speed of 2 miles an hour. Loaded they literally crawl along at a maximum of 1 mile an hour. It normally takes about 6 hours to make the trip to the launch pad from the VAB.

The vehicles are powered by two 2,750-horsepower diesel engines which drive four 1,000 kilowatt generators to provide electrical power to 16 traction motors. The traction motors, operating through gears, turn the crawler tracks.

The vehicles have a leveling system to keep the Shuttle vertical during the trip to the launch pad. This system also provides the leveling needed to move up the ramp leading to the launch pad and to keep the Shuttle level when it is raised and lowered on pedestals at the pad. Once the MLP is attached to the launch pad pedestals, the crawler is backed down the ramp and returned to its parking area.

The maintenance facility for Crawler Transporters is located just north of the OPF where repair and modification of the vehicles is carried out. The weather-protected facility includes a high bay with an overhead crane and a low bay where shops, parts storage and offices are located.

CRAWLERWAY. The roadway from the VAB to the launch pads for the Crawler Transporters is equally unique. It is as wide as an eight-lane freeway, consisting of two 40-ft.-wide lanes separated by a 50-ft. median strip. The distance from the VAB to Pad A is 3.44 mile, and to Pad B it is 4.24 mile. The surface on which the transporters move is covered with river gravel 8" thick on curves and 4" thick on the straightaway surfaces.

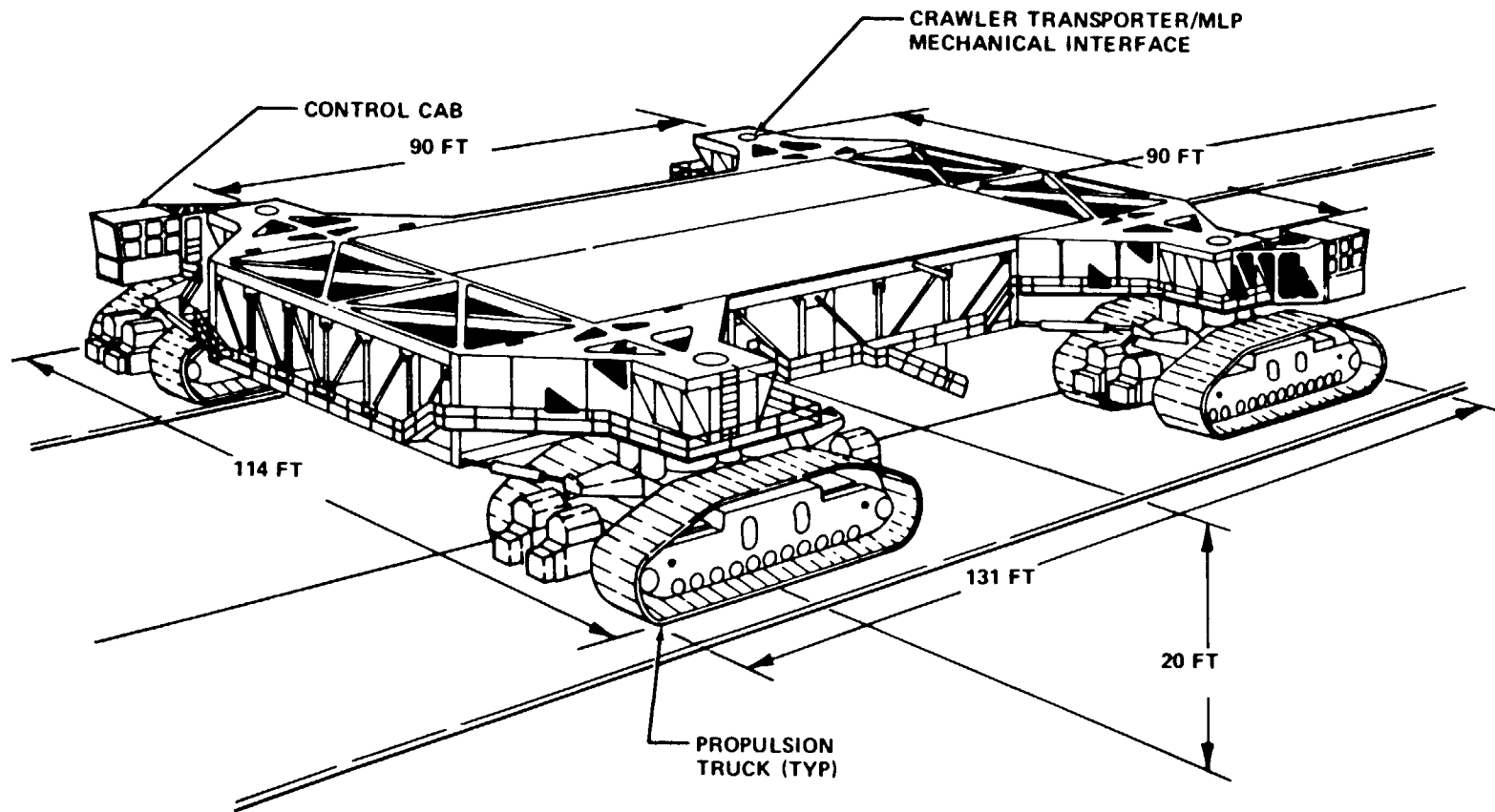

Crawler Transporter

COMPLEX 39 LAUNCH PAD FACILITIES

Kennedy Space Center's Launch Complex 39 (LC-39), has two identical launch pads which, like many Space Shuttle facilities, were originally designed and built for the Apollo lunar landing program. The pads, built in the 1960s, were used for all of the Apollo/Saturn V missions and the Skylab space station program.

Between 1967 and 1975, 12 Saturn V/Apollo vehicles, one Saturn V/Skylab workshop, three Saturn 1B/Apollo vehicles for Skylab crews, and one Saturn 1B/Apollo for the joint U.S.-U.S.S.R. Apollo Soyuz Test Project, were launched from these pads.

Each of the dual launch pads, designated Pads A and B, covers an area of about one-quarter of a square mile. Located not far from the Atlantic Ocean, Pad A is 48 ft. above sea level, while Pad B is 55 ft. above sea level. They are octagonal in shape.

To accommodate the Space Shuttle vehicle, major modifications to the pads were necessary. Initially, Pad A modifications were completed in mid-1978, while Pad B was finished in 1985 and first used for the ill-fated STS 51-L mission in January 1986.

Major pad modifications included construction of new hypergolic fuel and oxidizer support areas at the southwest and southeast corners of the pads; construction of new Fixed Service Structures (FSS); addition of a Rotating Service Structure (RSS); addition of 300,000-gallon water towers and associated plumbing; and, finally, replacement of the original flame deflectors with Shuttle-compatible deflectors.

Following the flight schedule delays resulting from the STS 51-L accident, an additional 105 pad modifications were made. Among them were installation of a sophisticated laser parking system on the Mobile Launch Platform (MLP) to facilitate mounting the Shuttle on the pad, and emergency escape system modifications to provide emergency egress for up to 21 people.

The emergency shelter bunker also was modified to allow easier access from the slidewire baskets.

FIXED SERVICE STRUCTURE. A Fixed Service Structure (FSS), is located on the west side of each pad. It is a square, steel tower which provides access to the orbiter and the Rotating Service Structure (RSS). It is an open framework structure about 40 feet square and, as its name implies, it is fixed permanently to the launch pad.

The FSS tower supports the hinge about which the rotary bridge supporting the RSS pivots as it moves between the orbiter checkout position and the retracted position. A hammerhead crane on the FSS provides hoisting capabilities as needed for pad operations. The FSS is 247 ft. high, and the crane is 265 ft. above the surface of the launch pad. Mounted on top of the FSS is a lightning mast (described later) which is 347 ft. above the pad surface.

Work platforms on the FSS are located at 20-ft. intervals starting at 27 ft. above the pad surface. The FSS has three service arms. These are the orbiter access arm, the external tank hydrogen vent line and access arm and the external tank gaseous oxygen vent arm.

Orbiter Access Arm. The Orbiter Access Arm (OAA) swings out to the orbiter crew hatch allowing access to the orbiter crew area. At the end of the arm is the environmentally-controlled chamber called the "White Room" which abuts against the orbiter hatch. It can hold up to six people. It is here that the astronaut flight crew is assisted in entering the orbiter.

The OAA remains in its extended position until about 7 minutes before launch. This is to provide emergency egress for the crew, if required. In an emergency, it can be mechanically or manually repositioned in 15 seconds. It is extended and retracted by four

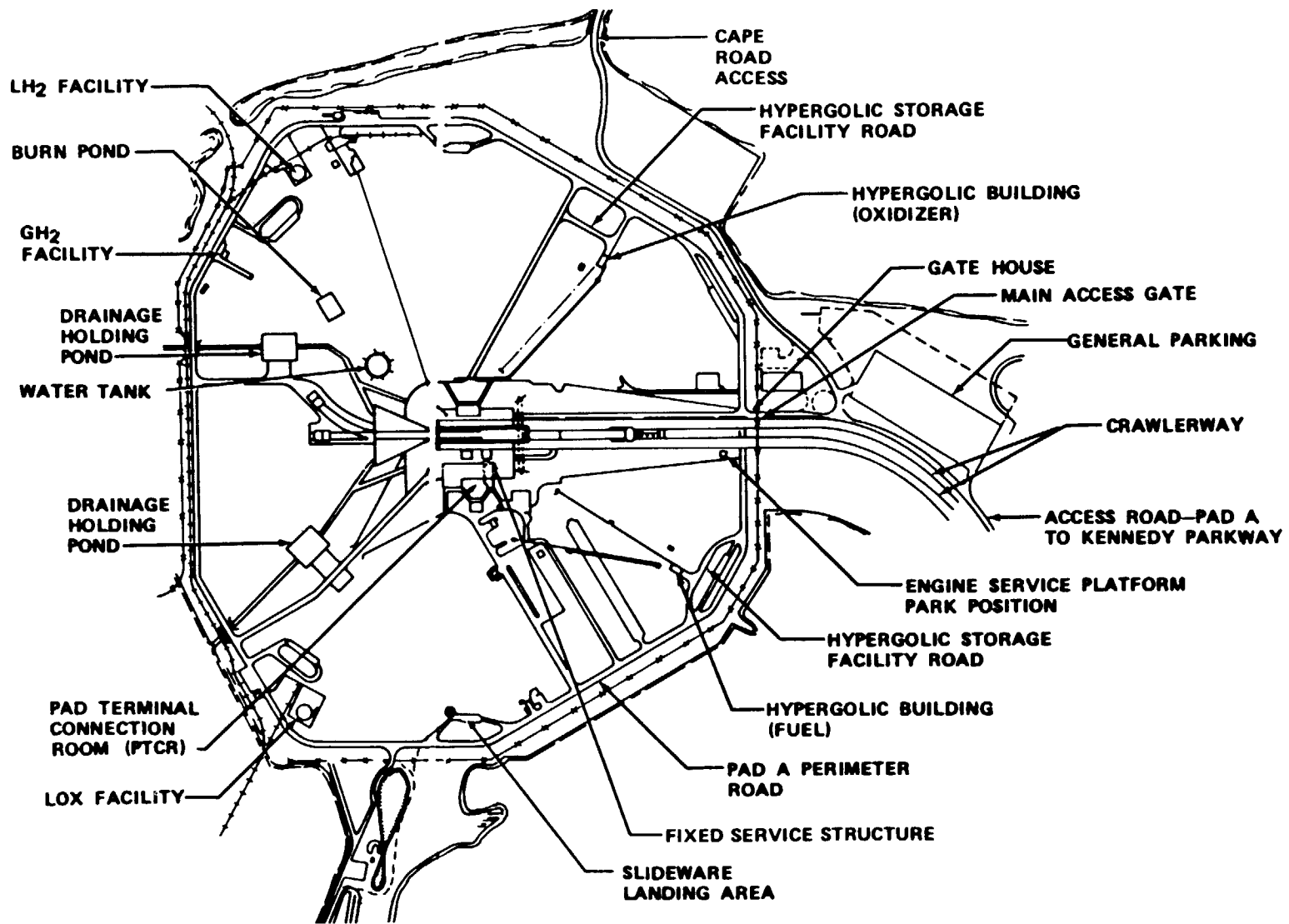

Launch Pad Facilities

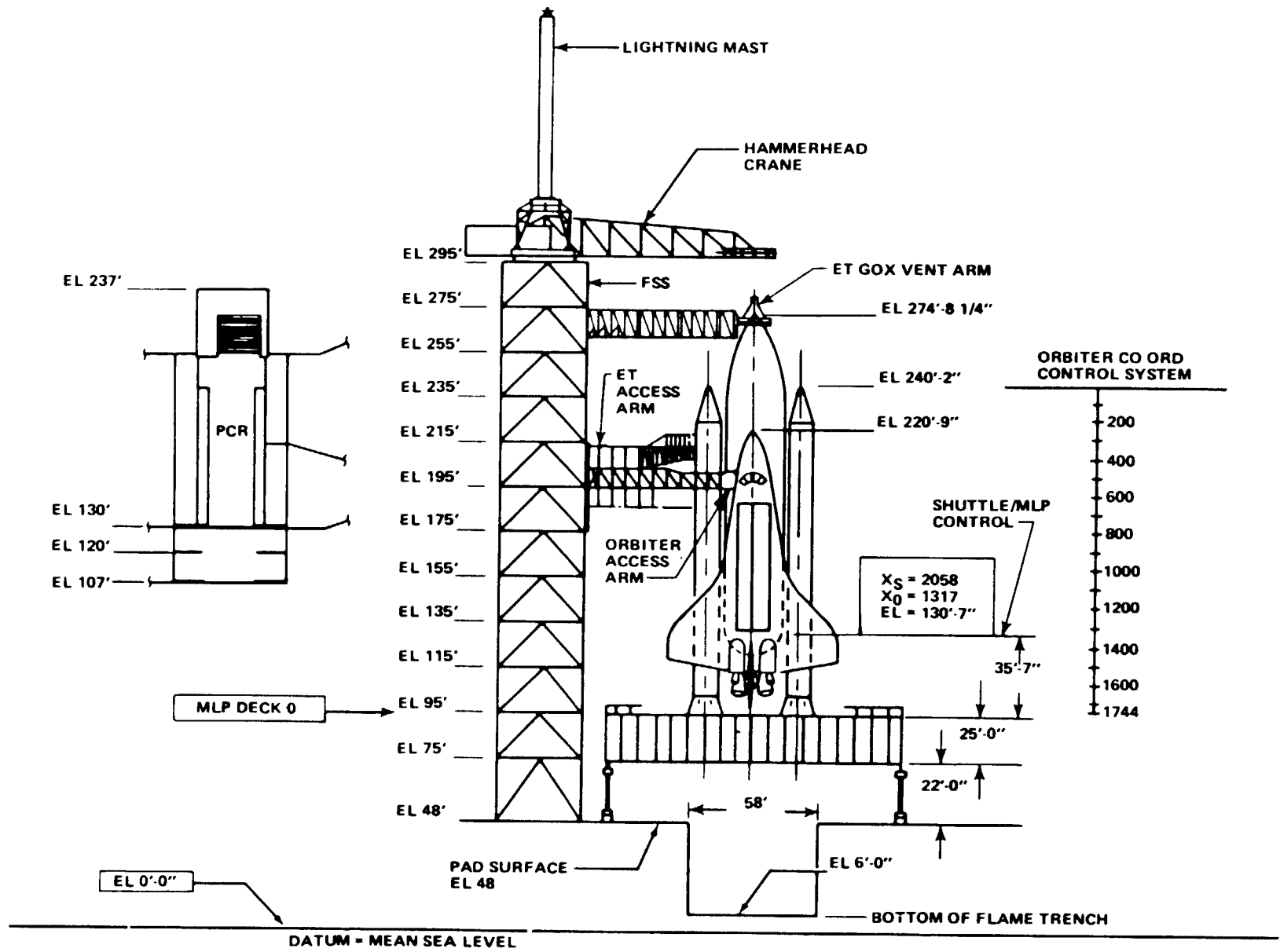

Launch Pad Elevations

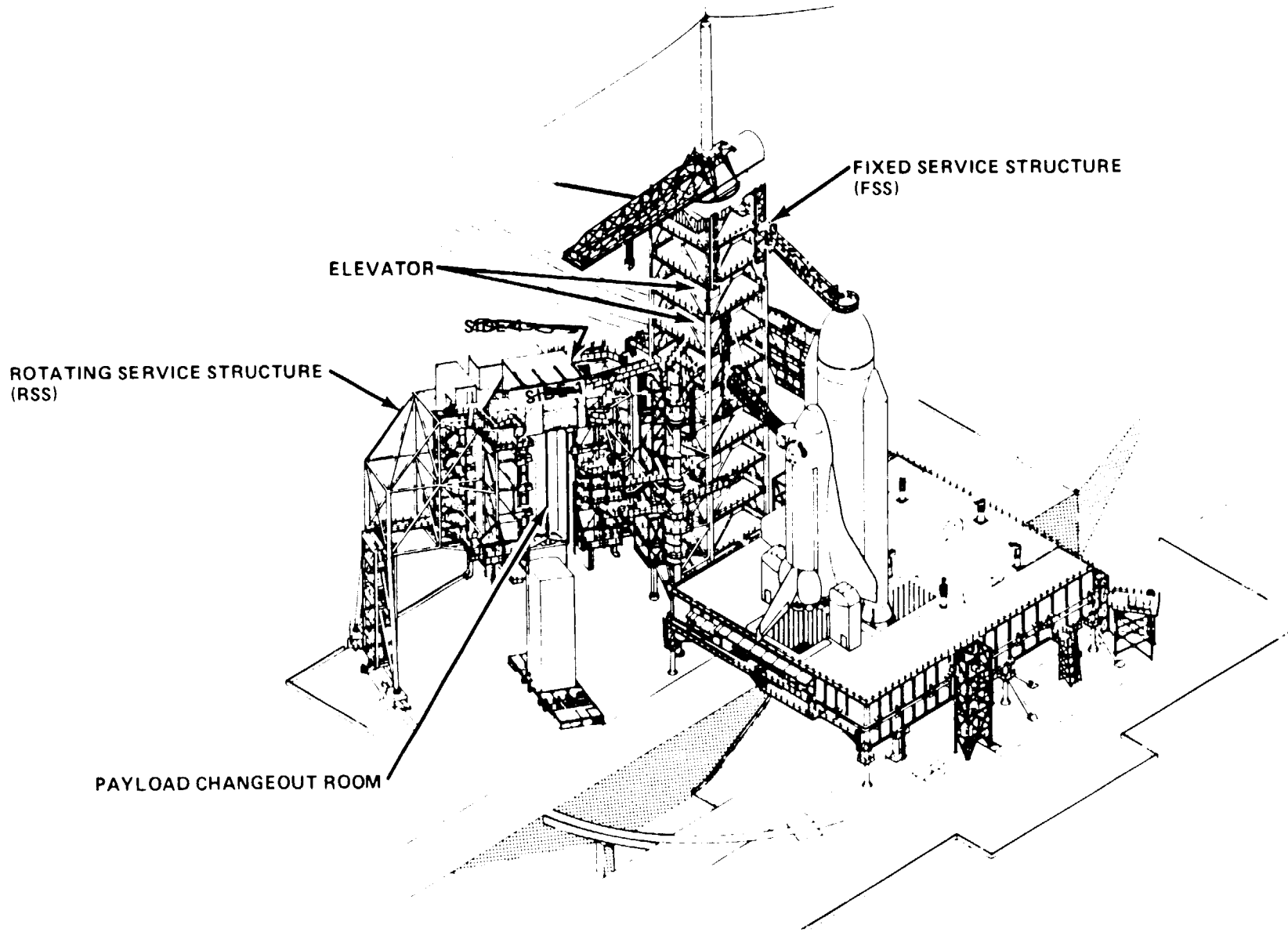

Space Shuttle on Launch Pad at Launch Complex 39

hydraulic cylinders. In its retracted position, it is latched to the FSS.

The OAA is located 147 ft. above the pad surface. It is 65 ft. long, 5 ft. wide and 8 ft. high and weighs 52,000 lb.

External Tank Hydrogen Vent Line and Access Arm.

The external tank hydrogen vent line and access arm consists of a retractable access arm and a fixed support structure. The system allows mating of the external tank umbilicals and contingency access to the tank interior, while at the same time, protecting sensitive components of the system from damage during launch.

The access arm supports small helium and nitrogen lines and electrical cables, all of which are located on an 8" diameter hydrogen vent line.

At SRB ignition, the umbilical is released from the Shuttle vehicle and retracted 33" into its latched position by a system of counterweights. The service lines rise about 18", pivot and drop to a vertical position on the fixed structure where they are protected from damage during launch. All of this activity occurs in just 2 seconds. The access arm itself rotates 120 degrees to its stowed position in approximately 3 minutes.

The fixed structure is mounted on the northeast corner of the FSS about 167 ft. above the pad surface. The access arm is 48 ft. long and weighs 15,000 lb.

External Tank Gaseous Oxygen Vent Arm. This retractable arm supports a vent hood that vacuums away liquid oxygen vapors as they boil off from the external tank. It also supports associated systems such as heated gaseous nitrogen lines, the liquid oxygen vapor ducts and electrical wiring.

Before the liquid oxygen and hydrogen are loaded, the arm is swung into position over the external tank and the vent hood is lowered into position over the liquid oxygen tank vents. Two inflatable "accordion" type seals cover the liquid oxygen vent

openings. A heated gaseous nitrogen purge of about 25 lb. per minute flows into the seal cavity, mixing with the cold liquid oxygen vapors preventing the outside from freezing.

At about 2 minutes and 30 seconds before launch, the vent hood is lifted to clear the external tank, and the arm is retracted into the "latchback" position against the FSS. In the event a countdown hold occurs after this time, the arm can be re-extended and the vent hood re-lowered onto the external tank. When the 2-minute, 30-second mark in the countdown is again reached, the arm once again is retracted.

Emergency Exit System. Also located on the FSS is the emergency exit system -- the "slidewire." This system provides an

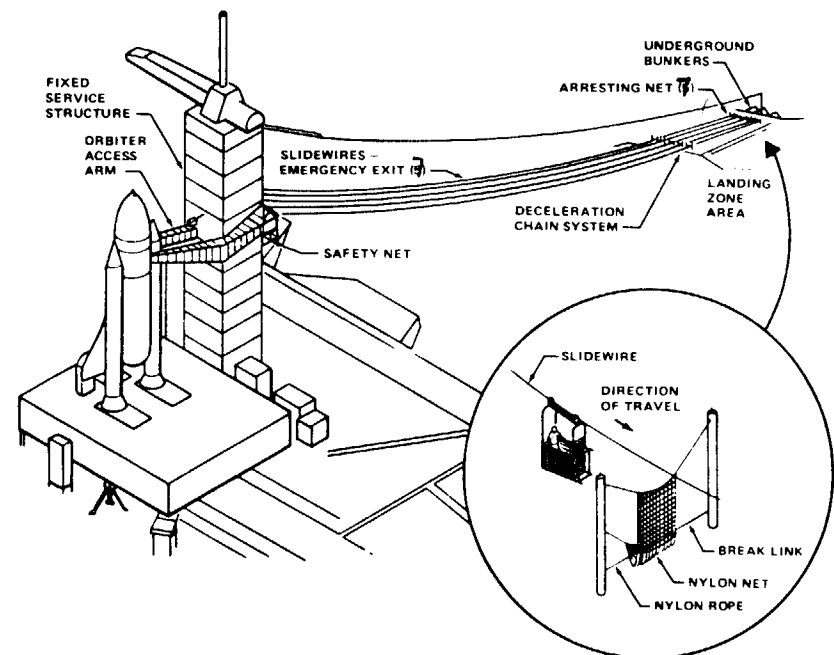

Overall View of Emergency Exit System

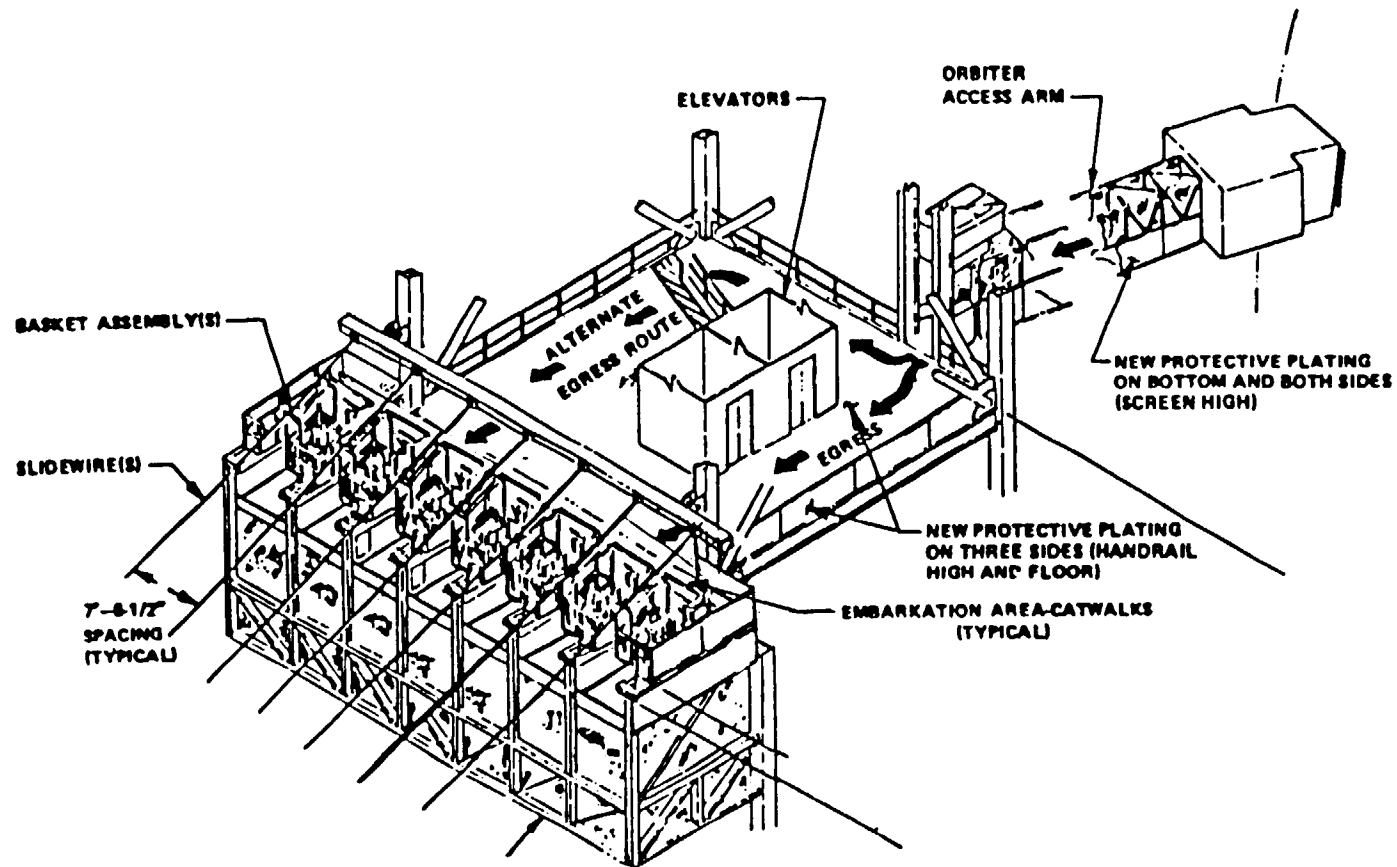

Emergency Exit System

emergency escape route for persons in the Shuttle vehicle and on the RSS until T-minus 30- seconds in the countdown. Seven slidewires extend from the orbiter access arm level to the ground on the west side of both pads.

A flatbottom basket surrounded by netting is suspended from each wire. Each basket can hold up to three persons, if necessary. When boarded, the basket quickly slides down a 1,200-ft.-long wire to the emergency shelter bunker located west of each pad. The baskets are slowed and brought to a stop at the landing zone by a

a deceleration system consisting of a breaking system catch net and drag chain.

Lightning Mast. The 80-ft.-tall lightning mast extends above the FSS to provide protection from lightning strikes. It is made of fiberglass and is grounded by a cable anchored in the ground 1,100 ft. south of the FSS and extends up and over the mast and then back down to a second ground anchor 1,100 ft. north of the FSS. The mast functions as an electrical insulator holding the cable away from the FSS and as a mechanical support in rolling contact with the cable. The cable becomes a catenary wire which provides a cone of protection for the pad and vehicle during a lightning storm. The mast support structure is 20 feet tall.

ROTATING SERVICE STRUCTURE. The Rotating Service Structure (RSS) provides access to and protects the orbiter during changeout and servicing of payloads at the launch pad

The RSS is supported by a rotating bridge which pivots about a vertical axis. It is located on the west side of each pad's flame trench. The RSS rotates 120 degrees (one-third of a circle). The hinge column sits on the pad surface and is braced to the FSS. Support for the outer end of the bridge is provided by two eight-wheel, motor-driven trucks moving along a circular twin-rail flush with the pad surface. The track crosses the flame trench on a permanent bridge.

The RSS is 102 feet long, 50 ft. wide and 130 ft. high. Its main structure extends from 59 ft. to 189 ft. above the pad floor.

The RSS has orbiter access platforms at five levels. These platforms provide closeout crew access to the payload bay while the orbiter is being serviced for launch. Each platform has independent extendable planks that can be arranged to conform to the shape and overall dimensions of a specific item of Space Shuttle

Payload Changeout Room. The Payload Changeout Room (PCR) is the enclosed, environmentally-controlled portion of the RSS which supports cargo delivery to the pad and subsequent

vertical installation into the orbiter payload bay. Seals around the mating surface of the PCR fit against the orbiter and allow the opening of the payload bay or canister doors and removal of the cargo without exposure to outside air and contaminants. A clean-air purge in the PCR maintains environmental control during PCR cargo operations. Cargo is removed from the payload canister and installed vertically in the orbiter by the Payload Ground Handling Mechanism (PGHM).

Orbiter Midbody Umbilical Unit. The Orbiter Midbody Umbilical Unit (OMBUU) provides access to and permits servicing of the mid-fuselage area of the orbiter. A sliding extension platform and a horizontally-moving line-handling mechanism provide access to the midbody umbilical door on the left side of the orbiter. Liquid oxygen and liquid hydrogen for the fuel cells and gases such as nitrogen and helium are provided through the OMBUU. Overall, the unit is 22 ft. long, 13 ft. wide and 20 ft. high. The OMBUU extends from the RSS at levels ranging from 158 ft. to 176 ft. above the pad surface.

Hypergolic Umbilical System. The hypergolic umbilical system (HUS) carries hypergolic fuel and oxidizer, helium and nitrogen service lines from the FSS to the Shuttle vehicle.

The system also provides for rapidly connecting the lines to and disconnecting them from the vehicle. Six umbilical handling units, manually operated and controlled at the pad, are attached to the RSS. The umbilical handling units consist of three pairs located to the left and right sides of the aft end of the orbiter to serve the Orbital Maneuvering Subsystem (OMS) and Reaction Control System (RCS), the payload bay, and the nose area of the orbiter.

The and the HUS connections with the orbiter are severed when the RSS is returned to its park site position before launch.

OMS Pod Heaters. The OMS pods are made of an epoxy material that absorbs moisture from the humid Central Florida subtropical climate. Two large clamshell-like enclosures located at

the base of the RSS completely surround the OMS pods when the RSS is in position around the orbiter. These enclosures are purged with heated air which absorbs the excess moisture.

SOUND SUPPRESSION WATER SYSTEM. The Sound Suppression Water System is designed to protect the orbiter and its payloads from damage by acoustical energy --tremendous sounds -- reflected from the Mobile Launcher Platform when launch occurs.

The system includes the 290-ft. high water storage tanks adjacent to each launch pad containing 300,000 gallons of water. The water is released just before ignition of the Shuttle's engines. Water pours from 16 nozzles on top of the flame deflectors as well as from outlets in the main engine exhaust hole in the MLP, starting at T-6.6 seconds. When the SRBs are ignited at T-O, a massive torrent of water floods onto the MLP from six large "quench" nozzles or "rainbirds" mounted on its surface.

In addition, water also is sprayed into the primary SRB exhaust holes providing overpressure protection to the Shuttle when the SRBs ignite. Nine seconds after liftoff the peak water flow takes place.

The MLP "rainbirds" are 12 ft. high. The center two are 42 in. in diameter while the other four have a 30 in. diameter. Acoustical levels peak when the Shuttle is about 300 ft. above the MLP.

Design specifications for the Space Shuttle allow withstanding acoustical loads of up to 145 decibels. The sound suppression water system cuts the acoustical level to 142 dB -- three dB below the design requirement.

SRB IGNITION OVERPRESSURE SUPPRESSION SYSTEM. The SRB Ignition Overpressure Suppression System purpose is to help alleviate the effect of the initial reflected pressure pulse when the SRBs ignite. Without the system, the pulse would exert pressure on the Shuttle's wings and ailerons close to their design limits cause damage to the heat shield tiles. The system was

installed after potentially damaging overpressures were noted during the first Shuttle launch in April 1981. The system reduced the overall pulse pressures by two-thirds.

The suppression system consists of two components. The first is a water spray system fed from large headers which provides a cushion of water directed down into and around the primary flame holes. This system is augmented by water bags in the primary and secondary flame holes which provide a mass of water to dampen the "blowback" pressure pulse from the engines.

MAIN ENGINE HYDROGEN BURNOFF SYSTEM. Hydrogen vapors which occur during the main engine start sequence are exhausted into the engine nozzles just before ignition resulting in a hydrogen-rich atmosphere in the engine bells, which could explode and damage the engine bells. To prevent this, six hydrogen burnoff pre-igniters were installed in the tail service mast. Just before main engine ignition they are activated, igniting the free hydrogen in the the engine nozzles. This precludes what is called "rough combustion" when the main engines ignite.

PAD SURFACE FLAME DEFLECTORS. The pad surface flame deflectors protect the flame trench floor and the pad surface from the intense heat which occurs at launch. The flame trench is 490 ft. long, 58 ft. wide and 40 ft. high.

The system includes the main engine or orbiter flame deflector which is 38 ft. high, 57.6 ft. wide and weighs 1.3 million lb. The SRB flame deflector abuts the orbiter flame deflector to form a flat, inverted V-shaped structure beneath the MLP's three exhaust holes. This deflector is 42.5 ft. high, 42 ft. long and weighs 1.1 million lb. Both deflectors are made of steel and are covered with a temperature-resistant concrete surface about 5 in. thick.

There also are two movable flame deflectors located on each side of the flame trench. They are 19.5 ft. high, 44 ft. long and 17.5 ft. long.

PROPELLANT STORAGE AND DISTRIBUTION.

Propellant servicing of the Space Shuttle's reaction control systems, the booster auxiliary power units and the external tank is performed at the launch pad. Fuel lines lead from various propellant storage facilities to the pad structure and umbilical connections. These facilities include the liquid oxygen and liquid hydrogen and the hypergolic storage and distribution facilities.

Liquid oxygen, the Shuttle's main engine oxidizer, is stored in a 900,000-gallon storage tank located in the northwest corner of each launch pad. These ball-shaped vessels are actually huge vacuum bottles called Dewar bottles which store the liquid oxygen at a temperature of minus 297 degrees F.

Liquid hydrogen is stored in 850,000-gallon storage tanks located in the northwest corner of each launch pad. These tanks also are enormous vacuum bottles able to store the liquid at temperatures below minus 423 degrees F. Liquid hydrogen is an extremely light weight super-cold liquid -- a gallon weighs about a half pound. Because of the liquid's light weight, pumps are not needed to transfer the propellant to the pad. Instead, vaporizers convert a small portion of the tanks liquid hydrogen into gas and it is the gas pressure exerted from the top of the tank that moves the liquid into the transfer lines to the pad. Vacuum-jacketed transfer lines permit the hydrogen to flow into the orbiter through the Tail Service Masts.

The orbiter's Orbital Maneuvering Subsystem (OMS) and Reaction Control System (RCS) engines use monomethyl hydrazine as fuel and nitrogen tetroxide as the oxidizer. These toxic fluids can be stored at ambient temperatures. Being hypergolic they ignite on contact with each other. Therefore, they are stored in well-separated locations, at the southwest and southeast corners of the pads.

These propellants are fed by transfer lines to the pad and through the FSS to the RSS Hypergolic Umbilical System with its three pairs of umbilicals attached to the orbiter.

LAUNCH PAD/LAUNCH PROCESSING SYSTEM INTERFACE. The vital links between the Launch Processing System in the Launch Control Center (LCC), the ground support equipment and the Shuttle's flight hardware at the pad are provided by elements located in the Pad Terminal Connection Room (PTCR) below the pad's elevated hardstand.

All pad Launch Processing System terminals--called Hardware Interface Modules--interface with the Central Data Subsystem in the LCC.

LAUNCH EQUIPMENT TEST FACILITY. The Launch Equipment Test Facility (LETf) is located in the KSC Industrial Area, south of the Operations and Checkout Building. It is here that extensive tests of launch-critical ground systems and equipment are conducted. Failure of any of these systems could cause serious consequences during launch.

The LETf can simulate launch events as such vehicle movement due to wind, orbiter engine ignition and liftoff and the effects of solar heating and cryogenic shrinkage. The ability of the ground systems to react properly to these events must be verified before committing the Shuttle to launch.

Examples of the systems tested at the facility include the external tank vent line, the external tank oxygen vent arm, the orbiter's access arm and the rolling beam umbilical system -- all are located in the FSS.

The FSS also tests the Mobile Launcher Platform structures such as the tail service masts and SRB holddown posts.

The test facilities include an SRB holddown test stand, a tower simulator, an orbiter access arm random motion simulator, an external tank oxygen vent system simulator, a tail service mast/external tank hydrogen vent line and a random motion and liftoff simulator. Tests in the facility are monitored in a control building on the west side of the LETf complex.

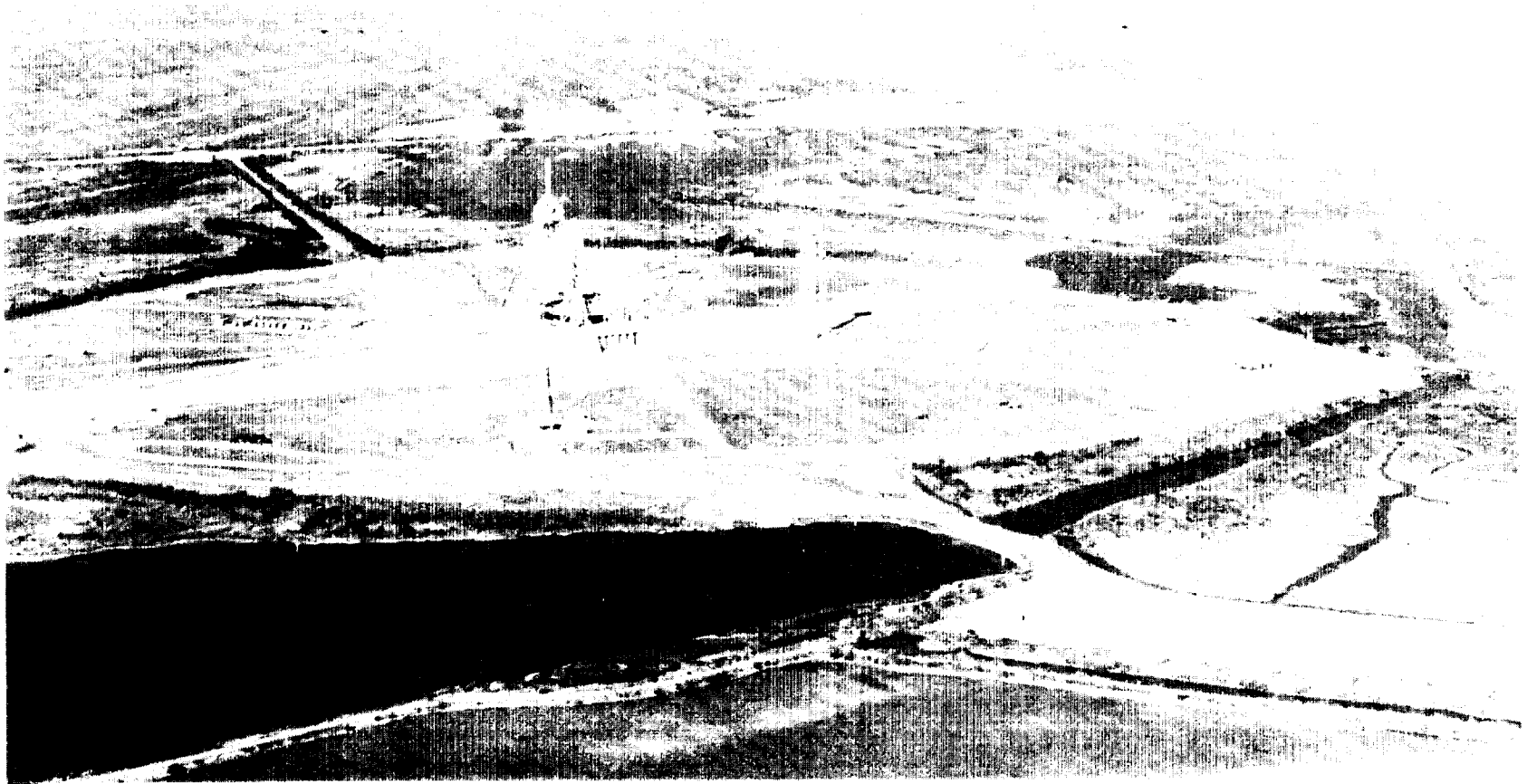

ORIGINAL PAGE IS
OF POOR QUALITY

The LETF test equipment was moved to KSC from NASA's Marshall Space Flight Center (MSFC) where many of its components were originally used for similar purposes during the Apollo program.

Aerial View Looking North of Launch Pads 39-A (near) and 39-B (far) at Launch Complex 39. Atlantic Ocean Is on the Right.

SPACE SHUTTLE CARGO PROCESSING

A wide variety of cargoes -- some deployed from the Shuttle, others carried into space and returned at the end of the mission are delivered to KSC where they undergo final processing, checkout and installation in the orbiter's payload bay.

Space Shuttle cargo processing is performed in parallel with vehicle processing so fully-integrated and tested payloads are ready for orbiter installation at the appropriate time to meet launch schedules.

In order to assure an efficient Shuttle turnaround flow, a simulated orbiter-to-cargo interface verification of the entire cargo is performed before it is installed in the orbiter.

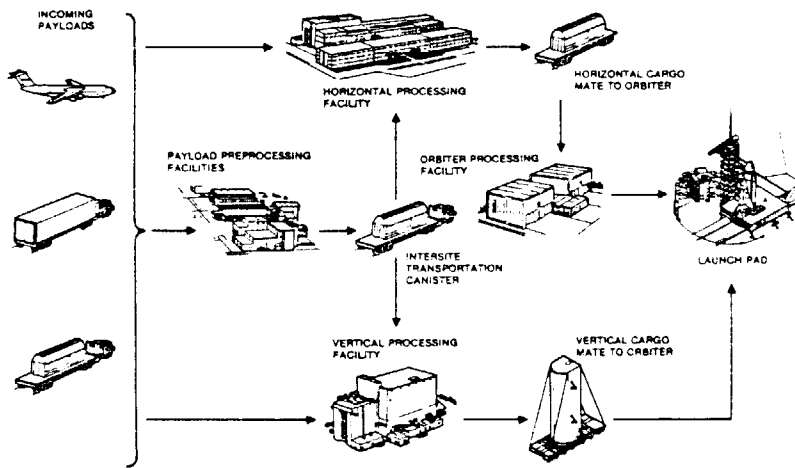

Space Shuttle Payload Operations

Payloads follow one of two functional flows: 1) those that are installed horizontally into the payload bay at the Orbiter Processing

Facility (OPF), and 2) those that are installed vertically into the payload bay at the launch pad.

MULTI-USE MISSION SUPPORT EQUIPMENT. Payload processing is facilitated by special payload handling equipment and devices called the Multi-Use Mission Support Equipment (MMSE). MMSE consists of the Payload Canister, the Payload Canister Transporter, the Payload Strongback and the Payload Handling Fixture.

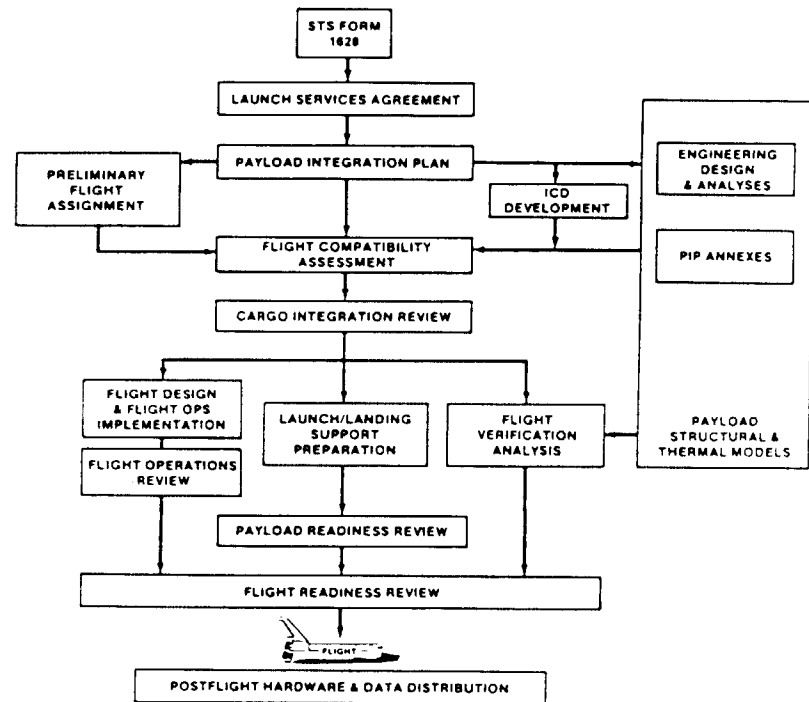

Cargo Integration Process

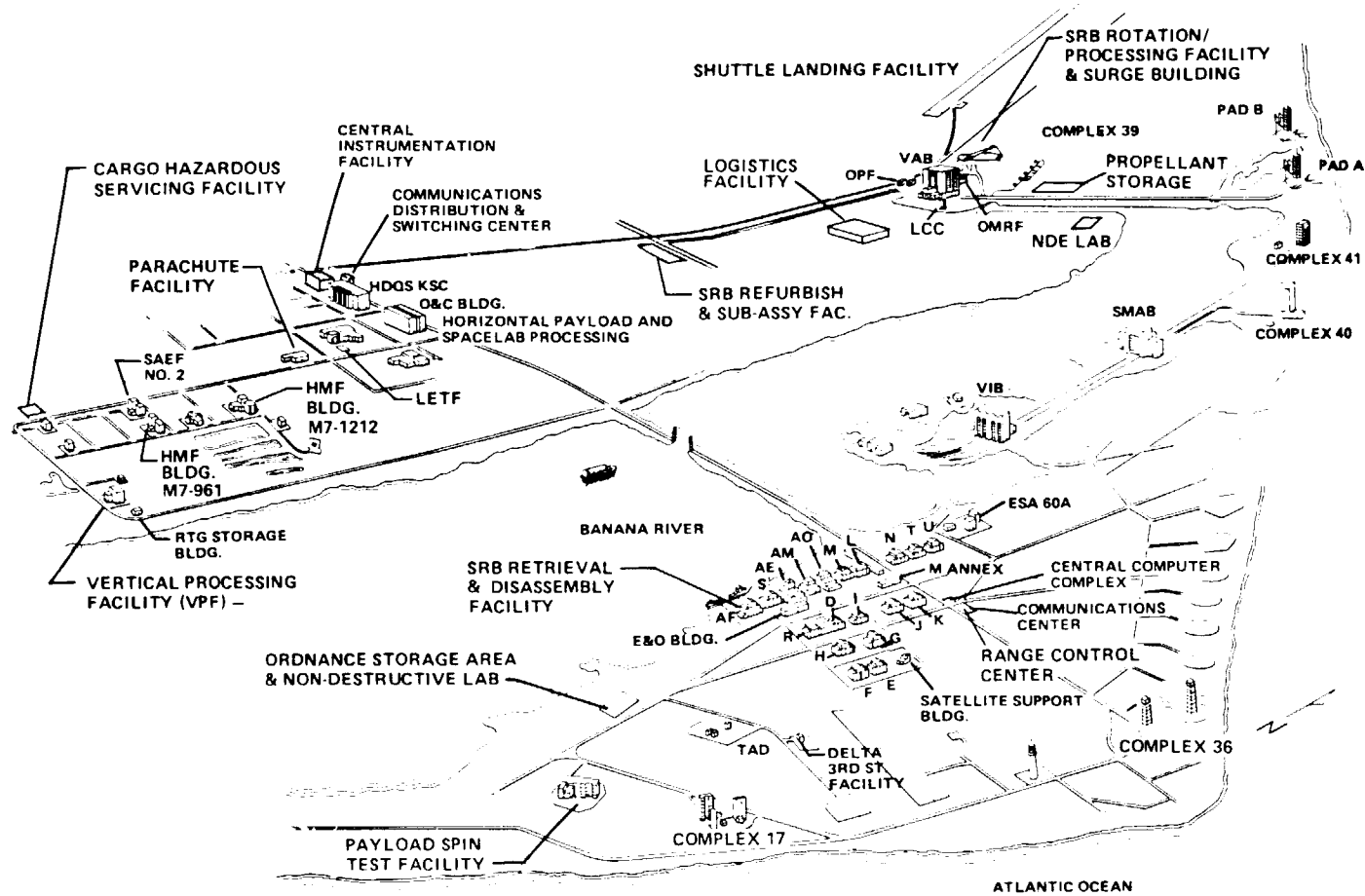

Space Shuttle Cargo Processing Facilities at Kennedy Space Center

The Payload Canister is a large, environmentally-controlled cargo container in which fully-integrated Shuttle payloads are transported from the Vertical Processing Facility (VPF) to the Payload Changeout Room at the launch pad, the Shuttle Payload Integration Facility (SPIF) or from the Operations and Checkout (O&C) Building to the OPF.

There are two Payload Canisters at KSC. They are 65 ft. long, 18 ft., 7 in. wide. The canisters can hold vertically or horizontally processed payloads of up to 15 ft. in diameter and 60 ft. in length - matching the cargo-carrying capacity of the orbiter's payload bay. They can hold payloads weighing up to 65,000 lb. and are

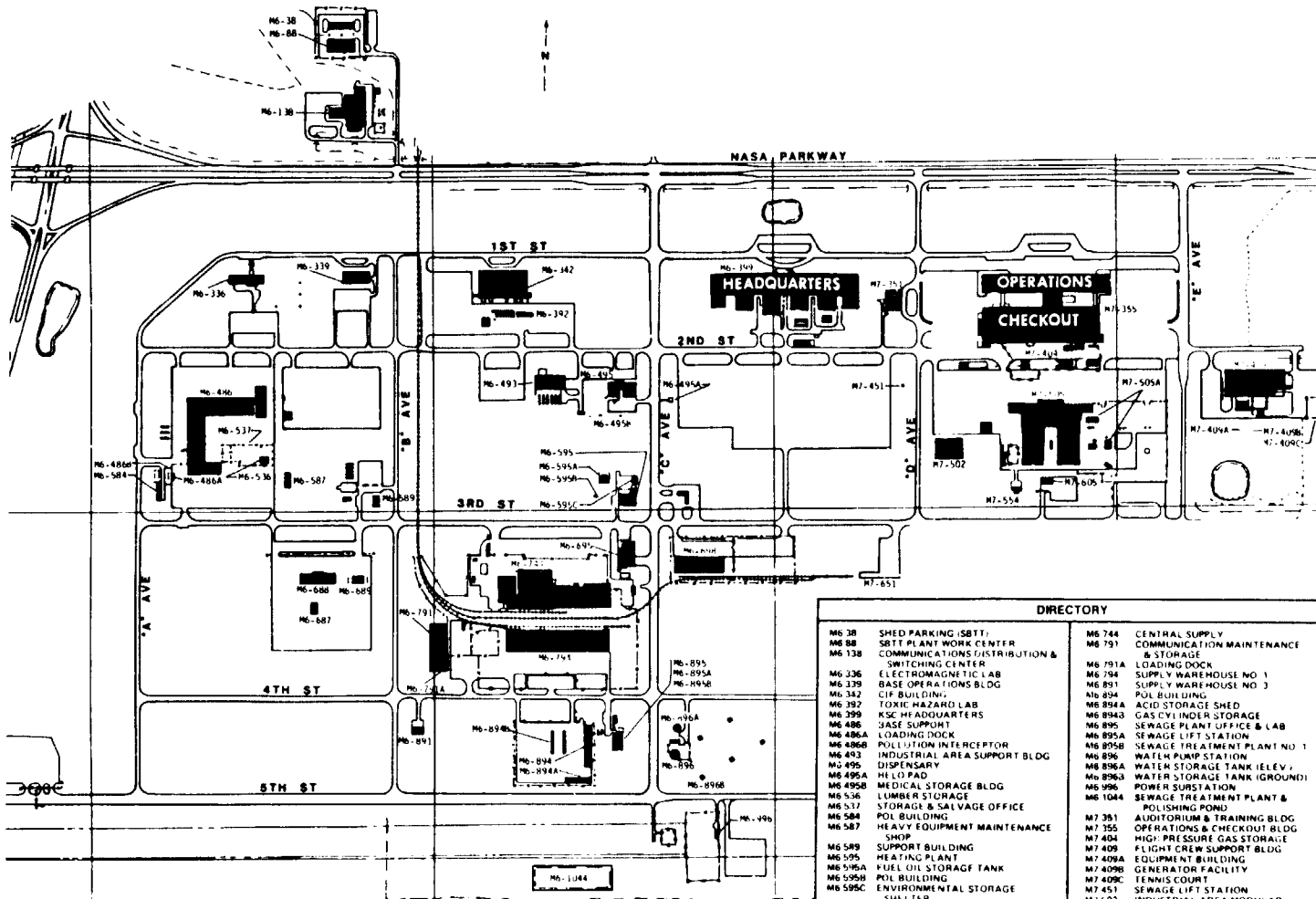

KSC INDUSTRIAL AREA

DIRECTORY			
M6 38	SHED PARKING (SBTT)	M6 744	CENTRAL SUPPLY
M6 88	SBTT PLANT WORK CENTER	M6 791	COMMUNICATION MAINTENANCE & STORAGE
M6 138	COMMUNICATIONS DISTRIBUTION & SWITCHING CENTER	M6 791A	LOADING DOCK
M6 336	ELECTROMAGNETIC LAB	M6 794	SUPPLY WAREHOUSE NO 1
M6 339	BASE OPERATIONS BLDG	M6 891	SUPPLY WAREHOUSE NO 3
M6 382	CIP BUILDING	M6 894	POL BUILDING
M6 392	TOXIC HAZARD LAB	M6 894A	ACID STORAGE SHED
M6 399	KSC HEADQUARTERS	M6 894B	GAS CYLINDER STORAGE
M6 486	JASE SUPPORT	M6 895	SEWAGE PLANT OFFICE & LAB
M6 486A	LOADING DOCK	M6 895A	SEWAGE LIFT STATION
M6 486B	POLLUTION INTERCEPTOR	M6 895B	SEWAGE TREATMENT PLANT NO 1
M6 493	INDUSTRIAL AREA SUPPORT BLDG	M6 896	WATER PUMP STATION
M6 495	DISPENSARY	M6 896A	WATER STORAGE TANK (ELEV.)
M6 495A	HELIPAD	M6 896B	WATER STORAGE TANK (GROUND)
M6 495B	MEDICAL STORAGE BLDG	M6 896C	POWER SUBSTATION
M6 536	LUMBER STORAGE	M6 1044	SEWAGE TREATMENT PLANT & POLISHING POND
M6 537	STORAGE & SALVAGE OFFICE	M7 351	AUDITORIUM & TRAINING BLDG
M6 584	POL BUILDING	M7 355	OPERATIONS & CHECKOUT BLDG
M6 587	HEAVY EQUIPMENT MAINTENANCE	M7 404	HIGH PRESSURE GAS STORAGE
M6 589	SHOP	M7 409	FLIGHT CREW SUPPORT BLDG
M6 595	SUPPORT BUILDING	M7 409A	EQUIPMENT BUILDING
M6 595A	HEATING PLANT	M7 409B	GENERATOR FACILITY
M6 595B	FUEL OIL STORAGE TANK	M7 409C	TENNIS COURT
M6 595C	POL BUILDING	M7 451	SEWAGE LIFT STATION
M6 595C	ENVIRONMENTAL STORAGE	M7 502	INDUSTRIAL AREA MODULAR OFF BLDG
M6 687	AUTOMOTIVE MAINTENANCE & SERVICE NO 1	M7 505	SUPPLY SHIPPING & RECEIVING NO 1
M6 688	AUTOMOTIVE MAINTENANCE & SERVICE NO 2	M7 505A	LAUNCH EQUIPMENT TEST FACILITY
M6 689	FUELING FACILITY	M7 554	OPERATIONS POL BUILDING
M6 695	FIRE STATION	M7 605	CONTRACTOR SUPPORT BLDG NO 3
M6 696	SUPPLY WAREHOUSE NO 2		

Kennedy Space Center Industrial Area

OFFICE OF THE DIRECTOR
 KENNEDY SPACE CENTER
 WASHINGTON, D.C. 20546

ORIGINATOR'S NAME IS OF POOR QUALITY

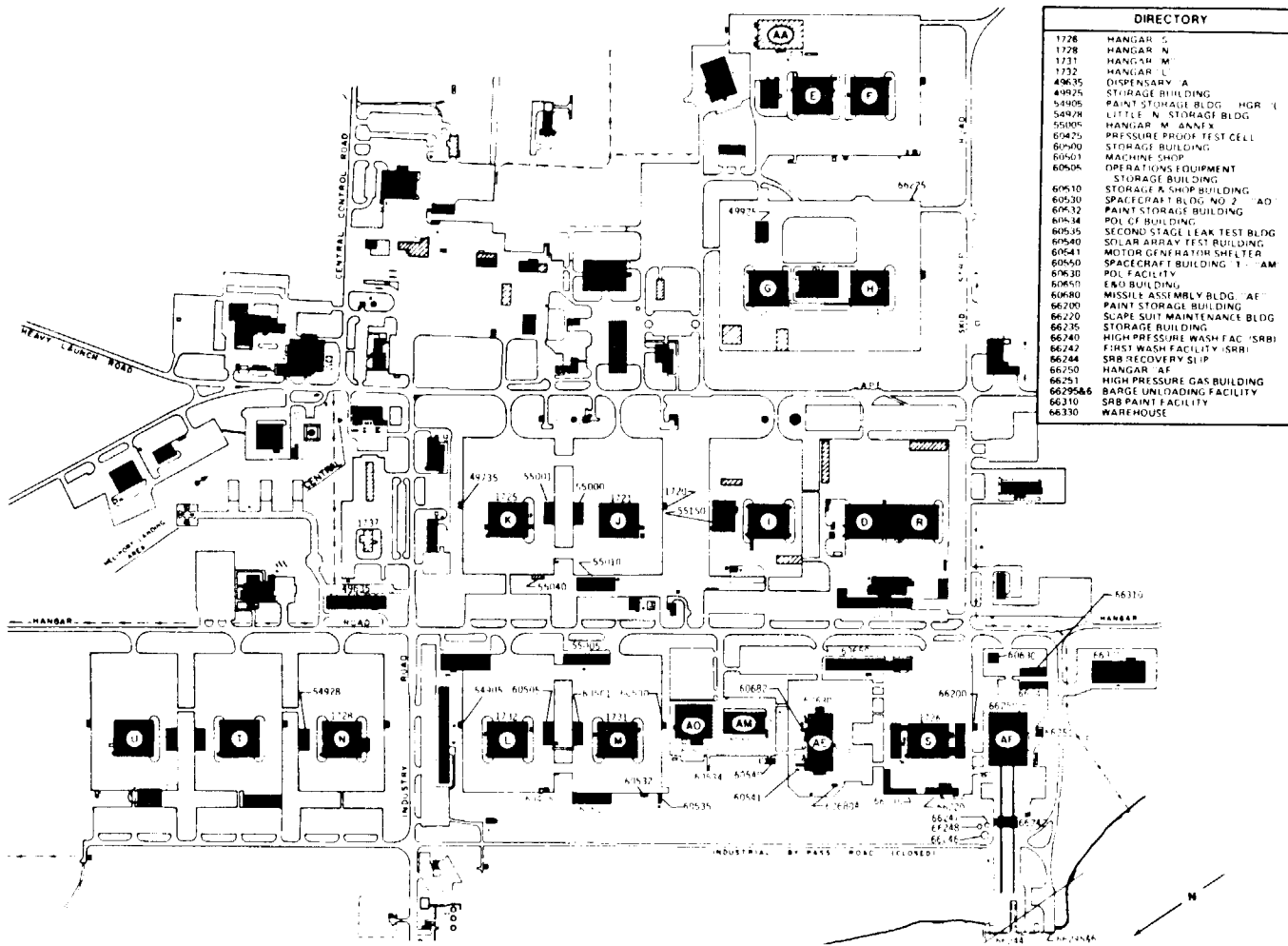

DIRECTORY	
1728	HANGAR S
1728	HANGAR N
1731	HANGAR M
1732	HANGAR L
49635	DISPENSARY A
49925	STORAGE BUILDING
54905	PAINT STORAGE BLDG HGR 1
54928	LITTLE N STORAGE BLDG
55005	HANGAR M ANNEX
60425	PRESSURE PROOF TEST CELL
60900	STORAGE BUILDING
60501	MACHINE SHOP
60504	OPERATIONS EQUIPMENT STORAGE BUILDING
60510	STORAGE K SHOP BUILDING
60530	SPACECRAFT BLDG NO 2 AD
60532	PAINT STORAGE BUILDING
60534	POL CE BUILDING
60535	SECOND STAGE LEAK TEST BLDG
60540	SOLAR ARRAY TEST BUILDING
60541	MOTOR GENERATOR SHELTER
60550	SPACECRAFT BUILDING T-AM
60630	POL FACILITY
60650	ERO BUILDING
60680	MISSILE ASSEMBLY BLDG AF
66200	PAINT STORAGE BUILDING
66220	SLAPE SUIT MAINTENANCE BLDG
66235	STORAGE BUILDING
66240	HIGH PRESSURE WASH FAC (SRB)
66242	FIRST WASH FACILITY (SRB)
66244	SRB RECOVERY SLIP
66250	HANGAR AF
66251	HIGH PRESSURE GAS BUILDING
66295&6	BARGE UNLOADING FACILITY
66310	SRB PAINT FACILITY
66330	WAREHOUSE

Cape Canaveral Air Force Station Industrial Area

supported the same way as they are in the payload bay -- by trunnion and keel supports. Their clamshell-shaped doors are the same size as those on the orbiter.

Equally unique are the two vehicles used to move payload canisters -- the Payload Canister Transporters. They are self-propelled and have 48 wheels, each of which is independently steerable, allowing movement forward, back, sideways or around. They are 65 ft. long and 23 ft. wide. They weigh 140,000 lb. empty. Fully loaded they have a gross weight of 170,500 lb. Their flatbeds can be raised and lowered from 5 to 7 ft. as needed. Their top speed, unloaded is 16. Loaded they have a top speed of 5 mil. an hr. In what is called their "creep mode" they can slow down to a quarter of an inch per second, which is 0.0142 mil. an hr. They can carry the Payload Canister in either a horizontal or vertical position.

The Payload Strongback supports horizontally processed payload sections and postflight payload and airborne support equipment (ASE) removal. It consists of a rigid steel frame with adjustable beams, brackets and clamps designed to prevent bending or twisting of payload elements. Overall, it is 60 ft. long, 16 ft. wide and 9 ft. high weighing 40,000 lb.

The fourth key element of the MMSE is the Payload Handling Fixture. It is designed to handle Shuttle payloads at the contingency landing sites and can be airlifted by Air Force C-5A aircraft.

VERTICAL CARGO PROCESSING FACILITIES.

Automated, communications satellites, free-flyer pallets and small self-contained payloads (Getaway Specials), including upper stages, are received and processed at NASA facilities at the Cape Canaveral Air Force Station (CCAFS).

Larger Shuttle payloads such as the Tracking and Data Relay Satellite (TDRS), Spacelab and the Hubble Space Telescope are received and prepared for launch in the KSC Industrial Area located on Merritt Island across the Banana River from CCAFS.

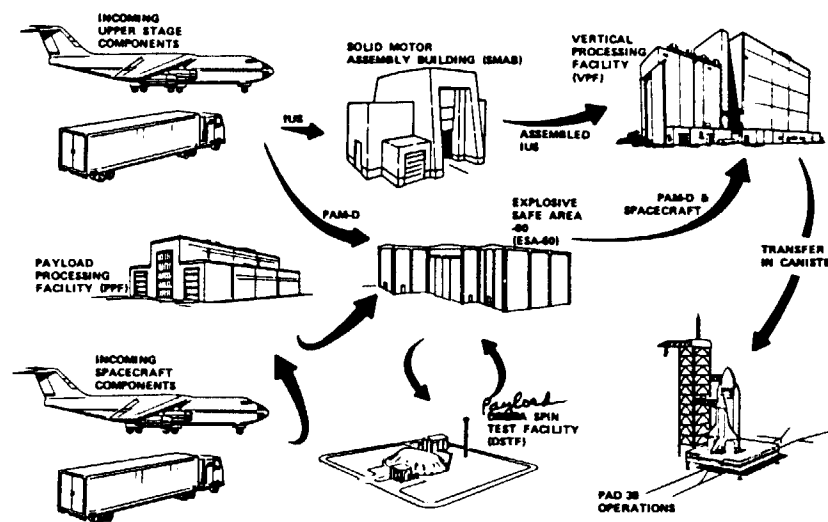

Vertical Payload Processing Flow

Major facilities used by NASA at CCAFS to process deployable payloads include Buildings AE, AO, AM and Hangar S. These facilities have been used since the early days of the U.S. space program. In fact, Hangar S dates back to the Mercury program. It is now used to prepare free-flyer pallets. Buildings AE, AO and AM contain high bay areas where large automated spacecraft are processed. In other facilities at CCAFS, small self-contained payloads are processed at the modified Delta Third Stage Facility building.

Upper stages for geosynchronous satellites, such as the Payload Assist Module (PAM), are received and integrated in a facility called the Explosive Safe Area 60A.

After the upper stage and the spacecraft have been mated, they are moved to the Vertical Processing Facility (VPF) in the KSC Industrial Area for integrated testing. Those payloads that use the

Delta-class spin-stabilized upper stages undergo checkout at the Payload Spin Test Facility.

Processing the Air Force's Inertial Upper Stage (IUS) takes place at the Solid Motor Assembly Building (SMAB) at the Titan III Complex at CCAFS. The IUS and its payloads are mated at the VPF.

All vertically-processed payloads are integrated in the VPF in the KSC Industrial Area. This large facility has an environmentally-controlled high bay and airlock containing 10,153 square ft. of floor space. It is 105 ft. high. Payloads are brought to the high bay through a 71 ft. high, 38 ft.-wide door.

The VPF has two payload workstands each with six fixed platforms. They are serviced by a 2-ton hoist. Two bridge-type cranes -- one with a 25-ton capacity and the other 12 tons -- can be linked to provide a single lift capability of up to 35 tons, if required. Also available is a 10-ton-capacity monorail crane in the airlock. Other KSC vertical payload checkout facilities include:

***Spacecraft Assembly and Encapsulation Facility** used to assemble, test, encapsulate and sterilize heavy payloads. Located in the Industrial Area, it has a high bay, two low bays, an airlock, a test cell, a sterilization oven, a control room, as well as administrative offices and mechanical support rooms. The facility was built originally for prelaunch processing of Viking and Voyager planetary mission spacecraft.

***Radioisotope Thermoelectric Generator Storage Building.** Located in a remote area of the Industrial Area, radioisotope thermoelectric generators used for spacecraft power-generating systems are stored before they are installed in the spacecraft prior to launch.

***Cargo Hazardous Servicing Facility.** A relatively new building where hazardous fuel loading and ordinance servicing takes place. The building is 120 ft. high, 200 ft. long and contains 6,000 square ft. of floor work space. It can accommodate the

largest vertical or horizontally loaded spacecraft, including the Payload Canister. It has two complete spacecraft checkout and communications ground stations, an airlock, large rolling doors and two overhead cranes with 15- and 50-ton lifting capabilities. The facility also includes a separate Control Building to monitor payload servicing operations.

***Payload Changeout Room.** The PCR attached to the Rotating Service Structure at the launch pad is an environmentally-controlled facility where Shuttle cargo is delivered and vertically installed in the payload bay. Seals around the mating surface of the room inflate, allowing the orbiter's payload bay doors to open for installation of the payload without exposure to outside contamination. A clean air purge in the room maintains the necessary environmental control. Cargo is taken from the Payload Canister and installed vertically in the orbiter using the Payload Ground Handling Mechanism (PGHM). Access is provided by fixed and extensible work platforms.

VERTICAL CARGO PROCESSING OPERATIONS. Processing, testing and integrating vertically-installed payloads is carried out in the VPF under controlled-environment conditions. Processing varies depending on the type of upper stage involved. For example, a spacecraft already mated to a PAM-D is placed directly on one of two workstands after its removal from the Transporter Canister. Those payloads using the IUS upper stage are mated together at the VPF.

No matter where the upper stages are mated to their spacecraft, the entire cargo is assembled on a single workstand where checkout is accomplished by Cargo Integration Test Equipment (CITE), a process that begins with power activation. The overall procedure includes numerous functional tests, computer and communications interface checks and tests of the command and monitor functions.

The last major VPF activity is the Payload Interface Verification Test. This involves verifying payload/cargo mechanical and functional connections are compatible with the orbiter. When this is assured, the cargo is placed in the Payload Canister and taken to

the Payload Changeout Room at the launch pad and installed in the orbiter.

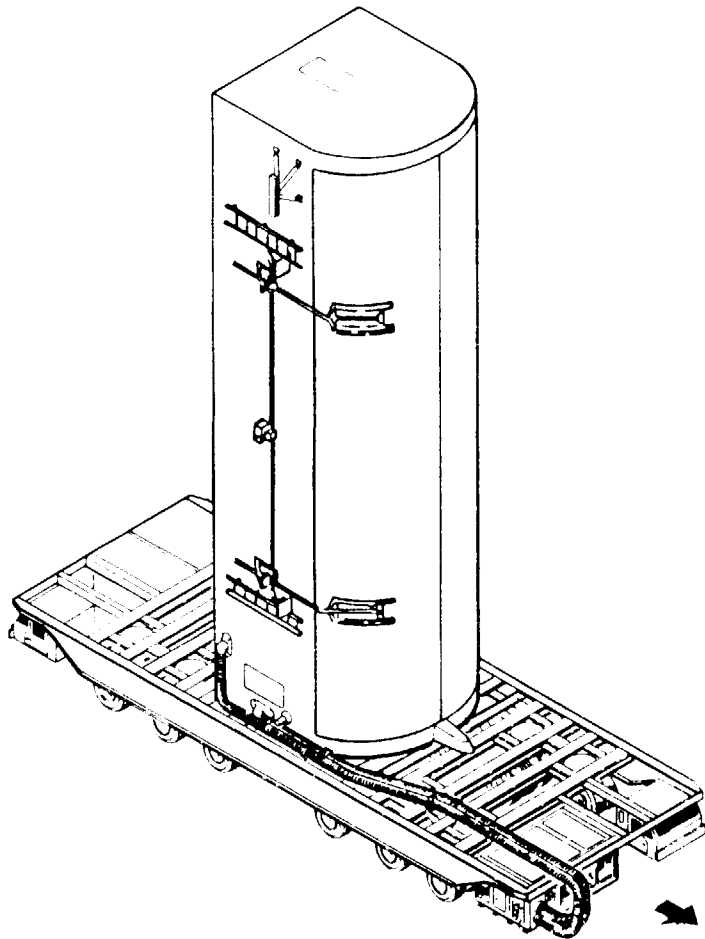

Payload Canister with Transporter in Vertical Mode

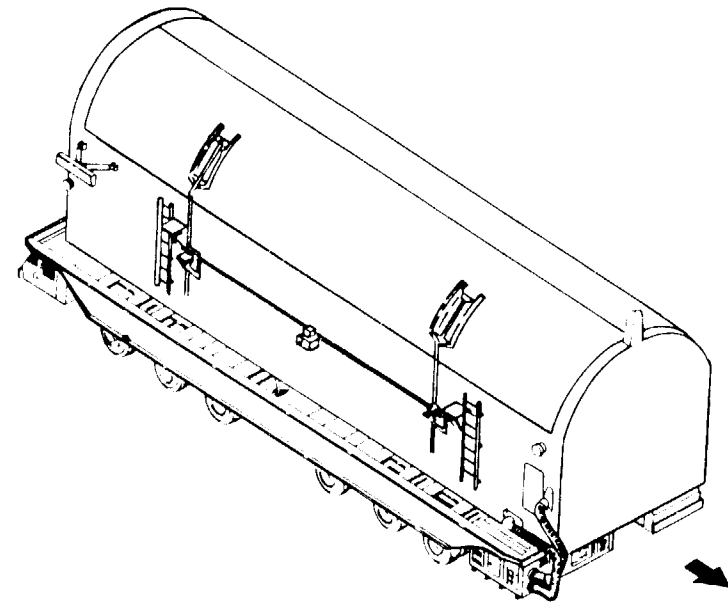

Payload Canister with Transporter in Horizontal Mode

HORIZONTAL CARGO PROCESSING FACILITIES. Payloads that must be integrated horizontally are processed in the Operations and Checkout Building (O&C) at KSC. Spacelab, in its various flight configurations, is the primary horizontally-processed Space Shuttle payload.

The O&C Building is a 5-story, 600,000 square-ft. structure containing offices, laboratories, astronaut crew living quarters, and spacecraft assembly areas. It is located in the Industrial Area, east of the KSC Headquarters Building.

O&C BUILDING SPACELAB FACILITIES. Spacelab checkout facilities in the O&C Building were originally used to

assemble and test the Apollo spacecraft. They have been modified extensively for the Spacelab program.

Officially called the Spacelab Assembly and Test Area, the facility is 650 ft. long and 85 ft. wide. It is divided into a high bay, 157 ft. long and 104 ft. high, and a low bay, 475 ft. long and 70 ft. high. Environmentally, the area is maintained at 75 degrees F (plus or minus 2 degrees), with relative humidity controlled at 60 percent or lower.

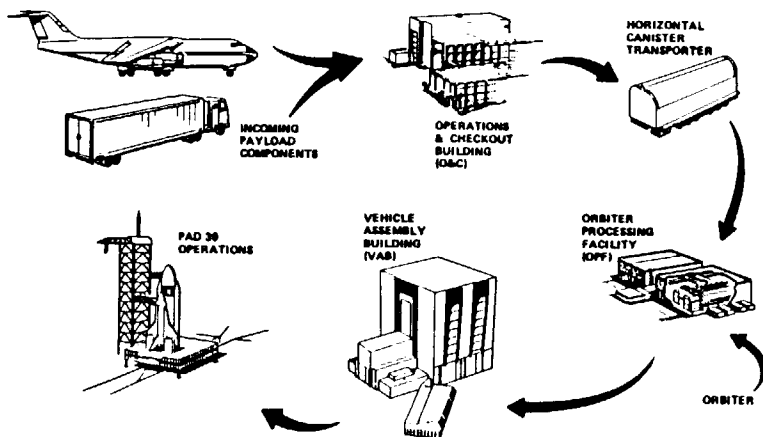

Horizontal Payload Processing Flow

Within the Spacelab checkout area, there are two Cargo Integration Test Equipment (CITE) assembly and checkout workstands, an engineering model workstand, pallet staging workstands, a rack/floor workstand, a tunnel maintenance area, an airlock maintenance area and two end cone stands. The two CITE workstands are controlled from two automatic test equipment control rooms located on the third floor of the O&C Building.

The mechanical and electrical ground support equipment needed for Spacelab checkout is located in and around the

workstands. The facility is designed to handle two separate Spacelab processing flows simultaneously. An orbiter/Spacelab interface adapter and two racks which simulate the orbiter's aft flight deck are attached to the end of the workstands. Orbiter utility interfaces for electrical, gas and fluids are available through ground support equipment cables or lines.

Spacelab Processing and Integration Operations. The Spacelab processing concept allows users to design and develop experiments which can be integrated with other individual experiments into a complete Spacelab payload.

Spacelab processing starts with the integration and checkout of experiment packages and equipment with the appropriate structural mounting elements such as racks for the Spacelab pressurized module and pallet segments for experiments designed to be exposed to the space environment.

Those experiments provided by the European Space Agency (ESA), undergo preliminary integration in Europe before they are shipped to the United States. In fact, all Spacelab payload elements are delivered to KSC as flight-ready as possible.

When individual experiments and payloads are delivered to the O&C Building, the special Spacelab "train" of pallets and racks is assembled using the pallet and/or rack stands. After mechanical build-up of the payload train, these elements are moved to the Spacelab integration workstand and mated with the Spacelab module or the support systems igloo. Operational hardware is refurbished and built-up in parallel with the payload build-up. When the complete Spacelab and payload configuration is ready, the Spacelab module's aft and forward end cones are installed, pallets are positioned and utilities are connected between pallets and the module.

The CITE stand simulates the orbiter and supports highly realistic Space Shuttle/Spacelab electrical and mechanical interface testing.

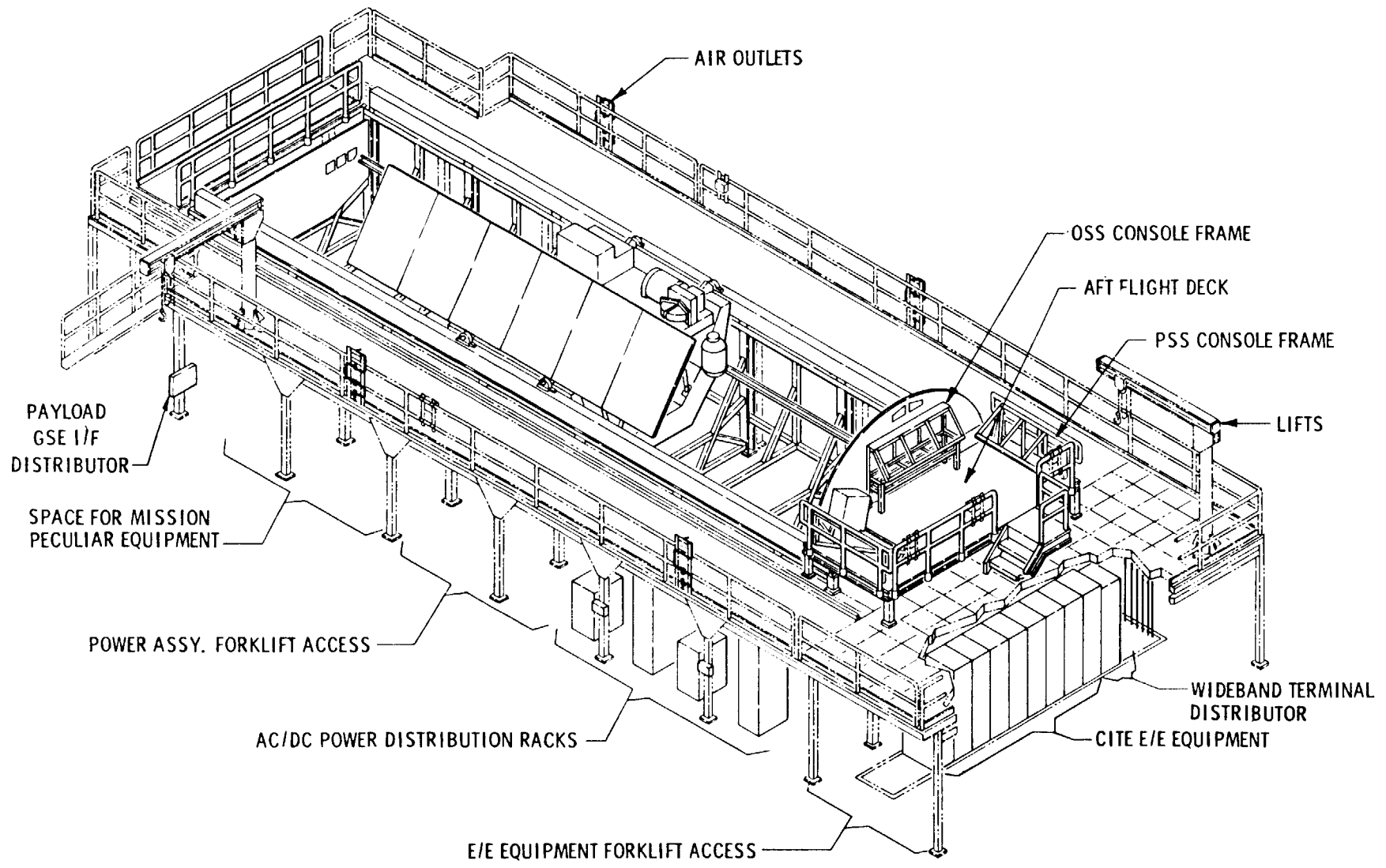

Horizontal Cargo Integration Test Equipment Stand

When checkout and integration tests are completed the Spacelab is hoisted into the payload canister. It is then moved to the Orbiter Processing Facility (OPF) in the payload canister transporter.

Once in the OPF the Spacelab is hoisted horizontally from the payload canister transporter by a crane, positioned over the orbiter, lowered, and installed in the payload bay. After installation it is connected to the orbiter interfaces. A payload/orbiter interface test is then conducted to verify the Spacelab is properly installed.

When all of these activities are completed, the payload bay doors are closed and latched. The payload bay environment is maintained at 65 degrees F. -- plus or minus 5 degrees -- with a relative humidity of 30 to 50 percent. The orbiter is then powered down and moved to the VAB where it is mated to the external tank and the SRBs. The Spacelab payload requires no further access before launch, although it is possible to open the payload bay doors and reach the Spacelab using the Payload Ground Handling Mechanism, if required.

The payload air purge and environmentally controlled conditions resume after the Shuttle vehicle is mated with the external tank and the SRB on the Mobile Launcher Platform (MLP).

After movement to the launch pad, the Space Shuttle and the MLP are mated "hard down" on the pad and umbilicals are connected. The Shuttle again is powered up and preparations for launch proceed.

GETAWAY SPECIAL PAYLOADS. Processing of "Getaway Special" payloads -- officially called small self-contained payloads -- is carried out at the Getaway Special Facility on the Cape Canaveral Air Force Station (CCAFS) in what was formerly the Delta Third Stage Facility.

Since these payloads are self-contained they require only limited interfaces with the orbiter. Therefore, they do not need to

be processed in the CITE facility. Instead, once processed at the Getaway Special Facility, they are mounted on a bridge beam in the payload bay while the orbiter is undergoing checkout and testing in the OPF.

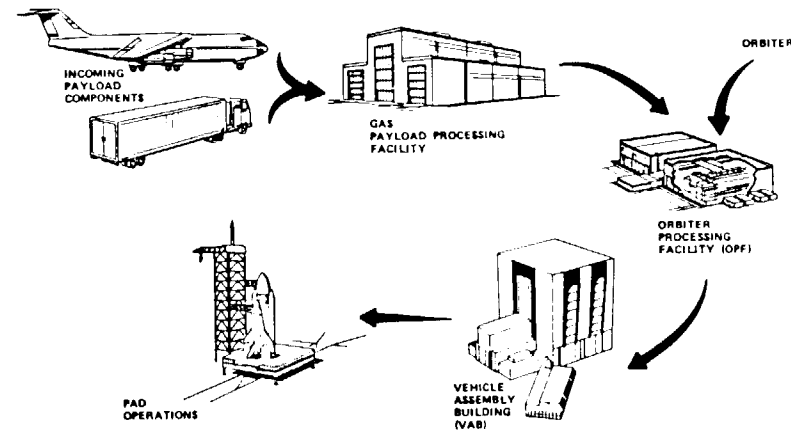

Getaway Special Processing Flow

LIFE SCIENCES PAYLOADS. Life sciences payloads are usually processed in a manner similar to other horizontally-integrated payloads. The live specimens used for these payloads are housed at Hangar L on the CCAFS, where facilities include laboratories, specimen holding areas and offices for principal investigators.

Life sciences programs are managed for NASA by the Ames Research Center, Mountain View, Calif. KSC is responsible for life sciences payload operations and logistical support.

At the launch pad, live specimens or those already in flight containers, are placed in the orbiter in one of two ways: by opening the payload bay doors and installing the specimens from a special access platform mounted on the Payload Ground Handling Mechanism (PGHM), or through the crew entry hatch with the

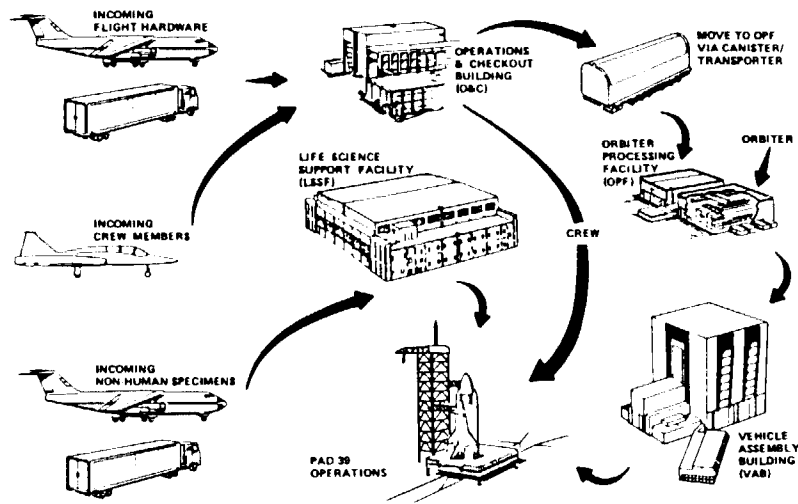

Life Sciences Payload Processing

specimens in containers which are then mounted on the orbiter middeck area.

DEPARTMENT OF DEFENSE PAYLOADS. The Department of Defense (DOD) conducts its own payload build-up and integration at the CCAFS under secure conditions. These procedures are similar to NASA's.

DOD payloads usually arrive by aircraft at the Skid Strip on CCAFS. Those requiring assembly and other testing are taken to an assembly area such as the Air Force-operated Satellite Assembly Building on CCAFS. When work there is completed, the payload is moved to the Shuttle Payload Integration Facility (SPIF) which is quite similar to the VPF at KSC. The SPIF is located in the Solid Motor Assembly Facility Building (SMAB) at the Titan Integrate, Transfer and Launch Complex.

Payloads that need little assembly go directly from the Skid Strip to the SPIF. It is at the SPIF where upper stages are mated with the spacecraft, as required.

Once the cargo elements are mated, cargo processing procedures are the same as those followed by NASA. For example, integration testing uses the DOD Orbiter Functional Simulator, a system very similar to the Cargo Integration Test Equipment at KSC. Once the complete payload is checked out it is placed in a NASA-provided canister for transport from the SPIF to the launch pad.

At the launch pad, the DOD cargo is placed in the Payload Changeout Room on the Rotating Service Structure. From there it is installed in the payload bay for final checkout and interface verification testing. Once testing activities are complete the payload and payload bay are closed out for flight.

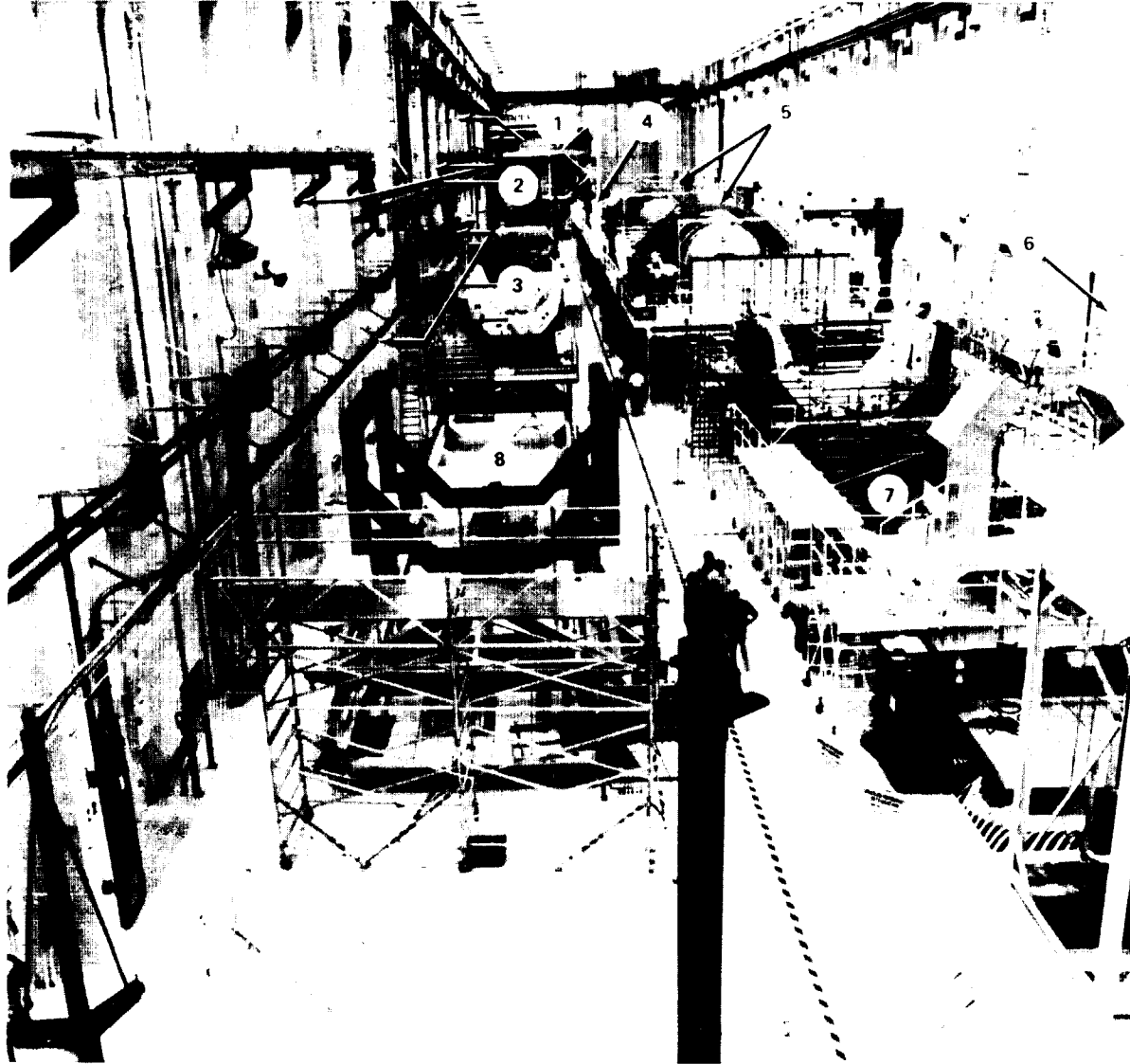

- ① THREE USER ROOMS AND HITS ROOM
- ② CONTROL ROOMS
CITE
SPACELAB
LEVEL IV
- ③ LEVEL IV LABS AND SIGNAL ACQUISITION ROOM
- ④ CITE STAND
- ⑤ LEVEL III/II STANDS
- ⑥ LEVEL IV LABS
- ⑦ SOUTH LEVEL IV STAND
- ⑧ NORTH LEVEL IV STAND

Facilities Description inside Operations and Checkout Building at Kennedy Space Center

ORIGINAL PAGE
BLACK AND WHITE PHOTOGRAPH

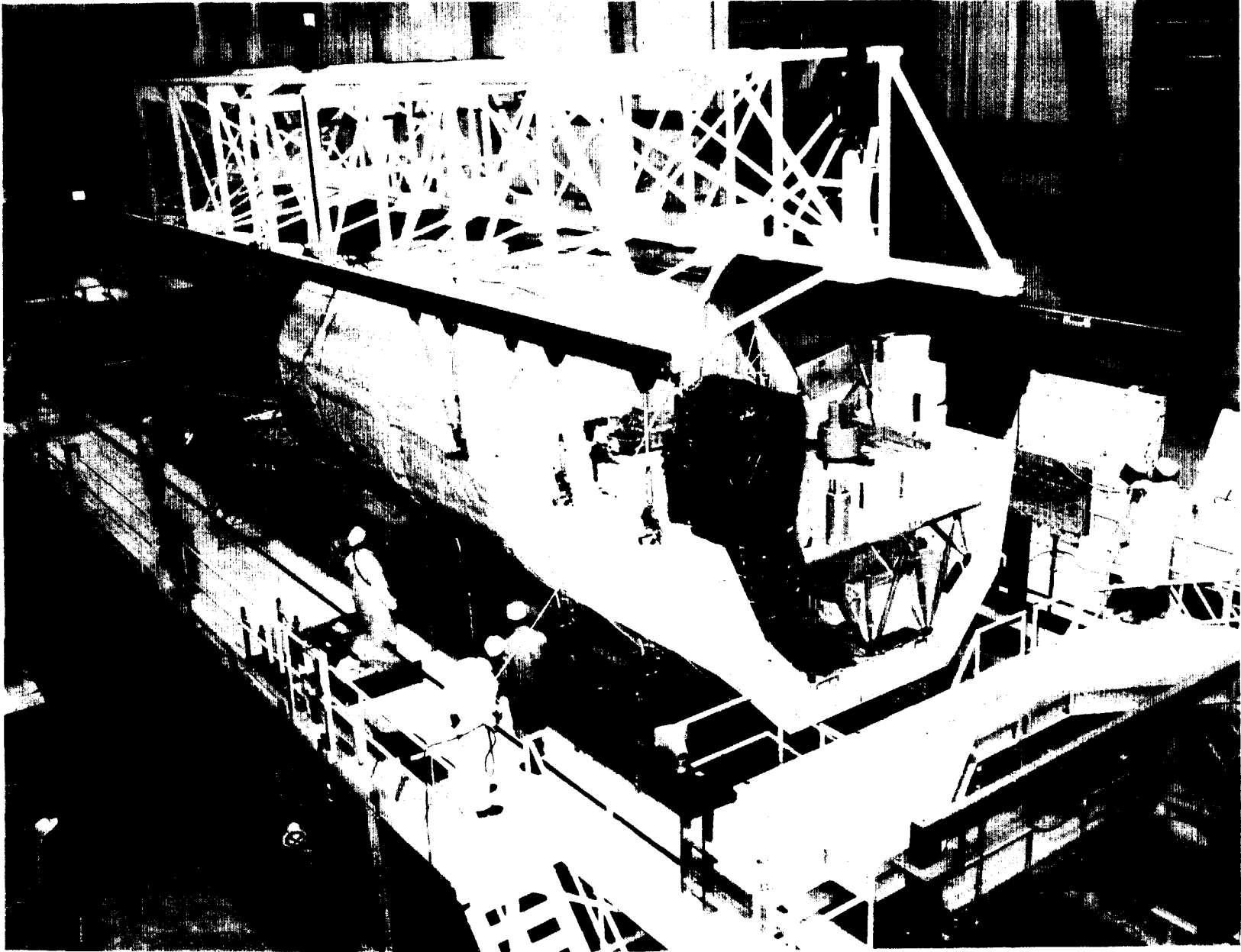

Spacelab 1 Habitable Module and Pallet Being Lowered into Cargo Integration Test Equipment Stand Prior to its Flight

ORIGINAL PAGE
BLACK AND WHITE PHOTOGRAPH

LAUNCH AND FLIGHT OPERATIONS

PRE-LAUNCH OPERATIONS

After the Space Shuttle has been rolled out to the launch pad on the Mobile Launcher Platform (MLP), all pre-launch activities are controlled from the Launch Control Center (LCC).

After the Shuttle is in place on the launch pad support columns, and the Rotating Service Structure (RSS) is placed around it, power for the vehicle is activated. The MLP and the Shuttle are then electronically and mechanically mated with support launch pad facilities and ground support equipment. An extensive series of validation checks verify that the numerous interfaces are functioning properly.

Meanwhile, in parallel with pre-launch pad activities, cargo operations get underway in the RSS's Payload Changeout Room.

Vertically integrated payloads are delivered to the launch pad before the Shuttle is rolled out. They are stored in the Payload Changeout Room until the Shuttle is ready for cargo loading. Once the RSS is in place around the orbiter, the payload bay doors are opened and the cargo is installed. Final cargo and payload bay closeouts are completed in the Payload Changeout Room and the payload bay doors are closed for flight.

Pre-launch Propellant Loading. Initial Shuttle propellant loading involves pumping hypergolic propellants into the orbiter's aft and forward Orbital Maneuvering System and Reaction Control System storage tanks, the orbiter's hydraulic Auxiliary Power Units, and SRB hydraulic power units. These are hazardous operations, and while they are underway work on the launch pad is suspended.

Since these propellants are hypergolic -- that is they ignite on contact with one another--oxidizer and fuel loading operations are carried out serially, never in parallel.

Finally, dewar tanks on the Fixed Service Structure (FSS), are filled with liquid oxygen and liquid hydrogen, which will be loaded into the orbiter's Power Reactant and Storage Distribution (PRSD) tanks during the launch countdown.

Final Pre-launch Activities. Before the formal Space Shuttle launch countdown starts, the vehicle is powered down while pyrotechnic devices -- various ordinance components -- are installed or hooked up. The extravehicular Mobility Units (EMUs) -- space suits -- are stored On Board along with other items of flight crew equipment.

When closeouts of the Space Shuttle and the launch pad are completed, all is in readiness for the countdown to get underway.

LAUNCH CONTROL CENTER. While the VAB can be considered the heart of LC-39, the Launch Control Center (LCC) can easily be called its brain.

The LCC is a 4-story building connected to the east side of the VAB by an elevated, enclosed bridge. It houses four firing rooms that are used to conduct NASA and classified military launches of the Space Shuttle. Each firing room is equipped with the Launch Processing System (LPS) which monitors and controls most Shuttle assembly, checkout and launch operations. Physically, the LCC is 77 ft. high, 378 ft. long and 181 ft. wide.

Thanks to the LPS, the countdown for the Space Shuttle takes only about 40 hours, compared with the 80 plus hours usually needed for a Saturn/Apollo countdown. Moreover, the LPS calls for only about 90 people to work in the firing room during launch operations -- compared with about 450 needed for earlier manned missions.

From the outside, the LCC is virtually unchanged from its original Apollo-era configuration, except that a fourth floor office



OPERATIONAL LIFE IS
OF POOR QUALITY

Firing Room at Kennedy Space Center's Launch Control Center

INTERNAL PAGE
BLACK AND WHITE PHOTOGRAPH

has been added to the southwest and northwest corners corner of the building.

The interior of the LCC has undergone extensive modifications to meet the needs of the Space Shuttle era.

Physically, the LCC is constructed as follows: the first floor is used for administrative activities and houses the building's utilities systems control room; the second floor is occupied by the Control Data Subsystem; the four firing rooms occupy practically all of the third floor, and the fourth floor, as mentioned, earlier is used for offices.

During the Shuttle Orbital Flight Test program and the early operational missions, Firing Room 1 was the only fully-equipped control facility available for vehicle checkout and launch. However, as the Shuttle launch rate increased during the first half of the 1980s, the other three firing rooms were activated. Although NASA operates the firing rooms, the Department of Defense uses Firing Rooms 3 and 4 to support its classified, Shuttle-dedicated missions. Additionally, Firing Room 4 serves as an engineering analysis and support facility for launch and checkout operations.

LAUNCH COUNTDOWN. As experience was gained by launch crews during the early years of the Space Shuttle program, the launch countdown was refined and streamlined to the point where the average countdown now takes a little more than 40 hours. This was not the case early in the program, when countdowns of 80 hours or more were not uncommon.

The following is a narrative description of the major events of a typical countdown for the Space Shuttle. The time of liftoff is predicated on what is called the launch window -- that point in time when the Shuttle must be launched in order to meet specific mission objectives such as the deployment of spacecraft at a predetermined time and location in space.

Launch Minus 3 Days. The countdown gets underway with the traditional call to stations by the NASA Test Director. This verifies that the launch team is in place and ready to proceed.

The first item of business is to checkout the backup flight system and the software stored in the mass memory units and display systems. Backup flight system software is then loaded into the Shuttle's fifth general purpose computer (GPC's).

Flight crew equipment stowage begins. Final inspection of the orbiter's middeck and flight decks are made, and removal of work crew module platforms begin. Loading preparations for the external tank get underway, and the Shuttle main engines are readied for tanking. Servicing of fuel cell storage tanks also starts. Final vehicle and facility closeouts are made.

Launch Minus 2 Days. The launch pad is cleared of all personnel while liquid oxygen and hydrogen are loaded into the Shuttle fuel cell storage tanks. Upon completion, the launch pad area is reopened and the closeout crew continues its prelaunch preparations.

The orbiter's flight control, navigation and communications systems are activated. Switches located on the flight and mid-decks are checked and, if required, mission specialist seats are installed. Preparations also are made for rollback of the Rotating Service Structure (RSS).

At launch minus 11 hours a planned countdown hold -- called a built-in hold -- begins and can last for up to 26 hours, 16 minute depending on the type of payload, tests required and other factors. This time is used, if needed, to perform tasks in the countdown that may not have been completed earlier.

Launch Minus 1 Day. Countdown is resumed after the built-in hold period has elapsed. The RSS is rolled back and remaining items of crew equipment are installed. Cockpit switch positions are verified, and oxygen samples are taken in the crew area. The fuel cells are activated following a fuel cell flow through

purge. Communications with the Johnson Space Center's Mission Control Center (MCC) are established.

Finally, the launch pad is again cleared of all personnel while conditioned air that has been blowing through the payload bay and other orbiter cavities is switched to inert gaseous nitrogen in preparation for filling the external tank with its super-cold propellants.

Launch Day. Filling the external tank with liquid oxygen and hydrogen gets underway. Communications checks are made with elements of the Air Force's Eastern Space and Missile Center. Gimbal profile checks of the Orbital Maneuvering System (OMS) engines are made. Preflight calibration of the Inertial Measurement Units (IMU) is made, and tracking antennas at the nearby Merritt Island Tracking Station are aligned for liftoff.

At launch minus 5 hours, 20 minutes -- T minus 5 hours, 20 minutes -- a 2-hour built-in hold occurs. During this hold, an ice inspection team goes to the launch pad to inspect the external tank's insulation to insure that there is no dangerous accumulation of ice on the tank caused by the super-cold liquids. Meanwhile, the closeout crew is preparing for the arrival of the flight crew.

Meanwhile, the flight crew, in their quarters at the Operations and Checkout (O&C) Building, eat a meal and receive a weather briefing. After suiting up, they leave the O&C Building at about T minus 2 hours, 30 minutes for the launch pad -- the countdown having resumed at T minus 3 hours.

Upon arriving at the white room at the end of the orbiter access arm, the crew, assisted by white room personnel, enter the orbiter. Once on board they conduct air-to-ground communications checks with the LCC and MCC. Meanwhile, the orbiter hatch is closed and hatch seal and cabin leak checks are made. The IMU preflight alignment is made and closed-loop tests with Range Safety are completed. The white room is then evacuated and the closeout crew proceeds from the launch pad to a fallback area. At this time,

primary ascent guidance data is transferred to the backup flight system.

At T minus 20 minutes a planned 10-minute hold begins. When the countdown is resumed on-board computers are commanded to their launch configuration and fuel cell thermal conditioning begins. Orbiter cabin vent valves are closed and the backup flight system transitions into its launch configuration.

At T minus 9 minutes another planned 10-minute hold occurs. Just prior to resuming the countdown, the NASA Test Director gets the "go for launch" verification from the launch team. At this point, the Ground Launch Sequencer (GLS) is turned on and the terminal countdown starts. All countdown functions are now automatically controlled by the GLS computer located in the Firing Room Integration Console.

At T minus 7 minutes, 30 seconds, the orbiter access arm is retracted. Should an emergency occur requiring crew evacuation from the orbiter, the arm can be extended either manually or automatically in about 15 seconds.

At T minus 5 minutes, 15 seconds the MCC transmits a command that activates the orbiter's operational instrumentation recorders. These recorders store information relating to ascent, on-orbit and descent performance during the mission. These data are analyzed after landing.

At T minus 5 minutes, the crew activates the Auxiliary Power Units (APU) to provide pressure to the Shuttle's three hydraulic systems which move the main engine nozzles and the aero-aerosurfaces. Also at this point, the firing circuit for SRB ignition and the range safety destruct system devices are mechanically enabled by a motor-driven switch called the safe and arm device.

At about T minus 4 minutes, 55 seconds, the liquid oxygen vent on the external tank is closed. It had been open to allow the super-cold liquid oxygen to boil off, thus preventing over pressurization while the tank remained near its full level. Now,

with the vent closed, preparations are made to bring the tank to its flight pressure. This occurs at T minus 2 minutes, 55 seconds.

At T minus 4 minutes the final helium purge of the Shuttle's three main engines is initiated in preparation for engine start. Five seconds later, the orbiter's elevons, speed brakes and rudder are moved through a pre-programmed series of maneuvers to position them for launch. This is called the aerosurface profile.

At T minus 3 minutes, 30 seconds, the ground power transition takes place and the Shuttle's fuel cells transition to internal power. Up to this point, ground power had augmented the fuel cells. Then, 5 seconds later, the main engine nozzles are gimballed through a pre-programmed series of maneuvers to confirm their readiness.

At T minus 2 minutes, 50 seconds, the external tank oxygen vent hood -- known as the beanie cap -- is raised and retracted. It had been in place during tanking operations to prevent ice buildup on the oxygen vents. Fifteen seconds later, at T minus 2 minutes, 35 seconds, the piping of gaseous oxygen and hydrogen to the fuel cells from ground tanks is terminated and the fuel cells begin to use the on board reactants.

At T minus 1 minute, 57 seconds, the external tank's liquid hydrogen is brought to flight pressure by closing the boil off vent, as was done earlier with the liquid oxygen vent. However, during the hydrogen boil off, the gas is piped out to an area adjacent to the launch pad where it is burned off.

At T minus 31 seconds, the Shuttle's on-board computers start their terminal launch sequence. Any problem after this point will require calling a "hold" and the countdown recycled to T minus 20 minutes. However, if all goes well, only one further ground command is needed for launch. This is the "go for main engine start," which comes at the T-minus-10-second point. Meanwhile, the Ground Launch Sequencer (GLS) continues to monitor more than several hundred launch commit functions and is able automatically to call a "hold" or "cutoff" if a problem occurs.

At T minus 28 seconds the SRB booster hydraulic power units are activated by a command from the GLS. The units provide hydraulic power for SRB nozzle gimbaling. At T minus 16 seconds, the nozzles are commanded to carry out a pre-programmed series of maneuvers to confirm they are ready for liftoff. At the same time -- T minus 16 seconds -- the sound suppression system is turned on and water begins to pour onto the deck of the MLP and pad areas to protect the Shuttle from acoustical damage at liftoff.

At T minus 11 seconds, the SRB range safety destruct system is activated.

At T minus 10 seconds, the "go for main engine start" command is issued by the GLS. (The GLS retains the capability to command main engine stop until just before the SRBs are ignited.) At this time flares are ignited under the main engines to burn away any residual gaseous hydrogen that may have collected in the vicinity of the main engine nozzles. A half second later, the flight computers order the opening of valves which allow the liquid hydrogen and oxygen to flow into the engine's turbopumps.

At T minus 6.6 seconds, the three main engines are ignited at intervals of 120 milliseconds. The engines throttle up to 90 percent thrust in 3 seconds. At T minus 3 seconds, if the engines are at the required 90 percent, SRB ignition sequence starts. All of these split-second events are monitored by the Shuttle's four primary flight computers.

At T minus zero, the holddown explosive bolts and the T-O umbilical explosive bolts are blown by command from the on-board computers and the SRBs ignite. The Shuttle is now committed to launch. The mission elapsed time is reset to zero and the mission event timer starts. The Shuttle lifts off the pad and clears the tower at about T plus 7 seconds. Mission control is handed over to JSC after the tower is cleared.

MISSION CONTROL CENTER

Space Shuttle flights are controlled through the Mission Control Center (MCC) at Johnson Space Center, Houston, Texas. It has been central control for more than 60 NASA manned space flights since becoming operational in June 1965, for the Gemini 4 mission.

Located in a square, windowless, 3-story building, designated Building 30, the MCC has two Flight Control Rooms (FCRs--the acronym is pronounced "fickers") from which Shuttle missions are managed. These rooms are functionally identical. One located on the second floor is used for NASA-controlled missions, the other, on the third floor, is dedicated primarily to Department of Defense missions. However, either FCR can be used for mission control. They also can be used simultaneously to control separate flights if required.

The MCC takes over mission control functions when the Space Shuttle clears the service tower at the Kennedy Space Center's Launch Complex 39. Shuttle systems data, voice communications and television are relayed almost instantaneously to MCC through the NASA Ground and Space Networks, the latter using the orbiting Tracking and Data Relay Satellites. The MCC retains its mission control function until the end of a mission, when the orbiter lands and rolls to a stop. At that point the Kennedy Space Center again assumes control.

In the event MCC becomes inoperative because of a hurricane or other disaster, backup mission control capability would shift to the NASA Ground Terminal at JSC's White Sands Test Facility near Las Cruces, NIMI. This emergency control center is a stripped-down version of MCC, with minimal equipment and instrumentation to allow controllers to support a mission to its conclusion.

In the FCRs, teams of up to 30 flight controllers sit at consoles directing and monitoring all aspects of the flight 24 hours a day, 7

days a week. Each team is headed by a flight director and normally works an 8-hour shift.

Over the years, the flight controller teams have become specialized. One team, for example, becomes responsible for ascent-to-orbit and return-from-orbit, two others for in-space operations and a fourth planning next-day mission activities. Augmenting the FRC teams are groups of engineers, flight controllers and technicians who monitor and analyze flight data from adjacent staff support areas.

There are normally 16 major flight control consoles operating in an FCR during a Space Shuttle mission. Each console is identified by title or a "call sign" which is used when communicating with other controllers or the astronaut flight crew.

These mission command and control positions, their individual initials, call signs and responsibilities include:

66

FLIGHT DIRECTOR (FD), with the call sign "Flight," is the leader of the flight control team. The Flight Director is responsible for mission and payload operations and decisions relating to safety and flight conduct.

SPACECRAFT COMMUNICATOR (CAPCOM), with the familiar call sign "CAPCOM" -- Capsule Communicator -- is the primary communicator between MCC and the Shuttle crew. The acronym dates from the Mercury program when the Mercury spacecraft was called a capsule.

FLIGHT DYNAMICS OFFICER (FDO), call sign "Fido," plans orbiter maneuvers and follows the Shuttle's flight trajectory along with the Guidance Officer.

GUIDANCE OFFICER (GDO), call sign "Guidance," is responsible for monitoring the orbiter navigation and guidance computer software.

DATA PROCESSING SYSTEMS ENGINEER (DPS), keeps track of the orbiter's data processing systems, including the five on-board general purpose computers, the flight-critical and launch data lines, the malfunction display system, mass memories and systems software.

FLIGHT SURGEON (Surgeon) monitors crew activities and is for the medical operations flight control team, providing medical consultations with the crew, as required, and keeping the Flight Director informed on the state of the crew's health.

BOOSTER SYSTEMS ENGINEER (Booster) is responsible for monitoring and evaluating the main engine, solid rocket booster and external tank performance before launch and during the ascent phases of a mission.

PROPULSION SYSTEMS ENGINEER (PROP) monitors and evaluates performance of the reaction control and orbital maneuvering systems during all flight phases and is charged with management of propellants and other consumables for various orbiter maneuvers.

GUIDANCE NAVIGATION AND CONTROL SYSTEMS ENGINEER (GNC) is charged with monitoring all Shuttle guidance, navigation and control systems. GNC also keeps the Flight Director and crew notified of possible abort situations and keeps the crew informed of any guidance problems.

ELECTRICAL, ENVIRONMENTAL AND CONSUMABLES SYSTEMS ENGINEER (EECOM) is responsible for monitoring the cryogenic supplies available for the fuel cells, avionics and cabin cooling systems, as well as electrical distribution, cabin pressure and orbiter lighting systems.

INSTRUMENTATION AND COMMUNICATIONS SYSTEMS ENGINEER (INCO) is charged with planning and monitoring in-flight communications and instrumentation systems.

GROUND CONTROL (GC) is responsible for maintenance and operation of MCC hardware, software and support facilities. GC also coordinates tracking and data activities with the Goddard Space Flight Center (GSFC), Greenbelt, Md.

FLIGHT ACTIVITIES OFFICER (FAO), plans and supports crew activities, checklists, procedures and schedules.

PAYLOADS OFFICER (Payloads) is in charge of coordinating the ground and on-board system interfaces between the flight control team and the payload user. The Payloads Officer also monitors Spacelab and upper stage systems and their interfaces with payloads.

MAINTENANCE, MECHANICAL ARM AND CREW SYSTEMS ENGINEER (MMACS), call sign "Max," monitors operation of the remote manipulator arm and the orbiter's structural and mechanical systems. Max also observes crew hardware and in-flight equipment maintenance.

PUBLIC AFFAIRS OFFICER (PAO) provides mission commentary, augments and explains air-to-ground conversations and flight control operations for the news media and public.

During Spacelab missions another flight control position is needed. This is the Command and Data Management Systems Officer (CDMS), who is primarily responsible for data processing of the Spacelab's two main computers. To support Spacelab missions the EECOM and the DPS both work closely with the CDMS since the missions involve monitoring additional displays involving almost 300 items and coordinating their activities with the Marshall Space Flight Center's Payload Operations Control Center (POCC).

One of the most unusual support facilities of the FCRs is the display/control system. It consists of a series of projection screens displays on the front wall which show the orbiter's "realtime" location, live television pictures of crew activities, Earth views and extravehicular activities. Other displays include mission elapsed



Mission Control Center at the Lyndon B. Johnson Space Center, Houston, Texas

time as well as time remaining before a maneuver or other major mission event.

Many of the decisions or recommendations made by flight controllers are based on information shown on the display/control system displays. Telemetry data is processed instantaneously for display allowing controllers to keep current on the status of Shuttle systems. Consoles in the FCR, the adjacent multipurpose support room, and POCCs have one or more TV screens and switches to allow the controllers to view data displays on a number of different channels. It is possible to call up data of special interest simply by changing channels. Also, an extensive library of reference data is a

available to display static data, while digital-to-television display generators can provide dynamic, or constantly changing data.

Eventually, it is planned that the Apollo-era consoles will be superseded by modern state-of-the-art work stations that will provide more capability to monitor and analyze vast amounts of data. Moreover, instead of driving the consoles with a single main computer, each console will eventually have its own smaller computer which will be able to monitor a specific system and be linked into a network capable of sharing the data.

While the FCRs are the nerve center for MCC operations, there are other behind-the-scene work areas that are vital to successful

Shuttle operations. These include the Network Interface Processor (NIP), and the Data Computation Complex (DCC) both of which are located on the first floor of the MCC building.

The NIP, as its name implies, processes incoming digital data and distributes it in realtime to the FCR and support room displays. This system also handles digital command signals to the orbiter permitting ground controllers to keep on-board guidance computers current.

The DCC processes incoming tracking and telemetry data and compares what is happening with what should be happening. Normally, it will display information only if a problem occurs. It also will decide what maneuvers should be made to correct the problem. The DCC also predicts where the orbiter will be at a specific point in flight, and it aids ground tracking stations to point their antennas in the right direction.

The DCC uses five primary computers each of which can support the FCR. During critical phases of a mission, one of the five computers is designated a "dynamic standby," processing data concurrently in case the prime computer fails. The DCC computers also are used to develop computer programs for future Shuttle missions.

Operating in conjunction with the FCRs are facilities known as Payload Operations Control Centers (POCCs) where principal investigators and commercial users can monitor and control payloads being carried on board the Shuttle. One of the most extensive POCCs is located at the Marshall Space Flight Center, Huntsville, Ala., where Spacelab missions will be coordinated with MCC. It is the command post, communications hub and data relay station for the principal investigators, mission managers and support teams. Here decisions on payload operations are made, coordinated with the MCC Flight Director, and sent to the Spacelab or Shuttle.

The POCC at Goddard Space Flight Center, controls free-flying spacecraft that are deployed, retrieved or serviced by the

Shuttle. Planetary mission spacecraft are controlled from the POCC at NASA's Jet Propulsion Laboratory, Pasadena, Calif. Finally, private sector payload operators and foreign governments maintain their own POCCs at various locations for control of spacecraft systems under their control.

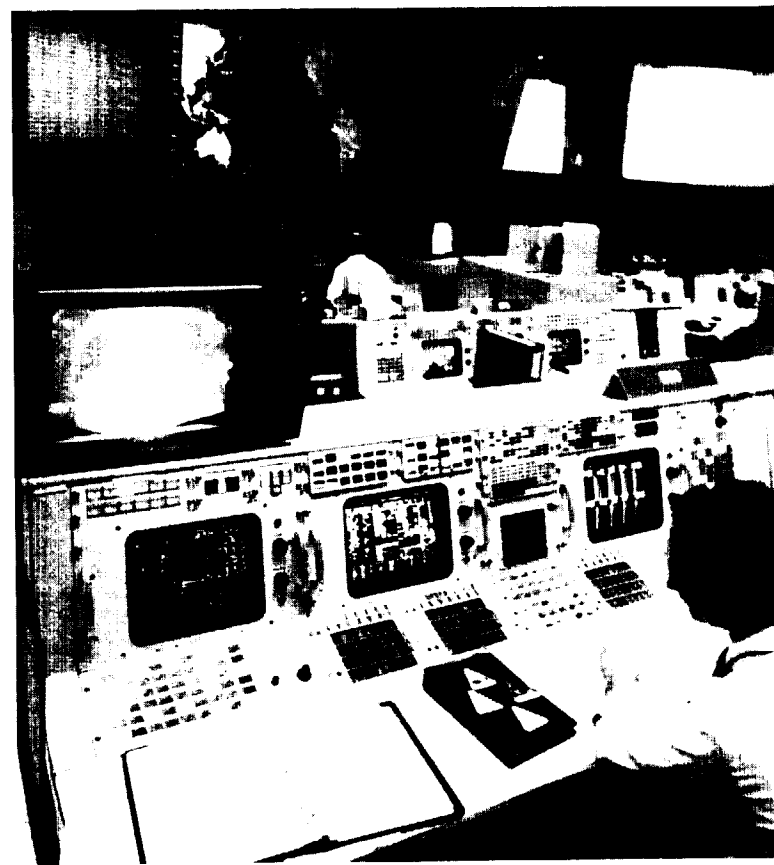

*INCO (Instrumentation and Communications Officer)
 Console inside the Mission Control Center,
 In the Background Orbiter Earth Tracks Are
 Shown on the Orbital Tracking Screen*

MARSHALL PAYLOAD OPERATIONS CONTROL CENTER

The Payload Operations Control Center (POCC) operated by the NASA's Marshall Space Flight Center (MSFC), Huntsville, Ala., is the largest and most diverse of the various POCCs associated with the Space Shuttle program. Since its functions in many respects parallel those of other POCCs operated by private industry, the academic community and government agencies, a description of what it does, how it operates and who operates it will serve as an overview of this type of control center.

The Marshall POCC -- like all POCCs -- is a facility designed to monitor, coordinate, and control on-orbit operation of a Shuttle payload, particularly Spacelab. During non-mission periods it also is used for crew training and simulated space operations. It is, in effect, a command post for payload activities, just as the JSC Mission Control Center (MCC) is a command post for the flight and operation of the Space Shuttle.

Both control centers work closely in coordinating mission activities. In fact, the Marshall POCC originally was housed in Building 30 at JSC, adjacent to the MCC. It has since been moved to Building 4663 at Marshall and is an important element of the Huntsville Operations Support Center (HOSC), which augments the MCC by monitoring Shuttle propulsion systems.

The Marshall POCC Capabilities Document states that the "POCC provides physical space, communications, and data system capabilities to enable user access to payload data (digital, video, and analog), command uplink, and coordination of activities internal and external to the POCC."

Members of the Marshall mission management team and principal investigators and research teams work in the POCC or in adjacent facilities around-the-clock controlling and directing payload experiment operations. Using the extensive POCC facilities they are able to communicate directly with mission crews and direct experiment activities from the ground. They also can

operate experiments and support equipment on board the Shuttle and manage payload resources.

The POCC operations concept requires a team consisting of the Payload Mission Manager (PMM) directing the POCC cadre which has overall responsibility for managing and controlling POCC operations. Its scientific counterpart, the investigator's operations team, is the group that conducts, monitors and controls the experiments carried on the Shuttle, primarily those related to Spacelab.

Generally, POCC operations are carried out by a management/scientific team of 10 key individuals, headed by the Payload Operations Director (POD), who is a senior member of the PMM's cadre. The POD is charged with managing the day-to-day mission operations and directing the payload operations team and the science crew.

Other POCC key personnel include:

MISSION SCIENTIST (MSCI) who represents scientists who have experiments on a specific flight and serves as the interface between the PMM and the POD in matters relating to mission science operations and accomplishments.

CREW INTERFACE COORDINATOR (CIC), who coordinates communications between the POCC and the payload crew.

ALTERNATE PAYLOAD SPECIALIST (APS) is a trained payload specialist not assigned to flight duty who aids the payload operations team and the payload crew in solving problems, troubleshooting and modifying crew procedures, if necessary, and who advises the MSCI on the possible impact of any problem areas.

PAYLOAD ACTIVITY PLANNER (PAP), who directs mission replanning activities, as required, and coordinates mission timeline changes with POCC personnel.

MASS MEMORY UNIT MANAGER (MUM) who sends experiment command uplinks to the flight crew based on data received from the POCC operations team.

OPERATIONS CONTROLLER (OC), who coordinates activities of the payload operations team to insure the efficient accomplishment of activities supporting real-time execution of the mission timeline.

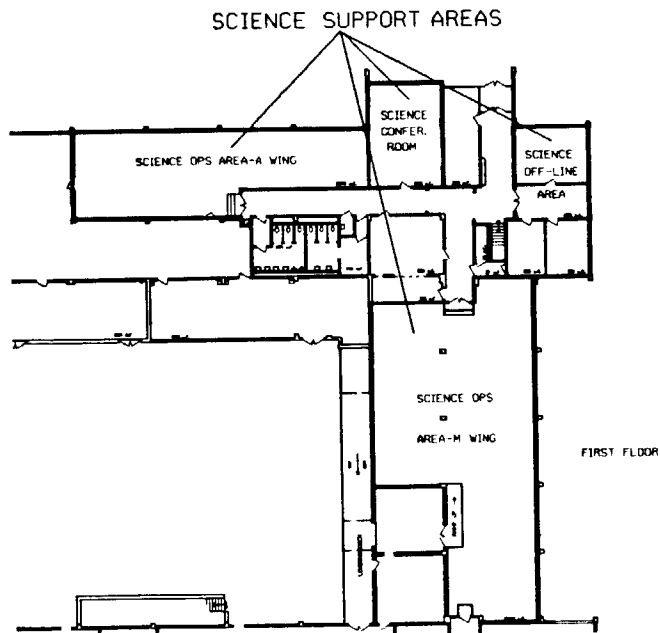

*George C. Marshall Space Flight Center
Payload Operations Control Center Floor Plan, 1st Floor*

PAYLOAD COMMAND COORDINATOR (PAYCOM), who configures the POCC for ground command operation and controls the flow of experiment commands from the POCC to the flight crew.

DATA MANAGEMENT COORDINATOR (DMC), who is responsible for maintaining and coordinating the flow of payload experiment data to and within the POCC the DMC also assesses the impact of proposed changes to the experiment timeline and payload data requirements that affect the payload downlink data.

PUBLIC AFFAIRS OFFICER (PAO), who provides mission commentary on payload activities and serves as the primary source of information on mission progress to the news media and public.

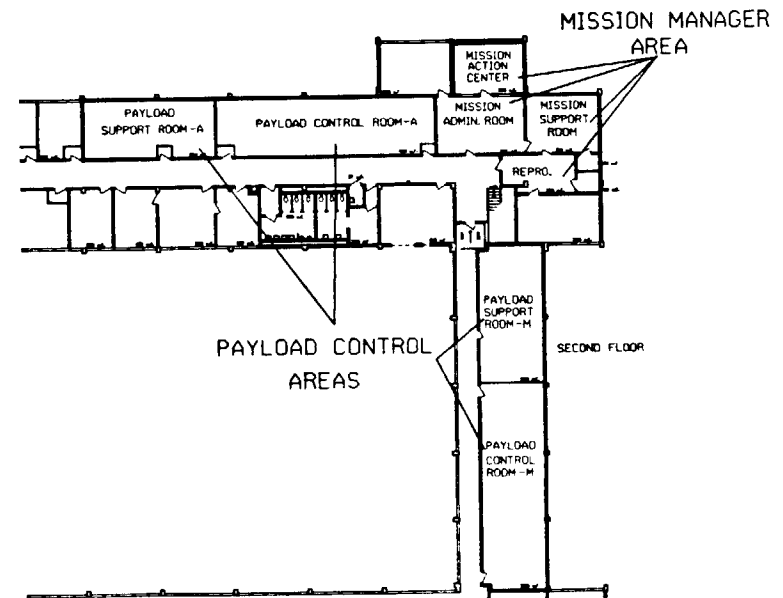

*George C. Marshall Space Flight Center
Payload Operations Control Center Floor Plan, 2nd Floor*

SPACE TRACKING AND DATA ACQUISITION

Responsibility for Space Shuttle tracking and data acquisition is charged to the Goddard Space Flight Center, Greenbelt, Md. This involves integrating and coordinating all of the worldwide NASA and Department of Defense tracking facilities needed to support Space Shuttle missions.

These facilities include the Goddard-operated Ground Network (GN) and Space Network (SN); the Deep Space Network (DSN) managed for NASA by the Jet Propulsion Laboratory (JPL), Pasadena, Calif.; the Ames-Dryden Flight Research Facility, (ADFRF) Edwards, Calif.; and extensive Department of Defense tracking systems at the Eastern and Western Space and Missile Centers, as well as the Air Force Satellite Control Network's (AFSCN) remote tracking stations.

GROUND NETWORK. The Ground Network (GN) is a worldwide network of tracking stations and data-gathering facilities which support Space Shuttle missions and also maintain communications with low Earth-orbiting spacecraft. Station management is provided from the Network Control Center at Goddard. Basically, commands are sent to orbiting spacecraft from the GN stations and, in return, scientific data are transmitted to the stations.

The system consists of 12 stations, including three DSN facilities. GN stations are located at Ascension Island, a British Crown Colony in the south Atlantic Ocean; Santiago, Chile; Bermuda; Dakar, Senegal, on the West Coast of Africa; Guam; Hawaii; Merritt Island, Fla.; Ponce de Leon, Fla.; and the Wallops Flight Facility on Virginia's Eastern Shore. The DSN tracking stations are located at Canberra, Australia; Goldstone, Calif.; and Madrid, Spain.

The GN stations are equipped with a wide variety of tracking and data-gathering antennas, ranging in size from 14 to 85 feet in diameter. Each is designed to perform a specific task, normally in

a designated frequency band, gathering radiated electronic signals (telemetry) transmitted from spacecraft.

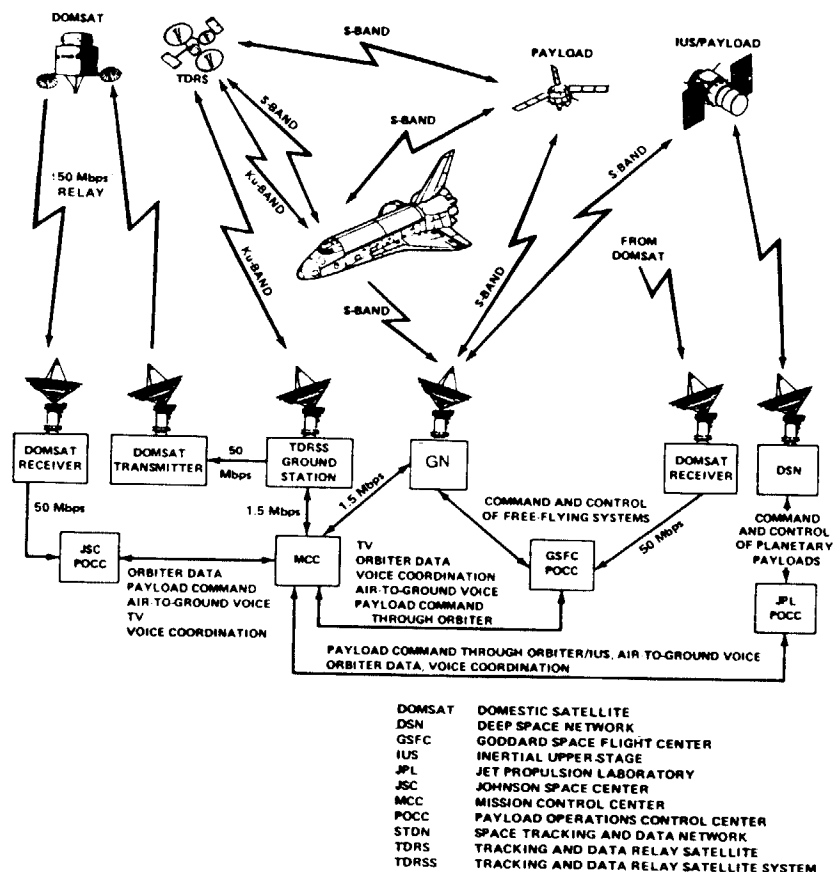

Ground and Space Network Communications Links

The communications hub for the GN is the Goddard-operated NASA Communications Center (NASCOM). It consists of more

than 2 million miles of electronic circuitry linking the tracking stations and the MCC at the Johnson Space Center. NASCOM has six major switching centers to insure the prompt flow of data. In addition to Goddard and JSC, the other switching centers are located at JPL, KSC, Canberra and Madrid.

The system includes telephone, microwave, radio, submarine cable and geosynchronous communications satellites in 11 countries. It includes communications facilities operated by 15 different domestic and foreign carriers. The system also has a wide-band and video capability. In fact, Goddard's wide-band system is the largest in the world.

A voice communications system called Station Conferencing and Monitoring Arrangement (SCAMA) can conference link up hundreds of the 220 different voice channels throughout the United States and abroad with instant talk/listen capability. With its built-in redundancy, SCAMA has realized a mission support reliability record of 99.6 percent. The majority of Space Shuttle voice traffic is routed through Goddard to the MCC.

As would be expected, computers play an important role in GN operations. They are used to program tracking antenna pointing angles, send commands to orbiting spacecraft and process data which is sent to the JSC and Goddard control centers.

Shuttle data is sent from the tracking network to the main switching computers at GSFC. These are UNISYS 1160 computers which reformat and transmit the information to JSC almost instantaneously at a rate of 1.5 million bits per second, via domestic communications satellites.

SPACE NETWORK. Augmenting the GN and eventually replacing it, is a unique tracking network called the Space Network (SN). The uniqueness of this network is that instead of tracking the Shuttle and other Earth-orbiting spacecraft from a world-wide network of ground stations, its main element is an in-orbit series of satellites called the Tracking and Data Relay Satellite System (TDRSS), designed to gather tracking and data information from

geosynchronous orbit and relay it to a single ground terminal located at White Sands, N.M.

The first spacecraft in the TDRS system, TDRS-1, was deployed from the Space Shuttle Challenger on April 4, 1983. Although problems were encountered in establishing its geosynchronous orbit at 41 degrees west longitude (over the northeast corner of Brazil), TDRS-1 proved the feasibility of the tracking station-in-space concept when it became operational later in the year.

Ultimately, the SN will consist of three TDRS spacecraft in orbit, one of which will be a backup or spare to be available for use if one of the operational spacecraft fails. Each satellite in the TDRS system is designed to operate for 10-years.

Following its planned deployment from the Space Shuttle Discovery scheduled for the STS-26 mission, TDRS-2 will be tested and then positioned in a geosynchronous orbit southwest of Hawaii at 171 degrees west longitude, about 130 degrees from TDRS-1. With these two spacecraft and the White Sands Ground Terminal (and eventually a backup terminal) operational, the SN will be able to provide almost full-time communications and tracking of the Space Shuttle, as well as for up to 24 other Earth-orbiting spacecraft simultaneously. The global network of ground stations can provide only about 20 percent of that coverage. Eventually some of the current ground stations will be closed when the SN becomes fully operational.

After data acquired by the TDRS spacecraft are relayed to the White Sands Ground Terminal, they are sent directly by domestic communications satellite to NASA control centers at JSC for Space Shuttle operations, and to Goddard which schedules TDRSS operations including those of many unmanned satellites.

The TDRS are among the largest and most advanced communications satellites ever developed. They weigh almost 5,000 lb. and measure 57 ft. across at their solar panels. They operate in the S-band and Ku-band frequencies and their complex

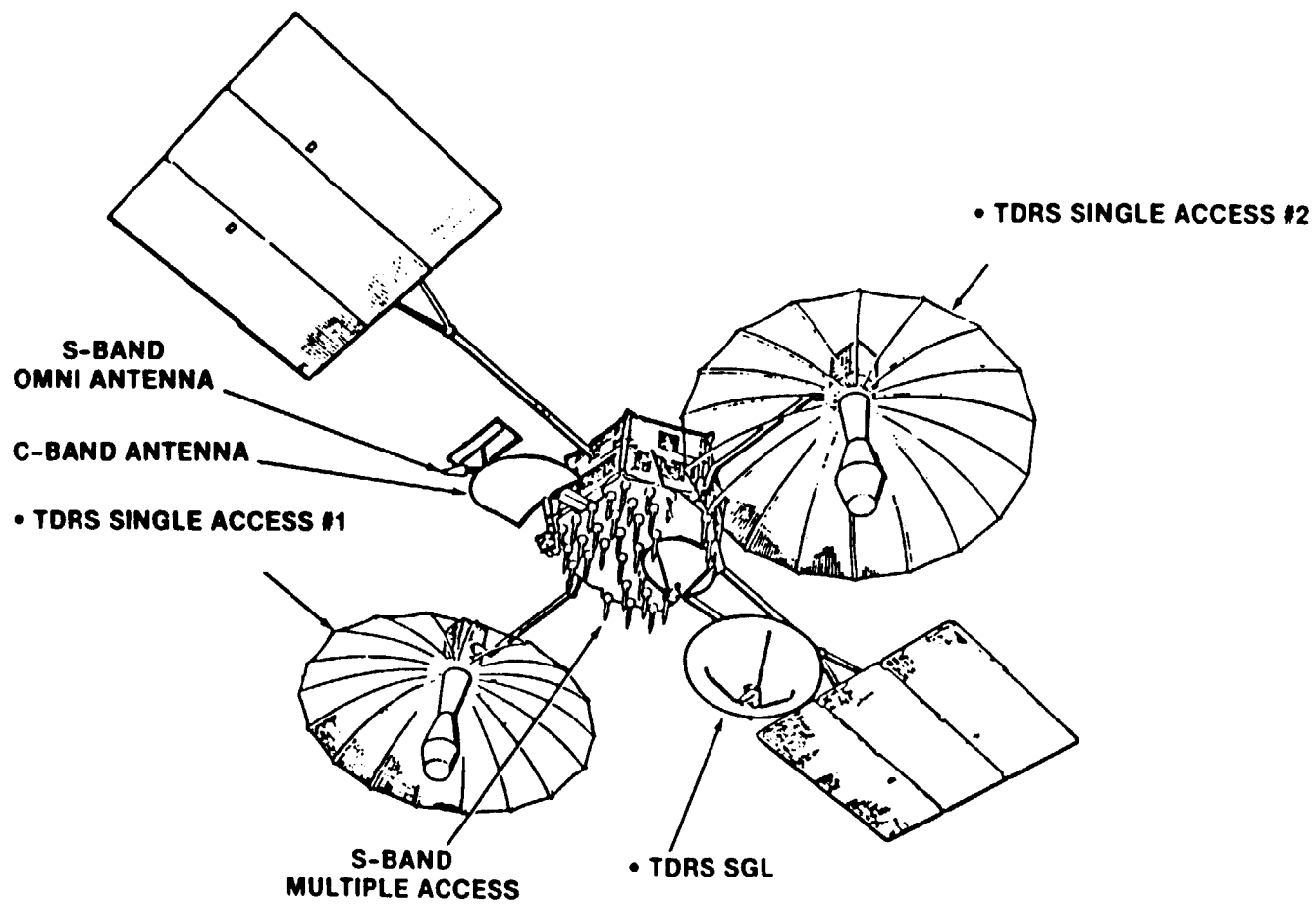

Tracking and Data Relay Satellite On-orbit Configuration

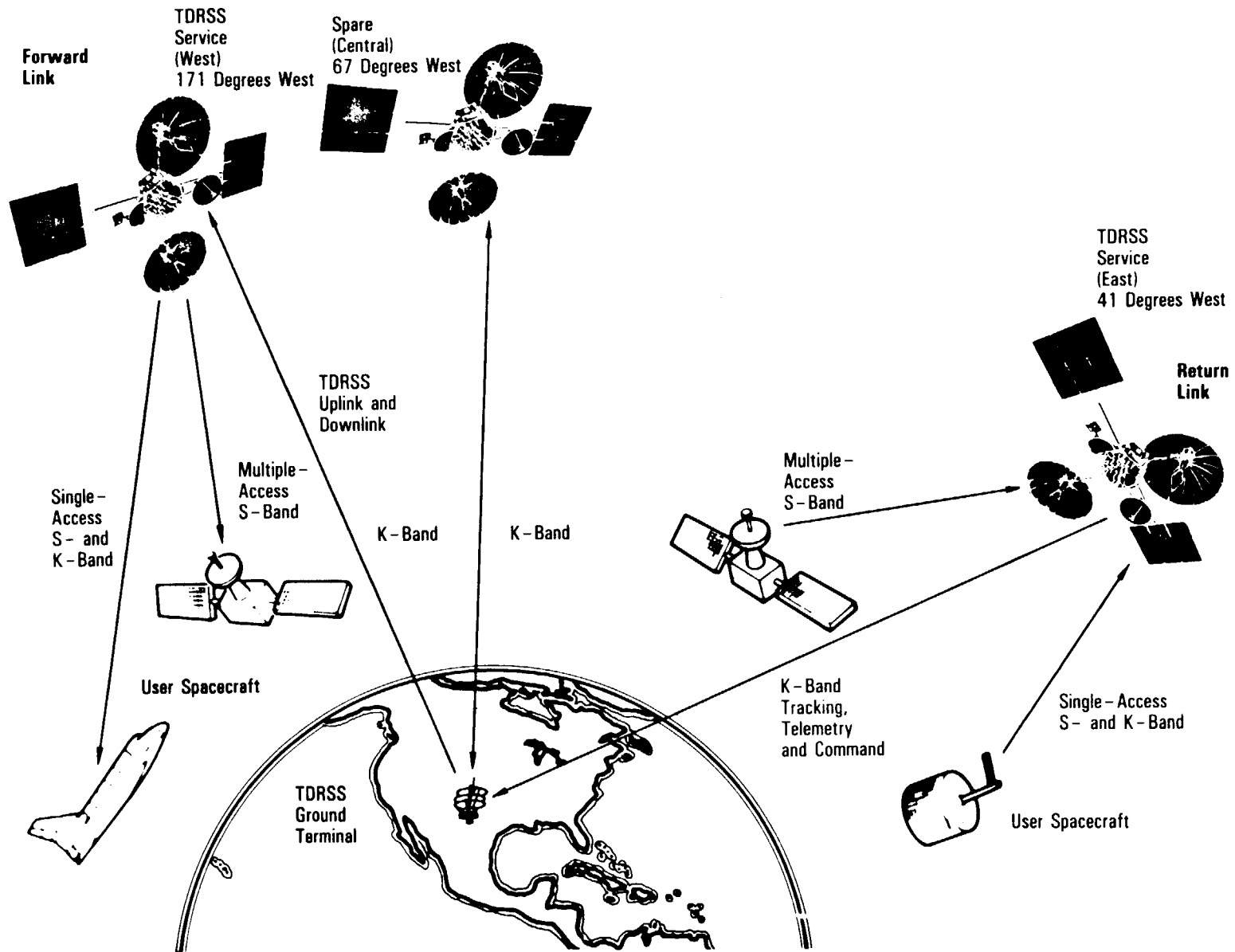

Linking Three Identical and Interchangeable Satellites with the TDRSS Earth Station at White Sands, New Mexico

electronics systems can handle up to 300 million bits of information each second from a single user spacecraft. Among the distinguishing features of the spacecraft are their two huge, wing-like solar panels which provide 1,850 watts of electric power and their two 16-ft. diameter high-gain parabolic antennas which resemble large umbrellas. These antennas weigh about 50 lb. each.

The communications capability of the TDRSS covers a wide spectrum that includes voice, television, analog and digital signals. No signal processing is done in orbit. Instead, the raw data flows directly to the ground terminal. During Space Shuttle missions, mission data and commands pass almost continuously back and forth between the orbiter and the MCC at JSC.

Like the TDRS, the White Sands ground terminal is one of the most advanced in existence. Its most prominent features include three 60-ft.-diameter Ku-band antennas which receive and transmit data. A number of smaller antennas are used for S-band and other Ku-band communications.

Ground was broken in September 1987, for a second back-up ground terminal at White Sands to accommodate increased future mission support required from the TDRSS.

The TDRSS segment of the Space Network, including the ground terminal, is owned and operated for NASA by CONTEL Federal Systems Sector, Atlanta, Ga. The spacecraft are built by the TRW Federal Systems Division, Space and Technology Group, Redondo Beach, Calif. TRW also provides software support for the White Sands facility. The TDRS parabolic antennas are built by the Harris Corp's Government Communications Systems Division, Melbourne, Fla. Harris also provides ground antennas, radio frequency equipment and other ground terminal equipment.

FLIGHT OPERATIONS

The Space Shuttle, as it thunders away from the launch pad with its main engines and solid rocket boosters (SRB) at full power, is an unforgettable sight. It reaches the point of maximum dynamic pressure (max Q) -- when dynamic pressures on the Shuttle are greatest -- about 1 minute after liftoff, at an altitude of 33,600 ft. At this point the main engines are "throttled down," to about 75 percent, thus keeping the dynamic pressures on the vehicle's surface to about 580 lb. per square foot. After passing through the max Q region, the main engines are throttled up to full power. This early ascent phase is often referred to as "first stage" flight.

Little more than 2 minutes into the flight, the SRBs, their fuel expended, are jettisoned from the orbiter. The Shuttle is at an altitude of about 30 miles and traveling at a speed of 2,890 miles an hour. The spent SRB casings continue to gain altitude briefly before they begin falling back to Earth. When the spent casings have descended to an altitude of about 17,000 ft., the parachute deployment sequence starts, slowing them for a safe splashdown in the ocean. This occurs about 5 minutes after launch. The boosters are retrieved, returned to a processing facility for refurbishment and eventual reused.

Meanwhile, the "second stage" phase of the flight is underway with the main engines propelling the vehicle ever higher on its ascent trajectory. At about 8 minutes into the flight, at an altitude of about 60 miles, main engine cut-off (MECO) occurs. The Shuttle is now traveling at a speed of 16,697 mph.

After MECO, the orbiter and the external tank are moving along a trajectory that, if not corrected, would result in the vehicle entering the atmosphere about halfway around the world from the launch site. However, a brief firing of the orbiter's two Orbital Maneuvering System (OMS) thrusters changes the trajectory and orbit is achieved. This takes place just after the external tank has been jettisoned and while the orbiter is flying "upside down" in relation to Earth.

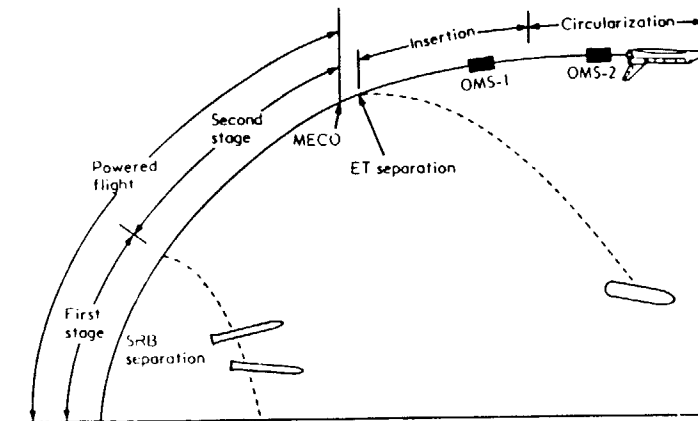

Space Shuttle Nominal Ascent Profile

The separated external tank continues on a ballistic trajectory and enters the Earth's atmosphere to break up over a remote area of the Indian Ocean. Meanwhile, an additional firing of the OMS thrusters places the orbiter into its planned orbit, which can range from 115 to 600 miles above the Earth.

There are two ways in which orbit can be accomplished. These are the conventional OMS insertion method called "standard" and the direct insertion method.

The OMS insertion method involves a brief burn of the OMS engines shortly after MECO, placing the orbiter into an elliptical orbit. A second OMS burn is initiated when the orbiter reaches apogee in its elliptical orbit. This brings the orbiter into a near circular orbit. If required during a mission, the orbit can be raised or lowered by additional firings of the OMS thrusters.

The direct insertion technique uses the main engines to achieve the desired orbital apogee, or high point, thus saving OMS propellant. Only one OMS burn is required to circularize the orbit,

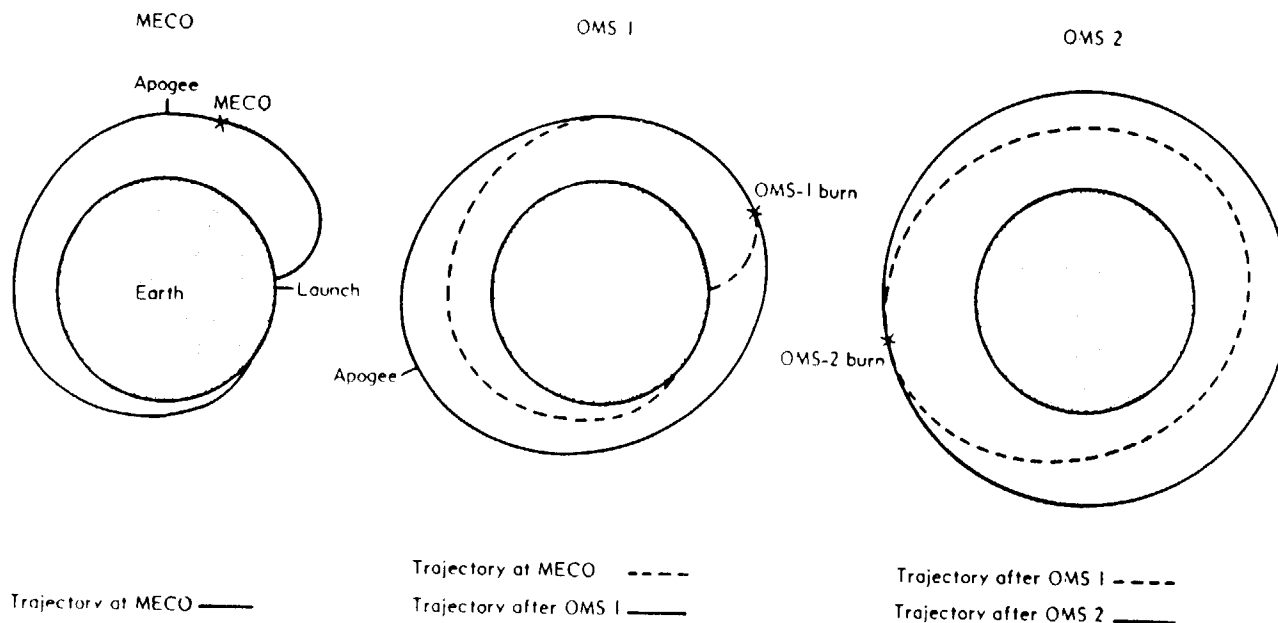

The trajectory at MECO is suborbital. The OMS-1 and OMS-2 maneuvers raise the trajectory to a circular orbit. In these drawings the trajectory altitudes are exaggerated in relation to the diameter of the Earth.

Sequence of Events Necessary to Achieve an Earth Orbit Using the Space Shuttle System

and the remaining OMS fuel can then be used for frequent changes in the operational orbit, as called for in the flight plan.

The first direct insertion orbit was accomplished during the STS 41-C mission in April 1984, when the Challenger was placed in a 288-mile-high circular orbit where its flight crew was able to successfully capture, repair and redeploy a free-flying spacecraft, the Solar Maximum satellite (Solar Max) -- an important "first" for the Space Shuttle program.

LAUNCH ABORT MODES. During the ascent phase of a Space Shuttle flight, if a situation occurs that puts the mission in jeopardy -- the loss, for example, of one or more of the main engines or the OMS thrusters -- the mission may have to be aborted. During the ascent phase, there are two basic Shuttle abort modes: intact aborts and contingency aborts. NASA has attempted to anticipate all possible emergency situations that could occur, and mission plans are prepared accordingly.

Intact aborts -- there are four different types -- permit the safe return of the orbiter and its crew to a pre-planned landing site.

When an intact abort is not possible, the contingency abort option becomes necessary. This crucial abort mode is designed to permit crew survival following a severe systems failure in which the vehicle is lost. Generally, if a contingency abort becomes necessary, the damaged vehicle would fall toward the ocean and the crew would exercise escape options that were developed in the aftermath of the Challenger accident. The four intact abort modes are:

Return to Launch Site (RTL_S)

Trans-Atlantic Abort Landing (TAL)

Abort Once Around (AOA)

Abort to Orbit (ATO)

Since an intact abort could result in an emergency landing, before each flight, potential contingency landing sites are designated and weather conditions at these locations are monitored closely before a launch. Space Shuttle flight rules include provisions for minimum acceptable weather conditions at these potential landing sites in the event of intact abort is necessary.

In an abort situation, the type and time of the failure determines which abort mode is possible. There is a definite order of preference for an abort. In cases where performance loss is the only factor, the preferred modes would be ATO, AOA, TAL or RTL_S, in that order. The mode selected normally would be the highest preferred one that can be completed with the remaining vehicle performance.

In the case of an extreme system failure -- the loss of cabin pressure or orbiter cooling systems -- the preferred mode would be the one that would terminate the mission as quickly as possible. This means that the TAL or RTL_S modes would be more preferable than other modes.

An ascent abort during powered flight can be initiated by turning a rotary switch on a panel in the orbiter cockpit. The switch is accessible to both the commander and the pilot. Normally, flight rules call for the abort mode selection to be made by the commander upon instructions from the Mission Control Center. Once the abort mode is selected, the on board computers automatically initiate abort action for that particular abort.

A description of the intact abort modes follows.

RETURN TO LAUNCH SITE (RTL_S). The RTL_S abort is a critical and complex one that becomes necessary if a main engine failure occurs after liftoff and before the point where a TAL or AOA is possible. RTL_S cannot be initiated until the SRBs have

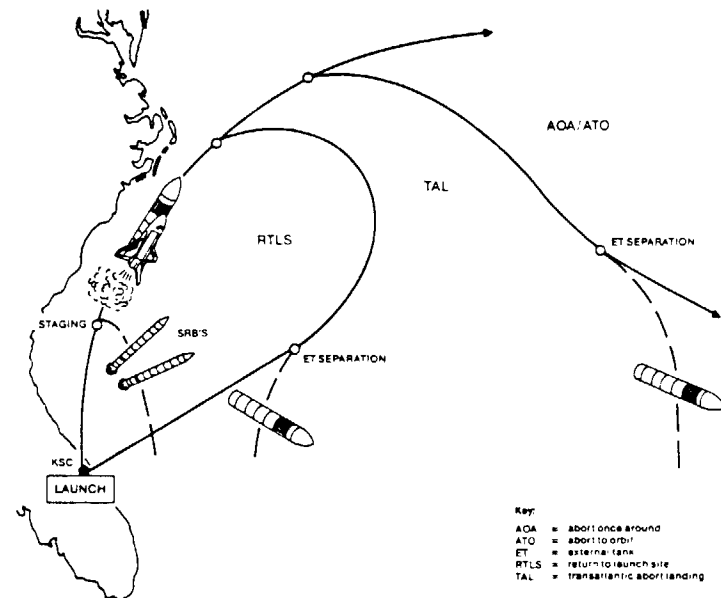

Space Shuttle Ascent Abort Modes

completed their normal burn and have been jettisoned. Meanwhile, the orbiter with the external tank still attached continues on its downrange trajectory with the remaining operational main engines, the two OMS and four aft RCS thrusters firing until the remaining main engine propellant equals the amount needed to reverse the direction of flight and return for a landing. A "pitch-around" maneuver of about 5 degrees per second is then performed to place the orbiter and the external tank in an attitude pointing back toward the launch site. OMS fuel is dumped to adjust the orbiter's center of gravity.

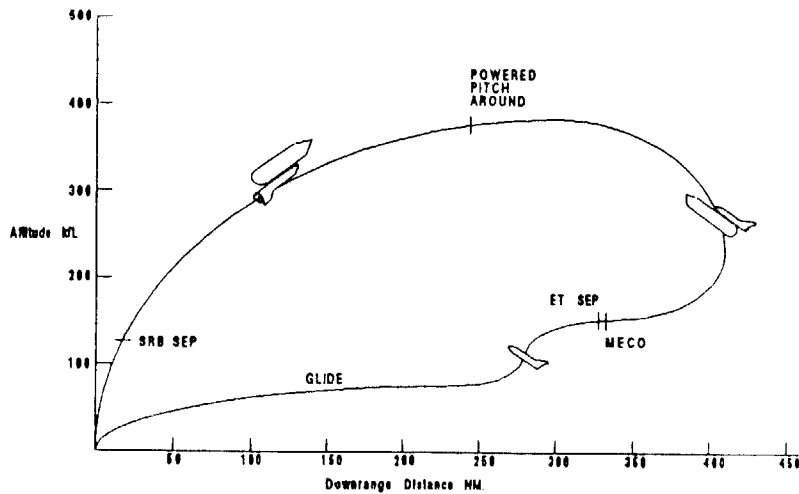

Return to Launch Site (RTL) Abort Profile

When altitude, attitude, flight path angle, heading, weight, and velocity/range conditions combine for external tank jettisoning, MECO is commanded, and the external tank separates and falls into the ocean. After this, the orbiter should glide to a landing at the launch site landing facility. From the foregoing, it can be appreciated why RTL is the least preferred intact abort mode.

TRANS-ATLANTIC ABORT LANDING (TAL). The TAL abort mode is designed to permit an intact landing after the Shuttle has flown a ballistic trajectory across the Atlantic Ocean and lands at a designated landing site in Africa or Spain. This abort mode was developed for the first Shuttle launch in April 1981, and has since evolved from a crew-initiated manual procedure to an automatic abort mode. The TAL capability provides an abort option between the last RTLS opportunity up to the point in ascent known as the "single-engine press to MECO" capability --meaning that the orbiter has sufficient velocity to achieve main engine cutoff and abort to orbit, even if two main engines are shut down. TAL also can be selected if other system failures occur after the last RTLS opportunity. The TAL abort mode does not require any OMS maneuvers.

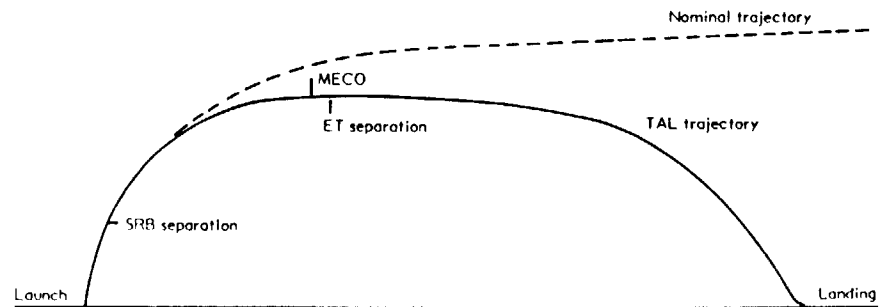

Transatlantic (TAL) Abort Profile

Landing sites for a TAL vary from flight to flight, depending on the launch azimuth. For the first three Space Shuttle missions, the trajectory inclination was about 28 degrees which made the U.S. Air Force bases at Zaragoza and Moron in Spain, the most ideal landing sites for TAL. Later Shuttle missions called for air fields at Dakar, Senegal, and Casablanca, Morocco, as TAL-option landing sites. In March 1988, NASA announced that in addition to the TAL sites in Spain, that two new African contingency landing sites had been selected for future Shuttle missions: a site near Ben Guerir, Morocco, about 40 miles north of Marrakesh with a 14,000-foot runway; and at Banjul, the capital of the west African

nation of The Gambia, which has an international airfield with an 11,800-foot runway.

ABORT ONCE AROUND (AOA). This abort mode becomes available about 2 minutes after SRB separation, up to the point just before an abort to orbit is possible. AOA normally would be called for because of a main engine failure. This abort mode allows the Shuttle to fly once around the Earth and make a normal entry and landing at Edwards AFB, Calif., or White Sands Space Harbor, near Las Cruces, N.M. An AOA abort usually would require two OMS burns, the second burn being a deorbit maneuver.

There are two different AOA entry trajectories. These are the so-called normal AOA and the shallow. The entry trajectory for the

normal AOA, is similar to a normal end-of-mission landing. The shallow AOA, on the other hand, results in a flatter entry trajectory, which is less desirable but uses less propellant for the OMS burn. The shallow trajectory also is less desirable because it exposes the orbiter to a longer period of atmospheric entry heating and to less predictable aerodynamic drag forces.

ABORT TO ORBIT (ATO). The ATO mode is the most benign of the various abort modes. ATO allows the orbiter to achieve a temporary orbit that is lower than the planned. ATO is usually necessary because of a main engine failure. It places fewer performance demands on the orbiter. It also gives ground controllers and the flight crew time to evaluate the problem. Depending on the seriousness of the situation, one ATO option is to make an early deorbit and landing. If there are no major

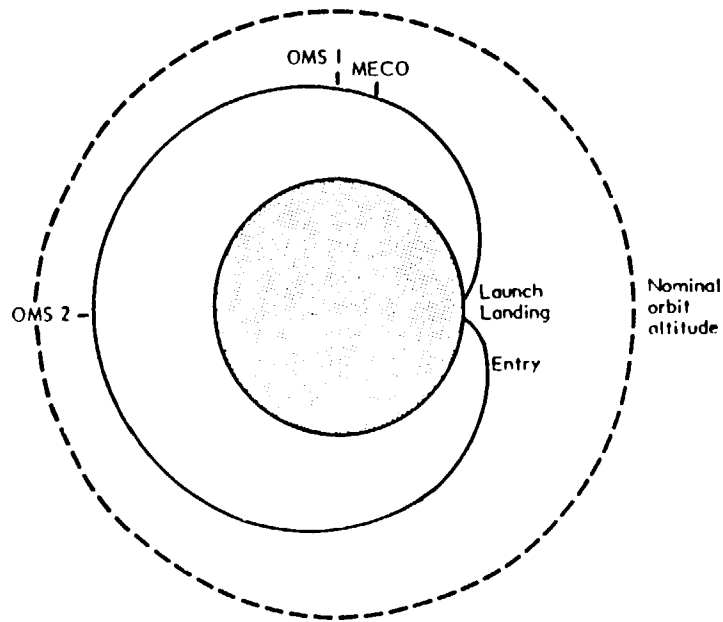

Abort Once Around (AOA) Abort Profile

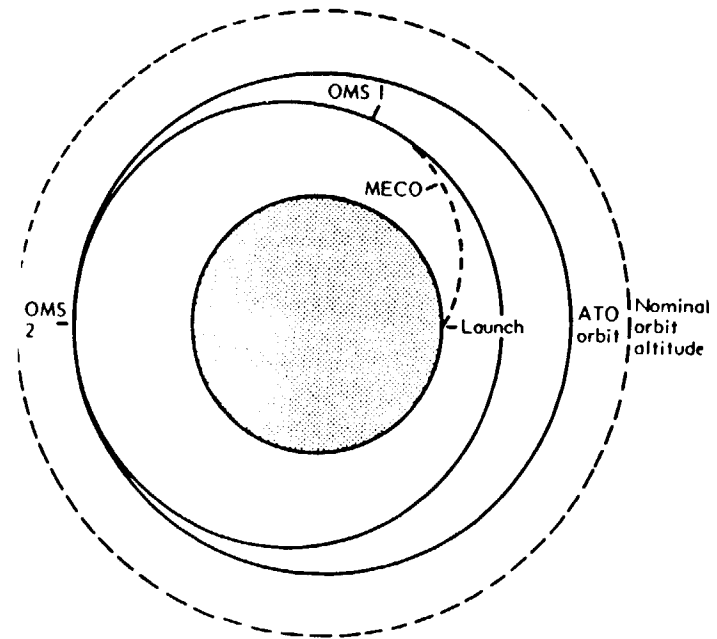

Abort Once Around (AOA) Abort Profile

other than the main engine one, an OMS maneuver is made to raise the orbit and the mission is continued as planned.

The first Space Shuttle program ATO occurred on July 29, 1985, following the STS 51-F Challenger launch, when one of the main engines was shut down early by computer command because of a failed temperature sensor. Within 10 seconds of the shutdown, Mission Control declared an ATO situation, and although a lower than planned orbit was attained, the 7-day mission carrying Spacelab-2 was successfully completed.

ON-ORBIT OPERATIONS. Space Shuttle flights are controlled by Mission Control Center (MCC) -- usually referred to as "Houston" in air to ground conversations.

During a flight, Shuttle crews and ground controllers work from a common set of guidelines and planned events called the Flight Data File. The Flight Data File includes the crew activity plan, payload handbooks and other documents which are put together during the elaborate flight planning process.

Each mission includes the provision for at least two crew members to be trained for extravehicular activity (EVA). EVA is an operational requirement when satellite repair or equipment testing is called for on a mission. However, during any mission, the two crew members must be ready to perform a contingency EVA if, for example, the payload bay doors fail to close properly and must be closed manually, or equipment must be jettisoned from the payload bay.

The first Space Shuttle program contingency EVA occurred in April 1985, during STS 51-D, a Discovery mission, following deployment of the SYCOM IV-3 (Leasat 3) communications satellite. Leasats' sequencer lever failed and initiation of the antenna deployment and spin-up and perigee kick motor start sequences did not take place. The flight was extended 2 days to give mission specialists Jeffrey Hoffman and David Griggs an opportunity to try to activate the lever during EVA operations which involved using

the RMS. The effort was not successful, but was accomplished on a later mission.

Each Shuttle mission carries two complete pressurized spacesuits called Extra Vehicular Mobility Units (EMU) and backpacks called Primary Life Support Systems (PLSS). These units, along with necessary tools and equipment, are stored in the airlock off the middeck area of the orbiter, ready for use if needed.

As already mentioned, for each mission, two crew members are trained and certified to perform EVAs, if necessary. For those missions in which planned EVAs are called for, the two astronauts receive realistic training for their specific tasks in the Weightless Environment Training Facility at Johnson, with its full-scale model of the orbiter payload bay.

MANEUVERING IN ORBIT. Once the Shuttle orbiter goes into orbit, it is operating in the element for which it was designed: the near gravity-free vacuum of space. However, to maintain proper orbital attitude and to perform a variety of maneuvers, an extensive array of large and small rocket thrusters are used -- 46 in all. Each of these thrusters, despite their varying sizes, burn a mixture of nitrogen tetroxide and monoethylhydrazine, an efficient but toxic combination of fuels which ignite on contact with each other.

The largest of the 46 control rockets are the two Orbital Maneuvering System (OMS) thrusters which are located in twin pods at the aft end of the orbiter, between the vertical stabilizer and just above the three main engines. Each of the two OMS engines can generate 6,000 lb. of thrust. They can cause a more than 1,000 foot-per-second change in velocity of a fully loaded orbiter. This velocity change is called Delta V.

A second and smaller group of thrusters make up the Reaction Control System (RCS) of which there are two types: the primaries and the verniers. Each orbiter has 38 primary thrusters, 14 in the forward nose area and 12 on each OMS pod. Each primary thruster can generate 870 lb. of thrust. The smallest of the RCS thrusters,

the verniers, are designed to provide what is called "fine tuning" of the orbiter's attitude. There are two vernier thrusters on the forward end of the orbiter and four aft, each generates 24 pounds of thrust.

LANDING, POSTLANDING AND SRB RETRIEVAL OPERATIONS

SHUTTLE LANDING OPERATIONS

When a mission's planned in-orbit operations have been accomplished, the emphasis on board the orbiter turns to the task of preparing the vehicle for its return to Earth. Usually, the last full day in orbit is devoted primarily to stowing equipment, cleaning up the living areas and making final systems configurations which will facilitate post-landing processing.

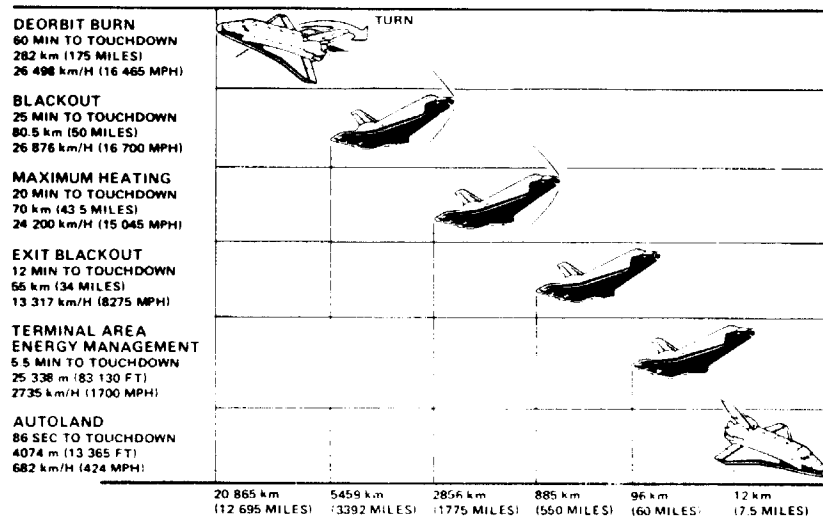

Deorbit Maneuver to Autoland Interface Events

The crew schedule, or timeline, is designed such that crew members are awake and into their "work day" 6 to 8 hours before landing. At about 4 hours before deorbit maneuvers are scheduled, the crew and flight controllers have finished with the Crew Activity Plan for that mission. They now work from the mission's Deorbit

Prep handbook, which covers the major deorbit events leading up to touchdown. Major events include the "go" from MCC to close the payload bay doors, and the final OK to perform the deorbit burn which will bring the orbiter back to Earth.

However, before the deorbit burn is performed, the orbiter is turned to a tail-first attitude. (That is, the aft end of the orbiter faces the direction of travel.) At a predesignated time, the OMS engines are fired to slow the orbiter down and to permit deorbit. The RCS

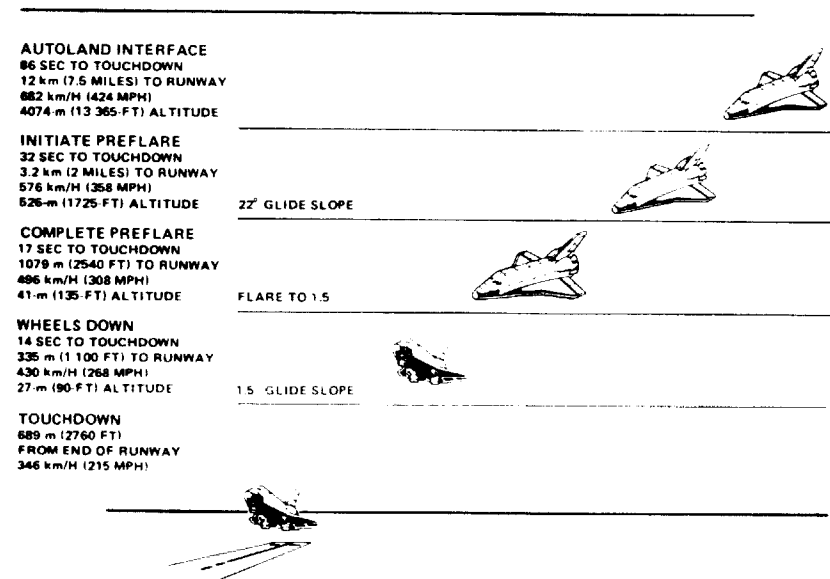

Autoland Interface to Touchdown Events

thrusters are then used to turn the orbiter back into a nose-first attitude. These thrusters are used during much of the reentry pitch, roll and yaw maneuvering until the orbiter's aerodynamic, aircraft-like control surfaces encounter enough atmospheric drag to control the landing. This is called Entry Interface (EI) and usually occurs

30 minutes before touchdown at about 400,000 ft. At this time, a communications blackout occurs as the orbiter is enveloped in a sheath of plasma caused by electromagnetic forces generated from the high heat experienced during entry into the atmosphere.

As the orbiter glides toward a landing, initially at a velocity of 25,000 feet per second at the EI point, its velocity is gradually slowed by a series of banks and roll reversals. As the atmospheric density increases, the forward RCS thrusters are turned off, while the aft RCS jets continue to maneuver the orbiter until a dynamic pressure of 10 lb. per square foot is sensed by instruments on board. At this point, the ailerons on orbiter's delta-shaped wings begin to operate and the aft RCS roll thrusters are stopped.

When the dynamic pressure reaches 20 lb. per square foot, the orbiter's wing elevators become operational and the RCS pitch thrusters are stopped. A speed brake on the vertical tail opens when the orbiter's velocity falls below Mach 10. Then, at Mach 3.5, the rudder is activated and the final RCS burns -- the yaw jets -- are stopped. The orbiter is now at an altitude of 45,000 ft., and is beginning what are called "area energy management maneuvers" which enable it to intercept the landing approach corridor at the desired altitude and velocity.

As it nears the landing site, the orbiter is steered into the nearest of two heading alignment circles called HACs. Each has a radius of 18,000 ft. The orbiter is now in subsonic flight, at 49,000 ft., and about 22 mile from its touchdown point.

In the future, final approach and landing will be controlled at this point the commander takes over control of the orbiter for final approach and landing maneuvers by the Microwave Scanning Beam Landing System (MSBLS) -- called autoland -- which will take over control 2 minutes before touchdown while the orbiter is at an altitude of 15,489 ft., 9.8 mile from the runway touchdown point, traveling at a speed of 410 mph. This phase of the flight will be completely automatic and the crew's main task will be to monitor the MSBLS.

The initial orbiter landing approach is at a glide slope of 19 degrees. This is six times steeper than the 3-degree glide slope of a typical commercial jet airliner as it approaches landing.

Just before the orbiter touches down, flare or pull-up maneuvers are required to bring it into its final landing glide slope of 1.5 degrees. At touchdown -- nominally about 2,500 ft. beyond the runway threshold -- the orbiter is traveling at a speed ranging from 213 to 226 mph.

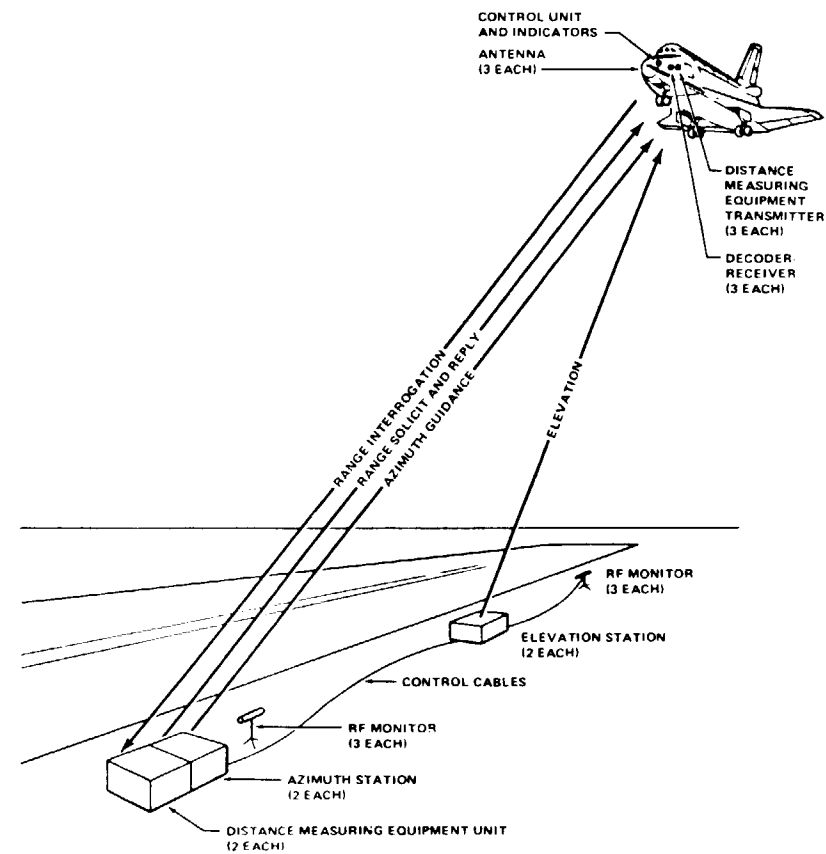

Microwave Scanning Beam Landing System

POST-LANDING OPERATIONS

Once the orbiter has rolled to a stop on the runway, post-landing activities get underway involving the Orbiter Recovery Convoy. Mission responsibility has shifted from the Johnson Space Center back to the Kennedy Space Center.

RECOVERY CONVOY. The Orbiter Recovery Convoy consists of a number of specially-designed vehicles and a team of specialists who safe and service the orbiter and assist in crew egress. Included in the convoy are 11 special vehicles and units. A brief description of these follows.

Scape Trailer. Self-Contained Atmospheric Protection Ensemble (SCAPE), vehicle, parked at a midfield location during landing, contains the equipment necessary to support recovery including recovery crew SCAPE suits, liquid air packs, and a crew who assist recovery personnel in suiting-up in protective clothing.

Vapor Dispersal Unit. The Vapor Dispersal Unit is a mobile wind-making machine able to produce a directed wind stream of up to 45 mph. It is an adaptation of a standard 14-ft. agricultural wind machine designed to protect fragile agricultural crops from frost damage or freezing. It is used by the recovery team to blow away toxic or explosive gases that may occur in or around the orbiter after landing. The fan can move 200,000 square feet of air a minute.

Coolant Umbilical Access. This apparatus is a stair and platform unit mounted on a truck bed which permits access to the aft port side of the orbiter where ground support crews attach coolant lines from the Orbiter Coolant Transporter.

Orbiter Coolant Transporters. This unit is a tractor-trailer carrying a refrigeration unit that provides Freon 114 through the orbiter's T-O umbilical into its cooling system.

Purge Umbilical Access Vehicle. This vehicle is similar to the Coolant Umbilical Access Vehicle in that it has an access

stairway and platform allowing crews to attach purge air lines to the orbiter on its aft starboard side.

Orbiter Purge Transporter. This vehicle is a tractor-trailer which carries an air conditioning unit powered by two 300 KW, 60 Hz electric generators. The unit blows cool or dehumidified air into the payload bay to remove possible residual explosive or toxic gases.

Crew Hatch Access Vehicle. The Crew Hatch Access Vehicle consists of a stairway and platform on which is located a white room equipped with special orbiter interface seals. It contains pressurized filtered air to keep toxic or explosive gases, airborne dust or other contaminants from getting into the orbiter during crew egress.

Astronaut Transporter Van. As its name implies, this van is used to transport the flight crew from the landing area. It is a modified recreational vehicle in which the crew can remove their flight suits and be examined by a physician while enroute.

Helium Tube Bank. This specialized vehicle is a trailer on which is mounted a 12-tube bank container which provides helium to purge hydrogen from the orbiter's main engines and lines. The bank contains 85,000 cubic feet of helium at 6,000 psi.

Orbiter Tow Vehicle. This unit is very much like the typical towing units used for large aircraft. However, it is equipped with a special towing bar designed specifically for the orbiter. It is used to move the orbiter from the landing facility to the OPF. It also is used for moving the orbiter from the OPF to the VAB.

Mobile Ground Power Unit. The final special vehicle for orbiter post-landing operations is the Mobile Ground Power Unit which provides power to the orbiter if the fuel cells have to be shut

down. It can deliver a nominal load of 10 kilowatts of direct power to the orbiter.

Augmenting these special orbiter recovery convoy vehicles are various conventional command and emergency vehicles.

RECOVERY CONVOY OPERATIONS. The main job of the recovery convoy is to service the orbiter, prepare it for towing, assist the crew in leaving the orbiter and finally to tow it to servicing facilities.

Even before the Shuttle is launched, the recovery convoy begins its post-landing preparations by warming up coolant and purge equipment, readying ground service equipment and carrying out extensive communications checks.

During the Shuttle flight, the recovery convoy is on call in the event an earlier than planned landing is necessary.

Major activity begins at about 2 hours before the orbiter is scheduled to land. At this time chilldown of the purge and coolant units begins. About 1 hour, 40 minutes before landing, the recovery crew puts on their SCAPE suits and makes final communications checks. At 5 minutes before touchdown, the recovery convoy is ready to go to work.

After landing, the first staging position of the convoy is 200 ft. up wind from the orbiter. The safety assessment team in the SCAPE van moves to about 100 ft. of the port side of the orbiter. A SCAPE-dressed crew then moves to the rear of the orbiter using a high range flammability vapor detector to obtain vapor level readings and to test for possible explosive hazards and toxic gases. Two readings from three different locations are made to determine concentrations of hydrogen, monomethyl hydrazine, and hydrazine and ammonia. If they find that high levels of gases are present, and if wind conditions are calm, the Vapor Dispersal Unit -- the mobile wind machine -- moves into place and blows away the potentially dangerous gases.

Meanwhile, the Purge and Coolant Umbilical Access Vehicles are moved behind the orbiter and the safety assessment team continues to determine whether hazardous gases are present in the area. Once the umbilical access vehicles are in position, and as soon as it is possible to connect up to the liquid hydrogen T-O umbilical on the orbiter, the ground half of the on board hydrogen detection sample lines are connected to determine the hydrogen concentration. If the concentration is less than 4 percent, convoy operations continue. However, if it should be greater than 4 percent, an emergency power down of the orbiter is ordered. The flight crew is evacuated from the orbiter immediately and the convoy personnel clear the area and wait for the hydrogen to disperse.

If the hydrogen level is below 4 percent, the carrier plate for the starboard liquid oxygen T-O umbilical is attached to permit insertion of purge air ducts. After the carrier plates have been installed, the Freon line and purge duct connections are completed and the flow of coolant and purge air through the umbilical lines begins.

Purge air provides cool and humidified air conditioning to the payload bay and other cavities thereby removing any residual explosive or toxic fumes.

When it is determined that the area around and in the orbiter is safe, non-SCAPE suit operations begin. First, in the forward orbiter area, the priority is to assist the flight crew off the orbiter.

The Crew Hatch Access Vehicle moves to the hatch side of the orbiter. When the access white room is secured, the orbiter hatch is opened and a physician boards the orbiter to make a brief preliminary medical examination of the crew. The crew then leaves the orbiter and departs in the Astronaut Transporter Van.

The flight crew is replaced on board the orbiter by an exchange crew who make preparations for ground towing operations, installing switch guards and removing data packages from onboard experiments, if required.

Meanwhile, after allowing for a 30-minute orbiter tire cool down, the Tow Vehicle crew installs the landing gear lock pins, and disconnects the nose landing gear drag link. The Tow Vehicle is positioned in front of the orbiter and the tow bar connection is made. Finally, about two hours after landing the orbiter is towed off the runway.

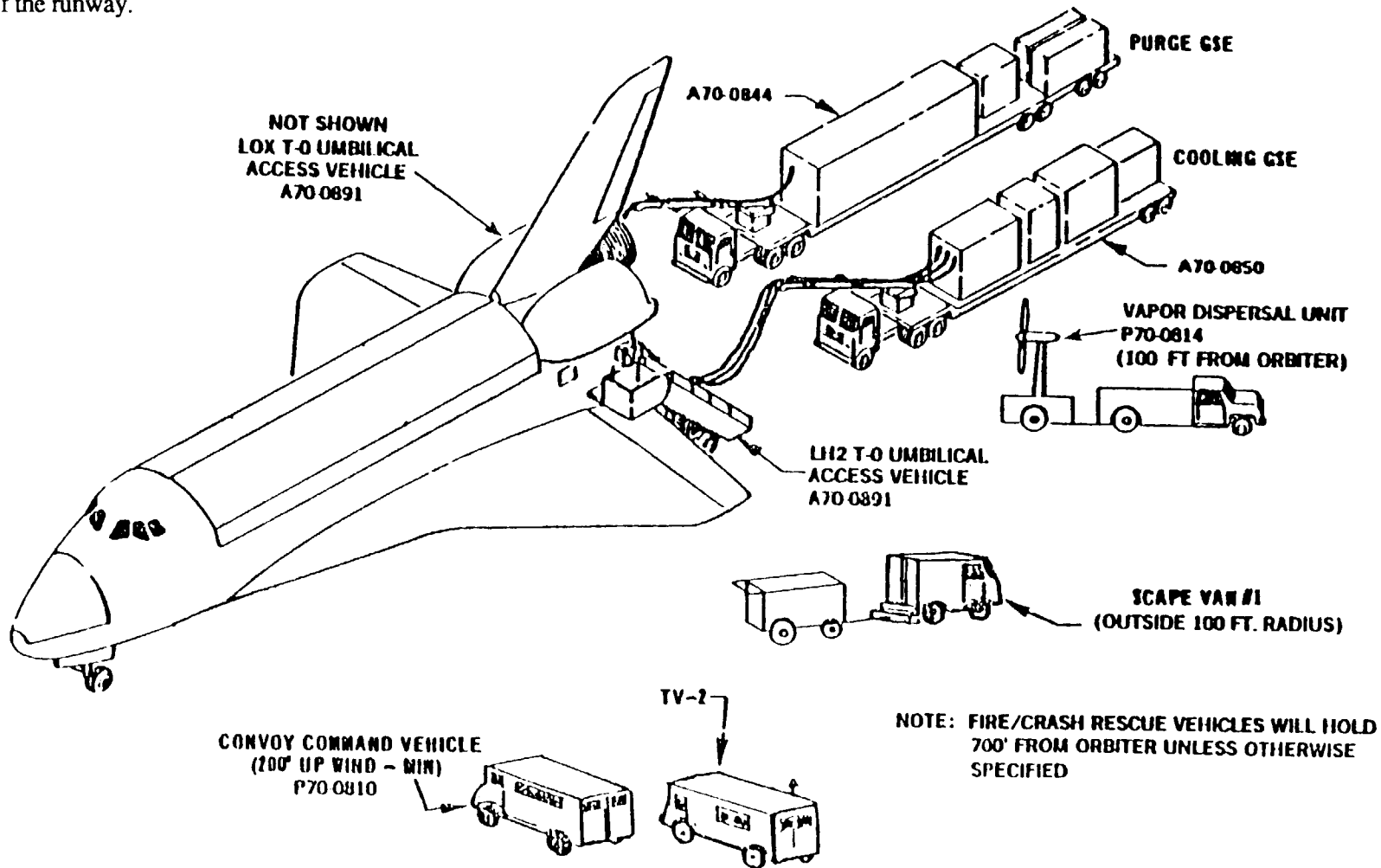

Recovery Convoy Initial Tasks

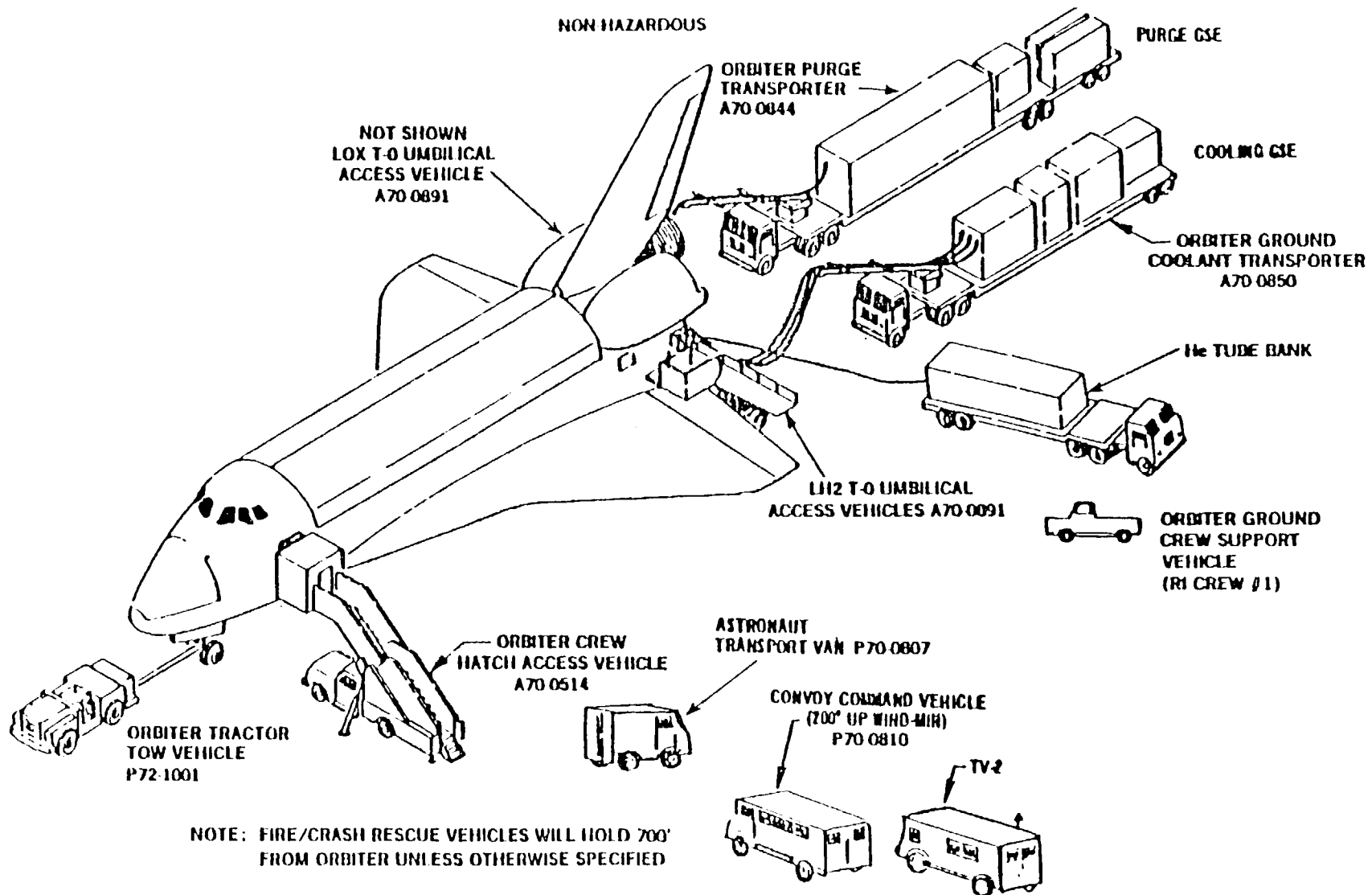

Recovery Convoy Non-Hazardous Tasks

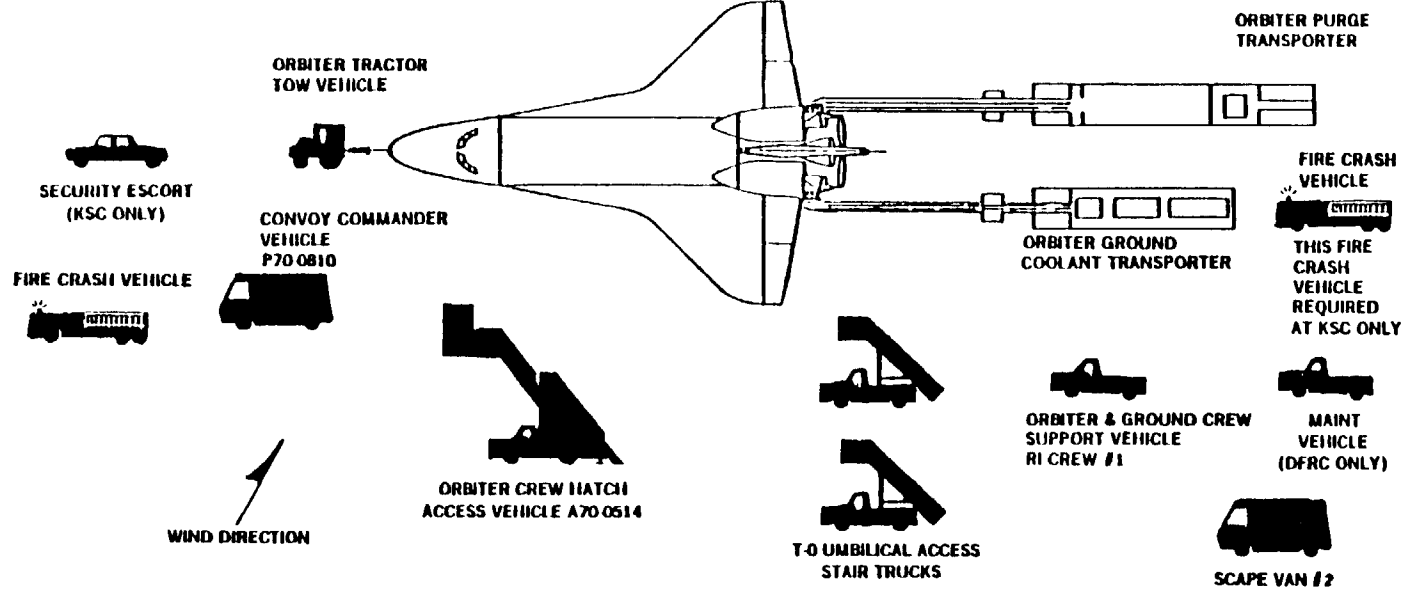

Recovery Convoy Tow Configuration

SOLID ROCKET BOOSTER RETRIEVAL OPERATIONS

After the Space Shuttle is launched, the Solid Rocket Boosters (SRB) are jettisoned at 2 minutes, 7 seconds into the flight. They are retrieved from the Atlantic Ocean by special recovery vessels and returned for refurbishment and eventual reuse on future Shuttle flights.

SRB separation occurs at an altitude of about 30 miles. The separated boosters then coast up to an altitude of 47 miles and free-fall into an impact zone in the ocean about 158 miles downrange. The so-called splash "footprint" is in an area about 7 miles wide and about 10 miles long.

When a free-falling booster reaches an altitude of about 3 miles its nose cap is jettisoned and the SRB pilot parachute pops open. The pilot parachute then pulls out the 54-ft. diameter, 1,100-lb. drogue parachute. The drogue parachute stabilizes and slows down the descent to the ocean.

At an altitude of 6,240 ft., the frustum, a truncated cone at the top of the SRB where it joins the nose cap, is separated from the forward skirt, causing the three main parachutes to pop out. These parachutes are 115 ft. in diameter and have a dry weight of about 1,500 lb. each. When wet with sea water they weigh about 3,000 lb.

At 6 minute and 44 seconds after liftoff, the spent SRBs, weighing about 165,000 lb., have slowed their descent speed to about 62 mph and splashdown takes place in the predetermined area.

The parachutes remain attached to the boosters until they are detached by recovery personnel.

Waiting near the impact area are two 176-ft.-long, specially-designed SRB recovery vessels. Their first job is to recover the main SRB parachutes. Each vessel is equipped with four 5 ft. 6 in.

-diameter reels which wind the parachute winch lines onto the reel similar to the way line is wound onto a fishing reel.

The frustum-drogue parachute also is reeled in until the 5,000-lb. frustum is about 100 ft. from the recovery ship. The drogue parachute lines are then reeled in until the frustum can be lifted out of the ocean by a 10-ton-capacity crane.

Next, the empty SRB casings are recovered using a special device called the Diver Operated Plug (DOP). This procedure calls for a team of underwater divers to descend to a depth of about 110 ft. and place the DOP into the nozzle of the casing. A 2,000-ft.-long air line attached to the DOP is plugged into an air compressor on the recovery vessel. Air is pumped into the booster at 120 psi to empty water from the casing -- a procedure called "dewatering."

Under ideal weather and sea conditions, the retrieval operation takes about 5 and 1/2 hours. The recovery ships with the retrieved SRBs in tow, sail to Port Canaveral, travel north up the Banana River and dock near Hangar AF at the Cape Canaveral Air Force Station, their mission completed.

SRB DISASSEMBLY OPERATIONS. The retrieval ships take the SRBs to a dock at the Solid Rocket Booster Disassembly Facility (SRBDF) located at Hangar AF -- a building originally used for Project Mercury, the first U.S. manned space program.

The SRBs are unloaded onto a hoisting slip and mobile gantry cranes lift them onto tracked dollies where they are safed and undergo their first washing.

The casings are then taken to the SRBDF for disassembly into their four main segments: two aft skirt and two forward skirt assemblies. The main casing segments undergo further cleaning, after which they are placed on railroad cars and shipped to the

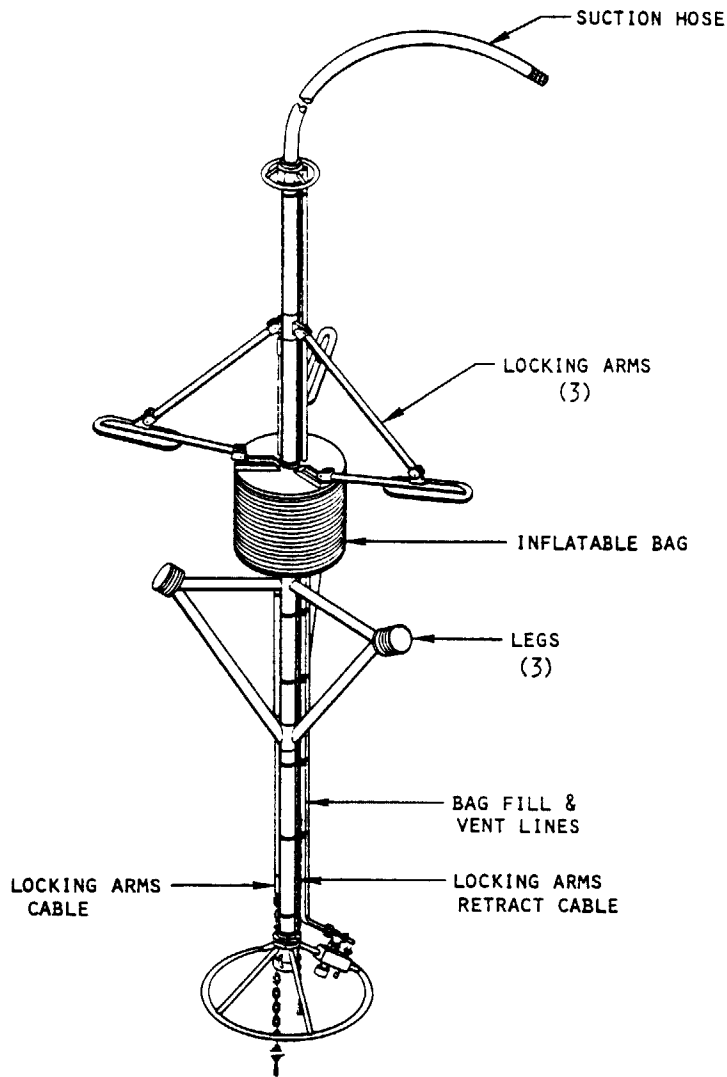

Diver Operated Plug

manufacturing plant in Utah where they undergo final refurbishment and are again loaded with propellant.

Meanwhile, the nose cone frustums and parachutes are processed at the Parachute Refurbishment Facility in the KSC Industrial Area.

PARACHUTE REFURBISHMENT. The SRB Parachute Refurbishment Facility (PRF) was originally built to process the parachutes used in the Gemini manned space program and was modified for the Shuttle program.

The SRB parachutes are taken to the PRF for refurbishment on the reels from the recovery vessels. The PRF also receives and stores new parachutes and hardware for the SRBs.

Specific procedures for refurbishment of the SRB parachutes include untangling the lines, and hanging them on an overhead monorail and automatically washing and drying them. When this is completed, and final inspections are conducted, the parachutes are folded on 64-ft.-long tables and stored in canisters for eventual reuse.

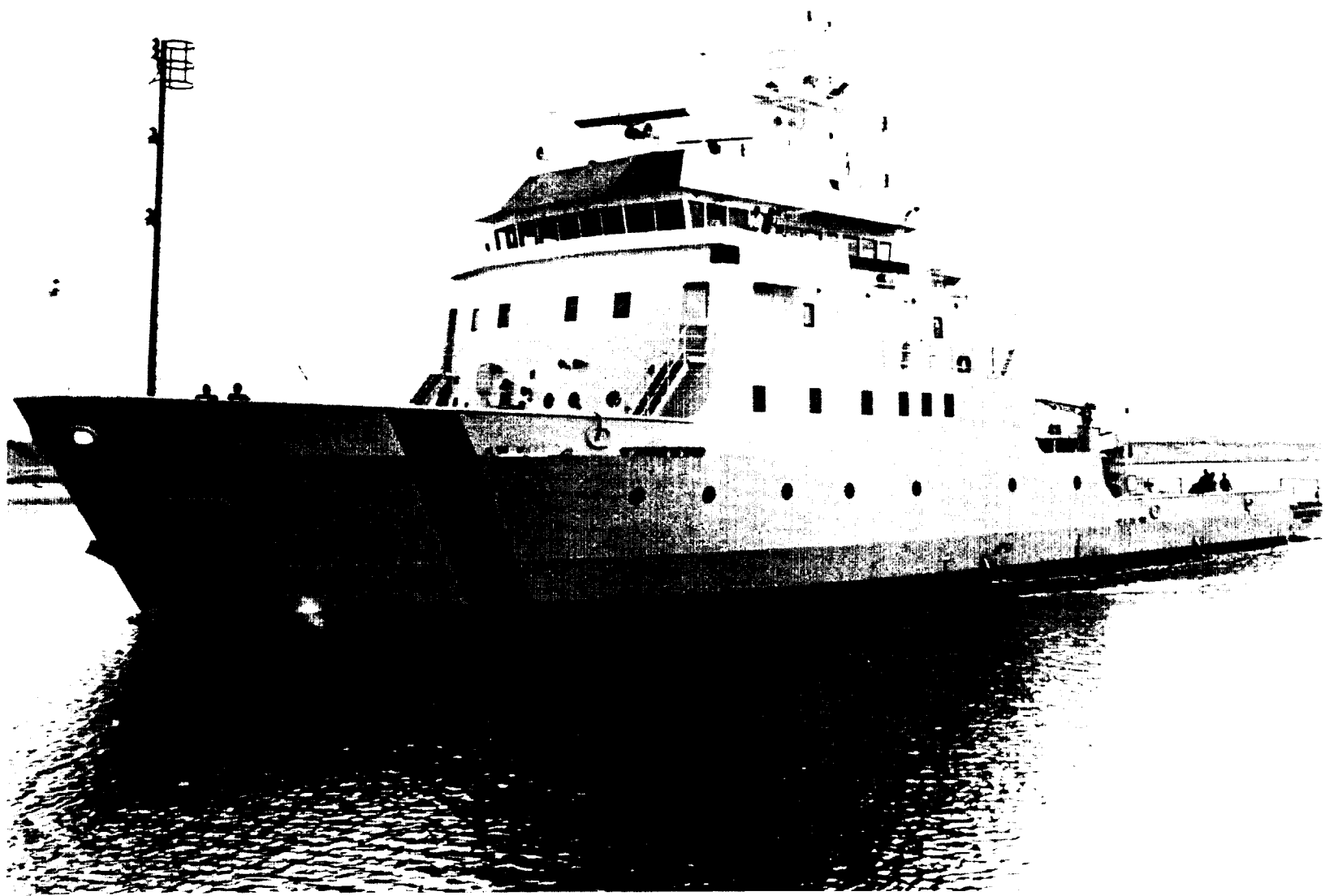

Solid Rocket Booster Recovery Ship, "Independence"

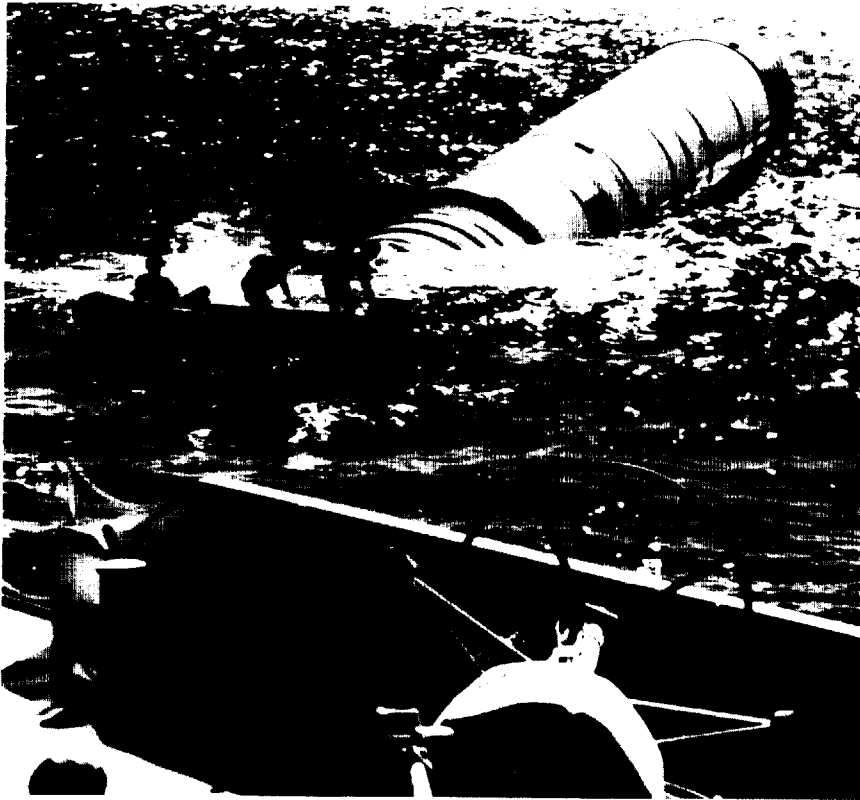

Divers Recovering a Solid Rocket Booster

ORIGINAL PAGE
BLACK AND WHITE PHOTOGRAPH

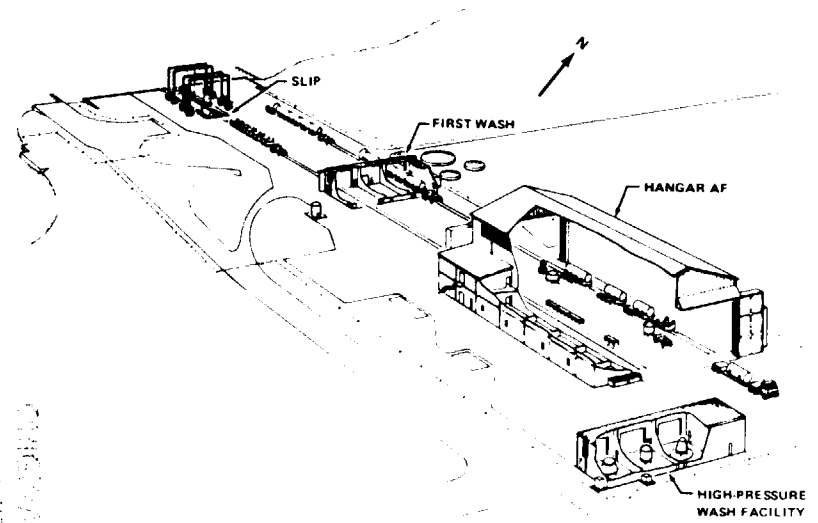

*Solid Rocket Booster Disassembly Facility
At Kennedy Space Center*

SPACE SHUTTLE PROGRAM MANAGEMENT

The Space Shuttle program is the major segment of NASA's National Space Transportation System (NSTS) managed by the Office of Space Flight (OSF) at NASA Headquarters in Washington, D. C. The office is headed by an associate administrator who reports directly to the NASA administrator and is charged with providing executive leadership, overall direction and effective accomplishment of the Space Shuttle and associated programs, including unmanned launch vehicles.

The Associate Administrator for Space Flight exercises institutional management authority over the activities of the NASA field organizations whose primary functions are related to the NSTS program. These are Johnson Space Center (JSC), Houston, Texas; Kennedy Space Center (KSC), Fla.; Marshall Space Flight Center (MSFC), Huntsville, Ala.; and Stennis Space Center (formerly National Space Technology Laboratories), Bay St. Louis, Miss.

The directors of these organizations, along with the Associate Administrator for Space Flight, also are members of the Office of Space Flight Management Council. This group meets regularly to review Shuttle program progress and to provide an independent and objective assessment of the status of the overall program.

NSTS ORGANIZATION

Within the OSF, centralized management authority for the Space Shuttle program is charged to the Director, NSTS. This individual is the program's general manager and has full responsibility and authority for the operation and conduct of the Shuttle program. These responsibilities include program control, budget planning and preparation, scheduling and the maintenance of a balanced program. The NSTS director reports to the Associate Administrator for Space Flight.

Organizational elements of the NSTS office are located at NASA Headquarters, JSC, KSC, MSFC and at the Vandenberg Launch Site (VLS); in California.

The NSTS office has two deputies who are responsible for the day-to-day management and operation of the Shuttle program. They are: Deputy Director, NSTS Program, a NASA Headquarters employee whose duty station is at JSC, and the Deputy Director, NSTS Operations, also a NASA Headquarters employee, whose duty station is at KSC. Both individuals report directly to the NSTS director.

Specific major responsibilities of the Deputy Director, NSTS Program, include the following:

- Establishing policy and providing continuous direction to all elements engaged in Shuttle program activities.
- Establishing and controlling the Level II requirements baseline that provides the detailed requirements that supplement and implement the Level I requirements.
- Detailed program planning, budgeting, scheduling, system configuration management and program direction.
- System engineering and integration of the flight vehicle, ground systems and facilities.
- Integration of payloads with orbiter.
- Mission planning and integration.

There are five organizational elements under the Deputy Director, NSTS Program, charged with accomplishing the management responsibilities of the program. They are: NSTS Engineering Integration, NSTS Management Integration, NSTS Program Control and NSTS Integration and Operations -- all of

which are located at JSC. The fifth division is the Shuttle Projects Office, located at MSFC, which has overall management and coordination of the MSFC elements -- the solid rocket boosters, external tank and main engines -- involved in the Shuttle program.

The Deputy Director, NSTS Operations, on the other hand, is specifically charged with the following major functions:

- Formulating policy, program plans and budget requirements in support of Shuttle operations at KSC, JSC, Edwards AFB and Vandenberg AFB, as well as other program operations facilities including the worldwide contingency landing sites.
- Final vehicle preparation, mission execution and return of the orbiter for processing for its next flight.
- Management of the presentation and scheduling of the Flight Readiness Review (FRR).
- Chairing and management of the Mission Management Team (MMT).

The duties of the NSTS Deputy Director, Operations, are carried out by three Operations Integration offices located at JSC, KSC and MSFC.

Management relationships in the centralized NSTS organization are configured into four basic management levels which are designed to reduce the potential for conflict between the program organizations and NASA institutional organizations.

The NSTS Director serves as the Level I manager and is responsible for the overall program requirements, budgets and schedules.

The NSTS Deputy Directors are Level II managers and responsible for management and integration of all elements of the program. This includes integrated flight and ground system requirements, schedules and budgets.

NSTS project managers located at JSC, KSC and MSFC are classified as Level III managers and are responsible for managing design, qualification and manufacturing of Shuttle components, as well as a launch and landing operations.

NSTS design authority personnel and contractors are Level IV managers and are responsible for the design, development, manufacturing, test and qualification of Shuttle systems.

LAUNCH CONSTRAINT PROCEDURES

As part of the FRR, a launch constraints list is established and approved by the Associate Administrator. The Deputy Director, NSTS Operations, has the responsibility to tract each of the constraints and to assure that they are properly closed out prior to the L-2 day MMT review. The Associate Administrator or his designee (Director, NSTS) has the final closeout authority.

LAUNCH DECISION PROCESS

Major decision-making meetings leading to a decision to launch are FRRs and MMT reviews.

The FRR is usually held 2 weeks before a scheduled launch. Its chairman is the Associate Administrator for Space Flight. Present at the review are all senior program and field organization management officials and support contractor representatives.

During the review, each manager must assess his readiness for launch based on hardware status, problems encountered during launch processing, launch constraints and open items. Each NASA project manager and major Shuttle component support contractor representative is required to sign a Certificate of Flight Readiness.

The MMT, made up of program/project level managers, and chaired by the Deputy Director, NSTS Operations, provides a forum for resolving problems and issues outside the guidelines and constraints established for the Launch and Flight Directors.

The MMT will be activated at launch minus 2 days (L-2) for a launch countdown status briefing. The objective of the L-2 day meeting is to assess any deltas to flight readiness since the FRR and to give a "go/no-go" to continue the countdown.

The MMT will remain active during the final countdown and will develop recommendations on vehicle anomalies and required changes to previously agreed to launch commit criteria. The MMT chairman will give the Launch Director a "go" for coming out of the L-9 minute hold and is responsible for the final "go/no-go" decision.

MANAGEMENT COMMUNICATIONS

In the area of management communications, weekly integrated program schedules are published which provide detailed data from each project element and the NSTS Engineering Office. These widely distributed schedules are designed to create management awareness of the interrelated tasks and critical program paths needed to meet important program milestones.

Additionally, all project and program management personnel meet monthly at the Program Director Management Review to brief the program status and to resolve any program issues and concerns. This review is followed by a meeting of the Management Council to also review status and to resolve any issues brought forward by the Director, NSTS.

SPACE SHUTTLE MISSION SUMMARIES

From April 1981 through January 1986, 25 Space Shuttle launches were conducted. All four orbiters in the fleet -- Columbia, Challenger, Discovery and Atlantis -- were flown. However, 1 minute, 13 seconds after liftoff -- during the 25th launch -- on Jan. 28, 1986, the Space Shuttle exploded. The orbiter Challenger was destroyed and its crew of seven killed. The accident had a far-reaching impact on the Space Shuttle program. Launchings were suspended for more than 2 years, while recommendations of a Presidential Commission which investigated the accident were implemented, along with changes called for by NASA itself.

STS-1

The first launch of the Space Shuttle occurred on April 12, 1981, when the orbiter Columbia, with two crew members, astronauts John W. Young, commander, and Robert L. Crippen, pilot, lifted off from Pad A, Launch Complex 39, at the Kennedy Space Center -- the first of 24 launches from Pad A. It was exactly 7 a.m. EST. A launch attempt, 2 days before, was scrubbed because of a timing problem in one of the Columbia's general purpose computers.

Not only was this the first launch of the Space Shuttle, but it marked the first time that solid fuel rockets were used for a U.S. manned launch. The STS-1 orbiter, Columbia, also holds the record for the amount of time spent in the Orbiter Processing Facility (OPF) before launch -- 610 days, time needed for replacement of many of its heat shield tiles.

Primary mission objectives of the maiden flight were to check out the overall Shuttle system, accomplish a safe ascent into orbit and to return to Earth for a safe landing. All of these objectives were met successfully and the Shuttle's worthiness as a space vehicle was verified.

The only payload carried on the mission was a Development Flight Instrumentation (DFI) package which contained sensors and

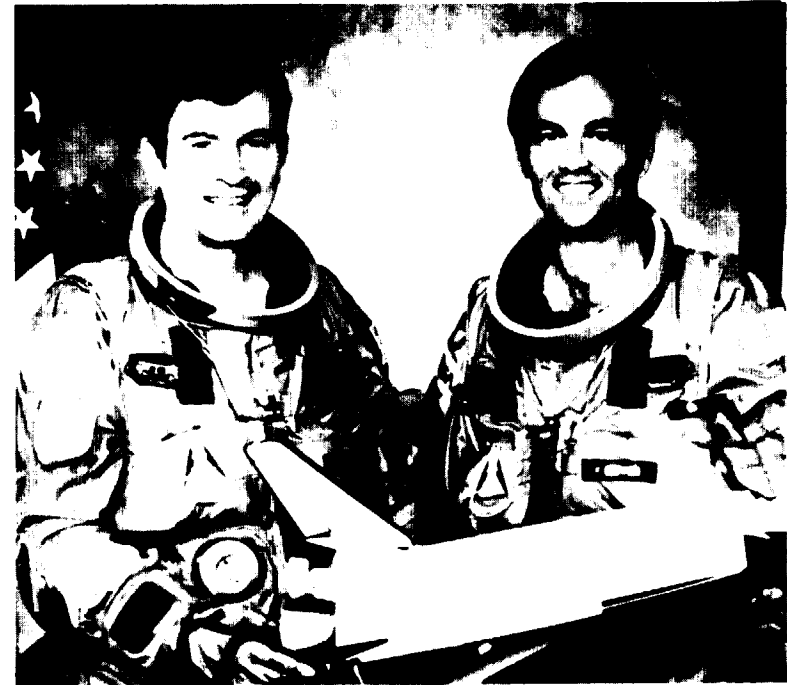

*John Young, Commander and Robert Crippen, Pilot
STS-1 Mission on Columbia*

measuring devices to record orbiter performance and the stresses that occurred during launch, ascent, orbital flight, descent and landing.

The 36-orbit, 933,757-mile-long flight lasted 2 days, 6 hours, 20 minutes and 32 seconds. Landing took place on Runway 23 at Edwards AFB, Calif., on April 14, 1981, at 10:21 a.m. PST. Post-flight inspection of the Columbia revealed that an overpressure wave which occurred when the SRB ignited resulted in the loss of 16 heat shield tiles and damage to 148 others. In all other respects,

other respects, however, Columbia came through the flight with flying colors, and it was to fly the next four Shuttle missions.

Columbia was returned to Kennedy Space Center from California on April 28 atop its 747 carrier aircraft.

STS-2

Launch of the second Space Shuttle took place 7 months later, on Nov. 12, 1981, with liftoff at 10:10 a.m. EST. The planned launch time of 7:30 a.m. was delayed while a faulty data transmitting unit on Columbia was replaced. Originally the launch had been set for Oct. 9, but it was delayed by a nitrogen tetroxide spill during loading of the forward Reaction Control System (RCS) tanks. It was next scheduled for Nov. 4, but was again scrubbed when high oil pressures were discovered in two of the three Auxiliary Power Units (APU) that control the orbiter's hydraulic system. Prior to launch Columbia had spent 103 days in the OPF.

The flight marked the first time a manned space vehicle had been reflown with a second crew: Joseph H. Engle, commander, and Richard H. Truly, pilot. It again carried the DFI package, as well as the OSTA-1 payload -- named for the NASA Office of Space and Terrestrial Applications -- which consisted of a number of remote sensing instruments mounted on a Spacelab pallet in the payload bay. These instruments, including the Shuttle Imaging Radar-A (SIR-1), successfully carried out remote sensing of Earth resources, environmental quality, ocean and weather conditions. In addition, the Canadian-built Remote Manipulator System (RMS) arm was successfully operated in all its various operating modes for the first time.

Although the STS-2 mission had been planned for 5 days, the flight was cut short when one of the three fuel cells that produce electricity and drinking water failed.

Landing took place on Runway 23, at Edwards AFB, at 1:23 p.m. PST, Nov. 14, after a 36-orbit, 933,757-mile flight that lasted 2 days, 6 hours, 13 minutes, 13 seconds.

Despite the truncated flight, more than 90 percent of the mission's objectives were achieved. Moreover, modifications of the water sound suppression system at the pad to absorb the solid rocket booster overpressure wave during launch were effective -- no tiles were lost and only 12 were damaged. The Columbia was flown back to KSC on Nov. 25, 1981.

STS-3

Columbia was launched on its third flight at 11:00 a.m. EST, on March 22, 1982, the planned launch date. The launch was delayed 1 hour because of the failure of a heater on a nitrogen gas ground support line. Columbia had spent only 70 days in the Orbiter Processing Facility -- a record checkout time. The two-man crew included Jack R. Lousma, commander, and Charles G. Fullerton, pilot.

Major objectives of the flight were to continue testing the RMS arm, and to carry out extensive thermal testing of the Columbia by exposing its tail, nose and top to the sun for varying periods of time.

In addition, in its payload bay, Columbia again carried the DFI package, and OSS-1 -- named for the NASA Office of Space Science and Applications -- which consisted of a number of instruments mounted on a Spacelab pallet to obtain data on the near-Earth environment and the extent of contamination caused by the orbiter itself. A test cannister for the Small Self-Contained Payload program -- also known as the Getaway Special (GAS) -- was mounted on a side of the payload bay.

For the first time a number of experiments were carried in the middeck lockers. These included a Continuous Flow Electrophoresis System experiment to study separation of biological components and a Monodisperse Latex Reactor experiment to produce uniform micron-sized latex particles. The first Shuttle Student Involvement Project (SSIP) -- the study of insect motion -- also was carried in a middeck locker.

During the flight, both crew members experienced some space sickness, the toilet malfunctioned, one Auxiliary Pacer Unit overheated (but worked properly during descent), and three communications links were lost on March 26.

STS-3 was planned as a 7-day flight. However, it was extended an extra day because of high winds at the backup landing site, Northrup Strip, White Sands, N.M., since the planned landing site at Edwards AFB was too wet for a safe landing.

Touchdown finally took place at 9:05 a.m. MST, March 30, 1982, at Northrup Strip (later renamed White Sands Space Harbor). Columbia had made 129 orbits and traveled 3.3 million miles, during its 8-day, 4-minute, 45-second flight. A total of 36 tiles were lost and 19 were damaged. It was returned to KSC on April 6, 1982.

STS-4

This mission marked the first time the Space Shuttle was launched precisely at its scheduled launch time. It also was the last research and development flight in the program. Liftoff took place on June 27, 1982, at 11:00 a.m. EST, with Thomas K. Mattingly as commander, and Henry W. Hartsfield as pilot. Its cargo consisted of the first Getaway Special payloads which included nine scientific experiments provided by students from Utah State University, and a classified Air Force payload.

In the middeck, a Continuous Flow Electrophoresis System and the Monodisperse Latex Reactor were flown for the second time. The crew conducted a lightning survey with handheld cameras, and performed medical experiments on themselves for two student projects. They also operated the RMS with an instrument called the Induced Environment Contamination Monitor mounted on its end designed to obtain information on gases or particles being released by the orbiter in flight.

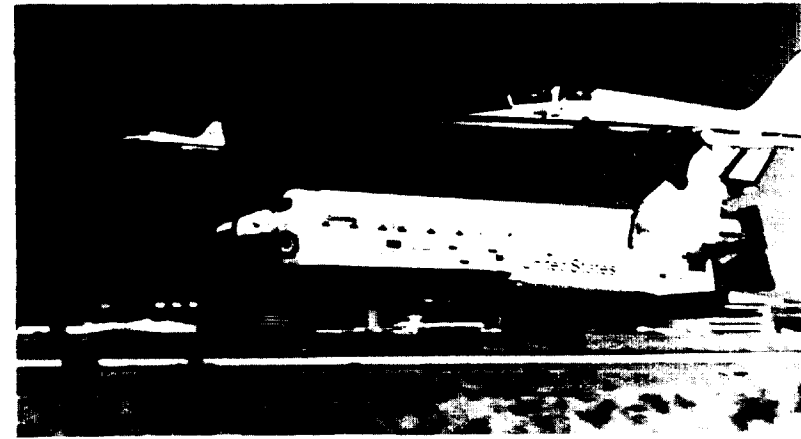

Columbia Makes the First Shuttle Hard Surface Landing on Mission STS-4

STS-4 was a planned 7-day mission and landing occurred on July 4, 1982, at 9:10 a.m. PDT, on the 15,000-ft. concrete Runway 22 at Edwards AFB -- the first Shuttle landing on a concrete runway.

The flight lasted 7 days, 1 hour, 9 minutes, 40 seconds. Distance traveled was 2.9 million miles in 112 complete orbits. All mission objectives were achieved, although the two SRBs were lost when their main parachutes failed causing the empty casings to hit the water at high speeds and sink. The Columbia was returned to KSC on July 15.

STS-5

STS-5, the first operational mission, also carried the largest crew up to that time -- four astronauts -- and the first two commercial communications satellites to be flown.

The fifth launch of the orbiter Columbia took place at 7:19 a.m. EST, Nov. 11, 1982. It was the second on-schedule launch. The crew included Vance Brand, commander; Robert F. Overmyer,

pilot; and the first mission specialists to fly the Shuttle -- Joseph P. Allen and William B. Lenoir.

The two communications satellites were deployed successfully and subsequently propelled into their operational geosynchronous orbits by booster rockets. Both were Hughes-built HS-376 series satellites -- SBS-3 owned by Satellite Business Systems, and Anik owned by Telesat of Canada. In addition to the first commercial satellite cargo, the flight carried a West German-sponsored microgravity GAS experiment canister in the payload bay. The crew also conducted three student experiments during the flight.

A planned spacewalk by the two mission specialists had to be cancelled -- it would have been the first for the Shuttle program -- when the two space suits that were to be used developed problems.

Columbia landed on Runway 22, at Edwards AFB, on Nov. 16, 1982, at 6:33 a.m. PST, having traveled 2 million miles in 81 orbits during a mission that lasted 5 days, 2 hours, 14 minutes and 26 seconds. Columbia was returned to KSC on Nov. 22.

STS-6

On April 4, 1983, STS-6, the first Challenger mission, lifted off at 1:30 p.m. EST. It was the first use of a new lightweight external tank and lightweight SRB casings.

The mission originally had been scheduled for launch on Jan. 30, 1983. However, a hydrogen leak in one of the main engines was discovered. Later, after a flight readiness firing of the main engines on Jan. 25, 1983, fuel line cracks were found in the other two engines. A spare engine replaced the engine with the hydrogen leak and the other two engines were removed, repaired and reinstalled.

Meanwhile, as the engine repairs were underway, a severe storm caused contamination of the primary cargo for the mission, the first Tracking and Data Relay Satellite (TDRS), while it was in the Payload Changeout Room on the Rotating Service Structure at



Astronaut Story Musgrave Performs an Extravehicular Activity (EVA) on Mission STS-6

the launch pad. This meant the satellite had to be taken back to its checkout facility where it was cleaned and rechecked. The Payload Changeout Room and the payload bay also had to be cleaned.

STS-6 carried a crew of four -- Paul J. Weitz, commander; Karol J. Bobko, pilot; Donald H. Peterson and Story Musgrave, both mission specialists. Using new space suits designed specifically for the Space Shuttle, Peterson and Musgrave successfully accomplished the program's first extravehicular activity (EVA), performing various tests in the payload bay. Their space walk lasted for 4 hours, 17 minutes.

Although the 5,000-lb. TDRS was successfully deployed from the Challenger, its two-stage booster rocket, the Interim Upper

Stage (IUS), shut down early, placing the satellite into a low elliptical orbit. Fortunately, the satellite contained extra propellant beyond what was needed for its attitude control system thrusters, and during the next several months the thrusters were fired at carefully planned intervals gradually moving TDRS-1 into its geosynchronous operating orbit thus saving the \$100-million satellite.

Other STS-6 cargo included three GAS canisters and continuation of the Monodisperse Latex Reactor and the Continuous Flow Electrophoresis experiments.

Challenger returned to Earth on April 9, 1983, at 10:53 a.m. PST, landing on Runway 22 at Edwards AFB. It completed 80 orbits, traveling 2 million miles in 5 days, 24 minutes, 32 seconds. It was flown back to KSC on April 16.

STS-7

The Challenger's second flight began at 7:33 a.m. EST, June 18, 1983, with another on-time liftoff. It was the first flight of an American woman in space -- Sally K. Ride -- and also the largest crew to fly in a single spacecraft up to that time, five persons.

Crew members included Robert L. Crippen, commander, making his second Shuttle flight; Frederick C. Hauck, pilot; Ride, John M. Fabian and Norman Thagard, all mission specialists. Thagard conducted medical tests of the Space Adaptation Syndrome nausea and sickness frequently experienced by astronauts during the early phase of a space flight.

Two communications satellites -- Anik C-2 for Telesat of Canada, and Palapa B-1 for Indonesia -- were successfully deployed during the first 2 days of the mission. The mission also carried the first Shuttle Pallet Satellite (SPAS-1) built by Messerschmitt-Bolkow-Blohm, a West German aerospace firm. SPAS-1 was unique in that it was designed to operate in the payload bay or be deployed by the RMS as a free-flying satellite. It carried 10 experiments to study formation of metal alloys in microgravity,

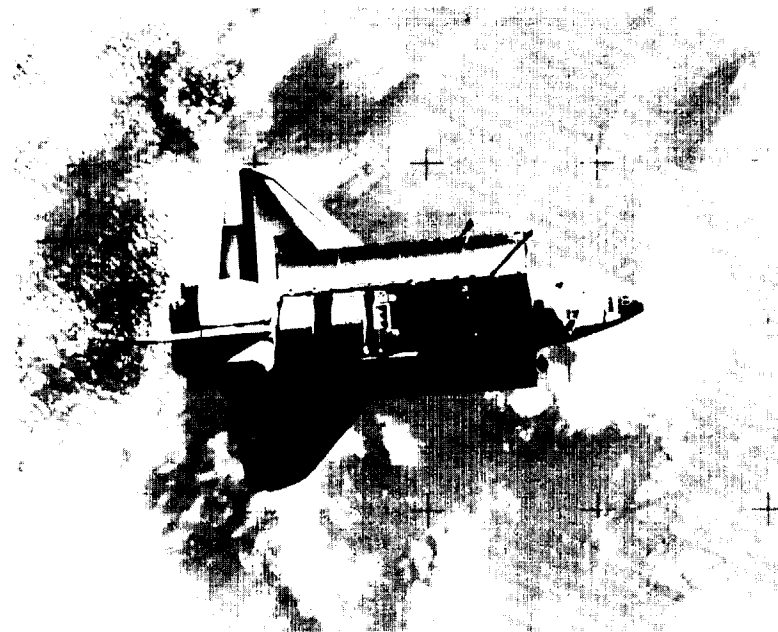

A View of Challenger from the SPAS-01 Retrievable Spacecraft on Mission STS-7

the operation of heat pipes, instruments for remote sensing observations, and a mass spectrometer to identify various gases in the payload bay. It was deployed by the RMS and flew alongside and over Challenger for several hours while a U.S.-supplied camera took pictures from the SPAS-1 of the orbiter performing various maneuvers. The RMS later grappled the pallet and returned it to the payload bay.

This mission also carried seven GAS canisters which contained a wide variety of experiments, as well as the OSTA-2 payload, a joint U.S.-West German scientific pallet payload. Finally, the orbiter's Ku-band antenna was able to relay data through the Tracking and Data Relay Satellite to a ground terminal for the first time.

STS-7 was scheduled to make the first Shuttle landing at the Kennedy Space Center's Shuttle Landing Facility. However, unacceptable weather forced a change to Runway 23 at Edwards AFB. The landing took place June 24, 1983, at 6:57 a.m. PDT. The mission lasted 6 days, 2 hours, 23 minutes, 59 seconds. It covered about 2.2 million miles during 97 orbits of the Earth. Challenger was returned to KSC on June 29.

STS-8

Challenger was back in space on Aug. 30, 1983, after it lifted off at 2:32 a.m. EDT, following a 17-minute delay due to bad weather. It was the first night launch in the Space Shuttle program. A night launch required for tracking requirements for the primary payload, the Indian National Satellite, INSAT 1B, a multipurpose satellite owned by India that was deployed successfully on the second day of the flight.

The 5-member crew, included the first black American to fly in space, mission specialist Guion S. Bluford Jr. The commander was Richard H. Truly, making his second Shuttle flight; Daniel C. Brandenstein, was the pilot, while Bluford, Dale A. Gardner and William Thornton served as mission specialists.

In addition to INSAT, the payload bay carried 12 GAS canisters. Four contained experiments while the remaining eight canisters contained special STS-8 postal covers. Two other boxes of covers were mounted on an instrument panel, bringing the total number of the special philatelic covers on board to 260,000. These were later sold to collectors by the Postal Service.

The fourth Continuous Flow Electrophoresis System experiment was flown, using live human cells from a pancreas, kidney and pituitary gland. Also, six live rats were carried in an enclosure module being tested for the first time.

Other activities during the mission included a test of the RMS arm, using a special 7,460-lb. Development Flight Instrumentation Pallet. Numerous tests of the orbiter's S-band and Ku-band

antenna systems were performed with the Tracking and Data Relay Satellite. Thornton carried out biomedical experiments on himself and other members of the crew in a continuation of the Space Adaptation Syndrome studies begun by Thagard during the STS-7 mission.

STS-8 also conducted the first night landing in the program at 12:40 a.m. PDT, Sept. 5, 1983, on Runway 22 at Edwards AFB. The mission lasted 6 days, 1 hour, 8 minutes, 43 seconds. Challenger had traveled 2.2 million miles and orbited the Earth 97 times. It was back at KSC in the record-breaking time of 4 days after its California landing.



Crew Portrait of the Commander, Pilot and Mission Specialists on STS-8, the First Night Shuttle Launch

STS-9

For the STS-9 mission Columbia was once again back in orbit. The launch occurred at 11 a.m. EST, Nov. 28, 1983, after a 2-month delay because of a nozzle problem with one of the SRBs. This necessitated moving the vehicle back to the Vehicle Assembly Building where the nozzle was replaced.

The 6-member crew -- a manned space flight record at the time -- included John W. Young, commander, on his second Shuttle flight; Brewster H. Shaw, pilot; Owen Garriott and Robert A. Parker, both mission specialists; and Byron K. Lichtenberg and Ulf Merbold payload specialists -- the first two non-astronauts to fly on the Shuttle. Merbold, a citizen of West Germany, also was the first foreign citizen to participate in a Shuttle flight. Lichtenberg was a researcher at Massachusetts Institute of Technology.

The mission was devoted entirely to Spacelab 1, a joint NASA/European Space Agency (ESA) program designed to demonstrate the ability to conduct advanced scientific research in space, with astronauts and payload specialists working in the Spacelab module and coordinating their efforts with scientists at the Marshall Payload Operations Control Center (POCC) then located at the Johnson Space Center. Funding for Spacelab 1 was provided by ESA.

The crew was divided into two teams, each working 12-hour shifts for the duration of the mission. Young, Parker and Merbold formed the Red Team, while Shaw, Garriott and Lichtenberg made up the Blue Team. Usually, the commander and the pilot team members were assigned to the flight deck, while the mission and payload specialists worked inside the Spacelab.

Seventy-two scientific experiments were carried out in the fields of atmospheric and plasma physics, astronomy, solar physics, material sciences, technology, life sciences and Earth observations. The effort went so well that the mission was extended an additional day to 10 days, making it the longest duration Shuttle flight to date.



Artist Concept of Artificially Induced Aurora on the First Spacelab Mission, STS-9, a Joint Mission with the European Space Agency

The Spacelab 1 mission was highly successful, having proved the feasibility of the concept of carrying out complex experiments in space using non-NASA persons trained as payload specialists in

collaboration with a POCC. Moreover, the Tracking and Data Relay Satellite, now fully operational, was able to relay vast amounts of data through its ground terminal to the POCC.

Columbia landed on Runway 17 at Edwards AFB, on Dec. 8, 1983, at 3:47 p.m. PST, completing 166 orbits and traveling 4.3 million miles. Columbia was ferried back to KSC on Dec. 15.

STS 41-B

Following STS-9, the flight numbering system for Space Shuttle missions was changed. Thus, the next flight, instead of being designated STS-10, became STS 41-B. The new numbering system was designed to be more specific in that the first numeral stood for the fiscal year in which the launch was to take place, the "4" being 1984. The second numeral represented the launch site 1 for KSC and 2 for Vandenberg AFB, Calif. The letter represented the order of launch assignment, " B" was the second launch scheduled in that fiscal year. (Following the Challenger accident, NASA reestablished the original numerical numbering system. Thus the first flight following 51-L is STS-26.)

The mission was the fourth flight of the Challenger. Liftoff occurred at 8 a.m. EST, on Feb. 3, 1984. Two communications satellites were one for Western Union (WESTAR) and the other for Indonesia (Palapa B-2) were deployed about 8 hours after launch. However, the Payload Assist Modules (PAM) for both satellites malfunctioned placing them into a lower than planned orbit. Both satellites were retrieved successfully the following November during STS 51-A, the 14th mission, by the orbiter Discovery.

The STS 41-B crew included commander Vance D. Brand, making his second Shuttle flight; pilot Robert L. Gibson; and mission specialists, Bruce McCandless II, Ronald E. McNair and Robert L. Stewart.

A highlight of the mission took place on the first day when astronauts McCandless and Stewart performed the first untethered space walk operating the Manned Maneuvering Unit (MMU) for



Bruce McCandless Performs the First Untethered Space Walk on Mission 41-B

the first time. McCandless -- the first human Earth-orbiting satellite -- ventured out 320 feet from the orbiter, while Stewart tested the "work station" foot restraint at the end of the RMS. The seventh day of the mission, both astronauts performed an EVA to practice capture procedures for the Solar Maximum Mission satellite retrieval and repair operation planned for the next mission, STS 41-C.

Another important "first" for STS 41-B was the reflight of the West German-sponsored SPAS-1 pallet/satellite originally flown on

STS-7. This time, however, it remained in the payload bay because of an electrical problem in the RMS. The mission also carried five GAS canisters, six live rats in the middeck area, a Cinema-360 camera and continuation of the Continuous Flow Electrophoresis System and the Monodisperse Latex Reactor experiments.

The 7-day, 23-hour, 15-minute, 55-second flight ended on Feb. 11, at 7:15 a.m. EST; at KSC's Shuttle Landing Facility -- the first landing of a spacecraft at its launch site. Challenger completed 127 orbits and traveled 2.8 million miles.

STS 41-C

The following April, Challenger was once again flying in space, this time on the STS 41-C mission. Liftoff took place at 8:58 a.m. EDT, on April 6, 1984. It marked the first direct ascent trajectory for the Shuttle which reached its 288-mile-high orbit using the Orbiter Maneuvering System engines only once -- to circularize its orbit.

The flight had two primary objectives. The first was to deploy the huge Long Duration Exposure Facility (LDEF), a passive, retrievable, 21,300-lb., 12-sided cylinder, 14 feet in diameter and 30 feet long carrying 57 experiments. The second objective was to capture, repair and redeploy the malfunctioning Solar Maximum Mission satellite -- "Solar Max" -- launched in 1980.

The five-man crew included Robert L. Crippen, commander, on his third Shuttle flight; pilot Francis R. Scobee; and mission specialists, James D. van Hoften, Terry J. Hart and George D. Nelson.

On the second day of the flight, the LDEF was grappled by the RMS arm and successfully released into orbit. Its 57 experiments, mounted in 86 removable trays were contributed by 200 researchers from eight countries. Retrieval of the passive LDEF had been scheduled during 1985, but schedule delays and the Challenger accident have postponed the retrieval effort.

On the third day of the mission, Challenger's orbit was raised to about 300 miles, and it maneuvered to within 200 feet of Solar Max. Astronauts Nelson and van Hoften, wearing space suits, entered the payload bay. Nelson, using the MMU, flew out to the satellite and attempted to grasp it with a special capture tool called the Trunnion Pin Acquisition Device (TPAD). Three attempts to clamp the TPAD onto the satellite failed. It began tumbling when van Hoften attempted to grasp it with the RMS arm, and the effort was called off.

During the night, the Solar Max POCC, at Goddard Space Flight Center, Greenbelt, Md., was able to establish control over the satellite by sending commands ordering the magnetic torque bars to stabilize the tumbling action. This was successful and the Solar Max went into a slow, regular spin.

The next day, Nelson and van Hoften tried to capture it again. This time they succeeded on the first try. They placed Solar Max on a special cradle in the payload bay using the RMS. They then began the repair operation, replacing the satellite's attitude control mechanism and the main electronics system of the coronagraph instrument. The ultimately successful repair effort took two separate space walks. Solar Max was deployed back into orbit the next day, thus concluding one of the most unique rescue and repair missions in the history of the space program.

After a 30-day checkout by the Goddard POCC, Solar Max resumed full operation.

Other STS 41-C mission activities included a student experiment located; in a middeck locker to determine how honeybees make honeycomb cells in a microgravity environment. They did so successfully, just as on Earth.

The 6-day, 23-hour, 40-minute, 7-second mission ended on April 13, at 5:38 a.m. PST, with Challenger landing on Runway 17, at Edwards AFB. It had completed 108 orbits and traveled 2.87 million miles. Challenger was returned to KSC on April 18.

STS 41-D

The orbiter Discovery was launched on its maiden flight --the 12th in the program -- on Aug. 30, 1984. It was the third orbiter built and the lightest one thus far because of its lightweight thermal blanket material.

The mission was originally planned for June 25, but because of a variety of technical problems, including rollback to the VAB to replace a main engine, the launch did not take place until 8:41 a.m. EDT, Aug. 30, after a 6-minute, 50-2nd delay when a private aircraft flew into the restricted air space near the launch pad. It was the fourth launch attempt for Discovery.

Because of the 2-month delay, the STS 41-F mission was cancelled (STS 41-E had already been cancelled) and its primary payloads were included on the STS 41-D flight. The combined cargo weighed over 47,000 lb., a Space Shuttle record up to that time.

The six-person flight crew consisted of Henry W. Hartsfield Jr., commander, making his second Shuttle mission; pilot Michael L. Coats; three mission specialists: -- Judith A. Resnik, Richard M. Mullane and Steven A. Hawley; and a payload specialist, Charles D. Walker, an employee of the McDonnell Douglas Corp. Walker was the first commercially-sponsored payload specialist to fly aboard the Shuttle.

The primary cargo consisted of three communications satellites, SBS-D for Satellite Business Systems, Telstar 3-C for Telesat of Canada and SYCOM IV-2, or Leasat-2, a Hughes-built satellite leased to the Navy. Leasat-2 was the first large communications satellite designed specifically to be deployed from the Space Shuttle. All three satellites were deployed successfully and became operational.

Another payload was the OAST-1 solar array, a device 13 feet wide, and 102 feet high, which folded into a package 7 inches

deep. The wing carried a number of different types of experimental solar cells and was extended to its full height several times. It was the largest structure ever extended from a manned spacecraft and demonstrated the feasibility of large lightweight solar arrays for future application to large facilities in space such as the Space Station.

The McDonnell Douglas-sponsored Continuous Flow Electrophoresis System (CFES) experiment, using living cells, was more elaborate than the one flown previously and payload specialist Walker operated it for more than 100 hours during the flight. A student experiment to study crystal growth in microgravity was carried out, and the IMAX motion picture camera was operated during much of the flight.

The mission lasted 6 days, 56 minutes, with landing on Runway 17 at Edwards AFB, at 6:37 a.m. PDT, on Sept. 5. It traveled 2.21 million miles and made 97 orbits. It was transported back to KSC on Sept. 10.

STS 41-G

On Oct. 5, 1984, Challenger returned to flight with its launch at 7:03 a.m. EDT, marking the start of the STS 41-G mission. It was Challenger's sixth mission and the 13th liftoff in the Space Shuttle program.

On board were seven crew members -- the largest flight crew ever to fly on a single spacecraft at that time. They included commander Robert L. Crippen, making his fourth Shuttle flight; pilot Jon A. McBride; three mission specialists -- David C. Leestma, Sally K. Ride and Kathryn D. Sullivan -- (the first time two female astronauts had flown together); and two payload specialists, Paul Scully-Power and Marc Garneau, the first Canadian citizen to serve as a Shuttle crew member.

Astronaut Sullivan became the first woman to walk in space when she and David C. Leestma performed a 3 hour EVA on Oct. 11

demonstrating the Orbital Refueling System (ORS) and proving the feasibility of refueling satellites in orbit.

Nine hours after liftoff, the 5,087-lb, Earth Radiation Budget Satellite (ERBS) was deployed from the payload bay by the RMS arm, and its on-board thrusters boosted it into an orbit 350 miles above the Earth. ERBS was the first of three planned satellites designed to measure the amount of energy received from the sun and reradiated into space. It also studied the seasonal movement of energy from the tropics to the polar regions.

Another major mission activity, operation of the Shuttle Imaging Radar-B (SIR-B) was conducted. SIR-B was part of the OSTA-3 experiment package in the payload bay, which also included the Large Format Camera (LFC) to photograph Earth, another camera called MAPS which measured air pollution, and a feature identification and location experiment called FILE which consisted of two TV cameras and two 70mm still cameras.

The SIR-B effort was an improved version of a similar device flown on the OSTA-1 package during STS-2. It had an eight-panel antenna array measuring 35 by 7 feet. It operated throughout the flight but problems were encountered with the Challenger's Ku-band antenna and therefore much of the data had to be recorded on board the orbiter rather than transmitted to Earth in real-time as originally planned.

Payload Specialist Scully-Powers, an employee of the U.S. Naval Research Laboratory, performed a series of oceanography observations during the mission. Gameau conducted experiments sponsored by the Canadian government, called CANEX, which were related to medical, atmospheric, climatic, materials and robotic sciences. A number of GAS canisters covering a wide variety of materials testing and physics were also flown.

STS 41-G was an 8-day, 5-hour, 23-minute, 33-second mission which traveled 4.3 million miles and completed 132 orbits. It landed at the Shuttle Landing Facility at KSC -- the second Shuttle landing there -- on Oct. 13, at 12:26 p.m. EDT.

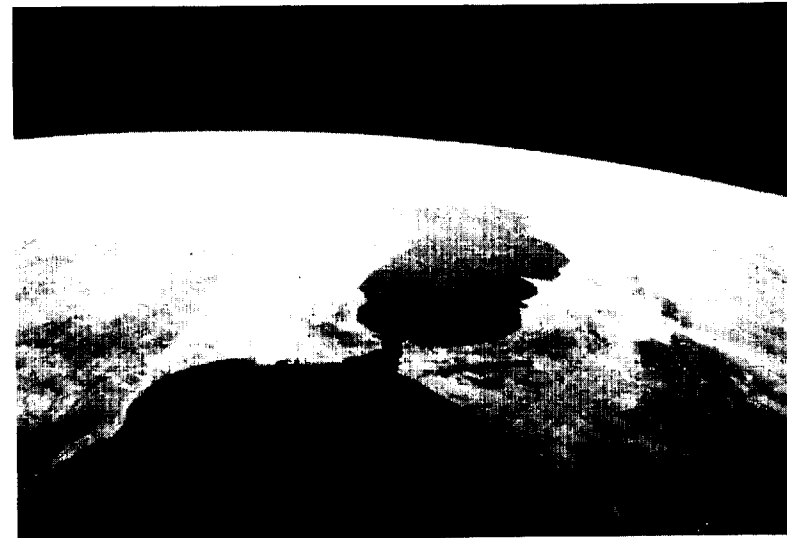

The Strait of Gibraltar As Viewed by the Shuttle Crew on Mission STS 41-G

109

STS 51-A

Less than a month after the 41-G flight, the 14th Space Shuttle mission and the second for Discovery, STS 51-A was launched at 7:15 a.m. EST, Nov. 8, 1984. A launch attempt the day before was scrubbed at the T minus 20-minute built-in hold because of high shear winds in the upper atmosphere.

The five-person flight crew consisted of Frederick H. Hauck, commander, on his second flight; pilot David M. Walker; and three mission specialists -- Anna L. Fisher, Dale A. Gardner and Joseph P. Allen. Both Gardner and Allen were making their second Shuttle flights.

This mission was unique in that it marked the first time the Shuttle had deployed two communications satellites and then went about retrieving from orbit two other communications satellites. B-2 and 6 had been deployed during the STS 41-B mission earlier in



*Mission Specialist Dale Gardner Docks with Westar 6 Satellite
During the First Shuttle Satellite Retrieval on Mission STS 51-A*

the year and had been placed into improper orbits because their kick motors malfunctioned.

The two communications satellites successfully deployed were the Canadian Anik D2 -- on the second day of the mission -- and IV-1, also known as Leasat 1, on the third day.

The orbiter then began a series of maneuvers to meet up with the first of the two satellites to be recovered, PALAPA B-2. (The

orbits of both satellites had been lowered by ground commands from about 600 mile to 210 mile to facilitate recovery operations.) On day five, the Discovery rendezvoused with PALAPA. Mission specialists Allen and Gardner performed an EVA, capturing the satellite with a device known as a "Stinger," which was inserted into the apogee motor nozzle by Allen. The satellite's rotation was slowed to 1 RPM and Fisher, operating from a position on the end of the RMS, attempted unsuccessfully to grapple the satellite. However, was not lost, because Allen was able manually to maneuver the satellite into its cradle with Gardner's help and aided by the RMS which was operated by Fisher. The successful, improvised rescue effort took two hours.

The recovery of Westar 6 was not as difficult and took place a day later. This time Gardner, using the same muscle power technique Allen had used for the rescue, captured the satellite. With Allen's help, he placed it in a cradle in the cargo bay.

The STS 51-A mission also carried the Diffused Mixing of Organic Solutions (DMOS) experiment. It was the first of a series of comprehensive organic and polymer science experiments sponsored by the 3M Corp. This middeck experiment was successful and the proprietary results of the chemical mixes were turned over to 3M. One other experiment, the radiation monitoring experiment, was also performed.

This second Discovery mission ended at 7 a.m. EST, Nov. 16, with landing on Runway 33, at KSC, after a 7-day, 23-hour, 45-minute flight, which covered 3.3 million miles during 126 complete orbits. It was the third Shuttle landing at KSC and the fifth and last Shuttle mission of 1984.

STS 51-C

Discovery was to make its third flight in January 1985 to conduct the first mission totally dedicated to the Department of Defense. The classified payload was deployed successfully and boosted into its operating orbit by an Inertial Upper Stage (IUS) booster according to an Air Force announcement.

The launch occurred on Jan. 24, 1985, at 2:40 p.m. EST -- the first of 10 Shuttle missions that year. It was originally scheduled for Jan. 23, but was delayed because of freezing weather conditions. Challenger had been scheduled for this flight, but Discovery was substituted when thermal tile problems were encountered with Challenger.

The 51-C included Thomas K. Mattingly, commander; Loren J. Shriver, pilot; two mission specialists, James F. Buchli and Ellison S. Onizuka; and Gary E. Payton, a payload specialist.

The mission lasted 3 days, 1 hour, 33 minutes. Discovery touched down on Runway 15 at KSC on Jan. 27 at 4:23 p.m. EST.

STS 51-D

The 16th mission, officially designated STS 51-D, was launched at 8:59 a.m. EST, on April 12, 1985, just 55 seconds before the close of the launch window. It marked the fourth flight by Discovery.

Its seven-person crew included Karol J. Bobko, commander; Donald E. Williams, pilot; three mission specialists -- M. Rhea Seddon, S. David Griggs and Jeffrey A. Hoffman; and two payload specialists -- Charles D. Walker of McDonnell Douglas and E.J. "Jake" Garn, a U.S. senator from Utah -- the first elected official to fly on board the Space Shuttle. Garn was chairman of the Senate committee with oversight responsibilities for the NASA budget.

The primary objective of the flight was deployment of two communications satellites, Anik C-1, third in a series of Canadian satellites, and IV-3, also known as Leasat 3. Anik's deployment was carried out successfully a few hours after launch and its booster kick motor propelled it into its operational orbit. The deployment took place the next day. However, its booster stage failed to fire as programmed because the satellite's sequence start

lever had failed to open. A possible "fix" was attempted by placing two so-called flyswatter devices on the end of the RMS to snag and tug on the failed lever. The mission was extended 2 days and astronauts Griggs and Hoffman performed an EVA to attach the flyswatter devices to the end of the RMS. Astronaut Seddon then manipulated the RMS, attempting to activate the lever into its operating position. The attempt failed. However, during the STS 51-I mission in August, the lever was repaired and the satellite reached its geosynchronous orbit and became operational.

Other activities during the flight included operation of a larger Continuous Flow Electrophoresis Experiment by payload specialist Charles Walker; two student experiments, one of which failed; and an informal science study of how mechanical toys operate in microgravity.

Discovery landed on Runway 33 at KSC at 8:55 a.m. EST, April 19. Its right main gear tire blew out just as the orbiter was rolling to a stop. The mission lasted 6 days, 23 hours, 55 minutes. Distance traveled was 2 million miles during 109 complete orbits.

STS 51-B

The second Spacelab mission, with the European-built Spacelab in its operational configuration, began on April 29, 1985, at 12:02 p.m. EDT, with the liftoff of Challenger on its seventh journey into space.

The seven-man crew was headed by commander Robert F. Overmyer, Frederick D. Gregory, pilot; three mission specialists - Don L. Lind, Norman E. Thagard, William E. Thornton; and two payload specialists - Lodewijk van den Berg of EG&G Energy Management, Inc., and Taylor G. Wang of NASA's Jet Propulsion Laboratory.

The crew was divided into two teams each working 12-hour shifts, as would be the case on all Spacelab missions.

Spacelab 3 carried 15 primary experiments involving five basic scientific disciplines: materials and life sciences, fluid mechanics, atmospheric physics; and astronomy. All but one of the experiments provided good scientific data. The mission was supported around the clock by the Marshall POCC.

In addition to the Spacelab effort, the flight carried two monkeys and 24 rodents in special cages for biomedical experimentation. Two GAS experiments were flown which, for the first time, required that payloads be deployed from the canisters. One of them, the Global Low Orbiting Message Relay Satellite, (GLOMAR) did not deploy and was returned to Earth. The other called NUSAT, for Northern Utah Satellite worked successfully.

Challenger landed at Edwards AFB, Calif., at 9:11 a.m. PDT, on May 6, after completing 110 orbits during its 7-day, 8-minute, 46-second mission.

STS 51-G

The 18th Space Shuttle mission was flown by Discovery following its liftoff at 7:33 a.m. EDT, on June 17, 1985. The cargo included three commercial communications satellites, a deployable/retrievable spacecraft called Spartan 1, six GAS experiment canisters, a tracking experiment for the Defense Department's Strategic Defense Initiative, a materials processing furnace and a series of biomedical experiments sponsored by France.

The seven-member STS 51-G crew included Daniel Brandenstein, commander; John Creighton, pilot; three mission specialists: Shannon Lucid, Steven Nagel and John Fabian; and two payload specialists Patrick Baudry of France and Prince Sultan Salman Al-Saud of Saudi Arabia.

The three communications satellites were successfully deployed and their booster stages placed them into their planned operating

operating orbits. They included Arabsat 1-B, owned by the Arab Satellite Communications Organization; Morelos 1, the first Mexican-operated communications satellite; and Telstar 3-D an American domestic communications satellite owned by American Telephone and Telegraph (AT&T).

The NASA-sponsored Spartan 1 carried a series of astronomy experiments and was the first in a planned series of short duration free flyers designed to extend the capabilities of sounding rocket type experiments. It weighed 2,223 pounds and was deployed and operated successfully, independent of the orbiter, before being retrieved by the RMS later in the mission.

The materials furnace, the French biomedical experiments, and the six Getaway Specials all operated successfully although one GAS experiment shut down early.

The Shuttle test of the Strategic Defense Initiative tracking experiment, called the High Precision Tracking Experiment (HPTE), failed during orbit 37 because the orbiter was in the wrong attitude. However, the test was successfully completed during orbit 64.

The mission ended at 6:11 a.m. PDT, June 24 on Runway 23 at Edwards AFB, Calif. It traveled 2.9 million miles, and made 111 complete orbits during its 7-day, 1-hour, 38-minute, 52-second flight.

STS 51-F

Challenger was to return to orbit on July 12, 1985, with its launch marking the 19th Space Shuttle mission. A launch attempt on July 12 was stopped at the T-3 second mark -- after main engine ignition had occurred -- because of a failed coolant valve in the number two engine and all three engines were shut down. The launch was delayed until July 29, when liftoff occurred at 5 p.m. EDT, after a 1-hour, 37-minute delay because of problems with the orbiter.



The Shuttle Crew on Mission STS 51-F Gathers for an Orbital Portrait on this Solar and Astronomy Science Flight

Although liftoff was normal, at 5 minutes, 45 seconds after launch, the number one main engine shutdown prematurely and an abort-to-orbit was declared. An orbit of 124 by 165 mile was achieved, and later raised to an altitude of about 196 mile by a series of Orbital Maneuvering System burns.

Despite this initial problem, the mission, a third Spacelab effort officially called Spacelab-2, was successful. (Spacelab-3 was flown out of sequence ahead of Spacelab-2 on STS 51-B as an operational mission, Spacelab-2 being the last Shuttle/Spacelab verification mission.)

The seven-man crew included Charles G. Fullerton, commander; Roy D. Bridges, pilot; three mission specialists F. Story Musgrave, Anthony W. England and Karl G. Henize; and two payload specialists Loren W. Acton of Lockheed Corp., and John-David Bartoe from the Naval Research Laboratory.

The Spacelab-2 payload consisted of an igloo and three pallets in the payload bay, containing scientific instruments dedicated to life sciences, plasma physics, astronomy, high-energy astrophysics, solar physics, atmospheric physics and technology research.

A major objective of the mission was to verify the performance of the Spacelab systems with the orbiter as well as to measure the environment created by the vehicle in space.

The flight marked the first time ESA Instrument Pointing System (IPS) was tested in orbit. This unique experiment pointing instrument was designed with an accuracy of one arc second. Initially, some problems were experienced when it was commanded to track the Sun. A series of software fixes were made and the problem was corrected. The flight crew and the experts on the ground in the Marshall POCC worked closely together and much valuable scientific data was acquired.

Inside the pressurized orbiter cabin four other experiments were carried out. These included two dealing with Vitamin D metabolites and bone demineralization which involved, among other things, taking physiological measurements of crew members. A third experiment dealt with determining the effect of microgravity on lignification in plants. Finally, the fourth cabin experiment, which was added late in planning for the mission, was concerned with protein crystal growth. All four experiments were declared successful.

The mission ended with Challenger landing at Edwards AFB, Calif., at 12:45 p.m. PDT, Aug. 6, on orbit 127. Mission duration was 7 days, 22 hours, 45 minutes, 26 seconds.

STS 51-I

The orbiter Discovery flew the 20th Space Shuttle mission with its launch at 6:58 a.m. EDT, Aug. 27, 1985. Two earlier launch attempts, one on Aug. 24 and another on Aug. 25 were scrubbed -- the first because of poor weather and the second because the backup orbiter computer failed and had to be replaced. The successful Aug. 27 launch took place just before an approaching storm front reached the launch pad area.

The five-man STS 51-I crew included Joe H. Engle, commander; Richard O. Covey, pilot; and three mission specialists James van Hoften, John M. Lounge and William F. Fisher. Their primary mission was to deploy three commercial communications satellites and retrieve and repair IV-3 which was deployed during the STS 51-D mission in April 1985 and had malfunctioned. In addition, a middeck materials processing experiment was flown.

The three communications satellites included I, a multi-purpose spacecraft owned by Australia; the ASC-1 owned and operated by the American Satellite Co.; and IV-4 leased to the Department of Defense by its builder, the Hughes Co. Both I and ASC-1 were deployed on launch day, Aug. 27. IV-4, was deployed two days later. All three achieved proper geosynchronous orbits and became operational.

On the fifth day of the mission, astronauts Fisher and van Hoften began repair efforts on the malfunctioning IV-3 following a successful rendezvous maneuver with Discovery. The effort was slowed because of a problem in the RMS elbow joint. In any event, after a second EVA by Fisher and van Hoften, the lever was repaired, permitting commands from the ground to activate the spacecraft's systems and eventually sending it into its proper geosynchronous orbit. The two EVAs took 11 hours and 27 minutes.

Discovery landed on Runway 23 at Edwards AFB at 6:16 a.m. PDT on Sept. 3. The flight took 7 days, 2 hours, 18 minutes, 42 seconds, completing 111 orbits of the Earth.



Astronaut Bill Fisher "Hangs On" to Syncom IV-3 Satellite during Mission STS 51-I

STS 51-J

The first flight by the orbiter Atlantis occurred Oct. 3, 1985, its successful launch at 11:15 a.m. EDT. STS 51-J was the second Space Shuttle mission totally dedicated to the Department of Defense.

Defense. The cargo, orbital parameters and other details of the flight were classified. Its five-man crew included Karol L. Bobko, commander; Ronald J. Grabe, pilot; two mission specialists: Robert L. Steward and David Hilmers; and one payload specialist, William A. Pailles.

Atlantis performed well on its maiden flight and the mission was declared successful. Landing took place at Edwards AFB at 10:00 a.m. PDT, Oct. 7. The flight duration was 4 days, 1 hour, 45 minutes.

STS 61-A

The STS 61-A mission -- the first dedicated West German Spacelab -- saw the Challenger liftoff at 12 Noon EST, Oct. 30, 1985. The 22nd launch in the Shuttle program and the countdown and ascent to orbit went flawlessly.

The eight-person crew was the largest ever to fly a sizeable spacecraft at one time. The crew included Henry W. Hartsfield, commander; Steven R. Nagel, pilot; Bonnie J. Dunbar, James F. Buchli and Guion S. Bluford, mission specialists, and three payload specialists Ernst Messerschmid and Reinhard Furrer of West Germany and Wubbo Ockels from the ESA, a citizen of The Netherlands.

The primary objective of the mission, officially designated Spacelab D-1, was to conduct a series of experiments relating to materials processing. This fourth Spacelab mission was the first Shuttle flight to be largely financed and conducted by another nation. NASA was responsible for operation of the Shuttle and for safety and control functions, controlling the flight from the Mission Control Center in Houston. West Germany was responsible for the Spacelab scientific research. The flight crew, on 12-hour shifts, worked closely with ground controllers at the German Space Operations Center at Oberpfaffenhofen near Munich.

Two other STS 61-A mission objectives included deployment of the Global Low Orbiting Message Relay (GLOMR) satellite -- its



Astronaut Crew of Mission STS 61-A Returns to Earth After a Successful Spacelab Scientific Mission for the Federal Republic of Germany (D-1)

second flight -- which was to be deployed from a Getaway Special canister, and operation of five materials processing experiments mounted in the cargo bay on a structure called the German Unique Support Structure. The GLOMR deployment and the materials processing experiments were successful.

The Spacelab D-1 scientific research effort consisted of 75 separate experiments most of which were repeated several times during the mission. Since the effort was directed primarily at materials processing science, the primary experiments were related to fluid physics, solidification experiments, biological, and medical investigations. It was the most comprehensive investigation of materials processing in space and associated human activities ever undertaken.

Challenger landed on Runway 17 at Edwards AFB at 9:45 a.m. PST, Nov. 6. The mission duration was 7 days, 44 minutes, 51 seconds.

STS 61-B

Atlantis made its second voyage into space on Nov. 26, 1985, with its launch at 7:29 p.m. EST -- the second night launch in the program. Liftoff occurred on schedule and the countdown and ascent to orbit, as on the previous flight, went flawlessly.

The seven-person crew was comprised of Brewster H. Shaw Jr., commander; Bryan D. O'Conner was the pilot; three mission specialists Mary L. Cleave, Sherwood C. Spring and Jerry L. Ross; and two payload specialists, Rodolfo Neri Vela from Mexico and Charles Walker of McDonnell Douglas on his second Shuttle flight.

The primary objective of the mission was to deploy three communications satellites -- the Mexican-owned Morelos-B, 2 for Australia, and Ku-2, owned and operated by RCA American Communications (RCA Americom). All three satellites were deployed as planned and subsequently achieved their geosynchronous operating orbits.

Two experiments designed to test the feasibility of assembling erectable structures in space were also carried out. These were the Experimental Assembly of Structures in Extravehicular Activity (EASE), a geometric structure composed of beams and nodes

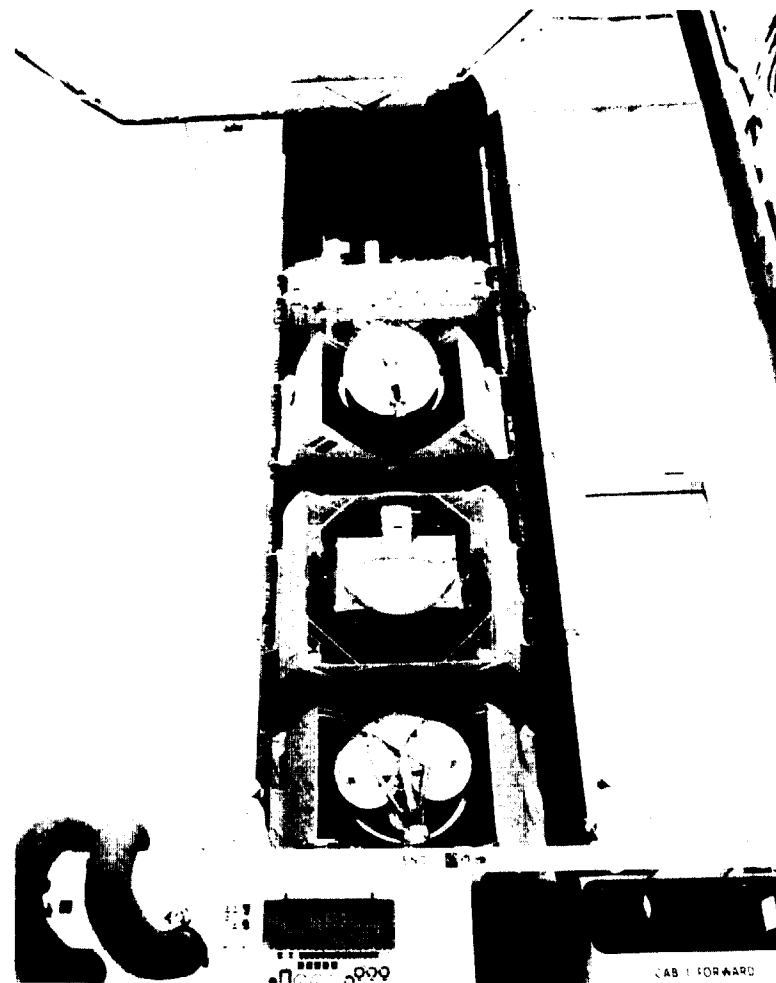

Mission STS 61-B Cargo, Sunshields Open, Is Loaded into the Payload Canister at the Operations and Checkout Building, KSC

shaped like an inverted pyramid, and for the Assembly Concept for Construction of Erectable Space Structures (ACCESS), which was

a tall tower consisting of numerous small struts and nodes. The lightweight metal structures were assembled by astronauts Ross and Spring during two EVAs which lasted 5 hours, 32 minutes, and 6 hours, 38 minutes. These activities were captured on film by the large-screen motion picture camera, IMAX.

During the flight, payload specialist Walker again operated the Continuous Flow Electrophoresis System experiment which was designed to produce commercial pharmaceutical products in microgravity. Mexican payload specialist Rudolfo Neri Vela carried out a number of human physiology experiments. Another experiment, the 3M's Diffuse Mixing of Organic Solutions (DMOS) was successfully operated, growing large, pure single crystals in microgravity. A Canadian-sponsored GAS canister to fabricate mirrors in space was also conducted.

STS 61-B was a 6-day, 21-hour, 4-minute, 49-second mission. Landing occurred at 1:33 p.m. PST, Dec. 3, on Runway 22, at Edwards AFB.

STS 61-C

Mission 24 in the Space Shuttle program saw the orbiter Columbia returned to flight for the first time since the STS-9 mission in November 1983, after having undergone major modifications by Rockwell International in California.

The launch originally was scheduled for Dec. 18, but the closeout of an aft orbiter compartment was delayed and the mission was rescheduled for the next day on Dec. 19, the countdown was stopped at T-14 seconds because of a -- out-of-tolerance turbine reading on the right SRBs hydraulic system.

Another launch attempt on Jan. 6, 1986, was terminated at T-31 seconds because a problem in a valve in the liquid oxygen system could not be fixed before the end of the launch window. Other launch attempts were made on Jan. 7, scrubbed because of bad weather at contingency landing sites at Dakar, Senegal, and Moron, Spain; on Jan. 9, delayed because of a problem with a

main engine prevalve; and on Jan. 10 because of heavy rain in the launch area.

The launch finally took place at 6:55 a.m. EST, on Jan. 12 without further problems.

The flight crew included Robert L. Gibson, commander; Charles F. Bolden, pilot; three mission specialists Franklin Chang-Diaz, Steven A. Hawley and George D. Nelson; and two payload specialists Robert Cenker RCA Astro-Electronics and U.S. Congressman Bill Nelson.

The primary objective of the mission was to deploy the Ku-1 communications satellite, second in a planned series of geosynchronous satellites owned and operated by RCA Americom. The deployment was successful and the satellite eventually became operational. The flight also carried a large number of small experiments, including 13 GAS canisters devoted to investigations involving the effect of microgravity on materials processing, seed germination, chemical reactions, egg hatching, astronomy and atmospheric physics. Other cargo included a Materials Science Laboratory-2 structure for experiments involving liquid bubble suspension by sound waves, melting and resolidification of metallic samples and containerless melting and solidification of electrically conductive specimens. Another small experiment carrier located in the payload bay was the Hitchiker G-1 (HHG-1) with three experiments to 1) study film particles in the orbiter environment, 2) test a new heat transfer system and 3) determine the effects of contamination and atomic oxygen on ultraviolet optics materials. There were also four in-cabin experiments, three of them part of the Shuttle Student Involvement Program.

Finally, an experiment called the Comet Halley Active Monitoring Program (CHAMP), consisting of a 35mm camera to photograph Comet Halley through the aft flight deck overhead window, was not successful because of battery problems.

Not only was the STS 61-C mission difficult to get off the ground, it proved to be difficult getting it back to Earth. A landing

attempt on Jan. 16 was cancelled because of unfavorable weather at Edwards AFB. Continued bad weather forced another wave-off the following day, Jan. 17. The flight was extended one more day to provide for a landing opportunity at KSC on the Jan. 18th -- this in order to avoid time lost in an Edwards AFB landing and turnaround. However, bad weather at the KSC landing site resulted in still another wave-off.

Columbia finally landed at Edwards AFB at 5:59 a.m. PST, on Jan. 18. Mission elapsed time was 6 days, 2 hours, 3 minutes, 51 seconds.

STS 51-L

The 25th mission in the Space Shuttle program -- flown by the Challenger -- ended tragically with the loss of its seven crew members and destruction of the vehicle when it exploded shortly after launch.

The launch -- the first from Pad B at KSC's Launch Complex 39 -- occurred at 11:38 a.m. EST, on Jan. 28, 1986. The flight had been scheduled six times earlier, but was delayed because of technical problems and bad weather.

One minute, 13 seconds after liftoff, the vehicle exploded and was destroyed.

All seven members of the crew were killed. They were Francis R. Scobee, commander; Michael J. Smith, pilot; three mission specialists: Judith A. Resnik, Ellison Onizuka and Ronald E. McNair; one payload specialist, Gregory Jarvis of Hughes Aircraft, and S. Christa McAuliffe, a New Hampshire teacher -- the first Space Shuttle passenger/observer participating in the NASA Teacher in Space Program. She had planned to teach planned lessons during live television transmissions.

The primary cargo was the second Tracking and Data Relay Satellite (TDRS). Also on board was another Spartan free-flying module which was to observe Halley's Comet.



*The crew of STS 51-L: Seated (from the left)
Michael J. Smith, Francis R. Scobee, Ronald E. McNair.
Standing (from the left)
Ellison S. Onizuka, S. Christa McAuliffe,
Gregory B. Jarvis, Judith A. Resnik*

"The future is not free: the story of all human progress is one of a struggle against all odds. We learned again that this America, which Abraham Lincoln called the last, best hope of man on Earth, was built on heroism and noble sacrifice. It was built by men and women like our seven star voyagers, who answered a call beyond duty, who gave more than was expected or required and who gave it little thought of worldly reward."

-President Ronald Reagan January 31, 1986

CHRONOLOGY

1972		Aug. 12	First free flight Approach and Landing Test (ALT) of orbiter Enterprise from Shuttle carrier aircraft at Dryden Flight Research Center, Calif. Flight duration: 5 minutes, 21 seconds. Landing occurred on Runway 17.
Jan. 5	President Nixon proposes development of a reusable space transportation system, the Space Shuttle.		
March 15	NASA selects the three-part configuration for the Space Shuttle -- reusable orbiter, partly reusable SRB and an expendable external tank.	Sept. 13	Second Enterprise ALT flight of 5 minutes, 28 seconds; landing on Runway 15. (Three more ALT flights were flown by Enterprise on Sept. 23 Oct. 12 and Oct. 25.)
Aug. 9	Rockwell receives NASA contract for construction of the Space Shuttle orbiter.		
		1978	
1975		Jan. 18	Thiokol conducts second test firing of an SRB.
Oct. 17	First Space Shuttle main engine tested at the National Space Technology Laboratories, Miss.		
		1979	
Sept. 17	Rollout of orbiter Enterprise (OV-101).	March 8	Orbiter Columbia (OV-102) transported 38 miles overland from Palmdale to Dryden Flight Research Center.
1976		March 20-24	Columbia flown on Shuttle carrier aircraft to Kennedy Space Center with overnight stops at El Paso and San Antonio, Texas, and Eglin AFB, Fla.
July 18	Thiokol conducts 2-minute firing of an SRB at Brigham City, Utah.	June 15	First SRB qualification test firing; 122 seconds.

1980

Nov. 26 Columbia mated to SRBs and external tank at Vehicle Assembly Building (VAB) for STS-1 mission.

Dec. 29 Space Shuttle vehicle moved from VAB to Launch Complex 39A for STS-1 mission. 1981

Feb. 20 Flight readiness firing of Columbia's main engines; 20 seconds.

April 20-21 Columbia returned to KSC by Shuttle carrier aircraft via Tinker AFB, Okla.

Aug. 4 Columbia mated with SRBs and external tank for STS-2 mission.

Aug. 26 Space Shuttle vehicle moved to Launch Complex 39A for STS-2 mission.

Nov. 12-14 STS-2, first flight of an orbiter previously flown in space.

Nov. 24-25 Columbia transported back to KSC via Bergstrom AFB, Texas.

Dec. 11 Spacelab 1 arrives at KSC.

1982

Feb. 3 Columbia moved to VAB for mating in preparation for STS-3 mission.

Feb. 16 Assembled Space Shuttle vehicle moved from VAB to launch pad for STS-3 mission.

March 22-30 STS-3 mission; landing at White Sands, N.M.

April 6 Columbia returned to KSC from White Sands.

May 16 Columbia moved to VAB for mating in preparation for STS-4.

May 25 STS-4 vehicle moved to launch pad.

June 27-July 4 STS-4 mission flown; first concrete runway landing at Edwards AFB.

June 30 Orbiter Challenger (OV-099) rolled out at Palmdale.

July 1 Challenger moved overland to Dryden.

July 4-5 Challenger flown to KSC via Ellington AFB, Texas.

July 14-15 Columbia flown to KSC via Dyess AFB, Texas.

Sept. 9 Columbia mated with SRBs and external tank in preparation for STS-5.

Sept. 21 STS-5 vehicle moved to launch pad.

Nov. 11-16 STS-5 mission; landing at Edwards AFB.

Nov. 21-22 Columbia returned to KSC via Kelly AFB, Texas.

Nov. 23	Challenger moved to VAB and mated for STS-6.	Sep. 9	Challenger returned to KSC via Sheppard AFB, Texas.
Nov. 30	STS-6 vehicle moved to launch pad.	Sept. 23	Columbia moved to VAB for mating in preparation for STS-9.
Dec. 18	Flight readiness firing of Challenger's main engines; 20 seconds.	Sept. 28	STS-9 vehicle moved to launch pad.
1983		Oct. 17	STS-9 launch vehicle moved back to VAB from pad because of SRB nozzle problem.
Jan. 22	Second flight readiness firing of Challenger's main engines; 22 seconds.	Oct. 19	Columbia moved to Orbiter Processing Facility.
April 4-9	STS-6 mission, first flight of Challenger.	Nov. 5	Orbiter Discovery (OV-103) moved overland to Dryden.
May 21	Challenger moved to VAB for mating in preparation for STS-7 mission.	Nov. 6	Discovery transported to Vandenberg AFB, Calif.
May 26	Challenger moved to launch pad for STS-7.	Nov. 8	STS-9 vehicle again moved to launch pad.
June 18-24	STS-7 mission flown with landing at Edwards AFB.	Nov. 8-9	Discovery flown from Vandenberg AFB to KSC via Carswell AFB, Texas.
July 26	Challenger moved to VAB for mating in preparation for STS-8.	Nov. 28-Dec. 8	STS-9 mission; landing at Edwards AFB.
June 28-29	Challenger flown back to KSC via Kelly AFB.	Dec. 14-15	Columbia flown to KSC via El Paso, Kelly AFB and Egin AFB.
Aug. 2	STS-8 vehicle moved to launch pad.	1984	
Aug. 30-Sept. 5	STS-8 mission; first night launch and landing at Edwards AFB.	Jan. 6	Challenger moved to VAB for mating in preparation of STS 41 B mission.
		Jan. 11	STS 41-B vehicle moved to launch pad.

Feb. 3-11	STS 41-B mission; first landing at KSC.		
March 14	Challenger moved to VAB for mating in preparation for STS 41-C mission.	Sept. 9-10	Discovery returned to KSC via Altus AFB, Okla.
March 19	STS 41-C vehicle moved to launch pad.	Sept. 13	STS 41-G launch vehicle moved to launch pad.
April 6-13	STS 41-C mission; landing at Edwards AFB.	Oct. 5-13	STS 41-G mission; landing at KSC.
April 17-18	Challenger flown back to KSC via Kelly AFB.	Oct. 18	Discovery moved to VAB for mating in preparation for STS 51-A mission.
May 12	Discovery moved to VAB for mating in preparation for STS 41-D.	Oct. 23	STS 51-A launch vehicle moved to launch pad.
May 19	STS 41-D vehicle moved to launch pad.	Nov. 7	STS 51-A launch scrubbed because of high shear winds.
June 2	Flight readiness firing of Discovery's main engines.	Nov. 8-16	STS 51-A mission; landing at KSC.
June 25	STS 41-D launch attempt scrubbed because of computer problem.	1985	
June 26	STS 41-D launch attempt scrubbed following main engine shutdown at T minus 4 seconds.	Jan. 5	Discovery moved to launch pad for STS 51-C mission.
July 14	STS 41-D vehicle moved back to VAB for remanifest of payloads.	Jan. 24-27	STS 51-C mission landing at KSC.
Aug. 9	STS 41-D vehicle again moved out to the launch pad.	Feb. 10	Challenger moved to VAB for mating in preparation for STS 51-E mission.
Aug. 30-Sept. 5	STS 41-D mission; first flight of Discovery; landing at Edwards AFB.	Feb. 15	STS 51-E vehicle moved to launch pad.
Sept. 8	Challenger moved to VAB for mating in preparation for STS 41-G mission.	March 4	STS 51-E vehicle rolled back to VAB; mission cancelled; payloads combined with STS 51-B.

March 23	Discovery moved to VAB for mating in preparation for STS 51-D mission.	June 29	STS 51-F vehicle moved to the launch pad.
March 28	STS 51-D vehicle moved to launch pad.	July 11	Refurbished Columbia moved overland from Palmdale to Dryden.
April 6	Atlantis (OV-104) rollout at Palmdale.	July 12	STS 51-F launch scrubbed at T-minus 3 seconds because of main engine shutdown.
April 10	Challenger moved to VAB for mating in preparation for STS 51-B mission.	July 14	Columbia returned to KSC via Offutt AFB, Neb.
April 12-19	STS 51-D mission; landing at KSC.	July 29-Aug. 6	STS 51-F mission landing at Edwards AFB.
April 13	Atlantis ferried to KSC via Ellington AFB, Texas.	July 30	Discovery moved to VAB for mating in preparation for STS 51-I mission.
April 15	Challenger moved to launch pad for 51-B missing.	Aug. 6	STS 51-I vehicle moved to the launch
April 29-May 6	STS 51-B mission; landing at Edwards AFB.	Aug. 10-11	Challenger flown to KSC via Davis-Monthan AFB, Ariz.; Kelly AFB; and Eglin AFB.
May 10	Challenger transported back to KSC via Kelly AFB.	Aug. 24	STS 51-I mission scrubbed at T minus 5 minutes because of bad weather.
May 28	Discovery moved to VAB for mating in preparation for STS 51-G.	Aug. 25	STS 51-I mission scrubbed at T-minus 9 minutes because of an onboard computer problem.
June 4	STS 51-G vehicle moved to the launch pad.	Aug. 27-Sept. 3	STS 51-I mission; landing at Edwards AFB.
June 17-24	STS 51-G mission; landing Edwards AFB.	August 29	Atlantis moved to launch pad for the 51-J mission.
June 24	Challenger moved to VAB for mating in preparation for STS 51-F.		
June 28	Discovery ferried back to KSC via Bergstrom AFB, Texas.		

Sept. 7-8	Discovery flown back to KSC via Kelly AFB.		
Sept. 12	Flight readiness firing of Atlantis' main engines; 20 seconds.	Dec. 1	STS 61-C vehicle moved to launch pad.
Oct. 3-7	STS 51-J mission; landing at Edwards AFB.	Dec. 7	Atlantis returned to KSC via Kelly AFB.
Oct. 11	Atlantis returned to KSC via Kelly AFB.	Dec. 16	Challenger moved to VAB for mating in preparation for the STS 51-L mission.
Oct. 12	Challenger moved to VAB for mating in preparation for the STS 61-A mission.	Dec. 19	STS 61-C mission scrubbed at T minus 13 seconds because of SRB auxiliary power unit problem.
Oct. 16	Challenger vehicle moved to the launch pad for STS 61-A mission.	Dec. 22	STS 51-L vehicle moved to Launch Pad 39B.
Oct. 30-Nov. 6	STS 61-A mission; landing at Edwards AFB.	1986	
Nov. 8	Atlantis moved to VAB for mating in preparation for the STS 61-B.	Jan. 6	STS 61-C mission scrubbed at T minus 31 seconds because of liquid oxygen valve problem on pad. 124
Nov. 10-11	Challenger flown back to KSC via Davis-Monthan AFB, Kelly AFB and Eglin AFB.	Jan. 7	STS 61-C mission scrubbed at T minus 9 minutes because of weather problems at contingency landing sites.
Nov. 12	STS 61-B vehicle moved to the launch pad.	Jan. 10	STS 61-C mission scrubbed T minus 9 minutes because of bad weather at KSC.
Nov. 18	Enterprise (OV-101) flown from KSC to Dulles Airport, Washington, D.C., and turned over to the Smithsonian Institution.	Jan. 12-18	STS 61-C mission; landing at Edwards AFB.
Nov. 22	Columbia moved to the VAB for mating in preparation STS 61-C.	Jan. 22-23	Columbia returned to KSC via Davis-Monthan AFB, Kelly AFB and Eglin AFB.
Nov. 26-Dec. 3	STS 61-B mission landing at Edwards AFB.		

Jan. 27-28	STS 51-L launched from Pad B. Vehicle exploded 1 minute, 13 seconds after liftoff resulting loss of seven crew members.	Sept. 5	Study contracts were awarded to five aerospace firms for conceptual designs of an alternative or Block II Space Shuttle solid rocket motor.
Feb. 3	President Reagan announced the formation of the Presidential Commission on the Space Shuttle Challenger Accident, headed by William P. Rogers, former Secretary of State.	Sept. 10	Astronaut Bryan O'Connor was named chairman of Space Flight Safety Panel. This panel, with oversight responsibility for all NASA manned space program activities, reports to the Associate Administrator for Safety, Reliability, Maintainability and Quality Assurance.
March 24	NASA publishes "Strategy for Safely Returning the Space Shuttle to Flight Status."		
May 12	President Reagan appoints Dr. James C. Fletcher NASA Administrator.	Oct. 2	After an intensive study, NASA announced the decision to test fire the redesigned solid rocket motor in a horizontal attitude to best simulate the critical conditions on the field joint which failed during the 51-L mission.
July 8	NASA establishes Safety, Reliability Maintainability, and Quality Assurance Office.		
July 14	NASA's plan to implement the recommendations of the Rogers commission was submitted to President Reagan.	Oct. 30	Discovery moved to OPF where more than 200 modification are accomplished for STS-26 mission.
Aug. 15	President Reagan announced his decision to support a replacement for the Challenger. At the same time, it was announced that NASA no longer would launch commercial satellites, except for those which are Shuttle-unique or have national security or foreign policy implications.	Nov. 6	Office of the Director, National Space Transportation System, established in the NASA Headquarters Office of Space Flight.
		1987	
Aug. 22	NASA announced the beginning of a series of tests designed to verify the ignition pressure dynamics of the Space Shuttle solid rocket motor field joint.	July 31	Rockwell International awarded contract to build a fifth orbiter to replace the Challenger.

Aug. 3 Discovery in the Orbital Processing Facility is powered up for STS-26 mission.

1988

Mid-Jan. Main engines are installed in Discovery.

March 28 Stacking of Discovery's SRBs gets underway.

May 28 Stacking of Discovery's SRBs completed.

June 10 SRBs and External Tank are mated.

June 14 The fourth full-duration test firing of the redesigned SRB motor is carried out.

June 21 Discovery rolls over from OPF to the VAB.

July 4 Discovery moved to Launch Pad 39B for STS-26 mission.

Aug. 10 Flight Readiness Firing of Discovery's main engines is conducted successfully.

GLOSSARY OF ACRONYMS AND ABBREVIATIONS

AFSCN	Air Force Satellite Control Network	EAFB	Edwards Air Force Base
AL	Approach and Landing	ECLSS	Environmental Control & Life Support System
ALT	Approach and Landing Test	EECOMP	Electrical, Environmental & Consumables Systems Engineer
AMU	Astronaut Maneuvering Unit	EI	Entry Interface
AOA	Abort Once Around	EMU	Extravehicular Mobility Unit
APS	Alternate Payload Specialist	ESA	European Space Agency
APU	Auxiliary Power Unit	ESMC	Eastern Space and Missile Center
ASE	Airborne Support Equipment	ET	External Tank
ATE	Automatic Test Equipment	EVA	Extravehicular Activity
ATO	Abort to Orbit		
BFC	Backup Flight Control	FAO	Flight Activities Officer
BOC	Base Operations Contract	FAWG	Flight Assignment Working Group
		FBSC	Fixed Base Crew Stations
CAPCOM	Capsule Communicator	F/C	Flight Controller
CCAFS	Cape Canaveral Air Force Station	FCT	Flight Crew Trainer
CCMS	Checkout, Control and Monitor Subsystem	FCTS	Flight Crew Trainer Simulator
CCTV	Closed Circuit Television	FD	Flight Director
CDR	Commander	FDF	Flight Data File
CDMS	Command & Data Management Systems Officer	FDO	Flight Dynamics Officer
CDS	Central Data System	FOD	Flight Operations Directorate
CFES	Continuous Flow Electrophoresis System	FOE	Flight Operations Engineer
CIC	Crew Interface Coordinator	FOPG	Flight Operations Planning Group
CIE	Communications Interface Equipment	FOSO	Flight Operations Scheduling Officer
CTTE	Cargo Integration Test Equipment	FR	Firing Room
CTS	Call to Stations	FRC	Flight Control Room
		FRCS	Forward Reaction Control System
DCC	Data Computation Complex	FRF	Flight Readiness Firing
DCS	Display Control System	FRR	Flight Readiness Review
DIG	Digital Image Generation	FSE	Flight Simulation Engineer
DFI	Development Flight Instrumentation	FSS	Fixed Service Structure
DFRF	Hugh L. Dryden Flight Research Facility		
DMC	Data Management Coordinator	GAS	Getaway Special
DMOS	Diffusive Mixing of Organic Solutions	GC	Ground Control
DOD	Department of Defense	GDO	Guidance Officer
DOP	Diver Operated Plug	GLS	Ground Launch Sequencer
DPS	Data Processing System	GN	Ground Network

GNC	Guidance, Navigation & Control Systems Engineer	MCC	Mission Control Center
GPC	General Purpose Computer	MD	Mission Director
GSE	Ground Support Equipment	MDD	Mate/Demate Device
GSFC	Goddard Space Flight Center	ME	Main Engine
HAC	Heading Alignment Circle	MECO	Main Engine Cutoff
HB	High Bay	MET	Mission Elapsed Time
HMF	Hypergolic Maintenance Facility	MLP	Mobile Launch Platform
HPPF	Horizontal Payloads Processing Facility	MLR	Monodisperse Latex Reactor
HUS	Hypergolic Umbilical System	MLS	Microwave Landing System
IECM	Induced Environment Contamination Monitor	MMACS	Maintenance, Mechanical Arm & Crew Systems Engineer
IG	Inertial Guidance	MMPSE	Multiuase Mission Payload Support Equipment
ILS	Instrument Landing System	MMSE	Multiuase Mission Support Equipment
IMF	In Flight Maintenance	MMU	Manned Maneuvering Unit
IMU	Inertial Measurement Unit	MOD	Mission Operations Directorate
INCO	Instrumentation & Communications Officer	MOP	Mission Operations Plan
IRIG	Interrange Instrumentation Group	MPGHM	Mobile Payload Ground Handling Mechanism
ISP	Integrated Support Plan	MPPSE	Multipurpose Payload Support Equipment
IUS	Inertial Upper Stage	MPS	Main Propulsion System
IVA	Intravehicular Activity	MS	Mission Specialist
JPL	Jet Propulsion Laboratory	MSBLS	Microwave Scanning Beam Landing System
JSC	Lyndon B. Johnson Space Center	MSCI	Mission Scientist
KSC	John F. Kennedy Space Center	MSFC	George C. Marshall Space Flight Center
LC	Launch Complex	MSS	Mobile Service Structure
LCC	Launch Control Center	MST	Mobile Service Tower
LCS	Launch Control System	MUM	Mass Memory Unit Manager
LDEF	Long Duration Exposure Facility	NASCOM	NASA Communications Network
LETF	Launch Equipment Test Facility	NBT	Neutral Bouyancy Facility
LOX	Liquid Oxygen	NIP	Network Interface Processor
LPS	Launch Processing System	NOCC	Network Operations Control Center
LSA	Launch Services Agreement	NSRS	NASA Safety Reporting System
LWG	Logistics Working Group	NSTL	National Space Technology Laboratories
MBCS	Motion Base Crew Station	NSTS	National Space Transportation System
		OAA	Orbiter Access Arm
		OC	Operations Coordinator
		O&C	Operations and Checkout (Building)
		OAST	Office of Aeronautics & Space Technology

OFI Operational Flight Instrumentation
 OFT Orbiter Flight Test
 OMBUU Orbiter Midbody Umbilical Unit
 OMRF Orbiter Maintenance & Refurbishment Facility
 OMS Orbital Maneuvering System
 OPF Orbiter Processing Facility
 OSF Office of Space Flight
 OSS Office of Space Science
 OSSA Office of Space Science and Applications
 OSTA Office of Space and Terrestrial Applications
 OV Orbiter Vehicle

 PACE Prelaunch Automatic Checkout Equipment
 PAM Payload Assist Module
 PAYCOM Payload Command Coordinator
 PCR Payload Changeout Room
 PDRS Payload Deployment & Retrieval System
 PGHM Payload Ground Handling Mechanism
 PHF Payload Handling Fixture
 PIP Payload Integration Plan
 PLSS Portable Life Support Subsystem
 PLT Pilot
 POCC Payload Operations Control Center
 POD Payload Operations Director
 PRC Payload Changeout Room
 PRF Parachute Refurbishment Facility
 PRSD Power Reactant Storage & Distribution
 PS Payload Specialist

 R&D Research Development
 RCS Reaction Control System
 RMS Remote Manipulator System
 RPS Record Playback Subsystem
 RSS Rotating Service Structure
 RTLS Return to Launch Site

 SAEF Spacecraft Assembly & Encapsulation Facility
 SAIL Shuttle Avionics Integration Laboratory
 SCA Shuttle Carrier Aircraft

SCAMMA Station Conferencing & Monitoring Arrangement
 SCAPE Self-Contained Atmospheric Protection Ensemble
 SID Simulation Interface Device
 SIP Standard Interface Panel
 SIT Shuttle Interface Test
 SL Spacelab
 SLF Shuttle Landing Facility
 SMAB Solid Motor Assembly Building
 SMCH Standard Mixed Cargo Harness
 SMS Shuttle Mission Simulator
 SN Space Network
 SPIF Shuttle Payload Integration Facility
 SPOC Shuttle Portable On-Board Computer
 SRB Solid Rocket Booster
 SRBDF Solid Rocket Booster Dissassembly Facility
 SRM&QA Safety, Reliability, Maintainability and Quality Assurance

 SSCP Small Self-Contained Payload
 SSIP Shuttle Student Involvement Project
 SSP Standard Switch Panel
 SSME Space Shuttle Main Engines
 SSC John C. Stennis Space Center
 SST Single System Trainer
 STA Shuttle Training Aircraft
 STS Space Transportation System

 T Time
 TACAN Tactical Air Navigation
 TAEM Terminal Area Energy Management
 TAL Trans-Atlantic Abort Landing
 TDRS Tracking and Data Relay Satellite
 TPAD Trunnion Pin Acquisition Device
 TPS Thermal Protection System
 TSM Tail Service Mast

 UHF Ultra high Frequency
 UV Ultraviolet

 VAB Vehicle Assembly Building

VLF Very Low Frequency
VPF Vertical Processing Facility

WCS Waste Collection System
WSMC Western Space & Missile Center
WSSH White Sands Space Harbor

METRIC CONVERSION TABLE

<u>Multiply</u>	<u>By</u>	<u>To Obtain</u>
Length:		
Inches	25.4	Millimeters (mm)
Feet	304.8	Millimeters (mm)
Yards	0.9144	Meters (m)
Miles	1.609	Kilometers (km)
Inches	2.54	Centimeters (cm)
Feet	0.3048	Meters (m)
Area:		
Square Inches	6.452	Centimeters Squared (cm ²)
Square Feet	0.0929	Meters Squared (m ²)
Square Yards	0.8361	Meters Squared (m ²)
1 Acre	0.4047	Hectares (ha)
Square Miles	2.59	Kilometers Squared (km ²)
Square Miles	259.1	Hectares (ha)
Volume:		
Cubic Inches	16.39	Cubic Centimeters (cm ³)
Cubic Feet	0.0283	Cubic Meters (m ³)
Cubic Yards	0.7646	Cubic Meters (m ³)
Fluid Ounces	29.57	Milliliters (mL)
Fluid Quarts	0.9464	Liters (L)
Gallons	3.7854	Liters (L)
Fluid Ounces	0.0296	Liters (L)
Mass:		
Ounces	28.35	Grams (g)
Pounds (lb)	0.4536	Kilograms (kg)
1 Ton (2,000 pounds)	0.9072	Metric Tons (t)
Speed:		
Miles per Hour (mph)	{ 0.447	Meters per Second (m/s)
	1.609	Kilometers per Hour (km/h)
Knots	1.852	Kilometers per Hour (km/h)
Distance:		
Nautical Miles (nmi)	1.852	Kilometers (km)
Statute Miles (sm)	1.609	Kilometers (km)
Nautical Miles (nmi)	1.1508	Statute Miles (sm)
Statute Miles (sm)	0.8689	Nautical Miles (nmi)
Statute Miles (sm)	1,760	Yards

<u>Multiply</u>	<u>By</u>	<u>To Obtain</u>
Acceleration:		
Inches per Second Squared	2.54	Centimeters per Second Squared (cm ² /s)
Feet per Second	0.3048	Meters per Second (m/s)
Meters per Second (m/s)	2.237	Statute Miles per Hour
Feet per Second	0.6818	Statute Miles per Hour
Feet per Second	0.5925	Nautical Miles per Hour
Pressure:		
Pounds per Square Inch (psi)	6.895	Kilonewtons per Square Meter (kilopascals—kPa)
Millimeters Mercury	133.32	Newtons per Square Meter (Pascals—Pa)
Pounds per Square Inch (psi)	51.75	Millimeters of Mercury (mmHg)
Force:		
Ounces Force	0.278	Newtons (N)
Pounds Force	4.448	Newtons (N)
Newtons	0.225	Pounds
Kilograms (kg)	9.807	Newtons (N)
Flow Rate:		
Cubic Feet per Minute	0.283	Cubic Meters per Second (m ³ /s)
Gallons per Minute	3.7854	Liters per Minute (L/m)
Pounds Mass per Hour	0.4536	Kilograms per Hour (kg/hr)
Pounds Mass per Minute	0.4536	Kilograms per Minute (kg/m)
Pounds Mass per Second	0.4536	Kilograms per Second (kg/s)
Pounds Mass per Cubic Foot	16.02	Kilograms per Cubic Meter (kg/m ³)
Power:		
British Thermal Units (Btu)	1.054	Kilojoules per Hour (kJ/hr)
Brake Horsepower	0.7457	Kilowatts (kw)
Electric Horsepower	0.746	Kilowatts (kw)
Energy:		
Kilowatt Hours	3.60	Megajoules (Mj)
Temperature:		
°F - 32		Degrees Celsius (C)

CONTACTS

Additional information may be obtained by contacting NASA Public Affairs offices:

Sarah G. Keegan/Barbara E. Selby
NASA Headquarters
Washington, D.C. 20546
202 453-8536

Barbara L. Schwartz
Johnson Space Center
Houston, Texas 77058
713 483-5111

Carter Dove
Goddard Space Flight Center
Greenbelt, Maryland 20771
301 286-5566

Lisa Malone
Kennedy Space Center
Florida 32899
407 867-2468

Ed Medal/Jerry Berg
Marshall Space Flight Center
Alabama 35812
205 544-0034

Ralph B. Jackson
Ames-Dryden Flight Research Facility
P.O. Box 273
Edwards, California 93523
805 258-8381