

# Rendezvous

## STS-122

---

**Mission Operations Directorate  
Flight Design and Dynamics Division**

**Final  
October 3, 2007**

National Aeronautics and  
Space Administration

**Lyndon B. Johnson Space Center**  
Houston, Texas





RENDEZVOUS STS-122	FINAL (Oct 3, 2007)
--------------------	---------------------

## PCN-1 (Nov 9, 2007) Sheet 1 of 1

List of Implemented Change Requests (482s):

RNDZ-1295B  
RNDZ-1296

Incorporate the following:

1. Replace v thru x
2. Replace 4-11 thru 4-14, 4-17 thru 4-20
3. Replace 8-3 & 8-4  
After 8-12, add 8-12a & 8-12b

Prepared by: *Neville O'Donoghue* 11/12/07  
Book Manager

Approved by: *Sgt. M. Wall* 11-13-07  
Lead, Rendezvous Guidance and Procedures  
Group

Accepted by: *Richard T. Jones* 11/13/07  
Chief, Orbit Dynamics Branch

Encl: 18 pages

**File this PCN immediately behind the front cover as a permanent record**



MISSION OPERATIONS DIRECTORATE

**RENDEZVOUS  
STS-122**

FINAL  
October 3, 2007

PREPARED BY:

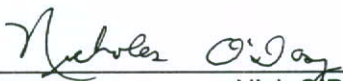
 10/3/07  
\_\_\_\_\_  
Nick O'Dosey  
Book Manager

APPROVED BY:

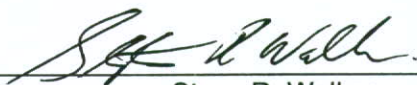
  
\_\_\_\_\_  
Steve R. Walker  
Lead, Rendezvous Guidance and Procedure Group

ACCEPTED BY:

  
\_\_\_\_\_  
R. T. Gavin  
Chief, Orbit Dynamics Branch

This document is under the configuration control of the Crew Procedures Control Board (CPCB). All proposed changes must be submitted via FDF Workflow Crew Procedure Change Request (CR) to DO3/FDF Manager.

Additional distribution of this book, for official use only, may be requested in writing to DO3/PMO Administrator. The request must include justification and requester's name, organization, position, and phone number. Contractor requests are made through the NASA or DOD organization supported. Deletions, reduction in quantity, or change of address may be submitted to DO3/FDF Management Office, 281-244-1184.

Incorporates the following:			
482#:	RNDZ-1271	RNDZ-1283	RNDZ-1288
	RNDZ-1276	RNDZ-1285	RNDZ-1289
	RNDZ-1278	RNDZ-1286	
	RNDZ-1282	RNDZ-1287	

AREAS OF TECHNICAL RESPONSIBILITY

Book Manager	DM34/N. O'Dosey	281-483-6178
Rendezvous Guidance and Procedures	DM34/M. Machula	281-483-3889
Flight Dynamics	DM32/D. Leleux	281-483-2660
Rendezvous Design	USA/J. Bacher	281-282-2763
PROX OPS Design	USA/M. Schrock	281-282-2777
Flight Design	USA/A. Haggord	281-244-0274
Rendezvous Training	DT35/J. Tuxhorn	281-244-7446
APDS	DF52/J. Dake	281-483-6538

### NOTE

This checklist is the controlling crew document for the ISS-1E rendezvous and separation. The Rendezvous Timeline begins at Ti -3:00 hr and continues through docking. This is a complete stand-alone document. The Separation Timeline begins 45 min prior to undock and continues through 1:15 after undock.

Timeline pages assume an FD3 rendezvous and undocking on FD10. Lighting is based on planned rendezvous altitude of 205 nm. Targeting I-Loads are based on 210 nm.

## ACRONYMS

AZ, AZM	Azimuth
D/N	Day/Night
EL, ELEV	Elevation
IAH	Inertial
LOS	Line of Sight
LVLH	Local Vertical, Local Horizontal
R	Range
$\dot{R}$ , RDOT	Range Rate
R, RBAR	Radius Vector (toward Earth)
RNDZ	Rendezvous
RR	Rendezvous Radar
SK	Stationkeeping
ST, STRK	Star Tracker
V, VBAR	Velocity Vector (direction of orbital travel)
$\pm X, Y, ZLV$	$\pm X, Y, \text{ or } Z$ Local Vertical ( $\pm X, Y, \text{ or } Z$ toward Earth)
X, Y, ZPOP	X, Y, or Z orbiter body axis Perpendicular to Orbit Plane (aligned with the angular momentum vector)
$\pm X, Y, ZVV$	$\pm X, Y, \text{ or } Z$ orbiter body axis along the LVLH Velocity Vector



RENDEZVOUS  
STS-122

**LIST OF EFFECTIVE PAGES**

	FINAL PCN-1	10/03/07 11/09/07	
Sign Off .....	* 122/FIN	4-3 .....	122/FIN
ii .....	* 122/FIN	4-4 .....	122/FIN
iii.....	* 122/FIN	4-5 .....	122/FIN
iv .....	* 122/FIN	4-6 .....	122/FIN
v .....	* 122/FIN 1	4-7 .....	122/FIN
vi .....	* 122/FIN 1	4-8 .....	122/FIN
vii.....	* 122/FIN 1	4-9 .....	122/FIN
viii.....	* 122/FIN	4-10 .....	122/FIN
ix .....	122/FIN	4-11 .....	122/FIN 1
x .....	122/FIN 1	4-12 .....	122/FIN
xi .....	122/FIN	4-13 .....	122/FIN
xii.....	122/FIN	4-14 .....	122/FIN 1
1-1 .....	122/FIN	4-15 .....	122/FIN
1-2 .....	122/FIN	4-16 .....	122/FIN
1-3 .....	122/FIN	4-17 .....	122/FIN 1
1-4 .....	122/FIN	4-18 .....	122/FIN 1
1-5 .....	122/FIN	4-19 .....	122/FIN 1
1-6 .....	122/FIN	4-20 .....	122/FIN 1
1-7 .....	122/FIN	4-21 .....	122/FIN
1-8 .....	122/FIN	4-22 .....	122/FIN
1-9 .....	122/FIN	5-1 .....	122/FIN
1-10.....	122/FIN	5-2 .....	122/FIN
2-1 .....	122/FIN	5-3 .....	122/FIN
2-2 .....	122/FIN	5-4 .....	122/FIN
2-3 .....	122/FIN	5-5 .....	122/FIN
2-4 .....	122/FIN	5-6 .....	122/FIN
2-5 .....	122/FIN	5-7 .....	122/FIN
2-6 .....	122/FIN	5-8 .....	122/FIN
2-7 .....	122/FIN	5-9 .....	122/FIN
2-8 .....	122/FIN	5-10 .....	122/FIN
2-9 .....	122/FIN	5-11 .....	122/FIN
2-10.....	122/FIN	5-12 .....	122/FIN
3-1 .....	122/FIN	5-13 .....	122/FIN
3-2 .....	122/FIN	5-14 .....	122/FIN
3-3 .....	122/FIN	5-15 .....	122/FIN
3-4 .....	122/FIN	5-16 .....	122/FIN
3-5 .....	122/FIN	5-17 .....	122/FIN
3-6 .....	122/FIN	5-18 .....	122/FIN
3-7 .....	122/FIN	5-19 .....	122/FIN
3-8 .....	122/FIN	5-20 .....	122/FIN
3-9 .....	122/FIN	5-21 .....	122/FIN
3-10.....	122/FIN	5-22 .....	122/FIN
3-11.....	122/FIN	5-23 .....	122/FIN
3-12.....	122/FIN	5-24 .....	122/FIN
4-1 .....	122/FIN	5-25 .....	122/FIN
4-2 .....	122/FIN	5-26 .....	122/FIN

\* – Omit from flight book

5-27 .....	122/FIN	8-1 .....	122/FIN
5-28 .....	122/FIN	8-2 .....	122/FIN
5-29 .....	122/FIN	8-3 .....	122/FIN 1
5-30 .....	122/FIN	8-4 .....	122/FIN
5-31 .....	122/FIN	8-5 .....	122/FIN
5-32 .....	122/FIN	8-6 .....	122/FIN
5-33 .....	122/FIN	8-7 .....	122/FIN
5-34 .....	122/FIN	8-8 .....	122/FIN
5-35 .....	122/FIN	8-9 .....	122/FIN
5-36 .....	122/FIN	8-10 .....	122/FIN
5-37 .....	122/FIN	8-11 .....	122/FIN
5-38 .....	122/FIN	8-12 .....	122/FIN
5-39 .....	122/FIN	8-12a .....	122/FIN 1
5-40 .....	122/FIN	8-12b .....	122/FIN 1
5-41 .....	122/FIN	8-13 .....	122/FIN
5-42 .....	122/FIN	8-14 .....	122/FIN
6-1 .....	122/FIN	8-15 .....	122/FIN
6-2 .....	122/FIN	8-16 .....	122/FIN
6-3 .....	122/FIN	8-17 .....	122/FIN
6-4 .....	122/FIN	8-18 .....	122/FIN
6-5 .....	122/FIN	8-19 .....	122/FIN
6-6 .....	122/FIN	8-20 .....	122/FIN
6-7 .....	122/FIN	8-21 .....	122/FIN
6-8 .....	122/FIN	8-22 .....	122/FIN
6-9 .....	122/FIN	8-23 .....	122/FIN
6-10 .....	122/FIN	8-24 .....	122/FIN
6-11 .....	122/FIN	8-25 .....	122/FIN
6-12 .....	122/FIN	8-26 .....	122/FIN
6-13 .....	122/FIN	8-27 .....	122/FIN
6-14 .....	122/FIN	8-28 .....	122/FIN
7-1 .....	122/FIN	8-29 .....	122/FIN
7-2 .....	122/FIN	8-30 .....	122/FIN
7-3 .....	122/FIN	8-31 .....	122/FIN
7-4 .....	122/FIN	8-32 .....	122/FIN
7-5 .....	122/FIN	8-33 .....	122/FIN
7-6 .....	122/FIN	8-34 .....	122/FIN
7-7 .....	122/FIN	8-35 .....	122/FIN
7-8 .....	122/FIN	8-36 .....	122/FIN
7-9 .....	122/FIN	8-37 .....	122/FIN
7-10 .....	122/FIN	8-38 .....	122/FIN
7-11 .....	122/FIN	8-39 .....	122/FIN
7-12 .....	122/FIN	8-40 .....	122/FIN
7-13 .....	122/FIN	8-41 .....	122/FIN
7-14 .....	122/FIN	8-42 .....	122/FIN
7-15 .....	122/FIN	8-43 .....	122/FIN
7-16 .....	122/FIN	8-44 .....	122/FIN
7-17 .....	122/FIN	9-1 .....	*
7-18 .....	122/FIN	9-2 .....	*
7-19 .....	122/FIN	CC 9-3 .....	*
7-20 .....	122/FIN	CC 9-4 .....	*
7-21 .....	122/FIN	CC 9-5 .....	*
7-22 .....	122/FIN	CC 9-6 .....	*
7-23 .....	122/FIN	CC 9-7 .....	*
7-24 .....	122/FIN	CC 9-8 .....	*

\* – Omit from flight book

CC 9-9.....	*	122/FIN	CC 9-18.....	*	122/FIN
CC 9-10.....	*	122/FIN	CC 9-19.....	*	122/FIN
CC 9-11.....	*	122/FIN	CC 9-20.....	*	122/FIN
CC 9-12.....	*	122/FIN	CC 9-21.....	*	122/FIN
CC 9-13.....	*	122/FIN	CC 9-22.....	*	122/FIN
CC 9-14.....	*	122/FIN	CC 9-23.....	*	122/FIN
CC 9-15.....	*	122/FIN	9-24.....	*	122/FIN
CC 9-16.....	*	122/FIN	CC 9-25.....	*	122/FIN
CC 9-17.....	*	122/FIN	CC 9-26.....	*	122/FIN

### RENDEZVOUS CUE CARDS

<u>TITLE</u>	<u>Ref. Page</u>	<u>Card No.</u>
RCS BURN (+X, -X, Multi-axis) (Front).....	CC 9-3	RNDZ-1a/122/O/A
RENDEZVOUS PRPLT PAD (Back).....	CC 9-4	RNDZ-1b/122/O/A
KU OPS (Front).....	CC 9-5	RNDZ-2a/122/O/A
(Back).....	CC 9-6	RNDZ-2b/122/O/A
APPROACH (Front).....	CC 9-7	RNDZ-3a/122/O/B
VBAR APPROACH (Back).....	CC 9-8	RNDZ-3b/122/O/B
C/L CAMERA TARGET ALIGNMENT (+VBAR) (Front) .....	CC 9-9	RNDZ-4a/122/O/A
(Back).....	CC 9-10	RNDZ-4b/122/O/A
DOCKING SEQUENCE (Front).....	CC 9-11	RNDZ-5a/122/O/B
(Back).....	CC 9-12	RNDZ-5b/122/O/A
STOPWATCH RDOT CONVERSION (Front).....	CC 9-13	RNDZ-6a/122/O/A
(Back).....	CC 9-14	RNDZ-6b/122/O/A
GPC/MDM FAILURE RESPONSE DURING RNDZ (Front).....	CC 9-15	RNDZ-7a/122/O/B
RNDZ REF DATA (Back).....	CC 9-16	RNDZ-7b/122/O/A
C/L CAMERA CORRIDOR AND ALIGNMENT.....	CC 9-17	RNDZ-8a/122/O/A
CAMERA A/D RANGE RULER.....	CC 9-18	RNDZ-9a/122/O/A
C/L CAMERA ZOOM CALIBRATION (RING READY FOR DOCK).....	CC 9-19	RNDZ-10a/122/O/A
FLIGHT SUB ANG RULER.....	CC 9-20	RNDZ-13a/122/O/A
V10 MONITOR CORRIDOR.....	CC 9-21	RNDZ-14a/122/O/A
A31P PGSC DISPLAY OF C/L CAMERA CORRIDOR AND ALIGNMENT.....	CC 9-22	RNDZ-15a/122/O/A
A31P PGSC CAMERA A/D RANGE RULER.....	CC 9-23	RNDZ-16a/122/O/A
RCS FAILURE RESPONSE DURING PROX OPS .....	CC 9-25	RNDZ-17a/122/O/A
RCS/DPS/EPS FAILURE IMPACTS.....	CC 9-26	RNDZ-17b/122/O/A

\* – Omit from flight book

This Page Intentionally Blank

<u>CONTENTS</u>	<u>PAGE</u>
<u>FLIGHT RULES SUMMARY &amp; FLIGHT PROFILE</u> .....	1-1
FLIGHT RULES SUMMARY .....	1-2
RNDZ/PROX OPS BREAKOUT PROCEDURES OVERVIEW .....	1-2
RNDZ BURN SOLUTION SELECTION GUIDELINES.....	1-3
ENGINE SELECTION GUIDELINES .....	1-3
FAILURE/RESPONSE SUMMARY.....	1-4
ORBT RENDEZVOUS PROFILE .....	1-5
POST Ti PROFILE .....	1-6
TERMINAL PHASE, RPM, AND TORVA.....	1-7
VBAR APPROACH .....	1-8
UNDOCKING, TORS/TORF, AND FINAL SEPARATION.....	1-9
<u>UNDOCKING/SEPARATION TIMELINE</u> .....	2-1
<u>MANEUVER PADS</u> .....	3-1
<u>RENDEZVOUS TIMELINE</u> .....	4-1
<u>CONTINGENCY OPS</u> .....	5-1
RNDZ OMS BURN.....	5-3
SENSOR FAIL .....	5-7
S TRK NAV – HIGH INITIAL RESID .....	5-8
FLTR MINUS PROP .....	5-9
COAS NAVIGATION .....	5-10
BACKOUT/BREAKOUTS.....	5-11
VBAR CORRIDOR BACKOUT .....	5-12
BREAKOUT .....	5-14
SHUTTLE NOSE IN-PLANE BREAKOUT (R < 700 ft) .....	5-16
RNDZ BREAKOUT .....	5-18
EXPEDITED SEPS .....	5-19
SHUTTLE EMERGENCY SEPARATION.....	5-21
ANY ATTITUDE SEPARATION .....	5-23
Ti DELAY BURN .....	5-27
RNDZ NAV RECOVERY.....	5-29
TGT ITER.....	5-30
LOSS OF COMM .....	5-31
DEGRADED CONTROL .....	5-33
DEGRADED +X TRANSLATION .....	5-35
-X TRANSLATION .....	5-36
LOSS OF FORWARD SIDE-FIRING JETS.....	5-37
ONE FxD JET .....	5-38
BOTH FxD JETS (SAME SIDE).....	5-39
VRCS.....	5-41
<u>REFERENCE DATA</u> .....	6-1
ISS RNDZ OPS DAP CONFIGURATIONS.....	6-2
POST-CONTACT THRUST (PCT) REFERENCE DATA.....	6-3
TARGETING DATA.....	6-4
POST NC .....	6-6
Ti .....	6-7
MC3.....	6-8
TCS REFLECTOR VISIBILITY DURING APPROACH .....	6-9
HHL AIMING LOCATIONS .....	6-10
SHUTTLE CENTERLINE TARGET .....	6-11
ISS ATTITUDE CONTROL SYSTEM MODING INDICATORS.....	6-12
RANGING CHARTS.....	6-13
COAS SUBTENDED ANGLES (DEG) VS RANGE (FT).....	6-14

<u>RENDEZVOUS TOOLS</u> .....	7-1
CCTV CONFIG FOR DOCKING/UNDOCKING .....	7-2
RNDZ TOOLS CHECKOUT .....	7-4
TROUBLESHOOTING .....	7-5
HAND-HELD LIDAR CHECKOUT .....	7-6
STOW .....	7-6
OPS .....	7-7
RPOP INITIALIZATION.....	7-8
OPS .....	7-9
FUNCTION KEY SUMMARY .....	7-11
KEYSTROKE SUMMARY .....	7-15
TRAJECTORY DATA SOURCE OPTIONS .....	7-16
TCS ACTIVATION .....	7-18
MANUAL ACQUISITION.....	7-19
DEACTIVATION .....	7-20
LIMITS .....	7-21
TRAD FAIL RANGE AND RANGE RATE DETERMINATION .....	7-21
NOMINAL OPS .....	7-21
RADAR FAIL .....	7-22
TCS FAIL.....	7-22
HHL FAIL.....	7-22
PCMMU/WINDECOM FAIL.....	7-23
PGSC FAIL (NO PROP, NO TCS) .....	7-23
 <u>APDS</u> .....	 8-1
<u>APDS NOMINAL</u> .....	8-3
DOCKING MECHANISM INITIALIZATION .....	8-4
POWERUP .....	8-5
POWERDOWN.....	8-6
PREP.....	8-7
UNDOCKING PREP .....	8-7
DOCKING RING EXTENSION.....	8-8
RETRACTION (NOT MATED).....	8-9
AIRLOCK FAN ACT AND ODS VOLUME PREP .....	8-10
POST DOCKING HATCH LEAK CHECK.....	8-11
AIRLOCK PREP FOR INGRESS – BYPASS CONFIG.....	8-12
BOOSTER FAN ACTIVE .....	8-12a
 <u>APDS OFF-NOMINAL</u> .....	 8-13
POWER FAILED OFF (STATUS LTS OFF).....	8-14
DAMPING FAILED ON .....	8-15
CAPTURE LT FAILED ON.....	8-15
FIXERS FAILED ON .....	8-16
OFF LT FAILED ON.....	8-18
OFF .....	8-18
RING FAILS TO DRIVE .....	8-19
DRV CMD OFF .....	8-19
FINAL POSITION LT FAILED ON.....	8-20
FORCE RING ALIGNMENT.....	8-20
CLUTCH NOT 'LOCK'.....	8-21
APDS CIRCUIT PROTECT OFF LT FAILED OFF.....	8-21
HOOKS 1(2) OPEN LT FAILED ON .....	8-21
NOT CLOSED WITHIN SINGLE MTR TIME .....	8-22
READY TO HOOK LT FAILED ON .....	8-23
HOOKS 1(2) CLOSED LT FAILED ON.....	8-23
LATCHES OPEN LT FAILED OFF.....	8-24
APDS POWER FAILED OFF .....	8-24
DOCKING MECHANISM DEMATE/REIMATE.....	8-25
ODS HOOKS OPEN – CONTINGENCY.....	8-27

PMA 2/3 HOOKS OPEN – CONTINGENCY.....	8-30
APDS FAILED CAPTURE RECONFIG.....	8-33
PMA 2/3 HOOKS CLOSE .....	8-35
OPEN .....	8-37
REFERENCE DATA .....	8-39
APDS FAILURE/IMPACT MATRIX .....	8-40
(TLM).....	8-43
<u>CUE CARD CONFIGURATION</u> .....	9-1

This Page Intentionally Blank



## FLIGHT RULES SUMMARY & FLIGHT PROFILE

FLIGHT RULES SUMMARY .....	1-2
RNDZ/PROX OPS BREAKOUT PROCEDURES OVERVIEW .....	1-2
RNDZ BURN SOLUTION SELECTION GUIDELINES .....	1-3
ENGINE SELECTION GUIDELINES .....	1-3
FAILURE/RESPONSE SUMMARY .....	1-4
ORBT RENDEZVOUS PROFILE .....	1-5
POST Ti PROFILE .....	1-6
TERMINAL PHASE, RPM, AND TORVA .....	1-7
VBAR APPROACH .....	1-8
UNDocking, TORS/TORF, AND FINAL SEPARATION .....	1-9

## FLIGHT RULES SUMMARY

### RNDZ/PROX OPS BREAKOUT PROCEDURES OVERVIEW

RANGE BREAKOUT REQD	BREAKOUT PROCEDURE AND SUMMARY
Prior to Ti	Discontinue RNDZ burns; specific breakout only on MCC call
Ti - 5 Minutes	If GO for Ti not received, Perform Ti Delay Burn, 5-27
Between Ti and TORVA init (+X burns to start TORVA are complete)	RNDZ BREAKOUT ( <u>CONTINGENCY OPS</u> ), 5-18 3 fps retrograde
Between TORVA init (+X burns to start TORVA are complete) and Vbar arrival	SHUTTLE NOSE IN-PLANE BREAKOUT ( <u>CONTINGENCY OPS</u> ), 5-16 1.5 fps $\pm$ X burn, followed in 30 min by 4.3/3.6 fps retrograde/out-of-plane burn (posigrade if second approach is desired)
Between Vbar arrival and contact OR Between undock and flyaround start	VBAR BREAKOUT ( <u>CONTINGENCY OPS</u> ), 5-14 If RNG < 150 ft, back out to 150 ft. When RNG > 150 ft, perform 1.5 fps radial up burn in LO Z, followed in 28 min by 3.0 fps posigrade/retrograde burn
During flyaround	SHUTTLE NOSE IN-PLANE BREAKOUT ( <u>CONTINGENCY OPS</u> ), 5-16 1.5 fps $\pm$ X burn, followed in 30 min by 4.3/3.6 fps retrograde/out-of-plane burn (posigrade if second approach is desired)
Otherwise:	<u>SEP MANEUVER</u> (ORB OPS), Perform 1 fps away from target, followed in 2 min by 2 fps out of plane, followed in 15 min by 3 fps posigrade
<b>SHUTTLE BACKOUT</b>	
Prior to docking	See VBAR CORRIDOR BACKOUT ( <u>CONTINGENCY OPS</u> ), 5-12

## RNDZ BURN SOLUTION SELECTION GUIDELINES

BURN	SOLUTION PRIORITY
All burns prior to, but not including, NCC	1) Ground solution
NCC & Ti	1) Onboard FLTR solution if STRK or RR NAV converged* (for COAS, use step 2 below) 2) Onboard FLTR solution if it agrees with ground solution** 3) Onboard PROP solution if it agrees with ground solution 4) Ground solution
Post-Ti midcourse corrections	1) Onboard solution

\*For the purpose of burn solution selection, NAV is converged if for the present sensor in acquisition (RR or STRK), at least 40 marks have been accepted with state vector position update of less than 0.5 Kft for at least the last 4 marks; or if state vector updates are small and stable. These criteria do not apply to COAS NAV

\*\*Burn solutions are considered to be in agreement if delta Vs differ by no more than the 'final-ground' limits for each axis

## RNDZ BURN ENGINE SELECTION GUIDELINES

DELTA V	ENGINE
< 4 fps	RCS – Primary technique is multi-axis
4 to 6 fps	RCS – Primary technique is +X
> 6 fps	OMS – Single engine

## RNDZ FAILURE/RESPONSE SUMMARY

FAILURE	RESPONSE
No sensor data (RR, STRK, or COAS) during RNDZ and no visual acquisition	Breakout Burn by MC2 + 20 min
Good sensor data (RR, STRK, or COAS) during RNDZ, but no visual or RR acquisition	Breakout Burn by MC2 + 24 min
Target > 30 deg from COAS horizontal at start of radar fail correction	Breakout ASAP; use RNDZ BREAKOUT ( <u>CONTINGENCY OPS</u> ), 5-18, until RBAR arrival
Prop quantities violate bingo numbers on <u>RNDZ PRPLT PAD</u> (Cue Card) <u>or</u> Orbiter systems malfunctions require breakout	Breakout per overview on 1-2
SYSTEMS: DPS: < 2 GNC GPCs	2 GNC GPCs reqd for Ti and PROX OPS within 250 ft. Loss of GNC GPC redundancy inside 250 ft requires backout to 250 ft and stationkeep until reconfiguration to a 2 GNC redundant set is complete
GNC: Loss of redundant +Z Trans <u>or</u> PRCS TRANS, any axis ↓ <u>or</u> PRCS ROT, any axis ↓ <u>or</u> AFT THC (-Z sense), > 1 TX contact ↓, all TY contacts ↓, all TZ contacts ↓ <u>or</u> AFT RHC, all channels, any axis ↓ <u>or</u> < 2 IMUs	PROX OPS within 250 ft not permitted
Both Left Aft firing jets ↓ or Both Right Aft firing jets ↓	Continue Approach, per DEGRADED +X TRANSLATION ( <u>CONTINGENCY OPS</u> )
Two Forward firing jets ↓	Continue Approach, per DEGRADED -X TRANSLATION ( <u>CONTINGENCY OPS</u> )
Both Forward Right firing jets ↓ or Both Forward Left firing jets ↓	PROX OPS within 250 ft not permitted. Approach or Backout to 250 ft per LOSS OF FORWARD SIDE FIRING JETS ( <u>CONTINGENCY OPS</u> )
One Forward Down firing jet ↓	Continue Approach per LOSS OF ONE FxD JET ( <u>CONTINGENCY OPS</u> )
Both Forward Down firing jets same side ↓	PROX OPS within 250 ft not permitted. Approach or Backout to 250 ft per LOSS OF BOTH FxD JETS (SAME SIDE) ( <u>CONTINGENCY OPS</u> )
Loss of VRCS	Use ALT in place of VERN during RNDZ, approach <u>outside</u> 2000 ft, and sep Use PRI in place of VERN during approach <u>inside</u> 2000 ft, and flyaround See LOSS OF VRCS ( <u>CONTINGENCY OPS</u> )
MECH: 1 KU ANTENNA STOW MOTOR ↓	Normal ops

# ORBT RENDEZVOUS PROFILE

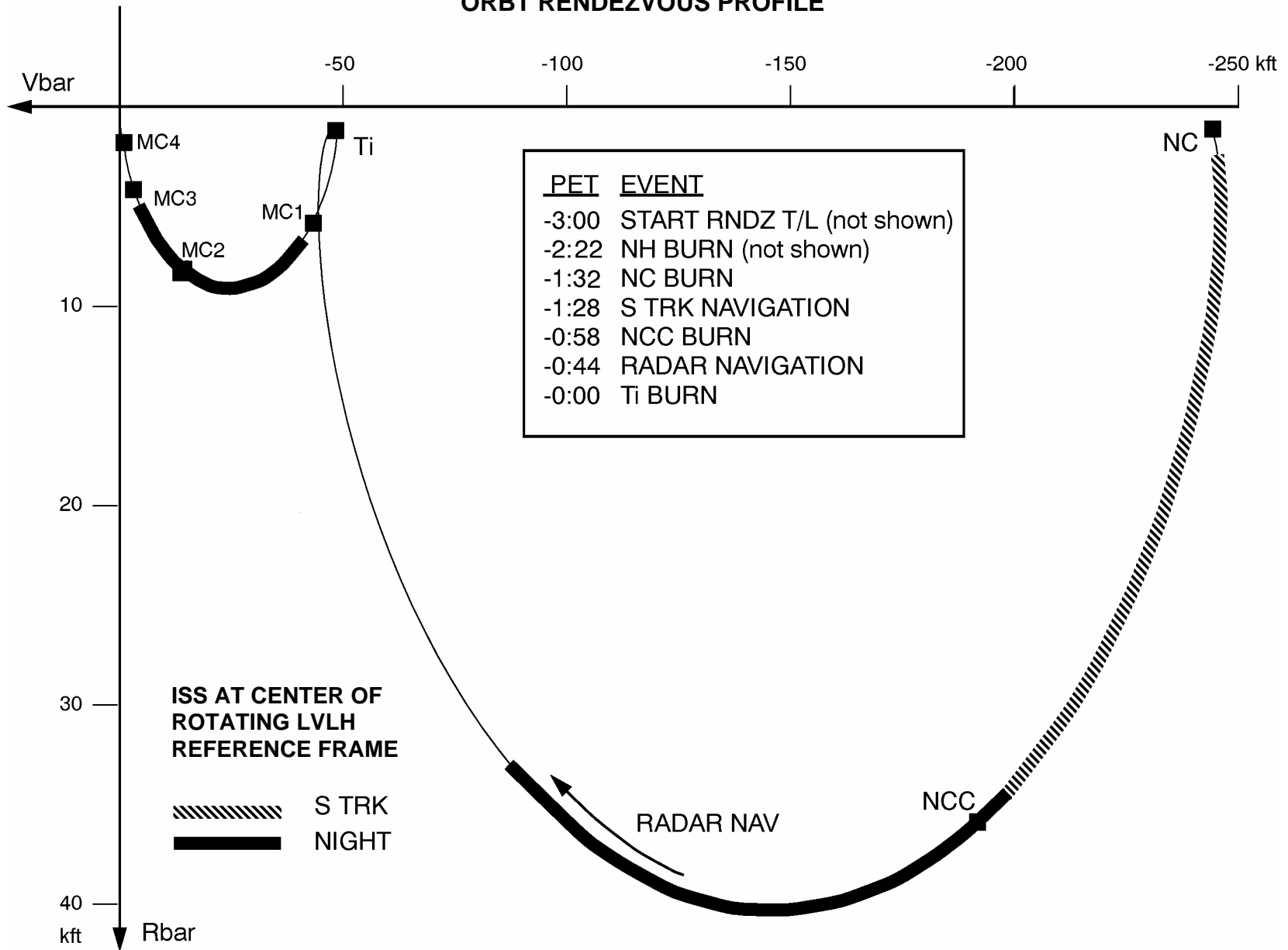

# ORBT POST Ti PROFILE

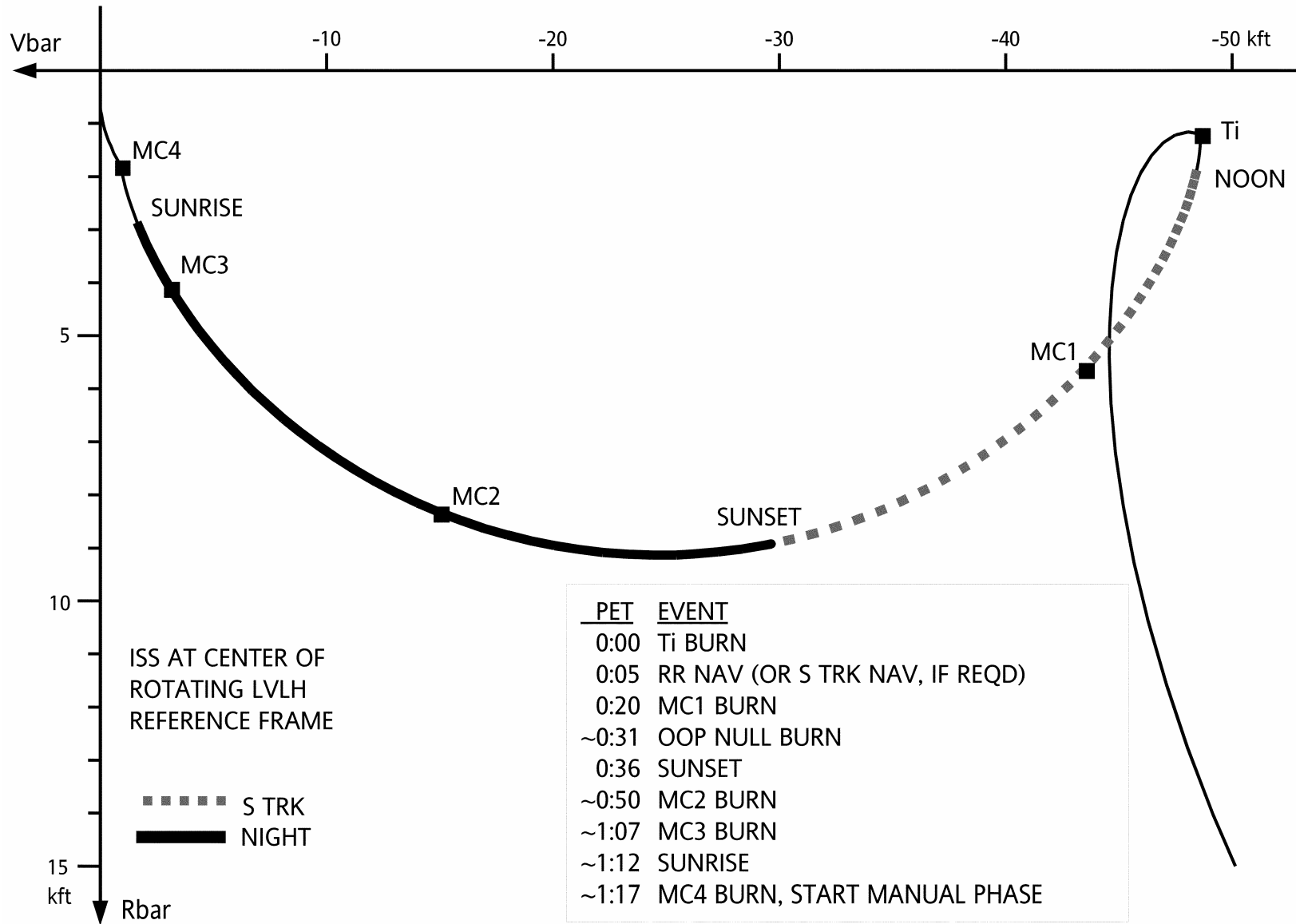

## TERMINAL PHASE, RPM, AND TORVA

I

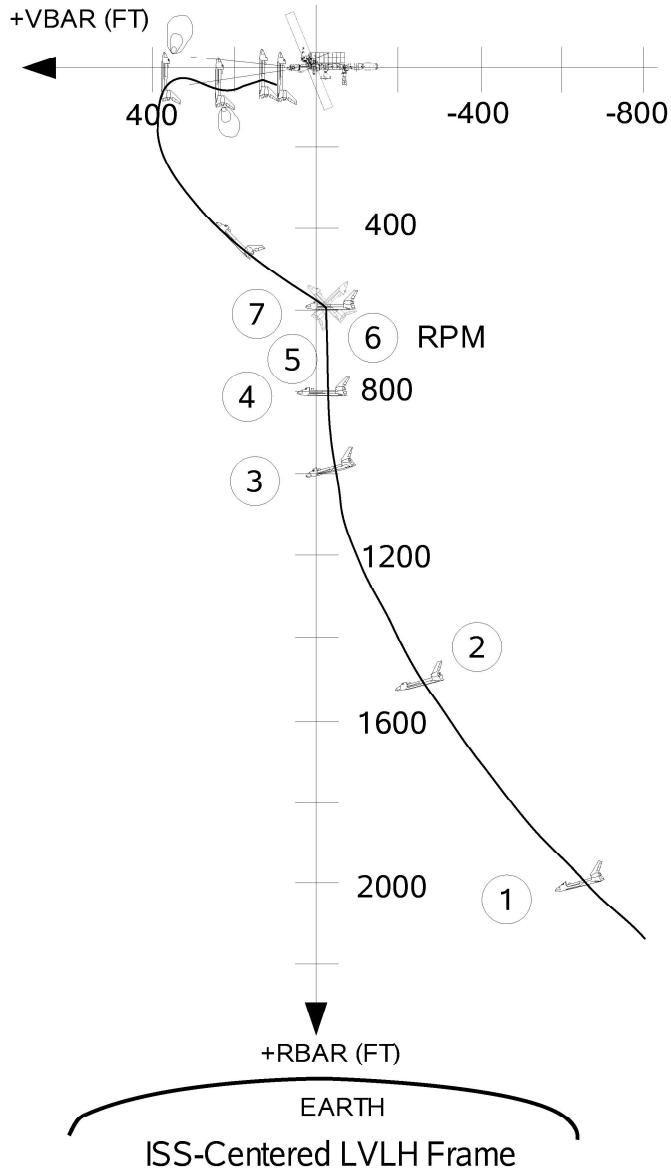

	MC2 ET (h:mm)	Range (ft) CG - CG	Rdot (fps)	EVENT
1	0:27	2000	-3.0	MANUAL PHASE TAKEOVER (POST-MC4)
	0:29	1700	-2.4	
2	0:31	1500	-2.1	TRANSITION TO LOWZ
3	0:36	1000	-1.3	
	0:37	900	-1.1	WHEN IN RBAR ATTITUDE: LOAD DAP A9/B9 MOD DAP A PRI/VERN ROT RATE TO 0.75 DEG/SEC AND YAW JET OPTION TO BOTH NOSE & TAIL (ALL) LOAD UNIV PTG P=145 DEG
4		800	-0.9	
		700	-0.6	
		650	-0.4	
5	0:46	620	0.0	
6	1:00	OPT 620 T 600 I 580 O N	-0.35 -0.25 -0.15	<b>INITIATE RPM:</b> DAP A/PRI, ITEM 19 WHEN -Z ADI PITCH > 100 DEG; DAP A/VERN WHEN -Z ADI PITCH > 170 DEG; DAP FREE, RESET UNIV PTG P=270 DEG, ITEM 19, DAP PRI DIGITAL IMAGERY TAKEN FROM ISS SM WHEN -Z ADI PITCH > 10 DEG: DAP AUTO WHEN RPM COMPLETE: DAP VERN
7	1:11	OPT 600 T 550 I O N 500	-0.7 -0.6 -0.4	RELOAD DAP A9, LOAD UNIV PTG P=179 DEG, REESTABLISH RDOT PER TORVA ICs <b>INITIATE TORVA:</b> DAP A, ITEM 19 (+X PULSES AS REQ'D TO NULL TARGET MOTION IN CAMERA)

# VBAR APPROACH

I

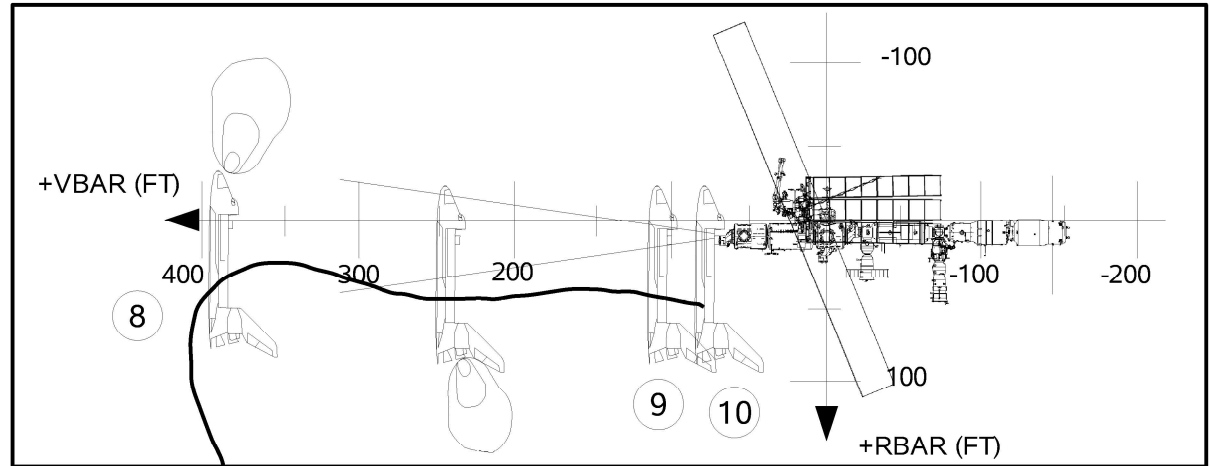
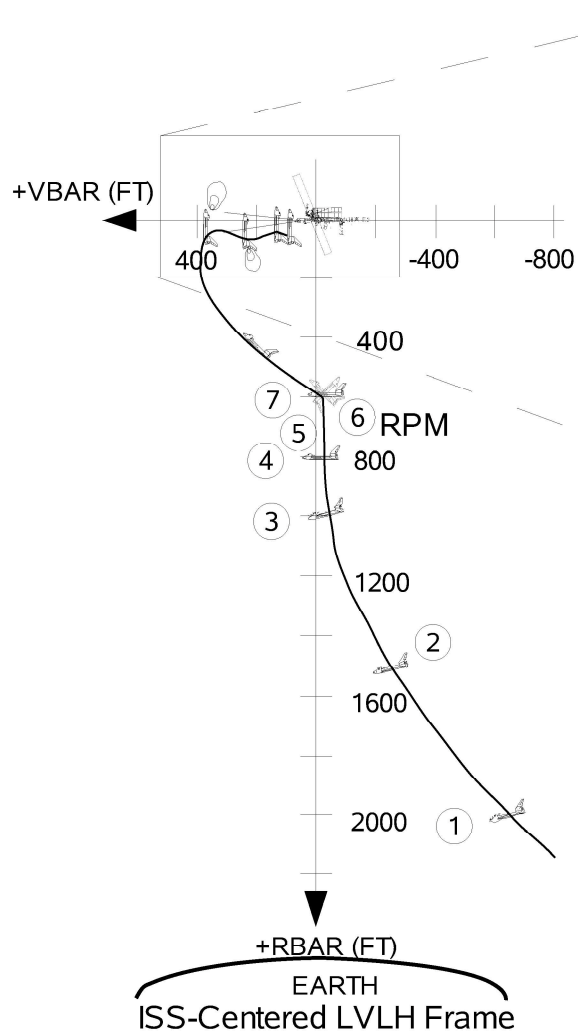

	MC2 ET (h:mm)	Range (ft) DP - DP	Rdot (fps)	EVENT
8	1:25	320	-0.20	VBAR ARRIVAL (-X PULSES AS REQ'D TO NULL TARGET MOTION IN CAMERA)
	1:42	110	-0.15	
	1:46	75	-0.10	TRANSITION TO NORMZ, LOAD DAP A10/B10, CONFIGURE FOR SINGLE -X JET (DESELECT F1F/F2F)
9	1:54	30	-0.07	STATIONKEEP FOR 5 MINUTES IF ANGULAR ALIGNMENT MANEUVER REQUIRED
10	2:05	0	-0.10	DOCKING



## UNDOCKING, TORS/TORF, AND FINAL SEPARATION

I

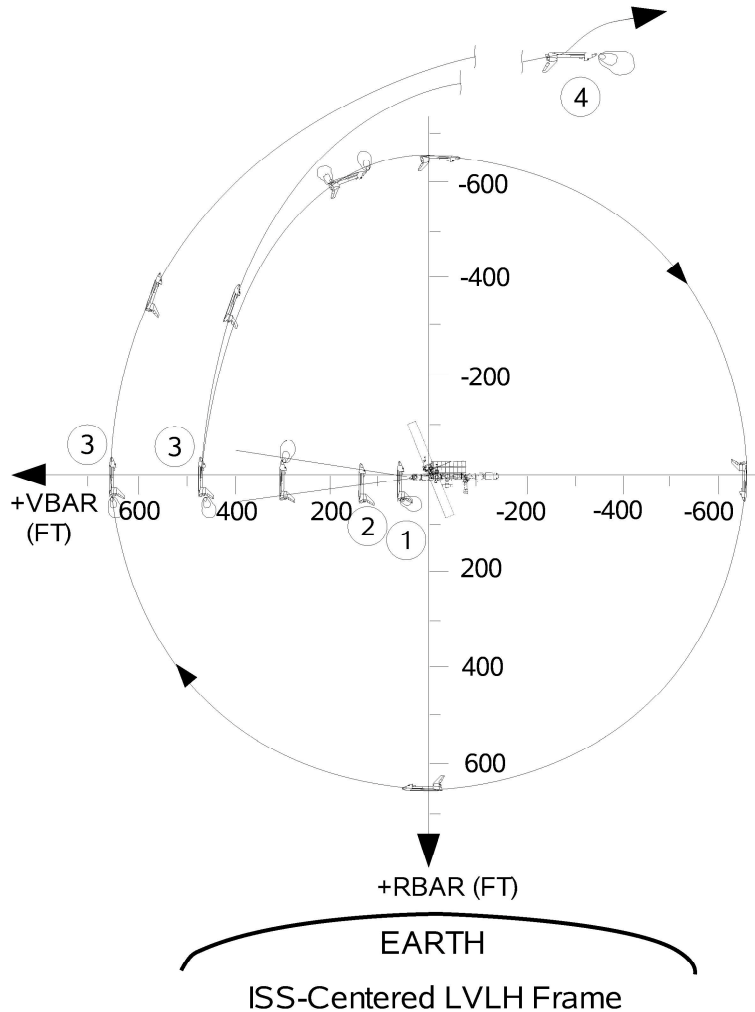

	UNDOCK ET (h:mm)	Range (ft) DP - DP	EVENT
	-0:03	0	ORBITER AND ISS IN FREE DRIFT TO BEGIN UNHOOKING (ISS LVLH PYR 0, 0, 0, ATTITUDE)
1	0:00	0 2	<b>UNDOCKING</b> ; DAP B/ALT MODE TO LVLH; MAINTAIN CORRIDOR
	0:01		SELECT VERNIS; PERFORM DAP B +Z NORMZ BURNS AT 10 SEC INTERVALS TO BUILD OPENING RATE TO 0.15 FPS
	>0:03	>30	DAP B +Z NORMZ BURNS AT 10 SEC INTERVALS TO BUILD OPENING RATE TO 0.20 FPS
		50	RESELECT -X JETS (F1F, F2F)
2	0:07	75	TRANSITION TO LOWZ
3	0:29 [1:15]*	>400 (CG-CG)	<b>SEP1</b> : 1.5 FPS +X RADIAL BURN [IF PROP AVAILABLE, PERFORM 1/4 LAP TORS BETWEEN 400 AND 600 FT (CG-CG); NULL OPENING RATE OUTSIDE 600 FT; PERFORM 3/4 LAP TORF BETWEEN 600 AND 700 FT; THEN PERFORM SEP1]
4	0:57 [1:43]*	>2000 (CG-CG)	<b>SEP2</b> : 1.0 FPS -X, NORMZ POSIGRADE BURN

\* Alternate Times are for Flyaround Case

This Page Intentionally Blank

UNDOCKING/SEPARATION TIMELINE

This Page Intentionally Blank

THIS PAGE INTENTIONALLY BLANK

UNDOCKING/SEPARATION PAD

Nominal Undocking Time:

<input type="text"/>	/	<input type="text"/>	<input type="text"/>	:	<input type="text"/>	<input type="text"/>	:	<input type="text"/>	<input type="text"/>
----------------------	---	----------------------	----------------------	---	----------------------	----------------------	---	----------------------	----------------------

Orbiter Weight:

<input type="text"/>	<input type="text"/>	<input type="text"/>	<input type="text"/>	<input type="text"/>	<input type="text"/>
----------------------	----------------------	----------------------	----------------------	----------------------	----------------------

Flyaround Terminate Criteria Post-Undocking:

When FRCS QTY <  % or L or R RCS QTY <  % :

Go to SHUTTLE NOSE IN-PLANE BREAKOUT (CONTINGENCY OPS), 5-16 >>

PET

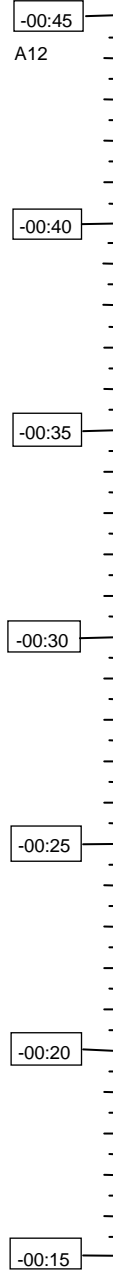

√DPS config for Undocking Ops - STRING 1233

A12

CONFIGURE FOR SEPARATION [5A]

MCC UPDATE  
ORB SV  
TGT SV  
Covar Matrix

MCC UPDATE  
Undocking Time [4A]

-00:40

ENABLE RENDEZVOUS NAV [5B]

On RPOP PGSCs:

Perform RPOP INITIALIZATION (RNDZ TOOLS), 7-8, then:  
Perform RPOP OPS, (RNDZ TOOLS), 7-9, then:  
Perform TCS ACTIVATION, steps 1 thru 3 (RNDZ TOOLS), 7-18, then:  
Perform TCS MANUAL ACQUISITION, step 1 (RNDZ TOOLS), 7-19  
(Set RANGE = 4 ft, AZIMUTH = 0, ELEVATION = 0)  
NOTE: TCS will not track until after undock

-00:35

Perform HHL CHECKOUT (RNDZ TOOLS), 7-6

-00:30

Perform DOCKING MECHANISM POWERUP (APDS), 8-5  
UNDOCKING PREP (APDS), 8-7

-00:25

Perform CCTV CONFIG FOR DOCKING/UNDOCKING(RNDZ TOOLS), 7-2

-00:20

√MCC  
DAP: FREE  
O14:F, RJDA 1A L2/R2 MANF DRIVER - OFF  
O15:F, RJD MANF L5/F5/R5 DRIVER - OFF  
O16:F Pri RJD LOGIC (eight) - ON

-00:15

√MCC FOR GO TO POWER UP Vern and Pri DRIVERS (Pri in [6A])  
RJD MANF L5/F5/R5 DRIVER - ON  
Wait 5 sec.  
DAP: AUTO

CONFIGURE FOR SEPARATION [5A]

GNC 20 DAP CONFIG

CRT √DAP config: A12  
√DAP: LO Z  
√DAP: A(B)/AUTO/VERN(ALT)

R1 O2 TK3 HTR A - AUTO

A6U ADI ATT - LVLH  
ERR - MED  
RATE - MED  
SENSE - -Z  
√FLT CNTLR PWR - OFF

GNC 23 RCS

CRT RCS F - ITEM 1 EXEC (\*)  
JET DES F1L - ITEM 9 EXEC (no \*)  
F3L - ITEM 11 EXEC (no \*)  
F2R - ITEM 13 EXEC (no \*)  
F4R - ITEM 15 EXEC (no \*)  
F1U - ITEM 17 EXEC (no \*)  
F3U - ITEM 19 EXEC (no \*)  
F2U - ITEM 21 EXEC (no \*)

GNC UNIV PTG

TGT ID √+2  
BODY VECT √+5  
P √+180  
Y √+0  
OM √+0  
√TRK - ITEM 19 EXEC (CUR - \*)  
√ERR TOT - ITEM 23 EXEC (\*)

OPS 202 PRO

GNC ORBIT MNVR EXEC

Set TIG to Undocking Time and update Orbiter Weight per [4A]  
Enter any non-zero ΔV  
LOAD - ITEM 22 EXEC  
TIMER - ITEM 23 EXEC  
OPS 201 PRO

Install -Z COAS  
KU OPS Cue Card  
CORRIDOR Overlay  
RANGE RULER Overlay

ENABLE RENDEZVOUS NAV [5B]

GNC 33 REL NAV

CRT RNDZ NAV ENA - ITEM 1 EXEC (\*)  
SV SEL, ITEM 4 - FLTR

**UNDOCKING OPERATIONS [6A]**

1. **PREP FOR UNDOCKING**

When MCC-H and ISS issue GO for Undocking:

[GNC 33 REL NAV]

CRT ORB TO TGT - ITEM 10 EXEC

O14, All DDU cbs (six) - cl  
O15,  
O16:E

A6U FLT CNTLR PWR - ON

2. **RECONFIGURE DAP**

[GNC UNIV PTG]

When ATT and RATES in limits:

<b>ATT ERR (Each Axis)</b>	<b>≤ 3.0 (VERN) ≤ 5.0 (ALT)</b>
<b>ROLL, YAW RATE</b>	<b>≤ 0.05 (VERN) ≤ 0.07 (ALT)</b>
<b>PITCH RATE</b>	<b>-0.115 ≤ RATE ≤ -0.015 (VERN) -0.135 ≤ RATE ≤ +0.005 (ALT)</b>

-03:00 > DAP: FREE  
O14:F, Pri RJD DRIVER (eight) - ON  
O15:F,  
O16:F

[GNC 20 DAP CONFIG]

CRT Config DAP A,B to A9,B9  
X Jets ROT ENA - ITEM 7 EXEC (no \*)  
DAP: B/FREE/ALT  
DAP TRANS: NO LO Z  
√DAP TRANS: PULSE/PULSE/PULSE  
√SENSE: -Z

3. **COMMAND UNDOCKING**

[SM 167 DOCKING STATUS]

A7L \* If HOOKS 1(2) OPEN It failed on: \*  
\* APDS POWER A<sub>DS</sub> - OFF (√A<sub>DS</sub> and failed Its off) \*

APDS CIRC PROT OFF pb - push  
√CIRCUIT PROTECT OFF It - It on

-02:20 > UNDOCKING pb - push  
√HOOKS 1, HOOKS 2 CLOSED It (two) - It off [HK1, HK2 POS (two)  
< 92% + decr]

CRT \* If Hooks 1(2) fail to drive (HK1(2) DRV CMD - OFF): \*  
A7L \* OPEN HOOKS pb - push \*  
\* If Hooks 1(2) appear to stop before reaching end of travel \*  
\* [HK1(2) Pos > 4% + not decr]: \*  
\* Allow for single motor drive time (~4:40) before performing \*  
\* POWER OFF pb - push \*  
\* ON pb - push \*

-00:30 > √INTERF SEALED It - It off  
√READY TO HOOK It - It off [HK1, HK2 POS (two) approx 30%]

00:00 √HOOKS 1, HOOKS 2 OPEN It (two) - It on [HK1, HK2 POS (two) = 4-5%]  
√UNDOCK COMPLETE It - It on

\* (+02:20) If HOOKS 1(2) fail to open \*  
\* (confirmed by no physical separation): \*  
\* Inform MCC: "Hooks failed to open" \*  
\* POWER OFF pb - push \*  
\* ON pb - push \*  
\* CLOSE HOOKS pb - push \*  
\* √HK1, HK2 POS (two) - incr \*  
\* √HOOKS 1, HOOKS 2 CLOSED It (two) - It on [HK1, HK2 POS=92-93%] \*  
\* POWER OFF pb - push \*  
\* Perform DOCKING MECHANISM POWERDOWN (APDS), 8-6 \*  
\* √MCC for IFM capability \*  
\* Prepare for 96 BOLT EVA TIMELINE (EVA FS, ORB CONT EVA), \*  
\* then, \*  
\* Perform ODS HOOKS OPEN-CONTINGENCY (APDS), 8-27 >> \*

00:00 > 4. **POST UNDOCKING**  
Inform MCC-H and ISS:  
"Physical Separation"

When petals clear:  
DAP: B/LVLH/ALT  
√DAP TRANS: PULSE/PULSE/PULSE, NO LO Z  
THC: as reqd to maintain C/L target within 8 deg corridor on C/L camera  
Note: DAP A allowed for ±X and -Z (in) THC

At physical sep + 1:00:  
DAP: VERN(ALT)  
THC: +Z (out) pulses at 10 sec intervals to build to 0.15 fps  
Record time (mm:ss) of VERN select or last pulse: \_\_\_\_\_ : \_\_\_\_\_  
Perform TCS MANUAL ACQUISITION, step 2 (RNDZ TOOLS), 7-19

At last pulse TIG+2:00 and when RNG > 30 ft (DP-DP):  
THC: +Z (out) pulses at 10 sec intervals as reqd to establish and maintain RDOT > 0.2 fps

When RNG = 50 ft (DP-DP):

[GNC 23 RCS]

CRT √RCS FWD - ITEM 1 EXEC (\*)  
JET DES F1F - ITEM 31 EXEC (no \*)  
F2F - ITEM 35 EXEC (no \*)

A7L 5. **POWER OFF**  
POWER OFF pb - push  
√STATUS It (eighteen) - It off

GO TO SEP/FLYAROUND [8A]



PET

-00:15

A12

√MCC: GO FOR UNDOCKING

MCC UPDATE  
GO for  
Undocking

-00:10

-00:05

← UNDOCKING OPERATIONS 6A

A9(B9)

00:00

← **UNDOCK COMPLETE**

00:05

00:10

00:15

SEP/FLYAROUND [8A]

1. When RNG > 75 ft (DP-DP):  
DAP: LO Z  
THC: Maintain RDOT > 0.2 fps  
Maintain C/L tgt within 8 deg corridor on C/L camera  
NOTE: DAP A allowed for ± X and ± Z THC

If TCS not tracking during corridor sep or flyaround, provide periodic HHL range updates to MCC

2. When RNG > 150 ft (DP-DP): If radar desired, INIT RADAR ACQ [10A]  
NOTE: DAP A allowed for all THC Inputs

3. When RNG > 250 ft: Set RPOP POR: ORB CG - TGT CG  
Set RPOP Overlay: Flyaround Zone [Shift]/[F7]  
Perform DOCKING MECHANISM POWERDOWN (APDS), 8-6

4. When RNG = 450 ± 50 FT (CG-CG)

GNC UNIV PTG

TGT ID √+2  
BODY VECT √+5  
P +90 (-RBAR)  
Y √+0  
OM √+0

√ERR TOT – ITEM 23 (\*)

TRK – ITEM 19 EXEC (CUR - \*)

If no flyaround, Go to SEP BURN [8B]

If flyaround, Go to FLYAROUND [9A]

SEP BURNS [8B]

1. RADIAL BURN  
DAP TRANS: NORM/PULSE/PULSE  
THC: +X (up) 6 sec (1.5 fps)

DAP: A/AUTO/VERN(PRI)  
DAP TRANS: PULSE/PULSE/PULSE  
FLT CNTLR PWR – OFF

Inform MCC when SEP complete

Record Radial Burn TIG \_\_\_\_/\_\_\_\_:\_\_\_\_:\_\_\_\_

GNC 2 TIME

Set GNC TIMER counting to final burn (Radial Burn TIG + 28 min)

2. CONFIG FOR FINAL BURN  
At final burn TIG - 1 minute:

A6U √SENSE: -Z  
FLT CNTLR PWR – ON  
DAP TRANS: NORM/PULSE/PULSE  
DAP: NO LO Z

3. FINAL BURN  
At final burn TIG:

Aft THC: -X (down) 4 sec (1.0 fps)

DAP TRANS: PULSE/PULSE/PULSE  
FLT CNTLR PWR – OFF

Inform MCC when SEP complete

Go to TERMINATE SEP OPS [8C]

TERMINATE SEP OPS [8C]

If KU MODE – RDR PASSIVE,  
Perform KU OPS, step 4 (Cue Card)

GNC 33 REL NAV

CRT RNDZ NAV ENA - ITEM 1 EXEC (no \*)

GNC 20 DAP CONFIG

Config DAP A, B to A1, B1

A6L LIGHTS TRUSS FWD, AFT (two) - OFF  
VESTIBULE PORT, STBD (two) - OFF

Exit RPOP - [Shift]/[F10]  
Perform TCS DEACTIVATION (RNDZ TOOLS), 7-20  
Perform HHL STOW (RNDZ TOOLS), 7-6

R1 O2 TK3 HTR A – OFF

**Go to FLIGHT PLAN**

**FLYAROUND [9A]**

√Flyaround terminate criteria per [4A]

- \* If Breakout required during flyaround \*
- \* Go to SHUTTLE NOSE IN-PLANE BREAKOUT \*
- \* (CONTINGENCY OPS), 5-16 >> \*

1. DAP: A/AUTO/VERN(PRI)  
 THC: Maintain ISS cg inside  $\pm 15$  degree vertical and  
 $\pm 20$  degrees horizontal on C/L camera

2. Prior to -Rbar crossing (Aft ADI P = 270):

[GNC UNIV PTG]

P +0 (-VBAR)

TRK - ITEM 19 EXEC (CUR - \*)

When RNG > 600 ft (CG-CG):

THC: Maintain flyaround range of  $650 \pm 50$  ft (CG-CG)

3. Prior to -Vbar crossing (Aft ADI P = 0):

[GNC UNIV PTG]

P +270 (+RBAR)

TRK - ITEM 19 EXEC (CUR - \*)

4. Prior to +Rbar crossing (Aft ADI P = 90):

[GNC UNIV PTG]

P +180 (+VBAR)

TRK - ITEM 19 EXEC (CUR - \*)

5. Prior to +Vbar crossing (Aft ADI P = 180):

[GNC UNIV PTG]

P +90 (-RBAR)

TRK - ITEM 19 EXEC (CUR - \*)

6. Repeat steps 2 thru 5 as reqd to continue flyaround

7. At flyaround completion -10 minutes:

If radar not tracking target:

[INITIAL RADAR ACQ [10A]

8. When flyaround complete (in +Vbar attitude),

Go to [SEP BURN [8B]

**FLYAROUND RANGE REFERENCE**

NOTE: Range conversion assumes ISS cg in center of centerline camera at a cg-range of 650 ft, with HHL aim point directly between HHL and ISS cg  
 650 FT cg to cg

**HHL RANGE CONVERSION**

HHL Aim Point	Raw HHL Range (ft)
Node - Fwd	579
Centerline Target	572
ISS Airlock	632
Progress/ATV - Aft	517

**TCS/Reflector Visibility During Flyaround for Flight ISS-1E (STS-122)**

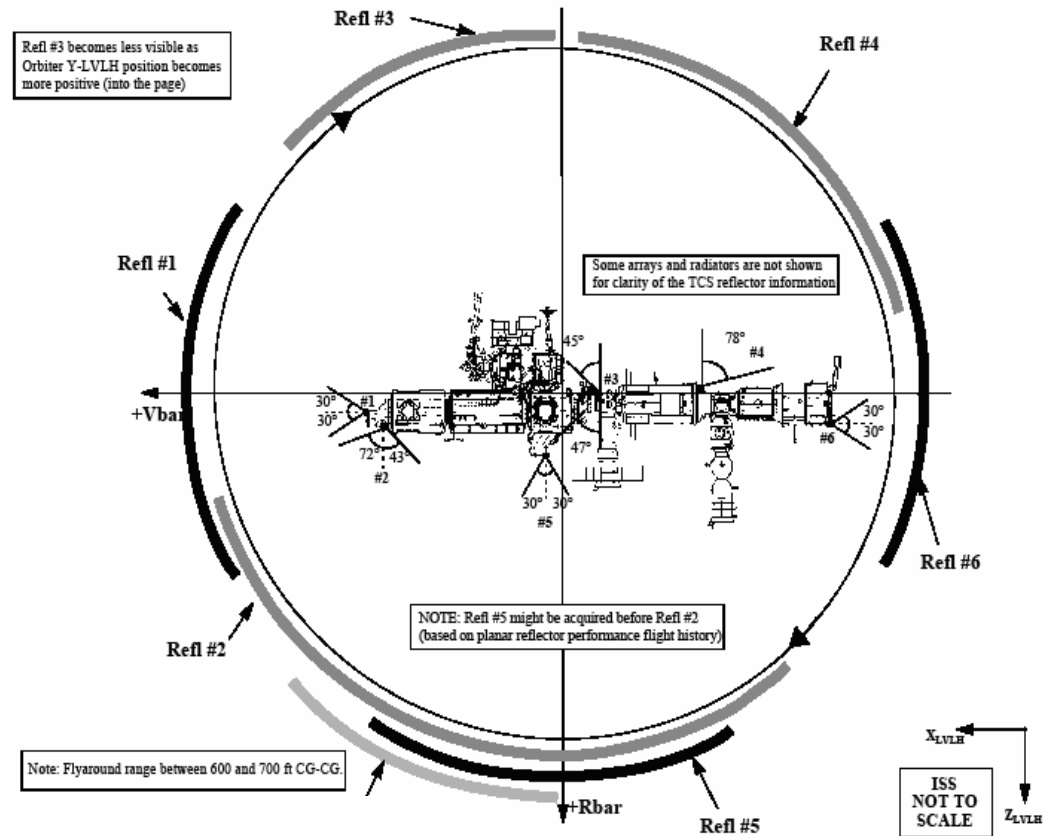

**Notes**

1. Refl #3 becomes less visible as Orbiter  $Y_{LVLH}$  position becomes more positive (into the page)
2. Refl #5 is on PMA 3 and out of plane (into the page)
3. Flyaround between 600 - 700 ft
4. ISS is not to scale

**INITIAL RADAR ACQ** 10A

**GNC 33 REL NAV**

CRT √INH RNG, ITEM 18 - (\*)  
√RDOT, ITEM 21 - (\*)  
√Angles, ITEM 24 - (\*)  
KU ANT ENA - ITEM 2 EXEC (\*)  
GNC I/O RESET  
√SV SEL, ITEM 4 - (FLTR)  
RADAR - ITEM 13 EXEC (\*)

**SM ANTENNA**

CRT RDR RNG MIN - ITEM 17 EXEC (\*)  
A2 DIGI-DIS sel - R/RDOT  
A1U KU PWR - STBY  
MODE - RR PASSIVE  
RADAR OUTPUT - LO  
√sel - GPC  
CNTL - PNL (wait 3 seconds)  
PWR - ON

**IF NO RADAR LOCK-ON WITHIN 2 MIN**

KU sel - AUTO TRK  
SLEW EL,AZ to 0,0 deg

KU SEARCH - SEARCH (tb-gray)

When lock on occurs:

**GNC 33 REL NAV**

CRT AUT RNG - ITEM 17 EXEC (\*)  
RDOT - ITEM 20 EXEC (\*)  
Angles - ITEM 23 EXEC (\*)  
If RATIO > 1.0,  
Force aff mark until RATIO < 1.0

When RESIDs small and stable,

**SM ANTENNA**

RDR RNG AUTO - ITEM 16 EXEC (\*)

MANEUVER PADS

**MNVR PADS**

# MNVR PADS

## PRELIMINARY ORBIT MANEUVER PAD FOR NH

OMS BOTH 1

L 2

R 3

RCS SEL 4  +X  
 -X  
 MULTI-AXIS

TV ROLL 5

BURN ATT

R 24

P 25

Y 26

$\Delta VTOT$

TGO

VGO X

VGO Y

VGO Z

TGT HA   
HP

TRIM LOAD P 6

LY 7

RY 8

WT 9

TIG 10

TGT PEG 7  $\Delta VX$  19   
 $\Delta VY$  20   
 $\Delta VZ$  21

**NOTES**

OMS GMBL CK: PRE POST-BURN

L PRI

L SEC

R PRI

R SEC

NONE

RCS I'CNCT:

L OMS  $\rightarrow$  RCS

R OMS  $\rightarrow$  RCS

NONE

DOWN MODE OPTIONS:

2 OMS  $\rightarrow$  1 OMS

1 OMS  $\rightarrow$  RCS

NONE

OMS HE REG TEST:  NONE

L GPC OP CL A  B

R GPC OP CL A  B

-X RCS BURNS:

BURN ATT LVLH ATT

P 15  R

Y 16  P

OM 17  Y

ORBIT BURN MONITOR

GPC FILL-INS \_\_ ( \_\_ )

CRIT BURN

NON-CRIT BURN

MAX TIG SLIP \_\_ MIN

DO NOT UPDATE TIG

UPDATE TIG AFTER \_\_ MIN

NOTES

# FINAL ORBIT MANEUVER PAD FOR NH

OMS BOTH 1

L 2

R 3

RCS SEL 4  +X  
-X  
MULTI-AXIS

TV ROLL 5

BURN ATT

R 24

P 25

Y 26

$\Delta VTOT$

TGO

VGO X

VGO Y

VGO Z

TGT HA    HP

TRIM LOAD P 6

LY 7

RY 8

WT 9

TIG 10    /   :   :   .

TGT PEG 7  $\Delta VX$  19

$\Delta VY$  20

$\Delta VZ$  21

NOTES

OMS GMBL CK: PRE POST-BURN

L PRI

L SEC

R PRI

R SEC

NONE

RCS I'CNCT:  L OMS → RCS  
 R OMS → RCS  
 NONE

DOWN MODE OPTIONS:  2 OMS → 1 OMS  
 1 OMS → RCS  
 NONE

OMS HE REG TEST:  NONE

L R

GPC OP CL GPC OP CL

A    A

B    B

-X RCS BURNS:

BURN ATT LVLH ATT

P 15    R

Y 16    P

OM 17    Y

ORBIT BURN MONITOR

GPC FILL-INS  (  )

CRIT BURN  
 NON-CRIT BURN

MAX TIG SLIP \_\_\_ MIN

DO NOT UPDATE TIG  
 UPDATE TIG AFTER \_\_\_ MIN

NOTES

# PRELIMINARY ORBIT MANEUVER PAD FOR NC

OMS BOTH 1

L 2

R 3

RCS SEL 4  +X  
-X  
MULTI-AXIS

TV ROLL 5

BURN ATT

R 24

P 25

Y 26

$\Delta$ VTOT

TGO

VGO X

VGO Y

VGO Z

TGT HA    HP

TRIM LOAD P 6

LY 7

RY 8

WT 9

TIG 10   /   :   :   .

TGT PEG 7  $\Delta$ VX 19

$\Delta$ VY 20

$\Delta$ VZ 21

NOTES

OMS GMBL CK: PRE POST-BURN

L PRI

L SEC

R PRI

R SEC

NONE

RCS I'CNCT:  L OMS  $\rightarrow$  RCS  
 R OMS  $\rightarrow$  RCS  
 NONE

DOWN MODE OPTIONS:  2 OMS  $\rightarrow$  1 OMS  
 1 OMS  $\rightarrow$  RCS  
 NONE

OMS HE REG TEST:  NONE

L R

GPC OP CL GPC OP CL

A    A

B    B

-X RCS BURNS:

BURN ATT LVLH ATT

P 15    R

Y 16    P

OM 17    Y

ORBIT BURN MONITOR

GPC FILL-INS  (  )

CRIT BURN  
 NON-CRIT BURN

MAX TIG SLIP \_\_\_ MIN

DO NOT UPDATE TIG  
 UPDATE TIG AFTER \_\_\_ MIN

NOTES



# FINAL ORBIT MANEUVER PAD FOR NC

OMS BOTH 1

L 2

R 3

RCS SEL 4  +X  
-X  
MULTI-AXIS

TV ROLL 5

BURN ATT

R 24

P 25

Y 26

$\Delta VTOT$

TGO

VGO X

VGO Y

VGO Z

TGT HA    HP

TRIM LOAD P 6

LY 7

RY 8

WT 9

TIG 10   /   :   :   .

TGT PEG 7  $\Delta VX$  19

$\Delta VY$  20

$\Delta VZ$  21

NOTES

OMS GMBL CK: PRE POST-BURN

L PRI

L SEC

R PRI

R SEC

NONE

RCS I'CNCT:  L OMS  $\rightarrow$  RCS  
 R OMS  $\rightarrow$  RCS  
 NONE

DOWN MODE OPTIONS:  2 OMS  $\rightarrow$  1 OMS  
 1 OMS  $\rightarrow$  RCS  
 NONE

OMS HE REG TEST:  NONE

L R

GPC OP CL GPC OP CL

A    A

B    B

-X RCS BURNS:

BURN ATT LVLH ATT

P 15    R

Y 16    P

OM 17    Y

ORBIT BURN MONITOR

GPC FILL-INS  (  )

CRIT BURN

NON-CRIT BURN

MAX TIG SLIP \_\_\_ MIN

DO NOT UPDATE TIG

UPDATE TIG AFTER \_\_\_ MIN

NOTES

# PRELIMINARY ORBIT MANEUVER PAD FOR Ti

OMS BOTH	1	<input type="text"/>
L	2	<input type="text"/>
R	3	<input type="text"/>
RCS SEL	4	<input type="text"/>
TV ROLL	5	<input type="text"/> <input type="text"/> <input type="text"/>

}	<input type="text"/>	+X
	<input type="text"/>	-X
	MULTI-AXIS	

BURN ATT	
R 24	<input type="text"/> <input type="text"/> <input type="text"/>
P 25	<input type="text"/> <input type="text"/> <input type="text"/>
Y 26	<input type="text"/> <input type="text"/> <input type="text"/>

ΔVTOT	<input type="text"/> <input type="text"/> <input type="text"/> <input type="text"/>
TGO	<input type="text"/> <input type="text"/> : <input type="text"/> <input type="text"/>
VGO X	<input type="text"/> ( ) <input type="text"/> <input type="text"/> <input type="text"/> <input type="text"/>
VGO Y	<input type="text"/> ( ) <input type="text"/> <input type="text"/> <input type="text"/> <input type="text"/>
VGO Z	<input type="text"/> ( ) <input type="text"/> <input type="text"/> <input type="text"/> <input type="text"/>
TGT	HA <input type="text"/> <input type="text"/> <input type="text"/> HP ( ) <input type="text"/> <input type="text"/> <input type="text"/>

TRIM LOAD	P 6	<input type="text"/> ( ) <input type="text"/> . <input type="text"/>
	LY 7	<input type="text"/> ( ) <input type="text"/> . <input type="text"/>
	RY 8	<input type="text"/> ( ) <input type="text"/> . <input type="text"/>
	WT 9	<input type="text"/> <input type="text"/> <input type="text"/> <input type="text"/> <input type="text"/> <input type="text"/>
	TIG 10	<input type="text"/> <input type="text"/> / <input type="text"/> <input type="text"/> : <input type="text"/> <input type="text"/> : <input type="text"/> <input type="text"/> . <input type="text"/>
TGT PEG 7	ΔVX 19	<input type="text"/> ( ) <input type="text"/> <input type="text"/> <input type="text"/> . <input type="text"/>
	ΔVY 20	<input type="text"/> ( ) <input type="text"/> <input type="text"/> <input type="text"/> . <input type="text"/>
	ΔVZ 21	<input type="text"/> ( ) <input type="text"/> <input type="text"/> <input type="text"/> . <input type="text"/>

<p><b>OMS GMBL CK:</b></p> <table border="0"> <tr> <td></td> <td>PRE</td> <td>POST-BURN</td> </tr> <tr> <td>L PRI</td> <td><input type="text"/></td> <td><input type="text"/></td> </tr> <tr> <td>L SEC</td> <td><input type="text"/></td> <td><input type="text"/></td> </tr> <tr> <td>R PRI</td> <td><input type="text"/></td> <td><input type="text"/></td> </tr> <tr> <td>R SEC</td> <td><input type="text"/></td> <td><input type="text"/></td> </tr> <tr> <td>NONE</td> <td><input type="text"/></td> <td><input type="text"/></td> </tr> </table>		PRE	POST-BURN	L PRI	<input type="text"/>	<input type="text"/>	L SEC	<input type="text"/>	<input type="text"/>	R PRI	<input type="text"/>	<input type="text"/>	R SEC	<input type="text"/>	<input type="text"/>	NONE	<input type="text"/>	<input type="text"/>	<p><b>NOTES</b></p> <table border="0"> <tr> <td style="width: 30%;"> <p><b>RCS I'CNCT:</b></p> <input type="text"/> L OMS → RCS  <input type="text"/> R OMS → RCS  <input type="text"/> NONE                 </td> <td style="width: 70%;"> <p><b>DOWN MODE OPTIONS:</b></p> <input type="text"/> 2 OMS → 1 OMS  <input type="text"/> 1 OMS → RCS  <input type="text"/> NONE                 </td> </tr> </table>	<p><b>RCS I'CNCT:</b></p> <input type="text"/> L OMS → RCS <input type="text"/> R OMS → RCS <input type="text"/> NONE	<p><b>DOWN MODE OPTIONS:</b></p> <input type="text"/> 2 OMS → 1 OMS <input type="text"/> 1 OMS → RCS <input type="text"/> NONE
	PRE	POST-BURN																			
L PRI	<input type="text"/>	<input type="text"/>																			
L SEC	<input type="text"/>	<input type="text"/>																			
R PRI	<input type="text"/>	<input type="text"/>																			
R SEC	<input type="text"/>	<input type="text"/>																			
NONE	<input type="text"/>	<input type="text"/>																			
<p><b>RCS I'CNCT:</b></p> <input type="text"/> L OMS → RCS <input type="text"/> R OMS → RCS <input type="text"/> NONE	<p><b>DOWN MODE OPTIONS:</b></p> <input type="text"/> 2 OMS → 1 OMS <input type="text"/> 1 OMS → RCS <input type="text"/> NONE																				

<b>TIDELAY</b>		
TGT PEG 7	ΔVX 19	<input type="text"/> ( ) <input type="text"/> <input type="text"/> <input type="text"/> . <input type="text"/>
	ΔVY 20	<input type="text"/> ( ) <input type="text"/> <input type="text"/> <input type="text"/> . <input type="text"/>
	ΔVZ 21	<input type="text"/> ( ) <input type="text"/> <input type="text"/> <input type="text"/> . <input type="text"/>
NEW Ti ( BASETIME )	<input type="text"/> <input type="text"/> / <input type="text"/> <input type="text"/> : <input type="text"/> <input type="text"/> : <input type="text"/> <input type="text"/> . <input type="text"/>	

<p><b>OMS HE REG TEST:</b></p> <input type="checkbox"/> NONE	<p><b>-X RCS BURNS:</b></p> <table border="0"> <tr> <td colspan="2" style="text-align: center;"><b>BURN ATT</b></td> <td colspan="2" style="text-align: center;"><b>LVLH ATT</b></td> </tr> <tr> <td>P 15</td> <td><input type="text"/><input type="text"/><input type="text"/></td> <td>R</td> <td><input type="text"/><input type="text"/><input type="text"/></td> </tr> <tr> <td>Y 16</td> <td><input type="text"/><input type="text"/><input type="text"/></td> <td>P</td> <td><input type="text"/><input type="text"/><input type="text"/></td> </tr> <tr> <td>OM 17</td> <td><input type="text"/><input type="text"/><input type="text"/></td> <td>Y</td> <td><input type="text"/><input type="text"/><input type="text"/></td> </tr> </table>	<b>BURN ATT</b>		<b>LVLH ATT</b>		P 15	<input type="text"/> <input type="text"/> <input type="text"/>	R	<input type="text"/> <input type="text"/> <input type="text"/>	Y 16	<input type="text"/> <input type="text"/> <input type="text"/>	P	<input type="text"/> <input type="text"/> <input type="text"/>	OM 17	<input type="text"/> <input type="text"/> <input type="text"/>	Y	<input type="text"/> <input type="text"/> <input type="text"/>	<p><b>ORBIT BURN MONITOR</b></p> <p>GPC FILL-INS __ ( __ )</p> <input type="checkbox"/> CRIT BURN <input type="checkbox"/> NON-CRIT BURN
<b>BURN ATT</b>		<b>LVLH ATT</b>																
P 15	<input type="text"/> <input type="text"/> <input type="text"/>	R	<input type="text"/> <input type="text"/> <input type="text"/>															
Y 16	<input type="text"/> <input type="text"/> <input type="text"/>	P	<input type="text"/> <input type="text"/> <input type="text"/>															
OM 17	<input type="text"/> <input type="text"/> <input type="text"/>	Y	<input type="text"/> <input type="text"/> <input type="text"/>															

**TIG SLIP:** If Ti not started by nominal TIG + \_\_\_ min,  
go to Ti DELAY, 5-27

Max Ti DELAY TIG slip \_\_\_ min —

DO NOT UPDATE TIG  
 UPDATE TIG AFTER \_\_\_ MIN

**NOTES**

# FINAL ORBIT MANEUVER PAD FOR Ti

OMS BOTH 1

L 2

R 3

RCS SEL 4

TV ROLL 5

+X

-X

MULTI-AXIS

BURN ATT

R 24

P 25

Y 26

$\Delta$ VTOT

TGO

VGO X

VGO Y

VGO Z

TGT HA

TGT HP

TRIM LOAD P 6

LY 7

RY 8

WT 9

TIG 10

**NOTES**

OMS GMBL CK:

	PRE	POST-BURN
L PRI	<input type="text"/>	<input type="text"/>
L SEC	<input type="text"/>	<input type="text"/>
R PRI	<input type="text"/>	<input type="text"/>
R SEC	<input type="text"/>	<input type="text"/>
NONE	<input type="text"/>	<input type="text"/>

RCS I'CNCT:

<input type="text"/>	L OMS → RCS
<input type="text"/>	R OMS → RCS
<input type="text"/>	NONE

DOWN MODE OPTIONS:

<input type="text"/>	2 OMS → 1 OMS
<input type="text"/>	1 OMS → RCS
<input type="text"/>	NONE

TGT PEG 7  $\Delta$ VX 19

$\Delta$ VY 20

$\Delta$ VZ 21

OMS HE REG TEST:  NONE

	L			R		
	GPC	OP	CL	GPC	OP	CL
A	<input type="text"/>	<input type="text"/>	<input type="text"/>	<input type="text"/>	<input type="text"/>	<input type="text"/>
B	<input type="text"/>	<input type="text"/>	<input type="text"/>	<input type="text"/>	<input type="text"/>	<input type="text"/>

-X RCS BURNS:

	BURN ATT			LVLH ATT		
	P	15	<input type="text"/>	R	<input type="text"/>	<input type="text"/>
	Y	16	<input type="text"/>	P	<input type="text"/>	<input type="text"/>
	OM	17	<input type="text"/>	Y	<input type="text"/>	<input type="text"/>

ORBIT BURN MONITOR

GPC FILL-INS  (  )

<input type="text"/>	CRIT BURN
<input type="text"/>	NON-CRIT BURN

**TIDELAY**

TGT PEG 7  $\Delta$ VX 19

$\Delta$ VY 20

$\Delta$ VZ 21

NEW Ti ( BASETIME )

TIG SLIP: If Ti not started by nominal TIG +  min,  
go to Ti DELAY, 5-27

Max Ti DELAY TIG slip  min

<input type="text"/>	DO NOT UPDATE TIG
<input type="text"/>	UPDATE TIG AFTER <input type="text"/> MIN

**NOTES**

# ORBIT MANEUVER PAD FOR \_\_\_\_\_

OMS BOTH 1

L 2

R 3

RCS SEL 4  +X  
-X  
MULTI-AXIS

TV ROLL 5

BURN ATT

R 24

P 25

Y 26

$\Delta$ VTOT     .

TGO   :

VGO X  ( )    .

VGO Y  ( )    .

VGO Z  ( )    .

TGT HA    HP  ( )

TRIM LOAD P 6  ( )   .

LY 7  ( )   .

RY 8  ( )   .

WT 9

TIG 10   /   :   :   .

TGT PEG 7  $\Delta$ VX 19  ( )    .

$\Delta$ VY 20  ( )    .

$\Delta$ VZ 21  ( )    .

NOTES

OMS GMBL CK: PRE POST-BURN

L PRI

L SEC

R PRI

R SEC

NONE

RCS I'CNCT:  L OMS  $\rightarrow$  RCS  
 R OMS  $\rightarrow$  RCS  
 NONE

DOWN MODE OPTIONS:  
 2 OMS  $\rightarrow$  1 OMS  
 1 OMS  $\rightarrow$  RCS  
 NONE

OMS HE REG TEST:  NONE

L R

GPC OP CL GPC OP CL

A    A

B    B

-X RCS BURNS:

BURN ATT LVLH ATT

P 15    R

Y 16    P

OM 17    Y

ORBIT BURN MONITOR

GPC FILL-INS \_\_ ( \_\_ )

CRIT BURN  
 NON-CRIT BURN

MAX TIG SLIP \_\_ MIN  DO NOT UPDATE TIG  
 UPDATE TIG AFTER \_\_ MIN

NOTES

# ORBIT MANEUVER PAD FOR \_\_\_\_\_

OMS BOTH 1

L 2

R 3

RCS SEL 4  +X  
-X  
MULTI-AXIS

TV ROLL 5

BURN ATT

R 24

P 25

Y 26

$\Delta$ VTOT     .

TGO   :

VGO X  ( )    .

VGO Y  ( )    .

VGO Z  ( )    .

TGT HA    HP ( )

TRIM LOAD P 6 ( )   .

LY 7 ( )   .

RY 8 ( )   .

WT 9

TIG 10   /   :   :   .

TGT PEG 7  $\Delta$ VX 19 ( )     .

$\Delta$ VY 20 ( )     .

$\Delta$ VZ 21 ( )     .

NOTES

OMS GMBL CK: PRE POST-BURN

L PRI

L SEC

R PRI

R SEC

NONE

RCS I'CNCT:  L OMS  $\rightarrow$  RCS  
 R OMS  $\rightarrow$  RCS  
 NONE

DOWN MODE OPTIONS:  2 OMS  $\rightarrow$  1 OMS  
 1 OMS  $\rightarrow$  RCS  
 NONE

OMS HE REG TEST:  NONE

L R

GPC OP CL GPC OP CL

A    A

B    B

-X RCS BURNS:

BURN ATT LVLH ATT

P 15    R

Y 16    P

OM 17    Y

ORBIT BURN MONITOR

GPC FILL-INS \_\_ ( \_\_ )

CRIT BURN

NON-CRIT BURN

MAX TIG SLIP \_\_\_ MIN  DO NOT UPDATE TIG

UPDATE TIG AFTER \_\_\_ MIN

NOTES

# ORBIT MANEUVER PAD FOR \_\_\_\_\_

OMS BOTH 1

L 2

R 3

RCS SEL 4  +X  
-X  
MULTI-AXIS

TV ROLL 5

BURN ATT

R 24

P 25

Y 26

$\Delta$ VTOT

TGO

VGO X

VGO Y

VGO Z

HA    HP

TGT

TRIM LOAD P 6

LY 7

RY 8

WT 9

TIG 10   /   :   :   .

TGT PEG 7  $\Delta$ VX 19

$\Delta$ VY 20

$\Delta$ VZ 21

NOTES

OMS GMBL CK: PRE POST-BURN

L PRI

L SEC

R PRI

R SEC

NONE

RCS I'CNCT:  L OMS  $\rightarrow$  RCS  
 R OMS  $\rightarrow$  RCS  
 NONE

DOWN MODE OPTIONS:  2 OMS  $\rightarrow$  1 OMS  
 1 OMS  $\rightarrow$  RCS  
 NONE

OMS HE REG TEST:  NONE

L R

GPC OP CL GPC OP CL

A    A

B    B

-X RCS BURNS:

BURN ATT LVLH ATT

P 15    R

Y 16    P

OM 17    Y

ORBIT BURN MONITOR

GPC FILL-INS \_\_ ( \_\_ )

CRIT BURN

NON-CRIT BURN

MAX TIG SLIP \_\_\_ MIN  DO NOT UPDATE TIG  
 UPDATE TIG AFTER \_\_\_ MIN

NOTES

# ORBIT MANEUVER PAD FOR \_\_\_\_\_

OMS BOTH 1

L 2

R 3

RCS SEL 4  +X  
-X  
MULTI-AXIS

TV ROLL 5

BURN ATT

R 24

P 25

Y 26

$\Delta$ VTOT

TGO

VGO X

VGO Y

VGO Z

HA

HP

TGT

TRIM LOAD P 6

LY 7

RY 8

WT 9

TIG 10    /   :   :   .

TGT PEG 7  $\Delta$ VX 19

$\Delta$ VY 20

$\Delta$ VZ 21

NOTES

OMS GMBL CK: PRE POST-BURN

L PRI

L SEC

R PRI

R SEC

NONE

RCS I'CNCT:  L OMS  $\rightarrow$  RCS  
 R OMS  $\rightarrow$  RCS  
 NONE

DOWN MODE OPTIONS:  
 2 OMS  $\rightarrow$  1 OMS  
 1 OMS  $\rightarrow$  RCS  
 NONE

OMS HE REG TEST:  NONE

L R

GPC OP CL GPC OP CL

A    A

B    B

-X RCS BURNS:

BURN ATT LVLH ATT

P 15    R

Y 16    P

OM 17    Y

ORBIT BURN MONITOR

GPC FILL-INS \_\_ ( \_\_ )

CRIT BURN

NON-CRIT BURN

MAX TIG SLIP \_\_\_ MIN  DO NOT UPDATE TIG

UPDATE TIG AFTER \_\_\_ MIN

NOTES

# ORBIT MANEUVER PAD FOR \_\_\_\_\_

OMS BOTH 1

L 2

R 3

RCS SEL 4  +X  
-X  
MULTI-AXIS

TV ROLL 5

BURN ATT

R 24

P 25

Y 26

$\Delta$ VTOT     .

TGO   :

VGO X  ( )    .

VGO Y  ( )    .

VGO Z  ( )    .

TGT HA    HP ( )

TRIM LOAD P 6 ( )   .

LY 7 ( )   .

RY 8 ( )   .

WT 9

TIG 10   /   :   :   .

TGT PEG 7  $\Delta$ VX 19 ( )     .

$\Delta$ VY 20 ( )     .

$\Delta$ VZ 21 ( )     .

NOTES

<p>OMS GMBL CK:</p> <table style="width: 100%;"> <tr> <td></td> <td style="text-align: center;">PRE</td> <td style="text-align: center;">POST-BURN</td> </tr> <tr> <td>L PRI</td> <td><input type="checkbox"/></td> <td><input type="checkbox"/></td> </tr> <tr> <td>L SEC</td> <td><input type="checkbox"/></td> <td><input type="checkbox"/></td> </tr> <tr> <td>R PRI</td> <td><input type="checkbox"/></td> <td><input type="checkbox"/></td> </tr> <tr> <td>R SEC</td> <td><input type="checkbox"/></td> <td><input type="checkbox"/></td> </tr> <tr> <td>NONE</td> <td><input type="checkbox"/></td> <td><input type="checkbox"/></td> </tr> </table>		PRE	POST-BURN	L PRI	<input type="checkbox"/>	<input type="checkbox"/>	L SEC	<input type="checkbox"/>	<input type="checkbox"/>	R PRI	<input type="checkbox"/>	<input type="checkbox"/>	R SEC	<input type="checkbox"/>	<input type="checkbox"/>	NONE	<input type="checkbox"/>	<input type="checkbox"/>	<p>RCS I'CNCT:</p> <p><input type="checkbox"/> L OMS → RCS</p> <p><input type="checkbox"/> R OMS → RCS</p> <p><input type="checkbox"/> NONE</p>	<p>DOWN MODE OPTIONS:</p> <p><input type="checkbox"/> 2 OMS → 1 OMS</p> <p><input type="checkbox"/> 1 OMS → RCS</p> <p><input type="checkbox"/> NONE</p>
	PRE	POST-BURN																		
L PRI	<input type="checkbox"/>	<input type="checkbox"/>																		
L SEC	<input type="checkbox"/>	<input type="checkbox"/>																		
R PRI	<input type="checkbox"/>	<input type="checkbox"/>																		
R SEC	<input type="checkbox"/>	<input type="checkbox"/>																		
NONE	<input type="checkbox"/>	<input type="checkbox"/>																		

<p>OMS HE REG TEST: <input type="checkbox"/> NONE</p> <table style="width: 100%;"> <tr> <td></td> <td style="text-align: center;">L</td> <td></td> </tr> <tr> <td></td> <td style="text-align: center;">GPC OP CL</td> <td></td> </tr> <tr> <td>A</td> <td><input type="checkbox"/> <input type="checkbox"/> <input type="checkbox"/></td> <td></td> </tr> <tr> <td>B</td> <td><input type="checkbox"/> <input type="checkbox"/> <input type="checkbox"/></td> <td></td> </tr> </table>		L			GPC OP CL		A	<input type="checkbox"/> <input type="checkbox"/> <input type="checkbox"/>		B	<input type="checkbox"/> <input type="checkbox"/> <input type="checkbox"/>		<p>-X RCS BURNS:</p> <table style="width: 100%;"> <tr> <td></td> <td style="text-align: center;">BURN ATT</td> <td></td> <td style="text-align: center;">LVLH ATT</td> </tr> <tr> <td>P 15</td> <td><input type="checkbox"/> <input type="checkbox"/> <input type="checkbox"/></td> <td>R</td> <td><input type="checkbox"/> <input type="checkbox"/> <input type="checkbox"/></td> </tr> <tr> <td>Y 16</td> <td><input type="checkbox"/> <input type="checkbox"/> <input type="checkbox"/></td> <td>P</td> <td><input type="checkbox"/> <input type="checkbox"/> <input type="checkbox"/></td> </tr> <tr> <td>OM 17</td> <td><input type="checkbox"/> <input type="checkbox"/> <input type="checkbox"/></td> <td>Y</td> <td><input type="checkbox"/> <input type="checkbox"/> <input type="checkbox"/></td> </tr> </table>		BURN ATT		LVLH ATT	P 15	<input type="checkbox"/> <input type="checkbox"/> <input type="checkbox"/>	R	<input type="checkbox"/> <input type="checkbox"/> <input type="checkbox"/>	Y 16	<input type="checkbox"/> <input type="checkbox"/> <input type="checkbox"/>	P	<input type="checkbox"/> <input type="checkbox"/> <input type="checkbox"/>	OM 17	<input type="checkbox"/> <input type="checkbox"/> <input type="checkbox"/>	Y	<input type="checkbox"/> <input type="checkbox"/> <input type="checkbox"/>	<p>ORBIT BURN MONITOR</p> <p>GPC FILL-INS __ ( __ )</p> <p><input type="checkbox"/> CRIT BURN</p> <p><input type="checkbox"/> NON-CRIT BURN</p>
	L																													
	GPC OP CL																													
A	<input type="checkbox"/> <input type="checkbox"/> <input type="checkbox"/>																													
B	<input type="checkbox"/> <input type="checkbox"/> <input type="checkbox"/>																													
	BURN ATT		LVLH ATT																											
P 15	<input type="checkbox"/> <input type="checkbox"/> <input type="checkbox"/>	R	<input type="checkbox"/> <input type="checkbox"/> <input type="checkbox"/>																											
Y 16	<input type="checkbox"/> <input type="checkbox"/> <input type="checkbox"/>	P	<input type="checkbox"/> <input type="checkbox"/> <input type="checkbox"/>																											
OM 17	<input type="checkbox"/> <input type="checkbox"/> <input type="checkbox"/>	Y	<input type="checkbox"/> <input type="checkbox"/> <input type="checkbox"/>																											

MAX TIG SLIP \_\_\_ MIN DO NOT UPDATE TIG  
UPDATE TIG AFTER \_\_\_ MIN

NOTES



RENDEZVOUS TIMELINE

RENDEZVOUS  
TIMELINE

This Page Intentionally Blank

THIS PAGE INTENTIONALLY BLANK

AFT FLT STATION CONFIG FOR RNDZ 4A

O14,16:E √cb MNA,C DDU AFT (two) - cl

A6U ADI ATT - LVLH  
ERR - MED  
RATE - MED  
SENSE - minus Z

R13 √KU ANT - GND  
A1U PWR - STBY  
sel - MAN SLEW  
MODE - RDR PASSIVE  
RADAR OUTPUT - HI  
CNTL - PNL (wait 3 seconds)  
PWR - ON  
SIG STRENGTH sel - KU  
SLEW RATE - as reqd

A2 DIGI-DIS sel - R/RDOT  
X-PNTR SCALE - X1

SM ANTENNA

CRT SELF TEST - ITEM 7 EXEC (\*)

NOTE  
SELF TEST runs about 3 min

A1U √KU SCAN WARN tb - gray  
√TRACK tb - gray  
√SEARCH tb - gray

A2 √RANGE - 888.8  
DIGI-DIS sel - EL/AZ

CRT SELF TEST - ITEM 7 EXEC (no \*)

A1U KU MODE - COMM  
sel - GPC  
CNTL - CMD

Install:

-Z COAS  
RCS BURN Cue Card  
KU OPS Cue Card  
APPROACH Cue Card  
TARGET ALIGNMENT Cue Card  
DOCKING SEQUENCE Cue Card  
Velcro over Aft DAP PCT pbi (SPARE pbi)

PET

-03:00

CDR AFT FLT STATION CONFIG FOR RNDZ 4A

A7(B7) PLT RNDZ OPS INITIALIZATION 5A

-02:55

MS Perform 6.105 SSOR ACTIVATION, steps 1 and 2 (SODF: JOINT OPS, COMM/DATA)

-02:50

CDR If NH reqd:  
If OMS BURN, Perform RNDZ OMS BURN, steps 1-4 (CONTINGENCY OPS), 5-4  
If +X RCS burn, Perform RCS BURN, steps 1-5 (Cue Card)  
  
Postburn DAP: A/LVLH/VERN(ALT)

-02:45

-02:40

-02:35

-02:30

MCC UPDATE  
Final NH Burn Pad,  
3-5 (if reqd)  
MCC UPLINK  
ORB SV  
TGT SV  
Drag K-factor

RNDZ OPS INITIALIZATION 5A

√DPS Config for Rndz Ops - String 1233

SM 2 TIME

Set SM TIMER counting to Ti TIG per burn Pad, 3-6

Config DAP A,B to A7,B7

Record nominal TIGs in burn solution blocks per Execute Package:

NCC TIG pg 4-11

MC1 TIG pg 4-17

MC2 TIG pg 4-18

GNC 55 GPS STATUS

DES RCVR, ITEM 27 - (\*)

√INH GPS to G&C, ITEM 33 - (\*)

NAV, ITEM 36 - (\*)

THIS PAGE INTENTIONALLY BLANK

PET

-02:30

A7(B7)

← TIG-5 MIN

-02:25

← If reqd,  
NH TIG  
 Postburn DAP: A/LVLH/VERN(ALT)

-02:20

-02:15

PLT ENABLE RENDEZVOUS NAV [7A]

MS √PGSCs setup per PGSC Usage Chart (if available) or UTILITY OUTLET PLUG-IN  
 PLAN ORBIT CONFIGURATION (REF DATA FS, UTIL PWR)

PLT, On RPOP PGSCs:  
 MS Perform RPOP INITIALIZATION (RNDZ TOOLS), 7-8, then  
 Perform RPOP OPS (RNDZ TOOLS), 7-9, then  
 Perform TCS ACTIVATION, step 1 (RNDZ TOOLS), 7-18

-02:10

MS Perform HHL CHECKOUT (RNDZ TOOLS), 7-6

-02:05

MCC UPDATE  
 Final NC Burn Pad,  
 3-3

-02:00

ENABLE RENDEZVOUS NAV [7A]

1. GNC 33 REL NAV  
 CRT RNDZ NAV ENA - ITEM 1 EXEC (\*)  
 √SV SEL, ITEM 4 - PROP  
 √S TRK, ITEM 12 - (\*)
2. GNC 34 ORBIT TGT  
 TGT NO - ITEM 1 +1 EXEC  
 Set BASE TIME to Ti TIG, (Ti Burn Pad, 3-6)  
 LOAD - ITEM 26 EXEC

THIS PAGE INTENTIONALLY BLANK



PET

-02:00

A7(B7)

CDR LOAD TARGET TRACK [9A]

MCC UPDATE  
 STAR TRK NAV  
 IMU DES \_\_\_\_\_  
 [10A] , 4-10

NOTE

If NH performed, delay mnvr to NC burn attitude until NC TIG - 5 min to minimize attitude mnvr

CDR If OMS BURN, Perform RNDZ OMS BURN, steps 1-4 (CONTINGENCY OPS), 5-4  
 If +X RCS burn, Perform RCS BURN, steps 1-5 (Cue Card)

-01:55

-01:50

-01:45

-01:40

← TIG-5 MIN

-01:35

← [NC TIG]

CDR INITIATE TARGET TRACK [9B]

-01:30

PLT TARGET NCC BURN [11A] (Preliminary), 4-11

LOAD TARGET TRACK [9A]

√DAP: A/LVLH/VERN(ALT)

[GNC UNIV PTG]

CRT CNCL - ITEM 21 EXEC  
 TGT ID +1

	<u>-Z AXIS</u>	<u>-Y STRK</u>
BODY VECT	+3 (-Z)	+4
P	√+90	√+0
Y	√+0	√+280.57
OM	+0	+90

Do not INITIATE TARGET TRACK [9B] until post NC

INITIATE TARGET TRACK [9B]

[GNC UNIV PTG]

TRK - ITEM 19 EXEC (CUR - \*)  
 DAP: B/AUTO/ALT

When MNVR cmplt,  
 DAP: A/AUTO/VERN(ALT)

STAR TRACKER NAV 10A

1. CONFIG FOR STRK NAV

√DAP: A/AUTO/VERN(ALT)

Turn down cabin lights to optimize target viewing through -Z COAS/overhead window

IMU for Deselect \_\_\_\_ (If no comm, use IMU 1 for deselect)

GNC 21 IMU ALIGN

CRT IMU DES - ITEM 7(8,9) EXEC (\*)

√MCC for NAV selected IMU \_\_\_\_

GNC 33 REL NAV

If first NAV pass,

√SV SEL, ITEM 4 - PROP

If previous NAV,

√SV SEL, ITEM 4 - FLTR

√INH Angles, ITEM 24 - (\*)

√S TRK, ITEM 12 - (\*)

GNC 22 S TRK/COAS CNTL

-Y THOLD - ITEM 13 +3 EXEC

-Z THOLD - ITEM 14 +3 EXEC

-Z (-Y) TGT TRK - ITEM 6(5) EXEC (\*)

√STATUS - blank

√SHUTTER - op

2. INITIAL MEASUREMENT EVALUATION

GNC 22 S TRK/COAS CNTL

When S PRES - (\*), continue

GNC 33 REL NAV

Monitor RESID V and H each NAV cycle for at least four consecutive cycles (~30 sec)

Record init RESID V = \_\_\_\_\_

H = \_\_\_\_\_

If RESID V or H changes by > 0.05 each cycle:

GNC 22 S TRK/COAS CNTL

-Z(-Y) BREAK TRK - ITEM 8(7) EXEC

Repeat Step 2

If RESID V or H > 0.6:

GNC 22 S TRK/COAS CNTL

-Z(-Y) BREAK TRK - ITEM 8(7) EXEC

When S PRES - (\*), if RESID V or H still > 0.6 and stable:

Perform S TRK NAV - HIGH INITIAL RESID (CONTINGENCY OPS), 5-8

3. INCORPORATE DATA INTO NAV

If SV SEL = PROP:

AUTO Angles - ITEM 23 EXEC (\*)

Record 1st SV UPDATE POS = \_\_\_\_\_

When SV UPDATE POS < 1.0 and Angle ACPT > 9:

SV SEL - ITEM 4 EXEC (FLTR) >>

If SV = FLTR:

FLTR TO PROP - ITEM 8 EXEC

AUTO Angles - ITEM 23 EXEC (\*)

Record 1st SV UPDATE POS = \_\_\_\_\_

\* If FLTR MINUS PROP changes by more than 8 kft within a S TRK pass: \*

\* Perform S TRK NAV - HIGH FLTR MINUS PROP \*

\* (CONTINGENCY OPS), 5-9 \*

END S TRK NAV 10B

GNC 33 REL NAV

CRT INH Angles - ITEM 24 EXEC (\*)

GNC 21 IMU ALIGN

IMU DES - ITEM 7(8,9) EXEC (no \*)

PET

-01:30

A7(B7)

PLT STAR TRACKER NAV 10A

MCC UPDATE  
Nav Selected IMU

-01:25

MCC UPDATE  
Ground NCC Burn  
Solution

When NAV converged (SV UPDATES small and stable):  
CDR TARGET NCC BURN 11A (Intermediate)

-01:20

-01:15

-01:10

-01:05

← TIG-10 MIN √MCC for burn type

```

*****
* If no comm *
* If ΔVT > 6 fps: *
* | END S TRK NAV 10B *
* | TARGET NCC BURN 11A (Final) *
* | Perform RNDZ OMS BURN (CONTINGENCY OPS), 5-4 *
* If ΔVT > 4 fps: *
* | END S TRK NAV 10B *
* | TARGET NCC BURN 11A (Final) *
* | Perform +X Burn, RCS BURN (Cue Card) *
*****

```

PLT END S TRK NAV 10B

← TIG-5 MIN

PLT TARGET NCC BURN 11A (Final)

-01:00

CDR Perform RCS BURN (Cue Card)

TARGET NCC BURN 11A

**FINAL SOLUTION**

OPS 202 PRO  
GNC ORBIT MNVR EXEC  
√Eng Sel CORRECT

CRT √SV SEL correct

GNC 34 ORBIT TGT

TGT NO - ITEM 1 +9 EXEC

√TGT Set data:

T1 TIG = NCC BURN SOLUTION TIG

EL +0

ΔT +57.7

ΔX -48.6

ΔY +0.0

ΔZ +1.2

COMPUTE T1 - ITEM 28 EXEC

Record solution in PAD

**FINAL SOLUTION**

If > 40 marks in current sensor pass and  
SV UPDATE POS < 0.5 for the last 4 marks:

| Burn FLTR soln

If FLTR within ground solution limits:

| Burn FLTR soln

If PROP within ground solution limits:

| Burn PROP soln

If none of the above:

Burn ground soln EXT ΔVs

**NCC BURN SOLUTION**

TIG [ ] [ ] [ ] / [ ] [ ] : [ ] [ ] : [ ] [ ]

**PRELIMINARY**

**INTERMEDIATE**

ΔVX	( )			.	
ΔVY	( )			.	
ΔVZ	( )			.	
ΔVT	( )			.	

ΔVX	( )			.	
ΔVY	( )			.	
ΔVZ	( )			.	
ΔVT	( )			.	

**FINAL**

**GROUND**

**FINAL - GROUND LIMITS**

ΔVX	( )			.	
ΔVY	( )			.	
ΔVZ	( )			.	
ΔVT	( )			.	

ΔVX	( )			.	
ΔVY	( )			.	
ΔVZ	( )			.	
ΔVT	( )			.	

(0.8)

(1.4)

(2.3)

-Z AXIS TARGET TRACK 12A

GNC UNIV PTG

CRT  $\sqrt{\text{TGT ID}}$  +1  
BODY VECT +3 (-Z)  
OM +0

C3 DAP: B/AUTO/ALT  
CRT TRK - ITEM 19 EXEC (CUR - \*)

When MNVR cmplt,  
DAP: A/AUTO/VERN(ALT)

PET

-01:00

A7(B7)

← NCC TIG

-00:55

PLT TARGET Ti BURN 13A (Preliminary)

**IF Y S TRK TRACK**

CDR -Z AXIS TARGET TRACK 12A

-00:50

When:

GNC 33 REL NAV

NAV RNG < 150 KFT:

KU OPS, step 1 (Cue Card)

MS

-00:45

If no lock-on by

10 minutes after initial search:

KU OPS, step 2 (Cue Card)

MS

-00:40

When RR RNG < 135 KFT:

Perform RR NAVIGATION 13B

PLT

-00:35

When NAV converged (SV UPDATES small and stable):

PLT TARGET Ti BURN 13A (Intermediate)

-00:30

MCC UPDATE  
RNDZ PRPLT PAD

TARGET Ti BURN 13A

CRT √SV SEL correct  
GNC 34 ORBIT TGT  
TGT NO - ITEM 1 +1.0 EXEC  
√TGT Set data:  
T1 TIG = BASE TIME  
EL +0  
ΔT +76.9  
ΔX -0.9  
ΔY +0  
ΔZ +1.8  
COMPUTE T1 - ITEM 28 EXEC  
Record solution in PAD

RR NAVIGATION 13B

GNC 33 REL NAV

CRT RR - ITEM 13 EXEC (\*)  
√Elev, Az approx 0

Record Initial RESID RANGE = \_\_\_\_\_  
RDOT = \_\_\_\_\_

**IF RESID RANGE > 5.0 or  
RDOT > 3.0**

SV SEL - ITEM 4 EXEC (PROP)  
Proceed with taking data and contact MCC  
as soon as practical

FLTR TO PROP - ITEM 8 EXEC  
AUTO RNG - ITEM 17 EXEC (\*)  
RDOT - ITEM 20 EXEC (\*)  
Angles - ITEM 23 EXEC (\*)

Record 1st SV UPDATE POS = \_\_\_\_\_

**IF SV SEL = PROP**

When SV UPDATE POS < 0.3 and MARK ACPT > 9:  
SV SEL - ITEM 4 EXEC (FLTR)

Ti BURN SOLUTIONS

PREL FLTR

( )			.	
( )			.	
( )			.	
			.	

INTER FLTR

( )			.	
( )			.	
( )			.	
			.	

FINAL FLTR

( )			.	
( )			.	
( )			.	
			.	

GND

( )			.	
( )			.	
( )			.	
			.	

FINAL Ti Burn Pad, 3-7

PROP  
(If Reqd)

( )			.	
( )			.	
( )			.	
			.	

FINAL - GROUND  
LIMITS

$\Delta V_X$  (1.3)  
 $\Delta V_Y$  (1.3)  
 $\Delta V_Z$  (1.1)

PET

-00:30

A7(B7)

-00:25

√MCC for burn type. If no comm:

If  $\Delta VT > 6$ , at TIG-17:

| Perform RNDZ OMS BURN (CONTINGENCY OPERATIONS), 5-4

If  $4 \leq \Delta VT \leq 6$ , at TIG-17:

| Perform +X RCS burn, RCS BURN (Cue Card)

If  $\Delta VT < 4$ , at TIG-5:

| Perform multi-axis RCS burn, RCS BURN (Cue Card)

MCC UPDATE

Ti Final Ground Soln,

Ti DELAY Soln, 3-7

-00:20

**If GO for Ti not received by TIG - 5 or RNDZ DELAY called by MCC**

CDR Perform Ti DELAY BURN (CONTINGENCY OPS), 5-27

← TIG-17

If Ti is multi-axis burn, delay final targeting until TIG-5

PLT TARGET Ti BURN 15A (Final)

-00:15

If Ti is +X RCS burn:

| Perform RCS BURN (Cue Card)

If Ti is OMS BURN:

| Perform RNDZ OMS BURN (CONTINGENCY OPERATIONS), 5-4

MCC UPDATE

GO for Ti

-00:10

-00:05

← TIG-5

If Ti is multi-axis burn:

CDR Perform RCS BURN (Cue Card)

00:00

← Ti TIG

TARGET Ti BURN 15A (Final)

CRT OPS 202 PRO

GNC ORBIT MNVR EXEC

Load Eng Sel, TVR, WT and Trims for Ti per Final Ti Burn Pad  
LOAD - ITEM 22 EXEC

GNC 33 REL NAV

√SV SEL correct

GNC 34 ORBIT TGT

TGT NO - ITEM 1 +10 EXEC

√TGT Set data:

T1 TIG = BASE TIME

EL +0

$\Delta T$  +76.9

$\Delta X$  -0.9

$\Delta Y$  +0

$\Delta Z$  +1.8

COMPUTE T1 - ITEM 28 EXEC

Record solution in PAD

**FINAL SOLUTION**

If > 40 marks in current sensor pass and  
SV UPDATE POS < 0.5 for the last 4 marks:

| Burn FLTR soln

If FLTR within ground solution limits:

| Burn FLTR soln

If PROP within ground solution limits:

| Burn PROP soln

If none of the above:

Burn ground soln EXT  $\Delta V$ s

POST Ti NAV 16A

A6U √DAP: A/AUTO/VERN(ALT)  
A1U √KU sel - GPC

GNC 33 REL NAV

IF SV SEL = FLTR:

FLTR TO PROP - ITEM 8 EXEC (\*)

If RR Tracking TGT:

√AUTO Angles - ITEM 23 EXEC (\*)

If RR NOT Tracking TGT:

√Inhibit Data

Perform KU OPS, steps 2 and 3 (Cue Card)

If still no RR ACQ, assume RR Fail

GNC 22 S TRK/COAS CNTL

CRT √ Z TGT TRK - ITEM 6 EXEC (\*)

**IF RR FAIL**

If -Z Star Tracker:

√-Z TGT TRK ATT, then:

Perform STAR TRACKER NAV 10A

If COAS NAV:

√-Z TGT TRK ATT, then:

Perform COAS NAVIGATION (CONTINGENCY OPS), 5-10

If -Y Star Tracker:

GNC UNIV PTG

TGT ID +1

BODY VECT +4

P √+0

Y √+280.57

OM +90

DAP: B/AUTO/ALT

TRK - ITEM 19 EXEC

When MNVR cmlt:

DAP: A/AUTO/VERN(ALT)

Perform STAR TRACKER NAV 10A



PET

00:00 PLT TARGET MC 1 BURN 17A (Preliminary)  
A7(B7)

CDR When MNVR to att cmlt:  
POST TI NAV 16A

00:05

MCC UPDATE  
Prox Ops Cov Matrix

00:10 PLT When NAV converged, (SV UPDATES small and stable):  
TARGET MC 1 BURN 17A (Intermediate)

MS √Time of OOP null

00:15

← TIG-3 MIN  
PLT TARGET MC 1 BURN 17A (Final)  
Perform RCS BURN (Cue Card)

00:20 ← MC 1 TIG

PLT TARGET MC 2 BURN 17B (Preliminary)

00:25

PLT When Y = 0:  
MANUAL OUT-OF-PLANE NULL 19A

00:30

TARGET MC 1 BURN 17A

CRT √SV SEL correct  
GNC 34 ORBIT TGT  
TGT NO - ITEM 1 +1 1 EXEC  
√TGT Set data:  
T1 TIG = MC1 BURN SOLUTION TIG  
EL +0  
ΔT +56.9  
ΔX -0.9  
ΔY +0  
ΔZ +1.8  
COMPUTE T1 - ITEM 28 EXEC  
Record solution in PAD

MC 1 BURN SOLUTION

TIG				/			:			:		
	PRELIMINARY						INTERMEDIATE					
ΔVX	( )			.				( )			.	
ΔVY	( )			.				( )			.	
ΔVZ	( )			.				( )			.	
ΔVT				.							.	
	FINAL						MEAN ± (3σ VARIATION)					
ΔVX	( )			.								-0.1 ± (0.5)
ΔVY	( )			.								-0.1 ± (0.5)
ΔVZ	( )			.								-0.3 ± (1.6)
ΔVT				.								

TARGET MC 2 17B (Preliminary)

CRT √SV SEL correct  
GNC 34 ORBIT TGT  
TGT NO - ITEM 1 +1 2 EXEC  
√TGT Set data:  
T1 TIG = MC2 BURN SOLUTION TIG  
EL +29.07  
ΔT +27.0  
ΔX -0.9  
ΔY +0  
ΔZ +1.8  
COMPUTE T1 - ITEM 28 EXEC  
NOTE  
If TGT EL ANG Alarm,  
ΔV still valid for current TIG,  
TIG slip limits still apply  
Record solution in PAD

**TARGET MC 2 BURN** 18A (Intermediate)

CRT  $\sqrt$ SV SEL correct  
GNC 34 ORBIT TGT  
 TGT NO - ITEM 1 +1 2 EXEC  
 COMPUTE T1 - ITEM 28 EXEC  
 Record solution in PAD

**TARGET MC 2 BURN** 18B (Final)

CRT  $\sqrt$ SV SEL correct  
GNC 34 ORBIT TGT  
 TGT NO - ITEM 1 +1 2 EXEC  
 COMPUTE T1 - ITEM 28 EXEC  
 $\sqrt$ TIG change

**IF TIG CHANGE < -3 OR > +7 MIN**

Set BASE TIME to (Nominal MC 2 TIG -3 or +7 min as appropriate)  
 LOAD - ITEM 26 EXEC  
 TGT NO - ITEM 1 +1 9 EXEC

$\sqrt$ TGT Set data:

T1 TIG = BASE TIME  
 EL +0  
 $\Delta$ T +27.0  
 $\Delta$ X -0.9  
 $\Delta$ Y +0  
 $\Delta$ Z +1.8

COMPUTE T1 - ITEM 28 EXEC

Set EVENT TIMER counting to MC 2 TIG  
 Record solution in PAD

GNC 33 REL NAV

CRT FLTR TO PROP - ITEM 8 EXEC

**END S TRK NAV** 18C

GNC 33 REL NAV

CRT INH Angles - ITEM 24 EXEC (\*)

GNC 21 IMU ALIGN

IMU DES - ITEM 7(8,9) EXEC (no \*)

**-Z AXIS TARGET TRACK** 18D

GNC UNIV PTG

CRT  $\sqrt$ TGT ID +1  
 BODY VECT +3 (-Z)  
 OM +0

C3 DAP: B/AUTO/ALT  
 CRT TRK - ITEM 19 EXEC (CUR - \*)

When MNVR cmplt,  
 DAP: A/AUTO/VERN(ALT)

**MC 2 BURN SOLUTION**

	PRELIMINARY	INTERMEDIATE	
$\Delta$ VX	( )	( )	
$\Delta$ VY	( )	( )	
$\Delta$ VZ	( )	( )	
$\Delta$ VT	( )	( )	
	<b>FINAL</b>	<b>MEAN <math>\pm</math> (3<math>\sigma</math> VARIATION)</b>	
$\Delta$ VX	( )	+0.0 $\pm$ (0.3)	
$\Delta$ VY	( )	+0.0 $\pm$ (0.2)	
$\Delta$ VZ	( )	+0.3 $\pm$ (2.4)	
$\Delta$ VT	( )		
		<b>TIG</b>	<b>TIG SLIP (COMPUTED-NOM)</b>
PREL	[ ] / [ ] [ ]	[ ] [ ] : [ ] [ ]	[ ] [ ] : [ ] [ ]
INTER	[ ] / [ ] [ ]	[ ] [ ] : [ ] [ ]	[ ] [ ] : [ ] [ ]
FINAL	[ ] / [ ] [ ]	[ ] [ ] : [ ] [ ]	[ ] [ ] : [ ] [ ]
NOMINAL	[ ] / [ ] [ ]	[ ] [ ] : [ ] [ ]	[ ] [ ] : [ ] [ ]

**NIGHTTIME STRK OPS** 18E

1. GNC 33 REL NAV  
 INH Angles - ITEM 24 EXEC (\*)

At sunset,

2. GNC 22 S TRK/COAS CNTL  
 -Z(-Y) THOLD - ITEM 14(13) +0 EXEC

3. Perform STAR TRACKER NAV 10A , steps 2 and 3

PET

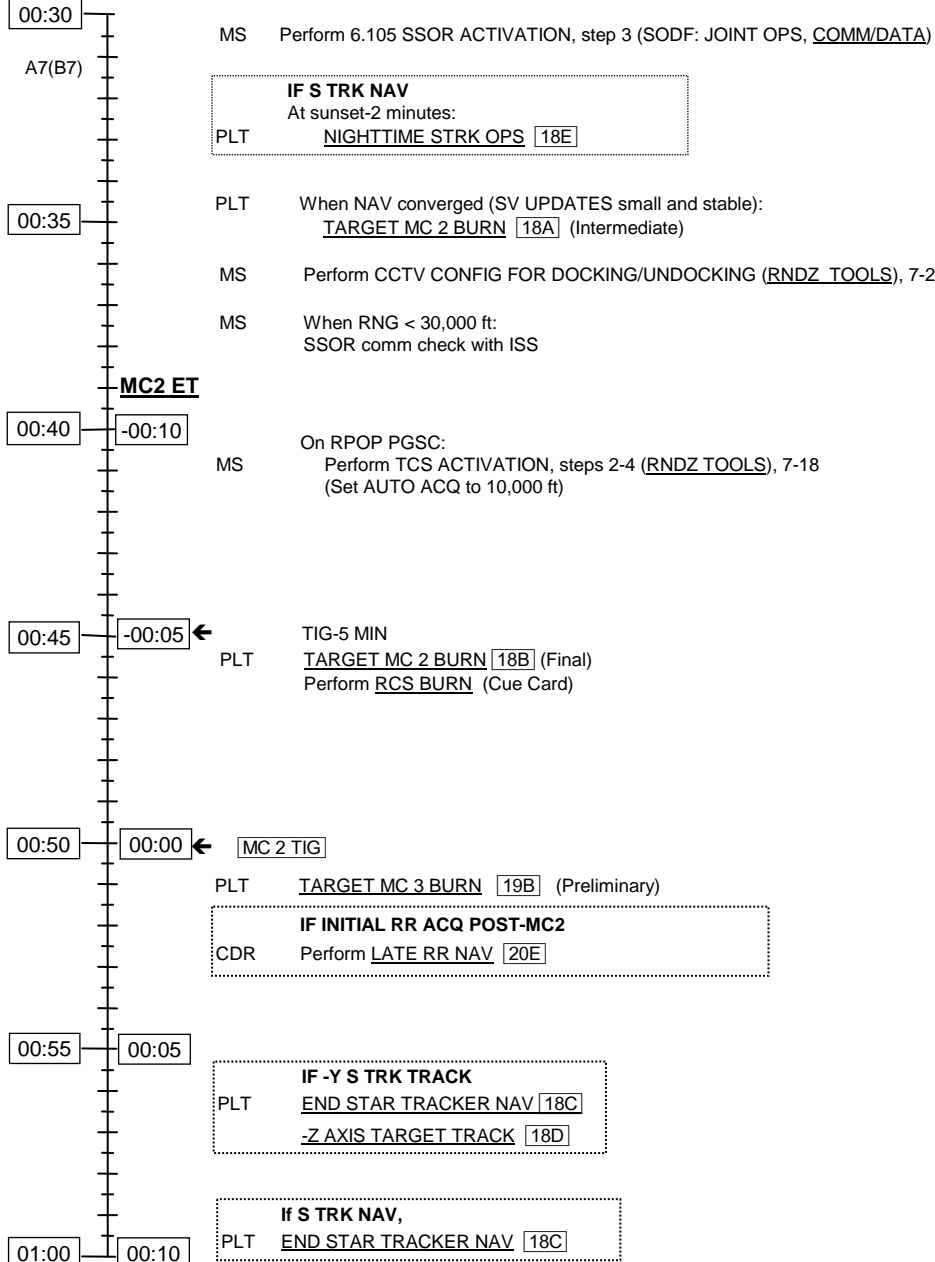

MANUAL OUT-OF-PLANE NULL [19A]

GNC 33 REL NAV

CRT When Y = 0:  
F7 FLT CNTLR PWR - ON  
DAP: A/AUTO/PRI  
DAP TRANS: as reqd  
THC: Null YDOT

If -Z AXIS TRACK,  
+YDOT = FWD THC left  
AFT THC right

If -Y S TRK TRACK,  
+YDOT = FWD THC down  
AFT THC out

F7 FLT CNTLR PWR - OFF  
DAP: A/AUTO/ALT  
When rates nulled:  
DAP: VERN(ALT)

TARGET MC 3 [19B]

CRT √SV SEL correct  
GNC 34 ORBIT TGT  
TGT NO - ITEM 1 +1.3 EXEC  
√TGT Set data:  
T1 TIG = BASE TIME + 0/00:17:00  
EL +0  
ΔT +10.0  
ΔX -0.9  
ΔY +0  
ΔZ +1.8  
COMPUTE T1 - ITEM 28 EXEC  
Record solution in PAD

MC 3 BURN SOLUTION

TIG	[ ] [ ] [ ] / [ ] [ ] : [ ] [ ] : [ ] [ ]					
	PRELIMINARY		FINAL		MEAN ± (3σ VARIATION)	
ΔVX	( )	[ ] [ ] [ ] [ ]	( )	[ ] [ ] [ ] [ ]		+0.2 ± (1.2)
ΔVY	( )	[ ] [ ] [ ] [ ]	( )	[ ] [ ] [ ] [ ]		+0.0 ± (0.4)
ΔVZ	( )	[ ] [ ] [ ] [ ]	( )	[ ] [ ] [ ] [ ]		+0.7 ± (2.4)
ΔVT	[ ] [ ] [ ] [ ]	[ ] [ ] [ ] [ ]	[ ] [ ] [ ] [ ]	[ ] [ ] [ ] [ ]		

MC 4 BURN SOLUTION

TIG [ ] [ ] [ ] / [ ] [ ] : [ ] [ ] : [ ] [ ]

	PRELIMINARY				FINAL				MEAN ± 3σ VARIATION
ΔVX	( )			.	( )			.	+1.3 ± (2.6)
ΔVY	( )			.	( )			.	-0.0 ± (0.5)
ΔVZ	( )			.	( )			.	+0.9 ± (3.1)
ΔVT				.				.	

TARGET MC 4 BURN [20A]

CRT √SV SEL correct  
 [GNC 34 ORBIT TGT]  
 TGT NO - ITEM 1 +14 EXEC  
 √TGT Set data:  
 T1 TIG = BASE TIME + 0/00:27:00  
 EL +0  
 ΔT +13.0  
 ΔX +0  
 ΔY +0  
 ΔZ +0.6  
 COMPUTE T1 - ITEM 28 EXEC  
 Record solution in PAD

ESTABLISH RBAR [20C]

A6U FLT CNTLR PWR - ON  
 [GNC UNIV PTG]  
 CRT TRK - ITEM 19 EXEC (CUR - \*)  
 DAP: A/AUTO/VERN(PRI)  
 THC: as reqd to control TGT motion in COAS

CONFIG FOR RBAR [20B]

[GNC UNIV PTG]  
 √ERR TOT - ITEM 23 EXEC (\*)

When ERR <2 deg each axis  
 [GNC 20 DAP CONFIG]  
 Config DAP A,B to A8,B8

[GNC UNIV PTG]  
 TGT ID +2  
 BODY VECT +5  
 P +270  
 Y +0  
 OM +0

Do not initiate Target Track until ESTABLISH RBAR [20C]

LATE RADAR NAV [20E]

[GNC 33 REL NAV]  
 CRT FLTR TO PROP - ITEM 8 EXEC  
 SV SEL, ITEM 4 - PROP  
 √RR - ITEM 13 EXEC (\*)  
 AUTO RNG - ITEM 17 EXEC (\*)  
 RDOT - ITEM 20 EXEC (\*)  
 Angles - ITEM 23 EXEC (\*)  
 Go to RADAR FAIL PROCEDURE [20D]

RADAR FAIL PROCEDURE [20D]

Note: When TGT visible, report TGT Tally-Ho to MCC  
 MS If TGT outside COAS reticle, config CCTV as reqd to measure vertical position

- At MC2 TIG+14:00 (MC3 TIG-3:00):  
 PLT TARGET MC3 [19B] (final)  
 CDR Perform RCS BURN (Cue Card)

**AT MC2+18 IF NO VISUAL ACQUISITION OR  
 TARGET > 30 DEG FROM COAS HORIZONTAL**  
 CDR Go to RNDZ BREAKOUT (CONTINGENCY OPS), 5-18 >>

- At MC2 TIG + 19:00:  
 A6U FLT CNTLR PWR - ON  
 √SENSE - -Z  
 DAP: A/LVLH/PRI  
 √COAS for TGT vertical position  
 THC: +X (or -X) per COAS LOGIC:  
 If TGT = N deg high in COAS, perform 2N +X (up) pulses  
 If TGT = N deg low in COAS, perform 1N -X (down) pulses  
 DAP: A/LVLH/VERN(PRI)  
 Inform MCC of TGT vertical position in COAS and number of pulses performed  
 Following radar fail X correction,  
 THC: As reqd to control out of plane motion and manage RDOT  
 Perform CONFIG FOR RBAR [20B]
- At MC2 TIG + 24:00 or 2000 ft, whichever comes first:  
 [GNC UNIV PTG]  
 CRT TRK - ITEM 19 EXEC (CUR - \*)  
 A6U DAP: A/AUTO/VERN (PRI)  
 THC: as reqd to stabilize and maintain TGT docking port between 0 and 10 deg  
 high in COAS

At 2000 ft:  
 Perform APPROACH (Cue Card)

PET **MC2 ET**

01:00 00:10

A7(B7)

**IF NO RR INTO NAV**  
 CDR Go to RADAR FAIL PROCEDURES [20D]

01:05 00:15



TIG-3 MIN  
 PLT TARGET MC3 BURN [19B] (Final)  
 Perform RCS BURN (Cue Card)



MC 3 TIG

CREW REPORT  
 ISS tally-ho

A8(B8)

01:10 00:20

PLT TARGET MC 4 BURN [20A] (Preliminary)  
 CDR CONFIG FOR RBAR [20B]  
 MS Perform HHL OPS (RNDZ TOOLS), 7-7



TIG-3 MIN  
 PLT TARGET MC 4 [20A] (Final)  
 Perform RCS BURN (Cue Card)

HHL REPORT  
 R and Rdot

01:15 00:25



MC 4 TIG

CDR ESTABLISH RBAR [20C]

01:20 00:30

Perform APPROACH (Cue Card)

**Manual Trajectory Control**

01:25 00:35

01:30 00:40

TERMINATE RNDZ OPS 22A

1. ORBITER CONFIG FOR MATED ATTITUDE CONTROL

PLT  
O14:F, Pri RJD LOGIC, DRIVER (sixteen) - OFF  
O15:F, RJDA 1A L2/R2 MANF DRIVER - ON  
O16:F

O14:E, All DDU cbs (six) - op  
O15:E,  
O16:E

CDR A6U √FLT CNTRLR PWR - OFF

PLT GNC 23 RCS  
CRT RCS F - ITEM 1 EXEC (\*)

JET DES F1L - ITEM 9 EXEC (\*)  
F3L - ITEM 11 EXEC (\*)  
F2R - ITEM 13 EXEC (\*)  
F4R - ITEM 15 EXEC (\*)  
F1U - ITEM 17 EXEC (\*)  
F3U - ITEM 19 EXEC (\*)  
F2U - ITEM 21 EXEC (\*)

GNC 20 DAP CONFIG

Config DAP A,B to A12,B12  
X JET ROT ENA - ITEM 7 EXEC (\*)  
EDIT A9 - ITEM 3 + 9 EXEC  
PRI RATE DB - ITEM 52 + 0.2 EXEC  
LOAD - ITEM 5 EXEC  
EDIT B9 - ITEM 4 + 9 EXEC  
PRI RATE DB - ITEM 52 + 0.2 EXEC  
LOAD - ITEM 5 EXEC

SM 167 DOCKING STATUS

CRT √ 12 hooks closed  
DAP: LO Z

If Loss of Verns:  
| DAP: A/ALT  
| DAP: LVLH

If VERN:  
DAP: LVLH

\* If ISS attitude control required, \*  
\* Perform 3.111 HANDOVER ATTITUDE CONTROL ORBITER TO \*  
\* CMG TA, (SODF: JOINT OPS, MATED OPERATIONS) \*

2. ORBITER CONFIG FOR MATED OPS

MS Perform DOCKING MECHANISM POWERDOWN (APDS), 8-6  
A6L LTS TRUSS FWD, AFT (two) - OFF  
VEST PORT, STBD (two) - OFF

Exit RPOP - [Shift]/[F10]  
Perform HHL STOW (RNDZ TOOLS), 7-6  
-Z COAS - OFF

CRT

GNC 22 S TRK/COAS CNTL

-Z(-Y) STAR TRK - ITEM 4(3) EXEC (\*)  
-Y THOLD - ITEM 13 + 0 EXEC  
-Z THOLD - ITEM 14 + 0 EXEC

GNC 55 GPS STATUS

DES RCVR - ITEM 27 (no \*)

GNC 33 REL NAV

RNDZ NAV ENA - ITEM 1 EXEC (no \*)

**RETURN TO FLIGHT PLAN**

## CONTINGENCY OPS

RNDZ OMS BURN.....	5-3
SENSOR FAIL .....	5-7
S TRK NAV – HIGH INITIAL RESID .....	5-8
FLTR MINUS PROP.....	5-9
COAS NAVIGATION.....	5-10
BACKOUT/BREAKOUTS .....	5-11
VBAR CORRIDOR BACKOUT .....	5-12
BREAKOUT .....	5-14
SHUTTLE NOSE IN-PLANE BREAKOUT (R < 700 ft) .....	5-16
RNDZ BREAKOUT .....	5-18
EXPEDITED SEPS.....	5-19
SHUTTLE EMERGENCY SEPARATION.....	5-21
ANY ATTITUDE SEPARATION .....	5-23
Ti DELAY BURN .....	5-27
RNDZ NAV RECOVERY .....	5-29
TGT ITER.....	5-30
LOSS OF COMM .....	5-31
DEGRADED CONTROL .....	5-33
DEGRADED +X TRANSLATION .....	5-35
-X TRANSLATION .....	5-36
LOSS OF FORWARD SIDE-FIRING JETS.....	5-37
ONE FxD JET .....	5-38
BOTH FxD JETS (SAME SIDE) .....	5-39
VRCS.....	5-41

This Page Intentionally Blank



RNDZ OMS BURN

# RNDZ OMS BURN

RNDZ OMS  
BURN

- |             |  |
|-------------|--|
|             | 1. <u>OMS BURN PREP</u>  |
| C2<br>Wedge | Install <u>OMS2/ORBIT OMS BURNS</u> (Cue Cards) (two) and<br><u>ORBIT BURN MONITOR</u> (Cue Cards) (two) (F6,F8) |
|             | <span style="border: 1px solid black; padding: 2px;">1: GNC 20 DAP CONFIG</span>                                 |
| CRT1        | √DAP config A7,B7<br>GNC, OPS 202 PRO  |
|             | <span style="border: 1px solid black; padding: 2px;">1: GNC ORBIT MNVR EXEC</span>                               |
|             | <span style="border: 1px solid black; padding: 2px;">2: GNC SYS SUMM 2</span>                                    |
|             | 2. <u>LOAD TGT DATA</u>  |
|             | If onboard-computed burn:  |
|             | √Eng sel, TV ROLL, TRIM LOAD, and WT per Burn Pad  |
|             | √TIG and TGT PEG 7 ΔVs per Final ORBIT TGT solution  |
|             | √Guidance option is LAMBERT  |
|             | If ground-computed burn:   |
|             | √TGT data per Burn Pad (reload WT as reqd)   |
|             | LOAD – ITEM 22 EXEC  |
|             | TIMER – ITEM 23 EXEC   |
|             | √Burn data   |
| C3          | DAP: A/AUTO/ALT(B/ALT as reqd)   |
| CRT1        | MNVR – ITEM 27 EXEC (*)  |
|             | If RR ops:   |
| A1U         | KU sel – AUTO TRK  |
|             | <span style="border: 1px solid black; padding: 2px;">1: GNC 33 REL NAV</span>                                    |
| CRT1        | INH Angles – ITEM 24 EXEC (*)  |
|             | <span style="border: 1px solid black; padding: 2px;">1: GNC ORBIT MNVR EXEC</span>                               |
|             | When mnvr to att complete:   |
| C3          | √DAP: A/AUTO/ALT   |
| TIG-3       | 3. <u>PERFORM RNDZ OMS BURN</u>  |
| F6,F8       | FLT CNTLR PWR (two) – ON<br>Perform <u>OMS2/ORBIT OMS BURNS</u> (Cue Card)                                       |
|             | 4. <u>OMS POST BURN RECONFIGURATION</u>  |
| F6,F8<br>O8 | FLT CNTLR PWR (two) – OFF<br>L,R OMS He PRESS/VAP ISOL (four) – CL   |
| C3          | DAP: B/INRTL/ALT<br>DAP TRANS: PULSE/PULSE/PULSE   |
| CRT1        | RCS SEL – ITEM 4 EXEC (*)<br>Perform OMS TVC GMBL CK per Burn Pad  |
|             | * If down arrow(s) or M(s), *  |
|             | * select good GMBL *   |
|             | GNC, OPS 201 PRO   |

Cont next page

5. MNVR TO POST BURN ATTITUDE

1: GNC UNIV PTG

√Desired UNIV PTG load active

C3            DAP: B/AUTO/ALT

If RR ops, when ATT ERR < 30 deg:

A1U            KU sel – GPC

√KU TRACK tb – gray

1: GNC 33 REL NAV

CRT1            AUTO Angles – ITEM 23 EXEC (\*)

1: GNC UNIV PTG

When in attitude and rates nulled:

C3            DAP: A/AUTO/VERN(ALT)

This Page Intentionally Blank

**SENSOR  
FAIL**

SENSOR FAIL

## S TRK NAV – HIGH INITIAL RESID

### 1. NAV SAFING

1: GNC 33 REL NAV

CRT1 √INH Angles – ITEM 24 EXEC (\*)

On MCC GO (if no comm, continue):

### 2. CHECK FOR S TRK FALSE LOCK

2: GNC 22 S TRK/COAS CNTL

If -Z S TRK, perform COAS visual check:

#### NOTE

GNC 33 REL NAV: COAS X (+up) and COAS Y (+left)  
provide approx TGT position in COAS based on -Z  
S TRK measurement

√For debris near TGT position

If no debris near TGT position or TGT not visible:

Go to step 3

If debris near TGT position:

-Z BREAK TRK – ITEM 8 EXEC

When S PRES – (\*):

CRT2  
CRT1 Monitor RESID V and H. Repeat BREAK TRK as reqd until  
stable lock-on

Go to STAR TRACKER NAV, step 2 10A

If -Y S TRK, perform visual check through W1:

√For debris near TGT line-of-sight

If no debris near TGT line-of-sight or TGT not visible:

Go to step 3

If debris near TGT line-of-sight:

-Y BREAK TRK – ITEM 7 EXEC

When S PRES – (\*):

CRT2  
CRT1 Monitor RESID V and H. Repeat BREAK TRK as reqd until  
stable lock-on

Go to STAR TRACKER NAV, step 2 10A

### 3. CHECK IMU MISALIGNMENT

2: GNC 21 IMU ALIGN

CRT2 Nav sel IMU – des,sel (If Nav sel IMU unknown, pick one of two remaining IMUs)

CRT1 Record RESID V \_\_\_\_\_ and H \_\_\_\_\_

If RESID V and H < 0.6:

Go to STAR TRACKER NAV, step 3 10A

CRT2 Other IMU – des,sel

CRT1 Record RESID V \_\_\_\_\_ and H \_\_\_\_\_

### 4. RESUME PASS

Continue with pass per STAR TRACKER NAV, step 3 10A, then:

After S TRK pass, on MCC GO:

#### NOTE

SELF-TEST may false fail. √MCC for S TRK status

2: GNC 22 S TRK/COAS CNTL

CRT2 -Z(-Y) SELF-TEST – ITEM 2(1) EXEC (\*)

SENSOR  
FAIL

## S TRK NAV – HIGH FLTR MINUS PROP

### 1. NAV SAFING

**1: GNC 33 REL NAV**

CRT1 INH Angles – ITEM 24 EXEC (\*)

On MCC GO (continue if no comm):

### 2. CHECK FOR S TRK FALSE LOCK

**2: GNC 22 S TRK/COAS CNTL**

If -Z S TRK, perform COAS visual check:

#### NOTE

GNC 33 REL NAV: COAS X (+up) and COAS Y (+left)  
provide approx TGT position in COAS based on -Z  
S TRK measurement

√For debris near TGT position

If no debris near TGT position or TGT not visible:

Go to step 3

If debris near TGT position:

SV SEL – ITEM 4 EXEC (PROP)

PROP TO FLTR – ITEM 9 EXEC

-Z BREAK TRK – ITEM 8 EXEC

CRT2

When S PRES – (\*):

CRT1

Monitor RESID V and H. Repeat BREAK TRK as reqd until stable  
lock-on

Go to STAR TRACKER NAV, step 2 **10A**

If -Y S TRK, perform visual check through W1:

√For debris near TGT line-of-sight

If no debris near TGT line-of-sight or TGT not visible:

Go to step 3

If debris near TGT line-of-sight:

SV SEL – ITEM 4 EXEC (PROP)

PROP TO FLTR – ITEM 9 EXEC

-Y BREAK TRK – ITEM 7 EXEC

CRT2

When S PRES – (\*):

CRT1

Monitor RESID V and H. Repeat BREAK TRK as reqd until stable  
lock-on

Perform STAR TRACKER NAV, step 2 **10A**

### 3. RESUME PASS

AUTO Angles – ITEM 23 EXEC (\*)

Continue -Z S TRK pass

After S TRK pass, on MCC GO:

#### NOTE

SELF-TEST may false fail. √MCC for S TRK status

**2: GNC 22 S TRK/COAS CNTL**

CRT2

-Z(-Y) SELF-TEST – ITEM 2(1) EXEC (\*)

## COAS NAVIGATION

### NOTE

Do not execute MC1 or Out-Of-Plane null.  
Prior COAS cal reqd to perform COAS NAV.  
VERNs reqd to perform COAS NAV.  
COAS Nav must be started within ~10 min of Ti to guarantee adequate geometry for nav convergence.  
Breakout – If tgt not visible at MC2+18, refer to 1-4 for breakout criteria

1. COAS NAV CONFIG
  - A6U √SENSE: -Z  
√DAP: B7/AUTO/VERN(ALT)
  - CRT 

GNC 22 STRK/COAS CNTL
-----------------------

  
COAS: SIGHT MODE – ITEM 22 EXEC (\*)  
REQD ID – ITEM 21 +1 EXEC  
√POS -Z: ITEM 27 (\*)
  - CRT 

GNC 33 REL NAV
----------------

  
INH Angles – ITEM 24 EXEC (\*)  
√SV SEL, ITEM 4 – FLTR  
If TGT NOT in COAS FOV:  
| √MCC  
If TGT in COAS FOV:  
FLTR TO PROP – ITEM 8 EXEC  
COAS – ITEM 14 EXEC (\*)
  - Upon MCC uplink of COVARIANCE MATRIX,  
COVAR REINIT – ITEM 16 EXEC
  - A6U 2. COAS MARKS  
FLT CNTLR PWR – ON  
DAP: B/FREE/PRI  
RHC: As reqd to move TGT near COAS center and maintain BODY YAW  
ERR < 10 deg  
DAP: B/FREE/VERN  
RHC: As reqd to maintain TGT at COAS center and maintain BODY YAW  
ERR < 10 deg  
  
When TGT centered in COAS, ATT REF pb – push
  - CRT 

GNC 33 REL NAV
----------------

  
If X and Y RESID magnitudes ≥ 1.0:  
| √MCC  
If X and Y RESID magnitudes < 1.0:  
FOR – ITEM 25 EXEC  
√SV UPDATE – non-zero (within 8 sec), then  
– 0.0 (after 8 sec more)
  - Repeat step 2 per schedule:  
One mark every 10 to 20 sec until sunset Post-Ti
  - At sunset,
  - A6U 3. END COAS NAV  
DAP: A7/AUTO/VERN(ALT)  
FLT CNTLR PWR – OFF
  - CRT 

GNC 22 STRK/COAS CNTL
-----------------------

  
COAS: DES – ITEM 25 EXEC (\*)  
  
Resume rendezvous timeline



BACKOUT/BREAKOUTS

**BACKOUT/  
BREAKOUTS**

## VBAR CORRIDOR BACKOUT

### CAUTION

Constraints for use:  
Orbiter on + Vbar in approach corridor

If RNG < 75 ft:

1. INITIATE CORRIDOR BACKOUT  
DAP: B/LVLH/VERN(PRI), no LO Z

NOTE: DAP A allowed for  $\pm X$  and  $-Z$  (in) THC

THC: +Z (out) to establish a +0.1 ft/sec opening rate  
Maintain 8 deg corridor

If PCT ARMED:

F4 DISARM PCT: SPDBRK/THROT pb – AUTO  
 $\sqrt{lt}$  – OFF

If 30 ft STATIONKEEPING desired:

Maintain tgt in 5 deg corridor

When RNG = 30 ft:

THC:  $-Z$  (in) as reqd establish  $30 \pm 5$  ft stationkeeping >>

When RNG > 50 ft:

DAP config: A9/B9

GNC 23 RCS

RCS F – ITEM 1 EXEC (\*)

JET DES F1F – ITEM 31 EXEC (no \*)

F2F – ITEM 35 EXEC (no \*)

If(When) RNG > 75 ft:

2. INITIATE(CONTINUE) CORRIDOR BACKOUT  
DAP: A(B)/LVLH/VERN(PRI), LO Z

NOTE: DAP A allowed for  $\pm X$  and  $\pm Z$  THC

THC: +Z (out) to establish a +0.1 ft/sec opening rate  
Maintain 8 deg corridor

DAP: B(A)

When opening rate established and RNG > 150:

3. PERFORM CORRIDOR BACKOUT OR BREAKOUT

If BREAKOUT desired:

| Go To VBAR BREAKOUT, 5-14 >>

Else:

Maintain 8 deg corridor

When desired stationkeeping range reached:

THC:  $-Z$  (in) as reqd to establish stationkeeping range

BACKOUT/  
BREAKOUTS

Cont next page

4. REAPPROACH  
DAP: AUTO

Go to VBAR APPROACH (Cue Card) from current stationkeeping range

## VBAR BREAKOUT

### CAUTION

Constraints for use:

Orbiter on  $\pm$  Vbar in approach attitude  
Range < 1000 ft cg to cg  
Tgt stable on orbiter -Z axis  
Orbiter X and Z axes are in-plane

If RNG < 75 ft:

1. INITIATE CORRIDOR BACKOUT

DAP: B/LVLH/VERN(PRI), no LO Z

NOTE: DAP A allowed for  $\pm$ X and -Z (in) THC

THC: +Z (out) to establish a +0.1 ft/sec opening rate  
Maintain 8 deg corridor

When RNG > 50 ft:

DAP config: A9/B9

GNC 23 RCS

RCS F – ITEM 1 EXEC (\*)

JET DES F1F – ITEM 31 EXEC (no \*)

F2F – ITEM 35 EXEC (no \*)

If(When) 75 < RNG < 150 ft:

2. INITIATE(CONTINUE) CORRIDOR BACKOUT

DAP: A(B)/LVLH/VERN(PRI), LO Z

NOTE: DAP A allowed for  $\pm$ X and  $\pm$ Z THC

THC: +Z (out) to establish a +0.1 ft/sec opening rate  
Maintain 8 deg corridor

DAP: B(A)

If(When) RNG > 150 ft:

3. PERFORM RADIAL BURN ON  $\pm$ VBAR

If Rdot negative (closing on the target):

THC: +Z (out) to null closing rate (Rdot  $\geq$  0 fps)

Config DAP A,B to A7,B7

DAP: A/LVLH/VERN(PRI), LO Z

DAP TRANS: NORM/PULSE/PULSE

THC: +X (up) for 6 sec (1.5 fps)

DAP TRANS: PULSE/PULSE/PULSE

FLT CNTLR PWR – OFF

DAP: A/INRTL/VERN(ALT)

Record Radial Burn TIG \_\_\_/\_\_\_:\_\_\_:\_\_\_

Inform MCC when SEP complete

Cont next page

4. PERFORM POSIGRADE/RETROGRADE BURN

√MCC for breakout direction

NOTE

Posigrade burn performed if second docking attempt desired

GNC, OPS 202 PRO

GNC ORBIT MNVR EXEC

√RCS SEL – ITEM 4 EXEC (\*)

If radial burn from +Vbar:

TV ROLL – ITEM 5 +1 8 0 EXEC

If radial burn from -Vbar:

TV ROLL – ITEM 5 +0 EXEC

Set TIG to Radial Burn +28 min:

If Posigrade Sep:

TGT PEG 7  $\Delta$ VX – ITEM 19 +3 EXEC

$\Delta$ VY – ITEM 20 +0 EXEC

$\Delta$ VZ – ITEM 21 +0 EXEC

If Retrograde Sep:

TGT PEG 7  $\Delta$ VX – ITEM 19 –3 EXEC

$\Delta$ VY – ITEM 20 +0 EXEC

$\Delta$ VZ – ITEM 21 +0 EXEC

LOAD – ITEM 22 EXEC

TIMER – ITEM 23 EXEC

When RNG > 1000 ft:

DAP: NO LO Z

At TIG -8:00:

DAP: B/AUTO/ALT

MNVR – ITEM 27 EXEC

At TIG -0:30:

DAP: A/INRTL/PRI

FLT CNTLR PWR – ON

At TIG, THC: Trim VGOs  $\leq$  0.2 fps

FLT CNTLR PWR – OFF

DAP: A/INRTL/VERN(ALT)

Inform MCC when SEP complete

GNC, OPS 201 PRO

## SHUTTLE NOSE IN-PLANE BREAKOUT (R < 700 ft)

### CAUTION

Constraints for use:

Orbiter X and Z axes in-plane

Range  $\leq$  700 ft cg to cg\*

Tgt stable on orbiter -Z axis

\*On approach use RNDZ Breakout until TORVA init  
(+X burns to start TORVA are complete)

If RNG < 75 ft:

#### 1. INITIATE CORRIDOR BACKOUT

√DAP: B/LVLH/VERN(PRI), no LO Z

THC: +Z (out) to establish a +0.1 ft/sec opening rate  
Maintain 8 deg corridor

### NOTE

DAP A allowed for  $\pm$ X and -Z (in) THC

When RNG > 75 ft:

If single -X jet configuration:

GNC 23 RCS

RCS F – ITEM 1 EXEC (\*)

JET DES F1F – ITEM 31 EXEC (no \*)

F2F – ITEM 35 EXEC (no \*)

Config DAP A,B to A9,B9

DAP: LO Z

When RNG > 150 ft

#### 2. PERFORM +X OR -X BURN

DAP TRANS: NORM/PULSE/PULSE

If Nose-Forward (TGT ID = 2 and OM = 0):

| THC: +X (up) for 6 sec (1.5 fps)

If Tail-Forward (TGT ID = 2 and OM = 180):

THC: -X (down) for 6 sec (1.5 fps)

DAP TRANS: PULSE/PULSE/PULSE

DAP: A/INRTL/VERN(ALT)

Record ( $\pm$ X) Burn TIG \_\_\_/\_\_\_:\_\_\_:\_\_\_

Report Tig to MCC

A6U

FLT CNTLR PWR – OFF

Cont next page

3. PERFORM FINAL BURN (+X Burn, Posigrade/Retrograde and Out-of-Plane)

GNC, OPS 202 PRO

GNC ORBIT MNVR EXEC

√RCS SEL – ITEM 4 EXEC (\*)

√MCC for breakout direction and TV ROLL

NOTE

Posigrade burn will be performed if second docking attempt desired

Set TIG to ( $\pm$ X) burn + 30 min

If Posigrade Sep:

TGT PEG 7  $\Delta$ VX – ITEM 19 +4.3 EXEC

$\Delta$ VY – ITEM 20 +3.6 EXEC

$\Delta$ VZ – ITEM 21 +0 EXEC

If Retrograde Sep:

TGT PEG 7  $\Delta$ VX – ITEM 19 -4.3 EXEC

$\Delta$ VY – ITEM 20 +3.6 EXEC

$\Delta$ VZ – ITEM 21 +0 EXEC

TV ROLL – ITEM 5 +      EXEC

LOAD – ITEM 22 EXEC

TIMER – ITEM 23 EXEC

Config DAP A,B to A7,B7

At TIG -8 min:

DAP: B/ALT, NO LO Z

MNVR – ITEM 27 EXEC (\*)

DAP: AUTO

At TIG -0:30:

DAP TRANS: as reqd

DAP: A/INRTL/PRI

F7 FLT CNTLR PWR – ON

At TIG, THC: Trim VGOs  $\leq$  0.2 fps

F7 FLT CNTLR PWR – OFF

DAP TRANS: PULSE/PULSE/PULSE

DAP: A/INRTL/VERN(ALT)

GNC, OPS 201 PRO

On MCC call:

Go to TERMINATE SEP OPS 8C, 2-8

## RNDZ BREAKOUT

### NOTE

This procedure may be performed anytime between Ti and TORVA init (+X burns to start TORVA are complete)

1. BREAKOUT BURN PREP  
DAP: A/AUTO/PRI  
FLT CNTLR PWR – ON
  
- CRT 2. 3 FPS RETROGRADE  
OPS 202 PRO  

GNC ORBIT MNVR EXEC
---------------------

  
√RCS SEL – ITEM 4 (\*)  
Set TIG to current time  
TGT PEG 7  $\Delta V_X$  – ITEM 19 -3 EXEC  
 $\Delta V_Y$  – ITEM 20 +0 EXEC  
 $\Delta V_Z$  – ITEM 21 +0 EXEC  
LOAD – ITEM 22 EXEC  
TIMER – ITEM 23 EXEC  
Do not maneuver to burn attitude  
DAP TRANS: as reqd  
Deflect THC to null VGOs  
FLT CNTLR PWR – OFF
  
- CRT OPS 201 PRO  
DAP: A/AUTO/VERN(ALT)



EXPEDITED SEPS

**EXPEDITED  
SEPS**

This Page Intentionally Blank

# SHUTTLE EMERGENCY SEPARATION

## NOTE

9.101 JOINT EMERGENCY UNDOCK AND SEPARATION (SODF: JOINT OPS, EMERGENCY RESPONSE) meets all constraints for use.

Constraints for use:

- Maneuver mated stack to the  $\pm V$ bar attitude
- Attitude rates  $\leq 0.12$  deg/axis
- Initial separation includes APDS spring pushoff
- Nominal Undock Orbiter DAP and RCS config

## 1. INITIAL SEPARATION SEQUENCE

When petals clear:

DAP: B9/LVLH/ALT

√DAP TRANS: PULSE/PULSE/PULSE, no LO Z

THC: as reqd to maintain target within 8 degree corridor on C/L camera or COAS

NOTE: DAP A allowed for  $\pm X$  and  $-Z$  (in) THC

At physical sep + 1:00:

DAP: VERN(ALT)

THC: +Z (out) pulses at 10 sec intervals to establish RDOT > 0.1 fps

At physical sep + 3:00 and when RNG > 30 ft (DP-DP):

THC: +Z (out) as reqd at 10 sec intervals to establish and maintain RDOT > 0.2 fps

When RNG > 50 ft (DP-DP):

GNC 23 RCS

√RCS FWD – ITEM 1 EXEC (\*)

JET DES F1F – ITEM 31 EXEC (no \*)

F2F – ITEM 35 EXEC (no \*)

When RNG > 75 ft (DP-DP):

DAP: LO Z

NOTE: DAP A allowed for  $\pm X$  and  $\pm Z$  THC

When RNG > 100 ft (DP-DP):

If radar desired, perform INIT RADAR ACQ 10A, 2-10

Perform DOCKING MECHANISM POWERDOWN (APDS), 8-6

## 2. PERFORM RADIAL BURN ON $\pm V$ BAR

When RNG > 150 ft (DP-DP):

DAP: A/LVLH/VERN(PRI), LO Z

DAP TRANS: NORM/PULSE/PULSE

THC: +X (up) for 12 sec (3.0 fps)

DAP TRANS: PULSE/PULSE/PULSE

FLT CNTLR PWR – OFF

DAP: A/INRTL/VERN(ALT)

Record Radial Burn TIG \_\_\_ / \_\_\_ : \_\_\_ : \_\_\_

Inform MCC when burn complete

At radial burn TIG + 6 min or when RNG > 1000 ft confirmed:

GNC 20 DAP CONFIG

Config DAP A,B to A7,B7

DAP: no LO Z

Cont next page

### 3. PERFORM FINAL BURN

NOTE: OMS burns:

If initial sep from +Vbar attitude, Final burn TIG should be NET Radial Burn

TIG + 13 min and NLT Radial Burn TIG + 60 min

If initial sep from -Vbar attitude, Final burn TIG should be NET Radial Burn

TIG + 13 min and NLT Radial Burn TIG + 40 min

+ X burns:

Final Burn TIG is Radial Burn TIG + 13 min

If performing emergency deorbit:

√MCC/PGSC for deorbit burn TIG/PAD

TV ROLL – ITEM 5 +1 8 0 EXEC

Go to EMERGENCY DEORBIT PREP/ENTRY (CONT DEORBIT,  
EMERGENCY)

Use single OMS burn procedures >>

If prop leak:

Go to LEAKING OMS PRPLT/He BURN (ORB PKT, OMS) >>

If other OMS burn:

Go to RNDZ OMS BURN, 5-4, use single OMS burn procedures >>

If +X burn:

√MCC for +X burn TIG and direction

NOTE: Posigrade burn should be performed if second docking attempt  
desired or if deorbit same day

GNC, OPS 202 PRO

GNC ORBIT MNVR EXEC

√RCS SEL – ITEM 4 EXEC (\*)

If posigrade sep desired:

TGT PEG 7 ΔVX – ITEM 19 +3 EXEC

ΔVY – ITEM 20 +0 EXEC

ΔVZ – ITEM 21 +0 EXEC

If retrograde sep desired:

TGT PEG 7 ΔVX – ITEM 19 –3 EXEC

ΔVY – ITEM 20 +0 EXEC

ΔVZ – ITEM 21 +0 EXEC

LOAD – ITEM 22 EXEC

TIMER – ITEM 23 EXEC

MNVR – ITEM 27 EXEC (\*)

DAP: B/AUTO/PRI

At TIG -0:30:

FLT CNTLR PWR – ON

DAP: A/INRTL/PRI

At TIG:

THC: Trim VGOs ≤ 0.2 fps

FLT CNTLR PWR – OFF

DAP: A/INRTL/VERN(ALT)

GNC, OPS 201 PRO

Go to TERMINATE SEP OPS 8C, 2-8

## ANY ATTITUDE SEPARATION

### CAUTION

For time-critical undocking procedures, go to 9.101 JOINT EXPEDITED UNDOCKING AND SEPARATION (SODF: JOINT OPS, EMERGENCY RESPONSE)

If not hard-mated, start in step 3

Constraints for use:

Stack angular rates  $\leq 0.12$  deg/sec per axis

APDS ring relative misalignment  $< 5^\circ$  per axis (as read in C/L camr)

#### 1. INSTALL RNDZ TOOLS

If rendezvous tools already installed, go to step 2

Perform C/L CAM INSTALL (PHOTO/TV, CENTERLINE (C/L) CAMR)

Perform CCTV CONFIG FOR DOCKING/UNDOCKING (RNDZ TOOLS), 7-2

If reqd, install -Z COAS

If RPOP setup reqd:

GNC 33 REL NAV

ORB TO TGT – ITEM 10 EXEC

RNDZ NAV ENA – ITEM 1 EXEC (\*)

Perform RPOP INITIALIZATION (RNDZ TOOLS), 7-8, then:

Perform RPOP OPS (RNDZ TOOLS), 7-9, then:

Perform TCS ACTIVATION (RNDZ TOOLS), 7-18, steps 1 to 3, then:

Perform TCS MANUAL ACQUISITION (RNDZ TOOLS), 7-19, step 1

(Set RANGE = 4 ft, AZIMUTH = 0, ELEVATION = 0)

Note: TCS will not track until after undock

Perform HHL CHECKOUT (RNDZ TOOLS), 7-6

#### 2. CONFIGURE FOR UNDOCKING

√ISS: FREE

A6U √DAP: FREE

√SENSE: -Z

AFT ADI ATT – LVLH

ERR – MED

RT – MED

GNC 20 DAP CONFIG

Config DAP A,B to A9/B9

X Jets ROT ENA – ITEM 7 EXEC (no \*)

DAP: B/FREE/ALT, no LO Z

√DAP TRANS: PULSE/PULSE/PULSE

GNC 23 RCS

Reselect manually deselected primary jets (no \*) except F1F and F2F

O14:E, All DDU cbs (six) – cl

O15:E,

O16:E

O14:F, Pri RJD LOGIC, DRIVER (sixteen) – ON

O15:F,

O16:F

Perform DOCKING MECHANISM POWERUP (APDS), 8-5

Cont next page

3. COMMAND SEPARATION

Perform UNDOCKING PREP (APDS), 8-7

If APDS spring-assisted separation not expected (not hard-mated):

A7L

On MCC GO, and when  $-0.12 \leq \text{ROLL, PITCH, YAW RATE} \leq 0.12$

APDS CIRC PROT OFF pb – push

√CIRCUIT PROTECT OFF It – It on

OPEN LATCHES pb – push

√LATCHES CLOSED It – It off

√OPEN It – It on

If APDS spring-assist expected (hard-mated):

On MCC Go, and when  $-0.12 \leq \text{ROLL, PITCH, YAW RATE} \leq 0.12$

Perform UNDOCKING OPERATIONS 6A, 2-6, step 3

4. INITIAL SEPARATION SEQUENCE

A6U

FLT CNTLR PWR – ON

When capture latches/hooks open:

If no spring-assisted separation:

DAP: B/FREE/ALT, no LO Z

THC: +Z (out) 4 pulses at 10 sec intervals

Do not attempt to maintain 8 degree corridor

If spring-assisted separation:

When petals clear:

DAP: B/LVLH/ALT, no LO Z

THC: as reqd to maintain target within 8 deg corridor on C/L camera

At physical sep +1:00:

DAP: LVLH/VERN(PRI)

THC: as reqd to maintain target within 8 degree corridor on C/L camera

THC: +Z (out) pulses at 10 sec intervals to establish  $\text{RDOT} > 0.1 \text{ fps}$ , then  
no +Z (out) pulses until 30 ft step

Note: DAP A allowed for  $\pm X$  and  $-Z$  (in) THC

If Rdot falls below 0.02 fps, establish opening rate  $\leq 0.05 \text{ fps}$  using +Z (out) pulses at 10 second intervals, then wait  $>2 \text{ min}$  to perform 30 ft step

If reqd, perform TCS MANUAL ACQUISITION (RNDZ TOOLS), 7-19, step 2 |

At physical sep +3:00 and when  $\text{RNG} > 30 \text{ ft}$  (DP to DP):

THC: +Z (out) as reqd at 10 sec intervals to establish and maintain  $\text{RDOT} > 0.2 \text{ fps}$

When  $\text{RNG} > 50 \text{ ft}$  (DP to DP):

GNC 23 RCS

√RCS FWD – ITEM 1 EXEC (\*)

JET DES F1F – ITEM 31 EXEC (no \*)

F2F – ITEM 35 EXEC (no \*)

When  $\text{RNG} > 75 \text{ ft}$  (DP to DP):

DAP: LO Z

Note: DAP A allowed for  $\pm X$  and  $\pm Z$  THC

When  $\text{RNG} > 100 \text{ ft}$  (DP to DP):

If radar desired, perform INIT RADAR ACQ 10A, 2-10

A7L

POWER OFF pb – push

If reqd, perform DOCKING RING RETRACTION (NOT MATED) (APDS), 8-9

Perform DOCKING MECHANISM POWERDOWN (APDS), 8-6

Cont next page

5. PERFORM +X BURN AT RNG > 150 FT

When RNG > 150 ft (DP-DP):

DAP: A/LVLH/VERN(PRI), LO Z

DAP TRANS: NORM/PULSE/PULSE

THC: +X (up) for 8 sec (2.0 fps)

DAP TRANS: PULSE/PULSE/PULSE

Record +X Burn TIG \_\_\_ / \_\_\_ : \_\_\_ : \_\_\_

Stop maintaining 8 deg corridor

Inform MCC when burn complete

6. ROTATE TO PLACE AND MAINTAIN ISS IN OVHD WINDOW

DAP: A/INRTL/PRI

Perform manual pitch rotation as reqd:

DAP ROT: DISC/PULSE/DISC

RHC: ± PITCH as reqd to place and maintain ISS in OVHD Window

When RNG > 1000 ft (CG-CG):

DAP: no LO Z

7. PERFORM OUT-OF-PLANE BURN

GNC 20 DAP CONFIG

Config DAP A,B to A7/B7

GNC, OPS 202 PRO

GNC ORBIT MNVR EXEC

√RCS SEL – ITEM 4 EXEC (\*)

Set TIG to +X Burn TIG + 22 min

TGT PEG 7 ΔVX – ITEM 19 +0 EXEC

ΔVY – ITEM 20 +2.5 EXEC

ΔVZ – ITEM 21 +0 EXEC

LOAD – ITEM 22 EXEC

TIMER – ITEM 23 EXEC

If VGO Z is negative:

TGT PEG 7 ΔVY – ITEM 20 -2.5 EXEC

LOAD – ITEM 22 EXEC

TIMER – ITEM 23 EXEC

√VGO Z ≥ 0

Do not maneuver to burn attitude

At TIG:

√RNG > 1500 ft (CG-CG)

A6U FLT CNTLR PWR – OFF

DAP ROT: DISC/DISC/DISC

F6 FLT CNTLR PWR – ON

THC: trim VGOs ≤ 0.2 fps

FLT CNTLR PWR – OFF

Record Out-of-Plane Burn TIG \_\_\_ / \_\_\_ : \_\_\_ : \_\_\_

Cont next page

8. PERFORM FINAL BURN

√MCC for final burn engine selection and breakout direction

NOTE: Posigrade burn should be performed if second docking attempt desired  
or if deorbit same day

If single OMS burn:

√MCC for burn TIG

Perform RNDZ OMS BURN, 5-4

If + X burn:

If posigrade sep desired:

If  $\Delta VY$  from Out-of-Plane burn (step 4) was positive:

TV ROLL – ITEM 5 +2 7 0 EXEC

If  $\Delta VY$  from Out-of-Plane burn (step 4) was negative:

TV ROLL – ITEM 5 +9 0 EXEC

TGT PEG 7  $\Delta VX$  – ITEM 19 +7.0 EXEC

$\Delta VY$  – ITEM 20 +0 EXEC

$\Delta VZ$  – ITEM 21 +0 EXEC

If retrograde sep desired:

If  $\Delta VY$  from Out-of-Plane burn (step 4) was positive:

TV ROLL – ITEM 5 +9 0 EXEC

If  $\Delta VY$  from Out-of-Plane burn (step 4) was negative:

TV ROLL – ITEM 5 +2 7 0 EXEC

TGT PEG 7  $\Delta VX$  – ITEM 19 -7.0 EXEC

$\Delta VY$  – ITEM 20 +0 EXEC

$\Delta VZ$  – ITEM 21 +0 EXEC

Set TIG to Out-of-Plane Burn TIG + 22 min

LOAD – ITEM 22 EXEC

TIMER – ITEM 23 EXEC

MNVR – ITEM 27 EXEC (\*)

DAP: B/AUTO/PRI

At TIG -0:30:

F6 FLT CNTLR PWR – ON

DAP: A/INRTL/PRI

At TIG:

F6 THC: trim VGOs  $\leq 0.2$  fps

FLT CNTLR PWR – OFF

DAP: A/INRTL/VERN(ALT)

GNC, OPS 201 PRO

Go to TERMINATE SEP OPS 8C, 2-8



## Ti DELAY BURN

### 1. OPS 202 PRO

GNC ORBIT MNVR EXEC

Load Ti Delay Pad, 3-7

If no Ti Delay targets available:

Add 3.0 fps to  $\Delta V_x$  of last Ti burn solution

Burn  $\Delta V_y$  and  $\Delta V_z$  as computed in last Ti burn solution

Max TIG Slip is 4 minutes

#### NOTE

Guidance will downmode to EXT  $\Delta V$

If RCS:

Perform RCS BURN (Cue Card)

If OMS:

Perform RNDZ OMS BURN (CONTINGENCY OPS), 5-4

### 2. Reload new BASETIME per final Ti PAD, 3-7

GNC 34 ORBIT TGT

TGT NO – ITEM 1 +1 EXEC

Set BASETIME to new Ti TIG \_\_\_/\_\_\_:\_\_\_:\_\_\_

Load – ITEM 26 EXEC

Reset ET, SM timers to new Ti TIG

If Ti Delay executed because no comm:

Add 0/01:32:00 to BASE TIME for subsequent delay rev

See LOSS OF COMM (CONTINGENCY OPS), 5-31

If no comm for 2 delay revs:

#### NOTE

Ti Delay breakout is a 1.5 fps posigrade burn at the next Ti point

Perform RNDZ BREAKOUT (CONTINGENCY OPS), 5-18, with the following deltas:

Set TIG to BASE TIME

TGT PEG 7  $\Delta V_x$  – ITEM 19 +1.5 EXEC

$\Delta V_y$  – ITEM 20 +0 EXEC

$\Delta V_z$  – ITEM 21 +0 EXEC

Perform TERMINATE SEP OPS 8C, 2-8

### 3. Perform Post Ti Nav 16A, 4-16, then

Return to RENDEZVOUS TIMELINE at PET: -01:25, 4-11

#### NOTE

Extra NCC Burn and Ti Onboard Solution pads, 5-28

### NCC BURN SOLUTION

TIG

			/			:			:		
--	--	--	---	--	--	---	--	--	---	--	--

PRELIMINARY

INTERMEDIATE

ΔVX

( )			.	
-----	--	--	---	--

( )			.	
-----	--	--	---	--

ΔVY

( )			.	
-----	--	--	---	--

( )			.	
-----	--	--	---	--

ΔVZ

( )			.	
-----	--	--	---	--

( )			.	
-----	--	--	---	--

ΔVT

			.	
--	--	--	---	--

			.	
--	--	--	---	--

FINAL

GROUND

FINAL-GROUND  
LIMITS

ΔVX

( )			.	
-----	--	--	---	--

( )			.	
-----	--	--	---	--

( . )

ΔVY

( )			.	
-----	--	--	---	--

( )			.	
-----	--	--	---	--

( . )

ΔVZ

( )			.	
-----	--	--	---	--

( )			.	
-----	--	--	---	--

( . )

ΔVT

			.	
--	--	--	---	--

			.	
--	--	--	---	--

( . )

### Ti ONBOARD SOLUTIONS

PREL FLTR

1ST INTER FLTR

2ND INTER FLTR  
(IF REQD)

( )			.	
( )			.	
( )			.	
			.	

( )			.	
( )			.	
( )			.	
			.	

( )			.	
( )			.	
( )			.	
			.	

FINAL FLTR

PROP  
(IF REQD)

FINAL-GROUND  
LIMITS

( )			.	
( )			.	
( )			.	
			.	

( )			.	
( )			.	
( )			.	
			.	

( )			.	
( )			.	
( )			.	
			.	

FINAL Ti PAD (MNVR PADS)

## RNDZ NAV RECOVERY

1. If Recovery from OPS MODE RECALL:  
 (add/delete GPC to/from redundant set)  
GNC 33 REL NAV  
  
 RNDZ NAV ENA – ITEM 1 EXEC (\*)  
GNC UNIV PTG  
 TRK – ITEM 19 (CUR-\*)  
 Go to step 3
  
2. If Recovery from OPS TRANSITION (G8/G3 to G2):  
GNC 34 ORBIT TGT  
 TGT NO – ITEM 1 +1 EXEC  
 Set BASE TIME to Ti TIG (Ti Burn Pad, 3-6)  
 LOAD – ITEM 26 EXEC  
GNC 33 REL NAV  
 Upon MCC uplink of TGT SV,  
 RNDZ NAV ENA – ITEM 1 EXEC (\*)

### NOTE

If RNDZ NAV not enabled (no \*),  
**DO NOT PROCEED.** √MCC

Select appropriate target track attitude

GNC UNIV PTG

	-Z	-Y (STRK)	+Y
TGT ID	+1	+1	+1
BODY VECT	+3	+4	+5
P	√+90	√+0	+0
Y	√+0	√+280.6	+90
OM	+0	+90	+180

TRK – ITEM 19 (CUR-\*)

- C3
3. DAP: ALT  
 DAP: A/AUTO  
 DAP ROT: DISC/DISC/DISC  
 When in attitude, DAP: VERN

If NAV sensor data available:

If STRK NAV:

Go to STAR TRACKER NAV 10A, 4-10 >>

If RR NAV:

GNC 33 REL NAV

CRT KU ANT ENA – ITEM 2 (\*)

GNC I/O RESET

Go to RR NAVIGATION 13B, 4-13

## TGT ITER

When in Lambert Targeting and TGT ITER occurs:

If PRED MATCH other than 999999 (all 9s):

√MCC and read down PRED MATCH from SPEC 34 (MCC has delta Vs)

On MCC GO or if no comm:

Recall TGT set and recompute

If TGT ITER recurs and PRED MATCH less than 400:

Contact MCC and read down PRED MATCH from SPEC 34

On MCC GO or if no comm:

Load current delta Vs and execute as Lambert burn >>

If TGT ITER recurs and PRED MATCH greater than 400:

Contact MCC and read down PRED MATCH from SPEC 34

On MCC GO or if no comm:

Load ground solution and execute as EXT DV burn

(If MC burn, uplink of ground solution reqd) >>

If ground solution not available: No burn >>

If PRED MATCH 999999 (all 9s):

On MCC GO or if no comm:

Load ground solution and execute as EXT DV burn

(If MC burn, uplink of ground solution reqd) >>

If ground solution not available: No burn >>

## LOSS OF COMM

If comm with MCC is lost during rendezvous ops, attempt to establish comm by performing 6.105 SSOR ACTIVATION (SODF: JOINT OPS, COMM/DATA), and COMM LOST (ORB PKT, COMM). Do not maneuver out of target track attitude unless all other means of acquiring comm are expended

### Ground-Targeted Burns

1. If NH or NC PADs not available, do not perform burn
2. If a day of rendezvous NC or NH maneuver was not performed nominally, then discontinue rendezvous operations
3. If the day of rendezvous NC maneuver is performed using preliminary pads, a large NCC burn can be expected

### Lambert-Targeted Burns

1. If "GO for Ti" not received from MCC by Ti TIG - 5 min, perform Ti DELAY BURN (CONTINGENCY OPS), 5-27. If comm is not recovered after two delay revs, perform modified RNDZ BREAKOUT per Ti DELAY BURN (CONTINGENCY OPS), 5-27
2. If radar nav was stopped in an attempt to get Ku comm during the delay, do not perform second or third NCC burn unless radar nav is re-enabled and sufficient radar marks are taken to provide a converged solution
3. If no comm for any midcourse correction (MC) burn, perform burn and continue to prox ops

### Prox Ops

1. If "GO for RPM" not received from MCC, do not perform Rbar Pitch Maneuver. Proceed directly to the TORVA and continue to the Vbar. On the Vbar, stationkeep for a maximum of 1 rev and attempt to re-establish comm. If no comm after 1 rev of stationkeeping, perform VBAR BREAKOUT (CONTINGENCY OPS), 5-14
2. If "GO to proceed inside 600 ft" not received from MCC, do not approach inside 600 ft (CG-CG). Stationkeep on the Vbar outside of 600 ft for a maximum of 1 rev and attempt to re-establish comm. If no comm after 1 rev of stationkeeping, perform VBAR BREAKOUT (CONTINGENCY OPS), 5-14
3. If "go for docking" not received from MCC do not attempt docking. Back out (if required) and stationkeep outside of 250 ft for a maximum of 1 rev and attempt to re-establish comm. If no comm after 1 rev of stationkeeping, go to VBAR BREAKOUT (CONTINGENCY OPS), 5-14

This Page Intentionally Blank

DEGRADED CONTROL

DEGRADED  
CONTROL

This Page Intentionally Blank

DEGRADED  
CONTROL



## DEGRADED +X TRANSLATION

### NOTE 1

Degraded +X occurs with loss of L1A and L3A or R1A and R3A.  
Perform these procedures in addition to nominal approach or separation procedures.

√MCC for additional procedure updates

### NOTE 2

NO-GO for RPM.

LO Z +Z translation is not effective, do not perform LO Z +Z translation (braking).

+X translation pulses must be doubled to attain desired  $\Delta V$ .

+X translation couples into Y translation toward the failed jets  
(selection of DAP P,Y – ALL minimizes coupling)

1. Between Ti and TORVA initiation, continue to Rbar and initiate TORVA:

Perform APPROACH (Cue Card), with the following deltas:

Bias Rdot 0.1 fps slower than Cue Card

Do not perform LO Z +Z translation (braking)

Perform DAPS A9, B9 PITCH AND YAW TO ALL [A]

Do not perform RPM

Initiate TORVA with approx 0.1 fps slower Rdot

Double +X pulses to initiate TORVA

Null Ydot (approx 0.1 fps) immediately after TORVA initiation

2. Between TORVA initiation and RNG = 250, continue to Vbar:

Perform APPROACH (Cue Card) with the following deltas:

Do not perform LO Z +Z translation (braking)

Perform DAPS A9, B9 PITCH AND YAW TO ALL [A]

When ready to ESTABLISH VBAR,

DAP: No LO Z, stay No LO Z thru dock

If Rdot exceeds cue card limit:

DAP: B

THC: Brake to cue card limit using 10 sec pulse spacing

3. Inside RNG = 250, continue approach to docking

Perform VBAR APPROACH (Cue Card) with the following deltas:

If RNG > 75 ft:

DAP: No LO Z, stay No LO Z thru dock

Perform DAPS A9, B9 PITCH AND YAW TO ALL [A]

If Rdot exceeds cue card limit:

DAP: B

THC: Brake to cue card limit using 10 sec pulse spacing

If RNG < 75 ft,

No changes to approach procedures

DAPS A9, B9 PITCH AND YAW TO ALL [A]

GNC 20 DAP CONFIG

DAP EDIT – ITEM 3 +9 EXEC

PRI P OPTION – ITEM 55 EXEC – (ALL)

PRI Y OPTION – ITEM 56 EXEC – (ALL)

LOAD – ITEM 5 EXEC

DAP EDIT – ITEM 4 +9 EXEC

PRI P OPTION – ITEM 55 EXEC – (ALL)

PRI Y OPTION – ITEM 56 EXEC – (ALL)

LOAD – ITEM 5 EXEC

4. During docked operations, or undocking and separation:

√MCC for updates to UNDOCKING/SEP TIMELINE

## DEGRADED -X TRANSLATION

### NOTE 1

Degraded -X occurs with loss of any two forward-firing jets (F1F, F2F, F3F). Perform these procedures in addition to nominal approach or separation procedures.

√MCC for additional procedure updates

### NOTE 2

LO Z +Z translation (braking) couples strongly into +X translation.  
Forward-firing jet deselect/reselect at 75 ft not required

During approach, backout, breakout, or separation:

If LO Z +Z translation (braking) is required, perform 4-6 -X pulses for every 1 LO Z +Z pulse

Double the number of degraded -X pulses to achieve desired -X translation

## LOSS OF FORWARD SIDE-FIRING JETS

### NOTE 1

This failure occurs with the loss of F1L and F3L or F2R and F4R. Perform these procedures in addition to the nominal approach, or separation procedures.

√MCC for additional procedure updates

### NOTE 2

DAP disables  $\pm Y$  translation.

NO-GO for RPM, approach within 250 ft, or docking

During approach:

If failure occurs post-Ti:

Do not trim VGO Y on MC1-4

If in -Z TGT TRK, do not perform MANUAL OUT-OF-PLANE NULL 19A, 4-19

Do not approach inside 250 ft (interface to interface)

If inside 250 ft, perform VBAR CORRIDOR BACKOUT (CONTINGENCY OPS), 5-12 to RNG > 250 ft, with the following deltas:

Maintain 8 deg corridor in X-axis direction

If 8 deg corridor is violated in X or Y direction and 250 ft > RNG > 150 ft, go to VBAR BREAKOUT (CONTINGENCY OPS), 5-14

When RNG = 250 ft, √MCC for further actions

## LOSS OF ONE FxD JET

### NOTE

Failure occurs with the loss of any one of the following jets: F1D, F2D, F3D, or F4D.

Perform these procedures in addition to nominal approach or separation procedures.  
NO-GO for RPM

If VERNS failed, perform APPROACH and VBAR APPROACH Cue Cards with following deltas:

Do not perform braking (LO Z or NORM Z) between 600 ft and the Vbar (PITCH ERR < 2 deg)

When in Vbar attitude (PITCH ERR < 2 deg):

DAP: NO LO Z, maintain NORM Z until docking

For braking, use DAB B +Z (out) pulses at 10-sec intervals

When RNG = 75 ft:

10-sec intervals for +Z (out) pulses no longer required

When RNG = 30 ft:

Stationkeep:

THC: +Z (out) as reqd to null Rdot

When ready to initiate final approach:

THC: -Z (in) as reqd to establish Rdot = -0.07 fps

Note: This verifies the health of the remaining FxD jet

## LOSS OF BOTH FxD JETS (SAME SIDE)

- \* Perform the IMMEDIATE ACTIONS for the 2FxD CASE on the \*  
\* RCS FAILURE DURING PROX OPS Cue Card \*

### NOTE 1

Failure occurs with loss of F1D and F3D, or F2D and F4D.  
Perform these procedures in addition to nominal approach or separation procedures.

√MCC for additional procedure updates

### NOTE 2

NO-GO for RPM, approach within 250 ft, or docking.

DAP disables  $\pm Y$  translation.

Reselecting failed forward down-firing jet overrides DAP lockout of  $\pm Y$  translation.

Do not perform LO Z +Z translation(braking) or PCT.

LO Z +Z translation(braking) will couple into -Z translation(closing) and Y translation toward failed jets.

Norm Z DAP B braking on Vbar (when RNG > 75 ft) is to be performed at 10-sec intervals (pulses at 10 sec intervals minimizes structural resonance).

-Z translation couples into Y translation toward failed jets.

-X translation couples into -Z translation (closing) in LO Z PRI control.

DAP PRI P OPTION – TAIL, Y OPTION – ALL minimizes Y translation effects resulting from attitude control firings

1. If failure occurs prior to  $T_i$ , delay RNDZ until failed jet(s) recovered:  
Perform CONFIG PITCH OPTION TO TAIL [A]  
If failed jet(s) not recovered, √MCC for breakout procedure >>
2. If failure occurs between  $T_i$  and TORVA initiation, continue to Rbar:  
Perform CONFIG PITCH OPTION TO TAIL [A]  
Do not trim VGO Y on MC1-4  
If in -Z TGT TRK, do not perform MANUAL OUT-OF-PLANE NULL [19A], 4-19  
After CONFIG FOR RBAR [20B], 4-20 perform CONFIG PITCH OPTION TO TAIL [A]  
Perform APPROACH (cue card) with following deltas:  
Bias Rdot 0.1 ft/s slower than cue card  
Do not perform LO Z +Z(braking) translation  
Perform CONFIG YAW OPTION TO ALL [B]  
Do not perform RPM  
Do not initiate TORVA  
If failed jet(s) not recovered by RNG = 500 ft,  
Go to RNDZ BREAKOUT (CONTINGENCY OPS), 5-18 with following deltas:  
Do not trim VGO Y >>

Cont next page

3. If failure occurs between TORVA initiation and Vbar arrival, continue approach:
  - Perform CONFIG YAW OPTION TO ALL [B]
  - Do not perform LO Z +Z (braking) translations
  - If RNG < 345 cg-cg (280 dp-dp) prior to Vbar arrival, or if 8 deg corridor violated in Y-axis direction:
    - Go to SHUTTLE NOSE IN-PLANE BREAKOUT (R < 700 ft), 5-16 >>
  - When ready to ESTABLISH VBAR (PITCH ERR ≤ 2 deg):
    - DAP: No LO Z
    - Use DAP B +Z (out) pulses at 10 second intervals to maintain Interface RNG > 250 ft
    - Perform REGAIN Y CONTROL [C]
    - Establish and maintain 8 deg corridor
    - If failed jet(s) not recovered, go to step 6
  
4. If failure occurs after Vbar arrival, backout to RNG > 250 ft:
  - Perform VBAR CORRIDOR BACKOUT (CONTINGENCY OPS), 5-12 with following deltas:
    - After establishing opening rate:
      - Config DAP to A9, B9
      - Perform REGAIN Y CONTROL [C]
      - Perform CONFIG DAP YAW OPTION TO ALL [B]
    - When RNG > 75 ft,
      - √DAP: No LO Z
      - Use DAP B +Z (out) pulses at 10-second intervals to maintain opening RDOT
      - If 8 deg corridor violated and 250 ft > RNG > 150 ft, go to step 6
      - When RNG > 250 ft, do not perform -Z translation (maintain opening RDOT)
      - If failed jet(s) not recovered, go to step 6
  
5. If failure occurs while docked, or during undocking/separation:
  - √MCC for updates to UNDOCKING/SEP TIMELINE >>
  
6. Perform VBAR BREAKOUT (CONTINGENCY OPS), 5-14 with following deltas:
  - √DAP: No LO Z
  - In steps 2 and 3, do not select DAP LO Z
  - After step 3:
    - Perform DESELECT FAILED FORWARD DOWN-FIRING JET [D]
    - DAP: LO Z
  - In step 4, do not trim VGO Y

CONFIG PITCH OPTION TO TAIL [A]  
GNC 20 DAP CONFIG  
 A PRI P OPTION – ITEM 15 EXEC (twice)(TAIL)  
 B PRI P OPTION – ITEM 35 EXEC (twice)(TAIL)

CONFIG YAW OPTION TO ALL [B]  
GNC 20 DAP CONFIG  
 A PRI Y OPTION – ITEM 16 EXEC (ALL)  
 B PRI Y OPTION – ITEM 36 EXEC (ALL)

REGAIN Y CONTROL [C]  
 √MCC for which jet to reselect  
GNC 23 RCS  
 RCS FWD – ITEM 1 EXEC (\*)  
 JET DES FxD – ITEM XX EXEC (no \*)

NOTE: Do not perform any THC: -Z (in) commands

DESELECT FAILED FORWARD DOWN-FIRING JET [D]  
 Deselect manually reselected jet  
GNC 23 RCS  
 RCS FWD – ITEM 1 EXEC (\*)  
 JET DES FxD – ITEM XX EXEC (\*)

## LOSS OF VRCS

### NOTE

This procedure overrides LOSS OF VERNIERS (ORB OPS, RCS) during rendezvous ops

1. Utilize VERN fail downmodes (PRI/ALT) specified in parentheses and follow VERN fail starred blocks per timeline. If VERN fail downmode not specified, use PRI Nose and Tail control
2. COAS NAV should not be performed if VERN fail
3. Additional braking pulses (+Z) may be reqd due to LO Z PRI attitude control cross coupling
4. PCT modes to FREE/VERN. In the event of failed capture, mode DAP to PRI per FAILED CAPTURE block, step 2
5. Twelve hooks reqd for mated attitude control in ALT

This Page Intentionally Blank



REFERENCE DATA

ISS RNDZ OPS DAP CONFIGURATIONS.....	6-2
POST-CONTACT THRUST (PCT) REFERENCE DATA.....	6-3
TARGETING DATA .....	6-4
POST NC .....	6-6
Ti .....	6-7
MC3.....	6-8
TCS REFLECTOR VISIBILITY DURING APPROACH.....	6-9
HHL AIMING LOCATIONS .....	6-10
SHUTTLE CENTERLINE TARGET .....	6-11
ISS ATTITUDE CONTROL SYSTEM MODING INDICATORS .....	6-12
RANGING CHARTS .....	6-13
COAS SUBTENDED ANGLES (DEG) VS RANGE (FT).....	6-14

**REFERENCE  
DATA**

ISS RNDZ OPS DAP CONFIGURATIONS

	RNDZ		TERMINAL PHASE		PROX OPS		DOCKING		SPEC 20 ITEM #	
	A7	B7	A8	B8	A9	B9	A10	B10	A	B
<b>PRI</b>										
ROT RATE	0.200	0.500	0.050	0.050	0.130	0.130	0.050	0.050	10	30
ATT DB	2.00	2.00	2.00	2.00	2.00	2.00	0.60	0.60	11	31
RATE DB	0.20	0.20	0.20	0.20	0.10	0.10	0.10	0.10	12	32
ROT PLS	0.10	0.04	0.10	0.04	0.10	0.04	0.10	0.04	13	33
COMP	.000	.000	.000	.000	.000	.000	.000	.000	14	34
P OPTION	ALL	ALL	ALL	ALL	TAIL	TAIL	TAIL	TAIL	15	35
Y OPTION	ALL	ALL	ALL	ALL	TAIL	TAIL	TAIL	TAIL	16	36
TRANS PLS	0.10	0.05	0.10	0.05	0.05	0.01	0.05	0.01	17	37
<b>ALT</b>										
RATE DB	0.10	0.10	0.10	0.10	0.10	0.10	0.10	0.10	18	38
JET OPT	ALL	ALL	ALL	ALL	TAIL	TAIL	TAIL	TAIL	19	39
# JETS	2	2	2	2	2	2	2	2	20	40
ON TIME	0.08	0.08	0.08	0.08	0.08	0.08	0.08	0.08	21	41
DELAY	0.00	0.00	0.00	0.00	0.00	10.00	0.00	0.00	22	42
<b>VERN</b>										
ROT RATE	0.016	0.200	0.050	0.050	0.130	0.130	0.050	0.050	23	43
ATT DB	1.00	1.00	1.00	1.00	1.00	1.00	0.50	0.50	24	44
RATE DB	0.020	0.020	0.020	0.020	0.020	0.020	0.020	0.020	25	45
ROT PLS	0.010	0.002	0.05	0.020	0.050	0.020	0.050	0.020	26	46
COMP	.000	.000	.000	.000	.000	.000	.000	.000	27	47
CNTL ACC	0	0	0	0	0	0	0	0	28	48

## POST-CONTACT THRUST (PCT) REFERENCE DATA

### PBI FUNCTION WHENEVER IN OPS 2:

PBI	When PCT is disarmed. . .	When PCT is armed. . .	When PCT is active. . .
L or R AUTO SB PBI (PBI lit when PCT armed/active)	Arms PCT	Disarms PCT	Disarms and Terminates PCT <sup>1</sup>
L AUTO/MAN BF PBI or DAP: Spare PBI (PBI lit when PCT active)	No Effect	Modes to DAP: FREE/PRI and activates PCT <sup>2</sup>	Terminates PCT <sup>1</sup>
DAP: FREE PBI	Normal Function	Normal Function	Terminates PCT <sup>1</sup>

<sup>1</sup> The following actions occur when PCT terminated by either automatic timeout or manual abort via above PBIs:

- PCT firing sequence terminated
- DAP moded to A/VERN
- DAP A,B configured to A9,B9 (Prox Ops DAP)

<sup>2</sup> Once PBI is depressed, PCT sequence will be initiated within maximum of 0.28 sec. The PCT sequence for ISS docking missions consists of 0.56 sec jet firing sequence, followed by 0.96 delay, completed with 0.88 sec jet firing sequence, giving total PCT sequence duration of 2.4 sec. Two nose jets and two tail jets fire during sequence

- PCT firing sequence can also be aborted by taking RHC/THC out of detent

### TARGETING DATA

SPEC 34 ITEM NO	1			6	17	18	19	20	
TGT ALTITUDE	TGT NO	DESCRIPTION	T1 REL TO BASETIME	EL (DEG)	DT (MIN)	DX (KFT)	DY (KFT)	DZ (KFT)	NOTES
130	9	NCC	-0/00:55:48	0	55.8	-48.6	0	+1.2	BASETIME = Ti TIG
	10	Ti	0/00:00:00	0	74.4	-0.9	0	+1.8	
	11	MC1	0/00:20:00	0	54.4	-0.9	0	+1.8	
	12	MC2	0/00:47:24	28.45	27.0	-0.9	0	+1.8	BASETIME = MC2 TIG
	13	MC3	0/00:17:00	0	10.0	-0.9	0	+1.8	
	14	MC4	0/00:27:00	0	13.0	0	0	+0.6	
	19	MC2 ON TIME	0/00:00:00	0	27.0	-0.9	0	+1.8	
150	9	NCC	-0/00:56:18	0	56.3	-48.6	0	+1.2	BASETIME = Ti TIG
	10	Ti	0/00:00:00	0	75.1	-0.9	0	+1.8	
	11	MC1	0/00:20:00	0	55.1	-0.9	0	+1.8	
	12	MC2	0/00:48:06	28.46	27.0	-0.9	0	+1.8	BASETIME = MC2 TIG
	13	MC3	0/00:17:00	0	10.0	-0.9	0	+1.8	
	14	MC4	0/00:27:00	0	13.0	0	0	+0.6	
	19	MC2 ON TIME	0/00:00:00	0	27.0	-0.9	0	+1.8	
170	9	NCC	-0/00:56:48	0	56.8	-48.6	0	+1.2	BASETIME = Ti TIG
	10	Ti	0/00:00:00	0	75.7	-0.9	0	+1.8	
	11	MC1	0/00:20:00	0	55.7	-0.9	0	+1.8	
	12	MC2	0/00:48:42	28.66	27.0	-0.9	0	+1.8	BASETIME = MC2 TIG
	13	MC3	0/00:17:00	0	10.0	-0.9	0	+1.8	
	14	MC4	0/00:27:00	0	13.0	0	0	+0.6	
	19	MC2 ON TIME	0/00:00:00	0	27.0	-0.9	0	+1.8	
190	9	NCC	-0/00:57:12	0	57.2	-48.6	0	+1.2	BASETIME = Ti TIG
	10	Ti	0/00:00:00	0	76.3	-0.9	0	+1.8	
	11	MC1	0/00:20:00	0	56.3	-0.9	0	+1.8	
	12	MC2	0/00:49:18	28.85	27.0	-0.9	0	+1.8	BASETIME = MC2 TIG
	13	MC3	0/00:17:00	0	10.0	-0.9	0	+1.8	
	14	MC4	0/00:27:00	0	13.0	0	0	+0.6	
	19	MC2 ON TIME	0/00:00:00	0	27.0	-0.9	0	+1.8	
210	9	NCC	-0/00:57:42	0	57.7	-48.6	0	+1.2	BASETIME = Ti TIG
	10	Ti	0/00:00:00	0	76.9	-0.9	0	+1.8	
	11	MC1	0/00:20:00	0	56.9	-0.9	0	+1.8	
	12	MC2	0/00:49:54	29.07	27.0	-0.9	0	+1.8	BASETIME = MC2 TIG
	13	MC3	0/00:17:00	0	10.0	-0.9	0	+1.8	
	14	MC4	0/00:27:00	0	13.0	0	0	+0.6	
	19	MC2 ON TIME	0/00:00:00	0	27.0	-0.9	0	+1.8	

### TARGETING DATA (Cont)

SPEC 34 ITEM NO	1			6	17	18	19	20	
TGT ALTITUDE	TGT NO	DESCRIPTION	T1 REL TO BASETIME	EL (DEG)	DT (MIN)	DX (KFT)	DY (KFT)	DZ (KFT)	NOTES
230	9	NCC	-0/00:58:12	0	58.2	-48.6	0	+1.2	BASETIME = Ti TIG
	10	Ti	0/00:00:00	0	77.6	-0.9	0	+1.8	
	11	MC1	0/00:20:00	0	57.6	-0.9	0	+1.8	
	12	MC2	0/00:50:36	29.32	27.0	-0.9	0	+1.8	BASETIME = MC2 TIG
	13	MC3	0/00:17:00	0	10.0	-0.9	0	+1.8	
	14	MC4	0/00:27:00	0	13.0	0	0	+0.6	
	19	MC2 ON TIME	0/00:00:00	0	27.0	-0.9	0	+1.8	
250	9	NCC	-0/00:58:42	0	58.7	-48.6	0	+1.2	BASETIME = Ti TIG
	10	Ti	0/00:00:00	0	78.2	-0.9	0	+1.8	
	11	MC1	0/00:20:00	0	58.2	-0.9	0	+1.8	
	12	MC2	0/00:51:12	29.55	27.0	-0.9	0	+1.8	BASETIME = MC2 TIG
	13	MC3	0/00:17:00	0	10.0	-0.9	0	+1.8	
	14	MC4	0/00:27:00	0	13.0	0	0	+0.6	
	19	MC2 ON TIME	0/00:00:00	0	27.0	-0.9	0	+1.8	
270	9	NCC	-0/00:59:06	0	59.1	-48.6	0	+1.2	BASETIME = Ti TIG
	10	Ti	0/00:00:00	0	78.9	-0.9	0	+1.8	
	11	MC1	0/00:20:00	0	58.9	-0.9	0	+1.8	
	12	MC2	0/00:51:54	29.80	27.0	-0.9	0	+1.8	BASETIME = MC2 TIG
	13	MC3	0/00:17:00	0	10.0	-0.9	0	+1.8	
	14	MC4	0/00:27:00	0	13.0	0	0	+0.6	
	19	MC2 ON TIME	0/00:00:00	0	27.0	-0.9	0	+1.8	
290	9	NCC	-0/00:59:36	0	59.6	-48.6	0	+1.2	BASETIME = Ti TIG
	10	Ti	0/00:00:00	0	79.5	-0.9	0	+1.8	
	11	MC1	0/00:20:00	0	59.5	-0.9	0	+1.8	
	12	MC2	0/00:52:30	30.03	27.0	-0.9	0	+1.8	BASETIME = MC2 TIG
	13	MC3	0/00:17:00	0	10.0	-0.9	0	+1.8	
	14	MC4	0/00:27:00	0	13.0	0	0	+0.6	
	19	MC2 ON TIME	0/00:00:00	0	27.0	-0.9	0	+1.8	
310	9	NCC	-0/00:60:06	0	60.1	-48.6	0	+1.2	BASETIME = Ti TIG
	10	Ti	0/00:00:00	0	80.1	-0.9	0	+1.8	
	11	MC1	0/00:20:00	0	60.1	-0.9	0	+1.8	
	12	MC2	0/00:53:06	30.25	27.0	-0.9	0	+1.8	BASETIME = MC2 TIG
	13	MC3	0/00:17:00	0	10.0	-0.9	0	+1.8	
	14	MC4	0/00:27:00	0	13.0	0	0	+0.6	
	19	MC2 ON TIME	0/00:00:00	0	27.0	-0.9	0	+1.8	

# POST NC

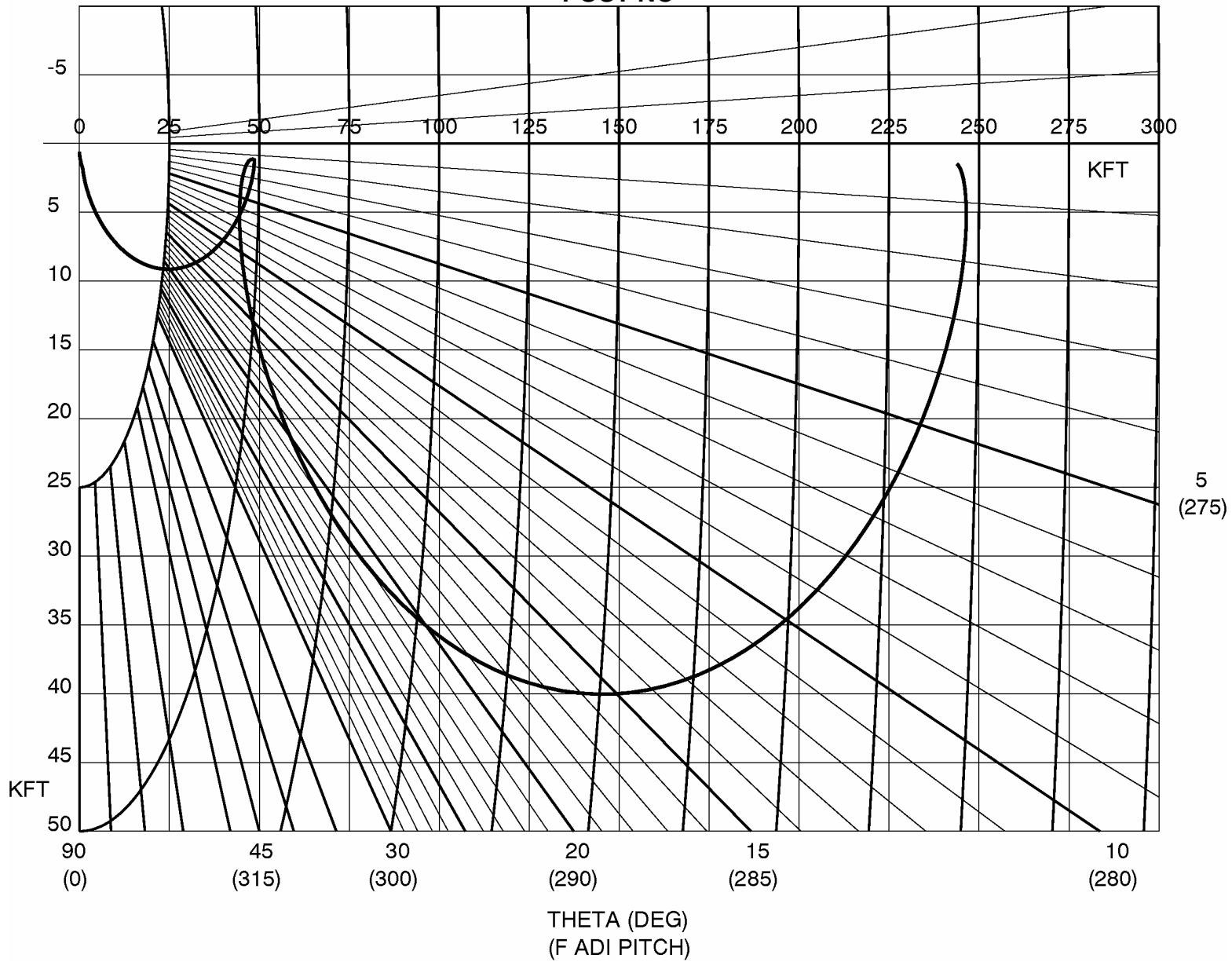

POST Ti

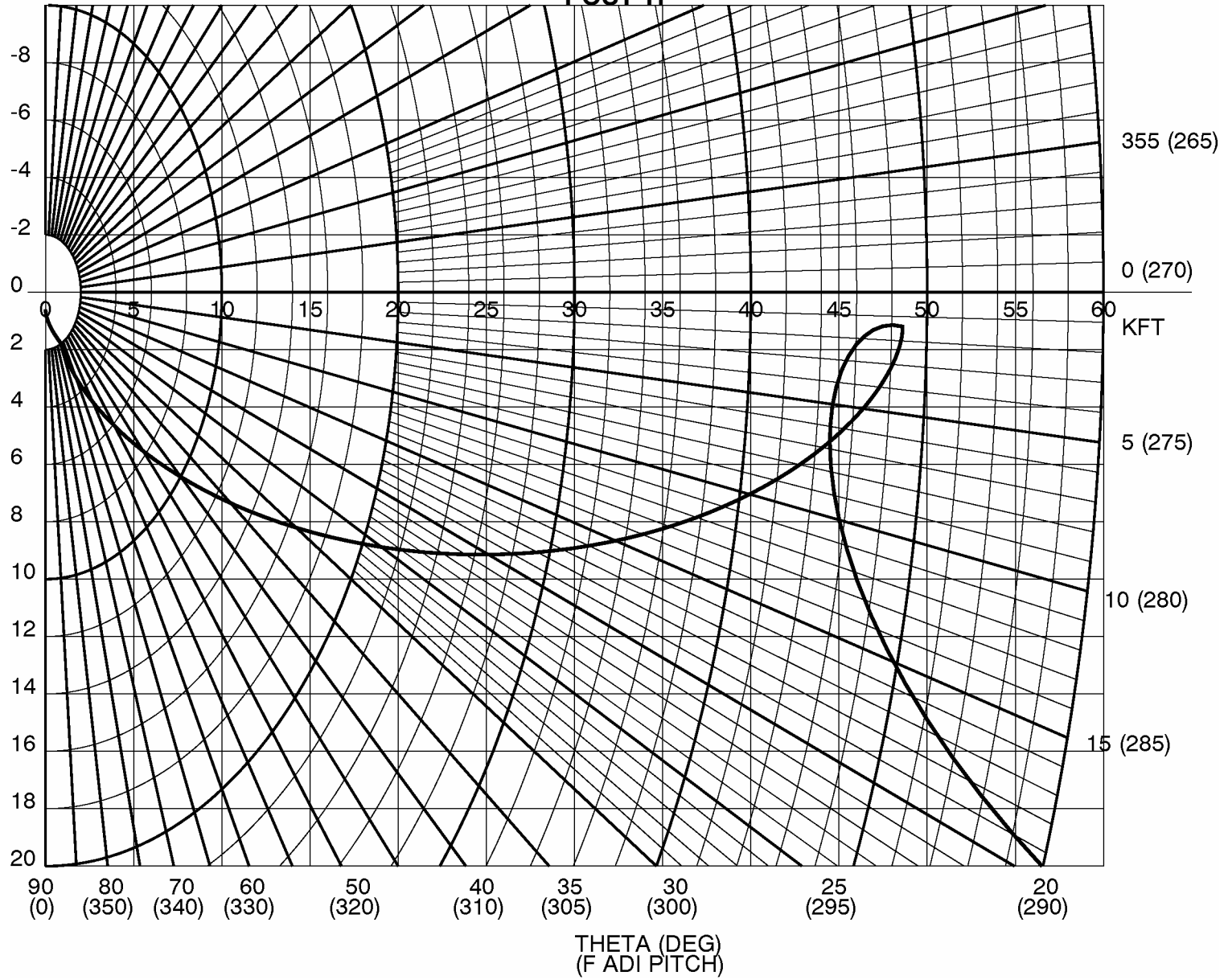

# POST MC3

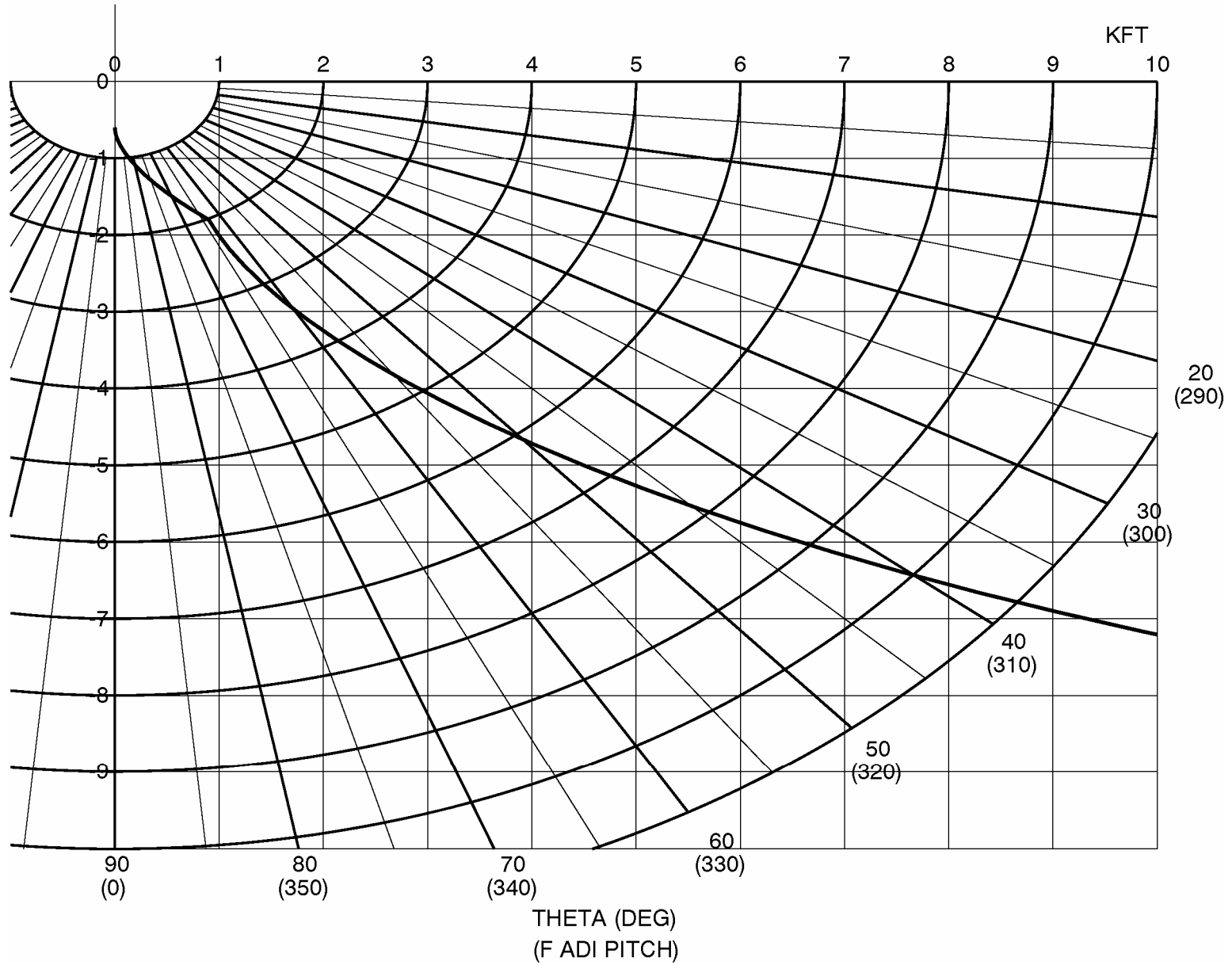



# TCS REFLECTOR VISIBILITY DURING APPROACH

Some arrays and radiators are not shown for clarity of the TCS reflector information

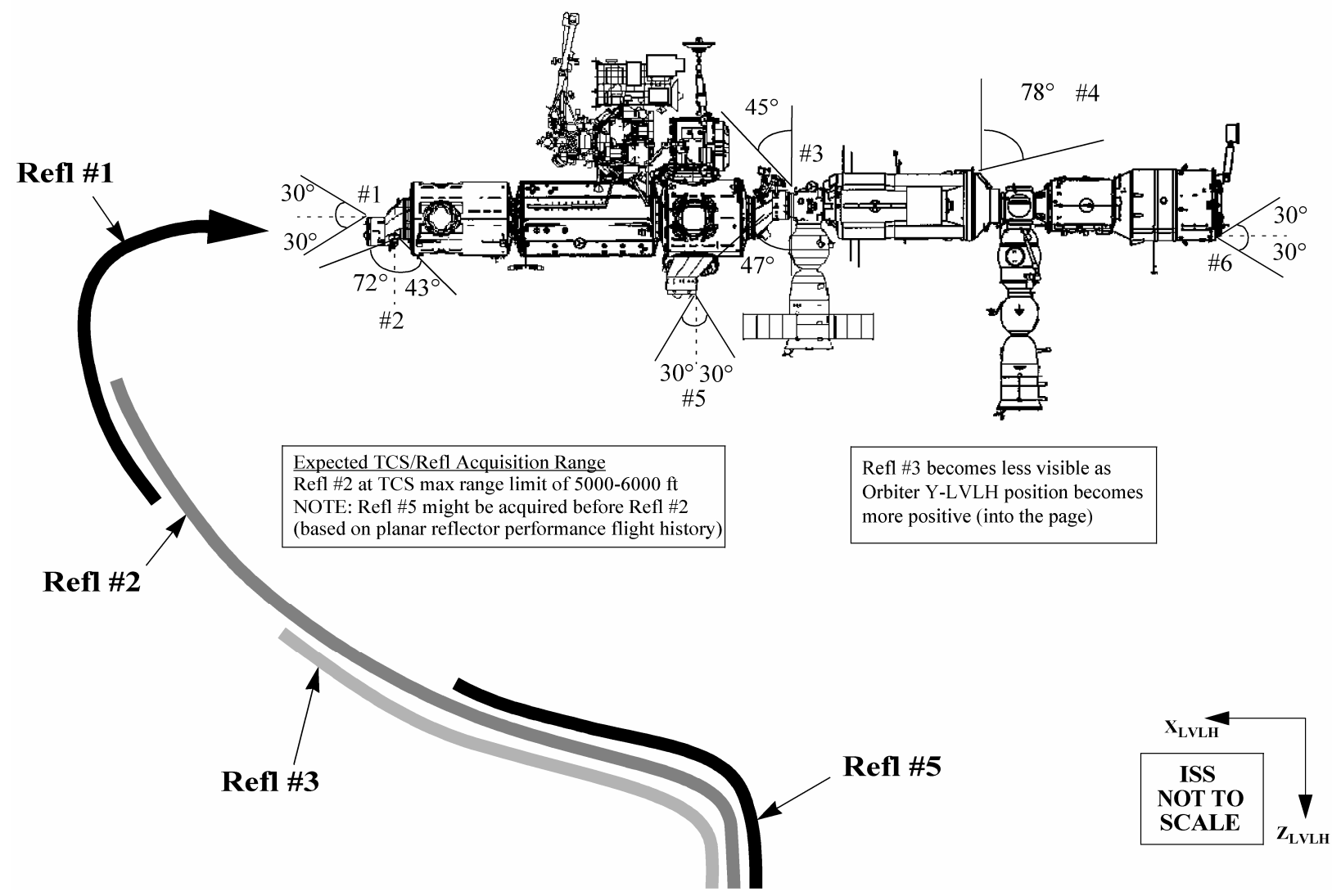

Expected TCS/Refl Acquisition Range  
 Refl #2 at TCS max range limit of 5000-6000 ft  
 NOTE: Refl #5 might be acquired before Refl #2  
 (based on planar reflector performance flight history)

Refl #3 becomes less visible as  
 Orbiter Y-LVLH position becomes  
 more positive (into the page)

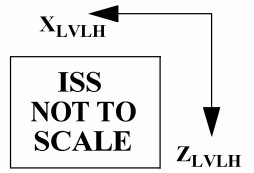

# HHL AIMING LOCATIONS

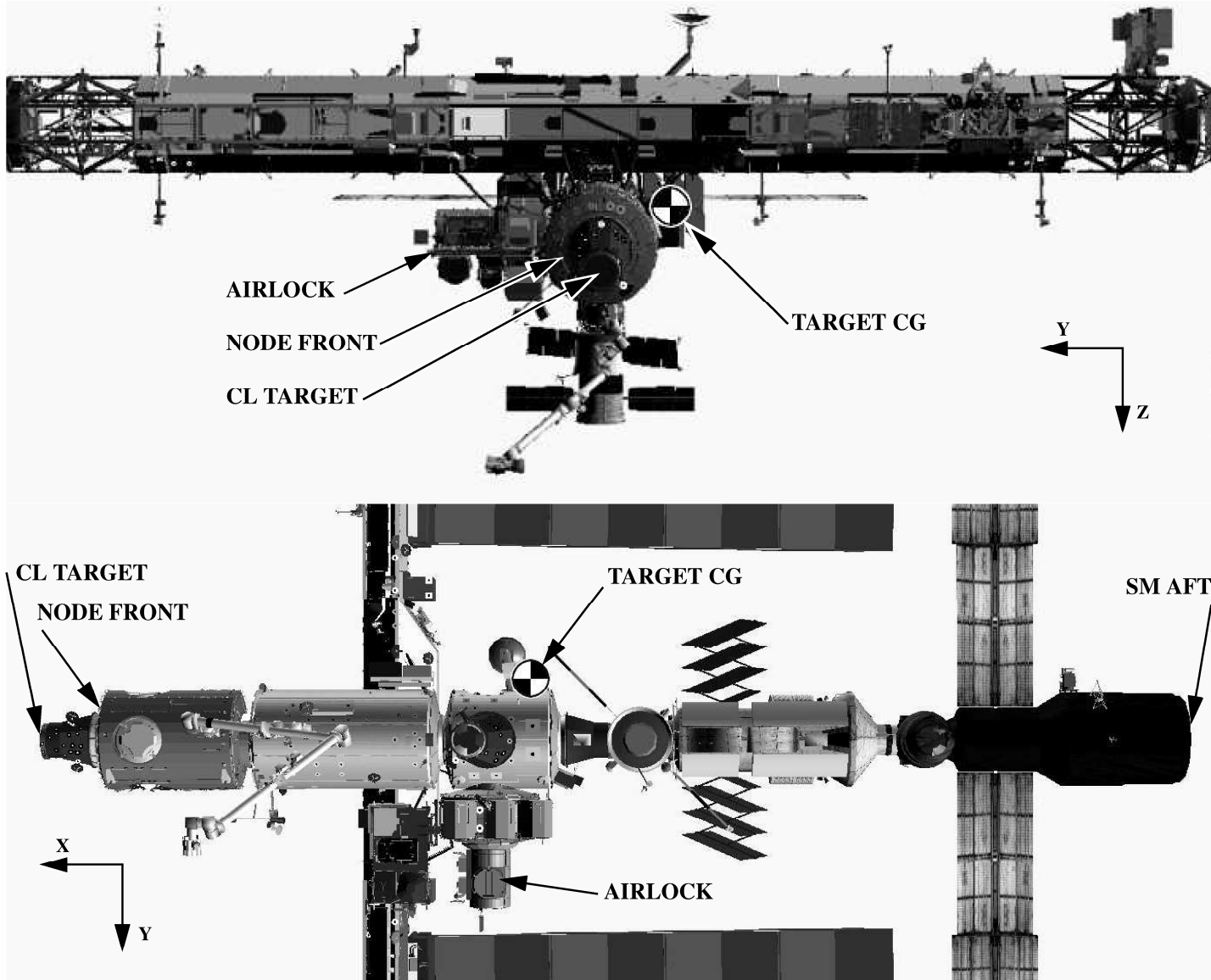

# SHUTTLE CENTERLINE TARGET

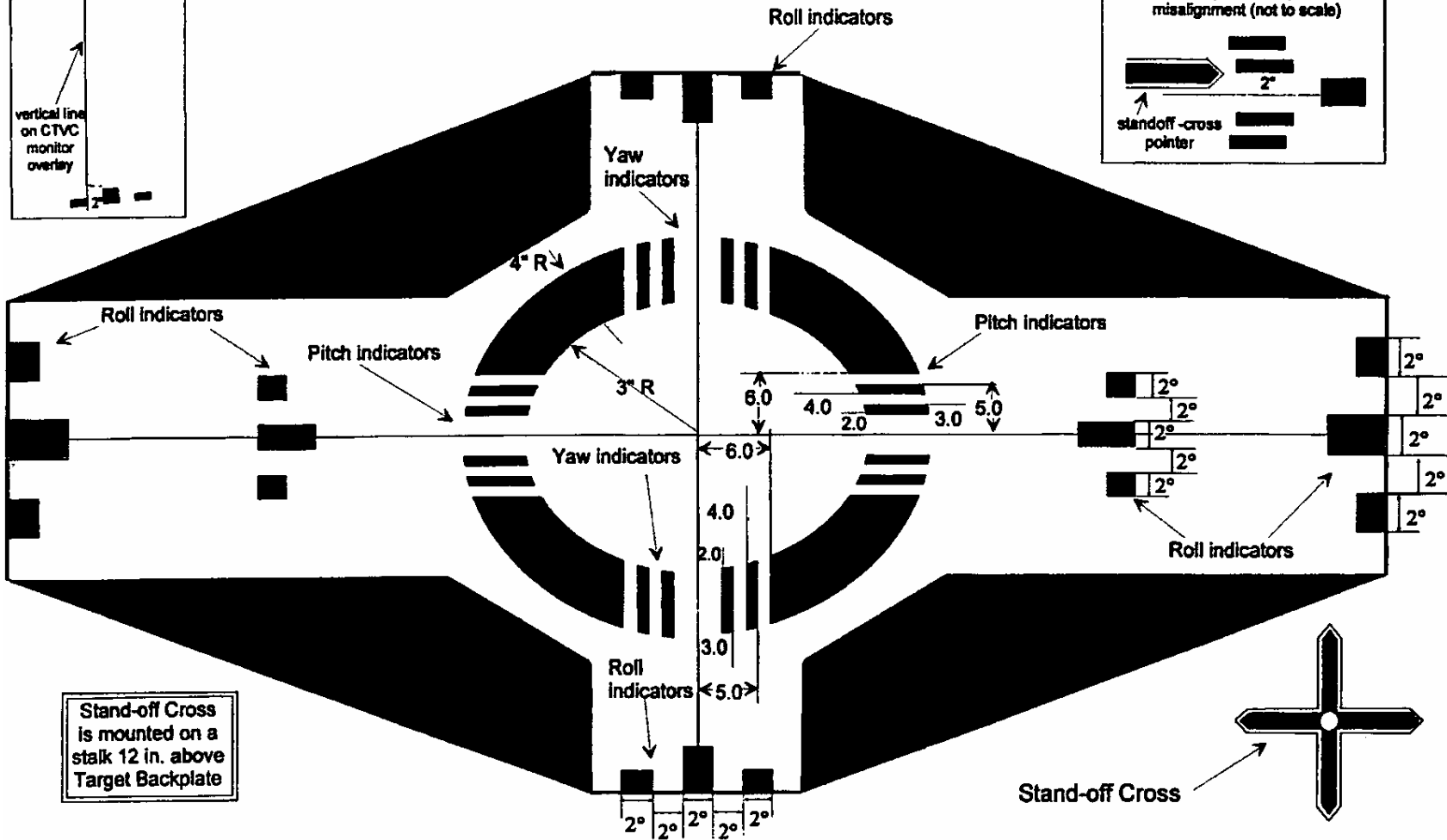
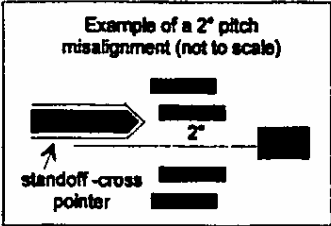
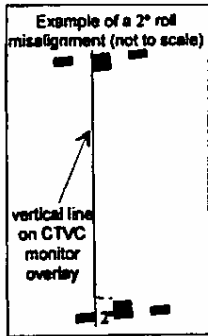

Stand-off Cross is mounted on a stalk 12 in. above Target Backplate

Roll indicators are to be used with the vertical and horizontal lines on the CTVC monitor overlays. All six sets of roll indicators are sized to give roll misalignments in increments of 2 degrees. At least two sets of roll indicators on opposite sides of the target backplate are required during roll misalignment determination (see roll misalignment example). The outer roll indicators (extra set on horizontal axis) may not be used with the inner roll indicators.

Pitch and yaw indicators are to be used with the pointers on the stand-off cross (see pitch misalignment example). Both sets of pitch indicator and yaw indicators are sized to give misalignments in increments of 2, 3, 4, 5, and 6 degrees.

## ISS ATTITUDE CONTROL SYSTEM MODING INDICATORS

- INDICATOR LIGHTS STEADY                    —                    ISS ACS ACTIVE
- INDICATOR LIGHTS FLASHING                —                    ISS IN FREE DRIFT
- INDICATOR LIGHTS OFF                        —                    LIGHTS FAILED OR SOFTWARE OFF

<u>Unit/LEDs</u>	<u>MDM</u>	<u>Card/Channel</u>
Starboard LEDs 1 & 2	LA-1	DIO Card Slot 4 Channel 13
Starboard LEDs 3 & 4	LA-1	DIO Card Slot 4 Channel 14

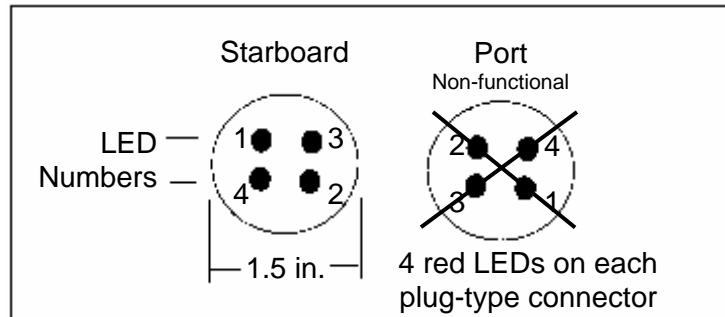

Bottom View

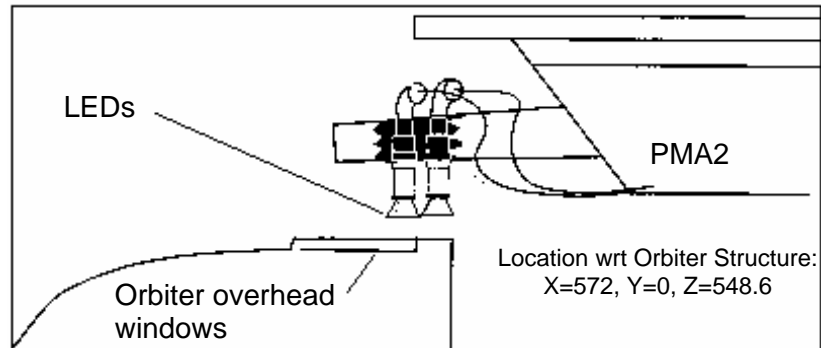

Side View

# RANGING CHARTS

## COAS SUBTENDED ANGLE VS RANGE

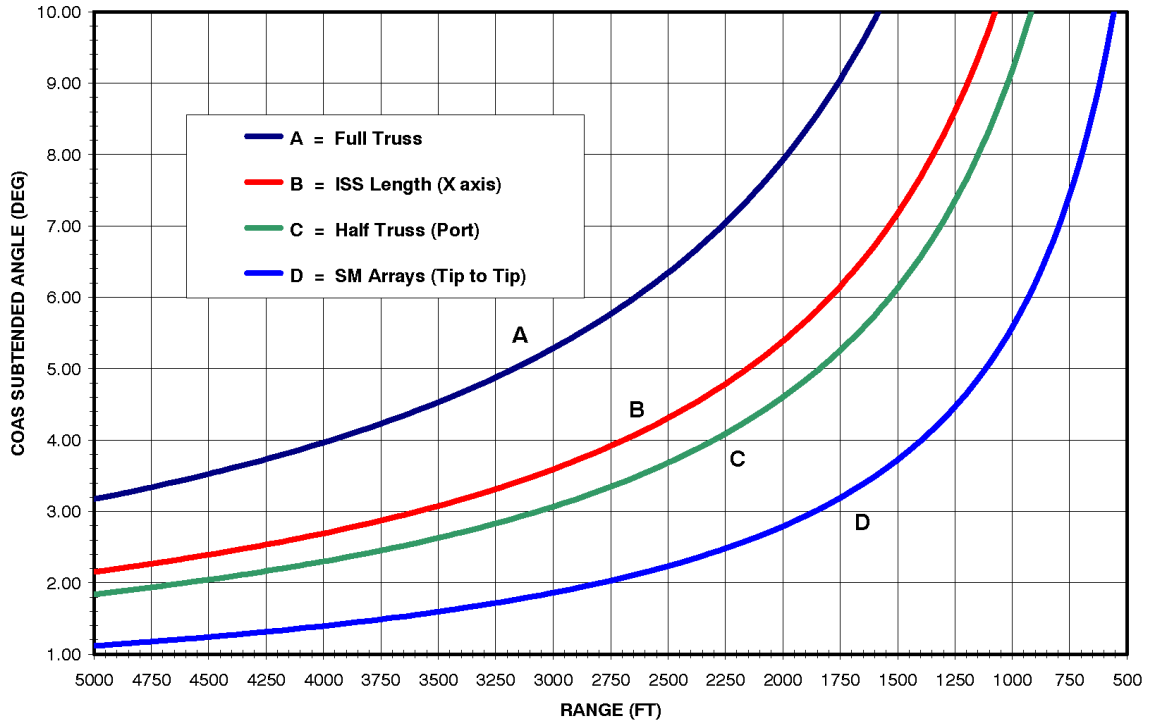

## CAMERA SUBTENDED ANGLE VS RANGE

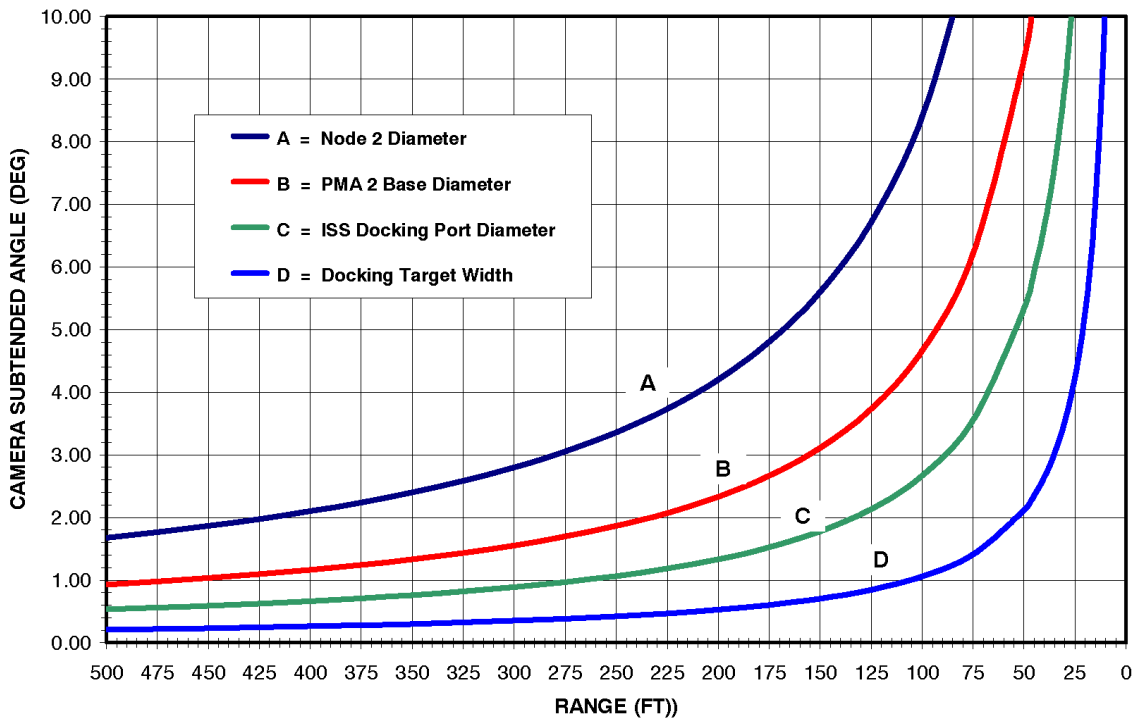

**COAS SUBTENDED ANGLES (DEG) VS RANGE (FT)**  
 (SA DIMENSIONS TIP TO TIP)

I

<b>Deg</b>	<b>Full Truss*</b>	<b>Half Truss**</b>	<b>SM SA</b>	<b>Node2 Dia.</b>
0.5	31739	18407	11178	1682
<b>1</b>	<b>15869</b>	<b>9203</b>	<b>5589</b>	<b>841</b>
1.5	10579	6135	3726	561
<b>2</b>	<b>7934</b>	<b>4601</b>	<b>2794</b>	<b>421</b>
2.5	6347	3681	2235	336
<b>3</b>	<b>5289</b>	<b>3067</b>	<b>1863</b>	<b>280</b>
3.5	4533	2629	1596	237
<b>4</b>	<b>3966</b>	<b>2300</b>	<b>1397</b>	<b>210</b>
4.5	3525	2044	1241	187
<b>5</b>	<b>3172</b>	<b>1840</b>	<b>1117</b>	<b>168</b>
5.5	2883	1672	1015	152
<b>6</b>	<b>2643</b>	<b>1533</b>	<b>931</b>	<b>140</b>
6.5	2439	1414	859	129
<b>7</b>	<b>2264</b>	<b>1313</b>	<b>797</b>	<b>120</b>
7.5	2113	1225	744	112
<b>8</b>	<b>1980</b>	<b>1149</b>	<b>698</b>	<b>105</b>
8.5	1864	1081	656	98
<b>9</b>	<b>1760</b>	<b>1020</b>	<b>620</b>	<b>93</b>
9.5	1667	967	587	88
<b>10</b>	<b>1583</b>	<b>918</b>	<b>558</b>	<b>84</b>
10.5	1507	874	531	80
<b>11</b>	<b>1438</b>	<b>834</b>	<b>507</b>	<b>76</b>
11.5	1375	798	484	73
<b>12</b>	<b>1318</b>	<b>764</b>	<b>464</b>	<b>70</b>

\* Full Truss from S5 to P6

\*\*Half Truss is the Port side of ISS from P6 to center of ISS

## RENDEZVOUS TOOLS

CCTV CONFIG FOR DOCKING/UNDOCKING .....	7-2
RNDZ TOOLS CHECKOUT .....	7-4
TROUBLESHOOTING .....	7-5
HAND-HELD LIDAR CHECKOUT .....	7-6
STOW .....	7-6
OPS .....	7-7
RPOP INITIALIZATION .....	7-8
OPS .....	7-9
FUNCTION KEY SUMMARY .....	7-11
KEYSTROKE SUMMARY .....	7-15
TRAJECTORY DATA SOURCE OPTIONS .....	7-16
TCS ACTIVATION .....	7-18
MANUAL ACQUISITION .....	7-19
DEACTIVATION .....	7-20
LIMITS .....	7-21
TRAD FAIL RANGE AND RANGE RATE DETERMINATION .....	7-21
NOMINAL OPS .....	7-21
RADAR FAIL .....	7-22
TCS FAIL .....	7-22
HHL FAIL .....	7-22
PCMMU/WINDECOM FAIL .....	7-23
PGSC FAIL (NO PROP, NO TCS) .....	7-23

# CCTV CONFIG FOR DOCKING/UNDOCKING

RNDZ  
TOOLS

## 1. ACTIVATION

Perform ACTIVATION (Cue Card, TV)

√Monitors set to USCAN – ON

√MCC: VSU Sync/Async configuration

Pwr up Cameras for Docking/Undocking:

CENTERLINE

Camrs A,C,D

Camr B

Install Monitor Sunshades

## 2. SET CCTV CAMERA FUNCTIONS

2.1 For Centerline Camera:

ALC pb – press

AVG pb – press

√GAM BLK STR – ON

√COLOR BAL – SUN

2.2 For Cameras A,C,D:

ALC pb – press

AVG pb – press

GAM BLK STR – ON

√COLOR BAL – SUN

SHUTTER – ON pb press as reqd

2.3 For Camera B:

ALC pb – press

AVG pb – press

LT LEVEL pb – press

NIGHT pb – press

GAM BLK STR – ON

## 3. SET CAMERA ZOOM SETTINGS

<u>CAMERA</u>	<u>ZOOM</u>	<u>OVERLAY</u>
Centerline	40.0° (Corridor)	Corridor
	10.1° (full zoom)	Grid

## 4. MONITOR SETUP

MON 1,2 L-DATA – on

C-DATA – grn

XHAIR – grn

## 5. CAMERA SETUP – CAMERA A,D

A7

MON 2 – Camr A (Range Ruler), D (Backup Range Ruler)

Zoom = 74.4° FOV (full unzoom), Focus = 12 ft

Pan: as reqd to center ODS in monitor (see figure next page)

Tilt: as reqd until bottom of ODS Interface Ring touches bottom of screen (see figure next page)

## 6. FINAL CONFIG FOR APPROACH AND UNDOCKING/SEP

MON 1 – CENTERLINE

MON 2 – RANGE RULER

Install CORRIDOR overlay:

Use green XHair to center overlay

Install RANGE RULER overlay:

Place contact ring tangent line on top of ODS Contact Ring (see figure next page)



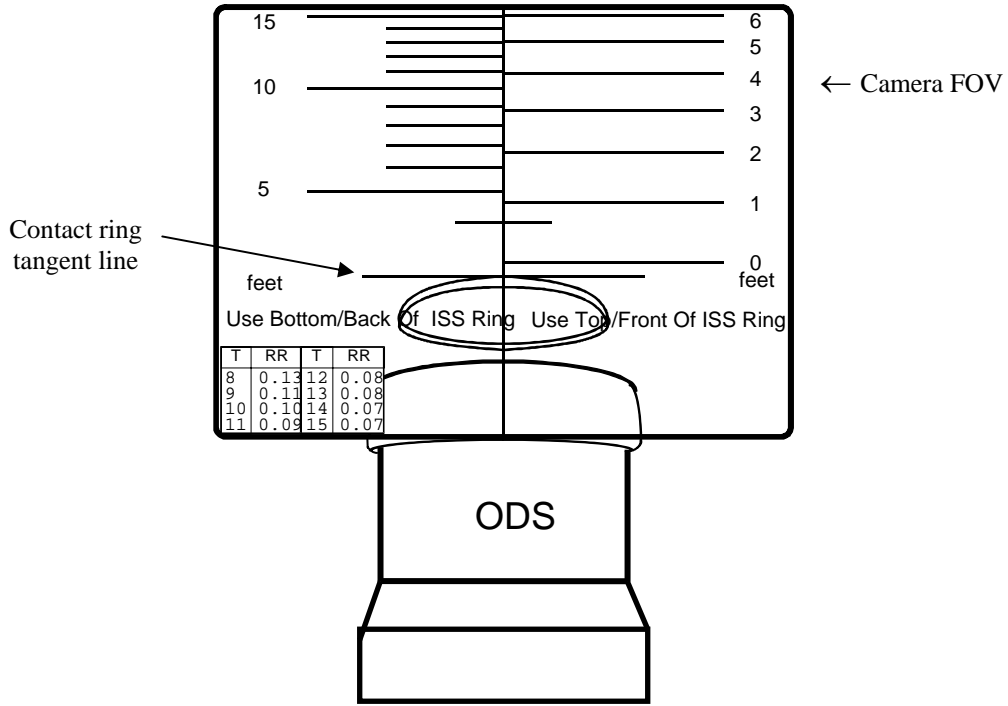

**Camr A,D Range Ruler View  
Approach Config**

## RNDZ TOOLS CHECKOUT

1. √MCC uplink to TGT SV  
    GNC 33 REL NAV  
    RNDZ NAV ENA – ITEM 1 EXEC (\*)
  2. √RNDZ TOOLS connected per PGSC Usage Chart (if available) or UTILITY  
    OUTLET PLUG-IN PLAN ORBIT CONFIGURATION (REF DATA FS,  
    UTIL PWR)
  3. Perform WINDECOM OPS – ACT (ORB OPS, PGSC)
  4. Perform RPOP INITIALIZATION, 7-8
- On MCC GO:
5. Perform TCS ACTIVATION, steps 1 and 2, 7-18
  6. Perform HAND-HELD LIDAR CHECKOUT, 7-6
  7. When checkout complete, perform TCS DEACTIVATION, 7-20, then:  
    Exit RPOP – [SHIFT]/[F10], then:  
    HHL PWR SW – OFF, then:  
    Temp stow Rndz Tools as reqd
  8. GNC 33 REL NAV  
    RNDZ NAV ENA – ITEM 1 EXEC (no \*)

## **RNDZ TOOLS TROUBLESHOOTING**

Notify MCC of problem; then perform each step from appropriate procedure, one at a time, until functionality restored. Troubleshooting steps assume RPOP is configured to receive PCMMU data via the RS-422 data cable

### **TCS CADS NOT RECEIVING TCS DATA**

1. ✓Windows system tray for PC card icon to verify good connection to MCIU/Quatech card
2. ✓TX/RX end of TCS data cable connected to MCIU/Quatech card COM2
3. ✓Correct port config in TCS CADS s/w
4. Quit and restart TCS CADS
5. Change out TCS data cable and MCIU/Quatech card
6. Reboot PGSC and restart TCS CADS
7. On MCC GO, perform TCS DEACTIVATION, 7-20, followed by TCS ACTIVATION, 7-18
8. ✓MCC

### **RPOP NOT RECEIVING PCMMU DATA**

1. ✓Windows system tray for PC card icon to verify good connection to MCIU/Quatech card
2. ✓Correct end of RS-422 Y data cable connected to MCIU/Quatech card COM4
3. ✓Correct port config in RPOP s/w
4. Quit and restart RPOP
5. Change out RS-422 Y data cable and MCIU/Quatech card
6. Reboot PGSC and restart RPOP
7. ✓MCC

### **RPOP NOT RECEIVING HHL DATA**

1. ✓HHL cable securely connected to HHL unit and COM1
2. ✓RPOP port config set to COM1 for HHL
3. Quit and restart RPOP
4. Reboot RPOP PGSC and restart RPOP
5. Connect HHL cable to backup RPOP PGSC COM1 to check data flow. Swap to backup HHL data cable or backup HHL as reqd
6. ✓MCC

### **RPOP NOT RECEIVING TCS DATA (TCS CADS IS RECEIVING DATA ON SAME PGSC)**

1. ✓RPOP configured to receive TCS data via DLL
2. Quit and restart RPOP
3. Reboot RPOP PGSC and restart RPOP and TCS CADS
4. ✓MCC

## HAND-HELD LIDAR CHECKOUT

1. Unstow HHL, Battery Pack(s), and RS-232 cable

Connect RS-232 cable from HHL to PGSC  
Plug Battery Pack into HHL

Verify RPOP program enabled per RPOP INITIALIZATION, 7-8

2. Perform HAND-HELD LIDAR OPS, 7-7
3. Take multiple (~10) Range and Velocity measurements using top center of aft PLB bulkhead or S0 Truss Segment as TGT  
√HHL data received by RPOP (HHL trajectory source must be selected)

Range check:

√Range from aft port window to bulkhead = 60 ft  
or

√Range from overhead window to S0 Truss Segment = ~44 ft

Velocity check:

Depress trigger for 5 sec

√Velocity = 0.0 fps

Report range and velocity discrepancies to MCC

Self-Test: Press and hold Test Mode button, √8.8.8.8. Select range

## HAND-HELD LIDAR STOW

Power sw – OFF

Remove RS-232 cable  
Unplug Battery Pack

Stow HHL, Battery Pack(s), and RS-232 cable

## HAND-HELD LIDAR OPS

Power sw – ON

### NOTE

If msg 'LoB' or flashing 8888 on display or irregular tone emitted, replace battery

Display Intensity knob – Adjust intensity to minimum acceptable level

Select Range or Velocity decimal place by toggling RANGE/VELOCITY buttons

Range pb – 1 ft or 0.1 ft

Velocity pb – 0.1 fps or 0.01 fps

Center red dot on TGT

Depress trigger for each measurement

Hold trigger for velocity measurements

Velocity accuracy increases with trigger hold duration:

<u>Duration</u>	<u>Accuracy</u>
0.5	0.15
1.0	0.06
2.0	0.03
5.0	0.01

To verify lock-on (if desired):

1. Push Test Mode button
2. Center red dot on TGT
3. Depress and hold trigger. Pitch on tone proportional to received signal strength
4. Press Range or Velocity button to return to Operational Mode

Error Codes:

E01 Never acquired target because target out of range or target too close

E02 Excessive percentage of total laser pulses in measurement sample unsatisfactory

E03 Excessive number of consecutive laser pulses in measurement sample unsatisfactory

## RPOP INITIALIZATION

1. Power on RPOP/TCS PGSCs  
√Data, power cables installed per PGSC Usage Chart (if available) or UTILITY OUTLET PLUG-IN PLAN, ON-ORBIT CONFIG (REF DATA FS, UTIL PWR)
2. Select Shuttle Apps Icon  
Select RPOP folder  
Select appropriate RPOP icon
3. Enter current MET:  
Days>\_\_\_\_/Hrs>\_\_\_\_:Min>\_\_\_\_:Sec>\_\_\_\_

Click [OK] to continue

### NOTE

Time synchronized on [OK]

4. √RPOP window title bar – verify mission specific scenario  
√MET correct (upper right corner of trajectory display)
5. √PCM selected – status displayed above F6 in Function Key Menu  
If “No PCM” displayed, select PCM mode with [CNTL]/[F6]  
√RPOP is receiving PCMMU data  
Verify no “RPOP is not receiving PCMMU data” message on display  
If RPOP not receiving PCMMU data, √MCC and refer to RNDZ TOOLS TROUBLESHOOTING, 7-5

### NOTE

If no target state vector on board, expect error message  
If RNDZ NAV not enabled, expect bad relative state

## RPOP OPS

1. Select desired trajectory/sensor data as needed (F1 thru F4 keys)  
Reference TRAD FAIL RANGE AND RANGE RATE DETERMINATION, 7-21,  
for recommended RPOP and TRAD configuration

2. Configure HHL settings

[CNTL]/[F4] HHL

√Appropriate aimpoint configuration per table

	HHL Aim Point	Angle Source	Angle Aim Point
Manual phase	Tgt CG	Dock Cam	Tgt CG
+Vbar	Node2-Fwd/Top	Dock Cam	C/L Target
Flyaround	As appropriate		

Configure Vert(deg) and Horiz(deg) angles to 0 deg

Lock Vert(deg) and Horiz(deg) angles (click box below input field)

NOTE: user may unlock angles and input angle data if desired

Click [Update Settings] button to close HHL window

3. Use [F5] to display/hide Rdot window

Click [sources] button to select/deselect additional data sources

NOTE: nominal configuration is to display “HHL/dt” and “HHLRaw”

4. Adjust configuration as required

Use [SHIFT]/[F1] thru [SHIFT]/[F4] to show/hide trajectory plots

NOTE: cannot hide currently selected trajectory/sensor

Use [CNTL]/[F8] to cycle through Points of Reference (POR)

Use [F11] to cycle thru declutter levels

Use [F12] to snap a range ruler mark; [SHIFT]/[F12] to delete it

Use [SPACEBAR] to toggle on-screen Function Key Menu ON/OFF

Move axes or zoom in/out per RPOP KEYSTROKE SUMMARY, 7-15

For other options, reference RPOP FUNCTION KEY SUMMARY, 7-11

### NOTE

Display of some data input windows (such as [CNTL]/[F4] HHL) prevents background sensor processing (e.g., TCS NAV).

Minimize the time that these data input windows are displayed as much as practical.

Sensor processing is NOT affected by display of the Rdot or THC-to-Go windows or associated sub-windows

5. To exit RPOP program – [SHIFT]/[F10]

- \* Configure TCS reflectors \*
- \* [CNTL]/[F10] RPOP Configuration \*
- \* Select [TCS/Refl...] button Select TCS/Reflector Set \*
- \* Select appropriate Reflector No. \*
- \* NOTE: for a single TCS unit, TCS No. selection is irrelevant \*
- \* Configure RPOP Guidance, if desired for approach \*
- \* [CNTL]/[F5] Select Guidance Type \*
- \* Select desired flight phase to start prox ops guidance sequence \*
- \* If +Rbar Acquisition, \*
- \* If no RPM, uncheck “with RPM” option \*
- \* If RPM stationkeeping (SK) required, \*
- \* Select “with SK until MET” \*
- \* Enter RPM start window open time (per APPROACH cue card) \*
- \* Update target attitude \*
- \* √MCC for target attitude data \*
- \* [SHIFT]/[F6] Enter Target Vehicle Attitude Info \*
- \* Input appropriate reference frame and attitude (PYR Seq) \*
- \* Pitch>\_\_\_\_\_ Yaw>\_\_\_\_\_ Roll>\_\_\_\_\_ \*
- \* Input appropriate attitude rate mode and rates \*
- \* NOTE: nominal dock and undock settings are “LVLH to Tgt Body”, \*
- \* 0 / 0 / 0 deg attitude, and “LVLH Hold” rate \*
- \* Input subtended angle data \*
- \* [F5] Rdot \*
- \* Click [sources] button, then select “SubAng” option \*
- \* Click [SubAng] button or [F6] to open data input window \*
- \* NOTE: timetag is recorded when [SubAng] or [F6] button is clicked \*
- \* Input appropriate structural element and angle (measured via COAS or \*
- \* CCTV with SUB ANG RULER overlay) \*
- \* Click [OK] to incorporate mark, or [Back 1] to delete previous mark \*
- \* Configure comm ports \*
- \* [CNTL]/[F10] RPOP Configuration \*
- \* Select [Comm Ports...] button RPOP Communications Setup \*
- \* Configure com ports and DLL \*
- \* NOTE: TCS source must be set to DLL \*
- \* HHL source must be set to COM1 \*
- \* PCMMU source if TLMServer (network or serial) is DLL \*
- \* PCMMU source if no TLMServer (serial) is COM4 \*
- \* For assistance with other options, √MCC, [F10] Help , or RPOP FUNCTION \*
- \* KEY SUMMARY, 7-11 \*



## RPOP FUNCTION KEY SUMMARY

### TRAJECTORY DATA KEYS (Columns F1 → F4)

---

- [F1→F4]** PRIME KEY  
(SV, RR, HHL, CCTV or TCS)  
Make this Trajectory Prime Trajectory
- Only one trajectory can be Prime at a time
  - Prime Trajectory has orbiter graphics, predictors, and color-coordinated digital data
- [SHIFT]/[F1→F4]** SHOW/HIDE KEY  
(Show/Hide)  
Show or Hide this Trajectory (toggle)
- Prime Trajectory cannot be hidden
  - Background processing of trajectory continues even when hidden  
(Exception: HHL trajectory data will not prompt for user input when hidden)
- [CTRL]/[F1→F4]** DATA KEY  
(Data)  
Configure/input data for trajectory
- Allows user to configure specific Trajectory Data Source Options
  - Allows user to input manual data
  - Allows user to reconfigure function key to another Trajectory Data Source
  - Duplicate Trajectory Data Source configurations are permitted (e.g., HHL could be configured for both F3 and F4, if desired)

#### NOTE

Although duplicate data source configurations are permitted, duplicate automatic data modes (namely, State Vector, RR Auto, TCS Auto and TCS Nav) are not permitted. In such a situation, duplicated auto mode option grayed out in Trajectory Data Source Options dialog box

## **GENERAL FUNCTION KEYS (Columns F5 → F12)**

---

<b>[F5]</b> (Rdot)	<b>RDOT WINDOW</b> Toggles display of Rdot Window
<b>[SHIFT]/[F5]</b> (Orb Att)	<b>ORBITER ATTITUDE</b> Update orbiter attitude and attitude rate
<b>[CTRL]/[F5]</b> (Guid)	<b>GUIDANCE</b> Select guidance cues on demand Available options are: <ul style="list-style-type: none"><li>+Rbar acquisition – provides THC recommendations for acquiring the +Rbar. Includes options for targeting pre-TORVA conditions, pre-RPM conditions, or a pre-RPM stationkeep</li><li>TORVA – provides THC recommendations for performing the +Rbar to +Vbar transfer</li><li>+Vbar Acquisition – provides THC recommendations for acquiring the +Vbar in preparation for final approach</li><li>Glideslope Approach – provides THC recommendations for flying the final approach along a glideslope</li><li>CW Targeting – given a burn time, transfer time, and desired LVLH position, CW Targeting will provide required THC inputs</li><li>LVLH Velocity Null – provides THC recommendations for nulling LVLH velocities in each direction</li><li>Average Rdot – information for timed approach</li></ul>
<b>[F6]</b> (Sub Ang)	<b>SUBTENDED ANGLE</b> Enter subtended angle in Rdot Window to get range and range rate. Only active when SubAng source active on Rdot Window
<b>[SHIFT]/[F6]</b> (Tgt Att)	<b>TARGET ATTITUDE</b> Update Target attitude and attitude rate
<b>[CTRL]/[F6]</b> (PCMMU)	<b>PCMMU MODE</b> No PCM mode (displays No PCM) Requires orbiter attitude data to be entered manually with each sensor mark PCM MODE (displays PCM) Orbiter attitude is automatically computed using PCMMU data
<b>[F7]</b> (View)	<b>VIEW</b> If Tgt-Centered LVLH, cycle through views: XZ, XY, YZ If Orb-Centered LVLH, cycle through views: XZ, XY, YZ, CAM View identification displayed upper left-hand corner of Trajectory Display
<b>[SHIFT]/[F7]</b> (Ovrlay)	<b>OVERLAY</b> Cycle through displays of overlays
<b>[F8]</b> (Tgt/Orb)	<b>REFERENCE FRAME</b> Toggle display between Tgt-Centered LVLH plot and Orb-Centered LVLH plot
<b>[SHIFT]/[F8]</b> (Low Z)	<b>LO Z</b> Toggle jet-select between No Low Z and Low Z for making THC “What If” inputs. Displays Low Z
<b>[CTRL]/[F8]</b> (POR)	<b>POINT OF REFERENCE</b> Cycle through preselected orbiter Point-Of-Reference to Target Point-Of-Reference sets (e.g., CG to CG, Dock Port to Dock Port)

## **GENERAL FUNCTION KEYS (Columns F5 → F12) (Cont)**

---

<b>[F9]</b> (THC Clr)	THC CLEAR Clear THC “What if” inputs from the Prime Trajectory
<b>[SHIFT]/[F9]</b> (TrajClr)	TRAJECTORY CLEAR Clear Prime Trajectory history of all but 2 most recent data inputs
<b>[CTRL]/[F9]</b> (Back 1)	BACK 1 Delete last data input from the Prime Trajectory

---

**[F10]**  
(Help)                      HELP  
Access on-line help information

**[SHIFT]/[F10]**  
(Exit)                      EXIT  
Save output files and exit RPOP program

**[CTRL]/[F10]**  
(Config)                    RPOP CONFIGURATION  
Configure following RPOP options:

Debug

Enable serial port I/O debug text to be displayed. Displays Debug

Data Freq...

Change frequency of automatic acceptance (plotting) of PCM data (SV or RR Auto) or TCS data (TCS Auto)

Predictors...

Change number and/or time increment of displayed predictors

Update MET...

Change the mission elapsed time

Altitude...

Change altitude of target vehicle

Comm Ports...

Reconfigure serial ports and/or the DLL

TCS/Refl...

Select TCS ID number (1-2) and reflector ID number (1-6)

Views...

Enable/disable Tgt- and Orb-Centered views

NOTE

Currently displayed view (both Tgt- and Orb-Centered) cannot be disabled

THC “What if”...

Select DAP setting (trans pulse size) to be used for THC “What if” inputs  
Options include: Rndz DAP, Prox Ops DAP, and a User-Configurable DAP

## **GENERAL FUNCTION KEYS (Columns F5 → F12) (Cont)**

---

- [F11]**           DECLUTTER  
Cycle RPOPs display through three different levels of declutter
- [F12]**           RANGE RULER SNAP  
Computes range rate based on time between snaps and assumed delta range interval. Feature available only if I-loaded delta range interval has non zero value
- [SHIFT]/[F12]**   RANGE RULER CLEAR  
Clears range ruler display from screen. Feature available only if I-loaded delta range interval has non zero value

## RPOP KEYSTROKE SUMMARY

[CTRL]/[←] or l	Move Vertical axis left
[CTRL]/[→] or r	Move Vertical axis right
[CTRL]/[↑] or u	Move Horizontal axis up
[CTRL]/[↓] or d	Move Horizontal axis down

[CTRL]/[PGUP]	Zoom IN on Trajectory Display
[CTRL]/[X]/[PGUP]	Zoom IN on X axis only
[CTRL]/[Y]/[PGUP]	Zoom IN on Y axis only
[CTRL]/[Z]/[PGUP]	Zoom IN on Z axis only

[CTRL]/[PGDN]	Zoom OUT on Trajectory Display
[CTRL]/[X]/[PGDN]	Zoom OUT on X axis only
[CTRL]/[Y]/[PGDN]	Zoom OUT on Y axis only
[CTRL]/[Z]/[PGDN]	Zoom OUT on Z axis only

### NOTE

Use [SHIFT] in combination with any of above keystrokes in order to scale/move axes in finer increments. Each view may be independently scaled and/or autoscaled

[CTRL]/[HOME]	Resume autoscaling and reset scale
[SPACEBAR]	Toggle on-screen Function Key Menu ON/OFF

### THC "What if" (-Z sense) Keystrokes (Prime Trajectory only)

	<u>DAP A8</u>	<u>DAP B8</u>
Z IN	[SHIFT]/[→]	[→]
Z OUT	[SHIFT]/[←]	[←]
X UP	[SHIFT]/[↑]	[↑]
X DOWN	[SHIFT]/[↓]	[↓]

## TRAJECTORY DATA SOURCE OPTIONS

**SV** STATE VECTOR  
*Options include:*  
State Vector – Enable automatic acceptance of the Onboard Nav states  
None – Turn State Vector processing off  
Config... – Reconfigure Trajectory Data Source for this function key

**RR** RENDEZVOUS RADAR  
*Options include:*  
Manual – Manually enter Radar RNG, EL and AZ  
Auto – Enable automatic acceptance of Radar RNG, EL and AZ  
None – Turn Radar processing off  
Config... – Reconfigure the Trajectory Data Source for this function key

**HHL** HANDHELD LASER  
Manually select HHL Aim Point, Angle Source, and Angle Source Aim Point  
Manually enter HHL RNG and two Angle Source angles (an in-plane and out-of-plane)

*Options include:*  
Lock – Hold the in-plane angle constant (locked) for each HHL mark  
Lock – Hold the out-of-plane angle constant (locked) for each HHL mark  
Uppdate Settings – Accept configuration changes to Aim Points, Angle Source, and Lock option without incorporating a trajectory mark  
Config... – Reconfigure the Trajectory Data Source for this function key

*Angle Source options include:*  
Fwd CCTV, Aft CCTV, Dock Cam, COAS, Radar, TCS, *Other*

### NOTE

Manual inputs reqd for all angle sources except Radar and TCS. If Radar or TCS selected, angles will be automatically snapped (if available). *Other* camera is *optional*, and may be completely specified via I-load

*Aim Point options include:*  
HHL Aim Pt, Tgt CG, *Point of Interest #1, Point of Interest #2, Point of Interest #3*

### NOTE

HHL Aim Pt is always available and may be completely specified via I-load. Tgt CG is always available *Points of Interest 1-3* are *optional*, and may be completely specified via I-load. For Angle Source Radar, angle aim point is Tgt CG. For Angle Source TCS, angle aim point is current reflector number

**CCTV** CLOSED CIRCUIT TELEVISION CAMERAS  
Manually enter FWD and AFT CCTV tilt angles  
*Options include:*  
Config... – Reconfigure Trajectory Data Source for this function key

## TCS

### TRAJECTORY CONTROL SENSOR

*Options include:*

Manual – Manually enter TCS RNG, EL and AZ

Auto – Enable automatic acceptance of TCS RNG, EL and AZ

Nav – Enable TCS NAV (Kalman Filtering)

Display Resids and Ratios

Force Measurements

Re-Initialize on [OK]

None – Turn TCS processing off

Config – Reconfigure the Trajectory Data Source for this function key

## TCS ACTIVATION

### 1. CADS BOOTUP

PGSC      √RPOP/TCS PGSC powered ON  
          √Data cables installed per PGSC Usage Chart (if available) or UTILITY OUTLET  
          PLUG-IN PLAN ORBIT CONFIGURATION (REF DATA FS, UTIL PWR)

SHUTTLE APPS

> TCS

### 2. TCS PWRUP/INITIALIZATION

L12      TCS PWR – ON (tb-gray)

\* If tb – bp, cycle sw    \*

\* If no joy, notify MCC \*

PGCS

TCS Self Test

	<u>Status</u>	<u>Override</u>
√Shutter:	Passed	Off
√Z Latch:	Passed	Off
√CW Laser:	Passed	Off
√Pulse Laser:	Passed	Off

√MSG: INITIALIZATION COMPLETE

\* If error msg received during initialization, \*

\* √MCC \*

TCS OPS

√Mode: Stby

√Z Latch: Unlocked

√Pulse: Avail

√CW: Active

\* If not in config, \*

\* √MCC \*

### 3. TIME REFERENCE SELECT

TCS C&DI

Commands > Send TCS Time

CAD Clock

Enter MET

> Send

√Messages – ‘TCS Clock has been set’

### 4. ENABLE AUTO ACQUISITION

TCS C&DI

> Config > Automatic > Acquisition

Update ‘Maximum Range’ for auto acquisition to begin as desired

> OK

Inform MCC of range entered



# TCS MANUAL ACQUISITION

## 1. ACQUIRE

PGSC

TCS OPS

√Pulse: Avail  
√CW: Active

TCS C&DI

> Macros > ACQUISITION

Target Acquisition Data

Input current estimate of range to Target and zero for Azimuth and Elevation:

RANGE > \_\_\_\_\_  
AZIMUTH > \_\_\_\_\_  
ELEVATION > \_\_\_\_\_

√95% RANGE GATE – (no X)  
> SEND

TCS OPS

If first acquisition:

√Shutter – Open (after ~22 sec)

\* If shutter fails to open: \*  
\* > Commands > Standby \*  
\* > Commands > Open Shutter \*  
\* > Commands > Acquire \*

√Data – Good (and active tracking data)

\* If TCS not tracking and no RPOP or Auto Seed \*  
\* Update disabled, \*  
\* TCS C&DI \*  
\* > Commands > Acquire \*  
\* Update Range estimate and zero AZ & EL \*  
\* > Send \*

## 2. ENABLE AUTO ACQUISITION

√Data – Good (and active tracking data)

TCS C&DI

> Config > Automatic

If Seed Update – (no √)

> Seed Update

√Maximum Range (ft): 5000

>OK

> Config > Automatic

If Acquisition – (no √)

> Acquisition

√Maximum Range (ft): 5000

> OK

> Config > Automatic

√Initialization – (√)

√Seed Update – (√)

√Acquisition – (√)

## TCS DEACTIVATION

### 1. SHUTDOWN TCS

PGSC

TCS C&DI

> Macros > SHUTDOWN

- \* If error msg received during SHUTDOWN, \*
- \* √MCC \*

TCS OPS

√Shutter: Closed (takes ~22 sec)

- \* If shutter fails to close: \*
- \* > Commands > Close shutter \*

If Final TCS deactivation for mission:

### 2. SECURE Z AXIS

PGSC

TCS C&DI

> Commands > Lock Z Axis Latch

TCS OPS

√Z Latch: Locked

- \* If Z Latch fails to lock: \*
- \* If Z Latch: Transit \*
- \* TCS C&DI \*
- \* > Commands > Lock Z Axis \*
- \* Latch \*
- \* Otherwise \*
- \* √MCC \*

### 3. POWERDOWN TCS

L12

TCS PWR – OFF (tb-bp)

- \* If tb – gray, cycle sw \*
- \* If no joy, notify MCC \*

### 4. SHUTDOWN CADS

PGSC

TCS C&DI

> File > Exit TCS CAD

## TCS LIMITS

TEMPERATURE (degC)	LOW ALERT	HIGH	
		ALERT	AUTOSAFE
CW Laser	-40.0	45.0	50.0
APD	-40.0	65.0	70.0
CPU	-40.0	80.0	85.0
DC Power	-40.0	80.0	85.0
Galvos	-40.0	80.0	85.0

VOLTAGES	LOW ALERT	HIGH ALERT
5V	4.75	5.25
5.5V	5.00	6.00
12V	11.00	12.75
15V	14.25	15.50

## TRAD FAIL RANGE AND RANGE RATE DETERMINATION

1. Maintain a prime and a backup range and rdot estimate
2. Prime and backup range and rdot estimates shall have independent sensor sources
3. Maintain prime and backup RPOP PGSCs
4. Refer to tables below for the recommended prime and backup source/configuration for NOMINAL OPS, RADAR FAIL, TCS FAIL, HHL FAIL, PCMMU/WINDECOM FAIL, and PGSC FAIL (No RPOP, No TCS) scenarios

## NOMINAL OPS

Phase	Prime Source: Configuration	Backup Source: Configuration
1. <b>Manual Takeover thru TCS lock-on</b> (R > 3000 ft assumed for TCS nominal lock-on*)	<b>State data:</b> SV	<b>Rdot window:</b> HHL/Dt <u>NOTE:</u> Configure HHL angle source to Dock Cam and lock angles to 0
2. <b>TCS lock-on thru 15 ft</b>	<b>State data:</b> TCS NAV	<b>Rdot window:</b> HHL/Dt <u>NOTE:</u> Configure HHL angle source to Dock Cam and lock angles to 0
3. <b>15 ft thru dock</b>	<b>Raw data:</b> TCS Raw	<b>Rdot Window:</b> Range Ruler (F12)

\*If no joy on TCS lock-on by 1200 ft, start subtended angle operations so that subtended angle estimates can back up the HHL/Dt inside of 1000 ft

## RADAR FAIL

Phase	Prime Source: Configuration	Backup Source: Configuration
1. Manual Takeover thru TCS lock-on* <u>NOTE</u> : RPOP State data: (HHL/SV) can be suspect	<b>Rdot window:</b> HHL/Dt <u>NOTE</u> : Configure HHL angle source to Dock Cam and lock angles to 0	<b>Rdot window:</b> Subtended angles
2. TCS lock-on thru 15 ft	<b>State data:</b> TCS NAV	<b>Rdot window:</b> HHL Dt <u>NOTE</u> : Configure HHL angle source to Dock Cam and lock angles to 0
3. 15 ft thru dock	<b>Raw data:</b> TCS Raw	<b>Rdot Window:</b> Range Ruler (F12)

\*Start Subtended angle ops after the radar fail correction if no joy on TCS lock-on

## TCS FAIL

Phase	Prime Source: Configuration	Backup Source: Configuration
1. Manual Takeover thru ~1200 ft <u>NOTE</u> : Transition from phase 1 to phase 2 should be gradual. Start transition at ~1500 ft and complete it prior to 1000 ft braking gate	<b>State data:</b> SV	<b>Rdot window:</b> HHL/Dt <u>NOTE</u> : Configure HHL angle source to Dock Cam and lock angles to 0 <b>Rdot window:</b> HHL/ Dt
2. ~1200 ft thru 15 ft <u>NOTE</u> : Spec 33: FLTR, and State data: HHL can be suspect	<b>Rdot window:</b> HHL Dt <u>NOTE</u> : Configure HHL angle source to Dock Cam and lock angles to 0	<b>Rdot window:</b> Subtended angles <b>Spec 33:</b> Raw Radar*
3. 15 ft thru dock	<b>Rdot Window:</b> Range Ruler (F12)	<b>Rdot window:</b> HHL/Dt**

\*Radar data will be unusable at close ranges. The range at which the data becomes unusable is dependent on the target size, geometry, and physical characteristics, but can not be accurately predicted. For ISS the RR can become too noisy to use at ranges as great as 1000 ft

\*\*HHL will not work if the aimpoint surface is closer than 12 feet (5 ft DP-DP)

## HHL FAIL

Phase	Prime Source: Configuration	Backup Source: Configuration
1. Manual Takeover thru TCS lock-on	<b>State data:</b> SV	<b>Rdot window:</b> Subtended Angle
2. TCS lock-on thru 15 ft	<b>State data:</b> TCS NAV	<b>Spec 33:</b> Raw RR* <b>Rdot window:</b> Subtended Angle
3. 15 ft thru dock	<b>Raw data:</b> TCS Raw	<b>Rdot Window:</b> Range Ruler (F12)

\*Radar data will be unusable at close ranges. The range at which the data becomes unusable is dependent on the target size, geometry, and physical characteristics, but cannot be accurately predicted. For ISS the RR can become too noisy to use at ranges as great as 1000 ft

## PCMMU/WINDECOM FAIL

Phase	Prime Source: Configuration	Backup Source: Configuration
<b>1. Manual Takeover thru ~1200 ft</b> <u>NOTE:</u> Transition from phase 1 to 2 should be gradual. Start transition at ~1500 ft and complete it prior to 1000 ft braking gate <u>NOTE:</u> RPOP state data is bad	<b>Spec 33: FLTR</b>	<b>Rdot window: HHL/Dt</b> <u>NOTE:</u> RPOP prompts user for Orb attitude after 1 <sup>st</sup> HHL mark. Enter P/Y/R= (90/0/0)* and check "Do not prompt for attitude" <b>TCS CADS:</b> Raw TCS (pulse active) <u>NOTE:</u> Range data good, rdot can be quite noisy <u>NOTE:</u> Resize and reposition the RPOP window so that the TCS mode (pulse/CW) is visible
<b>2. ~1200 ft thru TCS CW lock-on(~800 ft)</b> <u>NOTE:</u> RPOP State data is bad	<b>Rdot window: HHL/Dt</b> <u>NOTE:</u> RPOP uses the last two marks with Dt > 30 sec to calculate the Rdot estimate	<b>TCS CADS:</b> Raw TCS (pulse active) <u>NOTE:</u> Range data good, rdot can be quite noisy <b>Rdot window: Generic</b> <u>NOTE:</u> Manually enter raw TCS range marks. RPOP uses the last two marks with Dt > 30 sec to calculate the Rdot estimate
<b>3. TCS CW lock-on (~800 ft) thru Vbar arrival</b> <u>NOTE:</u> RPOP State data is bad	<b>TCS CADS:</b> Raw TCS (cw active)	<b>Rdot window: HHL/Dt</b>
<b>4. Vbar arrival thru 15 ft</b>	<b>TCS CADS:</b> Raw TCS (cw active) and/or  <b>State Data: TCS AUTO</b> <u>NOTE:</u> Check Orb Att = (90/0/0), and set TCS frequency to 30 sec [CNTRL F10]	<b>Rdot window: HHL/Dt</b>
<b>5. 15 ft thru dock</b>	<b>TCS CADS:</b> TCS Raw (cw active)	<b>Rdot window: Range Ruler(F12)</b>

\*Orbiter attitude displayed on RPOP will not be correct until maneuver to Vbar attitude is complete. Until Vbar arrival, do not use the RPOP trajectory data other than the data in the Rdot Window

## PGSC FAIL (NO RPOP, NO TCS)

Phase	Prime Source: Configuration	Backup Source: Configuration
<b>1. Manual Takeover thru ~1200 ft (noisy RR angles)</b>	<b>Spec 33: SV, Raw RR</b>	For range – <b>HHL (back of unit):</b> Raw HHL For Rdot – <b>Rdot vs. <math>\Delta Rng/\Delta t</math> Cue Card:</b> Record Raw HHL range and times on cue card
<b>2. ~1200 ft thru 15 ft</b>	For Range: <b>HHL (back of unit):</b> Raw HHL(short pulls) For Rdot: <b>HHL (back of unit):</b> Raw HHL(long pulls)	For range – <b>Subtended Angle table(6-13):</b> COAS or Centerline Cam subtended angle For Rdot – <b>Rdot vs. <math>\Delta Rng/\Delta t</math> Cue Card:</b> Record subtended angle range and times on cue card
<b>3. 15 ft thru dock</b>	For Range: <b>Range Ruler Overlay:</b> Camera A/D For Rdot: <b>HHL (back of unit):</b> Raw HHL* (long trigger pulls) <b>Rdot table on Range Ruler Overlay:</b> Dt between 1 ft DRange	

\*HHL will not work if the aimpoint surface is closer than 12 feet (5 ft DP-DP)

This Page Intentionally Blank

APDS

APDS

This Page Intentionally Blank



APDS NOMINAL

DOCKING MECHANISM INITIALIZATION.....	8-4
POWERUP.....	8-5
POWERDOWN .....	8-6
PREP .....	8-7
UNDOCKING PREP .....	8-7
DOCKING RING EXTENSION .....	8-8
RETRACTION (NOT MATED) .....	8-9
AIRLOCK FAN ACT AND ODS VOLUME PREP .....	8-10
POST DOCKING HATCH LEAK CHECK .....	8-11
AIRLOCK PREP FOR INGRESS – BYPASS CONFIG .....	8-12
BOOSTER FAN ACTIVE .....	8-12a

APDS  
NOMINAL

## DOCKING MECHANISM INITIALIZATION

- A6L      1.    cb ESS 1BC SYS PWR CNTL SYS 1 – cl  
                         2CA SYS PWR CNTL SYS 2 – cl  
                         1BC DEP SYS 1 VENT ISOL – cl  
                         2CA DEP SYS 2 VENT ISOL – cl  
                         MN A DEP SYS 1 VENT – cl  
                                 B DEP SYS 2 VENT – cl  
                         MN A,MN B DOCK LT (four) – cl  
                         MN A,MN B,MN C LOGIC (six) – cl  
                         √PMA 2/3 GRP 1,GRP 2 HOOKS (eight) – op  
                         √SYS PWR MN A,MN B (two) – ctr  
                                 √SYS 1,SYS 2 tb (two) – OFF  
                         √PYRO PWR MN A,MN C (two) – OFF  
                         √PMA 2/3 HOOKS SYS A,SYS B (two) – ctr  
                                 √GRP 1,2 tb (two) – bp  
                         √PSU PWR MN A,MN B (two) – OFF  
                         √LT TRUSS,VEST (four) – OFF
- A7L      2.    √CONTROL PANEL POWER A,B,C (three) – OFF  
                         √HEATERS/DCU POWER (three) – OFF  
                         √APDS POWER A<sub>DS</sub>,B<sub>DS</sub>,C<sub>DS</sub> (three) – OFF  
                                 √A<sub>DS</sub>,B<sub>DS</sub>,C<sub>DS</sub> lt (three) – lt off  
                         √STATUS lt (eighteen) – lt off  
                         √PYROS A<sub>P</sub>,B<sub>P</sub>,C<sub>P</sub> (three) – OFF  
                                 √A<sub>P</sub>,B<sub>P</sub>,C<sub>P</sub> lt (three) – lt off  
                         √PYRO CIRCUIT PROTECT OFF lt – lt off
- A6L      3.    SYS PWR MN A,MN B (two) – ON (hold 5 sec)  
                         √SYS 1,SYS 2 tb (two) – ON  
                         √VEST DEP VLV SYS 1,SYS 2 VENT (two) – ctr (tb-CL)  
   √ISOL (two) – ctr (tb-CL)  
                         cb ESS 1BC DEP SYS 1 VENT ISOL – op  
                                 2CA DEP SYS 2 VENT ISOL – op  
                                 MN A DEP SYS 1 VENT – op  
   B DEP SYS 2 VENT – op  
                         √VEST DEP VLV SYS 1,SYS 2 VENT tb (two) – bp  
   √ISOL tb (two) – bp
- ML86B:C      cb MNA EXT ARLK HTR VEST Z1/2/3 – cl

APDS  
NOMINAL

I

## DOCKING MECHANISM POWERUP

### SM 167 DOCKING STATUS

- A6L 1. √SYS PWR SYS 1, SYS 2 tb (two) – ON  
 PSU PWR MN A, MN B (two) – ON  
 If in Undocking timeline and ODS VEST/PMA HATCH LEAK CHECK complete:  
 √VEST DEP VLV SYS 1(SYS 2) VENT – ctr (tb-OP)
- A7L 2. HEATERS/DCU POWER (three) – ON  
 CRT √HTR/DCU PWR – A/B/C  
 √RNG DR BUS – 1/2  
 √HKS DR BUS – 1/2  
 √DAMPER BUS – 1/2  
 √FIXER BUS – 1/2
- A7L 3. CONTROL PANEL POWER A,B,C (three) – ON  
 CRT √CNTL PNL PWR – A/B/C
- A7L 4. APDS POWER A<sub>DS</sub>, B<sub>DS</sub>, C<sub>DS</sub> (three) – ON  
 CRT √A<sub>DS</sub>, B<sub>DS</sub>, C<sub>DS</sub> It (three) – It on  
 √PWR – A/B/C
- A7L 5. LAMP TEST pb – push  
 √STATUS It (eighteen) – It on  
 √PYRO CIRCUIT PROTECT OFF It – It on
- CRT,A7L \* If CNTL PNL PWR A(C) tlm blank, and STATUS Its nominal, \*
- \* tlm failure only >> \*
- CRT \* If CNTL PNL PWR B tlm blank: \*
- A7L \* CONTROL PANEL POWER A(C) – OFF \*
- \* POWER ON pb – push (√ and report STATUS Its to MCC) \*
- \* If any STATUS It on, tlm failure only \*
- \* CONTROL PANEL POWER A(C) – ON \*

## DOCKING MECHANISM POWERDOWN

### SM 167 DOCKING STATUS

- A7L 1.  $\sqrt{\text{STATUS}}$  It (eighteen) – It off
2. APDS POWER  $A_{DS}, B_{DS}, C_{DS}$  (three) – OFF  
 $\sqrt{A_{DS}, B_{DS}, C_{DS}}$  It (three) – It off
- CRT  $\sqrt{\text{PWR}}$  (three) – blank
- A7L 3. CONTROL PANEL POWER A,B,C (three) – OFF  
CRT  $\sqrt{\text{CNTL PNL PWR A,B,C}}$  (three) – blank
- A7L 4. HEATERS/DCU POWER (three) – OFF  
CRT  $\sqrt{\text{HTR/DCU PWR}}$  (three) – blank
- A6L 5. PSU PWR MN A,MN B (two) – OFF
6. If post-undocking:  
VEST DEP VLV SYS 1(SYS 2) VENT – CL (tb-CL)  
ISOL – CL (tb-CL)
- cb MNA DEP SYS 1 VENT – op  
 $\sqrt{\text{MNB DEP SYS 2 VENT}}$  – op  
ESS 1BC DEP SYS 1 VENT ISOL – op  
 $\sqrt{2\text{CA DEP SYS 2 VENT ISOL}}$  – op
- ML86B:C MNA EXT ARLK HTR VEST Z1/2/3 – op  
MNB EXT ARLK HTR VEST Z1/2/3 – cl

## DOCKING PREP

### SM 167 DOCKING STATUS

- A6L 1. LTS TRUSS AFT,FWD (two) – ON  
VEST PORT,STBD (two) – ON (if reqd)
- A7L 2. POWER ON pb – push  
√ON It – It on  
√RING ALIGNED It – It on  
√INITIAL POSITION It – It on  
√HOOKS 1,HOOKS 2 OPEN It (two) – It on  
√LATCHES CLOSED It – It on
- CRT √CLUTCH – blank/SLIP

## UNDOCKING PREP

- A6L 1. LTS TRUSS FWD,AFT (two) – ON (as reqd)  
VEST PORT,STBD (two) – ON (if reqd)
- A7L 2. POWER ON pb – push  
√ON It – It on  
√RING ALIGNED It – It on  
√READY TO HOOK It – It on  
√INTERF SEALED It – It on  
√HOOKS 1,HOOKS 2 CLOSED It (two) – It on  
√LATCHES OPEN It – It on  
√RING FINAL POSITION It – It on

## DOCKING RING EXTENSION

		SM 167 DOCKING STATUS	
A7L	1.	POWER ON pb – push √ON It – It on √RING ALIGNED It – It on √HOOKS 1,HOOKS 2 OPEN It (two) – It on √LATCHES CLOSED It – It on √RING FINAL POSITION It – It on	
CRT		√CLUTCH – LOCK/blank	
A7L	2.	APDS CIRC PROT OFF pb – push √CIRCUIT PROTECT OFF It – It on	
0:00	3.	RING OUT pb – push	
0:10		√FINAL POSITION It – It off	
CRT		√DRV CMD – ON √FIXERS – ON √PETAL POS BASE (three) – incr	
A7L		* If RING INITIAL POSITION It failed on (ring stops after 1 sec,*	
CRT		* and CLUTCH – blank/SLIP):	*
A7L		* FIXER OFF pb – push	*
		* √FIXERS OFF It – It on	*
		* RING OUT pb – push	*
CRT		* When PETAL POS BASE (three) = $76 \pm 3\%$ :	*
A7L		* POWER OFF pb – push	*
		* ON pb – push	*
		* √FIXERS OFF It – It off	*
		* APDS CIRC PROT OFF pb – push	*
		* √CIRCUIT PROTECT OFF It – It on	*
		* RING OUT pb – push	*
		* After 1 sec:	*
CRT		* √RING DRV CMD – OFF	*
		* *	*
		* If RING FORWARD POSITION It failed on (ring stops after	*
		* 10 sec):	*
A7L		* RING OUT pb – push	*
		* Within 10 sec:	*
		* APDS POWER $A_{DS}, B_{DS}, C_{DS}$ (three) – OFF	*
		* APDS POWER $A_{DS}, B_{DS}, C_{DS}$ (three) – ON	*
		* CIRC PROT OFF pb – push	*
		* √CIRCUIT PROTECT OFF It – It on	*
		* When RING INITIAL POSITION It – It on:	*
		* RING OUT pb – push	*

Cont next page

3:40	A7L	4. √RING INITIAL POSITION It – It on	
	CRT	√PETAL POS BASE (three): 76 ± 3%	
3:50		√CLUTCH – blank/SLIP	
		* If CLUTCH – blank/blank:	*
A7L		* √APDS CIRCUIT PROTECT OFF It – It on	*
		* RING OUT pb – push (expect 1 sec of drive), wait	*
		* 10 sec	*
CRT		* √RING DRV CMD – OFF	*
		*	*
		* If CLUTCH – LOCK/blank:	*
A7L		* √RING INITIAL POSITION It – It on	*
		* √FIXERS OFF It – It off	*
		* √APDS CIRCUIT PROTECT OFF It – It on	*
		* RING OUT pb – push (expect 1 sec of drive), wait	*
		* 10 sec	*
CRT		* √RING DRV CMD – OFF	*
		*	*
		* If not CLUTCH – blank/SLIP:	*
		* √MCC	*
A7L		5. POWER OFF pb – push	
		√STATUS It (eighteen) – It off	

### DOCKING RING RETRACTION (NOT MATED)

		<span style="border: 1px solid black; padding: 2px;">SM 167 DOCKING STATUS</span>	
A7L	1.	POWER ON pb – push	
		√ON It – It on	
		√RING ALIGNED It – It on	
		√INITIAL POSITION It – It on	
		√HOOKS 1,HOOKS 2 OPEN It (two) – It on	
		√LATCHES CLOSED It – It on	
CRT		√CLUTCH – blank/SLIP	
0:00	A7L	2. RING IN pb – push	
		√INITIAL POSITION It – It off	
CRT		√CLUTCH – LOCK/blank	
	A7L	* If RING FINAL POSITION It failed on (ring stops after	*
		* 10 sec):	*
		* RING IN pb – push	*
3:40	CRT	* When PETAL POS BASE = 5 ± 3% and not decr:	*
		* Wait 10 sec, then:	*
	A7L	* POWER OFF pb – push	*
		* √STATUS It (eighteen) – It off >>	*
3:40	A7L	3. √RING FINAL POSITION It – It on	
3:50	CRT	√DRV CMD – OFF	
	A7L	4. POWER OFF pb – push	
		√STATUS It (eighteen) – It off	

## AIRLOCK FAN ACT AND ODS VOLUME PREP

- MIDDK 1. Disconnect bypass duct from middeck floor fitting. Remove cap from Airlock Fan outlet and temp stow. Unstow, install diffuser on middeck floor fitting
- TNL EXT 2. Attach bypass duct to Airlock Fan outlet
- MA73C:G 3. √cb AC1,2 ARLK TNL FAN A,B (six) – cl
- MO13Q 4. AIRLK FAN A(B) – ON
- EXT A/L 5. √Airflow at top of external airlock halo and muffler
- If in Approach CC perform the following:
6. Unstrap centerline camera diffuser flex duct from EXT A/L wall  
Attach flex duct to camera bracket to direct air flow to window  
If required, tape diffuser open
- AW18A 7. LTG FLOOD 1(3,4) – OFF
- MO13Q 8. AIRLK 2 – OFF/ON
- MIDDK 9. Close Inner Hatch:  
Position handle to preclosing posn per decal  
Hatch – rotate about hinge and push  
Handle – CCW to LATCH  
Lock lever to LOCKED
10. Equal vlv (two) – OFF, install caps
- MO10W 11. √14.7 CAB REG INLET SYS 1, SYS 2 (two) vlv – CL



## POST DOCKING HATCH LEAK CHECK

### NOTE

ISS will concurrently perform a leak check of the PMA2 volume

1. Notify **MCC** and ISS, "Beginning initial Hatch leak checks"

MO10W 2. √14.7 CAB REG INLET SYS 1, SYS 2 (two) vlv – CL

**SM 177 EXTERNAL AIRLOCK**

3. Record EXT A/L PRESS: \_\_\_\_\_ psia  
Record A/L-VEST ΔP: \_\_\_\_\_ psid
4. Wait 20 min
  - \* If EXT A/L Press  $\leq$  previously recorded – 0.16 psia \*
  - \* Notify **MCC-H** (possible leakage from EXT A/L) \*
  - \*
  - \* If A/L-VEST ΔP  $\leq$  previously recorded – 0.16 psid \*
  - \* Notify **MCC-H** (possible leakage through Hatches) \*
5. Notify **MCC** and ISS: "Initial hatch leak checks complete. Ready for vestibule pressurization"

## AIRLOCK PREP FOR INGRESS – BYPASS CONFIG

- Inner Hatch
  - 1. Equal vlv caps (two) – remove
  - 2. Equal vlv (two) – NORM
  - 3.  $\sqrt{\text{Hatch } \Delta P < 0.2 \text{ psid}}$
  - 4. Open Hatch per decal
  - 5. Equal vlv (two) – OFF, reinstall caps
  - 6. AIRLK 2 – ON/OFF
  - 7. ARLK FAN A(B) – OFF
- TNL EXT MIDDK
  - 8. Disconnect bypass duct from Airlock Fan outlet  
Remove diffuser from middeck floor fitting and temp stow  
Connect bypass duct to middeck floor fitting. Unstow, install cap on Airlock Fan outlet
- AW18A
  - 9. As required, LTG FLOOD 1(3,4) – ON
- EXT A/L
  - 10. Unstrap centerline camera diffuser flex duct from camera bracket  
Stow duct along Stbd top of EXT A/L wall (in straps)
  - 11.  $\sqrt{\text{Airflow at top of external airlock halo}}$
  - 12. Go to P/TV02 DOCK, DEACTIVATION, step 2 (PHOTO/TV, SCENES)

## AIRLOCK PREP FOR INGRESS – BOOSTER FAN ACTIVE

I

- Inner Hatch 1. Equal vlv caps (two) – remove
2. Equal vlv (two) – NORM
3.  $\sqrt{\text{Hatch } \Delta P < 0.2 \text{ psid}}$
4. Open Hatch per decal
5. Equal vlv (two) – OFF, reinstall caps
- MO13Q 6. AIRLK 2 – ON/OFF
7. ARLK FAN A(B) – OFF
- TNL EXT MIDDK 8. Remove diffuser cap from Aft Middeck Floor Fitting. Unstow fwd flex duct from Tunnel extension wall. Attach one end to airlock booster fan muffler inlet. Attach free end to Aft Middeck Floor Fitting
9. Remove mylar sleeve/tape from outer screen of Fwd Middeck Floor Fitting and temp stow
- MO13Q 10. AIRLK FAN A(B) – ON
- AW18A 11. As required, LTG FLOOD 1(3,4) – ON
- EXT A/L 12. Unstrap Centerline Camera diffuser flex duct from camera bracket  
Stow duct along stbd top of EXT A/L wall (in straps)
13.  $\sqrt{\text{Airflow at top of external airlock halo}}$
14. Go to P/TV02 DOCK, DEACTIVATION, step 2 (PHOTO/TV, SCENES)

This Page Intentionally Blank

## APDS OFF-NOMINAL

POWER FAILED OFF (STATUS LTS OFF) .....	8-14
DAMPING FAILED ON .....	8-15
CAPTURE LT FAILED ON.....	8-15
FIXERS FAILED ON .....	8-16
OFF LT FAILED ON.....	8-18
OFF .....	8-18
RING FAILS TO DRIVE .....	8-19
DRV CMD OFF .....	8-19
FINAL POSITION LT FAILED ON .....	8-20
FORCE RING ALIGNMENT .....	8-20
CLUTCH NOT 'LOCK' .....	8-21
APDS CIRCUIT PROTECT OFF LT FAILED OFF .....	8-21
HOOKS 1(2) OPEN LT FAILED ON .....	8-21
NOT CLOSED WITHIN SINGLE MTR TIME .....	8-22
READY TO HOOK LT FAILED ON .....	8-23
HOOKS 1(2) CLOSED LT FAILED ON.....	8-23
LATCHES OPEN LT FAILED OFF .....	8-24
APDS POWER FAILED OFF .....	8-24
DOCKING MECHANISM DEMATE/REMATE .....	8-25
ODS HOOKS OPEN – CONTINGENCY .....	8-27
PMA 2/3 HOOKS OPEN – CONTINGENCY .....	8-30
APDS FAILED CAPTURE RECONFIG .....	8-33
PMA 2/3 HOOKS CLOSE .....	8-35
OPEN .....	8-37

## POWER FAILED OFF (STATUS LTS OFF)

### CAUTION

Pre-Contact, if all STATUS lts off, **NO-GO** for docking until power recovered. Initiate VBAR CORRIDOR BACKOUT (CONTINGENCY OPS) while attempting power recovery steps

- A7L
1. CONTROL PANEL POWER A – OFF  
POWER ON pb – push  
If expected STATUS lts on:  
Continue in DOCKING SEQUENCE (Cue Card), as reqd >>
  2. CONTROL PANEL POWER A – ON  
APDS POWER A<sub>DS</sub> – OFF  
POWER ON pb – push  
If expected STATUS lts on:  
If Undocking:  
| Continue in UNDOCKING OPERATIONS, as reqd >>  
If Docking:  
Continue in DOCKING SEQUENCE (Cue Card) through step 16, then:  
Go to POWER FAILED OFF (STATUS LTS OFF), step 4
  3. APDS POWER A<sub>DS</sub> – ON  
B<sub>DS</sub> – OFF  
POWER ON pb – push  
If STATUS lts (eighteen) – lts off:  
| √MCC >>  
If expected STATUS lts on:  
If Undocking:  
| Continue in UNDOCKING OPERATIONS, as reqd >>  
If Docking:  
Continue in DOCKING SEQUENCE (Cue Card) through step 16, then:  
Go to POWER FAILED OFF (STATUS LTS OFF), step 4
  4. APDS CIRC PROT OFF pb – push  
√CIRCUIT PROTECT OFF lts – lts on  
OPEN LATCHES pb – push  
√LATCHES CLOSED lts – lts off  
APDS POWER C<sub>DS</sub> – OFF  
A<sub>DS</sub>, B<sub>DS</sub> (two) – ON  
POWER ON pb – push  
If STATUS lts (eighteen) – lts off:  
| APDS POWER B<sub>DS</sub> – OFF  
C<sub>DS</sub> – ON  
| POWER ON pb – push  
APDS CIRC PROT OFF pb – push  
√CIRCUIT PROTECT OFF lts – lts on  
Go to DOCKING SEQUENCE (Cue Card), step 17

APDS  
OFF-NOMINAL

## DAMPING FAILED ON

### CAUTION

Pre-Contact, **NO-GO** for docking if DAMPING – ON.  
Initiate VBAR CORRIDOR BACKOUT  
(CONTINGENCY OPS) while attempting to power  
off dampers

### SM 167 DOCKING STATUS

- A6L  
CRT  
A6L
1. PSU PWR MN A, MN B (two) – OFF  
If DAMPING – ON (TLM failure only):  
PSU PWR MN A, MN B (two) – ON  
Continue approach or DOCKING SEQUENCE (Cue Card), as reqd >>
  

CRT  
A6L

  2. PSU PWR MN A – ON  
If DAMPING – ON:  
PSU PWR MN A – OFF  
MN B – ON
  

CRT

  3. PSU PWR MN A, MN B (two) – OFF  
Pre-Contact:  
Continue Approach  
Post-Capture, wait 5 sec then:  
PSU PWR MN A (MN B) – ON  
Continue in DOCKING SEQUENCE (Cue Card), with the following  
change:  
After step 3:  
PSU PWR MN A (MN B) – OFF >>
  

A6L

  4. PSU PWR MN A, MN B (two) – ON  
Pre-Contact:  
Continue Approach  
Post-Capture, wait 5 sec then:  
PSU PWR MN A, MN B (two) – ON  
Continue in DOCKING SEQUENCE (Cue Card), starting in step 8

## CAPTURE LT FAILED ON

### CAUTION

Pre-Contact, **NO-GO** for docking if DAMPING – ON.  
Initiate VBAR CORRIDOR BACKOUT  
(CONTINGENCY OPS) while attempting to power  
off dampers

### SM 167 DOCKING STATUS

- CRT
- If Pre-Contact:  
If DAMPING – OFF:  
| Continue Approach >>  
If DAMPING – ON:
- A6L
- PSU PWR MN A, MN B (two) – OFF  
Continue Approach  
Post-Capture (no physical separation):  
PSU PWR MN A, MN B (two) – ON  
Continue in DOCKING SEQUENCE (Cue Card), as reqd

## FIXERS FAILED ON

<b>CAUTION</b> Pre-Contact, <b>NO-GO</b> for docking if RING FIXERS – ON. Initiate VBAR CORRIDOR BACKOUT ( <u>CONTINGENCY OPS</u> ) while attempting to power off fixers
--

### SM 167 DOCKING STATUS

- A7L 1. POWER OFF pb – push  
CRT If RING FIXERS – ON:  
A7L POWER ON pb – push  
Continue Approach or DOCKING SEQUENCE (Cue Card), as reqd  
>>
2. POWER ON pb – push  
APDS POWER A<sub>DS</sub> – OFF  
CRT If RING FIXERS – ON:  
A7L APDS POWER A<sub>DS</sub> – ON  
B<sub>DS</sub> – OFF  
CRT If RING FIXERS – OFF:  
Pre-Contact:  
Continue Approach  
Post-Capture, continue in DOCKING SEQUENCE (Cue Card), as  
reqd, with the following change:  
After DOCKING SEQUENCE (Cue Card), step 16:  
A7L APDS POWER A<sub>DS</sub> (B<sub>DS</sub>) – ON >>
3. APDS POWER B<sub>DS</sub> – ON  
A6L PSU PWR MN A, MN B (two) – OFF  
If post-contact:  
√MCC for subsequent steps  
Continue Approach  
Post-capture wait 7 seconds, then:  
A7L APDS POWER A<sub>DS</sub>, B<sub>DS</sub>, C<sub>DS</sub> (three) – OFF  
A6L PSU PWR MN A, MN B (two) – ON  
CRT √DAMPING – ON
- DISABLE DAMPING
4. When no relative motion [PETAL POS BASE (three) not changing for  
60 sec]:  
A6L PSU PWR MN A, MN B (two) – OFF  
A7L APDS POWER A<sub>DS</sub>, B<sub>DS</sub>, C<sub>DS</sub> (three) – ON  
POWER ON pb – push

Cont next page



COMMAND CLUTCH TO LOCK

- CRT 5. When no relative motion [PETAL POS BASE (three) not changing for 30 sec]:  
If PETAL POS BASE (three) not within 5% of each other:  
√MCC
- A7L RING IN pb – push  
POWER ON pb – push
- A6L PSU PWR MN A,MN B (two) – ON
- CRT √DAMPING – OFF  
√CLUTCH – LOCK/blank
- A6L PSU PWR MN A,MN B (two) – OFF

RETRACT RING

- A7L 6. RING IN pb – push  
APDS POWER A<sub>DS</sub>,B<sub>DS</sub>,C<sub>DS</sub> (three) – OFF
- 0:00 A6L PSU PWR MN A,MN B (two) – ON
- CRT √RING DRV CMD – ON [PETAL POS BASE (three) – decr]
- 0:05 A6L PSU PWR MN A,MN B (two) – OFF
- A7L APDS POWER A<sub>DS</sub>,B<sub>DS</sub>,C<sub>DS</sub> (three) – ON  
POWER ON pb – push

EXTEND RING

- CRT 7. When no relative motion [PETAL POS BASE (three) not changing for 30 sec]:
- A7L APDS CIRC PROT OFF pb – push  
√CIRCUIT PROTECT OFF It – It on  
RING OUT pb – push  
APDS POWER A<sub>DS</sub>,B<sub>DS</sub>,C<sub>DS</sub> (three) – OFF
- 0:00 A6L PSU PWR MN A,MN B (two) – ON
- CRT √RING DRV CMD – ON [PETAL POS BASE (three) – incr]
- 0:05 A6L PSU PWR MN A,MN B (two) – OFF
- A7L APDS POWER A<sub>DS</sub>,B<sub>DS</sub>,C<sub>DS</sub> (three) – ON  
POWER ON pb – push
8. If RING ALIGNED It – It off:  
√MCC
- A6L PSU PWR MN A,MN B (two) – ON  
Go to DOCKING SEQUENCE (Cue Card), step 8

## FIXERS OFF LT FAILED ON

### SM 167 DOCKING STATUS

- If performing DOCKING RING EXTENSION, 8-8:
- CRT 1. If RING FIXERS – ON during ring drive:  
Continue in DOCKING RING EXTENSION, 8-8 >>
- A7L 2. FIXER OFF pb – push  
POWER OFF pb – push  
ON pb – push  
If FIXERS OFF It – It off:  
Continue in DOCKING RING EXTENSION, 8-8 >>
3. APDS CIRC PROT OFF pb – push  
√CIRCUIT PROTECT OFF It – It on  
RING OUT pb – push
- CRT When PETAL POS BASE (three) =  $76 \pm 3\%$ :  
A7L POWER OFF pb – push  
Go to APDS DIRECT DRIVE USING BOB (IFM, PROCEDURES A THRU E) to drive slip clutch to SLIP

## FIXERS OFF LT FAILED OFF

### SM 167 DOCKING STATUS

- A7L 1. POWER OFF pb – push  
ON pb – push  
FIXER OFF pb – push  
If FIXERS OFF It – It on:  
Continue in DOCKING SEQUENCE (Cue Card), as reqd >>
- CRT 2. If not CLUTCH – LOCK/blank  
A6L PSU PWR MN A, MN B (two) – OFF  
A7L RING IN pb – push  
POWER ON pb – push
- 0:00 A6L PSU PWR MN A, MN B (two) – ON  
0:05 CRT √CLUTCH – LOCK/blank
- A6L 3. PSU PWR MN A, MN B (two) – OFF  
A7L RING IN pb – push  
APDS POWER  $A_{DS}, B_{DS}, C_{DS}$  (three) – OFF  
– ON
- 0:00 A6L PSU PWR MN A, MN B (two) – ON (ring will begin to drive in this step)  
CRT √PETAL POS BASE (three) – decr
- 0:05 A7L POWER ON pb – push  
CRT √RING DRV CMD – OFF
- A6L 4. PSU PWR MN A, MN B (two) – OFF  
APDS CIRC PROT OFF pb – push  
√CIRCUIT PROTECT OFF It – It on  
A7L RING OUT pb – push  
APDS POWER  $A_{DS}, B_{DS}, C_{DS}$  (three) – OFF  
– ON
- 0:00 A6L PSU PWR MN A, MN B (two) – ON (ring will begin to drive in this step)  
CRT √PETAL POS BASE (three) – incr
- 0:05 A7L POWER ON pb – push  
CRT √RING DRV CMD – OFF
5. Go to DOCKING SEQUENCE (Cue Card), step 8

## RING FAILS TO DRIVE

- SM 167 DOCKING STATUS**
- A7L 1. POWER ON pb – push  
APDS CIRC PROT OFF pb – push  
√CIRCUIT PROTECT OFF It – It on  
FIXER OFF pb – push  
√FIXERS OFF It – It on
- CRT 2. RING OUT pb – push  
A7L If PETAL POS BASE (three) incr:  
POWER ON pb – push  
√MCC
- CRT 3. If PETAL POS BASE (three) not incr:  
A7L If RING DRV CMD – ON:  
If not CLUTCH – LOCK/blank:  
POWER OFF pb – push  
ON pb – push  
Go to CLUTCH NOT 'LOCK' >>
- CRT If RING DRV CMD – OFF:  
Go to RING DRV CMD OFF

## RING DRV CMD OFF

- SM 167 DOCKING STATUS**
- A7L 1. POWER OFF pb – push  
ON pb – push  
If STATUS It (eighteen) – It off:  
CONTROL PANEL POWER A – OFF  
POWER ON pb – push  
If STATUS It (eighteen) – It off:  
Go to step 3  
Continue in DOCKING SEQUENCE (Cue Card), as reqd >>
- CRT 2. APDS POWER A<sub>DS</sub> – OFF  
A7L RING IN pb – push  
If RING DRV CMD – OFF:  
APDS POWER A<sub>DS</sub> – ON  
C<sub>DS</sub> – OFF  
RING IN pb – push
- CRT If RING DRV CMD – OFF:  
Go to step 3
- A7L POWER ON pb – push  
Continue in DOCKING SEQUENCE (Cue Card) through step 16, then:  
APDS POWER A<sub>DS</sub> (C<sub>DS</sub>) – ON  
OPEN LATCHES pb – push  
After 5 sec:  
√LATCHES OPEN It – It on  
APDS POWER A<sub>DS</sub> (C<sub>DS</sub>) – OFF  
Go to DOCKING SEQUENCE (Cue Card), step 18 >>
3. If free drift, comm, and power level constraints permit (√MCC):  
Go to APDS DIRECT DRIVE USING BOB (IFM, PROCEDURES A THRU F)  
to complete docking >>
4. Go to FAILED CAPTURE (VBAR APPROACH, Cue Card) to undock

## RING FINAL POSITION LT FAILED ON

### SM 167 DOCKING STATUS

Continue in DOCKING SEQUENCE (Cue Card), as reqd, with the following changes:

- In step 8, after the ring stops (10 sec after having previously pushed the RING IN pb):
- A7L RING IN pb – push
- In step 11, to stop ring drive
- CRT POWER ON pb – push
- In step 18, when PETAL POS BASE (three) =  $5 \pm 3\%$  and not changing for 10 sec:
- A7L POWER OFF pb – push

## FORCE RING ALIGNMENT

- A7L 1. APDS CIRC PROT OFF pb – push  
 $\sqrt{\text{CIRCUIT PROTECT OFF It – It on}}$
2. FIXER OFF pb – push  
 $\sqrt{\text{FIXERS OFF It – It on}}$
- 0:00 3. RING OUT pb – push  
 CRT  $\sqrt{\text{DRV CMD – ON [PETAL POS BASE (three) – incr]}}$   
 $\sqrt{\text{FIXERS – OFF}}$
- 0:05  $\sqrt{\text{CLUTCH – LOCK/blank}}$   
 A7L  $\sqrt{\text{RING INITIAL POSITION It – It on (}\sqrt{\text{off at ~0:30)}})$
- \* If RING FORWARD POSITION It failed on (ring stops after 10 sec):\*
  - \* RING OUT pb – push \*
  - \* Within 10 sec: \*
  - \* APDS POWER  $A_{DS}, B_{DS}, C_{DS}$  (three) – OFF \*
  - \* APDS POWER  $A_{DS}, B_{DS}, C_{DS}$  (three) – ON \*
  - \* CIRC PROT OFF pb – push \*
  - \*  $\sqrt{\text{CIRCUIT PROTECT OFF It – It on}}$  \*
  - CRT \* When PETAL POS BASE (any) = 92%: \*
  - A6L \* PSU PWR MN A, MN B (two) – OFF \*
  - CRT \* When PETAL POS BASE (three) not changing for 30 sec: \*
  - A6L \* PSU PWR MN A, MN B (two) – ON \*
  - CRT \* When PETAL POS BASE (three) = 98%: \*
  - A7L \* RING OUT pb – push \*
  - \* Go to step 7 \*
- CRT 4. When PETAL POS BASE (any) = 92%:  
 A7L POWER ON pb – push
- CRT 5. When PETAL POS BASE (three) not changing for 30 sec:  
 A7L RING OUT pb – push
- 0:00 6.  $\sqrt{\text{RING FORWARD POSITION It – It on [PETAL POS BASE (three) = 98\%]}}$
- 0:10 CRT 7.  $\sqrt{\text{RING DRV CMD – OFF}}$   
 A7L  $\sqrt{\text{FIXERS OFF It – It off}}$   
 $\sqrt{\text{RING ALIGNED It – It on [PETAL POS RING (three) } 50 \pm 1\% \text{] and [PETAL POS BASE (three) within 1\%]}}$
8. Return to DOCKING SEQUENCE (Cue Card), step 8

## CLUTCH NOT 'LOCK'

- CRT SM 167 DOCKING STATUS  
If no ring motion when RING DRV CMD – ON
- A7L 1. APDS CIRC PROT OFF pb – push  
    √CIRCUIT PROTECT OFF It – It on  
    FIXER OFF pb – push  
    √FIXERS OFF It – It on  
    RING OUT pb – push  
    After 10 sec:  
        POWER OFF pb – push  
        ON pb – push
- CRT If CLUTCH – LOCK/blank:  
    Continue in DOCKING SEQUENCE (Cue Card), as reqd >>
- A7L 2. RING IN pb – push  
    After 10 sec:  
        POWER ON pb – push
- CRT If CLUTCH – LOCK/blank:  
    Continue in DOCKING SEQUENCE (Cue Card), as reqd >>
3. If free drift, comm, and power level constraints permit (√MCC):  
    Go to APDS DIRECT DRIVE USING BOB (IFM, PROCEDURES A THRU F) to complete docking

## APDS CIRCUIT PROTECT OFF LT FAILED OFF

- CRT SM 167 DOCKING STATUS  
If APDS CIRC PROT – ON:
- A7L POWER OFF pb – push  
    ON pb – push  
    APDS CIRC PROT OFF pb – push
- A7L If APDS CIRCUIT PROTECT OFF It – It on or  
CRT APDS CIRC PROT – OFF:  
    Continue sequence as required >>  
    Go to APDS DIRECT DRIVE USING BOB (IFM, PROCEDURES A THRU F)  
    for RING OUT, OPEN HOOKS, OPEN LATCHES, and UNDOCKING pb  
    commands

## HOOKS 1(2) OPEN LT FAILED ON

### NOTE

The following procedure should be performed immediately after DOCKING SEQUENCE (Cue Card) completed or prior to undocking as applicable

- A7L 1. POWER ON pb – push  
    APDS POWER A<sub>DS</sub> – OFF  
    If HOOKS 1(2) OPEN It – It off:  
        Go to nominal UNDOCKING OPERATIONS per nominal mission timeline with  
        APDS POWER A<sub>DS</sub> – OFF >>
2. Prior to nominal undocking:  
    Go to APDS DIRECT DRIVE USING BOB (IFM, PROCEDURES A THRU F) to open affected hooks

## HOOKS 1(2) NOT CLOSED WITHIN SINGLE MTR TIME

		SM 167 DOCKING STATUS
CRT	1.	If no hook motion when commanded:
A7L		APDS POWER A <sub>DS</sub> – OFF CLOSE HOOKS pb – push
CRT		If no hook motion after 10 sec:
A7L		APDS POWER A <sub>DS</sub> – ON B <sub>DS</sub> – OFF CLOSE HOOKS pb – push
CRT		If Hook Pos increasing after 10 sec: Continue in <u>DOCKING SEQUENCE</u> (Cue Card) with the following change: After step 16:
A7L		APDS POWER A <sub>DS</sub> (B <sub>DS</sub> ) – ON >>
	2.	APDS POWER A <sub>DS</sub> (B <sub>DS</sub> ) – ON POWER OFF pb – push ON pb – push
	3.	If other hook gang closed: Continue in <u>DOCKING SEQUENCE</u> (Cue Card), as reqd After <u>DOCKING SEQUENCE</u> (Cue Card) complete, go to PMA 2/3 HOOKS CLOSE, 8-35, to secure interface with 12 hooks >>
	4.	If neither hook gang closed: √MCC for IFM capability Go to APDS DIRECT DRIVE USING BOB (IFM, <u>PROCEDURES A THRU F</u> ) and PMA 2/3 HOOKS CLOSE, 8-35, as reqd, to secure interface with 12 hooks >>
	5.	If no IFM capability or time does not permit IFM: APDS CIRC PROT OFF pb – push √CIRCUIT PROTECT OFF It – It on OPEN HOOKS pb – push
0:00	CRT	√HK1, HK2 POS (two) – decr
	A7L	√HOOKS 1, HOOKS 2 OPEN It (two) – It on RING OUT pb – push
3:40	CRT	√PETAL POS BASE (three) – incr
	A7L	√RING INITIAL POSITION It – It on Go to <u>FAILED CAPTURE</u> ( <u>VBAR APPROACH</u> , Cue Card) to undock

## READY TO HOOK LT FAILED ON

- A7L 1. Immediately prior to step 4 in DOCKING SEQUENCE (Cue Card):  
APDS POWER A<sub>DS</sub> – OFF  
If READY TO HOOK It – It off:  
: If HOOKS 1(2) OPEN It – It off:  
: : APDS CIRC PROT OFF pb – push  
: : √CIRCUIT PROTECT OFF It – It on  
: : OPEN HOOKS pb – push  
: L √HOOKS 1,HOOKS 2 OPEN It (two) – It on  
: Continue in DOCKING SEQUENCE (Cue Card), as reqd, with the  
: following change:  
: After hooks begin to drive closed in step 10:  
L APDS POWER A<sub>DS</sub> – ON >>
2. APDS POWER A<sub>DS</sub> – ON  
Continue in DOCKING SEQUENCE (Cue Card), as reqd, with the following changes:  
Immediately after RING IN pb – push in step 4:  
APDS CIRC PROT OFF pb – push  
√CIRCUIT PROTECT OFF It – It on  
OPEN HOOKS pb – push  
CRT √HK1(2) POS decreasing to 5%
- A7L Immediately after RING IN pb – push in step 8:  
APDS CIRC PROT OFF pb – push  
√CIRCUIT PROTECT OFF It – It on  
OPEN HOOKS pb – push  
CRT √HK1(2) POS decreasing to 5%
- A7L When PETAL POS BASE (three) ≤ 7%:  
CLOSE HOOKS pb – push

## HOOKS 1(2) CLOSED LT FAILED ON

- A7L 1. APDS POWER A<sub>DS</sub> – OFF
2. If HOOKS 1(2) CLOSED It – It off:  
3. If Pre-Contact:  
APDS POWER A<sub>DS</sub> – ON  
Continue Approach
4. Post-Capture, continue in DOCKING SEQUENCE (Cue Card). If affected hooks do not close in step 10:  
APDS POWER A<sub>DS</sub> – OFF  
CLOSE HOOKS pb – push
5. Continue in DOCKING SEQUENCE (Cue Card) with the following change:  
After step 13:  
APDS POWER A<sub>DS</sub> – ON >>
6. If HOOKS 1(2) CLOSED It – It on:  
APDS POWER A<sub>DS</sub> – ON  
Continue in DOCKING SEQUENCE (Cue Card). If affected hooks do not close in step 10:  
After DOCKING SEQUENCE (Cue Card) complete:  
Go to APDS DIRECT DRIVE USING BOB (IFM, PROCEDURES A THRU F), to secure the interface with 12 hooks

## LATCHES OPEN LT FAILED OFF

### SM 167 DOCKING STATUS

- CRT 1. If CAP LAT IND – OP/blank:  
Continue in DOCKING SEQUENCE (Cue Card) >>
- A7L 2.  $\sqrt{APDS}$  POWER  $A_{DS}, B_{DS}, C_{DS}$  (three) – ON  
 $\sqrt{A_{DS}, B_{DS}, C_{DS}}$  It (three) – It on  
CIRC PROT OFF pb – push  
 $\sqrt{CIRCUIT}$  PROTECT OFF It – It on  
OPEN LATCHES pb – push
- A7L, CRT If LATCHES OPEN It – It on or CAP LAT IND – OP/blank:  
Continue in DOCKING SEQUENCE (Cue Card) >>
3. Continue in DOCKING SEQUENCE (Cue Card), deleting step 18, then:  
On MCC GO:  
Go to 2.109 CAPTURE LATCH MANUAL RELEASE, HATCH OPENING  
AND DUCT INSTALL (JOINT OPS, INGRESS STATION)

## APDS POWER FAILED OFF

### SM 167 DOCKING STATUS

- A7L If any APDS POWER  $A_{DS}, B_{DS}, C_{DS}$  It off:

#### CAUTION

Associated capture latch cannot be driven open, resulting in inability to separate interfaces once the structural interfaces are within 3 inches of each other

Post-Capture:

Continue in DOCKING SEQUENCE (Cue Card), deleting steps 17 and 18

On MCC GO:

Go to 2.109 CAPTURE LATCH MANUAL RELEASE, HATCH  
OPENING AND DUCT INSTALL (JOINT OPS, INGRESS STATION)



# DOCKING MECHANISM DEMATE/REMATE

## NOTE

This procedure assumes vestibule leak check failed, or both ODS hook gangs jammed simultaneously. Docking ring will recapture PMA petals, hooks will be driven open, interface will be separated, and second mating attempt will be performed. Procedure assumes DOCKING SEQUENCE (Cue Card) completed.

Successful completion of this procedure ends with Shuttle resuming attitude control

1. Perform steps 1 and 2 of ANY ATTITUDE SEPARATION, (CONTINGENCY OPS), 5-23

### SM 167 DOCKING STATUS

#### RECAPTURE PMA PETALS

- |              |            |  |
|--------------|------------|--|
| 0:00         | A7L        | 2. POWER ON pb – push<br>CLOSE LATCHES pb – push<br>√LATCHES OPEN It – It off  |
| 0:05         |            | √CLOSED It – It on   |
| 0:00         |            | 3. APDS CIRC PROT OFF pb – push<br>√CIRCUIT PROTECT OFF It – It on<br>FIXER OFF pb – push<br>√FIXERS OFF It – It on<br>RING OUT pb – push<br>√FINAL POSITION It – It off |
| 0:20         |            | 4. When CAPTURE It – It on:<br>POWER OFF pb – push<br>ON pb – push<br>√CAPTURE It – It off   |
| 0:00<br>0:10 | CRT<br>A7L | 5. RING IN pb – push<br>POWER ON pb – push<br>√RING FINAL POSITION It – It off<br>√DRV CMD – OFF<br>√LATCHES CLOSED It – It on   |

#### WARNING

Vehicle separation may occur when ODS hooks opened if RING FINAL POSITION It is ON or LATCHES CLOSED It is OFF. Be prepared to pick up in ANY ATTITUDE SEPARATION (CONTINGENCY OPS), step 4

#### OPEN ODS HOOKS

- |      |   |
|------|---|
| 0:00 | 6. APDS CIRC PROT OFF pb – push<br>√CIRCUIT PROTECT OFF It – It on<br>OPEN HOOKS pb – push<br>√HOOKS 1,HOOKS 2 CLOSED It (two) – It off |
| 2:20 | √OPEN It (two) – It on  |

Cont next page

EXTEND RING TO INITIAL POSITION FOR INTERFACE SEPARATION:

- 0:00 CRT A7L 7. RING OUT pb – push  
√DRV CMD – ON  
√INTERF SEALED It – It off
- 3:40 CRT √RING INITIAL POSITION It – It on  
√DRV CMD – OFF  
√PETAL POS BASE = 76 ± 3%

8. √Interface clear of debris or other obstruction

RETRACT RING FOR SECOND MATING ATTEMPT:

- 0:00 A7L CRT 9. RING IN pb – push  
√DRV CMD – ON [PETAL POS BASE (three) - decr]  
√CLUTCH – LOCK/blank
- 3:15 A7L √READY TO HOOK It – It on
- 0:00 √HOOKS 1,HOOKS 2 OPEN It (two) – It off
- ≤1:30 √INTERF SEALED It – It on
- 2:20 √HOOKS 1,HOOKS 2 CLOSED It (two) – It on

10. √APDS CIRCUIT PROTECT OFF It – It on

- 0:00 RING OUT pb – push  
CRT √DRV CMD – ON
- 0:10 A7L POWER ON pb – push  
CRT √RING DRV CMD – OFF

- 0:00 A7L 11. OPEN LATCHES pb – push  
√LATCHES CLOSED It – It off
- 0:05 √OPEN It – It on

- 0:00 12. RING IN pb – push
- 0:10 √FINAL POSITION It – It on
- 0:20 CRT √DRV CMD – OFF

- A7L 13. POWER OFF pb – push  
√STATUS It (eighteen) – It off

14. Perform DOCKING MECHANISM POWERDOWN, 8-6, if reqd, then:

- A6U 15. Perform TERMINATE RNDZ OPS 22A, 4-22, step 1

16. Return to FLIGHT PLAN

## ODS HOOKS OPEN – CONTINGENCY

### NOTE

Procedure assumes PMA 2/3 hooks have not been closed at any time during the mission, and either ODS hooks could not be opened nominally or ODS hooks were driven full open and physical separation did not occur. If PMA 2/3 hooks have been closed at any point during the mission, go to PMA 2/3 HOOKS OPEN – CONTINGENCY, 8-30.

To undock, the crew will start in the ANY ATTITUDE SEPARATION (AAS), 5-23, to prep for undocking, then transition to this procedure. Once in this procedure, steps 3-6 will recapture the PMA petals in preparation for firing the ODS hook pyros. Steps 7-8 re-open the ODS hooks. The capture latches maintain the connection between the two vehicles. Steps 9-11 will discharge the active hook pyros. When the active docking ring is extended in step 12, separation is expected at the interface between the fixed shuttle APDS structural ring and the fixed PMA structural ring. Vehicles maintain a physical connection via the active docking ring until the capture latches are opened after returning to the AAS procedure in step 20. If there is no separation in step 12, the passive hook pyros are discharged in steps 14-16. Interface separation is attempted again in step 17. As in step 12, the vehicles will maintain a physical connection via the active docking ring capture latches. In step 20, the crew will transition back to the AAS procedure where the capture latches will be opened and the actual vehicle separation performed.

Procedure also assumes that an EVA crew is prepared to immediately perform the 96 BOLT EVA if ODS pyros are discharged and physical separation does not occur

1. Perform steps 1 and 2 of ANY ATTITUDE SEPARATION (CONTINGENCY OPS), 5-23

A7L 2. POWER ON pb – push

SM 167 DOCKING STATUS

### RECAPTURE PMA PETALS

3. CLOSE LATCHES pb – push  
√LATCHES OPEN It – It off  
√CLOSED It – It on
4. APDS CIRC PROT OFF pb – push  
√CIRCUIT PROTECT OFF It – It on  
FIXER OFF pb – push  
√FIXERS OFF It – It on  
RING OUT pb – push  
√FINAL POSITION It – It off
5. When CAPTURE It – It on:  
POWER OFF pb – push  
ON pb – push  
√CAPTURE It – It off

Cont next page

0:00  
0:10

- CRT  
A7L
6. RING IN pb – push  
POWER ON pb – push  
√RING FINAL POSITION It – It off  
√DRV CMD – OFF  
√LATCHES CLOSED It – It on

<p><u>WARNING</u> Vehicle separation may occur when ODS hooks opened or pyros discharged if RING FINAL POSITION It is ON or LATCHES CLOSED It is OFF. Be prepared to pick up in ANY ATTITUDE SEPARATION, (CONTINGENCY OPS) step 4, 5-23</p>
---

- A7L
- RE-OPEN CLOSED HOOKS
7. APDS CIRC PROT OFF pb – push  
√CIRCUIT PROTECT OFF It – It on  
OPEN HOOKS pb – push
  8. When good HOOKS 1(2) OPEN It on  
and jammed HK2(1) POS not decr:  
POWER OFF pb – push  
ON pb – push

- A6L  
A7L
- DISCHARGE ACTIVE HOOK PYROS
9. PYRO PWR MN A,MN C (two) – ON  
PYROS A<sub>P</sub>,B<sub>P</sub>,C<sub>P</sub> (three) – ON  
√A<sub>P</sub>,B<sub>P</sub>,C<sub>P</sub> It (three) – It on  
PYRO CIRC PROT OFF pb – push  
√CIRCUIT PROTECT OFF It – It on
  10. ACT HOOKS FIRING pb – push
  11. PYRO CIRC PROT ON pb – push  
√CIRCUIT PROTECT OFF It – It off  
PYROS A<sub>P</sub>,B<sub>P</sub>,C<sub>P</sub> (three) – OFF  
√A<sub>P</sub>,B<sub>P</sub>,C<sub>P</sub> It (three) – It off
- A6L
- PYRO PWR MN A,MN C (two) – OFF

- A7L
- EXTEND RING TO INITIAL POSITION FOR INTERFACE SEPARATION
12. APDS CIRC PROT OFF pb – push  
√CIRCUIT PROTECT OFF It – It on
- 0:00
- RING OUT pb – push  
√INTERF SEALED It – It off
- CRT
- If interface separates [PETAL POS BASE (three) incr after 20 sec]:  
Go to step 19

- A7L  
A6L  
A7L
- RECONFIGURE AND DISCHARGE PASSIVE HOOK PYROS
13. POWER ON pb – push  
PSU PWR MN A,MN B (two) – OFF  
RING IN pb – push  
APDS POWER A<sub>DS</sub>,B<sub>DS</sub>,C<sub>DS</sub> (three) – OFF  
– ON
- A6L  
CRT  
A7L
- PSU PWR MN A,MN B (two) – ON  
When PETAL POS BASE (three) = ~6% and not decr:  
POWER ON pb – push

Cont next page

- A6L 14. PYRO PWR MN A,MN C (two) – ON  
 A7L PYROS A<sub>P</sub>,B<sub>P</sub>,C<sub>P</sub> (three) – ON  
     √A<sub>P</sub>,B<sub>P</sub>,C<sub>P</sub> It (three) – It on  
 PYRO CIRC PROT OFF pb – push  
     √CIRCUIT PROTECT OFF It – It on
15. PAS HOOKS FIRING pb – push
16. PYRO CIRC PROT ON pb – push  
     √CIRCUIT PROTECT OFF It – It off  
 PYROS A<sub>P</sub>,B<sub>P</sub>,C<sub>P</sub> (three) – OFF  
     √A<sub>P</sub>,B<sub>P</sub>,C<sub>P</sub> It (three) – It off
- A6L PYRO PWR MN A,MN C (two) – OFF

REATTEMPT EXTENDING RING TO INITIAL POSITION FOR INTERFACE SEPARATION

- 0:00 A7L 17. √APDS CIRCUIT PROTECT OFF It – It on  
 RING OUT pb – push  
     √INTERF SEALED It – It off
- CRT If interface separates [PETAL POS BASE (three) incr after 20 sec]:  
 Go to step 19

RECONFIGURE AND PREPARE FOR 96 BOLT EVA

- A7L 18. POWER ON pb – push  
 RING IN pb – push
- CRT When PETAL POS BASE (three) = ~6% and not decr:
- A7L POWER OFF pb – push  
 Perform DOCKING MECHANISM POWERDOWN, 8-6, then:  
 Go to 96 BOLT EVA TIMELINE (EVA, ORB CONT EVA) >>

FINAL PREPARATION FOR VEHICLE SEPARATION

- ~3:20 CRT 19. √RING INITIAL POSITION It – It on  
     √DRV CMD – OFF  
     √PETAL POS BASE (three) = 76 ± 3%
20. Go to step 3 of ANY ATTITUDE SEPARATION (CONTINGENCY OPS), 5-23. Expect no spring assisted separation

## PMA 2/3 HOOKS OPEN – CONTINGENCY

### NOTE

Procedure assumes PMA 2/3 hooks could not be opened nominally or ODS hooks were driven fully open and physical separation did not occur and PMA 2/3 were closed at some point during the mission.

To undock, the crew will start in the ANY ATTITUDE SEPARATION (AAS), 5-23, to prep for undocking, then transition to this procedure. Once in this procedure, steps 3-6 will recapture the PMA petals in preparation for firing the ODS hook pyros. Steps 7-9 re-open the ODS hooks. The capture latches maintain the connection between the two vehicles. Step 10 commands the ring out to verify that the initial problem still exists before firing the pyros. When the active docking ring is extended in step 10, separation is expected at the interface between the fixed shuttle APDS structural ring and the fixed PMA structural ring. Vehicles maintain a physical connection via the active docking ring until the capture latches are opened after returning to the AAS procedure in step 23. Steps 12-14 will discharge the passive hook pyros. Interface separation is attempted again in step 15. As in step 10, the vehicles will maintain a physical connection via the active docking ring capture latches. If there is no separation in step 15, the active hook pyros are discharged in steps 17-19. Interface separation is attempted again in step 20. As in step 10, the vehicles will maintain a physical connection via the active docking ring capture latches. In step 23, the crew will transition back to the AAS procedure where the capture latches will be opened and the actual vehicle separation performed.

Procedure also assumes that an EVA crew is prepared to immediately perform the 96 BOLT EVA if ODS pyros are discharged, and physical separation does not occur

1. Perform steps 1 and 2 of ANY ATTITUDE SEPARATION  
(CONTINGENCY OPS), 5-23
- A7L 2. POWER ON pb – push  

SM 167 DOCKING STATUS

  
RECAPTURE PMA PETALS
3. CLOSE LATCHES pb – push  
√LATCHES OPEN It – It off  
√CLOSED It – It on
4. APDS CIRC PROT OFF pb – push  
√CIRCUIT PROTECT OFF It – It on  
FIXER OFF pb – push  
√FIXERS OFF It – It on  
RING OUT pb – push  
√FINAL POSITION It – It off
5. When CAPTURE It – It on:  
POWER OFF pb – push  
ON pb – push  
√CAPTURE It – It off
- 0:00 6. RING IN pb – push  
0:10 POWER ON pb – push  
√RING FINAL POSITION It – It off  
CRT √DRV CMD – OFF  
A7L √LATCHES CLOSED It – It on

Cont next page

WARNING

Vehicle separation may occur when ODS hooks opened or pyros discharged if RING FINAL POSITION It is ON or LATCHES CLOSED It is OFF. Be prepared to pick up in ANY ATTITUDE SEPARATION,(CONTINGENCY OPS), step 4, 5-23

OPEN ODS HOOKS

7. APDS CIRC PROT OFF pb – push  
√CIRCUIT PROTECT OFF It – It on
- 0:00 8. OPEN HOOKS pb – push  
√HOOKS 1,HOOKS 2 CLOSED It (two) – It off  
CRT √HK1,HK2 POS (two) < 92% and decr
- 2:20 A7L 9. √HOOKS 1,HOOKS 2 OPEN It (two) – It on

ATTEMPT TO EXTEND RING TO INITIAL POSITION FOR INTERFACE SEPARATION

- 0:00 A7L 10. RING OUT pb – push  
√INTERF SEALED It – It off  
CRT If interface separates [PETAL POS BASE (three) incr after 20 sec]:  
Go to step 22

RECONFIGURE AND DISCHARGE PASSIVE HOOK PYROS

- A7L 11. POWER ON pb – push  
A6L PSU PWR MN A,MN B (two) – OFF  
A7L RING IN pb – push  
APDS POWER A<sub>DS</sub>,B<sub>DS</sub>,C<sub>DS</sub> (three) – OFF  
– ON
- A6L PSU PWR MN A,MN B (two) – ON  
CRT When PETAL POS BASE (three) = ~6% and not decr:  
A7L POWER ON pb – push
- A6L 12. PYRO PWR MN A,MN C (two) – ON  
A7L PYROS A<sub>P</sub>,B<sub>P</sub>,C<sub>P</sub> (three) – ON  
√A<sub>P</sub>,B<sub>P</sub>,C<sub>P</sub> It (three) – It on  
PYRO CIRC PROT OFF pb – push  
√CIRCUIT PROTECT OFF It – It on
13. PAS HOOKS FIRING pb – push
14. PYRO CIRC PROT ON pb – push  
√CIRCUIT PROTECT OFF It – It off  
PYROS A<sub>P</sub>,B<sub>P</sub>,C<sub>P</sub> (three) – OFF  
√A<sub>P</sub>,B<sub>P</sub>,C<sub>P</sub> It (three) – It off  
A6L PYRO PWR MN A,MN C (two) – OFF

REATTEMPT EXTENDING RING TO INITIAL POSITION FOR INTERFACE SEPARATION

- 0:00 A7L 15. √APDS CIRCUIT PROTECT OFF It – It on  
RING OUT pb – push  
√INTERF SEALED It – It off  
CRT If interface separates [PETAL POS BASE (three) incr after 20 sec]:  
Go to step 22

Cont next page

RECONFIGURE AND DISCHARGE ACTIVE HOOK PYROS

- A7L 16. POWER ON pb – push  
A6L PSU PWR MN A,MN B (two) – OFF  
A7L RING IN pb – push  
APDS POWER A<sub>DS</sub>,B<sub>DS</sub>,C<sub>DS</sub> (three) – OFF  
– ON
- A6L PSU PWR MN A,MN B (two) – ON  
CRT When PETAL POS BASE (three) = ~6% and not decr:  
A7L POWER ON pb – push
- A6L 17. PYRO PWR MN A,MN C (two) – ON  
A7L PYROS A<sub>P</sub>,B<sub>P</sub>,C<sub>P</sub> (three) – ON  
√A<sub>P</sub>,B<sub>P</sub>,C<sub>P</sub> It (three) – It on  
PYRO CIRC PROT OFF pb – push  
√CIRCUIT PROTECT OFF It – It on
18. ACT HOOKS FIRING pb – push
19. PYRO CIRC PROT ON pb – push  
√CIRCUIT PROTECT OFF It – It off  
PYROS A<sub>P</sub>,B<sub>P</sub>,C<sub>P</sub> (three) – OFF  
√A<sub>P</sub>,B<sub>P</sub>,C<sub>P</sub> It (three) – It off  
A6L PYRO PWR MN A,MN C (two) – OFF

REATTEMPT EXTENDING RING TO INITIAL POSITION FOR INTERFACE SEPARATION

- 0:00 A7L 20. √APDS CIRCUIT PROTECT OFF It – It on  
RING OUT pb – push  
√INTERF SEALED It – It off  
CRT If interface separates [PETAL POS BASE (three) incr after 20 sec]:  
Go to step 22

RECONFIGURE AND PREPARE FOR 96 BOLT EVA

- A7L 21. POWER ON pb – push  
RING IN pb – push  
CRT When PETAL POS BASE (three) = ~6% and not decr:  
A7L POWER ON pb – push  
Perform DOCKING MECHANISM POWERDOWN, 8-6, then:  
Go to 96 BOLT EVA TIMELINE (EVA, ORB CONT EVA) >>

FINAL PREPARATION FOR VEHICLE SEPARATION

- ~3:20 A7L 22. √RING INITIAL POSITION It – It on  
CRT √DRV CMD – OFF  
√PETAL POS BASE (three) = 76 ± 3%
23. Go to step 3 of ANY ATTITUDE SEPARATION (CONTINGENCY OPS),  
5-23. Expect no spring assisted separation



## APDS FAILED CAPTURE RECONFIG

		SM 167 DOCKING STATUS		
0:00	A7L	1. If LATCHES OPEN It – It on: CLOSE LATCHES pb – push √LATCHES OPEN It – It off		
0:05		√CLOSED It – It on		
		2. √APDS CIRCUIT PROTECT OFF It – It on		
0:00		3. FIXER OFF pb – push √FIXERS OFF It – It on RING OUT pb – push		
0:05	CRT	√PETAL POS BASE (three) – incr		
	A7L	√CLUTCH – LOCK/blank √RING INITIAL POSITION It – It on (for ~16 sec), then It off		
		* If RING FORWARD POSITION It failed on (ring stops * * after 10 sec): *		
		* RING OUT pb – push *		
		* Within 10 sec: *		
		* APDS POWER A <sub>DS</sub> , B <sub>DS</sub> , C <sub>DS</sub> (three) – OFF *		
		* APDS POWER A <sub>DS</sub> , B <sub>DS</sub> , C <sub>DS</sub> (three) – ON *		
		* CIRC PROT OFF pb – push *		
		* √CIRCUIT PROTECT OFF It – It on *		
		* √RING INITIAL POSITION It – It on (for ~16 sec), *		
		* then It off *		
	CRT	* When PETAL POS BASE (three) = 98 ± 2%: *		
	A7L	* RING OUT pb – push *		
		* After 10 sec: *		
	CRT	* √RING DRV CMD – OFF *		
1:15	A7L	4. √RING FORWARD POSITION It – It on √ALIGNED It – It on		
		√FIXERS OFF It – It off		
	CRT	√PETAL POS BASE (three): 98 ± 2%		
0:00	A7L	5. RING IN pb – push		
	CRT	√CLUTCH – LOCK/blank		
	A7L	√RING FORWARD POSITION It – It off		
1:15		√INITIAL POSITION It – It on (for ~16 sec), then It off		
		* If RING FINAL POSITION It failed on (ring stops after 10 sec): *		
0:00		* RING IN pb – push *		
		* √FORWARD POSITION It – It off *		
1:15		* √INITIAL POSITION It – It on (for ~16 sec), then It off *		
4:50	CRT	* When PETAL POS BASE (three) = 5 ± 3% and not decr: *		
	A7L	* POWER ON pb – push *		
		6. √RING FINAL POSITION It – It on		
5:00	CRT	√DRV CMD – OFF		
0:00	A7L	7. APDS CIRC PROT OFF pb – push √CIRCUIT PROTECT OFF It – It on		
		RING OUT pb – push		
	CRT	√CLUTCH – LOCK/blank		
0:10	A7L	√RING FINAL POSITION It – It off		

Cont next page

		* If RING INITIAL POSITION It failed on (ring stops after	*
		* 1 sec, and Clutch drives to SLIP):	*
		* FIXER OFF pb – push	*
		* √FIXERS OFF It – It on	*
		* RING OUT pb – push	*
CRT		* When PETAL POS BASE (three) = $76 \pm 3\%$ :	*
A7L		* POWER OFF pb – push	*
		* POWER ON pb – push	*
		* √FIXERS OFF It – It off	*
		* APDS CIRC PROT OFF pb – push	*
		* √CIRCUIT PROTECT OFF It – It on	*
		* RING OUT pb – push	*
		* After 1 sec:	*
CRT		* √RING DRV CMD – OFF	*
		*	*
A7L		* If RING FORWARD POSITION It failed on (ring stops	*
		* after 10 sec):	*
		* RING OUT pb – push	*
		* Within 10 sec:	*
		* APDS POWER $A_{DS}, B_{DS}, C_{DS}$ (three) – OFF	*
		* APDS POWER $A_{DS}, B_{DS}, C_{DS}$ (three) – ON	*
		* CIRC PROT OFF pb – push	*
		* √CIRCUIT PROTECT OFF It – It on	*
		* When RING INITIAL POSITION It on:	*
		* RING OUT pb – push	*
		*	*
3:40		8. √RING INITIAL POSITION It – It on	
CRT		√PETAL POS BASE (three) – $76 \pm 3\%$	
		√CLUTCH – blank/SLIP	
		* If CLUTCH – blank/blank:	*
A7L		* √APDS CIRCUIT PROTECT OFF It – It on	*
		* RING OUT pb – push (expect 1 sec of drive),	*
		* wait 10 sec	*
CRT		* √RING DRV CMD – OFF	*
		* If CLUTCH – LOCK/blank:	*
A7L		* √RING INITIAL POSITION It – It on	*
		* √FIXERS OFF It – It off	*
		* √APDS CIRCUIT PROTECT OFF It – It on	*
		* RING OUT pb – push (expect 1 sec of drive),	*
		* wait 10 sec	*
		* √RING DRV CMD – OFF	*
CRT		* If not CLUTCH – blank/SLIP:	*
		* √MCC	*
		*	*
A7L		9. POWER OFF pb – push	
		√STATUS It (eighteen) – It off	

## PMA 2/3 HOOKS CLOSE

### CAUTION

Procedure assumes one ODS Hook Gang has failed and one PMA 2/3 Hook Gang can be used to recover a total of 12 hooks. ODS to PMA 2/3 interface must be hard mated, as verified by the ODS X3/X4 connector mate indications, in order to provide PMA 2/3 active hook control and tlm through the interface X-connectors

### NOTE

PMA2/3 Active Hooks 1(2) engage ODS Passive Hooks 2(1). Therefore, if ODS Active Hooks 1(2) is failed, it is preferable to close PMA Active Hooks 2(1)

### SM 167 DOCKING STATUS

CRT 1. √ODS CONN X3,X4 (two) – ON

A6L 2. √cb PMA 2/3 GRP 1,2 HOOKS (eight) – op  
√PMA 2/3 HOOKS SYS A,SYS B (two) – ctr  
√GRP 1 tb – bp  
√GRP 2 tb – bp

### TO CLOSE HOOKS 1, PERFORM STEPS 3 THRU 6

3. cb PMA 2/3 GRP 1 HOOKS SYS A OP,CL (two) – cl  
B OP,CL (two) – cl

CRT √PMA 2/3 HOOKS GRP 1 tb – OP  
√HK1 IND OP – 1,2  
√IND CL – blank  
√HK CLS 1/3/5, 7/9/11 (two) – blank

\* If either IND CL present, hooks may operate single \*  
\* motor. If both IND CL present, hooks may not drive: \*  
\* √MCC \*

0:00 A6L 4. PMA 2/3 HOOKS SYS A,SYS B (two) – CL  
√GRP 1 tb – bp

CRT √HK1 CMD CL – 1,2  
√IND OP – blank

2:20 A6L 5. √PMA 2/3 HOOKS GRP 1 tb – CL

CRT √HK1 IND CL – 1,2  
√CMD CL – blank  
√HK CLS 1/3/5, 7/9/11 (two) – CL

A6L 6. PMA 2/3 HOOKS SYS A,SYS B (two) – ctr  
cb PMA 2/3 GRP 1 HOOKS SYS A OP,CL (two) – op  
B OP,CL (two) – op

TO CLOSE HOOKS 2, PERFORM STEPS 7 THRU 10

7. cb PMA 2/3 GRP 2 HOOKS SYS A OP,CL (two) – cl  
B OP,CL (two) – cl

CRT           √PMA 2/3 HOOKS GRP 2 tb – OP  
                  √HK2 IND OP – 1,2  
                  √CL – blank  
                  √HK CLS 2/4/6, 8/10/12 (two) – blank

\* If either IND CL present, hooks may operate single \*  
\* motor. If both IND CL present, hooks may not drive: \*  
\*   √MCC \*

0:00   A6L       8. PMA 2/3 HOOKS SYS A,SYS B (two) – CL

CRT           √GRP 2 tb – bp  
                  √HK2 CMD CL – 1,2  
                  √IND OP – blank

2:20   A6L       9. √PMA 2/3 HOOKS GRP 2 tb – CL

CRT           √HK2 IND CL – 1,2  
                  √CMD CL – blank  
                  √HK CLS 2/4/6, 8/10/12 (two) – CL

A6L       10. PMA 2/3 HOOKS SYS A,SYS B (two) – ctr  
            cb PMA 2/3 GRP 2 HOOKS SYS A OP,CL (two) – op  
                  B OP,CL (two) – op

## PMA 2/3 HOOKS OPEN

### CAUTION

ODS to PMA 2/3 interface must remain hard mated by at least one gang of ODS hooks through entire procedure in order to provide PMA 2/3 active hook control and tlm through the interface X-connectors

### SM 167 DOCKING STATUS

- A6L 1. √cb PMA 2/3 GRP 1,2 HOOKS (eight) – op  
√PMA 2/3 HOOKS SYS A,SYS B (two) – ctr (tb-bp)  
√GRP 1 tb – bp  
√GRP 2 tb – bp

### TO OPEN HOOKS 1, PERFORM STEPS 2 THRU 5

2. cb PMA 2/3 GRP 1 HOOKS SYS A OP,CL (two) – cl  
B OP,CL (two) – cl  
√PMA 2/3 HOOKS GRP 1 tb – CL  
CRT √HK1 IND CL – 1,2  
√OP – blank  
√HK CLS 1/3/5, 7/9/11 (two) – CL

\* If either IND OP present, hooks may operate single \*  
\* motor. If both IND OP present, hooks may not drive. \*

- 0:00 A6L 3. PMA 2/3 HOOKS SYS A,SYS B (two) – OP  
√GRP 1 tb – bp  
CRT √HK1 CMD OP – 1,2  
√IND CL – blank  
√HK CLS 1/3/5, 7/9/11 (two) – blank

- 2:20 A6L 4. √PMA 2/3 HOOKS GRP 1 tb – OP  
CRT √HK1 IND OP – 1,2  
√CMD OP – blank

- A6L \* If PMA 2/3 HOOKS fail to drive, or do not reach end-of- \*  
\* travel after single motor drive time (~4:40): \*  
\* PMA 2/3 HOOKS SYS A,SYS B (two) – ctr \*  
\* cb PMA 2/3 GRP 1 HOOKS SYS A OP,CL (two) – op \*  
\* cb PMA 2/3 GRP 1 HOOKS SYS B OP,CL (two) – op \*  
\* Perform PMA 2/3 HOOKS OPEN – CONTINGENCY, \*  
\* 8-30 \*

5. PMA 2/3 HOOKS SYS A,SYS B (two) – ctr  
cb PMA 2/3 GRP 1 HOOKS SYS A OP,CL (two) – op  
B OP,CL (two) – op

Cont next page

TO OPEN HOOKS 2, PERFORM STEPS 6 THRU 9

6. cb PMA 2/3 GRP 2 HOOKS SYS A OP,CL (two) – cl  
B OP,CL (two) – cl

CRT           √PMA 2/3 HOOKS GRP 2 tb – CL  
                  √HK2 IND CL – 1,2  
                  √IND OP – blank  
                  √HK CLS 2/4/6, 8/10/12 (two) – CL

\* If either IND OP present, hooks may operate single   \*  
\* motor. If both IND OP present, hooks may not drive   \*

0:00   A6L       7. PMA 2/3 HOOKS SYS A,SYS B (two) – OP

CRT           √GRP 2 tb – bp  
                  √HK2 CMD OP – 1,2  
                  √IND CL – blank  
                  √HK CLS 2/4/6, 8/10/12 (two) – blank

2:20   A6L       8. √PMA 2/3 HOOKS GRP 2 tb – OP

CRT           √HK2 IND OP – 1,2  
                  √CMD OP – blank

A6L           \* If PMA 2/3 HOOKS fail to drive, or do not reach       \*  
                  \* end-of-travel after single motor drive time (~4:40):   \*  
                  \* PMA 2/3 HOOKS SYS A,SYS B (two) – ctr       \*  
                  \* cb PMA 2/3 GRP 2 HOOKS SYS A OP,CL (two) – op \*  
                  \* cb PMA 2/3 GRP 2 HOOKS SYS B OP,CL (two) – op \*  
                  \* Perform PMA 2/3 HOOKS OPEN – CONTINGENCY, \*  
                  \* 8-30    \*

9. PMA 2/3 HOOKS SYSA,SYS B (two) – ctr  
cb PMA 2/3 GRP 2 HOOKS SYS A OP,CL (two) – op  
B OP,CL (two) – op

REFERENCE DATA

APDS FAILURE/IMPACT MATRIX.....	8-40
(TLM) .....	8-43

REFERENCE  
DATA

# APDS FAILURE/IMPACT MATRIX

REFERENCE DATA

APDS Status It	APDS FAILURE s = potential single failure m = multiple failures reqd	IMPACT	OFF NOMINAL PROCEDURE (IF APPLICABLE)
POWER ON pb	Failed ON (m)	Continuous PWR ON will inhibit ring, damping, and fixer commands. Relays may overheat preventing future powerup. [Detectable only during powerup or ring drive operations]	RING DRV CMD OFF
	Failed OFF (m)	If all STATUS Its are off, loss of all logic power to APDS. Docking system cannot be operated	POWER FAILED OFF (STATUS LTS OFF)
APDS CIRCUIT PROTECT OFF	Failed ON (m)	RING OUT, OPEN LATCHES, OPEN HOOKS, and UNDOCKING pb commands are enabled	
	Failed OFF (m)	No RING OUT, OPEN LATCHES, OPEN HOOKS, or UNDOCKING pb capability	APDS CIRCUIT PROTECT OFF LT FAILED OFF
RING ALIGNED	Failed ON (m)	Prime alignment cue lost. Use CRT RING ALIGN and PETAL POS BASE 1,2,3 indications as backup. Erroneous ind possible with significant pitch motion (sensors rotated 360°)	
	Failed OFF (s)	Prime alignment cue lost. Use CRT RING ALIGN and PETAL POS BASE 1,2,3 indications as backup	
RING INITIAL POSITION	Failed ON (s)	Ring will only drive for 1 sec with RING OUT pb commands. Slip clutch will drive alternately between the SLIP and LOCK positions	Starred blocks in the DOCKING RING EXTENSION and DOCKING MECHANISM DEMATE/REMATE
	Failed OFF (m)	INITIAL CONTACT It disabled. Slip clutch will not drive to SLIP	APDS DIRECT DRIVE USING BOB required to drive slip clutch
FIXERS OFF	Failed ON (m)	IFM may be required to drive clutch to SLIP if failure occurs during ring extension. During docking, only centering springs maintain alignment during ring retraction	FIXERS OFF LT FAILED ON
	Failed OFF (m)	Unable to inhibit fixer operation during manual ring drive	FIXERS OFF LT FAILED OFF
HOOKS 1(2) OPEN	Failed ON (s)	Logic prevents hooks from driving open	HOOKS 1(2) OPEN LT FAILED ON [UNDOCKING]
	Failed OFF (m)	Hooks will not stop driving at Open position	
LATCHES CLOSED	Failed ON (s)	If ring retraction to Final Position is attempted, ring will stall against capture latches if latches are failed closed. No impact if latches open on SPEC 167	
	Failed OFF (m)	No impact to nominal sequence. [May not be able to recapture, if reqd, if capture latches are not closed. Multiple failures reqd to inadvertently drive a latch motor open]	



## APDS FAILURE/IMPACT MATRIX (Cont)

APDS Status It	APDS FAILURE s = potential single failure m = multiple failures reqd	IMPACT	OFF NOMINAL PROCEDURE (IF APPLICABLE)
UNDOCK COMPLET	Failed ON (s)	If light comes on when APDS CIRC PROT OFF pb is pressed, hooks may be continuously commanded open	
	Failed OFF (m)	No impact. Indication is not used by any logic	
INITIAL CONTACT	Failed ON (s)	One contact cue disabled. RING ALIGNED It, and CRT RING ALIGN and PETAL POS BASE 1,2,3 indications, may be used as contact indications	
	Failed OFF (m)	One contact cue disabled. [Not detectable prior to contact]	
CAPTURE	Failed ON (m)	Auto sequence may be active (dampers, fixers, ring/hook drive). May be unable to reset dampers. Potential Shuttle/PMA 2/3 mechanism damage if no damping or damping failed on	CAPTURE LT FAILED ON
	Failed OFF (m)	Auto Sequence may be inactive; no active damping resulting in excessive relative motion	Must use visual cues (no sep) and DAMPING indication to verify capture
RING FORWARD POSITION	Failed ON (s)	Ring will only drive out for 10 sec at a time	Starred blocks in affected procedures
	Failed OFF (m)	Ring will continue to drive at Forward Position until terminated by a PWR On/Off reset	
READY TO HOOK	Failed ON (s)	Hooks will begin driving closed with RING IN pb command	READY TO HOOK LT FAILED ON
	Failed OFF (m)	Auto hook drive disabled. Ring will not stop driving at In-Between Hooks position	Manual CLOSE HOOKS pb command required to drive hooks closed per starred block on <u>DOCKING SEQUENCE</u> (Cue Card)
INTERF SEALED	Failed ON (s)	No impact to APDS operations. Indication is not used by any logic	
	Failed OFF (m)	No impact to APDS operations. Indication is not used by any logic	
HOOKS 1(2) CLOSED	Failed ON (s)	Logic prevents associated hooks from driving closed	HOOKS 1(2) CLOSED LT FAILED ON
	Failed OFF (m)	Hooks will not stop driving when closed position reached	HOOKS 1(2) NOT CLOSED WITHIN SINGLE MTR TIME if hooks not verified closed via CRT
LATCHES OPEN	Failed ON (s)	Ring will drive in once CAPTURE is achieved, or immediately if CAPTURE already present	
	Failed OFF (m)	If Latches failed closed, ring will stall against Latches if Ring commanded to Final Position	LATCHES OPEN LT FAILED OFF
RING FINAL POSITION	Failed ON (s)	During ring retraction, ring will only drive 10 sec 1st time. After 2nd Ring In command, ring will not stop driving at In-Between Hooks position and/or Final Position	RING FINAL POSITION LT FAILED ON
	Failed OFF (m)	During Ring retraction to Final Position, ring will not stop driving at Final Position	

## APDS FAILURE/IMPACT MATRIX (Cont)

APDS Status It	<b>APDS FAILURE</b> s = potential single failure m = multiple failures reqd	<b>IMPACT</b>	<b>OFF NOMINAL PROCEDURE (IF APPLICABLE)</b>
<b>APDS POWER</b> A <sub>DS</sub> , B <sub>DS</sub> , C <sub>DS</sub>	Failed ON (s)	One logic bus remains powered. Still at least two failures from any inadvertent ops	
	Failed OFF (s)	Loss of one capture latch motor. Next failure results in loss of all APDS avionics logic	APDS POWER FAILED OFF
<b>A6L SYSTEM POWER</b> A(B) tb	Failed OFF (s)	Loss of redundancy to APDS logic busses, Control Panel Power busses, and PMA hook power. Loss of some docking lights and vestibule depress valves capability	
<b>PYROS</b> A <sub>P</sub> , B <sub>P</sub> , C <sub>P</sub>	Failed ON (s)	One Pyro logic bus powered. Still more than two failures from charging pyros	
	Failed OFF (s)	Loss of Pyro logic redundancy	
<b>PYRO CIRCUIT PROTECT OFF</b>	Failed ON (m)	Possible loss of Pyro charge/fire inhibits	
	Failed OFF (m)	Loss of capability to arm/fire Pyros	

## APDS FAILURE/IMPACT MATRIX (TLM)

APDS TLM	APDS FAILURE s = potential single failure m = multiple failures reqd	IMPACT	OFF NOMINAL PROCEDURE (IF APPLICABLE)
<b>DAMPING</b>	Failed ON (s)	Mechanism may not have compliance on contact; load capability may be exceeded. Failed-on dampers slow ring drive to about single motor drive time	DAMPING FAILED ON
	Failed OFF (s)	No impact for single failure. If all dampers failed, large rates/misalignments may cause mechanism to hit hard stops, exceeding its load capability	
<b>RING FIXERS</b>	Failed ON (s)	Mechanism may not have compliance on contact; load capability may be exceeded	FIXERS FAILED ON
	Failed OFF (s)	No impact for single fixer failure. For multiple failure case, alignment may be lost during ring retraction. [Detectable only during ring drive operations]	
<b>CLUTCH – SLIP</b>	Failed ON (s)	If slip clutch locking mechanism failed in SLIP, resistance created by dampers and/or pusher springs will load actuator sufficiently to prevent ring motion	APDS DIRECT DRIVE USING BOB required to drive slip clutch to LOCK
	Failed OFF (s)	Must verify clutch in SLIP prior to contact	
<b>CLUTCH – LOCK</b>	Failed ON (s)	Must verify clutch in SLIP prior to contact, otherwise mechanism may not have compliance on contact; load capability may be exceeded	APDS DIRECT DRIVE USING BOB required to drive slip clutch to SLIP
	Failed OFF (s)	If slip clutch locking mechanism failed in SLIP, resistance created by dampers and/or pusher springs will load ring actuator sufficiently to prevent ring motion	
<b>CAP MAN REL</b>	Failed OP (s)	If latch is released, may be unable to draw interfaces together	
<b>CNTL PNL PWR</b>	Failed ON (s)	One logic bus remains powered. Still at least two failures from any inadvertent ops	
	Failed OFF (s)	Loss of pb command redundancy. CNTL PNL PWR A will remove power from columns 1 & 3 of the STATUS light matrix. CNTL PNL PWR C will remove power from columns 2 and 4 of the STATUS lights matrix. (Pyro pbs are not affected)	Next failure may require APDS Direct Drive IFM to complete docking or separate, or require manual capture latch release
<b>RNG DR BUS 1(2)</b>	Failed OFF (s)	Loss of ring drive motor 1(2)	
<b>HKS DR BUS 1(2)</b>	Failed OFF (s)	Loss of hook drive motor 1(2) [Affects both Hooks 1 & 2]	
<b>DAMPER BUS 1(2)</b>	Failed OFF (s)	BUS 1 (MN A): Dampers 1,2 failed. BUS 2 (MN B): Damper 3 failed	
<b>FIXER BUS 1(2)</b>	Failed OFF (s)	BUS 1 (MN A): Fixers 1,2 failed. BUS 2 (MN B): Fixers 3,4,5 failed	

This Page Intentionally Blank

## CUE CARD CONFIGURATION

RCS BURN (+X, -X, Multi-axis) (Front).....	CC 9-3
RENDEZVOUS PRPLT PAD (Back).....	CC 9-4
KU OPS (Front).....	CC 9-5
(Back).....	CC 9-6
APPROACH (Front).....	CC 9-7
VBAR APPROACH (Back).....	CC 9-8
C/L CAMERA TARGET ALIGNMENT (+VBAR) (Front) .....	CC 9-9
(Back).....	CC 9-10
DOCKING SEQUENCE (Front) .....	CC 9-11
(Back).....	CC 9-12
STOPWATCH RDOT CONVERSION (Front).....	CC 9-13
(Back) .....	CC 9-14
GPC/MDM FAILURE RESPONSE DURING RNDZ (Front).....	CC 9-15
RNDZ REF DATA (Back).....	CC 9-16
C/L CAMERA CORRIDOR AND ALIGNMENT .....	CC 9-17
CAMERA A/D RANGE RULER.....	CC 9-18
C/L CAMERA ZOOM CALIBRATION (RING READY FOR DOCK).....	CC 9-19
FLIGHT SUB ANG RULER.....	CC 9-20
V10 MONITOR CORRIDOR.....	CC 9-21
A31P PGSC DISPLAY OF C/L CAMERA CORRIDOR AND ALIGNMENT.....	CC 9-22
A31P PGSC CAMERA A/D RANGE RULER.....	CC 9-23
RCS FAILURE RESPONSE DURING PROX OPS .....	CC 9-25
RCS/DPS/EPS FAILURE IMPACTS.....	CC 9-26

This Page Intentionally Blank

HOOK  
VELCRO

HOOK  
VELCRO

RNDZ-1a/122/O/A

**RCS BURN (+X, -X, Multi-axis)**

1. GNC, OPS 202 PRO  

GNC ORBIT MNVR EXEC
---------------------

  - √RCS SEL, ITEM 4 – (\*)
2. If onboard computed burn:
  - √TIG and TGT PEG 7 ΔVs per Final solution
  - √Guidance option is LAMBERT
 If ground computed burn:
  - √TGT data per Burn Pad (reload WT as reqd)
 LOAD – ITEM 22 EXEC  
 TIMER – ITEM 23 EXEC
3. If +X burn:
  - DAP: A/AUTO/ALT(B/ALT as reqd)
  - MNVR – ITEM 27 EXEC (\*)
  - If RR ops:
    - KU – AUTO TRK

GNC 33 REL NAV
----------------

    - INH Angles – ITEM 24 EXEC (\*)

**TIG-0:30**

4. FLT CNTLR PWR – ON  
 DAP TRANS: as reqd  
 If Multi-axis:
  - DAP: A/AUTO/PRI
 If +X or -X:
  - DAP: A/INRTL/PRI

**TIG**

5. If VGO Z is neg, Z,X,Y seq;  
 otherwise, X,Y,Z  
 THC: Trim VGOs < 0.2 fps  
 FLT CNTLR PWR – OFF  
 DAP: ALT  
 DAP TRANS: PULSE/PULSE/PULSE  
 GNC, OPS 201 PRO
6. If +X burn:
  - DAP: A/AUTO(B/AUTO/ALT as reqd)
  - If RR ops, when ATT ERR < 30 deg:
    - KU – GPC
    - √KU TRACK tb – gray

GNC 33 REL NAV
----------------

    - AUTO Angles – ITEM 23 EXEC (\*)
7. When in attitude:
  - DAP: A/AUTO/VERN(ALT)

TOP, BACK OF 'RCS BURN (+X, -X, Multi-axis)

HOOK  
VELCRO

HOOK  
VELCRO

**RENDEZVOUS PRPLT PAD**

When L or R RCS QTY <  :

I'CNCT:  OMS to RCS (ORB PKT, RCS)

When G23  OMS/RCS QTY >  :

I'CNCT TK SWITCH: (ORB PKT, RCS)

When G23  OMS/RCS QTY >  :

I'CNCT RETURN (ORB PKT, RCS)

When L or R RCS QTY <  :

or when FRCS QTY <  :

**DAP: NO LO Z**

When L or R RCS QTY <  :

or when FRCS QTY <  :

If prior to Ti:

Do not perform Ti

If after Ti, but prior to TORVA init (+X burns to start TORVA are complete):

Go to RNDZ BREAKOUT (CONTINGENCY OPS), 5-18

If during TORVA:

Go to SHUTTLE NOSE IN-PLANE BREAKOUT (CONTINGENCY OPS), 5-16

If stable on +VBAR:

Go to VBAR BREAKOUT (CONTINGENCY OPS), 5-14

RNDZ-1b/122/O/A

(reduced copy)



HOOK  
VELCRO

**KU OPS**

1. CONFIGURE KU FOR RR TGT ACQ

GNC 33 REL NAV

CRT   √SV SEL, ITEM 4    – FLTR  
       √INH RNG, ITEM 18 – (\*)  
           RDOT, ITEM 21 – (\*)  
           Angles, ITEM 24 – (\*)

      KU ANT ENA    – ITEM 2 EXEC (\*)  
       GNC I/O RESET

A2     DIGI-DIS sel   – R/RDOT  
 A1U    KU PWR       – STBY  
       MODE         – RDR PASSIVE  
       √RDR OUTPUT – HI  
       CNTL         – PNL (wait 3 sec)  
       PWR          – ON

KU SEL – GPC >>

2. AUTO TRK ACQ

KU SEL – AUTO TRK  
 SLEW – as reqd (as seen in COAS)  
 √EL, AZ angles < 30 deg  
 KU SEARCH – SEARCH (tb-gray)  
 Repeat slew and search as reqd  
 If acquisition not successful, √MCC >>

3. RR NAVIGATION

GNC 33 REL NAV

CRT   √RADAR, ITEM 13 – (\*)

      \* If RATIO > 1.0: \*  
       \*   √MCC        \*  
       FLTR TO PROP – ITEM 8 EXEC (\*)  
       AUT RNG     – ITEM 17 EXEC (\*)  
       RDOT       – ITEM 20 EXEC (\*)  
       Angles     – ITEM 23 EXEC (\*) >>

4. CONFIGURE KU FOR COMM

GNC 33 REL NAV

CRT   INH RNG    – ITEM 18 (\*)  
       RDOT     – ITEM 21 (\*)  
       Angles   – ITEM 24 (\*)  
       KU ANT ENA – ITEM 2 (no \*)

A1U    KU PWR    – STBY  
       MODE     – COMM  
       √sel      – GPC  
       CNTL     – CMD

A2     DIGI-DIS sel – EL/AZ

HOOK  
VELCRO

RNDZ-2a/122/O/A

TOP  
BACK OF 'KU OPS'

HOOK  
VELCRO

HOOK  
VELCRO

RNDZ-2b/122/O/A

(reduced copy)

CC 9-6

RNDZ/122/FIN

HOOK  
VELCRO

**APPROACH**

RNDZ-3a/122/O/B

CG to CG RNG (ft)	RPM & CONT TORVA RDOT (ft/s)	MC2 ET w/ RPM (h:mm:ss)	DAP	EVENT	NO-RPM RDOT (ft/s)	HHL RNG (ft) (to ISS cg)	Raw TCS RNG* (ft) (Refl #2)
2000	-3.0	0:27:00	A8/B8 AUTO/ VERN (PRI)	If RDOT falls below value for next gate, THC: -Z (in) as reqd to maintain RDOT	-3.0	1990 HHL Report	2015
1700	-2.4	0:29:00			-2.6	1690	1698
1500	-2.1	0:31:00			-2.3	1490	1498
1000	-1.3	0:36:00	LO Z	<b>MCC UPDATE: Go for RPM, Go to proceed within 600 ft</b> If no-go to proceed inside 600 ft, perform <b>CONTINGENCY 600 FT TORVA</b> <b>C</b>	-1.5	990	985
900	-1.1	0:37:00		<b>If Go for RPM, report to ISS: 10 min to RPM start</b> F6, A6U ADI ATT - \LVLH	-1.3	890	885
800	-0.9	0:38:00	A9/B9	A1U KU BD RDR OUTPUT - LOW When in Rbar attitude, config DAP to A9,B9	↓	790 HHL Report	786
700	-0.6	0:41:00		Null ISS rates in C/L camr <b>If Go for RPM, perform RPM SETUP</b> <b>A</b>		690	686
650	-0.4	0:42:30		<b>Report to ISS: Range 650 ft</b>	↓	640	636
620 600 580	-0.4 < Rdot < -0.3 -0.3 < Rdot < -0.2 -0.2 < Rdot < -0.1			<b>If Go for RPM</b> Null Xdot to 0 ± 0.1 ft/sec prior to mnvr start If reqd: stationkeep at 600-620 ft until RPM window opens <b>Perform RBAR PITCH MNVR</b> <b>B</b>	-0.8	610 590 570	606 586 566
600 550 500	-0.7 -0.6 -0.4	0:56:00	A9/B9	<b>TORVA</b> <b>GNC UNIV PTG</b> P ITEM 15 + 17.9 EXEC TRK - ITEM 19 EXEC (CUR-*) THC: +X (up) as reqd to null tgt motion in C/L camr and initiate flyaround Maintain ISS within C/L camr FOV	-0.8 -0.7 -0.5	590 540 490 HHL Report	586 536 486
400	0.0 to -0.1			RPOP POR - Orb DP to Tgt DP Maintain RNG > 250 ft (DP-DP) until VBAR arrival ISS CG within 10° of C/L camr Start video recorders	0.0 to -0.1	390 HHL Report	343
When Pitch Error < 2°		1:10:00		<b>ESTABLISH VBAR</b> THC: -X (down) as reqd to null ISS in C/L camr, as reqd to maintain ISS in C/L camr FOV		<b>HHL RNG (to Node)</b>	<b>TCS Refl. 1</b>
415-315 (350-250 DP-DP)	-0.2	1:10:30		Perform <b>CONFIGURE FOR DOCKING</b> <b>D</b> Perform <b>VBAR APPROACH</b> (Cue Card)	-0.2	357-257 HHL Report	355-255

\* Raw TCS Range assumes ISS in docking attitude

**RPM SETUP** **A**  
**GNC 20 DAP CONFIG**  
A PRI ROT RATE - ITEM 10 + 0.75 EXEC  
A VERN ROT RATE - ITEM 23 + 0.75 EXEC  
A PRI Y OPTION - ITEM 16 EXEC (ALL)  
**GNC UNIV PTG**  
P - ITEM 15 + 145.0 EXEC  
THC: center Node 1 in centerline camr ± 5 deg  
**GNC 33 REL NAV**  
INH RNG, RDOT, ANGLES  
A1U KU sel - AUTO TRK

**CONTINGENCY 600 FT TORVA** **C**  
**If Go for RPM, perform nominal RPM actions per APPROACH cue card**  
Continue APPROACH cue card with the following deltas:  
Initiate TORVA at range 700 ft Rdot -0.3 ft/s (alternate range 650 ft Rdot -0.1 ft/s)  
Maintain RNG > 600 ft (CG-CG) until VBAR arrival  
On VBAR, stationkeep RNG 630-530 (DP-DP), maintain ISS in C/L camr FOV  
  
On MCC GO, perform **CONFIGURE FOR DOCKING** **D** and **VBAR APPROACH** (Cue Card)

**RBAR PITCH MNVR** **B**

AFT (FWD) ADI Pitch	DAP/UPTG	ISS Calls / Other
P = 90 (0) (Rbar attitude)	A/AUTO/PRI TRK - ITEM 19 EXEC FLT CNTLR PWR - OFF	<b>Initiating RPM (with mark)</b>
P = 100 (10)	VERN (PRI)	
P = 170 (80)	FREE P - ITEM 15 + 270 EXEC TRK - ITEM 19 EXEC	
P = 235 (145)		<b>Start Photos</b>
P = 305 (215)		<b>End Photos</b>
P = 10 (280)	PRI A/AUTO	
P = 90 (0) (mnvr complete)	VERN (PRI) FLT CNTLR PWR - ON THC: set up for TORVA Reload DAP A9	KU SEL - GPC When Lock On Occurs: KU OPS step 3 (cue card)

**CONFIGURE FOR DOCKING** **D**  
Perform AIRLOCK FAN ACT AND ODS VOLUME PREP (APDS), 8-10  
Perform DOCKING MECHANISM POWERUP (APDS), 8-5  
Perform DOCKING PREP (APDS), 8-7

**RPM START WINDOW (MET)**  
OPEN: \_\_\_ / \_\_\_ : \_\_\_ : \_\_\_  
CLOSE: \_\_\_ / \_\_\_ : \_\_\_ : \_\_\_

HOOK  
VELCRO

**VBAR APPROACH**

RNDZ-3b/122/O/B

Interface RNG (ft)	RDOT (ft/s)	MC2 ET h:mm:ss (doc-PET)	DAP	EVENT	HHL RNG (to Node 2) (ft)	Raw TCS RNG* (Ref #1)
250	-0.20 ±0.05	1:15:00 (-34:00)	√LO Z	<b>MCC UPDATE: Go for docking</b> Maintain ISS docking target within 8 deg Corridor	257 HHL Report	255
(170 ± 10) 170	(0.00) -0.20 ±0.05	1: 21:30 (-27:30)	DAP: B	Note: DAP A allowed for ±X and ±Z THC If reqd, THC: as reqd to null Rdot and perform VBAR stationkeeping	177 HHL Report	175
110	-0.15 ±0.05	1:26:30 (-22:30)		Perform CONFIGURE KU FOR COMM (Cue Card, KU OPS)	117	115
75	-0.10 ±0.05	1:30:30 (-18:30)	No LO Z A10,B10 √DAP: B	Note: DAP A allowed for ±X and -Z THC (in) <b>GNC 23 RCS</b> (Maintain through contact) √RCS FWD – ITEM 1 EXEC (*) JET DES F1F – ITEM 31 EXEC (*) F2F – ITEM 35 EXEC (*)	82 HHL Report	80
30 ± 5	0.0	1:38:00 (-11:00)	√A10,B10 √DAP: B	5° Corridor If Flyout Reqd: THC: +Z (out) as reqd to null RDOT Perform <u>AUTO ANGULAR FLYOUT</u> (Cue Card) outside 25 ft Review FAILED CAPTURE, steps 1 thru 3, CAUTION (Cue Card, <u>DOCKING SEQUENCE</u> ) √A7L Panel Config Set EVENT TIMER for CAPTURE (counting up from 00:00)	32-42 HHL Report	30-40
30	-0.07 ±0.02	1:43:00 (-06:00)		√5° Corridor THC: as reqd to establish RDOT = -0.07 ± 0.02 fps <b>Report to MCC and ISS: Initiating final approach</b>	37	35
25	↑	1:44:00 (-05:00)		Maintain <b>GNC 23 RCS</b> through contact	32	30
10	-0.10 ±0.03	1:47:20 (-01:40)	√No LO Z	<u>ARM PCT</u> F2(F4) SPDBK/THROT pb – AUTO – √lt on	17	15
3	-0.10 ±0.03	1:48:30 (-00:30)		Maintain 3 inch lateral alignment cylinder	N/A	8
CONTACT or ~2 in	-0.10 ±0.03	1:49:00 (00:00)	PCT (SPARE pbi)	<u>CAPTURE</u>	N/A	5

\* Raw TCS Range assumes ISS in docking attitude

CAPTURE

MS START EVENT TIMER = 00:00:00  
A7L √CAPTURE It – It on  
Notify ISS and MCC-H: "Capture Confirmed"  
DISARM PCT:  
F4 SPDBK/THROT pb – push (lt off)  
  
√ISS in FREE DRIFT (ISS indicator lights flashing)  
  
\* IF NO INDICATION OF ISS FREE \*  
\* DRIFT AT CAPTURE + 65 SEC: \*  
\* Go to FAILED CAPTURE \*  
  
When capture confirmed and ISS in FREE  
A6U FLT CNTLR PWR – OFF  
Perform TCS DEACTIVATION (RNDZ TOOLS), 7-20  
Go to DOCKING SEQUENCE (Cue Card)

FAILED CAPTURE

- APDS CIRC PROT OFF pb – push  
√CIRCUIT PROTECT OFF It – It on  
OPEN LATCHES pb – push  
√LATCHES CLOSED It – It off  
√OPEN It – It on
- √DAP: NO LO Z  
  
\* IF VERN FAIL: \*  
\* DAP: PRI \*
- If petals clear:  
DAP: A(B)/LVLH
- THC: +Z (out) to establish 0.1 fps opening rate  
√DAP: B/LVLH  
If ISS in FREE DRIFT:  
Use ISS CG as corridor reference  
Maintain 8 degree corridor  
Inform MCC-H and ISS: Failed Capture  
Maintain opening rate of at least 0.1 fps
- Go to VBAR CORRIDOR BACKOUT, CONTINGENCY OPS, 5-12

HOOK  
VELCRO

**C/L CAMERA TARGET ALIGNMENT (+VBAR)**

**PITCH (P)  
ITEM 15**

Target Displaced DOWN  
(Cross Displaced UP)



P = \_\_\_\_\_

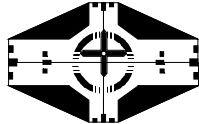

P = \_\_\_\_\_

3. PITCH = 179 - P = \_\_\_\_\_(A)  
5. PITCH = PITCH - P = \_\_\_\_\_(D)

Target Displaced UP  
(Cross Displaced DOWN)



P = \_\_\_\_\_

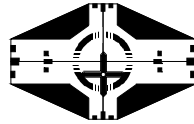

P = \_\_\_\_\_

3. PITCH = 179 + P = \_\_\_\_\_(A)  
5. PITCH = PITCH + P = \_\_\_\_\_(D)

**ROLL (R)  
ITEM 16**

Rotated CW

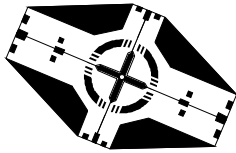

R = \_\_\_\_\_

R = \_\_\_\_\_

3. YAW = 360 - R = \_\_\_\_\_(B)  
5. YAW = YAW - R = \_\_\_\_\_(E)

Rotated CCW



R = \_\_\_\_\_

R = \_\_\_\_\_

3. YAW = 0 + R = \_\_\_\_\_(B)  
5. YAW = YAW + R = \_\_\_\_\_(E)

**YAW (Y)  
ITEM 17**

Target Displaced RIGHT  
(Cross Displaced LEFT)



Y = \_\_\_\_\_



Y = \_\_\_\_\_

3. OM = 0 + Y = \_\_\_\_\_(C)  
5. OM = OM + Y = \_\_\_\_\_(F)

Target Displaced LEFT  
(Cross Displaced RIGHT)

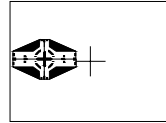

Y = \_\_\_\_\_

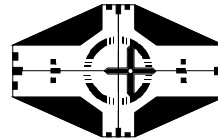

Y = \_\_\_\_\_

3. OM = 360 - Y = \_\_\_\_\_(C)  
5. OM = OM - Y = \_\_\_\_\_(F)

RNDZ-4a/122/O/A

TOP  
BACK OF 'C/L CAMERA TARGET ALIGNMENT (+VBAR)'

HOOK  
VELCRO

AUTO ANGULAR FLYOUT

**CAUTION**  
AUTO ANGULAR FLYOUT must be  
completed by RNG = 10 ft

1. RECORD ANGULAR MISALIGNMENT

√DAP: A10, B10

Read error from ISS centerline target

PITCH \_\_\_\_\_ (P)

YAW \_\_\_\_\_ (Y)

ROLL \_\_\_\_\_ (R)

Report misalignment to MCC

If all axes within 1.0 deg of zero, no mnvr reqd >>

2. CALCULATE UNIV PTG INPUTS

Use diagrams in TARGET ALIGNMENT (Cue Card) to determine  
UNIV PTG inputs for step 3

3. EXECUTE ALIGNMENT MNVR

**GNC UNIV PTG**

√TGT ID +2

√BODY VECT +5

PITCH +(A)

YAW +(B)

OM +(C)

TRK – ITEM 19 EXEC (CUR-\*)

When mnvr cplt,

4. RECORD REMAINING ANGULAR MISALIGNMENT

Record error from ISS centerline target:

PITCH \_\_\_\_\_ (P)

YAW \_\_\_\_\_ (Y)

ROLL \_\_\_\_\_ (R)

If all axes within 1.0 deg of zero, no additional mnvr reqd >>

Otherwise,

5. REPEAT ALIGNMENT

a. Calculate UNIV PTG inputs:

Use diagrams in TARGET ALIGNMENT (Cue Card) to  
determine UNIV PTG inputs for step 5b

b. Execute alignment MNVR

**GNC UNIV PTG**

√TGT ID +2

√BODY VECT +5

PITCH +(D)

YAW +(E)

OM +(F)

TRK – ITEM 19 EXEC (CUR-\*)

RNDZ-4b/122/O/A

(reduced copy)

HOOK  
VELCRO

**DOCKING SEQUENCE**

<u>CAUTION</u>	
If following failures occur during final approach (< 30 ft), <b>NO-GO</b> for docking. Initiate Corridor Backout. Then proceed with APDS OFF-NOMINAL procedures ( <u>APDS</u> )	
POWER Failed OFF (All STATUS Its OFF)	DAMPING tlm Failed ON
CAPTURE It Failed ON	FIXERS tlm Failed ON

CAUTION

If any Docking Sequence command occurs out of order or if any STATUS It functions erroneously:  
 A7L POWER OFF pb – push  
       ON pb – push  
 Proceed with APDS OFF-NOMINAL procedures (APDS)

**Event Time**

<b>Contact/Capture/Damping</b>		<b>SM 167 DOCKING STATUS</b>
0:00	A7L	1. √CAPTURE It – It on (expect RING INITIAL POSITION It off)
0:05	CRT	2. √DAMPING – ON
<b>Disable and Release Dampers</b>		
		3. When no relative motion [PETAL POS BASE (three) not changing for 60 sec]:
	A7L	POWER ON pb – push
	CRT	√DAMPING – OFF
		4. When no relative motion [PETAL POS BASE (three) not changing for 30 sec]:
	A7L	FIXER OFF pb – push
		√FIXERS OFF It – It on
0:00		RING IN pb – push
	CRT	√DRV CMD – ON [PETAL POS BASE (three) – decr]
		√CLUTCH – LOCK/blank
0:05	A7L	5. POWER ON pb – push
	CRT	√RING DRV CMD – OFF
		6. On MCC GO [PETAL POS BASE (three) not changing for 30 sec]:
	A7L	APDS CIRC PROT OFF pb – push
		√CIRCUIT PROTECT OFF It – It on
0:00		RING OUT pb – push
	CRT	√DRV CMD – ON [PETAL POS BASE (three) – incr]
0:05	A7L	7. POWER OFF pb – push
		ON pb – push
		√FIXERS OFF It – It off
	CRT	√RING DRV CMD – OFF

TOP  
BACK OF 'DOCKING SEQUENCE'

HOOK  
VELCRO

RNDZ-5b/122/O/A

<b>Retract Ring</b>		
0:00	A7L CRT	8. On MCC GO (RING ALIGNED It on and [PETAL POS BASE (three) not changing] for 30 sec): RING IN pb – push √DRV CMD – ON [PETAL POS BASE (three) – decr] √FIXERS – ON √CLUTCH – LOCK/blank
	CRT,A7L A7L	* If PETAL POS BASE (three) > 20 % and RING ALIGNED It off: * * POWER ON pb – push * * Wait for ring alignment (up to 30 min) *
	A7L,CRT	* When RING ALIGNED It on and [PETAL POS BASE (three) not changing] for 30 sec: *
	A7L	* RING IN pb – push *
3:15	A7L CRT	9. √READY TO HOOK It – It on √PETAL POS BASE (three) ≤ 7%
<b>Close Hooks</b>		
0:00	A7L CRT	10. √HOOKS 1,HOOKS 2 OPEN It (two) – It off √HK1,HK2 DRV CMD (two) – ON √POS (two) ≥ 5% & incr
	A7L	* If HK1(2) DRV CMD – OFF or HK1(2) POS not incr: * * CLOSE HOOKS pb – push * * If HOOKS 1(2) CLOSED It failed ON: * * Perform HOOKS 1(2) CLOSED LT FAILED ON, 8-23 *
0:20	CRT	11. √RING DRV CMD – OFF * If RING DRV CMD – ON 20 sec after hooks begin * * driving in step 10: *
	A7L	* POWER ON pb – push *
≤ 1:30	A7L	12. √INTERF SEALED It – It on (expect intermittent It initially)
2:20	CRT	13. √HOOKS 1,HOOKS 2 CLOSED It (two) – It on √HK1,HK2 POS (two) = 92 - 93% √IND (two) – blank/CL √ODS INDIV HK CL (twelve) – CL
<b>Load Relieve Capture Latches (Extend Ring)</b>		
	A7L	14. APDS CIRC PROT OFF pb – push √CIRCUIT PROTECT OFF It – It on
0:00	CRT	15. RING OUT pb – push √DRV CMD – ON
0:10	A7L CRT	16. POWER ON pb – push √RING DRV CMD – OFF
<b>Open Capture Latches</b>		
0:00	A7L	17. OPEN LATCHES pb – push √LATCHES CLOSED It – It off
0:05		√OPEN It – It on
<b>Retract Ring to FNL POS</b>		
0:00	CRT	18. RING IN pb – push √DRV CMD – ON [PETAL POS BASE (three) – decr] √FIXERS – ON
0:10	A7L	√FINAL POSITION It – It on
	CRT	√PETAL POS BASE (three) = 5 ± 3%
0:20		√RING DRV CMD – OFF
<b>Power Off</b>		
	A7L	19. POWER OFF pb – push √STATUS It (eighteen) – It off
		20. Go to TERMINATE RNDZ OPS <span style="border: 1px solid black; padding: 0 2px;">22A</span> , 4-22 >>

(reduced copy)



TOP

HOOK  
VELCRO

**STOPWATCH RDOT CONVERSION**

TIME BETWEEN 1 FT MARKS (SEC)	RANGE RATE (FT/SEC)
2	0.50
3	0.33
4	0.25
5	0.20
5.5	0.18
6	0.17
6.5	0.15
7	0.14
7.5	0.13
8	0.125
8.5	0.12
9	0.11
10	0.10
11	0.09
12	0.08
13	0.075
14	0.07
15	0.067
16	0.063
18	0.056
20	0.050

NOTE

HHL SPECS state that the HHL will not work if the aimpoint surface is closer than 12 ft from the HHL unit; therefore, no HHL use should be expected at an HHL range less than 12 ft (5 ft interface-to-interface)

RNDZ-6a/122/O/A

TOP  
BACK OF 'STOPWATCH RDOT CONVERSION'

HOOK  
VELCRO

RDOT vs DELTA RNG/DELTA TIME

ΔRng (ft) AT (m:ss)		Rdot (fps)													
		1000	800	700	600	500	400	300	250	200	150	100	50	25	10
0:45							8.9	6.7	5.6	4.4	3.3	2.2	1.1	0.56	0.22
0:50					10.0	8.0	6.0	5.0	4.0	3.0	2.0	1.0	0.50	0.20	
0:55					9.1	7.3	5.5	4.5	3.6	2.7	1.8	0.91	0.45	0.18	
1:00				10.0	8.3	6.7	5.0	4.2	3.3	2.5	1.7	0.83	0.42	0.17	
1:10			10.0	8.6	7.1	5.7	4.3	3.6	2.9	2.1	1.4	0.71	0.36	0.14	
1:20		10.0	8.8	7.5	6.3	5.0	3.8	3.1	2.5	1.9	1.3	0.63	0.31	0.13	
1:30		8.9	7.8	6.7	5.6	4.4	3.3	2.8	2.2	1.7	1.1	0.56	0.28	0.11	
1:40	10.0	8.0	7.0	6.0	5.0	4.0	3.0	2.5	2.0	1.5	1.0	0.50	0.25	0.10	
1:50	9.1	7.3	6.4	5.5	4.5	3.6	2.7	2.3	1.8	1.4	0.91	0.45	0.23	0.09	
2:00	8.3	6.7	5.8	5.0	4.2	3.3	2.5	2.1	1.7	1.3	0.83	0.42	0.21	0.08	
2:20	7.1	5.7	5.0	4.3	3.6	2.9	2.1	1.8	1.4	1.1	0.71	0.36	0.18	0.07	
2:40	6.3	5.0	4.4	3.8	3.1	2.5	1.9	1.6	1.3	0.9	0.63	0.31	0.16	0.06	
3:00	5.6	4.4	3.9	3.3	2.8	2.2	1.7	1.4	1.1	0.8	0.56	0.28	0.14	0.06	

NOTE:  
If RPOP is available, use RPOP  
subtended angle function

TIME	DELTA TIME	RANGE	DELTA RANGE
_____	_____	_____	_____
_____	_____	_____	_____
_____	_____	_____	_____
_____	_____	_____	_____
_____	_____	_____	_____
_____	_____	_____	_____
_____	_____	_____	_____
_____	_____	_____	_____

RNDZ-6b/122/O/A

HOOK V E R N S

HOOK V E R N S

## GPC/MDM FAILURE RESPONSE DURING RNDZ

NOTES

1. Perform appropriate ORB PKT procedure in parallel with IMMEDIATE ACTIONS on card as soon as practical
2. Use this card during Rndz T/L thru MC4 burn (if RR FAIL PROCEDURES, thru RR fail correction burn)
3. GPC assignments assume 1233 NBAT
4. Do NOT restring for Non-Universal I/O Errors. Otherwise, a restring for GPC 1,2,3 fails will recover everything (see expected restring below)
5. If any GNC GPC fails, VERNs ↓
6. If IMUs not commfaulted, THCs are normally GO
7. Loss of FF2, FF4, FA3, and FA4 do not impact Rndz (unless other failures)

GPC	MDM	IMMEDIATE ACTION	MAJOR IMPACT
<b>GPC1</b> (3232*)	<b>FF1</b>	1. If -Z ST NAV, INH ST to NAV 2. If -Z ST not recovered: Use -Y ST, if reqd	1. C3 DAP lights latched (go out with MDM pwr fail) 2. -Z ST ↓
	<b>FA1</b>	DAP: ALT/AUTO	VERNs ↓
<b>GPC2</b> (1313*)	<b>FA2</b>	DAP: ALT/AUTO	VERNs ↓
<b>Man OMS Shutdown</b>  <b>GPC3</b> (1212*)  <b>Loss of Aft DAP</b>	<b>FF3</b>	1. DAP: ALT/AUTO 2. If RR NAV, INH RR to NAV 3. If -Y ST NAV, INH ST to NAV 4. If RR not recovered: Work RR FAIL procedures	1. VERNs ↓ 2. RR → NAV/RPOP ↓ (Panel A2 OK) 3. A6 DAP lights latched (go out with MDM pwr fail) 4. -Y ST ↓ 5. Also for loss of GPC3: R OMS GMBL PRI/SEC ↓
<b>GPC4</b> (1212*)	<b>PL</b>	If Ku breaks lock: Ku sel – AUTO TRK	1. GPC Ku ptg ↓, slew in AUTO TRK if Ku breaks lock 2. No Ku self-test

\* Expect this NBAT if GPC fail

MALFUNCTION	>>

TOP  
BACK OF 'GPC/MDM FAILURE RESPONSE DURING RNDZ'

HOOK  
VELCRO

**RNDZ REF DATA**

HOOK  
VELCRO

<p><b>FF1</b> F MANF 1 JETS C3 DAP LTS IMU 1 -Z STRK L OMS GMBL PRI ENA L ADI sw, ATT REF F,A THC contact 1 L,A RHC channel 1 PNL O3 F,L,R RCS OX QTY PNL O3 F,L RCS LOW QTY</p> <p><b>FF2</b> F MANF 2 JETS IMU 2 L OMS GMBL SEC ENA R ADI sw, ATT REF F,A THC contact 2 A RHC P,Y channel 2 L RHC channel 2 R RHC channel 1</p>	<p><b>FF3</b> VERNS F MANF 4 JETS A6 DAP LTS IMU 3 RR→ NAV/RPOP -Y STRK R OMS GMBL SEC ENA A ADI sw, ATT REF F,A THC contact 3 L,A RHC channel 3 R RHC channel 2 PNL O3 R RCS LOW QTY PNL O3 F,L,R RCS FU QTY</p> <p><b>FF4</b> F MANF 3 JETS R OMS GMBL PRI ENA A RHC Roll channel 2 R RHC channel 3</p> <p><b>PL1</b> GPC KU PTG KU self-test</p>	<p><b>FA1</b> VERNS L,R MANF 1 JETS L OMS GMBL PRI</p> <p><b>FA2</b> VERNS L,R MANF 3 JETS L OMS GMBL SEC</p> <p><b>FA3</b> L,R MANF 2 JETS R OMS GMBL SEC</p> <p><b>FA4</b> L,R MANF 4 JETS R OMS GMBL PRI</p> <p><b>MDM OA1(OA2)</b> L(R) OMS DEORB ONLY</p>
<p><b>DSC OF2</b> VERNS &amp; F MANF 3,4 RM F RCS OX, FU QTY</p> <p><b>DSC OF4</b> F MANF 1,2 RM</p> <p><b>DSC OL1</b> VERNS &amp; L MANF 1,2 RM L OMS DEORB ONLY L RCS OX QTY</p> <p><b>DSC OL2</b> LMANF 3,4 RM L RCS FU QTY</p> <p><b>DSC OR1</b> VERNS &amp; R MANF 1,2 RM R OMS DEORB ONLY R RCS OX QTY</p> <p><b>DSC OR2</b> R MANF 3,4 RM R RCS FU QTY</p> <p><b>DSC OA2</b> VERNS RM</p>		

**CNTL AB1**  
PLB LTS (Fwd-P, Aft-S, Bulkhead)  
L ADI ATT REF  
CCTV CONTR UNIT PRI

**CNTL AB2**  
F MANF 1 JETS  
L ADI switches, ATT REF

**CNTL AB3**  
C3 DAP ROT,TRANS pbs

**CNTL BC1**  
VERNS  
PLB LTS (Fwd-S, Mid-P)  
R ADI ATT REF  
CCTV CONTR UNIT SEC

**CNTL BC2**  
VERNS  
F MANF 2 JETS  
A6 DAP ROT,TRANS pbs (PCT)  
R ADI switches, ATT REF

**CNTL BC3**  
C3 DAP ROT,TRANS pbs

**CNTL CA1**  
PLB LTS (Aft-P, Mid-S)  
OVHD DOCK, RMS SPOT LTS  
A ADI ATT REF

**CNTL CA2**  
F MANF 3 JETS  
A6 DAP ROT,TRANS pbs (PCT)  
A ADI switches, ATT REF

**CNTL CA3**  
F MANF 4 JETS

**MAIN A**  
FPC1: MCIU  
FLC1: F MANF 1 JETS  
AC1B: PNL O3 RCS/OMS QTY  
FWD EVENT TIMER  
APC4:  
APC1: VERNS  
L OMS GMBL PRI  
R OMS GMBL SEC  
ALC1: VERNS  
O14: -Z STRK  
AFT EVENT TIMER  
O14/A8: RMS PRI PWR  
R14: CCTV CAM-C,D  
CCTV MON-1  
CCTV CONTR UNIT PRI  
MPC1: APDS RING DAMP 1,2  
APDS HK, RING MTR 1  
RMS PRI PWR  
OVHD DOCK, RMS LTS  
PLB LTS (Fwd-P, Aft-S)

**MAIN B**  
FPC2:  
FLC2: F MANF 2 JETS  
AC2C: PNL A2 DIGITALS  
APC5:  
APC2: VERNS  
LOMS GMBL SEC  
ALC2: VERNS  
O15: -Y STRK  
FWD EVENT TIMER  
O15/A8: RMS B/U PWR  
R14: KU COMM & RR  
CCTV CAM-A, RMS  
CCTV MON-2  
CCTV CONTR UNIT SEC  
VPU (C/L CAM CMDS)  
MPC2: KU COMM & RR  
APDS RING DAMP 3  
APDS HK, RING MTR 2  
RMS B/U PWR  
PLB LTS(Fwd-S,  
Mid-P, Bulkhead)  
AUX PL B: TCS

**MAIN C**  
FPC3: KU COMM & RR  
FLC3: VERNS  
F MANF 4 JETS  
AC3A: COAS PWR  
APC6:  
APC3: R OMS GMBL PRI  
O16: PNL O3 OMS/RCS QTY  
R14: KU SIG PROC (RR OK)  
CCTV CAM-B  
CABIN TV UTIL PORT  
MPC3: PLB LTS (Aft-P, Mid-S)

**ESS 2CA**  
TCS

**CABIN PL (Fit Specific)**  
CCTV C/L CAM

RNDZ-7b/122/O/A

Note: Fabricate As Transparency

C/L CAMERA

CORRIDOR AND ALIGNMENT

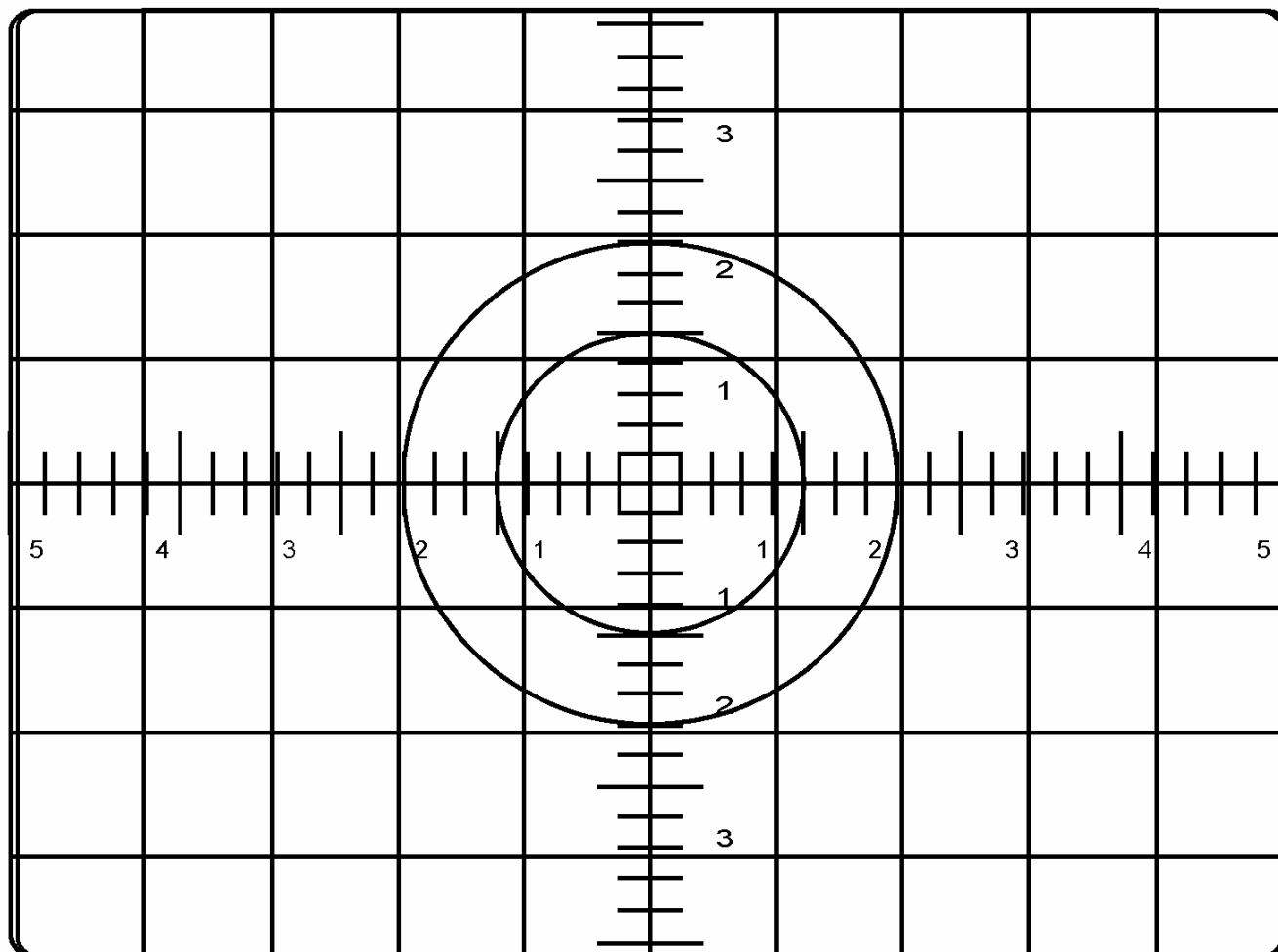

CTVC 40.0 DEG HFOV - CORRIDOR  
CTVC FULL ZOOM - ALIGNMENT

RNDZ-8a/122/O/A

(reduced copy)

CC 9-17

RNDZ/122/FIN

Note: Fabricate As Transparency

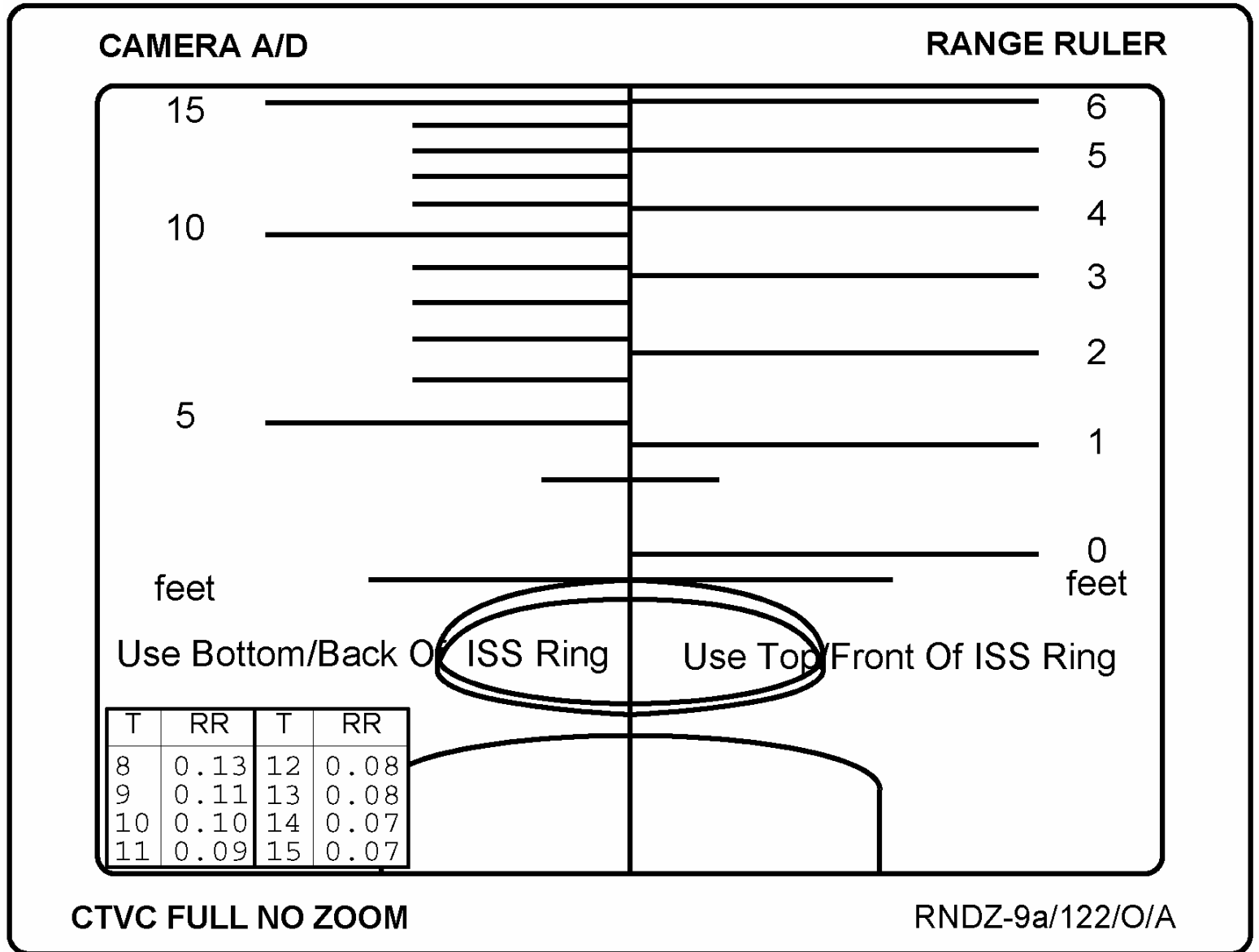

(reduced copy)

CC 9-18

RNDZ/122/FIN

Note: Fabricate As Transparency

**C/L CAMERA**

**ZOOM CALIBRATION (RING READY FOR DOCK)**

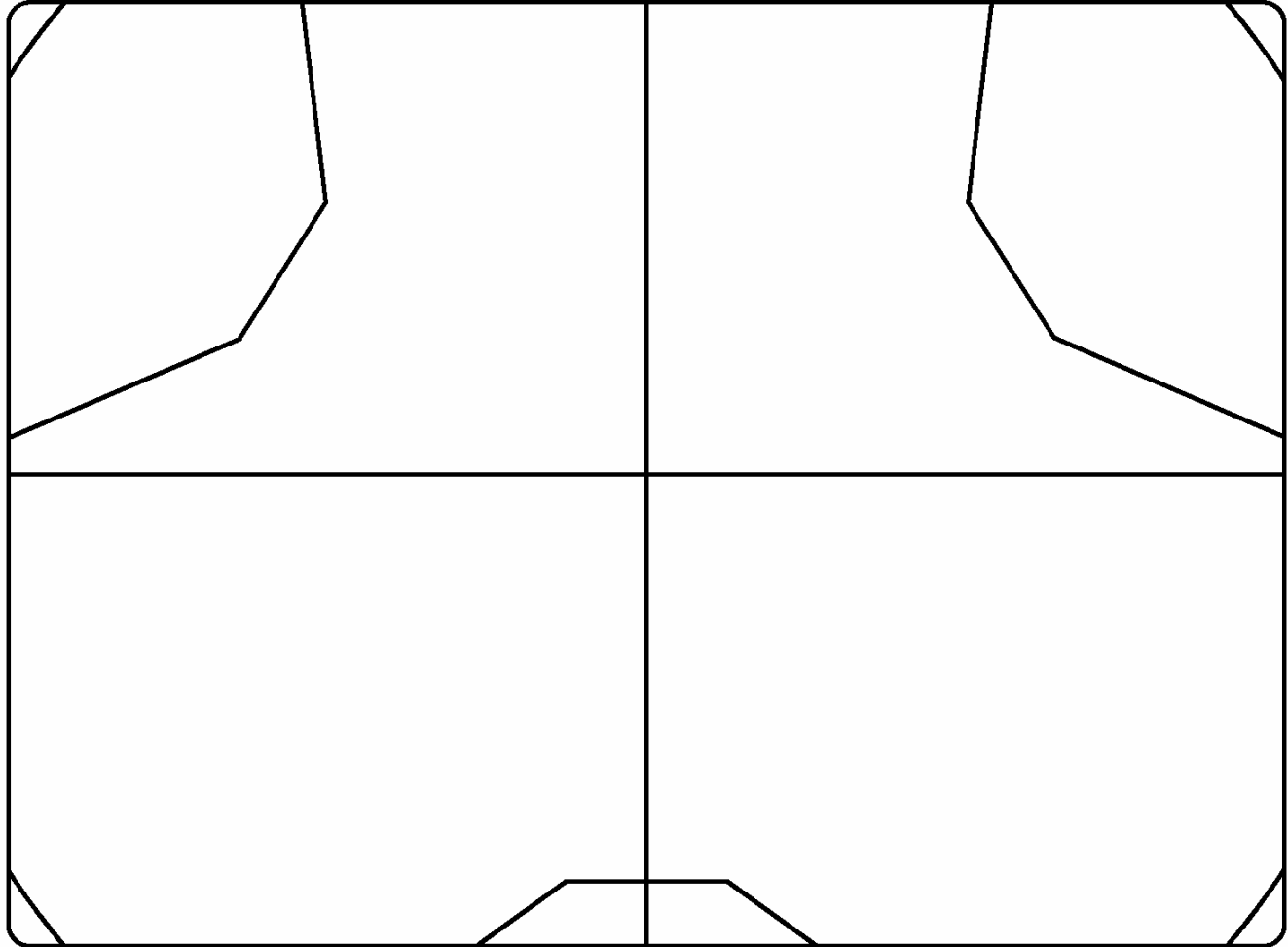

**CTVC AT HFOV = 40.0 DEG**

RNDZ-10a/122/O/A

(reduced copy)

CC 9-19

RNDZ/122/FIN

# FLIGHT

# SUB ANG RULER

H-FOV

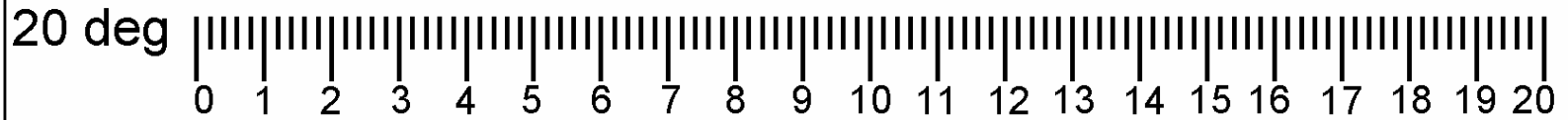

RNDZ-13a/122/O/A

(reduced copy)

CC 9-20

RNDZ/122/FIN



Note: Fabricate As Transparency

RNDZ-14a/122/O/A

V10 MONITOR

CORRIDOR

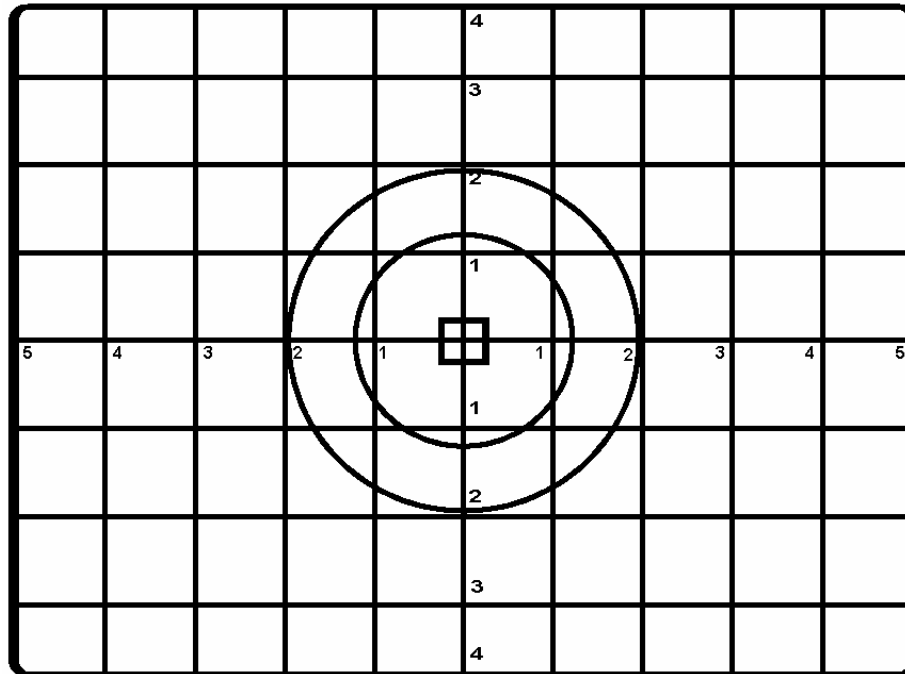

CTVC 40.0 DEG HFOV - CORRIDOR

CTVC FULL ZOOM - ALIGNMENT

**A31P PGSC DISPLAY OF C/L CAMERA**

**CORRIDOR AND ALIGNMENT**

**A31P PGSC DISPLAY OF C/L CAMERA**

**CORRIDOR AND ALIGNMENT**

Note: Fabricate As Transparency

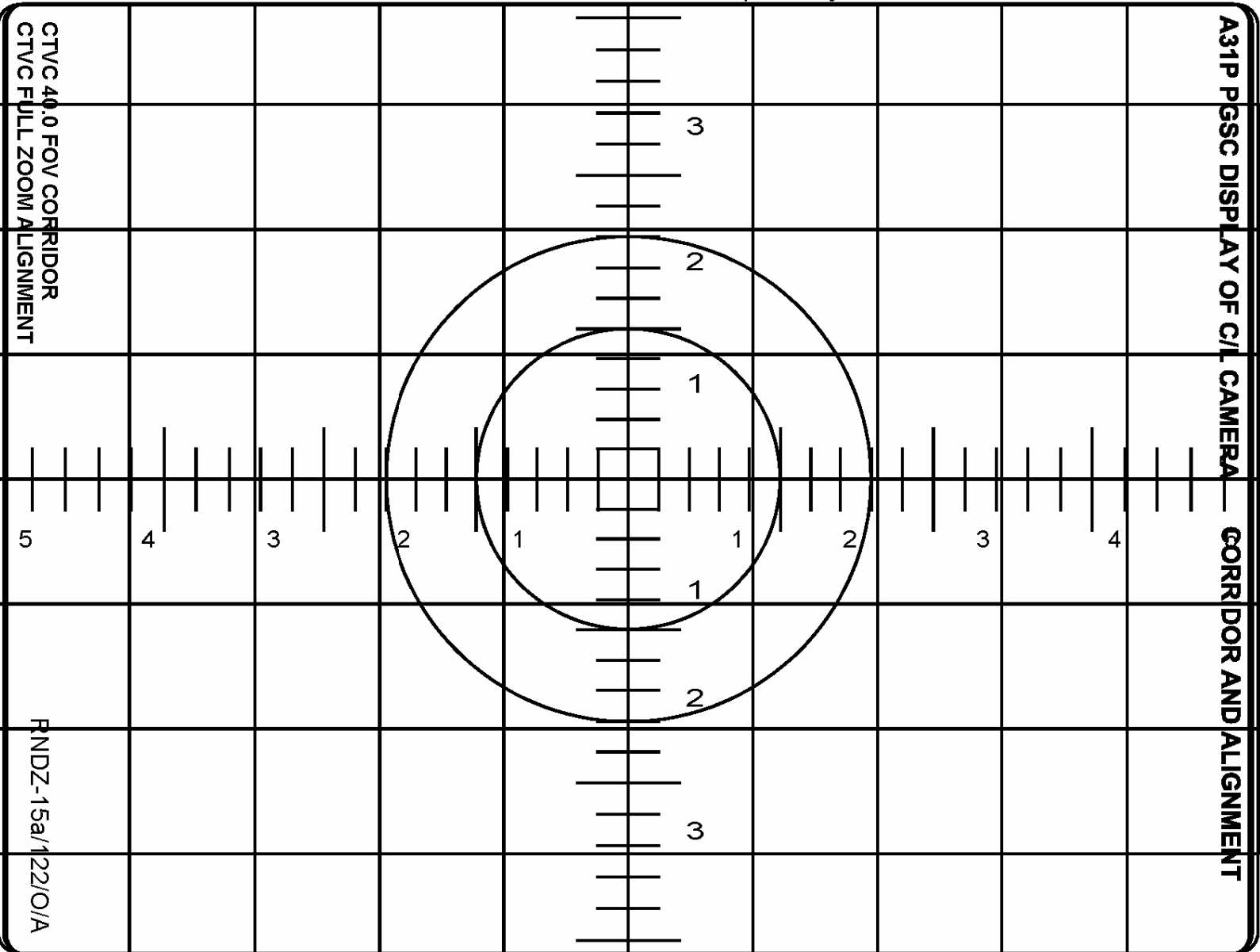

CTVC 40.0 FOV CORRIDOR  
 CTVC FULL ZOOM ALIGNMENT  
 CTVC 40.0 FOV CORRIDOR

RNDZ-15a/122/O/A  
 RNDZ-15a/122/O/A

(reduced copy)

Note: Fabricate As Transparency

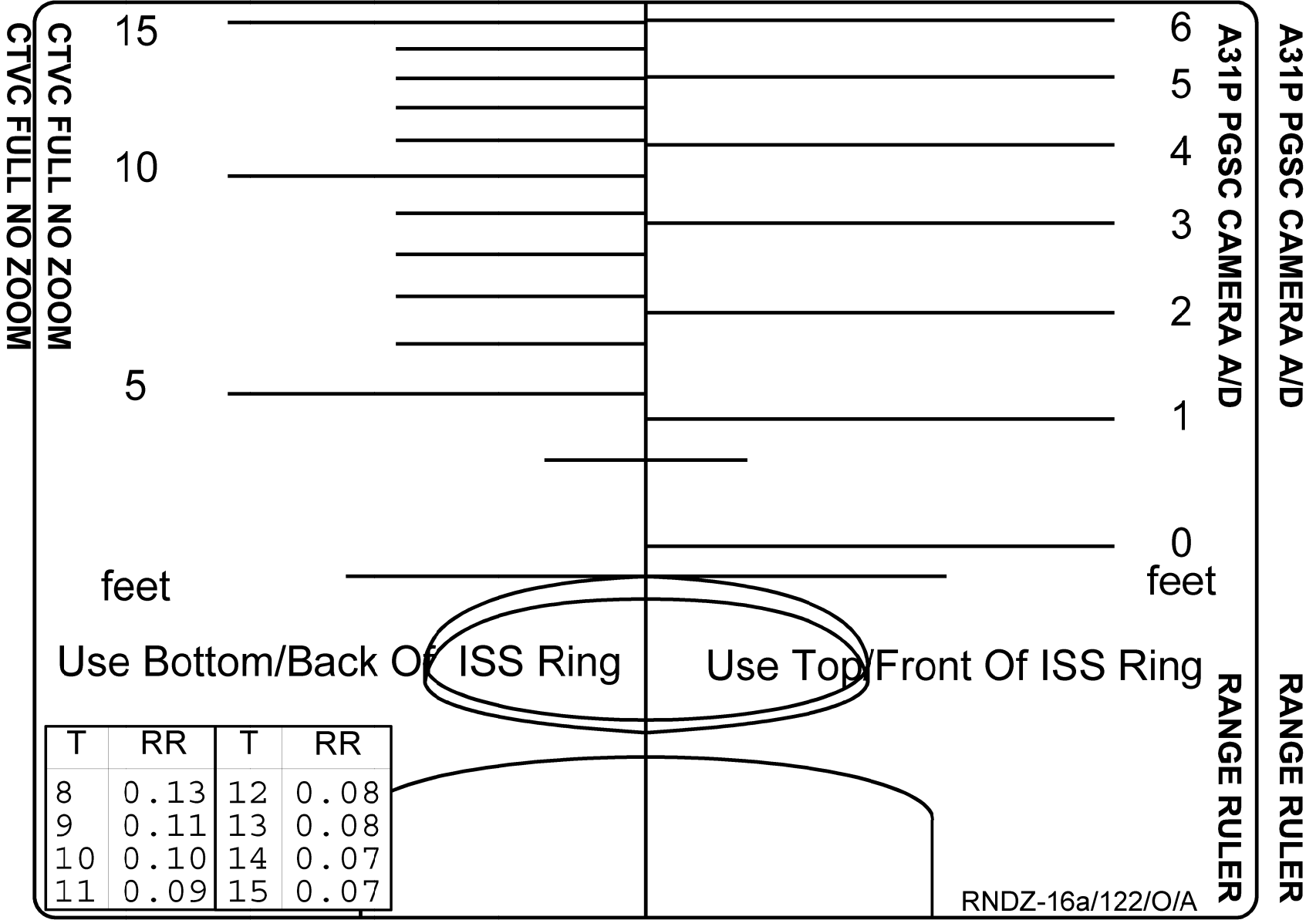

CTVC FULL NO ZOOM  
CTVC FULL NO ZOOM

(reduced copy)

CC 9-23

RNDZ/122/FIN

This Page Intentionally Blank

HOOK  
VELCRO

HOOK  
VELCRO

**RCS FAILURE RESPONSE DURING PROX OPS**

<p>Note 1: Use this card during Rndz T/L after MC4 burn (if RR FAIL PROCEDURES, after RR fail correction burn)          Note 2: If multiple cases apply, perform cases in order          Note 3: Perform appropriate ORB PKT procedure in parallel with IMMEDIATE ACTIONS on card as soon as practical</p>		<p>FLT RULES</p>	
CASE	IMMEDIATE ACTIONS/PROCEDURES REFERENCE	RPM	R<250
2FxD	<p><b>DO NOT PERFORM LOW Z +Z (BRAKING) PULSES</b></p> <p>* If during RPM, *</p> <p>* DAP: FREE *</p> <p>* FLT CNTLR PWR – OFF *</p> <p>* √MCC for further actions *</p> <p>* If on Vbar and RNG &gt; 75 ft, *</p> <p>* DAP: No LOW Z *</p> <p>* DAP: B/VERN(PRI) *</p> <p>* √DAP: AUTO *</p> <p>* THC: +Z (out) at 10 sec intervals as reqd to *</p> <p>* establish 0.1 fps opening *</p> <p>* If RNG &lt; 75 ft, *</p> <p>* √DAP: No LOW Z *</p> <p>* DAP: B/VERN(PRI) *</p> <p>* √DAP: AUTO *</p> <p>* THC: +Z (out) as reqd to establish 0.1 fps opening *</p> <p>Do not perform PCT</p> <p>NOTE: DAP disables ±Y translation</p> <p>Perform LOSS OF BOTH FxD JETS (SAME SIDE) (CONTINGENCY OPS), 5-39</p>	NO-GO	NO-GO
VERN	<p>DAP: PRI/AUTO</p> <p>Perform LOSS OF VRCS (CONTINGENCY OPS), 5-41</p>	GO	GO
Y	<p>NOTE: DAP disables ±Y translation</p> <p>Perform LOSS OF FORWARD SIDE-FIRING JETS (CONTINGENCY OPS), 5-37</p>	NO-GO	NO-GO
+X	<p>Do not perform LOW Z +Z (braking) pulses</p> <p>Perform DEGRADED +X TRANSLATION (CONTINGENCY OPS), 5-35</p>	NO-GO	GO
-X	<p>Perform DEGRADED -X TRANSLATION (CONTINGENCY OPS), 5-36</p>	GO	GO
1FxD	<p>Review IMMEDIATE ACTIONS for 2FxD CASE</p> <p>Perform LOSS OF ONE FxD JET (CONTINGENCY OPS), 5-38</p>	NO-GO	GO

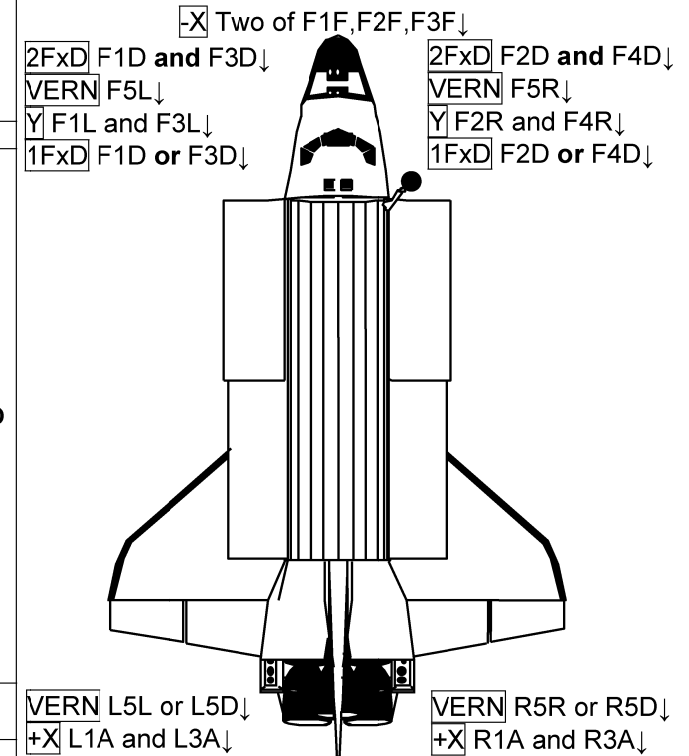

CC 9-25

RNDZ/122/FIN

RNDZ-17a/122/O/A

TOP  
BACK OF 'RCS FAILURE RESPONSE DURING PROX OPS'

HOOK  
VELCRO

HOOK  
VELCRO

**RCS/DPS/EPS FAILURE IMPACTS**

DPS		FRCS JET GROUPS								EPS					
GPC	MDM	1	2	3	4	5	6	VERNS		DC SUBBUS		MAIN	CNTL		
	FF1	F1F	F1L		F1U		F1D			FLC1	FPC1	MN A DA1	AB2		
	FF2	F2F		F2R	F2U	F2D				FLC2	FPC2	MN B DA2	BC2	BC1	
	FF3			F4R		F4D			F5L	F5R	FLC3	FPC3	MN C DA3	CA3	
	FF4	F3F	F3L		F3U		F3D				N/A REDUNDANT POWER				
CASE	1 JET↓					1FxD	1FxD	VERN	VERN	1 JET↓		CASE			
	2 JETS↓	-X	Y	Y		2FxD	2FxD			2 JETS↓					

DPS		ARCS JET GROUPS										EPS						
GPC	MDM	7	8	9	10	11	12	13	14	VERNS		DC SUBBUS		MAIN	CNTL			
	FA1	R1A	L1A	L1L	R1R	L1U	R1U					L5L	L5D	N/A REDUNDANT POWER				
												R5R	R5D	APC1	APC4	MN A DA1	BC1	BC2
	FA2													APC2	APC5	MN B DA2		
			R3A	L3A	L3L	R3R			L3D	R3D					ALC1			
	FA3			L2L	R2R	L2U	R2U	L2D	R2D					N/A REDUNDANT POWER				
	FA4			L4L	R4R	L4U	R4U	L4D	R4D									
CASE	1 JET↓									VERN	VERN	1 JET↓		CASE				
	2 JETS↓	+X	+X									2 JETS↓						

1. For RCS failures, strike aff jet(s). For DPS/EPS failures, strike all jets in same row(s) as aff GPC/MDM/bus
2. For each group with failed jet(s), read down to 1 JET↓ or 2 JETS↓ as appropriate to determine applicable case
3. Refer to reverse side for appropriate procedures and flight rule impacts for each applicable case
4. If 1 JET↓, read down to 2 JETS↓ to determine case for next worse failure, then read back up to determine which RCS/DPS/EPS failures can result in next worse failure. Review IMMEDIATE ACTIONS for next worse failure

CC 9-26

RNDZ/122/FIN

RNDZ-17b/122/O/A

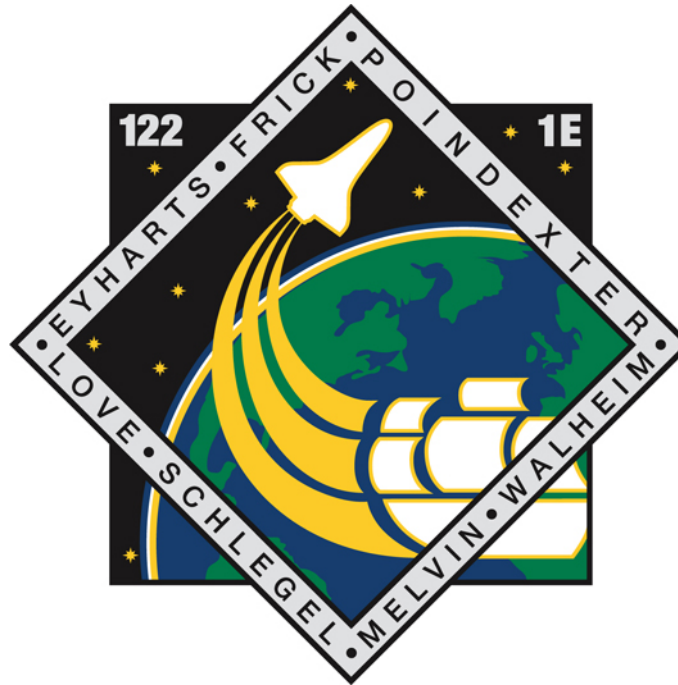

**RENDEZVOUS**

**STS  
122**