

Rendezvous

STS-125/STS-400

**Mission Operations Directorate
Flight Design and Dynamics Division**

**Final
September 10, 2008**

National Aeronautics and
Space Administration

Lyndon B. Johnson Space Center
Houston, Texas



RENDEZVOUS STS-125/STS-400

FINAL (Sept 10, 2008)

PCN-1 (Apr 20, 2009) Sheet 1 of 1

List of Implemented Change Requests (482s):

RNDZ-1364	RNDZ-1370A
RNDZ-1365	RNDZ-1371
RNDZ-1366	RNDZ-1372
RNDZ-1367	RNDZ-1374
RNDZ-1368	RNDZ-1377

Incorporate the following:

1. Replace v thru viii
2. Replace 2-1 and 2-2, 2-13 and 2-14, 2-17 and 2-18, 2-23 thru 2-26, CC 2-29 and CC 2-30
After 2-32, add 2-32a and 2-32b
Replace 2-33 thru 2-56
3. Replace 4-9 and 4-10
4. Replace CC 8-7 thru CC 8-12

Prepared by:

Book Manager

Approved by:

Lead, Rendezvous Guidance and Procedures
Group

Accepted by:

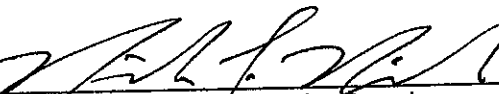
 (ACTING FOR SCOTT DUNHAM)
Chief, Orbit Dynamics Branch

Encl: 50 pages

File this PCN immediately behind the front cover as a permanent record

MISSION OPERATIONS DIRECTORATE

**RENDEZVOUS
STS-125/STS-400**

FINAL
September 10, 2008

PREPARED BY:



Sean O'Rourke
Book Manager

APPROVED BY:



Steve R. Walker
Lead, Rendezvous Guidance and Procedure Group

ACCEPTED BY:

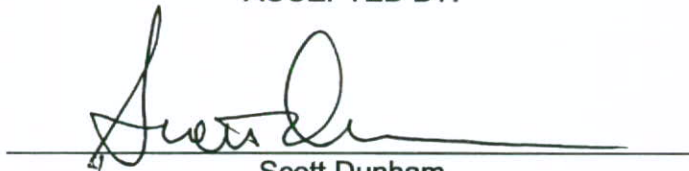

Scott Dunham
Chief, Orbit Dynamics Branch

This document is under the configuration control of the Crew Procedures Control Board (CPCB). All proposed changes must be submitted via FDF Workflow Crew Procedure Change Request (CR) to DO3/FDF Manager.

Additional distribution of this book, for official use only, may be requested in writing to DO3/PMO Administrator. The request must include justification and requester's name, organization, position, and phone number. Contractor requests are made through the NASA or DOD organization supported. Deletions, reduction in quantity, or change of address may be submitted to DO3/FDF Management Office, 281-244-1184.

Incorporates the following:			
482#:	RNDZ-1315	RNDZ-1324	RNDZ-1330
	RNDZ-1316	RNDZ-1325	RNDZ-1333
	RNDZ-1321	RNDZ-1327	RNDZ-1334
	RNDZ-1322	RNDZ-1328C	MULTI-1825
	RNDZ-1323	RNDZ-1329	

AREAS OF TECHNICAL RESPONSIBILITY

STS-125

Book Manager	DM34/S. O'Rourke	281-244-5522
Rendezvous Guidance and Procedures	DM34/N. O'Dosey	281-483-6178
Rendezvous Training	DM34/A. Fox	281-244-7376
Flight Dynamics	DM32/W. Tracy	281-483-0576
Rendezvous Design	USA/J. Bacher	281-282-2763
PROX OPS Design	USA/J. Pascucci	281-282-2777
Flight Design	USA/D. Gabriel	281-483-1305

STS-400

Book Manager	DM34/S. O'Rourke	281-244-5522
Rendezvous Guidance and Procedures	DM34/N. O'Dosey	281-483-6178
Rendezvous Training	DM34/J. Frank	281-244-7846
Flight Dynamics	DM32/J. Mendeck	281-483-8020
Rendezvous Design	USA/T. Stuit	281-282-4456
PROX OPS Design	USA/W. Summa	281-282-3032
Flight Design	USA/R. Moreno	281-483-8040

NOTE

This checklist is the controlling crew document for both STS-125 HST rendezvous and the STS-400 rendezvous with a potentially stranded STS-125 orbiter. The Rendezvous Timelines (Section 4 for STS-125 and Section 2 for STS-400) begin at $T_i - 3:00$ hr and continue through grapple. Their lighting information is based on a planned rendezvous altitude of 305 nmi. Targeting I-Loads are based on 310 nmi.

This is a complete stand-alone document. STS-125 deploy procedures are in a separate document. |

ACRONYMS

AZ, AZM	Azimuth
D/N	Day/Night
EL, ELEV	Elevation
IAH	Inertial
LOS	Line of Sight
LVLH	Local Vertical, Local Horizontal
R	Range
\dot{R} , RDOT	Range Rate
R, RBAR	Radius Vector (toward Earth)
RNDZ	Rendezvous
RR	Rendezvous Radar
SK	Stationkeeping
ST, STRK	Star Tracker
V, VBAR	Velocity Vector (direction of orbital travel)
$\pm X, Y, ZLV$	$\pm X, Y, \text{ or } Z$ Local Vertical ($\pm X, Y, \text{ or } Z$ toward Earth)
X, Y, ZPOP	X, Y, or Z orbiter body axis Perpendicular to Orbit Plane (aligned with the angular momentum vector)
$\pm X, Y, ZVV$	$\pm X, Y, \text{ or } Z$ orbiter body axis along the LVLH Velocity Vector

RENDEZVOUS
STS-125/STS-400

LIST OF EFFECTIVE PAGES

	FINAL PCN-1	09/10/08 04/20/09	
Sign Off	* 125/FIN	2-31	400/FIN
ii.....	* 125/FIN	2-32	400/FIN
iii.....	* 125/FIN	2-32a	400/FIN 1
iv.....	* 125/FIN	2-32b	400/FIN 1
v	* 125/FIN 1	2-33	400/FIN 1
vi.....	* 125/FIN 1	2-34	400/FIN 1
vii.....	* 125/FIN 1	2-35	400/FIN 1
viii.....	* 125/FIN	2-36	400/FIN 1
ix.....	125/FIN	2-37	400/FIN 1
x	125/FIN	2-38	400/FIN 1
1-1	125/FIN	2-39	400/FIN 1
1-2	125/FIN	2-40	400/FIN 1
1-3	125/FIN	2-41	400/FIN 1
1-4	125/FIN	2-42	400/FIN 1
1-5	125/FIN	2-43	400/FIN 1
1-6	125/FIN	2-44	400/FIN 1
1-7	125/FIN	2-45	400/FIN 1
1-8	125/FIN	2-46	400/FIN 1
2-1	400/FIN 1	2-47	400/FIN 1
2-2	400/FIN	2-48	400/FIN 1
2-3	400/FIN	2-49	400/FIN 1
2-4	400/FIN	2-50	400/FIN 1
2-5	400/FIN	2-51	400/FIN 1
2-6	400/FIN	2-52	400/FIN 1
2-7	400/FIN	2-53	400/FIN 1
2-8	400/FIN	2-54	400/FIN 1
2-9	400/FIN	2-55	400/FIN 1
2-10	400/FIN	2-56	400/FIN 1
2-11	400/FIN	2-57	delete
2-12	400/FIN	2-58	delete
2-13	400/FIN	2-59	delete
2-14	400/FIN 1	2-60	delete
2-15	400/FIN	2-61	delete
2-16	400/FIN	2-62	delete
2-17	400/FIN 1	3-1	125/FIN
2-18	400/FIN	3-2	125/FIN
2-19	400/FIN	3-3	125/FIN
2-20	400/FIN	3-4	125/FIN
2-21	400/FIN	3-5	125/FIN
2-22	400/FIN	3-6	125/FIN
2-23	400/FIN 1	3-7	125/FIN
2-24	400/FIN	3-8	125/FIN
2-25	400/FIN 1	3-9	125/FIN
2-26	400/FIN	3-10	125/FIN
2-27	400/FIN	3-11	125/FIN
2-28	400/FIN	3-12	125/FIN
CC 2-29.....	400/FIN 1	4-1	125/FIN
CC 2-30.....	400/FIN	4-2	125/FIN

* – Omit from flight book

4-3	125/FIN	6-1	125/FIN
4-4	125/FIN	6-2	125/FIN
4-5	125/FIN	6-3	125/FIN
4-6	125/FIN	6-4	125/FIN
4-7	125/FIN	6-5	125/FIN
4-8	125/FIN	6-6	125/FIN
4-9	125/FIN 1	6-7	125/FIN
4-10	125/FIN	6-8	125/FIN
4-11	125/FIN	7-1	125/FIN
4-12	125/FIN	7-2	125/FIN
4-13	125/FIN	7-3	125/FIN
4-14	125/FIN	7-4	125/FIN
4-15	125/FIN	7-5	125/FIN
4-16	125/FIN	7-6	125/FIN
4-17	125/FIN	7-7	125/FIN
4-18	125/FIN	7-8	125/FIN
4-19	125/FIN	7-9	125/FIN
4-20	125/FIN	7-10	125/FIN
4-21	125/FIN	7-11	125/FIN
4-22	125/FIN	7-12	125/FIN
4-23	125/FIN	7-13	125/FIN
4-24	125/FIN	7-14	125/FIN
4-25	125/FIN	7-15	125/FIN
4-26	125/FIN	7-16	125/FIN
4-27	125/FIN	7-17	125/FIN
4-28	125/FIN	7-18	125/FIN
4-29	125/FIN	7-19	125/FIN
4-30	125/FIN	7-20	125/FIN
4-31	125/FIN	7-21	125/FIN
4-32	125/FIN	7-22	125/FIN
5-1	125/FIN	7-23	125/FIN
5-2	125/FIN	7-24	125/FIN
5-3	125/FIN	7-25	125/FIN
5-4	125/FIN	7-26	125/FIN
5-5	125/FIN	7-27	125/FIN
5-6	125/FIN	7-28	125/FIN
5-7	125/FIN	8-1	* 125/FIN
5-8	125/FIN	8-2	* 125/FIN
5-9	125/FIN	CC 8-3	* 125/FIN
5-10	125/FIN	CC 8-4	* 125/FIN
5-11	125/FIN	CC 8-5	* 125/FIN
5-12	125/FIN	CC 8-6	* 125/FIN
5-13	125/FIN	CC 8-7	* 125/FIN 1
5-14	125/FIN	CC 8-8	* 125/FIN 1
5-15	125/FIN	CC 8-9	* 125/FIN 1
5-16	125/FIN	CC 8-10	* 125/FIN 1
5-17	125/FIN	CC 8-11	* 125/FIN
5-18	125/FIN	CC 8-12	* 125/FIN 1
5-19	125/FIN	CC 8-13	* 125/FIN
5-20	125/FIN	CC 8-14	* 125/FIN
5-21	125/FIN	CC 8-15	* 125/FIN
5-22	125/FIN	CC 8-16	* 125/FIN
5-23	125/FIN	CC 8-17	* 125/FIN
5-24	125/FIN	CC 8-18	* 125/FIN
5-25	125/FIN	CC 8-19	* 125/FIN
5-26	125/FIN	8-20	* 125/FIN

* – Omit from flight book

RENDEZVOUS CUE CARDS

<u>TITLE</u>	<u>Ref. Page</u>	<u>Card No.</u>
RCS BURN (+X, -X, Multi-axis) (Front).....	CC 8-3	RNDZ-1a/125/O/A
RENDEZVOUS PRPLT PAD (Back).....	CC 8-4	RNDZ-1b/125/O/A
KU OPS (Front).....	CC 8-5	RNDZ-2a/125/O/A
(Back).....	CC 8-6	RNDZ-2b/125/O/A
HST RBAR APPROACH (Front).....	CC 8-7	RNDZ-3a/125/O/D
(Back).....	CC 8-8	RNDZ-3b/125/O/C
HST CONTINGENCY INRTL APPROACH (Front).....	CC 8-9	RNDZ-4a/125/O/D
(Back).....	CC 8-10	RNDZ-4b/125/O/C
HST BREAKOUT FLOWCHART (Front).....	CC 8-11	RNDZ-5a/125/O/B
TOOL CHASING (Back).....	CC 8-12	RNDZ-5b/125/O/B
NOMINAL RADAR ANGLES AND CAMERA ANGLES		
RANGING CHART (Front).....	CC 8-13	RNDZ-6a/125/O/A
(Back).....	CC 8-14	RNDZ-6b/125/O/A
GPC/MDM FAILURE RESPONSE DURING RNDZ		
(Front).....	CC 8-15	RNDZ-7a/125/O/B
RNDZ REF DATA (Back).....	CC 8-16	RNDZ-7b/125/O/A
C/L CAMERA CORRIDOR AND ALIGNMENT.....	CC 8-17	RNDZ-8a/125/O/A
A31P PGSC DISPLAY OF C/L CAMERA CORRIDOR		
AND ALIGNMENT.....	CC 8-18	RNDZ-9a/125/O/A
SUB ANG RULER.....	CC 8-19	RNDZ-10a/125/O/A
STS-400 RBAR APPROACH (Front).....	CC 2-29	RNDZ-11a/400/O/B
(Back).....	CC 2-30	RNDZ-11b/400/O/A

This Page Intentionally Blank

<u>CONTENTS</u>	<u>PAGE</u>
<u>FLIGHT RULES SUMMARY & FLIGHT PROFILE</u>	1-1
FLIGHT RULES SUMMARY	1-2
RNDZ/PROX OPS BREAKOUT PROCEDURES OVERVIEW	1-2
RNDZ BURN SOLUTION SELECTION GUIDELINES.....	1-3
ENGINE SELECTION GUIDELINES	1-3
FAILURE/RESPONSE SUMMARY	1-4
ORBT RENDEZVOUS PROFILE	1-5
POST Ti PROFILE	1-6
STS-125 TERMINAL PHASE, RBAR APPROACH, AND INERTIAL GRAPPLE.....	1-7
 <u>STS-400 PROCEDURES</u>	 2-1
 <u>MANEUVER PADS</u>	 3-1
 <u>STS-125 RENDEZVOUS TIMELINE</u>	 4-1
CONTINGENCY INERTIAL APPROACH TIMELINE.....	4-23
 <u>CONTINGENCY OPS</u>	 5-1
RNDZ OMS BURN.....	5-3
SENSOR FAIL	5-7
S TRK NAV – HIGH INITIAL RESID	5-8
FLTR MINUS PROP	5-9
COAS NAVIGATION	5-10
BACKOUT/BREAKOUTS.....	5-11
PROXIMITY OPS BACKOFF	5-12
HST RBAR BREAKOUT.....	5-13
FLYAROUND/LOSS OF LO Z BREAKOUT	5-14
RNDZ BREAKOUT.....	5-16
Ti DELAY BURN	5-17
RNDZ NAV RECOVERY.....	5-19
TGT ITER.....	5-20
LOSS OF COMM	5-21
DEGRADED CONTROL	5-23
LOSS OF VRCS.....	5-25
LO Z BRAKING.....	5-26
 <u>REFERENCE DATA</u>	 6-1
STS-125 HST RNDZ OPS DAP CONFIGURATIONS	6-2
TARGETING DATA.....	6-3
POST NC	6-5
Ti	6-6
MC3.....	6-7
COAS SUBTENDED ANGLES (DEG) VS RANGE (FT).....	6-8
 <u>RENDEZVOUS TOOLS</u>	 7-1
CCTV CONFIG FOR DOCKING/UNDOCKING	7-2
RNDZ TOOLS CHECKOUT	7-4
TROUBLESHOOTING.....	7-5
TCS CADS NOT RECEIVING TCS DATA.....	7-6
RPOP NOT RECEIVING PCMMU DATA.....	7-7
HHL DATA	7-8
TCS DATA (CADS RCV DATA ON SAME PGSC)....	7-9
PGSC REBOOT.....	7-9
TOOLS CONFIGURATION STATUS.....	7-10

HAND-HELD LIDAR CHECKOUT/OPS	7-14
STOW	7-14
RPOP INITIALIZATION.....	7-15
OPS	7-16
TCS ACTIVATION	7-18
MANUAL ACQUISITION.....	7-19
DEACTIVATION	7-20
TRAD FAIL RANGE AND RANGE RATE DETERMINATION	7-21
RNDZ TOOLS REFERENCE DATA	7-22
RPOP FUNCTION KEY SUMMARY	7-22
KEYSTROKE SUMMARY	7-25
RPOP TRAJECTORY DATA SOURCE OPTIONS.....	7-26
HHL REF DATA	7-28
TCS LIMIT DATA	7-28
<u>CUE CARD CONFIGURATION</u>	8-1

FLIGHT RULES SUMMARY & FLIGHT PROFILE

FLIGHT RULES SUMMARY.....	1-2
RNDZ/PROX OPS BREAKOUT PROCEDURES OVERVIEW.....	1-2
BURN SOLUTION SELECTION GUIDELINES	1-3
ENGINE SELECTION GUIDELINES.....	1-3
FAILURE/RESPONSE SUMMARY	1-4
ORBT RENDEZVOUS PROFILE.....	1-5
POST TI PROFILE.....	1-6
STS-125 TERMINAL PHASE, RBAR APPROACH, AND INERTIAL GRAPPLE.....	1-7

**FLT RULES &
FLT PROFILE**

FLIGHT RULES SUMMARY

RNDZ/PROX OPS BREAKOUT PROCEDURES OVERVIEW

RANGE BREAKOUT REQD	BREAKOUT PROCEDURE AND SUMMARY
Prior to Ti	Discontinue RNDZ burns; specific breakout only on MCC call
Between Ti and stable at 500 ft on the +RBAR	3 fps retrograde see RNDZ BREAKOUT (Contingency Operations), 5-16
In PROX OPS: If between 500 ft and INERTIAL ALIGNMENT FLYAROUND	3 fps posigrade or retrograde (MCC call). See HST RBAR BREAKOUT (CONTINGENCY OPERATIONS), 5-13
If between INERTIAL ALIGNMENT FLYAROUND and 30 ft	1.7 fps -X burn, manual pitch, 2 fps out-of-plane, 3.5 fps posigrade or retrograde (MCC call). See HST FLYAROUND/LOSS OF LO Z BREAKOUT (CONTINGENCY OPERATIONS), 5-14
If inside 30 ft	Maintain LO Z backout to > 30 ft then 1.7 fps -X burn, manual pitch, 2 fps out-of-plane, 3.5 fps posigrade or retrograde (MCC call). See HST FLY AROUND/LOSS of LO Z BREAKOUT (CONTINGENCY OPERATIONS), 5-14

**FLT RULES &
FLT PROFILE**

RNDZ BURN SOLUTION SELECTION GUIDELINES

BURN	SOLUTION PRIORITY
All burns prior to, but not including, NCC	1) Ground solution
NCC & Ti	1) Onboard FLTR solution if STRK or RR NAV converged* (for COAS, use step 2 below) 2) Onboard FLTR solution if it agrees with ground solution** 3) Onboard PROP solution if it agrees with ground solution 4) Ground solution
Post-Ti midcourse corrections	1) Onboard solution

*For the purpose of burn solution selection NAV is converged if, for the present sensor in acquisition (RR or STRK), at least 40 marks have been accepted with state vector position update of less than 0.5 Kft for at least the last 4 marks; or if state vector updates are small and stable. This criteria does not apply to COAS NAV

** Burn solutions are considered to be in agreement if delta Vs differ by no more than the 'final-ground' limits for each axis

RNDZ BURN ENGINE SELECTION GUIDELINES

DELTA V	ENGINE
< 4 fps	RCS – Primary technique is multi-axis
4 to 6 fps	RCS – Primary technique is +X
> 6 fps	OMS – Single engine

ORBT RENDEZVOUS PROFILE

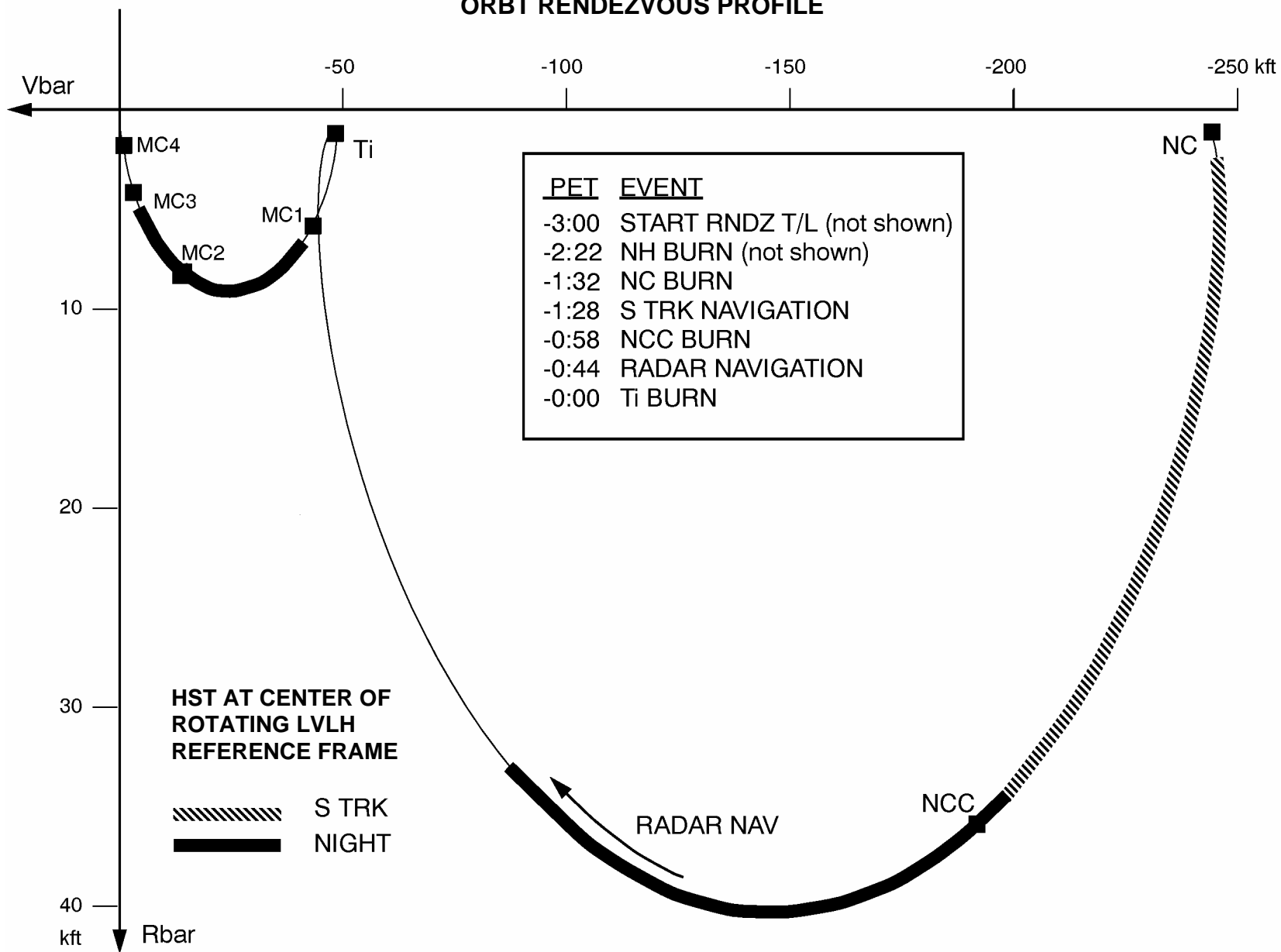

ORBT POST Ti PROFILE

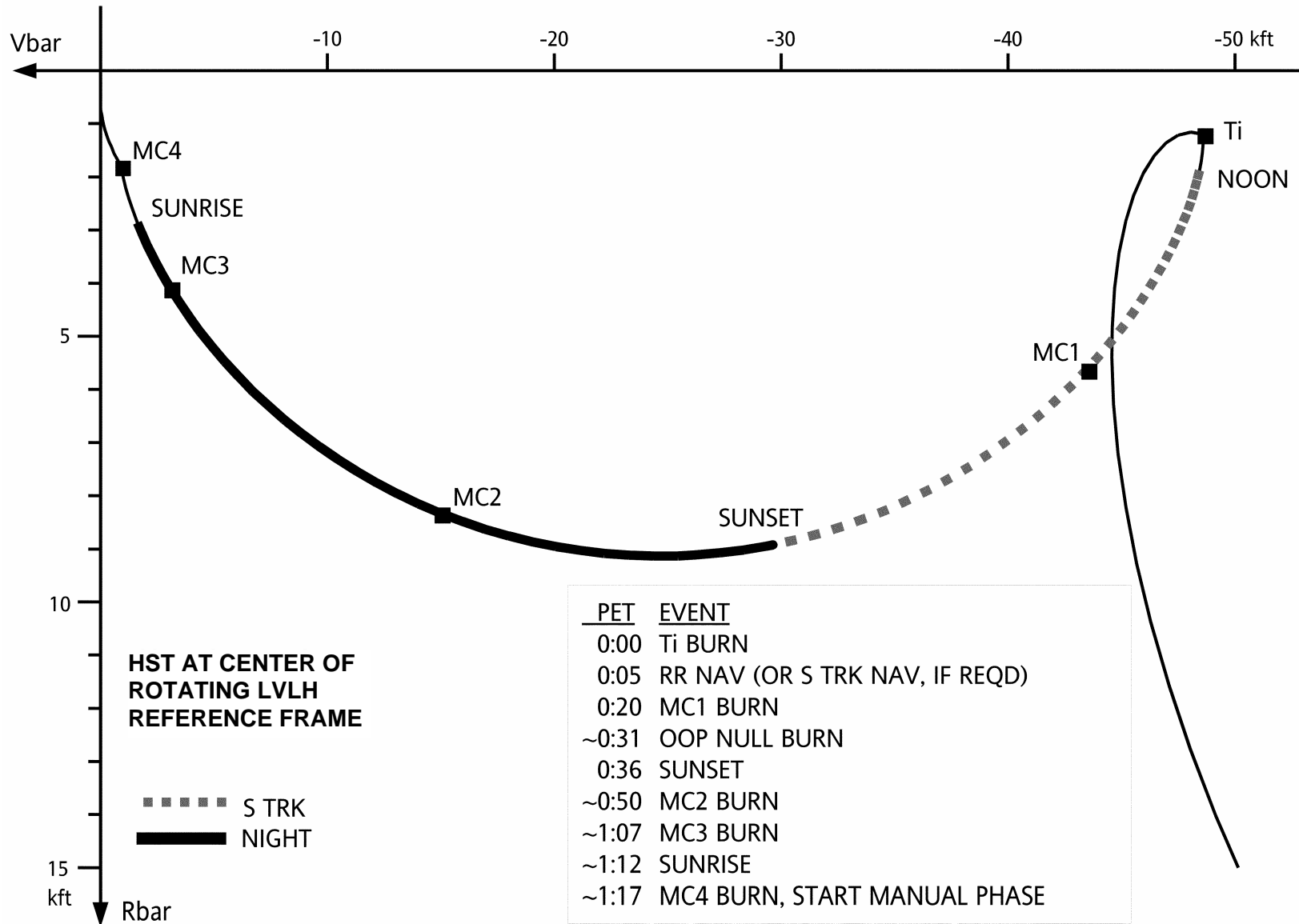

STS-125 TERMINAL PHASE, RBAR APPROACH, AND INERTIAL GRAPPLE

APPROX	PET	
(min)	(min)	
1	0	MANUAL PHASE TAKEOVER (POST-MC4) 2000 FT RANGE RATE GATE (RDOT = -3.0 FPS)
	2	1700 FT RANGE RATE GATE (RDOT = -2.6 FPS)
2	3	1500 FT RANGE RATE GATE (RDOT = -2.3 FPS) TRANSITION TO LOWZ
3	8	1000 FT RANGE RATE GATE (RDOT = -1.5 FPS)
4	13	600 FT (RDOT = -0.8 FPS) ALLOW RDOT TO FALL TO -R/1000 FPS
5	31	200 FT (MAINTAIN RDOT = -0.2 FPS)
	38	120 FT (ALLOW RDOT TO FALL TO -0.1 FPS)
6	50	INRTL WHEN HST V1 AXIS ALIGNED WITH ORBITER -Z AXIS
	51	35 FT GRAPPLE POSITION (FINAL LOWZ BRAKING)
7	53	STABILIZE AND GRAPPLE

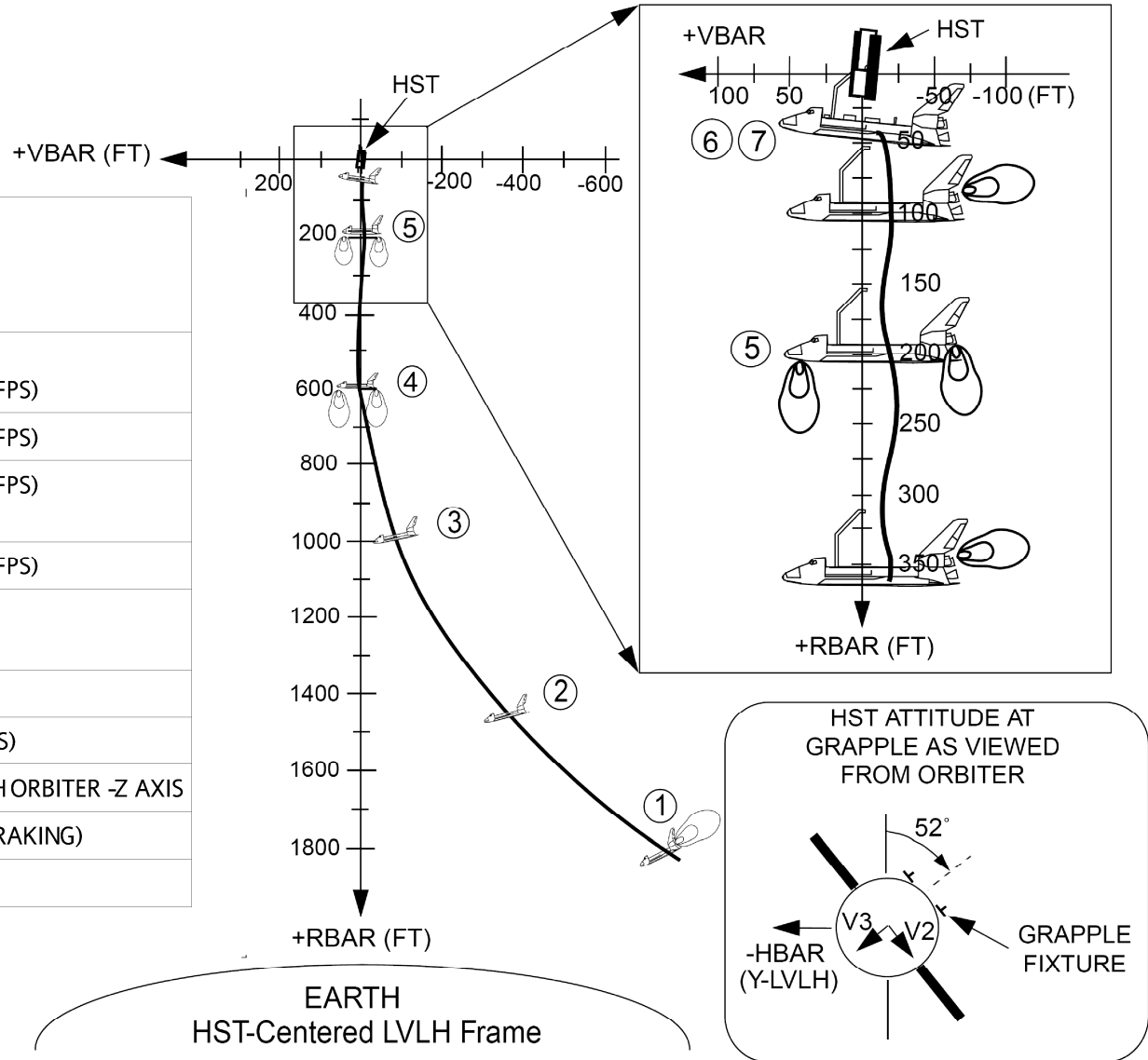

This Page Intentionally Blank

STS-400 PROCEDURES

FLIGHT PROFILE.....	2-3
TERMINAL PHASE AND +RBAR APPROACH.....	2-4
UNGRAPPLE AND -VBAR SEPARATION	2-5
RENDEZVOUS OPS	2-7
SSOR ACTIVATION	2-9
RENDEZVOUS TIMELINE.....	2-10
STS-400 RBAR APPROACH.....	CC 2-29
RELEASE OPS.....	2-31
STS-125 VEHICLE CONFIG FOR RELEASE.....	2-32a
RELEASE PREP.....	2-33
RELEASE.....	2-35
RELEASE T/L	2-41

This Page Intentionally Blank

This Page Intentionally Blank

FLIGHT PROFILE

TERMINAL PHASE AND +RBAR APPROACH

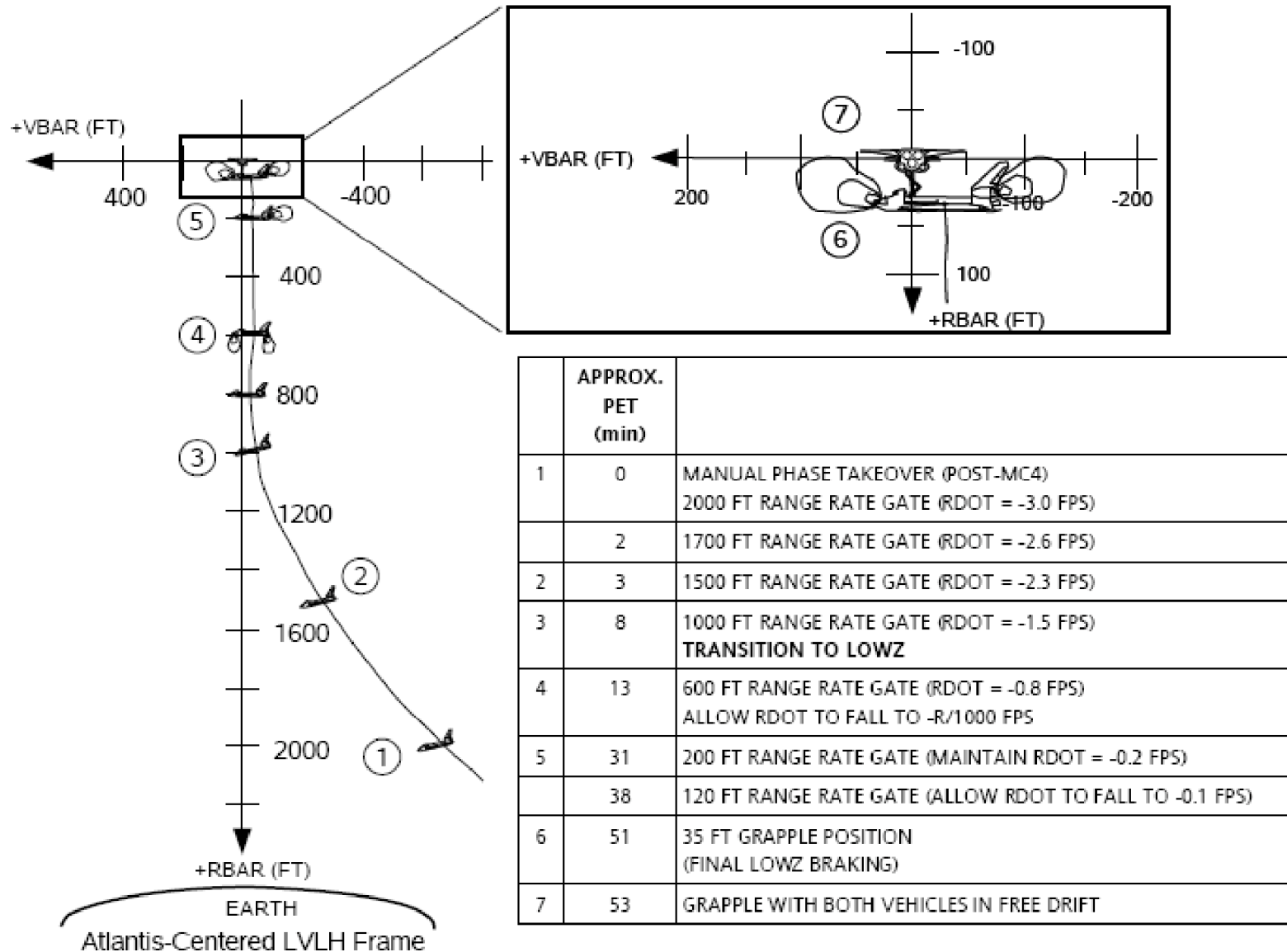

UNGRAPPLE AND -VBAR SEPARATION

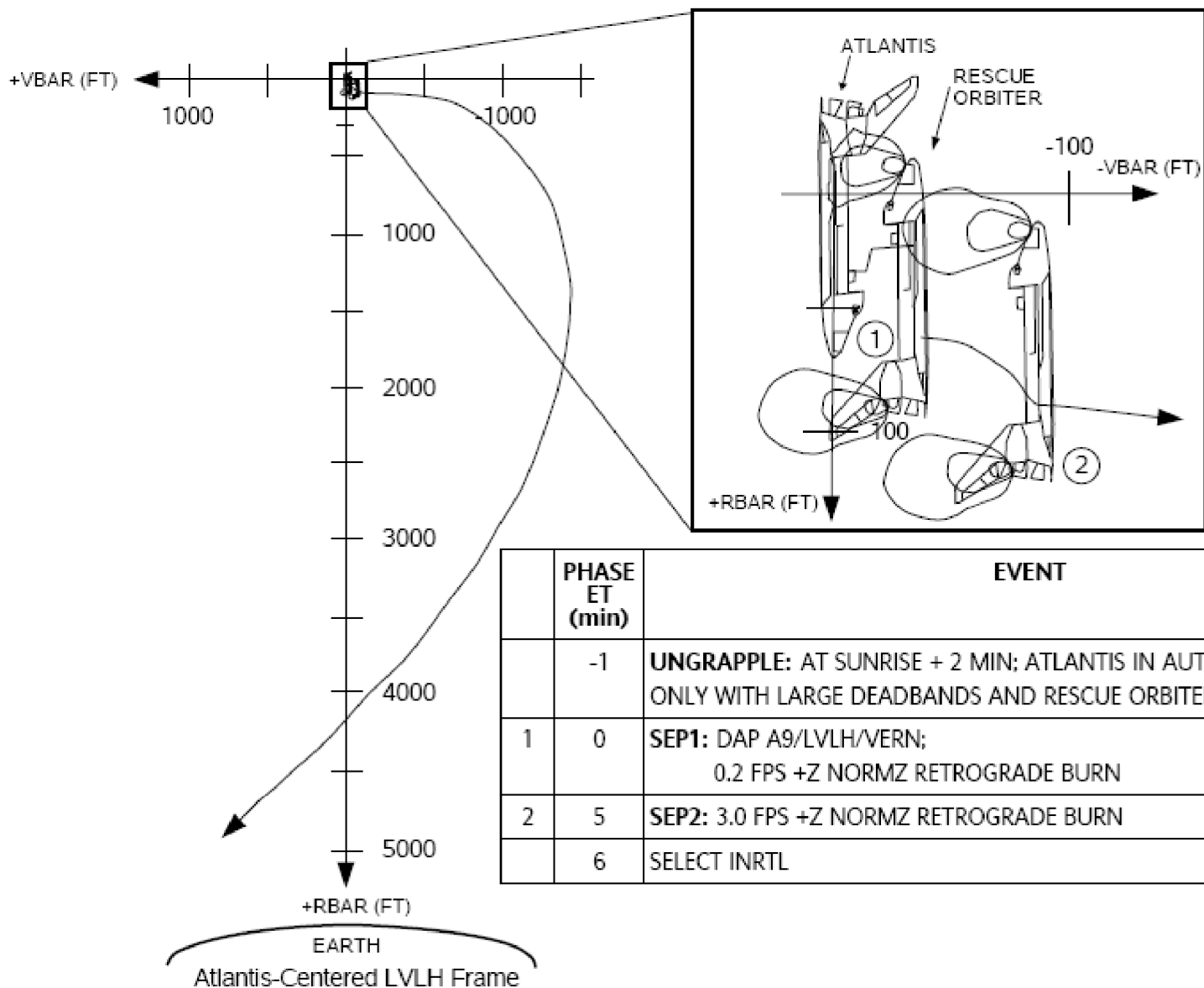

This Page Intentionally Blank

This Page Intentionally Blank

RENDEZVOUS
OPS

This Page Intentionally Blank

SSOR ACTIVATION

- R14:C 1. √cb MNA UHF EVA – cl
 √MNC UHF EVA – cl
- O6 2. √UHF SPLX/EVA PWR AMP – OFF
 √SPLX/EVA XMIT FREQ: 259.7/414.2
 √EVA STRING: 1
 MODE – EVA
- A1R 3. AUD CTR UHF A/G 1 (2) – T/R
4. Perform voice checks as required after SSORs are within communicating range
 (less than 30,000 feet)

SM 76 COMMUNICATIONS

√SSOR FRM SYNC 1 – YES

5. **MCC** uplinks PCMMU/PDI/OIU configurations as required

AFT FLT STATION CONFIG FOR RNDZ 10A

O14,16:E cb MNA,C DDU AFT (two) - cl

A6U ADI ATT - LVLH
ERR - MED
RATE - MED
SENSE - minus Z

R13 KU ANT - GND
A1U PWR - ON
sel - MAN SLEW
MODE - RDR PASSIVE
RADAR OUTPUT - HI
CNTL - PNL
SIG STRENGTH sel - KU
SLEW RATE - as reqd

A2 DIGI-DIS sel - R/RDOT
X-PNTR SCALE - X1

SM ANTENNA

CRT SELF TEST - ITEM 7 EXEC (*)

NOTE

SELF TEST runs about 3 min

A1U KU SCAN WARN tb - gray
TRACK tb - gray
SEARCH tb - gray

A2 RANGE - 888.8
DIGI-DIS sel - EL/AZ

CRT SELF TEST - ITEM 7 EXEC (no *)

A1U KU MODE - COMM
sel - GPC
CNTL - CMD

Install:

-Z COAS

RCS BURN Cue Card

KU OPS Cue Card

APPROACH Cue Card

PET

-03:00

CDR AFT FLT STATION CONFIG FOR RNDZ **10A**

A7(B7)

PLT RNDZ OPS INITIALIZATION **11A**

-02:55

MS (125 and 400) Perform SSOR ACTIVATION, steps 1 and 2, 2-9

-02:50

CDR If NH reqd:
 If -X RCS, Perform -X RCS NH Burn **11B**
 If +X RCS burn, Perform RCS BURN, steps 1-5 (Cue Card)
 If OMS BURN, Perform RNDZ OMS BURN, steps 1-4 (CONTINGENCY OPS), 5-4

Postburn DAP: A/LVLH/VERN(ALT)

-02:45

-02:40

-02:35

-02:30

MCC UPDATE
 Final NH Burn Pad,
 3-3 (if reqd)

MCC UPLINK
 ORB SV
 TGT SV
 Drag K-factor

RNDZ OPS INITIALIZATION **11A**

√DPS Config for Rndz Ops - String 1233

SM 2 TIME

Set SM TIMER counting to T1 TIG per burn Pad, 3-6

Config DAP A,B to A7,B7

Record nominal TIGs in burn solution blocks per Execute Package:

NCC TIG pg 2-17
 MC1 TIG pg 2-23
 MC2 TIG pg 2-24

GNC 55 GPS STATUS

DES RCVR, ITEM 27 - (*)
 √INH GPS to G&C, ITEM 33 - (*)
 NAV, ITEM 36 - (*)

PERFORM -X RCS NH BURN **11B**

GNC UNIV PTG

CRT TGT ID +2
 BODY VECT +5

	Per PAD	Ref Values for NH
P	---	+100
Y	---	+0
OM	---	+0

C3 TRK - ITEM 19 EXEC (CUR - *)
 DAP: A/AUTO/ALT (B/ALT as reqd)

When in burn attitude,
 Perform RCS BURN, steps 1 thru 5 (Cue Card)

THIS PAGE INTENTIONALLY BLANK

PET

-02:30

A7(B7) ← TIG-5 MIN

-02:25

← If reqd,
NH TIG
Postburn DAP: A/LVLH/VERN(ALT)

-02:20

-02:15

PLT ENABLE RENDEZVOUS NAV 13A

MS √PGSCs setup per PGSC Usage Chart (if available) or UTILITY OUTLET PLUG-IN
PLAN ORBIT CONFIGURATION (REF DATA FS, UTIL PWR)

PLT, On RPOP PGSCs:
MS Perform RPOP INITIALIZATION (RNDZ TOOLS), 7-15, then
Perform RPOP OPS (RNDZ TOOLS), 7-16, then
Perform TCS ACTIVATION, step 1 (RNDZ TOOLS), 7-14

-02:10

MS Perform HHL CHECKOUT (RNDZ TOOLS), 7-14

-02:05

MCC UPDATE
Final NC Burn Pad, 3-5

-02:00

ENABLE RENDEZVOUS NAV 13A

1. GNC 33 REL NAV
CRT RNDZ NAV ENA - ITEM 1 EXEC (*)
√S TRK, ITEM 12 - (*)
2. GNC 34 ORBIT TGT
TGT NO - ITEM 1 +1 EXEC
Set BASE TIME to Ti TIG, (Ti Burn Pad, 3-6)
LOAD - ITEM 26 EXEC

MNVR TO BIASED +YLV +ZVV 14A

GNC UNIV PTG

CRT TGT ID +2
BODY VECT +5
P +90
Y +70
OM +270

DAP: B/AUTO/ALT
TRK - ITEM 19 EXEC

When MNVR cmplt:
DAP: A/AUTO/VERN(ALT)

PET

-02:00

A7(B7)

CDR LOAD TARGET TRACK [15A]

NOTE

If NH performed, delay mnvr to NC burn attitude until NC TIG - 5 min to minimize attitude mnvr

CDR If -X RCS, Perform -X RCS NC Burn [15B]

If +X RCS burn, Perform RCS BURN, steps 1-5 (Cue Card)

If OMS BURN, Perform RNDZ OMS BURN, steps 1-4 (CONTINGENCY OPS), 5-4

-01:55

-01:50

125 CDR If prop available, perform MNVR TO BIASED +YLV +ZVV [14A]

-01:45

← TIG-5 MIN

-01:40

← NC TIG

-01:35

CDR INITIATE TARGET TRACK [15C]

PLT TARGET NCC BURN [17A] (Preliminary), 2-17

PLT STAR TRACKER NAV [16A]

-01:30

MCC UPDATE
STAR TRK NAV
IMU DES _____
[16A], 2-16

LOAD TARGET TRACK [15A]

√DAP: A/LVLH/VERN(ALT)

[GNC UNIV PTG]

CRT CNCL - ITEM 21 EXEC
TGT ID +1

	<u>-Z AXIS</u>	<u>-Y STRK</u>
BODY VECT	+3 (-Z)	+4
P	√+90	√+0
Y	√+0	√+280.57
OM	+0	+90

Do not INITIATE TARGET TRACK [15C] until post NC

PERFORM -X RCS NC BURN [15B]

[GNC UNIV PTG]

CRT TGT ID +2
BODY VECT +5

	<u>Per PAD</u>	<u>Ref Values for NC</u>
P	---	+100
Y	---	+0
OM	---	+0

C3 TRK - ITEM 19 EXEC (CUR - *)
DAP: A/AUTO/ALT (B/ALT as reqd)

When in burn attitude,
Perform RCS BURN, steps 1 thru 5 (Cue Card)

[GNC UNIV PTG]

CRT TGT ID +1

	<u>-Z AXIS</u>	<u>-Y STRK</u>
BODY VECT	+3 (-Z)	+4
P	√+90	√+0
Y	√+0	√+280.57
OM	+0	+90

INITIATE TARGET TRACK [15C]

[GNC UNIV PTG]

TRK - ITEM 19 EXEC (CUR - *)
DAP: B/AUTO/ALT

When MNVR cmplt,
DAP: A/AUTO/VERN(ALT)

STAR TRACKER NAV 16A

1. CONFIG FOR STRK NAV

√DAP: A/AUTO/VERN(ALT)

Turn down cabin lights to optimize target viewing through -Z COAS/overhead window

IMU for Deselect _____ (If no comm, use IMU 1 for deselect)

GNC 21 IMU ALIGN

CRT IMU DES - ITEM 7(8,9) EXEC (*)

√MCC for NAV selected IMU _____

GNC 33 REL NAV

If first NAV pass,

√SV SEL, ITEM 4 - PROP

If previous NAV,

√SV SEL, ITEM 4 - FLTR

√INH Angles, ITEM 24 - (*)

√S TRK, ITEM 12 - (*)

GNC 22 S TRK/COAS CNTL

-Z (-Y) TGT TRK - ITEM 6(5) EXEC (*)

√STATUS - blank

√SHUTTER - op

2. INITIAL MEASUREMENT EVALUATION

GNC 22 S TRK/COAS CNTL

When S PRES - (*), continue

GNC 33 REL NAV

Monitor RESID V and H each NAV cycle for at least four consecutive cycles (~30 sec)

Record init RESID V = _____

H = _____

If RESID V or H changes by > 0.05 each cycle:

GNC 22 S TRK/COAS CNTL

-Z(-Y) BREAK TRK - ITEM 8(7) EXEC

Repeat Step 2

If RESID V or H > 0.6:

GNC 22 S TRK/COAS CNTL

-Z(-Y) BREAK TRK - ITEM 8(7) EXEC

When S PRES - (*), if RESID V or H still > 0.6 and stable:

Perform S TRK NAV - HIGH INITIAL RESID (CONTINGENCY OPS), 5-8

3. INCORPORATE DATA INTO NAV

If SV SEL = PROP:

AUTO Angles - ITEM 23 EXEC (*)

Record 1st SV UPDATE POS = _____

When SV UPDATE POS < 1.0 and Angle ACPT > 9:

SV SEL - ITEM 4 EXEC (FLTR) >>

If SV = FLTR:

FLTR TO PROP - ITEM 8 EXEC

AUTO Angles - ITEM 23 EXEC (*)

Record 1st SV UPDATE POS = _____

* If FLTR MINUS PROP changes by more than 8 kft within a S TRK pass: *

* Perform S TRK NAV - HIGH FLTR MINUS PROP *

* (CONTINGENCY OPS), 5-9 *

END S TRK NAV 16B

GNC 33 REL NAV

CRT INH Angles - ITEM 24 EXEC (*)

GNC 21 IMU ALIGN

IMU DES - ITEM 7(8,9) EXEC (no *)

PET

-01:30

A7(B7)

-01:25

-01:20

-01:15

-01:10

-01:05

-01:00

When NAV converged (SV UPDATES small and stable):
CDR TARGET NCC BURN 17A (Intermediate)

← TIG-17 MIN

← TIG-10 MIN √MCC for burn type * If no comm *

PLT END S TRK NAV 16B

← TIG-5 MIN

PLT TARGET NCC BURN 17A (Final)

CDR Perform RCS BURN (Cue Card)

← NCC TIG

MCC UPDATE
Nav Selected IMU

MCC UPDATE
Ground NCC Burn
Solution

TARGET NCC BURN 17A

FINAL SOLUTION

OPS 202 PRO
GNC ORBIT MNVR EXEC

√Eng Sel CORRECT

CRT √SV SEL correct

GNC 34 ORBIT TGT

TGT NO - ITEM 1 +9 EXEC

√TGT Set data:

T1 TIG = NCC BURN SOLUTION TIG

EL +0

ΔT +60.1

ΔX -48.6

ΔY +0.0

ΔZ +1.2

COMPUTE T1 - ITEM 28 EXEC

Record solution in PAD

FINAL SOLUTION

If > 40 marks in current sensor pass and
SV UPDATE POS < 0.5 for the last 4 marks:

Burn FLTR soln

If FLTR within ground solution limits:

Burn FLTR soln

If PROP within ground solution limits:

Burn PROP soln

If none of the above:

Burn ground soln EXT ΔVs

NCC BURN SOLUTION

TIG [] [] [] / [] [] : [] [] : [] []

PRELIMINARY

ΔVX	()		.	
ΔVY	()		.	
ΔVZ	()		.	
ΔVT			.	

INTERMEDIATE

	()		.	
	()		.	
	()		.	
			.	

FINAL

ΔVX	()		.	
ΔVY	()		.	
ΔVZ	()		.	
ΔVT			.	

GROUND

	()		.	
	()		.	
	()		.	
			.	

FINAL - GROUND LIMITS

(0.6)

(1.5)

(2.5)

THIS PAGE INTENTIONALLY BLANK

PET

-01:00

A7(B7)

PLT TARGET Ti BURN 19A (Preliminary)

IF Y S TRK TRACK
 CDR -Z AXIS TARGET TRACK 19C

-00:55

MCC UPDATE
 RNDZ PRPLT PAD

When:

GNC 33 REL NAV

NAV RNG < 150 KFT:

MS

KU OPS, step 1 (Cue Card)

-00:50

If no lock-on by

10 minutes after initial search:

MS

KU OPS, step 2 (Cue Card)

-00:45

When RR RNG < 135 KFT:

Perform RR NAVIGATION 19B

PLT

-00:40

When NAV converged (SV UPDATES small and stable):

PLT TARGET Ti BURN 19A (Intermediate)

-00:30

TARGET Ti BURN 19A

CRT √SV SEL correct

GNC 34 ORBIT TGT

TGT NO - ITEM 1 +1 Q EXEC

√TGT Set data:

T1 TIG = BASE TIME

EL +0

ΔT +80.1

ΔX -0.9

ΔY +0

ΔZ +1.8

COMPUTE T1 - ITEM 28 EXEC

Record solution in PAD

RR NAVIGATION 19B

GNC 33 REL NAV

CRT RR - ITEM 13 EXEC (*)

√Elev, Az approx 0

Record Initial RESID RANGE = _____

RDOT = _____

**IF RESID RANGE > 5.0 or
 RDOT > 3.0**

SV SEL - ITEM 4 EXEC (PROP)

Proceed with taking data and contact MCC
 as soon as practical

FLTR TO PROP - ITEM 8 EXEC

AUTO RNG - ITEM 17 EXEC (*)

RDOT - ITEM 20 EXEC (*)

Angles - ITEM 23 EXEC (*)

Record 1st SV UPDATE POS = _____

IF SV SEL = PROP

When SV UPDATE POS < 0.3 and MARK ACPT > 9:

SV SEL - ITEM 4 EXEC (FLTR)

-Z AXIS TARGET TRACK 19C

GNC UNIV PTG

CRT √TGT ID +1

BODY VECT +3 (-Z)

OM +0

C3 DAP: B/AUTO/ALT

CRT TRK - ITEM 19 EXEC (CUR - *)

When MNVR cmplt,

DAP: A/AUTO/VERN(ALT)

Ti BURN SOLUTIONS

PREL FLTR

()			.	
()			.	
()			.	
			.	

INTER FLTR

()			.	
()			.	
()			.	
			.	

FINAL FLTR

()			.	
()			.	
()			.	
			.	

GND

()			.	
()			.	
()			.	
			.	

FINAL Ti Burn Pad, 3-7

PROP
(If Reqd)

()			.	
()			.	
()			.	
			.	

FINAL - GROUND
LIMITS

ΔV_X (0.9)
 ΔV_Y (1.3)
 ΔV_Z (1.2)

PET

-00:30

A7(B7)

√MCC for burn type. If no comm:

If $\Delta VT > 6$, at TIG-17:

| Perform RNDZ OMS BURN (CONTINGENCY OPERATIONS), 5-4

If $4 \leq \Delta VT \leq 6$, at TIG-17:

| Perform +X RCS burn, RCS BURN (Cue Card)

If $\Delta VT < 4$, at TIG-5:

| Perform multi-axis RCS burn, RCS BURN (Cue Card)

MCC UPDATE

Ti Final Ground Soln,

Ti DELAY Soln, 3-7

-00:25

If GO for Ti not received by TIG - 5 or RNDZ DELAY called by MCC

CDR Perform Ti DELAY BURN (CONTINGENCY OPS), 5-17

-00:20

← TIG-17

If Ti is multi-axis burn, delay final targeting until TIG-5

PLT TARGET Ti BURN [21A] (Final)

MCC UPDATE

GO for Ti

-00:15

If Ti is +X RCS burn:

CDR | Perform RCS BURN (Cue Card)

If Ti is OMS BURN:

| Perform RNDZ OMS BURN (CONTINGENCY OPERATIONS), 5-4

-00:10

-00:05

← TIG-5

If Ti is multi-axis burn:

CDR | Perform RCS BURN (Cue Card)

00:00

← Ti TIG

TARGET Ti BURN [21A] (Final)

CRT OPS 202 PRO

[GNC ORBIT MNVR EXEC]

Load Eng Sel, TVR, WT and Trims for Ti per Final Ti Burn Pad
LOAD - ITEM 22 EXEC

[GNC 33 REL NAV]

√SV SEL correct

[GNC 34 ORBIT TGT]

TGT NO - ITEM 1 +1_0 EXEC

√TGT Set data:

T1 TIG = BASE TIME

EL +0

ΔT +80.1

ΔX -0.9

ΔY +0

ΔZ +1.8

COMPUTE T1 - ITEM 28 EXEC

Record solution in PAD

FINAL SOLUTION

If > 40 marks in current sensor pass and
SV UPDATE POS < 0.5 for the last 4 marks:

| Burn FLTR soln

If FLTR within ground solution limits:

| Burn FLTR soln

If PROP within ground solution limits:

| Burn PROP soln

If none of the above:

Burn ground soln EXT ΔV s

POST Ti NAV [22A]

A6U √DAP: A/AUTO/VERN(ALT)
A1U √KU sel - GPC

GNC 33 REL NAV

IF SV SEL = FLTR:

FLTR TO PROP - ITEM 8 EXEC (*)

√AUTO Angles - ITEM 23 EXEC (*)

If RR NOT Tracking TGT:

√Inhibit Data

Perform KU OPS, steps 2 and 3 (Cue Card)

If still no RR ACQ, assume RR Fail

GNC 22 S TRK/COAS CNTL

CRT √ Z TGT TRK - ITEM 6 EXEC (*)

IF RR FAIL

If -Z Star Tracker:

√-Z TGT TRK ATT, then:

Perform STAR TRACKER NAV [16A]

If COAS NAV:

√-Z TGT TRK ATT, then:

Perform COAS NAVIGATION (CONTINGENCY OPS), 5-10

If -Y Star Tracker:

GNC UNIV PTG

TGT ID +1

BODY VECT +4

P √+0

Y √+280.57

OM +90

DAP: B/AUTO/ALT

TRK - ITEM 19 EXEC

When MNVR cplmt:

DAP: A/AUTO/VERN(ALT)

Perform STAR TRACKER NAV [16A]

PET

00:00 PLT TARGET MC 1 BURN [23A] (Preliminary)
A7(B7)

CDR When MNVR to att cmlpt:
POST Ti NAV [22A]

00:05 MS1 POISED FOR CAPTURE POSITION (PDRS, NOMINAL STS 125 OPS)

00:10 PLT When NAV converged, (SV UPDATES small and stable):
TARGET MC 1 BURN [23A] (Intermediate)

MS $\sqrt{\text{Time of OOP null}}$

00:15 ← TIG-3 MIN

PLT TARGET MC 1 BURN [23A] (Final)
Perform RCS BURN (Cue Card)

00:20 ← MC 1 TIG

PLT TARGET MC 2 BURN [23B] (Preliminary)

00:25 PLT When Y = 0:
MANUAL OUT-OF-PLANE NULL [25A]

125 CDR If power available, turn on payload bay lights

00:30 A6L LTS TRUSS AFT,FWD (two) - ON
VEST PORT,STBD (two) - ON

MCC UPDATE
Prox Ops Cov Matrix

TARGET MC 1 BURN [23A]

CRT $\sqrt{\text{SV SEL correct}}$
GNC 34 ORBIT TGT
TGT NO - ITEM 1 +1 1 EXEC
 $\sqrt{\text{TGT Set data:}}$
T1 TIG = MC1 BURN SOLUTION TIG
EL +0
 ΔT +60.1
 ΔX -0.9
 ΔY +0
 ΔZ +1.8
COMPUTE T1 - ITEM 28 EXEC
Record solution in PAD

MC 1 BURN SOLUTION

TIG / : :

	PRELIMINARY				INTERMEDIATE			
ΔV_X	()			.	()			.
ΔV_Y	()			.	()			.
ΔV_Z	()			.	()			.
ΔV_T				.				.

	FINAL		MEAN \pm (3 σ) VARIATION)	
ΔV_X	()	.	0.0 \pm (0.5)	
ΔV_Y	()	.	0.1 \pm (0.5)	
ΔV_Z	()	.	0.0 \pm (1.2)	
ΔV_T		.		

TARGET MC 2 [23B] (Preliminary)

CRT $\sqrt{\text{SV SEL correct}}$
GNC 34 ORBIT TGT
TGT NO - ITEM 1 +1 2 EXEC
 $\sqrt{\text{TGT Set data:}}$
T1 TIG = MC2 BURN SOLUTION TIG
EL +30.25
 ΔT +27.0
 ΔX -0.9
 ΔY +0
 ΔZ +1.8
COMPUTE T1 - ITEM 28 EXEC
NOTE
If TGT EL ANG Alarm,
 ΔV still valid for current TIG,
TIG slip limits still apply
Record solution in PAD

TARGET MC 2 BURN [24A] (Intermediate)

CRT √SV SEL correct
 [GNC 34 ORBIT TGT]
 TGT NO - ITEM 1 +1 2 EXEC
 COMPUTE T1 - ITEM 28 EXEC
 Record solution in PAD

TARGET MC 2 BURN [24B] (Final)

CRT √SV SEL correct
 [GNC 34 ORBIT TGT]
 TGT NO - ITEM 1 +1 2 EXEC
 COMPUTE T1 - ITEM 28 EXEC
 √TIG change

IF TIG CHANGE < -3 OR > +7 MIN

Set BASE TIME to (Nominal MC 2 TIG -3 or +7 min as appropriate)
 LOAD - ITEM 26 EXEC
 TGT NO - ITEM 1 +1 9 EXEC

√TGT Set data:

T1 TIG = BASE TIME
 EL +0
 ΔT +27.0
 ΔX -0.9
 ΔY +0
 ΔZ +1.8

COMPUTE T1 - ITEM 28 EXEC

Set EVENT TIMER counting to MC 2 TIG
 Record solution in PAD

[GNC 33 REL NAV]

CRT FLTR TO PROP - ITEM 8 EXEC

-Z AXIS TARGET TRACK [24C]

[GNC UNIV PTG]

CRT √TGT ID +1
 BODY VECT +3 (-Z)
 OM +0
 C3 DAP: B/AUTO/ALT
 CRT TRK - ITEM 19 EXEC (CUR - *)

When MNVR cmplt,
 DAP: A/AUTO/VERN(ALT)

CCTV CONFIG [24D]

A7U VID OUT - MON 1
 IN - A
 OUT - MON 2
 IN - B
 Aim A at B and B at A at full zoom in
 PAN/TILT - RESET
 For both camrs:
 PAN - 0.0 deg
 TILT - 90.0 deg
 Repeat for Camr C & D

MC 2 BURN SOLUTION

	PRELIMINARY	INTERMEDIATE
ΔVX	()	()
ΔVY	()	()
ΔVZ	()	()
ΔVT	()	()

	FINAL	MEAN ± (3σ VARIATION)
ΔVX	()	0.1 ± (0.5)
ΔVY	()	0.0 ± (0.2)
ΔVZ	()	0.5 ± (3.0)
ΔVT	()	

	TIG	TIG SLIP (COMPUTED-NOM)
PREL	[] / [] : [] : []	_____ : _____
INTER	[] / [] : [] : []	_____ : _____
FINAL	[] / [] : [] : []	_____ : _____
NOMINAL	[] / [] : [] : []	

END S TRK NAV [24E]

[GNC 33 REL NAV]
 CRT INH Angles - ITEM 24 EXEC (*)

[GNC 21 IMU ALIGN]
 IMU DES - ITEM 7(8,9) EXEC (no *)

PET

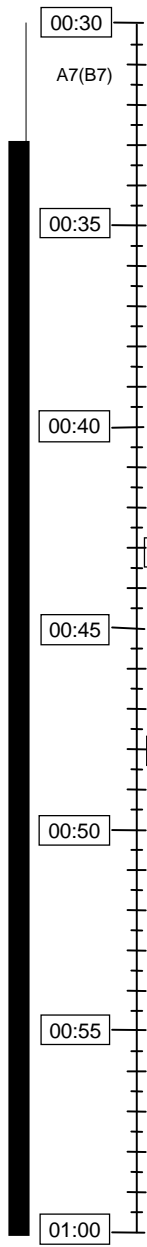

If S TRK NAV,
At Sunset
PLT **END STAR TRACKER NAV** [24E]

MS (125 and 400) Perform SSOR ACTIVATION, steps 3 and 4, 2-9

PLT When NAV converged (SV UPDATES small and stable):
TARGET MC 2 BURN [24A] (Intermediate)

MC2 ET

-00:10 MS On RPOP PGSC:
Perform TCS ACTIVATION, steps 2-4 (**RNDZ TOOLS**), 7-18
(Set AUTO ACQ to 10,000 ft)
SSP2 DRGNEYE PWR - ON (tb-gray)

MS √P/TV01 VIDEO SETUP
(PHOTO/TV FS, **SCENES**) complete
CCTV CONFIG [24D]

-00:05 ← PLT TIG-5 MIN
TARGET MC 2 BURN [24B] (Final)
Perform **RCS BURN** (Cue Card)

00:00 ← **MC 2 TIG**
PLT **TARGET MC 3 BURN** [25B] (Preliminary)

IF -Y S TRK TRACK
PLT **-Z AXIS TARGET TRACK** [24C]

IF INITIAL RR ACQ POST-MC2
CDR Perform **LATE RR NAV** [26B]

IF NO RR INTO NAV
CDR Go to **RADAR FAIL PROCEDURES** [26A]

MANUAL OUT-OF-PLANE NULL [25A]

GNC 33 REL NAV
CRT When Y = 0:
F7 FLT CNTLR PWR - ON
DAP: A/AUTO/PRI
DAP TRANS: as reqd

THC: Null YDOT
If -Z AXIS TRACK,
+YDOT = FWD THC left
AFT THC right
If -Y S TRK TRACK,
+YDOT = FWD THC down
AFT THC out

F7 FLT CNTLR PWR - OFF
DAP: A/AUTO/ALT
When rates nulled:
DAP: VERN(ALT)

TARGET MC 3 [25B]
CRT √SV SEL correct
GNC 34 ORBIT TGT
TGT NO - ITEM 1 +1 3 EXEC
√TGT Set data:
T1 TIG = BASE TIME + 0/00:17:00
EL +0
ΔT +10.0
ΔX -0.9
ΔY +0
ΔZ +1.8
COMPUTE T1 - ITEM 28 EXEC
Record solution in PAD

MC 3 BURN SOLUTION

TIG / : :

	PRELIMINARY	FINAL	MEAN ± (3σ VARIATION)
ΔVX	()	()	0.0 ± (0.5)
ΔVY	()	()	0.1 ± (0.5)
ΔVZ	()	()	0.0 ± (1.2)
ΔVT	()	()	

RADAR FAIL PROCEDURE [26A]

Note: At sunrise, report TGT Tally-Ho to MCC
 MS If TGT outside COAS reticle, config CCTV as reqd to measure vertical position

- At MC2 TIG+14:00 (MC3 TIG-3:00):
 PLT **TARGET MC3** [25B] (final)
 CDR Perform **RCS BURN**, steps 1 thru 5 (Cue Card), then:

**AT MC2+18 IF NO VISUAL ACQUISITION OR
 TARGET > 30 DEG FROM COAS HORIZONTAL**
 CDR Go to RNDZ BREAKOUT (**CONTINGENCY OPS**), 5-16 >>

- At MC2 TIG + 19:00:
 A6U FLT CNTLR PWR - ON
 √SENSE - -Z
 DAP: A/LVLH/PRI
 √COAS for TGT vertical position
 THC: +X (or -X) per COAS LOGIC:
 If TGT = N deg high in COAS, perform 2N +X (up) pulses
 If TGT = N deg low in COAS, perform 1N -X (down) pulses
 DAP: A/LVLH/VERN(PRI)
 Inform MCC of TGT vertical position in COAS and number of pulses performed
 Following radar fail X correction,
 THC: As reqd to control out-of-plane motion and manage RDOT
 Perform **CONFIG FOR RBAR** [27B]

- At MC2 TIG + 24:00 or 2000 ft, whichever comes first:
 CRT **GNC UNIV PTG**
 TRK - ITEM 19 EXEC (CUR - *)
 A6U DAP: A/AUTO/VERN (PRI)
 THC: as reqd to stabilize and maintain TGT between 0 deg and 10 deg
 high in COAS

At 2000 ft:
 Perform **STS 400 RBAR APPROACH** (Cue Card)

LATE RADAR NAV [26B]

- CRT **GNC 33 REL NAV**
 FLTR TO PROP - ITEM 8 EXEC
 √SV SEL, ITEM 4 - PROP
 √RR - ITEM 13 EXEC (*)
 AUTO RNG - ITEM 17 EXEC (*)
 RDOT - ITEM 20 EXEC (*)
 Angles - ITEM 23 EXEC (*)

Go to **RADAR FAIL PROCEDURE** [20A]

MC 4 BURN SOLUTION

TIG [] [] [] / [] [] : [] [] : [] []

	PRELIMINARY				FINAL				MEAN ± 3σ VARIATION
ΔVX	()			.	()			.	1.2 ± (2.7)
ΔVY	()			.	()			.	0.0 ± (0.6)
ΔVZ	()			.	()			.	0.4 ± (3.0)
ΔVT				.				.	

PET **MC2 ET**

01:00
A7(B7)
00:10
01:05
A8(B8)
01:10
00:20
01:15
00:25
01:20
00:30
01:25
00:35
01:30

IF NO RR INTO NAV
CDR Go to RADAR FAIL PROCEDURES [26A]

← TIG-3 MIN
PLT TARGET MC3 BURN [25B] (Final)
Perform RCS BURN (Cue Card)

← MC 3 TIG
PLT TARGET MC 4 BURN [27A] (Preliminary)

CDR CONFIG FOR RBAR [27B]

MS Perform HHL OPS (RNDZ TOOLS), 7-14

125 CDR Perform MNVR 125 ORBITER TO GRAPPLE ATTITUDE [27D]

← TIG-3 MIN
PLT TARGET MC 4 [27A] (Final)
Perform RCS BURN, steps 1-5 (Cue Card)

← MC 4 TIG
CDR ESTABLISH RBAR [27C]
Go to STS-400 RBAR APPROACH (Cue Card)

MANUAL TRAJECTORY CONTROL

CREW REPORT
TGT tally-ho

HHL REPORT
R and Rdot

TARGET MC 4 BURN [27A]
CRT √SV SEL correct
GNC 34 ORBIT TGT
TGT NO - ITEM 1 +1 4 EXEC
√TGT Set data:
T1 TIG = BASE TIME + 0/00:27:00
EL +0
ΔT +13.0
ΔX +0
ΔY +0
ΔZ +0.6
COMPUTE T1 - ITEM 28 EXEC
Record solution in PAD

CONFIG FOR RBAR [27B]
GNC UNIV PTG
√ ERR TOT - ITEM 23 EXEC (*)
When ERR <2 deg each axis
GNC 20 DAP CONFIG
Config DAP A,B to A8,B8
GNC UNIV PTG
TGT ID +2
BODY VECT +5
P +270
Y +0
OM +0
Do not initiate Target Track until ESTABLISH RBAR [27C]

ESTABLISH RBAR [27C]
A6U FLT CNTLR PWR - ON
GNC UNIV PTG
CRT TRK - ITEM 19 EXEC (CUR - *)
DAP: A/AUTO/VERN(PRI)
THC: as reqd to control TGT motion in COAS

MNVR 125 ORBITER TO GRAPPLE ATTITUDE [27D]
GNC UNIV PTG
CRT Config DAP A,B to A8/B8
GNC UNIV PTG
Y +0
DAP: B/AUTO/ALT
TRK - ITEM 19 EXEC
When MNVR cmplt:
DAP: A/AUTO/VERN(ALT), LO Z

THIS PAGE INTENTIONALLY BLANK

HOOK
VELCRO

STS-400 RBAR APPROACH

CG to CG RNG (ft)	RDOT (ft/s)	MC2 ET h:mm:ss	DAP	COMMENTS	HHL Range (ft) (to Orbiter CG)
BRAKING GATES			A8/B8 AUTO/VERN (PRI)	If RDOT falls below value for next gate, THC: -Z (in) as reqd to maintain RDOT	1990 HHL Report
2000	-3.0	0:27:00			
1700	-2.6	0:29:00			1690
1500	-2.3	0:30:00		MS Perform P/TV02 RNDZ/GRAPPLE (PHOTO/TV FS, SCENES)	1490
1000	-1.5	0:34:30	LO Z		990 HHL Report
800	↓			A1U KU OUTPUT – LO	790
600	-0.8	0:40:30	A9,B9	Maintain STS-125 airlock in the centerline camera	590 HHL Report
500	-0.5	0:41:30			490
400	-0.4	0:44:30			390
300	-0.3				290
300 (EE-GF:269)	-0.3	0:51:30		Switch HHL Aimpoint to Airlock Switch RPOP POR to EE-GF	HHL RNG (to Airlock) 282
EE-GF 200	-0.2	0:58:00		C/L Camera Full Zoom	223 HHL Report
150	-0.2	1:02:00		Configure Camera B/C with EE at bottom	173
120	-0.20 ↓	1:05:00		Perform CONFIGURE KU FOR COMM (Cue Card, <u>KU OPS</u>)	143
100	-0.1	1:07:00			123 HHL Report
50	-0.1	1:18:00		Configure Camera B/C centered on the RMS EE	73
-5	0.0	1:19:00		When Airlock fills full zoom C/L camera: THC: as required to null motion Verify STS-125 ready for Grapple (Free Drift) DAP: Free Perform <u>STS-125 GRAPPLE</u> ; PDRS OPS Then <u>TERMINATE RNDZ OPS</u> Go to FLIGHT PLAN	28 Ready to grapple

TERMINATE RNDZ OPS

CDR A6U √FLT CNTLR PWR – OFF

MS Perform HHL STOW (RNDZ TOOLS), 7-14
EXIT RPOP – [SHIFT]/[F10]
Perform TCS DEACTIVATION (RNDZ TOOLS), 7-20
SSP2 DRGNEYE PWR – OFF (tb-bp)
-Z COAS – OFF

PLT GNC 33 REL NAV
RNDZ NAV ENA – ITEM 1 EXEC (no *)

GNC 55 GPS STATUS
DES RCVR – ITEM 27 (no *)

GNC 22 S TRK/COAS CNTL
-Z(-Y) STAR TRK – ITEM 4(3) EXEC (*)

GNC 23 RCS
RCS F – ITEM 1 EXEC (*)
F1U – ITEM 17 EXEC (*)
F3U – ITEM 19 EXEC (*)
F2U – ITEM 21 EXEC (*)

DAP: A15/ALT
DAP: LVLH

RNDZ-11a/400/O/B

TOP
BACK OF 'STS-400 RBAR APPROACH'

HOOK
VELCRO



(reduced copy)

RNDZ-11b/400/O/A



This Page Intentionally Blank

RELEASE
OPS

This Page Intentionally Blank

STS-125 VEHICLE CONFIG FOR RELEASE

I

NOTE

To be completed before leaving STS-125 Vehicle

1. POWERUPS

As reqd, perform

PRIORITY PWRUP GRP C (OPCL, PRIORITY PWRDN)

2. CONFIGURE FREE DRIFT DAP

√DAP: FREE

GNC 20 DAP CONFIG

ITEM 2 + 8 EXEC

ITEM 31 + 4 0 EXEC

ITEM 38 + 5 EXEC

ITEM 42 + 1 0 EXEC

DAP: B/AUTO/PRI

3. CONFIGURE OMS ENGINES FOR DISPOSAL

L,R OMS HE PRESS/VAP ISOL (two) A – OP

(two) B – GPC

OMS ENG (two) – ARM/PRESS

4. UPDATE ORBITER WEIGHT

√MCC: Predicted Orbiter Weight at Release

GNC OPS 202 PRO

GNC ORBIT MNVR EXEC

Update Orbiter weight

√PEG 7 not all zero and TIG in future

ITEM 22 – LOAD

OPS 201 PRO

5. CONFIGURE GPS FOR RELEASE

Perform GPS PWRUP (ORBIT OPS, GNC)

6. CONFIGURE IDPs FOR COMMANDING

√IDP/CRT 1,2 (two) PWR – ON, major function to GNC

IDP/CRT 4 PWR – ON, major function to GNC

1: GNC UNIV PTG | 2: GNC 20 DAP CONFIG

7. MCC CHECK COMMANDING CONFIG

√ 1: GNC UNIV PTG (DSM 20102 to the GNC if reqd)

√ 2: GNC 20 DAP CONFIG (DSM 20103 to the GNC if reqd)

4: GNC 23 RCS (DSM 20130 to the GNC)

C2
R11

This Page Intentionally Blank

RELEASE PREP

√MCC

Verify STS125 Ready for Release and Separation

Install -Z COAS

- A7 1. CAMR SETUP
√PL BAY FLOODS FWD, MID, AFT (six) – as reqd
P/TV03 RELEASE (PHOTO/TV FS, SCENES) perform SETUP

- A6U M 2. ADI SETUP
ADI ATT – LVLH
ERR – MED
RATE – LO
SENSE: -Z

O14:E, √cb DDU (six) – cl
O15:E,
O16:E

- A1U 3. KU RDR SETUP
√KU CNTL – CMD
√PWR – STBY
MODE – RDR PASSIVE
RADAR OUTPUT – LO
sel – GPC
√SIG STRENGTH sel – KU
SLEW RATE – as reqd

- A2 DIGI-DIS sel – R/RDOT
√X-PNTR SCALE – X1
SM ANTENNA
√RDR RNG AUTO (ITEM 16) – (*)

4. UPDATE ORBITER WEIGHT
GNC, OPS 202 PRO
GNC ORBIT MNVR EXEC
Load WT – ITEM 9 + _____ EXEC
√PEG 7 not all zero and TIG in future
LOAD – ITEM 22 EXEC
GNC, OPS 201 PRO

A8U M 5. RMS SETUP
 ATTITUDE HOLD/EVA posn

	X	Y	Z	PITCH	YAW	ROLL	PL ID
√	-878	0	-964	0	0	180	3
	SY	SP	EP	WP	WY	WR	
√	-63.8	+58.6	-29.9	+33.9	-12.8	-47.4	

√SAFING tb – gray

A7U CCTV – config for ungrapple
 – install PDRS TARGET OVERLAY FOR CTVM
 – RMS WRIST, zoom 34.0 HFOV
 focus 5 ft

M 6. ENABLE RNDZ NAV

GNC 33 REL NAV

ORB TO TGT – ITEM 10 EXEC

RNDZ NAV ENA – ITEM 1 EXEC (*)

√SV SEL (ITEM 4) – PROP

√INH RNG (ITEM 18) – (*)

√RDOT (ITEM 21) – (*)

√Angles (ITEM 24) – (*)

√RR – ITEM 13 EXEC (*)

M 7. MNVR TO RELEASE ATTITUDE

GNC UNIV PTG

√TGT ID +2

BODY VECTOR +2

OM +180

DAP: A/AUTO/ALT

TRK – ITEM 19 EXEC (CUR - *)

When in Attitude:

DAP: VERN

RMS	STS-400 Orbiter
<p>RELEASE</p> <p>[M] 1a. <u>RELEASE PREPS</u> On MCC GO for Release: √VTR Recording</p>	<p>-03:00 [M] 1b. <u>RELEASE PREPS</u> √ATT ERR < 5 deg √RATES: ROLL, YAW ≤ 0.070 deg/sec PITCH: -0.004 ≤ RATE ≤ +0.136 deg/sec</p> <p>SSP2 AFT FLT CNTLR PWR – ON DRGNEYE PWR – ON (tb-gray)</p>

RMS		STS-400 Orbiter	
	<p>[M] 2a. <u>RELEASE</u></p> <p>* If Single Joint, execute starred * * block Manual Release below, * * SEP 1 will maneuver RMS clear *</p>		<p>[M] 2b. <u>RELEASE</u></p> <p><u>GNC 33 REL NAV</u> ORB TO TGT – ITEM 10 EXEC If VRCS, DAP: FREE If ALT, DAP: FREE</p>
RHC/A8U	RATE – VERN (RATE MIN tb-ON) -----	:-01:00	
A8U	BRAKES – OFF (tb-OFF) MODE – END EFF, ENTER	:-00:30	
	<u>SM 169 PDRS STATUS</u>		
	<div style="border: 1px solid black; padding: 5px; width: fit-content; margin: 10px auto;"> <p style="text-align: center;">CAUTION</p> <p style="text-align: center;">Monitor EE tb timing to prevent EE motor burnout</p> </div>		
	<p>* If manual release reqd: *</p> <p>* EE MODE – MAN *</p> <p>* EE MAN CONTR – DERIGID (hold until *</p> <p style="padding-left: 40px;">DERIGID tb-gray, *</p> <p style="padding-left: 40px;">5 sec max) *</p> <p>* *</p> <p>* -00:00 RELEASE sw – depress (hold until OPEN *</p> <p style="padding-left: 40px;">tb-gray, 3 sec max) *</p> <p>* *</p> <p>* Mnv r arm 5 ft (minimum) clear *</p> <p>* *</p> <p>* EE MAN CONTR – DERIGID (hold until *</p> <p style="padding-left: 40px;">EXTEND tb-gray, *</p> <p style="padding-left: 40px;">20 sec max) *</p> <p>* EE MODE – OFF *</p>		<p>* If Single Joint, after Manual Release, *</p> <p>* execute SEP 1 in FREE DRIFT to *</p> <p>* maneuver RMS clear *</p>
			<p><u>GNC 20 DAP CONFIG</u> Change DAP A,B to A9,B9 DAP: A/FREE/VERN(PRI) DAP TRANS: PULSE/PULSE/PULSE, No LO Z</p>

RMS		STS-400 Orbiter													
-:00:00	RHC														
	EE MODE – AUTO RELEASE sw – depress (mom)														
	When OPEN tb – gray, mnvr arm 5 ft (minimum) clear of grapple pin														
A8U	<table border="0"> <tr> <td><input checked="" type="checkbox"/></td> <td>RIGID</td> <td><input checked="" type="checkbox"/></td> <td>CLOSE</td> <td><input checked="" type="checkbox"/></td> <td>CAPTURE</td> </tr> <tr> <td><input type="checkbox"/></td> <td>DERIGID</td> <td><input type="checkbox"/></td> <td>OPEN</td> <td><input type="checkbox"/></td> <td>EXTEND</td> </tr> </table>	<input checked="" type="checkbox"/>	RIGID	<input checked="" type="checkbox"/>	CLOSE	<input checked="" type="checkbox"/>	CAPTURE	<input type="checkbox"/>	DERIGID	<input type="checkbox"/>	OPEN	<input type="checkbox"/>	EXTEND		
<input checked="" type="checkbox"/>	RIGID	<input checked="" type="checkbox"/>	CLOSE	<input checked="" type="checkbox"/>	CAPTURE										
<input type="checkbox"/>	DERIGID	<input type="checkbox"/>	OPEN	<input type="checkbox"/>	EXTEND										
	CRITICAL TIMES (28-sec total): DERIGID tb – gray, 5-sec max, then OPEN tb – gray, 3-sec max, then EXTEND tb – gray, 20-sec max														
	When clear of GF pin: EE MODE – OFF														
	BRAKES – ON (tb-ON) - - - - -														
	If STS-125 Not Released √BRAKES – OFF (tb-OFF) Perform BACKUP RELEASE (PDRS, MISCELLANEOUS PROCEDURES)	ASAP	<input type="checkbox"/> M												
	Non-time critical: <input type="checkbox"/> SM 96 PDRS CONTROL PL ID – ITEM 3 + 0 EXEC INIT ID – ITEM 24 + 0 EXEC														
		SEP 1 +05:00													
			3. <u>SEP 1 BURN</u> When RMS motion has stopped: DAP: A/LVLH/VERN(PRI) * If Single Joint, * * DAP: FREE *												
			AFT THC: +Z(out) 4 pulses (0.2 fps) Record MET: ___/___:___:___ (burn init) Report TIG to MCC √DAP: A/LVLH/VERN(PRI)												
			4. <u>SEP 2 BURN</u> At SEP 1 TIG +5 min: DAP TRANS: PULSE/PULSE/NORM AFT THC: +Z(out) 8 sec (3.0 fps) Record MET: ___/___:___:___ (burn init) AFT FLT CNTLR PWR – OFF Report TIG to MCC DAP TRANS: PULSE/PULSE/PULSE DAP: A/INRTL/VERN(ALT)												

RMS	STS-400 Orbiter
<p>Actions Complete</p>	<p>5. <u>RADAR ACQUISITION</u> √Range ≥ 100 ft <u>GNC 33 REL NAV</u> KU ANT ENA – ITEM 2 EXEC (*) GNC I/O RESET</p> <p>A1U √KU RADAR OUTPUT – LO √sel – GPC √MODE – RDR PASSIVE CNTL – PNL (wait 3 sec) PWR – ON</p> <p>A2 √DIGI-DIS SEL – R/RDOT</p> <p>A1U * If no lock within 2 min: * * KU sel – AUTO TRACK * * SLEW ELEV – as seen in COAS * * AZ – as seen in COAS * * √EL, AZ angles < 30 deg * * KU SEARCH – SEARCH (tb-gray) * * Repeat slew and search as reqd * * If acquisition not successful, √MCC *</p> <p>6. <u>RR NAVIGATION</u> √KU TRACK tb – gray <u>GNC 33 REL NAV</u> √RR (ITEM 13) – (*)</p> <p> * If RATIO > 1.0, * * √MCC *</p> <p> AUTO RNG – ITEM 17 EXEC (*) RDOT – ITEM 20 EXEC (*) Angles – ITEM 23 EXEC (*)</p> <p> When SV UPDATE POS < 0.03 and MARK ACPT > 9, SV SEL – ITEM 4 EXEC (FLTR)</p> <p>A1U When R > 600 ft, KU RDR OUTPUT – HI</p>

RMS	STS-400 Orbiter
<p>Actions Complete</p>	<p>When R > 1000 ft, 7. <u>-Z TARGET TRACK</u> <div style="border: 1px solid black; display: inline-block; padding: 2px;">GNC UNIV PTG</div> TGT ID + 1 BODY VECTOR + 3 OM + 180 TRK – ITEM 19 EXEC (CUR - *) DAP: A/AUTO/VERN(ALT)</p> <p>8. <u>P/TV DEACTIVATION</u> Go to P/TV03 HST RELEASE, DEACTIVATION (PHOTO/TV FS, <u>SCENES</u>)</p> <p>9. <u>CONFIG KU FOR COMM</u> When RANGE > 5000 FT: <div style="border: 1px solid black; display: inline-block; padding: 2px;">GNC 33 REL NAV</div> INH RNG – ITEM 18 EXEC (*) RDOT – ITEM 21 EXEC (*) Angles – ITEM 24 EXEC (*) KU ANT ENA – ITEM 2 EXEC (no *)</p> <p>A1U KU MODE – COMM √SEL – GPC CNTL – CMD</p> <p>A2 DIGI-DIS SEL – EL/AZ</p> <p>SSP2 DRGNEYE PWR – OFF (tb-bp)</p> <p>Return to Timeline</p>

This Page Intentionally Blank

NOTE:
This is the timeline for the STS-400 Release, Separation and Disposal of the STS-125 vehicle.



PET

-01:30

-01:25

-01:20

-01:15

-01:10

-01:05

-01:00

SET RELEASE TIMER 43A

MCC: CONFIGURE STS-125 RCS JETS FOR RELEASE 43B

MCC UPDATE
RELEASE Time 43A

SET RELEASE TIMER 43A

Nominal:

		/		:		:		
--	--	---	--	---	--	---	--	--

Backup:

		/		:		:		
--	--	---	--	---	--	---	--	--

Set SM and GNC timers counting down to release time

CONFIGURE STS-125 RCS JETS FOR RELEASE 43B

MCC Uplink: Jet reselects

GNC 23 RCS

RCS F – ITEM 1 EXEC (*)	(DSM 20131 to the GNC, IDP 4)
F1U - ITEM 17 (no *)	(DSM 20132 to the GNC, IDP 4)
F3U - ITEM 19 (no *)	(DSM 20133 to the GNC, IDP 4)
F2U - ITEM 21 (no *)	(DSM 20134 to the GNC, IDP 4)
RCS L – ITEM 2 EXEC (*)	(DSM 20135 to the GNC, IDP 4)
L4U - ITEM 17 (no *)	(DSM 20136 to the GNC, IDP 4)
L2U - ITEM 19 (no *)	(DSM 20137 to the GNC, IDP 4)
L1U - ITEM 21 (no *)	(DSM 20138 to the GNC, IDP 4)
RCS R – ITEM 3 EXEC (*)	(DSM 20139 to the GNC, IDP 4)
R4U - ITEM 17 (no *)	(DSM 20140 to the GNC, IDP 4)
R2U - ITEM 19 (no *)	(DSM 20141 to the GNC, IDP 4)
R1U - ITEM 21 (no *)	(DSM 20142 to the GNC, IDP 4)
RESUME	(DSM 20102 to the GNC, IDP 4)

THIS PAGE INTENTIONALLY BLANK

PET

-01:00

-00:55

-00:50

-00:45

-00:40

-00:35

-00:30

CONFIGURE RCS JETS FOR RELEASE 45A

CONFIGURE GPS FOR RELEASE 45B

√MCC: Verify STS-125 Ready for Release and Separation

Perform RELEASE PREP, 2-33

If reflector installed on STS-125
CONFIGURE TCS FOR SEPARATION 45C

MCC UPDATE
ORB SV
TGT SV

MCC UPLINK
Configure TFL for
TCS operations

CONFIGURE RCS JETS FOR RELEASE 45A

GNC 23 RCS

RCS F - ITEM 1 EXEC (*)
F1U - ITEM 17 (no *)
F3U - ITEM 19 (no *)
F2U - ITEM 21 (no *)

CONFIGURE GPS FOR RELEASE 45B

Perform GPS PWRUP (ORBIT OPS, GNC)

GNC 55 GPS STATUS

DES RCVR - ITEM 27 EXEC (no *)
√INH GPS to G&C - ITEM 33 EXEC (*)
NAV - ITEM 36 EXEC (*)

CONFIGURE TCS FOR SEPARATION 45C

√PGSCs setup per PGSC Usage Chart (if available) or UTILITY OUTLET PLUG-IN PLAN ORBIT CONFIGURATION (REF DATA FS, UTIL PWR)
NOTE: power PGSCs via source not on MAIN B (example: A15 connector)

On RPOP PGSCs:

Perform RPOP INITIALIZATION (RENDEZVOUS, RNDZ TOOLS), 7-15 then:
Perform RPOP OPS (RENDEZVOUS, RNDZ TOOLS), 7-16, then:
In RPOP, set POR - ORB DP to TGT DP, then:
set TGT attitude to LVLH TO TGT BODY 90,0,0 PYR, then:
Perform TCS ACTIVATION, steps 1 thru 3 (RENDEZVOUS, RNDZ TOOLS), 7-18, then:
Perform TCS MANUAL ACQUISITION (RENDEZVOUS, RNDZ TOOLS), 7-19
set RANGE = 4 ft, AZIMUTH = 0, ELEVATION = 0

THIS PAGE INTENTIONALLY BLANK

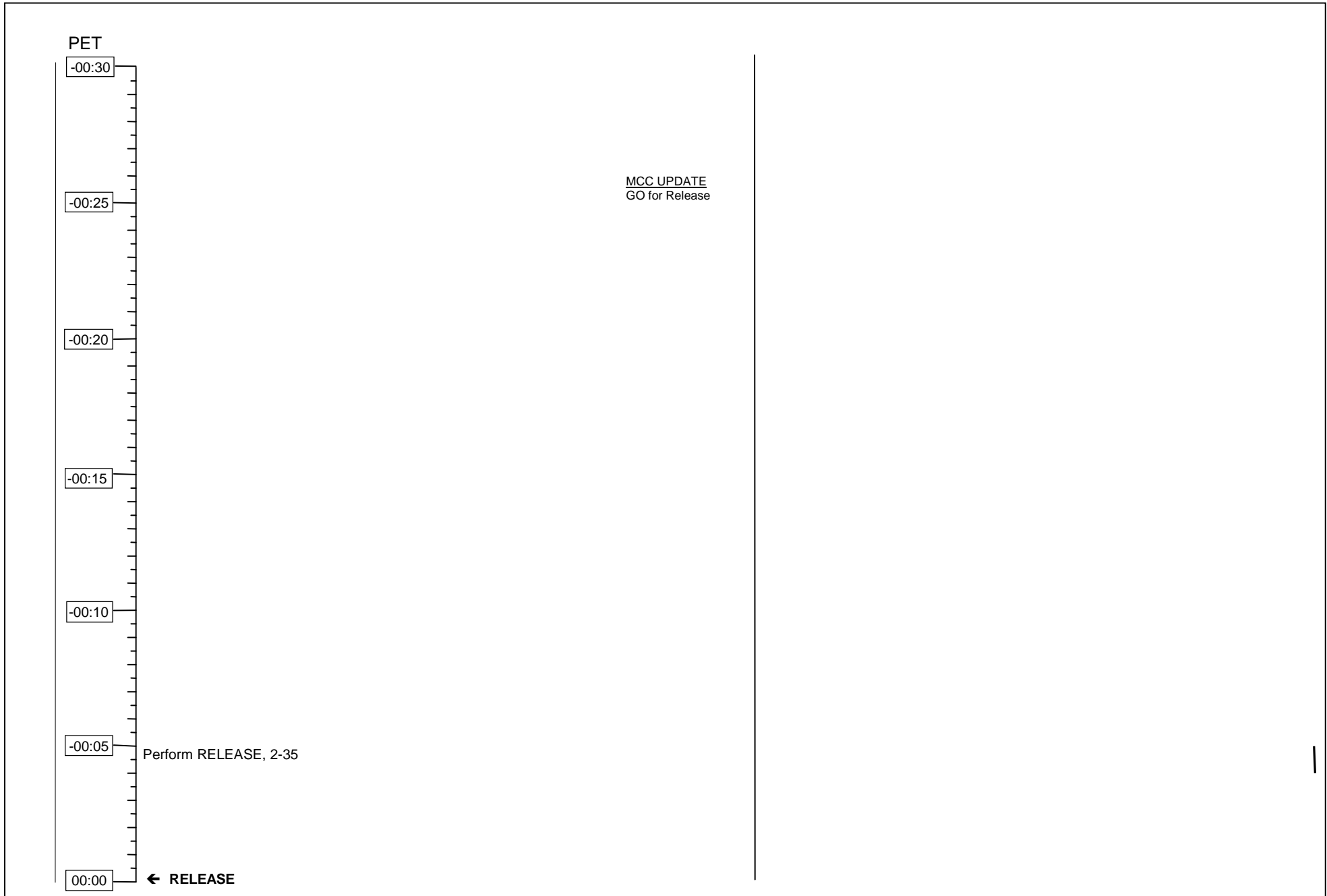

UNGRAPPLE AND -VBAR SEPARATION

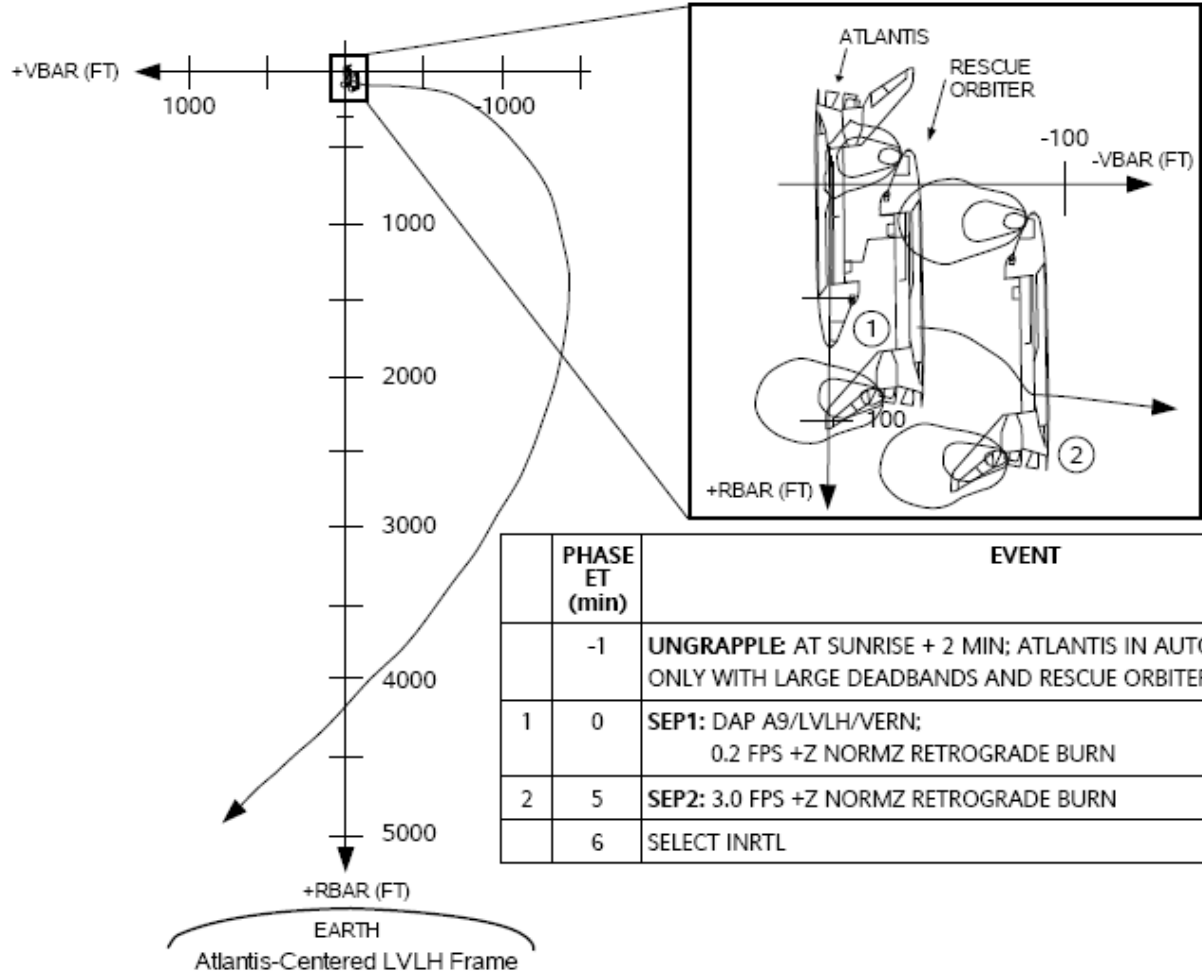

	PHASE ET (min)	EVENT
	-1	UNGRAPPLE: AT SUNRISE + 2 MIN; ATLANTIS IN AUTO/PRI TAIL ONLY WITH LARGE DEADBANDS AND RESCUE ORBITER IN FREE DRIFT
1	0	SEP1: DAP A9/LVLH/VERN; 0.2 FPS +Z NORMZ RETROGRADE BURN
2	5	SEP2: 3.0 FPS +Z NORMZ RETROGRADE BURN
	6	SELECT INRTL

PET

00:00

← SEP1 BURN

00:05

← SEP2 BURN

00:10

00:15

00:20

MCC UPDATE
STS-125 Orbiter vent
(DSM 42601)

00:25

← STS-400 Separation Complete
STS-400 crew and MCC team Return to Flight Plan>>
STS-125 MCC Team continue with Release/Disposal Timeline

00:30

THIS PAGE INTENTIONALLY BLANK

PET

00:30

00:35

00:40

00:45

00:50

00:55

01:00

THIS PAGE INTENTIONALLY BLANK

PET D/O BURN

01:00 -00:30 MCC: MANEUVER TO DISPOSAL BURN ATTITUDE 53A

01:05 -00:25

01:10 -00:20

01:15 -00:15

01:20 -00:10

01:25 -00:05

MCC:
When within 15 seconds of TIG, EXECUTE DISPOSAL BURN 53B
NOTE: Disposal burn may be performed later to optimize trajectory

01:30 00:00 ← DISPOSAL BURN

MCC UPDATE
Orbiter SV (DSM 40101)

MANEUVER TO DISPOSAL BURN ATTITUDE 53A

MCC uplink: OPS 202 PRO (DSM 20121 to the GNC, IDP1)

MCC uplink: disposal burn/deorbit targets

MCC uplink: load target and maneuver to burn attitude:

MNVR EXEC

LOAD - ITEM 22 EXEC (DSM 20122 to the GNC, IDP1)

MNVR - ITEM 27 EXEC (DSM 20123 to the GNC, IDP1)

EXECUTE DISPOSAL BURN 53B

MNVR EXEC

EXEC (DSM 20124 to the GNC, IDP1)

THIS PAGE INTENTIONALLY BLANK

PET D/O BURN

01:30 00:00 ← DISPOSAL BURN

01:35 00:05

01:40 00:10 MCC: When Disposal burn complete, if reqd, MANEUVER STS-125 TO POST BURN ATTITUDE 55A

01:45 00:15

01:50 00:20

01:55 00:25

02:00 00:30

MANEUVER STS-125 TO POST BURN ATTITUDE 55A

If maneuver required after disposal burn:
MCC: OPS 201 PRO (DSM 20125 to the GNC, IDP1)

Configure disposal attitude (-XLV -ZVV):

- GNC UNIV PTG
- ITEM 8 + 2 EXEC (DSM 20126 to the GNC, IDP1)
- ITEM 14 + 2 EXEC (DSM 20127 to the GNC, IDP1)
- ITEM 17 + 1 8 0 EXEC (DSM 20128 to the GNC, IDP1)
- ITEM 19 EXEC (DSM 20119 to the GNC, IDP1)

THIS PAGE INTENTIONALLY BLANK

MANEUVER PADS

MNVR PADS

MNVR PADS

PRELIMINARY ORBIT MANEUVER PAD FOR NH

OMS BOTH 1

L 2

R 3

RCS SEL 4 +X
-X
MULTI-AXIS

TV ROLL 5

BURN ATT

R 24

P 25

Y 26

$\Delta VTOT$

TGO

VGO X

VGO Y

VGO Z

TGT HA HP

TRIM LOAD P 6

LY 7

RY 8

WT 9

TIG 10 / : : .

TGT PEG 7 ΔVX 19

ΔVY 20

ΔVZ 21

OMS GMBL CK:

	PRE	POST-BURN
L PRI	<input type="text"/>	<input type="text"/>
L SEC	<input type="text"/>	<input type="text"/>
R PRI	<input type="text"/>	<input type="text"/>
R SEC	<input type="text"/>	<input type="text"/>
NONE	<input type="text"/>	<input type="text"/>

NOTES

RCS I'CNCT:

L OMS \rightarrow RCS

R OMS \rightarrow RCS

NONE

DOWN MODE OPTIONS:

2 OMS \rightarrow 1 OMS

1 OMS \rightarrow RCS

NONE

OMS HE REG TEST:

NONE

	L			R		
	GPC	OP	CL	GPC	OP	CL
A	<input type="text"/>	<input type="text"/>	<input type="text"/>	<input type="text"/>	<input type="text"/>	<input type="text"/>
B	<input type="text"/>	<input type="text"/>	<input type="text"/>	<input type="text"/>	<input type="text"/>	<input type="text"/>

-X RCS BURNS:

	BURN ATT	LVLH ATT
P 15	<input type="text"/> <input type="text"/> <input type="text"/>	<input type="text"/> <input type="text"/> <input type="text"/>
Y 16	<input type="text"/> <input type="text"/> <input type="text"/>	<input type="text"/> <input type="text"/> <input type="text"/>
OM 17	<input type="text"/> <input type="text"/> <input type="text"/>	<input type="text"/> <input type="text"/> <input type="text"/>

ORBIT BURN MONITOR

GPC FILL-INS ()

CRIT BURN

NON-CRIT BURN

MAX TIG SLIP ___ MIN

DO NOT UPDATE TIG

UPDATE TIG AFTER ___ MIN

NOTES

FINAL ORBIT MANEUVER PAD FOR NH

OMS BOTH 1

L 2

R 3

RCS SEL 4 +X
-X
MULTI-AXIS

TV ROLL 5

BURN ATT

R 24

P 25

Y 26

$\Delta VTOT$

TGO

VGO X

VGO Y

VGO Z

TGT HA HP

TRIM LOAD P 6

LY 7

RY 8

WT 9

TIG 10 / : : .

TGT PEG 7 ΔVX 19

ΔVY 20

ΔVZ 21

NOTES

OMS GMBL CK: PRE POST-BURN

L PRI

L SEC

R PRI

R SEC

NONE

RCS I'CNCT: L OMS → RCS
 R OMS → RCS
 NONE

DOWN MODE OPTIONS: 2 OMS → 1 OMS
 1 OMS → RCS
 NONE

OMS HE REG TEST: NONE

-X RCS BURNS:

L			R		
GPC	OP	CL	GPC	OP	CL
A	<input type="text"/>	<input type="text"/>	A	<input type="text"/>	<input type="text"/>
B	<input type="text"/>	<input type="text"/>	B	<input type="text"/>	<input type="text"/>

BURN ATT LVLH ATT

P 15	<input type="text"/>	<input type="text"/>	R	<input type="text"/>	<input type="text"/>
Y 16	<input type="text"/>	<input type="text"/>	P	<input type="text"/>	<input type="text"/>
OM 17	<input type="text"/>	<input type="text"/>	Y	<input type="text"/>	<input type="text"/>

ORBIT BURN MONITOR

GPC FILL-INS ()

CRIT BURN
 NON-CRIT BURN

MAX TIG SLIP ___ MIN

DO NOT UPDATE TIG
 UPDATE TIG AFTER ___ MIN

NOTES

PRELIMINARY ORBIT MANEUVER PAD FOR NC

OMS BOTH 1

L 2

R 3

RCS SEL 4 +X
-X
MULTI-AXIS

TV ROLL 5

BURN ATT

R 24

P 25

Y 26

$\Delta VTOT$

TGO

VGO X

VGO Y

VGO Z

TGT HA HP

TRIM LOAD P 6

LY 7

RY 8

WT 9

TIG 10 / : : .

TGT PEG 7 ΔVX 19

ΔVY 20

ΔVZ 21

NOTES

OMS GMBL CK: PRE POST-BURN

L PRI

L SEC

R PRI

R SEC

NONE

RCS I'CNCT: L OMS → RCS
 R OMS → RCS
 NONE

DOWN MODE OPTIONS: 2 OMS → 1 OMS
 1 OMS → RCS
 NONE

OMS HE REG TEST: NONE

-X RCS BURNS:

L			R		
GPC	OP	CL	GPC	OP	CL
A	<input type="text"/>	<input type="text"/>	A	<input type="text"/>	<input type="text"/>
B	<input type="text"/>	<input type="text"/>	B	<input type="text"/>	<input type="text"/>

BURN ATT LVLH ATT

BURN ATT			LVLH ATT		
P	Y	OM	R	P	Y
15	<input type="text"/>	<input type="text"/>	15	<input type="text"/>	<input type="text"/>
16	<input type="text"/>	<input type="text"/>	16	<input type="text"/>	<input type="text"/>
17	<input type="text"/>	<input type="text"/>	17	<input type="text"/>	<input type="text"/>

ORBIT BURN MONITOR

GPC FILL-INS ()

CRIT BURN
 NON-CRIT BURN

MAX TIG SLIP ___ MIN

DO NOT UPDATE TIG
 UPDATE TIG AFTER ___ MIN

NOTES

FINAL ORBIT MANEUVER PAD FOR NC

OMS BOTH 1

L 2

R 3

RCS SEL 4 +X
-X
MULTI-AXIS

TV ROLL 5

BURN ATT

R 24

P 25

Y 26

$\Delta VTOT$

TGO

VGO X

VGO Y

VGO Z

TGT HA HP

TRIM LOAD P 6

LY 7

RY 8

WT 9

TIG 10 / : : .

TGT PEG 7 ΔVX 19

ΔVY 20

ΔVZ 21

NOTES

OMS GMBL CK: PRE POST-BURN

L PRI

L SEC

R PRI

R SEC

NONE

RCS I'CNCT: L OMS \rightarrow RCS
 R OMS \rightarrow RCS
 NONE

DOWN MODE OPTIONS: 2 OMS \rightarrow 1 OMS
 1 OMS \rightarrow RCS
 NONE

OMS HE REG TEST: NONE

-X RCS BURNS:

<p>L</p> <p>GPC OP CL</p> <p>A <input type="text"/> <input type="text"/> <input type="text"/></p> <p>B <input type="text"/> <input type="text"/> <input type="text"/></p>	<p>R</p> <p>GPC OP CL</p> <p>A <input type="text"/> <input type="text"/> <input type="text"/></p> <p>B <input type="text"/> <input type="text"/> <input type="text"/></p>	<p>BURN ATT</p> <p>P 15 <input type="text"/> <input type="text"/> <input type="text"/></p> <p>Y 16 <input type="text"/> <input type="text"/> <input type="text"/></p> <p>OM 17 <input type="text"/> <input type="text"/> <input type="text"/></p>	<p>LVLH ATT</p> <p>R <input type="text"/> <input type="text"/> <input type="text"/></p> <p>P <input type="text"/> <input type="text"/> <input type="text"/></p> <p>Y <input type="text"/> <input type="text"/> <input type="text"/></p>
---	---	---	---

ORBIT BURN MONITOR

GPC FILL-INS ()

CRIT BURN

NON-CRIT BURN

MAX TIG SLIP ___ MIN

DO NOT UPDATE TIG

UPDATE TIG AFTER ___ MIN

NOTES

PRELIMINARY ORBIT MANEUVER PAD FOR Ti

OMS BOTH 1 L 2 R 3 RCS SEL 4 TV ROLL 5	<table border="1" style="width: 100%; height: 100px;"> <tr><td style="width: 20px; height: 20px;"></td></tr> <tr><td style="width: 20px; height: 20px;"></td></tr> <tr><td style="width: 20px; height: 20px;"></td></tr> <tr><td style="width: 20px; height: 20px;"></td></tr> </table>					<table border="1" style="width: 100%; height: 100px;"> <tr><td style="width: 20px; height: 20px;"></td></tr> <tr><td style="width: 20px; height: 20px;"></td></tr> <tr><td style="width: 20px; height: 20px;"></td></tr> <tr><td style="width: 20px; height: 20px;"></td></tr> </table>					+X -X MULTI-AXIS	BURN ATT R 24 P 25 Y 26	<table border="1" style="width: 100%; height: 100px;"> <tr><td style="width: 20px; height: 20px;"></td><td style="width: 20px; height: 20px;"></td><td style="width: 20px; height: 20px;"></td></tr> <tr><td style="width: 20px; height: 20px;"></td><td style="width: 20px; height: 20px;"></td><td style="width: 20px; height: 20px;"></td></tr> <tr><td style="width: 20px; height: 20px;"></td><td style="width: 20px; height: 20px;"></td><td style="width: 20px; height: 20px;"></td></tr> </table>										ΔVTOT TGO VGO X VGO Y VGO Z TGT HA HP	<table border="1" style="width: 100%; height: 100px;"> <tr><td style="width: 20px; height: 20px;"></td><td style="width: 20px; height: 20px;"></td><td style="width: 20px; height: 20px;"></td><td style="width: 20px; height: 20px;"></td></tr> <tr><td style="width: 20px; height: 20px;"></td><td style="width: 20px; height: 20px;"></td><td style="width: 20px; height: 20px;"></td><td style="width: 20px; height: 20px;"></td></tr> <tr><td style="width: 20px; height: 20px;"></td><td style="width: 20px; height: 20px;"></td><td style="width: 20px; height: 20px;"></td><td style="width: 20px; height: 20px;"></td></tr> </table>												
TRIM LOAD P 6 LY 7 RY 8 WT 9 TIG 10 TGT PEG 7 ΔVX 19 ΔVY 20 ΔVZ 21	<table border="1" style="width: 100%; height: 100px;"> <tr><td style="width: 20px; height: 20px;"></td><td style="width: 20px; height: 20px;"></td><td style="width: 20px; height: 20px;"></td><td style="width: 20px; height: 20px;"></td></tr> <tr><td style="width: 20px; height: 20px;"></td><td style="width: 20px; height: 20px;"></td><td style="width: 20px; height: 20px;"></td><td style="width: 20px; height: 20px;"></td></tr> <tr><td style="width: 20px; height: 20px;"></td><td style="width: 20px; height: 20px;"></td><td style="width: 20px; height: 20px;"></td><td style="width: 20px; height: 20px;"></td></tr> </table>													<table border="1" style="width: 100%; height: 100px;"> <tr><td style="width: 20px; height: 20px;"></td><td style="width: 20px; height: 20px;"></td><td style="width: 20px; height: 20px;"></td><td style="width: 20px; height: 20px;"></td><td style="width: 20px; height: 20px;"></td><td style="width: 20px; height: 20px;"></td></tr> </table>							<table border="1" style="width: 100%; height: 100px;"> <tr><td style="width: 20px; height: 20px;"></td><td style="width: 20px; height: 20px;"></td><td style="width: 20px; height: 20px;"></td><td style="width: 20px; height: 20px;"></td><td style="width: 20px; height: 20px;"></td><td style="width: 20px; height: 20px;"></td><td style="width: 20px; height: 20px;"></td><td style="width: 20px; height: 20px;"></td><td style="width: 20px; height: 20px;"></td><td style="width: 20px; height: 20px;"></td><td style="width: 20px; height: 20px;"></td><td style="width: 20px; height: 20px;"></td></tr> </table>													OMS GMBL CK: PRE POST-BURN L PRI L SEC R PRI R SEC NONE	RCS I'CNCT: L OMS → RCS R OMS → RCS NONE	DOWN MODE OPTIONS: 2 OMS → 1 OMS 1 OMS → RCS NONE
TIDELAY TGT PEG 7 ΔVX 19 ΔVY 20 ΔVZ 21 NEW Ti (BASETIME)	<table border="1" style="width: 100%; height: 100px;"> <tr><td style="width: 20px; height: 20px;"></td><td style="width: 20px; height: 20px;"></td><td style="width: 20px; height: 20px;"></td><td style="width: 20px; height: 20px;"></td><td style="width: 20px; height: 20px;"></td><td style="width: 20px; height: 20px;"></td></tr> <tr><td style="width: 20px; height: 20px;"></td><td style="width: 20px; height: 20px;"></td><td style="width: 20px; height: 20px;"></td><td style="width: 20px; height: 20px;"></td><td style="width: 20px; height: 20px;"></td><td style="width: 20px; height: 20px;"></td></tr> </table>													OMS HE REG TEST: NONE L GPC OP CL R GPC OP CL A B A B	-X RCS BURNS: BURN ATT LVLH ATT P 15 Y 16 OM 17 R P Y	ORBIT BURN MONITOR GPC FILL-INS __ (__) CRIT BURN NON-CRIT BURN																				
NOTES		TIG SLIP: If Ti not started by nominal TIG + ___ min, go to Ti DELAY, 5-17 Max Ti DELAY TIG slip ___ min																																		
DO NOT UPDATE TIG UPDATE TIG AFTER ___ MIN																																				

FINAL ORBIT MANEUVER PAD FOR Ti

OMS BOTH	1	<input type="text"/>
L	2	<input type="text"/>
R	3	<input type="text"/>
RCS SEL	4	<input type="text"/>
TV ROLL	5	<input type="text"/> <input type="text"/> <input type="text"/>

}	<input type="text"/>	+X
	<input type="text"/>	-X
	MULTI-AXIS	

BURN ATT

R	24	<input type="text"/> <input type="text"/> <input type="text"/>
P	25	<input type="text"/> <input type="text"/> <input type="text"/>
Y	26	<input type="text"/> <input type="text"/> <input type="text"/>

ΔVTOT	<input type="text"/> <input type="text"/> <input type="text"/> <input type="text"/>
TGO	<input type="text"/> <input type="text"/> : <input type="text"/> <input type="text"/>

VGO	X	<input type="text"/> <input type="text"/> <input type="text"/> <input type="text"/>
VGO	Y	<input type="text"/> <input type="text"/> <input type="text"/> <input type="text"/>
VGO	Z	<input type="text"/> <input type="text"/> <input type="text"/> <input type="text"/>

TGT	HA	<input type="text"/> <input type="text"/> <input type="text"/>	HP	<input type="text"/> <input type="text"/> <input type="text"/> <input type="text"/>
-----	----	--	----	---

TRIM LOAD	P	6	<input type="text"/> <input type="text"/> <input type="text"/> <input type="text"/>
	LY	7	<input type="text"/> <input type="text"/> <input type="text"/> <input type="text"/>
	RY	8	<input type="text"/> <input type="text"/> <input type="text"/> <input type="text"/>
	WT	9	<input type="text"/> <input type="text"/> <input type="text"/> <input type="text"/> <input type="text"/> <input type="text"/>
	TIG	10	<input type="text"/> <input type="text"/> / <input type="text"/> <input type="text"/> : <input type="text"/> <input type="text"/> : <input type="text"/> <input type="text"/> . <input type="text"/> <input type="text"/>

OMS GMBL CK:		NOTES	
	PRE	POST-BURN	
L PRI	<input type="text"/>	<input type="text"/>	RCS I'CNCT: <input type="text"/> L OMS → RCS <input type="text"/> R OMS → RCS <input type="text"/> NONE
L SEC	<input type="text"/>	<input type="text"/>	
R PRI	<input type="text"/>	<input type="text"/>	
R SEC	<input type="text"/>	<input type="text"/>	
NONE	<input type="text"/>	<input type="text"/>	
			DOWN MODE OPTIONS: <input type="text"/> 2 OMS → 1 OMS <input type="text"/> 1 OMS → RCS <input type="text"/> NONE

TGT PEG 7	ΔVX	19	<input type="text"/> <input type="text"/> <input type="text"/> <input type="text"/>
	ΔVY	20	<input type="text"/> <input type="text"/> <input type="text"/> <input type="text"/>
	ΔVZ	21	<input type="text"/> <input type="text"/> <input type="text"/> <input type="text"/>

OMS HE REG TEST:		<input type="checkbox"/> NONE	-X RCS BURNS:		ORBIT BURN MONITOR			
	L	R	BURN ATT	LVLH ATT	GPC FILL-INS __ (__) <input type="checkbox"/> CRIT BURN <input type="checkbox"/> NON-CRIT BURN			
	GPC	OP	CL	GPC			OP	CL
A	<input type="text"/>	<input type="text"/>	<input type="text"/>	A			<input type="text"/>	<input type="text"/>
B	<input type="text"/>	<input type="text"/>	<input type="text"/>	B	<input type="text"/>	<input type="text"/>		
			P 15	<input type="text"/> <input type="text"/> <input type="text"/>	R	<input type="text"/> <input type="text"/> <input type="text"/>		
			Y 16	<input type="text"/> <input type="text"/> <input type="text"/>	P	<input type="text"/> <input type="text"/> <input type="text"/>		
			OM 17	<input type="text"/> <input type="text"/> <input type="text"/>	Y	<input type="text"/> <input type="text"/> <input type="text"/>		

TIDELAY	
TGT PEG 7	ΔVX 19 <input type="text"/> <input type="text"/> <input type="text"/> <input type="text"/>
	ΔVY 20 <input type="text"/> <input type="text"/> <input type="text"/> <input type="text"/>
	ΔVZ 21 <input type="text"/> <input type="text"/> <input type="text"/> <input type="text"/>
NEW Ti (BASETIME)	<input type="text"/> <input type="text"/> / <input type="text"/> <input type="text"/> : <input type="text"/> <input type="text"/> : <input type="text"/> <input type="text"/> . <input type="text"/> <input type="text"/>

TIG SLIP: If Ti not started by nominal TIG + ___ min, go to Ti DELAY, 5-17

Max Ti DELAY TIG slip ___ min

{	<input type="checkbox"/>	DO NOT UPDATE TIG
	<input type="checkbox"/>	UPDATE TIG AFTER ___ MIN

NOTES

ORBIT MANEUVER PAD FOR _____

OMS BOTH 1

L 2

R 3

RCS SEL 4 +X
-X
MULTI-AXIS

TV ROLL 5

BURN ATT

R 24

P 25

Y 26

Δ VTOT .

TGO :

VGO X () .

VGO Y () .

VGO Z () .

TGT HA HP ()

TRIM LOAD P 6 () .

LY 7 () .

RY 8 () .

WT 9

TIG 10 / : : .

TGT PEG 7 Δ VX 19 () .

Δ VY 20 () .

Δ VZ 21 () .

NOTES

OMS GMBL CK: PRE POST-BURN

L PRI

L SEC

R PRI

R SEC

NONE

RCS I'CNCT: L OMS \rightarrow RCS
 R OMS \rightarrow RCS
 NONE

DOWN MODE OPTIONS: 2 OMS \rightarrow 1 OMS
 1 OMS \rightarrow RCS
 NONE

OMS HE REG TEST: NONE

L R

	GPC	OP	CL		GPC	OP	CL
A	<input type="checkbox"/>	<input type="checkbox"/>	<input type="checkbox"/>	A	<input type="checkbox"/>	<input type="checkbox"/>	<input type="checkbox"/>
B	<input type="checkbox"/>	<input type="checkbox"/>	<input type="checkbox"/>	B	<input type="checkbox"/>	<input type="checkbox"/>	<input type="checkbox"/>

-X RCS BURNS:

	BURN ATT		LVLH ATT
P 15	<input type="checkbox"/> <input type="checkbox"/> <input type="checkbox"/>	R	<input type="checkbox"/> <input type="checkbox"/> <input type="checkbox"/>
Y 16	<input type="checkbox"/> <input type="checkbox"/> <input type="checkbox"/>	P	<input type="checkbox"/> <input type="checkbox"/> <input type="checkbox"/>
OM 17	<input type="checkbox"/> <input type="checkbox"/> <input type="checkbox"/>	Y	<input type="checkbox"/> <input type="checkbox"/> <input type="checkbox"/>

ORBIT BURN MONITOR

GPC FILL-INS ()

CRIT BURN
 NON-CRIT BURN

MAX TIG SLIP ___ MIN DO NOT UPDATE TIG
 UPDATE TIG AFTER ___ MIN

NOTES

ORBIT MANEUVER PAD FOR _____

OMS BOTH 1

L 2

R 3

RCS SEL 4 +X
-X
MULTI-AXIS

TV ROLL 5

BURN ATT

R 24

P 25

Y 26

Δ VTOT .

TGO :

VGO X () .

VGO Y () .

VGO Z () .

HA HP ()

TGT ()

TRIM LOAD P 6 () .

LY 7 () .

RY 8 () .

WT 9

TIG 10 / : : .

TGT PEG 7 Δ VX 19 () .

Δ VY 20 () .

Δ VZ 21 () .

NOTES

OMS GMBL CK: PRE POST-BURN

L PRI

L SEC

R PRI

R SEC

NONE

RCS I'CNCT: L OMS → RCS
 R OMS → RCS
 NONE

DOWN MODE OPTIONS: 2 OMS → 1 OMS
 1 OMS → RCS
 NONE

OMS HE REG TEST: NONE

L R

GPC OP CL GPC OP CL

A A

B B

-X RCS BURNS:

BURN ATT LVLH ATT

P 15 R

Y 16 P

OM 17 Y

ORBIT BURN MONITOR

GPC FILL-INS __ (__)

CRIT BURN

NON-CRIT BURN

MAX TIG SLIP ___ MIN DO NOT UPDATE TIG
 UPDATE TIG AFTER ___ MIN

NOTES

ORBIT MANEUVER PAD FOR _____

OMS BOTH 1

L 2

R 3

RCS SEL 4 +X
-X
MULTI-AXIS

TV ROLL 5

BURN ATT

R 24

P 25

Y 26

Δ VTOT .

TGO :

VGO X () .

VGO Y () .

VGO Z () .

TGT HA HP ()

TRIM LOAD P 6 () .

LY 7 () .

RY 8 () .

WT 9

TIG 10 / : : .

TGT PEG 7 Δ VX 19 () .

Δ VY 20 () .

Δ VZ 21 () .

NOTES

OMS GMBL CK: PRE POST-BURN

L PRI

L SEC

R PRI

R SEC

NONE

RCS I'CNCT: L OMS → RCS
 R OMS → RCS
 NONE

DOWN MODE OPTIONS: 2 OMS → 1 OMS
 1 OMS → RCS
 NONE

OMS HE REG TEST: NONE

L R

GPC OP CL GPC OP CL

A A

B B

-X RCS BURNS:

BURN ATT LVLH ATT

P 15 R

Y 16 P

OM 17 Y

ORBIT BURN MONITOR

GPC FILL-INS __ (__)

CRIT BURN
 NON-CRIT BURN

MAX TIG SLIP ___ MIN DO NOT UPDATE TIG
 UPDATE TIG AFTER ___ MIN

NOTES

ORBIT MANEUVER PAD FOR _____

OMS BOTH 1

L 2

R 3

RCS SEL 4 +X
-X
MULTI-AXIS

TV ROLL 5

BURN ATT

R 24

P 25

Y 26

Δ VTOT .

TGO :

VGO X () .

VGO Y () .

VGO Z () .

TGT HA HP ()

TRIM LOAD P 6 () .

LY 7 () .

RY 8 () .

WT 9

TIG 10 / : : .

TGT PEG 7 Δ VX 19 () .

Δ VY 20 () .

Δ VZ 21 () .

NOTES

OMS GMBL CK: PRE POST-BURN

L PRI

L SEC

R PRI

R SEC

NONE

RCS I'CNCT: L OMS \rightarrow RCS
 R OMS \rightarrow RCS
 NONE

DOWN MODE OPTIONS: 2 OMS \rightarrow 1 OMS
 1 OMS \rightarrow RCS
 NONE

OMS HE REG TEST: NONE

L R

GPC OP CL GPC OP CL

A A

B B

-X RCS BURNS:

BURN ATT LVLH ATT

P 15 R

Y 16 P

OM 17 Y

ORBIT BURN MONITOR

GPC FILL-INS __ (__)

CRIT BURN

NON-CRIT BURN

MAX TIG SLIP ___ MIN DO NOT UPDATE TIG

UPDATE TIG AFTER ___ MIN

NOTES

ORBIT MANEUVER PAD FOR _____

OMS BOTH 1

L 2

R 3

RCS SEL 4 +X
-X
MULTI-AXIS

TV ROLL 5

BURN ATT

R 24

P 25

Y 26

ΔV_{TOT}

TGO

VGO X

VGO Y

VGO Z

TGT HA HP

TRIM LOAD P 6

LY 7

RY 8

WT 9

TIG 10 / : : .

TGT PEG 7 ΔV_X 19

ΔV_Y 20

ΔV_Z 21

NOTES

OMS GMBL CK: PRE POST-BURN

L PRI

L SEC

R PRI

R SEC

NONE

RCS I'CNCT: L OMS → RCS
 R OMS → RCS
 NONE

DOWN MODE OPTIONS: 2 OMS → 1 OMS
 1 OMS → RCS
 NONE

OMS HE REG TEST: NONE

-X RCS BURNS:

L			R		
GPC	OP	CL	GPC	OP	CL
A	<input type="checkbox"/>	<input type="checkbox"/>	A	<input type="checkbox"/>	<input type="checkbox"/>
B	<input type="checkbox"/>	<input type="checkbox"/>	B	<input type="checkbox"/>	<input type="checkbox"/>

BURN ATT LVLH ATT

BURN ATT			LVLH ATT		
P	Y	OM	R	P	Y
15	<input type="checkbox"/>	<input type="checkbox"/>	15	<input type="checkbox"/>	<input type="checkbox"/>
16	<input type="checkbox"/>	<input type="checkbox"/>	16	<input type="checkbox"/>	<input type="checkbox"/>
17	<input type="checkbox"/>	<input type="checkbox"/>	17	<input type="checkbox"/>	<input type="checkbox"/>

ORBIT BURN MONITOR

GPC FILL-INS ()

CRIT BURN
 NON-CRIT BURN

MAX TIG SLIP ___ MIN DO NOT UPDATE TIG
 UPDATE TIG AFTER ___ MIN

NOTES

STS-125 RENDEZVOUS TIMELINE

STS-125 RNDZ
TIMELINE

This Page Intentionally Blank

THIS PAGE INTENTIONALLY BLANK

AFT FLT STATION CONFIG FOR RNDZ 4A

O14,16:E √cb MNA,C DDU AFT (two) - cl

A6U ADI ATT - LVLH
ERR - MED
RATE - MED
SENSE - minus Z

R13 √KU ANT - GND
A1U √PWR - ON
sel - MAN SLEW
MODE - RDR PASSIVE
RADAR OUTPUT - HI
CNTL - PNL
SIG STRENGTH sel - KU
SLEW RATE - as reqd

A2 DIGI-DIS sel - R/RDOT
X-PNTR SCALE - X1

SM ANTENNA

CRT SELF TEST - ITEM 7 EXEC (*)

NOTE

SELF TEST runs about 3 min

A1U √KU SCAN WARN tb - gray
√TRACK tb - gray
√SEARCH tb - gray

A2 √RANGE - 888.8
DIGI-DIS sel - EL/AZ

CRT SELF TEST - ITEM 7 EXEC (no *)

A1U KU MODE - COMM
sel - GPC
CNTL - CMD

Install:

-Z COAS

RCS BURN Cue Card

KU OPS Cue Card

APPROACH Cue Card

PET

-03:00

CDR AFT FLT STATION CONFIG FOR RNDZ [4A]

A7(B7)

PLT RNDZ OPS INITIALIZATION [5A]

-02:55

-02:50

If NH reqd:
 CDR If -X RCS, Perform -X RCS NH Burn [5B]
 If +X RCS burn, Perform RCS BURN, steps 1-5 (Cue Card)
 If OMS BURN, Perform RNDZ OMS BURN, steps 1-4 (CONTINGENCY OPS), 5-4

Postburn DAP: A/LVLH/VERN(ALT)

-02:45

-02:40

-02:35

-02:30

MCC UPDATE
 Final NH Burn Pad,
 3-3 (if reqd)

MCC UPLINK
 ORB SV
 TGT SV
 Drag K-factor

RNDZ OPS INITIALIZATION [5A]

√DPS Config for Rndz Ops - String 1233

SM 2 TIME

Set SM TIMER counting to T1 TIG per burn Pad, 3-6

Config DAP A,B to A7,B7

Record nominal TIGs in burn solution blocks per Execute Package:

NCC TIG pg 4-11
 MC1 TIG pg 4-17
 MC2 TIG pg 4-18

GNC 55 GPS STATUS

DES RCVR, ITEM 27 - (*)
 √INH GPS to G&C, ITEM 33 - (*)
 NAV, ITEM 36 - (*)

PERFORM -X RCS NH BURN [5B]

GNC UNIV PTG

CRT TGT ID +2
 BODY VECT +5

	Per PAD	Ref Values for NH
P	—	+100
Y	—	+0
OM	—	+0

C3 TRK - ITEM 19 EXEC (CUR - *)
 DAP: A/AUTO/ALT (B/ALT as reqd)

When in burn attitude,
 Perform RCS BURN, steps 1 thru 5 (Cue Card)

THIS PAGE INTENTIONALLY BLANK

PET

-02:30

A7(B7)

← TIG-5 MIN

-02:25

← If reqd,
NH TIG
Postburn DAP: A/LVLH/VERN(ALT)

-02:20

-02:15

PLT ENABLE RENDEZVOUS NAV 7A

MS √PGSCs setup per PGSC Usage Chart (if available) or UTILITY OUTLET PLUG-IN
PLAN ORBIT CONFIGURATION (REF DATA FS, UTIL PWR)

PLT, On RPOP PGSCs:
MS Perform RPOP INITIALIZATION (RNDZ TOOLS), 7-15, then
Perform RPOP OPS (RNDZ TOOLS), 7-16, then

-02:10

MS Perform HHL CHECKOUT (RNDZ TOOLS), 7-14

-02:05

MCC UPDATE
Final NC Burn Pad, 3-5

-02:00

ENABLE RENDEZVOUS NAV 7A

1. GNC 33 REL NAV
CRT RNDZ NAV ENA - ITEM 1 EXEC (*)
√S TRK, ITEM 12 - (*)
2. GNC 34 ORBIT TGT
TGT NO - ITEM 1 +1 EXEC
Set BASE TIME to Ti TIG, (Ti Burn Pad, 3-6)
LOAD - ITEM 26 EXEC

THIS PAGE INTENTIONALLY BLANK

PET

-02:00

A7(B7)

CDR LOAD TARGET TRACK [9A]

NOTE

If NH performed, delay mnvr to NC burn attitude until NC TIG - 5 min to minimize attitude mnvr

CDR If -X RCS, Perform -X RCS NC Burn [9B]

If +X RCS burn, Perform RCS BURN, steps 1-5 (Cue Card)
If OMS BURN, Perform RNDZ OMS BURN, steps 1-4 (CONTINGENCY OPS), 5-4

-01:55

MS Perform PI CONFIG, steps 1-4 only (PL OPS, RETRIEVAL OPS)

-01:50

-01:45

← TIG-5 MIN

-01:40

MCC UPDATE
STAR TRK NAV
IMU DES _____
[10A], 4-10

← NC TIG

-01:35

CDR INITIATE TARGET TRACK [9C]

PLT TARGET NCC BURN [11A] (Preliminary), 4-11

PLT STAR TRACKER NAV [10A]

-01:30

LOAD TARGET TRACK [9A]

√DAP: A/LVLH/VERN(ALT)

[GNC UNIV PTG]

CRT CNCL - ITEM 21 EXEC
TGT ID +1

	<u>-Z AXIS</u>	<u>-Y STRK</u>
BODY VECT	+3 (-Z)	+4
P	√+90	√+0
Y	√+0	√+280.57
OM	+0	+90

Do not INITIATE TARGET TRACK [9C] until post NC

PERFORM -X RCS NC BURN [9B]

[GNC UNIV PTG]

CRT TGT ID +2
BODY VECT +5

	<u>Per PAD</u>	<u>Ref Values for NC</u>
P	—	+100
Y	—	+0
OM	—	+0

C3 TRK - ITEM 19 EXEC (CUR - *)
DAP: A/AUTO/ALT (B/ALT as reqd)

When in burn attitude,
Perform RCS BURN, steps 1 thru 5 (Cue Card)

[GNC UNIV PTG]

CRT TGT ID +1

	<u>-Z AXIS</u>	<u>-Y STRK</u>
BODY VECT	+3 (-Z)	+4
P	√+90	√+0
Y	√+0	√+280.57
OM	+0	+90

INITIATE TARGET TRACK [9C]

[GNC UNIV PTG]

TRK - ITEM 19 EXEC (CUR - *)
DAP: B/AUTO/ALT

When MNVR cmplt,
DAP: A/AUTO/VERN(ALT)

STAR TRACKER NAV 10A

1. CONFIG FOR STRK NAV

√DAP: A/AUTO/VERN(ALT)

Turn down cabin lights to optimize target viewing through -Z COAS/overhead window

IMU for Deselect _____ (If no comm, use IMU 1 for deselect)

GNC 21 IMU ALIGN

CRT IMU DES - ITEM 7(8,9) EXEC (*)

√MCC for NAV selected IMU _____

GNC 33 REL NAV

If first NAV pass,

√SV SEL, ITEM 4 - PROP

If previous NAV,

√SV SEL, ITEM 4 - FLTR

√INH Angles, ITEM 24 - (*)

√S TRK, ITEM 12 - (*)

GNC 22 S TRK/COAS CNTL

-Z (-Y) TGT TRK - ITEM 6(5) EXEC (*)

√STATUS - blank

√SHUTTER - op

2. INITIAL MEASUREMENT EVALUATION

GNC 22 S TRK/COAS CNTL

When S PRES - (*), continue

GNC 33 REL NAV

Monitor RESID V and H each NAV cycle for at least four consecutive cycles (~30 sec)

Record init RESID V = _____

H = _____

If RESID V or H changes by > 0.05 each cycle:

GNC 22 S TRK/COAS CNTL

-Z(-Y) BREAK TRK - ITEM 8(7) EXEC

Repeat Step 2

If RESID V or H > 0.6:

GNC 22 S TRK/COAS CNTL

-Z(-Y) BREAK TRK - ITEM 8(7) EXEC

When S PRES - (*), if RESID V or H still > 0.6 and stable:

Perform S TRK NAV - HIGH INITIAL RESID (CONTINGENCY OPS), 5-8

3. INCORPORATE DATA INTO NAV

If SV SEL = PROP:

AUTO Angles - ITEM 23 EXEC (*)

Record 1st SV UPDATE POS = _____

When SV UPDATE POS < 1.0 and Angle ACPT > 9:

SV SEL - ITEM 4 EXEC (FLTR) >>

If SV = FLTR:

FLTR TO PROP - ITEM 8 EXEC

AUTO Angles - ITEM 23 EXEC (*)

Record 1st SV UPDATE POS = _____

* If FLTR MINUS PROP changes by more than 8 kft within a S TRK pass: *

* Perform S TRK NAV - HIGH FLTR MINUS PROP *

* (CONTINGENCY OPS), 5-9 *

END S TRK NAV 10B

GNC 33 REL NAV

CRT INH Angles - ITEM 24 EXEC (*)

GNC 21 IMU ALIGN

IMU DES - ITEM 7(8,9) EXEC (no *)

PET

-01:30

A7(B7)

-01:25

When NAV converged (SV UPDATES small and stable):
CDR TARGET NCC BURN 11A (Intermediate)

-01:20

← TIG-17 MIN

-01:15

-01:10

← TIG-10 MIN √MCC for burn type

```

*****
* If no comm *
* If ΔVT > 6 fps: *
*   END S TRK NAV 10B *
*   TARGET NCC BURN 11A (Final) *
*   Perform RNDZ OMS BURN (CONTINGENCY OPS), 5-4 *
* If ΔVT > 4 fps: *
*   END S TRK NAV 10B *
*   TARGET NCC BURN 11A (Final) *
*   Perform +X Burn, RCS BURN (Cue Card) *
*****

```

PLT END S TRK NAV 10B

-01:05

← TIG-5 MIN

PLT TARGET NCC BURN 11A (Final)

CDR Perform RCS BURN (Cue Card)

-01:00

← NCC TIG

MCC UPDATE
Nav Selected IMU

MCC UPDATE
Ground NCC Burn
Solution

TARGET NCC BURN 11A

FINAL SOLUTION

OPS 202 PRO
GNC ORBIT MNVR EXEC
√Eng Sel CORRECT

CRT √SV SEL correct
GNC 34 ORBIT TGT
TGT NO - ITEM 1 +9 EXEC
√TGT Set data:
T1 TIG = NCC BURN SOLUTION TIG
EL +0
ΔT +60.1
ΔX -48.6
ΔY +0.0
ΔZ +1.2
COMPUTE T1 - ITEM 28 EXEC
Record solution in PAD

FINAL SOLUTION

If > 40 marks in current sensor pass and
SV UPDATE POS < 0.5 for the last 4 marks:
Burn FLTR soln
If FLTR within ground solution limits:
Burn FLTR soln
If PROP within ground solution limits:
Burn PROP soln
If none of the above:
Burn ground soln EXT ΔVs

NCC BURN SOLUTION

TIG [] [] [] / [] [] : [] [] : [] []

PRELIMINARY

ΔVX	()			.	
ΔVY	()			.	
ΔVZ	()			.	
ΔVT				.	

INTERMEDIATE

	()			.	
	()			.	
	()			.	
				.	

FINAL

ΔVX	()			.	
ΔVY	()			.	
ΔVZ	()			.	
ΔVT				.	

GROUND

	()			.	
	()			.	
	()			.	
				.	

FINAL - GROUND LIMITS

(0.6)
(1.5)
(2.5)

THIS PAGE INTENTIONALLY BLANK

PET

-01:00

A7(B7)

PLT TARGET Ti BURN 13A (Preliminary)

IF Y S TRK TRACK
CDR -Z AXIS TARGET TRACK 13C

-00:55

MCC UPDATE
RNDZ PRPLT PAD

When:

GNC 33 REL NAV

NAV RNG < 150 KFT:

MS

KU OPS, step 1 (Cue Card)

-00:50

If no lock-on by

10 minutes after initial search:

MS

KU OPS, step 2 (Cue Card)

-00:45

When RR RNG < 135 KFT:

Perform RR NAVIGATION 13B

PLT

-00:40

-00:35

When NAV converged (SV UPDATES small and stable):

PLT TARGET Ti BURN 13A (Intermediate)

-00:30

TARGET Ti BURN 13A

CRT √SV SEL correct

GNC 34 ORBIT TGT

TGT NO - ITEM 1 +1 Q EXEC

√TGT Set data:

T1 TIG = BASE TIME

EL +0

ΔT +80.1

ΔX -0.9

ΔY +0

ΔZ +1.8

COMPUTE T1 - ITEM 28 EXEC

Record solution in PAD

RR NAVIGATION 13B

GNC 33 REL NAV

CRT RR - ITEM 13 EXEC (*)

√Elev, Az approx 0

Record Initial RESID RANGE = _____

RDOT = _____

IF RESID RANGE > 5.0 or
RDOT > 3.0

SV SEL - ITEM 4 EXEC (PROP)

Proceed with taking data and contact MCC
as soon as practical

FLTR TO PROP - ITEM 8 EXEC

AUTO RNG - ITEM 17 EXEC (*)

RDOT - ITEM 20 EXEC (*)

Angles - ITEM 23 EXEC (*)

Record 1st SV UPDATE POS = _____

IF SV SEL = PROP

When SV UPDATE POS < 0.3 and MARK ACPT > 9:

SV SEL - ITEM 4 EXEC (FLTR)

-Z AXIS TARGET TRACK 13C

GNC UNIV PTG

CRT √TGT ID +1

BODY VECT +3 (-Z)

OM +0

C3 DAP: B/AUTO/ALT

CRT TRK - ITEM 19 EXEC (CUR - *)

When MNVR cmplt,

DAP: A/AUTO/VERN(ALT)

Ti BURN SOLUTIONS

PREL FLTR

()			.	
()			.	
()			.	
			.	

INTER FLTR

()			.	
()			.	
()			.	
			.	

FINAL FLTR

()			.	
()			.	
()			.	
			.	

GND

()			.	
()			.	
()			.	
			.	

FINAL Ti Burn Pad, 3-7

PROP
(If Reqd)

()			.	
()			.	
()			.	
			.	

FINAL - GROUND
LIMITS

ΔV_X (0.9)
 ΔV_Y (1.3)
 ΔV_Z (1.2)

PET

-00:30

A7(B7)

√MCC for burn type. If no comm:

If $\Delta VT > 6$, at TIG-17:

Perform RNDZ OMS BURN (CONTINGENCY OPERATIONS), 5-4

If $4 \leq \Delta VT \leq 6$, at TIG-17:

Perform +X RCS burn, RCS BURN (Cue Card)

If $\Delta VT < 4$, at TIG-5:

Perform multi-axis RCS burn, RCS BURN (Cue Card)

MCC UPDATE

Ti Final Ground Soln,

Ti DELAY Soln, 3-7

-00:25

If GO for Ti not received by TIG - 5 or RNDZ DELAY called by MCC

CDR Perform Ti DELAY BURN (CONTINGENCY OPS), 5-17

-00:20



TIG-17

If Ti is multi-axis burn, delay final targeting until TIG-5

PLT

TARGET Ti BURN 15A (Final)

MCC UPDATE

GO for Ti

-00:15

CDR

If Ti is +X RCS burn:

Perform RCS BURN (Cue Card)

If Ti is OMS BURN:

Perform RNDZ OMS BURN (CONTINGENCY OPERATIONS), 5-4

-00:10

-00:05



TIG-5

If Ti is multi-axis burn:

Perform RCS BURN (Cue Card)

CDR

If HST Door Open, go to CONTINGENCY INERTIAL APPROACH TIMELINE, 4-25

00:00



Ti TIG

TARGET Ti BURN 15A (Final)

CRT OPS 202 PRO

GNC ORBIT MNVR EXEC

Load Eng Sel, TVR, WT and Trims for Ti per Final Ti Burn Pad
LOAD - ITEM 22 EXEC

GNC 33 REL NAV

√SV SEL correct

GNC 34 ORBIT TGT

TGT NO - ITEM 1 +1_0 EXEC

√TGT Set data:

T1 TIG = BASE TIME

EL +0

ΔT +80.1

ΔX -0.9

ΔY +0

ΔZ +1.8

COMPUTE T1 - ITEM 28 EXEC

Record solution in PAD

FINAL SOLUTION

If > 40 marks in current sensor pass and
SV UPDATE POS < 0.5 for the last 4 marks:

Burn FLTR soln

If FLTR within ground solution limits:

Burn FLTR soln

If PROP within ground solution limits:

Burn PROP soln

If none of the above:

Burn ground soln EXT ΔV s

POST Ti NAV [16A]

A6U √DAP: A/AUTO/VERN(ALT)
A1U √KU sel - GPC

GNC 33 REL NAV

IF SV SEL = FLTR:

FLTR TO PROP - ITEM 8 EXEC (*)

√AUTO Angles - ITEM 23 EXEC (*)

If RR NOT Tracking TGT:

√Inhibit Data

Perform KU OPS, steps 2 and 3 (Cue Card)

If still no RR ACQ, assume RR Fail

GNC 22 S TRK/COAS CNTL

CRT √Z TGT TRK - ITEM 6 EXEC (*)

IF RR FAIL

If -Z Star Tracker:

√-Z TGT TRK ATT, then:

Perform STAR TRACKER NAV [10A]

If COAS NAV:

√-Z TGT TRK ATT, then:

Perform COAS NAVIGATION (CONTINGENCY OPS), 5-10

If -Y Star Tracker:

GNC UNIV PTG

TGT ID +1

BODY VECT +4

P √+0

Y √+280.57

OM +90

DAP: B/AUTO/ALT

TRK - ITEM 19 EXEC

When MNVR cmlt:

DAP: A/AUTO/VERN(ALT)

Perform STAR TRACKER NAV [10A]

PET

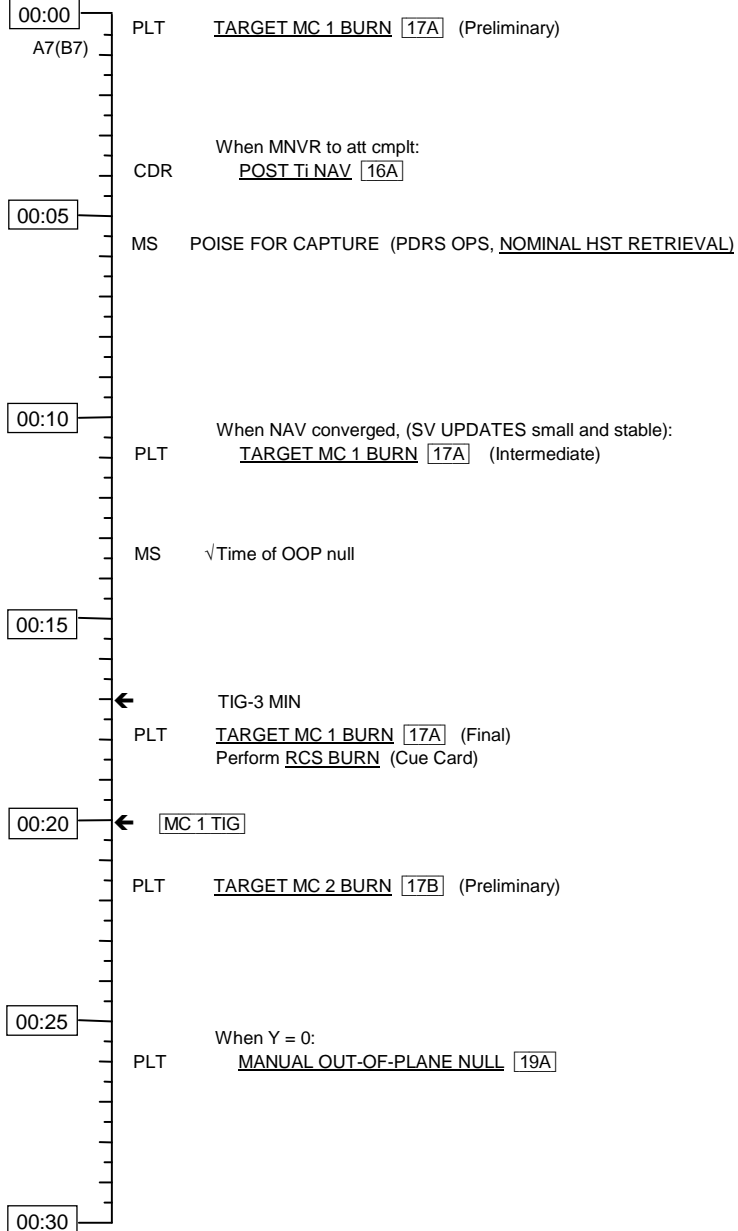

MCC UPDATE
Prox Ops Cov Matrix

MCC
ESTABLISH
PI COMM

TARGET MC 1 BURN [17A]

CRT $\sqrt{\text{SV SEL correct}}$
[GNC 34 ORBIT TGT]
TGT NO - ITEM 1 +1 1 EXEC
 $\sqrt{\text{TGT Set data:}}$
T1 TIG = MC1 BURN SOLUTION TIG
EL +0
 ΔT +60.1
 ΔX -0.9
 ΔY +0
 ΔZ +1.8
COMPUTE T1 - ITEM 28 EXEC
Record solution in PAD

MC 1 BURN SOLUTION

TIG [][][] / [][] : [][] : [][]

	PRELIMINARY				INTERMEDIATE			
$\Delta V X$	()			.	()			.
$\Delta V Y$	()			.	()			.
$\Delta V Z$	()			.	()			.
$\Delta V T$.				.

	FINAL	MEAN \pm (3 σ VARIATION)	
$\Delta V X$	()		0.0 \pm (0.5)
$\Delta V Y$	()		0.1 \pm (0.5)
$\Delta V Z$	()		0.0 \pm (1.2)
$\Delta V T$			

TARGET MC 2 [17B] (Preliminary)

CRT $\sqrt{\text{SV SEL correct}}$
[GNC 34 ORBIT TGT]
TGT NO - ITEM 1 +1 2 EXEC
 $\sqrt{\text{TGT Set data:}}$
T1 TIG = MC2 BURN SOLUTION TIG
EL +30.25
 ΔT +27.0
 ΔX -0.9
 ΔY +0
 ΔZ +1.8
COMPUTE T1 - ITEM 28 EXEC
NOTE
If TGT EL ANG Alarm,
 ΔV still valid for current TIG,
TIG slip limits still apply
Record solution in PAD

TARGET MC 2 BURN [18A] (Intermediate)

CRT √SV SEL correct
 [GNC 34 ORBIT TGT]
 TGT NO - ITEM 1 +1 2 EXEC
 COMPUTE T1 - ITEM 28 EXEC
 Record solution in PAD

TARGET MC 2 BURN [18B] (Final)

CRT √SV SEL correct
 [GNC 34 ORBIT TGT]
 TGT NO - ITEM 1 +1 2 EXEC
 COMPUTE T1 - ITEM 28 EXEC
 √TIG change

IF TIG CHANGE < -3 OR > +7 MIN

Set BASE TIME to (Nominal MC 2 TIG -3 or +7 min as appropriate)
 LOAD - ITEM 26 EXEC
 TGT NO - ITEM 1 +1 9 EXEC

√TGT Set data:

T1 TIG = BASE TIME
 EL +0
 ΔT +27.0
 ΔX -0.9
 ΔY +0
 ΔZ +1.8

COMPUTE T1 - ITEM 28 EXEC

Set EVENT TIMER counting to MC 2 TIG
 Record solution in PAD

[GNC 33 REL NAV]

CRT FLTR TO PROP - ITEM 8 EXEC

-Z AXIS TARGET TRACK [18C]

[GNC UNIV PTG]

CRT √TGT ID +1
 BODY VECT +3 (-Z)
 OM +0
 C3 DAP: B/AUTO/ALT
 CRT TRK - ITEM 19 EXEC (CUR - *)

When MNVR cmplt,
 DAP: A/AUTO/VERN(ALT)

CCTV CONFIG [18D]

A7U VID OUT - MON 1
 IN - A
 OUT - MON 2
 IN - B
 Aim A at B and B at A at full zoom in
 PAN/TILT - RESET
 For both camrs:
 PAN - 0.0 deg
 TILT - 90.0 deg
 Repeat for Camr C & D

MC 2 BURN SOLUTION

	PRELIMINARY	INTERMEDIATE
ΔVX	()	()
ΔVY	()	()
ΔVZ	()	()
ΔVT	()	()

	FINAL	MEAN ± (3σ VARIATION)
ΔVX	()	0.1 ± (0.5)
ΔVY	()	0.0 ± (0.2)
ΔVZ	()	0.5 ± (3.0)
ΔVT	()	

	TIG	TIG SLIP (COMPUTED-NOM)
PREL	[] / [] : [] : []	___ : ___
INTER	[] / [] : [] : []	___ : ___
FINAL	[] / [] : [] : []	___ : ___
NOMINAL	[] / [] : [] : []	

END S TRK NAV [18E]

[GNC 33 REL NAV]
 CRT INH Angles - ITEM 24 EXEC (*)
 [GNC 21 IMU ALIGN]
 IMU DES - ITEM 7(8,9) EXEC (no *)

PET

00:30

A7(B7)

If S TRK NAV,
At Sunset
PLT END STAR TRACKER NAV [18E]

00:35

PLT When NAV converged (SV UPDATES small and stable):
TARGET MC 2 BURN [18A] (Intermediate)

00:40

MC2 ET

-00:10

MS √ P/TV04 HST RETRIEVE/BERTH SETUP
(PHOTO/TV FS, SCENES) complete
CCTV CONFIG [18D]

00:45

-00:05 ←

TIG-5 MIN
PLT TARGET MC 2 BURN [18B] (Final)
Perform RCS BURN (Cue Card)

00:50

00:00 ←

MC 2 TIG

PLT TARGET MC 3 BURN [19B] (Preliminary)

00:55

IF -Y S TRK TRACK
PLT -Z AXIS TARGET TRACK [18C]

IF INITIAL RR ACQ POST-MC2
CDR Perform LATE RR NAV [20B]

00:05

IF NO RR INTO NAV
CDR Go to RADAR FAIL PROCEDURES [20A]

01:00

MCC
LGA SWITCH
AFT TO FWD

MANUAL OUT-OF-PLANE NULL [19A]

GNC 33 REL NAV
CRT When Y = 0:
F7 FLT CNTLR PWR - ON
DAP: A/AUTO/PRI
DAP TRANS: as reqd
THC: Null YDOT
If -Z AXIS TRACK,
+YDOT = FWD THC left
AFT THC right
If -Y S TRK TRACK,
+YDOT = FWD THC down
AFT THC out
F7 FLT CNTLR PWR - OFF
DAP: A/AUTO/ALT
When rates nulled:
DAP: VERN(ALT)

TARGET MC 3 [19B]

CRT √SV SEL correct
GNC 34 ORBIT TGT
TGT NO - ITEM 1 +1 3 EXEC
√TGT Set data:
T1 TIG = BASE TIME + 0/00:17:00
EL +0
ΔT +10.0
ΔX -0.9
ΔY +0
ΔZ +1.8
COMPUTE T1 - ITEM 28 EXEC
Record solution in PAD

MC 3 BURN SOLUTION

TIG	[] [] [] [] / [] [] [] [] : [] [] [] [] : [] [] [] []				
	PRELIMINARY		FINAL		MEAN ± (3σ VARIATION)
ΔVX	()	[] [] [] []	()	[] [] [] []	0.0 ± (0.5)
ΔVY	()	[] [] [] []	()	[] [] [] []	0.1 ± (0.5)
ΔVZ	()	[] [] [] []	()	[] [] [] []	0.0 ± (1.2)
ΔVT	[] [] [] []	[] [] [] []	[] [] [] []	[] [] [] []	

RADAR FAIL PROCEDURE [20A]

Note: At sunrise, report TGT Tally-Ho to MCC
 MS If TGT outside COAS reticle, config CCTV as reqd to measure vertical position

- At MC2 TIG+14:00 (MC3 TIG-3:00):
 PLT **TARGET MC3 [19B]** (final)
 CDR Perform **RCS BURN**, steps 1 thru 5 (Cue Card), then:

**AT MC2+18 IF NO VISUAL ACQUISITION OR
 TARGET > 30 DEG FROM COAS HORIZONTAL**
 CDR Go to RNDZ BREAKOUT (**CONTINGENCY OPS**), 5-16 >>

- At MC2 TIG + 19:00:
 A6U FLT CNTLR PWR - ON
 √SENSE - -Z
 DAP: A/LVLH/PRI
 √COAS for TGT vertical position
 THC: +X (or -X) per COAS LOGIC:
 If TGT = N deg high in COAS, perform 2N +X (up) pulses
 If TGT = N deg low in COAS, perform 1N -X (down) pulses
 DAP: A/LVLH/VERN(PRI)
 Inform MCC of TGT vertical position in COAS and number of pulses performed
 Following radar fail X correction,
 THC: As reqd to control out-of-plane motion and manage RDOT
 Perform **CONFIG FOR RBAR** [21B]

- At MC2 TIG + 24:00 or 2000 ft, whichever comes first:
 CRT **GNC UNIV PTG**
 TRK - ITEM 19 EXEC (CUR - *)
 A6U DAP: A/AUTO/VERN (PRI)
 THC: as reqd to stabilize and maintain TGT between 0 deg and 10 deg
 high in COAS

At 2000 ft:
 Perform **HST RBAR APPROACH** (Cue Card)

LATE RADAR NAV [20B]

- CRT **GNC 33 REL NAV**
 FLTR TO PROP - ITEM 8 EXEC
 √SV SEL, ITEM 4 - PROP
 √RR - ITEM 13 EXEC (*)
 AUTO RNG - ITEM 17 EXEC (*)
 RDOT - ITEM 20 EXEC (*)
 Angles - ITEM 23 EXEC (*)

Go to **RADAR FAIL PROCEDURE** [20A]

MC 4 BURN SOLUTION

TIG [] [] [] / [] [] : [] [] : [] []

	PRELIMINARY				FINAL				MEAN ± 3σ VARIATION
ΔVX	()			.	()			.	1.2 ± (2.7)
ΔVY	()			.	()			.	0.0 ± (0.6)
ΔVZ	()			.	()			.	0.4 ± (3.0)
ΔVT				.				.	

PET **MC2 ET**

01:00
A7(B7)
00:10
01:05
A8(B8)
01:10
00:20
01:15
00:25
01:20
00:30
01:25
00:35
01:30

IF NO RR INTO NAV
CDR Go to RADAR FAIL PROCEDURES [20A]

← TIG-3 MIN
PLT TARGET MC3 BURN [19B] (Final)
Perform RCS BURN (Cue Card)

← MC 3 TIG
PLT TARGET MC 4 BURN [21A] (Preliminary)

CDR CONFIG FOR RBAR [21B]
MS Perform HHL OPS (RNDZ TOOLS), 7-14

← TIG-3 MIN
PLT TARGET MC 4 [21A] (Final)
Perform RCS BURN, steps 1-5 (Cue Card)

← MC 4 TIG
CDR ESTABLISH RBAR [21C]
Go to HST RBAR APPROACH (Cue Card)

MANUAL TRAJECTORY CONTROL

CREW REPORT
TGT tally-ho

HHL REPORT
R and Rdot

TARGET MC 4 BURN [21A]
CRT √SV SEL correct
GNC 34 ORBIT TGT
TGT NO - ITEM 1 +1 4 EXEC
√TGT Set data:
T1 TIG = BASE TIME + 0/00:27:00
EL +0
ΔT +13.0
ΔX +0
ΔY +0
ΔZ +0.6
COMPUTE T1 - ITEM 28 EXEC
Record solution in PAD

CONFIG FOR RBAR [21B]
GNC UNIV PTG
√ ERR TOT - ITEM 23 EXEC (*)
When ERR <2 deg each axis
GNC 20 DAP CONFIG
Config DAP A,B to A8,B8
GNC UNIV PTG
TGT ID +2
BODY VECT +5
P +270
Y +0
OM +0
Do not initiate Target Track until ESTABLISH RBAR [21C]

ESTABLISH RBAR [21C]
A6U FLT CNTLR PWR - ON
GNC UNIV PTG
CRT TRK - ITEM 19 EXEC (CUR - *)
DAP: A/AUTO/VERN(PRI)
THC: as reqd to control TGT motion in COAS

THIS PAGE INTENTIONALLY BLANK

CONTINGENCY INERTIAL APPROACH TIMELINE

CONT INERTIAL
APPROACH

This Page Intentionally Blank

CONTINGENCY INERTIAL APPROACH TIMELINE

NOTE:

Perform nominal rendezvous timeline activities though PET 00:00.
For NCC targeting, use TGT NO - ITEM 1 +2 9 EXEC
For Ti targeting, use TGT NO - ITEM 1 +3 0 EXEC
For Ti and NCC targeting blocks, \sqrt TGT Set data per TARGETING DATA, 310 Inertial
(REFERENCE DATA), 6-4.

TARGET MC 1 INERTIAL [26A]

CRT √SV SEL correct
 GNC 34 ORBIT TGT
 TGT NO - ITEM 1 + 3 1 EXEC
 √TGT Set data:
 T1 TIG = MC1 BURN SOLUTION TIG
 EL +0
 ΔT +59.1
 ΔX +0
 ΔY +0
 ΔZ +0
 COMPUTE T1 - ITEM 28 EXEC
 Note solution in PAD

POST T1 NAV [26B]

A6U √DAP: A/AUTO/VERN(ALT)
A1U √KU sel - GPC

GNC 33 REL NAV
IF SV SEL = FLTR:
 FLTR TO PROP - ITEM 8 EXEC (*)
 √AUTO Angles - ITEM 23 EXEC (*)
If RR NOT Tracking TGT:
 √Inhibit Data
 Perform **KU OPS**, steps 2 and 3 (Cue Card)
 If still no RR ACQ, assume RR Fail

GNC 22 S TRK/COAS CNTL

CRT √ Z TGT TRK - ITEM 6 EXEC (*)
 -Z THOLD - ITEM 14 + 3 EXEC

IF RR FAIL

If -Z Star Tracker:
 √-Z TGT TRK ATT, then:
 Perform **STAR TRACKER NAV [10A]**
If COAS NAV:
 √-Z TGT TRK ATT, then:
 Perform COAS NAVIGATION (**CONTINGENCY OPS**), 5-10
If -Y Star Tracker:
 GNC 22 S TRK/COAS CNTL
 √-Y THOLD - ITEM 13 +0 EXEC
 GNC UNIV PTG
 TGT ID +1
 BODY VECT +4
 P √+0
 Y √+280.57
 OM +90
 DAP: B/AUTO/ALT
 TRK - ITEM 19 EXEC
 When MNVR cmplt:
 DAP: A/AUTO/VERN(ALT)
 Perform **STAR TRACKER NAV [10A]**

TARGET MC 2 INERTIAL [26C] (Preliminary)

CRT √SV SEL correct
 GNC 34 ORBIT TGT
 TGT NO - ITEM 1 +3 2 EXEC
 √TGT Set data:
 T1 TIG = MC2 BURN SOLUTION TIG
 EL +29.49
 ΔT +32.7
 ΔX +0
 ΔY +0
 ΔZ +0
 COMPUTE T1 - ITEM 28 EXEC

NOTE

If TGT EL ANG Alarm,
 ΔV still valid for current TIG,
 TIG slip limits still apply

Note solution in PAD

PET

00:00

A7(B7)

CDR TARGET MC 1 INERTIAL [26A] (Preliminary)

When mnvr to att complete,

CDR POST Ti NAV [26B]

00:05

MS1 POISE FOR CAPTURE (PDRS OPS, NOMINAL HST RETRIEVAL)

MCC UPLINK
Prox Ops Cov Matrix

00:10

CDR When NAV converged, (SV UPDATES small and stable)
TARGET MC 1 INERTIAL [26A] (Intermediate)

00:15

√FOR TIME OF OOP NULL

MCC
ESTABLISH
PI COMM

00:20

TIG -03:00
CDR TARGET MC 1 INERTIAL [26A] (Final)

Perform RCS BURN (cue card)

00:25

← MC 1 TIG

CDR TARGET MC 2 INERTIAL [26C] (Preliminary)

00:30

CDR When Y = 0
MANUAL OUT-OF-PLANE NULL [27A]

MC 1 BURN SOLUTION

TIG [] [] [] / [] [] : [] [] : [] []

PRELIMINARY

ΔVX	()			.	
ΔVY	()			.	
ΔVZ	()			.	
ΔVT				.	

INTERMEDIATE

()				.	
()				.	
()				.	
				.	

FINAL

ΔVX	()			.	
ΔVY	()			.	
ΔVZ	()			.	
ΔVT				.	

MANUAL OUT-OF-PLANE NULL [27A]

GNC 33 REL NAV

CRT When Y = 0:
F7 FLT CNTLR PWR - ON
DAP: A/AUTO/PRI
DAP TRANS: as reqd
THC: Null YDOT
If -Z AXIS TRACK,
+YDOT = FWD THC left
AFT THC right
If -Y S TRK TRACK,
+YDOT = FWD THC down
AFT THC out
F7 FLT CNTLR PWR - OFF
DAP: A/AUTO/ALT
When rates nulled:
DAP: VERN(ALT)

TARGET MC 2 INERTIAL [28A] (Intermediate)

GNC 34 ORBIT TGT

CRT TGT NO - ITEM 1 +3 2 EXEC
 COMPUTE T1 - ITEM 28 EXEC

Note solution in PAD

-Z AXIS TARGET TRACK [28B]

GNC UNIV PTG

CRT √TGT ID +1
 BODY VECT +3 (-Z)
 OM +0
 C3 DAP: B/AUTO/ALT
 CRT TRK - ITEM 19 EXEC (CUR - *)

When MNVR cmplt,
 DAP: A/AUTO/VERN(ALT)

END S TRK NAV [28C]

GNC 33 REL NAV

CRT INH Angles - ITEM 24 EXEC (*)

GNC 21 IMU ALIGN

IMU DES - ITEM 7(8,9) EXEC (no *)

MC2 BURN SOLUTION

PRELIMINARY

ΔVX	()			.	
ΔVY	()			.	
ΔVZ	()			.	
ΔVT				.	

INTERMEDIATE

()				.	
()				.	
()				.	
				.	

FINAL

ΔVX	()			.	
ΔVY	()			.	
ΔVZ	()			.	
ΔVT				.	

TIG

**TIG SLIP
(COMPUTED-NOM)**

PREL	<input type="text"/>	/	<input type="text"/>	:	<input type="text"/>	:	<input type="text"/>	_____	:	_____
INTER	<input type="text"/>	/	<input type="text"/>	:	<input type="text"/>	:	<input type="text"/>	_____	:	_____
FINAL	<input type="text"/>	/	<input type="text"/>	:	<input type="text"/>	:	<input type="text"/>	_____	:	_____
NOMINAL	<input type="text"/>	/	<input type="text"/>	:	<input type="text"/>	:	<input type="text"/>		:	

PET

00:30
A7(B7)

At sunset,
If RR NAV
| GNC 22 STRK/COAS CNTL
| -Z STAR TRK - ITEM 4 EXEC (*)
If S TRK NAV,
| END S TRK NAV 28C
If no sensor data (RR,STRK,COAS) at any time during the RNDZ,
Go to RNDZ BREAKOUT (CONTINGENCY OPERATIONS), 5-16

00:35

CDR When NAV converged, (SV UPDATE small and stable)
TARGET MC 2 INERTIAL 28A (Intermediate)

00:40

00:45

MC2 ET

-00:05

TIG -05:00
CDR TARGET MC 2 INERTIAL 29A (Final)

00:50

Perform RCS BURN (cue card)

MCC
LGA SWITCH
FWD TO AFT

00:00

← MC 2 TIG
CDR TARGET MC 3 INERTIAL 29B (Preliminary)

00:55

IF -Y S TRK TRACK
PLT -Z AXIS TARGET TRACK 28B

00:05

**IF NO POST-Ti SENSOR DATA AND NO VISUAL (OR RR) ACQ BY MC2+20 MIN,
OR
IF POST-Ti SENSOR DATA AVAILABLE, BUT NO VISUAL (OR RR) ACQ BY MC2+25 MIN:**
Go to RENDEZVOUS BREAKOUT (CONTINGENCY OPERATIONS), 5-16

01:00

TARGET MC 2 INERTIAL 29A (Final)

CRT √SV SEL correct
GNC 34 ORBIT TGT
TGT NO - ITEM 1 +3 2 EXEC
COMPUTE T1 - ITEM 28 EXEC
√TIG change

IF TIG CHANGE < -3 OR > +7 MIN

Set BASE TIME to (Nominal MC 2 TIG -3 or +7 min as appropriate)
LOAD - ITEM 26 EXEC
TGT NO - ITEM 1 +3 9 EXEC

√TGT Set data:
T1 TIG = BASE TIME
EL +0
ΔT +32.7
ΔX +0
ΔY +0
ΔZ +0
COMPUTE T1 - ITEM 28 EXEC

Set EVENT TIMER counting to MC 2 TIG
Note solution in PAD

GNC 33 REL NAV
CRT FLTR TO PROP - ITEM 8 EXEC

TARGET MC 3 INERTIAL 29B

CRT √SV SEL correct
GNC 34 ORBIT TGT
TGT NO - ITEM 1 +3 3 EXEC
√TGT Set data:
T1 TIG = BASE TIME + 0/00:10:00
EL +0
ΔT +22.7
ΔX +0
ΔY +0
ΔZ +0
COMPUTE T1 - ITEM 28 EXEC
Note solution in PAD

MC 3 BURN SOLUTION

TIG [] [] [] / [] [] : [] [] : [] []

	PRELIMINARY				FINAL			
ΔVX	()			.	()			.
ΔVY	()			.	()			.
ΔVZ	()			.	()			.
ΔVT				.				.

MC 4 BURN SOLUTION

TIG / : :

PRELIMINARY

FINAL

ΔVX	()			.		()			.	
ΔVY	()			.		()			.	
ΔVZ	()			.		()			.	
ΔVT				.					.	

CCTV CONFIG 30A

A7U VID OUT – MON 1
 IN – A
 OUT – MON 2
 IN – B
 Aim A at B and B at A at full zoom
 PAN/TILT - RESET
 for both camrs
 | PAN – 0.0 deg
 | TILT – 90.0 deg
 Repeat for Camr C & D

TARGET MC 3 INERTIAL 30B

CRT √SV SEL correct
 GNC 34 ORBIT TGT
 TGT NO - ITEM 1 +3 3 EXEC
 √TGT Set data:
 T1 TIG = BASE TIME + 0/00:10:00
 EL +0
 ΔT +22.7
 ΔX +0
 ΔY +0
 ΔZ +0
 COMPUTE T1 - ITEM 28 EXEC
 Note solution in PAD

PET

MC2 ET

01:00

TIG - 03:00
CDR TARGET MC 3 INERTIAL [30B] (Final)
Perform RCS BURN (Cue Card)

A7(B7)

00:10

← MC 3 TIG

CDR TARGET MC 4 INERTIAL [31A] (Preliminary)

01:05

MS √P/TV04 HST RETRIEVE/BERTH SETUP
(PHOTO/TV FS, SCENES) complete
CCTV CONFIG [30A]

00:15

01:10

TIG -03:00
CDR TARGET MC 4 INERTIAL [31A] (Final)
Perform RCS BURN, (Cue Card)

00:20

← MC 4 TIG

Go to HST CONTINGENCY INRTL APPROACH (Cue Card)

01:15

MANUAL TRAJECTORY CONTROL

00:25

01:20

00:30

01:25

00:35

01:30

TARGET MC 4 INERTIAL [31A]

CRT √SV SEL correct
GNC 34 ORBIT TGT
TGT NO - ITEM 1 +3 4 EXEC
√TGT Set data:
T1 TIG = BASE TIME + 0/00:20:00
EL +0
ΔT +12.7
ΔX +0
ΔY +0
ΔZ +0
COMPUTE T1 - ITEM 28 EXEC
Note solution in PAD

THIS PAGE INTENTIONALLY BLANK

CONTINGENCY OPS

RNDZ OMS BURN.....	5-3
SENSOR FAIL	5-7
S TRK NAV – HIGH INITIAL RESID	5-8
FLTR MINUS PROP.....	5-9
COAS NAVIGATION.....	5-10
BACKOUT/BREAKOUTS	5-11
PROXIMITY OPS BACKOFF	5-12
HST RBAR BREAKOUT	5-13
HST FLYAROUND/LOSS OF LO Z BREAKOUT.....	5-14
RNDZ BREAKOUT	5-16
Ti DELAY BURN.....	5-17
RNDZ NAV RECOVERY	5-19
TGT ITER.....	5-20
LOSS OF COMM	5-21
DEGRADED CONTROL.....	5-23
LOSS OF VRCS.....	5-25
LO Z BRAKING	5-26

This Page Intentionally Blank

RNDZ OMS BURN

RNDZ OMS BURN

RNDZ OMS
BURN

1. OMS BURN PREP
 - C2 Wedge Install OMS2/ORBIT OMS BURNS (Cue Cards) (two) and ORBIT BURN MONITOR (Cue Cards) (two) (F6,F8)
 - 1: GNC 20 DAP CONFIG
 - CRT1 √DAP config A7,B7
GNC, OPS 202 PRO
 - 1: GNC ORBIT MNVR EXEC
 - 2: GNC SYS SUMM 2

2. LOAD TGT DATA
 - If onboard-computed burn:
 - √Eng sel, TV ROLL, TRIM LOAD, and WT per Burn Pad
 - √TIG and TGT PEG 7 ΔVs per Final ORBIT TGT solution
 - √Guidance option is LAMBERT
 - If ground-computed burn:
 - √TGT data per Burn Pad (reload WT as reqd)
 - LOAD – ITEM 22 EXEC
 - TIMER – ITEM 23 EXEC
 - √Burn data

- C3 DAP: A/AUTO/ALT(B/ALT as reqd)
- CRT1 MNVR – ITEM 27 EXEC (*)

- If RR ops:
 - A1U KU sel – AUTO TRK
 - 1: GNC 33 REL NAV
 - CRT1 INH Angles – ITEM 24 EXEC (*)
 - 1: GNC ORBIT MNVR EXEC

- When mnvr to att complete:
 - C3 √DAP: A/AUTO/ALT

3. PERFORM RNDZ OMS BURN
 - TIG-3 F6,F8 ADI RATE (two) – MED (1 deg/sec) |
 - FLT CNTLR PWR (two) – ON
 - Perform OMS2/ORBIT OMS BURNS (Cue Card)

4. OMS POST BURN RECONFIGURATION
 - F6,F8 O8 FLT CNTLR PWR (two) – OFF
 - L,R OMS He PRESS/VAP ISOL (four) – CL
 - C3 DAP: B/INRTL/ALT
 - DAP TRANS: PULSE/PULSE/PULSE
 - CRT1 RCS SEL – ITEM 4 EXEC (*)
 - Perform OMS TVC GMBL CK per Burn Pad

- * If down arrow(s) or M(s), *
- * select good GMBL *

- GNC, OPS 201 PRO

Cont next page

5. MNVR TO POST BURN ATTITUDE

1: GNC UNIV PTG

√Desired UNIV PTG load active

C3 DAP: B/AUTO/ALT

If RR ops, when ATT ERR < 30 deg:

A1U KU sel – GPC

√KU TRACK tb – gray

1: GNC 33 REL NAV

CRT1 AUTO Angles – ITEM 23 EXEC (*)

1: GNC UNIV PTG

When in attitude and rates nulled:

C3 DAP: A/AUTO/VERN(ALT)

This Page Intentionally Blank

**SENSOR
FAIL**

SENSOR FAIL

S TRK NAV – HIGH INITIAL RESID

1. NAV SAFING

1: GNC 33 REL NAV

CRT1 √INH Angles – ITEM 24 EXEC (*)

On MCC GO (if no comm, continue):

2. CHECK FOR S TRK FALSE LOCK

2: GNC 22 S TRK/COAS CNTL

If -Z S TRK, perform COAS visual check:

NOTE

GNC 33 REL NAV: COAS X (+up) and COAS Y (+left)
provide approx TGT position in COAS based on -Z
S TRK measurement

√For debris near TGT position

If no debris near TGT position or TGT not visible:

Go to step 3

If debris near TGT position:

-Z BREAK TRK – ITEM 8 EXEC

When S PRES – (*):

CRT2
CRT1 Monitor RESID V and H. Repeat BREAK TRK as reqd until
stable lock-on

Go to STAR TRACKER NAV, step 2 **10A**

If -Y S TRK, perform visual check through W1:

√For debris near TGT line-of-sight

If no debris near TGT line-of-sight or TGT not visible:

Go to step 3

If debris near TGT line-of-sight:

-Y BREAK TRK – ITEM 7 EXEC

When S PRES – (*):

CRT2
CRT1 Monitor RESID V and H. Repeat BREAK TRK as reqd until
stable lock-on

Go to STAR TRACKER NAV, step 2 **10A**

3. CHECK IMU MISALIGNMENT

2: GNC 21 IMU ALIGN

CRT2 Nav sel IMU – des,sel (If Nav sel IMU unknown, pick one of two remaining IMUs)

CRT1 Record RESID V _____ and H _____

If RESID V and H < 0.6:

Go to STAR TRACKER NAV, step 3 **10A**

CRT2 Other IMU – des,sel

CRT1 Record RESID V _____ and H _____

4. RESUME PASS

Continue with pass per STAR TRACKER NAV, step 3 **10A**, then:

After S TRK pass, on MCC GO:

NOTE

SELF-TEST may false fail. √MCC for S TRK status

2: GNC 22 S TRK/COAS CNTL

CRT2 -Z(-Y) SELF-TEST – ITEM 2(1) EXEC (*)

SENSOR
FAIL

S TRK NAV – HIGH FLTR MINUS PROP

1. NAV SAFING

1: GNC 33 REL NAV

CRT1 INH Angles – ITEM 24 EXEC (*)

On MCC GO (continue if no comm):

2. CHECK FOR S TRK FALSE LOCK

2: GNC 22 S TRK/COAS CNTL

If -Z S TRK, perform COAS visual check:

NOTE

GNC 33 REL NAV: COAS X (+up) and COAS Y (+left)
provide approx TGT position in COAS based on -Z
S TRK measurement

√For debris near TGT position

If no debris near TGT position or TGT not visible:

Go to step 3

If debris near TGT position:

SV SEL – ITEM 4 EXEC (PROP)

PROP TO FLTR – ITEM 9 EXEC

-Z BREAK TRK – ITEM 8 EXEC

CRT2

When S PRES – (*):

CRT1

Monitor RESID V and H. Repeat BREAK TRK as reqd until stable
lock-on

Go to STAR TRACKER NAV, step 2 **10A**

If -Y S TRK, perform visual check through W1:

√For debris near TGT line-of-sight

If no debris near TGT line-of-sight or TGT not visible:

Go to step 3

If debris near TGT line-of-sight:

SV SEL – ITEM 4 EXEC (PROP)

PROP TO FLTR – ITEM 9 EXEC

-Y BREAK TRK – ITEM 7 EXEC

CRT2

When S PRES – (*):

CRT1

Monitor RESID V and H. Repeat BREAK TRK as reqd until stable
lock-on

Perform STAR TRACKER NAV, step 2 **10A**

3. RESUME PASS

AUTO Angles – ITEM 23 EXEC (*)

Continue -Z S TRK pass

After S TRK pass, on MCC GO:

NOTE

SELF-TEST may false fail. √MCC for S TRK status

2: GNC 22 S TRK/COAS CNTL

CRT2

-Z(-Y) SELF-TEST – ITEM 2(1) EXEC (*)

COAS NAVIGATION

NOTE

Do not execute MC1 or Out-Of-Plane null.
Prior COAS cal reqd to perform COAS NAV.
VERNs reqd to perform COAS NAV.
COAS Nav must be started within ~10 min of Ti to guarantee adequate geometry for nav convergence.
Breakout – If tgt not visible at MC2+18, refer to 1-4 for breakout criteria

1. COAS NAV CONFIG
 - A6U √SENSE: -Z
√DAP: B7/AUTO/VERN(ALT)
 - CRT

GNC 22 STRK/COAS CNTL

COAS: SIGHT MODE – ITEM 22 EXEC (*)
REQD ID – ITEM 21 +1 EXEC
√POS -Z: ITEM 27 (*)
 - | |
|----------------|
| GNC 33 REL NAV |
|----------------|

INH Angles – ITEM 24 EXEC (*)
√SV SEL, ITEM 4 – FLTR
If TGT NOT in COAS FOV:
| √MCC
If TGT in COAS FOV:
FLTR TO PROP – ITEM 8 EXEC
COAS – ITEM 14 EXEC (*)
 - Upon MCC uplink of COVARIANCE MATRIX,
COVAR REINIT – ITEM 16 EXEC
2. COAS MARKS
 - A6U FLT CNTLR PWR – ON
DAP: B/FREE/PRI
RHC: As reqd to move TGT near COAS center and maintain BODY YAW
ERR < 10 deg
DAP: B/FREE/VERN
RHC: As reqd to maintain TGT at COAS center and maintain BODY YAW
ERR < 10 deg
 - When TGT centered in COAS, ATT REF pb – push
 - CRT

GNC 33 REL NAV

If X and Y RESID magnitudes ≥ 1.0:
| √MCC
If X and Y RESID magnitudes < 1.0:
FOR – ITEM 25 EXEC
√SV UPDATE – non-zero (within 8 sec), then
– 0.0 (after 8 sec more)
 - Repeat step 2 per schedule:
One mark every 10 to 20 sec until sunset Post-Ti
 - At sunset,
3. END COAS NAV
 - A6U DAP: A7/AUTO/VERN(ALT)
FLT CNTLR PWR – OFF
 - CRT

GNC 22 STRK/COAS CNTL

COAS: DES – ITEM 25 EXEC (*)
 - Resume rendezvous timeline

BACKOUT/BREAKOUTS

BACKOUT/
BREAKOUTS

PROXIMITY OPS BACKOFF

NOTE

Procedure assumes orbiter nose in target's plane

A6U

√SENSE: -Z
√ADI ATT: - LVLH
√DAP: LO Z as reqd

1. If immediate backoff reqd,
THC +Z (out) – init 0.2 fps opening rate
2. If on +RBAR:
√DAP: A/AUTO/VERN(PRI)
THC as reqd to maintain opening rate and target over PLB (-Z axis)
Null opening rate at 250 ft
THC: as reqd to stationkeep >>
3. If not on +RBAR, + or – VBAR:
DAP: INRTL
THC as reqd to maintain target over PLB (-Z axis)
4. When + or - VBar reached (Aft ADI pitch = 180 or 0):
DAP: LVLH
Config UNIV PTG with tail or nose to Earth track as appropriate

GNC UNIV PTG

TGT ID: +2
BODY VECT: +2 (tail to Earth: +VBar)
 +1 (nose to Earth: -VBar)
OM: +0
TRACK – ITEM 19 EXEC (CUR – *)
DAP: AUTO

THC: as reqd to maintain target over PLB
(-Z axis) – low in COAS

5. If opening rate not established (step 1 not performed),
THC: +Z (out) – init 0.2 fps opening rate
6. Null opening rate when safe range reached (standard range = 250 ft,
flight specific as reqd),
THC: as reqd to stationkeep

BACKOUT/
BREAKOUTS

HST RBAR BREAKOUT

CAUTION

Constraints for use:
Orbiter on +Rbar in + XVV attitude
Range < 500 ft cg to cg
Tgt stable on Orbiter -Z axis

1. AFT STATION CONFIG

√SENSE: -Z
√A/AUTO/VERN(PRI)
√DAP: LO Z

If RNG < 75 ft

2. INITIATE BACKOUT

If RNG ≤ 75 ft:
THC: +Z (out) as reqd to establish a +0.1 ft/sec opening rate
Maintain lateral position within 8 deg of RBAR

When RNG > 75 ft

3. PERFORM POSIGRADE/RETROGRADE BURN ON +RBAR

Config DAP A,B to A7,B7
√MCC for breakout direction

NOTE

Posigrade burn will be performed if
second rendezvous attempt is desired

DAP: A/AUTO/PRI
DAP TRANS: NORM/PULSE/PULSE

If Posigrad Sep:
| THC: +X (up) for 12 sec (3.0 fps)
If Retrograde Sep:
THC: -X (down) for 12 sec (3.0 fps)

DAP TRANS: PULSE/PULSE/PULSE
FLT CNTLR PWR – OFF
DAP: A/INRTL/VERN(ALT)

Inform MCC when SEP complete

When RNG > 1500 ft:
DAP: NO LO Z

HST FLYAROUND/LOSS OF LO Z BREAKOUT

CAUTION

Constraints for use:

HST near orbiter -Z axis

RNG >30 ft (EE to grapple fixture)

RNG < 150 ft (nominal approach)

or

Post +Vbar crossing (inertial approach)

1. AFT STATION CONFIG

√SENSE: -Z

√DAP: LO Z

Verify RMS clearance to HST

2. 1st BURN

DAP TRANS: NORM/PULSE/PULSE

DAP: A/FREE/VERN(PRI)

THC: -X (dn) for 7 sec (1.7 fps)

* If single fwd firing jet *

* THC: -X (dn) for 14 sec *

At TIG + 01:00,

DAP: A/INRTL/PRI

DAP TRANS: PULSE/PULSE/PULSE

3. PLACE AND MAINTAIN HST IN OVHD WINDOW

DAP: A/INTRL/VERN(PRI)

Perform manual pitch rotation as reqd:

DAP ROT: DISC/PULSE/DISC

RHC: +/- PITCH as reqd to place and maintain HST in OVHD Window

4. 2nd BURN (Out-Of-Plane)

When RNG > 1500 ft:

DAP: no LO Z

DAP ROT: DISC/DISC/DISC

GNC, OPS 202 PRO

GNC ORBIT MNVR EXEC

√RCS SEL – ITEM 4 EXEC (*)

Set TIG to current time + 1 min

TGT PEG 7 ΔVX – ITEM 19 +0 EXEC

ΔVY – ITEM 20 +2 EXEC

ΔVZ – ITEM 21 +0 EXEC

LOAD – ITEM 22 EXEC

TIMER – ITEM 23 EXEC

√VGO Z ≥ 0; if VGO Z < 0 then:

* TGT PEG 7 ΔVY – ITEM 20 -2 EXEC *

* LOAD – ITEM 22 EXEC *

* TIMER – ITEM 23 EXEC *

*√VGO Z ≥ 0 *

Cont next page

Do not MNVR to BURN ATT

At TIG, deflect THC to null VGOs

Record 2nd Burn TIG ___/___:___:___

5. 3rd BURN (Posigrade/Retrograde)

√MCC for breakout direction

If Posigrade Sep:

If ΔVY (step 3) +2:

TV ROLL – ITEM 5 +2 7 0 EXEC

If ΔVY (step 3) -2:

TV ROLL – ITEM 5 +9 0 EXEC

Set TIG to 3rd Burn + 22 min:

TGT PEG 7 ΔVX – ITEM 19 +3.5 EXEC

ΔVY – ITEM 20 +0 EXEC

ΔVZ – ITEM 21 +0 EXEC

If Retrograde Sep:

If ΔVY (step 3) +2:

TV ROLL – ITEM 5 +9 0 EXEC

If ΔVY (step 3) -2:

TV ROLL – ITEM 5 +2 7 0 EXEC

Set TIG to 3rd Burn + 22 min:

TGT PEG 7 ΔVX – ITEM 19 -3.5 EXEC

ΔVY – ITEM 20 +0 EXEC

ΔVZ – ITEM 21 +0 EXEC

LOA D – ITEM 22 EXEC

TIMER – ITEM 23 EXEC

MNVR – ITEM 27 EXEC

DAP: B/AUTO/PRI

At TIG-0:30

DAP: A/INTRL/PRI

At TIG, deflect THC to null VGOs

FLT CNTLR PWR – OFF

DAP: A/INTRL/VERN(ALT)

GNC, OPS 201 PRO

RNDZ BREAKOUT

NOTE

This procedure may be performed anytime between Ti and 500 ft. For the contingency inertial approach, this procedure may be performed anytime between Ti and the +V bar crossing

1. BREAKOUT BURN PREP
DAP: A/LVLH/PRI
FLT CNTLR PWR – ON
2. 3 FPS OUT OF PLANE (CONTINGENCY INERTIAL APPROACH RNDZ ONLY)
DAP TRANS: PULSE/NORM/PULSE, NO LO Z
GNC 33 REL NAV

CRT

If Y > 0:
| FWD THC: +Y (right) 16 sec
| (AFT THC: left)
If Y < 0:
| FWD THC: -Y (left) 16 sec
| (AFT THC: right)
DAP TRANS: PULSE/PULSE/PULSE

3. 3 FPS RETROGRADE
If RANGE < 1500 ft:
Config DAP B to B7
DAP: LO Z
DAP: B/AUTO/PRI
When in attitude:
DAP: A/LVLH/PRI

CRT

OPS 202 PRO
GNC ORBIT MNVR EXEC
√RCS SEL – ITEM 4 (*)
Set TIG to current time + 1:00
If Contingency Inertial Approach Rndz:
Set TIG to current time + 15:00
TGT PEG 7 ΔVX – ITEM 19 -3 EXEC
ΔVY – ITEM 20 +0 EXEC
ΔVZ – ITEM 21 +0 EXEC
LOAD – ITEM 22 EXEC
TIMER – ITEM 23 EXEC
DO NOT MNVR TO BURN ATT
At TIG, deflect THC to null VGOs
FLT CNTLR PWR – OFF

CRT

OPS 201 PRO
DAP: A/AUTO/VERN

Ti DELAY BURN

1. OPS 202 PRO

GNC ORBIT MNVR EXEC

Load Ti Delay Pad, 3-7

If no Ti Delay targets available:

Add 3.0 fps to ΔV_x of last Ti burn solution

Burn ΔV_y and ΔV_z as computed in last Ti burn solution

Max TIG Slip is 4 minutes

NOTE

Guidance will downmode to EXT ΔV

If RCS:

Perform RCS BURN (Cue Card)

If OMS:

Perform RNDZ OMS BURN (CONTINGENCY OPS), 5-4

2. Reload new BASETIME per final Ti PAD, 3-7

GNC 34 ORBIT TGT

TGT NO – ITEM 1 +1 EXEC

Set BASETIME to new Ti TIG ___/___:___:___

Load – ITEM 26 EXEC

Reset ET, SM timers to new Ti TIG

If Ti Delay executed because no comm:

Add 0/01:36:00 to BASE TIME for subsequent delay rev

See LOSS OF COMM (CONTINGENCY OPS), 5-21

If no comm for 2 delay revs:

NOTE

Ti Delay breakout is a 1.5 fps posigrade burn at the next Ti point

Perform RNDZ BREAKOUT (CONTINGENCY OPS), 5-16, with the following deltas:

Set TIG to BASE TIME

TGT PEG 7 ΔV_x – ITEM 19 +1.5 EXEC

ΔV_y – ITEM 20 +0 EXEC

ΔV_z – ITEM 21 +0 EXEC

Go to TERMINATE RNDZ OPS (Cue Card, HST RBAR APPROACH) >>

3. Perform Post Ti Nav 16A, 4-16, then

Return to RENDEZVOUS TIMELINE at PET: -01:25, 4-11

NOTE

Extra NCC Burn and Ti Onboard Solution pads, 5-18

NCC BURN SOLUTION

TIG

			/			:			:		
--	--	--	---	--	--	---	--	--	---	--	--

PRELIMINARY

INTERMEDIATE

ΔVX

()			.	
-----	--	--	---	--

()			.	
-----	--	--	---	--

ΔVY

()			.	
-----	--	--	---	--

()			.	
-----	--	--	---	--

ΔVZ

()			.	
-----	--	--	---	--

()			.	
-----	--	--	---	--

ΔVT

			.	
--	--	--	---	--

			.	
--	--	--	---	--

FINAL

GROUND

FINAL-GROUND LIMITS

ΔVX

()			.	
-----	--	--	---	--

()			.	
-----	--	--	---	--

(.)

ΔVY

()			.	
-----	--	--	---	--

()			.	
-----	--	--	---	--

(.)

ΔVZ

()			.	
-----	--	--	---	--

()			.	
-----	--	--	---	--

(.)

ΔVT

			.	
--	--	--	---	--

			.	
--	--	--	---	--

(.)

Ti ONBOARD SOLUTIONS

PREL FLTR

1ST INTER FLTR

2ND INTER FLTR (IF REQD)

()			.	
()			.	
()			.	
			.	

()			.	
()			.	
()			.	
			.	

()			.	
()			.	
()			.	
			.	

FINAL FLTR

PROP (IF REQD)

FINAL-GROUND LIMITS

()			.	
()			.	
()			.	
			.	

()			.	
()			.	
()			.	
			.	

()			.	
()			.	
()			.	
			.	

FINAL Ti PAD (MNVR PADS)

RNDZ NAV RECOVERY

1. If Recovery from OPS MODE RECALL:
(add/delete GPC to/from redundant set)
GNC 33 REL NAV
 RNDZ NAV ENA – ITEM 1 EXEC (*)
GNC UNIV PTG
 TRK – ITEM 19 (CUR-*)
 Go to step 3
2. If Recovery from OPS TRANSITION (G8/G3 to G2):
GNC 34 ORBIT TGT
 TGT NO – ITEM 1 +1 EXEC
 Set BASE TIME to Ti TIG (Ti Burn Pad, 3-6)
 LOAD – ITEM 26 EXEC
GNC 33 REL NAV
 Upon MCC uplink of TGT SV,
 RNDZ NAV ENA – ITEM 1 EXEC (*)

NOTE

If RNDZ NAV not enabled (no *),
DO NOT PROCEED. √MCC

Select appropriate target track attitude

GNC UNIV PTG

	-Z	-Y (STRK)	+Y
TGT ID	+1	+1	+1
BODY VECT	+3	+4	+5
P	√+90	√+0	+0
Y	√+0	√+280.6	+90
OM	+0	+90	+180

TRK – ITEM 19 (CUR-*)

- C3
3. DAP: ALT
 DAP: A/AUTO
 DAP ROT: DISC/DISC/DISC
 When in attitude, DAP: VERN

If NAV sensor data available:

If STRK NAV:

Go to STAR TRACKER NAV 10A, 4-10 >>

If RR NAV:

GNC 33 REL NAV

CRT

KU ANT ENA – ITEM 2 (*)

GNC I/O RESET

Go to RR NAVIGATION 13B, 4-13

TGT ITER

When in Lambert Targeting and TGT ITER occurs:

If PRED MATCH other than 999999 (all 9s):

√MCC and read down PRED MATCH from SPEC 34 (MCC has delta Vs)

On MCC GO or if no comm:

Recall TGT set and recompute

If TGT ITER recurs and PRED MATCH less than 400:

Contact MCC and read down PRED MATCH from SPEC 34

On MCC GO or if no comm:

Load current delta Vs and execute as Lambert burn >>

If TGT ITER recurs and PRED MATCH greater than 400:

Contact MCC and read down PRED MATCH from SPEC 34

On MCC GO or if no comm:

Load ground solution and execute as EXT DV burn

(If MC burn, uplink of ground solution reqd) >>

If ground solution not available: No burn >>

If PRED MATCH 999999 (all 9s):

On MCC GO or if no comm:

Load ground solution and execute as EXT DV burn

(If MC burn, uplink of ground solution reqd) >>

If ground solution not available: No burn >>

LOSS OF COMM

If comm with MCC is lost during rendezvous ops, attempt to establish comm by performing COMM LOST (ORB PKT, COMM). Do not maneuver out of target track attitude unless all other means of acquiring comm are expended

Ground-Targeted Burns

1. If NH or NC PADs not available, do not perform burn
2. If a day of rendezvous NC or NH maneuver was not performed nominally, then discontinue rendezvous operations
3. If the day of rendezvous NC maneuver is performed using preliminary pads, a large NCC burn can be expected

Lambert-Targeted Burns

1. If "GO for Ti" not received from MCC by Ti TIG - 5 min, perform Ti DELAY BURN (CONTINGENCY OPS), 5-17. If comm is not recovered after two delay revs, perform modified RNDZ BREAKOUT per Ti DELAY BURN (CONTINGENCY OPS), 5-17
2. If radar nav was stopped in an attempt to get Ku comm during the delay, do not perform second or third NCC burn unless radar nav is re-enabled and sufficient radar marks are taken to provide a converged solution
3. If no comm for any midcourse correction (MC) burn, perform burn and continue to prox ops

Prox Ops

1. Continue on best effort basis

This Page Intentionally Blank

DEGRADED CONTROL

DEGRADED
CONTROL

DEGRADED
CONTROL

This Page Intentionally Blank

LOSS OF VRCS

NOTE

This procedure overrides LOSS OF VERNIERS (ORB OPS, RCS) during rendezvous ops

1. Utilize VERN fail downmodes (PRI/ALT) specified in parentheses and follow VERN fail starred blocks per timeline. If VERN fail downmode not specified, use PRI Nose and Tail control
2. COAS NAV should not be performed if VERN fail
3. Additional braking pulses (+Z) may be reqd due to LO Z PRI attitude control cross coupling

LOSS OF LO Z BRAKING

During Approach:

If 2 -X jets ↓ (Degraded LO Z braking):

CAUTION

LO Z +Z translation with a single -X jet will couple strongly into +X translation

Maintain DAP: LO Z

Minimize LO Z +Z translations

Continue approach and attempt grapple >>

If 3 -X jets ↓ (Loss of LO Z Braking and/or -X translation not available):

If RNG > 150 ft:

Breakout 3 fps posigrade or retrograde per MCC

If RNG < 150 ft:

Breakout using ±Y translation or NORM Z braking as reqd to avoid collision

√MCC for subsequent maneuvers >

If 2 +X jets ↓ in same pod (Loss of LO Z Braking):

If 150 < RNG < 1500 ft:

Maintain Rbar within 10 deg (do not initiate flyaround)

Maintain DAP: LO Z

If LO Z not recoverable:

If 500 < RNG < 1500

Perform RNDZ BREAKOUT, 5-16

If 150 < RNG < 500

Perform HST RBAR BREAKOUT, 5-13

If possibility of recovering LO Z:

Establish station keeping at 120 ft ± 10 ft

If RNG < 150 ft and range to grapple > 30 ft:

Perform HST FLYAROUND/LOSS OF LO Z BREAKOUT (CONTINGENCY OPERATIONS), 5-14

If Range to Grapple < 30 ft:

Proceed with NORM Z braking and perform grapple

Maintain DAP: LO Z when not braking

REFERENCE DATA

STS-125 HST RNDZ OPS DAP CONFIGURATIONS 6-2
TARGETING DATA 6-3
POST NC 6-5
 Ti 6-6
 MC3..... 6-7
COAS SUBTENDED ANGLES (DEG) VS RANGE (FT)..... 6-8

REFERENCE
DATA

STS-125 HST RNDZ OPS DAP CONFIGURATIONS

	RNDZ		TERMINAL PHASE		FLYAROUND		SPEC 20 ITEM #	
	A7	B7	A8	B8	A9	B9	A	B
PRI								
ROT RATE	0.200	0.500	0.0500	0.0500	0.200	0.200	10	30
ATT DB	2.00	2.00	2.00	2.00	1.00	1.00	11	31
RATE DB	0.20	0.20	0.20	0.20	0.10	0.10	12	32
ROT PLS	0.10	0.04	0.10	0.04	0.10	0.04	13	33
COMP	.000	.000	.000	.000	.000	.000	14	34
P OPTION	ALL	ALL	ALL	ALL	TAIL	TAIL	15	35
Y OPTION	ALL	ALL	ALL	ALL	TAIL	TAIL	16	36
TRAN PLS	0.10	0.05	0.10	0.05	0.05	.01	17	37
ALT								
RATE DB	0.10	0.10	0.10	0.10	0.10	0.10	18	38
JET OPT	ALL	ALL	ALL	ALL	TAIL	TAIL	19	39
# JETS	2	2	2	2	2	2	20	40
ON TIME	0.08	0.08	0.08	.08	0.08	0.08	21	41
DELAY	0.00	0.00	0.00	0.00	0.00	0.00	22	42
VERN								
ROT RATE	0.0160	0.2000	0.0500	0.0500	0.200	0.200	23	43
ATT DB	1.00	1.00	1.00	1.00	1.000	1.000	24	44
RATE DB	0.020	0.020	0.020	0.020	0.020	0.020	25	45
ROT PLS	0.010	0.002	0.050	0.020	0.050	0.020	26	46
COMP	.000	.000	.000	.000	.000	.000	27	47
CNTL ACC	0	0	0	0	0	0	28	48

TARGETING DATA

SPEC 34 ITEM NO	1			6	17	18	19	20	
TGT ALTITUDE	TGT NO	DESCRIPTION	T1 REL TO BASETIME	EL (DEG)	DT (MIN)	DX (KFT)	DY (KFT)	DZ (KFT)	NOTES
150	9	NCC	-0/00:56:18	0	56.3	-48.6	0	+1.2	BASETIME = Ti TIG
	10	Ti	0/00:00:00	0	75.1	-0.9	0	+1.8	
	11	MC1	0/00:20:00	0	55.1	-0.9	0	+1.8	
	12	MC2	0/00:48:06	28.46	27.0	-0.9	0	+1.8	BASETIME = MC2 TIG
	13	MC3	0/00:17:00	0	10.0	-0.9	0	+1.8	
	14	MC4	0/00:27:00	0	13.0	0	0	+0.6	
	19	MC2 ON TIME	0/00:00:00	0	27.0	-0.9	0	+1.8	
170	9	NCC	-0/00:56:48	0	56.8	-48.6	0	+1.2	BASETIME = Ti TIG
	10	Ti	0/00:00:00	0	75.7	-0.9	0	+1.8	
	11	MC1	0/00:20:00	0	55.7	-0.9	0	+1.8	
	12	MC2	0/00:48:42	28.66	27.0	-0.9	0	+1.8	BASETIME = MC2 TIG
	13	MC3	0/00:17:00	0	10.0	-0.9	0	+1.8	
	14	MC4	0/00:27:00	0	13.0	0	0	+0.6	
	19	MC2 ON TIME	0/00:00:00	0	27.0	-0.9	0	+1.8	
190	9	NCC	-0/00:57:12	0	57.2	-48.6	0	+1.2	BASETIME = Ti TIG
	10	Ti	0/00:00:00	0	76.3	-0.9	0	+1.8	
	11	MC1	0/00:20:00	0	56.3	-0.9	0	+1.8	
	12	MC2	0/00:49:18	28.85	27.0	-0.9	0	+1.8	BASETIME = MC2 TIG
	13	MC3	0/00:17:00	0	10.0	-0.9	0	+1.8	
	14	MC4	0/00:27:00	0	13.0	0	0	+0.6	
	19	MC2 ON TIME	0/00:00:00	0	27.0	-0.9	0	+1.8	
210	9	NCC	-0/00:57:42	0	57.7	-48.6	0	+1.2	BASETIME = Ti TIG
	10	Ti	0/00:00:00	0	76.9	-0.9	0	+1.8	
	11	MC1	0/00:20:00	0	56.9	-0.9	0	+1.8	
	12	MC2	0/00:49:54	29.07	27.0	-0.9	0	+1.8	BASETIME = MC2 TIG
	13	MC3	0/00:17:00	0	10.0	-0.9	0	+1.8	
	14	MC4	0/00:27:00	0	13.0	0	0	+0.6	
	19	MC2 ON TIME	0/00:00:00	0	27.0	-0.9	0	+1.8	
230	9	NCC	-0/00:58:12	0	58.2	-48.6	0	+1.2	BASETIME = Ti TIG
	10	Ti	0/00:00:00	0	77.6	-0.9	0	+1.8	
	11	MC1	0/00:20:00	0	57.6	-0.9	0	+1.8	
	12	MC2	0/00:50:36	29.32	27.0	-0.9	0	+1.8	BASETIME = MC2 TIG
	13	MC3	0/00:17:00	0	10.0	-0.9	0	+1.8	
	14	MC4	0/00:27:00	0	13.0	0	0	+0.6	
	19	MC2 ON TIME	0/00:00:00	0	27.0	-0.9	0	+1.8	

TARGETING DATA (Cont)

SPEC 34 ITEM NO	1			6	17	18	19	20	
TGT ALTITUDE	TGT NO	DESCRIPTION	T1 REL TO BASETIME	EL (DEG)	DT (MIN)	DX (KFT)	DY (KFT)	DZ (KFT)	NOTES
250	9	NCC	-0/00:58:42	0	58.7	-48.6	0	+1.2	BASETIME = Ti TIG
	10	Ti	0/00:00:00	0	78.2	-0.9	0	+1.8	
	11	MC1	0/00:20:00	0	58.2	-0.9	0	+1.8	
	12	MC2	0/00:51:12	29.55	27.0	-0.9	0	+1.8	BASETIME = MC2 TIG
	13	MC3	0/00:17:00	0	10.0	-0.9	0	+1.8	
	14	MC4	0/00:27:00	0	13.0	0	0	+0.6	
	19	MC2 ON TIME	0/00:00:00	0	27.0	-0.9	0	+1.8	
270	9	NCC	-0/00:59:06	0	59.1	-48.6	0	+1.2	BASETIME = Ti TIG
	10	Ti	0/00:00:00	0	78.9	-0.9	0	+1.8	
	11	MC1	0/00:20:00	0	58.9	-0.9	0	+1.8	
	12	MC2	0/00:51:54	29.80	27.0	-0.9	0	+1.8	BASETIME = MC2 TIG
	13	MC3	0/00:17:00	0	10.0	-0.9	0	+1.8	
	14	MC4	0/00:27:00	0	13.0	0	0	+0.6	
	19	MC2 ON TIME	0/00:00:00	0	27.0	-0.9	0	+1.8	
290	9	NCC	-0/00:59:36	0	59.6	-48.6	0	+1.2	BASETIME = Ti TIG
	10	Ti	0/00:00:00	0	79.5	-0.9	0	+1.8	
	11	MC1	0/00:20:00	0	59.5	-0.9	0	+1.8	
	12	MC2	0/00:52:30	30.03	27.0	-0.9	0	+1.8	BASETIME = MC2 TIG
	13	MC3	0/00:17:00	0	10.0	-0.9	0	+1.8	
	14	MC4	0/00:27:00	0	13.0	0	0	+0.6	
	19	MC2 ON TIME	0/00:00:00	0	27.0	-0.9	0	+1.8	
310	9	NCC	-0/00:60:06	0	60.1	-48.6	0	+1.2	BASETIME = Ti TIG
	10	Ti	0/00:00:00	0	80.1	-0.9	0	+1.8	
	11	MC1	0/00:20:00	0	60.1	-0.9	0	+1.8	
	12	MC2	0/00:53:06	30.25	27.0	-0.9	0	+1.8	BASETIME = MC2 TIG
	13	MC3	0/00:17:00	0	10.0	-0.9	0	+1.8	
	14	MC4	0/00:27:00	0	13.0	0	0	+0.6	
	19	MC2 ON TIME	0/00:00:00	0	27.0	-0.9	0	+1.8	
310 INTRL APPROACH	29	NCC	-0/00:60:06	0	60.1	-48.6	0	-1.2	BASETIME = Ti TIG
	30	Ti	0/00:00:00	0	85.5	0	0	0	
	31	MC1	0/00:26:24	0	59.1	0	0	0	
	32	MC2	0/00:52:48	29.49	32.7	0	0	0	BASETIME = MC2 TIG
	33	MC3	0/00:10:00	0	22.7	0	0	0	
	34	MC4	0/00:20:00	0	12.7	0	0	0	
	39	MC2 ON TIME	0/00:00:00	0	32.7	0	0	0	

POST NC

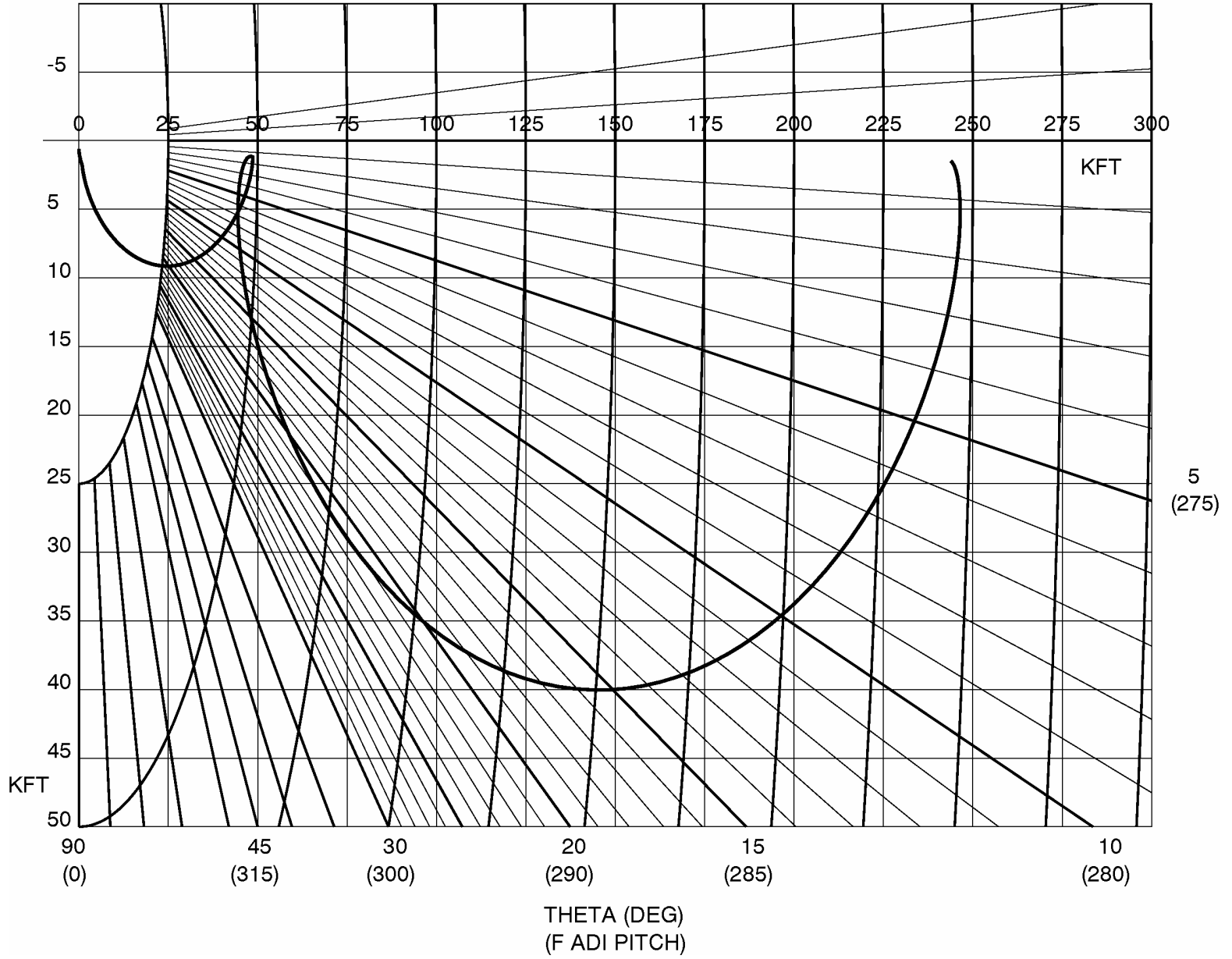

POST Ti

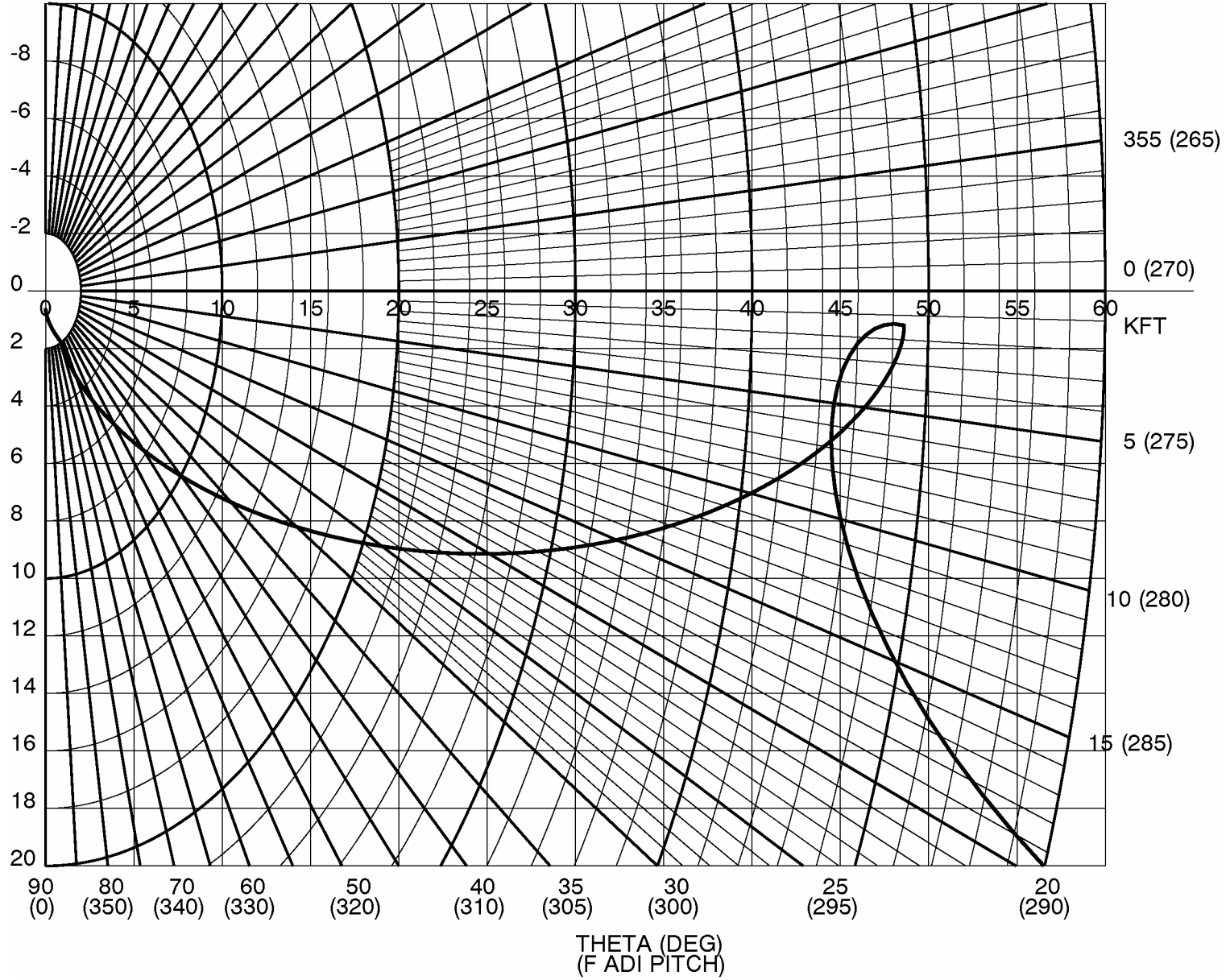

POST MC3

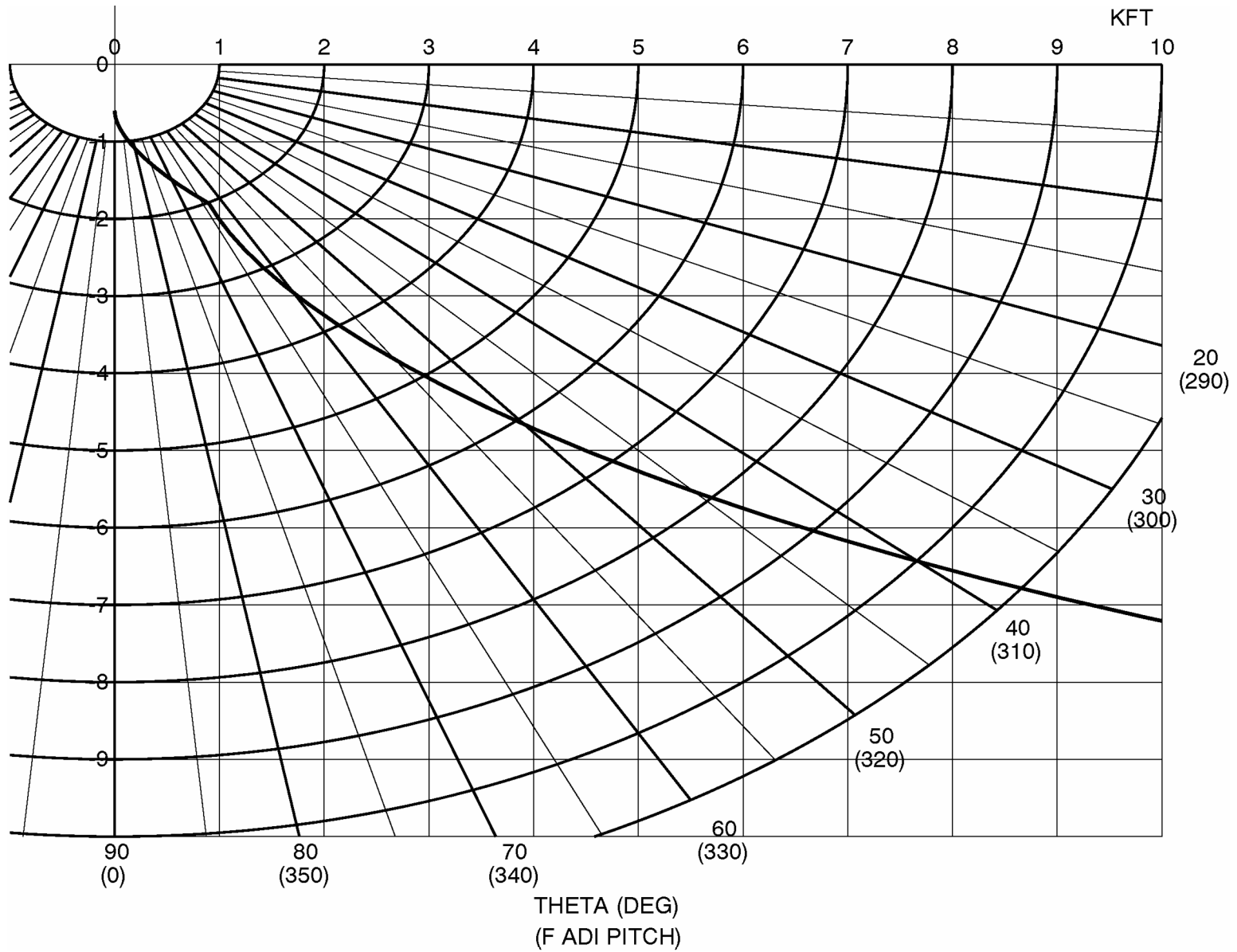

COAS SUBTENDED ANGLE (DEG) VS RANGE (FEET)

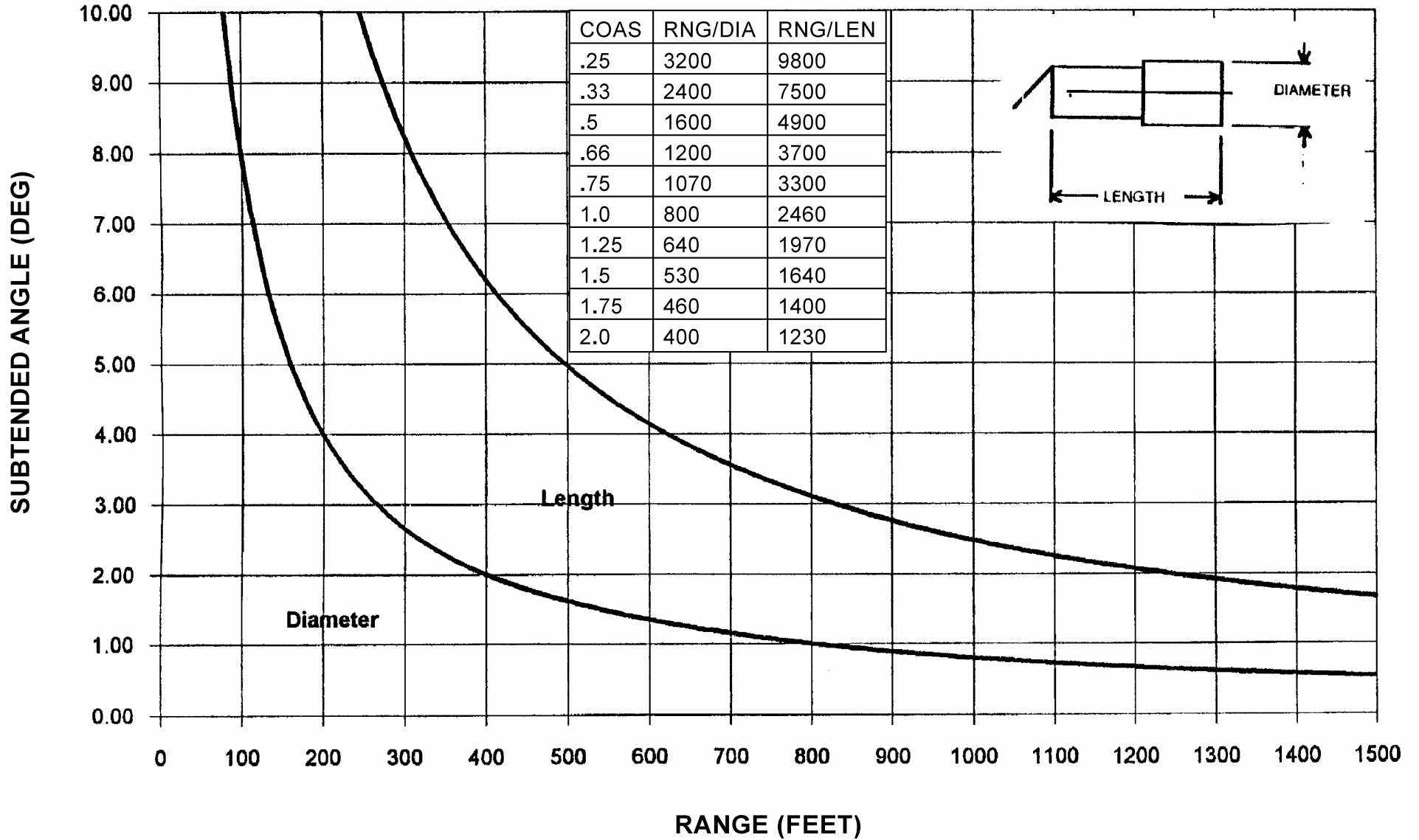

RENDEZVOUS TOOLS

CCTV CONFIG FOR DOCKING/UNDOCKING	7-2
RNDZ TOOLS CHECKOUT	7-4
TROUBLESHOOTING	7-5
TCS CADS NOT RECEIVING TCS DATA	7-6
RPOP NOT RECEIVING PCMMU DATA	7-7
HHL DATA	7-8
TCS DATA (CADS RCV DATA ON SAME PGSC)	7-9
PGSC REBOOT	7-9
TOOLS CONFIGURATION STATUS	7-10
HAND-HELD LIDAR CHECKOUT/OPS	7-14
STOW	7-14
RPOP INITIALIZATION	7-15
OPS	7-16
TCS ACTIVATION	7-18
MANUAL ACQUISITION	7-19
DEACTIVATION	7-20
TRAD FAIL RANGE AND RANGE RATE DETERMINATION	7-21
RNDZ TOOLS REFERENCE DATA	7-22
RPOP FUNCTION KEY SUMMARY	7-22
KEYSTROKE SUMMARY	7-25
RPOP TRAJECTORY DATA SOURCE OPTIONS	7-26
HHL REF DATA	7-28
TCS LIMIT DATA	7-28

**RNDZ
TOOLS**

CCTV CONFIG FOR DOCKING/UNDOCKING

1. ACTIVATION

Perform ACTIVATION (Cue Card, TV)

√Monitors set to USCAN – ON

√MCC: VSU Sync/Async configuration

Pwr up Cameras for Docking/Undocking:

CENTERLINE

Camrs A,C,D

Camr B

Install Monitor Sunshades

2. SET CCTV CAMERA FUNCTIONS

2.1 For Centerline Camera:

ALC pb – press

AVG pb – press

√GAM BLK STR – ON

√COLOR BAL – SUN

2.2 For Cameras A,C,D:

ALC pb – press

AVG pb – press

GAM BLK STR – ON

√COLOR BAL – SUN

SHUTTER – ON pb press as reqd

2.3 For Camera B:

ALC pb – press

AVG pb – press

LT LEVEL pb – press

NIGHT pb – press

GAM BLK STR – ON

3. SET CAMERA ZOOM SETTINGS

<u>CAMERA</u>	<u>ZOOM</u>	<u>OVERLAY</u>
Centerline	40.0° (Corridor)	Corridor
	10.1° (full zoom)	Grid

4. MONITOR SETUP

MON 1,2 L-DATA – on

C-DATA – grn

XHAIR – grn

5. CAMERA SETUP – CAMERA A,D

A7

MON 2 – Camr A (Range Ruler), D (Backup Range Ruler)

Zoom = 74.4° FOV (full unzoom), Focus = 12 ft

Pan: as reqd to center ODS in monitor (see figure next page)

Tilt: as reqd until bottom of ODS Interface Ring touches bottom of screen (see figure next page)

6. FINAL CONFIG FOR APPROACH AND UNDOCKING/SEP

MON 1 – CENTERLINE

MON 2 – RANGE RULER

Install CORRIDOR overlay:

Use green XHair to center overlay

Install RANGE RULER overlay:

Place contact ring tangent line on top of ODS Contact Ring (see Figure 7-1)

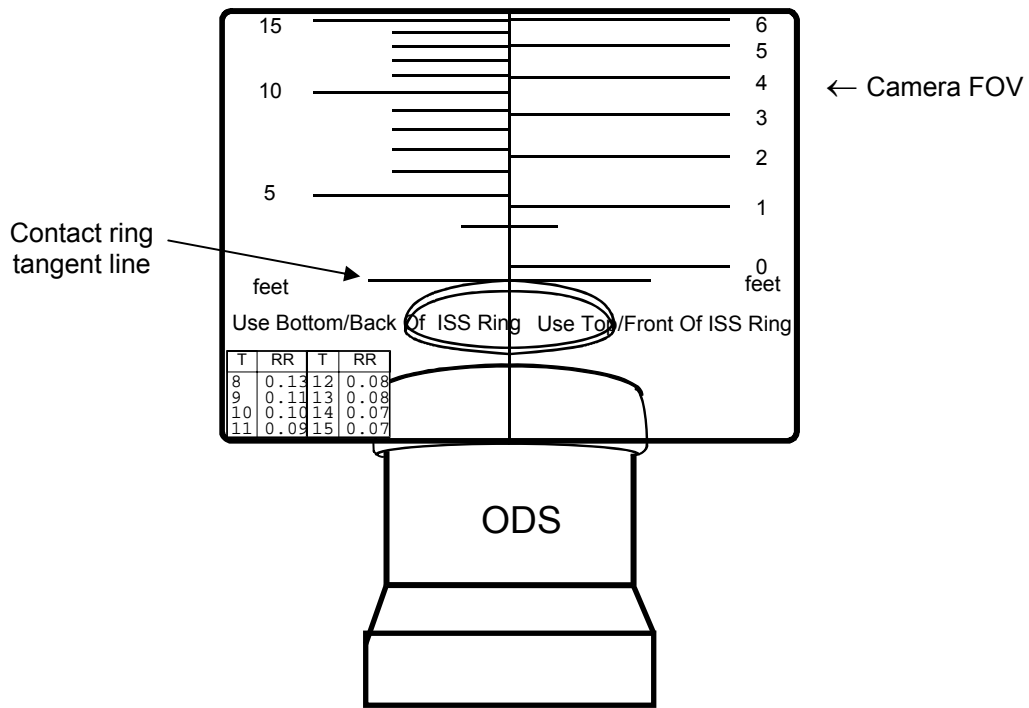

Figure 7-1.— Camr A,D Range Ruler View Approach Config.

RNDZ TOOLS CHECKOUT

1. ✓MCC uplink to TGT SV
 GNC 33 REL NAV
 RNDZ NAV ENA – ITEM 1 EXEC (*)

2. ✓RNDZ TOOLS connected per PGSC Usage Chart (if available) or UTILITY
 OUTLET PLUG-IN PLAN ORBIT CONFIGURATION (REF DATA FS,
 UTIL PWR)

3. Perform WINDECOM OPS – ACT (ORB OPS, PGSC)
 If WinDecom data is static:
 Perform WINDECOM OPS – TROUBLESHOOTING (ORB OPS, PGSC)
 Steps C-1 through C-5 as required to receive data
 Report status to MCC

4. Perform RPOP INITIALIZATION, 7-15
 Verify good WinDecom data to RPOP
 If “RPOP is not receiving PCMMU Data” is displayed:
 Perform RPOP not receiving PCMMU Data, 7-7
 Report status to MCC

- On MCC GO:
5. Perform TCS ACTIVATION, steps 1 and 2, 7-18

6. Perform HAND-HELD LIDAR CHECKOUT/OPS, 7-14

- On MCC GO:
7. When checkout complete, perform TCS DEACTIVATION, 7-20, then:
 Exit RPOP – [SHIFT]/[F10], then:
 HHL PWR SW – OFF, then:
 Temp stow Rndz Tools as reqd

8. GNC 33 REL NAV
 RNDZ NAV ENA – ITEM 1 EXEC (no *)

RNDZ TOOLS TROUBLESHOOTING

Notify MCC of problem, verify the configuration, then perform each step from the appropriate procedure, one at a time, until functionality restored. Inform MCC of the status after each step

The objective of these actions is to quickly return functionality to a minimum TRAD system (one RPOP with PCMMU data via serial RS422 data) and minimize time spent trying to recover the Network/Telemetry Server or determine the root cause of the problem

Troubleshooting steps assume RPOP is configured to receive PCMMU data via the network with Telemetry Server, but the RS-422 data cables are connected as a backup

INITIAL CONFIGURATION

Verify the current configuration before contacting MCC (and inform MCC of the status)

COMM Port Config:

On RPOP: Config [CNTL]/[F10] > Comm Ports

Config	Com1	Com2	Com3	Com4	DLL
TIm Server	HHL	None	None	None	PCMMU TCS
Serial	HHL	None	None	PCMMU	TCS

On TCS CADS: Config > Comm Port > COM2 (√)

WinDecom

TFL Correct per (ORB OPS FS, COMM/INST)

Telemetry Monitor

Status and Packet data not backlit yellow or red

Telemetry Tab > Stream > "STSXXX-rt gnc"

Status = OK

Packet 40 Present (may need to scroll down)

Telemetry Server (status icon in Windows system tray)

Verify green (GO) indicator displayed

TROUBLESHOOTING

Each step below is an independent troubleshooting attempt. Inform MCC the status after each step. These may repeat some of the steps from the INITIAL CONFIGURATION section

A. TCS CADS not receiving TCS data

NOTE: Assumes TCS ACTIVATION has been completed successfully

NOTE: If problem on Backup RPOP PGSC, continue use of Prime RPOP PGSC (do not alter config of Prime RPOP PGSC or TCS unit)

- A1. If TCS MODE = Acq and reflector out of field-of-view >>
- A2. ✓TX/RX end of TCS cable securely connected to Prime RPOP PGSC Quatech card COM2 (A)
✓RX end of TCS cable securely connected to Backup RPOP PGSC Quatech card COM2 (A)
✓PDIP PORT end of TCS cable connected to PDIP J101 port
If serial extension cables in use, verify all connections are secure
- A3. If TCS CAD "Error Reading from Device" message (Quatech card problem)
If on Prime RPOP PGSC:
 | TCS PWR – OFF (tb-bp)
 | Perform RPOP PGSC Reboot, 7-9
 | Perform TCS ACTIVATION, 7-18 steps 1–3 (expect "Auto Seed" message)
If on B/U RPOP PGSC:
 | If time permits, check connections (Quatech card and serial cable)
 | If serial cable unplugged – reconnect cable
 | If Quatech card unseated: Perform RPOP PGSC Reboot, 7-9
 | Perform TCS ACTIVATION 7-18, step 1 and 3
 | (expect "Auto Seed message")
If TCS status information restored:
 | If reqd, perform RPOP INITIALIZATION, 7-15
 | perform RPOP OPS, 7-16
 | If Prime RPOP PGSC, perform TCS ACTIVATION, 7-18, step 4 >>
If TCS data not restored, inform MCC
- A4. Perform TCS CADS software restart (per the following sequence):
 | If problem on Prime RPOP PGSC, TCS PWR – OFF (tb-bp)
 | TCS CADS: File > Exit TCS CAD
 | Perform TCS ACTIVATION, 7-18 (if backup RPOP, step 1 and 3 only)
- A5. Remove and replace TCS cable (including serial extension cables, if applicable) and Quatech card (per the following sequence):
 | If problem on Prime RPOP PGSC, TCS PWR – OFF (tb-bp)
 | Shut down suspect PGSC
 | Install backup TCS cable and Quatech card
 | Disconnect PCMMU data cables
 | Verify TX/RX end of TCS cable connected to Quatech card COM2
 | Perform RPOP PGSC Reboot, 7-9
 | Perform RPOP INITIALIZATION, 7-15
 | Perform RPOP OPS, 7-16
 | Perform TCS ACTIVATION, 7-18 (if backup RPOP, step 1 and 3 only)
If TCS data not restored, inform MCC
- A6. ✓MCC for steps in RNDZ TOOLS CONFIGURATION STATUS, 7-10

Cont next page

B. RPOP not receiving PCMMU data

If either RPOP PGSC is receiving good PCMMU data, the WinDecom PGSC is NOT the source of the problem. Start on step B2

- B1. On WinDecom PGSC, verify WinDecom receiving dynamic data
If WinDecom data is static,
√PCMMU cable connection to Panel O5 (port as reqd) and WinDecom PGSC
If WinDecom data active and RPOP not receiving PCMMU Data:
Reboot WinDecom PGSC and restart WinDecom – Prime

NOTE

Perform steps B2 thru B5 for both Prime and/or Backup RPOP PGSC

- B2. Verify Telemetry Server status indicator in the Windows system tray
If red (STOP) indicator:
Double left click the red (STOP) indicator to open Telemetry Server window
If “Not Connected to WinDecom” displayed:
Check wireless card or network cable and reconnect if required
> File > Reset Server
Wait 30 seconds, then reassess PCMMU data to RPOP
If yellow (TFL) indicator: Contact MCC >>
If green (GO) indicator:
Shut down any other programs running on that PGSC (except TSC CADS), then
Double left click the green (GO) indicator to open Telemetry Server window
> View > Applications Using The Server
Verify RPOP is the only application listed
- B3. On RPOP, verify configuration for PCMMU data
Config [CNTL]/[F10] > [Comm Ports...]
Under DLL, verify that PCMMU is selected
Verify “PCM” mode selected – status displayed above F6 in Function Key Menu
If “No PCM” displayed,
Select PCM mode with [CNTL]/[F6]
TCS Data [CNTL] / [F3] > Select “NAV (filtered)”
- B4. Verify correct end of RS-422 Y-cable connections to Quatech card COM4 (B) lead
Prime RPOP PGSC: TX/RX
B/U RPOP PGSC: RX
WinDecom PGSC: SRC
If serial extension cables in use, verify all connections
- B5. Configure RPOP ports for serial data:
Config [CNTL]/[F10] > [Comm Ports...]
Under COM4, select PCMMU, then “OK” both RPOP Config windows
If “Access is denied” error message received, repeat step B5.
If no joy, repeat step B5 one more time

NOTE

This terminates the Telemetry Server, so expect the status indicator in the Windows system tray to disappear

Cont next page

- B6. Verify Quatech card securely seated in the RPOP PGSC
 If connection not secure or card temporarily disconnected:
 Perform RPOP PGSC Reboot, 7-9
 Perform RPOP INITIALIZATION, 7-15
 Perform step B5 to configure RPOP for serial port
 If PCMMU data recovered:
 Perform RPOP OPS, 7-16
 If Prime RPOP: Perform TCS ACTIVATION, 7-18 (all steps) >>
 If B/U RPOP: Perform TCS ACTIVATION, 7-18, step 1 and 3 only >>
- B7. Remove and replace RS-422 PCMMU serial cable (including serial extension cables, if applicable) and Quatech card (per the following sequence):
 If Prime RPOP PGSC:
 Perform RPOP PGSC Reboot, 7-9 (install new card/cable at step E2)
 Perform RPOP INITIALIZATION, 7-15
 Perform step B5 to configure RPOP for serial port
 Perform RPOP OPS, 7-16
 Perform TCS ACTIVATION, 7-18
 If B/U RPOP PGSC: inform MCC >>
 (Do not alter config of Prime RPOP PGSC if it is working)
- B8. ✓MCC for steps in RNDZ TOOLS CONFIGURATION STATUS, 7-10

C. RPOP not receiving HHL data

- C1. Verify good raw HHL data displayed on HHL unit
 C2. ✓HHL cable securely connected to HHL unit and COM1
 C3. ✓RPOP port config for HHL
 Config [CNTL]/[F10] > [Comm Ports...]
 Under COM1, verify that HHL is selected
 C4. Connect HHL cable to other RPOP PGSC (COM1 port) and check data flow
 C5. As reqd, swap to backup HHL data cable or backup HHL unit
 C6. ✓MCC for steps in RNDZ TOOLS CONFIGURATION STATUS, 7-10

D. RPOP not receiving TCS data (TCS CADS is receiving data on the same PGSC)

D1. ✓RPOP configured to receive TCS data via DLL

Config [CNTL]/[F10] > [Comm Ports...]

Under DLL, verify that TCS is selected

D2. On [RPOP], verify that RPOP is receiving PCMMU data

If RPOP not receiving PCMMU data, perform RPOP is not receiving PCMMU data, 7-7

D3: On [RPOP], reset DLL function by cycling TCS config

Config [CNTL]/[F10] > [Comm Ports...]

Under DLL, deselect TCS, then “OK” both RPOP Config windows

Config [CNTL]/[F10] > [Comm Ports...]

Under DLL, reselect TCS, then “OK” both RPOP Config windows

Wait 30 seconds, then reassess TCS data to RPOP

D4. Quit and restart RPOP:

Exit RPOP – [SHIFT]/[F10], (Expect TCS CADS “Auto seed message”) then:

Perform RPOP INITIALIZATION, 7-15

Perform RPOP OPS, 7-16

D5. Reboot RPOP PGSC and restart RPOP (per the following sequence):

Perform RPOP PGSC Reboot, 7-9 (step E2 not reqd)

Perform RPOP INITIALIZATION, 7-15

Perform RPOP OPS, 7-16

Perform TCS ACTIVATION, 7-18

D6. ✓MCC for steps in RNDZ TOOLS CONFIGURATION STATUS, 7-10

E. RPOP PGSC Reboot

E1. Shut down/power off PGSC

E2. Eject and reseal Quatech card

E3. Disconnect serial data cables from Quatech card

E4. Reboot PGSC

When “Time-Vector Server” finished (in Windows task bar)

E5. Reconnect serial data cables

RNDZ TOOLS CONFIGURATION STATUS

On MCC request, provide the answers to the following questions:

RPOP (answer for all suspect RPOP PGSCs)

1	Which PGSC is being used?	1.
2	Which version of RPOP (per RPOP title bar)? (On request, report the exact location of the RPOP icon)	2.
3	COM1 port (on PGSC aft) a. Report associated cable label b. Cable securely connected?	3a. 3b.
4	COM4 port (on Quatech card, B leg) a. Report associated cable label b. Cable securely connected? c. Grey box installed in proper orientation? d. If serial cable extension in use, verify 4a and 4b at extension cable interface	4a. 4b. 4c. 4d.
5	Network a. Network card securely intalled in PGSC? b. Cable securely connected? c. Verify secure network cable connections between WinDecom and RPOP PGSCs (and/or wireless router) d. If wireless network, report wireless router status.	5a. 5b. 5c. 5d.
6	Check Quatech card status a. Start > Settings > Control Panel > Administrative Tools > Computer Management > Device Manager > Ports > Quatech PCMCIA Serial Ports (COM2 and/or COM4) b. Quatech card securely installed in PGSC? c. Verify correct orientation of card(s), i.e., right side up	6a. 6b. 6c.
7	RPOP > Config (CNTL/F10) > Comm Ports: report config a. COM1, COM2, COM3, COM4 b. DLL	7a. 7b.
8	PCMMU data to RPOP a. Red error message "RPOP not receiving PCMMU data" displayed? b. Is there active data on SV (F1) or Radar (F2)? (check for "Prop Age" updates in upper-left corner of display) c. What is displayed above F6 in the Function Key Menu? ("PCM" or "No PCM")	8a. 8b. 8c.
9	TCS data to RPOP (if applicable) a. Red error message "RPOP not receiving TCS data" displayed? b. Is there active data on TCS (F3)? (check for "Prop Age" updates in upper-left corner of TCS(F3) display) c. What is displayed above F3 in the Function Key Menu? (TCS NAV, TCS AUTO, TCS MAN, NONE)	9a. 9b. 9c.
10	HHL data to RPOP (if applicable) a. When taking an HHL marks, does "Prop Age" update? (RPOP > HHL(F4), upper-left corner of display) b. When taking an HHL marks, does HHL data "Age" update? (RPOP > Rdot window (F5)) c. Does RPOP request orbiter attitude with each mark? (If not, is attitude override box checked on SHIFT/F5?)	10a 10b. 10c.
11	Any unusual messages (popup windows, state vector messages, etc)?	11.
12-20	Reserved	

Cont next page

TCS (answer for all suspect RPOP PGSCs)

21	Which PGSC is being used?	21.
22	Which version of TCS CADS (per Help > About TCS CAD...)? (On request, report the exact location of the CADS icon)	22.
23	COM2 port a. Report associated cable label b. Cable securely connected? c. Grey box installed in proper orientation?	23a. 23b. 23c.
24	PDIP panel a. Report associated cable label b. Report associated PDIP port c. Cable securely connected?	24a. 24b. 24c.
25	Check Quatech card status a. Start > Settings > Control Panel > Administrative Tools > Computer Management > Device Manager > Ports > Quatech PCMCIA Serial Ports (COM2 and/or COM4) b. Quatech card securely installed in PGSC? c. Verify correct orientation of card(s), i.e., right side up	25a. 25b. 25c.
26	TCS OPS window a. Report Mode status (Acq, Stby, blank) b. Report Data status (Good or Bad) c. Report hardware status d. Report messages in message box e. If self-test failed, click "Self-Test" button and report status (Shutter, Z-Latch, CW laser, Pulse laser) f. If TCS CADS processing TCS data (active Range, Rdot, etc.), does the data appear stable and reasonable? g. If TCS CADS processing TCS data (active Range, Rdot, etc.), is the data being received by RPOP?	26a. 26b. 26c. Shutter _____ Z-Latch _____ CW _____ CW Pwr _____ Pulse _____ Seed Rng _____ Temp _____ Cal _____ Volts _____ Self Tst _____ 26d. 26e. 26f. 26g.
27	TCS C&DI (menus) a. Macros > report macros available (not greyed out) b. Commands > report cmds available (not greyed out) c. Override > report any selected items d. Config > Com Port > report current config	27a. 27b. 27c. 27d.
28	Was TCS CADS started before TCS was powered on?	28.
29-40	Reserved	

HHL (answer for all suspect RPOP PGSCs)

41	HHL unit unresponsive? a. Report power status -- switch ON, battery connected? If no power, have you tried alternate batteries? b. Did you adjust the display brightness?	41a. 41b.
42	HHL marks unsuccessful a. Did you try "test" mode? If so, what were the results? b. Have you tried taking test marks on alternate targets?	42a. 42b.
43	HHL marks successful, but no transfer to PGSC a. Which PGSC is being used? b. Verify cable securely connected on HHL unit c. Check COM port config -- refer to question 7	43a. 43b. 43c.
44- 60	Reserved	

WinDecom

61	Which PGSC is being used?	61.
62	Which version of WinDecom was launched? (WinDecom-Prime, WinDecom-RMS, or WinDecom-FCMS)?	62.
63	COM4 port a. Report associated cable label b. Cable securely connected? c. Grey box installed in proper orientation?	63a. 63b. 63c.
64	Network a. Network card securely intalled in PGSC? b. Cable securely connected? c. Verify secure network cable connections between WinDecom and RPOP PGSCs (and/or wireless router) d. If wireless network, report wireless router status	64a. 64b. 64c. 64d.
65	Check Quatech card status a. Start > Settings > Control Panel > Administrative Tools > Computer Management > Device Manager > Ports > Quatech PCMCIA Seria Ports (COM2 and/or COM4) b. Verify correct orientation of card(s), i.e., right side up	65a. 65b.
66	Is WinDecom processing data a. Report GNC packet status (any yellow or red backlight?) b. Verify packet (PKT) 40 data is processing	66a. 66b.
67- 80	Reserved	

Telemetry Server (answer for all suspect RPOP PGSCs)

81	Which PGSC is being used?	81.
82	What indicator is shown in the system tray? (red "stop" sign, green "go" light, etc) ** Double left click this icon to open Telemetry Server window	82.
83	Which version of Telemetry Server (window title bar)	83.
84	What message is being displayed? (e.g., green highlight "Receiving serial data from...")	84.
85	Report packets being processed (main TImSrvr window)	85.
86	View > Applications Using the Server -- report results	86.
87	Source > report current config (Serial Windecom; Networked Windecom; Networked ISP)	87.
88	If Serial Windecom: a. Port -- report current config (COM1 thru COM7) b. Baud -- report current config (9600, 19200, 38400)	88a. 88b.
89	Report any other messages	89.
90	Did you attempt a "File > Reset Server"?	90.

HAND-HELD LIDAR CHECKOUT/OPS

1. Unstow HHL, Battery Pack(s), and RS-232 cable

Connect RS-232 cable from HHL to PGSC

Plug Battery Pack into HHL

Display Intensity knob – Adjust intensity to minimum acceptable level

Verify RPOP program enabled per RPOP INITIALIZATION, 7-15

2. Power sw – ON

NOTE

If msg 'LoB' or flashing 8888 on display or irregular tone emitted, replace battery

3. Take multiple (~10) Range and Velocity measurements using top center of aft PLB bulkhead or S0 Truss Segment as TGT
Select Range or Velocity decimal place by toggling RANGE/VELOCITY buttons
Range pb – 1 ft or 0.1 ft
Velocity pb – 0.1 fps or 0.01 fps

√HHL data received by RPOP (HHL trajectory source must be selected)

Range check:

√Range from aft port window to bulkhead = 60 ft
or

√Range from overhead window to S0 Truss Segment = ~44 ft

Velocity check:

Depress trigger for 5 sec

√Velocity = 0.0 fps

Report range and velocity discrepancies to MCC

Self-Test: Press and hold Test Mode button, √8.8.8.8. Select range

HAND-HELD LIDAR STOW

Power sw – OFF

Remove RS-232 cable

Unplug Battery Pack

Stow HHL, Battery Pack(s), and RS-232 cable

RPOP INITIALIZATION

1. Power on RPOP/TCS PGSCs
√Data, power cables installed per PGSC Usage Chart (if available) or UTILITY OUTLET PLUG-IN PLAN, ON-ORBIT CONFIG (REF DATA FS, UTIL PWR)
2. Select Shuttle Apps Icon
Select RPOP folder
Select appropriate RPOP icon
3. Enter current MET:
Days>____/Hrs>____:Min>____:Sec>____

Click [OK] to continue

NOTE

Time synchronized on [OK]

4. √RPOP window title bar – verify mission-specific scenario
√MET correct (upper right corner of trajectory display)
5. √PCM selected – status displayed above F6 in Function Key Menu
If “No PCM” displayed, select PCM mode with [CNTL]/[F6]
√RPOP is receiving PCMMU data
If RPOP not receiving PCMMU data,
“RPOP is not receiving PCMMU data” message on display
Inform MCC and refer to RNDZ TOOLS TROUBLESHOOTING, 7-5

NOTE

If no target state vector on board, expect error message
If RNDZ NAV not enabled, expect bad relative state

RPOP OPS

1. Select desired trajectory/sensor data as needed (F1 thru F4 keys)
Reference TRAD FAIL RANGE AND RANGE RATE DETERMINATION, 7-21, for recommended RPOP and TRAD configuration
2. Configure HHL settings
[CNTL]/[F4] [HHL]
√Appropriate aimpoint configuration per table

	HHL Aim Point	Angle Source	Angle Aim Point
Manual phase	Tgt CG	Dock Cam	Tgt CG
+Vbar	Node2-Fwd/Top	Dock Cam	C/L Target
Flyaround	As appropriate		

Configure Vert(deg) and Horiz(deg) angles to 0 deg

Lock Vert(deg) and Horiz(deg) angles (click box below input field)

NOTE: User may unlock angles and input angle data if desired

Click [Update Settings] button to close [HHL] window

3. Use [F5] to display/hide [Rdot] window
Click [sources] button to select/deselect additional data sources
NOTE: Nominal configuration is to display “HHL/dt” and “HHLRaw”
4. Adjust configuration as required
Use [SHIFT]/[F1] thru [SHIFT]/[F4] to show/hide trajectory plots
NOTE: Cannot hide currently selected trajectory/sensor
Use [CNTL]/[F8] to cycle through Points of Reference (POR)
Use [F11] to cycle thru declutter levels
Use [F12] to snap a range ruler mark; [SHIFT]/[F12] to delete it
Use [SPACEBAR] to toggle on-screen Function Key Menu ON/OFF
Move axes or zoom in/out per RPOP KEYSTROKE SUMMARY, 7-25
For other options, reference RPOP FUNCTION KEY SUMMARY, 7-22

NOTE

Display of some data input windows (such as [CNTL]/[F4] [HHL]) prevents background sensor processing (e.g., TCS NAV). Minimize the time that these data input windows are displayed as much as practical.

Sensor processing is NOT affected by display of the [Rdot] or [THC-to-Go] windows or associated sub-windows

5. To exit RPOP program – [SHIFT]/[F10]

* Configure TCS reflectors *

* [CNTL]/[F10] RPOP Configuration *

* Select [TCS/Refl...] button Select TCS/Reflector Set *

* Select appropriate Reflector No. *

* NOTE: for a single TCS unit, TCS No. selection is irrelevant *

* Configure RPOP Guidance, if desired for approach *

* [CNTL]/[F5] Select Guidance Type *

* Select desired flight phase to start prox ops guidance sequence *

* If +Rbar Acquisition, *

* If no RPM, uncheck “with RPM” option *

* If RPM stationkeeping (SK) required, *

* Select “with SK until MET” *

* Enter RPM start window open time (per APPROACH cue card) *

* Update target attitude *

* √MCC for target attitude data *

* [SHIFT]/[F6] Enter Target Vehicle Attitude Info *

* Input appropriate reference frame and attitude (PYR Seq) *

* Pitch>____ Yaw>____ Roll>____ *

* Input appropriate attitude rate mode and rates *

* NOTE: nominal dock and undock settings are “LVLH to Tgt Body”, *

* 0 / 0 / 0 deg attitude, and “LVLH Hold” rate *

* Input subtended angle data *

* [F5] Rdot *

* Click [sources] button, then select “SubAng” option *

* Click [SubAng] button or [F6] to open data input window *

* NOTE: timetag is recorded when [SubAng] or [F6] button is clicked *

* Input appropriate structural element and angle (measured via COAS or *

* CCTV with SUB ANG RULER overlay) *

* Click [OK] to incorporate mark, or [Back 1] to delete previous mark *

* Configure comm ports *

* [CNTL]/[F10] RPOP Configuration *

* Select [Comm Ports...] button RPOP Communications Setup *

* Configure com ports and DLL *

* NOTE: TCS source must be set to DLL *

* HHL source must be set to COM1 *

* PCMMU source if TLMServer (network or serial) is DLL *

* PCMMU source if no TLMServer (serial) is COM4 *

* For assistance with other options, √MCC, [F10] Help, or RPOP FUNCTION *

* KEY SUMMARY, 7-22 *

TCS ACTIVATION

1. CADS BOOTUP
- PGSC √RPOP/TCS PGSC powered ON
√Data cables installed per PGSC Usage Chart (if available) or UTILITY OUTLET PLUG-IN PLAN ORBIT CONFIGURATION (REF DATA FS, UTIL PWR)

SHUTTLE APPS
> RPOP > TCS_CADS

- L12 2. TCS PWRUP/INITIALIZATION
TCS PWR – ON (tb-gray)

- * If tb – bp, cycle sw *
- * Verify Pnl R1: AUX – ON *
- * If no joy, notify MCC *

PGSC

TCS Self Test

	<u>Status</u>	<u>Override</u>
√Shutter:	Passed	Off
√Z Latch:	Passed	Off
√CW Laser:	Passed	Off
√Pulse Laser:	Passed	Off

TCS OPS

√Messages – INITIALIZATION COMPLETE

If “Initialization Complete” not received,

Record the last message received _____

Macro > Initialization

Continue when “Initialization Complete” message received

- * If error msg received during initialization, or *
- * “Initialization Complete” not received, √MCC *

TCS OPS

√Mode: Stby
√Z Latch: Unlocked
√CW: Active
√Pulse: Avail

- * If not in config, √MCC *

3. TIME REFERENCE SELECT

TCS C&DI

Commands > Send TCS Time

CAD Clock

Enter MET

[Send]

√Messages – ‘TCS Clock has been set’

4. ENABLE AUTO ACQUISITION

TCS C&DI

Config > Automatic > Acquisition

Automatic Acquisition

Update ‘Maximum Range’ for auto acquisition to begin as desired

[OK]

Inform MCC of range entered

TCS MANUAL ACQUISITION

1. ACQUIRE

PGSC

TCS OPS

√Pulse: Avail

√CW: Active

TCS C&DI

Macros > ACQUISITION

Target Acquisition Data

RANGE > current estimate of range to Target

AZIMUTH > 0

ELEVATION > 0

√95% RANGE GATE – (no X)

[Send]

TCS OPS

If first acquisition:

√Shutter – Open (after ~22 sec)

- * If shutter fails to open: *
- * Commands > Standby *
- * Commands > Open Shutter *
- * Commands > Acquire *

√Mode – Acq

√Data – Good (and active tracking data)

- * If TCS not tracking and no RPOP (or Auto Seed Update disabled), *
- * TCS C&DI *
- * Commands > Acquire *
- * Update Range estimate and zero AZ & EL *
- * [Send] *

2. ENABLE AUTO ACQUISITION

√Data – Good (and active tracking data)

TCS C&DI

Config > Automatic >

If Seed Update – (no √)

Select Seed Update

Automatic Acquisition

√Maximum Range (ft): 5000

[OK]

Config > Automatic >

If Acquisition – (no √)

Select Acquisition

Automatic Acquisition

√Maximum Range (ft): 5000

[OK]

Config > Automatic >

√Initialization – (√)

√Seed Update – (√)

√Acquisition – (√)

TCS DEACTIVATION

1. SHUTDOWN TCS

PGSC

TCS C&DI

Macros > SHUTDOWN

- * If error msg received during SHUTDOWN, *
- * √MCC *

TCS OPS

√Shutter: Closed (takes ~22 sec)

- * If shutter fails to close: *
- * Commands > Close shutter *

If Final TCS deactivation for mission:

2. SECURE Z AXIS

PGSC

TCS C&DI

Commands > Lock Z Axis Latch

TCS OPS

√Z Latch: Locked

- * If Z Latch fails to lock: *
- * If Z Latch: Transit *
- * TCS C&DI *
- * Commands > Lock Z Axis Latch *
- * Otherwise *
- * √MCC *

3. POWERDOWN TCS

L12

TCS PWR – OFF (tb-bp)

- * If tb – gray, cycle sw *
- * If no joy, notify MCC *

4. SHUTDOWN CADS

PGSC

TCS C&DI

File > Exit TCS CAD

TRAD FAIL RANGE AND RANGE RATE DETERMINATION

1. Maintain a prime and a backup range and rdot estimate from independent sensor sources
2. Maintain prime and backup RPOP PGSCs
3. Refer to table and notes below for recommended prime/backup source/configuration.

	Man Phase	TCS Lock (>3 kft)	1200 ft	800 ft	Vbar	15 ft - dock
NOMINAL	1: SV 2: HHL/dt	1: TCS NAV 2: HHL/dt				1: TCS raw 2: Rng ruler
RADAR↓	1: HHL/dt 2: SubAng	1: TCS NAV 2: HHL/dt				1: TCS raw 2: Rng ruler
HHL↓	1: SV 2: SubAng	1: TCS NAV 2: Raw radar and SubAng				1: TCS raw 2: Rng ruler
TCS↓	1: SV 2: HHL/dt		1: HHL/dt and raw radar Rdot 2: SubAng			1: Rng ruler 2: HHL raw or HHL/dt
PCMMU↓	1: G33 FLTR 2: HHL/dt or TCS-Pulse (Generic)		1: HHL/dt 2: TCS-Pulse (Generic)	1: TCS-CW 2: HHL/dt	1: TCS-CW or TCS Auto 2: HHL/dt	1: TCS raw 2: Rng ruler
PGSC↓ (No RPOP, No TCS)	1: SV, raw radar 2: HHL raw: raw range, Rdot vs $\Delta R/\Delta t$ cue card for Rdot		1: HHL raw: short pull for rng, long pull for Rdot 2: SubAng: Rdot vs $\Delta R/\Delta t$ cue card for Rdot			1: Rng ruler (table on overlay) 2: HHL raw

Nominal notes:

1. If no TCS lock by 1200 ft, start SubAng ops to backup HHL/dt inside 1000 ft.

Radar fail notes:

2. State vector data suspect.

HHL fail notes:

3. Radar data will be unusable at close ranges. The range at which the data becomes unusable is dependent on target size, geometry, and physical characteristics, but can not be accurately predicted. For ISS, the Radar can become too noisy to use at ranges as great as 1000 ft.

TCS fail notes:

4. State vector: G33 COVAR REINIT as desired.
5. Begin gradual transition to HHL/dt and SubAng at ~1500 ft.
6. HHL will not work if the aimpoint surface is closer than 12 ft (5 ft DP-DP).

Refer to Note 3 (above)

PCMMU fail notes:

7. RPOP state data, TCS NAV, and HHL FLTR are not usable without PCMMU data.
8. RPOP prompts user for orbiter attitude after first TCS/HHL mark. Enter P/Y/R = 90/0/0 (LVLH to Orb Body) and check "Do not prompt for attitude." Orbiter attitude on RPOP will not be correct until mnvr to Vbar attitude is complete. Until Vbar arrival, do not use RPOP trajectory data other than the data in the Rdot window.
9. TCS pulse laser Rdot may be noisy (range OK). Can manually enter raw TCS range marks into 'Generic' on the RPOP Rdot window to calculate Rdot. Monitor TCS pulse/CW status on RPOP or TCS CADS.
10. Begin gradual transition to HHL/dt and TCS raw at ~1500 ft.
11. For TCS AUTO [CNTL/F3], set orbiter attitude [SHIFT/F5] P/Y/R = 90/0/0 (LVLH to Orb Body) and set TCS data frequency to 30 sec [CNTL/F10].

PGSC fail notes:

Refer to note 6 (above).

RNDZ TOOLS REFERENCE DATA

RPOP FUNCTION KEY SUMMARY

RPOP TRAJECTORY DATA KEYS (Columns F1 → F4)

- [F1→F4]** PRIME KEY
(SV, RR, HHL, CCTV or TCS)
Make this Trajectory Prime Trajectory
- Only one trajectory can be Prime at a time
 - Prime Trajectory has orbiter graphics, predictors, and color-coordinated digital data
- [SHIFT]/[F1→F4]** SHOW/HIDE KEY
(Show/Hide)
Show or Hide this Trajectory (toggle)
- Prime Trajectory cannot be hidden
 - Background processing of trajectory continues even when hidden
(Exception: HHL trajectory data will not prompt for user input when hidden)
- [CTRL]/[F1→F4]** DATA KEY
(Data)
Configure/input data for trajectory
- Allows user to configure specific Trajectory Data Source Options
 - Allows user to input manual data
 - Allows user to reconfigure function key to another Trajectory Data Source
 - Duplicate Trajectory Data Source configurations are permitted (e.g., HHL could be configured for both F3 and F4, if desired)

NOTE

Although duplicate data source configurations are permitted, duplicate automatic data modes (namely, State Vector, RR Auto, TCS Auto and TCS Nav) are not permitted. In such a situation, duplicated auto mode option grayed out in Trajectory Data Source Options dialog box

RPOP GENERAL FUNCTION KEYS (Columns F5 → F12)

[F5] (Rdot)	RDOT WINDOW Toggles display of Rdot Window
[SHIFT]/[F5] (Orb Att)	ORBITER ATTITUDE Update orbiter attitude and attitude rate
[CTRL]/[F5] (Guid)	GUIDANCE Select guidance cues on demand Available options are: +Rbar acquisition – provides THC recommendataions for acquiring the +Rbar. Includes options for targeting pre-TORVA conditions, pre-RPM conditions, or a pre-RPM stationkeep. TORVA – provides THC recommendations for performing the +Rbar to +Vbar transfer +Vbar Acquisition – provides THC recommendations for acquiring the +Vbar in preparation for final approach Glideslope Approach – provides THC recommendations for flying the final approach along a glideslope CW Targeting – given a burn time, transfer time, and desired LVLH position, CW Targeting will provide required THC inputs LVLH Velocity Null – provides THC recommendations for nulling LVLH velocities in each direction Average Rdot – information for timed approach
[F6] (Sub Ang)	SUBTENDED ANGLE Enter subtended angle in Rdot Window to get range and range rate. Only active when SubAng source active on Rdot Window
[SHIFT]/[F6] (Tgt Att)	TARGET ATTITUDE Update Target attitude and attitude rate
[CTRL]/[F6] (PCMMU)	PCMMU MODE No PCM mode (displays No PCM) Requires orbiter attitude data to be entered manually with each sensor mark PCM MODE (displays PCM) Orbiter attitude is automatically computed using PCMMU data
[F7] (View)	VIEW If Tgt-Centered LVLH, cycle through views: XZ, XY, YZ If Orb-Centered LVLH, cycle through views: XZ, XY, YZ, CAM View identification displayed upper left-hand corner of Trajectory Display
[SHIFT]/[F7] (Ovrlay)	OVERLAY Cycle through displays of overlays
[F8] (Tgt/Orb)	REFERENCE FRAME Toggle display between Tgt-Centered LVLH plot and Orb-Centered LVLH plot
[SHIFT]/[F8] (Low Z)	LO Z Toggle jet-select between No Low Z and Low Z for making THC “What If” inputs. Displays Low Z
[CTRL]/[F8] (POR)	POINT OF REFERENCE Cycle through preselected orbiter Point-Of-Reference to Target Point-Of-Reference sets (e.g., CG to CG, Dock Port to Dock Port)
[F9]	THC CLEAR

Cont next page

(THC Clr)	Clear THC “What if” inputs from the Prime Trajectory
[SHIFT]/[F9] (TrajClr)	TRAJECTORY CLEAR Clear Prime Trajectory history of all but 2 most recent data inputs
[CTRL]/[F9] (Back 1)	BACK 1 Delete last data input from the Prime Trajectory

[F10] (Help)	HELP Access on-line help information
[SHIFT]/[F10] (Exit)	EXIT Save output files and exit RPOP program
[CTRL]/[F10] (Config)	RPOP CONFIGURATION Configure following RPOP options: <u>Debug</u> Enable serial port I/O debug text to be displayed. Displays Debug <u>Data Freq...</u> Change frequency of automatic acceptance (plotting) of PCM data (SV or RR Auto) or TCS data (TCS Auto) <u>Predictors...</u> Change number and/or time increment of displayed predictors <u>Update MET...</u> Change the mission elapsed time <u>Altitude...</u> Change altitude of target vehicle <u>Comm Ports...</u> Reconfigure serial ports and/or the DLL <u>TCS/Refl...</u> Select TCS ID number (1-2) and reflector ID number (1-15) <u>Views...</u> Enable/disable Tgt- and Orb-Centered views

NOTE
Currently displayed view (both Tgt- and Orb-Centered) cannot be disabled

	<u>THC “What if”...</u> Select DAP setting (trans pulse size) to be used for THC “What if” inputs Options include: Rndz DAP, Prox Ops DAP, and a User-Configurable DAP
--	--

RPOP GENERAL FUNCTION KEYS (Columns F5 → F12) (Cont)

[F11]	DECLUTTER Cycle RPOPs display through three different levels of declutter
[F12]	RANGE RULER SNAP Computes range rate based on time between snaps and assumed delta range interval. Feature available only if I-loaded delta range interval has non zero value
[SHIFT]/[F12]	RANGE RULER CLEAR Clears range ruler display from screen. Feature available only if I-loaded delta range interval has non zero value

RPOP KEYSTROKE SUMMARY

[CTRL]/[←] or l	Move Vertical axis left
[CTRL]/[→] or r	Move Vertical axis right
[CTRL]/[↑] or u	Move Horizontal axis up
[CTRL]/[↓] or d	Move Horizontal axis down
[CTRL]/[PGUP]	Zoom IN on Trajectory Display
[CTRL]/[X]/[PGUP]	Zoom IN on X axis only
[CTRL]/[Y]/[PGUP]	Zoom IN on Y axis only
[CTRL]/[Z]/[PGUP]	Zoom IN on Z axis only
[CTRL]/[PGDN]	Zoom OUT on Trajectory Display
[CTRL]/[X]/[PGDN]	Zoom OUT on X axis only
[CTRL]/[Y]/[PGDN]	Zoom OUT on Y axis only
[CTRL]/[Z]/[PGDN]	Zoom OUT on Z axis only

NOTE

Use [SHIFT] in combination with any of above keystrokes in order to scale/move axes in finer increments. Each view may be independently scaled and/or autoscaled

[CTRL]/[HOME]	Resume autoscaling and reset scale
[SPACEBAR]	Toggle on-screen Function Key Menu ON/OFF

THC “What if” (-Z sense) Keystrokes (Prime Trajectory only)

	<u>DAP A8</u>	<u>DAP B8</u>
Z IN	[SHIFT]/[→]	[→]
Z OUT	[SHIFT]/[←]	[←]
X UP	[SHIFT]/[↑]	[↑]
X DOWN	[SHIFT]/[↓]	[↓]

RPOP TRAJECTORY DATA SOURCE OPTIONS

SV STATE VECTOR
Options include:
State Vector – Enable automatic acceptance of the Onboard Nav states
None – Turn State Vector processing off
Config... – Reconfigure Trajectory Data Source for this function key

RR RENDEZVOUS RADAR
Options include:
Manual – Manually enter Radar RNG, EL and AZ
Auto – Enable automatic acceptance of Radar RNG, EL and AZ
None – Turn Radar processing off
Config... – Reconfigure the Trajectory Data Source for this function key

HHL HANDHELD LASER
Manually select HHL Aim Point, Angle Source, and Angle Source Aim Point
Manually enter HHL RNG and two Angle Source angles (an in-plane and out-of-plane)

Options include:
Lock – Hold the in-plane angle constant (locked) for each HHL mark
Lock – Hold the out-of-plane angle constant (locked) for each HHL mark
Uppdate Settings – Accept configuration changes to Aim Points, Angle Source, and Lock option without incorporating a trajectory mark
Config... – Reconfigure the Trajectory Data Source for this function key

Angle Source options include:
Fwd CCTV, Aft CCTV, Dock Cam, COAS, Radar, TCS, *Other*

NOTE

Manual inputs reqd for all angle sources except Radar and TCS. If Radar or TCS selected, angles will be automatically snapped (if available). *Other* camera is *optional*, and may be completely specified via I-load

Aim Point options include:
HHL Aim Pt, Tgt CG, *Point of Interest #1, Point of Interest #2, Point of Interest #3*

NOTE

HHL Aim Pt is always available and may be completely specified via I-load. Tgt CG is always available *Points of Interest 1-3* are *optional*, and may be completely specified via I-load. For Angle Source Radar, angle aim point is Tgt CG. For Angle Source TCS, angle aim point is current reflector number

CCTV CLOSED CIRCUIT TELEVISION CAMERAS
Manually enter FWD and AFT CCTV tilt angles
Options include:
Config... – Reconfigure Trajectory Data Source for this function key

Cont next page

TCS

TRAJECTORY CONTROL SENSOR

Options include:

Manual – Manually enter TCS RNG, EL and AZ

Auto – Enable automatic acceptance of TCS RNG, EL and AZ

Nav – Enable TCS NAV (Kalman Filtering)

Display Resids and Ratios

Force Measurements

Re-Initialize on [OK]

None – Turn TCS processing off

Config – Reconfigure the Trajectory Data Source for this function key

HHL REF DATA

Velocity accuracy increases with trigger hold duration:

<u>Duration</u>	<u>Accuracy</u>
0.5s	±0.15 fps
1.0s	±0.06 fps
2.0s	±0.03 fps
5.0s	±0.01 fps

To verify lock-on (if desired):

1. Push Test Mode button
2. Center red dot on TGT
3. Depress and hold trigger. Pitch on tone proportional to received signal strength
4. Press Range or Velocity button to return to Operational Mode

Error Codes:

- E01 Never acquired target because target out of range or target too close
- E02 Excessive percentage of total laser pulses in measurement sample unsatisfactory
- E03 Excessive number of consecutive laser pulses in measurement sample unsatisfactory

TCS LIMIT DATA

TEMPERATURE (degC)	LOW ALERT	HIGH	
		ALERT	AUTOSAFE
CW Laser	-40.0	45.0	50.0
APD	-40.0	65.0	70.0
CPU	-40.0	80.0	85.0
DC Power	-40.0	80.0	85.0
Galvos	-40.0	80.0	85.0

VOLTAGES	LOW ALERT	HIGH ALERT
5V	4.75	5.25
5.5V	5.00	6.00
12V	11.00	12.75
15V	14.25	15.50

CUE CARD CONFIGURATION

RCS BURN (+X, -X, Multi-axis) (Front).....	CC 8-3
RENDEZVOUS PRPLT PAD (Back).....	CC 8-4
KU OPS (Front).....	CC 8-5
(Back).....	CC 8-6
HST RBAR APPROACH (Front).....	CC 8-7
(Back).....	CC 8-8
HST CONTINGENCY INRTL APPROACH (Front).....	CC 8-9
(Back).....	CC 8-10
HST BREAKOUT FLOWCHART (Front)	CC 8-11
TOOL-CHASING (Back)	CC 8-12
NOMINAL RADAR ANGLES AND CAMERA ANGLES RANGING CHART (Front)	CC 8-13
(Back).....	CC 8-14
GPC/MDM FAILURE RESPONSE DURING RNDZ (Front).....	CC 8-15
RNDZ REF DATA (Back).....	CC 8-16
C/L CAMERA CORRIDOR AND ALIGNMENT	CC 8-17
A31P PGSC DISPLAY OF C/L CAMERA CORRIDOR AND ALIGNMENT.....	CC 8-18
SUB ANG RULER.....	CC 8-19

CUE CARD
CONFIG

This Page Intentionally Blank

HOOK
VELCRO

HOOK
VELCRO

RNDZ-1a/125/O/A

RCS BURN (+X, -X, Multi-axis)

1. GNC, OPS 202 PRO

GNC ORBIT MNVR EXEC

 - √RCS SEL, ITEM 4 – (*)
2. If onboard computed burn:
 - √TIG and TGT PEG 7 ΔVs per Final solution
 - √Guidance option is LAMBERT
 If ground computed burn:
 - √TGT data per Burn Pad (reload WT as reqd)
 LOAD – ITEM 22 EXEC
 TIMER – ITEM 23 EXEC
3. If +X burn:
 - DAP: A/AUTO/ALT(B/ALT as reqd)
 - MNVR – ITEM 27 EXEC (*)
 - If RR ops:
 - KU – AUTO TRK

GNC 33 REL NAV

 - INH Angles – ITEM 24 EXEC (*)

TIG-0:30

4. FLT CNTLR PWR – ON
 DAP TRANS: as reqd
 If Multi-axis:
 - DAP: A/AUTO/PRI
 If +X or -X:
 - DAP: A/INRTL/PRI

TIG

5. If VGO Z is neg, Z,X,Y seq;
 otherwise, X,Y,Z
 THC: Trim VGOs < 0.2 fps
 FLT CNTLR PWR – OFF
 DAP: ALT
 DAP TRANS: PULSE/PULSE/PULSE
 GNC, OPS 201 PRO
6. If +X burn:
 - DAP: A/AUTO(B/AUTO/ALT as reqd)
 - If RR ops, when ATT ERR < 30 deg:
 - KU – GPC
 - √KU TRACK tb – gray

GNC 33 REL NAV

 - AUTO Angles – ITEM 23 EXEC (*)
7. When in attitude:
 - DAP: A/AUTO/VERN(ALT)

TOP, BACK OF 'RCS BURN (+X, -X, Multi-axis)'

HOOK
VELCRO

HOOK
VELCRO

RENDEZVOUS PRPLT PAD

When L or R RCS QTY < :

I'CNCT: OMS to RCS (ORB PKT, RCS)

When G23 OMS/RCS QTY > :

I'CNCT TK SWITCH: (ORB PKT, RCS)

When G23 OMS/RCS QTY > :

I'CNCT RETURN (ORB PKT, RCS)

When L or R RCS QTY < :

or when FRCS QTY < :

DAP: NO LO Z

When L or R RCS QTY < :

or when FRCS QTY < :

If prior to Ti,

Do not perform Ti

If after Ti, but prior to 500 ft:

Perform RNDZ BREAKOUT (CONTINGENCY OPERATIONS), 5-16

If after 500 ft, but prior to INRTL ALIGNMENT

FLYAROUND:

Perform HST RBAR BREAKOUT (CONTINGENCY OPERATIONS), 5-13

If after INRTL ALIGNMENT FLYAROUND, but prior to 30 ft:

Perform HST FLYAROUND/LOSS OF LO Z BREAKOUT (CONTINGENCY OPERATIONS), 5-14

If inside 30 ft:

Back out to 30 ft

Perform HST FLYAROUND/LOSS OF LO Z BREAKOUT (CONTINENCY OPERATIONS), 5-14

RNDZ-1b/125/O/A

(reduced copy)

KU OPS

HOOK
VELCRO

1. CONFIGURE KU FOR RR TGT ACQ

GNC 33 REL NAV

CRT √SV SEL, ITEM 4 – FLTR
 √INH RNG, ITEM 18 – (*)
 RDOT, ITEM 21 – (*)
 Angles, ITEM 24 – (*)

A2 KU ANT ENA – ITEM 2 EXEC (*)
 GNC I/O RESET

A1U DIGI-DIS sel – R/RDOT
 KU PWR – STBY
 MODE – RDR PASSIVE
 √RDR OUTPUT – HI
 CNTL – PNL (wait 3 sec)
 PWR – ON

KU SEL – GPC >>

2. AUTO TRK ACQ

KU SEL – AUTO TRK
 SLEW – as reqd (as seen in COAS)
 √EL, AZ angles < 30 deg
 KU SEARCH – SEARCH (tb-gray)
 Repeat slew and search as reqd
 If acquisition not successful, √MCC >>

3. RR NAVIGATION

GNC 33 REL NAV

CRT √RADAR, ITEM 13 – (*)

* If RATIO > 1.0: *
 * √MCC *
 * *

FLTR TO PROP – ITEM 8 EXEC (*)
 AUT RNG – ITEM 17 EXEC (*)
 RDOT – ITEM 20 EXEC (*)
 Angles – ITEM 23 EXEC (*) >>

4. CONFIGURE KU FOR COMM

GNC 33 REL NAV

CRT INH RNG – ITEM 18 (*)
 RDOT – ITEM 21 (*)
 Angles – ITEM 24 (*)
 KU ANT ENA – ITEM 2 (no *)

A1U KU PWR – STBY
 MODE – COMM
 √sel – GPC
 CNTL – CMD

A2 DIGI-DIS sel – EL/AZ

HOOK
VELCRO

RNDZ-2a/125/O/A

TOP
BACK OF 'KU OPS'

HOOK
VELCRO



HOOK
VELCRO

RNDZ-2b/125/O/A



(reduced copy)

CC 8-6

RNDZ/125/FIN

HOOK
VELCRO

HST RBAR APPROACH

RNDZ-3a/125/O/D

RNG	RDOT	MC2 ET h:mm:ss	DAP	COMMENTS	MCC
BRAKING GATES			A8/B8 AUTO/VERN (PRI)	If RDOT falls below value for next gate, THC: -Z (in) as reqd to maintain RDOT	
2000	-3.0	0:27:00			
1700	-2.6	0:29:00			
1500	-2.3	0:30:00	LO Z		
1000	-1.5	0:34:30		A1L S-BD PL XMTR PWR – LO	PI to PWR – LO
800	↓			A1U KU OUTPUT – LO	
600	-0.8	0:40:30	A9,B9	HHL range callouts every 100 ft	UPDATE SUNPT TIMER EXP
500	-0.5	0:41:30			
400	-0.4	0:44:30			
300	-0.3	0:51:30			
200	-0.2	0:58:00		√HST in capture attitude After LGA switch, <u>HST COMM CHECK</u>	LGA switch FWD to AFT
150	-0.2	1:02:00		If HST out of attitude, perform flyaround as reqd: <u>RBAR YAW ALIGNMENT</u> or <u>MANUAL INERTIAL FLYAROUND</u> <u>ALIGNMENT</u> or <u>AUTO INERTIAL FLYAROUND</u>	
120	-0.20 ↓	1:05:00			
100	-0.1	1:07:00		CONFIGURE KU FOR COMM (Cue Card, <u>KU OPS</u>) When HST V1 axis in alignment with orbiter -Z axis DAP: A/INRTL/VERN(PRI) THC: as reqd to stabilize approach along V1 axis <u>GNC UNIV PTG</u> CNCL – ITEM 21 EXEC If capture within 5 min of HST sunpt mnvr, <u>DISABLE SUNPT TIMER</u>	
Tgt in EE camera	0.0	1:19:00		THC: +Z (OUT) TO NULL RATES Perform HST CAPTURE (PDRS OPS, <u>NOMINAL</u> <u>HST RETRIEVAL</u>), When Captured (within 30s) <u>HST TO DRIFT</u> Then <u>TERMINATE RNDZ OPS</u> Go to FLIGHT PLAN	

DISABLE SUNPT TIMER

180 MIN SUNPOINT TIMER EXPIRATION TIME:
MET = ___/___:___:___
PET = ___/___:___:___

SM 210 HST SYS
PCS SNPT DIS – ITEM 8 +9 9 EXEC
√DIS – YES

IF PCS SNPT DIS – NO
PCS SNPT DIS – ITEM 8 +9 9 EXEC

IF PCS SNPT DIS – NO
Perform PROXIMITY OPERATIONS BACKOFF
(CONT OPS), 5-12

TERMINATE RNDZ OPS

CDR A6U √FLT CNTLR PWR – OFF
MS Perform HHL STOW (RNDZ TOOLS), 7-14
EXIT RPOP – [SHIFT]/[F10]
-Z COAS – OFF

PLT GNC 33 REL NAV
RNDZ NAV ENA – ITEM 1 EXEC (no *)
GNC 55 GPS STATUS
DES RCVR – ITEM 27 (no*)
GNC 22 S TRK/COAS CNTL
-Z(-Y) STAR TRK – ITEM 4(3) EXEC (*)
GNC 20 DAP CONFIG
Modify DAP A7 for SEP:
EDIT DAP A7 – ITEM 3 +7 EXEC
A VERN ROT RATE – ITEM 63 +0.2 EXEC
LOAD – ITEM 5 EXEC

If VERNs available:
O14:F Pri RJD LOGIC, DRIVER(sixteen) – OFF
O15:F RJDA 1A L2/R2 MANF DRIVER – ON
O16:F

HST COMM CHECK

SM 210 HST SYS
√TLM COUNT – incr
√RCVR 2(1) LOCK – *
√PCS MODE – NORM

* If PCS MODE – SNPT: *
* √MCC prior to 120 ft *

√PCS SNPT DIS – NO

HST TO DRIFT

SM 210 HST SYS
√TLM COUNT – incr
√RCVR 2(1) LOCK – *
PCS MODE – ITEM 7 +9 2 (9 1) EXEC (DRFT)
√PCS SNPT DIS – YES

TOP
BACK OF 'HST RBAR APPROACH'

HOOK
VELCRO

RNDZ-3b/125/O/C

AUTO INERTIAL FLYAROUND ALIGNMENT	MANUAL INERTIAL FLYAROUND ALIGNMENT TRIM
<p style="text-align: center;">NOTE</p> <p>THC as required to keep center point of payload centered in keel camera</p> <ol style="list-style-type: none"> 1. <u>Maintain Range and Range Rate:</u> R < 150 ft -.3 ft/sec < Rdot < + .3 fps 2. <u>Check Initial Config:</u> √Sense: -Z √DAP A9/B9 √DAP TRANS: PULSE/PULSE/PULSE DAP: B/INRTL/VERN (PRI) √DAP ROT: DISC/DISC/DISC 3. <u>Flyout Sequence – The Sox Sequence:</u> -Z Sense: Roll – align orbiter XZ plane with the HST V1 Pitch – align orbiter -Z with the HST V1 Roll – align orbiter camera view with end of HST Body Sense: Yaw – align orbiter XZ plane with the HST V1 Pitch – align orbiter -Z with the HST V1 Yaw – align orbiter camera view with end of HST 3a. <u>Align -Z Sense Roll (Orbiter Body Yaw)</u> To Start Rotation: GNC UNIV PTG Body Vect = 5 For -Z Sense -Roll (+Body yaw): P = 270 For -Z Sense +Roll (-Body yaw): P = 90 Y = 0 ROT – ITEM 20 EXEC DAP: A/AUTO/VERN (PRI) To Stop Rotation: DAP: A/INRTL/VERN (PRI) 3b. <u>Align -Z Sense Pitch (Orbiter Body Pitch)</u> To Start Rotation: GNC UNIV PTG Body Vect = 5 P = 0 For -Z Sense -Pitch (+Body pitch): Y = 90 For -Z Sense +Pitch (-Body pitch): Y = 270 ROT – ITEM 20 EXEC DAP: A/AUTO/VERN (PRI) To Stop Rotation: DAP: A/INRTL/VERN (PRI) 3c. <u>Align -Z Sense Yaw (Orbiter Body Roll)</u> To Start Rotation: GNC UNIV PTG For -Z Sense -Yaw (+Body Roll): BV(ITEM 14 + 1) For -Z Sense +Yaw (-Body Roll): BV(ITEM 14 + 2) ROT – ITEM 20 EXEC DAP: A/AUTO/VERN (PRI) To Stop Rotation: DAP: A/INRTL/VERN (PRI) <p style="text-align: center;">NOTE</p> <p>Orbiter body roll rotations will require Orbiter body Y translations. In DAP: Lo Z, body Ys cause a relatively large closing rate, which in turn costs prop to fly out</p> <ol style="list-style-type: none"> 4. <u>Check Final Config</u> GNC UNIV PTG CNCL – ITEM 21 EXEC √DAP: B/INRTL/VERN, LO Z 	<p style="text-align: center;">NOTE</p> <p>THC as required to keep center point of payload centered in keel camera</p> <ol style="list-style-type: none"> 1. <u>Maintain Range and Range Rate:</u> R < 150 ft -.3 ft/sec < Rdot < + .3 fps 2. <u>Check Initial Config:</u> √Sense: -Z √DAP A9/B9 √DAP TRANS: PULSE/PULSE/PULSE DAP: B/INRTL/VERN (PRI) 3. <u>Flyout Sequence:</u> -Z Sense: Pitch/Yaw/Roll Body Sense: Pitch/Roll/Yaw 3a. <u>Align -Z Sense Pitch (Orbiter Body Pitch)</u> To Start Rotation: DAP ROT: DISC/PULSE/DISC RHC: Pitch as reqd To Stop Rotation: DAP ROT: DISC/DISC/DISC 3b. <u>Align -Z Sense Yaw (Orbiter Body Roll):</u> To Start Rotation: DAP ROT: DISC/DISC/PULSE RHC: Yaw as reqd To Stop Rotation: DAP ROT: DISC/DISC/DISC <p style="text-align: center;">NOTE</p> <p>Orbiter body roll rotations will require Orbiter body Y translations. In DAP: Lo Z, body Ys cause a relatively large closing rate, which in turn costs prop to fly out</p> <ol style="list-style-type: none"> 3c. <u>Align -Z Sense Roll (Orbiter Body Yaw):</u> To Start Rotation: DAP ROT: PULSE/DISC/DISC RHC: Roll as reqd To Stop Rotation: DAP ROT: DISC/DISC/DISC 4. <u>Check Final Config:</u> GNC UNIV PTG CNCL ITEM 21 EXEC √DAP: B/INRTL/VERN (PRI), LO Z
	<p style="text-align: center;">NOTE</p> <p>Complete RBAR YAW ALIGN prior to selecting INRT</p> <ol style="list-style-type: none"> 1. <u>Check Initial Config</u> √Sense: -Z √DAP: A9/B9 √DAP TRANS: PULSE/PULSE/PULSE DAP: A/LVLH/VERN (PRI) 2. <u>Align -Z Sense Roll (Orbiter Body Yaw)</u> DAP ROT: PULSE/DISC/DISC RHC: Roll as reqd To Stop Rotation: DAP ROT: DISC/DISC/DISC

HOOK
VELCRO

HST CONTINGENCY INRTL APPROACH

RNDZ-4a/125/O/D

RNG	RDOT	MC2 ET h:mm:ss	DAP	COMMENTS	MCC
BRAKING GATES					
		0:22:00	A7/B7 INRTL/ VERN (PRI)	THC: ±X as reqd until TGT stationary in COAS √ADI ATT – LVLH RHC: as reqd until Yaw = 0 GNC UNIV PTG CNCL – ITEM 21 EXEC ERR (TOT) DAP as desired – ITEM (23) 24 EXEC (*)	
2000	-4.0	0:27:00		If RDOT falls below value for next gate, THC: -Z (in) as reqd to maintain RDOT	
1500	-2.0	0:30:00	LO Z		
1000	-1.0	0:35:30		A1L S-BD PL XMTR PWR – LO	PI to PWR – LO
900	-0.9				
800	-0.8			A1U KU OUTPUT – LO	
700	-0.7				
600	-	0:44:00	A9,B9	HHL range callouts every 100 ft	UPDATE SUNPT TIMER EXP
500	-0.5	0:47:00			
400	-0.4	0:51:00			
300	-0.3	0:59:00			
200	-0.2	1:05:30		√HST in capture attitude HST COMM CHECK	
150	-0.2	1:09:30		If HST out of attitude, perform flyaround as reqd: <u>MANUAL INERTIAL FLYAROUND ALIGNMENT</u> or <u>AUTO INERTIAL FLYAROUND</u>	
120	-0.20 ↓	1:12:00			
100	-0.1	1:14:00		CONFIGURE KU FOR COMM (Cue Card, <u>KU OPS</u>) If capture within 5 min of HST sunpt mnvr, <u>DISABLE SUNPT TIMER</u>	
Tgt in EE camera	0.0	1:26:00		THC: +Z (out) to null rates Perform HST CAPTURE (PDRS OPS, <u>NOMINAL HST RETRIEVAL</u>), When Captured (within 30s) <u>HST TO DRIFT</u> Then <u>TERMINATE RNDZ OPS</u> Go to <u>FLIGHT PLAN</u>	

DISABLE SUNPT TIMER

180 MIN SUNPOINT TIMER EXPIRATION TIME:
 MET = ___/___:___:___
 PET = ___/___:___:___

SM 210 HST SYS
 PCS SNPT DIS – ITEM 8 +9 9 EXEC
 √DIS – YES

IF PCS SNPT DIS – NO
 PCS SNPT DIS – ITEM 8 +9 9 EXEC

IF PCS SNPT DIS – NO
 Perform PROXIMITY OPERATIONS BACKOFF
 (CONT OPS), 5-12

HST COMM CHECK

SM 210 HST SYS
 √TLM COUNT – incr
 √RCVR 2(1) LOCK – *
 √PCS MODE – NORM

* If PCS MODE – SNPT: *
 * √MCC prior to 120 ft *

√PCS SNPT DIS – NO

TERMINATE RNDZ OPS

CDR A6U √FLT CNTLR PWR – OFF

MS Perform HHL STOW (RNDZ TOOLS), 7-14
 EXIT RPOP – [SHIFT]/[F10]
 -Z COAS – OFF

PLT GNC 33 REL NAV
 RNDZ NAV ENA – ITEM 1 EXEC (no *)

GNC 55 GPS STATUS
 DES RCVR – ITEM 27 (no*)

GNC 22 S TRK/COAS CNTL
 -Z(-Y) STAR TRK – ITEM 4(3) EXEC (*)

GNC 20 DAP CONFIG
 Modify DAP A7 for SEP:
 EDIT DAP A7 – ITEM 3 +Z EXEC
 A VERN ROT RATE – ITEM 63 +0.2 EXEC
 LOAD – ITEM 5 EXEC

If VERNs available:
 O14:F Pri RJD LOGIC, DRIVER(sixteen) – OFF
 O15:F RJDA 1A L2/R2 MANF DRIVER – ON
 O16:F

HST TO DRIFT

SM 210 HST SYS
 √TLM COUNT – incr
 √RCVR 2(1) LOCK – *
 PCS MODE – ITEM 7 +9 2 (9 1) EXEC (DRFT)
 √PCS SNPT DIS – YES

HOOK
 VELCRO

RNDZ-4b/125/O/C

AUTO INERTIAL FLYAROUND ALIGNMENT

NOTE
 THC as required to keep center point of payload centered in keel camera

- Maintain Range and Range Rate:**
 R < 150 ft
 -.3 ft/sec < Rdot < + .3 fps
- Check Initial Config:**
 \Sense: -Z
 \DAP A9/B9
 \DAP TRANS: PULSE/PULSE/PULSE
 DAP: B/INRTL/VERN (PRI)
 \DAP ROT: DISC/DISC/DISC
- Flout Sequence – The Sox Sequence:**
 -Z Sense: Roll – align orbiter XZ plane with the HST V1
 Pitch – align orbiter -Z with the HST V1
 Roll – align orbiter camera view with end of HST
 Body Sense: Yaw – align orbiter XZ plane with the HST V1
 Pitch – align orbiter -Z with the HST V1
 Yaw – align orbiter camera view with end of HST
- Align -Z Sense Roll (Orbiter Body Yaw)**
 To Start Rotation:
 GNC UNIV PTG
 Body Vect = 5
 For -Z Sense -Roll (+Body yaw): P = 270
 For -Z Sense +Roll (-Body yaw): P = 90
 Y = 0
 ROT – ITEM 20 EXEC
 DAP: A/AUTO/VERN (PRI)
 To Stop Rotation:
 DAP: A/INRTL/VERN (PRI)
- Align -Z Sense Pitch (Orbiter Body Pitch)**
 To Start Rotation:
 GNC UNIV PTG
 Body Vect = 5
 P = 0
 For -Z Sense -Pitch (+Body pitch): Y = 90
 For -Z Sense +Pitch (-Body pitch): Y = 270
 ROT – ITEM 20 EXEC
 DAP: A/AUTO/VERN (PRI)
 To Stop Rotation:
 DAP: A/INRTL/VERN (PRI)
- Align -Z Sense Yaw (Orbiter Body Roll)**
 To Start Rotation:
 GNC UNIV PTG
 For -Z Sense -Yaw (+Body Roll): BV(ITEM 14 + 1)
 For -Z Sense +Yaw (-Body Roll): BV(ITEM 14 + 2)
 ROT – ITEM 20 EXEC
 DAP: A/AUTO/VERN (PRI)
 To Stop Rotation:
 DAP: A/INRTL/VERN (PRI)

NOTE
 Orbiter body roll rotations will require Orbiter body Y translations.
 In DAP: Lo Z, body Ys cause a relatively large closing rate,
 which in turn costs prop to fly out

- Check Final Config**
 GNC UNIV PTG
 CNCL – ITEM 21 EXEC
 \DAP: B/INRTL/VERN, LO Z

MANUAL INERTIAL FLYAROUND ALIGNMENT TRIM

NOTE
 THC as required to keep center point of payload centered in keel camera

- Maintain Range and Range Rate:**
 R < 150 ft
 -.3 ft/sec < Rdot < + .3 fps
- Check Initial Config:**
 \Sense: -Z
 \DAP A9/B9
 \DAP TRANS: PULSE/PULSE/PULSE
 DAP: B/INRTL/VERN (PRI)
- Flout Sequence:**
 -Z Sense: Pitch/Yaw/Roll
 Body Sense: Pitch/Roll/Yaw
- Align -Z Sense Pitch (Orbiter Body Pitch)**
 To Start Rotation:
 DAP ROT: DISC/PULSE/DISC
 RHC: Pitch as reqd
 To Stop Rotation:
 DAP ROT: DISC/DISC/DISC
- Align -Z Sense Yaw (Orbiter Body Roll):**
 To Start Rotation:
 DAP ROT: DISC/DISC/PULSE
 RHC: Yaw as reqd
 To Stop Rotation:
 DAP ROT: DISC/DISC/DISC

NOTE
 Orbiter body roll rotations will require Orbiter body Y translations.
 In DAP: Lo Z, body Ys cause a relatively large closing rate,
 which in turn costs prop to fly out

- Align -Z Sense Roll (Orbiter Body Yaw):**
 To Start Rotation:
 DAP ROT: PULSE/DISC/DISC
 RHC: Roll as reqd
 To Stop Rotation:
 DAP ROT: DISC/DISC/DISC
- Check Final Config:**
 GNC UNIV PTG
 CNCL ITEM 21 EXEC
 \DAP: B/INRTL/VERN (PRI), LO Z



HST BREAKOUT FLOWCHART

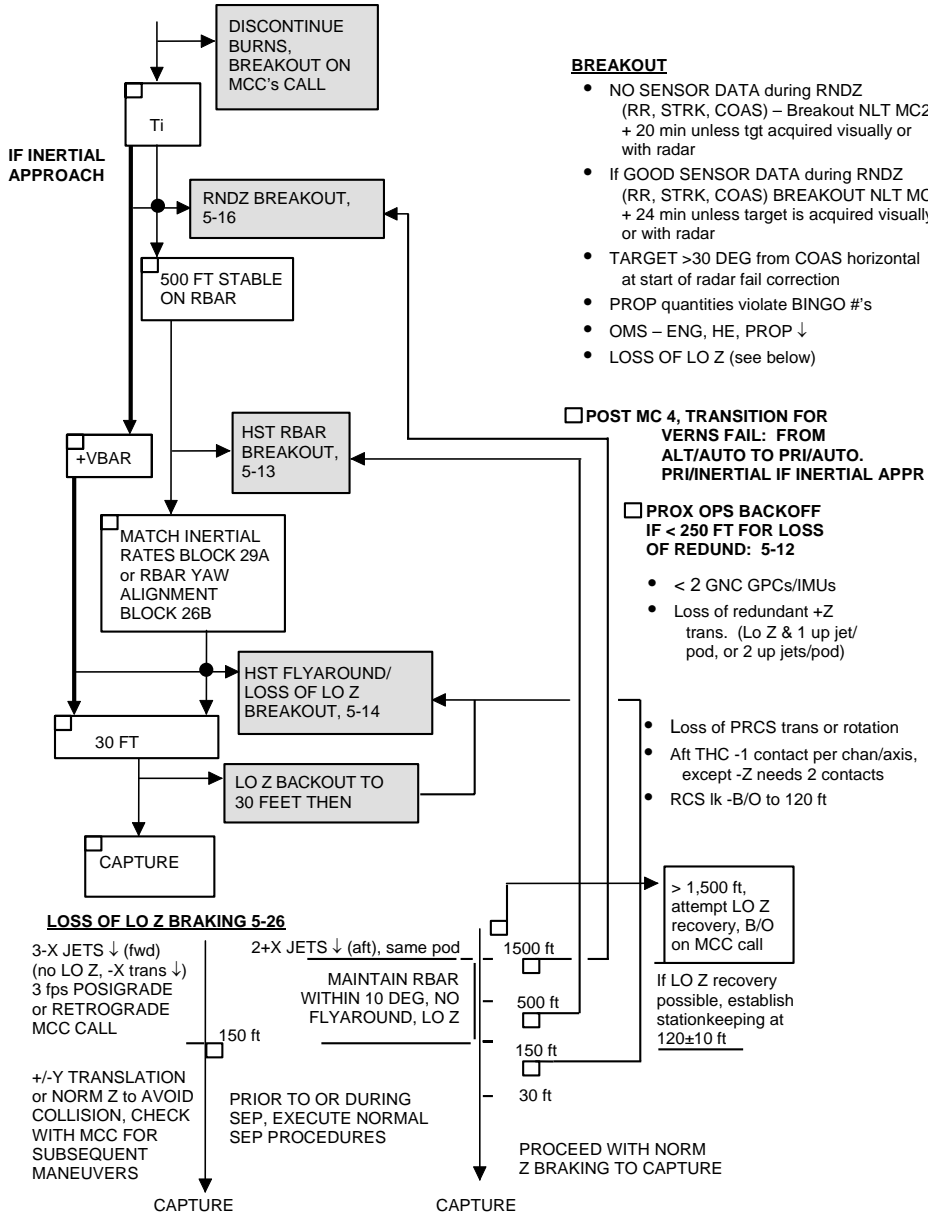

BREAKOUT

- NO SENSOR DATA during RNDZ (RR, STRK, COAS) – Breakout NLT MC2 + 20 min unless tgt acquired visually or with radar
- If GOOD SENSOR DATA during RNDZ (RR, STRK, COAS) BREAKOUT NLT MC2 + 24 min unless target is acquired visually or with radar
- TARGET >30 DEG from COAS horizontal at start of radar fail correction
- PROP quantities violate BINGO #'s
- OMS – ENG, HE, PROP ↓
- LOSS OF LO Z (see below)

POST MC 4, TRANSITION FOR VERNIS FAIL: FROM ALT/AUTO TO PRI/AUTO. PRI/INERTIAL IF INERTIAL APPR

PROX OPS BACKOFF IF < 250 FT FOR LOSS OF REDUND: 5-12

- < 2 GNC GPCs/IMUs
- Loss of redundant +Z trans. (Lo Z & 1 up jet/pod, or 2 up jets/pod)

- Loss of PRCS trans or rotation
- Aft THC -1 contact per chan/axis, except -Z needs 2 contacts
- RCS lk -B/O to 120 ft

LOSS OF LO Z BRAKING 5-26

3-X JETS ↓ (fwd)
(no LO Z, -X trans ↓)
3 fps POSIGRADE
or RETROGRADE
MCC CALL

+/-Y TRANSLATION
or NORM Z to AVOID
COLLISION, CHECK
WITH MCC FOR
SUBSEQUENT
MANEUVERS

2+X JETS ↓ (aft), same pod
MAINTAIN RBAR
WITHIN 10 DEG, NO
FLYAROUND, LO Z

PRIOR TO OR DURING
SEP, EXECUTE NORMAL
SEP PROCEDURES

PROCEED WITH NORM
Z BRAKING TO CAPTURE

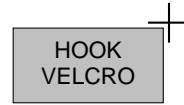
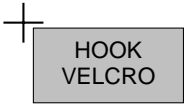

TOOL-CHASING

1. $\sqrt{\text{SENSE: -Z}}$

GNC 20 DAP CONFIG

 $\sqrt{\text{Dap A trans pulse size = .05 fps}}$
 $\sqrt{\text{DAP TRANS: PULSE/PULSE/PULSE, no LO Z}}$

O14:E,
O16:E
O14:F,
O15:F,
O16:F
A6U

2. $\sqrt{\text{cb DDU AFT (two) - cl}}$
 PRI RJD DRIVER,LOGIC (sixteen) – ON

 DAP: A/LVLH/VERN(ALT)
 FLT CNTLR PWR – ON

3. Tool-Chasing burns:

CAUTION

Maintain 5 ± 1 sec between X pulses
 Maintain 5 ± 1 sec between Y pulses
 Maintain 5 ± 1 sec between Z pulses
 Do not exceed 3 pulses

DAP: FREE
 THC: As reqd
 Record # of Pulses: (_____)

4. At TIG+2 min:
 If additional pulses required:
 | Repeat step 3
 If additional pulses not required:
 FLT CNTLR PWR – OFF
 A/AUTO/VERN(ALT 10)
 cb DDU AFT (two) – as reqd

O14:E,
O16:E
O14:F,
O15:F,
O16:F

PRI RJD DRIVER,LOGIC (sixteen) – as reqd



TOP

HOOK
VELCRO

NOMINAL
RADAR ANGLES AND CAMERA ANGLES RANGING CHART

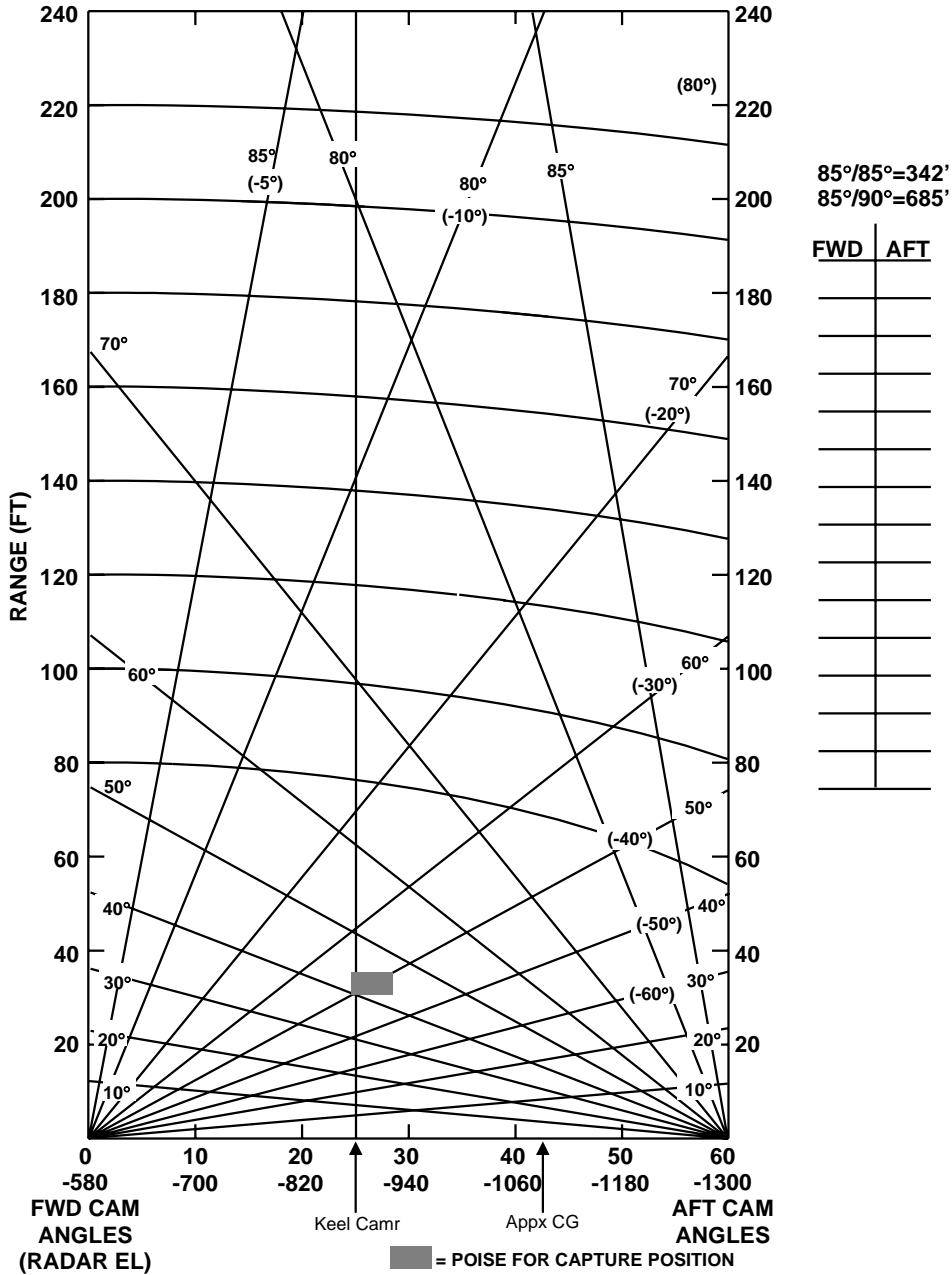

HOOK
VELCRO

RNDZ-6a/125/O/A

(reduced copy)

TOP
BACK OF 'NOMINAL RADAR ANGLES AND CAMERA ANGLES RANGING CHART'

HOOK
VELCRO

HOOK
VELCRO

RNDZ-6b/125/O/A

(reduced copy)

H
O
O
K

V
E
L
C
R
O

GPC/MDM FAILURE RESPONSE DURING RNDZ

H
O
O
K

V
E
L
C
R
O

NOTES

1. Perform appropriate ORB PKT procedure in parallel with IMMEDIATE ACTIONS on card as soon as practical
2. Use this card during Rndz T/L thru MC4 burn (if RR FAIL PROCEDURES, thru RR fail correction burn)
3. GPC assignments assume 1233 NBAT
4. Do NOT restrng for Non-Universal I/O Errors. Otherwise, a restrng for GPC 1,2,3 fails will recover everything (see expected restrng below)
5. If any GNC GPC fails, VERNs ↓
6. If IMUs not commfaulted, THCs are normally GO
7. Loss of FF2, FF4, FA3, and FA4 do not impact Rndz (unless other failures)

GPC	MDM	IMMEDIATE ACTION	MAJOR IMPACT
GPC1 (3232*)	FF1	1. If -Z ST NAV, INH ST to NAV 2. If -Z ST not recovered: Use -Y ST, if reqd	1. C3 DAP lights latched (go out with MDM pwr fail) 2. -Z ST ↓
	FA1	DAP: ALT/AUTO	VERNs ↓
GPC2 (1313*)	FA2	DAP: ALT/AUTO	VERNs ↓
Man OMS Shutdown GPC3 (1212*) Loss of Aft DAP	FF3	1. DAP: ALT/AUTO 2. If RR NAV, INH RR to NAV 3. If -Y ST NAV, INH ST to NAV 4. If RR not recovered: Work RR FAIL procedures	1. VERNs ↓ 2. RR → NAV/RPOP ↓ (Panel A2 OK) 3. A6 DAP lights latched (go out with MDM pwr fail) 4. -Y ST ↓ 5. Also for loss of GPC3: R OMS GMBL PRI/SEC ↓
GPC4 (1212*)	PL1	If Ku breaks lock: Ku sel – AUTO TRK	1. GPC Ku ptg ↓, slew in AUTO TRK if Ku breaks lock 2. No Ku self-test

* Expect this NBAT if GPC fail

MALFUNCTION	>>

TOP
BACK OF 'GPC/MDM FAILURE RESPONSE DURING RNDZ'

HOOK
VELCRO

RNDZ REF DATA

HOOK
VELCRO

FF1
F MANF 1 JETS
C3 DAP LTS
IMU 1
-Z STRK
L OMS GMBL PRI ENA
L ADI sw, ATT REF
F,A THC contact 1
L,A RHC channel 1
PNL O3 F,L,R RCS OX
QTY
PNL O3 F,L RCS LOW QTY

FF2
F MANF 2 JETS
IMU 2
L OMS GMBL SEC ENA
R ADI sw, ATT REF
F,A THC contact 2
A RHC P,Y channel 2
L RHC channel 2
R RHC channel 1

FF3
VERNS
F MANF 4 JETS
A6 DAP LTS
IMU 3
RR→ NAV/RPOP
-Y STRK
R OMS GMBL SEC ENA
A ADI sw, ATT REF
F,A THC contact 3
L,A RHC channel 3
R RHC channel 2
PNL O3 R RCS LOW QTY
PNL O3 F,L,R RCS FU QTY

FF4
F MANF 3 JETS
R OMS GMBL PRI ENA
A RHC Roll channel 2
R RHC channel 3

PL1
GPC KU PTG
KU self-test

FA1
VERNS
L,R MANF 1 JETS
L OMS GMBL PRI

FA2
VERNS
L,R MANF 3 JETS
L OMS GMBL SEC

FA3
L,R MANF 2 JETS
R OMS GMBL SEC

FA4
L,R MANF 4 JETS
R OMS GMBL PRI

MDM OA1(OA2)
L(R) OMS DEORB
ONLY

DSC OF2
VERNS & F MANF 3,4 RM
F RCS OX, FU QTY

DSC OF4
F MANF 1,2 RM

DSC OL1
VERNS & L MANF 1,2 RM
L OMS DEORB ONLY
L RCS OX QTY

DSC OL2
L MANF 3,4 RM
L RCS FU QTY

DSC OR1
VERNS & R MANF 1,2 RM
R OMS DEORB ONLY
R RCS OX QTY

DSC OR2
R MANF 3,4 RM
R RCS FU QTY

DSC OA2
VERNS RM

CNTL AB1
PLB LTS (Fwd-P, Aft-S, Bulkhead)
L ADI ATT REF
CCTV CONTR UNIT PRI

CNTL BC1
VERNS
PLB LTS (Fwd-S, Mid-P)
R ADI ATT REF
CCTV CONTR UNIT SEC

CNTL CA1
PLB LTS (Aft-P, Mid-S)
OVHD DOCK, RMS SPOT LTS
A ADI ATT REF

CNTL AB2
F MANF 1 JETS
L ADI switches, ATT REF

CNTL BC2
VERNS
F MANF 2 JETS
A6 DAP ROT,TRANS pbs (PCT)
R ADI switches, ATT REF

CNTL CA2
F MANF 3 JETS
A6 DAP ROT,TRANS pbs (PCT)
A ADI switches, ATT REF

CNTL AB3
C3 DAP ROT,TRANS pbs

CNTL BC3
C3 DAP ROT,TRANS pbs

CNTL CA3
F MANF 4 JETS

MAIN A
FPC1: MCIU
FLC1: F MANF 1 JETS
AC1B: PNL O3 RCS/OMS QTY
FWD EVENT TIMER
APC4:
APC1: VERNS
L OMS GMBL PRI
R OMS GMBL SEC
ALC1: VERNS
O14: -Z STRK
AFT EVENT TIMER
O14/A8: RMS PRI PWR
R14: CCTV CAM-C,D
CCTV MON-1
CCTV CONTR UNIT PRI
MPC1: APDS RING DAMP 1,2
APDS HK, RING MTR 1
RMS PRI PWR
OVHD DOCK, RMS LTS
PLB LTS (Fwd-P, Aft-S)

MAIN B
FPC2:
FLC2: F MANF 2 JETS
AC2C: PNL A2 DIGITALS
APC5:
APC2: VERNS
LOMS GMBL SEC
ALC2: VERNS
O15: -Y STRK
FWD EVENT TIMER
O15/A8: RMS B/U PWR
R14: KU COMM & RR
CCTV CAM-A, RMS
CCTV MON-2
CCTV CONTR UNIT SEC
VPU (C/L CAM CMDS)
MPC2: KU COMM & RR
APDS RING DAMP 3
APDS HK, RING MTR 2
RMS B/U PWR
PLB LTS(Fwd-S,
Mid-P, Bulkhead)
AUX PL B: TCS

MAIN C
FPC3: KU COMM & RR
FLC3: VERNS
F MANF 4 JETS
AC3A: COAS PWR
APC6:
APC3: R OMS GMBL PRI
O16: PNL O3 OMS/RCS QTY
R14: KU SIG PROC (RR OK)
CCTV CAM-B
CABIN TV UTIL PORT
MPC3: PLB LTS (Aft-P, Mid-S)

ESS 2CA
TCS

CABIN PL (Flt Specific)
CCTV C/L CAM

RNDZ-7b/125/O/A

Note: Fabricate As Transparency

C/L CAMERA

CORRIDOR AND ALIGNMENT

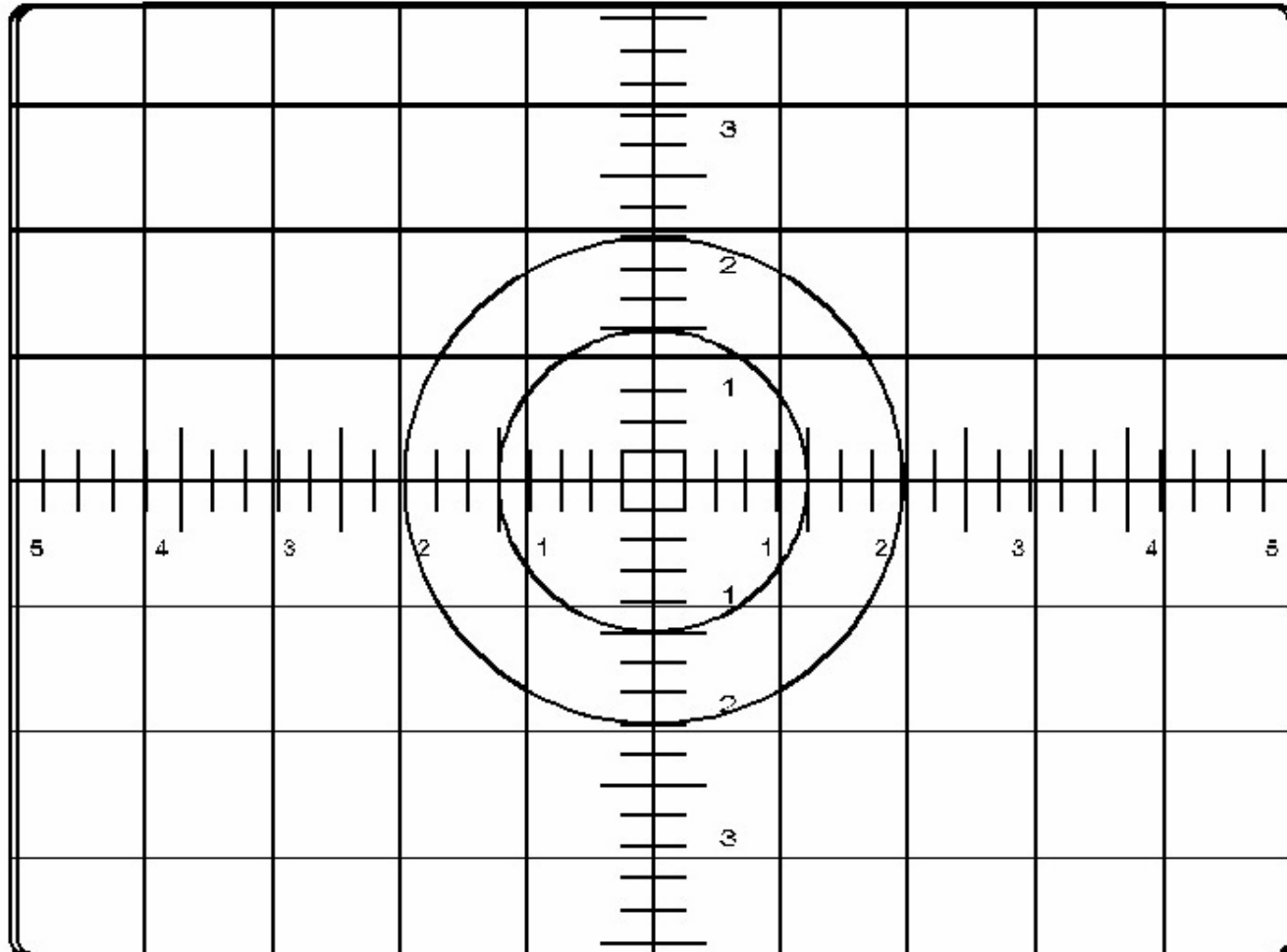

CTVC 40.0 DEG HFOV - CORRIDOR
CTVC FULL ZOOM - ALIGNMENT

RNDZ-8a/125/O/A

(reduced copy)

CC 8-17

RNDZ/125/FIN

A31P PGSC DISPLAY OF C/L CAMERA CORRIDOR AND ALIGNMENT

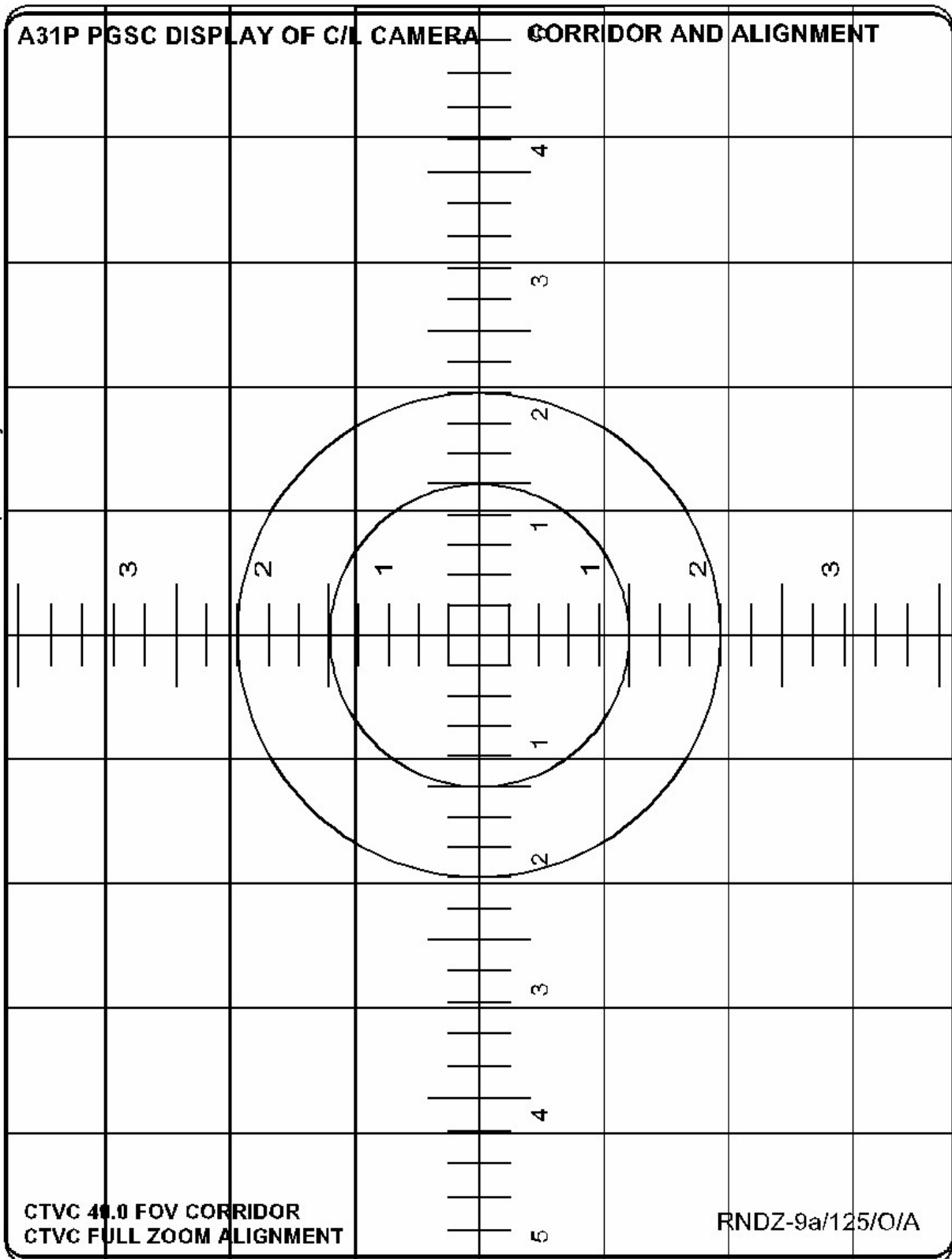

Note: Fabricate As Transparency

CTVC 40.0 FOV CORRIDOR
CTVC FULL ZOOM ALIGNMENT

RNDZ-9a/125/O/A

CTVC 40.0 FOV CORRIDOR
CTVC FULL ZOOM ALIGNMENT

RNDZ-9a/125/O/A

(reduced copy)

Fabricate as transparency

FLIGHT

SUB ANG RULER

H-FOV

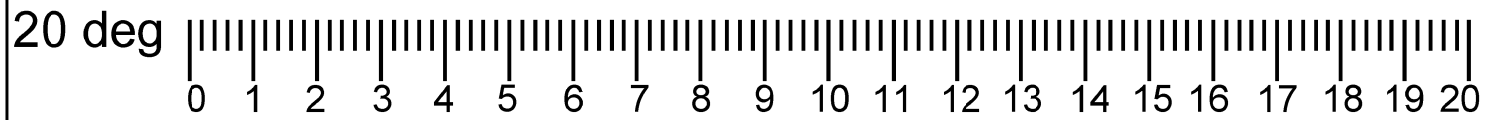

RNDZ-10a/125/O/A

(reduced copy)

CC 8-19

RNDZ/125/FIN

This Page Intentionally Blank



RENDEZVOUS

**STS
125**