

TDC 72-7817

N71-33051

N71-33066

NASA TECHNICAL  
MEMORANDUM

NASA TM X-58063  
Volume I

NASA TM X-58063  
Volume I

PROCEEDINGS OF THE SPACE SHUTTLE INTEGRATED  
ELECTRONICS CONFERENCE

NASA Manned Spacecraft Center  
Houston, Texas  
May 11-13, 1971

1. Report No. <b>TM X-58063 - Volume I</b>	2. Government Accession No.	3. Recipient's Catalog No.	
4. Title and Subtitle <b>PROCEEDINGS OF THE SPACE SHUTTLE INTEGRATED ELECTRONICS CONFERENCE</b>		5. Report Date	
		6. Performing Organization Code	
7. Author(s)		8. Performing Organization Report No.	
		10. Work Unit No.	
9. Performing Organization Name and Address		11. Contract or Grant No.	
		13. Type of Report and Period Covered <b>Technical Memorandum</b>	
12. Sponsoring Agency Name and Address <b>National Aeronautics and Space Administration Washington, D.C. 20546</b>		14. Sponsoring Agency Code	
		15. Supplementary Notes <b>Held at the NASA Manned Spacecraft Center, May 11-13, 1971</b>	
16. Abstract <p>The symposium encompassed five specific categories within the general category of space shuttle integrated electronics. The five categories are published in three volumes as follows:</p> <p>Volume I - Electronics Overview and Guidance, Navigation, and Control  II - Instrumentation and Power Distribution and Communications  III - Data Systems</p> <p><i>space shuttles navigation spacecraft control guidance</i></p>			
17. Key Words (Suggested by Author(s))		18. Distribution Statement <b>Unclassified - unlimited</b>	
19. Security Classif. (of this report) <b>Unclassified</b>	20. Security Classif. (of this page) <b>Unclassified</b>	21. No. of Pages <b>398</b>	22. Price*

Page Intentionally Left Blank

## FOREWORD

As a follow-up of the Space Transportation System Technology Symposium held at the NASA-Lewis Research Center, Cleveland, Ohio, July 15-17, 1970, a series of discipline-oriented conferences was planned, with the Office of Advanced Research and Technology/Office of Manned Space Flight (OART/OMSF) Space Shuttle Integrated Electronics Technology Conference being held at the NASA Manned Spacecraft Center, Houston, Texas, May 11-13, 1971. The Conference goal was to present a timely review of the status of Space Shuttle technology in the major areas of electronics and power systems for the benefit of the industry, Government, university, and foreign participants considered to be contributors to the program. In addition, the Conference offered an opportunity to identify the responsible individuals already engaged in the program. The Conference sessions were intended to confront each presenter with his technical peers as listeners, and this was substantially accomplished.

Because of the high interest in the material presented, it is being published essentially as it was presented, utilizing mainly the illustrations used by the presenters along with brief words of explanation. The document is unclassified, and each of the authors has determined that his paper can be published in this manner. This publication is aimed at revealing the substance and significance of the work in this manner now, rather than in a more refined form much later.



**Page Intentionally Left Blank**

# CONTENTS

	Page
<b>INTRODUCTION</b>	
A. O. Tischler, NASA Headquarters . . . . .	1
<b><u>ELECTRONICS OVERVIEW</u></b>	
<b>DEVELOPMENT PROGRAM PLANNING FOR SHUTTLE AVIONICS</b>	
D. M. Petrie, The Boeing Company . . . . .	9
<b>RELIABILITY PLANNING AND MANAGEMENT</b>	
J. D. Selby and S. G. Miller, General Electric Company . . . . .	29
<b>A REALISTIC APPROACH TO A COST EFFECTIVE DESIGN AND TEST PROGRAM FOR FUTURE SPACECRAFT EQUIPMENT</b>	
Gilbert Friedenreich and Howard Wright, Grumman Aerospace Corporation . . . . .	51
<b><u>GUIDANCE, NAVIGATION, AND CONTROL</u></b>	
<b>SHUTTLE ASCENT GUIDANCE AND CONTROL REQUIREMENTS</b>	
J. C. Blair and J. A. Lovingood, NASA-Marshall Space Flight Center . . . . .	73
<b>KEY ISSUES FOR SPACE SHUTTLE ASCENT GUIDANCE</b>	
J. G. Rupert, Honeywell Incorporated . . . . .	103
<b>SURVEY OF AUTONOMOUS NAVIGATION SCHEMES FOR DOD SPACE SHUTTLE MISSIONS</b>	
R. J. Farrar, The Aerospace Corporation . . . . .	141
<b>ENTRY NAVIGATION ANALYSIS</b>	
B. A. Kriegsman and D. E. Gustafson, MIT C. S. Draper Lab . . . . .	143
<b>GUIDANCE AND CONTROL CONSIDERATIONS FOR AN UNPOWERED ORBITER FROM ENTRY TO TOUCHDOWN</b>	
David W. Gilbert, Manned Spacecraft Center . . . . .	167
<b>A PRELIMINARY EVALUATION OF NAVIGATION AND GUIDANCE CONCEPTS FOR THE SPACE SHUTTLE ORBITER FROM THE END OF REENTRY TO TOUCHDOWN</b>	
Robert D. Showman, William R. Wehrend, Jr., and Kenneth C. White, NASA-Ames Research Center . . . . .	195
<b>NAVIGATION FOR SPACE SHUTTLE APPROACH AND LANDING USING AN INERTIAL NAVIGATION SYSTEM AUGMENTED BY VARIOUS DATA SOURCES</b>	
L. A. McGee, G. L. Smith, D. M. Hegarty, R. B. Merrick, and T. M. Carson, NASA-Ames Research Center; and S. F. Schmidt, Analytical Mechanics Associates . . . . .	221

	Page
<b>MULTIPLE INERTIAL MEASURING UNITS (IMU) FOR USE IN THE SPACE SHUTTLE VEHICLE (SSV)</b>	
H. Brown and B. Doran, NASA-Marshall Space Flight Center; and T. R. Armstrong, Sperry Rand . . . . .	257
<b>ASSESSMENT OF FLY-BY-WIRE TECHNOLOGY FOR SPACE SHUTTLE</b>	
Paul E. Blatt, Air Force Flight Dynamics Laboratory . . . . .	269
<b>A SURVEY OF SHUTTLE CONTROL PROBLEMS</b>	
C. R. Stone and T. W. Chase, Honeywell Incorporated . . . . .	303
<b>DESIGN PRINCIPLES FOR A SPACE SHUTTLE DIGITAL AUTOPILOT</b>	
Richard Gran, Grumman Aerospace Corporation . . . . .	347
<b>NASA FLIGHT RESEARCH CENTER FLY-BY-WIRE FLIGHT-TEST PROGRAM</b>	
Shu W. Gee and Melvin E. Burke, NASA Flight Research Center . . . . .	365

## INTRODUCTION

A. O. Tischler

National Aeronautics and Space Administration  
Washington, D. C.

The main purpose of having opening remarks for a conference is, of course, to provide an opportunity for latecomers to be seated before anything really begins to happen. Let me use a few minutes to tell those of you already seated something about this meeting.

This conference is the fourth of a series of four spring conferences on the technology effort supporting the Shuttle Program. Our recent conferences at the Langley Research Center, at Phoenix in connection with the AIAA meeting, and at the Marshall Space Flight Center have examined the technological questions of the shuttle in all the major areas except electronics and power systems. This conference therefore completes the circle of reviews, although not the work to be done, nor the results still to be obtained. In contrast to the meeting at Cleveland about 10 months ago, most of these meetings have presented results and hard data on which to build the discussion. I trust that this meeting, too, will be able to consider real results instead of plans. Proceedings of all of these will be published and will therefore be available for your study and use.

This conference is on the general subject of electronics and electrical power systems for the shuttle. I know something about what an electron is, but how to build machinery which makes all those little things work together is to me a little baffling. Nevertheless, I know that the demands of the shuttle systems for automatic check-out, continuous monitoring of systems, automatic fault isolation, computer-driven displays, data-busing, and relegation of flight control procedures and functions to an avionics system without jeopardizing the reliability of the vehicle itself constitutes an enormous total program, even though I sense that the technology of individual pieces of that total problem are fairly well in hand. These are among the things that this conference will cover or uncover, and I am sure that anything else I say about them can be labeled superfluous.

At the Langley meeting Charles Donlan, OMSF's Acting Shuttle Program Manager, reviewed the time framework for the Shuttle Program. Many of you are quite familiar with that and with its relation to the Shuttle Technology Program. Others, however, are not. It may be worth the time to use a couple of charts to provide this background orientation for the ensuing discussions.

The first chart shows the shuttle development schedule as planned by the Office of Manned Space Flight. Selection of a contractor to build the long-lead shuttle engines is already under way. The phase B and continuing phase A studies carried out by various airframe contractors will end on June 30. Requests for proposals to develop the shuttle vehicle system will be issued this fall. Contractor selection will be made by spring. Phase C

will begin then, with phase D, which represents a final commitment to the design of the shuttle, to begin about a year later.

Note two dates also shown on the schedule. One is labeled the PDR, which stands for preliminary design review. This occurs in early 1973. At this point the contractor must make all his initial commitments to design approach. However, he may put off absolute final design decisions until the CDR, or critical design review. This occurs in early 1974. After that, any continuing technological work on approaches other than specified by the contractor is for backup or product improvement, or else we're in deep trouble with this schedule.

2

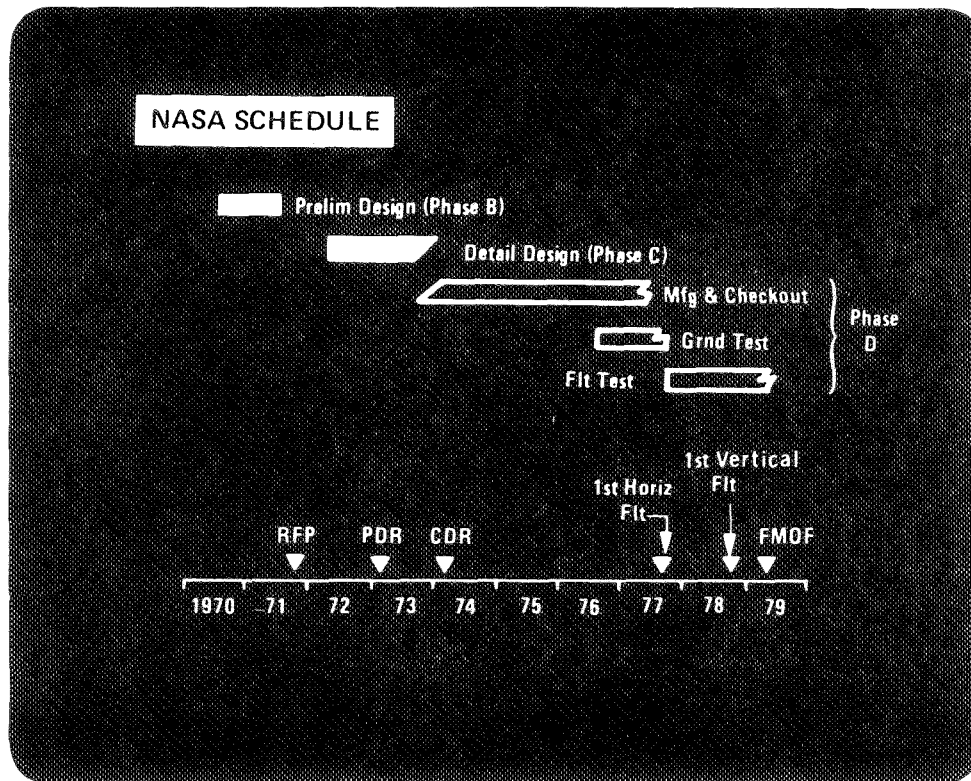

The technological work represented on the next chart, where it is categorized by working group activities, indicates that some technological work continues into CY 1974. This doesn't violate my prior statement if the contractor's design choices are in harmony with the technical efforts indicated. Of course, no overview chart, such as this one, can portray the real picture. To do that requires a project-by-project review of the work. We have laid out the technological work on a project-by-project scheduling basis, with a view to matching technological work end-points with the dates the contractors will need results in order to build them into their designs.

### SHUTTLE TECHNOLOGIES

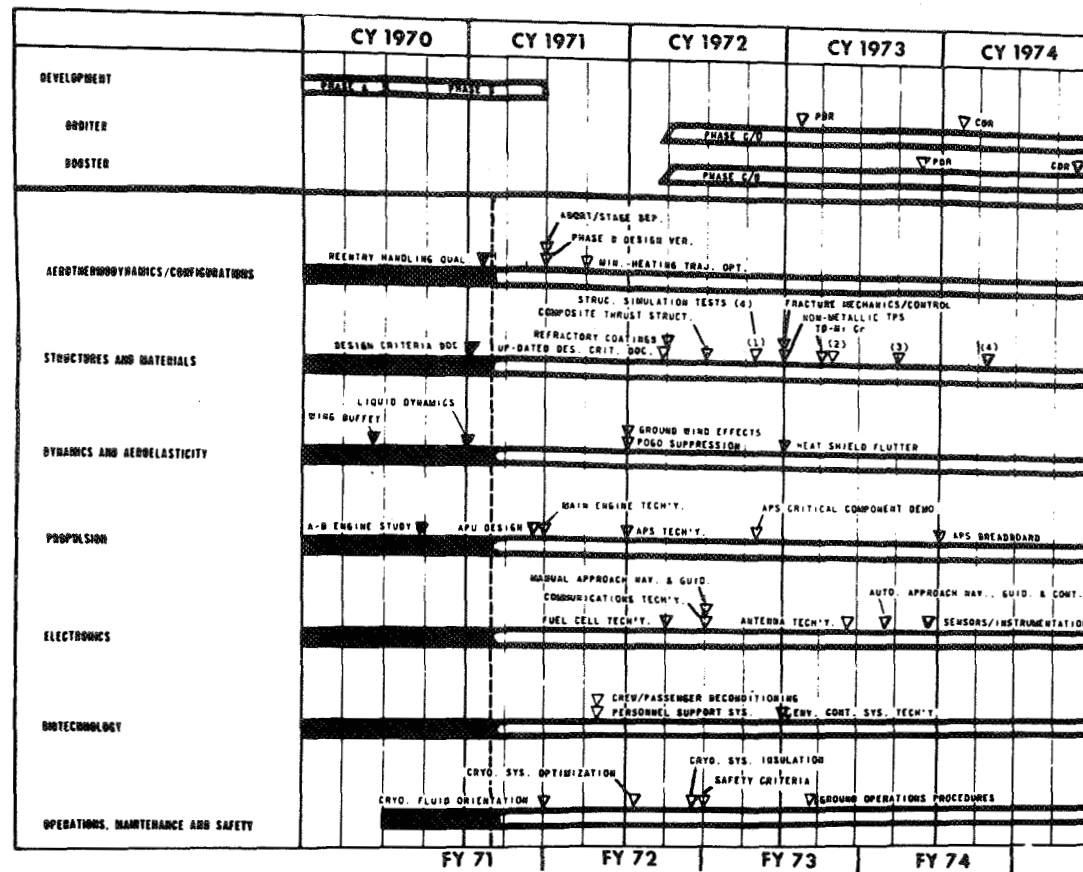

I am confident that our engineering teams will be able to hold up their end of this total job when the time comes to do so. I don't know what the limit of our NASA and industry capabilities really is because that limit has never really been tested before, and we've done some remarkable things. I do know that the Technology Program, which draws together the efforts, both in-house and contracted, of our research, our space flight centers, and DOD, is now making real progress in spite of jurisdictional problems that occur when strong-willed project people encounter strong-minded research personnel. I am confident that in developing cooperation and communication channels across organizational boundaries we are building a stronger people base and technological base than we had to undergird previous programs.

The growing knowledge of the technological status of the problems relating to the total vehicle system has two dimensions. One, which we can call either height or depth, is obviously the identification and verification of new ideas, designs, techniques, and the like. The other is breadth. There is an increasing number of people in the centers and in the contractors' plants who are becoming currently and correctly aware of the best present technology. Pay attention to that. In this complex technological world, it's a rare idea indeed that can be described as unique. However, in our democratic approach to accepting new ideas, it's also a rare day when one or two technologically astute individuals get an opportunity to outvote a more pragmatic project office. The point I'm really driving at, however, is that the broadening of our technical base among involved people is as important to the successful development of a truly low-operating-cost transportation system as the deepening of that informational base among a few specialists. This program represents my attempt to make those two groups talk and listen to each other to develop experience without the usual procedure of "doing it over." To accomplish this end, the Technology Program and its organization have been designed to penetrate the walls of the organizational box from which project planning, development, and operations have traditionally been conducted. At the same time, that box is opened for others to observe and adapt the methods and results of the learning process to their own technical problems.

By setting up these conferences with participation of in-house, contractor, and even non-aerospace people, we are exposing the work, the results, and our thinking about them to all who are potential contributors to the shuttle program. We are also, in a broader sense, promoting the widest spread of shuttle-oriented technology as part of a national up-grading process, in which some of these ideas may be applied in less glamorous, and probably more profitable, business ventures. Thus, we are fulfilling the national interest to advance modern science and technology and to extract from the benefits it holds for this country's economy, education, and standard of living.

If this can be said about the Shuttle Technology Program in its entirety, then it can be underscored for the electronics and power systems part of it. In the work covered by this conference, I see future technological transfers not only to general aviation but also to commercial use of the sensing, data transfer and digestion, computer read out, and communications equipment stemming from this program. The areas of electronic communication and data handling already account for about 5 percent of this nation's gross national product and have every prospect for continued growth.

Having thus amplified a few shuttle electrons to the scale of the gross national product, let me readjust the gain back to this conference. I want to avail myself now of this opportunity to thank Bob Gilruth and his staff for providing this fine facility. I also want to thank Bob Gardner, who was my debating partner in school about 35 years ago, for his work as conference chairman. My thanks also to Cline Frasier who, as chairman of the electronics working group, was instrumental in establishing the program you're going to hear about. Cline is about to undertake a sojourn at the Massachusetts Institute of Technology in New England. I wish him well. His chairmanship of the electronics working group will be taken over by Cliff Bradford of this center.

Now, I believe we've come to the time when I call again on my old partner to flesh out my opening remarks. Bob, it's your show — please take over.





## **ELECTRONICS OVERVIEW**



## DEVELOPMENT PROGRAM PLANNING FOR SHUTTLE AVIONICS

D. M. Petrie

The Boeing Company  
Seattle, Washington

### SUMMARY

The development program, management techniques, and special tools that are unique to the integrated avionics concept being advanced by the Space Shuttle are described. Emphasis is placed on the test beds and facilities that are necessary to negotiate the interdisciplinary problem that threatens the success of the integrated design approach. Among the facilities required are an integrated avionics demonstrator, a test bed airplane, a mission control/GSE van, and an "iron bird" with operating subsystems. These requirements are related to the specialized tools necessary to support discrete technology developments. The calendar phasing and typical costs of these facilities are described.

## INTRODUCTION

The "integrated" concept being advanced for the space shuttle electronics is in danger of foundering unless certain key elements of this approach have gained the willing support of the affected technology factions. The interdisciplinary cooperation that is required will not come readily, - even if autocratic management directives are employed; rather, a carefully developed research program, that is aimed at this problem, will evolve the required methodology.

Before discussing such a research program, it is appropriate to review why the integrated approach is necessary. In a typical airplane, 25% of the gross take-off weight is payload. In contrast, the shuttle payload is approximately 1% of the launch weight. Accordingly, shared usage of wiring, computers, sensors, displays, and radio links, being one way to reduce the inert weight fraction, can have a strong affect on the transportation efficiency of the vehicle. The involvement of fewer subcontractors is also believed to be an effective way to reduce equipment and maintenance costs, presuming the development costs peculiar to the integrated approach do not grow disproportionately, when compared with the conventional non-integrated approach. Another reason to go "integrated" is that the overhead costs associated with Ground Support operations and Mission Control, as now practiced in the Apollo Program, represent a significant fraction of the cost/pound of payload delivered to orbit. Data collection, processing, and navigation are simplified by centralizing many of these functions within the vehicle. This is known as "operational autonomy."

Another reason to select a more advanced approach for a government-financed program, when a choice is available, is the more abstract need to keep the program sold to the weary taxpayer. For example, the subsystem management techniques and mission control methods being advanced for shuttle have a direct corollary to, respectively, plant automation and future air traffic control procedures. Data bus techniques will also help show the way to better utilization of phone lines and the 300 Mhz bandwidth of cable TV: remote reading of utilities (gas, power, water), bedside medical data pickup, and facsimile print-out of library material.

# DEVELOPMENT PROGRAM PLANNING FOR SHUTTLE AVIONICS

## WHY GO "INTEGRATED" ?

- LOWER OPERATIONAL COSTS, WEIGHT, AND DDT&E
- ADVANCE ELECTRONIC TECHNOLOGY FOR COMMERCIAL FALL-OUT

## HOW IMPLEMENTED ?

- ONBOARD CHECKOUT, MONITORING, AND MISSION CONTROL
- SHARED USAGE OF EQUIPMENT

## MAJOR HURDLE

- INTERDISCIPLINARY COMMUNICATION

## HOW RESOLVED

- SYSTEMS ENGINEERING DIRECTORATE
- MULTI-TECHNOLOGY DEVELOPMENTAL TEST BEDS



## UNI-TECHNOLOGY TEST BEDS

There is generally a high correlation in any given program between the engineering organization chart, the hardware architecture, and the laboratory facilities. As a means to introduce the multi-technology test beds that are the main topic of this paper, it is important to differentiate between the developmental facilities involving several technologies and those that are primarily oriented to support the activities of one technology group.

The facing page shows the familiar simulations, mockups, and breadboard hardware that are used to aid discrete technology developments. Frequently, a test bed, that was originally intended to stay within the meets and bounds of one group's organizational charter, expands and overlaps the function of a technically adjacent test bed. A classic example is the flight control system. Initially, a simulation of the airframe flight dynamics and related control laws of the flight control electronics is set up on a general-purpose computing facility. Only mathematic models of the hardware are involved at the outset. Eventually, a breadboard version of the flight control electronics replaces the simulated control laws.

In a separate development, the redundant hydraulic actuation system for the aerodynamic mode of control is connected to a dynamic equivalent of the surfaces and the surrounding attachment structure. Next, a need for actuator load equalization within the servo drive section of the flight control electronics appears; and aerodynamic hinge moment data from the flight dynamics math model is needed to physically load the actuation test rig. A marriage of these two test beds is now appropriate. If this is not done, the group responsible for actuation may be motivated to develop their own flight dynamics simulation and load equalization electronics.

In a similar example, a group responsible for CRT displays development may be motivated to design a complete flight deck and crew station, - the latter also being done by a Human Factors technology group. The need to eventually combine these test beds again appears. Eventually, the pilot handling qualities experiments being done with the aforementioned flight control simulator will need to be combined with the crew station/display breadboard. As the test bed integration process continues, the technology groups find themselves competing for time and emphasis on the multi-purpose test beds. This further motivates the discrete technology groups to want to "do their own thing" in a uni-technology development facility that is dedicated to their work charter. The duplication of effort that results is not 100% bad; what is important, however, is that we openly discuss this problem in the context of what it means to the "integrated" concept for shuttle electronics. That is, the uni-technology cliquishness that is normally present forms a natural resistance to going "integrated."

None of the above, of course, is news: the problem exists whether we go "integrated" or "non-integrated." The message here is that the shared usage of equipment, as required for the "integrated" way, will increase the interdisciplinary communication problem to a level that can make the more experienced management people despair.

# UNI-TECHNOLOGY TEST BEDS

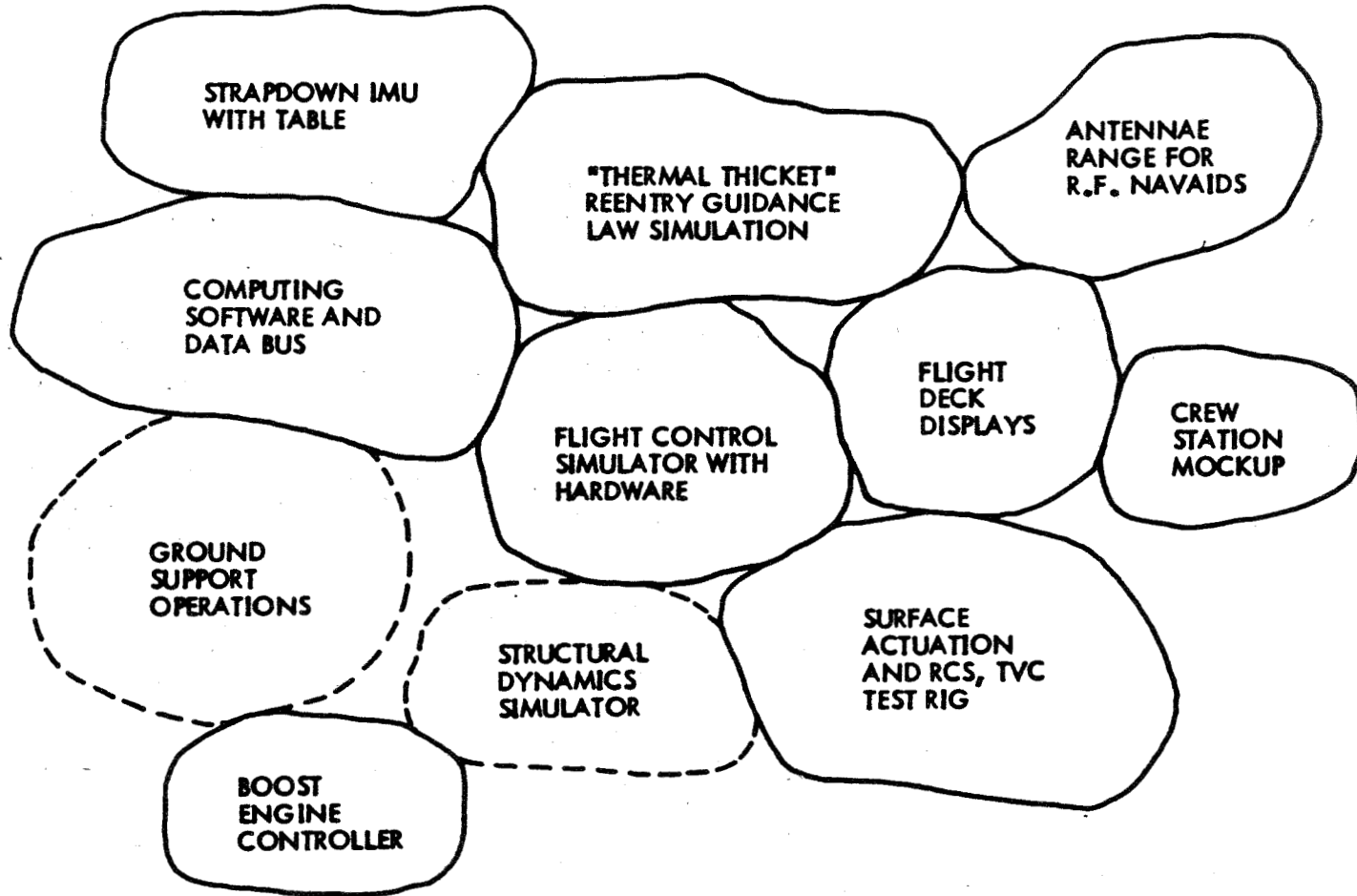



## MULTI-TECHNOLOGY TEST BEDS

The key to selling the integrated approach is demonstrated success of the integrated concept, using a number of carefully devised developmental (not prototype) test beds. These test beds are of the breadboard variety, with plenty of freedom to try new ideas as they evolve: only the gross objectives need be established to prevent their progress from going astray. The test results are used as "feeders" to the baseline designs, providing confidence to either proceed or to retract from the new features of the integrated approach, where field experience is now lacking.

The facing chart shows the four test beds that are clearly of the multi-technology type. The calendar phasing shown is intended to support the mainstream Phase C/D effort, with the First Manned Orbital Flight (FMOF) scheduled in April, 1978.

It should be noted that one of the objectives of the Integrated Avionics Demonstrator (IAD) is to develop the equipment and interfaces that will later be installed in the avionics test bed airplane. The correlation is not one-for-one, however, because the emphasis and calendar phasing within these two test beds is different. For example, installing a digital Fly-By-Wire flight controller is the first logical step in the airplane program. This can be enabled by a uni-technology development sub-program. This is followed by installation in the airplane of manually-monitored sensors of the second-generation landing aid that is required for the operational orbiter. In the meantime, displays and controls that have been previously developed in a uni-technology effort are being integrated with the data management computers, bus, and simulated subsystems of the IAD. Further downstream, test anomalies uncovered in the airplane program are analyzed on the IAD for corrective action. And so on.

Similarly, the Mission Control/GSE Van is initially used for ground support of the autoland phase of the airplane program. Later, a digital data link with associated data processing equipment is added to the Van to begin exploration of the extent to which the autonomous Mission Control concept is practicable.

The Iron Bird is the most complete assembly of operating subsystems that is considered practical, short of a Ground Test Vehicle. The segment of this facility, known as the Integrated Avionics Test Fixture, utilizes interdisciplinary experience gained on the IAD, but contains prototype avionics, rather than breadboard equipment.

# MULTI-TECHNOLOGY TEST BEDS

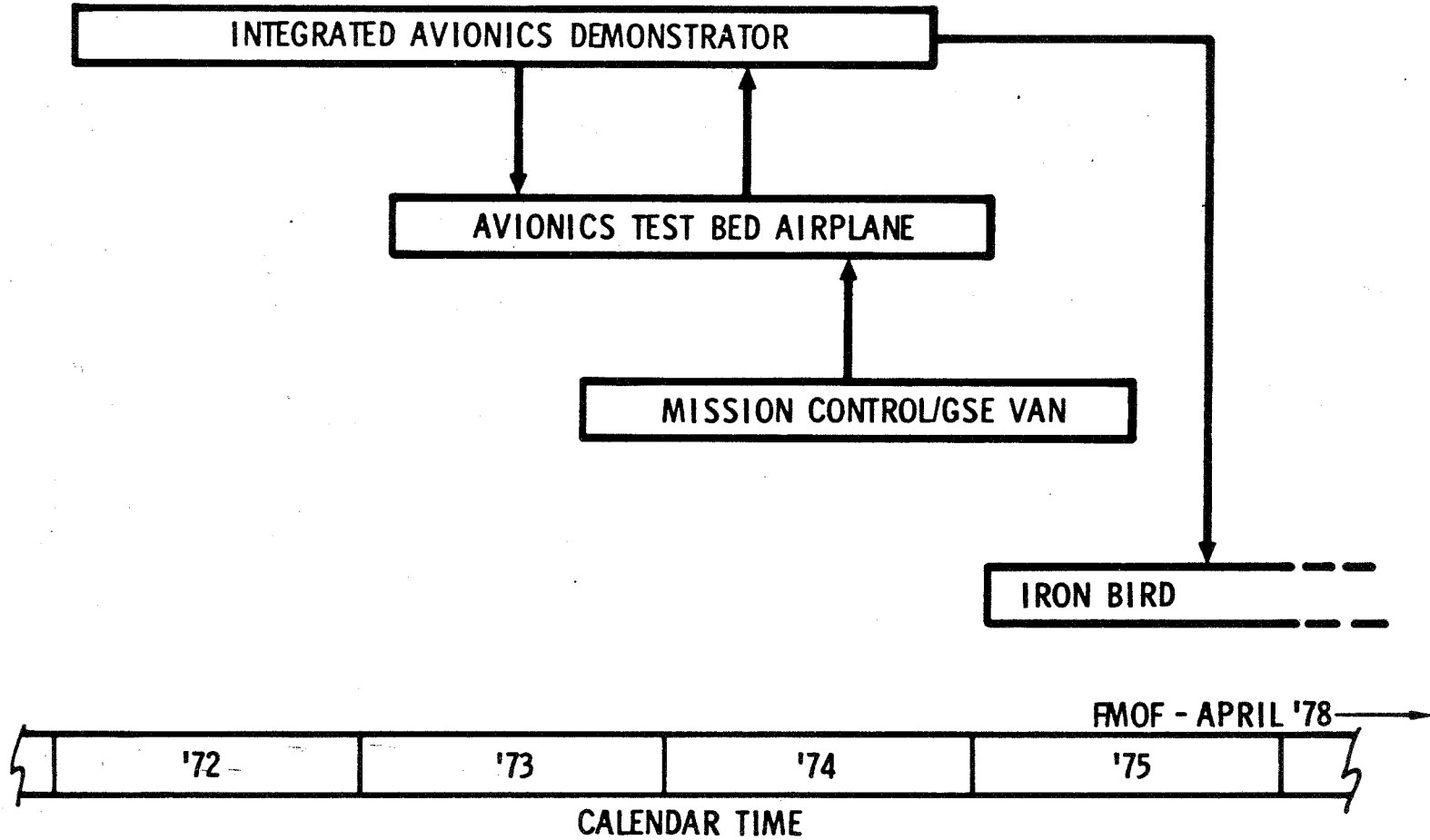

## INTEGRATED AVIONICS DEMONSTRATOR

This test bed, acronymed IAD, is an extension of the flight simulators that we have seen on most aerospace programs over the past 20 years.

The order of facility buildup can vary; however, in a typical phasing, it begins with a long-period flight trajectory simulation, to study the dynamic interactive affects of winds, navigation accuracy, guidance laws, and structural heating. Non-electronic technologies are obviously involved at this stage. Eventually, the first-order lag used to simulate the flight control system is replaced by the math model of the short-period flight dynamics and its associated control system, these having been previously developed on a uni-technology test bed.

The next major phase involves the addition of breadboard hardware to replace the math models. Again, the sequence can vary, but typically, a cab with working displays and controls is now added to give the astronaut group a realistic feel of the "machine" and their interfaces with it. Next, a central computer and data bus are added in conjunction with working models of the subsystems that must be actuated, monitored, and checked out by the Data Management Computer. As a general rule-of-thumb, these models of the Environmental Control and Life Support System (ECLSS), Attitude Control Propulsion System (ACPS), and the various hydro-mechanical actuators should cost no more than 1% of the real article. The purists among us may question the validity of such crude models. Others may wince at the Barnum and Bailey flavor that attends such a noisy and visually active array of equipment. But there are those of us from Missouri who have to be shown. And students of the learning process assure us that these simple audio-visual aids are nourishing.

Later, the breadboard version of the flight control electronics and, perhaps, a strapdown IMU, mounted on an articulated table, are added. The modulation, decoding, and tuning section of the data link can be added in a final phase of the hardware buildup. We eventually have a breadboard version of the Integrated Avionics Test Fixture that is an anticipated requirement of the Phase C/D SOW.

The facing page shows the physical organization of the simulation equipment and flight hardware. Note that a duplicate version of the equipment labeled "avionics" in the Vehicle Equipment Room is destined to be installed in the avionics test bed airplane; and that modified versions of the flight path plotter, mission control computer and mass memory units in the Math Model Simulations room are destined to be installed in the Mission Control/GSE Van.

# INTEGRATED AVIONICS DEMONSTRATOR

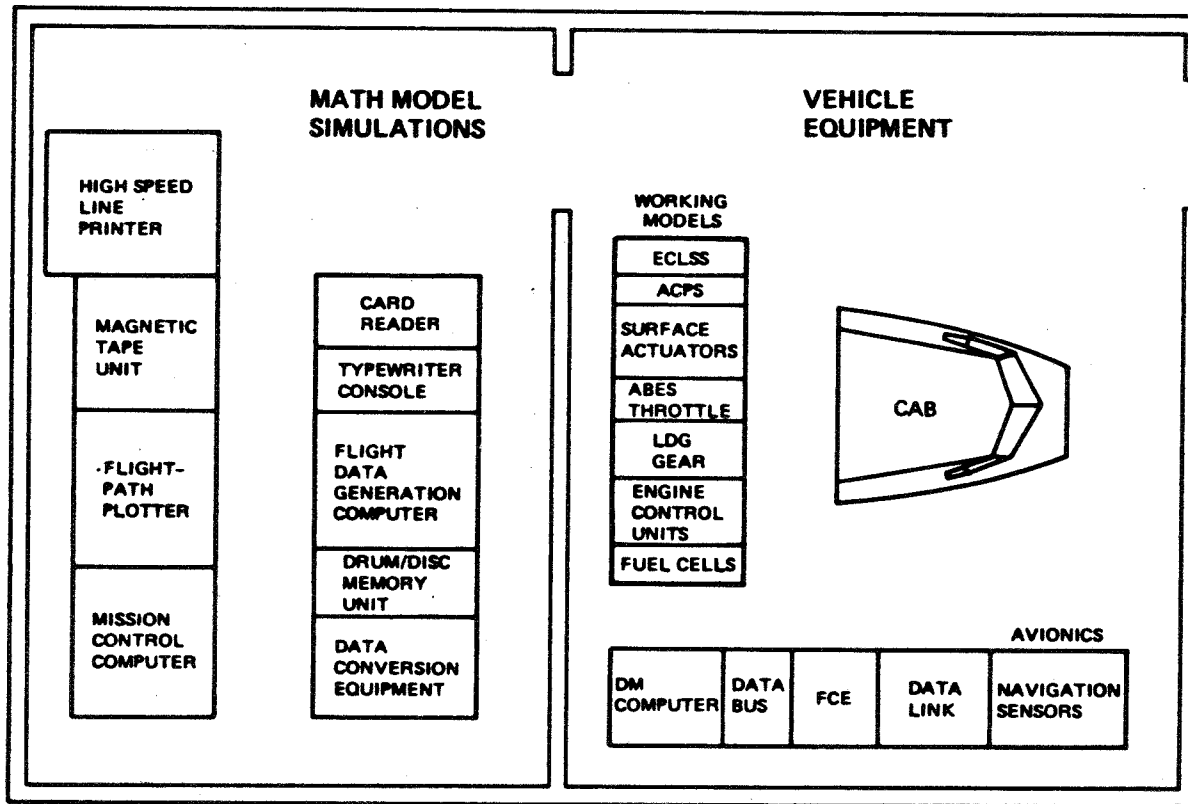

## AVIONICS TEST BED AIRPLANE

The objectives of this test bed must be carefully delineated relative to the objectives of the IAD, lest unnecessary duplication and phasing conflicts occur. Because flight testing costs run about \$10,000/hour, only those features of the shuttle system that cannot be satisfactorily demonstrated on the ground are assigned to the airplane test bed. Many of the tests are not addressed to avionics matters, per se, even though avionics are always involved. Crew training for manual energy management of the unpowered orbiter, operational procedures for certain failure modes, and the utility of aerodynamic speed brakes are typical non-avionic tests.

An avionics test bed has been used on the C-5, using a C-141, and, is planned for the B-1. There have also been numerous other flying test beds involving only critical elements of the avionics system, e.g. BOMARC, AWACS, and every autoland effort.

The airplane should be large enough to accommodate a dozen test engineers and visitors, in addition to the avionics equipment.

A somewhat new approach to flight testing an experimental avionics system is considered necessary for shuttle. In the past, a "tack-on" approach has been used for testing a specific device. If this process continues, a disorderly arrangement eventually results, and reliability and serviceability are disappointing. Instead, a palletized cab, installed through a cargo door, will permit fabrication and modification of the assembly in the superior environment of the laboratory. Installation of the cab amidships in the airplane, electrically attached to power sources, electro-mechanical elements and antennas via umbilicals permits a relatively "clean" operation. Another reason for this design approach is that the extensive use of multi-purpose CRT displays and keysets in the shuttle crew station area make the patchwork approach most awkward. And no pilot has yet shown much willingness to take off in an airplane with a complete new nose job, - fly-by-wire and all, without having something familiar to fall back on when something goes wrong. Placing the new cab above the original one (747 style) involves major surgery to the airplane and degrades the serviceability feature of the palletized cab.

The data management computer used for guidance/navigation, and for provision of data to the display processor, is located in a 1 foot deep sandwich section added beneath the floorboards of the cab used in the IAD. Inertial navigation, multiplex data bus, data link, and R.F. Navaid equipments are also located in this avionics bay.

The autoland system that is tested, immediately after the fly-by-wire flight controller development phase, is compatible with what the Radio Technical Commission for Aeronautics has tentatively selected for commercial aviation in the post-1980's era.

Out-the-windscreen viewing is provided by two vidicons mounted above and below the standard cab.

## AVIONICS TEST BED AIRPLANE

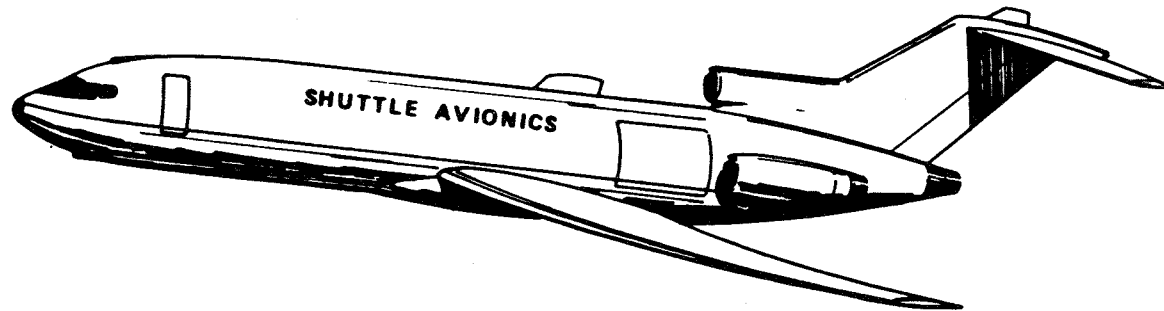

- PALLETIZED CAB WITH INTEGRAL AVIONICS MODULE INSTALLED AMID SHIPS
- SECOND-GENERATION AUTOLAND CONCEPT (RTCA 117)
- ENERGY MANAGEMENT OF GLIDING ORBITER
- CREW TRAINER FOR OPTIONAL MANUAL MODES

## MISSION CONTROL/GSE VAN

The primary purpose of the Van is to provide ground-based support to the airplane test bed. Initially, it is not meant to be a test bed for the Mission Operations Project (managed by MSC) or the Launch Operations Project (managed by KSC) anticipated for shuttle. However, many of the elements of the mission control function, and a few of the elements of the GSE function, are desirable adjuncts to this test bed. The Van can be loaded aboard a C-130 transport, giving it mobility for testing at any proposed landing or ferry site.

Early tests involve only the K<sub>u</sub>-band scanning beam autoland ground station. Addition of a data link permits demonstration of the multi-purpose data/voice link. Next, addition of one display for flight path monitoring and another for remote readout of any display available to the flight crew will begin to demonstrate how far the Manned Spaceflight Network (MSFN) can be streamlined. The potential of this Van to show the way to lowering the cost of the current MSFN is enormous, particularly if license to do so can be arranged.

Bulk storage of trajectory constants and mission options, that have been developed in a separate mission planning operation, is included to demonstrate the commonality between shuttle mission control and air traffic control of the post-1985 era.

Finally, data from other tracking and communication centers are brought into the Van via phone lines for further demonstration of the more autonomous method of mission control intended for shuttle operations.

## MISSION CONTROL/GSE VAN

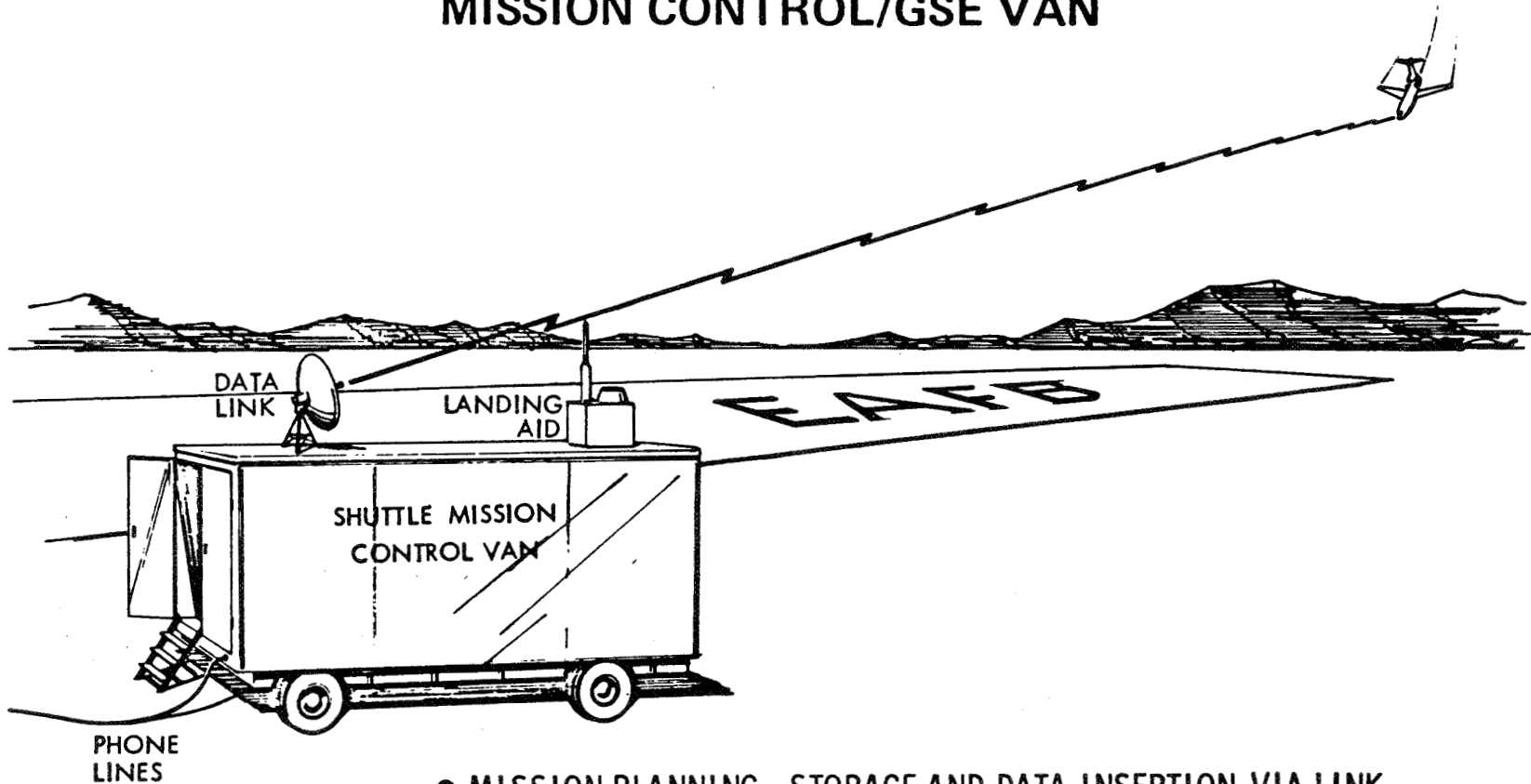

- MISSION PLANNING: STORAGE AND DATA INSERTION VIA LINK
- MISSION CONTROL DEMONSTRATOR OF "AUTONOMOUS" OPERATION
- GROUND SUPPORT EQUIPMENT FOR PREFLIGHT MONITOR & TEST
- TELEMETER, COMMUNICATION, AND AUTOLAND R.F. AIDS



## IRON BIRD

A final stage of testing, prior to horizontal flight tests with the actual orbiter and booster, is with all vehicle equipment operating together in a Systems Integration Laboratory (SIL) or Iron Bird. (The name "Iron Bird" derives from the I-beam and angle-iron type of structure used to simulate the mass and compliance of the structural elements). Although the initial purpose of this test bed is the development of hydro-mechanical and electro-mechanical actuation devices, the ultimate purpose is to ferret out the subsystem interaction problems. It should be noted that avionics is only one of several subsystems being played together on this test bed. Combustive operation of the rocket and airbreathing propulsion systems are obviously not practical here, - limited operation of the attitude control propulsion system (ACPS) may be practical in an adjacent, isolated test cell; however, the value/cost ratio is not likely to support such testing here.

In aircraft using mechanical cables for actuator signalling, the iron bird must be essentially the same size as the full-scale vehicle; because friction, hysteresis, and compliances must be adequately simulated. In the case of the SST, the building housing this facility is the size of a football field. For shuttle, fly-by-wire obviates the need for such physical scaling; however, in order to minimize the number of surprises in the flight test program, it is desirable to locate equipments in a physical proximity similar to that in the full-scale vehicle. Electro-magnetic interference and hydro-mechanical cross-talk are problems that can be expected to be initially troublesome, because so much of the avionics employs pulses in its operation, and there are complex, redundant hydraulic equipments.

A special feature that can be implemented in a facility of this type, - especially if the planning is done early in a given program, - is the clustering together of the uni-technology and multi-technology test beds in such a way that a common computer complex results. This is shown as the "flight simulation complex" on the facing drawing.

The buildup of prototype avionics equipment is similar to that done on a more experimental basis in the IAD: the math model simulations of the avionics subsystems are gradually replaced by prototype units (not necessarily flight-rated) as they become available.

# IRON BIRD\*

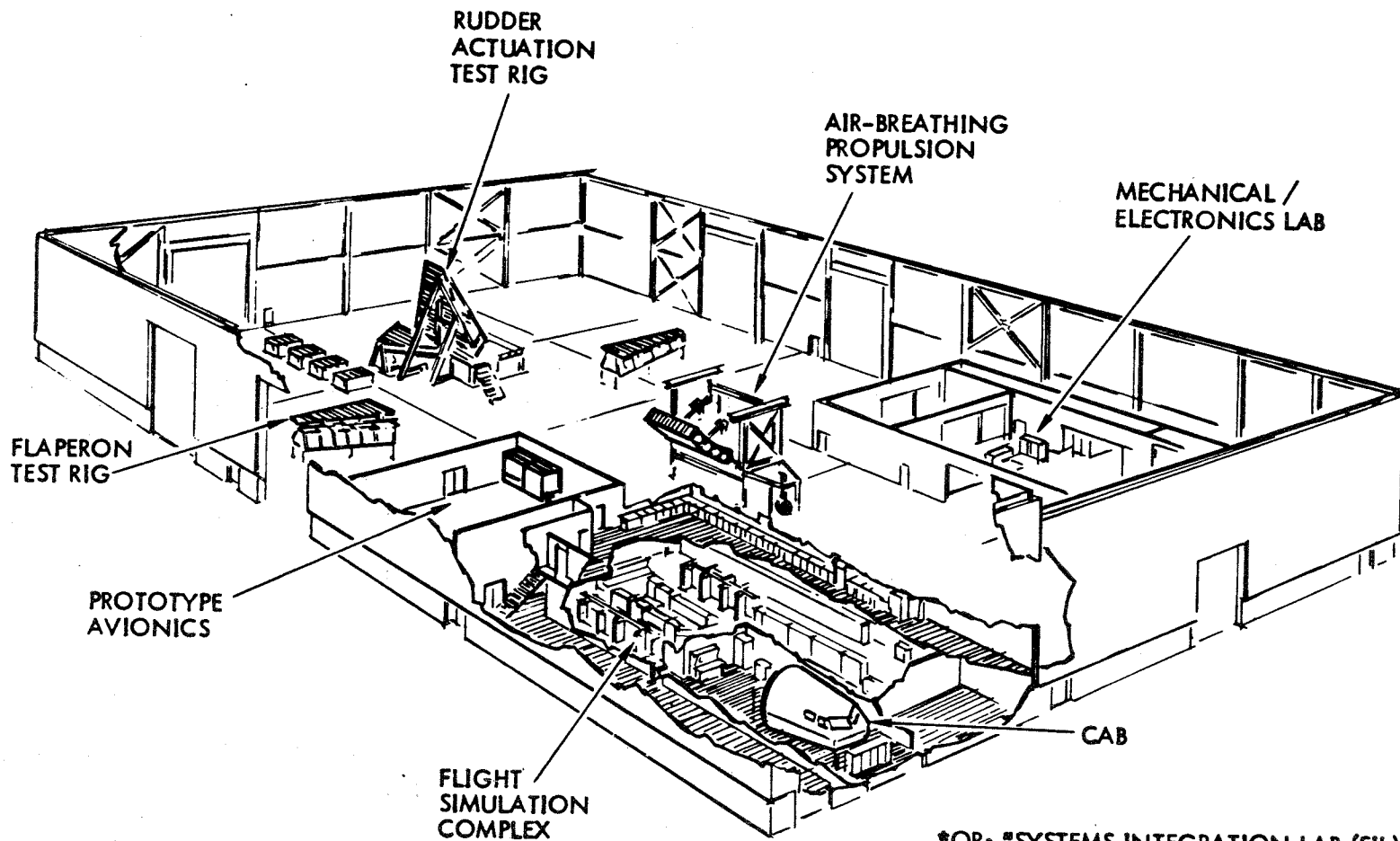

\*OR: "SYSTEMS INTEGRATION LAB (SIL)"

## TYPICAL COSTS

A credible estimate of the costs of these four multi-technology test beds is, of course, a major undertaking. The costs shown are scaled from some similar Boeing programs, and are only meant to be typical and relative. The actual costs of these individual facilities are very sensitive to the level of detail required to simulate the item under investigation, and the thoroughness felt necessary to prove or disprove the issue at hand. For example, a feasibility experiment, done early in a program, can be much less costly than development of the same equipment at the prototype stage. This is common knowledge, but the point needs to be kept in mind when detailing those parts of the shuttle electronics development program that need to be undertaken in order to assure success of the integrated/autonomous concept.

The first three test beds listed on the facing page were costed in a research program begun in the Commercial Airplane Division of Boeing in January 1967. The aggregate costs for this 3 1/2 year program were estimated to be \$5.5M, based on cost sharing support from the avionics industry and use of a Company-owned airplane. Economic downturns in the commercial aviation industry have since forced a stretch-out and reorientation of this program and, consequently, there is scant evidence to grade our estimating ability. Nevertheless, this estimate is still useful as a relative yardstick, because 55 man-months were spent in planning this program. Comparison with other similar programs in the industry at large is beyond the scope of this paper, but would provide an interesting additional set of data points for planning purposes of the NASA shuttle program.

The cost estimates for the Iron Bird were based on the SST CODE (Controls Development) facility, which was well over half-completed at the time of program cancellation. However, the cost estimate shown is for an austere version, the original estimate being \$22M.

## TYPICAL COSTS

<b>INTEGRATED AVIONICS DEMONSTRATOR</b>		<b>\$ 2.2 M</b>
<b>PURCHASED EQUIPMENT</b>	<b>\$0.9 M</b>	
<b>TEST PROGRAM</b>	<b>\$1.3 M</b>	
<b>AVIONICS TEST BED AIRPLANE</b>		<b>\$ 6.4 M</b>
<b>AIRPLANE</b>	<b>\$3.5 M</b>	
<b>AVIONICS</b>	<b>\$1.8 M</b>	
<b>DESIGN &amp; TEST</b>	<b>\$1.1 M</b>	
<b>MISSION CONTROL/GSE VAN</b>		<b>\$3.7 M</b>
<b>PURCHASED EQUIPMENT</b>	<b>\$2.1 M</b>	
<b>DESIGN &amp; TEST</b>	<b>\$1.6 M</b>	
<b>IRON BIRD (SIL)</b>		<b>\$12.8 M</b>
<b>DESIGN</b>	<b>\$5.5 M</b>	
<b>ACTUATORS, ELECTRONICS</b>	<b>\$2.2 M</b>	
<b>HYDRAULICS, INSTRUMENTATION</b>	<b>\$2.35 M</b>	
<b>TEST PROGRAM</b>	<b>\$2.75 M</b>	

## CONCLUSIONS

The four multi-technology test beds described will provide the catalyst to break the interdisciplinary log-jam that now jeopardizes the success of the "integrated" avionics concept. A coordinated development plan will make these test beds far more effective than if they are undertaken as unrelated uni-technology activities. It is essential that the management of these test beds be provided in such a way that no single technology faction can lay sole claim to a given facility, even if it geographically resides within, and is provided with the major engineering support from, a single technology group. On the other hand, it is also important that uni-technology test beds be encouraged to overlap, if facility work load requirements make it cost-effective to do so.

The multi-technology test beds will obviously be exciting activities. If we can get the equipment manufacturers and the various elements of the NASA and industry teams to either participate in, or witness, demonstrations of the "integrated" approach, we should be able to hold up the electronic end of the goals set out for space transportation economy.

# CONCLUSIONS

- AN INTERWOVEN DEVELOPMENT PLAN (TECHNICAL, COST, MANAGEMENT) FOR MULTITECHNOLOGY TEST BEDS SHOULD BE MADE FOR SHUTTLE ELECTRONICS TO:

- OVERCOME SUBJECTIVE BARRIER AGAINST SHARED USAGE OF EQUIPMENT

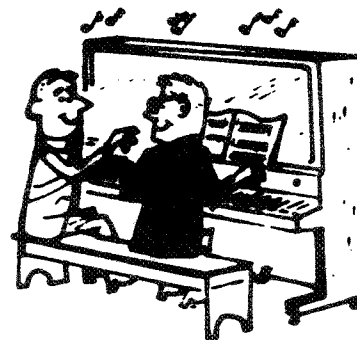

- SHOW HOW SYSTEMS-ORIENTED MANAGEMENT CAN SATISFY NEEDS OF DISCRETE TECHNOLOGIES



- HELP DEFINE THE ORBITER/BOOSTER EQUIPMENT COMMONALITY



- DEVELOP MISSION CONTROL/GSE ELECTRONIC INTERFACES FOR NASA INTEGRATION TASK

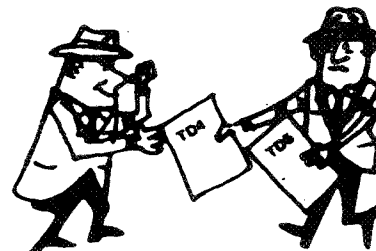



**RELIABILITY PLANNING AND MANAGEMENT\***

**J. D. Selby and S. G. Miller**

**General Electric Company  
Utica, New York**

\*This paper was presented at the conference by P. Kroeger, General Electric Company.



## **PRODUCT REQUIREMENTS AND EXPERIENCE - THE 1950's AND 1960's**

The trend in product reliability requirements from the 1950's through the 1960's is portrayed by the reliability plot from MIL-STD-756A as updated and augmented by experience of GE/AESD's products manufactured in the 1960's. This plot relates system's MTBF to system's complexity as experienced by the Navy for airborne Avionics through the early 1960's. A series active element is defined as an electron tube or transistor or ten computer diodes or an integrated circuit.

30

Evident from the above plot and chart are trends indicating that during the decade of the 1960's the reliability requirements and product complexity have, on the average, each increased by a factor of 10.

Projecting forward to the requirements and product needs of the technically sophisticated 1970's, it appears reasonable to expect an extension of this trend, resulting in an additional order-of-magnitude rise in reliability technical challenge in the 1970's.

# PRODUCT REQUIREMENTS AND EXPERIENCE THE 1950'S AND 1960'S

31

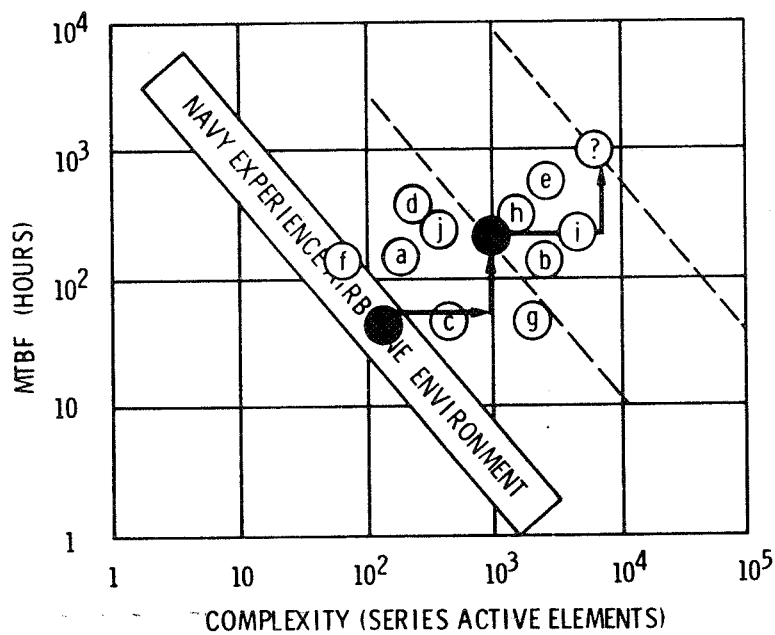

● CENTROID OF REQUIREMENTS

PROGRAM	MTBF (HRS)		EQUIPMENTS	
	REQ'D	DEMO	SHIPPED	THRU ENVIR. TEST
a RAPID TUNE	200	277	868	868
b AN/APQ-113	137	202	341	341
b AN/APQ-114	137	212	105	105
c AN/ALQ-87	50	56	1025	1025
d AN/AXR-13	500	655	78	64
e AN/AYA-8 (LU)	800	1200	76	73
f MISSILE	150	618	4000	176
g EXX RADAR	77	NEW	-	-
h EXX RDP	500	NEW	-	-
b AN/APQ-144	137	262	34	34
i F-111 FLT CONT	310	375	510	510
j AN/ASG-23	450	1578	112	112

## WEAPONS SYSTEM FIELD RELIABILITY COMPARISON

A credibility gap confronting DOD and industry is the disparity between stated equipment reliability requirements and realized or realizable achievement.

A review of the field performance of a 1968/1969 vintage Avionic Weapons System during the first three quarters of 1970 illustrates this disparity:

- Equipment's achieved MTBF vs contractual MTBF differs by as much as 20 to 1.
- Typical noncompliance is 10 to 1.
- Only a few select products are compliant.

This performance for diverse products manufactured by a spectrum of reputable vendors suggests that management, both government and industry, has lacked a uniform quantitative yardstick with which to dimension, plan, manage, fund, and monitor reliability growth as an integral part of product development.

## WEAPONS SYSTEM FIELD RELIABILITY COMPARISON\*

SUBSYSTEM	MTBF GOAL	FLIGHT MTBF (HOURS)	% MTBF ACHIEVEMENT
		JAN- NOV 1970	JAN- NOV 1970
LOGIC UNITS	800	1812	226
TAPE TRANSPORT	500	510	102
DISPLAY C	1000	1396	140
INDICATOR	333	352	105
SEARCH RADAR	150	40	30
COMPUTER	1500	77	5
UHF COMMUNICATIONS SET	1200	150	12
FLIGHT DIR COMPUTER	1000	82	10
HF COMMUNICATIONS SET	1200	70	5
INERTIAL NAVIGATION	750	42	5
DISPLAY A	1000	86	10
DISPLAY B	2000	114	5
NAVIGATION-ALTITUDE RADAR	1000	51	5

\* AIRCRAFT WEAPONS SYSTEM 1968/1969 VINTAGE

- $\bar{R}$  PROGRAM PER MIL-STD-785
- $\bar{R}$  DEMONSTRATION
- $\bar{R}$  ACCEPTANCE
- FACI

## A WEAPONS SYSTEM AVIONICS SUPPLIER'S PERFORMANCE

Insight into the cause and impact of the lack of timely reliability achievement may be gained from a review of the time-phased performance of Avionic suppliers on another Avionic Weapons System. A number of observations become clear from the following historical data:

- The original Weapons System reliability apportionments were realistic as evidenced by their eventual achievement
- Timely R&D compliant performance was not achieved
- Substantial quantities of reliability nonconforming production hardware were delivered
- Modified equipments with their attendant reduced development risks achieved compliance in a more orderly and timely fashion than newly developed equipments
- The initial average achieved reliability was approximately 10% of specified requirement
- Each equipment required extensive test evaluation and improvement before achieving compliance
- Noncompliance applied to all contractors and product types.

What caused the disparity between the required and the initially achieved reliability? The main cause of the credibility gap is that management, both industry and government, was readily willing to accept an analytical prediction of performance, derived from adding piece-part failure rates, as a projection of expected, initial, product performance. Obviously, such a projection is an invalid premise.

- Reliability growth is an inherent part of the product development cycle.
- The inability to dimension a framework for this growth is a void in development program planning.

# A WEAPONS SYSTEM AVIONICS SUPPLIER'S PERFORMANCE

EQUIPMENT	MTBF AT 90%	COMPLEXITY	NEW OR MOD	MEAS INIT DEMO HRS	% OF REQMT	SYS QUAL RQT HRS	SERIAL NO. OF DEMO COMPLIANCE															
							RDT&E		PRODUCTION													
							10	20	20	40	60	80	100	120								
FLIGHT CONTROL COMPUTER	300	17K	N	25	8	5.5K	█	█	█	█	█	█	█	█	█	█	█	█	█	█	█	█
FORWARD LOOKING RADAR	134	10.7K	N	11	8	3K	█	█	█	█	█	█	█	█	█	█	█	█	█	█	█	█
CENTRAL COMPUTER	560	1K	N	32	5	9.0K	█	█	█	█	█	█	█	█	█	█	█	█	█	█	█	█
BOMB / NAV SET	243	5.7K	N	8	3	5.6K	█	█	█	█	█	█	█	█	█	█	█	█	█	█	█	█
ECM RECEIVER	152	11K	N	18	12	5.3K	█	█	█	█	█	█	█	█	█	█	█	█	█	█	█	█
AVOIDANCE RADAR	108	4K CH	MOD	34	35	3K	█	█	█	█	█	█	█	█	█	█	█	█	█	█	█	█
LEAD COMPUTING OPTICAL SIGHT	300	.8K	MOD	85	28	9.6K	█	█	█	█	█	█	█	█	█	█	█	█	█	█	█	█
COUNTERMEASURES	150	3K	N	25	16	8.9K	█	█	█	█	█	█	█	█	█	█	█	█	█	█	█	█
ALTIMETER	500	.8K CH	MOD				█	█	█	█	█	█	█	█	█	█	█	█	█	█	█	█

1965 VINTAGE

- R REQUIREMENTS PER MIL-R-26667
- R QUALIFICATION
- R ACCEPTANCE
- FACI

## RELIABILITY PLANNING AND MANAGEMENT

Reliability Planning and Management (RPM) is a new methodology developed by GE/AESD to relate reliability criteria to program planning options and constraints. It incorporates demonstrated reliability growth rates based on visible evidence of performance, enabling the dimensioning of time, resources, assets, and facilities required to bridge the gap between the sterile stated reliability requirements and the practical reality of program execution.

To apply RPM, certain axioms must be accepted:

- 1) No design is ready for release to product manufacture until (using MIL-Handbook 217A failure rates) a reliability prediction (at a minimum) 125% of requirement is established.
- 2) Based on historical data, initial product performance will be approximately 10% of the predicted value.
- 3) Reliability growth is predictable and can therefore be planned based on a Reliability Growth model.

Accepting these axioms then, the scope of a reliability growth program can be reduced to one simple chart, as shown here, portraying a requirement, a prediction of performance against that requirement, a dimensioned initial product performance, and a sized time to compliance. This then is the Reliability Planning and Management model as presented by GE to government and industry.

# RELIABILITY PLANNING & MANAGEMENT

- INITIALLY RELEASED DESIGN - APPROXIMATELY 10% OF PREDICTED INHERENT CAPABILITY
- GROWTH-PLAN PROGRAM BASED ON DUANE GROWTH AND RPM TRADEOFFS
- PREDICTION - SIMPLIFY DESIGN UNTIL MIL-HDBK-217 PREDICTION IS 125% OF REQUIREMENT
- SCREENING/ PROCESSING - ADJUST LEVELS TO MEET MTBF REQUIREMENT

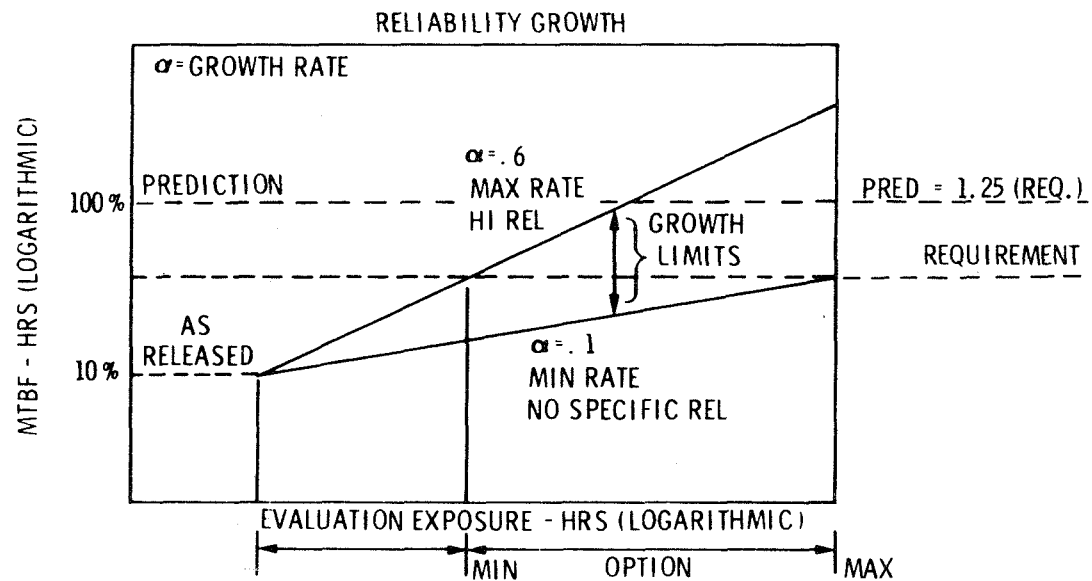

## PROGRAM PLANNING OPTIONS

- EQUIPMENTS
- FACILITIES
- LEVEL OF CORRECTIVE ACTION

## PROGRAM CONSTRAINTS

- CHANGE LIMITATIONS, i. e., CONFIGURATION CONTROL
- STATE OF THE ART
- DOLLARS
- TIME



## RELIABILITY GROWTH MODEL

In 1962, J. T. Duane, at the GE Motor and Generator Department, examined the performance of electromechanical and hydromechanical products which had undergone many thousands of test hours. His efforts resulted in the formulation of a technique for predicting the reliability growth of complex equipment.

# RELIABILITY GROWTH MODEL

- $MTBF = \alpha t + b$  ON LOG-LOG SCALES
- AXIOMS
  - RELIABILITY IMPROVEMENT OF COMPLEX EQUIPMENT FOLLOWS A MATHEMATICALLY PREDICTABLE PATTERN
  - RELIABILITY IMPROVEMENT IS APPROXIMATELY INVERSELY PROPORTIONAL TO THE SQUARE ROOT OF CUMULATIVE OPERATING (TEST) TIME
  - FOR A CONSTANT LEVEL OF CORRECTIVE ACTION EFFORT AND IMPLEMENTATION, RELIABILITY GROWTH CLOSELY APPROXIMATES A STRAIGHT LINE ON LOG-LOG SCALES
  - THESE RELATIONSHIPS PERMIT USE OF A SIMPLE TECHNIQUE FOR MONITORING PROGRESS TOWARD A PREDETERMINED RELIABILITY GOAL
- DATA SOURCE
  - INITIAL PATTERNS DEVELOPED IN EARLY 1960's FROM DATA ON FIVE DIVERGENT GROUPS OF PRODUCTS BASED ON TYPICALLY 50,000 HOURS OPERATING DATA  
2 HYDROMECHANICAL DEVICES, 2 COMPLEX AIRCRAFT GENERATORS,  
1 AIRCRAFT JET ENGINE
  - PATTERN CONFIRMED BY AESD TO BE APPLICABLE TO AVIONICS FROM DATA ON 4 PROGRAMS
- PUBLICATIONS
  - GE TECHNICAL INFORMATION SERIES DF62MD300 BY J.T. DUANE, DC MOTOR AND GENERATOR DEPARTMENT
  - 1968 ANNUAL SYMPOSIUM ON RELIABILITY — "RELIABILITY GROWTH IN REAL LIFE" BY E.O. CODIER, GE/AESD

## ORIGINAL DUANE DATA

Duane's findings resulted in the birth of the following concept:

Reliability improvement for complex equipment is mathematically predictable and follows a pattern which is inversely proportional to the square root of the cumulative test hours when the equipment is operating in its intended use environment.

For a constant level of effort toward, and timely implementation of, corrective action, reliability growth closely approximates a straight line on log-log scales.

Note that the slope ( $\alpha$ ) ranges from 0.35 to 0.5. Growth limits are estimated to have a maximum rate of approximately 0.5. A rate of 0.1 can be expected on programs where no concentrated effort is directed toward reliability improvement but where action is taken only in response to major field problems or customer complaints. This is the key to sizing the scope of the test evaluation program necessary to effect compliance. Our higher order RPM model incorporating the ability to dimension initial reliability performance was born out of this original work by Duane and out of studies at AESD aimed at deriving a meaningful development model.

# ORIGINAL DUANE DATA

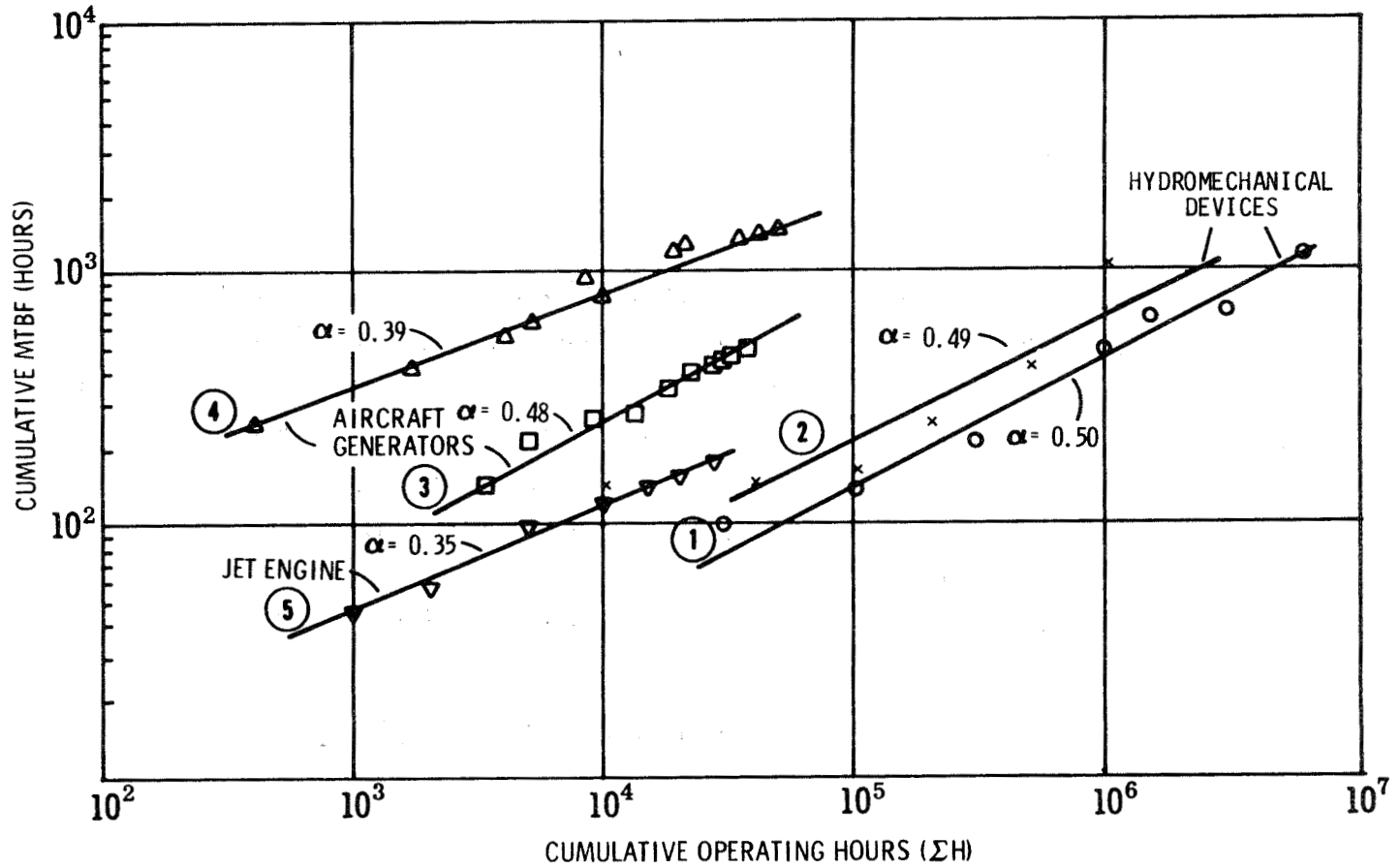

## RPM MODEL PROGRAM 1

The first AESD program examined was Rapid Tune, a 2000 piece-part Automatic Frequency Control for a Fire Control Radar System. All aspects of this program showed excellent correlation with the Reliability Growth Model and provided initial insight leading to this higher order RPM model. The new equipment initially performed at approximately 10% of the predicted MTBF and achieved a reliability growth rate ( $\alpha$ ) of 0.48, taking 10,000 hours of evaluation test to grow the as-released configuration to one that was conforming. The reliability growth rate did not persist for the additional 10,000 hours of Acceptance Test during the production program under change control constraints.

# RPM MODEL PROGRAM 1

VINTAGE 1961 - 1965

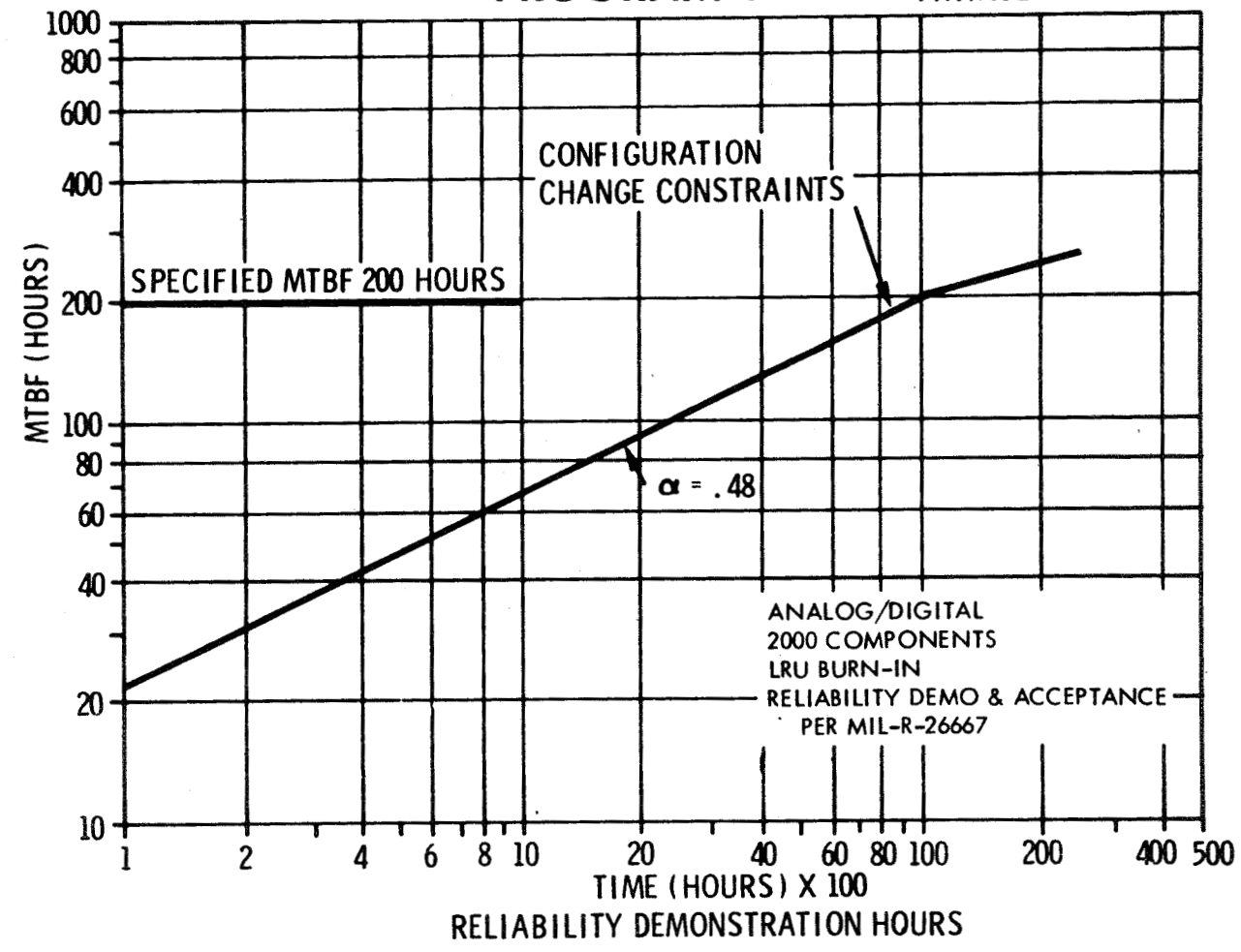

## RPM MODEL PROGRAM 2

A second correlation of the Reliability Growth concept was a midprogram study of the AN/APQ-113, a 1965 vintage radar for the F-111 Program and 5 times more complex a product than Rapid Tune. Excellent model correlation was shown. Initial performance with the 16,000 part configuration was 9 hours versus a 90 hour MTBF prediction, but well shy of the 137 hour minimum requirement. A redesign reduced parts count to 10,000, which with concurrent incorporation of extended parts and product screening resulted in initial performance of 18 hours versus a 180 hour prediction. Reliability growth rate ( $\alpha$ ) was 0.5 with change introduction flexibility, and much lower under production change control constraints.

# RPM MODEL PROGRAM 2

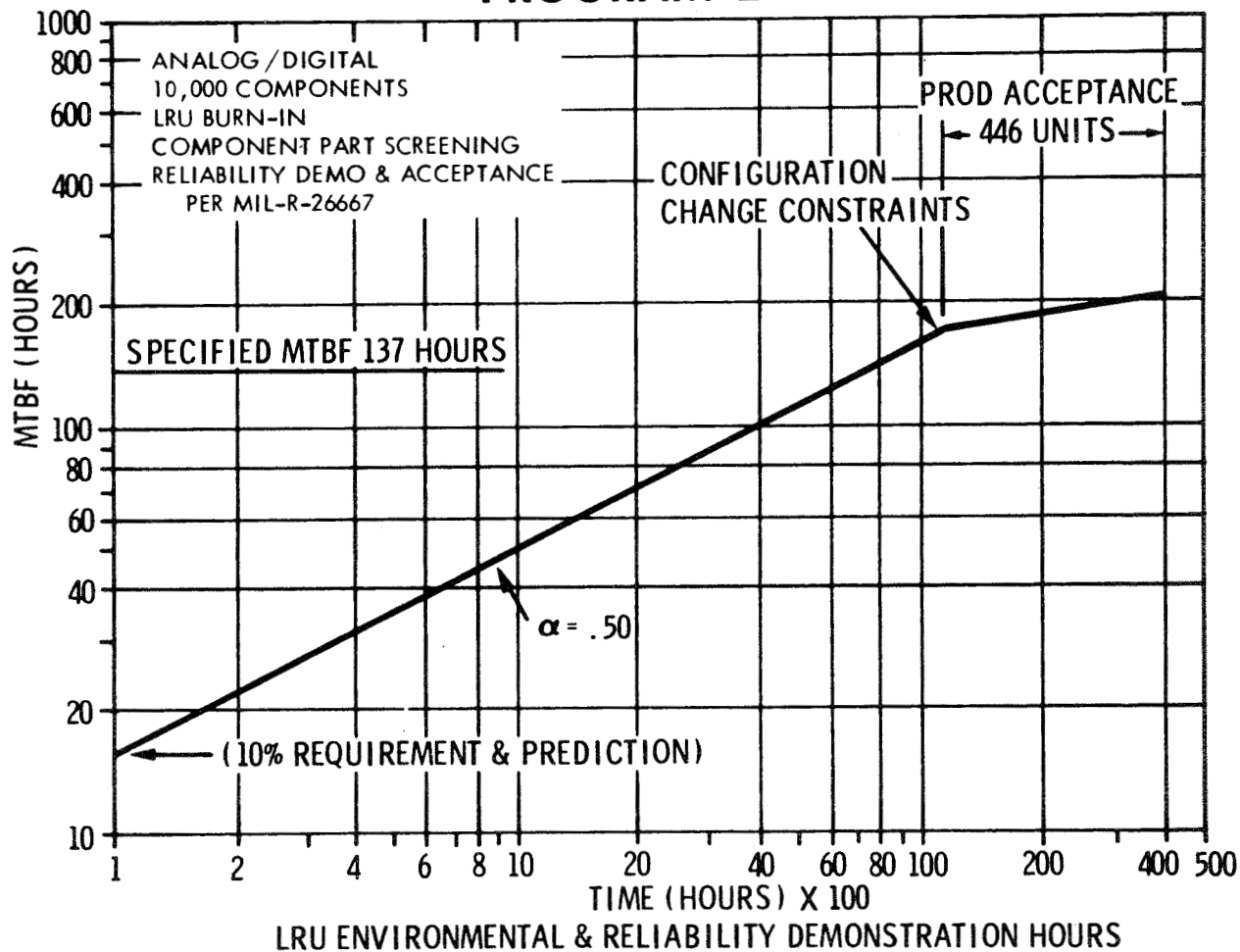



### RPM MODEL PROGRAM 3

The RPM model, postulated post facto for the Rapid Tune and AN/APQ-113 programs, was applied in forward fit for the first time by AESD at the inception of the AN/APQ-114 program, a 20% design-modified version of the AN/APQ-113 radar.

A composite model based on projected performance of changed and unchanged hardware forecast an initial performance of 33 hours MTBF. A conservative reliability growth slope ( $\alpha$ ) of 0.375 was projected, and a 3750 hour test program was structured, negotiated, and conducted. Correlation between performance and projection was excellent. The 21 systems which were subjected to Reliability Acceptance Testing measured 212 hours MTBF, making all hardware delivered on the program compliant with reliability requirements.

# RPM MODEL PROGRAM 3 EVENT HISTORY

EVENT		1966				1967				1968				1969				1970				
		1	2	3	4	1	2	3	4	1	2	3	4	1	2	3	4	1	2	3	4	
HDWARE	DEVELOPMENT MODELS 3 SYSTEMS																					
	PRODUCTION (20% CHANGE HARDWARE) 84 SYSTEMS																					
REL	TEST & FIX (3750 HOURS) 3 SYSTEMS																					
	PROD ACCEPTANCE TEST 21 SYSTEMS																					

MTBF = 212 HR

47

## RELIABILITY GROWTH-PREDICTED vs EXPERIENCED

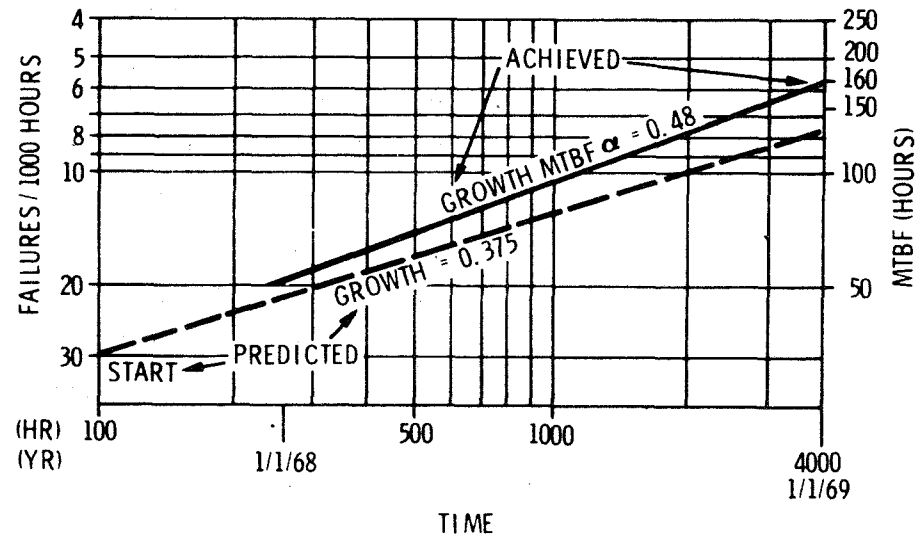

## PLANNING EXAMPLE

### RFQ Requirement

- New equipment - within state of art
- R & D target time - 36 months
- MTBF 150 hours - Weapons System apportioned
- $\bar{R}$  program per MIL-STD-785
- Test per MIL-STD-781 level F
- FACI and configuration control - 1st production item

### Initial Contractor Plan

- Complexity
  - Estimate - 11K electrical piece parts, 220 hour prediction
- High Reliability Program
  - Design disciplines,  $\bar{R}$  parts, screening, evaluation testing
- Time Phase Plan
  - 15 month design, 6 month manufacturing, 12 month evaluation, 3 month production transition
- Implementation Options
  - Minimum assets
    - 1 equipment, spares, 24 month evaluation
  - Compliant time
    - 2 equipments, spares, 12 month evaluation
  - Least risk
    - 3 equipments, spares, 8 month evaluation
    - Growth contingency 25%, 12 month evaluation

# PLANNING EXAMPLE

## OPTIMIZATIONS:

MINIMUM ASSETS - VARY TIME COMPLIANT SCHEDULE

COMPLIANT TIME - ADEQUATE ASSETS

LEAST RISK - CONTINGENCY ASSETS

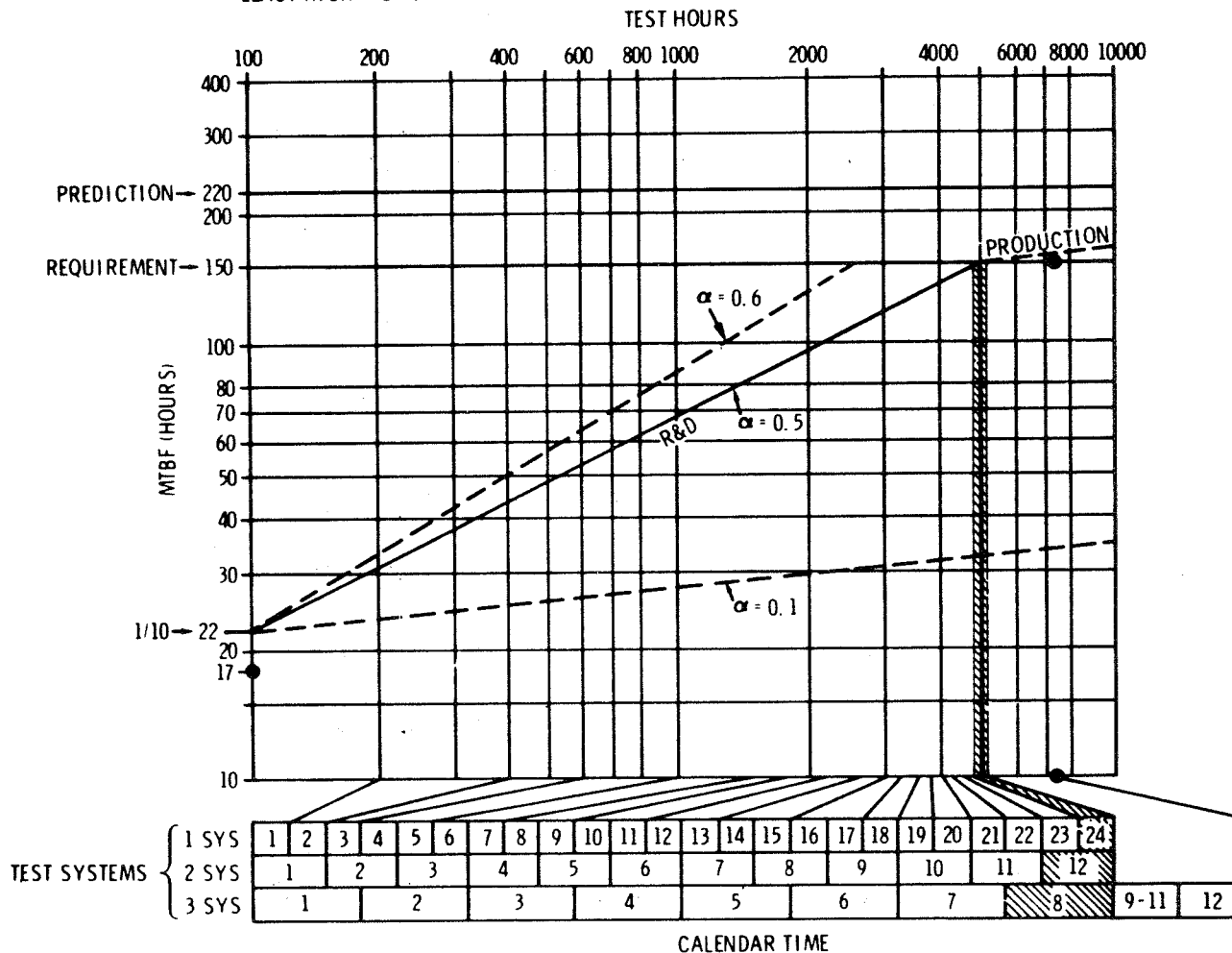

# RPM APPLIED TO SPACE SHUTTLE

$$(MTBF = \alpha t + b)$$

- BEWARE OF NEW EQUIPMENT DESIGNS (b)  
where reliability will be approximately 10% of prediction
- ADDRESS TIME CONSTRAINTS (t)  
through accelerated testing (step stress, overkill)
- ACCELERATE RELIABILITY GROWTH ( $\alpha$ )  
through aggressive problem identification, corrective action,  
and test validation
- ASSURE THAT SUBSTANTIVE RELIABILITY PREDICTIONS EXCEED REQUIREMENTS (MTBF)  
by sufficient margin to enhance achievability and allow  
for uncertainties
- OPTIMIZE LEVEL OF SCREENING TESTS (MTBF)  
commensurate with reliability requirements

**A REALISTIC APPROACH  
TO A  
COST EFFECTIVE DESIGN AND TEST PROGRAM  
FOR  
FUTURE SPACECRAFT EQUIPMENT**

**Gilbert Friedenreich  
Section Chief Reliability & Maintainability  
and  
Howard Wright  
Assistant Director Space Shuttle Program**

**Grumman Aerospace Corporation  
Bethpage, L.I., N.Y. 11714**

## ABSTRACT

This paper will present the results of an analysis to develop specific cost effective guidelines for the design, test and maintenance of reusable spacecraft hardware. The analysis is based on a study of hardware performance and reliability that is thoroughly documented in the Apollo Lunar Module Program.

The paper will cover all phases of equipment testing and utilization. The paper concludes that major program expenditures in the past were avoidable - and that early implementation of an effective program, augmented by a rigorous management discipline, can prevent unnecessary cost in the future.

# **OBJECTIVE**

**ANALYSIS OF HISTORICAL DATA TO STRUCTURE  
A COST EFFECTIVE TEST PROGRAM**

- **SPACE – APOLLO – OAO**
- **AIRCRAFT – MILITARY**



## IMPACT OF ENVIRONMENT OVER PROGRAM LIFE

- **Failure Due to Environment Causes**  
**Decrease as Total System Matures**
  - **Changes Due to Special Efforts –**
    - **Corrective Action Teams**
    - **Incorporation of ECP's - Based on Field Results**
    - **Special Test Efforts**
  
- **Elimination of These Problems Should Be Accomplished**  
**by Means of Early & Effective Test Programs**
  - **Verification**
  - **Acceptance**

# IMPACT OF ENVIRONMENT OVER PROGRAM LIFE

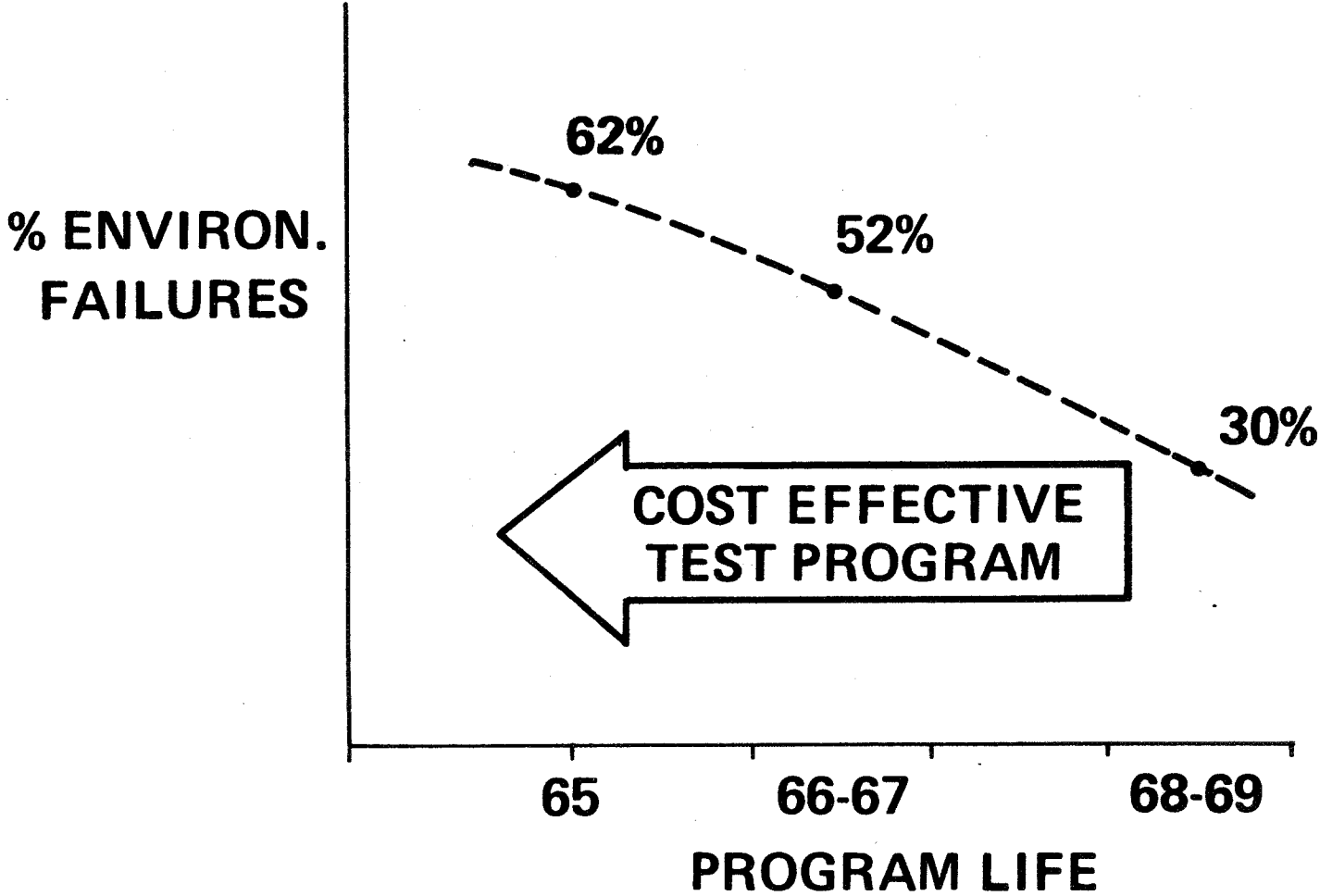

## TEST PHASES

### All Programs are Logically Divided Into Test Phases

- Group I (Dev, Qual, & Demo) - To Verify Design Integrity
- Group II (Acceptance) - To Confirm Quality

**Group I – Basic Design Must Be Environmentally Sound & Confirmed Thru Development, Qual, & Finally Reliability Demonstration Test**

**Group II – The Workmanship, Q/C, & MFG Defect Type of Problem Must Be Eliminated (Burn-In). Also, The Reliability Originally Designed & Proven in I Above, Must Not Be Allowed To Degrade in Production. Failure-Free Environmental Tests Accomplish This.**

# TEST PHASES

- DEVELOPMENT
  - QUALIFICATION
  - RELIABILITY DEMONSTRATION
  - RELIABILITY ACCEPTANCE
    - CONTROL QUALITY OF PRODUCT
    - WORKMANSHIP PROBLEMS
    - PROCESS CONTROL
    - MATERIAL DEFECTS
- } VERIFY DESIGN INTEGRITY GROUP I
- } PRODUCT CONTROL GROUP II

## DESIGN VERIFICATION TESTING DURING DEVELOPMENT

- **Comparison of Design Failure Distribution**
- **Similar End Results - Equal Failures in Vehicle Level Tests -  
But With Strong DVT Much More Efficient**
  - **Limited DVT**
    - **Majority of Design Failures in Qual & Accept**
    - **Big Impact on Cost & Schedule**
  - **Strong DVT**
    - **Majority of Design Failures in DVT**
    - **Minimal Impact on Cost & Schedule**

# DESIGN VERIFICATION TESTING DURING DEVELOPMENT TYPICAL SPACE PROGRAM (1968)

DESIGN
  QUALITY

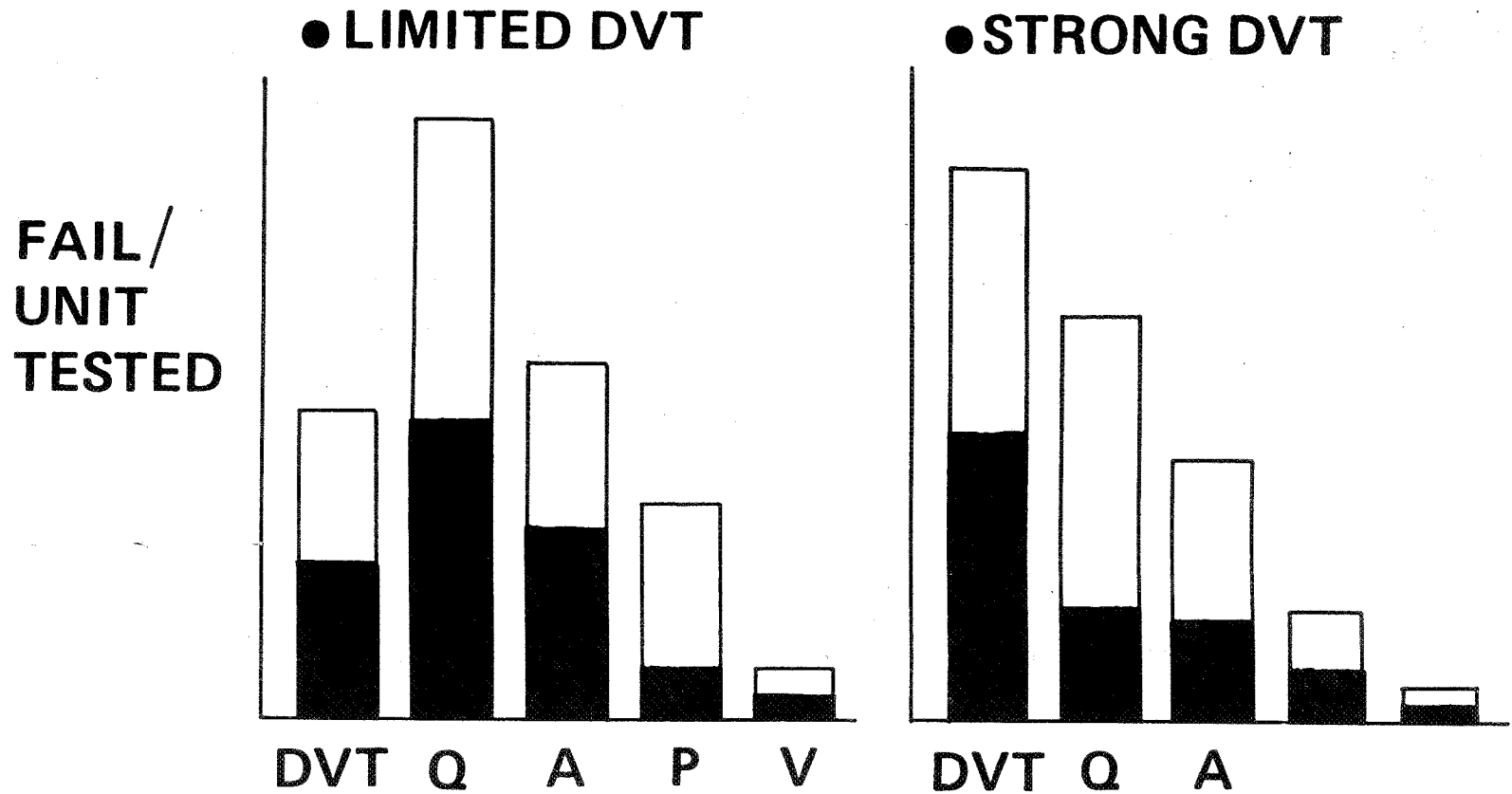

STEP STRESS TEST EFFECTIVENESS

- Field Data Comparison for Three Equip. Subjected to Step Stress Tests
- Time Periods Covered Six Months & Total Operating Times (Prior to & After C/A) Approx Equal
- Appreciable Savings Realized for These Equipments Even When:
  - Limited Time Period Considered
  - Conservative Failure Cost Utilized

TYPICAL AIRCRAFT PROGRAM

	NUMBER OF FAILURES		% SAVINGS	
	PRIOR TO C/A	AFTER C/A	FAIL	COSTS
DIRECT VIEW RADAR IND	31	14	55	43
ANALOG DISP IND	39	5	87	69
PILOTS HORIZ DISPLAY	32	1	97	89
<b>COST SAVING OF REPAIR LESS REDESIGN &amp; SST COSTS</b>				

# TOTAL FIELD FAILURE DISTRIBUTION

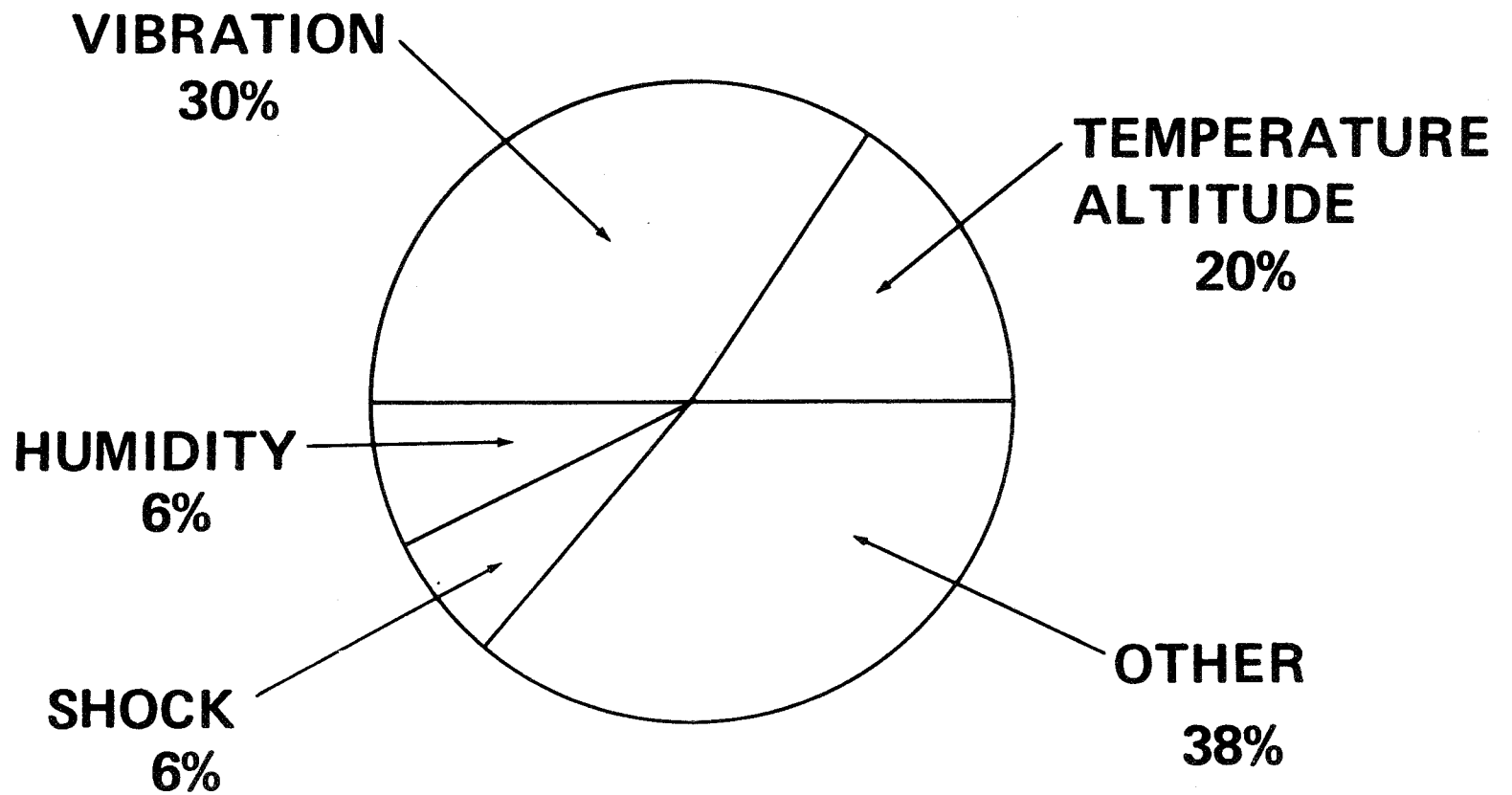



## RELIABILITY DEMONSTRATION

- **COSTLY & LENGTHY**
- **INEFFICIENT FOR REVEALING DESIGN PROBLEMS**

**BUT.....**

- **PROVIDES CONFIDENCE IN EQUIP. RELIABILITY**
- **ASSESSES TIME – DEPENDENT PROBLEMS**
- **EXTREMELY EFFECTIVE IN CONTROLLING  
EQUIPMENT RELIABILITY**

# RELIABILITY DEMONSTRATION - TYPICAL TEST PLAN

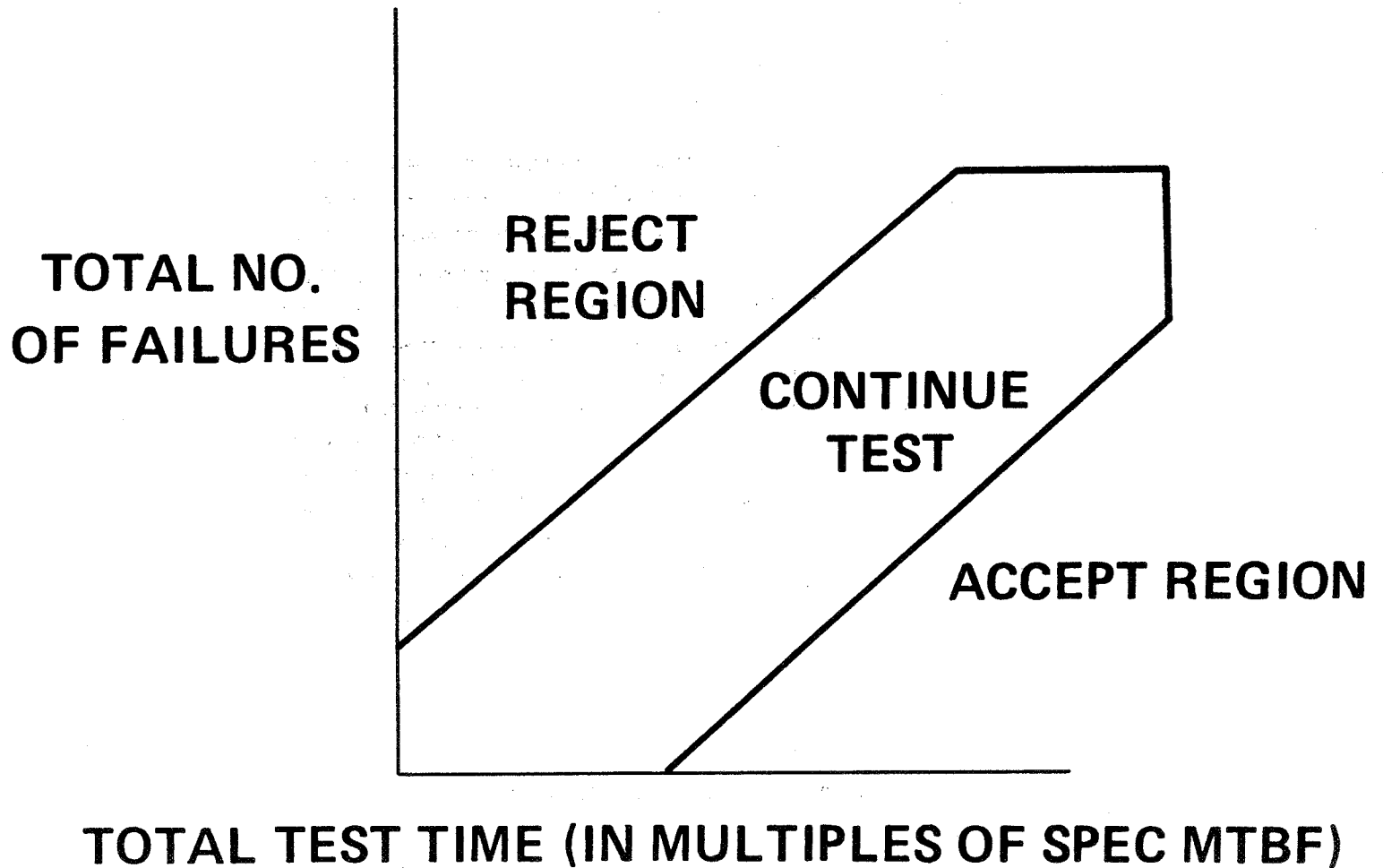

## **A-D CONVERTER TEST & FIELD RESULTS**

- **Burn-In Plus Reliability Acceptance Tests Must Be Applied to Each Item for Effective Control**
- **The A-D Converter Was Subjected to 50 – 100 Hrs of Total Test Time which Served to:**
  - **Burn-in Equipment**
  - **Force Subcontractor to Accomplish 25 Hours of Failure-Free Operation (Implicit in This, is the Fact That Proper Remedial Action Be Taken to Permit Completion of Failure-Free Tests)**
- **Although Obviously Effective, Failures Still Evident After 600 Hrs & Failure Rate is Still Not Constant**
- **Investigation Revealed Time-Dependent Failures**
- **At Present, an In-House Study is Being Undertaken to Establish More Effective Methods of Detecting Latent Defects**

# A-D CONVERTER TEST & FIELD RESULTS

AT MANUFACTURERS  
PLANT

FIELD

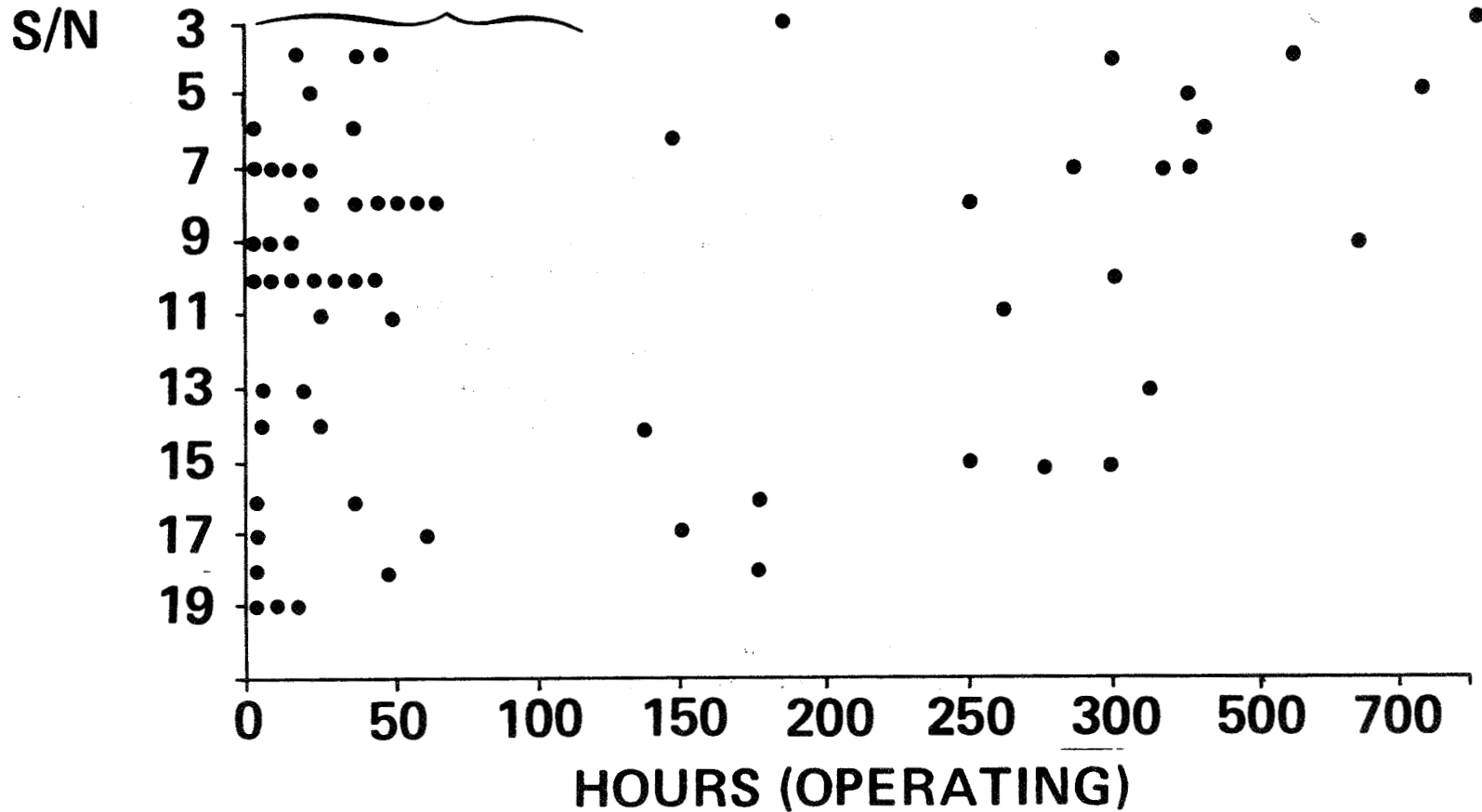

● DENOTES FAILURE

**BURN-IN EFFECTIVENESS FOR PRIMARY  
TAPE DIAL INDICATORS**

- **Burn-In Tests Required to Eliminate Workmanship & Q/C Problems**
- **Environmental Exposure Mandatory**
- **Duration**
  - **Function of Equipment Type**
  - **Initial Data Used to Establish Time to Constant Failure Rate. Subsequent Test Times Dependent on Initial Test Results.**
- **Data, Plus Experience, Indicates that Avionic Equipment Requires Longer Burn-in to Achieve Constant Failure Rate than Non-Avionics Equipment**

# BURN-IN EFFECTIVENESS FOR PRIMARY TAPE DIAL INDICATORS

67

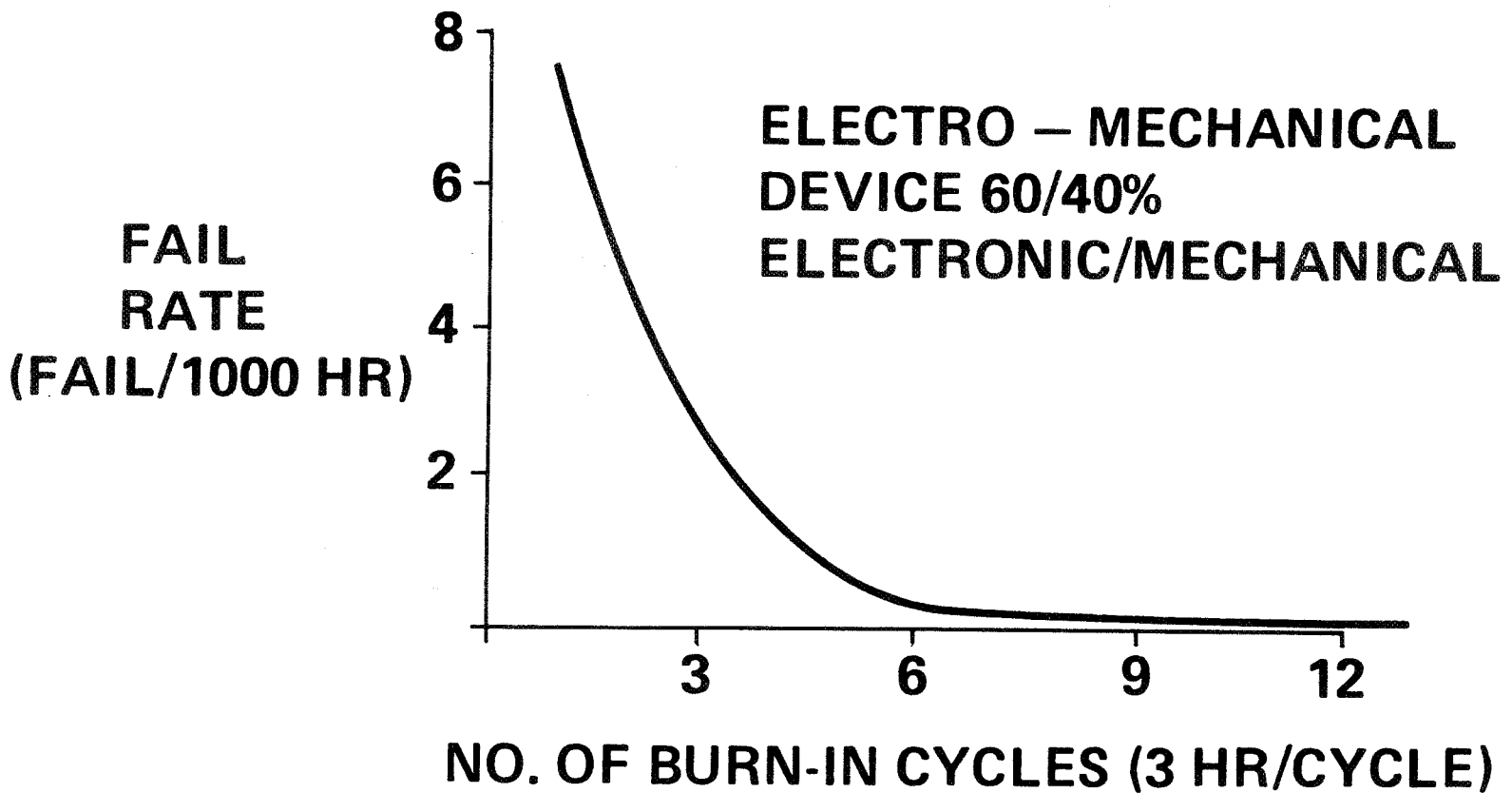

## VHF TRANSCEIVER

- **Cost Drivers**

- **Higher Level Parts**
- **Increased Redundancy**
- **More Intensive Testing**
- **More Stringent Mission Requirements**

# VHF TRANSCEIVER

## TYPICAL SUBSYSTEM COMPONENT COSTS vs MTTF

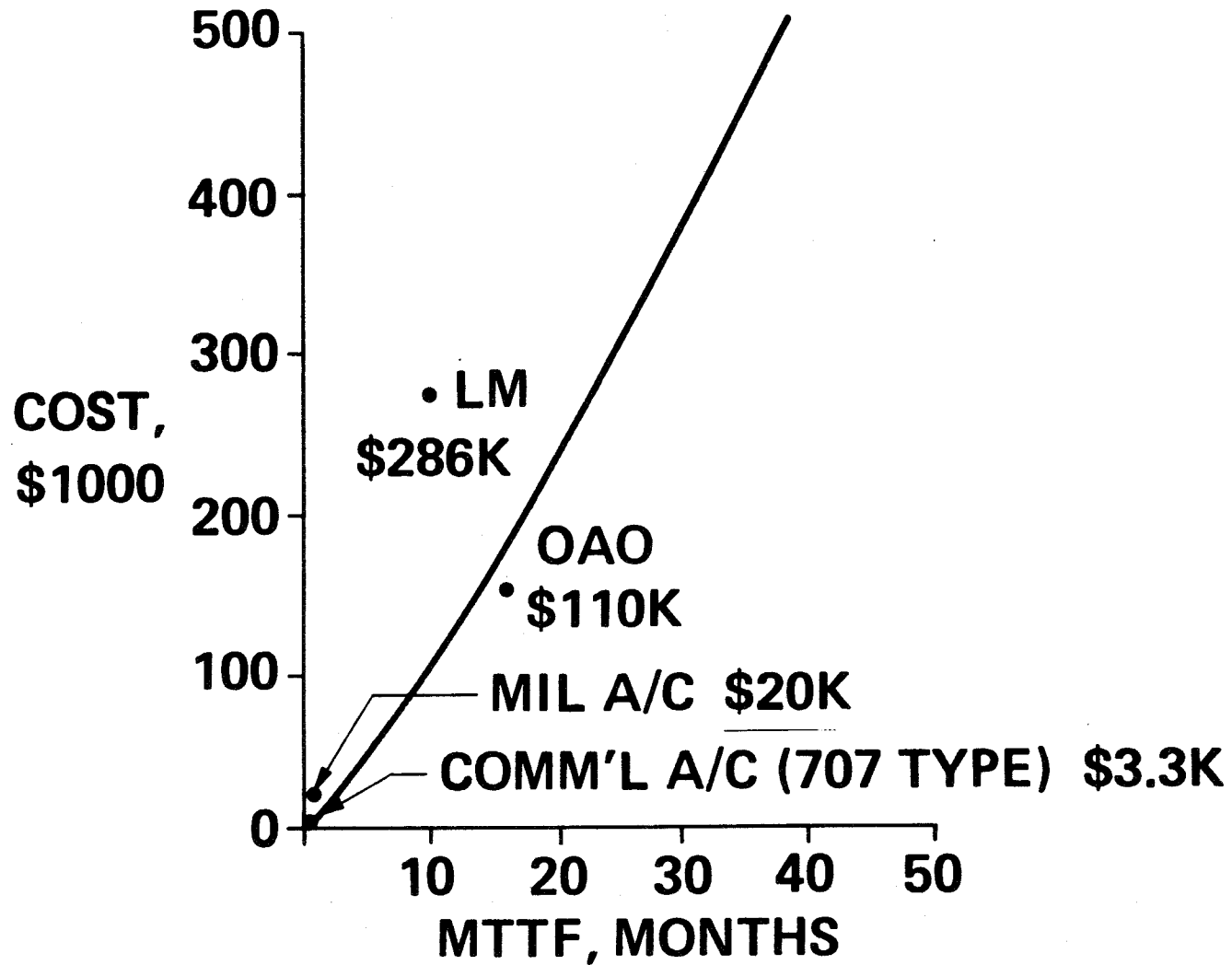



# CONCLUSIONS

## RECOMMENDED APPROACH

- **STRONG EARLY DEVELOPMENT TEST PROGRAM**
  - DESIGN VERIFICATION TEST
  - STEP STRESS TEST
- **EFFECTIVE QUALIFICATION PROGRAM**
  - CORRECT SIMULATION
  - STRONG MANAGEMENT CONTROL
- **SELECTIVE RELIABILITY DEMONSTRATION TESTS**
  - COMPLEX LOW MTBF SYSTEMS
- **100% ENVIRONMENT ACCEPTANCE**
  - BURN-IN
  - FAILURE-FREE

**GUIDANCE, NAVIGATION, AND CONTROL**

2000-01-01

**SHUTTLE ASCENT GUIDANCE AND CONTROL REQUIREMENTS**

**J. C. Blair and J. A. Lovingood**

**NASA-Marshall Space Flight Center  
Huntsville, Alabama**

## SHUTTLE LAUNCH VEHICLE CHARACTERISTICS AFFECTING ASCENT GUIDANCE AND CONTROL

In the combined booster/orbiter ascent configuration, the space shuttle is a launch vehicle which has a number of characteristics unlike previous launch vehicles. These new characteristics necessitate an examination of the shuttle ascent guidance and control philosophy to insure that stringent requirements will be met. The slide lists some of these characteristics which may force a departure from conventional launch vehicle guidance and control practice. Selected characteristics will be discussed in more detail, and their impact on ascent guidance and control requirements will be summarized.

## *SHUTTLE LAUNCH VEHICLE CHARACTERISTICS AFFECTING ASCENT GUIDANCE & CONTROL*

CONFIGURATION DESIGNED FOR REUSE

HIGH PITCH STABILITY

HIGH YAW-ROLL COUPLING

PITCH - YAW ASYMMETRY

INTACT ABORT

MISSION MODEL

HIGH USE RATE, SHORT TURNAROUND TIME

WIDE RANGE OF MISSIONS

SMALL PAYLOAD FRACTION

MULTIPLE CONTROL VARIABLES

BENDING CHARACTERISTICS

COMPLEXITY

LACK OF FULL-SCALE

TESTING

LONGITUDINAL ACCELERATION

CONSTRAINT

BOOSTER FLYBACK

SIDE-BY-SIDE STAGE MATING

## COMBINED INTERACTION AND OPTIMIZATION

For the shuttle, more than for previous launch vehicles, there are both a need and an opportunity for combined optimization of the guidance and control systems along with the free configuration parameters which are related to flight mechanics. The smaller payload fraction of the shuttle makes the benefits of optimization more significant. The sensitivity of the payload to positioning of the total force vector during ascent, coupled with a relatively low control authority, implies a significant guidance/control interaction. At this time point in the shuttle development, adequate analytical and computational methods can be used to determine the best overall systems in time to influence configuration design as well as guidance and control.

# COMBINED INTERACTION AND OPTIMIZATION

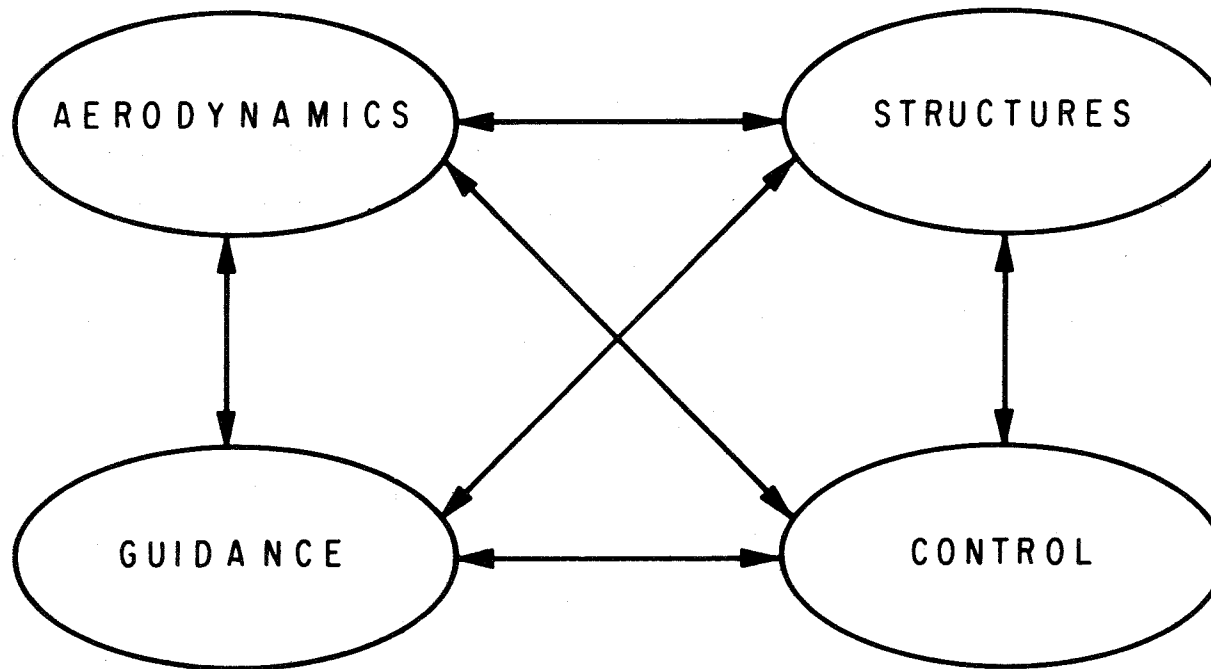



## ASCENT TRAJECTORIES

The fact that the shuttle vehicle is designed for flight phases other than launch and the strong need for maximizing the payload imply that the conventional gravity turn trajectory during atmospheric flight may not be a valid philosophy for the shuttle. The total ascent trajectory should be optimized, taking into account constraints on booster flyback and loading effects on structural weight. The time histories shown on this chart illustrate the differences between a trimmed gravity turn and a maximum payload trajectory optimized without structural or flyback considerations. Depending upon the configuration, optimal shaping can provide a significant gross increase in injected payload. The effect of structural and flyback considerations remains to be determined.

# ASCENT TRAJECTORIES

67

PITCH ATTITUDE,  $\chi$  (deg)

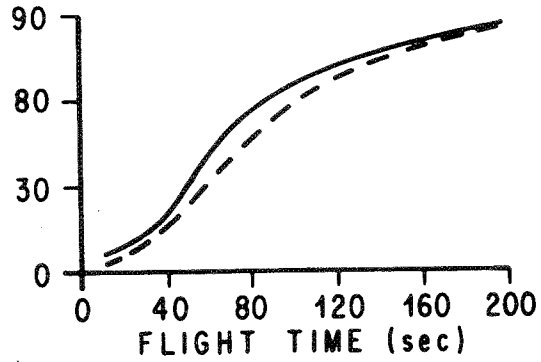

ANGLE OF ATTACK,  $\alpha$  (deg)

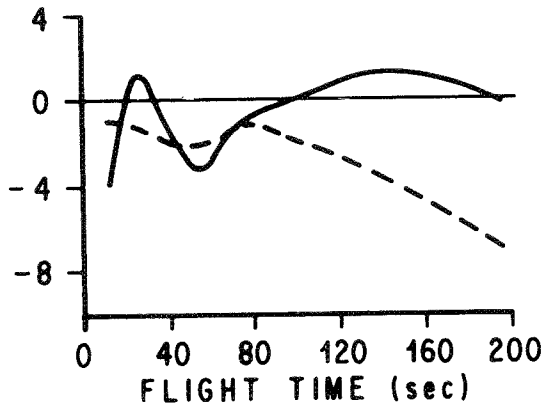

DYNAMIC PRESSURE,  $Q$  ( $N/m^2$ )

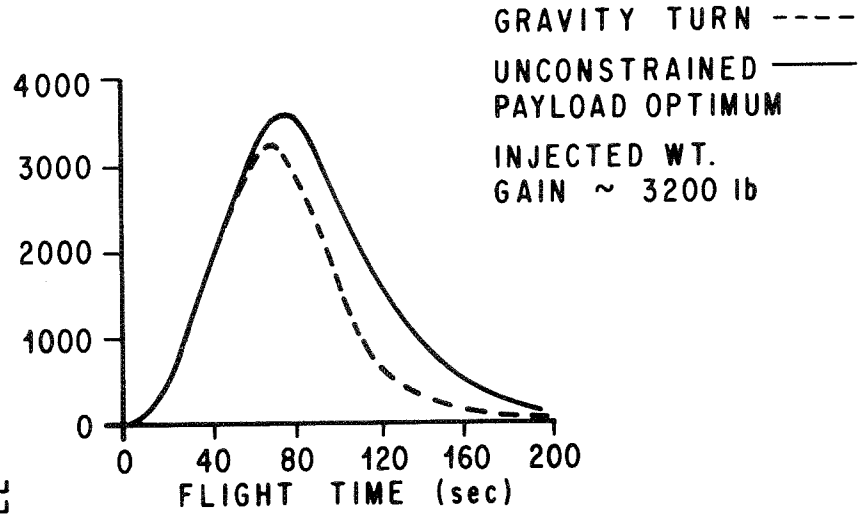

THRUST DEFLECTION ANGLE,  $\delta$  (deg)

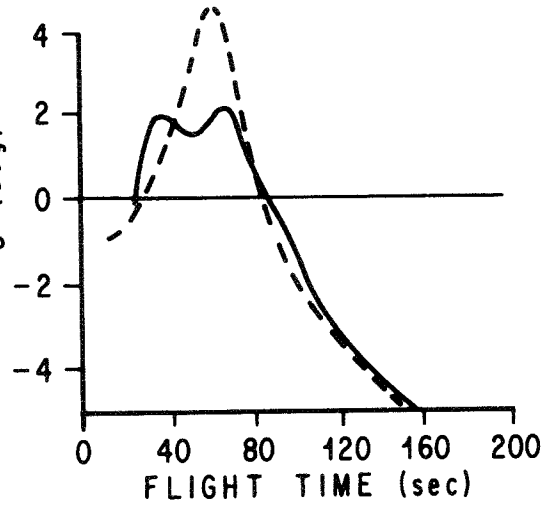

## EFFECT OF ATMOSPHERE ON TRAJECTORY OPTIMIZATION

The guidance system used for shuttle ascent (either open-loop tilt command or closed-loop guidance) must consider aerodynamics in its formulation. The payload effect of not including aerodynamics is shown in this graph. Injected weight is plotted versus time of initiation of the optimization for two trajectory optimization programs - one which includes aerodynamics in its formulation and one which does not (vacuum flight equations). The vacuum flight formulation results in a sharp payload loss when it is used near the maximum q region or earlier.

The guidance loop will be closed at some point during ascent in order to reduce dispersions and meet the end conditions. It appears likely that guidance or a path feedback loop will need to be closed early enough that aerodynamic forces will be a significant influence on the closed-loop system.

# EFFECT OF ATMOSPHERE ON TRAJECTORY OPTIMIZATION

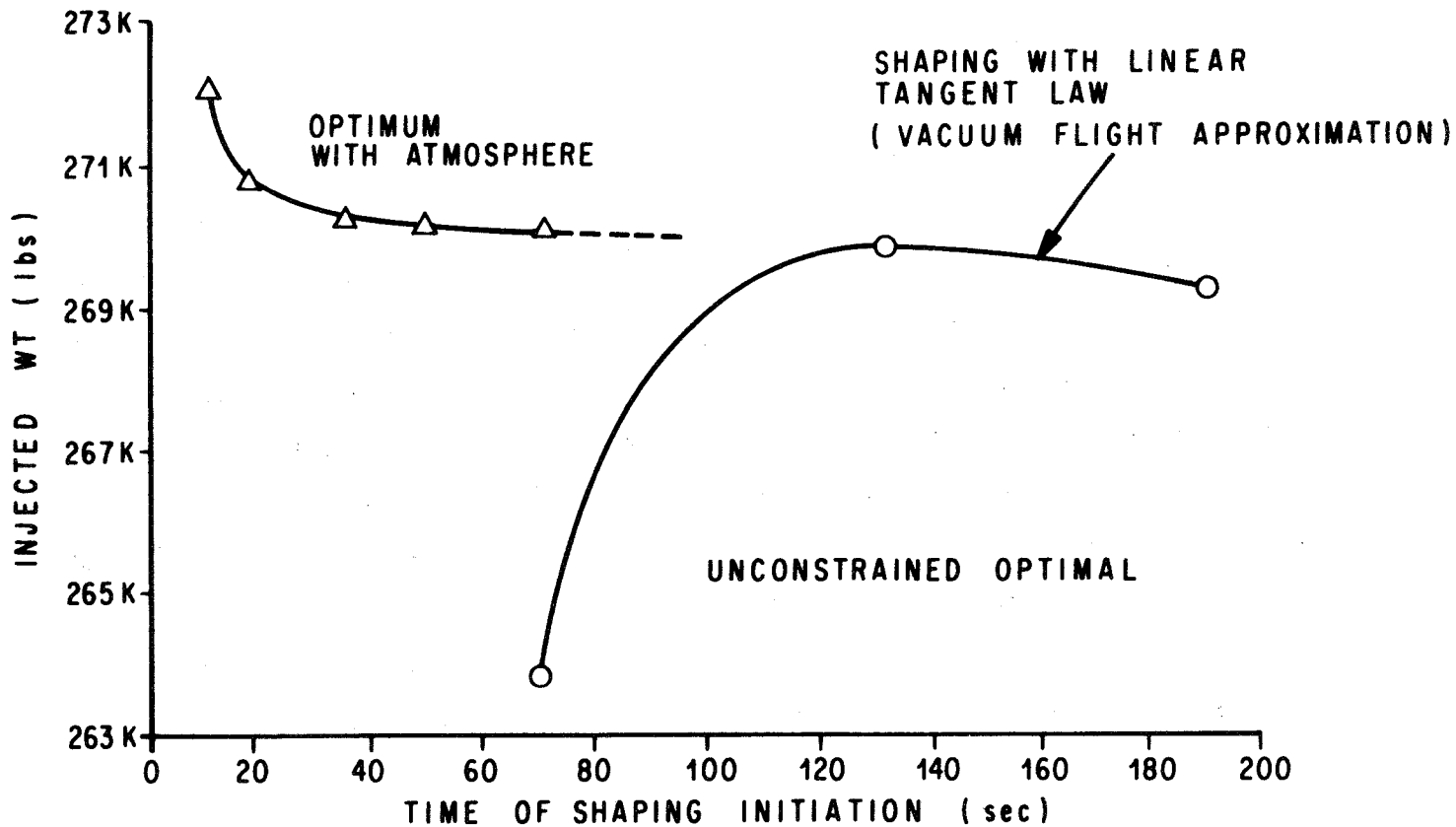

## TYPICAL AERODYNAMIC CHARACTERISTICS

Aerodynamic characteristics for a shuttle vehicle are shown on the chart. Typically, these vehicles have been neutrally stable in yaw and highly stable in pitch during the maximum dynamic pressure region as shown by the curves on the left. The curves on the right show the roll moment coefficient per degree sideslip angle  $C_{l\beta}$  and the roll moment per degree elevon deflection  $C_{l\delta_a}$  normalized to the max q flight condition. The surface effectiveness for generating roll peaks prior to Mach 1 and then has a very rapid decline so that at the crucial max q flight time, the effectiveness is less than one-half of its maximum value. This, of course, means that larger deflections are required at q max than at, say, Mach 1; but, perhaps more significant is the uncertainty in the value of the effectiveness from Mach 1 to max q because of the rapid change. Uncooperatively,  $C_{l\beta}$  manages to increase and hold fairly steady through the Mach 1 to max q region.

# TYPICAL AERODYNAMIC CHARACTERISTICS

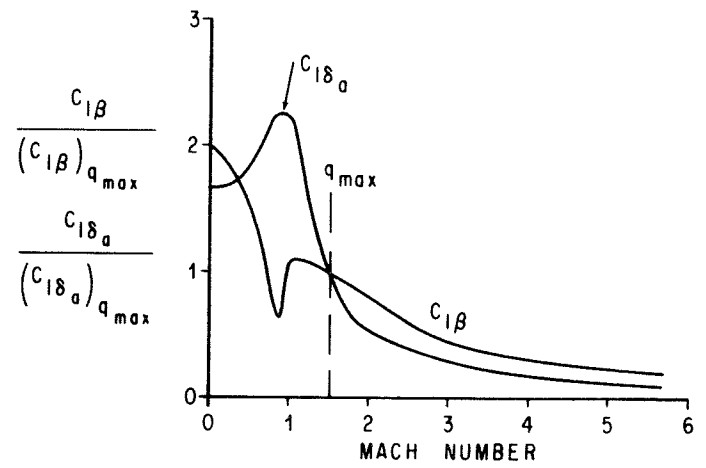
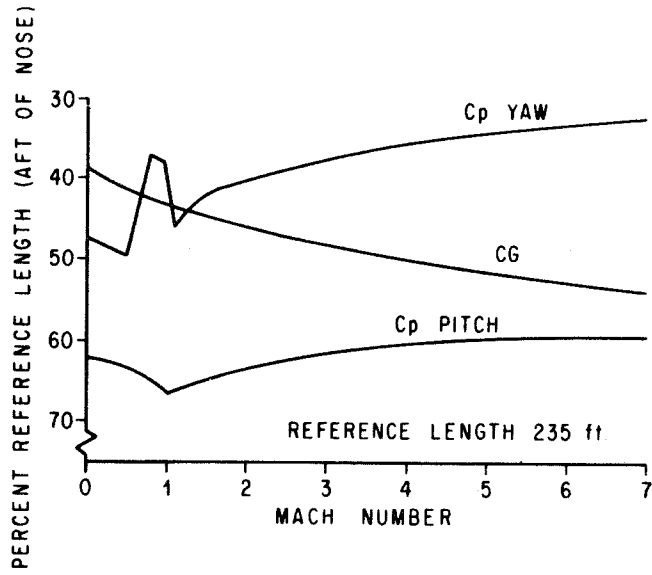

## PITCH GIMBAL ANGLE RESPONSE TO WIND

The high stability in pitch causes large gimbaling requirements in order to maintain satisfactory path performance in the presence of winds. The gimbaling requirement is increased further by the center of mass of the composite vehicle being off the geometric centerline and the aerodynamic lift for optimum performance being nonzero. For vacuum flight, the off-centerline center-of-mass would require the thrust vector to deflect so that the thrust would be directed through the mass center. However, because of the nonzero aerodynamic lift force required for optimum performance, the engine thrust must be deflected in a manner to counter the aerodynamic moment induced by this lift. The chart indicates the amount of engine gimbaling required for a modified gravity tilt point mass trajectory. The modifications were made to increase performance without causing excessive structural loading.

The effect of headwinds and tailwinds on gimbaling angle is also shown in the chart. One can readily see that this particular configuration requires at least  $10^\circ$  gimbaling angle because important factors such as an engine thrust failure, bending and slosh stabilization requirements plus uncertainties in the airframe dynamics have been omitted.

Path angle and integral of path angle feedback, along with the usual attitude and attitude rate feedbacks, were required in order to get the engines off the  $10^\circ$  stops for the 3 km altitude wind which was simulated. In addition to the path angle feedbacks reducing the gimbaling angle, a gain of 4,000 lbs payload was realized by their addition. This points out the very strong requirement that we can expect for some type of relatively high gain guidance during ascent - perhaps even a terminal guidance mode being initiated prior to max q.

# PITCH GIMBAL ANGLE RESPONSE TO WIND

3 km GUST ALTITUDE  
PATH ANGLE AND  $\int$  PATH ANGLE  
FEEDBACK

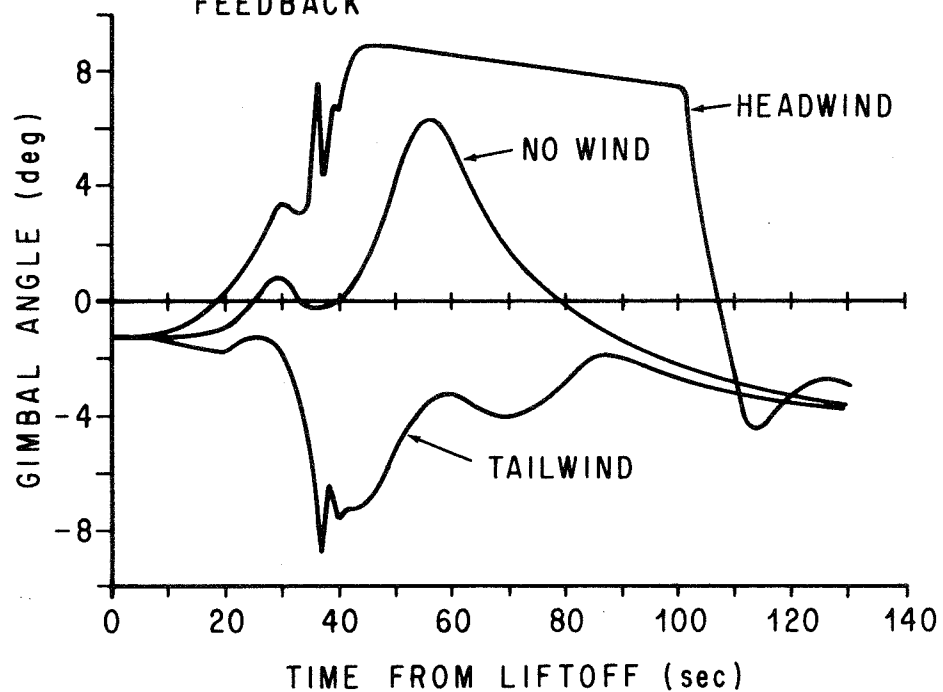



## EFFECT OF AERO SURFACE FOR ROLL CONTROL

This chart demonstrates the efficacy of differentially-deflected elevons in reducing roll excursions. The engines are deflected to their stops in the pitch plane as shown by the  $\delta_{p_1}$  and  $\delta_{p_6}$  traces. A roll angle  $\varphi$  of  $20^\circ$  and roll rate of 8.9 degrees/second are experienced, and sideslip  $\beta$  is held to less than  $4^\circ$ . The yaw gimbal angle  $\delta_y$  stays at reasonable values. (Differential gimbaling in yaw is not employed.) The lower figure shows a dramatic reduction in these parameters. Because of the high surface effectiveness, very small elevon deflections  $\delta_A$  occur.

Besides the effectiveness uncertainty being a problem, large surface deflections will introduce drag losses, and if it becomes necessary to increase the deflections to the extent that entry hinge moments are exceeded, the actuator hydraulic system requirements would increase. Consequently, the control system should mix the thrust vector and aero surface controls so that an "optimum" trade-off is obtained. The trade-off should not be limited to only the roll problem; in addition, the use of surfaces for trimming the aerodynamic moments in pitch, as well as possible rudder control in yaw, should all be considered to determine the best overall design from a performance, structures, and guidance and control viewpoint.

# EFFECT OF AERO SURFACE FOR ROLL CONTROL

95% YAW WIND ENGINE OUT AT 58 SEC

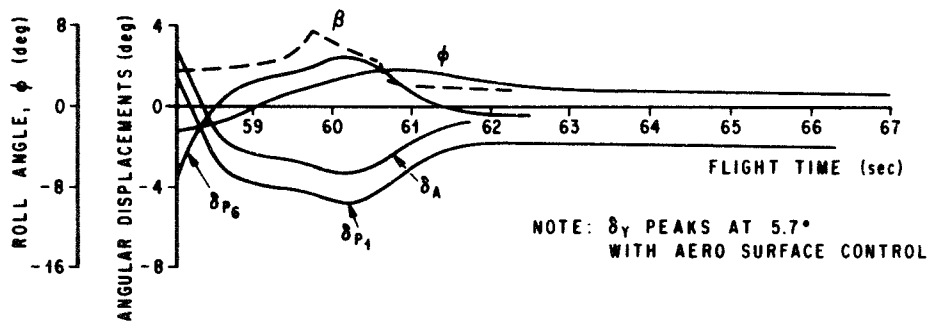
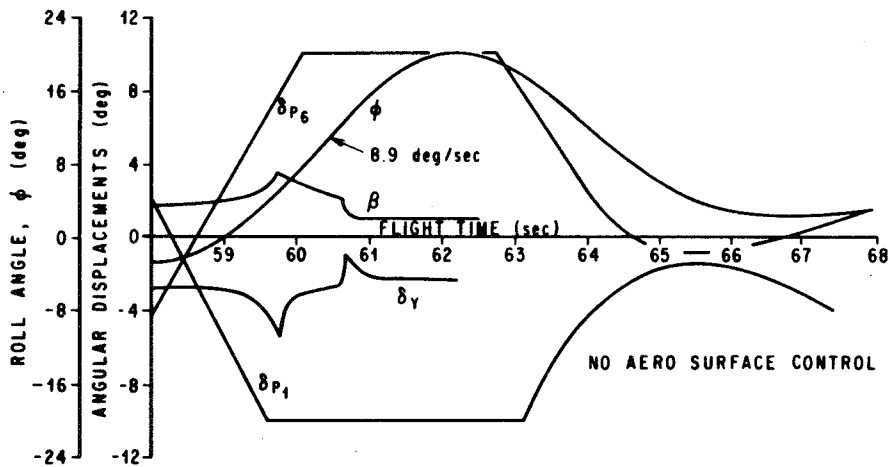

## POSSIBLE CONTROL SYSTEM SOLUTIONS

Preprogrammed attitude or angle of attack commands would sufficiently define the flight environment during ascent that time-programmed gains could be employed. However, trajectory sensitivities to winds and aerodynamic uncertainties might preclude such a procedure. Also, an uncertain variation of gain requirements as a function of flight time might occur because of abort contingency requirements. Consequently, air data sensors and gain scheduling as a function of dynamic pressure and Mach number might give better overall performance of the flight control system.

So far in the shuttle program, ascent loads have not really been a driver as far as the control system requirements are concerned. However, we are certain to face the requirements for load relief feedbacks such as normal accelerations and angle of attack as the shuttle program progresses; structural bending loads will certainly require load alleviation schemes of presently unknown sophistication. In pitch, some form of path feedback will be required, unless a closed loop terminal guidance scheme is employed. Alleviation of the yaw-roll coupling problem could be obtained by adjusting a sideslip feedback gain as a function of roll rates or attitudes. The adjustment would be made so that whenever high winds are encountered and excessive roll occurs, the yaw control channel would have increased sideslip feedback so that roll accelerations due to sideslip would be reduced. The sideslip gain would be decreased to some nominal, probably nonzero, value when the roll transients have been adequately damped.

Some control authority must be available for bending stabilization. Since several configurations studied during Phase B have exhibited dynamic characteristics which cause gimbal angles near the  $10^{\circ}$  mechanical limit, a suggestion has been made to electronically limit the attitude error command so that some reserve is always maintained for bending stabilization.

## *POSSIBLE CONTROL SYSTEM SOLUTIONS*

- *PITCH, ROLL AND YAW*

PREPROGRAMED ATTITUDE AND/OR ANGLE OF ATTACK  
COMMAND WITH TIME PROGRAMED GAINS (NOMINALLY  
ATTITUDE AND ATTITUDE RATE, ANGLE OF ATTACK)  
SCHEDULING OF CONTROL GAINS AS A FUNCTION OF  
DYNAMIC PRESSURE AND MACH NUMBER (FOR USE WITH  
ITERATIVE GUIDANCE AND FOR ABORT REQUIREMENTS)

- *PITCH*

PATH FEEDBACKS - PATH ANGLE, NORMAL VELOCITY  
LOAD RELIEF FEEDBACKS - NORMAL ACCELERATIONS,  
ANGLE OF ATTACK

- *YAW - ROLL*

SIDESLIP GAIN PROPORTIONAL TO ROLL RATE OR ATTITUDE  
PREPROGRAM OR GUIDANCE INITIATE ROLL MANEUVER  
BASED ON CROSS WINDS  
ELECTRICAL LIMIT OF YAW ATTITUDE FEEDBACK TO  
ALLOW RATE COMMAND FOR BENDING STABILIZATION



## STRUCTURAL BENDING CONSIDERATIONS

Structural bending modes are even more critical than on previous launch vehicles. The control system requirements at the present time are not determined because the structural models are not sufficiently well defined to permit a complete evaluation. However, initial models of the structure indicate that bending mode frequencies will be sufficiently separated from rigid body modes that conventional concepts of gain and phase stabilization can be employed. A departure from convention may be necessary because of the uncertainty of the structural data.

There will be no full scale vertical vibration testing of the launch configuration as we had for the Saturn and other programs. The main reason is cost. While mathematical modeling has improved significantly in recent years through finite element analysis techniques, the complex shuttle configuration presents new vibration problems. The piggy back arrangement of the orbiter and booster will cause aerodynamic interaction with the structural modes of two coupled bodies to an unknown extent. Wing bending during ascent must be considered and possibly even special procedures employed to damp wing bending modes. The use of aerodynamic surfaces on the wings for control during ascent will increase the coupling of these modes with the rigid body motion of the vehicle. The effect of torsion and bending at the booster/orbiter tie points will have to be carefully considered. Mathematical models of the structure may not adequately define the crucial bending data such as frequencies and mode shapes, and particularly, structural damping is available only from full scale testing. Verification of the math models will be obtained by scale model testing. However, while the

scale model results will certainly improve our confidence in the bending data, it will still leave a lot to be desired since to get accurate data requires an accurate model which again becomes prohibitive in cost. Component testing will also be employed but vibration data defined from such tests will still require mathematical techniques for joining the components.

The upshot of this is that sophisticated bending stabilization schemes may be required. The experience of aerospace research control engineers in the development of such schemes is legend. The last decade or so has seen the development of many adaptive bending stabilization concepts. One such system developed for and applied to the Saturn/Apollo is the Spectral Identification Adaptive Control Scheme shown on the chart. The concept involves a digital correlation of the outputs of the airframe to identify the frequencies of the elastic modes. Decoupling of these modes from the rigid body response is achieved by the use of notch filters. Results obtained with this system were very good; first mode frequency variations of 25% were handled, and much larger variations on the higher modes could be tolerated. Also, computer speed and storage requirements are reasonable. The identification concept can be used with other stabilization concepts; particularly, shaping filters could be employed to provide proper phasing to the control commands to stabilize the modes. This and other possible schemes should be examined in depth to determine first, what degree of sophistication in bending stabilization is required for the shuttle and second, what can be practically and reliably implemented.

# SPECTRAL IDENTIFICATION ADAPTIVE CONTROL SYSTEM

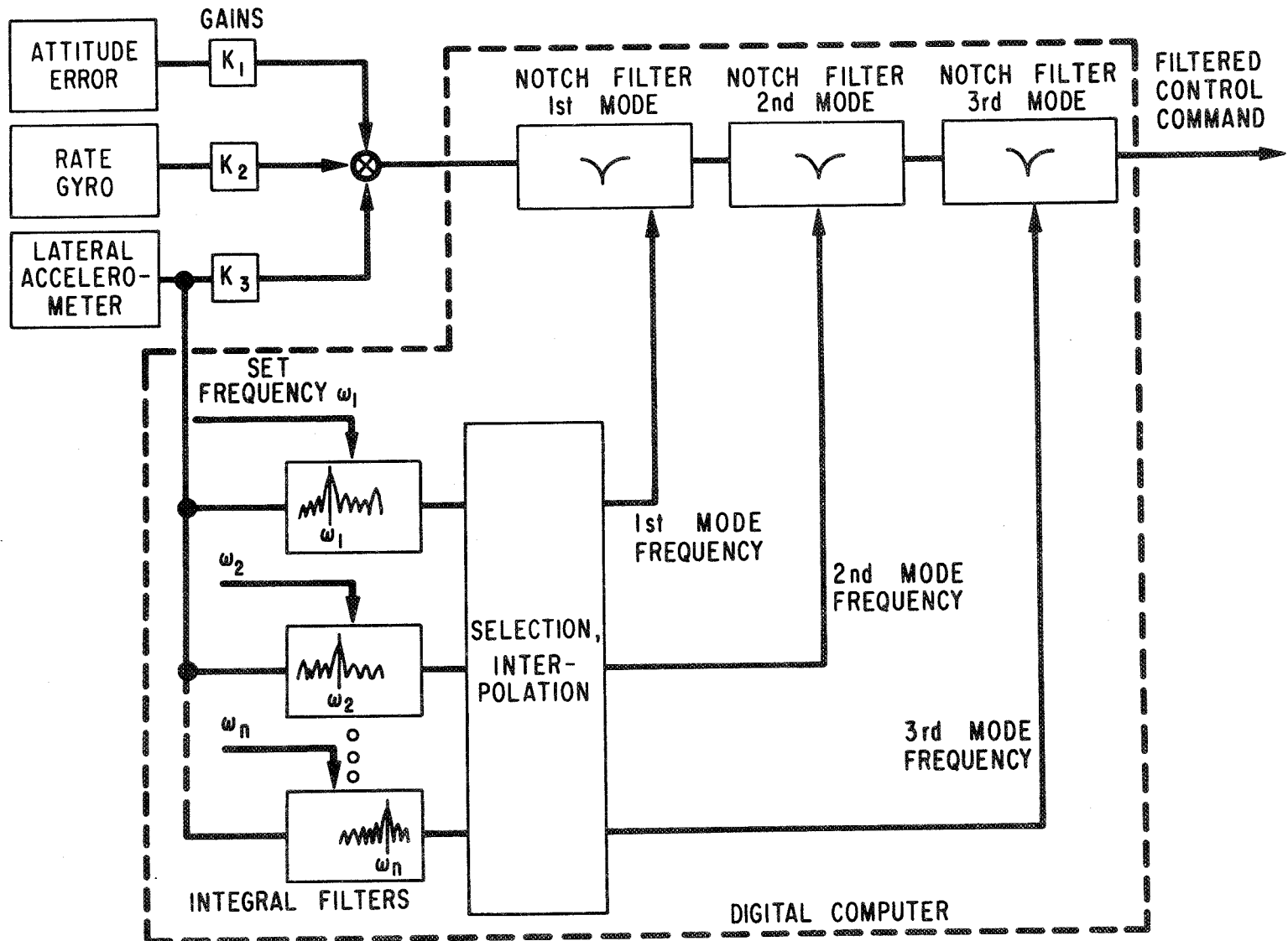



## MISSION MODEL EFFECTS

The mission model contains a variety of target orbits to be achieved by the shuttle, ranging in inclination from easterly launch to sun-synchronous and beyond, with a number of altitudes. Frequent launches are expected, and there exists the possibility of quick-response launches such as for rescue or DOD missions. These conditions dictate that the prelaunch guidance calculations be kept to a minimum. A self-targeting guidance system which can accept end condition changes in real time can provide the required flexibility and autonomy to meet these conditions. Also, approximations in the guidance formulation which require specially-computed tuning inputs should be avoided.

*MISSION MODEL*

VARIETY OF TARGET ORBITS  
HIGH TRAFFIC DENSITY  
QUICK RESPONSE



*NO EXTENSIVE PRELAUNCH  
ANALYSIS*

SELF-TARGETING GUIDANCE  
FEW SPECIAL-TUNING INPUTS  
TO GUIDANCE SYSTEM

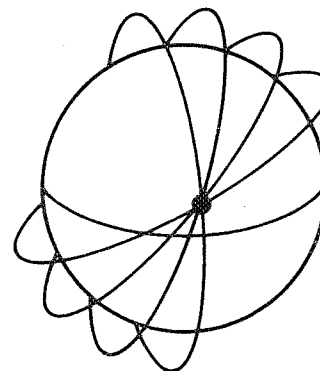

## INTACT ABORT

Intact abort places a strong requirement on the guidance and control system for flexibility (adaptability to change). An example of the diversity of flight conditions possible in an abort situation is illustrated in this slide. Altitude and velocity time histories are shown for a nominal ascent and for an abort-to-once-around mission which assumes one orbiter engine out at ignition.

The variety of trajectory and flight conditions possible for abort dictates a guidance system with onboard retargeting capability and a control system with gains scheduled by either air data or adaptive loops.

# INTACT ABORT ABORT TO ONCE-AROUND

—— NOMINAL INJECTION  
- - - - ONE ORBITER ENGINE OUT AT IGNITION

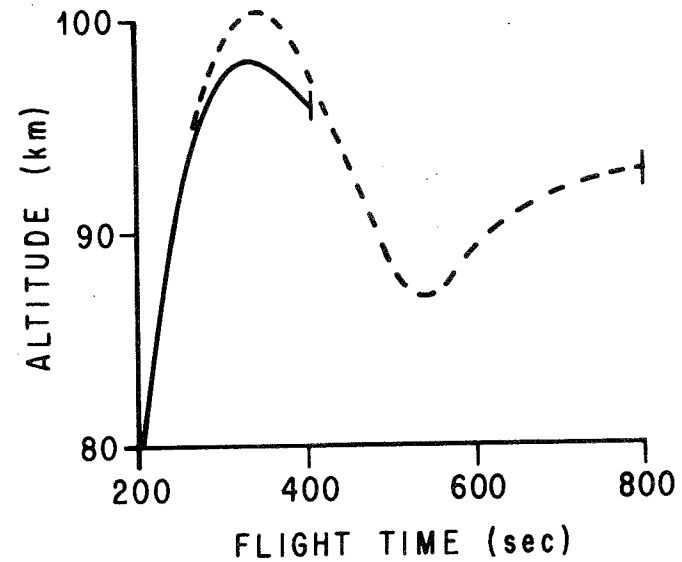
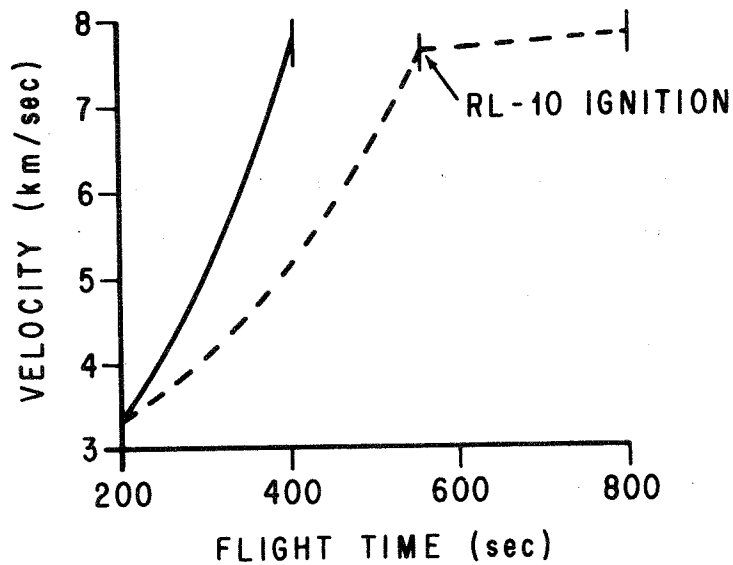

## BOOSTER FLYBACK CONSTRAINT

This slide is an example plot of the weight of booster flyback fuel required for a variety of staging conditions. A function similar to this must be included in the trajectory generator as part of the performance index in the design phase, or as a constraint for the post-design phase. Notice that the functions are nearly linear, which may facilitate their inclusion into a trajectory generator or guidance scheme.

# BOOSTER FLYBACK CONSTRAINT

66

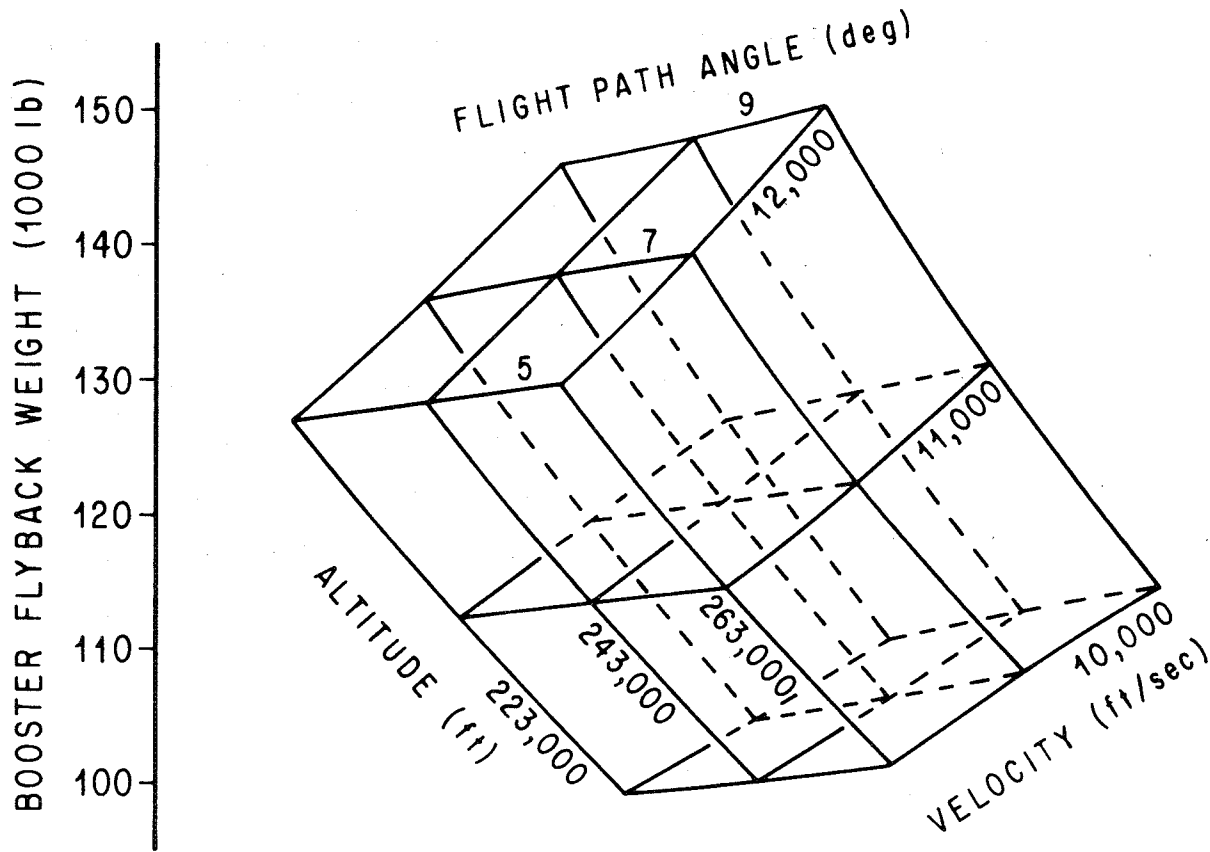

## SHUTTLE ASCENT GUIDANCE AND CONTROL REQUIREMENTS

The characteristics of the launch-configuration shuttle may be translated into requirements on the ascent guidance and control systems which are summarized in this chart. The list is not intended to be a comprehensive description of the system requirements, but includes many of the more significant or unconventional features which result. Some items listed are firm requirements under the current shuttle groundrules; others are possibilities or alternatives.

While most of the items have been previously discussed in the presentation, two of those listed under "hardware" need further comment. It seems likely that the guidance system requirements described herein can be met with a digital computer of reasonable speed and storage. Floating point arithmetic would be very desirable, considering the wide spectrum of conditions to be accommodated and the need to minimize prelaunch verification computations. In the control hardware requirements, the use of a digital rather than analog controller would permit the various control methods we have discussed (gain scheduling, bending accommodation, etc.) to be met without undue hardware complication.

# SHUTTLE ASCENT GUIDANCE AND CONTROL REQUIREMENTS

## ANALYSIS

### *GUIDANCE*

OPTIMIZE ATMOSPHERIC TRAJECTORY  
DEMONSTRATE PERFORMANCE FOR WIDE  
RANGE OF TARGETING CONDITIONS

### *CONTROL*

MULTIPLE-CONTROLLER SYNTHESIS  
ANALYSIS FOR BROAD SPECTRUM  
OF FLIGHT CONDITIONS

DISSIMILAR PITCH AND YAW PLANE ANALYSES  
OPTIMIZATION OF GUIDANCE, CONTROL, CONFIGURATION

## SOFTWARE

### *GUIDANCE*

ATMOSPHERIC CLOSED-LOOP GUIDANCE      OR  
FLYBACK, STRUCTURAL CONSTRAINTS  
REAL-TIME CHANGE OF END CONDITIONS  
GENERAL ( NOT APPROXIMATE ) FORMULATION

### *CONTROL*

PATH FEEDBACK  
LOAD RELIEF  
ADAPTIVE ALGORITHMS

ACCOMMODATION OF WIND BIASING

## HARDWARE

### *GUIDANCE*

DIGITAL COMPUTER REQUIREMENTS  
  
SPEED  
STORAGE  
FLOATING POINT ARITHMETIC

### *CONTROL*

SENSORS-Q BALL, NORMAL ACCELERATIONS  
MULTIPLE-RATE GYROS  
  
AIR DATA:  $q$ ,  $q$  - ALPHA, MACH  
DIGITAL CONTROLLER





## KEY ISSUES FOR SPACE SHUTTLE ASCENT GUIDANCE

J. G. Rupert

HONEYWELL INC.  
St. Paul, Minnesota

### FOREWORD

This paper presents trajectory analysis results for several NAR/GD vehicle configurations investigated during our Phase B Shuttle Program. Structural weight data and booster flyback propellant requirements needed to perform this study were provided by J. Joanides, R. Gatto and R. Wilson at NR and by G. Krus, W. Pense, and R. Bithell at GD. Special acknowledgement is due to D. Engels at NR and A. Nelson at GD who made our effort meaningful through coordination with related studies at NR and GD. R. K. Phelps at Honeywell was primarily responsible for the direction of this effort at Honeywell.

## INTRODUCTION

We have been studying the design of the first stage trajectory since the beginning of the Phase B Shuttle Program. Our motivation in this effort has been to determine the sensitivities of important variables affecting payload in order to design a guidance policy.

Primary factors influencing trajectory design include ascent fuel, structural weight requirements, booster flyback propellant requirements and the on-orbit propellant needed for an orbiter abort with an engine failure at staging. Each of **these variables depends strongly on the attack angle and throttling policy during the mated ascent.** The flyback propellant requirement and the abort requirement pose some new problems for trajectory optimization which **are unique to the Shuttle.**

Finally, sensitivity of the booster flyback propellant to the staging state makes it advantageous to consider this constraint in the closed loop first stage guidance law.

## **IMPORTANT VARIABLES IN ASCENT GUIDANCE AND CONTROL**

- **ASCENT FUEL**
- **STRUCTURAL WEIGHT**
- **BOOSTER FLYBACK PROPELLANT**
- **ABORT**
- **DISPERSION PENALTIES**

ORBITER STRUCTURAL WEIGHT REQUIREMENTS  
FAVOR POSITIVE ATTACK ANGLES

Slide 2 shows the dependence of orbiter structural weight on the attack angle at maximum dynamic pressure. To prepare this plot, the amount of load carrying structure required by flight conditions other than max  $q$  (e.g.; entry, landing, minimum gauge, etc.) was first computed. The additional orbiter structural weight required was then computed as a function of the  $q_\alpha$  loading at max  $q$ . Most of the additional structural weight required results from wing loading and skew to the curve is caused primarily by the negative wing incidence angle on the delta wing orbiter.

Both trajectory shaping and load relief influence the structural weight requirements. Because weight requirement depends asymmetrically on attack angle, trajectory shaping is used to bias the swing in  $q_\alpha$  loads obtained with headwinds and tailwinds in positive direction. Load relief is used to reduce the magnitude of the  $q_\alpha$  swing. The optimum trade off between fuel and structural weight requirements is obtained through an iterative process between trajectory shaping and load relief.

# ORBITER T ORBITER STRUCTURAL WEIGHT VERSUS $q\alpha$ AT MAX $q$

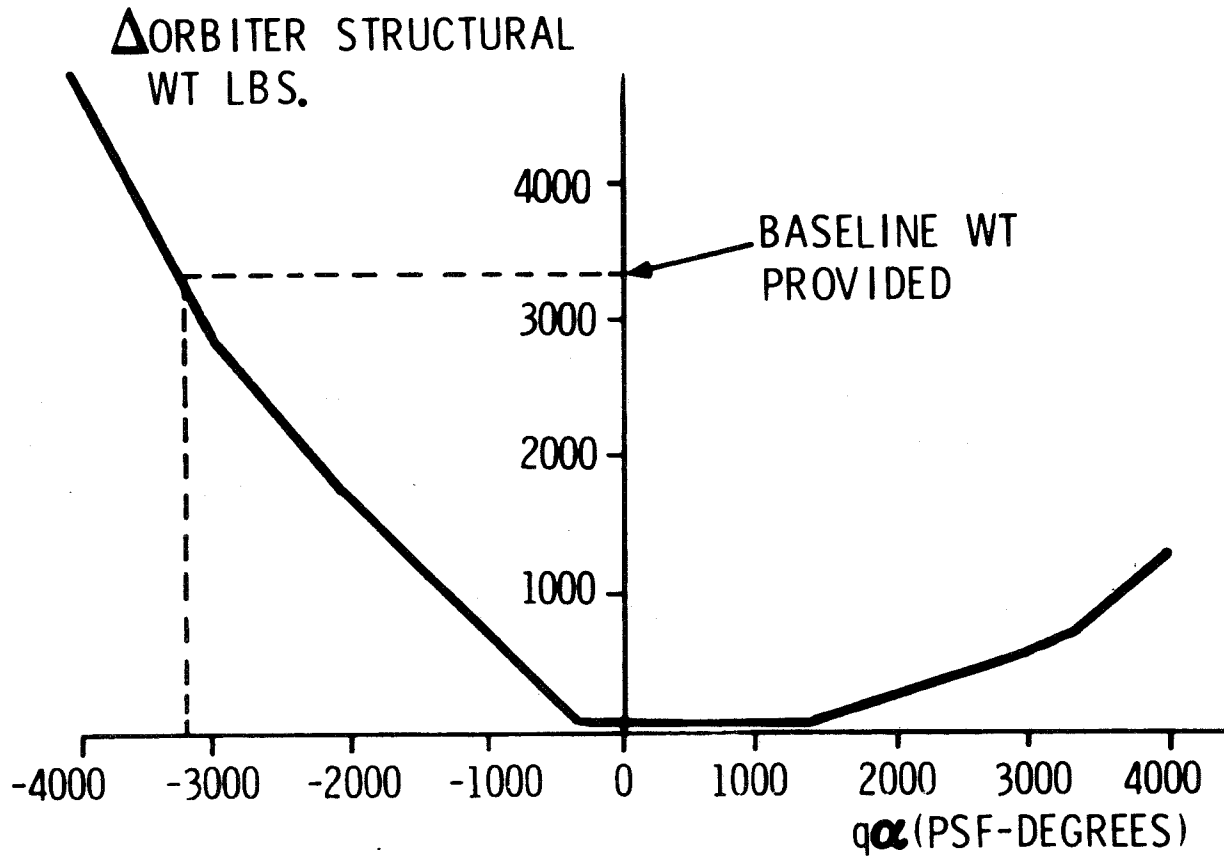

LOAD RELIEF STUDIES ON LIFTING TRAJECTORIES  
SHOW REDUCED STRUCTURAL WEIGHT REQUIREMENTS

The  $q_\alpha$  loads resulting from winds were compared for a lifting trajectory and the gravity turn. In the control system design, the degree of load relief was varied by changing the controller attitude gain during the high  $q$  region. Results obtained with  $K_\theta = 1$  (No Load Relief) and  $K_\theta = .1$  (With Load Relief) are illustrated in Slides 3 through 8. There are several major differences between lifting trajectories and the gravity turn depicted in these results.

First, Slides 3 and 4 illustrate the relative influence of trajectory shaping and load relief in reducing structural weight requirements. For both trajectories, the magnitude of the  $q_\alpha$  swing was significantly reduced with load relief. However, the positive bias given to the  $q_\alpha$  swings by the use of the lifting trajectory was a major contributing factor to the weight saving obtained. Using load relief and trajectory shaping, a net saving, in this case, of 4,000 lbs was realized.

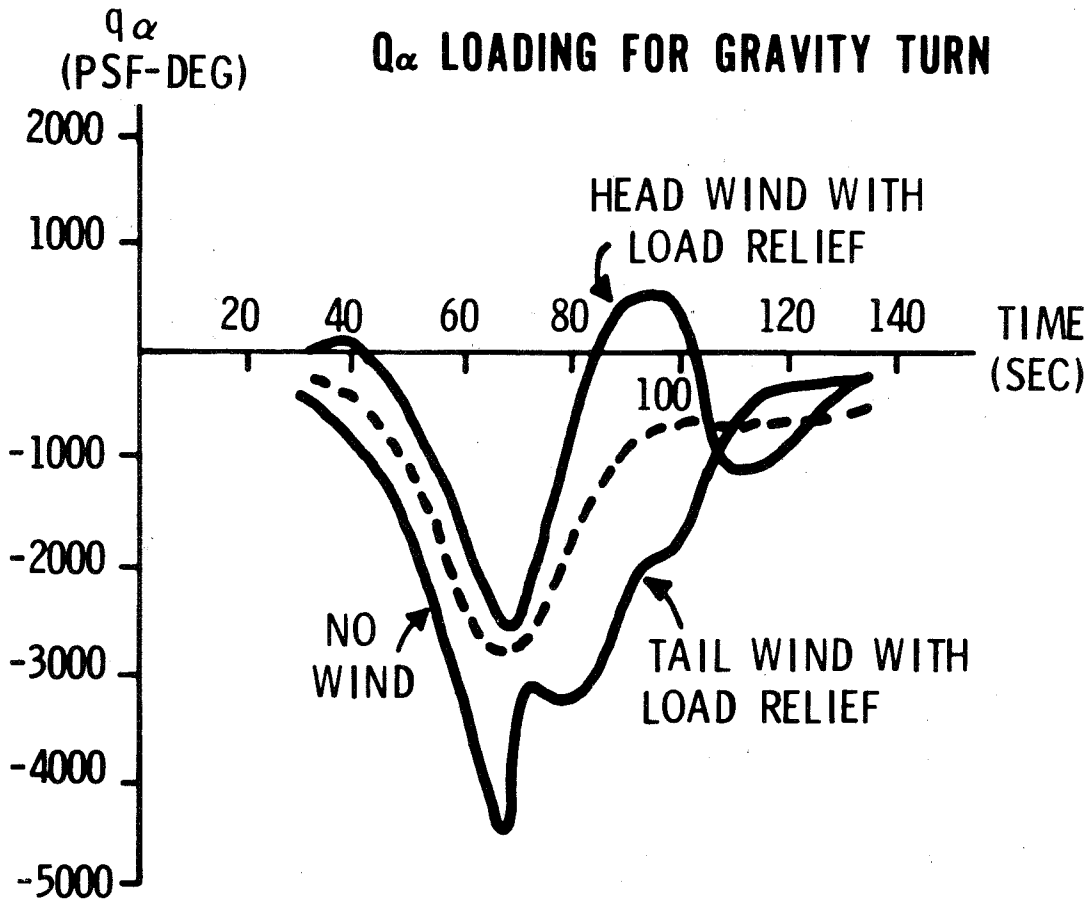



## LOAD RELIEF CAN PAY OFF

Slide 4 shows the time history of  $q\alpha$  with and without load relief for a zero alpha lifting trajectory. The use of load relief reduced the  $q\alpha$  tailwind load from -3000 psf to -1600 psf, which resulted in a structural weight saving of approximately 1800 lbs. By comparison, the fuel penalty (for the headwind condition) was increased by less than 100 lbs.

### $Q\alpha$ LOADING FOR ZERO ALPHA TRAJECTORY

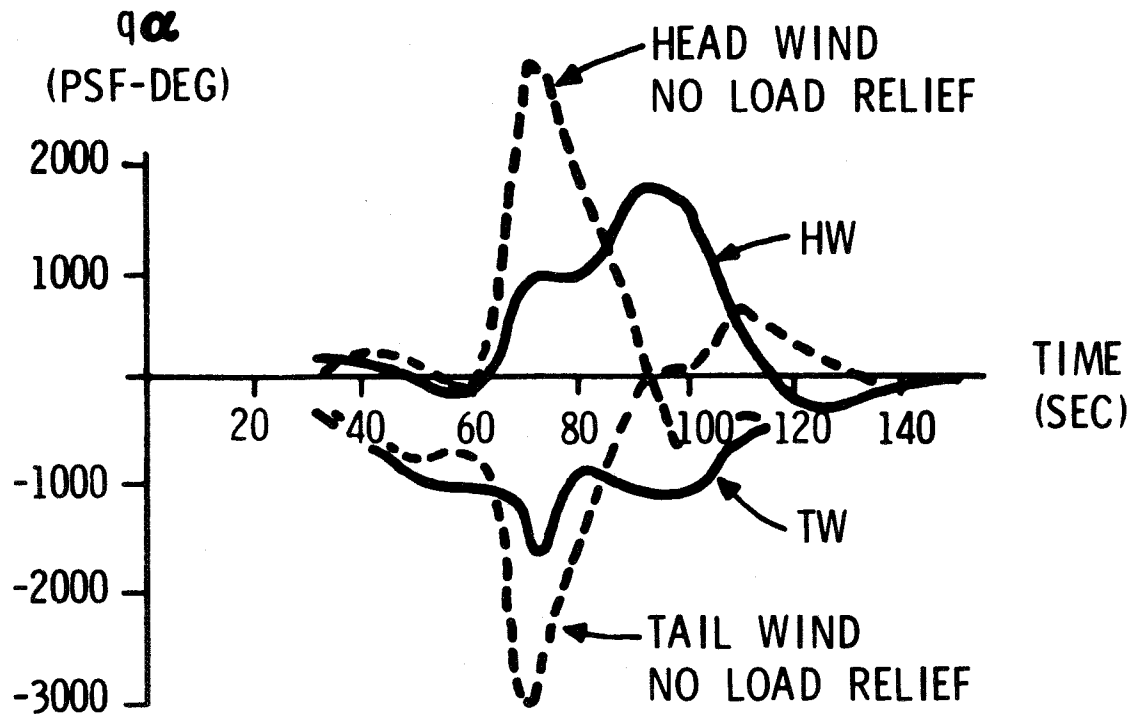

## LIFTING TRAJECTORIES RESULT IN HIGHER DYNAMIC PRESSURES

Another difference between lifting trajectories and the gravity turn is depicted in Slides 5 and 6. The lifting trajectory has a substantially higher maximum dynamic pressure than is obtained with the gravity turn (850 psf vs. 730 psf with the headwind). This result stems from the fact that lifting trajectories have lower curvature and fly lower through the atmosphere initially than the gravity turn.

### DYNAMIC PRESSURE FOR GRAVITY TURN

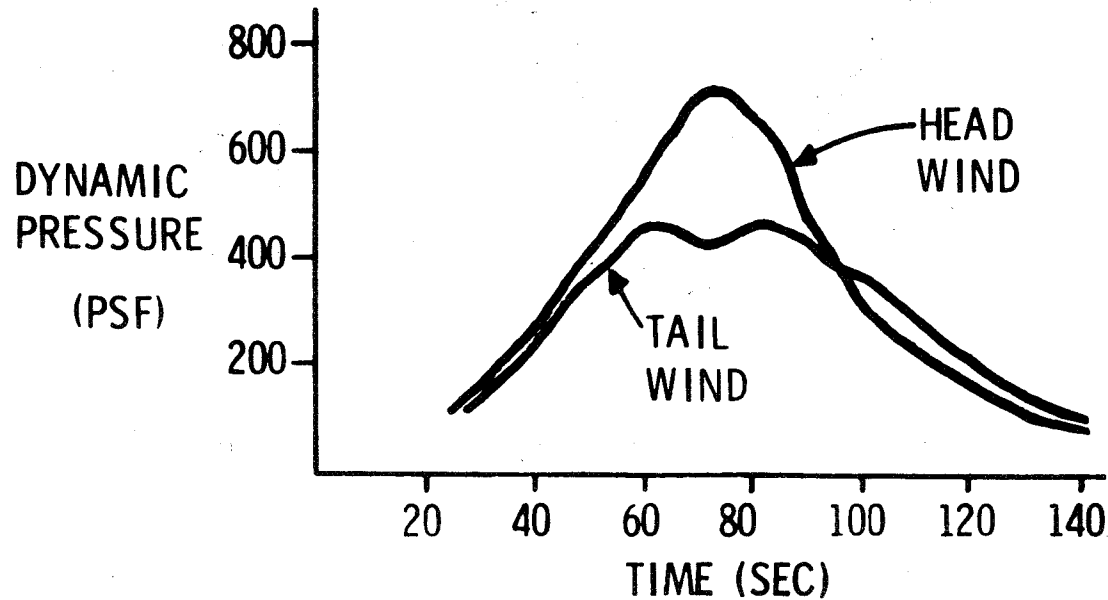

## DYNAMIC PRESSURE FOR LIFTING TRAJECTORY

Slide 6 shows the time history of dynamic pressure for a zero alpha lifting trajectory. The dynamic pressure for the headwind condition is higher than for the gravity turn pressures illustrated in Figure 5. Structural weight criteria given in Slide 2 were altered slightly (~ 200 lbs) as a result of the higher pressure.

### DYNAMIC PRESSURE FOR ZERO ALPHA TRAJECTORY

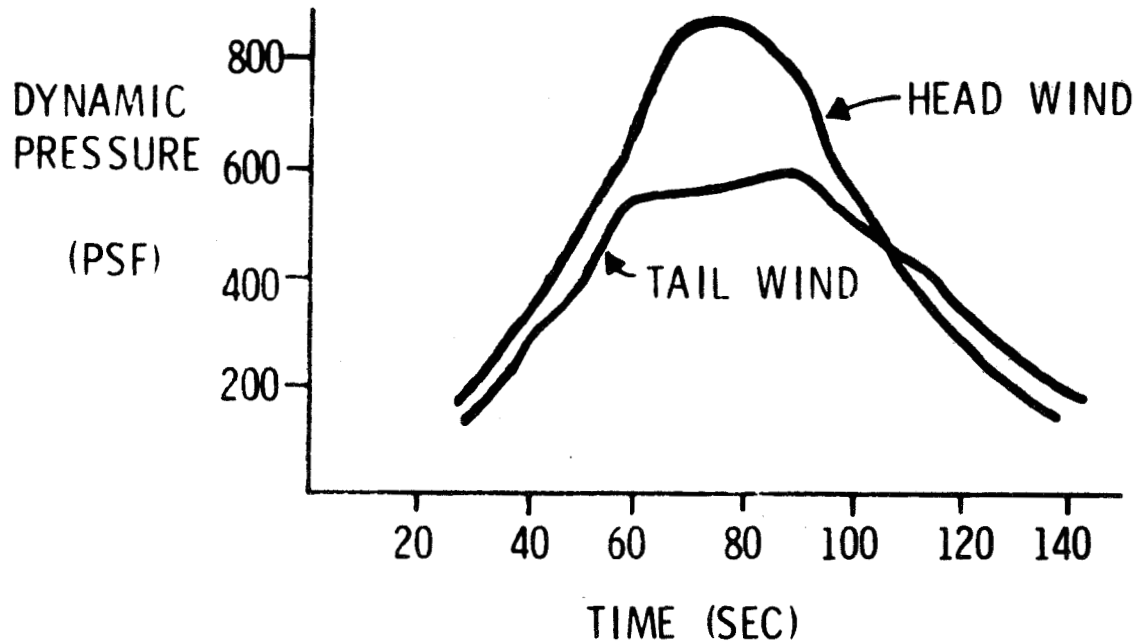

TRAJECTORY SHAPING INFLUENCES GIMBAL ANGLE REQUIREMENTS

Slides 7 and 8 show that the lifting trajectory reduced the gimbals angles.

This results from the positive bias to the  $q\alpha$  swings and the vehicle's aerodynamic stability. However, this was not a general result, since on some of the vehicles we investigated, the aerodynamic moment at zero angle of attack was sufficiently large at max  $q$  to cause the gimbal angle to be less than its value at lift-off which resulted in an increased gimbal angle requirement.

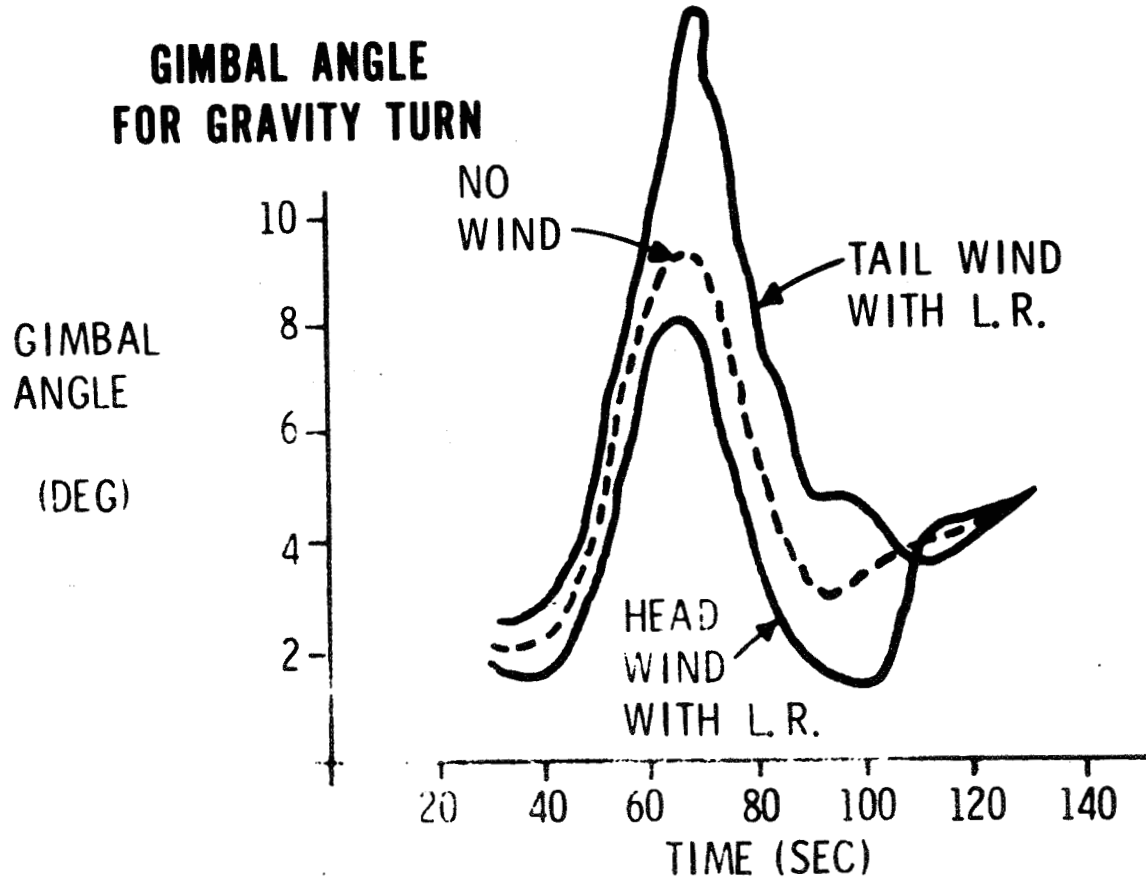

## GIMBAL ANGLES FOR LIFTING TRAJECTORY

Slide 8 shows the time history of the gimbal angle (referenced to the x body axis). On some vehicle configurations and larger attack angles the gimbal angle actually would go negative.

# GIMBAL ANGLE FOR ZERO ALPHA TRAJECTORY

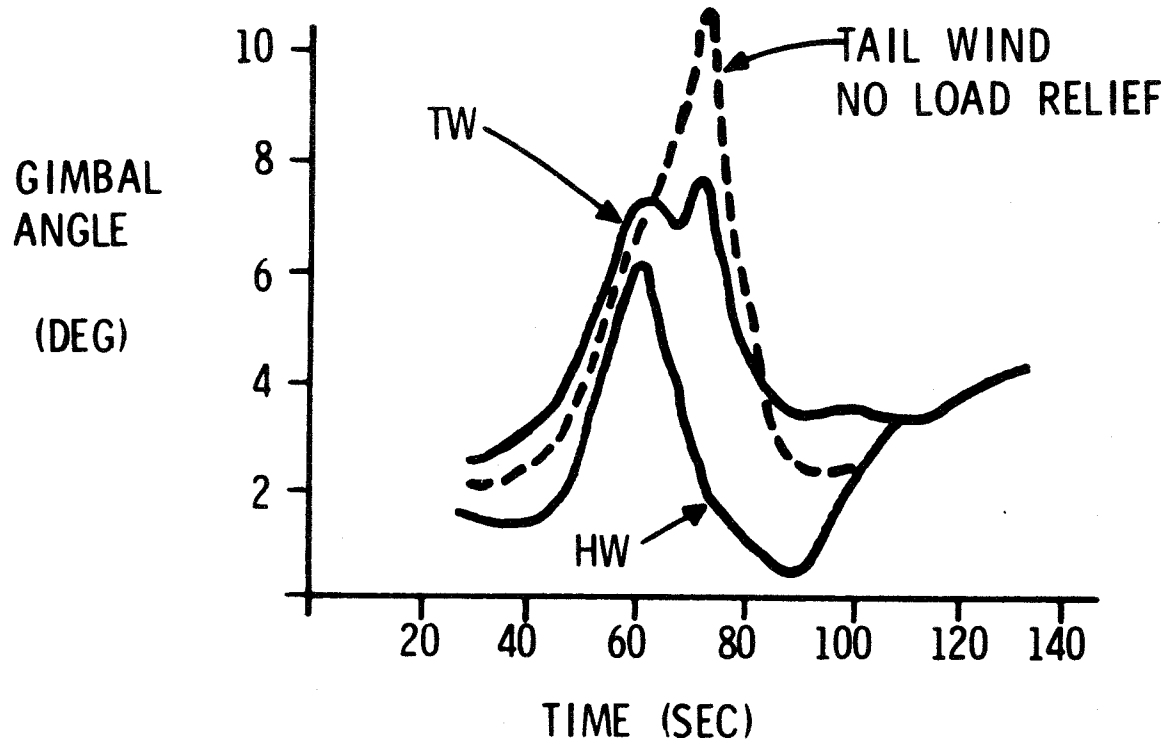

FLIGHT CONDITIONS DURING MATED ASCENT  
AFFECT STRUCTURAL WEIGHT REQUIREMENTS

Slide 9 shows the variation of booster peak limit ultimate load intensity with body station for several flight conditions. The highest load intensities, which determine shell thickness and structural weight, are seen to occur at three conditions: max dynamic pressure occurring approximately seventy seconds after lift-off, entry to the g constrained arc approximately 160 secs after lift-off, and at staging.

Slide 9 shows that roughly fifty percent of the booster structure is designed by conditions on the acceleration constrained arc. Reducing the g limit reduces booster structural requirements but results in increased fuel and flyback propellant requirements.

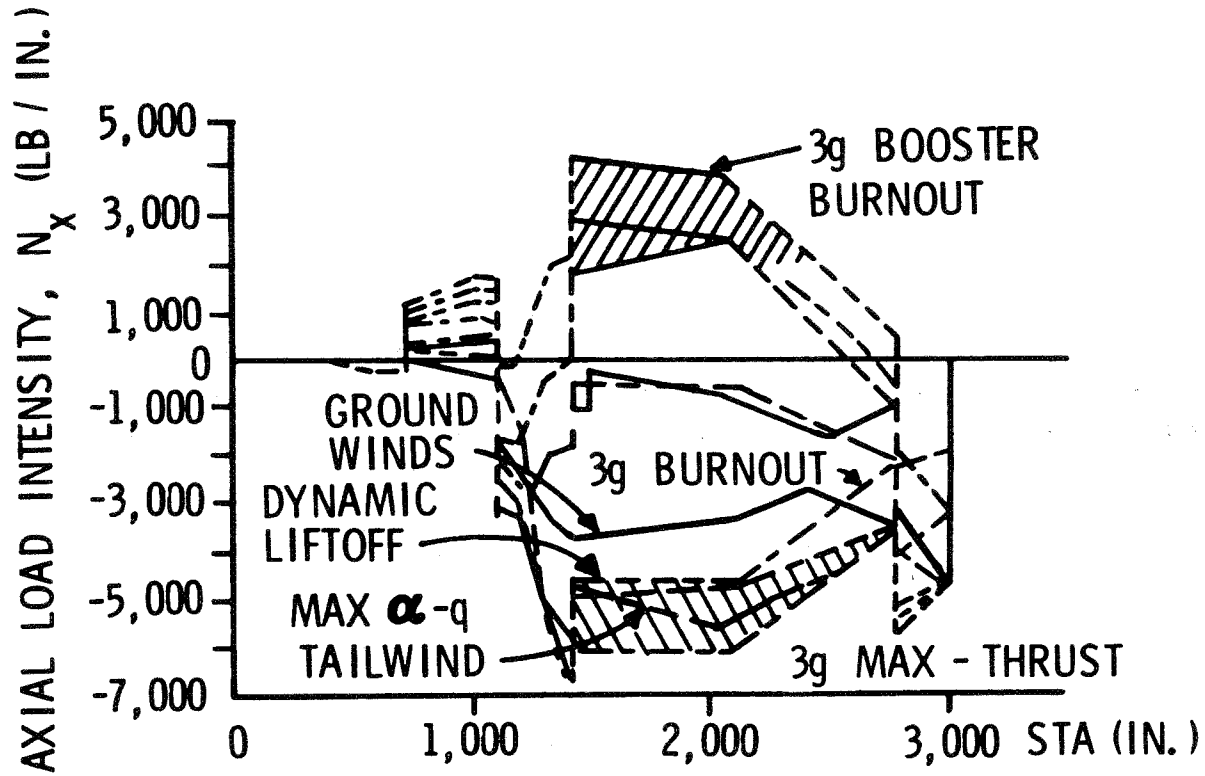
**BOOSTER PEAK LIMIT - AXIAL LOAD INTENSITIES**



Slide 10 illustrates how the acceleration limit affects fuel and structural weight requirements. The  $\Delta$ Wts shown are referenced to the baseline 3g limit. Weight changes indicated in the figure are:

- 1) Booster Structural Weight
- 2) Orbiter Structural Weight
- 3) Orbiter Ascent Fuel Corrected for Flyback Propellant Variations (See Slides 11 and 12)
- 4) The change in payload trading orbiter structure and fuel with payload on a 1-1 basis and booster structure with payload on a 6-1 basis

In this study, the g limit and  $q_\alpha$  weight trades were conducted independently. Close examination of the load intensity plots in Slide 9 indicates that they should be conducted in parallel.

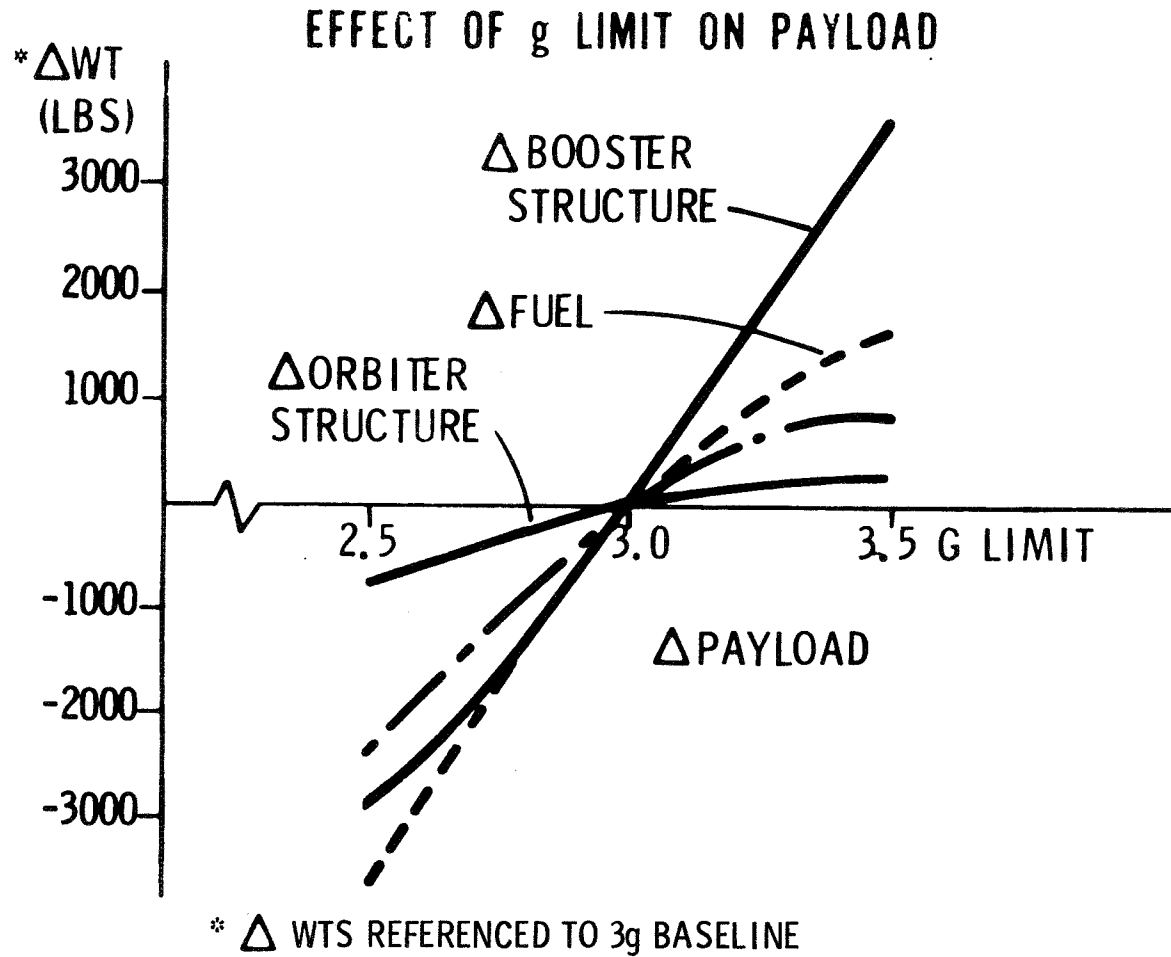

BOOSTER FLYBACK PROPELLANT REQUIREMENTS INFLUENCE  
TRAJECTORY OPTIMIZATION

The requirement that the booster fly back to the launch site has a significant effect on trajectory optimization. Flyback propellant requirements, WPFB, increase sharply with staging altitude and flight path angle as illustrated in Slides 11 and 12. Trajectory design was carried out, letting the staging condition and the flyback propellant be variables and seeking the optimum injected mass by trading flyback propellant and orbiter injected gross weight. Orbiter injected gross weight,  $M_p$ , must be penalized approximately 1 pound for every 7 pounds of additional flyback propellant required. Slide 12 shows that the optimum trade-off,  $M_f^*$ , between flyback propellant and orbiter injected mass calls for a staging altitude roughly 30,000 ft less than one would use if the constraint were not present. The resulting penalty on injected mass is approximately 3,000 pounds due to a less fuel optimal trajectory, in addition to the penalty of having to carry 140,000 lbs of flyback propellant.

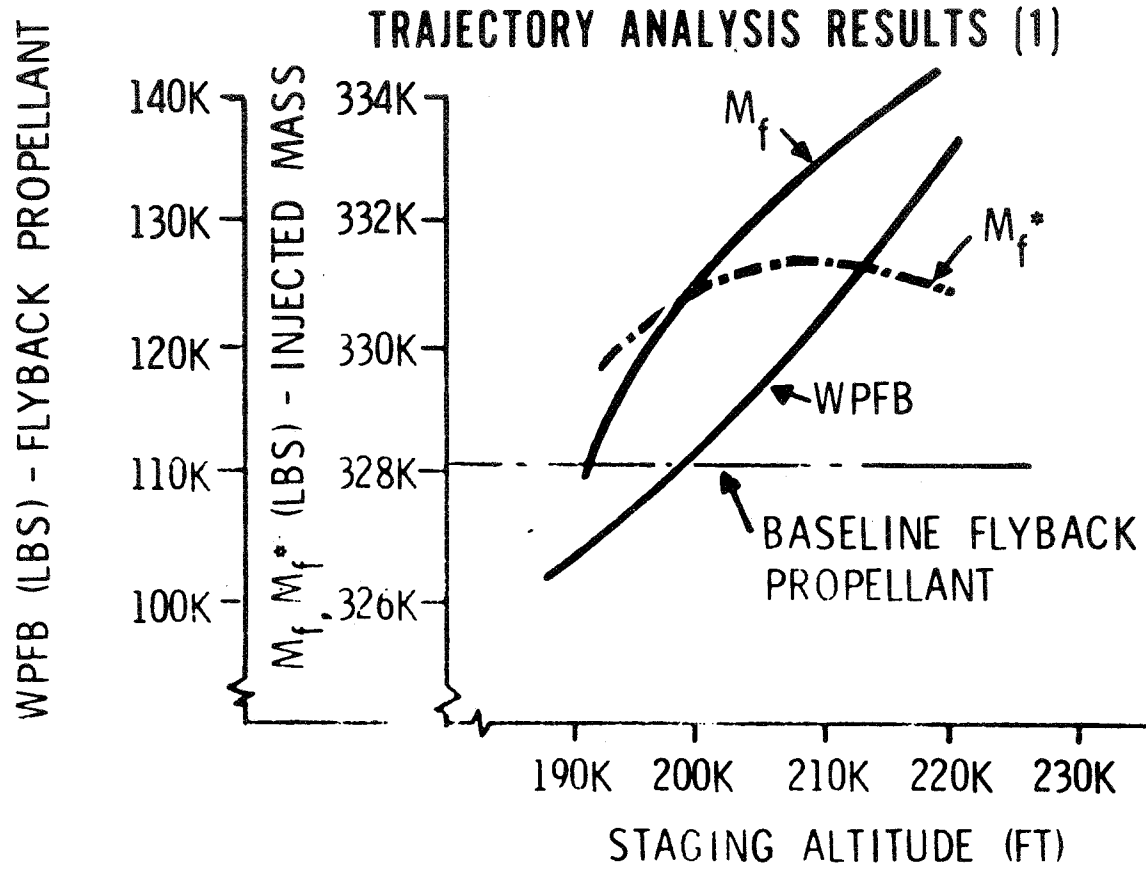

### TRADE OFF BETWEEN FLYBACK PROPELLANT AND FUEL

Slide 12 shows the variation of orbiter injected mass,  $M_f$ , flyback propellant, WPFB, and the trade-off,  $M_f^*$ , as a function of staging altitude. In Slide 12, the trajectory up through staging was a gravity turn.

Comparison of the  $M_f^*$  traces in Slides 11 and 12 brings out two additional differences between the gravity turn and lifting trajectories we have investigated:

- 1) Lifting trajectories want to stage lower than gravity turn trajectories when flyback propellant is considered. This is because they have less curvature and higher flight path angles at comparable staging altitudes. Flyback propellant requirements increase about 5000 lbs of flyback propellant per degree of flight path angle.
- 2) On this particular vehicle, the performance improvement with the lifting trajectory was approximately 5000 lbs. Improved performance with lifting trajectories was observed on all but one of the vehicles investigated during Phase B. However, performance gains were usually smaller.

### TRAJECTORY ANALYSIS RESULTS (2)

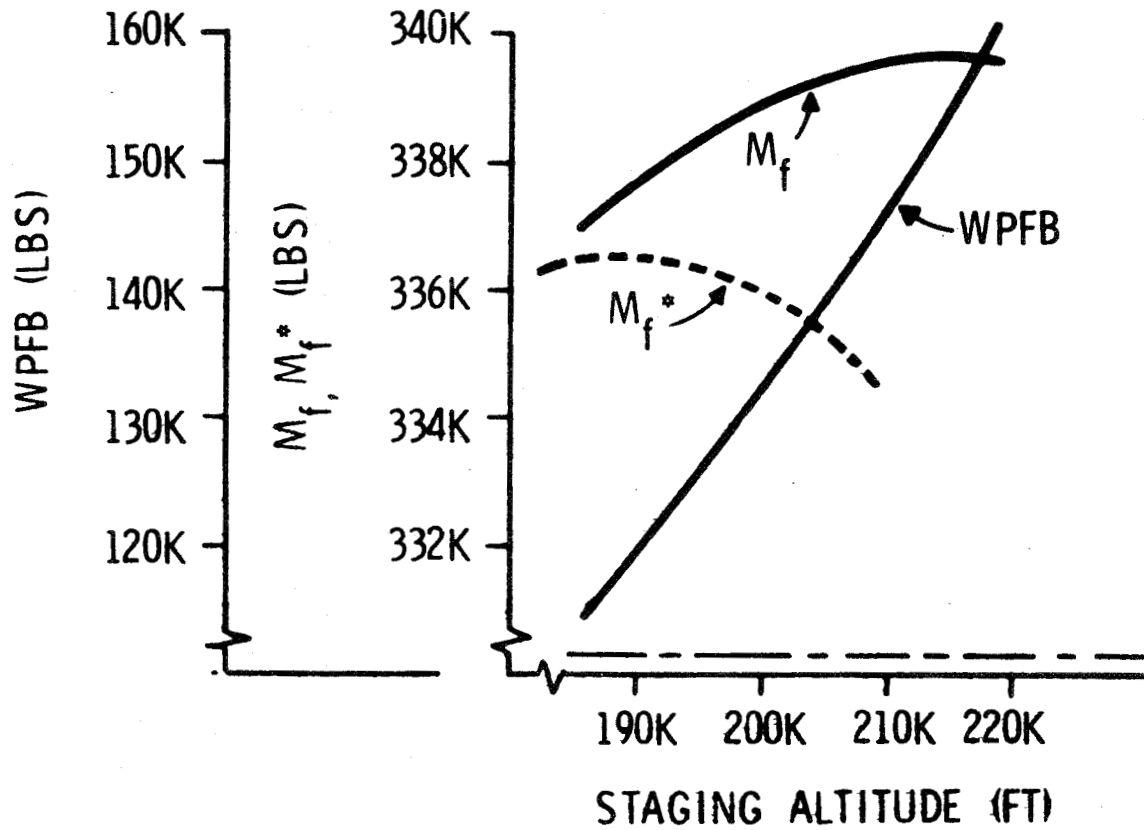

THE EFFECT OF THE ORBIT ENGINE OUT ABORT CONSTRAINT  
ON PAYLOAD

Slide 13 shows the effect of the orbiter engine out abort on the staging altitude for a particular lifting trajectory ( $\alpha = 0$ ). The orbiter abort condition considered was one engine failure at second stage ignition with the remaining engine operating at 109% thrust in parallel with OMS engines. The optimum staging altitude for the abort condition is higher than for the nominal trajectory due to the higher gravity loss with the lower thrust.

In trajectory optimization studies, the amount of main propellant for a given trajectory is determined for the nominal trajectory. The OMS propellant is then determined for the corresponding abort condition and must be traded with payload on a 1-1 basis.

# NOMINAL AND ORBITER ENGINE OUT PERFORMANCE

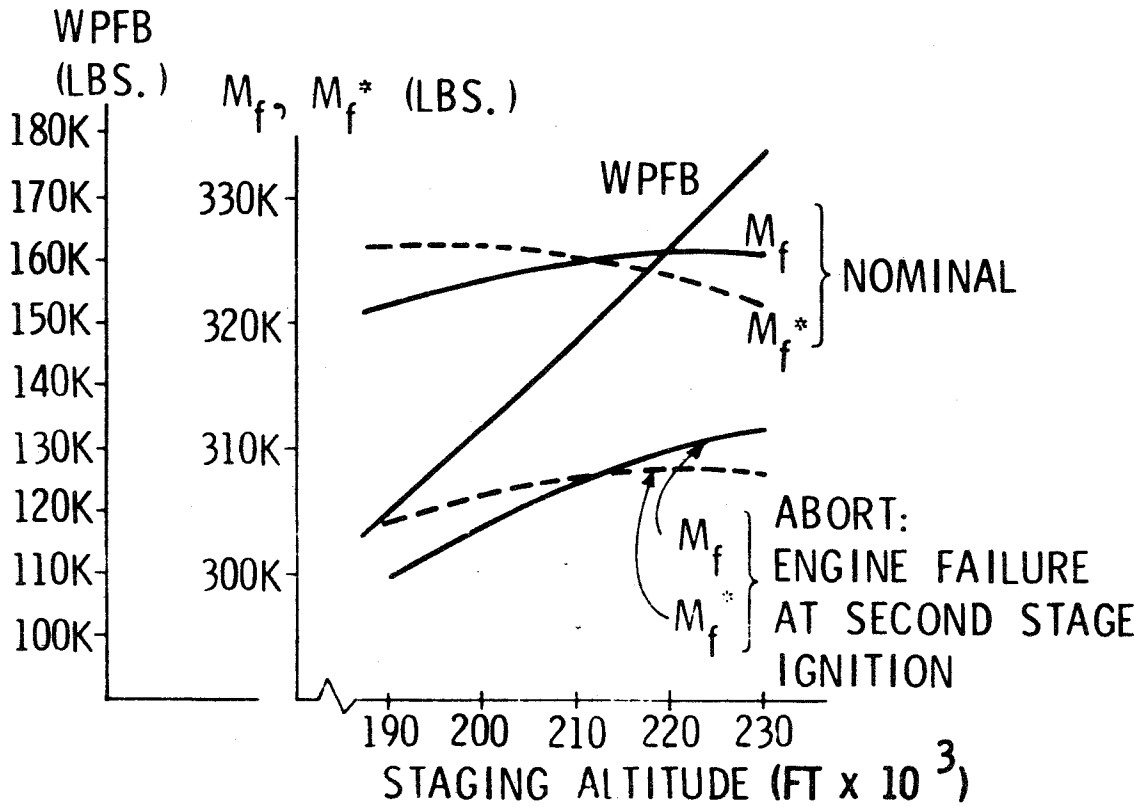



## LIFTING TRAJECTORIES SHOW IMPROVED PERFORMANCE

Lifting trajectories in which the net applied force on the vehicle was above the flight path angle were investigated on six different vehicle configurations during our Phase B effort. Gradient techniques were used rather than the more sophisticated variational methods; thus, the trajectories produced must be classified as sub-optimal in that they do not satisfy formal optimality criteria. However, we were able to show that lifting trajectories can pay off, and the methods used were convenient for the assessment of important factors other than fuel, such as structural criteria, booster flyback propellant, and orbiter OMS propellant needed for the abort situations.

Slide 14 shows very typical performance gains with lifting trajectories. The pre-staging adaptive guidance law noted in Slide 14 is discussed in a later slide and was used to maximize orbiter injected mass subject to the booster flyback propellant constraint using linear steering.

**TRAJECTORY OPTIMIZATION RESULTS**  
AERO MOMENT & REF AREA PRIOR TO UPDATE

<u>TRAJECTORY</u>	<u>MAX q (PSF)</u>	<u>WPFB (LBS)</u>	<u>M<sub>f</sub>(LBS)</u>	<u>M<sub>f</sub><sup>*</sup>(LBS)</u>
GRAVITY TURN	540	134,500	320,500	322,640
<b><math>\alpha</math></b> = 0	630	126,906	322,344	325,575
<b><math>\alpha</math></b> = -1	565	131,988	321,975	324,479
<b><math>\alpha</math></b> = +1	796	124,532	321,902	325,472
<b><math>\alpha</math></b> = +2	1127	161,683	319,474	317,732
<b><math>\alpha</math></b> = 0 WITH PRESTAGING ADAPTIVE GUIDANCE	638	134,071	323,410	325,620

## TRAJECTORY PERFORMANCE INSENSITIVE TO AERO MOMENT DATA

Performance gains with lifting trajectories were virtually insensitive to the aerodynamic data (the notable exception being drag). This is a rather important result in that this data is very vehicle dependent and difficult to estimate. The result is indicated here for a typical revision in the  $C_{mo}$  data shown in Slide 15. Comparison of Slides 14 and 16 shows that the 100% change in the  $C_{mo}$  data changed the performance analysis by a few hundred pounds.

The effect of off-nominal  $C_{mo}$  can have a substantial effect on dispersion penalties. This is discussed in a later slide.

# PITCHING MOMENT REVISION

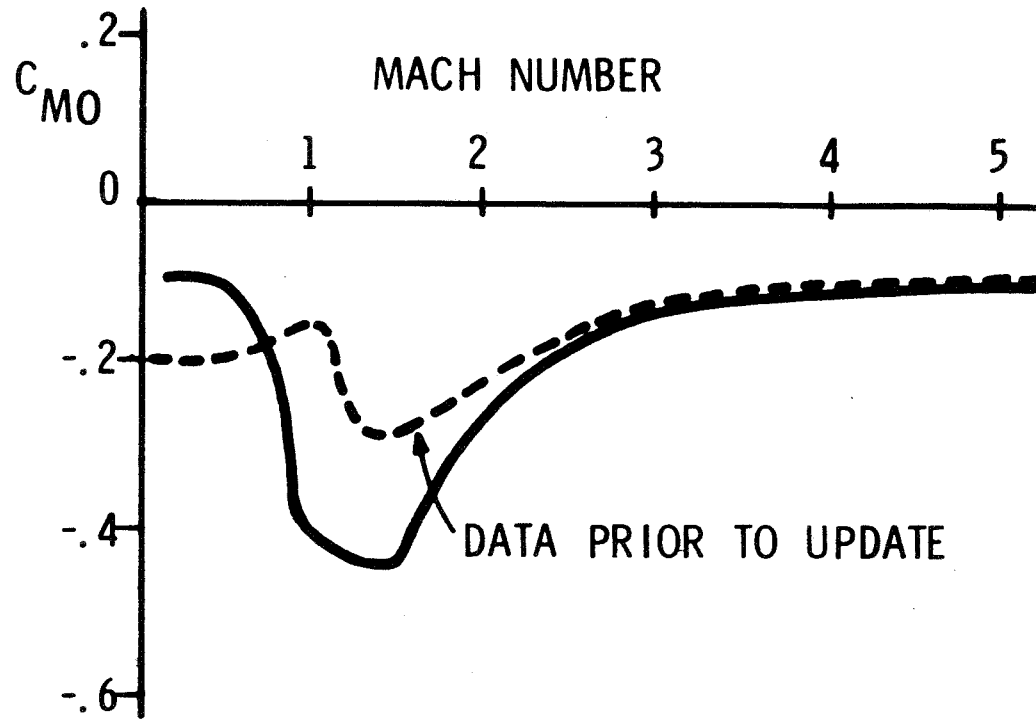

## LIFTING TRAJECTORY PERFORMANCE DATA

Slide 16 shows a comparison of performance data for several lifting trajectories with and without prestaging adaptive guidance. Comparison of this data with the data in Slide 14 shows the minimal effect of  $C_{mo}$  on the trajectory optimization results.

**TRAJECTORY OPTIMIZATION RESULTS**  
**AERO MOMENT DATA & REF AREA UPDATED**

TRAJECTORY	H <sub>s</sub> (FT)	WPFB (LBS)	M <sub>f</sub> (LBS)	M <sub>f</sub>
GRAVITY TURN	221,608	140,447	320,876	322,170
$\alpha = 0$	197,000	128,307	322,196	325,226
$\alpha = +1$	191,108	127,401	322,165	325,324
$\alpha = +2$	196,404	145,549	320,045	320,610
-----	-----	-----	-----	-----
GRAVITY TURN*	206,856	139,314	322,453	323,909
$\alpha = 0$ *	192,627	127,554	322,358	325,496
$\alpha = +1$ *	190,891	128,150	322,176	325,229

SLIDE 16

## THE NEED FOR CLOSED LOOP FIRST STAGE GUIDANCE

Slide 17 shows the sensitivity of ascent fuel and booster flyback propellant requirements to relatively small changes in the center of gravity position and the aerodynamic coefficients. These results were generated using no closed loop guidance prior to staging.

The slide illustrates a unique feature of the Shuttle's dispersion problem. In addition to ascent fuel penalties for off-nominal conditions, large changes in the booster flyback propellant requirements,  $\Delta$ WPFB, also have to be considered.

Typical sensitivities for flyback propellant are on the order of 5000 lbs per degree of flight path angle at staging and about 6000 lbs for a 10,000 ft change in staging altitude. Excess flyback propellant reserves for these conditions trade with payload on a 7 to 1 basis. Thus, the payload penalties for excess flyback propellant can be substantially greater than the ascent fuel penalty.

**PERTURBATION RESULTS  
WITHOUT PRESTAGING ADAPTIVE GUIDANCE**

<u>RUN</u>	<u> \Delta W PFB </u>	<u> \Delta M_f (LBS) </u>	
NOMINAL	0	0	
CG {	$\Delta Z = -.5 \text{ FT}$	22,998	1,194
	$\Delta X = -2.0 \text{ FT}$	3,453	147
$C_M = .95 C_M$	27,301	1,823	
$C_N = .95 C_N$	18,699	3,071	
$C_A = .95 C_A$	10,795	1,788	



PRESTAGING ADAPTIVE GUIDANCE SHOULD CONSIDER  
STAGING CONSTRAINTS

Sensitivity of the flyback propellant requirement to the state at staging makes it advantageous to consider this constraint in the prestaging adaptive guidance law. Ideally, prestaging adaptive guidance should be fuel optimal subject to the constraints.

During our Phase B effort, we investigated the use of a linear steering law of the form

$$\theta = \theta_0 + K(t - t_0)$$

in which the constants  $\theta_0$  and  $K$  were selected so as to maximize orbiter mass at injection and to make the flyback propellant requirement at staging equal to the amount on board.

Results with and without this adaptive guidance scheme are presented in Slides 17, 19, 20, and 21 for off-nominal conditions such as winds and vehicle performance.

No attempt was made to enforce the orbiter engine out abort constraint with prestaging adaptive guidance and the scheme was not compared with other prestaging adaptive guidance laws which do not consider the staging constraints.

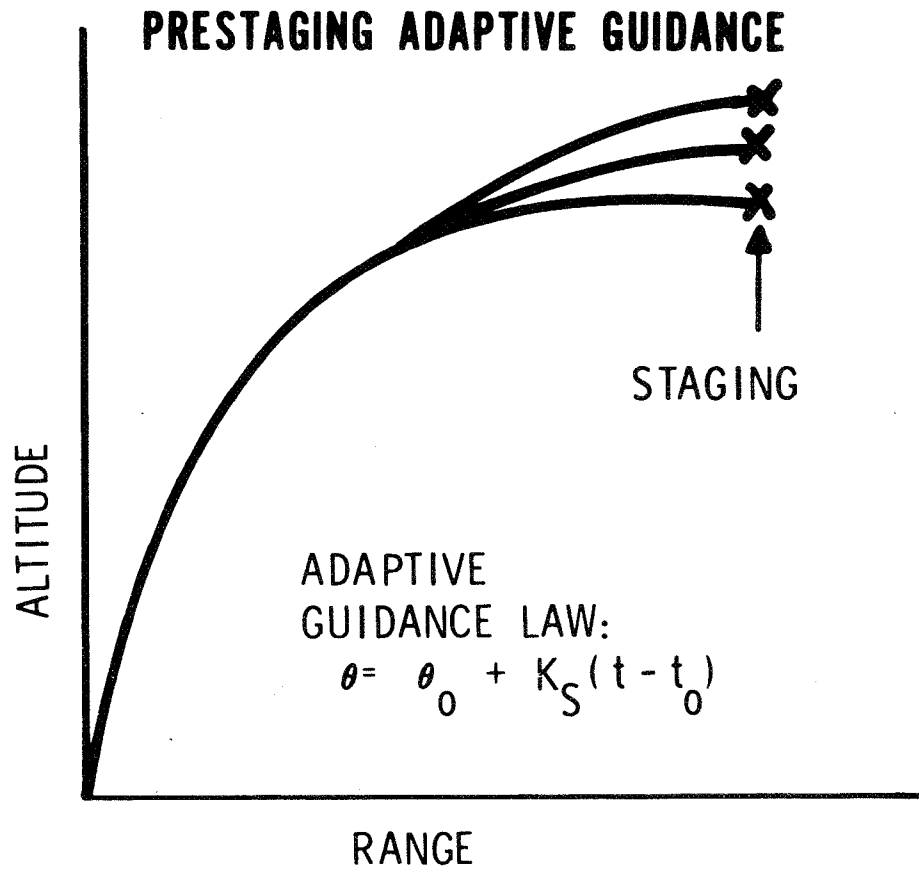

## DISPERSION PENALTIES WITH ADAPTIVE GUIDANCE

Comparison of the dispersion penalties in Slide 19 with those in Slide 17 show that a substantial payload saving was realized. The errors in flyback propellant with the adaptive guidance scheme were due to minor closing errors in the final seconds before staging and the extreme sensitivity of flyback propellant to flight path angle.

It should be pointed out that this guidance law reduces excess flyback propellants as a result of off-nominal conditions during the mated ascent. Excess flyback propellant reserves will still be needed for off-nominal conditions during entry and cruise.

## PERTURBATION RESULTS WITH ADAPTIVE GUIDANCES

<u>RUN</u>	<u><math> \Delta WPFBI </math></u>	<u><math> \Delta M_f(LBS) </math></u>
NOMINAL	0	0
CG { $\Delta z = -.5$ FT	1030	593
CG { $\Delta x = -2.0$ FT	50	0
$C_M = .95 C_M$	228	682
$C_N = .95 C_N$	899	435
$C_A = .95 C_A$	188	687

SLIDE 19

PAYLOAD PENALTIES DUE TO WINDS

Slide 20 shows the payload penalties due to wind gusts (MSFC Synthetic Wind Profiles) without closed loop first stage guidance. The payload penalty of 4,300 pounds results from the 2158 pound fuel penalty with the headwind and roughly one seventh of the 15,000 lb excess flyback fuel requirement.

**PAYLOAD PENALTIES  
WITHOUT PRESTAGING ADAPTIVE GUIDANCE**

<u>WIND GUSTS</u>	<u><math>\Delta</math>WPFB</u>	<u><math>\Delta M_f</math></u>
HEAD WIND AT 32,800 FT	+7980	-1248
TAIL WIND AT 32,800 FT	-8510	+1167
HEADWIND AT 12,600 FT	-210	<b>-2158</b>
TAILWIND AT 12,600 FT	<b>+15,000</b>	+1172
NET PAYLOAD PENALTY =		<b>4300</b>

WIND PENALTIES REDUCED WITH  
CLOSED LOOP FIRST STAGE GUIDANCE

Comparison of results in Slides 20 and 21 show the payload saving of approximately 2500 pounds realized with first stage adaptive guidance. Most of the saving resulted from the elimination of 15,000 lbs of excess flyback propellant.

**PAYLOAD PENALTIES WITH PRESTAGING  
ADAPTIVE GUIDANCE TO INSURE FLYBACK**

<u>WIND GUSTS</u>	<u><math>\Delta</math>WPFB</u>	<u><math>\Delta M_f</math></u>
HEADWIND AT 32,800 FT	-148	-1631
TAILWIND AT 32,800 FT	+333	+1653
HEADWIND AT 12,600 FT	+43	-1788
TAILWIND AT 12,600 FT	+335	-1460
NET PAYLOAD PENALTY =		1836



**SURVEY OF AUTONOMOUS NAVIGATION SCHEMES**

**FOR DOD SPACE SHUTTLE MISSIONS**

**R. J. Farrar**

**The Aerospace Corporation  
Los Angeles, California**

**This report was not available at the time of  
publication of this conference report. Copies can  
be obtained from the author.**





**ENTRY NAVIGATION ANALYSIS**

**B. A. Kriegsman and D. E. Gustafson**

**MIT C. S. Draper Lab  
Cambridge, Maryland**

## ENTRY NAVIGATION STUDIES

The basic navigation accuracy requirement stems from the fact that the vehicle must be sufficiently close to the selected runway after entry so that it can glide into a safe engines-off landing.

The primary navigation sensor is an inertial measurement unit (IMU). Initial-condition errors and inertial-instrument errors cause errors in the estimate of the vehicle's state which tend to increase during the entry phase. The plasma sheath surrounding the entry body makes state-vector updating by external radio nav aids very difficult during the major part of entry (from about 150,000 to 300,000 feet). The hypersonic maneuver capability of the vehicle decreases as the time remaining during entry becomes small. For this reason it is desirable to correct errors in the IMU-derived navigation data as soon as possible before the start of cruise.

Three particular aspects of the navigation problem are considered here:

- (1) A method for determining the IMU performance requirements
- (2) State-vector updating after blackout using VOR/DME and a baro-altimeter
- (3) Stabilization of navigation system altitude channel with drag measurements

## ENTRY NAVIGATION STUDIES

OBJECTIVE : Accurate knowledge of position and velocity of SSV during the entry phase of mission

KEY ITEMS :

- (1) Inertial-measurement unit (IMU) primary sensor
- (2) Radio-transmission blackout (150,000 - 300,000 ft altitude)
- (3) Engines-off cruise phase (following entry)
- (4) Vehicle characteristics of both entry body and aircraft

SCOPE :

- (1) Performance requirements for IMU
- (2) State-vector updating with VOR/ DME and baro-altimeter
- (3) Altitude-channel stabilization

## RADIO-PROPAGATION BARRIERS FOR ENTRY OF SSV

A good insight into the radio-transmission blackout problem can be obtained from the radio-propagation barrier curves developed by W. Tanner of MIT Draper Lab (more details are in 23N STS Memo #11, September 10, 1970). The propagation boundaries, as can be seen, are a function of vehicle speed, vehicle altitude, and the frequency of the radio transmission. Each boundary corresponds to a different transmission frequency. When the vehicle's trajectory lies below the boundary for a given frequency, i. e. is in the cross-hatched region, then that frequency cannot be transmitted to the vehicle.

The altitude vs. speed characteristics of typical high-cross-range vehicle trajectories with a range of about 5700 n.mi. are shown superposed on the radio-propagation barrier contours. The key point to be seen is the strong effect of transmission frequency on the blackout period, i. e. increasing frequency will decrease the blackout interval. In the particular case shown, 100 mhz transmission (VOR) is blacked out between altitudes of about 160,000 to 385,000 feet; 10 Ghz transmission (X-band), on the other hand, is blacked out only between altitudes of about 200,000 and 300,000 feet.

# RADIO-PROPAGATION BARRIERS FOR ENTRY OF SSV FOR DIFFERENT TRANSMISSION FREQUENCIES

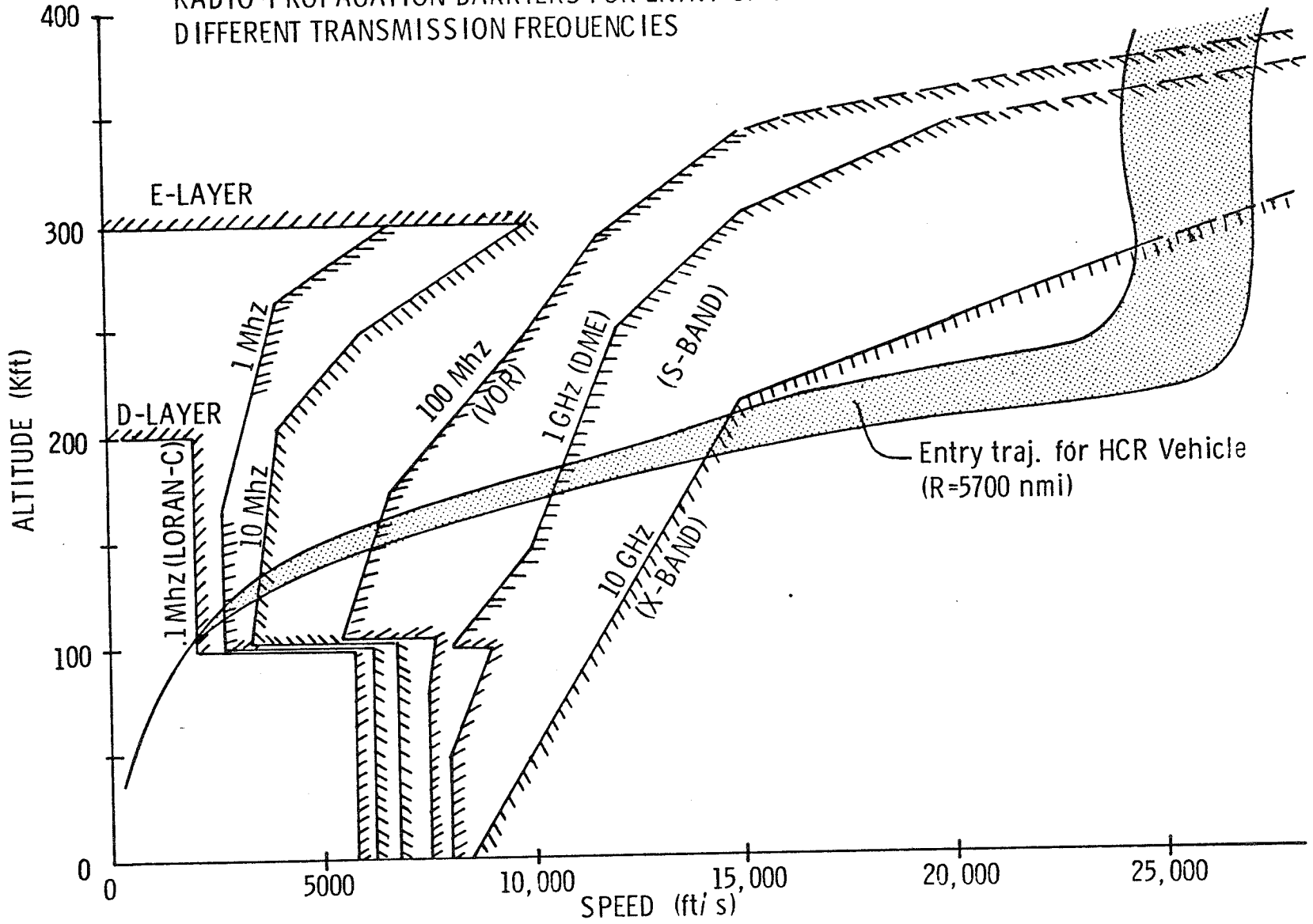

## IMU PERFORMANCE REQUIREMENTS --- BASIC ASSUMPTIONS

To minimize development costs and time, it was decided to keep requirements as close as possible to present state-of-the-art. At the present time it is expected that a large number of shuttle flights will be made. For this reason it was felt that on normal missions the post-entry position error should be within the specified value at least 99.9 percent of time. If the same probability were required on abort cases, a considerable increase in IMU accuracy would be necessary. Since abort cases should occur infrequently, it was felt that a post-entry position-error probability of 95 percent was sufficient here.

To facilitate the analysis of IMU performance requirements for the entry trajectory, the conservative and reasonable assumption was made that over the interval of interest the IMU errors (alignment, drift-rate, accelerometer uncertainties, etc.) were all bias errors normally distributed about zero mean values.

## IMU PERFORMANCE REQUIREMENTS-- BASIC ASSUMPTIONS

PERFORMANCE CRITERION : Probability that horizontal-plane position estimation errors after entry ( $h \approx 40,000$  ft) are less than a specified value

- GROUND RULES :
- (1) Hold requirements as close as possible to present state of the art
  - (2) No external updatings (e.g. radio nav aids) are permitted
  - (3) The performance criterion for normal entry trajectories should be very high (.999); on abort cases this can be relaxed (.95)
  - (4) Consider post-entry errors in range of 5 to 20 nmi
  - (5) All IMU errors are bias errors, normally distributed about a zero mean value
  - (6) No orbit-navigation errors (starting point)



## IMU PERFORMANCE REQUIREMENTS --- ANALYTICAL APPROACH

The approach adopted was to compute the statistical characteristics of the estimation errors for the trajectory of interest by direct forward integration of appropriate matrix differential equations. All of the relevant IMU error sources are included, with the individual errors modeled as bias errors normally distributed about a zero mean value. The resultant differential equations are linear, but with time-varying coefficients.

The two statistical quantities of prime interest are the estimation-error covariance matrix, and the correlation matrix between state estimation errors and IMU errors. Using the eigenvalues of the horizontal-plane position estimation-error covariance matrix, the probability that the error is less than a specified value is easily computed. The correlation matrix between estimation and IMU errors, when properly normalized by the r. m. s. values of the estimation and IMU errors, clearly shows the relative contribution of each IMU error source to the total position error. This is very useful as a guide to which individual-error specification should be changed. More details are given in MIT Draper Lab 23A STS Memo No. 23-71.

## IMU PERFORMANCE REQUIREMENTS-- ANALYTICAL APPROACH

- PROCEDURE :
- (1) Start with state-of-art IMU error model (all bias errors)
  - (2) Compute statistical characteristics of estimation errors for trajectory of interest (all IMU errors present)
  - (3) Use estimation-error covariance matrix (eigenvalues) to compute error probabilities
  - (4) Use correlation matrix between estimation errors and IMU errors to indicate the predominant and secondary error sources
  - (5) Modify the individual IMU instrument errors to obtain the desired post-entry error probability (guided by correlation matrix between estimation and IMU errors)

## IMU PERFORMANCE REQUIREMENTS --- SIMULATION RESULTS

Typical simulation results are presented for an abort trajectory on which the vehicle is required to return to the earth before injection into a circular 100-n.mile orbit. The total trajectory time duration was about 7500 seconds, and the entry range was 5470 n. miles. The statistical models in the simulation included drift-rate bias, accelerometer bias, accelerometer scale-factor, accelerometer alignment, g-sensitive drift, and east-gyro alignment errors. Both conventional gyrocompassing and optical techniques were considered for launch-pad azimuth alignment of the IMU; the leveling of the IMU at the launch pad was assumed to be accomplished by the horizontal accelerometers.

The selected maximum value for the post-entry position error is very important, as can be seen by the error-probability data presented for both 8 and 16 n.mile maximum errors. A simulation run made using the indicated 1-sigma IMU errors gave post-entry error probabilities which were too low. The correlation matrix between IMU and state-vector estimation errors indicated that the primary error sources were launch-pad azimuth alignment, accelerometer bias, and accelerometer scale-factor errors. By using optical techniques for azimuth alignment, and by increasing the accelerometer bias and scale-factor accuracy requirements by a factor of two, satisfactory post-entry error probabilities were obtained.

## IMU PERFORMANCE REQUIREMENTS --- SIMULATION RESULTS

Once-Around Abort Trajectory , HCR Vehicle, L/ D = 1.5,  $R_{ENT} = 5470$  nmi

- Initial IMU Error Model  
(1 - sigma values)

Drift-rate bias	---	$.015^0 / \text{hr}$
G-sensitive drift	---	$.04^0 / \text{hr/g}$
Accelerometer bias	---	$.0016 f / s^2$
Accel. scale factor	---	50 ppm
Accelerometer alignment	---	.11 mr
East-gyro alignment	---	.11 mr
Optical az. alignment at launch pad	---	.5 mr
Level IMU by horiz. accelerometers at launch pad		

- Typical Simulation Data

Description of Test Run		Probability that Post-Entry Position Error Less Than	
		8 nmi	16 nmi
1) Reference case with initial model (gyrocomp. )		.55	.90
2) Improve post-entry error probability by :	a) optical az. alignment	.70	.96
	b) reduce accel. bias and scale factor by 2	.68	.96
	c) optical az. align & b)	.86	.997

## BAROMETRIC ALTIMETER AND VOR/DME ERROR MODELS

At altitudes above 100,000 feet the predominant error source in the barometric altimeter is the static-pressure error. This error, which is the difference between the free-flow pressure and the actual port pressure, is typically of the order of 1 mbar (1-sigma). At altitudes below 100,000 feet, on the other hand, the predominant error is atmospheric density variations. These variations are strongly affected by the temperature of the atmosphere and, hence, vary with latitude, seasons, and time of day. A reasonable average error model for this source was felt to be a bias error of 7.5% of density (1-sigma). Instrument errors, i. e. from servos and transducers, are generally small in comparison to static-pressure and density-variation errors. More details on barometric altimeter error models are given in MIT Draper Lab 23A STS Memo No. 14-70.

The VOR/DME combination is a useful navigation aid during entry at altitudes below about 100,000 feet. VOR provides magnetic bearing with respect to the ground station, and DME measures line-of-sight distance to the ground station. VOR/DME is a particularly attractive navaid for the following reasons:

- (1) present coverage blankets the U.S. and is extensive in other countries;
- (2) its accuracy is high enough to significantly improve navigation-system performance;
- (3) it is relatively inexpensive and easy to operate.

More details on VOR/DME modeling for entry navigation studies are given in MIT Draper Lab 23A STS Memo No. 17-70.

## BAROMETRIC ALTIMETER AND VOR/ DME ERROR MODELS

### ● BAROMETRIC ALTIMETER

Type of Error	Error Model (1- $\sigma$ )
1) Static-pressure error	1 mbar (bias)
2) Instrument errors	.2% h (random)
3) Density variations	7.5 % $\rho$ (bias)

Note :

- 1) Data unreliable at Mach nos. between 0.9 and 1.1
- 2) Pressure too low for  $h > 130,000$  ft
- 3) Static-pressure errors dominate at  $h > 100,000$  ft, density vars. dominate for  $h < 100,000$  ft

### ● VOR/ DME

Error Source	Bias (1- $\sigma$ )	Random (1- $\sigma$ )
VOR	.76 deg	.9 deg (correl. noise $\tau = 5-15s$ )
DME	840 ft	12 ft (4-sec sampl. int.)

VOR acquisition delay .5-1.0 min

Coverage Envelope (FAA spec)

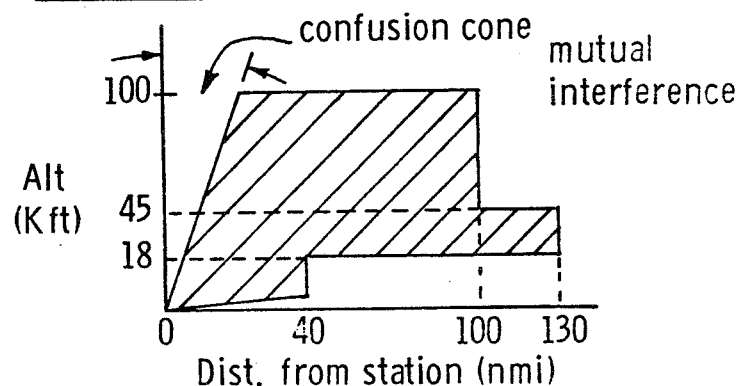

## NAVIGATION UPDATING BY VOR/DME AND PRESSURE ALTIMETER

A series of simulated entry trajectories were run to study the performance of VOR/DME and a pressure altimeter as nav aids during orbiter entry. The data presented are for a low-cross-range vehicle on a normal entry trajectory. A single VOR/DME station is assumed, located at the landing point, which is about 10 n. miles down range from the vehicle's position when at an altitude of 40,000 feet. A minimum variance filter is used to process the VOR/DME and pressure altimeter data.

Without the pressure and VOR/DME updating, it is seen that the r. m. s. position estimation errors after entry are about 2 n. mi. cross-track, 2.4 n. mi. down-range, and 3.4 n. mi. in altitude. The combination of the pressure altimeter and VOR/DME is seen to reduce the post-entry position estimation errors to about .2 n. mi cross-track, .25 n. mi. down-range, and .28 n. miles in altitude. It is interesting to note that the pressure measurement reduces the down-range position error along with the altitude error because of the correlation between these two errors. It should also be noted that the non-planar characteristics of the entry trajectory, i. e. the lateral maneuvering, provide a favorable geometry for DME so that all components of position error are reduced by these measurements.

## NAVIGATION UPDATING BY VOR/ DME AND PRESSURE ALTIMETER

### BASIC ASSUMPTIONS

- 1) Normal entry traj. from 270-mile circular orbit
- 2) Apollo-type IMU
- 3) Low-cross-range vehicle with  $L/D=0.5$
- 4) Single VOR/ DME station at landing site (10 nmi down range from 40,000.ft altitude point)
- 5) Minimum-variance on-board filter, updating position only
- 6) No pressure updatings when  $h > 150,000$  ft

### ● R. M. S. Estimation Errors after Entry ( $h \approx 40,000$ ft)

Measurements Used	R. M. S. Pos. Est. Errors (nmi)		
	Altitude	Cross Track	Down Range
None	3.4	2.0	2.4
Pressure	.30	2.0	1.9
VOR	2.8	.27	1.4
DME	.63	.67	.31
VOR/ DME	.57	.17	.27
Press. & VOR/ DME	.28	.17	.25

### ● R. M. S. Errors from 8 Simulation Runs--Press & VOR/ DME

2-sigma IMU, stat pres, & i.c. errors;  $45^{\circ}$  N. Lat density vars for Jan & July; 1-deg VOR bias, 1000 ft DME errors

Press. & VOR/ DME	.21	.19	.20
-------------------	-----	-----	-----



## R. M. S. POSITION ESTIMATION ERRORS FOR NORMAL ENTRY

Time histories of the r. m. s. errors in the estimates of orbiter position during a normal entry trajectory are presented for the case where a barometric altimeter and VOR/DME are used as nav aids. Also shown for comparison are the error profiles when the IMU is used alone. A minimum variance filter is used to process the pressure altimeter and VOR/DME measurements.

As can be seen, the pressure measurements come in first, starting at an altitude of about 150,000 feet. The altitude estimation errors are reduced by a factor of 2-3. DME comes in next at an altitude of about 100,000 feet, causing a significant reduction in down-range error from about 10,000 to 1,500 feet. Finally, at an altitude of about 75,000 feet (acquisition delay) VOR comes in, reducing the cross-track position error from about 6,000 to 1,500 feet. The overall effect of the pressure altimeter and VOR/DME nav aids combination is a reduction in post-entry position estimation errors by a factor of about 10 in each component.

# R. M. S. POSITION ESTIMATION ERRORS FOR NORMAL ENTRY

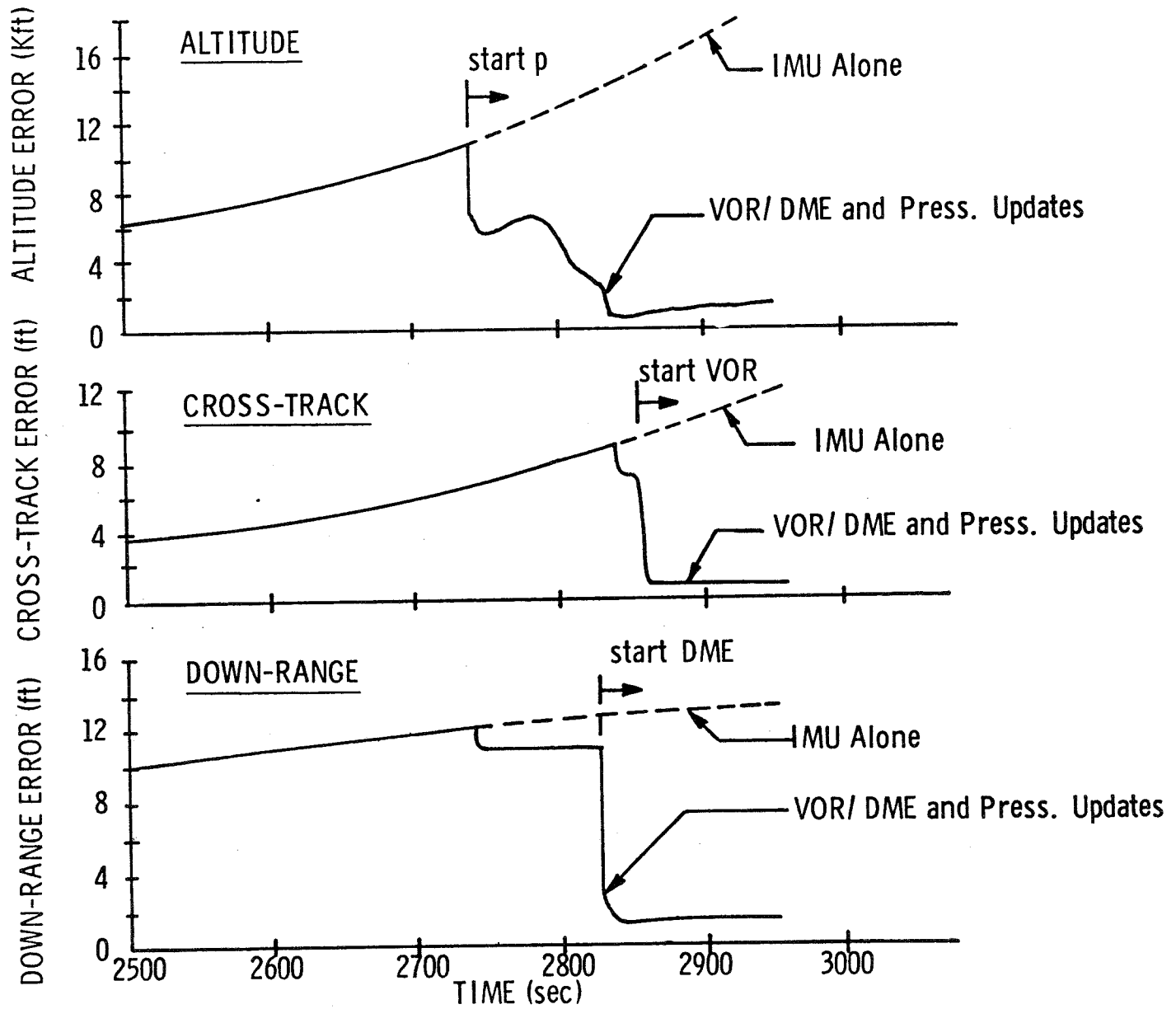

## STABILIZATION OF NAVIGATION SYSTEM'S ALTITUDE CHANNEL DURING ENTRY

IMU-derived estimates of vehicle altitude using conventional inertial-navigation techniques diverge very rapidly during the latter part of entry. Values of r. m. s. estimation errors as large as 30,000 feet after entry have been seen on HCR-vehicle trajectories. The basic objective is to see if the altitude estimation errors can be held to reasonable values prior to the end of entry, without requiring any external navaid updatings or additional navigation sensors other than the IMU.

Several different techniques have been investigated for accomplishing this. The details are given in MIT Draper Lab 23A STS Memos No. 10-71, 12-71, 13-71, 14-71, and 26-71. The most promising of the techniques studied was the one wherein the weighted difference between measured drag and its a-priori estimate was used to update the state estimate. This particular technique is described in more detail in the following slides.

## STABILIZATION OF NAVIGATION SYSTEM'S ALTITUDE CHANNEL DURING ENTRY

### PROBLEM DEFINITION

- IMU-derived estimates of orbiter altitude tend to diverge rapidly during the latter part of entry
- Stabilize without external navaid updates and without additional navigation sensors (prior to cruise phase)

### POSSIBLE SOLUTIONS CONSIDERED

- 1) Remove destabilizing gravity term by feedback of state-vector deviations from reference trajectory
- 2) Use reference-trajectory gravity in altitude channel (look-up vs speed)
- 3) Use reference-trajectory altitude (at est. speed) as current altitude estimate
- 4) Update state estimate with weighted difference between measured drag and its a-priori estimate
- 5) Update with weighted difference between meas. and a-priori est. of drag rate

## DESCRIPTION OF DRAG-MEASUREMENT SCHEME

The technique first determines a quantity called measured drag ( $\tilde{d}$ ), using the component of PIPA-measured velocity change ( $\Delta\tilde{v}$ ) along the vehicle's relative-velocity vector ( $\underline{u}_V$ ) in a time interval ( $\Delta t$ ). The measured drag ( $\tilde{d}$ ) is then compared with an a-priori estimate of drag ( $d'$ ), and the weighted difference is used to update the vehicle's state estimate ( $\underline{x}$ ). The computation of  $d'$  requires that models be stored a-priori of atmospheric density ( $\rho$ ) as a function of altitude ( $h$ ), and the vehicle's ballistic coefficient ( $W/C_D A$ ) as a function of angle-of-attack in the operating regions of interest.

In the studies of the scheme, a minimum variance filter was used to update the complete state vector ( $\underline{x}$ ). To keep the filter design relatively simple, the drag-measurement error model used in the filter was a 1-sigma bias error of 15% (of drag) and a 1-sigma random error of 7.5% (of drag). The bias errors were not estimated in these initial studies. Thus far this technique has been used only at altitudes below 200,000 feet because of the limited available data on density variations at higher altitudes.

## DESCRIPTION OF DRAG-MEASUREMENT SCHEME

### BASIC UPDATING EQUATIONS :

$$\underline{x} = \underline{x}' + \underline{w} (\tilde{d} - d')$$

$$\tilde{d} = \left| \Delta \tilde{V} \cdot \underline{u}_V \right| / \Delta t$$

$$d' = \frac{1}{2} \rho_c (h') v'^2 g (C_D A/W)_c$$

$\underline{x}$  = state estimate

$\tilde{d}$  = measured drag

$d'$  = a-priori est. drag

$\underline{w}$  = weighting vector

### IMPORTANT CHARACTERISTICS OF SCHEME :

- Start drag-measurement updating when altitude = 200,000 ft
- Use minimum-variance filter to update state, no bias estimation
- Filter model for drag meas. error : 15 % bias, 7.5 % random (1-sigma)

### MAJOR PROBLEM AREAS :

- (1) Density variations w. r. t. stored  $\rho_c (h')$
- (2) Variations in  $W/C_D A$  from the stored  $f(\alpha)$

## SIMULATION RESULTS FOR DRAG-MEASUREMENT SCHEME

A series of simulated entry trajectories were flown for a HCR vehicle to study the performance of the drag-measurement scheme. The real-world density-variation model was based on data for Cape Kennedy w. r. t. 1963 Patrick Reference Atmosphere (details are given in NASA TMX-53872 and in MIT Draper Lab 23A STS Memo No. 26-71). The 3-sigma variations go from about 10 percent at an altitude of 100,000 feet to about 25 percent at an altitude of 200,000 feet. Ballistic coefficient ( $W/C_D A$ ) variations of 10 and 33 percent were considered.

The particular trajectory studied here was a normal entry for a HCR vehicle with an L/D of 1.5 and an entry range of about 5400 n. miles. Two-sigma IMU and initial-condition (at deorbit time) errors were assumed. With no drag-measurement updating it is seen that altitude estimation errors after entry ( $h = 100,000$  feet) in the cases shown were over 50,000 feet. When drag-measurement updating was used, on the other hand, it was found that the altitude-estimation errors after entry ( $h = 100,000$  feet) were only about 5000 feet, even with 3-sigma density variations and 10 percent ballistic-coefficient variations.

## SIMULATION RESULTS FOR DRAG-MEASUREMENT SCHEME

### ASSUMPTIONS:

- Real-world density var. model for Cape Kennedy w. r. t. 1963 Patrick Reference Atmosphere (NASA TM X-53872)
- Entry traj. ---5400 nmi range, 2400 sec duration (L/D = 1.5)
- Filter error model--- 15 % drag bias and 7.5 % drag random (1- $\sigma$ )
- Start updating at altitude of 200,000 ft

Description	Density Vars.	W/ C <sub>D</sub> A Vars. (%)	Alt. Est. Errors at	
			h=150,000 ft	h=100,000 ft
1) No drag-meas. updating	- -	- -	41,680 ft -39,101	62,930 ft -58,825
2) Drag-meas. update with 3- $\sigma$ dens. var., 10 % var. W/ C <sub>D</sub> A, 2- $\sigma$ IMU and initial-cond. errors	3 $\sigma$	-10	- 6,762	- 5,066
	-3 $\sigma$	10	7,120	4,827
	3 $\sigma$	-10	- 6,700	- 5,028
	-3 $\sigma$	10	6,647	4,411
3) Drag-meas. update with 5- $\sigma$ dens. var., 33 % var W/ C <sub>D</sub> A	5 $\sigma$	-33	-16,000	-13,350
	-5 $\sigma$	33	14,800	10,423



## ENTRY NAVIGATION ANALYSIS-- SUMMARY

### IMU PERFORMANCE REQUIREMENTS

- Based on maximum post-entry maneuver capability
- Compute error probabilities from est. error covariance matrix
- Dominant errors indicated by correlation matrix between IMU and post-entry errors

### NAVIGATION UPDATING BY PRESSURE ALTIMETER AND VOR/ DME

- Analytical models developed for operational chars. and errors
- Simulation results show post-entry pos. errors reduced by a factor of about 10 to .2 nmi (each component)

### STABILIZATION OF NAVIGATION-SYSTEM ALTITUDE CHANNEL

- Update state with weighted difference between measured and a-priori estimate of drag
- Simulation runs show errors of 6000 ft or less after entry

**GUIDANCE AND CONTROL CONSIDERATIONS  
FOR AN UNPOWERED ORBITER  
FROM ENTRY TO TOUCHDOWN**

**DAVID W. GILBERT**

**MANNED SPACECRAFT CENTER  
HOUSTON, TEXAS**

## INTRODUCTION

Since the orbiter must land on a specific runway and for some missions, at least, will not have a cruise capability, it is necessary to have a terminal navigation aid that gives the guidance system its position accurately with respect to the runway. In order to make most effective use of the available energy, this relative position update should start as soon as possible after emerging from entry communications blackout. This paper is concerned primarily with the orbiter guidance problem following that first navigation update. An outline of the major topics is shown in the first figure. The entry portion of the mission is considered only to the extent necessary to account for the range of conditions that might exist at the time of the first navigation update. The vehicle ranging capability after that point is determined in the light of known and assumed constraints. A candidate strategy for the terminal area guidance target and the associated terminal area maneuvering are described. Finally, some results of a simulator evaluation of a specific terminal area guidance and control system are presented. The paper is intended to illustrate the need to consider the overall guidance and control problem from entry to touchdown and also to present some specific results from the work in the Guidance and Control Division at MSC. The results pertaining to ranging capability are considered typical of recent delta-wing high crossrange orbiter configurations, while the terminal area guidance and control evaluation was actually conducted with an earlier straight-wing orbiter configuration.

# OUTLINE

- GUIDANCE PHASES
- ENTRY PROFILES
- RANGING CAPABILITY AFTER  
NAVIGATION UPDATE
- CONTROL PROBLEMS AND IMPLICATIONS
- TERMINAL AREA GUIDANCE CONCEPT
- TERMINAL AREA GUIDANCE EVALUATION

## GUIDANCE PHASES

In analyzing the problem, we break the descent portion of the mission after deorbit into three phases. First is the hypersonic entry portion that is inertially guided and concerned with getting safely through the heat constraints while slowing the velocity and achieving most of the required range. The entry portion extends down to the point where the first navigation update is received after communications blackout. The actual point at which this occurs depends on the type of communications used to transmit the navigation information. For the purposes of this study, it was assumed this would occur at an altitude of 150,000 ft. At this point, the second or post-blackout phase starts. During this phase, the vehicle is maneuvered onto a course that will intercept a target point in the vicinity of the runway at a specified subsonic flight condition. This could occur at an altitude of 55,000 ft or less, depending on the target strategy and the initial navigation error to be adjusted. Forty thousand feet altitude is shown on the figure for illustrative purpose as the start of the Terminal Area Phase. During this phase, maneuvering is performed to adjust the remaining energy so that the orbiter enters the final approach plane of the runway with suitable conditions from which it can execute an equilibrium glide and flare to touchdown. It must also maintain sufficient energy margin to accommodate guidance and navigation errors and unknown winds.

The following figure illustrates the three guidance phases and also shows the expected time duration for this portion of the orbiter missions. Notice that the time of flight for this entire portion of the mission is two to four times longer than for a typical Apollo mission. This, coupled with the requirement to land on a specific runway, results in the requirement for a navigation update.

# GUIDANCE PHASES

ALTITUDE,  
FEET

400,000 FT

ENTRY

150,000 FT

POST BLACKOUT

40,000 FT

TERMINAL  
AREA

APOLLO

ORBITER

0

20

40

60

TIME, MINUTES

171

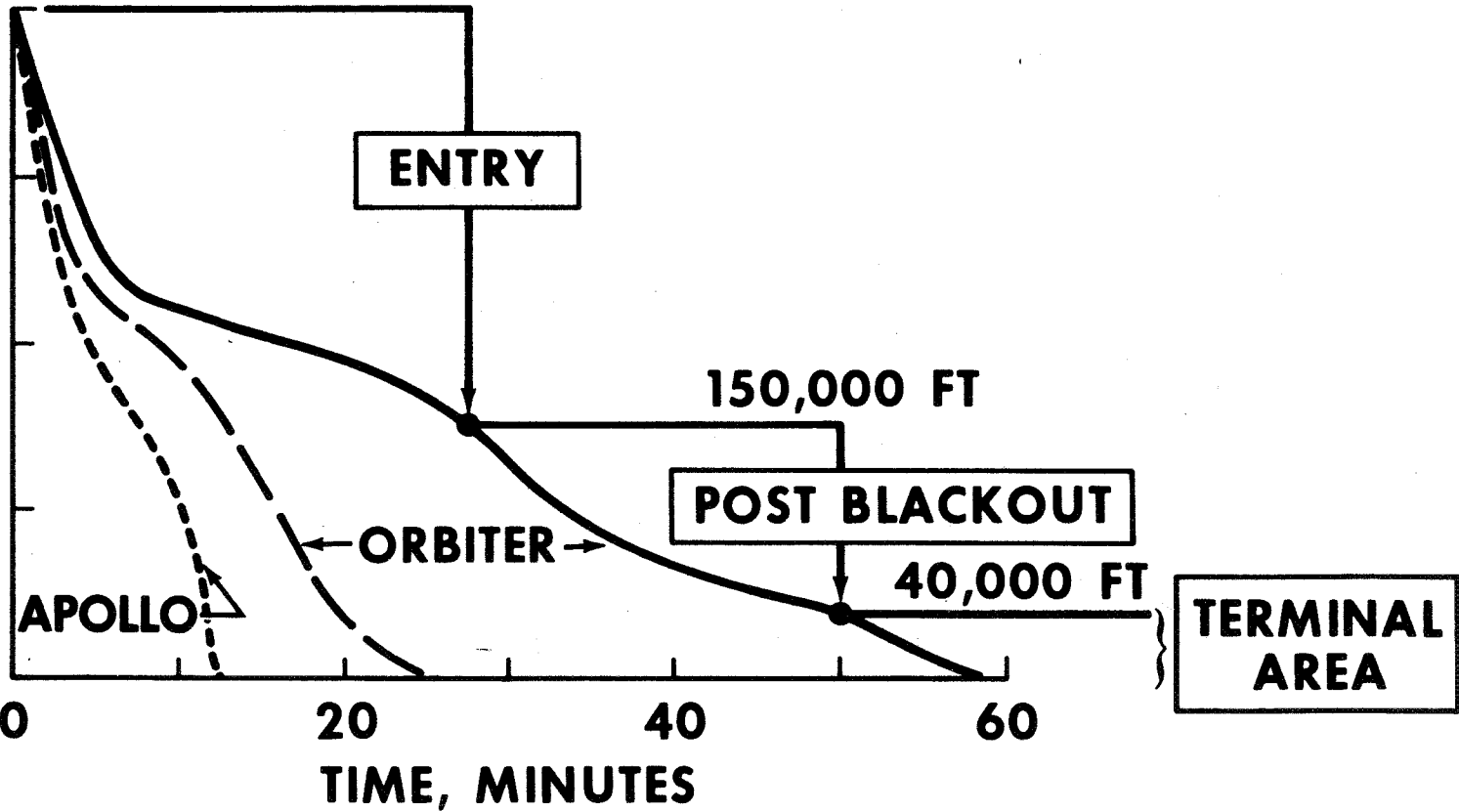

## ENTRY PROFILE

The large crossrange mission results in the longest time of flight. It would be possible to straighten out the crossrange component and fly a long downrange mission with the same altitude vs velocity profile when the crossrange was not required. This could be targeted to reach the same point on the ground as a shorter range trajectory. From a guidance viewpoint, there appears to be a number of advantages to doing this, or at least to achieving similar trajectory conditions at the time the first navigation update is received. The following figure shows a typical set of conditions at 150,000 ft for a short range entry and a long range entry. Notice that at this altitude the long range trajectory has farther to go to get to the landing site but it also has greater velocity and shallower flight path angle and angle of attack. The significant thing from a guidance standpoint is to determine the ranging capability from the nominal target after the navigation update is received. This establishes the capability to correct for errors, choose alternate landing sites, or change the approach path to the existing site. A study was made to evaluate this capability from 150,000 ft for the two typical sets of initial conditions. The results show a significant advantage for the condition associated with the long range trajectory. It is recognized, however, that the long range type of entry also stresses the thermal protection system (TPS) closer to its design limit than the short range entry. Depending on the type of material used and other factors, there can be a degradation in TPS performance associated with its previous usage history. For missions where the large crossrange is not required, there might be other conditions that favor one profile or the other.

# ENTRY PROFILES

$h = 400\text{K FT}$

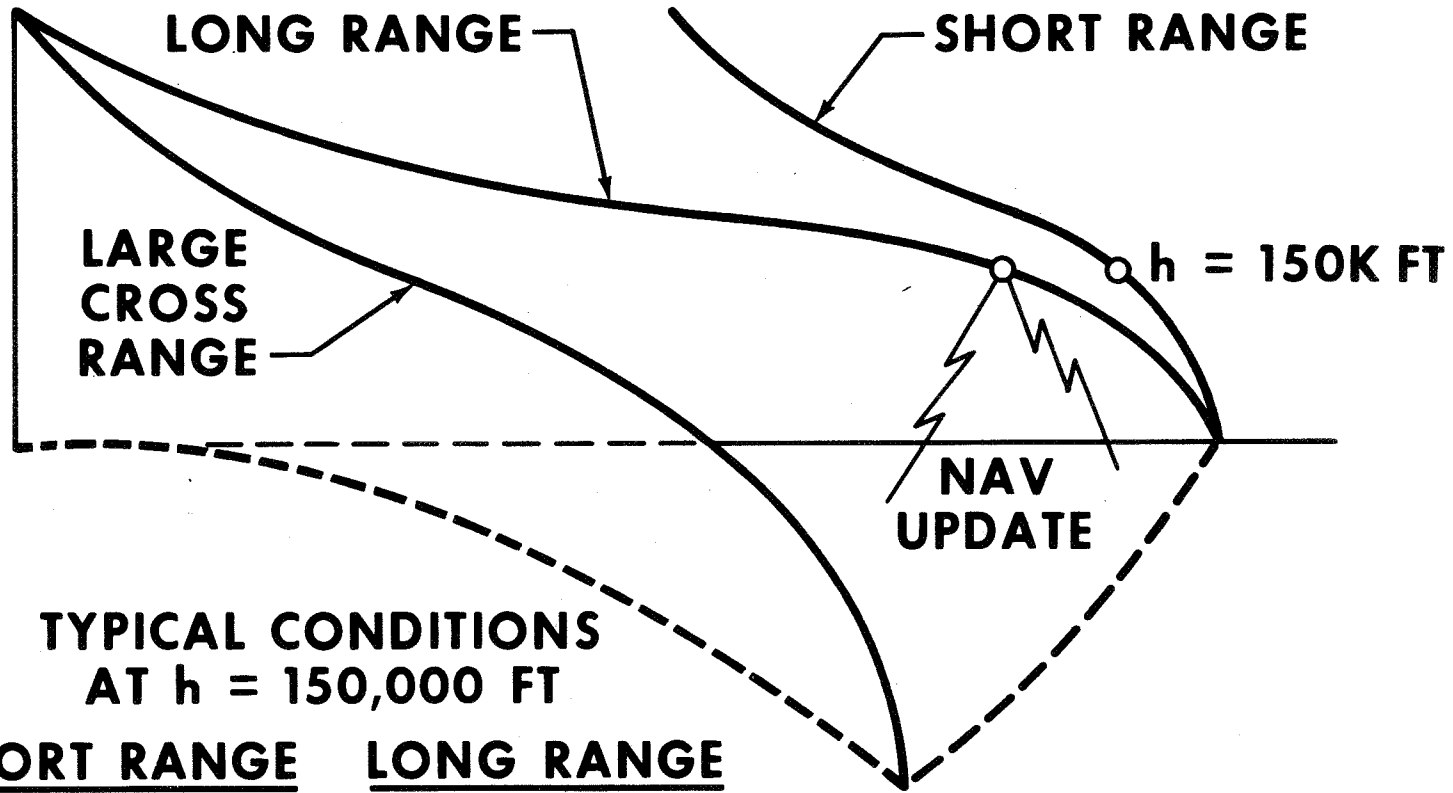

**TYPICAL CONDITIONS  
AT  $h = 150,000\text{ FT}$**

<u>SHORT RANGE</u>	<u>LONG RANGE</u>
$V = 5300\text{ FPS}$	$V = 7700\text{ FPS}$
$\gamma = -3.8^\circ$	$\gamma = -0.8^\circ$
$\alpha = 45^\circ$	$\alpha = 23^\circ$



#### VEHICLE RANGING CAPABILITY FROM 150,000 FT ALTITUDE

At 150,000 ft altitude, the orbiter would be nominally 200 to 400 n. mi. uprange from the landing site, depending on whether it is flying a short range or a long range trajectory and how the targeting is arranged. The following figure shows the ability to adjust the range after the navigation update for the two trajectory cases, assuming both were targeted for the same landing site. The footprints shown are at an altitude of 20,000 ft; therefore, there is actually another 15 miles or so available. The procedure was to fly an angle-of-attack profile associated with the range-to-go starting at 150,000 ft. At this time, a 30° bank angle was held in the proper direction until the heading to a particular point was obtained. The vehicle was then rolled wings-level and the required angle-of-attack profile continued. In all except the extreme lateral cases in the corners of the footprint, the vehicle was on the desired heading to the runway from a hundred miles or more out.

The back edges of these footprints are shown as dotted lines to indicate that they have been cut off, and there is some uncertainty in just where the line should be. If it is possible to maintain a 40° angle of attack down to Mach number 1.4, the back or lower edge of the footprint would not cut off quite so soon. Also, in determining these footprints, wings were held level from Mach number 1.4 to 0.8. This procedure cuts off a small portion of the extreme corners that curl back and in toward the center. This amount of cut-off is considered of minor importance.

Any restrictions on the usable angle of attack on the front side of the lift-to-drag ratio (L/D) characteristic have a significant effect on the ranging capability.

Most significant of all is the additional 50 to 60 miles of ranging provided by the long range type entry trajectory after the navigation update is received.

# POST-BLACKOUT VEHICLE RANGING CAPABILITY

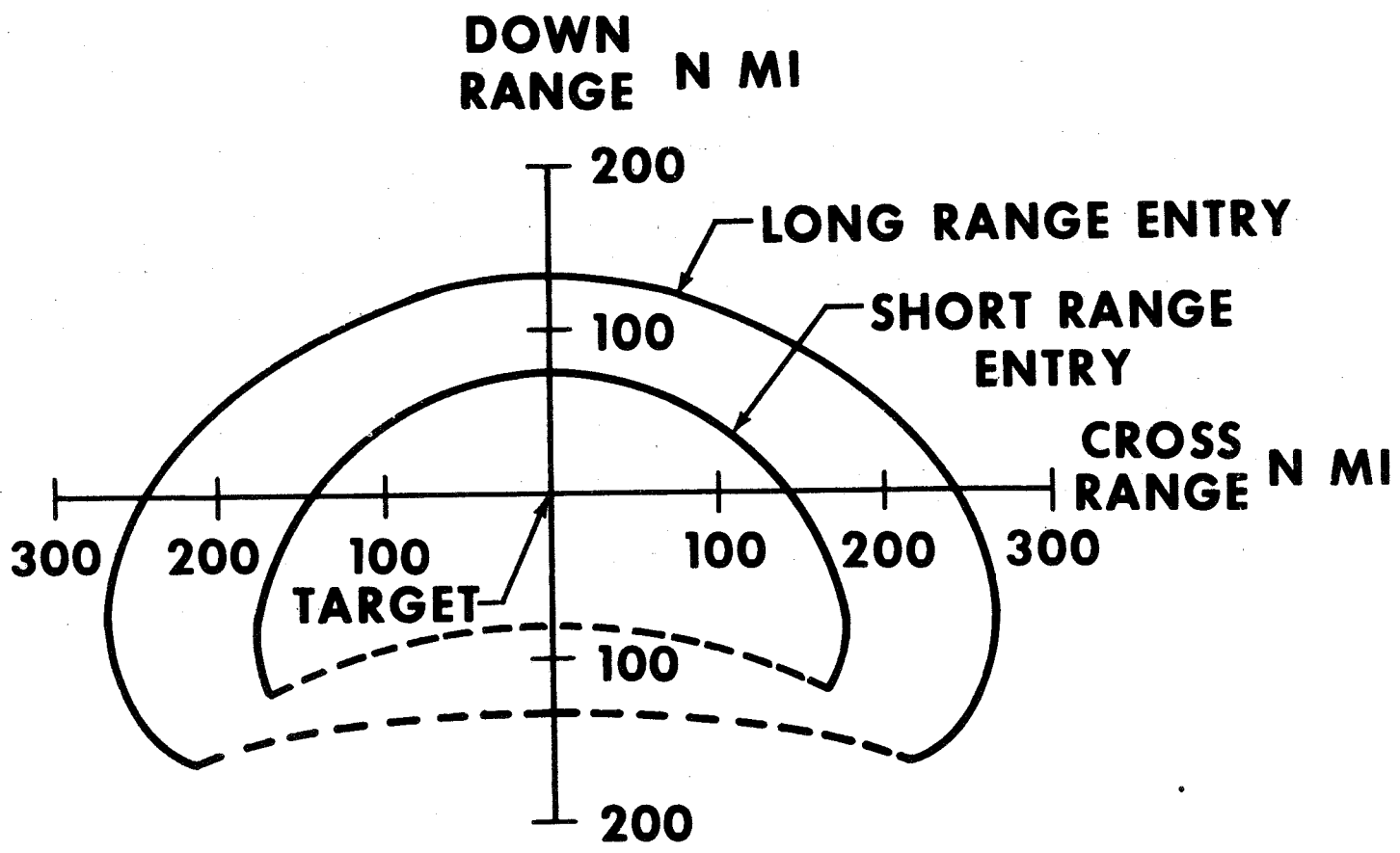

### POST-BLACKOUT RANGE CONTOURS

The curved lines shown in the following figure indicate the range achieved for a constant value of L/D maintained from an altitude of 150,000 ft down to an altitude of 20,000 ft. The two numbers associated with each line are the two values of angle of attack associated with each L/D value - one on the front side of the L/D vs  $\alpha$  curve and one on the back side (the larger one) as illustrated. We would like to pitch down to the lower value of angle of attack as soon as possible to eliminate the need to keep the reaction control system (RCS) on, but dynamic pressure limitations on the vehicle require we stay at the larger values of angle of attack until we reach a Mach number of 1.4 or less for some conditions.

In the nominal case, the landing site would be in the middle of the ranging footprint. If not, our present guidance concept uses the L/D vs contour information to determine the angle of attack to fly to adjust the predicted range to the range required as indicated by the navigation system. The cross-range capability shown is achieved using bank angles of  $30^\circ$  or less with wings level from Mach number 1.4 to 0.8. For all but the extreme cases in the corner of the footprint, the vehicle is on the correct heading to the runway with wings level well before it reaches transonic flight conditions; therefore, a wings-level restriction during this period has only a small effect on the ranging capability.

A horizontal situation display is being developed by using this type of format to provide a means of monitoring the guidance system and flying it manually if desired.

# POST-BLACKOUT RANGE CONTOURS FOR CONSTANT LIFT/DRAG

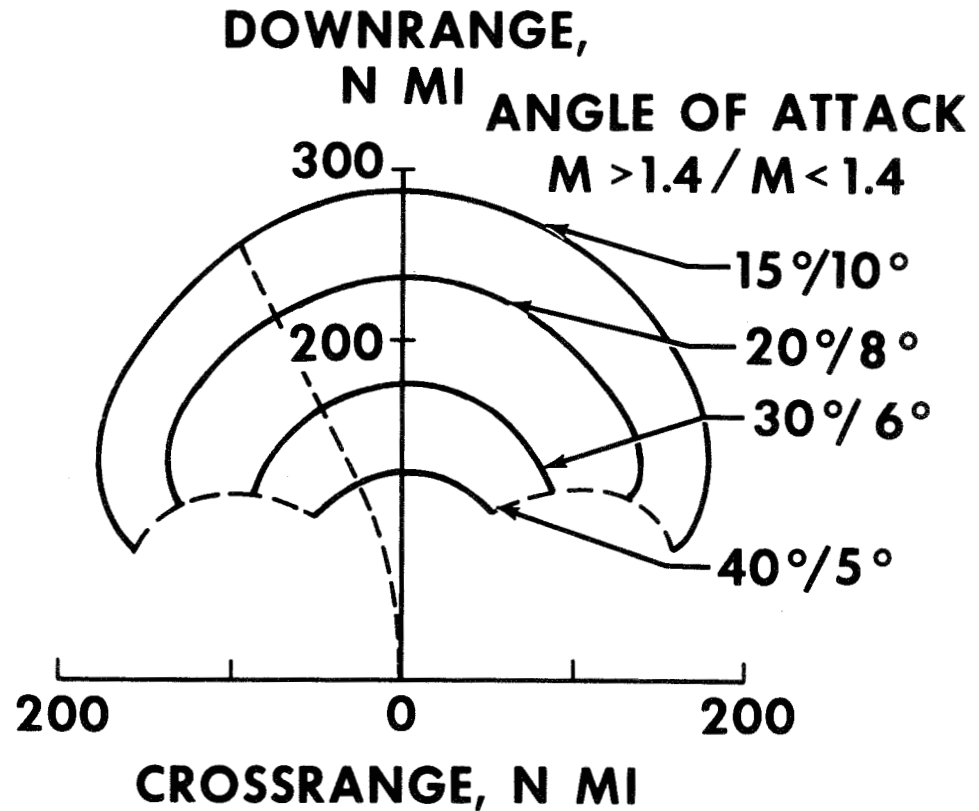
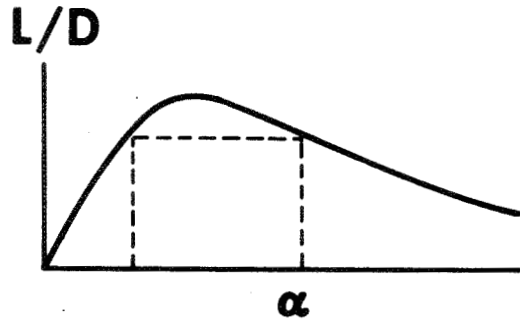

ANGLE-OF-ATTACK PROFILES

At an altitude of 150,000 ft, the orbiter is still operating at an angle of attack greater than that associated with maximum L/D in both types of entry. Depending on the situation defined by the first navigation update, the orbiter must adjust its L/D and bank angle to achieve the required range and heading to the target. Attempts to maneuver to the front side of the L/D characteristic at this point ( $M = 5$  to  $8$ ,  $h = 150,000$  ft) resulted in excessive dynamic pressure. The same L/D can be achieved at larger angles of attack on the back side of the curve, and it was found that not only does this result in acceptable dynamic pressures but there is no ranging penalty associated with it. At a Mach number of 1.4, it is possible to maneuver to the smaller angle of attack associated with the same L/D on the front side. This occurs between an altitude of 85,000 to 110,000 ft. It might be possible to make this transition to the front side sooner in some cases. The earliest acceptable point for each range-to-go was not determined, just one common condition that would be acceptable for all cases. The minimum range case was determined by the maximum angle of attack that could be maintained from Mach number 5 to 1.4. This was taken as an average value of  $40^\circ$ . There is actually a trim limit in this region which is a function of Mach number that is not yet well established. The maximum range case was limited by the dynamic pressure limit and the L/D available at an angle of attack of  $15^\circ$ .

In order to achieve the mid-range value or nominal case, the short range type trajectory requires a transition from a high angle of attack to a value of  $25^\circ$  to  $30^\circ$  at 150,000 ft altitude, then down to  $7^\circ$  at Mach number 1.4. For the long range trajectory, no significant change in angle of attack is required at 150,000 ft to achieve the nominal, mid-range case. The vehicle is already close to  $25^\circ$  angle of attack. For the long and short range cases, the maximum angle-of-attack adjustments required are smaller for the long range entry and tend to excite less oscillatory disturbance in the trajectory parameters.

Both types of trajectories reach subsonic flight conditions in the vicinity of 50,000 ft altitude, depending somewhat on whether the vehicle is attempting to go long or short after the navigation update.

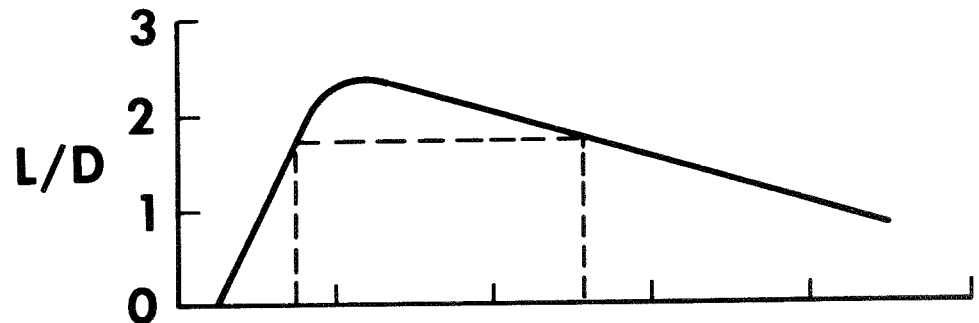

# POST-BLACKOUT ANGLE OF ATTACK PROFILES

ALTITUDE,  
1000 FT

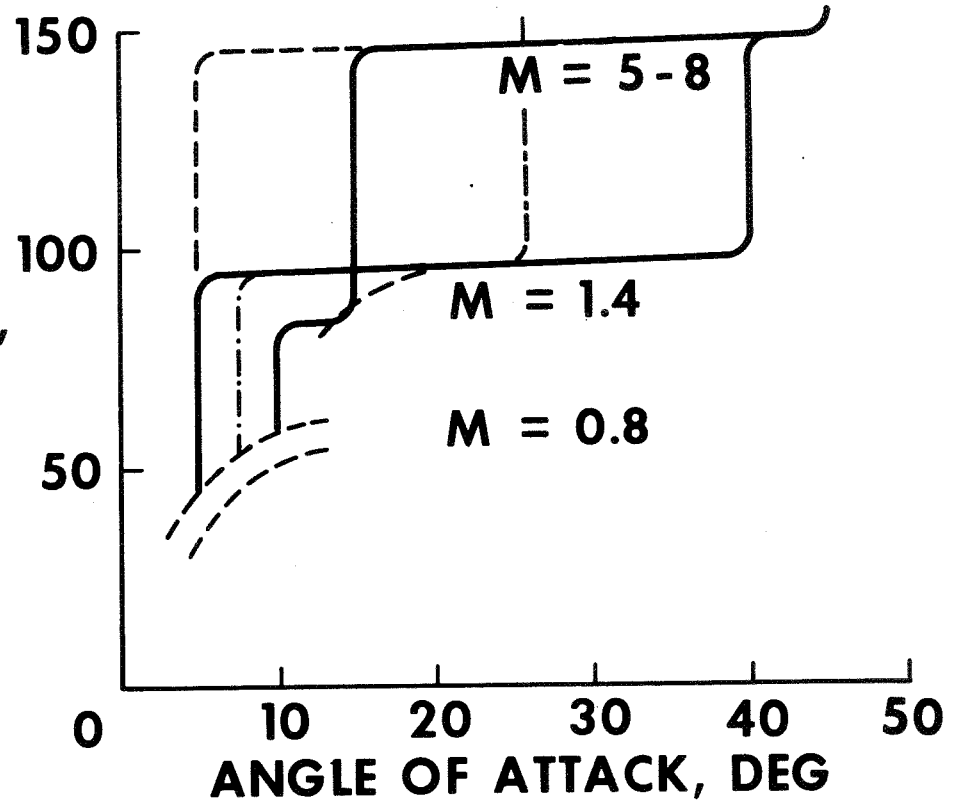

## CONTROL PROBLEMS AND IMPLICATIONS

The presently known problems that could affect the guidance capability are listed in the following figure.

The trim  $\alpha$  limit is not well defined at this time. It might not be significant at all in the final vehicle configuration. These studies assumed an average  $40^\circ$  angle-of-attack limit in the region between Mach number 5 and 1.4. If the actual effect is more severe, it will tend to remove a slice of area from the short range end of the footprint. Moderate amounts are not considered serious.

Lack of vehicle directional stability at large angles of attack requires RCS attitude control at least down to 80,000 ft altitude. The coupled lateral-directional motion is stable and will act to relieve the sideslip angle, but requires freedom in roll to respond. Whether this is compatible with guidance is not yet well understood. If guidance normally requires tighter roll control, then it might be necessary to interrupt guidance momentarily and switch control modes to allow the vehicle to respond to relieve sideslip angles greater than the RCS can hold. This, in turn, would use up a portion of the lateral ranging capability. The effect of this guidance and control interaction needs much more detail attention.

No specific limitations in the transonic region that affect the guidance were defined at the time this study was conducted. A wings-level requirement was found to have only a minor effect since the vehicle was normally on the correct heading well before it became transonic. Any limitation in angle of attack would have a more direct effect. Values between  $5^\circ$  and  $10^\circ$  were used in this study.

# CONTROL PROBLEM AND IMPLICATIONS

- **TRIM  $\alpha$  LIMIT**
  - **MINOR REDUCTION IN RANGING**
- **VEHICLE DIRECTIONAL STABILITY AT LARGE ANGLES OF ATTACK**
  - **REQUIRES RCS CONTROL DOWN TO 80,000 FT ALTITUDE**
  - **PROBABLY REQUIRES MOMENTARY GUIDANCE INTERRUPT IN THE EVENT OF LARGE WIND SHEARS ABOVE 80,000 FT ALTITUDE**
- **TRANSONIC STABILITY AND CONTROL**
  - **POSSIBLE LIMITATIONS ON MANEUVERING**
    - **BANK ANGLE - MINOR REDUCTION IN RANGING**
    - **ANGLE OF ATTACK - POSSIBLE SIGNIFICANT EFFECT ON RANGING**



#### POST-BLACKOUT TERMINAL AREA INTERFACE

In order to set a guidance target for the post-blackout phase, a maneuvering strategy for the terminal area must be defined that accommodates a nominal case, as well as the minimum energy cases and the higher energy cases. The following figure illustrates one possible approach. Notice that the scaling is discontinuous since the terminal area portion all takes place within 30 miles of the runway, while the post-blackout phase starts 200 to 400 miles out. We first define a minimum entry point about 4 miles out from the runway, at which point one can enter the glide slope and still make a normal landing approach. In the example shown, the terminal area target is set approximately one turn radius ahead of the minimum entry point so that in the minimum energy case, the vehicle could turn directly into the minimum entry point. The nominal case would be arranged so that the vehicle arrives over the target with a specified altitude and velocity. In this case, the vehicle would make an initial turn onto a downwind leg, then a final turn onto the glide slope. In any event, the terminal phase would actually start when the specified nominal energy state is reached. For low energy cases, this would occur before the target is reached, requiring either a shorter downwind leg or an earlier initial turn. For high energy cases, the vehicle would pass over the target point before reaching the specified energy state and start the initial turn later. At this time, it appears that there will probably be a priority list of desirable terminal area maneuvering features that the guidance will accommodate to the extent that the available energy permits. In the limiting case, however, it must fly the most efficient flight path that will result in an acceptable landing.

# POST-BLACKOUT TERMINAL AREA INTERFACE

**SUPERSONIC GUIDANCE**

$h = 150,000$  FT

(NOT TO SCALE)

**AIM FOR AN ENERGY STATE ABOVE MIN ENTRY POINT**

**TERMINAL AREA SUBSONIC GUID**

**START AT SPECIFIED ENERGY STATE**

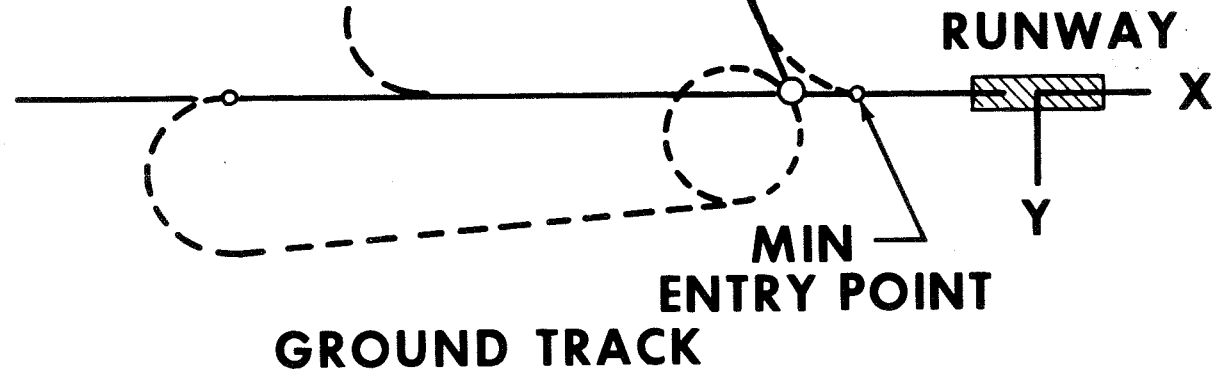

### BASIC FEATURES OF TERMINAL GUIDANCE

The following figure shows in a little more detail what the current version of the terminal area guidance actually does. In general, it always tries to find a two-turn solution to get from where it is to an entry to the final approach plane, i.e., the straight-in glide slope. Since there are always two possible choices for each turn, i.e., right turn or left turn, there are, in general, four possible solutions to the problem. The guidance compares the four combinations of two-turn solutions and selects the one that gets it on the glide slope with the greatest altitude. It also shifts the solution by the amount of expected wind drift based on input data or its onboard estimate. In some situations where the initial state vector lies close to the plane of the runway, a two-turn solution does not exist. In these special cases, a three-turn solution is used in lieu of opening the speed-brakes and diving off the excess energy.

# TERMINAL AREA AIRCRAFT GUIDANCE FOR SUBSONIC FLIGHT

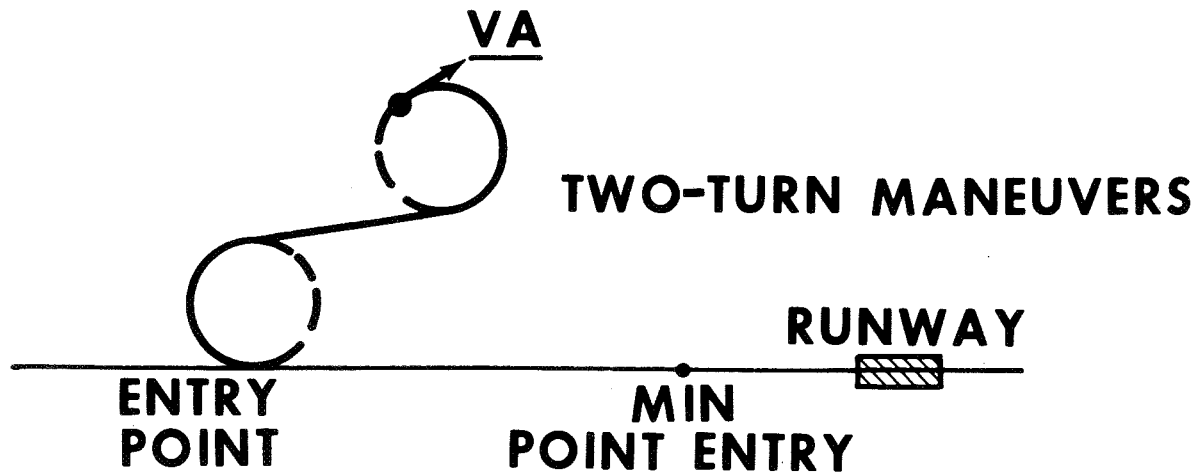

**SELECT BEST TURN MANEUVERS  
AND MANAGE ENERGY WITH  
ENTRY POINT LOCATION**

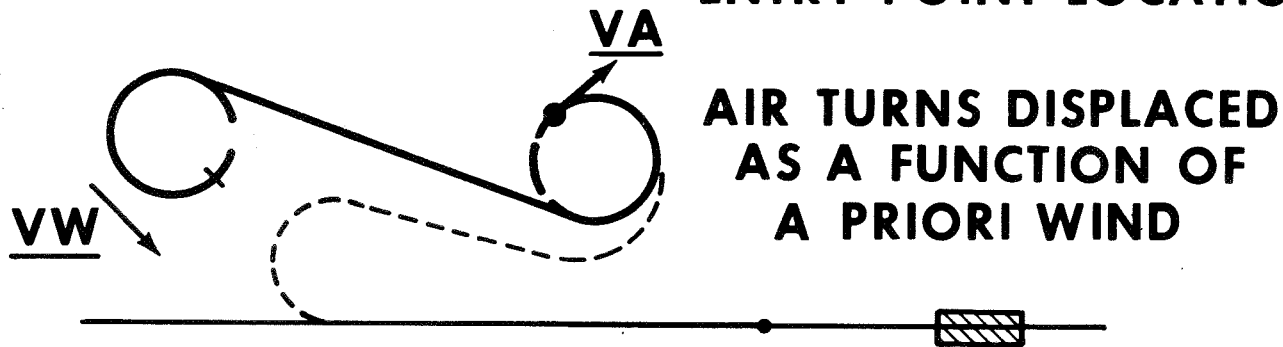

### FINAL APPROACH AND LANDING

The final approach and landing geometry for an unpowered straight-wing orbiter are shown in the following figure. Notice that the altitude scale is expanded relative to the range scale for purposes of illustration. An equilibrium glide path of minus  $10^\circ$  at an airspeed of 240 knots is maintained during the approach. Automatic speedbrake control is required to maintain airspeed for the automatic mode and greatly eases the pilot task during manual mode steering. The guidance concept requires either an actual glide slope beam or a computed pseudoglide slope as a reference for steering. At 650 ft altitude, gear and flaps are lowered and a preflare maneuver started to a more shallow  $2^\circ$  glide slope. The airspeed is steadily decreasing after this point, and a continuous nose-up rotation is required to maintain the flight path. Touchdown velocity is nominally 150 knots for the particular straight-wing vehicle used in this portion of the study. Actual touchdown conditions can be very configuration dependent and related to visibility of the runway just prior to touchdown, as well as aerodynamic parameters.

# FINAL APPROACH AND LANDING TRAJECTORY CHARACTERISTICS

ALTITUDE, FEET

1200

1000

800

600

400

200

0

APPROACH A/S 240  
(KCAS)

GEAR AND  
FLAPS DOWN  
AT 650 FT

$10^\circ$

$\approx 2^\circ$

RUNWAY

RANGE, THOUSANDS OF FEET

12

10

8

6

4

2

0

-2

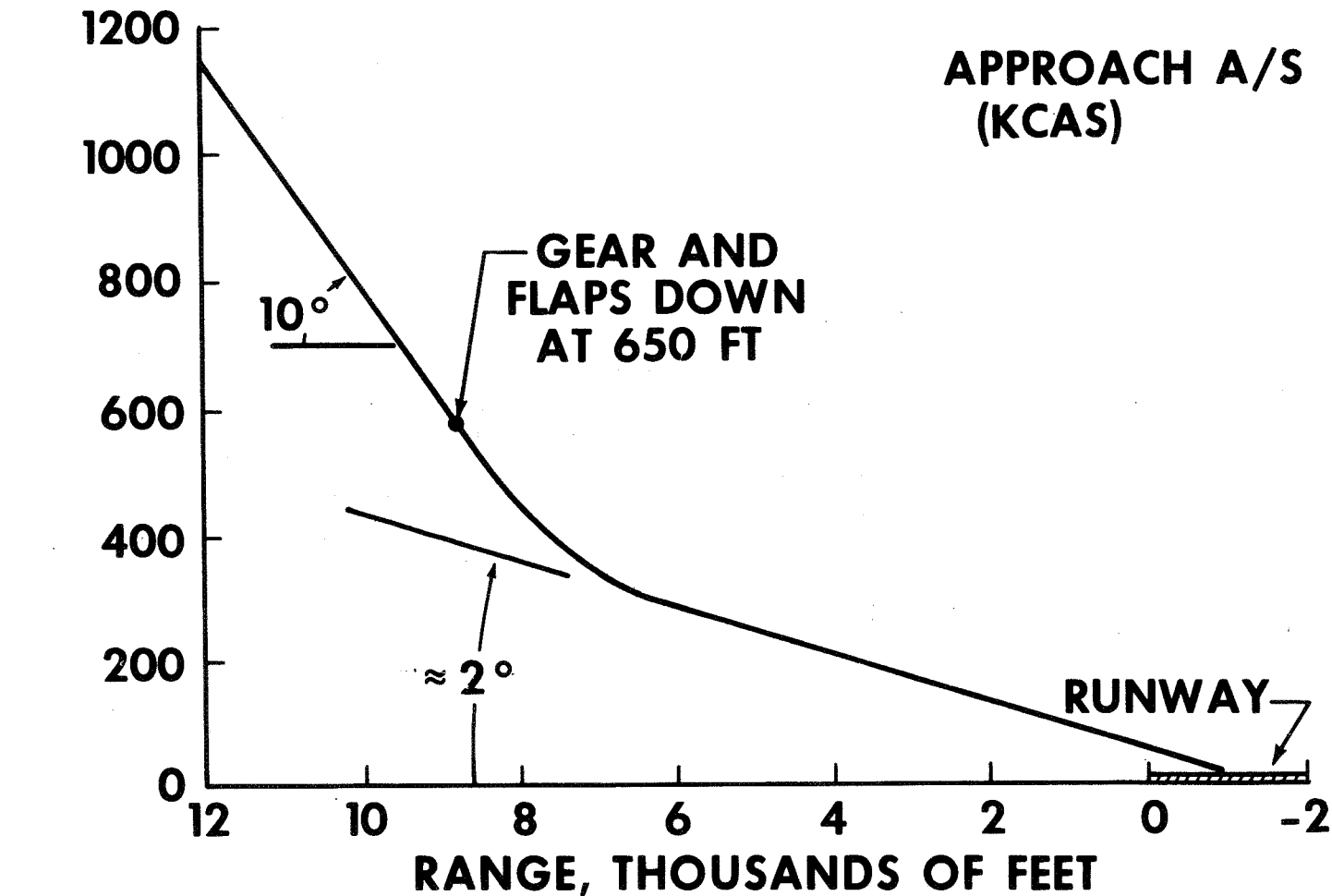

### VALIDATION TESTS

A specific terminal area guidance scheme has been evaluated on a hybrid real-time simulator in both automatic and manual control modes. It worked well for all nominal and excess energy cases. To evaluate it more completely, test cases were devised near the theoretical limit of the vehicle capability. Also, an unknown wind was added to the problem. The dotted circle about the minimum entry point in the following figure represents the limit of the vehicle capability for the worst case orientation with respect to the runway and/or the wind. Test cases were selected at three points on the perimeter of the footprint with different orientations, as shown in the figure. These cases were flown in both automatic and manual control modes. Of the 18 runs, four arrived at the minimum entry point with insufficient energy to land. Subsequent evaluation indicated that moving the starting point 2 to 3 miles closer would result in all cases making successful landings. The conclusion is that this terminal guidance, in its present form, can operate within 10 percent of the theoretical limit of vehicle capability.

# GUIDANCE FOOTPRINT VALIDATION TESTS

## INITIAL CONDITIONS

$h = 30,000$  FT

$V_T = 645$  FPS

$V_C = 233$  KCAS

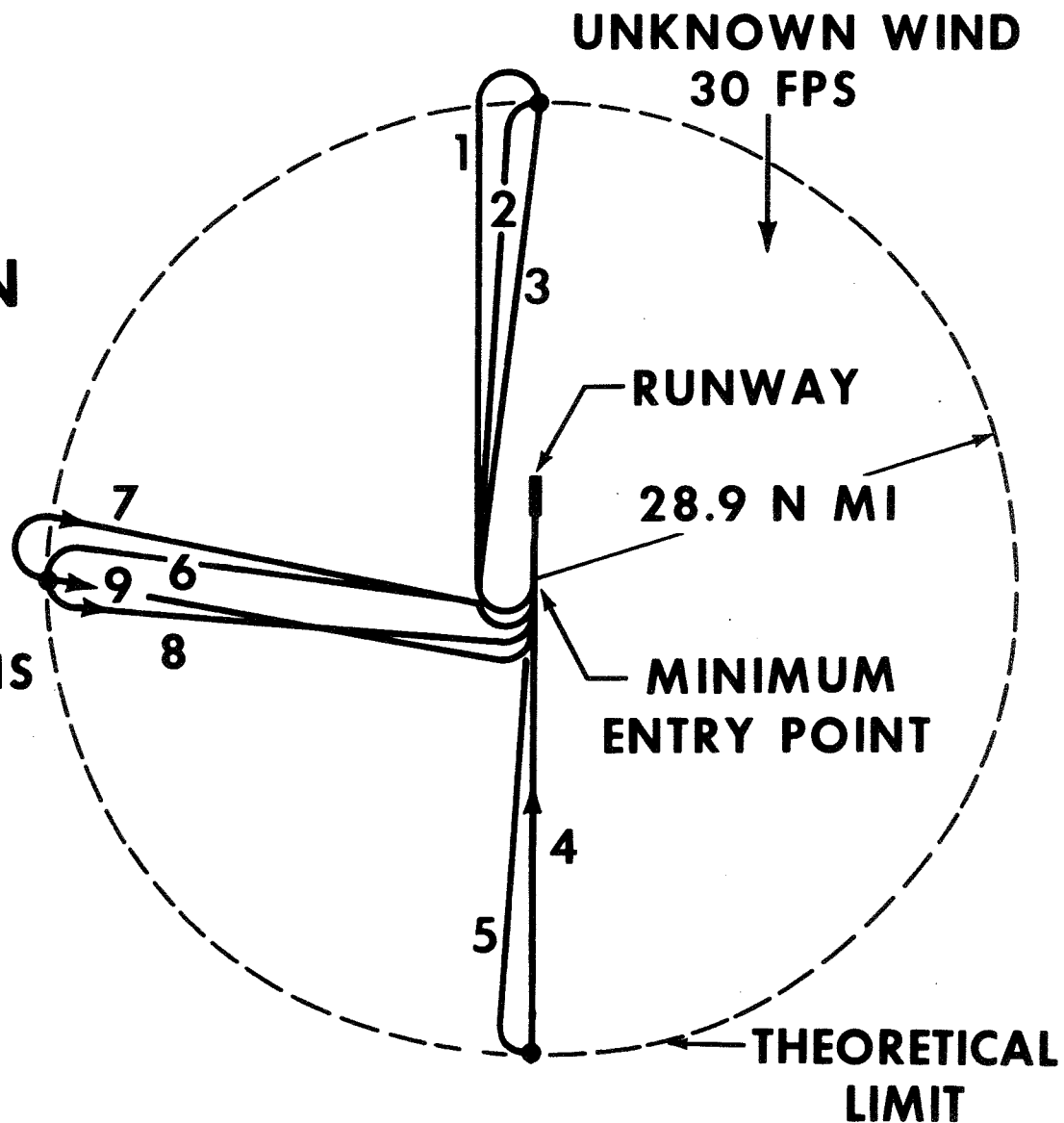



### TERMINAL AREA DISPLAY

Some effort has been directed toward the development of a terminal area energy management display to enable the crew to monitor the system in an overall way and to fly the approach manually if desired. It consists of the contour shown in the following figure and a series of semicircles representing final approach turns that lead onto the glide slope at different altitudes as shown. The orbiter should nominally cross the outer contour at an altitude of 20,000 ft or greater. If so, it flies at the airspeeds indicated. If not, it flies at maximum L/D all the way in. The contour is designed to take into account the approach heading with respect to the runway and the corresponding altitude loss in the turns required to get on the glide path. In use, the vehicle ground track would be superimposed on the display, and the pilot would fly to intercept one of the final approach turns. The three cases shown are near minimum energy cases that intercept some part of the last possible final approach turn. Higher energy cases would make an initial turn onto a downwind leg until the vehicle altitude coincided with the altitude to start the final turn. In conjunction with the usual altitude, airspeed, and heading information, this type of display could be used to monitor the system or fly a manual approach.

# TERMINAL AREA DISPLAY

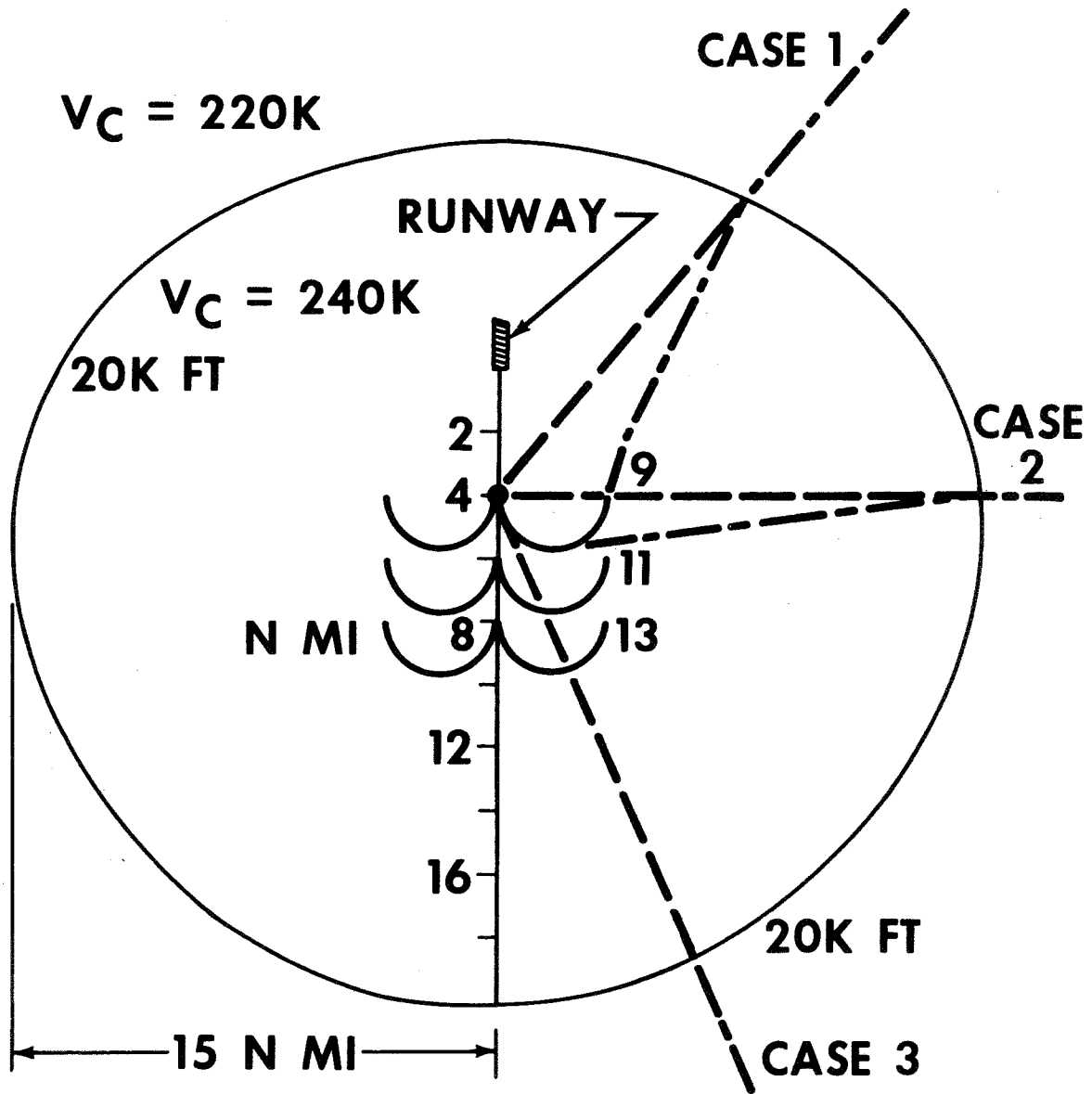

### TOUCHDOWN PERFORMANCE RESULTS

The terminal area guidance also includes the flare and touchdown. Several unpowered landing evaluations were flown on the simulator in three manual control modes and a fully automatic mode. The results are summarized in the following figure. Pilot ratings and performance results both indicate a clear advantage for the rate command, attitude hold mode for manual control. The particular straight-wing orbiter vehicle simulated had very slow short-period response and both of the closed-loop, rate-command-type control modes made a significant improvement. Actually, the bare airframe simulated would be judged adequate by military specifications and relative to some existing commercial transport aircraft. The indication is that the unpowered landing requires something better than presently accepted minimum response requirements. Ground effect and visibility of the runway, however, have a significant influence on what is minimally acceptable. A more than adequate closed-loop fly-by-wire control system, which provides response in the middle of the Level 1 military requirements, avoids the whole problem.

The touchdown parameters and standard deviations are summarized in the figure. These are all for undisturbed nominal cases, i.e., no winds or gusts. The manual runs used the rate command, attitude-hold control mode. X is the distance down the runway when touchdown occurred. Y is the distance from the centerline. A significant result is the much smaller deviations from the mean for the automatic mode. The mean value for the auto mode depends primarily on how the system was targeted. An objective was to attempt to contain the landing problem to the first 2000 ft of the runway. In the best manual mode, the three-sigma dispersions if valid are marginal, but even this performance required range markers on the runway. This made a significant improvement.

# TOUCHDOWN PERFORMANCE RESULTS

## CONTROL MODES

RCAH - PREFERRED

RC - ACCEPTABLE

DIRECT - NOT ACCEPTABLE

## TOUCHDOWN PARAMETERS

	MANUAL	AUTO
X	1268 ± 268 FT	749 ± 58 FT
Y	5 ± 17 FT	1 ± 0.4 FT
V	259 ± 7 FPS	256 ± 0.4 FPS
h	4.5 ± 1.2 FPS	3.7 ± 0.1 FPS

## CONCLUDING REMARKS

- CONDITIONS ASSOCIATED WITH THE LONG RANGE TYPE ENTRY ALSO RESULT IN INCREASED RANGING CAPABILITY AFTER BLACKOUT AND REQUIRE SMALLER ANGLE-OF-ATTACK CHANGES
- DELAYING THE TRANSITION TO THE FRONT SIDE OF THE L/D VS  $\alpha$  CHARACTERISTIC UNTIL  $M \leq 1.4$  PERMITS USE OF ALL THE ORBITER POST-BLACKOUT RANGING CAPABILITY WITHOUT EXCESSIVE DYNAMIC PRESSURE
- A TERMINAL AREA GUIDANCE SCHEME HAS BEEN EVALUATED AND FOUND CAPABLE OF OPERATING TO WITHIN TEN PERCENT OF THE VEHICLE THEORETICAL ENERGY LIMIT

A PRELIMINARY EVALUATION OF NAVIGATION AND GUIDANCE  
CONCEPTS FOR THE SPACE SHUTTLE ORBITER  
FROM THE END OF REENTRY TO TOUCHDOWN  
Robert D. Showman, William R. Wehrend, Jr.,  
and Kenneth C. White

NASA-Ames Research Center  
Moffett Field, California

GUIDANCE CONCEPTS FOR SSV ORBITER  
REENTRY TO TOUCHDOWN

Ames Research Center has been investigating navigation and guidance concepts to bring the Space Shuttle Vehicle (SSV) Orbiter from the end of reentry, which is assumed to be 100,000 feet to touchdown. Both automatic and manual systems are being considered for the unpowered, high-cross range (HCR) vehicle. Conceptually, two different guidance and control systems are used during the mission. At high altitudes, an Energy Management System is used to guide the vehicle to a specific altitude and distance from the runway with the desired heading and velocity. An Approach, Flare, and Runway Alignment System then guides the vehicle to touchdown.

The navigation and guidance concepts described in this paper were developed by Sperry Flight Systems Division (Contract No. NAS2-5084) and Bell Aerospace Corporation (Contract No. NAS2-6077) under contract to Ames Research Center. Sperry has developed concepts to guide the SSV from the end of reentry to touchdown. They have considered both the automatic and manual systems and have implemented these systems on a moving-base simulator at Ames. Due to the critical nature of the flare and runway alignment maneuver for the unpowered SSV, a second contract was negotiated with Bell to conduct an independent investigation to define the navigation and guidance concepts from initial flare to touchdown for the automatic mode only.

Ames has initiated a detailed program to evaluate the concepts. The data presented in this paper was obtained during the initial phase of the evaluation. All data was obtained using the North American Rockwell high-cross range (NAR-HCR), twin-fin configuration. However, the basic concepts should not vary drastically with different configurations. Ames will continue not only to evaluate the concepts using different configurations but also to develop the concepts described here since time did not permit the contractors to refine their systems.

# GUIDANCE CONCEPTS FOR SSV ORBITER REENTRY TO TOUCHDOWN

END OF REENTRY  
 $h = 100,000$  ft  
 $V = 3000$  ft/sec

- UNPOWERED ORBITER
- AUTOMATIC AND MANUAL MODES
- HIGH CROSS RANGE VEHICLE

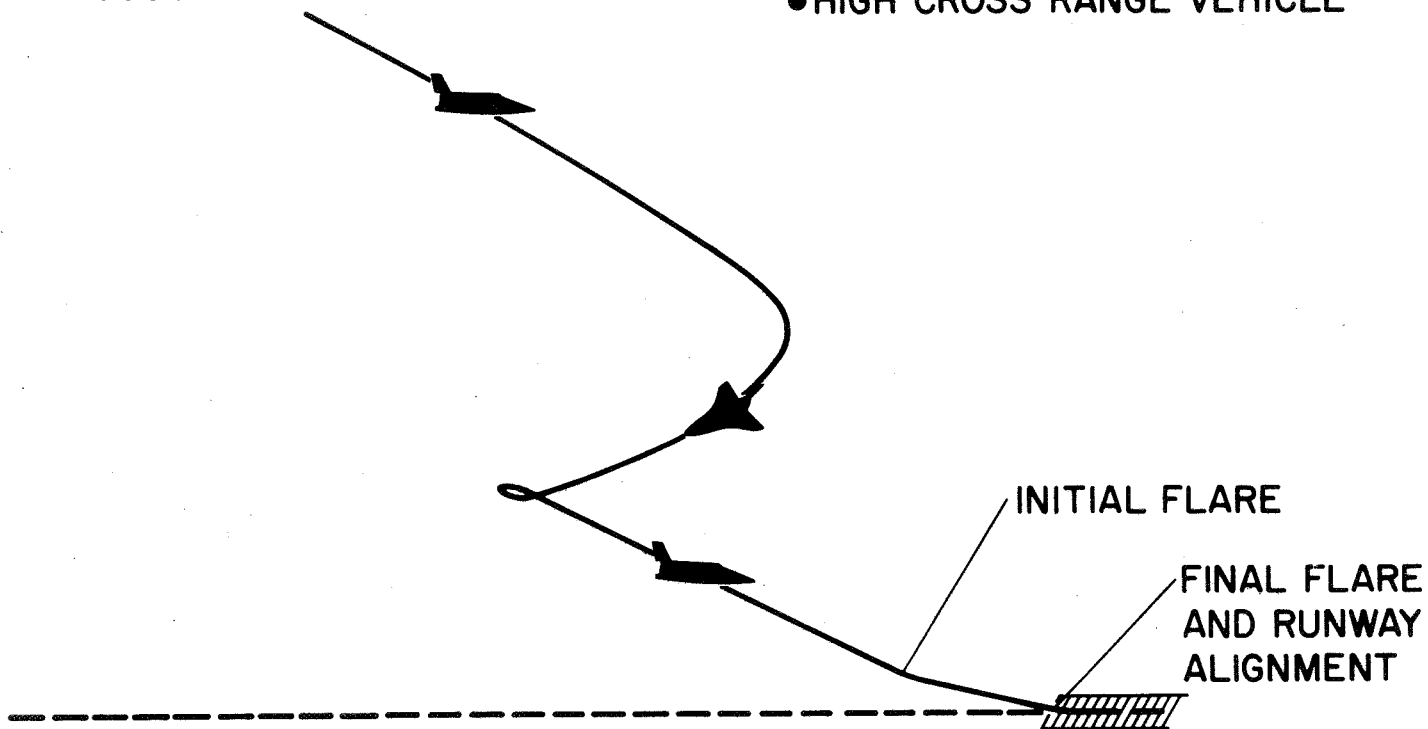



## ENERGY MANAGEMENT SPERRY SYSTEM

The system being used to guide the SSV during reentry would nominally bring the vehicle to a position on the target circle with the proper velocity, headed toward the center of the circle. The end of reentry is assumed to be at an altitude of 100,000 feet. For this study using the NAR-HCR twin-fin configuration, the vehicle at this altitude would be positioned on a target circle of radius about 400,000 feet with a velocity of approximately 3,000 feet/second. The center of the reentry target circle is located at 137,000 feet from the runway on an extension of the runway centerline.

The target circle is well within the vehicle maximum range surface which, at an altitude of 100,000 feet, is approximately circular with a radius of about 660,000 feet. If the vehicle is beyond the maximum range surface, it cannot reach the 20,000 feet altitude with the proper velocity, direction and range from the runway. The vehicle could be outside the surface and still have the capability of reaching the runway.

The objective of the energy management system is to bring the vehicle to an altitude of 20,000 feet at a range of 137,000 feet from the runway with the desired velocity and headed toward the runway.

The Sperry concept for energy management at high altitudes is reference trajectory guidance. A reference trajectory is stored in the on-board computer. Thus, the current vehicle energy (i.e., velocity and altitude) is compared with the reference trajectory values to obtain a measure of the vehicle status. The vehicle flies along a path tangent to the surface of the targeting cylinder whose center is located at the center of the reentry target circle. If excess energy exists, the radius of the targeting cylinder is increased to alter the direction of vehicle flight. This change in direction increases the total path length the vehicle must traverse allowing the excess energy to be dissipated.

Nominally, the vehicle will arrive at the targeting cylinder at an altitude of 50,000 feet and a velocity of 900 feet/second with an excess of energy. The vehicle is guided around the targeting cylinder until it is headed away from the runway. If the proper energy exists, the vehicle continues to make a 180° turn and begins tracking the final glide slope. However, if an excess amount of energy exists, the vehicle is guided on a path directed away from the runway until the excess energy is dissipated before turning into the final glide slope.

# ENERGY MANAGEMENT : SPERRY SYSTEM

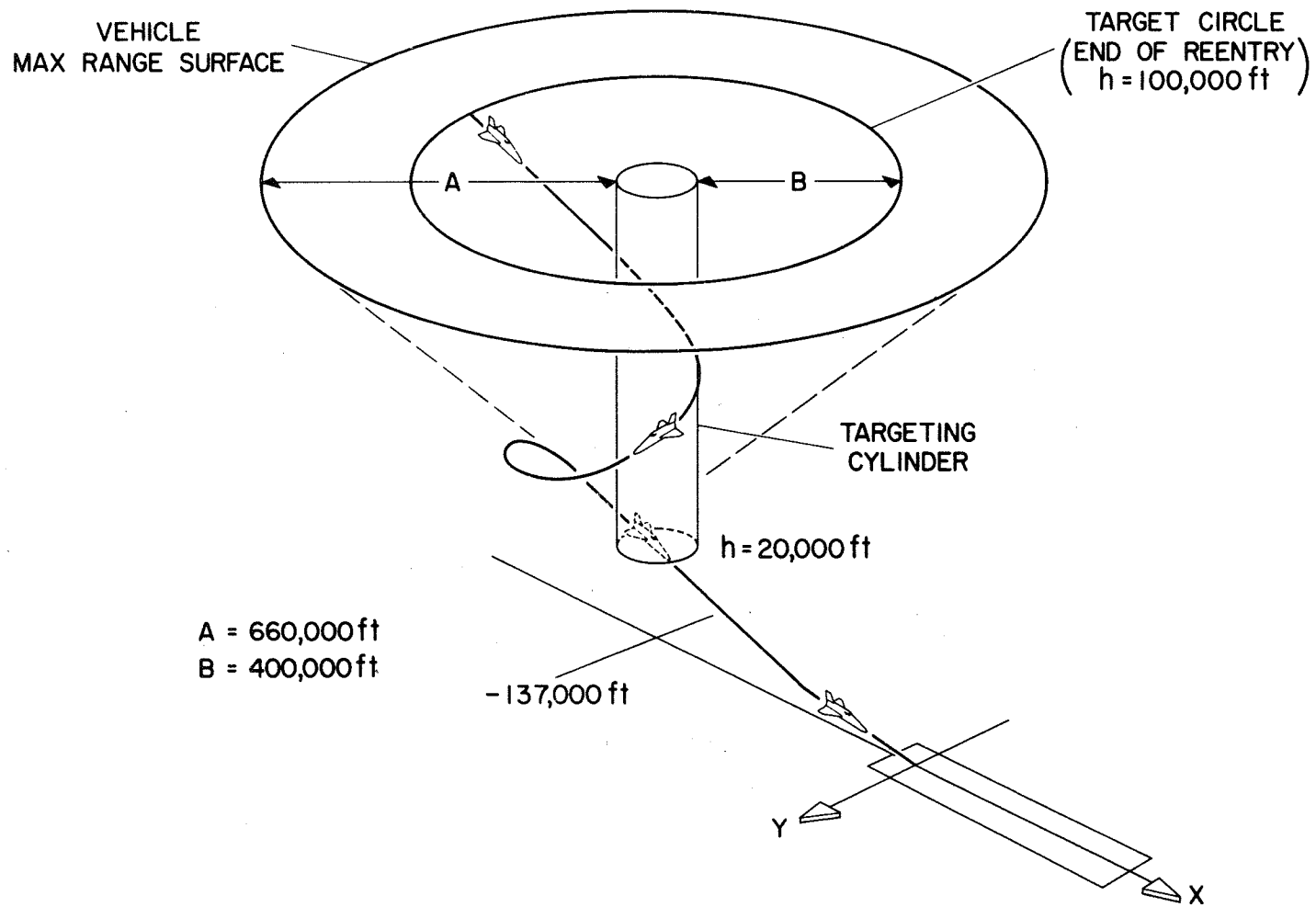

A = 660,000ft  
B = 400,000ft

-137,000 ft

## EXAMPLE ENERGY MANAGEMENT TRAJECTORIES

Two example trajectories indicating the performance of the energy management system are shown here. The vehicle is initially located on the target circle at the end of reentry with nominal velocity and direction. (No winds have been introduced.) The solid line shows a run initially headed toward the runway while the dotted line shows an initial heading perpendicular to the runway. In both cases, the energy management system makes a high altitude energy correction by commanding the vehicle to fly a path tangent to a larger than minimum radius targeting cylinder. The excess energy is rapidly dissipated and the vehicle begins to fly a path tangent to a targeting cylinder of constant radius. When the vehicle is headed directly away from the runway, excess energy in the form of excess altitude exists. The vehicle is guided away from the runway to dissipate this energy before being commanded to turn  $180^\circ$  and begin final approach. The run where the initial heading is perpendicular to the runway has a larger amount of excess energy and consequently must travel a greater distance from the runway before turning into the final glide slope. This greater amount of energy is shown in the figure by the higher altitude at  $X = -137,000$  feet for this run.

EXAMPLE ENERGY  
MANAGEMENT TRAJECTORIES

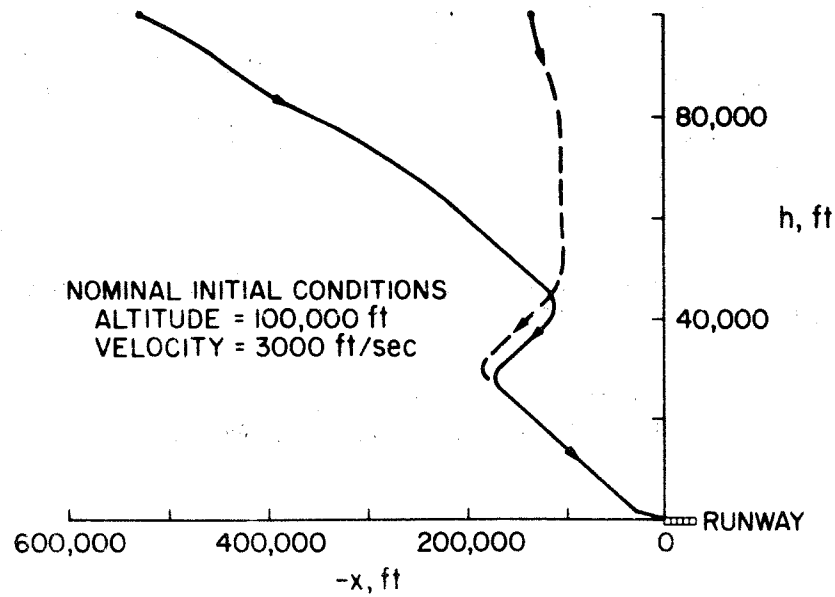
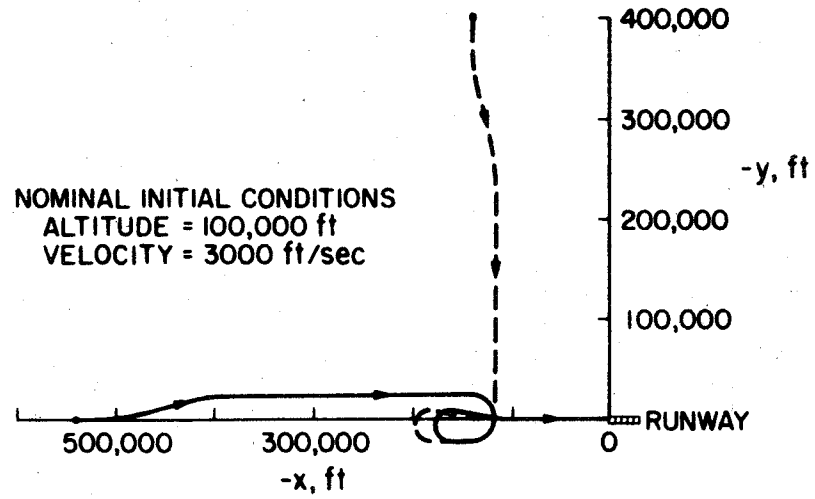

## GUIDANCE SYSTEM PERFORMANCE WITH OFF NOMINAL INITIAL CONDITIONS AND WIND

The results presented here show the effect of initial position errors and winds on the trajectory. In all cases, the trajectory begins at the nominal altitude, velocity and heading. However, the initial position of the vehicle is off the target circle. The runs will be discussed in the order from top to bottom.

The first run is initially positioned on the reentry target circle ( $X = 530,000$  feet). The influence of winds on the trajectory is observed by comparing this run with the example described previously. For example, the vehicle does not have excess energy to dissipate when it gets to the point on the targeting cylinder where it is headed away from the runway. Consequently, in the wind case, the vehicle continues to turn until it is tracking the glide slope.

The initial position for the second run is beyond the reentry target circle ( $X = 630,000$  feet) which implies a lower than nominal energy condition. The vehicle initially flies a path that is tangent to the targeting cylinder. When it reaches the cylinder, the vehicle does not have enough energy to go around the cylinder and proceeds directly in toward the runway.

The third run shows the vehicle starting closer to the runway than nominal ( $X = 430,000$  feet). Consequently, the vehicle has an excess amount of energy. The vehicle begins to fly a path tangent to a targeting cylinder with a large radius until the excess energy is dissipated. The radius of the targeting cylinder begins to decrease until the vehicle eventually flies a path tangent to a targeting cylinder of nominal radius. The maneuver around the targeting cylinder and into the approach glide slope is completed in a normal manner.

The fourth run shows the vehicle starting even closer to the runway ( $X = 330,000$  feet) than run 3 which results in a more severe excess energy state. Although more severe, the vehicle essentially completes the same type of trajectory as in run 3.

The performance of the system has been investigated for other conditions such as the effect of atmospheric density variations, weight increases, L/D variations, unknown winds, and initial condition errors. In all cases, except the initial condition errors, the effect of these variations on the trajectory has been small. The evaluation of the energy management system is not complete; nevertheless, it has uncovered some possible refinements that could be made. For that reason, Ames will continue to both evaluate and develop the system.

# GUIDANCE SYSTEM PERFORMANCE WITH OFF NOMINAL INITIAL CONDITIONS AND WIND

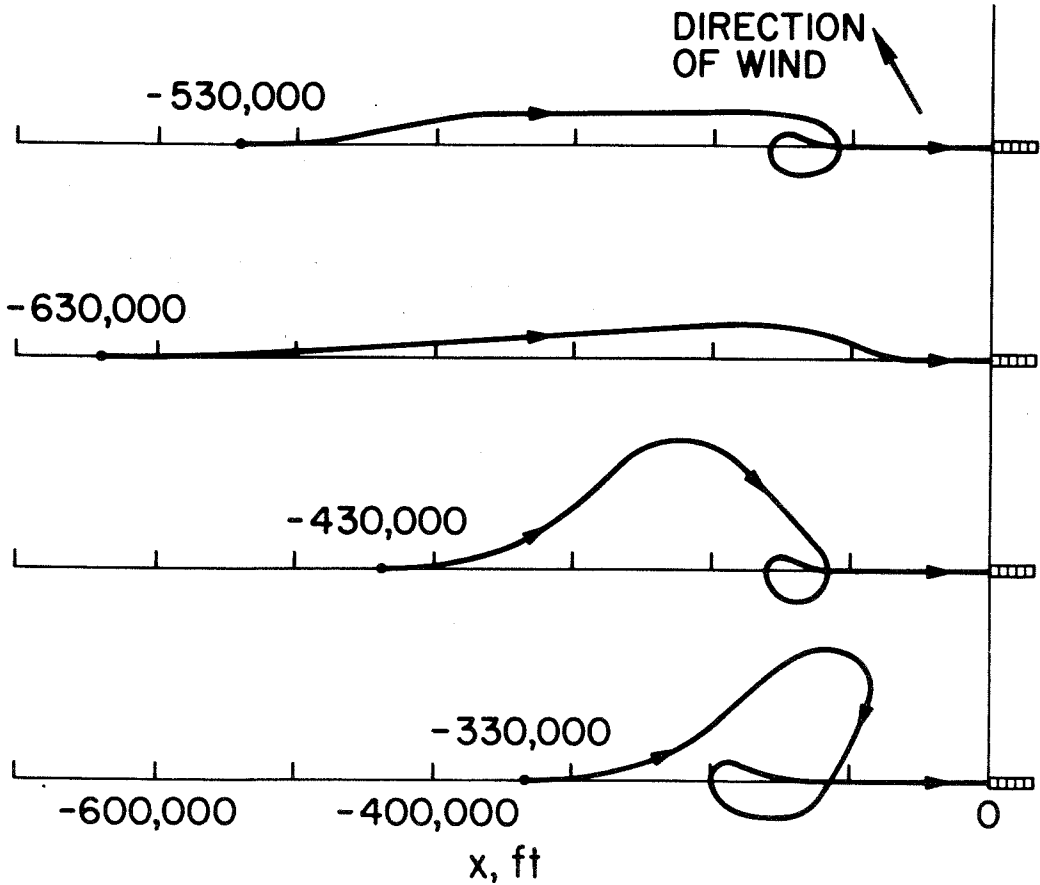

APPROACH, FLARE, AND RUNWAY ALIGNMENT  
SPERRY SYSTEM

The geometry for the Sperry approach, flare, and runway alignment system is shown. The approach system is a fixed path guidance scheme. The vehicle is guided along a  $-10^\circ$  glide slope at equilibrium velocity to an altitude of approximately 1700 feet. At this altitude, a constant "g" pitch maneuver is then initiated to flare the vehicle to a shallow glide slope of  $-2.5^\circ$ . The vehicle is constantly decelerating as it approaches the runway on the shallow glide slope. At an altitude of 300 feet, the gear is lowered. A final flare is initiated at an altitude of 45 feet to reduce the high sink rate, with the runway alignment maneuver (decrab) occurring at an altitude of 5 feet from touchdown. The nominal touchdown sink rate is 1.7 feet/second and air velocity is 333 feet/second (197 knots).

# APPROACH, FLARE, AND RUNWAY ALIGNMENT SPERRY SYSTEM

- FIXED PATH GUIDANCE
  - $V_{A_{TD}} = 333 \text{ ft/sec (197 KNOTS)}$
  - $\dot{h}_{TD} = -1.7 \text{ ft/sec}$
- } NOMINAL

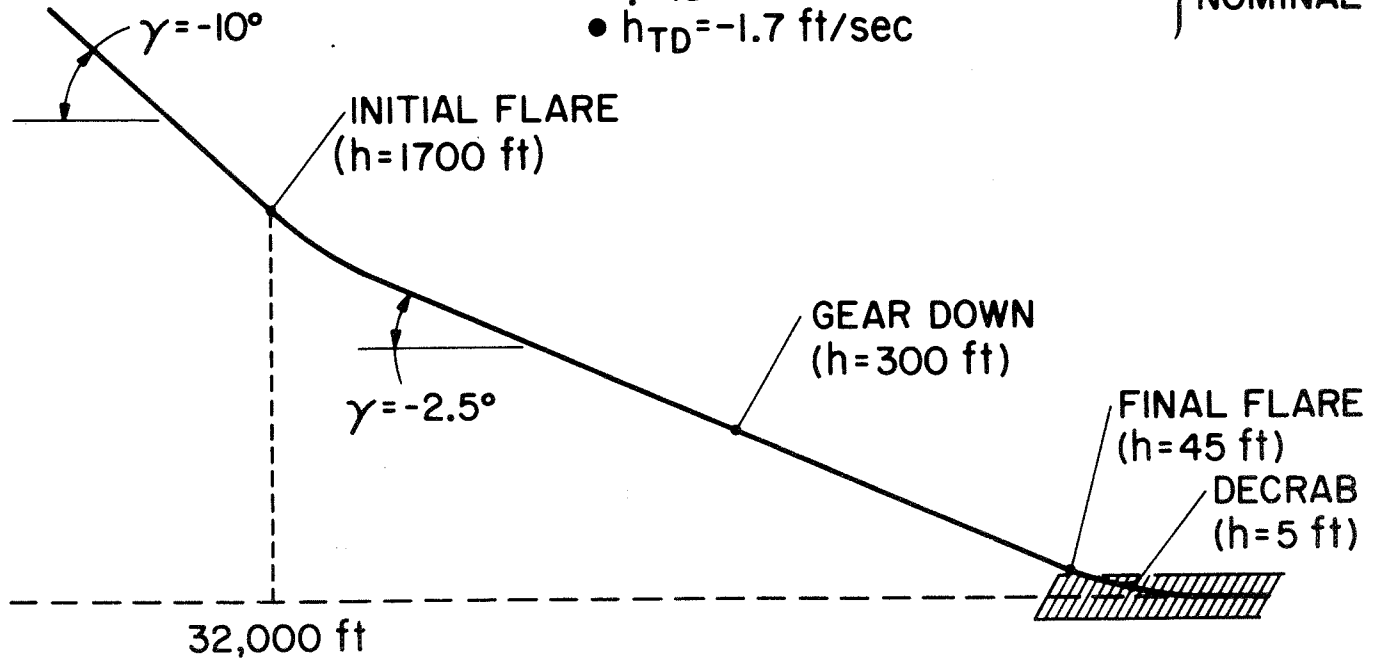



FLARE AND RUNWAY ALIGNMENT  
BELL SYSTEM

The Bell flare and runway alignment system is a predictive guidance scheme. The system predicts the point at which each event (i.e., initial flare, final flare) should occur as a function of the vehicle's current state and the environmental conditions (winds). For example, initial flare nominally occurs at an altitude of 1085 feet and a range of 21,000 feet. However, if a tailwind exists, the initial flare will occur at a higher altitude and further from the runway. Conversely, if a headwind exists, the flare will occur at a lower altitude and closer to the runway.

The landing gear is used for velocity control. Nominally, the gear is lowered at an altitude of 400 feet. The gear is lowered at a higher altitude if the vehicle is high and, conversely, at a lower altitude if the vehicle velocity is low.

The final flare to reduce sink rate nominally occurs at 100 feet altitude and the decrab maneuver occurs at an altitude of 8 feet. Nominal touchdown sink rate and air velocity are 2.9 feet/second and 276 feet/second, respectively.

# FLARE AND RUNWAY ALIGNMENT BELL SYSTEM

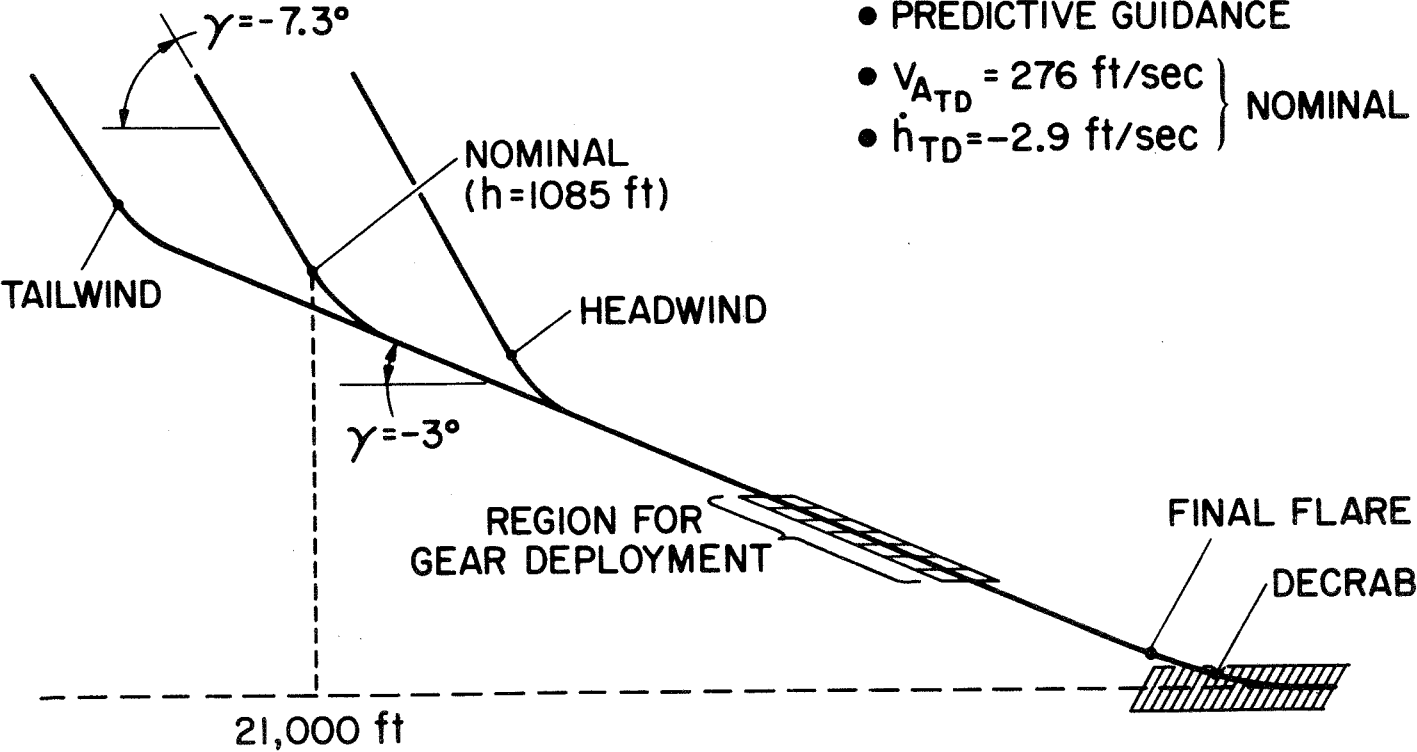

EFFECT OF TURBULENCE AND MEAN WINDS ON  
TOUCHDOWN PERFORMANCE: SPERRY SYSTEM

A preliminary evaluation of the two flare and runway alignment systems is provided by the data presented in the figures. The effect of mean wind and turbulence on the performance of the system at touchdown is shown for the most significant states. The mean wind varies with altitude, which introduces a wind shear. The turbulence model was the Dryden model suggested in MIL-F-8785B. (Note: Each mean wind case includes 10 individual runs.)

The data presented for the Sperry system indicates the following: (1) The longitudinal (X) and lateral (Y) dispersions are relatively large. These dispersions result partially, at least, from the low nominal sink rate (1.7 ft/sec) at touchdown. Sperry is currently investigating the possibility of both increasing the nominal sink rate at touchdown and incorporating additional logic in the flare law to reduce the dispersions. (2) When a tail wind exists, the vehicle lands the greatest distance down the runway and at the highest velocity. Based on recent studies, these results indicate that for a runway of length 10,000 feet, the distance remaining to stop the vehicle is sufficient if a drag chute is used but marginal, depending on the runway surface condition, if a chute is not used. (3) The dispersions in air velocity indicate the effect of no velocity control. Speed brakes, which exist on other configurations, would certainly reduce the dispersions.

## EFFECT OF TURBULENCE AND MEAN WINDS ON TOUCHDOWN PERFORMANCE: SPERRY SYSTEM

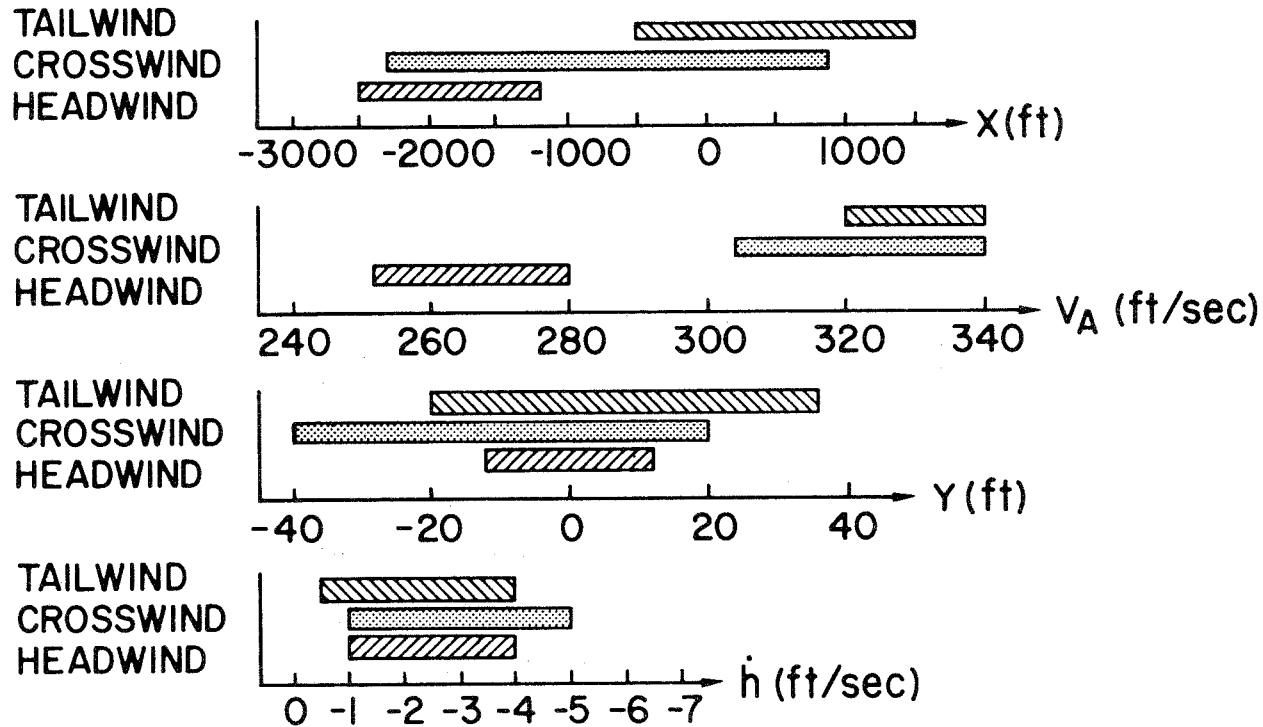

209

- HEADWIND = 35 ft/sec (20.8 KNOTS)
  - CROSSWIND = 21 ft/sec (12.5 KNOTS)
  - TAILWIND = 14 ft/sec (8.3 KNOTS)
- } @  
h=0

- $\sigma_{gust} = 4.6$  ft/sec
- NO MEASUREMENT ERRORS

EFFECT OF TURBULENCE AND MEAN WINDS ON  
TOUCHDOWN PERFORMANCE: BELL SYSTEM

The data presented for the Bell system shows the following:

- (1) Relatively small longitudinal dispersions, possibly resulting from the higher nominal touchdown sink rate and the velocity control achieved by lowering the landing gear at the appropriate time.
- (2) The large lateral dispersions partially result from a reduction in control power when landing at a lower speed. For example, the nominal air velocity at touchdown is 276 ft/sec for the Bell system and 333 ft/sec for the Sperry system.
- (3) The effect of lowering the landing gear and moving the aim point for initial flare to obtain velocity control is observed in the relatively small air velocity dispersions. Achieving velocity control in this manner does reduce the requirement for speed brakes.

## EFFECT OF TURBULENCE AND MEAN WINDS ON TOUCHDOWN PERFORMANCE: BELL SYSTEM

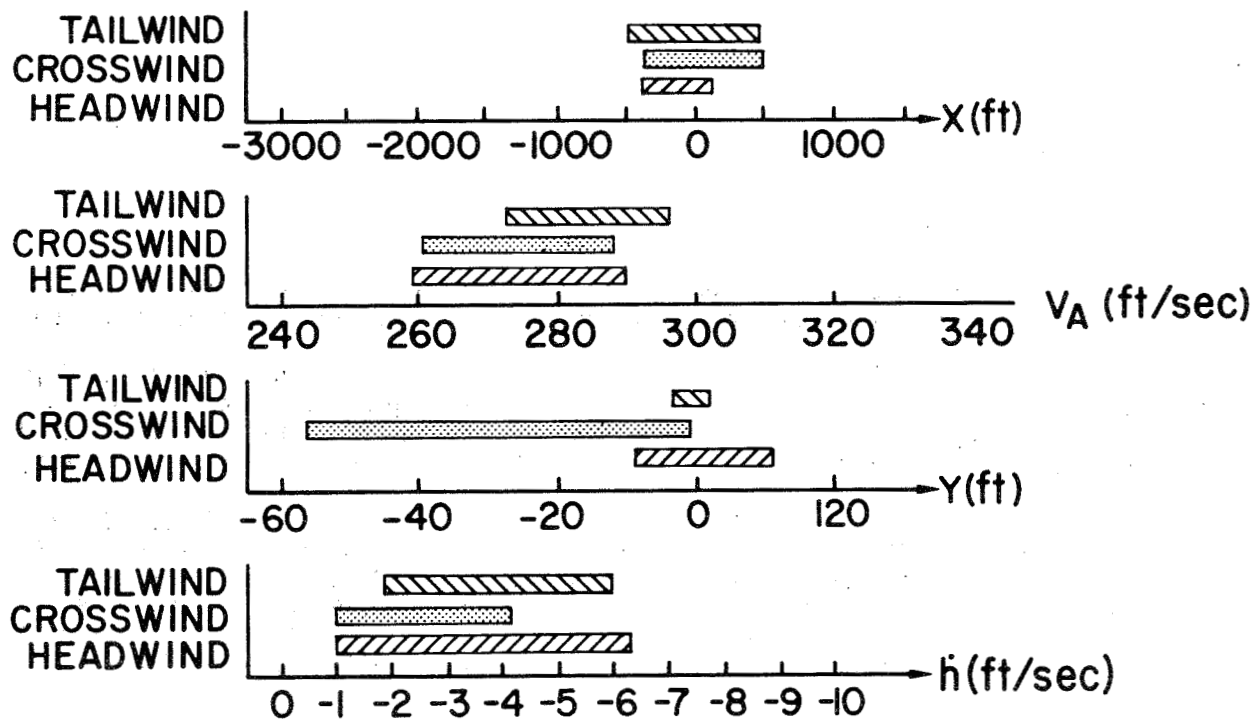

- HEADWIND = 35 ft/sec (20.8 KNOTS)
  - CROSSWIND = 21 ft/sec (12.5 KNOTS)
  - TAILWIND = 14 ft/sec (8.3 KNOTS)
- } @  
h=0

- $\sigma_{gust} = 4.6$  ft/sec
- NO MEASUREMENT ERRORS

ERROR MODELS FOR AND LOCATION OF  
GROUND NAVIGATION AIDS: BELL

The effect of state estimation errors on the performance of the Bell system has also been investigated. The navigation system consists of an inertial navigator on-board the SSV, updated with ground based guidance aids. The error model for the microwave scanning beam landing guidance system (MSBLGS) is comparable to the error model obtained from flight test of the system installed at NAFEC. The error model for the tracking radar corresponds to the Bell SPN-42 system.

The location Bell assumed for the transmitters is also shown in the figure. The localizer was positioned 2000 feet down the runway from the nominal touchdown point and 200 feet to the side for this phase of the study. All future studies will have the localizer positioned at the stop end of the runway.

The vehicle's state is estimated by combining the INS and ground-based information, using a blending algorithm. The blending algorithm is a quadratic complementary filter.

## ERROR MODELS FOR AND LOCATION OF GROUND NAVIGATION AIDS: BELL

SYSTEM	RANGE (FEET)		ELEVATION (MILLIRADIANS)		AZIMUTH (MILLIRADIANS)	
	NOISE( $1\sigma$ )	BIAS( $1\sigma$ )	NOISE( $1\sigma$ )	BIAS( $1\sigma$ )	NOISE( $1\sigma$ )	BIAS( $1\sigma$ )
MICROWAVE SCANNING BEAM LGS	75	10	0.61	0.87	0.39	0.63
TRACKING RADAR	8	1	0.3	0.3	0.3	0.3

213

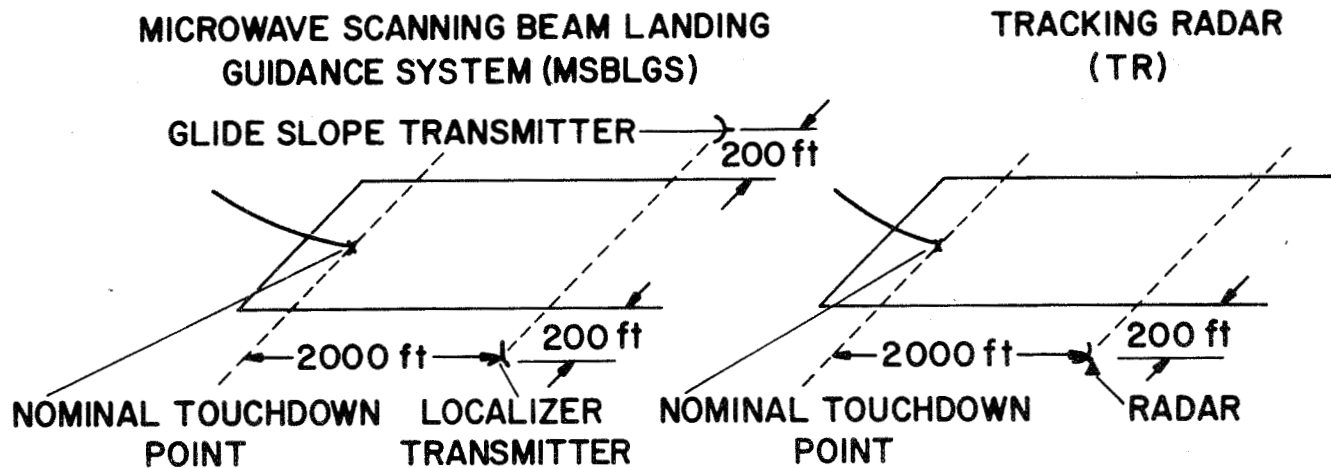



EFFECT OF MEASUREMENT ERRORS ON  
TOUCHDOWN PERFORMANCE: BELL SYSTEM

The dispersions at touchdown resulting from the state estimate errors indicate the longitudinal, air velocity, and altitude rate dispersions are somewhat less than the dispersions caused by mean wind and turbulence. The lateral dispersions are considerably less than the dispersions caused by mean wind and turbulence. Also, the longitudinal and lateral dispersions for the system using the tracking radar are approximately one-half the dispersions obtained when using the scanning beam system.

# EFFECT OF MEASUREMENT ERRORS ON TOUCHDOWN PERFORMANCE: BELL SYSTEM

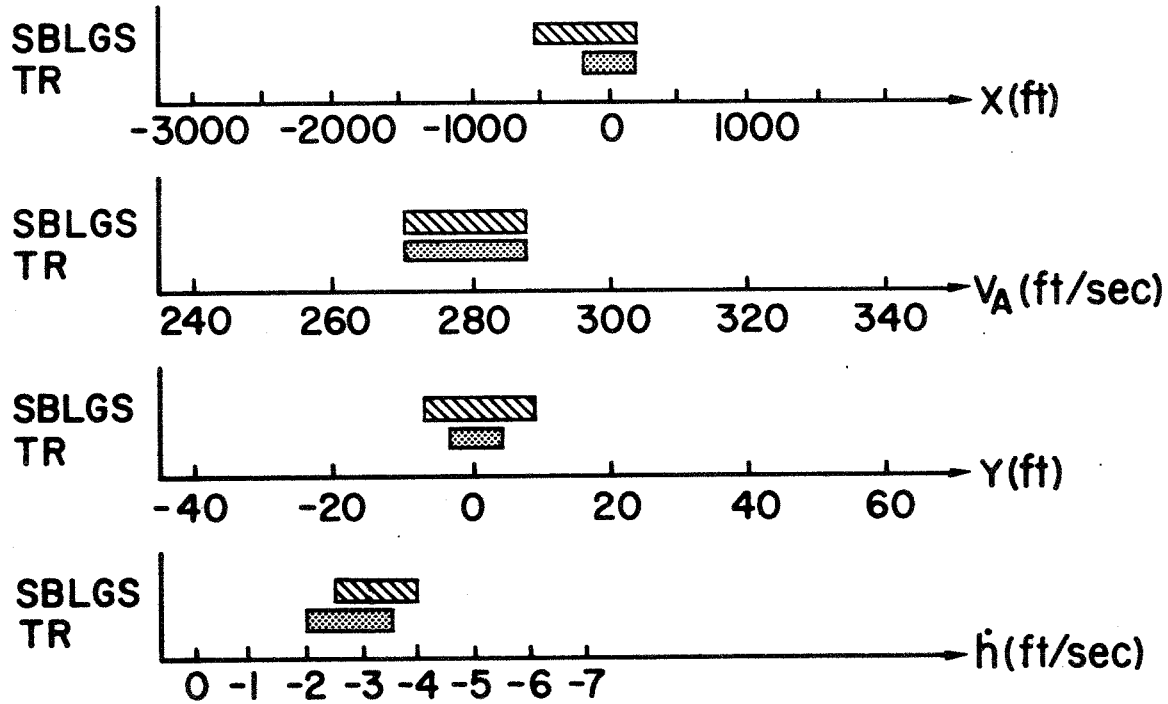

- NO TURBULENCE
- NO MEAN WIND

## SIMULATOR

All concepts described have been for the automatic system. As previously indicated, the system designed by Sperry has been implemented at Ames on a moving base simulator with an outside visual scene. The figure shows a photograph of the simulator.

Information for the pilot is displayed primarily on two indicators: The Electronic Attitude Display Indicator (EADI) located on the panel and the Horizontal Situation Indicator (HSI) located between the pilot's legs. The EADI displays attitude information, heading, altitude, and air velocity. Also, command (vertical and horizontal lines) and situation (rectangle near center of EADI) data is displayed. The HSI displays the vehicle's X and Y position as well as heading information. Additional information such as angle of attack ( $\alpha$ ), Mach number, and glide slope ( $\gamma$ ) is displayed on the meters located around the EADI.

The figure also shows the hand controller used for the manual control modes. The simulator has the capability for mechanizing flaps, speed brakes, and throttle.

The simulator is used to evaluate both the automatic and manual systems from 100,000 feet altitude to touchdown.



## CONCLUSIONS

The concepts described in this paper are capable of bringing the SSV from the end of reentry to touchdown. The concepts have not been optimized and continue to be developed by both contractors and Ames Research Center.

The results from the preliminary evaluation indicate the systems must be refined. The concepts will be evaluated in considerably more detail, especially with other candidate SSV configurations. Although all the data presented was obtained using the NAR-HCR twin-fin configuration, the concepts should not vary greatly for other configurations.

EXAMPLE TRAJECTORY  
REENTRY TO TOUCHDOWN

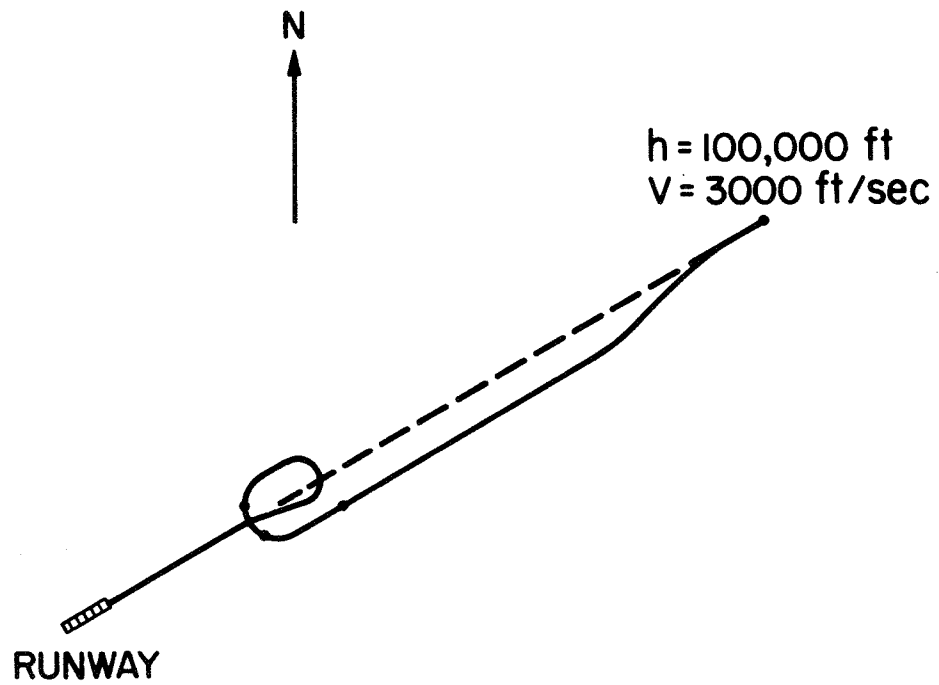



NAVIGATION FOR SPACE SHUTTLE APPROACH AND LANDING  
USING AN INERTIAL NAVIGATION SYSTEM AUGMENTED BY  
VARIOUS DATA SOURCES

L. A. McGee, G. L. Smith, D. M. Hegarty,  
R. B. Merrick, and T. M. Carson

NASA-Ames Research Center  
Moffett Field, California

and

S. F. Schmidt

Analytical Mechanics Associates  
Mountainview, California



## Ames SSV RAINPAL Navigation Study

Ames Research Center is conducting a navigation study program called RAINPAL - an acronym for Recursive Aided Inertial Navigation for Precision Approach and Landing - which will provide navigation information which is applicable to the stringent requirements of the unpowered SSV High Cross Range (HCR) orbiter.

The objective of this study is to determine the navigation accuracy obtainable with an augmented INS (Inertial Navigation System). Augmentation of the INS is through the use of a Kalman filter (square-root form) which processes external data from several candidate data source combinations.

The approach used in this study is one which has three basic phases. The first was the analysis phase. In this phase a specific set of inertial navigation equations was selected which produce navigation information in a runway coordinate system. This phase also involved development of other formulations such as the equations for the Kalman filter transition matrix and error models for various sensors. The second phase was the development of an IBM 360/67 simulation program which would form the basis for studying the basic concepts and the development of new techniques for filter mechanizations. The results to be presented in this paper were generated by this simulation program. The third phase involves the verification by flight test of the concepts being developed. The on-board program is at present approaching operational status.

## AMES SSV RAINPAL NAVIGATION STUDY

### OBJECTIVE:

- DETERMINE NAVIGATION ACCURACY  
OF AN AUGMENTED INS

### APPROACH:

- ANALYSIS
- SIMULATION
- FLIGHT TEST

## Illustration of RAINPAL Mechanization

This slide is an illustration of the RAINPAL mechanization. Specific forces are sensed by the IMU and the resulting acceleration signals,  $a$ , are integrated over a period of  $1/20$  second to produce changes in velocity,  $\Delta V$ . These velocity changes are then used by the navigation equations in the on-board digital computer to compute the estimated vehicle state in the runway coordinate system. Because of the relatively poor long term stability of an INS, the estimated state must be corrected by the use of external measurements such as ground navigation aids. In addition, the inherent instability of the vertical channel requires the stabilizing influence of devices such as a barometric altimeter since information about the vertical position may not be available from other ground navigation aid measurements.

All measurements are processed by a Kalman filter which, in the results presented in this paper, up-dated the state estimate every two seconds except as will be noted.

The accuracy of the state estimate is, of course, related to how well the error models used actually represent the errors in the various navigation aids. Recognizing this fact, the personnel involved with the RAINPAL study program are continuously attempting to refine the error models presently in use.

# ILLUSTRATION OF RAINPAL MECHANIZATION

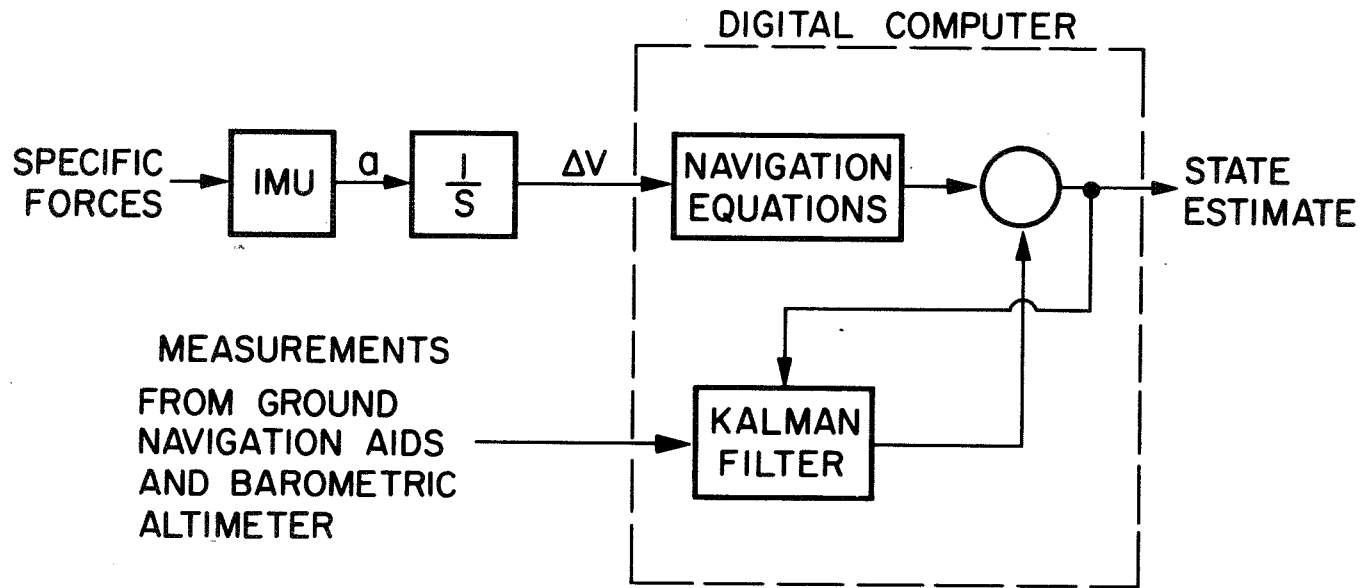

## Candidate Ground Navigation Aid Combinations Investigated

This slide lists the five candidate ground navigation aid combinations which were investigated in this paper. Each of these candidate combinations has been proposed as possible sources of navigation information which could be used for the SSV HCR orbiter.

There is considerable motivation to use navigation aids whose accuracy and reliability are established. These navigation aids also generally offer lower cost and are readily available but have the disadvantage that no single system is capable of providing the necessary navigation information throughout the entire mission. There is also motivation to use new navigation aids which may be expected to be in general use in a few years or to use others which offer the ability to provide navigation throughout the entire mission with a single system. The relative navigation performance, particularly during approach and landing, of the various aids and combinations of aids must be established. Once this is done, the candidate aids can be compared with the required performance specifications and the system with the least economic impact selected.

Of the five candidate systems, only one of the navigation aids listed may be unfamiliar to many readers. This aid has been called MACDME which stands for Maximum Accuracy Compatible DME. This is a new low-power, low-cost, high-accuracy DME being developed by the FAA for short range use in conjunction with terminal VOR's and with ILS.

CANDIDATE GROUND NAVIGATION AID  
COMBINATIONS INVESTIGATED

I. VOR/DME-ILS

II. VOR/DME-VOR/MACDME-ILS

III. VOR/DME-MSBLGS

IV. TRACKING RADAR-MSBLGS

V. PRECISION RANGE SYSTEM

NOTE: BAROMETRIC ALTIMETER COMMON  
TO ALL SYSTEMS

## Ground Navigation Aid Geometry

The landing site for the SSV orbiter in this study is runway 22 ( $224^{\circ}$  magnetic) at Edwards Air Force Base. The orbiter approaches the runway on an energy management trajectory which starts at 100,000 feet with a velocity of 3,000 ft./second and lands with a velocity of 263 ft./second down the runway and a sink rate of 2.69 ft./second. The touchdown point is 1,000 feet from the threshold of this runway whose length is 15,000 feet.

The ground navigation aids which were used for this part of the study are: (1) a conventional ILS whose localizer antenna is located at the stop end of the runway 15,000 feet from the touchdown point and whose glide slope antenna is located so as to provide the proper  $3^{\circ}$  glide slope; (2) a Tacan station located 6.7 miles from the runway threshold along the approach path; (3) a VOR station located 7.6 miles from the runway threshold along the approach path; (4) a MACDME co-located with the VOR station; and (5) two VORTAC stations: one located at Palmdale; the other located at Hector.

For combination I, VORTAC data from Palmdale and Hector are used initially. As the vehicle comes within 25 miles of the Edwards VOR, data from both the Edwards VOR and the Edwards Tacan are added as data sources. Continuing further, as the vehicle reaches 20,000 feet altitude, data from the ILS localizer is also added as a data source. Upon approach to the Edwards VOR "cone of confusion", the Edwards VOR and Tacan are dropped as data sources. When the vehicle intercepts the  $3^{\circ}$  glide slope at a little more than 4 miles from touchdown, the ILS glide slope signal is added and the two VORTAC stations are dropped as data sources. The ILS localizer and glide slope continue and are the only ground data sources of navigation aid data until approximately 100 feet altitude when the glide slope signal becomes unusable and is terminated, leaving only the localizer until touchdown.

Combination II differs from combination I in that the MACDME is added as a data source at the same time the Edwards VOR and Tacan are added and remains as a data source until touchdown.

The geometry shown in this slide is to scale with the exception of the Hector VORTAC which was moved about 17 miles west for illustration purposes only.

# GROUND NAVIGATION AID GEOMETRY

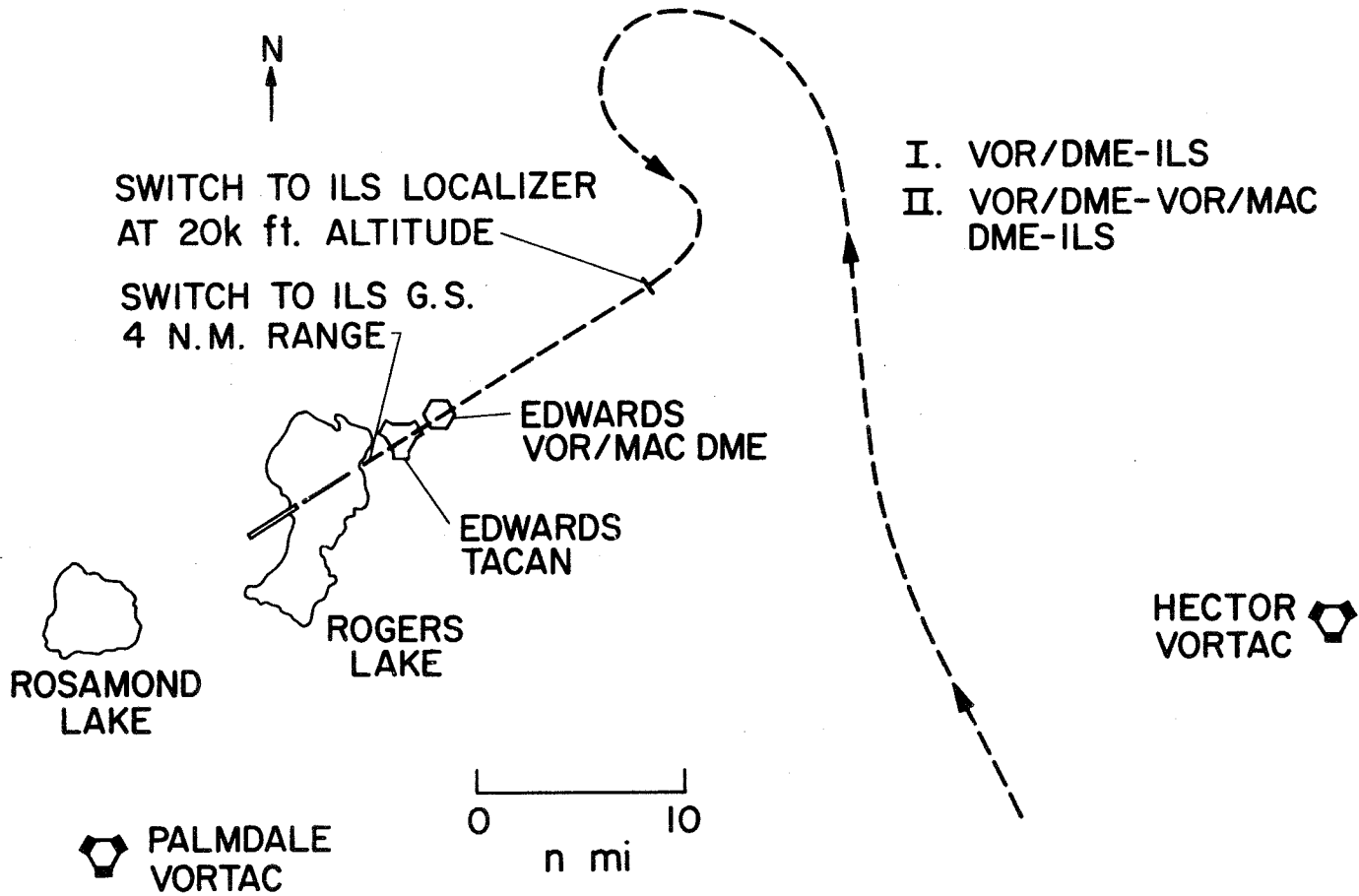



### State Estimation Error at Touchdown for Candidate Ground Aids I and II

The range of state estimation errors at touchdown which were obtained from 5 Monte Carlo runs for candidate ground aids I and II are shown. In both cases, the X (down runway) and Z (altitude) errors are rather large. The Y (across runway) errors are also quite large but might be acceptable when it is taken into consideration that the range of the across runway errors can be expected to be directly proportional to the unusual distance of the localizer antenna from the touchdown point - 15,000 feet in this instance. However, further analysis is indicated before it can be determined conclusively that ILS would not be adequate for the SSV.

Use of the MACDME resulted in an improvement in performance in the X and Z directions but, because of the location of the MACDME underneath the approach path, no additional information was available to the navigation system for improvement of performance in the Y direction. Further studies with MACDME should include locating the MACDME next to the ILS localizer antenna.

STATE ESTIMATION ERRORS AT TOUCHDOWN FOR CANDIDATE GROUND AIDS I AND II

I. VOR/DME-ILS

II. VOR/DME-VOR/MACDME-ILS

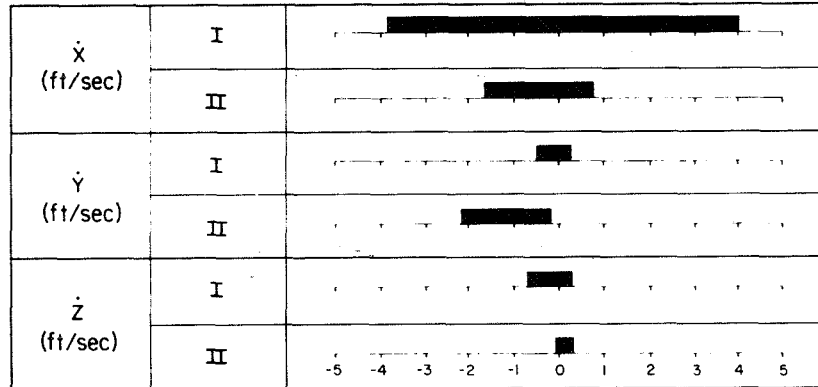
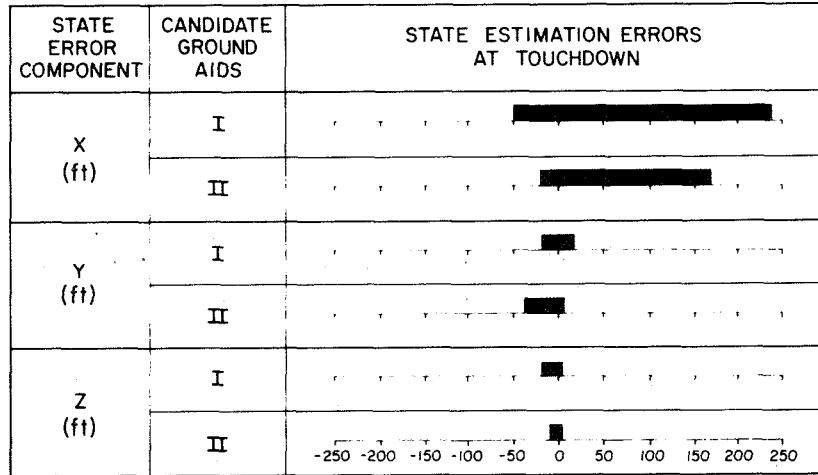

NOTE: 5 MONTE CARLO RUNS

## Ground Navigation Aid Geometry

This slide is basically the same as a previous slide except that it shows only the navigation aids used for combinations III and IV. The energy management trajectory is the same.

Combination III assumes an RTCA SC117 MSBLGS azimuth scanner located at the stop end of the runway 15,000 feet from the touchdown point and an elevation scanner 2,000 feet past the touchdown point and 200 feet to the left of runway 22. Initial data sources are the two VORTAC stations at Palmdale and Hector. Upon descending to 20,000 feet altitude, the two VORTAC stations are dropped as data sources and the range, azimuth and elevation from the MSBLGS are picked up as data sources and used until touchdown.

Combination IV replaces the two VORTAC stations with two radar trackers as data sources. The radar trackers are an FPS-16 and an MPS-19 located about 5 miles to the right of runway 22. As in combination III, the radar trackers are dropped as data sources at 20,000 feet altitude in favor of the MSBLGS.

# GROUND NAVIGATION AID GEOMETRY

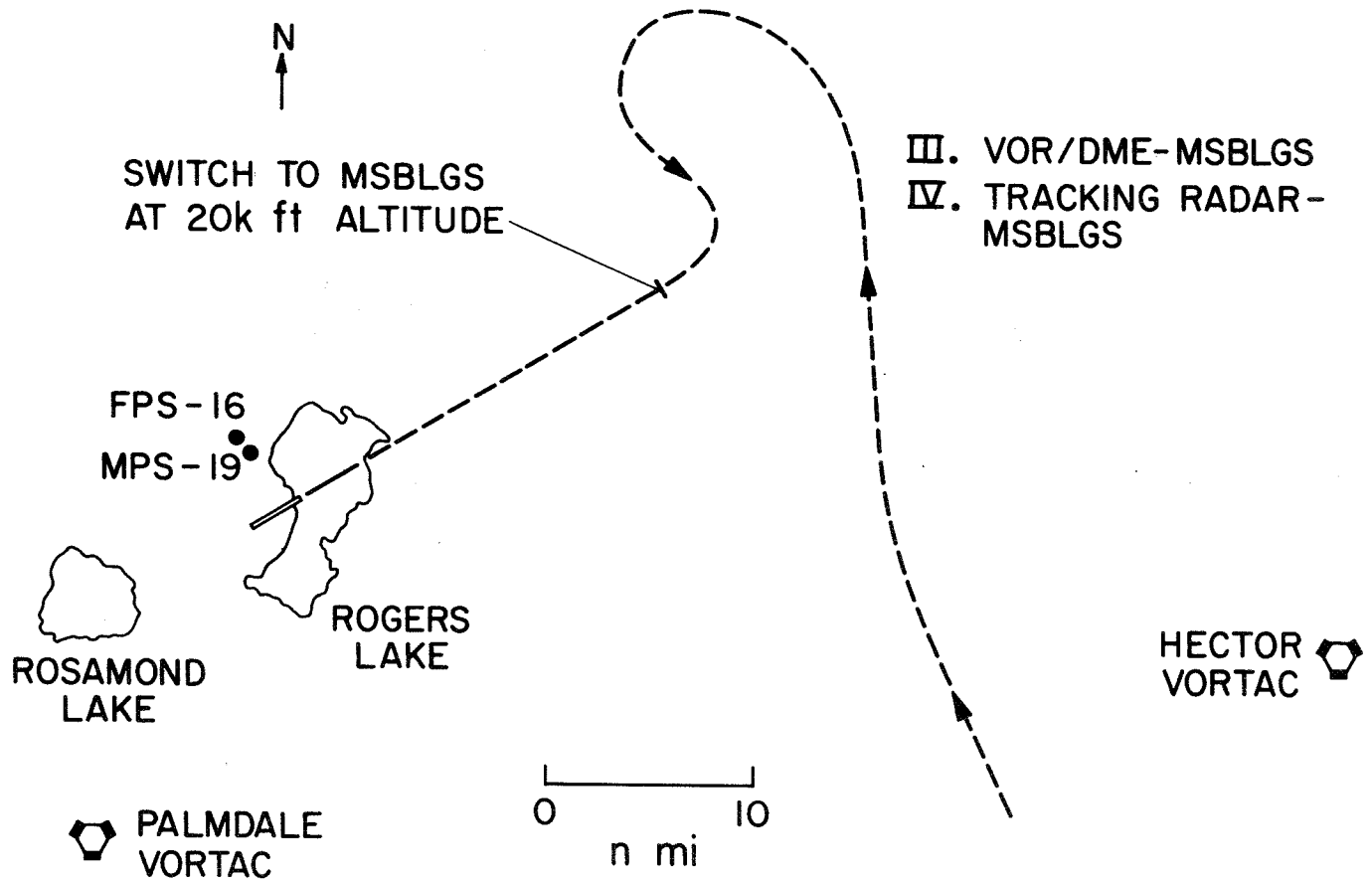

### State Estimation Errors at Touchdown for Candidate Ground Aids III and IV

This slide shows the range of state estimation errors at touchdown for candidate ground aids III and IV. These data indicate that the navigation performance with the RTCA SC117 MSBLGS is essentially unaffected at touchdown by any differences in navigation performance with either VOR/DME or tracking radar which may have existed at 20,000 feet altitude.

Both of these candidate ground aids exhibit improved navigation accuracy over the ILS in candidates I and II (note change in scale). When the results of further studies with these candidate aids are completed, it is expected that they will show conclusively that they will be adequate for SSV at touchdown.

The MSBLGS azimuth scanner - like the ILS localizer antenna - is located 15,000 feet down the runway from the touchdown point. The accuracy of the cross runway information obtained from the azimuth scanner, also like the ILS, is reduced by greater distances from the vehicle to the azimuth scanner.

STATE ESTIMATION ERRORS AT TOUCHDOWN FOR CANDIDATE GROUND AIDS III AND IV

III. VOR/DME-MSBLGS

IV. RADAR TRACKERS-MSBLGS

STATE ERROR COMPONENT	CANDIDATE GROUND AIDS	STATE ESTIMATION ERRORS AT TOUCHDOWN
X (ft)	III	
	IV	
Y (ft)	III	
	IV	
Z (ft)	III	
	IV	

$\dot{X}$ (ft/sec)	III	
	IV	
$\dot{Y}$ (ft/sec)	III	
	IV	
$\dot{Z}$ (ft/sec)	I	
	IV	

NOTE: 5 MONTE CARLO RUNS

### Ground Navigation Aid Geometry

Edwards Air Force Base is shown with three energy management trajectories and a pattern of five precision range system transponders located on the ground below. The two additional trajectories were included to determine if navigational accuracy is sensitive to the particular trajectory used. All three of the trajectories had approximately the same initial conditions - 100,000 feet altitude and a velocity of 3,000 feet/second. The initial true heading of each trajectory is shown.

The pattern of transponders was chosen intuitively based on previous experience. No optimization of location was attempted.

The antenna on board the SSV was assumed to be located on the underside of the vehicle and to have a hemispherical coverage with the ranges used in this study. The effect of vehicle "shadowing" in turns was taken into account in the simulation. Only the two closest unshadowed transponders were used at any time.

# GROUND NAVIGATION AID GEOMETRY

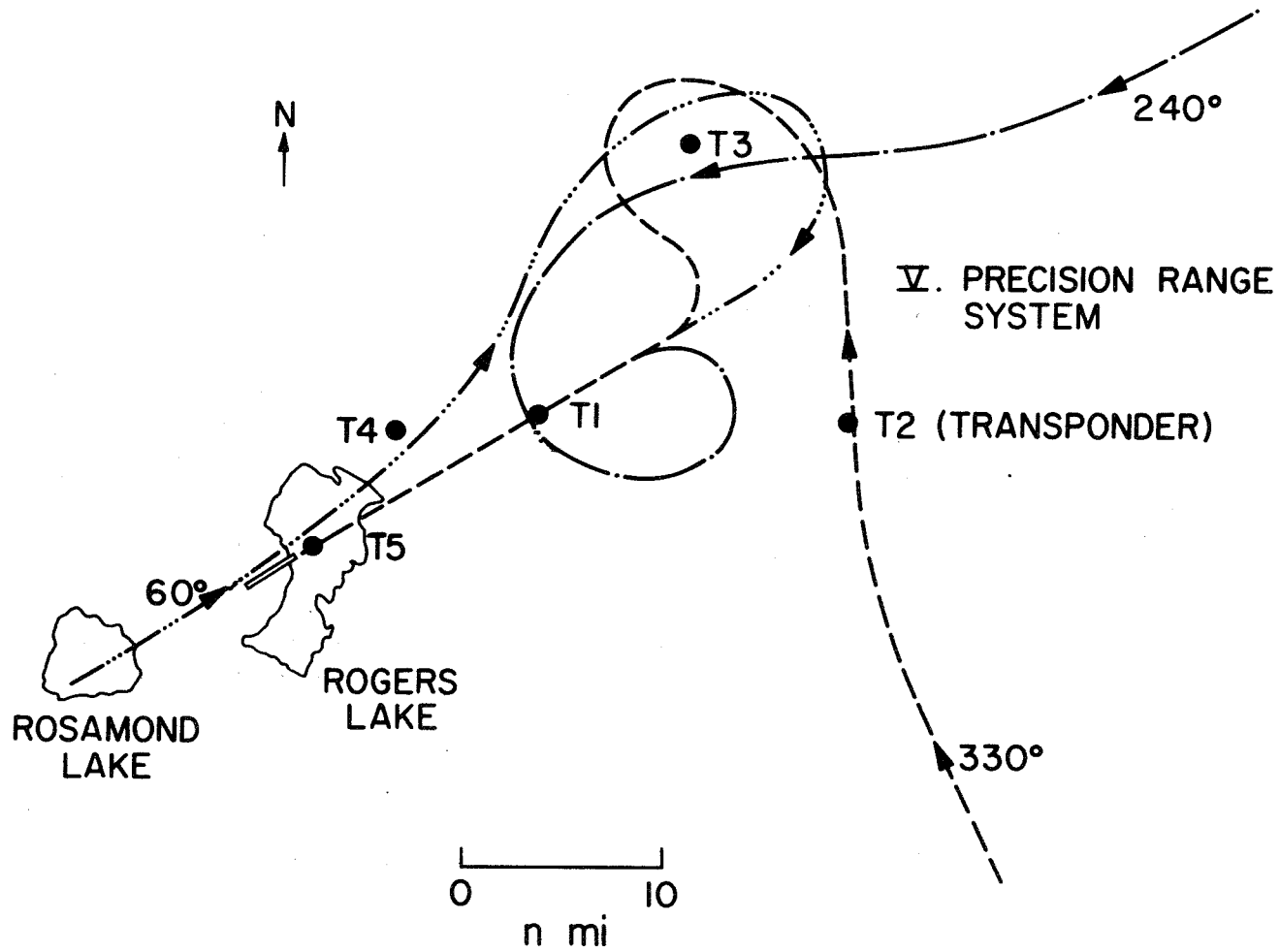



## State Estimation Errors at Touchdown Candidate Ground Aid V

The range of state estimation errors at touchdown for candidate ground aid V indicate that, at the level of significance obtainable with 5 Monte Carlo runs, there is little trajectory sensitivity among the three trajectories investigated.

The effect of data rates was found to be of considerable significance in this study. During the final approach to landing, the SSV passes over transponder five at low altitude and relatively high velocity. Under these conditions, and with a data rate of one range sample every two seconds, the likelihood of obtaining adequate vertical information from this transponder proved to be very low. In order to overcome these difficulties, the data rate using this transponder was increased from  $\frac{1}{2}$  to 8 per second insuring adequate vertical information from this transponder and reducing the range of Z position error by a factor of about 4 and the X error by a factor of about 2. No data rates other than the  $\frac{1}{2}$  and 8 per second were studied.

The operational implication of the higher data rate on the on-board computer is that additional computational capability would be required to increase the cycle rate of the Kalman filter. This does not mean that the Kalman filter would have to process 16 times as much data unless all other measurements were also processed at the higher rate. Instead it would mean only a modest increase in computational capability - easily within the capability of modern computers.

The results shown indicate that a more exhaustive study will conclude this candidate system is adequate for SSV, providing a higher data rate is used in the Z channel on the final approach. It is also implied by the results obtained here in the Z and X directions that a higher data rate for all transponder measurements might reasonably be expected to improve the navigation accuracy in all directions.

STATE ESTIMATION ERRORS AT TOUCHDOWN  
FOR CANDIDATE GROUND AID  $\nabla$   
 $\nabla$ . PRECISION RANGE SYSTEM

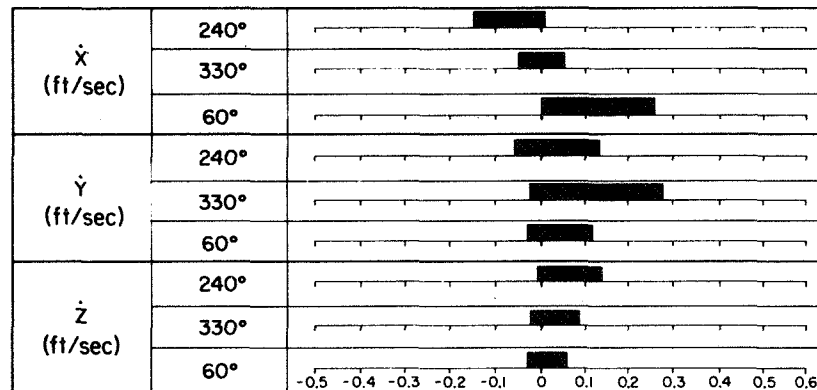
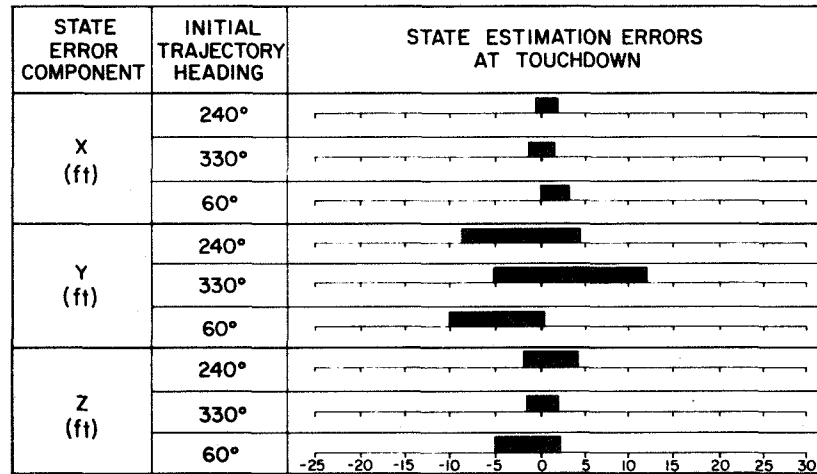

NOTE: 5 MONTE CARLO RUNS

## Estimated Standard Deviation of Errors at Touchdown

This slide compares the estimated standard deviation of errors at touchdown for all five candidate ground aids.

It should be emphasized that the results presented are preliminary and, with the level of significance obtained from 5 Monte Carlo samples, care should be exercised in ranking the various combinations used. This is particularly true when, as in these studies, no attempt has been made to optimize the filter weighting for each of the candidate ground aids to account for parameters which are not included as state variables. Furthermore, it should be pointed out that, in all the candidate ground aids studied, the barometric altimeter was given relatively little weight as a measurement device, particularly during the final approach. This allowed the barometric altimeter to have the desired stabilizing effect at high altitude and essentially forced each candidate system to stand on its own merits. The effect of data rate on the estimation performance of the filter with each of the candidate ground aids must be investigated further. It is possible that, with a proper choice of filter weighting and data rate, the navigation precision afforded by the augmented INS may allow sufficient navigation precision to be obtained with all of the candidate systems. The final selection of a system then may well be determined more by economic considerations than by technical considerations.

Ames plans to continue actively with further investigations into the candidate ground aids and publish the results in the near future. These investigations will also include flight test of the RAINPAL system. The results of these tests will be reported promptly.

## ESTIMATED STANDARD DEVIATION OF ERRORS AT TOUCHDOWN

CANDIDATE GROUND AIDS	X ft	Y ft	Z ft	$\dot{X}$ ft/sec	$\dot{Y}$ ft/sec	$\dot{Z}$ ft/sec	
I . VOR/DME-ILS	204	16	10	4.0	1.0	0.52	
II . VOR/DME-VOR/MACDME-ILS	97	20	5.0	1.2	0.50	0.12	
III . VOR/DME-MSBLGS	12	15	3.7	0.39	0.24	0.42	
IV . RADAR TRACKERS-MSBLGS	13	9.5	2.8	0.17	0.43	0.47	
V . PRECISION RANGE SYSTEM (5 TRANSPONDERS)	240°	0.96	7.0	2.9	0.070	0.092	0.075
	330°	1.5	9.5	3.3	0.046	0.16	0.054
	60°	1.6	5.4	3.8	0.12	0.073	0.046

NOTE: 5 MONTE CARLO RUNS

## Error Models for Barometric Altimeters

Two barometric altimeters were assumed to be on-board the SSV; one for 0 to 100,000 feet range and a second for the 0 to 10,000 feet range.

The barometric altimeters are subject to the following error sources: (1) non-standard atmosphere; (2) pitot-static; (3) random instrument errors; and (4) time lag.

The non-standard atmosphere is the deviation of the actual atmosphere from the atmospheric model to which the altimeter was calibrated. When the altimeter is corrected to read zero at the landing site, the 1-sigma variation of the deviation from the reference is approximated by a linear variation from zero at the landing site to 2% at 100,000 feet (reference 1).

The pitot-static errors are due to static port errors and other errors in the sensing system not associated with the altimeter itself. For an altimeter system which might be typical for SSV application a pressure coefficient,  $C_p$ , of  $\pm 0.005$  (max) seems reasonable. If it is assumed that  $C_p = \pm 0.005$  is a 3-sigma variation, then an expression for the 1-sigma altitude error  $\Delta h$  is

$$\Delta h = \frac{C_p/3}{(C_p/3)-1} \frac{V^2}{2g}$$

where:  $C_p$  = static pressure coefficient  
 $V$  = true airspeed  
 $g$  = 32.2 ft./sec.<sup>2</sup>

The random instrument errors are due to variations in the instrument which cannot be calibrated (altitude dependent) and on random noise on the output voltage.

Time lag errors are dependent on the altitude and the rate of change of the altitude. They are mainly due to the time required for pressure in the system to reach equilibrium. The best information at present is that these errors can be compensated for in the computer and therefore are not included in the model.

## ERROR MODELS FOR BAROMETRIC ALTIMETERS

### ERROR SOURCES:

#### 1. NON-STANDARD ATMOSPHERE

$$\Delta h = \frac{2 \times 10^{-7} h}{\rho g} (1\sigma)$$

h = ALTITUDE

$\rho$  = ATMOSPHERIC DENSITY

#### 2. PITOT-STATIC

$$\text{ASSUME } C_p = \frac{P - P_s}{P_t - P_s} = \pm 0.005 \text{ (max)}$$

$$\Delta h = \frac{C_p/3}{C_p/3 - 1} \frac{v^2}{2g} (1\sigma)$$

p = ATMOSPHERIC PRESSURE AT h

$p_t$  = TOTAL PRESSURE AT h

$p_s$  = STATIC PRESSURE

#### 3. RANDOM INSTRUMENT ERRORS (1 $\sigma$ )

$$0 < h \leq 10,000 \text{ ft} \quad \Delta h = [625 \times 10^{-10} h^2 + 0.25]^{1/2}$$

$$10,000 < h \leq 100,000 \text{ ft} \quad \Delta h = [625 \times 10^{-10} h^2 + 100]^{1/2}$$

## Error Model for the PRECISION RANGE SYSTEM

The error model for the precision range system was furnished by Cubic Corp. as being representative of the CR-100 system.

The range correction,  $\Delta R_e$ , for atmospheric refraction was computed from the following expressions:

$$\Delta R_e = 313 \times 10^{-6} I$$

where

$$I = \frac{1 - e^{-ch}}{c \sin \beta} \quad \text{for } \beta > 10^\circ$$

$$I = \left(\frac{\pi R_e}{2c}\right)^{1/2} e^{(cre \sin^2 \beta)/2} [\operatorname{erf} A - \operatorname{erf} B] \quad \text{for } \beta \leq 10^\circ$$

$$A = \left(\frac{cr_e}{2} \sin^2 \beta + ch\right)^{1/2}$$

$$B = \left(\frac{cr_e}{2} \sin^2 \beta\right)^{1/2}$$

$$c = 1/22,805 \text{ ft.}$$

$r_e$  = radius of earth

$$h = \text{altitude} = [(R \sin \beta + r_e)^2 + R^2 \cos^2 \beta]^{1/2} - r_e$$

$$\operatorname{erf}(x) = \left(\frac{4x^2}{\pi}\right)^{1/2} \left[1 - \frac{x^2}{1!3} + \frac{x^4}{2!5} - \frac{x^6}{3!7} + \dots\right]$$

$\beta$  = elevation angle at the transponder

$R$  = slant range

## PRECISION RANGE SYSTEM (PRS) ERROR MODEL

ERROR TYPE	MAGNITUDE, ft. ( $1\sigma$ )
<b>I. RANDOM</b>	
MULTIPATH	3.0
SIGNAL-TO-NOISE RATIO	1.0
PHASE SHIFT DUE TO:	
DYNAMIC RANGE	1.0
TEMPERATURE	1.0
OTHER SOURCES	<u>0.4</u>
RSS TOTAL	3.5
<b>II. BIAS</b>	
CALIBRATION	1.0
SCALE FACTOR	1.5 PPM
PROPAGATION ERROR:	
ASSUMED TO BE 20% OF THE COMPUTED RANGE	
CORRECTION FOR ATMOSPHERIC REFRACTION	



### Error Model for DME and MACDME

The DME error is modeled as the sum of two components:  $B_n$  and  $r_n$ . The 1-sigma value of  $B_n$  is 840 feet. The 1-sigma value of  $r_n$  is 12 feet (references 2, 3, 4 and 5).

The MACDME (Maximum Accuracy Compatible DME) error is modeled in much the same way as DME except that the roles of  $B_n$  and  $r_n$  are reversed. The 1-sigma values for  $B_n$  and  $r_n$  are based on the specifications and on information obtained in private telephone conversations with FAA personnel at NAFEC and FAA headquarters.

The specification for range errors for MACDME requires that it be less than 250 feet RMS. It is expected that high quality receivers will be able to use this system out to about 25 miles. General aviation will probably find it useful up to ranges of about 15 miles.

The measured ranges for both DME and MACDME were corrected for atmospheric refraction. The expressions used are the same as those used for the Precision Range System error model.

## ERROR MODELS FOR DME AND MACDME

### DME

---

$$\Delta R_n = B_n + r_n$$

$$B_n = \rho_b B_{n-1} + \sigma_b (1 - \rho_b)^{1/2} N1_n$$

$$r_n = \rho_r r_{n-1} + \sigma_r (1 - \rho_r^2)^{1/2} N2_n$$

WHERE :

$\Delta R_n$  IS THE  $n^{\text{th}}$  RANGE ERROR SAMPLE

$$\rho_b = e^{-0.002\Delta T}$$

$$\rho_r = e^{-\Delta T}$$

$$\sigma_b = 840 \text{ ft}$$

$$\sigma_r = 12 \text{ ft}$$

$\Delta T$  = TIME BETWEEN SAMPLES

$N1, N2$  = UNCORRELATED ZERO MEAN  
WHITE NOISE WITH UNIT  
VARIANCE

### MACDME

---

SAME AS DME EXCEPT

$$\sigma_b = 25 \text{ ft}$$

$$\sigma_r = 250 \text{ ft}$$

#### Error Model for VOR

This error model for VOR bearing error is the sum of two components; a slowly varying random component and a bias component (references 2, 3, 4 and 5).

## ERROR MODEL FOR VOR

$$\Delta Y_n = A_n + B_{rs}$$

$$A_n = \rho_A A_{n-1} + \sigma_A (1 - \rho_A^2)^{1/2} N_n$$

WHERE :

$\Delta Y_n = n^{\text{th}}$  BEARING ERROR SAMPLE

$B_{rs} = 18.67 \times 10^{-3}$  RADIAN-COMBINED  
RECEIVER / STATION BIAS ERROR ( $1\sigma$ )

$$\rho_A = e^{-\omega \Delta T}$$

$$\sigma_A = 1.57 \times 10^{-3} \text{ RADIANS}$$

$$\omega = 0.7 \times 10^{-3} \text{ V RADIANS / sec}$$

V = CRAFT SPEED, knots

$\Delta T$  = TIME BETWEEN SAMPLES

$N_n$  = ZERO MEAN WHITE NOISE  
WITH UNIT VARIANCE

## Error Models for the FPS-16 and MPS-19

### Tracking Radars

The error models and locations for FPS-16 and MPS-19 were taken from a Sperry Flight Systems report. This report gave RMS values for the random errors but no information about the biases. The biases were assumed to be twice the RMS value of the random error.

The measured radar ranges were corrected for atmospheric refraction as in the error model for the Precision Range System. In addition, a correction,  $e$ , was applied to the elevation angle to account for bending. This error is a function of the range atmospheric refraction correction and is

$$e = c \cos \beta \Delta R_e$$

where

- $c$  = 1/22,805
- $\beta$  = elevation angle at the radar
- $\Delta R_e$  = computed atmospheric refraction correction

## ERROR MODELS FOR TRACKING RADAR

### FPS-16

AZ AND El:

RANDOM 0.2 m RAD  
BIAS 0.4 m RAD

RANGE:

RANDOM 15 ft.  
BIAS 30 ft.

### MPS-19

AZ AND El:

RANDOM 0.5 m RAD  
BIAS 1.0 m RAD

RANGE:

RANDOM 30 ft.  
BIAS 60 ft.

Error Model for RTCA SC117 MSBLGS

(Slide 16)

This error model is based on the specifications for the RTCA SC117 MSBLGS. The bias values given ostensibly include site errors, but bias errors due to tilts of the mounting surfaces around axes other than the axis of measurement appear to have been neglected. In addition, no bias value for the DME was given; a value of two feet was assumed.

ERROR MODEL FOR RTCA SCII7 MSBLGS  
SPECIFICATIONS

AZIMUTH ( $1\sigma$ )

BIAS 0.63 m RAD  
NOISE 0.40 m RAD

ELEVATION ( $1\sigma$ )

BIAS 0.87 m RAD  
NOISE 0.61 m RAD

DME ( $1\sigma$ )

BIAS ASSUMED 2.0 ft.  
NOISE 20 ft.



## Error Model for Instrument Landing System (ILS)

This slide depicts a continuous model for both ILS glide slope and localizer errors. The transfer function given was taken from a Bell Aerospace monthly progress report which stated that the model was adequate for both the localizer and glide slope errors when driven by a zero mean white noise source with unit variance,  $N$ , and variable gain,  $K$ .

A discrete model was derived in the form

$$\begin{bmatrix} x_1 \\ E \end{bmatrix}_n = \phi \begin{bmatrix} x_1 \\ E \end{bmatrix}_{n-1} + W \begin{bmatrix} N_1 \\ N_2 \end{bmatrix}_n \quad (1)$$

where:  $\phi$  is a transition matrix relating the state at  $n$ th sample to the state at the previous  $(n-1)$ th sample;  $N_1$  and  $N_2$  are the zero mean unit variance driving noises.

$W$  = known matrix.

This discrete model also required that the error covariance,  $P$ , given by

$$P = E \left\{ \begin{bmatrix} x_1 \\ E \end{bmatrix} \begin{bmatrix} x_1 \\ E \end{bmatrix}^T \right\}$$

be preserved, that is,

$$\dot{P} = 0$$

This formulation involves evaluation of several very complex constants before equation (1) can be employed. These constants will not be given here since a complete description of the model is being published in the near future.

# INSTRUMENT LANDING SYSTEM (ILS) ERROR MODEL

## CONTINUOUS ERROR MODEL

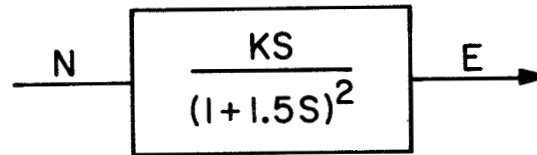

N = ZERO MEAN WHITE NOISE WITH UNIT VARIANCE

E = LOCALIZER OR GLIDE SLOPE ERROR

## ICAO SPECS FOR CAT II ILS

<u>RANGE (ft) (R)</u>	<u><math>E_L (1\sigma)</math> mrad</u>	<u><math>E_{G.S.} (1\sigma)</math> mrad</u>
$3500 > R \geq 0$	1.4	1.4
$4.5 \text{ NM} > R \geq 3500$	$1.4 + \frac{4.2(R-3500)}{23860}$	$1.4 + \frac{1.1(R-3500)}{23860}$
$25 \text{ NM} > R \geq 4.5 \text{ NM}$	5.6	2.5

## References

1. Daniels, Glenn E.: Terrestrial Environment (Climatic) Criteria Guidelines for Use in Space Vehicle Development, 1969 Revision, March 15, 1970, NASA TMX-53872 .
2. NASA CR-1588 by Henry Johansen: A Survey of General Coverage Nav aids for V/STOL Aircraft - A VOR/DME Error Model, May 1970.
3. MIT STS Memo No. 17-70 by D. E. Gustafson: Subject: A VOR/DME Model for SSV Navigation Analysis, June 23, 1970.
4. Cherry, George W. et al.: Space Shuttle Trajectory Management, Navigation, Guidance and Control During Approach and Landing, Interim Report R-662, Charles Stark Draper Laboratory, May 1970.
5. Kayton, M.; Fried, W.: Avionics Navigation Systems, J. Wiley and Sons, Inc., 1969.

MULTIPLE INERTIAL MEASURING UNITS (IMU) FOR USE IN THE SPACE SHUTTLE VEHICLE (SSV)

H. Brown and B. Doran

NASA-Marshall Space Flight Center  
Huntsville, Alabama

and

T. R. Armstrong

Sperry Rand,  
Phoenix, Arizona

## INTRODUCTION

An inertial navigation system (INS) employing multiple IMUs is being considered for use on SSV. Although multiple IMU navigation systems are currently in use, SSV requirements create some unique problems with this implementation concept.

This paper addresses some of these problems. Subjects covered include:

1. SSV-INS functions and requirements
2. Background of multiple IMU usage
3. Candidate IMU configurations and a selected configuration
4. Identification of the technology areas associated with multiple IMU usage in SSV
5. Identification of specific areas in which studies are required before the shuttle INS implementation is defined
6. Current MSFC activity in the subject area

## INTRODUCTION

- FUNCTIONS AND REQUIREMENTS
- BACKGROUND
- CONFIGURATIONS
- TECHNOLOGY TASKS
- STUDIES
- ACTIVITY

## FUNCTIONS AND REQUIREMENTS

The function of the inertial navigation system is to provide vehicle position and attitude information during the flights of the Space Shuttle vehicle. In addition, the INS should not restrict the attitude of the vehicle during the Space Shuttle mission. The requirement that the vehicle have an all azimuth launch capability will place additional requirements on the INS system. The INS system must meet a fail operational/fail operational/fail safe (FO/FO/FS) requirement. In addition, it is desirable that checkout of the INS system be performed on-board. In this paper FO/FO is assumed to mean that the INS system must function without loss in performance after the first two critical failures in the system. The fail safe requirement is understood to mean that the INS system must function such that a safe return of the vehicle can be accomplished after the third critical failure in the INS system.

Goals for the INS checkout system should include: provision for having the preflight checkout controlled by the on-board computer system; use of built in test equipment (BITE) to scan for those failures that are not readily detectable by IMU output comparisons; easy serviceability. At this time reliability requirements have not been established.

### FUNCTIONS OF INS

- PROVIDE VEHICLE VELOCITY AND POSITION DATA
- PROVIDE ATTITUDE AND ATTITUDE RATE DATA

### REQUIREMENTS FOR THE INS

- FAIL OPERATIONAL/FAIL OPERATIONAL/FAIL SAFE
- SHALL NOT RESTRICT VEHICLE ATTITUDE
- SHALL NOT RESTRICT LAUNCH AZIMUTH

### DESIGN OBJECTIVES FOR THE INS

- COMPUTER CONTROLLED ON-BOARD CHECKOUT
- GOOD MAINTAINABILITY
- HIGH RELIABILITY

## BACKGROUND

The INS configuration supplied as standard equipment with the Boeing 747 employs three IMUs. Among the factors influencing the 747 INS configuration were: The requirement for increased system reliability and accuracy over early INS installations; the requirement that the INS equipment also provide basic attitude and heading information; and the provision for later adaptation of the 747 system to a fail-operational configuration.

The McDonnell Douglas DC-10 INS employs three IMUs, as does the optional INS package for the Lockheed L-1011.

The Concorde and Boeing 2707 supersonic transport (SST) aircraft both specify INS packages employing three independent inertial navigation systems. The use of three independent INS units on both of these aircraft is based, to a large extent, on a desire to enhance the overall navigation system reliability. The FAA requirements concerning INS accuracy and their requirement that one failure must not result in the loss of the aircraft's required navigational capability have also impacted the SST-INS designs.

Studies of candidate navigation systems for an Advanced SST included analyses of two different three IMU configurations. One configuration specified that all three IMUs operate continuously, whereas the other called for two operating IMUs and one standby IMU.

A number of studies have included analyses of candidate configurations for the guidance and navigation system for the Air Force Space Transportation System - Earth Orbit Shuttle (STS-EOS). One recommended system called for three IMUs with backup redundant rate gyros and star trackers. Another study recommended that the guidance and navigation system employ four-gimbal IMUs.

In addition to studies of multiple IMU systems for specific applications, a number of analyses of redundancy management and alignment concepts have been made that are directly applicable to multiple IMU configurations.

BACKGROUND

● AIRCRAFT

- BOEING 747
- DC-10
- L-1011
- CONCORDE
- BOEING 2707
- ASST

● OTHER



## CONFIGURATIONS

The launch azimuth, no attitude restriction and on-board checkout requirements for the Space Shuttle can be met by a simplex IMU system. A simplex system, however, will not meet the FO/FO/FS requirement. In general, for one system to meet an FO/FO/FS requirement it must be composed of at least four identical components. In addition, a failure detection, isolation, and correction (FDIC) system is required to manage the four components in such a manner that the FO/FO/FS requirement is met. Note that when only four components are used, the FDIC system must be able to detect and isolate a failure when only two components remain. In most FDIC systems simultaneous failures present special problems.

There exist concepts for both the strapdown and four-gimbal IMU systems which have the potential for meeting the FO/FO/FS requirement. Some examples that can meet the shuttle INS requirements are systems employing redundant strapdown IMUs, the dodecahedron strapdown IMU, and the four four-gimbal IMUs. No known operational redundant sensor gimbal IMU exists, however some concepts employing this technique are being considered.

At this stage of the shuttle phase B studies, INS baseline configurations employ four four-gimbal IMUs.

### CANDIDATE CONFIGURATIONS

- STRAPDOWN
  - REDUNDANT IMU'S
  - REDUNDANT SENSOR IMU
  
- GIMBAL
  - REDUNDANT SENSOR IMU
  - REDUNDANT IMU'S

### RECOMMENDED CONFIGURATION

- FOUR 4-GIMBAL IMU'S

## TECHNOLOGY TASKS

The on-board checkout operations are divided into three phases: preflight, inflight, and postflight. During the preflight phase, the flight readiness of the INS must be verified in a way that is consistent with short turnaround time. A minimum amount of ground equipment should be required, and there should be high confidence in flight readiness following checkout. Here, flight readiness of the INS means verification of the IMUs, IMU interfaces, failure detection, and redundancy management functions. Current checkout techniques for IMUs vary with application from a manual procedure supported by ground checkout equipment to an on-board computer-controlled operation (e.g. Minuteman).

The typical preflight checkout sequence will include hangar tests, pad tests, and countdown checks. Of these, the hangar test will be the most thorough. It will include self-calibration and self-alignment checks, combined system tests, servo transient response tests, validation of redundancy management functions, and, possibly, optical alignment tests.

Inflight checkout of the IMUs will also be required, particularly if one or more of the IMUs are shut down during non-critical mission phases. Postflight checkout will be used to aid in scheduling required maintenance during the turnaround period.

## TECHNOLOGY TASKS

- ON-BOARD CHECKOUT
  - PREFLIGHT
  - INFLIGHT
  - POSTFLIGHT

## TECHNOLOGY TASKS (CONT'D)

In today's aircraft INS systems some on-board automatic system comparisons are performed, but the flight crew is involved in the evaluation of proper system operation. The characteristics of the shuttle mission point toward automatic IMU failure detection, isolation, and correction procedures.

It is expected that failure detection and isolation can be performed by comparing outputs from the IMUs. Additional information, other than normal IMU outputs, such as BITE data, external source data (e.g., from star sensors, horizon sensors, radio navigation aids, skewed or redundant IMU sensor data, etc.) will also be available to enhance the confidence level of the decision process.

Generally, three types of IMU failures must be considered; soft failures; hard failures; and built-in test failures. Of the various failure detection schemes known, only IMU output comparison is available throughout the mission and has the capability to detect hard and soft failures. It is likely that no single technique will be satisfactory and that multiple error detection mechanisms will be used. Practical techniques for comparing IMU outputs in real time while operating in a severe environment, such as the boost or ascent phase, have yet to be developed and demonstrated.

The success of a particular failure detection scheme (e.g., voting schemes, statistical output estimator/comparator schemes) depends upon the definition of appropriate failure detection levels. Sensitivity must be sufficient to detect faulty IMUs before mission requirements are impaired, and the failure detection method must be relatively insensitive to transients, noise, and quantization effects. A tradeoff is required between maximum reliability achieved with minimum false alarms and allowable system error. Increased reliability may be achieved by use of inertial systems whose performance is better than normally required to meet the mission requirements since some performance degradation could be tolerated before the sensor or system must be switched out. Through use of an adaptive threshold function it is possible to optimize the tradeoff between false alarms and undetected failures. The overall system errors then would become a function of mission phase. Hard failure detection technology will probably evolve from commercial practices that use BITE as the prime means of failure detection.

To complement the failure detection and isolation system, a redundancy management system will be used to decide which of the redundant data from the IMUs is to be used for the navigation calculations, and how these data are to be presented. For example, redundant IMU outputs may be statistically combined (least squares, average, etc.) and the resulting data would then be passed to the navigation computer. On the other hand, outputs from a single unfailed IMU could be passed to the navigation computer.

TECHNOLOGY TASKS (CONT'D)

● FAILURE DETECTION AND ISOLATION

● BITE (CENTRAL-DEDICATED)

● OUTPUT COMPARISON

● COMBINATIONS

● REDUNDANCY MANAGEMENT

● COMBINED OUTPUT

● INDIVIDUAL OUTPUTS

## SUPPORTING STUDIES

Some development of these IMUs for shuttle application will be required, but this should consist primarily of thermal and mechanical modifications to accommodate the shuttle environment. In order to develop the checkout, failure detection and isolation, and redundancy management systems associated with the use of multiple IMUs, a number of technical studies should be performed. These investigations should include analyses of:

1. On-board preflight and inflight checkout and diagnostic data requirements
2. Relative orientations for platform and sensor axes
  - Parallel (vs) skewed platform axes
  - Orthogonal (vs) skewed sensor axes - also redundant sensor axis
3. Failure detection and isolation methods, including consideration of:
  - Failure scan rates
  - Failure threshold levels defined as functions of mission phase and hardware characteristics
  - "Self-healing" techniques (reinstatement of soft failed systems in non-critical mission phases)
  - Two IMU failure identification
  - System failure mode and effect analyses - gross investigation of failure modes and effects based on a representative IMU in a 4 IMU-INS system configuration
4. Redundancy management techniques
  - Data management impact; error propagation; control system interaction
5. Effects of dispersal of the IMUs
  - Flexible body effects; safety; impact on calibration, alignment, and failure detection
6. Crew interaction/response with the redundant system
  - Crew override capability; crew diagnostic functions
7. Calibration and alignment procedures (preflight and inflight)
  - Calibration requirements; schedules and procedures; serial (vs) parallel calibration and alignment; updating
8. Gimbal flip effects - (Non-simultaneous gimbal flip may degrade failure detection)

While the technology subject in this paper has been focused on the use of multiple IMUs, results of the recommended studies will have application to other shuttle subsystems.

#### **SUPPORTING STUDIES**

- **ON-BOARD CHECKOUT**
- **IMU & SENSOR ORIENTATION**
- **FAILURE DETECTION AND ISOLATION**
- **REDUNDANCY MANAGEMENT**
- **IMU LOCATIONS**
- **CREW INTERACTION**
- **CALIBRATION AND ALIGNMENT**
- **GIMBAL FLIP**

## CURRENT MSFC ACTIVITY

MSFC is conducting a study program to define an on-board checkout, failure detection, isolation and redundancy management system. This program will investigate those areas previously identified as supporting studies and will generate a recommended approach/design for these systems. An experimental program is also being prepared to test and demonstrate the recommended concepts and to evaluate system parameters such as failure scan rates, failure tolerances, effects of IMU errors on failure detection systems, gimbal flip effects, etc. The study is a nine month program that will be followed by the experimental phase. Results of the phase I study will be available in early 1972 with experimental results expected by late 1972.

### CURRENT MSFC ACTIVITY

- SPONSORING STUDY PROGRAM TO DEFINE
  - ON-BOARD CHECKOUT SYSTEM
  - FAILURE DETECTION - ISOLATION APPROACH
  - REDUNDANCY MANAGEMENT SCHEME
  - EXPERIMENTAL TEST PHASE

ASSESSMENT OF FLY-BY-WIRE TECHNOLOGY FOR SPACE SHUTTLE

Paul E. Blatt

Air Force Flight Dynamics Laboratory  
Air Force Systems Command  
Wright-Patterson Air Force Base, Ohio



## 1. Introduction

Flight control design for the Space Shuttle is compounded by the fact that, effectively, three vehicle configurations are involved: (1) a mated booster/orbiter combination having c.g. offset and unsymmetrical aerodynamic configurations, (2) an orbital vehicle which must perform both as a spacecraft and as an aeronautical vehicle for entry and landing, and (3) a recoverable booster which is also an aeronautical vehicle. Magnitude of the flight control problem is typically depicted in the Figure 1 sketch of the McDonnell Douglas/Martin Marietta Space Shuttle Configuration in which the booster weighs typically in excess of 3.75 million pounds at lift-off and has a landing weight of 700,000 pounds (Ref. 1). The orbiter weighs approximately 840,000 pounds at lift-off and 270,000 pounds at landing. Control moments must be generated through various blended combinations of aerodynamic control surfaces, reaction controls, and thrust vector controls throughout each phase of the mission. Autonomous self-test equipment is to be incorporated for low maintenance and fast turn-around between flights of the re-usable Space Shuttle system. Principal automatic and manual flight control modes must be provided for the following phases of the mission:

Launch and Ascent Trajectory Guidance

Separation of Booster & Orbiter

Orbit Injection

Rendezvous and Docking

Orbital Mission

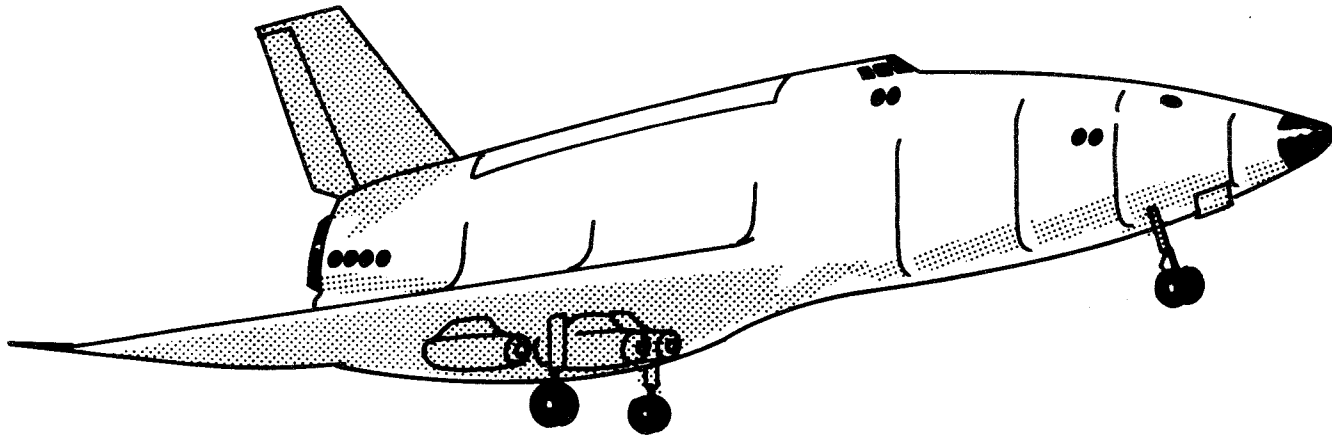

ORBITER

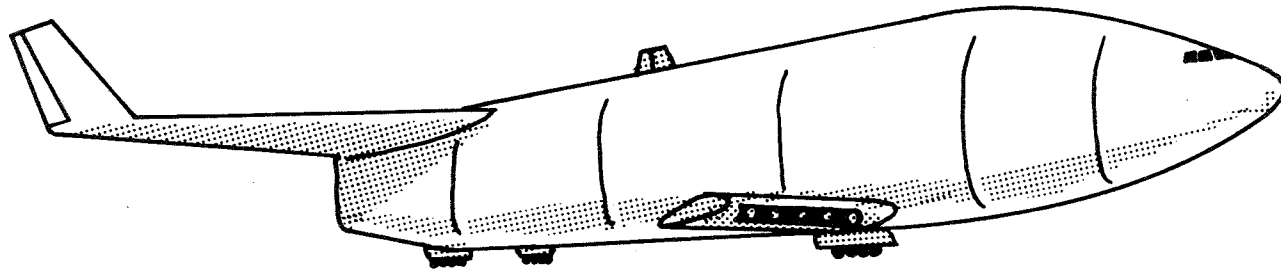

BOOSTER

FIG. 1 SPACE SHUTTLE (MCDONNELL DOUGLAS/MARTIN MARIETTA CONFIGURATION)

Retro-fire

Entry Energy Management

- (1) Guidance
- (2) Phugoid Damping
- (3) Constraint Limiting - Temp, g, q

Landing/Go-Around

To perform these mission phases, complete dependence upon closed-loop control augmentation techniques is essential. Integration of flight control and guidance functions is important. Considerable signal blending mode variation and use of different control force and moment generation devices are required. Fly-by-wire flight control techniques offer the only practical solutions to these requirements.

For purposes of this paper, fly-by-wire will be defined as a primary flight control system which transmits command intelligence from the pilot's stick and rudder pedals to the flight control actuators by electrical rather than mechanical means. It also includes the concept of a closed-loop control system which makes vehicle motion the controlled variable.

The magnitude of signal processing required and the flexibility desired for various flight phases and between missions make digital signal processing highly attractive. Prime candidates are (1) integrated avionics having redundant central digital multiprocessors, (2) redundant dedicated digital computers for flight control, and (3) digital processors for automatic control and built-in-test functions with redundant analog "hardened SAS" control loops for manual control. Since flight control closed-loop designs impact on

the total flight safety of the vehicle and interact strongly with other technical disciplines such as aerodynamics, structural, propulsion, flying qualities, guidance, etc., flight control engineers will cringe at the thought of being considered "just another set of equations to be processed in a central digital computer." Past utilization of digital computers for navigation and guidance functions in aircraft have not had the responsibility for instantaneous stability and control augmentation flight safety requirements levied on them. Major hardware and software engineering problems remain to be resolved.

## 2. Fly-By-Wire Technology Summary

First common use of the term "Fly-by-Wire" probably originated with the Mercury capsule which had one mode of control which was entirely electrical from the pilot's controller to the reaction controls. Although there were a number of studies and breadboard electrical control system investigations prior to the Mercury program, the astronauts' messages from space popularized the term "fly-by-wire." Since that time, fly-by-wire (FBW) technology has evolved to the point of practical application for primary flight control through a series of development programs as shown in Fig. 2. Basically, the components, control laws, and redundancy-monitoring techniques developed and verified to date for conventional aircraft have been of an analog or hybrid (discrete digital logic elements) mechanization. Control laws implemented with currently available sensors and actuators fall naturally into the analog field. Built-in-test and monitoring functions are more easily mechanized with digital logic elements which can be greatly miniaturized. However, with the current forms of control sophistication and redundancy, the control law and interface electronics may typically account for 40 percent of the electronics while the built-in-test and monitoring schemes can account for the remaining 60 percent of the electronics.

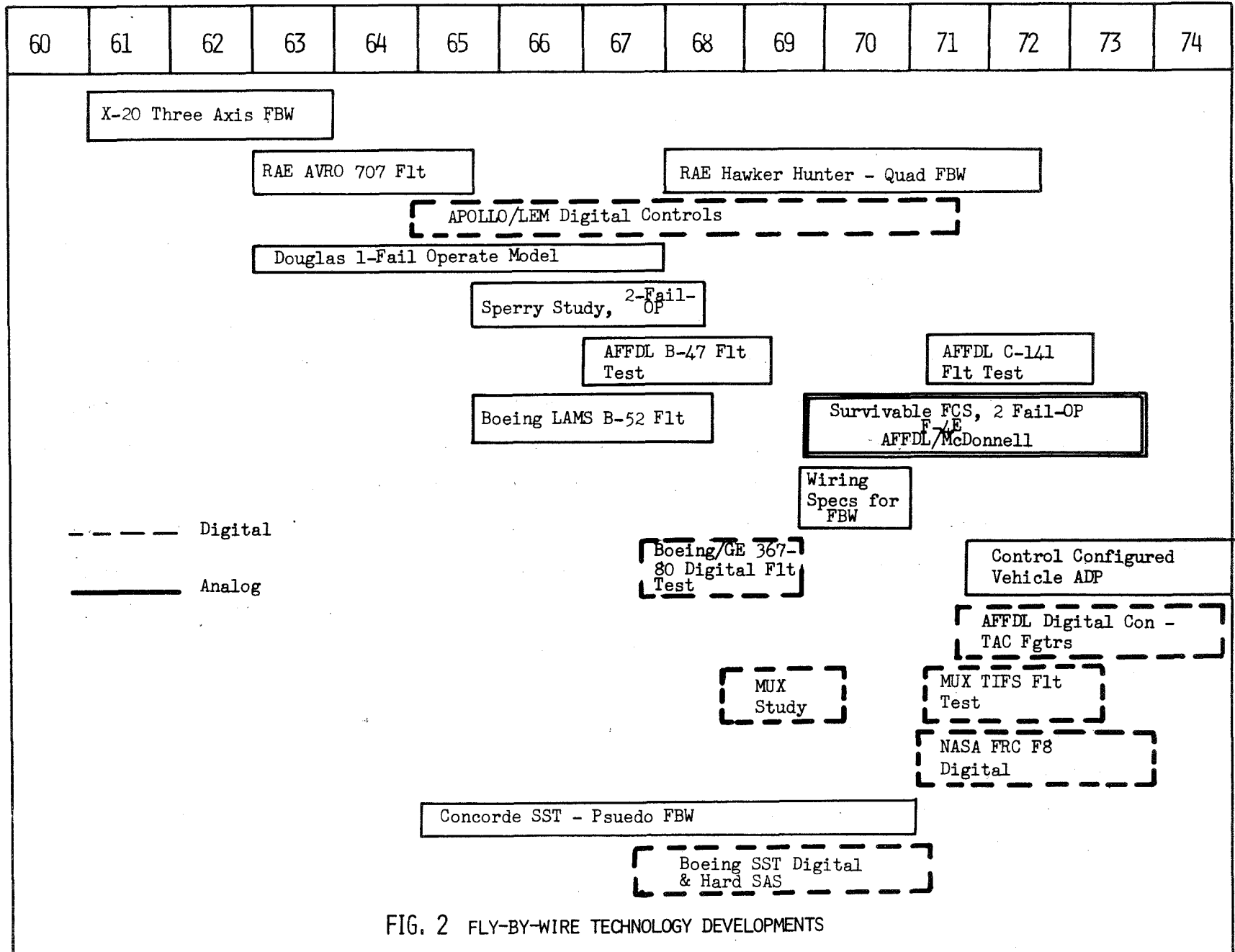

274

FIG. 2 FLY-BY-WIRE TECHNOLOGY DEVELOPMENTS

## 2.1 Analog Fly-by-Wire Control Systems

The X-20 Dyna Soar program represented one of the first major developments for fly-by-wire (FBW) controls in a manned aerodynamic vehicle and was recognized as the only practical solution for the mission. Elevons, rudders, reaction controls, and thrust vector controls were controlled through fly-by-wire signal transmissions from the pilot's sidestick and rudder pedals. Both automatic and manual control modes were available through the same FBW equipment. Three forms of longitudinal control laws were selectable by the pilot: (1) a self-adaptive pitch rate augmentation system which was based on the X-15 flight experience, (2) a pitch rate augmentation system with three pilot-selectable fixed gain states, and (3) a manual direct open-loop signal with controlled surface position. Reaction controls were automatically blended with aerodynamic controls until a given forward loop gain was achieved in the self-adaptive controller. At this point, the reaction controls were automatically turned off. Fly-by-wire electronics were triply redundant using a majority voting scheme to isolate a failed channel. FBW actuators were dual redundant. At the conclusion of the program in 1964, most Dyna Soar flight control design problems appeared to be solved (with the exception that vehicle structural mode dynamics were near the critical self-adaptive limit cycle identification band-width), and the system was packaged in its final flight-worthy form (See Fig. 3). Following the termination of the Dyna Soar program, extensive Dyna Soar simulation tests were conducted by the Air Force Flight Dynamics Laboratory (AFFDL) for evaluation of the fly-by-wire electronics, actuators, and cockpit controls. Test results were very good overall and met basic specification requirements throughout the flight envelope. No failures occurred in the fly-by-wire system over several hundred hours of operation in the simulation. Several channel disconnects occurred due to out-of-tolerance

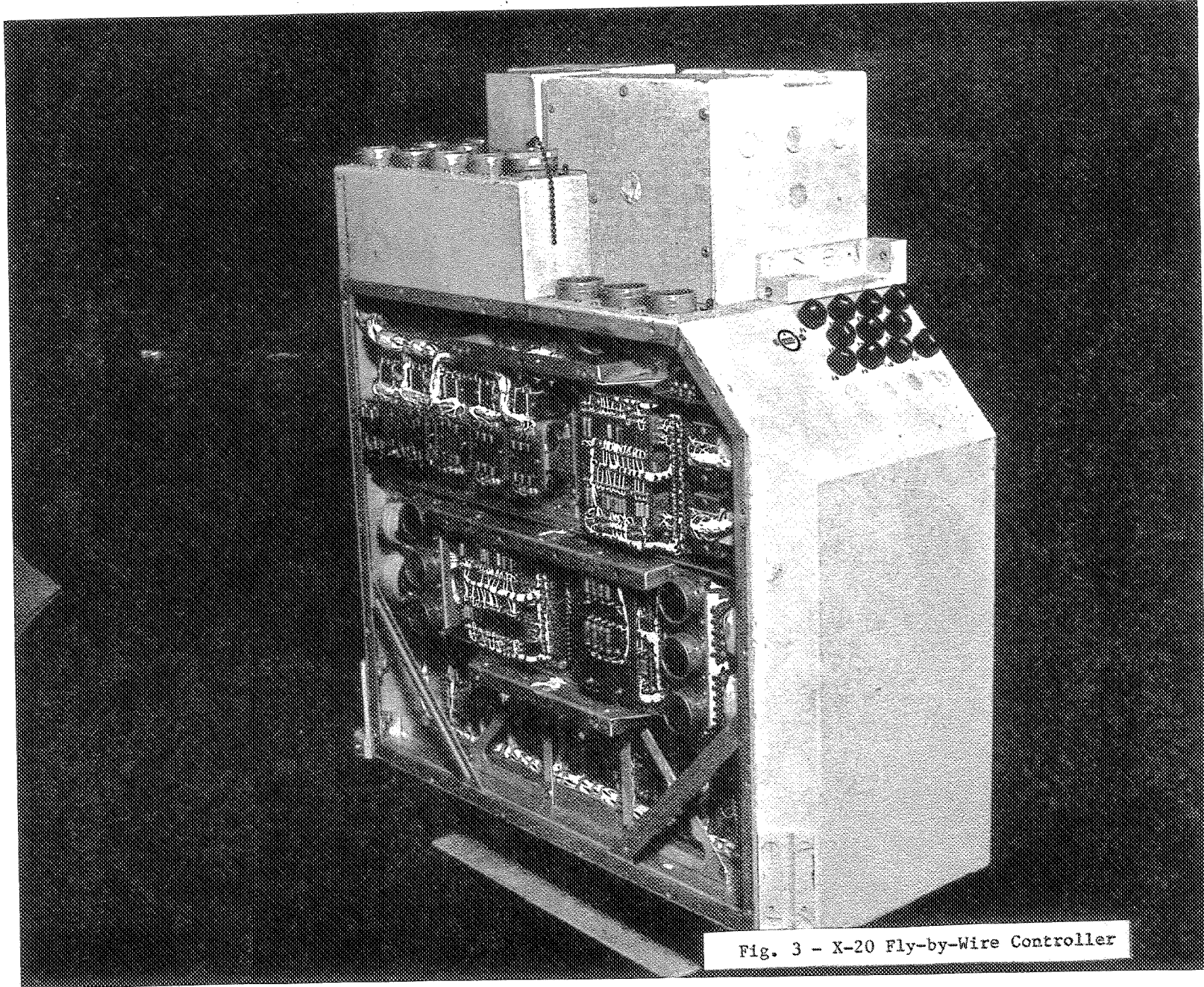

Fig. 3 - X-20 Fly-by-Wire Controller

tracking problems under large maneuvers, but the channel could be re-engaged by the pilot. Some flying quality difficulties were encountered at the transition between hypersonic and supersonic flight regimes where steep trim gradient changes occurred aerodynamically.

Original fundamental FBW developments by the AFFDL attempted to design highly simplified ac controls which would require no electronic amplification switching, or shaping. These attempts were unsuccessful due to the inability to develop efficient ac torquers for the hydraulic servovalves and the very large, high-power LVDT's required for stick position pickoffs when no amplification was permitted. The program was later redirected to a more conventional dc electronic form of fly-by-wire, and a triply redundant, single-axis demonstrator unit was built. Principal innovation in the Douglas program was the mechanical "median select" mechanism incorporated in the servo-actuator. See Ref 2.

A detailed study of modern analog fly-by-wire technology (components, monitoring devices, system mechanizations, and applications) was performed by Sperry Phoenix and is reported in Ref 3. This document is a classic for fly-by-wire designers. System design tradeoff factors were described in an attempt to clarify the advantages and limitations of competing techniques; particularly performance degradations with various failure mode characteristics. Following the study, Sperry implemented a realistic two-fail-operate demonstrator model of a three-axis fly-by-wire control system including simplified built-in-test functions and a triply redundant, force-shared servo-actuator. Each axis of the system electronics included three active channels and a model channel. Under a two-fail-operate status, the three active channel servo-commands are voted. Recently,



this demonstrator model was loaned to NASA for modification to a Space Shuttle configuration by McDonnell-Douglas and Sperry.

To gain practical experience with fly-by-wire control, the AFFDL in conjunction with Hydraulics Research and Manufacturing Company modified a B-47 aircraft with a non-redundant system in a three phase program (Ref. 4 & 5). First step was to install a FBW actuator in the pitch axis controlled by an electrical position pickoff on the normal control column. Flight tests indicated relatively little control difference from the normal mechanical control system, except at high q flight conditions, where the electrical system provided considerably better control response. Normal mechanical cable compliance, under load, reduced vehicle response. Following proof of the FBW actuator, a C\* (linear blend of pitch rate, pitch acceleration, and normal acceleration) feedback control law was mechanized in the longitudinal axis, and a roll rate loop was closed in the lateral axis (See Fig 4). A rather crude, two-axis sidestick was installed to separate the FBW control system from the standard mechanical controls and feel system. Pilots quickly gained confidence in the system, and performed a series of flying quality tasks to evaluate performance. One of these critical tasks involved low-level visual terrain following over a Kentucky ground track. Pilot work load was greatly reduced with the closed-loop FBW system and sidestick. Cooper-Harper ratings for this task with the mechanical controls were seven or eight as compared to 2.5 to 3.5 with the FBW system. Finally, in the third phase of the program, a quad-redundant hydrologic servo-actuator was installed in the longitudinal axis, and inflight failures were simulated to evaluate transient response and failure isolation. This was the first flight evaluation of a quad servoactuator. During the flight test, the actuator correctly removed all of the failures injected and exhibited

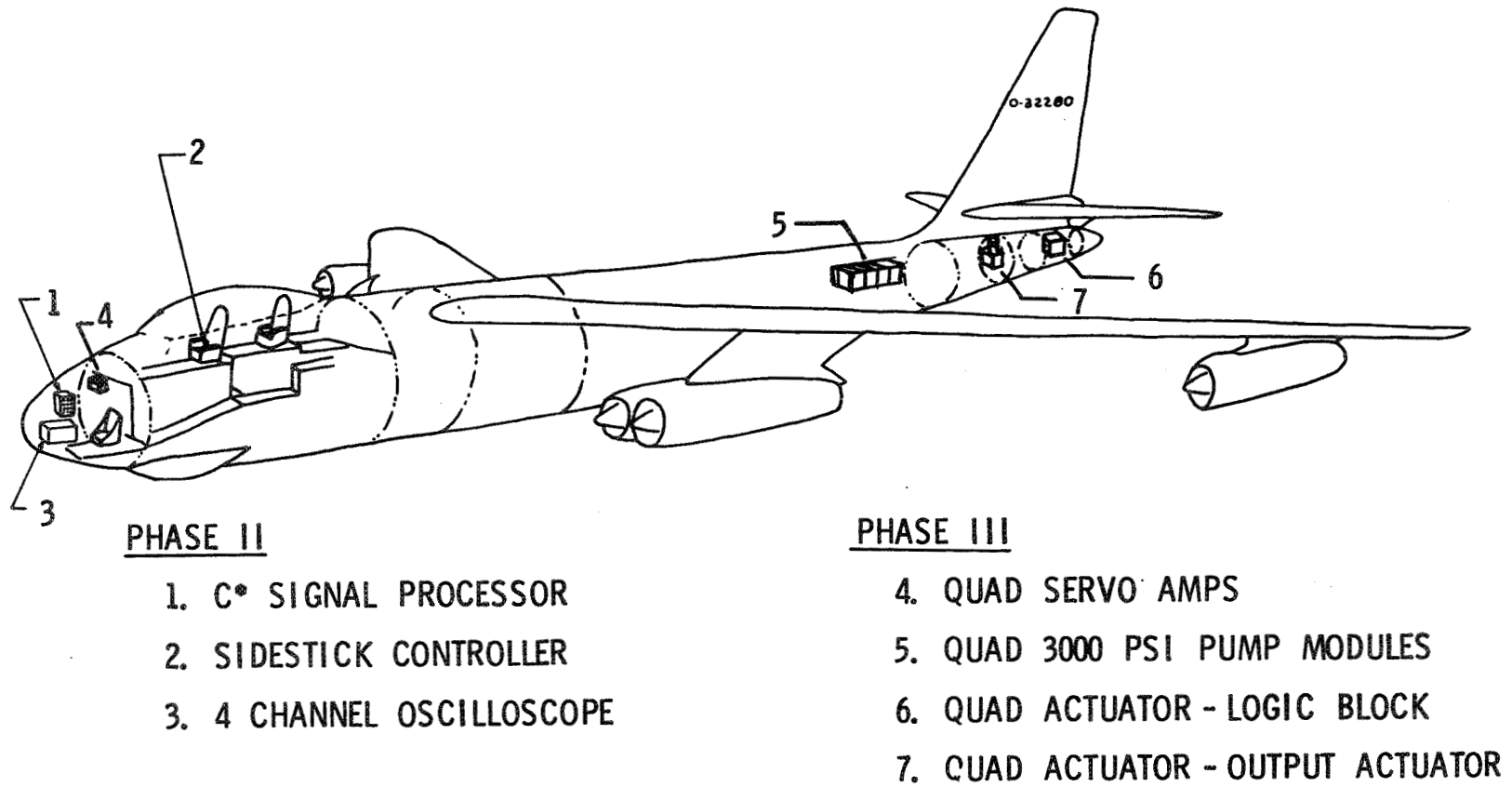

FIGURE 4 B-47 FLY-BY-WIRE EQUIPMENT LOCATION

no nuisance disconnects. The effects of injected failure during level flight conditions with both hard-over and open failures were negligible. Failures inserted while pulling one-half g turns at 400 knots produced transients of less than 0.2 g's peak-to-peak with no difference between the first and second injected failure. There was no loss of actuator performance with one or two failures. The fail-neutral function was also successfully flight evaluated. The need for non-linear stick characteristics to achieve small precision control as well as large maneuvering capability was established in this B-47 program as well as several later flight test programs.

Active aeroelastic control through sensor blending has been in common use on large flexible missiles and actively tested in two flight programs for aircraft. Angular rate and/or acceleration sensors located strategically throughout the aircraft structure can be used to obtain a desirable feedback signal for controlling multiple force or moment generators for active structural mode control. Fly-by-wire techniques are most natural for implementing these functions. The control law can provide a signal related to rigid body control exclusive of the structural flexibility dynamics as well as a signal proportional to the structural mode motions which are to be controlled. Development programs have included:

Load Alleviation and Mode Stabilization (LAMS) - An advanced development program has been completed by Boeing Company and Honeywell which demonstrated in a B-52 aircraft that advanced flight control techniques could be used to alleviate gust and maneuver loads and control structural mode oscillation through the use of conventional control surfaces and appropriate control laws (Ref. 6). An optimal control law was derived which

produced the blended controller. In the longitudinal axis (See Fig. 5), four rate sensors were employed to detect bending, two located in the wings to control a wing bending mode and two located fore and aft in the fuselage. In the lateral axis, two roll rate gyros and four yaw rate gyros mounted in the fuselage were used to obtain the control signals. All available control surfaces, elevators, ailerons, and spoilers were used to provide the necessary moments and forces. Broad-bandwidth (12 CPS) actuators having both mechanical and electrical inputs were installed on all surfaces. Flight test results show that significant reductions in fatigue damage rates occurred. In addition, a C-5A LAMS analytical study was performed to demonstrate that the technology developed for the B-52 could be applied to another aircraft. Conclusions reached from the LAMS program are (1) it is practical to design a control system which will provide structural mode control and good rigid body stability augmentation compatible with outer-loop modes, (2) multiple sensor blending is required, (3) linear optimal control theory must be applied in the design involving multi-variable sensing and control generation, and (4) current state-of-the-art actuators can support this technology. A B-52 direct lift control mode was also investigated in flight which greatly simplified formation flying for refueling and approach and landing.

Gust Alleviation Structural Dynamics Stability Augmentation System (GASDSAS) - An extensive exploratory development program conducted by North American showed that at least two techniques, (1) identical location of acceleration sensors and the force application and (2) dual angular accelerometer systems, could be applied successfully controlling structural bending of large flexible aircraft. Also, the study showed that interface problems between the structural mode control system and outer-loop control modes such as terrain following

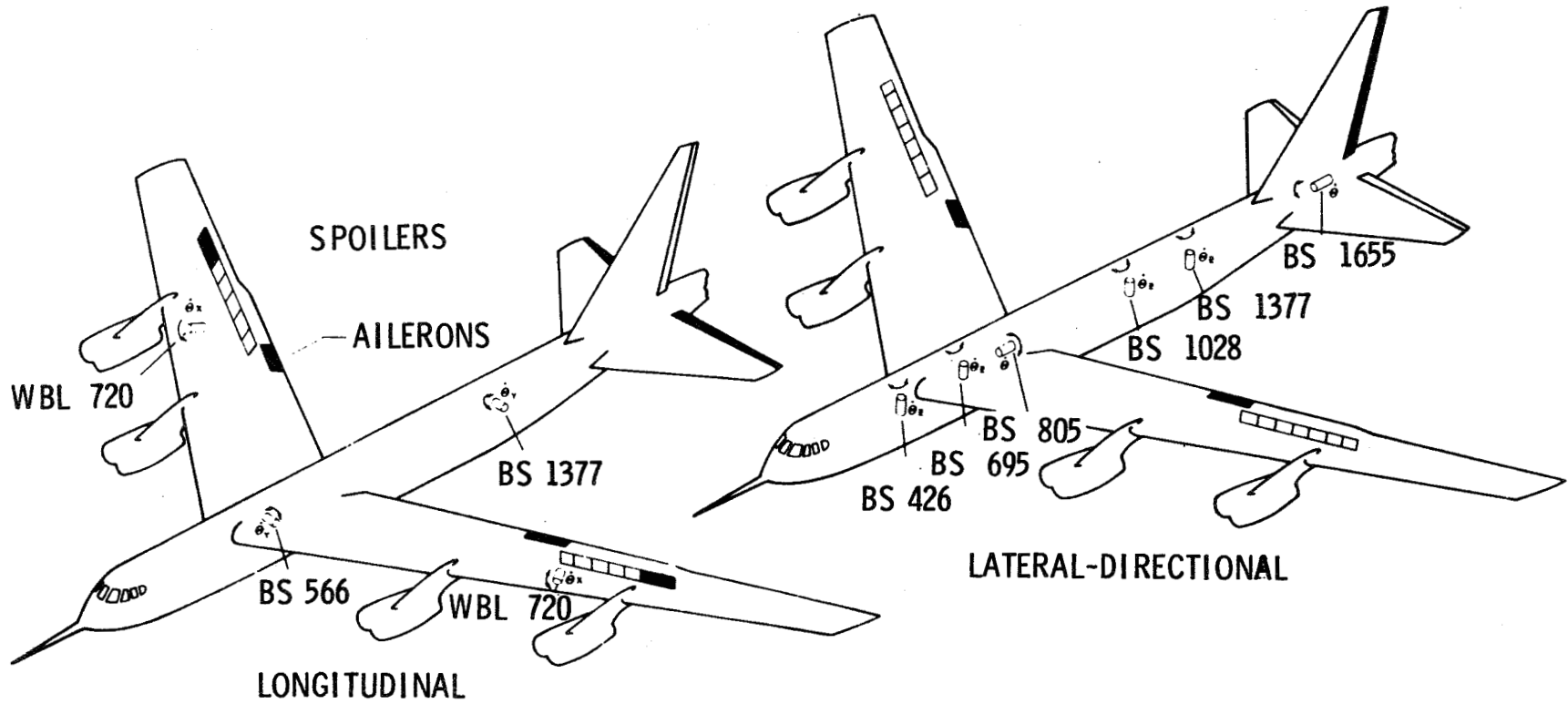

FIGURE 5 LAMS SENSOR LOCATIONS

could be overcome. This study led to a joint USAF/NASA flight test of this technique on the XB-70 aircraft which demonstrated the effectiveness of this concept.

Full "man-rating" of fly-by-wire flight control technology is being developed under a major Advanced Development Program for Survivable Flight Control Systems by the Air Force. This system which combines two-fail-operate, fly-by-wire dispersed analog electronics, and sensors with integrated actuator packages (See Fig. 6) will establish criteria for practical application to tactical fighters. McDonnell-Douglas is the primary contractor and will install and flight test the system in an F-4E aircraft. The aircraft may be controlled either by electrical transducers mounted in the center stick or by a two-axis sidestick through closed-loop controls. A direct electrical link is also available to control surface position should three "like" closed-loop failures occur simultaneously. Initially, a disengaged mechanical backup control will be available in the pitch and yaw axis, but this will be removed in later flights to demonstrate complete confidence in the system. Two forms of quad-secondary actuators are being developed to drive the existing stabilator, aileron/spoiler, and rudder power rams. One secondary actuator is electro-hydraulic and the second design employs electro-mechanical elements. Considerable design effort is being applied to the redundant electrical and hydraulic power supplies to insure isolation and protection from single failure points. Design reliability requirements for the total systems are failure rates not to exceed  $\lambda = 2.3 \times 10^{-7}$ .

In a related program, fly-by-wire control laws applicable to large transports operating under low altitude turbulent flight conditions will be evaluated in a C-141 flight test by the AFFDL. This system will

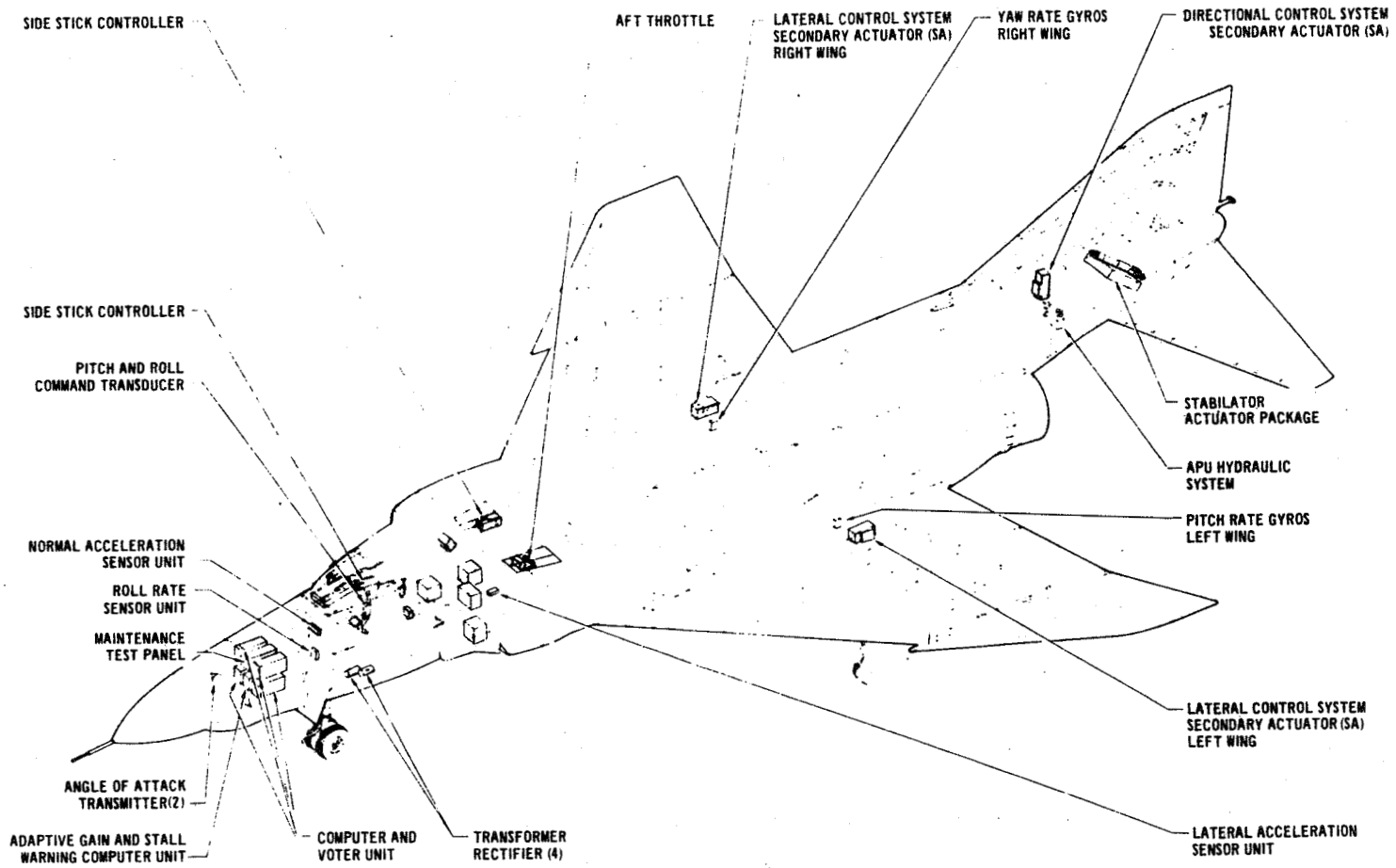

FIGURE 6 FLY-BY-WIRE TEST INSTALLATION

depend upon the Survivable Flight Control System program to fully man-rate the fly-by-wire quadruple redundancy techniques and will concentrate on performance factors for transports attributable to fly-by-wire to achieve improved flying qualities. This system, to be developed and built by Honeywell, will consist of a two axis, dual redundant, fail-safe set of analog electronics and sensors. Control of the aircraft will revert automatically to the normal mechanical system if a failure occurs. A two-axis side stick will be installed on the co-pilot's armrest for control of the fly-by-wire system. Feasibility of direct lift control implementation through symmetric spoiler control is also being investigated.

First commercial application of fly-by-wire controls will be the Concorde SST which will employ dual analog electrically signalled (command augmentation) and hydraulically powered systems for primary control and a normally disengaged mechanical system as a standby. The design was selected on the basis of pilot flying quality requirements and passenger comfort. Length of the aircraft and thermal expansion made design of a mechanical primary flight control system which could satisfy the requirements, very difficult. Split elevons and rudders, each controlled by a separate servo-actuator, provide safety through the partition principle. Servo-valve control is novel in that each servo control is supplied with two electrical inputs and a clutched mechanical input. Each signal (electrical and mechanical) can operate the slide valve controlling the actuator position. In normal operation, only one electrical signal drives the slide valve, and the second channel operates as a "hot spare." In case of identification of failure in the first electrical channel, a transfer to the second electrical channel is affected. A second failure transfers control to the mechanical system. Relative



comparison of split surface position serves as the monitor function. Flying qualities of the Concorde have been reported to be very good in flight tests conducted to date.

Where flight safety is totally dependent upon electrical fly-by-wire controls, reliability of electrical wiring and connectors must be given considerably greater design and installation attention than for normal avionics equipments. As a result of a considerable number of failures of these components in military AFCS installations, a study was conducted by Boeing to establish electrical wiring and connectors design, installation, and quality control practices. Results from Apollo and Minuteman high reliability programs and a survey of most airframe manufacturers' wiring practices were incorporated in the report. Particular attention was given to the problems of (1) separation of FBW wiring and protection by color coded jackets, (2) junction box integrated termination interconnections, (3) selection of suitable electrical connectors, (4) dispersed redundant channels and early design routing of wire bundles, and (5) physical and electrical protection for wiring.

Final results are published in a design handbook form (Ref. 7).

## 2.2 Digital Fly-by-Wire Control Systems

Until very recently, digital flight controls for aircraft could not compete with analog techniques due to (1) computational speed and slew rate required to achieve sufficient band-width, (2) flight safety factors, (3) cost for redundant systems, and (4) the interface with analog sensors and actuators. Greater emphasis on more sophisticated automatic controls, increased flexibility for changing control parameters and control laws,

increased desire for improved built-in-test and monitoring functions, and interface compatibility with hybrid navigational and guidance computations makes digital flight controls appear highly attractive, particularly in view of achievements in recent airborne digital computer technology. Competition for Boeing's SST automatic flight control system produced two advanced digital flight control systems which did much to expand the technology in this vital area. However, primary flight control functions in the SST were provided by a triply redundant electrical command augmentation analog system and a quadruply redundant hardened analog stability augmentation system which provided various levels of degraded performance if failures occurred throughout the system.

Sperry Phoenix was selected by Boeing as the contractor for the SST automatic flight control system. Basically, the system consisted of three general-purpose digital computers having a high degree of monitoring, failure reporting, and built-in test capability. Sperry Univac 1819A machines were employed. Flight control data processors provide D/A and A/D conversions for the computers and its related subsystems. Built-in test functions permit detailed checks of element gains, time constants, filters, etc., which provide system checks with considerably greater thoroughness than is possible with a basic analog system. Total computer capacity is strongly dependent upon the level of built-in-test functions, even more than the control laws incorporated. System failures, both ground-based tests and in-flight failures are read out on a pilot's diagnostic panel and a flight engineer's printer with instructions of what action should be taken. Considerable automatic flight management was programmed into the machine including the Category III all-weather landing capability.

General Electric also developed triplex digital flight control computers based on variable increment computation techniques. These computers were specifically designed for flight control requirements and include the capability for performing stability augmentation functions as well as fault detection and some fault annunciation. An autoland flight test evaluation of these computers was performed on a Boeing 367-80 airplane using control laws derived by Boeing in 1969. Performance was reported to have been very good.

A digital fly-by-wire flight control system for helicopters is being developed in a joint Canadian/United States program by CAE Industries of Montreal and Boeing Vertol. The triplex system is scheduled to begin flight testing this summer in two CH-47C helicopters.

Data bus concepts for multiplexing multiple electronic subsystem signals on a relatively few transmission lines prompted a study and development of a breadboard multiplexor to determine the requirements for interfacing with analog fly-by-wire flight control systems. Objectives of the study (Ref. 8), which was conducted by General Dynamics of Fort Worth for AFFDL, were:

- a. Formulate a system which reduces the multitude of wires required for signal transmission, monitoring, and self-test without destroying the benefits of redundancy.
- b. Perform trade studies in which the reliability, survivability, maintainability, weight, and cost of various multiplexing concepts are compared. Use a realistic quadruplex fly-by-wire closed-loop flight control system for the study.
- c. Select a preferred multiplexed system.

d. Design and fabricate a significant portion of the system to permit its demonstration by means of breadboard hardware with a simulation.

Seven levels of multiplexing were applied to the base-line fly-by-wire system in the tradeoff study. A configuration in which multiplexing was applied in all signal and discrete monitoring paths was selected, and the relative comparison of performance factors with the baseline configuration are shown in the following table. A critical design factor is the number and location of monitors in the redundant flight control system.

TABLE I

COMPARATIVE FACTORS FOR HARD-WIRED FLY-BY-WIRE SYSTEM VS MULTIPLEXED SYSTEM (Ref 8)

	<u>Hard-Wired</u> <u>QUAD FBW</u>	<u>Fully Multiplexed</u> <u>QUAD FBW</u>
Reliability	.9999974	.9999948
Survivability	.992593	.997177
Availability	.9252	.9282
Weight (lbs)	474.4	253.3
Cost	\$156,800	\$192,360

The multiplexing technique selected (Ref 8) was a pulse-coded, code divided (Bi-phase Manchester), digital data technique employing twisted-shielded pair transmission lines. The design has an update rate of 400 samples per second based on an assumed maximum flight control band-width of 20 Hertz for future applications. Phase lag at 20 Hertz produced by the sum of the data propagation delay and the sample period is 13.3 degrees. Practicality of the techniques selected were demonstrated in the breadboard mechanization and

simulation of a three-degree-of-freedom lateral-directional control system of a high performance fighter. Figure 7 describes tests of the breadboard multiplexor unit being used to control redundant servo-actuators in laboratory bench test.

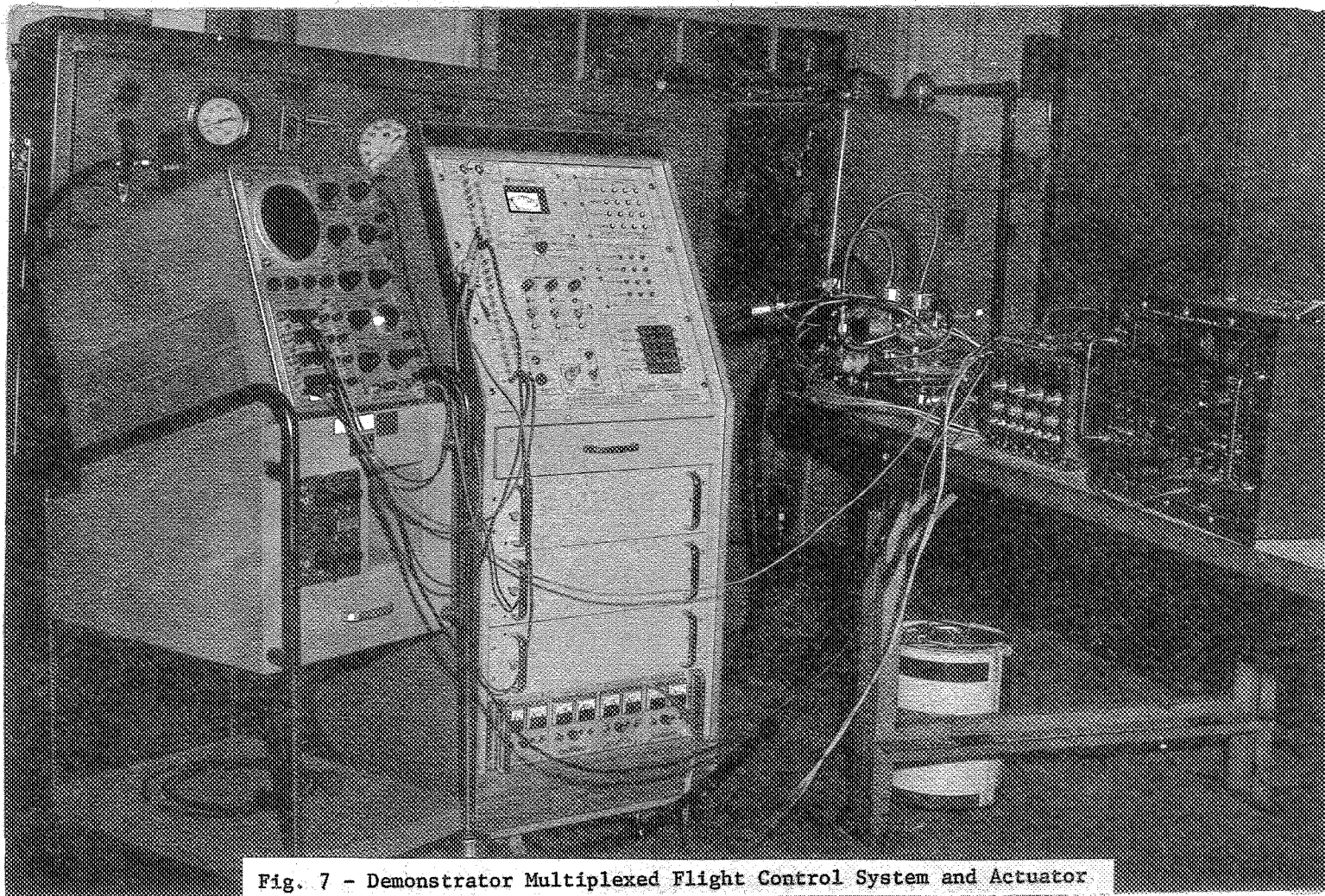

Fig. 7 - Demonstrator Multiplexed Flight Control System and Actuator

Realistic flight environment requirements for multiplexed flight control systems will be established in a subsequent program in which a flight-worthy breadboard unit will be flight tested on the AFFDL total in-flight simulator (TIFS) in 1972. Two-axis pitch and roll controls and monitoring functions will be evaluated. Special emphasis is being placed on shielding and EMI requirements.

Technology for primary digital flight controls including augmentation will be developed under two current programs: (1) NASA Flight Research program which will install digital controls in an F-8 aircraft, described under a separate paper by Messrs. Burke and Gee, and (2) an AFFDL study and simulation program to establish basic digital memory, word lengths, iteration rates, computer organization, and interface requirements for tactical fighter multimode flight controls.

### 3. Principal Fly-by-Wire Control Technology and Design Problems Anticipated

From the summary description of the fly-by-wire flight control development and application programs, it can be seen that extensive development of analog components, control laws, redundancy techniques, and criteria have been or soon will be validated through a series of flight tests. Failure detection and built-in-test elements have been mechanized by discrete digital logic elements, but the complexity of these circuits can far exceed the component part count required to implement the normal control law circuits applied. In general, digital

flight control developments have been successfully applied to ICBM missiles, but digital flight controls for aircraft have been limited to automatic flight control functions (outer-loop) and have received only limited flight test evaluation to-date. If digital flight controls are to be applied in the Space Shuttle for both AFCS and control augmentation stabilization of the vehicle, major digital flight control developments and flight test verification in representative test aircraft are warranted. Assuming that current digital computer technology is adequate to solve the Space Shuttle flight control problem, the following typical criteria and requirements must be accurately established before the first flight of the Space Shuttle:

a. Computation Requirements - Sensitivity of flight control solutions to variations in word length, sample rates, bit errors, computer organization, scaling vs signal resolution, dynamic response to change in input signals, dynamic filtering requirements (digital vs analog or hybrid), etc. Computer capacity requirements for the automatic and manual flight control functions with special emphasis on signal shaping or correction of sensor data (i.e., air data signals). Software executive functions. Validate multiplexing techniques with transmission of high density traffic data bus avoiding interference of primary flight control signals. Establish compatible multiplexed data sampling rate to satisfy both high-speed flight control requirements and low-speed, precision navigation and guidance requirements.

b. Control Laws - Definition of automatic, manual, and emergency flight control laws making maximum use of techniques unique to digital solutions. Establish gain changer requirements and select technique to implement. Design structural mode active control system or passive filters. Integrate primary flight control system, thrust vector controls, energy management guidance, and automatic landing system.

c. Built-In-Test and Failure Detection - Select number, location, and method of monitor functions using internal self-monitoring features of digital computers to maximum extent possible. Determine optimum level of built-in-test equipment and test signals for the re-usable Space Shuttle mission.

d. Redundancy - Establish optimum combinations of (1) central processors, (2) dedicated digital flight control signal processors, or (3) central processor with redundant analog control loops for manual control to satisfy flight safety, reliability, and mission performance requirements. Physical separation of electronic equipment and transmission lines is essential. Determination of the levels of redundant sensors and electrical and hydraulic power supplies required is an important design factor. Two-fail-operate performance has been specified. Thorough failure analysis and test must be conducted.

e. Criteria - Prepare detailed specification and design handbook for digital flight control hardware, software, and interface requirements.

From previous AFFDL design simulations of manned delta lifting vehicles having broad cross-range maneuvering capability (Ref. 9), many flight control problems were investigated which may offer solutions to the Space Shuttle control system. In the longitudinal axis, inner-loop fly-by-wire controls were configured as model-following pitch rate feedback systems having generally a minimum of three gain states to satisfy flying quality requirements from re-entry to touchdown. Gain changes can be implemented either as scheduled functions of inertial velocity or  $q$ , or as self-adaptive identification. A variety of modern self-adaptive techniques are available which would satisfy these requirements. Angle-of-attack command loops were provided for either constant or modulated automatic control by the energy management guidance system. Safety constraints during re-entry consisted of



(1) temperature sensors located at critical nose, wing, and vertical fin leading edges; (2) g accelerometers; and (3) q sensors for high speed flight at lower altitudes. Structural mode/flight control interactions can be anticipated to be one of the critical design problems of the Space Shuttle as it has been for all other large flexible vehicles. Best estimates of the structural mode dynamics should be included in the flight control design from its inception. Since wing loading can be anticipated to be a limiting design factor, full advantage of active maneuver load control techniques such as were developed by LAMS and for large booster controls should be applied to minimize structural weight and to alleviate affects of gusts, aerothermalelastic deformations, and fuel sloshing. Flight control system/vehicle bandwidth selection represents a critical design parameter as it has significant impact on the design of the digital computation solution rates, multiplexing techniques, actuators, and sensor designs. The closed-loop bandwidth initially selected should be sufficiently broad to provide stability augmentation, gust alleviation, and active structural mode control. Bandwidth can easily be reduced but it is very difficult to increase bandwidth once actuator designs have been frozen. Iterative vehicle configuration/flight control design variations should be investigated to achieve the optimum combinations.

In the lateral-directional axis, some of the orbiter configurations are characterized by statically unstable directional characteristics and also relatively low rudder effectiveness during hypersonic flight due to blanketing of the center line fin at high angles of attack. Characteristically, delta re-entry vehicles have exhibited large adverse yaw characteristics due to aileron displacements and inertial cross-axis coupling terms.

Directional controls in hypersonic flight will be strongly dependent upon large reaction controls. Roll attitude control can be provided by a blend of aerodynamic and reaction controls. Decoupling of the roll-yaw

interactions and blending of the aerodynamic and reaction controls can readily be accomplished by the fly-by-wire control system, but the specific control laws to be implemented in the lateral-directional control axes represent sizable design challenges. Stability of the lateral-directional control will be a strong function of angle of attack and may be a limiting factor at certain Mach numbers. Tight sideslip control is essential throughout the flight envelope.

Primary flight control actuators will represent a sizable design problem due to (1) the extremely large hinge moments required to drive the large control surfaces needed to generate adequate control moments, (2) stiffness constraints to avoid surface flutter, (3) minimization of weight, and (4) temperature constraints on the hydraulic fluid. It appears that considerably greater safety and reduced size actuators would result from the use of split surface flight controls. Redundancy could be carried through to the actual control surface. Monitoring and comparison of the split control surface displacement would ease failure detection. No single failure points should exist. Static and dynamic loads on each actuator would be lessened. Temperature loads on the actuators and hydraulic fluids caused by aerodynamic heating and internal working energy must be carefully analyzed. Temperature limits on conventional hydraulic fluids are being pressed to the extremes in conventional fighter aircraft.

Interface of the fly-by-wire controls with the primary actuators, accomplished either directly with redundant monitored servo-valves or by secondary actuators which in turn drive the valve, is important. Interface of the actuator with the multiplexed data base must be carefully analyzed. Small noise levels induced by the D/A units

can produce large instabilities within the actuator. Location of the electronics used in conjunction with actuator electrical feedback is a principal design problem as phase lags in coding and decoding signals around the closed loop can become excessive.

Flying quality criteria for designing the fly-by-wire flight control system for very large manned re-usable boosters and orbiters is lacking. Results published to date by Cornell Aeronautical Laboratory for the AFFDL (Ref. 10) concentrated on medium-to-high L/D lifting re-entry vehicles operating in final terminal flight at low supersonic, transonic, and subsonic speeds and were based on flight results of the M2-F2, HL-10, and X-24 class of smaller research vehicles. A working draft specification has been prepared. Current efforts are underway to extrapolate the specification requirements to larger vehicles such as the Space Shuttle. Development of the Total Inflight Simulator (TIFS), a turboprop C-131 aircraft modified by the addition of a separate simulation cockpit and equipped with a variable stability and control system (See Fig. 8), has been completed and is available to provide realistic shuttle flying quality investigations in the landing mode. However, flying qualities criteria for the ascent, orbital, entry, and transition phases of flight will be dependent upon extensive ground-based simulation programs being sponsored by NASA Ames and Marshall Space Flight Center.

#### 4. Conclusions

Compound, multi-mode, flight control requirements for the Space Shuttle Booster/Orbiter (having considerable flexibility to accommodate (1) variations in mission requirements and payload configurations, (2) heavy demands for on-board self-test features to minimize launch and turn-around time for the re-usable vehicles, and (3) integration of guidance, control, and thrust vector functions) effectively dictate use of digital multiprocessors and

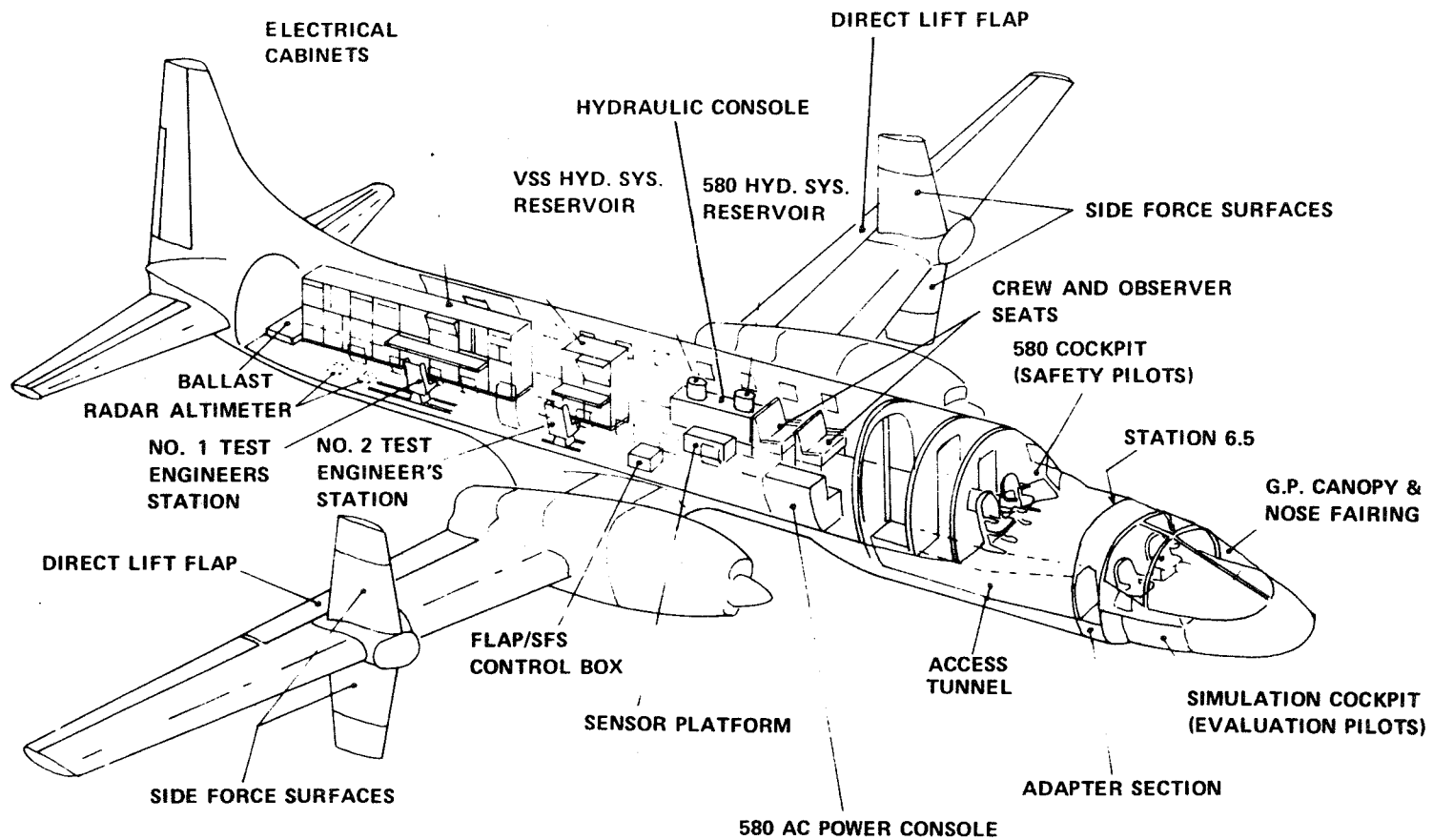

Fig. 8 - Total In-Flight Simulator (TIFS) Configuration

fly-by-wire flight control techniques. Major questions exist as to use of integrated avionics having redundant central digital processors for all on-board computations vs dedicated digital computers for flight control and other functions vs digital processors for automatic control functions and built-in-test with redundant analog "hardened SAS" control loops for manual control. The critical question is not can central digital processors be implemented to satisfy all flight control requirements (they can), but rather are we willing to afford the cost and time for an advanced development program to solve the myriad of engineering problems of total digital flight control hardware and software which remain unanswered or even unknown to satisfy the safety and performance requirements for this application. The confidence level for applying digital automatic and primary flight controls to aeronautical vehicles is very low today due to lack of flight experience. Solutions can be found to these problems, but the Space Shuttle mission is far too critical to afford the numerous "debugging" flights typical of most aeronautical flight control systems. Thus, if digital processing is proposed for both automatic and manual flight control functions, an advanced development program to design, fabricate, and flight test evaluate a representative digital flight control hardware and software system on a large transport or bomber aircraft is warranted.

Other principal space shuttle flight control design problems anticipated are: (1) structural/control interactions; (2) aerodynamic stability variations and cross-axis coupling effects with angle of attack and limited aerodynamic control margins and effectiveness at certain flight conditions; (3) flight control actuator power, redundancy, and temperature limitations; (4) avoidance of single-fail points in redundant channels; and (5) lack of flying qualities design criteria applicable to large vehicles for ascent, entry, transition, and landing.

#### REFERENCES

1. "Flight Control Design Studies, Phase B", McDonnell/Douglas/Martin-Marietta Team. Set of papers presented at SAE Aerospace Vehicle Flight Control Systems Committee, Grand Junction, Colorado. 17-19 March 1971.
2. Sethre, V. C., R. V. Hupp and G. A. Rayburn. Design and Evaluation of a Single Axis Redundant Fly-by-Wire System. AFFDL-TR-68-81, Air Force Flight Dynamics Laboratory, Wright-Patterson AFB, Ohio. July 1968.
3. Miller, F. L. and J. E. Emfinger. Fly-by-Wire Techniques. AFFDL-TR-67-53, Air Force Flight Dynamics Laboratory, Wright-Patterson AFB, Ohio. July 1967.
4. Jenney, G. D. JB-47E Fly-by-Wire Flight Test Program. AFFDL-TR-69-40 Air Force Flight Dynamics Laboratory, Wright-Patterson AFB, Ohio. September 1969.
5. Jenney, G. D. Fly-by-Wire B-47 Phases II and III. AFFDL-TR-69-119, Vol II, Air Force Flight Dynamics Laboratory, Wright-Patterson AFB, Ohio. August 1970.
6. Burris, P. M. and M. A. Bender. Aircraft Load Alleviation and Mode Stabilization (LAMS). AFFDL-TR-68-158, Air Force Flight Dynamics Laboratory, Wright-Patterson AFB, Ohio. April 1969.
7. Boeing Co., "Electrical Interconnections for Fly-by-Wire Flight Control Systems." AFFDL-TR-70-134 Air Force Flight Dynamics Laboratory, Wright-Patterson AFB, Ohio. December 1970.
8. Mrazek, J. G., R. O. Roberts, and D. H. Daggett. Research into the Definition and Demonstration of an Optimum Solid State Switching and Multiplexing System for use in a Fly-by-Wire Flight Control System. AFFDL-TR-70-80 Air Force Flight Dynamics Laboratory, Wright-Patterson AFB, Ohio. June 1970.
9. Laflamme, H. A., Report on the FDL-7 Simulation Studies, Phase I. AFFDL-TM-69-7. (Phase II and III reports being published) Air Force Flight Dynamics Laboratory, Wright-Patterson AFB, Ohio. September 1969.
10. Working Draft. Preliminary Handling Qualities Requirements for Medium-to-High Maneuvering Listing Re-entry Vehicles. Air Force Flight Dynamics Laboratory, Wright-Patterson AFB, Ohio. July 1970.

## **MULTIPLE IMU USAGE IN SSV**

## INTRODUCTION

### FUNCTIONS AND REQUIREMENTS

#### BACKGROUND

#### CONFIGURATIONS

#### TECHNOLOGY TASKS

#### STUDIES

#### ACTIVITY

## FUNCTIONS AND REQUIREMENTS

### FUNCTIONS OF THE INS

- PROVIDE VEHICLE VELOCITY AND POSITION DATA
- PROVIDE VEHICLE ATTITUDE AND ATTITUDE RATE

### REQUIREMENTS FOR THE INS

- FAIL OPERATIONAL/FAIL OPERATIONAL/FAIL SAFE
- SHALL NOT RESTRICT VEHICLE ATTITUDE
- SHALL NOT RESTRICT LAUNCH AZIMUTH

### DESIGN OBJECTIVES FOR THE INS

- COMPUTER CONTROLLED ON-BOARD CHECKOUT
- GOOD MAINTAINABILITY
- HIGH RELIABILITY

## BACKGROUND

### AIRCRAFT

- BOEING 747
- DC-10
- L-1011
- CONCORDE
- BOEING 2707
- ASST

### OTHER

## CONFIGURATIONS

### CANDIDATE CONFIGURATIONS

- STRAPDOWN
  - REDUNDANT IMU'S
  - REDUNDANT SENSOR IMU'S
- GIMBAL
  - REDUNDANT SENSOR IMU
  - REDUNDANT IMU'S

### RECOMMENDED CONFIGURATION

- FOUR - 4 GIMBAL IMU'S



## TECHNOLOGY TASKS

### ON-BOARD CHECKOUT

- PRE-FLIGHT
- IN-FLIGHT
- POST-FLIGHT

## TECHNOLOGY TASKS (CONT'D)

### FAILURE DETECTION AND ISOLATION

- BITE (CENTRAL-DEDICATED)
- OUTPUT COMPARISON
- COMBINATIONS

### REDUNDANCY MANAGEMENT

- COMBINED OUTPUT
- INDIVIDUAL OUTPUTS

## SUPPORTING STUDIES

ON-BOARD CHECKOUT  
IMU AND SENSOR ORIENTATION  
FAILURE DETECTION AND ISOLATION  
REDUNDANCY MANAGEMENT  
IMU LOCATIONS  
CREW INTERACTION  
CALIBRATION AND ALIGNMENT  
GIMBAL FLIP

## CURRENT MSFC ACTIVITY

### SPONSORING STUDY PROGRAM TO DEFINE

- ON-BOARD CHECKOUT SYSTEM
- FAILURE DETECTION-ISOLATION APPROACH
- REDUNDANCY MANAGEMENT SCHEME
- EXPERIMENTAL TEST PHASE

A SURVEY OF SHUTTLE CONTROL PROBLEMS

C.R. Stone and T.W. Chase

Honeywell Inc.  
St. Paul, Minnesota

## FOREWORD

This paper is an abridgement of "Development of Control Systems for Space Shuttle Vehicles" prepared under Contract No. NAS8-25181 for the George C. Marshall Space Flight Center.

The contract was conducted under the direction of Mr. John L. Livingston of the Aero-Astro Ballistics Laboratory of the MSFC.

The report was authored by Messrs. C.R. Stone, T.W. Chase, Milton W. Reed, E.D. Skelley and M.D. Ward; Mrs. B.M. Kiziloz; and Dr. G. Stein. Work was performed at the Systems and Research Center of Honeywell, Inc., in Minneapolis, Minnesota.

Data for the North American 130G, 134C and 134D orbiters were used without restriction by permission of Mr. A.B. Kehlet of the North American Rockwell Corporation.

## INTRODUCTION

The table on the following two pages summarizes the results of "Development of Control Systems for Space Shuttle Vehicles". The table is too detailed for use during the oral presentation. Work that led to entries in the table is discussed.

Control Requirements Summary

Flight Regime	Problem	Cause	Solution	Remarks
Pitch Launch	Trim gimbals requirements (up to $\pm 5.5$ deg)	Depth-wise center-of-gravity travel	Mount orbiter more forward; increase booster/orbiter mass ratio; reshape trajectory	Up to $\pm 5$ deg to track center of gravity  Trajectory shaping may have adverse side effects.
	Perturbation gimbals requirements (up to $\pm 6$ deg)	Aerodynamic forces	Change booster to orbiter to cant angle; tailor booster and/or orbiter aerodynamics	Up to $\pm 4.5$ to compensate for aerodynamics.
		Winds	Control; trajectory shaping; vehicle design	For a statically stable vehicle (which most shuttle configurations appear to be) perturbation gimbals requirements can be required to $\pm 1.5$ deg.
		Inflight loads	Winds	Control
Terminal drift	Winds	Control	There is a modest increase in inflight loads as terminal dispersions are reduced from 19,000 ft to 4,000 ft.	
Lateral Launch	Roll gimbals requirements (up to $\pm 15$ deg)	Side winds and rolling moment due to sideslip	Control  Allow the vehicle to roll to large angles so the wind is resolved into the pitch plane  Use ailerons  Change gimbals slewing arrangement  Trajectory shaping  Change booster and/or orbiter dihedral; provide more gimbals deflection; increase booster base area	It is believed better control can reduce this to $\pm 5$ deg. Some roll gimbals slewing arrangements increase pitch gimbals requirements.  Pilots may object to the large roll angles. It may reduce overall control capabilities because of analytical difficulties. Controller complexity is increased.  Aerodynamicists are having difficulties in developing ailerons that are effective in the high-dynamic pressure transonic regime where they are required.  Effectiveness of this potential solution is not known.  Potential side effects may be adverse. It will only be effective for those configurations using swept-back wings.  $C_{L_0}$ can be made zero at a particular point on the trajectory. It is a strong function of the center of gravity, so this reduces rather than eliminates the difficulty. Changing dihedral will have adverse effects in other flight regimes. The decision to provide only $\pm 7$ deg has been made. This will increase roll effectiveness by increasing gimbals moment arms. The drag increase would decrease orbital payloads.
	Yaw gimbals requirements (up to $\pm 6$ deg)	Side winds	Control  Vehicle design	It is believed better control can reduce these requirements to $\pm 3$ deg.  Increasing directional stability would decrease yaw gimbals requirements.

	Inflight loads	Side winds	Control	Loads are demonstrated to be sensitive to control policy. It is believed improvements of excellent control over good control would be similar to that achieved for pitch control.
	Terminal drift	Side winds	Control	This is not a significant problem.
Orbiter Injection	None			
Orbiter Pad Abort	Collision-free launch	Clearances between booster and launch tower in winds	Nose thruster, orbiter tilt	Weight penalties of additional force procedures; mechanical problems in achieving tilt.
Orbiter Inflight Abort	Control	Increase inflight envelope	Not fully resolved	Provision for inflight abort of the orbiter has major implications on the orbiter control and guidance. Problems appear to be resolvable without major revisions of the vehicles or their control, but detailed investigations are necessary. Section V of this report examines some of the problems and presents some solutions.
Orbiter Entry	ACPS fuel consumption	Directional stability of single vertical-tailed orbiters	Control  Vehicle design	Guidance demands are small. Controls must be designed to meet minimal requirements to avoid wasting propellant.  The twin vertical-tailed orbiters can rely on aerodynamics. They appear to be currently unpopular because of large hinge moments at high-dynamic pressures.
Orbiter Subsonic Flight	None			Unaugmented airframes have inherently good handling characteristics. Control augmentation to meet handling qualities specifications is minimal.
Unpowered Orbiter Landing				
"Spec" type	High landing speeds and large flight path angles	Small vehicle lift-drag ratio and compatibility for manual landing		All known efforts for landing fly a constant-speed approach on the "front side" of the power required curve. This provides the beneficial effects of inherent speed stability and large control power. The adverse effects are steep approach paths (above 10 deg), high approach speeds, and high landing speeds.
"Non-spec" type				
Reduced Roll Power	Manual flight in high winds not possible	Small control surface rate capabilities	Control	For the case of a delta-wing orbiter that is examined in Section VII, aileron and rudder rates can be reduced from 20 deg/sec and 6 deg/sec to 3 deg/sec and 3 deg/sec, respectively. It is believed these reductions imply large increases in orbital payload.
Shallow Approaches	Manual flight would be difficult	Pilot has to control both height and speed	Control	Approach would be at 3 deg and be compatible with conventional ILS equipment. Approach initiation speed would be very high. Touchdown speed would be close to stall. The lower landing speed would decrease braking requirements and increase orbital payload.

## OVERVIEW

The five statements present a succinct (though overly simplified) overview.

## OVERVIEW

NO PROBLEM IN LAUNCH PITCH CONTROL

LAUNCH ROLL GIMBAL EXCESSIVE

ABORT DESIGNS THE ORBITER TVC & ECS

NO PROBLEM IN SUBSONIC HANDLING

SPECIFICATIONS COST WEIGHT

## LAUNCH CONTROL

The MSFC Vehicle B Booster/Orbiter (circa January 1970) is used for the boost phase results presented. This shuttle has a gross takeoff weight of 3.5 million pounds. Control is achieved by vectoring the 13 rocket engines on the booster.

Time-varying perturbation control is considered. Pitch and lateral motions are assumed to be uncoupled.

The pitch axis is disturbed by Vaughan-Skelton winds normal to the flight path. The Vaughan-Skelton winds are also used as side disturbances. For rolling gusts the NASA specification\* wind of the Dryden form is used with a scale length of 1750 ft. and of the same magnitude as for the Vaughan-Skelton wind. The effects of rolling gusts are negligible.

The Vaughan-Skelton wind is made up of mean and random components. The mean wind is taken to be the E-W component of the March wind at Cape Canaveral as tabulated by Vaughan\*\*. Random winds are generated by Skelton's \*\*\* time-varying second-order differential equation model of the "Dryden" form that fits Vaughan's covariance data.

---

\* Staff of the NASA Flight Research Center, "Preliminary Flying Qualities Specification for Space Shuttle Vehicles," January 28, 1970.

\*\* Vaughan, W.W., "Interlevel and Intralevel Correlations of Wind Components for Six Geographic Locations," NASA TN D-501, December 1960.

\*\*\* Skelton, G.B. et al, "Design of a Load Relief System," Honeywell Final Report 12013-FR1 prepared under Contract NAS8-20155 to the George C. Marshall Space Flight Center, May 9, 1966.

# MSFC SHUTTLE VEHICLE B

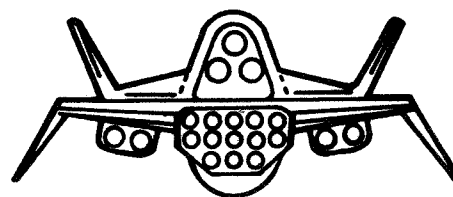
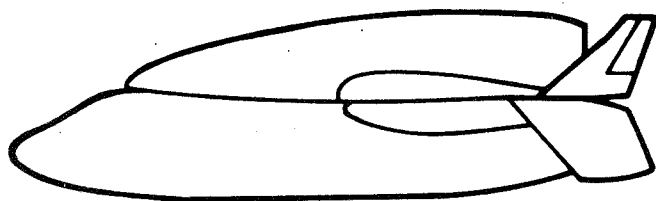
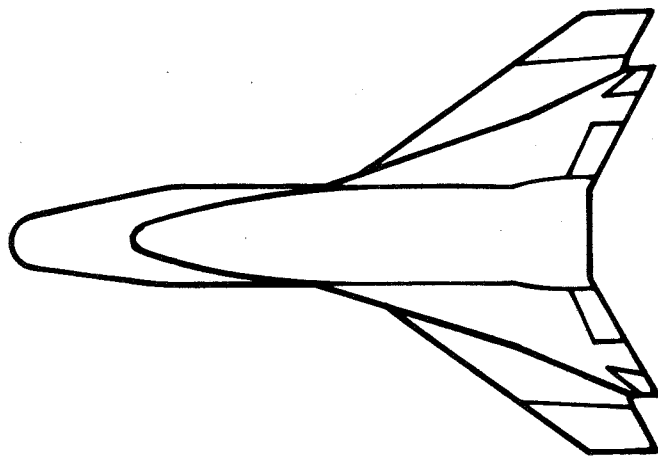



## LAUNCH PITCH CONTROL

Evaluation of nine pitch controllers is presented. Seven of these controllers were synthesized by use of conventional control techniques (guided by experiences with control of Saturn class vehicles), and two were subsequently developed from quadratic control theory.

Single sample analog simulations were performed for the seven conventional controllers. This was accomplished by generating a "synthetic wind" by simulating the Vaughan-Skelton differential equations. Samples of the random wind and the mean wind were stored on magnetic tape.

Covariance analyses on all nine controllers were performed.

The figure shows the maximum perturbation values of  $n_{IT}$  (normal acceleration at the pilot's seat),  $\bar{q}$ ,  $\alpha$ , and  $\delta$  (gimbal deflection).

Normal acceleration at the pilot's seat is insignificant. Vectorial addition with the axial boost acceleration does not significantly change the pilot's acceleration.

For  $\bar{q}$ ,  $\alpha$  and  $\delta$  the covariance results are always more severe than those obtained from the single-sample analog simulation. This was unexpected because the one sigma single-sample wind has a  $3\sigma$  peak near maximum  $\bar{q}$ .

Comparative performance of the conventional controllers shows generally the same trend characteristics as determined by simulation and covariance analyses. The result for  $\bar{q}$ ,  $\alpha$  for the  $\bar{q}$ ,  $\alpha$  controller is one of the exceptions.

Maximum allowables for the responses of the vehicle were not known. The quadratic controllers were synthesized to reduce all inflight responses uniformly. The 15th iteration quadratic achieves poorer inflight performance than the 13th because its terminal drift is lower.

# PITCH CONTROL PERTURBATION $n$ , $\bar{q}\alpha$ , AND $\delta$

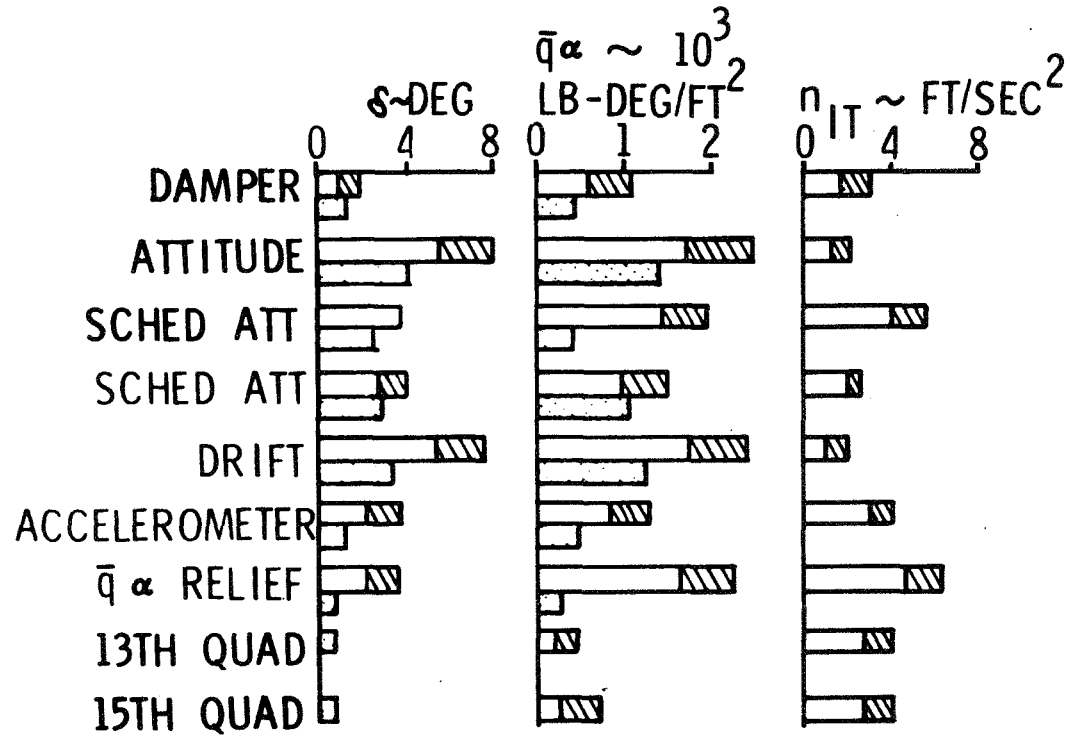

## LAUNCH PITCH CONTROL

Maximum bending moments at three body stations are shown. They generally display the same trend characteristics as for  $n_{IT}$  and  $\bar{q} \alpha$ . An exception is noted for the forward body bending moment. Here the quadratic controllers were only able to achieve a 25 percent reduction below that attained with the best conventional control.

# PITCH CONTROL BENDING MOMENTS

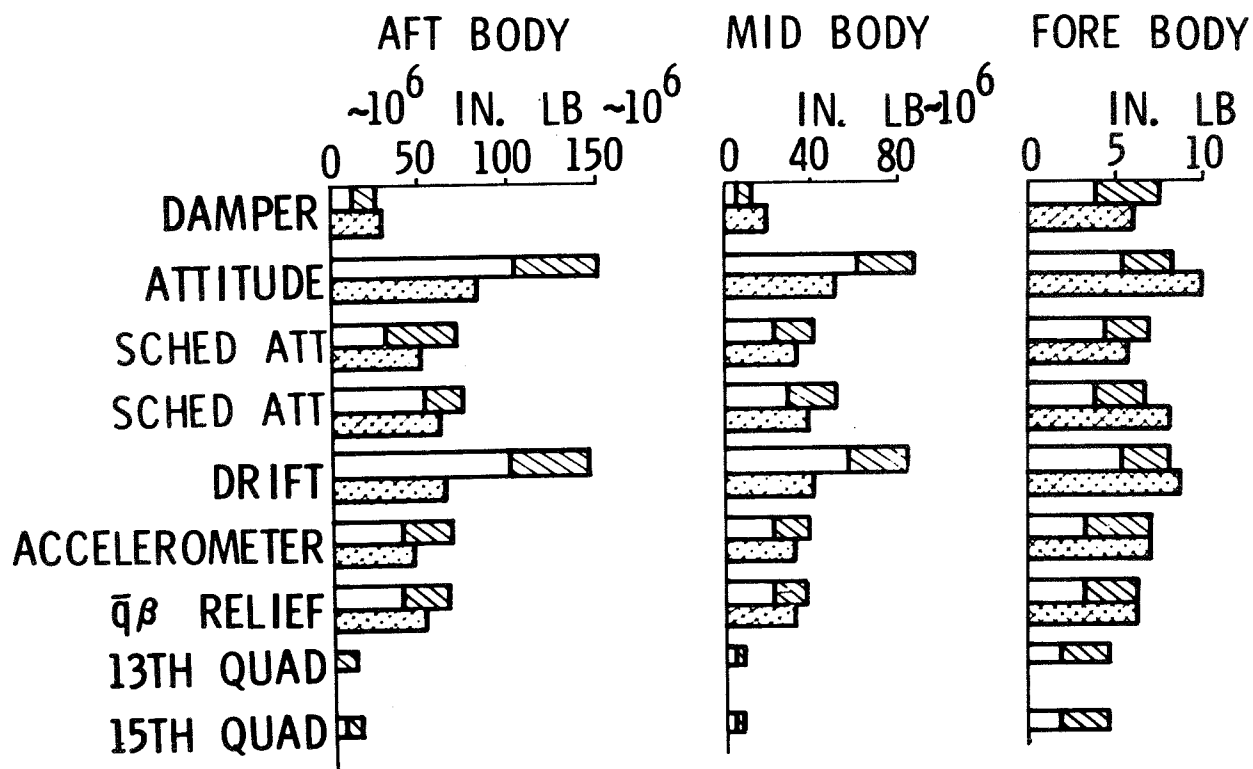

## LAUNCH PITCH CONTROL

Terminal drift is shown. Most noteworthy is the extremely low value achieved by the conventional minimum drift controller. Its drift feedback is  $3 \times 10^4$  larger than the maximum value used for the 13th iteration quadratic controller. This in part accounts for its poorer inflight performance. However, most of its poorer inflight performance is attributed to its use of the same inner loop feedback gains as are used in the pitch attitude controller.

We conclude the pitch control presentation with the observation that the perturbation  $\bar{q} \alpha$  can be maintained below 2200 deg-psf ( $|\mu| + 3\sigma$ ) with less than  $\pm 1.5$  deg. of gimbal. Inflight loads are selectively and collectively subject to reduction by good control techniques. Terminal drift ( $|\mu| + \sigma$ ) is reduced from 19,000 ft. to 4,000 ft. at the expense of inflight demands.

# PITCH CONTROL TERMINAL DRIFT

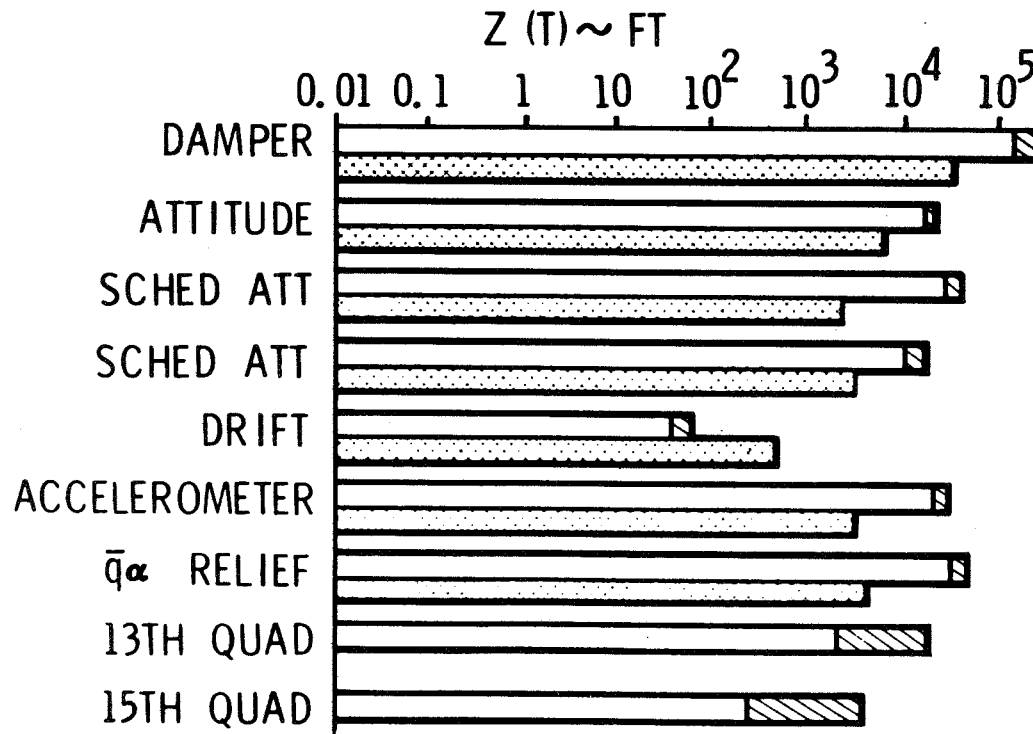

## LAUNCH LATERAL CONTROL

Evaluation of five conventional lateral axes controllers is presented. The roll axis control for all five employed the same roll rate and roll angle feedbacks.

The roll gimbal deflection ( $\hat{\alpha}_p$ ) and the yaw gimbal deflection ( $\hat{\alpha}_r$ ) generate uncoupled roll and yaw torques, respectively.

Single-sample analog simulations and covariance analyses are performed on all controllers. Results for gimbal requirements are shown on the accompanying figure. Comparative performance shows generally the same trend characteristics as determined by simulation and covariance analyses. The result for yaw gimbal requirement for the  $\bar{q} \beta$  is an exception. Covariance results are again more severe than those obtained from analog simulations.

Yaw gimbal requirements are marginally acceptable. They can be met with less than 7 deg. of gimbal.

Roll gimbal requirements are excessive. Even with mean wind biasing on the drift controller, the  $3 \sigma$  covariance result implies that  $\pm 13.5$  deg. are required.

Roll gimbal requirements are generated by the rolling moment due to sideslip. It is believed (based on experience with the pitch axis) roll gimbal requirements can be reduced to  $\pm 5$  deg. The roll gimbal requirement can also be reduced by allowing the vehicle to roll.

# LATERAL LAUNCH CONTROL GIMBAL DEFLECTION

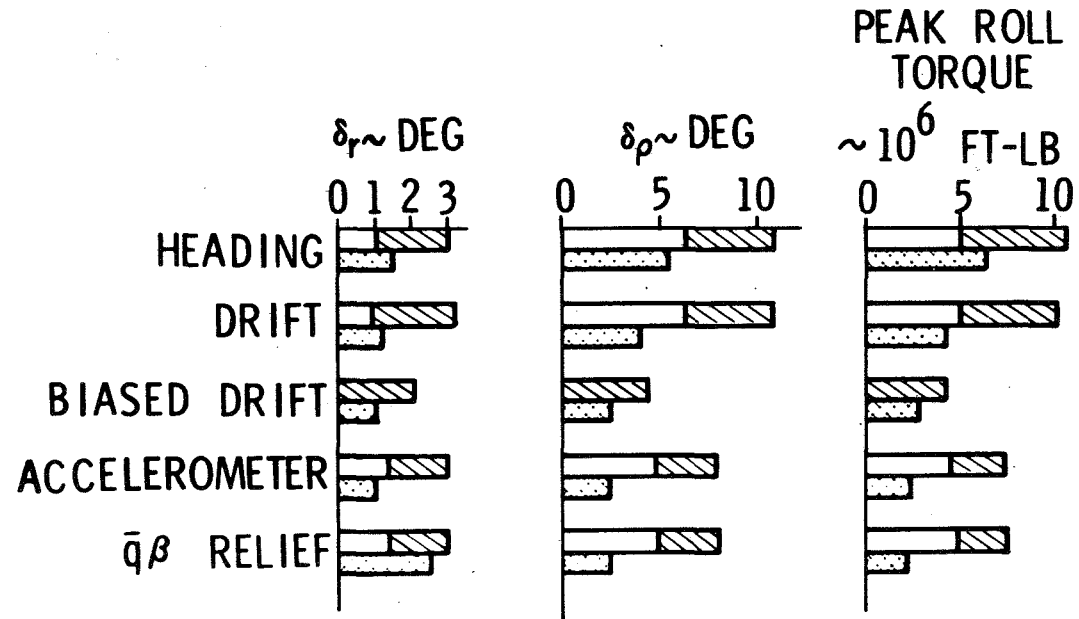



Inflight loads are shown. They are significantly affected by controller type.

## LATERAL LAUNCH CONTROL INFLIGHT LOADS

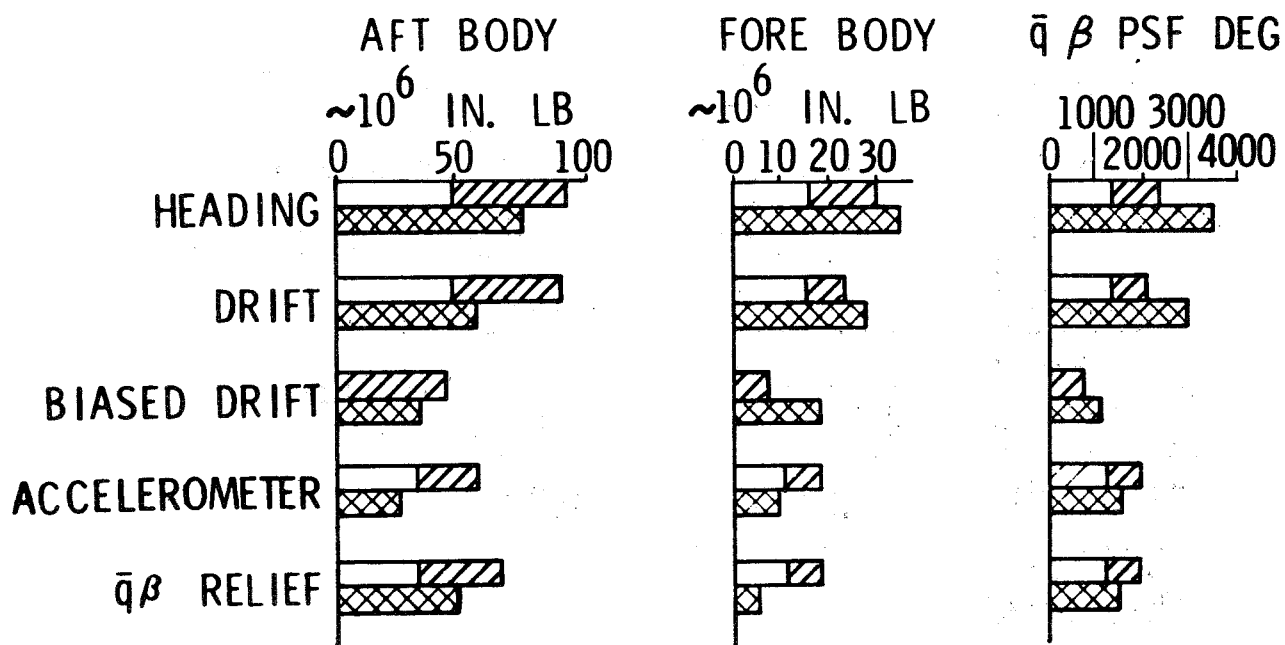

Terminal drifts are shown. They are acceptably small for all controllers.

We conclude that lateral drift requirements are easily achieved. The maximum value of  $\bar{q}\beta$  can be maintained within 2100 deg-psf. For the controllers analyzed, yaw gimbal requirements are marginal and roll gimbal requirements are excessive. It is conjectured gimbal requirements can be reduced markedly with better control.

## LATERAL LAUNCH CONTROL TERMINAL DRIFT

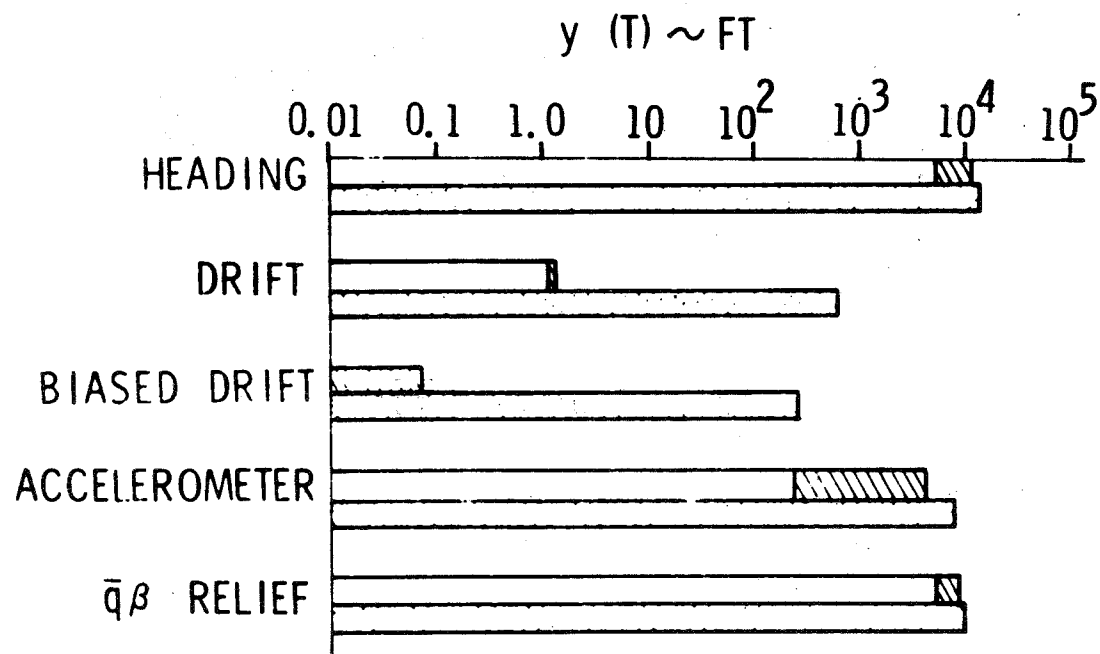

### THREE-ENGINE ORBITER INJECTION

A linear fixed-gain thrust vector controller was designed. It utilizes angular rate and angular displacement feedbacks about each axis. Adequate stability is achieved throughout the nominal injection flight envelope and at reduced power levels (including engine out).

### THREE-ENGINE ORBITER

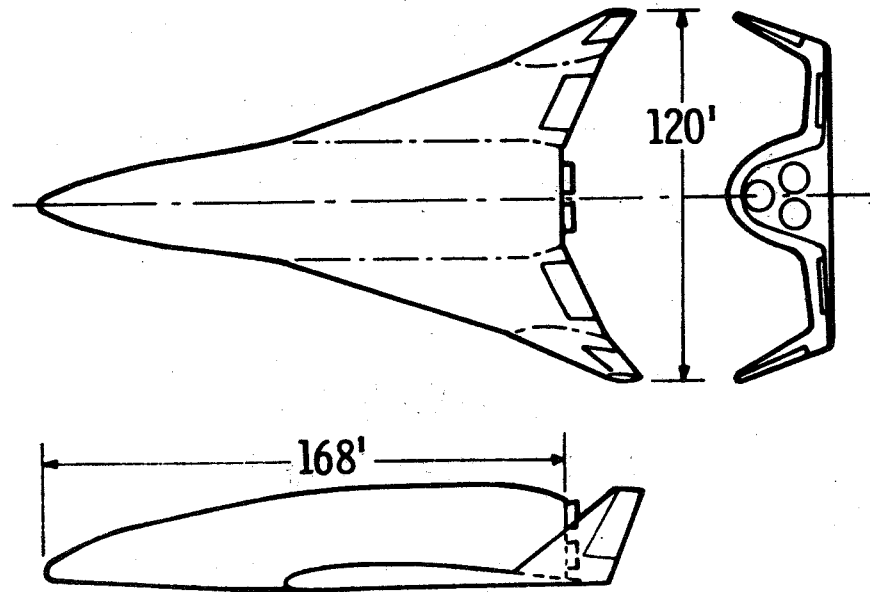

## TWO-ENGINE ORBITER INJECTION

Comments are identical to those for three-engine injection except that ACPS is required for roll control with an engine out.

### NAR 134C ORBITER

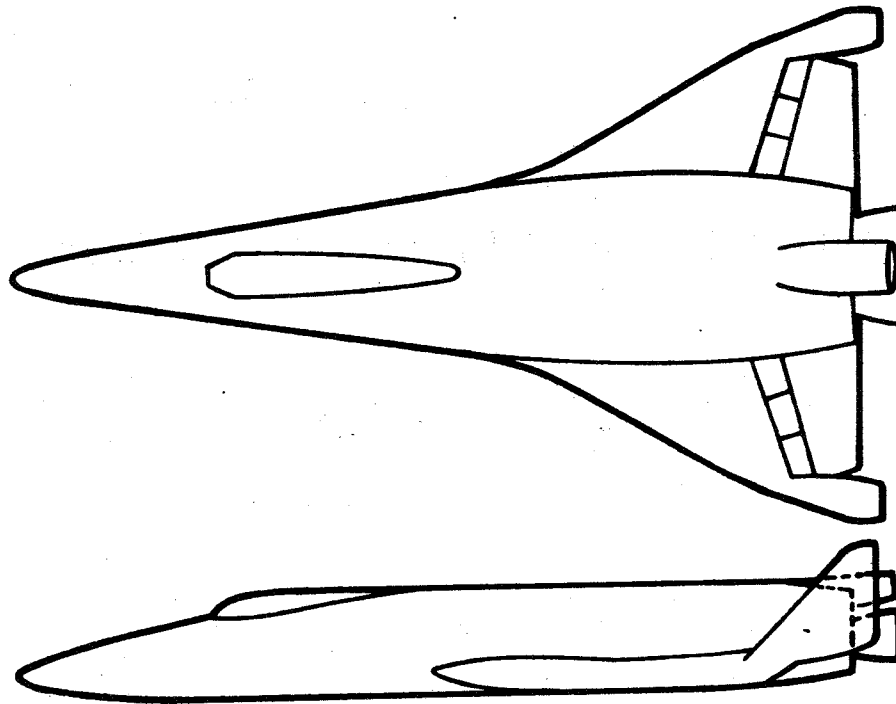

ENTRY CONTROL SYSTEM  
(NAR 134D SINGLE TAIL  $\Delta W_0$ )

Elevons are sufficiently effective that they can be used for pitch and roll control. The rudder is ineffective and the directional stability is negative. Hence, an attitude control propulsion system is used to generate yaw torques.

The control system is a conventional gain-scheduled system with command signal limiting. Linear switching with a deadband control of the yaw ACPS is used.

**ENTRY CONTROL SYSTEM**  
**(SINGLE TAIL  $\Delta W_0$ )**

**AERODYNAMIC PITCH AND ROLL CONTROL**

**ACPS YAW CONTROL**

**GAIN SCHEDULED SYSTEM ( $\bar{q}$ , M)**

## ENTRY CONTROL

The sideslip must be maintained within a very small range because the directional stability is negative, the aileron yawing moments are adverse, and the yawing authority is limited. Sideslip is maintained within a small range by limiting maneuver rates through command signal limiting of aileron displacement.

## ENTRY CONTROL

### PROBLEM

KEEP  $|\beta| \leq 0.75$  DEG

$$C_{n\beta} < 0$$

$$C_{n\delta_a} > 0$$

### YAW AUTHORITY

ACPS FUEL

### SOLUTION

$|\delta_a| \leq 2.5$  DEG

DEADBAND

### REMARK

ACPS FUEL = 1350 LB

## ORBITER PAD ABORT

A collision free launch of the orbiter may be necessary to escape from an impending explosion of the booster. A 40 kt wind from the gantry side is assumed.

## ORBITER PAD ABORT

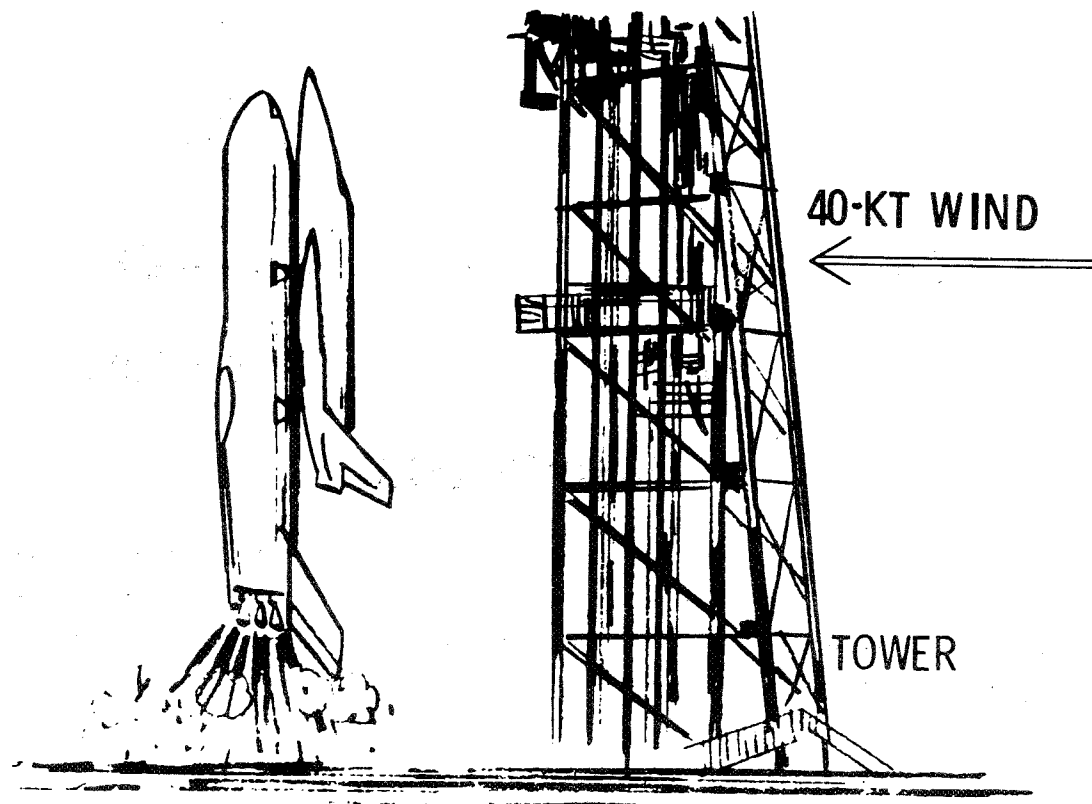

ORBITER PAD ABORT

Thrusters at the orbiter nose or orbiter tilt provide alternative methods for achieving collision free lift off the orbiter. Numerical values cited are for the NAR 134C or D delta wing orbiter and for the NAR 130G straight wing orbiter.

**ORBITER PAD ABORT  
SOLUTIONS**

MECHANISM	$\Delta$ WO	SWO
NOSE THRUST ~ LB	19,000	27,000
NOSE TILT ~ DEG	4.0	7.5



INFLIGHT ABORT  
(FOR THE NAR 1-4D SINGLE TAIL, TWIN-ENGINE ΔWO)

Inflight abort of the orbiter increases the size of the flight envelope over which the vehicle is required to operate. Thrust vector control is required over a much larger flight envelope than for nominal injection, and the entry flight regime is increased.

The consequence is the requirement that the control system be effective over a larger range of vehicle parameters and for more demanding input commands. Abort considerations influence the design of both the thrust vector control system for injection and the entry control system (ECS).

Satisfactory control during abort is achieved by modification to the TVC and ECS, by tailoring guidance commands, by fuel tank sequencing, and by providing additional fuel tank baffling.

The abort trajectory, on which these results are based, is indicated at 226,956 ft., at 10,308 fps, at 6 deg. flight path angle. Launch is to the northeast. The abort trajectory is for recovery in Canada. Two engines are operative for 142 sec. The orbiter then operates on single engine to 332 sec.

Satisfactory abort control was achieved with the control system described on the following page.

# INFLIGHT ABORT CONTROL

SIMULTANEOUS OPERATION OF

THRUST VECTOR CONTROL SYSTEM

ORBIT ROLL AND PITCH CONTROL SYSTEM

ENTRY CONTROL SYSTEM

NOMINAL TVC MODIFIED

POWER LEVEL GAIN ADJUSTMENTS

COMMAND SIGNAL LIMITING

ORBIT ROLL CTRL REQUIRED FOR SINGLE  
ENGINE TVC

## ABORT CONTROL

The system was simulated near the abort initiation point. Pitch and roll commands were applied. Limit cycles occurred because of actuator rate saturation at 10 deg/sec. Provision of the command signal limits shown below eliminated the limit cycles.

### ABORT CONTROL

PROBLEM: TVC LIMIT CYCLING WITH PITCH  
OR ROLL COMMANDS

CAUSE: ACTUATOR RATE SATURATION

CURE: COMMAND SIGNAL LIMITING

$$|q_c| \leq 2 \text{ DEG/SEC}$$

$$|p_c| \leq 5 \text{ DEG/SEC}$$

$$|r_c| \leq 4 \text{ DEG/SEC}$$

## ABORT CONTROL

Significant forces normal to the vehicle occur during early portions of the abort. These would not be present during nominal injection.

The normal forces present unusual fuel sloshing problems as is indicated on the following figure. More extensive tank baffling would probably provide a solution, but more extensive modeling and analysis are required.

### INFLIGHT ABORT

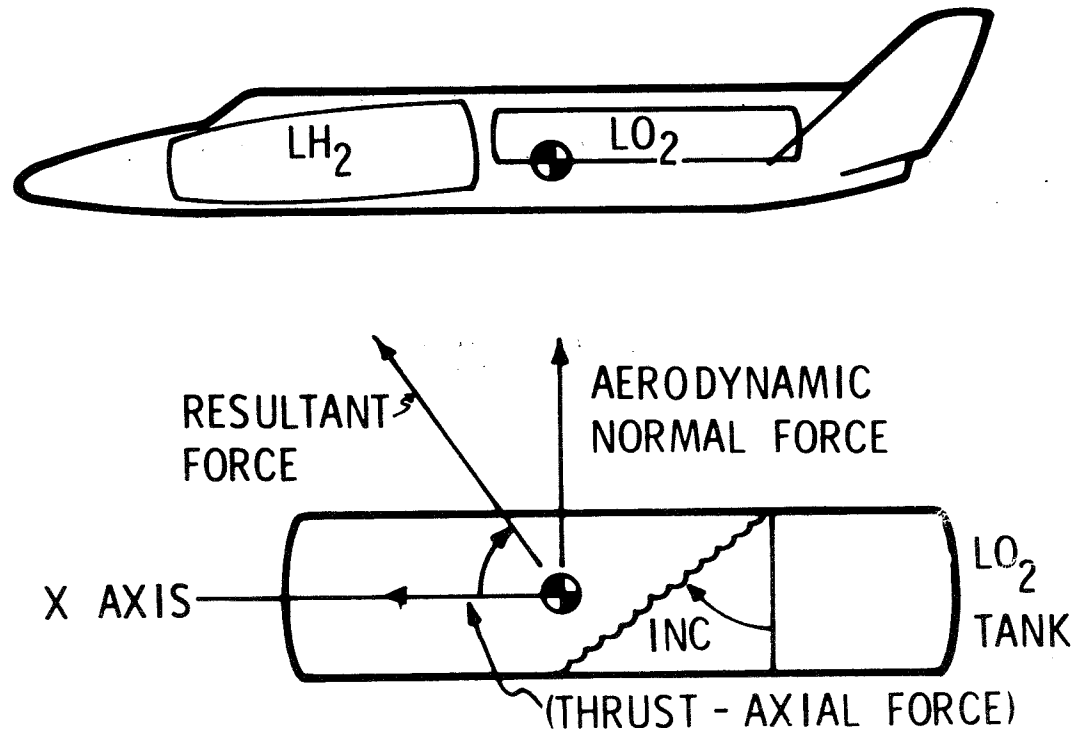

## ABORT CONTROL

For nominal operation the main and orbit propellants are used sequentially. This yields an aft c.g. location at the time the main propellant has been consumed. The problem outlined below occurs as a consequence.

## ABORT CONTROL

PROBLEM: THE ORBITER DIVERGED IN PITCH  
AT 240 SEC

CAUSE: AFT C.G.

CURE: CHANGE FROM SEQUENTIAL BURN  
OF MAIN AND ORBIT PROPELLANTS  
TO PARALLEL BURN

## ABORT CONTROL

The problem of transition from single engine thrust vector control to control with the entry control system is outlined below.

### ABORT CONTROL

PROBLEM: CONTROL AT SINGLE ENGINE  
BURNOUT AT 332 SEC

CAUSES: 5 DEG OF  $\beta$  DURING SINGLE ENGINE  
OPERATION  
0.75 OF  $\beta$  ECS CONTROL AUTHORITY

CURE: DECRAB AT BURNOUT

## ABORT CONTROL

Guidance commands were developed from point mass trajectories. Simultaneous pitch up and roll commands were called for at 715 sec. The orbiter diverged. Initiating a 15 sec. ramp pitch command at 700 sec. cured the divergence.

## ABORT CONTROL

PROBLEM: DIVERGENCE AT 715 SEC

CAUSE: SIMULTANEOUS PITCH AND ROLL  
COMMANDS

CURE: REVISE THE GUIDANCE COMMANDS

LATERAL HANDLING CAPABILITIES  
OF A STRAIGHT WING ORBITER

Data for the North American (NAR) 130G straight wing orbiter are used for this study. The 130G has

- a conventional rudder
- differential stabilizer operation (for ailerons)
- slow acting spoiler ailerons.

The basic (unaugmented) aircraft meets NASA specs with ailerons and rudder except for

- marginal roll rate oscillations from aileron commands at moderate dynamic pressure
- excessive proverse sideslip during moderate dynamic pressure flight
- marginal roll effectiveness at landing.

With control augmentation the aircraft meets level 1 requirements with ailerons and rudder. It meets level 3 requirements with spoilers and rudder.



# HANDLING CAPABILITIES NAR 130G STRAIGHT WING ORBITER

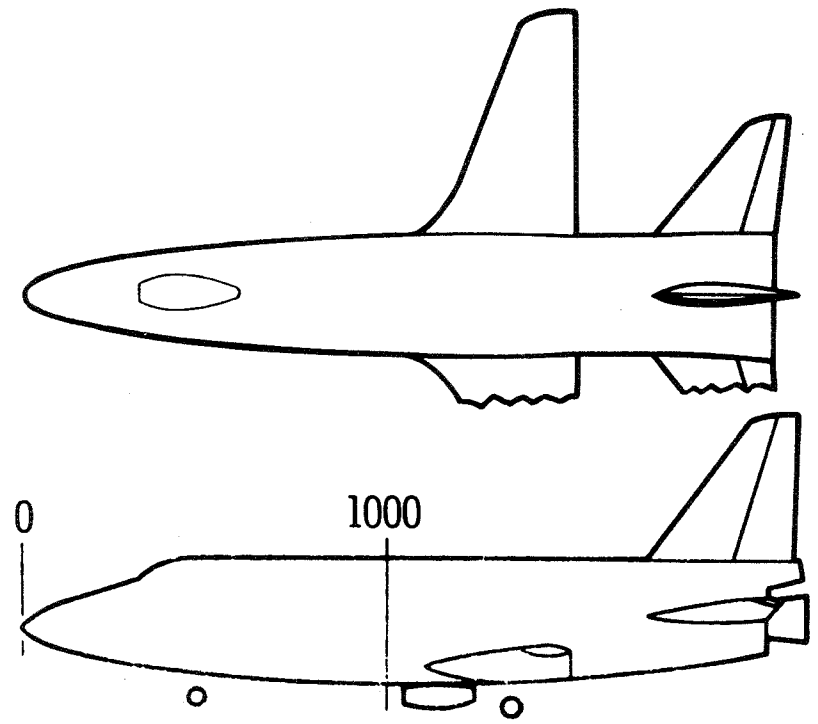

HANDLING CAPABILITIES  
BASIC AIRFRAME CHARACTERISTICS

FLT. CONDITION	MODERATE $\bar{q}$	LANDING
Mach	0.650	0.226
Speed ~ fps	574	252
Dynamic pressure ~ psf	287	75.5
Altitude ~ ft.	20,000	0

DEFICIENCIES ( $\delta_a \sim \delta_r$ )

Roll Rate Oscillations

Proverse Sideslip

Bank Angle Response

## BASIC AIRFRAME CHARACTERISTICS

SYMBOL	VALUE	REQUIREMENT	VALUE	REQUIREMENT
$\omega_d$	1.47	$> 0.4$	0.87	$\geq 0.4$
$\delta_d \omega_d$	0.56	$> 0.35$	0.46	$\geq 0.15$
$T_R$	0.36	$\leq 1.4$	0.90	$\leq 1.4$
$1/T_s$	0.0053	$> -0.035$	-0.012	$\geq -0.035$
$(\omega_\phi/\omega_d)^2$	1.29		0.83	
$\delta_\phi \omega_\phi - \delta_d \omega_d$	-0.18		-0.13	
$P_{osc}/P_{avg}$	0.067	$\leq 0.05$	0	$\leq 0.60$
$\Delta\beta/k$	9.6(PRO)	$\leq 2.0$	6.0(AD)	$\leq 10.0$
$\phi_t$	32° IN 1.5	$\geq 30^\circ$ IN 1.5	27° IN 2.5	$\geq 30^\circ$ IN 2.5

## HANDLING CAPABILITIES

The lateral response differential equations contain 11 free and independent parameters. NASA flying qualities specifications\* provide 11 independent requirements. Hence, an ideal aircraft response model can be defined.

By use of the specification, numerical values for the parameters are chosen to be

$$\omega_d = 1$$

$$\zeta_d \omega_d = 1$$

$$T_R = .75$$

$$1/T_s = 0$$

$$L_\beta = -2.5$$

$$(\omega_\phi/\omega_d)^2 = 1.$$

$$(\zeta_\phi \omega_\phi - \zeta_d \omega_d) = 0$$

$$\Delta\beta_{\max} = -.035$$

$$(p_m/c_a)_{ss} = -2.$$

$$(\beta_m/c_r)_{ss} = -.5$$

$$(p_m/c_r)_{ss} = -.2$$

These values are used to determine the coefficients in the ideal response model shown on the following page.

---

\*Staff of NASA Flight Research Center, "Preliminary Flying Qualities Specifications for Space Shuttle Vehicles," January 28, 1970.

## HANDLING CAPABILITIES

$$\frac{d}{dt} \begin{pmatrix} p_m \\ r_m \\ \beta_m \\ \varphi_m \end{pmatrix} = \begin{pmatrix} -1.33 & 1.55 & -2.50 & 0 \\ .0715 & -.468 & .752 & 0 \\ 0 & -1.0 & -.532 & .0715 \\ 1 & 0 & 0 & 0 \end{pmatrix} \begin{pmatrix} p_m \\ r_m \\ \beta_m \\ \varphi_m \end{pmatrix}$$

$$+ \begin{pmatrix} 1.39 & -2.66 \\ -0.5 & 0 \\ 0 & 0 \\ 0 & 0 \end{pmatrix} \begin{pmatrix} c_a \\ c_r \end{pmatrix}$$

## HANDLING CAPABILITIES

A model following controller is designed to enforce correspondence between the model response and the aircraft response. The block diagram is shown on the following page.

In principle, control gains could be determined by a number of methods. The method of Stein and Henke\* is used here and is found to be most efficient.

By using this procedure, a controller is designed, and it is established that level 1 requirements can be met with ailerons and rudder. Level 3 requirements can be met with spoilers and rudder.

---

\*Stein, Gunter and Henke, Allen H., "A Design Procedure and Handling-Quality Criteria for Lateral-Directional Flight Control Systems," Technical Report AFFDL-TR-70-152, Air Force Flight Dynamics Laboratory, February 1971.

# HANDLING CAPABILITIES HANDLING QUALITY CONTROLLER DESIGN

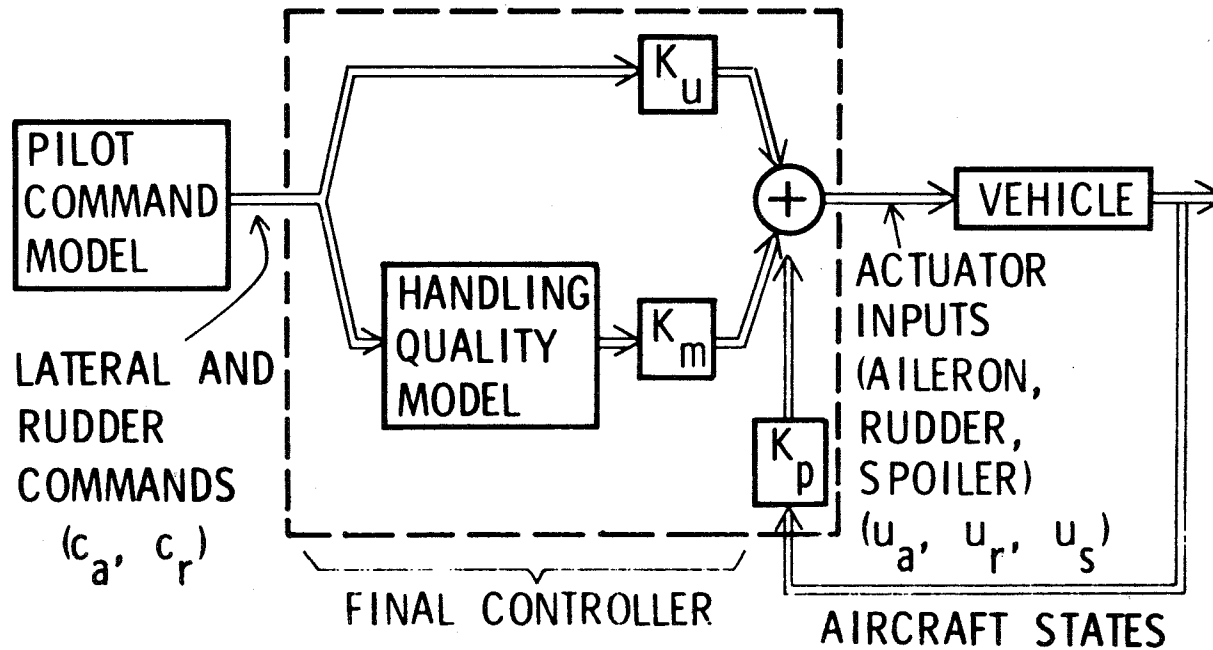

## ROLL POWER REQUIREMENTS

Smaller actuator rate capabilities are sought. Achievement would increase orbital payload by reducing the hydraulic power and weight.

Smaller actuator rate requirements would be achieved by designing to the intent rather than to the letter of NASA specifications. For landing, aileron rate requirements could be reduced from 20 deg/sec. to 3 deg/sec; rudder rate could be reduced from 6 deg/sec. to 3 deg/sec.

Surface rates are presently determined by the requirement for 30 deg. of roll in 2.5 sec. The intent of the specification is control in turbulence. With a good controller the NAR 134D orbiter at 172 kt and 600 ft. altitude in specification turbulence has rms dispersions in bank angle of 0.63 deg, heading of 0.80 deg, and lateral displacements of 2.0 ft. This demonstrates that the intent of the specification can be met with small rate capabilities cited.



# ROLL POWER NAR 134D DELTA WING ORBITER

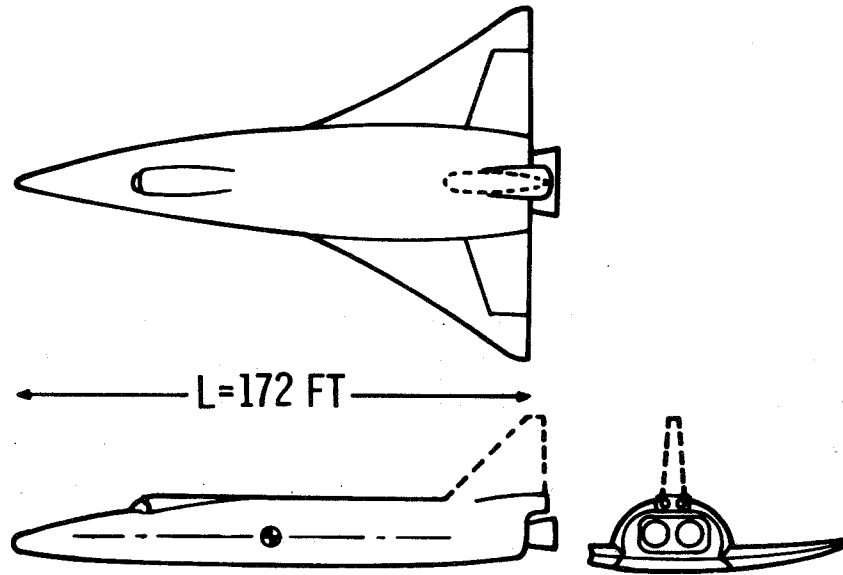

## ROLL POWER REQUIREMENTS

The controller used is of the low pass type. This assures that flexure modes will not be excited.

Open and closed loop pole positions for those poles that can be affected by control are shown.

## ROLL POWER CONTROL SYSTEM ROOTS

× OPEN LOOP

□ CLOSED LOOP

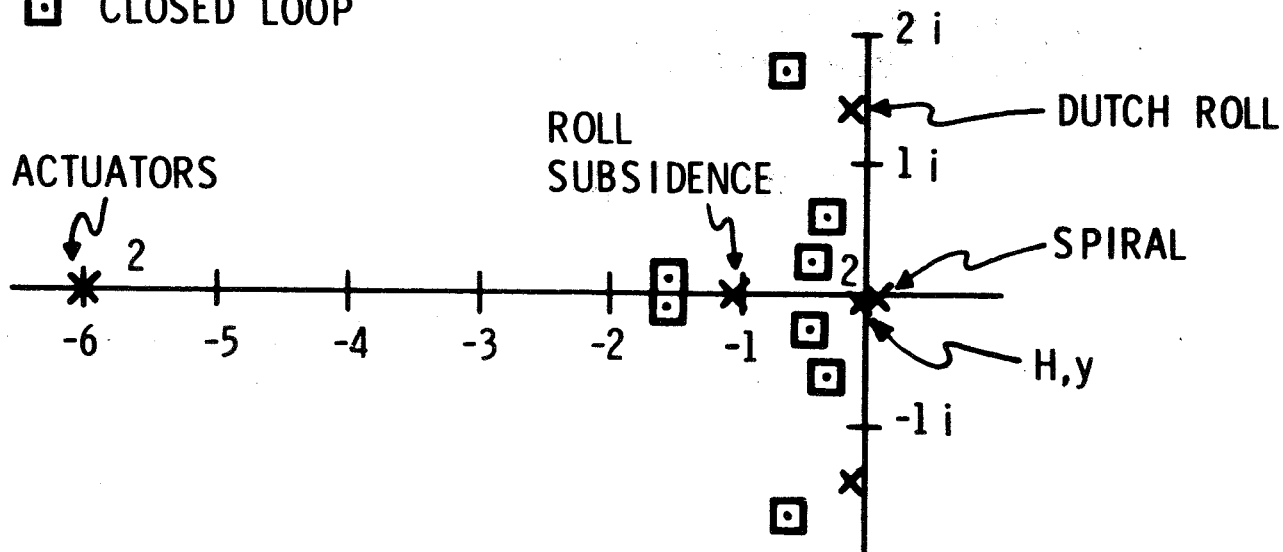

## ROLL POWER REQUIREMENTS

The left strip shows the sidestep response of the controller designed for control in turbulence. Response time is 6 sec.

Control in turbulence (with the magnitude of rolling turbulence at six times the specification value) without surface saturation limits is shown in the right strip. Maximum surface rates are below 6 deg/sec. Maximum values of lateral displacement (y), heading (H), and bank angle ( $\phi$ ) are below 7 ft, 3 deg, and 3 deg.

## ROLL POWER

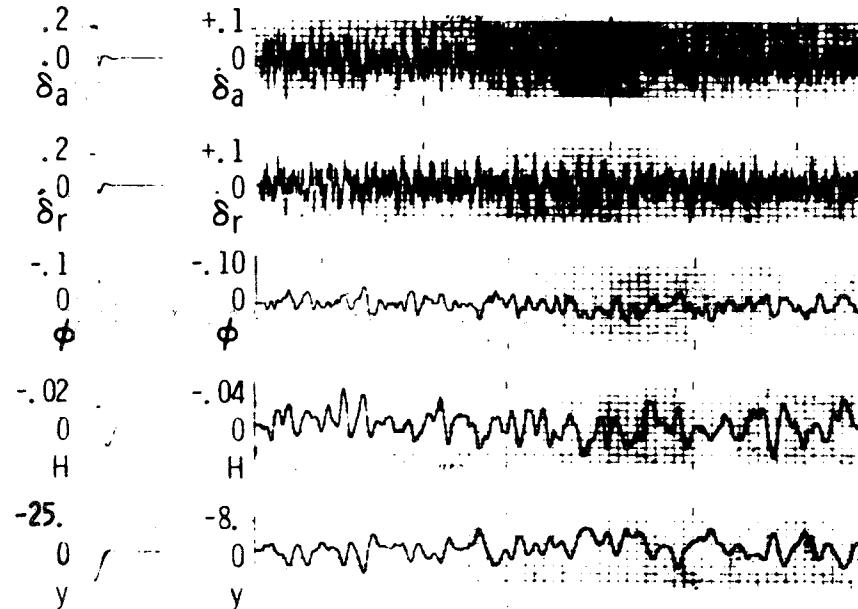

## ROLL POWER REQUIREMENTS

Control in turbulence with surface rate saturation limits of 2.86 deg/sec is shown. For 400 sec the aircraft is controlled with dispersions, only slightly larger than without saturation. At 400 sec. the system breaks into a limit cycle oscillation. With larger saturation limits the system is divergence free.

### ROLL POWER

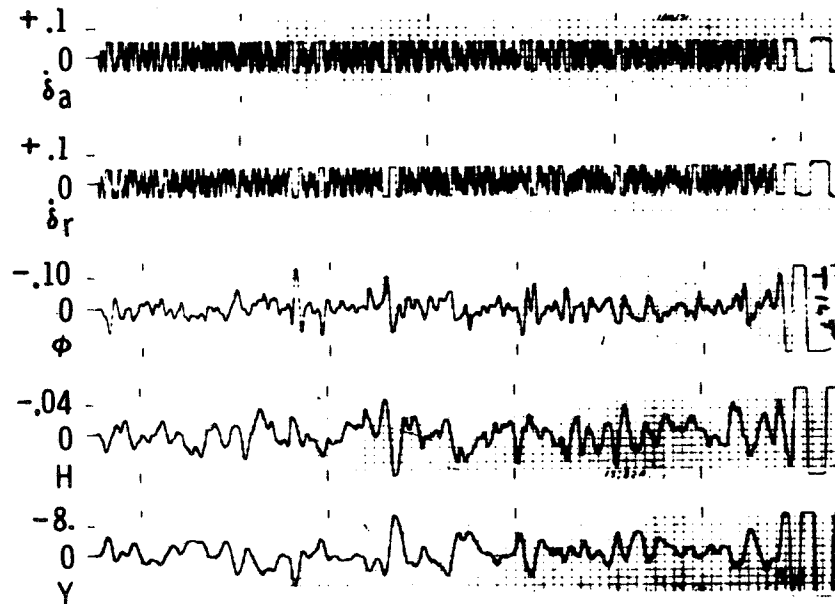



**DESIGN PRINCIPLES FOR A SPACE SHUTTLE DIGITAL AUTOPILOT**

**Richard Gran**

**Research Department  
Grumman Aerospace Corporation  
Bethpage, New York 11714**

## ABSTRACT

The synthesis of a digital autopilot for the Space Shuttle, in all phases of operation, can proceed in an orderly way of using the fundamental dynamic equations of motion. This approach uses many recent developments in the theory of control system synthesis. In particular, the theories of "Linear Optimal Control," "Optimal Linear Estimation," and "Pole Matching" are used to provide answers to some commonly asked questions. For example, one can answer the following:

- What is the sampling rate for the control system?
- What can be expected for the computation time?
- What is the simplest autopilot that will do the job?

The exposition attempts to exploit the relationship between the "modern" design approach and the classical design techniques of synthesis (i.e., pole-zero design, bode plot, and compensation techniques). Some of the features of the resulting autopilot are:

- Simplicity of Design - available design computer programs are used throughout. Trial and error design is eliminated.
- A systematic way of arriving at the sampling time is provided.
- The configuration that yields the minimum computation time is readily identified.
- Many different avenues for design simplification can be easily exploited.
- Sensitivity to parameter variations can be easily explored.

# DIGITAL CONTROL SYSTEM DESIGN

## 1. DESIGN PROBLEMS

- SAMPLING TIME
- CONTROL SYSTEM CONFIGURATION
- SYSTEM MODELLING ACCURACY
  - STATISTICS
  - DYNAMICS
- COMPUTATION OF CONTROL GAINS AND COMPENSATION

## 2. IMPLEMENTATION PROBLEMS

- MINIMIZATION OF COMPUTATION TIME
- MINIMIZATION OF STORAGE
- COMPUTER INTERFACE WITH CONTROL SURFACES



## SAMPLING TIME

One of the stumbling blocks to the appreciation of the capability of digital control systems has been the insistence upon sampling the environment at "twice the highest frequency" contained in the dynamics describing the environment. A stubborn application of this "rule of thumb" leads to unrealistically fast sampling times in situations that do not require them. Using this simple example, it can be seen why this "rule of thumb" is not necessary and, in fact, is really misleading.

## SAMPLING TIME

BASED ON THE SAMPLING THEOREM, A "RULE OF THUMB" HAS BEEN

"SAMPLING TIME SHOULD BE APPROX  $10/f_{MAX}$ "

IN PRACTICE ONE MAY SAMPLE MUCH SLOWER. THE REASON IS THAT THE SAMPLING THEOREM SPECIFIES THE MINIMUM INFORMATION ONE HAS TO HAVE TO RECONSTRUCT A SIGNAL FROM ITS SAMPLES. IN CONTROL PROBLEMS A GOOD MODEL OF THE SYSTEM EXISTS. THIS MODEL MAY BE USED TO EXTRAPOLATE FROM SAMPLE TO SAMPLE.

EXAMPLE:

SYSTEM MODEL:

$$\dot{x} + ax = au \quad \text{OR} \quad U(s) \rightarrow \boxed{\frac{a}{s+a}} \rightarrow X(s)$$

$u \equiv$  CONTROL  $a \equiv$  TIME CONSTANT  $x \equiv$  OUTPUT

FOR A KNOWN  $u(t)$  WE CAN SOLVE

$$x(t) = e^{-a(t-t_0)} x(t_0) + \int_{t_0}^t e^{-a(t-\tau)} u(\tau) d\tau$$

THE TRUE LIMITATION ON SAMPLING TIME IS OUR  
IMPRECISE KNOWLEDGE OF THE SYSTEM  
i.e. UNCERTAINTY

When the uncertainty in our knowledge of  $x(t)$  exceeds some value, - determined by the control system accuracy requirements - then a sample must be made to lower this uncertainty. The uncertainty in the state can be determined a priori by propagating the covariance matrix with initial value of zero, and the time when the elements of the matrix exceed some preselected value will determine the sampling time.

**THE TRUE LIMITATION ON SAMPLING TIME IS OUR IMPRECISE KNOWLEDGE OF THE SYSTEM  
i.e. UNCERTAINTY**

$$\dot{x} + ax = au + n_1 \quad (1)$$

$$y = mx + n_2 \quad (2)$$

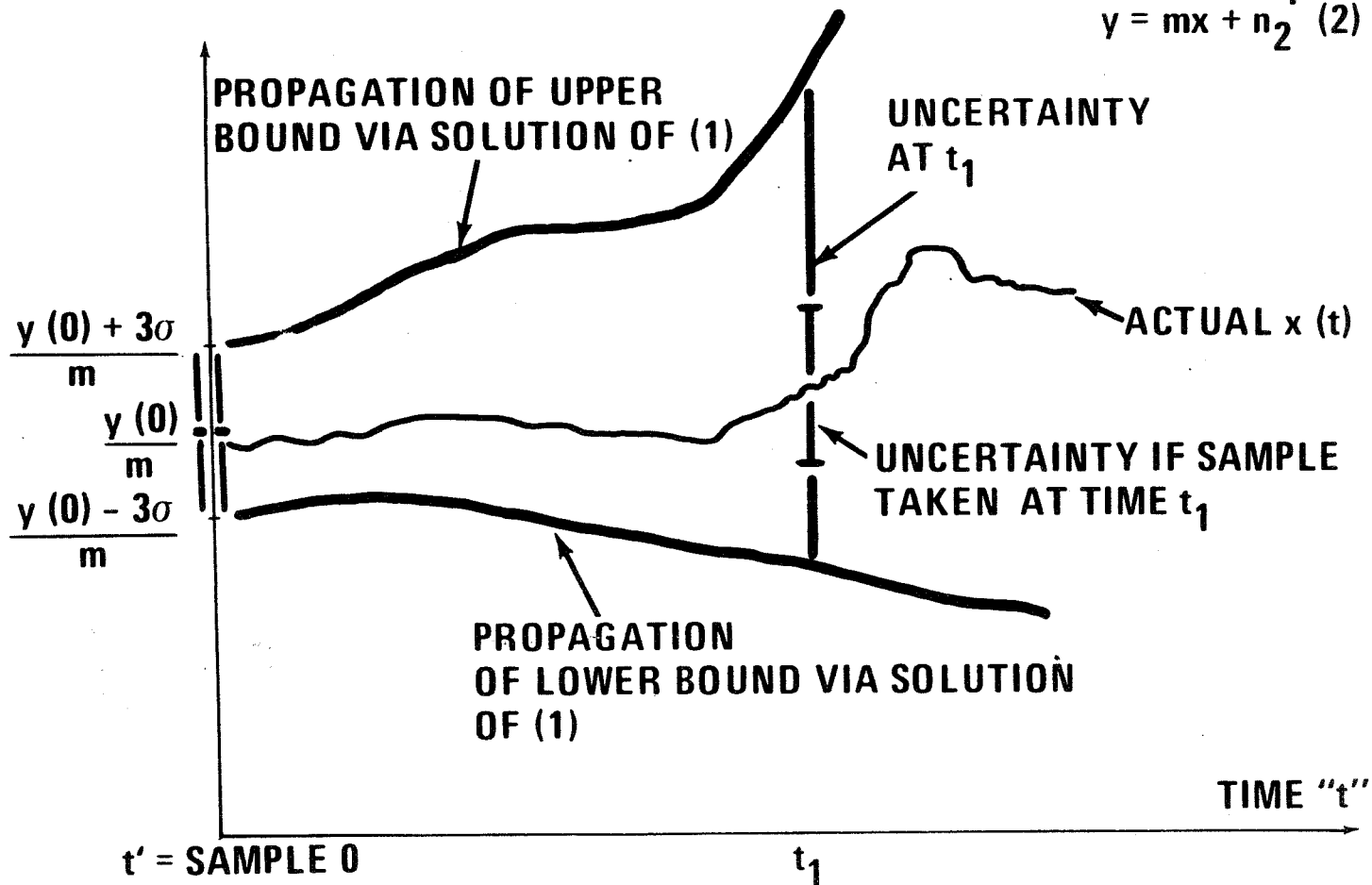

## CONTROL SYSTEM CONFIGURATION

The closed loop system configuration uses the "Separation Theorem". We assume the system is adequately described by linear dynamics, and design a Kalman Filter and an optimal control gain. The resulting block diagram is shown here. The noise  $n$ , may be a colored noise, in which case the filter is devised using an augmented state model.

## CONTROL SYSTEM CONFIGURATION

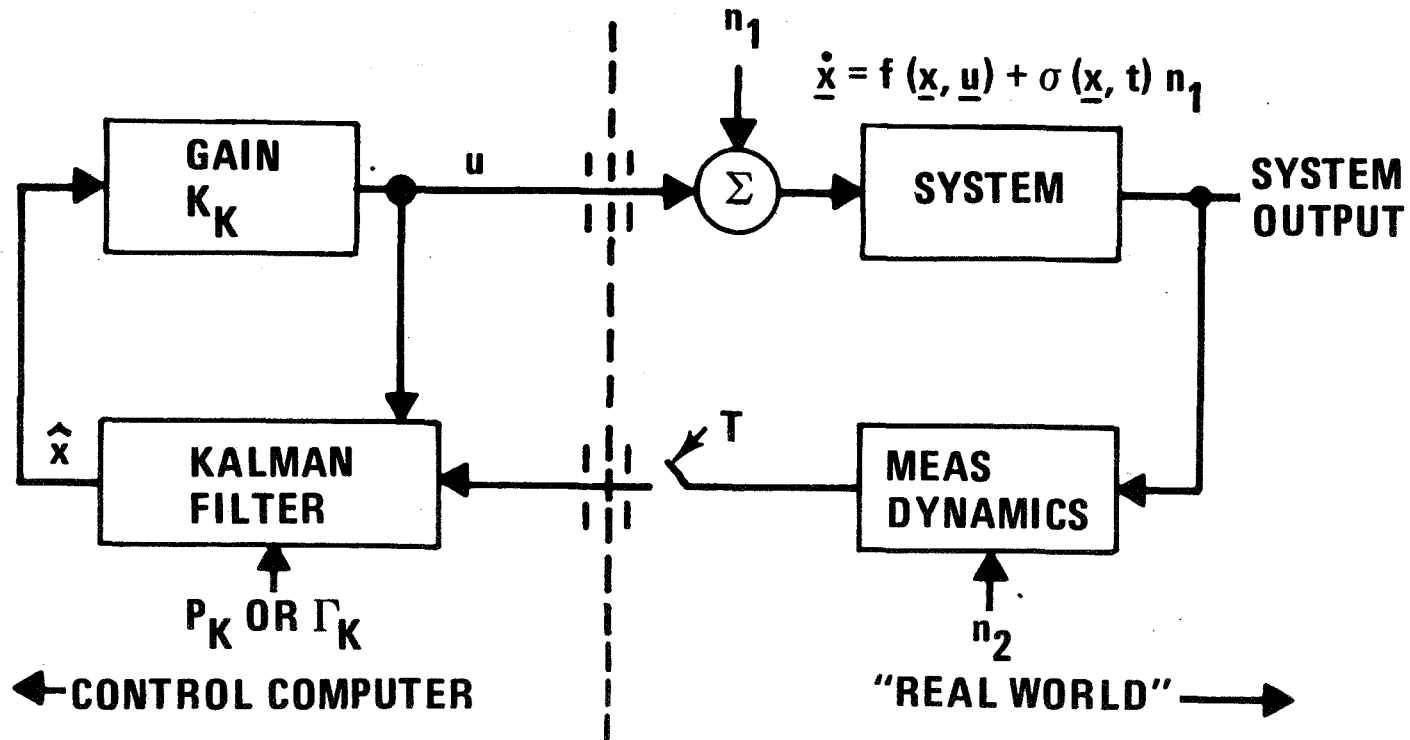

$$\underline{u} = K \hat{x} \text{ WHERE } \hat{x} = E \{ \underline{x} \mid \text{MEASUREMENTS} \}$$

THIS IS THE "SEPARATION THEOREM". WE ASSUME LINEARITY.

## CLOSED LOOP SYSTEM DYNAMICS

### 1. SYSTEM MODEL IN CONTINUOUS TIME

$$\dot{\underline{x}} = \underline{A}\underline{x} + \underline{B}\underline{u} + \underline{C}\underline{n}_1 \quad (1)$$

$$\underline{y} = \underline{H}\underline{x} + \underline{G}\underline{n}_2 \quad (2)$$

### 2. SYSTEM MODEL IN DISCRETE TIME

a) SOLVE (1) FOR ANY  $t_1$

$$\text{THEREFORE } \underline{x}(t_1) = \Phi(t_1 - t_0) \underline{x}(t_0) + \int_{t_0}^{t_1} \Phi(t_1 - \tau) [\underline{B}\underline{u}(\tau) + \underline{C}\underline{n}_1] d\tau$$

b) ASSUME:

- $t_0$  = LAST SAMPLE
- $t_1$  = PRESENT SAMPLE

i.e. IF  $T$  = SAMPLE TIME,  $t_0 = KT$ ,  $t_1 = (K+1)T$

- $\underline{u}(\tau)$  AND  $\underline{n}_1$  ARE CONSTANT OVER  $t_0 - t_1$

THEN:

$$\underline{x} [(K+1)T] = \Phi(T) \underline{x}(KT) + \underline{D}\underline{B}\underline{u}(KT) + \underline{D}\underline{C}\underline{n}_1(KT)$$

$$\text{WHERE } \underline{D} = \int_0^T \Phi(T-\tau) d\tau; \underline{y}_K = \underline{H}\underline{x}(KT) + \underline{G}\underline{n}_2(KT)$$

## CLOSED LOOP SYSTEM DYNAMICS (CONT)

$$3. \begin{bmatrix} \underline{X}_{K+1} \\ \underline{\hat{X}}_{K+1} \end{bmatrix} = \begin{bmatrix} \Phi(T) & DBK \\ \Gamma H & \Phi(T) + DBK \end{bmatrix} \begin{bmatrix} \underline{X}_K \\ \underline{\hat{X}}_K \end{bmatrix} + \begin{bmatrix} DC & 0 \\ 0 & \Gamma G \end{bmatrix} \begin{bmatrix} \underline{n}_1 \\ \underline{n}_2 \end{bmatrix}$$

↙ 2n VECTOR

**K IS CONTROL GAIN**

**4.  $\Gamma$  IS SOLUTION OF "MATRIX RICATTI EQUATION"**

**K CAN BE OBTAINED BY:**

a) **OPTIMIZING A PERFORMANCE INDEX  $J = \int_0^{\infty} (x' Qx + u' Ru) dt$**

b) **POLE MATCHING**

**5. USING 4b)**

- **PERMITS SENSITIVITY TO BE CONSIDERED**
- **ALLOWS CLOSED LOOP SYSTEM TO BE SIMILAR TO OTHER BOOSTERS**

# BLOCK DIAGRAM OF KALMAN FILTER

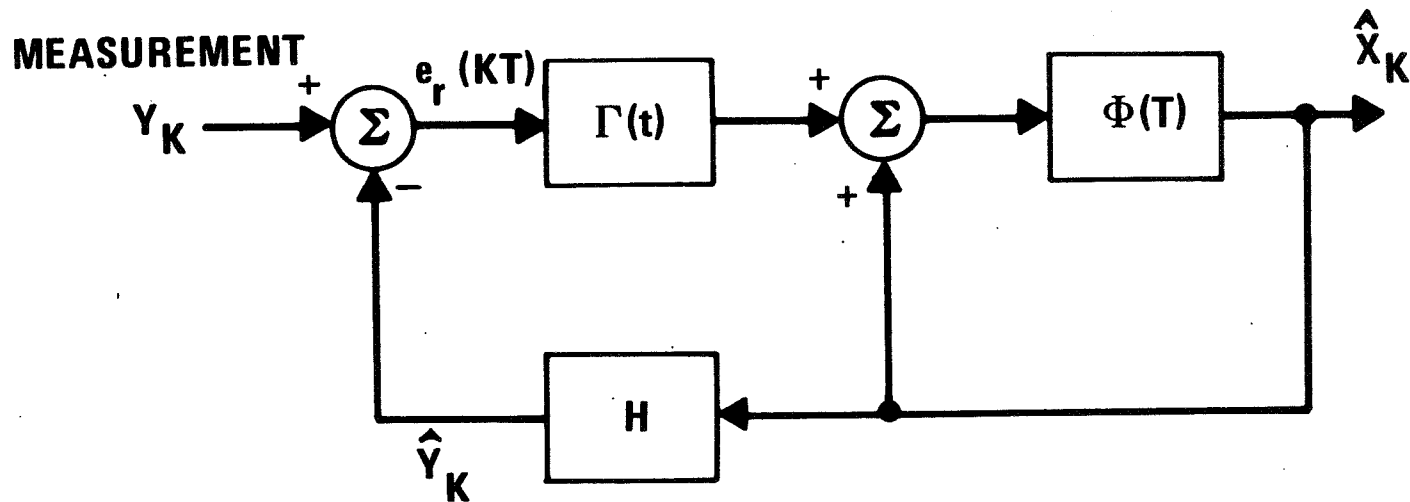

$e_r(kT)$  – RESIDUAL, ALSO CALLED INNOVATIONS PROCESS  
FOR OPTIMAL CASE,  $e_r(t)$  IS WHITE NOISE

$\hat{x}_k$  – OPTIMAL ESTIMATE, AT TIME  $kT$



## Z-TRANSFORM OF THE OPEN LOOP, COMPENSATOR, AND CLOSED LOOP SYSTEM

This set of figures, from Reference 1, shows the results of designing a control system using the optimal control approach. One of the problems is that the design could be overly sensitive to the assumed plant model. The use of pole matching allows a set of closed loop pole locations to be selected based on considerations which will give a better sensitivity.

BY TAKING THE Z-TRANSFORM OF THE CLOSED LOOP SYSTEM ONE MAY ANALYZE THE SENSITIVITY OF THE DESIGN USING ROOT LOCUS IDEAS (DESIGNED BY W. WIDNALL): OPEN LOOP

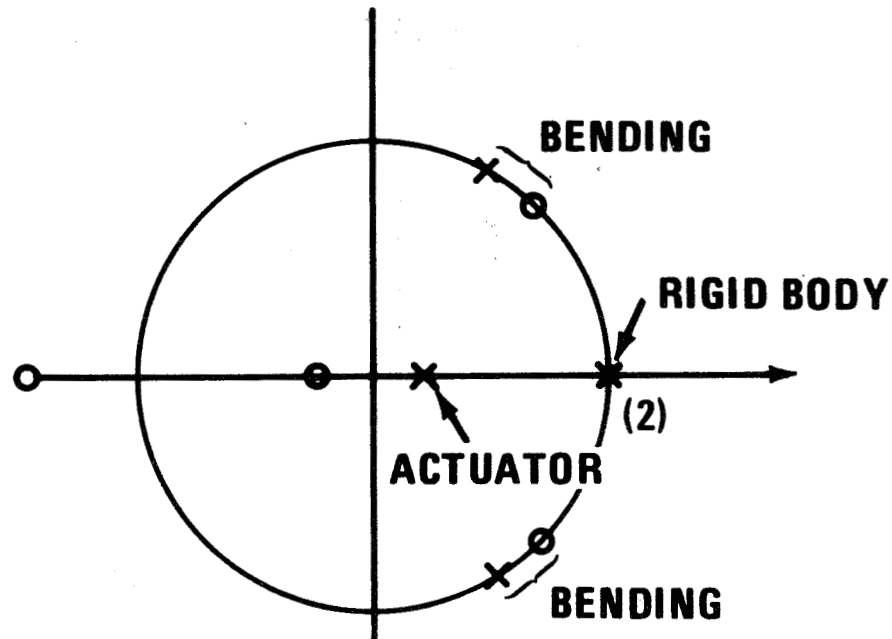

DIGITAL AUTOPILOT DESIGN FOR RE-ENTRY (NO-AERODYNAMICS)

BY TAKING THE Z-TRANSFORM OF THE CLOSED LOOP SYSTEM ONE MAY ANALYZE THE SENSITIVITY OF THE DESIGN USING ROOT LOCUS IDEAS (DESIGNED BY W. WIDNALL): COMPENSATOR (OPTIMAL)

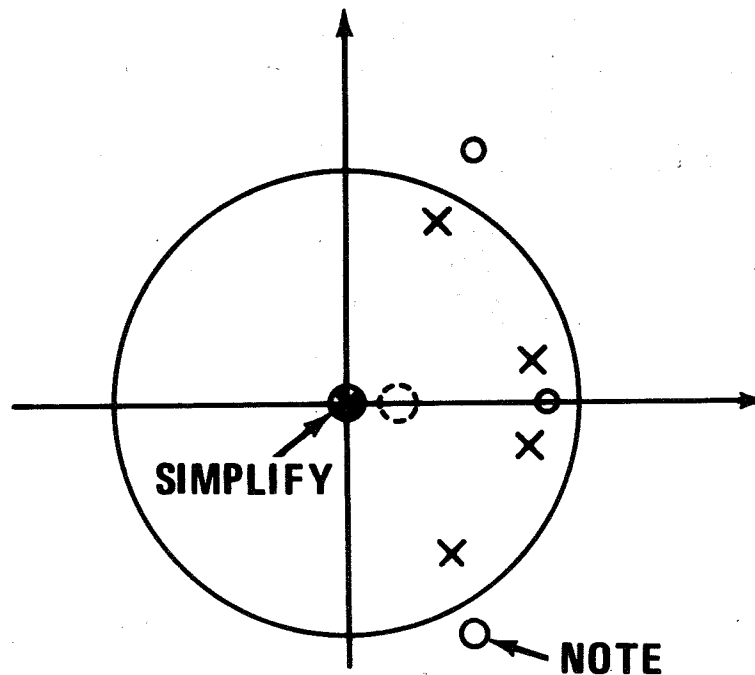

DIGITAL AUTOPILOT DESIGN FOR RE-ENTRY

BY TAKING THE Z-TRANSFORM OF THE CLOSED LOOP SYSTEM ONE MAY ANALYZE THE SENSITIVITY OF THE DESIGN USING ROOT LOCUS IDEAS (DESIGNED BY W. WIDNALL): RESULTING CLOSED LOOP SYSTEM

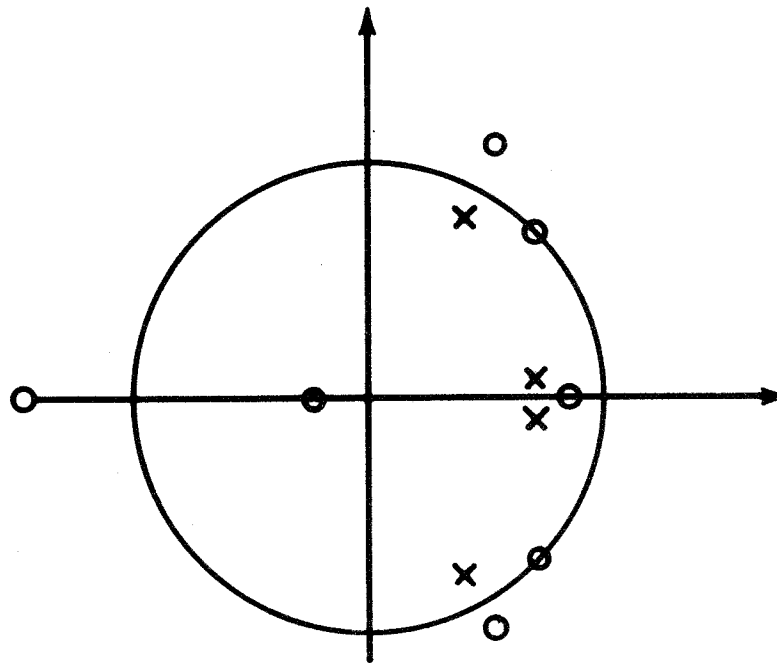

DIGITAL AUTOPILOT DESIGN FOR RE-ENTRY

## **FUTURE WORK**

- **ANALYZE NON-LINEAR SYSTEM**
  - **LINEARIZE SYSTEM IN REAL TIME (ABOUT CURRENT ESTIMATE)**
  - **USE SOME FORM OF ACTUAL NON-LINEAR FILTER**
  - **DISCOVER THE NATURE OF CONTROL & ESTIMATION SEPARATION**
- **COMPARE NON-LINEAR IMPLEMENTATION WITH LINEAR**
  - **DOES THE ADDITIONAL COMPLICATION "PAY"?**
- **COMPLETE DESIGN OF ALL DIGITAL AUTOPILOT PHASES**
  - **BOOST (SEPARATION INCLUDED - SHUTDOWN - IF ANY)**
  - **ORBITAL (RENDEZVOUS - DOCKING - STATION KEEPING ETC)**
  - **RE-ENTRY**
  - **LANDING (AERODYNAMIC PHASE)**

## REFERENCES

1. Widnall, W., On the Design of Nearly Optimal Linear Time-Varying Sampled-Data Stochastic Controllers, MIT Instrumentation Laboratory Report T-446; also available under the title "Applications of Optimal Control Theory to Computer Controller Design", RM-48, MIT Press, Cambridge, Mass., 1966.
2. Gran, R. and Zetkov, G., On the Optimal Stochastic Control of Systems with Noisy Measurements, Grumman Advanced Development Report, ADR-05-06-69.1, 1969.



**NASA FLIGHT RESEARCH CENTER FLY-BY-WIRE FLIGHT-TEST PROGRAM**

**Shu W. Gee and Melvin E. Burke**

**NASA Flight Research Center  
Edwards, California**



## NASA FRC DIGITAL FLY-BY-WIRE FLIGHT-TEST PROGRAM

Equipping the space shuttle vehicle with a digital fly-by-wire flight control system has been discussed within NASA. The past and present space programs have demonstrated performance and reliability of such a system in a space environment; however, only limited actual flight data in an atmospheric environment are available on which to base confidence in the performance of such a system.

A technology development program is underway at the NASA Flight Research Center that should provide information on the performance of digital fly-by-wire systems for aerodynamic control. This program, which utilizes an F-8C aircraft as a flight-test vehicle, is being conducted in two phases. Phase 1 is the development and flight testing of a single-channel digital system with a triple redundant direct electrical backup system. Phase 2 is the development and flight testing of a redundant all digital fly-by-wire system.

The mechanical flight control system will be deactivated for this program.

# **NASA FRC DIGITAL FLY-BY-WIRE FLIGHT-TEST PROGRAM**

## **F-8C AIRCRAFT**

### **PHASE 1**

**DEVELOP AND FLIGHT TEST A SINGLE-CHANNEL DIGITAL FLY-BY-WIRE  
SYSTEM WITH A TRIPLEX DIRECT ELECTRICAL BACKUP SYSTEM**

### **PHASE 2**

**DESIGN, DEVELOP, AND FLIGHT TEST A REDUNDANT ALL DIGITAL  
FLY-BY-WIRE SYSTEM**

## PHASE 1 CONFIGURATION

For the Phase 1 configuration, hardware from the Apollo program is used for a primary single-channel digital system. This hardware is space proven in terms of reliability and performance.

The pilot's inputs are sensed by position transducers on the pilot's controls and fed to the Apollo guidance computer (AGC) as well as the triple redundant backup system. The desired response of the vehicle is computed in the computer and compared with the measured aircraft motion from the Apollo IMU. The error signal is used to further change the aircraft motion until the desired response is achieved.

The triple redundant backup system is a direct mode for surface control. It might be noted that, because this system will be on an F-8C, it will not be necessary to provide stability augmentation; the inherent stability of the vehicle, and therefore surface command, is adequate from a flight safety standpoint.

The system utilizes the secondary actuator concept in that the redundant secondary actuators control the position of the control surface power actuators.

# PHASE 1 CONFIGURATION

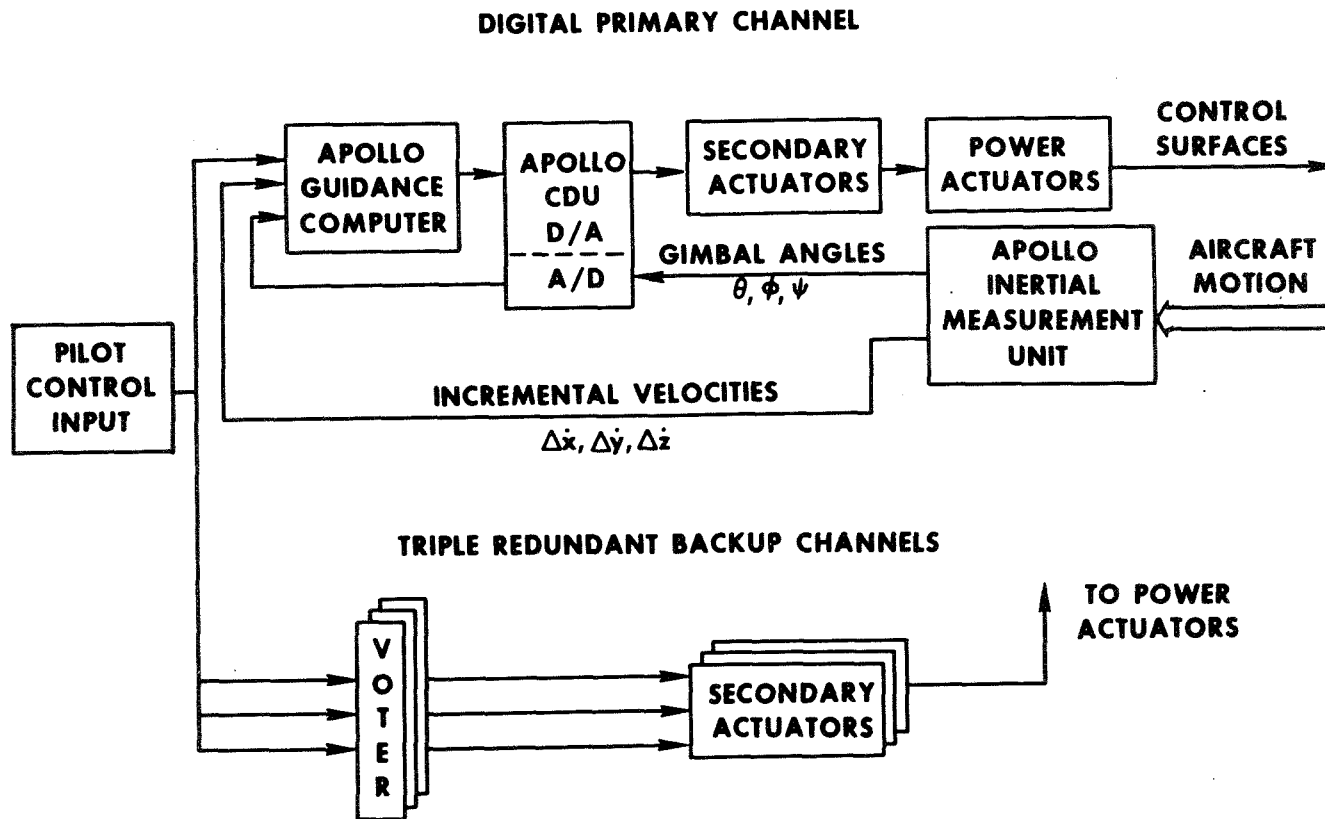

## DIGITAL SYSTEM PITCH CONTROL LAWS

The pilot will have the option of selecting one of three different control laws in pitch and roll and one of two different control laws in yaw. The control laws are programmed on the AGC and are selected by means of a mode control and monitoring panel in the cockpit.

For pitch control, the command augmentation mode (CAS mode) will provide improved handling qualities for the F-8C aircraft. The pilot's stick input is filtered and shaped to a desired  $C^*$  response, and this signal is compared with a blend of the actual pitch rate and normal acceleration of the vehicle. The difference between these signals, or error signal, is fed to a D/A converter, and the analog signal is used to drive the elevator actuator. The error signal is reduced to zero through the closed-loop dynamics of the airframe. The integral bypass permits passage of the higher frequency signals for maneuvering flight and also permits the desired steady state  $C^*$  response. The pilot also has a trim capability.

In the SAS mode, elevator position is controlled by the pilot. Pitch rate feedback is summed with the pilot's input to provide a simple pitch damper.

In the Direct mode, there is no rate feedback and operation of the controls is similar to operation with a direct mechanical linkage.

It might be of interest to note that attitude rates are derived from the gimbal angles, and the rates are then converted from attitude to body axis.

# DIGITAL SYSTEM PITCH CONTROL LAWS

## CAS MODE

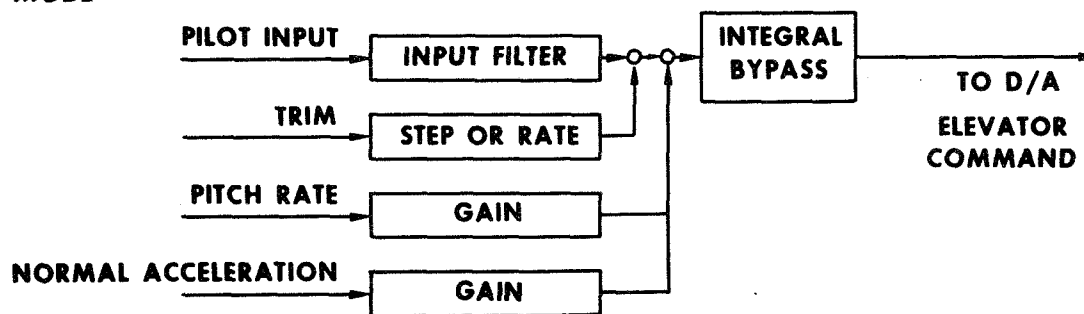

## SAS MODE

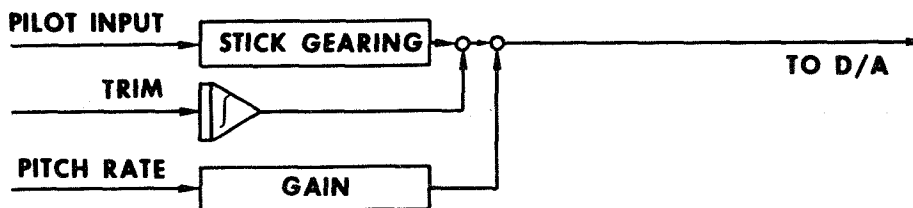

## DIRECT MODE

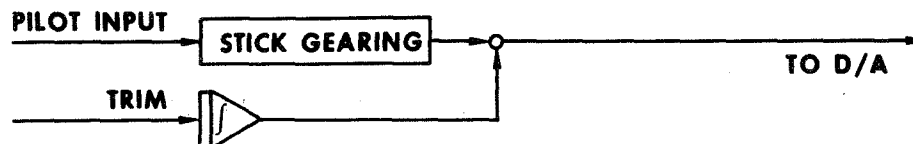

## DIGITAL SYSTEM ROLL CONTROL LAWS

The Roll Rate Command (RRC) mode is implemented to improve the roll handling qualities of the F-8C. In this mode of operation, the pilot's input commands a desired roll rate. Integral bypass is again used to give the desired roll rate response.

The mechanization of the roll SAS and roll Direct modes is similar to that for the pitch SAS and pitch Direct modes.

# DIGITAL SYSTEM ROLL CONTROL LAWS

## RCC MODE

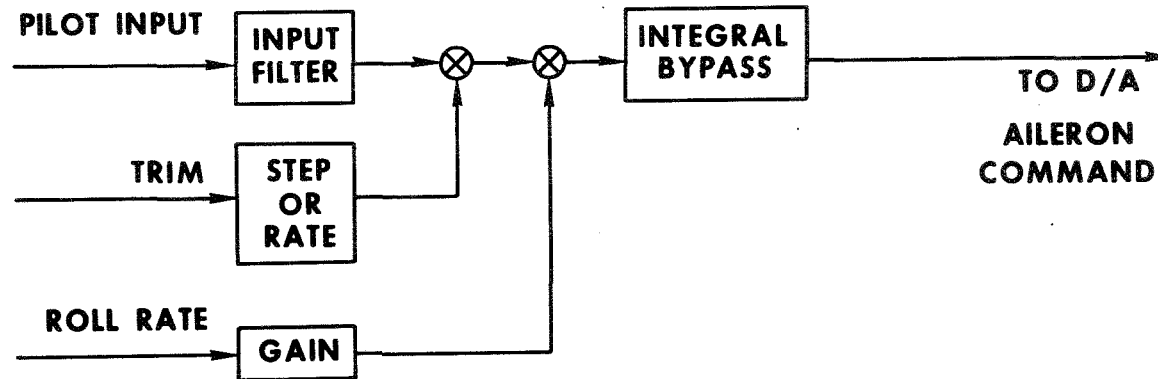

## SAS MODE

SIMILAR TO PITCH

## DIRECT MODE

SIMILAR TO PITCH



## DIGITAL SYSTEM YAW CONTROL LAWS

In the SAS mode, rate and acceleration are fed back to provide some yaw axis static stability and damping. The washout circuit in the rate feedback loop causes the rate signal to go to zero during steady-state turns. Rudder trim is provided, and an interconnect is added to improve the handling qualities of the F-8C.

The Direct mode is rudder surface position command.

# DIGITAL SYSTEM YAW CONTROL LAWS

SAS MODE

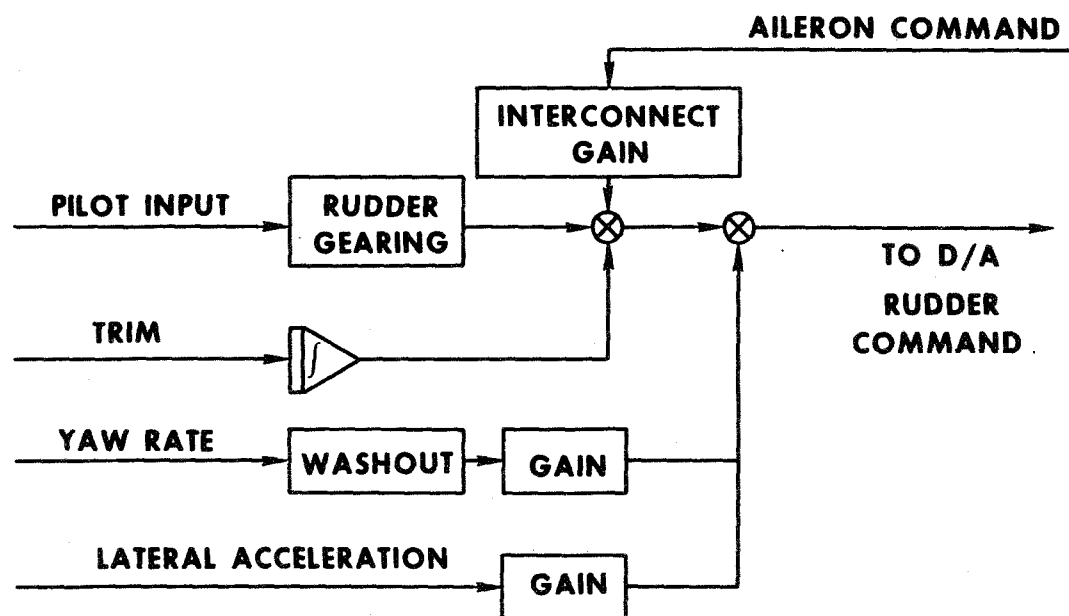

DIRECT MODE

SIMILAR TO PITCH

## FAILURE DETECTION IN PRIMARY SYSTEM

The reliability and performance of the failure detection and switching logic determine the reliability of the total system. The philosophy used in this concept is that one failure in the digital channel causes an automatic switch to the backup channels. The pilot can override the automatic switching circuit at any time. There is a comparator (C) at the output of redundant stick position LVDT's. If the outputs differ, the system switches into backup.

The Apollo digital computer has internal monitoring of the computer (AGC), coupling data unit (CDU), and the inertial measuring unit (IMU). If a malfunction is detected in any of these units, the system switches into backup.

The dual parallel outputs of the digital computer are used to drive servovalves and monitors for the right and left secondary actuators for the pitch or roll control surfaces. If the active and monitor signals differ, the system switches into backup.

The position feedbacks from the primary and backup channel LVDT's are passed through a voter. The primary LVDT is also fed back to the monitor valve to protect against failure of the voter.

# FAILURE DETECTION IN PRIMARY SYSTEM

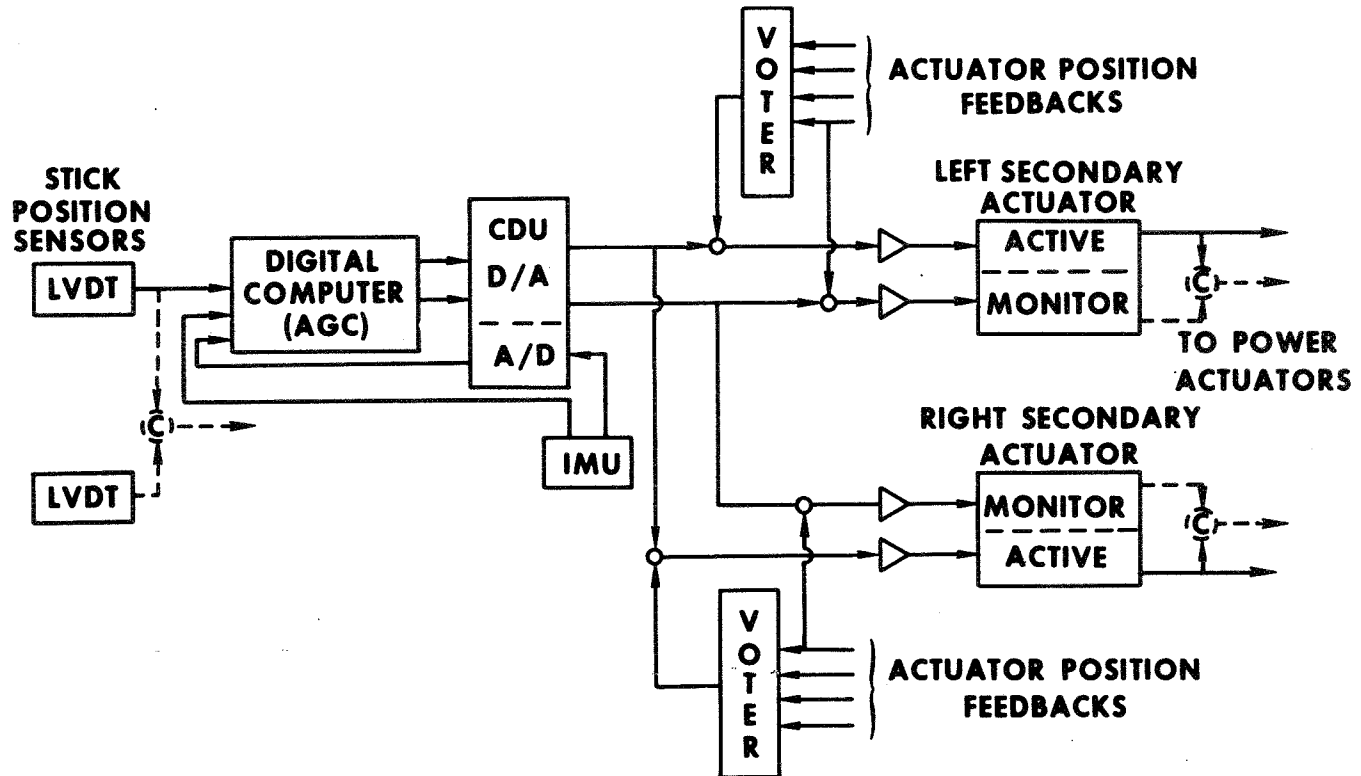

## TRIPLEX BACKUP ELECTRICAL FLIGHT CONTROL SYSTEM

The mechanization of only one of the three redundant channels of the triplex backup system is shown. This control loop is a control surface position loop. The output of the stick position sensors is passed through a voter and fed directly to driver amplifiers for the secondary actuators where actuator position and, hence, control surface position, is fed back.

Because of control law difference between the primary and backup systems, the signal to the primary servo may be different from the signal for the backup. The function of the integrator in the circuit is to store the difference between the primary and the backup and to add this difference to the backup servo to synchronize the backup servo with the primary servo. The trim input is a "beep" trim and is normally zero.

# TRIPLEX BACKUP ELECTRICAL FLIGHT CONTROL SYSTEM

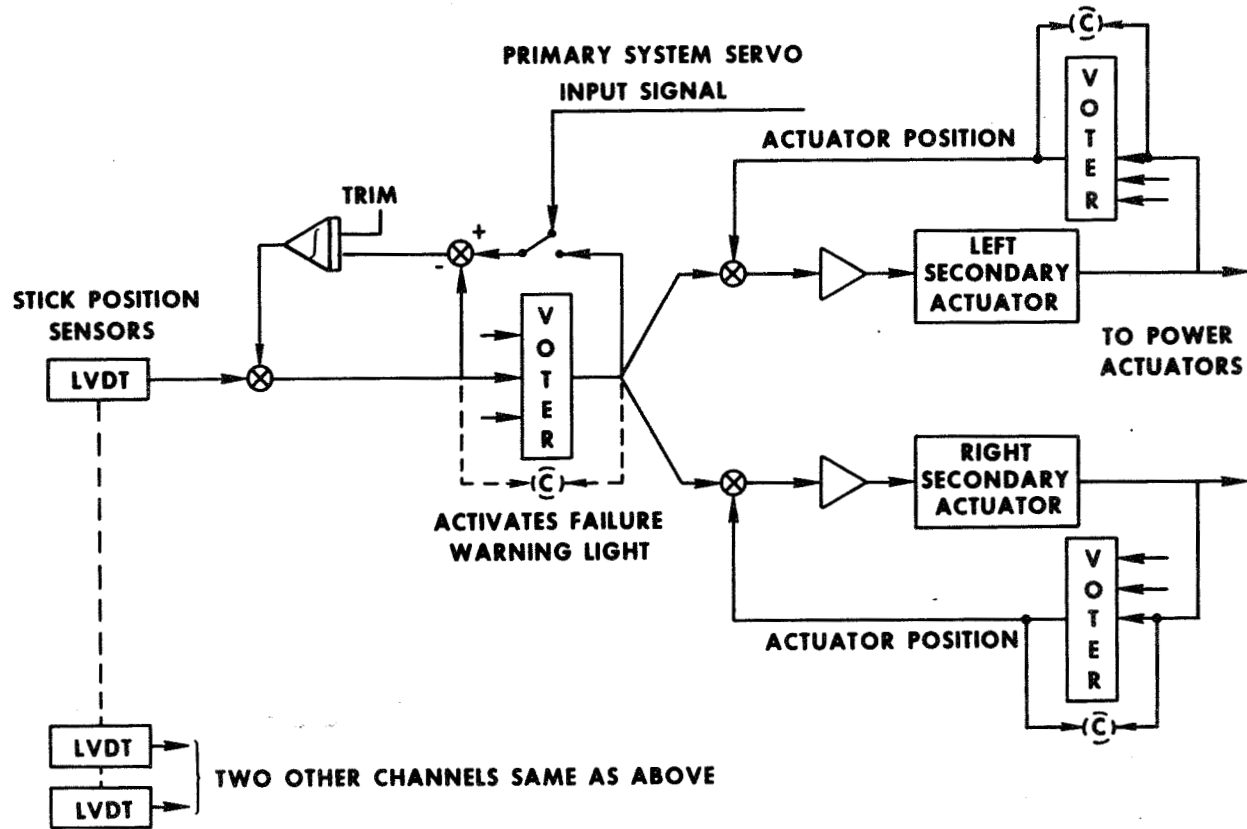

## ACTIVE-STANDBY/FORCE SUM SERVO ACTUATOR

The secondary actuator is a three-piston-ram configuration operated from a dual hydraulic system. The monitor, active, and number 3 valves share one system, and the number 2 and number 4 valves share the other system.

The active-standby concept is used when the system is in the primary mode of operation. The active valve has complete authority of the ram, and the transfer valves for the three backup channels are closed. The signals to these valves, however, are synchronized with the signal to the active primary valve and are therefore ready to take over when a transfer is made.

If a first failure occurs, a difference will exist between the active and monitor valve and the transfer valve to the active valve closes with the simultaneous opening of the three valves for the backup system. The output force of the ram then becomes the sum of the forces of the three pistons.

If a second failure occurs, it is detected by a difference in one of the differential pressures that are monitored at the backup servovalves. The malfunctioned channel is then shut off.

If a third failure occurs, it is detected by a difference between the two remaining differential pressures. When this occurs, both channels are automatically shut off. The pilot is then required to determine which of the two remaining channels is good and manually engage it.

# ACTIVE-STANDBY/FORCE SUM SERVO ACTUATOR

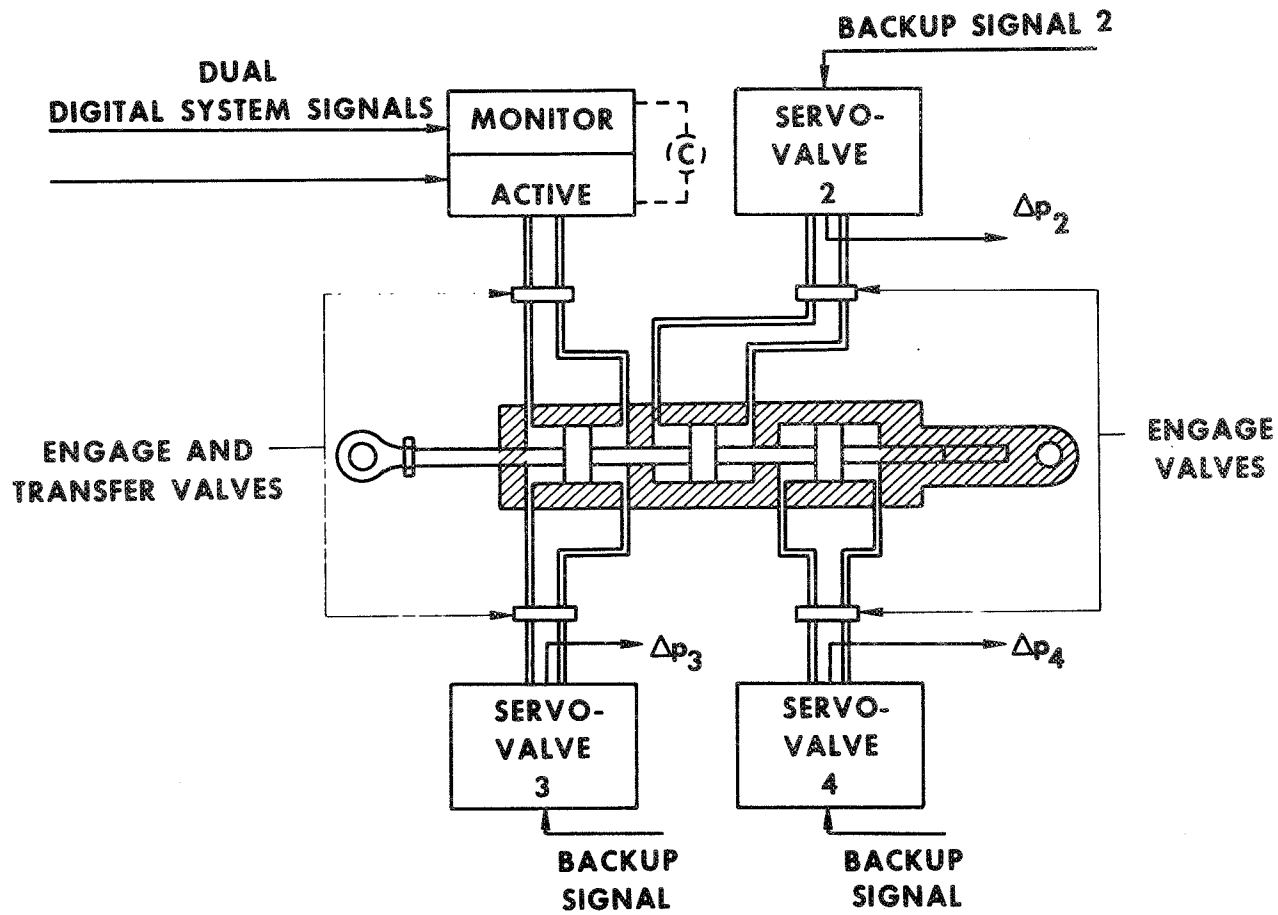



## LOCATION OF DISPLAY PANELS

Two control and display panels are located in the cockpit for the flight control system.

The Digital Mode Select Panel is at the top center of the instrument panel. This panel contains controls for alinement of the IMU and selection of the individual control modes: C\*, SAS, and Direct for pitch; RRC, SAS, and Direct for roll; and SAS and Direct for yaw. The panel also provides failure monitoring of the IMU and the AGC.

A System Status Panel for the backup system is located on the left-hand console. This panel contains monitors of the electronics and servo valves for each axis in each channel of the backup system. Selector switch features for each servo valve permit the pilot to override the automatic switching function of the flight control system.

# LOCATION OF DISPLAY PANELS

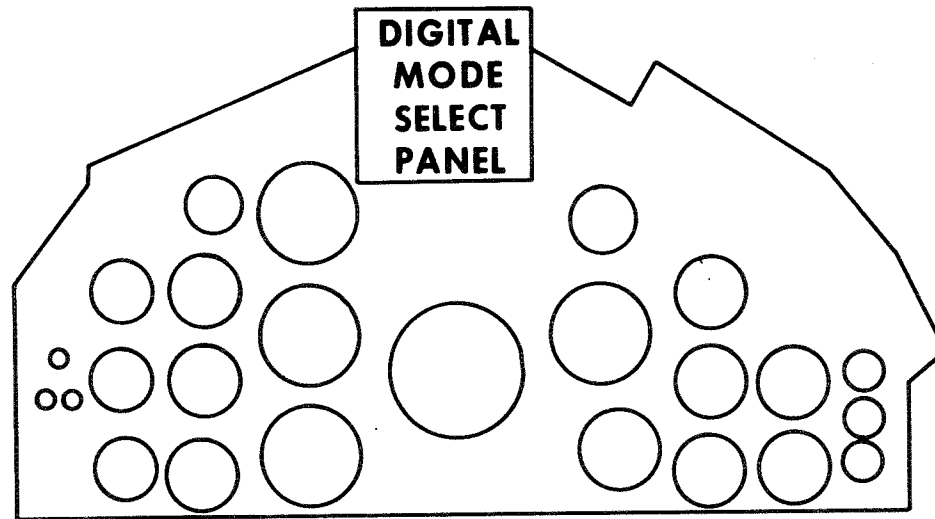

**SYSTEM  
STATUS  
PANEL**

## REDUNDANT ELECTRICAL POWER SYSTEM

The electrical system for the fly-by-wire system will be completely independent of the aircraft primary electrical system. An independent gear-driven dc generator will supply the FCS bus. Each system is then independently run from a separate bus which is backed up by a battery. For further backup operation, the FCS bus can also be switched to the main aircraft dc bus or emergency dc bus, if required.

# REDUNDANT ELECTRICAL POWER SYSTEM

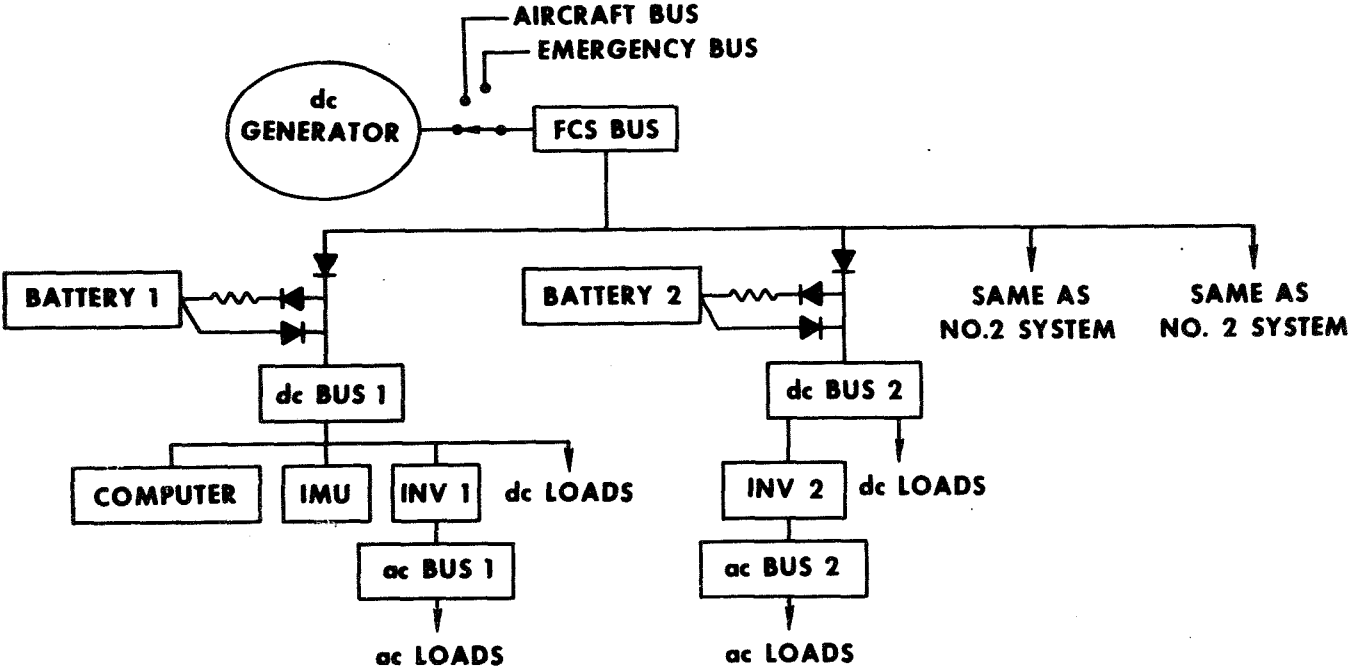

## HYDRAULIC FUNCTION DIAGRAM

The existing hydraulic system in the F-8C aircraft is a dual redundant system with a ram air turbine (RAT) on the number 1 system. The reliability and power capability are adequate for the fly-by-wire flight control system; therefore, modifications to the hydraulics will be limited to those necessary to implement the new active-standby actuators that replace the present secondary actuators which were only dual redundant. The number 2 hydraulic system will be shared by the digital primary and the number 3 backup systems. The number 1 hydraulic system will be shared by the number 2 and number 4 backup systems.

# HYDRAULIC FUNCTION DIAGRAM

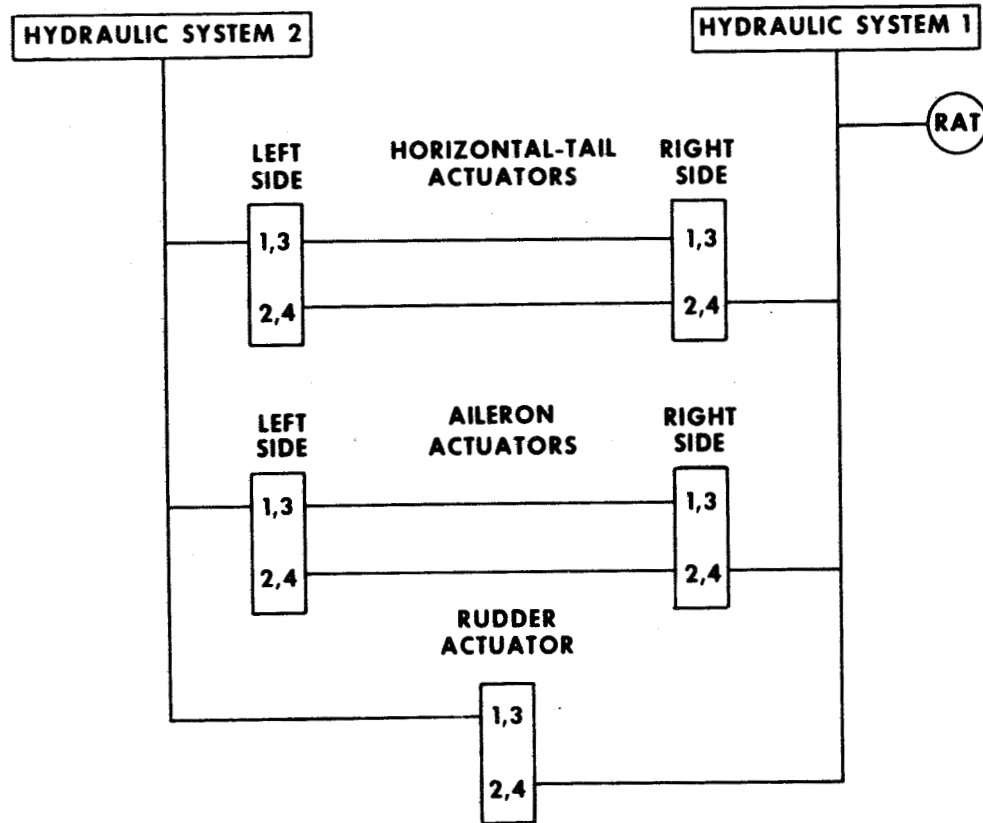

## NASA FRC DIGITAL FLY-BY-WIRE FLIGHT-TEST PROGRAM SCHEDULE

Phase 1 was approved at the beginning of the calendar year.

The preliminary studies and system definition effort are paper studies of systems, cost, and schedules.

In the design and simulation phase, system design studies have started with a computer simulation of the system. As the hardware becomes available it will be added to the simulation. The final ground simulation will utilize much of the actual hardware. This hardware will be installed in the grounded aircraft using the same bracketry and installation techniques as will be used in the flight vehicle. Systems response tests, including frequency and structural responses, and functional and operational tests will be conducted.

The Phase 2 effort is undefined at this time, and the dates shown are desirable target dates for the program.

# NASA FRC DIGITAL FLY-BY-WIRE FLIGHT-TEST PROGRAM SCHEDULE

389

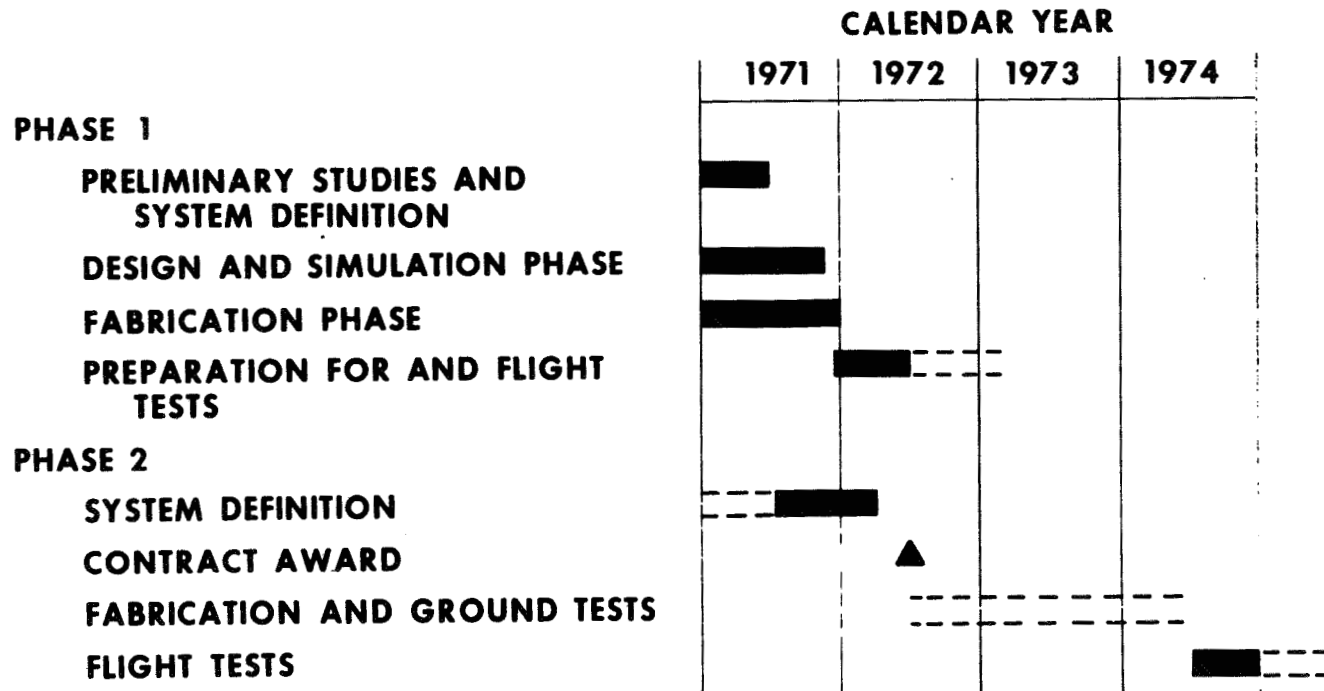



## EXPECTED RESULTS

The expected results of this program would be a higher confidence level in fly-by-wire control systems through actual experience with an operational system. The flight testing of a fly-by-wire system with no mechanical system for backup would be a significant breakthrough in control systems technology for the aviation community.

Specifically, the digital system should provide experience in multichannel operation, a demonstration of digital techniques, operational reliability, fault detection, and self-correcting features.

As a result of this effort, we will have a versatile system that can be used for research to advance the state-of-the-art of digital flight control systems.

# **EXPECTED RESULTS**

## **DIGITAL FLY-BY-WIRE**

**EXPERIENCE WITH MULTICHANNEL OPERATION**

**DEMONSTRATION OF SYSTEM UTILIZING REPRESENTATIVE COMPUTERS**

**OPERATIONAL RELIABILITY**

**COMMON FAILURE MODES**

## **FLIGHT CONTROL SYSTEMS RESEARCH**

**A VERSATILE SYSTEM WILL RESULT THAT CAN BE USED FOR GENERAL  
RESEARCH OF DIGITAL CONTROL SYSTEMS**