

STS-2 Orbiter Mission Report

February 1982



National Aeronautics and
Space Administration

Lyndon B. Johnson Space Center
Houston, Texas

STS-2 ORBITER
MISSION REPORT

PREPARED BY
MISSION EVALUATION TEAM

CONCURRED BY

Michael A. Collins, Jr.
Chief, Integration Division

R. A. Colonna 2-22-82
Manager, Program Operations Office

APPROVED BY

Aaron Cohen 2/22/82
Manager, Orbiter Project

NATIONAL AERONAUTICS AND SPACE ADMINISTRATION

LYNDON B. JOHNSON SPACE CENTER

HOUSTON, TEXAS

February, 1982

TABLE OF CONTENTS

1.0	<u>INTRODUCTION/SUMMARY</u>	1
2.0	<u>ORBITER SUBSYSTEMS</u>	3
2.1	<u>PROPULSION SUBSYSTEMS</u>	3
2.1.1	<u>Main Propulsion Subsystem</u>	3
2.1.2	<u>Orbital Maneuvering System</u>	10
2.1.3	<u>Reaction Control System</u>	14
2.2	<u>POWER SYSTEMS</u>	18
2.2.1	<u>Auxiliary Power Units</u>	18
2.2.2	<u>Hydraulic Systems</u>	19
2.2.3	<u>Power Reactant Storage and Distribution</u>	23
2.2.4	<u>Power Generation Subsystem</u>	28
2.2.5	<u>Electrical Power Distribution and Control</u>	28
2.3	<u>AVIONICS SUBSYSTEM</u>	30
2.3.1	<u>Orbital Insertion Operations</u>	30
2.3.2	<u>On-Orbit Operations</u>	31
2.3.3	<u>Entry</u>	31
2.3.4	<u>Communications and Tracking</u>	35
2.3.5	<u>Hardware Performance</u>	36
2.3.6	<u>Data Processing System</u>	38
2.3.7	<u>Primary Software</u>	38
2.3.8	<u>Backup Flight System</u>	38
2.3.9	<u>Displays and Controls</u>	38
2.3.10	<u>Instrumentation</u>	39
2.3.11	<u>Systems Management</u>	40
2.3.12	<u>Redundancy Management</u>	40
2.4	<u>ENVIRONMENTAL CONTROL AND LIFE SUPPORT SYSTEM</u>	41
2.4.1	<u>Active Thermal Control Subsystem</u>	41
2.4.2	<u>Air Revitalization Subsystem</u>	46
2.4.3	<u>Air Revitalization Pressure Control Subsystem</u>	47
2.4.4	<u>Airlock Support System</u>	47
2.4.5	<u>Water and Waste Management System</u>	47
2.5	<u>CREW STATION AND EQUIPMENT</u>	48
2.5.1	<u>Cabin Temperature Survey</u>	48
2.5.2	<u>Theodolite System</u>	48
2.5.3	<u>Stowage Lockers</u>	48
2.5.4	<u>Crew-Operated Cameras</u>	48
2.5.5	<u>Noise Level Survey</u>	49
2.6	<u>STRUCTURES</u>	50
2.6.1	<u>Overpressure Effects</u>	50
2.6.2	<u>Flutter/Buffer</u>	50
2.6.3	<u>Stress Evaluation</u>	50
2.6.4	<u>Entry Flight Loads</u>	55
2.6.5	<u>Window Cavity Conditioning Systems</u>	55
2.7	<u>MECHANICAL SYSTEMS</u>	58
2.7.1	<u>Purge and Vent and Drain</u>	58
2.7.2	<u>Orbiter/External Tank Separation and Umbilical Devices</u>	59
2.7.3	<u>Payload Bay Doors and Radiators</u>	63
2.7.4	<u>Manipulator Positioning Mechanism</u>	63
2.7.5	<u>Star Tracker Doors</u>	63
2.7.6	<u>Air Data Probe</u>	63
2.7.7	<u>Landing/Deceleration Subsystem</u>	63
2.7.8	<u>Aerothermal Seals</u>	64
2.7.9	<u>Crew Escape System</u>	67
2.7.10	<u>Pyrotechnics</u>	67

TABLE OF CONTENTS (Continued)

2.8	<u>THERMAL</u>	67
2.8.1	<u>Thermal Control</u>	67
2.8.2	<u>Thermal Protection System and Leading Edge Structural Subsystem</u>	73
2.8.3	<u>Aerothermodynamics</u>	88
2.9	<u>ENTRY AERODYNAMICS</u>	95
2.9.1	<u>Flight Test Requirements Accomplished</u>	95
2.9.2	<u>Mass Properties Comparison Based on Deorbit Maneuver Data</u>	95
2.9.3	<u>Hypersonic Lift-to-Drag Ratio and Trim</u>	100
2.9.4	<u>Landing Drag Performance</u>	100
2.9.5	<u>Air Data System</u>	100
2.9.6	<u>Elevon Hinge Moment Coefficients</u>	100
2.9.7	<u>Aerodynamic Coefficient Instrumentation Package</u>	100
2.9.8	<u>Stability and Control Maneuver Results</u>	106
2.10	<u>REMOTE MANIPULATOR SYSTEM</u>	106
2.10.1	<u>Arm Controllability</u>	106
2.10.2	<u>Common Validation Runs</u>	106
2.10.3	<u>Auto Trajectory Runs</u>	124
2.10.4	<u>RMS Dynamics</u>	124
2.10.5	<u>Thermal Control</u>	124
2.10.6	<u>Consistency Check</u>	124
2.10.7	<u>Back-up Drive Anomaly</u>	125
3.0	<u>ENVIRONMENTS ANALYSIS</u>	126
3.1	<u>ACOUSTIC ENVIRONMENT</u>	126
3.2	<u>VIBRATION ENVIRONMENT</u>	126
4.0	<u>CREW REPORT</u>	130
5.0	<u>BIOMEDICAL EVALUATION</u>	131
5.1	<u>EVALUATION OF CREW HEALTH</u>	131
5.2	<u>HEALTH STABILIZATION</u>	131
5.3	<u>TOXICOLOGY</u>	131
5.4	<u>RADIATION</u>	132
5.5	<u>NOISE ASSESSMENT</u>	132
5.6	<u>MOTION SICKNESS PROPHYLAXIS</u>	132
5.7	<u>MICROBIOLOGY</u>	132
5.8	<u>BIOINSTRUMENTATION</u>	132
6.0	<u>DESCENT TRAJECTORY</u>	133
7.0	<u>ORBITER ANOMALY SUMMARY</u>	134

1.0 INTRODUCTION/SUMMARY

This report presents a summary of the in-depth evaluation and analysis of the Orbiter subsystems performance, a discussion of all Orbiter and GFE anomalies, and a discussion of the flight test objectives accomplished on STS-2. Also included are the problem closeout reports and the corrective action required for STS-3.

The STS-2 mission initially was to be launched on Nov. 4, 1981. However, a hold at T-31 seconds for out-of-tolerance measurements could not be resolved in time to support the scheduled launch time. Subsequent evaluation of the lubrication oil pressures on auxiliary power units 1 and 3 resulted in a decision to delay the launch until the APU (auxiliary power unit) 1 and 3 lubrication oil systems could be flushed and the filters replaced.

The November 12, 1981, launch of the Orbiter on the STS-2 mission marked the beginning of the era of the reusable Shuttle vehicle with the refurbished Columbia making its second space flight. The mission had a planned duration of approximately 5 days and 4 hours; however, the fuel cell 1 failure just prior to 5 hours into the mission resulted in a decision to shorten the mission to the preplanned minimum mission guidelines, about 54 1/2 hours. During this shortened mission, over 90 percent of the high priority flight tests were successfully accomplished. The remote manipulator system tests were successful as was the earth observation data collection by the OSTA-1 pallet experiments. Since a majority of the planned STS-2 flight tests were accomplished, only minor changes to the STS-3 and -4 flight planning will be necessary.

The STS-2 mission also demonstrated important designed-in operational capabilities with the continuation of all major flight operations, including a successful return, in the presence of a significant subsystem failure. All other subsystems of the Orbiter operated satisfactorily in completing the STS-2 mission. The sequence of events is presented in Table 1-I.

Standard units of measurement are used throughout the report. Unless otherwise specified, all given times are referenced to Greenwich mean time (G.m.t.), with lift-off specified as 316:15:09:59.8 G.m.t. (day:hour:minute:second). All weights are referenced to earth gravity.

TABLE 1-I.- STS-2 SEQUENCE OF EVENTS

Event	Planned* G.m.t.	Actual G.m.t.
APU activation (1)	316:15:04:57	316:15:05:06
(2)	-----	316:15:05:17
(3)	-----	316:15:05:24
MPS start command (Engine 3)	316:15:09:54	316:15:09:53.2
MPS 90 percent thrust (Engine 1)	316:15:09:57.4	316:15:09:57.3
SRB ignition command from GPC (lift-off)	316:15:10:00	316:15:09:59.8
Main engine throttledown to 68 percent thrust	316:15:10:43.5	316:15:10:44.5
Maximum dynamic pressure	316:15:10:52.2	316:15:10:54
MPS throttleup to 100 percent thrust	316:15:11:02.9	316:15:11:04.2
SRB separation command	316:15:12:11	316:15:12:09.7
MPS throttledown for 3g acceleration	316:15:14:56	316:15:17:36.5
3g acceleration	-----	316:15:17:36.6
Main engine cutoff (MECO) command	316:15:18:38	316:15:18:33.6
External tank separation command	316:15:18:54	316:15:18:51.7
OMS-1 ignition	316:15:20:32.9	316:15:20:33.9
OMS-1 cutoff	316:15:21:57.9	316:15:21:50.9
APU deactivation (1)	316:15:25:00	316:15:24:35
(2)	-----	316:15:24:36
(3)	-----	316:15:22:18
OMS-2 ignition	316:15:51:50.9	316:15:51:51.7
OMS-2 cutoff	316:15:53:00.9	316:15:53:00.9
Payload bay doors start opening command	316:16:30:00	316:16:57:24
Payload bay doors open	316:17:25:00	316:17:25:29
Payload (OSTA) activation	316:19:10:00	316:19:10:00
Fuel cell 1 failure	-----	316:19:45:00
OMS-3A ignition	316:21:27:42	316:22:54:59.8
OMS-3A cutoff	316:21:28:52	316:22:55:11.8
OMS-3B ignition	316:21:31:52	316:22:59:14.8
OMS-3B cutoff	316:21:33:02	316:22:59:38.8
OMS-4 ignition	316:22:15:40	316:23:43:20.0
OMS-4 cutoff	316:22:16:01	316:23:43:58.7
RMS group 1 test activities start	317:14:55:00	317:14:25:00
OSTA experiment deactivation	321:11:50:00	318:14:26
Payload bay doors closed	321:15:08:00	318:17:02:53
APU 3 activation	321:18:19:04	318:20:18:33
Deorbit burn ignition	321:18:22:04	318:20:23:14.8
Deorbit burn cutoff	321:18:24:33	318:20:26:05.7
APU 2 and 1 activation	321:18:35:00	318:20:37:41
Entry interface (400,000 ft)	321:18:48:18	318:20:50:39.3
End blackout	321:19:07:11	318:21:10:30
Terminal area energy management	321:19:19:03	318:21:16:31
Main landing gear contact	321:19:20:00	318:21:23:12.88
Nose landing gear contact	321:19:20:10	318:21:23:25.9
Wheels stop	321:19:20:24	318:21:24:02.6
APU deactivation completion	-----	318:21:38:16

NOTE:

*As a result of the fuel cell failure and the mission's being shortened to about 54 hours, all events, beginning with pallet deactivation, occur almost 3 days earlier than planned. The planned times shown are from the original 5-day 4-hour mission plan. New planned times for the end of the mission, based on the minimum mission were not published.

2.0 ORBITER SUBSYSTEMS

All Orbiter systems performed satisfactorily and within their specification limits during the flight except for the failure of one fuel cell. The fuel cell problem was analyzed, corrective action was taken and the analysis of the remaining flight data revealed no major anomalies that will affect the STS-3 flight.

2.1 PROPULSION SUBSYSTEMS

2.1.1 Main Propulsion Subsystem

The MPS (main propulsion system) performance during ascent was satisfactory. The engine start and cutoff commands occurred as planned, and the systems responded to all throttling and gimbaling commands. The dump of residual propellants and the systems inerting was accomplished as planned. For detailed assessment of the overall MPS operation, see the Marshall Space Flight Center STS-2 flight reports. This section will cover overlapping areas that require detailed Orbiter subsystem evaluation to complete the analysis.

The loading operation was performed satisfactorily. The liquid hydrogen recirculation pumps started normally during loading.

During the tanking test, the liquid hydrogen T-0 umbilical gaseous hydrogen concentration went above the redline. Because of this condition, the purge was increased and the hazardous gas sensors recalibrated. Following this activity, the concentration of hydrogen was below the redline, and propellant loading was accomplished as planned. No launch delay resulted from this activity.

The leak emanated from the MPS 8-inch liquid hydrogen T-0 disconnect. This disconnect also leaked during STS-1 and the STS-2 tanking tests. Upon landing, the T-0 8-inch disconnect inserts were checked and were found to be loose. (Section 7.0, flight test problem report 35.)

The pressurization system performed satisfactorily during loading and the external tank pressurization sequences. The pressurization ullage pressures remained in the control bands of 20 to 22 psig for the liquid oxygen tank and 41 to 44 psia for the liquid hydrogen tank throughout prelaunch operations.

Prestart propellant conditions were within the established Shuttle Operational Data Book limits for both hydrogen and oxygen systems, as shown in figure 2-1, prior to lift-off.

The Orbiter/external tank gaseous oxygen and hydrogen pressures and temperatures were within established limits.

The helium system performed satisfactorily during the prelaunch period. The overall end result was a system temperature slightly lower than for STS-1.

The concentration of hydrogen and oxygen in the aft compartment was determined by a mass spectrometer system before launch and by a flight sample bottle system during ascent.

The oxygen concentration before launch was generally below 100 ppm except for a few short transient spikes. The gaseous hydrogen level was below 400 ppm, which is within the 500 ppm redline.

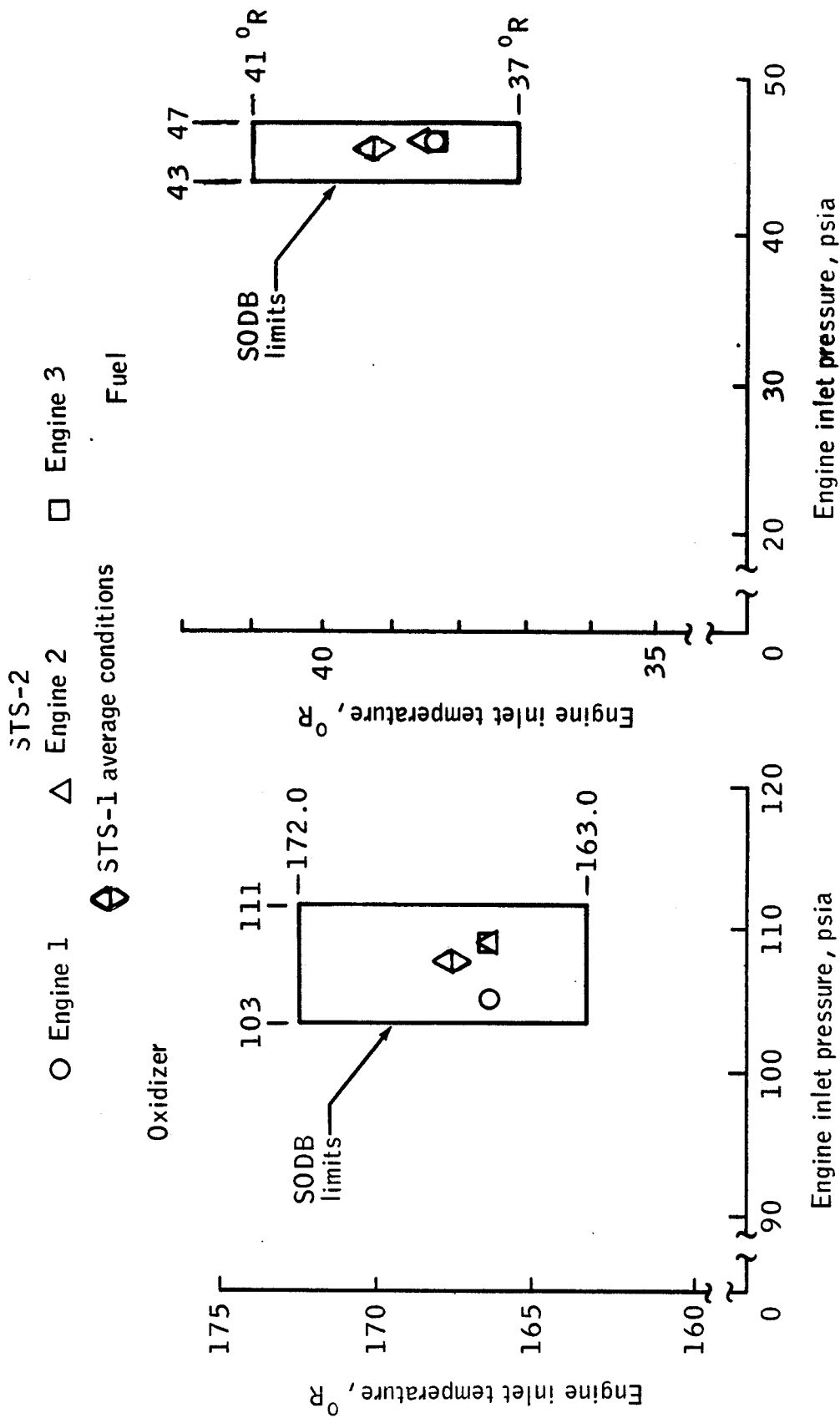

Figure 2-1.- Prestart propellant conditions.

The gaseous hydrogen concentrations during ascent are found on figure 2-2 together with the results from STS-1. The gas sampling device failed on one bank of three bottles; therefore, no samples were collected in those three bottles. (Section 7.0, flight test problem report 42.) Of the remaining three bottles, one leaked and contained air. The concentrations in the two good sample bottles are shown on figure 2-2. The STS-2 data were significantly above the STS-1 concentrations, but well below the flammability limit, indicating a hazardous concentration did not exist.

The MPS performed normally for the STS-2 flight. Ignition of the main engines commenced at 316:15:09:53.249 G.m.t., with engine 3 starting first, as planned. System performance throughout ascent was very satisfactory. A normal guidance-commanded MECO (main engine cutoff) occurred at 316:15:18:33.609 G.m.t., shutting down all three engines simultaneously. The total firing time on each of the main engines was 520.4 seconds, including approximately 6.6 seconds of start transient and firing time prior to lift-off. Following MECO, a normal ET (external tank) separation was accomplished at 316:15:18:51.699 G.m.t.

The pressurization system maintained the external tank ullage pressures within the control bands, 33 to 35 psia for hydrogen and 20 to 22 psig for oxygen, required for satisfactory operation during ascent. Engine inlet temperature and pressure conditions for all three main engines are shown in table 2-1.

The propellant dump from the Orbiter feedlines was initiated 2 min, 1.7 sec after MECO and continued for 3 min, 1.5 sec. Within a few minutes after the dump was completed, the Orbiter feed system was vacuum inerted by opening the fill and drain valves for approximately 13 minutes.

The MPS hydrogen and oxygen dumps were successful.

The oxygen dump through the engines was very similar to STS-1. The only major difference between the two was that the STS-2 dump through main engine 3 (right engine) was prematurely terminated when APU 3 was shut down approximately 16 seconds prior to the scheduled end of the dump. The loss of hydraulic power caused the main oxidizer valve, as well as the hydrogen bleed valve on engine 3, to automatically close pneumatically, thereby terminating the dump. This early engine 3 dump termination was near the scheduled dump termination time and, therefore, had no apparent effect on the effectiveness of the oxygen dump.

The STS-2 hydrogen dump procedures were altered from those of STS-1 to include a 30-second dump of the hydrogen manifold through the RTLS (return-to-launch-site) valves, starting 10 seconds after MECO. This additional procedure eliminates the need for hydrogen manifold relieving between MECO and the primary dump (MECO + 120 seconds) and minimizes any potential effects of a failed-closed hydrogen relief valve. This procedure was partially successful in that the manifold relief valve was only in operation during the last 10 to 15 seconds of the 120-second period in question. Extending the RTLS dump valve operation by 15 seconds should fulfill the purpose of this procedure. Also noted during the RTLS hydrogen manifold dump was that the hydrogen trapped in the feedlines relieved into the manifold because of the increased differential pressure caused by the RTLS dump valve operation. Specifically, feedline 3 relieved through its preclude shortly after the RTLS manifold dump when the differential pressure between the feedline and manifold pressures reach 39 psid. Feedlines 1 and 2 began to relieve through their preclude relief valves at approximately 37 psid. Relieving halted at approximately 28 psid for all three feedlines. This feedline relief phenomenon was expected and was within the preclude relief specification requirements. At MECO + 120 seconds the manifold and feedline pressures had returned to levels comparable to those seen on STS-1. The remainder of the hydrogen dump proceeded normally and was very similar to the STS-1 hydrogen dump.

TABLE 2-I.- MAIN ENGINE 1 INLET CONDITIONS

Event/time, sec	Liquid oxygen						Liquid hydrogen					
	Pressure, psia		Temperature, °R		Pressure, psia		Temperature, °R		Pressure, psia		Temperature, °R	
	Predicted	Actual	Predicted	Actual	Predicted	Actual	Predicted	Actual	Predicted	Actual	Predicted	Actual
Pre-start	105.0	105.0	165.2	166.0	45.5	46.0	37.2	38.2	46.0	46.0	37.2	38.2
Maximum startup conditions	127.0	121.0	165.2	166.0	46.8	49.0	37.2	38.2	49.0	49.0	37.2	38.2
T ₀ + 100	158.0	157.0	165.4	165.8	32.2	33.8	37.2	38.2	33.8	33.8	37.2	38.2
T ₀ + 200	65.0	68.0	165.1	165.6	28.4	29.2	37.2	38.2	29.2	29.2	37.2	38.2
T ₀ + 300	83.0	85.0	165.2	165.6	28.3	29.6	37.3	38.2	29.6	29.6	37.3	38.2
T ₀ + 400	118.0	117.0	165.3	165.8	28.2	28.8	37.4	38.3	28.8	28.8	37.4	38.3
T ₀ + 500	162.0	160.0	165.6	165.8	30.5	30.0	37.9	38.4	30.5	30.0	37.9	38.4
Maximum shutdown conditions	157.0	137.0	165.6	165.8	36.9	36.4	38.0	39.0	36.9	36.4	38.0	39.0

TABLE 2-I.- CONTINUED
(Main Engine No. 2)

Event/time, sec	Liquid oxygen				Liquid hydrogen			
	Pressure, psia		Temperature, °R		Pressure, psia		Temperature, °R	
	Predicted	Actual	Predicted	Actual	Predicted	Actual	Predicted	Actual
Pre-start	109.0	109.0	165.2	166.0	47.0	46.0	37.2	38.4
Maximum startup conditions	121.0	124.0	165.2	166.0	46.8	49.0	37.2	38.4
$T_0 + 100$	159.0	160.00	165.4	165.5	30.2	33.0	37.2	38.4
$T_0 + 200$	65.0	68.0	165.1	165.3	27.0	29.0	37.2	38.6
$T_0 + 300$	83.0	88.0	165.2	165.3	26.9	28.6	37.3	38.6
$T_0 + 400$	117.0	118.0	165.3	165.4	26.8	28.4	37.4	38.6
$T_0 + 500$	162.0	162.0	165.6	165.6	29.8	31.5	37.9	38.7
Maximum shutdown conditions	162.0	145.0	165.6	165.6	36.4	38.0	38.0	39.0

TABLE 2-I.- CONCLUDED
(Main Engine No. 3)

Event/time, sec	Liquid oxygen						Liquid hydrogen					
	Pressure, psia		Temperature, °R		Pressure, psia		Temperature, °R		Pressure, psia		Temperature, °R	
	Predicted	Actual	Predicted	Actual	Predicted	Actual	Predicted	Actual	Predicted	Actual	Predicted	Actual
Pre-start	110.0	109.0	165.2	166.0	47.0	46.0	37.2	38.2				
Maximum startup conditions	125.0	132.0	165.2	166.0	45.8	49.0	37.2	38.2				
$T_0 + 100$	156.0	160.00	165.4	165.8	31.6	31.5	37.2	38.2				
$T_0 + 200$	62.0	66.0	165.1	165.6	28.4	29.0	37.2	38.2				
$T_0 + 300$	79.0	87.0	165.2	165.6	28.3	29.0	37.3	38.2				
$T_0 + 400$	114.0	117.0	165.3	165.7	28.2	28.8	37.4	38.3				
$T_0 + 500$	160.0	161.0	165.6	165.9	30.6	30.8	37.9	38.4				
Maximum shutdown conditions	159.0	137.0	165.6	165.8	36.5	36.4	38.0	39.0				

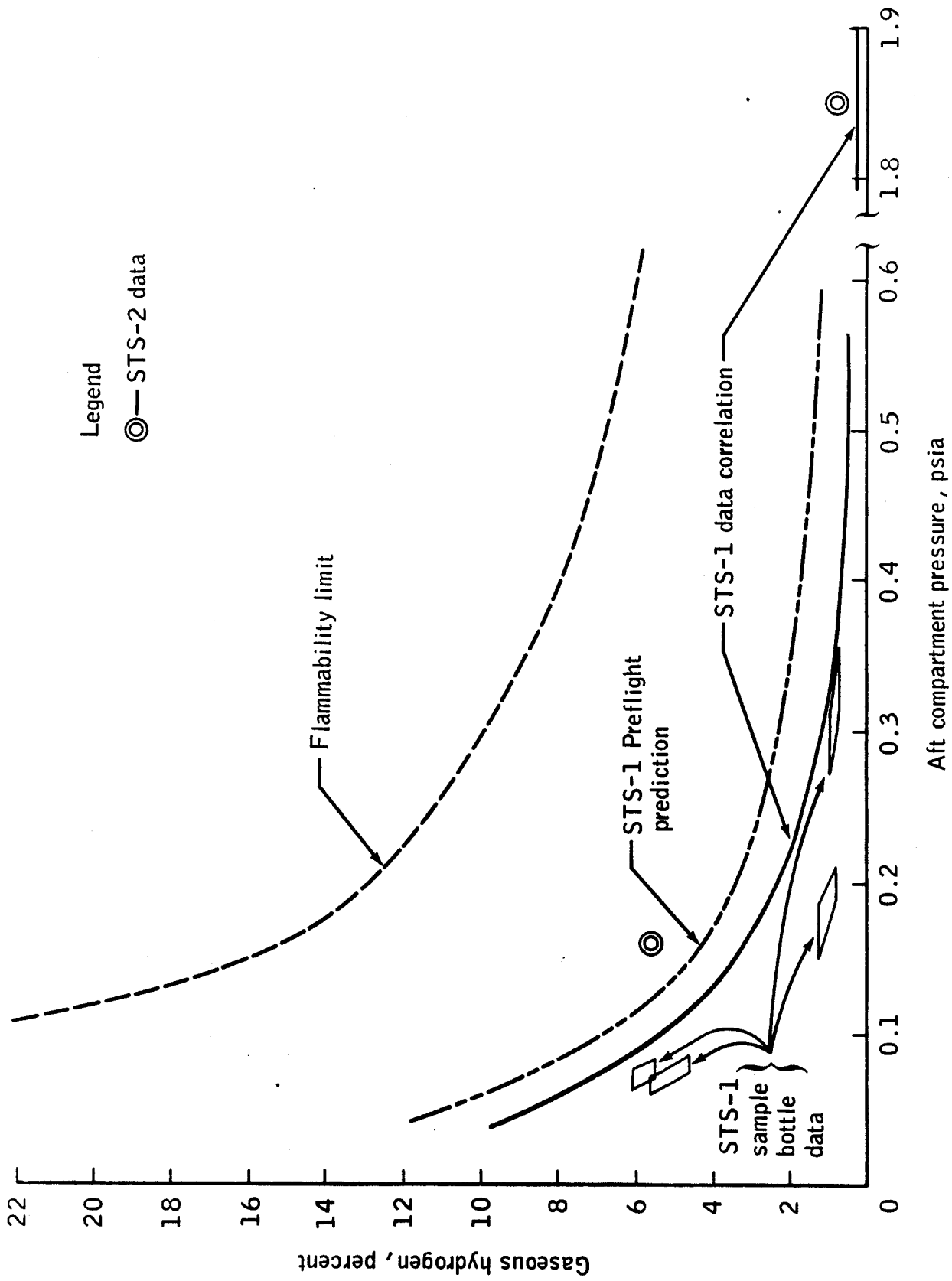

Figure 2-2.- Aft compartment hydrogen concentration.

It appears that the dump and the subsequent vacuum inerting procedures removed all residual propellant from the Orbiter feedlines, although the indication of a small amount of residual hydrogen was evident. A second vacuum inerting was not performed because of the restrictions on crew activity during this flight.

During the MPS reconfiguration, the helium isolation valves were configured as expected. When the pneumatic system and left engine isolation valves were placed in the GPC (general purpose computer) position, the valves were opened since an open signal had been stored in the MDM (multiplexer-demultiplexer). Forty-two pounds of helium were lost before the problem was recognized and the oxygen prevalues closed, thus preventing the oxygen side of the engines from being purged. The prevalues were opened after rollout to provide as much purge as possible. Heated nitrogen purges were later applied to the engines, and moisture measurements were made that indicated no problem. (Section 7.0, flight test problem report 32.)

2.1.2 Orbital Maneuvering System

The OMS (orbital maneuvering system) performance was satisfactory and met all mission requirements. System pressures, temperatures, and propellant usage were as expected for the mission flown. Several anomalies are discussed section 7. Most of the flight test objectives were accomplished successfully.

OMS propellant servicing was performed October 17-20, 1981. The OMS helium loading was accomplished on October 21 and 22 and gaseous nitrogen loading on October 31. Because of concern over the iron nitrate level in the oxidizer, the oxidizer was loaded at a temperature of 60° F.

To protect the overfilled RCS (reaction control system) tanks from an overpressure condition, the left OMS crossfeed valves were opened for most of the pad stay time so that the OMS could provide an ullage for the RCS. The OMS ullage pressure was conditioned to 280 to 284 psia prior to RCS helium servicing to prevent the transfer of propellant from the RCS to the OMS.

The first (OMS-1) firing was the orbital insertion maneuver performed following ET separation. The OMS-1 maneuver was a normal-feed two-engine firing. Because of the high ullage pressures at lift-off, the first 23 seconds of the firing were performed in the blowdown condition. The firing time, differential velocity, and consumable status for the OMS-1 maneuver and all other OMS firings are listed in table 2-II. A comparison between predicted and actual values for key performance parameters is presented in table 2-III. At the end of the 15-second gaging lockout period, the right oxidizer total channel experienced an upward shift of approximately 20 percent. This gage continued to indicate erroneous values throughout the mission. (Section 7.0, flight test problem report 5.)

The OMS-2 maneuver, performed to circularize the orbit, was also a normal-feed two-engine firing. Other than the quantity gage problem discussed previously, the maneuver was completely normal.

The OMS-3 and OMS-4 maneuvers were performed to raise the orbital altitude to 137 nmi. The OMS-3 maneuver was separated into two parts (OMS-3A and OMS-3B) to satisfy a flight test objective (FTO 242-02, OMS Engine Restart). OMS-3A and 3B were performed using the left pod engine and tankage. Feed mode switchover during an OMS firing was demonstrated during OMS-4 to satisfy FTO 242-01 (Simulated Engine Failure). OMS-4 was started as a single engine, normal-feed firing using the right pod; a mid-firing feed mode switch was accomplished, and the firing was completed with left pod tankage feeding the right engine. OMS performance during these firings was as expected.

TABLE 2-II. - STS-2 OMS CONSUMABLES - PLANNED/MEASURED QUANTITIES

Event/Time, G.m.t.	ΔV, ft/sec Planned/ Actual	Firing Duration, sec Planned/ Actual	Propellant Gaging, percent				GN2, psia		GHe, psia	
			Left Oxidizer Planned/ Actual	Left Fuel Planned/ Actual	Right Oxidizer Planned/ Actual	Right Fuel Planned/ Actual	Left Planned/ Actual	Right Planned/ Actual	Left Planned/ Actual	Right Planned/ Actual
Lift-off	N/A	N/A	66.9/ 66.8	66.7/ 66.2	71.9/ 71.6	71.7/ 71.4	2270/ 2270	2240/ 2240	4650/ 4620	4690/ 4670
OMS-1 316:15:20:33.9	144.0/ 141.5	83.0/ 77.0	54.4/ 55.6	54.4/ 56.0	59.4/ 74.2 (59.4)*	59.5/ 60.8	2150/ 2110	2120/ 2080	4183/ 4240	4201/ 4270
OMS-2 316:15:51:51.7	121.0/ 121.0	69.7/ 69.2	44.1/ 46.2	44.2/ 45.6	49.0/ 60.0 (49.0)*	49.3/ 49.0	2030/ 2038	2000/ 2040	3732/ 3900	3749/ 3920
OMS-3A 316:22:54:59.8	10.0/ 12.0	11.4/ 12.0	42.4/ 44.6	42.6/ 43.8	49.0/ 60.0 (49.0)*	49.3/ 49.6	1910/ 1890	2000/ 2040	3912/ 3970	3749/ 4010
OMS-3B 316:22:59:14.8	20.6/ 21.0	23.6/ 24.0	38.9/ 43.4	39.1/ 40.2	49.0/ 57.2 (49.0)*	49.3/ 49.6	1790/ 1760	2000/ 2030	3740/ 3810	3749/ 4020
OMS-4 316:23:43:20.0	15.3/ no data	35.8/ 38.7	36.4/ 43.2	36.5/ 36.0	46.3/ 56.0 (46.3)*	46.7/ 46.8	1790/ 1890	1880/ 1890	3696/ 3700	3881/ 3880
OMS/RCS Interconnect Operations Left-RCS Right-RCS	N/A	N/A	30.9/ 43.2	30.8/ 36.0	42.0/ 56.0 (45.6)*	42.1/ 46.8	1790/ 1750	1880/ 1800	3602/ 3750	3815/ 3840
Deorbit 318:20:23:14.8	272.3/ 313.4	149.0/ 170.9	8.8/ 10.6	9.0/ 10.2	19.7/ 40.2 (18.1)*	20.3/ 20.8	1670/ 1740	1760/ 1810	2600/ 2880	2808/ 2900

*Estimated actual quantity.

TABLE 2-III.- ENGINE PERFORMANCE SUMMARY

LEFT OMS ENGINE

Firing	Reconstructed					Observed	
	Isp, sec	Mixture ratio	Flowrate, lbm/sec	Chamber pressure, percent	Fuel temperature out of regenerative cooled jacket, °F	Chamber pressure, percent	Fuel temperature out of regenerative cooled jacket, °F
OMS-1	314.7	1.662	19.01	103.8	223	102	231
OMS-2	314.7	1.662	19.16	104.7	223	103	231
OMS-3A	314.8	1.668	19.24	105.1	223	104	232
OMS-3B	314.8	1.668	19.29	105.4	223	103	231
Deorbit	314.8	1.664	19.24	105.1	223	103	228

RIGHT OMS ENGINE

Firing	Reconstructed					Observed	
	Isp, sec	Mixture ratio	Flowrate, lbm/sec	Chamber pressure, percent	Fuel temperature out of regenerative cooled jacket, °F	Chamber pressure, percent	Fuel temperature out of regenerative cooled jacket, °F
OMS-1	314.3	1.668	19.15	104.4	223	104	234
OMS-2	314.2	1.659	19.28	105.1	222	102	234
OMS-4 ^N	314.3	1.660	19.37	105.6	222	105	*
OMS-4 ^X	313.9	1.645	18.77	102.3	222	102	229
Deorbit	314.3	1.664	19.41	105.8	222	105	229

*Right engine regenerative cooled temperature varied between 221° F and 226° F as the feed system was being configured for crossfeed from left.

^N Normal feed from right pod.

^X Crossfeed from left pod.

The OMS-to-RCS interconnect was used twice during the mission (once from the left pod and once from the right pod) to conserve RCS propellants, but the OMS-to-RCS propellant interconnect flight test objective (FTO 242-03) was not accomplished. At 317:20:14:30 G.m.t., a failure of the left OMS B leg crossfeed valve close position indicators was noted. (Section 7.0, flight test problem report 17.) This caused the valve motor power to be continuously applied. The cockpit switch was placed to the GPC position to remove power.

The deorbit maneuver was modified because of the greater OMS propellant quantity resulting from the shortened mission, giving a longer deorbit maneuver than planned. The right-pod propellant tanks were not repressurized following the termination of RCS interconnect; so the deorbit maneuver began with lower than normal ullage pressures in the right pod. However, the pressures were well within limits, and the firing was normal.

The OMS pressurization system performance was normal throughout the mission. As was noticed on STS-1, ullage pressures during the first OMS firing were 3 to 4 psi lower than the other firings. This is apparently an effect of having the regulators at lockup for an extended period of time prior to the first firing.

The acquisition system performance was excellent. Data have been reviewed from all on-orbit OMS starts, and no gas ingestion by the engines was observed.

As a result of the analysis of STS-1 flight data, two major changes were recommended for the OMS gaging probes: (1) increased vent area in the top of the forward fuel probes and (2) increased drain hole size in the aft support cup for the oxidizer and fuel probes. Only one of these changes was implemented for STS-2; i.e., the right-hand forward fuel probe was replaced with a unit incorporating the increased upper vent area. During STS-2, this probe experienced no performance anomalies and met design performance requirements. The left-hand fuel forward probe, which was not modified, gave propellant quantity indicator hangup problems very similar to STS-1. Both the right- and left-hand aft fuel probes performed normally.

The left-hand oxidizer forward probe performed well until the OMS-3B maneuver when the gaging system failed to go into the ungageable countdown at the bottom of the forward probe. The gaging system remained at 43.4/43.2 percent during the OMS-3B and OMS-4 maneuvers. Approximately 67 seconds into the deorbit maneuver, the gage did start into the ungageable countdown and completed the countdown approximately 10 seconds prior to the firing completion. Post-deorbit maneuver left-hand pod oxidizer gage quantities were in close agreement with predicted quantities. The left-hand oxidizer aft gaging probe performed normally during STS-2. The right-hand forward and aft oxidizer probes indicated anomalously high quantities during STS-2. Similar performance was not experienced on STS-1, and the cause has not been isolated. Section 7.0, flight test problem report 5 contains a discussion of this anomaly.

The feed system performance appeared normal, including the right oxidizer feed system that experienced an increased pressure drop during STS-1. The left-pod oxidizer and fuel as well as the right-pod fuel pressure drops compared very closely with STS-1 values. The right pod oxidizer pressure drops and the pressure drops for left-pod-to-right-engine crossfeed were as predicted. In the crossfeed mode, hydraulic hammer was very noticeable on shutdown, as was experienced on STS-1 and at the White Sands Test Facility during ground tests; however, this hammering condition was not detrimental to the system.

2.1.2.1 Engine.- Table 2-III shows the reconstructed engine performance based on the observed propellant tank and engine inlet pressures. Engine performance was as expected and engine chamber pressure and regenerative cooling jacket outlet temperatures compared well with observed values (within the accuracy of the instrumentation). Engine valve timing and start and shutdown transients were normal.

2.1.2.2 Flight Test Objectives.- The OMS-4 maneuver successfully performed FTO 242-01 (Simulated OMS Engine Failure). This test was to demonstrate the in-flight dynamic response of the feed system while initiating crossfeed during a firing. Engine inlet pressures responded as expected and were similar to the pressures seen during STS-1.

FTO 242-02 (OMS Engine Restart) was successfully performed during the OMS-3A and OMS-3B maneuvers. These maneuvers were to demonstrate the capability of the OMS engines to restart under zero g and hard vacuum conditions with a minimum length of time (240 seconds) between firings. Actual time interval between OMS-3A cutoff and OMS-3B ignition was 243 seconds. Engine performance was normal during both firings, and no harmful effects were seen in performing the restart. Verification of satisfactory demonstration of this FTO will require a detailed review of the engine DFI data.

This FTO (FTO 242-03) OMS-to-RCS Interconnect Test was canceled from the mission and has been rescheduled to STS-4.

Post-landing inspections indicated two of the clips connecting sensor V43T9112A (nozzle lip temperature 2) to the left OMS engine nozzle were loose. A similar problem was experienced on STS-1 with the same measurement. DFI data indicate this problem did not affect the temperature readings from this thermocouple. This was a different nozzle and thermocouple from that used during STS-1. Thus, it appears that a problem exists with the method of attaching the clips to the nozzle. (Section 7.0, flight test problem report 41.)

2.1.3 Reaction Control System

The operation of the RCS throughout the flight of STS-2 was excellent. Two flight test objectives were accomplished successfully.

The system configuration for launch, as for STS-1, had both pressurization paths open (leg A and leg B) in all modules and the aft propellant tanks again in the "overfilled" condition (no gas ullage in the tank). Pressure regulation for the aft tanks was normal preflight and during the flight at 250 psig, but the forward module oxygen tank pressurization prior to launch indicated a lockup pressure higher than expected from a primary regulator, 255 psig. Throughout the initial usage, the regulation on the oxidizer side remained at this higher than normal regulation band. On orbit, however, when one of the regulation paths (leg B) was closed, the pressure dropped to the expected lockup pressure of 250 psig and maintained this throughout the rest of the flight. (Section 7.0, flight test problem report 30.)

The entry flight test objectives required extensive RCS usage, commanding the aft thrusters to fire in excess of 1,000 pulses and consuming approximately 1,800 lb of propellant. Because of the problem with "zots" when firing the thrusters below 70,000 ft, special precautions were taken to prevent them from occurring. In all, 75 thruster firings were commanded at altitudes less than 70,000 ft. The last firing occurred at an altitude of about 49,000 ft.

Propellant consumption from the RCS was significantly different from preflight predictions, primarily because the mission was radically altered due to the fuel cell failure. A tabulation of propellant used from the RCS as a function of mission phase is as follows:

	<u>Quantity of propellant used, lb</u>		
<u>Mission phase</u>	<u>Left RCS</u>	<u>Right RCS</u>	<u>Forward RCS</u>
Ascent	165	158	120
On Orbit	519	460	422
Orbit-to-entry-interface	80	103	1415
Entry-interface-to-landing	901	893	---

In addition to the propellant used from the RCS tanks, propellant was also consumed from the left and right OMS tanks. In the interconnect mode, the RCS consumed 50 lb of propellant from the left OMS tanks and an unknown quantity (approximately 150 lb) from the right OMS tank. The quantity used from the right OMS tank is uncertain since the OPS-3 software does not provide data when the RCS is in the interconnect mode to that tank.

The large quantity of propellant was consumed from the forward module after the deorbit maneuver due to a planned propellant dump to control the Orbiter c.g. for entry. The dump consisted of two long-duration firings, separated by approximately 40 seconds. The first firing was 67 seconds, and the second was 49 seconds. The dump was performed in two separate firings to comply with RCS tank constraints. The dump was normal, with gas-free propellant for the entire duration, and the firing took the RCS quantity gage to 0 percent usable. After the dump, the forward module was still used for an additional 48 firings with no problem.

The thermal environment for STS-2 was again benign, as was STS-1. The RCS propellant tanks were loaded with 82° F propellant so that 70° F or warmer propellant would be available for entry to avoid "zots" below 70,000 ft. The propellant was maintained at 76° F. All engines stayed at or above their minimum heater set points for the entire mission. The only exception was vernier engine F5R, which fell to 127° F during the vernier heater test. (See fig. 2-3). The only higher-than-expected temperature limit was noted approximately 52 hours into the mission. This apparently resulted from the consistent and repeated pulsing of the left-side verniers in a duty cycle caused by a disturbance torque from flash evaporator venting. Three hours of continuous pulsing at a rate of 2 seconds on and 20 seconds off drove the fuel valve body temperature on engines F5L above its upper instrumentation limit of 250° F for approximately 15 minutes. Since the valve seal temperature is 10° F hotter, the Teflon exceeded its qualification limit of 250° F for approximately 40 minutes. A peak temperature of 265 to 270° F was reached. The concern with this higher-than-expected temperature is the possible cold-flow distortion of the Teflon seal and the consequent valve leakage. No leakage, however, was observed. (Section 7.0, flight test problem report 46.)

The forward primary down-firing thrusters F4D and F2D reached a peak temperature of 204° F on the leak detectors during entry. Using this temperature and a DFI measurement located on the valve body, the maximum valve-seat temperature was estimated to be about 155° F, about 15° F higher than was experienced on STS-1 but significantly below the valve's capability.

In addition to the normal on-orbit functions, the RCS also was used to accomplish two flight test objectives successfully. They were FTO 212-03 (vernier injector heater evaluation) and FTO 247-01 (RCS thruster leak detection test). The first FTO was a test to determine the vernier heater performance by not allowing the vernier engine to fire for a 10-hour period, allowing only the vernier heater to maintain the injector temperature. The test was added based on STS-1 results when a vernier heater did not maintain the temperature within its cycle limits. The test demonstrated that the 10W heaters on the forward verniers are marginal. They could not hold the injector above the leak detection threshold, 130° F, when facing deep space. The vernier engines, therefore, require occasional firing to maintain the injector above the leak detection limit. FTO 244-01 was a test to determine whether a primary thruster leak detector can be falsely tripped by the evaporation of the propellant residual left between the valve and injector. It was observed on STS-1 that a fuel leak detector cooled as much as 20° F after a firing and that a leak detector on STS-1 was seen to reach 37° F. The FTO was composed of firing ten 80-millisecond pulses at four different off-times to determine the worst-case cooldown duty cycle. Figure 2-4 shows the fuel leak detectors on the engines tested. The data show that on-orbit with an engine starting at 78° F or greater and propellant of 76° F or greater, the lowest temperature registered was 39° F after 10 pulses. No deselections occurred. However, about 6 minutes after entry interface, the fuel leak detector on primary thruster RIU fell, after two pulses, to 33° F, about 3° above the

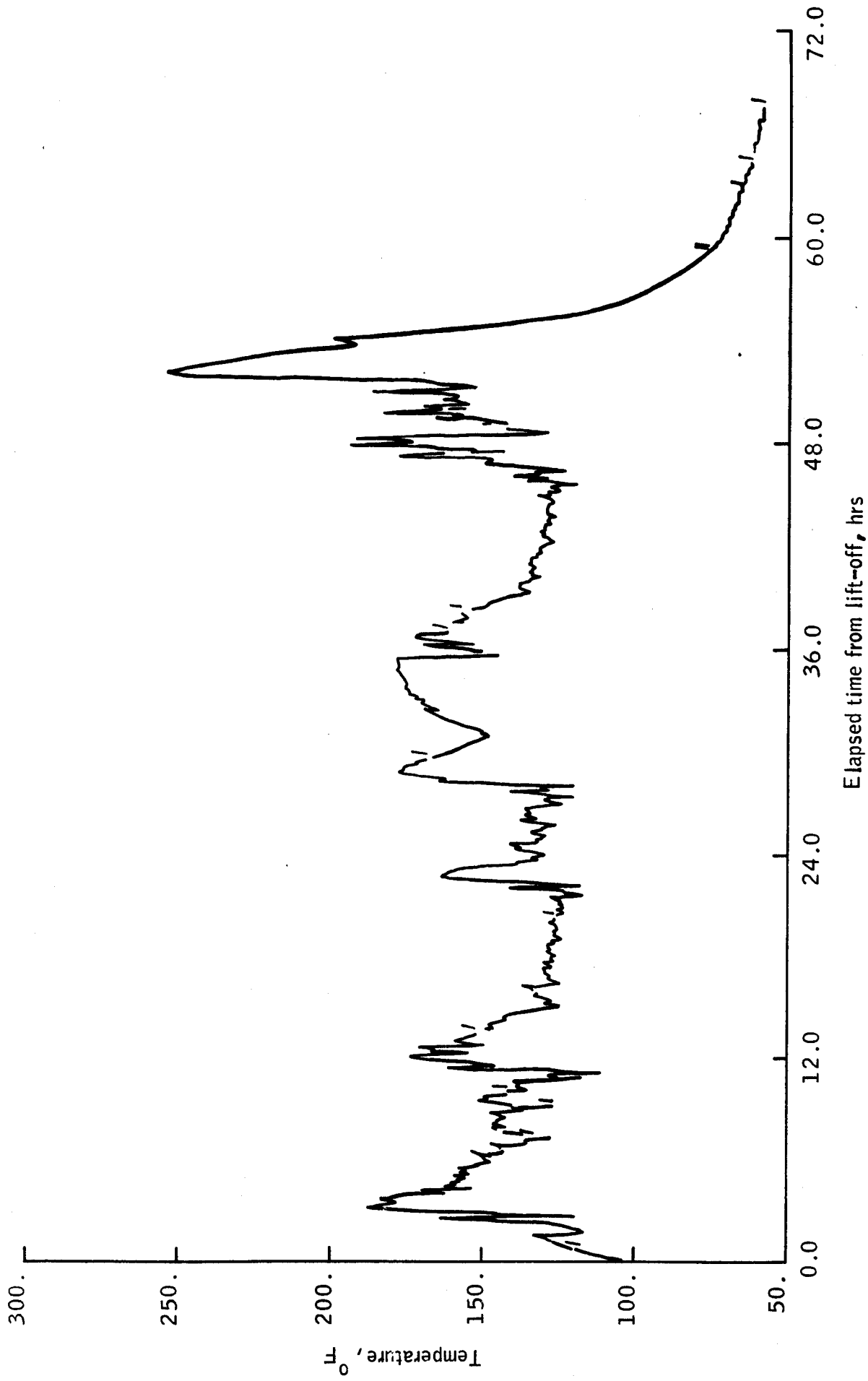

Figure 2-3.- Engine F5R temperature response during mission .

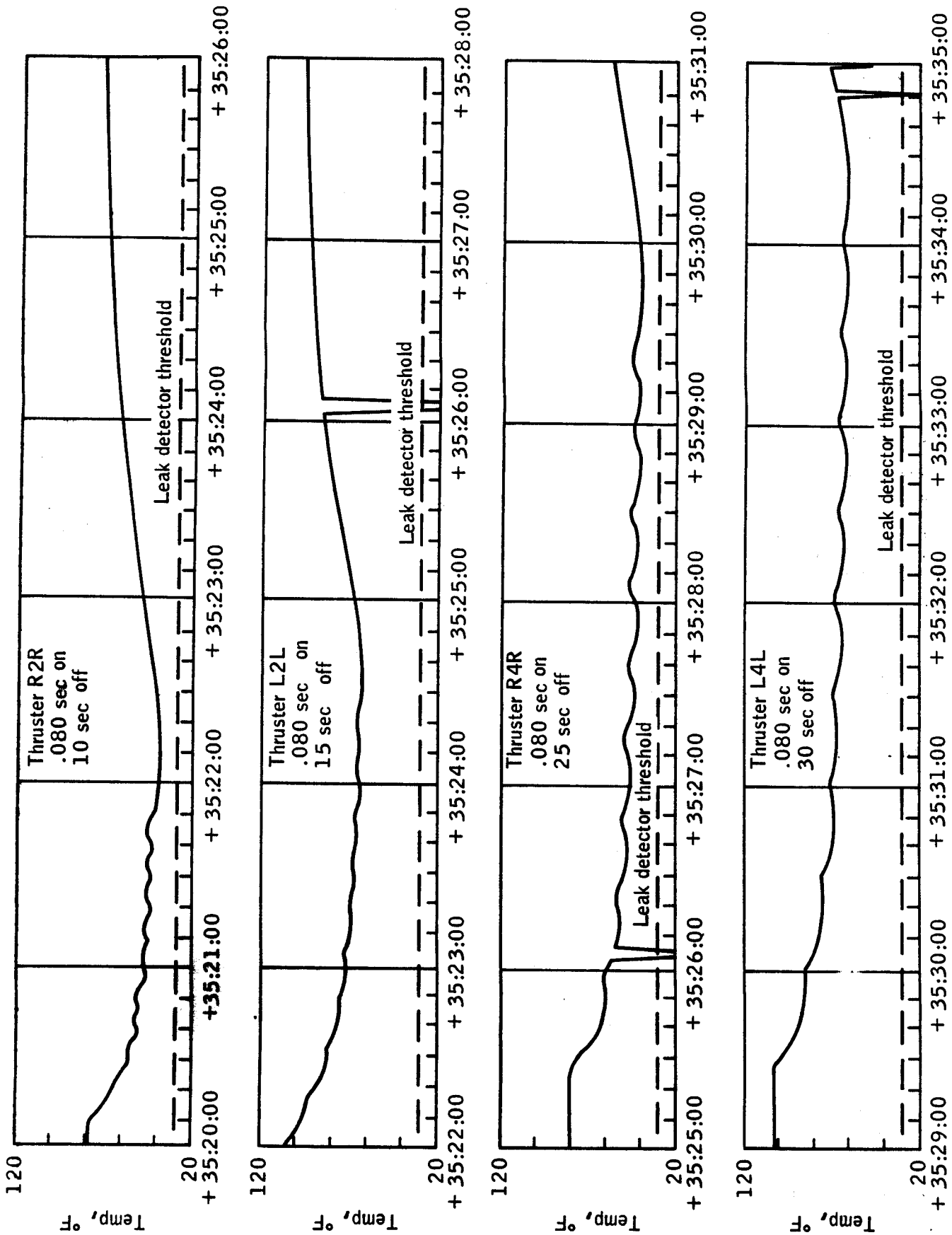

Figure 2-4.- Tests for FT0 244-01.

leak detector limit. This appears to have been caused by the fuel dribble volume's pooling in the injector because of the effects of gravity (approximately 0.05g) and, therefore, providing additional cooling to the leak detector. The data indicate that a deselection may occur.

In configuring the Orbiter for ferry flight, the aft RCS propellant tanks were erroneously subjected to a reverse pressurization during two improper propellant tank draining operations, conducted on November 20 and 22, 1981. The first incident involved the left aft RCS fuel tank, and the second involved both the left and right fuel and oxidizer propellant tanks. (Section 7.0, flight test problem report 36.)

2.2 POWER SYSTEMS

2.2.1 Auxiliary Power Units

The APU performance was normal during STS-2 with the exception of a water cooling failure on APU 1, lubrication oil over-temperature on APU 3, and low gas-generator chamber pressures indicative of a bubble on APU 1 and, to a lesser extent, on APU 3. Plugging of lubrication system filters on APUs 1 and 3 occurred during the STS-2 launch attempt on Nov. 4, 1981.

The three APUs were started 5 minutes before launch and, except for APU 3, were shut down after the MPS was dumped. APU 3 was shut down before the dump sequence was complete because of the over-temperature condition that existed. (Section 7.0, flight test problem report 4.) On-orbit checkout was performed with APU 2. For entry, APU 3 was started 5 minutes before ignition for the deorbit maneuver, and APUs 1 and 2 were started at entry interface minus 13 minutes. Total run times are as follows:

Phase	APU 1	APU 2	APU 3
Ascent	19 min 29 sec	19 min 19 sec	16 min 54 sec
On-orbit		4 min 7 sec	
Descent	1 hr 0 min 32 sec	1 hr 0 min 41 sec	1 hr 19 min 43 sec

Total consumables used during the mission were as follows:

Phase	Fuel, lb		
	APU 1	APU 2	APU 3
Ascent	51	59	55
On-orbit		13	
Descent	122	170	199
Total	173	242	254

Water, lb
 Primary 2.4
 Secondary 0.9
 Injector 0

The fuel usage has been determined from a pressure volume temperature calculation. More accurate values will be obtained at the time of loading for STS-3.

2.2.1.1. APU Performance.- Performance of all three APUs during the various mission phases was normal with the exception of lubrication system temperature, contamination problems, and gas-generator pressures indicative of a bubble. None of these problems affected the APUs' ability to provide power to the hydraulic pump.

During the first launch attempt, APUs 1 and 3 lubrication oil outlet pressures increased to over 100 psia, indicating that the filter was plugged, as shown in figures 2-5 and 2-6. (Section 7.0, flight test problem report 1.) The lubrication oil was drained, the filters examined, and a contaminant isolated. The contaminant was pentaerythritol, a crystal formed when hydrazine penetrates the gearbox. The gearboxes were flushed and reserviced. No plugging was indicated during ascent, but the APU 1 filter plugged again briefly during descent.

During ascent, the APU 3 lubrication oil temperatures exceeded the caution and warning limit of 290° F. This problem was due to freezing in the water boiler and prompted the crew to shut that APU down early. (Section 7.0, flight test problem report 4.)

APUs 1 and 3 showed indications of a bubble during the first launch attempt, as indicated by a dip in the chamber pressure. APU 1 also indicated a bubble during ascent. For descent, APUs 1 and 3 again showed signs of a bubble. For APU 3 the bubble was apparently slight, but it lasted in APU 1 for approximately 10 minutes. The bubble also affected the chamber pressure level. During startup for descent, APU 1 chamber pressure was approximately 890 psia, as shown in figure 2-7. After the bubble disappeared, the gas generator pressure was approximately 1240 psia. APU 1 has been removed from the vehicle to determine the cause of the bubble generation. (Section 7.0, flight test problem report 7.)

2.2.1.2 Fuel Pump/Gas Generator Valve Module Cooling.- The FP/GGVM (fuel pump/gas generator valve module) water cooling system maintained the pump and GGVM of APUs 2 and 3 well within the maximum temperature limits following the ascent and flight control system checkout shutdowns. APU 1 experienced a cooling failure of both the primary and the secondary cooling systems. (Section 7.0, flight test problem report 7.)

One pulse was observed immediately after shutdown, and no further cooling was observed until approximately 1-1/2 hours later when several pulses were noted.

2.2.1.3 Thermal Control System.- The thermal control system heaters for the APUs' fuel, lubrication oil, and water systems maintained temperatures within critical limits throughout the on-orbit APU nonoperational periods. Five cases of thermostat instability (chattering) were noted on the heater circuits of the APU 2 pump water line, APUs 1 and 3 gas generator water cooling systems, APU 1 fuel feedline, and APU 1 seal cavity drain line. (Section 7.0, flight test problem report 3.)

2.2.1.4 Fuel Pump Seal Cavity Drain.- The fuel pump seal cavity drain pressures did not exceed 23 psia, indicating that pump shaft seal leakage was not excessive. The measured seal leakage quantities drained from the catch bottles during postflight operations were as follows: APU 1, 25 cc; APU 2, 6 cc; and APU 3, 8 cc.

2.2.2 Hydraulic Systems

Overall system performance was excellent. Three anomalies that occurred were the freeze-up of WSB (water spray boiler) 3 during ascent (Section 7.0, flight test problem report 4), and the loss of 30 percent in system 1 reservoir volume during landing (Section 7.0, flight test problem report 24) and the WSB ready indicator was inoperative (Section 7.0, flight test problem report 28). The first anomaly caused premature shutdown at APU 3 due to the lubrication oil over-temperature condition. No problems with WSB 3 were encountered during entry. The second anomaly did not affect the landing but did result in the ground's telling the crew to close the system 1 landing gear isolation valve shortly after touchdown (to preclude further hydraulic fluid loss if an external leak had occurred). The third anomaly, minor in nature on WSB 1, did occur during early entry as follows: The WSB 1 "ready" indication was off from 318:21:14 to 318:21:30 G.m.t. This resulted in an erroneous "bypass" indication on the hydraulic bypass valve. The valve actually functioned properly and was in the "heat exchanger" position.

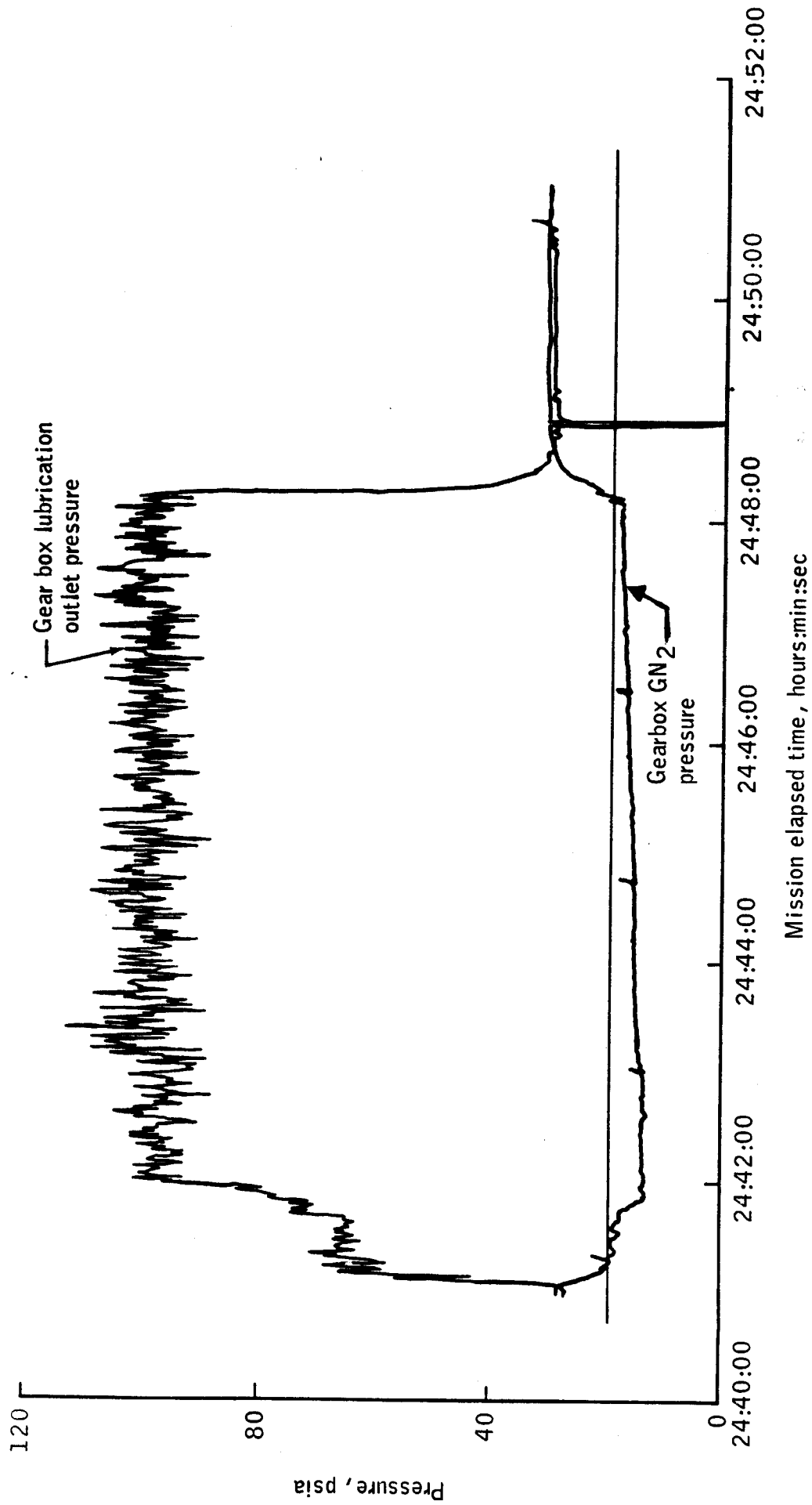

Figure 2-5.- APU I lubrication oil outlet pressure.

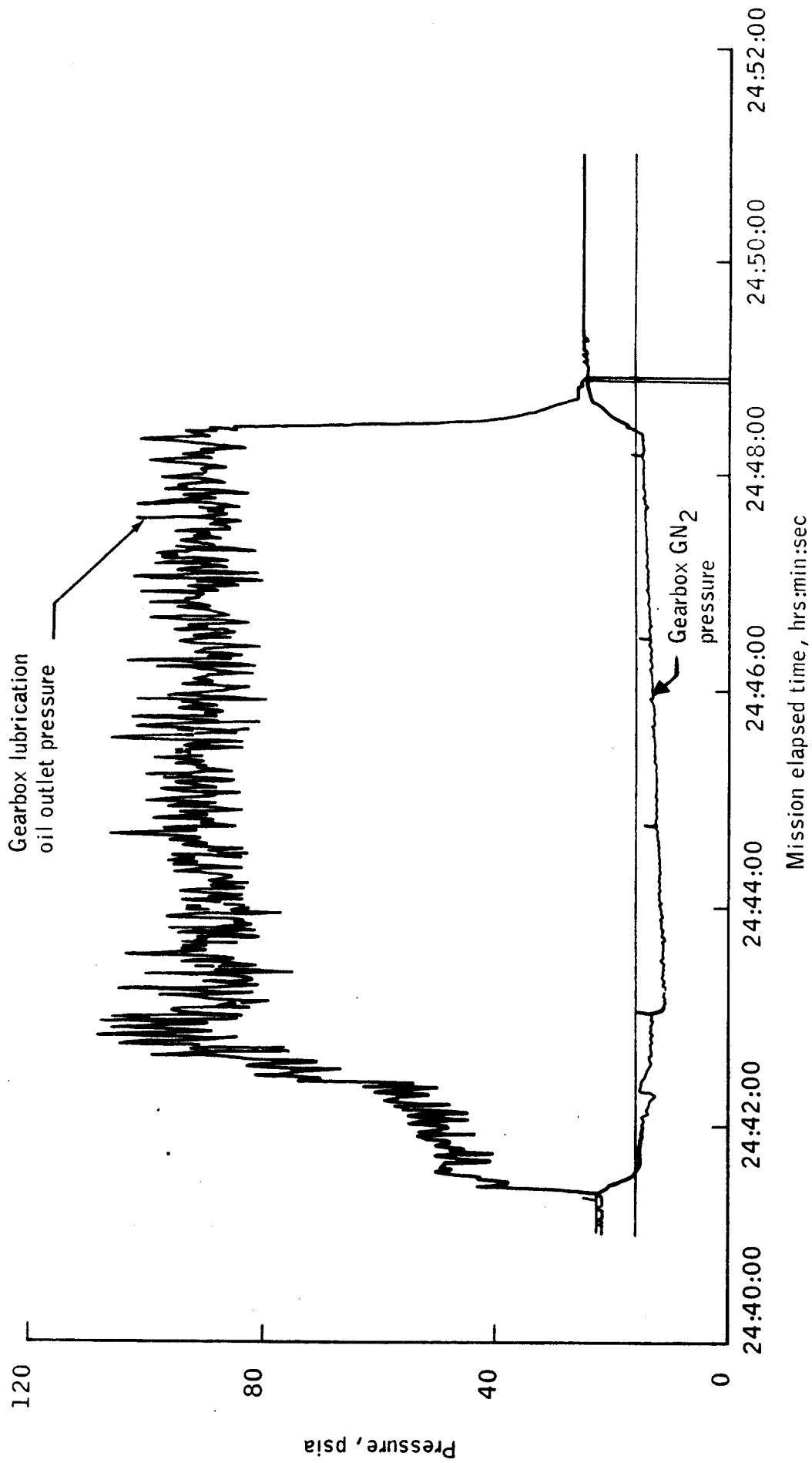

Figure 2-6.- APU 3 lubrication oil outlet pressure.

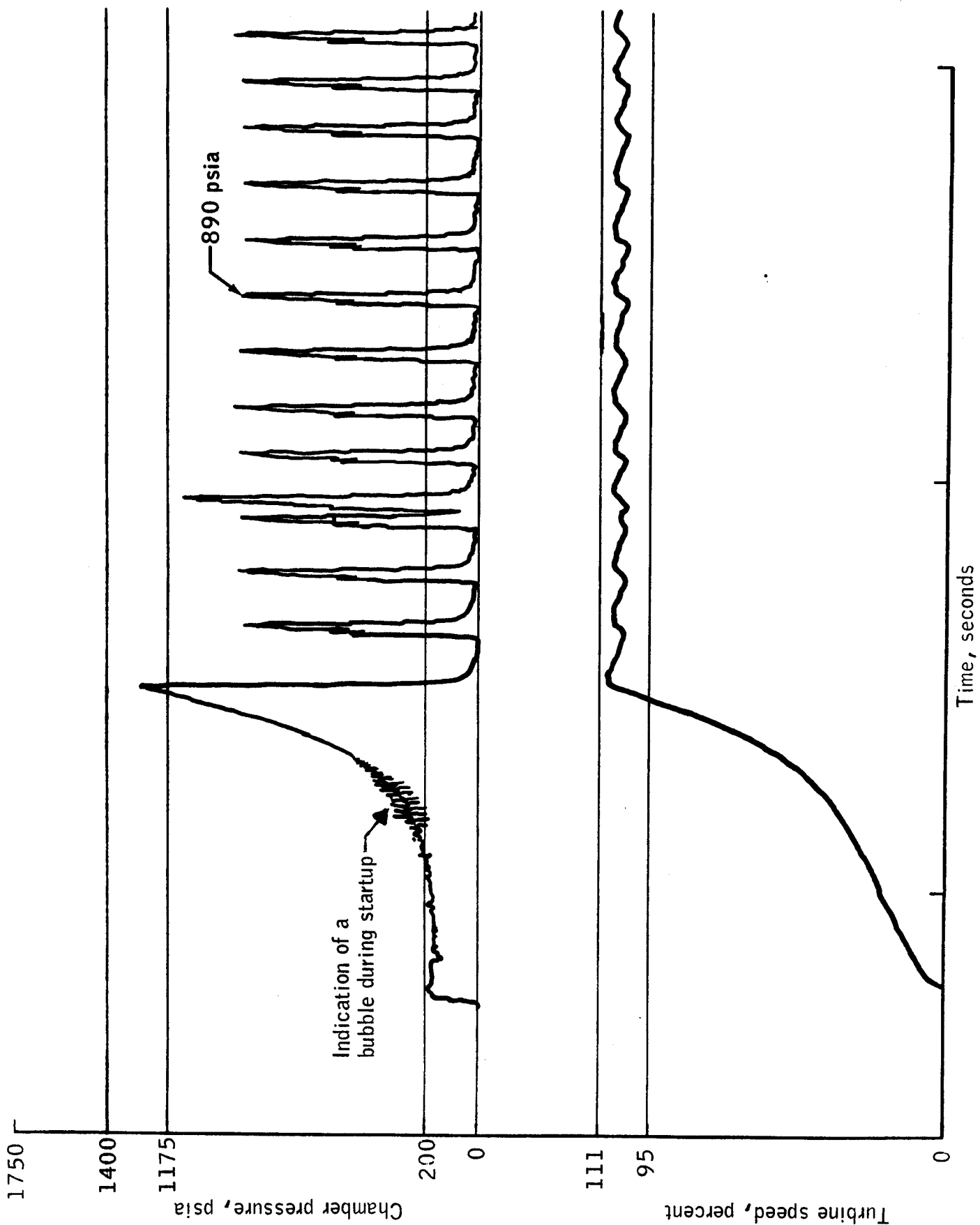

Figure 2-7.- APU 1 descent start up conditions.

The circulation pump startup was satisfactory, and no cycling of the bootstrap pressurization system was noted.

2.2.2.1 Ascent.- At APU startup, the main engine TVC (thrust vector controller) actuators stepped from near the start position to the launch position (up to 1.6 degree). The step movement did not cause any problems. The step occurred because the main engines were left commanded to the launch position on the aborted launch and had drifted to a new position at APU start.

The APU 3 lubrication oil over-temperature condition during ascent indicated a WSB anomaly. (Section 7.0, flight test problem report 4.) The WSB 3 instrumentation showed a WSB freeze-up, as indicated by the boiler tank's temperature going below 32° F. This phenomenon also occurred on STS-1; however, on STS-1 the WSB thawed by the time the lube oil reached 285° F. On STS-2 the lubrication oil temperature went above 307° F (figure 2-8), and the WSB was switched to the "B" controller. This switchover did not rectify the problem, indicating that the spray bars were frozen. Approximately 28 minutes after lift-off, the boiler tank temperature was normal, indicating the WSB had thawed.

Because of the WSB anomaly, which is discussed in section 7, (flight test problem report 4), APU 3 was shut down early in the following configuration: WSB 3 on B controller (resulting in loss of WSB 3 instrumentation) and TVC isolation valve 3 open (because pressure is required to close it).

2.2.2.2 On Orbit.- On orbit system performance was satisfactory. Because of the early shutdown of APU 3, circulation pump 3 was operated to close the TVC isolation valve 3. Circulation pump operation was satisfactory.

One of the primary tests to be conducted during this mission was DTO 243, (On orbit Circulation Thermal Test). Due to the fuel cell 1 failure, the test was redefined to system 2 only. The test was conducted with 15 minutes on-time, 45 minute off-time for three cycles. (The third cycle was to simulate system 1 with the landing gear isolation valve closed.) Only 4 of the 5 minutes of operation were conducted with the isolation valve closed because of a procedural problem, and therefore, this may not give sufficient data to evaluate the differences between systems 2 and 1.

2.2.2.3 Entry, Descent and Landing.- The hydraulic systems met all performance requirements during the entry, descent, and landing phases of the mission. System reservoir quantities were at 57.5, 55.9, and 55.1 percent for systems 1, 2 and 3, respectively, prior to APU start. During the descent and landing phases, a 30-percent reduction in system 1 reservoir fluid volume created concern that there was a leak, and the flight crew reclosed the isolation valve shortly after rollout. (Section 7.0, flight test problem report 24.)

System 1 reservoir fluid level fell from 66.6 percent to 51.5 percent in 168 seconds after the landing gear isolation valve was opened. (Section 7.0, flight test problem report 24.) The fluid level then stabilized for 97 seconds. At this point, the landing gear was deployed, and the reservoir's level fell to 36.8 percent in 5 seconds. The reservoir fluid level then fell another 0.8 percent until the system 1 isolation valve was reclosed (329 seconds after opening).

2.2.3 Power Reactant Storage and Distribution

The PRSD (power reactant storage and distribution) subsystem performance was satisfactory during all phases of the STS-2 mission. The planned FTO 245-01 (Stratification Test) was cancelled due to the minimum mission.

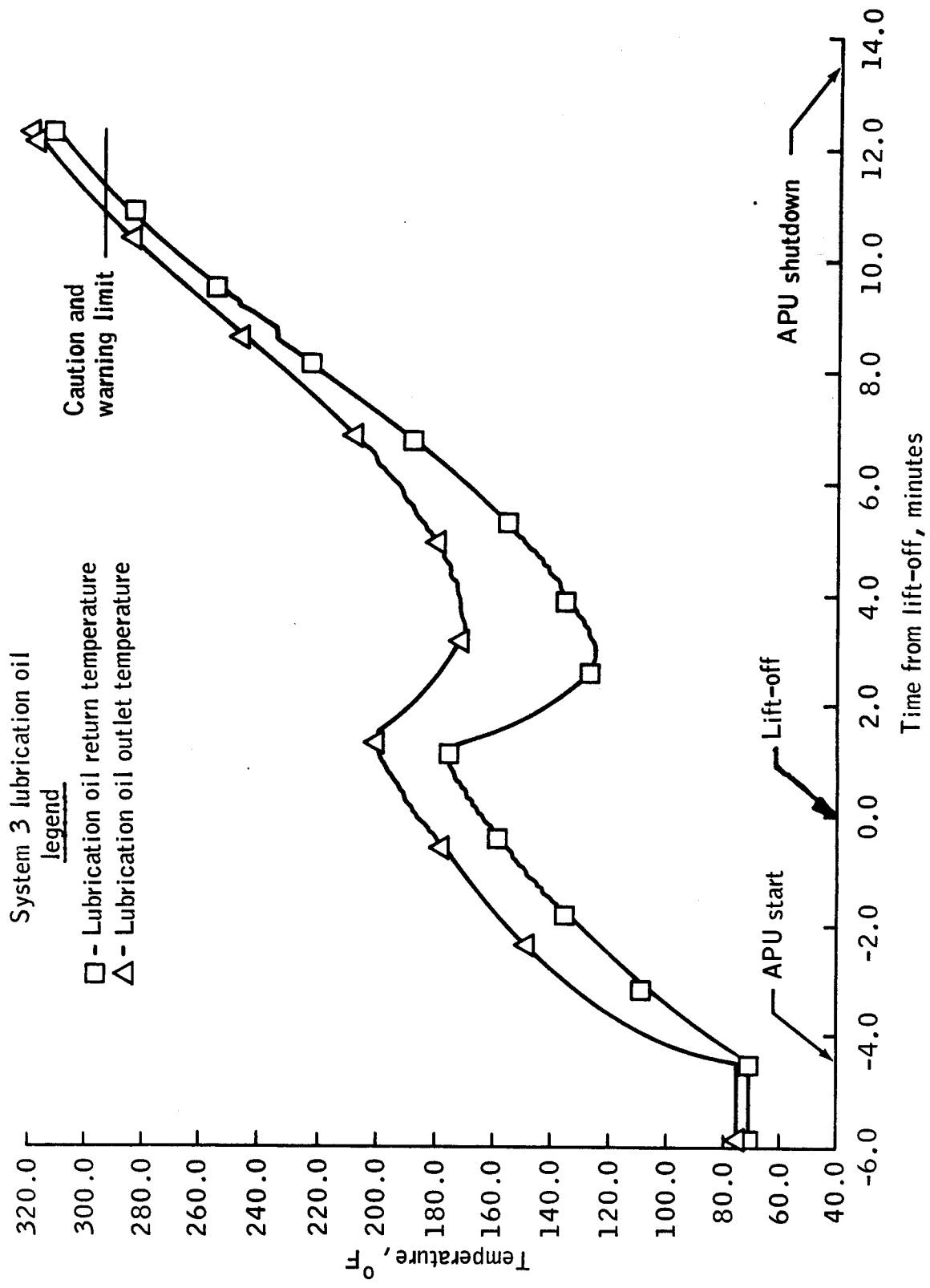

Figure 2-8.- Lubrication oil temperatures during ascent.

2.2.3.1 First Launch Attempt.- The power reactant storage and distribution (PRSD) subsystem was loaded for the first launch attempt on November 2, 1981. During this loading, oxygen tank 2 started to lose quantity prior to oxygen tanks 1 and 3 being full. This resulted in a change to the loading procedure in that tanks 1 and 3 were filled and pressurized; then, tank 2 was topped off and pressurized separately. When tank 2 started to off-load, the problem was found to be the high back pressure created by flashing liquid oxygen in the vent line. This back pressure, in combination with the head pressure due to the higher elevation of tank 2 in the Orbiter, caused the off-loading to occur. The hydrogen fill and pressurization procedure went as expected and caused no problems.

During the final stages of the count, the oxygen pressures were noted as not being maintained at the proper levels by the ground support equipment supply; i.e., between 905 psia and 975 psia. As the demand on the system increased; i.e., higher fuel cell loads, the supply pressure continued to drop. This resulted in the tank pressures being lower than the required pressure of 866 psia at the time of closing the T-0 valve (T-2 min 35 sec.). This resulted in the launch processing system why possessive stopping the count at T-31 sec. and a recycle why possessive being started. A high pressure (3000 psia to 1500 psia) oxygen regulator was found failed and was replaced prior for the next launch attempt. This problem was associated with the ground system used for launching the vehicle.

2.2.3.2 Second Launch Attempt.- The tanks were reloaded for the second launch attempt on November 10, 1981. Again, the oxygen system encountered problems during the fill, and tank 3 had to be topped off and pressurized by itself.

After the first launch attempt, the launch commit criteria were reviewed and revised to the following values. The pressures at T-31 sec were not changed from 800 psia for oxygen and 235 psia for hydrogen. The requirement for pressure at T-2:35 (T-0 valve closed) was changed to 905 psia for oxygen and 250 psia for hydrogen. In addition, a decay rate for the first minute after valve closure was set at 30 psi for oxygen and 4 psi for hydrogen. At the time of valve closure, the tank pressures were satisfactory, and the decay rates for the first minute were much lower than allowed. As a result, the tank pressures were well above the limits at launch.

The quantities of oxygen and hydrogen for the mission are shown in figures 2-9 and 2-10.

The hydrogen manifold pressures oscillated after closing the T-0 valve, much as was noted on STS-1. After about 12 minutes, the oscillations damped out.

As a result of the powerdown after the fuel cell failure, the stratification test (DTO 245-01), was canceled. This test would have established the stratification limits for pressure drop and temperature rise for the oxygen and hydrogen tanks. An illustration of stratification effects on the quantity was seen on oxygen tank 3 after it was turned off. The quantity increased approximately 1 percent after the heater cycling quit and remained at the new level for the remainder of the mission.

During the flight, the flow rate for hydrogen tank 3 was greater than expected by a factor of two. This was not observed during STS-1 on any tank since the heaters were never in the off position long enough to see this effect, and also, tank 3 was added for STS-2.

During the heater-off periods, hydrogen tank 3 indicated a boil-off of 0.139 lb/hr, and hydrogen tank 2 had a boil-off of 0.095 lb/hr. The tanks are designed and tested for a constant steady-state flow. While in use, a pulse mode was caused by having some tanks cycle in "auto" and other tanks in "off." As the fluid flows from the tank, cold fluid is drawn into the supply line, and then, when the flow is stopped by the check valve's closing, this fluid warms up and is forced back into the tank. This then carries heat back into the tank, which results in a higher boiloff rate. An analysis has shown that the resulting boil-off rates are compatible with mission plans: 4 tanks/7 days.

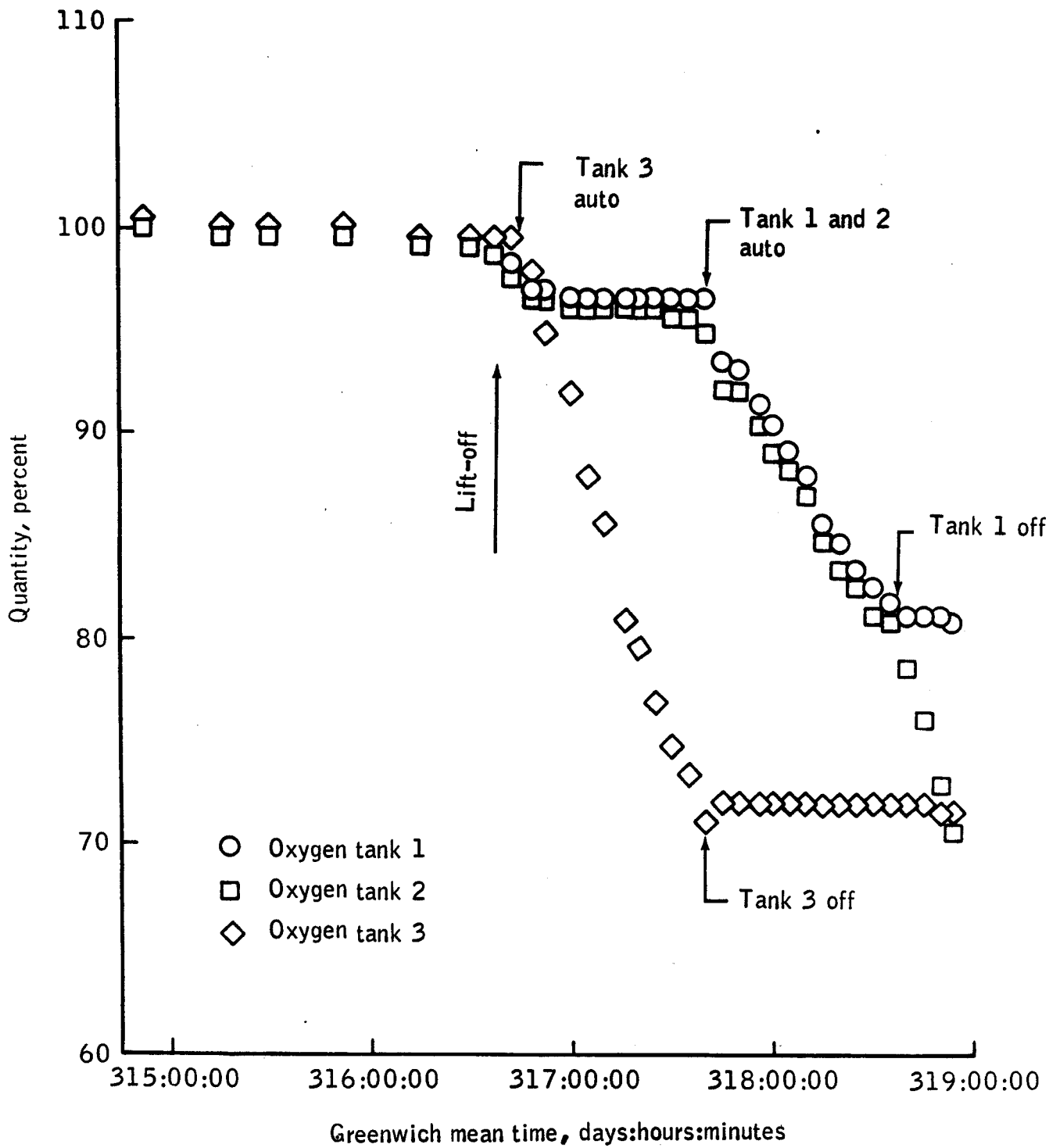

Figure 2-9.- STS-2 oxygen quantity.

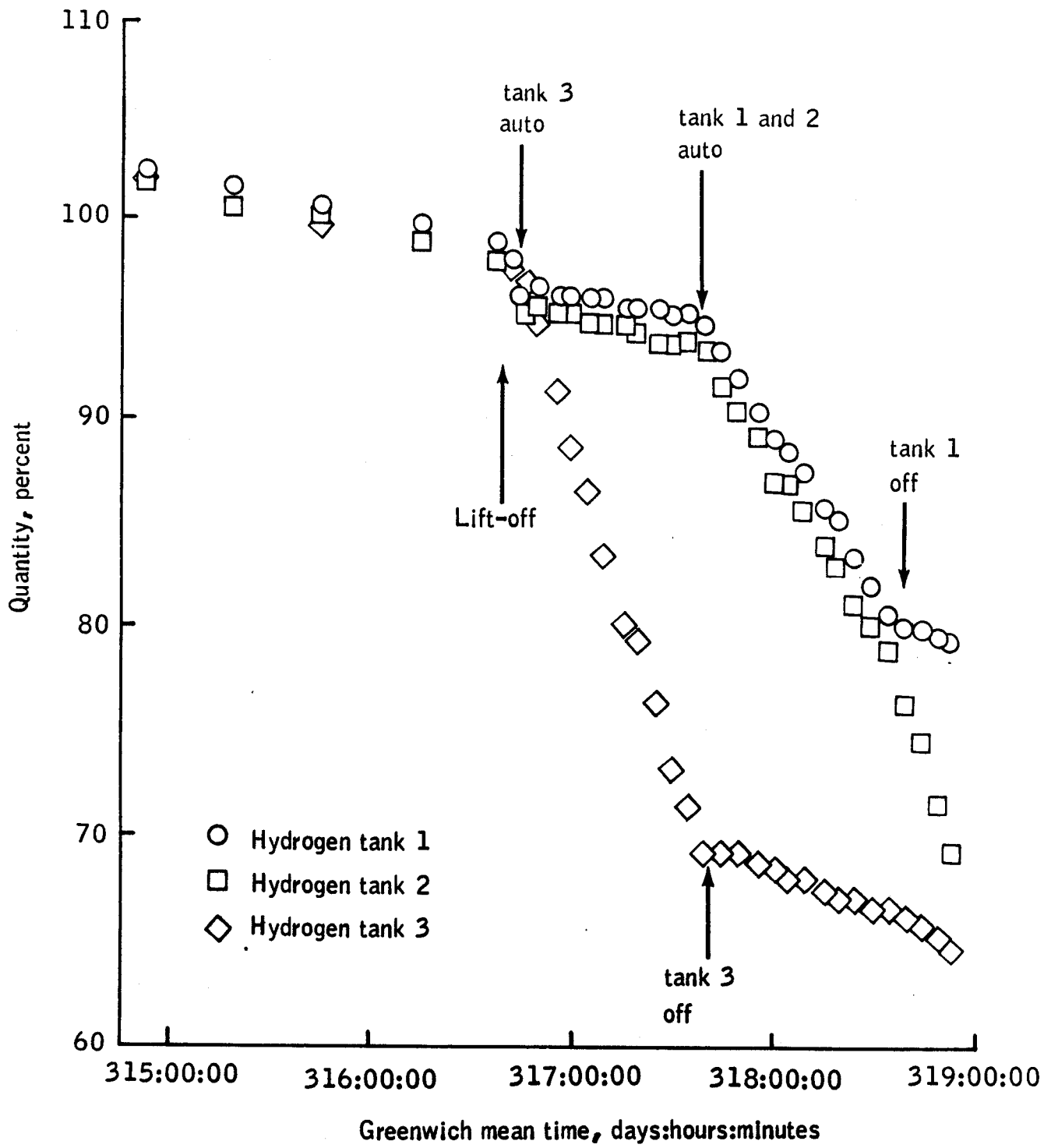

Figure 2-10.- STS-2 hydrogen quantity.

For entry operations, the system was configured with oxygen tank 2 and hydrogen tank 2 only in "auto" with 1/2 heater power. This results in a minimum power configuration for the system, and in this mode the system was able to support fuel cell loads of approximately 18 kW. At this time, the quantity in oxygen tank 2 was 70.7 percent and in hydrogen tank 2 was 69.2 percent. At these quantities, the system could provide 20 kW.

All other system performance was normal.

2.2.4 Power Generation Subsystem

The fuel cell performance was normal during prelaunch and ascent. During on orbit operation, fuel cell 1 failed and was shut down. Fuel cells 2 and 3 provided electrical power for the remainder of the mission.

The fuel cells were activated for the first launch attempt at 308:06:08 G.m.t. and, following the scrub, were shut down at 308:20:11 G.m.t. The fuel cells were activated for the second launch attempt at 316:08:38 G.m.t. Full loads were applied at 316:15:06 G.m.t., preceding lift-off at 316:15:10 G.m.t. The power output during ascent was approximately 23.2 kW at 800 A.

On orbit the fuel cell 1 pH sensor indicated a high pH at 316:17:37 G.m.t. while the performance remained normal. However, at 316:19:55 G.m.t., fuel cell 1 performance began to degrade rapidly. (Section 7.0, flight test problem report 8.) The voltage began to decrease at 4.33 hours into the mission. The fuel cell was taken off bus A and shut down (316:20:15 G.m.t.). Because of the possibility that water was being electrolyzed, thus forming an explosive mixture in the fuel cell, a depressurization procedure was performed. This procedure expended the oxygen and hydrogen from the reactant cavities in the fuel cell. Fuel cells 2 and 3 provided electrical power for the remainder of the shortened mission. The two remaining fuel cells were shut down at 320:02:12 G.m.t., 29 hours after landing.

The hydrogen flowmeter on fuel cell 1 read about 0.2 lb/hr low until the fuel cell failed. (Section 7.0, flight test problem report 18.) The oxygen flowmeter on fuel cell 2 went high at 316:17:00 G.m.t. and remained high for the duration of the mission. (Section 7.0, flight test problem report 9.) Fuel cell 3 oxygen flowmeter was erratic from 317:13:50 G.m.t. to the end of the mission. (Section 7.0, flight test problem report 12.) Malfunctioning flowmeters prevented the use of general purpose computer (GPC) automatic purging of the fuel cells to verify FTR V45VV010. Therefore, the fuel cells were purged in the manual mode.

The total electrical power output for the flight was 27521 A-hr, with an average current output of 508 A at 15 kW. Table 2-IV summarizes the total operating time accumulated on each of the three fuel cells. The total operating time includes all testing and verification before the flight.

2.2.5 Electrical Power Distribution and Control

The electrical power distribution and control (EPDC) performance during STS-2 was satisfactory. STS-2 marked the first usage of the bus tie operation in support of the fuel cell 1 loss. During prelaunch operations, no launch commit criteria redlines were violated, and there were adequate voltage margins for all of the redlines.

The transition from ground power to internal power was accomplished very smoothly during the T-20 minute hold period. At T-3 minutes 30 seconds the ground launch sequencer automatically opened the ground power connect motor switches on the Orbiter to complete the transfer to full internal power.

TABLE 2-IV.- OPERATING TIME ON FUEL CELLS

Fuel cell	Operating time at end of			
	Launch attempt on November 4		STS-2	
	Elapsed time, hr:min	Total operating time on fuel cells, hr:min	Elapsed time, hr:min	Total operating time on fuel cells, hr:min
1	13:57	102:03	6:32	108:35
2	13:57	101:01	89:12	190:13
2	13:20	15:32 (New fuel cell)	88:53	104:25

TABLE 2-V.- STS-2 ACTUAL VERSUS PREDICTED AVERAGE LOAD PROFILE

Flight Phase	Average total load, kW ^a	
	Predicted	Actual
Ascent (Lift-off to OMS-2)	22.6 ^b	21.7 (3 fuel cells)
On-Orbit	15 to 22 ^b	12 to 17
Descent	16 ^c	17 (2 fuel cells)

^aDifferences between actual and predicted values are due primarily to the unpredictability of cyclic heaters and the difficulties inherent in predicting exact on/off configurations and the exact sequencing of Orbiter electrical equipment.

^bPreflight prediction (3 fuel cells).

^cNear-real-time prediction based upon planned entry powerdown for loss of one fuel cell.

All of the Orbiter bus voltages were well within their design limits for STS-2. All of the EPDC hardware performed well. The bus tie operation of tying main bus A to main bus B was performed at approximately lift-off plus 4 hours 50 minutes prior to disconnecting fuel cell 1 from main bus A. Improved load sharing by the two remaining fuel cells (main bus B and C) was accomplished by switching off the cryogenic tank heaters and cabin fan B on bus B and switching on the cryogenic tank heaters and cabin fan A powered from bus C. Prior to entry and after the cooling pump on the OSTA-1 pallet was turned off, the avionics bay fans powered by bus B were turned on. The ascent load profile was approximately 0.5 to 2.0 kW lower than had been predicted, while the two fuel-cell entry-load profile was about 1.0 kW higher than predicted. The differences between the actual and the predicted profiles is attributed in part to the unpredictability of cyclic heater duty cycles and in part to the difficulties inherent in predicting exact on/off configurations and precise operating sequences of Orbiter electrical equipment. Specifically, the actual STS-2 descent differed from the predicted one-fuel-cell-out powerdown procedures in that the DFI wideband mission switch was left on and one additional display unit was used (1.2 kW avg). Table 2-V compares the actual average total loads and the predicted average total loads. The ac power system supported all of its power requirements adequately throughout the mission.

The events control subsystem performed well in support of STS-2, with no anomalies attributed to any components of the system.

All monitored PIC (pyrotechnic initiator controller) voltages were good, and the range safety system was armed and safed on command. The SRB (solid rocket booster) ET separations and ET tumbling were as programmed, indicating the mission events controller responded to its computer commands and provided the proper signals to implement the respective functions. At landing, all landing gear PIC's were armed, however, only the nose landing gear extender PIC's were required to fire.

At OSTA-1 activation, data showed that phase A of the ac power to the OSTA-1 cooling pump was inoperative. (Section 7.0, flight test problem report 10.) Troubleshooting isolated the problem to circuit breaker CB16 on panel MA73C. The second problem was the failure of the left OMS fuel and oxidizer crossfeed B valves position indications (Refer to section 7.0, flight test problem report 17 for a discussion of this anomaly.) At approximately the same time as the indications failed, the motor valves started operating again. The crew had to remove power from the motor valves manually by switching the panel switch from the "close" to the "GPC" position.

2.3 AVIONICS SUBSYSTEM

The evaluation of the avionics subsystem during the prelaunch and ascent periods is contained in the STS-2 Integrated Systems Evaluation Final Report (JSC-). This report begins with the insertion firings in its evaluation of the avionics.

2.3.1 Orbital Insertion Operations

The orbital maneuvering system (OMS-1 and -2 insertion) firings were normal, and all sensors and effectors performed normally.

The bending excitation in 1.0-degree steps every second during the slew of the main engines to the dump position during the post-MECO period was larger than for STS-1. Pitch rate gyros registered 0.6 deg/sec peak-to-peak versus 0.4 deg/sec peak-to-peak on STS-1.

2.3.2 On-Orbit Operations

The vernier RCS propellant usage (and associated duty cycles) was much higher than expected during the time interval when the payload bay doors were closed. The suspected cause is a higher-than-expected disturbance torque from the ECLSS high-load evaporator, probably caused by exhaust gas plume impingement on the Orbiter.

Also the vernier RCS engine activity was higher than expected during the manual COAS calibration (FTO 273-03). This was caused by performing the test in "discrete rate" rather than "pulse" mode. The problem was compounded by the fact that rotation coupling compensation was enabled.

Procedural precautions are to be taken on future flights to insure that coupling compensation is not engaged during "discrete rate" or "auto" modes.

FTO 274-07 (PRCS Narrow Deadband Attitude Hold) was performed using a 0.5-degree deadband rather than the planned 0.1-degree deadband. This test should be rescheduled for a future flight.

FTO 274-11 (VRCS Plume Impingement) was not successful due to a combination of the ACIP recorder failure and downlist data dropout caused by synchronization loss. The STS-2 I-loads did not account for the vernier impingement effects that resulted in excessive vernier engine pulsing, which, in turn, caused "over temperature" problems on some of the vernier engine valves. This test is to be rescheduled.

VRCS propellant usage during Y-POP-ZLV (Y axis perpendicular to orbital plane - Z axis local vertical) tracking with a 0.1-degree deadband was about 3.5 lb/hr compared to preflight predictions of 1 lb/hr. This is believed to be due to larger-than-predicted disturbance torque from the ECLSS topping evaporator vents while the payload bay doors were closed. The larger disturbance is suspected to have been caused by unmodelled plume impingement effects. Procedural changes are being implemented that will use the aft primary RCS thrusters when the payload bay doors are closed.

2.3.3 Entry

2.3.3.1 Entry Guidance.- The guidance was operated in the closed-loop (auto) mode in all three major phases: entry, TAEM (terminal area energy management), and autoland. The entry trajectory resulting from the minimum mission was somewhat different from the reference profile. Even so, guidance operations, in both auto and manual, were excellent. However, there were three deviations from the pre-mission profile: early first roll reversal, low energy at nominal TAEM/autoland transition point, and auto mode preflare.

The entry guidance energy/range performance was nearly identical to preflight predictions, achieving the TAEM interface well within 1σ conditions. The interactions of the aerodynamic extraction maneuvers with the guidance were minimal, as predicted by preflight simulations.

The first roll reversal in the minimum mission return occurred about 20 seconds earlier than planned preflight. This maneuver was commanded while the crew was completing the pushover/pull-up at Mach 21, forcing a corresponding 20-second delay in the maneuver execution. The overall effect was to shift the ground track approximately 25 miles to the south, well within the overall guidance capability.

2.3.3.2 Terminal Area Energy Management.- TAEM guidance engagement and flight to the heading alignment circle was accomplished as planned with several aerodynamic data extraction maneuvers being performed en route. A 95th percentile tail wind was encountered during this portion of the trajectory. Throughout the flight to the heading alignment

circle, the vehicle energy was properly managed by the guidance in the presence of this wind. The tail wind caused some excursion outside the circle following the initial manual roll command to the circle. The expected early circle turn (to compensate for wind) was delayed to complete a structural flight test requirement. A 60° bank was commanded by the pilot in the initial portion of the turn, and this forced the ground track back inside the circle to compensate for the expected head wind on final approach. The 2g vehicle limit was observed, with peak g reaching 1.9. As the bank angle was decreased, the angle of attack reduced, resulting in significant energy loss with respect to the "as flown" ground track. (Section 7.0, flight test problem report 33.) Had a shortened ground track been maintained, the energy would have been more normal. However, at this point, the pilot elected to return the guidance to auto which commanded the vehicle out to the reference ground track. Following this ground track, the energy state continued to decrease as the head wind component began to build and the speedbrake sweep was performed.

After the speedbrake sweep, the auto modes were reengaged and promptly commanded maximum lift-to-drag minimum dynamic pressure to conserve energy. Because of the large energy deviation, a lightly damped low-frequency longitudinal oscillation ensued. This phenomenon had been encountered in preflight simulations when the energy error was below expected deviations (fig. 2-11b). This oscillation continued for four cycles while energy converged toward the reference. At 5000-foot altitude autoland guidance was automatically forced, with the energy error now being primarily due to low airspeed.

2.3.3.3 Flight Control.- The entry flight control performed well. Most of the entry was flown in the automatic mode, as planned, with the crewman engaging control stick steering at the first roll maneuver, prior to TAEM interface, prior to the heading alignment circle, and at the aerodynamic data extraction maneuver points. All of these mode transitions were accomplished without any problem. The crew were able to accomplish all the defined data maneuvers, and no anomalies were observed. All of the automatic maneuvers were crisp, and during the manual maneuvers, the vehicle followed the pilot's stick inputs very well. No evidence of a flight control/bending interaction was observed. The lateral and longitudinal trim logic worked well. RCS usage during entry was approximately 1850 pounds. This number compares well with the Flight Simulation Laboratory results from nonstress cases. These results ranged from 1700 to 1900 pounds. APU fuel usage was also well within budget.

2.3.3.4 Lateral Directional Performance.- Lateral performance was very similar to that seen in STS-1. There were no large transients at the transition from major mode 303 (pre-entry monitor) to 304 (entry). Following the transition, the expected beta deadbanding was seen until the beta loops were opened at a dynamic pressure of 2 psf. The aileron activation of 2 psf was smooth, and the low dynamic pressure data maneuvers were well damped. Due to the beta oscillations seen at the first roll maneuver on STS-1, it was determined that this maneuver must be done manually until STS-5. The beta oscillation were caused by improperly predicted roll due to yaw thrusters in the software. Software changes to correct this condition will be incorporated for STS-5. The STS-2 results are in agreement with preflight predictions using the STS-1 derived yaw-engine torque data.

All the lateral program test inputs were accomplished, and the results were near preflight predictions. No indications of poor damping were seen on any of the maneuvers.

The first three reversals were performed in auto; all were crisp and achieved the required 5 deg/sec roll rate. The fourth reversal occurred near the entry/TAEM transition point and was done in manual. The response to the pilot's stick inputs at the fourth reversal was normal.

No evidence of a lateral trim offset was seen nor was any evidence of a rudder/aileron force light observed when the rudder became active at Mach 3.5.

The "quarter Hz" roll oscillation seen in STS-1 between Mach 2.5 and Mach 1 could not be verified because the program test inputs in this region never allowed the system to remain quiet for more than a few seconds. Most of this interval was flown manually to accomplish the planned tests. STS-3 should provide a better chance to observe this oscillation since no aerodynamic tests are planned in this region.

The last yaw RCS engine firing was at Mach 1.0. This firing occurred because the Mach 1.1 data maneuver was still in progress as the vehicle went through Mach 1.

As the pilot flew the vehicle around the heading alignment circle, the vehicle followed the commands well. The final auto engagement occurred just as the vehicle was leaving the circle and starting the final approach. No problem was seen at the transition, but shortly afterwards the guidance went into prefinal phase, and a moderately damped long-period (22 seconds) oscillation was seen (fig. 2-11a).

Roll-angle excursions during autoland were less than 2 degrees. Control remained good after the pilot switched to manual at 2500 feet above the runway.

2.3.3.5 Longitudinal Performance.- Longitudinal performance was good, and trim surface positions matched preflight predictions using STS-1 derived data. At the start of mode 304, a 6-degree pitchdown maneuver was required. This maneuver was done smoothly at -0.3 deg/sec. Alpha command tracking was good, with light RCS engine requirements, and the elevators were able to maintain alpha control after the pitch engines were turned off at a dynamic pressure of 20 psf. The elevator activation at a dynamic pressure of 2 psf was smooth. All of the pitch test maneuvers were accomplished as planned. Surface and engine activity associated with each maneuver was near preflight predictions, and the crew noted no problems.

Normal acceleration command tracking during TAEM and autoland appeared reasonable, although most of TAEM was flown in manual pitch. A low-frequency pitch oscillation (fig. 2-11b) was seen during the prefinal phase of TAEM. The pilot returned to manual pitch at about 300 feet above the runway and made a smooth landing and rollout.

2.3.3.6 Speedbrake.- The speedbrake correctly followed the planned profile down to Mach 0.9 where the guidance starts active speedbrake control. The speedbrake was initially closed and then fully opened by the guidance. As the airspeed decreased going around the heading alignment circuit, the speedbrake was commanded closed. The pilot accomplished the planned speedbrake sweep on the last half of the circle. During the sweep, the speedbrake was manually cycled from its minimum allowed setting to full open and back to its minimum setting. The speedbrake was then kept at its minimum allowed setting until the brake was manually opened during rollout. During rollout, some normal speedbrake backoff occurred when rudder pedal steering commands deflected the rudder.

2.3.3.7 Body flap.- The body flap position time history matched the preflight predictions based on STS-1 derived data. The body flap correctly drove to maintain the elevator on its planned trim schedule. The pilot successfully completed the body flap pulse at Mach 21.5.

2.3.3.8 Autoland Guidance.- State deviations from the reference were too large to allow normal autoland engagement; consequently, the engagement was forced at 5000-ft altitude with the vehicle flying lower by 240 ft, slower by 55 knots, and shallower (-13°), but on the runway centerline. Engagement was positive and smooth. The vehicle nosed over and acquired the -19° steep slope and tracked it within 20 feet thereafter. Accelerating down the steep slope, the vehicle arrived at the 2000-foot preflare altitude with almost normal flight conditions except that it was still 20 knots slow.

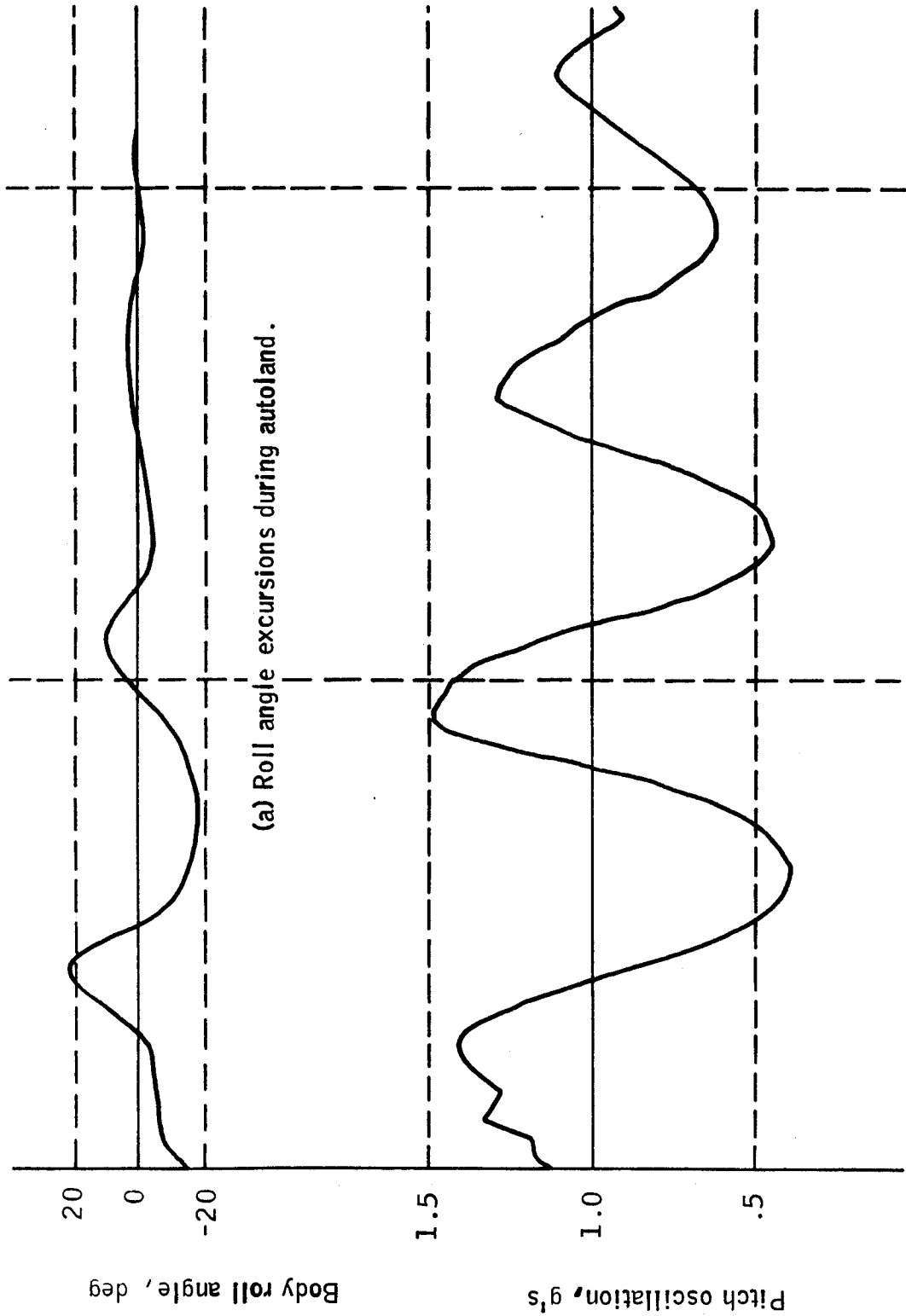

Greenwich mean time, day:hour:minute:second

b) Low-frequency pitch oscillation during prefinal phase of TAEM.

Figure 2-11.- Oscillations during descent operations.

Contrary to preflight planning, the preflare was also flown on auto. Although small hand controller inputs were made by the commander, they did not exceed the pitch hot-stick downmode threshold until autoland had flown a smooth, precise maneuver down to 300 feet. Roll/yaw mode to manual at 1300 feet, although there was little activity in the lateral channel ($1 < 2^\circ$). The manual takeover transient was quickly damped and was followed by a smooth final flare and touchdown was 780 feet beyond the threshold.

2.3.4 Communications and Tracking

The overall performance of the communications and tracking system was excellent. Good quality S-band and UHF voice, real-time and playback telemetry data, and real-time television were received through the ground network. The command system performance was flawless, and the teleprinter operation was normal. The S-band ranging system and the RF nav aids provided good quality data. The wireless crew communications systems, flying for the first time on this mission, performed well.

2.3.4.1 S-band Network Equipment.- The S-band RF equipment performance was normal during all mission phases. The S-band PM (Phase Modulation) string 2 equipment was configured in the high-power mode for ascent. The PM system was operated in the STDN or SBLS low-power modes for on-orbit communications. The FM (Frequency Modulation) string 2 was used for real-time TV, main engine data, and playback telemetry transmission over a ground station and was turned off between station passes to conserve power. The S-band PM and FM string 1 equipment was not used during the mission. All S-band antenna management was accomplished in the automatic GPC mode.

2.3.4.2 Orbiter UHF Transceiver.- The Orbiter EVA/ATC UHF (extravehicular activity/air traffic control ultra-high-frequency) equipment performance was good during all mission phases. The deletion of squelch in some ground stations provided increased voice coverage at the expense of some noise during weak signal conditions.

2.3.4.3 Audio Distribution.- During the mission, several audio crew stations were used with the MHS (mini-headsets). The wireless transceivers were also used during certain phases of the mission. Performance was normal in all cases, with good voice quality. As expected, the audio signal was rather noisy due to the ambient, acoustic noise in the cabin. The SMUs (speaker microphone units) were apparently not used. No acoustic feedback (squeal) (observed during STS-1) was noted. Both crewmen used eyeglass clips to retain the MHS in position, and no problems were experienced. During teleprinter operation, the receive tone was retained in the "on" position longer than expected. This could be caused by a voice signal on the teleprinter audio bus.

2.3.4.4 Hand-Held Radio.- The hand-held radio was not used during the postlanding period.

2.3.4.5 Teleprinter.- No problems with the teleprinter were reported during the mission. One message was garbled, and this was probably caused by noise or crosstalk on land communication links between MCC (Mission Control Center) and GSTDN (Goddard Space Tracking and Data Network) and GSTDN stations and was not due to misconfiguration of onboard audio switches. No errors in transmitted teleprinter messages were found in a review of onboard printouts. The "garbled" printouts were apparently printouts of low-level noise received following teleprinter message transmissions while still in contact with the ground station.

2.3.4.6 Television.- The CCTV (closed-circuit television) performed well during the planned crew TV activities except for the problems described in the following paragraphs. The CCTV was operated by both ground- and crew-originated commands. Television scenes were transmitted in real time to the ground or recorded on the onboard VTR (video tape recorder). The VTR was not dumped to a ground station during the mission. The three CCTV problems are as follows:

- a. Overtemperature of aft/port TV camera - On day 2, during a real-time TV pass, the TV camera "B" (located on the aft/port bulkhead) temperature rose to 45° C. The overtemperature flag was noted in the downlink video. (Section 7.0, flight test problem report 13.) The camera was immediately turned off by the crew. An examination of the other bulkhead cameras at this time showed their temperatures to be 38 to 40° C. The temperature data from the video tapes indicate that the camera temperature started at 10° C and increased to the 43 to 45° C range after 4.5 hours of operation. The camera performance was normal for this range of temperatures.
- b. The RMS (remote manipulator system) TV Circuit Breaker Trip - On day 2, the circuit breaker that powers the pan/tilt and TV cameras on the RMS was tripped. The breaker was reset by the crew and then tripped again. Postmission tests showed that the camera drew excessive current; consequently, it was removed and returned to the vendor for failure analysis. (Section 7.0, flight test problem report 14.)
- c. Lens Contamination of Payload Bay TV Cameras - During the day 2 real-time TV downlink, out-of-focus video was noted from camera "B". Postmission evaluation of video tapes also shows that cameras "A" and "C" have the same condition. (Section 7.0, flight test problem report 15.)

2.3.5 Hardware Performance

2.3.5.1 Navigation Hardware.- The entry navigation subsystem performed well during the STS-2 flight. Two areas of concern that arose are discussed in the following paragraphs.

2.3.5.1.1 Star Tracker/Light Shade Optical Contamination: The light shade/bright object sensor are visually examined after each flight for evidence of optical contamination which might affect star tracker performance during a subsequent mission. The STS-2 post-mission optical contamination inspection was performed and small amounts of sand-like particulates were found in both the -Y and -Z light shades and in the -Z bright object sensor, however, this contamination is not significant and replacement of components is not warranted.

The thermal blankets surrounding the -Y and -Z light shades showed evidence of localized discoloration appearing as brown-yellowish spots and streaks just away from the shade area. This problem is also discussed in section 7.0, flight test problem report 43.

2.3.5.1.2 Star Tracker Alarms: During STS-2, the -Z star tracker detected several incoming mode command words which were improperly formed. These detections, labeled MNV (manchester not valid), resulted in the annunciation of several "G22 STAR TRKR" alarms. This problem is discussed in section 7.0, flight test problem 38.

2.3.5.2 Inertial Measurement Unit.- All three IMUs (inertial measurement units) were selected alternately for navigation by onboard RM (redundancy management). IMU 2 was the most frequently selected IMU, while IMUs 1 and 3 were selected about equally. The velocity tracking data for IMU pairs 1 and 2 and 1 and 3 increased briefly to about 0.8 ft/sec at 150,000-ft altitude. The redundancy management threshold at that time was about 2 ft/sec. Except for this brief excursion, the velocity tracking data generally remained below 0.2 ft/sec for all three IMU pairs.

The IMU attitude tracking data indicated that the attitude difference remained below 0.2 degree for all three IMU pairs. The onboard RM threshold was within the 0.5 degree limit. The requirements in FTR 71V02 (IMU Performance Verification) were successfully completed for STS-2.

2.3.5.3 TACAN Performance

2.3.5.3.1 Entry: The TACAN subsystem was turned on after blackout. The Orbiter was traveling at Mach 9.6 at an altitude of 157,600 ft. All three TACAN units were locked on in bearing and range. The upper antenna was selected throughout entry.

TACAN unit 1 experienced one 40° bearing jump at 318:21:12:00 G.m.t. This was just after lock-on and before TACAN data were incorporated into the navigation computer.

The TACAN units performed normally until 318:21:18:41 G.m.t., when unit 2 and unit 3 bearings dropped lock for 20 seconds. These dropouts occurred when the Orbiter was in the cone of confusion.

TACAN bearing and range data stayed locked on to an altitude of less than 1500 ft (TACAN data lockout) except for a jump of 40° in bearing at an altitude of 3600 ft for TACAN units 1 and 2. On the basis of automatic gain control values, the Orbiter altitude, and the position of the chase planes, it was concluded that the bearing jump was caused by multipath.

2.3.5.3.2 On Orbit: During orbits 33 and 36, the TACAN units were turned on for on orbit ranging and bearing checks with selected ground stations to determine if the TACAN could be used for on orbit navigation. The bearing data were noisy, and time in lock was short. Ranging locked up for 50 seconds on TACAN unit 1, with an indicated range between 210 and 308 nmi. On orbit 36, TACAN unit 3 locked on Edwards AFB and Cimarron, New Mexico, but the data were poor. TACAN unit 2 had ranging lock with Edwards for 48 seconds (260 to 370 nmi) and with Cimarron for 41 seconds (100 to 251 nmi). The test results based on the short acquisition time and poor quality data are inconclusive.

2.3.5.4 Microwave Scanning Beam Landing System.- The MSBLS (microwave scanning beam landing system) operated satisfactorily, and data were first acquired at about 16,500 ft altitude. All three channels of the three components remained solidly locked on below about 12,000 ft altitude. The system remained available below the 1.5-degree elevation angle and past touchdown in range and azimuth. The three channels (azimuth, elevation and distance) had solid lock on as follows:

Azimuth	-14.4°
Elevation	18.4°
Distance	12.8 nmi

After lock on the three navset outputs for angle and distance compared favorably through landing, except for some differences between the navset's reading in azimuth. These differences were expected because of thermal protection tile effects (cross-polarization error).

2.3.5.5 Radar Altimeter.- Both radar altimeters locked on at approximately 5100-ft altitude and tracked very well down to landing gear deployment, which was at an altitude of 107 ft. At this time, altimeter 1 broke lock for a 2-second period and then reacquired at an erroneous reading of 9 ft. Altimeter 2 tracked to 80 ft and then jumped to an erroneous reading of 22 ft. Both altimeters appeared to track the ground properly again at about the time of main gear touchdown. This condition was caused by an interfering signal reflecting off of the nose landing gear and is similar to that experienced on STS-1.

2.3.5.6 Controls.- The AA (accelerometer assemblies) and RGAs (rate gyro assemblies) performed very well. Preflight and in-flight data comparisons showed that all of the components were very stable. A review of all the rate and acceleration channel data during ascent and entry showed that channel-to-channel differentials were well below the failure detection thresholds. In no case did the rate or accelerometer data exceed more than 40 percent of their respective failure detection threshold.

The pilot's rotational hand controller failed in roll trim on orbit and just after landing. Trouble shooting showed a broken conductor. (Section 7.0, flight test problem report 34.)

2.3.6 Data Processing System

The data processing system hardware performed normally with the exception of two prelaunch MDM (multiplexer/demultiplexer) failures and two DU (display unit) anomalies. The first MDM failed about 30 hours prior the initial launch attempt. The spare MDM also did not function properly. A MDM from vehicle OV-099 was shipped to KSC, installed, and flown without incident. (Section 7.0, flight test problem report 2.)

While on-orbit DU (display unit) no. 1 went blank and power was recycled without success. The crew performed inflight maintenance and replaced DU no. 1 with DU no. 4 from the aft station. This unit operated successfully throughout the remainder of the mission, however after the back up crew entered the vehicle, it too failed. (Section 7.0, flight test problem report 20).

2.3.7 Primary Software

The primary software performance for STS-2 was normal. No anomalies were observed.

2.3.8 Backup Flight System

The BFS (backup flight system) performed as expected during prelaunch countdown. The BFS was moded to MM 101 and tracked PASS (primary avionics software system) on all four flight-critical strings. All BFS prelaunch navigation was well within redlines, and BFS received and processed uplink commands according to requirements and accepted waivers.

During launch and ascent, the BFS performed as expected and sequenced through all major modes correctly. BFS navigation performance was satisfactory. BFS guidance-calculated MECO and OMS firing targets agreed with PASS.

All flight-critical input/output errors were seen by both BFS and PASS, and BFS performed as expected. All BFS systems management fault messages annunciated were proper.

During on-orbit operations, the BFS performed correctly with the moding of the GPC memory loads and the display unit switches. The BFS was placed in OPS 0 (standby) for most of the on-orbit period.

In all functions associated with preparation for and execution of the deorbit maneuver, the BFS performed as expected. During the deorbit maneuver, the BFS guidance solution agreed with the PASS solution. During entry the BFS performed as expected and moded correctly through all major modes. BFS navigation performed satisfactorily.

2.3.9 Displays and Controls

The performance of the display and controls system on STS-2 was excellent. The system provided the crew with the capability to control and monitor the vehicle rotation, translation and flight path; to control and monitor the status of onboard systems; and to detect and make safe any hazardous conditions.

The caution and warning subsystem operated very well, with no system failures.

The cabin interior lighting and payload bay lighting were adequate for all mission phases. The remote manipulator arm light was turned on for only a very short time, and its operation was not evaluated.

The flight displays all worked properly, and the crew reported that they were readable during all mission phases.

There are no constraints to STS-3 as a result of STS-2 performance.

There was one system anomaly associated with the STS-2 flight. The anomaly was a failure of a circuit breaker to provide power when closed. Panel MA73C, "Payload 3 phase," CB16. During the flight, only two of the three phases of the payload pallet pump were working. Postflight checkout at KSC isolated the fault to a three-phase circuit breaker. The breaker has been removed from the vehicle and replaced. This problem is discussed in section 7.0, flight test problem report 10.

2.3.10 Instrumentation

2.3.10.1 Operational Instrumentation.- The OI (operational instrumentation) subsystem performed satisfactorily during STS-2. There were 2741 OI measurements, 11 of which were not operational for STS-2 due to their repair being deferred to STS-3. Three OI measurements failed during the flight.

One minute into the flight the main propulsion system engine 2 gaseous hydrogen outlet pressure (V41P1260A) failed off scale low. Two minutes into the flight main propulsion system engine 2 gaseous hydrogen pressure outlet temperature (V41T1261A) went off scale high for 6 minutes. The measurement thereafter was operating normally. (Section 7.0, flight test problem report 6.) These two measurements also failed during the STS-1 launch, and the sensors were replaced.

At 318:03:38 G.m.t., the measurement V64P0201A extravehicular life support system water supply pressure (V64P0201A) failed off-scale high. The failed sensor has been replaced for STS-3. (Section 7.0, flight test problem report 23.)

The three Shuttle recorders used in the OI subsystem operated normally throughout the mission.

The OEX (orbital experiments) recorder failed and caused a loss of some flight control and aerodynamic FTO data. This problem is discussed in section 7.0, flight test problem report 25.

2.3.10.2 Developmental Flight Instrumentation.- The DFI (developmental flight instrumentation) system performed satisfactorily. The wideband analog ascent recorder operated during ascent and the OMS-1 and OMS-2 firings. The wideband analog mission recorder and the PCM recorder operated during ascent, all OMS firings, and entry and landing. On orbit the PCM recorder generally remained in the low-sample-rate mode. The PCM and ascent recorders did not experience the transient lift-off data loss seen on STS-1 because the ignition overpressure pulse was relieved. The PCM recorder was successfully dumped from the Orbiter at the landing site. The wideband ascent and mission recorders were dumped, but signal discrepancies occurred on numerous tracks. The problem was later found to be due to high resistance contacts in the T-0 umbilical "connector savers", which suffered overheating during entry (normally replaced between flights). The recorders were successfully redumped after replacing these savers.

Approximately 2 percent of the 3500 DFI measurements had discrepant conditions. These will be repaired where accessible prior to STS-3. (Section 7.0, flight test problem report 44.) The DFI RF downlink transmission operated satisfactorily, and PCM data were recorded at the S-band ground stations during vehicle signal acquisition periods.

A portion of the DFI system was deenergized during entry (coolant pump and 150 pressure transducers) as power reductions were required due to the fuel cell failure. Upon landing, each of the MLG (main landing gear) inboard and outboard wheel tire pressure measurement harnesses was severed at the hub. The cut wire ends were centrifugally propelled, through wheel rotation, and damaged six TPS tiles. (See Section 7.0, flight test problem report 19.) For STS-3, shorter wire service loops will be used, and the wiring restraints redefined and relocated. The extended DFI/DATE system (19 measurements on OSTA-1 pallet and 19 on Orbiter side of pallet interface) opened satisfactorily during ascent, but due to subsequent loss of the OEX recorder, no entry data were retrieved.

2.3.11 Systems Management

Systems management performance for STS-2 was normal, with no anomalies observed.

2.3.12 Redundancy Management

The basic function of RM is to direct the use of the guidance, navigation, and control system hardware and software during all Orbiter flight phases. RM performance on STS-2 was excellent, with significant events occurring with the IMU, RCS, and GN&C switch-processing RM areas. In all areas, RM successfully provided the best source data to all users (selection filtering) while maintaining a comfortable margin of component performance evaluation when compared to the RM fault detection thresholds.

In the case of the IMU system, IMU BITE/T fault messages occurred on all three IMUs around MECO. No functional impact resulted since the IMU BITE is not used by RM unless the system has previously been downmoded to the two-level. Additionally, since every IMU was experiencing the BITE condition (even if the system had been at the two-level), the simultaneous BITE indications inhibit individual LRU downmoding should a disagreement exist. The downmoding would thereby be delayed until the true failure could be determined on a single unit. Data analysis subsequent to the mission has verified that the fault messages were generated by the redundant rate gyro monitoring software as a result of the larger-than-predicted environmental rates associated with MECO decelerations. The small margins in the software filters and thresholds had been noted after STS-1. However, the low probability of occurrences combined with the benign effects of the conditions and the impacts of a fix were not considered justification enough to make any modifications before STS-2. Such modifications are currently being reconsidered for future implementation.

Several observations were made during STS-2 on-orbit operations concerning the design performance of the RCS RM and its interfaces with the RCS hardware. Initially, the selection of vernier engine control modes was delayed due to one vernier thruster's temperature not reading an RM limit soon enough. The small heaters used to maintain the vernier above 130° F, to assure RM leak detection capability, simply did not have the capability to heat the engine as quickly as predicted. Had the verniers been selected prior to the 130° F temperature, RM would have determined the engine to be leaking, deselected the engine, and sounded associated alarms. Analysis of the engine temperature data provided confidence that there was no leak, and a decision was made to override the RCS RM for this engine, firing the engine to initially heat it up, and then reinstating the RM. This did not occur since the engine reached acceptable temperatures soon after the initial delay. This concern also arose during a test which was run to gather thermal performance data for the RCS vernier engine heater capabilities. With the vernier engines inhibited from firing, the temperature decay on the engines was being monitored, and it was noted that the RCS RM did not declare a leak on the vernier engines until the temperature read 128° F rather than the 130° F of the software requirement. However, this was a known discrepant condition which had been waived for this flight because it posed no danger to the hardware.

The final RM concern dealt with the GN&C switch processing associated with the pilot's rotational hand controller trim switch. During OPS 8 checkout, one contact on the switch did not function properly for a plus roll command. This condition did not repeat, and no steps were taken by the crew to deselect the contact. During the hydraulic load test performance postlanding, the switch was accidentally pushed, and RM determined that the switch contact had failed. This has been verified to be an intermittent condition in the rotational hand controller. (Section 7.0, flight test problem report 34.)

2.4 ENVIRONMENTAL CONTROL AND LIFE SUPPORT SYSTEM

2.4.1 Active Thermal Control Subsystem

The active thermal control subsystem performed satisfactorily during the mission. Several unexpected conditions are discussed in the following paragraphs.

The flow proportioning modules for the STS-2 mission were positioned (preflight) to the eight-radiator panel configuration, and during the flight they were set to the "payload" position for most of the on-orbit portion of the mission. During entry, flow through the radiators was initiated at 100,000 ft, and the ammonia boiler subsystem was activated about 10 minutes after touchdown. The remaining active thermal control subsystem configuration was identical to STS-1. Two measurements which were operational during STS-1 were determined to be inoperative prior to STS-2. The measurements were developmental flight instrumentation coolant loop, package 2, freon outlet temperature (V63T9161A) and a flash evaporator system topping duct temperature (V63T9215A). No launch commit criteria were violated during prelaunch operations.

During ascent, about 1.5 minutes after lift-off, an unexplained cooling of the freon coolant loops between the ammonia boiler inlet and the flash evaporator outlet occurred. This cooling also occurred during the STS-1 mission and is possibly due to evaporation of condensation in the flash evaporator cores. Figure 2-12 shows this freon cooling. Also shown in the figure 2-12 is the transient in the flash evaporator freon outlet temperature that occurred about 8.5 minutes after launch following main engine cutoff. This transient is caused by the change in the flash evaporator feed water pressure resulting from the change in g forces at MECO.

About 2.5 hours after launch, upon positioning the flow proportioning modules to the "payload" position, fault messages were triggered during the normal momentary drop in interchanger freon flowrates as the valves moved. The port radiator heat rejection during the STS-2 mission was significantly less than the starboard heat rejection during the top-to-earth, nose-on velocity-vector attitude. This behavior is due to the high beta angle flown, causing a higher amount of solar radiation to enter the forward radiator cavity on the port side than on the starboard side, as shown in figure 2-13. The radiator inlet and outlet temperatures are shown in figure 2-14 where FCL (freon coolant loop 1) (port side) was not controlled to the 38° F set point while FCL 2 (starboard side) was controlled to the 38° F set point. (Section 7.0, flight test problem report 11.)

The STS-2 data portions of flight test requirements (FTR) 63VV001 (ATCS Performance), and FTR 63VV003 (ATCS Flash Evaporator) are expected to be satisfied. Data covering detailed test objective 265 (Radiator Inherent Thermal Capacity) have been reviewed and the objective was met. Figure 2-15 shows the entry/postlanding portion of DTO 265. Due to the minimum mission requirements resulting from the loss of the fuel cell, DTO 266 (Radiator Performance Test) was not performed as scheduled. However, with the stowing of the port radiator on day 2 of the mission, a portion of DTO 266 was accomplished.

During the flash evaporator freon outlet temperature transient after MECO, the flash-evaporator primary A controller shut down. Figure 2-12 shows this shutdown and the subsequent successful restart. A description of this shutdown and subsequent flash evaporator anomalies is given in section 7.0, flight test problem report 11.

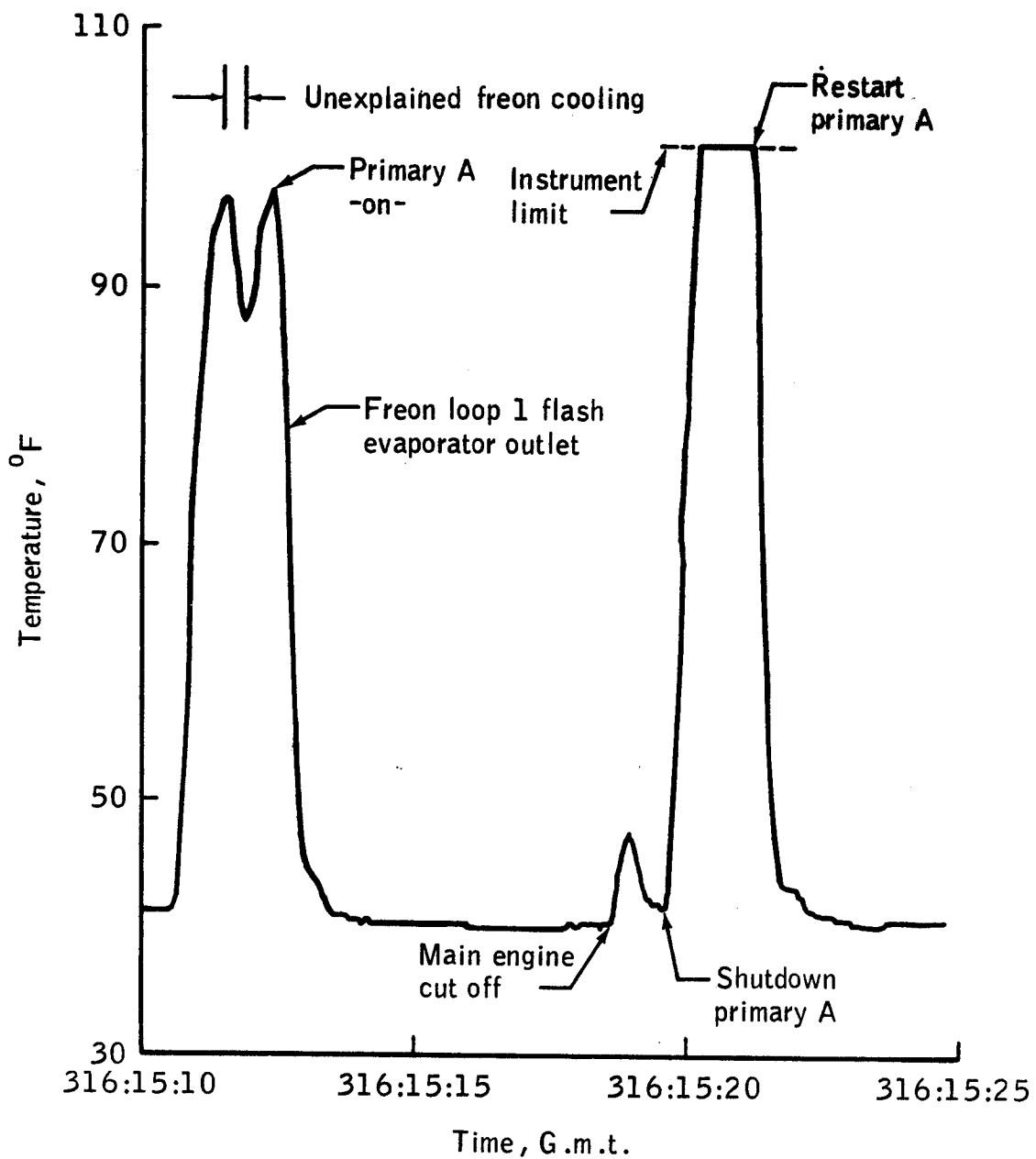

Figure 2-12.- Flash evaporator transients during ascent.

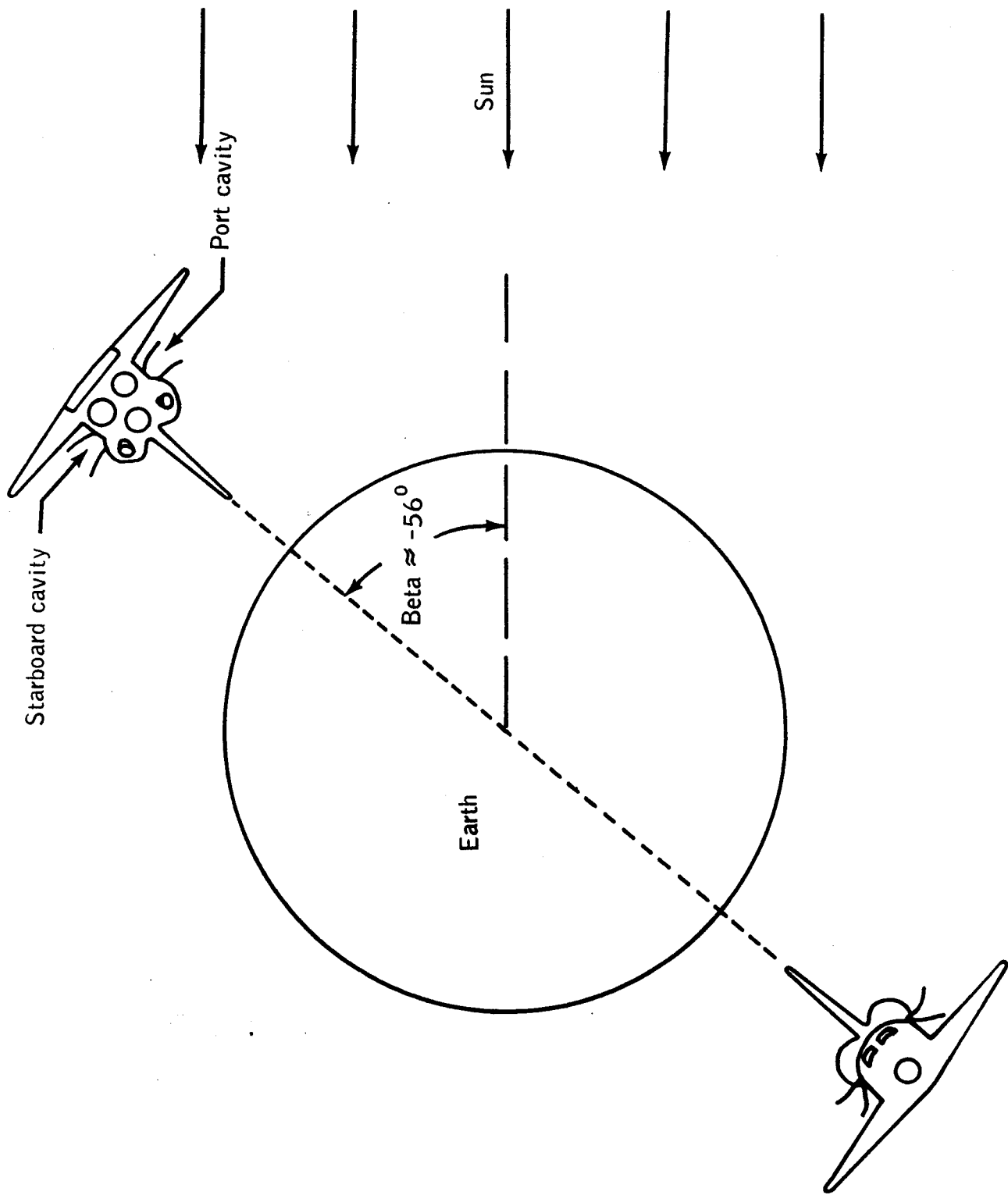

Figure 2-13.- Vehicle attitude with top-to-earth, and nose-on-velocity-vector.

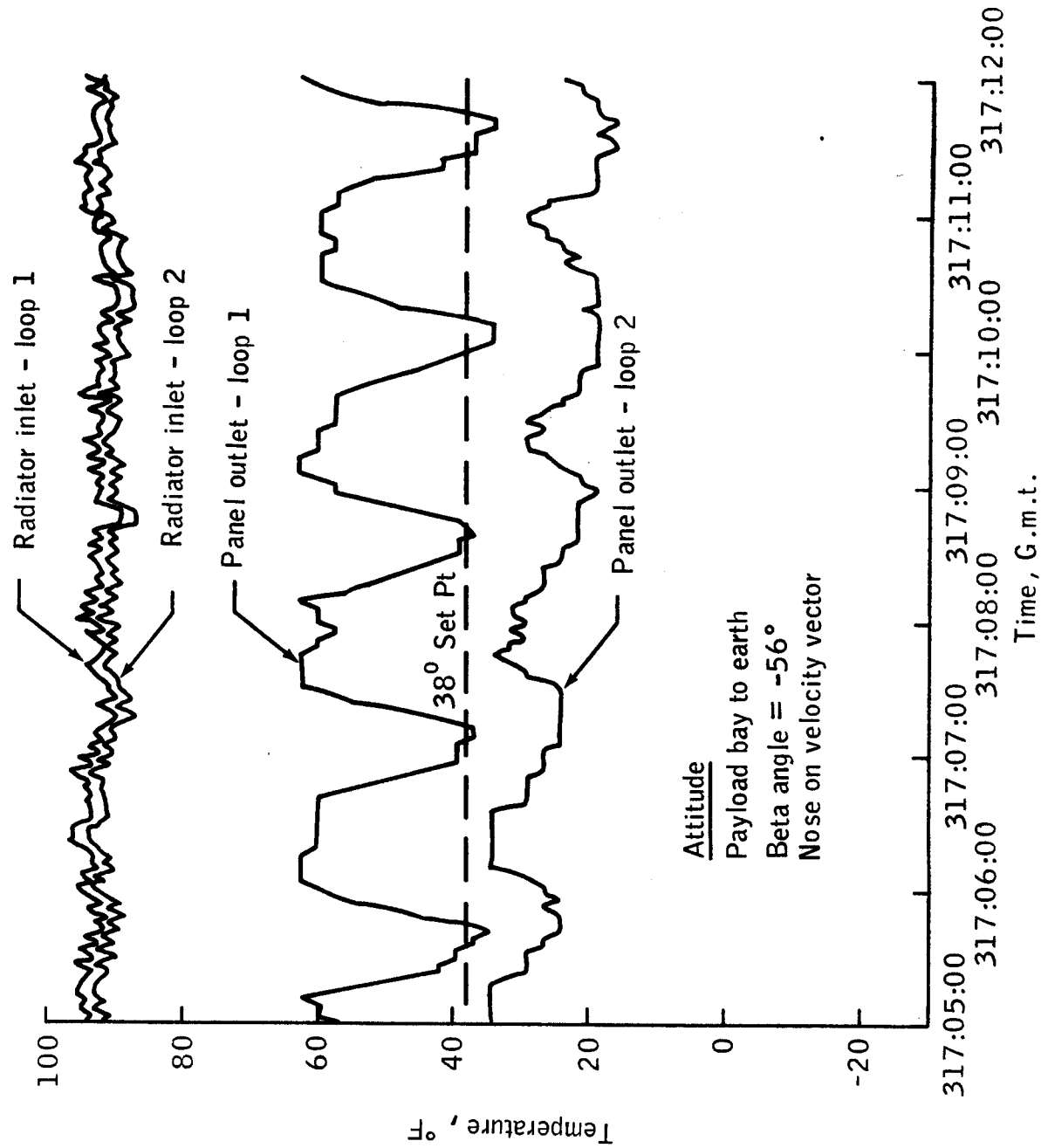

Figure 2-14.- STS-2 radiator performance.

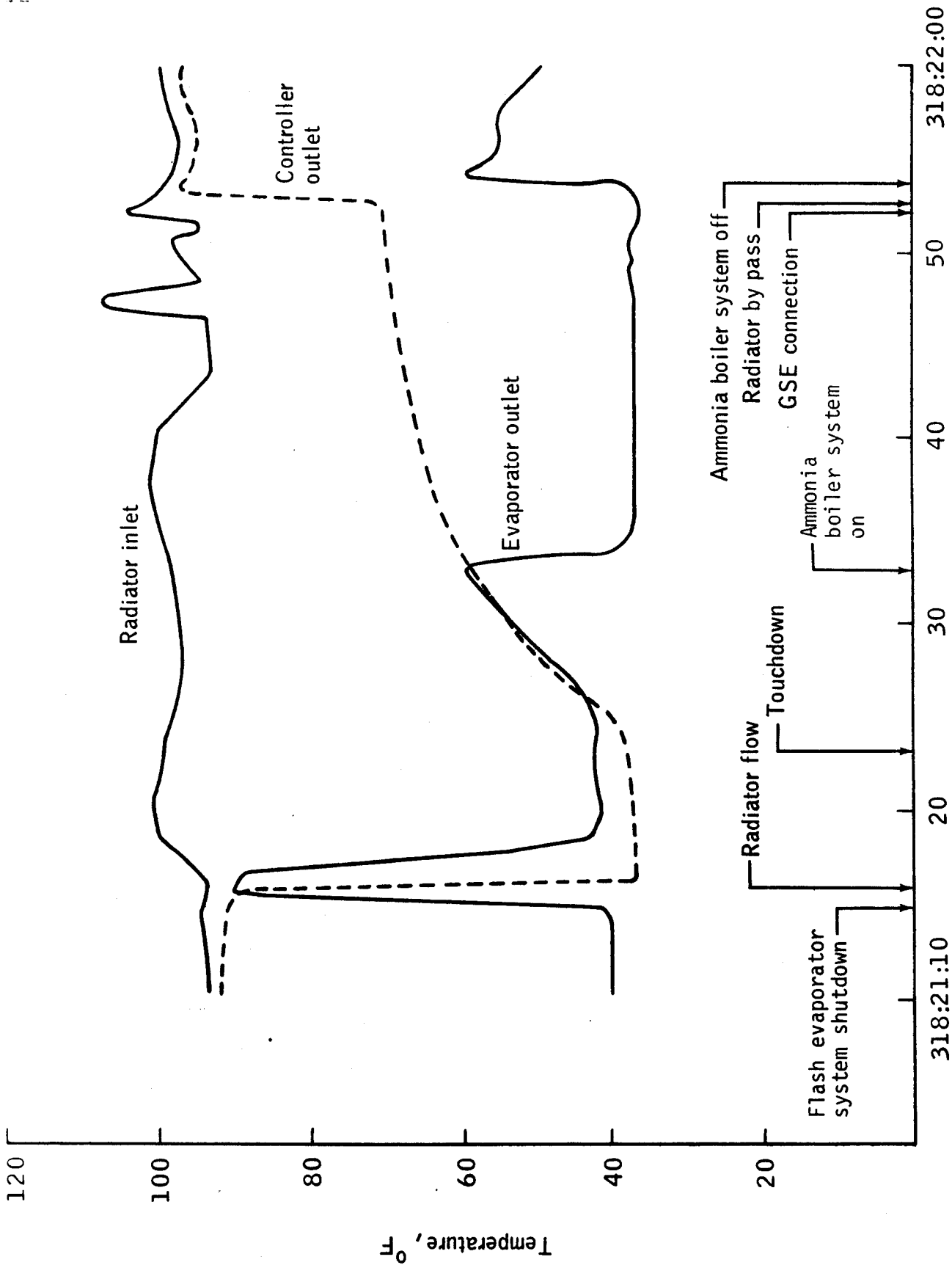

Figure 2-15.- STS-2 entry radiator flow in freon coolant loop 1.

When fuel cell 1 was shut down, the heat load on the fuel-cell heat exchanger dropped accordingly, with no adverse effect on the performance of the active thermal control subsystem. About 30 hours after launch, the forward radiator panels on the port side were stowed in an effort to preclude FES operation during each orbit. This resulted in less absorbed solar heat (a higher heat rejection) by the port radiators during the light side of each orbit and a reduced radiator heat rejection during the dark side of each orbit (see figure 2-13).

Twice during the STS-2 mission, the developmental flight instrumentation freon coolant pump was deactivated. The first time was during the period from 318:01:08 G.m.t. to 318:03:57 G.m.t. The second time was from 318:19:27 G.m.t. to 318:21:45 G.m.t.

Between 318:13:30 G.m.t. and 318:14:10 G.m.t., the flash evaporator was tested in the full-up mode; that is, with the radiators bypassed and the high-load evaporator enabled.

During this test, the primary A, primary B, and secondary controllers were checked out and determined to be operating properly when in the full-up mode. Also during this flash evaporator test, a radiator coldsoak was performed in a top-to-earth, nose-on-velocity-vector attitude for about 34 minutes. The ammonia boiler subsystem, when activated after touchdown, was not activated with the primary controller as planned but was, instead, activated with the secondary controller. Following the planned deactivation of the ammonia boiler system, the ammonia boiler was reactivated to provide cooling because of a ground cooling problem.

2.4.2 Air Revitalization Subsystem

The performance of the ARS (air revitalization subsystem) was normal and within predicted values with the exception of temperature excursions caused by the shutdowns of the flash evaporator system. Flash evaporator shutdowns and high beta-angle radiator performance caused the freon heat sink temperature at the interchanger to cycle between 38° F and 51° F with each orbit. This deviation from the nominal 40° F heat sink temperature affected the ARS performance. The STS-2 ARS (air revitalization subsystem) configuration differed from STS-1 in two respects. The automatic cabin temperature controller was not used because of environment-influenced, high-temperature sensor readings experienced during STS-1, and the interchanger water flow rate was reduced by approximately 125 lb/hr at launch. The ARS underwent a slightly warmer ascent followed by a second more severe period of no cooling as the flash evaporator shut down following MECO. The cabin heat exchanger air bypass valve was to be pinned in the full cool position during work phases and pinned in the full warm position during sleep periods. The first day of the STS-2 mission, the crew elected to leave the cabin heat exchanger air bypass valve pinned full cool during the sleep period rather than full warm as was planned under nominal conditions. The second sleep period the crew elected to pin the valve to full warm. On entry day, the cabin heat exchanger was again pinned to full cool for the work phase after being full warm for the sleep period.

The STS-2 data portion of FTR 61VV001 (ARS Performance) is expected to be satisfied. DTO 263 (Airlock and EVA Systems Demonstration) was not included in the minimum mission profile. DTO 267 (Cabin Temperature Measurement) was scheduled to have the crew perform eight cabin temperature surveys during the various STS-2 mission phases; however, only three surveys were obtained because of the shortened mission.

The interchanger water flow rate adjustment was lowered for STS-2, resulting in warmer temperatures in the avionics bays. This change in configuration resulted from implementing a calibration curve that differed slightly from that used for STS-1. Adjustment of the interchanger water flow rate by the crew to the specified 950 lb/hr as indicated by the onboard instrumentation resulted in an actual interchanger water flow rate of 775 lb/hr as compared to 900 lb/hr flow rate for STS-1. The interchanger water flow rate was readjusted to a higher flow rate of 870 lb/hr in preparation for entry.

The flash evaporator shutdown after MECO resulted in the freon supply's temperature to the ARS climbing approximately 18° F higher than that seen during the ascent phase transient of STS-1. ARS thermal performance was affected by the orbital cycling of the interchanger freon inlet temperature from 38° F to 51° F during most of the mission. In addition, ARS temperatures were affected by the operation of both flow proportioning modules in the "payload" position in contrast to the "interchanger" position operation during STS-1. The net result of these two conditions was a cycling interchanger water outlet temperature during on-orbit operation ranging from 9° F to 20° F above that seen on STS-1.

2.4.3 Air Revitalization Pressure Control Subsystem

The air revitalization pressure control subsystem had no major anomaly during the STS-2 mission. The ARPCS (air revitalization pressure control subsystem) has had significant configuration changes since STS-1. Hardware changes included the changeout of the nitrogen/oxygen control and supply panels, the oxygen partial pressure sensors and the addition of improved cabin regulators.

One LCC (launch commit criterion) parameter was violated because of a relatively large zero shift in the airlock-to-cargo bay differential pressure measurement (V64P0101A). The 0.32 psid shift added to the existing 0.16 psid differential pressure gave a reading of 0.48 psid, thus violating the LCC maximum redline of 0.40 psid. Because of the 0.32 psid zero shift the LCC differential pressure maximum was raised to 0.72 psid.

A minor problem occurred with the cabin vent isolation valve talkback indication during the STS-2 scrubbed launch attempt. After the cabin pressure integrity check, the vent isolation valve is closed and verified by an onboard talkback indication. However, on STS-2, after the vent isolation valve was closed, the onboard talkback did not indicate properly. The switch was again closed but still no indication and then, finally, cycled open and closed, after which the talkback showed closed.

Cabin leak rate calculations show the pressure shell leak rate was less than STS-1 (0.7 lb/day compared to 2.7 lb/day for STS-1.)

2.4.4 Airlock Support System

The scheduled extravehicular activity rehearsal during STS-2 was canceled because of the shortened mission and therefore, the airlock system was not used. The extravehicular life support system water supply pressure sensor failed during the flight and is discussed in section 7.0, flight test problem report 23.

2.4.5 Water and Waste Management System

During STS-2, the WWMS (water and waste management system) was normal except for the configuration changes to the potable and supply water system that were made because of the high pH water from fuel cell 1. Potable water tank A was isolated from the fuel cells by closing the tank A inlet valve when the high pH warning was activated. The high pH water was diverted to supply tank B and was isolated from the flash evaporators by closing the tank B outlet valve. After fuel cell 1 was shut down, the tank B inlet valve was closed to isolate the high pH water for the remainder of the flight. As the potable tank inlet valve was not reopened, the crew drank water directly from the supply line from the fuel cells. Since the fuel cell water flowrate was only 15 lb/hr, excessive time was required for filling drink bags (2 to 3 minutes). The crew noted that there were excessive gas bubbles in the drink bags, and as a result of these two problems, the crew drank much less than planned. (Section 7.0, flight test problem report 27.)

The waste water and waste collection system operation was normal during STS-2, except for an odor, as reported by the crew, in the area of the commode. (Section 7.0, flight test problem report 49.)

There were no smoke alarms, and the smoke detector readings remained at the background noise levels. The smoke detectors all self-tested satisfactorily during their check in flight. The fire suppression system was not used.

2.5 CREW STATION AND EQUIPMENT

Performance of the crew station and flight crew equipment, such as food, clothing, tools, communications equipment, cameras, and mechanical equipment, was satisfactory. Additionally, the cabin arrangement and cabin environment was good.

2.5.1 Cabin Temperature Survey

The cabin temperature survey (DT0266) conducted on STS-2 was insufficient, because of the reduction in mission length and transient cabin temperature conditions, to select a new location for the cabin temperature control and measurement sensors. Only three of the eight planned temperature surveys were performed during the mission. The data were inconclusive for selecting a new location for the cabin temperature sensors. The data did verify that the cabin temperature sensors are currently located in a hot area of the cabin and are biased high by the surrounding atmosphere and electronic equipment.

2.5.2 Theodolite System

The theodolite system was used to measure payload bay door alignment accuracy. Instability of the theodolite mount did not permit the measurements to be made (Section 7.0, flight test problem report 47).

2.5.3 Stowage Lockers

The crew reported a similar problem with stowage lockers on STS-2, as had been noted on STS-1. Eight lockers were difficult to close and lock in the zero g conditions. Five lockers had only one fastener secured and three others were taped shut. (Section 7.0, flight test problem report 37.)

2.5.4 Crew-Operated Cameras

2.5.4.1 General Operations.- The camera systems provided for STS-2 usage were primarily from previous programs. The 35mm interior camera was changed from an electric drive used on STS-1 to a manual version which simplified film loading and usage. Changes to the 70mm exterior camera system included the use of a commercial "off-the-shelf" 100mm lens to replace the 80mm lens used previously and the use of a commercial film magazine holding 155 exposures of film. New 16mm cameras for the mission included six payload-bay-mounted PDRS (payload deployment and retrieval system) cameras and a NOSL (nighttime optical survey lightning) experiment camera system.

Because of the shortened mission duration and the compressed crew timeline, many of the photographic test objectives were only partially satisfied.

2.5.4.2 16mm Cameras.- The 16mm crew compartment cameras operated satisfactorily, with no anomalies reported. Interior photography was underexposed, however. A different film for interior photography (Kodak type 7250) is being evaluated for future flights in an effort to overcome the problem of low-light levels in the crew compartment. Five of the six payload deployment and retrieval system cameras operated satisfactorily. The sixth camera failed at the beginning of the first usage; so no data were obtained by that camera. (Section 7.0, flight test problem report 21.)

Postflight analysis of the film from the PDRS 16mm cameras indicated that the cameras on the Orbiter payload bay aft bulkhead operated at faster frame rates than those on the forward bulkhead. Investigation of the problem revealed that the cameras are sensitive to electrical ground in the 12 frame per second mode and the resistance in the control cable to the aft bulkhead was sufficient to cause the cameras to ignore a 12 frame per second command and revert to operation at 24 frames per second. For STS-3 procedures have been changed to allow operation at 6 or 24 frames per second only (Section 7.0, flight test problem report 50).

2.5.4.3 35mm-Camera Operation.- The 35mm camera was used primarily for crew compartment photography, with the photography being spontaneous rather than controlled by the flight plan. The compressed timeline made fewer photo opportunities available than had been planned for, and only 40 usable exposures were obtained.

2.5.4.4 70mm-Camera Operations.- The 70mm camera was used for approximately 840 exposures. Thirty-six of these were taken of the payload bay areas while the remainder were earthlooking targets of opportunity. This flight obtained extensive coverage of North Africa, the Middle East and Far East areas, with many good stereo pairs of significant value to oceanographers, meteorologists, and geologists.

2.5.5 Noise Level Survey

An acoustic noise survey was taken three times during the STS-2 mission to fulfill the requirements of functional test objective 261-01. The measurements were as follows:

<u>Time</u>	<u>Deck</u>	<u>Location</u>	<u>Overall level, dB</u>
0/1043	Flight	Between W7/W8 windows	67*
0/1048	Flight	Aft air outlet (port side)	77*
0/1055	Mid	IMU inlet	68*
0/1057	Mid	Sleep station	61
1/0754	Mid	Forward avionics bay, floor level	80
1/0759	Mid	WCS operation, seat level	87
1/1922	Flight	F5 air outlet	76
1/1925	Mid	Sleep station	64*
1/1935	Flight	Middeck center	68
1/1935	Mid	Ceiling air outlet	71
1/1937	Mid	WCS air inlet	75
1/2001	Mid	ARS servicing housing	77

The starred numbers were also measured in the octave bands defined by the center frequencies of 63, 125, 250, 500, 1000, 2000, 4000, and 8000 Hertz. The noise measurements were made using a Bruel and Kjaer type 2215 sound level meter.

The overall noise levels were significantly higher than the specified NC-50 standard with the highest noise levels at the various air outlets and machinery areas. The quietest area was the sleep station. The orbit station and the center of the middeck were also relatively quiet. There was no significant difference between comparable octave-band measurements made during STS-1 and STS-2.

Figure 2-16 shows the data taken on the flight deck. The aft air outlet level was well above the NC-50 design requirement standard for Shuttle operations. The overall level was 22 dB above NC-50. (For reference purposes, a 10 dB increase in noise is perceived as being twice as loud as the original level). This location was expected to be a high-noise-level area. The W7/W8 window level was below NC-50 for frequencies below the 250 Hz band. The overall level was 12 dB above NC-50.

Figure 2-17 compares the W7/W8 window levels for STS-1 and STS-2. Overall, STS-2 was 1 dB louder than STS-1. The differences between the data are insignificant.

Figure 2-18 shows the data taken on the middeck. In both places, the noise level was above NC-50 except at very low frequencies. The two measurements differ significantly from each other only above 1000 Hz.

Figure 2-19 compares the sleep-station levels for STS-1 and STS-2. Overall, STS-2 was 2 dB quieter than STS-1. The differences between the data are insignificant.

2.6 STRUCTURES

2.6.1 Overpressure Effects

Orbiter loading due to SRB ignition overpressure at STS-2 lift-off was significantly reduced from that experienced on STS-1. Acoustic sensors at the center of the Orbiter base heat shield measured a maximum of approximately 0.2 psi versus 2.0 psi on STS-1. Overpressure-induced differential pressures across the fuselage were also reduced significantly from those on STS-1 thus resulting in a reduced dynamic response of the vehicle at lift-off when compared to STS-1.

2.6.2 Flutter/Buffer

Examination of response data from lifting and control surface instrumentation yielded no indication of flutter during entry (FTR 08VV010) (Lifting Surface - Control Flutter - Descent). Low-level control surface buffet (FTR 08VV012) was detected in the transonic region; however, this was anticipated. Response to structural PTI (programmed test inputs) was detected on the fin and rudder during ascent and entry. A response to PTI inputs during ascent was masked on the wing and elevons because of the buffet response; however, the response was observable during entry. The outputs of accelerometers in or near the crew module indicate that cabin buffet levels were moderate. The maximum accelerations noted on the lifting and control surfaces during STS-2 were essentially the same as noted on STS-1, and all were within design limits.

2.6.3 Stress Evaluation

No flight-measured design strain excesses have been noted in the STS-2 data evaluation that is still in progress. In general, the measured strains on STS-2 in the wing and vertical fin were slightly higher than those measured during STS-1. This is compatible with the higher load factors and different entry thermal conditions encountered during STS-2.

The peak stress levels on the fuselage during ascent occurred at post-SRB staging, as anticipated. The longerons and fuselage bottom skins indicated maximum stress levels of approximately 20,000-psi compression and 10,000-psi tension, respectively. Fuselage strain data indicated positive bending during SRB ignition and post-SRB staging and negative bending during the maximum dynamic pressure period of ascent.

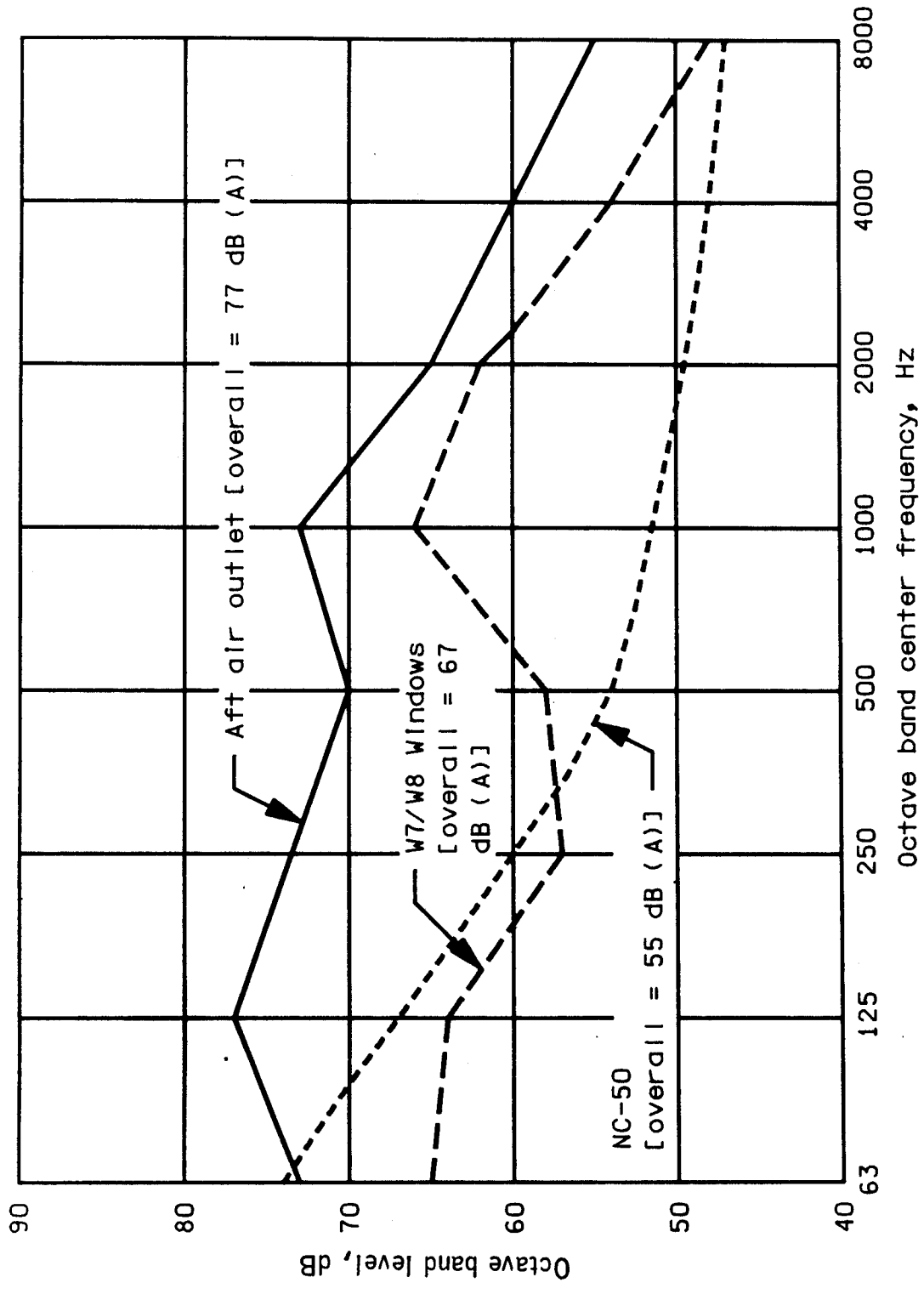

Figure 2-16. - STS-2 on-orbit cabin acoustic noise levels at flight deck.

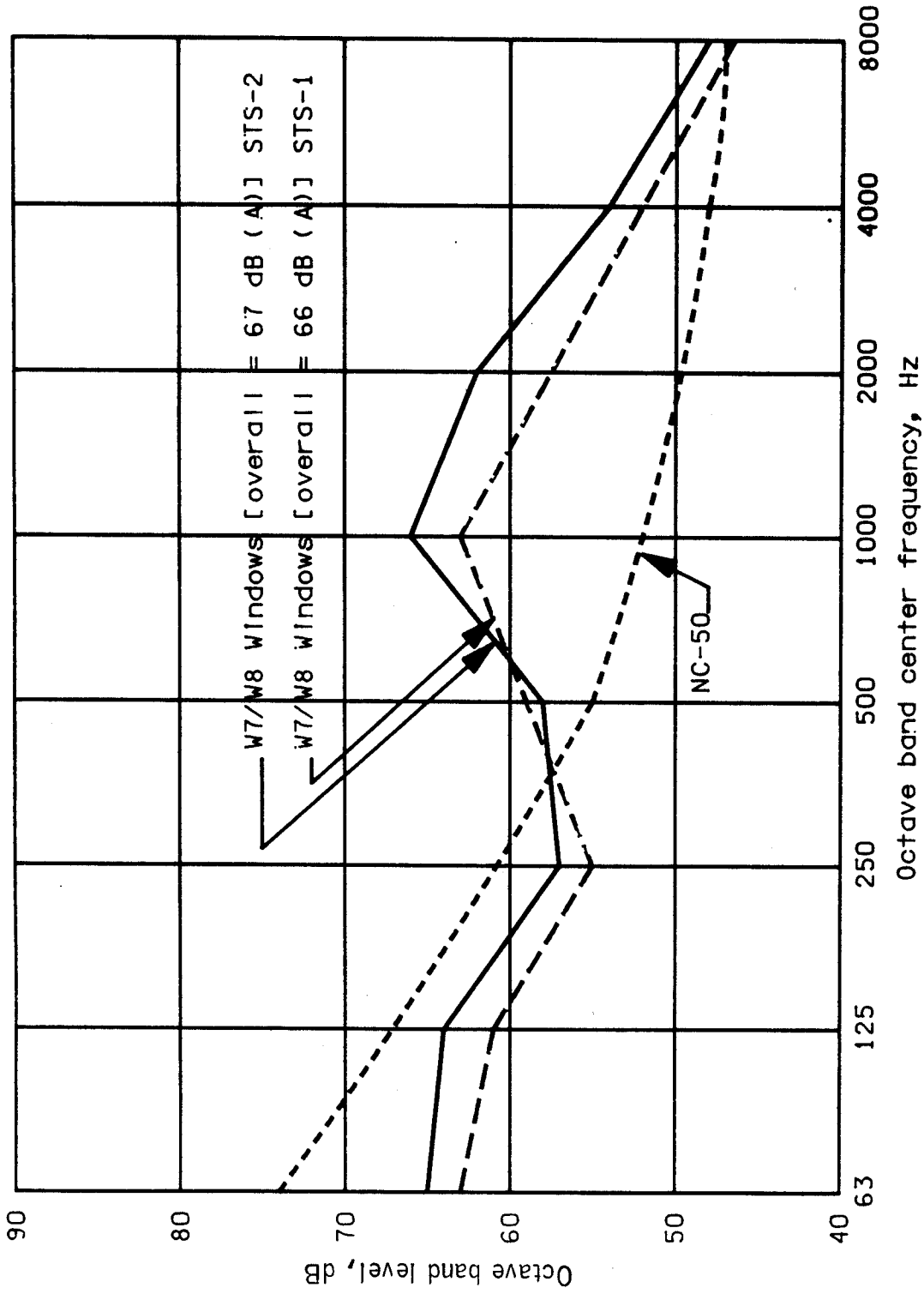

Figure 2-17.- STS-1/STS-2 on-orbit cabin acoustic noise levels at W7/W8 windows.

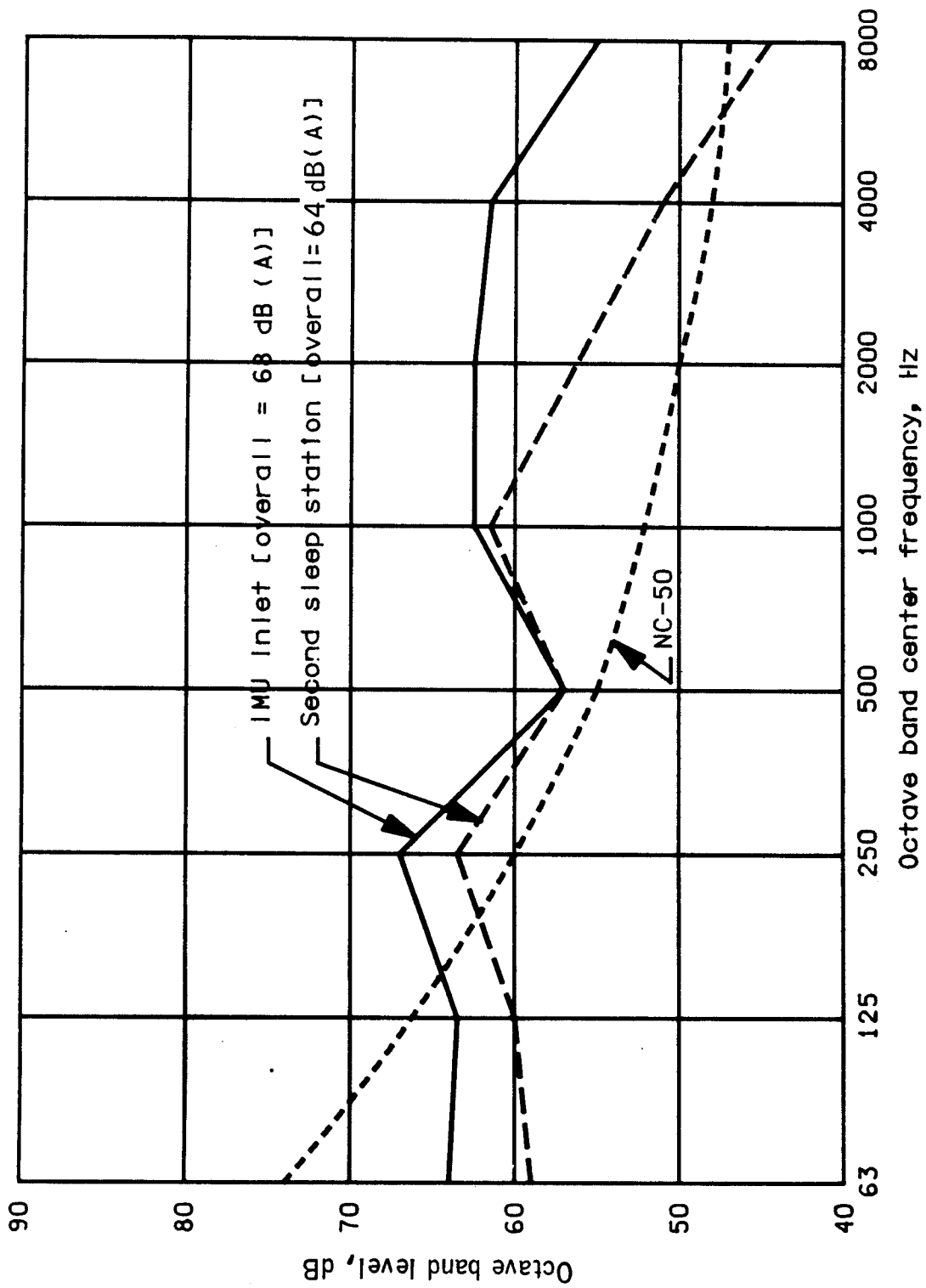

Figure 2-18. - STS-2 on-orbit cabin acoustic noise levels on middeck.

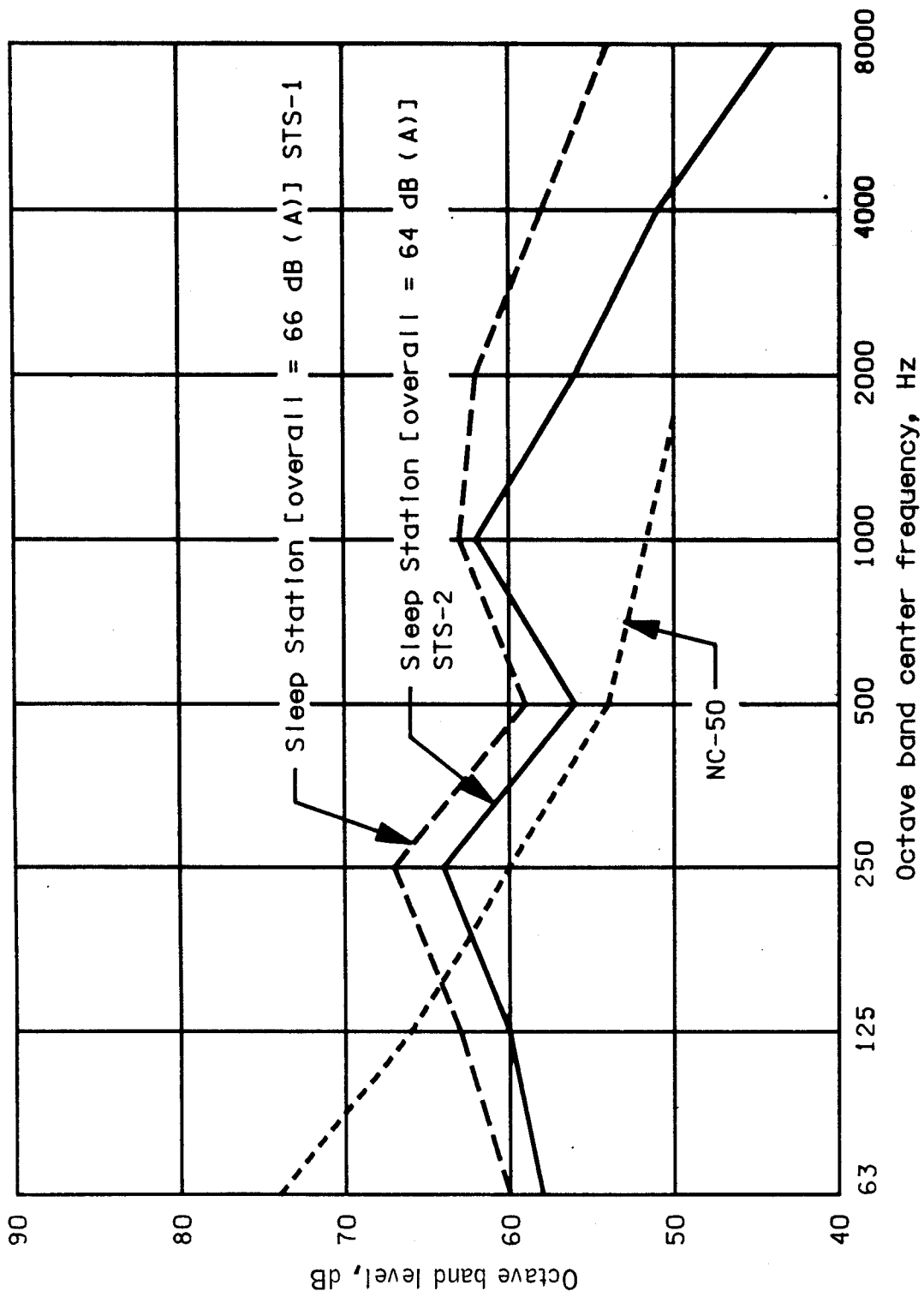

Figure 2-19. - STS-1/STS-2 on-orbit cabin acoustic noise levels at middeck sleep station.

Analysis of descent phase strain data is still in progress. For the midfuselage at X-station 891, the critical location, a two-dimensional thermal stress analysis using STS-2 flight temperature data indicates that the peak thermal stresses occurred on the bottom skin near Y-station 85. For STS-1, similar analysis indicated that the peak stress occurred inboard near Y-station 0. This outboard shift in the peak stress location from STS-1 to STS-2 is due to an increase in temperature gradients experienced on the second flight.

The temperature difference between the Y-station 85 and Y-station 0 locations on the bottom skin was 10° F during STS-1 and 35° F during STS-2. For STS-1, the peak outboard location temperature was 203° F versus 219° F for STS-2. The significance of this shift in peak stress cannot be fully assessed until all data have been analyzed.

Following STS-2, a determination was made that approximately 18 strain measurement sensors located in the region of high thermal stress had not functioned during the mission. It is not clear at this time to what extent the loss of these data will compromise the STS-2 fuselage thermal stress assessment.

The Space Shuttle main engine-mounted heat shield functioned satisfactorily on both STS-1 and STS-2; however, during post-STS-2 inspection, two thermal blankets on the center engine (no. 1) heat shield were discolored and frayed at the lower ends (fig. 2-20). Also, minor local thermally induced damage was evident on the blankets of engines 2 and 3. The seals which are protected by these blankets were not damaged. The thermal blankets for engines 2 and 3 were repaired at KSC. The engine 1 blankets were returned to the Orbiter contractor, where the damaged portions were removed and the blankets repaired. These blankets have been returned to KSC and reinstalled on OV-102. The damaged portions of the engine 1 blankets are undergoing detailed inspection and assessment at the Orbiter contractor's plant.

2.6.4 Entry Flight Loads

Entry loading conditions were within design limits for the Orbiter and within flight restrictions established for the STS-2 mission. The maximum vertical load factor experienced during STS-2 entry was 1.9g versus a flight restriction of 2.0g. The maximum load factors measured in the Orbiter payload bay are presented in the following table.

	<u>STS-1</u>	<u>STS-2</u>
N_x	0.4/~0	0.4/~0
N_y	0.16/~0.15	±0.2
N_z	1.65/~0	1.90/~0

Maximum dynamic pressure during STS-2 entry was 280 psf at Mach 0.7 (375 psf allowable, at Mach numbers <u>5.0</u>).

Landing gear vertical velocities at touchdown were well within flight restriction limits. Main gear vertical impact was approximately 1 ft/sec vs. a 6 ft/sec restriction, and nose gear impact velocity was 5.1 ft/sec vs. 11.0 ft/sec design limit. Orbiter response to main gear impact as detected by low-frequency accelerometers located in the crew cabin and midfuselage was low; response to nose gear impact is presented in table 2-VI.

2.6.5 Window Cavity Conditioning Systems

After the first launch attempt, the crew commented that the through-the-window visibility was marginal. (Section 7.0, flight test problem report 39). The windows were cleaned and were acceptable for the STS-2 launch. The window desiccant system functioned normally.

TABLE 2-VI.- ORBITER RESPONSE TO NOSE GEAR IMPACT AT LANDING

Axis	Measurement location			Airframe response, g		
	X ₀	Y ₀	Z ₀	STS-1 h=5.7 ft/sec	STS-2 h=5.1 ft/sec	Preflight verification limit
Normal Y	511	3	424	0.1	0.14	0.21
Normal Z	511	3	424	1.85	1.48	4.08
Normal Z	825	-102	407	1.62	1.28	2.79
Normal Z	974	102	407	1.41	1.28	2.07
Normal Z	973	-102	407	1.40	1.22	2.23
Normal Y	979	-11	302	0.1	0.17	0.42
Normal X	1294	-2	297	0.58	0.52	0.84
Normal Y	1294	-2	300	0.1	0.14	0.23
Normal Z	1294	-2	289	1.38	1.21	1.92

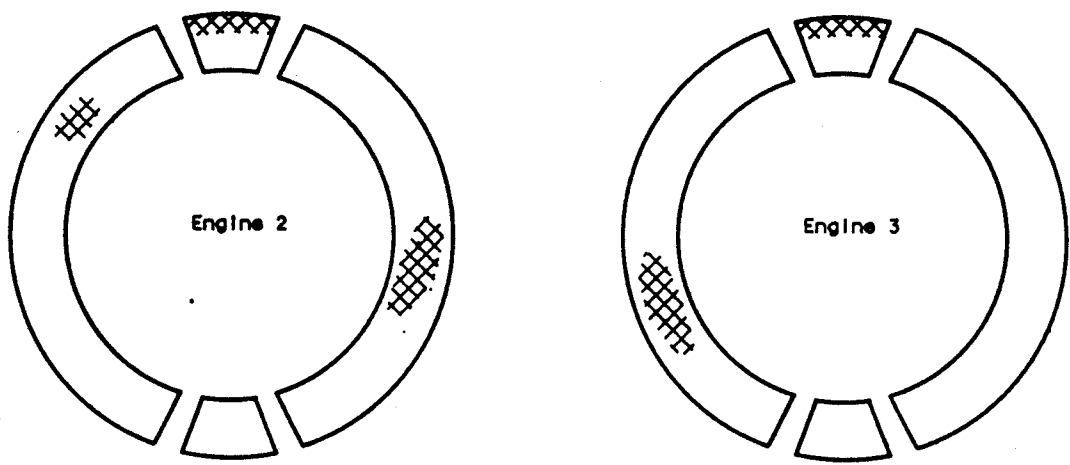
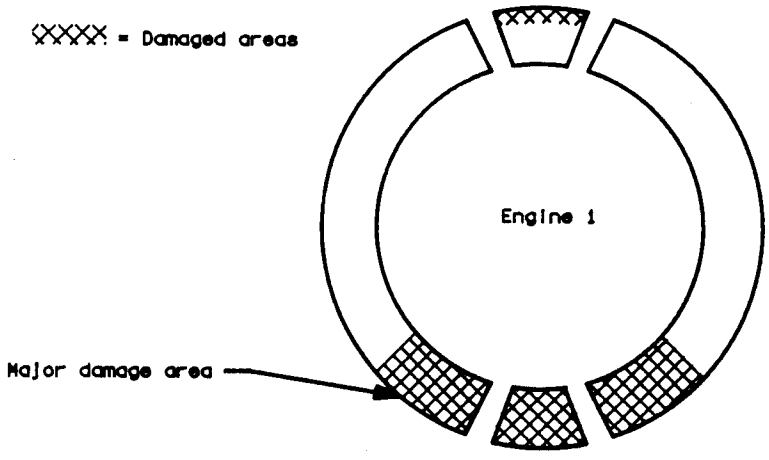
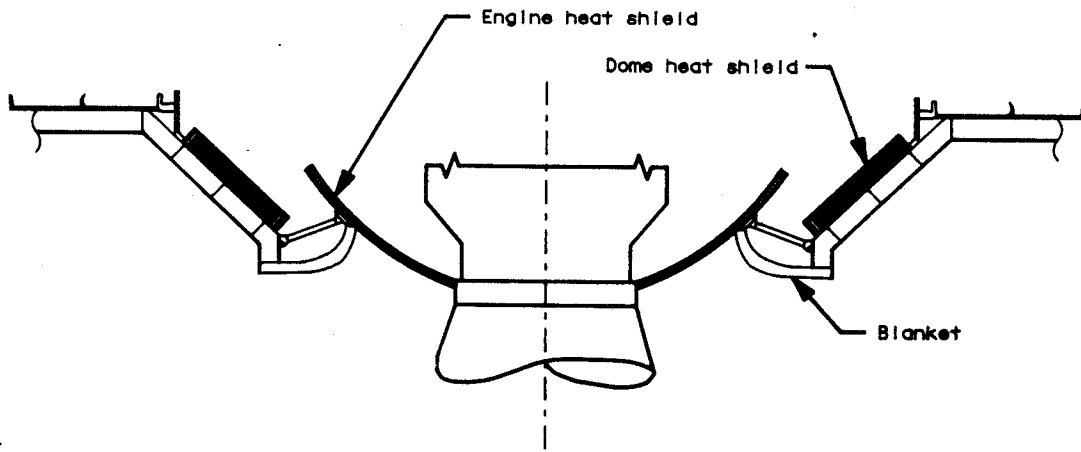

Figure 2-20.- Heat shield damage in main engine area.

The crew indicated that a film deposit was observed on the outer window panes after SRB separation, but the inner panes remained clear throughout the flight, indicating that the desiccant system functioned satisfactorily.

2.7 MECHANICAL SYSTEMS

The following mechanical systems functioned during STS-2: ingress/egress hatch, purge and vent door drives, Orbiter/ET separation, payload bay door drives and latches, radiator deploy/stow and latch or manipulator positioning mechanism and retention latches, star tracker door drives, air data probes deploy/retract, and landing and deceleration. The aerothermal seals subsystem is a passive subsystem used primarily to provide thermal protection for structural elements during ascent and entry. The ejection seats were required to perform the following primary functions: crew support and constraint; vertical positioning; back angle positioning for ascent; suit oxygen and ventilation connections; and communication and biomedical connections. The airlock hatches A and B and seat ejection access door operational subsystems were not operated during STS-2.

2.7.1 Purge and Vent and Drain

The purge and vent subsystem provided the unpressurized compartments of the Orbiter with an air purge that thermally conditioned system components, prevented hazardous gas accumulation, and equalized compartment pressures during ascent and descent. All purge and vent requirements were satisfactorily accomplished, except for the wing vent relief door that opened during descent. (Section 7.0, flight test problem report 45.) The prelaunch purge changeover from air to gaseous nitrogen occurred at 316:06:57 G.m.t. The prelaunch gaseous nitrogen purge flow rates and temperatures were as shown in the following table:

	<u>Flowrate,</u> <u>lbs/min</u>	<u>Temperature, °F</u>
Forward fuselage purge circuit	98	88
Mid fuselage purge circuit	169	72.8
Aft fuselage purge circuit	107	102.4

Beginning at T-37.6 seconds the vent doors were commanded to a fully open position. The vent doors were fully open by T-10.17 seconds, well ahead of the planned time of T-4 second all-vent-door-open criteria and well within the two-motor design time of 5 seconds. The vent doors remained open until 1 hour prior to the deorbit maneuver, at which time all the vent doors were closed except the left-hand forward fuselage and left-hand aft fuselage/OMS POD vent doors. These doors remained open to preclude Orbiter overpressurization in the event of a fuel leak during the firing. At entry interface minus 6 minutes, the two left-hand vent doors remaining open were closed. The doors were closed during the high heating phase of entry to protect the structure around the vents from the effects of entry heating.

The GPC (general purpose computer) commanded the vent doors to open during descent when the ground relative velocity reached 2400 ft/sec, and the vent doors were fully open 8 seconds later.

After landing, the crew commanded the vent doors to the postlanding purge configuration. The postlanding purge was initiated about 5 minutes later. The postlanding purge flowrates and temperatures were as shown:

	<u>Flowrate,</u> <u>lbs/min</u>	<u>Temperature, °F</u>
Forward fuselage purge circuit	90	55
Mid fuselage purge circuit	185	55
Aft fuselage purge circuit	70	55

Measured internal compartment pressures have been reviewed for both ascent and entry. The preflight predicted ascent compartment pressures compared favorably with the actual measured pressures. Figures 2-21, 2-22 and 2-23 present a comparison between preflight predicted and measured compartment to ambient differential pressures for the forward RCS, payload bay, and rudder compartments.

Postflight inspection revealed both the left-hand and right-hand descent wing vent relief doors were open. (Section 7.0, flight test problem report 45.) Both relief doors should remain closed since the primary active wing vent doors functioned normally.

2.7.2 Orbiter/External Tank Separation and Umbilical Devices

The Orbiter/ET separation subsystem (i.e., umbilical separation and retract, Orbiter/ET structural separation and umbilical doors closure) performed normally during STS-2.

The umbilical separation and retraction mechanism showed no evidence of damage to either of the electrical disconnects or the umbilical closeout curtains. Also, the postflight inspection indicated no damage to the umbilical blast containers as was observed and reported after STS-1.

The Orbiter/ET structural separation system performed normally on STS-2. A postflight inspection of the separation hardware showed that the forward structural attachment functioned as required. The separation bolt/monoball assembly was rotated to the flush position by the centering mechanism, and the shear-bolt piston was recessed within the outer moldline 0.012-in. (well within the aerothermal smoothness requirement of ± 0.030 -in.).

The aft structural attachments also separated normally; however, a review of the ET separation films showed an Orbiter insert drifting free from the Orbiter's left-hand aft structural attachment at external tank separation. (Section 7.0, flight test problem report 40.) It was also reported that the right-hand insert was loose. This part is normally retained inside the Orbiter socket fittings by spring retainers after tank separation. This anomaly is under investigation. Likewise, the separation films showed that the aft attach bolts had retracted into the ET ball fittings as expected. Additionally, the 35mm ET separation camera showed the bolt tip to be in or near the bolt hole in the right-hand ball fitting. Also, the aft attach hole pluggers, which minimize the escape of debris after separation, had closed off the Orbiter bolt holes.

The ET umbilical doors closure was initiated (i.e., command to stow centerline latches), 18 minutes after lift-off, 3 minutes before planned time. Door closure was completed 44 seconds later. The accumulative time from the operation of each ET door mechanical function to achieve door closure was 31.81 seconds; the specification time based on two-motor operation is 36 seconds. Therefore, the ET doors functioned normally during the STS-2 mission.

Postflight review of the three ET separation camera films and visual inspection of the Orbiter/ET umbilical cavity showed evidence that the purge curtain had caused some minor TPS damage. The purge curtain is constructed from a 2-mil thick Kapton material and installed in the hydrogen and oxygen Orbiter/ET umbilical cavities. The purpose of the curtain is to prevent icing during ET tanking, and it is designed to tear away during ascent. The STS-2 purge curtain in the oxygen cavity (right-hand side) was installed with fixed retainers around the inner and outer periphery. However, the hydrogen cavity (left-hand side) was installed with fixed retainers on the outside periphery and a channel/drawstring on the inner periphery. Postflight inspection revealed minor tile abrasion on the trailing edge of the left-hand door. The abrasion could be attributed to the cord's whipping as noted on ET separation camera films. (Section 7.0, flight test problem report 19.)

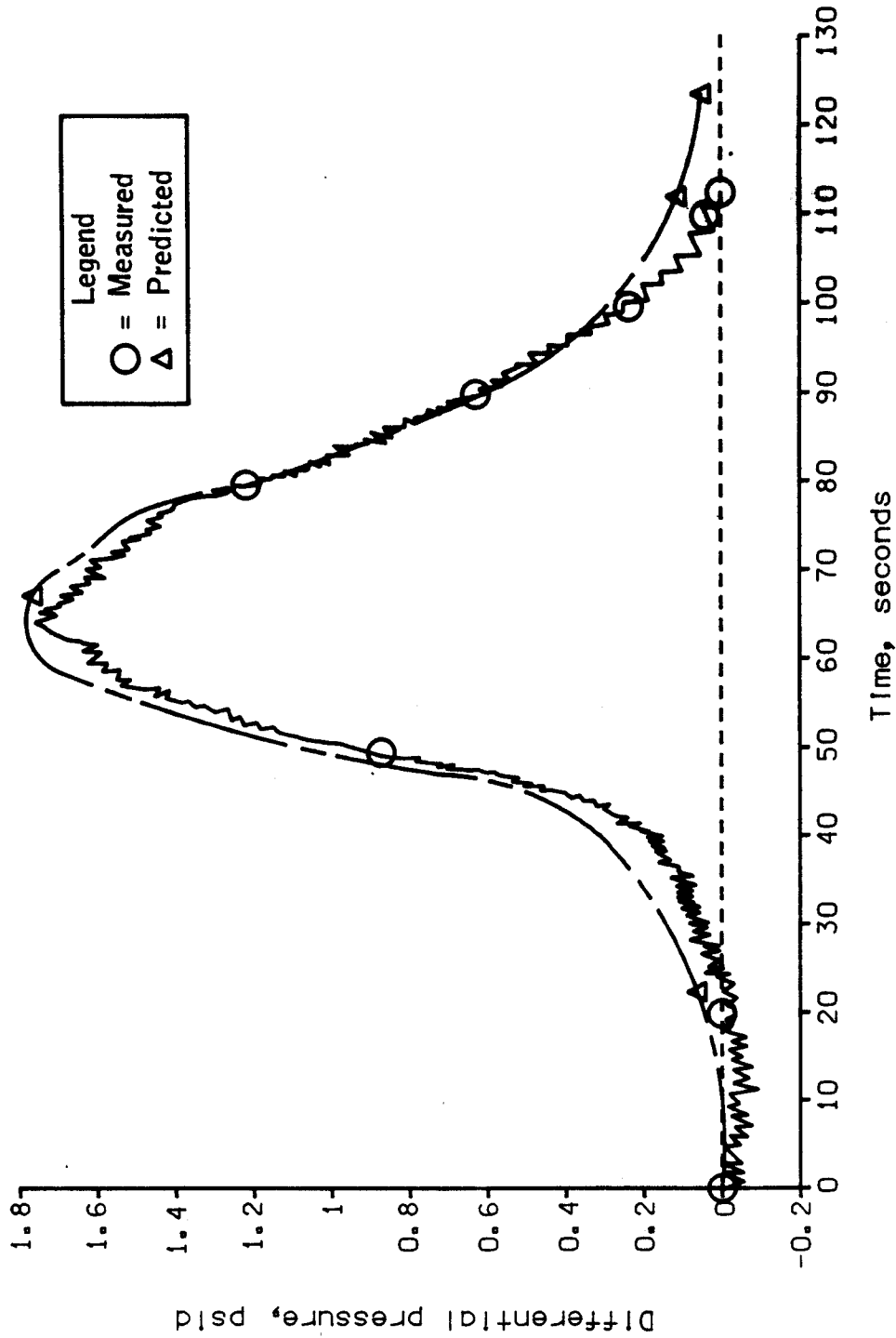

Figure 2-21.- STS-2 ascent vent correlation, forward RCS to ambient.

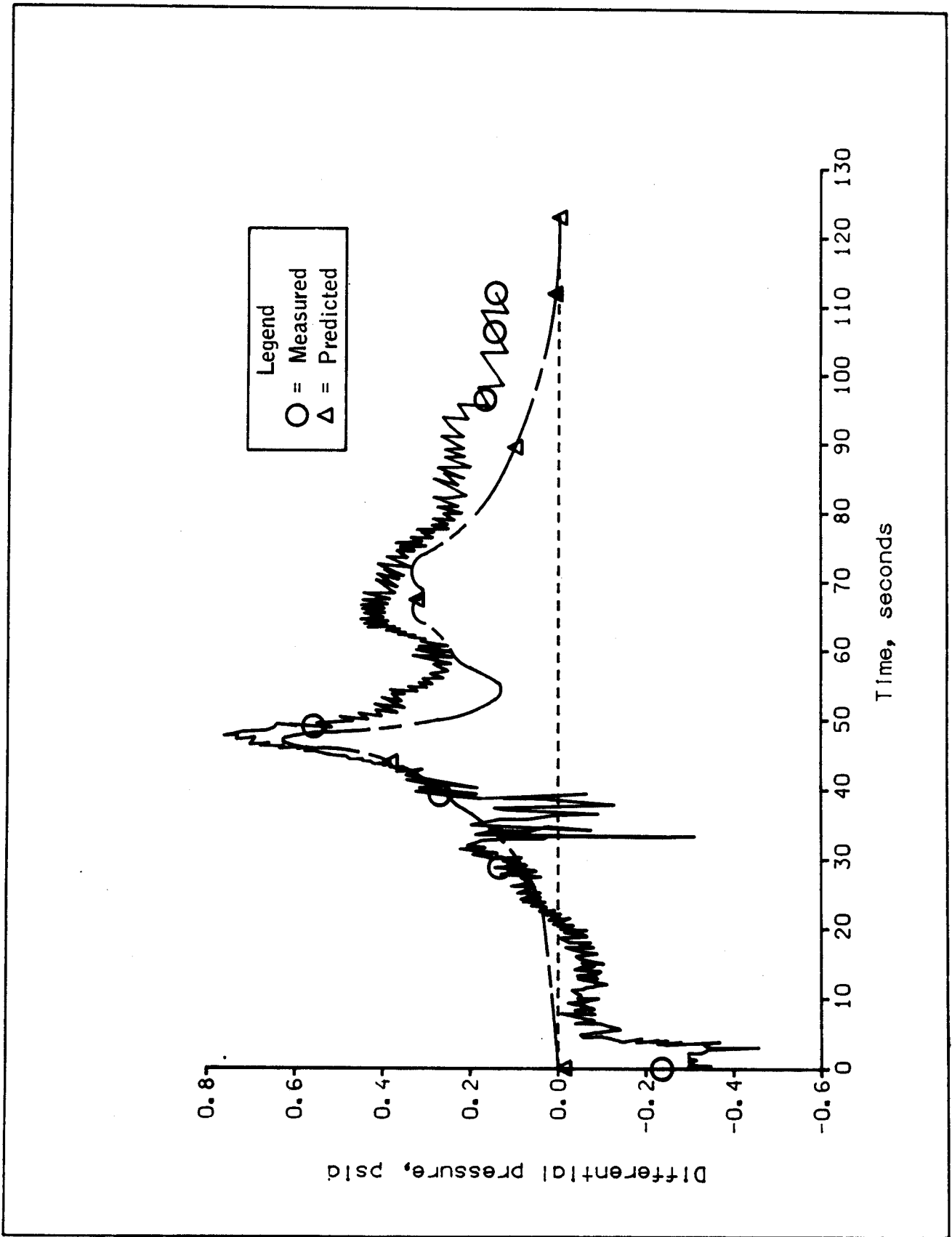

Figure 2-22.- STS-2 ascent vent correlation, payload bay to ambient.

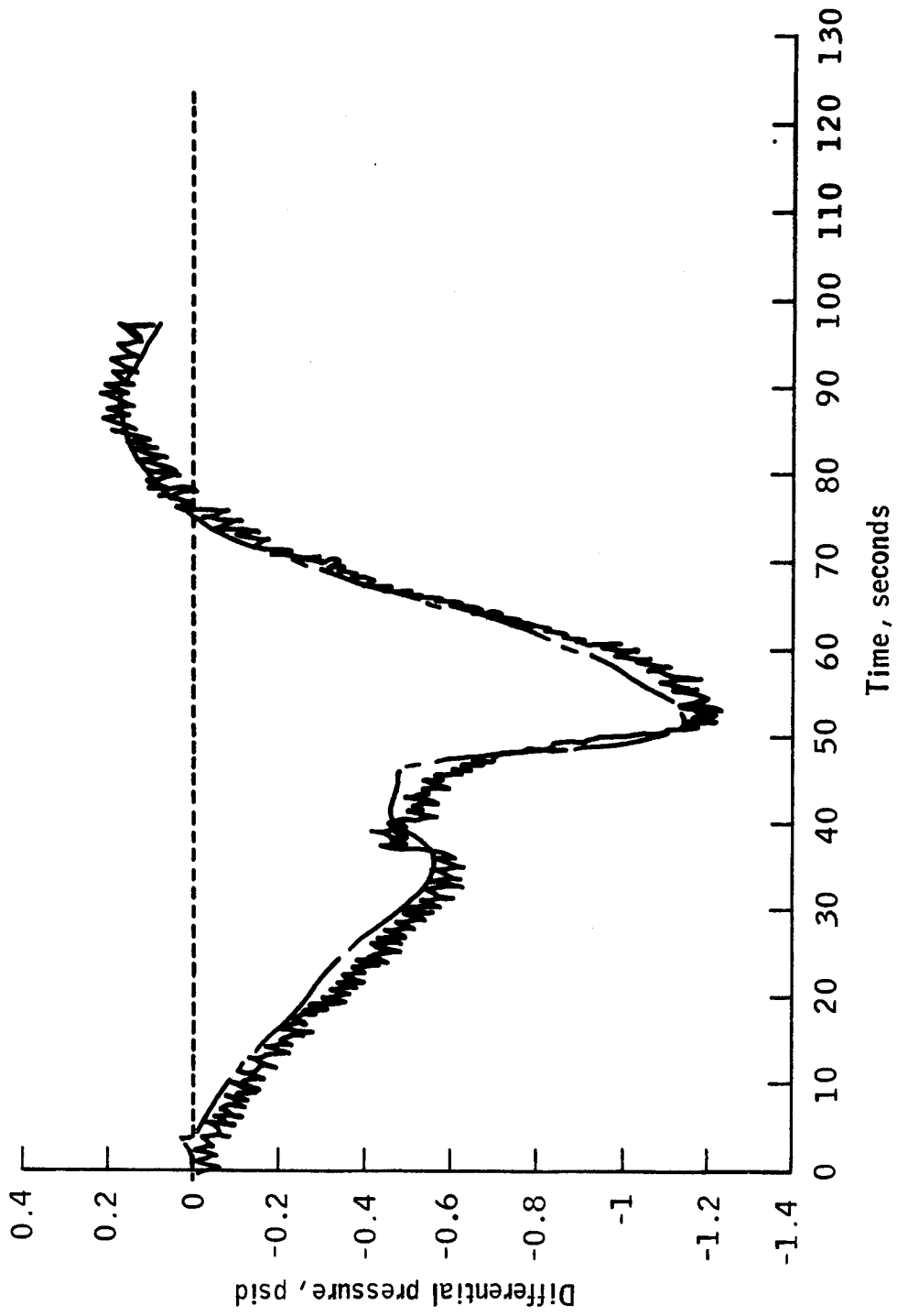

Figure 2-23. - STS-2 Ascent vent correlation rudder compartment to ambient.

2.7.3 Payload Bay Doors and Radiators

The operational times for the payload bay doors mechanical components (i.e., door actuators and latch mechanism) were representative of two-motor operation and consistent with the times recorded during STS-1. Also, the operational times for the radiator actuators and latching mechanism were representative of two-motor operation and consistent with the times recorded during STS-1.

On launch day, upon completion of manual operation, the payload bay doors were opened using the auto mode. Data indicate normal operation.

The STS-2 door deflections predicted for the launch and entry day door closures compared favorably with preflight predictions. On launch day, the STS-2 visual report was consistent with STS-1 data. On entry day, the visual report of a 1.0-in. (approximately) overlap at latch no. 3 compared to a 3.5 in. (approximately) overlap at latch 12 on STS-1 mission. The crew's visual determination of the door overlap condition during closure should be continued on subsequent missions to establish confidence in the door math model.

2.7.4 Manipulator Positioning Mechanism

The RMS (remote manipulator system) positioning mechanism performed normally during the STS-2 mission. The crew reported that the MPM (manipulator positioning mechanism) functioned satisfactorily during deployment and stowage operations. Also, the crew stated that the visual guide marks were very effective aides during berthing of the RMS. The MPM actuation times were within two-motor predicted time requirements. Postflight inspection of the MPM showed the actuation mechanism pedestals and linkage were properly aligned and locked. Also, the thermal blankets were in place and secured.

The MRL (manipulator retention latches) actuation times were normal (i.e. within predicted two-motor operational time), and all microswitch indications were received at the proper time.

2.7.5 Star Tracker Doors

The star tracker door actuation mechanism performed normally during the STS-2 mission. The operational time to open the doors was 5 to 7 seconds; closing times were 4 to 5 seconds. The design time for door actuation is 8 seconds for two motors and 15 seconds for one motor.

2.7.6 Air Data Probe

The air data probe deployment mechanism performed normally during the STS-2 mission. Total deployment time for each probe was 13 and 16 seconds based on ISS data. The design deployment time is 15 seconds for two motors and 30 seconds for one motor. The data sampling rate accounts for the 1 second discrepancy in the deployment rate versus the specification value.

2.7.7. Landing/Deceleration Subsystem

The landing/deceleration system provided exceptional performance during the STS-2 deployment, landing, and rollout.

2.7.7.1 Landing Gear Deployment.- Deployment of the landing gear was initiated 18 seconds before touchdown, and the last gear was down and locked 12 seconds before touchdown. The deployment time of 6 seconds was well within the 10 seconds required for deployment. All deployment mechanisms, hydraulics, and pyrotechnic devices performed normally; no backup pyrotechnic systems were required for deployment.

Just prior to vehicle stacking, the ground support equipment indicated that the left main landing gear bungee, which aids deployment, was not armed. It was decided to proceed with the mission since this deployment assist was not required for STS-2 flight conditions. The bungee performed normally during deployment; postflight inspection revealed that the bungee position microswitch had provided an erroneous indication. This will be corrected for STS-3.

2.7.7.2 Landing and Rollout.- Touchdown occurred at 318:21:23:12.88 G.m.t., at a sink rate of less than 1 ft/sec. Table 2-VII provides detailed performance values regarding landing velocities, distances, pitch rates, and times. Figure 2-24 is a plot of ground speed during landing. Nose wheel steering was not engaged, but differential braking was used to maintain a course within 36 feet of the runway centerline.

During rollout, the commander applied moderate braking to achieve the desired 7 to 8 ft/sec² deceleration rate. The commander reported some difficulty in maintaining a constant deceleration rate due to a fluctuating deceleration indication.

Postflight inspection of the main tires revealed that three had received small (4 in. x 5 in. x .05 in.) flat spots in the center of the tread areas. This amount of tread wear will not prevent tire reuse. The cause is assumed to be related to touchdown spinup wear.

After landing, several thermal protection system tiles near each of the main landing gear wheel wheels were found to have been damaged by instrumentation wires leading to the tire pressure and temperature sensors. At main-wheel touchdown, these wires disconnect between the wheel and axle, leaving a "pigtail" section free to swing out with the rotation of the wheel. (Section 7.0, flight test problem report 19.) For STS-2, these wires were manufactured excessively long, thus contributing to their tendency to flail and subsequently impact the TPS. STS-3 wheel instrumentation wires will be shorter and more securely attached.

2.7.8 Aerothermal Seals

Postflight inspection has revealed only slight damage to the aerothermal seals.

The nose landing gear door thermal barrier was debonded up to a maximum of 1 in. from the outer mold line. The fabric was frayed in localized areas.

The main landing gear door thermal barrier Macor (Machineable glass ceramic) supports did not show as many discolorations as STS-1. This is attributed to the new, improved flow barriers installed on all lower surface doors to decrease flow.

The payload bay door thermal seals showed some damage, unlike any occurring on STS-1. A 1-ft (approximately) long segment of the door environmental seal, located in the left-hand door's forward expansion joint, became loose and protruded through the S-glass thermal barrier. A poorly installed bonding strap had bent and interfered with the environmental seal, cutting it and debonding it in some areas. Also, some minor damage occurred at some repaired splices.

The payload bay door aft expansion joint thermal barrier did not properly center at the top centerline. This resulted in the door belly band riding up on the glass pile and debonding the carbon epoxy door edge.

The Inconel spring of the rudder speed brake perimeter seal located at the bottom aft corner was found to be damaged. This spring had a fatigue crack, apparently caused by aerodynamic loads. A similar crack occurred on STS-1. The wing/elevon cavity showed evidence of leakage, as volatile deposits were found in the cavity. These deposits are typical of those experienced on STS-1.

TABLE 2-VII.- LANDING/DECELERATION SUBSYSTEM PERFORMANCE

Parameter	Velocity, knots	
	Equivalent air speed	Ground relative velocity
Main gear touchdown ^a	194.3	185.8
Nose gear touchdown	145.6	135.0
Braking initiated	120.6	108.8
Distance from main to nose wheel contact, ft.		3649
Distance from nose contact to brake initiation, ft.		1351
Braked roll, ft.		2711
Braked duration, seconds		30
Pitch rate at nose wheel contact, deg/sec		4.4
Sink rate at main gear touchdown, ft/sec		< 1
Total rollout, ft ^b		7711
Rollout duration, seconds		50
Touchdown points from threshold		
Left main, ft		780
Right main, ft		805

Note:

^aTouchdown 8.33 ft to right of runway centerline.

^bDrifted 36.83 ft to the right of the centerline during rollout but stopped on the centerline.

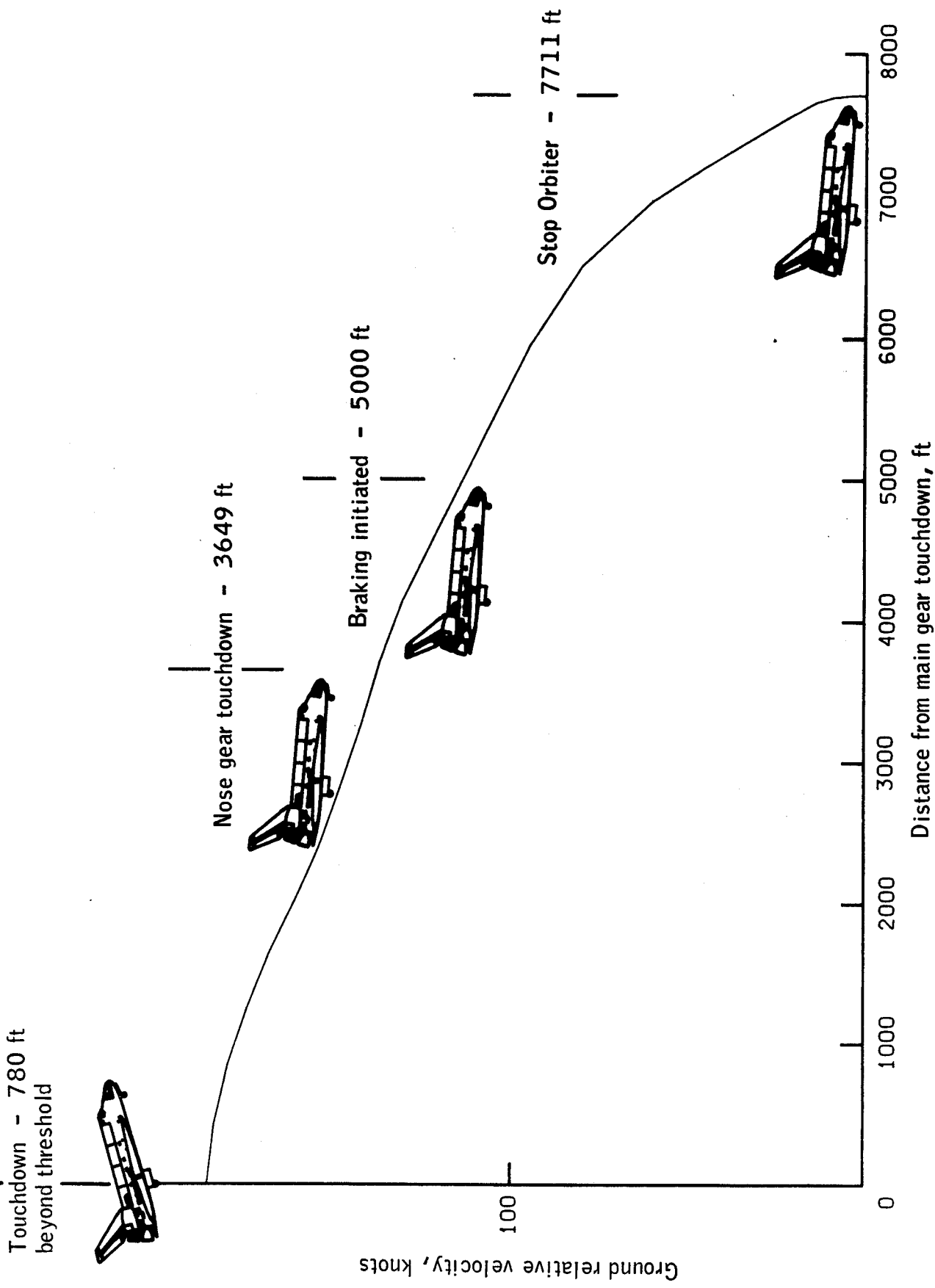

Figure 2-24.- STS-2 rollout parameters.

2.7.9 Crew Escape System

The crew escape system ejection seats provided the crew with support and constraint, vertical positioning, back angle positioning for ascent, oxygen and ventilation connections for suited operations, and communications and biomedical connections. No difficulties were reported during the STS-2 mission.

2.7.10 Pyrotechnics

All pyrotechnic functions on the Orbiter were successfully completed with the exception of the gas sampling system. (Section 7.0, flight test problem report 42.)

The forward attachment shear bolt and two aft frangible nuts, along with six frangible nuts on the umbilical plates, separated the Orbiter from the external tank after ascent. The nose landing gear extension thruster assisted in deploying the nose gear and doors just prior to landing. No backup or emergency devices were fired.

2.8 THERMAL

2.8.1 Thermal Control

2.8.1.1 Prelaunch and Ascent.- All thermal control system temperatures were maintained within allowable limits during the prelaunch and ascent phases of STS-2. The effects of the MPS cryogenic chilldown were similar to those experienced during STS-1. The warmer STS-2 aft fuselage (circuit 3) nitrogen purge of 160° F resulted in minimum temperatures of the bulk gas and base heat shield of 42° F and 37° F, respectively, as compared to the STS-1 aft fuselage purge of 95° F which resulted in minimum bulk temperature of 32° F and a minimum base heat shield temperature of 34° F.

Differential pressure gage V07P9083 exceeded 0.10 psid approximately 23 seconds after lift-off and reached a maximum of 0.32 psid approximately 75 seconds after lift-off, causing concern that the ultimate design pressure differential of 0.14 psid for the payload bay liner, which will be flown for the first time on STS-4, would be violated. This same condition existed on STS-1. Postflight inspection revealed that a dust cover had not been removed from one of the sensing ports.

2.8.1.2 On Orbit.- The on orbit structural temperatures were within expected ranges and were consistent with temperature trends observed on STS-1. Because of the high (-53° to -56°) beta angle (angle between orbit plane and sun vector) and the payload bay-to-earth attitude with the nose along the velocity vector, large port-to-starboard temperature gradients were observed. The maximum port-to-starboard gradient in the midfuselage was 143° F, with port and starboard bondline temperatures of -47° F and 96° F, respectively, (See figure 2-25). STS-1 exhibited a 50° F maximum gradient in the opposite direction (30° beta angle with tail forward).

Pre-entry bondline temperatures were well within acceptable entry interface requirements as a result of the pre-entry cooldown attitudes. Critical bottom fuselage bondline entry interface temperatures ranged from 3° F to 34° F compared to normal entry requirements of 60° F and greater.

The PTC (passive thermal control) thermal test (FTO 212-02) was deleted for the minimum mission. The purpose of the test was to obtain a direct comparison of payload bay down (local vertical) temperatures with those of PTC to determine the feasibility of using local vertical attitudes in lieu of PTC for thermal conditioning. The test will not be replanned since STS-3 and 4 will provide data to make an analytical determination. Thermal control system heaters maintained systems within allowable limits.

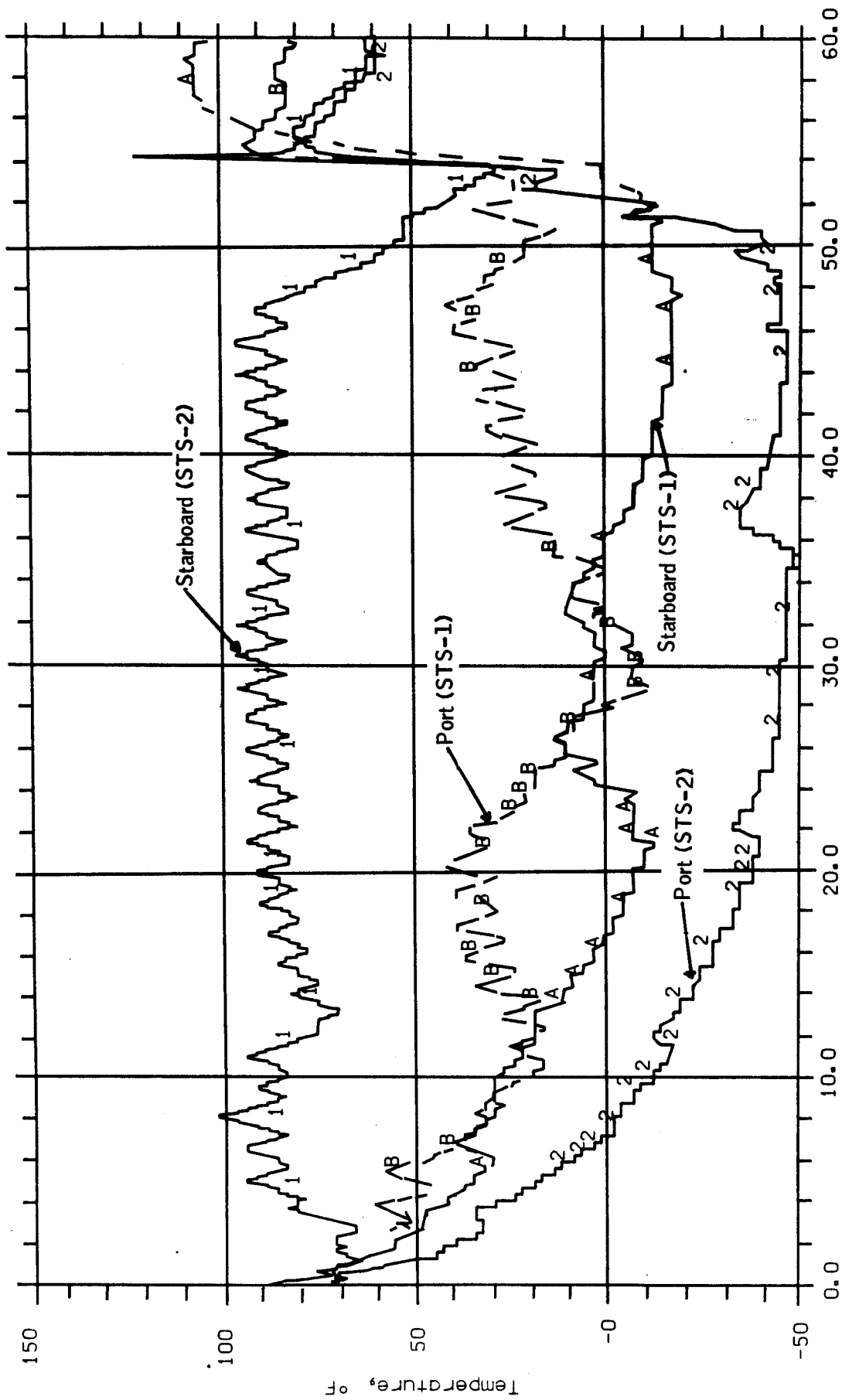

Figure 2-25.- Temperature profile showing maximum port to starboard gradient.

The APU 2 pump secondary water cooling line (V46T0294) and APU 3 injector water cooling line (V46T0503) heater thermostats exhibited dither (apparent change in set points to a very small dead band). No attempt was made to switch to backup heater systems as acceptable temperatures were being maintained. A total of ten thermostats dithered. (Section 7.0, flight test problem report 3.) Table 2-VIII lists all heater circuits that exhibited thermostatic dither.

The forward RCS compartment heater performance, as expected, was similar to that experienced on STS-1. The 100-percent duty cycle experienced during both flights is of concern from the standpoint of overheating components and bulk propellant. A change is to be made relocating the thermostats during the OV-102 modification period or, if the compartment is removed during the remaining OFT (Orbital flight test) period.

The forward RCS compartment heater performance is shown in figure 2-26. The starboard heater initially came on at 317:12:32 G.m.t. at 100-percent duty cycle until disabled (to minimize fuel cell loads) for the hydraulic circulation pump test at 318:01:10 G.m.t. The compartment heater was re-enabled at 318:03:58 G.m.t. and continued at the 100-percent duty cycle until a heater switch configuration from system A to system B occurred at 318:13:18 G.m.t. The heater system then cycled off because of a warmer system B thermostat location and remained off until the heaters were disabled for entry.

Forward starboard primary RCS engines (F2R, F4R, F2D, F4D) heaters operated at duty cycles approximately twice as high as on STS-1. Higher duty cycles were expected because of the colder conditions encountered as a result of the higher beta angle. However, the 65-percent duty cycles on engines F2D and F4D are cause for concern for colder missions. Further thermal analysis is required to determine the design adequacy of these heaters.

The primary RCS engine duty cycle firing thermal soakback test (FTO 212-01) was deleted for the minimum mission. It will be performed on STS-3 or STS-4.

The VRCS (vernier RCS) injector heater evaluation (FTO 212-03) was initiated at 317:19:41 G.m.t. and terminated at 318:02:51 G.m.t. As expected, the VRCS starboard forward engine, F5R, exhibited the fastest cooldown response. The oxidizer injector temperature (V42T1501) dropped to approximately 150° F at 317:20:30 G.m.t., at which time the temperature rose slightly and then continued to drop (approximately 4° F/hr) until it reach 127° F at the end of the test and the engines were enabled. This cool-down rate may require periodic VRCS engine firings to preclude violating the 130° F leak detection limit.

At approximately 318:17 G.m.t. to 318:18 G.m.t., heavy VRCS firing activity occurred, causing the F5L engine fuel valve temperature (V42T9111) to reach 250° F while the oxidizer injector temperature (V42T1529) had exceeded its upper transducer range of 250° F, (figure 2-27). (Section 7.0, flight test problem report 46.)

No hydraulic system component heaters were activated, and all hydraulic system return line temperatures, except the system 3 body flap line, which reached -4° F, were above the 0° F circulation pump turn-on limit. The hydraulic system circulation pump thermal conditioning performance tests (FTO 243-01, 02, and 03) are reported in section 2.2.2. The major concerns of these tests are high supply pressures causing thermal bypass valves to close and prevent adequate warming of lines and components. However, data show circulation pump supply pressures running lower than predictions and component return lines reaching higher temperatures than predicted because the temperatures depend on the viscosity affects of the fluid at low temperatures.

TABLE 2-VIII.- STS-2 THERMOSTAT DITHER^a

Measurement	Title	Thermostat no.
V43T6234	OMS mid fuel high point bleed	S2121 (Sys B)
V43T6235	OMS mid ox high point bleed	S2131 (Sys B)
V43T6238	OMS aft fuel high point bleed	S2101 (Sys B)
V46T0104	APU 1 fuel feed line	S14B
V46T0294 ^b	APU 2 pump secondary water line	S015B
V46T0394	APU 3 pump secondary water line	S013B
V46T0501	APU 1 injector water line	S04B
V46T0503 ^c	APU 3 injector water line	S03B
V63T1870	Port FES water feed line zone 1L	S5 (Sys 1)
V63T1873 ^c	Stbd FES water feed line zone 2R	S12 (Sys 1)

^aOn-orbit only unless noted.

^bPrelaunch only.

^cPrelaunch and on-orbit.

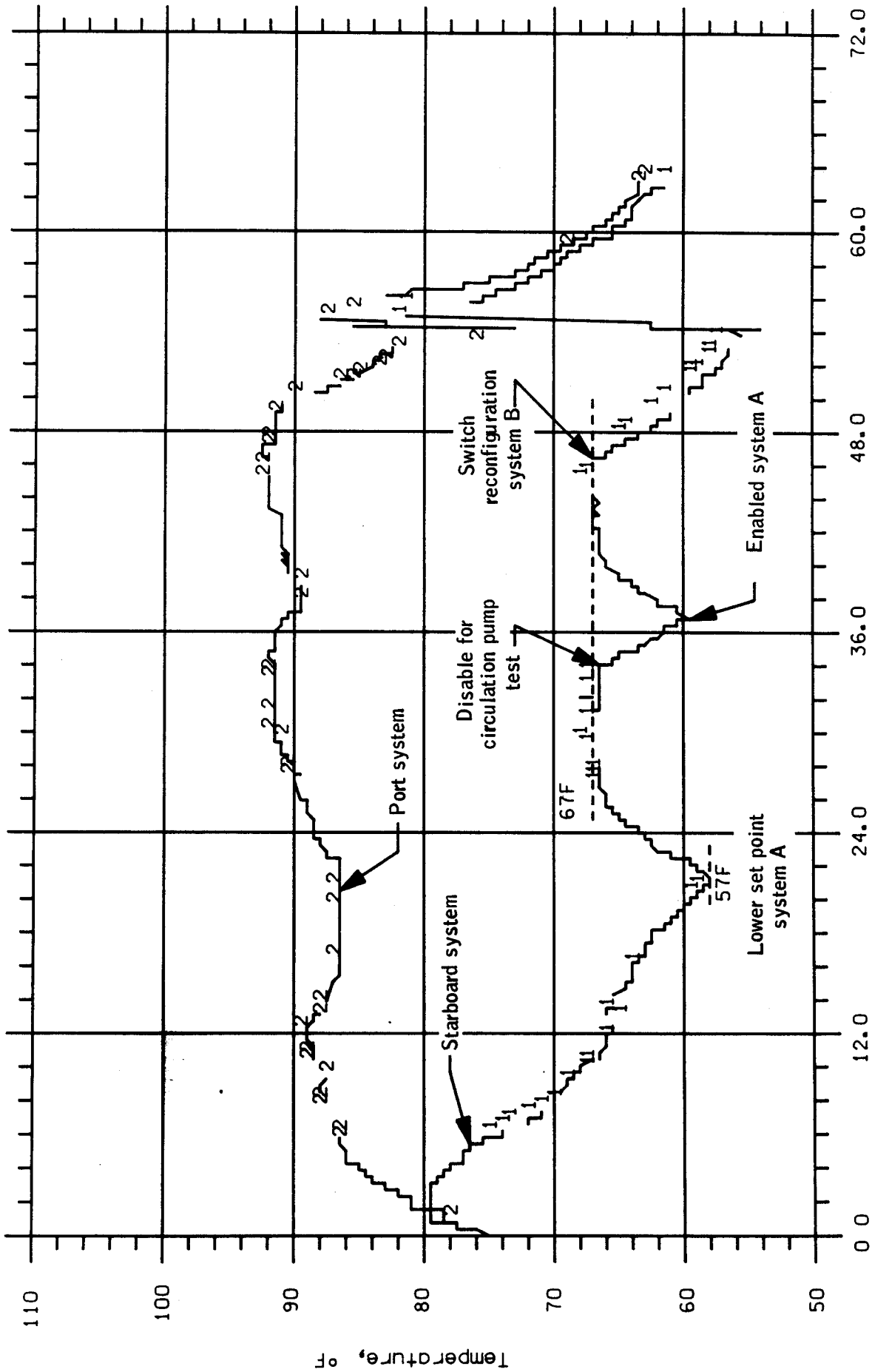

Figure 2-26.- Forward RCS temperature history during STS-2 mission.

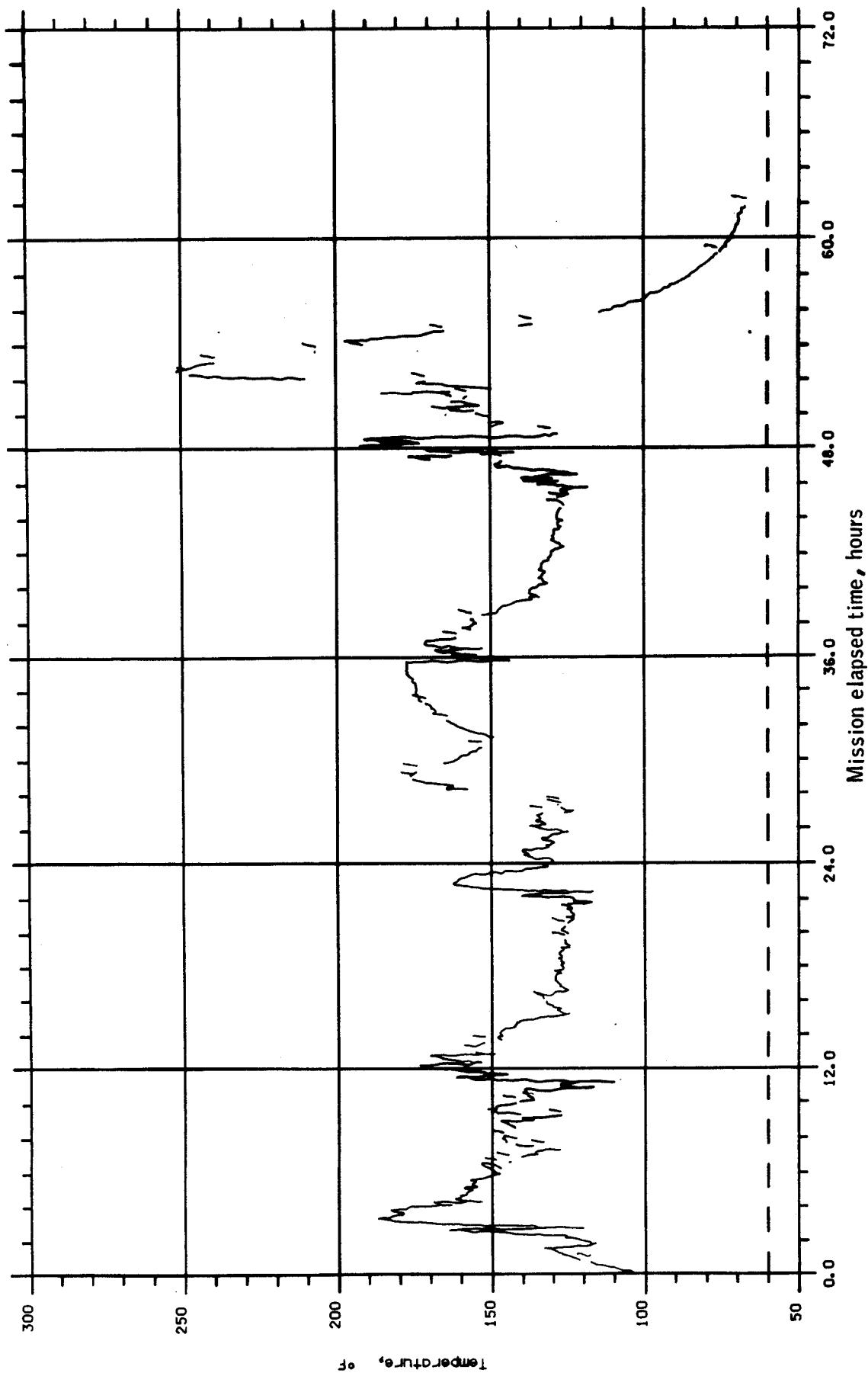

Figure 2-27.- Fuel valve temperature on engine F5L.

The main and nose landing gear strut actuators and landing gear dump valves were significantly above their minimum full performance temperature limits of -35°F and -20°F . These components cooled from their lift-off temperature of 78°F for the NLG (nose landing gear) strut actuator and 70°F for the MLG (main landing gear) actuator and dump valve down to 57°F for the NLG strut actuator, 41°F for the dump valve, and 9°F for the right MLG strut actuator.

2.8.1.3 Entry/Postlanding.- The maximum bondline temperatures observed during entry were 260°F , on the starboard OMS pod and 237°F on the port OMS pod (figure 2-28). Initial entry interface temperatures for these locations were 24°F and 11°F for the starboard and port pods, respectively. In general, the bottom fuselage bondline maximum entry temperatures on STS-2 were slightly cooler than STS-1, however, in one case, the maximum peak STS-2 bondline temperature at station X_0 1215 was hotter at 214°F as compared to 180°F on STS-1.

The hydraulic fluid entry thermal conditioning test (FTO-244) was initiated immediately after the APUs were started and the hydraulic system fully pressurized. This occurred at entry interface minus 13 minutes. The aero surfaces were cycled for approximately 5 minutes. All hydraulic lines met the required temperature levels except that the system 1 standby lines to the elevons were at 15°F , well below the desired 35°F . Additional analysis will be accomplished to define the aero surface cycling times and rates required to achieve the 35°F level. All hydraulic temperature limits were met at the critical time of touchdown minus 10 minutes.

To minimize fuel cell loads after landing, hydraulic circulation pump operation was restricted to when local overtemperature due to soakback was eminent. Since adequate instrumentation on the hydraulics systems does not exist to make this determination, a number of structural bondline temperatures were identified for this purpose. None of the bondline temperatures exceeded the 240°F limit defined for circulation pumps' activation.

2.8.1.4 Thermal Control DTO/FTO Summary.- Of the eight thermal control DTO/FTO's planned for STS-2, three were completed as planned, three were abbreviated and redefined for the minimum mission, and two were deleted. A summary and status are provided in Table 2-IX.

2.8.2 Thermal Protection System and Leading Edge Structural Subsystem

2.8.2.1 Nose Cap.- The nose cap surface was examined visually for evidence of cracks, chips, etc., due to the STS-2 mission. No evidence of any of those conditions was found except for two small room temperature vulcanizing (RTV) 566 contamination spots on the nose cap surface near the geometrical center. Inspection of the nose cap RCC/tile interface area showed no problems. The gap fillers looked clean except for one small dark area on the right-hand lower centerline. Actual material (i.e., brittleness, breakage, etc.) condition could not be determined since these gap fillers are recessed below the outer mold line.

Table 2-X presents a summary of the STS-2 nose cap DFI temperature measurements. These data are consistent with the STS-1 flight measurements. The DFI radiometer temperature measurements of the RCC shell are suspiciously low and are considered unreliable when compared to surface temperature measurements on the nose cap bulkhead door tiles. Since the nose cap radiometer data are considered questionable, a peak nose-cap RCC temperature of approximately 2400°F has been estimated by using STS-2 flight data, preflight predictions, and qualification test data from the nose cap system tests.

2.8.2.2 Wing Leading Edge.- The wing leading edge panels were examined externally for evidence of anomalies, chips, cracks, etc., resulting from the STS-2 mission. Areas of discoloration were evident on the wing leading edge upper access interface panels at RCC left-hand panels 9, 10, 11, 12, and 13 and right-hand panels 10, 11, 12 and 13.

TABLE 2-IX.- THERMAL CONTROL DTO/FTO SUMMARY

DTO/FTO	Title	Data Status	Evaluation Status
211-01	Pre-entry thermal conditioning	Adequate data obtained	Post-flight evaluation required to determine adequacy/need for end of mission wing glove thermal conditioning
243-01,02,03	Hydraulic system circulation pump thermal conditioning performance	Test redefined (highly abbreviated for minimum mission)	Preliminary post-flight analysis shows data to be adequate for STS-3 certification is supporting FCHL test data obtained
244	Hydraulic fluid entry thermal conditioning	Test accomplished	Preliminary post-flight analyses indicates adequate data obtained for definition of operational warmup procedure
212-01	Primary RCS engine duty cycle firing thermal soakback	Deleted	Test to be rescheduled
212-02	PTC test to determine feasibility of substituting Z-LV	Deleted	Rescheduling not required
212-03	Vernier thruster heater evaluation	Results show heater inadequate to hold 130° F leak detection limit	Hardware changes impractical for STS-3 and 4. Procedures changes may be required

TABLE 2-X.- COMPARISON OF STS-1 and STS-2 LEADING EDGE STRUCTURAL SYSTEM AND NOSE CAP FLIGHT DATA

Nose Cap		STS-1	STS-2
Sensor No. V09T(P)XXXXA	Location Component	Maximum temperature, °F	Maximum temperature, °F
9941	Lower centerline support link	a	725
9942	Lower centerline bulkhead	185	178
9943	Lower centerline HRSI/RCC TB	a	a
9944	120 centerline bulkhead	170	170
9945	120 centerline support link	700	710
9946	120 centerline HRSI/RCC TB	a	a
9947	Upper centerline support link	350	360
9948	Upper centerline HRSI/RCC TB	a	a
9949	Bulkhead HRSI	1750 ^b	2000
9959	Bulkhead HRSI bondline	180	173
9951	Bulkhead HRSI	1150 ^b	1190
9952	Lower centerline support link	610	610
9953	DELETED		
9954	DELETED		
9955	Stagnation RCC	1360 ^b	1450 ^a
9956	Lower centerline RCC	a	a
9957	Lower tang. RCC	1075 ^b	1200 ^a
9958	Upper centerline RCC	700 ^b	860 ^a

^aSensor inoperative or data questionable.

^bMaximum value at start of data.

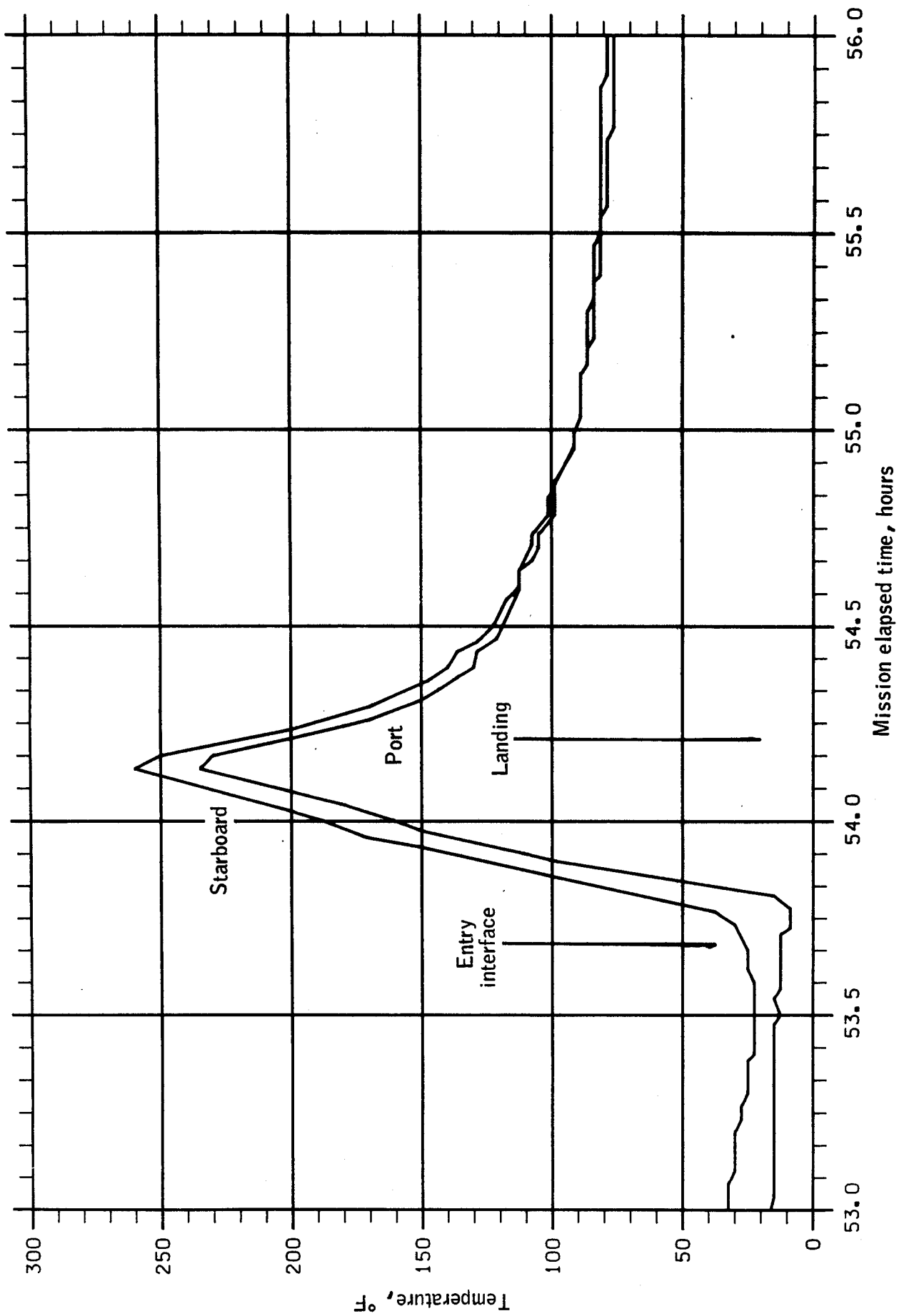

Figure 2-28.- OMS bondline temperature during entry.

This discoloration (white deposit/streaking on black tiles) is believed to be a result of flow through the subject panels at the RCC/RSI interface. The discoloration of the right-hand wing tiles is not nearly as predominant as the streaking on the left-hand wing interface tiles. An examination of the lower access panels removed at KSC shows gap filler heating, embrittlement, and discoloration. Inspection of the wing leading edge front spar shows evidence of gas flow streaking and heating of the tile filler bar (discoloration, scorching, burning) at RCC panel/T-seal joints.

Table 2-XI presents a summary of the wing leading edge DFI temperature measurements for the STS-2 flight. These data are also consistent with the available STS-1 measurements. The DFI radiometer inner moldline RCC temperature measurement (fig. 2-29) obtained at the 55 percent semi-span (panel 9-left hand) is approximately 400 to 500° F higher than the predicted STS-2 nominal and RSS temperatures. Increased heating was expected on the basis of wind tunnel testing in this area of the wing leading edge due to interaction of the bow shock and the wing shock (double-shock region). However, the measured radiometer temperature (approximately 2900° F) is not consistent with phase-change paint data (approximately 2200° F) also obtained at this panel location. An erroneous calibration curve for this particular radiometer (V09T9926) was the source of this anomalous reading. Correcting the V09T9926 radiometer reading using the appropriate calibration curve results in an RCC inner moldline temperature of 2470° F. A summary of peak inner moldline temperatures is shown in figure 2-30.

The STS-2 flight data indicate that the thermal performance of the LESS (leading edge structural system), nose cap and wing leading edge was outstanding, with no degradation in thermal performance for the STS-1/STS-2 flights. Detailed inspection, however, does indicate a flow influx at the wing leading edge RCC T-seal/interface panel joints.

2.8.2.3 RCC - Forward ET Attachment.- The RCC plates had some discoloration attributed to an acoustic sensor on the nose landing gear door and some deposits from a thermal barrier around that same door (fig. 2-31). These discolorations, also observed after STS-1, have no effect on the performance of the RCC. No DFI data measurements exist for the external tank attachment plates; however, an examination of available DFI data near this location would indicate a peak RCC temperature of 1600 to 1800° F.

2.8.2.4 Windows (Thermal Panes).- Detailed inspection of the windows has confirmed increased window contamination from STS-1 to STS-2. Likewise, the forward window thermal panes do appear to have an increased amount of deposit (smoke) as a result of the STS-2 flight. The RSI overhang tiles on the right-hand forward and middle windows and the left-hand forward window have impact damage (holes through coating) on the overhanging lip portion of the tiles. Some particle impact on the thermal pane and subsequent reflection onto the tile may have occurred. The windows have been cleaned of some of the contamination and are acceptable for STS-3.

2.8.2.5 Elevon/Elevon Ablators.- The ablators were examined for STS-2 heating effects. In general, the ablator appears to be comparable to the STS-1 results. However, the outboard elevon ablator fiberglass miter joint was not protruding and separated as much as observed after STS-1. The separation of the fiberglass from the ablator on the inboard elevon ablators was similar to that observed from STS-1. A flow-channel effect at the intersection of the rib and spill and tip ablators was observed on the right-hand wing. Preliminary char depth measurements were taken for comparison to the STS-1 results. These initial results indicate a thicker char layer from the STS-2 flight. Ablator average char depths are 25 to 65 percent greater than on STS-1. The ablators have been removed for detailed sectioning to aid in STS-2 heating/thermal performance evaluations.

TABLE 2-XI.- COMPARISON OF STS-1 AND STS-2 WING LEADING
EDGE SUBSYSTEM FLIGHT DATA

Wing Leading Edge			STS-1	STS-2
Sensor No. V09T(P)XXXXA	Location	Component	Maximum temperature, °F	Maximum temperature, °F
9901	Panel 4	Lower clevis	a	a
9902	Panel 4	Lower spar bracket	170	196
9903	Panel 4	Lower IF panel	162	187
9904	Panel 4	Upper clevis	425	445
9905	Panel 4	Upper spar bracket	81	104
9906	Panel 4	Insulation surface	1260 ^b	1300
9907	Panel 4	Insulation bondline	122	137
9908		DELETED		
9909	Panel 4	Lower RCC temperature	1625 ^b	1890
9910	Panel 9	Lower clevis	915	875
9911	Panel 9	Lower spar bracket	295	305
9912	Panel 9	HRSI facing RCC	1220	1205
9913	Panel 9	Lower IF panel	300	a
9914	Panel 9	Upper clevis	--	--
9915	Panel 9	Upper spar bracket	267	250
9916	Panel 9	Upper HRSI facing RCC	1300 ^b	1650
9917	Panel 9	Upper IF panel	270	a
9918	Panel 9	Insulation surface	1975 ^b	a
9919	Panel 9	Insulation in-depth	1165 ^b	1155
9920	Panel 9	Insulation in-depth	889	900
9921	Panel 9	Insulation bondline	400	411
9922	Panel 9	Insulation surface	1840 ^b	2025
9923	Panel 9	Insulation surface	1675 ^b	1750
9924	Panel 9	Cavity pressure	--	--
9925		DELETED		
9926	Panel 9	Lower RCC temperature	2450 ^b	2470
9927	Panel 9	Upper RCC temperature	1390 ^b	1920
9928	Panel 16	Lower clevis	580	570
9929	Panel 16	Lower bracket	257	270
9930	Panel 16	Upper clevis	425	435
9931	Panel 16	Insulation surface	2400 ^a	2400 ^a
9932	Panel 16	Insulation bondline	215	197
9933		DELETED		
9934	Panel 16	Lower RCC temperature	1890 ^b	2170
9935	Panel 22	Lower clevis	565	570
9936	Panel 22	Lower bracket	169	177
9937	Panel 22	Insulation surface	1110 ^b	1150
9938	Panel 22	Insulation bondline	122	122
9939	Panel 22	Cavity pressure	--	--
9940	Panel 22	Lower RCC temperature	1750 ^b	1850

^aSensor inoperative or data questionable.

^bMaximum value at start of available data.

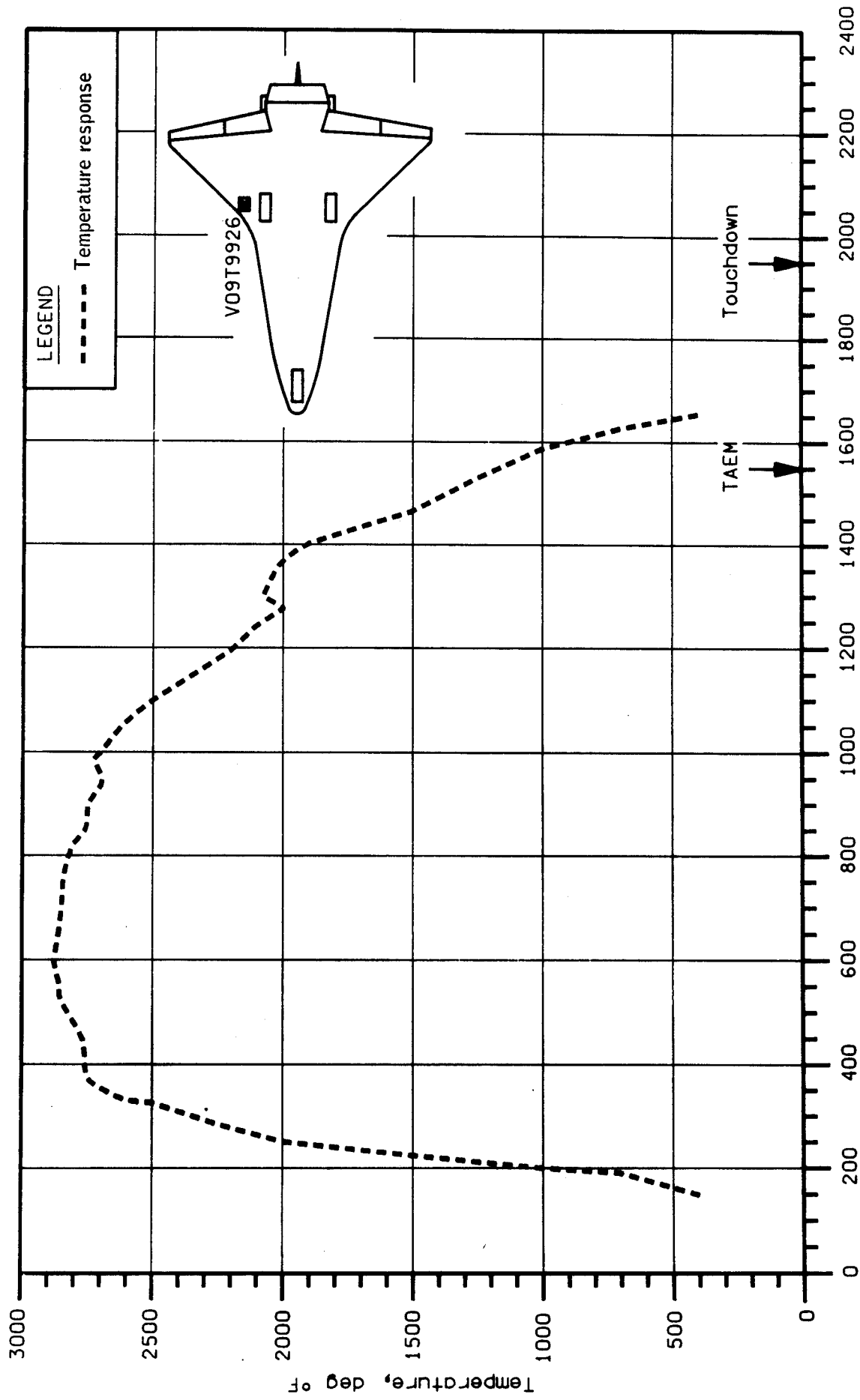

Figure 2-29.- LESS panel 9 RCC temperature.

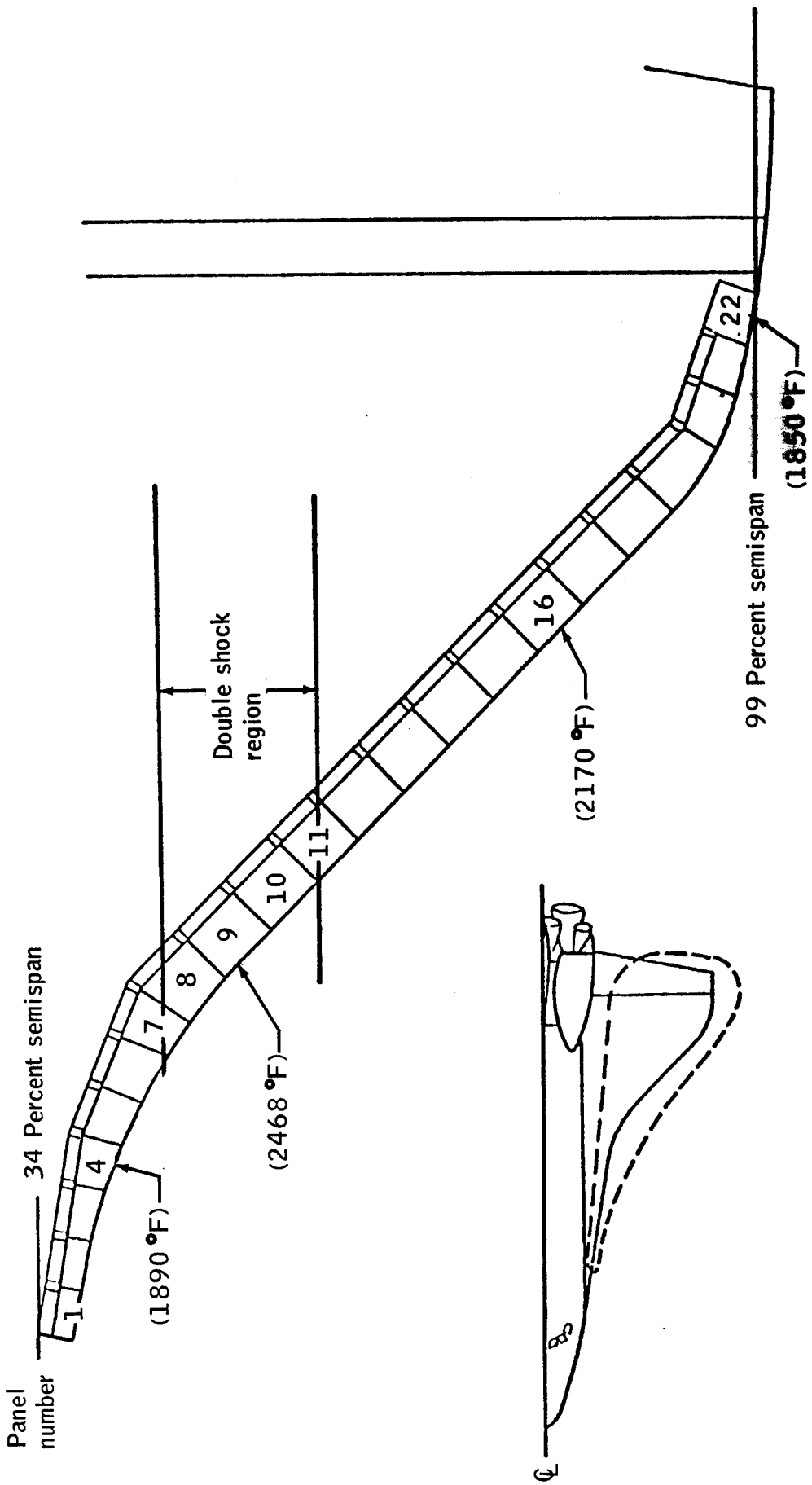

Figure 2-30.- STS-2 peak wing leading edge temperatures.



Figure 2-31.- Discolorations and deposits around the nose landing gear door.

2.8.2.6 Thermal Protection Reusable Surface Insulation Subsystem.- The objective of the Orbiter TPS (thermal protection system) verification FTR (flight test requirement) 09VV001 is to verify the thermal performance, structural integrity, and reusability of the thermal protection system for the operational entry conditions. This verification will be demonstrated during the orbital flight test program by a combination of post-flight detailed inspections and comparisons of flight data with analysis predictions. Data loss during STS-1 allowed only partial completion of the STS-1 objectives. For the most part, good ascent and entry temperature data were obtained during STS-2. Entry pressure data, were not obtained because the fuel cell failure resulted in the power down of these measurements. This will again impede full satisfaction of the FTR objectives due to the extreme variation of RSI (reusable surface insulation) thermal conductivity with pressure. Figures 2-32, 2-33, and 2-34 show some typical comparisons of the flight data with nominal heating predictions at three locations on the lower fuselage.

Detailed postflight inspections of the vehicle were conducted, and these inspections indicated the following:

a. Extensive minor damage to the surface of the RSI tiles occurred during STS-2 (similar to, but less than for STS-1). Inspection showed 334 surface dings and gouges and 19 tile coating chips had occurred. As during STS-1, a large number of the dings and gouges occurred during ascent, as evidenced by entry heating effects associated with the damage. A detailed investigation of the debris sources is underway, as was done after STS-1.

Launch pad cameras documented pad debris damage to tiles on the Orbiter lower aft fuselage (fig. 2-35). Significant impact damages occurred on the body flap (fig. 2-36). As occurred during STS-1, the body flap damage propagated into some melting and excessive tile shrinkage during entry heating.

Minor tile surface damage was found on tiles aft of the main landing gear doors. This damage resulted from impact of instrumentation wires which detached from the landing gear.

b. Extensive surface contamination of the TPS outer surfaces occurred during STS-2 (STS-1 contamination was considerably more extensive). RTV (room temperature vulcanizing) 577 and 602 decomposition products (calcium and zinc oxide) were deposited locally on the surface of numerous tiles. The majority seemed to originate from Ames gap fillers and TPS 29 repairs. The lower fuselage acoustic sensors deposited iron oxide, chrome, and nickel on the surface of downstream tiles (similar to STS-1). The aluminum oxide deposits on the aft control surfaces occurred again as on STS-1. Figure 2-37 indicates an additive buildup of aluminum oxide on the body flap lower surface. The black tiles were replaced after STS-1; whereas, the adjacent light grey tiles have seen two flights of contamination exposure.

c. Some excessive tile-to-tile gap heating, as seen during STS-1, occurred. There were fewer occurrences during STS-2; approximately 260 occurred during STS-2 versus 614 during STS-1. Detailed measurements (step, gap, etc.) are being taken at a number of these locations for the analysis to determine the specific causes. The nose gear door thermal barrier, which breached during STS-1, performed as designed during STS-2.

d. The AFRSI (advanced flexible reusable surface insulation) which replaced the elevon-cove FRSI (flexible reusable surface insulation) that had charred during STS-1, performed very well during STS-2. Some local flow intrusions occurred at a number of locations on the elevon cove tile carrier panels. Tempilabels (instrumentation) on the carrier plates indicated local temperatures as high as 400° F. All FRSI was replaced with AFRSI in the cove for STS-3.

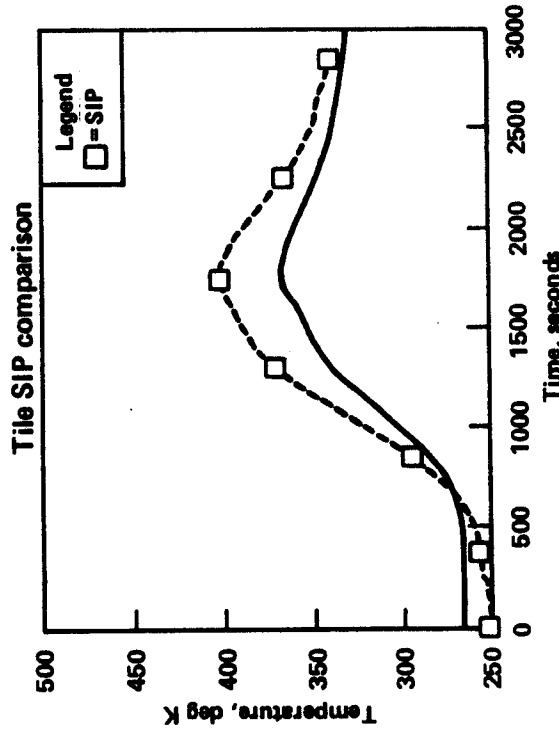
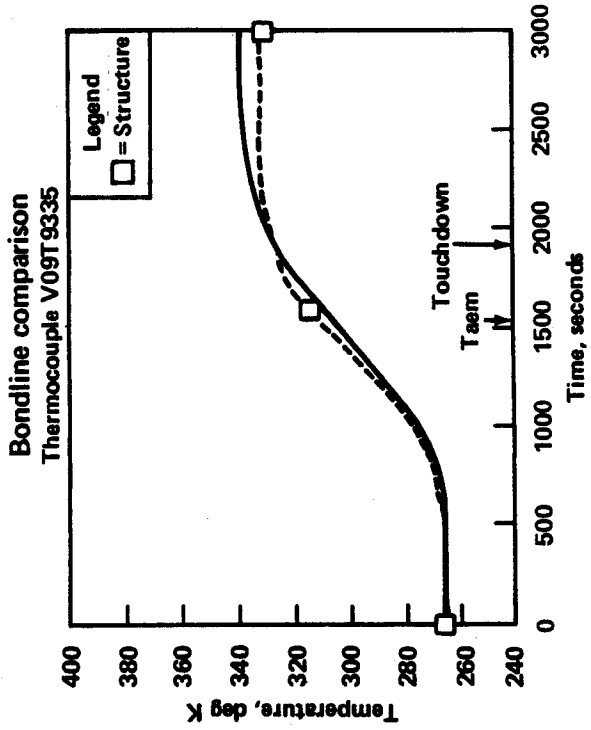
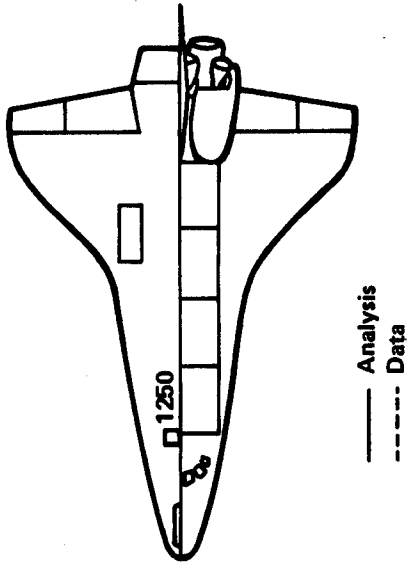
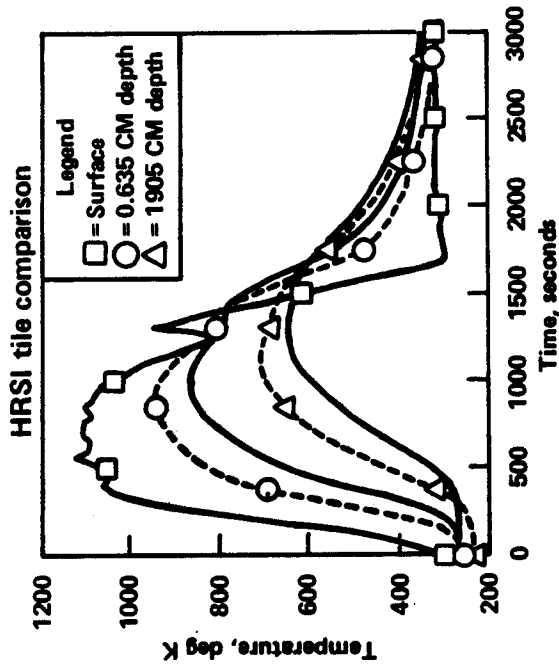

Figure 2-32.- Comparison of analysis and actual temperature data at station 1250.

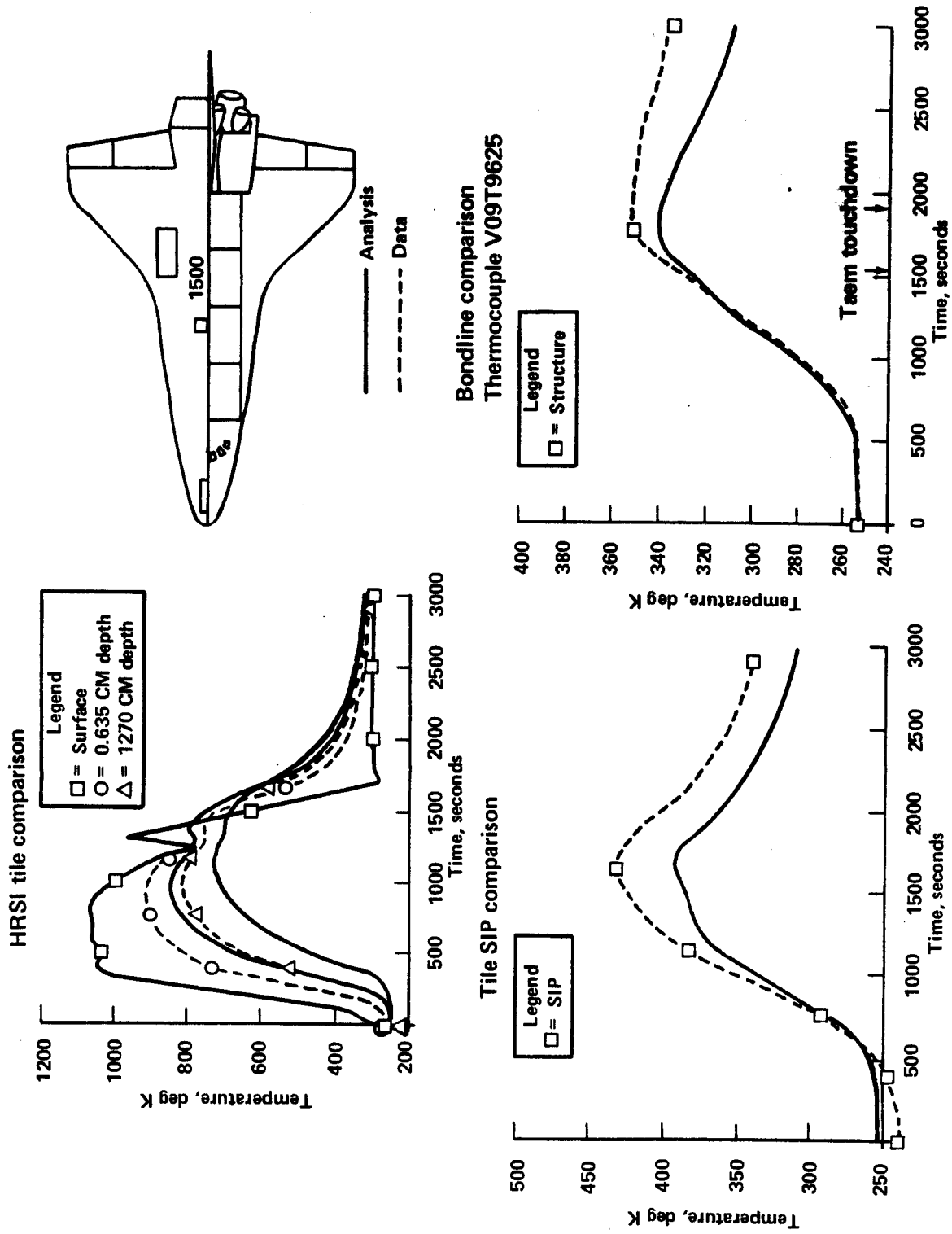

Figure 2-33.- Comparison of analysis and actual temperature data at station 1500.

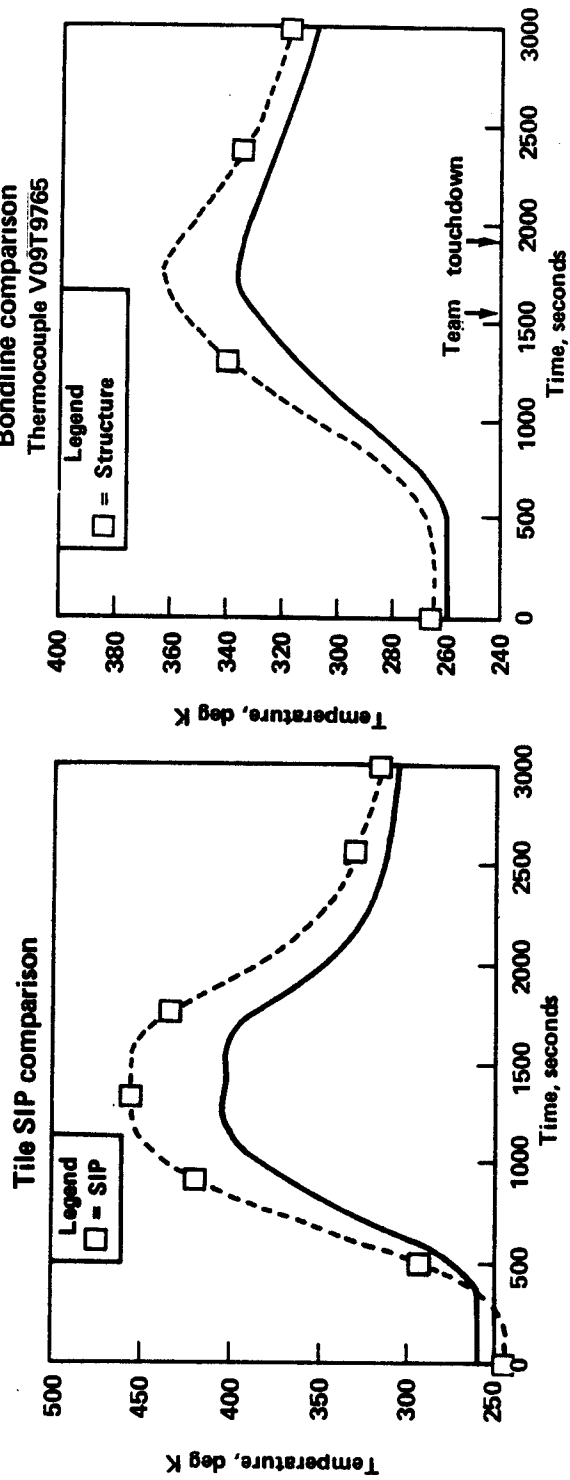
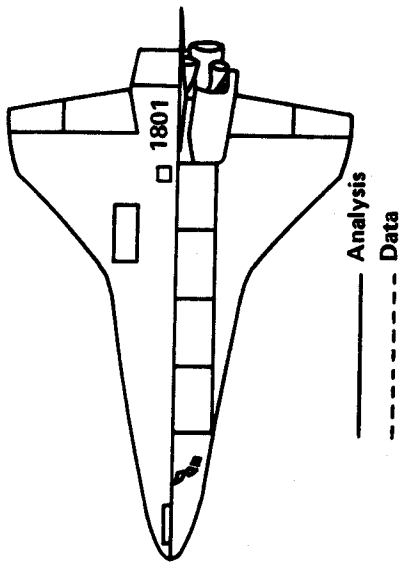
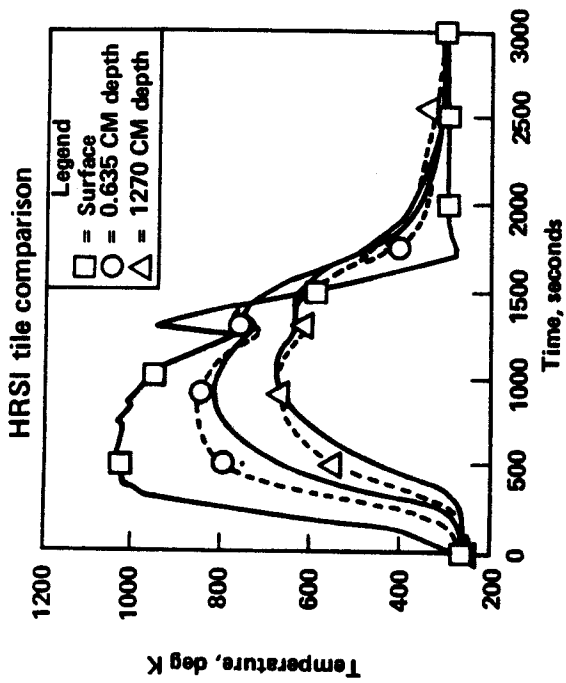

Figure 2-34.- Comparison of analysis and actual temperature data at station 1801.

S81 40234

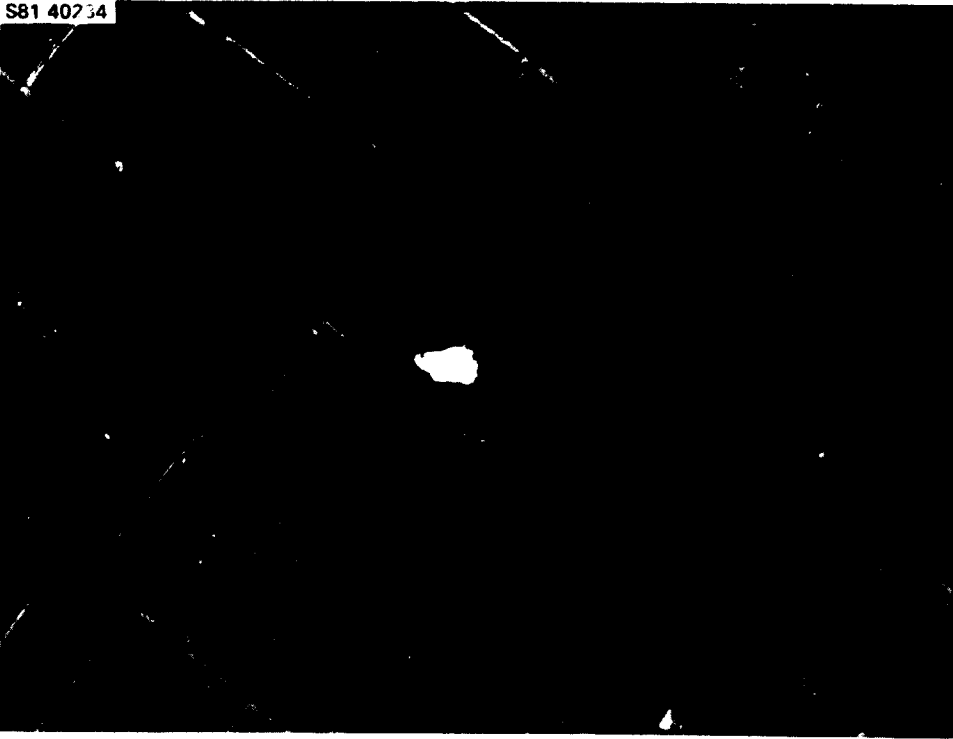

Figure 2-35.- Damage to tiles from pad debris.

S81 40233

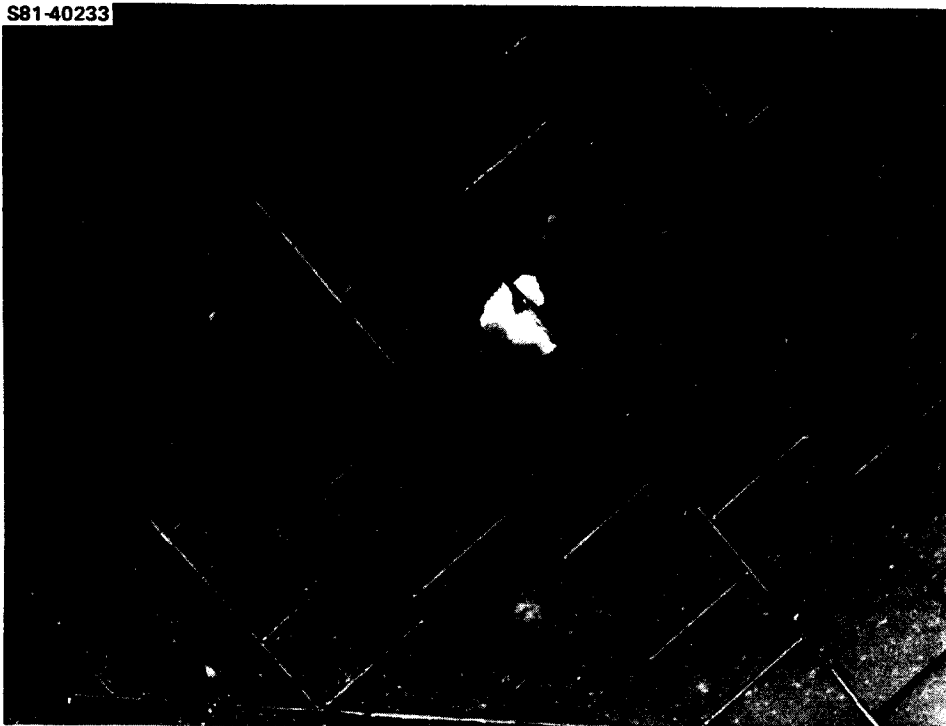

Figure 2-36.- Impact damage to body flap.

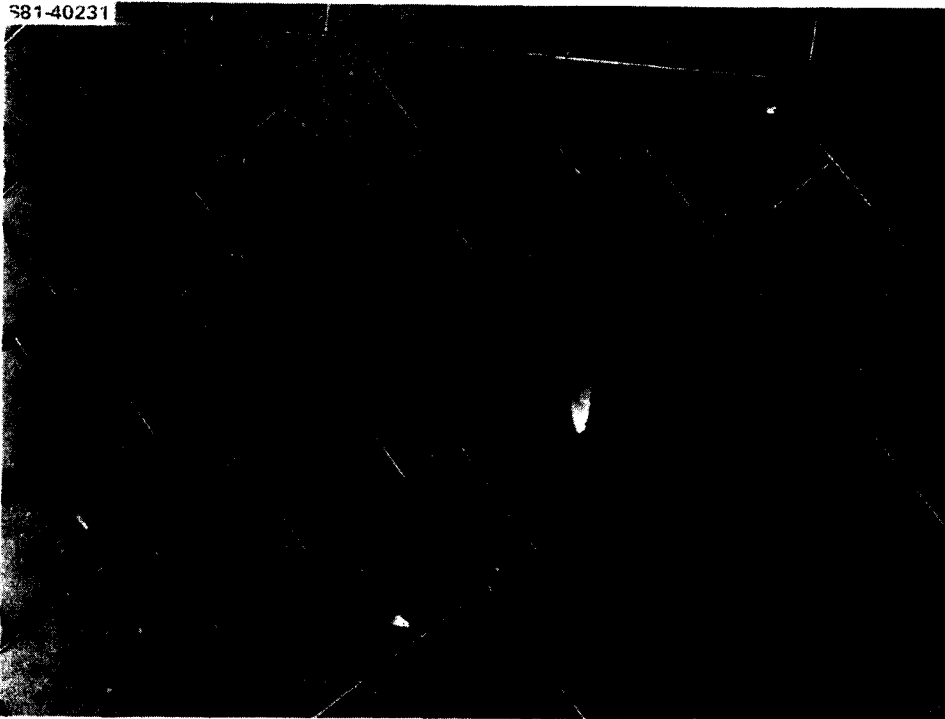

Figure 2-37.- Aluminum oxide deposits on the body flap lower surface.



Figure 2-38.- FRSI shrinkage at interface of LRSI tiles on right pod.

e. The OMS pod RSI tiles performed outstandingly during STS-2 as compared to STS-1. No LRSI (low temperature reusable surface insulation) tiles or pieces of tiles were lost, indicating the post-STs-1 modifications solved the STS-1 problem. A small region of excessive FRSI shrinkage on the right pod (indicating excessive heating) at the interface with the forward LRSI tiles occurred during STS-2 (fig. 2-38). This excessive heating/shrinkage caused local damage to the graphite epoxy pod structure (approximately 0.5" diameter spot). HRSI (high temperature reusable surface insulation) tiles replaced the OMS pod side FRSI, which degraded badly during STS-1. This tile modification was satisfactory during STS-2. The DFI surface thermocouple placed in this region to understand the environment did not function during STS-2.

The FRSI on the forward region of the pods experienced higher heating again, as during STS-1, resulting in scorching of the white FRSI coating.

The surface coating of 12 body flap lower surface tiles bubbled during the STS-2 entry (fig. 2-36, 2-37, and 2-39). Four of the 12 had breached bubbles and subsequent shrinkage of the base LI-900 material (fig. 2-39). The tiles were removed for laboratory evaluations. (Section 7.0, flight test problem report 19).

Six tiles on the right wing glove/fuselage chine had partial in-place fractures of their outer portions (fig. 2-40 and 2-41). Two had almost complete loss of the outermost 0.4" of material (fig. 2-42 and 2-43). Four had a loss of 0.4" of material over approximately 50 percent of the tile planform (fig. 2-44, 2-45, and 2-46). The remaining tile portions were removed for laboratory evaluations. (Section 7.0, flight test problem report 19).

Overheating of FRSI on the aft section of the payload bay door was observed on STS-2 but not on STS-1 (fig. 2-47). This overheating was substantiated in the vicinity of a thermocouple which measured a peak temperature of 900° F. The maneuver involved a transient angle of attack change that resulted in higher upper surface heating.

The overall performance of the RSI was outstanding. Minimal modifications will fix the majority of the anomalies for multiple mission usage. Total tile replacements required prior to STS-3 are estimated at approximately 200, which is significantly below preflight estimates.

Completion of repairs/replacements of the tiles is the only RSI constraint for STS-3.

2.8.3 Aerothermodynamics

2.8.3.1 Summary.- Most of the aerothermodynamic test objectives were satisfied during STS-2 entry. However, no surface pressure measurements were obtained because these transducers were part of the standard power down sequence resulting from the loss of one fuel cell. Thermocouple data were obtained throughout the entry, and this enabled boundary layer transition to be observed all along the windward side of the fuselage. STS-1 provided data only after the blackout period of the entry trajectory, and transition could be observed only on the forward region of the vehicle. The pushover/pullup maneuver was performed at a velocity of 20,500 ft/sec, and the catalytic experiment demonstrated the effectiveness of the thermal protection system coating as a partial catalytic surface.

2.8.3.2 Boundary-Layer Transition.- Figure 2-48 shows comparisons of wind tunnel data predictions of boundary layer transition for various roughness values with flight-observed transition times. An interesting observation can be made upon examination of this figure. The STS-1 data, denoted with circles, follow the trend of the predictions and lie between a smooth surface and an 0.05-inch roughness value despite the large gouge in the nose landing gear door TPS. The STS-2 data (denoted with squares), on the other hand, behave as a roughness-induced transition since transition times occur almost

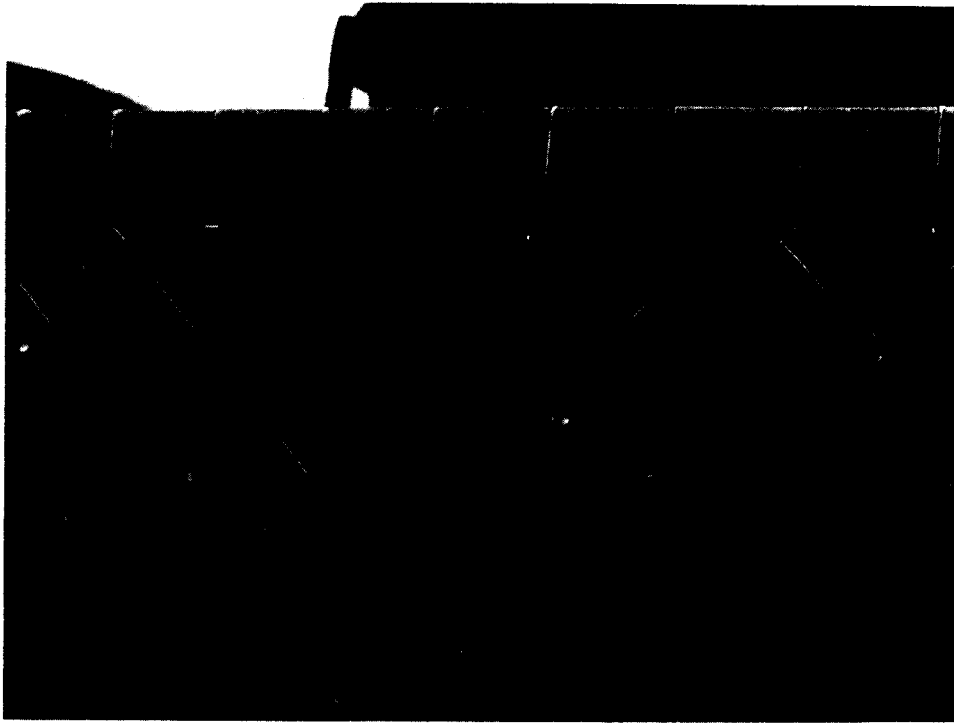

Figure 2-39.- Bubbled surface on body flap lower surface and shrinkage in breached bubbled areas.

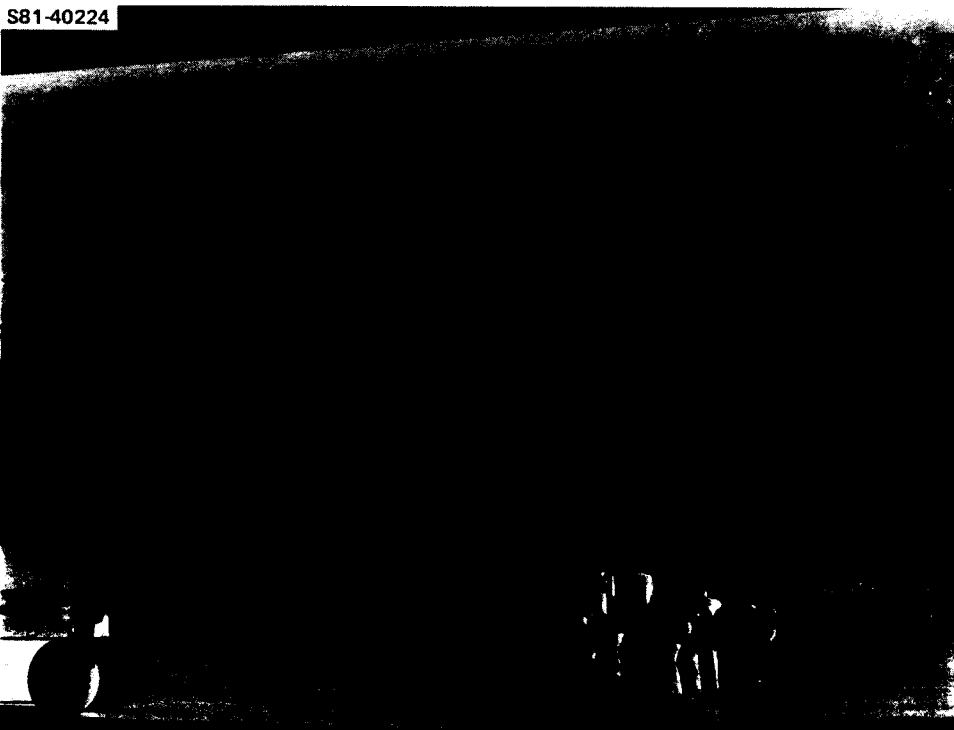

Figure 2-40.- Inplace fractures of outer portions of right wing glove/fuselage chine.

S81-40225



Figure 2-41.- Inplace fractures of outer portions of right wing glove/fuselage chine.

S81 40239

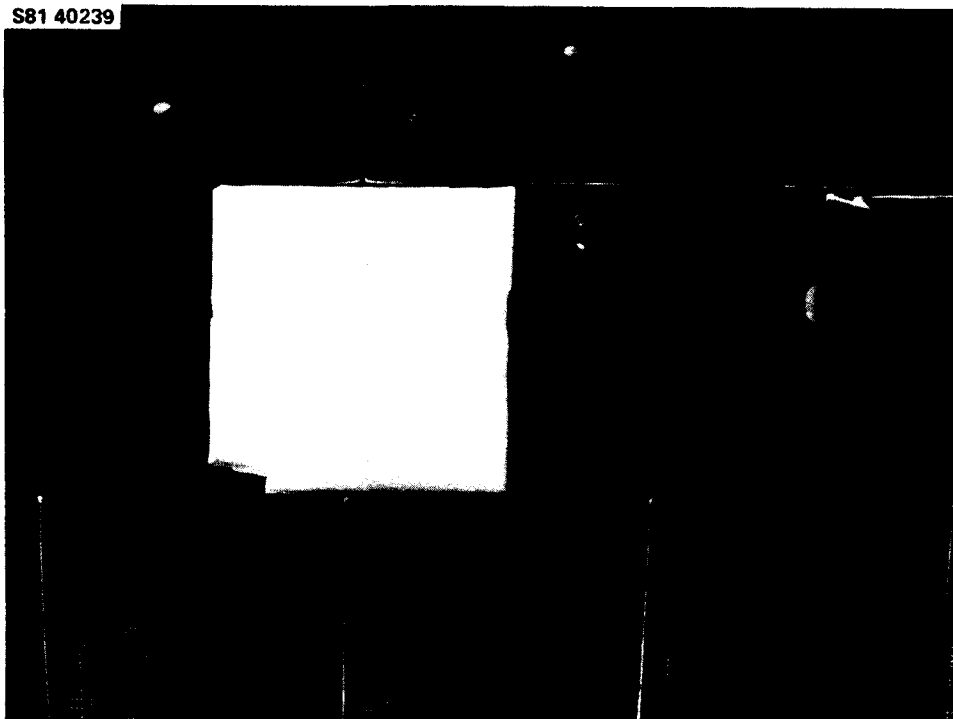

Figure 2-42.- Tile showing almost complete loss of outer 0.4 in. of material.

S81-40242

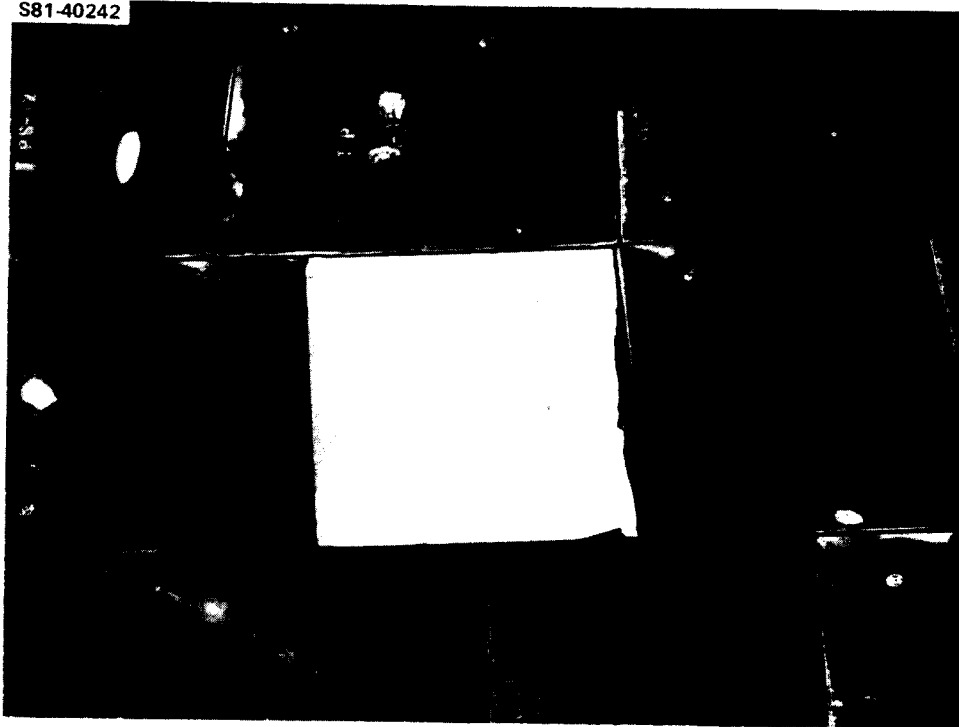

Figure 2-43.- Tile showing almost complete loss of outer 0.4 in. of material.

S81-40240

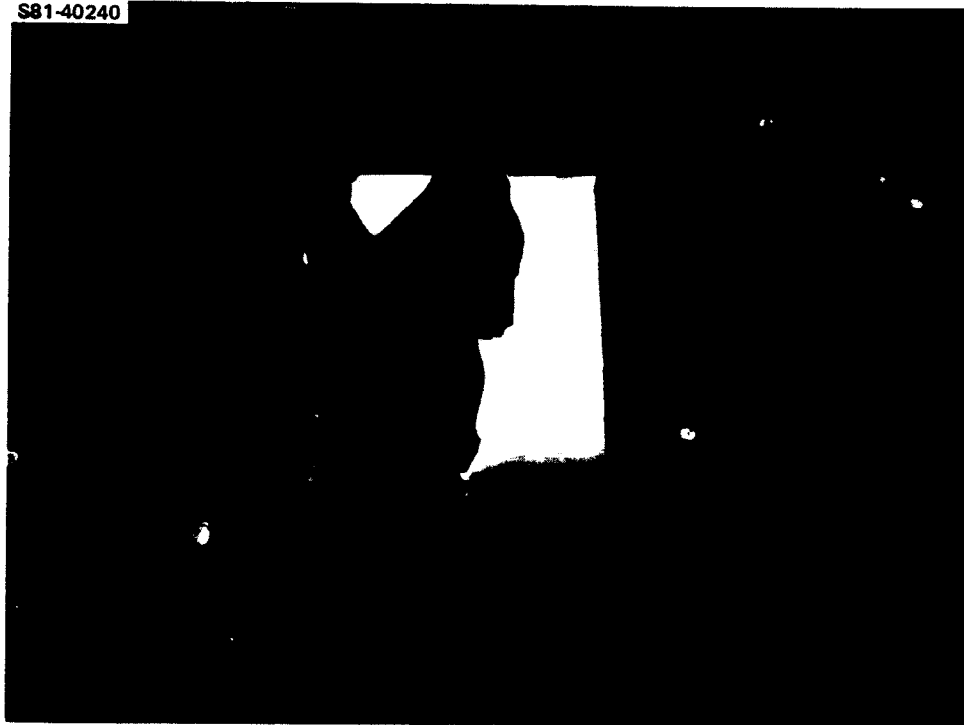

Figure 2-44.- Tile with nearly 50 percent of outer surface missing to a depth of 0.4 in.

S81-40241

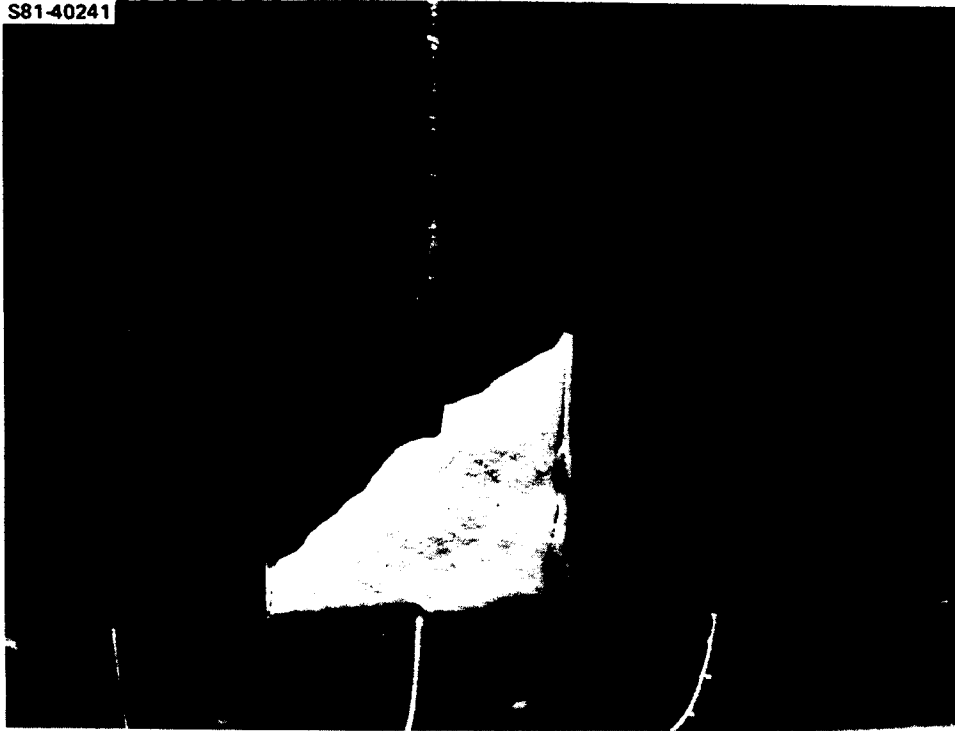

Figure 2-45.- Tile with nearly 50 percent of outer surface missing to a depth of 0.4 in.



Figure 2-46.- Tiles with more than 50 percent of outer surface missing to a depth of 0.4 in.



Figure 2-47.- Overheating of FRSI on aft Section of payload bay door.

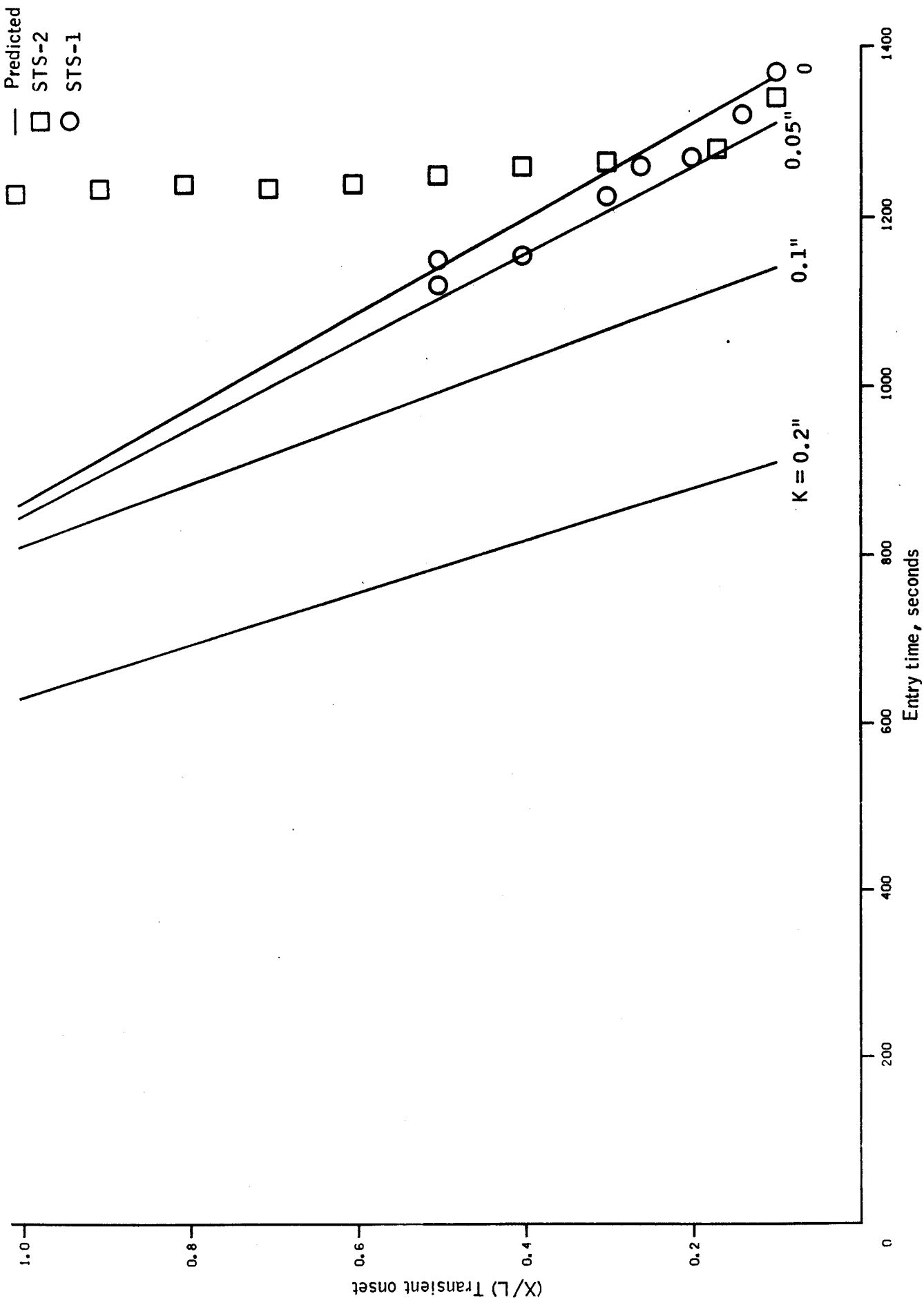

Figure 2-48.- TPS roughness effect on boundary-layer transition .

simultaneously all along the fuselage. The vehicle experienced transition later than the wind tunnel predictions, as expected, but the trend of the STS-2 flight data requires investigation.

2.8.3.3 Push Over/Pull Up.- The pushover/pullup maneuver was originally proposed to obtain aerodynamic coefficient information. However, this maneuver also provides supplemental aerothermodynamic data for heating environment certification for variable angle-of-attack, long-crossrange entries. The maneuver, which was performed at 20,500 ft/sec velocity, consisted of the pilot's pushing the Orbiter down from 40° angle of attack to 35° and then pulling up to 45° before returning to the original attitude of 40°. An example of the effect of this maneuver on the thermocouple response is presented in figure 2-49. Superimposed on the figure are STS-1 measurements for this location. The value of the maneuver was to determine the impact on the OMS pod of higher heating during the lower angles of attack.

2.8.3.4 Catalytic Experiment.- A distribution of the STS-2 measured temperature on the windward centerline is shown in figure 2-50 for an arbitrarily chosen time of 500 sec after entry interface. The open symbols are measurements on the baseline coated tiles and the filled symbols on the catalytically coated tiles. The differences in temperature, particularly at the forward location ($X/L = 0.164$), indicate that the baseline coating is relatively noncatalytic and that the heating to the TPS is less than design, which had deliberately assumed a fully catalytic surface.

2.9 ENTRY AERODYNAMICS

2.9.1 Flight Test Requirements Accomplished

All aerodynamic maneuvers were performed as planned to satisfy FTRs. These maneuvers included eight ASI (aero stick input) maneuvers that were completed with excellent technique. Also, the one pushover-pullup maneuver that was performed had the correct characteristics. In addition, three body flap pulses and 12 PTI's were performed as scheduled, and, subsonically, the speed brake sweep was completed. No flight rules were violated in performing these maneuvers, and no anomalies have been detected in the data obtained during these maneuvers.

2.9.2 Mass Properties Comparison Based on Deorbit Maneuver Data

2.9.2.1 Calculated Versus Estimated Weight: The weight at the deorbit maneuver was estimated for STS-1 and STS-2 by dividing OMS thrust by acceleration. For STS-1 the difference was negligible while for STS-2 the difference was 1000 to 1500 lb, with the calculated weight being less than the predicted weight. Table 2-XII contains the results of the determination for STS-1 and STS-2.

2.9.2.2 Longitudinal Center-of-Gravity Determination: Figure 2-51 compares the STS-1 and STS-2 data, assuming the total acceleration vector passed through the OMS gimbal point and the vehicle center of gravity. The mass properties predictions are shown with an uncertainty of ± 1 inch in the X axis and ± 3 inches in the Z axis, with the pre-maneuver and post-maneuver locations shown as a +. The acceleration vector is shown as an arrow at both the beginning and the end. The comparison appears to confirm that the calculated and predicted values show the same center of gravity.

TABLE 2-XII.- WEIGHT DETERMINATION BASED ON DEORBIT MANEUVER DATA

STS-1	Resultant Thrust	Resultant Acceleration	Weight		
			Calculated*	Estimated	Difference
Beginning of maneuver	11979.1 lb	0.05842 g	205063 lb	205090 lb	27 lb
End of maneuver	12006.2 lb	0.05032 g	199067 lb	199371 lb	304 lb

STS-2: Time into maneuver	Resultant Thrust	Resultant Acceleration	Weight		
			Calculated*	Estimated	Difference
25 sec	12165 lb	0.05650 g	215295 lb	216826 lb	1531 lb
45 sec	12147 lb	0.05652 g	214907 lb	216006 lb	1099 lb
145 sec	12107 lb	0.05757 g	210676 lb	211909 lb	1233 lb
170 sec	12119 lb	0.05773 g	209914 lb	210885 lb	971 lb

NOTE: *Uncertainty on calculated weight = ±2000 lb, based on 1 percent error in thrust.

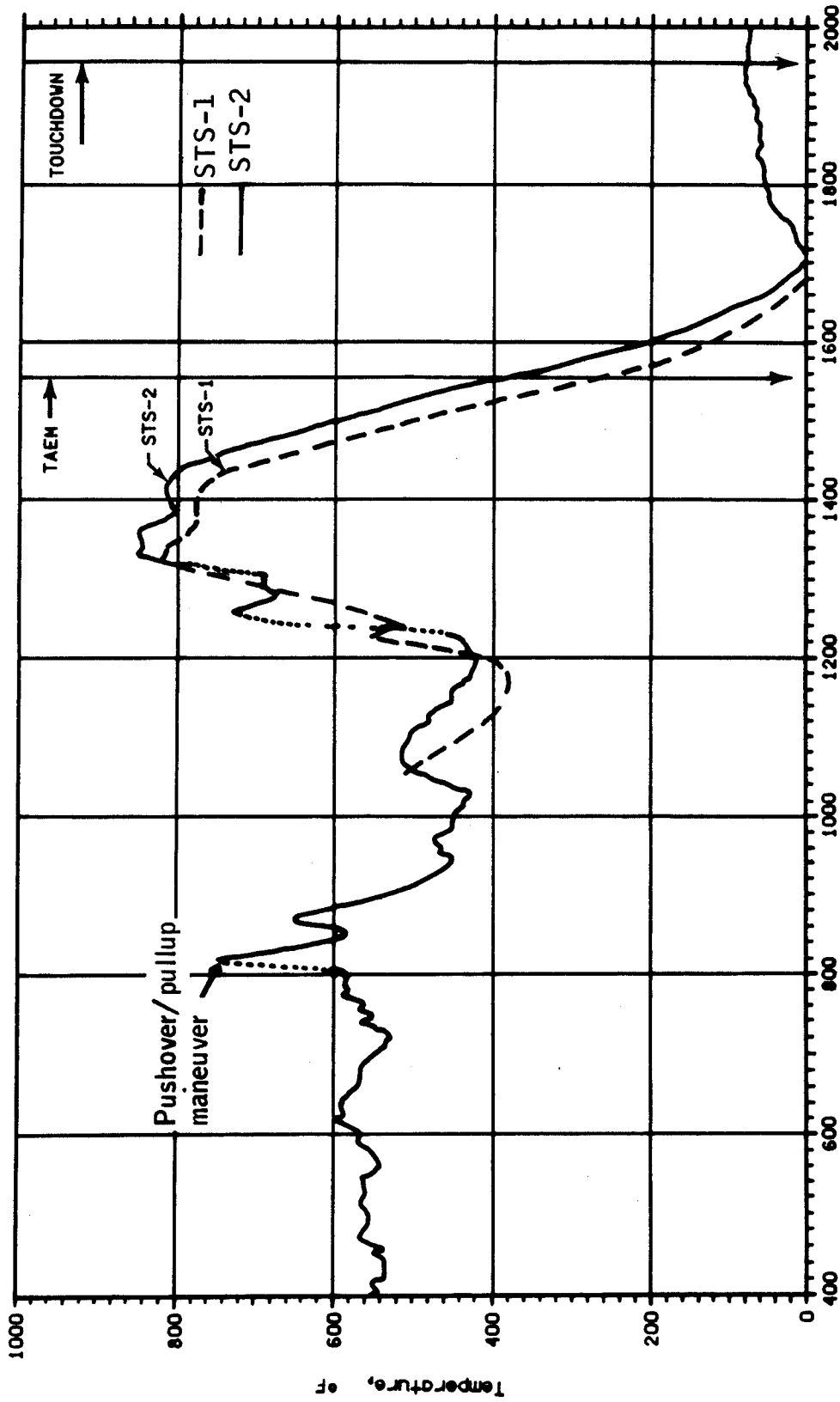

Figure 2-49.- Comparison of STS-1 and STS-2 OMS pod temperature (V07T9976) during entry.

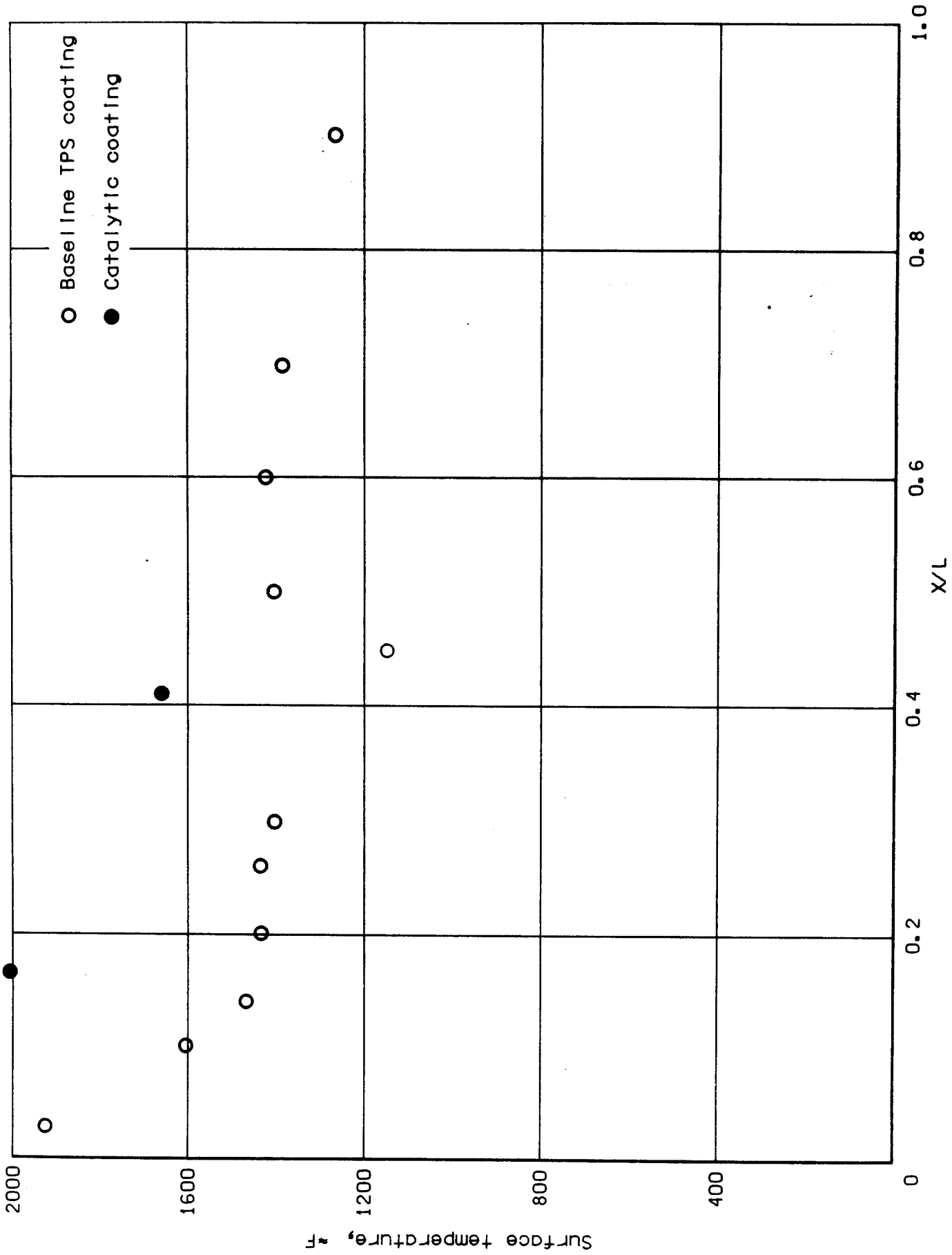

Figure 2-50.- Windward centerline temperature distribution measured during entry at 500 seconds.

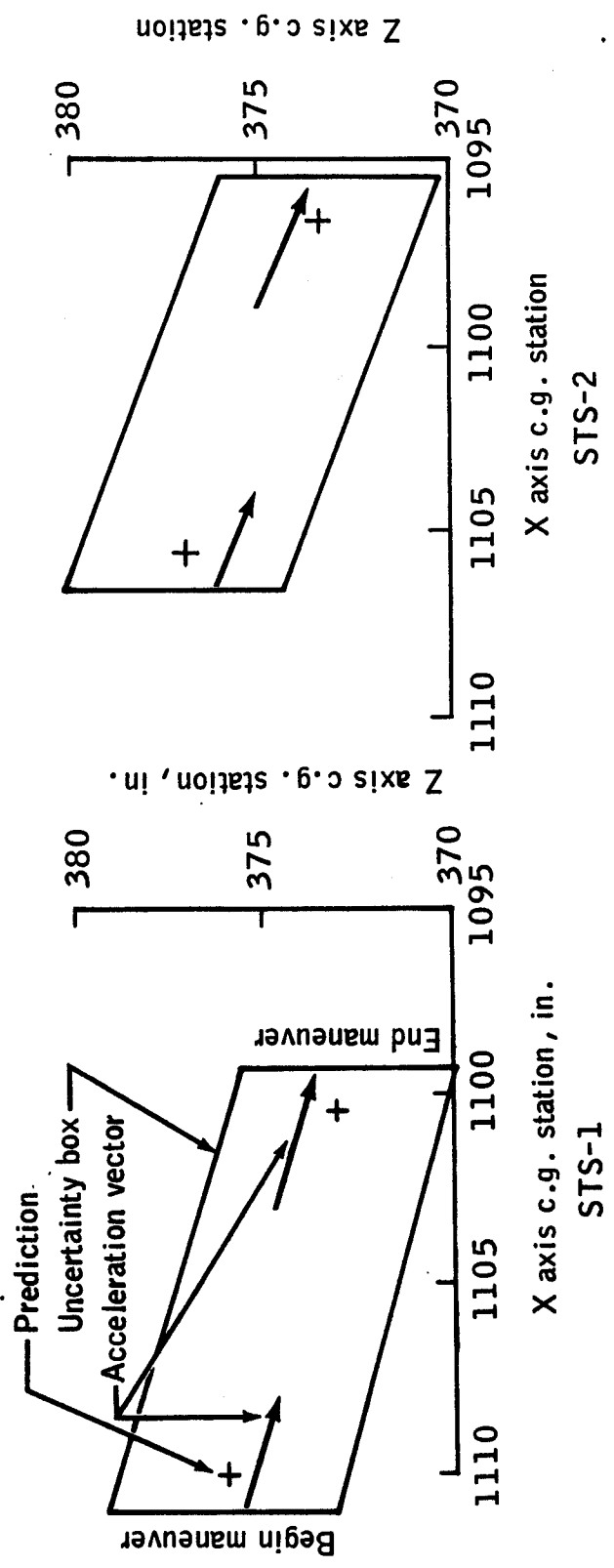

Figure 2-51.- Center of gravity comparison based on the deorbit maneuver data.

2.9.3 Hypersonic Lift-to-Drag Ratio and Trim

The hypersonic L/D (lift-to-drag) at Mach ≥ 5.0 is presented in figure 2-52. The flight L/D was predictable, with an excellent correlation between the flight data and that derived from predictions using flight conditions and configurations. STS-1 showed similar results.

The flight body flap positions required for trim are presented in figure 2-53, with predictions derived from the basic STS-1 Aerodynamics Data Book and the STS-1 Aerodynamics Data Book plus STS-1 flight-derived differences. The STS-2 results agree well with the STS-1 flight-corrected Aerodynamics Data Book predictions.

2.9.4 Landing Drag Performance

Based on the difference between the Aerodynamic Data Book predicted drag and the measured STS-1 and STS-2 coefficients, a drag correction of $\Delta C_D = -0.007$ has been obtained and the results are presented in figures 2-54 and 2-55, for STS-1 and STS-2, respectively.

2.9.5 Air Data System

On both STS-1 and STS-2, the air data system was deployed about Mach 3 and introduced into the general purpose computer at Mach 2.5 as planned. The air data system operated within specification for both flights, with no known anomalies.

2.9.6 Elevon Hinge Moment Coefficients

On STS-1 and STS-2, the measured and predicted elevon hinge moment coefficients compared favorably. Shown in figure 2-56 is the preliminary comparison of the STS-2 flight and predicted coefficients versus Mach number.

2.9.7 Aerodynamic Coefficient Instrumentation Package

The ACIP (aerodynamic coefficient instrumentation package) functioned properly on STS-2, but due to the OEX recorder failure, no information is available on ACIP during entry.

In losing ACIP data, the prime source of data for aerodynamic analysis, the postflight aerodynamic data evaluation was somewhat compromised. Backup signals for some of these parameters were obtained from the onboard data systems. The backup data on the OI system consisted of one channel for each of the following: A_y , A_z , S_e , S_{e2} , S_{e3} , S_{e4} , S_r , P , θ , r . The sample rate for these data is 25 samples per second, except for the rudder, which is 50 samples per second. These sample rates are adequate for data extraction. However, the ACIP is considerably more accurate since the sample rate is much higher. Another factor in the degradation of results is the unknown time correlation between signals. Time skews have been discovered on the accelerations of 80 ms. and the rates of 20 ms. The loss of the ACIP A_x will degrade all longitudinal stability and control analyses.

The results are affected by these degradations in the following ways. All results are more uncertain due to poorer resolution. The smaller maneuvers below Mach 3.5 and the early g maneuvers are particularly affected. Losses in lateral directional data accuracies are on the order of 10 percent. The loss of A_x is a particular problem for the longitudinal stability and control data. The A_x signal becomes an important input parameter at high angles of attack. As a result, longitudinal coefficients will be difficult to obtain. A 50 to 75 percent loss in longitudinal accuracies is expected. In addition, small maneuvers which are inherent to the flight will not be as useful as they would be if ACIP data were available.

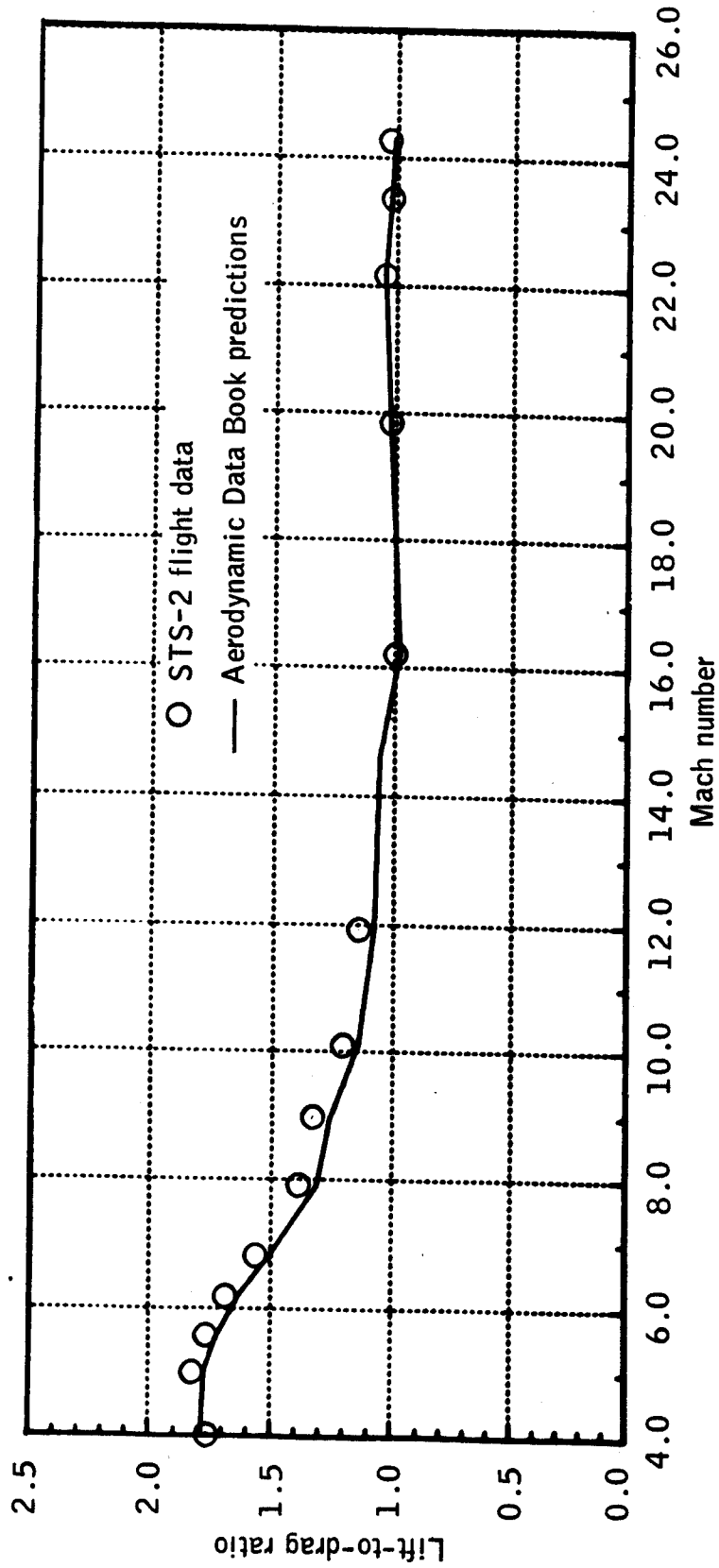

Figure 2-52. - Hypersonic lift-to-drag ratio.

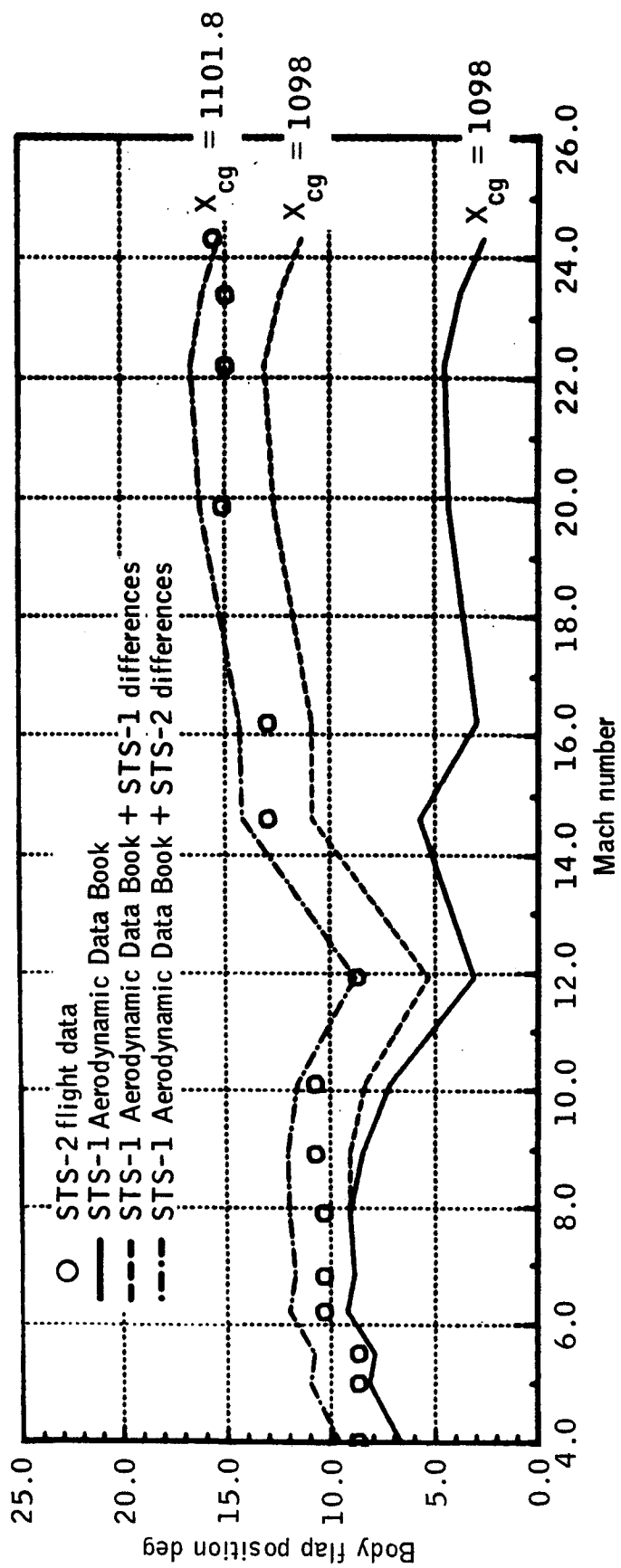

Figure 2-53. - Hypersonic body flap trim.

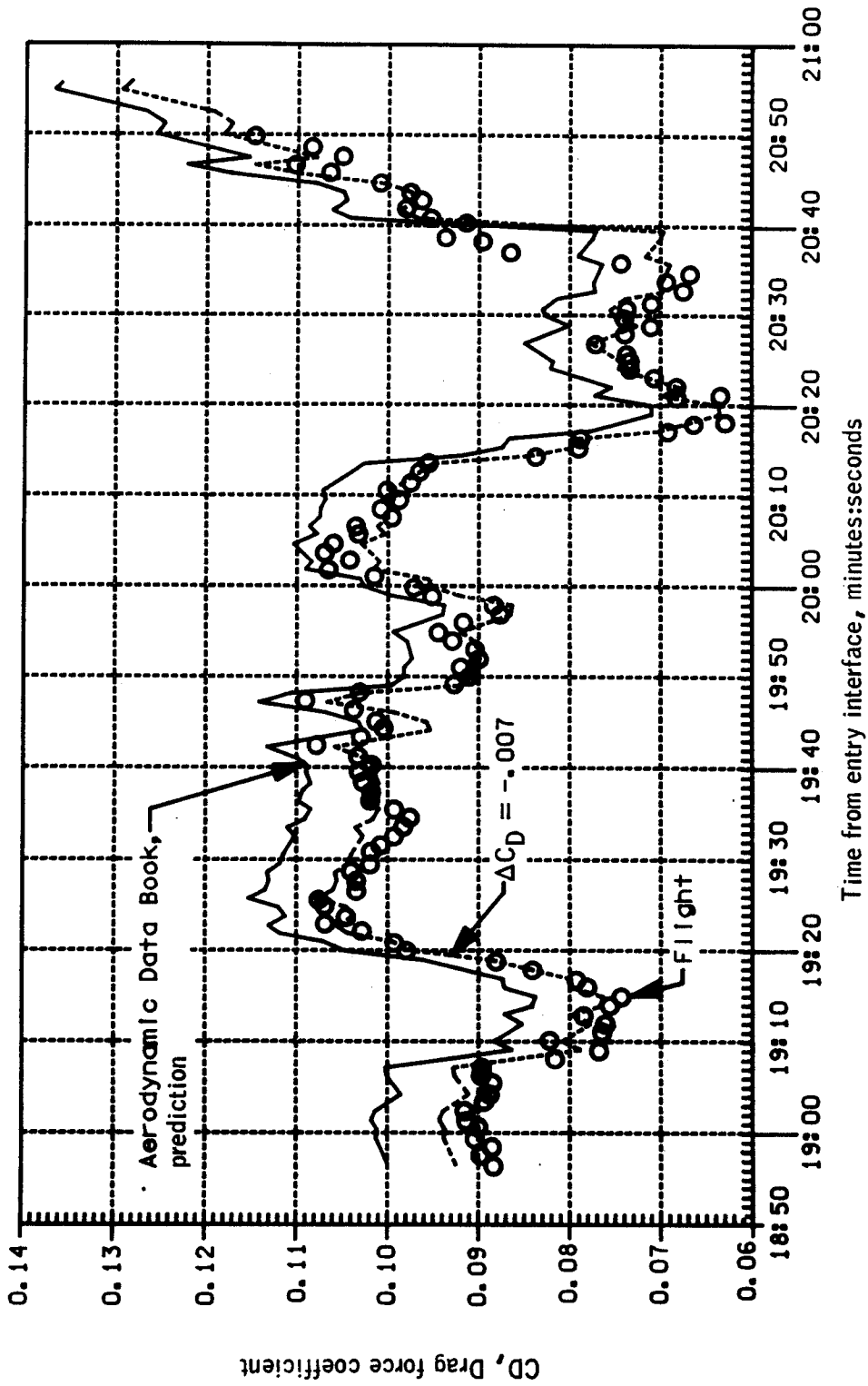
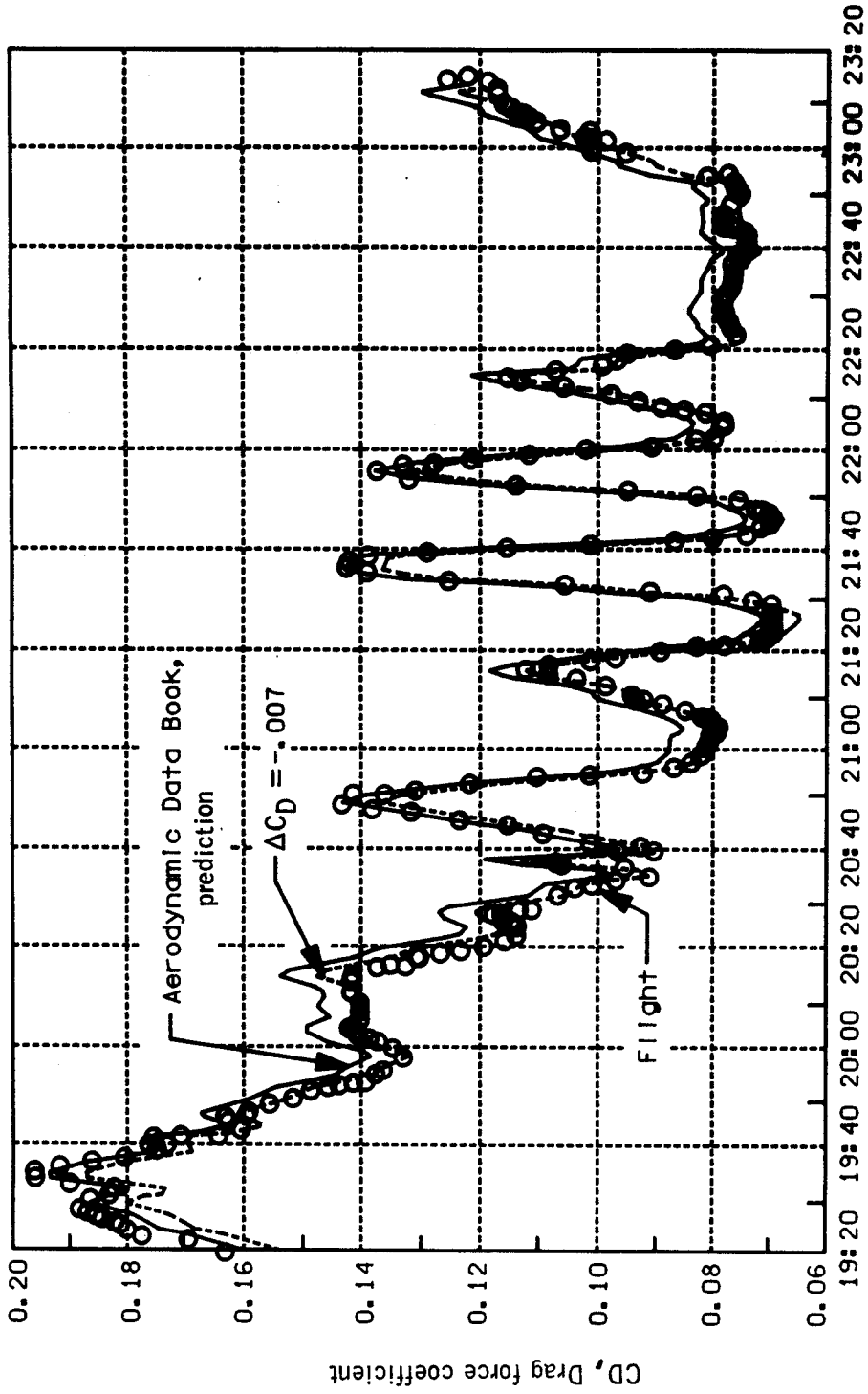

Figure 2-54.- STS-1 drag correction factor.



Time from entry interface, minutes:seconds
 Figure 2-55.- STS-2 drag correction factor.

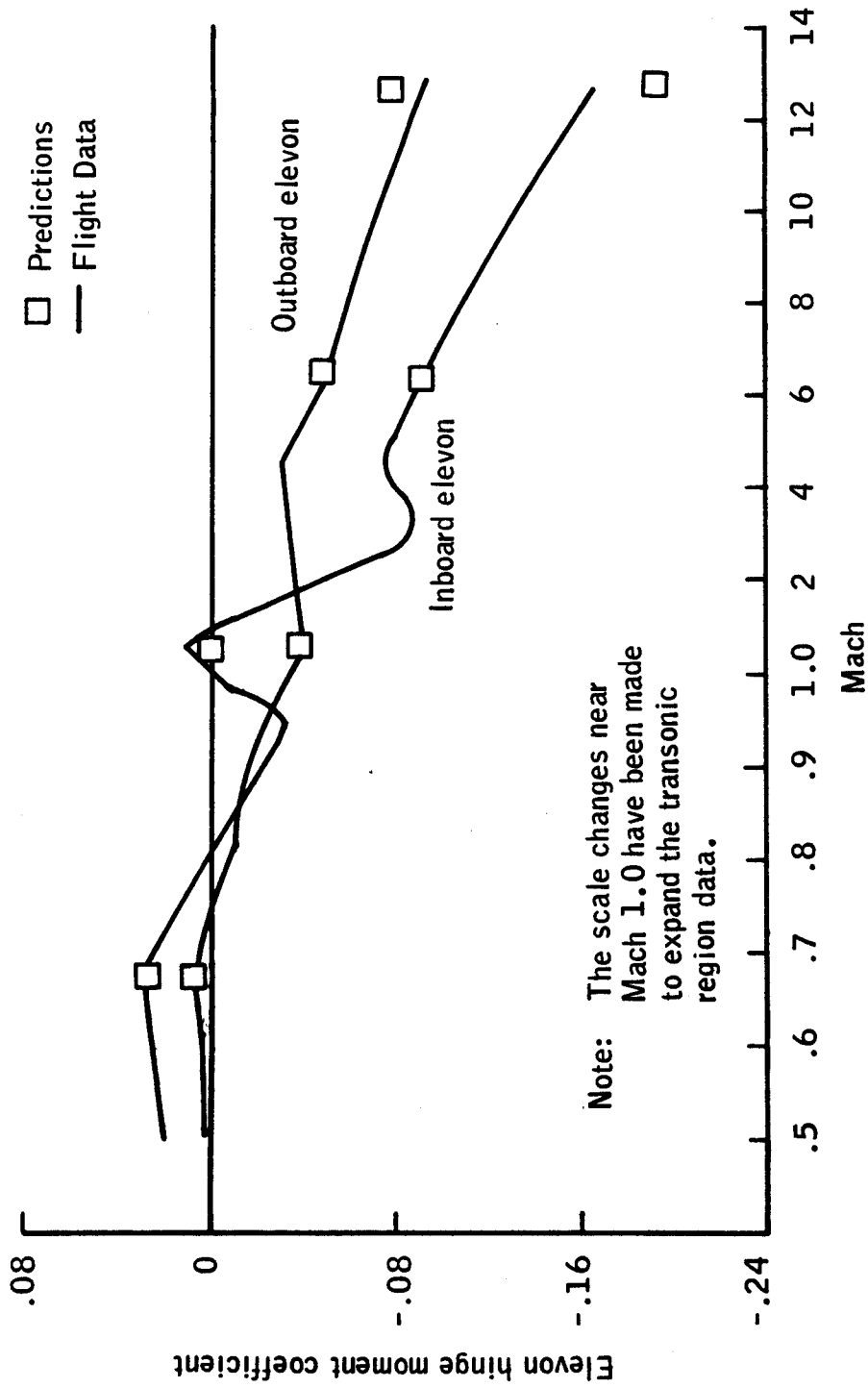

Figure 2-56.- Comparison of STS-2 flight and predicted elevon hinge moment coefficients.

2.9.8 Stability and Control Maneuver Results

2.9.8.1 Beta derivatives: Beta derivatives determined from PTIs (programmed test inputs), ASIs (aero stick inputs) and bank reversals are shown in figures 2-57 through 2-62. As compared to STS-1, the more precise maneuvers yielded higher quality data and were closer to predicted. Fairing of the curves shown represents the best estimate of the actual value of the data.

2.9.8.2 Aileron derivatives: Figures 2-63 through 2-66 contain the values obtained from STS-2 maneuvers for the aileron derivatives. No fairing is shown for $C_{y\delta a}$ and $C_{n\delta a}$. $C_{l\delta a}$ appears to be slightly different than predicted as shown in figures 2-64 and 2-65.

2.9.8.3 Rudder derivatives: Rudder derivatives are shown in figures 2-67 through 2-69. STS-1 data indicated that $C_{l\delta r}$ might be outside variations as determined from 0.26 Hertz oscillations. STS-2 data indicate that all rudder derivatives were nominal values.

2.9.8.4 RCS force and moment data: Figures 2-70 through 2-72 show certain of the thruster data from STS-2 maneuvers. Figure 2-70, showing the STS-2 rolling moment interaction due to yaw thruster; shows good agreement with data obtained from STS-1. The curve fairing shown was drawn for the STS-1 data. Figure 2-71 shows roll due roll thruster interaction which is outside of variations. This effect was not predicted from STS-1. Figure 2-72 shows pitching moment due to pitch thrusters which also indicates values outside variations. All of these three effects indicate that the thrusters are more effective than predicted in the low g regime. As this effect becomes better understood, a savings in RCS fuel will eventually be predictable.

2.9.8.5 Longitudinal data: No data other than pitching moment due to pitch thruster were found to be other than nominal. These data are questionable due to the loss of Ax from the ACIP.

2.10 REMOTE MANIPULATOR SYSTEM

The high priority RMS (remote manipulator system) test objectives identified pre-mission were flown. These included all RMS control modes, handling evaluations, and control dynamics tests. Evaluation of the continuous time plots shows that the arm performed as expected. This evaluation is based on the rates from the flight compared with SIMFAC pre-mission simulation data. The preliminary review of the data indicates that the arm performance is very close to that of SIMFAC. Postflight inspection revealed no discrepancies.

The only RMS anomaly occurred during test of the back-up mode and is discussed in paragraph 2.10.7.

2.10.1 Arm Controllability

The arm was uncradled and cradled in two modes (single and direct). Back-up cradling was not attempted due to the anomaly discussed in paragraph 2.10.7. Phasing tests were run and approaches to the grapple fixture were made by both crewmen (see fig. 2-73). The arm was well behaved and very easily controlled with smooth responses. Test mode and the position-hold mode were shown to perform as expected.

2.10.2 Common Validation Runs

The prescribed runs were made in manual augmented mode (Orbiter unloaded), direct, and single. Comparison of the individual arm joint rates, point of resolution position and velocities, and joint rate limit characteristics with similar runs made in SIMFAC, PDRSS (payload deployment and retrieval system simulator), and other simulations shows that these control system parameters are well within the previously established validation criteria. The direct mode was of particular interest since it is not computer controlled.

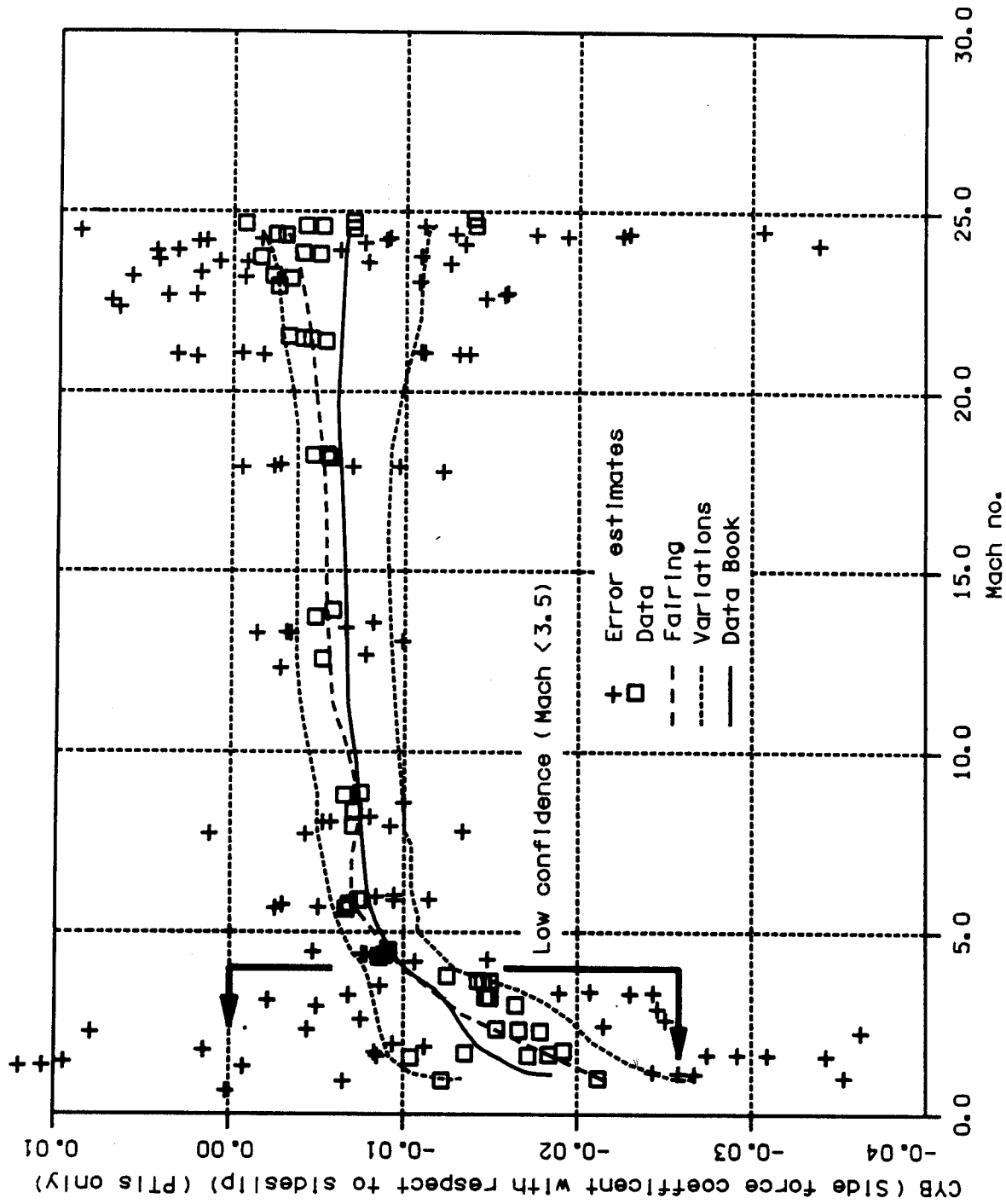

Figure 2-57.- Side force coefficient with respect to sideslip (PTIs only).

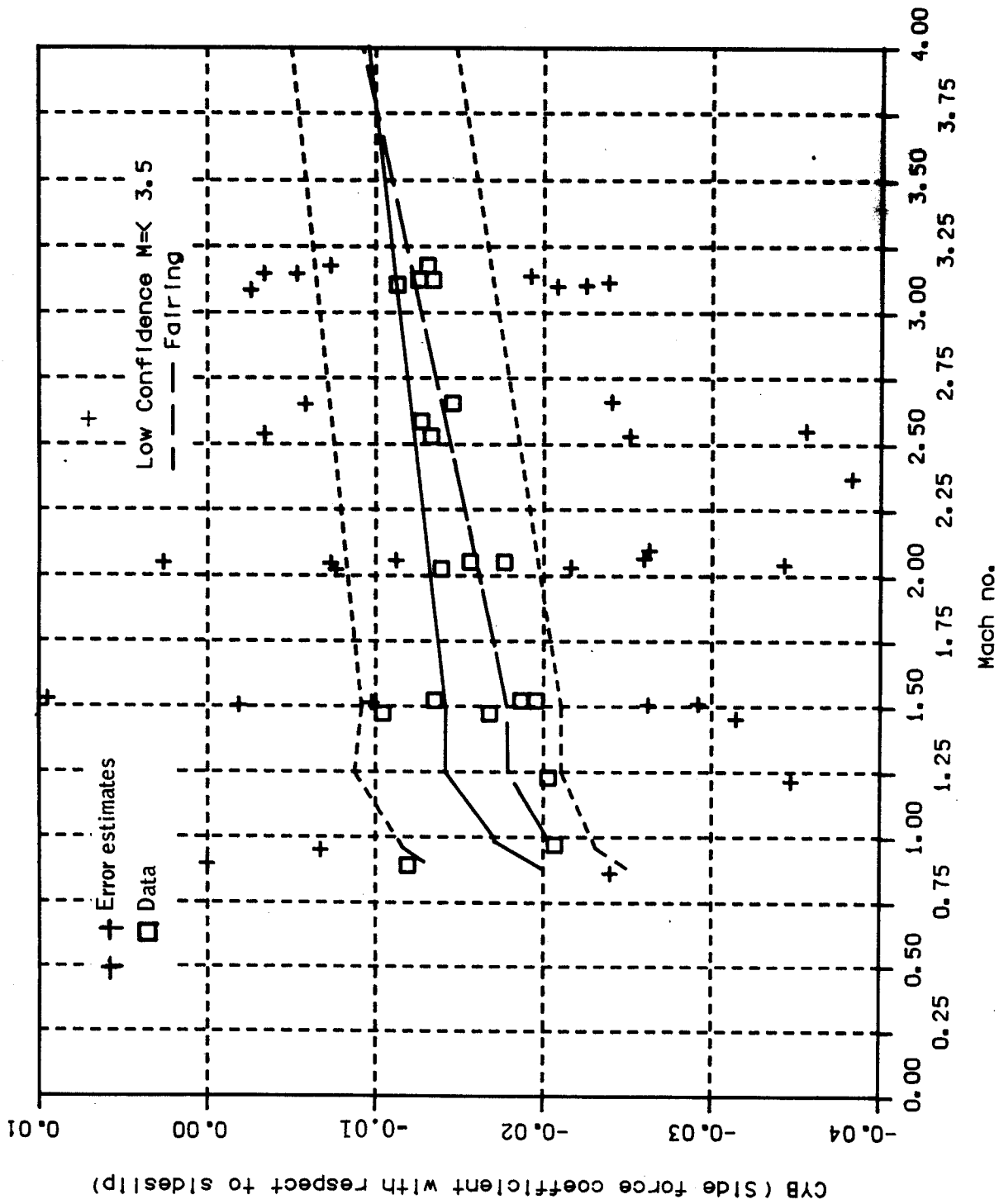

Figure 2-58.- Side force coefficient with respect to sideslip (ASIs and PTIs).

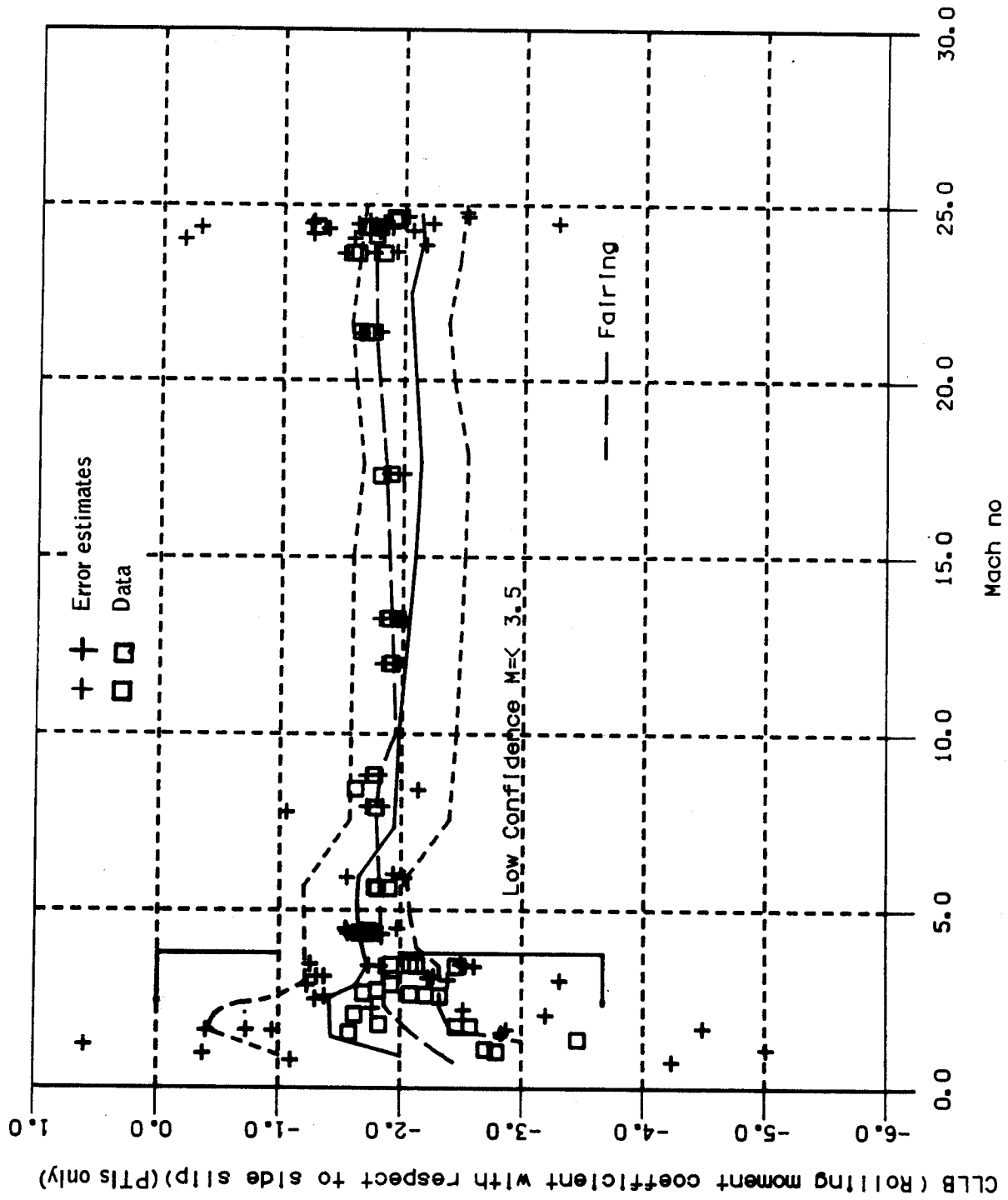

Figure 2-59.- Rolling moment coefficient with respect to sideslip (PTIs only).

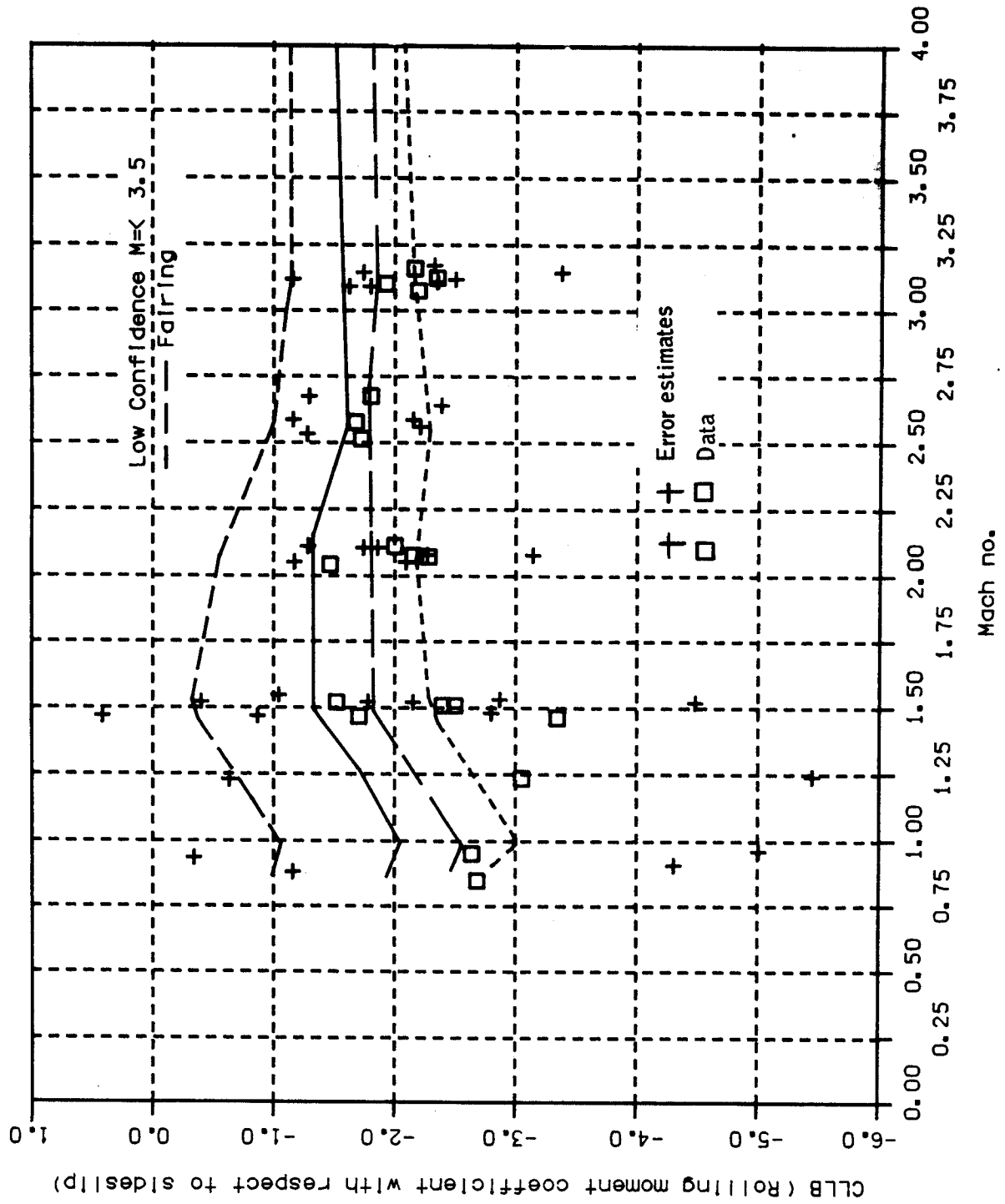

Figure 2-60.- Rolling moment with respect to sideslip.

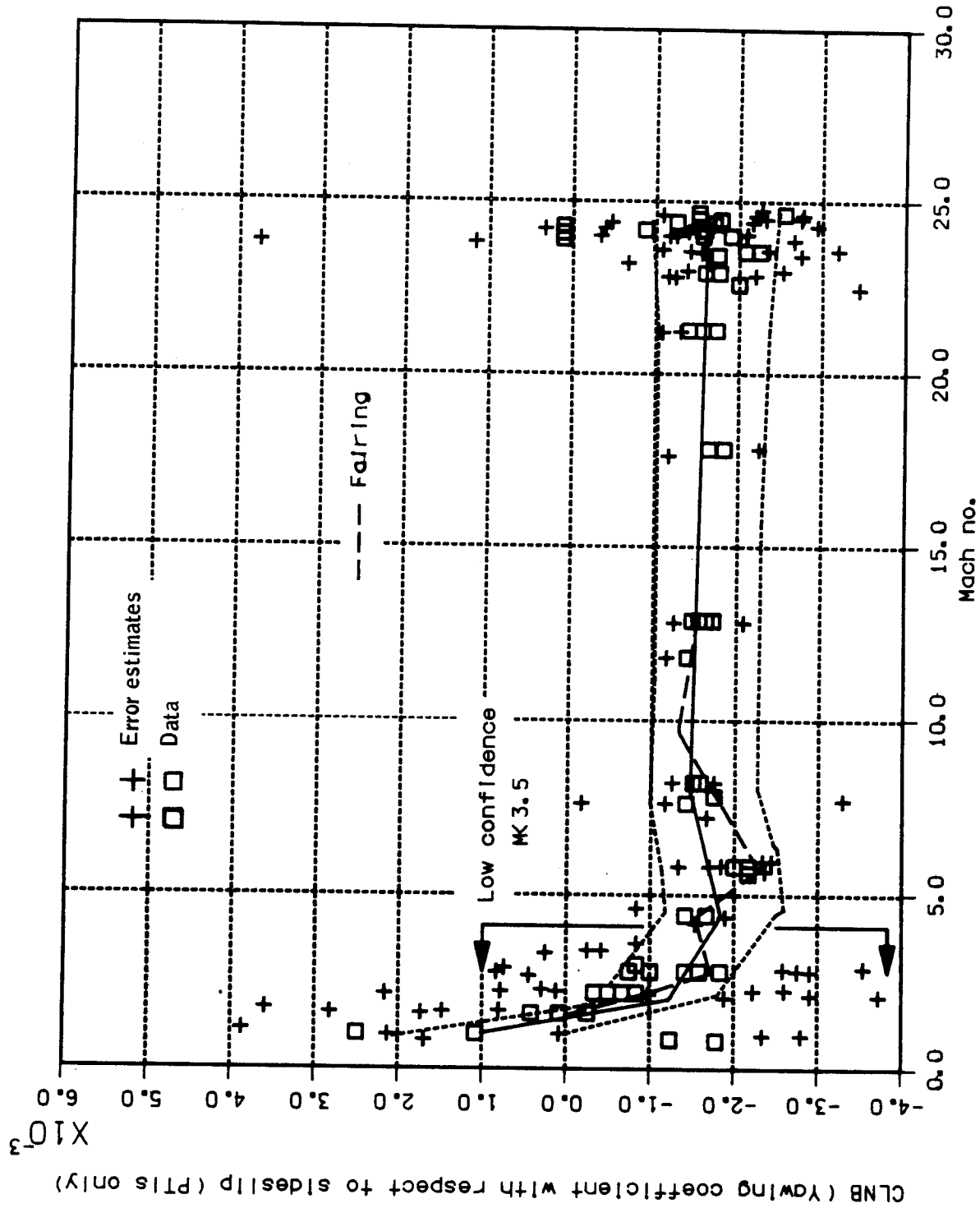

Figure 2-61.- Yawing moment coefficient with respect to sideslip (PTIs only).

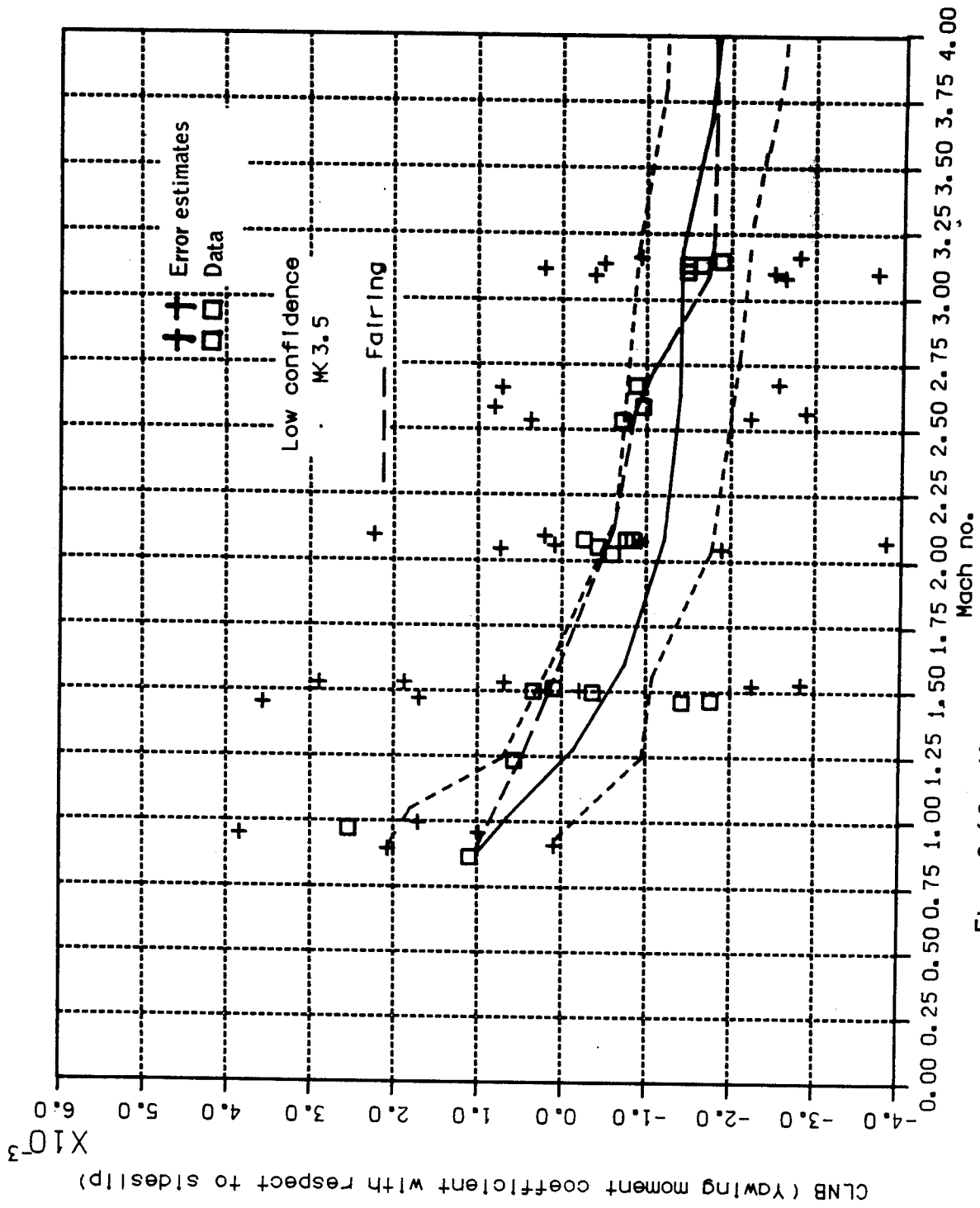

Figure 2-62.- Yawing moment coefficient with respect to sideslip.

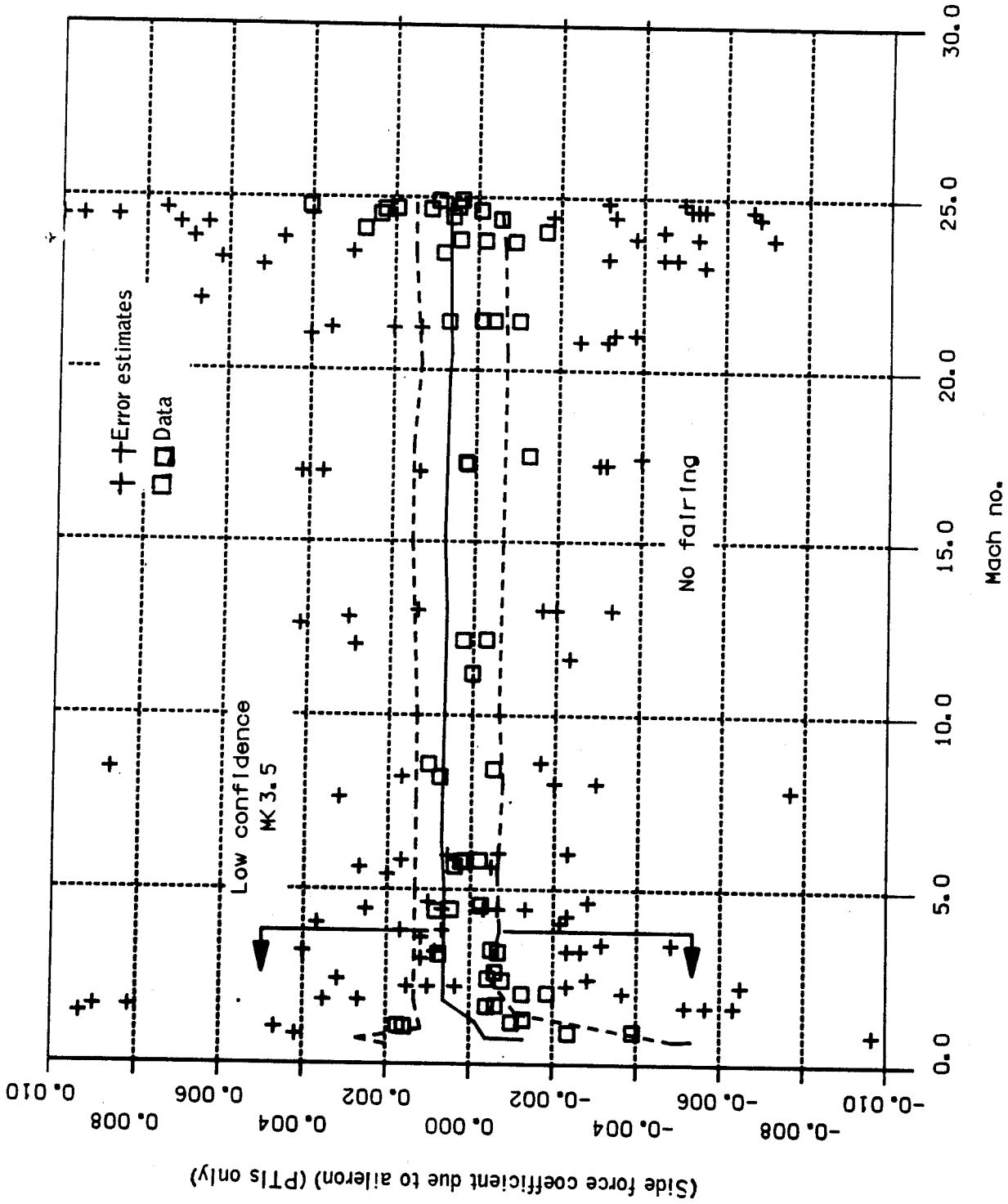

Figure 2-63.- Side force coefficient due to aileron (PTIs only).

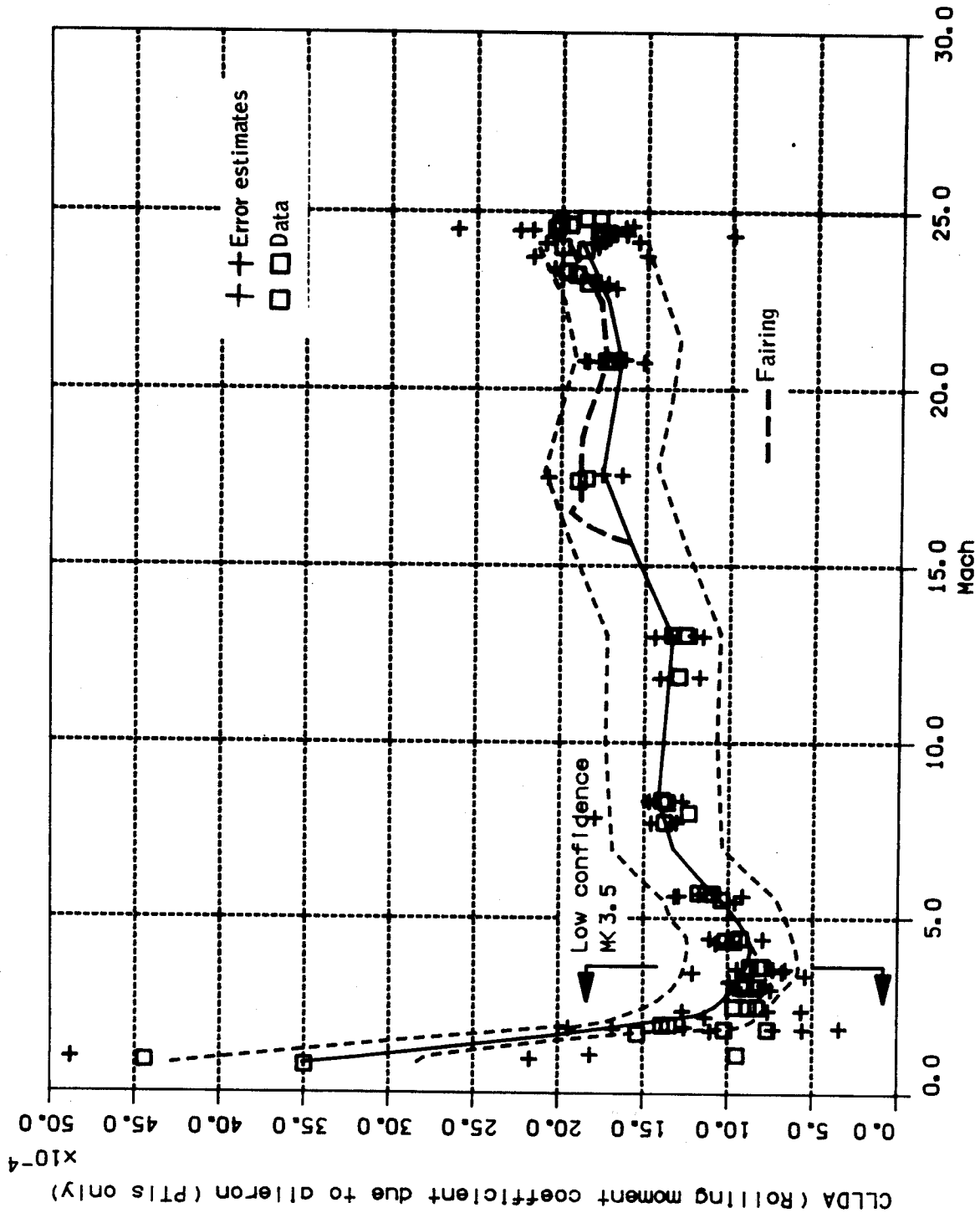

Figure 2-64.- Rolling moment coefficient due to aileron (PTIs only).

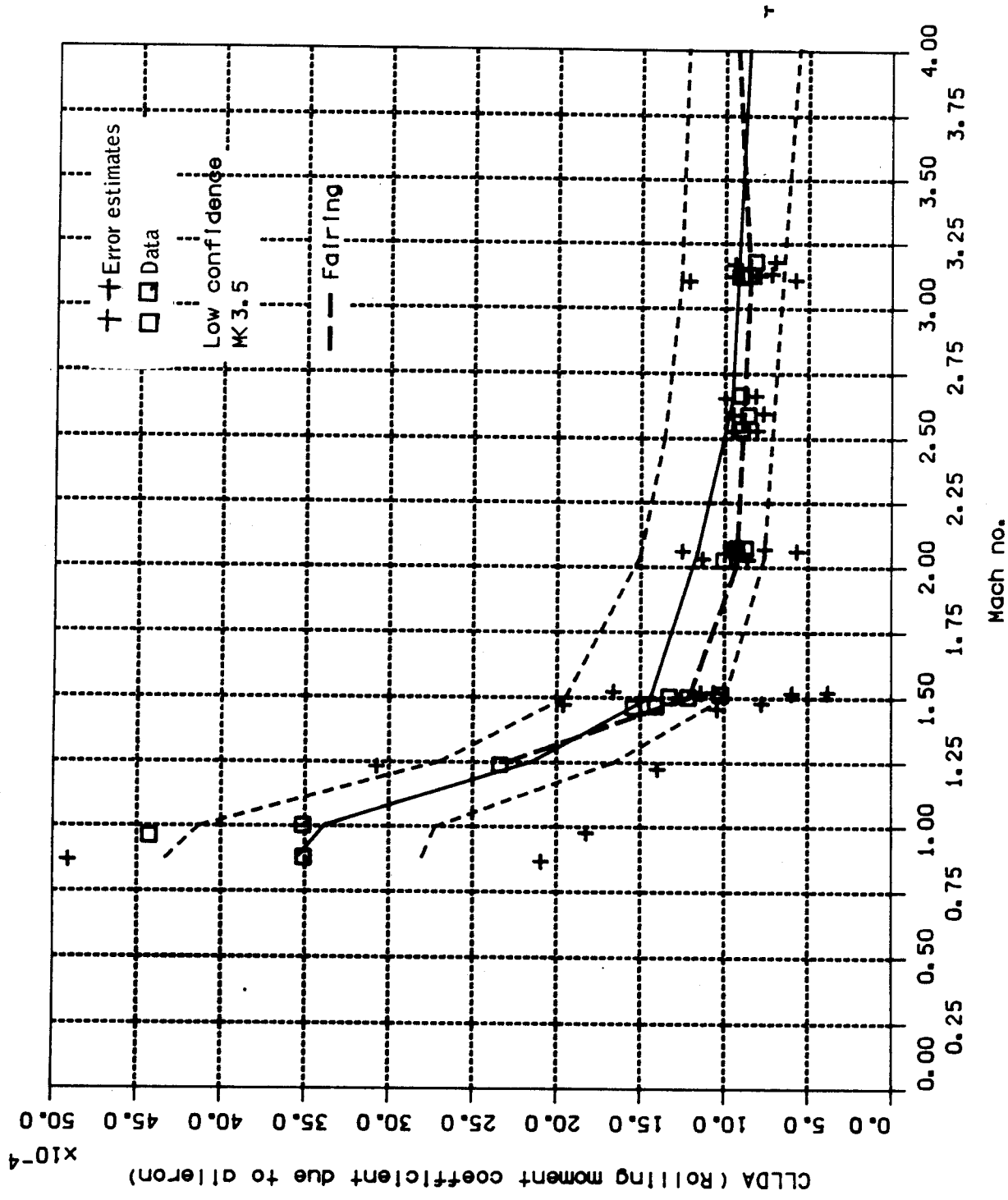

Figure 2-65.- Rolling moment coefficient due to aileron.

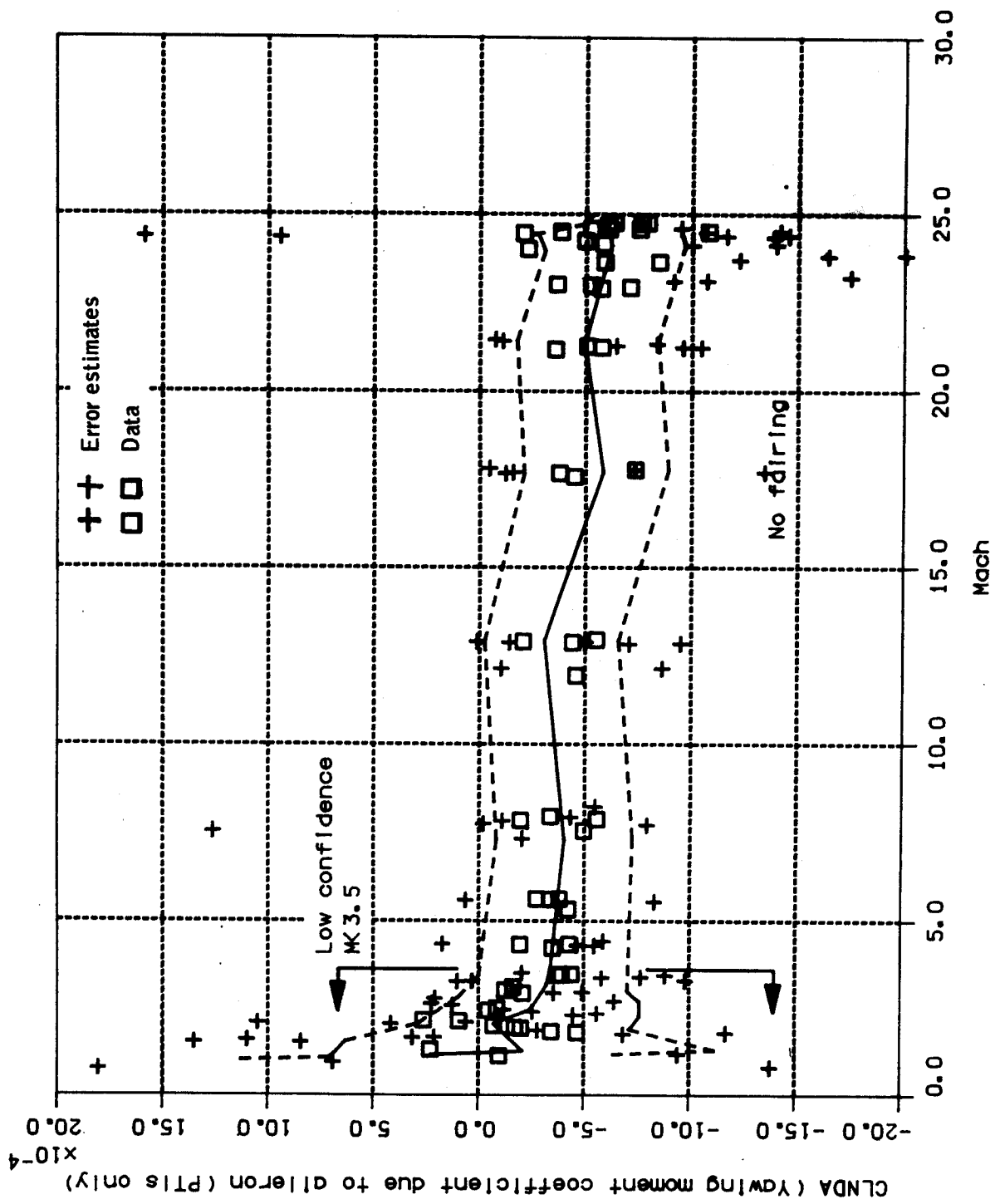

Figure 2-66.- Yawing moment coefficient due to aileron (PTIs only).

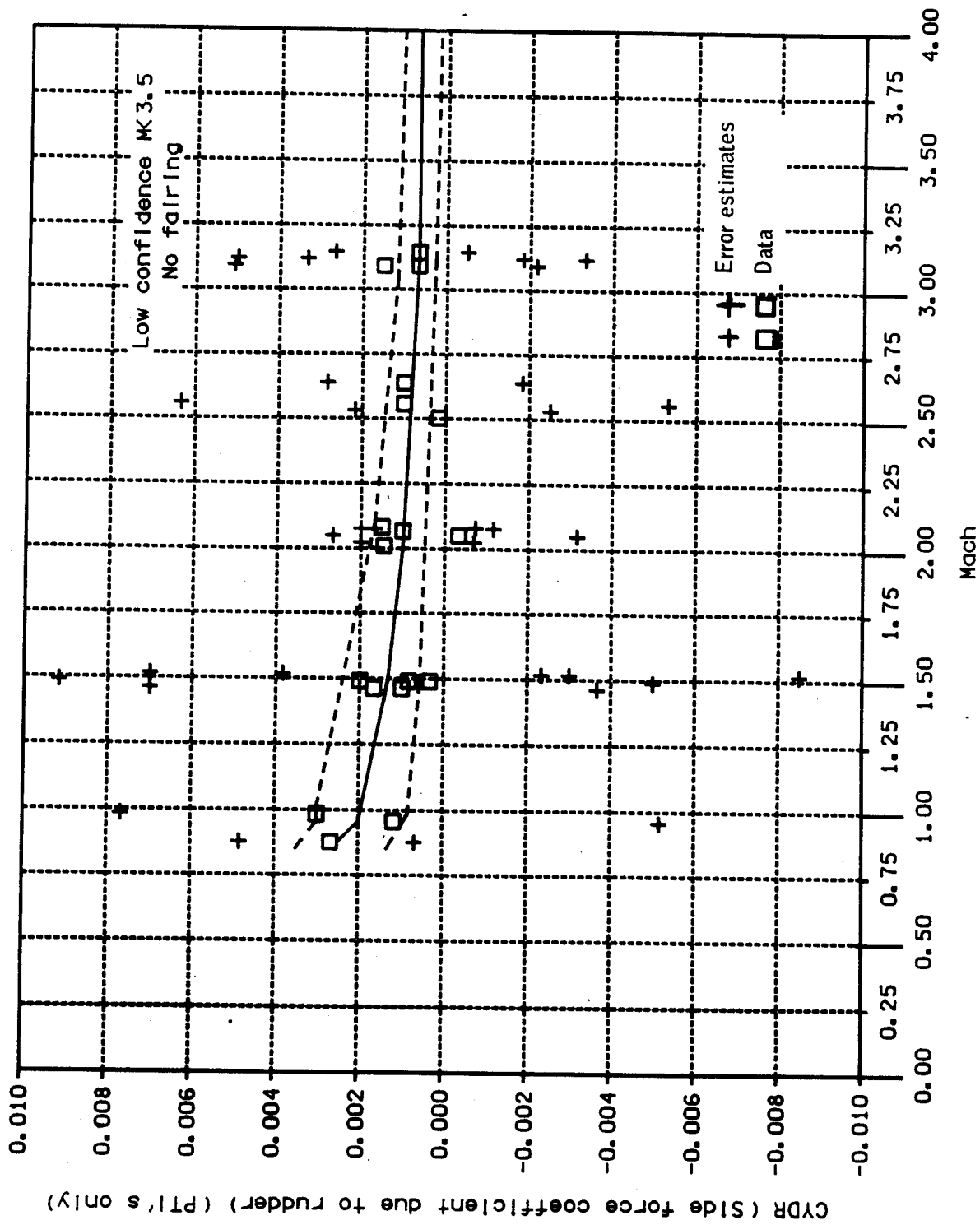

Figure 2-67.- Side force coefficient due to rudder (PTI's only).

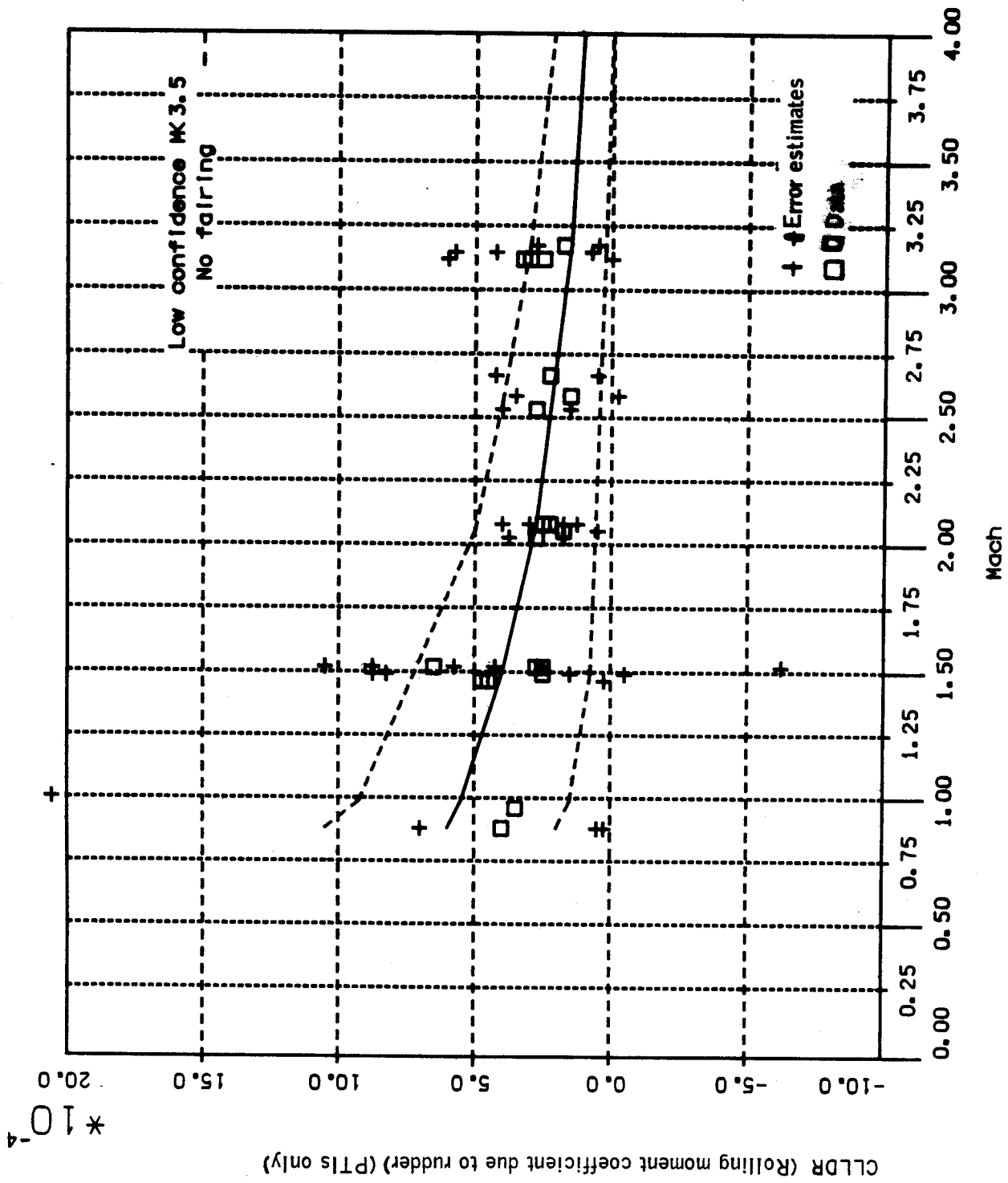

Figure 2-68.- Yawing moment coefficient due to rudder (PTIs only).

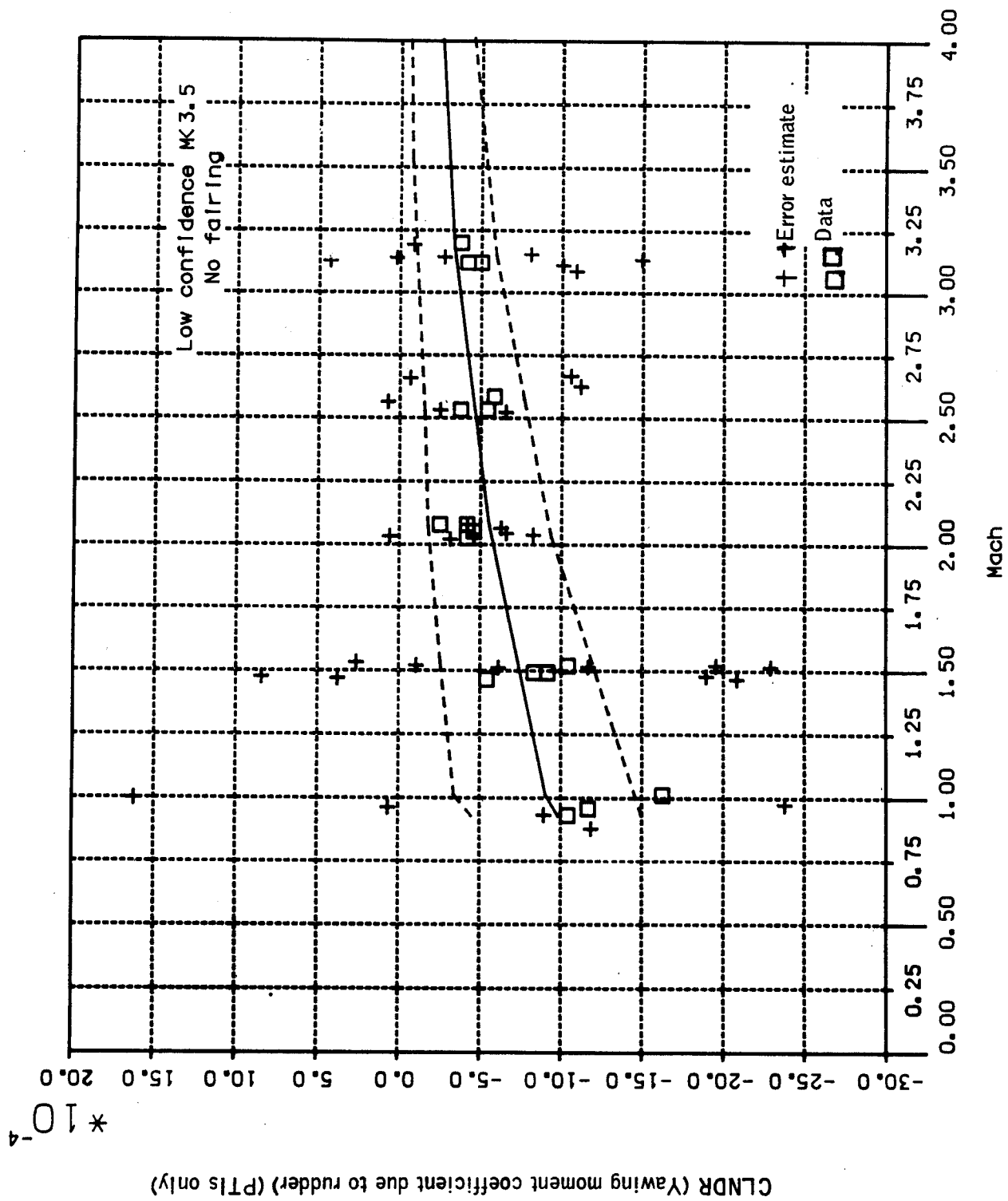

Figure 2-69.- Yawing moment coefficient due to rudder (PTIs only).

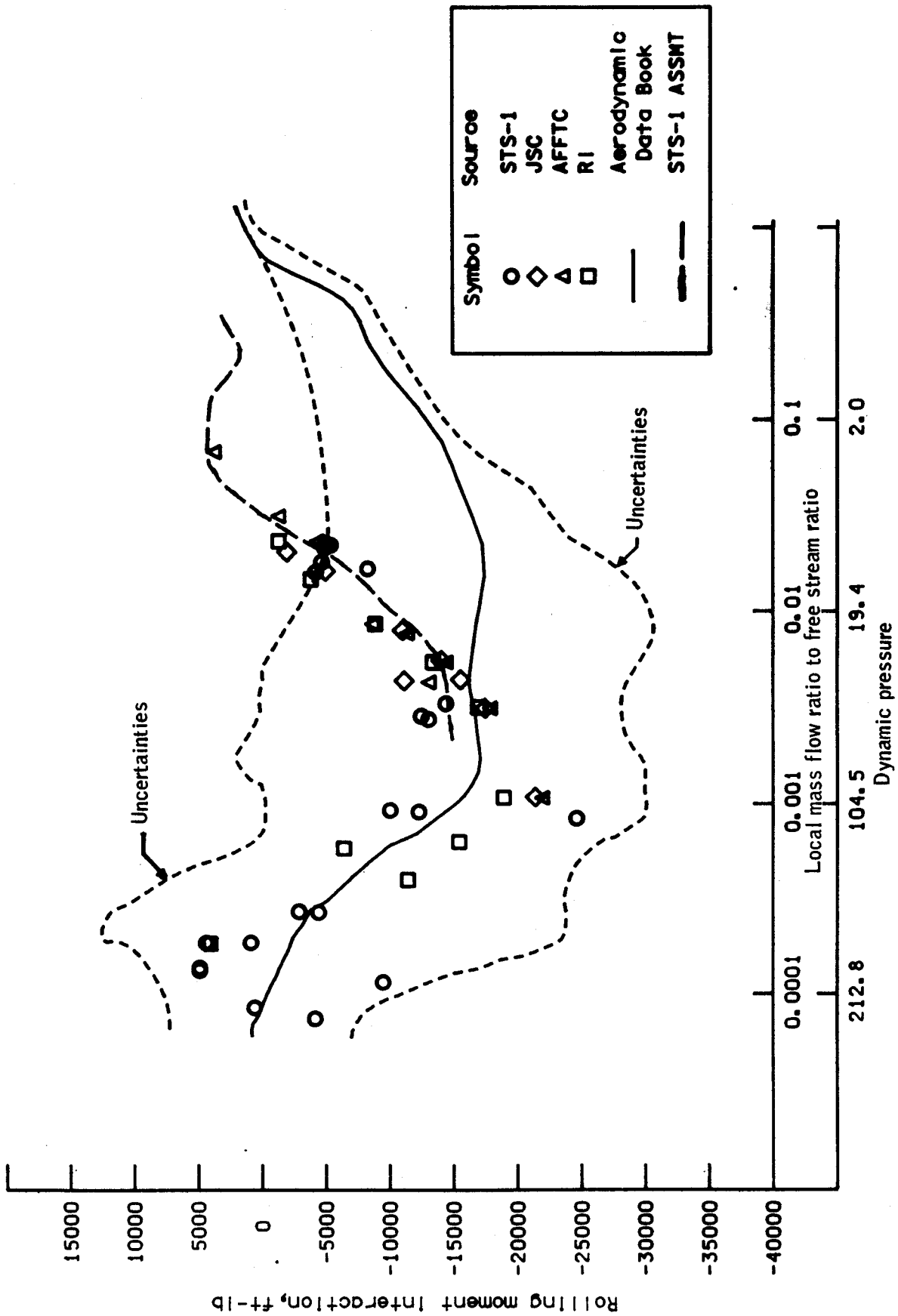

Figure 2-70.- Rolling moment thruster interaction for left-hand yaw thruster.

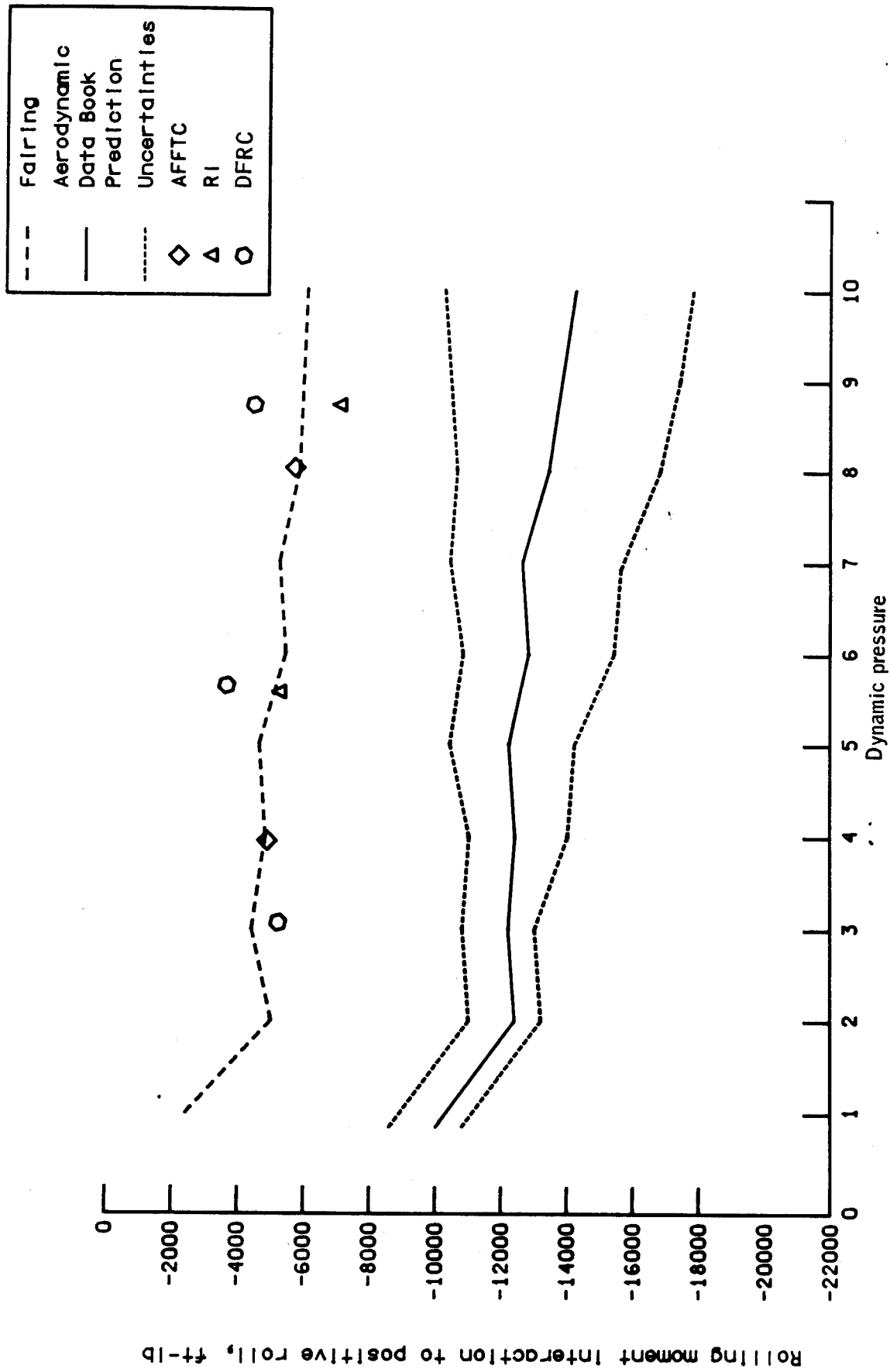

Figure 2-71.- Rolling moment interaction effect due to positive two-thruster roll coupling.

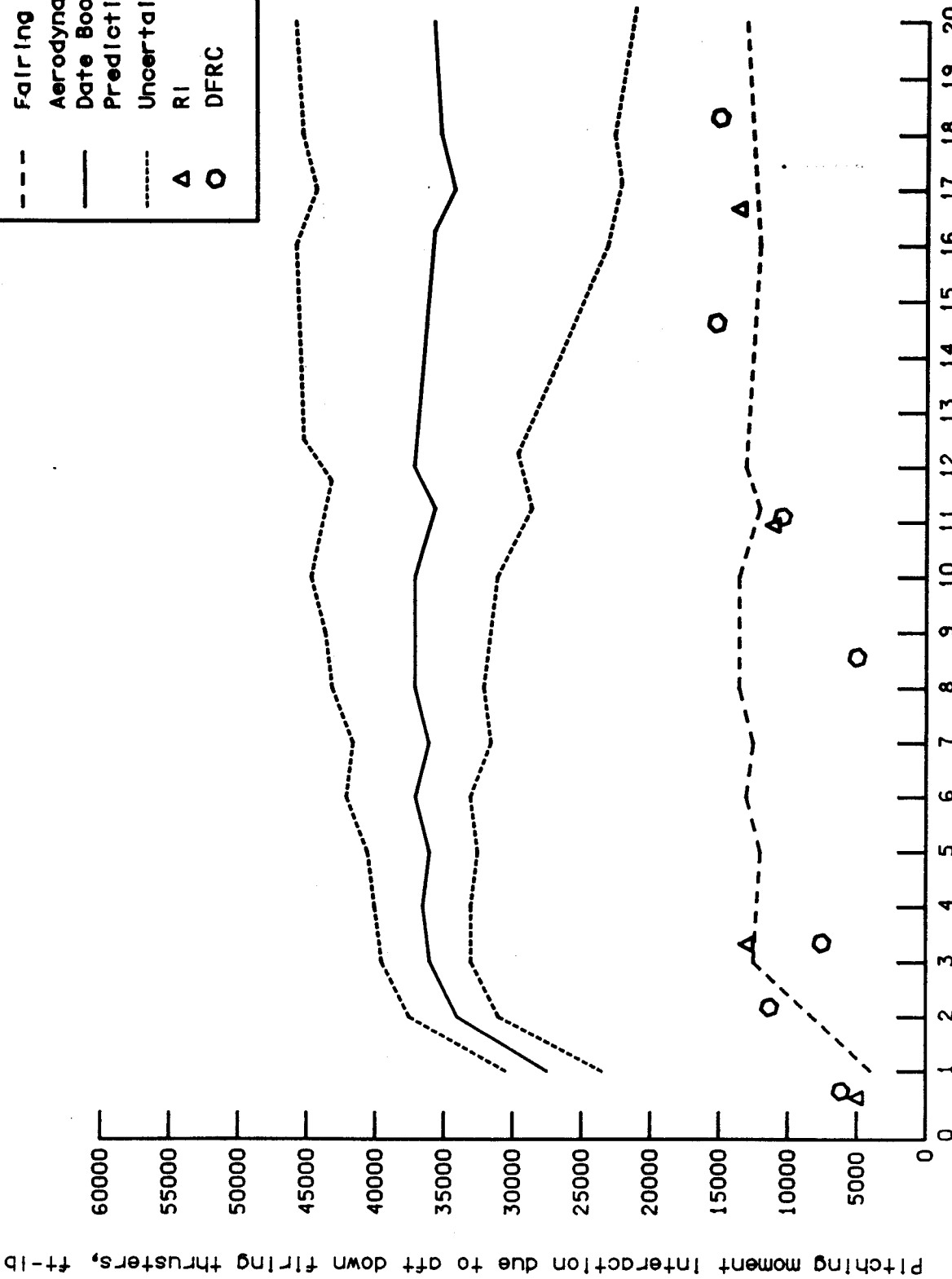
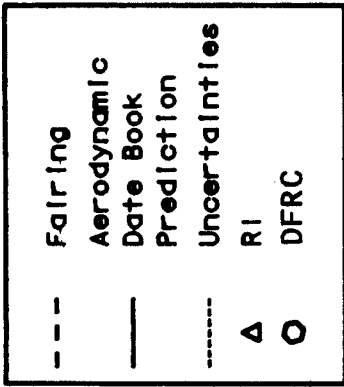

Figure 2-72.- Pitching moment interaction effect due to aft down firing thrusters - one each side.

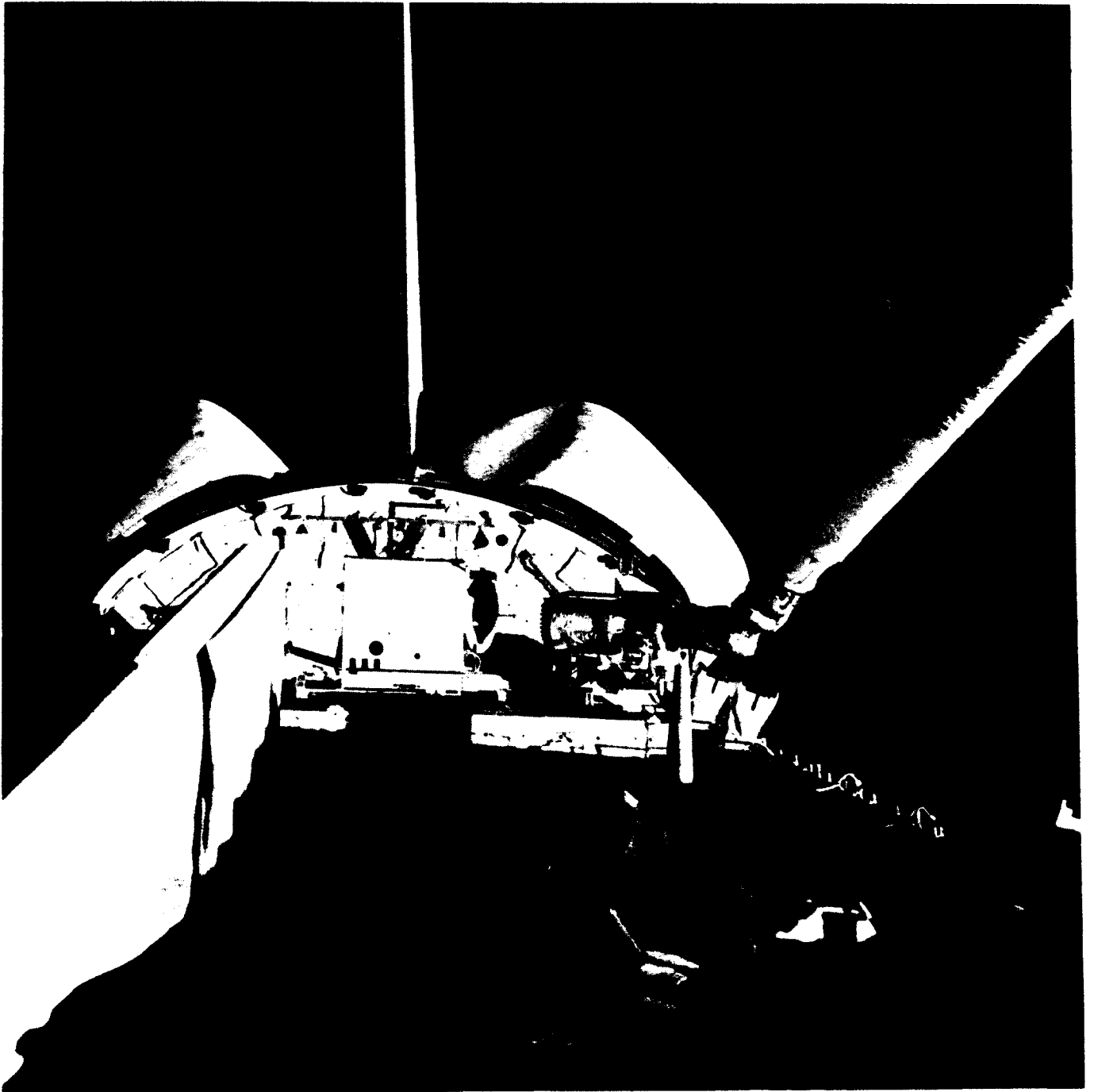

Figure 2-73.- RMS arm approaching IECM grapple fixture and target.

Results of these validation tests showed that the three joints tested (shoulder-pitch, elbow-pitch, and wrist-pitch) provided rates of 25 to 26 radians/sec, which compared well with the ground tests results of 22 to 25 rad/sec.

Joint rates are not yet available since there is no instrumentation in this mode and the alternate data sources (16mm cameras and television) malfunctioned during this test. Limited data may be available from enhanced 16mm film processing, but these tests have been rescheduled for STS-3.

2.10.3 Auto Trajectory Runs

The primary objective of the auto trajectory tests was to test the accuracy of the RMS auto mode software translation and rotation capabilities. Of the six auto-trajectories planned for FTO 252-07 (RMS Auto Mode Performance), the two most important trajectories (1 and 5) were selected for use during the minimum mission. These trajectories were chosen because they are relatively quick and allow direct and separate observation of the accuracy of the rotation and the translation. Preliminary analysis of data and direct observation of video tape indicate that the desired accuracy was achieved during the execution of the two auto-trajectories. The additional objectives which were not accomplished have been merged into the activities planned for future missions.

The operator-commanded mode was successfully used (FTO 252-08) to initialize the automatic sequences. This mode proved accurate in maneuvering the arm to within the tolerance of position and attitude required to initiate an automatic sequence. The operator-commanded mode terminated in all cases with the "ready light on" indicating that the required accuracy of placement had been achieved. The usefulness of the operator-commanded mode to place the RMS quickly and accurately in a position ready for an automatic sequence was proven with this flight test objective.

2.10.4 RMS Dynamics

Application of RMS brakes and safing commands in the common validation runs provided information on the RMS structural characteristics. Pulses of the Orbiter primary RCS also provided dynamics input. Arm-based instrumentation is available on these runs, however, the 16mm cameras and television views are the primary data sources and these data had problems as noted previously.

2.10.5 Thermal Control

The RMS heaters were turned off during crew-awake periods to obtain thermal response data. The temperatures never approached the thermostat turn-on point. During crew-sleep periods, the heaters were in the auto mode and again the data indicate that the heaters never cycled on. Temperatures throughout the RMS for the entire mission ranged from 10° to 15° F higher than predicted. The lowest temperature observed was 22° F for the shoulder electronics and the highest was 63° F for the shoulder-pitch readout.

The cold-case temperature profile test FTO was not performed because of the shortened mission.

2.10.6 Consistency Check

There were no RMS malfunctions which would have triggered the consistency check alarms. Equally significant is that the unloaded consistency check did not produce any false alarms. The consistency check depends on the joint forward/backdrive flag logic which has been difficult to simulate on the ground. Limited comparisons of the STS-3 data with SAIL data indicate general agreement on the flag state, oscillations during maneuvers, and trends on change-of-state frequency along the arm joints.

2.10.7 Back-up Drive Anomaly

The last scheduled RMS activity was back-up mode performance (FTO 252-04). The crew went from primary to back-up power and conducted a phasing check of each joint operation, starting from the wrist end. All joints performed normally down to the shoulder yaw, which happened to be the sixth and last joint. The crew was unable to drive this joint in either + or - direction, and immediately went back to primary power and cradled the arm. (Section 7.0, flight test problem report 16).

3.0 ENVIRONMENTS ANALYSIS

3.1 ACOUSTIC ENVIRONMENT

Acoustic data were reviewed for compliance with design criteria and comparison with the STS-1 results. The data were reviewed for the following events; main engine ignition, solid rocket booster (SRB) start and lift-off, transonic region, maximum q and supersonic flight. Data for the entry phase were not processed because the levels experienced on STS-1 were within the noise threshold of the transducers with no reason to believe STS-2 to be different.

Reliable data were obtained from 26 of the 30 microphones located internally and externally on the Orbiter. For STS-2, there were seven microphones activated at new locations that were not used on STS-1. The measured data on the external surfaces during the selected time intervals of the STS-2 flight compared favorably with the data from STS-1. Figure 3-1 is a typical sound pressure level plot of the aft fuselage heat shield that compares environments of STS-1 and STS-2. Figure 3-2 is a sound pressure level plot of one of the new microphones that was located on the wing elevon actuator and the levels are slightly higher (1 to 2 dB) in the upper frequency range when compared to the predicted specification criteria.

The measured noise level at the pilot's seat in the crew compartment cabin area (figure 3-3) is 2 dB lower than the overall levels that were measured on STS-1 for the same ascent event (SRB ignition/lift-off), and are well below specification level. A cursory review was made of the data during the OMS and RCS firings and the levels were in the noise threshold of the transducers.

In summary, the acoustic levels measured during STS-1 were a repeat of the levels that the Orbiter experienced on STS-1 and the levels are considered satisfactory.

3.2 VIBRATION ENVIRONMENT

Vibration data from all transducers have been scanned for overall quality and comparison with the levels experienced by STS-1. The levels appear to be representative of those measured on the STS-1 flight. A cursory review of the ASD (acceleration spectral density) plots further confirms that the levels are comparable with the two flights as well as with the predicted specification criteria.

The APU system 2 (Reference STS-1 Final Orbiter Mission Report, JSC-17378) experienced high level of system vibration on STS-1, but did not demonstrate that same high level on STS-2. APU-2 was replaced between flights. APU system 3 showed a level above the STS-1 data. Although these levels are within the specification criteria, they do warrant further investigation to ascertain the cause for the increase in level after 8 minutes of flight and to determine the mission life impact.

The elevated vibration level on the PRSD liquid oxygen tank strut that appeared during STS-1 was also present on STS-2. The experienced flight level is above previous test levels and additional testing at a revised level is underway. The higher level experienced on the STS-1 and STS-2 does not affect OFT flights, but it could impact mission life.

A more thorough study of the ASD plots will be made to confirm that the flight environments are within the specification criteria.

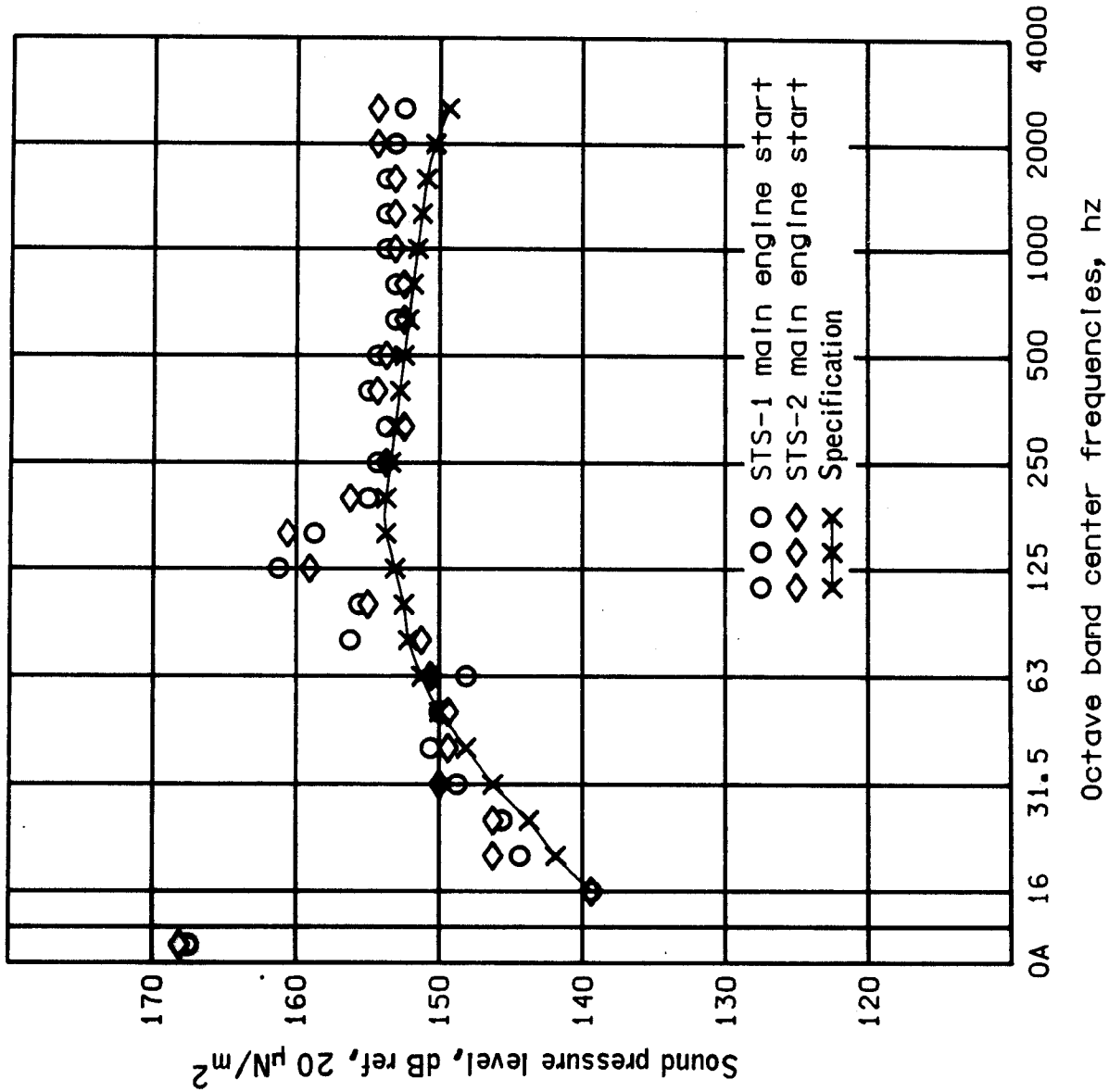

Figure 3-1.- Acoustic measurements on aft fuselage heat shield (V08Y9686).

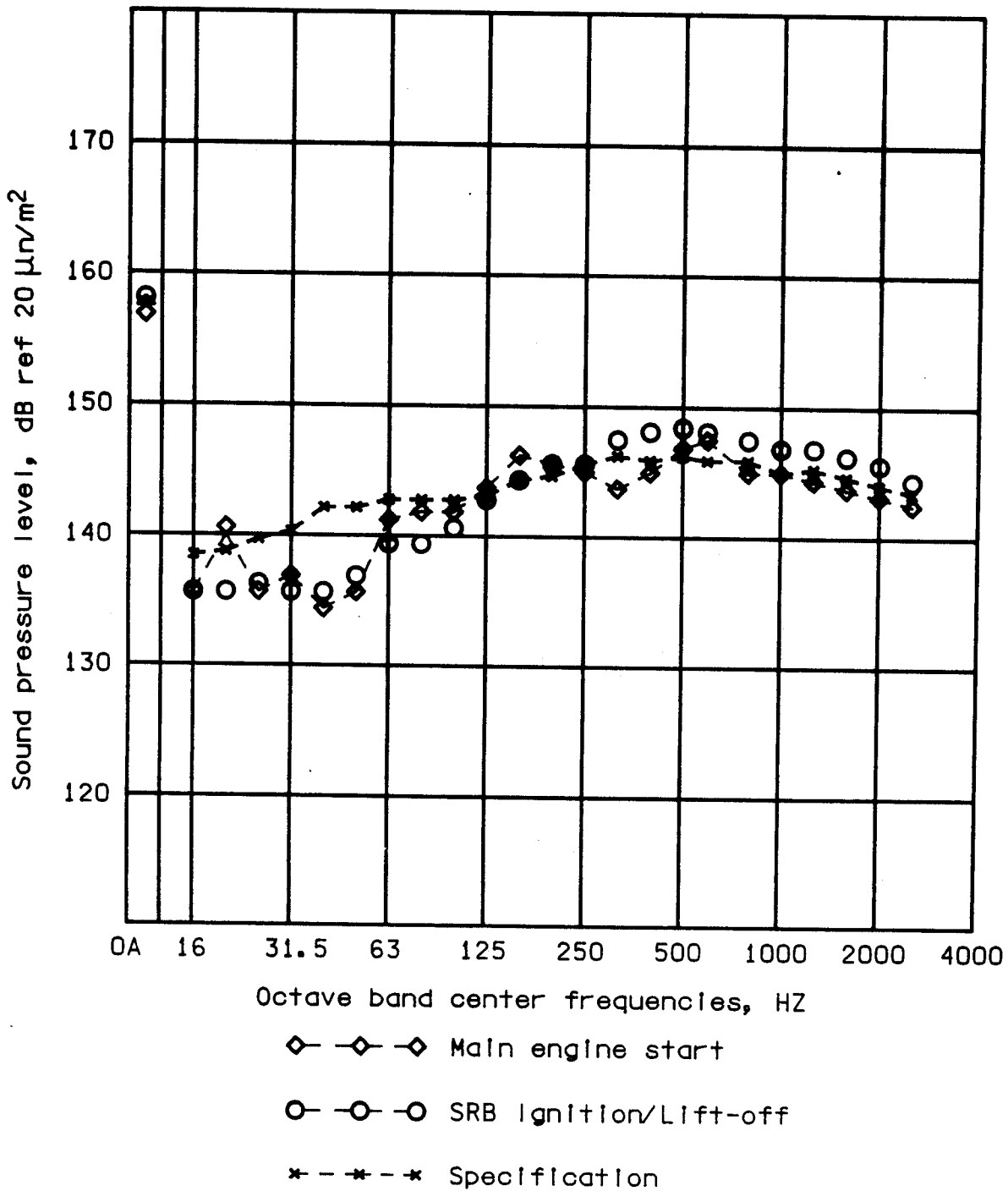

Figure 3-2.- Comparison of STS-2 launch phase noise level on Inboard elevon actuator (not measured on STS-1).

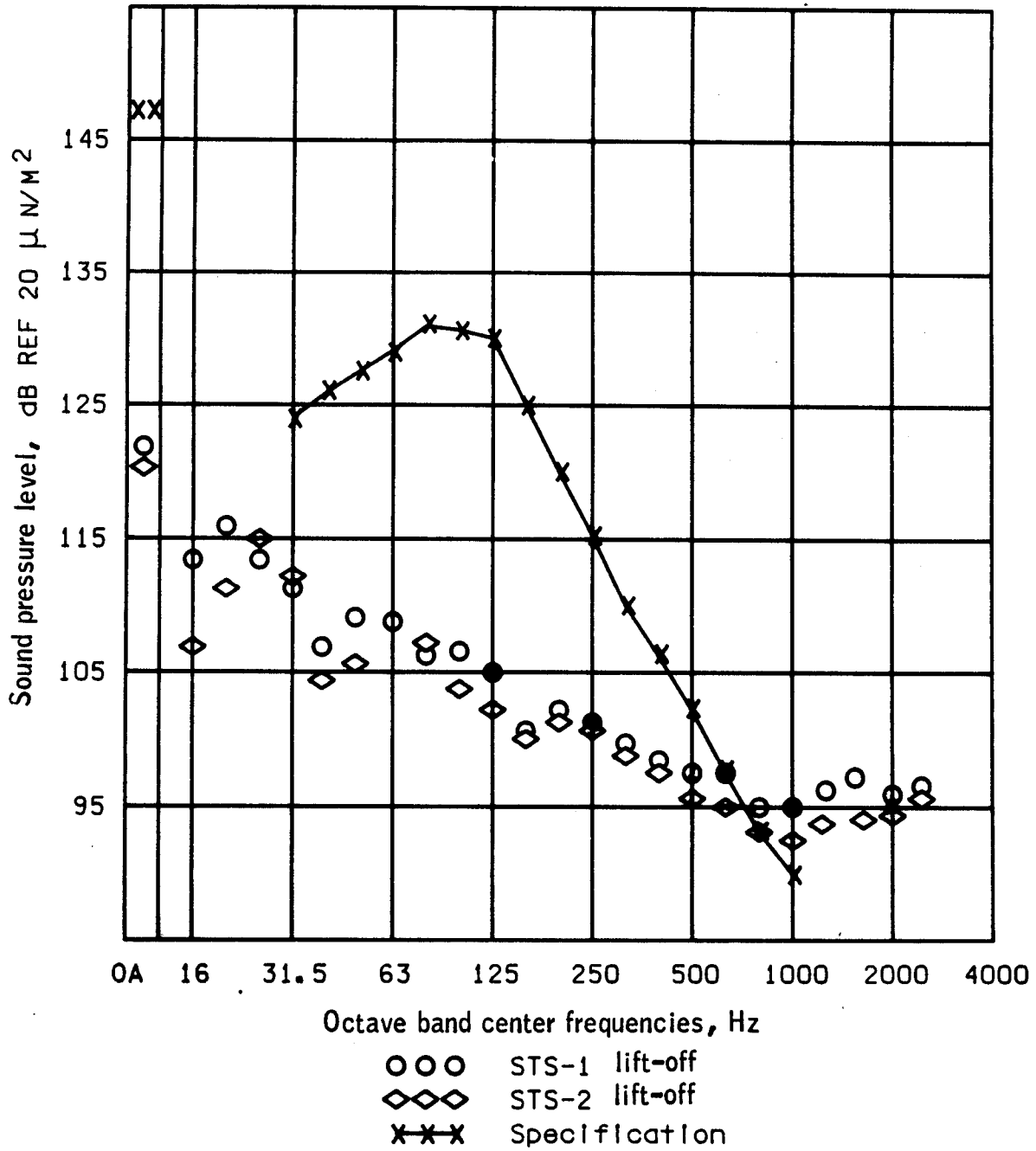

Figure 3-3.- Acoustic measurements at the pilot seat in cabin area.

4.0 CREW REPORT

This section will be issued as an addendum to the report.

5.0 BIOMEDICAL EVALUATION

The primary objective of the medical operations effort is to assure the health and well-being of flight personnel during all phases of the mission.

5.1 EVALUATION OF CREW HEALTH

The preflight evaluation of crew health occurred on F-30 (September 10) day, F-10 (October 21) day, F-2 (November 2 and November 10) day, and launch morning (November 4 and November 12). The crew were in excellent health throughout the preflight period. In-flight, the crew reported no major medical problems. No medications were taken except those for prevention of motion sickness. Postflight analysis shows that each crewmember ate an average of approximately 1100 calories of food per day. Because of the fuel cell problem, the water system was reconfigured. Drinking water was obtained directly from the fuel cell with the result that the system delivered water very slowly, requiring 2 to 3 minutes for each 8 oz. of water. (Section 7.0, flight test problem report 8). The first sleep period was interrupted three times, with the longest uninterrupted period being approximately 5 hours. The second sleep period was interrupted five times, with the longest uninterrupted period being approximately 1.5 hours. Postflight the crew had some symptoms of dehydration, but were generally in good condition. The crew were reevaluated at landing plus 4 days and were found to be in excellent condition and returned to full duty.

5.2 HEALTH STABILIZATION

Problems with infectious disease during the early Apollo missions resulted in the establishment of a preflight health stabilization program for Apollo 14. No infectious diseases have been reported in prime crew members from Apollo 14 through STS-2. The number of people authorized to be primary contacts was reduced from 972 for STS-1 to 164 for STS-2. There was one possible break in the health stabilization program reported for STS-2. This occurred at Patrick Air Force Base, FL, when security permitted some members of the press and a few autograph seekers to approach the crew.

5.3 TOXICOLOGY

The cabin atmosphere gas composition was evaluated by three different means of atmospheric sampling. There were: 4 evacuated cylinders, a specially developed adsorbent material known as TENAX, and charcoal samples taken from the carbon dioxide scrubber cartridges. A total of 99 different contaminant gases were identified and quantitated. Each of the gases was placed into one of four categories, depending upon physiological effects in humans. These categories are: (1) irritants, (2) CNS depressants, (3) systemic poisons and (4) asphyxiants. One of these categories, viz. systemic poisons exceeded the NHB 8060.1B limit of unity (1) for summations of groups of contaminants. The limit value for systemic poisons is 1.00. The value determined from the STS-2 samples was 1.22. The other three categories were well below the NHB 8060.1B limit value of 1.00.

The reason the systemic poisons category exceeded this limit value was due to the presence of a relatively high concentration of toluene. Toluene was found at 17 ppm in one sampling cylinder (its spacecraft maximum allowable concentration is 20 ppm). Relatively high concentrations of toluene were also found in the solid adsorbent samples and in samples of carbon taken from the carbon dioxide cartridge used during STS-2.

The source of toluene found in the cabin is not presently known and is being investigated.

5.4 RADIATION

Radiation doses projected for the STS-2 crewmen were 21 millirad. Measured doses were 11.2 ± 2.4 millirad and 12.5 millirad. The HZE Flux was measured at 5 ± 3 particles/cm². There were 14 South Atlantic anomaly passes, and the solar-flare activity was moderate and had no input at the measured location in the Orbiter. The dosimeter packs were not deployed; however, personal dosimeters were worn.

5.5 NOISE ASSESSMENT

Measured STS-2 noise levels are discussed in section 2.5.5.

5.6 MOTION SICKNESS PROPHYLAXIS

The test objectives were to provide motion sickness prophylaxis and to collect relevant data. Crew motion sickness experience was evaluated preflight, and the motion sickness susceptibility test was completed. Side effects of anti-motion sickness drugs were evaluated. A microcassette recorder was used in flight to record crew data. Two scopolamine/dexedrine tablets were taken and two transdermal scopolamine patches were used. After landing, the crew did not experience any disorientation or postural disequilibrium.

5.7 MICROBIOLOGY

The prime crewmen were evaluated on the following days - F-62, F-22, F-10, F-2, L+0, and L+4. Both crewmen exhibited normal microbial flora in the ears, nose, throat, urine, and feces cultures. No significant increase in potential pathogens was observed postlanding, and no apparent microbial exchange occurred between crewmen.

Orbiter samples for microbial evaluation were collected from interior surfaces and air on the following days - F-72, F-35, F-10, F-2 and L+0. Low numbers of microorganisms were isolated, and no appreciable buildup occurred during the mission. No microbes were isolated from potable water at F-3. Species of Pseudomonas were isolated postflight, but no overt pathogens were detected.

5.8 BIOINSTRUMENTATION

Bioinstrumentation equipment functioned well, and heart rate data were within expected limits. Stomaseals were not applied to in-flight electrodes, and the crew took appropriate corrective action, but the pilot's electrocardiogram was not received during entry.

6.0 DESCENT TRAJECTORY

The entry phase trajectory for STS-2 was normal with wind levels near the mean value for November. The entry interface (400000-ft altitude) was reached with a range of 4473.6 nmi. compared to the pre-deorbit nominal of 4463 nmi. This range error increased to a -55 nmi. (closer to the runway) because of the low dynamic pressure test maneuvers and was nulled by the guidance when the Orbiter had decelerated to 19500 ft/sec relative velocity. The entry groundtrack shifted approximately 25 nmi. to the south of the predicted groundtrack because of a delay in the first roll reversal. This delay was caused by a conflict with this roll reversal and the Mach 21.5 test maneuvers. This groundtrack shift had no effect on energy management. At terminal area energy management (TAEM) interface, the Orbiter was within 870 ft of the predicted range at normal TAEM interface.

The wind conditions during the TAEM phase (Mach 2.5 to Autoland) was near 95 percential and consisted of tailwind turning into a headwind on final approach to the runway. This wind condition and the test maneuver on the heading alignment circle caused the Orbiter to be low on energy and delayed the autoland test until 5000 ft altitude. (Section 7.0, flight test problem report 33).

7.0 ORBITER ANOMALY SUMMARY

This section contains a summary listing (Table 7-I) of each anomaly defined during the mission, postflight testing, and during data analysis. Also included are the problem closeout reports with the status of each problem at the time of publication of this report.

TABLE 7-I.- SUMMARY STATUS OF PROBLEM TRACKING LIST

No.	Title	Status
1	APU's 1 and 3 lubrication oil outlet pressure high at 100 to 112 psia, normal is 50 to 60 psia.	CLOSED
2	MDM OF3 failed, Port 2.	CLOSED
3	Temperature measurements indicate that thermostats are dithering. a. APU 2 pump secondary water line (V46T0294) b. APU 3 gas generator injection water cooling line (V46T0503A) c. OMS aft fuselage fuel high point bleed line (V43T6238) d. OMS oxidizer high point bleed (V43T6235) e. APU 1 injector water cooling line (V46T0501) f. APU 1 fuel feed line (V46T0104) g. APU 1 fuel pump seal cavity drain line (V46T0186) h. APU 3 pump secondary water line (V46T0394) i. FES port water feed line zone 1 (V63T1870) j. FES starboard water feed line zone 2 (V63T1873)	CLOSED
4	APU 3 lubrication oil gear box outlet temperature (V46T0354) exceeded 350° FDA limit.	CLOSED
5	Right OMS oxidizer quantity read 14 percent high at end of OMS-1 firing. Left OMS oxidizer quantity hung up during OMS-3B firing.	CLOSED
6	MPS engine 2 gaseous hydrogen pressurant pressure (V41P1260A) failed. Temperature (V41T1261A) off-scale high from main engine ignition to MECO.	CLOSED
7	APU 1 outlet and body temperatures above 200° upper limit, outlet (V46T0112) 250°, body (V46T0192) 253°.	CLOSED
8	Fuel cell 1 failure.	CLOSED
9	Fuel cell 2 oxygen flow meter reads off scale high. (V45R0260A)	CLOSED

TABLE 7-I. Continued

No.	Title	Status
10	Low delta pressure (P03P1028) on OSTA pallet pump. Normal 78 psid, read 69 to 71 psid.	CLOSED
11	FES control system "A" inoperative and system "B" erratic.	CLOSED
12	Fuel cell 3 oxygen flow meter erratic (V45T0360A)	CLOSED
13	TV camera "B" overheated.	CLOSED
14	RMS wrist/elbow TV cameras circuit breaker popped. Reset. Popped again.	OPEN
15	Payload bay cameras A, B and C lenses contaminated.	CLOSED
16	RMS shoulder yaw joint could not move in backup mode.	CLOSED
17	Left OMS fuel and oxidizer crossfeed B valves position indications failed.	CLOSED
18	Fuel cell 1 hydrogen flow meter reading low.	CLOSED
19	Thermal protection system debris damage during ascent, entry, and landing.	CLOSED
20	CRT 1 went blank	CLOSED
21	RMS low aft DAC camera indicated no run light.	CLOSED
22	SIR-A reflected power indication is erratic.	Transferred
23	EVCSS water supply pressure transducer (V64P0201) off-scale high.	CLOSED
24	Hydraulic system 1 reservoir quantity dropped 14 percent when landing isolation valve opened. System 3 dropped 6 percent.	CLOSED
25	OEX recorder did not respond to uplink commands.	CLOSED
26	DELETE	
27	Bubbles in potable water.	OPEN
28	WSB 1 ready signal lost after blackout.	CLOSED
29	DELETE	
30	Forward RCS regulator B read high after loading.	CLOSED
31	DELETE	
32	Moisture intrusion in SSME's during entry.	CLOSED

TABLE 7-I. Concluded

No.	Title	Status
33	Entry energy management landing short.	CLOSED
34	Pilot's hand controller +roll trim switch malfunction.	CLOSED
35	8" fill and drain sleeves found loose on both O ₂ and H ₂ sides.	CLOSED
36	Aft RCS tank bulkhead exposed to high ΔP during deservicing.	CLOSED
37	Stowage locker doors did not lock properly.	CLOSED
38	G22 message occurred on -Z Star-tracker. Problem occurred at least two (2) additional times.	CLOSED
39	Salt spray on window observed during initial launch.	CLOSED for STS-3
40	ET attach spacers came loose.	CLOSED
41	Loose transducers on OMS nozzle.	CLOSED
42	Hazardous gas sample detection system did not operate properly except for 2 of 3 bottles on right side.	CLOSED
43	Star tracker cavity discolored.	CLOSED
44	Development flight instrumentation (DFI) measurement discrepancies.	OPEN
45	Descent wing vent duct relief doors opened when wing active vent doors operated normally.	CLOSED
46	RCS vernier thruster F5L exceeded 250° F limit.	CLOSED
47	Theodolite loose within mounting system.	CLOSED
48	Improper duration Range Safety System arm/fire pulses during closed loop test.	CLOSED for STS-3, 4, & 5
49	Cabin odor.	CLOSED
50	PDRS cameras operated at different speeds.	CLOSED
51	IECM battery switched to Orbiter power after rollout.	Transferred

Statement of problem: Auxiliary power units (APU) 1 and 3 lubrication oil outlet pressure was high at 100 to 112 psia. The normal pressure is 50 to 60 psia.

Discussion: During the initial countdown, the outlet oil pressure on APU's 1 and 3 were observed to be at a level of about 100 psi compared to APU 2 which was between 50 and 60 psi. This pressure difference was at the value of the filter bypass relief valve. Following the launch scrub, the oil and filters were replaced and the high-pressure of the lubrication oil was confirmed to be caused by the filter being plugged with pentaerythritol, a crystalline substance that forms when hydrazine penetrates the gearbox. The hydrazine enters the gearbox around the seal between the fuel pump and the gearbox.

The lubrication oil systems will be flushed and the filters changed after each flight. Also, the gearbox pressure will be maintained at a minimum of 5 psi above the seal cavity drain line at all times while the APUs are not operating.

Continuing action will investigate keeping the seal cavity drain line vented and separating the lubrication oil seal leakage from the fuel pump seal leakage.

Conclusions: The hydrazine penetrated the gearbox from the seal cavity drain, and formed contaminants which plugged the filter.

Corrective action: Procedures at KSC have been changed to maintain a positive pressure on the gearbox at all times. The oil has been drained, and the gearboxes flushed and reserviced on all APU's in preparation for STS-3.

APPROVED

A. Cohen



12/23/81

Date

Effect on subsequent missions: NONE

Personnel assigned: Renee J. Lance/EP4; R. J. Ward/WA3

Resolution: CLOSED 12/17/81

Statement of problem: MDM OF3 Secondary Port failed prelaunch.

Discussion: Prelaunch data indicated an MDM failure that was isolated to the OF3 secondary port. The MDM was replaced with an on-site spare, but the spare had a failed power supply. An MDM from OV-099 replaced the spare MDM and there were no MDM failures during flight.

The first failure was in a semiconductor die used in a hybrid component due to "channeling" from impurities within the silicon. This contamination causes a time-dependent degradation that is a function of operating voltage and temperature. The failure is the first one in this lot code die on the MDM program.

The second failure resulted from an internal diode short attributed to a cracked die with probable silver migration. Records indicate a one-time vendor inspection escape prior to encapsulation. This diode is used extensively across the program with no other reported failures.

Conclusions: Two MDM failures during countdown were the result of non-generic component failures. "Channeling" within a semiconductor die used in a hybrid component due to impurities within the silicon caused the first failure. An internal diode short due to a cracked die that escaped detection prior to encapsulation resulted in the second failure.

Corrective action: MDM spares available for installation at KSC will be checked out for each flight starting with STS-3. The problems were one-time non-generic component failures warranting no further action.

APPROVED

Aaron Cohen
A. Cohen

2/9/82
Date

Effect on subsequent missions: None

Personnel assigned: B. Hood/EH7; P. Sollock/EH4; R. J. Ward/WA3

Resolution: CLOSED 02/08/82

Statement of problem: Ten Orbiter heater system thermostats exhibited "dither" during the STS-2 mission.

Discussion: A number of heater system thermostats exhibited dither, an apparent change in set points to a smaller deadband. A bimetallic disc in each thermostat flexes because of temperature changes with a minimum acceptance deadband of 6° F. The discs are sensitive to the rate of change in temperature and may flex only partially at low rates resulting in a reduced deadband. The concern was that dithering at the lower or upper limit of the maximum allowable deadband could potentially result in exceeding limits on systems fluid lines since the heat losses caused by brackets, supports, and couplings required a non-uniform distribution of heater wire and therefore non-uniform temperature distribution.

Postflight analyses have shown that dithering thermostats result in temperatures within the range experienced by the system when the maximum allowable deadband is applied. An evaluation has been performed on all other thermostats to determine whether a temperature limit would be exceeded should dithering occur and in all cases, the temperatures remained within limits.

Conclusions: Dithering thermostats provide acceptable system temperatures.

Corrective action: None

APPROVED

A. Cohen
A. Cohen

1/20/82
Date

Effect on subsequent missions: None

Personnel assigned: J. T. Taylor/ES3, R. J. Ward/WA3

Resolution: CLOSED 01/12/82

Statement of problem: Icing in the water spray boiler 3 inhibited lubrication oil cooling and caused the APU 3 gearbox outlet temperature (V460354) to exceed the 330° F failure detection annunciator limit at 316:15:22 G.m.t.

Discussion: APU 3 was shutdown about 2 minutes earlier than the other 2 APU's at 316:15:23:27 G.m.t., or 13 1/2 minutes after lift-off.

Each of the 3 water spray boilers had a 5 lb preload of water that was added to provide cooling, should a water flow failure occur during the ascent phase.

The water preload covered the lube oil cooling tubes and the spray bars. Rapid boiling of the preload due to decreasing ambient pressure during ascent carried free water overboard and allowed the remaining water to cool very quickly. Once the water was below the lubrication oil tube bundle, water froze on the spray bars. Heat from the boiler tank and tubes thawed the ice in boilers 1 and 2 in seconds on both flights, whereas boiler 3 remained frozen for 1.5 minutes on STS-1 and 17.5 minutes on STS-2 before normal cooling returned. Differences in thaw times may be due to variations in APU heat load, different rates of free water ejection and variations of the ambient pressure profile at the water spray boiler exists.

Analysis has shown that lowering the water preloads will preclude icing, yet will provide adequate cooling capacity for launch should there be a water supply failure to the spray bars.

Conclusions: The lubrication oil overtemperature was caused by a high water preload in the water spray boilers that resulted in excessive water boiloff and thereby cooled the remaining water to the freezing point.

Corrective action: Load STS-3 water spray boilers 1, 2 and 3 with 4 lb, 3 lb and 2 lb of water, respectively.

APPROVED

A. Cohen

 12/23/81
Date

DCJ 12/23/81

Effect on subsequent missions: NONE

Personnel assigned: D. Hyatt/EP4; B. Rosenbaum/EP4; A. Reubens/WA3

Resolution: CLOSED 12/17/81

Statement of problem: Right OMS oxidizer quantity read 14 percent high at end of OMS-1 firing. Left OMS oxidizer quantity hung up during OMS-3B firing.

Discussion: Three areas in which the quantity gages did not perform according to specification were encountered:

The right oxidizer totalizer channel jumped 20 percent 15 seconds into OMS-1 firing and gave erroneously high readings throughout the mission. The reading from the aft probe was also high at the end of mission. Checkout of the right pod totalizer and forward and aft probe electronics modules has been accomplished without finding the problem. Detail troubleshooting of the totalizer was also performed without finding the problem. When the vehicle was powered up in the vertical position, the gage reading corresponded closely with the predictions for propellant remaining. Ground instrumentation will be used for loading. Should the quantity gage continue to be erratic during the flight, prediction techniques using burn times and estimates of RCS usage will be used to determine quantity.

A hang-up in the forward oxidizer probes was observed and this also occurred during STS-1. The hang-up in the forward probes is believed to be due to inadequate drain from the aft support cup. A modification to the totalizer is required to correct this problem.

Hang-up occurred in left fuel probe during OMS-1 and OMS-2. This also occurred on STS-1 in both fuel probes. This hang-up is attributed to inadequate vent area at the top of the probe. The right fuel probe was replaced with one having increased vent area and the problem did not recur.

Conclusions: The specific cause is not known, however the troubleshooting accomplished to date indicates the problem is in either the probe or the probe electronics, both of which are inaccessible.

Corrective action: None. Ground instrumentation will be used for loading. Flight quantities can be determined analytically.

APPROVED

A. Cohen
A. Cohen

2/17/82
Date

Effect on subsequent missions: Loading accuracy is decreased and this will result in additional propellants being loading to account for accuracy loss.

Personnel assigned: R. J. Ward/WA3; C. Humphries/EP2

Resolution: CLOSED for STS-3, 4 and 5 or until such a time as the right-hand OMS pod is removed. 02/16/82

Statement of problem: MPS engine 2 GH₂ pressurant pressure failed. Temperature went off-scale high from main engine ignition to MECO.

Discussion: The pressure transducer (V41P1260A) operates in a vibration environment that is more severe than its qualification level. There is a history of failure on the MPS with this component during MPTA testing and STS-1. The pressure transducer on MPS engine 2 was moved to a less severe location for STS-3.

The temperature transducer (V41T1261A) operates in a vibration environment that is more severe than the qualification level. The transducer was replaced after STS-1 because it failed. During STS-2, the temperature transducer worked prelaunch and after re-entry. During trouble shooting, the transducer, connector, wiring, and the MDM were checked, but the cause of the problem could not be located. An improved design temperature transducer is planned for installation on MPS engine 2 for STS-4 and subs. Vibration levels for qualification testing of the new temperature sensor have been revised from 2000 to 5000 Hz but are still significantly below the 16,000 Hz experienced in flight.

Conclusions: The flight environment for the two transducers is more severe than the qualification level. The pressure transducer has been relocated. The temperature transducer will be flown on STS-3 as is.

Corrective action: The pressure transducer has been relocated for STS-3 and has been checked out on the vehicle.

The temperature transducer will be left as is for STS-3. A new design will be delivered for testing in April 1982.

APPROVED *[Signature]*
A. Cohen

1/27/82

Date

Effect on subsequent missions: None

The temperature transducer is expected to fail during STS-3. A new design should be installed for STS-4 and subs.

Personnel assigned: M. Buchanan/EP2; R. J. Ward/WA3

Resolution: CLOSED 01/27/82

Statement of problem: APU 1 outlet and body temperatures above 200° F upper limit.

Discussion: Cooling system A did not provide cooling to the APU 1 fuel pump and valve. Switching to cooling system B still did not cool the pump and valve. Several pulses were noted at approximately 1 1/2 hours after shutdown.

The failure investigation showed that the water pulse valve operated properly and all lines were clear. The fitting at the APU manifold was found to be badly galled. This galling resulted in a leak path for the water which flashed when exposed to vacuum. This produces a significant heat loss and the freezing of the water in the line. Heat soakback from the APU thawed the water and the valve operated for a short period. Then the phenomenon repeated.

Conclusions: The failure was caused by water freezing in the line because of a leak in a galled fitting which allowed the water to flash when exposed to a vacuum.

Corrective action: The APU side of the galled fitting was removed and replaced during APU replacement. The cooling system side of the fitting was inspected prior to APU installation. The fitting passed a leak check after APU installation. A leak check of this fitting has been implemented for STS-3 and all future change outs. The check will be done by flowing GN₂ at 30 psig through the line and performing a bubble leak check.

APPROVED

[Signature]
1-19-82

Aaron Cohen
A. Cohen

1/20/82
Date

Effect on subsequent missions: NONE

Personnel assigned: R. Lance/EP4, R. J. Ward/WA3

Resolution: CLOSED 01/18/82

Statement of problem: Fuel cell 1 failure

Discussion: Fuel cell 1 indicated "pH High" upon acquisition of signal at 2:27 Mission elapsed time (M.e.t.). However, the performance remained acceptable until 4:45 M.e.t. when a sudden performance loss of 0.75 volt occurred within a 2-minute period, and this is indicative of "flooding" (KOH expulsion) of the power section. The fuel cell was removed from the bus at 4:52 M.e.t. and shutdown at 5:05 M.e.t.; the reactant valves to fuel cell 1 were closed after shutdown. A safing procedure was performed at 7:07 M.e.t. using internal fuel cell 1 heater loads to consume the trapped reactants, and thereby eliminate any possibility of reactant mixing. The remaining fuel cells (2 and 3) satisfied all electrical power requirements thereafter.

Review and analysis of ac bus 1 data showed higher than normal phase-current levels and current fluctuations whenever fuel cell 1 was operating; however, during reactant purges the current returned to normal levels and was steady. This behavior is typical for the presence of water at the hydrogen pump impeller rim and, therefore, indicates hydrogen pump rim aspirator malfunction. This condition was confirmed as having been present during the Sept. 1981 fuel-cell confidence run, the STS-2 launch scrub and STS-2 pre-launch fuel cell operation.

Disassembly of fuel cell 1 at the vendor showed flooding of 4 cells at the inlet end of the cell stack. All 64 cells' magnesium plates were in excellent conditions and no evidence of any power section abnormality was found. The cell reactant ports were not blocked.

(Continued)

Conclusions: The most likely failure scenario was blockage in the aspirator system creating a sufficient pressure imbalance to cause some water to backflow to the pump impeller rim. This produced the observed ac current behavior. The pump began to sling water back into the stack, and the water droplets collected in some of the hydrogen ports of the first 4 cells, thus reducing the hydrogen flow rate through those cells. Since this circulating hydrogen removes the water (as vapor) produced in the cells, the ability to remove water was therefore reduced; the high water production rates concomitant with the ascent electrical loads caused the water to build up in these cells faster than it could be removed. The volumetric capacity of these cells was eventually exceeded, and the KOH - water solution flowed out of the cells into the hydrogen stream, where it was then discharged from the fuel cell, causing the pH sensor to alarm. As the cells continued to lose electrolyte, the performance dropped ~0.75 volt, probably because of the expelled water/KOH solution shorting across one or more of the cells in the hydrogen manifold.

Corrective action: Fuel cell 1 was replaced. All 3 STS-3 fuel cells plus 5 production fuel cells have been inspected for aspirator nozzle blockage. No contamination or corrosion has been found. A fuel cell confidence run is planned for early March. The hydrogen pump ac current data will be carefully reviewed and analyzed during this run and all subsequent fuel cell operations to ensure proper operation.

Signature
2/2/82

APPROVED

Signature
A. Cohen

Signature
2/2/82
Date

Effect on subsequent missions: Long-term corrective action under consideration includes filtration of critical aspirator passages, alternate materials for aspirator nozzles and pump inlet housings, and additional fuel cell instrumentation to provide greater visibility into potential problems.

Personnel assigned: F. Plauche/EP4; R. J. Ward/WA3

Resolution: CLOSED 02/03/82

Discussion - Continued: The accessory section was also found to be normal except for the hydrogen circulating loop that showed extensive evidence of KOH corrosion in the aluminum parts of the system. The hydrogen pump inlet housing, which contains the aspirator nozzles and water discharge valve, was removed and tested with another functional hydrogen pump. These tests showed that the hydrogen pump impeller rim aspirator backflowed water to the pump rim at a rate sufficient to produce the same ac current signature observed prior to the time of failure. Subsequent inspection showed that the pump rim aspirator nozzle was partially plugged. The particle was removed and analyzed and determined to be largely aluminum hydroxide; most of the inner parts of the pump were coated with aluminum hydroxide. The removed particle was very small (<.020" dia.) and, therefore, difficult to analyze. It is possible that the particle was an external contaminant resulting from the manufacturing process. The particle became coated with aluminum hydroxide which was formed by the reaction of KOH with aluminum particles. Efforts are continuing to obtain a positive identification of the core of the particle to enable possible determination of its source for long-term corrective action.

Statement of problem: Fuel cell 2 oxygen flowmeter went to an off-scale high reading.

Discussion: The flowmeter sensor (V45R0260A) indicated an off-scale high reading about 1 hour and 50 minutes into the mission and remained at the upper limit throughout the mission. The oxygen flow meters have a history of marginal accuracy.

Temperature compensation electronics were modified prior to STS-1 and new sensors were installed. The flow meters functioned within specification during the preflight tests for STS-1 and STS-2, but varied from specification during both flights. Flow meters along with the fuel cells were changed out after STS-1. During the STS-2 countdown, the flow meters were again erratic. Extensive evaluation, redesign, and qualification of a new meter system would be required to solve this problem.

The outputs of the flow meters were used by the general purpose computer for automatic fuel cell purge control by monitoring the flow rate to sense that the purge valve had opened or closed. The flow meters could also be used to detect a leak in the fuel cells. Leak detection can also be derived over a longer period of time by monitoring tank consumables.

The minimal operational impact of erratic flow meters does not justify an extensive effort for a new system.

Conclusions: Flow meter was defective.

Corrective action: GPC automatic purge software will be modified to inhibit purge valve open/close checks. The flowmeter is to be reflown.

APPROVED
~~1-11-82~~

A. Cohen
A. Cohen

1/11/82
Date

Effect on subsequent missions: None

Personnel assigned: F. Plauche and F. Balamonte/EP5, R. J. Ward/WA3

Resolution: CLOSED 01/06/82

Statement of problem: Three-Phase Circuit Breaker Indicated Open Circuit on One Phase

Discussion: During STS-2, the OSTA pallet pump circuit breaker (CB16 on Panel MA73C) indicated an open circuit on one phase. During postflight ground checkout, the flight problem was duplicated by cycling the circuit breaker. Additional cycling cleared the problem. All connections to the circuit breaker were verified to be intact before it was removed and replaced. After installation of the new breaker all three phases of the a.c. power were one to two volts low. Subsequent cycling of the new breaker cleared the low voltage problem.

X-rays of the removed breaker showed a slight misalignment of the contacts, but not enough to have caused the problem. Subsequent disassembly did not reveal any major contamination; however, a slight amount of residual solder flux was present on all contacts.

Additional laboratory analysis and tests did not identify a plausible cause for the anomaly.

Crew procedures are being revised to require cycling of the circuit breaker should this problem recur.

Conclusions: Minor solder flux contamination was present on all contacts. Exact cause of failure is not known.

Corrective action: Circuit breaker replaced for STS-3. Crew procedures revised to require cycling of the circuit breaker should this problem recur.

APPROVED *dae*

A. Cohen

Clay McCallum

1/27/82

Date

Effect on subsequent missions: None

Personnel assigned: A. J. Farkas/EH5; D. Suiter/WA3

Resolution: CLOSED 01/26/82

Statement of problem: Flash Evaporator System (FES) Control System "A" Inoperative and System "B" Erratic

Discussion: During ascent following MECO, FES control system "A" shutdown. Manual restart of system "A" by the crew was successful. However, following radiator system activation and payload bay door opening, system "A" topping FES failed to automatically restart from "standby". Manual restart of system "A" was unsuccessful, resulting in activation of control system "B". System "B" operated, but also failed to automatically restart from "standby". Manual restarts by the crew were successful.

Diagnostic tests were conducted to determine FES health for entry. Proper full-up (high load and topping) FES operation on both system "A" and "B" was verified. Proper high load FES operation on the secondary control system (-742) also was demonstrated.

Postflight on-board failure investigations revealed that the control system "A" outlet temperature shutdown sensor had shifted 2°F high and the system "B" midpoint temperature sensor had shifted 1.9°F low. The remaining 7 FES temperature sensors were within specification limits.

Anomalous primary FES controller "A" and "B" operation was the result of temperature sensor drift. The drift in the system "A" outlet sensor can cause a rate shutdown under small heat load transients even if the FES is operating properly. The drift in the "B" midpoint temperature sensor causes the FES to be activated late and depending on the heat load can result in an over-temperature shutdown. The secondary controller has no shutdown provisions.

Conclusions: Anomalous primary controller operation was the result of temperature sensor drift.

Corrective action: The OV-102 FES has been reconfigured electrically by interchanging connectors so that primary FES controllers "A" and "B" use accurate sensors. The secondary controller will use the outlet sensor that drifted for topping evaporator operation and a new replacement sensor for high load operation. The outlet sensor will not be replaced because of reinstallation concerns.

APPROVED

Aaron Cohen
A. Cohen

1/20/82
Date

Effect on subsequent missions: None.

Personnel assigned: A. F. Behrend/EC3; R. J. Ward/WA3

Resolution: CLOSED 1/15/82

Statement of problem: Fuel cell 3 oxygen flowmeter operation was erratic.

Discussion: The flowmeter reading (V45R0360A) was erratic from 22 hours 40 minutes into the mission through the end of the mission. The oxygen flowmeters have a history of marginal accuracy. See problem number 9. Extensive evaluation, redesign, and qualifications would be required for a new system.

The flow meters were used to sense that the purge valve had opened or closed during GPC automatic purge. The meters can also be used for leak detection.

The minimal operational impact of erratic flow meters does not justify an extensive effort for a new system.

Conclusions: Flow meter was defective.

Corrective action: GPC automatic purge software will be modified to inhibit purge valve open/close checks. The flowmeter is to be reflown.

APPROVED
RCB
1-11-82

A. Cohen
A. Cohen

1/11/82
Date

Effect on subsequent missions: None

Personnel assigned: F. Plauche and F. Balamonte/EP5, R. J. Ward/WA3

Resolution: CLOSED 01/06/82

Statement of problem: CCTV camera B, located on aft/port bulkhead, overheated during Day 2 operation.

Discussion: During a TV pass, TV camera B reached a temperature of 45° C. Ground control advised the crew to turn the camera off.

Post-mission evaluation of on-board video tapes show that all payload bay/RMS TV cameras were operated continuously for 4.5 hours during the Day 2 RMS activities. The temperature data from the video tapes show that each payload bay camera started at approximately 10° C when turned on and then gradually increased to the 43 to 45° C range after 4.5 hours of operation. Later mission operation and post-mission ground tests demonstrated proper operation of each TV camera.

Post-mission tests show that with the STS-2 payload bay orientation, the bulkhead TV cameras will normally reach a 45° C temperature after 4.5 hours operation.

Conclusions: With the payload bay orientation of STS-2, the bulkhead TV cameras will normally reach 45° C after 4.5 hours of operation. There was no anomalies conditions within the CCTV hardware.

Corrective action: Restrict the planned TV camera operating time as required based on the mission thermal profile.

WAZ

 APPROVED

 A. Cohen

1/13/82
 Date

Effect on subsequent missions: None

Personnel assigned: R. Edmiston/EE2, R. J. Ward/WA3

Resolution: CLOSED 01/12/82

Statement of problem: The RMS wrist/elbow circuit breaker opened.

Discussion: During a TV telecast on day-2 RMS operations, the RMS wrist/elbow TV camera circuit breaker opened. Resetting the breaker did not resolve the problem. Troubleshooting isolated the problem to excessive current draw by the elbow TV camera. The camera was removed and returned to the vendor where the problem has been isolated to the power supply. Analysis of the specific failure cause is in process.

Conclusions: Problem has been isolated to a power supply in the wrist elbow TV camera.

Corrective action: TV camera has been replaced.

APPROVED

A. Cohen

Date

Effect on subsequent missions: None

Personnel assigned: R. Edministon/EE2

Resolution: OPEN

Statement of problem: Payload bay CCTV cameras A, B, and C experienced lens contamination during the mission.

Discussion: During Day 2 TV operations, payload bay bulkhead camera A, B, and C demonstrated "out-of-focus" video. Post-mission investigation determined the anomalous condition to be caused by oily deposits within the lens assemblies. Chemical analysis of the oil led to the determination that the lens manufacturer had added oil to the lens assembly during manufacturing. The thermal characteristics resulted in the oil vaporizing and depositing on the glass elements, thereby degrading the optical image presented to the TV camera.

Conclusions: The degraded video was caused by outgassing of oil added to the lens assemblies by the manufacturer.

Corrective action: Lens assemblies were cleaned.

APPROVED

A. Cohen
1/12/82
Date

Effect on subsequent missions: None

Personnel assigned: R. Edmiston/EE2, R. J. Ward/WA3

Resolution: CLOSED 01/12/82

Statement of problem: RMS shoulder yaw joint could not move in backup mode.

Discussion: Postflight inspection of a cable installed between the remote manipulator system (RMS) display and control panel and the Orbiter wiring leading to the RMS shoulder showed that the wire to pin 5 was not connected. Four other wires were removed and pull-tested. Each wire failed in tension within 11.2 and 12.2 pounds force (specification: 8.0 pounds minimum). All five wires were inspected using a stereo microscope and a scanning electron microscope (SEM). Results of this inspection indicated that the wire to pin 5 failed due to excessive tensile loads. The inspection eliminated fatigue as a cause as well as crimp damage, although some evidence of crimp damage to 5 strands of the 19-strand wire was present. In any event, the 14 remaining strands should have provided adequate strength for normal handling loads. The 5 wires have been repaired and tested.

Review of the work activity at KSC indicates that the display and controls panel was pulled forward to allow access to the RMS rotational hand controller after the RMS V1110 test sequence. Based on the inspection and pull test results, the most likely cause is considered to be excessive loads imposed on the cable during ground handling operations. Low-fidelity mock-up studies indicate that some handling stress is to be expected and that a longer cable length may help alleviate the load.

Conclusions: The broken cable was caused by excessive loads during ground handling activities.

Corrective action: The cable has been repaired and reverified.

Consideration is being given to lengthening the cable, changing wire materials and tethering the midpoint of the cable to reduce the chance of wire damage on future vehicles.

PK

 DM
 1/12/82
 SC
 1/12/82

 APPROVED Aaron Cohen 1/12/82
 A. Cohen Date

Effect on subsequent missions: None

Personnel assigned: J. Peck/MP, R. J. Ward/WA3

Resolution: CLOSED 01/12/82

Statement of problem: Left OMS crossfeed B valves position indicators failed.

Discussion: At 317:20:14:30 G.m.t., the telemetered close valve position indicators (VPI) on the left pod B leg crossfeed valves went to zero (indicating not closed). The telemetered open valve indicators continued to read not open, with the cockpit switch in the manual position and the crew talkback correctly read valves closed. When the close position indicators went to zero, power was applied to the valves through the motor control assembly. Power was removed by having the crew place the cockpit switch to GPC position. Inspection and test at KSC could not duplicate the flight anomaly. Both valves were cycled and the valve position indicators worked properly. Wiring that was accessible at the time of the inspection was wiggled in an attempt to isolate any loose wires without success.

The valves can be cycled manually or in GPC and the crew read-out of the valve position indicators are working properly. Since crew procedure changes are being implemented to prevent continuous power application to the valves, no further action is planned.

Conclusions: An intermittent on the telemetered close-valve position indicators of the Left OMS crossfeed B valves caused continuous power application to the valves.

Corrective action: Crew procedure change is being implemented requiring crew to place Left OMS crossfeed B valve switch in the GPC position after every valve configuration change to prevent continuous power application to valve.

APPROVED

A. Cohen
A. Cohen

1/11/82
Date

Effect on subsequent missions: None

Personnel assigned: W. Boyd/EP2, R. J. Ward/WA3

Resolution: CLOSED 01/12/82

Statement of problem: Fuel cell 1 hydrogen flow meter read low.

Discussion: The flowmeter reading (V45R0170A) started reading low during STS-2 countdown and read about 25 percent low throughout the mission.

The flow meters have a history of marginal accuracy. See problem numbers 9 and 12. Extensive evaluation, redesign, and qualification would be required for a new system.

The flow meters were used to sense that the purge valve had opened or closed during GPC automatic purge. The meters can also be used for leak detection.

The minimal operational impact of erratic flow meters does not justify an extensive effort for a new system.

Conclusions: Flow meter was defective.

Corrective action: GPC automatic purge software will be modified to inhibit purge valve open/close checks. Flow meter replaced because of replacement of fuel cell 1.

APPROVED

REB
1-11-82

A. Cohen
A. Cohen

1/11/82
Date

Effect on subsequent missions: None

Personnel assigned: F. Plauche and F. Baïamonte/EP5, R. J. Ward/WA3

Resolution: CLOSED 01/06/82

Statement of problem: Debris damaged the thermal protection system during ascent, entry, and landing.

Discussion: Minor damage occurred at several locations on the thermal protection system (TPS). Damage was slightly less than on STS-1. Minor coating damage occurred to two tiles aft of the left ET door. This is assumed to be caused by baggy cord impact during ascent, or by ascent debris impact damage. The right ET door used clips for baggy attachment rather than cord and no damage occurred.

Minor damage occurred to 9 tiles behind the left main landing gear (LMLG) and 4 tiles behind the RMLG resulting from impact of instrumentation wires that disconnected from the main landing gears during landing.

The surface coating of 12 tiles on the body flap bubbled during entry probably due to moisture entrapped under the surface.

Six (6) tiles on the surface wing glove/fuselage chine had partial in-plane fracture of their outer portions. These fractures have been proven to be the result of entrapped water (ice after ascent) which, when subjected to temperatures below -90° F during orbit, contracted and partially fractured the RSI fibers in-plane at the interface between the un-waterproofed and waterproofed tile material. The heat of re-entry generated steam pressure from the interior ice causing completion of the in-plane fracture. This occurred early in re-entry as evidenced by shrinkage of tile material along the downstream (relative to entry flow) edge of each cavity. Testing and analysis indicate that the only Orbiter region cold enough to damage the tile interior during STS-2 was the right glove. All of the tile sidewalls in this area were inspected with the result that 10 fractured tiles were replaced. An improved post-flight water repellant treatment was applied to the exposed tile surfaces prior to STS-3 roll-out.

Conclusions: Two tiles aft of the left ET door were damaged probably by the baggy cord. Loose MLG instrumentating wiring damaged 13 tiles behind the MLGs. The surface coating of 12 tiles on the body flap bubbled during entry probably due to entrapped water which also fractured 10 tiles on the right wing glove/fuselage chine.

Corrective action:

The left ET door baggy attachment was changed to utilize clips. Redesign of MLG instrumentation wiring installation has been incorporated for STS-3. The damaged tiles on the body flap and right wing glove were replaced. Sidewall inspection cleared the wing glove region for flight. Improved water repellant was applied before rollout.

APPROVED
2/25/82

A. Cohen
A. Cohen

2/9/82
Date

Effect on subsequent missions: None

Personnel assigned: J. A. Smith, R. Dotts/ES3; R. J. Ward/WA3

Resolution: CLOSED 02/03/82

Statement of problem: Display Unit CRT 1 went blank.

Discussion: DU (display unit) 1 CRT (cathode ray tube) went blank during on-orbit operations. Recycling power did not resolve the problem. The unit was removed in flight and replaced by the DU from the aft station. This unit operated for the remainder of the mission, but it also went blank after prime crew egress.

The first failure was an internal short in a deflection amplifier power transistor due to particulate contamination from weld splash during the capping operation on the transistors. Transistors will now be Particle Induced Noise Detection (PIND) tested for contamination. Zero-g usage on STS-1 and 2 provides an acceptable screen for the two CRTs that were not replaced.

The second failure resulted from internal arcing in the high voltage power supply. Additional in-process inspection and burn-in was implemented together with an in-process corona screen during early build.

Conclusions: Two display unit failures in the DU 1 slot during and after STS-2 were the result of two different component failures. Particle contamination from weld splash during the capping operation on a power transistor caused the first failure. Corona in the high voltage power supply failed the replacement unit.

Corrective action: Power transistors were PIND tested and high voltage power supplies were corona screened for replacement display units in slots 1 and 4 on STS-3. All future units will be PIND tested and corona screened. Tested and screened spare units will be available for installation prior to STS-3 launch.

APPROVED *Aaron Cohen*
~~2/8-19/82~~ A. Cohen

2/9/82
Date

Effect on subsequent missions: None

Personnel assigned: B. Hood/EH7; P. Sollock/EH4; R. J. Ward/WA3

Resolution: CLOSED 02/08/82

Statement of problem: Run light for low aft data acquisition camera did not operate.

Discussion: The non-operating run light indicated that the camera was not operating. Post-flight investigation revealed a blown fuse. The fuse was replaced and operation was attempted. The camera motor would operate, but the gear train would not. The clutch was slipping, indicating a mechanical hang-up in the gear train. The camera covers were removed and the gear train was examined. A small piece of lacing cord was found under the bevel gears at the front end of the drive shaft. The piece of cord had become entangled in the gears causing them to bind and overload the motor.

Conclusions: A piece of lacing cord left from camera wiring mods became entangled in the bevel gears causing a motor overload and blowing the fuse.

Corrective action: The camera was cleaned and all particles removed. The other cameras are being examined for similar conditions and will be cleaned of any particles prior to re-flight.

APPROVED

~~RET~~
1-11-82

A. Cohen

1/11/82
Date

Effect on subsequent missions: None

Personnel assigned: H. D. Yeates/ED24, R. J. Ward/WA3

Resolution: CLOSED 01/05/82

Statement of problem: Pressure transducer, located in water line to airlock, failed to off-scale high.

Discussion: Pressure transducer V64P0201, located on the extravehicular cooling and servicing system water supply, failed off-scale high. The failure occurred at the beginning of a supply water dump when the water pressure normally drops about 5 psig.

Conclusions: Pressure transducer failure.

Corrective action: Transducer has been removed and replaced.

APPROVED
~~XXX~~
1-19-82

Aaron Cohen
A. Cohen

1/20/82
Date

Effect on subsequent missions: None

Personnel assigned: F. Samonski/EC3; R. J. Ward/WA3

Resolution: CLOSED 01/15/82

Statement of problem: The hydraulic reservoir 1 fluid level dropped 14 percent and the reservoir 3 level dropped 6 percent when the landing gear isolation valves were opened for gear deployment. Following deployment, volumes decreased uniformly at a rate of about 6 percent/minute (approx. 5 gpm).

Discussion: The landing gear hydraulic circuit is isolated early in the Orbiter Processing Facility (OPF) turnaround activities and the isolation valves remain closed until late in the entry operations. The return lines are isolated with a check valve to reduce the risk of fluid loss.

A compressibility test early in the STS-1 turnaround operations showed that no voids existed in the system. An inspection after STS-2 showed no evidence of external leakage and a compressibility test showed no voids.

When the Orbiter is raised to the vertical position, the resulting head pressure in the landing gear circuit requires a reservoir pressure of at least 40 psi to prevent fluid drain back from the nose gear lines. Additionally, the GSE is located about 60 ft below the reservoirs and if the back pressure drops below the minimum allowable value, portions of the fluid in the landing gear lines could drain back into either the flight or GSE reservoirs. Further, the check valves will prevent the voids caused by drain back from refilling until the isolation valves are opened during the entry phase of the next mission, at which time the return flow from the brake servos will slowly fill the voids. The landing gear lines can accommodate the observed reservoir volume drops. Also, the brake servos flow rates are in the range of the observed volume decrease rates. Finally, several normally static return-line temperature sensors showed increased values coincident with the flow of warmer fluid in to the voids.

Conclusions: The noted decreases in reservoir fluid volume resulted from filling the voids in the landing gear circuit. These voids were probably caused by a momentary drop in back pressure when performing hydraulic operations during the turnaround activities.

Corrective action: The KSC procedures will be modified to require a short period (momentary) opening of all three landing gear isolation valves during the final servicing. This momentary opening will refill any existing voids.

APPROVED

Sidney C. Jones
for A. Cohen

12/14/81

Effect on subsequent missions: This change is effective on STS-3 and subsequent.

Personnel assigned: C. D. Haines/EP4, R. J. Ward/WA3

Resolution: CLOSED 12/15/81

Statement of problem: OEX recorder did not respond to uplink commands.

Discussion: During the orbit prior to entry, the OEX recorder was running while it was in the standby mode. The recorder did not run during entry. Telemetry indicated that the tape was completely rewound onto the supply reel. Postflight data processing verified satisfactory recorder performance through the last on-orbit recording period with ACIP operation during the vernier RCS vehicle control mode.

Troubleshooting found the flat Kapton belt (0.005" thick, 0.312" wide, and 19.7" long) that connects the intermediate (jack) pulley to the take-up reel pulley had broken. After loss of tension by the take-up reel, the supply reel pulled the tape in reverse while the recorder was in standby.

The belt failure was caused by the wrinkling or "scalloping" of the belt which was evident along the entire length of one edge. The belt mis-tracked on the driving pulley becoming scalloped when it rode hard against the pulley flange. Mis-tracking was most probably caused by residual stresses or belt asymmetry which was induced during the manufacturing process.

Conclusions: The belt on the take-up reel broke before entry after becoming scalloped due to mis-tracking that was probably caused by residual stresses or belt asymmetry. Loss of ACIP data during entry reduced the accuracy of extracted aerodynamic coefficients.

Corrective action: Replaced take-up jack pulley, cleaned all pulley faces and replaced all seven belts after screening for asymmetry, residual stresses, surface cracks, or edge nicks. Verified proper belt tracking after installation and after 50 hours of recorder operating time.

APPROVED

A. Cohen
A. Cohen

1/20/82
Date

Effect on subsequent missions: Subsequent flights will require maneuvers to gather aerodynamic data to clear the c.g. envelope.

Personnel assigned: R. L. Giescke/ED5; R. J. Ward/WA3

Resolution: CLOSED 01/19/82

Statement of problem: The crew observed excessive gas in the drinking water.

Discussion: Postflight analysis of the drinking water bags showed that 35 percent of the volume was gas of which .3 percent was hydrogen and the remainder air. As a result of the fuel cell 1 problem, tank A, which maintains a 30 to 35 psi head on the H₂ separator and the water gun, was isolated. This resulted in the water gun not operating with a normal 15 psid. It is believed that this reduced pressure lowered the efficiency of the hydrogen separator due to lower partial pressure differences. More significantly, this resulted in the drinking water bags being filled at a very slow rate. Although the specific mechanism which introduced air into the drinking bags is not known, the cause of the problem is considered to be the low pressure.

Conclusions: Problem was caused by low pressure on the H₂ separator and the water gun which resulted in excessive air in the drinking bags.

Corrective action: Malfunction procedures have been modified to reconfigure the system to provide a 30 to 35 psia pressure head should a fuel cell problem recur.

scj
2/2/82
APPROVED

Aaron Cohen
A. Cohen

2/2/82
Date

Effect on subsequent missions: None

Personnel assigned: H. Rotter/EC3

Resolution: CLOSED 02/03/82

Statement of problem: Water Spray Boiler (WSB), System 1, "Ready" Signal Lost After Blackout.

Discussion: Water spray boiler (WSB) 1 "Ready" signal was off from 318:21:14 to 318:21:30 G.m.t. during STS-2 descent. This was caused by an anomalous "bypass" indication on the hydraulic bypass valve when the hydraulic fluid temperature was such that the valve should have been in the "heat exchanger" position. Other data indicate that the valve itself functioned properly and the WSB performed satisfactorily throughout the flight.

Postflight testing demonstrated that the bypass valve, ready indication and output signal all were functioning properly.

WSB controller qualification testing demonstrated that the output signal from the "Ready" indicator is on the low end of the MDM requirement when the controller operates at the low voltage limit. A controller modification planned for STS-5 or at any earlier controller replacement will correct the marginal output signal from the WSB "Ready" indicator.

Conclusions: "Ready" signal was lost as a result of a spurious indication during descent from the hydraulic bypass valve due to a marginal output signal to the MDM. The WSB performed satisfactorily during flight. The "Ready" signal is used as information for APU start only and is not an interlock.

Corrective action: Postflight testing demonstrated proper WSB functioning. Modified controllers will be installed on STS-5 or at any earlier controller replacement correcting the marginal output signal from the WSB "Ready" indicator.

APPROVED

1-27-82

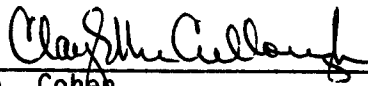
A. Cohen

1/27/82

Date

Effect on subsequent missions: None. Loss of WSB 1 "Ready" signal may occur on STS-3 and STS-4.

Personnel assigned: J. Wiltz, D. Hyatt/EP4; R. J. Ward/WA3

Resolution: CLOSED 01/27/82

Statement of problem: Forward RCS B leg oxidizer regulator high lockup pressure.

Discussion: The forward RCS oxidizer regulator overshot the maximum specification value of 268 psia (ambient reference) during helium loading prior to STS-2. The maximum specification value was exceeded when the regulators locked up at 274 to 276 psia as measured on the flight instrumentation. Subsequent cooldown of the RCS ullage indicated the regulators flowed at about 271 psia. The flight data indicated that the regulator lockup was 255 psia (253 psia maximum specification with vacuum reference) with both the A and B regulators on line as they had been during the prelaunch period. However, when the B Leg was closed, the lockup dropped off the normal range (about 250 psia). This indicated that the B Leg regulator had a high lockup pressure. Postflight checkout was performed on the B Leg regulator primary and secondary stages. Both stages locked up at the upper specification limit and no flow or leakage anomalies were observed. The lockup pressure of the primary stage was 268 psia measured by ground Hiese gage and 269 psia as measured by the flight instrumentation. At least part of the overshoot may be accounted for by the flight transducer reading.

Conclusions: The B Leg oxidizer regulator experienced a slightly high lockup pressure before STS-2 and during the initial flight phase. Postflight checkout revealed no problem with the regulator. The slight overshoot is not detrimental to system operation.

Corrective action: None

APPROVED
~~1-15-82~~

Aaron Cohen
A. Cohen

1/20/82
Date

Effect on subsequent missions: None

Personnel assigned: R. Blevins/EP4; R. J. Ward/WA3

Resolution: CLOSED 01/18/82

Statement of problem: Moisture intrusion in SSME's during entry.

Discussion: LPS commands latent in the MDMs opened the MPS helium isolation valves when the flight crew put the valve switches in "GPC" position during the MPS entry purge prep procedure. To control the resultant helium leakage through the SSME's, the flight crew closed the MPS LO₂ prevalues, preventing the LO₂ system entry purge. After landing, the prevalues were opened to allow residual helium to purge the LO₂ system. Because of the lack of an LO₂ entry purge, there was concern that moisture may have entered the LO₂ system. However, postflight dew point data confirmed that moisture level was acceptable.

The helium valve LPS command was retained in the MDMs from prelaunch because the open command was not terminated by the LPS or the flight software. The LPS will reset the helium system command prior to launch for STS-3 and subs. All other LPS commands were verified to be left in the proper state for left off. A flight software change is in process which will terminate the open commands upon transition to OPS 2. MPS entry helium purge was initiated manually by the crew on STS-1.

Conclusions: A latent LPS command in the MDMs opened the MPS helium isolation valves when the "GPC" valve position was selected during the MPS entry purge.

Corrective action: LPS commands will be reset and left in the proper state prior to lift off for STS-3 and subs. A modification to flight software is being considered for future flights.

APPROVED

Ray McCallough
for A. Cohen

1/27/82

Date

Effect on subsequent missions: None

Personnel assigned: D. Prevett/EP2; R. J. Ward/WA3

Resolution: CLOSED 01/26/82

Statement of problem: Entry energy management landing short.

Discussion: The Orbiter touched down about 800 ft past the threshold of the runway at 197 knots equivalent air speed. The touchdown point was approximately 3300 feet short of the premission prediction. Postflight analysis incorporating Rawinsonde wind and atmospheric density measurements, LIDAR wind data, estimated weight, and onboard state vectors explained this deviation to within 200 feet. Low energy at TAEM/autoland interface and a 25-knot headwind were the largest contributors to landing short. Except for some indication that the vehicle accelerated on the steep glide slope faster than the post STS-1 aerodynamics predicted; postflight analysis provided a satisfactory explanation for the short touchdown point on STS-2. Minor adjustments have been made to the C_L and C_D in the aerodynamic data base.

Conclusions: Postflight analysis, incorporating revised input data within low energy at TAEM/autoland interface and a 25-knot headwind, accounted for all but 200 feet of the 3300 feet that STS-2 touchdown was short of the preflight prediction.

Corrective action: Aerodynamic data base being revised to reflect STS-2 results. SMS and Shuttle training aircraft to include revised data base. Nominal outer glide slope aimpoint and inner glide slope aimpoint were moved 1000 feet and 500 feet, respectively, closer to the threshold.

APPROVED
R.S. 2/9/82

A. Cohen
A. Cohen

2/9/82
Date

Effect on subsequent missions: None

Personnel assigned: L. Hayman/EX3; J. West/FM4; R. J. Ward/WA3

Resolution: CLOSED 02/05/82

Statement of problem: Pilot's hand controller plus (+) roll trim switch malfunction.

Discussion: The pilot's plus (+) roll trim function (channel B) was intermittent during rotational hand controller (RHC) trim switch operation on orbit and at rollout. The plus roll channel 1 versus 2 miscompare was duplicated by postflight troubleshooting when a pitch deflection was introduced during roll trim.

The cause of the intermittent was a broken wire in a cable in the pilot's RHC. The broken wire was the result of localized stress introduced in the conductor during the manufacturing process at the supplier of the cable. No other wire in the cable was damaged. Detail inspection of the wiring stock and the manufacturing process did not reveal any other damage in wires.

Conclusions: A wire broke in a cable due to localized stress induced during the cable manufacturing process.

Corrective action: The pilot's RHC was removed, replaced and tested for proper operation. The onboard rotational hand controllers are acceptable for flight based on the existing qualification test data and the successful completion of additional life cycle tests (4500 cycles in each axis) performed in all 3 axes on a controller.

APPROVED

A. Cohen

R 1/24/82

Date

Effect on subsequent missions: None

Personnel assigned: B. Hood/EH7; J. Lewis/EH6; R. J. Ward/WA3

Resolution: CLOSED 02/05/82

Statement of problem: Following the STS-2 landing, an inspection showed that both the T-0 LO₂ and LH₂ 8-in fill and drain disconnect interface-seal-insert assemblies were loose.

Discussion: After OV-102 was returned to KSC following STS-2, the torque values for the 12 fastener bolts on the interface-seal-insert assemblies were between 1 and 2 in-lb compared with the required value of 32 in-lb. Installation procedures were reviewed and an evaluation showed that the fastener bolts required torquing to 32 in-lb between 6 and 12 times and in a specific pattern to insure that the bolts would not relax after installation. Also, the installation and removal of the GSE leakage pressure plate would cause the torqued insert fastener bolts to relax.

Conclusions: The installation procedure was not adequate to maintain proper bolt torque values.

Corrective action: The installation procedure has been rewritten, and the bolt torque values will be verified.

APPROVED

A. Cohen

12/16/81

Effect on subsequent missions: This change is effective on STS-3 and subsequent.

Personnel assigned: M. Buchanan/EP2, R. J. Ward/WA3

Resolution: CLOSED 12/15/81

Statement of problem: Aft RCS Propellant Tanks Exposed to Pressure Surges During Deservicing.

Discussion: The aft RCS propellant tanks were exposed on two occasions to a back-pressure surge that could have damaged the tank bulkheads or entry sumps. The incidents occurred when the tanks were at 80 psia pad pressure and the manifolds were at 250 psia GN₂ pressure. The RCS tanks had been drained to minimum residuals. During Incident 1, the 1/2 tank isolation valves were opened on the left band pod and the fuel tank was exposed to a surge. During Incident 2, the left and right oxidizer and fuel tanks were exposed because of an open crossfeed valve to surges when the 3/4/5A tank isolation valves were opened because of an error in the power up switch list. Tests were performed on the aft RCS qual test article to simulate the incidents that occurred on the fuel and oxidizer tanks. No damage occurred and therefore the orbiter tanks were considered acceptable for flight.

Conclusions: The OV 102 tank were not damaged by the pressure surge incidents during deservicing.

Corrective action: Deservicing procedures are being modified to preclude over pressurization of the tanks.

APPROVED

SC
2/2/82

A. Cohen

2/2/82

Date

Effect on subsequent missions: None

Personnel assigned: R. Blevins/EP4; R. J. Ward/WA3

Resolution: CLOSED 02/03/82

Statement of problem: Eight Middeck Modular Stowage Locker Doors did not close properly.

Discussion: The crew indicated that several middeck stowage locker doors did not close and lock properly. This condition also occurred on STS-1 and some of the lockers were reshimmed as a result. The doors operated and mated properly during postflight troubleshooting. The cause of the problem is believed to be the pressurized cabin distortion which causes the stowage locker doors to become misaligned with the locking fasteners.

Conclusions: The middeck modular stowage lockers were distorted by vehicle structural movement in flight since the supporting structures deforms when the cabin is pressurized.

Corrective action: Rework of the modular locker door fasteners will increase the "float" tolerance of the mating halves of the door-to-frame fastener, allowing for locker distortion and misaligned fasteners. The leading edge of the frame half of the fasteners was increased to allow thread alignment prior to engagement. Also, the Orbiter wire trays were shimmed for improved inflight locker door operation. Should the problem recur inflight, the 8 in. punch will be used to pry the doors into proper alignment to permit closure.

APPROVED *[Signature]* 1/26/82
~~RSB~~ A. Cohen Date
 1-26-82

Effect on subsequent missions: None

Personnel assigned: F. McAllister/EC3; R. J. Ward/WA3

Resolution: CLOSED 01/25/82

Statement of problem: G22 star tracker alarms on -Z star tracker.

Discussion: The -Z Star Tracker (ST) detected several improperly formed incoming command words and issued transmission error bits resulting in the annunciation of three "G22 Star TRKR" alarms. During each inertial measurement unit (IMU)/Star Tracker alignment, several Manchester Not Valid (MNV) error bits were issued, and during 3 of the alignment periods, these error bits were seen by the Fault Detection System and annunciated. The Fault Detection System samples the Star Tracker register every 960 milliseconds while the star tracker samples the Manchester code error bits every 160 milliseconds. Several Bit Count Error (CBCE) and Parity Error (PE) bits also were seen in the -Z ST data while turned off. In addition, approximately 50 BCE, MNV and PE error bits were seen in the -Z data during the 17-minute interval from 318:00:05 to 318:00:22 G.m.t. while the -Z star tracker was turned off. Significantly, the only Y star tracker transmission errors were also seen during this period although the Y star tracker was operated during the entire 51 hours on orbit.

Transmission error bits are being generated in the GPC/MDM/ST/MDM/GPC PCM loop with the Z star tracker both on and off. Since the command word is repeated continuously, there is no impact to the star tracker performance.

Conclusions: Transmission error bits are being generated in the PCM loop with the Z star tracker both on and off. These error bits are not a problem for star tracker operation.

Corrective action: Software has been changed to remove the "G22 Star TRKR" alarm. STS-3 data will be reviewed to determine if any further action is required.

APPROVED

DAW
A. Cohen

Clay McCallough

1/27/82
Date

Effect on subsequent missions: None

Personnel assigned: M. Biggs/EH6; R. J. Ward/WA3

Resolution: CLOSED 01/27/82

Statement of problem: The visibility through the Orbiter windows was marginal for the first launch attempt.

Discussion: The crew reported that the salt spray was heavy on the Orbiter windows and that condition would have resulted in marginal visibility had an RTLS abort been necessary. The windows were cleaned after the initial launch attempt and had acceptable visibility for the STS-2 flight.

A design change is in process of development which provides for a boom attached to the Orbiter access arm with pull off window covers. Development of this system will not be available until STS-5.

Conclusions: Visibility through the Orbiter windows was degraded because of the salt spray.

Corrective action: For STS-3 and 4, window covers for the Orbiter forward windows will be installed while the Orbiter is on the pad and will be removed as late as is practical in the launch countdown.

Design change is being developed for pull-away window covers for STS-4 and subsequent.

APPROVED *Aaron Cohen*
 R.B. A. Cohen
 2/10/82

2/19/82
 Date

Effect on subsequent missions:

Personnel assigned: W. Riles/LG; P. Deans/ME

Resolution: CLOSED for STS-3 and 4 2/10/82

Statement of problem: External tank attach spacers came loose.

Discussion: External tank (ET) separation films showed the left-hand aft structural attachment spacer coming out. The right-hand spacer was found loose during postflight inspection when the ET door was opened.

The spacer or insert is normally held inside the Orbiter socket fitting by spring retainers after tank separation. No problem was encountered on STS-1. The hardware was successfully tested during four separation certification tests before STS-1 and reflown on STS-2.

From 5 to 10 pounds of force is required to pull out the spacer, depending on the condition of the retention hardware and the force direction. Retention of the insert is required to minimize debris at separation.

Spacers, retention hardware, aft attachment bolts and base assemblies were inspected postflight and no problem was identified. Pull tests on the retention springs demonstrated acceptable performance. Improper spring installation could reduce retention capability. The STS-3 installation will be verified by inspection.

Conclusions: Retention hardware allowed the ET attachment spacers to come loose. Spring force could be marginal, retention hardware may not be reusable or retention springs may have been installed improperly.

Corrective action: The retention hardware and aft attachment bolts were replaced for STS-3. An improved retention design is being considered.

APPROVED *Clay McCallough* 1/27/82
RJD A. Coher Date
 1-27-82

Effect on subsequent missions: Retention hardware will be replaced and inspected after STS-3. Considering design change for STS-4 and subs.

Personnel assigned: W. F. Rogers/EW3; R. J. Ward/WA3

Resolution: CLOSED 01/25/82

Statement of problem: OMS engine nozzle thermocouple wiring loose.

Discussion: Postflight inspection revealed that two of the clips connecting the wiring for nozzle outboard lip temperature (V43T9112A) to the left engine nozzle had debonded. A similar problem was encountered during STS-1, and a new nozzle and thermocouples were used for STS-2. The data from the STS-2 flight has been reviewed and the loose wiring had little effect on the temperature measurements. The data from both nozzle lip temperatures located 90° apart on the left OMS engine have been verified good.

DFI data obtained on STS-2 is adequate to evaluate OMS engine nozzle thermal characteristics without the nozzle outboard lip temperature data from STS-3 and 4.

Conclusions: Adequate data have been obtained from the STS-1 and -2 flights, and therefore, the measurement is not required for future flights.

Corrective action: The lead wire to the nozzle lip temperature thermocouple will be cut and removed. A metallurgical inspection has been performed on the area where the clip debonded. This inspection will be continued for STS-3 and subs.

APPROVED

RED
1-13-82
A. Cohen1/13/82
Date

Effect on subsequent missions: None

Personnel assigned: W. Boyd/EP2, R. J. Ward/WA3

Resolution: CLOSED 01/12/82

FLIGHT TEST PROBLEM REPORT

NO. 42

Statement of problem: The hazardous gas sample detection system on STS-2 did not operate properly except for 2 of 3 bottles on the right side.

Discussion: Two failures were found during postflight inspection and troubleshooting.

During sample recovery procedures, the sample bottle for sample SN-1028 (right side position 6) was found full of ambient air. Further inspection found a broken glass seal on the vacuum gage tube which accounts for the air in the bottle. Preflight vacuum checks at the time of system installation showed no problem. This failure has not occurred during qualification tests and pyro firing tests. Flight level vibration tests have been run with the left hand sampling system and no glass seal failures occurred. The exact cause of the failure is unknown.

Postflight, it was found that the valve pyros in the left-hand system did not fire and the pyro timing circuit battery was discharged. A short to ground was found in the power wire of the microphone which initiates the pyro timing sequence. The short was due to insulation damage caused by an improper junction technique used to ground the braided shield of the microphone wire.

Conclusions: The most likely cause of the glass seal fracture in the right-hand gas sampler system is a manufacturing flaw.

The failure of the left-hand gas sampler to sequence was a discharged battery caused by a short to ground in the microphone cable.

Corrective action: The failed gas sampler units have been replaced. Microphone cable braided shield ground connections for all gas sampler units will be repaired.

APPROVED
A.C.S.
2-16-82

Aaron Cohen
A. Cohen

2/17/82
Date

Effect on subsequent missions: None

Personnel assigned: C. Walsh/WC; J. Chandler

Resolution: CLOSED 02/12/82

Statement of problem: Discoloration found in star tracker cavity on thermal blankets, after STS-2.

Discussion: Postflight inspection showed that portions of the white thermal blankets in the star tracker cavity had a yellowish-brown color.

Inspections of star tracker eyelid doors indicated that they were properly closed and sealed during reentry. Additionally, the star tracker cavity temperatures during entry did not exceed 85° F.

No evidence of light shade optical degradation was found. Analysis of samples of the discoloration indicates that it was caused by on-orbit deposition of hydrated silica, which is produced from outgassing of the red RTV material under the TPS system. The hydrated silica is deposited on all exposed spacecraft surfaces and entered the star tracker cavity through the open star tracker doors. The hydrated silica can not be removed by cleaning, but the deposition from STS-1 and 2 has not degraded star tracker performance.

Conclusions: The discoloration was due to hydrated silica outgassing from the red RTV and depositing on exposed surfaces.

Corrective action: Deposition of silica on star tracker protective windows and lightshades may require periodic removal and replacement of these items. Frequency to be assessed after STS-4.

APPROVED
~~1-15-82~~

A. Cohen
A. Cohen

1/20/82
Date

Effect on subsequent missions: (See corrective action)

Personnel assigned: I. Savlietis/EH6; R. J. Ward/WA3

Resolution: CLOSED 01/18/82

Statement of problem: Seventy (70) development flight instrumentation measurements failed.

Discussion: Data review of all the available measurements resulted in determining that 70 measurements failed during the STS-2 mission.

Troubleshooting has been performed on almost all of the accessible measurements. The list of specific measurements which have not been fixed and validated is being developed.

Conclusions:

Corrective action:

APPROVED

A. Cohen

Date

Effect on subsequent missions:

Personnel assigned: Sinderson/EE3; C. Walsh/WC6

Resolution: OPEN

Statement of problem: Left-hand and right-hand descent wing vent relief doors opened.

Discussion: Postflight inspection revealed that both the left-hand and right-hand descent wing vent relief doors were open. Both relief doors should remain closed since the primary active wing vent doors functioned normally.

Data show the descent relief doors opened 50 seconds into the flight at a maximum pressure differential of 0.2 psid and under an ascent vibration environment. A qualification test that subjected the descent relief door to the specification vibration environment showed the doors would not open until the pressure differential reached 0.5 psid.

When the descent wing vent relief doors open, the wing volume is vented into the payload bay and this venting could result in contamination of sensitive payloads primarily from tire outgassing and particle migration. The STS-1 and 2 flights show that the tire outgassing is insignificant and the particle migration is not of concern, since, should the wing vent relief doors open, the flow is through the payload bay liner that acts as filter.

Conclusions: Descent relief doors were more sensitive to flight dynamic environments than the tested specification vibration environments. Outgassing and particle migration into the payload bay as a result of the wing vent relief door opening are insignificant.

Corrective action: None

APPROVED

~~RES~~
1-17-82

A. Cohen
A. Cohen

1/20/82
Date

Effect on subsequent missions: None

Personnel assigned: J. Janney/ES3; R. J. Ward/WA3

Resolution: CLOSED 01/18/82

Statement of problem: Vernier RCS Thruster F5L exceeded 250° F Limit

Discussion: At the end of STS-2 orbital phase, there was extensive vernier use caused by a disturbance torque from flash evaporator venting. Three hours of continuous pulsing at a rate of 2 seconds on and 20 seconds off resulted in the fuel valve body temperature on engine F5L reaching and estimated 256° F at 52 hours M.e.t. Since the valve seal temperature is about 10° F hotter, the teflon seal exceeded its qualification limit of 250° F for approximately 40 minutes, reaching an estimated peak temperature of 266° F. The concern with this higher-than-expected temperature is the possible cold flow distortion of the teflon seal and the consequent valve leakage. No leakage, however, has been observed during the flight or in subsequent ground testing.

Primary thrusters will be used on future missions when the payload bay doors are closed and flash evaporator dumps are expected to require extended periods of time.

Conclusions: High temperature did not damage seals.

Corrective action: Primary thrusters will be used on future missions for extended flash evaporator dumps with payload bay doors closed.

APPROVED

Aaron Cohen
A. Cohen

2/3/82
Date

Effect on subsequent missions: None

Personnel assigned: W. Hohmann/EP4; R. J. Ward/WA3

Resolution: CLOSED 02/04/82

Statement of problem: Theodolite loose within mounting system.

Discussion: During the theodolite operation, the crewman reported instrument instability. Inspection determined that there was minimum play between the Orbiter console and the bracket and also between the bracket and the theodolite interface.

The anomaly was found to be:

1. The theodolite internal spring forces were not sufficient to provide the required stability.
2. The clearance between the parts inside the instrument was excessive.

Changes to the theodolite increasing the preload and reducing the clearances were incorporated for STS-3 and subsequent. These modifications were evaluated and accepted by the STS-3 flight crew.

Conclusions: The theodolite instability was caused by:

1. The preload force of the internal spring too low
2. The clearance between the internal parts of the instrument was excessive.

Corrective action: 1. Increased the preload force of the spring from 17 lb to 27 lb.
2. Reduced the clearance between the internal parts of the theodolite.
3. Briefed the flight crews to avoid using the theodolite as a handhold during use.

APPROVED 
2/2/82 A. Cohen

2/2/82
Date

Effect on subsequent missions: None

Personnel assigned: R. Garcia/ED54; R. J. Ward/WA3

Resolution: CLOSED 02/01/82

Statement of problem: The downlist indication of a command response pulse was missed during RSS (range safety system) checkout for STS-2.

Discussion: Checkout of the RSS prelaunch involves transmitting 10 arm and 10 fire commands to each RSS receiver/decoder. It is required that 9 of the 10 commands be received. The decoder provides a pulse output for each command received and decoded. Command receipt is verified by sampling the output of a pulse stretcher which is triggered by the decoder output.

The pulse stretcher output should provide pulses of 90ms on 90ms off, thus providing 2 samples per state at the 25 Hz downlist sample rate. Design tolerances in the pulse stretcher result in a pulse structure in which the first "on" state is $115\text{ms} \pm 10\text{ms}$ and subsequent pulses are $90\text{ms} \pm 10\text{ms}$. This stretching in conjunction with the asynchronism between the downlist acquisition process and the pulse generation, and the software architecture which allows missed samples due to process overlap, results in the possibility that only one sample of a given state may be detected or in the case of the first pulse completely missed.

Since the pass fail criteria allows one miss, this mechanization supports current requirements. A change in RSS design is proposed for STS-6 that will use four pulses with a $45\text{ms} \pm 1\text{ms}$ on time and a $135\text{ms} \pm 1\text{ms}$ off time. The pass fail criteria for the prelaunch checkout will require 4 of 4 command pulses detected.

Conclusions: The current RSS and software structure that will be used through STS-5 is satisfactory.

Corrective action: The software mechanization for solid rocket booster downlist is being reviewed for potential improvement. Timing tests on the software are underway to attempt to quantify the probability of missing data samples.

APPROVED

A. Cohen

Date

Effect on subsequent missions: The proposed STS-6 RSS design with the current downlist mechanization will result in a high probability of missed command response pulses. The potential for a fundamental incompatibility between RSS design and avionics architecture exists for STS-6 and subsequent.

Personnel assigned: Carol Dawson/MG

Resolution: CLOSED for STS-3, 4 and 5

Statement of problem: Offensive Odor in the Cabin

Discussion: The crew reported an offensive odor near the waste collector compartment. Postflight inspection of the commode area did not indicate any odor around the commode. Inspection of the returned trash bag did reveal that a strong offensive odor was evident in a wet trash bag which had been installed on the waste collector compartment door. A used emesis bag had been placed into the trash bag without having been vacuum dried. Vacuum drying would have removed the odor. Further the trash bag zipper will not seal in odors. Venting of the wet trash bag will remove odors. The design of this commode is such that odors can only escape into the cabin when the commode is at cabin pressure (when the commode is in use); this only occurred for 4 minutes on the second day. During commode usage, a charcoal filter is used for odor control as well as the cabin LiOH cannisters. The source of the specific odor that the crew commented on could not be isolated. Charcoal cannisters are to be flown for STS-3 and subsequent. Should an odor problem occur one of the charcoal cannisters will be installed in 1 of the 2 LIOH cannister slots in the atmospheric revitalization system. In addition an odor masking device will be flown.

Conclusions: One source of odor was isolated to the wet trash bag. The specific offensive odor was not isolated.

Corrective action: Procedures will emphasize vacuum drying and the stowing of emesis bags in the commode. Further, the wet trash bag will be vented continuously. Charcoal cannisters will be flown and be installed in the ARS system should an odor problem occur. Further, an odor masking device will be added.

APPROVED

Aaron Cohen
A. Cohen
R.B. 2/4/82

2/4/82
Date

Effect on subsequent missions: None

Personnel assigned: F. Samonski/EC3; R. J. Ward/WA3

Resolution: CLOSED 02/10/82

Statement of problem: Film evaluation from payload deployment and retrieval system (PDRS) cameras indicates that two cameras may have run at wrong frame rate.

Discussion: The six PDRS cameras are operated in pairs for positional data for RMS operations. The frame rates for both cameras in a pair are selected by a single switch. Therefore, both cameras in a pair should operate at equal frame rates and, therefore, consume equal amounts of film. Postflight evaluation revealed that the aft cameras in two pairs apparently operated at faster frame rates than the forward cameras in those pairs.

Laboratory testing at JSC and checks in the Orbiter at KSC reveal no wiring problems with the Orbiter and cameras and control panel. However, electrical resistance in the 6 ft/sec and 12 ft/sec signal lines between the camera control panel and the aft bulkhead in the Orbiter was measured at 5.2 ohms for all three aft cameras. When a 5 ohm resistance was added into the 6 ft/sec and 12 ft/sec signal lines in the JSC laboratory set-up, the aft cameras operated at 24 ft/sec when 12 ft/sec was selected at the control panel. The forward cameras operated at 12 ft/sec in this case. At 6 ft/sec and 24 ft/sec all cameras operated properly.

Conclusions: The 12 ft/sec circuitry in the camera is sensitive to proper grounding. The 5.2 ohm resistance is sufficient to cause the loss of electrical ground in the 12 ft/sec position.

Corrective action: For STS-3 and STS-4, procedures will be revised to allow operation only at 24 ft/sec.

For subsequent usage, circuitry will be added to camera enclosures to assure that cameras have proper grounding.

APPROVED

A. Cohen

1/27/82

Date

Effect on subsequent missions: Operation for STS-3 and STS-4 will be constrained procedurally to 6 ft/sec and 24 ft/sec.

Personnel assigned: H. D. Yeates/ED24; R. J. Ward/WA3

Resolution: CLOSED 01/27/82