



International Space Station Robotics Group Robotics Book - Flight Specific

ISS-ULF3

Mission Operations Directorate
Operations Division

31 OCT 09

This publication replaces
all previous publications.
These procedures are available
electronically on the SODF Homepage
at <http://mod.jsc.nasa.gov/do3>

National Aeronautics and
Space Administration

Lyndon B. Johnson Space Center
Houston, Texas

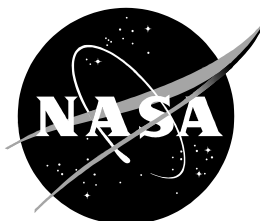

United Space Alliance

**INTERNATIONAL SPACE STATION
ROBOTICS GROUP
ROBOTICS BOOK - FLIGHT SPECIFIC
ISS-ULF3**

31 OCT 09

APPROVED BY:



Elizabeth A. Buckner
Book Manager



Scott Wenger
Lead, Robotics Systems Group



Quinn L. Carelock
Chief, Robotics Operations Branch



SODF Coordinator

ACCEPTED BY:

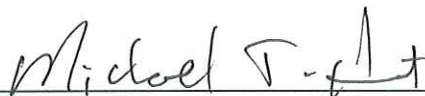

Michael T. Hurt
SODF Manager

This document is under the configuration control of the Systems Operations Data File Control Board (SODFCB).

Incorporates the following:		
CR: Robotics_FSU421a	Robotics_FSU429a	Robotics_FSU439
Robotics_FSU423a	Robotics_FSU430a	Robotics_FSU440
Robotics_FSU424	Robotics_FSU431a	Robotics_FSU441
Robotics_FSU425a	Robotics_FSU432a	Robotics_FSU447
Robotics_FSU427a	Robotics_FSU437	
Robotics_FSU428a	Robotics_FSU438	

Uplinked Messages (or Approved Flight Notes) replaced by this revision,
remove from Book:

None

**INTERNATIONAL SPACE STATION
ROBOTICS GROUP
ROBOTICS BOOK - FLIGHT SPECIFIC
ISS-ULF3**

LIST OF EFFECTIVE PAGES

31 OCT 09

Sign Off.....	* 31 OCT 09	36.....	19 OCT 09
ii.....	* 31 OCT 09	37.....	20 OCT 09
iii.....	* 31 OCT 09	38.....	20 OCT 09
iv.....	* 31 OCT 09	39.....	29 OCT 09
v.....	31 OCT 09	40.....	29 OCT 09
vi.....	31 OCT 09	41.....	29 OCT 09
1.....	31 OCT 09	42.....	29 OCT 09
2.....	31 OCT 09	43.....	29 OCT 09
3.....	30 OCT 09	44.....	29 OCT 09
4.....	30 OCT 09	45.....	29 OCT 09
5.....	30 OCT 09	46.....	29 OCT 09
6.....	30 OCT 09	47.....	29 OCT 09
7.....	30 OCT 09	48.....	29 OCT 09
8.....	30 OCT 09	49.....	29 OCT 09
9.....	30 OCT 09	50.....	29 OCT 09
10.....	30 OCT 09	51.....	30 OCT 09
11.....	30 OCT 09	52.....	30 OCT 09
12.....	30 OCT 09	53.....	30 OCT 09
13.....	30 OCT 09	54.....	30 OCT 09
14.....	TPIB	55.....	30 OCT 09
15.....	19 OCT 09	56.....	30 OCT 09
16.....	19 OCT 09	57.....	30 OCT 09
17.....	19 OCT 09	58.....	30 OCT 09
18.....	19 OCT 09	59.....	30 OCT 09
19.....	19 OCT 09	60.....	30 OCT 09
20.....	19 OCT 09	61.....	30 OCT 09
21.....	19 OCT 09	62.....	30 OCT 09
22.....	19 OCT 09	63.....	30 OCT 09
23.....	19 OCT 09	64.....	TPIB
24.....	19 OCT 09	65.....	30 OCT 09
25.....	19 OCT 09	66.....	30 OCT 09
26.....	19 OCT 09	67.....	30 OCT 09
27.....	19 OCT 09	68.....	30 OCT 09
28.....	19 OCT 09	69.....	30 OCT 09
29.....	19 OCT 09	70.....	30 OCT 09
30.....	19 OCT 09	71.....	30 OCT 09
31.....	19 OCT 09	72.....	30 OCT 09
32.....	19 OCT 09	73.....	30 OCT 09
33.....	19 OCT 09	74.....	30 OCT 09
34.....	19 OCT 09	75.....	30 OCT 09
35.....	19 OCT 09	76.....	30 OCT 09

* - Omit from flight book

77.....	30 OCT 09	128.....	TPIB
78.....	30 OCT 09	129.....	31 OCT 09
79.....	30 OCT 09	130.....	31 OCT 09
80.....	30 OCT 09	131.....	31 OCT 09
81.....	31 OCT 09	132.....	31 OCT 09
82.....	31 OCT 09	133.....	20 OCT 09
83.....	19 OCT 09	134.....	20 OCT 09
84.....	19 OCT 09	135.....	20 OCT 09
85.....	19 OCT 09	136.....	20 OCT 09
86.....	19 OCT 09	137.....	19 OCT 09
87.....	19 OCT 09	138.....	19 OCT 09
88.....	19 OCT 09	139.....	19 OCT 09
89.....	30 OCT 09	140.....	19 OCT 09
90.....	30 OCT 09	141.....	19 OCT 09
91.....	30 OCT 09	142.....	19 OCT 09
92.....	30 OCT 09	143.....	30 OCT 09
93.....	30 OCT 09	144.....	30 OCT 09
94.....	30 OCT 09	145.....	30 OCT 09
95.....	30 OCT 09	146.....	30 OCT 09
96.....	30 OCT 09	147.....	30 OCT 09
97.....	30 OCT 09	148.....	30 OCT 09
98.....	30 OCT 09	149.....	30 OCT 09
99.....	30 OCT 09	150.....	30 OCT 09
100.....	30 OCT 09	151.....	30 OCT 09
101.....	30 OCT 09	152.....	30 OCT 09
102.....	30 OCT 09	153.....	30 OCT 09
103.....	30 OCT 09	154.....	TPIB
104.....	30 OCT 09	155.....	31 OCT 09
105.....	30 OCT 09	156.....	31 OCT 09
106.....	TPIB	157.....	19 OCT 09
107.....	29 OCT 09	158.....	TPIB
108.....	29 OCT 09	159.....	20 OCT 09
109.....	29 OCT 09	160.....	TPIB
110.....	29 OCT 09	161.....	19 OCT 09
111.....	29 OCT 09	162.....	TPIB
112.....	29 OCT 09	163.....	19 OCT 09
113.....	29 OCT 09	164.....	TPIB
114.....	29 OCT 09	165.....	19 OCT 09
115.....	29 OCT 09	166.....	TPIB
116.....	29 OCT 09	167.....	19 OCT 09
117.....	29 OCT 09	168.....	TPIB
118.....	29 OCT 09	169.....	19 OCT 09
119.....	29 OCT 09	170.....	TPIB
120.....	29 OCT 09	171.....	19 OCT 09
121.....	29 OCT 09	172.....	TPIB
122.....	29 OCT 09	173.....	19 OCT 09
123.....	29 OCT 09	174.....	TPIB
124.....	29 OCT 09		
125.....	29 OCT 09		
126.....	29 OCT 09		
127.....	29 OCT 09		

CONTENTS

NOMINAL OPS	1
1.110 ELC1 Handoff and Install	3
1.210 EVA1- SASA Transfer and LEE Lube Ops.....	15
1.220 EVA1 to MT Translation Config (No FI).....	37
1.310 ELC2 Handoff and Install	39
1.320 ELC2 Release, Walkoff to MBS PDGF 1 and Mnv to MT Translation Config	51
1.410 EVA3 - HPGT Transfer.....	65
FOCUSED INSPECTION OPS	81
2.110 Walkoff to Node 2 PDGF (WS4).....	83
2.120 OBSS Unberth and Handoff	89
2.130 OBSS Handoff, Reberth and MBS PDGF1 Grapple (WS4)	107
GROUND PROCEDURES	129
3.110 GC ELC1 Release and WS7 to WS4 Pre-Translation Survey	IPV
3.120 Ground ELC1 Release and Mnv to MT Translation Config	IPV
3.210 GC MBS PDGF1 Release Survey.....	IPV
3.220 Ground MBS PDGF 1 Release (WS4)	IPV
3.230 Ground Node 2 Release (WS4)	IPV
3.310 GC Node 2 Release and WS4 to WS2 Pre-Translation Survey	IPV
3.410 GC Walkoff to MBS PDGF2 Survey	IPV
3.420 Ground Walkoff to MBS PDGF 2 (WS2)	IPV
3.510 GC WS2 to WS3 Pre-Translation Survey.....	IPV
3.610 GC WS3 to WS4 Pre-Translation Survey.....	IPV
CONTINGENCY	131
4.210 EVA1- No POA or JEM Lube	133
4.220 EVA1- No JEM Lube	137
4.310 ELC2 Install: Missing RTL	141
4.320 ELC2 Install on S3 Lower Outboard PAS.....	143
REFERENCE	155
5.110 ELC1 Install.....	157
5.120 P3.....	159
5.210 OBSS	161
5.310 ELC2 Install.....	163
5.320 S3.....	165
5.410 HPGT Mnv	167
5.420 HPGT on ELC2	169
5.430 HPGT Install.....	171
5.510 ISS.....	173

This Page Intentionally Blank

NOMINAL OPS

This Page Intentionally Blank

1.110 ELC1 HANDOFF AND INSTALL

(RBT FS/ULF3/FIN/SPN)

Page 1 of 11 pages

NOTE

For all OCASes if the joint angles are incorrect after loaded, then **cmd** Cancel on the PCS and reload the correct destination.

1. SETUP

THC/ RHC Deflect all axes to positive and negative hard stops.

Configure Cameras and overlays as required.

Monitor 1	Monitor 2	Monitor 3	V10
24: Tip Elbow (+10, 0)	09: P1 Lower Outboard (-180, +40)	37: MBS Mast (+95, +5)	Camera B (-45, +30)

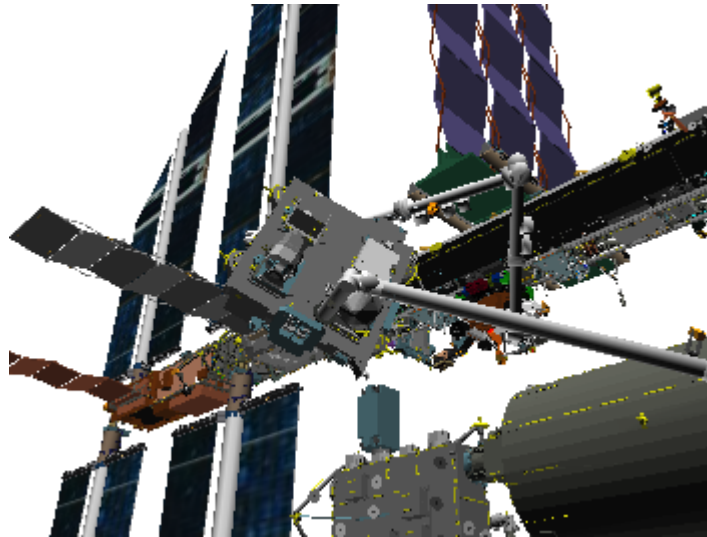

Figure 1.- Stage Park
(Camera B: -45, +30).

PCS

Change Loaded Parameters ► ELC ► ELC1 Install SRH
Verify 'Loaded Parameters' (two) – ELC1 Install, SR Held

Verify Unloaded Parameters – ✓

Change Unloaded Parameters ► Unloaded ► LEE Tip SYH
Verify 'Unloaded Parameters' (two) – LEE Tip, SY Held

Change Display ► ISS ► ISSACS (Verify ISS>ISSACS)

Verify Command – SSRMS>Internal

1.110 ELC1 HANDOFF AND INSTALL

(RBT FS/ULF3/FIN/SPN)

Page 2 of 11 pages

Verify SSRMS at Stage Park (within 5 cm/1 deg).

SR	SY	SP	EP	WP	WY	WR
+58.1	+67.9	-42.7	-105.2	+15.0	+2.0	+89.5
X	Y	Z	Pitch	Yaw	Roll	
+453	-1742	+1185	-90.0	-53.7	-162.9	
FOR	Unloaded – LEE Tip, SY Held					
Disp	ISS>ISSACS					

2. JOCAS TO ELC1 PRE-GRAPPLE AT HANDOFF (1 MINUTE)

MSS: SSRMS: MSS Safing:

cmd 'SSRMS' Remove (Verify Not Safed)

DCP BRAKES SSRMS → OFF (Verify OFF)

RHC RATE → COARSE (Verify Coarse on PCS)

PCS MSS: SSRMS:

Enter Mode – Joint OCAS (Verify blue)

pick File ► ELC1 ► Pre-Grapple Handoff

Verify 'Joint Angles' 'Destination' for Pre-Grapple at Handoff position.

SR	SY	SP	EP	WP	WY	WR
+58.1	+67.9	-42.7	-105.2	-50.3	-116.7	+89.5

cmd Load (Verify Sequence Status – Confirm or Cancel)

MON Verify Joint Angles and errors are correct on Joint Angle Position overlay.

	SR	SY	SP	EP	WP	WY	WR
(current)	+58.1	+67.9	-42.7	-105.2	+15.0	+2.0	+89.5
TGT	+58.1	+67.9	-42.7	-105.2	-50.3	-116.7	+89.5
ERR	0.0	0.0	0.0	0.0	+65.3	+118.7	0.0

PCS **cmd** Confirm (Verify Sequence Status – Auto Seq sw - Hot)

DCP AUTO SEQ → PROC

PCS MSS: SSRMS:

Verify Posn Hold – orange

Verify Joint Angle values.

SR	SY	SP	EP	WP	WY	WR
+58.1	+67.9	-42.7	-105.2	-50.3	-116.7	+89.5

1.110 ELC1 HANDOFF AND INSTALL

(RBT FS/ULF3/FIN/SPN)

3. ELC1 GRAPPLE AT HANDOFF

3.1 Grapple Setup

Configure Cameras and overlays as required.

Monitor 1	Monitor 2	Monitor 3	V10
24: Tip Elbow (+10, +20) 07: P1 Lower Inboard (-120, +35)	25: Tip LEE (fully zoomed out)	37: MBS Mast (+95, +5)	Camera B (-45, +30)

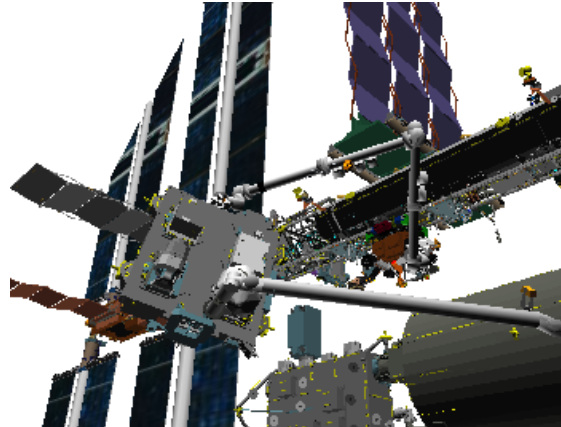

Figure 2.- ELC1 Pre-Grapple at Handoff
(Camera B: -45, +30).

RHC RATE → VERNIER (Verify Vernier on PCS)

PCS MSS: SSRMS: Rate:

Set 'Scale' 'Vernier' Rate Scale: 0.6 (Verify 0.6)

3.2 Maneuver to ELC1 Grapple

 * If using Shuttle attitude control
 * | Verify in attitude and rates damped.
 * | DAP: FREE

MSS: SSRMS: Thrusters:

Verify 'Desat Request:' – Inh

On SRMS Operator, 'GO for ELC1 Grapple Maneuver:'

MSS: SSRMS:

Enter Mode – Manual (Verify blue)

1.110 ELC1 HANDOFF AND INSTALL

(RBT FS/ULF3/FIN/SPN)

Page 4 of 11 pages

MSS: SSRMS: SSRMS Manual: Joint Lock: Joint Lock

cmd Shoulder Yaw (Verify SY – Locked)

THC/ RHC

Maneuver to within grapple envelope.

3.3 Slow Capture Commands

PCS

MSS: SSRMS: Tip LEE: SSRMS Tip LEE

cmd Capture ► Automatic ► Slow, Limp (Verify Speed – Slow)

Verify '**Confirm or Terminate**' prompt.

cmd Confirm (Verify RHC Trigger Hot icon)

Verify LEE Mode – Auto Capture

3.4 ELC1 Grapple

RHC

TRIGGER → press (momentarily)

PCS

Verify 'Snare' Close, Capture (two) – blue (12 s max)

Verify Capture to Latch – Yes (SCR 19282)

Verify 'Carriage' Tension ~5500 N (90 s max)

Verify 'Carriage' Retract – blue

Verify 'Latch' Latch – blue (80s max)

3.5 Mate Umbilicals

Verify with **MCC-H** that Payload and PDGF power inhibits have been confirmed

cmd 'Umbilical' Mate (Verify '**Confirm or Terminate**' prompt)

cmd Confirm (Verify RHC Trigger Hot icon)

Verify LEE Mode – Mate

RHC

TRIGGER → press (momentarily)

PCS

Verify 'Umbilical' Mate – blue (10 s max)

Verify 'Connector Continuity' Prime, Redundant (two) – Yes

3.6 Grapple Cleanup

Verify Posn Hold – orange

Verify Loaded Parameters – √

Verify 'Loaded Parameters' (two) – ELC1 Install, SR Held

DCP

BRAKES SSRMS → ON (Verify ON)

Give SRMS Operator, 'GO for ELC1 Ungrapple:'

1.110 ELC1 HANDOFF AND INSTALL

(RBT FS/ULF3/FIN/SPN)

PCS

MSS: SSRMS: Power:

cmd 'Payload' Prime On (Verify On)

4. HANDOFF CLEANUP SETUP

Configure Cameras and overlays as required.

Monitor 1	Monitor 2	Monitor 3	V10L	V10R
07: P1 Lower Inboard (-120, +35)	09: P1 Lower Outboard (-180, +40)	37: MBS Mast (+95, +5)	Camera B (-45, +30)	SRMS Elbow (+80, +10)

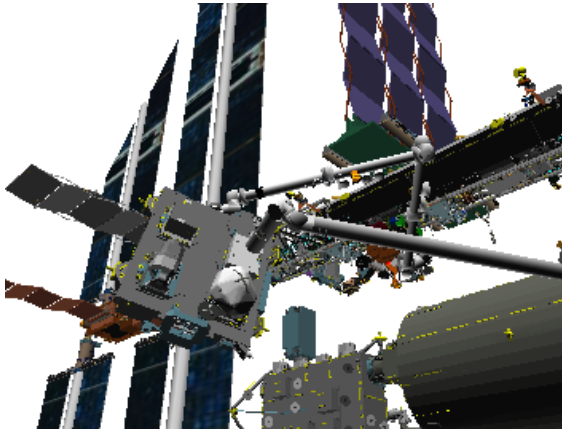

Figure 3.- ELC1 Grapple at Handoff
(Camera B: -45, +30).



Figure 4.- ELC1 Grapple at Handoff
(SRMS Elbow: +80, +10).

Change Display ► P3 ► ELC1 Install P3L (Verify P3>ELC1 Install P3L)

RHC

RATE → COARSE (Verify Coarse on PCS)

On SRMS Operator, 'GO for ELC1 Maneuver to Install:'

DCP

BRAKES SSRMS → OFF (Verify OFF)

PCS

MSS: SSRMS:

Enter Mode – Joint OCAS (Verify blue)

If all of the following joint angles are within 3 degrees then Go to step 6, otherwise Continue on to step 5.

SR	SY	SP	EP	WP	WY	WR
+78.0	+67.9	-20.8	-99.2	-73.4	-118.7	+74.0

1.110 ELC1 HANDOFF AND INSTALL

(RBT FS/ULF3/FIN/SPN)

5. HANDOFF CLEANUP

pick File ► ELC1 ► ELC1 Handoff

Verify 'Joint Angles' 'Destination' for ELC1 Handoff position.

SR	SY	SP	EP	WP	WY	WR
+78.0	+67.9	-20.8	-99.2	-73.4	-118.7	+74.0

cmd Load (Verify Sequence Status – Confirm or Cancel)

MON

Verify joint angles are correct on Joint Angle Position overlay.

TGT

SR	SY	SP	EP	WP	WY	WR
+78.0	+67.9	-20.8	-99.2	-73.4	-118.7	+74.0

PCS

cmd Confirm (Verify Sequence Status – Auto Seq sw Hot)

DCP

AUTO SEQ → PROC

PCS

MSS: SSRMS:

Verify Posn Hold – orange

Verify Joint Angle values.

SR	SY	SP	EP	WP	WY	WR
+78.0	+67.9	-20.8	-99.2	-73.4	-118.7	+74.0

6. JOCAS TO INTERMEDIATE POSITION (11 MINUTES)

```
*****
* If using shuttle attitude control and attitude maintenance required
*   |   BRAKES SSRMS → ON (Verify ON)
*   |   DAP: LVLH
*   |   When rates damped
*   |   |   DAP: FREE > 2 sec
*   |   |   DAP: AUTO
*   |   |   When in attitude and rates damped
*   |   |   |   DAP: FREE
*   |   |   |   BRAKES SSRMS → OFF (Verify OFF)
*****
```

pick File ► ELC1 ► ELC1 Intermediate

Verify 'Joint Angles' 'Destination' for ELC1 Intermediate position.

SR	SY	SP	EP	WP	WY	WR
+38.8	+59.5	-103.0	-32.7	-104.6	+19.4	+180.7

cmd Load (Verify Sequence Status – Confirm or Cancel)

1.110 ELC1 HANDOFF AND INSTALL

(RBT FS/ULF3/FIN/SPN)

Page 7 of 11 pages

MON Verify joint angles and errors are correct on Joint Angle Position overlay.

	SR	SY	SP	EP	WP	WY	WR
(current)	+78.0	+67.9	-20.8	-99.2	-73.4	-118.7	+74.0
TGT	+38.8	+59.5	-103.0	-32.7	-104.6	+19.4	+180.7
ERR	+39.2	+8.4	+82.2	-66.5	+31.2	-138.1	-106.7

PCS **cmd** Confirm (Verify Sequence Status – Auto Seq sw - Hot)

DCP AUTO SEQ → PROC

PCS MSS: SSRMS:

Verify Posn Hold – orange

Verify Joint Angle values.

SR	SY	SP	EP	WP	WY	WR
+38.8	+59.5	-103.0	-32.7	-104.6	+19.4	+180.7

```

*****
* If using shuttle attitude control and attitude maintenance required
*
*   Configure DAP A CNTL ACC per DOCKED DAP
*   REFERENCE (ORB OPS FS, Reboost/DAP).
*
*   BRAKES SSRMS → ON (Verify ON)
*   DAP: LVLH
*   When rates damped
*   |   DAP: FREE > 2 sec
*   |   DAP: AUTO
*   |   When in attitude and rates damped
*   |   |   DAP: FREE
*   |   |   BRAKES SSRMS → OFF (Verify OFF)
*****
    
```

7. FOROCAS TO ELC1 PRE-INSTALL (8 MINUTES)

RHC RATE → VERNIER (Verify Vernier on PCS)

PCS MSS: SSRMS: Rate:

√'Scale' 'Vernier' Current: 1.0

MSS: SSRMS:

Enter Mode – FOR OCAS (Verify blue)

MSS: SSRMS: SSRMS FOR OCAS: Joint Lock:

cmd Shoulder Roll (Verify SR – Locked)

1.110 ELC1 HANDOFF AND INSTALL

(RBT FS/ULF3/FIN/SPN)

SSRMS FOR OCAS

pick File ► ELC1 ► ELC1 Pre-Install

Verify 'FOR' 'Destination' for ELC1 Pre-Install position.

X	Y	Z	Pitch	Yaw	Roll
-200	0	0	0	0	0

cmd Load (Verify Sequence Status – Confirm or Cancel)

MON

Verify FOR and errors are correct on FOR Position overlay.

	X	Y	Z	Pitch	Yaw	Roll
FOR	-650	+250	-230	0	0	0
TGT	-200	0	0	0	0	0
ERR	-450	+250	-230	0	0	0

PCS

cmd Confirm (Verify Sequence Status – Auto Seq Sw – Hot)

DCP

AUTO SEQ → PROC

PCS

MSS: SSRMS: SSRMS

Verify Posn Hold – orange

Verify SSRMS at ELC1 Pre-Install position (within 5 cm/1 deg).

Locked						
SR	SY	SP	EP	WP	WY	WR
+38.8	+34.6	-104.6	-63.0	-67.9	+6.0	+159.1
X	Y	Z	Pitch	Yaw	Roll	
-200	0	0	0	0	0	
FOR	Loaded – ELC1 Install, SR Held					
Disp	P3>ELC1 Install P3L					

```
*****
* If using shuttle attitude control and attitude maintenance required
* |   BRAKES SSRMS → ON (Verify ON)
* |   DAP: LVLH
* |   When rates damped
* |   |   DAP: FREE > 2 sec
* |   |   DAP: AUTO
* |   |   When in attitude and rates damped
* |   |   |   DAP: FREE
* |   |   |   BRAKES SSRMS → OFF (Verify OFF)
*****
```

MSS: SSRMS: Thrusters: Thruster Controls for MSS Ops

Verify 'Desat Request:' – Inh

8. MANUAL MANEUVER TO ELC1 INSTALL

8.1 Setup

Configure Cameras, EBCS Targets and USOS Effector overlays.

Monitor 1	Monitor 2	Monitor 3	V10
22: Base Elbow (-90, +5)	28: EBCS	09: P1 Lower Outboard (-70, -20)	Camera B (-45, +30)

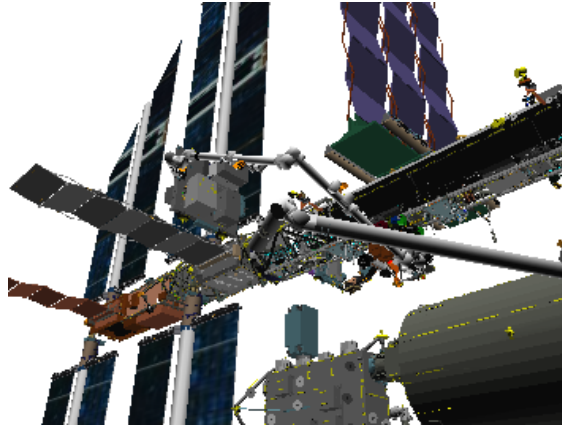

Figure 5.- ELC1 Pre-Install
(Camera B: -45, +30).

NOTE

1. The EBCS Camera view used for the Install will be the left camera, unless otherwise notified by **MCC-H**.
2. Due to the USOS Effector overlay having the incorrect RTL configuration, use the following PCS display:
P3: S&M: UCCAS 2 Latch:

MSS: SSRMS: Rate:

Set 'Scale' 'Vernier' Rate Scale: 0.4

8.2 ELC1 Install on P3

MSS: SSRMS:

Enter Mode – Manual (Verify blue)

MSS: SSRMS: SSRMS Manual: Joint Lock:

cmd Shoulder Roll (Verify SR – Locked)

THC Perform "+X" Manual Maneuver to X: -90 (THC in).

Make alignment corrections as needed.

1.110 ELC1 HANDOFF AND INSTALL

(RBT FS/ULF3/FIN/SPN)

8.3 Maneuvering ELC1 to Install on P3 Nadir UCCAS

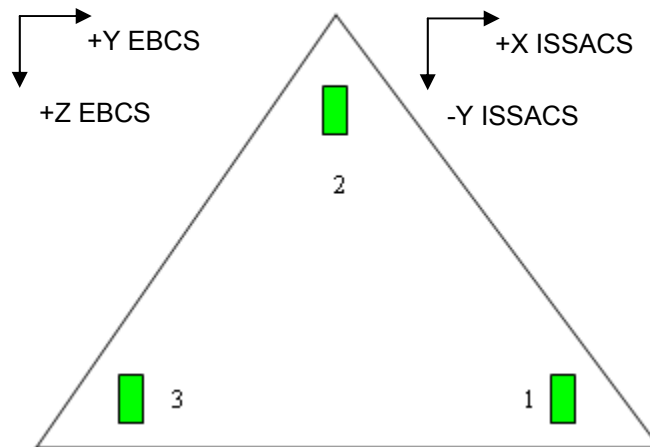

Figure 6.- ELC1 EBCS Install RTL Diagram.

Maneuver ELC1 2cm past the last RTL indication.
 If ELC1 is deep into the UCCAS envelope and
 RTL(s) are missing due to orientation errors
 Refer to Table 1.

Table 1.

Missing RTLs	RHC Input
1	+Pitch, -Yaw
2	-Pitch
3	+Pitch, +Yaw
1, 2	-Pitch then -Yaw
2, 3	-Pitch then +Yaw
1, 3	+Pitch

THC/RHC

Maneuver ELC1 to Ready-To-Latch position until RTLs (three) – green

Locked						
SR	SY	SP	EP	WP	WY	WR
+38.8	+30.3	-103.7	-78.8	-52.7	+3.5	+155.6
X	Y	Z	Pitch	Yaw	Roll	
-6	0	0	0	0	0	
FOR	Loaded – ELC1 Install, SR Held					
Disp	P3> ELC1 Install P3L					

1.110 ELC1 HANDOFF AND INSTALL

(RBT FS/ULF3/FIN/SPN)

Page 11 of 11 pages

PCS

MSS: SSRMS: SSRMS

Enter Mode – Standby (Verify blue)

8.4 SSRMS UCCAS Coordination

Notify **UCCAS Operator**, “Maneuver to RTL complete - Go for First Phase Capture.”

MSS: SSRMS: Power: SSRMS Power

cmd ‘Payload’ Prime(Redundant) Off (Verify two Off)

On **UCCAS Operator**, “First Phase Capture complete - Go to limp SSRMS.”

MSS: SSRMS: Limp: SSRMS Limp

cmd All Limp (Verify Limp – blue)

MSS: SSRMS: SSRMS

Verify all joints – Limped

Notify **UCCAS Operator**, “Go for Second Stage Capture - All joints limped.”

On **UCCAS Operator**, “Capture complete - Go for SSRMS Brakes On.”

NOTE

Expect the following message when safing is commanded:

‘R3Z - MSS OCS SSRMS Prime(Redun) ACU SRT Cat-1 Brk Stat Fail’ (SCR 17495)

This message should return to Norm.

DCP

BRAKES SSRMS → ON (Verify ON)

Give **MCC-H**, ‘Go for SSRMS Ground Operations.’

```

*****
* If using shuttle attitude control
* |   DAP: LVLH
* |   When rates damped
* |       DAP: FREE > 2 sec
* |       DAP: AUTO
*****

```

This Page Intentionally Blank

NOTE

1. For all OCASes if the Joint Angles are incorrect after loaded, then **cmd** Cancel on the PCS and reload the correct destination.
2. For SASA operations, shuttle VRCS control allowed when > 2 ft from structure.
 Otherwise:
 Verify in attitude and rates damped then DAP: FREE

 Return to AUTO when > 2ft from structure:
 √**MCC** or
 Perform RATE DAMPING (ORB OPS FS, REBOOST/DAP)

1. SETUP
 Configure Cameras and overlays as required.

Monitor 1	Monitor 2	Monitor 3	V10L	V10R
37: MBS Mast (+175, +10)	03: S1 Lower Outboard (+50, -20)	13: LAB Stbd Zenith (+160, +55)	Camera C (+20, +20)	SRMS Elbow (-120, +20)

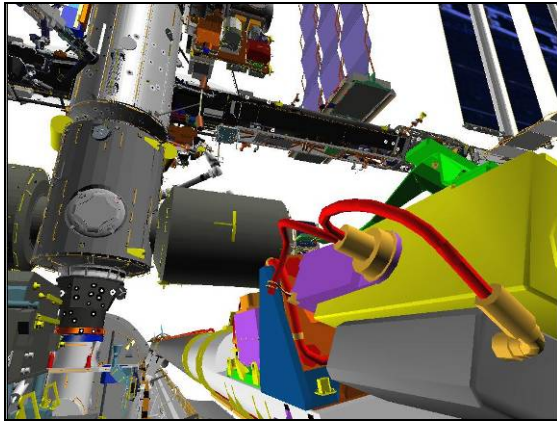

Figure 1.- MT Translate Position
 (Camera C: +20, +20).

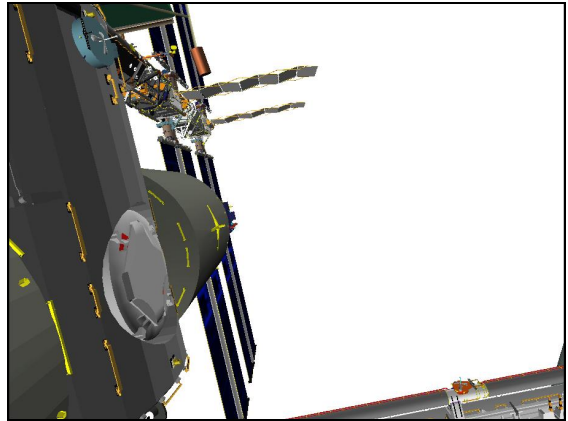

Figure 2.- MT Translate Position
 (SRMS Elbow: -120, +20).

PCS Verify Unloaded Parameters – √

Change Unloaded Parameters ► Unloaded ► LEE Tip SRH
 Verify 'Unloaded Parameters' (two) – LEE Tip, SR Held

√Display – ISS>ISSACS

Change Command ► ISS ► ISSACS/Internal (Verify
 ISS>ISSACS/Internal)

Verify SSRMS at MT Translate position (within 5 cm/1 deg).

SR	SY	SP	EP	WP	WY	WR
-100.0	+110.0	-8.0	-156.0	-72.0	-180.0	+157.4
X	Y	Z	Pitch	Yaw	Roll	
+609	+766	-320	+82.6	-3.2	-129.3	
FOR	Unloaded – LEE Tip, SR Held					
Disp	ISS>ISSACS					

2. EVA1 TRUSS INGRESS JOCAS (3 MINUTES)

Verify with **MCC-H** S1 TRRJ parked at 0 deg.

MSS: SSRMS: MSS Safing:

cmd 'SSRMS' Remove (Verify Not Safed)

DCP BRAKES SSRMS → OFF (Verify OFF)

PCS MSS: SSRMS:

√Vernier

MSS: SSRMS:

Enter Mode – Joint OCAS (Verify blue)

pick File ► EVA1 ► Truss Ingress

Verify 'Joint Angles' 'Destination' for EVA1 Truss Ingress position.

SR	SY	SP	EP	WP	WY	WR
-100.0	+128.0	-126.0	-61.6	-51.7	-189.0	+95.0

cmd Load (Verify Sequence Status – Confirm or Cancel)

MON Verify Joint Angles and errors are correct on Joint Angle Position overlay.

	SR	SY	SP	EP	WP	WY	WR
(current)	-100.0	+110.0	-8.0	-156.0	-72.0	-180.0	+157.4
TGT	-100.0	+128.0	-126.0	-61.6	-51.7	-189.0	+95.0
ERR	0.0	-18.0	+118.0	-94.4	-20.3	+9.0	+62.4

PCS **cmd** Confirm (Verify Sequence Status – Auto Seq sw - Hot)

DCP AUTO SEQ → PROC

PCS MSS: SSRMS:

Verify Posn Hold – orange

Verify Joint Angle values.

SR	SY	SP	EP	WP	WY	WR
-100.0	+128.0	-126.0	-61.6	-51.7	-189.0	+95.0

DCP BRAKES SSRMS → ON (Verify ON)

3. APFR INSTALL AND INGRESS MANEUVER
On EV “GO,” ‘Ready for GCA APFR Install and Ingress:’

BRAKES SSRMS → OFF (Verify OFF)

MSS: SSRMS:

Enter Mode – Manual (Verify blue)

MSS: SSRMS: SSRMS Manual: Joint Lock:

cmd Shoulder Roll (Verify SR – Locked)

THC Perform EVA GCA as required for APFR Install and Ingress.

Expected Truss Ingress position:

Locked						
SR	SY	SP	EP	WP	WY	WR
-100.0	+115.0	-125.0	-62.0	-54.8	-195.4	+106.5
X	Y	Z	Pitch	Yaw	Roll	
+315	+1817	+59	+101.6	-1.5	-175.8	
FOR	Unloaded – LEE Tip, SR Held					
Disp	ISS>ISSACS					

DCP BRAKES SSRMS → ON (Verify ON)

Change Unloaded Parameters ► EVA ► Chest 12/PP/F/6 SRH
 Verify ‘Unloaded Parameters’ (two) – Chest 12/PP/F/6, SR Held

4. TRUSS BACKOFF MANUAL MANEUVER
On EV “GO,” ‘Ready for Truss Backoff:’

DCP BRAKES SSRMS → OFF (Verify OFF)

PCS MSS: SSRMS:

Enter Mode – Manual (Verify blue)

MSS: SSRMS: SSRMS Manual: Joint Lock:

cmd Shoulder Roll (Verify SR – Locked)

THC/ RHC Maneuver EV to Truss Clearance position (within 5 cm/1 deg).

Locked						
SR	SY	SP	EP	WP	WY	WR
-100.0	+128.0	-126.0	-61.6	-51.7	-189.0	+95.0
X	Y	Z	Pitch	Yaw	Roll	
+466	+1793	-80	-168.0	-12.8	-178.4	
FOR	Unloaded – Chest 12/PP/F/6, SR Held					
Disp	ISS>ISSACS					

5. COLUMBUS CLEARANCE JOCAS (3 MINUTES)

RHC RATE → COARSE (Verify Coarse on PCS)

PCS MSS: SSRMS:

Enter Mode – Joint OCAS (Verify blue)

pick File ► EVA1 ► Columbus Clearance

Verify 'Joint Angles' 'Destination' for Columbus Clearance position.

SR	SY	SP	EP	WP	WY	WR
-100.0	+119.7	-160.0	-84.3	-132.4	-199.2	+113.3

cmd Load (Verify Sequence Status – Confirm or Cancel)

MON Verify Joint Angles and errors are correct on Joint Angle Position overlay.

	SR	SY	SP	EP	WP	WY	WR
(current)	-100.0	+128.0	-126.0	-61.6	-51.7	-189.0	+95.0
TGT	-100.0	+119.7	-160.0	-84.3	-132.4	-199.2	+113.3
ERR	0.0	+8.3	+34.0	+22.7	+80.7	+10.2	-18.3

PCS **cmd** Confirm (Verify Sequence Status – Auto Seq sw - Hot)

DCP AUTO SEQ → PROC

PCS MSS: SSRMS:

Verify Posn Hold – orange

Verify Joint Angle values.

SR	SY	SP	EP	WP	WY	WR
-100.0	+119.7	-160.0	-84.3	-132.4	-199.2	+113.3

6. SASA ALIGNMENT JOCAS (5 MINUTES)

Configure Cameras and overlays as required.

Monitor 1	Monitor 2	Monitor 3	V10L	V10R
24: Tip Elbow (-110, -10)	03: S1 Lower Outboard (+50, +20)	13: LAB Stbd Zenith (-10, -20)	Camera C (+20, +20)	SRMS Elbow (-120, +20)

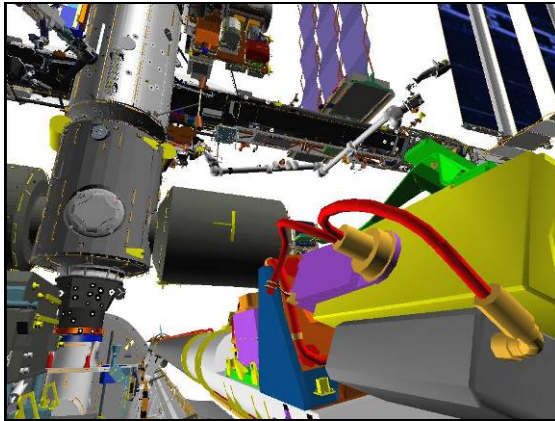

Figure 3.- Columbus Clearance
(Camera C: +20, +20).

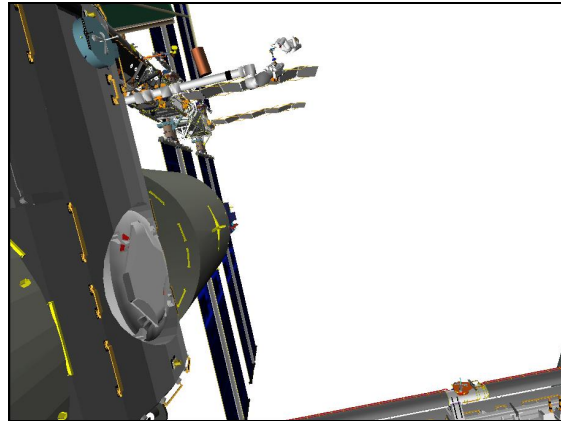

Figure 4.- Columbus Clearance
(SRMS Elbow: -120, +20).

NOTE

The following four maneuvers (steps 6 thru 9) have the following clearance concerns:

- a. Clearance between the SSRMS Tip Boom and the Columbus is below 40in. This clearance can be monitored with the SRMS Elbow Camera or the S1 Lower Outboard Camera.
- b. Clearance between the SSRMS Base Boom and the UHF Antenna is below 40in. This clearance can be monitored with Camera C or the S1 Lower Outboard Camera.
- c. Clearance between the SSRMS Base Boom and the Lab Camera is below 40in. The clearance can be monitored with the Tip Elbow Camera.

RHC RATE → VERNIER (Verify Vernier on PCS)

SSRMS Joint OCAS

pick File ► EVA1 ► SASA Alignment

Verify 'Joint Angles' 'Destination' for SASA Alignment position.

SR	SY	SP	EP	WP	WY	WR
+19.2	+115.6	-132.6	-74.5	-11.8	-14.6	+16.8

cmd Load (Verify Sequence Status – Confirm or Cancel)

MON Verify Joint Angles and errors are correct on Joint Angle Position overlay.

	SR	SY	SP	EP	WP	WY	WR
(current)	-100.0	+119.7	-160.0	-84.3	-132.4	-199.2	+113.3
TGT	+19.2	+115.6	-132.6	-74.5	-11.8	-14.6	+16.8
ERR	-119.2	+4.1	-27.4	-9.8	-120.6	-184.6	+96.5

PCS **cmd** Confirm (Verify Sequence Status – Auto Seq sw - Hot)

DCP AUTO SEQ → PROC

PCS MSS: SSRMS:

Verify Posn Hold – orange

Verify Joint Angle values.

SR	SY	SP	EP	WP	WY	WR
+19.2	+115.6	-132.6	-74.5	-11.8	-14.6	+16.8

7. SASA PICKUP MANUAL MANEUVER

Configure Cameras and overlays as required.

Monitor 1	Monitor 2	Monitor 3	V10L	V10R
24: Tip Elbow (-10, +5)	22: Base Elbow (-15, +5)	13: LAB Stbd Zenith (-10, -20)	Camera C (+10, +10)	SRMS Elbow (-120, +20)

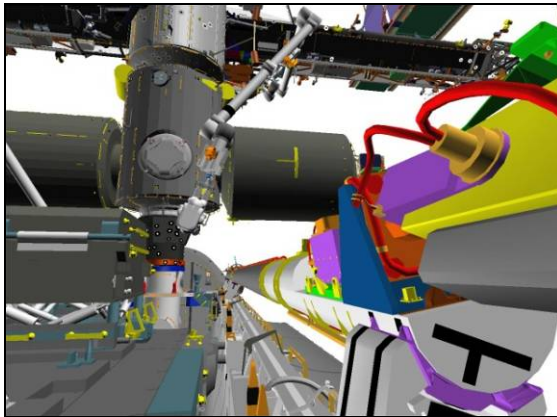

Figure 5.- SASA Alignment
(Camera C: +10, +10).

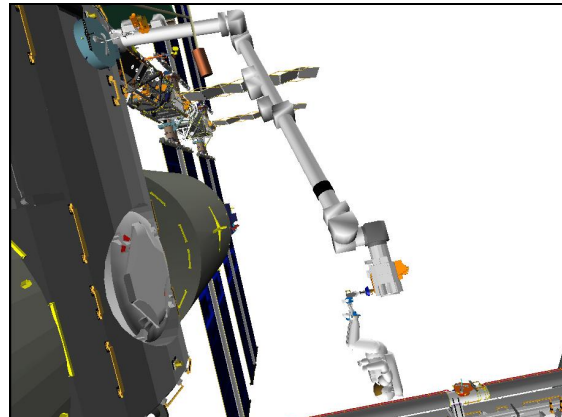

Figure 6.- SASA Alignment
(SRMS Elbow: -120, +20).

MSS: SSRMS:

Change Display ► ISS ► OBAS (Verify ISS>OBAS)

Change Command ► ISS ► OBAS/Internal (Verify ISS>OBAS/Internal)

1.210 EVA1- SASA TRANSFER AND LEE LUBE OPS
 (RBT FS/ULF3/FIN) Page 7 of 22 pages

MSS: SSRMS:

Enter Mode – Manual (Verify blue)

MSS: SSRMS: SSRMS Manual: Joint Lock:

cmd Shoulder Roll (Verify SR – Locked)

THC/ RHC Perform EVA GCA as required for SASA Removal.
 (Expect “+Z” and “+X” motion; THC down and in)

Expected SASA Removal position:

Locked						
SR	SY	SP	EP	WP	WY	WR
+19.2	+121.9	-149.0	-69.1	0.0	-9.6	+20.8
X	Y	Z	Pitch	Yaw	Roll	
-1907	+131	-1059	+0.3	0.0	-160.0	
FOR	Unloaded – Chest 12/PP/F/6, SR Held					
Disp	ISS>OBAS					

8. [SASA BACKOUT MANUAL MANEUVER](#)
On EV “GO,” ‘SASA Removal complete:’

Maneuver EVA to SASA Backout position (within 5 cm/1 deg).
 (Expect “-X” and “-Z” motion; THC out and up)

Locked						
SR	SY	SP	EP	WP	WY	WR
+19.2	+112.5	-125.0	-82.4	-12.0	-17.0	+14.7
X	Y	Z	Pitch	Yaw	Roll	
-2098	+131	-1400	+0.3	0.0	-160.0	
FOR	Unloaded – Chest 12/PP/F/6, SR Held					
Disp	ISS>OBAS					

9. [PAYLOAD BAY CLEARANCE JOCAS \(4 MINUTES\)](#)
 Change Display ► ISS ► ISSACS (Verify ISS>ISSACS)

Change Command ► SSRMS ► Internal (Verify SSRMS>Internal)

PCS MSS: SSRMS:

Enter Mode – Joint OCAS (Verify blue)

pick File ► EVA1 ► Payload Bay Clear

Verify 'Joint Angles' 'Destination' for Payload Bay Clearance position.

SR	SY	SP	EP	WP	WY	WR
-100.0	+119.7	-160.0	-84.3	+7.4	-22.7	+18.4

cmd Load (Verify Sequence Status – Confirm or Cancel)

MON Verify Joint Angles and errors are correct on Joint Angle Position overlay.

	SR	SY	SP	EP	WP	WY	WR
(current)	+19.2	+112.5	-125.0	-82.4	-12.0	-17.0	+14.7
TGT	-100.0	+119.7	-160.0	-84.3	+7.4	-22.7	+18.4
ERR	+119.2	-7.2	+35.0	+1.9	-19.4	+5.7	-3.7

PCS **cmd** Confirm (Verify Sequence Status – Auto Seq sw - Hot)

DCP AUTO SEQ → PROC

PCS MSS: SSRMS:

Verify Posn Hold – orange

Verify Joint Angle values.

SR	SY	SP	EP	WP	WY	WR
-100.0	+119.7	-160.0	-84.3	+7.4	-22.7	+18.4

10. TRUSS CLEARANCE SINGLE JOINT MANEUVER

Configure Cameras and overlays as required.

Monitor 1	Monitor 2	Monitor 3	V10L	V10R
22: Base Elbow (-125, -10)	03: S1 Lower Outboard (+60, +10) 37: MBS Mast (-175, 0)	13: LAB Stbd Zenith (-170, +90)	Camera C (+20, +20)	Camera D (-90, +45)

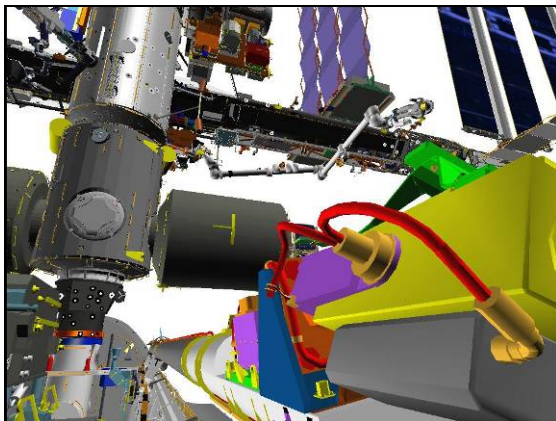

Figure 7.- Payload Bay Clearance
(Camera C: +20, +20).

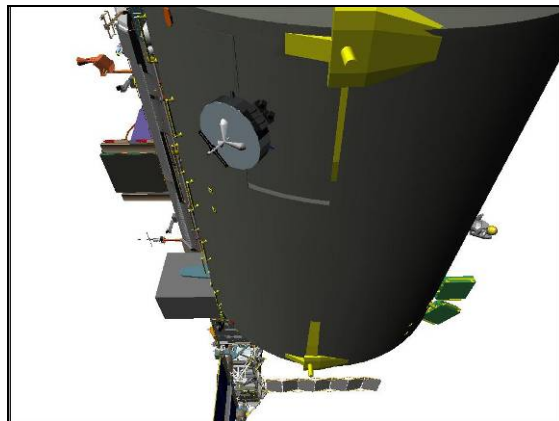

Figure 8.- Payload Bay Clearance
(Camera D: -90, +45).

MSS: SSRMS:

Enter Mode – Single (Verify blue)

WARNING
The active joint must be checked on the PCS before initiating motion. Failure to do so may result in movement of the wrong joint.

DCP JOINT SELECT → SHOULDER PITCH (Verify SP – Selected on PCS)

THC Perform “+” Single Joint maneuver to SP: -80.0 (THC up)

11. SASA INSTALL SETUP JOCAS (8 MINUTES)

Configure Cameras and overlays as required.

Monitor 1	Monitor 2	Monitor 3	V10L	V10R
24: Tip Elbow (-5, 0)	51: JEM MA EE	13: LAB Stbd Zenith	Camera C (+20, +20)	Camera D (-110, +55)
37: MBS Mast (-115, 0)	(+40, +25)	(+160, +60)		

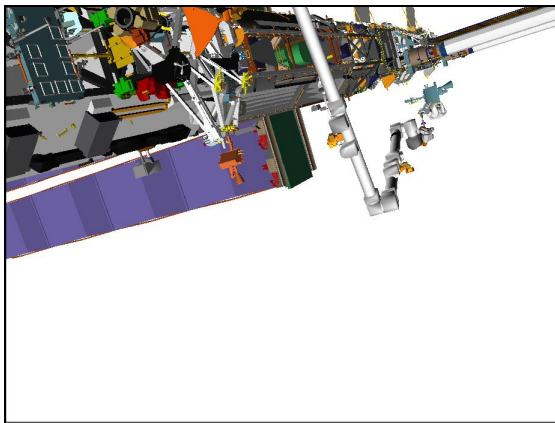

Figure 9.- Truss Clearance
(JEM EE: +40, +25).

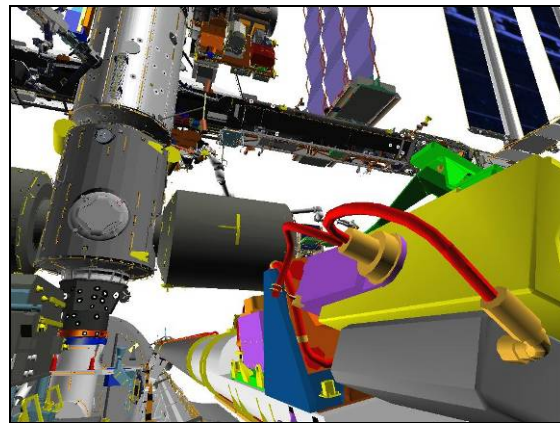

Figure 10.- Truss Clearance
(Camera C: +20, +20).

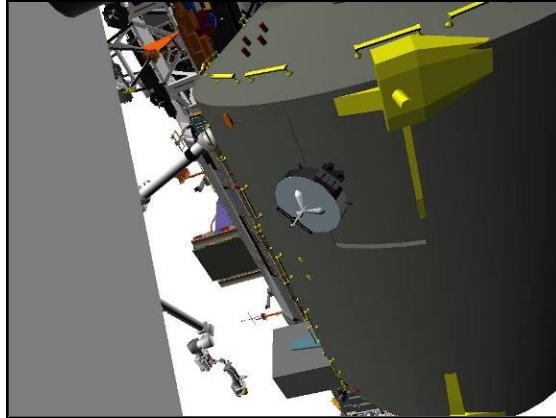

Figure 11.- Truss Clearance
(Camera D: -110, +55).

PCS MSS: SSRMS:

Enter Mode – Joint OCAS (Verify blue)

pick File ► EVA1 ► SASA Install Setup

Verify 'Joint Angles' 'Destination' for SASA Handoff Setup position.

SR	SY	SP	EP	WP	WY	WR
-115.0	+213.4	-73.4	+86.8	-96.2	-191.9	-100.9

cmd Load (Verify Sequence Status – Confirm or Cancel)

MON Verify Joint Angles and errors are correct on Joint Angle Position overlay.

	SR	SY	SP	EP	WP	WY	WR
(current)	-100.0	+119.7	-80.0	-84.3	+7.4	-22.7	+18.4
TGT	-115.0	+213.4	-73.4	+86.8	-96.2	-191.9	-100.9
ERR	+15.0	-93.7	-6.6	-171.1	+103.6	+169.2	+119.3

NOTE
Expect a singularity warning for the EP between -15 and +15 deg.

PCS **cmd** Confirm (Verify Sequence Status – Auto Seq sw - Hot)

DCP AUTO SEQ → PROC

PCS MSS: SSRMS:

Verify Posn Hold – orange

1.210 EVA1- SASA TRANSFER AND LEE LUBE OPS

(RBT FS/ULF3/FIN)

Verify Joint Angle values.

SR	SY	SP	EP	WP	WY	WR
-115.0	+213.4	-73.4	+86.8	-96.2	-191.9	-100.9

12. SASA INSTALL MANUAL MANEUVER

Configure Cameras and overlays as required.

Monitor 1	Monitor 2	Monitor 3
37: MBS Mast (-165, -25) 13: LAB Stbd Zenith (+160, +30)	24: Tip Elbow (+5, +10)	22: Base Elbow (+90, -10) 03: S1 Lower Outboard (+105, -10)

MSS: SSRMS:

Enter Mode – Manual (Verify blue)

MSS: SSRMS: SSRMS Manual: Joint Lock:

cmd Shoulder Roll (Verify SR – Locked)

THC/ RHC Perform EVA GCA as required.

Expected SSRMS at SASA Install position:

Locked						
SR	SY	SP	EP	WP	WY	WR
-115.0	+212.9	-58.3	+108.5	-132.9	-191.8	-101.4
X	Y	Z	Pitch	Yaw	Roll	
-432	+240	+143	+168.8	-65.5	-12.3	
FOR	Unloaded – Chest 12/PP/F/6, SR Held					
Disp	ISS>ISSACS					

On EV “GO,” ‘Ready for Toolbag pickup:’

THC/ RHC Perform EVA GCA as required for toolbag pickup.

13. Z1 BACKOUT MANUAL MANEUVER

On EV “GO,” ‘Toolbag pickup complete:’

PCS MSS: SSRMS:

Enter Mode – Manual (Verify blue)

MSS: SSRMS: SSRMS Manual: Joint Lock:

cmd Shoulder Roll (Verify SR – Locked)

1.210 EVA1- SASA TRANSFER AND LEE LUBE OPS

(RBT FS/ULF3/FIN)

THC/ RHC Maneuver EV to Z1 Backout position (within 5 cm/1 deg).

Locked						
SR	SY	SP	EP	WP	WY	WR
-115.0	+213.6	-80.7	+91.5	-93.6	-191.9	-100.7
X	Y	Z	Pitch	Yaw	Roll	
-361	+401	-335	+168.8	-65.5	-12.3	
FOR	Unloaded – Chest 12/PP/F/6, SR Held					
Disp	ISS>ISSACS					

14. POA LUBE INTERMEDIATE JOCAS (6 MINUTES)

Configure Cameras and overlays as required.

Monitor 1	Monitor 2	Monitor 3
24: Tip Elbow (+15, 0)	51: JEM MA EE (+40, +25)	13: LAB Stbd Zenith (-175, +35)

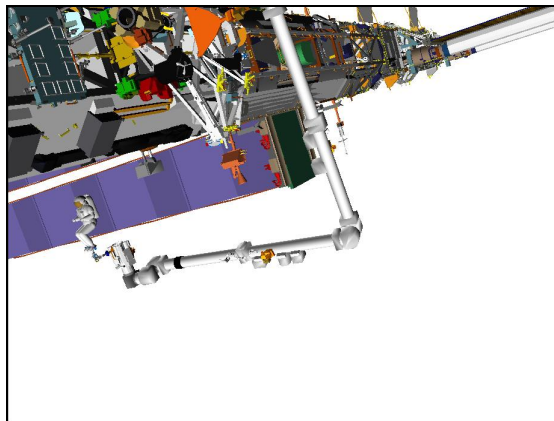

Figure 12.- Z1 Backoff
(JEM EE: +40, +25).

PCS

MSS: SSRMS:

Enter Mode – Joint OCAS (Verify blue)

pick File ► EVA1 ► POA Lube Intermed

Verify 'Joint Angles' 'Destination' for POA Lube Intermediate position.

SR	SY	SP	EP	WP	WY	WR
-115.0	+135.8	-74.8	+82.0	+32.0	+10.7	+178.8

cmd Load (Verify Sequence Status – Confirm or Cancel)

1.210 EVA1- SASA TRANSFER AND LEE LUBE OPS

(RBT FS/ULF3/FIN)

MON Verify Joint Angles and errors are correct on Joint Angle Position overlay.

	SR	SY	SP	EP	WP	WY	WR
(current)	-115.0	+213.6	-80.7	+91.5	-93.6	-191.9	-100.7
TGT	-115.0	+135.8	-74.8	+82.0	+32.0	+10.7	+178.8
ERR	0.0	+77.8	-5.9	+9.5	-125.6	-202.6	-279.5

PCS **cmd** Confirm (Verify Sequence Status – Auto Seq sw - Hot)

DCP AUTO SEQ → PROC

PCS MSS: SSRMS:

Verify Posn Hold – orange

Verify Joint Angle values.

SR	SY	SP	EP	WP	WY	WR
-115.0	+135.8	-74.8	+82.0	+32.0	+10.7	+178.8

15. POA LUBE SETUP JOCAS (2 MINUTES)

Configure Cameras and overlays as required.

Monitor 1	Monitor 2	Monitor 3
37: MBS Mast (0, -5) 32: MBS POA	09: P1 Lower Outboard (+120, -20) 51: JEM MA EE (+40, +25)	13: LAB Stbd Zenith (-170, -30)

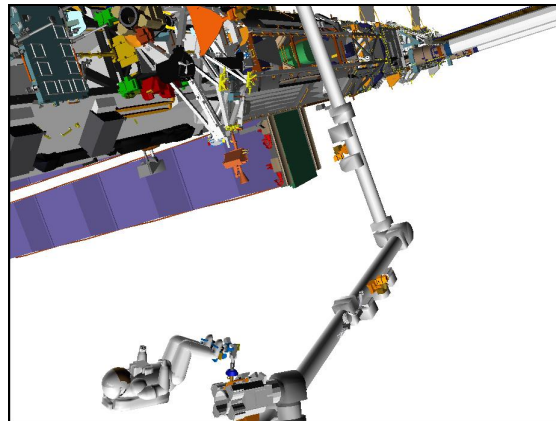

Figure 13.- POA Lube Intermediate
(JEM EE: +40, +25).

PCS MSS: SSRMS:

Enter Mode – Joint OCAS (Verify blue)

1.210 EVA1- SASA TRANSFER AND LEE LUBE OPS

(RBT FS/ULF3/FIN)

Page 14 of 22 pages

SSRMS Joint OCAS

pick File ► EVA1 ► POA Lube Setup

Verify 'Joint Angles' 'Destination' for POA Lube Setup position.

SR	SY	SP	EP	WP	WY	WR
-162.4	+154.9	-94.8	+105.8	+64.1	-15.8	+230.9

cmd Load (Verify Sequence Status – Confirm or Cancel)

MON

Verify Joint Angles and errors are correct on Joint Angle Position overlay.

	SR	SY	SP	EP	WP	WY	WR
(current)	-115.0	+135.8	-74.8	+82.0	+32.0	+10.7	+178.8
TGT	-162.4	+154.9	-94.8	+105.8	+64.1	-15.8	+230.9
ERR	+47.4	-19.1	+20.0	-23.8	-32.1	+26.5	-52.1

PCS

cmd Confirm (Verify Sequence Status – Auto Seq sw - Hot)

DCP

AUTO SEQ → PROC

PCS

MSS: SSRMS: SSRMS

Verify Posn Hold – orange

Verify Joint Angle values.

SR	SY	SP	EP	WP	WY	WR
-162.4	+154.9	-94.8	+105.8	+64.1	-15.8	+230.9

16. [POA LUBE MANUAL MANEUVER](#)

MSS: SSRMS: SSRMS

Enter Mode – Standby (Verify blue)

Change Unloaded Parameters ► EVA ► Chest 12/PP/F/6 SYH

Verify 'Unloaded Parameters' (two) – Chest 12/PP/F/6, SY Held

Enter Mode – Manual (Verify blue)

MSS: SSRMS: SSRMS Manual: Joint Lock: Joint Lock

cmd Shoulder Yaw (Verify SY – Locked)

THC/ RHC

Perform EVA GCA as required for POA Lube.

1.210 EVA1- SASA TRANSFER AND LEE LUBE OPS

(RBT FS/ULF3/FIN)

Page 15 of 22 pages

16.1 POA Snare Close **On EV “GO,” ‘Ready to close snares:’**

PCS MSS: MBS: MSS Safing:

cmd ‘MBS’ Remove (Verify Not Safed)

PCS MSS: MBS: POA:

cmd ‘Snare’ Close ► Slow, Soft Stops

Verify Speed – Slow

Verify Stops – Soft

Verify ‘**Confirm or Terminate**’ prompt.

cmd Confirm (Verify RHC Trigger Hot icon)

Verify POA Mode – Close Snares

RHC TRIGGER → press (hold until ‘Snare’ Brakes – On) (12 s max)

PCS Verify ‘Snare’ Close – blue

Give EV “GO” to ‘continue snare cable lubing.’

16.2 POA Snare Partial Open **On EV “GO,” ‘Ready for partial snare open:’**

MSS: MBS: POA:

cmd ‘Snare’ Open ► Hard Stops ► Slow, Hard Stops

Verify Speed – Slow

Verify Stops – Hard

Verify ‘**Confirm or Terminate**’ prompt.

cmd Confirm (Verify RHC Trigger Hot icon)

Verify POA Mode – Open Snares

RHC TRIGGER → press (3 seconds)

Verify with EV “rotating end of snare cable is beyond edge of cam cutout.”

PCS MSS: MBS: POA:

cmd Terminate (Verify ‘Motors’ - Inh)

Give EV “GO” for ‘snare cable exercising.’

16.3 POA LEE Lube Complete
On EV “GO,” ‘Ready for snare checkout:’

MSS: MBS: POA:

cmd Capture ► Setup ► Slow (Verify Speed – Slow)

Verify **‘Confirm or Terminate’** prompt.

cmd Confirm (Verify Trigger Hot icon)

Verify POA Mode – Setup for Capture

RHC TRIGGER → press (momentarily)

PCS Verify ‘Snare’ Open – blue
Verify ‘Carriage’ Extend – blue
Verify ‘Latch’ Unlatch – blue
Verify Motors – Inh (340 s max)

cmd ‘Snare’ Close ► Slow, Soft Stops

Verify Speed – Slow

Verify Stops – Soft

Verify **‘Confirm or Terminate’** prompt.

cmd Confirm (Verify RHC Trigger Hot icon)

Verify POA Mode – Close Snares

RHC TRIGGER → press (hold until ‘Snare’ Brakes – On) (12 s max)

PCS Verify ‘Snare’ Close – blue

cmd Capture ► Setup ► Slow (Verify Speed – Slow)

Verify **‘Confirm or Terminate’** prompt.

cmd Confirm (Verify Trigger Hot icon)

Verify POA Mode – Setup for Capture

RHC TRIGGER → press (momentarily)

PCS Verify ‘Snare’ Open – blue
Verify ‘Carriage’ Extend – blue
Verify ‘Latch’ Unlatch – blue
Verify Motors – Inh (340 s max)

17. POA BACKOUT MANUAL MANEUVER

On EV "GO," 'POA Lube complete:'

Change Command ► ISS ► ISSACS (Verify ISS>ISSACS)

NOTE
-Y HC input will move EV away from the POA and should be input first.

THC/ RHC Maneuver EV as required to POA Backout position (within 5 cm/1 deg).

Locked						
SR	SY	SP	EP	WP	WY	WR
-162.4	+154.9	-94.8	+105.8	+64.1	-15.8	+230.9
X	Y	Z	Pitch	Yaw	Roll	
+424	-177	+14	+140.5	+83.8	+12.7	
FOR	Unloaded – Chest 12/FF/F/12, SY Held					
Disp	ISS>ISSACS					

MSS: SSRMS: SSRMS

Enter Mode – Standby (Verify blue)

Change Unloaded Parameters ► EVA ► Chest 12/PP/F/6 SRH
Verify 'Unloaded Parameters' (two) – Chest 12/PP/F/6, SR Held

18. JEM RMS LUBE SETUP JOCAS (4 MINUTES)

Configure Cameras and overlays as required.

Monitor 1	Monitor 2	Monitor 3
37: MBS Mast (0, -5) 32: MBS POA	09: P1 Lower Outboard (+115, -15)	13: LAB Stbd Zenith (-170, -30)

PCS MSS: SSRMS: SSRMS

Enter Mode – Joint OCAS (Verify blue)

SSRMS Joint OCAS

pick File ► EVA1 ► JEM Lube Setup

Verify 'Joint Angles' 'Destination' for JEM Lube Setup position.

SR	SY	SP	EP	WP	WY	WR
-124.4	+117.0	-43.0	+61.5	-35.2	+17.1	+123.1

cmd Load (Verify Sequence Status – Confirm or Cancel)

1.210 EVA1- SASA TRANSFER AND LEE LUBE OPS

(RBT FS/ULF3/FIN)

MON Verify Joint Angles and errors are correct on Joint Angle Position overlay.

	SR	SY	SP	EP	WP	WY	WR
(current)	-162.4	+154.9	-94.8	+105.8	+64.1	-15.8	+230.9
TGT	-124.4	+117.0	-43.0	+61.5	-35.2	+17.1	+123.1
ERR	-38.0	+37.9	-51.8	+44.3	+99.3	-32.9	+107.8

PCS **cmd** Confirm (Verify Sequence Status – Auto Seq sw - Hot)

DCP AUTO SEQ → PROC

PCS MSS: SSRMS:

Verify Posn Hold – orange

Verify Joint Angle values.

SR	SY	SP	EP	WP	WY	WR
-124.4	+117.0	-43.0	+61.5	-35.2	+17.1	+123.1

19. JEM RMS LUBE MANUAL MANEUVER

Configure Cameras and overlays as required.

Monitor 1	Monitor 2	Monitor 3
13: LAB Stbd Zenith (-160, -20)	51: JEM MA EE (+40, +25)	09: P1 Lower Outboard (+120, +20)

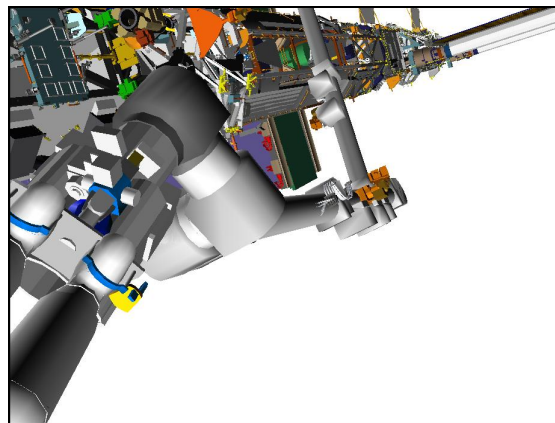

Figure 14.- JEM RMS Lube Setup
(JEM EE: +40, +25).

MSS: SSRMS:

Change Command ► SSRMS ► Internal (Verify SSRMS>Internal)

MSS: SSRMS:

Enter Mode – Manual (Verify blue)

1.210 EVA1- SASA TRANSFER AND LEE LUBE OPS

(RBT FS/ULF3/FIN)

MSS: SSRMS: SSRMS Manual: Joint Lock:

cmd Shoulder Roll (Verify SR – Locked)

THC/ RHC Perform EVA GCA as required for JEM RMS Lube.

20. JEM LUBE BACKOFF MANUAL MANEUVER

On EV “GO,” ‘JEM RMS Lube complete:’

PCS MSS: SSRMS:

Change Command ► ISS ► ISSACS (Verify ISS>ISSACS)

THC/ RHC Maneuver EV as required to JEM RMS Backoff position.

Verify SSRMS at JEM RMS Backoff position (within 5 cm/1 deg).

Locked						
SR	SY	SP	EP	WP	WY	WR
-124.4	+117.0	-43.0	+61.5	-35.2	+17.1	+123.1
X	Y	Z	Pitch	Yaw	Roll	
+920	-912	-354	-20.6	-15.3	-66.6	
FOR	Unloaded – Chest 12/PP/F/6, SR Held					
Disp	ISS>ISSACS					

21. TRUSS EGRESS SETUP JOCAS (9 MINUTES)

Configure Cameras and overlays as required.

Monitor 1	Monitor 2	Monitor 3	V10L	V10R
37: MBS Mast (-10, +30) 22: Base Elbow (-55, 0)	51: JEM MA EE (+40, +25)	13: LAB Stbd Zenith (-160, -20) 09: P1 Lower Outboard (+120, -15)	Camera D (-100, +50)	Camera C (+20, +30)

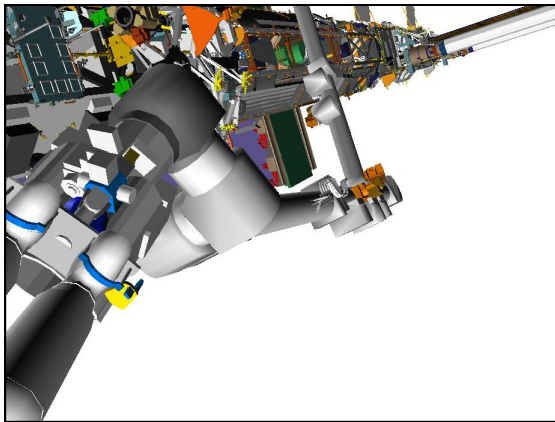

Figure 15.- JEM RMS Backoff
(JEM EE: +40, +25).

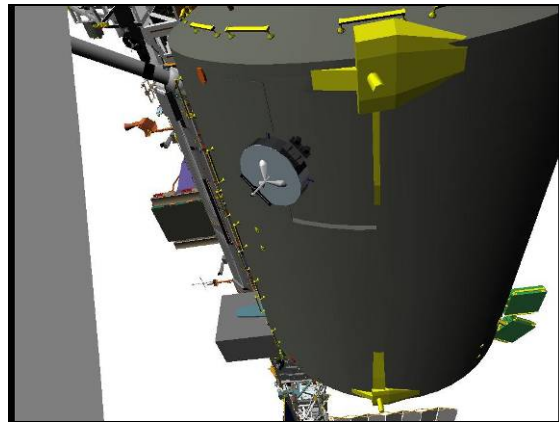

Figure 16.- JEM RMS Backoff
(Camera D: -100, +50).

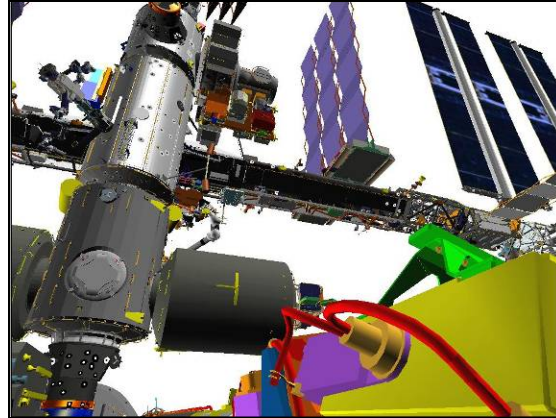

Figure 17.- JEM RMS Backoff
 (Camera C: +20, +30).

PCS

MSS: SSRMS:

Enter Mode – Joint OCAS (Verify blue)

pick File ► EVA1 ► Truss Egress

Verify 'Joint Angles' 'Destination' for Truss Egress Setup position.

SR	SY	SP	EP	WP	WY	WR
-100.0	+128.0	-126.0	-61.6	-51.7	-189.0	+95.0

cmd Load (Verify Sequence Status – Confirm or Cancel)

NOTE
Expect a singularity warning for the EP between -15 and +15 deg.

MON

Verify Joint Angles and errors are correct on Joint Angle Position overlay.

	SR	SY	SP	EP	WP	WY	WR
(current)	-124.4	+117.0	-43.0	+61.5	-35.2	+17.1	+123.1
TGT	-100.0	+128.0	-126.0	-61.6	-51.7	-189.0	+95.0
ERR	-24.4	-11.0	+83.0	+123.1	+16.5	+206.1	+28.1

PCS

cmd Confirm (Verify Sequence Status – Auto Seq sw - Hot)

DCP

AUTO SEQ → PROC

PCS

MSS: SSRMS:

Verify Posn Hold – orange

1.210 EVA1- SASA TRANSFER AND LEE LUBE OPS

(RBT FS/ULF3/FIN)

Verify Joint Angle values.

SR	SY	SP	EP	WP	WY	WR
-100.0	+128.0	-126.0	-61.6	-51.7	-189.0	+95.0

22. TRUSS EGRESS MANUAL MANEUVER

Configure Cameras and overlays as required.

Monitor 1	Monitor 2	Monitor 3	V10L
37: MBS Mast (+175, +10)	03: S1 Lower Outboard (+50, -20)	13: LAB Stbd Zenith (-180, +55)	Camera C (+20, +20)

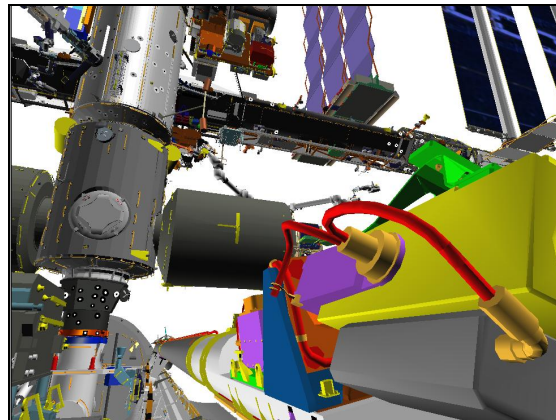

Figure 18.- Truss Egress Setup
(Camera C: +20, +20).

Change Command ► ISS ► ISSACS/Internal (Verify ISS>ISSACS/Internal)

MSS: SSRMS:

Enter Mode – Manual (Verify blue)

MSS: SSRMS: SSRMS Manual: Joint Lock:

cmd Shoulder Roll (Verify SR – Locked)

THC Perform -X (THC out) and EVA GCA as required to Truss Egress.

Expected Truss Egress position:

Locked						
SR	SY	SP	EP	WP	WY	WR
-100.0	+115.0	-125.0	-62.0	-54.8	-195.4	+106.5
X	Y	Z	Pitch	Yaw	Roll	
+198	+1793	-78	-168.0	-12.9	-178.5	
FOR	Unloaded – Chest 12/PP/F/6, SR Held					
Disp	ISS>ISSACS					

On EV “GO,” ‘Ready for Truss Egress:’

PCS MSS: SSRMS:

Enter Mode – Standby (Verify blue)

23. TRUSS EGRESS BACKOFF MANUAL MANEUVER

On EV “GO,” ‘APFR removed and EV clear for backoff:’

Change Unloaded Parameters ► Unloaded ► LEE Tip SRH
 Verify ‘Unloaded Parameters’ (two) – LEE Tip, SR Held

MSS: SSRMS:

Enter Mode – Manual (Verify blue)

MSS: SSRMS: SSRMS Manual: Joint Lock:

cmd Shoulder Roll (Verify SR – Locked)

THC Perform +X (THC in) maneuver Truss Backoff position.

Locked						
SR	SY	SP	EP	WP	WY	WR
-100.0	+128.0	-126.0	-61.6	-51.7	-189.0	+95.0
X	Y	Z	Pitch	Yaw	Roll	
+583	+1817	+59	+101.6	-1.5	-175.8	
FOR	Unloaded – LEE Tip, SR Held					
Disp	ISS>ISSACS					

DCP BRAKES SSRMS → ON (Verify ON)

NOTE

For all OCASes if the joint angles are incorrect after loaded, then **cmd** Cancel on the PCS and reload the correct destination.

1. SETUP

Configure Cameras and overlays as required.

Monitor 1	Monitor 2	Monitor 3	V10
03: S1 Lower Outboard (+50, -20)	13: Lab Stbd Zenith (-180, +70)	37: MBS Mast (-170, 0)	Camera C (+20, +30)

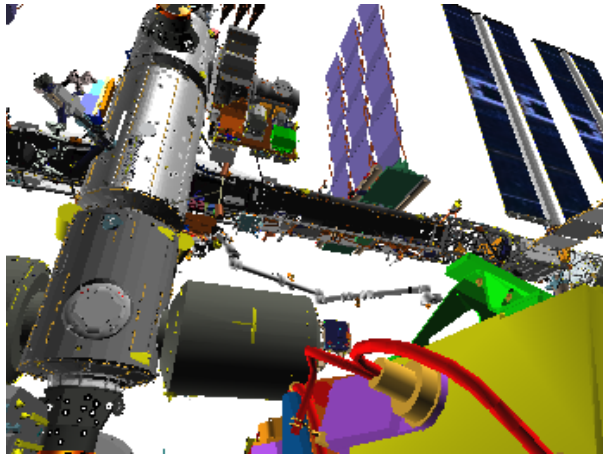

Figure 1. Truss Egress Backoff Position (Camera C: +20, +30).

Verify Unloaded Parameters – √
 Verify 'Unloaded Parameters' (two) – LEE Tip, SR Held

√Display – ISS>ISSACS

√Vernier

Verify SSRMS at Truss Egress Backoff position (within 5 cm/1 deg).

SR	SY	SP	EP	WP	WY	WR
-100.0	+128.0	-126.0	-61.6	-51.7	-189.0	+95.0
X	Y	Z	Pitch	Yaw	Roll	
+583	+1817	+59	+101.6	-1.5	-175.8	
FOR	Unloaded – LEE Tip, SR Held					
Disp	ISS>ISSACS					

2. EVA1 TRUSS EGRESS TO MT TRANSLATION JOCAS (2 MINUTES)

DCP BRAKES SSRMS → OFF (Verify OFF)

PCS MSS: SSRMS:

Enter Mode – Joint OCAS (Verify blue)

1.220 EVA1 TO MT TRANSLATION CONFIG (NO FI)

(RBT FS/ULF3/FIN/SPN)

RHC RATE → COARSE (Verify Coarse on PCS)

SSRMS Joint OCAS

pick File ► MT ► Translate

Verify 'Joint Angles' 'Destination' for MT Translate position.

SR	SY	SP	EP	WP	WY	WR
-100.0	+110.0	-8.0	-156.0	-72.0	-180.0	+157.4

cmd Load (Verify Sequence Status – Confirm or Cancel)

MON Verify Joint Angles and errors are correct on Joint Angle Position overlay.

	SR	SY	SP	EP	WP	WY	WR
(current)	-100.0	+128.0	-126.0	-61.6	-51.7	-189.0	+95.0
TGT	-100.0	+110.0	-8.0	-156.0	-72.0	-180.0	+157.4
ERR	0.0	+18.0	-118.0	+94.4	+20.3	-9.0	-62.4

PCS **cmd** Confirm (Verify Sequence Status – Auto Seq sw - Hot)

DCP AUTO SEQ → PROC

PCS MSS: SSRMS: **SSRMS**

Verify Posn Hold – orange

Verify SSRMS at MT Translation Position (within 5 cm/1 deg).

SR	SY	SP	EP	WP	WY	WR
-100.0	+110.0	-8.0	-156.0	-72.0	-180.0	+157.4
X	Y	Z	Pitch	Yaw	Roll	
+609	+766	-320	+82.6	-3.2	-129.3	
FOR	Unloaded – LEE Tip, SR Held					
Disp	ISS>ISSACS					

NOTE

Expect the following message when safing is commanded:

'R3Z - MSS OCS SSRMS Prime(Redun) ACU SRT Cat-1 Brk Stat Fail' (SCR 17495)

This message should return to Norm.

DCP SAFING → SAFE (Verify ON)

1.310 ELC2 HANDOFF AND INSTALL

(RBT FS/ULF3/FIN/SPN)

Page 1 of 12 pages

NOTE

For all OCASes if the joint angles are incorrect after loaded, then **cmd** Cancel on the PCS and reload the correct destination.

1. SETUP

THC/ RHC Deflect all axes to positive and negative hard stops.

Configure Cameras and overlays as required.

Monitor 1	Monitor 2	Monitor 3	V10L	V10R
13: LAB Stbd Zenith (-15, +25)	25: Tip LEE (fully zoomed out)	37: MBS Mast (+150, -20) 24: Tip Elbow (-120, -20)	Camera B (+45, +30)	SRMS Elbow (-50, +40)

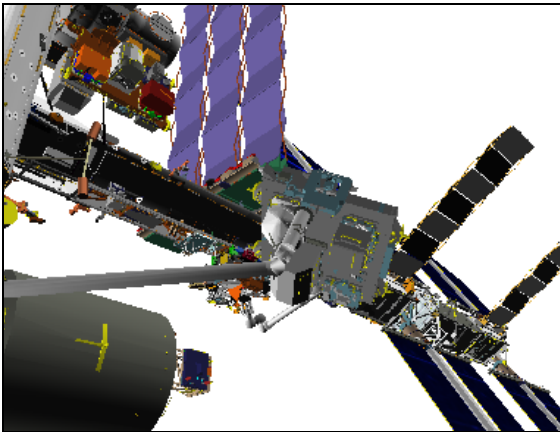

Figure 1.- Park Position
(Camera B: +45, +30).

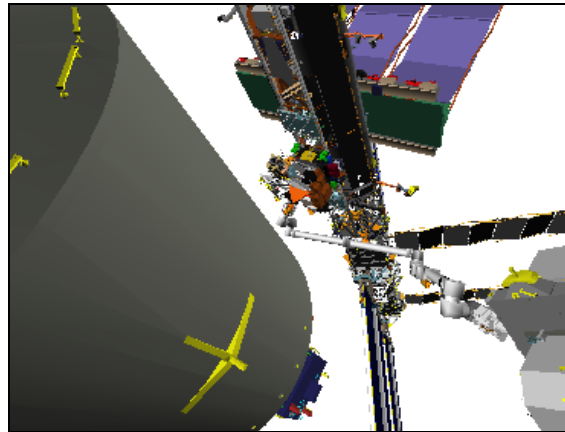

Figure 2.- Park Position
(SRMS Elbow: -50, +40).

Verify with **MCC-H** that Stbd SARJ is locked and clear for ELC2 Install.

Change Loaded Parameters ► ELC ► ELC2 Install SYH
Verify 'Loaded Parameters' (two) – ELC2 Install, SY Held

Verify Unloaded Parameters – ✓

Change Unloaded Parameters ► Unloaded ► LEE Tip SRH
Verify 'Unloaded Parameters' (two) – LEE Tip, SR Held

Change Display ► S3 ► ELC2 Install S3UO (Verify S3>ELC2 Install S3UO)

✓Command – SSRMS>Internal

RHC RATE → VERNIER (Verify Vernier on PCS)

PCS MSS: SSRMS: Rate:

Set 'Scale' 'Vernier' Rate Scale: 0.6

29 OCT 09

21681.doc

1.310 ELC2 HANDOFF AND INSTALL

(RBT FS/ULF3/FIN/SPN)

Verify SSRMS at Park position (within 5 cm/1 deg).

SR	SY	SP	EP	WP	WY	WR
+234.0	+62.4	+198.5	-70.6	+12.4	-2.6	+53.4
X	Y	Z	Pitch	Yaw	Roll	
+1188	+818	-1220	+56.0	+19.0	-103.1	
FOR	Unloaded – LEE Tip, SR Held					
Disp	S3>ELC2 Install S3UO					

2. ELC2 GRAPPLE AT HANDOFF

- * If using shuttle attitude control
- * | Verify in attitude and rates damped, then
- * | DAP: FREE

MSS: SSRMS: Thrusters:

Verify 'Desat Request:' – Inh

2.1 Grapple Setup

On SRMS Operator, 'GO for ELC2 Grapple Maneuver:'

NOTE

This maneuver brings the SSRMS Base Boom within 38in of MBS PDGF 1. This clearance can be monitored with the Tip Elbow Camera or MBS Mast Camera

MSS: SSRMS: MSS Safing:

cmd 'SSRMS' Remove (Verify Not Safed)

DCP BRAKES SSRMS → OFF (Verify OFF)

2.2 Manuever to ELC2 Grapple

PCS MSS: SSRMS:

Enter Mode – Manual (Verify blue)

MSS: SSRMS: SSRMS Manual: Joint Lock:

cmd Shoulder Roll (Verify SR – Locked)

THC/ RHC Maneuver to within grapple envelope.

2.3 Slow Capture Commands

PCS MSS: SSRMS: Tip LEE:

cmd Capture ► Automatic ► Slow, Limp (Verify Speed – Slow)

Verify '**Confirm or Terminate**' prompt.

1.310 ELC2 HANDOFF AND INSTALL

(RBT FS/ULF3/FIN/SPN)

Page 3 of 12 pages

cmd Confirm (Verify RHC Trigger Hot icon)

Verify LEE Mode – Auto Capture

RHC 2.4 Grapple
TRIGGER → press (momentarily)

PCS Verify 'Snare' Close, Capture (two) – blue (12 s max)
Verify Capture to Latch – Yes (SCR 19282)
Verify 'Carriage' Tension ~5500 N (90 s max)
Verify 'Carriage' Retract – blue
Verify 'Latch' Latch – blue (80s max)

2.5 Mating Umbilicals

Verify with **MCC-H** - Payload and PDGF power inhibits have been confirmed.

cmd 'Umbilical' Mate (Verify '**Confirm or Terminate**' prompt)

cmd Confirm (Verify RHC Trigger Hot icon)

Verify LEE Mode – Mate

RHC TRIGGER → press (momentarily)

PCS Verify 'Umbilical' Mate – blue (10 s max)
Verify 'Connector Continuity' Prime, Redundant (two) – Yes

2.6 Grapple Cleanup

Verify Posn Hold – orange

Verify Loaded Parameters – √

Verify 'Loaded Parameters' (two) – ELC2 Install, SY Held

DCP BRAKES SSRMS → ON (Verify ON)

Give SRMS Operator, 'GO for ELC2 Ungrapple.'

Expected ELC2 Handoff position:

Locked						
SR	SY	SP	EP	WP	WY	WR
+234.0	+62.7	+184.5	-47.7	+3.5	-2.4	+53.6
X	Y	Z	Pitch	Yaw	Roll	
+1603	+854	-1704	+43.4	-11.5	+67.7	
FOR	Loaded – ELC2 Install, SY Held					
Disp	S3>ELC2 Install S3UO					

1.310 ELC2 HANDOFF AND INSTALL

(RBT FS/ULF3/FIN/SPN)

Page 4 of 12 pages

PCS

MSS: SSRMS: Power:

cmd 'Payload' Prime On (Verify On)

3. HANDOFF CLEANUP SETUP

Configure Cameras and overlays as required.

Monitor 1	Monitor 2	Monitor 3	V10L	V10R
03: S1 Lower Outboard (+30, +30)	37: MBS Mast (+150, -20)	13: LAB Stbd Zenith (-10, +10)	Camera B (+45, +30)	Camera C (+35, +40)

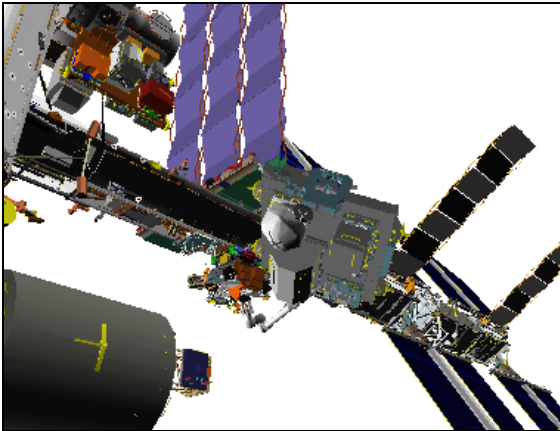

Figure 3.- ELC2 Handoff (Camera B: +45, +30).

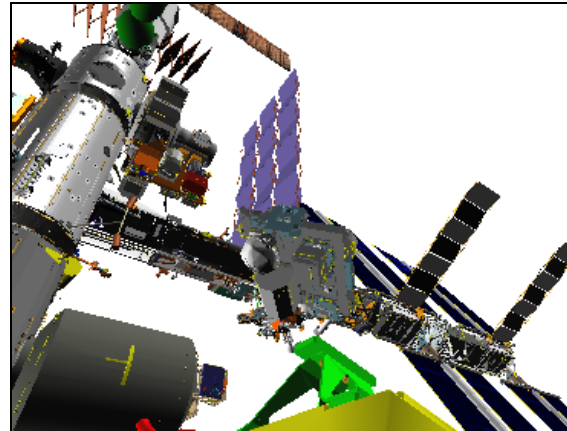

Figure 4.- ELC2 Handoff (Camera C: +35, +40).

On SRMS Operator, 'GO for ELC2 Intermediate JOCAS:'

DCP BRAKES SSRMS → OFF (Verify OFF)

PCS MSS: SSRMS:

Enter Mode – Joint OCAS (Verify blue)

MSS: SSRMS: Rate:

√'Scale' 'Vernier' Current: 1.0

If all of the following joint angles are within 3 degrees then go to step 5, otherwise continue on to step 4.

SR	SY	SP	EP	WP	WY	WR
+234.0	+62.7	+184.5	-47.7	+3.5	-2.4	+53.6

1.310 ELC2 HANDOFF AND INSTALL

(RBT FS/ULF3/FIN/SPN)

4. HANDOFF CLEANUP

SSRMS Joint OCAS

pick File ► ELC2 ► ELC2 Handoff

Verify 'Joint Angles' 'Destination' for ELC2 Handoff position.

SR	SY	SP	EP	WP	WY	WR
+234.0	+62.7	+184.5	-47.7	+3.5	-2.4	+53.6

cmd Load (Verify Sequence Status – Confirm or Cancel)

MON

Verify Joint Angles are correct on Joint Angle Position overlay.

SR	SY	SP	EP	WP	WY	WR
+234.0	+62.7	+184.5	-47.7	+3.5	-2.4	+53.6

PCS

cmd Confirm (Verify Sequence Status – Auto Seq sw - Hot)

DCP

AUTO SEQ → PROC

PCS

MSS: SSRMS: SSRMS

Verify Posn Hold – orange

Verify Joint Angle values.

SR	SY	SP	EP	WP	WY	WR
+234.0	+62.7	+184.5	-47.7	+3.5	-2.4	+53.6

5. JOCAS TO INTERMEDIATE (6 MINUTES)

```
*****
* If using shuttle attitude control and attitude maintenance required
* | DAP: LVLH
* |
* | When rates damped
* | | DAP: FREE > 2 seconds
* | | DAP: AUTO
* |
* | When in attitude and rates damped
* | | DAP: FREE
*****
```

NOTE

This maneuver has the following clearance concerns:

- a. Clearance between the SSRMS Base Boom and MBS PDGF 1 is 41in.
- b. Clearance between the SSRMS Base Elbow Camera and the S3 Truss is 58in.

These clearances can be monitored with the MBS Mast Camera or S1 Lower Outboard Camera (+10, -30).

RHC

RATE → COARSE (Verify Coarse on PCS)

1.310 ELC2 HANDOFF AND INSTALL

(RBT FS/ULF3/FIN/SPN)

SSRMS Joint OCAS

pick File ► ELC2 ► Intermediate

Verify 'Joint Angles' 'Destination' for Intermediate position.

SR	SY	SP	EP	WP	WY	WR
+234.0	+80.0	+250.0	-125.0	-45.0	+13.2	+53.6

cmd Load (Verify Sequence Status – Confirm or Cancel)

MON

Verify Joint Angles and errors are correct on Joint Angle Position overlay.

	SR	SY	SP	EP	WP	WY	WR
(current)	+234.0	+62.7	+184.5	-47.7	+3.5	-2.4	+53.6
TGT	+234.0	+80.0	+250.0	-125.0	-45.0	+13.2	+53.6
ERR	0.0	-17.3	-65.5	+77.3	+48.5	-15.6	0.0

PCS

cmd Confirm (Verify Sequence Status – Auto Seq sw - Hot)

DCP

AUTO SEQ → PROC

PCS

MSS: SSRMS: SSRMS

Verify Posn Hold – orange

Verify Joint Angle values.

SR	SY	SP	EP	WP	WY	WR
+234.0	+80.0	+250.0	-125.0	-45.0	+13.2	+53.6

Give SRMS Operator 'Go for ELC2 Install Viewing:'

```
*****
* If using shuttle attitude control and attitude maintenance required
* | Configure DAP A CNTL ACC per DOCKED DAP REFERENCE
* | (ORB OPS FS, Reboost/DAP), then:
* |
* | DAP: LVLH
* |
* | When rates damped
* | | DAP: FREE > 2 seconds
* | | DAP: AUTO
* |
* | When in attitude and rates damped
* | | DAP: FREE
*****
```

1.310 ELC2 HANDOFF AND INSTALL

(RBT FS/ULF3/FIN/SPN)

Page 7 of 12 pages

6. JOCAS TO CLEARANCE POSITION (25 MINUTES)

Configure Cameras and overlays as required.

Monitor 1	Monitor 2	Monitor 3	V10L	V10R
13: LAB Stbd Zenith (-10, +80)	37: MBS Mast (+160, -20)	22: Base Elbow (-10, +15)	Camera B (+45, +30)	SRMS Elbow (+80, -50)
09: P1 Lower Outboard (+100, -10)	03: S1 Lower Outboard (+10, -30)	24: Tip Elbow (-95, -20)	Camera D (-100, +30)	

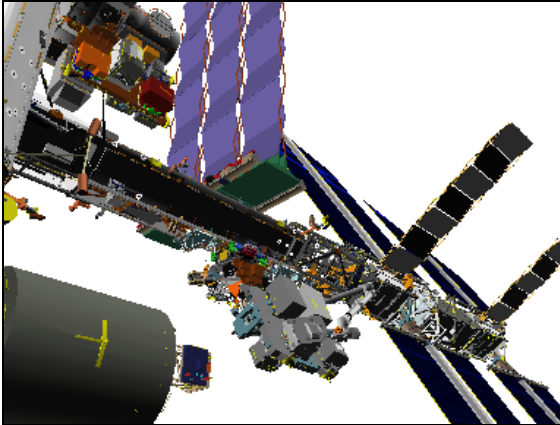

Figure 5.- Intermediate Position
(Camera B: +45, +30).

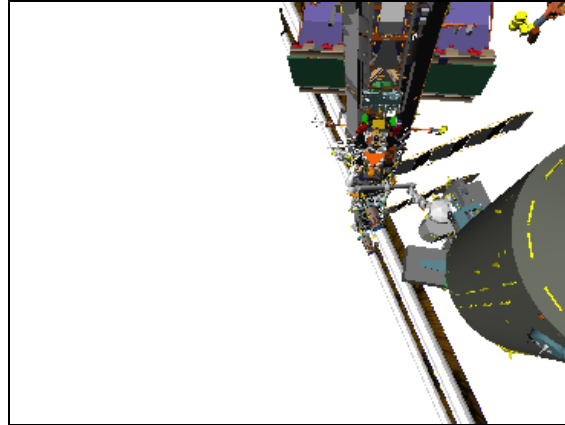

Figure 6.- Intermediate Position
(SRMS Elbow: +80, -50).

NOTE

1. When the SR becomes less than +188.0, pause the JOCAS and switch from coarse to vern.
2. This maneuver has the following clearance concerns:
 - a. Clearance between the SSRMS Tip Boom and ELC2 is 31in. This clearance can be monitored with the Stbd Zenith Camera.
 - b. Clearance between the SSRMS Base Boom and MBS PDGF 1 is 35in. This clearance can be monitored with the S1 Lower Outboard Camera, MBS Mast Camera or Tip Elbow Camera.
 - c. Clearance between the SSRMS Base Boom and the MBS Mast Camera is 40in. This clearance can be monitored with the Base Elbow Camera, S1 Lower Outboard Camera or Tip Elbow Camera.
 - d. Clearance between the CTC on ELC2 and the FPMU is 58in. This clearance can be monitored with the Tip Elbow Camera.

On SRMS Operator 'GO for ELC2 Install:'

SSRMS Joint OCAS

pick File ► ELC2 ► Clearance

1.310 ELC2 HANDOFF AND INSTALL

(RBT FS/ULF3/FIN/SPN)

Verify 'Joint Angles' 'Destination' for Clearance position.

SR	SY	SP	EP	WP	WY	WR
+159.5	+29.9	-43.8	-84.1	-112.9	+13.2	-74.7

cmd Load (Verify Sequence Status – Confirm or Cancel)

MON

Verify Joint Angles and errors are correct on Joint Angle Position overlay.

	SR	SY	SP	EP	WP	WY	WR
(current)	+234.0	+80.0	+250.0	-125.0	-45.0	+13.2	+53.6
TGT	+159.5	+29.9	-43.8	-84.1	-112.9	+13.2	-74.7
ERR	+74.5	+50.1	+293.8	-40.9	+67.9	0.0	+128.3

PCS

cmd Confirm (Verify Sequence Status – Auto Seq sw - Hot)

DCP

AUTO SEQ → PROC

PCS

MSS: SSRMS:

Verify Posn Hold – orange

Verify Joint Angle values.

SR	SY	SP	EP	WP	WY	WR
+159.5	+29.9	-43.8	-84.1	-112.9	+13.2	-74.7

 * If using shuttle attitude control and attitude maintenance required
 * | DAP: LVLH
 * |
 * | When rates damped
 * | | DAP: FREE > 2 seconds
 * | | DAP: AUTO
 * |
 * | When in attitude and rates damped
 * | | DAP: FREE

MSS: SSRMS: Thrusters:

Verify 'Desat Request:' – Inh

7. MANUAL MANEUVER TO ELC2 INSTALL

7.1 Install Setup

Configure Cameras, EBCS Targets and USOS Effector overlays.

Monitor 1	Monitor 2	Monitor 3	V10L	V10R
13: LAB Stbd Zenith (-10, +80) 03: S1 Lower Outboard (+20, -45)	24: Tip Elbow (-80, 0) 28: EBCS	22: Base Elbow (0, +5) 24: Tip Elbow (-125, -5)	Camera B (+45, +30) Camera D (-100, +30)	SRMS EE

1.310 ELC2 HANDOFF AND INSTALL

(RBT FS/ULF3/FIN/SPN)

Page 9 of 12 pages

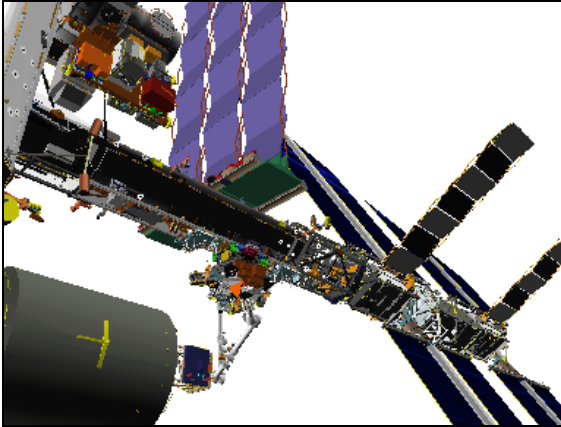

Figure 7.- Clearance Position
(Camera B: +45, +30).

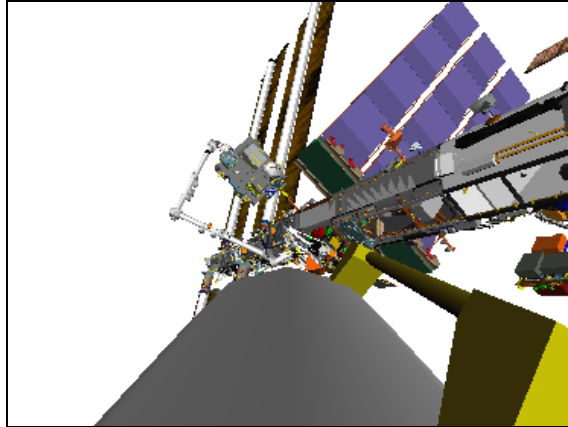

Figure 8.- Clearance Position
(SRMS EE).

NOTE

1. The EBCS Camera view used for the Install will be the left Camera, unless otherwise notified by **MCC-H**.
2. Due to the USOS Effector overlay having the incorrect RTL configuration, use the following PCS display:
S3: S&M: PAS 1 Latch:
3. This maneuver has the following clearance concerns:
 - a. Clearance between the SSRMS Tip Boom and the ELC2 is 26in. This clearance can be monitored with the LAB Stbd Zenith Camera.
 - b. Clearance between the CTC on ELC2 and the FPMU is 58in. This clearance can be monitored with the Base Elbow Camera (-60, -5).

√Vernier

MSS: SSRMS: Rate:

Set 'Scale' 'Vernier' Rate Scale: 0.4 (verify 0.4)

MSS: SSRMS:

Enter Mode – Manual (Verify blue)

MSS: SSRMS: SSRMS Manual: Joint Lock:

cmd Shoulder Yaw (Verify SY – Locked)

1.310 ELC2 HANDOFF AND INSTALL

(RBT FS/ULF3/FIN/SPN)

7.2 Manual Pre-Install

THC

Maneuver ELC2 to Pre-Install position (within 5 cm/1 deg).
Expected +Z, THC down.

Locked						
SR	SY	SP	EP	WP	WY	WR
+170.4	+29.9	-45.3	-68.5	-122.4	+5.1	-69.7
X	Y	Z	Pitch	Yaw	Roll	
-200	0	0	0.0	0.0	0.0	
FOR	Loaded – ELC2 Install, SY Held					
Disp	S3>ELC2 Install S3UO					

```

*****
* If using shuttle attitude control and attitude maintenance required
* |   BRAKES SSRMS → ON (Verify ON)
* |
* |   DAP: LVLH
* |
* |   When rates damped
* |   |   DAP: FREE > 2 seconds
* |   |   DAP: AUTO
* |   |
* |   |   When in attitude and rates damped
* |   |   |   DAP: FREE
* |   |   |
* |   |   |   BRAKES SSRMS → OFF (Verify OFF)
*****
    
```

PCS

MSS: SSRMS: Thrusters: Thruster Controls for MSS Ops

Verify 'Desat Request:' – Inh

7.3 ELC2 Install on S3UO

Perform "+X" Manual Maneuver to X: -90 (THC in).

Make alignment corrections as needed.

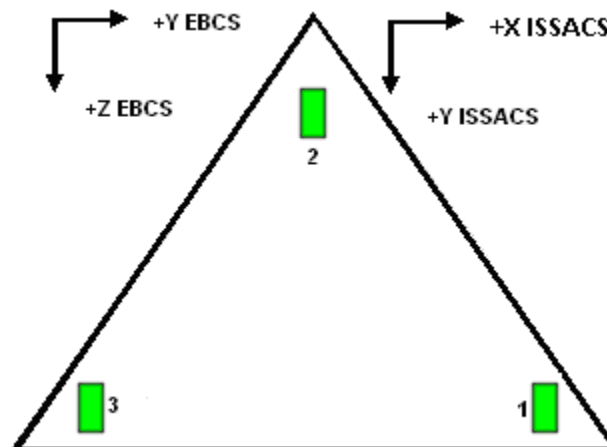

Figure 9.- ELC2 EBCS Install RTL Diagram.

1.310 ELC2 HANDOFF AND INSTALL

(RBT FS/ULF3/FIN/SPN)

Maneuver ELC2 2cm past the last RTL indication.
If ELC2 is deep into the PAS envelope and are missing RTL(s) due to orientation errors, refer to Table 1.

Table 1.

Missing RTLs	RHC Input
1	+Pitch, -Yaw
2	-Pitch
3	+Pitch, +Yaw
1, 2	-Pitch then -Yaw
2, 3	-Pitch then +Yaw
1, 3	+Pitch

THC/ RHC

Maneuver ELC2 to Ready-To-Latch Position until RTLs (three) – green

Verify SSRMS at RTL Ready to Latch position (within 5 cm/1 deg).

	Locked					
SR	SY	SP	EP	WP	WY	WR
+175.6	+29.9	-39.0	-85.3	-109.5	+1.5	-67.2
X	Y	Z	Pitch	Yaw	Roll	
-6	0	0	0.0	0.0	0.0	
FOR	Loaded – ELC2 Install, SY Held					
Disp	S3>ELC2 Install S3UO					

PCS

MSS: SSRMS:

Enter Mode – Standby (Verify blue)

7.4 SSRMS PAS Coordination

Notify **PAS Operator**, “Maneuver to RTL complete - go for First Phase Capture.”

MSS: SSRMS: Power:

cmd ‘Payload’ Prime(Redundant) Off (Verify two Off)

On **PAS Operator**, “First Phase Capture complete - go to limp SSRMS.”

MSS: SSRMS: Limp:

cmd All Limp (Verify Limp – blue)

1.310 ELC2 HANDOFF AND INSTALL

(RBT FS/ULF3/FIN/SPN)

Page 12 of 12 pages

MSS: SSRMS: SSRMS

Verify all joints – Limped

Notify **PAS Operator**, “Go for Second Stage Capture - All joints limped.”

On **PAS Operator**, “Capture complete - go for SSRMS Brakes On.”

NOTE

Expect the following message when safing is commanded:
**‘R3Z - MSS OCS SSRMS Prime(Redun) ACU SRT Cat-1
Brk Stat Fail’** (SCR 17495)
This message should return to Norm.

DCP

SAFING → SAFE (Verify ON)

```
*****
* If using shuttle attitude control
* | DAP: LVLH
* |
* | When rates damped
* | | DAP: FREE > 2 seconds
* | | DAP: AUTO
*****
```

1.320 ELC2 RELEASE, WALKOFF TO MBS PDGF 1 AND MNVR TO MT TRANSLATION CONFIG

(RBT FS/ULF3/FIN/SPN)

Page 1 of 13 pages

NOTE

For all OCASes if the Joint Angles are incorrect after loaded, then **cmd** Cancel on the PCS and reload the correct destination.

1. SETUP

Configure Cameras and overlays as required.

Monitor 1	Monitor 2	Monitor 3	V10L	V10R
13: LAB Stbd Zenith (-10, +80) 22: Base Elbow (0, +5)	25: Tip LEE (fully zoomed out)	24: Tip Elbow (-15, +5)	Camera B (+45, +30)	SRMS EE

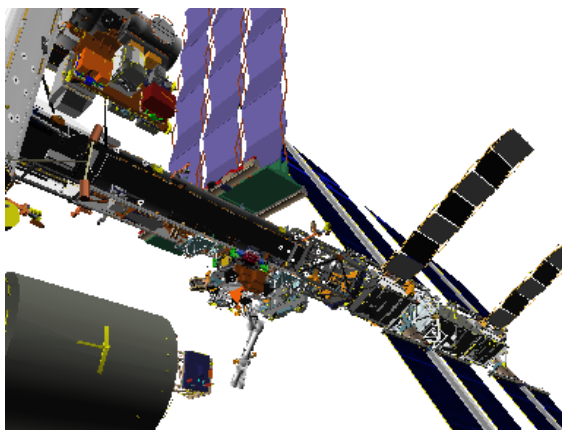

Figure 1.- ELC2 Install (Camera B: +45, +30).

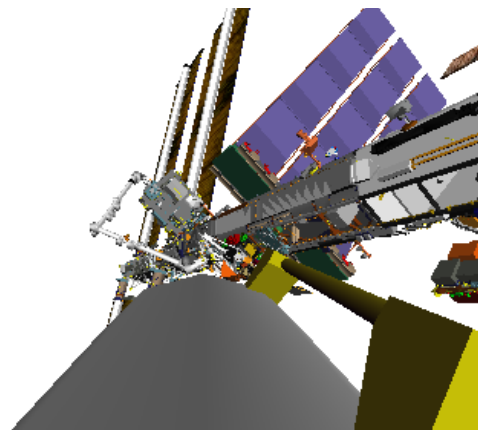

Figure 2.- ELC2 Install (SRMS EE).

Verify with **MCC-H** that Stbd SARJ is locked and clear for ELC2 Release.

√ Verify Loaded Parameters – √

Verify 'Loaded Parameters' (two) – ELC2 Install, SY Held

Change Unloaded Parameters ► Unloaded ► LEE Tip SYH

Verify 'Unloaded Parameters' (two) – LEE Tip, SY Held

Change Display ► S3 ► ELC2 PVGF1 S3UO (Verify S3>ELC2 PVGF1 S3UO)

√ Command – SSRMS>Internal

√ Vernier

PCS

MSS: SSRMS: Rate:

Set 'Scale' 'Vernier' Rate Scale: 1.0 (Verify 1.0)

30 OCT 09

21682.doc

1.320 ELC2 RELEASE, WALKOFF TO MBS PDGF 1 AND MNVR TO MT TRANSLATION CONFIG

(RBT FS/ULF3/FIN/SPN)

Page 2 of 13 pages

Verify SSRMS at ELC2 Install position (within 5 cm/1 deg).

SR	SY	SP	EP	WP	WY	WR
+175.7	+29.9	-38.9	-85.7	-109.1	+1.3	-67.1
X	Y	Z	Pitch	Yaw	Roll	
+460	-32	-185	+32.7	-5.4	+171.6	
FOR	Loaded – ELC2 Install, SY Held					
Disp	S3>ELC2 PVGF1 S3UO					

2. ELC2 RELEASE

2.1 Release Setup

MSS: SSRMS: MSS Safing:

cmd 'SSRMS' Remove (Verify Not Safed)

DCP

BRAKES SSRMS → OFF (Verify OFF)

2.2 SSRMS Limp

PCS

MSS: SSRMS: Limp:

cmd All Limp (Verify Limp – blue)

MSS: SSRMS:

Verify all joints – Limped

2.3 Auto Release

Verify with **MCC-H** that payload and PDGF power inhibits have been confirmed.

MSS: SSRMS: Tip LEE:

cmd Release ► Automatic ► Slow (Verify Speed – Slow)

Verify '**Confirm or Terminate**' prompt.

cmd Confirm (Verify RHC Trigger Hot icon)

Verify LEE Mode – Auto Release

RHC

TRIGGER → press (momentarily)

PCS

Verify 'Umbilical' Demate – blue (10 s max)

Verify 'Latch' Unlatch – blue (65 s max)

Verify 'Carriage' Retract – gray (90 s max)

Verify 'Snare' Open – blue (12 s max)

Verify 'Carriage' Derigidize – blue

Verify 'Carriage' Extend – blue (90 s max)

1.320 ELC2 RELEASE, WALKOFF TO MBS PDGF 1 AND MNVR TO MT TRANSLATION CONFIG

(RBT FS/ULF3/FIN/SPN)

Page 3 of 13 pages

2.4 SSRMS Backoff

MSS: SSRMS: Limp:

cmd None Limp (Verify Standby – blue)

MSS: SSRMS:

√Vernier

Enter Mode – Manual (Verify blue)

MSS: SSRMS: SSRMS Manual: Joint Lock:

cmd Shoulder Yaw (Verify SY – Locked)

THC/ RHC

Maneuver SSRMS to ELC2 Backoff position (within 5 cm/1 deg).

	Locked					
SR	SY	SP	EP	WP	WY	WR
+175.9	+29.9	-44.1	-68.2	-121.3	+1.2	-67.0
X	Y	Z	Pitch	Yaw	Roll	
-150	0	0	0.0	0.0	0.0	
FOR	Unloaded – LEE Tip, SY Held					
Disp	S3>ELC2 PVGF1 S3UO					

Give **MCC-H** 'GO' to power ELC2

3. JOCAS TO MBS PDGF 1 PRE-GRAPPLE

3.1 Setup

Configure Cameras and overlays as required.

Monitor 1	Monitor 2	Monitor 3	V10L	V10R
13: LAB Stbd Zenith (-10, +80)	22: Base Elbow (0, +5)	03: S1 Lower Outboard (+20, -45)	Camera B (+45, +30)	SRMS EE

1.320 ELC2 RELEASE, WALKOFF TO MBS PDGF 1 AND MNVR TO MT TRANSLATION CONFIG

(RBT FS/ULF3/FIN/SPN)

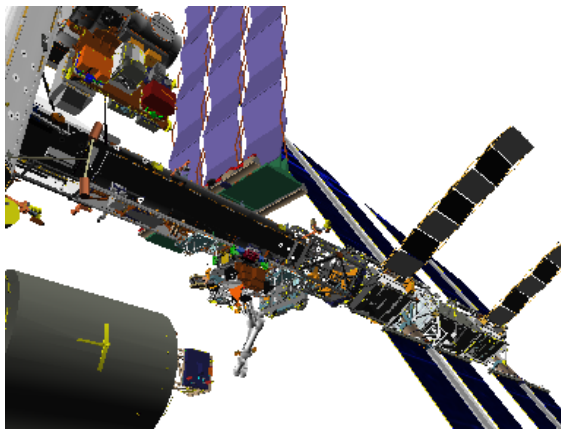

Figure 3.- ELC2 Backoff
(Camera B: +45, +30).

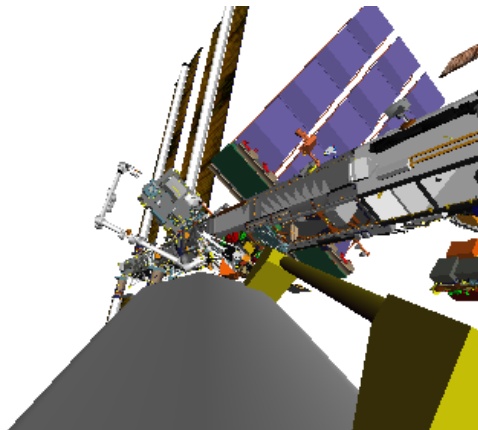

Figure 4.- ELC2 Backoff
(SRMS EE).

NOTE

1. Expect the cross cluster warning to annunciate and persist into step 7.
2. Expect the singularity warning for EP between -165 and -195 deg.

Change Display ► MBS ► PDGF 1 (Verify MBS>PDGF 1)

3.2 JOCAS to MBS PDGF 1 Pre-Grapple (5 Minutes)

PCS

MSS: SSRMS:

Enter Mode – Joint OCAS (Verify blue)

Input 'Joint Angles' 'Destination' for MBS PDGF1 Pre-Grapple.

SR	SY	SP	EP	WP	WY	WR
-26.4	+174.5	-170.4	-203.1	+42.0	+1.2	+76.6

cmd Load (Verify Sequence Status – Confirm or Cancel)

MON

Verify Joint Angles and errors are correct on Joint Angle Position overlay.

	SR	SY	SP	EP	WP	WY	WR
(current)	+175.9	+29.9	-44.1	-68.2	-121.3	+1.2	-67.0
TGT	-26.4	+174.5	-170.4	-203.1	+42.0	+1.2	+76.6
ERR	+202.3	-144.6	+126.3	+134.9	-163.3	0.0	-143.6

PCS

cmd Confirm (Verify Sequence Status – Auto Seq sw - Hot)

1.320 ELC2 RELEASE, WALKOFF TO MBS PDGF 1 AND MNVR TO MT TRANSLATION CONFIG

(RBT FS/ULF3/FIN/SPN)

Page 5 of 13 pages

DCP AUTO SEQ → PROC

PCS MSS: SSRMS:

Verify Posn Hold – orange

Verify 'Joint Angles' values.

SR	SY	SP	EP	WP	WY	WR
-26.4	+174.5	-170.4	-203.1	+42.0	+1.2	+76.6

3.3 Single Joint Maneuver to MBS PDGF 1 Pre-Grapple

MSS: SSRMS:

Enter Mode – Single (Verify blue)

WARNING

The active joint must be checked on the PCS before initiating motion. Failure to do so may result in movement of the wrong joint.

DCP JOINT SELECT → WRIST YAW (Verify WY – Selected on PCS)

THC Perform “+” Single Joint maneuver to WY: +18.9 (THC up).

Verify SSRMS at MBS PDGF1 Pre-Grapple position (within 5 cm/1 deg).

SR	SY	SP	EP	WP	WY	WR
-26.4	+174.5	-170.4	-203.1	+42.0	+18.9	+76.6
X	Y	Z	Pitch	Yaw	Roll	
-150	0	0	0.0	0.0	0.0	
FOR	Unloaded – LEE Tip, SY Held					
Disp	MBS>PDGF 1					

PCS MSS: SSRMS:

Enter Mode – Standby (Verify blue)

4. MBS PDGF 1 GRAPPLE

4.1 Grapple Setup

Configure Cameras and overlays as required.

Monitor 1	Monitor 2	Monitor 3	V10
13: LAB Stbd Zenith (+10, +80)	25: Tip LEE (fully zoomed out)	03: S1 Lower Outboard (+20, -40) 37: MBS Mast (+140, -15)	Camera B (+45, +15)

1.320 ELC2 RELEASE, WALKOFF TO MBS PDGF 1 AND MNVR TO MT TRANSLATION CONFIG

(RBT FS/ULF3/FIN/SPN)

Page 6 of 13 pages

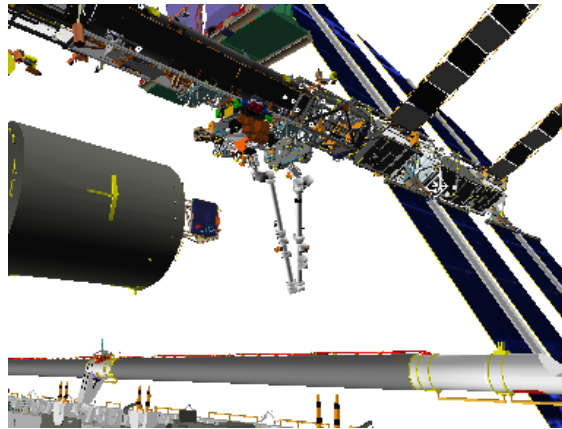

Figure 5.- MBS PDGF 1 Pre-Grapple
(Camera B: +45, +15).

Change Loaded Parameters ► Walk Off ► MBS PDGF 1
Verify 'Loaded Parameters' (two) – MBS PDGF 1, SR Held

√Vernier

MSS: SSRMS: Rate:

Set 'Scale' 'Vernier' Rate Scale: as desired

4.2 Maneuver to MBS PDGF 1 Grapple

MSS: SSRMS:

Enter Mode – Manual (Verify blue)

MSS: SSRMS: SSRMS Manual: Joint Lock:

cmd Shoulder Yaw (Verify SY – Locked)

THC/ RHC

Maneuver to within grapple envelope.

4.3 Slow Capture Commands

PCS

MSS: SSRMS: Tip LEE:

cmd Capture ► Automatic ► Slow, Limp (Verify Speed – Slow)

Verify '**Confirm or Terminate**' prompt.

cmd Confirm (Verify RHC Trigger Hot icon)

Verify LEE Mode – Auto Capture

30 OCT 09

1.320 ELC2 RELEASE, WALKOFF TO MBS PDGF 1 AND MNVR TO MT TRANSLATION CONFIG

(RBT FS/ULF3/FIN/SPN)

Page 7 of 13 pages

- 4.4 MBS PDGF 1 Grapple
- RHC TRIGGER → press (momentarily)
- PCS Verify 'Snare' Close, Capture (two) – blue (12 s max)
Verify Capture to Latch – Yes (SCR 19282)
Verify 'Carriage' Tension ~5500 N (90 s max)
Verify 'Carriage' Retract – blue
Verify 'Latch' Latch – blue (80s max)
- 4.5 Mating Umbilicals
- Verify with **MCC-H** that payload and PDGF power inhibits have been confirmed.
- cmd** 'Umbilical' Mate (Verify '**Confirm or Terminate**' prompt)
- | |
|--|
| NOTE
Expect ' R3L - SSRMS Pwr Flags Fail ' Robotics Advisory message when mating is complete (SCR 19019). |
|--|
- cmd** Confirm (Verify RHC Trigger Hot icon)
- Verify LEE Mode – Mate
- RHC TRIGGER → press (momentarily)
- PCS Verify 'Umbilical' Mate – blue (10 s max)
Verify 'Connector Continuity' Prime, Redundant (two) – Yes
- 4.6 De-Rigidize
- MSS: SSRMS: Tip LEE: SSRMS Tip LEE
- cmd** 'Carriage' Derigidize ► Slow (Verify Speed – Slow)
- Verify '**Confirm or Terminate**' prompt.
- cmd** Confirm (Verify RHC Trigger Hot icon)
- Verify LEE Mode – Deridigize
- RHC TRIGGER → press (momentarily) (SCR 19064)
- PCS Verify 'Carriage' Retract – gray (90 s max)
Verify 'Carriage' Tension < 555 N
Verify 'Carriage' Brakes – On (90 s max)

1.320 ELC2 RELEASE, WALKOFF TO MBS PDGF 1 AND MNVR TO MT TRANSLATION CONFIG

(RBT FS/ULF3/FIN/SPN)

Page 8 of 13 pages

4.7 Grapple Cleanup

Verify Posn Hold – orange

Verify Loaded Parameters – √

Verify 'Loaded Parameters' (two) – MBS PDGF 1, SR Held

NOTE

Expect the following message when safing is commanded:

**'R3Z - MSS OCS SSRMS Prime(Redun) ACU SRT
Cat-1 Brk Stat Fail'** (SCR 17495)

This message should return to Norm.

DCP

SAFING → SAFE (Verify ON)

Verify SSRMS at MBS PDGF 1 Grapple Position.
(within 5 cm/1 deg)

Locked		SR	SY	SP	EP	WP	WY	WR	
		-13.1	+174.5	-139.0	-197.6	+1.6	+24.8	+89.4	
		X	Y	Z	Pitch	Yaw	Roll		
		0	0	0	0.0	0.0	0.0		
FOR	Loaded – MBS PDGF 1, SR Held								
Disp	MBS>PDGF 1								

Give **MCC-H** 'GO for SSRMS Base Change.'

5. BASE CHANGE

On **MCC- H** "GO," 'Base Change complete:'

Verify Loaded Parameters – √

Verify 'Loaded Parameters' (two) – MBS PDGF 2, SR Held

Verify 'Unloaded Parameters' (two) – LEE Tip, SY Held

Change Display ► MBS ► PDGF 2 (Verify MBS>PDGF 2)

√Command – SSRMS>Internal

√Vernier

PCS

MSS: SSRMS: Rate: SSRMS Rate

√'Scale' 'Vernier' Current: 1.0

1.320 ELC2 RELEASE, WALKOFF TO MBS PDGF 1 AND MNVR TO MT TRANSLATION CONFIG

(RBT FS/ULF3/FIN/SPN)

Page 9 of 13 pages

Expected MBS PDGF 2 Grapple position (within 5 cm/1 deg).

SR	SY	SP	EP	WP	WY	WR
+89.4	-24.8	+1.6	-197.6	-139.0	-174.5	-13.1
X	Y	Z	Pitch	Yaw	Roll	
0	0	0	0.0	0.0	0.0	
FOR	Loaded – MBS PDGF 2, SR Held					
Disp	MBS>PDGF 2					

6. MBS PDGF 2 RELEASE

6.1 Release Setup

Configure Cameras and overlays as required.

Monitor 1	Monitor 2	Monitor 3	V10
13: LAB Stbd Zenith (-10, +80) 03: S1 Lower Outboard (+20, -40)	25: Tip LEE (fully zoomed out)	37: MBS Mast (-150, -25)	Camera B (+45, +15)

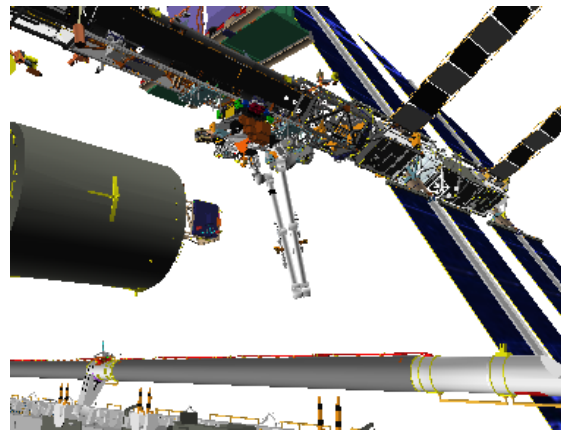

Figure 6.- MBS PDGF 2 Grapple (Camera B: +45, +15).

MSS: SSRMS: MSS Safing:

cmd 'SSRMS' Remove (Verify Not Safed)

DCP

BRAKES SSRMS → OFF (Verify OFF)

6.2 SSRMS Limp

PCS

MSS: SSRMS: Limp:

cmd All Limp (Verify Limp – blue)

1.320 ELC2 RELEASE, WALKOFF TO MBS PDGF 1 AND MNVR TO MT TRANSLATION CONFIG

(RBT FS/ULF3/FIN/SPN)

Page 10 of 13 pages

MSS: SSRMS:

Verify all joints – Limped

6.3 Auto Release

Verify with **MCC-H** that payload and PDGF power inhibits have been confirmed.

MSS: SSRMS: Tip LEE:

cmd Release ► Automatic ► Slow (Verify Speed – Slow)

Verify '**Confirm or Terminate**' prompt.

cmd Confirm (Verify RHC Trigger Hot icon)

Verify LEE Mode – Auto Release

RHC TRIGGER → press (momentarily)

PCS
Verify 'Umbilical' Demate – blue (10 s max)
Verify 'Latch' Unlatch – blue (65 s max)
Verify 'Carriage' Retract – gray (90 s max)
Verify 'Snare' Open – blue (12 s max)
Verify 'Carriage' Derigidize – blue
Verify 'Carriage' Extend – blue (90 s max)

6.4 SSRMS Backoff

MSS: SSRMS: Limp:

cmd None Limp (Verify Standby – blue)

MSS: SSRMS:

√Vernier

Enter Mode – Manual (Verify blue)

MSS: SSRMS: SSRMS Manual: Joint Lock:

cmd Shoulder Yaw (Verify SY – Locked)

1.320 ELC2 RELEASE, WALKOFF TO MBS PDGF 1 AND MNVR TO MT TRANSLATION CONFIG

(RBT FS/ULF3/FIN/SPN)

THC

Maneuver SSRMS to MBS PDGF 2 Backoff position (within 5 cm/1 deg).

	Locked					
SR	SY	SP	EP	WP	WY	WR
+93.7	-24.8	-22.7	-208.9	-104.8	-176.1	-9.5
X	Y	Z	Pitch	Yaw	Roll	
-200	0	0	0.0	0.0	0.0	
FOR	Unloaded – LEE Tip, SY Held					
Disp	MBS>PDGF 2					

7. JOCAS TO ELC2 CLEARANCE POSITION (2 MINUTES)

Configure Cameras and overlays as required.

Monitor 1	Monitor 2	Monitor 3	V10
13: LAB Stbd Zenith (-10, +80)	03: S1 Lower Outboard (+10, -30)	22: Base Elbow (+30, -5)	Camera B (+45, +15)

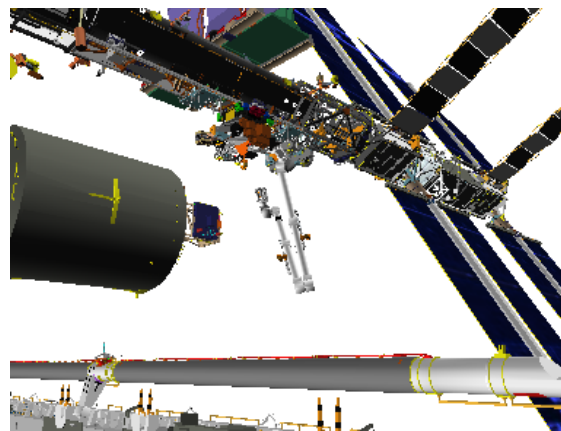

Figure 7.- MBS PDGF 2 Backoff (Camera B: +45, +15).

NOTE

The following maneuver will bring the SSRMS Tip within 44in of the MBS Mast Camera. This clearance can be monitored with the Tip Elbow Camera or the LAB Stbd Zenith Camera. Note that this clearance is acceptable in coarse rates because the MBS Mast Camera remains outside the 5ft clearance cone.

RHC

RATE → COARSE (Verify Coarse on PCS)

PCS

MSS: SSRMS:

Enter Mode – Joint OCAS (Verify blue)

1.320 ELC2 RELEASE, WALKOFF TO MBS PDGF 1 AND MNVR TO MT TRANSLATION CONFIG

(RBT FS/ULF3/FIN/SPN)

Page 12 of 13 pages

pick File ► MBS1 Walkoff ► ELC2 Clearance

Verify 'Joint Angles' 'Destination' for ELC2 Clearance position.

SR	SY	SP	EP	WP	WY	WR
0.0	+40.0	+15.0	-209.0	-104.7	-176.1	-9.5

cmd Load (Verify Sequence Status – Confirm or Cancel)

MON

Verify Joint Angles and errors are correct on Joint Angle Position overlay.

	SR	SY	SP	EP	WP	WY	WR
(current)	+93.7	-24.8	-22.7	-208.9	-104.7	-176.1	-9.5
TGT	0.0	+40.0	+15.0	-209.0	-104.7	-176.1	-9.5
ERR	+93.7	-64.8	-37.7	+0.1	0.0	0.0	0.0

PCS

cmd Confirm (Verify Sequence Status – Auto Seq sw - Hot)

DCP

AUTO SEQ → PROC

PCS

MSS: SSRMS:

Verify Posn Hold – orange

Verify Joint Angle values.

SR	SY	SP	EP	WP	WY	WR
0.0	+40.0	+15.0	-209.0	-104.7	-176.1	-9.5

8. JOCAS TO MT TRANSLATION POSITION (2 MINUTES)

pick File ► MT ► Translate

Verify 'Joint Angles' 'Destination' for MT Translation position

SR	SY	SP	EP	WP	WY	WR
-100.0	+110.0	-8.0	-156.0	-72.0	-180.0	+157.4

NOTE

Expect singularity warning for EP between -165 and -195 deg.

cmd Load (Verify Sequence Status – Confirm or Cancel)

1.320 ELC2 RELEASE, WALKOFF TO MBS PDGF 1 AND MNVR TO MT TRANSLATION CONFIG

(RBT FS/ULF3/FIN/SPN)

Page 13 of 13 pages

MON Verify Joint Angles and errors are correct on Joint Angle Position overlay.

	SR	SY	SP	EP	WP	WY	WR
(current)	0.0	+40.0	+15.0	-209.0	-104.7	-176.1	-9.5
TGT	-100.0	+110.0	-8.0	-156.0	-72.0	-180.0	+157.4
ERR	+100.0	-70.0	+23.0	-53.0	-32.7	+3.9	-166.9

PCS **cmd** Confirm (Verify Sequence Status – Auto Seq sw - Hot)

DCP AUTO SEQ → PROC

PCS MSS: SSRMS:

Verify Posn Hold – orange

Verify SSRMS at MT Translation position (within 5 cm/1 deg).

SR	SY	SP	EP	WP	WY	WR
-100.0	+110.0	-8.0	-156.0	-72.0	-180.0	+157.4
X	Y	Z	Pitch	Yaw	Roll	
-444	+9	-177	+127.0	+56.2	+56.0	
FOR	Unloaded – LEE Tip, SY Held					
Disp	MBS>PDGF 2					

Give SRMS Operator 'GO for Maneuver to Pre-cradle.'

NOTE

Expect the following message when safing is commanded:
'R3Z - MSS OCS SSRMS Prime(Redun) ACU SRT Cat-1 Brk Stat Fail' (SCR 17495)
 This message should return to Norm.

DCP SAFING → SAFE (Verify ON)

This Page Intentionally Blank

1.410 EVA3 - HPGT TRANSFER

(RBT FS/ULF3/FIN/SPN)

Page 1 of 16 pages

NOTE

1. For all OCASes if the joint angles are incorrect after loaded, then **cmd** Cancel on the PCS and reload the correct destination.
2. Shuttle VRCS control allowed when >2 ft from structure.
Otherwise:
Verify in attitude and rates damped then DAP: FREE

Return to AUTO when >2ft from structure:
√**MCC** or
Perform RATE DAMPING (FDF, ORB OPS FS, Reboost/DAP)

1. SETUP

THC/ RHC Deflect all axes to positive and negative hard stops.

Configure Cameras and overlays as required.

Monitor 1	Monitor 2	Monitor 3	V10L	V10R
37: MBS Mast (-155, 0)	03: S1 Lower Outboard (+70, -30)	22: Base Elbow (-40, +10)	Camera B (+40, +20)	Camera D (-100, +40)

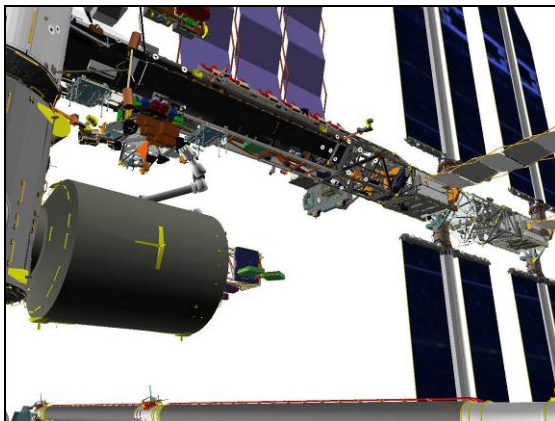

Figure 1.- MT Translation Position
(Camera B: +40, +20).

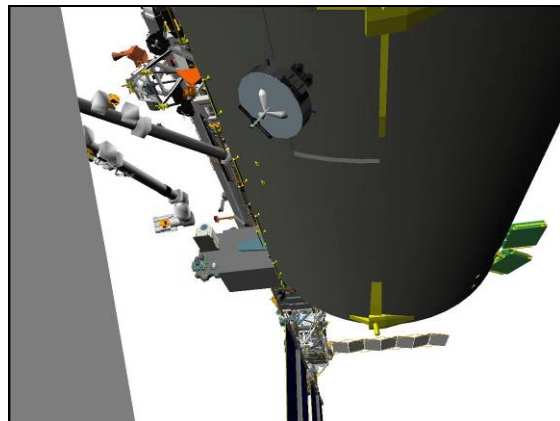

Figure 2.- MT Translation Position
(Camera D: -100, +40).

Change Loaded Parameters ► HPGT ► HPGT Mnvr SYH
Verify 'Loaded Parameters' (two) – HPGT Mnvr, SY Held

Verify Unloaded Parameters – √

Change Unloaded Parameters ► Unloaded ► LEE Tip SYH
Verify 'Unloaded Parameters' (two) – LEE Tip, SY Held

Change Display ► ISS ► ISSACS (Verify ISS>ISSACS)

Change Command ► SSRMS ► Internal (Verify SSRMS>Internal)

1.410 EVA3 - HPGT TRANSFER

(RBT FS/ULF3/FIN/SPN)

Verify SSRMS at MT Translation position (within 5 cm/1 deg).

SR	SY	SP	EP	WP	WY	WR
-100.0	+110.0	-8.0	-156.0	-72.0	-180.0	+157.4
X	Y	Z	Pitch	Yaw	Roll	
+609	+1275	-320	+82.7	-3.2	-129.3	
FOR	Unloaded – LEE Tip, SY Held					
Disp	ISS>ISSACS					

2. HPGT PRE-GRAPPLE JOCAS (3 MINUTES)

Verify with **MCC-H** S1 TRRJ parked at 0 deg.

PCS MSS: SSRMS: MSS Safing:

cmd 'SSRMS' Remove (Verify Not Safed)

DCP BRAKES SSRMS → OFF (Verify OFF)

RHC RATE → VERNIER (Verify Vernier on PCS)

PCS MSS: SSRMS: Rate:

Set 'Scale' 'Vernier' Rate Scale: as desired

MSS: SSRMS:

Enter Mode – Joint OCAS (Verify blue)

pick File ► EVA3 ► HPGT Pre-Grapple

Verify 'Joint Angles' 'Destination' for HPGT Pre-Grapple position.

SR	SY	SP	EP	WP	WY	WR
-80.0	+33.6	-73.1	-58.9	-122.1	-135.9	+90.0

cmd Load (Verify Sequence Status – Confirm or Cancel)

MON Verify Joint Angles and errors are correct on Joint Angle Position overlay.

	SR	SY	SP	EP	WP	WY	WR
(current)	-100.0	+110.0	-8.0	-156.0	-72.0	-180.0	+157.4
TGT	-80.0	+33.6	-73.1	-58.9	-122.1	-135.9	+90.0
ERR	-20.0	+76.4	+65.1	-97.1	+50.1	-44.1	+67.4

PCS **cmd** Confirm (Verify Sequence Status – Auto Seq sw - Hot)

DCP AUTO SEQ → PROC

1.410 EVA3 - HPGT TRANSFER

(RBT FS/ULF3/FIN/SPN)

PCS MSS: SSRMS:

Verify Posn Hold – orange

Verify Joint Angle values.

SR	SY	SP	EP	WP	WY	WR
-80.0	+33.6	-73.1	-58.9	-122.1	-135.9	+90.0

3. HPGT GRAPPLE

3.1 Grapple Setup

Configure Cameras and overlays as required.

Monitor 1	Monitor 2	Monitor 3	V10L	V10R
37: MBS Mast (-155, -15)	25: Tip LEE (fully zoomed out)	24: Tip Elbow (0, +25) 22: Base Elbow (-140, -20)	Camera B (+40, +20)	Camera D (-100, +40)

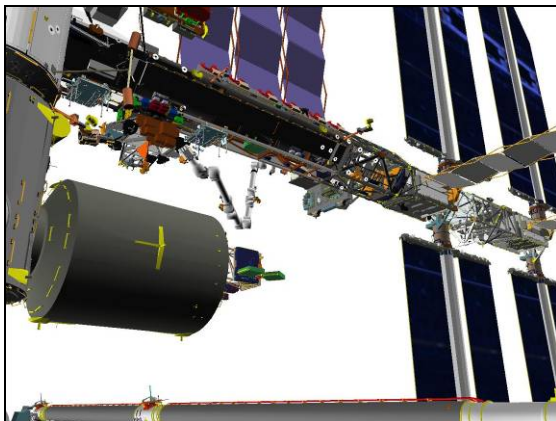

Figure 3.- HPGT Pre-Grapple
(Camera B: +40, +20).

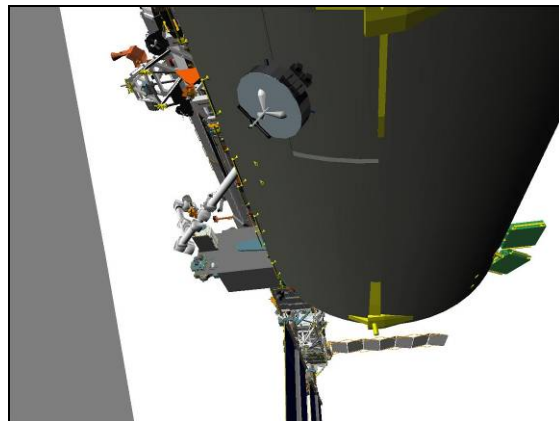

Figure 4.- HPGT Pre-Grapple
(Camera D: -100, +40).

MSS: SSRMS: Rate:

Set 'Scale' 'Vernier' Rate Scale: as desired

On EV "GO," 'Ready for HPGT Grapple:'

MSS: SSRMS:

Enter Mode – Manual (Verify blue)

MSS: SSRMS: SSRMS Manual: Joint Lock:

cmd Shoulder Yaw (Verify SY – Locked)

1.410 EVA3 - HPGT TRANSFER

(RBT FS/ULF3/FIN/SPN)

Page 4 of 16 pages

3.2 Slow Capture Commands

MSS: SSRMS: Tip LEE: SSRMS Tip LEE

cmd Capture ► Automatic ► Slow, Limp (Verify Speed – Slow)

Verify '**Confirm or Terminate**' prompt.

cmd Confirm (Verify RHC Trigger Hot icon)

Verify LEE Mode – Auto Capture

THC/RHC

Maneuver to within grapple envelope.

3.3 HPGT Grapple

RHC

TRIGGER → press (momentarily)

PCS

Verify 'Snare' Close, Capture (two) – blue (12 s max)

Verify Capture to Latch – No (SCR 19282)

Verify 'Carriage' Tension ~5500 N (90 s max)

Verify 'Carriage' Retract – blue

Verify 'Carriage' Brakes – On (15 s max)

Verify Posn Hold – orange

Verify Loaded Parameters – √

Verify 'Loaded Parameters' (two) – HPGT Mnvr, SY Held

Expected HPGT Grapple position:

		Locked				
SR	SY	SP	EP	WP	WY	WR
-71.9	+33.6	-73.4	-40.2	-137.7	-142.3	+91.1
X	Y	Z	Pitch	Yaw	Roll	
-145	+2365	-615	*	+89.8	*	
FOR	Loaded – HPGT Mnvr, SY Held					
Disp	ISS>ISSACS					

* Display Singularity

Give EV 'GO to release RET from HPGT.'

Enter Mode – Standby (Verify blue)

1.410 EVA3 - HPGT TRANSFER

(RBT FS/ULF3/FIN/SPN)

4. HPGT BACKOFF

4.1 Backoff Setup

Configure Cameras and overlays as required.

Monitor 1	Monitor 2	Monitor 3	V10L	V10R
37: MBS Mast (-155, -15)	13: LAB Stbd Zenith (-90, +90)	24: Tip Elbow (0, +15) 22: Base Elbow (-160, -20)	Camera B (+40, +20)	Camera D (-100, +40)

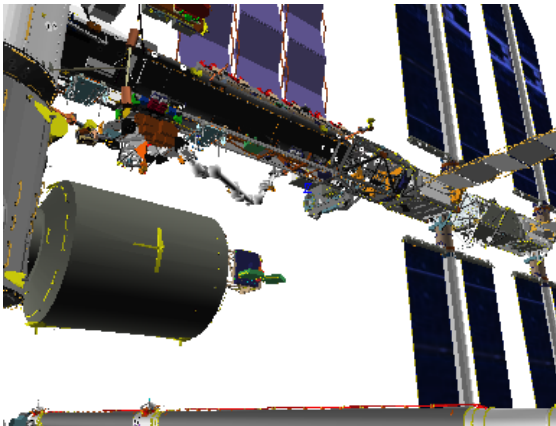

Figure 5.- HPGT Grapple
(Camera B: +40, +20).

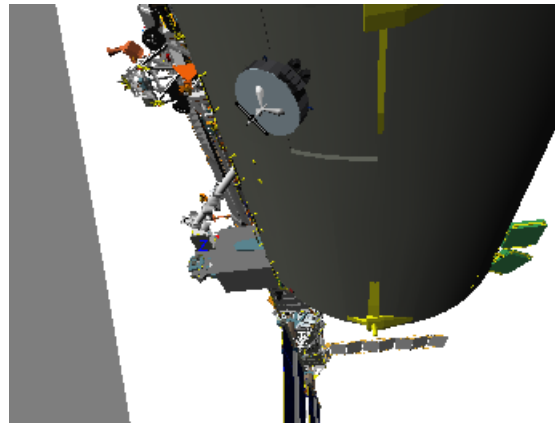

Figure 6.- HPGT Grapple
(Camera D: -100, +40).

Change Command ► ISS ► ISSACS (Verify ISS>ISSACS)

PCS

MSS: SSRMS: Rate:

Set 'Scale' 'Vernier' Rate Scale: 1.0 (Verify 1.0)

4.2 HPGT Backoff Manual Maneuver **On EV "GO," "Ready for HPGT Backoff:"**

Enter Mode – Manual (Verify blue)

MSS: SSRMS: SSRMS Manual: Joint Lock:

cmd Shoulder Yaw (Verify SY – Locked)

THC/ RHC

Maneuver HPGT clear of ELC2 (Translational axis within 5 cm).
(The following FOR OCAS will clean up remaining axes.)

	Locked					
SR	SY	SP	EP	WP	WY	WR
-79.5	+33.6	-66.1	-70.5	-117.2	-136.2	+93.6
X	Y	Z	Pitch	Yaw	Roll	
-145	+2140	-615	*	+89.1	*	
FOR	Loaded – HPGT Mnvr, SY Held					
Disp	ISS>ISSACS					

* Display Singularity

1.410 EVA3 - HPGT TRANSFER

(RBT FS/ULF3/FIN/SPN)

Page 6 of 16 pages

4.3 HGPT Backoff FOR OCAS (4 Minutes)

RHC RATE → COARSE (Verify Coarse on PCS)

PCS MSS: SSRMS:

Enter Mode – FOR OCAS (Verify blue)

MSS: SSRMS: SSRMS FOR OCAS: Joint Lock:

cmd Shoulder Yaw (Verify SY – Locked)

pick File ► EVA3 ► HPGT Backoff

Verify 'FOR' 'Destination' for HPGT Backoff position.

X	Y	Z	Pitch	Yaw	Roll
+502	+2096	-575	+88.0	+80.0	+1.8

cmd Load (Verify Sequence Status – Confirm or Cancel)

MON Verify FOR and errors are correct on FOR Position overlay.

	X	Y	Z	Pitch	Yaw	Roll
FOR	-143	+2140	-616	-142.5	+89.8	-127.6
TGT	+502	+2096	-575	+88.0	+80.0	+1.8
ERR	-645	+44	-41	*	+9.8	*

PCS **cmd** Confirm (Verify Sequence Status – Auto Seq Sw-Hot)

DCP AUTO SEQ → PROC

PCS MSS: SSRMS:

Verify Posn Hold – orange

Verify SSRMS at HPGT Backoff position (within 5 cm/1 deg).

	Locked					
SR	SY	SP	EP	WP	WY	WR
-82.5	+33.6	-30.1	-89.5	-134.6	-143.6	+3.3
X	Y	Z	Pitch	Yaw	Roll	
+502	+2096	-575	+88.0	+80.0	+1.8	
FOR	Loaded – HPGT Mnvr, SY Held					
Disp	ISS>ISSACS					

1.410 EVA3 - HPGT TRANSFER

(RBT FS/ULF3/FIN/SPN)

Page 7 of 16 pages

5. TRUSS CLEARANCE FOR OCAS (5 MINUTES)

Configure Cameras and overlays as required.

Monitor 1	Monitor 2	Monitor 3	V10L	V10R
37: MBS Mast (+175, +5)	13: LAB Stbd Zenith (+10, +90)	24: Tip Elbow (0, +15) 22: Base Elbow (-120, -20)	Camera B (+30, +20)	Camera D (-100, +40)

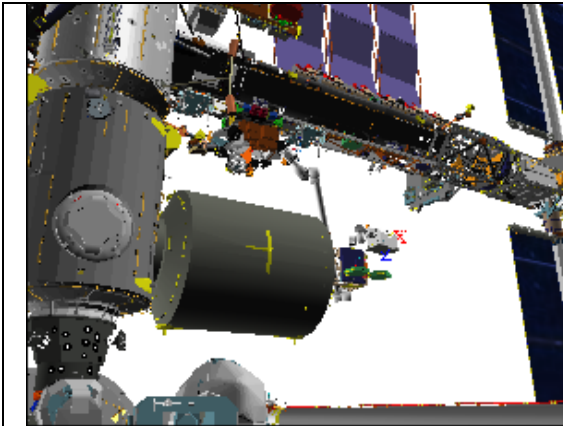

Figure 7.- HPGT Backoff
(Camera B: +30, +20).

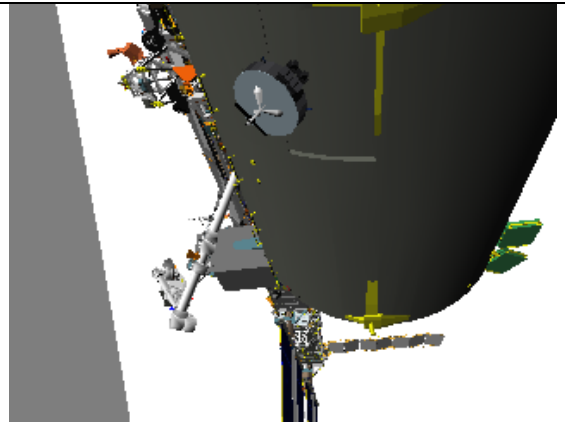

Figure 8.- HPGT Backoff
(Camera D: -100, +40).

SSRMS FOR OCAS

pick File ► EVA3 ► Truss Clearance

Verify 'FOR' 'Destination' for HPGT Truss Clearance position.

X	Y	Z	Pitch	Yaw	Roll
+502	+2096	+600	+88.0	+80.0	+1.8

cmd Load (Verify Sequence Status – Confirm or Cancel)

MON

Verify FOR and errors are correct on FOR Position overlay.

	X	Y	Z	Pitch	Yaw	Roll
FOR	+502	+2096	-575	+88.0	+80.0	+1.8
TGT	+502	+2096	+600	+88.0	+80.0	+1.8
ERR	0	0	-1175	0.0	0.0	0.0

PCS

cmd Confirm (Verify Sequence Status – Auto Seq Sw-Hot)

DCP

AUTO SEQ → PROC

PCS

MSS: SSRMS:

Verify Posn Hold – orange

1.410 EVA3 - HPGT TRANSFER

(RBT FS/ULF3/FIN/SPN)

Verify SSRMS at Truss Clearance position (within 5 cm/1 deg).

	Locked					
SR	SY	SP	EP	WP	WY	WR
+3.6	+33.6	+1.8	-100.7	-108.0	-199.8	-39.5
X	Y	Z	Pitch	Yaw	Roll	
+502	+2096	+600	+88.0	+80.0	+1.8	
FOR	Loaded – HPGT Mnvr, SY Held					
Disp	ISS>ISSACS					

6. JOCAS TO INTERMEDIATE 1 POSITION (8 MINUTES)

Configure Cameras and overlays as required.

Monitor 1	Monitor 2	Monitor 3	V10
13: LAB Stbd Zenith (+70, +90) 37: MBS Mast (+145, +5)	03: S1 Lower Outboard (+40, 0)	24: Tip Elbow (+15, -5) 22: Base Elbow (-120, -10)	Camera B (+20, +20)

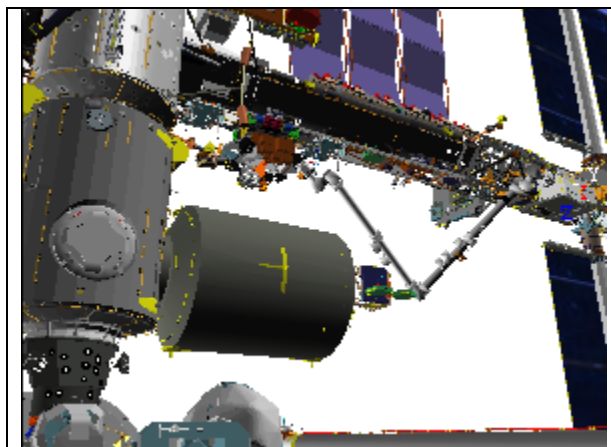

Figure 9.- Truss Clearance
(Camera B: +30, +20).

MSS: SSRMS:

Enter Mode – Joint OCAS (Verify blue)

pick File ► EVA3 ► Intermediate 1

Verify 'Joint Angles' 'Destination' for HPGT Intermediate 1 position.

SR	SY	SP	EP	WP	WY	WR
-5.0	-16.1	-87.6	-84.1	-67.3	-42.6	+42.5

cmd Load (Verify Sequence Status – Confirm or Cancel)

1.410 EVA3 - HPGT TRANSFER

(RBT FS/ULF3/FIN/SPN)

MON Verify Joint Angles and errors are correct on Joint Angle Position overlay.

	SR	SY	SP	EP	WP	WY	WR
(current)	+3.6	+33.6	+1.8	-100.7	-108.0	-199.8	-39.5
TGT	-5.0	-16.1	-87.6	-84.1	-67.3	-42.6	+42.5
ERR	+8.6	+49.7	+89.4	-16.6	-40.7	-157.2	-82.0

PCS **cmd** Confirm (Verify Sequence Status – Auto Seq sw - Hot)

DCP AUTO SEQ → PROC

PCS MSS: SSRMS:

Verify Posn Hold – orange

Verify Joint Angle values.

SR	SY	SP	EP	WP	WY	WR
-5.0	-16.1	-87.6	-84.1	-67.3	-42.6	+42.5

7. AIRLOCK ALIGNMENT FOR OCAS (5 MINUTES)

Configure Cameras and overlays as required.

Monitor 1	Monitor 2	Monitor 3	V10
13: LAB Stbd Zenith (+70, +40)	03: S1 Lower Outboard (+120, 0)	24: Tip Elbow (-25, +25) 22: Base Elbow (-90, -50)	Camera B (+40, +40)

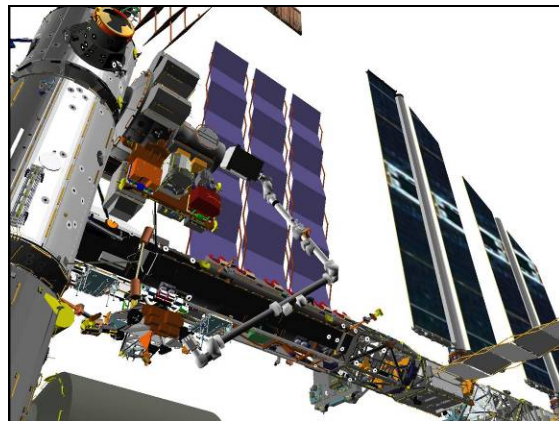

Figure 10.- HPGT Intermediate 1
(Camera B: +40, +40).

Enter Mode – Standby (Verify blue)

Change Loaded Parameters ► HPGT ► HPGT Mnvr SRH
Verify 'Loaded Parameters' (two) – HPGT Mnvr, SR Held

Change Unloaded Parameters ► Unloaded ► LEE Tip SRH
Verify 'Unloaded Parameters' (two) – LEE Tip, SR Held

1.410 EVA3 - HPGT TRANSFER

(RBT FS/ULF3/FIN/SPN)

Change Display ► Airlock ► HPGT Mnvr (Verify Airlock>HPGT Mnvr)

Change Command ► SSRMS ► Internal (Verify SSRMS>Internal)

RHC RATE → VERNIER (Verify Vernier on PCS)

PCS MSS: SSRMS:

Enter Mode – FOR OCAS (Verify blue)

MSS: SSRMS: SSRMS FOR OCAS: Joint Lock:

cmd Shoulder Roll (Verify SR – Locked)

Load the following FOR OCAS Destination.

X	Y	Z	Pitch	Yaw	Roll
-300	0	-30	0.0	0.0	0.0

cmd Load (Verify Sequence Status – Confirm or Cancel)

MON Verify FOR and errors are correct on FOR Position overlay.

	X	Y	Z	Pitch	Yaw	Roll
FOR	-628	-100	+47	0.5	-0.4	0.0
TGT	-300	0	-30	0.0	0.0	0.0
ERR	-328	-100	+77	+0.5	-0.4	0.0

PCS **cmd** Confirm (Verify Sequence Status – Auto Seq Sw-Hot)

DCP AUTO SEQ → PROC

PCS MSS: SSRMS:

Verify Posn Hold – orange

Verify SSRMS at Airlock Alignment position (within 5 cm/1 deg).

Locked	SR	SY	SP	EP	WP	WY	WR
	-5.0	-7.9	-104.7	-88.7	-40.7	-38.2	+50.9
	X	Y	Z	Pitch	Yaw	Roll	
	-300	0	-30	0.0	0.0	0.0	
FOR	Loaded – HPGT Mnvr, SR Held						
Disp	Airlock>HPGT Mnvr						

1.410 EVA3 - HPGT TRANSFER

(RBT FS/ULF3/FIN/SPN)

Page 11 of 16 pages

8. MANUAL MANEUVER TO HPGT LOW HOVER

NOTE

The following three maneuvers (steps 8 thru 10) have the following clearance concerns:

- a. Clearance between the SSRMS Base Elbow Camera and the S1 Truss is ~18in.
- b. Clearance between the SSRMS Base Boom and the S1 CETA light is ~20 in.

These clearances can be monitored with the Lab Stbd Zenith Camera, the S1 Lower Outboard Camera or Camera B.

√Vernier

MSS: SSRMS: Rate:

Set 'Scale' 'Vernier' Rate Scale: 0.6 (Verify 0.6)

MSS: SSRMS:

Enter Mode – Manual (Verify blue)

MSS: SSRMS: SSRMS Manual: Joint Lock:

cmd Shoulder Roll (Verify SR – Locked)

THC/ RHC Maneuver HPGT to Low Hover position (within 5 cm/1 deg).

Locked						
SR	SY	SP	EP	WP	WY	WR
-5.0	-0.4	-124.7	-79.4	-25.7	-33.5	+58.3
X	Y	Z	Pitch	Yaw	Roll	
0	+45	-60	0.0	0.0	0.0	
FOR	Loaded – HPGT Mnvr, SR Held					
Disp	Airlock>HPGT Mnvr					

PCS MSS: SSRMS:

Enter Mode – Standby (Verify blue)

9. MANUAL MANEUVER TO HPGT RELEASE **On EV "GO," 'Ready for HPGT GCA Install:'**

MSS: SSRMS:

Enter Mode – Manual (Verify blue)

MSS: SSRMS: SSRMS Manual: Joint Lock:

cmd Shoulder Roll (Verify SR – Locked)

1.410 EVA3 - HPGT TRANSFER

(RBT FS/ULF3/FIN/SPN)

THC/RHC Maneuver HPGT per GCA to Airlock Release position.

Locked						
SR	SY	SP	EP	WP	WY	WR
-5.0	+2.3	-123.4	-78.3	-26.6	-31.8	+60.7
X	Y	Z	Pitch	Yaw	Roll	
0	0	-15	0.0	0.0	0.0	
FOR	Loaded – HPGT Mnvr, SR Held					
Disp	Airlock>HPGT Mnvr					

10. HPGT RELEASE AND BACKOFF

10.1 Release Setup

Configure Cameras and overlays for grapple.

Monitor 1	Monitor 2	Monitor 3	V10
13: LAB Stbd Zenith (+70, +40) 03: S1 Lower Outboard (+120, 0)	25: Tip LEE (fully zoomed out)	24: Tip Elbow (-5, +20) 22: Base Elbow (-110, -10)	Camera B (+30, +40)

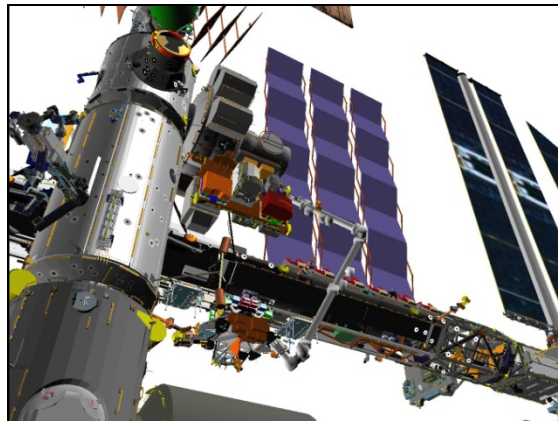

Figure 11.- HPGT Backoff (Camera B: +30, +40).

On EV “GO,” ‘Ready for Release and Backoff:’

10.2 Semi-Manual Release

PCS

MSS: SSRMS: Tip LEE: SSRMS Tip LEE

cmd Release ► Semi-manual ► Slow (Verify Speed – Slow)

Verify ‘**Confirm or Terminate**’ prompt.

cmd Confirm (Verify RHC Trigger Hot icon)

Verify LEE Mode – Semi-manual Release

1.410 EVA3 - HPGT TRANSFER

(RBT FS/ULF3/FIN/SPN)

Page 13 of 16 pages

RHC TRIGGER → Press (hold until 'Carriage' Brakes – On) (90 s max)

PCS Verify 'Carriage' Derigidize – blue

TRIGGER → Press (hold until 'Snare' Brakes – On) (12 s max)

Verify 'Snare' Open – blue

THC Back off from grapple fixture until clear of pin.

RHC TRIGGER → Press (hold until 'Carriage' Brakes – On) (90 s max)

PCS Verify 'Carriage' Extend – blue

10.3 HPGT Backoff

THC/ RHC Maneuver SSRMS to HPGT Backoff position (within 5 cm/1 deg).
(Expect -X, THC out.)

Locked	SR	SY	SP	EP	WP	WY	WR
	-5.0	-11.5	-97.4	-91.5	-46.6	-40.2	+47.2
	X	Y	Z	Pitch	Yaw	Roll	
	-500	0	-100	0.0	0.0	0.0	
FOR	Unloaded – LEE Tip, SR Held						
Disp	Airlock>HPGT Mnvr						

DCP BRAKES SSRMS → ON (Verify ON)

11. JOCAS TO INTERMEDIATE 2 POSITION (4 MINUTES)

Configure Cameras and overlays as required.

Monitor 1	Monitor 2	Monitor 3	V10
13: LAB Stbd Zenith (+70, +40)	03: S1 Lower Outboard (+120, 0)	24: Tip Elbow (-5, +20) 22: Base Elbow (-110, -10)	Camera B (+40, +30)

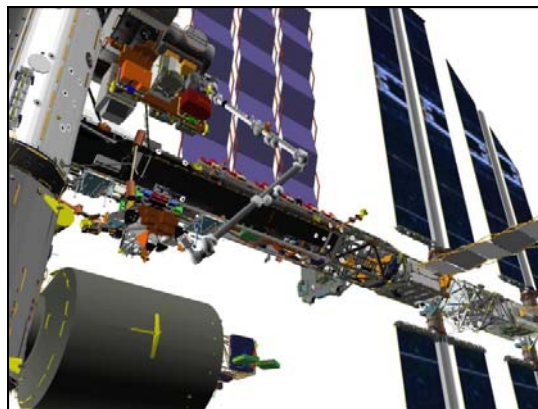

Figure 12.- HPGT Install Backout
(Camera B: +40, +30).

1.410 EVA3 - HPGT TRANSFER

(RBT FS/ULF3/FIN/SPN)

Page 14 of 16 pages

PCS MSS: SSRMS:

Change Display ► ISS ► ISSACS (Verify ISS>ISSACS)

On **MCC-H** "GO," 'MMOD Shields clear for SSRMS maneuver:'

DCP BRAKES SSRMS → OFF (Verify OFF)

MSS: SSRMS:

Enter Mode – Joint OCAS (Verify blue)

pick File ► EVA3 ► Intermediate 2

Verify 'Joint Angles' 'Destination' for HPGT Intermediate 2 position.

SR	SY	SP	EP	WP	WY	WR
+1.0	+34.0	+3.0	-102.0	-72.0	-180.0	+157.4

cmd Load (Verify Sequence Status – Confirm or Cancel)

MON Verify Joint Angles and errors are correct on Joint Angle Position overlay.

	SR	SY	SP	EP	WP	WY	WR
(current)	-5.0	-11.5	-97.4	-91.5	-46.6	-40.2	+47.2
TGT	+1.0	+34.0	+3.0	-102.0	-72.0	-180.0	+157.4
ERR	-6.0	-45.5	-100.4	+10.5	+25.4	+139.8	-110.2

PCS **cmd** Confirm (Verify Sequence Status – Auto Seq sw - Hot)

DCP AUTO SEQ → PROC

PCS MSS: SSRMS:

Verify Posn Hold – orange

Verify Joint Angle values.

SR	SY	SP	EP	WP	WY	WR
+1.0	+34.0	+3.0	-102.0	-72.0	-180.0	+157.4

12. JOCAS TO MT TRANSLATION POSITION (3 MINUTES)

Configure Cameras and overlays as required.

Monitor 1	Monitor 2	Monitor 3	V10
13: LAB Stbd Zenith (+10, +80)	03: S1 Lower Outboard (+25, +5)	37: MBS Mast (+175, -15)	Camera B (+40, +30)

1.410 EVA3 - HPGT TRANSFER

(RBT FS/ULF3/FIN/SPN)

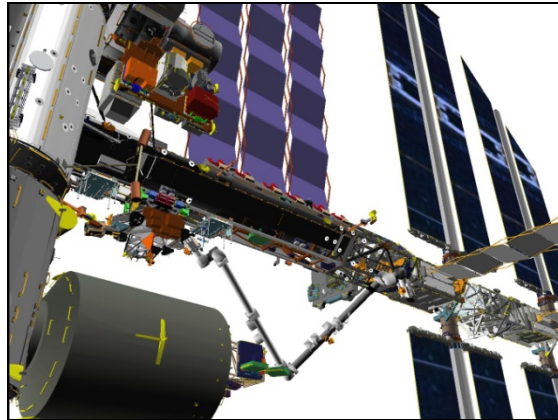

Figure 13.- HPGT Intermediate 2
(Camera B: +40, +30).

pick File ► MT ► Translate

Verify 'Joint Angles' 'Destination' for MT Translation position.

SR	SY	SP	EP	WP	WY	WR
-100.0	+110.0	-8.0	-156.0	-72.0	-180.0	+157.4

cmd Load (Verify Sequence Status – Confirm or Cancel)

MON

Verify Joint Angles and errors are correct on Joint Angle Position overlay.

	SR	SY	SP	EP	WP	WY	WR
(current)	+1.0	+34.0	+3.0	-102.0	-72.0	-180.0	+157.4
TGT	-100.0	+110.0	-8.0	-156.0	-72.0	-180.0	+157.4
ERR	+101.0	-76.0	+11.0	+54.0	0.0	0.0	0.0

PCS

cmd Confirm (Verify Sequence Status – Auto Seq sw - Hot)

DCP

AUTO SEQ → PROC

PCS

MSS: SSRMS:

Verify Posn Hold – orange

Verify SSRMS at MT Translation position (within 5 cm/1 deg).

SR	SY	SP	EP	WP	WY	WR
-100.0	+110.0	-8.0	-156.0	-72.0	-180.0	+157.4
X	Y	Z	Pitch	Yaw	Roll	
+609	+1275	-320	+82.7	-3.2	-129.3	
FOR	Unloaded – LEE Tip, SR Held					
Disp	ISS>ISSACS					

1.410 EVA3 - HPGT TRANSFER

(RBT FS/ULF3/FIN/SPN)

Page 16 of 16 pages

NOTE

Expect the following message when safing is commanded:

**'R3Z - MSS OCS SSRMS Prime(Redun) ACU SRT Cat-1 Brk Stat
Fail'** (SCR 17495)

This message should return to Norm.

DCP

SAFING → SAFE (Verify ON)

FOCUSED INSPECTION OPS

This Page Intentionally Blank

2.110 WALKOFF TO NODE 2 PDGF (WS4)

(RBT FS/ULF3/FIN/SPN)

Page 1 of 6 pages

NOTE

For all OCASes if the joint angles are incorrect after loaded, then **cmd Cancel** on the PCS and reload the correct destination.

1. SETUP

Configure Cameras and overlays as required.

Monitor 1	Monitor 2	Monitor 3	V10L	V10R
03: S1 Lower Outboard (+70, -30)	09: P1 Lower Outboard (+95, -10)	37: MBS Mast (-160,0)	Camera C (+10, +30)	Camera D (-125, +65)

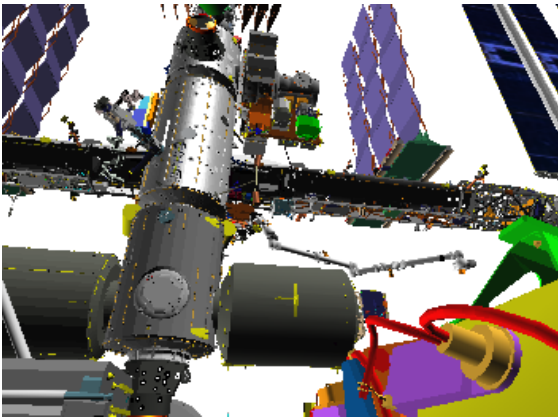

Figure 1.- SSRMS at Truss Clearance (Camera C: +10,+30).

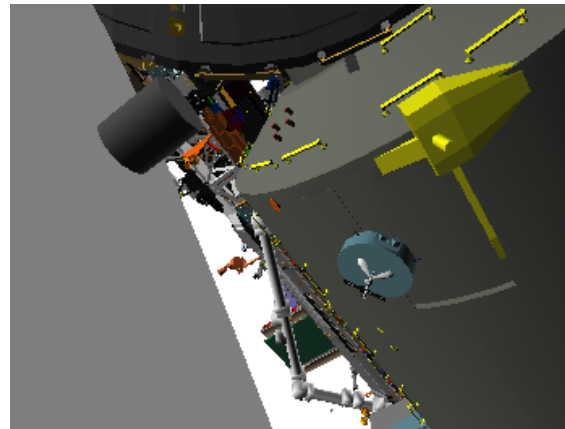

Figure 2.- SSRMS at Truss Clearance (Camera D: -125, +65).

PCS

Change Loaded Parameters ► Walk Off ► Node 2 PDGF
Verify 'Loaded Parameters' (two) – Node 2 PDGF, SR Held

Verify Unloaded Parameters – ✓

Change Unloaded Parameters ► Unloaded ► LEE Tip SYH
Verify 'Unloaded Parameters' (two) – LEE Tip, SY Held

Change Display ► Node2 ► PDGF (Verify Node2>PDGF)

Change Command ► SSRMS ► Internal (Verify SSRMS>Internal)

RHC

RATE → COARSE (Verify Coarse on PCS)

Verify SSRMS at Truss Clearance position (within 5 cm/1 deg).

SR	SY	SP	EP	WP	WY	WR
-100.0	+128.0	-126.0	-61.6	-51.7	-189.0	+95.0
X	Y	Z	Pitch	Yaw	Roll	
+954	+175	+1723	+10.9	+11.7	-86.1	
FOR	Unloaded – LEE Tip, SY Held					
Disp	Node2>PDGF					

2.110 WALKOFF TO NODE 2 PDGF (WS4)

(RBT FS/ULF3/FIN/SPN)

Page 2 of 6 pages

2. JOCAS TO INTERMEDIATE POSITION (2 MINUTES)

DCP BRAKES SSRMS → OFF (Verify OFF)

PCS MSS: SSRMS:

Enter Mode – Joint OCAS (Verify blue)

pick File ► FI Walkoff ► Intermediate 1

Verify 'Joint Angles' 'Destination' for Intermediate position.

SR	SY	SP	EP	WP	WY	WR
-45.0	+80.0	0.0	+25.0	-123.5	-24.1	-19.0

cmd Load (Verify Sequence Status – Confirm or Cancel)

MON Verify joint angles and errors are correct on Joint Angle Position overlay.

	SR	SY	SP	EP	WP	WY	WR
(current)	-100.0	+128.0	-126.0	-61.6	-51.7	-189.0	+95.0
TGT	-45.0	+80.0	0.0	+25.0	-123.5	-24.1	-19.0
ERR	-55.0	+48.0	-126.0	-86.6	+71.8	-164.9	+114.0

PCS **cmd** Confirm (Verify Sequence Status – Auto Seq sw - Hot)

NOTE

Expect singularity warning for EP between -15 and +15 deg.

DCP AUTO SEQ → PROC

PCS MSS: SSRMS:

Verify Posn Hold – orange

Verify Joint Angle values.

SR	SY	SP	EP	WP	WY	WR
-45.0	+80.0	0.0	+25.0	-123.5	-24.1	-19.0

3. JOCAS TO NODE 2 PRE-GRAPPLE POSITION (8 MINUTES)

Configure Cameras and overlays as required.

Monitor 1	Monitor 2	Monitor 3	V10L	V10R
03: S1 Lower Outboard (+70, -20)	13: Lab Stbd Zenith (-20, -10)	37: MBS Mast (+100,+20)	Camera C (+10, +30)	SRMS Elbow (-150, +45)

2.110 WALKOFF TO NODE 2 PDGF (WS4)

(RBT FS/ULF3/FIN/SPN)

Page 3 of 6 pages

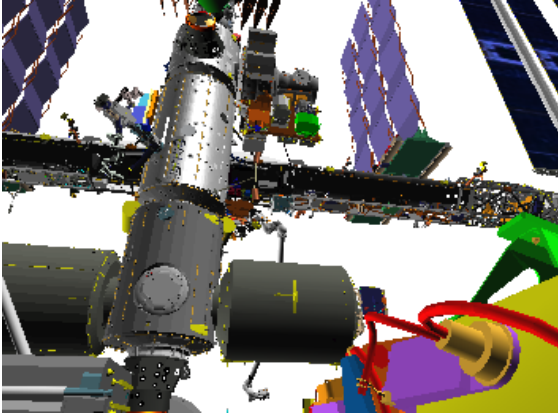

Figure 3.- Intermediate Position
(Camera C: +10, +30).

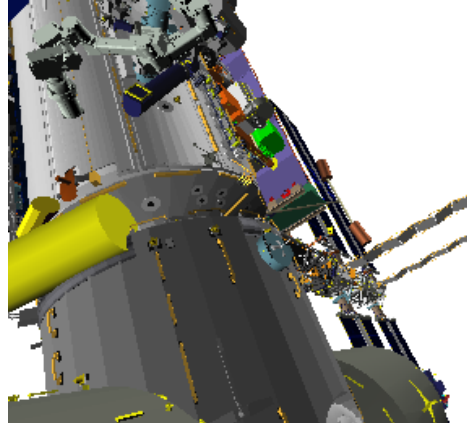

Figure 4.- Intermediate Position
(SRMS Elbow: -150, +45).

NOTE

1. Expect singularity warning for EP between -15 and +15 deg.
2. This maneuver has the following clearance concerns:
 - a. Clearance between the SSRMS Base Boom to the LAB Camera is 56 cm (23 in).
 - b. Clearance from the SSRMS Elbow to the Columbus is 111 cm (44 in).
 - c. Clearance from the SSRMS Tip Boom to the UHF Antenna is 73 cm (29 in).

Monitor clearances with MBS Mast Camera, LAB Stbd Zenith Camera and S1 Lower Outboard Camera.
3. For clearance purposes, the LAB Stbd Zenith Camera should be left at (-20, -10).

RHC

RATE → VERNIER (Verify Vernier on PCS)

SSRMS Joint OCAS

pick File ► FI Walkoff ► Node 2 Pre-Grapple

Verify 'Joint Angles' 'Destination' for Node 2 Pre-Grapple position.

SR	SY	SP	EP	WP	WY	WR
+85.2	+27.8	-36.1	-92.0	-121.8	-15.1	-21.0

cmd Load (Verify Sequence Status – Confirm or Cancel)

MON

Verify joint angles and errors are correct on Joint Angle Position overlay.

	SR	SY	SP	EP	WP	WY	WR
(current)	-45.0	+80.0	0.0	+25.0	-123.5	-24.1	-19.0
TGT	+85.2	+27.8	-36.1	-92.0	-121.8	-15.1	-21.0
ERR	-130.2	+52.2	+36.1	+117.0	-1.7	-9.0	+2.0

PCS

cmd Confirm (Verify Sequence Status – Auto Seq sw - Hot)

19 OCT 09

2.110 WALKOFF TO NODE 2 PDGF (WS4)

(RBT FS/ULF3/FIN/SPN)

Page 4 of 6 pages

DCP AUTO SEQ → PROC

PCS MSS: SSRMS:

Verify Posn Hold – orange

Verify Joint Angle values.

SR	SY	SP	EP	WP	WY	WR
+85.2	+27.8	-36.1	-92.0	-121.8	-15.1	-21.0

4. MANUAL NODE 2 GRAPPLE

4.1 Grapple Setup

Configure Cameras and overlays as required.

Monitor 1	Monitor 2	Monitor 3	V10L	V10R
24: Tip Elbow (-20, +5) 03: S1 Lower Outboard (+70,+10)	25: Tip LEE (fully zoomed out)	37: MBS Mast (+100, +20)	Camera C (+10, +30)	SRMS Elbow (-150, +45)

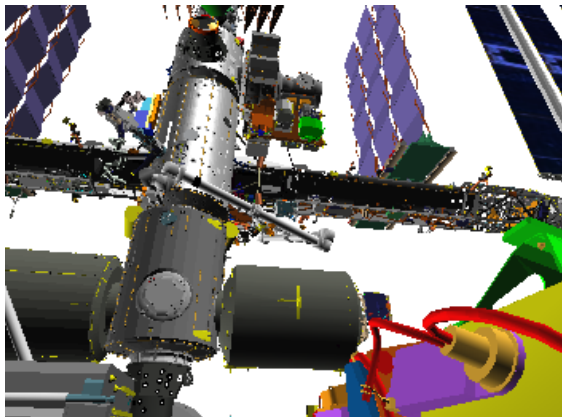

Figure 5.- Node 2 Pre-Grapple
(Camera C: +10, +30).

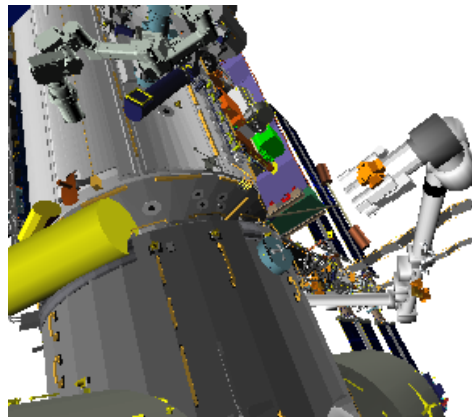

Figure 6.- Node 2 Pre-Grapple
(SRMS Elbow: -150, +45).

NOTE

This maneuver has the following clearance concerns:

- Clearance between the SSRMS Base Boom and the LAB Camera is 28 in.
- Clearance between the SSRMS Elbow and Columbus is 27 in.
- Clearance between the SSRMS Tip Boom and the UHF Antenna is 25 in.

These clearances can be monitored with the MBS Mast Camera or LAB Stbd Zenith Camera.

PCS MSS: SSRMS: Rate:

Set 'Scale' 'Vernier' Rate Scale: as desired

2.110 WALKOFF TO NODE 2 PDGF (WS4)

(RBT FS/ULF3/FIN/SPN)

Page 5 of 6 pages

4.2 Maneuver to Node 2 Grapple

MSS: SSRMS:

Enter Mode – Manual (Verify blue)

MSS: SSRMS: SSRMS Manual: Joint Lock:

cmd Shoulder Yaw (Verify SY – Locked)

THC/RHC

Maneuver to within grapple envelope.

4.3 Slow Capture Commands

PCS

MSS: SSRMS: Tip LEE:

cmd Capture ► Automatic ► Slow, Limp (Verify Speed – Slow)

Verify '**Confirm or Terminate**' prompt.

cmd Confirm (Verify RHC Trigger Hot icon)

Verify LEE Mode – Auto Capture

4.4 Node 2 Grapple

RHC

TRIGGER → press (momentarily)

PCS

Verify 'Snare' Close, Capture (two) – blue (12 s max)

Verify Capture to Latch – Yes (SCR 19282)

Verify 'Carriage' Tension ~5500 N (90 s max)

Verify 'Carriage' Retract – blue

Verify 'Latch' Latch – blue (80s max)

4.5 Mating Umbilicals

Verify with **MCC-H** that payload and PDGF power inhibits have been confirmed.

cmd 'Umbilical' Mate (Verify '**Confirm or Terminate**' prompt)

cmd Confirm (Verify RHC Trigger Hot icon)

Verify LEE Mode – Mate

RHC

TRIGGER → press (momentarily)

PCS

Verify 'Umbilical' Mate – blue (10 s max)

Verify 'Connector Continuity' Prime, Redundant (two) – Yes

4.6 Grapple Cleanup

Verify Posn Hold – orange

Verify Loaded Parameters – √

2.110 WALKOFF TO NODE 2 PDGF (WS4)

(RBT FS/ULF3/FIN/SPN)

Page 6 of 6 pages

Verify 'Loaded Parameters' (two) – Node 2 PDGF, SR Held

Expected Node 2 Grapple position (within 5 cm/1 deg).

	Locked					
SR	SY	SP	EP	WP	WY	WR
+87.9	+27.8	-29.8	-106.1	-112.5	-17.3	-20.1
X	Y	Z	Pitch	Yaw	Roll	
0	0	0	0.0	0.0	0.0	
FOR	Loaded – Node 2 PDGF, SR Held					
Disp	Node2>PDGF					

NOTE

Expect the following message when safing is commanded:

'R3Z - MSS OCS SSRMS Prime(Redun) ACU SRT Cat-1 Brk Stat Fail' (SCR 17495)

This message should return to Norm.

DCP

SAFING → SAFE (Verify ON)

2.120 OBSS UNBERTH AND HANDOFF

(RBT FS/ULF3/FIN/SPN)

Page 1 of 17 pages

NOTE

For all OCASes if the joint angles are incorrect after loaded, then **cmd** Cancel on the PCS and reload the correct destination.

1. SETUP

THC/ RHC Deflect all axes to positive and negative hard stops.

Configure Cameras and overlays as required.

Monitor 1	Monitor 2	Monitor 3	V10L	V10R
03: S1 Lower Outboard (+60, +15)	22: Base Elbow (-75, -10)	24: Tip Elbow (-85,0) 37: MBS Mast (+105, +25)	SRMS Elbow (-105, +40)	Camera C (+10, +20)

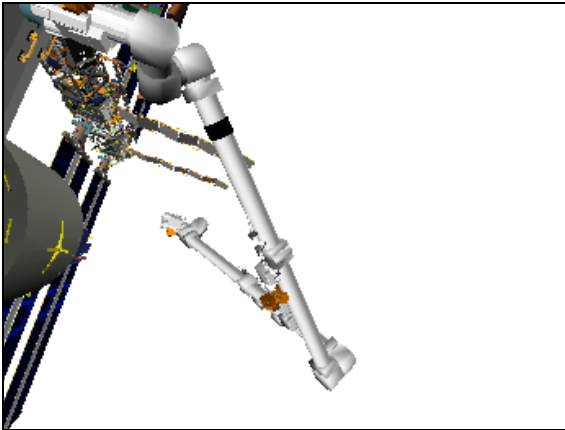

Figure 1.- Overnight Park (SRMS Elbow: -105, +40).

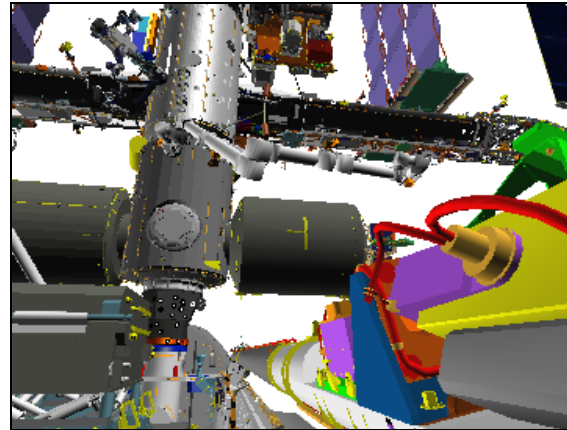

Figure 2.- Overnight Park (Camera C: +10, +20).

PCS MSS: SSRMS:

Change Loaded Parameters ► OBSS ► OBSS Mid MPM SRH
Verify 'Loaded Parameters' (two) – OBSS Mid MPM, SR Held

Verify Unloaded Parameters – √

Change Unloaded Parameters ► Unloaded ► LEE Tip SRH
Verify 'Unloaded Parameters' (two) – LEE Tip, SR Held

Change Display ► Orbiter ► OBSS FRGF (Verify Orbiter>OBSS FRGF)

√Command – SSRMS>Internal

RHC RATE → COARSE (Verify Coarse on PCS)

30 OCT 09

21685.doc

2.120 OBSS UNBERTH AND HANDOFF

(RBT FS/ULF3/FIN/SPN)

Page 2 of 17 pages

Verify SSRMS at Overnight Park position (within 5 cm/1 deg).

SR	SY	SP	EP	WP	WY	WR
-19.6	+34.8	-40.0	-107.5	-41.1	+35.0	+82.7
X	Y	Z	Pitch	Yaw	Roll	
-516	-744	+345	-90.3	-2.5	+17.8	
FOR	Unloaded – LEE Tip, SR Held					
Disp	Orbiter>OBSS FRGF					

2. [JOCAS TO OBSS PRE-GRAPPLE \(1 MINUTE\)](#)

PCS

MSS: SSRMS: MSS Safing:

cmd 'SSRMS' Remove (Verify Not Safed)

On SRMS Operator 'GO for OBSS Grapple, SRMS at Pre-Grapple at Handoff:'

DCP

BRAKES SSRMS → OFF (Verify OFF)

PCS

MSS: SSRMS:

Enter Mode – Joint OCAS (Verify blue)

pick File ► OBSS ► OBSS Pre-Grapple

Verify 'Joint Angles' 'Destination' for OBSS Pre-Grapple position.

SR	SY	SP	EP	WP	WY	WR
-82.2	-14.8	+13.1	-133.5	+28.2	-3.1	+5.9

cmd Load (Verify Sequence Status – Confirm or Cancel)

MON

Verify Joint Angles and errors are correct on Joint Angle Position overlay.

	SR	SY	SP	EP	WP	WY	WR
(current)	-19.6	+34.8	-40.0	-107.5	-41.1	+35.0	+82.7
TGT	-82.2	-14.8	+13.1	-133.5	+28.2	-3.1	+5.9
ERR	+62.6	+49.6	-53.1	+26.0	-69.3	+38.1	+76.8

PCS

cmd Confirm (Verify Sequence Status – Auto Seq sw - Hot)

DCP

AUTO SEQ → PROC

PCS

MSS: SSRMS:

Verify Posn Hold – orange

2.120 OBSS UNBERTH AND HANDOFF

(RBT FS/ULF3/FIN/SPN)

Page 3 of 17 pages

Verify Joint Angle values.

SR	SY	SP	EP	WP	WY	WR
-82.2	-14.8	+13.1	-133.5	+28.2	-3.1	+5.9

3. OBSS GRAPPLE

3.1 Grapple Setup

Configure Cameras and overlays as required.

Monitor 1	Monitor 2	Monitor 3	V10L	V10R
03: S1 Lower Outboard (+60, +15)	25: Tip LEE (fully zoomed out)	13: LAB Stbd Zenith (-30, -30)	SRMS Elbow (-105, +15)	Camera C (+10,+20)

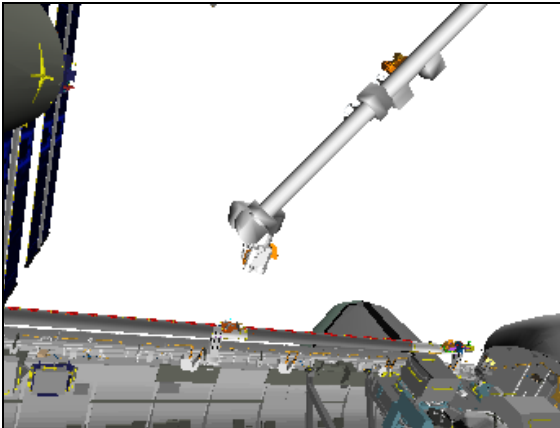

Figure 3.- OBSS Pre-Grapple (SRMS Elbow: -105, +15).

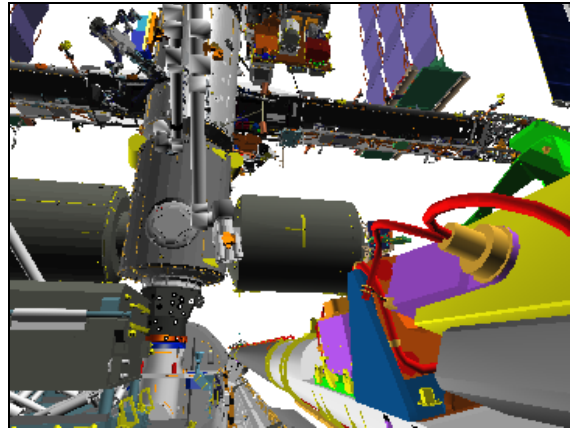

Figure 4.- OBSS Pre-Grapple (Camera C: +10, +20).

RHC RATE → VERNIER (Verify Vernier on PCS)

PCS MSS: SSRMS: Rate:

Set 'Scale' 'Vernier' Rate Scale: as desired

3.2 Maneuver to OBSS Grapple

MSS: SSRMS:

Enter Mode – Manual (Verify blue)

MSS: SSRMS: SSRMS Manual: Joint Lock:

cmd Shoulder Roll (Verify SR – Locked)

THC/ RHC Maneuver to within grapple envelope.

2.120 OBSS UNBERTH AND HANDOFF

(RBT FS/ULF3/FIN/SPN)

Page 4 of 17 pages

3.3 Slow Capture Commands
 PCS MSS: SSRMS: Tip LEE: SSRMS Tip LEE
cmd Capture ► Automatic ► Slow, Limp (Verify Speed – Slow)
 Verify '**Confirm or Terminate**' prompt.
cmd Confirm (Verify RHC Trigger Hot icon)
 Verify LEE Mode – Auto Capture

3.4 OBSS Grapple
 RHC TRIGGER → press (momentarily)
 PCS Verify 'Snare' Close, Capture (two) – blue (12 s max)
 Verify Capture to Latch – No (SCR 19282)
 Verify 'Carriage' Tension ~5500 N (90 s max)
 Verify 'Carriage' Retract – blue
 Verify 'Carriage' Brakes – On (15 s max)

3.5 Grapple Cleanup
 Verify Posn Hold – orange
 DCP BRAKES SSRMS → ON (Verify ON)
 Verify Loaded Parameters – √
 Verify 'Loaded Parameters' (two) – OBSS Mid MPM, SR Held
 Change Display ► Orbiter ► OBSS Mid MPM (Verify Orbiter>OBSS Mid MPM)

Expected OBSS Berthed position:

Locked						
SR	SY	SP	EP	WP	WY	WR
-82.2	-16.4	-4.0	-118.2	+30.2	-3.2	+7.5
X	Y	Z	Pitch	Yaw	Roll	
0	0	0	0.0	0.0	0.0	
FOR	Loaded – OBSS Mid MPM, SR Held					
Disp	Orbiter>OBSS Mid MPM					

2.120 OBSS UNBERTH AND HANDOFF

(RBT FS/ULF3/FIN/SPN)

Page 5 of 17 pages

4. OBSS UNBERTH

4.1 Attitude Control Configuration

- * If using shuttle attitude control
- * | Verify in attitude and rates damped, then
- * | DAP: FREE

4.2 MRL Release

Give shuttle crew, 'GO for Stbd MRL Release.'

NOTE

Standby for OBSS thermal clock start time:

____ / ____ : ____ : ____

SRMS SPEE power must be applied within 90 minutes to prevent sensor damage.

*If 'R3Q - SSRMS LEE Uncommanded Derigidize' Caution was annunciated

*

* MSS: SSRMS: Tip LEE: SSRMS Tip LEE

*

* **cmd** 'Carriage' Rigidize ► Slow (Verify Speed – Slow)

*

* Verify '**Confirm or Terminate**' prompt.

*

* **cmd** Confirm (Verify RHC Trigger Hot icon)

*

* Verify LEE Mode – Rigidize

*

RHC * TRIGGER → press (momentarily) (SCR 19064)

*

PCS * Verify 'Carriage' Tension ~5500 N (90 s max)

*

* Verify 'Carriage' Retract – blue

5. OBSS LOW HOVER

Configure Cameras and overlays as required.

Monitor 1	Monitor 2	Monitor 3	V10L	V10R
03: S1 Lower Outboard (+60, +15)	71 : Mux D/C D(-22,-3) FL=+25mm C(+26,-8) FL=+10mm	24: Tip Elbow (-30,+5)	SRMS Elbow (-145, 0) FL=+20mm	Camera B (+80, 0) FL=+15mm

2.120 OBSS UNBERTH AND HANDOFF

(RBT FS/ULF3/FIN/SPN)

Page 6 of 17 pages

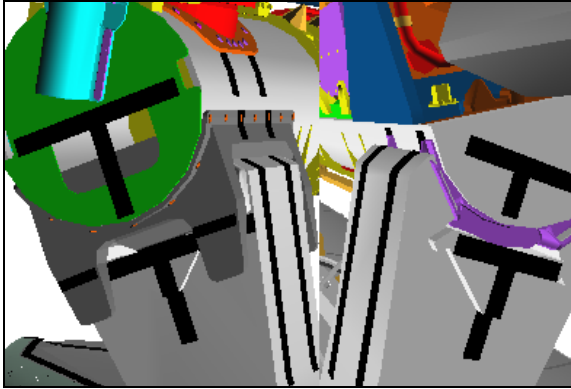

Figure 5.- OBSS Grapple at Berth
(71: MUX D/C).



Figure 6.- OBSS Grapple at Berth
(SRMS Elbow: -145, 0).

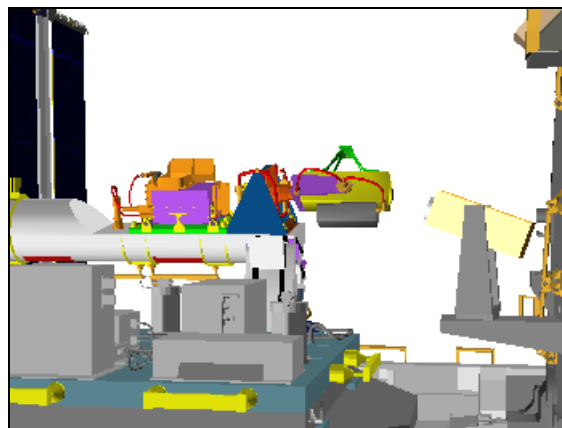

Figure 7.- OBSS Grapple at Berth
(Camera B: +80, 0).

NOTE

This maneuver will bring the OBSS within 28in of Columbus. This clearance can be monitored with the Tip Elbow Camera or SRMS Elbow Camera.

Change Command ► Orbiter ► OBSS Mid MPM (Verify Orbiter>OBSS Mid MPM)

√Vernier

MSS: SSRMS: Rate:

Set 'Scale' 'Vernier' Rate Scale: as desired

On shuttle crew 'GO for OBSS Unberth, MRL Release complete:'

DCP BRAKES SSRMS → OFF (Verify OFF)

PCS MSS: SSRMS:

Enter Mode – Manual (Verify blue)

30 OCT 09

21685.doc

2.120 OBSS UNBERTH AND HANDOFF

(RBT FS/ULF3/FIN/SPN)

Page 7 of 17 pages

MSS: SSRMS: SSRMS Manual: Joint Lock: Joint Lock

cmd Shoulder Roll (Verify SR – Locked)

THC

Maneuver OBSS to Low Hover position (within 5 cm/1 deg).
(-Z/THC up)

Locked						
SR	SY	SP	EP	WP	WY	WR
-82.2	-28.0	+13.9	-128.7	+23.6	-3.5	+19.1
X	Y	Z	Pitch	Yaw	Roll	
0	0	-200	0.0	0.0	0.0	
FOR	Loaded – OBSS Mid MPM, SR Held					
Disp	Orbiter>OBSS Mid MPM					

 * If using shuttle attitude control and attitude maintenance required
 * | DAP: LVLH
 * |
 * | When rates damped
 * | | DAP: FREE > 2 seconds
 * | | DAP: AUTO

6. JOCAS TO INTERMEDIATE POSITION (2 MINUTES)

Configure Cameras and overlays as required.

Monitor 1	Monitor 2	Monitor 3	V10L	V10R
03: S1 Lower Outboard (+60, +15) 09: P1 Lower Outboard (+120,+20)	71: Camera D (-20, +25)	24: Tip Elbow (-30, +5)	SRMS Elbow (-105, +10)	Camera C (+25, +25)



Figure 8.- OBSS Low Hover
(71: Camera D: -20, +25).

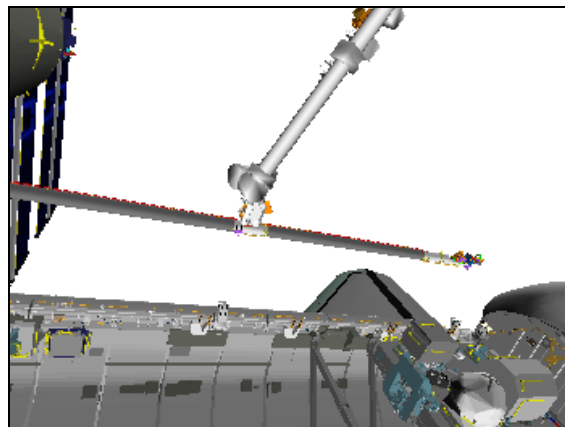

Figure 9.- OBSS Low Hover
(SRMS Elbow: -105, +10).

2.120 OBSS UNBERTH AND HANDOFF

(RBT FS/ULF3/FIN/SPN)

Page 8 of 17 pages

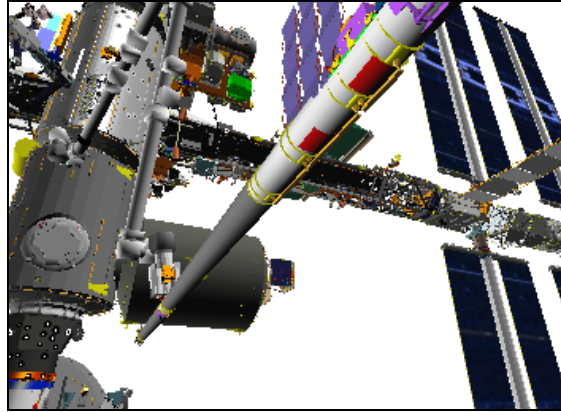

Figure 10.- OBSS Low Hover
(Camera C: +25, +25).

NOTE

This maneuver will increase the clearance between the OBSS and Columbus. This can be monitored with the Tip Elbow Camera, Camera D or the SRMS Elbow Camera.

PCS

MSS: SSRMS:

Enter Mode – Joint OCAS (Verify blue)

pick File ► OBSS ► Intermediate

Verify 'Joint Angles' 'Destination' for Intermediate position.

SR	SY	SP	EP	WP	WY	WR
-82.2	-37.2	+18.7	-104.9	+4.4	-3.7	+28.3

cmd Load (Verify Sequence Status – Confirm or Cancel)

MON

Verify Joint Angles and errors are correct on Joint Angle Position overlay.

	SR	SY	SP	EP	WP	WY	WR
(current)	-82.2	-28.0	+13.9	-128.7	+23.6	-3.5	+19.1
TGT	-82.2	-37.2	+18.7	-104.9	+4.4	-3.7	+28.3
ERR	0.0	+9.2	-4.8	-23.8	+19.2	+0.2	-9.2

PCS

cmd Confirm (Verify Sequence Status – Auto Seq sw - Hot)

DCP

AUTO SEQ → PROC

PCS

MSS: SSRMS:

Verify Posn Hold – orange

30 OCT 09

21685.doc

2.120 OBSS UNBERTH AND HANDOFF

(RBT FS/ULF3/FIN/SPN)

Page 9 of 17 pages

Verify Joint Angle values.

SR	SY	SP	EP	WP	WY	WR
-82.2	-37.2	+18.7	-104.9	+4.4	-3.7	+28.3

7. JOCAS TO OBSS HANDOFF (2 MINUTES)

Configure Cameras and overlays as required.

Monitor 1	Monitor 2	Monitor 3	V10L	V10R
03: S1 Lower Outboard (+60, +30)	71: Camera D (-20, +25) 72: Camera A (+10,+20)	09: P1 Lower Outboard (+120,+20) 13: LAB Stbd Zenith (-30,-30)	SRMS Elbow (-105, +10)	Camera C (+45, +30)

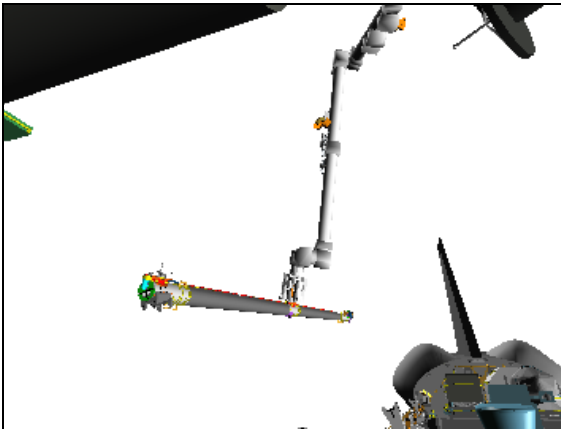

Figure 11.- OBSS Intermediate Position (71: Camera D: -20, +25).

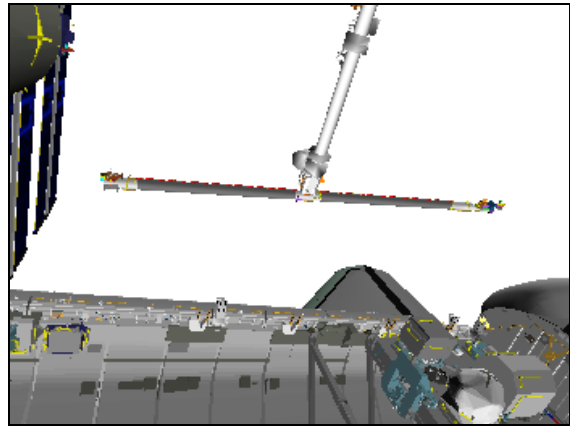

Figure 12.- OBSS Intermediate Position (SRMS Elbow: -105, +10).

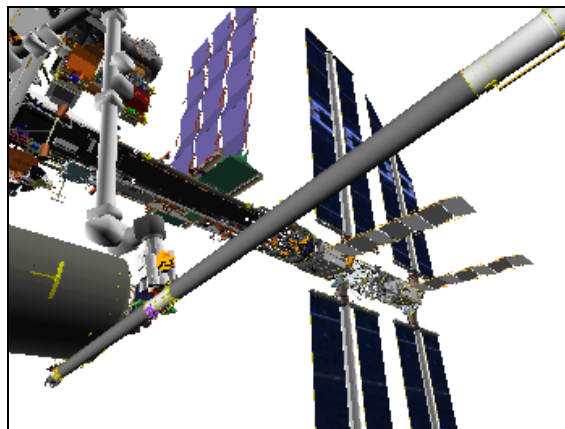

Figure 13.- OBSS Intermediate Position (Camera C: +45, +30).

RHC

RATE → COARSE (Verify Coarse on PCS)

30 OCT 09

21685.doc

2.120 OBSS UNBERTH AND HANDOFF

(RBT FS/ULF3/FIN/SPN)

Page 10 of 17 pages

SSRMS Joint OCAS

pick File ► OBSS ► OBSS Handoff

Verify 'Joint Angles' 'Destination' for OBSS Handoff position.

SR	SY	SP	EP	WP	WY	WR
-82.2	+28.1	+45.2	-125.9	+4.4	-1.0	-128.4

cmd Load (Verify Sequence Status – Confirm or Cancel)

MON

Verify Joint Angles and errors are correct on Joint Angle Position overlay.

	SR	SY	SP	EP	WP	WY	WR
(current)	-82.2	-37.2	+18.7	-104.9	+4.4	-3.7	+28.3
TGT	-82.2	+28.1	+45.2	-125.9	+4.4	-1.0	-128.4
ERR	0.0	-65.3	-26.5	+21.0	0.0	-2.7	+156.7

PCS

cmd Confirm (Verify Sequence Status – Auto Seq sw - Hot)

DCP

AUTO SEQ → PROC

PCS

MSS: SSRMS: SSRMS

Verify Posn Hold – orange

Verify Joint Angle values.

SR	SY	SP	EP	WP	WY	WR
-82.2	+28.1	+45.2	-125.9	+4.4	-1.0	-128.4

DCP

BRAKES SSRMS → ON (Verify ON)

PCS

MSS: SSRMS: Thrusters: Thruster Controls for MSS Ops

Verify 'Desat Request:' – Inh

```
*****
* If using shuttle attitude control
* | Verify in attitude and rates damped, then
* | DAP: FREE
*****
```

Give SRMS Operator 'GO for OBSS Grapple, SSRMS at OBSS Handoff.'

2.120 OBSS UNBERTH AND HANDOFF

(RBT FS/ULF3/FIN/SPN)

Page 11 of 17 pages

8. OBSS RELEASE AND BACKOFF

8.1 Release Setup

On SRMS Operator 'GO for OBSS Release, OBSS Grapple complete and SRMS brakes on:'

Configure Cameras and overlays as required.

Monitor 1	Monitor 2	Monitor 3	V10L	V10R
03: S1 Lower Outboard (+60, +30) 09: P1 Lower Outboard (+120,+20)	25: Tip LEE (fully zoomed out)	72: Camera A (+10, +20)	SRMS Elbow (0, +85)	Camera C (-30, +40)

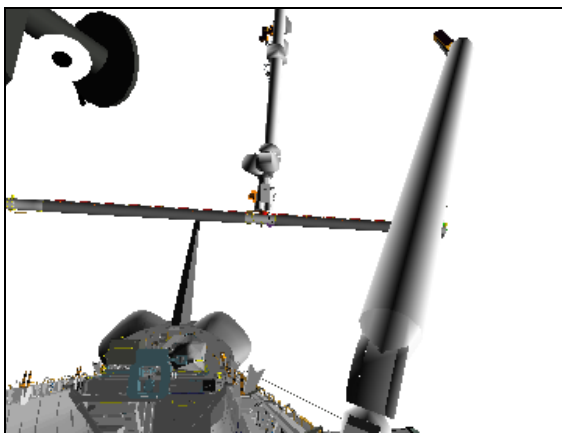

Figure 14.- OBSS Handoff (72: Camera A: +10, +20).

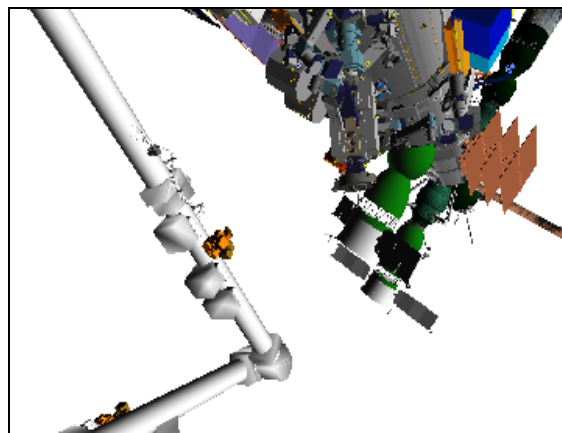

Figure 15.- OBSS Handoff (SRMS Elbow: 0, +85).

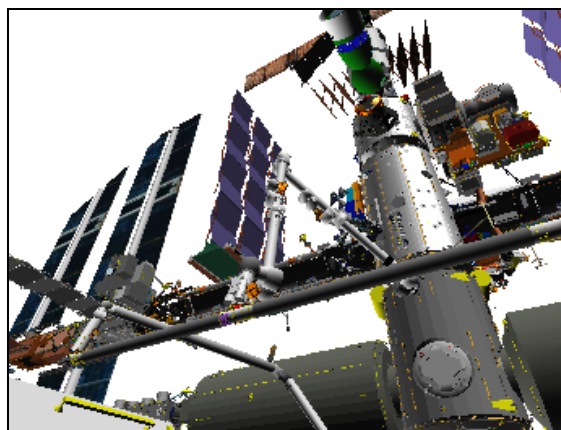

Figure 16.- OBSS Handoff (Camera C: -30, +40).

NOTE

This maneuver will bring the SSRMS Elbow within 50in of SPD. This clearance can be monitored with the S1 Lower Outboard Camera or the SRMS Elbow Camera.

2.120 OBSS UNBERTH AND HANDOFF

(RBT FS/ULF3/FIN/SPN)

Page 12 of 17 pages

Change Command ► SSRMS ► Internal (Verify SSRMS>Internal)

DCP BRAKES SSRMS → OFF (Verify OFF)

RHC RATE → VERNIER (Verify Vernier on PCS)

8.2 SSRMS Limp

PCS MSS: SSRMS: Limp:

cmd All Limp (Verify Limp – blue)

MSS: SSRMS:

Verify all joints – Limped

8.3 Auto Release

MSS: SSRMS: Tip LEE:

cmd Release ► Automatic ► Slow (Verify Speed – Slow)

Verify '**Confirm or Terminate**' prompt.

cmd Confirm (Verify RHC Trigger Hot icon)

Verify LEE Mode – Auto Release

RHC TRIGGER → press (momentarily)

PCS Verify 'Carriage' Retract – gray (90 s max)
Verify 'Snare' Open – blue (12 s max)
Verify 'Carriage' Extend – blue (90 s max)

8.4 SSRMS Backoff

MSS: SSRMS: Limp:

cmd None Limp (Verify Standby – blue)

MSS: SSRMS:

Enter Mode – Manual (Verify blue)

MSS: SSRMS: SSRMS Manual: Joint Lock:

cmd Shoulder Roll (Verify SR – Locked)

√Vernier

2.120 OBSS UNBERTH AND HANDOFF

(RBT FS/ULF3/FIN/SPN)

Page 13 of 17 pages

THC/ RHC

Maneuver SSRMS to Backoff position (within 5 cm/1 deg).

Locked						
SR	SY	SP	EP	WP	WY	WR
-82.2	+28.3	+60.8	-131.7	-5.4	-1.1	-128.6
X	Y	Z	Pitch	Yaw	Roll	
+267	+746	-381	-75.4	-18.9	-85.6	
FOR	Unloaded – LEE Tip, SR Held					
Disp	Orbiter>OBSS Mid MPM					

DCP

BRAKES SSRMS → ON (Verify ON)

Give SRMS Operator 'GO for SRMS maneuver to OBSS Clearance Position.'

9. JOCAS TO CLEARANCE POSITION (3 MINUTES)

On SRMS Operator 'GO for SSRMS Maneuevr to FI Viewing Position, SRMS at OBSS Clearance Position:'

Configure Cameras and overlays as required.

Monitor 1	Monitor 2	Monitor 3	V10L	V10R
03: S1 Lower Outboard (+60, +30)	71: Camera B (+20,+40)	09: P1 Lower Outboard (+120,+20) 13: LAB Stbd Zenith (-30,-30)	SRMS Elbow (0, +85)	Camera C (-10, +40)

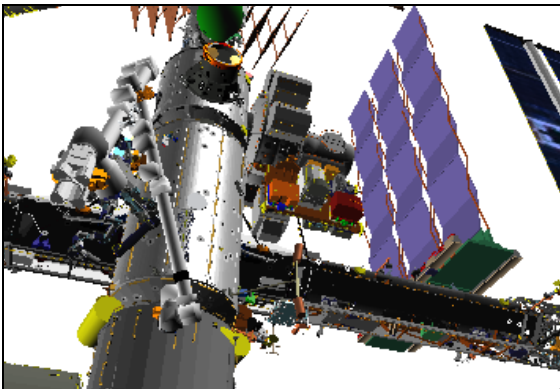

Figure 17.- OBSS Backoff at Handoff (71: Camera B: +20, +40).

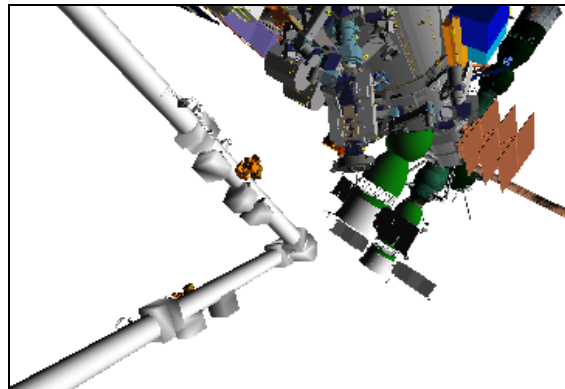

Figure 18.- OBSS Backoff at Handoff (SRMS Elbow: 0, +85).

2.120 OBSS UNBERTH AND HANDOFF

(RBT FS/ULF3/FIN/SPN)

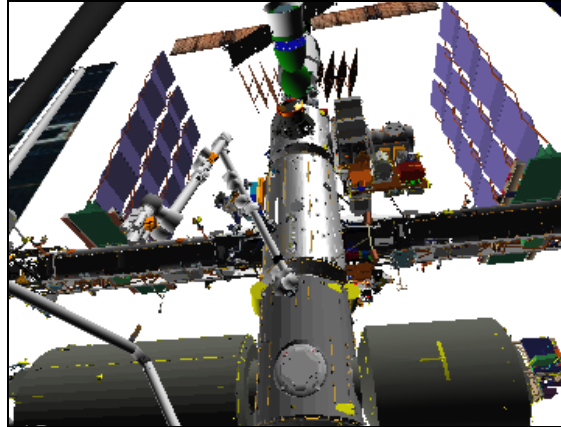

Figure 19.- OBSS Backoff at Handoff
(Camera C: -10, +40).

NOTE

This manuever has the following clearance concerns:

- a. The clearance between the SSRMS and SPDM will increase.
- b. The clearance between the SSRMS Base and Node 2 is 27in.

These clearances can be monitored with the S1 Lower Outboard Camera or the SRMS Elbow Camera.

√Vernier

DCP BRAKES SSRMS → OFF (Verify OFF)

PCS MSS: SSRMS: SSRMS

Enter Mode – Joint OCAS (Verify blue)

SSRMS Joint OCAS

pick File ► OBSS ► OBSS Clearance

Verify 'Joint Angles' 'Destination' for Clearance position.

SR	SY	SP	EP	WP	WY	WR
-82.2	-76.9	-30.0	-22.8	-117.9	+31.0	+2.4

cmd Load (Verify Sequence Status – Confirm or Cancel)

MON Verify Joint Angles and errors are correct on Joint Angle Position overlay.

	SR	SY	SP	EP	WP	WY	WR
(current)	-82.2	+28.3	+60.8	-131.7	-5.4	-1.1	-128.6
TGT	-82.2	-76.9	-30.0	-22.8	-117.9	+31.0	+2.4
ERR	0.0	+105.2	+90.8	-108.9	+112.5	-32.1	-131.0

PCS **cmd** Confirm (Verify Sequence Status – Auto Seq sw - Hot)

2.120 OBSS UNBERTH AND HANDOFF

(RBT FS/ULF3/FIN/SPN)

Page 15 of 17 pages

DCP AUTO SEQ → PROC

PCS MSS: SSRMS:

Verify Posn Hold – orange

Verify Joint Angle values.

SR	SY	SP	EP	WP	WY	WR
-82.2	-76.9	-30.0	-22.8	-117.9	+31.0	+2.4

10. SJ TO FI VIEWING POSITION

Configure Cameras and overlays as required.

Monitor 1	Monitor 2	Monitor 3	V10L	V10R
03: S1 Lower Outboard (+60, +30)	24: Tip Elbow (-25, -10)	22: Base Elbow (-145, 0)	Camera D (-30, 0)	Camera C (+20, +5)

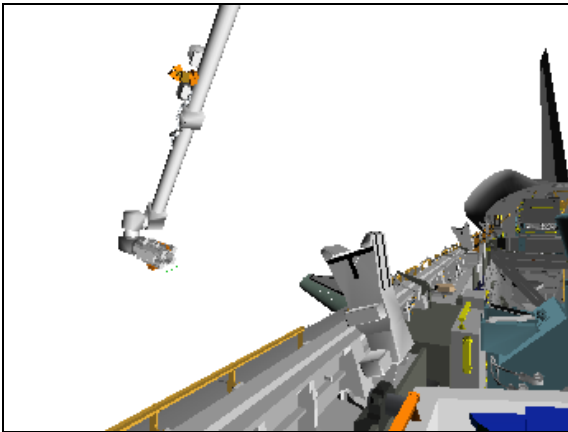

Figure 20.- Clearance Position
(Camera D: -30, 0).

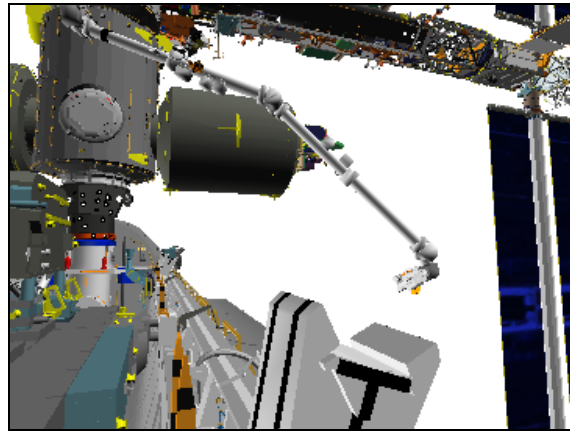

Figure 21.- Clearance Position
(Camera C: +20, +5).

PCS MSS: SSRMS:

Enter Mode – Single (Verify blue)

WARNING

The active joint must be checked on the PCS before initiating motion. Failure to do so may result in movement of the wrong joint.

DCP JOINT SELECT → SHOULDER PITCH (Verify SP – Selected on PCS)

THC Perform “-” Single Joint maneuver to SP: -51.3 (THC down).

30 OCT 09

21685.doc

2.120 OBSS UNBERTH AND HANDOFF

(RBT FS/ULF3/FIN/SPN)

Page 16 of 17 pages

Verify SSRMS at FI Viewing position (within 5 cm/1 deg).

SR	SY	SP	EP	WP	WY	WR
-82.2	-76.9	-51.3	-22.8	-117.9	+31.0	+2.4
X	Y	Z	Pitch	Yaw	Roll	
-221	-475	+273	-60.7	+71.5	-117.8	
FOR	Unloaded – LEE Tip, SR Held					
Disp	Orbiter>OBSS Mid MPM					

DCP BRAKES SSRMS → ON (Verify ON)

Give SRMS Operator 'GO for FI, SSRMS at FI Viewing Position.'

11. FOCUSED INSPECTION VIEWING

Configure Cameras and overlays as required.

Monitor 1	Monitor 2	Monitor 3
03: S1 Lower Outboard (+60, +25)	25: Tip LEE	24: Tip Elbow (-15, -10)

NOTE

The WY joint can be used to position the Tip LEE Camera for Focused Inspection Survey Support. Moving the WY in the positive direction will permit viewing of Orbiter aft. Moving the WY in the negative direction will permit viewing of Orbiter forward. Maximum range of WY motion required will be $-18.2 \text{ deg} < \text{WY} < +103.5 \text{ deg}$.

DCP BRAKES SSRMS → OFF (Verify OFF)

RHC RATE – as desired (COARSE permitted for WY motion only)

PCS MSS: SSRMS:

Enter Mode – Single (Verify blue)

WARNING

The active joint must be checked on the PCS before initiating motion. Failure to do so may result in movement of the wrong joint.

DCP JOINT SELECT → WRIST YAW (Verify WY – Selected on PCS)

THC Perform +WY or -WY Single Joint maneuver as required for OBSS to Orbiter clearance viewing ($-18.2 \text{ deg} < \text{WY} < +103.5 \text{ deg}$).

When Focused Inspection complete, return WY to +31.0 deg.

2.120 OBSS UNBERTH AND HANDOFF

(RBT FS/ULF3/FIN/SPN)

Page 17 of 17 pages

Verify SSRMS at FI Viewing position (within 5 cm/1 deg).

SR	SY	SP	EP	WP	WY	WR
-82.2	-76.9	-51.3	-22.8	-117.9	+31.0	+2.4
X	Y	Z	Pitch	Yaw	Roll	
-221	-475	+273	-60.7	+71.5	-117.8	
FOR	Unloaded – LEE Tip, SR Held					
Disp	Orbiter>OBSS Mid MPM					

DCP

BRAKES SSRMS → ON (Verify ON)

This Page Intentionally Blank

2.130 OBSS HANDOFF, REBERTH AND MBS PDGF1 GRAPPLE (WS4)

(RBT FS/ULF3/FIN/SPN)

Page 1 of 21 Pages

NOTE

For all OCASes if the joint angles are incorrect after loaded, then **cmd** Cancel on the PCS and reload the correct destination.

1. SETUP

Configure Cameras and overlays as required.

Monitor 1	Monitor 2	Monitor 3	V10L	V10R
03: S1 Lower Outboard (+60, +30)	22: Base Elbow (-145, 0)	24: Tip Elbow (-25,-10)	Camera D (-30, 0) SRMS Elbow (-120, +20)	Camera C (+20, +5)

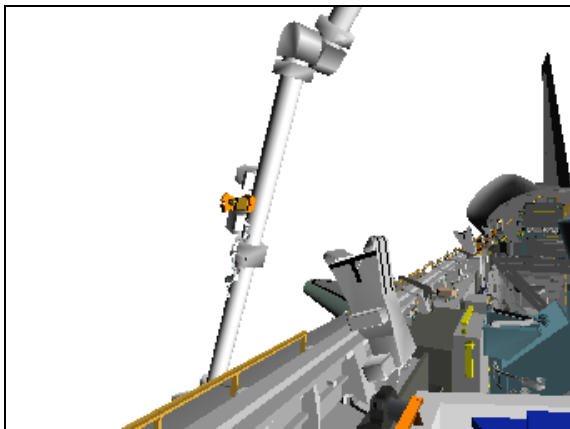

Figure 1.- FI Viewing Position
(Camera D: -30, 0).

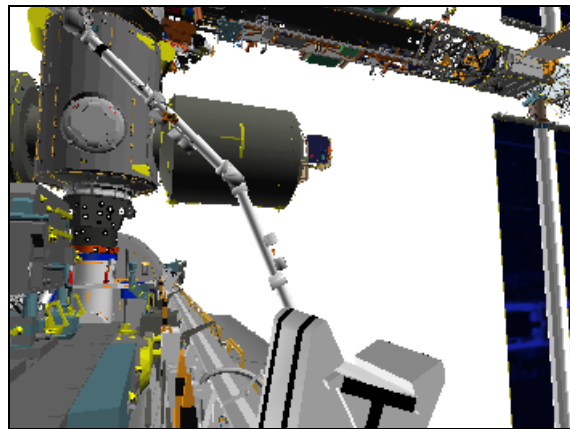

Figure 2.- FI Viewing Position
(Camera C: +20, +5).

PCS

MSS: SSRMS:

Verify 'Loaded Parameters' (two) – OBSS Mid MPM, SR Held

Verify Unloaded Parameters – √

Verify 'Unloaded Parameters' (two) – LEE Tip, SR Held

Verify Display – Orbiter>OBSS Mid MPM

√Command – SSRMS>Internal

√Vernier

Verify SSRMS at FI Viewing position (within 5 cm/1 deg).

SR	SY	SP	EP	WP	WY	WR
-82.2	-76.9	-51.3	-22.8	-117.9	+31.0	+2.4
X	Y	Z	Pitch	Yaw	Roll	
-221	-475	+273	-60.7	+71.5	-117.8	
FOR	Unloaded – LEE Tip, SR Held					
Disp	Orbiter>OBSS Mid MPM					

2.130 OBSS HANDOFF, REBERTH AND MBS PDGF1 GRAPPLE (WS4)

(RBT FS/ULF3/FIN/SPN)

Page 2 of 21 Pages

2. SJ TO CLEARANCE POSITION

On SRMS Operator 'GO for maneuver to Pre-Grapple Position, SRMS at OBSS Clearance Position:'

DCP BRAKES SSRMS → OFF (Verify OFF)

PCS MSS: SSRMS:

Enter Mode – Single (Verify blue)

WARNING

The active joint must be checked on the PCS before initiating motion. Failure to do so may result in movement of the wrong joint.

NOTE

This maneuver brings the SSRMS Base within 27in of Node 2. This clearance can be monitored with the S1 Lower Outboard Camera.

DCP JOINT SELECT → SHOULDER PITCH (Verify SP – Selected on PCS)

THC Perform “+” Single Joint maneuver to SP: -30.0 (THC up).

Verify SSRMS at Clearance position (within 5 cm/1 deg).

SR	SY	SP	EP	WP	WY	WR
-82.2	-76.9	-30.0	-22.8	-117.9	+31.0	+2.4
X	Y	Z	Pitch	Yaw	Roll	
-70	-703	-158	-73.6	+54.1	-95.1	
FOR	Unloaded – LEE Tip, SR Held					
Disp	Orbiter>OBSS Mid MPM					

3. JOCAS TO OBSS PRE-GRAPPLE AT HANDOFF (3 MINUTES)

Configure Cameras and overlays as required.

Monitor 1	Monitor 2	Monitor 3	V10L	V10R
03: S1 Lower Outboard (+60, +30)	72: SRMS Elbow (-120, +20)	71: Camera B (+20,+25) 13: LAB Stbd Zenith (-30,-10)	Camera D (-30, +15)	Camera C (+20, +20)

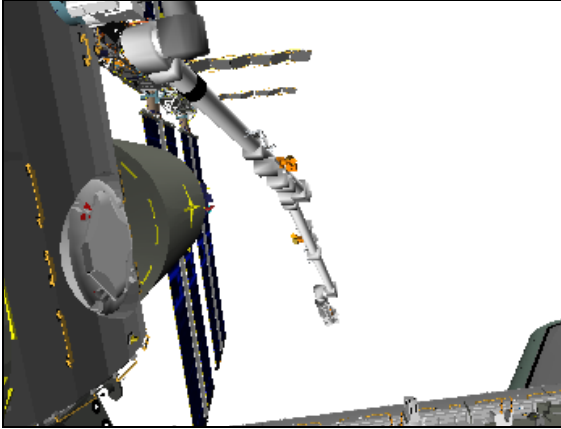

Figure 3.- Clearance Position
 (72: SRMS Elbow: -120, +20).

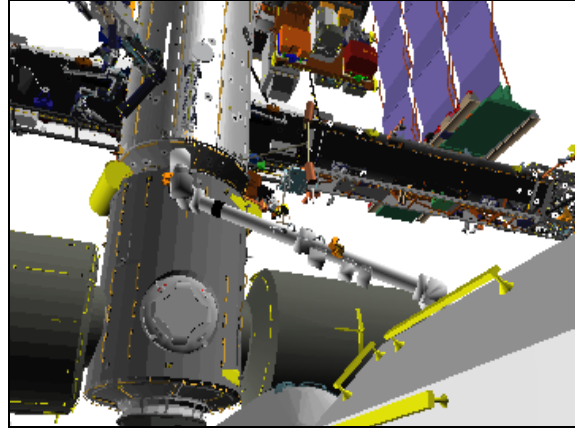

Figure 4.- Clearance Position
 (71: Camera B: +20, +25).

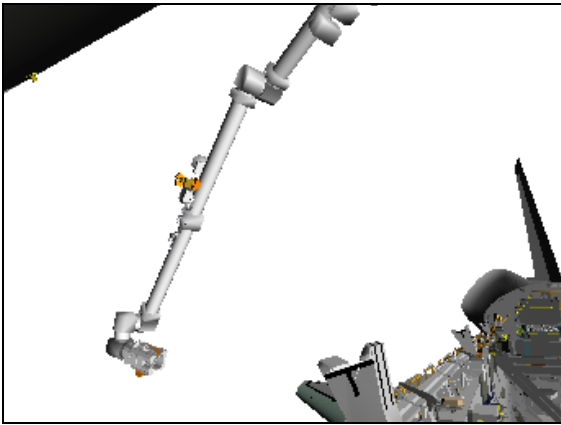

Figure 5.- Clearance Position
 (Camera D: -30, +15).

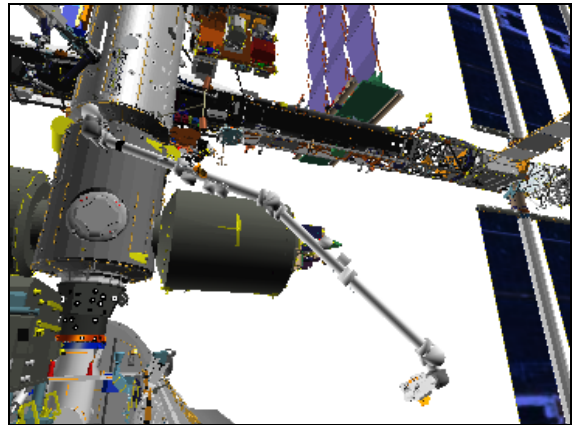

Figure 6.- Clearance Position
 (Camera C: +20, +20).

NOTE

This maneuver brings the SSRMS Elbow within 50in of SPDM. This clearance can be monitored with the S1 Lower Outboard Camera or the SRMS Elbow Camera.

PCS

MSS: SSRMS:

Enter Mode – Joint OCAS (Verify blue)

SSRMS Joint OCAS

pick File ► OBSS ► Handback Pre-Grapple

Verify 'Joint Angles' 'Destination' for OBSS Pre-Grapple at Handoff position.

SR	SY	SP	EP	WP	WY	WR
-82.2	+28.3	+60.8	-131.7	-5.4	-1.1	-128.6

2.130 OBSS HANDOFF, REBERTH AND MBS PDGF1 GRAPPLE (WS4)

(RBT FS/ULF3/FIN/SPN)

Page 4 of 21 Pages

cmd Load (Verify Sequence Status – Confirm or Cancel)

MON Verify Joint Angles and errors are correct on Joint Angle Position overlay.

	SR	SY	SP	EP	WP	WY	WR
(current)	-82.2	-76.9	-30.0	-22.8	-117.9	+31.0	+2.4
TGT	-82.2	+28.3	+60.8	-131.7	-5.4	-1.1	-128.6
ERR	0.0	-105.2	-90.8	+108.9	-112.5	+32.1	+131.0

PCS **cmd** Confirm (Verify Sequence Status – Auto Seq sw - Hot)

DCP AUTO SEQ → PROC

PCS MSS: SSRMS:

Verify Posn Hold – orange

Verify SSRMS at OBSS Pre-Grapple at Handoff position
(within 5 cm/1 deg).

SR	SY	SP	EP	WP	WY	WR
-82.2	+28.3	+60.8	-131.7	-5.4	-1.1	-128.6
X	Y	Z	Pitch	Yaw	Roll	
+267	+746	-381	-75.4	-18.9	-85.6	
FOR	Unloaded – LEE Tip, SR Held					
Disp	Orbiter>OBSS Mid MPM					

DCP BRAKES SSRMS → ON (Verify ON)

Give SRMS Operator ‘GO for manuevr to OBSS Handoff, SSRMS at OBSS Pre-Grapple at Handoff.’

4. OBSS GRAPPLE SETUP

Configure Cameras and overlays for grapple.

Monitor 1	Monitor 2	Monitor 3	V10L	V10R
03: S1 Lower Outboard (+60, +30)	25: Tip LEE (fully zoomed out)	09: P1 Lower Outboard (+120, +40)	SRMS Elbow (-115, +80)	Camera C (-15, +30)

2.130 OBSS HANDOFF, REBERTH AND MBS PDGF1 GRAPPLE (WS4)

(RBT FS/ULF3/FIN/SPN)

Page 5 of 21 Pages



Figure 7.- OBSS Pre-Grapple at Handoff
(SRMS Elbow: -115, +80).

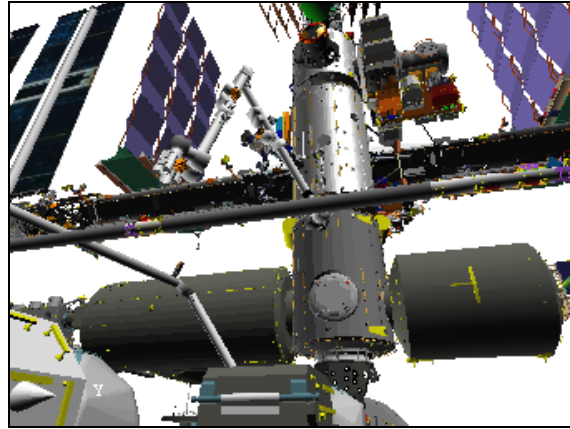

Figure 8.- OBSS Pre-Grapple at Handoff
(Camera C: -15, +30).

NOTE

This maneuver will increase the clearance between the SSRMS Elbow and SPDM. This clearance can be monitored with the S1 Lower Outboard Camera or the SRMS Elbow Camera.

5. OBSS GRAPPLE

5.1 Grapple Setup

On SRMS Operator 'GO for OBSS Grapple:'

* If using shuttle attitude control
* | Verify in attitude and rates damped, then
* | DAP: FREE

MSS: SSRMS: Rate:

Set 'Scale' 'Vernier' Rate Scale: as desired.

DCP

BRAKES SSRMS → OFF (Verify OFF)

5.2 Maneuver to OBSS Grapple

MSS: SSRMS:

Enter Mode – Manual (Verify blue)

MSS: SSRMS: SSRMS Manual: Joint Lock:

cmd Shoulder Roll (Verify SR – Locked)

THC/ RHC

Maneuver to within grapple envelope.

2.130 OBSS HANDOFF, REBERTH AND MBS PDGF1 GRAPPLE (WS4)

(RBT FS/ULF3/FIN/SPN)

Page 6 of 21 Pages

5.3 Slow Capture Commands
 PCS MSS: SSRMS: Tip LEE: SSRMS Tip LEE
cmd Capture ► Automatic ► Slow, Limp (Verify Speed – Slow)
 Verify **'Confirm or Terminate'** prompt.
cmd Confirm (Verify RHC Trigger Hot icon)
 Verify LEE Mode – Auto Capture

5.4 OBSS Grapple
 RHC TRIGGER → press (momentarily)
 PCS Verify 'Snare' Close, Capture (two) – blue (12 s max)
 Verify Capture to Latch – No (SCR 19282)
 Verify 'Carriage' Tension ~5500 N (90 s max)
 Verify 'Carriage' Retract – blue
 Verify 'Carriage' Brakes – On (15 s max)

5.5 Grapple Cleanup
 Verify Posn Hold – orange
 DCP BRAKES SSRMS → ON (Verify ON)
 Verify Loaded Parameters – √
 Verify 'Loaded Parameters' (two) – OBSS Mid MPM, SR Held

Expected OBSS Grapple position:

Locked	SR	SY	SP	EP	WP	WY	WR
	-82.2	+28.1	+45.2	-125.9	+4.4	-1.0	-128.4
	X	Y	Z	Pitch	Yaw	Roll	
	+326	+705	-198	+91.2	-70.6	+47.3	
FOR	Loaded – OBSS Mid MPM, SR Held						
Disp	Orbiter>OBSS Mid MPM						

Give SRMS Operator 'GO for OBSS Release.'

6. JOCAS TO INTERMEDIATE POSITION (3 MINUTES)

Configure Cameras and overlays as required.

Monitor 1	Monitor 2	Monitor 3	V10L	V10R
03: S1 Lower Outboard (+60, +30)	71: Camera B (+15, +40)	09: P1 Lower Outboard (+120, +40)	SRMS Elbow (0, +75)	Camera C (-15, +30)

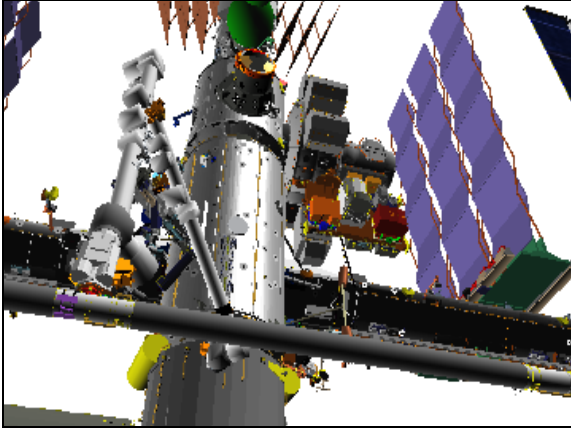

Figure 9.- OBSS Grapple at Handoff
 (71: Camera B: +15, +40).

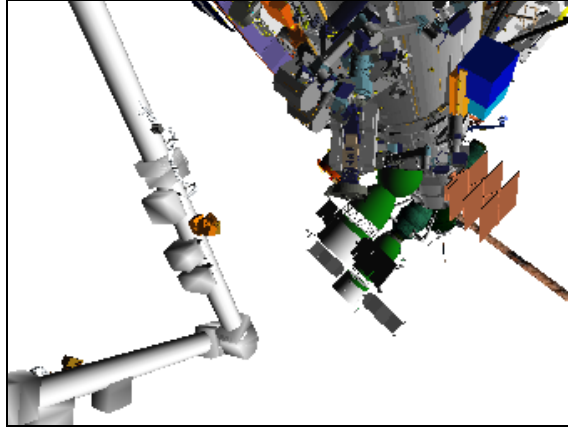

Figure 10.- OBSS Grapple at Handoff
 (SRMS Elbow: 0, +75).

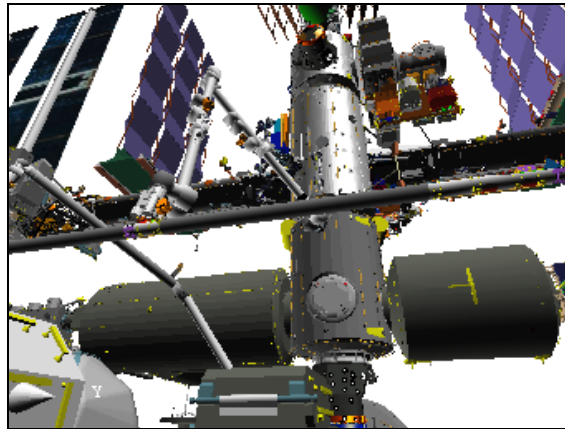

Figure 11.- OBSS Grapple at Handoff
 (Camera C: -15, +30).

On SRMS Operator 'GO for OBSS Berth:'

```

*****
* If using shuttle attitude control and attitude maintenance required
*   |
*   | DAP: LVLH
*   |
*   | When rates damped
*   |   |
*   |   | DAP: FREE > 2 seconds
*   |   | DAP: AUTO
*****
    
```

NOTE

Standby for OBSS thermal clock start time:

____ / ____ : ____ : ____

RMS HTR power must be applied within 90 minutes to prevent sensor damage.

2.130 OBSS HANDOFF, REBERTH AND MBS PDGF1 GRAPPLE (WS4)

(RBT FS/ULF3/FIN/SPN)

Page 8 of 21 Pages

RHC RATE → COARSE (Verify Coarse on PCS)

DCP BRAKES SSRMS → OFF (Verify OFF)

PCS MSS: SSRMS:

Enter Mode – Joint OCAS (Verify blue)

pick File ► OBSS ► Intermediate

Verify 'Joint Angles' 'Destination' for Intermediate position.

SR	SY	SP	EP	WP	WY	WR
-82.2	-37.2	+18.7	-104.9	+4.4	-3.7	+28.3

cmd Load (Verify Sequence Status – Confirm or Cancel)

MON Verify Joint Angles and errors are correct on Joint Angle Position overlay.

	SR	SY	SP	EP	WP	WY	WR
(current)	-82.2	+28.1	+45.2	-125.9	+4.4	-1.0	-128.4
TGT	-82.2	-37.2	+18.7	-104.9	+4.4	-3.7	+28.3
ERR	0.0	+65.3	+26.5	-21.0	0.0	+2.7	-156.7

PCS **cmd** Confirm (Verify Sequence Status – Auto Seq sw - Hot)

DCP AUTO SEQ → PROC

PCS MSS: SSRMS:

Verify Posn Hold – orange

Verify Joint Angle values.

SR	SY	SP	EP	WP	WY	WR
-82.2	-37.3	+18.7	-104.9	+4.4	-3.7	+28.3

7. OBSS LOW HOVER JOCAS (2 MINUTES)

Configure Cameras and overlays as required.

Monitor 1	Monitor 2	Monitor 3	V10L	V10R
03: S1 Lower Outboard (+60, +30)	72: Camera D (-20, +25) 24: Tip Elbow (-35, +25)	09: P1 Lower Outboard (+120,+20)	SRMS Elbow (-105, +10)	Camera C (+20, +30)

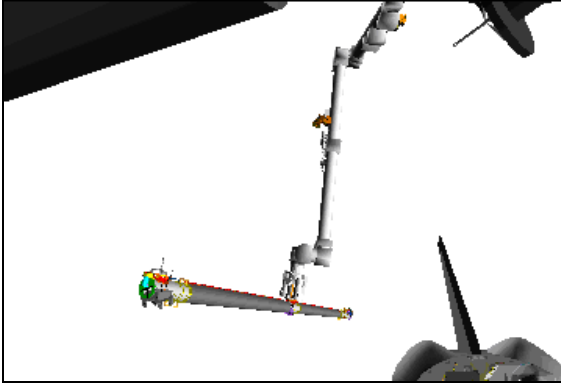

Figure 12.- Intermediate Position
 (72: Camera D: -20, +25).

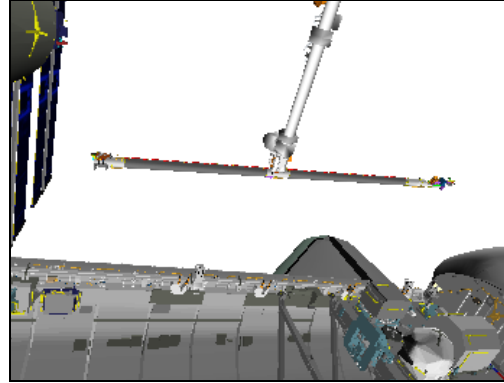

Figure 13.- Intermediate Position
 (SRMS Elbow: -105, +10).

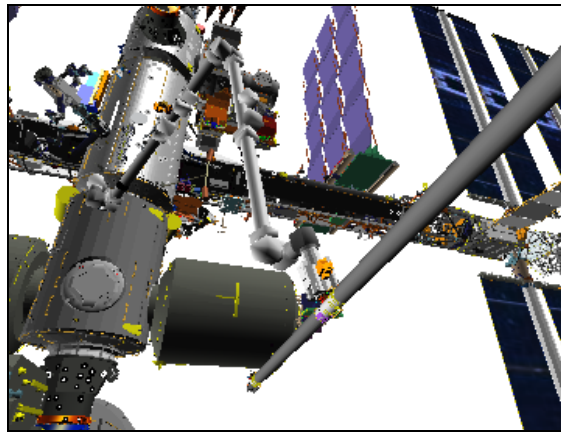

Figure 14.- Intermediate Position
 (Camera C: +20, +30).

NOTE

This maneuver will bring the OBSS within 28in of Columbus. This clearance can be monitored with the Tip Elbow Camera, Camera D or the SRMS Elbow Camera.

RHC RATE → VERNIER (Verify Vernier on PCS)

PCS MSS: SSRMS: Rate:

√'Scale' 'Vernier' Current: 1.0

SSRMS Joint OCAS

Input 'Joint Angles' 'Destination' for Low Hover position.

SR	SY	SP	EP	WP	WY	WR
-82.2	-28.0	+13.9	-128.7	+23.6	-3.5	+19.1

cmd Load (Verify Sequence Status – Confirm or Cancel)

2.130 OBSS HANDOFF, REBERTH AND MBS PDGF1 GRAPPLE (WS4)

(RBT FS/ULF3/FIN/SPN)

Page 10 of 21 Pages

MON Verify Joint Angles and errors are correct on Joint Angle Position overlay.

	SR	SY	SP	EP	WP	WY	WR
(current)	-82.2	-37.3	+18.7	-104.9	+4.4	-3.7	+28.3
TGT	-82.2	-28.0	+13.9	-128.7	+23.6	-3.5	+19.1
ERR	0.0	-9.3	+4.8	+23.8	-19.2	-0.2	+9.2

PCS **cmd** Confirm (Verify Sequence Status – Auto Seq sw - Hot)

DCP AUTO SEQ → PROC

PCS MSS: SSRMS:

Verify Posn Hold – orange

Verify SSRMS at OBSS Low Hover position (within 5 cm/1 deg).

SR	SY	SP	EP	WP	WY	WR
-82.2	-28.0	+13.9	-128.7	+23.6	-3.5	+19.1
X	Y	Z	Pitch	Yaw	Roll	
0	0	-200	0.0	0.0	0.0	
FOR	Loaded – OBSS Mid MPM, SR Held					
Disp	Orbiter>OBSS Mid MPM					

8. OBSS BERTH

- * If using shuttle attitude control
- * | Verify in attitude and rates damped, then
- * | DAP: FREE

Configure Cameras and overlays as required.

Monitor 1	Monitor 2	Monitor 3	V10L	V10R
03: S1 Lower Outboard (+60, +30)	72 :Mux D/C D : (-22, -5) FL=+25mm	24: Tip Elbow (-30, +5)	SRMS Elbow (-130, 0)	Camera B (+85, +5)
09: P1 Lower Outboard (+120,+20)	C: (+26, -8) FL=+10mm			

2.130 OBSS HANDOFF, REBERTH AND MBS PDGF1 GRAPPLE (WS4)

(RBT FS/ULF3/FIN/SPN)

Page 11 of 21 Pages



Figure 15.- OBSS Low Hover
(72: Mux D/C).

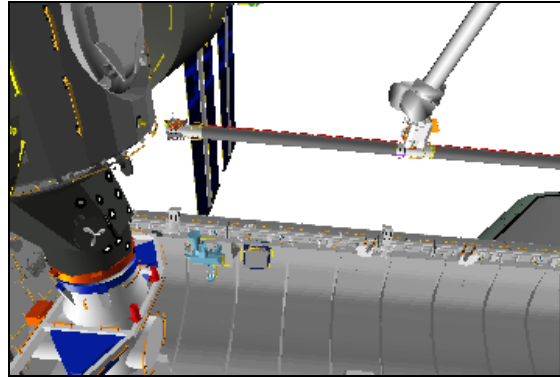

Figure 16.- OBSS Low Hover
(SRMS Elbow: -130, 0).



Figure 17.- OBSS Low Hover
(Camera B: +85, +5).

NOTE

This maneuver will increase the clearance between the OBSS and Columbus. This clearance can be monitored with the Tip Elbow Camera.

Verify shuttle crew standing by for Stbd RMS R-F-L callouts during berth.

Change Command ► Orbiter ► OBSS Mid MPM (Verify Orbiter>OBSS Mid MPM)

√Vernier

MSS: SSRMS: Rate:

Set 'Scale' 'Vernier' Rate Scale: as desired.

PCS

MSS: SSRMS:

Enter Mode – Manual (Verify blue)

29 OCT 09

2.130 OBSS HANDOFF, REBERTH AND MBS PDGF1 GRAPPLE (WS4)

(RBT FS/ULF3/FIN/SPN)

Page 12 of 21 Pages

MSS: SSRMS: SSRMS Manual: Joint Lock:

cmd Shoulder Roll (Verify SR – Locked)

THC/ RHC Maneuver OBSS to OBSS Berthed position
(until shuttle crew callout that three of three RMS R-F-L tb - gray).
(Expect "+Z" motion, THC down)

Locked	SR	SY	SP	EP	WP	WY	WR
	-82.2	-16.4	-4.0	-118.2	+30.2	-3.2	+7.5
	X	Y	Z	Pitch	Yaw	Roll	
	0	0	0	0.0	0.0	0.0	
FOR	Loaded – OBSS Mid MPM, SR Held						
Disp	Orbiter>OBSS Mid MPM						

PCS MSS: SSRMS:

Verify Posn Hold – orange

Enter Mode – Standby (Verify blue)

9. [MRL LATCHING SEQUENCE](#)

9.1 [Limp Wrist Joints](#)

MSS: SSRMS: Limp:

sel WP, WY, WR

cmd Execute

MSS: SSRMS:

Verify Limp – blue

Verify WP, WY, WR – Limped

9.2 [Latching MRLs to TC](#)

Give **MRL Operator** 'GO to latch MRLs to Topological Capture.'

9.3 [Carriage Derigidization](#)

On **MRL Operator** 'GO to Limp all SSRMS joints and derigidize:'

MSS: SSRMS: Limp:

cmd All Limp (Verify Limp – blue)

MSS: SSRMS:

Verify all joints – Limped

2.130 OBSS HANDOFF, REBERTH AND MBS PDGF1 GRAPPLE (WS4)

(RBT FS/ULF3/FIN/SPN)

Page 13 of 21 Pages

MSS: SSRMS: Tip LEE: SSRMS Tip LEE

cmd 'Carriage' Derigidize ► Slow (Verify Speed – Slow)

Verify '**Confirm or Terminate**' prompt.

cmd Confirm (Verify RHC Trigger Hot icon)

Verify LEE Mode – Derigidize

RHC TRIGGER → press (momentarily) (SCR 19064)

PCS Verify 'Carriage' Retract – grey
Verify 'Carriage' Brakes – On (90 s max)

Give **MRL Operator** 'GO to complete latching of Stbd MRLs.'

10. OBSS RELEASE SETUP

On **MRL Operator** 'GO for OBSS Release:'

NOTE

Carriage rigidization is performed in this step to re-seat the SSRMS LEE over the OBSS GF prior to initiating a nominal push-off release operation.

MSS: SSRMS: Tip LEE: SSRMS Tip LEE

cmd 'Carriage' Rigidize ► Slow (Verify Speed – Slow)

Verify '**Confirm or Terminate**' prompt.

cmd Confirm (Verify RHC Trigger Hot icon)

Verify LEE Mode – Rigidize

RHC TRIGGER → press (momentarily) (SCR 19064)

PCS Verify 'Carriage' Tension ~5500 N (90 s max)
Verify 'Carriage' Retract – blue
Verify 'Carriage' Brakes – On (15 s max)

MSS: SSRMS: Limp: SSRMS Limp

cmd None Limp (Verify Standby – blue)

2.130 OBSS HANDOFF, REBERTH AND MBS PDGF1 GRAPPLE (WS4)

(RBT FS/ULF3/FIN/SPN)

Page 14 of 21 Pages

```
*****
* If using shuttle attitude control and attitude maintenance required
* |   DAP: LVLH
* |
* |   When rates damped
* |   |   DAP: FREE > 2 seconds
* |   |   DAP: AUTO
*****
```

11. OBSS RELEASE

11.1 Release Setup

Configure Cameras and overlays for release.

Monitor 1	Monitor 2	Monitor 3	V10L	V10R
03: S1 Lower Outboard (+60, +15)	25: Tip LEE (fully zoomed out)	13: LAB Stbd Zenith (-50, -20) FL=+40mm	Camera D (-5, +5) SRMS Elbow (-105, +10)	Camera C (+5, +10) Camera A (-25, +5)

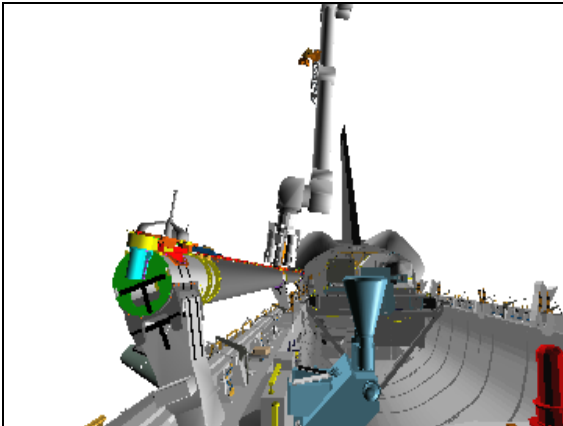

Figure 18.- OBSS Berthed
(Camera D: -5, +5).

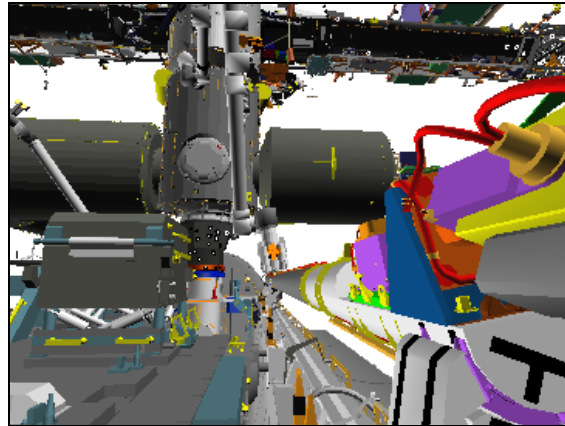

Figure 19.- OBSS Berthed
(Camera C: +5, +10).

MSS: SSRMS:

Change Display ► Orbiter ► OBSS FRGF (Verify Orbiter>OBSS
FRGF)

Change Command ► SSRMS ► Internal (Verify SSRMS>Internal)

√Vernier

MSS: SSRMS: Rate:

Set 'Scale' 'Vernier' Rate Scale: as desired.

2.130 OBSS HANDOFF, REBERTH AND MBS PDGF1 GRAPPLE (WS4)

(RBT FS/ULF3/FIN/SPN)

Page 15 of 21 Pages

11.2 SSRMS Limp

MSS: SSRMS: Limp:

cmd All Limp (Verify Limp – blue)

MSS: SSRMS:

Verify all joints – Limped

11.3 Auto Release

MSS: SSRMS: Tip LEE:

cmd Release ► Automatic ► Slow (Verify Speed – Slow)

Verify '**Confirm or Terminate**' prompt.

cmd Confirm (Verify RHC Trigger Hot icon)

Verify LEE Mode – Auto Release

RHC

TRIGGER → press (momentarily)

PCS

Verify 'Carriage' Retract – gray (90 s max)

Verify 'Snare' Open – blue (12 s max)

Verify 'Carriage' Derigidize – blue

Verify 'Carriage' Extend – blue (90 s max)

11.4 SSRMS Backoff

MSS: SSRMS: Limp:

cmd None Limp (Verify Standby – blue)

MSS: SSRMS:

Verify Unloaded Parameters – ✓

MSS: SSRMS:

Enter Mode – Manual (Verify blue)

MSS: SSRMS: SSRMS Manual: Joint Lock:

cmd Shoulder Roll (Verify SR – Locked)

2.130 OBSS HANDOFF, REBERTH AND MBS PDGF1 GRAPPLE (WS4)

(RBT FS/ULF3/FIN/SPN)

Page 16 of 21 Pages

THC/ RHC

Maneuver to OBSS Backoff position (within 5 cm/1 deg).
(Expect “-X” motion, THC out)

Locked						
SR	SY	SP	EP	WP	WY	WR
-82.2	-14.8	+13.1	-133.5	+28.3	-3.1	+5.9
X	Y	Z	Pitch	Yaw	Roll	
-200	0	0	0.0	0.0	0.0	
FOR	Unloaded – LEE Tip, SR Held					
Disp	Orbiter>OBSS FRGF					

PCS

MSS: SSRMS:

Enter Mode – Standby (Verify blue)

12. JOCAS TO INTERMEDIATE POSITION (1 MINUTE)

Configure Cameras and overlays as required.

Monitor 1	Monitor 2	Monitor 3	V10L	V10R
03: S1 Lower Outboard (+60, +15) 09: P1 Lower Outboard (+120, +20)	37: MBS Mast (+110, +15)	13: LAB Stbd Zenith (-20, -30)	Camera D (-5, +35) Camera B (+30, +30)	Camera C (+10, +30)

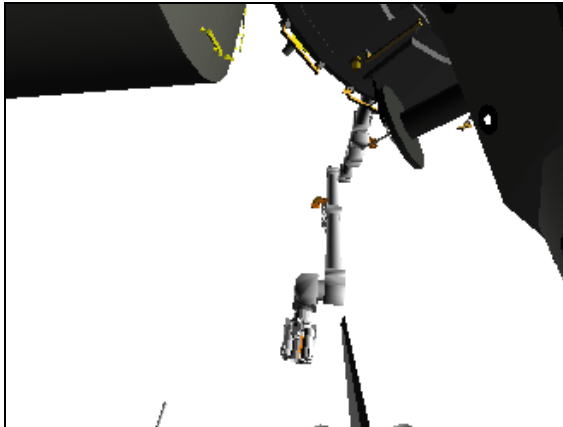

Figure 20.- OBSS Backoff
(Camera D: -5, +35).

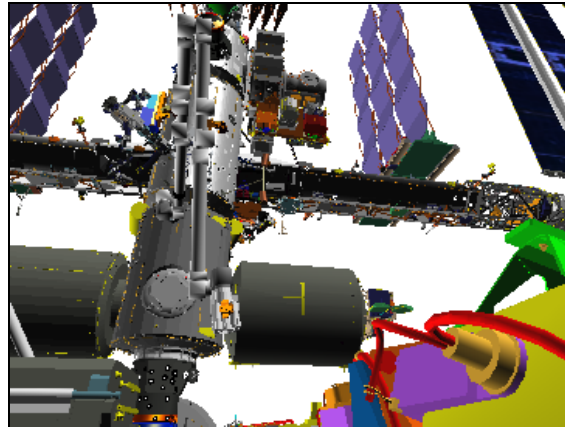

Figure 21.- OBSS Backoff
(Camera C: +10, +30).

Change Loaded Parameters ► Walk Off ► MBS PDGF 1
Verify 'Loaded Parameters' (two) – MBS PDGF 1, SR Held

Change Display ► MBS ► PDGF 1 (Verify MBS>PDGF 1)

RHC

RATE → COARSE (Verify Coarse on PCS)

29 OCT 09

21686.doc

2.130 OBSS HANDOFF, REBERTH AND MBS PDGF1 GRAPPLE (WS4)

(RBT FS/ULF3/FIN/SPN)

Page 17 of 21 Pages

PCS MSS: SSRMS:

Enter Mode – Joint OCAS (Verify blue)

pick File ► FI Walkoff ► Intermediate 2

Verify 'Joint Angles' 'Destination' for Intermediate position.

SR	SY	SP	EP	WP	WY	WR
-19.6	+34.8	-40.0	-107.5	-41.1	+35.0	+82.7

cmd Load (Verify Sequence Status – Confirm or Cancel)

MON Verify Joint Angles and errors are correct on Joint Angle Position overlay.

	SR	SY	SP	EP	WP	WY	WR
(current)	-82.2	-14.8	+13.1	-133.5	+28.3	-3.1	+5.9
TGT	-19.6	+34.8	-40.0	-107.5	-41.1	+35.0	+82.7
ERR	-62.6	-49.6	+53.1	-26.0	+69.4	-38.1	-76.8

PCS **cmd** Confirm (Verify Sequence Status – Auto Seq sw – Hot)

DCP AUTO SEQ → PROC

PCS MSS: SSRMS:

Verify Posn Hold – orange

Verify Joint Angle values.

SR	SY	SP	EP	WP	WY	WR
-19.6	+34.8	-40.0	-107.5	-41.1	+35.0	+82.7

13. JOCAS TO MBS PDGF1 PRE-GRAPPLE (2 MINUTES)

NOTE

This maneuver has the following clearance concerns:

- Clearance between the SSMRS Elbow and the Columbus is 29in.
- Clearance between the SSRMS Tip Boom and the UHF Antenna is 37in.
- Clearance between the SSRMS Base Boom and the LAB Stbd Zenith Camera is 48in.

These clearances can be monitored with the MBS Mast Camera or the LAB Stbd Zenith Camera

RHC RATE → VERNIER (Verify Vernier on PCS)

PCS MSS: SSRMS: Rate:

√'Scale' 'Vernier' Current: 1.0

29 OCT 09

21686.doc

2.130 OBSS HANDOFF, REBERTH AND MBS PDGF1 GRAPPLE (WS4)

(RBT FS/ULF3/FIN/SPN)

SSRMS Joint OCAS

pick File ► FI Walkoff ► MBS1 Pre-Grapple

Verify 'Joint Angles' 'Destination' for MBS PDGF 1 Pre-Grapple position.

SR	SY	SP	EP	WP	WY	WR
-19.1	+12.1	-101.9	-107.8	-41.1	-30.5	+82.7

cmd Load (Verify Sequence Status – Confirm or Cancel)

MON

Verify Joint Angles and errors are correct on Joint Angle Position overlay.

	SR	SY	SP	EP	WP	WY	WR
(current)	-19.6	+34.8	-40.0	-107.5	-41.1	+35.0	+82.7
TGT	-19.1	+12.1	-101.9	-107.8	-41.1	-30.5	+82.7
ERR	-0.5	+22.7	+61.9	+0.3	0.0	+65.5	0.0

PCS

cmd Confirm (Verify Sequence Status – Auto Seq sw - Hot)

DCP

AUTO SEQ → PROC

PCS

MSS: SSRMS: **SSRMS**

Verify Posn Hold – orange

Verify Joint Angle values.

SR	SY	SP	EP	WP	WY	WR
-19.1	+12.1	-101.9	-107.8	-41.1	-30.5	+82.7

14. MBS PDGF 1 GRAPPLE

14.1 Grapple Setup

Configure Cameras and overlays as required.

Monitor 1	Monitor 2	Monitor 3	V10L	V10R
03: S1 Lower Outboard (+75, -10) FL=+25mm	25: Tip LEE (fully zoomed out)	37: MBS Mast (+115, +15) 13: LAB Stbd Zenith (-20, +30)	SRMS Elbow (-130, +50)	Camera B (+30, +30)

2.130 OBSS HANDOFF, REBERTH AND MBS PDGF1 GRAPPLE (WS4)

(RBT FS/ULF3/FIN/SPN)

Page 19 of 21 Pages



Figure 22.- MBS PDGF 1 Pre-Grapple
(SRMS Elbow: -130, +50).

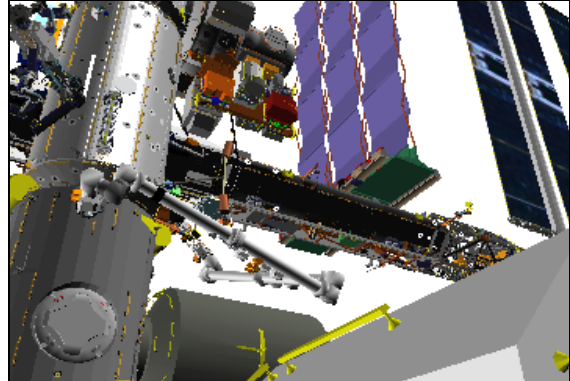

Figure 23.- MBS PDGF 1 Pre-Grapple
(Camera B: +30, +30).

NOTE

1. This maneuver has the following clearance concerns:
 - a. Clearance between the SSRMS Elbow and Columbus is 31in.
 - b. Clearance between the SSRMS Tip Boom and the UHF Antenna is 24in.
 - c. Clearance between the SSRMS Base Boom and the LAB Stbd Zenith Camera is 28in.These clearances can be monitored with the MBS Mast Camera, the LAB Stbd Zenith Camera or Camera B.
2. For clearance purposes keep the LAB Stbd Zenith Camera pan at -20 and tilt between -5 and +30.

√Vernier

MSS: SSRMS: Rate:

Set 'Scale' 'Vernier' Rate Scale: as desired

14.2 Maneuver to MBS PDGF 1 Grapple

MSS: SSRMS:

Enter Mode – Manual (Verify blue)

MSS: SSRMS: SSRMS Manual: Joint Lock:

cmd Shoulder Roll (Verify SR – Locked)

THC/ RHC

Maneuver to within grapple envelope.

14.3 Slow Capture Commands

PCS

MSS: SSRMS: Tip LEE:

cmd Capture ► Automatic ► Slow, Limp (Verify Speed – Slow)

29 OCT 09

21686.doc

2.130 OBSS HANDOFF, REBERTH AND MBS PDGF1 GRAPPLE (WS4)

(RBT FS/ULF3/FIN/SPN)

Page 20 of 21 Pages

Verify '**Confirm or Terminate**' prompt.

cmd Confirm (Verify RHC Trigger Hot icon)

Verify LEE Mode – Auto Capture

RHC 14.4 PDGF 1 Grapple
TRIGGER → press (momentarily)

PCS Verify 'Snare' Close, Capture (two) – blue (12s max)
Verify Capture to Latch – Yes (SCR 19282)
Verify 'Carriage' Tension ~5500 N (90s max)
Verify 'Carriage' Retract – blue
Verify 'Latch' Latch – blue (80s max)

14.5 Mating Umbilicals

Verify with **MCC-H** - Payload and PDGF power inhibits have been confirmed.

cmd 'Umbilical' Mate (Verify '**Confirm or Terminate**' prompt)

NOTE

Expect '**R3L - SSRMS Pwr Flags Fail**' Robotics Advisory message when mating is complete (SCR 19019).

cmd Confirm (Verify RHC Trigger Hot icon)

Verify LEE Mode – Mate

RHC TRIGGER → press (momentarily)

PCS Verify 'Umbilical' Mate – blue (10 s max)
Verify 'Connector Continuity' Prime, Redundant (two) – Yes

14.6 Grapple Cleanup

Verify Posn Hold – orange

Verify Loaded Parameters – √

Verify 'Loaded Parameters' (two) – MBS PDGF 1, SR Held

Expected MBS PDGF 1 Grapple position (within 5 cm/1 deg).

Locked	SR	SY	SP	EP	WP	WY	WR
	-19.1	+17.0	-112.0	-106.2	-30.0	-28.8	+88.0
	X	Y	Z	Pitch	Yaw	Roll	
	0	0	0	0.0	0.0	0.0	
FOR	Loaded – MBS PDGF1, SR Held						
Disp	MBS> PDGF 1						

2.130 OBSS HANDOFF, REBERTH AND MBS PDGF1 GRAPPLE (WS4)

(RBT FS/ULF3/FIN/SPN)

Page 21 of 21 Pages

NOTE

Expect the following message when safing is commanded:
**'R3Z - MSS OCS SSRMS Prime(Redun) ACU SRT Cat-1
Brk Stat Fail'** (SCR 17495)
This message should return to Norm.

DCP

SAFING → SAFE (Verify ON)

Give **MCC-H** 'GO for SSRMS Ground Ops.'

This Page Intentionally Blank

GROUND PROCEDURES

**GROUND
PROCEDURES**

This Page Intentionally Blank

CONTINGENCY

CONTINGENCY

This Page Intentionally Blank

CONTINGENCY

4.210 EVA1- NO POA OR JEM LUBE

(RBT FS/ULF3/FIN)

NOTE

- For all OCASes if the joint angles are incorrect after loaded, then **cmd Cancel** on the PCS and reload the correct destination.

1. SETUP

Configure Cameras and overlays as required.

Monitor 1	Monitor 2	Monitor 3	V10L	V10R
37: MBS Mast (-125, -10)	13: Lab Stbd Zenith (+140, +40)	22: Base Elbow (+100, -10)	Camera C (+20, +20)	Camera D (-110, +40)

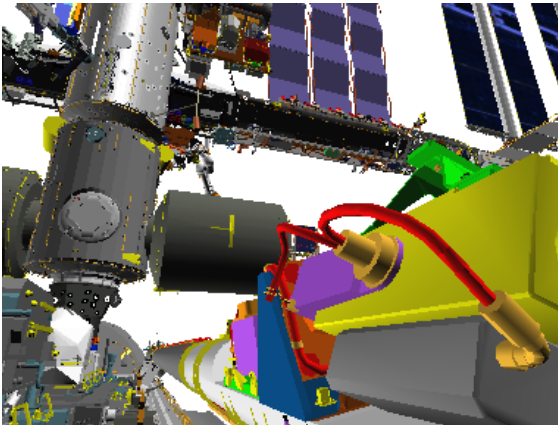

Figure 1.- Z1 Backoff
(Camera C: +20, +20).

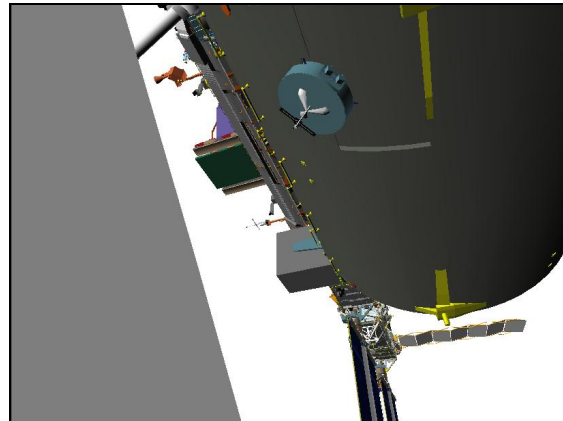

Figure 2.- Z1 Backoff
(Camera D: -110, +40).

PCS

MSS: SSRMS:

Enter Mode – Standby (Verify blue)

Verify Unloaded Parameters – √

Verify 'Unloaded Parameters' (two) – Chest 12/PP/F/6, SR Held

√Display – ISS>ISSACS

Change Command ► ISS ► ISSACS/Internal (Verify
ISS>ISSACS/Internal)

√Vernier

Verify SSRMS at Z1 Backout position (within 5 cm/1 deg).

SR	SY	SP	EP	WP	WY	WR
-115.0	+213.6	-80.7	+91.5	-93.6	-191.9	-100.7
X	Y	Z	Pitch	Yaw	Roll	
-361	+402	-335	+168.7	-65.5	-12.4	
FOR	Unloaded – Chest 12/PP/F/6, SR Held					
Disp	ISS>ISSACS					

4.210 EVA1- NO POA OR JEM LUBE

(RBT FS/ULF3/FIN)

Page 2 of 4 pages

2. TRUSS EGRESS SETUP JOCAS (8 MINUTES)

NOTE

Expect a singularity warning for the EP between -15 and +15 deg.

MSS: SSRMS:

Enter Mode – Joint OCAS (Verify blue)

pick File ► EVA1 ► Truss Egress

Verify 'Joint Angles' 'Destination' for Truss Egress position.

SR	SY	SP	EP	WP	WY	WR
-100.0	+128.0	-126.0	-61.6	-51.7	-189.0	+95.0

cmd Load (Verify Sequence Status – Confirm or Cancel)

MON

Verify joint angles and errors are correct on Joint Angle Position overlay.

	SR	SY	SP	EP	WP	WY	WR
(current)	-115.0	+213.6	-80.7	+91.5	-93.6	-191.9	-100.7
TGT	-100.0	+128.0	-126.0	-61.6	-51.7	-189.0	+95.0
ERR	-15.0	+85.6	+45.3	+153.1	-41.9	-2.9	-195.7

PCS

cmd Confirm (Verify Sequence Status – Auto Seq sw - Hot)

DCP

AUTO SEQ → PROC

PCS

MSS: SSRMS:

Verify Posn Hold – orange

Verify Joint Angle values.

SR	SY	SP	EP	WP	WY	WR
-100.0	+128.0	-126.0	-61.6	-51.7	-189.0	+95.0

3. TRUSS EGRESS MANUAL MANEUVER

Configure Cameras and overlays as required.

Monitor 1	Monitor 2	Monitor 3	V10L
37: MBS Mast (+175, +10)	03: S1 Lower Outboard (+50, -20)	13: Lab Stbd Zenith (-180, +55)	Camera C (+20, +20)

4.210 EVA1- NO POA OR JEM LUBE

(RBT FS/ULF3/FIN)

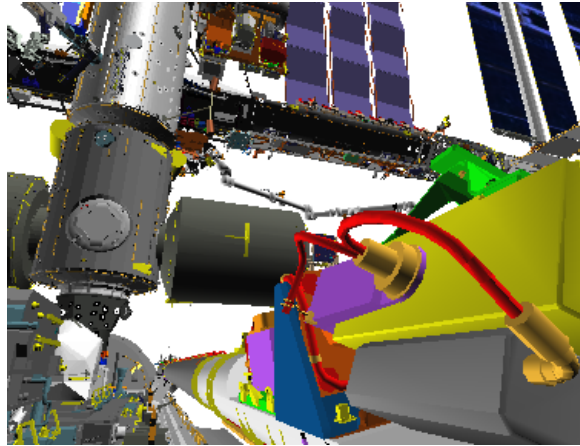

Figure 3.- Truss Egress Setup
(Camera C: +20, +20).

PCS

MSS: SSRMS:

Enter Mode – Manual (Verify blue)

MSS: SSRMS: SSRMS Manual: Joint Lock:

cmd Shoulder Roll (Verify SR – Locked)

THC

Perform -X (THC out) and EVA GCA as required to Truss Egress.

Expected Truss Egress position:

Locked						
SR	SY	SP	EP	WP	WY	WR
-100.0	+115.0	-125.0	-62.0	-54.8	-195.4	+106.5
X	Y	Z	Pitch	Yaw	Roll	
+198	+1793	-78	-168.0	-12.9	-178.5	
FOR	Unloaded – Chest 12/PP/F/6, SR Held					
Disp	ISS>ISSACS					

On EV “GO,” ‘Ready for Truss Egress:’

PCS

MSS: SSRMS:

Enter Mode – Standby (Verify blue)

4. TRUSS EGRESS BACKOFF MANUAL MANEUVER

On EV “GO,” ‘APFR removed and EV clear for backoff:’

Change Unloaded Parameters ► Unloaded ► LEE Tip SRH
Verify ‘Unloaded Parameters’ (two) – LEE Tip, SR Held

MSS: SSRMS:

Enter Mode – Manual (Verify blue)

4.210 EVA1- NO POA OR JEM LUBE

(RBT FS/ULF3/FIN)

Page 4 of 4 pages

MSS: SSRMS: SSRMS Manual: Joint Lock:

Joint Lock

cmd Shoulder Roll (Verify SR – Locked)

THC

Perform +X (THC in) maneuver Truss Backoff position.

Locked						
SR	SY	SP	EP	WP	WY	WR
-100.0	+128.0	-126.0	-61.6	-51.7	-189.0	+95.0
X	Y	Z	Pitch	Yaw	Roll	
+583	+1817	+59	+101.6	-1.5	-175.8	
FOR	Unloaded – LEE Tip, SR Held					
Disp	ISS>ISSACS					

DCP

BRAKES SSRMS → ON (Verify ON)

4.220 EVA1- NO JEM LUBE

(RBT FS/ULF3/FIN)

Page 1 of 4 pages

NOTE

For all OCASes if the joint angles are incorrect after loaded, then **cmd** Cancel on the PCS and reload the correct destination.

1. SETUP

Configure Cameras and overlays as required.

Monitor 1	Monitor 2	Monitor 3	V10
37: MBS Mast (-20, +10)	13: Lab Stbd Zenith (-180, +30)	03: S1 Lower Outboard (+50, -20)	Camera C (+20, +20) Camera D (-100, +40)

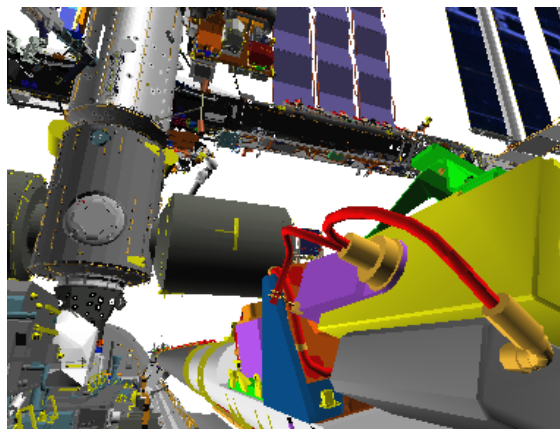

Figure 1.- POA Backout
(Camera C: +20, +20).

PCS

MSS: SSRMS:

Enter Mode – Standby (Verify blue)

Change Unloaded Parameters ► EVA ► Chest 12/PP/F/6 SRH
Verify 'Unloaded Parameters' (two) – Chest 12/PP/F/6, SR Held

√Display – ISS>ISSACS

Change Command ► ISS ► ISSACS/Internal (Verify
ISS>ISSACS/Internal)

√Vernier

4.220 EVA1- NO JEM LUBE

(RBT FS/ULF3/FIN)

Verify SSRMS at POA Backout position (within 5 cm/1 deg).

SR	SY	SP	EP	WP	WY	WR
-162.4	+154.9	-94.8	+105.8	+64.1	-15.8	+230.9
X	Y	Z	Pitch	Yaw	Roll	
+424	-177	+14	+140.5	+83.8	+12.7	
FOR	Unloaded – Chest 12/PP/F/6, SR Held					
Disp	ISS>ISSACS					

2. TRUSS EGRESS SETUP JOCAS (9 MINUTES)

NOTE
Expect a singularity warning for the EP between -15 and +15 deg.

MSS: SSRMS:

Enter Mode – Joint OCAS (Verify blue)

pick File ► EVA1 ► Truss Egress

Verify 'Joint Angles' 'Destination' for Truss Egress position.

SR	SY	SP	EP	WP	WY	WR
-100.0	+128.0	-126.0	-61.6	-51.7	-189.0	+95.0

cmd Load (Verify Sequence Status – Confirm or Cancel)

MON

Verify Joint Angles and errors are correct on Joint Angle Position overlay.

	SR	SY	SP	EP	WP	WY	WR
(current)	-162.4	+154.9	-94.8	+105.8	+64.1	-15.8	+230.9
TGT	-100.0	+128.0	-126.0	-61.6	-51.7	-189.0	+95.0
ERR	-62.4	+26.9	+31.2	+167.4	+115.8	+173.2	+135.9

PCS

cmd Confirm (Verify Sequence Status – Auto Seq sw - Hot)

DCP

AUTO SEQ → PROC

PCS

MSS: SSRMS:

Verify Posn Hold – orange

Verify Joint Angle values.

SR	SY	SP	EP	WP	WY	WR
-100.0	+128.0	-126.0	-61.6	-51.7	-189.0	+95.0

4.220 EVA1- NO JEM LUBE

(RBT FS/ULF3/FIN)

Page 3 of 4 pages

3. TRUSS EGRESS MANUAL MANEUVER

Configure Cameras and overlays as required.

Monitor 1	Monitor 2	Monitor 3	V10
37: MBS Mast (+175, +10)	03: S1 Lower Outboard (+50, -20)	13: Lab Stbd Zenith (-180, +55)	Camera C (+20, +20)

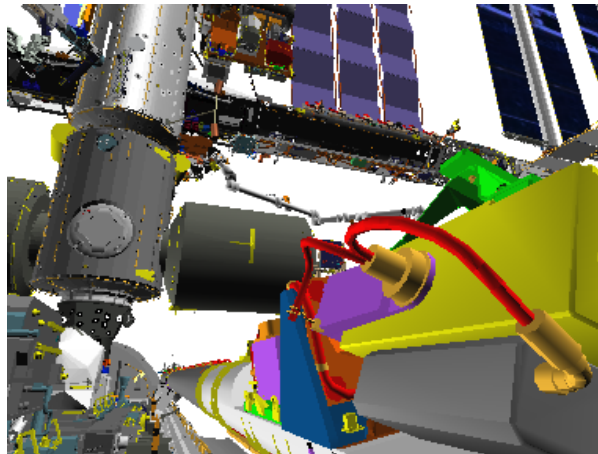

Figure 2.- Truss Egress Setup
(Camera C: +20, +20).

MSS: SSRMS:

Enter Mode – Manual (Verify blue)

MSS: SSRMS: SSRMS Manual: Joint Lock:

cmd Shoulder Roll (Verify SR – Locked)

THC Perform -X (THC out) and EVA GCA as required to Truss Egress.

Expected Truss Egress position:

Locked	SR	SY	SP	EP	WP	WY	WR
	-100.0	+115.0	-125.0	-62.0	-54.8	-195.4	+106.5
	X	Y	Z	Pitch	Yaw	Roll	
	+198	+1793	-78	-168.0	-12.9	-178.5	
FOR	Unloaded – Chest 12/PP/F/6, SR Held						
Disp	ISS>ISSACS						

On EV “GO,” ‘Ready for Truss Egress:’

PCS MSS: SSRMS:

Enter Mode – Standby (Verify blue)

4.220 EVA1- NO JEM LUBE

(RBT FS/ULF3/FIN)

Page 4 of 4 pages

4. TRUSS EGRESS BACKOFF MANUAL MANEUVER

On EV "GO," 'APFR removed and EV clear for backoff:'

Change Unloaded Parameters ► Unloaded ► LEE Tip SRH
Verify 'Unloaded Parameters' (two) – LEE Tip, SR Held

MSS: SSRMS:

Enter Mode – Manual (Verify blue)

MSS: SSRMS: SSRMS Manual: Joint Lock:

cmd Shoulder Roll (Verify SR – Locked)

THC

Perform +X (THC in) maneuver Truss Backoff position.

Locked						
SR	SY	SP	EP	WP	WY	WR
-100.0	+128.0	-126.0	-61.6	-51.7	-189.0	+95.0
X	Y	Z	Pitch	Yaw	Roll	
+583	+1817	+59	+101.6	-1.5	-175.8	
FOR	Unloaded – LEE Tip, SR Held					
Disp	ISS>ISSACS					

DCP

BRAKES SSRMS → ON (Verify ON)

4.310 ELC2 INSTALL: MISSING RTL

(RBT FS/ULF3/FIN)

Page 1 of 2 pages

NOTE

The intent of this document is to provide a reminder of additional cues in the event of a failed RTL on the S3 PAS 1 during the ELC2 Install.

1. EBCS VERIFICATION

The EBCS was designed such that, if the data below is true, then the ELC is guaranteed to be within the PAS capture envelope.

Refer to Figure 1. Note that this view was taken at the fully installed position and not at the RTL indication position.



Figure 1.- EBCS View at Install.

Range Cue: Green overlay horizontal RTL lines within the horizontal lines of the white target box.

Lateral Cue: Center of green overlay cross-hair within the white target box.

Wobble Cue: Center of LED ring within the green overlay circle.

Roll Cue: Green overlay cross-hair tick marks visually contacting the white target cross tape.

4.310 ELC2 INSTALL: MISSING RTL

(RBT FS/ULF3/FIN)

Page 2 of 2 pages

2. CAMERA VERIFICATION

The SRMS EE Camera view, shown in Figure 2, can be used to verify that the ELC guide vane is contacting the RTL 2 gate.

The Camera also shows a view of the ELC guide vane within the RTL 1 V guide.

Visual verification of RTL 3 is not possible.

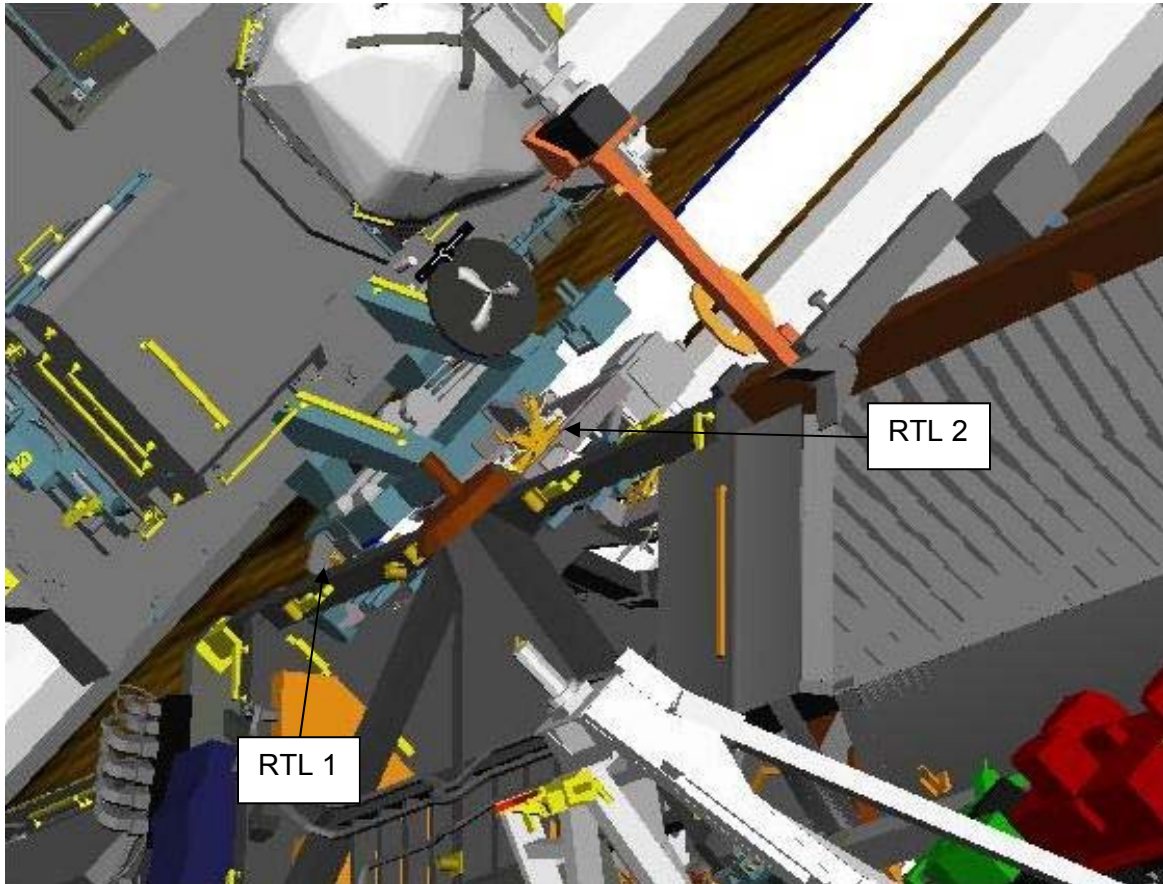

Figure 2.- ELC2 at RTL Position
(SRMS EE: Full Zoom).

NOTE

For all OCASes if the Joint Angles are incorrect after loaded, then **cmd** Cancel on the PCS and reload the correct destination.

1. SETUP

Configure Cameras and overlays as required.

Monitor 1	Monitor 2	Monitor 3	V10L	V10R
13: LAB Stbd Zenith (-10, +80) 09: P1 Lower Outboard (+100, -10)	37: MBS Mast (+165, -20) 03: S1 Lower Outboard (+40, -35)	22: Base Elbow (-60, -5) 24: Tip Elbow (-10, 0)	Camera B (+45, +30) Camera D (-100, +30)	SRMS Elbow (+90, -40)

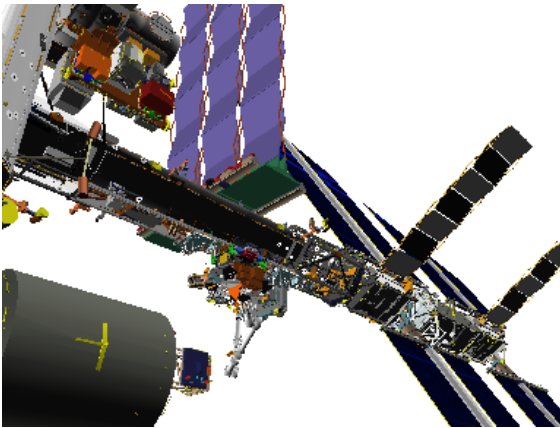

Figure 1.- ELC2 S3UO Pre-Install
(Camera B: +45, +30).



Figure 2.- ELC2 S3UO Pre-Install
(SRMS Elbow: +90, -40).

Verify Loaded Parameters – √

Change Loaded Parameters ► ELC ► ELC2 Install SRH
Verify 'Loaded Parameters' (two) – ELC2 Install, SR Held

Change Unloaded Parameters ► Unloaded ► LEE Tip SRH
Verify 'Unloaded Parameters' (two) – LEE Tip, SR Held

Change Display ► S3 ► ELC2 Install S3LO (Verify S3>ELC2 Install S3LO)

√Command – SSRMS>Internal

√Vernier

√'Scale' 'Vernier' Current: 1.0

4.320 ELC2 INSTALL ON S3 LOWER OUTBOARD PAS

(RBT FS/ULF3/FIN/SPN)

Page 2 of 11 pages

Verify SSRMS at ELC2 S3UO Pre-Install position (within 5 cm/1 deg).

SR	SY	SP	EP	WP	WY	WR
+170.4	+29.9	-45.3	-68.5	-122.4	+5.1	-69.7
X	Y	Z	Pitch	Yaw	Roll	
+611	0	-35	+180.0	-0.1	0.0	
FOR	Loaded – ELC2 Install, SR Held					
Disp	S3>ELC2 Install S3LO					

 * If using shuttle attitude control and attitude maintenance required
 * | DAP: LVLH
 * | When rates damped
 * | | DAP: FREE > 2 sec
 * | | DAP: AUTO
 * | | When in attitude and rates damped
 * | | DAP: FREE

2. JOCAS TO CLEARANCE POSITION (3 MINUTES)

NOTE

This maneuver has the following clearance concerns:

1. Clearance between the SSRMS Tip Boom and ELC2 is 26in. This clearance can be monitored with the Tip Elbow Camera.
2. Clearance between CTC on ELC2 and the FPMU is 58in. This clearance can be monitored with the Base Elbow Camera.

PCS MSS: SSRMS: MSS Safing:

cmd 'SSRMS' Remove (Verify Not Safed)

DCP BRAKES SSRMS → OFF (Verify OFF)

PCS MSS: SSRMS:

Enter Mode – Joint OCAS (Verify blue)

pick File ► ELC2 ► Clearance

Verify 'Joint Angles' 'Destination' for Clearance position.

SR	SY	SP	EP	WP	WY	WR
+159.5	+29.9	-43.8	-84.1	-112.9	+13.2	-74.7

cmd Load (Verify Sequence Status – Confirm or Cancel)

4.320 ELC2 INSTALL ON S3 LOWER OUTBOARD PAS

(RBT FS/ULF3/FIN/SPN)

Page 3 of 11 pages

MON Verify Joint Angles and errors are correct on Joint Angle Position overlay.

	SR	SY	SP	EP	WP	WY	WR
(current)	+170.4	+29.9	-45.3	-68.5	-122.4	+5.1	-69.7
TGT	+159.5	+29.9	-43.8	-84.1	-112.9	+13.2	-74.7
ERR	+10.9	0.0	-1.5	+15.6	-9.5	-8.1	+5.0

PCS **cmd** Confirm (Verify Sequence Status – Auto Seq sw – Hot)

DCP AUTO SEQ → PROC

PCS MSS: SSRMS: SSRMS

Verify Posn Hold – orange

Verify Joint Angle values.

SR	SY	SP	EP	WP	WY	WR
+159.5	+29.9	-43.8	-84.1	-112.9	+13.2	-74.7

 * If using shuttle attitude control and attitude maintenance required
 * | DAP: LVLH
 * | When rates damped
 * | | DAP: FREE > 2 sec
 * | | DAP: AUTO
 * | | When in attitude and rates damped
 * | | DAP: FREE

3. JOCAS TO INTERMEDIATE POSITION (24 MINUTES)

NOTE

1. When the SR becomes greater than +188.0, pause the JOCAS and switch from vern to coarse.
2. This maneuver has the following clearance concerns:
 - a. Clearance between the SSRMS Tip Boom and ELC2 is 31in. This clearance can be monitored with Tip Elbow Camera.
 - b. Clearance between the SSRMS Base Boom and MBS PDGF 1 is 35in. This clearance can be monitored with S1 Lower Outboard Camera or MBS Mast Camera.
 - c. Clearance between the SSRMS Base Boom and the MBS Mast Camera is 40in. This Clearance can be monitored with the S1 Lower Outboard Camera.
 - d. Clearance between the SSRMS Base Boom and the S3 Truss is 53in. This clearance can be monitored with the MBS Mast Camera.
 - e. Clearance between ELC2 and the FPMU is 58in. This clearance can be monitored with the Base Elbow Camera.

4.320 ELC2 INSTALL ON S3 LOWER OUTBOARD PAS

(RBT FS/ULF3/FIN/SPN)

Page 4 of 11 pages

pick File ► ELC2 ► Intermediate

Verify 'Joint Angles' 'Destination' for Intermediate position.

SR	SY	SP	EP	WP	WY	WR
+234.0	+80.0	+250.0	-125.0	-45.0	+13.2	+53.6

cmd Load (Verify Sequence Status – Confirm or Cancel)

MON

Verify Joint Angles and errors are correct on Joint Angle Position overlay.

	SR	SY	SP	EP	WP	WY	WR
(current)	+159.5	+29.9	-43.8	-84.1	-112.9	+13.2	-74.7
TGT	+234.0	+80.0	+250.0	-125.0	-45.0	+13.2	+53.6
ERR	-74.5	-50.1	-293.8	+40.9	-67.9	0.0	-128.3

PCS

cmd Confirm (Verify Sequence Status – Auto Seq sw - Hot)

DCP

AUTO SEQ → PROC

PCS

MSS: SSRMS:

Verify Posn Hold – orange

Verify Joint Angle values.

SR	SY	SP	EP	WP	WY	WR
+234.0	+80.0	+250.0	-125.0	-45.0	+13.2	+53.6

```
*****
* If using shuttle attitude control and attitude maintenance required
* | DAP: LVLH
* | When rates damped
* |   DAP: FREE > 2 sec
* |   DAP: AUTO
* | When in attitude and rates damped
* |   DAP: FREE
*****
```

4. JOCAS TO HANDOFF POSITION (6 MINUTES)

Configure Cameras and overlays as required.

Monitor 1	Monitor 2	Monitor 3	V10L	V10R
03: S1 Lower Outboard (+30, 0)	37: MBS Mast (+165, -20)	13: LAB Stbd Zenith (-10, +70)	Camera B (+45, +30)	SRMS Elbow (+90, -40)

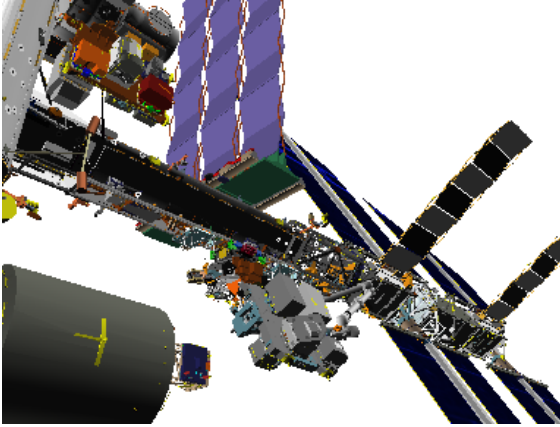

Figure 3.- Intermediate Position
 (Camera B: +45, +30).



Figure 4.- Intermediate Position
 (SRMS Elbow: +90, -40).

NOTE

This maneuver has the following clearance concerns:

1. Clearance between the SSRMS Base Boom and MBS PDGF 1 is 38in.
2. Clearance between the SSRMS Base Elbow Camera and the the S3 Truss is 54in.
3. Clearance between the SSRMS Wrist and the ELC2 Frame is 49in.

These clearances can be monitored with the MBS Mast Camera or the S1 Lower Outboard Camera.

SSRMS Joint OCAS

pick File ► ELC2 ► ELC2 Handoff

Verify 'Joint Angles' 'Destination' for ELC2 Handoff position.

SR	SY	SP	EP	WP	WY	WR
+234.0	+62.7	+184.5	-47.7	+3.5	-2.4	+53.6

cmd Load (Verify Sequence Status – Confirm or Cancel)

MON Verify Joint Angles and errors are correct on Joint Angle Position overlay.

	SR	SY	SP	EP	WP	WY	WR
(current)	+234.0	+80.0	+250.0	-125.0	-45.0	+13.2	+53.6
TGT	+234.0	+62.7	+184.5	-47.7	+3.5	-2.4	+53.6
ERR	0.0	+17.3	+65.5	-77.3	-48.5	+15.6	0.0

PCS **cmd** Confirm (Verify Sequence Status – Auto Seq sw - Hot)

DCP AUTO SEQ → PROC

PCS MSS: SSRMS: SSRMS

Verify Posn Hold – orange

4.320 ELC2 INSTALL ON S3 LOWER OUTBOARD PAS
 (RBT FS/ULF3/FIN/SPN) Page 6 of 11 pages

Verify Joint Angle values.

SR	SY	SP	EP	WP	WY	WR
+234.0	+62.7	+184.5	-47.7	+3.5	-2.4	+53.6

```
*****
* If using shuttle attitude control and attitude maintenance required
* | Configure DAP A CNTL ACC per DOCKED DAP REFERENCE
* | (ORB OPS FS, REBOOST/DAP).
* |
* | DAP: LVLH
* | When rates damped
* |   DAP: FREE > 2 sec
* |   DAP: AUTO
* | When in attitude and rates damped
* |   DAP: FREE
*****
```

5. JOCAS TO MIDWAY POSITION (13 MINUTES)

Configure Cameras and overlays as required.

Monitor 1	Monitor 2	Monitor 3	V10L	V10R
13: LAB Stbd Zenith (-15, +15)	03: S1 Lower Outboard (+50, +30)	37: MBS Mast (+165, -20) 24: Tip Elbow (-120, -20)	Camera B (+45, +30)	SRMS Elbow (+90, -40)

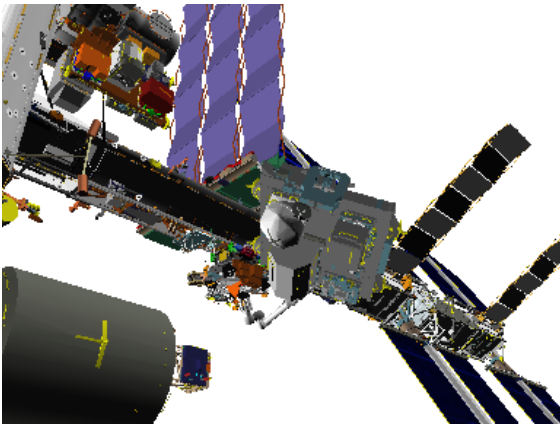

Figure 5.- ELC2 Handoff
(Camera B: +45, +30).



Figure 6.- ELC2 Handoff
(SRMS Elbow: +90, -40).

NOTE

1. The following maneuver will bring the SSRMS Base Boom within 35in of MBS PDGF1. This clearance can be monitored with the MBS Mast Camera.
2. Expect singularity warning for EP between +15 and -15 deg.

4.320 ELC2 INSTALL ON S3 LOWER OUTBOARD PAS

(RBT FS/ULF3/FIN/SPN)

SSRMS Joint OCAS

Input 'Joint Angles' 'Destination' for Midway position.

SR	SY	SP	EP	WP	WY	WR
+234.0	+62.7	+175.0	+55.0	-90.0	-200.0	+180.0

cmd Load (Verify Sequence Status – Confirm or Cancel)

MON

Verify Joint Angles and errors are correct on Joint Angle Position overlay.

	SR	SY	SP	EP	WP	WY	WR
(current)	+234.0	+62.7	+184.5	-47.7	+3.5	-2.4	+53.6
TGT	+234.0	+62.7	+175.0	+55.0	-90.0	-200.0	+180.0
ERR	0.0	0.0	+9.5	-102.7	+93.5	+197.6	-126.4

PCS

cmd Confirm (Verify Sequence Status – Auto Seq sw - Hot)

DCP

AUTO SEQ → PROC

PCS

MSS: SSRMS: SSRMS

Verify Posn Hold – orange

Verify Joint Angle values.

SR	SY	SP	EP	WP	WY	WR
+234.0	+62.7	+175.0	+55.0	-90.0	-200.0	+180.0

6. JOCAS TO ELC2 PRE-INSTALL ON S3LO (4 MINUTES)

NOTE
This maneuver will bring the SSRMS Base Boom within 29in of MBS PDGF1. This clearance can be monitored with the MBS Mast Camera.

Input 'Joint Angles' 'Destination' for ELC2 S3LO Pre-Install position.

SR	SY	SP	EP	WP	WY	WR
+170.2	+58.9	+137.0	+50.9	-70.1	-159.7	+244.3

cmd Load (Verify Sequence Status – Confirm or Cancel)

MON

Verify Joint Angles and errors are correct on Joint Angle Position overlay.

	SR	SY	SP	EP	WP	WY	WR
(current)	+234.0	+62.7	+175.0	+55.0	-90.0	-200.0	+180.0
TGT	+170.2	+58.9	+137.0	+50.9	-70.1	-159.7	+244.3
ERR	+63.8	+3.8	+38.0	+4.1	-19.9	-40.3	-64.3

PCS

cmd Confirm (Verify Sequence Status – Auto Seq sw - Hot)

DCP

AUTO SEQ → PROC

4.320 ELC2 INSTALL ON S3 LOWER OUTBOARD PAS

(RBT FS/ULF3/FIN/SPN)

Page 8 of 11 pages

PCS MSS: SSRMS:

Verify Posn Hold – orange

Verify SSRMS at ELC2 S3LO Pre-Install position (within 5 cm/1 deg).

SR	SY	SP	EP	WP	WY	WR
+170.2	+58.9	+137.0	+50.9	-70.1	-159.7	+244.3
X	Y	Z	Pitch	Yaw	Roll	
-200	0	0	0.0	0.0	0.0	
FOR	Loaded – ELC2 Install, SR Held					
Disp	S3>ELC2 Install S3LO					

7 ELC2 INSTALL

7.1 Install Setup

Configure Cameras, EBCS Targets and USOS Effector overlays.

Monitor 1	Monitor 2	Monitor 3	V10L	V10R
13: LAB Stbd Zenith (+15, +60)	28: EBCS	03: S1 Lower Outboard (-90, 0)	Camera B (+45, +30)	SRMS Elbow (+90, -40)
37: MBS Mast (+150, -20)		24: Tip Elbow (+75, +5)		

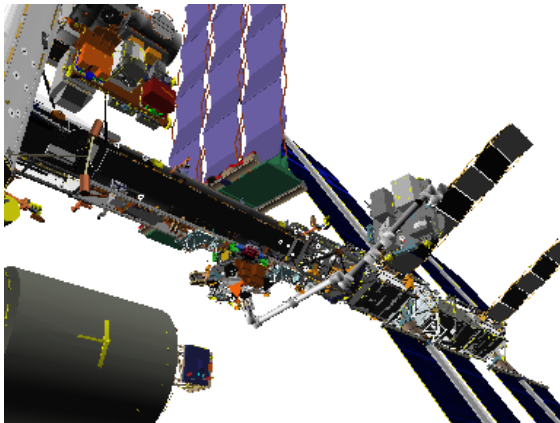

Figure 7.- ELC2 Pre-Install
(Camera B: +45, +30).



Figure 8.- ELC2 Pre-Install
(SRMS Elbow: +90, -40).

NOTE

1. The EBCS Camera view used for the Install will be the left Camera, unless otherwise notified by **MCC-H**.
2. Due to the USOS Effector overlay having the incorrect RTL configuration, use the following PCS display:
S3: S&M: PAS 3 Latch:
3. This maneuver will bring the SSRMS Base Boom within 35in of MBS PDGF 1. This clearance can be monitored with the MBS Mast Camera.

4.320 ELC2 INSTALL ON S3 LOWER OUTBOARD PAS
(RBT FS/ULF3/FIN/SPN) Page 9 of 11 pages

RATE → VERNIER (Verify Vernier on PCS)

MSS: SSRMS: Rate:

Set 'Scale' 'Vernier' Rate Scale: 0.4 (verify 0.4)

7.2 ELC2 Contingency Install on S3

MSS: SSRMS: Thrusters:

Verify 'Desat Request:' – Inh

MSS: SSRMS:

Enter Mode – Manual (Verify blue)

MSS: SSRMS: SSRMS Manual: Joint Lock:

cmd Shoulder Roll (Verify SR – Locked)

Perform "+X" Manual Maneuver to X: -90 (THC in).

Make alignment corrections as needed.

7.3 Maneuvering ELC2 to Install on S3 Lower Outboard Pas

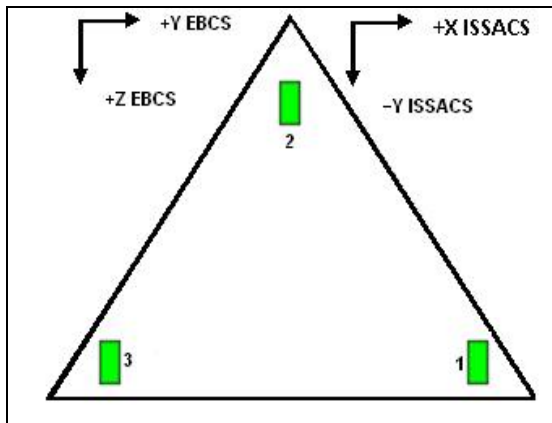

Figure 9.- ELC2 EBCS Install RTL Diagram.

Maneuver ELC2 2cm past the last RTL indication.

If ELC2 is deep into the PAS envelope and are missing RTL(s) due to orientation errors, refer to Table 1.

Table 1.

Missing RTLs	RHC Input
1	+Pitch, -Yaw
2	-Pitch
3	+Pitch, +Yaw
1, 2	-Pitch then -Yaw
2, 3	-Pitch then +Yaw
1, 3	+Pitch

THC/ RHC

Maneuver ELC2 to Ready-To-Latch Position until RTLs (three) – green

Verify SSRMS at RTL Ready to Latch position (within 5 cm/1 deg).

Locked	SR	SY	SP	EP	WP	WY	WR
	+170.2	+57.7	+128.1	+77.2	-87.1	-160.2	+245.5
	X	Y	Z	Pitch	Yaw	Roll	
	-6	0	0	0.0	0.0	0.0	
FOR	Loaded – ELC2 Install, SR Held						
Disp	S3>ELC2 Install S3LO						

PCS

MSS: SSRMS:

Enter Mode – Standby (Verify blue)

7.4 SSRMS Pas Coordination

Notify **PAS operator**, “Maneuver to RTL complete - go for First Phase Capture.”

MSS: SSRMS: Power:

cmd ‘Payload’ Prime(Redundant) Off (Verify two Off)

On **PAS operator**, “First Phase Capture complete - go to limp SSRMS:”

MSS: SSRMS: Limp:

cmd All Limp (Verify Limp – blue)

MSS: SSRMS:

Verify all joints – Limped

4.320 ELC2 INSTALL ON S3 LOWER OUTBOARD PAS

(RBT FS/ULF3/FIN/SPN)

Page 11 of 11 pages

Notify **PAS operator**, "Go for Second Stage Capture - All joints limped."

On **PAS operator**, "Capture complete - go for SSRMS Brakes On:"

NOTE

Expect the following message when safing is commanded:

'R3Z - MSS OCS SSRMS Prime(Redun) ACU SRT Cat-1 Brk Stat Fail' (SCR 17495)

This message should return to Norm.

DCP

SAFING → SAFE (Verify ON)

This Page Intentionally Blank

REFERENCE

This Page Intentionally Blank

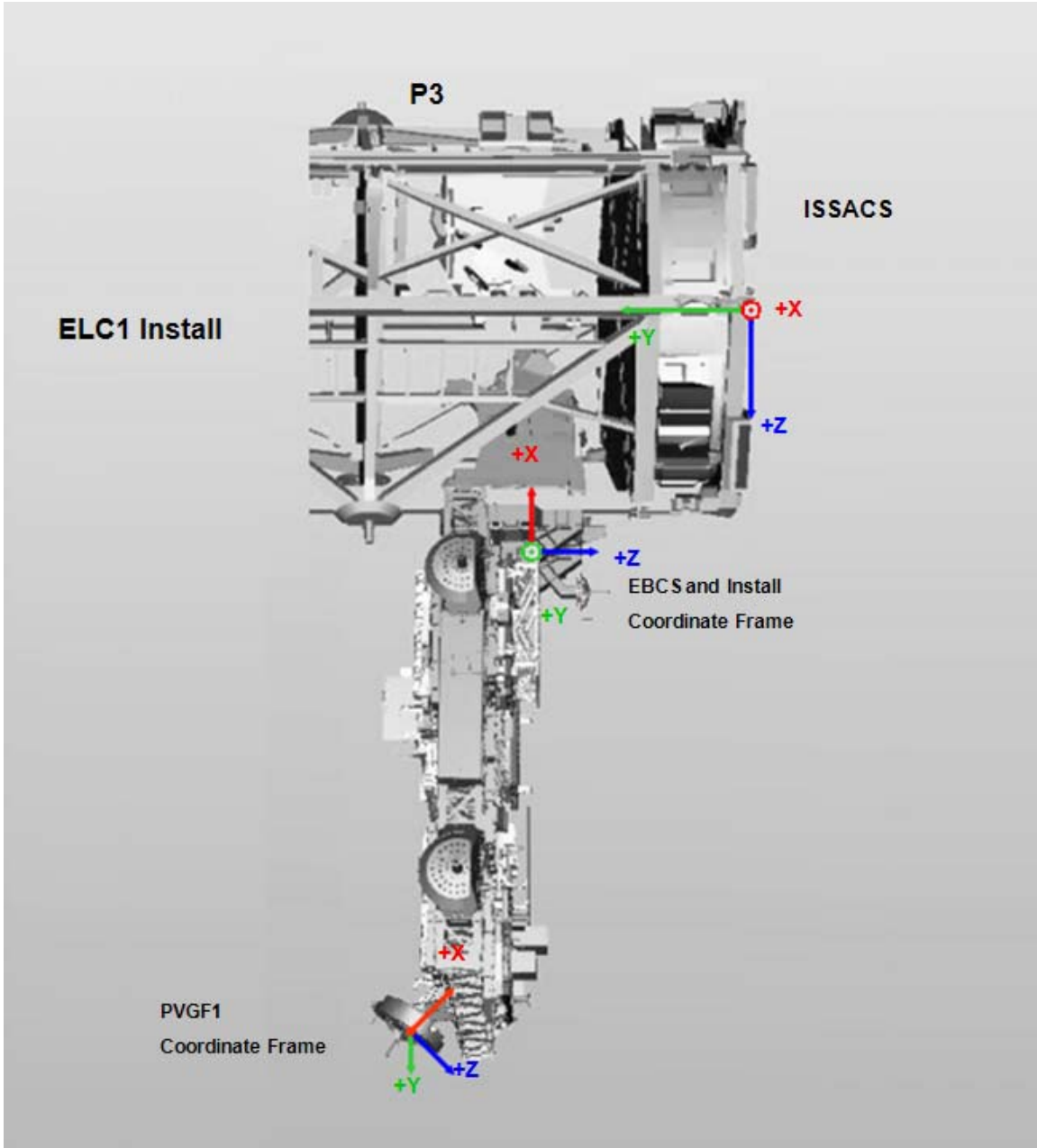

Figure 1.- ELC1 Install on P3.

This Page Intentionally Blank

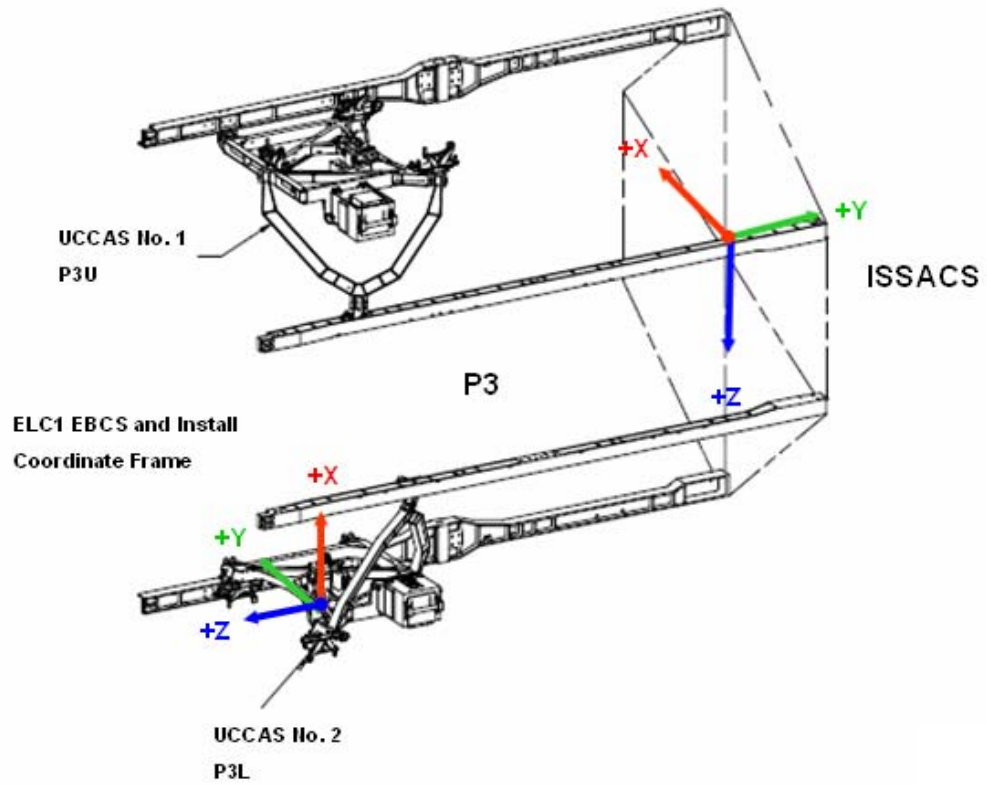

Figure 1.- P3.

This Page Intentionally Blank

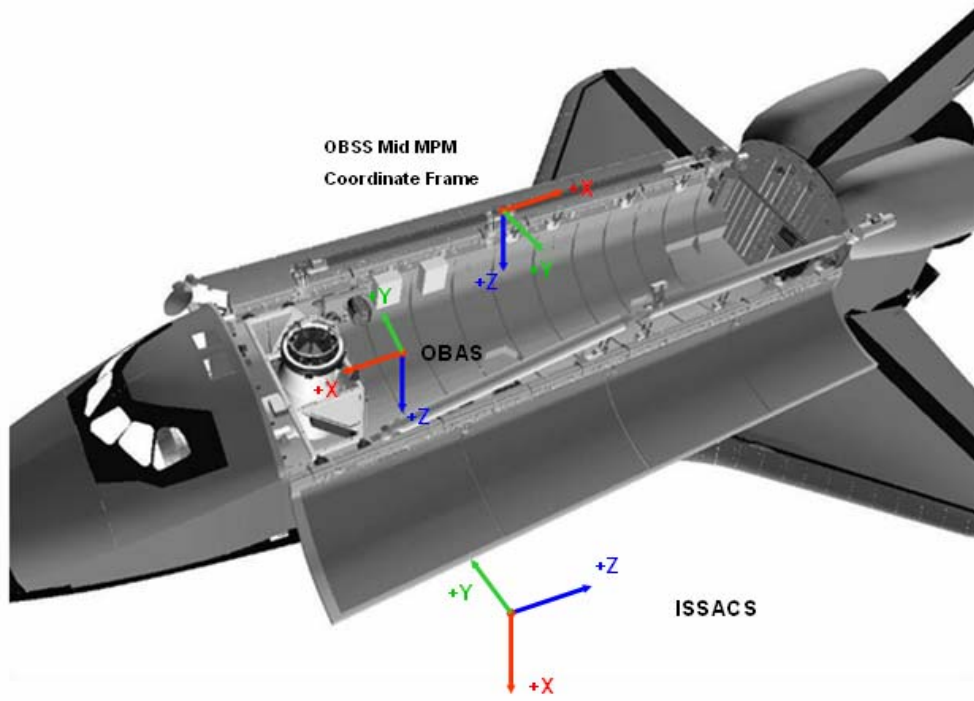

Figure 1.- OBSS.

This Page Intentionally Blank

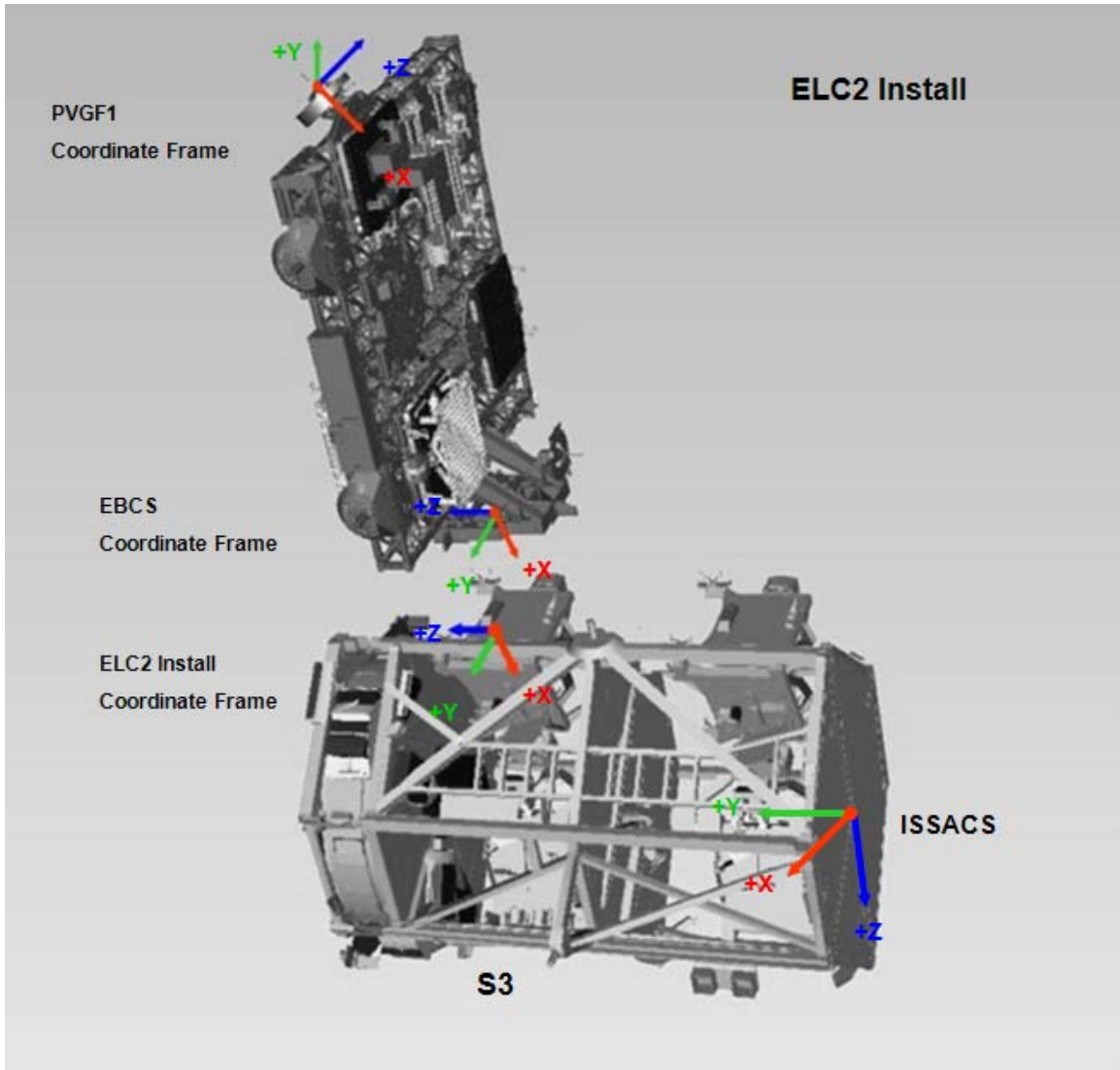

Figure 1.- ELC2 Install.

This Page Intentionally Blank

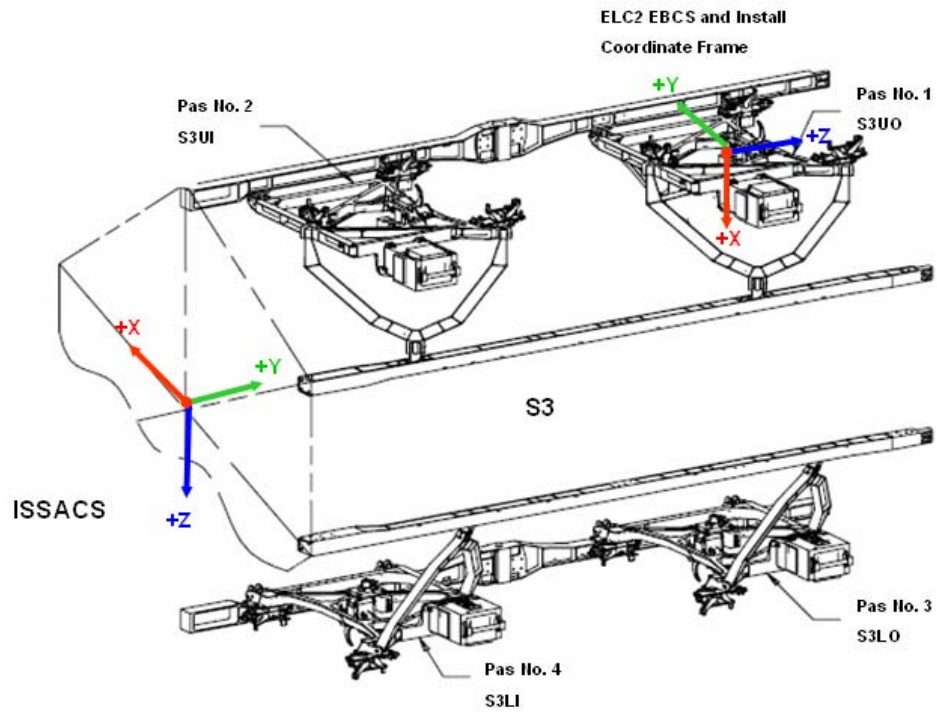

Figure 1.- S3.

This Page Intentionally Blank

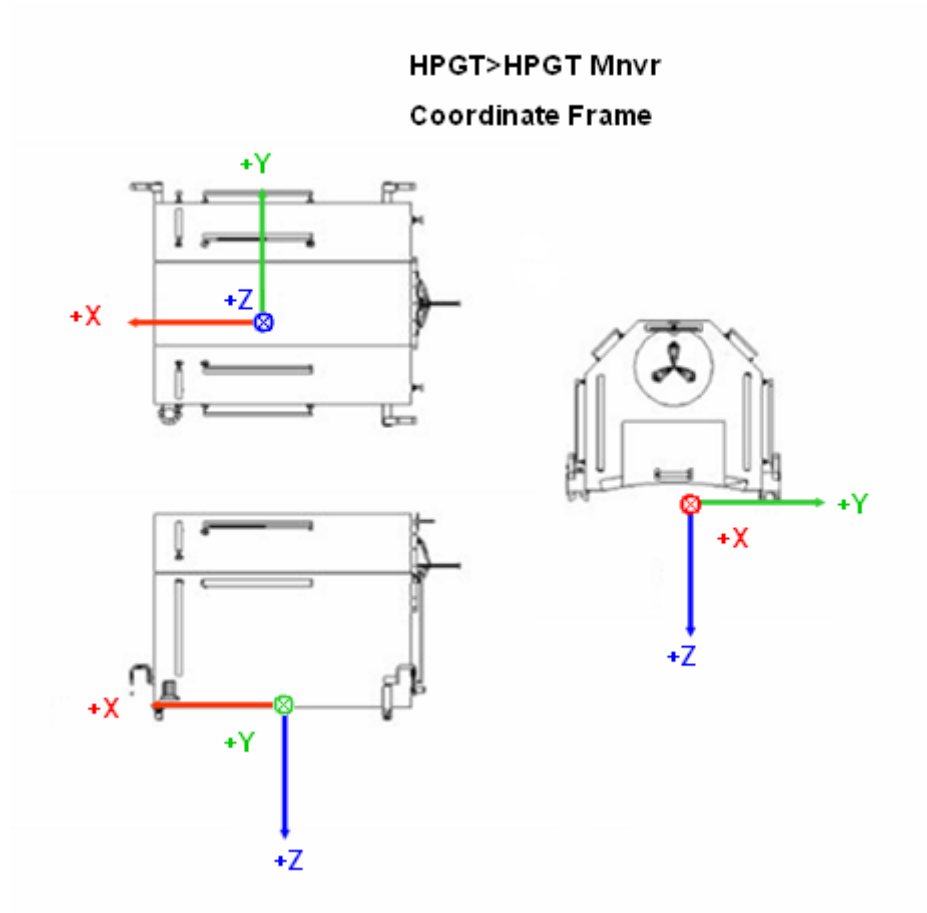

Figure 1.- HPGT Mnvr.

This Page Intentionally Blank

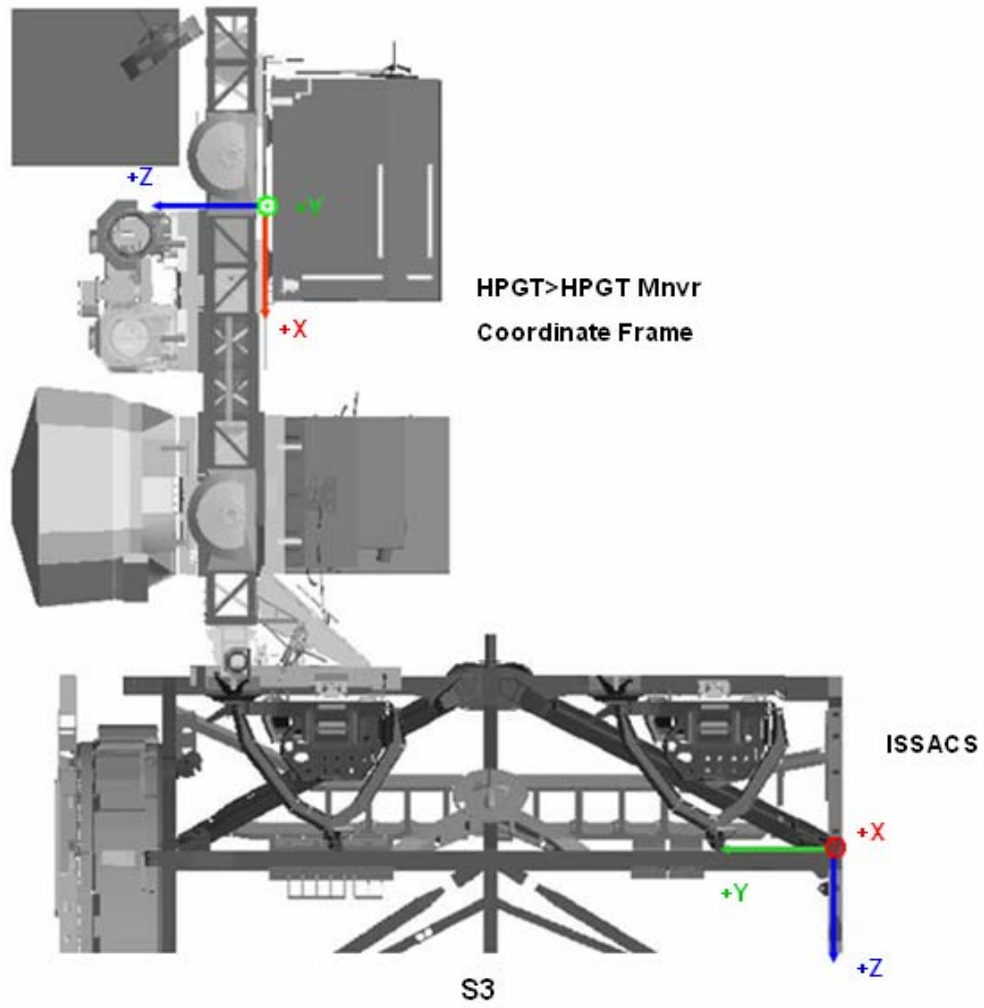

Figure 1.- HPGT on ELC2.

This Page Intentionally Blank

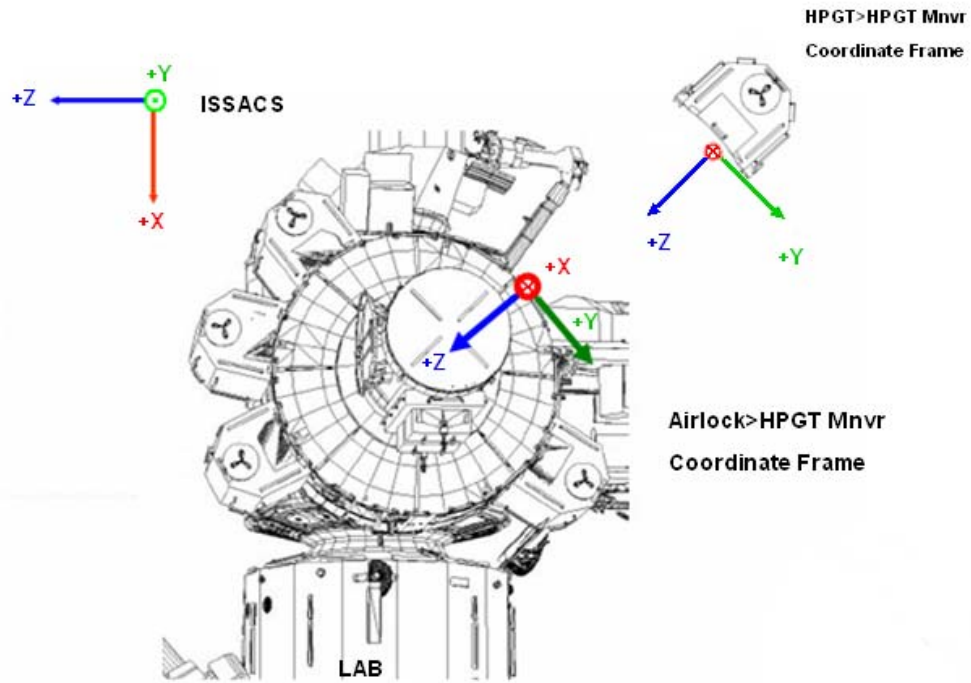

Figure 1.- HPGT Install.

This Page Intentionally Blank

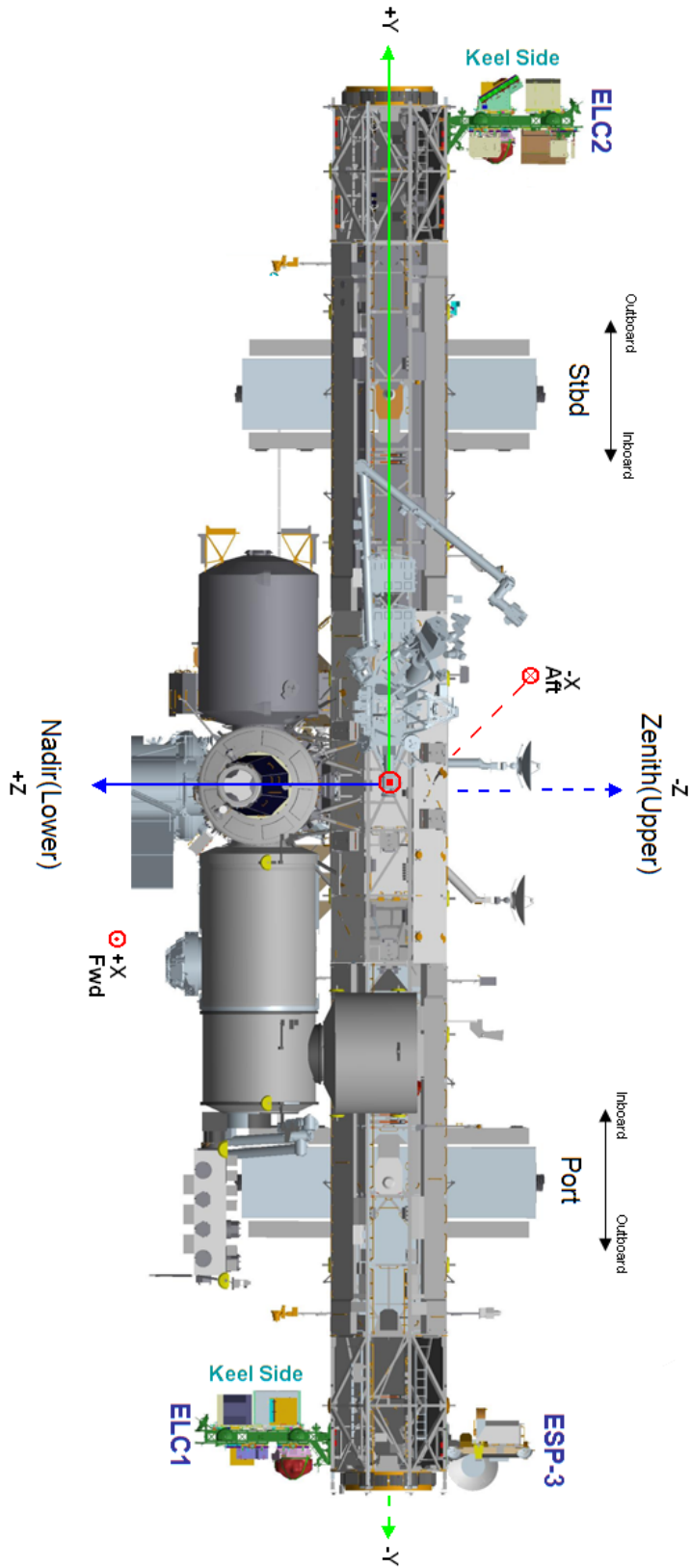

Figure 1.- ISS.

This Page Intentionally Blank



INTERNATIONAL SPACE STATION

ROBOTICS FS

Return on
STS-129

