

DATA CHANGE NOTICE

SHUTTLE CREW OPERATIONS MANUAL

AMENDMENT: Rev. B

DATE: October 4, 2000

PAGE: 1 of 1175

This edition of SCOM includes OI-28 updates, including moving the MEDS discussion to Section 2.18 and reordering all subsequent sections.

All previous versions of this document are obsolete and should be replaced with this version.

APPROVED BY

Brett L. Jackman
Project Manager, USA

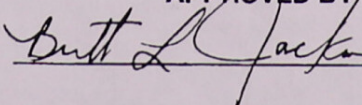

Date:

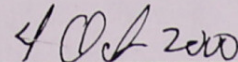

Space Flight Operations Contract

Shuttle Crew Operations Manual

OI-28

October 4, 2000

DRD-1.6.1.3-b

Contract NAS9-20000



Questions regarding the organization and content of the Shuttle Crew Operations Manual should be directed to one of the following SCOM representatives:

NASA

TBA, CB	281
Steve Hirshorn, DF	2814838428
Ed Gonzalez, DM	2814831927

USA

Brett Jackman, DT	2812448106
Project Manager	
Dave Pitre, DT	2812447416

Hernandez Engineering Inc.

Vicki Atkins	2812806787
--------------	------------

REVISION LOG

REV LETTER	CHNG NO.	DESCRIPTION	DATE
Baseline		SFOC baseline supersedes SCOM 1.6.	05/12/97
A		The header in the text portion of this document does not reflect Rev. A, however the entire document has been revised for OI-27.	10/01/98
B		The entire document has been updated for OI-28. MEDS has been moved from the appendix to Section 2.18.	10/04/00

ShuttleCrewOperationsManual

LISTOFEFFECTIVEPAGES

Thecurrentstatusofallpagesinthisdocumentisasshownbelow:

<u>PageNo.</u>	<u>ChangeNo.</u>	<u>PageNo.</u>	<u>ChangeNo.</u>
i-xx	Rev.B	31-34	Rev.B
11 -12	Rev.B	3.11-3.12	Rev.B
1.11-1.120	Rev.B	3.2.1-3.22	Rev.B
1.21-1.216	Rev.B	3.31-3.32	Rev.B
1.31-1.36	Rev.B	3.41-3.42	Rev.B
1.41-1.410	Rev.B	3.51-3.56	Rev.B
21-22	Rev.B	41-42	Rev.B
2.11-2.130	Rev.B	4.11-4.112	Rev.B
2.21-2.238	Rev.B	4.21-4.24	Rev.B
2.31-2.322	Rev.B	4.31-4.34	Rev.B
2.41-2.456	Rev.B	4.41-4.42	Rev.B
2.51-2.514	Rev.B	4.51-4.52	Rev.B
2.61-2.650	Rev.B	4.61-4.62	Rev.B
2.71-2.728	Rev.B	4.71-4.72	Rev.B
2.81-2.838	Rev.B	4.81-4.82	Rev.B
2.91-2.958	Rev.B	4.91-4.92	Rev.B
2.101-2.1018	Rev.B	4.101-4.104	Rev.B
2.111-2.1122	Rev.B	51-52	Rev.B
2.121-2.124	Rev.B	5.11-5.12	Rev.B
2.131-2.1370	Rev.B	5.21-5.28	Rev.B
2.141-2.1418	Rev.B	5.31-5.38	Rev.B
2.151-2.1514	Rev.B	5.41-5.410	Rev.B
2.161-2.1642	Rev.B	5.51-5.52	Rev.B
2.171-2.1722	Rev.B	61-62	Rev.B
2.181-2.1814	Rev.B	6.11-6.12	Rev.B
2.191-2.1932	Rev.B	6.21-6.26	Rev.B
2.201-2.208	Rev.B	6.31-6.38	Rev.B
2.211-2.212	Rev.B	6.41-6.44	Rev.B
2.221-2.2226	Rev.B	6.51-6.54	Rev.B
2.231-2.2326	Rev.B	6.61-6.62	Rev.B
2.241-2.244	Rev.B	6.71-6.74	Rev.B
2.251-2.2526	Rev.B	6.81-6.816	Rev.B
2.261-2.266	Rev.B	6.91-6.94	Rev.B
2.271-2.278	Rev.B	6.101-6.102	Rev.B

PageNo.	ChangeNo.	PageNo.	ChangeNo.
6.111-6.112	Rev.B	91-92	Rev.B
71-72	Rev.B	9.11-9.110	Rev.B
7.11-7.112	Rev.B	9.21-9.24	Rev.B
7.21-7.212	Rev.B	9.31-9.312	Rev.B
7.31-7.314	Rev.B	A1-A66	Rev.B
7.41-7.428	Rev.B	B1-B18	Rev.B
81-82	Rev.B	C1-C20	Rev.B
8.11-8.12	Rev.B	D1-D12	Rev.B
8.21-8.24	Rev.B	E1-E18	Rev.B
8.31-8.32	Rev.B		
8.41-8.42	Rev.B		
8.51-8.52	Rev.B		
8.61-8.62	Rev.B		
8.71-8.72	Rev.B		
8.81-8.82	Rev.B		

PREFACE

The Shuttle Crew Operations Manual (SCOM) is a unique document containing information about each shuttle system and every phase of a generic space shuttle mission.

The SCOM is a reference document for space shuttle crewmembers. The complexity of the shuttle systems and the unique operational environment, coupled with the numerous malfunction/emergency procedures, necessitated some departures from a Dash1/NATOPS approach. Nonetheless, the SCOM is the only single source document, written specifically for shuttle astronauts, with comprehensive data about shuttle systems and operations.

This document contains condensed information from a large number of space shuttle publications, including the Flight Data File (FDF), Crew Training workbooks, Flight Procedure Handbooks (FPH), Flight Rules, Shuttle Operational Data Book, and Shuttle Performance Assessment Data Book. The SCOM is not a replacement for any of these documents. It has been carefully reviewed by FCOD and MOD personnel to ensure accuracy of information. In all cases, should a conflict arise between the SCOM and FDF or Flight Rules, the FDF and Flight Rules will govern. If conflicts arise between the SCOM and workbooks or FPH, the conflicts should be resolved with the appropriate book manager or system representative.

Information contained in the SCOM is current as of October 2000 and OI28. CRT displays documented in the text and in Appendix B are the CRT displays documented in the Level C Functional Subsystem Software Requirements Display and Controls Specification, STS 83 0020H dated February 10, 1992, effectivity OI28 and subs. It should be noted that several CRT displays provided in the body of this document are for illustrative purposes only; certain CRT displays contain data combined in one illustration that do not appear simultaneously in operational use.

Additional information or clarification is presented in three formats: notes, cautions, and warnings. Notes provide amplifying informa-

tion of a general nature. Cautions provide information and instructions necessary to prevent hardware damage or malfunction. Warnings provide information and instructions necessary to ensure crew safety. The formats in which this material appears are illustrated below.

NOTE

A barberpole APU/HYD READY TO START talkback will not inhibit a start.

CAUTION

After an APU auto shutdown, the APU FUEL TK VLV switch must be taken to CLOSE prior to inhibiting auto shutdown logic. Failure to do so can allow the fuel tank isolation valves to reopen and flow fuel to an APU gas generator bed that is above the temperature limits for safe restart.

WARNING

The FUEL CELL REAC switches on panel R1 are in a vertical column with FUEL CELL 1 REAC on top, FUEL CELL 3 REAC in the middle, and FUEL CELL 2 REAC on the bottom. This was done to allow the schematic to be placed on the panel. Because the switches are not in numerical order, it is possible to inadvertently close the wrong fuel cell reactant valve when shutting down a fuel cell.

The SCOM will be updated according to the process described in the Configuration Control Plan.

Configuration Control Plan

Your inputs are vital for the SCOM to remain a useful document. Changes may be submitted via the SCOM Change Request (CR) Form. Corrections, additions, deletions, or other constructive suggestions should be submitted to mail code CBSCOM on the SCOM CR form. The form should be filled out in its entirety

except for the Disposition blocks and the Control Number block. CBSCOM will assign a control number. The initiator should clearly explain the correction or modification and list the applicable page number(s). Additional pages or annotated copies of the applicable SCOM pages may be submitted with the CR. Each CR should contain only corrections or modifications.

CRs containing recommended corrections will be verified by CB designated personnel and incorporated through pen and ink changes or page change notifications (PCNs). The CB representative will determine whether the number of verified corrections warrant a PCN prior to a semiannual review.

Semiannual reviews will be conducted by a Change Board to consider changes to the SCOM. The CB representative (or his designee) will chair the reviews. CRs recommending modifications will be reviewed and incorporated (with or without additional modification) or disapproved. Disapproved CRs will be returned to the initiator with a brief explanation. Initiators may resubmit the CR at a future review. Approved changes will be promulgated via PCNs subsequent to the reviews or at the direction of CB. Revisions (Rev's) will be published at the direction of CB if substantial changes to the manual are made.

NASA JOHNSON SPACE CENTER
SHUTTLE CREW OPERATIONS MANUAL
CHANGE REQUEST (CR)

DATE	INITIATOR (ORG/NAME/PHONE)	CORRECTION <input type="checkbox"/> MODIFY <input type="checkbox"/>	CONTROL #
RECOMMENDED CHANGE (use additional pages if required) Indicate SCOM page number(s)			
RATIONALE (use additional pages if required)			
INITIAL DISPOSITION		BOARD DISPOSITION	
<input type="checkbox"/> INCORPORATE CORRECTION <input type="checkbox"/> HOLD FOR NEXT REVIEW ON <input type="checkbox"/> RETURN FOR ADDITIONAL		<input type="checkbox"/> INCORPORATE AS WRITTEN <input type="checkbox"/> INCORPORATE WITH MODIFICATION <input type="checkbox"/> DISAPPROVED	
CB-SCOM	DATE	PCN/REV #	DATE

Program Documentation

There are many hundreds of documents delineating the organization and operation of the space shuttle program. Over 100 of these documents have been utilized in the development of the Shuttle Crew Operations Manual. The following flow chart depicts the

organization and hierarchy of the significant documents used in this effort. The level of a document in this "document tree" should not be equated with its relative importance to other shuttle publications. The level is strictly an indication of the management level that controls the development of the publication and subsequent changes.

PURPOSE

The Program Approval Document (PAD) is the contract between the NASA Administrator and the Associate Administrator for Space Flight for the NSTS objectives and content including top level management, financial and technical aspects.

The Program Requirements Document (PRD) establishes the Level I requirements that are controlled by the NSTS Director and imposed on the NSTS Deputy Directors.

NSTS 07700 Program Definition and Requirements Document (PDRD) establishes the Level II requirements, controlled by the NSTS Deputy Directors, that incorporate and expand the Level I requirements and are imposed on the Level III Projects and Level II Integration Offices.

APPROVAL AUTHORITY

LEVEL 0
NASA ADMINISTRATOR

ASSOCIATE ADMINISTRATOR
FOR SPACE FLIGHT

LEVEL I
NSTS DIRECTOR

LEVEL II
NSTS DEPUTY DIRECTOR

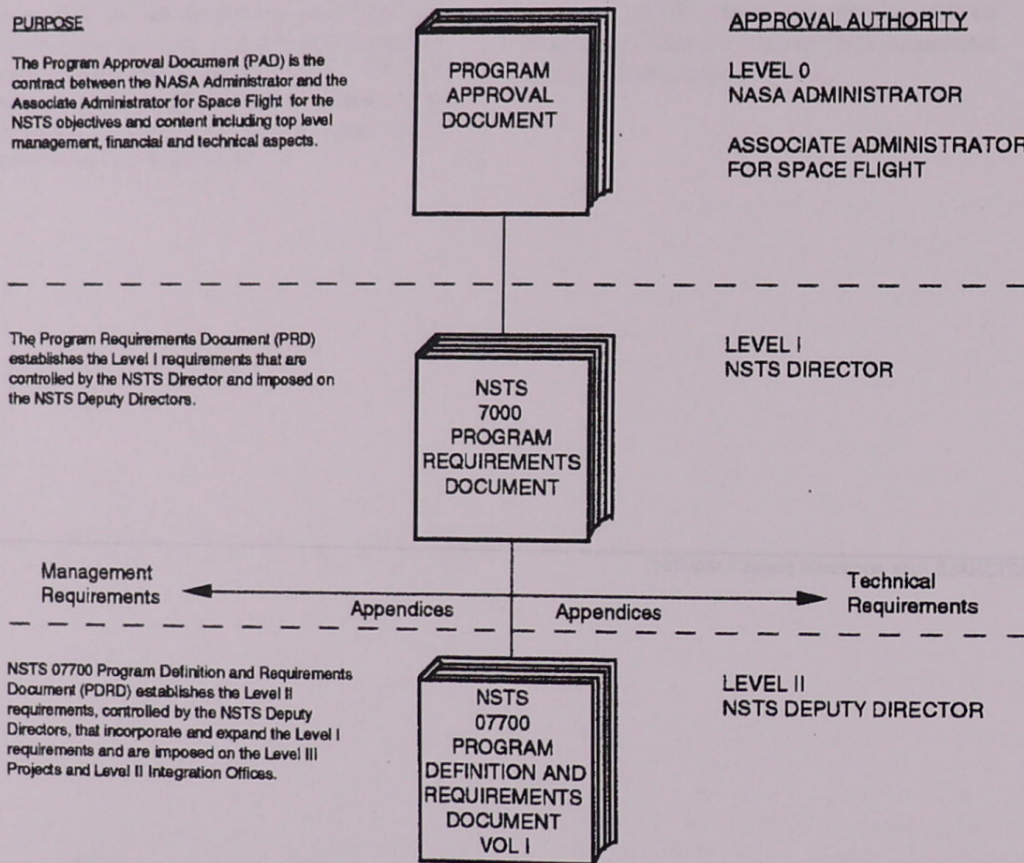

**NSTS
07700
PROGRAM
DEFINITION AND
REQUIREMENTS
DOCUMENT
VOL I**

LEVEL II
NSTS DEPUTY DIRECTORS

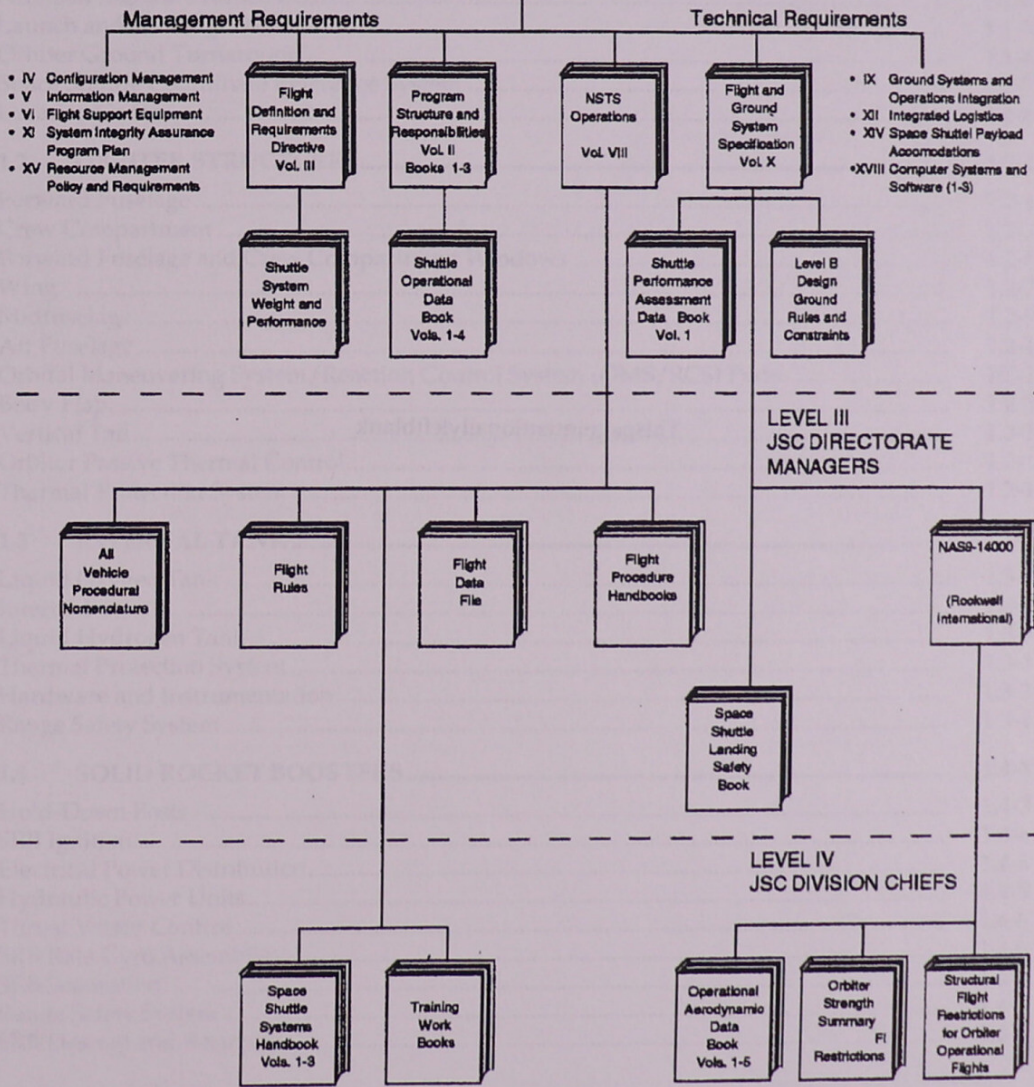

CONTENTS

Section	Page
PREFACE	i
Configuration Control Plan	i
Program Documentation	iv
1. GENERAL DESCRIPTION	1-1
1.1 OVERVIEW	1.1-1
Space Shuttle Requirements.....	1.1-1
Nominal Mission Profile.....	1.1-2
Launch and Landing Sites.....	1.1-5
Orbiter Ground Turnaround	1.1-6
Space Shuttle Coordinate Reference System	1.1-7
Location Codes	1.1-8
1.2 ORBITER STRUCTURE	1.2-1
Forward Fuselage.....	1.2-1
Crew Compartment	1.2-3
Forward Fuselage and Crew Compartment Windows	1.2-6
Wing	1.2-7
Midfuselage.....	1.2-9
Aft Fuselage	1.2-10
Orbital Maneuvering System/Reaction Control System (OMS/RCS) Pods	1.2-11
Body Flap.....	1.2-12
Vertical Tail	1.2-13
Orbiter Passive Thermal Control.....	1.2-14
Thermal Protection System	1.2-14
1.3 EXTERNAL TANK	1.3-1
Liquid Oxygen Tank	1.3-2
Intertank	1.3-2
Liquid Hydrogen Tank.....	1.3-3
Thermal Protection System	1.3-3
Hardware and Instrumentation	1.3-3
Range Safety System	1.3-4
1.4 SOLID ROCKET BOOSTERS	1.4-1
Hold-Down Posts	1.4-3
SRB Ignition.....	1.4-4
Electrical Power Distribution.....	1.4-5
Hydraulic Power Units.....	1.4-5
Thrust Vector Control.....	1.4-6
SRB Rate Gyro Assemblies.....	1.4-6
SRB Separation.....	1.4-6
Range Safety System	1.4-7
SRB Descent and Recovery	1.4-8

Section	Page
2. SYSTEMS.....	2-1
2.1 AUXILIARY POWER UNIT/ HYDRAULICS (APU/HYD).....	2.1-1
Description.....	2.1-1
Fuel System.....	2.1-2
Gas Generator and Turbine.....	2.1-5
Lubricating Oil.....	2.1-5
Electronic Controller.....	2.1-6
Injector Cooling System.....	2.1-10
APU Heaters.....	2.1-11
Water Spray Boilers.....	2.1-12
Main Hydraulic Pump.....	2.1-16
Hydraulic Reservoir.....	2.1-19
Hydraulic Accumulator.....	2.1-19
Circulation Pump and Heat Exchanger.....	2.1-19
Hydraulic Heaters.....	2.1-21
Operations.....	2.1-21
APU/HYD Caution and Warning Summary.....	2.1-23
APU/HYD Summary Data.....	2.1-24
APU/HYD Rules of Thumb.....	2.1-24
2.2 CAUTION AND WARNING SYSTEM (C/W).....	2.2-1
Description.....	2.2-1
Alarms.....	2.2-2
Smoke Detection and Fire Suppression.....	2.2-5
Rapid Cabin Depressurization.....	2.2-11
Operations.....	2.2-12
SPEC 60, SM Table Maintenance.....	2.2-15
C/W Summary Data.....	2.2-19
C/W Rules of Thumb.....	2.2-19
F7 Light Summary.....	2.2-19
Fault Message Summary.....	2.2-20
	2.2-23
2.3 CLOSED CIRCUIT TELEVISION (CCTV).....	2.3-1
Description.....	2.3-1
Video Processing Equipment.....	2.3-2
CCTV Cameras.....	2.3-6
CCTV Camera Lens Control.....	2.3-11
Pan/Tilt Units (PTUs).....	2.3-11
Cabin Cameras.....	2.3-12
Video Tape Recorders (VTRs).....	2.3-15
Special Purpose Video.....	2.3-17
Monitors.....	2.3-18
Payload Bay Camera Operations.....	2.3-20
CCTV Accessories.....	2.3-20
CCTV System Summary.....	2.3-22
2.4 COMMUNICATIONS.....	2.4-1
Description.....	2.4-1
S-Band Phase Modulation.....	2.4-2
S-Band Frequency Modulation.....	2.4-10
Ku-Band System.....	2.4-13

Section	Page
Payload Communication System	2.4-21
Ultrahigh Frequency System.....	2.4-24
Audio Distribution System	2.4-28
Instrumentation	2.4-40
Communications System Summary.....	2.4-45
Communications System Rules of Thumb.....	2.4-55
2.5 CREW SYSTEMS	2.5-1
Description	2.5-1
Crew Clothing/Worn Equipment.....	2.5-1
Personal Hygiene Provisions	2.5-1
Sleeping Provisions	2.5-1
Exercise Equipment.....	2.5-4
Housekeeping Equipment.....	2.5-4
Restraints and Mobility Aids	2.5-5
Stowage Containers.....	2.5-5
Reach and Visibility Aids	2.5-6
Photographic Equipment	2.5-8
Sighting Aids.....	2.5-10
Window Shades and Filters	2.5-10
Shuttle Orbiter Medical System.....	2.5-10
Operational Bioinstrumentation System	2.5-12
Radiation Equipment.....	2.5-14
Air Sampling System	2.5-14
2.6 DATA PROCESSING SYSTEM (DPS).....	2.6-1
Description	2.6-1
General Purpose Computers (GPCs)	2.6-2
Data Bus Network	2.6-7
Multiplexers/Demultiplexers (MDMs).....	2.6-11
Mass Memory Units.....	2.6-12
Multifunction CRT Display System	2.6-13
Master Timing Unit.....	2.6-15
Software	2.6-18
Operations	2.6-23
DPS Summary Data	2.6-45
DPS Rules of Thumb	2.6-49
2.7 DEDICATED DISPLAY SYSTEMS	2.7-1
Description	2.7-1
Display Driver Unit.....	2.7-2
Attitude Director Indicator (ADI)	2.7-4
Horizontal Situation Indicator (HSI)	2.7-9
Alpha/Mach Indicator	2.7-14
Altitude/Vertical Velocity Indicator	2.7-17
Surface Position Indicator	2.7-18
Flight Control System Pushbutton Indicators	2.7-19
Reaction Control System Command Lights.....	2.7-20
G-Meter (Non-MEDS).....	2.7-21
Head-Up Display.....	2.7-21
Dedicated Display Systems Summary Data	2.7-25

Section	Page
2.8 ELECTRICAL POWER SYSTEM (EPS).....	2.8-1
Description.....	2.8-1
Power Reactants Storage and Distribution System.....	2.8-1
Fuel Cell System.....	2.8-10
Electrical Power Distribution and Control.....	2.8-20
Operations.....	2.8-30
EPS Caution and Warning Summary.....	2.8-32
EPS Summary Data.....	2.8-38
EPS Rules of Thumb.....	2.8-38
2.9 ENVIRONMENTAL CONTROL AND LIFE SUPPORT SYSTEM (ECLSS)	2.9-1
Description.....	2.9-1
Pressure Control System.....	2.9-3
Atmospheric Revitalization System.....	2.9-12
Active Thermal Control System.....	2.9-22
Supply and Wastewater Systems.....	2.9-34
Operations.....	2.9-43
ECLSS Caution and Warning Summary.....	2.9-46
ECLSS Summary Data.....	2.9-47
ECLSS Rules of Thumb.....	2.9-58
2.10 ESCAPE SYSTEMS.....	2.10-1
Description.....	2.10-1
Launch Pad Egress Systems.....	2.10-1
Launch and Entry Suits.....	2.10-4
Personal Parachute Assembly.....	2.10-8
Crew Escape System Pyrotechnics.....	2.10-11
Egress Pole System.....	2.10-12
Emergency Egress Slide.....	2.10-12
Secondary Emergency Egress.....	2.10-16
Procedures for Bailout, Water Survival, and Rescue.....	2.10-17
Escape Systems Summary Data.....	2.10-18
2.11 EXTRAVEHICULAR ACTIVITY (EVA)	2.11-1
Description.....	2.11-1
Extravehicular Mobility Unit.....	2.11-2
Airlock.....	2.11-11
EVA Support Equipment.....	2.11-15
Simplified Aid for EVA Rescue.....	2.11-17
Operations.....	2.11-19
EVA Summary Data.....	2.11-22
EVA Rules of Thumb.....	2.11-22
2.12 GALLEY/FOOD.....	2.12-1
Description.....	2.12-1
Repackaged Galley.....	2.12-1
Volume A - Pantry.....	2.12-3
2.13 GUIDANCE, NAVIGATION, AND CONTROL (GNC)	2.13-1
Description.....	2.13-1
Navigation Hardware.....	2.13-5
Flight Control System Hardware.....	2.13-26

Section	Page
Digital Autopilot.....	2.13-46
Operations.....	2.13-53
GNC Caution and Warning Summary.....	2.13-62
GNC Summary Data.....	2.13-63
GNC Rules of Thumb.....	2.13-70
2.14 LANDING/DECELERATION SYSTEM.....	2.14-1
Description.....	2.14-1
Landing Gear.....	2.14-1
Drag Chute.....	2.14-4
Main Landing Gear Brakes.....	2.14-5
Nose Wheel Steering.....	2.14-9
Operations.....	2.14-10
Landing/Deceleration System Summary Data.....	2.14-17
Landing/Deceleration System Rules of Thumb.....	2.14-17
2.15 LIGHTING SYSTEM.....	2.15-1
Description.....	2.15-1
Interior Lighting.....	2.15-1
Exterior Lighting.....	2.15-12
Lighting System Summary Data.....	2.15-14
Lighting System Rules of Thumb.....	2.15-14
2.16 MAIN PROPULSION SYSTEM (MPS).....	2.16-1
Description.....	2.16-1
Space Shuttle Main Engines (SSMEs).....	2.16-3
Space Shuttle Main Engine Controllers.....	2.16-8
Propellant Management System (PMS).....	2.16-13
Helium System.....	2.16-19
MPS Hydraulic Systems.....	2.16-23
Malfunction Detection.....	2.16-25
Operations.....	2.16-28
Post Insertion.....	2.16-34
Orbit.....	2.16-35
Deorbit Prep.....	2.16-35
Entry.....	2.16-35
RTLS Abort Propellant Dump Sequence.....	2.16-35
TAL Abort Propellant Dump Sequence.....	2.16-36
MPS Caution and Warning Summary.....	2.16-37
MPS Summary Data.....	2.16-39
MPS Rules of Thumb.....	2.16-42
2.17 MECHANICAL SYSTEMS.....	2.17-1
Description.....	2.17-1
Active Vent System.....	2.17-2
External Tank Umbilical Doors.....	2.17-5
Payload Bay Door System.....	2.17-9
Mechanical Systems Summary Data.....	2.17-18
Mechanical Systems Rules of Thumb.....	2.17-21

Section	Page
2.18 MULTIFUNCTION ELECTRONIC DISPLAY SYSTEM (MEDS)	2.18-1
Description.....	2.18-1
Design.....	2.18-1
Hardware.....	2.18-1
Software.....	2.18-5
Operations.....	2.18-10
2.19 ORBITAL MANEUVERING SYSTEM (OMS)	2.19-1
Description.....	2.19-1
Engines.....	2.19-3
Helium System.....	2.19-9
Propellant Storage and Distribution.....	2.19-11
Thermal Control.....	2.19-19
Thrust Vector Control (TVC).....	2.19-20
Fault Detection and Identification.....	2.19-21
Operations.....	2.19-23
OMS Caution and Warning Summary.....	2.19-24
OMS Summary Data.....	2.19-31
OMS Rules of Thumb.....	2.19-31
2.20 ORBITER DOCKING SYSTEM	2.20-1
Description.....	2.20-1
External Airlock.....	2.20-2
Truss Assembly.....	2.20-2
Androgynous Peripheral Docking System.....	2.20-2
APDS Avionics Overview.....	2.20-2
APDS Operational Sequences (OPS).....	2.20-5
Operational Notes of Interest.....	2.20-7
2.21 PAYLOAD AND GENERAL SUPPORT COMPUTER.....	2.21-1
Description.....	2.21-1
Equipment.....	2.21-1
2.22 PAYLOAD DEPLOYMENT AND RETRIEVAL SYSTEM (PDRS)	2.22-1
Description.....	2.22-1
Remote Manipulator System.....	2.22-1
Manipulator Positioning Mechanism.....	2.22-10
Payload Retention Mechanisms.....	2.22-14
Operations.....	2.22-17
PDRS Caution and Warning Summary.....	2.22-21
PDRS Summary Data.....	2.22-22
PDRS Rules of Thumb.....	2.22-26
2.23 REACTION CONTROL SYSTEM (RCS).....	2.23-1
Description.....	2.23-1
Jet System.....	2.23-3
Propellant System.....	2.23-4
Helium System.....	2.23-9
Thermal Control.....	2.23-11
RCS Redundancy Management.....	2.23-12
Operations.....	2.23-16
RCS Caution and Warning Summary.....	2.23-18

Section	Page
RCS Summary Data	2.23-25
RCS Rules of Thumb	2.23-25
2.24 SPACEHAB.....	2.24-1
Description	2.24-1
Configurations	2.24-1
Flight Deck Interfaces	2.24-2
Command and Data Subsystem	2.24-3
Caution and Warning	2.24-3
Electrical Power Subsystem	2.24-3
Environmental Control Subsystem	2.24-3
Audio Communication Subsystem	2.24-4
Fire Suppression Subsystem	2.24-4
Closed Circuit Television Subsystem	2.24-4
2.25 SPACELAB.....	2.25-1
Description	2.25-1
Module.....	2.25-3
Pallet	2.25-4
Instrument Pointing Subsystem (IPS).....	2.25-5
Flight Deck Interfaces	2.25-5
Electrical Power	2.25-6
Command and Data Management System	2.25-10
Module Environmental Control and Life Support (ECLS).....	2.25-13
Spacelab Summary Data.....	2.25-18
2.26 STOWAGE.....	2.26-1
Description	2.26-1
Rigid Containers.....	2.26-1
Flexible Containers.....	2.26-4
Middeck Accommodations Rack.....	2.26-5
2.27 WASTE MANAGEMENT SYSTEM (WMS).....	2.27-1
Description	2.27-1
Operations	2.27-4
3. FLIGHT DATA FILE.....	3-1
3.1 CONTROL DOCUMENTS	3.1-1
Ascent Checklist	3.1-1
Post Insertion Book.....	3.1-1
Flight Plan	3.1-1
Deorbit Preparation Book.....	3.1-1
Entry Checklist.....	3.1-2
3.2 SUPPORT DOCUMENTS.....	3.2-1
Orbit Operations Checklist.....	3.2-1
Photo/TV Checklist	3.2-1
Payload Deployment and Retrieval System Operations Checklist.....	3.2-1
Extravehicular Activity Checklists.....	3.2-1
Rendezvous Checklist.....	3.2-1
Payload Operations Checklist.....	3.2-2

Section	Page
Deploy Checklist.....	3.2-2
Additional Support Documents.....	3.2-2
3.3 OFF-NOMINAL DOCUMENTS	3.3-1
Pocket Checklists.....	3.3-1
Ascent/Entry Systems Procedures Book.....	3.3-1
Systems Abort Once Around Book.....	3.3-1
Malfunction Procedures Book.....	3.3-1
In-Flight Maintenance Checklist.....	3.3-1
Payload Systems Data and Malfunction Procedures Book.....	3.3-1
Medical Checklist.....	3.3-2
Contingency EVA Operations Checklist.....	3.3-2
Contingency Deorbit Preparation Book.....	3.3-2
3.4 REFERENCE DOCUMENTS.....	3.4-1
Reference Data Book.....	3.4-1
Systems Data Book.....	3.4-1
Data Processing System Dictionary.....	3.4-1
Payload Systems Data/Malfunction Book.....	3.4-1
Maps and Charts Book.....	3.4-1
3.5 OPERATIONAL USE	3.5-1
FDF Fabrication.....	3.5-1
Preliminaries.....	3.5-1
Basic	3.5-1
482	3.5-2
Final	3.5-3
Flight	3.5-3
4. OPERATING LIMITATIONS	4-1
4.1 INSTRUMENT MARKINGS.....	4.1-1
Description.....	4.1-1
Panel F9 Meters.....	4.1-5
Panel O1 Meters.....	4.1-6
Panel O2 Meters.....	4.1-9
Panel O3 Meters.....	4.1-11
4.2 ENGINE LIMITATIONS.....	4.2-1
Space Shuttle Main Engines (SSMEs).....	4.2-1
Orbital Maneuvering System (OMS) Engines.....	4.2-2
Reaction Control System (RCS) Jets.....	4.2-3
4.3 AIRSPEED LIMITATIONS.....	4.3-1
Ascent.....	4.3-1
Entry	4.3-1
Landing.....	4.3-2
4.4 ANGLE OF ATTACK LIMITATIONS.....	4.4-1
Entry	4.4-1
4.5 SIDESLIP LIMITATIONS.....	4.5-1

Section	Page
4.6 LANDING WEIGHT LIMITATIONS	4.6-1
Maximum Landing Weight.....	4.6-1
4.7 DESCENT RATE LIMITATIONS	4.7-1
Main Gear Touchdown.....	4.7-1
Nose Gear Touchdown.....	4.7-1
4.8 CENTER OF GRAVITY LIMITATIONS.....	4.8-1
4.9 ACCELERATION LIMITATIONS.....	4.9-1
Ascent	4.9-1
Entry	4.9-1
Vn Diagrams	4.9-1
4.10 WEATHER LIMITATIONS.....	4.10-1
5. NORMAL PROCEDURES SUMMARY	5-1
5.1 PRELAUNCH	5.1-1
Prelaunch Procedures	5.1-1
5.2 ASCENT	5.2-1
Powered Flight.....	5.2-1
OMS Burns	5.2-3
Post Insertion	5.2-5
5.3 ORBIT	5.3-1
Orbit Operations.....	5.3-1
OMS (RCS) Burns	5.3-4
Rendezvous.....	5.3-4
Last Full On-Orbit Day.....	5.3-7
5.4 ENTRY	5.4-1
Deorbit Preparation.....	5.4-1
Deorbit Burn.....	5.4-3
Entry Interface	5.4-6
Terminal Area Energy Management (TAEM).....	5.4-8
Approach and Landing	5.4-8
5.5 POSTLANDING	5.5-1
6. EMERGENCY PROCEDURES.....	6-1
6.1 LAUNCH ABORT MODES AND RATIONALE.....	6.1-1
Mode 1 – Unaided Egress/Escape	6.1-1
Mode 2 – Aided Escape	6.1-1
Mode 3 – Aided Escape	6.1-2
Mode 4 – Aided Escape	6.1-2

Section	Page
6.2 ASCENT ABORTS	6.2-1
Performance Aborts.....	6.2-1
Systems Aborts.....	6.2-3
Range Safety	6.2-4
6.3 RETURN TO LAUNCH SITE	6.3-1
Powered RTLS.....	6.3-2
Gliding RTLS.....	6.3-6
6.4 TRANSOCEANIC ABORT LANDING	6.4-1
Nominal Transoceanic Abort Landing.....	6.4-1
Post MECO Transoceanic Abort Landing.....	6.4-3
6.5 ABORT ONCE AROUND	6.5-1
OMS-1.....	6.5-1
OMS-2.....	6.5-3
Entry	6.5-4
6.6 ABORT TO ORBIT	6.6-1
Powered Flight	6.6-1
OMS-1.....	6.6-1
OMS-2.....	6.6-1
6.7 CONTINGENCY ABORT	6.7-1
Powered Flight	6.7-1
Three-Engine-Out Automation	6.7-2
ET Separation	6.7-2
Entry	6.7-3
6.8 SYSTEMS FAILURES	6.8-1
APU/Hydraulics.....	6.8-2
Communications	6.8-5
Cryo	6.8-6
Data Processing System	6.8-6
Environmental Control and Life Support System	6.8-8
Electrical Power System	6.8-8
Guidance, Navigation, and Control	6.8-10
Mechanical.....	6.8-12
Main Propulsion System	6.8-12
Orbital Maneuvering System/Reaction Control System	6.8-14
6.9 MULTIPLE FAILURE SCENARIOS	6.9-1
MPS He Leak with APC/ALC Failure.....	6.9-1
Set Splits During Ascent	6.9-1
Stuck Throttle in the Bucket	6.9-1
Second Hydraulic Failure and 1 SSME Failed	6.9-1
Two APUs/Hydraulic Systems	6.9-1
APU 1 and Multiple Prox Box Failures	6.9-1
Two Freon/Water Loops	6.9-2
Total Loss of FES	6.9-2
Total Loss of FES with BFS Failure	6.9-2
Two Fuel Cells.....	6.9-2

Section	Page
Both OMS	6.9-2
OMS/RCS Leak with DPS/EPS Failures	6.9-2
Cryo Leak with Failed Manifold Valve	6.9-3
BFS Self Engage	6.9-3
6.10 SWITCH AND PANEL CAUTIONS	6.10-1
MPS Switches	6.10-1
Fuel Cell Reactant Valves	6.10-1
CRT Power Switch	6.10-1
GPC/MDM	6.10-1
PLB Mech Power/Enable	6.10-1
HYD Press and APU Controller Power Switches	6.10-1
OMS Kit	6.10-1
6.11 SYSTEMS FAILURE SUMMARY	6.11-1
7. TRAJECTORY MANAGEMENT AND FLIGHT CHARACTERISTICS	7-1
7.1 ASCENT	7.1-1
Powered Flight	7.1-1
Insertion OMS Burns	7.1-7
Backup Flight System	7.1-8
Sensory Cues	7.1-9
Ascent Rules of Thumb	7.1-11
7.2 ORBIT	7.2-1
Attitude Control	7.2-1
Translation	7.2-5
Rendezvous/Proximity Operations	7.2-6
Orbit Rules of Thumb	7.2-12
7.3 ENTRY	7.3-1
Overview of Entry Flying Tasks	7.3-1
Deorbit Burn	7.3-1
Entry	7.3-4
Backup Flight System	7.3-11
Sensory Cues	7.3-12
Ground Controlled Approach	7.3-12
Entry Rules of Thumb	7.3-14
7.4 TERMINAL AREA ENERGY MANAGEMENT AND APPROACH, LANDING, AND ROLLOUT (OPS 305)	7.4-1
Definition and Overview	7.4-1
Terminal Area Energy Management	7.4-1
Heading Alignment Cone	7.4-8
Outer Glideslope	7.4-9
Preflare	7.4-14
Inner Glideslope	7.4-15
Touchdown	7.4-16
Derotation	7.4-18
Rollout	7.4-19
Handling Qualities	7.4-20

Section	Page
Wind Effects on Trajectory	7.4-22
Backup Flight System	7.4-23
Off-Nominal Approaches	7.4-23
Sensory Cues	7.4-24
Autoland	7.4-24
Terminal Area Energy Management and Approach, Landing, and Rollout Rules of Thumb	7.4-27
8. INTEGRATED OPERATIONS.....	8-1
8.1 FLIGHT CREW DUTIES AND COORDINATION.....	8.1-1
Dynamic Flight Phases	8.1-1
Orbit Phase.....	8.1-1
Intercom Protocol.....	8.1-2
8.2 WORKING WITH MISSION CONTROL.....	8.2-1
MCC Resources.....	8.2-1
Operations Monitoring and Control.....	8.2-1
Air-to-Ground Voice Communications.....	8.2-2
Telemetry Uplink.....	8.2-3
8.3 PRELAUNCH.....	8.3-1
Flight Crew	8.3-1
Mission Control Center	8.3-1
Launch Control Center.....	8.3-1
8.4 LAUNCH	8.4-1
Flight Crew	8.4-1
Mission Control Center	8.4-2
Launch Control Center.....	8.4-2
8.5 ASCENT.....	8.5-1
Flight Crew	8.5-1
Mission Control Center	8.5-1
8.6 ORBIT.....	8.6-1
Flight Crew	8.6-1
Mission Control Center	8.6-1
8.7 ENTRY.....	8.7-1
Flight Crew	8.7-1
Mission Control Center	8.7-1
8.8 POSTLANDING.....	8.8-1
Flight Crew	8.8-1
Mission Control Center	8.8-1
Launch Control Center.....	8.8-1

Section	Page
9. PERFORMANCE	9-1
9.1 ASCENT	9.1-1
Payload	9.1-1
Launch Window	9.1-2
Squatcheloids	9.1-4
Main Engines	9.1-5
Altitude, Velocity, and Dynamic Pressure	9.1-5
MECO Targets	9.1-8
ET Impact	9.1-8
Abort Mode Boundaries	9.1-9
Minimum Safe Orbit	9.1-10
9.2 ORBIT	9.2-1
Drag	9.2-1
Period	9.2-1
Perturbations	9.2-1
OMS/RCS	9.2-2
9.3 ENTRY (OPS 304)	9.3-1
Downrange/Crossrange	9.3-1
Trajectory	9.3-2
Entry History	9.3-2
Entry RCS Use Data	9.3-2
Rollout/Braking	9.3-6
Loss of Braking	9.3-6
Rollout History	9.3-6
Performance Rules of Thumb	9.3-11
 Appendix	
APPENDIX A: PANEL DIAGRAMS	A-1
APPENDIX B: CRT DISPLAYS	B-1
APPENDIX C: STUDY NOTES	C-1
APPENDIX D: RULES OF THUMB	D-1
APPENDIX E: OI UPDATES	E-1
 Index	 I-1

1. GENERAL DESCRIPTION

CONTENTS

1.1 OVERVIEW	1.1-1
1.2 ORBITER STRUCTURE	1.2-1
1.3 EXTERNAL TANK	1.3-1
1.4 SOLID ROCKET BOOSTERS	1.4-1

The section provides general background information about the orbiter, its configuration and coordinate systems, the nominal mission profile, and general procedures followed during a shuttle mission. It also briefly discusses components, such as the external tank and solid rocket, that are not included in the next section on orbiter systems.

Space Shuttle - Requirements

The Space Shuttle system consists of four primary elements: an orbiter, external tank, solid rocket boosters (SRBs), an external tank (ET), a heavy lift and payload and three main stages (MS). The orbiter is designed to support payloads into near Earth orbit (NEO) 500 n. mi above the Earth. Payloads approved as a class 17 feet in diameter and 60,000 lbs. Maximum system requirements are that the orbiter and the two SRBs be reusable.

The orbiter has a rated life span of up to eight years. The nominal mission is 28 to 33 days in space. The crew compartment has a pressurized environment, and the maximum load is never greater than 3 g. In its return to Earth, the orbiter has a 75-degree maximum angle of attack and a maximum landing speed of about 1,200 mph.

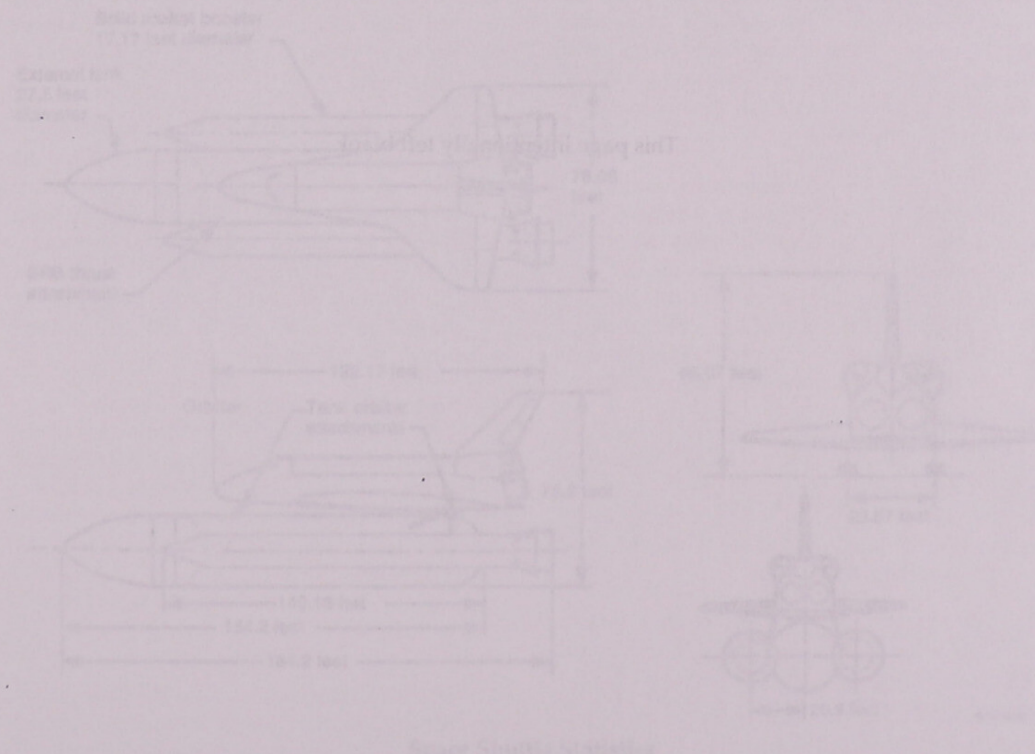

1.1 OVERVIEW

CONTENTS

Space Shuttle Requirements.....	1.1-1
Nominal Mission Profile.....	1.1-2
Launch and Landing Sites.....	1.1-5
Orbiter Ground Turnaround	1.1-6
Space Shuttle Coordinate Reference System	1.1-7
Location Codes	1.1-8

Space Shuttle Requirements

The space shuttle system consists of four primary elements: an orbiter spacecraft, two solid rocket boosters (SRBs), an external tank (ET) to house fuel and oxidizer, and three space shuttle main engines (SSMEs). The shuttle can transport payloads into near Earth orbit 100 to 312 n. mi. above the Earth. Payloads are carried in a bay 15 feet in diameter and 60 feet long. Major system requirements are that the orbiter and the two SRBs be reusable.

The orbiter has carried a flight crew of up to eight persons. The nominal mission is 4 to 16 days in space. The crew compartment has a shirtsleeve environment, and the acceleration load is never greater than 3 g's. In its return to Earth, the orbiter has a crossrange maneuvering capability of about 1,100 n. mi..

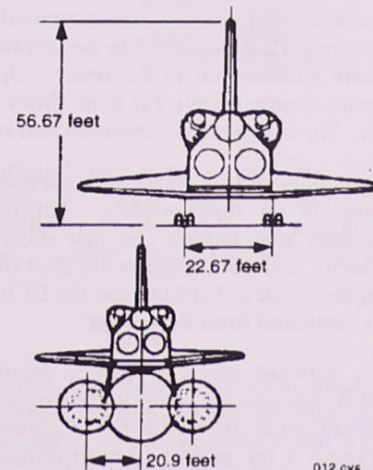
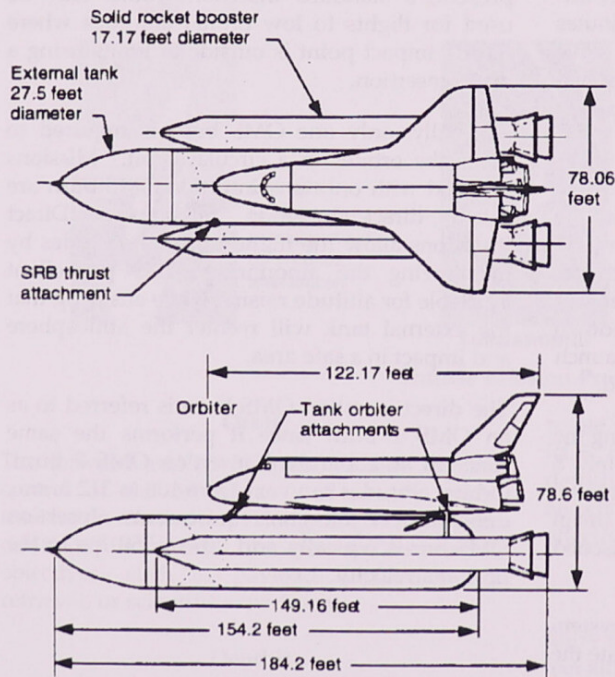

012.cvs

Space Shuttle Statistics

Nominal Mission Profile

Launch

In the launch configuration, the orbiter and two SRBs are attached to the ET in a vertical (nose-up) position on the launch pad. Each SRB is attached at its aft skirt to the mobile launcher platform by four bolts.

The three SSMEs, fed liquid hydrogen fuel and liquid oxygen oxidizer from the ET, are ignited first. When it has been verified that the engines are operating at the proper thrust level, a signal is sent to ignite the SRBs. At the proper thrust-to-weight ratio, initiators (small explosives) at eight hold-down bolts on the SRBs are fired to release the space shuttle for lift-off. Elapsed time is a few seconds.

Maximum dynamic pressure is reached early in the ascent, nominally 30 to 60 seconds after lift-off. Approximately 1 minute later (2 minutes into the ascent phase), the two SRBs have consumed their propellant and are jettisoned from the ET. This is triggered by a separation signal from the orbiter.

The boosters briefly continue to ascend, while small thrusters fire to carry them away from the space shuttle. The boosters then turn and descend, and at a predetermined altitude, parachutes are deployed to decelerate them for a safe splashdown in the ocean. Splashdown occurs approximately 141 n. mi. from the launch site. The boosters are recovered and reused.

The orbiter and ET continue to ascend, using the thrust of the three SSMEs. Approximately 8 minutes after launch and just short of orbital velocity, the three engines are shut down (main engine cutoff or MECO), and the ET is jettisoned on command from the orbiter.

The forward and aft reaction control system (RCS) jets provide attitude control, translate the orbiter away from the ET at separation, and maneuver the orbiter to burn attitude prior to

the orbital maneuvering system (OMS) burn. The ET continues on a ballistic trajectory and enters the atmosphere, where it disintegrates. Its nominal impact is in the Indian Ocean for a 28° inclination launch.

Orbit Insertion and Circularization

One type of mission profile, called a standard insertion because it was the standard early in the shuttle program, uses two OMS burns for orbital insertion. The first OMS burn (OMS 1) raises maximum altitude and occurs just a few minutes after MECO. The second OMS burn (OMS 2) occurs at the highest point of the trajectory after MECO/OMS 1. OMS 2 raises the lowest point of the orbit (perigee) and usually is targeted to achieve a circular orbit. Standard insertions were used on early flights when less information was available on SSME performance and targeting precision. At present, a standard insertion would only be used for flights to low orbital altitudes where the ET impact point is outside of limits using a direct insertion.

Normally, only one OMS burn is required to place the orbiter in a circular orbit. Missions planned with only one insertion OMS burn are called direct insertion missions. Direct insertions allow the highest orbital altitudes by maximizing the amount of OMS propellant available for altitude raising while ensuring that the external tank will reenter the atmosphere and impact in a safe area.

The direct insertion OMS burn is referred to as an OMS 2 burn since it performs the same function as a standard insertion OMS 2 burn. Orbital altitudes can vary from 100 to 312 n. mi., depending on mission requirements. Insertion OMS burns typically add 200 to 550 fps to the orbiter's velocity.

MAIN ENGINE CUTOFF, EXTERNAL TANKS SEPARATION

Altitude:
59 nautical miles
Velocity: 25,581 feet
per second about 8.5
minutes after launch
(just before orbit
insertion)



ORBITAL OPERATIONS

Mission:
Nominal 4 to 16
days; 100 to 316
nautical mile orbits;
25,000 feet per
second

**ORBITER INSERTION
AND CIRCULARIZATION**

For either one or two OMS burns to
change trajectory from suborbital
to orbital; typically 200 to 550 feet
per second velocity increase.
Altitude 100 to 312 nautical miles



SRB SEPARATION

Two minutes after
launch

DEORBIT

Velocity decreased nominal
(200 to 550 feet per second)
from Earth orbit operations



LAUNCH

Maximum dynamic
pressure about
60 seconds
after launch



TURNAROUND

LANDING

Touchdown speed
195 or 250 knots

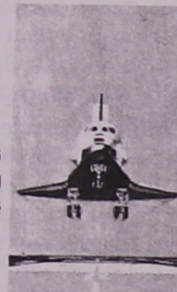

Shuttle Mission Profile

Orbit

The forward and aft RCS jets provide attitude control of the orbiter as well as any minor translation maneuvers along a given axis on orbit. While on orbit, the crew fulfills mission objectives, such as payload deployment or retrieval, or scientific experiments.

Deorbit

At the completion of orbital operations, the RCS is used to orient the orbiter in a tail first attitude. The two OMS engines are burned to slow the orbiter for deorbit. The deorbit burn usually decreases the orbiter's velocity 200 to 550 feet per second depending on orbital altitude. When the deorbit burn is complete, the RCS is used to

rotate the orbiter's nose forward for entry. The RCS controls the orbiter until atmospheric density is sufficient for the pitch, roll, and yaw aerodynamic control surfaces to become effective.

Entry

Entry interface is considered to occur at 400,000 feet altitude approximately 4,200 n. mi. from the landing site and at approximately 25,000 feet per second velocity. The orbiter is maneuvered to 0° roll and yaw (wings level) and a 40° angle of attack for entry. The flight control system issues the commands to roll, pitch, and yaw RCS jets for rate damping.

Without forward RCS programmed test inputs, the forward RCS jets are inhibited prior to entry interface, and the aft RCS jets maneuver the spacecraft until a dynamic pressure of 10 pounds per square foot is sensed. This is when the orbiter's ailerons become effective. The aft RCS roll jets are then deactivated. At a dynamic pressure of 2 pounds per square foot, the orbiter's elevators become active, and the aft RCS pitch jets are deactivated at a q -bar of 40. The orbiter's speed brake is used below Mach 10 to induce a more positive downward elevator trim deflection. At approximately Mach 5, the rudder becomes activated, and the aft RCS jets are deactivated at Mach 1.

Entry guidance must dissipate the tremendous amount of energy the orbiter possesses when it enters the Earth's atmosphere to assure that the orbiter does not either burn up (entry angle too steep) or skip out of the atmosphere (entry angle too shallow) and that the orbiter is properly positioned to reach the desired touchdown point.

During entry, energy is dissipated by the atmospheric drag on the orbiter's surface. The thermal protection system covering the entire orbiter provides the protection necessary for the orbiter to survive the extremely high temperatures encountered. Higher atmospheric drag levels enable faster energy dissipation with a steeper trajectory.

Normally, the angle of attack and bank angle enable the atmospheric drag of any flight vehicle to be controlled. However, for the orbiter, angle of attack was rejected because it creates surface temperatures above the design specification. The angle of attack scheduled during entry is loaded into the orbiter computers as a function of relative velocity, leaving bank angle for energy control. Increasing the bank angle decreases the vertical component of lift, causing a higher sink rate and energy dissipation rate. Increasing the bank angle does raise the surface temperature of the orbiter, but not nearly as drastically as an equal angle of attack increase.

If the orbiter is low on energy (current range-to-go much greater than nominal at current velocity), entry guidance will command lower than nominal drag levels. If the orbiter has too

much energy (current range-to-go much less than nominal at the current velocity), entry guidance will command higher-than-nominal drag levels to dissipate the extra energy.

Bank angle is used to control cross range. Azimuth error is the angle between the plane containing the orbiter's position vector and the heading alignment cone tangency point and the plane containing the orbiter's position vector and velocity vector. When the azimuth error exceeds a computer-loaded number, the orbiter's bank angle is reversed.

Thus, descent rate and downranging are controlled by bank angle. The steeper the bank angle, the greater the descent rate and the greater the drag. Conversely, the minimum drag attitude is wings level. Cross range is controlled by bank reversals. The entry thermal control phase is designed to keep the backface and surface temperatures within the design limits. A constant heating rate is established until below 19,000 feet per second.

The equilibrium glide phase transitions the orbiter from the rapidly increasing drag levels of the temperature control phase to the constant drag level of the constant drag phase. The equilibrium glide flight is defined as flight in which the flight path angle, which is the angle between the local horizontal and the local velocity vector, remains constant. Equilibrium glide flight provides the maximum downrange capability. It lasts until the drag acceleration reaches 33 feet per second squared.

The constant drag phase begins at that point. The angle of attack is initially 40° , but it begins to ramp down to approximately 36° by the end of this phase.

In the transition phase, the angle of attack continues to ramp down, reaching the approximately 14° angle of attack at the entry terminal area energy management (TAEM) interface, at approximately 83,000 feet altitude, 2,500 feet per second, and 60 n. mi. from the landing runway. Control is then transferred to TAEM guidance.

During the entry phases described, the orbiter's bank commands keep the orbiter on the drag profile and control cross range.

TAEM guidance steers the orbiter to one of two 18,000-ft radius heading alignment cones (HAC), which are located tangent to and on either side of the runway centerline on the approach end. In TAEM guidance, excess energy is dissipated with an S-turn. This increases the ground track range as the orbiter turns away from the HAC until sufficient energy is dissipated to allow a normal approach and landing guidance phase capture, which begins at 10,000 feet altitude. The orbiter also can be flown near the velocity for maximum lift over drag or wings level for the range stretch case. The spacecraft slows to subsonic velocity at approximately 49,000 feet altitude, about 26 n. mi. from the landing site.

At TAEM acquisition, the orbiter is turned until it is aimed at a point tangent to the HAC and continues until it reaches way point (WP) 1. At WP-1, the TAEM heading alignment phase begins. The HAC is followed until landing runway alignment, $\pm 20^\circ$, has been achieved. In the TAEM prefinal phase, the orbiter pitches down to acquire the steep glideslope, increases airspeed, banks to acquire the runway centerline, and continues until on the runway centerline, on the outer glideslope, and on airspeed. The approach and landing guidance phase begins with the completion of the TAEM prefinal phase and ends when the spacecraft comes to a complete stop on the runway.

Landing

The approach and landing trajectory capture phase begins at the approach and landing interface and continues to acquisition of the steep outer glideslope. The approach and landing phase begins at about 10,000 feet altitude at an equivalent airspeed of 300 knots equivalent airspeed (KEAS) and 5.8 or 6.3 n. mi. (for -20° or -18° glideslope, respectively) from touchdown. Approach and landing guidance is initiated at this point to guide the orbiter to the -20° or -18° glideslope aimed at a target 7,500 feet short of the runway. The speed brake is modulated to hold the reference velocity. The descent rate in the later portion of TAEM and approach and landing is greater than 10,000 feet per minute.

At 2,000 feet above ground level (AGL), a preflare maneuver is started to position the spacecraft for a 1.5° inner glideslope in

preparation for landing with the speed brake positioned to control touchdown energy. The flight crew deploys the landing gear at 300 feet AGL. The final flare reduces the sink rate of the spacecraft to a target value of 3 feet per second. Touchdown occurs approximately 2,500 feet past the runway threshold at a speed of 195 KEAS (lightweight orbiters) or 205 KEAS (heavyweight orbiters).

Launch and Landing Sites

The Kennedy Space Center (KSC) in Florida is used for all shuttle launches. Edwards Air Force Base in California and KSC are the primary landing sites. The incorporation of a drag chute and carbon/carbon brakes will now allow more missions to land at KSC. Contingency landing sites are also provided in the event the orbiter must return to Earth in an emergency.

A 035° azimuth launch places the spacecraft in an orbital inclination of 57° , which means the spacecraft in its orbital trajectories around Earth will never exceed an Earth latitude higher or lower than 57° north or south of the equator. A launch path from KSC at an azimuth of 090° (due east from KSC) will place the spacecraft in an orbital inclination of 28.5° .

These two azimuths, 035° and 090° , represent the current launch limits from KSC. Any azimuth angles further north or south would launch a spacecraft over a habitable land mass, adversely affect safety provisions for abort or vehicle separation conditions, or present the undesirable possibility that the SRB or external tank could land on inhabited territory.

The Earth rotates from west to east at a speed of approximately 900 nautical miles (n. mi.) per hour. For due east launches (090° azimuth), the Earth's rotational velocity adds to the velocity increase caused by the SRBs and main engines. Due east launches provide the maximum payload and altitude capability. Launches on azimuths other than due east benefit less and less from Earth's rotation as the launch azimuth approaches north or south. Westerly launches would decrease performance even further.

Orbiter Ground Turnaround

Spacecraft recovery operations at the nominal end-of-mission landing site are supported by approximately 160 space shuttle launch operations team members. Ground team members wearing self-contained atmospheric protective ensemble suits that protect them from toxic chemicals approach the spacecraft as soon as it stops rolling. The ground team members take sensor measurements to ensure the

A second GSE ground cooling unit is connected to the left-hand orbiter T-0 umbilical spacecraft Freon coolant loops to provide cooling for the flight crew and avionics during the postlanding and system checks. The spacecraft fuel cells remain powered up at this time. The flight crew then exits the spacecraft, and a ground crew powers down the spacecraft.

At KSC, the orbiter and GSE convoy move from the runway to the Orbiter Processing Facility

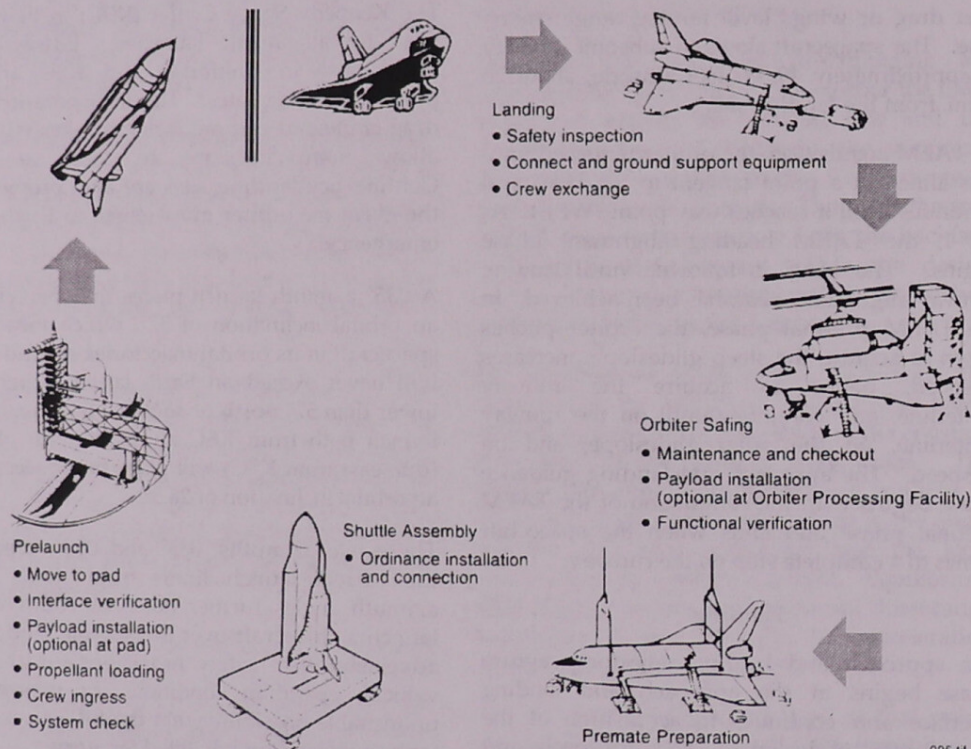

Kennedy Space Center Ground Turnaround Sequence

atmosphere in the vicinity of the spacecraft is not hazardous. In the event of propellant leaks, a wind machine truck carrying a large fan is moved into the area to create a turbulent airflow that will break up gas concentrations and reduce the potential for an explosion.

A ground support equipment (GSE) air-conditioning purge unit is attached to the right-hand orbiter T-0 umbilical so cool air can be directed through the orbiter's aft fuselage, payload bay, forward fuselage, wings, vertical stabilizer, and OMS/RCS pods to dissipate the heat of entry.

(OPF). If the spacecraft lands at Edwards Air Force Base in California, the same procedures and GSE are used after the orbiter has stopped on the runway. The orbiter and GSE convoy move from the runway to the orbiter mate and demate facility. After detailed inspection, the spacecraft is prepared to be ferried atop the Shuttle Carrier Aircraft from Edwards Air Force Base to KSC. For ferrying, a tail cone is installed over the aft section of the orbiter.

In the event of a landing at an alternate site, a crew of about eight will move to the landing site to assist the astronaut crew in preparing the

orbiter for loading aboard the Shuttle Carrier Aircraft for transport back to KSC. For landings outside the U.S., personnel at the contingency landing sites will be provided minimum training on safe handling of the orbiter with emphasis on crash rescue training, towing the orbiter to a safe area, and prevention of propellant conflagration.

Upon its return to the OPF at KSC, the orbiter is safed (ordnance devices safed), the payload (if any) is removed, and the orbiter payload bay is reconfigured for the next mission. Any required maintenance and inspections are also performed while the orbiter is in the OPF. A payload for the orbiter's next mission may be installed in the orbiter's payload bay in the OPF or when the orbiter is at the launch pad.

The spacecraft is then towed to the Vertical Assembly Building and mated to the external tank. The external tank and SRBs are stacked and mated on the mobile launcher platform while the orbiter is being refurbished. Space shuttle orbiter connections are made, the integrated vehicle is checked, and ordnance is installed.

The mobile launcher platform moves the entire space shuttle system on a crawler transporter to the launch pad, where connections are made, and servicing and checkout activities begin. If the payload was not installed in the OPF, it is installed at the launch pad followed by prelaunch activities.

KSC Launch Operations has responsibility for all mating, prelaunch testing, and launch control ground activities until the space shuttle vehicle clears the launch pad tower. Responsibility is then turned over to NASA's Johnson Space Center Mission Control Center. Mission Control's responsibility includes ascent, on-orbit operations, entry, approach, and landing until crew egress, at which time the orbiter is handed over to the postlanding operations at the landing site for turnaround and relaunch. At the launch site, the SRBs and ET are processed for launch, and the SRBs are recycled for reuse.

Space Shuttle Coordinate Reference System

The space shuttle coordinate reference system is a means of locating specific points on the orbiter. The system is measured in inches and decimal places; X_o designates the longitudinal axis, Y_o the lateral axis, and Z_o the vertical axis. The subscript "o" indicates orbiter; similar reference systems are used for the ET (T), SRB (B), and overall space shuttle system (S).

In each coordinate system, the X-axis zero point is located forward of the nose tip; that is, the orbiter nose tip location is 236 inches aft of the zero point (at $X_o = 236$), the ET nose cap tip location is at $X_T = 322.5$, and the SRB nose tip location is at $X_B = 200$. In the orbiter, the horizontal X_o , Y_o reference plane is located at $Z_o = 400$, which is 336.5 inches above the external tank horizontal X_T , Y_T reference plane located at

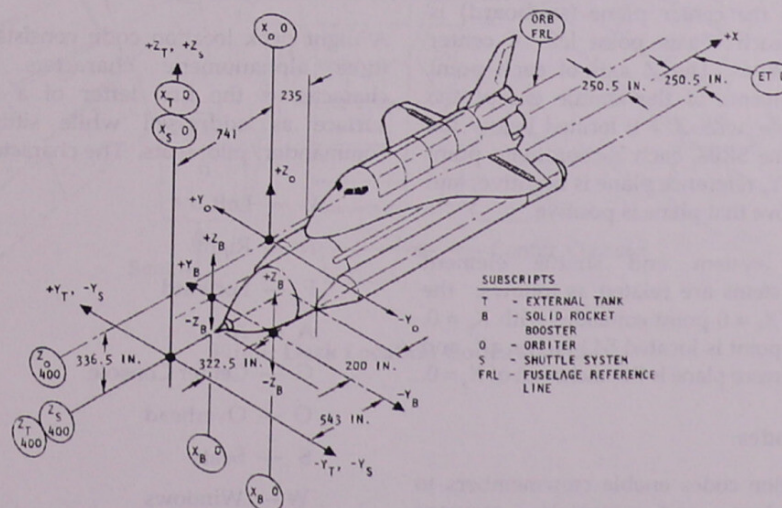

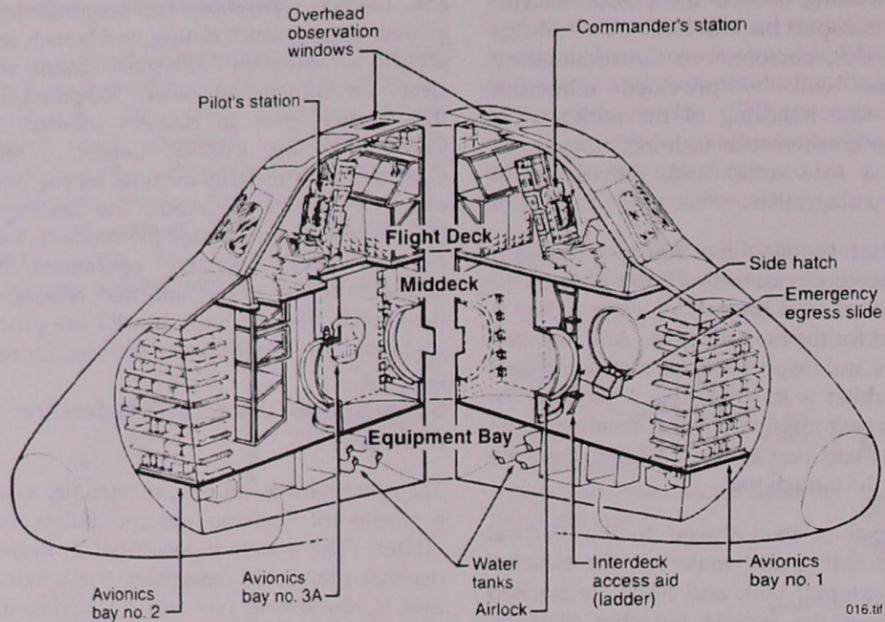

Crew Cabin (Cutaway View)

$Z_T = 400$. The solid rocket booster horizontal X_B , Y_B reference plane is located at $Z_B = 0$ and coincident with the external tank horizontal plane at $Z_T = 400$. The solid rocket booster vertical X_B , Z_T planes are located at $+Y_S = 250.5$ and $-Y_S = 250.5$. Also, the orbiter, external tank, and shuttle system center X , Z planes coincide.

From the $X = 0$ point, aft is positive, and forward is negative for all coordinate systems. Looking forward, each shuttle element Y -axis point right of the center plane (starboard) is positive and each Y -axis point left of center (port) is negative. The Z axis of each point within all elements of the shuttle except the SRBs is positive, with $Z = 0$ located below the element. In the SRBs, each Z -coordinate point below the X_B , Y_B reference plane is negative, and each point above that plane is positive.

The shuttle system and shuttle element coordinate systems are related as follows: the external tank $X_T = 0$ point coincides with $X_S = 0$, the SRB $X_B = 0$ point is located 543 inches aft, and the Y_0 , Z_0 reference plane is 741 inches aft of $X_S = 0$.

Location Codes

Orbiter location codes enable crewmembers to locate displays and controls, stowage

compartments and lockers, access panels, and wall-mounted equipment in the orbiter crew compartments. The orbiter crew compartments are the flight deck, middeck, and airlock. A fourth compartment becomes part of the configuration when the Spacelab is flown. Because of compartment functions and geometry, each has a unique location coding format.

Flight Deck Location Codes

A flight deck location code consists of two or three alphanumeric characters. The first character is the first letter of a flight deck surface as addressed while sitting in the commander/pilot seats. The characters are:

- L — Left
- R — Right
- F — Forward
- A — Aft
- C — Center Console
- O — Overhead
- S — Seats
- W — Windows

SURFACES	GENERAL NUMBERING PHILOSOPHY
L - Left R - Right C - Center console O - Overhead	<ul style="list-style-type: none"> Numbered from the top to bottom, forward to aft
F - Forward A - Aft	<ul style="list-style-type: none"> Numbered left to right, top to bottom (facing the surface)
W - Windows	<ul style="list-style-type: none"> The forward windows are numbered left to right (W1 through W6) facing forward The overhead windows are numbered left to right (W7 and W8) facing aft The aft windows are numbered left to right (W9 and W10) facing aft
S - Seats	<ul style="list-style-type: none"> The CDR's seat is <u>S1</u> and the PLT's seat is <u>S2</u>

The second and third characters are numerics identifying the relative location of components on each flight deck surface. The numbering system philosophy is summarized in the table above.

General Numbering Scheme for Flight Deck Surfaces

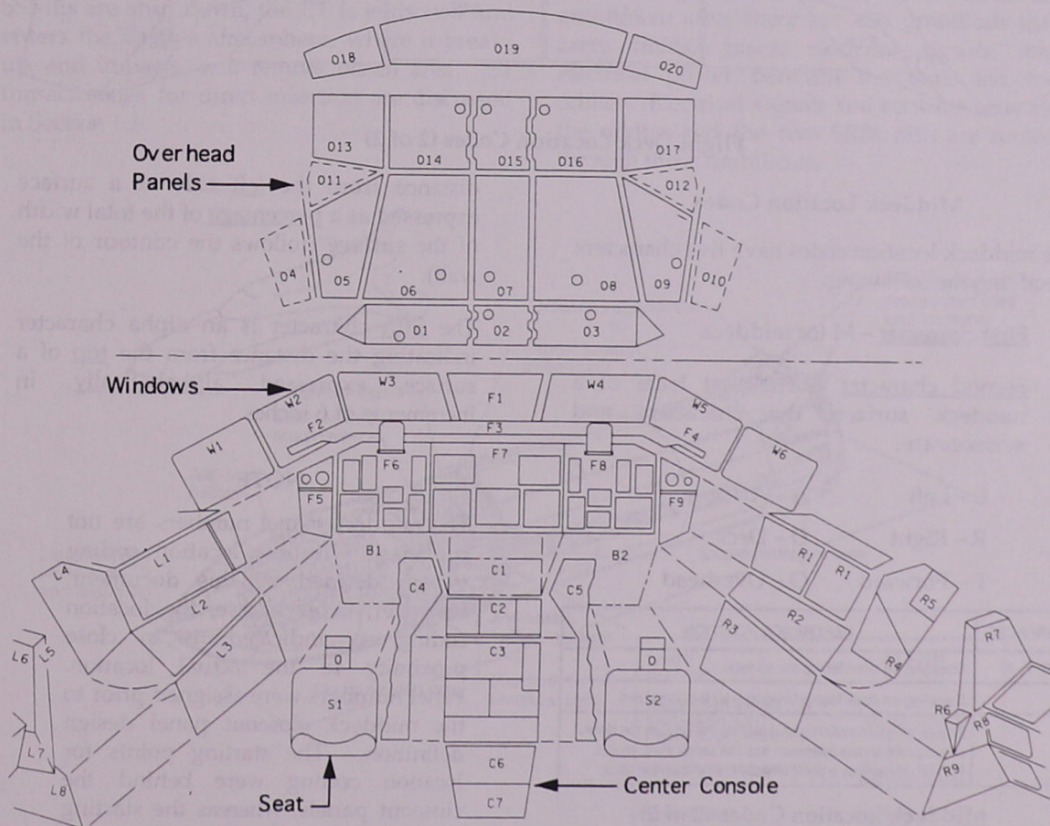

Flight Deck Location Codes (1 of 2)

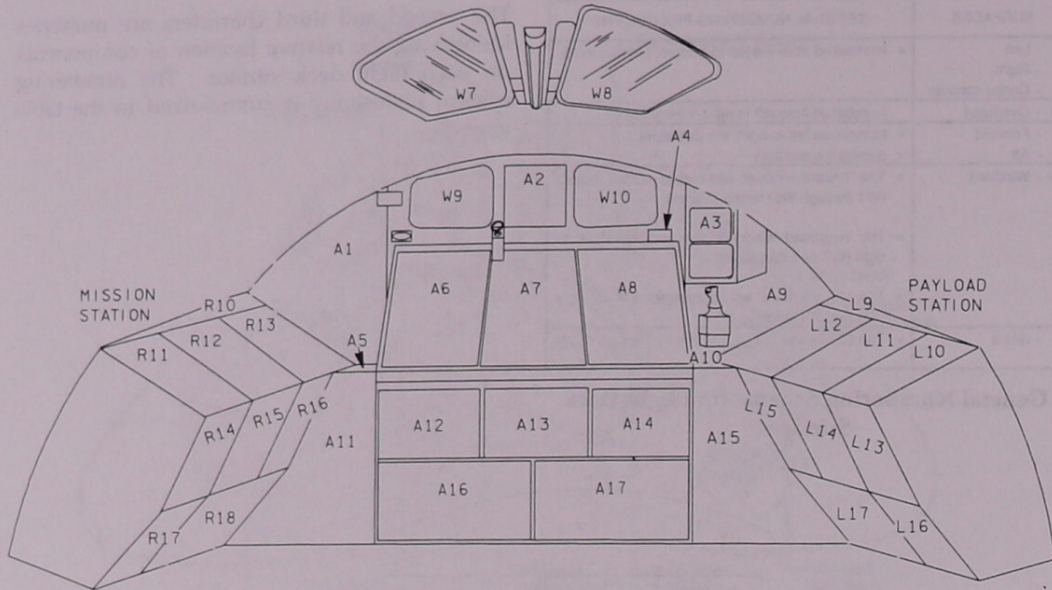

Flight Deck Location Codes (2 of 2)

Middeck Location Codes

The middeck location codes have five characters specifying the following:

First character – M for middeck

Second character – The first letter of a middeck surface; the characters and surfaces are:

- L – Left
- R – Right
- F – Forward
- A – Aft
- D – Deck
- O – Overhead

SURFACES	REFERENCE POSITION
L, R, F, A	Standing on deck facing the surface
D	Standing on deck facing forward (+X) looking down
O	The overhead location grid matches the grid on the deck; i.e., a point on the overhead has the same third, fourth, fifth characters as a point directly below it on the deck

Middeck Location Codes (2 of 2)

The reference position for identifying the surface is standing on the middeck floor (deck) facing forward (+X).

Third/fourth/fifth characters – These characters form a location grid on each middeck surface. The third and fourth characters are numerics indicating the

distance from the left side of a surface expressed as a percentage of the total width of the surface (follows the contour of the wall).

The fifth character is an alpha character indicating the distance from the top of a surface expressed alphabetically in increments of 6 inches.

NOTE

The middeck panel numbers are not consistent with the location coding system defined by this document. However, in each case, the location coding, as indicated, is in close proximity to the actual location. Panel numbers were assigned prior to the middeck closeout panel design definition. The starting points for location coding were behind the closeout panels, whereas the starting points used in this document are in front of the closeout panels.

1.3 EXTERNAL TANK

CONTENTS

Liquid Oxygen Tank	1.3-2
Intertank	1.3-2
Liquid Hydrogen Tank	1.3-2
Thermal Protection System	1.3-3
Hardware and Instrumentation	1.3-3
Range Safety System	1.3-4

The external tank (ET) contains the liquid hydrogen fuel and liquid oxygen oxidizer and supplies them under pressure to the three SSMEs in the orbiter during ascent. When the SSMEs are shut down, the ET is jettisoned and enters the Earth's atmosphere, where it breaks up and impacts in a remote ocean area. ET impact zones for direct insertion are discussed in Section 1.1.

The largest and heaviest (when loaded) element of the space shuttle, the ET, has three major components: the forward liquid oxygen tank, an unpressurized intertank that contains most of the electrical components, and the aft liquid hydrogen tank.

Since the STS-6 mission, a lightweight external tank (LWT) has been used. This tank weighs approximately 66,000 pounds inert. To help increase payload capability, a new super lightweight external tank (SLWT) was developed, which is the same size as the LWT but weighs approximately 7500 pounds less.

The ET is attached to the orbiter at one forward attachment point and two aft points. In the aft attachment area, there are also umbilicals that carry fluids, gases, electrical signals, and electrical power between the tank and the orbiter. Electrical signals and controls between the orbiter and the two SRBs also are routed through those umbilicals.

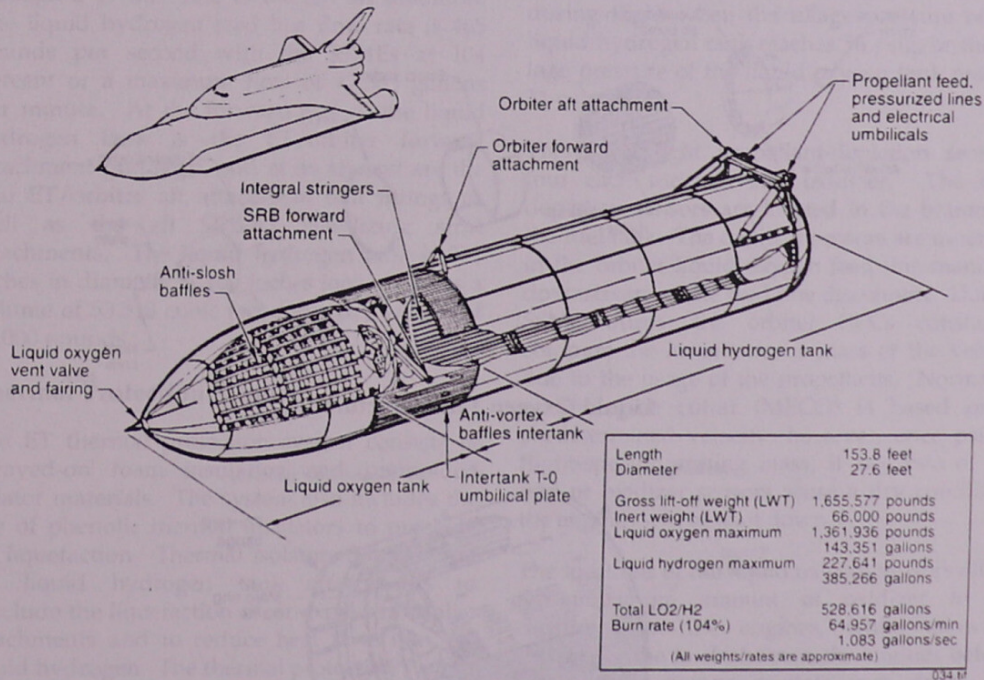

Lightweight External Tank

Liquid Oxygen Tank

The liquid oxygen tank is an aluminum monocoque structure composed of a fusion-welded assembly of preformed, chem-milled gores, panels, machined fittings, and ring chords. It operates in a pressure range of 20 to 22 psig. The tank contains anti-slosh and anti-vortex provisions to minimize liquid residuals and damp fluid motion. The tank feeds into a 17-inch-diameter feed line that conveys the liquid oxygen through the intertank, then outside the ET to the aft right-hand ET/orbiter disconnect umbilical. The 17-inch-diameter feed line permits liquid oxygen to flow at approximately 2,787 pounds per second with the SSMEs operating at 104 percent or permits a maximum flow of 17,592 gallons per minute. The liquid oxygen tank's double-wedge nose cone reduces drag and heating, contains electrical system components, and serves as a lightning rod. The liquid oxygen tank's volume

is 19,563 cubic feet. It is 331 inches in diameter, 592 inches long and weighs 12,000 pounds empty.

Intertank

The intertank is a steel/aluminum semimonocoque cylindrical structure with flanges on each end for joining the liquid oxygen and liquid hydrogen tanks. The intertank houses ET instrumentation components and provides an umbilical plate that interfaces with the ground facility arm for purge gas supply, hazardous gas detection, and hydrogen gas boiloff during ground operations. It consists of mechanically joined skin, stringers, and machined panels of aluminum alloy. The intertank is vented during flight. The intertank contains the forward SRB-ET attach thrust beam and fittings that distribute the SRB loads to the liquid oxygen and liquid hydrogen tanks. The intertank is 270 inches long, 331 inches in diameter, and weighs 12,100 pounds.

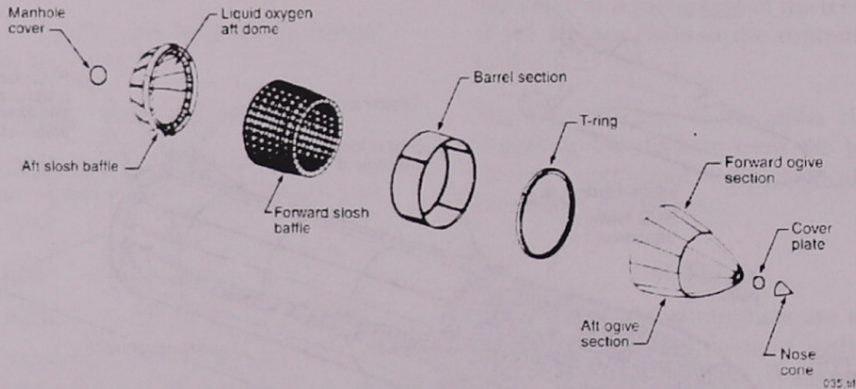

Liquid Oxygen Tank Structure

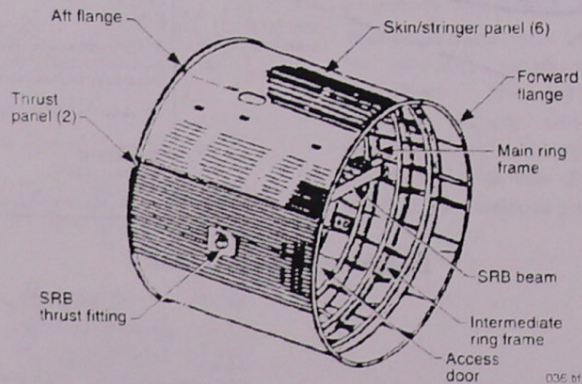

Intertank Structure

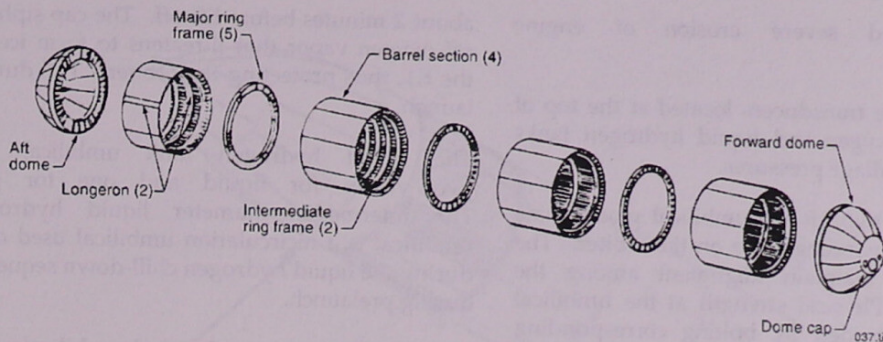

Liquid Hydrogen Tank Structure

Liquid Hydrogen Tank

The liquid hydrogen tank is an aluminum semimonocoque structure of fusion-welded barrel sections, five major ring frames, and forward and aft ellipsoidal domes. Its operating pressure range is 32 to 34 psia. The tank contains an anti-vortex baffle and siphon outlet to transmit the liquid hydrogen from the tank through a 17-inch line to the left aft umbilical. The liquid hydrogen feed line flow rate is 465 pounds per second with the SSMEs at 104 percent or a maximum flow of 47,365 gallons per minute. At the forward end of the liquid hydrogen tank is the ET/orbiter forward attachment pod strut, and at its aft end are the two ET/orbiter aft attachment ball fittings as well as the aft SRB-ET stabilizing strut attachments. The liquid hydrogen tank is 331 inches in diameter, 1,160 inches long, and has a volume of 53,518 cubic feet and a dry weight of 29,000 pounds.

Thermal Protection System

The ET thermal protection system consists of sprayed-on foam insulation and premolded ablator materials. The system also includes the use of phenolic thermal insulators to preclude air liquefaction. Thermal isolators are required for liquid hydrogen tank attachments to preclude the liquefaction of air-exposed metallic attachments and to reduce heat flow into the liquid hydrogen. The thermal protection system weighs 4,823 pounds.

Hardware and Instrumentation

The external hardware, ET/orbiter attachment fittings, umbilical fittings, electrical, and range safety system weigh 9,100 pounds.

Each propellant tank has a vent and relief valve at its forward end. This dual-function valve can be opened by ground support equipment for the vent function during prelaunch and can open during flight when the ullage pressure of the liquid hydrogen tank reaches 36 psig, or the ullage pressure of the liquid oxygen tank reaches 31 psig.

There are eight propellant-depletion sensors, four each for fuel and oxidizer. The fuel-depletion sensors are located in the bottom of the fuel tank. The oxidizer sensors are mounted in the orbiter liquid oxygen feed line manifold downstream of the feed line disconnect. During SSME burns, the orbiter GPCs constantly compute the instantaneous mass of the vehicle due to the usage of the propellants. Normally, main engine cutoff (MECO) is based on a predetermined velocity; however, once past a flight-specific arming mass, if any two of the fuel or oxidizer sensors sense a dry condition, the engines will be shut down.

The locations of the liquid oxygen sensors allow the maximum amount of oxidizer to be consumed in the engines, while allowing sufficient time to shut down the engines before the oxidizer pumps cavitate (run dry). In addition, 1,100 pounds of liquid hydrogen are loaded over and above that required by the 6:1 oxidizer/fuel engine mixture ratio. This ensures that MECO from the depletion sensors is fuel-rich; oxidizer-rich engine shutdowns can cause

burning and severe erosion of engine components.

Four pressure transducers located at the top of the liquid oxygen and liquid hydrogen tanks monitor the ullage pressures.

Each of the two aft ET umbilical plates mate with a corresponding plate on the orbiter. The plates help maintain alignment among the umbilicals. Physical strength at the umbilical plates is provided by bolting corresponding umbilical plates together. When the orbiter GPCs command external tank separation, the bolts are severed by pyrotechnic devices.

The ET has five propellant umbilical valves that interface with orbiter umbilicals: two for the liquid oxygen tank and three for the liquid hydrogen tank. One of the liquid oxygen tank umbilical valves is for liquid oxygen, the other for gaseous oxygen.

A swing-arm-mounted cap to the fixed service structure covers the oxygen tank vent on top of the ET during the countdown and is retracted

about 2 minutes before lift-off. The cap siphons off oxygen vapor that threatens to form ice on the ET, thus protecting the orbiter's TPS during launch.

The liquid hydrogen tank umbilical has two valves for liquid and one for gas. The intermediate-diameter liquid hydrogen umbilical is a recirculation umbilical used only during the liquid hydrogen chill-down sequence during prelaunch.

The ET also has two electrical umbilicals that carry electrical power from the orbiter to the tank and the two SRBs and provide information from the SRBs and ET to the orbiter.

Range Safety System

A range safety system provides for dispersing tank propellants if necessary. It includes a battery power source, a receiver/decoder, antennas, and ordnance.

Various parameters are monitored and displayed on the flight deck display and control panel and are transmitted to the ground.

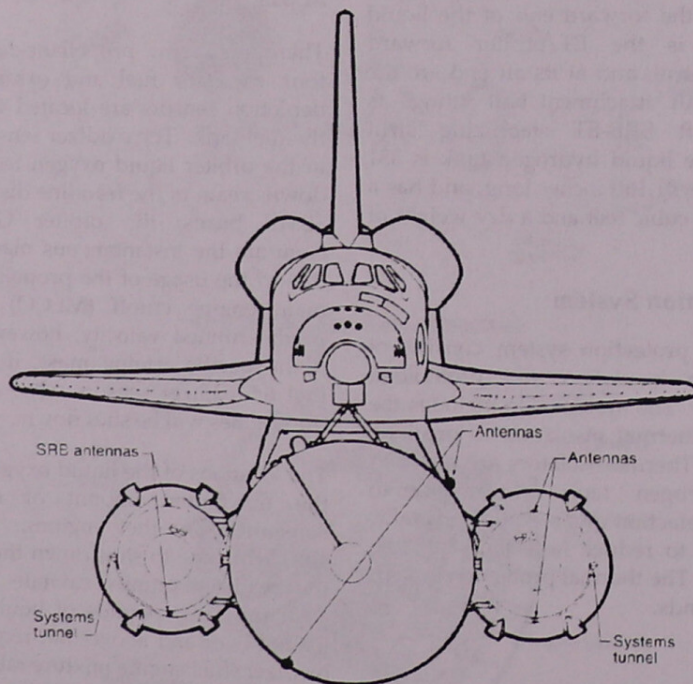

External Tank Range Safety System Antennas

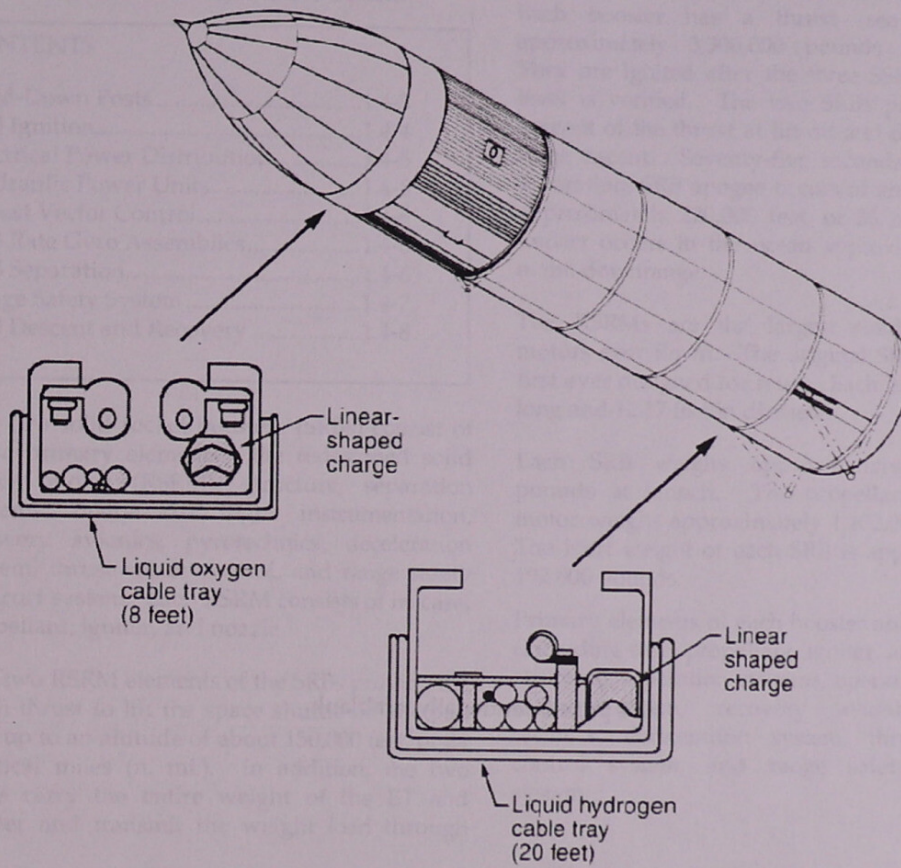

External Tank Range Safety System Linear-Shaped Charges

1.4 SOLID ROCKET BOOSTERS

CONTENTS

Hold-Down Posts	1.4-3
SRB Ignition.....	1.4-4
Electrical Power Distribution.....	1.4-5
Hydraulic Power Units.....	1.4-5
Thrust Vector Control.....	1.4-6
SRB Rate Gyro Assemblies.....	1.4-6
SRB Separation.....	1.4-6
Range Safety System.....	1.4-7
SRB Descent and Recovery	1.4-8

The two solid rocket boosters (SRBs) consist of these primary elements: the redesigned solid rocket motor (RSRM), structure, separation systems, operational flight instrumentation, recovery avionics, pyrotechnics, deceleration system, thrust vector control, and range safety destruct system. Each RSRM consists of its case, propellant, igniter, and nozzle.

The two RSRM elements of the SRBs provide the main thrust to lift the space shuttle off the pad and up to an altitude of about 150,000 feet, or 24 nautical miles (n. mi.). In addition, the two SRBs carry the entire weight of the ET and orbiter and transmit the weight load through

their structure to the mobile launcher platform. Each booster has a thrust (sea level) of approximately 3,300,000 pounds at launch. They are ignited after the three SSMEs' thrust level is verified. The two SRBs provide 71.4 percent of the thrust at lift-off and during first-stage ascent. Seventy-five seconds after SRB separation, SRB apogee occurs at an altitude of approximately 220,000 feet, or 35 n. mi. SRB impact occurs in the ocean approximately 122 n. mi. downrange.

The RSRMs are the largest solid-propellant motors ever flown. The original SRM was the first ever designed for reuse. Each is 149.16 feet long and 12.17 feet in diameter.

Each SRB weighs approximately 1,300,000 pounds at launch. The propellant for each motor weighs approximately 1,100,000 pounds. The inert weight of each SRB is approximately 192,000 pounds.

Primary elements of each booster are the motor (including case, propellant, igniter, and nozzle), structure, separation systems, operational flight instrumentation, recovery avionics, pyrotechnics, deceleration system, thrust vector control system, and range safety destruct system.

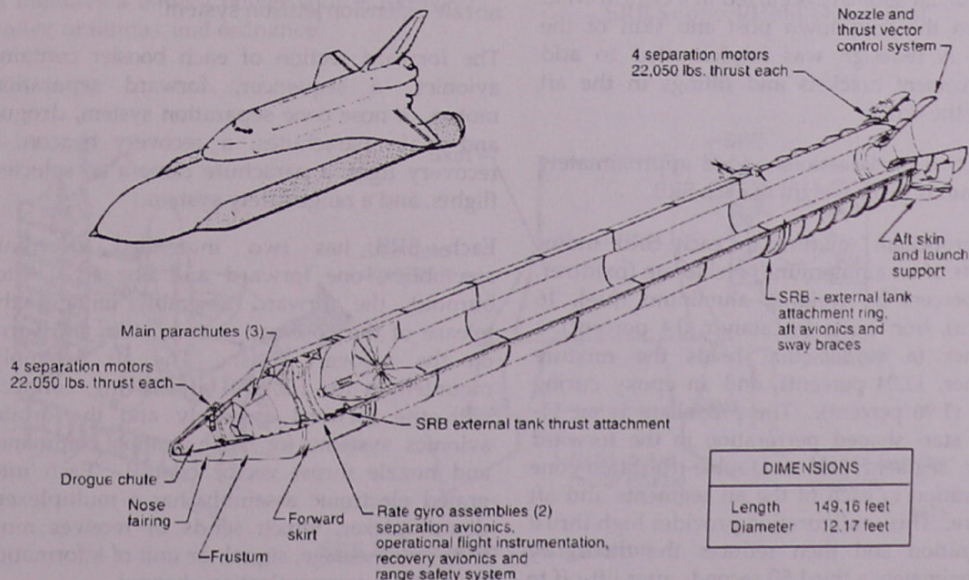

Solid Rocket Booster

Each booster is attached to the ET at the SRB's aft frame by two lateral sway braces and a diagonal attachment. The forward end of each SRB is attached to the external tank at the forward end of the SRB's forward skirt. On the launch pad, each booster also is attached to the mobile launcher platform at the aft skirt by four bolts and nuts that are severed by small explosives at lift-off.

During the downtime following the Challenger accident, detailed structural analyses were performed on critical structural elements of the SRB. Analyses were primarily focused in areas where anomalies had been noted during postflight inspection of recovered hardware.

One of the areas was the attach ring, where the SRBs are connected to the ET. Areas of distress were noted in some of the fasteners where the ring attaches to the SRB motor case. This situation was attributed to the high loads encountered during water impact. To correct the situation and ensure higher strength margins during ascent, the attach ring was redesigned to encircle the motor case completely (360°). Previously, the attach ring formed a "C" and encircled the motor case 270°.

Additionally, special structural tests were performed on the aft skirt. During this test program, an anomaly occurred in a critical weld between the hold-down post and skin of the skirt. A redesign was implemented to add reinforcement brackets and fittings in the aft ring of the skirt.

These two modifications added approximately 450 pounds to the weight of each SRB.

The propellant mixture in each SRB motor consists of an ammonium perchlorate (oxidizer, 69.6 percent by weight), aluminum (fuel, 16 percent), iron oxide (a catalyst, 0.4 percent), a polymer (a binder that holds the mixture together, 12.04 percent), and an epoxy curing agent (1.96 percent). The propellant is an 11-point star-shaped perforation in the forward motor segment and a double-truncated-cone perforation in each of the aft segments and aft closure. This configuration provides high thrust at ignition and then reduces the thrust by approximately a third 50 seconds after lift-off to

prevent overstressing the vehicle during maximum dynamic pressure.

The SRBs are used as matched pairs, and each is made up of four solid rocket motor segments. The pairs are matched by loading each of the four motor segments in pairs from the same batches of propellant ingredients to minimize any thrust imbalance. The segmented-casing design assures maximum flexibility in fabrication and ease of transportation and handling. Each segment is shipped to the launch site on a heavy-duty rail car with a specially built cover.

The nozzle expansion ratio of each booster, beginning with the STS-8 mission, is 7.72:1. The nozzle is gimbaled for thrust vector control. Each SRB has its own redundant auxiliary power units and hydraulic pumps. The all-axis gimbaling capability is 8°. Each nozzle has a carbon cloth liner that erodes and chars during firing. The nozzle is a convergent-divergent, movable design in which an aft pivot-point flexible bearing is the gimbal mechanism.

The cone-shaped aft skirt reacts to the aft loads between the SRB and the mobile launcher platform. The four aft separation motors are mounted on the skirt. The aft section contains avionics, a thrust vector control system that consists of two auxiliary power units and hydraulic pumps, hydraulic systems, and a nozzle extension jettison system.

The forward section of each booster contains avionics, a sequencer, forward separation motors, a nose cone separation system, drogue and main parachutes, a recovery beacon, a recovery light, a parachute camera on selected flights, and a range safety system.

Each SRB has two integrated electronic assemblies, one forward and one aft. After burnout, the forward assembly initiates the release of the nose cap and frustum and turns on the recovery aids. The aft assembly, mounted in the ET/SRB attach ring, connects with the forward assembly and the orbiter avionics systems for SRB ignition commands and nozzle thrust vector control. Each integrated electronic assembly has a multiplexer/demultiplexer, which sends or receives more than one message, signal, or unit of information on a single communication channel.

Eight booster separation motors (four in the nose frustum and four in the aft skirt) of each SRB burn for 1.02 seconds at SRB separation from the ET. Each solid rocket separation motor is 31.1 inches long and 12.8 inches in diameter.

Location aids are provided for each SRB, frustum/drogue chutes, and main parachutes. These include a transmitter, antenna, strobe/converter, battery, and salt water switch electronics. The location aids are designed for a minimum operating life of 72 hours and when refurbished are considered usable up to 20 times. The flashing light is an exception. It has an operating life of 280 hours. The battery is used only once.

The SRB nose caps and nozzle extensions are not recovered.

The recovery crew retrieves the SRBs, frustum/drogue chutes, and main parachutes. The nozzles are plugged, the solid rocket motors are dewatered, and the SRBs are towed back to the launch site. Each booster is removed from the water, and its components are disassembled and washed with fresh and deionized water to limit salt water corrosion. The motor segments, igniter, and nozzle are shipped back to the manufacturer for refurbishment.

Each SRB incorporates a range safety system that includes a battery power source, receiver/decoder, antennas, and ordnance.

Hold-Down Posts

Each SRB has four hold-down posts that fit into corresponding support posts on the mobile launcher platform. Hold-down bolts hold the SRB and launcher platform posts together. Each bolt has a nut at each end, but only the top nut is frangible. The top nut contains two NASA standard detonators (NSDs), which are ignited at solid rocket motor ignition commands.

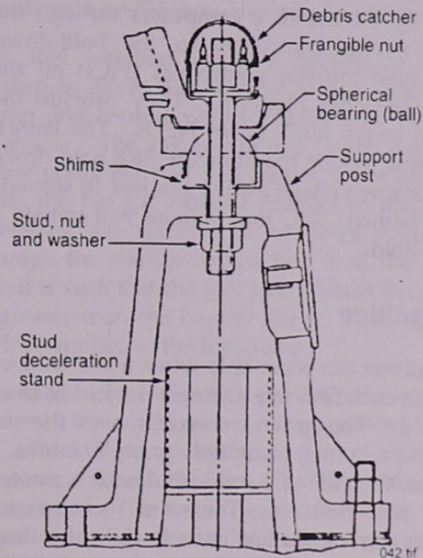

SRB Support/Hold-Down Post

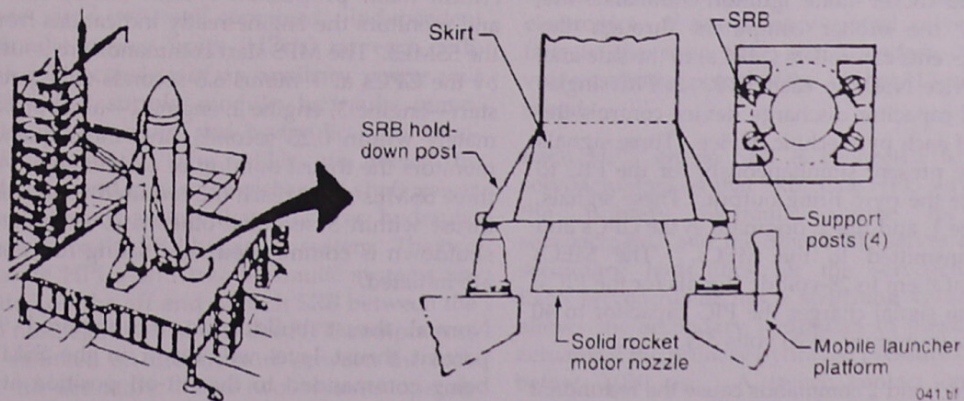

SRB Hold-Down Configuration

When the two NSDs are ignited at each hold-down, the hold-down bolt travels downward because of the release of tension in the bolt (pretensioned before launch), NSD gas pressure, and gravity. The bolt is stopped by the stud deceleration stand, which contains sand. The SRB bolt is 28 inches long and is 3.5 inches in diameter. The frangible nut is captured in a blast container.

The solid rocket motor ignition commands are issued by the orbiter's computers through the master events controllers to the hold-down pyrotechnic initiator controllers (PICs) on the mobile launcher platform. They provide the ignition to the hold-down NSDs. The launch processing system monitors the SRB hold-down PICs for low voltage during the last 16 seconds before launch. PIC low voltage will initiate a launch hold.

SRB Ignition

SRB ignition can occur only when a manual lock pin from each SRB safe and arm device has been removed. The ground crew removes the pin during prelaunch activities. At T minus 5 minutes, the SRB safe and arm device is rotated to the arm position. The solid rocket motor ignition commands are issued when the three SSMEs are at or above 90-percent rated thrust, no SSME fail and/or SRB ignition PIC low voltage is indicated, and there are no holds from the launch processing system.

The solid rocket motor ignition commands are sent by the orbiter computers through the master events controllers (MECs) to the safe and arm device NSDs in each SRB. A PIC single-channel capacitor discharge device controls the firing of each pyrotechnic device. Three signals must be present simultaneously for the PIC to generate the pyro firing output. These signals, arm, fire 1, and fire 2, originate in the GPCs and are transmitted to the MECs. The MECs reformat them to 28-volt dc signals for the PICs. The arm signal charges the PIC capacitor to 40 volts dc (minimum of 20 volts dc).

The fire 1 and 2 commands cause the redundant NSDs to fire through a thin barrier seal down a flame tunnel. This ignites a pyro booster charge, which is retained in the safe and arm device behind a perforated plate. The booster

charge ignites the propellant in the igniter initiator, and combustion products of this propellant ignite the solid rocket motor initiator, which fires down the length of the solid rocket motor igniting the solid rocket motor propellant.

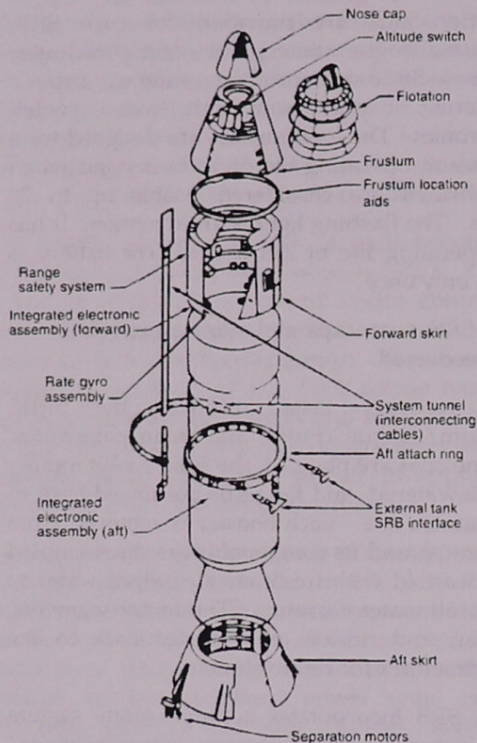

Solid Rocket Booster-Exploded View

The GPC launch sequence also controls certain critical main propulsion system (MPS) valves and monitors the engine-ready indications from the SSMEs. The MPS start commands are issued by the GPCs at T minus 6.6 seconds (staggered start—engine 3, engine 2, engine 1—all approximately within 0.25 second), and the sequence monitors the thrust buildup of each engine. All three SSMEs must reach the required 90-percent thrust within 3 seconds; otherwise, an orderly shutdown is commanded, and safing functions are initiated.

Normal thrust buildup to the required 90-percent thrust level will result in the SSMEs being commanded to the lift-off position at T minus 3 seconds as well as the fire 1 command being issued to arm the SRBs. At T minus 3 seconds, the vehicle base bending load modes are allowed to initialize (movement of

approximately 25.5 inches measured at the tip of the external tank, with movement towards the external tank).

At T minus 0, the two SRBs are ignited, separation of the four frangible nuts on each SRB hold down bolt is initiated, the two T-0 umbilicals (one on each side of the spacecraft) are retracted, the onboard master timing unit, event timer, and mission event timers are started, the three SSMEs are at 100 percent, and the ground launch sequence is terminated.

The solid rocket motor thrust profile is tailored to reduce thrust during the maximum dynamic pressure region.

Electrical Power Distribution

Electrical power distribution in each SRB consists of orbiter-supplied main dc bus power to each SRB via SRB buses A, B, and C. Orbiter main dc buses A, B, and C supply main dc bus power to corresponding SRB buses A, B, and C. In addition, orbiter main dc bus C supplies backup power to SRB buses A and B, and orbiter bus B supplies backup power to SRB bus C. This electrical power distribution arrangement allows all SRB buses to remain powered in the event one orbiter main bus fails.

The nominal dc voltage is 28 volts dc, with an upper limit of 32 volts dc and a lower limit of 24 volts dc.

Hydraulic Power Units

There are two self-contained, independent hydraulic power units (HPUs) on each SRB. Each HPU consists of an auxiliary power unit (APU), fuel supply module, hydraulic pump, hydraulic reservoir, and hydraulic fluid manifold assembly. The APUs are fueled by hydrazine and generate mechanical shaft power to a hydraulic pump that produces hydraulic pressure for the SRB hydraulic system. The two separate HPUs and two hydraulic systems are located on the aft end of each SRB between the SRB nozzle and aft skirt. The HPU components are mounted on the aft skirt between the rock and tilt actuators. The two systems operate from T minus 28 seconds until SRB separation from the orbiter and external tank. The two independent hydraulic systems are connected to the rock and tilt servoactuators.

The APU controller electronics are located in the SRB aft integrated electronic assemblies on the aft external tank attach rings.

The APUs and their fuel systems are isolated from each other. Each fuel supply module (tank) contains 22 pounds of hydrazine. The fuel tank is pressurized with gaseous nitrogen at 400 psi, which provides the force to expel (positive expulsion) the fuel from the tank to the fuel distribution line, maintaining a positive fuel supply to the APU throughout its operation.

The fuel isolation valve is opened at APU startup to allow fuel to flow to the APU fuel pump and control valves and then to the gas generator. The gas generator's catalytic action decomposes the fuel and creates a hot gas. It feeds the hot gas exhaust product to the APU two-stage gas turbine. Fuel flows primarily through the startup bypass line until the APU speed is such that the fuel pump outlet pressure is greater than the bypass line's. Then all the fuel is supplied to the fuel pump.

The APU turbine assembly provides mechanical power to the APU gearbox. The gearbox drives the APU fuel pump, hydraulic pump, and lube oil pump. The APU lube oil pump lubricates the gearbox. The turbine exhaust of each APU flows over the exterior of the gas generator, cooling it, and is then directed overboard through an exhaust duct.

When the APU speed reaches 100 percent, the APU primary control valve closes, and the APU speed is controlled by the APU controller electronics. If the primary control valve logic fails to the open state, the secondary control valve assumes control of the APU at 113-percent speed.

Each HPU on an SRB is connected to both servoactuators on that SRB. One HPU serves as the primary hydraulic source for the servoactuator, and the other HPU serves as the secondary hydraulics for the servoactuator. Each servoactuator has a switching valve that allows the secondary hydraulics to power the actuator if the primary hydraulic pressure drops below 2,050 psi. A switch contact on the switching valve will close when the valve is in the secondary position. When the valve is closed, a signal is sent to the APU controller that inhibits the 100-percent APU speed control logic

and enables the 113-percent APU speed control logic. The 113-percent APU speed enables one APU/HPU to supply sufficient operating hydraulic pressure to both servoactuators of that SRB.

The APU 100-percent speed corresponds to 72,000 rpm and 113-percent to 81,000 rpm.

The APUs/HPUs and hydraulic systems are reusable for 20 missions.

Thrust Vector Control

Each SRB has two hydraulic gimbal servoactuators: one for rock and one for tilt. The servoactuators provide the force and control to gimbal the nozzle for thrust vector control.

The space shuttle ascent thrust vector control (ATVC) portion of the flight control system directs the thrust of the three SSMEs and the two SRB nozzles to control attitude and trajectory during lift-off and ascent. Commands from the guidance system are transmitted to the ATVC drivers, which transmit signals proportional to the commands to each servoactuator of the main engines and SRBs. Four independent flight control system channels and four ATVC channels control six main engine and four SRB ATVC drivers, with each driver controlling one hydraulic port on each main and SRB servoactuator.

Each SRB servoactuator consists of four independent, two-stage servovalves that receive signals from the drivers. Each servovalve controls one power spool in each actuator, which positions an actuator ram and the nozzle to control the direction of thrust.

The four servovalves in each actuator provide a force-summed majority voting arrangement to position the power spool. With four identical commands to the four servovalves, the actuator force-sum action prevents a single erroneous command from affecting power ram motion. If the erroneous command persists for more than a predetermined time, differential pressure sensing activates a selector valve to isolate and remove the defective servovalve hydraulic pressure, permitting the remaining channels and servovalves to control the actuator ram spool.

Failure monitors are provided for each channel to indicate which channel has been bypassed. An isolation valve on each channel provides the capability of resetting a failed or bypassed channel.

Each actuator ram is equipped with transducers for position feedback to the thrust vector control system. Within each servoactuator ram is a splashdown load relief assembly to cushion the nozzle at water splashdown and prevent damage to the nozzle flexible bearing.

SRB Rate Gyro Assemblies

Each SRB contains two rate gyro assemblies (RGAs), with each RGA containing one pitch and one yaw gyro. These provide an output proportional to angular rates about the pitch and yaw axes to the orbiter computers and guidance, navigation, and control system during first-stage ascent flight in conjunction with the orbiter roll rate gyros until SRB separation. At SRB separation, a switchover is made from the SRB RGAs to the orbiter RGAs.

The SRB RGA rates pass through the orbiter flight aft multiplexers/demultiplexers to the orbiter GPCs. The RGA rates are then interchangeable mid-value-selected in redundancy management to provide SRB pitch and yaw rates to the user software. The RGAs are designed for 20 missions.

SRB Separation

SRB separation is initiated when the three solid rocket motor chamber pressure transducers are processed in the redundancy management interchangeable middle value select, and the head-end chamber pressure of both SRBs is less than or equal to 50 psi. A backup cue is the time elapsed from booster ignition.

The separation sequence is initiated, commanding the thrust vector control actuators to the null position and putting the main propulsion system into a second-stage configuration (0.8 second from sequence initialization), which ensures the thrust of each SRB is less than 100,000 pounds. Orbiter yaw attitude is held for 4 seconds, and SRB thrust drops to less than 60,000 pounds.

The SRBs separate from the external tank within 30 milliseconds of the ordnance firing command.

The forward attachment point consists of a ball (SRB) and socket (ET) held together by one bolt. The bolt contains one NSD pressure cartridge at each end. The forward attachment point also carries the range safety system cross-strap wiring connecting each SRB and the ET range safety systems with each other.

The aft attachment points consist of three separate struts: upper, diagonal and lower. Each strut contains one bolt with an NSD pressure cartridge at each end. The upper strut also carries the umbilical interface between its SRB and the external tank and on to the orbiter.

There are four booster separation motors (BSMs) on each end of each SRB. The BSMs separate the SRBs from the external tank. The solid rocket motors in each cluster of four are ignited by firing redundant NSD pressure cartridges into redundant confined detonating fuse manifolds.

The separation commands issued from the orbiter by the SRB separation sequence initiate the redundant NSD pressure cartridge in each bolt and ignite the BSMs to effect a clean separation.

Range Safety System

The shuttle has three range safety systems (RSSs). One is located in each SRB and one in the external tank. Any one or all three are capable of receiving two command messages (arm and fire) transmitted from the ground station. The RSS is used only if the shuttle vehicle violates a launch trajectory red line.

An RSS consists of two antenna couplers, command receivers/decoders, a dual distributor, a safe and arm device with two NSDs, two confined detonating fuse (CDF) manifolds, seven CDF assemblies, and one linear-shaped charge (LSC).

The antenna couplers provide the proper impedance for radio frequency and ground support equipment commands. The command receivers are tuned to RSS command frequencies and provide the input signal to the distributors when an RSS command is sent. The command decoders use a code plug to prevent any command signal other than the proper command signal from getting into the distributors. The distributors contain the logic to supply valid destruct commands to the RSS pyrotechnics.

The NSDs provide the spark to ignite the CDF, which in turn ignites the LSC for shuttle vehicle

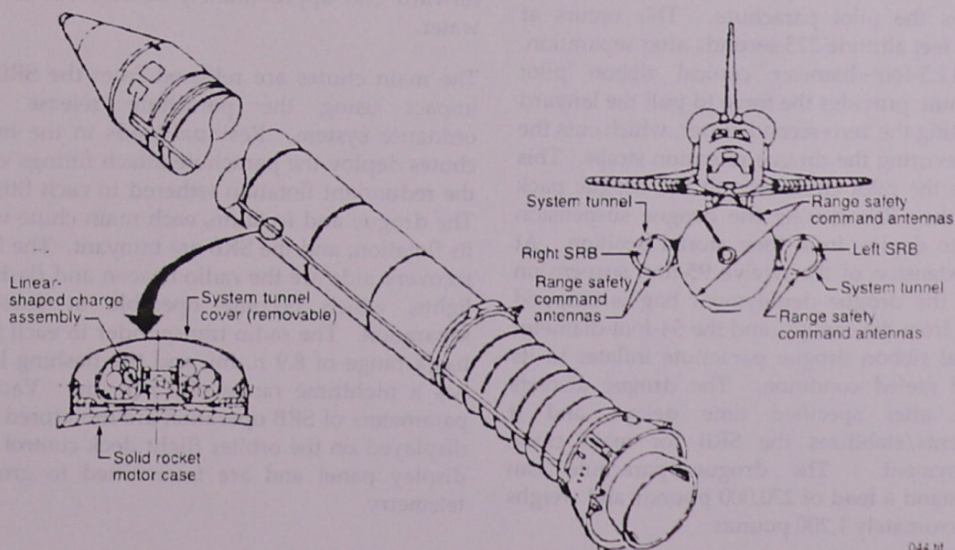

SRB Range Safety System

044.tif

destruction. The safe and arm device provides mechanical isolation between the NSDs and the CDF before launch and during the SRB separation sequence.

The first message, called arm, allows the onboard logic to enable a destruct and illuminates a light on the flight deck display and control panel at the commander and pilot station. The second message transmitted is the fire command.

The SRB distributors in the SRBs and the ET are cross-strapped together. Thus, if one SRB received an arm or destruct signal, the signal would also be sent to the other SRB and the ET.

Electrical power from the RSS battery in each SRB is routed to RSS system A. The recovery battery in each SRB is used to power RSS system B as well as the recovery system in the SRB. The SRB RSS is powered down during the separation sequence, and the SRB recovery system is powered up. Electrical power for the ET RSS system A and system B is independently supplied by two RSS batteries on the ET.

SRB Descent and Recovery

The recovery sequence begins with the operation of the high-altitude baroswitch, which triggers the functioning of the pyrotechnic nose cap thrusters. This ejects the nose cap, which deploys the pilot parachute. This occurs at 15,704 feet altitude 225 seconds after separation. The 11.5-foot-diameter conical ribbon pilot parachute provides the force to pull the lanyard activating the zero-second cutter, which cuts the loop securing the drogue retention straps. This allows the pilot chute to pull the drogue pack from the SRB, causing the drogue suspension lines to deploy from their stored position. At full extension of the twelve 95-foot suspension lines, the drogue deployment bag is stripped away from the canopy, and the 54-foot-diameter conical ribbon drogue parachute inflates to its initial reefed condition. The drogue disreefs twice after specified time delays, and it reorients/stabilizes the SRB for main chute deployment. The drogue parachute can withstand a load of 270,000 pounds and weighs approximately 1,200 pounds

After the drogue chute has stabilized the vehicle in a tailfirst attitude, the frustum is separated from the forward skirt by a charge triggered by the low-altitude baroswitch at an altitude of 5,975 feet 248 seconds after separation. It is then pulled away from the SRB by the drogue chute. The main chutes' suspension lines are pulled out from deployment bags that remain in the frustum. At full extension of the lines, which are 204 feet long, the three main chutes are pulled from the deployment bags and inflate to their first reefed condition. The frustum and drogue parachute continue on a separate trajectory to splashdown. After specified time delays, the main chutes' reefing lines are cut, and the chutes inflate to their second reefed and full open configurations. The main chute cluster decelerates the SRB to terminal conditions. Each of the 136-foot-diameter, 20° conical ribbon parachutes can withstand a load of 180,000 pounds and weighs 2,180 pounds. The nozzle extension is severed by pyrotechnic charge either at apogee or 20 seconds after low baroswitch operation.

Water impact occurs 295 seconds after separation at a velocity of 81 feet per second. The water impact range is approximately 140 miles off the eastern coast of Florida. Because the parachutes provide for a nozzlefirst impact, air is trapped in the empty (burned out) motor casing, causing the booster to float with the forward end approximately 30 feet out of the water.

The main chutes are released from the SRB at impact using the parachute release nut ordnance system. Residual loads in the main chutes deploy the parachute attach fittings with the redundant flotation tethered to each fitting. The drogue and frustum, each main chute with its flotation, and the SRB are buoyant. The SRB recovery aids are the radio beacon and flashing lights, which become operable at frustum separation. The radio transponder in each SRB has a range of 8.9 n. mi, and the flashing light has a nighttime range of 4.9 n. mi. Various parameters of SRB operation are monitored and displayed on the orbiter flight deck control and display panel and are transmitted to ground telemetry.

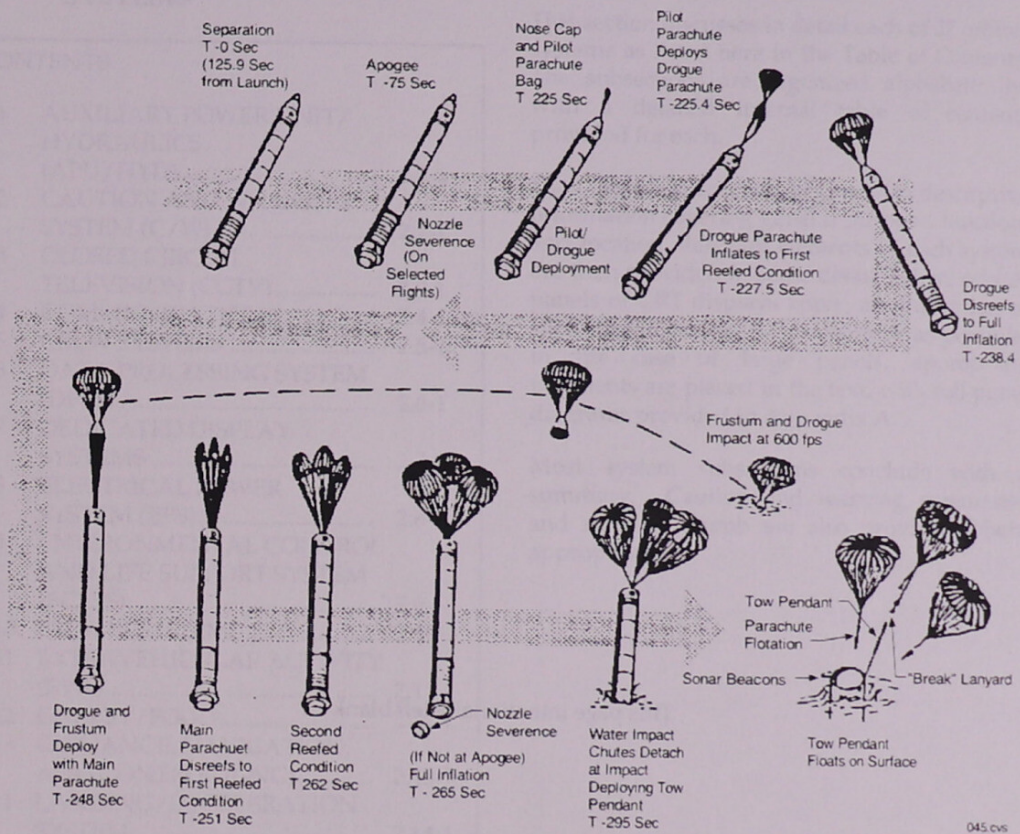

SRB Descent and Splashdown

2. SYSTEMS

CONTENTS

2.1	AUXILIARY POWER UNIT/ HYDRAULICS (APU/HYD)	2.1-1
2.2	CAUTION AND WARNING SYSTEM (C/W)	2.2-1
2.3	CLOSED CIRCUIT TELEVISION (CCTV)	2.3-1
2.4	COMMUNICATIONS	2.4-1
2.5	CREW SYSTEMS	2.5-1
2.6	DATA PROCESSING SYSTEM (DPS)	2.6-1
2.7	DEDICATED DISPLAY SYSTEMS	2.7-1
2.8	ELECTRICAL POWER SYSTEM (EPS)	2.8-1
2.9	ENVIRONMENTAL CONTROL AND LIFE SUPPORT SYSTEM (ECLSS)	2.9-1
2.10	ESCAPE SYSTEMS	2.10-1
2.11	EXTRAVEHICULAR ACTIVITY (EVA)	2.11-1
2.12	GALLEY/FOOD	2.12-1
2.13	GUIDANCE, NAVIGATION, AND CONTROL (GNC)	2.13-1
2.14	LANDING/DECELERATION SYSTEM	2.14-1
2.15	LIGHTING SYSTEM	2.15-1
2.16	MAIN PROPULSION SYSTEM (MPS)	2.16-1
2.17	MECHANICAL SYSTEMS	2.17-1
2.18	MEDS	2.18-1
2.19	ORBITAL MANEUVERING SYSTEM (OMS)	2.19-1
2.20	ORBITER DOCKING SYSTEM	2.20-1
2.21	PAYLOAD AND GENERAL SUPPORT COMPUTER	2.21-1
2.22	PAYLOAD DEPLOYMENT AND RETRIEVAL SYSTEM (PDRS)	2.22-1
2.23	REACTION CONTROL SYSTEM (RCS)	2.23-1
2.24	SPACEHAB	2.24-1
2.25	SPACELAB	2.25-1
2.26	STOWAGE	2.26-1
2.27	WASTE MANAGEMENT SYSTEM (WMS)	2.27-1

This section discusses in detail each of 27 orbiter systems as listed here in the Table of Contents. The subsections are organized alphabetically, with a detailed internal table of contents provided for each.

Each system subsection begins with descriptive information covering general purpose, function, and location. Relevant elements of each system are then provided in some detail. Where orbiter panels or CRT displays apply, an illustration of such appears as near the reference as possible. In the case of large panels, appropriate fragments are placed in the text, with full panel diagrams provided in Appendix A.

Most system subsections conclude with a summary. Caution and warning summaries and rules of thumb are also provided where appropriate.

2.1 AUXILIARY POWER UNIT/ HYDRAULICS (APU/HYD)

CONTENTS

Description	2.1-1
Fuel System	2.1-2
Gas Generator and Turbine.....	2.1-5
Lubricating Oil.....	2.1-5
Electronic Controller.....	2.1-6
Injector Cooling System.....	2.1-10
APU Heaters	2.1-11
Water Spray Boilers.....	2.1-12
Main Hydraulic Pump.....	2.1-16
Hydraulic Reservoir.....	2.1-19
Hydraulic Accumulator.....	2.1-19
Circulation Pump and Heat Exchanger	2.1-19
Hydraulic Heaters.....	2.1-21
Operations.....	2.1-21
APU/HYD Caution and Warning Summary.....	2.1-23
APU/HYD Summary Data.....	2.1-24
APU/HYD Rules of Thumb.....	2.1-24

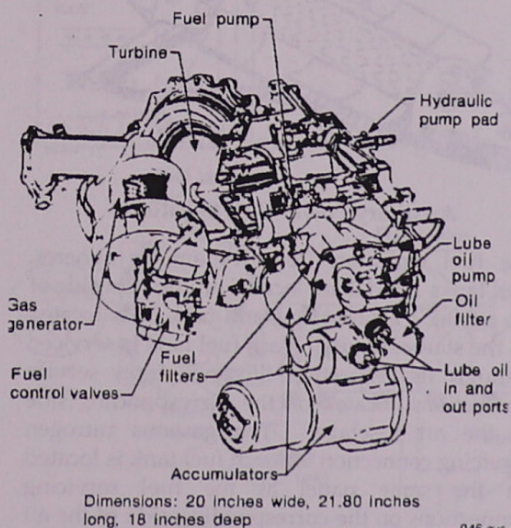

Auxiliary Power Unit

Description

The orbiter has three independent hydraulic systems. Each consists of a main hydraulic pump, hydraulic reservoir, hydraulic bootstrap accumulator, hydraulic filters, control valves, hydraulic/Freon heat exchanger, electrical circulation pump, and electrical heaters.

Each system provides hydraulic pressure to position hydraulic actuators for:

1. Thrust vector control of the main engines by gimbaling the three SSMEs
2. Actuation of various control valves on the SSMEs
3. Movement of the orbiter aerosurfaces (elevons, body flap, rudder/speed brake)
4. Retraction of the external tank/orbiter 17-inch liquid oxygen and liquid hydrogen disconnect umbilicals within the orbiter at external tank jettison
5. Main/nose landing gear deployment (system 1)/(system 1 or 2)
6. Main landing gear brakes and anti-skid
7. Nose wheel steering (system 1 with backup from system 2).

Each hydraulic system is capable of operation when exposed to forces or conditions caused by acceleration, deceleration, normal gravity, zero gravity, hard vacuum, and temperatures encountered during on-orbit dormant conditions.

Three identical, but independent, improved auxiliary power units (APUs; also called IAPUs) provide power for the orbiter hydraulic systems. The APU is a hydrazine-fueled, turbine-driven power unit that generates mechanical shaft power to drive a hydraulic pump that produces pressure for the orbiter's hydraulic system. Each unit weighs approximately 88 pounds and produces 135 horsepower.

Each APU consists of a fuel tank, a fuel feed system, a system controller, an exhaust duct, lube oil cooling system, and fuel/lube oil vents and drains. Redundant electrical heater systems and insulation thermally control the system above 45° F to prevent fuel from freezing and to maintain required lubricating oil viscosity. Insulation is used on components containing hydrazine, lube oil, or water to minimize electrical heater power requirements and to keep high surface temperatures within safe limits on the turbine and exhaust ducts.

The three APUs and fuel systems are located in the aft fuselage. Each APU fuel system supplies storable liquid hydrazine fuel to its respective fuel pump, gas generator valve module, and gas generator, which decomposes the fuel through catalytic action. The resultant hot gas drives a single-stage, dual pass turbine. The turbine exhaust flow returns over the exterior of the gas generator, cooling it, and is then directed overboard through an exhaust duct at the upper portion of the aft fuselage near the vertical stabilizer.

The turbine assembly provides mechanical power through a shaft to drive reduction gears in the gearbox. The gearbox drives a fuel pump, a hydraulic pump, and a lube oil pump. The hydraulic pump supplies pressure to the hydraulic system. The fuel pump increases the fuel pressure at its outlet to sustain pressurized fuel to the gas generator valve module and gas generator. The lube oil system supplies lubricant to the gearbox reduction gears and uses the reduction gears as scavenger pumps to supply lube oil to the inlet of the lube oil pump to increase the pressure of the lube oil system.

The lube oil of each APU is circulated through a heat exchanger in a corresponding water spray boiler. Three water spray boilers (WSBs), one for each APU, cool the lube oil systems. The hydraulic fluid of each hydraulic pump driven by an APU is also circulated through a hydraulic heat exchanger in the corresponding water spray boiler to cool hydraulic fluid during hydraulic system operation. The three WSBs are also located in the aft fuselage of the orbiter.

Fuel System

The APU fuel system (one for each of the three APUs) includes the fuel tank and fuel isolation valves, the fuel pump, and fuel control valves. The improved APUs use passive heat sinks and heat shields to minimize the effects of heat soakback.

Fuel Tanks

The APU fuel tanks are mounted on supports cantilevered from the sides of the internal portion of the aft fuselage. The fuel is storable liquid anhydrous hydrazine. The hydrazine is stored in a fuel tank with a total capacity of

about 350 pounds. The fuel tank, which incorporates a diaphragm at its center, is serviced with fuel on one side and the pressurant (gaseous nitrogen) on the other. The nitrogen is the force acting on the diaphragm (positive expulsion) to expel the fuel from the tank to the fuel distribution lines and maintain a positive fuel supply to the APU throughout its operation. Each typical prelaunch fuel tank load is approximately 325 pounds. The fuel supply supports the nominal power unit operating time of 90 minutes in a mission or any defined abort mode, such as an abort once around, when the APUs run continuously for approximately 110 minutes. Under operating load conditions, an APU consumes approximately 3 to 3.5 pounds of fuel per minute

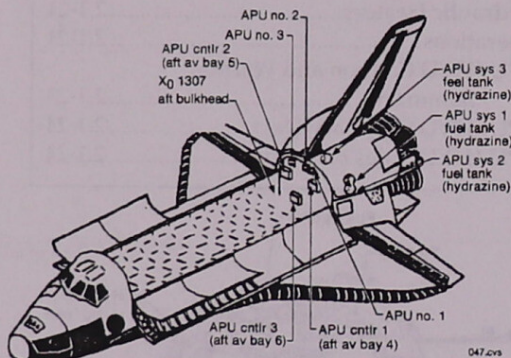

Auxiliary Power Unit Locations

The fuel tanks are 28-inch-diameter spheres. Fuel tanks 1 and 2 are located on the port side of the orbiter's aft fuselage, and tank 3 is located on the starboard side. Each fuel tank is serviced through its respective fill and drain service connections, located on the corresponding side of the aft fuselage. The gaseous nitrogen servicing connection for each fuel tank is located on the same panel as the fuel servicing connections on the corresponding side of the aft fuselage. The fuel tank is pressurized to 365 psi prelaunch.

Each fuel tank's temperature and gaseous nitrogen pressure are monitored by the APU controller and transmitted to the GPC, where quantity is calculated and transmitted to the APU FUEL/H₂O QTY meters on the dedicated MEDS display. When the switch below the meters on the dedicated MEDS display is

positioned to *FUEL*, the quantity in APU fuel tanks 1, 2, and 3 is displayed simultaneously in percent. The fuel quantity of 100 percent on the meter is equivalent to 350 pounds. Fuel pressure (psia) is shown on the FUEL PRESS meter on the dedicated MEDS display. Fuel quantity in percent is also displayed on the BFS SM SYS SUMM 2 display (FUEL QTY).

The gaseous nitrogen pressure in each fuel tank exerts a force on the diaphragm to expel the hydrazine fuel under pressure to the fuel distribution system. Filters are incorporated into each distribution line to remove any particles. The fuel distribution line branches into two parallel paths downstream of the filter. An isolation valve is installed in each parallel path, providing redundant paths to permit fuel flow to the APU or to isolate the APU from the fuel supply tanks.

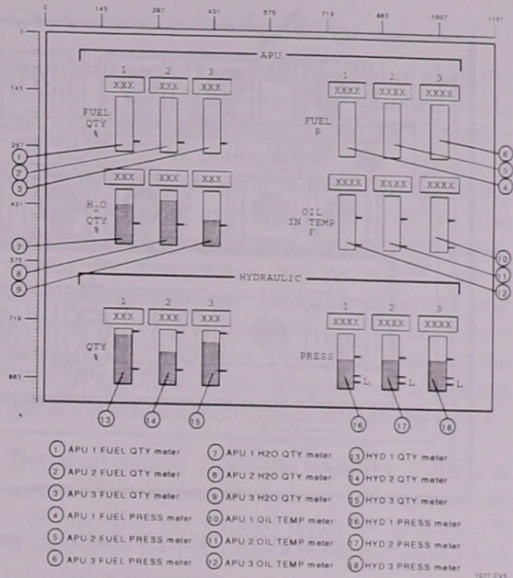

APU Meters and Switches on Panel F8

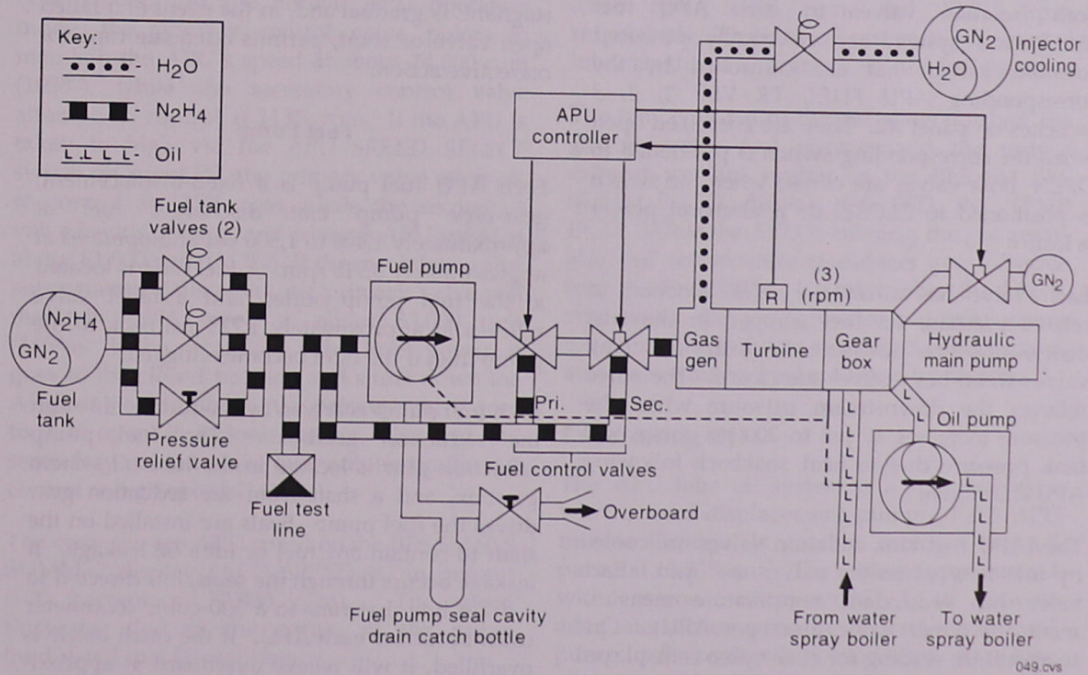

Improved APU Fuel System Schematic

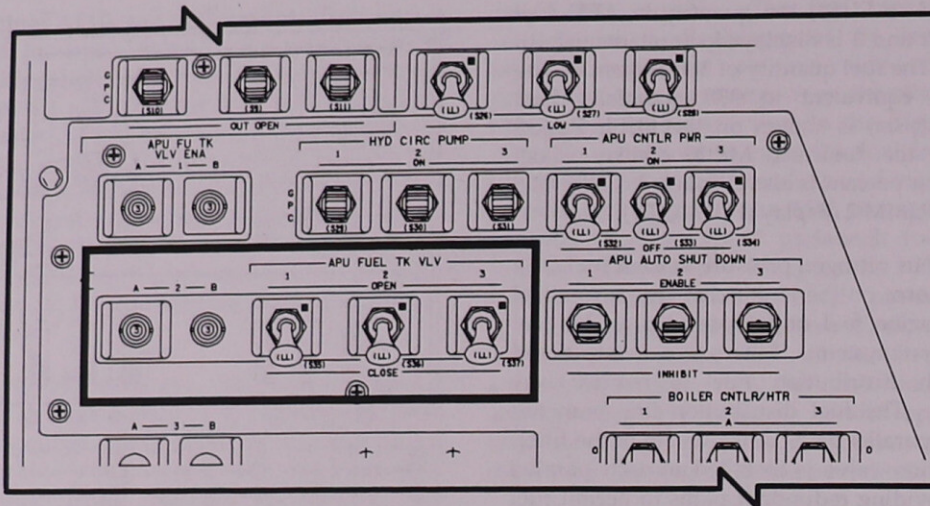

APU FUEL TK VLV Switches and Circuit Breakers on Panel R2

Fuel Tank Isolation Valves

Both isolation valves in each APU fuel distribution system are electrically powered solenoid valves that are controlled by the corresponding *APU FUEL TK VLV 1, 2, 3* switches on panel R2. They are energized open when the corresponding switch is positioned to *OPEN*; both valves are closed when the switch is positioned to *CLOSE*, or if electrical power is lost.

Each valve has a reverse relief function to relieve pressure on fuel trapped in the fuel distribution line downstream of the fuel tank valves when both valves are closed. The valve relieves the downstream pressure when the pressure increases 40 psi to 200 psi above fuel tank pressure due to heat soakback following APU shutdown.

The IAPU fuel tank isolation valves are cooled by fuel flow when the valves are open. Each valve has redundant temperature measurements (two per valve, four per APU). One temperature reading for each valve is displayed on the BFS SM SYS SUMM 2 display and the APU/HYD, DISP 86 display (Ops 201) beside the FU TK VLV AT and BT labels. There are two tank isolation valve circuit breakers per APU (one per valve) located on panel R2. These can be pulled to disconnect electrical power

from the solenoid if a valve fails open or shorts. The valve heating profile, when the fuel is stagnant, is gradual and, in the event of a failed open valve or short, permits adequate time for corrective action.

Fuel Pump

Each APU fuel pump is a fixed-displacement, gear-type pump that discharges fuel at approximately 1,400 to 1,500 psi and operates at approximately 3,918 rpm. A fuel filter is located at the fuel pump outlet, and a relief valve relieves at approximately 1,725 psi back to the pump inlet if the filter becomes clogged.

Each fuel pump is driven by the turbine through the reduction gearbox. The fuel pump reduction gear is located in the lube oil system gearbox, and a shaft from the reduction gear drives the fuel pump. Seals are installed on the shaft to contain any fuel or lube oil leakage. If leakage occurs through the seals, it is directed to a drain line that runs to a 500-cubic centimeter catch bottle for each APU. If the catch bottle is overfilled, it will relieve overboard at approximately 45 psia through a burst disk and drain port. After the disk bursts, the pressure relief valve will cycle at approximately 28 psia. On ascent or entry, the flight crew can monitor the catch bottle's line pressure on the BFS SM SYS SUMM 2 display (PMP LK P).

0001/ /079		SM SYS SUMM 2				5 008/23:29:22	
						BFS 000/00:00:00	
						MANF1 MANF2	
CRYO TK	1	2	3	4	5		
H2 PRESS	208	208	206	206	206	208	207
O2 PRESS	816	815	814	814	814	815	815
HTR T1	-248	-248	-248	-248	-248		
T2	-248	-248	-248	-248	-248		
APU	1	2	3				
TEMP EGT	942	942	942		HYD	1	2
B/U EGT	942	942	942		PRESS	3064	3064
OIL IN	250	250	250		ACTUM P	3080	3080
OUT	264	264	264		RSVR T	116	153
GG BED	511H	511H	511H		QTY	72	74
INJ	1271	1271	1271				
SPEED %	99	102	101		W/B		
FUEL QTY	59	60	62		H2O QTY	78	73
FMP LK P	14	14	14		BYP VLV	BYP	BYP
OIL OUT P	42	42	41				
FU TK VLV							
A T	63	65	62		THERM ONTL	1	28
B T	63	65	62		H2O PUMP P	23	63
AV BAY	1	2	3		FREON FLOW	2384	2384
TEMP	97	97	83		EVAP OUT T	38	38
A4 14	27.439	27.435					
						26.324	31.873
							18.48

APU Information on BFS SM SYS SUMM 2 Display

Fuel Control Valves

The APU's operating speed is controlled by the primary and secondary fuel control valves, which are installed in series downstream of the fuel pump. These are solenoid-operated pulsar-type valves. In the normal APU operating mode, the primary control valve pulses to maintain the APU's speed at about 74,000 rpm (103%), while the secondary control valve attempts to control at 113% rpm. If the APU is taken to high via the *APU SPEED SELECT* switch on panel R2, the primary valve attempts to control at 115% rpm, while the secondary valve begins pulsing, and controls APU speed at about 81,000 rpm (113%). If the secondary valve subsequently fails open, the primary valve will maintain APU speed at about 83,000 rpm (115%). If the secondary valve loses power, it goes to the closed position and shuts down the APU. As noted above, the primary valve goes to full open if it loses power, allowing the secondary valve to take over automatically and control at high speed (113%).

The crew can see APU speed on the BFS SM SYS SUMM 2 display (*APU SPEED %*) in percent (100 percent = 72,000 rpm). The speed fluctuates due to the nature of the pulse-modulated fuel flow system.

For safety reasons, each APU has an automatic shutdown feature that will shut the APU down if the speed falls below 80 percent (57,600 rpm) or rises above 129 percent (92,880 rpm).

Gas Generator and Turbine

Each gas generator consists of a bed of Shell 405 catalyst in a pressure chamber, mounted inside the APU exhaust chamber. When the hydrazine fuel comes into contact with the catalyst, it undergoes an exothermic reaction, decomposing into a hot gas at approximately 1,700° F. The gas expands rapidly and makes two passes through a single-stage turbine wheel, passes over the outside gas generator chamber and exits overboard through its own independent exhaust duct, located near the base of the vertical stabilizer. The temperature of the hot gas at the exhaust duct is approximately 1,000° F.

The shaft power from the spinning turbine is sent to the hydraulic main pump associated with the APU via a speed reduction gearbox. It is also used to drive the APU's fuel pump and lubrication oil pump.

The normal speeds of the hydraulic main pump, APU fuel pump, and APU lube oil pump are 3,918 rpm, 3,918 rpm, and 12,215 rpm, respectively. The lube oil system is necessary to lubricate the APU gearbox and the fuel pump.

The temperatures of the gas generator bed, the gas generator fuel injector, and the turbine exhaust gas are visible on the BFS SM SYS SUMM 2 CRT display (*GG BED*, *INJ*, *TEMP EGT*). While the APU is running, the gas generator bed temperature transducer goes off-scale high at about 500° F. On orbit, when the APU is shut down, the gas generator bed temperature transducer is useful to monitor the bed temperature when the bed is kept warm by heaters.

Lubricating Oil

The APU lube oil system is a scavenger-type with a fixed-displacement pump. Each APU turbine through its gearbox drives a lube oil pump at 12,215 rpm. The system is pressurized with gaseous nitrogen (GN₂) to provide adequate suction pressure to start the lube oil pump under zero-gravity conditions. Each lube oil system has its own nitrogen gas storage vessel that is pressurized to approximately 140 psia. The pressurization system for each lube oil system has a valve controlled by its corresponding APU controller. The GN₂ pressurization valve for each power unit is

energized open by its corresponding controller when the gearbox pressure is below 5.2 psi, plus or minus 1.3 psi, to ensure that gearbox pressure is sufficiently above the requirements for proper scavenging and lube pump operation.

The pump increases the lube oil pressure to approximately 60 psi, directs the lube oil through the corresponding water spray boiler for cooling, and returns the lube oil to the accumulators and gearbox. Two accumulators in each lube oil system allow thermal expansion of the lube oil, accommodate gas initially trapped in the external lube circuit, maintain lube oil pressure at a minimum of approximately 15 psia, and act as a zero-gravity, all-altitude lube reservoir.

The following information is transmitted to the BFS SM SYS SUMM 2 display by the APU controller via the GPC: lube oil pump outlet pressure (OIL OUT P) at approximately 45 psia, outlet temperature at approximately 270° F, and a return temperature from the water spray boiler (OIL IN, OUT) at approximately 250° F for each APU. The lube oil temperature of each APU is also monitored on the APU OIL TEMP meter on the dedicated MEDS display.

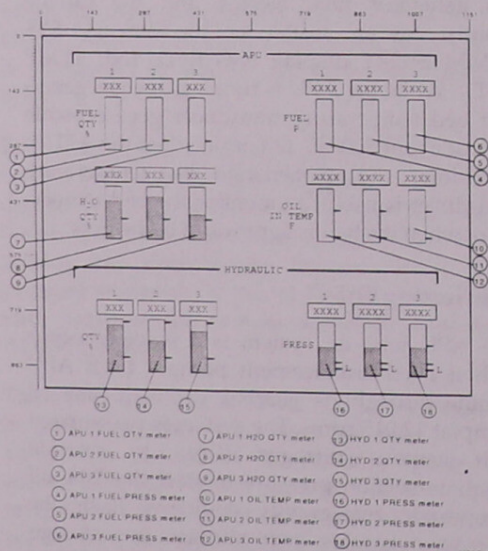

APU Meters and Switches on Panel F8

Electronic Controller

Each APU has its own digital controller. The controller detects malfunctions, controls turbine speed, gearbox pressurization, and fuel pump/gas generator heaters. Each controller is controlled by its corresponding *APU CNTLR PWR* switch on panel R2. When the switch is positioned to *ON*, 28-volt dc power is sent to that controller and APU. The controllers are redundantly powered via dual internal remote power controllers. When the switch is positioned to *OFF*, electrical power is removed from that controller and APU.

APU Start

An *APU/HYD READY TO START* talkback indicator for each APU is located on panel R2. The talkback signals gray when that APU hydraulic system is ready to start; that is, when the APU gas generator temperature is above 190° F, APU turbine speed is less than 80 percent, WSB controller is ready, a corresponding APU fuel tank isolation valve is open, and corresponding hydraulic main pump is depressurized. When the APU is started, and its turbine speed is greater than 80 percent of normal speed, the corresponding indicator shows barberpole.

NOTE

A barberpole *APU/HYD READY TO START* talkback will not inhibit a start.

APU OPERATE 1, 2, 3 switches are located on panel R2. When the switches are positioned to *START/RUN*, the corresponding APU controller activates the start of that unit and removes electrical power automatically from the unit's gas generator and fuel pump heaters.

To start the APU, fuel expelled from the hydrazine tank flows through the open tank valves and filter to the gas generator valve module, which contains the primary and secondary fuel control valve in series. The primary pulse control valve is normally open, and the secondary pulse control valve is energized open. Fuel flowing through the pump bypass valve is directed to the gas generator, because the fuel pump is not being driven at that moment by the APU turbine.

The fuel in the gas generator decomposes through catalytic reaction, creates hot gas, and directs the hot gas to the single-stage turbine, which begins to rotate. The turbine's mechanical shaft drives the reduction gears, rotating the fuel pump, lube oil pump, and hydraulic pump. The fuel pump increases the fuel pressure at its outlet and provides pressurized fuel to the gas generator valve module and gas generator.

The startup logic delays the APU underspeed logic check for 10.5 seconds after the start command is issued. This allows the APU to reach normal operating speed before the shutdown logic begins checking for a speed lower than 80 percent. The auto shutdown capability of the controller can be disabled by taking the *APU AUTO SHUT DOWN* switch on panel R2 to *INHIBIT*.

The startup logic does not delay the APU overspeed logic. If an overspeed is detected at any time by the controller, the F7 and MASTER ALARM will annunciate. If the *AUTO SHUT DOWN* on panel R2 is *ENABLED*, the controller will automatically close the tank isolation valves and close the secondary control valve.

CAUTION

After an APU auto shutdown, the *APU FUEL TK VLV* switch must be taken to *CLOSE* prior to inhibiting auto shutdown logic. Failure to do so can allow the fuel tank isolation valves to reopen and flow fuel to an APU gas generator bed that is above the temperature limits for safe restart.

APU Speed Control

When the APU turbine speed exceeds the control target (103 percent for NORMAL and 113 percent for HIGH) the appropriate control valve closes. The fuel is then diverted through a bypass line back to the fuel pump inlet. When the turbine speed drops below the control target, the appropriate valve opens directing fuel to the gas generator and closing off the bypass line. The primary fuel valve pulses to maintain APU speed. The frequency and duration of the primary fuel control valve pulses are functions of the hydraulic load on the unit.

The secondary fuel control valve normally stays fully open during the operation of the primary. If the primary valve loses power, it goes to the fully open position, and the secondary valve begins pulsing and controlling APU speed. If the secondary valve loses power at any time, the APU is shut down. If the auxiliary power unit is taken to a high speed (by the *APU SPEED SELECT* switch on panel R2), the primary valve attempts to control to 115 percent rpm, while the secondary valve controls the unit's speed at 113 percent rpm.

Each APU controller controls the speed of each unit upon the activation of the *APU SPEED SELECT* switch for each APU on panel R2. The *NORM* position controls the speed at 74,160 rpm, 103 percent, plus or minus 8 percent. The *HIGH* position controls the speed at 81,360 rpm, 113 percent, plus or minus 8 percent, with a second backup of 82,800 rpm, 115 percent, plus or minus 8 percent.

APU Auto Shutdown

The *APU AUTO SHUT DOWN* switches on panel R2 enable the automatic shutdown feature in the associated APU controllers. When the switch is positioned to *ENABLE*, each controller monitors its corresponding APU speed. If that APU speed falls below 57,600 rpm (80 percent) or rises above 92,880 rpm (129 percent), the controller automatically shuts down that unit. Each shutdown command closes that unit's secondary fuel valve and the tank isolation valves.

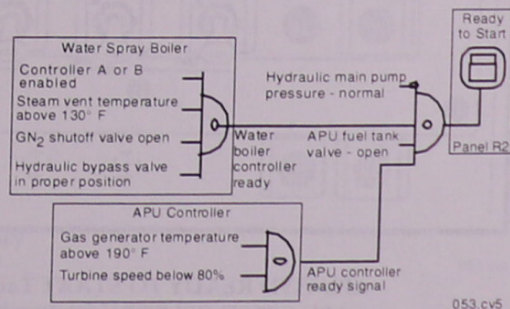

053.cv5

APU Ready-for-Start Talkback Indicator Logic

When an *APU AUTO SHUT DOWN* switch is positioned to *INHIBIT*, the automatic shutdown sequence for its APU controller is inhibited. If

the turbine speed falls below 80 percent or rises above 129 percent *APU UNDERSPEED* or *APU OVERSPEED* caution and warning lights on panel F7 will be illuminated, and a tone will be generated, even though the *APU AUTO SHUT DOWN* switch is in *INHIBIT*.

CAUTION

An APU should not be restarted after an overspeed shutdown. Uncontained overspeed and turbine wheel breakup could occur if restart is attempted.

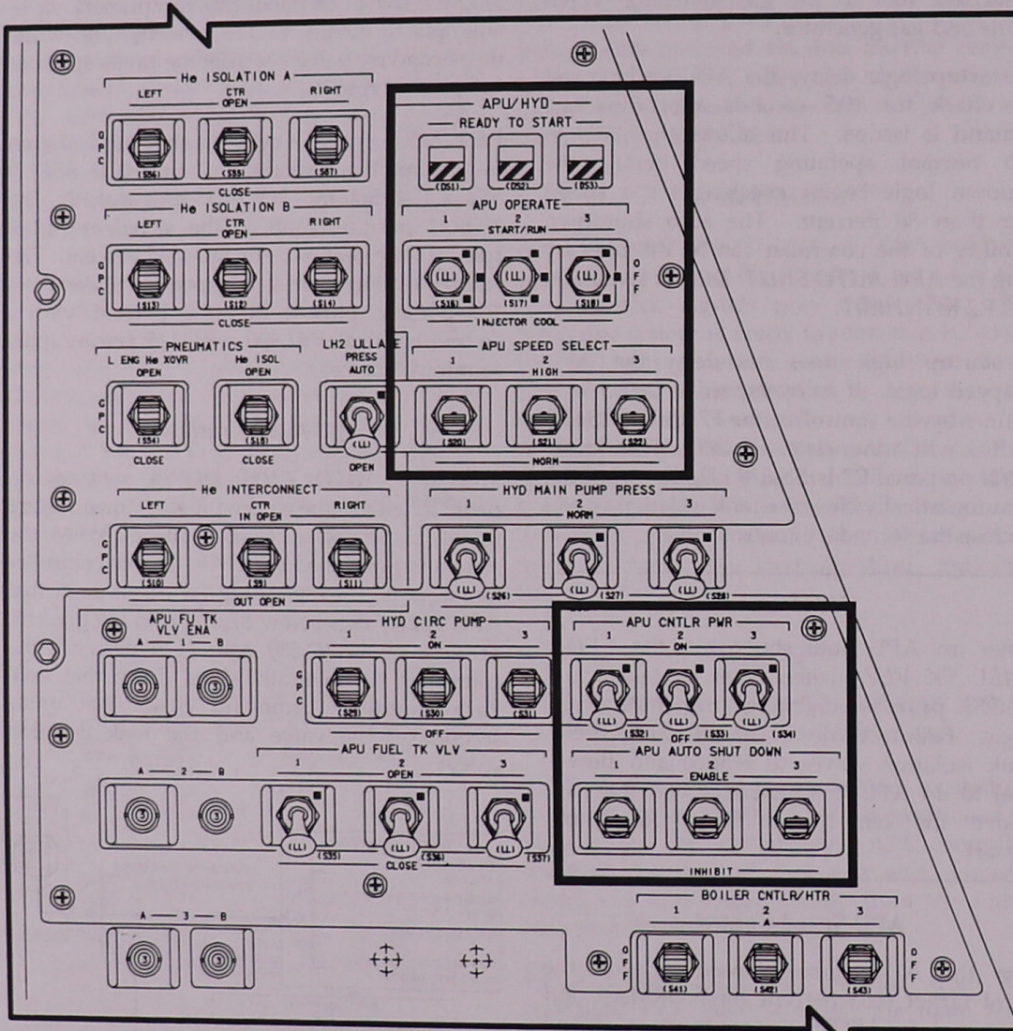

APU/HYD READY TO START Talkbacks, APU OPERATE Switches, APU SPEED SELECT Switches, APU CNTLR PWR Switches, and APU AUTO SHUT DOWN Switches on Panel R2

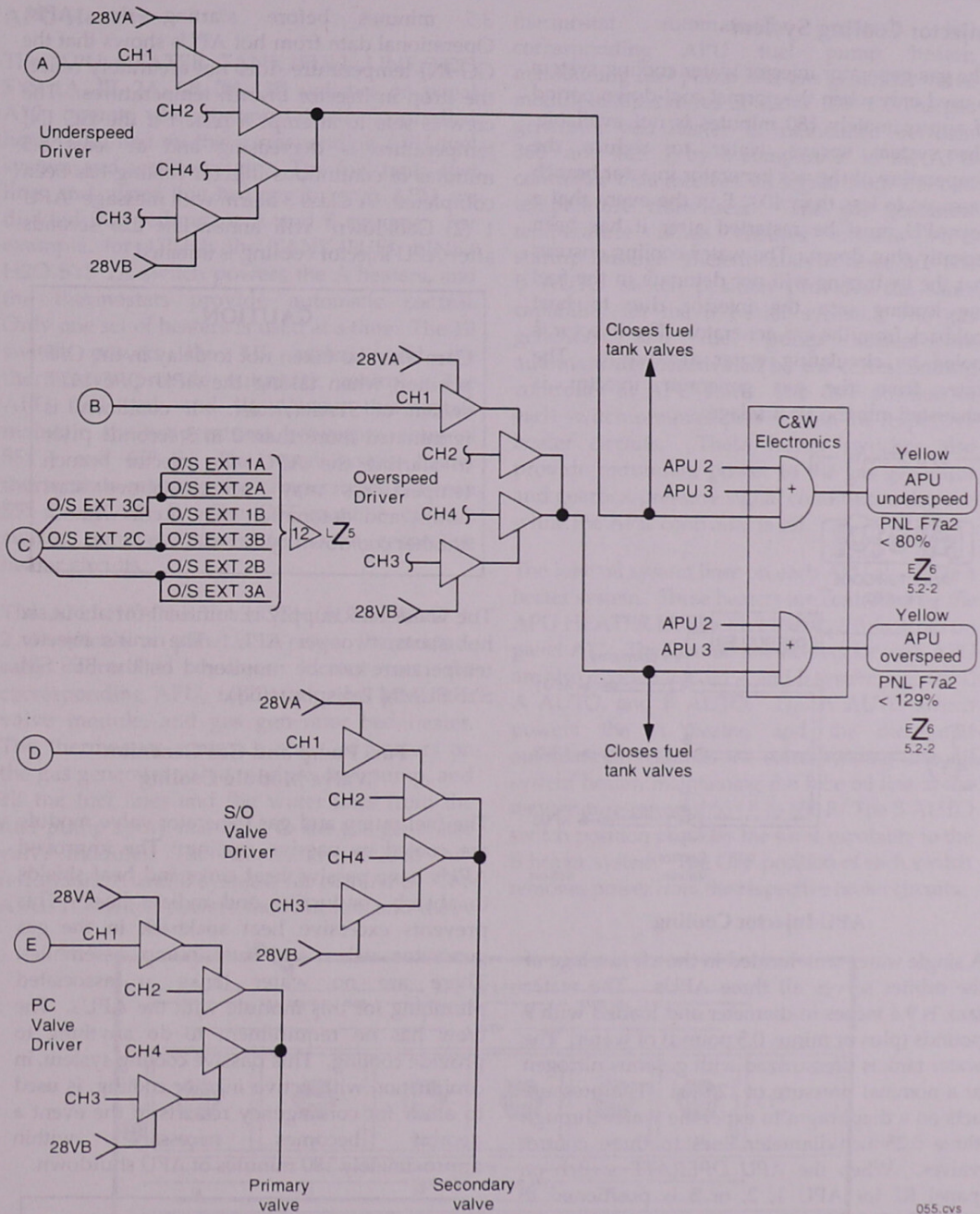

APU Overspeed/Underspeed Detection

055.cvs

Injector Cooling System

The gas generator injector water cooling system is used only when the normal cool-down period of approximately 180 minutes is not available. The system sprays water to reduce the temperature of the gas generator injector branch passages to less than 400° F in the event that a hot APU must be restarted after it has been recently shut down. The water cooling ensures that the hydrazine will not detonate in the fuel line leading into the injector due to heat soakback from the gas generator. The injector is cooled by circulating water around it. The water from the gas generator injector is exhausted into the aft fuselage.

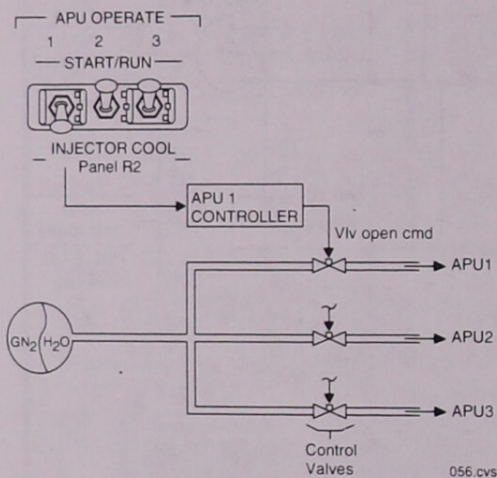

APU Injector Cooling

A single water tank located in the aft fuselage of the orbiter serves all three APUs. The water tank is 9.4 inches in diameter and loaded with 9 pounds (plus or minus 0.5 pound) of water. The water tank is pressurized with gaseous nitrogen at a nominal pressure of 120 psi. The pressure acts on a diaphragm to expel the water through three 0.25-inch-diameter lines to three control valves. When the *APU OPERATE* switch on panel R2 for APU 1, 2, or 3 is positioned to *INJECTOR COOL*, the water valve of that unit opens and directs the water into the gas generator injector to cool it.

If the injector branch (internal) temperature of an APU is above 400° F from heat soakback, or if the catalytic bed heater temperature is above 430° F, the flight crew must cool the injector for

3.5 minutes before starting the APU. Operational data from hot APUs shows that the GG INJ temperature does not accurately reflect the drop in injector branch temperatures. The crew is safe to attempt a restart if the GG INJ temperature is decreasing and at least 3.5 minutes of continuous injector cooling has been completed. A Class 3 alarm with message "APU 1 (2) Cooldown" will annunciate 225 seconds after APU injector cooling is initiated

CAUTION

Care must be taken not to delay in the *OFF* position when taking the *APU OPERATE* switch to *START/RUN*. If cooldown is terminated more than 2 to 3 seconds prior to starting the APU, the injector branch temperatures may increase above start limits, and detonation may occur without another cooldown cycle.

The water tank supply is sufficient for about six hot starts, two per APU. The unit's injector temperature can be monitored on the BFS SM SYS SUMM 2 display (INJ).

Fuel Pump and Gas Generator Valve Module Cooling

The fuel pump and gas generator valve module are cooled by passive cooling. The improved APUs have passive heat sinks and heat shields to absorb conductive and radiant heat. This prevents excessive heat soakback in the gas generator valve and fuel pump assemblies. There are no water tanks or associated plumbing for this module with the APUs. The crew has no requirement to do anything to provide cooling. This passive cooling system, in conjunction with active injector cooling, is used to allow for contingency restarts in the event a deorbit becomes necessary within approximately 180 minutes of APU shutdown.

CAUTION

An APU may not be restarted if the temperature of the fuel pump is above 210° F or the temperature of the gas generator valve module is above 200° F, because hydrazine detonation may occur.

APU Heaters

The APU HEATER TANK/FUEL LINE/H₂O SYS 1A, 1B, 2A, 2B, 3A, 3B switches on panel A12 operate the thermostatically controlled heaters located on the corresponding APU fuel system and water system. The fuel tank, fuel line, and water line heaters for each APU are divided into redundant A and B systems. For example, for APU 1, the TANK/FUEL LINE/H₂O SYS 1A switch powers the A heaters, and the thermostats provide automatic control. Only one set of heaters is used at a time. The 1B switch powers the 1B heaters, and the thermostats provide automatic control. The APU fuel tank and line heater thermostats maintain the temperatures between a nominal 55° F and 65° F. The water system heater thermostats maintain the temperatures between 55° F and 65° F. The OFF position of each switch removes power from the respective heater circuits.

The APU HEATER GAS GEN/FUEL PUMP 1, 2, 3 switches on panel A12 power thermostatically controlled heaters located on the corresponding APU, fuel pump, gas generator valve module, and gas generator bed heater. The thermostats control a series of heaters on the gas generator valve module, fuel pump, and all the fuel lines and the water lines from the fuel pump spray manifold to the gas generator valve module. The heaters are divided into redundant A and B systems for each APU. The A AUTO switch powers the A heater, and the A

thermostat automatically controls the corresponding APU fuel pump heater, maintaining fuel pump and gas generator valve module temperatures at about 100° F. The gas generator bed heater is maintained between 360° and 425° F by a comparator in the APU controller that receives its signal from the bed temperature transducer. The gas generator temperature range ensures efficient APU startup through efficient catalytic reaction. The B AUTO switch position provides the same capability for the B heater system. The gas generator and fuel pump heaters are automatically deactivated by the corresponding controller at APU start. The OFF position of each switch removes power from the respective heater circuits. These heater switches also provide redundant power to the gas generator and gearbox pressure signal conditioners for use while the APU controller is off.

The lube oil system lines on each APU also have a heater system. These heaters are controlled by the APU HEATER LUBE OIL LINE 1, 2, 3 switches on panel A12. The lube oil line heaters for each APU are also divided into an A and B system; e.g., for 1, A AUTO, and B AUTO. The A AUTO switch powers the A heater, and the thermostat automatically controls the corresponding lube oil system heater, maintaining the lube oil line in the temperature range of 55° F to 65° F. The B AUTO switch position provides the same capability to the B heater system. The OFF position of each switch removes power from the respective heater circuits.

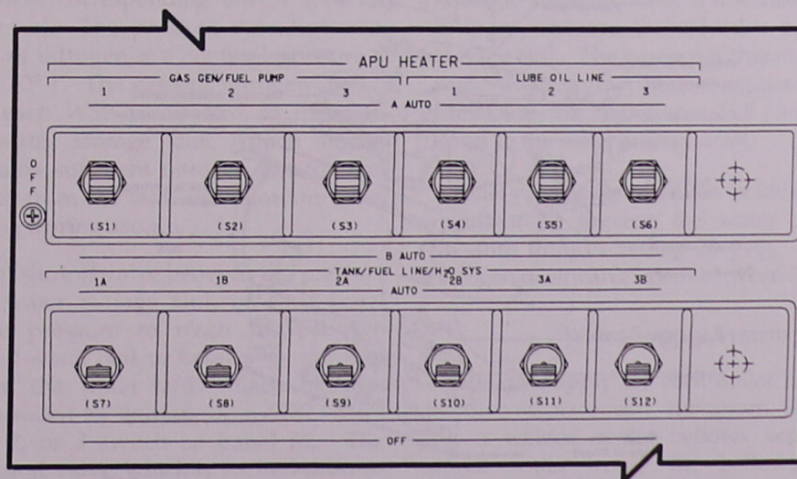

APU HEATER Controls on Panel A12

Water Spray Boilers

The water spray boiler (WSB) system consists of three identical independent water spray boilers, one for each APU/hydraulic system. The boilers are located in the aft fuselage of the orbiter. Each WSB cools the corresponding APU lube oil system and hydraulic system by spraying water onto their lines; as the water boils off, the lube oil and hydraulic fluid are cooled. The steam that boils off in each water spray boiler exits through its own exhaust duct, located on the starboard side of the vertical stabilizer.

Each WSB is 45 by 31 inches long by 19 inches wide, and including controller and vent nozzle, weighs 181 pounds. They are mounted in the orbiter aft fuselage between X₀ 1340 and 1400, at Z₀ 488 minus 15, and at Y₀ plus 15. Insulation blankets cover each boiler. The boiler's water capacity is 142 pounds.

Each WSB stores water in a bellows-type storage tank pressurized by gaseous nitrogen providing positive water expulsion to feed the boiler. Hydraulic fluid passes through the boiler three times. APU lube oil passes through the boiler twice. The hydraulic fluid tubes are sprayed with water from three water spray bars, and two water spray bars spray the APU lube oil. Separate

water feed valves allow independent control of the hydraulic fluid spray bars and APU lube oil spray bars. Redundant electrical controllers provide completely automatic operation.

The boiler system maintains APU lube oil temperature at approximately 250° F and the hydraulic fluid in the range of 210° to 220° F.

The crew can see the WSB water quantity (H2O QTY), nitrogen tank pressure (N2 P), nitrogen regulator pressure (REG P), and nitrogen tank temperature (N2 T) on the right side of the SM APU/HYD (DISP 86) display on orbit.

2011/ /086		APU/HYD			4 000/02:36:12					
					000/00:00:00					
APU		1	2	3	HYD	1	2	3		
B/U	EGT	313	313	310	B/U	P	64↓	64↓	64↓	
EGT		313	313	310	RSVR	T	58	64	66	
SPEED	%	0L	0L	0L		P	65	66	66	
FUEL	QTY	76	77	77		QTY	74	75	73	
TK	P	209	210	212	ACCUM	P	2616	2624	2624	
OUT	P	209	210	212						
TK	VLV	A	CL	CL	CL					
	A	T	61	62	62					
	B	CL	CL	CL	CL					
	B	T	61	62	62	W/B	1	2	3	
OIL	T	64	63	62						
OUT	T	63	62	60	CNTRLR	A	A	A		
OUT	P	25	25	25	H2O QTY	100	100	100		
GBX	P	25	25	25	N2	T	2499	2506	2492	
	N2	P	141	142	140		T	57	58	55
	BRG	T	82	81	84	REG	P	28	28	28
	GG BED	T	426	423	421	VENT	T	+122L	+122L	+122L
	PMP	T	94	92	90	TANK	T	+57	+58	+55
	VLV	T	114	111	107	BLR	T	+60	+58	+61

059

SM APU/HYD Display (DISP 86)

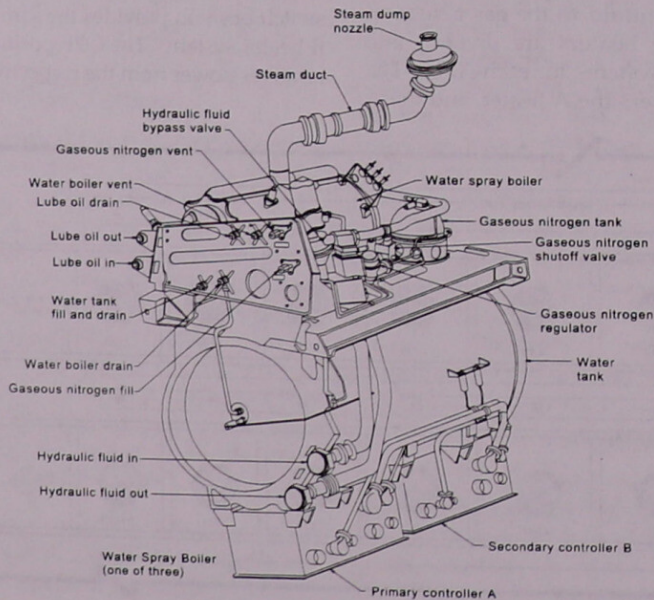

058.cvs

Water Spray Boiler Unit

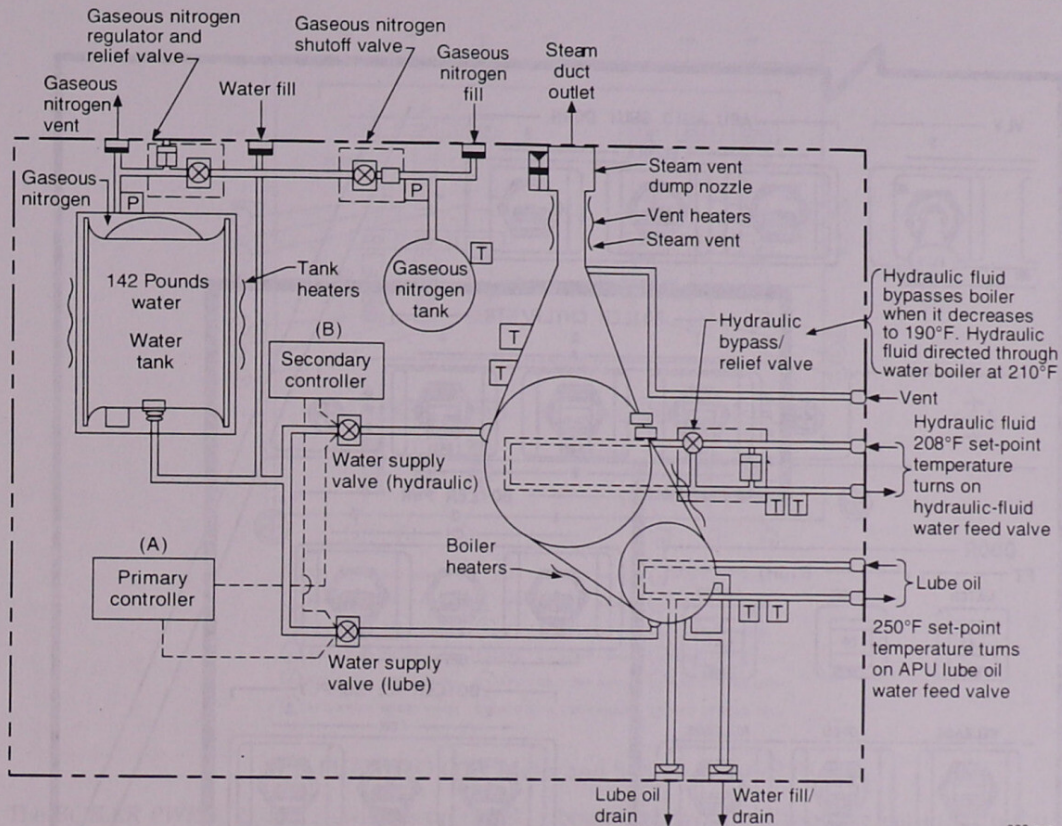

Water Spray Boiler (One of Three)

Nitrogen Supply System

The gaseous nitrogen pressure for each WSB is contained in a corresponding 6-inch spherical pressure vessel. The pressure vessel contains 0.77 pound of nitrogen at a nominal pressure of 2,400 psi at 70° F. The gaseous nitrogen storage system of each WSB is directed to its corresponding water storage tank. Each storage vessel contains sufficient nitrogen gas to expel all the water from the tank and allow for relief valve venting during ascent.

The nitrogen shutoff valve between the pressure valve and water storage tank of each boiler permits the pressure to reach the nitrogen regulator and water tank or isolates the nitrogen supply from the water tank. Each nitrogen valve is controlled by its respective *BOILER N2 SUPPLY 1, 2, or 3* switch on panel R2. The nitrogen shutoff valve, which is latched open or closed, consists of two independent solenoid

coils that permit valve control from either the primary or secondary controller.

A single-stage regulator is installed between the nitrogen pressure shutoff valve and the water storage tank. The gaseous nitrogen regulator for each water spray boiler regulates the high-pressure nitrogen between 24.5 and 26 psig as it flows to the water storage tank.

A relief valve is incorporated inside each nitrogen regulator to prevent the water storage tank pressure from exceeding 33 psig. The gaseous nitrogen relief valve opens between 30 to 33 psig.

Water Supply System

The water supply for each boiler is stored in a positive-displacement aluminum tank containing a welded metal bellows separating the stored water inside the bellows from the nitrogen expulsion gas.

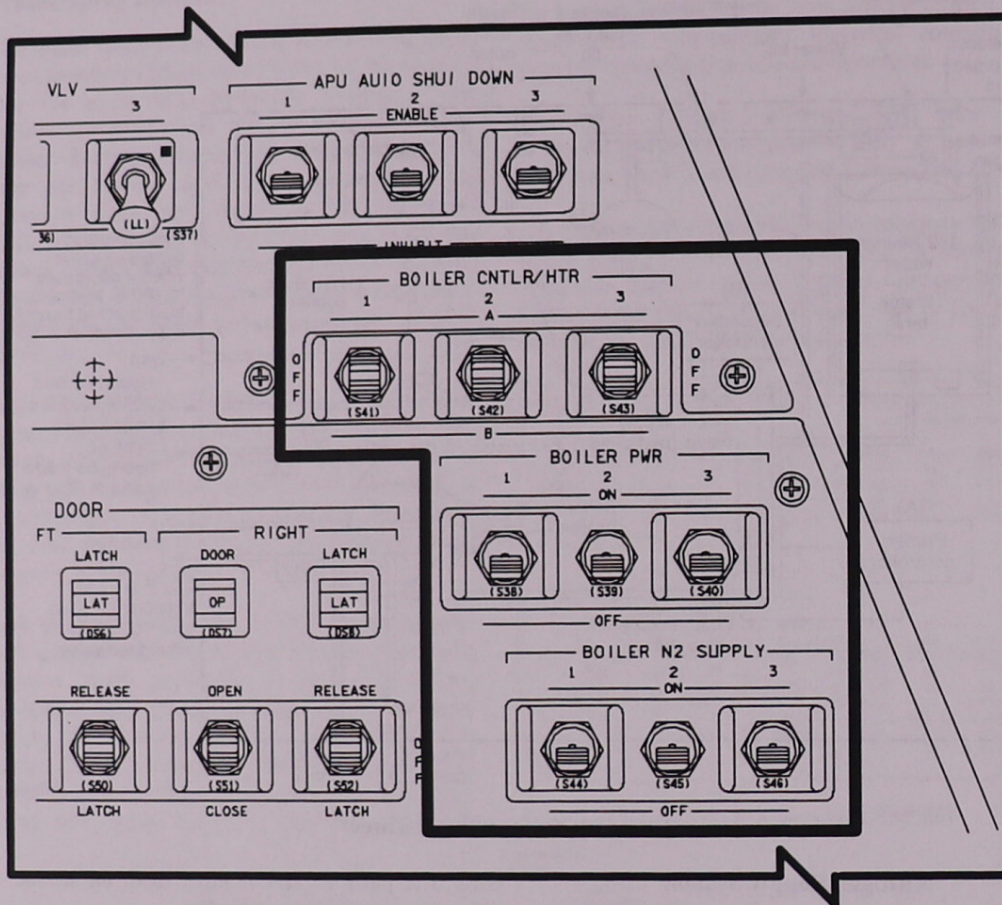

BOILER Switches on Panel R2

Redundant pressure and temperature sensors located downstream from the gaseous nitrogen pressure vessel and on the water tank for each boiler transmit the pressures and temperatures through each controller to the systems management general-purpose computer. The computer computes the water tank quantity from the pressure, volume, and temperature, and transmits the water tank quantity to the dedicated MEDS display for each boiler. Water quantity is available when either the A or B controller is powered.

Downstream of the water storage tank, the feedwater lines to each water boiler split into two parallel lines: one line goes to the hydraulic fluid flow section and one to the lube oil section

of the WSB. The H₂O spray valves in each feedline are controlled independently by the boiler controller.

Temperature Control

The two boiler controllers are operated by the respective *BOILER CNTLR/HTR* 1, 2, and 3 switches on panel R2. When the applicable switch is positioned to A, the A controller for that boiler is powered; if it is positioned to B, the B controller is powered. The OFF position removes electrical power from both controllers.

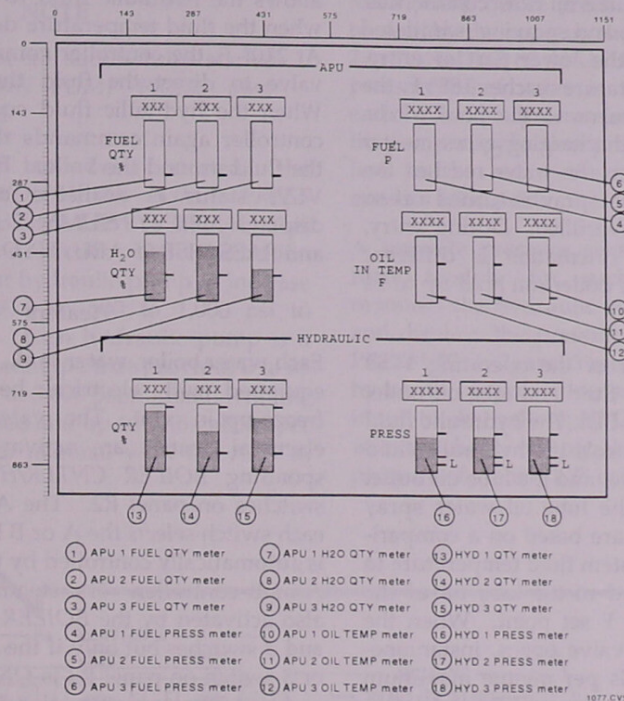

APU FUEL/H₂O QTY Meter and Switch on Panel F8

The *BOILER PWR 1, 2, and 3* switches on panel R2 enable (provide the automatic control functions) the specific controller A or B selected for that boiler by the *BOILER CNTLR/HTR 1, 2, and 3* switches on panel R2. When the applicable controller A or B is enabled for that boiler, a ready signal is transmitted to the corresponding *APU/HYD READY TO START* indicator on panel R2 if the following additional conditions are met: gaseous nitrogen shutoff valve is open, steam vent nozzle temperature is greater than 130° F, and hydraulic fluid bypass valve is in the correct position with regard to the hydraulic fluid temperature.

The core of each WSB is a stainless steel crimped-tube bundle. The hydraulic fluid section is divided into three 17-inch-long passes of smooth tubes (first pass-234 tubes, second pass-224 tubes, and third pass-214 tubes). The lube oil section of the APU comprises two passes with 103 crimped tubes in its first pass and 81 smooth tubes in the second pass. The tubes are 0.0125 of an inch in diameter with a wall thickness of 0.010 of an inch. Crimps located every 0.24 of an inch break up the internal

boundary layer and promote enhanced turbulent heat transfer. Although the second pass is primarily a low-pressure drop return section, approximately 15 percent of the unit's lube oil heat transfer occurs there. Three connected spray bars feed the hydraulic fluid section, while two spray bars feed the power unit's lube oil section in each boiler.

When the orbiter is in the vertical position on the launch pad, each boiler is loaded with up to 3.5 pounds of water, which is referred to as "pool mode" operation. When each APU/hydraulic system and WSB are in operation 5 minutes before lift-off, the APU lube oil tube bundle is immersed in the boiler water precharge. As the vehicle ascends during launch, the lube oil system of the APU heats up, eventually the boiler water precharge boils off, and the boiler goes into the spray mode about 13 minutes after launch. The hydraulic fluid usually does not heat up enough during ascent to require spray cooling.

When the APU/hydraulic combination is started for atmospheric entry, the hydraulic

fluid and power unit lube oil flow commences, fluid temperatures rise, and spraying is initiated as required. During the lower part of entry, when the boiler temperature reaches 188° F, the water spray boiler returns to the pool mode. The spray bars begin discharging excess water to fill the boiler. When the water reaches the liquid level sensors, the spray is turned off so that the boiler is not overfilled. During entry, because the orbiter's orientation is different from that of launch, the boiler can hold up to 14 pounds of water.

The enabled controller of the operating WSB monitors the hydraulic fluid and lube oil outlet temperature from the APU. The hydraulic fluid outlet temperature controls the hydraulic fluid H₂O spray control valve, and the lube oil outlet temperature controls the lube oil water spray control valve. Signals are based on a comparison of the hydraulic system fluid temperature to its 208° F set point and of the lube oil of the power unit to its 250° F set point. When the respective water feed valve opens, instantaneous flows of 10 pounds per minute maximum through the hydraulic section and 5 pounds per minute maximum through the lube oil section enter the water boiler through the corresponding spray bars to begin evaporative cooling of the hydraulic fluid and APU lube oil. The steam is vented out through the overboard steam vent.

The separate water feed valves modulate the water flow to each section of the tube bundle core in each WSB independently in 200-millisecond pulses that vary from one pulse every 10 seconds to one pulse every 0.25 of a second.

Because of the unique hydraulic system fluid flows, control valves are located in the hydraulic system fluid line section of each WSB. Normally, hydraulic system fluid flows at up to 21 gallons per minute; however, the hydraulic system experiences 1- to 2-second flow spikes at up to 63 gallons per minute. If these spikes were to pass through the boiler, pressure drop would increase ninefold and the boiler would limit the flow of the hydraulic system. To prevent this, a relief function is provided by a spring-loaded poppet valve that opens when the hydraulic fluid pressure drop exceeds 49 psi and is capable of flowing 43 gallons per minute at a differential pressure of 50 psi across the boiler. A temperature controller bypass valve

allows the hydraulic fluid to bypass the boiler when the fluid temperature decreases to 190° F. At 210° F, the controller commands the bypass valve to direct the fluid through the boiler. When the hydraulic fluid cools to 190° F, the controller again commands the valve to route the fluid around the boiler. Bypass valve (BYP VLV) status is available on the following displays: SM SYS SUMM 2 (PASS AND BFS) and PASS DISP 86 APU/HYD.

Heaters

Each water boiler, water tank, and steam vent is equipped with electrical heaters to prevent freeze-up in orbit. The water tank and boiler electrical heaters are activated by the corresponding *BOILER CNTLR/HTR 1, 2, and 3* switches on panel R2. The A or B position of each switch selects the A or B heater system and is automatically controlled by the corresponding A or B controller. The steam vent heaters are also activated by the *BOILER CNTLR/HTR 1, 2 and 3* switches but only if the *BOILER PWR 1, 2 or 3* switch on panel R2 is ON. The water tank and boiler heaters are cycled on at 50° F and off at 55° F. The steam vent heaters are not operated continuously in orbit; they are activated approximately two hours before APU startup. The steam vent heaters are cycled on at 150° F and cycled off at 175° F.

Main Hydraulic Pump

The main hydraulic pump for each hydraulic system is a variable displacement type. Each operates at approximately 3,900 rpm when driven by the corresponding APU.

Each main hydraulic pump has an electrically operated depressurization valve. The depressurization valve for each pump is controlled by its corresponding *HYD MAIN PUMP PRESS 1, 2, or 3* switch on panel R2. When the switch is positioned to LOW, the depressurization valve is energized to reduce the main hydraulic pump discharge pressure from its nominal range of 2,900 to 3,100 psi output to a nominal range of 500 to 1,000 psi to reduce the APU torque requirements during the start of the APU. "APU Press Low" is one of the inputs required to get a gray READY TO START talkback.

NOTE

An APU cannot be successfully started with *HYD MAIN PUMP PRESS* positioned to *NORM*.

After an APU has been started, the corresponding *HYD MAIN PUMP PRESS* switch is positioned from *LOW* to *NORM*. This de-energizes the respective depressurization valve, allowing that hydraulic pump to increase its outlet pressure from 500 to 1,000 psi to 2,900 to 3,100 psi. Each hydraulic pump is a variable displacement type that provides 0 to 63 gallons per minute at 3,000 psi nominal with the APU at normal speed and up to 69.6 gallons per minute at 3,000 psi nominal with the APU at high speed.

Main pump outlet pressure (*HYD PRESS*) can be seen by the crew on the *BFS SM SYS SUMM 2* or *PASS DISP 86 APU/HYD* displays. A high-pressure relief valve in the filter module for each hydraulic system also relieves the hydraulic pump supply line pressure into the return line in the event the supply line pressure exceeds 3,850 psid.

A separate pressure sensor (sensor A) in the filter module for each hydraulic system monitors the hydraulic system source pressure and displays the pressure on the *HYDRAULIC PRESSURE 1, 2, and 3* meters on panel F8. This hydraulic pressure sensor also provides an input to the yellow *HYD PRESS* caution and warning light on panel F7 if the hydraulic pressure of system 1, 2, or 3 is below 2,400 psi.

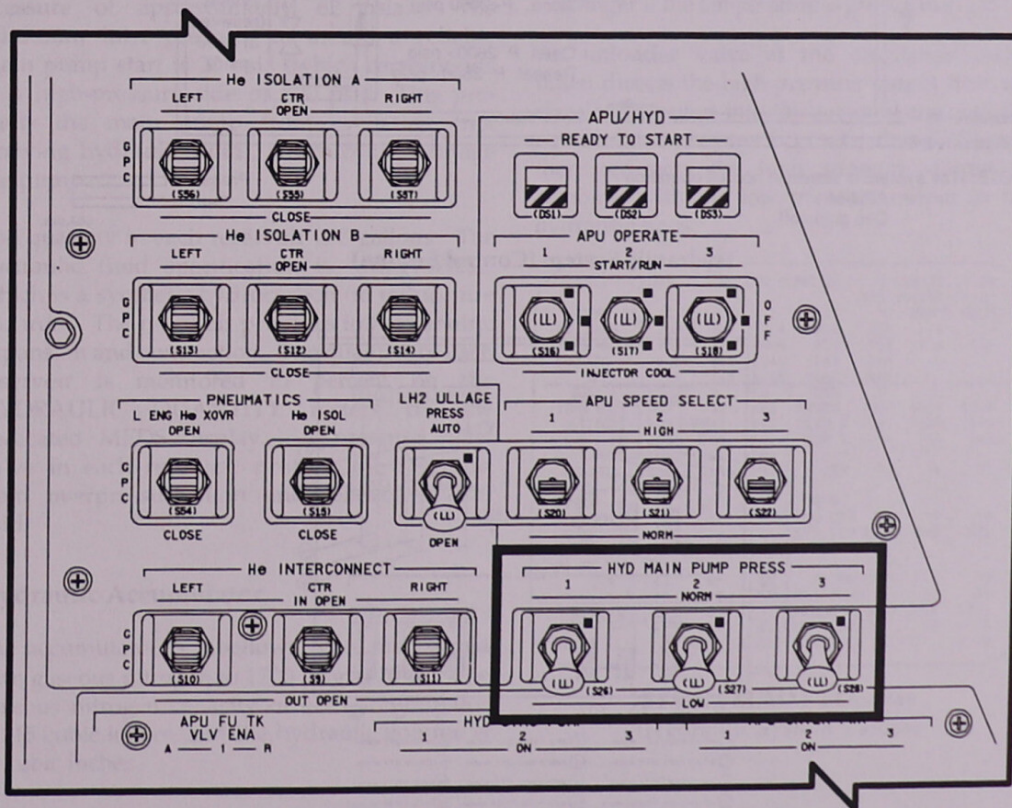

HYD MAIN PUMP PRESS 1, 2, 3 Switches on Panel R2

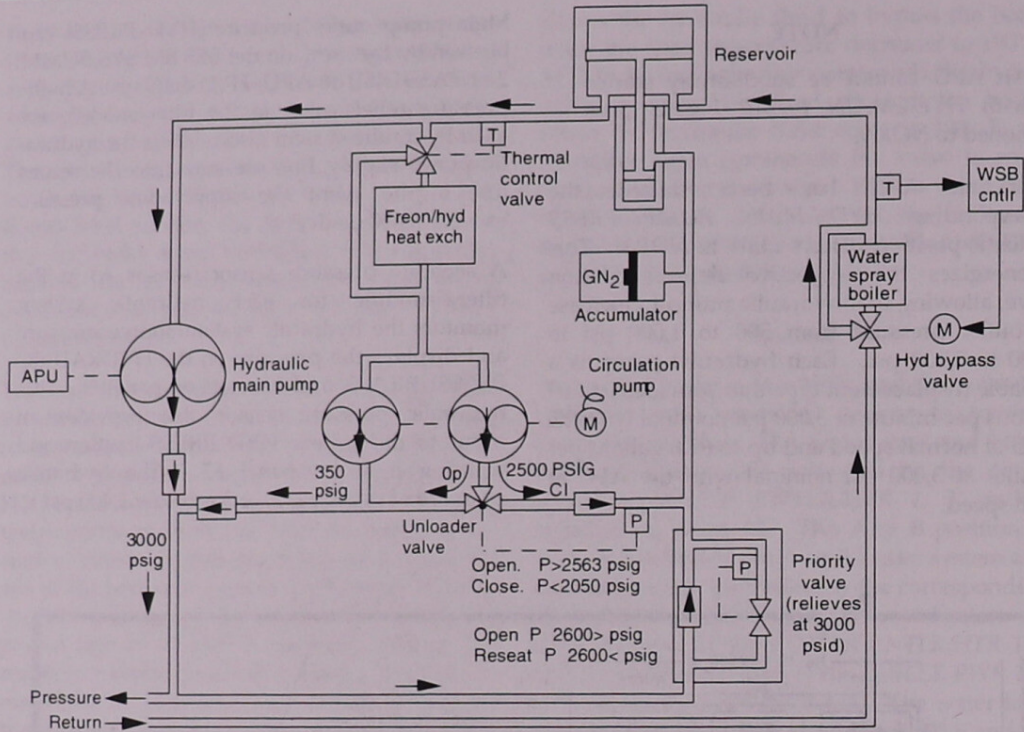

NOTE: The system is shown in normal operation
 - APU on
 - Circ pump off

Pressure
 Return
 064.cvs

Hydraulic System (Control Section)

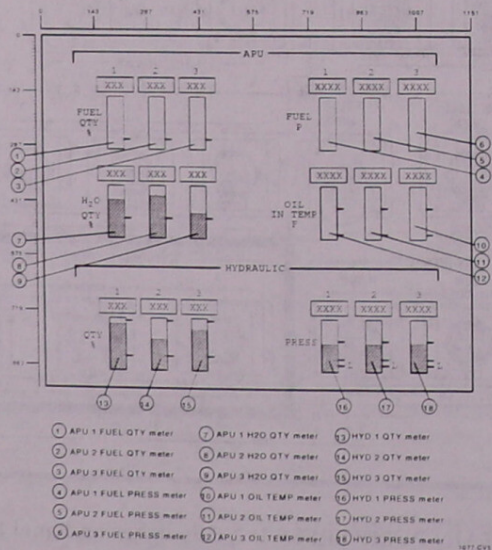

HYDRAULIC PRESSURE and QUANTITY Meters on Panel F8
 (Driven by different sensor than CRT)

Hydraulic Reservoir

Hydraulic reservoir pressure is maintained using an accumulator bootstrap mechanism. The bootstrap uses a variable area piston assembly to convert high pressure to the accumulator to lower pressure in the reservoir (roughly 40:1). This reservoir pressure maintains adequate hydraulic inlet pressure at both the main pump and circulation pump to prevent cavitation during startup and operation. When the main hydraulic pump is in operation, the high-pressure side of the piston and the bootstrap accumulator are pressurized to 3,000 psig from the main pump discharge line. When the main hydraulic pump is shut down, the priority valve closes, and the bootstrap accumulator maintains a pressure of approximately 2,500 psi. The 2,500 psi on the high side results in a main pump inlet (low side) pressure of approximately 62 psia. The minimum inlet pressure to assure a reliable main pump start is 20 psia (which corresponds to a high-pressure side of 800 psi). This prevents the main pump from cavitating (not drawing hydraulic fluid), which could damage the pump.

The quantity in each reservoir is 8 gallons. The hydraulic fluid specification is MIL-H-83282, which is a synthetic hydrocarbon (to reduce fire hazards). The reservoir provides for volumetric expansion and contraction. The quantity of each reservoir is monitored in percent on the HYDRAULIC QUANTITY meters on the dedicated MEDS display. A pressure relief valve in each reservoir protects the reservoir from overpressurization and relieves at 120 psid.

Hydraulic Accumulator

The accumulator is a bellows type, precharged with gaseous nitrogen to 1700 psig at 70° F. The gaseous nitrogen capacity of each accumulator is 115 cubic inches, and the hydraulic volume is 51 cubic inches.

Circulation Pump and Heat Exchanger

The circulation pump is actually two fixed-displacement gear-type pumps in tandem, driven by a single motor. One is a high pressure, low-volume pump (2,500 psig), which is used to maintain accumulator pressure while the hydraulic system is inactive in orbit. The other is a low pressure, high-volume pump (350 psig), which is used to circulate hydraulic fluid through the orbiter hydraulic lines while the hydraulic system is inactive in orbit in order to warm up cold spots. The hydraulic fluid is circulated through a Freon/hydraulic fluid heat exchanger to pick up heat from the orbiter Freon coolant loops. A temperature-controlled bypass valve directs the hydraulic fluid through the heat exchanger if the temperature at the heat exchanger inlet is less than 105° F. The bypass valve bypasses the fluid around the heat exchanger if the temperature is greater than 115° F.

An unloader valve at the circulation pump outlet directs the high pressure output from the circulation pump into the accumulator until the accumulator pressure is greater than 2,563 psia, then redirects the high pressure output to combine with the low pressure output to the hydraulic lines.

0001/ /079		SM SYS SUMM 2				5 008/23:29:22	
						BFS 000/00:00:00	
CRYO TK		1	2	3	4	5	MANF1 MANF2
H2 PRESS	208	208	206	206	206	208	207
O2 PRESS	816	815	814	814	814	815	815
HTR T1	-248	-248	-248	-248	-248	-248	-248
T2	-248	-248	-248	-248	-248	-248	-248
APU	1	2	3	HYD	1	2	3
TEMP EGT	942	942	942	PRESS	3064	3064	3064
B/U EGT	942	942	942	ACUM P	3080	3080	3080
OIL IN	250	250	250	RSVR T	116	153	142
OUT	264	264	264				
GG BED	511H	511H	511H	QTY	72	74	71
INJ	1271	1271	1271				
SPEED %	99	102	101	W/B			
FUEL QTY	59	60	62	H2O QTY	78	73	78
PMP LK P	14	14	14	BYP VLV BYP	BYP	BYP	BYP
OIL OUT P	42	42	41				
FU TK VLV							
A T	63	65	62	THERM CNTL	1	28	
B T	63	65	62	H2O PUMP P	23	63	
AV BAY	1	2	3	FREON FLOW	2384	2384	
TEMP	97	97	83	EVAP OUT T	38	38	
A4 14	27.439	27.435			26.324	31.873	18.48

051

**BFS SM SUMM 2 Display
(Hydraulic System Values)**

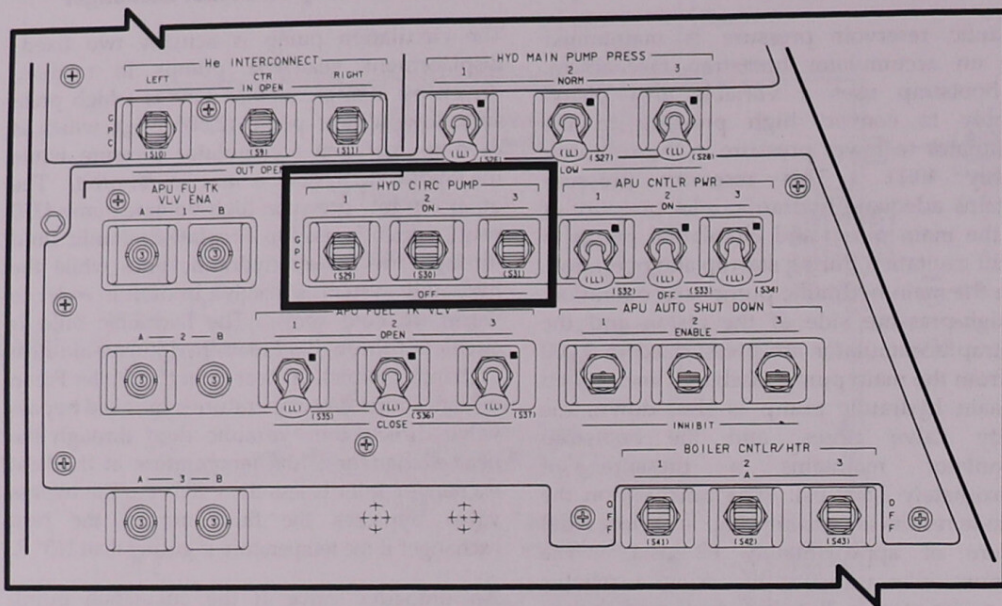

HYD CIRC PUMP Switches on Panel R2

Each circulation pump can be manually turned on or off with the corresponding *HYD CIRC PUMP* switch on panel R2. If the switch is placed in GPC, the pump will be activated and deactivated by the SM GPC according to a control software program based on certain hydraulic line temperatures and/or accumulator pressure. This program activates the appropriate circulation pump when any of the control temperatures drop below either 0° F, or -10° F, depending on their locations, and deactivates the circulation pump when all of the control temperatures for that system are greater than 20° F, or after 15 minutes for system 1 and 10 minutes for systems 2 and 3. The activation/deactivation limits for these control temperatures can be changed during the flight by crew or Mission Control.

The program also includes a timer to limit the maximum time a circulation pump will run, and a priority system to assure that only one circulation pump is on at a time (because of excessive power usage if more than one circulation pump is on). Each circulation pump uses 2 kW of electrical power. This software will also automatically provide for the

repressurization of the hydraulic accumulator when the pressure lowers to a value of 1,960 psi. In this contingency, the circulation pump will first receive the highest priority to operate and will be turned ON while other circulation pumps are operating in thermal mode (this means that two pumps can be operating simultaneously). After the pump has been repressurized, the accumulator above 1,960 psi, or a period of 2 minutes (this value can be changed by Mission Control Center uplink) has elapsed, the circulation pump will be commanded to OFF. It is possible to run all three circulation pumps at the same time to repressurize accumulators.

The circulation pump is automatically disconnected when its corresponding APU Run command is issued by the APU controller. Each circulation pump can be powered by one of two orbiter main electrical buses, selectable by the *HYD CIRC PUMP POWER* switches on panel A12.

The crew can see circulation pump outlet pressure as well as the hydraulic line and component temperatures on the PASS SM HYD THERMAL display, DISP 87.

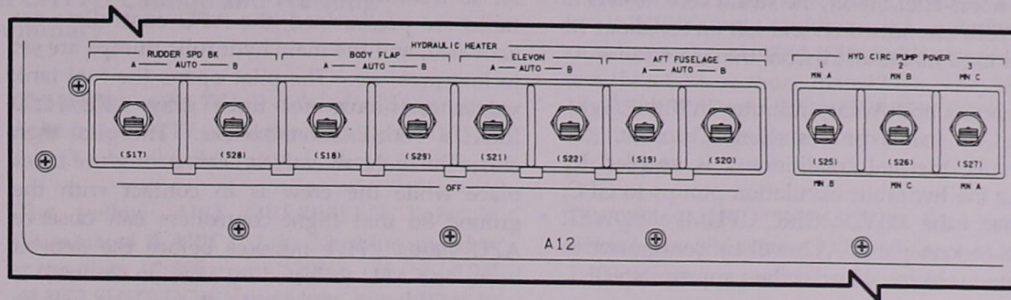

Hydraulic System Controls on Panel A12

2011/ /087		HYD THERMAL		4 000/02:36:29		000/00:00:00			
				CIRC PUMP CONTROL					
		1	2	3	LINE TEMPS	1	2	3	
HYD					ELEVON	LOB+	94	+ 61	+ 59
CIRC PMP	P	64	66	66	ELEVON	LOB+	94	+ 61	+ 59
CIRC PMP	P	64	66	66	LIB+	94	+ 61	+ 61	
PMP BDY	T+	61	+ 47	+ 47	RIB+	94	+ 61	+ 61	
RSVR	T+	58	+ 64	+ 66	ROB+	94	+ 59	+ 61	
ACCUM	P	2616	2624	2624	PDU+	97	+ 59	+ 59	
HX IN	T+	75	+ 75	+ 75	FUS+	97	+ 59	+ 59	
OUT	T+	59	+ 54	+ 54	BDYFLP	PDU+	97	+ 59	+ 59
SW VLV	PR	S1	S2		FUS+	97	+ 59	+ 59	
ELEV L	OB	3*	1	2	L BRAKE	WHL	+ 70	+ 45	
IB	2*	1	3		FUS	+ 70	+ 45		
R IB	3*	1	2		R BRAKE	WHL+	62	+ 70	+ 61
OB	2*	1	3		FUS+	40	+ 67	+ 61	
RUD/SPDK	1*	2	3		NG	UPLK+	40		
TIRE PRESS					MFUS	1+	40		
MG	LEFT	RIGHT			MG L	UPLK+	40		
IB	377	377	377	377	MG R	UPLK+	40		
OB	378	378	376	376	FUS+	40			
NG	369	369	364	364					

SM HYD THERMAL Display (DISP 87)

The SM APU/HYD display (DISP 86) shows the hydraulic system pressure, reservoir temperature, reservoir quantity (in percent), and hydraulic accumulator pressure.

Hydraulic Heaters

Areas of the hydraulic lines that cannot be warmed by fluid circulation while the system is inactive on-orbit are warmed by heaters. These heaters are automatically controlled by thermostats to maintain the hydraulic line temperatures in a specified range. Each heated area has redundant heaters (A and B), which are controlled by the HYDRAULIC HEATER switches on panel A12.

Operations

The WSB controllers are powered up at launch minus 8 hours, and the boiler water tanks are pressurized in preparation for APU activation. The controllers activate heaters on the water tank, boiler, and steam vent to assure that the water spray boiler is ready to operate for launch.

APU start is delayed as long as possible to save fuel. At T minus 6 minutes 15 seconds, the pilot begins the prestart sequence. The pilot confirms that the WSB is activated, then activates the APU controllers and depressurizes the main hydraulic pump. Depressurizing the main pump reduces the starting torque on the APU. The pilot then opens the fuel tank valves and looks for three APU ready-to-start indications (gray talkbacks). At T minus 5 minutes, the pilot starts the three units by setting the APU OPERATE switches to START/RUN and checks the hydraulic pressure gauges for an indication of approximately 800 psi. Then the pilot pressurizes the main pump and looks for approximately 3,000 psi on the gauges. All three hydraulic main pump pressures must be greater than 2,800 psi by T minus 4 minutes, or the automatic launch sequencer will abort the launch.

The APUs operate during the ascent phase and continue to operate through the first OMS burn. At the conclusion of the main engine purge, dump, and stow sequence, the APUs and WSBs are shut down. The same sequence applies for a delayed OMS-1 burn. If an abort once around is declared, the APUs are left running, but the hydraulic pumps are depressurized to reduce fuel consumption. The units are left running to avoid having to restart hot APUs for deorbit and re-entry.

Six hours after lift-off, or as soon as they are required, depending on the environment, the gas generator/fuel pump heaters are activated and are in operation for the remainder of the orbital mission. The fuel and water line heaters are activated immediately after APU/HYD SHUTDN in the post OMS-1 timeframe to prevent the lines from freezing as the APUs cool down.

Two hours after lift-off, the steam vent heaters of the WSBs are turned on and left on for about 1.5 hours to eliminate all ice from the steam vents.

Two hours and twenty minutes into the flight, while in the Post Insertion Checklist, the hydraulic thermal conditioning is enabled by taking the hydraulic circulation pumps to GPC. Further, the HYD CIRC PUMP POWER switch(es) on panel A12 will be configured to distribute electrical loads when appropriate.

While the vehicle is in orbit, the hydraulic circulation pumps are in the GPC mode--automatically activated when hydraulic line temperatures become too low and automatically deactivated when the lines warm up sufficiently.

On the day before deorbit, one APU is started to supply hydraulic pressure for flight control system checkout. (Hydraulic pressure is needed to move the orbiter aerosurfaces as part of this checkout.) The associated WSB controller is activated, landing gear isolation valves 2 and 3 are closed, and one APU (selected by the Mission Control Center) is started. The hydraulic main pump is set to normal pressure (approximately 3,000 psi), and aerosurface drive checks are made. After about 5 minutes, the checks are complete, and the APU is shut down. Normally, the unit does not run long enough to require WSB operation. The landing gear isolation valves on hydraulic systems 2 and 3 are reopened after the APU is shut down.

At 2.5 hours before the deorbit burn, the boilers' steam vent heaters are activated to prepare the system for operation during atmospheric entry. At about the same time, the landing gear isolation valves on hydraulic systems 2 and 3 are closed, and the circulation pumps are turned off.

At 45 minutes before deorbit, the WSB water tanks are pressurized, the APU controllers are activated, and the main hydraulic pumps are set to low pressure. The pilot opens the fuel tank valves and looks for three gray APU/HYD READY TO START talkbacks. The pilot then closes the fuel tank valves. This procedure takes place while the crew is in contact with the ground so that flight controllers can observe APU status. Five minutes before the deorbit burn, one APU (selected by Mission Control) is started to ensure that at least one unit will be operating for entry. The hydraulic pump is left in low-pressure operation. The APU operates through the deorbit burn. At 13 minutes before entry interface (400,000-foot altitude), while the orbiter is still in free fall, the other two APUs are started, and all three hydraulic pumps are pressurized to normal. Two main engine hydraulic isolation valves are cycled open and then closed to ensure that the engines are stowed for entry. Two minutes later, if required, the aerosurfaces are put through an automatic cycle sequence to make sure warm hydraulic fluid is available in the aerosurface drive units.

After touchdown, a hydraulic load test may be done to test the response of the auxiliary power units and hydraulic pumps under high load (i.e., high flow demand) conditions. This test cycles the orbiter aerosurfaces with one hydraulic system at a time in depressed mode (the remaining two APUs and hydraulic pumps have to drive all the aerosurfaces). This is typically done on the first flight of a new vehicle. Then the main engine hydraulic isolation valves are opened again, and the engines are set to the transport position. At this point, the hydraulic systems are no longer needed; the APUs and WSBs are shut down.

APU/HYD Caution and Warning Summary

- The yellow *APU TEMP* caution and warning light on panel F7 is illuminated if the APU 1, 2, or 3 lube oil temperature is above 290° F.
- The yellow *APU OVERSPEED* light is illuminated if APU 1, 2, or 3 turbine speed is more than 92,880 rpm (129%). If the *APU AUTO SHUT DOWN* switch on panel R2 is in *ENABLE*, an automatic shutdown of that APU will occur.
- The yellow *APU UNDERSPEED* light is illuminated if APU 1, 2, or 3 turbine speed is less than 57,600 rpm (80%). If the *APU AUTO SHUT DOWN* switch for that APU is in *ENABLE*, an automatic shutdown will occur.
- Placing the *APU AUTO SHUT DOWN* switch in *INHIBIT* only inhibits the automatic shutdown of that APU if its turbine speed is less than 80% or more than 129%. The *APU UNDERSPEED* or *APU OVERSPEED* light will always illuminate, and a tone will be generated.
- The yellow *HYD PRESS* light illuminates when hydraulic system 1, 2, or 3 drops below 2,400 psi for any reason.
- The blue *SM ALERT* illuminates, and the C/W tone is sounded if turbine speed falls below 80% or rises above 129%.
- The red *BACKUP C/W ALARM* illuminates if hydraulic pressure of system 1, 2, or 3 drops below 2,400 psi.

O ₂ PRESS	H ₂ PRESS	FUEL CELL REAC	FUEL CELL STACK TEMP	FUEL CELL PUMP
CABIN ATM _(R)	O ₂ HEATER TEMP	MAIN BUS UNDERVOLT	AC VOLTAGE	AC OVERLOAD
FREON LOOP	AV BAY/CABIN AIR	IMU	FWD RCS	RCS JET
H ₂ O LOOP	RGA/ACCEL	AIR DATA	LEFT RCS	RIGHT RCS
	LEFT RHC _(R)	RIGHT/AFT RHC	LEFT OMS _(R)	RIGHT OMS _(R)
PAYLOAD WARNING _(R)	GPC	FCS _(R) SATURATION	OMS KIT	OMS TVC _(R)
PAYLOAD CAUTION	PRIMARY C/W	FCS CHANNEL	MPS _(R)	
BACKUP C/W ALARM _(R)	APU TEMP	APU OVERSPEED	APU UNDERSPEED	HYD PRESS

070

APU/HYD Caution and Warning Lights on Panel F7

APU/HYD Summary Data

- The APU is a hydrazine-fueled, turbine-driven power unit that generates mechanical shaft power to drive a hydraulic pump that produces pressure for the orbiter's hydraulic system.
- The three orbiter hydraulic systems provide pressure to position hydraulic actuators for: gimbaling SSMEs, actuating SSME control valves, moving orbiter aerosurfaces, retracting ET disconnect umbilicals, deploying landing gear, and providing brake power, anti-skid, and nose wheel steering.
- The APUs are located in the aft fuselage of the orbiter.
- Each APU/HYD system has an independent water spray boiler for APU lube oil and hydraulic fluid cooling. Water is used after APU shutdown for injector cooling if a hot restart is required. The APUs share a central supply tank for injector cooling.
- The three APUs are started 5 minutes before lift-off. They continue to operate throughout the launch phase, and are shut down after the main engine propellant dump and stow are completed (post OMS-1). The APUs are restarted for entry: one APU prior to the deorbit burn, and the other two prior to entry interface.
- Each APU fuel tank load is approximately 325 pounds of hydrazine.
- APU/HYD controls are located on Panel R2; heater controls are on panel A12.
- CRTs that display APU/HYD information include the PASS and BFS SM SYS SUMM 2 display (DISP 79), APU/HYD display (DISP 86), HYD THERMAL (DISP 87), and APU/ENVIRON THERM (DISP 88).
- Several meters for monitoring APU/HYD parameters are located on panel F8.
- APUs can be manually shut down and restarted after completion of a full injector water cooling cycle (3.5 minutes), or after approximately 180 minutes of passive cooling on orbit.

APU/HYD Rules of Thumb

- APU fuel usage rates vary with loading, but average 1% per minute (3 to 3.5 lb/minute). Usage rates are reduced by about half if the hydraulic main pump is taken to low pressure (HYD MAIN PUMP PRESS switch on panel R2 set to LOW), as is done during the abort once around deorbit coast period.
- The APU injector cooling tank shared by all three APUs contains enough water for 21 minutes of continuous flow. This is enough for six complete 3.5-minute hot restart injector cooling cycles.
- If all water spray boiler cooling is lost to the lube oil after an APU reaches full operating temperatures, only 2 to 3 minutes of operating time are available before bearing seizure occurs.

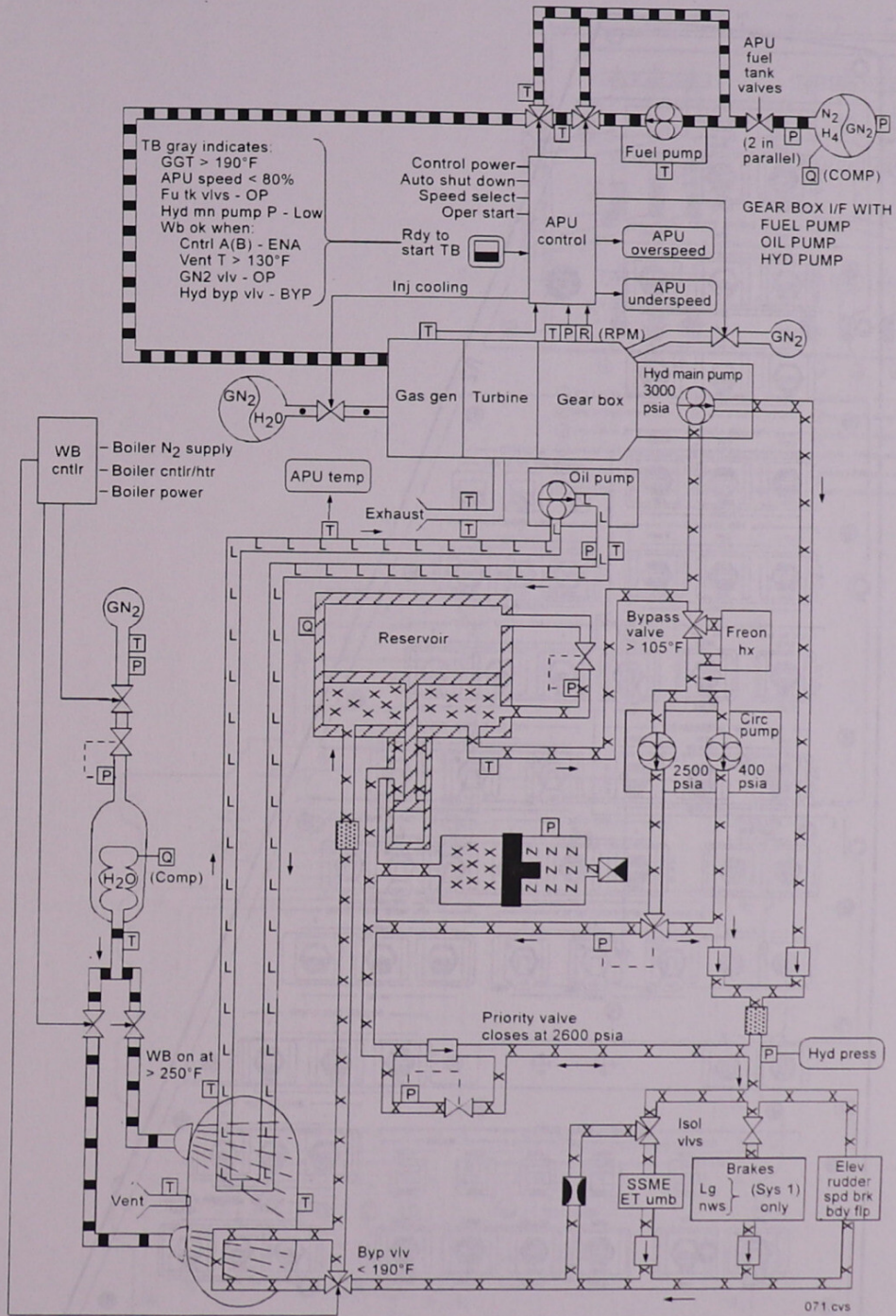

APU/Hydraulic Overview

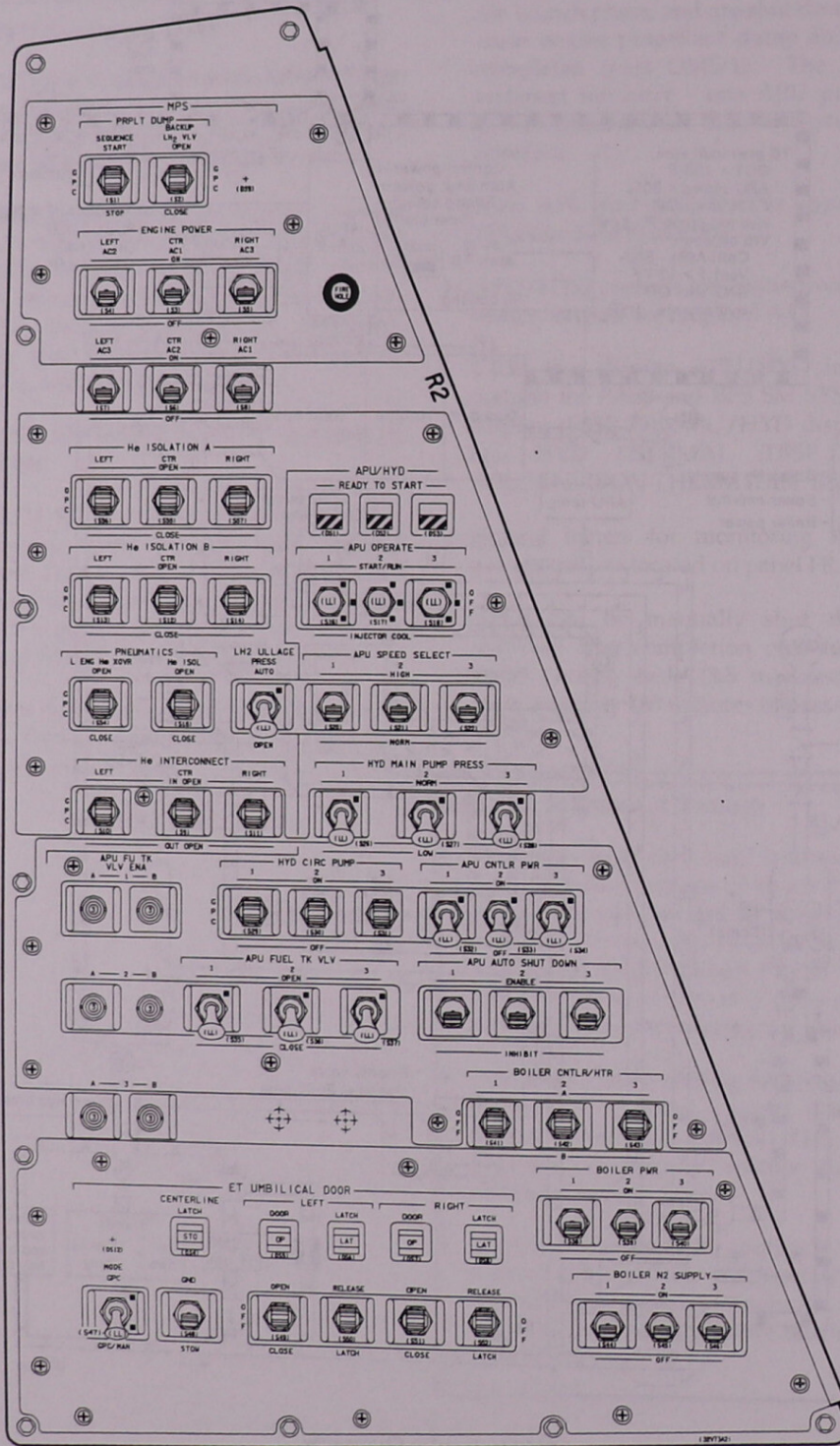

Panel R2

2. SYSTEMS

2.1-26

2.1 Auxiliary Power Unit/Hydraulics (APU/HYD)

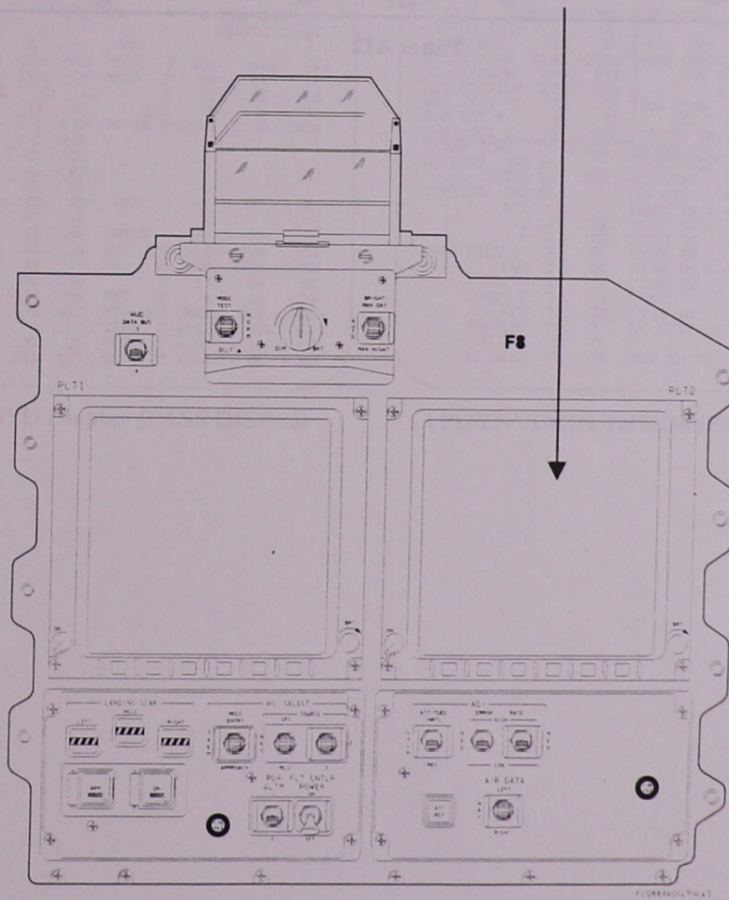
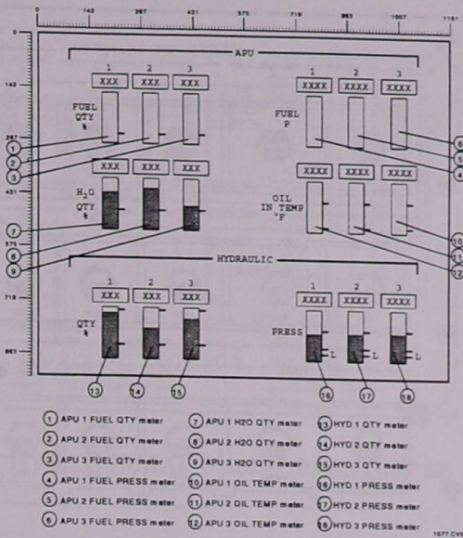

Panel F8

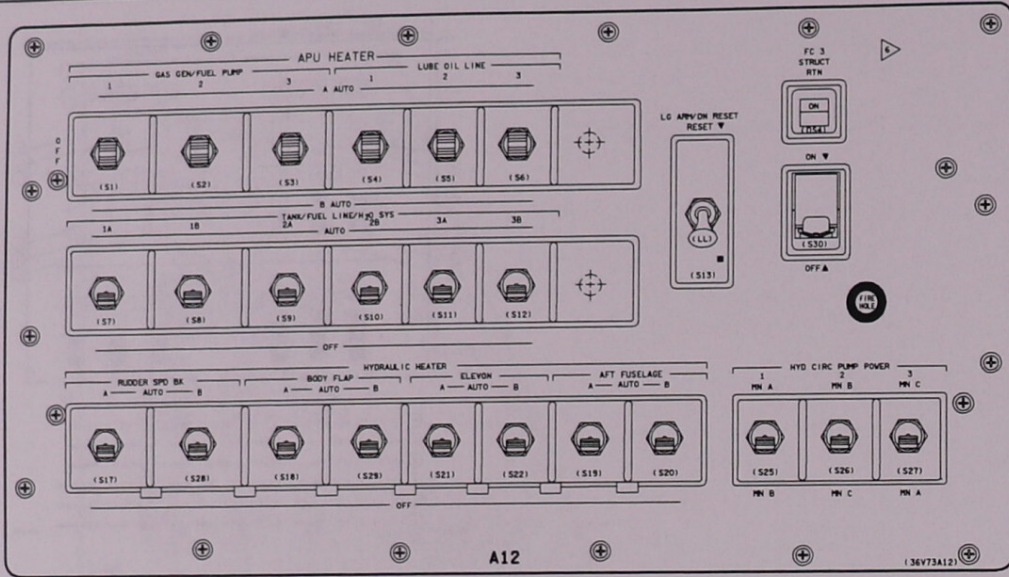

Panel A12

0001/ /079		SM SYS SUMM 2			5 008/23:29:22		
					BFS 000/00:00:00		
					5 MANF1 MANF2		
CRYO TK	1	2	3	4	5	6	7
H2 PRESS	208	208	206	206	206	208	207
O2 PRESS	816	815	814	814	814	815	815
HTR T1	-248	-248	-248	-248	-248		
T2	-248	-248	-248	-248	-248		
APU	1	2	3	HYD	1	2	3
TEMP EGT	942	942	942	PRESS	3064	3064	3064
B/U EGT	942	942	942	ACUM P	3080	3080	3080
OIL IN	250	250	250	RSVR T	116	153	142
OUT	264	264	264				
GG BED	511H	511H	511H	QTY	72	74	71
INJ	1271	1271	1271				
SPEED %	99	102	101	W/B			
FUEL QTY	59	60	62	H2O QTY	78	73	78
PMP LK P	14	14	14	BYP VLV	BYP	BYP	BYP
OIL OUT P	42	42	41				
FU TK VLV							
A T	63	65	62	THERM CNTL	1	28	
B T	63	65	62	H2O PUMP P	23	63	
AV BAY	1	2	3	FREON FLOW	2384	2384	
TEMP	97	97	83	EVAP OUT T	38	38	
A4 14	27.439	27.435			26.324	31.873	18.48

051

DISP 79 SM SYS SUMM 2 Display
(PASS and BFS)

2011/ /087		HYD THERMAL			4 000/02:36:29		
					000/00:00:00		
					CIRC PUMP CONTROL		
HYD	1	2	3	LINE TEMPS	1	2	3
CIRC PMP	64	66	66	ELEVON LOB+	94	+61	+59
CIRC PMP	64	66	66	ELEVON LOB-	94	+61	+59
PMP BDY	61	47	47	LIB	94	+61	+61
RSVR	58	+64	+66	RIB	94	+61	+61
ACCUM	2616	2624	2624	ROB	94	+59	+61
HX IN	75	+75	+75	RD/SB	PDU	97	+59
OUT	59	+54	+54	FUS	97	+59	+59
				BDYFLP	PDU	97	+59
SW VLV	PR	S1	S2	FUS	97	+59	+59
ELEV L OB	3*	1	2	L BRAKE WHL		+70	+45
IB	2*	1	3	FUS		+70	+45
R IB	3*	1	2	R BRAKE WHL		+70	+61
OB	2*	1	3	FUS		+40	+67
RUD/SPDBK	1*	2	3	NG	UPLK	40	
					MFUS	1	+40
TIRE PRESS					MG L	UPLK	40
MG	LEFT	RIGHT			MG R	UPLK	40
IB	377	377	377	377	FUS	40	
OB	378	378	376	376			
NG	369	369	364	364			

068

SM HYD THERMAL Display (PASS DISP 87)

2011/ /086		APU/HYD			4 000/02:36:12		
					000/00:00:00		
APU	1	2	3	HYD	1	2	3
B/U EGT	313	313	310	B/U P	64↓	64↓	64↓
EGT	313	313	310	RSVR T	58	64	66
SPEED %	OL	OL	OL	P	65	66	66
FUEL QTY	76	77	77	QTY	74	75	73
TK P	209	210	212	ACCUM P	2616	2624	2624
OUT P	209	210	212				
TK VLV A	CL	CL	CL				
B T	61	62	62	W/B	1	2	3
B	CL	CL	CL				
OIL T	64	63	62				
OUT T	63	62	60	CNTRLR	A	A	A
OUT P	25	25	25	H2O QTY	100	100	100
GEH P	25	25	25	N2 P	2499	2506	2492
N2 P	141	142	140	T	57	58	55
BRG T	82	81	84	REG P	28	28	28
GG BED T	426	423	421	BYP VLV	BYP	BYP	BYP
PUMP/VLV				VENT T	+122L	+122L	+122L
PMP T	94	92	90	TANK T	+57	+58	+55
VLV T	114	111	107	BLR T	+60	+58	+61

060

SM APU/HYD Display (PASS DISP 86)

2011/ /088		APU/ENVIRON THERM			4 000/02:36:51		
					000/00:00:00		
FREON LOOP	1	2		H2O LOOP	1	2	
ACCUM QTY	27	27		PUMP OUT P	64	62	
FREON FLOW	2193	2190		OUT T	64	63	
PL HX FLOW	290	286		P	30L	377	
AFT CP FLOW	279	278		ICH FLOW	564L	777	
RAD IN T	97	96		OUT T	41	38	
RAD OUT T	38	38		CAB HX IN T	42	38	
EVAP OUT T	38	38		ACCUM QTY	45	55	
EVAP TEMP	DUCT	NOZ		APU FUEL T	1	2	3
HI LOAD INED	259			TK SURE	+69	+67	+68
OUTED	259	312		TK HTR	+70	+68	+69
TOPPING	FWD	257		TEST LN 1	+62	+62	+63
AFT	257			TEST LN 2	+62	+63	+63
L	162	50		FEED LN	+57	+58	+58
R	162	50		PUMP IN	+57	+58	+58
EVAP FDLN	T	A	B	DRN LN 1	+62	+62	+63
FWD	80	80		DRN LN 2	+62	+62	+63
MID	1	80	80	OUT	+92	+90	+88
MID	2	79	75	BYP LN	+108	+106	+102
AFT	75	79		GG SPLY LN	113	111	107
TOPPING	75	79					
ACCUM	75	79					
HI LOAD	75	79		H2O LN INJ+	71	92	+72

078

APU/ENVIRON THERM (PASS DISP 88)

2.2 CAUTION AND WARNING SYSTEM (C/W)

CONTENTS

Description	2.2-1
Alarms.....	2.2-2
Smoke Detection and Fire Suppression	2.2-5
Rapid Cabin Depressurization	2.2-11
Operations.....	2.2-12
SPEC 60, SM Table Maintenance.....	2.2-15
C/W Summary Data.....	2.2-19
C/W Rules of Thumb	2.2-19
F7 Light Summary.....	2.2-20

Description

The caution and warning system warns the crew of conditions that may create a hazard to orbiter operation and/or crew. Under certain circumstances, the system also alerts the crew to situations that require time-critical (under 5 minutes) procedures to correct them. The system uses data such as temperature, pressure, flow rates, and switch positions to determine whether there is an alarm situation.

The system consists of software and electronics that provide the crew with visual and aural cues when a system exceeds predefined operating limits. Visual cues consist of four red MASTER ALARM lights, a 40-light array on panel F7, a 120-light array on panel R13U, GPC annunciated fault messages, and a blue SM light. The aural cue is sent to the communications system for distribution to flight crew headsets or speaker boxes.

The crew interfaces with the C/W system through panel R13U, panel C3, CRT displays, panel F7, panel L1, and the four red MASTER ALARM pushbutton indicators on panels F2, F4, A7, and MO52J.

The C/W system interfaces with the auxiliary power units, data processing system, environmental control and life support system, electrical power system, flight control system, guidance and navigation, hydraulics, main propulsion system, reaction control system, orbital maneuvering system, and payloads.

Inputs enter the software C/W logic circuitry from the onboard computers through multiplexers/demultiplexers (MDMs) to activate alarm tones and the BACKUP C/W ALARM. Some of these are used to turn on the BACKUP C/W ALARM light on panel F7 while crew input resets the MASTER ALARM lights and tones.

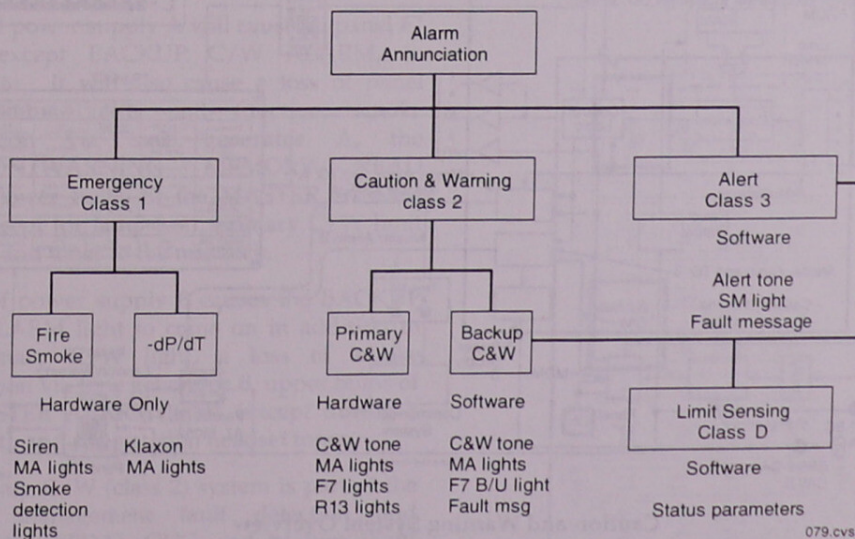

Caution and Warning Diagram

Alarms

Four alarm classes constitute the C/W system.

Class 1 - Emergency

There are two alarms in this class: (1) smoke detection/fire suppression and (2) rapid cabin depressurization. (These systems are discussed in more detail later in this section.) Class 1 is a hardware system only; its input is not processed by any MDMs or software. The system uses hardware, such as hard-wired sensors, to monitor parameters and to issue alarms. Because of the nature of the class 1 alarms, they always receive the highest priority for resolution.

The emergency (class 1) aural alarms consist of a siren (activated by the smoke detection system) and a klaxon (activated by the delta pressure/delta time sensor that recognizes a rapid loss of cabin pressure), and they are

annunciated by hardware. The siren tone is similar to emergency sirens on American police cars or other civilian emergency vehicles. The klaxon is a short repeating tone that is unique and readily distinguished from other C/W tones.

The emergency alarm visual cues consist of illumination of the four MASTER ALARM pushbutton indicators on panels F2, F4, A7, and MO52J. The smoke detection system also illuminates SMOKE DETECTION lights on panel L1 and displays information on the SM SYS SUMM 1 display (SMOKE). Similarly, cabin pressure information can be seen on the SM SYS SUMM 1 display (CABIN).

Class 2 - C/W

This class also consists of two subclasses: primary C/W, which is a hardware system, and backup (B/U) C/W, which is a software system.

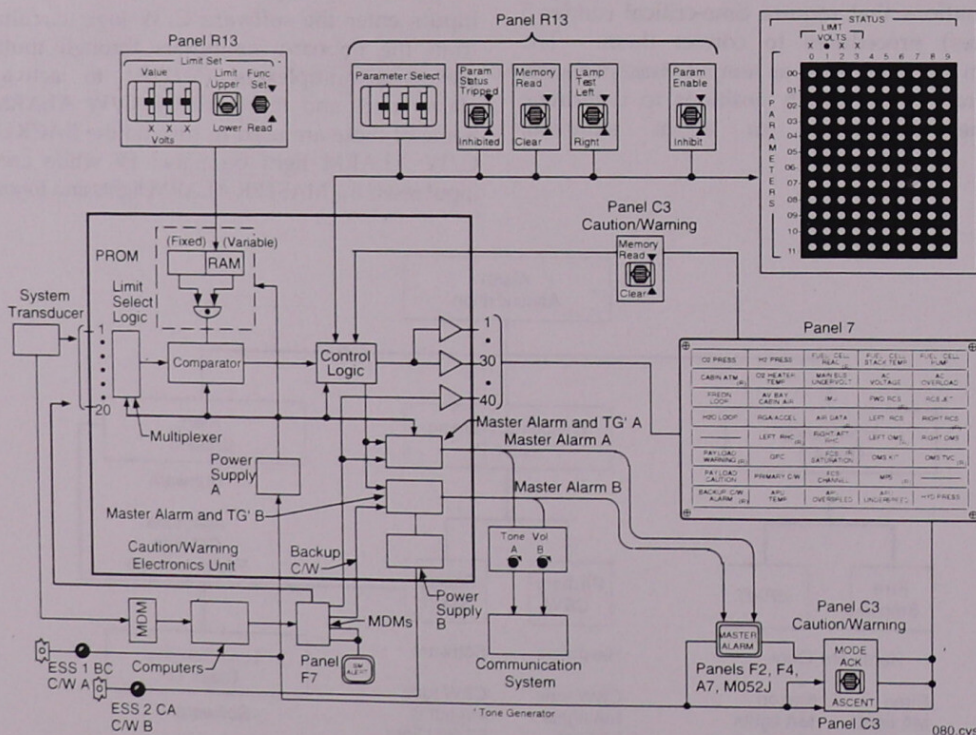

Cautions and Warning System Overview

The primary C/W system has the capacity to monitor 120 inputs, which are received from transducers through either signal conditioners or flight forward MDMs. Baselined limit values are stored in the C/W electronics unit located in avionics bay 3. These values can be changed by the crew through switches on panel R13U. However, if power is lost and subsequently recovered, the limits will return to their original values. The majority of the original stored values are identical to the backup C/W (software) values. Thirty-nine lights on the panel F7 annunciator matrix are dedicated to the primary C/W; the exception is the BACKUP C/W ALARM.

When a primary C/W alarm is issued, the appropriate lamp on the panel F7 annunciator matrix is illuminated, all four MASTER ALARM indicators are illuminated, and the C/W tone sounds. No GPC fault message is generated by the primary C/W.

The C/W system receives power from two sources. This power is supplied to the C/W electronics unit by power supplies that are internal to the electronics unit and are referred to as power supply A and power supply B. Power supply A receives power from the C/W A circuit breaker powered by ESS 1BC on panel 013, and power supply B from C/W B circuit breaker powered by ESS 2CA on panel 013.

A loss of power supply A will cause all panel F7 lights, except BACKUP C/W ALARM, to illuminate. It will also cause a loss of panel R13U status lights and function, smoke enunciation via tone generator A, the CAUTION/WARNING MEMORY READ switch, lower bulbs of the MASTER ALARM light (except for lamp test), primary C/W limit sensing, and tones to the middeck.

A loss of power supply B causes the BACKUP C/W ALARM light to come on in addition to the primary C/W light, a loss of smoke enunciation via tone generator B, upper bulbs of the MASTER ALARM lights (except during a lamp test), and sleep station headset tones.

The backup C/W (class 2) system is part of the systems management fault detection and annunciation (FDA), GNC, and backup flight system software programs. Only the C/W alarms that are produced by FDA (software that

monitors parameters and initiates alarms) have limits that can be changed and displayed in engineering units accessed through the SM TABLE MAINTENANCE specialist function display (SPEC 60). The remaining backup C/W alarms that are produced by the guidance and navigation program are accessed through general-purpose computer read/write procedures. A backup C/W out-of-tolerance condition will trigger illumination of the four MASTER ALARM lights, illuminate the red BACKUP C/W ALARM light on panel F7, and display a message on the fault message line and fault summary page.

O ₂ PRESS	H ₂ PRESS	FUEL CELL REAC (R)	FUEL CELL STACK TEMP	FUEL CELL PUMP
CABIN ATM (R)	O ₂ HEATER TEMP	MAIN BUS UNDERVOLT	AC VOLTAGE	AC OVERLOAD
FREON LOOP	AV BAY/ CABIN AIR	IMU	FWD RCS	RCSJET
H ₂ O LOOP	RGA/ACCEL (R)	AIR DATA	LEFT RCS	RIGHT RCS (R)
	LEFT RHC (R)	RIGHT/AFT RHC	LEFT OMS (R)	RIGHT OMS
PAYLOAD WARNING (R)	GPC	FCS (R) SATURATION	OMS KIT	OMS TVC (R)
PAYLOAD CAUTION (R)	PRIMARY CW	FCS CHANNEL	MPS (R)	
BACKUP C/W ALARM (R)	ARJ TEMP	ARJ OVERSPEED	ARJ UNDERSPEED	HYDPRESS

Caution and Warning Annunciator Matrix on Panel F7

(The 39 lights shown are dedicated to the primary C/W System. The BACKUP C/W ALARM light is dedicated to the entire backup C/W system. (R) signifies a red warning light.

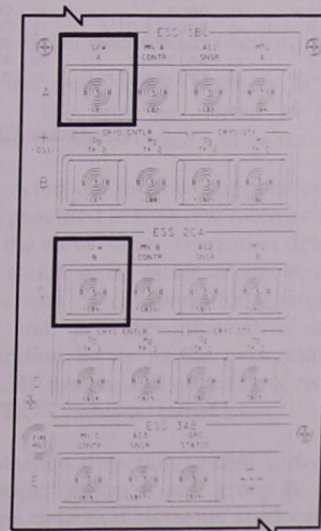

C/W Circuit Breaker on Panel 013

The class 2 (C/W) aural master alarm is activated by the primary (hardware) system, the backup (software) system, or both. The alternating C/W alarm tone is generated when the hardware system detects an out-of-limit condition on any of the 120 parameters it monitors or when the software (backup) system detects a parameter that is out of limits.

Class 2 primary and backup C/W visual cues include a 40-light annunciator matrix on panel F7. This matrix annunciates various system or functional failures. Each light is driven by one or more parameters. With the exception of the BACKUP C/W ALARM light, once a lamp has been illuminated, it will not be extinguished until all parameters driving that light are back within limits or inhibited. THE BACKUP C/W

ALARM light is extinguished once a MSG RESET key is pushed.

Panel R13U is the crew's interface with the primary C/W system. It includes a parameter status light matrix that is used to check the status of a parameter and also to check parameter limits. When used to check the status of parameters, the numbers on the left side of the matrix are read first to obtain the first two numbers of the parameter (row), then the number on the top is read to obtain the third number of the parameter. The matrix can display all 120 parameters (numbered from 000 to 119) of the primary C/W system.

C/W CH	PARAMETER NAME	C/W CH	PARAMETER NAME	C/W CH	PARAMETER NAME	C/W CH	PARAMETER NAME	C/W CH	PARAMETER NAME
0	CRYO O2 P TK1	25	GPC 3	50	CRYO H2 P TK1	*75		100	L RHC
1	CRYO O2 HTR1 TK1	26	RCS LEAK/TK P - F	51	CRYO O2HTR 2 TK3	*76	RCS TK P FU - R	101	FCS SATURATION
2	TC1 REAC O2	27	OMS ENG - L	52	FC3 REAC H2	*77		102	FC2 COOL PUMP
3	DC VOLT MAIN A	28	APU 3 EGT	53	AC3 VOLT (A, B, C)	78	APU 2 OVERSPEED	103	IMU
4	CAB PRESS	29	MPS HE TK P - R	54	CAB N2 FLOW 1	79	MPS MANF P LH2	104	AV BAY 3 TEMP
5	GPC 1	30	CRYO O2 P TK 4/5	*55		80	CRYO H2 P TK 4/5	105	H2O LOOP 1 PUMP OUT P
6	RCS TK P OX - F	31	CRYO O2 HTR 2 TK2	56	RCS LEAK/TK P - L	*81		106	FREON LOOP 1 FREON FLOW
7	OMS TK P OX - L	32	FC2 REAC H2	57	OMS ENG - R	82	FC3 STACK T	107	FREON LOOP 1 EVAP OUT T
8	APU 1 EGT	33	AC1 VOLT (A, B, C)	58	APU 3 OIL T	83	AC3 OVLD	108	APU 2 UNDERSPEED
9	MPS HE TK P - C	34	CAB PPO2 A	59	MS HE REG P - R	84	AV BAY 1 TEMP	109	HYD 2 P
10	CRYO O2 P TK2	35	GPC 4	60	CRYO H2 P TK2	*85		110	R/AFT RHC
11	CRYO O2 HTR 2 TK1	36	RCS TK P OX - L	61	CRYO O2 HTR 1 TK4	86	RCS LEAK/TK P - R	111	FCS CH BYPASS
12	FC1 REAC H2	37	OMS TK P OX - R	62	FC1 STACK T	*87		112	FC3 COOL PUMP
13	DC VOLT MAIN B	38	APU 1 OIL T	63	AC1 OVLD	88	APU 3 OVERSPEED	**113	
14	CAB O2 FLOW 1	39	MPS HE REG P - C	64	CAB N2 FLOW 2	*89		114	CAB HX OUT T
15	GPC 2	*40		*65		*90		115	HWO LOOP 2 PUMP OUT P
16	RCS TK P FU - F	41	CRYO O2 HTR 1 TK3	66	RCS TK P OX - R	91	ADTA	116	FREON LOOP 2 FREON FLOW
17	OMS TK P FU - L	42	FC3 REAC O2	67	OMS TVC	92	FC1 COOL PUMP	117	FREON LOOP 2 EVAP OUT T
18	APU 2 EGT	43	AC2 VOLT (A, B, C)	68	APU 1 OVERSPEED	93	RGAA/AA	118	APU 3 UNDERSPEED
19	MPS HE TK P - L	44	CAB PPO2 B	69	MPS MANF PL O2	94	AV BAY 2 TEMP	119	HYD 3 P
20	CRYO O2 P TK34	45	GPC 5	70	CRYO H2 P TK3	95	PL WARNING		
21	CRYO O2 HTR 1 TK2	46	RCS TK P FU - L	71	CRYO O2 HTR 2 TK4	96	RCS JET		Not used
22	FC2 REAC O2	47	OMS TK P FU - R	72	FC2 STACK T	97	PL CAUTION		
23	DC VO MAIN C	48	APU 2 OIL T	73	AC2 OVLD	98	APU 1 UNDERSPEED		
24	CAB O2 FLOW 2	49	MPS HE REG P - L	74	CAB FAN ΔP	99	HYD 1 P		

Hardware Caution and Warning Table

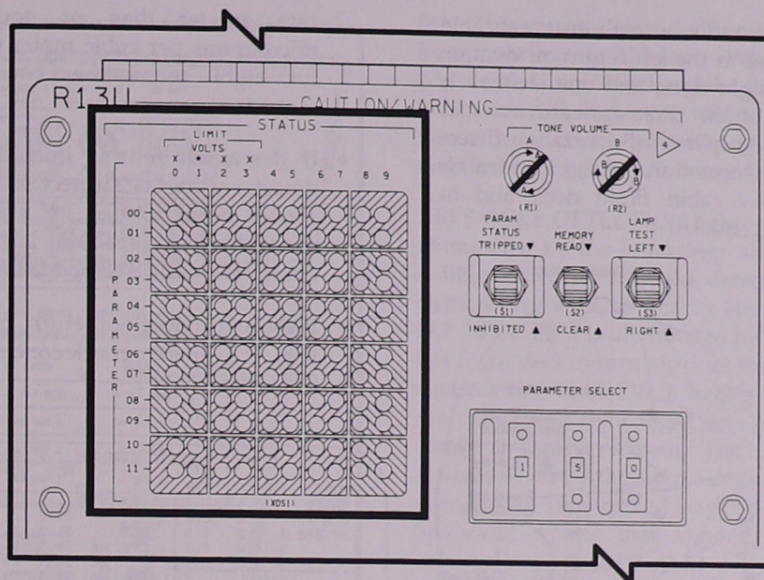

Parameter Status Light Matrix on Panel R13U

Class 3 - Alert

This class is a software system operated by the SM software. It would generally receive lower priority than a class 1 or 2 alarm. Class 3 alert is designed to inform the flight crew of a situation leading up to a class 2 alarm or one that may require a long procedure (over 5 minutes) in order to rectify the problem. When an alert parameter exceeds its limits, the blue SM ALERT light on panel F7 is illuminated, a discrete is sent to the primary C/W system to turn on the alert tone, and the software displays a fault message on the fault message line and fault summary page.

Both guidance, navigation, and control (GNC) and systems management (SM) software sense out-of-limit conditions. These software systems also serve some less critical parameters and annunciate the SM alert tone. This tone is a steady tone of predefined duration generated in the C/W electronics when activated by inputs from the onboard computers.

Class 0 - Limit Sensing

Class 0 is a software system consisting of up and down arrows on the CRT displays next to a parameter. It provides no aural annunciation.

A down arrow displayed next to a parameter would indicate that the low limit for that parameter had been met or violated. In addition, the down arrow is used to indicate a state that does not agree with the nominal state; for example, a fan that is nominally on (e.g., HUM SEP fan) is off.

An up arrow displayed next to a parameter would indicate that the upper limit for that parameter has been exceeded.

Smoke Detection and Fire Suppression

This emergency class 1 alarm is hardware driven. The crew is alerted to emergency situations by use of visual and audio alarms.

Smoke detection and fire suppression capabilities are provided in the crew cabin avionics bays and in the crew cabin. Ionization detection elements, which sense levels of smoke concentrations or rate of concentration change, trigger alarms and provide information on smoke concentration levels to the performance-monitoring CRT system and an array of red SMOKE DETECTION lights on panel L1.

The ionization detection system is divided into two groups: group A and group B. Group A ionization detection elements are located in the environmental control and life support system

cabin fan plenum outlet beneath the crew cabin middeck floor and in the left return air duct on the crew cabin flight deck, and one element is located in each of the three forward avionics bays (1, 2, and 3A). Group B ionization detection elements are located in the right return air duct on the crew cabin flight deck and in avionics bays 1, 2, and 3A.

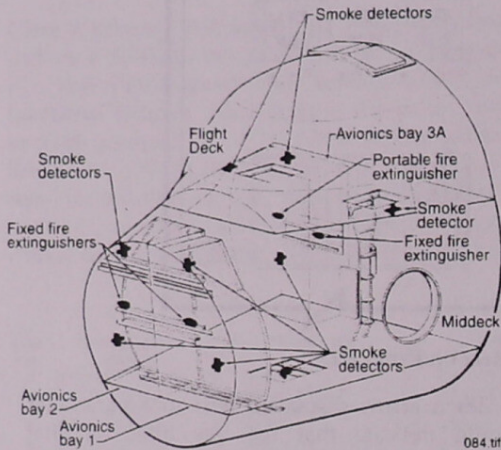

Smoke Detection and Fire Suppression System

If an ionization detection element senses a smoke particle concentration of 2,000 (± 200) micrograms per cubic meter for at least 5 seconds and/or a rate of smoke increase of 22 micrograms per cubic meter per second for eight consecutive counts in 20 seconds, a trip signal illuminates the applicable red SMOKE DETECTION light on panel L1, illuminates the four red MASTER ALARM lights on panels F2, F4, A7, and MO52J, and sounds the siren in the crew cabin. The normal reading on the SM SYS SUMM 1 display for the smoke detection elements is 0.3 to 0.4 milligram per cubic meter. A reading on the CRT of 2.0, plus or minus 0.2, corresponds to 2,000 (± 200) micrograms per cubic meter.

After an alarm and a reset of the detector, the following conditions may be observed:

- If the alarm returns in 5 seconds, it is due to the concentration exceeding 2,000 ± 200 micrograms per cubic meter for 5 seconds.
- If the alarm returns in 20 seconds, it is due to the concentration increasing at a

rate greater than or equal to 22 micrograms per cubic meter per second for eight consecutive counts in 20 seconds.

- If the alarm returns immediately, the detector would be suspect, and a self test should be performed. If available, the concentration readout should be observed on SM SYS SUMM 1.
- If the alarm does not return, perform self test. If available, check concentration on SM SYS SUMM 1.

0001 / /078 SM SYS SUMM 1		5 000/03:13:09		
		BFS 000/00:00:00		
SMOKE	1/A 2/B	DC VOLTS	1/A	2/B 3/C
CABIN	- 0.9	FC	31.1	31.1 31.1
L/R FD	- 0.4 0.2	MAIN	31.0	31.1 31.0
AV BAY 1-	1.2 - 0.0	CNTL AB	29.3	29.3 29.3
2-	0.6 0.3	BC	29.3	29.3 29.3
3-	0.1 - 0.9	CA	29.3	29.3 29.3
CABIN		ESS	29.8	29.8 29.8
PRESS	14.7	AC		
dP/dT	+ .00	VOLT ϕ A	117	117 117
BU/EQ	- .00 + .00	ϕ B	117	117 117
PPO2	3.02 3.02	ϕ C	117	117 117
FAN P	5.79	AMPS ϕ A	4.4	4.1 2.7
HX OUT T	49	ϕ B	3.9	4.2 3.2
N2 FLOW	0.0	ϕ C	2.4	3.2 4.8
IMU FAN AP	4.62	FUEL CELL PH		
AV FC1 FC2 FC3		AMPS	172	167 178
SS1	15 18 18	REAC VLV	OP	OP OP
SS2	16 20 11	STACK T	+204	+203 +203
SS3	22 26 26	EXIT T	150	150 151
TOTAL AMPS	510	COOL P	61	61 61
KW	15	PUMP		

SM SYS SUMM 1 (DISP 78)

Fire suppression in the crew cabin avionics bays is provided by three Halon extinguisher bottles permanently mounted in avionics bays 1, 2, and 3A. Each bottle contains 3.74 to 3.8 pounds of Halon in a pressure vessel that is 8 inches long and 4.25 inches in diameter. To activate the applicable bottle in an avionics bay, the corresponding FIRE SUPPRESSION switch on panel L1 is positioned to ARM, and the corresponding AGENT DISCH pushbutton indicator on panel L1 is depressed for at least 2 seconds. The AGENT DISCH pushbutton indicator activates the corresponding pyro initiator controller, which initiates a pyrotechnic valve on the bottle to discharge the Halon into the avionics bay. The discharge of Halon will produce a noise of approximately 130 decibels in the avionics bay.

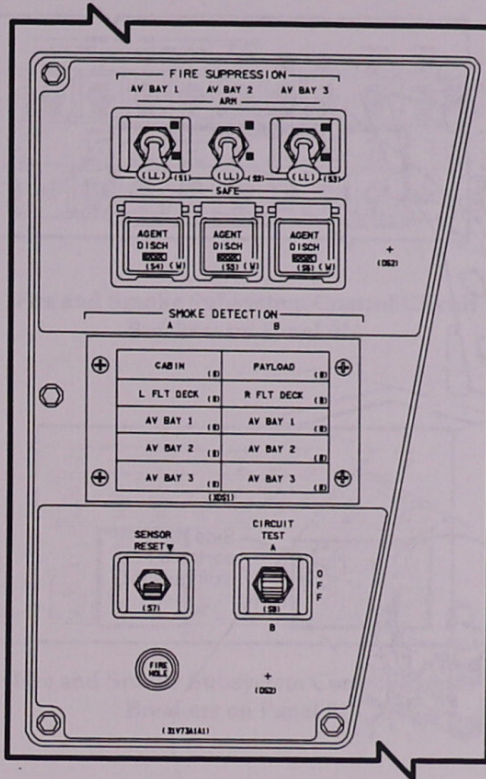

FIRE SUPPRESSION Switches and Push-buttons and SMOKE DETECTION Lights on Panel L1

The discharge will give a Halon concentration in the avionics bay of 7.5 to 9.5 percent. A 4 to 5 percent concentration is required to suppress a

fire. This concentration will provide protection for approximately 72 hours. When the AV bay fire bottles are discharged, the pushbutton indicators will illuminate when the pressure in the bottle falls below 60 ± 10 psig. This indicates that the bottle is fully discharged.

Red *SMOKE DETECTION* lights on panel L1 are illuminated by the following: the CABIN light is illuminated by a smoke detection ionization element in the ECLSS cabin fan plenum, the *L FLT DECK* light is illuminated by the crew cabin left flight deck return air duct smoke ionization element, the *R FLT DECK* light is illuminated by the crew cabin right flight deck return air duct smoke ionization element. The *PAYLOAD* light is illuminated by the smoke detection ionization elements in pressurized payload modules; i.e., Spacehab. Note that although the payload smoke detection light on L1 will illuminate, the smoke concentration data field on Sys Summ 1 will not display data for the payload smoke detector. The SPEC display for the payload will contain that data. The applicable smoke detection ionization element illuminates the applicable red *AV BAY* light on panel L1, activates the *C/W MASTER ALARM* red light, and sounds the siren in the crew cabin.

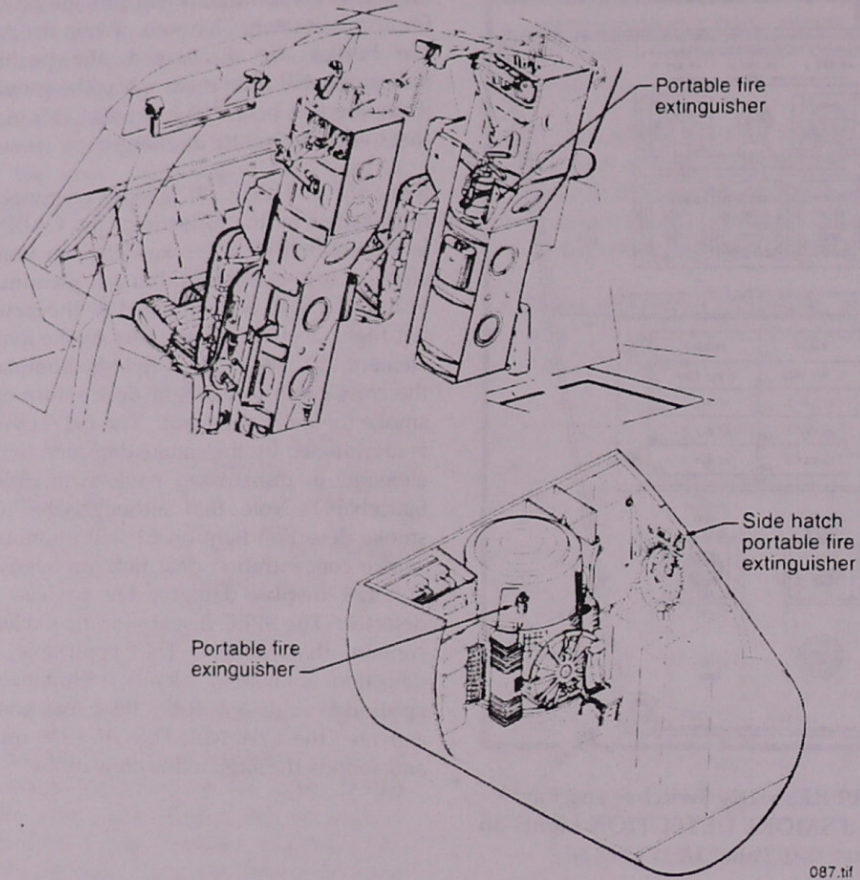

Fire Extinguisher Locations

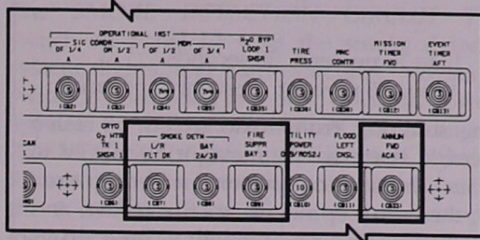

Fire and Smoke Subsystem Control Circuit Breakers on Panel 014

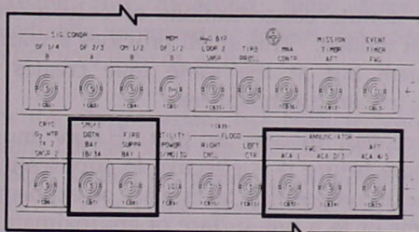

Fire and Smoke Subsystem Control Circuit Breakers on Panel 015

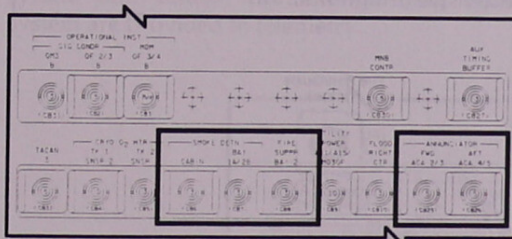

Fire and Smoke Subsystem Control Circuit Breakers on Panel 016

The circuit breakers that control the fire and smoke subsystem are located on panels 014, 015, and 016. Panel 014 contains the *MN A SMOKE DETN L/R FLT DK* and *BAY 2A/3B*, *FIRE SUPPR BAY 3*, and *ANNUN FWD ACA 1* circuit breakers. Panel 015 contains *MN B SMOKE DETN BAY 1B/3A*, *FIRE SUPPR BAY 1* and annunciator *FWD ACA 1* and *ACA 2/3* and *AFT ACA 4/5* circuit breakers. Panel 016 contains *MN C SMOKE DETN CABIN* and *BAY 1A/2B*, *FIRE SUPPR BAY 2*, and *ANNUNCIATOR FWD ACA 2/3* and *AFT ACA 4/5*.

Three hand-held fire extinguishers are available in the crew cabin. Two are located in the crew cabin middeck, and one is on the flight deck. Each fire extinguisher nozzle is tapered to fit fire hole ports located in several display and control panels. The holes are of two types: a 1/2-inch diameter hole covered with a marked label, and an unmarked 1/2- to 1/4-inch diameter tapered hole. These holes give access to the volume immediately behind the individual panel. To suppress a fire behind a panel or within an avionics bay, the extinguisher nozzle should be inserted into the fire hole and the actuating mechanism depressed for 15 seconds. This will ensure a complete discharge. The extinguishing agent is Halon-1301 (monobromotrifluoromethane). Halon-1301 minimizes the major hazards of a conflagration: smoke, heat, oxygen depletion, and formation of pyrolysis products such as carbon monoxide. The fire extinguishers are 13 inches long. The portable fire extinguishers can also be used as a backup for extinguishers in the avionics bays. Consideration should be given to the reactive force on the crewmember when discharging the extinguishers on orbit.

Halon 1301

Halon 1301 is used as the extinguishing agent for all fire suppression devices. It is colorless and odorless. Discharge of the agent may create a light mist in the vicinity of the discharge nozzle. Therefore, visibility is not adversely affected. Once the Halon is discharged into an enclosure, it is difficult to detect its presence through normal human senses.

Exposure to Halon in the 5 to 7 percent range produces little, if any, noticeable effect. At levels between 7 and 10 percent, mild central nervous system effects such as dizziness and tingling in the extremities have been reported. Above 10 percent, some subjects report a feeling of impending unconsciousness after a few minutes, although test subjects exposed to up to 14 percent for 5 minutes have not actually lost consciousness. These types of effects were completely reversible upon removal from exposure.

It is considered good practice to avoid all unnecessary exposure to Halon 1301 and to limit exposures to the following times:

- 7 percent and below: 15 minutes
- 7 to 10 percent: 1 minute

- 10 to 15 percent: 30 seconds
- Above 15 percent: prevent exposure.

Anyone suffering from toxic effects of Halon 1301 should immediately move or be moved to fresh air. In treating persons suffering toxic effects, the use of epinephrine (adrenaline) and similar drugs must be avoided. These drugs may produce cardiac arrhythmias, including ventricular fibrillation.

Although Halon 1301 has a low toxicity, its decomposition can be hazardous. These products have a characteristically sharp acrid odor, even in minute concentrations of only a few parts per million. This smell provides a warning system but at the same time creates a noxious, irritating atmosphere.

The accepted theory is that Halon must decompose before it is effective in suppressing fire. The decomposition takes place on exposure to a flame or to a hot surface of approximately 900° F.

Depending on the severity of the fire, length of time Halon is exposed to flame, and concentration of Halon, the decomposition products may be extensive or minimal.

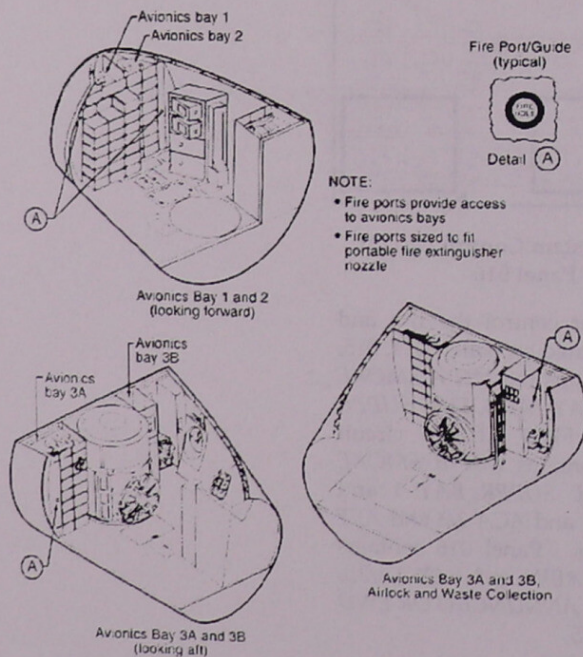

Fire Port Locations

The *SMOKE DETECTION CIRCUIT TEST* switch on panel L1 tests the smoke detection system, lights, and alarm circuitry. When the switch is positioned to *A* or *B*, electrical power is applied to the ACA channels controlling the *AGENT DISCH* lights, and the white lights are illuminated. Two tests are completed for both the *A* and the *B* circuits to test the complete logic circuitry of the smoke detection system. In one test, after approximately a 20-second delay, the *SMOKE DETECTION A* or *B* lights are illuminated, and the siren is triggered. In the other test, the *SMOKE DETECTION CIRCUIT TEST* switch is turned off in 5 to 10 seconds, bypassing the 20-second time delay and immediately annunciating a siren and a *SMOKE DETECTION* light (*A* or *B*).

Once the alarm system has been triggered, it remains latched until the *SMOKE DETECTION SENSOR* switch on panel L1 is positioned to *RESET*. When the system is latched, the emergency alarm system will not activate an alarm in case of another fire in the same or any other avionics bay.

Various parameters of the smoke detection system and remote fire extinguishing agent system are provided to telemetry.

Rapid Cabin Depressurization

The cabin pressurization rate, dP/dT , senses the rate at which atmospheric pressure is changing in the orbiter (in psi/min). There will be an alarm issued only for a rapid cabin depressurization. If a dP/dT alarm was issued, it would indicate that air was leaking at a rate much higher than normal. The system alerts the crew to a rapid pressure change with respect to time by annunciation of the four *MASTER ALARM* pushbutton indicators and sounding of the klaxon (class 1 alarm).

A dP/dT alarm will be issued if the change in pressure versus change in time decreases at a rate of -0.08 psi per minute or greater. The normal cabin dP/dT is zero psi per minute (± 0.01 psi for all normal operations).

In addition, a class 3 alarm will annunciate for a decrease in pressure greater than or equal to 0.12 psi per minute, based on equivalent dP/dT or backup dP/dT .

Values for dP/dT can be monitored on the *SM SYS SUMM 1* (dP/dT , dP/dT -EQ, dP/dT -BU), and the dedicated display on panel O1 (dP/dT).

The rapid dP/dT detector is powered by the *MN B PPO2 C CABIN DP/DT* circuit breaker on panel 015.

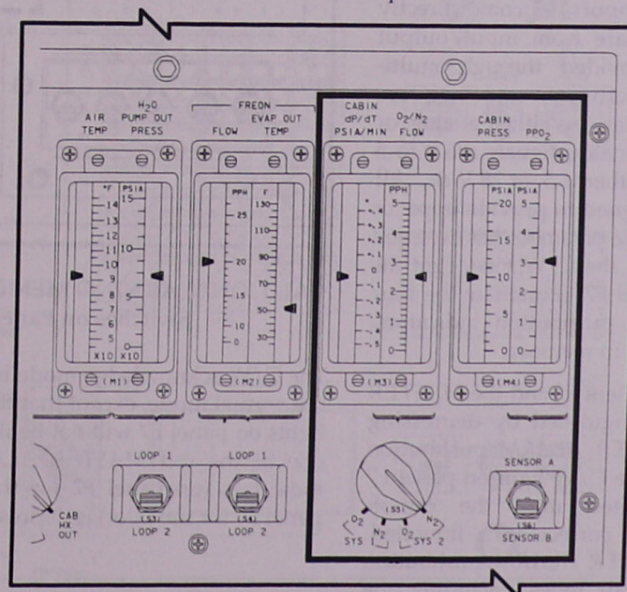

Cabin Pressure Meters and Switches on Panel 01

2011/ /066 ENVIRONMENT			4 000/02:33:38
			000/00:00:00
CABIN			AV BAY 1 2 3
dp/dt +.01	CABIN P	14.7	TEMP 90 90 78
PPO2	AIRLK P	14.8	FAN AP 3.80 3.77 3.92
A 3.04	FAN AP	5.55	SUPPLY H2O
B 3.04	HX OUT T	45L	QTY A 67 PRESS 32
C 3.04	CABIN T	71	B 18 DMP LN T 77
PPO2 1.9			C 94 NOZ T A 64
			D 94 B 64
O2 FLOW	0.0L	0.0L	WASTE H2O
REG P	100	100	QTY 1 15 PRESS 17
N2 FLOW	0.0L	0.0L	DMP LN T 58
REG P	202	202	NOZ T A 82
O2/N2 CNTL VLV	N2	O2	B 82
H2O TK N2 P	17	17	VAC VT NOZ T 224
N2 QTY	131	131	CO2 CNTLR 1 2
EMER O2 QTY	1	1	FILTER P 0.00L
REG P	4L		PPO2 - 0.0L
			TEMP 32.0L
IMU FAN	A B C AP		BED A PRESS 0.0L 0.0L
HUMID SEP	* * *	4.5	B PRESS 0.0L 0.0L
			AP 0.00L 0.00L
			VAC PRESS 0.0L

ENVIRONMENT Display (DISP 66)

Operations

Primary C/W System

The primary C/W system has three modes of operation: ascent, normal, and acknowledge. These modes are controlled by the CAUTION/WARNING MODE switch on panel C3. The switch has three settings: ASCENT, NORM, and ACK. The normal mode is discussed first.

The primary C/W system receives 120 inputs directly from transducers through signal conditioners, or from the flight forward multiplexer/demultiplexers, and are fed into a multiplexing system. Of these 120 inputs, 95 come directly from transducers, five are from input/output processors, 18 are provided through multiplexer/demultiplexer software, and two are spares. These inputs can be either analog or bilevel discrettes. The analog signals are 0 to 5 V dc; the discrettes are either 0, 5, or 28 V dc. All of these inputs are designed to provide upper or lower limit detection. If the parameter has exceeded its limits, it will turn on the C/W tone, light the appropriate light on panel F7, illuminate the four red MASTER ALARM pushbutton indicators, and store the parameter in memory.

The C/W tone can be silenced and the MASTER ALARM red light extinguished by depressing any one of the MASTER ALARM pushbutton indicators; however, the C/W light on panel F7 will remain illuminated until the out-of-tolerance condition is corrected or inhibited. Any one of the MASTER ALARM pushbutton indicators will reset all tones, including the systems management tone.

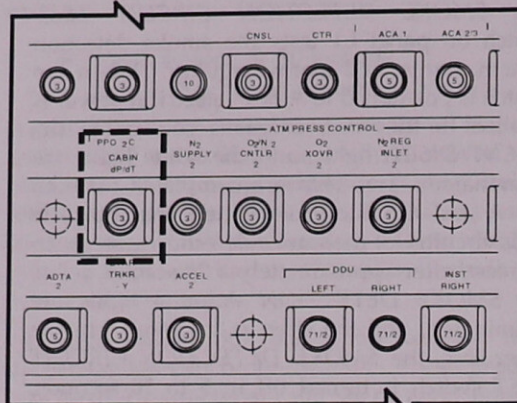

MN B PPO₂ C CABIN DP/DT Circuit Breaker on Panel 015

The C/W ascent mode is the same as the normal mode, except that the commander's red MASTER ALARM pushbutton indicator will not be illuminated.

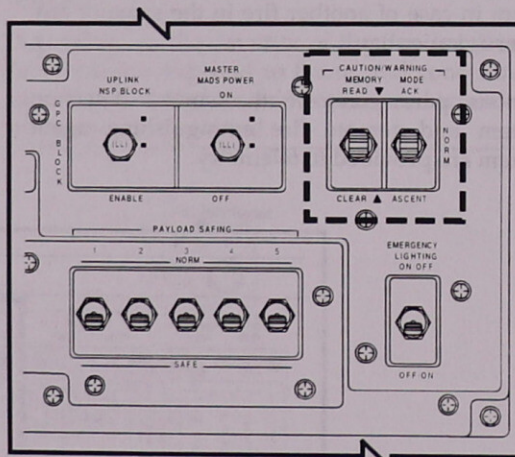

CAUTION/WARNING MEMORY and MODE Switches on Panel C3

The C/W acknowledge mode is also the same as the normal mode, except that the 40 annunciator lights on panel F7 will not be illuminated unless one of the red MASTER ALARM pushbutton indicators (on panel F2 for the commander or panel F4 for the pilot) is depressed.

Panel R13U

Each of the 120 status C/W red parameter lights on panel R13U receives an input from a specific parameter. A primary C/W parameter matrix cue card identifies the 120 input channels and correlates them to the panel F7 C/W annunciator light matrix. If an out-of-limit condition exists on a specific parameter that is set on panel R13U, it illuminates the corresponding light on panel F7. If the CAUTION/WARNING PARAM STATUS switch on panel R13U is held in the TRIPPED position when an out-of-limit parameter light on panel F7 is illuminated, the corresponding light on panel R13U will also be illuminated.

Some limits, and the list of parameters monitored, change with flight phase. The crew uses the PARAM ENABLE/INHIBIT and LIMIT switches on panel R13U to tailor the C/W system for their current configuration.

The three CAUTION/WARNING PARAMETER SELECT thumbwheels on panel R13U provide

signals to the C/W electronics unit to define a specific parameter. This is required for enabling and inhibiting the selected parameter and also for setting and reading a parameter's current limits.

The CAUTION/WARNING LIMIT SET switch grouping on panel R13U is used to change limits or to read a parameter's limits. The three VALUE thumbwheels provide the signals to the C/W unit, defining the voltage value setting of a parameter's upper or lower limit, X.XX.

The UPPER setting of the CAUTION/WARNING LIMIT SET LIMIT switch on panel R13U provides a signal to the C/W electronics unit, which modes the electronics to set or read the upper limit of a parameter specified by the settings on the PARAMETER SELECT thumbwheels for that parameter. The CAUTION/WARNING LIMIT SET FUNC switch is cycled to set or read the upper limit of that parameter. The LOWER setting functions in the same manner, except for the lower limit for a parameter.

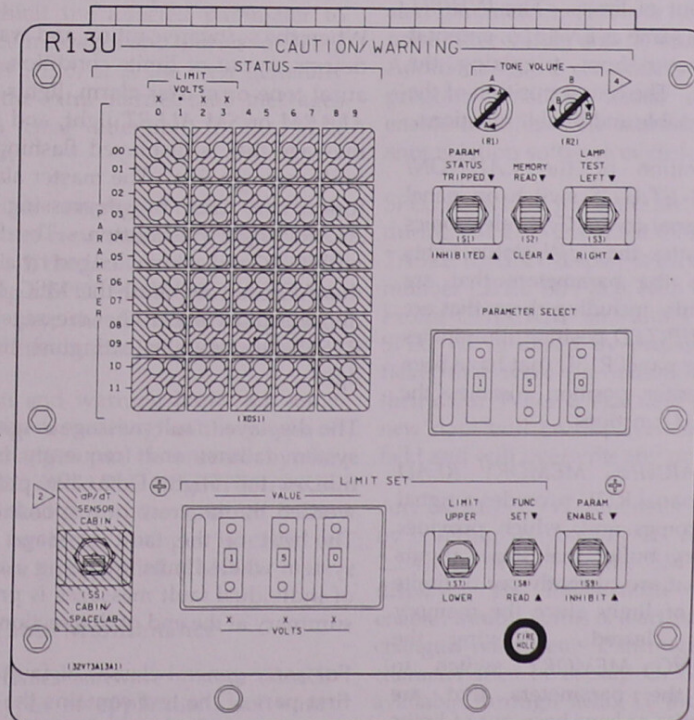

Panel R13U

The *CAUTION/WARNING LIMIT SET FUNC SET* switch position on panel R13U provides a signal to the C/W electronics unit, which sets the value specified by the *LIMIT SET VALUE* thumbwheels into the parameter as specified by the *PARAMETER SELECT* thumbwheels and *LIMIT SET LIMIT* switch. The *LIMIT SET FUNC READ* switch position on panel R13U provides a signal to the C/W electronics unit, which illuminates the lights under the *STATUS LIMIT VOLTS X.XX* columns on panel R13U that correspond to the voltage parameter limit specified by the

PARAMETER SELECT thumbwheels and the *LIMIT SET LIMIT* switch. The value read corresponds to the parameter's full-scale range on a scale of zero to 5 volts dc. The *LIMIT SET FUNC* switch center position disables the set and read functions.

The *ENABLE* position of the *CAUTION/WARNING PARAM* switch on panel R13U provides a signal to the C/W electronics unit to enable the parameter indicated on the *PARAMETER SELECT* thumbwheels, which allows the parameter to trigger the primary C/W alarm when out of limits. The *INHIBIT* position operates the same as *ENABLE*, except it inhibits the parameter from triggering the primary C/W alarm. The center position of the switch disables the enable and inhibit functions.

The *TRIPPED* position of the *CAUTION/WARNING PARAM STATUS* switch on panel R13U provides a signal to the C/W electronics unit, which illuminates the C/W status lights that correspond to the parameters that are presently out of limits, including those that are inhibited. The *INHIBITED* position illuminates those C/W lights on panel R13U that have been inhibited. The center position disables the tripped and inhibited functions.

The *CAUTION/WARNING MEMORY READ* switch position on panel R13U provides a signal to the C/W electronics unit, which provides access to a memory buffer that stores inputs from parameters that are currently out of limits or have been out of limits since the memory buffer was last cleared. Moving the *CAUTION/WARNING MEMORY* switch to *READ* displays the parameters that are currently out of limits or have been out of limits since the buffer was last cleared. The *CLEAR*

position on panel R13U or panel C3 provides a signal to the C/W electronics unit that clears from the memory any parameters that are back within limits, but any parameters that are out of limits during this action remain in memory. The center position of the switch on panel R13U or panel C3 disables the clear and read functions.

The *CAUTION/WARNING TONE VOLUME A* knob on panel R13U, when adjusted clockwise, increases the system A siren, klaxon, C/W, and SM tone generator output signals to the audio central control unit. The B knob functions the same as the A knob for system B tone generators.

The *CAUTION/WARNING LAMP TEST* switch on panel R13U, when positioned to *LEFT*, provides a signal to the C/W electronics unit, which illuminates the left five columns of the C/W status matrix lights on panel R13U. The *RIGHT* position functions the same as the *LEFT*, except for the right five columns of lights. This allows the verification of all 120 lights, making sure that none have burned out.

Software (Backup) Caution and Warning

When the software caution and warning system detects an out of limits condition, it sounds an aural tone or master alarm, lights the *MASTER ALARM* or *SM ALERT* light, and issues a fault message that is displayed flashing on the CRT fault message line. The master alarm light and tones are reset by depressing a *MASTER ALARM* light pushbutton. The fault message will flash until acknowledged by a depression of the *ACK* key or until the *MSG RESET* key is depressed to erase the message. The *MSG RESET* key will also extinguish the *SM ALERT* light.

The displayed fault message is used to diagnose system failures and frequently is used as the title of the Flight Data File procedure to be worked by the crew in response to the failure. The text of the fault message identifies the system where limits are being exceeded. A list of individual fault messages is presented in the summary at the end of this section.

For some general classes of fault messages, the first part of the text contains the *SPEC* number to be consulted to determine the specific

parameter that is out of limits. The GPCs declaring the fault are enumerated after the message text. In parentheses at the end of the fault message, software will display the number of other fault messages generated while the current message was being displayed. To view these messages and the time at which they were annunciated, the crew must look at the fault summary page, or scroll through them using the ACK key.

After reset of the displayed fault message, the message line will be blank until another new message is generated by the software. To avoid missing messages in a multi-failure scenario, crews should occasionally review all messages on the fault summary page and try to reset messages on the fault line as quickly as possible after reviewing them.

Fault messages for some parameters are issued every time the software completes the required number of data counts with the parameter out of limits. This can result in a steady stream of fault messages and *MASTER ALARMS* that may obscure other important fault messages. If this situation is encountered, the crew or Mission Control can inhibit the affected parameter to prevent nuisance messages and alarms in OPS 2 or OPS 4. In OPS 1, 6, or 3, the crew generally has to tolerate the extra alarms/fault messages and pay extra close attention to the fault summary display.

In order to clear messages from the fault summary page, the crew enters a SPEC 99 PRO on the keyboard. If the fault summary (DISP 99) is called up using a SPEC 99 PRO instead of the FAULT SUMM key, the fault summary page will appear, and then immediately clear itself.

Software caution and warning limits for some parameters change depending on the phase of flight. These changes can be entered by the crew via the SPEC 60 TABLE MAINTENANCE display or uplinked from the ground. The ground uplink for limits changes is called a Table Maintenance Block Uplink (TMBU).

SPEC 60, SM Table Maintenance

The primary avionics software system (PASS) includes three types of applications software, called major functions. The first, systems

management (SM), is the function that is active on orbit. The second, guidance, navigation, and control (GNC), is active during all flight phases. The third, payload software, provides operations support to payloads. The backup flight system (BFS), normally used only during ascent and entry, also contains both SM and GNC software.

Modules within both SM and GNC software monitor parameters and initiate alarms. To change the characteristics of the PASS GNC, BFS GNC, and BFS SM parameters, the crew would have to perform a GPC memory read/write procedure. (This procedure is described in the DPS HW/SW 21002 Training Manual.)

However, PASS SM parameters can be accessed directly by the crew. Within PASS SM is a module called fault detection and annunciation. This module monitors the backup C/W and alert parameters and initiates alarms.

SPEC 60 SM TABLE MAINT is the crew interface with the PASS SM parameters. Using SPEC 60, the crew can read and change the following for each PASS SM backup C/W or alert parameters: (1) lower and upper limits, (2) noise filter value, and (3) enable/inhibit status. Additionally, the crew can read and change SM program constants, initiate a checkpoint, and enable or inhibit the entire fault detection and annunciation software module.

SPEC 60, which is a PASS SM SPEC, is available during SM OPS 2 and SM OPS 4. When the SM TABLE MAINT display is called up by its SPEC number (SPEC 60 PRO), each field will be blank except CHECKPT time and FDA ENA. When SPEC 60 is called by pressing RESUME, the fields that were previously in use will retain their data. When a legal item entry is made, the new data will be displayed in the appropriate field and will overwrite any previous data.

Any backup C/W parameter may be accessed by entering its software ID number (see page 2.2-4) in item 1 of the SM TABLE MAINT display. The limits, noise filter value, and enable/inhibit status of alert parameters may be changed with items 2 through 10. The same characteristics of backup C/W parameters are available through items 11 through 15. These

CRT parameters are discussed in more detail below.

```
9011/060/ SM TABLE MAINT 4 000/02:31:37
SM COM BUFF RDY 000/00:00:00
PARAM
I ID
VALUE= []
ALERT LIMITS BACKUP C&W
LOW HI LOW HI
2 [] 3 [] 11 [] 12 []
4 [] 5 []
6 [] 7 []
8 FILTER 13 FILTER
ENA 9 ENA 14
INH 10 INH 15
CONSTANT
16 ID
17 VALUE= []
CHECKPT 0/00:00:00 FDA
INITIATE 18 ENA 19*
STATUS INH 20
```

SM TABLE MAINT (SPEC 60)

PARAM ID (Item 1) and PARAM Value

The software ID number for the desired fault detection and annunciation (FDA) parameters is entered in item 1. The software IDs are located in the C/W and FDF TABLE of the Flight Data File Reference Data Book.

When a valid ID is entered, the ID number will be displayed in the PARAM ID space, and the current value of the parameter will be displayed in the PARAM VALUE field. The status of the parameter is indicated by the presence or absence of an up or down arrow. The appropriate ALERT or BACKUP C/W data will appear in the LIMITS portion (items 2 through 10 or items 11 through 15 respectively). If the parameter is monitored by both the Alert and B/U C/W systems, then both sections will contain the proper data. Otherwise, one of the LIMITS sections will be blank.

If the PARAM ID is not valid, all associated data fields will be blank, and an ILLEGAL ENTRY message will be displayed.

Limits Alert Low and Hi (Items 2 through 7)

These fields contain the upper and lower alert limits of the FDA parameter identified in item 1. The limit values are displayed in engineering units and can be changed by entering the desired data in the appropriate items.

Alert parameters that are preconditioned may have two or three limits sets. All other alert parameters have only one limit set. The SM software selects which set of limits is currently active and places an asterisk next to that set (before item 2, 4, or 6). (There is no item entry that allows the crew to move the asterisk to directly select which set of limits is active. This is done exclusively by software.) If only one set of limits exists for the parameter, this set will be displayed in the first limit set location, and the asterisk will be placed by item 2. If a value is entered in a limit set that does not exist for the selected parameter, an illegal entry message will be displayed.

Limits Backup C/W Low and Hi (Items 11 and 12)

The backup C/W system limits for the FDA parameter identified in item 1 are displayed in these fields. The limit values, which are in engineering units, can be changed by entering the new data in the desired item. Backup C/W parameters have one set of limits.

Limits Alert Filter (Item 8)

The Alert parameter noise filter value can be read or changed through item 8. It is the number of consecutive times the parameter has to be sensed out of limits before an alarm annunciates. The reverse is true for returning back into limits. The range of valid values is 1 through 15.

Limits Backup C/W Filter (Item 13)

The backup C/W filter functions similarly to the Alert filter (item 8).

Limits Alert ENA or INH (Items 9 and 10)

The annunciation of an out-of-limits Alert parameter may be either enabled or inhibited by executing the respective item. The items are mutually exclusive, and an asterisk indicates the current annunciation status by appearing after the more recently selected item.

The class 0 status indicators (up and down arrows) and transducer data symbols (H, L, M, ?) are not affected by this item.

Limits Backup C/W ENA or INH (Items 14 and 15)

These backup C/W items operate similarly to the Alert items 9 and 10.

FDA ENA or INH (Items 19 and 20)

The PASS FDA software can be either inhibited or enabled by executing the respective item. The items are mutually exclusive, and an asterisk denotes the current state. The display is initialized with FDA enabled.

When FDA is inhibited, the following FDA functions are disabled:

- FDA alarm annunciation. This includes backup C/W (class 2), Alert (class 3), and limit sensing up or down arrows (class 0).
- Limit sensing (class 0). The last value of each out-of-limits parameters status indicator is displayed.
- Precondition steering.
- False alarm avoidance noise filters.

Other parameter status indicators (H, L, M, ?) are not affected because they are not generated by the FDA software.

Constants

SM constants may be accessed through items 16 and 17. These constants are primarily involved in SM special processes such as water loop pump cycling, alert preconditioning, and payload deployment.

Constant ID (Item 16)

When a constant ID number is entered in item 16, both the CONSTANT ID and VALUE fields are filled. If the ID was illegal, both data fields are blanked.

The constant IDs and values are not typically carried onboard the orbiter, although various malfunction procedures contain occasional constants. If a constant must be changed, Mission Control will either provide the crew with the data or directly change the constant through a TMB Uplink. (See TMBU description in this section.)

Constant Value (Item 17)

This field contains the current value of the constant identified in item 16. The constant value can be changed by entering the new data in item 17.

TMBU

TMBU is the type of uplink that Mission Control uses to change the following data:

- Parameter limit values
- Parameter noise filter values
- Parameter annunciation enable/inhibit status
- SM constant values.

The use of TMBUs decreases the crew's workload because the changes that are uplinked do not have to be entered on SPEC 60.

SPEC 60 operations and TMBUs are interlocked such that TMBU loads are rejected if SPEC 60 is active. If a TMBU is in progress when SPEC 60 is called, the flashing words UPLINK and UL will be displayed on the display, and all item entries will be prohibited by an ILLEGAL ENTRY message.

Uplink

The flashing word UPLINK is displayed in the top center of SPEC 60 to indicate that a TMBU is in progress.

UL

When any two-stage command (including a TMBU) is uplinked, a flashing UL is displayed in the upper right corner of all CRTs associated with the GPC(s) that are being commanded.

Checkpoints

When a checkpoint is performed, the following information is saved in a mass memory unit:

- Parameter limit values
- Parameter noise filter values
- Parameter annunciation enable/inhibit status
- SM constant values
- Checkpoint timetags

The checkpoint capability is valuable because changes made through item entries on SPEC 60 affect only the SM GPC software and not the mass memory unit software. If these changes are not saved in a mass memory unit, and the SM GPC fails, flight software will lose the changes that have been made. The changes would then have to be reentered.

When checkpoint retrieval is enabled, the software loaded into an SM GPC from a mass memory unit will contain the most recent version of changes saved during checkpoint.

Checkpoint Initiate (Item 18), Checkpoint Status, and Time

When item 18 is executed, the STATUS field will go blank. While the checkpoint is being performed, a flashing BSY will be displayed next to SM COMM BUFF at the top left of SPEC 60. This indicates that the SM communications buffer is in use. When the checkpoint is completed, the CHECK PT STATUS field will contain GOOD. If the SM common buffer was not available, CHECK PT STATUS will be FAIL, and item 18 should be executed again.

The mission elapsed time (MET) of the most recent successful checkpoint will be displayed as DD/HH:MM:SS, in the checkpoint time field.

SM COMM BUFF - BSY, or RDY

Either a flashing BSY or a status RDY is displayed after SM COMM BUFF to indicate the status of the SM Common Buffer. BSY (busy) indicates that the SM COMM BUFF is being used; RDY (ready) means the buffer is available.

Keypad entries are rejected if BSY is flashing.

CKPT RETRV ENA (SPEC 1, Item 12)

Executing this item will alternately select or deselect CKPT RETRV ENA. An asterisk appears next to item 12 when checkpoint retrieval is enabled.

MMU Assignment (DPS Utility - SPEC 1, Items 3 and 4)

A checkpoint saves the changes in the mass memory unit assigned to the SM software by item 3 or 4. In order to save the checkpoint in both, two checkpoints must be performed.

C/W Summary Data

- The C/W system consists of four alarm classes: emergency (class 1), C/W (class 2), alert (class 3), and limit sensing (class 0).
- Emergency alarms cover two situations: smoke detection/fire suppression and cabin pressure.
- Smoke detection and fire suppression capabilities are provided in the crew cabin avionics bays, the crew cabin, and the pressurized payload modules.
- Increased smoke particle concentration will illuminate *SMOKE DETECTION* lights on panel L1, illuminate four red *MASTER ALARM* lights on panels F2, F4, A7, and MO52J, and sound the siren in the crew cabin.
- Fire suppression in the crew cabin avionics bay is provided by one permanent Halon extinguisher bottle in avionics bays 1, 2, and 3A. The bottle is operated by switches on panel L1.
- Three portable hand-held extinguishers in the crew cabin are operated by inserting them into fire holes located in several display and control panels.
- A class 1 alarm (four *MASTER ALARM* pushbutton indicators and the sounding of the klaxon) is triggered when there is a rapid change in cabin pressure with respect to time.
- Class 2 alarms include primary (hardware) and backup (software) systems. The crew interfaces with the primary C/W system through the 40-light annunciator matrix on panel F7 and a 120-parameter monitor on panel R13U. The interface with the backup (software) system is via software messages and SPEC 60 TABLE MAINT.
- Some Class 3 alerts warn the crew of a situation leading up to a class 2 alarm or of one that may require a long procedure.
- Class 0, a software system, consists of up and down arrows displayed on the CRT displays next to a parameter.
- The SPEC 60 TABLE MAINT display allows the crew to change limits, noise filter values, and status of backup C/W or alert system parameters.
- Pressing the *MASTER ALARM* light will silence the alarm and reset the light.
- Pressing the ACK key will stop the fault messages from flashing. Subsequent pressing of ACK key will scroll through fault messages.
- Pressing the MSG RESET key will erase fault messages from the CRT scratch pad and extinguish the *SM ALERT* light.

C/W Rules of Thumb

- The *SENSOR RESET* switch on panel L1 should be pressed when smoke concentration goes below 1.8. This prevents masking of alarms.
- When panel R13U is not in use, the *PARAMETER SELECT* thumbwheels should be set to a value greater than 119.
- Crewmembers should reset fault messages as quickly as possible after review to avoid covering other messages.
- The fault summary should be reviewed regularly to avoid missed fault messages.

F7 Light Summary

NOTE

A Class 2 audible tone and *MASTER ALARM* lights accompany the appropriate C/W light. Most lights are hardware-driven, but many parameters are also software-sensed by the PASS or BFS GPCs. The software provides a GPC fault message and illuminates the *BACKUP C/W ALARM* light. The hardware channels listed below are the same as the channels on the C/W STATUS light matrix on panel R13U. The color of each light is indicated by (R) for red and (Y) for yellow.

O2 PRESS (Y): Indicates an O2 tank 1, 2, 3, or 4 pressure or the O2 kit (Tank 5) pressure out of limits. The hardware channels are 0, 10, 20, 30, and 40 for Tanks 1, 2, 3, 4, and 5, respectively.

H2 PRESS (Y): Indicates either an H2 Tank 1, 2, 3, or 4 pressure or the H2 kit (Tank 5) pressure out of limits. The hardware channels are 50, 60, 70, 80, and 90 for Tanks 1, 2, 3, 4, and 5, respectively.

FUEL CELL REAC (R): Indicates an O2 or H2 Fuel Cell 1, 2, or 3 reactant valve is closed. The hardware channels are 2, 22, 32, 42, and 52 for FC 1, 2, and 3 O2 and H2, respectively.

FUEL CELL STACK TEMP (Y): Indicates a Fuel Cell 1, 2, or 3 stack temperature out of limits. The hardware channels are 62, 72, and 82 for FC 1, 2, and 3, respectively.

FUEL CELL PUMP (Y): Indicates a Fuel Cell 1, 2, or 3 pump DP out of limits. The hardware channels are 92, 102, and 112 for FC 1, 2, and 3, respectively.

CABIN ATM (R): Indicates either cabin pressure, PPO2, O2 flow rate, or N2 flow rate out of limits. The hardware channels are 4, 14, 24, 34, 44, 54, and 64 for cabin press, O2 SYS 1 and 2 flow rate, PPO2 A and B, and N2 SYS 1 and 2 flow rate, respectively.

O2 HEATER TEMP (Y): Indicates an O2 Tank 1, 2, 3, or 4 heater temp or O2 kit (Tank 5) heater temp out of limits. The hardware channels are 1, 11, 21, 31, 41, 51, 61, 71, and 81 for O2 Tank 1 HTR 1 and 2, Tank 2 HTR 1 and 2, Tank 3 HTR 1 and 2, Tank 4 HTR 1 and 2, and Tank 5, respectively.

O ₂ PRESS	H ₂ PRESS	FUEL CELL REAC (R)	FUEL CELL STACK TEMP	FUEL CELL PUMP
CABIN ATM (R)	O ₂ HEATER TEMP	MAIN BUS UNDERVOLT	AC VOLTAGE	AC OVERLOAD
FREON LOOP	AV BAY/ CABIN AIR	IMU	FWD RCS (R)	RCS JET
H ₂ O LOOP	RGA/ACCEL	AIR DATA (R)	LEFT RCS	RIGHT RCS (R)
	LEFT RHC (R)	RIGHT/AFT RHC	LEFT OMS (R)	RIGHT OMS (R)
PAYLOAD WARNING (R)	GPC	FCS SATURATION (R)	OMS KIT	OMS TVC (R)
PAYLOAD CAUTION	PRIMARY C/W	FCS CHANNEL	MPS (R)	
BACKUP C/W ALARM (R)	APU TEMP	APU OVERSPEED	APU UNDERSPEED	HYD PRESS

098.cvs

Caution and Warning Light Matrix on Panel F7

F7 Light Summary (continued)

MAIN BUS UNDERVOLT (R): Indicates main bus A, B, or C voltage low. The hardware channels are 3, 13, and 23 for main bus A, B, and C respectively.

AC VOLTAGE (Y): Indicates AC bus 1, 2, or 3 phase A, B, or C out of limits. The hardware channels are 33, 43, and 53 for AC bus 1, 2, and 3 respectively.

AC OVERLOAD (Y): Indicates an inverter 1, 2, or 3 phase A, B, or C output of 225 percent overload for 20 sec or 300 percent for 4 to 6 sec. The hardware channels are 63, 73, and 83 for inverter 1, 2, and 3 respectively.

FREON LOOP (R): Indicates a low Freon loop 1 or 2 flow rate or a temperature out of limits. The hardware channels are 106, 116, 107, and 117 for loop 1 and 2 flow rate, and loop 1 and 2 temp respectively.

AV BAY/CABIN AIR (Y): Indicates out of limits condition on cabin fan DP, AV Bay 1, 2, or 3 air out temp, or cabin heat exchanger air temp. The hardware channels are 74, 84, 94, 104, and 114 for cabin fan DP, AV Bay 1, 2, or 3 Temp, and CAB HX temp respectively.

IMU (Y): Indicates detection of an inertial measurement unit (IMU) failure or dilemma. The hardware channel is 103 and is a discrete driven from the GNC software.

FWD RCS (R): Indicates detection of an out of limits condition on a forward RCS oxidizer tank ullage pressure, fuel tank ullage pressure, or forward oxidizer or fuel leak. The hardware channels are 6, 16, and 26 for oxidizer tank press, fuel tank press, and leak respectively.

RCS JET (Y): Indicates detection of an RCS jet failed on, failed off, or leaking. The hardware channel is 96 and is a discrete driven from the GNC software.

H2O LOOP (Y): Indicates an out of limits condition on H₂O loop 1 or 2 pump out pressure. The hardware channels are 105 and 115 for loop 1 and 2 respectively.

RGAI/ACCEL (Y): Indicates detection of a rate gyro assembly (RGA) 1, 2, 3, or 4 failure, or an accelerometer 1, 2, 3, or 4 failure. The hardware channel is 93 and is a discrete driven from the GNC software.

AIR DATA (R): Indicates detection of an air data transducer assembly (ADTA) dilemma. The hardware channel is 91 and is a discrete driven from the GNC software.

LEFT RCS (R): Indicates detection of a left RCS oxidizer, fuel tank ullage pressure out of limits, or left oxidizer or fuel leak. The hardware channels are 36, 46, and 56 for oxidizer tank press, fuel tank press, and leak respectively.

RIGHT RCS (R): Indicates detection of a right RCS oxidizer, fuel tank ullage pressure out of limits, or right oxidizer or fuel tank leak. The hardware channels are 66, 76, and 86 for oxidizer tank press, fuel tank press, and leak respectively.

SPARE: Available for future warning parameter growth.

LEFT RHC (R): Indicates detection of a left rotational hand controller (RHC) pitch, roll, and yaw disagree. The hardware channel is 100 and is a discrete driven from the GNC software.

RIGHT/AFT RHC (R): Indicates detection of a right or aft RHC pitch, roll, or yaw disagree. The hardware channel is 110 and is a discrete driven from the GNC software.

LEFT OMS (R): Indicates detection of a left OMS pod oxidizer, fuel tank ullage pressure out of limits, or an engine abnormal (OMS engine fail to cutoff, fail to ignite, or early shutdown) condition. The hardware channels are 37, 47, and 57 for the oxidizer, fuel tank press, and engine abnormal respectively. The hardware channels are 7, 17, and 27 for the oxidizer, fuel tank press, and engine abnormal respectively.

RIGHT OMS (R): Indicates detection of a right OMS pod fuel tank ullage pressure out of limits, or an engine abnormal (OMS engine fail to ignite, or early shutdown) condition.

F7 Light Summary (continued)

PAYLOAD WARNING (R): Indicates detection of up to five payload parameter inputs out of limits. The hardware channels are 55, 65, 75, 85, and 95.

GPC (Y): Indicates GPC 1, 2, 3, 4, or 5 has determined itself failed and issued a self-fail discrete. The hardware channels are 5, 15, 25, 35, and 45 for GPC 1, 2, 3, 4, and 5 respectively.

FCS SATURATION (Y): Indicates detection of elevon position or hinge moment saturation. The channel is 101 and is a discrete driven from the GNC software.

OMS KIT (Y): Indicates detection of an OMS kit oxidizer or fuel tank ullage pressure out of limits. The hardware channels are 77 and 87 for oxidizer and fuel respectively.

OMS TVC (R): Indicates detection of an OMS pitch or yaw gimbal failure. The hardware channel is 67. An OMS TVC failure may also result in a LEFT or RIGHT OMS light.

PAYLOAD CAUTION (Y): Indicates detection of a payload parameter input out of limits. The hardware channel is 97 and is not presently implemented.

PRIMARY C/W (Y): Indicates detection of a C/W system self-test failure internal to the C/W EU. The failures include the loss of power supply A or B, loss of A or B timing, or the inability of a C/W self-test parameter to pass limit check. No channel number. The parameter is internal to the C/W unit hardware itself. The light also illuminates each time the ESS 1BC C/W A circuit breaker is closed after being opened and extinguishes when the MASTER ALARM pushbutton indicator is depressed.

FCS CHANNEL (Y): Indicates detection of an elevon, rudder, or speedbrake actuator failure, SRB rock or tilt actuator failure, or MPS engine pitch and yaw actuator failure. The hardware channel is 111 and is a discrete driven from the GNC software.

MPS (R): Indicates detection of an MPS engine He tank press, He regulator out press, LO2 manifold press, or LH2 manifold press out of limits. The hardware channels are 9, 19, 29, 39, 49, 59, 69, and 79 for Engine 1, 2, and 3 He TK, He reg, and LO2 and LH2 pressure respectively.

SPARE (R): Available for future warning parameter growth.

BACKUP C/W ALARM (R): Indicates detection of a C/W alarm via SM, GNC, or BFS software monitoring. In OPS 2 SM parameter limits can be accessed, changed, enabled, and inhibited through SPEC 60 TABLE MAINT display.

APU TEMP (Y): Indicates an APU 1, 2, or 3 exhaust gas temp or lube oil temp out of limits. The hardware channels are 8, 18, 28, 38, 48, and 58 for APU 1, 2, and 3 EGT and lube oil temp respectively.

APU OVERSPEED (Y): Indicates an APU 1, 2, or 3 speed greater than a specified percentage of the designed speed. The hardware channels are 68, 78, and 88 for APU 1, 2, and 3 respectively.

APU UNDERSPEED (Y): Indicates an APU 1, 2, or 3 speed less than a specified percentage of the designed speed. The hardware channels are 98, 108, and 118 for APU 1, 2, and 3 respectively.

HYD PRESS (Y): Indicates a hydraulics system 1, 2, or 3 supply pressure out of limits. The hardware channels are 99, 109, and 119 for APU 1, 2, and 3 respectively.

Fault Message Summary

MESSAGE		OPS AVAIL		CAUSE	COMMENTS
		PASS	BFS		
S86 APU FUEL	1(2,3)	S2,4		<ul style="list-style-type: none"> • APU FUEL QTY ↓ • APU FUEL TK P ↑↓ 	
S86 APU GBX P	1(2,3)	S2,4		<ul style="list-style-type: none"> • GBX P ↓ • OIL OUT P ↑↓ 	
T	1(2,3)	S2,4		<ul style="list-style-type: none"> • OIL OUT T ↑↓ • GBX BRG T ↑ 	
S88 APU H2O T	1(2,3)	S2,4		<ul style="list-style-type: none"> • APU H2O LN INT T ↑↓ 	
SM2 APU SPD HI 1(2,3)			SM	<ul style="list-style-type: none"> • TURBINE OVERSPEED 	• NO MAL
SM2 APU SPD LO 1(2,3)			SM	<ul style="list-style-type: none"> • TURBINE UNDERSPEED 	• NO MAL
S86 APU TEMP	1(2,3)	S2,4		<ul style="list-style-type: none"> • BACKUP EGT ↑ 	
SM2 APU TEMP			SM	<ul style="list-style-type: none"> • OIL TEMP ↑↓ 	
S88 APU TK T	1(2,3)	S2,4		<ul style="list-style-type: none"> • APU TK SURFT ↓ • APU TK SKIN T ↑↓ 	
S66 AV BAY 1(2,3)	FAN	S2,4		<ul style="list-style-type: none"> • AV BAY 1(2,3) FAN ΔP ↑↓ 	
SM2 AV BAY FAN			SM		
BCE BYP	FLEX	S2,4		<ul style="list-style-type: none"> • BCE BYPASS ON FLEX/FLEX PAIR 	
BCE BYP	KU	S2,4		<ul style="list-style-type: none"> • PL 1 KU COMM/RADAR S10 FAIL 	<ul style="list-style-type: none"> • RADAR: GPC MODE NOT VALID UNLESS TRACKING. AUTO-TRACK MODE IS VALID
BCE BYP	MCIU	S2,4		<ul style="list-style-type: none"> • GPC DETECTED I/O LOSS WITH MCIU 	• NO MAL

MESSAGE		OPS AVAIL		CAUSE	COMMENTS
		PASS	BFS		
S62 BCE BYP OA		S2,4		<ul style="list-style-type: none"> • OA1, OA2, OR OA3 MDM OR MDM CARD FAIL 	
OFA		S2,4		<ul style="list-style-type: none"> • OF1 OR OF2 MDM OR MDM CARD FAIL 	
OFB		S2,4		<ul style="list-style-type: none"> • OF3 OR OF4 MDM OR MDM CARD FAIL 	
PDI		S2,4		<ul style="list-style-type: none"> • PDI INTERFACE TO SM GPC FAIL 	<ul style="list-style-type: none"> • MSG OCCURS AT SM OPS TRANSITION IF PDI POWER OFF
PL		S2,4		<ul style="list-style-type: none"> • PDI SSC OR EXC INTERFACE TO PCMMU FAIL 	<ul style="list-style-type: none"> • MSG OCCURS AT SM OPS TRANSITION IF PDI POWER OFF OR IF SPACELAB AND SSC OR EXC POWER OFF
PSP 1(2)		S2,4		<ul style="list-style-type: none"> • PSP 1(2) TO PL 1(2) MDM SERIAL I/O FAIL 	
BCE BYP	PL1(2)	S2,4		<ul style="list-style-type: none"> • BCE BYPASS ON PL BUSES 	
BCE BYP	SCA	S2,4		<ul style="list-style-type: none"> • BCE BYPASS ON SCA 	• NO MAL
BCE STRG 1	A	G1,2,3,6,8	G0,1,2,3,6	<ul style="list-style-type: none"> • ALL GPCs DETECTED PROBLEM RECEIVING DATA FROM INDICATED BCE ELEMENT OF STRING 1 AND HAVE BYPASSED THAT ELEMENT 	<ul style="list-style-type: none"> • BFS PRE-ENGAGE MUST BE IN SYNC WITH (TRACKING) PASS TO ANNUNCIATE
	ADTA	G1,3,6,8	G0,1,3,6		
	B	G1,2,3,6,8	G0,1,3,6		
	C	G1,2,3,6,8	G0,1,3,6		

MESSAGE		OPS AVAIL		CAUSE	COMMENTS
		PASS	BFS		
BCE STRG 1	D	G1,2,3,6,8	G0,1,3,6	• ALL GPCs DETECTED PROBLEM RECEIVING DATA FROM INDICATED BCE ELEMENT O STRING 1 AND HAVE BYPASSED THAT ELEMENT	• BFS PRE-ENGAGE MUST BE IN SYNC WITH (TRACKING) PASS TO ANNUNCIATE
	IMU	G1,2,3,6,8	G0,1,3,6		
	MLS	G1,3,6,8			
	MTU	G1,2,3,6,8,0	G0,1,3,6		
	NSP	G1,2,3,6,8,0	G0,1,3,6		
	STKR	G2,3,8			
	TAC	G1,3,6,8	G0,1,3,6		
PASS		G0,1,3,6	• BFS FAIL TO TRACK STRING 1	• NO MAL • I/O RESET MAY RESTORE PASS/BFS COMM	
BCE STRG 2	A	G1,2,3,6,8	G0,1,3,6	• ALL GPCs DETECTED PROBLEM RECEIVING DATA FROM INDICATED BCE ELEMENT OF STRING 1 AND HAVE BYPASSED THAT ELEMENT	• BFS PRE-ENGAGE MUST BE IN SYNC WITH (TRACKING) PASS TO ANNUNCIATE
	ADTA	G1,3,6,8	G0,1,3,6		

MESSAGE		OPS AVAIL		CAUSE	COMMENTS
		PASS	BFS		
BCE STRG2 (Cont)	B	G1,2,3,6,8	G0,1,3,6	• ALL GPCs DETECTED PROBLEM RECEIVING DATA FROM INDICATED BCE ELEMENT O STRING 1 AND HAVE BYPASSED THAT ELEMENT	• BFS PRE-ENGAGE MUST BE IN SYNC WITH (TRACKING) PASS TO ANNUNCIATE
	C	G1,2,3,6,8	G0,1,3,6		
	D	G1,2,3,6,8	G0,1,3,6		
	IMU	G1,2,3,6,8	G0,1,3,6		
	MLS	G1,3,6,8			
	MTU	G1,2,3,6,8,0	G0,1,3,6		
	TAC	G1,3,6,8	G0,1,3,6		
PASS		G0,1,3,6	• BFS FAIL TO TRACK STRING 1	• NO MAL • I/O RESET MAY RESTORE PASS/BFS COMM	
BCE STRG 3	A	G1,2,3,6,8	G0,1,3,6	• ALL GPCs DETECTED PROBLEM RECEIVING DATA FROM INDICATED BCE ELEMENT OF STRING 1 AND HAVE BYPASSED THAT ELEMENT	• BFS PRE-ENGAGE MUST BE IN SYNC WITH (TRACKING) PASS TO ANNUNCIATE
	ADTA	G1,3,6,8	G0,1,3,6		

MESSAGE	OPS AVAIL		CAUSE	COMMENTS		
	PASS	BFS				
BCE STRG3	B	G1,2,3, 6,8	G0,1,3, 6	<ul style="list-style-type: none"> ALL GPCs DETECTED PROBLEM RECEIVING DATA FROM INDICATED BCE ELEMENT O STRING 1 AND HAVE BYPASSED THAT ELEMENT 	<ul style="list-style-type: none"> BFS PRE-ENGAGE MUST BE IN SYNC WITH (TRACKING) PASS TO ANNUNCIATE 	
		C	G1,2,3, 6,8			G0,1,3, 6
	D		G1,2,3, 6,8			G0,1,3, 6
		IMU	G1,2,3, 6,8			G0,1,3, 6
	MLS		G1,3,6, 8			
		MTU	G1,2,3, 6,8,0			G0,1,3, 6
	NSP		G1,2,3, 6,8,0			G0,1,3, 6
		STKR	G2,3,8			
	TAC	G1,3,6, 8	G0,1,3, 6			
	PASS		G0,1,3, 6			<ul style="list-style-type: none"> BFS FAIL TO TRACK STRING 3

MESSAGE	OPS AVAIL		CAUSE	COMMENTS	
	PASS	BFS			
BCE STRG 4	A	G1,2,3, 6,8	G0,1,2, 3,6	<ul style="list-style-type: none"> ALL GPCs DETECTED PROBLEM RECEIVING DATA FROM INDICATED BCE ELEMENT OF STRING 1 AND HAVE BYPASSED THAT ELEMENT 	<ul style="list-style-type: none"> BFS PRE-ENGAGE MUST BE IN SYNC WITH (TRACKING) PASS TO ANNUNCIATE
		ADTA	G1,3,6, 8		
	B		G1,2,3, 6,8		
		C	G1,2,3, 6,8		
	D		G1,2,3, 6,8		
		PASS			
BDY FLP SW	L(R)	G3,6	<ul style="list-style-type: none"> BODY FLAP DN(UP) SW DISAGREE 	<ul style="list-style-type: none"> NO MAL DEFAULT TO NO OUTPUT 	
BODY FLAP	CYCL	G1,3,6	<ul style="list-style-type: none"> BODY FLAP LIMIT CYCLING BUT USABLE 	<ul style="list-style-type: none"> NO MAL 	
	FAIL	G1,3,6	<ul style="list-style-type: none"> BODY FLAP STALLED OR RUNAWAY 		
	HOLD	G1,3,6	<ul style="list-style-type: none"> BODY FLAP ONE CH FAILED BUT USABLE 		
SM0 BRAKE P 1/3			G0,1,3, 6	<ul style="list-style-type: none"> PRESSURE >180 PSI IN BRAKES DRIVEN BY HYDRAULIC SYSTEM 1/3 	
	2/3			G0,1,3, 6	<ul style="list-style-type: none"> PRESSURE >180 PSI IN BRAKES DRIVEN BY HYDRAULIC SYSTEM 2/3

MESSAGE		OPS AVAIL		CAUSE	COMMENTS
		PASS	BFS		
S66 CAB AIRLK	PRES	S2.4		• AIRLOCK P ↑ ↓	• AP AIRLOCK TO AMB (PL)
S66 CAB HX OUT	TEMP	S2.4		• CAB HX OUT T	• NO MAL (NO LIMITS)
S66 CAB H2O N2	P1(2)	S2.4		• H2O TK N2 P ↓	
S66 CAB N2 FLO	1(2)	S2.4		• NW FLOW ↑	
SM1 CABIN N2			SM		
S66 CAB N2 QTY	1(2)	S2.4		• N2 SPLY QTY ↓	
S66 CAB N2 REG	P1(2)	S2.4		• N2 REG P ↑ ↓	
S66 CAB O2 EMR	SPLY	S2.4		• EMER O2 QTY AND REG P	• EMER O2 MSG ONLY WHEN EMER O2 TK MANIFESTED
S66 CAB O2 FLO	1(2)	S2.4		• O2 FLOW ↑	
SM 1 CABIN O2			SM		
S66 CAB O2 REG	P1(2)	S2.4		• O2 REG P ↑	
S66 CAB PPCO2		S2.4		• PPCO2 ↑	
S78 CABIN	DP/DT	S2.4		• CABIN PRESS RATE OF CHANGE ↓	
S66 CABIN	FAN	S2.4		• CABIN FAN ΔP ↑ ↓	
SM1 CABIN FAN			SM		
S66 CABIN	PRESS	S2.4		• CAB P ↑ ↓	
SM1 CABIN FAN			SM		
S66 CABIN	TEMP	S2.4		• CAB T ↑	
S78 CABIN O2	CONC	S2.4		• O2 CONC ↑	• NO MAL

MESSAGE		OPS AVAIL		CAUSE	COMMENTS
		PASS	BFS		
S66 CABIN PPO2	A(B,C)	S2.4		• PPO2 ↑ ↓	• NO MAL
SM1 CABIN PPO2			SM		
SM1 CABIN DP/DT	BU		SM	• S/W CAB P RATE OF CHANGE COMP ↓	• NOT IN PRELAUNCH OPS 0
S78 CABN DP/DT	EQ	S2.4		• EQ CABIN PRESS RATE OF CHANGE ↓	
SM1 CABN DP/DT EQ			SM		
S60 CHECKPT FAIL		S2.4		• SM CHECKPOINT FAILED ON WRITE OR RESTORE DUE TO AN I/O FAILURE BETWEEN THE GPC AND MMU, OR MMU WAS OFF/BUSY	• ATTEMPT RECOVERY USING MMU MALS
CIRC PUMP		S2.4		• CIR PUMP FAILS TO TURN OFF	• INHIBITS CONTINUATION OF PUMP CYCLING SEQ
S87 CIRC PMP P	1(2,3)	S2.4		• CIRC PUMP P ↑ ↓	
S67 CNTL BUS	V	S2.4		• DC CNTL VOLT ↓	
RPC		S2.4		• DC CNTL BUS RPC = OFF	
CM BUF BSY	CRT1(2,3,4)	S2.4		• DEU IPL REQUEST WHEN THE SM COMMON BUFFER IS CURRENTLY BUSY	• NO MAL • WAIT FOR CONTENDING OPERATION TO COMPLETE, THEN RETRY THE SM DEU IPL
SM1 CNTLESS V			SM	• DC VOLT CNTL ↓ • DC VOLT ESS ↓	
S66 CO2 RL SYS	MALF	S2.4		• EDO CO2 CNTLR 1(2) MALFUNCTION	(OV102 ONLY) MALFUNCTION SIGNAL DURATION IS 6 SEC; RESULTING SPEC 66 '↓' WILL ONLY APPEAR FOR 6 SEC (PNL MO51F CONTROLLER FAIL LIGHT WILL REMAIN LATCHED)
S66 CABIN	FAN	S2.4		• CABIN FAN ΔP ↑ ↓	
SM1 CABIN FAN			SM		
S66 CABIN	PRESS	S2.4		• CAB P ↑ ↓	
SM1 CABIN FAN			SM		
S66 CABIN	TEMP	S2.4		• CAB T ↑	
S78 CABIN O2	CONC	S2.4		• O2 CONC ↑	• NO MAL

MESSAGE		OPS AVAIL		CAUSE	COMMENTS
		PASS	BFS		
S66 CO2 RL SYS	PCO2	S2.4		• EDO CO2 RCRS CO2 PARTIAL PRESS ↑	• OV102 ONLY
S66 CO2 RL SYS	VACP	S2.4			• (OV102 ONLY) CURRENTLY NO FDA ANNUNCIATION
S66 CO2 RL SYS	FAN	S2.4			
S76 COMM	CAM	TEMP	S2.4	• TV CAMERA OVERTEMP - YES ↓	• CAM TEMP MSG VALID ONLY WHEN CCTV IN SYNC MODE
	PA1	TEMP	S2.4	• POWER AMP 1 TEMP ↑	
	PA2	TEMP	S2.4	• POWER AMP 2 TEMP ↑	
S76 COMSEC 1	BITE	S2.4		• COMSEC XMIT AND/OR RCV FAILED	
S76 COMSEC 2	BITE	S2.4		• COMSEC XMIT AND/OR RCV FAILED	
CRT BITE	1(2,3,4)	ALL	ALL	• A BITE ERROR DETECTED IN INDICATED DEU	
SM2 CRYO H2 MANF			SM	• MANF P ↓	
	PRESS		SM	• TK CNTLP ↑ ↓	
SM2 CRYO O2 HTR			SM	• TK HTR ↑	
	MANF		SM	• MANF P ↓	
	PRESS		SM	• TK CNTLP ↑ ↓	
DAP RECONF		G2.8		• DESELECTION OF ONE OR MORE DOWNFIRING VERNIER JETS	<ul style="list-style-type: none"> • NO MAL • IF USING PRI RCS, MSG INDICATES FAILURE OF DOWNFIRING VERN JET W/O DOWNMODING • IF USING VERN RCS, OR UPON TRANS FROM PRI TO VERN RCS, DAP WILL DOWNMODE TO FREE DRIFT

MESSAGE		OPS AVAIL		CAUSE	COMMENTS
		PASS	BFS		
SM1 DC VOLT FC 1(2,3)			SM	• FC VOLT ↑ ↓	
S69 DELTA AMPS	1(2,3)	S2.4		• FC Δ AMPS ↑ ↓	
>3 DEU		ALL		• TOO MANY DEUs in COMMON SET	• NO MAL
DISPLAY SW	A	G2.8		• AFT ADI ERROR/RATE SW • AFT ADI ATT SEL SW	<ul style="list-style-type: none"> • NO MAL • MAY BE TRIGGERED BY COMM FAULT OR I/O RESET
	L	G1,2,3,6,8		<ul style="list-style-type: none"> • LH ADI ERROR/RATE SW • LH ADI ATT SEL SW • LH AIR DATA SW • LH HSI MODE/SOURCE/TRAN SW • LH RADAR ALT SW 	<ul style="list-style-type: none"> • MOVE APPROPRIATE SW TO GREEN DOT DEFAULT POS • AIR DATA/RADAR ALT SW NOT READ IN OPS 1,2 OR 8 FOR PASS
	R	G1,2,3,6,8		<ul style="list-style-type: none"> • RH ADI ERROR/RATE SW • RH ADI ATT SEL SW • RH AIR DATA SW • RH HSI MODE/SOURCE/TRAN SW • RH RADAR ALT SW 	
DK XMTR 1(2,3,4)			ALL	• BFS DK TRANSMITTER FAILED HIGH ON A PASS CONTROLLED CRT	<ul style="list-style-type: none"> • NO MAL • BFS WILL DOWNMODE AFFECTED DK BUS - NO COMMAND/LISTEN CAPABILITY ON THAT BUS • ASSIGN BFS TO AFFECTED CRT TO RECOVER BFS COMMAND/LISTEN CAPABILITY • BFS IS STILL ENGAGEABLE WITH FULL CAPABILITY
S67 ESS BUS V	1BC(2CA,3AB)	S2.4		• DC VOLT ESS ↓	

MESSAGE		OPS AVAIL		CAUSE	COMMENTS
		PASS	BFS		
ET SEP	AUTO	G6		• ET SEP MODE SW FAIL	• NO MAL • SW DEFAULTS TO AUTO IN G6
	INH	G1,6	G1,6	• AUTO SEP INH G1 = BODY RATES & FDLN DISC VLVS G6 = BODY RATES, α AND β	• NO MAL • USE CUE CARDS FOR DISC VLVS
	MAN	G1		• ET SEP SW FAIL (RM)	• NO MAL • USE SPEC 51 OVERRIDE
S77 EVA-MMU T	PORT STBD	S2,4		• MMU/FSS TEMP OUT OF LIMITS	
S88 EVAP FDLN	TA(B)	S2,4		• FDLN FWD,MID,AFT,TOOPPING,ACCUM LINE A(B) AND HI LOAD LINE A(B) T $\uparrow\downarrow$	• FES FEEDLINE TEMPS
S88 EVAP HI LD	TEMP	S2,4		• FES HI LOAD NOZ AND DUCT T $\uparrow\downarrow$	• HI LOAD IB/OB DUCT T AND NOZ T
S88 EVAP OUT T	1(2)	S2,4		• OUT T $\uparrow\downarrow$	
SM2 EVAP OUT T			SM		
S88 EVAP TOP	TEMP	S2,4		• FES TOPPING NOZ AND DUCT T $\uparrow\downarrow$	• TOPPING EVAP L(R) FWD(AFT) DUCT T AND L(4) NOZ T
167 EXT A/L	PRES	S2,4		• EXT AIRLOCK P $\uparrow\downarrow$	• EXTERNAL AIRLOCK ONLY
F RCS	JET		G1,3,6	• F JET MANF 1(2,3,4) FAIL ON/OFF	• NO FAIL LK DETECTION IN BFS
	DJET	G1,2,3, 6,8		• F DOWN JET 1(2,3,4) FAIL ON/OFF/LK	• FAIL OFF DETECTION NOT PERFORMED IN MM101 & 012 FOR PASS
	FJET	G1,2,3, 6,8		• F FWD JET 1(2,3) FAIL ON/OFF/LK	
	LJET	G1,2,3, 6,8		• FLEJT JET 1(3,5) FAIL ON/OFF/LK	

MESSAGE		OPS AVAIL		CAUSE	COMMENTS
		PASS	BFS		
F RCS	RJET	G1,2,3, 6,8		• F RIGHT JET 2(4,5) FAIL ON/OFF/LK	• FAIL OFF DETECTION NOT PERFORMED IN MM101 & 102 FOR PASS
	UJET	G1,2,3, 6,8		• F UP JET 1(2,3) FAIL ON/OFF/LK	• FAIL OFF DETECTION NOT PERFORMED IN MM101 & 012 FOR PASS
	He P	G2,8	G,1,3,6	• F He (FU OR OX) TK P 2 LOW	• PKT C/L - RCS LEAK ISOL
	LEAK	G,2,3,8	G1,3,6	• PROP/He LEAK	• OX/FU Δ QTY > 9.5%
	PVT	G2,3,8		• LOSS OF P OR T DATA FRO RCS QTY CALC	• NO MAL • QTY CALC SUSPENDED
TK P	G2,8	G1,3,6	• FWD RCS (FU OR OX) TK ULL PRESS HI/LOW	• QTY CALC SUSPENDED	
S69 FC AMPS	1(2,3)	S2,4		• FC AMPS $\uparrow\downarrow$	
SM1 FC AMPS 1(2,3)			SM		
S69 FC COOL P	1(2,3)	S2,4		• FC COOL P $\uparrow\downarrow$	
SM1 FC COOL P 1(2,3)			SM		
S69 FC DELTA V	1(2,3)	S2,4		• FC SUBSTACK $\Delta v > 150$ MV	
SM1 FC DELTA V 1(2,3)			SM		
S69 FC EXIT T	1(2,3)	S2,4		• FC EXIT T $\uparrow\downarrow$	
SM1 FC EXIT T 1(2,3)			SM		
S69 FC H2 FLOW	1(2,3)	S2,4		• FC H2 FLOW \uparrow	
S69 FC H2 PUMP	1(2,3)	S2,4		• FC H2 PUMP STATUS $\uparrow\downarrow$	

MESSAGE	OPS AVAIL		CAUSE	COMMENTS
	PASS	BFS		
S69 FC H2O ALT	1(2,3)	S2,4	• FC ALT H2O LNT ↑↓	• BOTH HTRS OFF OR BOTH HTRS INDICATING AUTO WILL ANNUNCIATE ALARM
PRI	1(2,3)	S2,4	• FC H2O LNT ↑↓	
RLF	1(2,3)	S2,4	• FC HWO RLF VLV T ↑↓	
HTR		S2,4	• FC H2O RLF HTR STATUS A,B ↑↓	
LINE		S2,4	• FC H2O RLF LNT ↑↓	
	NOZ	S2,4	• FC H2O RLF NOZ T A(B) ↑↓	
S69 FC O2 FLOW	1(2,3)	S2,4	• FC O2 FLOW ↑	
S69 FC PH	1(2,3)	S2,4	• FC PH - PH ↓	• PH > BILEVEL
SM1 FC PH 1(2,3)		SM	• FC PH HIGH	
S69 FC PRG LN	H2	S2,4	• FC H2 PURGE LNT 1(2) ↑	
	O2	S2,4	• FC O2 PURGE LNT ↑	
S69 FC PUMP	1(2,3)	S2,4	• FC COOL PUMP ΔP ↓	
SM1 FC PUMP 1(2,3)		SM		
FC PURGE	1(2,3)	S2,4	• FAILS FLOW CHECK AT PURGES AT END OF PURGE	• USE MAN FC PURGE PROC
	SEQ	S2,4	• LOSS OF PWR TO PURGE LN HTRS AFTER AUTO SEQ INIT OR LOSS OF SWITCH FUNCTION	• USE MAN FC PURGE PROC • SEQ FAIL FLAG TERMINATES AUTO PURGE SEQ
	TEMP	S2,4	• FC PURGE LINE TEMP TOO LOW TO PERFORM AUTO PURGE	• TERMINATES AUTO PURGE • USE MAN FC PURGE PROC
S69 FC REAC	1(2,3)	S2,4	• FC REAC ↓	FC REAC VLV - CL
SM1 FC REAC 1(2,3)		SM		
S69 FC READY	1(2,3)	S2,4	• FC READY ↓	

MESSAGE	OPS AVAIL		CAUSE	COMMENTS	
	PASS	BFS			
S69 FC STACK T	1(2,3)	S2,4	• FC STACK T ↑↓		
SM1 FC STACK T 1(2,3)		SM			
S69 FC VOLTS	1(2,3)	S2,4	• FC VOLT ↑↓		
FCS CH	1(2,3,4)	G1	G1	• SRB CHANNEL BYPASS	• NO MAL • ROCK & TILT ACT A(B,C,D) CH FAIL
		G1,3,6	G1,6	• MPS CHANNEL BYPASS	• NO MAL • MPS ENG PITCH(YAW) CH FAIL
		G1,3,6	G1,3,6	• AERO CHANNEL BYPASS	• NO MAL • ELEV (RUD,S/B) ACT CH FAIL
FCS SAT	POS	G3,6	G3,6	• L/R IB/OB ELEVON POSITION SATURATION	• NO MAL • ELEVON SAT (>+12 OR <-15 DEG)
	MOM	G3,6	G3,6	• L/R IB/OB PRI DELTA PRESS	• NO MAL • IN RTLS EXPECT HINGE MOM >2400 PSI (80% SYS MAX)
S67 FPC/FLC	1(2,3)	S2,4		• FWD PCA V ↓	
S88 FREON FLOW	1(2)	S2,4		• FLOW ↓	FCL ICH FLOW
SM2 FREON FLOW		SM			
S88 FREON QTY	1(2)	S2,4		• ACCUM QTY ↓	• FREON LOOP ACCUM QTY
S88 FREON RAD	1(2)	S2,4		• CNTL OUT T 1(2) ↓	• RAD CONTROLLER OUT TEMP
S88 FRN AFT CP	1(2)	S2,4		• AFT CP FREON FLOW ↓	• AFT CP FLOW
S88 FRN PL HX	1(2)	S2,4		• PL HX FREON FLOW ↓	• PL HX FLOW
S86 FU TK VLV	1(2,3)	S2,4		• APU FUEL TANK VLV TEMP ↑↓	
SM2 FU TK VLV APU		SM			

MESSAGE		OPS AVAIL		CAUSE	COMMENTS
		PASS	BFS		
S76 GCIL	FAIL	S2.4		• GCIL CONFIG FAILED TO PNL	
S86 GG/FU PMP	1(2.3)	S2.4		• APU GG BED T ↑↓	
GPC	BITE	ALL	ALL	• S/W FORCED CLOSED PROCESS DUE TO GPC H/W (S/W) FAULT	• IN PASS
				• BFS RESTART INDICATION	• IN BFS
	CONF	ALL		• NBAT TGT GPCs NOT IN RUN OR NOT SPECIFIED	• NO MAL • PROCEDURAL ERROR OR SWITCH ERROR
		SUM	ALL	• BFS GPC FAIL CHECKSUM	
		1	ALL	• INDICATED GPC HAS FAILED	
	2	ALL			
3	ALL				
4	ALL				
5	ALL		• GPC 5 HAS FAILED	• NO MAL	
GPC PWR			ALL	• PWR TRANSITIONS TO BFS GPC	• NO MAL • BFS WILL DISENGAGE • S/W DOES AUTO RESTART
S68 H2 CNTL P	1(2,3,4,5)	S2.4		• CNTL P ↑↓	
HTR T	1(2,3,4,5)	S2.4		• HTR T ↑	
MANF	PRES	S2.4		• MANF P ↓	
VLV		S2.4		• MANF VLV = CL	
TK P	1(2,3,4,5)	S2.4		• TK P ↑↓	

MESSAGE		OPS AVAIL		CAUSE	COMMENTS
		PASS	BFS		
168 HW CNTL P	6(7,8,9)	S2.4		• CNTL P ↑↓	
HTR T	6(7,8,9)	S2.4		• HTR T ↑	
TK P	6(7,8,9)	S2.4		• TK P ↑↓	
S69 H2O LN PH		S2.4		• H2O LINE PH ↓	• PH > 9 BILEVEL
S88 H2O LOOP 1(2)	FLOW	S2.4		• ICH FLOW	• ACTIVE LOOP ONLY
	QTY	S2.4		• ACCUM QTY ↓↑	
	TEMP	S2.4		• PUMP OUT T ↑↓ • CAB HX IN T ↓ • ICH OUT T ↓	• H2O LOOP TEMPS
S88 H2O PUMP P	1(2)	S2.4		• P 1(2) ↑↓ OR ΔP 1(2) ↑↓	• ΔP HIGH ONLY FOR INACTIVE LOOP • ΔP HIGH OR LOW FOR ACTIVE LOOP
SM2 H2O PUMP P			SM		• NO MAL
HIGH G		G3.6		• HIGH G	
S66 HUMID SEP	A(B)	S2.4		• HUM SEP SPEED ↓	
SM2 HYD ACUMP P 1(2,3)			SM	• ACCUM P ↓	
S86 HYD PRESS	1(2,3)	S2.4		• HYD SYS SPLY P ↑↓	• NO MAL
SM2 HYD PRESS			SM		
SM2 HYD QTY 1(2,3)			SM	• RSVR QTY ↑↓	
S86 HYD RSVR Q	1(2,3)	S2.4		• RSVR QTY ↑↓	
S86 HYD RSVR T	1(2,3)	S2.4		• RSVR T ↑↓	
SM2 HYD RSVR T 1(2,3)			SM		

2. SYSTEMS

2.2-30

2.2 Caution and Warning System (C/W)

MESSAGE	OPS AVAIL		CAUSE	COMMENTS
	PASS	BFS		
ILLEGAL ENTRY	ALL	ALL	<ul style="list-style-type: none"> ILLEGAL KYBD ENTRY WITH RESPECT TO OPS SELECT/TRANSITION, DATA LOAD, INITIALIZATION, MEM RECONFIG, GPC ASSIGN, KYBD SYNTAX, FREEZE DRY LOAD, ETC 	NO MAL IF APPROPRIATE, KYBD INPUT SHOULD BE REENTERED
S66 IMU FAN	DP	S2,4	<ul style="list-style-type: none"> IMU FAN ΔP \uparrow \downarrow 	
SM1 CABIN IMU		SM		
S66 IMU FN SPD	A(B,C)	S2,4	<ul style="list-style-type: none"> IMU FAN SPEED \downarrow 	
I/O ERROR	CRT1	ALL	<ul style="list-style-type: none"> ERROR IN DEU 1(2,3,4) MSG (I/O OR CHECKSUM) 	
	CRT2	ALL		
	CRT 3	ALL		
	CRT 4	ALL		
	D/L	ALL	<ul style="list-style-type: none"> I/O ERROR ON DOWNLIST INTERFACE WITH PCMMU 	
	FA1	G1,2,3,6,8	<ul style="list-style-type: none"> INPUT/OUTPUT ERROR ON INDICATED UNIT HAS BEEN DETECTED 	BFS PRE-ENGAGE MUST BE IN SYNC WITH (TRACKING) PASS TO ANNUNCIATE
	F2	G1,2,3,6,8		
	F3	G1,2,3,6,8		
	F4	G1,2,3,6,8		

MESSAGE	OPS AVAIL		CAUSE	COMMENTS
	PASS	BFS		
ITEM RJCT PSP	S2,4		<ul style="list-style-type: none"> PCP CC CMD REJECTED DUE TO PSP CMD DATA TRANSMISSION IN PROGRESS 	• NO MAL
S76 KU-GMBL A	TEMP	S2,4	<ul style="list-style-type: none"> KU GMBL A TEMP \uparrow 	
GMBL B	TEMP	S2,4	<ul style="list-style-type: none"> KU GMBL B TEMP \uparrow 	
GYRO	TEMP	S2,4	<ul style="list-style-type: none"> KU BYRO TEMP \uparrow 	
XMTR	TEMP	S2,4	<ul style="list-style-type: none"> KU XMTR TEMP \uparrow 	
L OMS	GMBL	G1,2,3	<ul style="list-style-type: none"> PITCH (YAW) CMD/FEEDBACK Δ^2 FOR 3.8 SEC 	• NO MAL
	PC	G1,2,3,6	<ul style="list-style-type: none"> ENG CHAMBER PRESS LOW 	
	QTY	G1,2,3,6,8	<ul style="list-style-type: none"> ENG FU OR OX TK LEVEL LOW 	
	TEMP	G1,3	<ul style="list-style-type: none"> ENG FU INJ T HI 	
	TK P	G2,8	<ul style="list-style-type: none"> FU OR OX TK ULLAGE P HI/LOW 	
		G1,3,6	<ul style="list-style-type: none"> He OR N2 TK P LOW N2 REG P HI/LOW 	
	VLV	G2	<ul style="list-style-type: none"> He P/VAP ISOL VLV MISMATCH 	• NO MAL
S89 L OMS	TEMP	S2,4	<ul style="list-style-type: none"> ENG FU INJ T HI/LOW 	• NO MAL

MESSAGE	OPS AVAIL		CAUSE	COMMENTS	
	PASS	BFS			
L RCS	JET		G1,3,6	• LEFT JET MANF 1(2,3,4) FAIL ON/OFF	• NO FAIL LK DETECTION IN BFS
	AJET	G1,2,3,6,8		• L AFT JET 1(3) FAIL ON/OFF/LK	• FAIL OFF DETECTION NOT PERFORMED IN MM101 & 102 FOR PASS
	DJET	G1,2,3,6,8		• L DOWN JET 2(3,4,5) FAIL ON/OFF/LK	
	LJET	G1,2,3,6,8		• L LEFT JET 1(2,3,4,5) FAIL ON/OFF/LK	
	UJET	G1,2,3,6,8		• L UP JET 1(2,4) FAIL ON/OFF/LK	
	He P	G2,8	G1,3,6	• L RCS AFT He (FU OR OX) TK PRESS - 2 LOW	• PKT CL - RCS LEAK ISOL
	LEAK	G2,3,8	G1,3,6	• PROP/He LEAK	• OX/FU ΔQTY > 9.5%
	PVT	G2,3,8		• LOSS OF P OR T DATA FOR RCS QTY CALC	• NO MAL • QTY CALC SUSPENDED
TK P	G2,8	G1,2,3,6	• L RCS AFT (FU OX OX) TK ULL PRESS HI/LOW		
XFEED	G1,3,6		• L RCS PROP TANK LOW PRESS	• FAILURE ON LEFT SIDE, AUTO XFEED FROM RIGHT	
S67 MAIN BUS V	A(B,C)	S2,4		• MN VOLTS ↓	
SM1 MAIN BUS V A(B,C)			SM		

MESSAGE	OPS AVAIL		CAUSE	COMMENTS	
	PASS	BFS			
MPS DATA	C(L,R)	G1,6	G1,6	• DATA PATH FAIL	• NO MAL • REF AESP CUE CARDS
MPS ELEC	C(L,R)	G1,6	G1,6	• ELECTRONIC LOCKUP MODE FAIL	• NO MAL • REF AESP CUE CARDS
MPS H2 OUT P C(L,R)			G1,6	• PREMATURE SSME SHUTDOWN • MPS GH2 OUT P ↓	• NO MAL • REF AESP CUE CARDS
MPS HYD	C(L,R)	G1,6	G1,6	• HYD LOCKUP MODE FAIL	• NO MAL • REF AESP CUE CARDS
MPS He P C(L,R)			G1,6	• MPS He TK P HI/LOW • HI LEAK RATE dP/dT	• NO MAL • REF AESP, APCL
			G1,3,6	• INDICATED REG P HI/LOW	• NO MAL • REF AESP, APCL, EPCL
MPS LH2/O2 MANF			G1,6	• MPS LH2 ENG MANF P HI • MPS LOX ENG MANF P HI	• NO MAL • REF AESP CUE CARDS
	ULL		G1,6	• ET ULL P HI/LO	•
MPS O2 OUT T C(L,R)			G1,6	• PREMATURE SSME SHUTDOWN • MPS OG2 OUT T ↓	• NO MAL • REF AESP CUE CARDS
MPS PNEU ACUM			G1,6	• MPS PNEU ACUM PRESS LOW	• NO MAL • REF AESP CUE CARDS
REG			G1,3,6	• MPS PNEU REG PRESS HI/LOW	• NO MAL • REF AESP, APCL, EPCL
TK			G1,6	• MPS PNEU TANK PRESS LOW	• NO MAL • REF AESP CUE CARDS
NAV EDIT		G2		• RNDZ NAV EDIT	• NO MAL
			G3,6	• DRAG H, ADTA, OR TACAN NAV EDIT	• BFS DOES NOT SUPPORT MLS • NO MAL

MESSAGE		OPS AVAIL		CAUSE	COMMENTS
		PASS	BFS		
NAV EDIT (Cont)	ALT	G3,6		<ul style="list-style-type: none"> ADTA ALT DATA NOT PROCESSING < M2.5 DRAG H DATA NOT PROCESSING 85.2K FT < H < 140K FT 	<ul style="list-style-type: none"> NO MAL MLS NAV EDIT MESSAGE (MLSNV) SEEN ONLY ON HUD
	TAC	G3,6		<ul style="list-style-type: none"> TACAN DATA NOT PROCESSING <140K FT 	<ul style="list-style-type: none"> NO MAL
S76 NSP 1	BITE	S2,4		<ul style="list-style-type: none"> NSP A/G 1 OR 2 XMIT AND/OR RCV VOICE MUX FAILED 	
S76 NSP 2	BITE	S2,4		<ul style="list-style-type: none"> NSP A/G 1 OR 2 XMIT AND/OR RCV VOICE MUX FAILED 	
S68 O2 CNTL P	1(2,3,4,5)	S2,4		<ul style="list-style-type: none"> CNTL P ↑ ↓ 	
HTR T	1(2,3,4,5)	S2,4		<ul style="list-style-type: none"> HTR T ↑ 	
TRP	1(2,3,4,5)	S2,4		<ul style="list-style-type: none"> HTR CUR SNSR = TRIP 	
MANF	PRESS	S2,4		<ul style="list-style-type: none"> MANF P ↓ 	
	VLV	S2,4		<ul style="list-style-type: none"> MANF VLV = CL 	
TK P	1(2,3,4,5)	S2,4		<ul style="list-style-type: none"> TK P ↑ ↓ 	
168 O2 CNTL P	6(7,8,9)	S2,4		<ul style="list-style-type: none"> CNTL P ↑ ↓ 	
HTR T	6(7,8,9)	S2,4		<ul style="list-style-type: none"> HTR T ↑ 	
TRTP	6(7,8,9)	S2,4		<ul style="list-style-type: none"> TKP ↑ ↓ 	
TK P	6(7,8,9)	S2,4		<ul style="list-style-type: none"> TK P ↑ ↓ 	
OFF/BUSY MMU	1(2)	ALL		<ul style="list-style-type: none"> AN MMU TRANSACTION IS REQUESTED WHEN THE MMU IS OFF/BUSY, FAILED OFF, OR SELECTED FOR IPL 	

MESSAGE		OPS AVAIL		CAUSE	COMMENTS
		PASS	BFS		
G23 OMS/RCS	QTY	G2		<ul style="list-style-type: none"> L(R) OMS TO RCS PROP TRANSFER EXCEEDS LIMIT 	<ul style="list-style-type: none"> NO MAL
OTT ST IN		G3,6	G3,6	<ul style="list-style-type: none"> INDICATED E/W LVL LESS THAN LVL REQD FOR OVHD APPROACH 	<ul style="list-style-type: none"> NO MAL MSG TERMINATES < 45 NM FROM LDG OR E/W LVL AGAIN MATCHES PROFILE
S76 PA1 OUTPUT	LOW	S2,4		<ul style="list-style-type: none"> PWR AMP OUTPUT ↓ 	
S76 PA2 OUTPUT	LOW	S2,4		<ul style="list-style-type: none"> PWR AMP OUTPUT ↓ 	
168 PALLET	H2 PRESS		S3,6	<ul style="list-style-type: none"> H2 TK 6 (7,8,9) CNTL P ↑ ↓ 	
	TK P		S3,6	<ul style="list-style-type: none"> H2 TK 6 (7,8,9) TK P ↑ ↓ 	
	O2 HTR		S3,6	<ul style="list-style-type: none"> O2 TK 6 (7,8,9) HTR T ↑ 	
	PRESS		S3,6	<ul style="list-style-type: none"> O2 TK 6 (7,8,9) CNTL P ↑ 	
	TK P		S3,6	<ul style="list-style-type: none"> O2 TK 6 (7,8,9) TK P ↑ 	
	T		S2,4	<ul style="list-style-type: none"> PALLET T ↑ ↓ 	
	V		S2,4	<ul style="list-style-type: none"> PALLET V A ↓ 	
			S2,4	<ul style="list-style-type: none"> PALLET V B ↓ 	
PDB CONFIG			S2,4	<ul style="list-style-type: none"> PLBD OUT-OF-SEQUENCE CONFIG 	<ul style="list-style-type: none"> CAUSES TERMINATION OF AUTO SEQUENCE
S63 PDB CONFIG			SM		
PBD CONFIG			S2,4	<ul style="list-style-type: none"> PLBD AUTO SEQ FAIL 	<ul style="list-style-type: none"> CAUSES TERMINATION OF AUTO SEQUENCE
S63 PDB CONFIG			SM		

MESSAGE		OPS AVAIL		CAUSE	COMMENTS
		PASS	BFS		
S62 PDI DECOM FAIL		S2.4		<ul style="list-style-type: none"> • DECOM 1 FMT ↑ • DECOM 2 FMT ↑ • DECOM 3 FMT ↑ • DECOM 4 FMT ↑ 	<ul style="list-style-type: none"> • MSG OCCURS IF DECOM FDA ENA AND PL TLM FAIL FOR PDI DECOM FAILS • MSG ALSO OCCURS IF PL DEPLOYED, PI FAIL, OR PSP FAIL
S96 PDRS ABE		COMM	S2.4	<ul style="list-style-type: none"> • ABE/MCIU MISCOMPARE 	
		JPC1	S2.4	<ul style="list-style-type: none"> • SHOULDER JPC FAIL 	
		JPC2	S2.4	<ul style="list-style-type: none"> • WRIST JPC FAIL 	
		SY	S2.4	<ul style="list-style-type: none"> • SPA PWR (COMMUTATOR, MDA) FAIL • TACH/PHASE LOCK LOOP FAIL 	<ul style="list-style-type: none"> • AUTO BRAKES APPLIED
		SP			
		EP			
		WP			
		WY			
		WR			
		EE	S2.4	<ul style="list-style-type: none"> • EE CMDS ↓, EE FLAG ↓, EEEU FAIL ↓ 	
		T CK	S2.4	<ul style="list-style-type: none"> • MCIU TEMP MONITOR CIRCUIT FAIL 	
		FS	S2.4	<ul style="list-style-type: none"> • MCIU EXTERNAL FRAME SYNC BITE OR BITE VERIFICATION FAILURE 	
		HC	S2.4	<ul style="list-style-type: none"> • RHC (THC) HARDOVER (ANY AXIS) • MCIU HC ↓ (MULTIPLEXER MISMATCH) 	<ul style="list-style-type: none"> • S/W DOWNMODE TO IDLE IF IN MANUAL (TEST)

MESSAGE		OPS AVAIL		CAUSE	COMMENTS
		PASS	BFS		
PDRS TEST		BRK C/W NMI FS LOSS	S2.4	<ul style="list-style-type: none"> • MCIU BITE VERIFICATION TEST FAILURE 	
PDRS CNTL		SY SP EP WP WY WR	S2.4	<ul style="list-style-type: none"> • CONSISTENCY CK - JOINT RUNAWAY • TACH DATA FAIL 	<ul style="list-style-type: none"> • AUTO BRAKES APPLIED
PDRS DERIG			S2.4	<ul style="list-style-type: none"> • UNCOMMANDED DERIGIDIZE 	<ul style="list-style-type: none"> • POSSIBLE EE STRUCT FAIL
S94 PDRS GPC			S2.4	<ul style="list-style-type: none"> • MCIU-DETECTED GPC COMM FAIL 	<ul style="list-style-type: none"> • MCIU SAFING COMMANDED • S/W DNMODE TO 'SUSPEND'
S96 PDRS MCIU		MADC	S2.4	<ul style="list-style-type: none"> • MADC REF VOLT TEST FAIL 	<ul style="list-style-type: none"> • AUTO BRAKES APPLIED
		MCPC	S2.4	<ul style="list-style-type: none"> • MCPC REF VOLT TEST FAIL 	<ul style="list-style-type: none"> • AUTO BRAKES APPLIED
		ICF	S2.4	<ul style="list-style-type: none"> • ICF FAIL 	<ul style="list-style-type: none"> • AUTO BRAKES APPLIED (MAY NOT BE IND)
PDRS RCH		SY SP EP WP WY WR	S2.4	<ul style="list-style-type: none"> • JOINT EXCEEDS POS OR NEG RCH LIMIT 	<ul style="list-style-type: none"> • APPROX 2" PRIOR TO S/W STOP • APPROX 4" PRIOR TO HARDSTOP
PDRS REL			S2.4	<ul style="list-style-type: none"> • UNCOMMANDED P/L RELEASE 	<ul style="list-style-type: none"> • POSSIBLE EE STRUCT FAIL

MESSAGE		OPS AVAIL		CAUSE	COMMENTS
		PASS	BFS		
PDRS SING	SY	S2.4		• SY/WY WITHIN 3 FT OR COALIGNMENT	• LOSE ±Y DEG OF FREEDOM AT SINGULARITY
	EP	S2.4		• EP > -7.6°	• LOSE -X DEG OF FREEDOM AT SINGULARITY
	WY	S2.4		• WY WITHIN ±15° OF ±90° SING	• LOSE ROLL DEG OF FREEDOM AT SINGULARITY
PDRS CNTL	SY	S2.4		• JOINT SLIPPAGE WITH THE BRAKES ON AND NOT IN DIRECT MODE	• SLIPPAGE GREATER THAN 0.5° PER JOINT OR SUM OF 2.0° FOR ALL JOINTS
	SP				
	EP				
	WP				
	WY				
	WR ALL				
PDRS TEMP	PORT STBD	S2.4		• JOINT/EE TEMP OUT OF LIMITS	
S94 PDRS WR R		S2.4		• PDRS WRIST ROLL RANGE CHECK FAILURE	
206 PL CL2			SM	• AV FAN ΔP ↑ • H2O PUMPS ΔP STAT ↓	• SEE ASCENT/ENTRY SYSTEMS PROCEDURES (SPACELAB MODULE CONFIGURATION ONLY)
PL CL3			SM	• AUX BUS A/B U/V ↓ • SS INV IN AMPS ↑ • SS TEMP ↑ • EXP INV IN APMPs ↑ • EXP TEMP ↑ • SS AC Φ(A,B,C) V ↑ ↓ • MAIN BUS V	• SEE ASCENT/ENTRY SYSTEMS PROCEDURES

MESSAGE		OPS AVAIL		CAUSE	COMMENTS	
		PASS	BFS			
PNL TRIM	L(R)	G3.6		• LH(RH) +/- P/R/Y TRIM SW DISAGREE	• NO MAL	
PROBES		G3.6		• EITHER ADTA PROBE NOT DEPLOYED DURING 1 < M < 2.5	• NO MAL	
S89 PRPLT THRM	OMS	S2.4		• OX(FU) LN STRUCT T HI/LOW		
	POD	S2.4		• PROP AND STRUCT T HI/LOW		
	RCS	S2.4		• FWD AND L/R RCS STRUCT T HI/LOW		
L OMS	GMBL	G1,2,3	G1,3	• PITCH (YAW) CMD/FEEDBACK Δ2° FOR 3.8 SEC	• NO MAL	
	PC	G1,2,3,6	G1,3,6	• ENG CHAMBER PRESS LOW		
	QTY	G1,2,3,6,8		• FU FU OR OX TK LEVEL LOW		
	TEMP		G1,3	• ENG FU INJ T HI		
	TK P		G2,8	G1,3		• FU OR OX TK ULLAGE P HI/LOW
				G1,3,6		• He OR N2 TK P LOW • N2 REG P HI/LOW
	VLV	G2		• OMS R POD He/P VAP ISOL VLV MISMATCH	• NO MAL	
S89 L OMS	TEMP	S2.4		• ENG FU INJ T HI/LOW	• NO MAL	

MESSAGE		OPS AVAIL		CAUSE	COMMENTS
		PASS	BFS		
L RCS	JET		G1,3,6	• RIGHT JET MANF 1(2,3,4) FAIL ON/OFF	• NO FAIL LK DETECTION IN BFS
	AJET	G1,2,3,6.8		• R AFT JET 1(3) FAIL ON/OFF/LK	• FAIL OFF DETECTION NOT PERFORMED IN MM101 & 102 FOR PASS
	DJET	G1,2,3,6.8		• R DOWN JET 2(3,4,5) FAIL ON/OFF/LK	
	RJET	G1,2,3,6.8		• R RIGHT JET 1(2,3,4,5) FAIL ON/OFF/LK	
	UJET	G1,2,3,6.8		• R UP JET 1(2,4) FAIL ON/OFF/LK	
	He P	G2,8	G1,3,6	• R RCS AFT He (FU OR OX) TK PRESS - 2 LOW	• PKT CL - RCS LEAK ISOL
	LEAK	G2,3,8	G1,3,6	• PROP/He LEAK	• OX/FU ΔQTY > 9.5%
	PVT	G2,3,8		• LOSS OF P OR T DATA FOR RCS QTY CALC	• NO MAL • QTY CALC SUSPENDED
	TK P	G2,8	G1,2,3,6	• R RCS AFT (FU OX OX) TK ULL PRESS HI/LOW	
	XFEED	G1,3,6		• R RCS PROP TANK LOW PRESS	• FAILURE ON RIGHT SIDE, AUTO XFEED FROM LEFT
G23 RCS SYSTEM	F(L,R)	G2,8		• F(L,R) RCS FU OR OX TK TEMP	
		G2,8		• F(L,R) RCS FU OR OX TK OUT PRESS	
RCS PWR	FAIL	G1,2,3,6.8		• LOSS OF VLV LOGIC PWR TO MANF ISOL VLVs	OMS/RCS VLVs WITH tb - bp STUCK IN CURRENT POSITION

MESSAGE		OPS AVAIL		CAUSE	COMMENTS
		PASS	BFS		
RM FAIL	ACC	G1,3,6		• FAIL	• NO MAL • DES/SEL AVAILABLE
	ADTA	G3,6	G3,6	• FAIL	• NO MAL • DES/SEL AVAILABLE
	IMU	G1,2,3,6.8	G1,3,6	• FAIL • COMM FAULT CAUSES BFS RM FAIL	• NO MAL • DES/SEL AVAILABLE
	MLS	G3,6		• FAIL	• NO MAL • DES/SEL AVAILABLE OPS 8 ONLY • NO CRT DAT OPS 3
	RGA	G1,3,6		• FAIL	• NO MAL • DES/SEL AVAILABLE
	TAC	G3,6		• FAIL	• NO MAL • DES/SEL AVAILABLE
	XFER		G1,3,6	• BFS NOT RECEIVE STATE VECTOR OR REFSMAT	• NO MAL
	G33 RNDZ RADAR		G2		• KU-BAND BREAKS TRACK WITH RADAR TARGET (GPC ANT STEERING MODE ONLY)
ROLL REF		G3	G3	• REF ROLL STATUS FAIL	• NO MAL
S86 RSVR/ACC P	1(2,3)	S2,4		• RSVR P ↓ • ACCUM P ↓	
SBTC/THC	A	G2,8		• AFT THC POS/NEG X/Y/Z OUTPUT A/B/C FAIL • AFT THC POS/NEG X/Y/Z OUTPUT DISAGREE	• NO MAL
	L	G3,6		• L SBTC CMD A(B,C) FAIL • L SBTC CMD A(B,C) DISAGREE	

MESSAGE	OPS AVAIL		CAUSE	COMMENTS
	PASS	BFS		
SBTC/THC	L	G2,3,8	<ul style="list-style-type: none"> FWD THC POS/NEG X/Y/Z OUTPUT A/B/C FAIL FWD THC POS/NEG X/Y/Z OUTPUT DISAGREE 	• NO MAL
	R	G3,6	<ul style="list-style-type: none"> R SBTC CMD A(B,C) FAIL R SBTC CMD A(B,C) DISAGREE 	
SEL AUTO		G2	• UNIV PTG MNVR T-30 & NOT AUTO	• NO MAL
SENSE SW		G2	• AFT SENSE SW DEFAULT	• NO MAL • DEFAULT POS IS 'Z'
212 SL LINK ERR		S2,4	<ul style="list-style-type: none"> ANY OF THE FOLLOWING MDM SERIAL I/O LINK ERROR CONDITIONS OCCURRED FOR SSC OR EXC. NO SL RESP ↓ GPC NO MATCH ↓ SL LENGTH ↓ AR NO MATCH ↓ SR NO MATCH ↓ MSG RJECT (ITEM OR GNC) ↓ MSG LINK BUSY ↓ MSG LINK DSBL ↓ 	• SL MAL, CDMS, MDM/MTU/PCMMU
212 SL LINK TERM		S2,4	<ul style="list-style-type: none"> MDM SERIAL I/O LINK TO SPACELAB TERMINATED, CAUSED BY ANY OF THE FOLLOWING FOR SSC OR EXC. NOP IND ↓ COMM ↓ LINK INTRPT ↓ 	• SL MAL, CDMS, MDM/MTU/PCMMU
SM1 SMOKE ALRM			SM	ANY SMOKE CONC ↑

MESSAGE	OPS AVAIL		CAUSE	COMMENTS	
	PASS	BFS			
SM1 SMOKE BAY	1A	S2,4	• AV BAY 1 SENSOR A CONC ↑	• NO MAL	
	1B	S2,4	• AV BAY 1 SENSOR B CONC ↑		
	2A	S2,4	• AV BAY 2 SENSOR A CONC ↑		
	2B	S2,4	• AV BAY 2 SENSOR B CONC ↑		
	3A	S2,4	• AV BAY 3 SENSOR A CONC ↑		
	3B	S2,4	• AV BAY 3 SENSOR B CONC ↑		
SM1 SMOKE CAB	LFD	S2,4	• LEFT FLT DECK SMOKE CONC ↑	• NO MAL	
	RFD	S2,4	• RIGHT FLT DECK SMOKE CONC ↑		
	HX	S2,4	• RETURN AIR CAB HX SMOKE CONC ↑		
SPD BRK		G3,6	• SPEED BRAKE POSITION > 20% FROM AUTO SCHEDULE DURING 0.95 < M < 9.8	• NO MAL	
S66 SPLY H2O	PRES	S2,4	• SUPPLY H2O IN P ↓ ↑		
	QTY	S2,4	• SUPPLY QTY TK A(B,C,D) ↓ C(D) ↑		
	TEMP	S2,4	• SPLY DUMP LINE T ↓ ↑ • SPLY NOZ T A(B) ↑		
SSME FAIL	C(L,R)	G1,6	G1,6	• PREMATURE ME SHUTDOWN • IN MM101, MSG ANNUNCIATED BY BFS ONLY	
SSME REPOS FAIL		G3	G3	<ul style="list-style-type: none"> MORE THAN ONE MPS/TVC ISOL VLV FAILED TO INDICATE OPEN LESS THAN TWO APU/HYD SYSTEMS INDICATED GOOD 	<ul style="list-style-type: none"> NO MAL SSME REPOSITIONING FOR DRAG CHUTE DEPLOY IS NOT COMPLETE MM304 AND 3.5 < MACH < 8

MESSAGE	OPS AVAIL		CAUSE	COMMENTS
	PASS	BFS		
SUMWORD ICC 1(2,3,4,5)	ALL		• SUMWORD MISCOMPARE IN DATA FROM INDICATED GPC	
SW TO MEP	G3.6	G3	• MEP ALERT	• NO MAL
TFL LOAD FAIL	S2.4	ALL	• READ COMPARE ERROR • UNSUCCESSFUL LOAD	• NO MAL • MAY BE RESULT OF GROUND UPLINK
TGT ΔT	G2		• REQUESTED TRANSFER TIME CAUSED SINGULARITY IN TARGETING ALGORITHM	
TGT EL ANG	G2		• EXCEEDED MAX NUMBER OF ITERATIONS ON TPI TIG FOR GIVEN ELEVATION ANGLE	• NO MAL
TGT ITER	G2		• LAMBERT TGT TRANSFER ANGLE NEAR SINGULARITY POINT • PARABOLIC TRANSFER • MAX NUMBER OF ITERATIONS	
S87 THERMAL HYD	S2.4		• HX OUT T ↓	
S87 THERMAL CNTL 1(2,3)	S2.4		• LN T ELEV RD/SPBK/BDY FLP ↑ ↓	• HYD CIRC PUMP NOT MAINTAINING HYD THERMAL ENVIR
SM0 THRM APU APU		SM	• GG BED ↓, APU INJ T ↓	• APCL, EPCL - THERM HTR
		SM	• APU FU FEED LN T ↑ ↓, PUMP IN T ↑ ↓, PUMP OUT T ↑ ↓, FU TEST LN T ↑ ↓, FU SERVICE LN T ↑ ↓, PUMP DRN LN T ↑ ↓, PUMP BYP LN T ↑ ↓, GGVM SPLY LN T ↓ ↑, H2O LN INJ ↑ ↓	
EVAP		a	• FES NOZ, DUCT OR FDLN T ↑ ↓	• ONLY SELECTED DUCTS AND FDLN Ts ARE SENSED FOR STATUS

MESSAGE	OPS AVAIL		CAUSE	COMMENTS
	PASS	BFS		
SM0 THRM (Cont) FRN		SM	• ACCUM QTY ↓ • RAD OUT T ↑ ↓	• NO ASC/ENT PKT C/L
H2O		a	• H2O SPLY IN P ↑ ↓	
HYD		a	• H2O BLR T ↑ ↓	• NO MAL • ACL, EPCL - THERM HTR
PRPLT		a	• OMS FU/OX BLD/DRAIN LN T • OMS POD RCS HOUSING • OMS RCS STRUCT T • OX ENG IN OR ENG FU FDLN T	
TIME MTU	ALL		• AUTOMATIC TIME SOURCE CHANGE	
TONE	ALL		• TIME MGT TIME TONE	• NO MAL
SM0 TIRE PRESS		G3.6	• NOSE GEAR/MLG TIRE PRESS ↓	
S66 VAC VNT NZ	TEMP	S2.4	• VACUUM VENT NOZ T	• NO MAL (NO LIMITS)
SM2 W/B QTY 1(2,3)		SM	• HYD SYS H2O BOILER FLUID QTY 40%	
S66 WASTE H2O PRES	S2.4		• WASTE LIQ P ↑ ↓	
QTY	S2.4		• WASTE QTY ↑ ↓	• NO MAL FOR QTY HIGH
TEMP	S2.4		• WASTE NOZ T ↑ ↓ • DUMPLINE T ↑ ↓	
S86 WSB P 1(2,3)	S2.4		• REG P ↑ ↓ • N2 P ↓	
Q 1(2,3)	S2.4		• H2O QTY ↓	
T 1(2,3)	S2.4		• TK T ↓ • BLR T ↑ ↓	

2.3 CLOSED CIRCUIT TELEVISION (CCTV)

CONTENTS

Description	2.3-1
Video Processing Equipment	2.3-2
CCTV Cameras	2.3-6
CCTV Camera Lens Control	2.3-11
Pan/Tilt Units (PTUs)	2.3-11
Cabin Cameras	2.3-12
Video Tape Recorders (VTRs)	2.3-15
Special Purpose Video	2.3-17
Monitors	2.3-18
Payload Bay Camera Operations	2.3-20
CCTV Accessories	2.3-20
CCTV System Summary	2.3-22

Description

The closed circuit television (CCTV) system is used on orbit to provide support to orbiter and payload activities. This support includes transmitting real-time and recorded video from the orbiter to MCC through either the S-band FM or Ku-band communications systems. Mission requirements for CCTV and camera

configurations are specified in the Flight Requirements Document for each shuttle flight.

The CCTV system consists of video processing equipment, TV cameras (and lens assemblies), pan/tilt units (PTUs), camcorders, video tape recorders (VTRs), color television monitors (CTVMs), and all the cabling and accessories required to make these components work together. The crew can control all CCTV operations. Most CCTV configuration commands can be executed by the Instrumentation and Communications Officer (INCO) at Mission Control. Among the commands MCC cannot uplink are those to configure and operate loose CCTV equipment, such as camcorders and VTRs, and selection of inputs to the color monitors.

Standard CCTV components are powered via circuit breakers located on panel R14. Flight-specific keel cameras (prox ops or berthing) are usually powered from a cabin payload bus. CCTV pushbuttons on panel A7U have lights that illuminate to provide visual feedback on camera and CCTV routing configuration. These lights are powered via the ANNUNCIATOR light switches located on panel A6U.

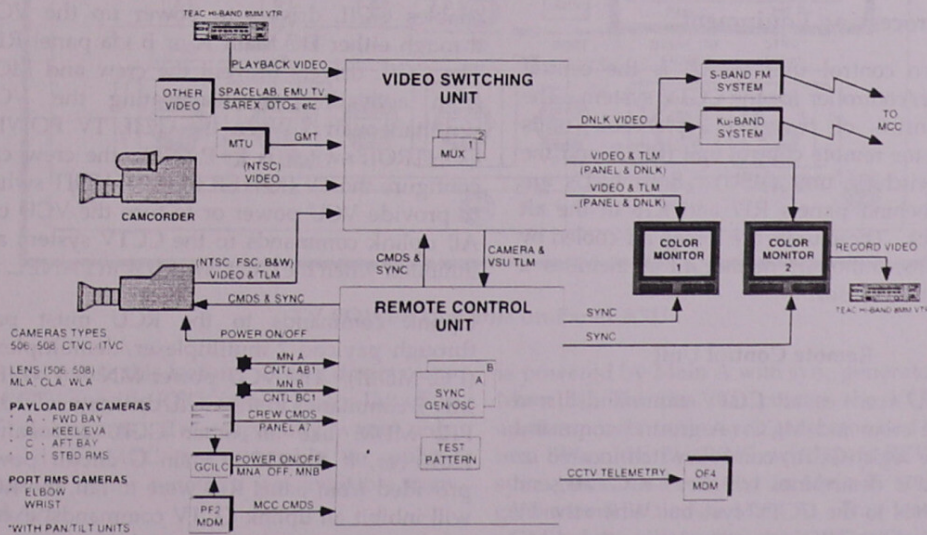

CCTV System Overview

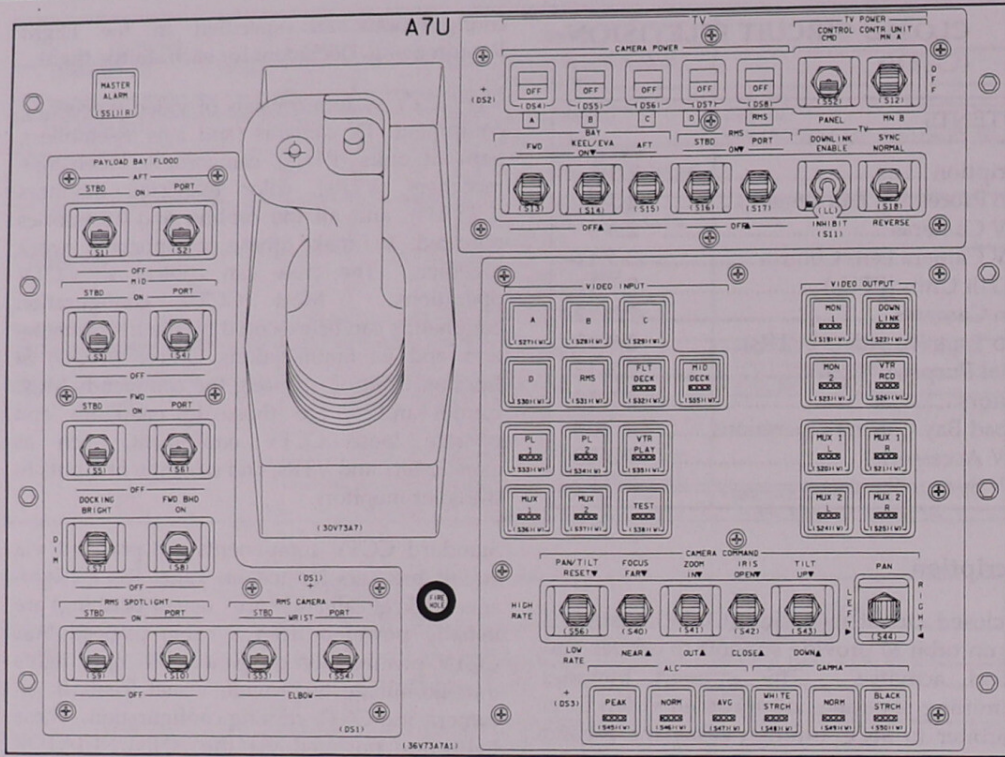

Panel A7U

Video Processing Equipment

The video control unit (VCU) is the central processor/controller for the CCTV system. The VCU consists of two line replaceable units (LRUs): the remote control unit (RCU) and the video switching unit (VSU). Both LRUs are located behind panels R17 and R18 in the aft flight deck. These units are forced air cooled by cabin fans, although neither LRU includes a temperature sensor.

Remote Control Unit

The RCU receives all CCTV commands from both the crew and MCC. A ground command interface logic (GCIL) control switch located on panel A7U determines whether MCC can send commands to the CCTV system. When the TV POWER CONTROL switch is in the CMD position, MCC can uplink commands to the CCTV system, and the crew will be able to use all panel A7U TV switches except the TV POWER CONTR UNIT MN A / OFF / MN B switch. This TV POWER CONTR UNIT switch

enables GCIL drivers to power up the VCU through either DC Main A or B via panel R14. The GCIL drivers prevent the crew and MCC from activating or deactivating the VCU simultaneously. When the GCIL TV POWER CONTROL switch is in PANEL, the crew can configure the TV POWER CONTR UNIT switch to provide VCU power or to turn the VCU off. All uplink commands to the CCTV system are inhibited when the GCIL switch is in PANEL.

Uplink commands to the RCU must pass through payload 2 multiplexer/demultiplexer (PF2 MDM). The VCU power MN A / OFF / MN B commands to the GCIL drivers use PF1 or PF2 MDM like all other GCIL commands. However, if the GCIL Main C circuit power provided from panel R14 were to fail, the RCU will inhibit all uplink CCTV commands, except for the VCU power-on commands.

The crew can send any uplink CCTV command by executing a real-time command (RTC) on SPEC 1 of the SM GPC. The TV POWER CONTROL switch must be in the CMD position

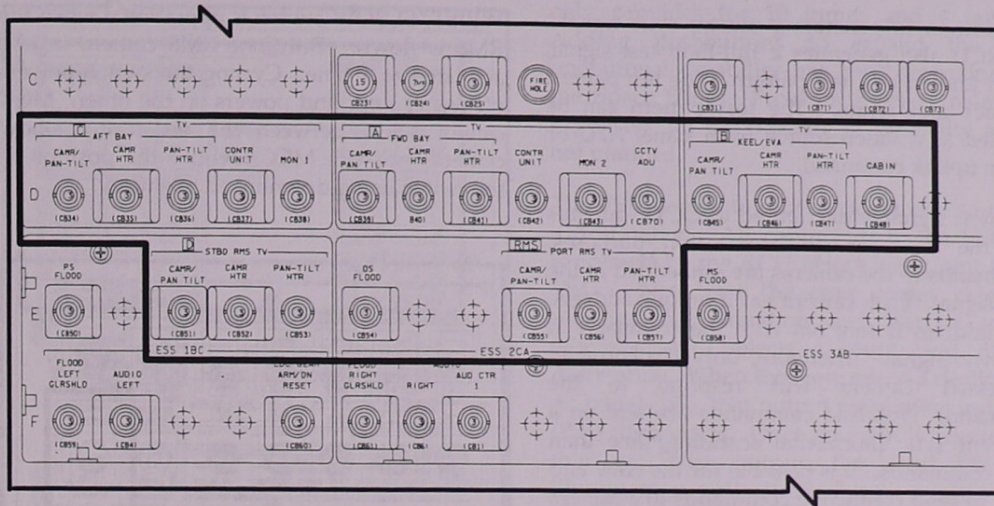

CCTV Circuit Breaker on Panel R14

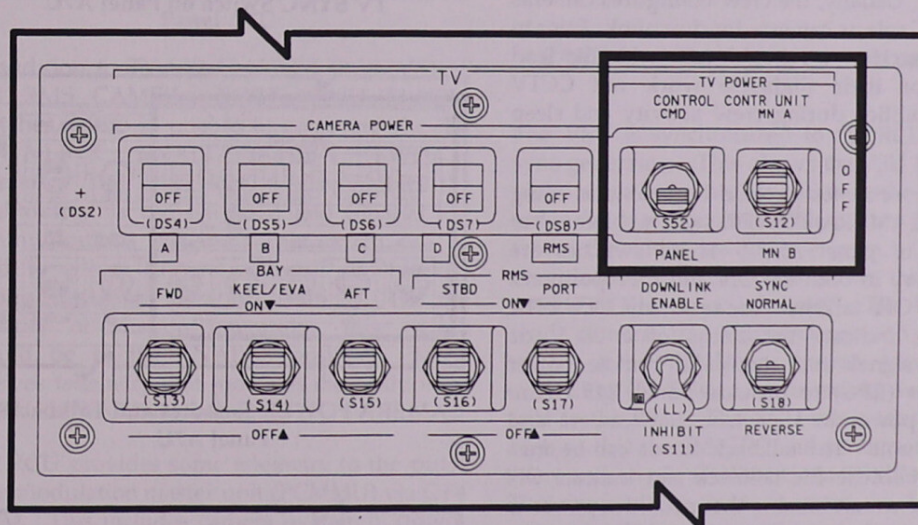

TV POWER Controls on Panel A7U

for crews to use this feature. Crews do not carry any CCTV specific RTCs in any Flight Data File (FDF) documents. This capability would only be used if MCC were unable to uplink commands or for functions not available from panel A7U.

The RCU includes two independent video sync generators. The sync generators are tied to the power on logic and TV SYNC NORMAL/REVERSE switch on panel A7U. When the TV SYNC switch is in NORMAL, sync generator A

is powered by Main A with sync generator B on Main B. The bus that powers the VCU also applies power to the sync generator tied to that bus. When the TV SYNC switch is in REVERSE, sync generator A is tied to Main B and sync generator B is tied to Main A. This feature is provided to allow the crew to switch sync generators without power cycling the VCU in case of a sync generator failure. MCC can see the status of this switch, but cannot send a command to switch sync generators without switching main bus power sources.

In addition to generating master sync signals, the RCU also generates a full-field test signal, better known as a test pattern. The test pattern is black and white. The test pattern can be selected as a video source from panel A7U or via an uplink command.

The sync signal is distributed to CCTV cameras and the VSU for synchronization purposes. Commands to the cameras are embedded in the sync signal. Each camera has a unique address. This address is sent out with the command in the sync signal. Therefore, only the correctly addressed camera will respond to the command. Uplinked commands are sent on a different sync (horizontal scanning) line than A7U commands. It is possible for the crew and MCC to send conflicting commands to a camera at the same time; coordination between crew and MCC is very important to prevent potential conflicts. Usually, the crew configures cameras and MCC selects cameras for downlink. Prior to launch, each crew should talk with the lead INCO for their flight to work out CCTV responsibilities during crew activity and sleep shifts.

The crew activates payload bay cameras using the TV CAMERA POWER switches located at the top of panel A7U. These switches are momentary in both the ON and OFF positions. The ON/OFF talkbacks are set by the RCU. The talkbacks indicate the status of a 28 V dc discrete signal that enables a remote power controller (RPC) to provide panel R15 circuit breaker power to a payload bay camera and pan/tilt unit. The talkback status can be misleading because the talkback can indicate ON when the circuit breaker that provides power to the camera is out. Crews should always use these switches to power off the cameras prior to deactivating the VCU to ensure correct camera powerdown.

There are two remote manipulator system (RMS) camera switches to note. In addition to the RMS PORT TV CAMERA POWER switch, another RMS camera switch is located directly below the aft RHC on panel A7U. The RMS CAMERA WRIST/ELBOW select switches toggle between the wrist (end effector) and elbow cameras. Only the RMS CAMERA PORT

WRIST/ELBOW switch is operational when the RMS is flown. Only one RMS camera can be activated at a time. Cycling the switch powers off one camera and powers on the other. MCC cannot select between the wrist and elbow cameras nor can MCC identify the position of the switch using downlinked telemetry.

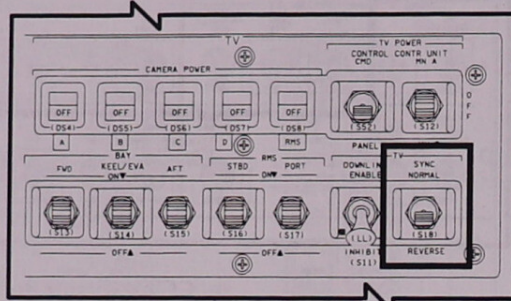

TV SYNC Switch on Panel A7U

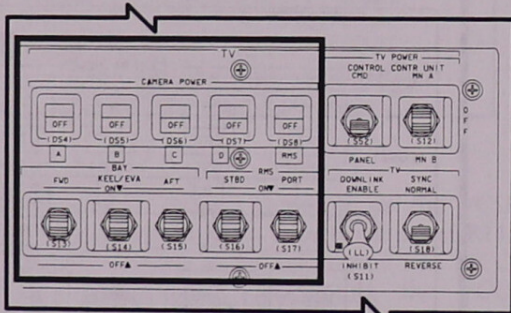

CAMERA POWER Switches and Talkbacks on Panel A7U

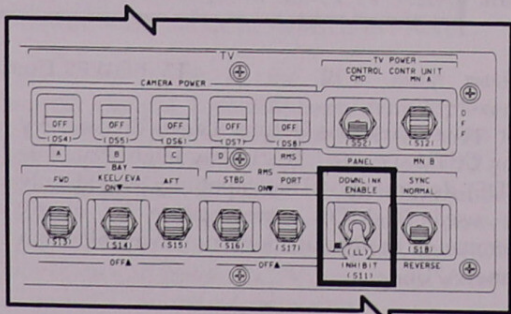

TV DOWN LINK Switch on Panel A7U

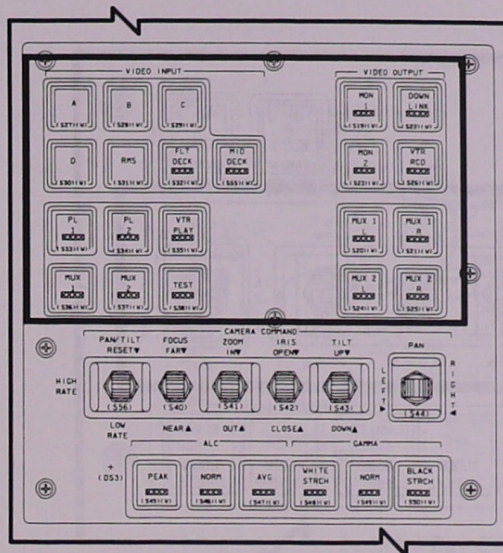

VIDEO INPUT and OUTPUT Push buttons on Panel A7U

In addition to TV SYNC NORMAL/REVERSE and RMS CAMERA PORT WRIST/ELBOW switches, MCC is unable to configure the TV DOWNLINK ENABLE/INHIBIT SWITCH function. This lever lock switch inhibits the VSU output to the Ku-Band and S-Band FM communications systems. This switch can be used to ensure that no video is downlinked during "sensitive" mission operations. For the majority of mission operations, this switch should be in the ENABLE position. MCC receives telemetry that indicates the position of the TV DOWNLINK switch.

The RCU provides some telemetry to the pulse code modulation master unit (PCMMU) via OF4 MDM. This includes camera overtemp, downlink enable, VCU power source, sync normal/reverse, sync generator active, and "camera select." The camera select is the camera selected for downlink. This may be a different camera from the one the crew or MCC is commanding at the time. The crew and MCC can command different cameras at the same time. The ALC/Gamma status of the downlink camera will be included in the telemetry to the PCMMU.

Video Switching Unit (VSU)

The VSU can accommodate up to 13 video inputs and 7 outputs. However, panel A7U

only provides for 10 inputs and 4 outputs. Adding pushbuttons to expand the VSU operational capability has been determined by the Space Shuttle Program (SSP) as being too expensive for the increase in capability and is not planned.

The VSU is used to route video from a source to a destination. All commands to the VSU are processed by the RCU before being sent to the VSU. Note that the crew routes video by selecting a destination and then a source, whereas MCC selects a source and then a destination. When the crew selects a destination on panel A7U, that output pushbutton indicator (PBI) illuminates. Once an input is selected for that particular output, the input PBI will illuminate as well. If the input is a camera, the crew can select ALC/Gamma PBI settings and/or send PTU/lens commands to that camera and pan/tilt unit.

CAMERA COMMAND Controls on Panel A7U

The VSU is synchronized to the RCU via the sync generators. This allows the VSU to change video sources for a destination at the end of a video field to prevent visible picture distortion when the video switches engage. The synchronization of CCTV also allows the VSU to read CCTV camera telemetry. The VSU can read camera ID, temperature, and pan/tilt angles. If the VSU detects a camera temperature exceeding 45° Celsius, an overtemp warning is sent to the RCU. The RCU sets a telemetry bit high so that the SM GPC will annunciate an SM Alert and an S76 COMM CAM TEMP message. The temperature limit is set in the VSU and cannot be changed by a table maintenance block update (TMBU). A TMBU can be used to inhibit the SM alert and message.

The VSU is also capable of generating multiplex (mux) scenes that appear as a split screen of two CCTV cameras. The VSU takes the center portion of a camera scene and places it on the left or right side of the mux picture. The VSU determines where to extract the center portion of the video source from the RCU's sync signals. The VSU can only mux synchronous video sources. VTR playback and camcorders cannot be muxed by the VSU.

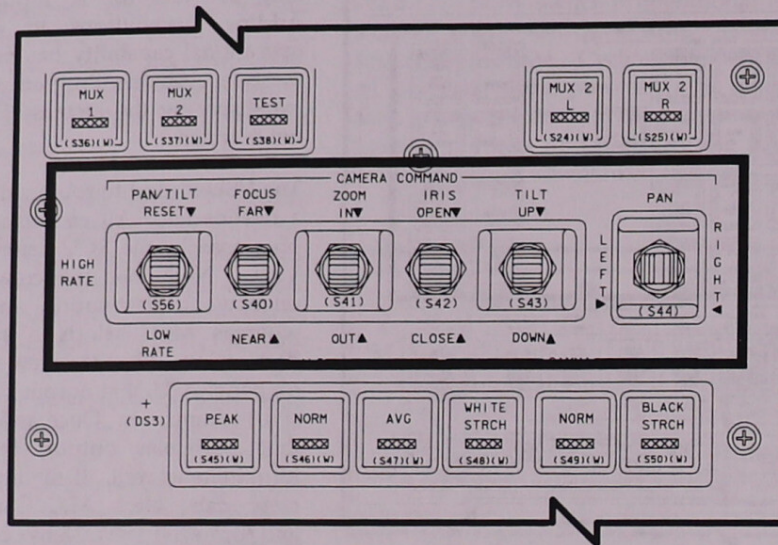

CAMERA COMMAND Controls on Panel A7U

The VSU receives GMT from the orbiter timing buffer. The GMT is formatted and inserted in the vertical retrace interval by the VSU, using sync timing from the RCU as a reference. This GMT is inserted in all incoming video lines when the VSU is in the sync mode. Since both camcorders and VTRs are asynchronous devices (i.e., not in sync with the RCU), the VSU fails to insert the GMT timetag in the correct location of the asynchronous video. Crews and flight controllers will see this as a thin, flashing, segmented white line that scrolls across the screen of the color monitors and in the downlink video. The VSU interprets the GMT as an elevated camera temperature. This will produce a false SM S76 COMM CAM TEMP message. An asynchronous (async) mode command is available to inhibit GMT timetags and disable the VSU's temperature sensing circuits. The async mode affects camera mode sensing in the VSU. The ALC and Gamma pushbuttons on panel A7U may remain static and not reflect the true configuration of standard orbiter payload bay cameras. This async mode is usually enabled for VTR playback to downlink and for downlinking camcorder video. Otherwise, a white line will be visible in the scene.

The asynchronous mode does not mean that the CCTV system is no longer sync'd together. CCTV cameras are still slaved to the RCU, as is

the VSU. Since almost all payload customers require a GMT timetag in recorded and real-time video, crews and flight controllers must coordinate the use of async mode.

The VSU includes the capability to interleave digitized voice in the downlink video. The PL BAY OUTLETS ICOM A and B switches will send either or both ICOM audio loops for digitization and interleaving with downlink video. This feature was provided in an effort to create lip sync between the audio and video. An uplinked command is required to enable the delta modulator to digitize these voice loops. This feature degrades the quality of the downlink video; the digital voice can be seen as distorted vertical color bands along the left side of the picture. This feature is no longer used.

CCTV Cameras

There are four types of CCTV cameras flown in the payload bay. The cameras are designated as -506, -508, color television camera (CTVC), and intensified television camera (ITVC). The first camera flown onboard the orbiter was the -506 camera. The -508 is an improved version of the -506. The CTVC first flew on STS-61. The ITVC is expected to fly first in mid-1995. The -506 and -508 cameras are expected to be phased out in 1996.

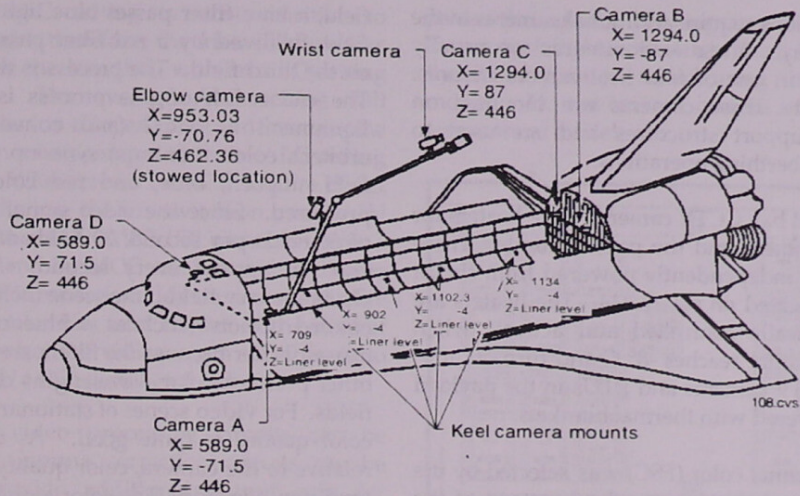

Payload Bay CCTV Camera Locations

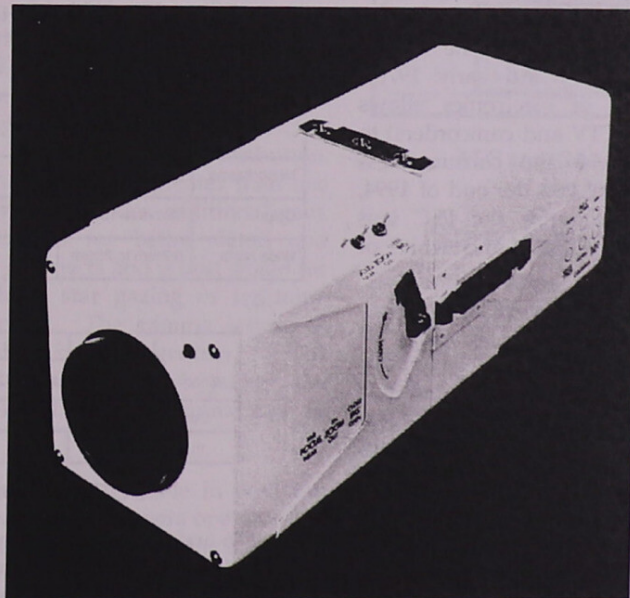

CCTV Lens (Color/Monochrome Lens Assembly Model)

Each payload bay camera has two names associated with its position. Camera ports were labeled before CCTV operations were finalized. Crews insisted upon naming cameras in a manner where camera ID could be more easily identified with the camera's location in the payload bay. The two names for each camera location are listed below:

FWD BAY	A
KEEL/EVA BAY	B
AFT BAY	C
RMS STBD	D
RMS PORT WRIST	WRIST
RMS PORT ELBOW	ELBOW

Some missions require additional cameras in the payload bay. These keel cameras are usually positioned in one of four keel camera mounts. Occasionally, these cameras are mounted on payload support structures and are used to assist with berthing operations.

All payload bay CCTV cameras have heaters for both the camera and the pan/tilt units. These heaters are independently powered from circuit breakers located on panel R14. The heaters are thermostatically controlled and activate when the temperature reaches -8° C and turn off at 0° C. All CCTV cameras and PTUs in the payload bay are covered with thermal blankets.

Field sequential color (FSC) was selected by the SSP as the color video standard instead of the National Television Standards Committee (NTSC) standard because NTSC cameras in the 1970s were much larger and consumed more power than their FSC counterparts. In addition, FSC cameras performed well for the Apollo program in the late 1960s and early 1970s. Today, miniaturization of electronics allows NTSC cameras (both CCTV and camcorders) to occupy a smaller volume and consume less power than in years past. By the end of 1994, the SSP is expected to retire the FSC lens assemblies and use only black and white or NTSC cameras.

-506, -508 Cameras

The -506 and -508 cameras compose the rear half of the old CCTV camera assembly, with the lens assembly occupying the front half. The imaging device within the camera is a silicon intensified target vidicon (tube). This vidicon provides excellent low-light performance, especially when used in conjunction with a monochrome lens assembly (MLA). The combination of MLA with the -508 camera is sensitive to 0.01 lux. The -508 and MLA combination is manifested for use where low-light capability is required,

The -506 and -508 cameras are monochrome, providing an RS-170 (black and white) video signal. The color lens assembly (CLA) and wide-angle lens assembly (WLA) have a rotating color wheel composed of primary color filters (green, blue, red). A green filter passes green component light into the camera in one

field, a blue filter passes blue light on the next field, followed by a red filter passing red light on the third field. The process is then repeated. The end result of this process is FSC video. Equipment at MCC (and converters in the orbiter's color monitors) sync up to the green field. Green, blue, and red color fields are processed. Since the video signal is composed of 60 fields per second, 20 fields of green, blue, and red appear every second. The contrast changes every field if the scene includes brightly colored objects (such as a blue ocean). This causes flicker because the filters are blocking the other primary color wavelengths on alternating fields. For video scenes of stationary objects, the color quality is quite good. As objects move relative to the camera, color quality and motion rendition degrade. The color along the perimeter of moving objects is not sharp (individual green, blue, and red lines are visible). Essentially, the only differences between the CLA and WLA are the field of view and zoom capabilities, as shown below.

Lens	Focal length (zoom)	Zoom ratio	Focus distance	F-stop (irs)
Monochrome	18mm to 108mm	6:1	2.5 ft to ∞	f1.6 to f16
Color	18mm to 108mm	6:1	2.5 ft to ∞	f1.6 to f16
Wide Angle	8.2mm to 25mm	3:1	2 ft to ∞	f3.5 to f22

Zoom	Focus	FOV (horizontal)	
		MLA & CLA	WLA
Out	Far	40.9°	83.3°
In	Far	6.6°	29.5°

CCTV Lens Data

The -506 and -508 cameras have automatic light control (ALC) circuitry to provide control of the camera lens' iris and the camera's silicon target high voltage supply. There are three ALC settings for these cameras: peak, normal, and average. To select an ALC mode, the crew will use panel A7U ALC and Gamma pushbuttons (PEAK, NORM, AVG). MCC/INCO can also select ALC settings via uplink commands. The ALC settings shift the camera's dynamic range from white (peak), to neutral (normal), to black (average).

The peak ALC setting is most sensitive to incoming light; therefore, the iris will allow less light to enter the lens than with an ALC setting of normal. The average ALC setting will command the iris to open more and increase the voltage gain when compared to the ALC setting of normal. When crews or MCC require direct control of the iris, the iris switch on panel A7U just above the ALC AVG PBI or an iris open/close command by MCC can be used to disable the ALC. This mode is called semi-manual. The camera operator has total control of the iris but does not control the vidicon gain since the auto gain control (AGC) is still enabled.

Additional video processing circuits can be activated. Gamma correction circuits can be used to provide additional output gain (or attenuation). Gamma circuits provide an exponential gain as opposed to a constant gain. The white stretch is selected by the WHITE STRCH pushbutton on panel A7U. The white stretch exponent is less than one (0.667), thus providing an attenuation. This provides for better contrast and detail within brightly lit objects, such as a payload reflecting sunlight. The black stretch is selected by the BLACK STRCH pushbutton. The black stretch exponent is greater than one (2.0), thus the circuit provides additional gain. This setting provides for better detail and contrast of dimly lit objects and is best suited for applications such as star gazing or lightning observations at night. The gamma setting of normal is selected by the gamma NORM pushbutton. Gamma normal bypasses the gamma circuit, providing no additional gain or attenuation.

A semi-manual mode is available in both the -506 and -508 cameras. The camera operator can select semi-manual mode by executing a manual iris command. The -508 camera further requires that gamma normal be selected. A full-manual mode is a feature of the -508 camera only. This is selected using white or black stretch gamma and having the ALC disabled by sending a manual iris command. The white and black stretch provides fixed voltage gain to the silicon target of the camera when the ALC setting is disabled. This feature provides for full control of the camera (iris and silicon target gain) by disabling the ALC and AGC. **CAUTION:** both semi- and full-manual modes leave the cameras vulnerable to damage by the Sun if sunlight

passes through the viewing area of the camera. Crews and flight controllers must be aware of the Sun's position when using these manual modes. Do not leave a camera unattended in any manual mode!

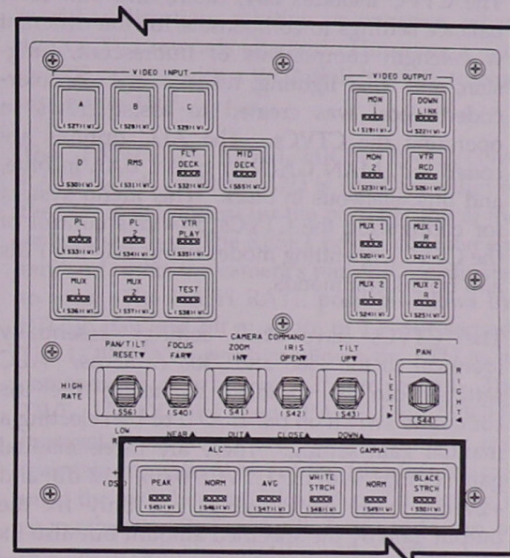

ALC and GAMMA Pushbutton
and Panel A7U

Color Television Camera (CTVC)

Unlike the -508 and -506 cameras that employ a special lens assembly (CLA or WLA) to provide a color (FSC) video signal, CTVC provides an RS-170A (NTSC) color video signal that does not require additional processing in MCC prior to distribution to the media. NTSC is the color video standard in North America, Japan, and other areas. Great Britain and France are among nations with television standards other than NTSC.

The CTVC is approximately the same size and shape as the -508 camera with a CLA or MLA lens. The CTVC does not have interchangeable lenses like the -508 camera. The CTVC lens is encased within the CTVC housing. The CTVC has a maximum horizontal field-of-view of 77° and a minimum of about 9°.

The CTVC uses three charge-coupled devices (CCDs) to take discrete samples of light passing through a prism after entering the lens. The red, green, and blue (RGB) light separated by the prism are directed to (RGB) CCDs. The CCDs are strobed by the camera's timing circuits to

provide RGB component signals. The RGB signals are processed independently to provide color balancing. Payload bay floodlights, compact portable lights (CPLs) in the cabin, and sunlight are composed of different light spectra. The CTVC includes bay, cabin, and sun color balance settings to compensate for the different wavelength components of fluorescent, tungsten, and solar lighting, respectively. A color-coded decal was created to assist crews in operating the CTVCs. The ALC options are coded red, MAN GAIN in green, BAL in blue, and miscellaneous in black. This menu system for configuring the CTVCs provides control of the CTVC's operating modes using existing PBIs and uplink commands.

The CTVCs have ALC settings essentially identical to the -508 and -506 cameras. ALC settings can be disabled by using the iris command switch on panel A7U or by selecting a manual gain setting. There are three manual gain settings with the CTVC: 0 dB; +12 dB; and +24 dB. The gain settings not only fix the output gain by the specified amount but also fix the iris to its current position. If the crew or MCC sends a manual iris command when in an ALC setting, the ALC is disabled, and the camera is moded to manual gain of 0 dB. The scene will immediately appear darker because the AGC will be disabled once the iris command is received by the camera.

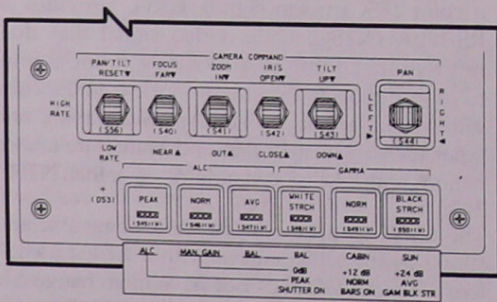

CTVC Decal

The CTVCs also include some miscellaneous settings, sometimes referred to as the "all-off" menu. A shutter can be activated to reduce vertical smearing caused by bright light. Color bars can be generated for the crew to calibrate the color monitors. Since the color bars are generated within the camera (as opposed to the B&W test pattern of the VCU), the color bars

could be used to inspect noise in the CCTV system if video appears degraded onboard. Gamma can be toggled between black stretch and linear.

The power on defaults are manual gain of 0 dB, color balance of sun, and gamma black stretch. The CCTV activation cue card instructs crews to select the applicable color balance for the environment and then select ALC of average.

The CTVCs provide full-level output at 20 lux and are designed to operate in a medium to bright light environment. These cameras operate poorly in low light. Colors cannot be distinguished in low light, so there was no need to design these cameras for that environment. Because CCTV camera operations are required for a low-light environment, a black and white camera was designed to meet these needs and operate similarly to the CTVC.

Intensified Television Camera (ITVC)

The ITVC is essentially a black and white version of the CTVC. The ALC, manual gain, and gamma settings are exactly the same. However, the ITVC only has one CCD (instead of the CTVC's three) and is optimized for a low-light environment. Instead of color balance, the ITVC includes day and night operating modes. The night mode provides additional gain, which can be used with any ALC setting as well as manual gain settings. This feature allows a high gain option without sacrificing the ALC protection, particularly around orbit sunrise. A combination of night mode and manual gain 24 dB will make the ITVC sensitive down to 0.03 lux and provide a full-level output at around 0.2 lux. If the night mode is used with daylight, the video will appear granular (noisy). The daylight mode essentially deactivates the night mode.

The ITVCs also include an aperture compensation that provides finer detail in low-light conditions. Although the ITVCs have been designed to work well in low light, these cameras are not quite as sensitive to light as are the -508 cameras coupled with the MLA. When the fleet inventory of ITVCs is sufficient, the -506 and -508 cameras are expected to be removed from service. Currently, there is no operations decal to assist in ITVC ALC/Gamma PBI operations.

Power-on defaults are similar to the ITVC. Manual mode of 0 dB is displayed on panel A7U and night operation mode and gamma black stretch are active in the background. The ITVCs will be configured using a menu based system that has ALC/Gamma PBI commands very similar to those of the CTVCs.

CCTV Camera Lens Control

Each CCTV camera type uses the same switches and command sequences to adjust the camera's field-of-view. Just above the six ALC/Gamma pushbutton indicators (PBIs) is a row of switches used to send commands to the cameras and pan/tilt units.

Lens commands are used to adjust the lens and iris settings. The focus, zoom, and iris commands provide the crew and MCC with direct control of lens settings. The CTVC and ITVC insert lens data into the video. The color monitors are able to display the lens data in the upper portion of the monitor's display. This data is also available to INCO in the MCC. In addition to changing the field-of-view, the zoom function can affect the apparent scene brightness when the camera is in an ALC mode. As bright objects increase or decrease in size, the ALC adjusts accordingly to increase or decrease the amount of light entering the lens. The -506 and -508 cameras tend to bloom in the presence of bright objects. Changing the field-of-view can usually reduce the blooming without changing the camera's auto or manual operating modes. The IRIS switch provides manual control of the iris to the user. Use of this switch disables ALC. When using this switch, crews must not leave the payload bay cameras unattended. Direct sunlight can permanently damage these cameras if a camera's iris remains open.

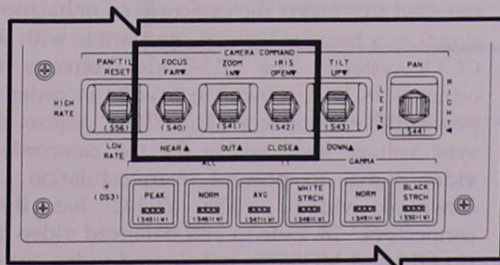

Focus, Zoom, and Iris Control

Pan/Tilt Units (PTUs)

The PTUs are used with cameras A, B, C, D, and RMS elbow. The PTUs are used to change the camera's field-of-view by moving a camera about two axes. The PTUs can pan and tilt 170° in either direction, positive or negative, when any CCTV camera is attached. However, a -506 or -508 camera with a WLA will limit tilt to plus and minus 150°.

The PAN/TILT RESET/HIGH RATE/LOW RATE switch on panel A7U is used to configure the rate of movement for the pan/tilt unit of the camera selected. The RESET position is momentary and resets the camera's pan/tilt coordinates to zero. The HIGH RATE position allows the PTU to pan and tilt at a rate of 12° per second. The LOW RATE position allows the PTU to be commanded at a rate of 1.2° per second. The TILT UP/DOWN and PAN LEFT/RIGHT momentary switches are used to initiate and maintain movement about the tilt and pan axis until the switches are released or a hardstop is encountered. Pan and tilt commands can be executed simultaneously. The PTUs may encounter clutch slippage during operation, particularly when configured for high rate. When the clutch slips, there is a temporary suspension in PTU movement. The camera will continue counting during this period because there is no feedback from the PTUs to the camera to suspend counting. This affects the accuracy of camera pointing in support of payload activities.

MCC is capable of configuring the pan/tilt rate to be different from what the crew has set. For uplinked commands, the rate defaults to high during CCTV activation. INCOs usually use the low rate for more effective management of CCTV camera movement because of the time delays in the orbiter's communications systems.

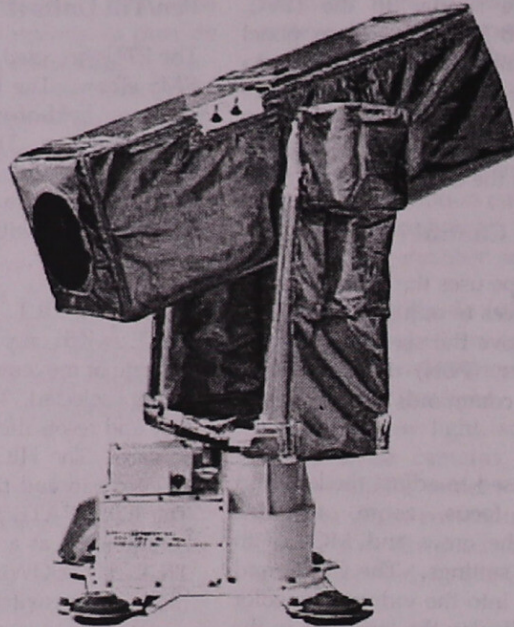

Pan/Tilt Unit with Camera Thermal Blankets

Cabin Cameras

Although all CCTV cameras are compatible with the TV outlets located on panels O19 and MO58F, there are no plans to regularly use these cameras in the flight deck or middeck areas. Camcorders have replaced the CCTVs in the orbiter's crew compartment. In addition to providing excellent real-time video, the camcorders can also record and play back video without using an external video recorder.

CCTV cameras will be used in the Spacelab module because these cameras can be remotely commanded by crews and MCC, unlike camcorders. If a CTVC is used in a Spacelab module, the crew should select a manual gain of +12 dB before manually adjusting the iris of the lens. Direct sunlight is not a concern, so crews should manually adjust the camera for the best possible picture.

Camcorders

The Canon A1 Hi-Band 8mm camcorder was the first camcorder selected for use on the orbiters back in 1990. In 1992, the Canon L1 Hi-Band 8mm camcorder gradually replaced the Canon A1. The Canon L1 camcorder uses removable lenses that can be changed in flight. As

camcorder models become commercially obsolete (no longer manufactured), the SSP is expected to phase-in new commercial-off-the-shelf (COTS) camcorders and other video equipment and accessories as necessary. Detailed model-specific camcorder features can be found in the Photo/TV Reference Manual.

Camcorders cannot interface directly with the CCTV system. COTS video equipment almost exclusively uses unbalanced video signals. Unbalanced video signals are referenced to a chassis ground (two lines, positive and ground). The orbiter's CCTV system uses balanced video signals that have a neutral reference (three lines: positive, negative, and ground). A VIU-C (video interface unit) is required to convert the camcorder's unbalanced signal to a balanced signal compatible with the CCTV system. The VIU-C also converts the orbiter's 28 V dc power to 6 volts in order to power the camcorders. The VIU-C adjusts the sync voltage level within the the camcorder's video signal to prevent overmodulation of downlink video. The VIU-C has three connectors: 28 V dc in and balanced video out (to O19 and MO58F); unbalanced video out (to portable LCD monitor); and 6 V dc out and unbalanced video in (from camcorder).

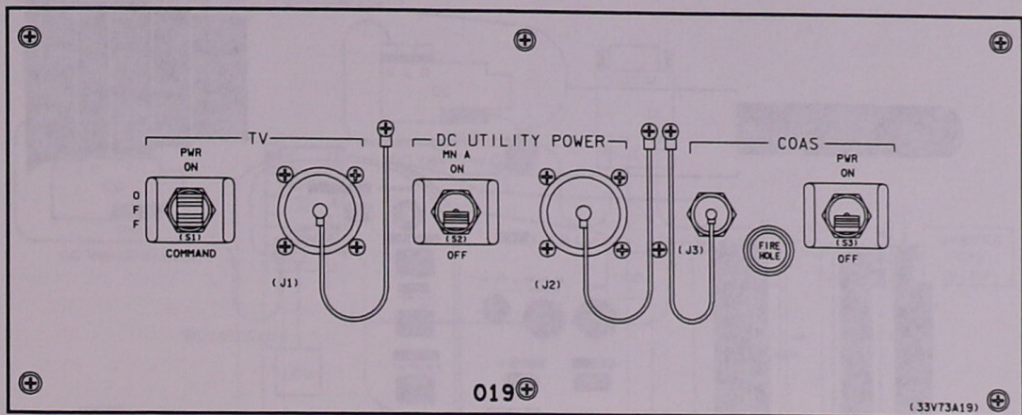

Cabin Camera Power Connectors/Control on Panel O19

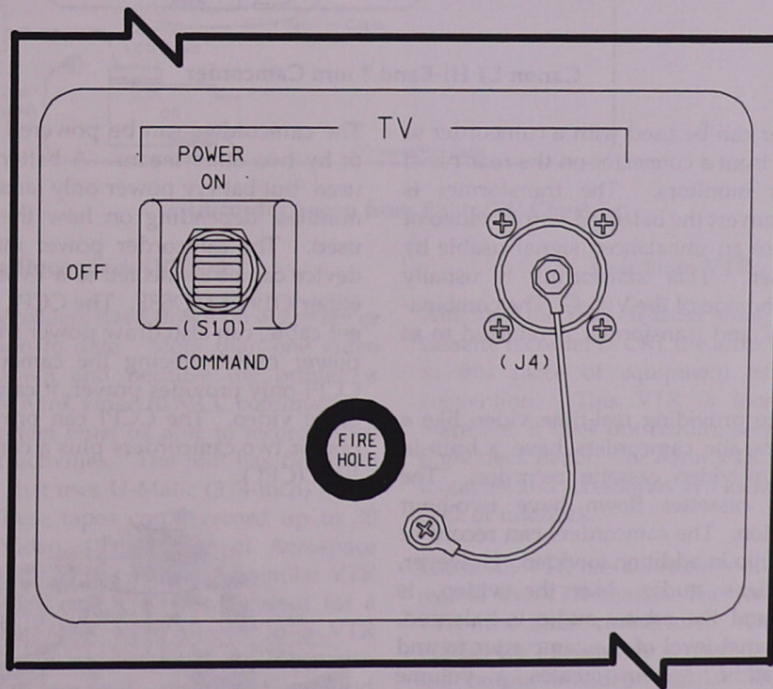

Cabin Camera Power Connectors/Controls on Panel MO58F

Multiple Camcorder w/Pigmy Cable and CCPI

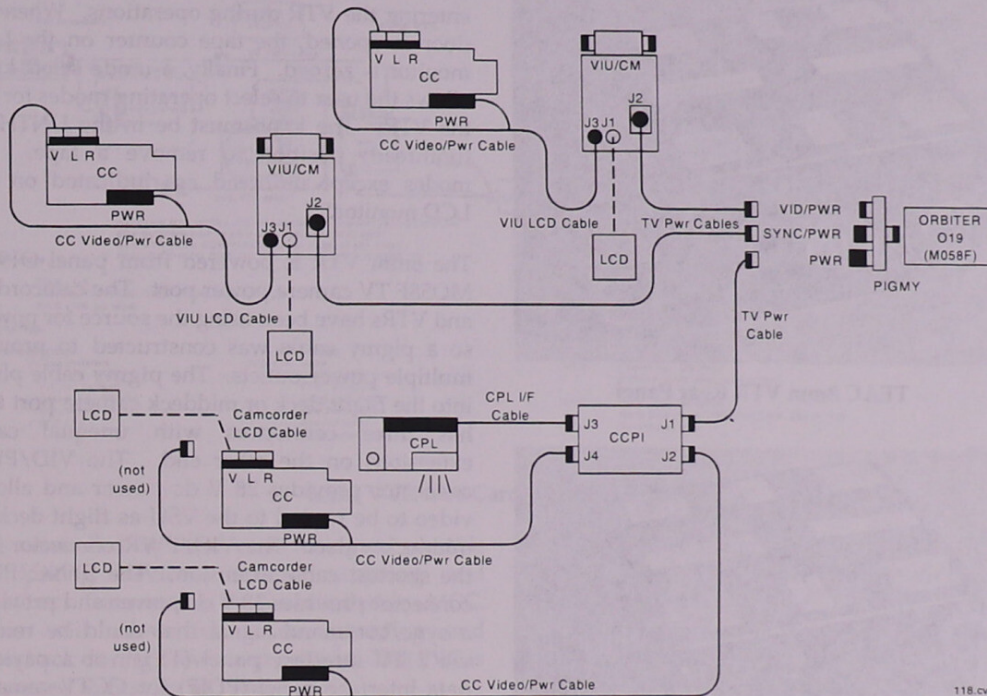

Camcorder Setup from Photo/TV Checklist

Video Tape Recorders (VTRs)

Video tape recorders have flown on every space shuttle mission to date. More than one video camera is flown and because the orbiter is unable to downlink video to MCC continuously, the CCTV system must be able to record video to document activities. The SSP has flown an interim VTR that uses U-Matic (3/4-inch) video cassettes. These tapes could record up to 30 minutes of video. The Office of Aerospace Technology (OAST) has supplied a similar VTR when more than one VTR was required for a mission. The VTRs were placed in a VTR bucket, which not only secured the VTR but also provided input/output configuration and power. The VTR buckets were placed in an aft flight deck panel (usually R11 or L10). Each VTR bucket would occupy half a panel. The OAST VTR was last flown on STS-51. Since STS-53, every mission has manifested at least one modified Teac Hi-Band 8mm video cassette recorder. The payload video console will replace loose video taping equipment used onboard.

Teac 8mm VTR

Although the Teac Hi-Band 8mm VTR is a video cassette recorder (VCR), the term VTR is applied to this piece of equipment as a matter of convention. This VTR is loose equipment; therefore, it does not require securing in an aft flight deck panel. The 8mm VTR is stowed with its cables and accessories in a locker on the flight deck or middeck.

The 8mm VTR has connectors on the front and rear of the VTR chassis. The rear panel of the VTR has three connectors. The POWER & VIDEO OUT receptacle is used to accept 28 V dc and output a video signal. The VIDEO IN connector receives a video signal from the J3 connector on the rear of a color television monitor. This allows the VTR to record video routed from the VSU to the color monitor. The AUDIO ATU/HIU connector provides an interface to an ATU via the ADS/VTR (audio distribution system) cable or a headset interface unit (HIU) in order to record or playback audio.

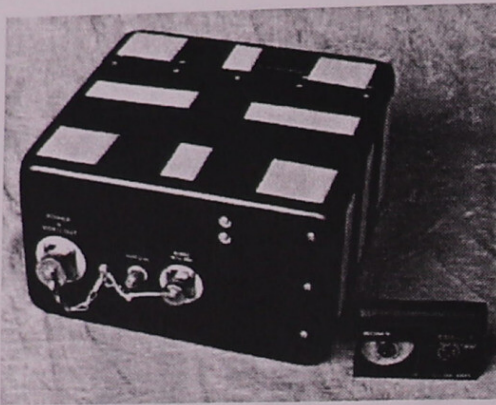

TEAC 8mm VTR Rear Panel

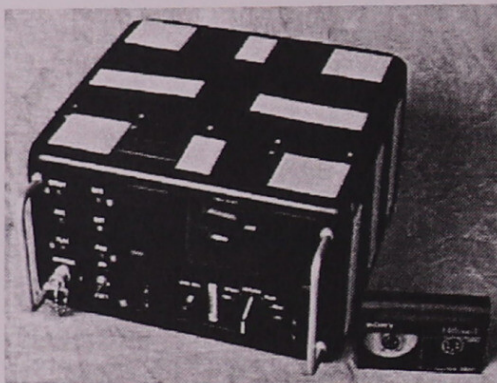

8 mm Video Tape Recorder (8 mm VTR)

The MONITOR connector on the front faceplate provides video to an LCD monitor. Tape counter and VTR mode indications will appear on the LCD screen. Six LEDs are present on the front faceplate. VTR modes of standby (STBY), record (REC), and PLAY are indicated by the illuminated LED. A power-on LED will indicate if 28 V dc is reaching the VTR. An end-of-tape (EOT) LED will indicate when the video cassette has reached its limit. A humidity sensor can activate the DEW LED. If condensation is present inside the VTR, the VTR will unthread the tape and will not operate.

Two switches and two rotary knobs are also located on the front faceplate. The ON/OFF switch enables or disables power to the VTR. The EMK REC is a momentary switch that can be used to record a 1 kHz tone when recording video. This tone can be used as an aural cue (marker) when playing back the video with audio. The PULL OPEN/LOCK knob is used to

secure a door that prevents contaminants from entering the VTR during operations. When the door is opened, the tape counter on the LCD monitor is zeroed. Finally, a mode select knob allows the user to select operating modes for the VTR. The knob must be in the UNTHRD (unthread) position to remove a tape. All modes except unthread are indicated on the LCD monitor.

The 8mm VTR is powered from panel O19 or MO58F TV camera power port. The camcorders and VTRs have been using the source for power, so a pigmy cable was constructed to provide multiple power outlets. The pigmy cable plugs into the flight deck or middeck camera port and has three connectors with unequal cable extensions on the other end. The VID/PWR connector provides 28 V dc power and allows video to be routed to the VSU as flight deck or middeck video. The VID/PWR connector has the shortest cable extension. The SYNC/PWR connector provides 28 V dc power and provides a sync/command signal that could be routed via a TV interface panel (TVIP) or a payload data interface panel (PDIP) for CCTV cameras in the payload bay that require synchronization with the CCTV system. This sync signal is usually required when more than one keel camera is used. The longest extension of the three has a PWR connector, which provides only 28 V dc power.

Camera overtemp alerts from the SM GPC can be inhibited by SM SPEC 60. The ITEM 1 allows the crew to enter a seven-digit parameter address. The current value of the term specified will be displayed underneath ITEM 1. ITEM 10 allows the crew to inhibit the caution and warning (C&W) system from annunciating alarms as a result of parameter violations. The sequence for inhibiting TV camera overtemperature sensing by SM is provided on the 8mm VTR cue card. MCC can also perform this task via a TMBU.

Payload Video Console (PVC)

The PVC is designed to mount two Teac Hi-band 8mm VTRs on panel R12. This will free up an inboard locker stowage container and reduce the number of cables the crew must configure for CCTV support. Configuration of the PVC, which includes what video to route, VTR operating modes, and audio configuration will

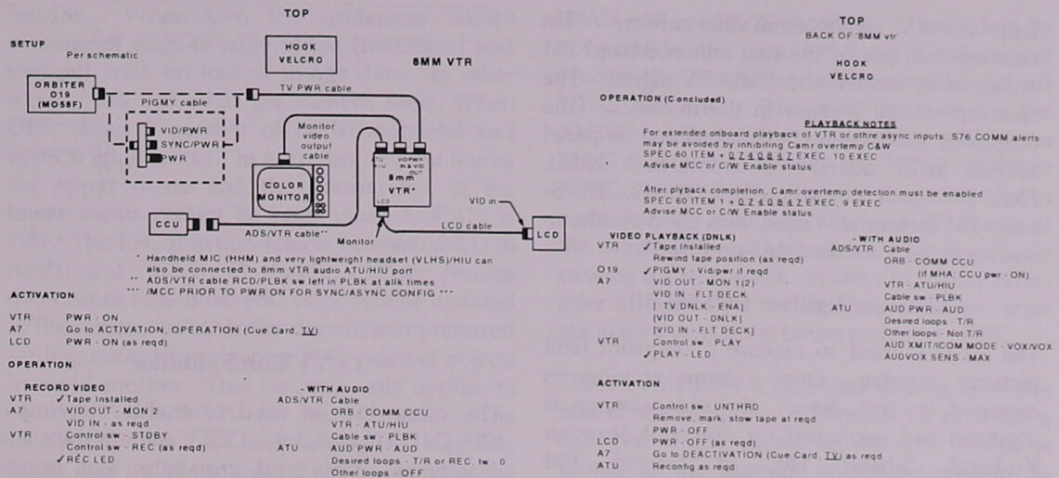

8mm VTR Cue Card (Front and Back)

be controlled by the crew using a portable computing device. Most recording and playback features can be commanded by MCC. This will allow for video recording and playback during crew sleep periods. The PVC is expected to first fly in 1996.

Special Purpose Video

On many missions, additional video sources are used above and beyond the payload bay, RMS, and cabin cameras (camcorders) in order to meet mission success. Keel (berthing and/or prox ops) cameras will be installed on rendezvous missions. These cameras are usually stationary CCTV cameras (no PTU) although mission-unique video cameras have been flown in the payload bay. Pressurized modules (Spacelab and Spacehab), include camera ports that can provide cabin or experiment video from the module to the orbiter CCTV system. Video can also be received via RF carrier (S-band FM) from an EVA crewmember or a deployed satellite, such as SPAS.

Spacelab

The Spacelab module, in addition to providing camera ports for sending video, includes a video analog switch (VAS) that can be configured by MCC or the crew to route video to and from the orbiter CCTV. The VAS can also downlink video directly to the Ku-band system (PL

analog, channel 3) and bypass the orbiter CCTV system. The VAS is used to route video and activate cameras in the module. Video recording equipment is installed in experiment racks for experiment video recording. Instead of using switches and pushbuttons for camera configuration and routing, the crew uses a payload and general support computer (PGSC) to input commands to the Spacelab experiment computer. Commands are then sent via a remote access unit (RAU) to the Spacelab video equipment.

The Spacelab module TV connectors include extra pins that are used to specify camera addresses not available in the orbiter. This provides for remote commanding of these cameras from MCC or from panel A7U. Therefore, cables designed for the orbiter cannot be used in Spacelab for use with standard orbiter CCTV cameras. Orbiter cables can be used with camcorders (with a VIU-C).

Additional information on the Spacelab CCTV system can be found in the S COMM 2102 training workbook.

EMU/Payload TV

The EVA crew can transmit television signals from an EMU suit if special equipment is attached to the helmet. The EMU camera is a CCD imaging device that sends its signal to an RF (S-band) transmitter. A receiver demodu-

lates the TV signal from the carrier. This receiver uses one of the two orbiter S-band FM antennas to receive the EMU TV signal. The receiver will be located in the middeck. The output of the receiver will be routed to panel MO58F to be distributed as middeck video. EMU TV was last attempted on STS-49. The S-band FM system was used with good results to receive video from the SPAS on STS-51.

Airborne Digitizer Unit (ADU)

The ADU is used to capture a snapshot (still picture) of video. Once a frame of video is captured by this device, the video image is digitized and encrypted for downlink through Ku-band, S-band FM, or S-band PM communication systems. This unit was used during DOD missions. The equipment remains certified for flight, although it is very unlikely it will be flown again on any upcoming NASA flights.

Monitors

The CCTV system uses a variety of monitors to display video. Two color television monitors located on panel A3 are always flown. The color monitors replaced black and white monitors that had been flown since the beginning of the SSP. Portable liquid crystal display (LCD) monitors are flown to display camcorder and VTR video without having to use either CCTV color monitor.

Color Television Monitor (CTVM)

The CTVMs are the primary display equipment of the CCTV system. These 10-inch monitors display NTSC and FSC color. Rotary knobs are used to control the contrast, brightness, color, and tint of the video displayed. The color and tint are only effective displaying NTSC video; they are not effective with FSC video.

Each monitor uses a graphical menu for configuration control. The menu can be displayed by activating either the FUNCTION or SELECT controls. The menu will be displayed for 10 seconds after the last command (FUNCTION or SELECT) is executed. The FUNCTION switch is used to move through different menu headings. The SELECT pushbutton allows the user to toggle between different options within each menu heading.

A3

MON
1

CCTV Color Monitor

The menu can be used to enable viewing of CTVC/ITVC lens data, CCTV camera data, and crosshairs. Data and crosshairs that appear green are characters generated within the color monitor and can be activated by selecting GRN for camera data and crosshairs by turning on lens data. White characters are generated within the VSU and can be displayed by selecting WHT for camera data and crosshairs. Lens data will display zoom, focus, and iris settings of the CTVC and ITVC cameras. These fields are static when a video source other than a CTVC or ITVC is displayed. Lens data, when activated, will appear at the top of the screen. The camera data will display camera ID, pan and tilt angles, and temperature, although the white data displays temperature of the camera only when the VSU detects a camera with an elevated temperature. Camera data is displayed in the lower portion of the screen.

Each color monitor can select from one of five independent video sources. PNL will display any video routed to the monitor using panel A7U. The DNLNK will allow the user to view any video selected for downlink. The C and D selections will view video from equipment connected to the C IN or D IN connectors on the front of the monitor. RGB will allow the user to view video that directly drives the red, green, and blue electron guns of the monitor (such as NTSC component). The RGB connector is located on the rear panel of the monitor. SPLT is another source available and provides a split screen image of C and D inputs.

Two ground checkout menu functions are located on the lower left portion of the menu (PULSE-X ON/OFF and GUNS R G B). USCAN ON/OFF enables or disables the underscanning

feature. When ON, the underscan allows viewing of edge-to-edge video (horizontal and vertical) with no loss of image data. In other words, you see what the camera sees. When OFF, about 5 percent of each horizontal and vertical edge is lost. In addition, the top line of the upper menu and the bottom line of the lower menu cannot be seen when USCAN is OFF. The FSC function selects between 6FLD (6 field) and 3FLD (3 field). This feature determines how often FSC color will be updated to the screen. 6FLD is the default and preferred setting, except for viewing FSC video of objects in rapid motion. This function only applies to cameras with WLA or CLA lenses. The DEGAUSS function will dissipate magnetic fields that build up around the monitor as the orbiter moves at high speed through the Earth's magnetic field, but only when DEGAUSS is in the default AUTO position. AUTO engages the degaussing circuitry every 10 minutes. OFF disables this feature.

The SYNC function of the monitor displays the source of sync used to display video and graphics (menu and green data). When no video is detected by the monitor, the field under SYNC will indicate EXT for external source. This means that the sync line from the RCU to the monitor is providing the sync pulses necessary to display the menu and data. This field can be useful for quick troubleshooting for loss of video (camera power fail vs. iris stuck closed).

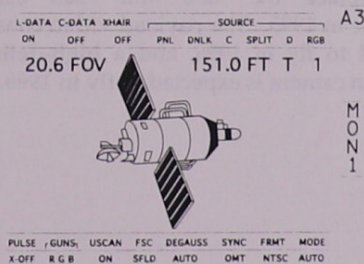

CCTV color monitor with menu and L-Data

Video format can be selected manually or automatically. The CTVMs default to AUTO MODE in which the monitor determines the video format from data embedded in the CCTV camera video. CTVCs will use the NTSC format, -506 and -508 cameras will use FSC, and

ITVCs will use B&W decoding. Camcorders do not provide this data, hence the monitors will process the camcorder video using the default NTSC converter. The crew can override the AUTO selected format by taking MODE to MAN and then toggling the FRMT to select NTSC, FSC, or B&W. If a mux scene is routed to a monitor, the monitor will select FSC because of the nature of the video processing by the VSU in creating the mux scene. In order to display NTSC color from a CTVC in a mux scene, the user must manually override the format and select NTSC.

The CTVMs have a connector labeled J3 on the rear of the monitor. This connector provides a balanced video signal of whatever video is routed to the monitor output pushbutton on panel A7U. A Teac VTR or a camcorder (using a VIU-CM) can record this video. Any VSU (white) data requested by the monitor will be recorded by the Teac or camcorder. Monitor (green) data will not be recorded.

Portable LCD Monitor

Portable LCD monitors are flown to display video at a VTR or a camcorder. Sony XV-M30 and FDM-330 LCD monitors have been used by the SSP for those purposes. Some modifications have been made to these monitors, which makes disconnecting cables from the LCD monitor more difficult in an effort to reduce accidental cable disconnections.

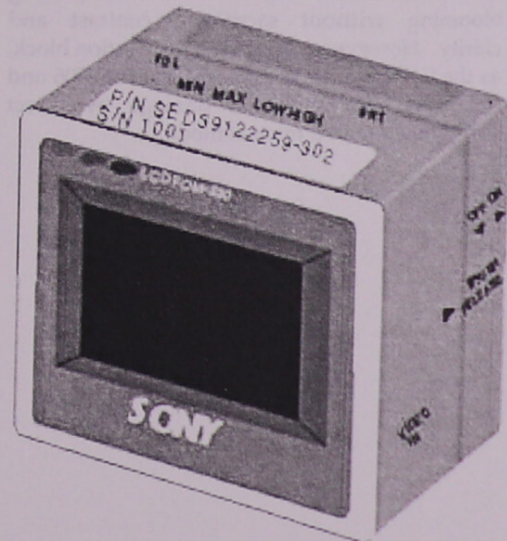

LCD Color Monitor

Viewfinder Monitor

The viewfinder monitor is used with a CCTV camera within the cabin or a module, such as Spacelab. This monitor is a 3.8-inch (diagonal) black and white portable monitor that can be connected via a power cable to a CCTV camera. The monitor is used to adjust the camera when a CCTV color monitor is not available for the task. This usually applies to cameras in the Spacelab module or cabin middeck areas. The viewfinder monitor includes brightness and contrast controls. The viewfinder monitor is usually mounted to the top or side of the CCTV camera.

Payload Bay Camera Operations

The CCTV ACTIVATION cue card includes activation procedures for the CCTV system and payload bay cameras. This cue card also includes steps that can command the cameras to different operating modes. The steps indicated are good guidelines for setting up cameras in a safe (ALC active) configuration. However, crews should not hesitate to command cameras out of their normal operating modes. Since lighting conditions on orbit are quite dynamic, ALC modes, manual gain modes, and gamma settings may require changes. Crews should take the initiative and adjust the cameras to provide the best possible video of the object(s) in view. CCTV camera operation is more of an art than a science when it comes to minimizing blooming without sacrificing contrast and clarity. However, please note the caution block, as the CCTV cameras (in particular the -506 and -508) are susceptible to damage by direct sunlight while in a manual mode.

CCTV Accessories

The CCTV system has many accessories that aid in CCTV operations. Light shades are used to reduce the amount of sunlight entering the flight deck. Shades are also available for reducing glare caused by cabin lights. Portable lighting, such as the compact portable light (CPL), is used to brighten areas for short durations. The shuttle photoflood uses fluorescent tubes powered by the orbiter 115 V ac 400Hz supply.

The ICOM recorder is a Sony WM-DC6 stereo audio cassette recorder. This device is used to record and playback voice from the orbiter audio system and the camcorder. ICOM recorder procedures are located in the Orbit Ops FDF.

Camcorders can share the same mounts, arms, and clamps with the photo equipment. These portable structures provide a secure base to position the camcorders in a microgravity environment.

Crews work with the engineering and flight controller organizations to improve CCTV operations. These improvements usually result in new cables or interface units that increase the CCTV system's capabilities. This cooperation has helped make CCTV one of the most frequently changing orbiter systems. The monitors, camcorders, and VTRs flown today are different from those flown as recently as 1992. The CTVCs and ITVCs are expected to fully replace the -506 and -508 cameras sometime in 1995. The payload video console is expected to fly in 1996, and a high-definition television camera is expected to fly in 1998.

TV

ACTIVATION A3 MON 1(2) PWR - ON
 A7 TV DNLK - ENABLE
 TV PWR - PNL, MN A, CMD
 *** V MCC PRIOR TO PWR ON FOR SYNC/ASYNC CONFIG ***

OPERATION

CTVC
 A7 TV CAMRs PWR - ON
 MON 1(2) - A (B, C, D, ...)
 BAL - SUN (OR AS REQD)
 ALC - AVG
 (REPEAT FOR OTHER TVs AS REQD)

MLA/CLA/WLA
 A7 TV CAMRs PWR - ON
 MON 1(2) - A (B, C, D, ...)
 ALC - AVG
 GAMMA - NORM
 (REPEAT FOR OTHER TVs AS REQD)

CC
 019, TV PWR - ON
 MO58F CC - ON

CAUTION
 DO NOT LEAVE CAMRs UNATTENDED IN MAUAL MODE
 DIRECT SUNLIGHT WILL DAMAGE CAMERAS

Manual Mode:
 A7 Man Gain - 0 dB (or as reqd)
 IRIS - OP/CL

Manual OFF:
 A7 ALC - AVG (or as reqd)

Multiplex ON:
 A3 CTVM 1(2) Mode - Auto
 A7 Mon 1(2) - Mux 1(2)
 Mux 1(2)L - Sel Camr
 Mux 1(2)R - Sel Camr
 *** Multiplex display will be B/W ***

IF Multiplex OFF:
 A7 Mon 1(2) - Sel any Video Input

TV DNLK:
 Coordinate Dnlk w/MCC
 Config Audio (if reqd)
 A7 On MCC Go: DNLK - Sel Video Input

DEACTIVATION A7 TV Camr Pwr(s) - OFF
 TV Pwr - PNL, OFF, CMD
 MON 1(2) Pwr - OFF

Manual Mode:
 A7 IRIS - OP/CL

Full Manual Mode:
 A7 IRIS - OP/CL
 GAMMA - WHT STRCH/BLK STRCH

Semi (Full) Manual OFF:
 A7 ALC pb - Press

Multiplex:
 A3 VCTVM 1(2) Mode - Auto
 A7 Mon 1(2) - Mux 1(2)
 Mux 1(2)L - Sel Camr
 Mux 1(2)R - Sel Camr

Multiplex OFF:
 A7 Mon 1(2) - Sel any Video Input

TV DNLK:
 Coordinate Dnlk w/MCC
 Config Audio (if reqd)
 A7 On MCC Go: DNLK - Sel Video Input

TV DNLK:
 Coordinate Dnlk w/MCC
 Config Audio (if reqd)
 A7 On MCC Go: DNLK - Sel Video Input

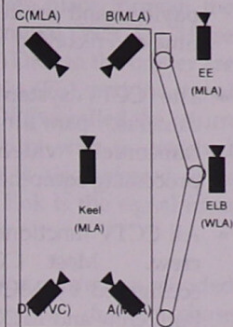

TV Cue Card From Photo/TV Checklist

CCTV System Summary

- The CCTV system is used on orbit to support payload and orbiter activities by using real-time and recorded video.
- The CCTV system is composed of CCTV cameras, pan/tilt units, color monitors, camcorders, video tape recorders, video processing equipment, and accessories.
- All CCTV functions can be controlled by the crew. Most CCTV functions can be configured by MCC via uplink commands. Both crew and MCC can command all CCTV camera functions.
- CCTV equipment is powered from circuit breakers located on panel R15.
- Crews use panel A7U to control the CCTV system.
- The video control unit is the heart of the CCTV system and is the central processor. The VCU is composed of the remote control unit and the video switching unit.
- The -506 and -508 cameras use one of three lens assemblies: monochrome, color, and wide-angle color.
- The CTVC provides NTSC color video. In addition to CCTV camera data, CTVCs also provide lens data.
- The ITVC generates black and white video. This CCTV camera is designed to operate in a low-light environment.
- The ALC and gamma PBIs on panel A7U perform different tasks with the CTVCs and ITVCs than with the -506 and -508 cameras.
- Camcorders are now used to provide cabin video. Camcorders require special interface equipment to operate in the orbiter.
- The Teac Hi-Band 8mm VTR is the VTR used by the SSP to record payload bay camera video. These VTRs are loose equipment and are stowed in lockers for ascent and entry. These VTRs record video from an output port on the color monitors and playback through flight deck and middeck camera ports.
- Two 10-inch color monitors display video onboard. The monitors are located on panel A3 and provide connectors for VTRs to use for recording. The monitors are configured via a display menu system.
- CCTV accessories, such as window and light shades, portable lights, mounting arms, ICOM recorders, and a wide variety of cables are used to improve the quality of CCTV video.

2.4 COMMUNICATIONS

CONTENTS

Description	2.4-1
S-Band Phase Modulation	2.4-2
S-Band Frequency Modulation	2.4-10
Ku-Band System	2.4-13
Payload Communication System	2.4-21
Ultrahigh Frequency System	2.4-24
Audio Distribution System	2.4-28
Instrumentation	2.4-40
Communications System Summary	2.4-45
Communications System	
Rules of Thumb	2.4-55

Description

The orbiter communication system transfers the following types of information:

- Telemetry information to the ground about orbiter operating conditions and configurations, systems, and payloads
- Commands from the ground to the orbiter systems to perform a function or configuration change
- Documentation from the ground that is printed out through an orbiter communications adapter and attached printer
- Voice communications among the flight crew members and between the flight crew and ground.

This information is transferred through hardline and radio frequency (RF) links. Hardline refers to wires that connect communicating devices, and RF refers to radio signals. RF communication takes place directly with the ground or through a tracking and data relay satellite (TDRS).

Direct communication for NASA missions takes place through space flight tracking and data network (STDN) ground stations. For military missions, Air Force Satellite Control Facility (AFSCF) remote tracking station sites, also known as space-ground link system (SGLS) ground stations, are used. Direct signals from the ground to the orbiter are referred to as

uplinks (UL), and signals from the orbiter to the ground are called downlinks (DL).

TDRS communication takes place through the White Sands Ground Terminal (WSGT). These indirect signals from the TDRS to the orbiter are referred to as forward links (FL), and the signal from the orbiter to the TDRS is called the return link (RL). Communication with a detached payload from the orbiter is also referred to as forward link, and return link is the signal from the payload to the orbiter.

The orbiter communication system is divided into several smaller systems: S-band phase modulation (PM), S-band frequency modulation (FM), Ku-band, ultrahigh frequency (UHF), payload communications, audio, and closed-circuit television (CCTV). (CCTV is discussed separately in Section 2.3.)

The S-band FM, S-band PM, Ku-band, and UHF systems are used to transfer information between the orbiter and the ground. The payload communication system is used to transfer information between the orbiter and its payloads through either hardline or RF links. The audio system provides analog voice between the orbiter comm station and MCC/POCC on the ground. The CCTV system is used to visually monitor and record activities.

The ground command interface logic (GCIL), also referred to as the ground command interface logic controller, controls selected functions of the S-band PM, S-band FM, Ku-band, payload communication, and CCTV systems. Commands are sent to the orbiter from the ground through S-band system uplink or Ku-band system forward link. All commands, whether sent on S-band or Ku-band, are routed to the onboard GPC through the network signal processor (NSP) and associated FF MDM. The GCIL takes commands for these systems from the GPC via the PF MDMs, for ground commands or from the appropriate panel for crew control.

With the exception of audio and UHF, each of the communications systems has an associated *CONTROL* switch with the positions *PANEL* and *CMD*. When the switch is set to *PANEL*, the system can be accessed by the crew using panel switches. When the switch is set to *CMD*, control is by ground command via GCIL. The

locations and operations of these switches are provided in the individual communications systems discussions that follow.

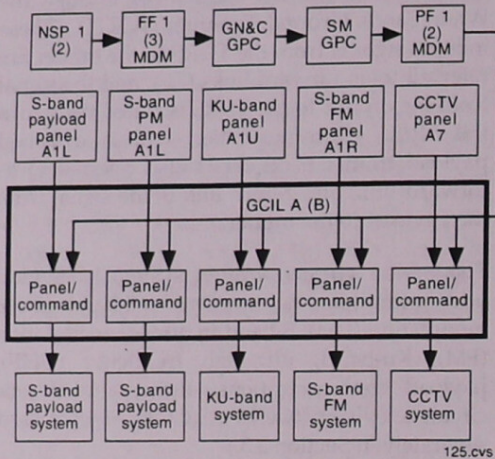

Ground Command Interface Logic

NOTE

Because of the large number of distinct elements of the Communications system, a separate Operations subsection is not included. That information is provided within the separate element discussions.

S-Band Phase Modulation

The S-band PM system provides two-way communication between the orbiter and the ground, either directly or through a relay satellite. It provides communication channels for five functions:

- Command channel: used to send commands from ground to orbiter.
- Voice channel(s): used for one-way and two-way voice communications between ground and orbiter.
- Telemetry channel: carries real-time orbiter and payload operational telemetry data to ground.
- Turnaround tone ranging channel: used to determine slant range from a known point to the orbiter. Tones are transmitted from the ground to the orbiter where they are "turned around"

and transmitted back to ground from the orbiter on a coherent RF carrier. Slant range can be computed from net total two-way phase delay of the major tone for the "round trip."

- Two-way Doppler tracking: used to aid in tracking the orbiter. An RF carrier, of precisely known frequency, is transmitted to the orbiter.

A characteristic of RF signals in the S-band range is that "line-of-sight" must exist between transmitting and receiving antennas to permit communications. With the availability of the Tracking Data Relay Satellite System (TDRSS) network, communications coverage can be about 80 percent, excluding a communications gap called the zone of exclusion (ZOE). In the ZOE, the orbiter, operating at typical attitudes, will not be in the line-of-sight with either satellite. Geographically, the ZOE is over the Indian Ocean region. During critical phases, such as orbit docking or OMS-2/deorbit burns, the ZOE can be covered by scheduling a TDRS Z satellite, thus providing nearly 100 percent of comm with MCC for these orbits. For some missions, vehicle attitude constraints imposed by payload experiment or station requirements may cause loss of comm because line-of-sight is obstructed, causing a loss of signal (LOS) or poor comm conditions; i.e., when TDRS is oriented off the nose or off the tail of the orbiter.

A fully operational TDRSS network provides most of the comm relay between the orbiter and MCC and connected POCCs. The TDRSS network has six satellites supported by the White Sands Ground Terminal facilities. Typically, the satellites used for operational support are located approximately 130° apart in geosynchronous orbit. The satellites are commonly referred to as "east" and "west," "A" and "B," or, more correctly, by their longitudinal locations, such as -47 and -171.

S-Band Forward Link

The S-band forward link operates through the STDN or TDRS. It is phase modulated on a center carrier frequency of either 2,106.4 MHz (primary) or 2,041.9 MHz (secondary) for NASA. The two frequencies would prevent interference if two users were in operation at the

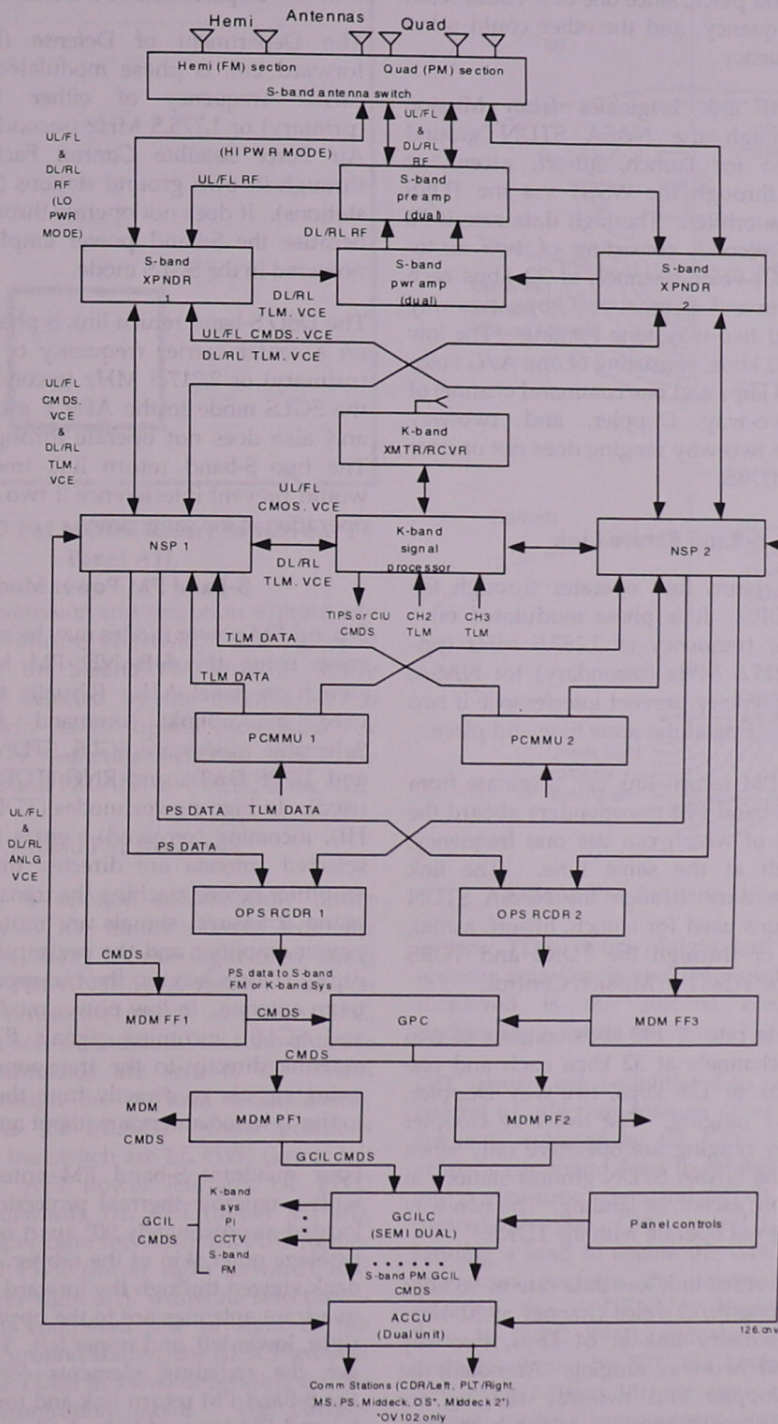

S-Band PM System Interfaces and Data Flow

same time and place, since one user could select the high frequency, and the other could select the low frequency.

The forward link originates from Mission Control through the NASA STDN ground stations used for launch, lift-off, ascent, or landing, or through the WSGT via the TDRS system to the orbiter. The high data rate is 72 kilobits per second, consisting of two air-to-ground (A/G) voice channels at 32 kbps each and one command channel at 8 kbps, two-way Doppler, and two-way tone ranging. The low data rate is 32 kbps, consisting of one A/G voice channel at 24 kbps and one command channel of 8 kbps, two-way Doppler, and two-way ranging. The two-way ranging does not operate through the TDRS.

S-Band Return Link

The S-band return link operates through the STDN or TDRS. It is phase modulated on a center carrier frequency of 2,287.5 MHz (primary) or 2,217.5 MHz (secondary) for NASA. The two frequencies prevent interference if two users are operating at the same time and place.

The S-band PM return link can originate from one of two S-band PM transponders aboard the orbiter, each of which can use one frequency, but not both at the same time. The link transmits the data through the NASA STDN ground stations used for launch, lift-off, ascent, or landing, or through the TDRS and TDRS system via the WSGT to Mission Control.

The high data rate of 192 kbps consists of two A/G voice channels at 32 kbps each and one telemetry link of 128 kbps, two-way Doppler, and two-way ranging. The two-way Doppler and two-way ranging are operative only when in view of the NASA STDN ground stations at launch, lift-off, ascent, or landing. The two-way ranging does not operate with the TDRS.

The S-band return link low data rate of 96 kbps consists of one A/G voice channel at 32 kbps and one telemetry link at 64 kbps, two-way Doppler, and two-way ranging. As noted, the two-way Doppler and two-way ranging are used in the same manner as in the high-data-rate mode.

Department of Defense Links

The Department of Defense (DoD) S-band forward link is phase modulated on a center carrier frequency of either 1,831.8 MHz (primary) or 1,775.5 MHz (secondary) from the Air Force Satellite Control Facility (AFSCF) through its own ground stations (SGLS ground stations). It does not operate through the TDRS because the S-band power amplifiers are not powered in the SGLS mode.

The DoD S-band return link is phase modulated on a center carrier frequency of 2,287.5 MHz (primary) or 2,217.5 MHz (secondary) through the SGLS mode to the AFSCF ground stations, and also does not operate through the TDRS. The two S-band return link frequencies also would prevent interference if two users were in operation at the same time.

S-Band PM Power Modes

S-band PM power modes may be selected by the crew using the S-BAND PM MODE rotary switch on panel A1L. (Usually this is configured by uplink command from MCC.) Selectable modes are SGLS, STDN LO and HI, and TDRS DATA and RNG (TDRS RNG is not used). In high power modes (TDRS and STDN HI), incoming (received) signals from a quad-selected antenna are directed through a preamplifier before reaching the transponder. Outgoing (transmit) signals are routed through a power amplifier and the preamplifier assembly diplexer after leaving the transponder en route to an antenna. In low power modes (STDN LO and SGLS), incoming signals flow from the antenna directly to the transponder, and outgoing signals go directly from the transponder to the selected antenna without amplification.

Four quadrant S-band PM antennas covered with a reusable thermal protection system are located approximately 90° apart on the forward fuselage outer skin of the orbiter. On the flight deck viewed through the forward windows, the quadrant antennas are to the upper right, lower right, lower left, and upper left. These antennas are the radiating elements for transmitting the S-band PM return link and for receiving the S-band PM forward link. Each quad antenna is a dual-beam unit that can "look" forward or aft

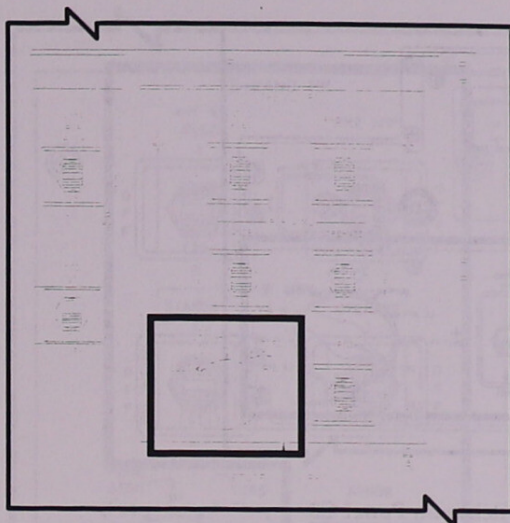

S-BAND PM MODE Rotary Switch on Panel A1L

for both transmission and reception without any physical movement, effectively creating eight antennas for the S-band PM system. These antennas are selected by the antenna switch electronics via GPC uplink command or manually by C3 antenna switches. The crew switch for S-band PM ANT SW ELEC is on A1L.

S-Band PM Antennas

The antenna is selected automatically under GPC control, by real-time command from the ground, or manually by the flight crew using the S-BAND PM ANTENNA rotary switch on panel C3. When the switch is set to GPC, antenna selection is automatic, and the antenna switching commands are sent to the switch assembly through the payload multiplexers/demultiplexers (PF MDMs). Other positions selectable by the switch are LL FWD (lower left forward), LL AFT (lower left aft), UL FWD (upper left forward), UL AFT (upper left aft), UR FWD (upper right forward), UR AFT (upper right aft), LR FWD (lower right forward), and LR AFT (lower right aft). Antenna selection is based on the computed line of sight to the NASA STDN ground station, the AFSCF ground station, or the TDRS in view, depending on the orbiter communication mode. The current antenna selection is shown on the OPS 201 ANTENNA display. Also on the display are related items such as the S-band ground station

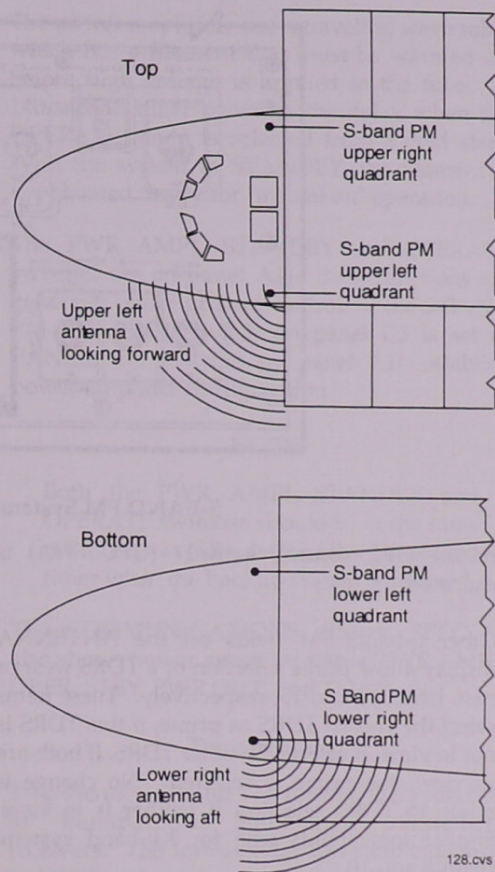

S-Band PM Antenna Locations

in view, TDRS in line of sight, and whether GPC antenna selection is enabled or inhibited. Also displayed is the antenna electronics unit performing antenna selections.

GPC control can be inhibited to permit ground control to select an antenna other than the one currently selected by the GPC. The ground sends a command load to inhibit GPC control and a real-time command (RTC) to select the desired antenna. GPC control is restored by sending a load to enable the GPC mode. The crew can perform the same functions by selecting the ANTENNA display, executing Item 12 (GPC INH), and then selecting the desired antenna by RTC via keyboard. Using GPC OVRD (Item 13), the crew can force the S-band antenna management software to the TDRS mode. An asterisk will be displayed by Item 13 while GPC override is in effect. To

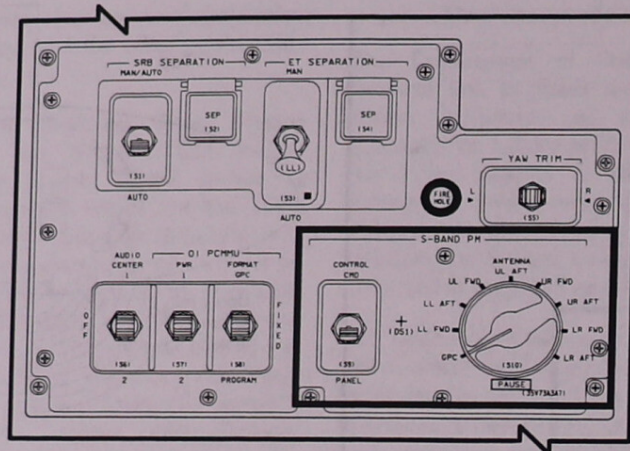

S-BAND PM System Switches on Panel C3

restore GPC control, Item 11 (GPC ENA) is executed.

Other S-band PM fields on the ANTENNA display allow prime selection of a TDRS west or east, Items 14 and 15, respectively. These items select the chosen TDRS as prime; if this TDRS is not in view, it selects the other TDRS. If both are in view, the prime is selected. No change is made to TDRS selection if neither is in view. Similar logic holds true for Ku-band system, Items 9 and 10.

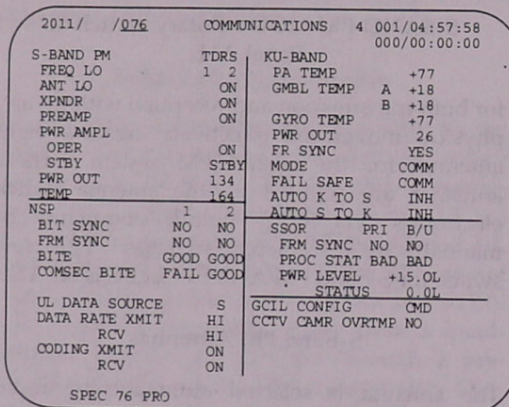

COMMUNICATIONS Display

Preamplifiers

The dual S-band preamplifier is used in the TDRS and STDN HI modes for amplification. In TDRS mode, the preamplifier is required full-time for the forward link radio frequency because of the much greater distance and, consequently, lower strength signal from the TDRS to the orbiter (minimum of about 22,300 miles) than from the STDN to the orbiter (typically, slant ranges are in the low hundreds of miles). The preamplifier is not used in the SGLS or STDN LO modes. One of the two units is used at a time, and the output of either unit can be cross-strapped to feed either transponder. The preamplifier provides an RF gain of about 25 decibels.

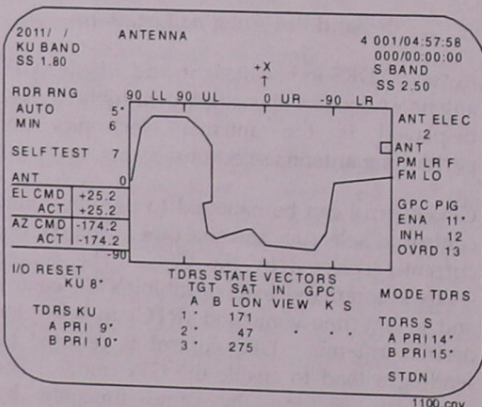

OPS 201 ANTENNA Display

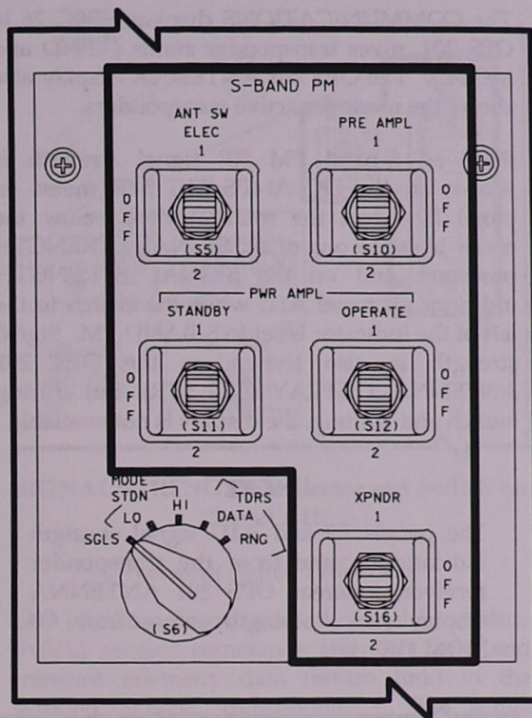

S-BAND PM ANT SW ELEC, PRE AMPL, PWR AMPL, and XPNDR Switches on Panel A1L

The PRE AMPL control switches are on panel A1L; this function is generally under ground command control. If the S-BAND PM CONTROL switch on panel C3 is set to PANEL, preamp 1 or 2 is selected, depending on the position of the S-BAND PM PRE AMPL switch on panel A1L. The COMMUNICATIONS display (SPEC 76) under SM OPS 201 shows preamp status and frequency configuration (PREAMP and FREQ).

Power Amplifiers

The S-band power amplifiers provide selectable amplification of transponder RF output for STDN HI and TDRS operational modes. The nominal power gain is about 17 decibels. There are two power amplifiers; one is used at a time, and the input of either can be cross-strapped with the output of either transponder. The output of the power amplifiers can also be routed through either frequency diplexer in the preamp assembly.

The power amplifiers use a traveling wave tube, which has a filament that must be warmed up before high voltage is applied to the tube. A 140-second timer provides the delay when the OPERATE mode is selected from a cold start. With the system in STANDBY, the filament is kept heated, ready for "instant on" operation.

The PWR AMPL STANDBY and OPERATE switches are on panel A1L; these functions are generally under ground control. If the S-BAND PM CONTROL switch on panel C3 is set to PANEL, the switches on panel A1L establish power amplifier configuration.

NOTE

Both the PWR AMPL STANDBY and OPERATE switches should be in the same position to avoid a reset of the 140-second timer when the backup system is selected.

The COMMUNICATIONS display, SPEC 76, also shows power amplifier status (PWR AMPL, OPER, STBY, PWR OUT, and TEMP).

Transponders

Two identical S-band PM transponders function as multipurpose, multimode transmitter/receivers. The transponder can simultaneously transmit and receive, transmit only, or receive only. Only one transponder operates at one time; the other is a redundant backup. The selected transponder transfers the forward link commands and voice to the network signal processor and receives the return link telemetry and voice from the network signal processor.

The transponders may be cross-strapped. Transponder 1 or 2 may be used with network signal processor 1 or 2. The radio frequency sections of either transponder can be used with either preamplifier and power amplifier 1 or 2.

The selected transponders provide a coherent turnaround of the PM forward link and PM return two-way Doppler and two-way tone ranging signals. These two-way signals operate when the orbiter is in view of the NASA STDN ground stations at launch, lift-off, ascent, landing, or when it is in view of SGLS mode ground stations. The two-way Doppler operates through the TDRS, but the two-way ranging does not.

Two-way Doppler is used by ground stations to track the orbiter. The S-band PM forward and return links are directly proportional to the forward link frequency (two-way Doppler). The S-band transponder provides a coherent turnaround of the forward link carrier frequency necessary for the two-way Doppler data. The transponder operates only when in view of the NASA STDN ground stations during launch, lift-off, ascent, or landing, or in view of SGLS mode ground stations. By measuring the forward link and using return link frequencies expected from the orbiter, the ground tracking station can measure the double Doppler shift that takes place and can calculate the radial velocity (range rate) of the orbiter with respect to the ground station. Because these links are PM, the S-band carrier center frequency is not affected by the modulating wave. It would be impossible to obtain valid Doppler data of the S-band carrier center frequency if it were affected by the modulating technique.

The S-band transponder also provides a subcarrier for two-way tone ranging. The transponder is used to determine slant range from a known point to the orbiter and operates only when in view of the NASA STDN ground stations during launch, lift-off, ascent, or landing, or in view of SGLS mode ground stations. This capability does not operate through the TDRS. The ground station forward-links ranging tones at 1.7 MHz and computes vehicle slant range from the time delay in receiving the return link 1.7-MHz tones to determine the orbiter's range. The orbiter's azimuth is determined from the ground station antenna angles.

A C-band skin-tracking mode also is provided from the ground station to track the orbiter and, again, is used only in view of the NASA STDN ground station associated with launch, lift-off, ascent or landing, or in view of SGLS mode ground stations. This capability does not operate through the TDRS.

The S-BAND PM XPNDR switch is located on panel A1L; this function is generally handled by ground command via the GCIL. If the S-BAND PM CONTROL switch on panel C3 is set to PANEL, the XPNDR selection is made from panel A1L.

The COMMUNICATIONS display, SPEC 76 in OPS 201, gives transponder status (XPND and MODE). The OPS 201 ANTENNA display also shows the mode for active transponders.

Received S-band PM RF signal strength is shown on the DC AMPS/SIG STR meter on panel F9 when the rotary switch below the meter is set to one of six SIGNAL STRENGTH positions, and on the SIGNAL STRENGTH indicator on panel A1U when the switch to the left of the indicator is set to S-BAND PM. Signal strength is also shown on the OPS 201 ANTENNA DISPLAY (SIG STR), but during launch and landing, the display is not available.

NOTE

The panels F9 and A1U signal strength indications come from the transponder receiver, whereas OPS 201 ANTENNA display signal strength comes from OI MDM OF3 data.

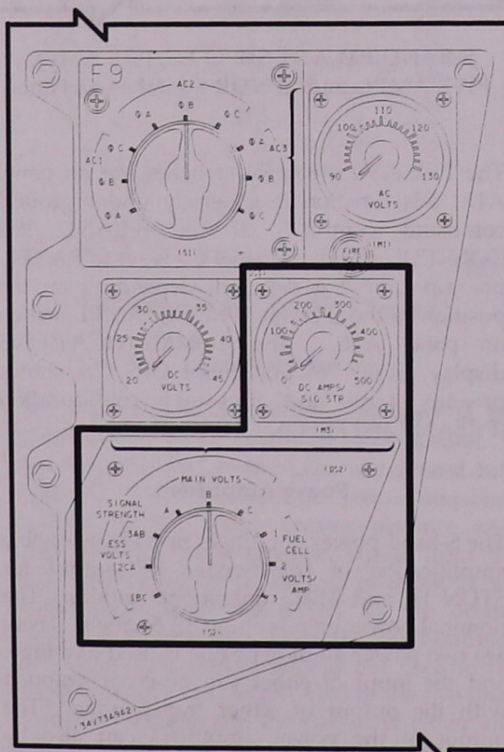

DCAMPS/SIG STR Meter and Rotary Switch
on Panel F9

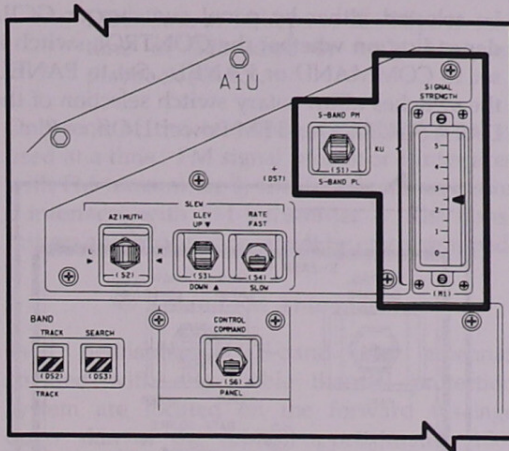

SIGNAL STRENGTH Indicator and Switch on Panel A1U

Network Signal Processors

One of two onboard network signal processors (NSPs) receive commands (forward link) and transmit telemetry data (return link) to the selected S-band transponder. The active processor receives one or two analog voice channels from the onboard audio central control unit, depending on whether one (in the low-data-rate mode) or both (in the high-data-rate mode) of the A/G channels are being used. Both voice channels are downlinked only if the NSP is high data rate on both forward and return links. It converts them to digital voice signals, time-division-multiplexes them with the telemetry from the pulse code modulation master unit, and sends the composite signal to the S-band PM transponder for transmission on the return link. On the forward S-band PM link, the NSP does just the reverse. It receives the composite signal from the S-band transponder and outputs it as either one or two analog voice

signals to the audio central control unit. The composite forward link also has ground commands that the NSP decodes and sends through the FF MDMs (nominally NSP 1 to FF 1 and NSP 2 to FF 3) to the onboard computers, which route the commands to the intended onboard systems. The NSP data routing/processing modes are controlled by command or the NETWORK SIG PROC switches on panel A1L.

NOTE

The NSP can also route return link (telemetry and voice) and receive forward link (commands and voice) via the Ku-band system.

Communications Security

Communications security (COMSEC) equipment provides the capability for encryption/decryption of operational data aboard the orbiter. The COMSEC equipment works with the NSPs to provide selectable transmit, receive, and record combinations under NSP mode control.

The NSP routes data of the indicated type through the COMSEC encryptor or decryptor as appropriate if "ENC" and gets the data back from the COMSEC line-replaceable unit encrypted/decrypted; if "BYP," the indicated data are handled directly by the NSP, and the COMSEC is bypassed.

The three ENCRYPTION switches on panel A1L provide power and routing control for encrypted data through the NSP. Our current operational mode is to use the COMSEC for receive (decrypt) mode only.

NSP ENCRYPTION Switch MODES		Link function
ALL (DOD)		Recorded Data Encrypted* Transmitted Data Encrypted Received Data Encrypted
SELECT (NASA)	T/R	Recorded Data Clear (unencrypted) ** Transmitted Data Encrypted Received Data Encrypted
	RCV	Recorded Data Clear (unencrypted) ** Transmitted Data Clear (unencrypted) Received Data Encrypted
	BYPASS	Recorded Data Clear (unencrypted) ** Transmitted Data Clear (unencrypted) Received Data Clear (unencrypted)

* Data rate determined by NSP downlink DTA RATE switch.
** HDR only.

With flight software version OI-28, BFS GNC OVERRIDE display (SPEC 51), the capability is being added for the crew to perform S-band PM communications system reconfiguration (TDRS, STDN HI, STDN LO, or SGLS) by a single item entry. The COMM status will show LOCK (if NSP is locked) and NOLK (if NSP is not locked), based on the status from the pulse code modulation master unit (PCMMU). LOCK will depend on the active NSP FRAME SYNCH lock. For Items 46-49, an asterisk "*" will show when telemetry conditions for TDRS, STDN HI, STDN LO, or SGLS, respectively, are met. No more than one asterisk will be displayed at one time. If data are not available from the PCMMU, all asterisks will be blanked.

XXXX/051/	OVERRIDE		XX X DDD/HH:MM:SS
			BFS DDD/HH:MM:SS
ABORT MODE	ENTRY FCS		
TAL 1X	ELEVON	FILTER	ATMOSPHERE
ATO 2X	AUTO 17X	NOM 20X	NOM 22X
ABORT 3X	FIXED 18X	ALT 21X	N POLE 23X
MAX THROT 4X	SSME REPOS 19 XXX	S POLE 24X	
PROPLT DUMP	IMU DES ATT	AA	RGA SURF
XXX ICNCT 5 XXXX	1 25X X	LRU DES	DES DES
OMS DUMP	2 26X	1 31X	35X 39X
	3 27X	2 32X	36X 40X
ARM 6X		3 33X	37X 41X
START 7X	ET SEP	4 34X	38X 42X
STOP 8X	AUTO 28X		
9 QUAN/SIDE XXX	SEP 29X		
OMS DUMP TTG XXX		ROLL MODE	
	ET LMB DR	WRAP MODE 45 XXX	
AFT RCS 13 XXX	CLOSE 30X	COMM XXXX	
14 TIME XXX		TDRS 46X	
	VENT DOOR CNTL	STDN-HI 47X	
FWD RCS 15 XXX	OPEN 43X XX	STDN-LO 48X	
16 TIME XXX	CLOSE 44X XX	SGLS 49X	

1098.cnv

OVERRIDE Display

S-Band Frequency Modulation

The S-band FM system cannot receive information; it is used to downlink data from up to seven different sources, one at a time, directly to the ground when there is a line of sight between the orbiter and STDN or Air Force ground stations. The S-band FM return link can originate from one of two S-band transmitters aboard the orbiter. Both transmitters are tuned to 2,250 MHz. The S-band FM return link can be transmitted simultaneously with the S-band PM return link to the STDN ground station or Mission Control or to the Air Force ground station. The S-band FM return link does not operate through the TDRS system.

Crew controls for the S-band FM system are on panel A1R. Status and configuration control of the S-band FM system electronic elements can

be selected either by panel switches or GCIL, depending on whether the CONTROL switch is set to COMMAND or PANEL. Set to PANEL, the switches allow rotary switch selection of the DATA SOURCE, and FM Power 1, Off, or 2.

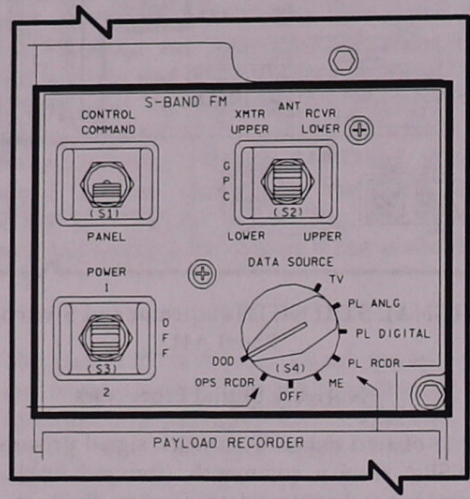

S-BAND FM Switches on Panel A1R

The FM signal processor is commanded to select one of seven sources for output to the S-band FM transmitter, which transmits it to the S-band FM return link through the STDN ground station used for launch, lift-off, ascent, or landing, or the DOD AFSCF ground station. Depending on the setting of the DATA SOURCE switch, the S-band FM return link transfers:

- Real-time SSME data from the engine interface units during launch at 60 kbps each (ME)
- Real-time video (TV)
- Operations recorder dumps of high- or low-data-rate telemetry at 1,024 kbps (OPS RCDR)
- Payload recorder at 25.5 kbps or 1,024 kbps (PL RCDR)
- Payload analog at 300 hertz or 4 MHz (PL ANLG)
- Payload digital data at 200 bps or 5 Mbps (PL DIGITAL)

- DOD data at 16 kbps or 256 kbps in real time or 128 kbps or 1,024 kbps of playback (DOD).

Only one of the two FM signal processors is used at a time. FM signal processor 1 interfaces with FM transmitter 1, and FM signal processor 2 interfaces with FM transmitter 2. The transmitters and processors cannot be cross-strapped.

S-Band FM Antennas

Two hemispherical S-band FM antennas covered with a reusable thermal protection system are located on the forward fuselage outer skin of the orbiter approximately 180° apart. On the flight deck, the hemispherical antennas are above the head (upper) and below the feet (lower) and radiate the S-band FM return link.

The S-band antenna switch assembly provides the signal switching among the two S-band FM transmitters and either of the two hemispherical antennas. The proper antenna is selected automatically by onboard or real-time command from the ground, computer control, or manual flight crew selection using the S-BAND FM XMTR UPPER, RCVR LOWER switch on panel A1R. In the GPC mode, the onboard SM computer selects the proper hemispherical antenna to be used whenever an S-band FM transmitter is active. The antenna selection is based on the computed line of sight to the NASA STDN ground station used for launch, lift-off, ascent, or landing, or the AFSCF ground stations.

The basic difference between the quadrant and hemispherical antennas is that the hemispherical antennas have a larger beamwidth, whereas the quadrant antennas have a higher antenna gain. The hemispherical antennas are so named because there are two of them, one on the top of the orbiter and one on the bottom.

The hemi antenna switch has a port that can route RF television from the astronaut's extravehicular mobility unit (EMU) to the orbiter's closed-circuit television system. An extravehicular mobility TV unit can transmit television on one hemi antenna/antenna switch path to the orbiter while the S-band FM system is routing FM downlink telemetry to ground on the other hemi antenna/antenna switch path. This requires an EMU TV receiver that is manifested for specific flights.

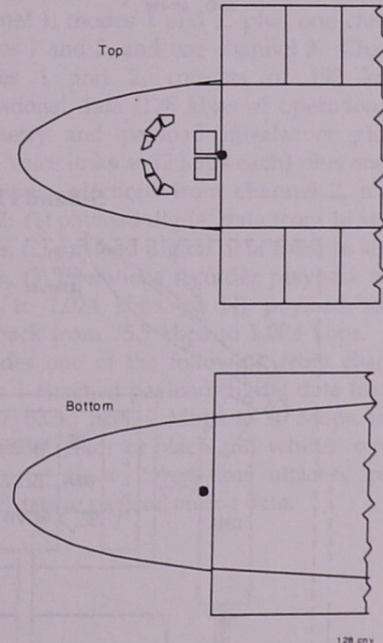

S-Band FM Antenna Locations

Ku-Band System

The Ku-band system operates between 15,250 MHz and 17,250 MHz. The Ku-band carrier frequencies are 13,755 GHz from the TDRS to the orbiter and 15,003 GHz from the orbiter to the TDRS. The Ku-band antenna is located in the payload bay. After the payload bay doors are opened, the Ku-band antenna is deployed. Once the antenna is deployed, the system can be used to transmit information to and receive information from the ground through the TDRS. The Ku-band antenna can also be used as a radar system for target tracking objects in space, but it cannot be used simultaneously for Ku-band communications and radar operations.

When the Ku-band antenna is deployed and activated in the communications mode, the NSP directs the return link data stream to both the Ku-band signal processor and the S-band transponder. The forward link is only accepted by the NSP from the Ku-band signal processor or the active S-band transponder. This depends on whether S-band or Ku-band has been selected through GCIL, by the ground, or by the NSP UPLINK DATA switch on panel A1L. For Ku-band, the return link data stream from the network signal processor is directed through the Ku-band signal processor and antenna to the TDRS in view, via the TDRS and DOMSAT systems, to Mission Control. The process is reversed for the Ku-band forward link. If the Ku-band forward link is lost, and the ground has enabled the fail-safe, the system reverts to S-band PM uplink mode. It is possible to run the downlink through the Ku-band and the forward link through the S-band, and vice versa.

Recent software upgrades (OI-27 and subs) have added the capability in the SM software to automatically switch NSP uplink configuration to support either Ku-band or S-band PM. The SM COMMUNICATIONS display (SPEC 76) shows an AUTO K TO S and AUTO S TO K status; the status fields will show Enable (ENB) or Inhibit (INH), based on uplink command configuration for these functions. If both are enabled and the correct conditions are met in the Ku-band system (good forward link), the AUTO S TO K commands through the GCIL to configure the NSP for TDRS Ku. If the Ku-band forward link is subsequently lost, or failures in the Ku-band uplink occur when using Ku-band forward link, the AUTO S TO K switches the NSP back to a TDRS S-band uplink configuration.

The Ku-band system return link consists of channel 1, modes 1 and 2, plus one channel 2, modes 1 and 2, and one channel 3. Channel 1, modes 1 and 2, consists of 192 kbps of operational data (128 kbps of operational data telemetry and payload interleaver plus two A/G voice links at 32 kbps each) plus one of the following selections from channel 2, modes 1 and 2: (1) payload digital data from 16 kbps to 2 Mbps, (2) payload digital data from 16 kbps to 2 Mbps, (3) operations recorder playback from 60 kbps to 1,024 kbps, or (4) payload recorder playback from 25.5 kbps to 1,024 kbps. It also includes one of the following from channel 3: mode 1 attached payload digital data (real-time or playback) from 2 Mbps to 50 Mbps, mode 2 television (color or black and white) composite video, or mode 2 real-time attached payload digital data or payload analog data.

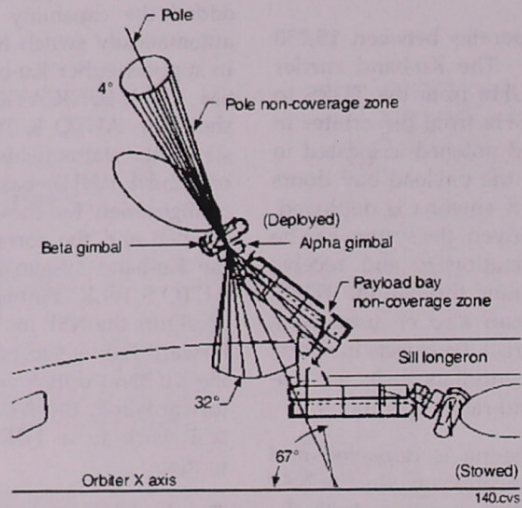

Ku-Band Antenna Non-Coverage Zones

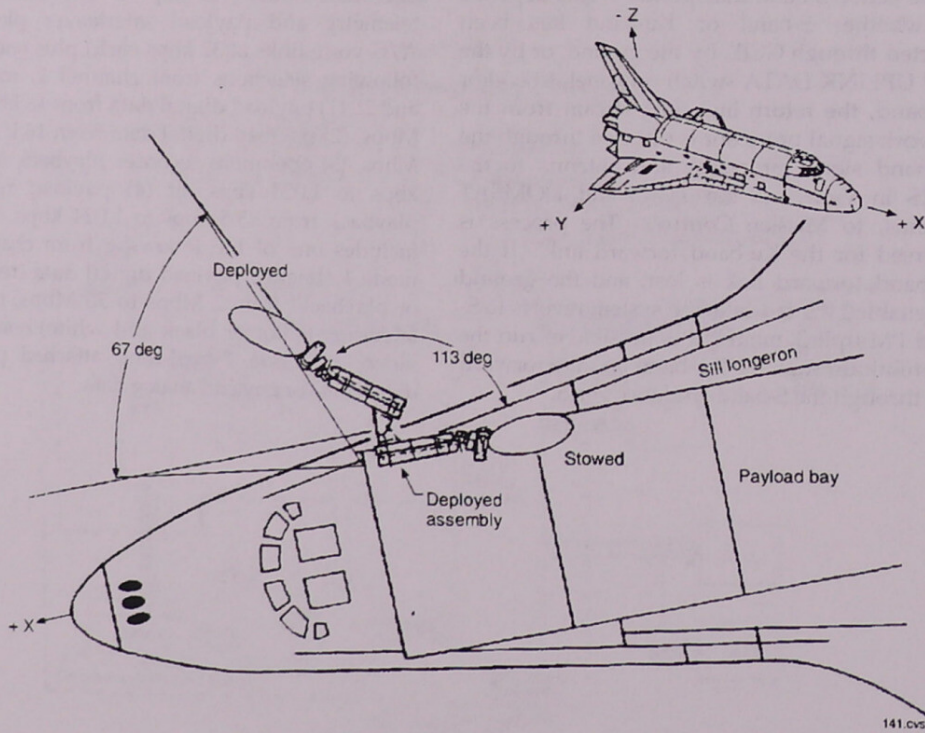

Ku-Band Deployed Assembly Location

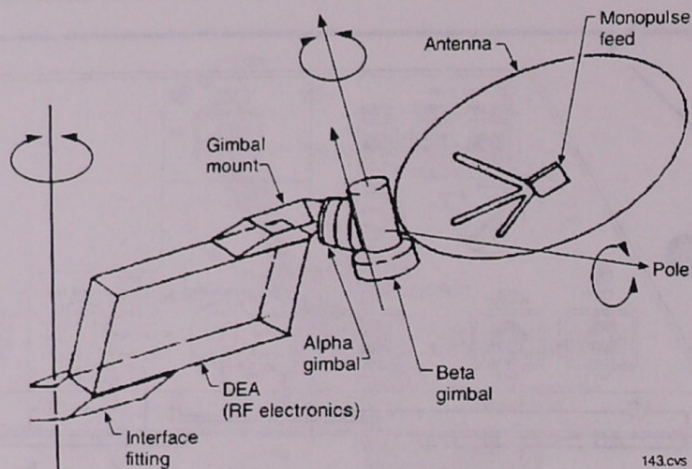

Ku-Band Deployed Assembly

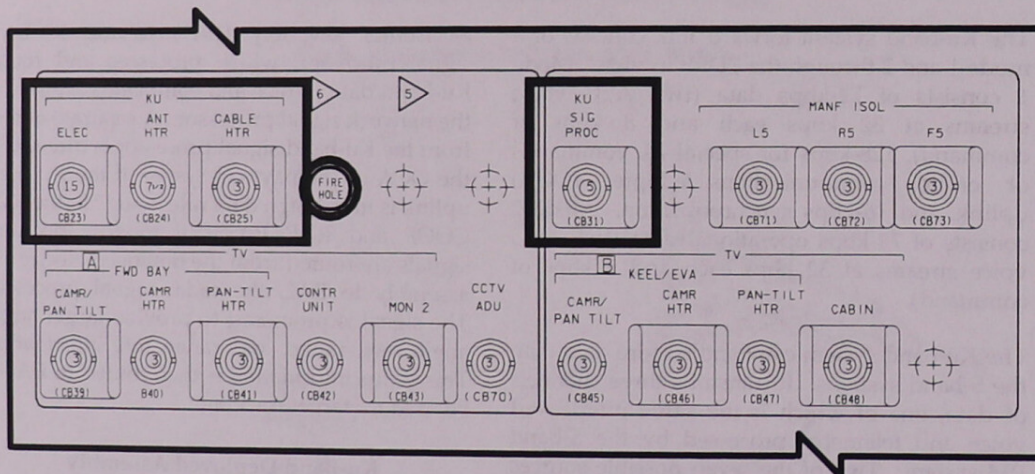

KU-BAND Circuit Breakers on Panel R15

The antenna dish is edge-mounted on a two-axis gimbal. The alpha gimbal provides a 360-degree roll movement around the pole or axis of the gimbal. The beta gimbal provides a 162-degree pitch movement around its axis. The alpha gimbal has a stop at the lower part of its movement to prevent wraparound of the beta gimbal control cable. Since the beta gimbal has only a 162-degree movement, there is a 4-degree non-coverage zone outboard around the pole and a 32-degree non-coverage zone toward the payload bay.

The antenna can be steered in several selectable modes under manual control by the flight crew using panel A1U or automatically by the SM

software. The KU BAND CONTROL switch on panel A1U selects COMMAND (control by GCIL or keyboard commands) or PANEL (crew control by panel switches and selectors). With the switch in PANEL, the antenna steering mode can be selected using the rotary switch on the left side of the panel. The switch positions are GPC (GPC pointing and auto track), GPC DESIG (GPC pointing only), AUTO TRACK (manual pointing and auto track), and MAN SLEW (manual pointing only).

At times, the Ku-band system, in view of a TDRS, is interrupted because the orbiter blocks the Ku-band antenna's view to the TDRS or because orbiter attitude requirements or

payloads' radiation sensitivities prohibit its use. In addition, the Ku-band antenna beta cabling may periodically require positioning to ensure that it does not become twisted in a way that could cause the antenna to bind.

When the Ku transmitter is enabled and outputting an RF carrier and when it is inhibited, the ground can control via ground uplink command to the SM GPC and Ku system. This control is called Ku antenna "masking." These masking modes are used to provide protection from Ku radiation for payloads and for crewmembers during EVAs and certain payload operations. The types of masking, commandable from the ground, include: 1) inhibiting the Ku transmitter when a specified beta gimbal angle is exceeded (beta MASK) or when both a specified beta gimbal angle and the orbiter hardware obscuration zone are exceeded (beta +MASK), 2) specifying an EVA protection zone, where the transmitter is disabled, within certain elevation and azimuth angle pointing of the antenna relative to a coordinate system, based on the orbiter's X, Y, and Z axes. New Ku software also modes the Ku system to standby mode, if the antenna remains near the beta stops for a certain period of time, to prevent excessive antenna gimbaling and cable binding.

None of these masking modes is readily evident to the crew unless they monitor RF out power on SM GPC SPEC 76. Only the orbiter hardware obscuration zone is shown on the SM ANTENNA SPEC (see ANTENNA display on page 2.4-6).

Ku-Band Antenna Deployment and Stowage

When the shuttle reaches orbit, before the Ku-band antenna is deployed, the KU ANT HTR circuit breaker on panel R15 is closed to energize thermostatically controlled heaters for the deployed electronics assembly, gimbals, and antenna assembly. During Ku-band activation, the KU ELEC and KU SIG PROC circuit breakers on panel R15 are closed. (There is also a CABLE HTR circuit breaker on panel R15. The Ku-band system was originally designed to have a cable heater, but it was never installed. Therefore, this circuit breaker is always left open.) These circuit breakers provide electrical power to the Ku-band electronic elements, electronics assemblies 1 and 2, the signal processor assembly, and Ku-band portions of panels A1U and A2. Actual deployment

involves the KU ANTENNA controls and associated talkback on panel R13L. The antenna is locked in the stowed position to clear the adjacent payload bay doors and radiators when they are closed or moving.

Twenty-three seconds are normally required to deploy or stow the assembly. In the deployed position, the assembly forms a 67-degree angle with the orbiter X axis. Activating the Ku electronics and taking the KU BAND POWER switch on panel A1U to ON frees the antenna gimbals by removing the gimbal locking pins. The beginning of stow operations contains approximately 30 seconds of gimbal lock sequencing before assembly stow begins.

The Ku-band antenna must be stowed before the orbiter payload bay doors are closed in preparation for entry. This is done by setting the KU ANTENNA three-position switch on panel R13L to the STOW position. If the assembly does not respond to normal stow operations, the KU ANTENNA DIRECT STOW switch on panel R13L is used. Setting this switch to ON bypasses the normal stow control sequences and causes the assembly to be driven inside the payload bay. The KU ANTENNA DIRECT STOW switch procedure is only used if locking of the alpha and beta antenna gimbals is successful in their stow position, because entry with antenna gimbals unlocked may cause unacceptable damage. DIRECT STOW merely positions the entire deployed assembly inside the payload bay and does not affect gimbal locking.

If neither the normal stow nor the DIRECT STOW can position the assembly inside the payload bay, the assembly can be jettisoned. To jettison the deployed assembly, the crew closes the MN A and MN C PYRO JETT SYS A and SYS B KU ANT circuit breakers on panel ML86B to provide redundant jettison power. The crew then activates the PYRO KU ANT ARM and JETT switches on panel A14, which causes a guillotine to cut the cables to the deployed assembly and releases a clamp holding it to the pivot assembly. The separation point is between the assembly and deployment mechanism about 20 inches above the sill longeron. No ejective force is imparted; the assembly is merely cut loose, and the orbiter maneuvers away from it. The jettison operation takes approximately 4 seconds.

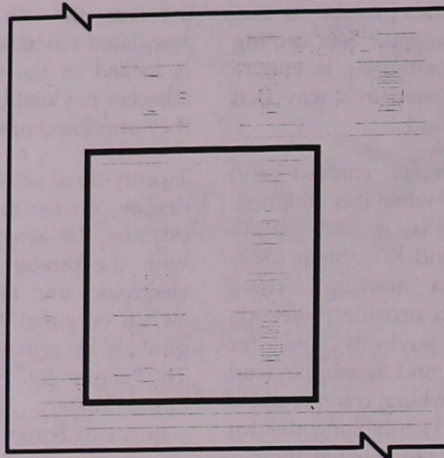

KU ANTENNA Switches and Talkback on Panel R13L

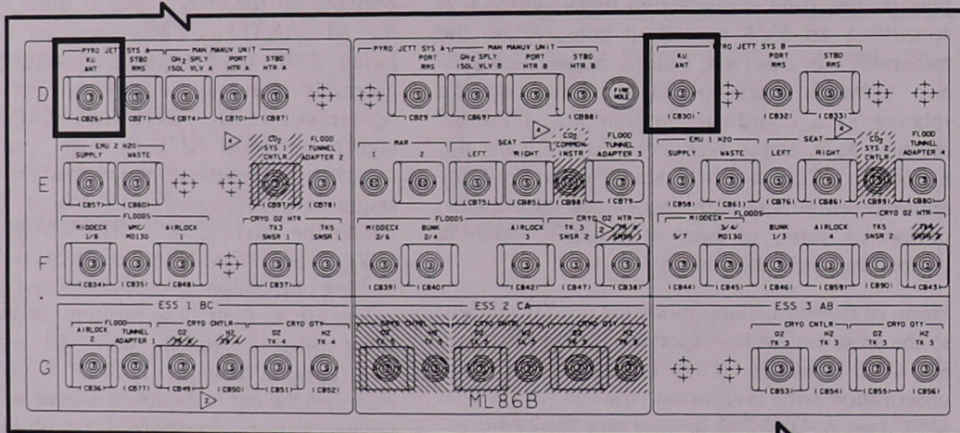

PYRO JETT KU Circuit Breakers on Panel ML86B

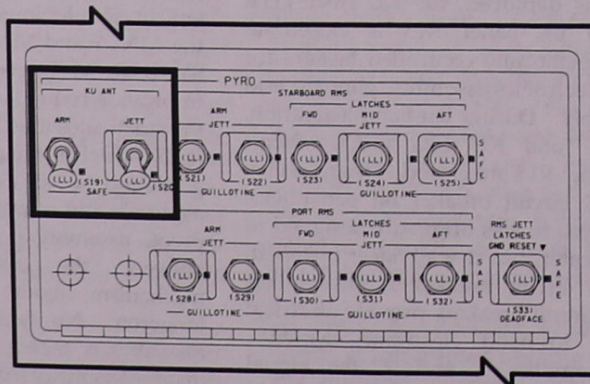

KU ANT Switches on Panel A14

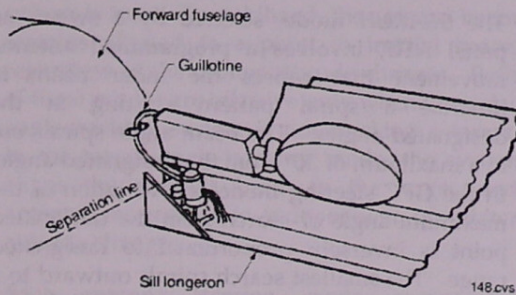

Ku-Band Antenna Jettison Separation

Ku-Band Rendezvous Radar

The orbiter Ku-band system includes a rendezvous radar that skin-tracks satellites or payloads in orbit. For large payloads that must be carried into orbit one section at a time, the orbiter will rendezvous with the payload segment currently in orbit to add on the next section. The gimbaling of the Ku-band antenna permits it to conduct a radar search for space hardware. The Ku-band system is first given the general location of the hardware by the orbiter computer; then the antenna makes a spiral scan of the area to pinpoint the target (in GPC mode).

Radar may also be used to search for space hardware using a wide spiral scan of up to 60°. Objects may be detected by reflecting the radar beam off the surface of the target (RDR PASSIVE MODE) or by using the radar to trigger a transponder beacon on the target (RDR COOP MODE). These modes are selectable using the KU BAND MODE switch on panel A1U. To date, only RDR PASSIVE MODE has been used.

During a rendezvous operation, the radar system is used as a sensor that provides target angle, angle rate, and range rate information for updating the rendezvous navigation data in the GNC computer. The operation is similar to using the crew optical alignment sight or star trackers, except that the radar provides range data in addition to angle data. Angle tracking maintains appropriate antenna pointing to keep the target within the antenna beam. Range tracking is accomplished by electronically measuring the time between a transmitted pulse and a return pulse from the target. The return pulse may be reflected from a passive (skin-tracked)

target or cooperative target transmitter that is triggered by the radar-initiated pulse. The latter provides a longer range capability.

Angle tracking can be accomplished in two ways: computer or manual designations or automatic (auto) servo. During manual or computer-designated tracking, the antenna beam angle is positioned by services external to the Ku-band system. Computer tracking (used in GPC and GPC DESIG modes) provides designated angle data based on combined target and orbiter state vector information. Manual tracking (used in MAN SLEW and AUTO TRACK modes) applies manually initiated rates to the antenna control system from switches at the orbiter aft flight deck station (A1U).

Automatic angle tracking applies error rates to the antenna control system from a receiving station that measures the target position relative to the antenna beam center. This closed-loop servosystem, internal to the Ku-band system, ignores external computer or manual designations. It is the only angle tracking mode that provides angle data for updating navigation data.

Range tracking is always automatic, although computer-designated ranges are applied to the Ku-band system until automatic tracking is achieved. In the automatic tracking mode, the Ku-band system provides actual antenna angle, angle rate, range, and range rate data through an MDM for rendezvous and proximity operations. Data routed to the indicators on panel A2 represent hard-wired azimuth, elevation, range, and range rate information, which is not processed by the GPCs.

Before any radar mode is used, the orbiter is normally maneuvered to an attitude with the minus Z axis pointing at the target location. In all modes, therefore, the radar antenna is normally maneuvered around the minus Z axis.

The Ku-band system provides for antenna steering modes, each with a different combination of capabilities for acquiring and tracking a target: GPC, GPC DESIG, AUTO TRACK, and MAN SLEW. All are mutually exclusive and crew selectable using the rotary switch on panel A1U.

The GPC mode is fully automatic in all phases of target acquisition. Two GPC CRT commands are required before this mode can be initiated (GNC SPEC 33, REL NAV DISP). One CRT command enables target position data to be routed from the GNC to the SM antenna management program through the intercomputer data bus (GNC SPEC 33, REL NAV DISP, item 1). The antenna management program converts the target position to antenna pointing angles and estimated orbiter-to-target range data. Another CRT command enables the antenna management program to send designated antenna pointing and range data to the Ku-band system through the payload 1 data bus and the payload forward 1 MDM (GNC SPEC 33, item 2).

When the GPC mode is selected, the antenna points to the commanded angles and adjusts the ranging system to the specified range. If a receive signal is detected, the automatic closed-loop system tracks the target in angles and range and provides data for the SM and GNC computers and panel displays. If the target is not detected, the antenna is automatically commanded to search around the designated point. The antenna is inertially stabilized during the search operation.

The *GPC DESIG* mode provides the same designated pointing as the GPC mode without angle search or angle-tracking capabilities. No closed-loop angle tracking is provided. The designated angles are updated every 2 seconds. Range search and tracking are automatic. The antenna may be either inertially or body stabilized.

The *AUTO TRACK* mode begins with manual antenna control, including a manually initiated search and inertial stabilization during the target acquisition phase. Once the target is detected, automatic angle and range tracking is initiated and manual control is inhibited until auto tracking is broken.

The *MAN SLEW* mode allows manual control of antenna movement with maximum automatic range search. Once the target is detected, an automatic range track is initiated, but angles are still under manual control. No angle search is available in this mode.

The *SEARCH* mode, selected by a switch on panel A1U, involves a programmed antenna movement that causes the radar beam to describe a spiral pattern starting at the designated angles. The beam angle spirals out to a maximum of 30° from the designated angle. In the GPC steering mode, the variation of the maximum angle of search from the designated point is inversely proportional to designated range. The smallest search spirals outward to a maximum of 6.2° from the designated point for ranges from 145 to 300 nautical miles (n. mi). At minimum ranges (0 to 8 n. mi.), the spiral search is the maximum 30° from the designated point. If the antenna drive system detects but overshoots the target during a spiral search, a miniscan program is automatically initiated near the point of detection. The miniscan searches to a maximum of 9° from the starting point in 1 minute. In the auto track steering mode, only the manually initiated main 30-degree scan is available.

In addition to angle search, the Ku-band system provides a range search. The process includes electronically varying the timing within the range system until it coincides with the time interval between the transmitted and received radar pulses. Once the intervals coincide, radar tracking is established, and the range data output represents the range between the target and the orbiter. The crew can read the range and range rate values as panel and CRT parameters.

The crew is provided with two controls associated with range. Transmitter power output is automatically varied in proportion to range when a target is being tracked to keep the return signal relatively constant, regardless of range. If, however, the track is lost, and the range system begins to search, the transmitter may transmit maximum power during the search. The crew can limit the maximum transmitter power by using an aft station panel control. The other control is a CRT command that limits the range search in GPC steering mode to 2,400 feet.

The Ku-band system has body and inertial antenna stabilization modes. When the body is stabilized, the antenna beam remains in a fixed relationship to the orbiter X, Y, and Z axes during orbiter attitude changes. When the

system is inertially stabilized, the antenna beam remains aligned to a point in inertial space, regardless of the orbiter attitude changes. Both of these modes are effective only when the radar angle-tracking system is not tracking a target. In the target angle-tracking mode, the system aligns the antenna beam to the target, and antenna movement is independent of orbiter attitude changes.

Each antenna steering mode, except the designate mode, has a specific stabilization mode. The designate mode selects either body or inertial stabilization on the basis of a real-time GPC command (not available to the crew). Since the designate mode provides range tracking only, inertial stabilization is effective during target tracking.

The COMM/RCDR display, DISP 76, provides the status of Ku-band temperatures (PA, GMBL, GYRO), power out (in watts), frame sync, and mode (COMM or RDR), to flight crews.

Payload Communication System

The payload communication system is used to transfer information between the orbiter and its payload or payloads. It supports hardline and radio frequency communications with a variety of payloads. The system is used to activate, check out, and deactivate attached and detached payloads.

Communication with an attached payload takes place through the payload patch panel at the crew compartment flight deck aft station, which is connected to payloads in the payload bay. All command and telemetry signals that meet the payload communication system specifications can be processed onboard. Incompatible signals can be sent to the ground through Ku-band or directly to payload ground stations. This method of transmission, referred to as bent-pipe telemetry, means that no onboard signal processing occurs before the telemetry is sent to the Ku-band system. Payload telemetry can go directly to the S-band FM or Ku-band systems for transmission to the ground, payload analog, or payload digital, to the payload recorder for later transmission, or to the payload data interleaver to be interleaved with other payload data. The system also processes commands and provides payload telemetry to the pulse code

modulation master unit (PCMMU), where the data can be accessed for display on various payload-related controls and displays.

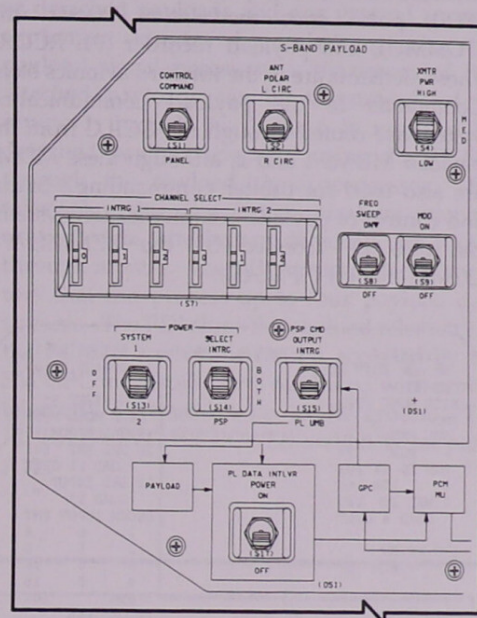

S-BAND PAYLOAD Switches on Panel A1L

The S-band payload antenna is located on the top of the outer skin of the orbiter's forward fuselage, just aft of the S-band FM upper hemispherical antenna. The payload antenna is covered with reusable thermal protection system. This antenna is used as the radiating element for S-band transmission and reception to and from the orbiter to detached payloads through the forward and return links.

Communication problems involving antenna position relative to payload position are not evident while the payload is within a half mile of the orbiter, along the minus Z axis. However, to maintain good communication with the orbiter from distances of several miles, the payload must be within an 80-degree beamwidth (with reference to the minus Z axis) of the orbiter's payload interrogator antenna. The boundary of the 80-degree beamwidth is the 3-decibel point (or half-power point), which must be considered during communication with deployed payloads. This constraint is normally satisfied by the payload deployment and retrieval process.

The basic elements in the payload communication system are the payload interrogator (PI), payload signal processor (PSP), communication interface unit (CIU), payload data interleaver (PDI), pulse code modulation master unit (PCMMU), and payload recorder (PL RCDR). These elements are in the forward avionics bays. Commands to the payload communication system are routed through the GCILC from the payload MDMs 1 and 2, although these MDMs are also used for orbiter commanding. Status and control of payload communication systems can also be accessed by the PCMMU/PL COMM display (SPEC 62).

2011/062/	PCMMU/PL COMM	4	001/05:03:16
SM COM BUFF RDY			000/00:00:00
PCMMU		PDI	
BITE WORD FFFF		I/O RESET 8*	
FMT		BITE WORD FFFF	
SEL FXD 1		9 SEL DECOM 5	
PGM 2*		10 SEL FMT 501	
PGM ID 64 103		LOAD 11 CPLT	
128 184		12 SEL INPUT -	
3 SEL ID 184		LOAD 13	
LOAD 4 CPLT		DECOM INPUT FMT	
I/O RESET		1 6 4	
PCM 5*		2 5 5	
		3 6 14	
		4 5 15	
		5-FRM 501	
		DECOM ENA	
PSP	PL INTRG	FDA 1 14*	
I/O RESET	1 CHANNEL 301	2 15	
PSP1 6*	2 CHANNEL	3 16*	
PSP2 7	PHASE LOCK YES	4 17	
SYNC	BIT YES ERR 17		
FRAME YES	XMIT PWR 1.05		
LOAD	PL SIG STR 1.75	18 TFL GPC SEL 0	

PCMMU/PL COMM Display (SPEC 62)

Payload Interrogator

Detached payloads communicate with the orbiter on an RF signal through the payload antenna by the payload interrogator. The payload interrogator is a transmitter/receiver/transponder unit that provides full duplex RF communications between the orbiter and a detached payload. It transmits commands to and receives telemetry from NASA- or DOD-compatible payloads through the payload antenna. Payload interrogator controls are located on panel A1L.

The main carrier frequency of the detached payload telemetry is demodulated by the payload interrogator. The telemetry is routed directly to the Ku-band system for transmission to the ground (bent-pipe telemetry) and to the payload signal processor. The payload signal processor demodulates the telemetry from the subcarrier and sends it to the payload data

interleaver to be interleaved with other payload data. Hardline payload commands are routed through the payload signal processor and then output through the payload patch panel directly to an attached payload. Detached RF commands are routed through the payload signal processor and then through the payload interrogator for transmission to the payload through the payload antenna.

The payload interrogator receiver automatically sweeps to acquire and track an unmodulated or modulated RF signal. Payload interrogator telemetry is available through an operational instrumentation MDM to verify signal strength and frequency lock. If payload frequencies are near the orbiter S-band frequencies, care must be taken to prevent interference.

When the payload outputs a data rate that is not compatible with the payload signal processor or communication interface unit, payload telemetry is throughput to the PDI without processing.

Payload Signal Processor

The payload signal processor is the RF and hardline command interface between the ground or flight crew and the payload. It is also a detached payload telemetry interface to the payload data interleaver. The payload signal processor is controlled by the switches on panel A1L. The payload signal processor output is commanded or selected by the PSP CMD OUTPUT switch.

The PI and PSP are commanded through GCILC/MCC or selected by the crew (A1L) using the two power switches.

Communication Interface Unit

The communication interface unit sometimes replaces the payload signal processor. The payload signal processor may be retained to act as a backup. The communication interface unit is commonly used with the inertial upper stage, although it may be used with other payloads compatible with SGLS. The communication interface unit interfaces indirectly with the payload data interleaver through the patch panel because the communication interface unit is treated as an attached payload accessed through a patch panel input of the payload data interleaver. The payload signal processor is

hard-wired directly to the payload data interleaver. This provides a command and telemetry path between the orbiter guidance, navigation, and control, GPC, and an SGLS-compatible payload or between the flight crew and an SGLS-compatible payload. The communication interface unit passes commands and telemetry to either attached or detached payloads. COMMUNICATION INTERFACE UNIT controls are on panel L11.

Payload Data Interleaver

In the NASA mission configuration, the payload patch panel interfaces attached payloads to the PDI. The PSP acts as the interface for detached payloads. Attached payloads are wired to specific input channels of the PDI via the payload patch panel during prelaunch activities. When the PDI is reconfigured by the flight crew, programming procedures include assigning inputs in the PDI to one of four decommutators.

The PDI allows the payload communication system to interface with the rest of the orbiter communication system and computers. It receives up to six different inputs from attached or detached payloads and one ground support equipment input. For missions using the payload signal processor, a maximum of five attached payloads can be accommodated on inputs 1 through 5. Input 6 is reserved for detached payload telemetry using the RF link through the payload signal processor. For missions using the communication interface unit, all data, attached or detached, are routed through input 5. The PDI has four decommutators that can process up to four payload data streams. The PDI ships the payload telemetry to the PCMMU, where it can be accessed by the SM GPC for display, and combined with orbiter telemetry for transmission to the ground. The *PL DATA INTLVR POWER* switch is on panel A1L.

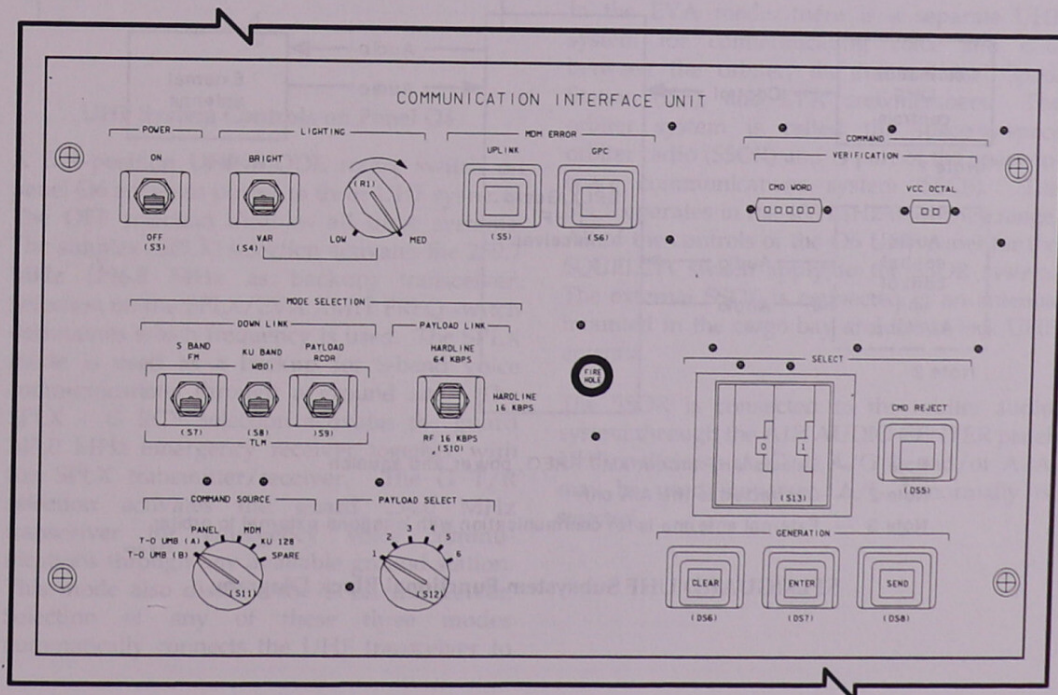

COMMUNICATION INTERFACE UNIT Controls on Panel L11

Ultrahigh Frequency System

The UHF system is used as a backup for the S-band PM and Ku-band voice communications, and is primary during EVA operations. For communications with MCC through the STDN or SGLS ground stations, the UHF system operates in a simplex mode, which means that the orbiter flight crew can transmit or receive, but cannot do both simultaneously. The UHF system may also be used for air traffic control and two-way voice with chase aircraft during landing operations.

In the SPLX or GUARD mode, the UHF transceiver takes the voice signal from the audio central control unit and routes it through the external UHF antenna on the bottom of the orbiter forward fuselage for transmission to the ground station. The incoming UHF signal goes

through the external antenna to the UHF transceiver, which demodulates it and routes it as an audio signal to the audio central control unit for distribution in the orbiter.

Part of the UHF configuration is controlled through three two-position toggle switches on panel O6 labeled XMIT FREQ, SPLX PWR AMPL, and SQUELCH. The XMIT FREQ switch selects one of the two UHF frequencies, 296.8 MHz primary or 259.7 MHz secondary, for external transmission. The SPLX PWR AMPL switch enables or inhibits the UHF power amplifier circuit. When the switch is positioned to ON, the UHF system transmits 10 watts of power through the antenna. When the switch is positioned to OFF, the power transmission is reduced to 0.25 watts by bypassing the power amplifier circuit. The SQUELCH switch permits ON or OFF selection of UHF squelch.

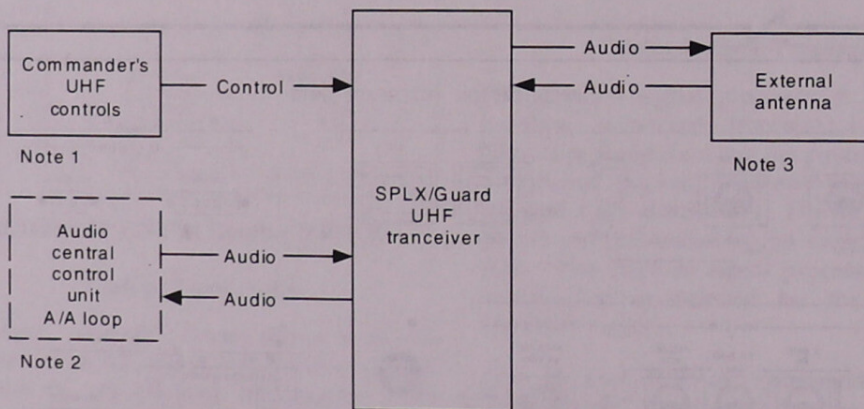

Note 1 — Selects UHF mode, XMT FREQ, power, and squelch

Note 2 — Connected to the A/A only

Note 3 — External antenna is for communication with locations external to orbiter

152.cnv

SPLX/GUARD UHF Subsystem Functional Block Diagram

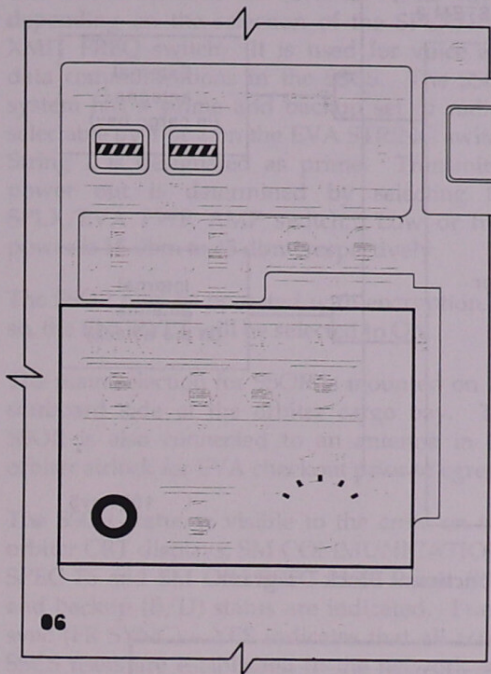

06

UHF System Controls on Panel O6

A five-position UHF MODE rotary switch on panel O6 activates power to three UHF systems. The OFF selection disables all three systems. The simplex (SPLX) selection activates the 259.7 MHz (296.8 MHz as backup) transceiver. Selection on the SPLX/EVA XMIT FREQ switch determines which frequency is used. The SPLX mode is used as a backup for S-band voice communications through a ground site. The SPLX + G RCV selection activates the guard 243.0 MHz emergency receiver together with the SPLX transmitter/receiver. The G T/R selection activates the guard 234.0 MHz transceiver for emergency voice communications through any available ground station. This mode also disables the SPLX transceiver. Selection of any of these three modes automatically connects the UHF transceiver to

the orbiter audio central control unit (ACCU) air-to-air (A/A) voice loop. The UHF SPLX transmission and reception is through an antenna mounted on the bottom of the orbiter beneath the heat shield.

The power out level of the SPLX UHF system is determined by the NO/OFF selection of the SPLX/EVA PWR AMP switch. The ON selection causes the transmitter output to be routed to the antenna through a power amplifier. The power out in this mode is 20 watts. The OFF selection causes the transmitter output to be routed directly to the antenna. Power out in this mode is 0.5 watts.

The SPLX SQUELCH is used in the SPLX mode only. The ON selection activates a squelch circuit to reduce background radio noise. This function may be selected to OFF if the voice communication is weak. This switch is normally selected to ON.

In the EVA mode, there is a separate UHF system for communicating voice and data between the orbiter, the International Space Station (ISS), and EVA crewmembers. The orbiter system is called the space-to-space orbiter radio (SSOR) and is part of the space-to-space communications system (SSCS). The SSCS operates in the 400 MHz frequency range. All of the controls of the O6 UHF panel for the SQUELCH switch apply to the SSOR system. The external SSOR is connected to an antenna mounted in the cargo bay and the airlock UHF antenna.

The SSOR is connected to the orbiter audio system through the A1R AUDIO CENTER panel UHF switches. A/G 1, A/G 2, and/or A/A may be used; however, A/G 1 normally is selected.

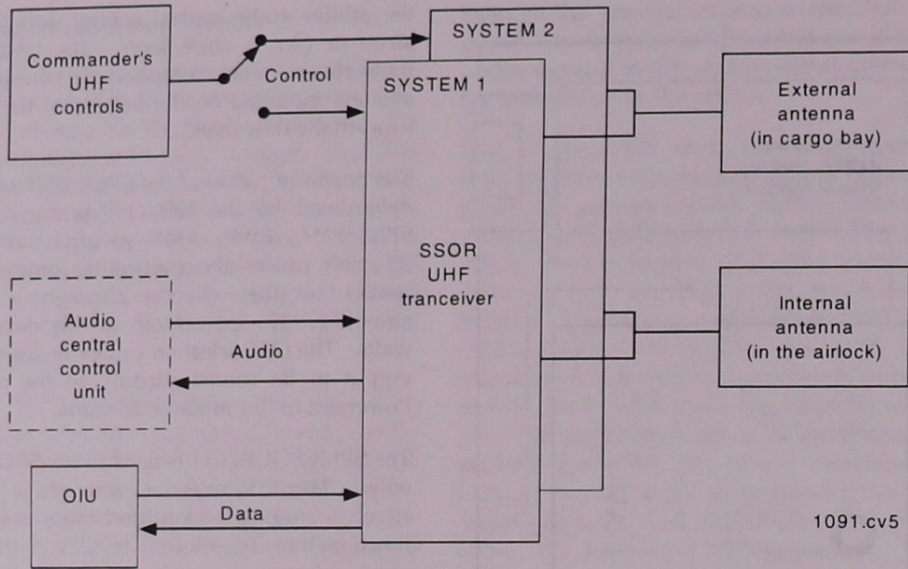

EVA/SSOR UHF Subsystem Functional Block Diagram

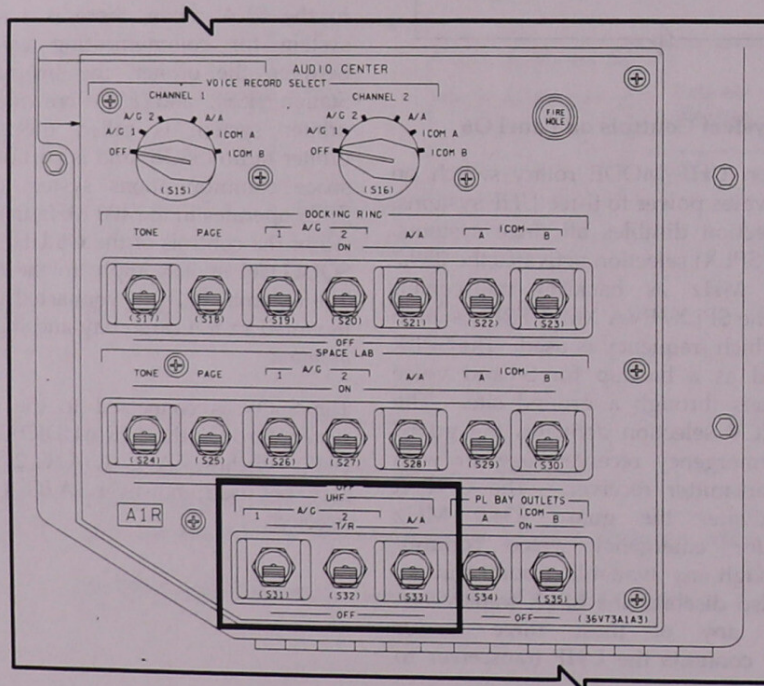

UHF Controls on Panel A1R

The UHF MODE EVA selection activates the UHF SSOR and disables the SPLX and GUARD UHF systems. In this mode, the SSOR becomes part of the SSCS. The SSCS is a time division multiplexed network that provides slots for five

users, including the SSOR, space-to-space station radio (SSSR), and up to three space-to-space EVA radios (SSER).

The SSOR operates at 417.1 or 454.2 MHz, depending on the selection of the SPLX/EVA XMIT FREQ switch. It is used for voice and data communications in the SSCS. The SSOR system has a prime and backup set of radios, selectable by 1 or 2 on the EVA STRING switch. String 1 is designated as prime. Transmitter power out is determined by selecting the SPLX/EVA PWR AMP switch. Low or high power is 15 dbm to 45 dbm, respectively.

The SSOR may be operated with encryption. If so, the ENCRYPT will be selected to ON.

The main selection for SSOR is mounted on the starboard side of the orbiter cargo bay. The SSOR is also connected to an antenna in the orbiter airlock for EVA checkout prior to egress.

The SSOR status is visible to the crew on two orbiter CRT displays, SM COMMUNICATIONS SPEC 76 and SM OIU SPEC 212. Prime (PRI) and backup (B/U) status are indicated. Frame sync (FR SYNC) – YES indicates that all active SSCS users are established in the network and communication should be good. FR SYNC – BAD indicates no communication in the network. Processor status (PROC STAT) – OK indicates which system is on. BAD indicates the system is off. The power level (PWR LEVEL) indication can be between 15 dbm and 45 dbm, depending on the SPLX/EVA PWR AMP switch selection.

NOTE

High power is used only when the ISS range is greater than 2 km. The maximum range is considered to be 7 km.

This parameter defaults +15.0 L when both systems are powered off (OFF or SPLX modes). The STATUS parameter indicates the system current, from 0 to 70 amps. Typically, 35 amps is indicated for the active system and 0.0 L is indicated if deactivated. The SPEC 76 and SPEC 212 displays indicate SSOR SYSTEM 2 is active and processing data.

2011/ /076		COMMUNICATIONS		4 001/04:57:58	
				000/00:00:00	
S-BAND PM	TDRS	KU-BAND			
FREQ LO	1 2	PA TEMP			+77
ANT LO	ON	GMBL TEMP	A		+18
XPNDR	ON		B		+18
PREAMP	ON	GYRO TEMP			+77
PWR AMPL		PWR OUT			26
OPER	ON	FR SYNC			YES
STBY	STBY	MODE			COMM
PWR OUT		FAIL SAFE			COMM
TEMP	164	AUTO K TO S			INH
N9P	1 2	AUTO S TO K			INH
BIT SYNC	NO NO	SSOR	PRI	B/U	
FRM SYNC	NO NO	FRM SYNC	NO	NO	
BITE	GOOD GOOD	PROC STAT	BAD	BAD	
COMSEC BITE	FAIL GOOD	PWR LEVEL			+15.0L
		STATUS			0.0L
UL DATA SOURCE	S	GCIL CONFIG			CMD
DATA RATE XMIT	HI	CCTV CAMR OVRIMP			NO
RCV	HI				
CODING XMIT	ON				
RCV	ON				
SPEC 76 PRO					

1099.csv

COMMUNICATIONS Display (SPEC 76)

2011/2/12/		OIU		4 003/18:29:28	
				00:00:00:00	
OIU 1 TEMP + 0		OIU TIME	07-13-97/11:33:03		
OIU 2 TEMP +141		ISS BC TIME	00-00-0000:00:00		
STATUS			1 FORMAT 001		
ACTIVE DEVICES	PDI				
AD PD BUS LOCK	DCM SYNC				BUS 1 RT 2
1 FGB2 3 YES 1	BWF				BC 3'
2 OIU 0 NONE 2	BWF				A 4'
3 OIU 0 NONE 3	↓↓↓				B 5
4 OIU 0 NONE 4	↓↓↓				BUS 2 RT 6
					BC 7'
					A 8'
OIU CMD CTR 001	PSPLAST				B 9
PSP I/F OK	CMD OK				BUS 3 RT 10
FLOAT POINT OK					BC 11'
	OIU LAST				A 12'
	CMD OK				B 13
SSOR					BUS 4 RT 14'
PRI FRM SYNC NO	18 SPARE CMD				BC 15
PRI STATUS OK	0				A 16'
B/U FRM SYNC YES					B 17
B/U STATUS OK					
ITEM (01)+2 EXEC					
18:29:24					

1006.csv

OIU Display (SPEC 212)

Space-to-Space COMM

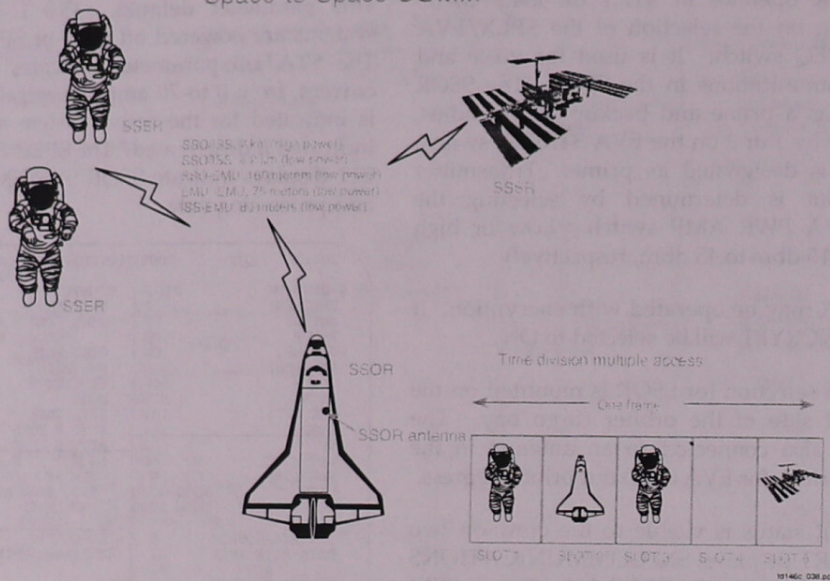

Time Division Multiplexing

For normal EVA operations, the orbiter transmits 296.8 MHz and receives 259.7 and 279.0 MHz. The EVA astronauts are transmitting voice and biomedical/suit data on their respective frequencies. The biomedical/suit data is routed through the OI system once it is removed from the UHF carrier.

The astronaut configured for mode A transmits on 259.7 MHz. The astronaut configured for mode B transmits on 279.0 MHz. Each of the two EVA astronauts receives the other on the respective transmitted frequencies. Every 2 minutes, biomedical data are replaced with suit telemetry data for 15 seconds. EVA conversations are routed to Mission Control via the S-band PM or Ku-band system on A/G 1 or A/G 2, depending on the configuration of the UHF A/G 1 and A/G 2 switches on panel A1R. As a backup procedure only when the orbiter is over a UHF ground station, the EVA astronauts, orbiter, and ground can switch to the 259.7-MHz UHF, simplex.

The UHF system may be used after entry during the approach and landing phase of the mission. UHF A/G voice communications may take place between the orbiter, the landing site control tower, and chase planes (if used).

Audio Distribution System

The audio distribution system gathers audio signals from multiple sources and routes them throughout the orbiter. It provides the means by which crew members communicate with each other and with external locations, such as Mission Control, through the S-band PM, Ku-band, and UHF systems. It also interfaces with the caution and warning system for reception of C/W (tone) signals and with the three tactical air navigation (TACAN) sets for monitoring the TACAN audio identification codes.

External communications are facilitated by routing AG1/2 through the NSP. The audio distribution system outputs audio for one or both of the A/G loops to the NSP where it is digitized and sent to the S-band PM and Ku-band systems for downlink to MCC. Uplink digitized A/G audio is routed through the S-band PM or Ku-band systems and the NSP, where it is converted to analog for use in the audio distribution system. This system also provides connections to the UHF transceiver via the AA loop for external communications with MCC through ground base sites that support UHF. As stated, UHF is also used as prime voice communications with EVA crewmembers. Normally in the EVA mode, the AG1 loop is

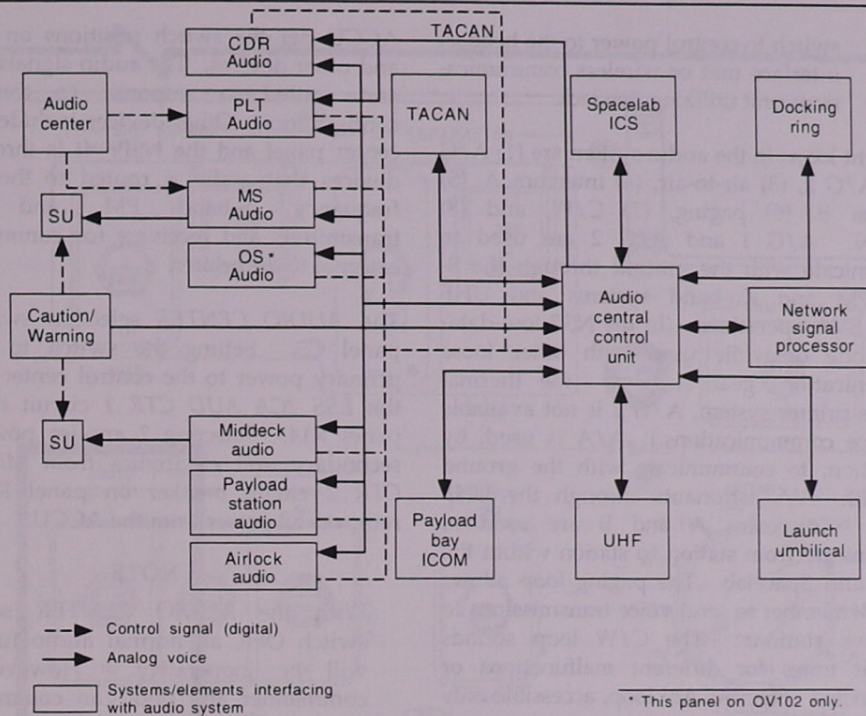

Audio Loops and System Interface

routed to and from the audio distribution system. The audio distribution routes audio signals to an onboard Spacelab module, docking ring, operations recorder, payload bay stations, and the video distribution system controlled by switches on panel A1R.

The major elements of the audio distribution system include:

1. Audio central control unit (ACCU) - acts as central "switchboard" to gather and route audio signals throughout the orbiter; internally redundant line-replaceable unit.
2. Audio terminal unit (ATU) - control panels at crew stations that permit crewmembers to select audio talk/listen buses and to control external/internal communication keying modes and listen volume levels.
3. Speaker unit (SU) - two speaker units are provided with the orbiter communications system. One unit is mounted on the flight deck aft A2 panel, the second is mounted on middeck ceiling panel MO29J. Both are connected to and subject to an associated ATU configuration.
4. Audio center panel - control center for extending audio buses to docking ring, Spacelab, payload bay outlets, video distribution system, and the UHF system, and for selecting up to two voice signals for recording on the operations recorder.
5. Loose communications equipment - miscellaneous small, stowable items such as the headset interface unit (HIU), headset/helmet cables, wireless crew communications unit (WCCU), and handheld or wireless handheld mic.
6. Crew communications umbilical (CCU) jack - individual panel-mounted jacks at crew stations where mating headset plugs give the crew access to audio buses. At each CCU location is an associated ON/OFF

switch to control power to the headset interface unit or wireless communications unit utilizing that jack.

The eight loops in the audio system are (1) A/G 1, (2) A/G 2, (3) air-to-air, (4) intercom A, (5) intercom B, (6) paging, (7) C/W, and (8) TACAN. A/G 1 and A/G 2 are used to communicate with the ground through the S-band PM and Ku-band systems and UHF during EVA operations. (In the NSP low-data-rate mode or while used with other loose communications gear such as the thermal impulse printer system, A/G 2 is not available for voice communications.) A/A is used, by convention, to communicate with the ground and with EVA astronauts through the UHF system. Intercoms A and B are used to communicate from station to station within the orbiter and Spacelab. The paging loop allows one crewmember to send voice transmissions to all active stations. The C/W loop sounds different tones for different malfunctions or emergencies. The TACAN loop, accessible only at the commander's and pilot's stations, is used to identify TACAN ground stations for navigation.

Audio Central Control Unit

The ACCU, the heart of the audio system, is located in the crew compartment middeck forward avionics bay. (There are two redundant ACCUs, but only one is used at any given time.) The unit identifies, switches, and distributes analog audio signals among the various audio distribution system components. Both digital and audio signals are received and processed by the ACCU. The digital signals are used to control the internal configuration of the

ACCU per the switch positions on the ATUs and other devices. The audio signals are keyed and routed in response to this internal configuration. Other devices include the audio center panel and the NSP. It is through these devices that audio is routed to the ultrahigh frequency, S-band PM, and Ku-band transmitters and receivers for communications external to the orbiter.

The *AUDIO CENTER* selection switch is on panel C3. Setting the switch to 1 applies primary power to the control center unit from the *ESS 2CA AUD CTR 1* circuit breaker on panel R14. Selecting 2 applies power to the secondary unit electronics from *MN C AUD CTR 2* circuit breaker on panel R14. OFF removes all power from the ACCU.

NOTE

With the *AUDIO CENTER* selection switch OFF, all normal audio functions will be inoperative. However, the commander and pilot can communicate via headset if one of their ATU CONTROL switches is set to the alternate position. This is also true for any two stations that share ATUs through the audio control switch position (i.e., mission specialist and payload specialist, airlock CCU 1 and 2, and middeck ATU).

The ACCU circuitry activates signals from the launch umbilical connection intercom A and B channels. Any crew station ATU can then be configured to transmit and receive intercom signals from the ground through the umbilical. (Only intercom signals are processed through the umbilical.)

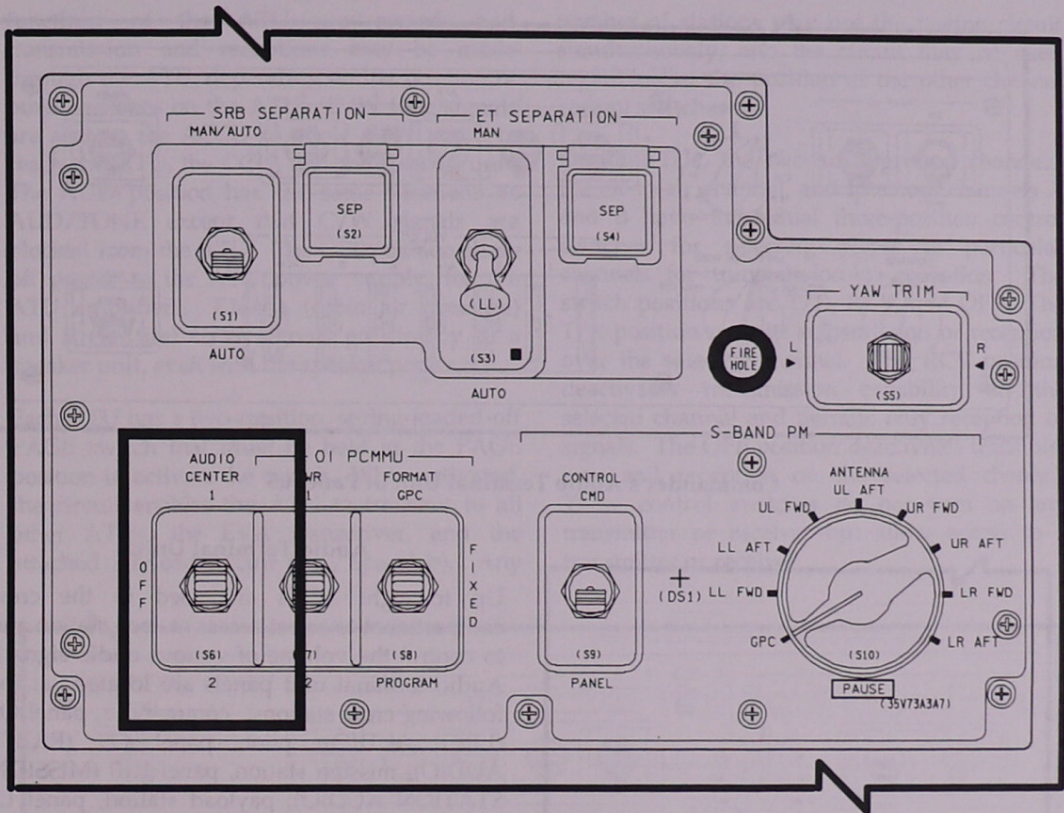

AUDIO CENTER Selection Switch on Panel C3

AUDIO CENTER Selection Switch on Panel C3
 This switch is used to select the audio center for the
 station. It is a three-position switch with the following
 positions:
 OFF - No audio signal is sent to the speaker.
 PROGRAM - The audio signal from the program source
 is sent to the speaker.
 FIXED - The audio signal from the fixed source
 is sent to the speaker.
 The switch is normally in the OFF position.
 To select the program source, move the switch to the
 PROGRAM position. To select the fixed source, move
 the switch to the FIXED position. To turn off the
 audio, move the switch to the OFF position.
 The switch is a three-position power switch to
 control all signals to or from the ATU. The
 switch positions are AUDIO, OFF, and
 GPC. In the AUDIO position, all available

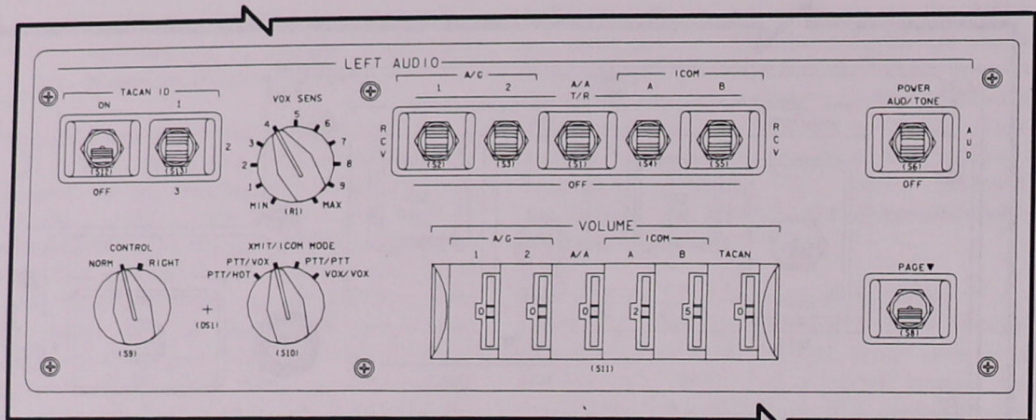

Commander's Audio Terminal Unit of Panel 05

Audio Terminal Units

Up to eight ATUs are used in the crew compartment to select access at each station and to control the volume of various audio signals. Audio terminal unit panels are located at the following crew stations: commander, panel O5 (LEFT AUDIO); pilot, panel O9 (RIGHT AUDIO); mission station, panel R10 (MISSION STATION AUDIO); payload station, panel L9 (PAYLOAD STATION AUDIO); middeck, panel M042F (MID DECK SPEAKER AUDIO); and airlock, panel AW18D (AIRLOCK AUDIO). These panels control signals to headsets or communication carrier assemblies through the communications umbilical. Orbiter OV-102 has two additional ATUs. One is in the flight deck (OS AUDIO), mounted on panel A13 for use with the flight deck speaker unit. (On all other orbiters, the MISSION STATION AUDIO audio terminal unit is used with the flight deck speaker unit.) The second ATU, in the middeck, is AIRLOCK 1 BACKUP, which is mounted at the M058F position and acts only as a backup for the airlock CCU1 headset CONTROL function. (The AIRLOCK AUDIO CCU 2 headset connection uses the MIDDECK SPEAKER AUDIO audio terminal unit as a control function backup.)

Each ATU has a three-position power switch to control all signals to or from the ATU. The switch positions are AUD/TONE, AUD, and OFF. In the AUD/TONE position, all available

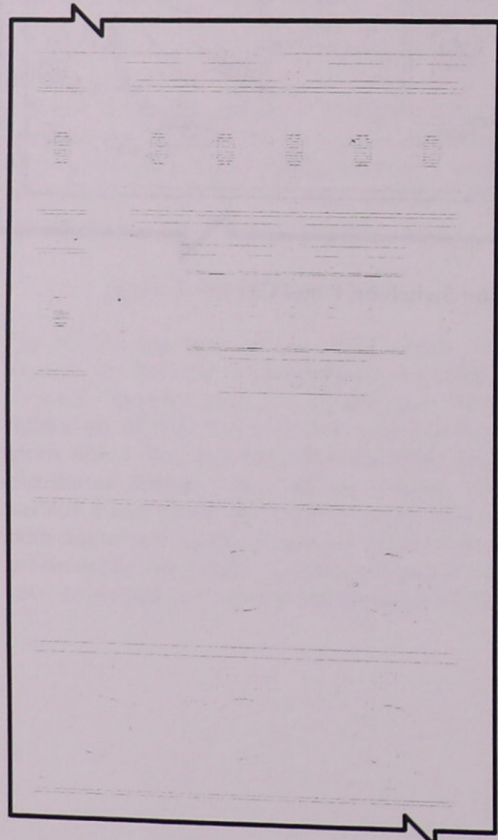

Audio Terminal Unit on Panel AW18D

functions of the ATU are armed, and transmission and receptions may be made through the ATU, depending on the position of other switches on the ATU. C/W tone signals are sent to the ACCU to allow C/W audio to reach the ATU, the CCU, and the speaker unit. The AUD position has the same functions as AUD/TONE except that C/W signals are blocked from the ATU. The OFF position shuts off power to the ATU power supply, for the ATU amplifiers. Klaxon (cabin air pressure) and siren (fire) C/W signals go directly to a speaker unit, even with the speaker power off.

Each ATU has a two-position, spring-loaded-off PAGE switch that must be held in the PAGE position to activate the circuit. When activated, the circuit enables the ATU to transmit to all other ATUs, the EVA transceiver, and the attached payload circuit (e.g., Spacelab). Any

number of stations may use the paging circuit simultaneously, and the circuit may be used regardless of the position of the other channel control switches.

On all ATUs, the two air-to-ground channels, the air-to-air channel, and intercom channels A and B have individual three-position control switches for selecting access to particular channels for transmission or reception. The switch positions are T/R, RCV, and OFF. The T/R position permits transmission or reception over the selected channel. The RCV position deactivates transmission capability on the selected channel and permits only reception of signals. The OFF position deactivates transmission and reception on the selected channel. These control switches do not turn on any transmitter or receiver but allow access to a transmitter or receiver.

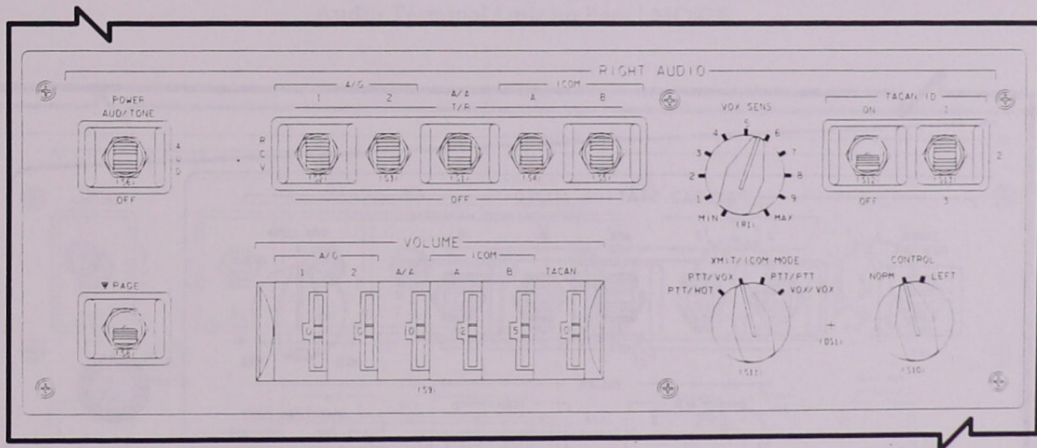

Pilot's Audio Terminal Unit on Panel O9

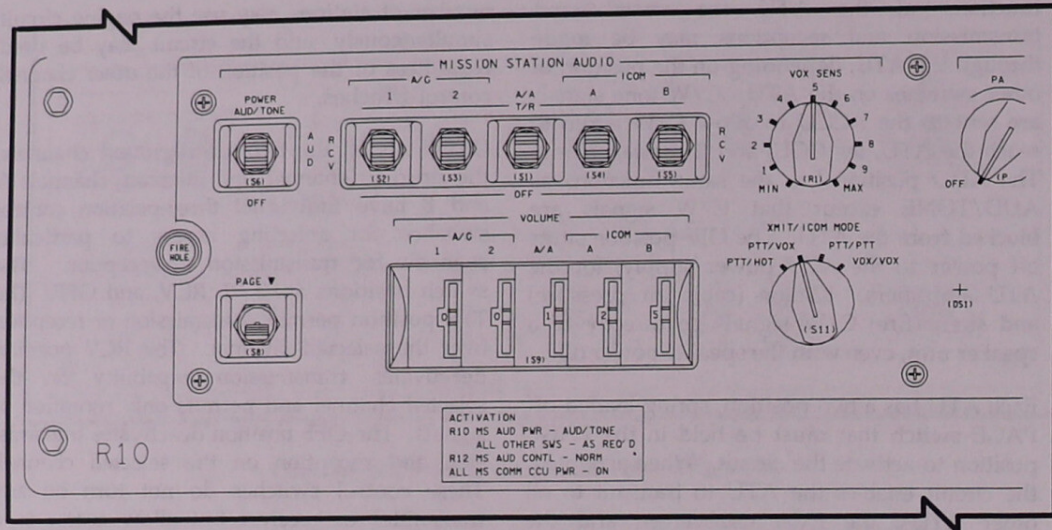

Audio Terminal Unit on Panel R10

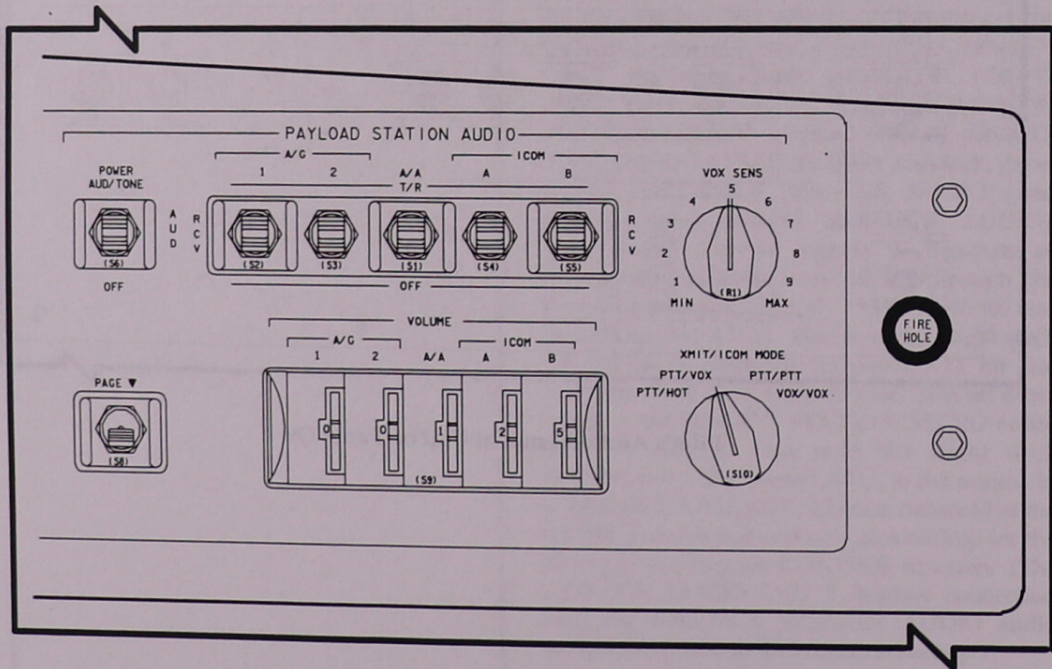

Audio Terminal Unit on Panel L9

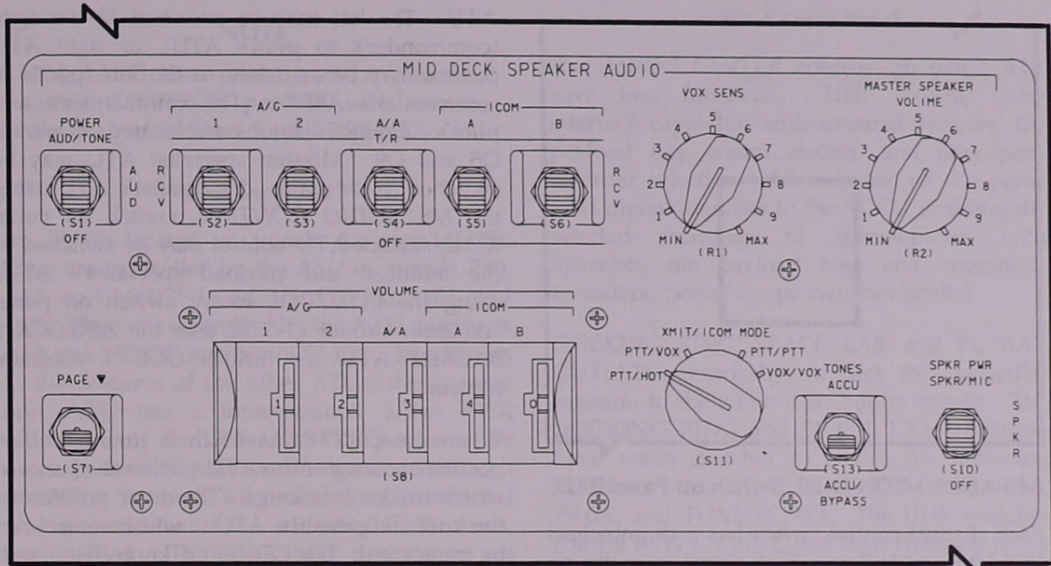

Audio Terminal Unit on Panel MO42F

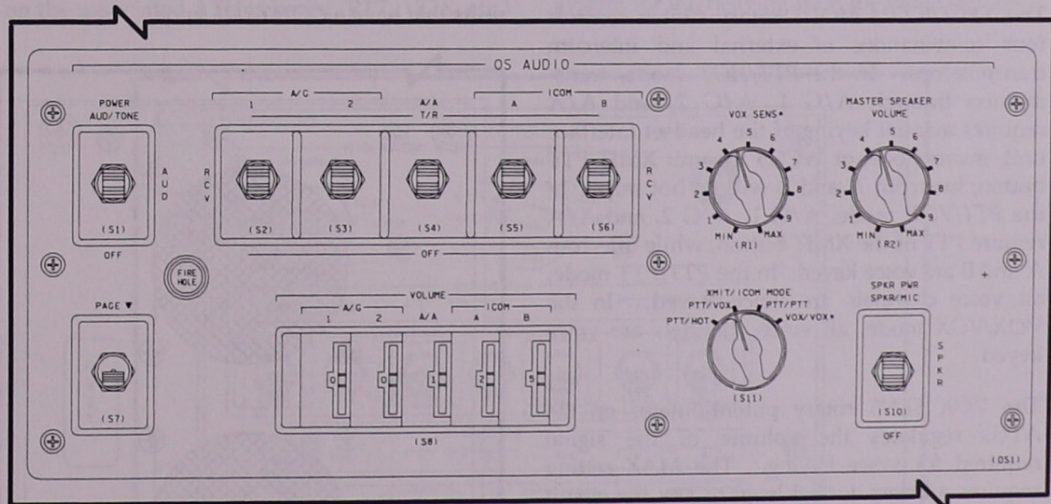

Audio Terminal Unit on Panel A13 (OV-102)

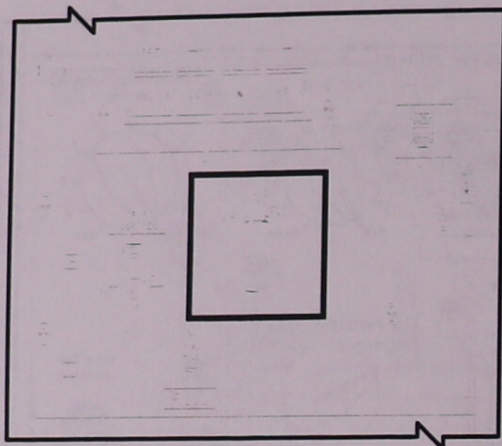

MS AUDIO CONTROL Switch on Panel R11L

Each channel control switch has a thumbwheel VOLUME control to adjust signal intensity on the related channel. The thumbwheels cover a range of approximately 27 decibels in 3-decibel increments.

The XMIT/ICOM MODE rotary switch controls four combinations of external and intercom transmissions. In the PTT/HOT mode, transmission through A/G 1, A/G 2, and A/A requires manual keying of the headset interface unit, microphone, or WCCS leg unit XMIT PTT button; intercom A and B will be hot mike. In the PTT/VOX mode, A/G 1, A/G 2, and A/A require PTT of the XMIT button, while intercom A and B are voice keyed. In the PTT/PTT mode, all voice channels are voice keyed. In the VOX/VOX mode, all voice channels are voice keyed.

The VOX SENS rotary potentiometer on the ATUs regulates the volume of the signal required for voice keying. The MAX setting requires a lower decibel level to key the circuit than the MIN setting.

Volume control of all incoming signals to speakers is adjusted by the MASTER SPEAKER VOLUME controls on panels A13 and M042F. The MASTER VOLUME 1 and 2 potentiometers on panel AW18D control volume to the respective CCU outlets in the airlock.

Four ATUs (on panels O5, O9, AW18D, and R10) allow a crewmember at a malfunctioning ATU to switch the CCU jack to an alternate

ATU. The left may be switched to the right (commander's to pilot's ATU), or right ATU control may be switched to the left (pilot's to commander's ATU). The commander's and pilot's CONTROL knobs are located on panels O5 and O9. Mission specialist ATU may be switched to the payload specialist's ATU using the MS AUDIO CONTROL switch on panel R11L. Airlock ATU control may be switched to the middeck and payload specialist's ATUs using the CONTROL rotary switch on panel AW18D. Orbiter OV-102 uses the AIRLOCK 1 BACKUP ATU for airlock CCU 1 alternate control.

When the CONTROL switch is in the NORM position, control of the ATU is from the panel to which the knob belongs. The other position of the knob indicates the ATU to which control can be transferred. The CONTROL knob changes all ATU functions to the alternative ATU except the master volume control. This redundancy protection is used in the event of a failure or malfunction of any of the four audio terminal units that have a CONTROL knob.

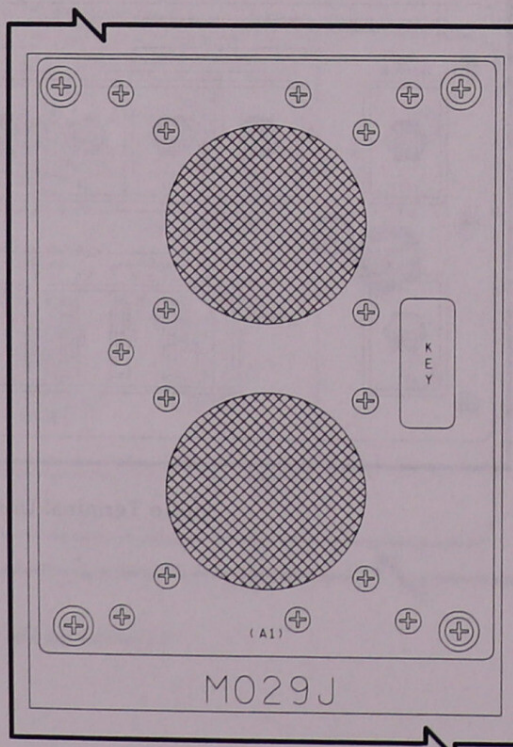

Speaker Unit on Panels A2 and M02J

NOTE

If an ATU loses power, switching to the other CONTROL position will restore listen capability but not talk capability.

Speaker Units

An SU is located on panels A2 and MO29J. They are controlled by the ATU on panels R10, A13, and MO42F in orbiters OV-103, -104, and -105. They are controlled by the ATU on panels A13 and MO42F in orbiter OV-102. In addition to the features of the other ATUs, the speaker unit ATU has a three-position SPKR PWR switch. Only the OFF and SPKR positions are used. In the OFF position, no signals go through the ATU. In the SPKR position, audio selected on the associated ATU, including C/W tones, are enabled. The SPKR/MIC position is not used. The top speaker is used for audio and the bottom is dedicated to the klaxon/siren.

The KEY light illuminates when a microphone on the associated ATU is keyed (PTT, VOX, etc.)

Audio Center Panel

The *AUDIO CENTER* controls on panel A1R have four functions: UHF control, voice interface capability with external vehicles, the payload bay comm outlets, and operations recorder selection. All switches on the panel send digital impulses to the ACCU, enabling the selected functions to communicate with Spacelab, the payload bay, and operations recorders. Sets of toggle switches labeled

DOCKING RING, *SPACE LAB*, and *PL BAY OUTLETS* electrically connect the particular function to the audio distribution system. The *DOCKING RING* and *SPACE LAB* subpanels have seven switches to enable the following functions: *A/A*, *A/G 1*, *A/G 2*, *ICOM A*, *ICOM B*, *PAGE*, and *TONE (C/W)*. The UHF switches control *A/G 1*, *A/G 2*, and *A/A* channels to the UHF transceiver. The *PL BAY OUTLETS* subpanel has two ON/OFF switches, one for intercom A and one for B. The *PL BAY OUTLETS* switches also route *ICOM A* and *B* to the *CCTV* system for interleaving with the video signals.

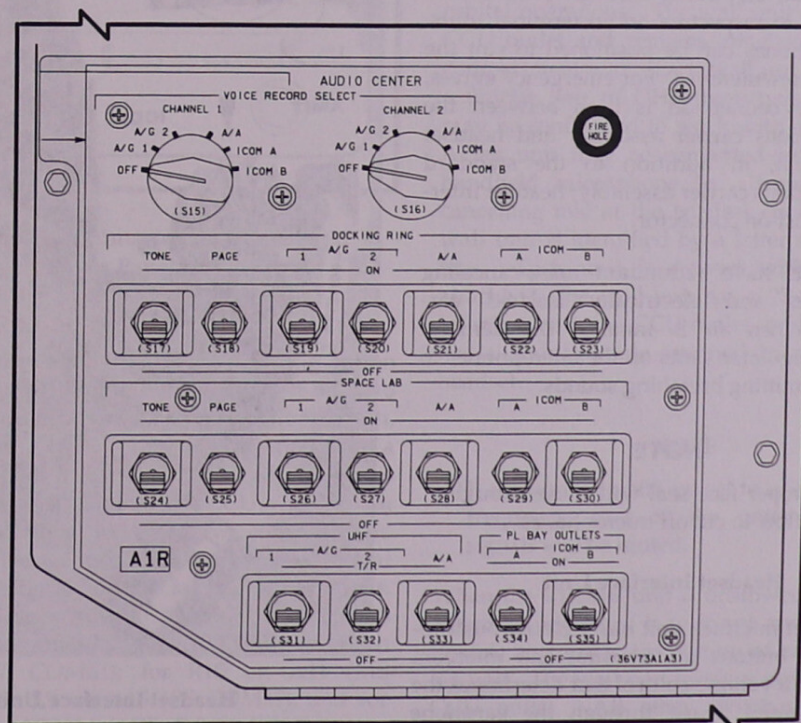

AUDIO CENTER Controls on Panel A1R

Two rotary knobs labeled *VOICE RECORD SELECT* control various audio signals to be sent to the operational recorders through the NSP. *A/G 1*, *A/G 2*, *A/A*, and *ICOM A* or *B* audio can be sent to either recorder. Any two signals may be recorded at the same time, one on channel 1 and the other on channel 2. Either channel may be turned off. A recorder input (RCDR INPUT) parameter on orbiter display S76 indicates whether the recorder is recording data (DATA) only or data plus the voice selected on the AUDIO CENTER panel (D/VO).

Loose Communications Equipment

Launch and Entry Helmets

During launch and entry, each flight crewmember wears a launch and entry helmet to lessen the severe noise levels encountered at launch and to allow intelligible air-to-ground communications. A communications carrier assembly headset containing microphones and earphones fits over the crewmember's head, and a connector and cable interface with the headset interface unit, connected through communications cables to respective audio terminal units. The microphones can be positioned to suit the individual crewmember. For emergency egress, a pull-away connection is used between the communications carrier assembly and headset interface unit, in addition to the standard communications carrier assembly/headset interface unit twist-on connector.

The helmets have redundant noise-canceling microphones and electrically isolated earphones. When air is inhaled, the demand breathing regulator shuts off the microphones to avoid transmitting breathing sounds.

NOTE

An improper face seal will cause enough oxygen flow to cut off microphones.

Headset Interface Unit

The headset interface unit has separate push-to-talk (PTT) buttons for transmit and intercom modes and a volume control that determines the level of sound heard through the earphone

(microphone sound level is determined by automatic gain control circuitry within the audio terminal unit). (Push-to-talk means that a pushbutton must be depressed to allow a crewmember to talk through the system.) The XMIT pushbutton allows access to intercom and external circuits, while the ICOM pushbutton is for intercom only. The volume control knob acts in series with the loop volume controls on the associated audio terminal unit. In addition, the commander and pilot have PTT switches on their rotational hand controllers for transmit (XMIT) keying.

The headset interface unit provides volume control and PTT capabilities to the communications carrier assembly used for EVA, and to the communications carrier assembly. The headset interface unit has a clip that attaches to the crew's flight suits.

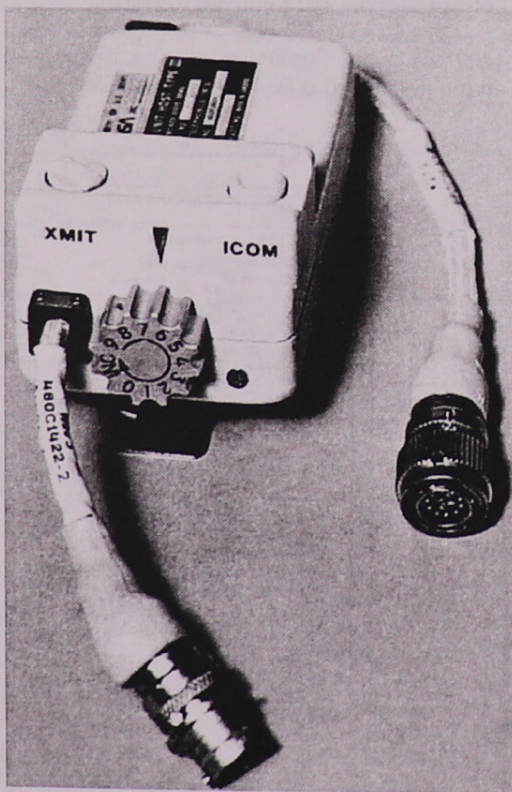

Headset Interface Unit

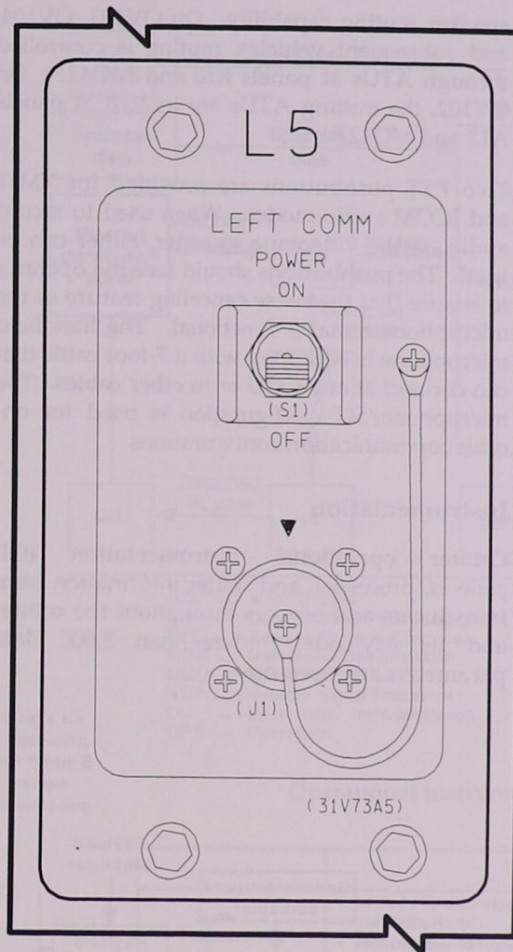

**Crewman Communications Umbilical
on Panel L5**

Cables

The communication cables vary in configuration depending on seat location. Each seat has two 4-foot communication cables or a 14-foot length, as required. One 4-foot cable is flown as a spare. The cables connect to crewman communications umbilical (CCU) outlets at various locations in the crew compartment. Each CCU has a specific audio terminal unit that controls communication loop configurations. The CCU associated with the ATU on panel O5 is located on panel L5 (*LEFT COMM*); for O9 on R6 (*RIGHT COMM*); for R10 on A11 (*MS COMM*), for L9 on A15 (*PS COMM*), and for MO42F on MO39M (*MID DECK COMM*); two others for the airlock ATU are located on panel AW82D (*CCU 1* and *CCU 2*).

Each CCU outlet has a power switch that controls the associated microphone power. Leaving CCU power off confines an individual to a listen-only mode, independent of audio terminal unit configuration.

Multiple Headset Adapter

A multiple headset adapter may be plugged into the CCU outlets. The three CCU outlets on the adapter allow up to three crewmembers to share one CCU outlet. When any one person connected to a multiple headset adapter keys (in PTT mode) or activates the voice-operated transmitter, all three individuals' microphones will be keyed, and individuals sharing the multiple headset adapter will hear each other talking on the side tone.

Wireless Communications Units

On orbit, the crew may use wireless communication units in place of communication cables. A wireless unit consists of one wall unit (audio interface unit) and two leg units (crew remote units) worn by crewmembers during orbital operations. The wall unit connects to a CCU outlet and remains attached to the crew compartment wall. Each wall unit transmits on a unique pair of UHF frequencies. Leg units may be configured to work with any wall unit. A leg unit may be converted into a wireless handheld microphone by attaching a noise-cancelling mic at the headset connector. Each wall unit is identified by a letter enclosed in a box. Each unit is stowed with its cabling attached. The wall unit has a 23-inch cable to interface with the CCU outlet, and the leg unit has a 22-inch cable attached to a lightweight headset.

NOTE

If the two leg units are set to use the same frequency, one of the units' transmit signals will be muted.

When the wireless unit is unstowed, part of the assembly necessary is to insert and tighten the flexible antenna in the bottom of each wall and leg unit. The wall unit receives power from the CCU outlet. All other switches are set as required; typically, the individual communication loops are used. The leg unit is attached to

the crewmember's leg with a wraparound elastic strap. The rotary ON/OFF/VOLUME knob (unlabeled) is turned clockwise past the ON/OFF detent, and the volume is set as desired. Each leg unit is powered by a replaceable lithium battery pack. A weak battery is identified by a continuous beeping sound when the leg unit is powered on. A single battery pack provides about 35 hours of service. Sliding a new battery pack into the unit causes both the electrical connector and mechanical connector to latch.

Very Lightweight Headset

The very lightweight headset is the interface between the leg unit and crewmember. A single-strand wire headband holds the earphone against the ear and supports a thin boom holding a noise-cancelling microphone near the mouth. A cable and connector are attached to the crewmember's leg unit. The lightweight headset cable and connector also can interface with the headset interface unit.

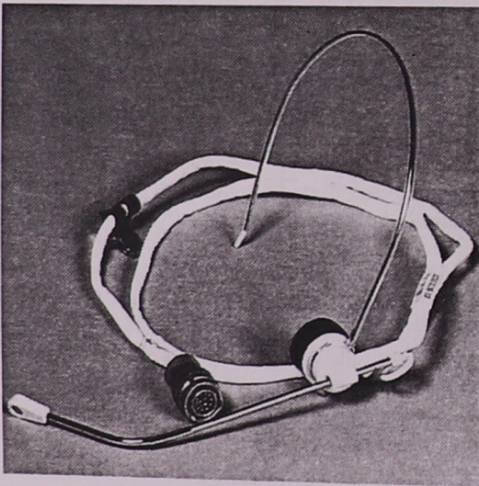

Very Lightweight Headset

Handheld Microphone

The handheld microphone is a noise-canceling microphone that connects directly to any CCU outlet. The microphone is used primarily with the SUs located at panels A2 and MO29J. To avoid feedback when using the speakers, one ATU and its corresponding CCU outlet on the aft flight deck and one ATU and associated CCU on the middeck are equipped with a

speaker muting capability. On OV103, OV104, and subsequent vehicles, muting is controlled through ATUs at panels R10 and MO42F. On OV102, the muting ATUs are located at panels A13 and MO42F.

Two PTT pushbuttons are provided for XMIT and ICOM audio modes. When used to record audio on the videotape recorder, either can be used. The pushbuttons should face the operator to ensure that the noise-canceling feature of the microphone remains functional. The handheld microphone is equipped with a 7-foot cable that can connect at any CCU or to other cables. The microphone/SU configuration is used for on-orbit communication configurations.

Instrumentation

Orbiter operational instrumentation (OI) collects, processes, and routes information from transducers and sensors throughout the orbiter and its payloads. More than 3,000 data parameters are monitored.

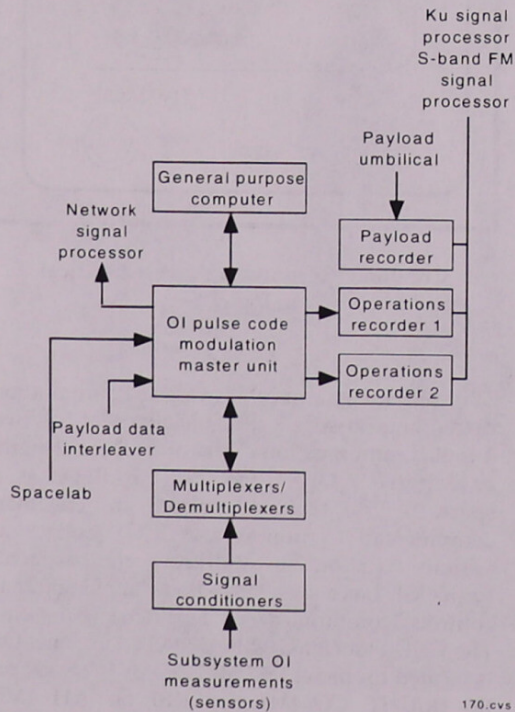

Simplified Instrumentation Data Flow

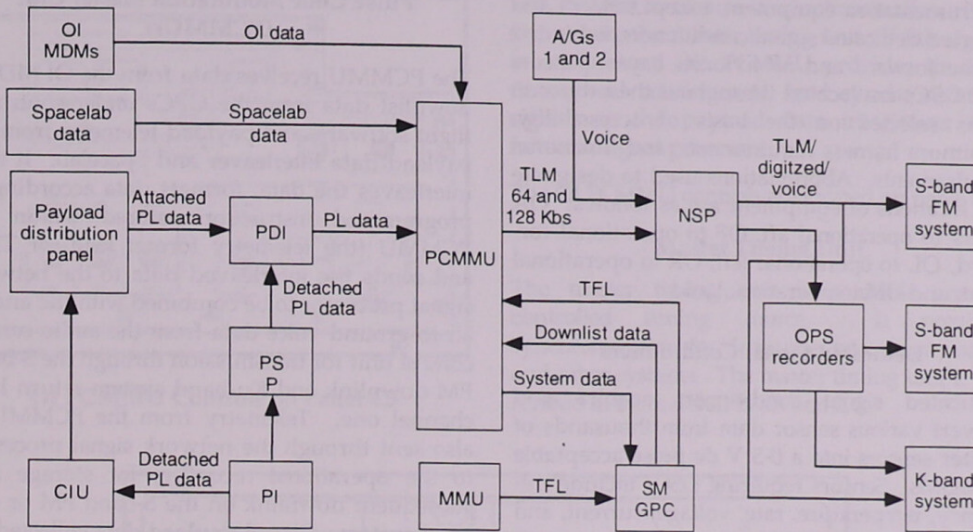

A/G — Air-to-Ground	PCMMU — Pulse Code Modulation Master Unit
CIU — Communication Interface Unit	PDI — Payload Data Interleaver
GPC — General Purpose Computer	PI — Payload Interrogator
MDM — Multiplexer/Demultiplexer	PL — Payload
MMU — Mass Memory Unit	PSP — Payload Signal Processor
NSP — Network Signal Processor	SM — Systems Management
OI — Operational Instrumentation	TFL — Telemetry Format Load
OPS — Operations	TLM — Telemetry

171.cvs

Operational instrumentation System Overview

AREA	CHARACTERISTICS
Signal Conditioning	<ul style="list-style-type: none"> • 14 DSCs conditioning approximately 1,200 channels, plus EDO DSCs (up to 4) • 6 WBSC to MDM • Approximately 45 high-level transducers • Distributes data to PCM data system panel displays, C/W, flight-critical MDMs
PCM Data System	<ul style="list-style-type: none"> • Acquires data through 7 OI MDMs, approximately 2,800 measurements • Receives and provides data to 5 computers • Accepts payload data through PDI or payload data bus (Spacelab) • Provides output data in 64 and 128-kbps formats • Provides synchronization to PDI and NSP • Provides data to NSP and T-0 umbilical
Payload Data Recorders	<ul style="list-style-type: none"> • Receives data directly from payload or PLSP • Provides data to GPCs and PCM • Stores 3 channels of engine data at 60-kbps rate • Stores interleaved voice and data at 96, 128, or 192-kbps rates • Stores payload data • Provides for playback of recorded data during and after mission
Master Timing	<ul style="list-style-type: none"> • Provides time reference to computers, OI PCM, display panel, and payload • Provides synchronization to instrumentation and other subsystems

OI System

The instrumentation system consists of transducers, 14 dedicated signal conditioners (additional dedicated signal conditioners (DSCs) for extended duration orbiter (EDO) missions), 7 MDMs, 2 PCMMUs, 2 operational recorders, 1 payload recorder, master timing equipment, and onboard checkout equipment.

The OI system senses, acquires, conditions, digitizes, formats, and distributes data for display, telemetry, recording, and checkout. It provides for pulse code modulation recording, voice recording, and master timing for onboard systems.

Instrumentation equipment, except sensors and selected dedicated signal conditioners, is located in the forward and aft avionics bays. Sensors and DSCs are located throughout the orbiter in areas selected on the basis of accessibility, minimum harness requirements, and functional requirements. Abbreviations used to designate the locations of equipment are as follows: OA refers to operational aft, OF to operational forward, OL to operational left, OR to operational right, and OM to operational mid.

Dedicated Signal Conditioners

Dedicated signal conditioners acquire and convert various sensor data from thousands of orbiter sensors into a 0-5 V dc pulse acceptable to MDMs. Sensors requiring DSCs include frequency, temperature, rate, voltage, current, and analog parameters.

There are 14 orbiter DSCs, 4 in forward avionic locations (OFs), 3 in the aft avionic bays (OAs), 3 under the payload bay (MID) (OMs), and 4 in the right and left tail sections (ORs and OLs). There can be up to four additional DSCs flown with the EDO.

Multiplexer/Demultiplexers (MDMs)

MDMs can operate in two ways. As multiplexers, they take data from several sources, convert the data to serial digital signals (a digitized representation of the applied voltage), and interleave the data into a single data stream. As demultiplexers, the MDMs take interleaved serial digital information, separate and convert it to analog, discrete, or serial digital, and send each separate signal to its appropriate destination.

The OI MDMs act only as multiplexers. Upon request from the pulse code modulation master unit (PCMMU), the MDMs send these interleaved streams to the PCMMU through the OI data buses. When the MDM is addressed by the PCMMU, the MDM selects, digitizes, and sends the requested data to the PCMMU in serial digital form. The PCMMU/OI MDM interface is based on demand and response; that is, the OI MDMs do not send data to the PCMMU until the PCMMU makes the request. There are seven OI MDMs, four OFs, and three OAs for forward and aft multiplexing of DSC and direct data signals.

Pulse Code Modulation Master Unit (PCMMU)

The PCMMU receives data from the OI MDMs, downlist data from the GPCs under control of flight software, and payload telemetry from the payload data interleaver and Spacelab. It then interleaves the data, formats data according to programmed instructions stored within the PCMMU (the telemetry format load, or TFL), and sends the interleaved data to the network signal processor to be combined with the analog signal processor to be combined with the analog air-to-ground voice data from the audio central control unit for transmission through the S-band PM downlink and Ku-band system return link, channel one. Telemetry from the PCMMU is also sent through the network signal processor to the operational recorders for storage and subsequent downlink on the S-band FM or Ku-band system. OI and payload data collected by the PCMMU are available to the GPCs for display and monitoring purposes upon request. All data received by the PCMMU are stored in memory and periodically updated.

The PCMMU has two formatter memories: programmable read only (PROM) and random access (RAM). The read-only memory is hard coded; the RAM is reprogrammed several times during flight. The PCMMU uses the formatters to load data from the computers and OI MDMs into PCM telemetry data streams for downlinking

NOTE

When the PCMMU is powered off (as when switching to the alternate unit), the TFL changes to the fixed format loaded in the PROM.

One of the two redundant PCMMUs and network signal processors operates at a time. The one used is controlled by the crew through the flight deck display and control panel. The primary port of each MDM operates with PCMMU 1 and the secondary port operates with PCMMU 2.

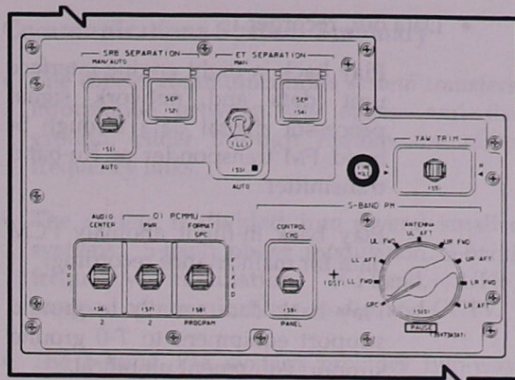

OI PCMMU Controls on Panel C3

The PCMMUs receive a synchronization clock signal from the master timing unit. If this signal is not present, the PCMMU provides its own timing and continues to send synchronization signals to the payload data interleaver and network signal processor.

The OI PCMMU controls are located on panel C3.

Master Timing Unit

The master timing unit is a stable crystal-controlled timing source. It provides synchronization for instrumentation, payloads, and other systems. The master timing unit is described in more detail in Section 2.6.

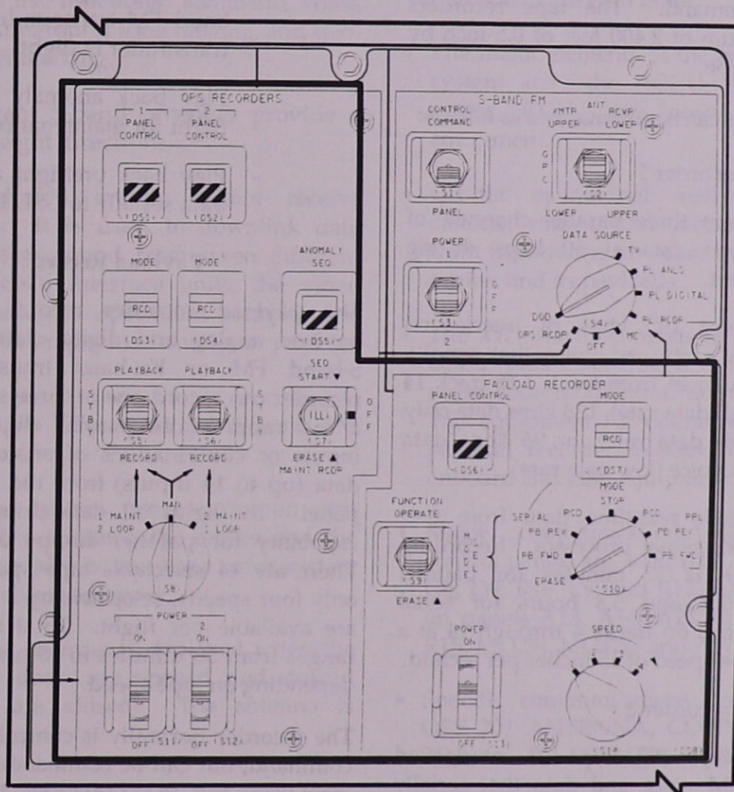

Recorder Controls on Panel A1R

Operations Recorders

Two recorders are used for serial recording and dumping of digital voice and pulse code modulation (PCM) data from the OI systems. The recorders normally are controlled by ground command, but they can be commanded

by the flight crew through the flight deck display and control panel keyboard or through the OPS RECORDERS switches on panel A1R or commanded via uplink. The input to the recorders is from the network signal processor, in main engine data at 60 kbps.

The operations recorders can be commanded to dump recorded data from one recorder while continuing to record real-time data on the other. The dump data are sent to the FM signal processor for transmission to the ground station through the S-band FM transmitter on the S-band FM return link or to the Ku-band signal processor. When the ground has verified that the received data are valid, the operations recorders can use that track on the tape to record new data. If ground is controlling recorders, the crew cannot, unless ground sets a "crew reset" command or its equivalent from SPEC 1.

Recorder speeds of 7.5, 15, 24, and 120 inches per second are provided by hardwire program plug direct command. The tape recorders contain a minimum of 2,400 feet of 0.5-inch by 1-mil magnetic tape.

Recorder functions can be summarized as follows:

- Data in, recorder 1
 - Accept three parallel channels of engine data at 60 kbps during ascent.
 - Accept 192 kbps of interleaved PCM data and voice that serially sequences from track 4 to track 14 (high data rate), 128 kbps data only (high data rate), or 96 kbps data and voice (low data rate).
 - Accept real-time data from network signal processor. Recording time is 32 minutes for parallel record and 5.8 hours for serial record on tracks 4 through 14 at a tape speed of 15 inches per second.
- Data in, recorder 2
 - Accept 192 kbps of interleaved PCM voice and data that serially sequences from track 1 to track 14 (high data rate), 128 kbps data only (high data rate), or 96 kbps data and voice (low data rate).
 - Accept real-time data from network signal processor. Recording time is 7.5 hours at a tape speed of 15 inches per second for serial record on 14 tracks.

- Data out, recorder 1
 - Play back in-flight engine interface unit data and network signal processor digital data through S-band FM transponder or Ku-band transmitter.
 - Play back in-flight anomaly PCM data for maintenance recording.
 - Play back data serially to ground support equipment to T-0 ground support equipment umbilical.
- Data out, recorder 2
 - Play back digital data through S-band FM transponder or Ku-band transmitter in flight.
 - Play back anomaly PCM data in flight for maintenance recording.
 - Play back preflight and postflight data serially to GSE T-0 umbilical.

Payload Recorder

The payload recorder records and dumps payload analog and digital data through the S-band FM or Ku-band transmitter. The recorder can record one of three serial inputs or a maximum of 14 parallel digital or analog inputs or combinations of analog and digital data (up to 14 inputs) from the payload patch panel. In flight, all data dumps are serial; capability for parallel dumps does not exist. There are 14 selectable tape speeds; however, only four speeds, selectable by a program plug, are available per flight. Total recording time ranges from 56 minutes to 18 hours 40 minutes depending on tape speed.

The recorder normally is controlled by ground command, but can be commanded by the flight crew using the *PAYLOAD RECORDER* switches on panel A1R.

Communications System Summary

- The orbiter communications system transfers information between the orbiter and the ground, either through hardline or radio frequency links.
- The system is divided into several smaller systems: S-band phase modulation, S-band frequency modulation, Ku-band, UHF, payload communications, audio, and CCTV.
- The S-band PM system provides two-way communication between the orbiter and the ground, through either an STDN/SGLS ground station or a relay satellite. It provides channels for five functions: command, voice, telemetry, turnaround tone ranging, and two-way Doppler tracking.
- Four quadrant S-band antennas provide a selection of eight directions.
- The S-band FM system cannot receive information. It is used to downlink data directly to the ground from seven different sources: SSME interface units, the video switching unit, the operations recorder, the payload recorder, payload analog, or payload digital.
- There are two hemispherical S-band FM antennas.
- The Ku-band system provides for on-orbit communication between the orbiter and the ground. It can also be used as a radar system for tracking objects in space.
- The Ku-band antenna is deployed when the payload bay doors are opened, and stowed when they are closed. The antenna is steerable.
- TV data can be downlinked over Ku-band and S-band FM only.
- The payload communication system is used to transfer information between the orbiter and its payloads.
- The UHF system is used as a backup for the S-band PM and Ku-band voice communications. UHF is used as the primary communications link with EVA astronauts.
- The audio distribution system gathers audio signals from multiple sources and routes them throughout the orbiter. It may be used as a means by which crewmembers communicate with each other.
- The major elements of the audio distribution system are: the ACCU, ATU, SU, audio center, CCU, and loose communications equipment.
- Orbiter operational instrumentation (OI) collects, routes, and processes information from transducers and sensors throughout the orbiter and its payloads.
- The OI system consists of transducers, 14 DSCs (plus EDO DSC if flown), 7 MDMs, 2 pulse code modulation master units, encoding equipment, 2 operations recorders, 1 payload recorder, master timing unit, and onboard checking equipment.
- Major communications equipment and control panels are A1R, A1U, A1L, R13L, O5, O6, O9, R10, L9, and R12. Others are found on panels A13, A14, A15, L5, F9, C3, R11L, R15, MO29J, MO42F, and AW18D.
- Specific communications system CRTs are OPS 201 ANTENNA, COMM/RCDR (DISP 76), and PC MMU/PL COMM (SPEC 62).

SITE ID	SITE TYPE	UPLINK DATA RATE	DOWNLINK DATA RATE		UHF	TV	COMMENTS
		OR CLEAR	ENCRYPTED	CLEAR			
MIL	STDN	HI/LO	HI/LO	HI/LO	√	√	
BDA					√		UHF ONLY
NHS	SGLS	HI/LO	HI/LO	HI/LO			
OTS	SGLS	HI/LO	HI/LO	HI/LO	√		
GTS	SGLS	HI/LO	HI/LO	HI/LO			
HTS	SGLS	HI/LO	HI/LO	HI/LO			
VTS	SGLS	HI/LO	HI/LO	HI/LO			
DFR	STDN	HI/LO	HI/LO	HI/LO	√		
GDX	STDN	HI/LO	HI/LO	HI/LO		√	
CTS	SGLS	HI/LO	HI/LO	HI/LO			
DGS	SGLS	HI/LO	HI/LO	HI/LO			
WLP	STDN	HI/LO	HI/LO	HI/LO			

Three-letter site designators may be inhibited on SM 2011 by MCC if site use was not planned. Check SPOC for sites that may be inhibited.

Comm S-Band PM Table

SB-SYS 1 PWR: CONTLBC1 AND MNBFLC2

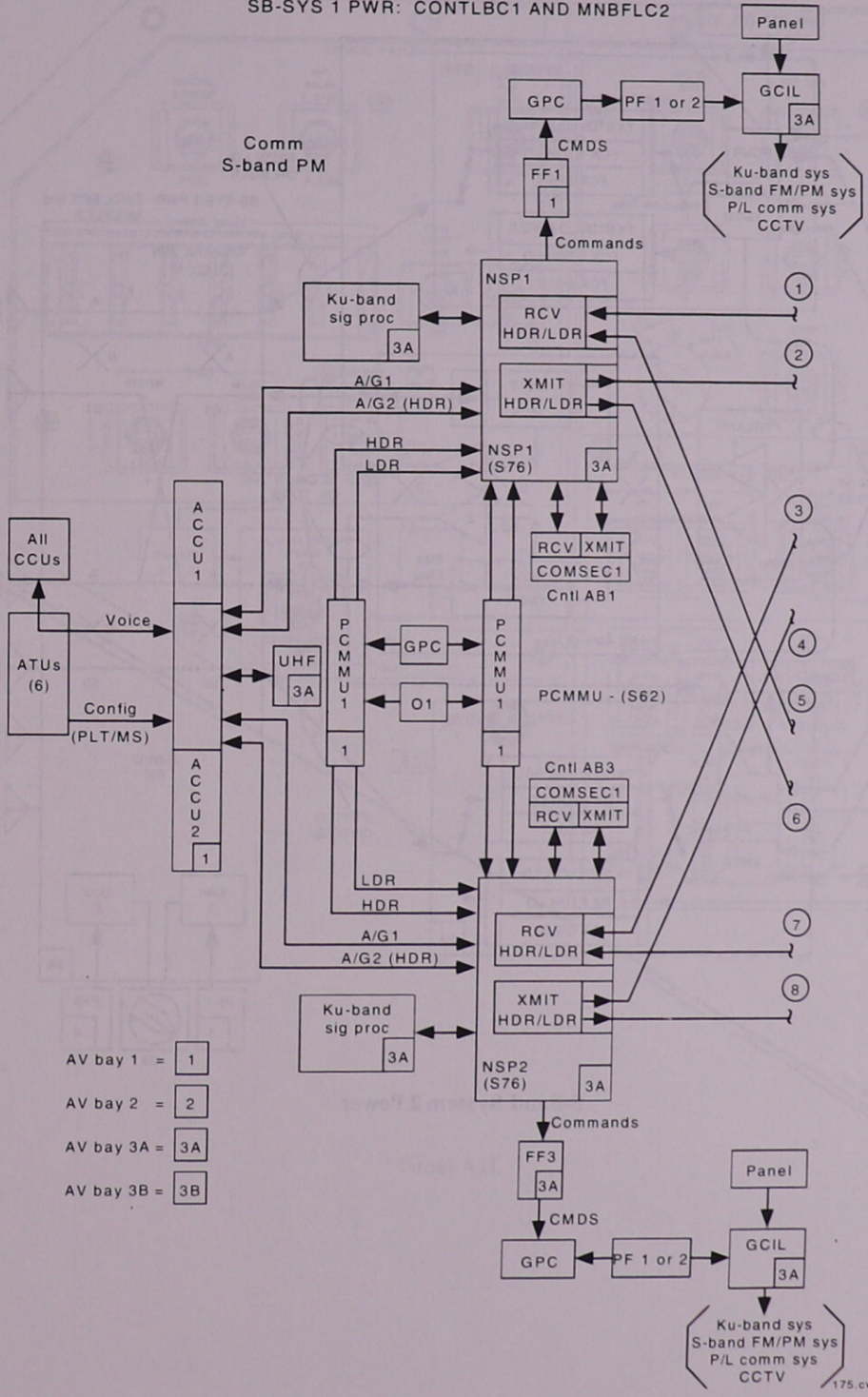

S-Band System 1 Power

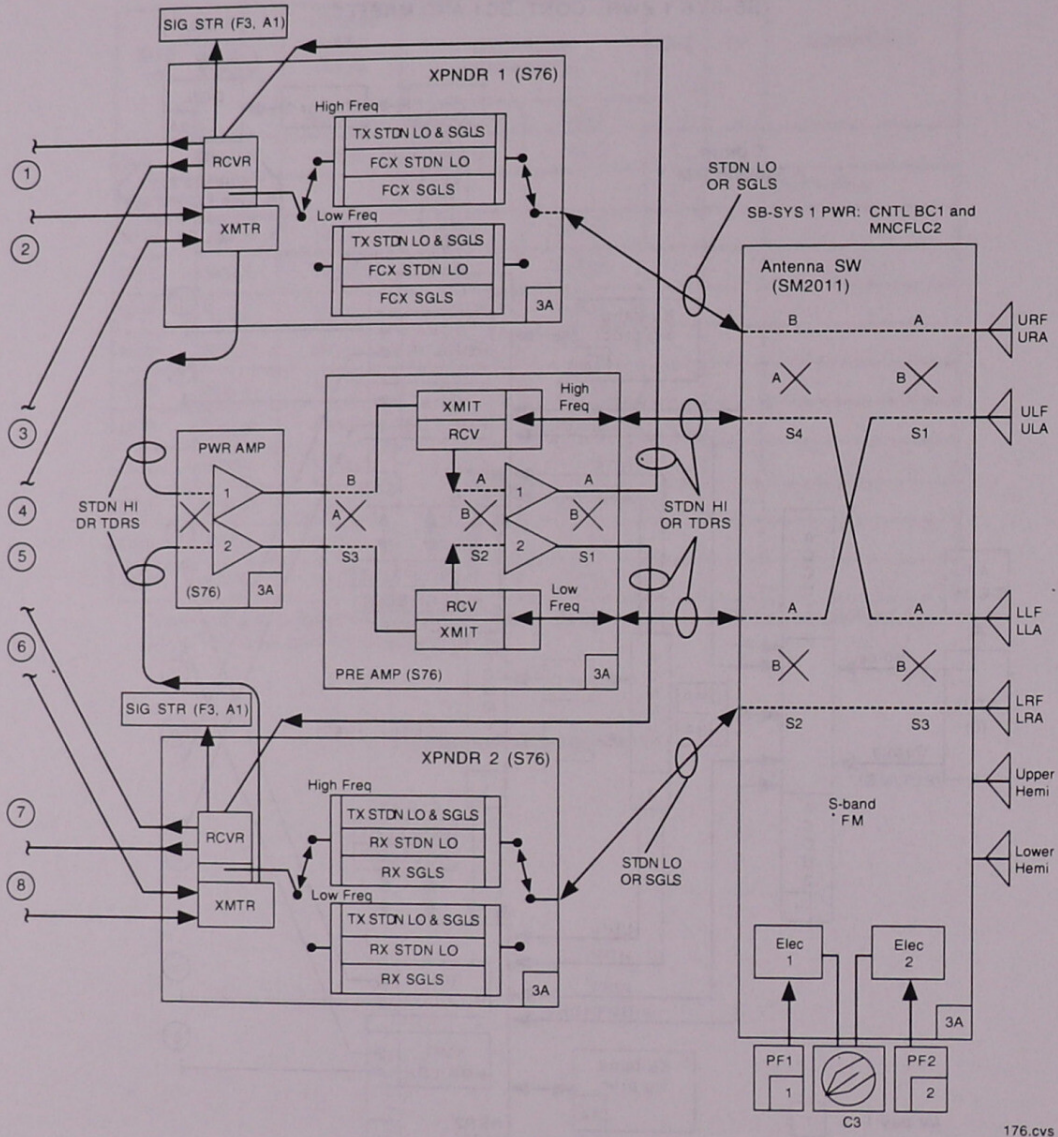

176.cvs

S-Band System 2 Power

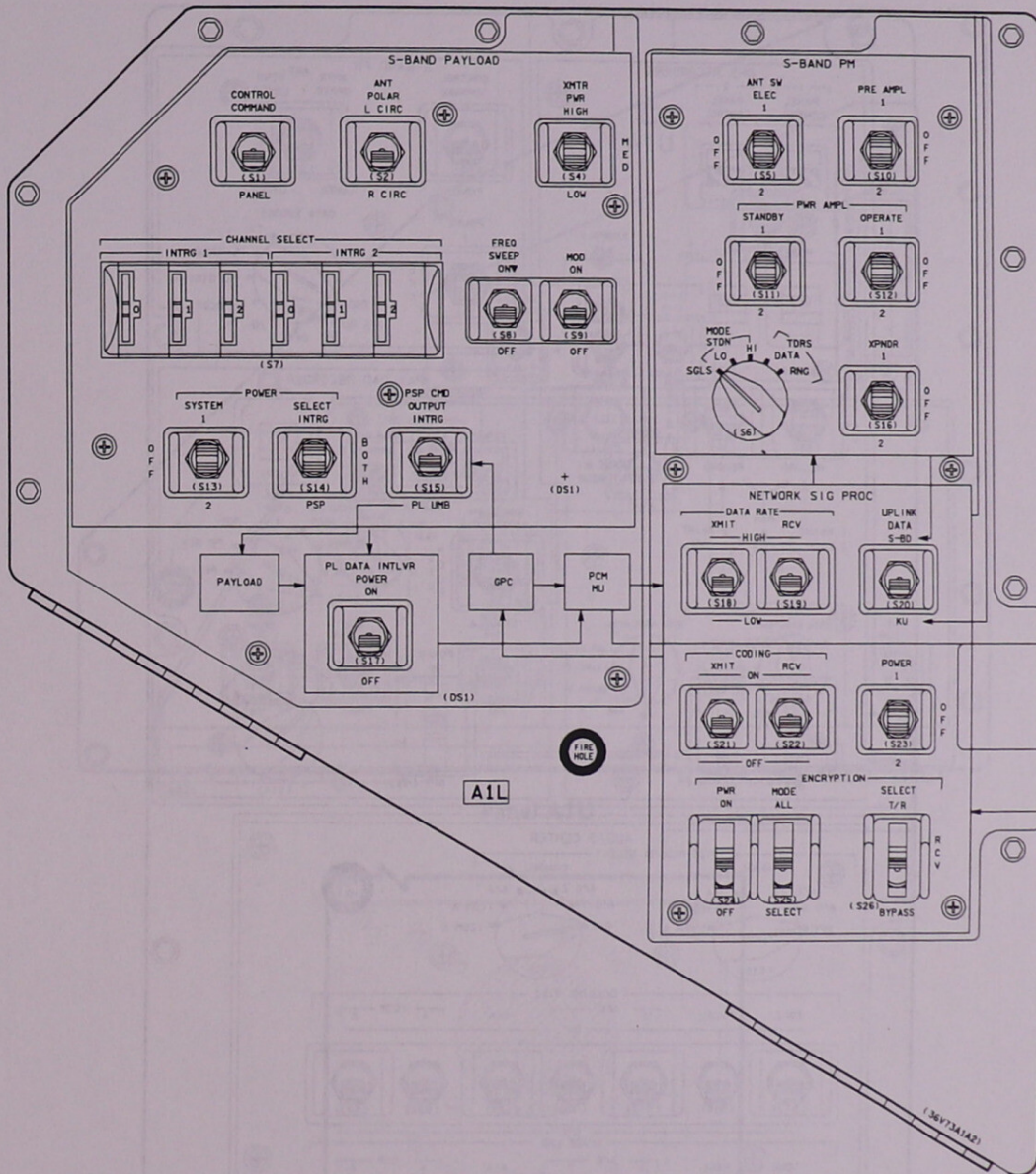

A1L

Panel A1L

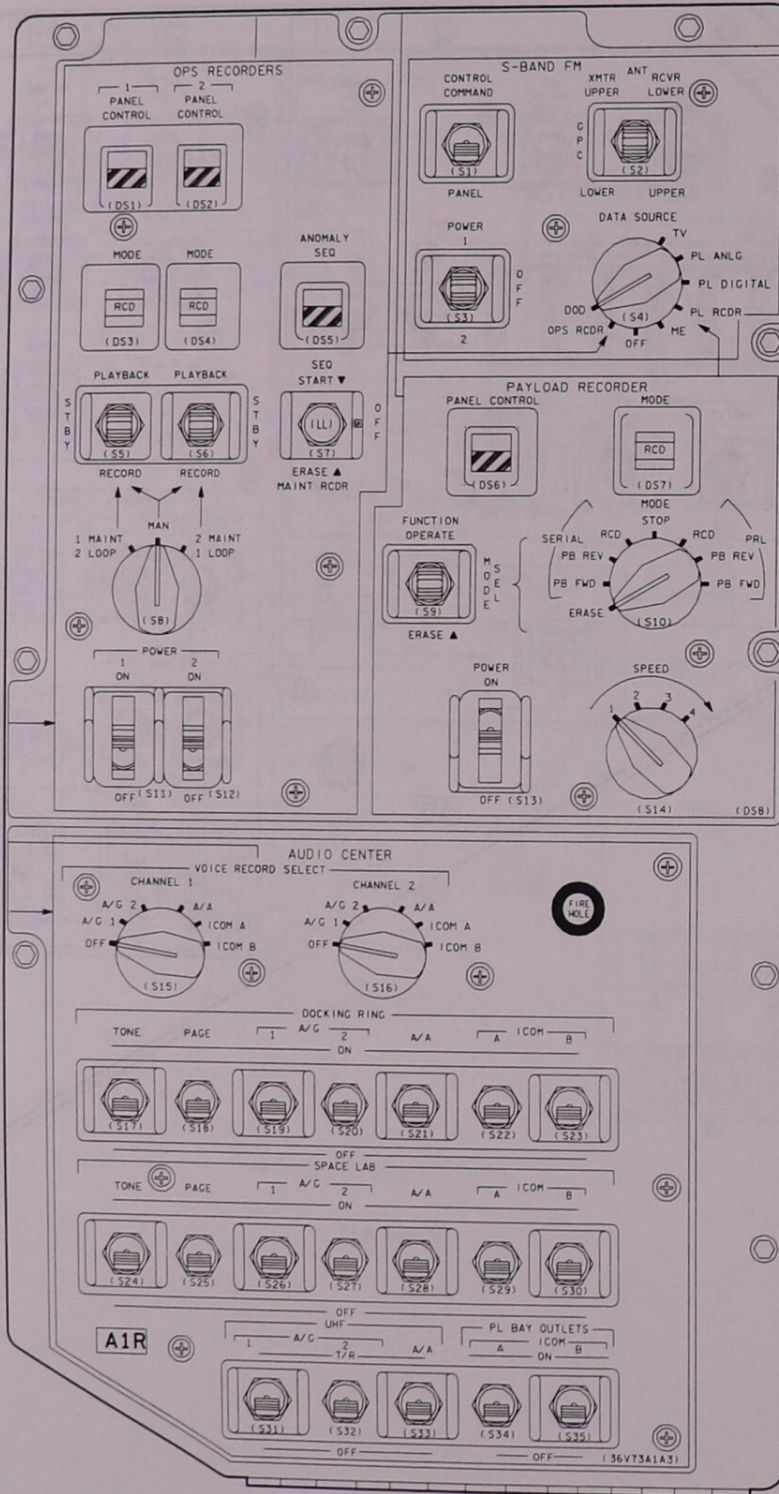

Panel A1R

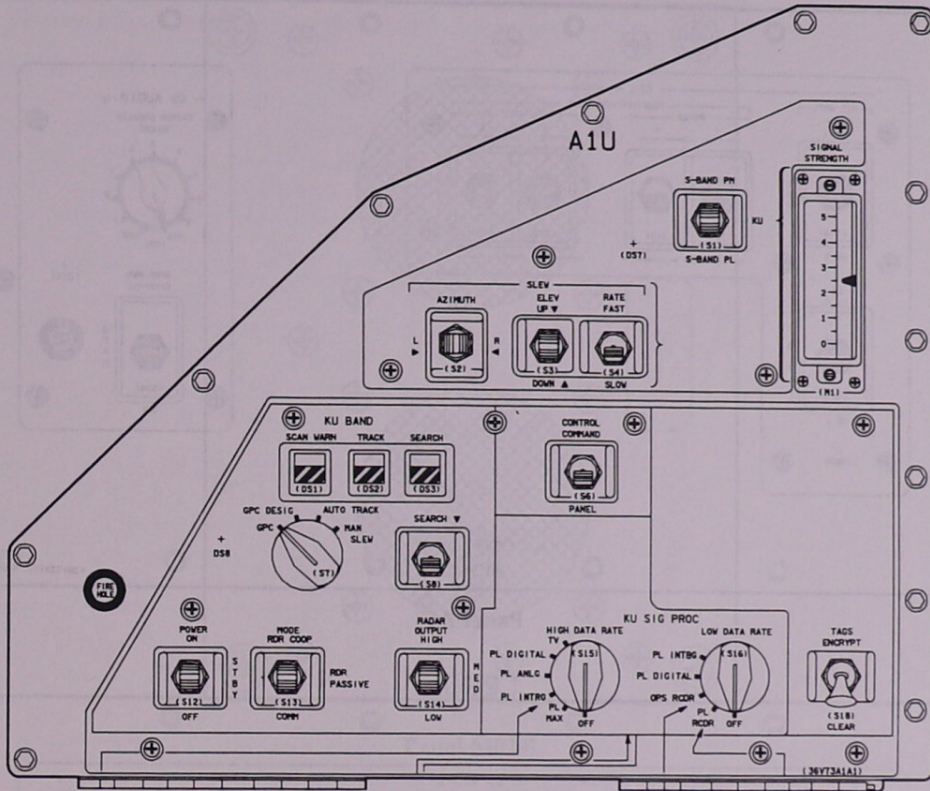

Panel A1U

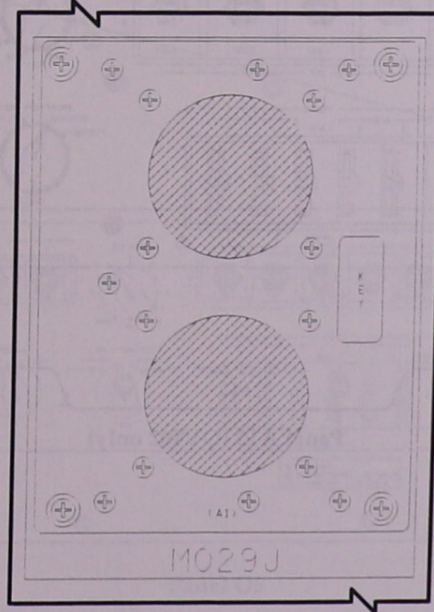

Panel A2

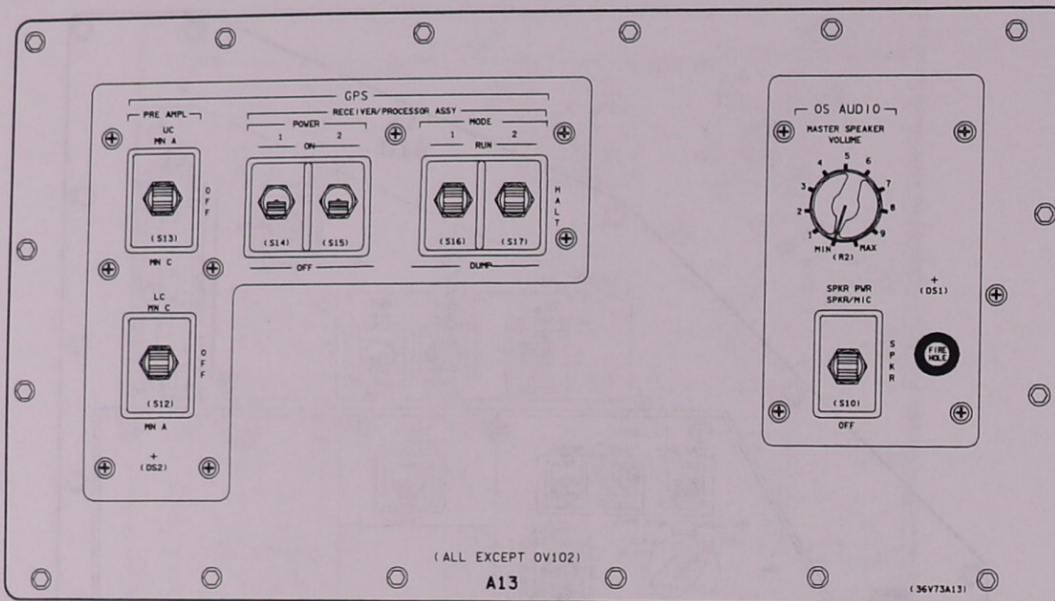

Panel A13

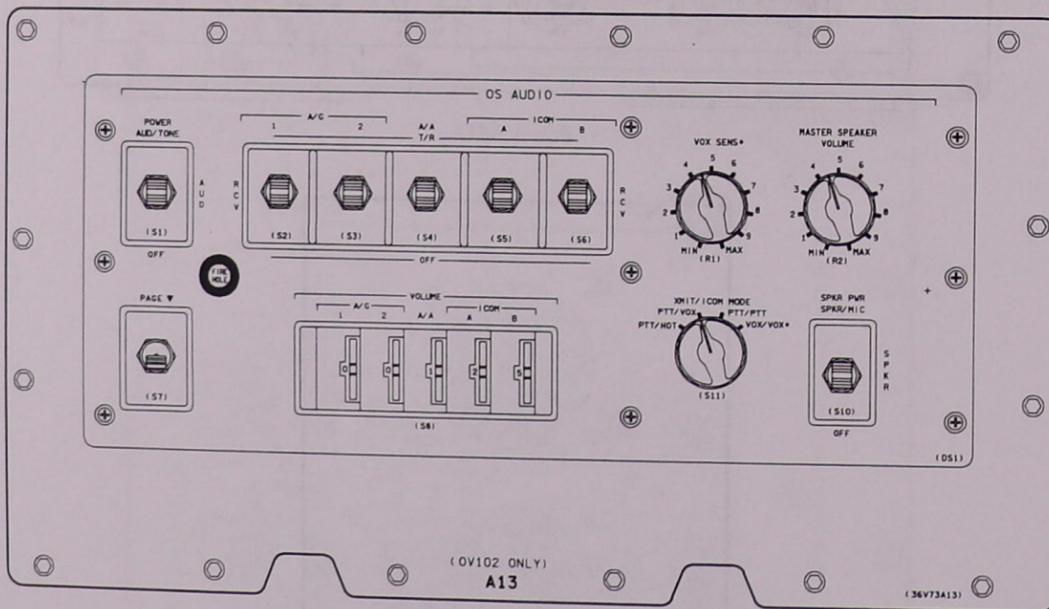

Panel A13 (OV102 only)

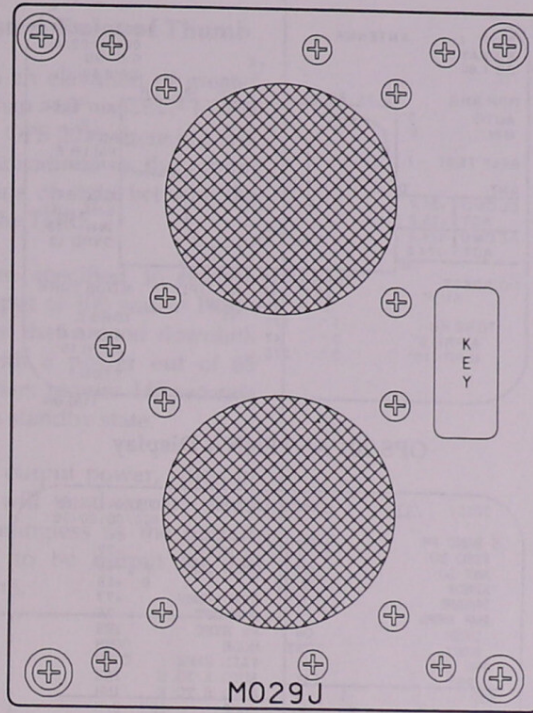

Panel M029J

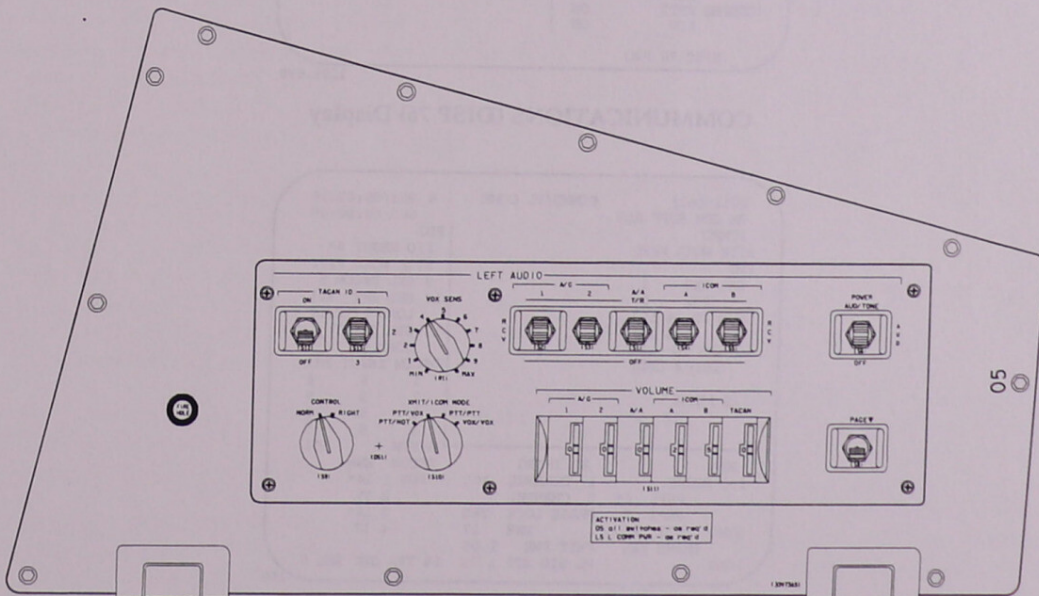

Panel O5

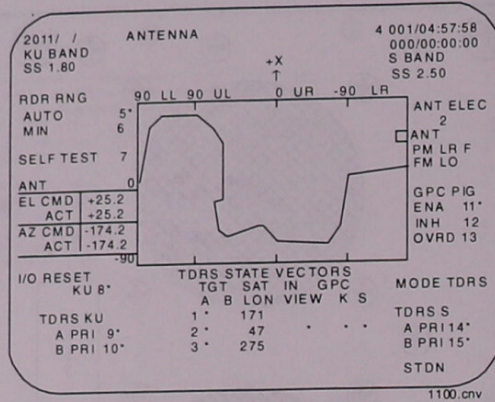

OPS 201 ANTENNA Display

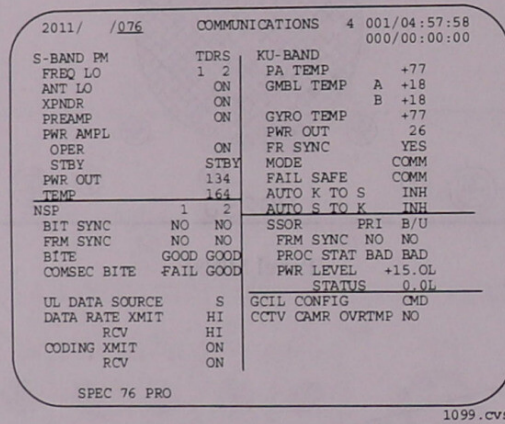

COMMUNICATIONS (DISP 76) Display

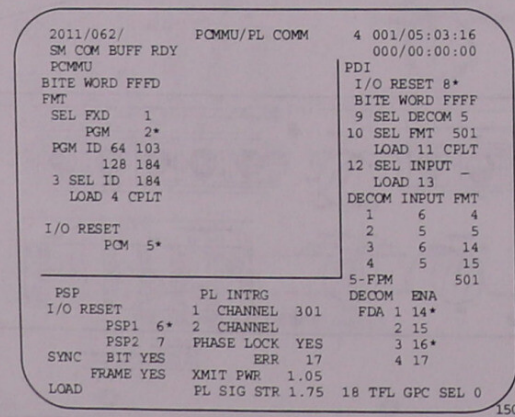

PCMMU/PL COMM Display (SPEC 62)

Communications System Rules of Thumb

- When the TDRS has an elevation of greater than $+70^\circ$ or less than -60° relative to the orbiter (as shown on OPS 201), there is a risk of degraded communications as the orbiter nose or tail blocks line of sight between the orbiter antenna and the TDRS.
- Power amplifiers are specified to have a minimum power output of 100 watts. Flight experience has shown that a good downlink can be sustained with a power out of 65 watts. Power amplifiers require 140 seconds to warm up if not in a standby state.
- Payload interrogator output power, when in low power mode, will read zero. This measurement is meaningless as the output power is too small to be output by the instrumentation system.

Description

Several types of equipment and systems that the crew uses are covered in other sections of this manual, since they are not necessarily part of any of the major systems. These items and systems, which focus on crew efficiency and comfort, are discussed in this section. Where appropriate, operations are described within each equipment/used area.

Crew Clothing/Worn Equipment

The crew clothing/worn equipment consists of items that provide for the personal needs of all crewmembers. Prior to each flight, crewmembers select clothing and worn equipment from a list of required and optional flight equipment.

Crew clothing used during orbital activities includes such items as trousers, jackets, shirts, sleep shirts, and slippers, and underwear.

Optional worn/carry-on equipment includes sunglasses, sunglasses, HFSS calculators, eye tape, headlight, crew army knife, pens and pencils, and chronographs.

Personal Hygiene Provisions

Personal hygiene and grooming provisions are provided for each crew member. These provisions include such items as toothbrushes, toothpaste, soap, and hairbrushes. Personal hygiene provisions are provided for each crew member and are located in the crew quarters.

A personal hygiene kit is provided for each crewmember. The kit includes such items as toothbrushes, toothpaste, soap, and hairbrushes. The kit is located in the crew quarters.

The kit includes such items as toothbrushes, toothpaste, soap, and hairbrushes. The kit is located in the crew quarters.

The kit includes such items as toothbrushes, toothpaste, soap, and hairbrushes. The kit is located in the crew quarters.

The kit includes such items as toothbrushes, toothpaste, soap, and hairbrushes. The kit is located in the crew quarters.

Sleeping Provisions

During a two-week operations mission, all crewmembers sleep continuously. At least one crewmember is always on duty to handle all ground reception of ground calls and other mission and warning alerts.

A 14-hour period is normally divided into a 4-hour sleep period and a 10-hour awake period for each crewmember. These hours are also called the pre/post sleep and the pre/post awake periods. During these periods, crewmembers perform housekeeping, eating, cleaning, sleep and wake preparation, personal hygiene, and food preparation and eating activities.

2.5 CREW SYSTEMS

CONTENTS

Description	2.5-1
Crew Clothing/Worn Equipment	2.5-1
Personal Hygiene Provisions	2.5-1
Sleeping Provisions	2.5-1
Exercise Equipment.....	2.5-4
Housekeeping Equipment.....	2.5-4
Restraints and Mobility Aids	2.5-5
Stowage Containers.....	2.5-5
Reach and Visibility Aids	2.5-6
Photographic Equipment	2.5-8
Sighting Aids.....	2.5-10
Window Shades and Filters	2.5-10
Shuttle Orbiter Medical System.....	2.5-10
Operational Bioinstrumentation	
System	2.5-12
Radiation Equipment.....	2.5-14
Air Sampling System	2.5-14

Description

Several types of equipment and systems that the crew uses are not covered in other sections of this manual, since they are not necessarily part of any of the larger systems. These items and systems, which focus on crew efficiency and comfort, are discussed in this section. Where appropriate, operations are described within each separate subject area.

Crew Clothing/Worn Equipment

The crew clothing/worn equipment consists of items that provide for the personal needs of all crewmembers. Prior to each flight, crewmembers select clothing and worn equipment from a list of required and optional flight equipment.

Crew clothing used during on-orbit activities includes such items as trousers, jackets, shirts, sleep shorts, soft slippers, and underwear.

Optional worn/carry-on equipment includes scissors, sunglasses, HP48 calculators, gray tape, flashlight, Swiss army knife, pens and pencils, and chronographs.

Personal Hygiene Provisions

Personal hygiene and grooming provisions are furnished for both male and female flight crewmembers. Ambient warm water for washing comes from a personal hygiene hose (PHH) attached to the galley auxiliary port. Other personal hygiene provisions are stowed in middeck lockers and/or the airlock stowage bag at launch and are removed for use on orbit.

A personal hygiene kit is furnished for each crewmember for brushing teeth, hair care, shaving, nail care, etc. Additional grooming and hygiene items are available for female crewmembers in the female preference bags.

Two washcloths and one towel per crewmember per day are provided. In addition, wet wipes, dry wipes, tissues, and Wash 'N Dri's are provided for personal hygiene. The Wash 'N Dri's are located in Volume G (spares), a middeck locker, and in the galley. Wet wipes and dry wipes are stowed in the waste management compartment (WMC) and in a middeck locker. Rubber grommets in the waste management compartment allow crewmembers to restrain their towels and washcloths.

If the WMS becomes nonfunctional, contingency equipment is located in Volume G. This equipment consists of Wash 'N Dri's, urine collection devices, diapers, and Apollo fecal bags.

Sleeping Provisions

During a one-shift operations mission, all crewmembers sleep simultaneously. At least one crewmember wears a communication headset to ensure reception of ground calls and orbiter caution and warning alarms.

A 24-hour period is normally divided into an 8-hour sleep period and a 16-hour wake period for each crewmember. Three hours are allocated for pre/post sleep activities in which crewmembers perform housekeeping, orbiter cleaning, sleep and wake preparation, personal hygiene, and food preparation and eating activities.

Sleeping provisions for flight crewmembers consist of sleeping bags and liners, or rigid sleep stations with one sleeping bag and two liners per bunk. Sleeping bags are installed on the starboard middeck wall and relocated for use on orbit. Some sleeping bags can remain on the starboard wall, and some can be attached via pip pins to the middeck lockers. Others can be relocated to the airlock, Spacelab, or flight deck (crew preference). A sleeping bag is furnished for each crewmember and contains a support pad with adjustable restraining straps and a reversible/removable pillow and head restraint.

Six adjustable straps permit the sleeping bag to be adjusted to its proper configuration. Three helical springs above the adjustable straps on one side of the bag relieve loads exerted by the crewmember on the crew compartment structure. Six pip pins allow the bag to be attached to the middeck locker face in either a horizontal or vertical configuration. Two elastic adjustable straps restrain the upper and lower parts of the body in the bag. Velcro strips on the ends of both sides of the head restraint attach it to the pillow. A double zipper arrangement permits the sleeping bag to be opened and closed from the bottom to the top of the bag. One zipper on each side of the sleeping bag allows the bag to be attached to a support pad for better rigidity.

A sleep kit is provided for each crewmember and is stowed in the crewmember's clothing locker during launch and entry. Each kit contains eye covers and ear plugs for use as required during the sleep period.

For 24-hour operations missions, the four-tier, rigid sleep station is flown. If manifested, it is installed on the starboard side of the middeck.

The four-tier rigid sleep stations contain a sleeping bag/liner, personal stowage provisions, a light, and a ventilation inlet and outlet in each of the tiers. The cotton sleeping bag is installed on the ground in each tier and held in place by six spring clips. The light in each tier is a single fluorescent fixture with a brightness control knob and an off position. The air ventilation inlet duct is an air diffuser similar to an automobile ventilation duct. It is adjusted by moving the vane control knob. The air ventilation outlet duct is located in the fixed panel at each tier and is opened or closed by moving the vane control knob. The air inlet is located at the crewmember's head. The outlet is at the feet. All crewmembers' heads are toward the airlock and their feet toward the avionics bay.

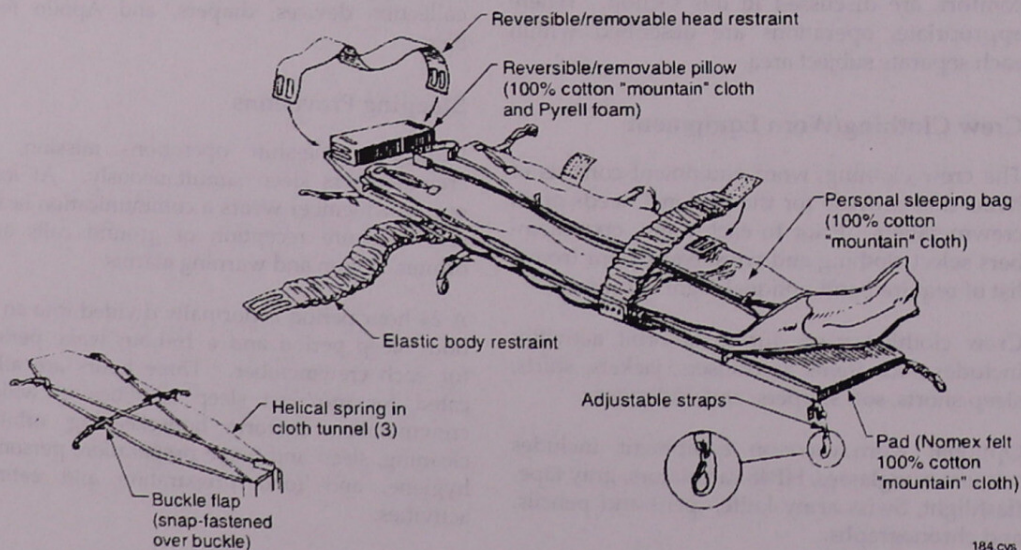

184.cvs

Operational Sleeping Bag

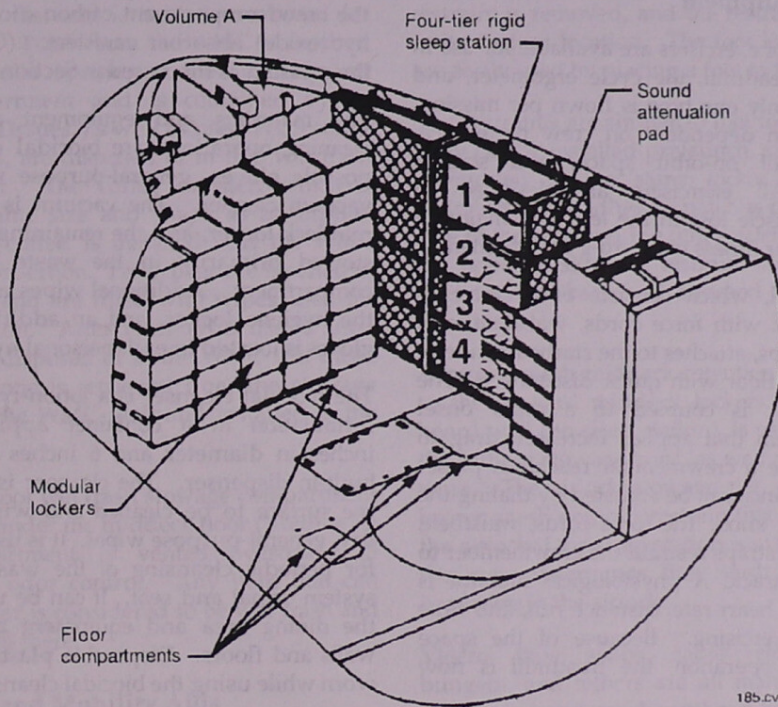

Four-Tier Horizontal Sleep Station

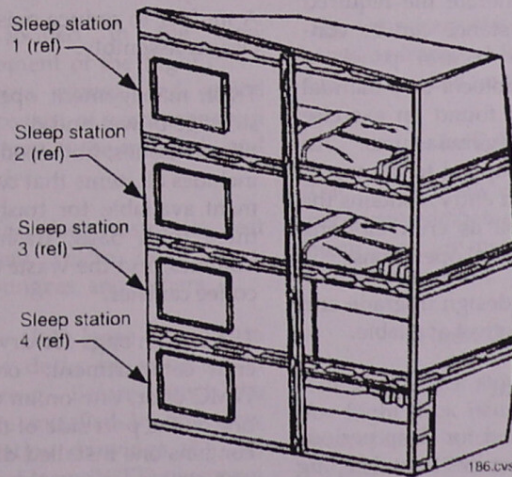

Four-Tier Rigid Sleep Station

Exercise Equipment

Three types of exercisers are available for use in flight: the treadmill, the cycle ergometer, and the rower. Only one type is flown per mission, with selection dependent on crew preference, availability of on-orbit space, and science objectives. All exercisers are designed to minimize muscle loss in the legs and maintain cardiovascular fitness in a zero-g environment.

The treadmill, which consists of a conveyor running track with force cords, waistbelt, and shoulder straps, attaches to the starboard side of the middeck floor with quick disconnects. The running track is coupled to a rapid onset braking system that applies increased drag to the track once a crewmember reaches a preset speed. Resistance can be adjusted by dialing the speed control knob. The force cords, waistbelt, and shoulder straps restrain the crewmember to the running track. A physiological monitor is used to track heart rate, distance run, and time run while exercising. Because of the space required for operation, the treadmill is now seldom flown.

The cycle ergometer (CE) attaches to the treadmill/entry middeck floor studs. The mounting frame is reconfigured on orbit to attach to standard seat floor studs on the flight deck or middeck. The CE uses a standard flywheel and braking band system to generate the required resistive force. Cycling resistance can be controlled electronically by a control panel or computer-driven exercise protocol or a manual adjustment similar to those found on exercise cycles used at home or in gymnasiums. An accessories bag, which is strapped to the top of the ergometer for launch and entry, contains the attachable hardware as well as crew clothing and shoes necessary for nominal operations.

The rower is undergoing a design upgrade and operational information is not yet available.

Housekeeping Equipment

In addition to time scheduled for sleep periods and meals, each crewmember has housekeeping tasks that require from 5 to 15 minutes of time at intervals throughout the day. These include cleaning of the waste management compartment, the dining area and equipment, floors and walls (as required), and the cabin air filters;

trash collection and disposal; and changeout of the crew compartment carbon dioxide (lithium hydroxide) absorber canisters. (Changeout of the canisters is discussed in Section 2.9.)

The materials and equipment available for cleaning operations are biocidal cleanser, disposable gloves, general-purpose wipes, and a vacuum cleaner. The vacuum is stowed in a middeck locker, and the remaining hardware is stowed primarily in the waste management compartment. Additional wipes are located in the hygiene locker, and an additional pair of gloves is located in each personal hygiene kit.

The biocidal cleanser is a lotion-type detergent formulation in a container approximately 2 inches in diameter and 6 inches long with a built-in dispenser. The cleanser is squirted on the surface to be cleaned and wiped off with dry, general-purpose wipes. It is used primarily for periodic cleansing of the waste collection system urinal and seat. It can be used to clean the dining area and equipment and to clean walls and floors. Disposable plastic gloves are worn while using the biocidal cleanser.

The vacuum cleaner is provided for general housekeeping and cleaning of the crew compartment air filters and Spacelab filters (on Spacelab missions). It has a normal hose, extension hose, and several attachments. It is powered by the orbiter dc electrical power system. A muffler to reduce noise is part of the vacuum cleaner assembly.

Trash management operations include routine stowage of wet and dry trash, such as expended wipes, tissues, and food containers. (Wet trash includes all items that could offgas.) The equipment available for trash management includes three trash bags, trash bag liners, wet trash volumes, and the waste collection system (WCS) coffee canister.

Three trash bags for dry trash are located in the crew compartment: one on the inside of the WMC door, one on an aft middeck locker, and one on the port side of the flight deck. Each bag contains one installed disposable trash bag liner and seven spare liners (located outside the installed liner but inside the trash bag). When the liner becomes full, it is removed and stowed in a jettison stowage bag. A new liner is then installed.

The WMC wet trash compartment has a volume of 1.85 cubic feet and is vented overboard for odor control. Trash from the WMC is inserted into the circular opening of the auxiliary wet trash compartment and is contained by an elbow bag. Tissues, as well as used WCS coffee canister bags, are disposed of in this wet trash compartment. The coffee canister, which is about the same size and shape as an off-the-shelf can of coffee, is installed near the WMC during post insertion. Trash bags are inserted in the canister and are filled with wipes used for fecal collection. After each WCS use, a used trash bag is disposed of in the WMC wet trash, and a new one is retrieved from the stowage volume on the WMC wall and installed in the canister.

An 8-cubic-foot wet trash stowage compartment is available under the middeck floor (Volume F). This compartment is vented overboard (3 lb/day) for odor control. Any item that can create an odor is considered to be wet trash and is disposed of there.

Restraints and Mobility Aids

Restraints and mobility aids are provided in the orbiter to enable the flight crew to perform all tasks safely and efficiently during ingress (1-g, orbiter vertical), egress (1-g, orbiter horizontal), and orbital flight (orbiter orientation arbitrary).

Mobility aids are located in the crew compartment for movement of the flight crewmembers during ingress, egress, and orbital flight. These devices consist of permanent and soft handholds, a platform in the middeck, and an interdeck access ladder.

Restraints consist of foot loop restraints, seat restraints, retention nets, Velcro, tape, snaps, cable restraints, clips, bungees, and tethers.

Foot loop restraints are cloth loops attached to the crew compartment decks by adhesive to provide stability in zero g. Before launch, the foot loop restraints are installed by the crew compartment configuration drawings (CCCD) or vehicle integration test team (VITT) personnel on the floor areas of the aft flight deck work stations, middeck, and near the waste management system and galley. Spares are stowed in the modular lockers. To install a foot restraint,

the protective backing on the underside of the restraint is removed, and the restraint is placed in its desired location. The foot loop restraints are easily used by placing a foot in the loop.

Seat restraints are similar to foot loop restraints. They can be installed prelaunch, and spares are manifested in the same locker as the foot restraints. One adhesive patch is placed on one side of the seat, and the other patch is placed on the opposite side. A restraint strap is placed over the seat back and attached to each patch via clips.

A brown mesh middeck retention net, attached to the forward middeck lockers and the starboard wall (no sleep station), is used to restrain the inflight stowage bags, as well as other hardware. The airlock stowage net, also made of brown mesh net, can restrain this equipment in the airlock if the sleep station is manifested, or if the crew determines they wish to stow this hardware in the airlock.

Velcro, tape, snaps, cable restraints, clips, bungees, and tethers are all manifested in the IFM locker and can be utilized for a variety of purposes.

Stowage Containers

Temporary Stowage Bag

The temporary stowage bag is used to restrain, stow, or transport loose equipment temporarily. One is installed on the flight deck.

Inflight Stowage Bags

Ten inflight stowage bags are manifested, one per crewmember plus spares. These brown mesh bags are used to stow suits, boots, and harnesses on orbit.

Flight Deck Stowage Bags

The flight deck stowage bags provide restraint for flight deck items when those items are not immediately returned to locker stowage compartments. These bags are manifested in the Flight Data File (FDF) locker and are installed on orbit on the back of the CDR and PLT seats (one per seat).

Jettison Stowage Bags

The jettison stowage bags are used for restraining dry trash or early return items, such as FDF, film, and cassettes. (See Section 2.24 for further details on all stowage bags.)

Reach and Visibility Aids

Reach and visibility aids are hardware items that assist the flight crew in monitoring and manipulating displays and controls throughout various phases of flight. These aids consist of CDR/PLT adjustable mirrors, CDR/PLT two axis (Z and X) seat adjustment, wicket tabs, and an auxiliary reach mechanism.

The adjustable mirrors are installed at launch on handholds located between windows 2 and 3 for the CDR and windows 4 and 5 for the PLT. During ascent and entry, the CDR and PLT use the adjustable mirrors to facilitate seeing controls that are in the obscured areas of their vision envelope. On orbit, mirrors can be removed and stowed, if desired.

To install the adjustable mirror, place the split clamp halves around the handhold, fit the handwheel stem into both clamp halves, and tighten the handwheel clockwise. To adjust the mirror, loosen the mirror-lock knob (counterclockwise), move the mirror to the desired orientation, and tighten the mirror-lock knob.

The CDR/PLT seats provide the CDR and PLT with the capability to move their seats along the orbiter Z- (vertical) and X- (longitudinal) axes to facilitate the reach and visibility of controls during the ascent and entry phase of flight. Seat movement for each axis is provided by a single ac motor. The total travel distances for the Z- and X-axes are 10 and 5 inches respectively. Seat adjustment controls are located on the left side of the seat pan. The controls consist of a three-position toggle switch for power bus selection and one spring-loaded, three-position toggle switch each for control of horizontal and vertical seat movement.

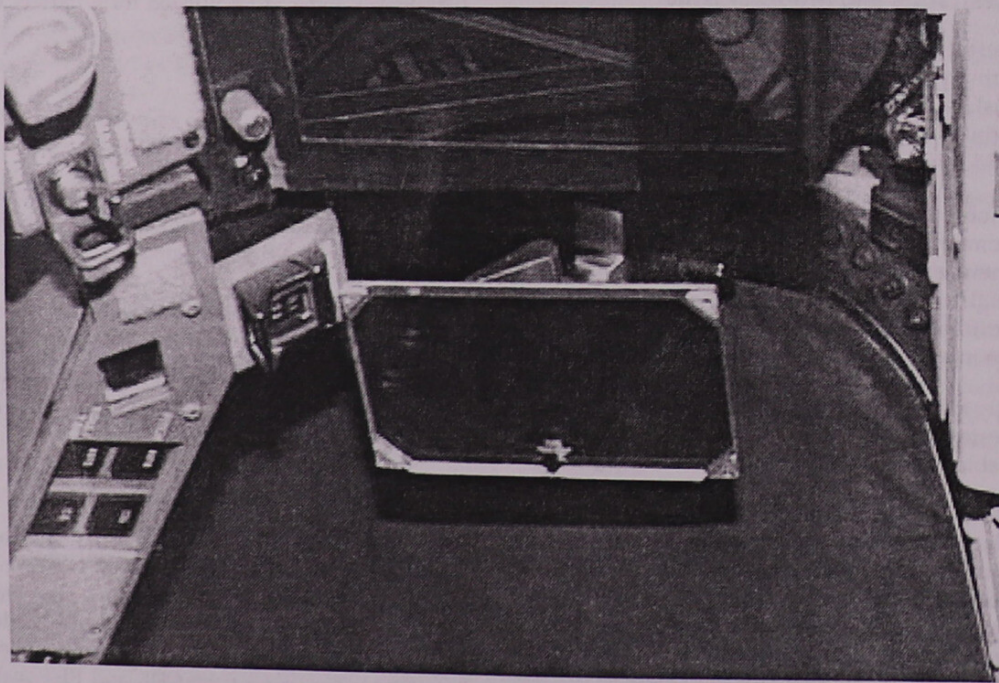

Adjustable Mirror

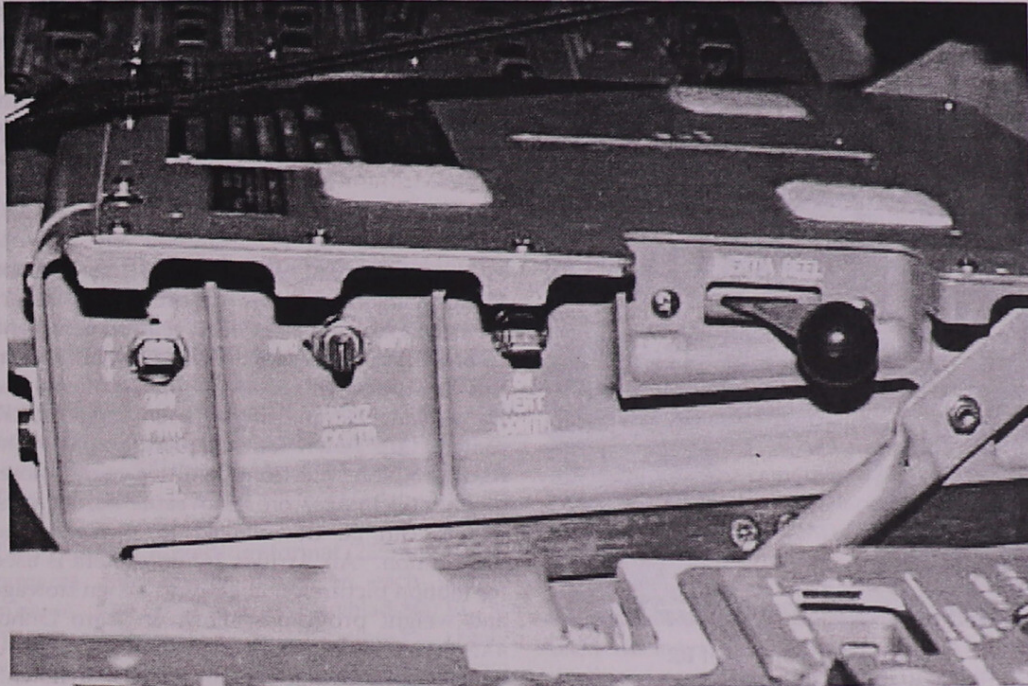

Seat Power and Controls

To operate the CDR/PLT seat, the crewmember must first assign ac power to his or her seat motors by moving the *POWER BUSS SEL* switch to AC2 (up) or AC3 (down). To move the seat along the horizontal axis, crewmembers must actuate the *HORIZ CONTR* toggle switch FWD to move the seat forward and AFT to move the seat aft. Similarly, to move the seat along the vertical axis, the crewmember must actuate the *VERT CONTR* toggle switch UP to move the seat upward and DN to move the seat downward.

If the seat motors fail to work, and seat adjustment is needed, manual adjustment capability is provided. However, manual seat adjustment can take place only on orbit and is accomplished with a special seat adjustment tool provided in the in-flight maintenance tool kit. Manual horizontal and vertical seat adjustment control locations are under the seat pan cushion and on the aft side of the fixed seat structure.

The seat adjustment tool is a ratchet-driven, 3/16-inch Allen wrench inserted into the vertical or horizontal manual adjustment to move the seat along the Z- or X-axis.

Wicket tabs are devices that help the crewmember activate controls when his or her vision is degraded. The tabs provide the crewmember with tactile cues to the location of controls to be activated as well as a memory aid to their function, sequence of activation, and other pertinent information. Wicket tabs are found on controls that are difficult to see on panels O8, C3, and R2 during the ascent and entry flight phases.

The auxiliary reach mechanism, sometimes known as the "swizzle stick," is a short adjustable bar with multipurpose end effectors that are used to actuate controls that are out of the reach of seated crewmembers. The reach aid is used to push in and pull out circuit breakers, move toggle switches, and turn rotary knobs. It is stowed on the inboard side of the PLT seat. It may be used during any phase of flight, but is not recommended for use during ascent because of the attenuation and switch-cueing difficulties resulting from acceleration forces.

Operation of the reach aid consists of extending it and actuating controls with the end effector. To extend the reach aid, the crewmember depresses the spring-loaded extension tab and pulls the end effector out to the desired length.

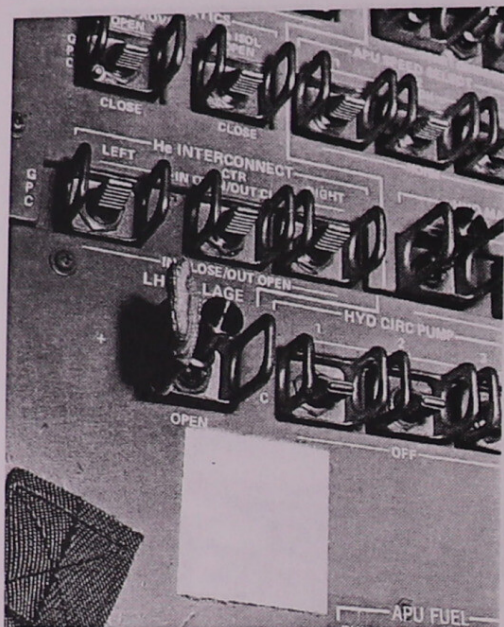

Wicket Tabs on Panel R2

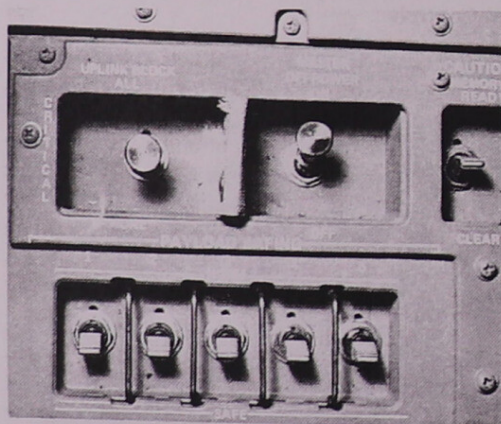

Wicket Tabs on Panel C3

The reach and visibility envelope of each crewmember is limited by the LES. Tactile cues are restricted by the LES pressure glove. Visibility is reduced because of the helmet and neck ring, and reach is restricted by the bulk of the LES and the parachute and harness. Crewmembers should practice techniques that enable them to adjust their reach and visibility envelope. The helmet can be swiveled on the neck ring. The neck ring tie down may be adjusted to help open up downward field of view. Mirrors, the auxiliary reach mechanism

(swizzle stick), and other crewmembers can aid in locating and actuating controls. Seat headrest pads and helmet pads may be used to adjust the position of the head in the seat and in the helmet. The CDR and PLT seats may be adjusted as necessary.

Photographic Equipment

Five still camera systems and one motion picture camera are used on orbit to document crew activities, meet payload requirements, and record Earth observations. Additional cameras can be stowed as required. Nikon 35mm and Hasselblad 70mm single lens reflex (SLR) cameras are flown for still photography. The Kodak/Nikon electronic still camera stores digital still images on removeable hard drives. Images can be downlinked for printing and distribution. An Arriflex 16mm camera is used for motion picture photography. When stowage and weight provisions allow, an Aero Linhof 4X5 aerial photography camera or a NASA-developed electronic still camera may be flown.

Additional camera systems may be flown for specific experiments or as part of an ongoing NASA evaluation of new cameras and technology. Periodically, the IMAX Corporation manifests its 70mm motion picture camera aboard the shuttle as a commercial payload.

Two slightly modified Nikon professional 35mm F4S autofocus SLR cameras are nominally manifested for each mission. The F4 provides state-of-the-art metering for automatic ambient light and flash exposure and exposures as brief as 1/8000 of a second. The camera incorporates a "full information" LCD viewfinder display. Interchangeable autofocus lenses of various focal lengths, including 28mm f/2.8, 24-50mm f/4.5 and 35-70mm f/2.8 zoom are available. A 300mm telephoto and 2X converter can be flown for photographing the shuttle external tank post-jettison. Manual focus lenses can be used on the F4, with the camera indicating when proper focus is achieved. The camera motor drive advances the film after each exposure or permits continuous exposure at 3.4 or 5.7 frames per second. It operates on six AA batteries. The F4 flash (SB-24) operates on four AA batteries. The F4 cameras are used primarily for in-cabin crew activities and experiments. They may also be used for payload deployments and Earth

observations. A wide variety of negative (print) and positive (slide) color 35mm films can be manifested for a mission. The 36 exposure rolls run the gamut of ISOs (ASAs) from 50 to 1600. Special purpose IR and black and white films may be flown as required.

One or two factory modified Nikon F3 35mm cameras are manifested for scheduled EVA missions or flights having a high probability of an EVA. A special camera thermal cover, sport finder eyepiece, and tabs to assist the EVA crew with camera operations are also manifested. This camera permits manual or automatic exposure. An EVA 35mm camera is loaded with a 36 exposure roll of 100 ISO negative film. Two lenses have been qualified for the harsh EVA environment. They are a 28mm f/2, and a 35mm f/1.4.

Two 70mm SLR medium format (2.25 in square) cameras are usually flown on each shuttle mission. The cameras are Hasselblad 500 EL/Ss (EL/Xs with minor modifications). Only manual exposure is available with the 70mm cameras. Two Minolta handheld reflected light spotmeters are manifested to provide exposure information as required. Interchangeable magazines provide approximately 95 exposures on Kodak 100 ISO Professional 70mm perforated positive film. Occasionally, color infrared film is used for Earth observations. Each magazine has a detachable data recording device that prints flight-specific data on the edge of the film. Interchangeable lenses, including 40mm f/4, 50mm f/4, 100mm f/3.5, and 250mm f/5.6, are part of the standard complement. The camera motor drive operates on five AA batteries. It permits single frame automatic film advance or a continuous rate of about one frame per second. The 70mm cameras are used exclusively for photography of payload bay activities and Earth observations. The Nikon flash can also be used with the 70mm cameras via photographic "pc" cords.

The 70mm camera can also be used EVA with a body lubricated especially for EVA usage. A 30mm f/3.5 or 60mm f/3.5 lens is available for EVA photography. A thermal cover encloses the camera, lens, and magazine.

Motion picture filming is accomplished with an Arriflex professional 16mm through-the-lens viewing rotary shutter camera with integral

light meter. The crystal-controlled camera motor transports film at 24 frames per second. The nominal shutter speed is 1/48 second. The camera utilizes an interchangeable 10 - 100mm f/2 zoom or 5.9mm f/1.8 wide angle lens. Both lenses permit manual exposure. The zoom lens aperture can be controlled by inputs from the camera light meter for automatic exposure as well. Interchangeable magazines are reloaded in flight with 380 ft rolls of 100 or 500 ISO Kodak tungsten light balanced color negative film. A full magazine will provide about 10.5 minutes of filming. Color correction filters must be used whenever sunlight is the main subject light. The camera is normally powered by a NASA developed 15 V dc battery containing 40 AA batteries. The camera may also be powered from the orbiter, via an adapter cable and the inflight maintenance (IFM) "breakout box." A rarely flown accessory provides variable frame rates for the Arriflex and bar code time data on the film. A photoflood light is available and is used during interior filming. The Arriflex is used primarily to document in-cabin and payload bay activities.

The Aero Linhof is a manual exposure 4X5 camera that is manifested approximately every other mission if stowage space and weight constraints allow. The camera produces large (4 in. by 5 in.) images on Kodak 100 ISO thin base positive film. Each removable magazine contains approximately 185 exposures. The camera uses a 90mm f/5.6 wide angle and a 250mm f/5.6 lens. Camera power is supplied by orbiter 28 V dc. An attachable viewfinder can be used to estimate the field-of-view (FOV) of the lens in use. The Linhof camera is used primarily for Earth observations photography.

Most of the photography and cinematography conducted in the orbiter are handheld. With the exception of flash photography, however, many of the images and scenes the crew captures on film can be improved through the use of the multiuse brackets, clamps, and baseplate adapter. Twenty-two mounts throughout the flight deck, middeck, and airlock permit the crew to mount cameras and accessories. The baseplate adapters (crew installed) provide quick mounts in windows 9 and 10. The multiuse clamp is used on switchguards or other structures to provide an attachment base for a multiuse arm. The multiuse arm is a

modified commercial device that attaches to a camera and a wall mount or clamp. The arm permits universal pointing of the camera until the center "elbow" knob is tightened. When the knob is secure, the camera is held rigidly at the selected orientation (zero g). Multiuse equipment is also used to mount the camcorder, and photo flood.

Sighting Aids

Sighting aids include all items used to aid the flight crew within and outside the crew compartment. The sighting aids include the crew optical alignment sight (COAS), binoculars, adjustable mirrors, and spotlights. (The COAS is discussed in detail in Section 2.13.)

Five models of binoculars are available for on-orbit use. Two models are routinely flown on each mission. Binocular models include the Zeiss 8X20, Fuji 10X40 gyro stabilized day/night, Fuji 14X40 gyro stabilized, Fuji 16X70, and the Zeiss 20X60 mechanically stabilized.

The spotlight is a high-intensity, handheld flashlight powered by a battery pack consisting of five 1.2-volt one-half D size nickel-cadmium batteries. The spotlight produces a 20,000-candlepower output with a continuous running time of 1.5 hours. The lamp is a 6-volt tungsten filament and cannot be replaced in flight.

The high intensity search light (HISL) is used in conjunction with the rangefinders during visual acquisition of satellites. It provides crewmembers with the capability to detect and maintain visual contact with a payload for effective rendezvous and station keeping at 700 to 1000 feet when on the dark side. The light is portable and has a stainless steel camera mounting rail on the handle that interfaces to the multiuse mounting brackets on the orbiter. The light is aimed out the aft, or overhead, windows of the flight deck.

Window Shades and Filters

Window shades and filters are provided for installation on the orbiter windows to minimize crewmember exposure to sunglare during ascent, entry, and orbital flight phases.

The window shades and filters are stowed in a compartmented bag attached to a mounting pallet on the starboard side of the aft middeck.

To install the W1 through W6 window shades, the crewmember unrolls the shade (white surface outboard) over the window and mates the Velcro with the Velcro on the window frame. Removal of the shades is accomplished by just the reverse. Demate the Velcro, and roll the shade up as compactly as possible (blue surface visible). Insert into window shade holders and close the holders by mating Velcro together.

Aft window shades and filters are installed simply by placing the correct shade or filter in the appropriate window (reflective side outboard) and securing it to the mating Velcro on the window ledges.

To remove a window shade from the window shade stowage container, the crewmember must unfasten the securing straps and pull the Velcro-restrained closure panel away from the desired stowage pouch.

Interdeck light shades are provided to minimize light leakage between the flight deck and middeck during in-cabin photography. The light shade is attached with Velcro to the flight deck floor around the interdeck access. Adjustable louvers are provided to regulate the amount of light between the flight deck and the middeck.

The side hatch viewport is the only optical-quality window on OV 102, 103, 104, and 105. Unlike the 10 windows on the flight deck, the side hatch viewport does not provide protection from solar ultraviolet (UV) rays, which can cause serious injury in as little as 10 seconds. Therefore, a removable UV filter must be placed on the side hatch viewport for on-orbit operations. The filter is held against the viewport by Velcro and is normally installed post insertion and removed during deorbit preparations.

Shuttle Orbiter Medical System

The shuttle orbiter medical system (SOMS) is required to provide medical care in flight for minor illnesses and injuries. It also provides support for stabilizing severely injured or ill crewmembers until they are returned to Earth.

The SOMS is provided in two separate packages: the medications and bandages kit (MBK) and the emergency medical kit (EMK). The MBK is blue with blue Velcro and a blue strap. The EMK is also blue with red Velcro and a red strap.

The medical kits are stowed in a middeck modular locker. If the kits are required on orbit, they are unstowed and installed on the locker doors with Velcro. The kits have a patch of Velcro on the bottom to match the Velcro on the outside of the doors.

Each kit contains pallets and a pocket inside the back. Pockets containing medications and equipment are mounted on each side of the pallets. The MBK pallet designators are E, F, and G. The E pallet contains pills, capsules, and suppositories. The F pallet contains bandage materials for covering or immobilizing body parts. The G pallet contains medications to be administered by topical application.

The EMK pallet designators are A, B, C, and D. The A pallet contains medications to be administered by injection. The B pallet contains emergency items and equipment for performing minor surgeries. The C pallet contains diagnostic/therapeutic items consisting of instruments for measuring and inspecting the body. The D pallet contains dental items, injectables, and intravenous fluid/administration sets.

The onboard medical checklist and medical checklist flight supplement specify the location of medications/equipment in the two medical kits by an alphanumeric code. The first character is the alphanumeric code of the pallet (A through G). The second character is the side of the pallet (1 or 2). The third and fourth characters are the number of the specific pocket on the pallet. The pallets are appropriately marked.

The medical accessory kit supplements the SOMS kit by providing additional storage capability for crew-specific and/or mission-specific medications, such as toxin antidotes, additional I.V. fluid, etc.

The SOMS also includes a resuscitator and patient/rescuer restraints. The resuscitator consists of a mask with a retaining cap, a manually activated/demand regulated oxygen supply valve, a 6-foot hose, and a quick disconnect

fitting. The resuscitator assembly is stored in a middeck locker with the EMK and MBK.

The resuscitator is emergency hardware to be utilized, along with the patient/rescuer restraints, in the case of a crewmember becoming ill as called out for in JSC-17327, Medical Checklist – All Flights.

The resuscitator provides the capability to deliver 100 percent oxygen, control ventilation, and perform CPR for extended periods of time.

The resuscitator valve can supply 100 percent supplemental oxygen in two ways: (1) at 40 LPM positive pressure for unconscious patients, and (2) on demand flow for conscious patients.

The resuscitator, upon unstowage, can be connected to the orbiter oxygen supply on the middeck connections on panels MO32M and MO69M and the flight deck connection on panel C6. Oxygen flow can be checked by depressing the O₂ trigger arm. Following verification of O₂ flow, a crewmember will position and tighten the resuscitator mask over the crewmember's face using the head cap and elastic straps.

The patient/rescuer restraints consist of one belt with two pip pins for the patient and two belts with two pip pins for the rescuer. They are designed to interface into the holes in the middeck locker latches.

The patient/rescuer restraint system is emergency hardware to be utilized in the case of a crewmember becoming ill. The restraints are stored in a middeck locker with the EMK and MBK.

The patient restraints will restrain the patient in the mid-calf area and the chest area. The restraints can be easily tightened to fit the patient. The rescuer restraint will wrap around the rescuer's waist and will have two extensions from the waist belt with pip pins on the end to fasten into the locker latches. This will allow the rescuer and patient to remain stationary.

The diagnostic equipment onboard and information from the flight crew will allow diagnosis and treatment of injuries and illnesses through consultation with flight surgeons in Mission Control.

Operational Bioinstrumentation System

The operational bioinstrumentation system (OBS) provides an amplified electrocardiograph (ECG) analog signal from any crewmember aboard the orbiter to the avionics system, where the signal is converted to digital signal and transmitted to the ground in real time or stored on tape for dump at a later time. On-orbit use is limited to crewmembers in EVA or to contingency situations (only at the request of the flight surgeon).

The OBS electrodes are attached to the skin with electrode paste to establish electrical contact. The electrode is composed of a plastic housing containing a non-polarizable pressed pellet. The housing is attached to the skin with double-sided adhesive tape, and the pellet contacts the skin. There are three electrodes on the harness, marked LC (lower chest), UC (upper chest), and G (ground).

The ECG signal conditioner is a hybrid microcircuit with variable gain (adjusted for each crewmember before flight). It provides a zero- to 5-volt output and has an ON/OFF switch within the input plug, which is actuated when the intravehicular activity (IVA) biomed cable is plugged in. The unit has batteries that will not be replaced in flight.

The IVA biomed cable connects to the signal conditioner and is routed under the IVA clothing to connect to the biomed seat cable. The biomed seat cable is routed to one of the BIOMED input connectors located on panel A11, A15, or M062M. Rotary control switches on panel R10 provide circuits from the biomed outlets to the orbiter's network signal processor for downlink or recording. The two rotary switches on panel R10 are BIOMED CHANNEL 1 and CHANNEL 2. Extravehicular activity positions provide circuits from the EVA UHF transceiver.

The electrode application kit contains components to aid in the application of electrodes. The components include wet wipes, double-sided adhesive tape, electrode paste, and a cue card illustrating electrode placement.

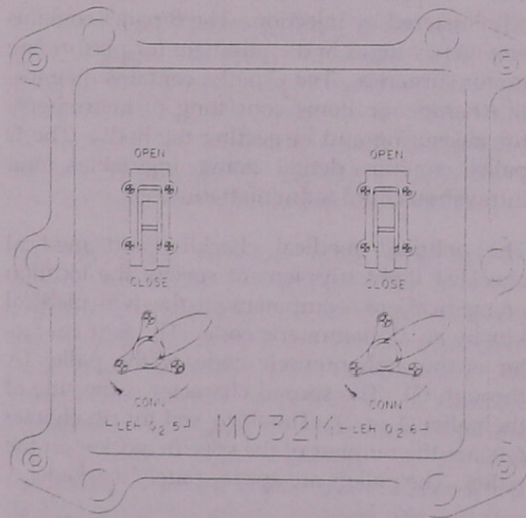
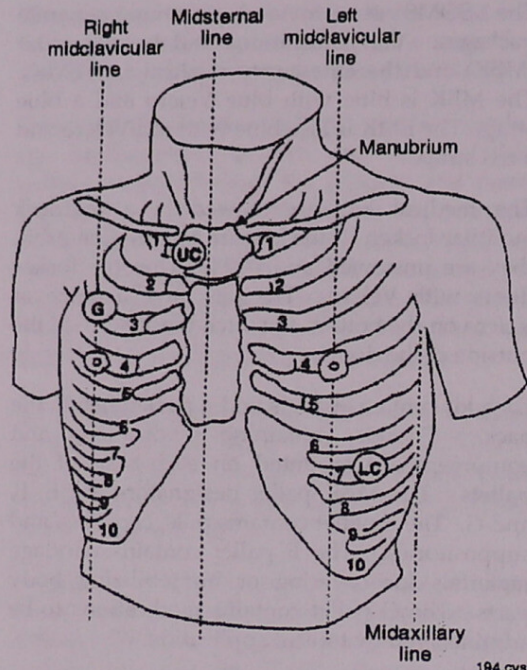

Panel M032M

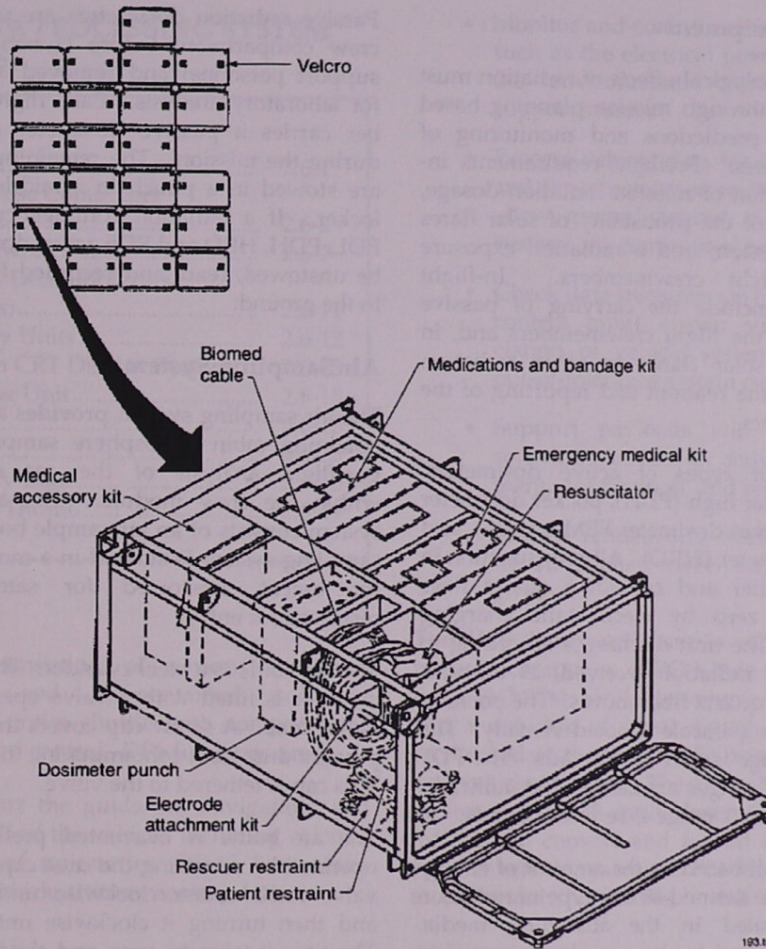

Modular Locker Equipment and Locations

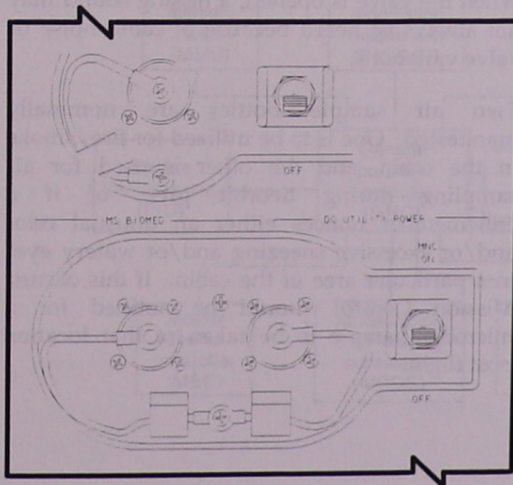

MS BIOMED Input Connector on Panel A11

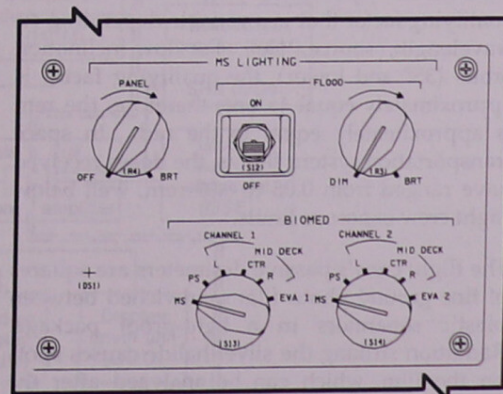

BIOMED Rotary Switches on Panel R10

Radiation Equipment

The harmful biological effects of radiation must be minimized through mission planning based on calculated predictions and monitoring of dosage exposures. Preflight requirements include a projection of mission radiation dosage, an assessment of the probability of solar flares during the mission, and a radiation exposure history of flight crewmembers. In-flight requirements include the carrying of passive dosimeters by the flight crewmembers and, in the event of solar flares or other radiation contingencies, the readout and reporting of the active dosimeters.

There are four types of active dosimeters: pocket dosimeter high (PDH), pocket dosimeter low (PDL), pocket dosimeter FEMA (PDF), and high-rate dosimeter (HRD). All four function in the same manner and contain a quartz fiber positioned to zero by electrostatic charging before flight. The unit discharges according to the amount of radiation received; as the unit discharges, the quartz fiber moves. The position of the fiber along a scale is noted visually. The PDH unit's range is zero to 100 rads. The PDF and PDL units' ranges are zero to 200 millirads, and the HRD unit's range is zero to 600 rads.

The rad is a unit based on the amount of energy absorbed and is defined as any type of radiation that is deposited in the absorbing media. Radiation absorbed by humans is expressed in roentgen equivalent in man, or rems. The rem is determined by multiplying rads times a qualifying factor that is a variable depending on wavelength, source, etc. For low-inclination orbits (35° and lower), the qualifying factor is approximately equal to one; therefore, the rem is approximately equal to the rad. In space transportation system flights, the doses received have ranged from 0.05 to 0.07 rem, well below flight crew exposure limits.

The flight crew's passive dosimeters are squares of fine-ground photo film sandwiched between plastic separators in a light-proof package. Radiation striking the silver halide causes spots on the film, which can be analyzed after the flight. Included in the badge dosimeters are thermoluminescent dosimeter chips, which are analyzed on Earth.

Passive radiation dosimeters are placed in the crew compartment before launch by ground support personnel and removed after landing for laboratory analysis. Each flight crewmember carries a passive dosimeter at all times during the mission. The remaining dosimeters are stowed in a pouch in a middeck modular locker. If a radiation contingency arises, the PDL, PDH, HRD and PDF active dosimeters will be unstowed, read, and recorded for downlink to the ground.

Air Sampling System

The air sampling system provides a method for obtaining cabin atmosphere samples to allow postflight analysis of the gas environment within the crew module. The air sampling system consists of an air sample bottle. The air sampling system is stowed in a modular locker for ascent, unstowed for sampling, and restowed for entry.

The air bottle is a steel cylinder. The end of the cylinder is fitted with a valve operated by the valve knob. A screw cap covers the air inlet to prevent dust from contaminating the air sample. This cap is tethered to the valve.

The air bottle is evacuated preflight and is operated by removing the dust cap, turning the valve knob counterclockwise until full open, and then turning it clockwise until full close. The time it takes to open and close the valve is sufficient to fill the cylinder with cabin gas. When the valve is opened, a hissing sound may not always be heard because of cabin noise or valve variations.

Two air sample bottles are nominally manifested. One is to be utilized for fire/smoke in the cabin, and the other is used for air sampling during deorbit prep, or if a crewmember notices either an unusual odor and/or excessive sneezing and/or watery eyes in a particular area of the cabin. If this occurs, Mission Control should be notified for a microbial sample to be taken of that location post flight.

2.6 DATA PROCESSING SYSTEM (DPS)

CONTENTS

Description	2.6-1
General Purpose Computers (GPCs)	2.6-2
Data Bus Network	2.6-7
Multiplexers/Demultiplexers (MDMs)	2.6-11
Mass Memory Units	2.6-12
Multifunction CRT Display System	2.6-13
Master Timing Unit	2.6-15
Software	2.6-18
Operations	2.6-23
DPS Summary Data	2.6-45
DPS Rules of Thumb	2.6-49

Description

The DPS, consisting of various hardware components and self-contained software, provides the entire shuttle with computerized monitoring and control. DPS functions are:

- Support the guidance, navigation, and control of the vehicle, including calculations of trajectories, SSME burn data, and vehicle attitude control data.

- Monitor and control vehicle subsystems, such as the electrical power system and the environmental control and life support system.
- Process vehicle data for the flight crew and for transmission to the ground, and allow ground control of some vehicle systems via transmitted commands.
- Check data transmission errors and crew control input errors; support annunciation of vehicle system failures and out-of-tolerance system conditions.
- Support payloads with flight crew/software interface for activation, deployment, deactivation, and retrieval.
- Process rendezvous, tracking, and data transmissions between payloads and the ground.

The DPS hardware consists of five general-purpose computers (GPCs), two mass memory units (MMUs) for large-volume bulk storage, and a network of serial digital data buses to accommodate the data traffic between the GPCs and vehicle systems. The DPS also includes 20 orbiter and 4 SRB multiplexers/demultiplexers (MDMs) to convert and format data from the various vehicle systems, 3 SSME interface units to command the SSMEs, a multifunction CRT

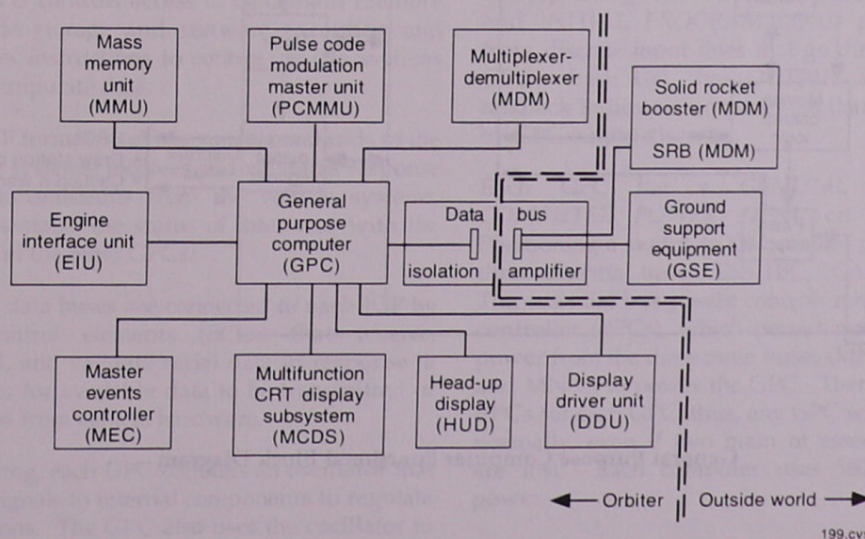

Data Processing System Interfacing Hardware

display system (MCDC) (or a multifunction electronic display system (MEDS)) used by the flight crew to monitor and control the vehicle and payload systems, 2 data bus isolation amplifiers to interface with the ground support equipment/launch processing system and the SRBs, 2 master events controllers, and a master timing unit.

DPS software accommodates almost every aspect of space shuttle operations, including orbiter checkout, prelaunch and final count-down for launch, turnaround activities, control and monitoring during launch, ascent, on-orbit activities, entry, and landing, and aborts or other contingency mission phases. A multi-computer mode is used for the critical phases of the mission, such as launch, ascent, orbit, entry, landing, and aborts.

General Purpose Computers (GPCs)

The orbiter has five identical IBM AP-101S GPCs. The GPCs receive and transmit data to and from interfacing hardware via the data bus network. GPCs also contain the software that provides the main on-board data processing capability. Up to four of the systems may run identical software. The fifth system runs different software, programmed by a different company, designed to take control of the vehicle if an error in the primary software or other multiple failures cause a loss of vehicle control. The software utilized by the four primary GPCs is referred to as PASS (primary avionics software system); the fifth GPC is referred to as BFS (backup flight system).

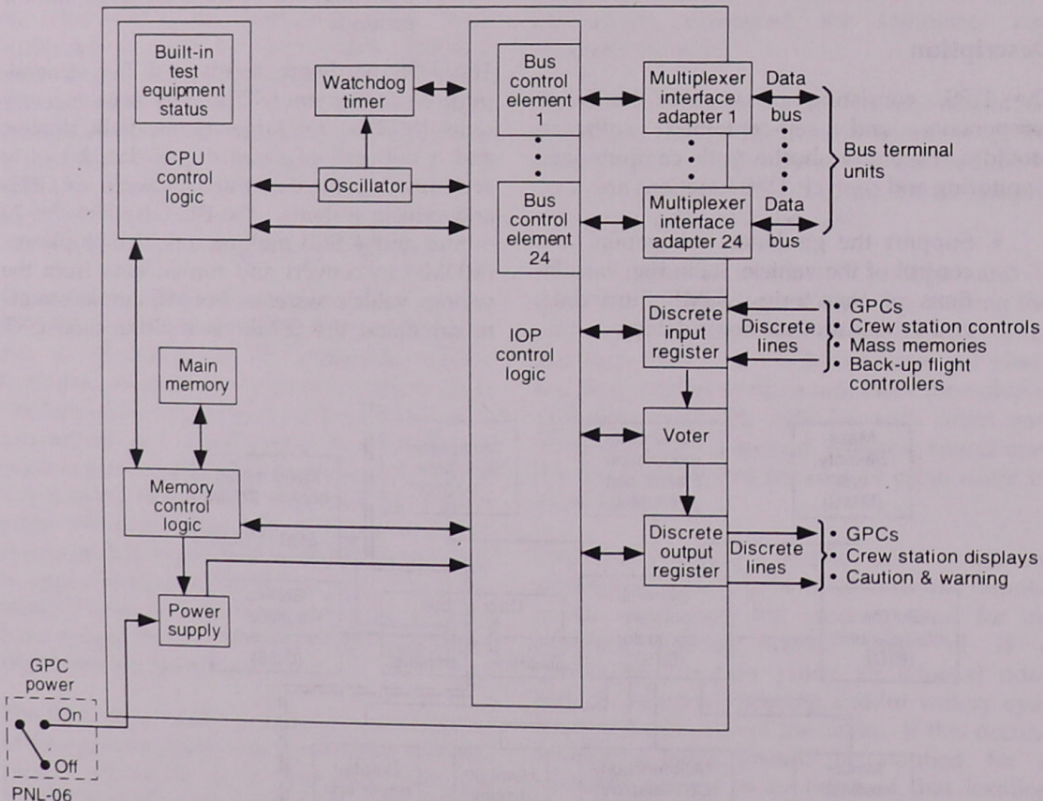

General Purpose Computer Functional Block Diagram

200.cvs

GPCs 1 and 4 are located in forward middeck avionics bay 1, GPCs 2 and 5 are located in forward middeck avionics bay 2, and GPC 3 is located in aft middeck avionics bay 3. The GPCs receive forced-air cooling from an avionics bay fan. (There are two fans in each avionics bay, but only one is powered at a time.)

CAUTION

If both fans in an avionics bay fail, the computers will overheat within 25 minutes (at 14.7 psi cabin pressure) or 17 minutes (at 10.2 psi) after which their operation cannot be relied upon. An operating GPC may or may not survive for up to an additional 30 minutes beyond the certifiable thermal limits.

Each GPC consists of a central processing unit (CPU) and an input/output processor (IOP) stored in one avionics box. The boxes are 19.55 inches long, 7.62 inches high, and 10.2 inches wide; they weigh approximately 68 pounds. The main memory of each GPC is volatile (the software is not retained if power is interrupted), but a battery pack preserves software contents when the GPC is powered off. The memory capacity of the GPCs is 256 k half-words, but only the lower 128 k half-words are normally used for software processing.

The CPU controls access to GPC main memory for data storage and software execution and executes instructions to control vehicle systems and manipulate data.

The IOP formats and transmits commands to the vehicle systems, receives and validates response data transmissions from the vehicle systems, and maintains the status of interfaces with the CPU and the other GPCs.

The 24 data buses are connected to each IOP by bus control elements (BCEs) that receive, convert, and validate serial data in response to requests for available data to be transmitted or received from vehicle hardware.

For timing, each GPC contains an oscillator that sends signals to internal components to regulate operations. The GPC also uses the oscillator to

maintain an internal clock to keep track of Greenwich mean time (GMT) and mission elapsed time (MET) as a backup to the timing signal from the master timing unit (MTU).

Each GPC contains a watchdog timer. The watchdog timer is an incrementing clock register in the GPC that is reset about once every second by a signal from the CPU. If the register ever overflows, then a problem exists and is annunciated by a self-fail indication from that GPC. The PASS set does not utilize this hardware feature since it operates in synchronization with each of its GPCs to ensure proper functioning. Since the BFS operates essentially standalone relative to the PASS set synchronization, the BFS mechanization does utilize the watchdog timer function to serve as a check on its operation.

The PASS GPCs use a hardware "voter" to monitor discrete inputs from the other GPCs. Should a GPC receive a fail vote from two or more of the other GPCs, it will cause the GPC to annunciate a self-fail indication that also causes the GPC to inhibit any fail votes of its own against the other GPCs.

GPC Controls

The *GENERAL PURPOSE COMPUTER* hardware controls are located on panel O6. Each of the five GPCs reads the position of its corresponding *OUTPUT* and *MODE* switches and *INITIAL PROGRAM LOAD* pushbuttons from discrete input lines that go directly to the GPC. Each GPC has *OUTPUT* and *MODE* talkback indicators on panel O6 that are driven by GPC output discretetes.

Each GPC has a *GENERAL PURPOSE COMPUTER POWER* switch on panel O6. Positioning a switch to ON enables power from three essential buses, ESS 1BC, 2CA, and 3AB. The essential bus power controls remote power controller (RPCs), which permit main bus DC power from the three main buses (MN A, MN B, and MN C) to power the GPC. There are three RPCs for each GPC; thus, any GPC will function normally, even if two main or essential buses are lost. Each computer uses 560 watts of power.

Each *GENERAL PURPOSE COMPUTER OUTPUT* switch on panel O6 is a guarded switch with *BACKUP*, *NORMAL*, and *TERMINATE* positions. The switch provides a hardware override to the GPC that precludes that GPC from outputting on the flight-critical buses. The switches for the *PASS GNC GPCs* are positioned to *NORMAL*, which permits them to output. The backup flight system switch (GPC 5) is positioned to *BACKUP*, which precludes it from outputting until it is engaged. The switch for a GPC designated on-orbit to be a systems management (SM) computer is positioned to *TERMINATE*, since the GPC is not to command anything on the flight-critical buses.

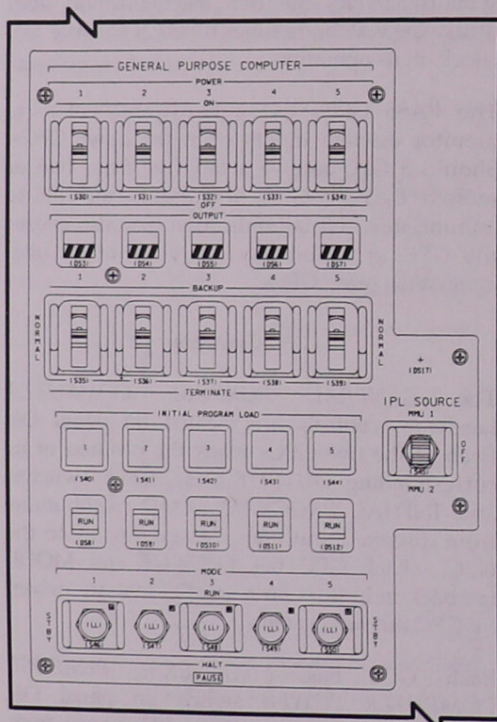

GENERAL PURPOSE COMPUTER Hardware Controls

The talkback indicator above each *OUTPUT* switch on panel O6 indicates gray if that GPC output is enabled and barberpole if it is not.

Each GPC receives *RUN*, *STBY*, or *HALT* discrete inputs from its *MODE* switch on panel O6, which determines whether that GPC can

process software. The *MODE* switch is lever-locked in the *RUN* position. The *HALT* position initiates a hardware-controlled state in which no software can be executed. A GPC that fails to synchronize with others is either powered *OFF* or moded to *HALT* as soon as possible to prevent the failed computer from outputting erroneous commands. The talkback indicator above the *MODE* switch for that GPC indicates barberpole when that computer is in *HALT*.

In *STBY*, a GPC is also in a state in which no *PASS* software can be executed, but it is in a software-controlled state. The *STBY* mode allows an orderly startup or shutdown of processing. It is necessary, as a matter of procedure, for a *PASS GPC* that is shifting from *RUN* to *HALT* or vice versa to be temporarily (more than 3 seconds) in the *STBY* mode before going to the next state. The *STBY* mode allows for an orderly software cleanup and allows a GPC to be correctly initialized (when reactivated) without an initial program load. If a GPC is moded to *RUN* or *HALT* without pausing in *STBY*, it may not perform its functions correctly. There is no *STBY* indication on the talkback indicator above the *MODE* switch.

The *RUN* position permits a GPC to support its normal processing of all active software and assigned vehicle operations. Whenever a computer is moded from *STBY* to *RUN*, it initializes itself to a state in which only system software is processed (called *OPS 0*). If a GPC is in another operational sequence (*OPS*) before being moded out of *RUN*, that software still resides in main memory; however, it will not begin processing until that *OPS* is restarted by flight crew keyboard entry. The *MODE* talkback indicator always reads *RUN* when that GPC switch is in *RUN*, and no failures exist.

Placing the backup flight system GPC in *STBY* does not stop *BFS* software processing or preclude *BFS* engagement; it only prevents the *BFS* from commanding the payload buses used by *BFS* systems management software.

The *PASS GPC/BUS STATUS* display (DISP 6) indicates the current mode of each *PASS GPC* in the common set. The display does not differentiate between *STBY* and *HALT*; only *RUN* or *HALT* is displayed (*GPC MODE*).

GPC		1	2	3	4	5
MODE	OPS	RUN	RUN	HALT	RUN	HALT
		G2	G2	0	S2	0
STRING	1 FF	*			↓	
	FA				↓	
	2 FF		*		↓	
	FA				↓	
	3 FF	*			↓	
	FA				↓	
	4 FF		*		↓	
	FA				↓	
PL	1	↓	↓		*	
	2	↓	↓		*	
LAUNCH	1	↓	↓		*	
	2	↓	↓		*	
CRT	1	*			↓	↓
	2		*		↓	↓
	3	↓	↓		↓	↓
	4	↓	↓		*	

GPC/BUS STATUS Display (DISP 6)

The INITIAL PROGRAM LOAD pushbutton for a GPC on panel O6 activates the initial program load command discrete input when depressed. When the input is received, that GPC initiates an initial program load (IPL) from the MMU specified by the IPL SOURCE switch on panel O6. The talkback indicator above the MODE switch for that GPC indicates IPL.

During non-critical periods in orbit, only one or two GPCs are used for GNC tasks, and another is used for systems management and payload operations.

A GPC on orbit can also be "freeze-dried"; that is, it can be loaded with the software for a particular memory configuration and then moded to HALT. Before an OPS transition to the loaded memory configuration, the freeze-dried GPC can be moded back to RUN and the appropriate OPS requested.

NOTE

Because all BFS software is loaded into the BFS GPC at the same time, the BFS GPC is sometimes referred to as being freeze-dried on orbit when it is placed in HALT. The BFS GPC can be moded to RUN prior to entry and will begin processing entry software following the OPS 3 request without having to access a mass memory unit. The term freeze-dry or freeze-dried is most often used with respect to the PASS GPCs.

GPC Modes of Operation

GPC modes of operation are redundant set, common set, and simplex. Redundant set operations refer to the mode in which two or more GPCs are concurrently receiving the same inputs, executing the same GNC software, and producing the same outputs. This mode uses a maximum amount of intercomputer communications, and the GPCs must maintain a high level of synchronization (called redundant set synchronization).

During redundant set operations, each GPC outputs only certain portions of its total software output to its interfacing hardware. Therefore, although each GPC "thinks" it is performing all its operations, only the GPC responsible for supporting a specific group of hardware will be able to actually transmit its data and commands. The redundant set GPCs compare all calculations to ensure that individual outputs are the same.

Common set operations occur when two or more GPCs communicate with one another while they are performing their individual tasks. They do not have to be performing the same major function (although they can be), but they do maintain common set synchronization. Any GPC operating as a member of the redundant set is also a member of the common set.

A simplex GPC is in RUN, but not a member of the redundant set. Systems management and payload major functions are always processed in a simplex GPC.

GPCs running together in the same GNC OPS are part of a redundant set performing identical tasks from the same inputs and producing identical outputs. Therefore, any data bus assigned to a commanding GNC GPC (except the instrumentation buses because each GPC has only one dedicated bus connected to it) is heard by all members of the redundant set. These transmissions include all keyboard inputs and mass memory transactions, as well as flight-critical data. If one or more GPCs in the redundant set fail, the remaining computers can continue operating in GNC. Each GPC performs about 1.2 million operations per second during critical phases.

Each computer in a redundant set operates in synchronized steps and cross-checks results of processing hundreds of times per second. Synchronization refers to the software scheme used to ensure simultaneous intercomputer communications of necessary GPC status information among the PASS computers. If a GPC operating in a redundant set fails to meet any redundant synchronization point, the remaining computers will immediately vote it out of the redundant set. If a GPC has a problem with one of its multiplexer interface adapter receivers during two successive reads of response data, or does not receive data while other members of the redundant set do receive data, the GPC with the problem will fail-to-sync. A failed GPC is either powered OFF or moded to HALT as soon as possible by the crew.

GPC Failure Indications

GPC failure votes are annunciated in a number of ways. Each GPC has discrete output lines for fail votes against each of the other GPCs that go to the other GPCs and the GPC status matrix. A GPC FAIL detection will cause a class 2 GPC fault message with illumination of the MASTER ALARM. Error indications may be displayed on DISP 18 GNC SYS SUMM 1 and DISP 6 GPC/BUS STATUS displays.

The GPC STATUS matrix (sometimes referred to as the GPC fail CAM) on panel O1 is a 5-by-5 matrix of lights. Each light corresponds to a GPC's fail vote against another GPC or itself. For example, if GPC 2 sends out a failure vote against GPC 3, the second white light in the third column is illuminated. The off-diagonal votes are votes against other GPCs. The yellow diagonal lights from upper left to lower right are self-failure votes. Whenever a GPC receives two or more failure votes from other GPCs, it illuminates its own yellow light and resets any failure votes that it made against other GPCs (any white lights in its row are extinguished). Any time a yellow matrix light is illuminated, the GPC caution and warning light on panel F7 is illuminated, in addition to MASTER ALARM illumination, and a GPC fault message is displayed on the CRT.

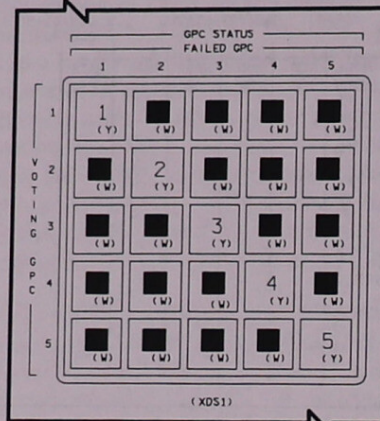

GPC STATUS Matrix on Panel O1
(W=white; Y=yellow)

2011/ /018 GNC SYS SUMM 1 1 000/02:46:03
000/00:00:00

RCS	JET	ISOL	POS	MCM	DPS	1	2	3	4	5
MENE	FAIL	VLV	SURF							
F1	OP	L OB			GPC					
2	OP	IB			MDM FF					
3	OP	R IB			FA					
4	OP	OB								
5	OP	AIL								
L1	OP	RUD			FCS CH	1	2	3	4	
2	OP	SPD BRK								
3	OP	BDY FLP								
4	OP									
5	OP									
R1	OP				NTLR	1	2	3		
2	OP				RHC L					
3	OP				R					
4	OP				A					
5	OP				THC L					
					A					
					SBTC L					
					R					

DPS Parameters on GNC SYS SUMM 11 Display (DISP 18)

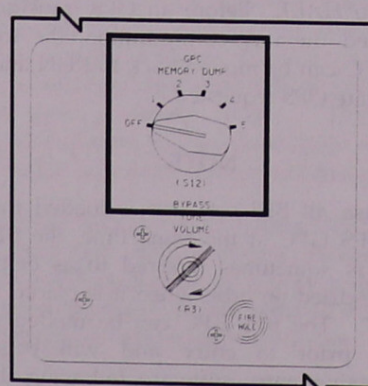

GPC MEMORY DUMP Switch on Panel M042F

A failed GPC's memory contents can be dumped by powering ON, switching the computer to *TERMINATE* and *HALT*, and then selecting the number of the failed GPC on the GPC MEMORY DUMP rotary switch on panel M042F. The GPC is then moded to *STBY* to start the dump. After 2 to 8 minutes, the dump is stopped by moding the GPC to *HALT* and the output to *NORM*. This process is referred to as a hardware-initiated, standalone memory (HISAM) GPC memory dump.

Data Bus Network

The data bus network supports the transfer of serial digital commands and data between the

GPCs and vehicle systems. The network is divided into seven groups that perform specific functions:

1. Flight-critical (FC) data buses that tie the GPCs to the flight-critical multiplexer/demultiplexers (MDMs), display driver units, head-up displays, engine interface units, and master events controllers
2. Payload data buses that tie the GPCs to the payload MDMs and the payload data interleaver (PDI), and possibly mission-dependent flex MDMs or sequence control assemblies

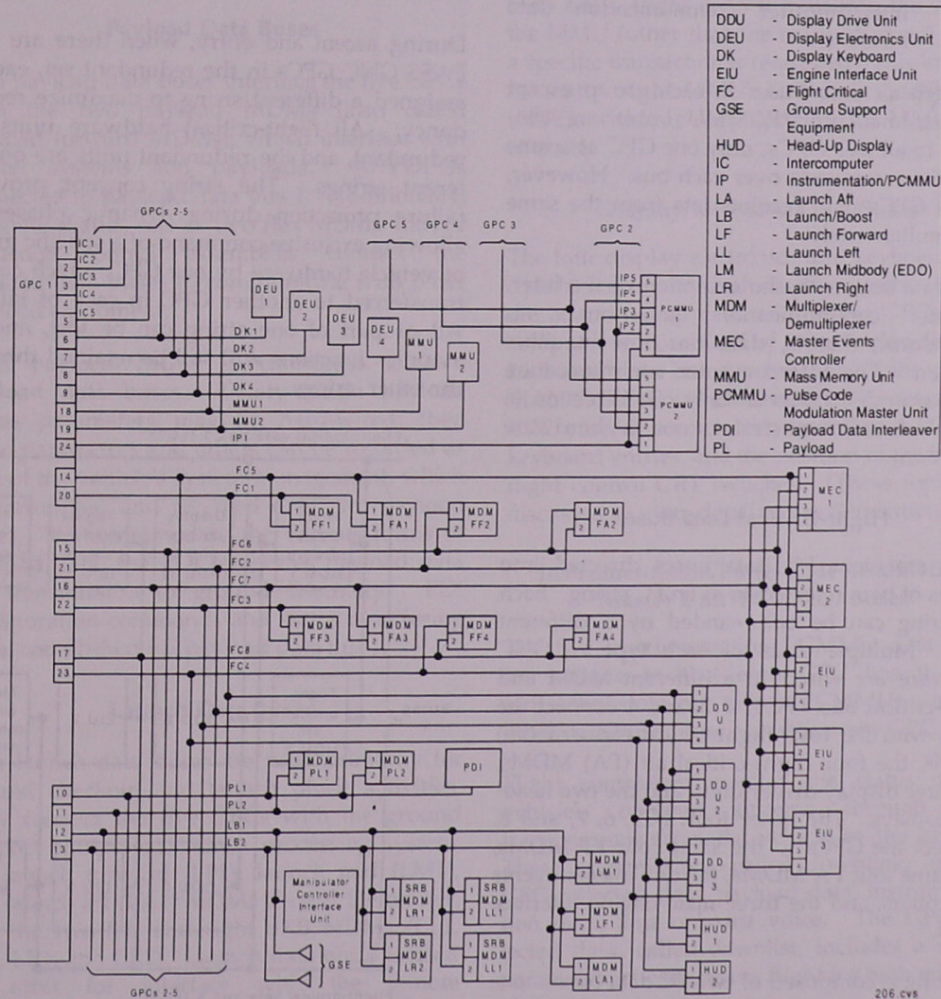

Data Bus Network

206.cvs

3. Launch data buses that tie the GPCs to ground support equipment, launch forward, launch aft, launch mid, and SRB MDMs, and the manipulator controller interface unit (MCIU) used by the remote manipulator system
4. Mass memory data buses for GPC/MMU transactions
5. Display/keyboard data buses for GPC/display electronics unit transactions
6. Instrumentation/pulse code modulation master unit (PCMMU) data buses
7. Intercomputer communication data buses.

Although all data buses in each group except the instrumentation/PCMMU buses are connected to all five GPCs, only one GPC at a time transmits commands over each bus. However, several GPCs may receive data from the same bus simultaneously.

Each data bus, with the exception of the intercomputer communication data buses, is bidirectional; that is, data can flow in either direction. The intercomputer communication data bus traffic flows in only one direction (a PASS software constraint, not a hardware restriction).

Flight-Critical Data Buses

There are eight FC data buses directed into groups of two, referred to as an FC string. Each FC string can be commanded by a different GPC. Multiple units of each type of GNC hardware are wired to a different MDM and flight-critical bus. FC1, 2, 3, and 4 connect the GPCs with the four flight-critical forward (FF) MDMs, the four flight-critical aft (FA) MDMs, the three display driver units, and the two head-up displays. The other four, FC5, 6, 7, and 8, connect the GPCs to the same four FF MDMs, the same four FA MDMs, the two master events controllers, and the three main engine interface units.

A string is composed of two FC data buses: one from the first group (FC1, 2, 3, or 4) and one from the second group (FC5, 6, 7, or 8). Vehicle

hardware is segmented into these groups to facilitate GPC command of these components for redundancy, to allow for nominal mission operations in the event of a loss of one string caused by a GPC or MDM failure, and to allow for safe return to Earth in the event of the loss of a second string.

String 1 consists of FC data buses 1 and 5, MDMs FF1 and FA1 and their hard-wired hardware, controls, and displays, the three engine interface units, the two master events controllers, the three display driver units, head-up display 1, and their associated displays. This distribution of hardware is fixed and cannot be changed. The other three strings are defined in a similar manner.

During ascent and entry, when there are four PASS GNC GPCs in the redundant set, each is assigned a different string to maximize redundancy. All flight-critical hardware units are redundant, and the redundant units are on different strings. The string concept provides failure protection during dynamic phases by allowing exclusive command of a specific group of vehicle hardware by one GPC, which can be transferred to another GPC in case of failure. All or part of one string can be lost, and all avionics functions will still be retained through the other strings.

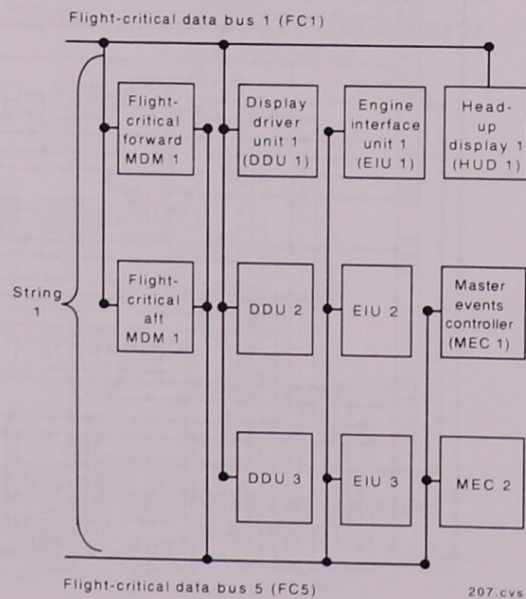

Components of String 1

With four PASS GNC GPCs in a redundant set, each GPC is responsible for issuing commands over the string assigned to it; that is, it is the commander of that string. The other GNC GPCs will monitor or listen on this string. When the string's commanding GPC sends a request for data to the hardware on the string, all the other GNC GPCs will hear and receive the same data coming back on the string. This transaction (one commanding GPC and multiple listening GPCs) is occurring in parallel with the other three strings. Therefore, all GNC GPCs will get a copy of all of the data from all four strings. Once all the data are received from the string, the GPCs then agree (or disagree) that the data are consistent.

Payload Data Buses

Two payload data buses interface the five GPCs with the two payload MDMs (also called payload forward MDMs), which interface with orbiter systems and payloads. A PDI is connected to payload data bus 1. Additionally, on some flights, one or two flex MDMs and/or sequence control assemblies connect the payload data buses to communicate with other payload equipment.

Each payload MDM is connected to two payload data buses. Safety-critical payload status parameters may be hard-wired; then these parameters and others can be recorded as part of the vehicle's system management, which is transmitted and received over two payload buses. To accommodate the various forms of payload data, the PDI integrates payload data for transmission to ground telemetry. PDI configuration commands and status monitoring are accomplished via payload data bus 1.

Launch Data Buses

Two launch data buses are used primarily for ground checkout and launch phase activities. They connect the five GPCs with the ground support equipment/launch processing system, the launch forward (LF1), launch mid (LM1), and launch aft (LA1) MDMs aboard the orbiter, and the two left and right SRB MDMs (LL1, LL2, LR1, and LR2). Launch data bus 1 is used on orbit for interface with the remote manipulator system controller by the SM GPC.

Mass Memory Data Buses

Each of two MMUs interfaces with its data bus via a multiplexer interface adapter, which functions just like the ones in the GPCs. Each data bus is connected to all five GPCs. Each MMU is connected to only one mass memory data bus.

In addition, each MMU has a separate discrete line called the "ready discrete" that goes to each of the GPCs. If the discrete is on, it tells the GPC the mass memory unit is ready for a transaction. When the discrete is off, the MMU is either busy with another transaction or is powered off.

Note that all MMU operations and transmissions to the GPCs are on an on-demand basis only. There is no insight into the state of the MMU (other than the ready discrete) unless a specific transaction is requested. This includes the status of the MMU's built-in test equipment (BITE), which is only updated for MMU read or write.

Display/Keyboard Data Buses

The four display electronics unit keyboard (DK) data buses, one for each display electronics unit, are connected to each of the five GPCs. The computer in command of a particular display/keyboard data bus is a function of the current *MAJOR FUNC* switch setting of the associated CRT, current memory configuration, GPC/CRT keyboard entries, and the position of the backup flight control CRT switches. (These topics are discussed in more detail under "Operations.")

Instrumentation/Pulse-Code Modulation Master Unit (PCMMU) Buses

The five instrumentation/PCMMU data buses are unique in that each GPC has its own individual data bus to two PCMMUs. All the other data buses interface with every GPC.

Flight controllers monitor the status of the vehicle's onboard systems through data transmissions from the vehicle to the ground. These transmissions, called downlink, include GPC-collected data, payload data, instrumentation data, and onboard voice. The GPC-collected data, called downlist, includes a set of parameters chosen before flight for each mission phase.

The system software in each GPC assimilates the specified GNC, systems management, payload, or DPS data according to the permission-defined format for inclusion in the downlist. Each GPC is physically capable of transmitting its downlist to the current active PCMMU over its dedicated instrumentation/PCMMU data bus. Only one PCMMU is powered at a time. It interleaves the downlist data from the different GPCs with the instrumentation and payload data according to the telemetry format load programmed in the PCMMU. The resulting composite data set, called the operational downlink, is transmitted to one of two network signal processors (NSPs). Only one NSP is powered at a time. In the NSP, the operational downlink is combined with onboard recorded voice for transmission to the ground. The S-band and Ku-band communications systems transmit the data either to the space flight tracking and data network remote site ground stations or through the Tracking and Data Relay Satellite (TDRS) system to Mission Control.

Uplink is the method by which ground commands originating in Mission Control are formatted, generated, and transmitted to the orbiter for validation, processing, and eventual execution by onboard software. This capability allows ground systems to control data processing, change modes in orbiter hardware, and store or change software in GPC memory and mass memory.

From Mission Control consoles, flight controllers issue commands and request uplink. The command requests are formatted into a command load for transmission to the orbiter either by the STDN sites or by the TDRS system. The S-band or Ku-band transponder receivers aboard the orbiter send the commands to the active NSP. The NSP validates the commands and, when they are requested by the GPCs through a flight-critical MDM, sends them on to the GPC. The GPCs also validate the commands before executing them. Those GPCs listening directly to the flight-critical data buses then forward uplink commands for those GPCs not listening to the FC buses over the intercomputer communication data buses.

The PCMMU also contains a programmable read-only memory for accessing subsystem data, a random-access memory in which to store

data, and a memory in which GPC data are stored for incorporation into the downlink.

To prevent the uplink of spurious commands from somewhere other than Mission Control, the flight crew can control when the GPCs accept uplink commands, and when uplink is blocked. The *GPC BLOCK* position of the *UPLINK* switch on panel C3 inhibits uplink commands during ascent and entry when the orbiter is not over a ground station or in TDRS coverage.

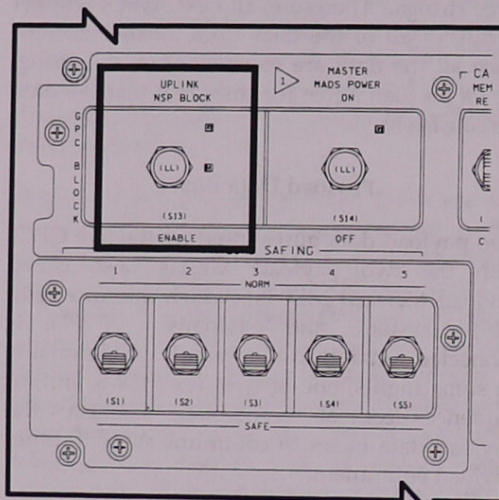

UPLINK Switch on Panel C3

Intercomputer Communication Data Buses

There are five intercomputer communication (ICC) data buses. The following information is exchanged over these buses for proper DPS operation: input/output errors, fault messages, GPC status matrix data, display electronics unit major function switch settings, GPC/CRT keyboard entries, resident GPC memory configuration, memory configuration table, operational sequences, master timing unit time, internal GPC time, system-level display information, uplink data, and state vectors.

All GPCs processing PASS software exchange status information over the ICC data buses. During launch, ascent, and entry, GPCs 1, 2, 3, and 4 are usually assigned to perform GNC tasks, operating as a redundant set, with GPC 5 as the backup flight system. Each of the PASS GPCs acts as a commander of a given ICC data bus and initiates all data bus transactions on that data bus.

The four PASS GPCs are loaded with the same software. Interconnecting the four ICC buses to the four PASS GPCs allows each GPC access to the status of data received or transmitted by the other GPCs so that identical results among the four PASS GPCs can be verified. Each ICC bus is assigned to one of the four PASS GPCs in the command mode, and the remaining GPCs operate in the listen mode for the bus. Each GPC can receive data from the other three GPCs, pass data to the others, and perform any other tasks required to operate the redundant set.

Multiplexers/Demultiplexers (MDMs)

The MDMs convert and format (demultiplex) serial digital GPC commands into separate parallel discrete, digital, and analog commands for various vehicle hardware systems. The MDMs also convert and format (multiplex) the discrete, digital, and analog data from vehicle systems into serial digital data for transmission to the GPCs. Each MDM has two redundant multiplexer interface adapters (MIAs), each connected to a separate data bus. The MDM's other functional interface is its connection to the appropriate vehicle system hardware by hard-wired lines.

There are 20 MDMs aboard the orbiter; 13 are part of the DPS, connected directly to the GPCs and named and numbered according to their location in the vehicle and hardware interface. The remaining seven MDMs are part of the vehicle instrumentation system and send vehicle instrumentation data to the PCMMUs. (They are termed operational instrumentation (OI) MDMs.)

The DPS MDMs consist of flight-critical forward (FF) MDMs 1 through 4, flight-critical aft (FA) MDMs 1 through 4, payload (PL) MDMs 1 and 2, and GSE/LPS launch forward (LF1), launch mid (LM1), and launch aft (LA1). One or two flex MDMs (FMDMs) may also be connected to the PL data buses, depending on the payload needs for a particular flight.

Of the seven operational instrumentation MDMs, four are located forward (OF1, OF2, OF3, and OF4), and three are located aft (OA1, OA2, and OA3).

Also recall, there are four SRB MDMs; i.e., SRB launch left (LL) MDMs 1 and 2 and launch right (LR) MDMs 1 and 2.

The system software in the redundant set GPC activates a GNC executive program and issues commands to authorized buses and MDMs to request a set of input data. Each MDM receives the command from the GPC assigned to command it, acquires the requested data from the GNC hardware wired to it, and sends the data to the GPCs.

Each FC data bus is connected to a flight forward and flight aft MDM. Each MDM has two MIAs, or ports, and each port has a channel through which the GPCs can communicate with an MDM; however, the GPCs can interface on the FC data buses with only one MIA port at a time. Port moding is the software method used to control the MIA port that is active in an MDM. Initially, these MDMs operate with port 1; if a failure occurs in port 1, the flight crew can select port 2. Since port moding involves a pair of buses, both MDMs must be port moded at the same time. The control of all other units connected to the affected data buses is unaffected by port moding. Port moding is a software-only process and does not involve any hardware changes.

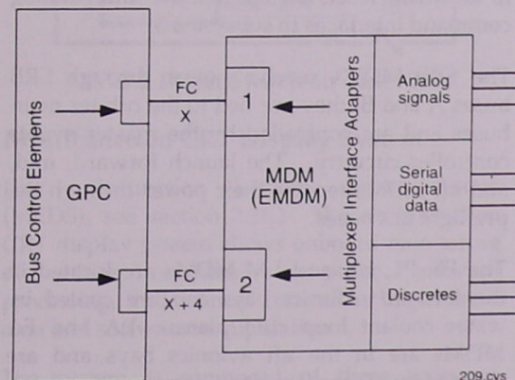

GPC/MDM Interfaces

Payload data bus 1 is connected to the primary MIA port of payload MDM 1, and payload data bus 2 is connected to the primary port of payload MDM 2. Payload data bus 1 is connected to the secondary MIA port of payload

MDM 2, and payload data bus 2 is connected to the secondary port of payload MDM 1. Which bus is used to communicate with each MDM is controlled by port moding.

The two launch data buses are also connected to dual launch MDM multiplexer interface adapter ports. The flight crew cannot switch these ports; however, if an input/output error is detected on LF1 or LA1 during prelaunch, an automatic switchover occurs.

The hardware controls for the MDMs are the *MDM PL1, PL2, PL3, FLT CRIT AFT*, and *FLT CRIT FWD* power switches on panel O6. These *ON/OFF* switches provide or remove power for the four aft and four forward flight-critical MDMs and PL1 and PL2 MDMs. The *PL3* switch is unwired and is not used. There are no flight crew controls for the SRB MDMs.

Each MDM is redundantly powered by two main buses. The power switches control bus power for activation of a remote power controller (RPC) for each main power bus to an MDM. The main buses power separate power supplies in the MDM. Loss of either the main bus or MDM power supply does not cause a loss of function because each power supply powers both channels in the MDM. Turning off power to an MDM resets all the discrete and analog command interfaces to subsystems.

The SRB MDMs receive power through SRB buses A and B; they are tied to the orbiter main buses and are controlled by the master events controller circuitry. The launch forward, mid, and aft MDMs receive their power through the preflight test buses.

The FF, PL, LF, and LM MDMs are located in the forward avionics bays and are cooled by water coolant loop cold plates. LA and FA MDMs are in the aft avionics bays and are cooled by Freon coolant loop cold plates. MDMs LL1, LL2, LR1, and LR2 are located in the SRBs and are cooled by passive cold plates.

Module (or card) configuration in an MDM was dictated by the hardware components to be accessed by that type of MDM. A flight-critical forward and aft MDM are not interchangeable. However, flight-critical MDMs of the same type may be interchanged with another and the payload MDMs may be interchanged.

Each MDM is 13 by 11 by 7 inches and weighs about 38.5 pounds. MDMs use less than 80 watts of power.

Enhanced MDMs (EMDMs) were installed in OV-105. EMDMs will be installed in the other vehicles only as MDMs require replacement (currently both types are on Columbia and Atlantis). The presence of EMDMs is transparent to the crew except in the case of an MDM OUTPUT message. With MDMs, the message means there is a problem with an MDM or a GPC. An MDM OUTPUT message with EMDMs means it is most likely a GPC problem. Crews flying with a combination of MDMs and EMDMs will receive assistance from flight controllers in interpreting an MDM OUTPUT message.

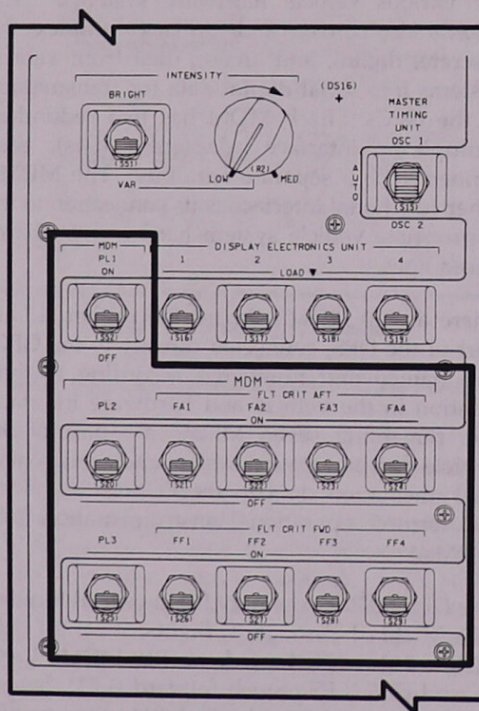

MDM Power Switches on Panel O6

Mass Memory Units

There are two mass memory units (MMUs) aboard the orbiter. Each is a coaxially mounted, reel-to-reel read/write digital magnetic tape storage device for GPC software and orbiter systems data.

Computing functions for all mission phases requires approximately 600,000 half-words of computer memory. The orbiter GPCs are loaded with different memory configurations from the MMUs. In this way, software can be stored in MMUs and loaded into the GPCs when actually needed.

To fit the required software into the available GPC memory space, programs are subdivided into eight memory configurations corresponding to functions executed during specific flight and checkout phases. Thus, in addition to the central memory in the GPCs themselves, 34 million bytes of information can be stored in each of the two MMUs. Critical programs and data are loaded in both MMUs and protected from erasure.

The principal function of the MMU, besides storing the basic flight software, is to store background formats and code for certain CRT displays and the checkpoints that are written periodically to save selected data in case the systems management GPC fails.

Operations are controlled by logic and the read and write electronics that activate the proper tape heads (read or write/erase) and validate the data.

Each MMU interfaces with its mass memory data bus through MIAs that function like the ones in the GPCs. Each mass memory data bus is connected to all five computers; however, each MMU is connected to only one mass memory data bus. All MMU operations are on an on-demand basis only.

The power switches are located on panel O14 for MMU 1 and panel O15 for MMU 2. The *MMU 1* switch on panel O14 positioned to ON allows control bus power to activate an RPC, which allows MNA power to MMU 1. The *MMU 2* switch on panel O15 positioned to ON operates in a similar manner with MNB power. An MMU uses 20 watts of power in standby and 70 watts when the tape is moving.

MMU 1 is located in crew compartment middeck avionics bay 1 and MMU 2 is in avionics bay 2. Each unit is cooled by water coolant loop cold plates. Each MMU is 7.6 inches high, 11.6 inches wide, 15 inches long and weighs 25 pounds.

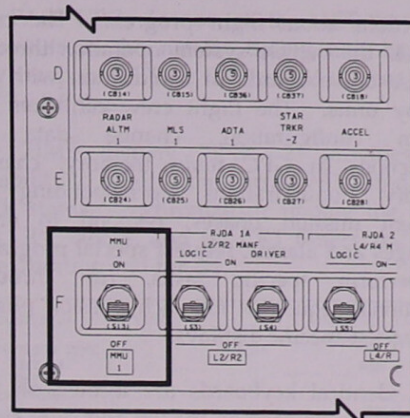

MMU 1 Power Switch on Panel O14

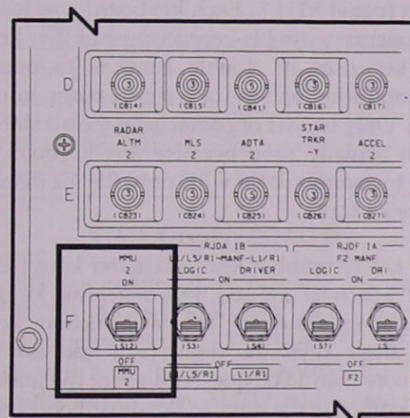

MMU 2 Power Switch on Panel O15

Multifunction CRT Display System

(For multifunction electronic display system (MEDS), see section 2.18.) The multifunction CRT display system allows onboard monitoring of orbiter systems, computer software processing, and manual control for flight crew data and software manipulation.

The system is composed of three types of hardware: four display electronics units (DEUs), four display units (DUs) or CRTs, and three keyboard units, which together communicate with the GPCs over the display/keyboard data buses.

The system provides almost immediate response to flight crew inquiries through displays, graphs, trajectory plots, and

predictions about flight progress. The crew controls the vehicle system operation through the use of keyboards in conjunction with the display units. The flight crew can alter the system configuration, change data or instructions in GPC main memory, change memory configurations corresponding to different mission phases, respond to error messages and alarms, request special programs to perform specific tasks, run through operational sequences for each mission phase, and request specific displays.

Three identical keyboards are located on the flight deck: one each on the left and right sides of the flight deck center console (panel C2) and one on the flight deck at the side aft flight station (panel R11L). Each keyboard consists of 32 momentary double-contact pushbutton keys. Each key uses its double contacts to permit communication on separate signal paths to two DEUs. Only one set of contacts on the aft station keys is actually used because this keyboard is wired to communicate with only the aft display electronics unit.

There are 10 number keys, six letter keys (used for hexadecimal inputs), two algebraic keys, a decimal key, and 13 special function keys. Using these keys, the flight crew can ask the GPC more than 1,000 questions about the mission and condition of the vehicle. (Keyboard operations are discussed in detail later in this section.)

Each of the four DEUs responds to computer commands, transmits data, executes its own software to process keyboard inputs, and sends signals to drive displays on the CRTs (or display units). The units store display data, generate the GPC/keyboard unit and GPC/display unit interface displays, update and refresh on-screen data, check keyboard entry errors, and echo keyboard entries to the CRT.

There are three CRTs on flight deck forward display and control panel F7 and one at the side aft flight deck station on panel R11L. Each CRT is 5 by 7 inches.

The display unit uses a magnetic-deflected, electrostatic-focused CRT. When supplied with deflection signals and video input, the CRT displays alphanumeric characters, graphic symbols, and vectors on a green monochrome

phosphorous screen activated by a magnetically controlled beam. Each CRT has a brightness control for ambient light and flight crew adjustment.

The DEUs are connected to the display/keyboard data buses by MIAs that function like those of the GPCs. Inputs to the DEU are from a keyboard or a GPC.

Positioning the *DISPLAY ELECTRONICS UNIT* 1, 2, 3, 4 switches on panel O6 to LOAD initiates a GPC request for a copy of DEU software stored in mass memory before operations begin. If the GPC software in control of the CRT is designed to support a DEU load (or IPL) request, then information is sent from the mass memory to the GPC and then loaded from the GPC into the DEU memory.

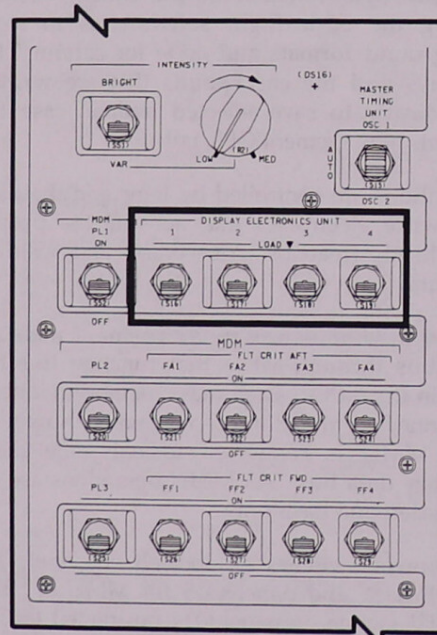

DISPLAY ELECTRONICS UNIT
Switches on Panel O6

It is possible to do in-flight maintenance and exchange CRT 4 with CRT 1 or 2. CRT 3 cannot be changed out because of interface problems with the orbiter jettison T-handle. Also, either individual keys or the entire forward keyboard can be replaced by the aft keyboard. The DEUs are located behind panels on the flight deck. DEUs 1 and 3 are on the left, and DEUs 2 and 4 are on the right. DEU 4 can replace any of the

others; however, if DEU 2 is to be replaced, only the cables are changed because 2 and 4 are next to each other.

The display electronics units and display units are cooled by the cabin fan system. The keyboard units are cooled by passive heat dissipation.

Master Timing Unit

The GPC complex requires a stable, accurate time source because its software uses Greenwich mean time (GMT) to schedule processing. Each GPC uses the master timing unit (MTU) to update its internal clock. The MTU provides precise frequency outputs for various timing and synchronization purposes to the GPC complex and many other orbiter subsystems. Its three time accumulators provide GMT and mission elapsed time (MET), which can be updated by external control. The accumulator's timing is in days, hours, minutes, seconds, and milliseconds up to 1 year.

The MTU is a stable, crystal-controlled frequency source that uses two oscillators for redundancy. The signals from one of the two oscillators are passed through signal shapers and frequency drivers to the three GMT/MET accumulators.

The MTU outputs serial digital time data (GMT/MET) on demand to the GPCs through the accumulators. The GPCs use this information for reference time and indirectly for time-tagging GNC and systems management processing. The MTU also provides continuous digital timing outputs to drive the four digital timers in the crew compartment: two mission timers and two event timers. In addition, the MTU provides signals to the PCMMUs, COMSECs, payload signal processor, and FM signal processor, as well as various payloads.

The GPCs start by using MTU accumulator 1 as their time source. Once each second, each GPC checks the accumulator time against its own internal time. If the time is within tolerance (less than one millisecond), the GPC updates its internal clock to the time of the accumulator, which is more accurate, and continues. However, if the time is out of tolerance, the GPC will try the other accumulators and then the lowest numbered GPC until it finds a successful comparison.

The PASS GPCs do not use the MET that they receive from the master timing unit because they compute MET on the basis of current GMT and lift-off time.

The TIME display (SPEC 2) provides the capability to observe the current MTU and GPC clock status, synchronize or update the MTU and GPC clocks, and set CRT timers and alert tone duration and timers.

1061/002/ TIME 1 008/12:12:12
000/00:25:12

MISSION TIME TONE
GMT 1* 3 : : : MSN T
MET 2 6 : : : : :
CRT TIMER
9 SET [] : : : 20 [] : : : CRT T
START 12 : : : STOP 13 : : :
14 START AT : : : MSN T 23 DURATION
17 COUNT TO : : : MSN T

MTU
24 GMT Δ [] / : : : : :
28 MET Δ [] / : : : : :
UPDATE 32 MET RESET 33

GPC TIME GMT TRY GPC
MTU ACCUM 1 008/12:12:12.000 34 2 AI
2 008/12:12:12.000 35 3 AI
3 008/12:12:12.000 36 4 AI
GPC 008/12:12:12.000 37 5 AI

TIME SYNC 38

214

TIME Display (SPEC 2)

The MTU is redundantly powered by the ESS 1BC MTU A and ESS 2CA MTU B circuit breakers on panel O13. The MASTER TIMING UNIT switch on panel O6 controls the MTU. When the switch is in AUTO, and a time signal from one oscillator is out of tolerance, the MTU automatically switches to the other oscillator. For nominal operations, the MTU is using oscillator 2 with the switch in AUTO. The OSC 1 or OSC 2 position of the switch manually selects oscillator 1 or 2, respectively.

The MTU is located in crew compartment middeck avionics bay 3B and is cooled by a water coolant loop cold plate. The hardware displays associated with the master timing unit are the mission and event timers. MISSION TIME displays are located on panels O3 and A4. They can display either GMT or MET in response to the GMT or MET positions of the switch below the displays. The forward EVENT TIME display is on panel F7, and it is controlled by the EVENT TIME switches on panel C2. The aft EVENT TIME display is on panel A4, and its EVENT TIME control switches are on panel A6U.

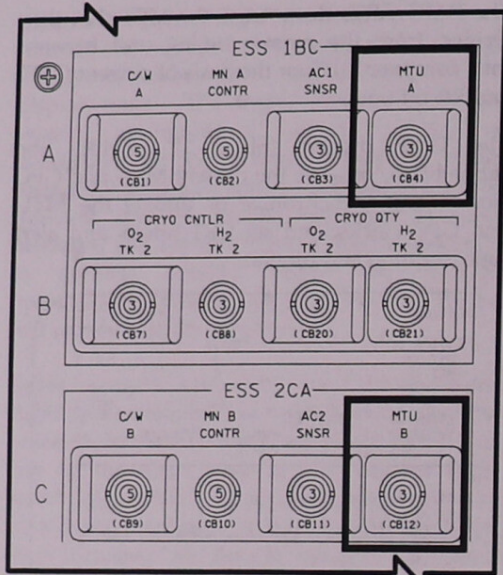

ESS 1BC MTU A and ESS 2CA MTU B Circuit Breakers on Panel O13

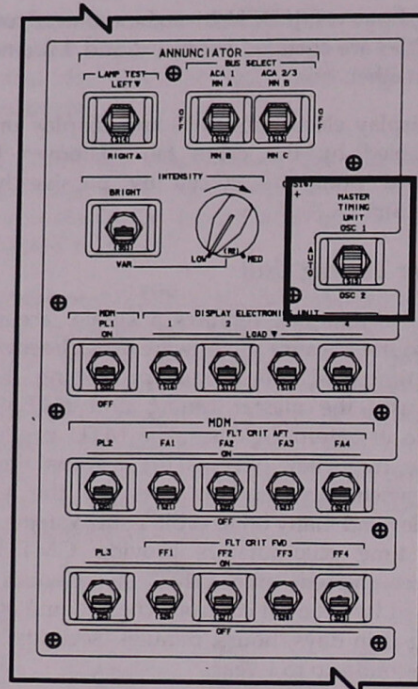

MASTER TIMING UNIT Switch on Panel O6

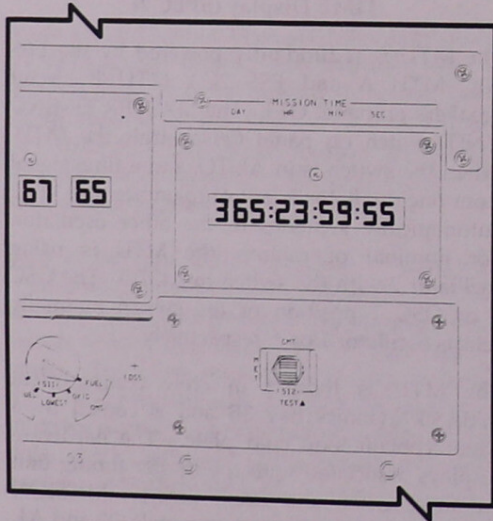

MISSION TIME Display and Switch on Panel O3

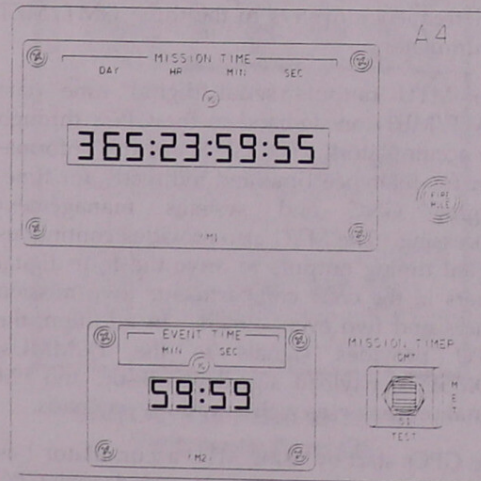

MISSION TIME and EVENT TIME Displays and MISSION TIMER Switch on Panel A4

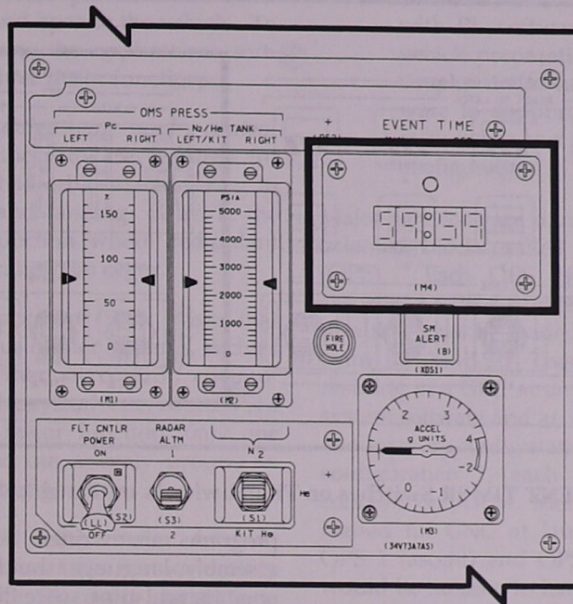

EVENT TIME Display on Panel F7

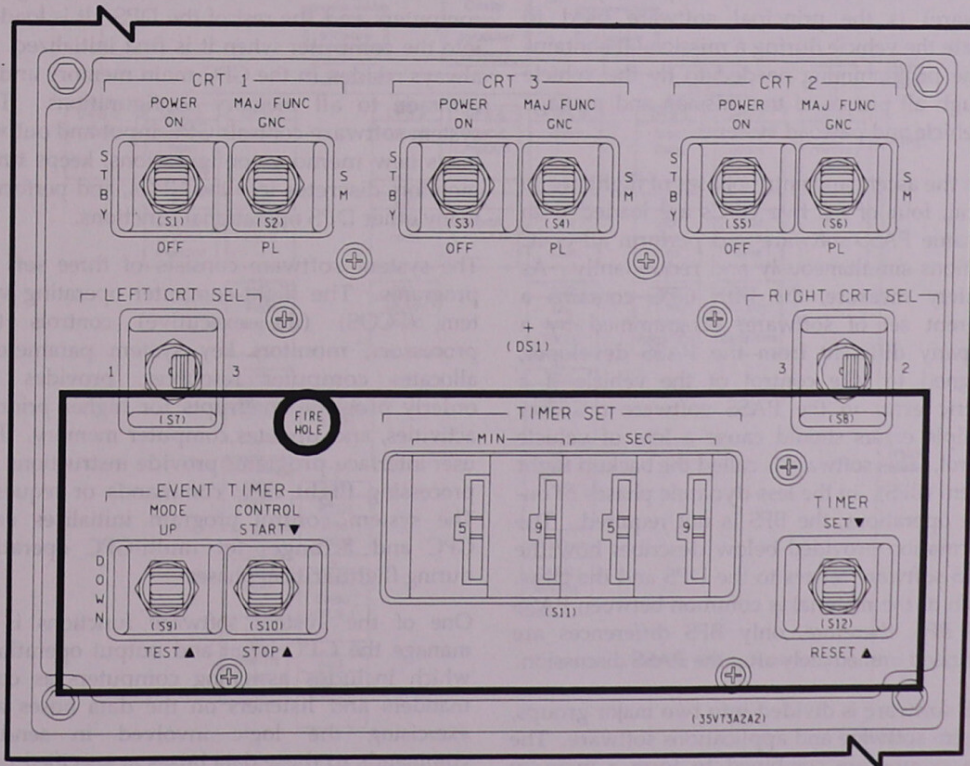

EVENT TIMER Switches and TIMER SET Thumbwheels on Panel C2

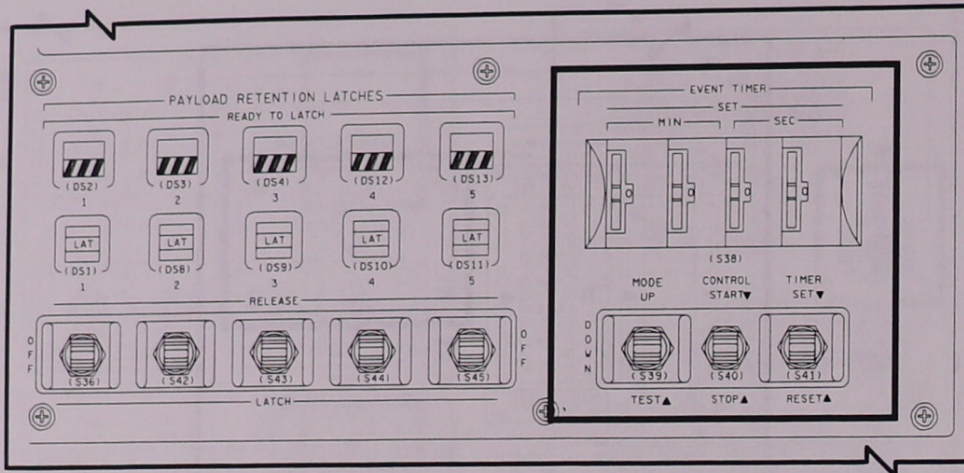

EVENT TIMER Switches on Thumbwheels on Panel A6U

Software

Primary Avionics Software System (PASS)

The PASS (also referred to as primary flight software) is the principal software used to operate the vehicle during a mission. It contains all the programming needed to fly the vehicle through all phases of the mission and manage all vehicle and payload systems.

Since the ascent and entry phases of flight are so critical, four of the five GPCs are loaded with the same PASS software and perform all GNC functions simultaneously and redundantly. As a safety measure, the fifth GPC contains a different set of software, programmed by a company different from the PASS developer, designed to take control of the vehicle if a generic error in the PASS software or other multiple errors should cause a loss of vehicle control. This software is called the backup flight system (BFS). In the less dynamic phases of on-orbit operations, the BFS is not required. The information provided below describes how the PASS software relates to the DPS and the crew. Much of the material is common between PASS and BFS; therefore, only BFS differences are discussed immediately after the PASS discussion.

DPS software is divided into two major groups, system software and applications software. The two groups are combined to form a memory configuration for a specific mission phase. The

programs are written in HAL/S (high-order assembly language/shuttle) specifically developed for real-time space flight applications.

System software is the GPC operating system software that controls the interfaces among the computers and the rest of the DPS. It is loaded into the computer when it is first initialized. It always resides in the GPC main memory and is common to all memory configurations. The system software controls GPC input and output, loads new memory configurations, keeps time, monitors discretes into the GPCs, and performs many other DPS operational functions.

The system software consists of three sets of programs. The flight computer operating system (FCOS) (the executive) controls the processors, monitors key system parameters, allocates computer resources, provides for orderly program interrupts for higher priority activities, and updates computer memory. The user interface programs provide instructions for processing flight crew commands or requests. The system control program initializes each GPC and arranges for multi-GPC operation during flight-critical phases.

One of the system software functions is to manage the GPC input and output operations, which includes assigning computers as commanders and listeners on the data buses and exercising the logic involved in sending commands to these data buses at specified rates and upon request from the applications software.

The applications software performs the functions required to fly and operate the vehicle. To conserve main memory, the applications software is divided into three major functions:

- **Guidance, navigation, and control (GNC):** specific software required for launch, ascent to orbit, maneuvering in orbit, entry, and landing. This is the only major function where redundant set synchronization can occur.
- **Systems management (SM):** tasks that monitor various orbiter systems, such as life support, thermal control, communications, and payload operations. SM is a simplex major function; only one GPC at a time can actively process an SM memory configuration.
- **Payload (PL):** this major function currently contains mass memory utility software. The PL major function is usually *unsupported* in flight, which

means that none of the GPCs are loaded with PL software. It is only used in vehicle preparation at KSC, and is also a simplex major function. Note that software to support payload operations is included as part of the SM GPC memory configuration.

Major functions are divided into mission phase oriented blocks called operational sequences (OPS). Each OPS of a major function is associated with a particular memory configuration that must be loaded separately into a GPC from the MMUs. Therefore, all the software residing in a GPC at any given time consists of system software and an OPS major function; i.e., one memory configuration. Except for memory configuration 1, each memory configuration contains one OPS. Memory configuration 1 is loaded for GNC at launch and contains both OPS 1 (ascent) and OPS 6 (RTLS), since there would be no time to load in new software for a return to launch site (RTLS) abort.

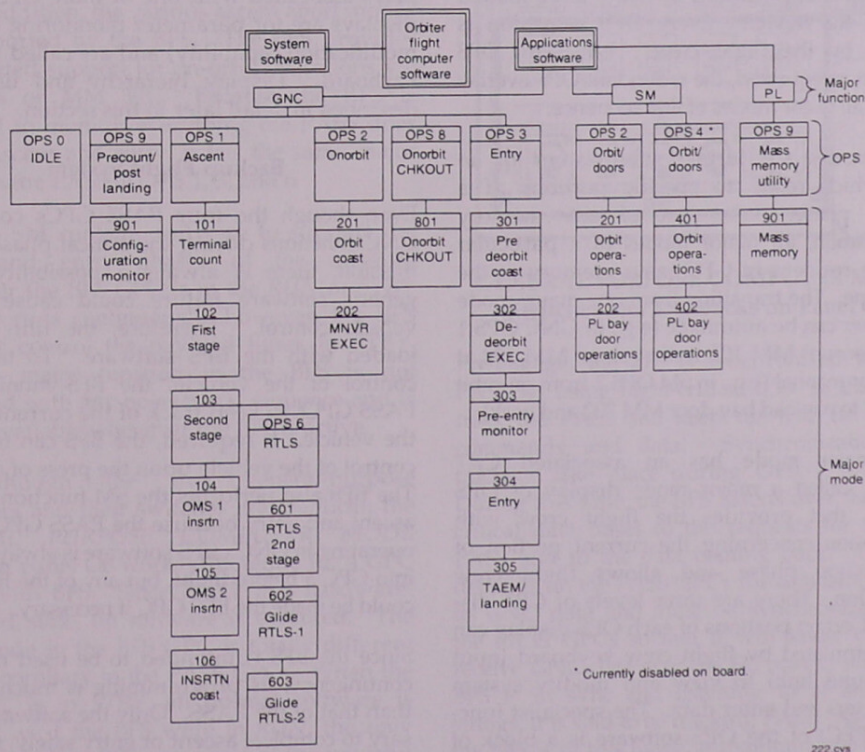

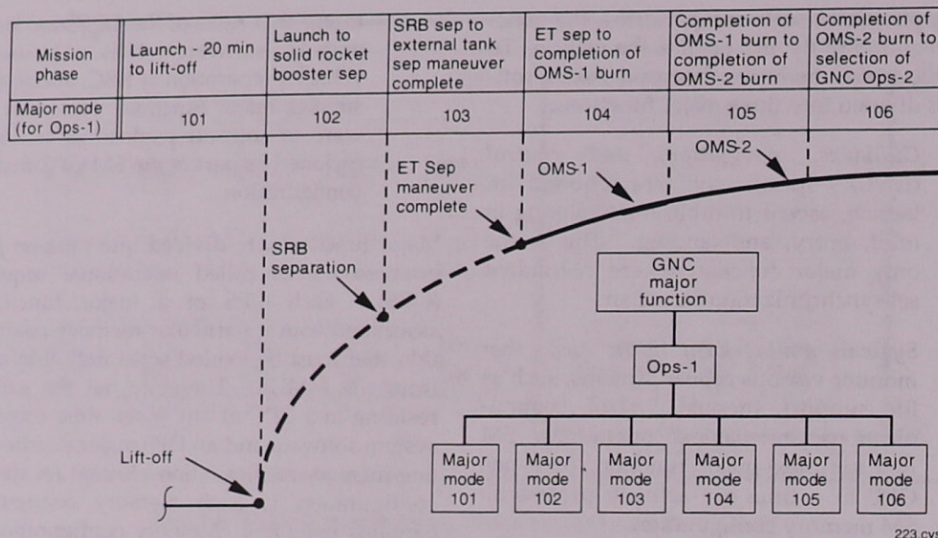

Major Modes

During the transition from one OPS to another, called an OPS transition, the flight crew requests a new set of applications software to be loaded in from the MMU. Every OPS transition is initiated by the flight crew. When an OPS transition is requested, the redundant OPS overlay contains all major modes of that sequence.

Major modes are further subdivisions of an OPS, which relate to specific portions of a mission phase. As part of one memory configuration, all major modes of a particular OPS are resident in GPC main memory at the same time. The transition from one major mode to another can be automatic (e.g., in GNC OPS 1 from precount MM 101 to first stage MM 102 at lift-off) or manual (e.g., in SM OPS 2 from on-orbit MM 201 to payload bay door MM 202 and back).

Each major mode has an associated CRT display, called a major mode display or OPS display, that provides the flight crew with information concerning the current portion of the mission phase and allows flight crew interaction. There are three levels of CRT displays. Certain portions of each OPS display can be manipulated by flight crew keyboard input (or ground link) to view and modify system parameters and enter data. The specialist function (SPEC) of the OPS software is a block of displays associated with one or more operational sequences and enabled by the flight crew to monitor and modify system parameters

through keyboard entries. The display function (DISP) of the OPS software is a group of displays associated with one or more OPS. These displays are for parameter monitoring only (no modification capability) and are called from the keyboard. Display hierarchy and usage are described in detail later in this section.

Backup Flight System

Even though the four PASS GPCs control all GNC functions during the critical phases of the mission, there is always a possibility that a generic software failure could cause loss of vehicle control. Therefore, the fifth GPC is loaded with the BFS software. To take over control of the vehicle, the BFS monitors the PASS GPCs to keep track of the current state of the vehicle. If required, the BFS can take over control of the vehicle upon the press of a button. The BFS also performs the SM functions during ascent and entry because the PASS GPCs are all operating in GNC. BFS software is always loaded into GPC 5 before flight, but any of the five GPCs could be made the BFS GPC if necessary.

Since the BFS is intended to be used only in a contingency, its programming is much simpler than that of the PASS. Only the software necessary to complete ascent or entry safely, maintain vehicle control in orbit, and perform SM functions during ascent and entry is included. Thus, all the software used by the BFS can fit

into one GPC and never needs to access mass memory. For added protection, the BFS software is loaded into the MMUs in case of a BFS GPC failure and the need to IPL a new BFS GPC.

The BFS, like PASS, consists of system software and applications software. System software in the BFS performs basically the same functions as it does in PASS. These functions include time management, PASS/BFS interface, multifunction CRT display system, input and output, uplink and downlink, and engage and disengage control. The system software is always operating when the BFS GPC is not in *HALT*.

Applications software in the BFS has two different major functions, GNC and systems management, but all its applications software resides in main memory at one time, and the BFS can process software in both major functions simultaneously. The GNC functions of the BFS, designed as a backup capability, support the ascent phase beginning at MM 101 and the deorbit/entry phase beginning at MM 301. In addition, the various ascent abort modes are supported by the BFS. The BFS provides only limited support for on-orbit operations via MM 106 or MM 301. Because the BFS is designed to monitor everything the PASS does during ascent and entry, it has the same major modes as the PASS in OPS 1, 3, and 6.

The BFS SM contains software to support the ascent and entry phases of the mission. Whenever the BFS GPC is in the *RUN* or *STBY* mode, it runs continuously; however, the BFS does not control the payload buses in *STBY*. The SM major function in the BFS is not associated with any operational sequence and is always available whenever the BFS is active.

Even though the five general-purpose computers and their switches are identical, the *GENERAL PURPOSE COMPUTER MODE* switch on panel O6 works differently for a GPC loaded with BFS. Since *HALT* is a hardware-controlled state, no software is executed. The *STBY* mode in the BFS GPC is totally different from its corollary in the PASS GPCs. When the BFS GPC is in *STBY*, all normal software is executed as if the BFS were in *RUN*; the only difference is that BFS command of the payload data buses is inhibited in *STBY*. The BFS is normally put in *RUN* for ascent and entry, and in

STBY whenever a *PASS* systems management GPC is operating. If the BFS is engaged while the *MODE* switch is in *STBY* or *RUN*, the BFS takes control of the flight-critical and payload data buses. The *MODE* talkback indicator on panel O6 indicates *RUN* if the BFS GPC is in *RUN* or *STBY* and displays barberpole if the BFS is in *HALT* or has failed.

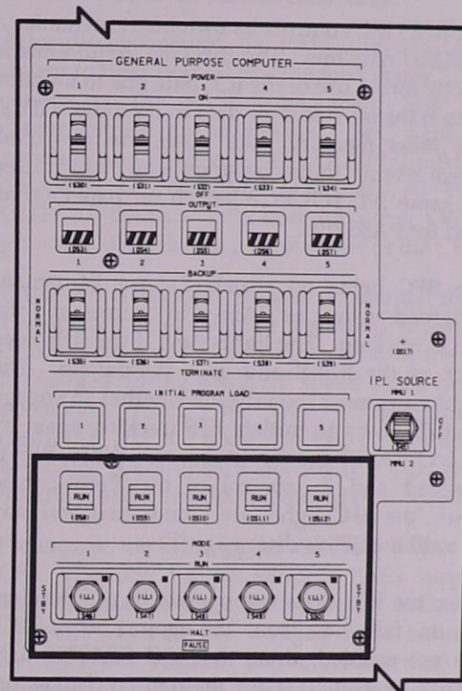

GENERAL PURPOSE COMPUTER MODE
Switches and Talkbacks on Panel O6

Pre-engage, the BFS is synchronized with the *PASS* set using flight-critical I/O so that it can track the *PASS* and keep up with its flow of commands and data. Synchronization and tracking take place during OPS 1, 3, and 6. During this time, the BFS listens over the flight-critical data buses to the requests for data by *PASS* and to the data coming back. The BFS depends on the *PASS* GPCs for acquisition of all its GNC data and must be synchronized with the *PASS* GPCs so that it will know when to receive GNC data over the FC buses. When the BFS is in sync and listening to at least two strings, it is said to be tracking *PASS*. As long as the BFS is in this mode, it maintains the current state vector and all other information necessary to fly the vehicle in case the flight crew needs to

engage it. When the BFS GPC is tracking the PASS GPCs, it cannot command over the FC buses but may listen to FC inputs through the listen mode. The BFS uses the MTU (like PASS) and keeps track of GMT over the flight-critical buses for synchronization. The BFS also monitors some inputs to PASS CRTs and updates its own GNC parameters accordingly.

The BFS GPC controls its own instrumentation/PCMMU data bus. The BFS GPC requirements strictly forbid use of the ICC data bus to monitor or to transmit status or data to the other GPCs. The mass memory data buses are not used except during initial program load, which uses the same IPL SOURCE switch on panel O6 as used for PASS IPL.

The BFC lights on panels F2 and F4 remain unlighted as long as PASS is in control, and the BFS is tracking. The lights flash if the BFS loses track of the PASS and goes standalone. The flight crew must then decide whether to engage the BFS or try to initiate BFS tracking again by an I/O RESET on the keyboard. When BFS is engaged and in control of the flight-critical buses, the BFC lights are illuminated and stay on until the BFS is disengaged.

Since the BFS does not operate in a redundant set, its fail votes from and against other GPCs are not enabled; thus, the GPC STATUS light matrix on panel O1 for the BFS GPC does not function as it does in PASS. The BFS can illuminate its own light on the GPC STATUS matrix if the watchdog timer in the BFS GPC times out when the BFS GPC does not complete its cyclic processing.

To engage the BFS, which is considered a last resort to save the vehicle, the crew presses a BFS ENGAGE momentary pushbutton located on the commander's and pilot's rotational hand controllers (RHCs). As long as the RHC is powered, and the appropriate OUTPUT switch on panel O6 is in BACKUP, depressing the ENGAGE pushbutton on either RHC engages the BFS and causes PASS to relinquish control. There are three contacts in each ENGAGE pushbutton, and all three contacts must be made to engage the BFS. The signals from the RHC are sent to the backup flight controller, which handles the engagement logic.

When the BFS is engaged, the BFC lights on panels F2 and F4 are steadily illuminated, the BFS's OUTPUT talkback indicator on panel O6 turns gray, all PASS GPC OUTPUT and MODE talkback indicators on panel O6 display barber-pole, the BFS controls the CRTs selected by the BFC CRT SELECT switch on panel C3, big X and poll fail appear on the remaining PASS-controlled CRTs, and all four GPC STATUS matrix diagonal indicators for PASS GPCs are illuminated on panel O1.

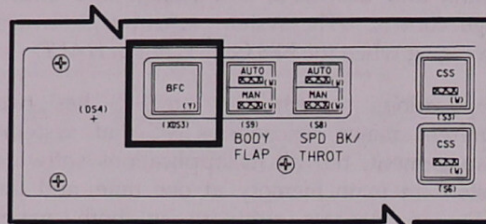

BFC Light on Panel F2

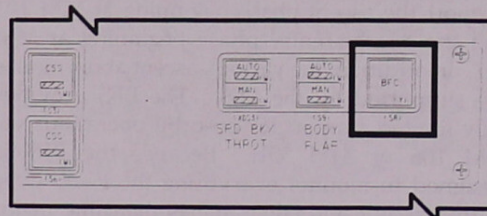

BFC Light on Panel F4

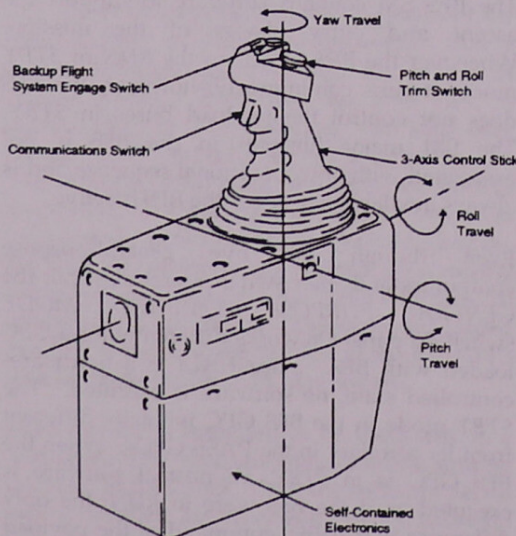

Rotational Hand Controller

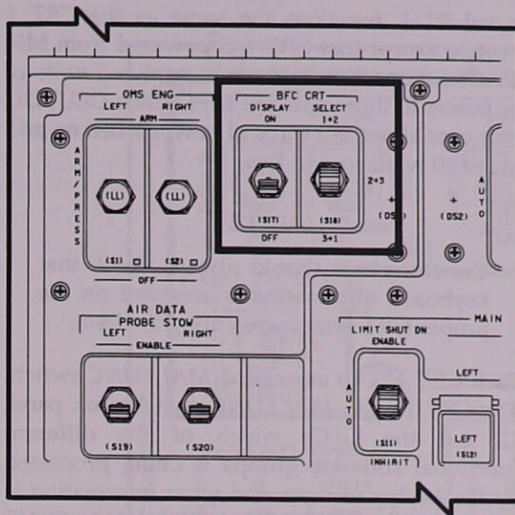

BFC CRT DISPLAY and SELECT Switches on Panel C3

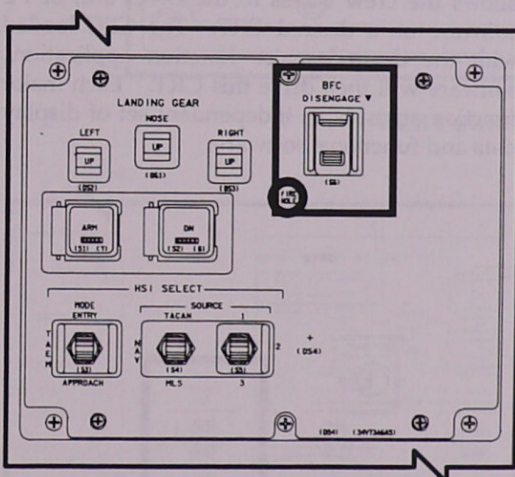

BFC DISENGAGE Switch on Panel F6

When the BFS is not engaged, and the *BFC CRT DISPLAY* switch on panel C3 is positioned to ON, the BFS commands the first CRT indicated by the *BFC CRT SELECT* switch. The *BFC CRT SELECT* switch positions on panel C3 are 1 + 2, 2 + 3, and 3+1. When the BFS is engaged, it assumes control of the second CRT as well.

If the BFS is engaged during ascent, the PASS GPCs can be recovered on orbit to continue a normal mission. This procedure takes about 2 hours, since the PASS inertial measurement unit reference must be reestablished. The BFS is

disengaged after all PASS GPCs have been hardware-dumped and reloaded with PASS software. Positioning the *BFC DISENGAGE* switch on panel F6 to the UP position disengages the BFS. The switch sends a signal to the BFCs that resets the engage discretes to the GPCs. The BFS then releases control of the flight-critical buses as well as the payload buses if it is in *STBY*, and the PASS GPCs assume command.

After disengagement, the PASS and BFS GPCs return to their normal pre-engaged states. Indications of the PASS engagement and BFS disengagement are as follows: BFC lights on panels F2 and F4 are out, BFS's *OUTPUT* talkback on panel O6 displays barberpole, all PASS *OUTPUT* talkback indicators on panel O6 are gray, and BFS releases control of one of the CRTs.

If the BFS is engaged, there is no manual thrust vector control or manual throttling capability during first- and second-stage ascent. If the BFS is engaged during entry, the speed brake can be positioned using the speed brake/throttle controller, and the body flap can be positioned manually. Control stick steering (CSS) by either the commander or pilot is required during entry.

Pre-engage, the BFS supplies attitude errors on the CRT trajectory display, whereas PASS supplies attitude errors to the attitude director indicators; however, when the BFS is engaged, the errors on the CRT are blanked, and attitude errors are supplied to the attitude director indicators.

Operations

The crew interfaces with the five GPCs via four CRTs and various dedicated display instruments. This section first discusses crew operations using PASS, and then discusses crew operations using the BFS.

CRT Switches

Switches on panel C2 designate which keyboard controls each forward display electronics unit. When the LEFT CRT SEL switch is positioned to 1, the left keyboard controls the left CRT 1; if the switch is positioned to 3, the left keyboard controls the center CRT 3. When the RIGHT CRT SEL switch on panel C2 is positioned to 2, the right keyboard controls the right CRT 2; if positioned to 3, it controls the center CRT 3.

Thus, flight crew inputs are made on the keyboards, and data are output from the GPCs on the CRT displays.

NOTE

If the *LEFT CRT SEL* and *RIGHT CRT SEL* switches are both positioned to 3, keystrokes from both keyboards are interleaved.

The aft station panel R11L keyboard is connected directly to the aft panel R11L display electronics unit and CRT (or DU); there is no select switch.

Each CRT has an associated power switch. The *CRT 1 POWER* switch on panel C2 positioned to *STBY* or *ON* allows control bus power to activate remote power controllers and sends MN A power to CRT 1. The *STBY* position warms up the CRT filament, only. The *ON* position provides high voltage to the CRT. The *CRT 2 POWER* switch on panel C2 functions the same as the *CRT 1* switch, except that CRT 2 is powered from MN B. The *CRT 3 POWER* switch on panel C2 functions the same as the *CRT 1* switch, except that CRT 3 is powered from MN C. The *CRT 4 POWER* switch on

panel R11L functions the same as the *CRT 1* switch, except that CRT 4 is powered from MN C. The respective keyboards receive 5 volts of ac power to illuminate the keys. Each DEU/DU pair uses about 290 watts of power when on and about 20 watts in standby.

NOTE

Crewmembers should always check that keyboard information is accepted on the proper CRT prior to executing the item.

Each CRT has an associated *MAJ FUNC* switch. The *CRT 1, 3, 2, MAJ FUNC* switches on panel C2 tell the GPCs which of the different functional software groups is being processed by the keyboard units and what information is presented on the CRT. The *CRT 4 MAJ FUNC* switch on panel R11L functions in the same manner. This three-position toggle switch allows the crew access to the *GNC, SM, or PL* software on a desired CRT. The GPC loaded with the desired major function applications software will then drive this CRT. Each major function accesses an independent set of display data and functional software.

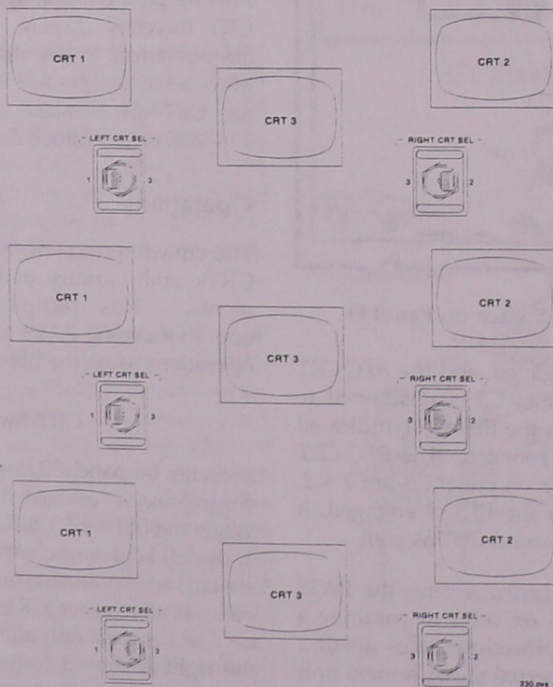

Possible CRT/Keyboard Assignments in the Forward Flight Station

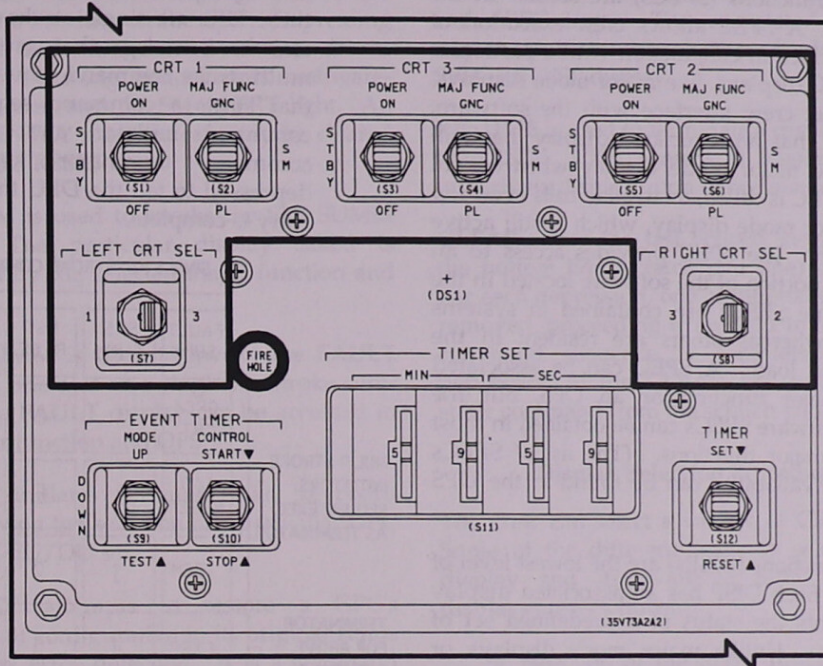

CRT Switches on Panel C2

Display Hierarchy

CRT display organization consists of three levels of crew software displays within any given major function. The display types parallel the different types of modules used in the GPC software. The established display hierarchy within applications software is operational sequences (OPS), specialist functions (SPEC), and display (DISP) functions. Each has a type of CRT page associated with it.

The OPS is the highest level of crew software control within a major function. Each memory configuration contains one or more OPS. Each OPS allows the crew to accomplish an associated mission phase task. Several operational sequences are defined, each covering some portion of the mission. For example, OPS 1 contains ascent software, OPS 2 contains on-orbit software, and OPS 3 contains entry software.

Each operational sequence is further divided into major modes. Each major mode has an associated display that allows direct crew interface with the software. These are OPS pages, and are also referred to as major mode pages.

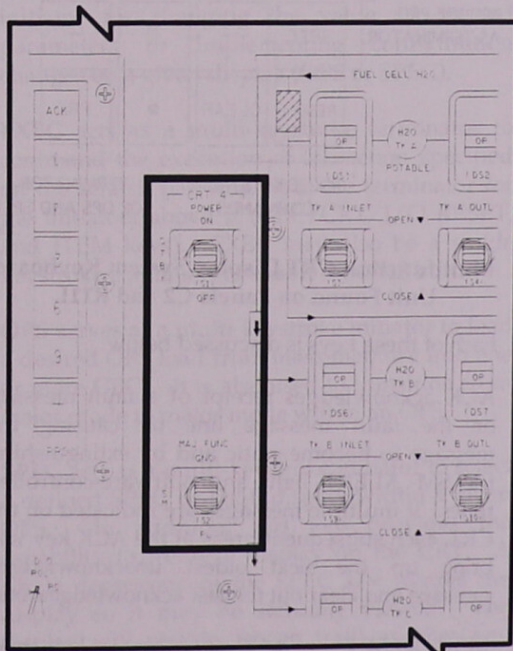

CRT 4 POWER and MAJ FUNC Switches on Panel R11L

Specialist functions (SPECS) are second in the hierarchy. A SPEC allows crew execution of other activities in conjunction with a particular OPS. SPEC displays, like major mode displays, allow direct crew interface with the software. Each SPEC has an associated display that will overlay the major mode display when called. When a SPEC is called, its display rolls in on top of the major mode display, which is still active underneath. The SPEC provides access to an associated portion of the software located in the GPC. Some SPECS are contained in systems software, whereas others are resident in the applications load. A SPEC can be associated with a major function or an OPS, but the systems software SPECS can be obtained in most OPS and major functions. (The list of SPECS and their availability can be found in the DPS Dictionary.)

Display functions (DISPs) are the lowest level of software. Each DISP has an associated display that presents the status of a predefined set of parameters. Unlike major mode displays or SPECS, a DISP cannot initiate a change in software processing because DISP displays do not permit direct crew interface with the software. They provide information only.

When called, a DISP will overlay the major mode display and the SPEC, if one is active. Both the SPEC and the major mode display are overlaid, and access to them can be easily regained. The method of terminating the processing of SPECS and DISPs will be discussed later.

The Keyboard

Each keyboard is composed of a 4 x 8 matrix of 32 pushbutton keys. This matrix consists of:

- Sixteen alphanumeric keys: 0 through 9 and A through F, for a hexadecimal numbering system
- Two sign keys (+ and -) serving the dual roles of sign indicators and delimiters. A delimiter is used to separate discrete keyboard entries from their associated data.
- One decimal point key for use in entering data with decimal notation

- Thirteen special function keys: some of these keys are single stroke commands, and some are keys that start or finish a multi-stroke command sequence. A key that starts a command sequence is a command initiator and requires a command terminator key to be depressed to tell the DEU the keyboard entry is complete.

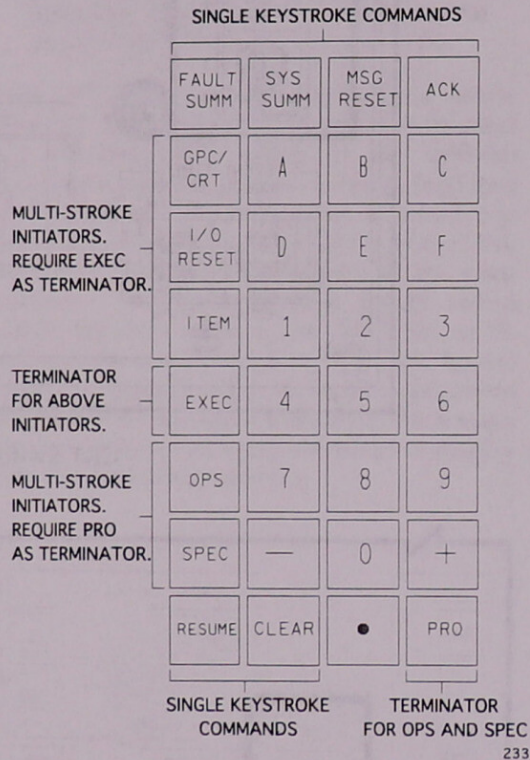

Multifunction CRT Display System Keyboard Unit Found on Panels C2 and R11L

Each of these keys is discussed below.

ACK acknowledges receipt of a fault message on the fault message line by causing the message to become static and by extinguishing the SM ALERT light and software-controlled tones. If multiple messages are indicated on the CRT, each subsequent press of the ACK key will bring up the next oldest unacknowledged message and clear out the last acknowledged one.

MSG RESET operates as a single keystroke command that clears both the currently annunciated fault message and the buffer message indicator (if any) from the fault

message line. The fault message line is the second to the last line on the CRT. Depressing this key will also extinguish all software-driven caution and warning annunciators, software-controlled tones, and the SM ALERT light. An ILLEGAL ENTRY message can only be cleared with the MSG RESET key.

SYS SUMM is used to invoke the SYS SUMM display. The particular display called is determined by the selected major function and active OPS.

FAULT SUMM is used to invoke the FAULT display. It operates as a single keystroke command. The FAULT display can be accessed in every major function and OPS.

GPC/CRT initiates a multistroke keyboard entry, allowing the selection of a particular GPC to drive a DEU/DU set.

I/O RESET attempts to restore a GPC's input/output configuration to its original status prior to any error detection. It is a command initiator and requires a terminator keystroke.

ITEM is used as a multi-keystroke command initiator for changing the value of defined parameters or implementing configuration changes on a given display (OPS or SPEC).

EXEC acts as a multi-keystroke terminator to command the execution of the action specified on the scratch pad line. It is the terminator for the initiators above it (GPC/CRT, I/O RESET, and ITEM keys). EXEC may also be a single keystroke command to enable an OMS burn.

OPS serves as a multi-keystroke initiator to load a desired OPS load from mass memory into one or more GPCs. It is also used to transition from major mode to major mode within an OPS.

SPEC acts as a multi-keystroke initiator to select a defined SPEC or DISP display within a given OPS. In addition, this key provides the capability to freeze a display on the CRT. A single depression of the SPEC key freezes the display so it may be statically viewed. The display will remain frozen until another key (other than ACK, MSG RESET, or another SPEC) is entered.

PRO (Proceed) serves as a terminator to the OPS and SPEC keys. The completed command sequence initiates the selection of a desired OPS, SPEC, or DISP display.

RESUME is used to terminate a displayed SPEC or DISP. CRT control is restored to the underlying display upon depression of this key.

CLEAR clears the last echoed keystroke from the bottom line (scratch pad line) of the CRT. For each depression, one additional keystroke is removed, proceeding from right to left. After a command sequence is completed, a single depression of the CLEAR key will erase the static command from the scratch pad line.

Display Selection Procedures

The crew can select a variety of CRT displays. Some of the different ways to select an OPS display and its available SPEC and DISP displays are as follows:

- Selection of the major function is done by placing the MAJ FUNC switch (on panel C2) associated with the CRT in use in the GNC, SM, or PL position.
- An OPS is loaded from the MMU via a three-step keyboard entry. A new OPS is called from mass memory by its first major mode. The OPS is loaded into the GPC that is currently driving the DEU/DU on which the keyboard entry is done. Once the OPS is loaded, access is provided to major modes in that OPS. Major mode displays are advanced by the same keyboard command. The steps for selecting an OPS display are as follows:
 1. Depress the OPS key.
 2. Key in the three numbers of the desired OPS. The first digit defines the OPS and the next two digits specify the major mode.
 3. Depress the PRO key. Once the OPS is loaded into one or more GPCs, that software can be accessed at any time through any CRT in the proper major function.

Selection of a major mode does not involve a mass memory access. Advancing major modes is done by the same keyboard command as loading an OPS. The first digit will be the same as the OPS number, but the last two digits specify the major mode. For example, to go to GNC MM 202, enter OPS 2 0 2 PRO.

Within each OPS, certain SPEC and DISP displays are available. The steps for selecting a SPEC or a DISP are as follows:

1. *Depress the SPEC key.* The SPEC key is used in calling both SPEC and DISP displays.
2. *Key in the SPEC or DISP number omitting all leading zeros.* SPEC and DISP numbers have three digits. They are differentiated by their numbering scheme. The display is a DISP only if the first digit is a 9, or if the last digit is a 6 through 9. To illustrate the method for keying in SPEC and DISP numbers, DISP number 106 would be keyed in as "106"; SPEC number 034 would be keyed "34"; DISP number 066 would be keyed "66"; and SPEC number 001 would be keyed "1."
3. *Depress the PRO key.*

OPS and Major Mode Transitions

Transitions from major mode to major mode or to another OPS are accomplished by either automatic transitions or proper command entry.

- **Automatic transitions:** Some major mode transitions occur automatically, usually as a function of some mission event. Examples of automatic transitions are between major modes 101 and 102 (SRB ignition) and between major modes 102 and 103 (SRB separation). Selection of an RTLS abort also results in an automatic OPS transition.
- **Command entry:** Proper command entry (OPS XXX PRO) is almost always used to transition from one OPS to another. In most cases, it is also a legal transition operation for proceeding from one major mode to the next (e.g.; 301 to 302).

Display Sequencing, Overlaying, and Retention

Certain rules have been established for proceeding from one display to another. These can be categorized into treatment of proper display sequencing, the overlaying of current displays by new displays, and the display retention hierarchy.

SPEC and DISP Displays

The hierarchy of overlaying SPECs and DISPs makes sense if one remembers that a SPEC allows crew interaction and control of specialized operations, whereas a DISP provides display information only. Both SPECs and DISPs overlay the current major mode display when called.

A SPEC need not be previously selected in order to call a DISP. If a DISP is on the CRT, and another SPEC or DISP is called, the current DISP is terminated. The terminated DISP can only be viewed again by entering its calling command once more.

If a SPEC is selected, and a DISP is called to overlay it, the SPEC is retained underneath the DISP. If another SPEC is then selected, the underlying SPEC as well as the DISP over it is terminated. The terminated SPEC can only be viewed again if it is recalled.

The RESUME key is used as a single keystroke entry to terminate the SPEC or DISP currently being displayed and to restore the underlying display. If the display being terminated is a DISP, CRT control will be restored to the underlying SPEC, or to the OPS display if no SPEC has been selected. If a SPEC display is terminated, CRT control is restored to the major mode display. It is advisable to press RESUME after viewing any SPEC or DISP to avoid confusion and to decrease the possibility of attempting to retain more SPEC displays than the software allows. Also, certain ground command functions may not be possible when corresponding SPECs are active or underlying a DISP. The RESUME key cannot be used to transition from one major mode display to another or to page backwards through major mode displays.

Display Retention Hierarchy

- **Major mode transitions:** Both SPECS and DISPs are retained during a major mode transition. If a SPEC or DISP is overlaying the major mode display, the new major mode display can't be seen until the overlaying displays are terminated with the RESUME key.
- **Major function change:** OPS and SPEC displays on the CRT screen are retained within their major function when major function positions are switched. When the crew returns to the first major function, the SPEC last viewed will appear on the screen. Depression of the RESUME key will restore the underlying OPS. If no SPEC had been selected, return to a major function would restore the last major mode display. DISP displays are not retained at major function switch transitions.
- **OPS transition:** SPECS, DISPs, and major mode displays are not retained through an OPS transition, since this involves loading an entirely new module of applications software in the GPC. The SPECS may be called again if they are available in the new OPS.

Standard Display Characteristics

Standard Display Features

Two discrete brightness intensities for displayed characters are designated "bright" and "overbright." The bulk of all material is displayed in the "bright" intensity. Special messages and special characters, such as parameter status indicators, are displayed in "overbright" to direct the crew's attention during their display scan.

Certain words and messages are designed to flash on and off. Fault messages will flash, indicating a message that needs to be acknowledged. Command initiators are designed to flash until the command is completed, and an incorrect keyboard entry will result in a flashing "ERR" to the right of the erroneous entry.

Formatting Similarities

OPS number: The four-digit field in the upper left corner of the first line designates the number of the OPS display being processed. The first digit represents the OPS; the next two digits indicate the major mode. The last digit is always a "1," and it is not used when making keyboard entries.

SPEC number: Directly to the right of the OPS number is a three-digit field. This field displays the number of the SPEC overlaying the OPS. This field is blank if no SPEC is selected.

DISP number: The last field in the upper left corner represents the DISP number. It is a three-digit field. This field is blank if no DISP is currently being displayed.

Display title: Centered on the top line of the display is the title of the display. Portions of some titles are dynamic and will specify the mission phase.

Uplink indicator: Directly to the right of the display title is a two-space field. When an uplink to the GPC is in progress, a flashing "UL" will be displayed. Otherwise this field is blank.

GPC driver: To the right of the uplink indicator is a one-digit field. A number in this field indicates the particular GPC (1, 2, 3, 4, or 5) that is commanding the CRT.

GMT/MET clock: This field displays time in days, hours, minutes, and seconds (DDD/HH:MM:SS). The field is updated every second. The time displayed may be either GMT or MET selectable via a keyboard entry to the SPEC 2 TIME display.

CRT timer: Directly below the GMT/MET clock is a CRT timer field also displayed in days, hours, minutes, and seconds (DDD/HH:MM:SS). This field is also updated every second, and can be set via a keyboard entry to the TIME SPEC display.

Fault message line: The second line from the bottom is reserved for fault messages. Illegal keyboard entry messages and systems fault messages are displayed on this line. In the case of system faults, a number in parentheses to the far right on this line indicates the number of fault messages that have not been viewed and acknowledged (further discussion of fault messages is covered in a later section).

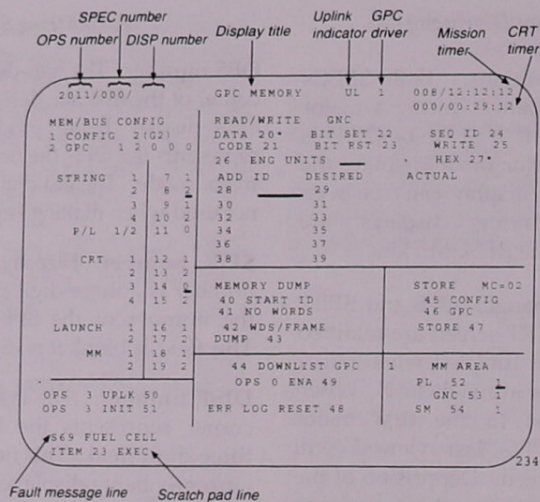

Formatting Conventions Common to All Displays

Scratch pad line: The bottom line of the display echoes keyboard entries made by the crew. Command initiators (OPS, SPEC, ITEM, GPC/CRT, and I/O RESET) will flash on the scratch pad line until the command is terminated. The keystrokes remain on the scratch pad line in a static mode until (a) a new command is initiated, (b) the CLEAR key is depressed, or (c) the MAJOR FUNC switch position is changed. Keyboard syntax errors detected by the DEU will result in a flashing "ERR" on the scratch pad line following the keyboard entry.

Specially Defined Symbols

These symbols include an asterisk and a set of parameter status indicators. Parameter status indicators are displayed in "overbright" intensity for quick recognition. These special symbols are defined as follows:

M: This symbol indicates missing data. It is displayed directly to the right of the affected parameter. The parameter value may be blanked, or the last value received by the GPC may be displayed. If data are missing for a parameter that has no numerical value associated with it, then an M is used to indicate the parameter status.

H: This symbol indicates that a parameter is off-scale high. This indicates a transducer limit has

been reached, and the scale is registering its highest possible value. The actual parameter being measured may, in fact, be higher than the recorded data, but the instrument in use does not have the capacity to measure the value. Off-scale high indicators do not appear on the display until several (normally two) consecutive readings have verified this finding. This symbol is displayed to the right of the data affected.

L: This symbol indicates off-scale low parameters. This means that the parameter value displayed is the lowest possible reading due to transducer limitations. The actual value of the parameter may exceed the displayed value, but the range of the hardware is not defined to evaluate this reading. As with the "H," the off-scale low indicator is not displayed until a set number of consecutive readings have verified this status.

Up arrow: This symbol, displayed to the right of the affected parameter, indicates a parameter driven out-of-limits high. The value displayed is a true reading but has equaled or exceeded the operational high limit established by the software. The fault detection and annunciation (FDA) software keeps track of the low and high limits for each parameter and annunciates any violation of these limits to the crew by displaying the appropriate "up arrow" or "down arrow" next to the parameter on the appropriate display.

In the case where the transducer limit is the same as the operational limit, the "H" symbol overrides the "up arrow" symbol. Several (normally two) consecutive readings verify this status before the "up arrow" symbol is displayed.

Down arrow: This symbol indicates that a parameter value is equal to or less than the operational low limit. The value displayed is outside the software limits placed upon the parameter. When the software limit established is the same as the transducer limit, the "L" symbol takes precedence over the "down arrow" symbol. A set number of consecutive readings verifies this indication before the "down arrow" is displayed.

In addition, the down arrow is used to indicate a discrete state that does not agree with the nominal state. For example, a high pressure gas supply valve state reading "closed" when its position is normally "open" would drive the "down arrow" symbol.

The down arrow is also used to indicate that a hardware unit has been declared failed by a GPC.

?: This symbol indicates a redundancy management dilemma. That is, if two hardware units measuring the same parameter disagree, and the software cannot isolate which of the two is failed, a "?" will be displayed in both places.

*****: This symbol indicates an active state or the selected item of mutually exclusive items.

Item Operations

Within a given display, certain operations can be performed by the crew. Those items that may be altered are identified by an item number. The item number is a maximum of two digits and is placed in such a way that it is readily identifiable with the parameter or status configuration with which it is associated. When item numbering is obvious, item numbers may be implied and will not appear on the display. Item numbering is sequentially ordered for each display. There are never more than 99 items per display. The two basic types of manipulations that the crew can perform are item configuration change and item data entry.

2011/ /078		SM SYS SUMM 1		4 000/14:44:12	
				000/00:00:00	
SMOKE	1/A 2/B	DC VOLTS	1/A 2/B 3/C		
CABIN	0.0	FC	30.6 30.1 31.0		
L/R FD	0.0 0.0	MAIN	30.6 30.1 31.0		
AV BAY 1	0.3 0.3	ESS	29.6 29.6 29.3		
	2 0.3 0.4				
	3 0.3 0.3	CNTL	1 29.4 29.4 29.6		
			2 29.4 29.4 29.4		
			3 29.4 29.4 29.4		
PRESS	14.0	AC			
DP/DT-EQ	+0.0 +0.000	VOLT	118 118M		
O2 CONC		OE	117 117 118		
PPO2	3.00 3.00	OC	117 117 118		
FAN ΔP	5.00	AMPS	4.3 6.3 2.1		
HX OUT T	46H	OE	5.5 6.6 2.2		
O2 FLOW	0.0 0.0	OC	3.1 5.0 3.2		
N2 FLOW	0.0 0.0L	FUEL CEL			
IMU FAN A B C		AMPS	180 232 146		
AV FC1 FC2 FC3		REAC VLV	OP OP OP		
SS1	22 21 22	STACK T	+202 +206 +200		
SS2	22 22 23	EXIT T	150 152 149		
SS3	23 21 21	COOL P	61 60 61		
TOTAL AMPS	557	PUMP			
KW	17				

235

2011/ /018		GNC SYS SUMM 1		1 000/02:46:03	
				000/00:00:00	
RCS	JET ISOL	SURF	POS	MDM	DPS 1 2 3 4 5
MANE	FAIL VLV				
F1	OP L OB			GPC	↓
2	OP IB			MDM FF	↓
3	OP R IB			FA	↓
4	OP OB				
5	OP AIL			FCS CH 1 2 3 4	
L1	OP RUD				
2	OP SPD BRK			M	↓
3	OP BDY FLP				
4	OP				
5	OP				
R1	OP			NRV	1 2 3 4
2	OP	CNTLR 1 2 3		IMU	? M ?
3	OP	RHC L		ACC	M
4	OP	R		RGD	M
5	OP	A		TAC	
		A		MLS	
		THC L		ADTA	
		A			
		SBTC L			
		R			

236

2011/ /006		GPC/BUS STATUS		2 008/02:56:10	
				000/00:11:10	
	GPC	1	2	3	4
MODE	RUN	RUN	HALT	RUN	HALT
OPS	G2	G2	0	S2	0
STRING 1	FF				
	FA				
2	FF				
	FA				
3	FF				
	FA				
4	FF				
	FA				
PL 1	↓	↓		*	
2	↓	↓		*	
LAUNCH 1	↓	↓		↓	
2	↓	↓		↓	
CRT 1	*	*		↓	
2				↓	
3	↓	↓		↓	
4	↓	↓		*	

237

Specially Defined Symbols on CRT Displays

Item Configuration Change

This operation allows the crew to choose any of a number of options or to initiate a specific action as defined by the particular display format. Typical purposes of this operation include selecting or deselecting an item, initiating and executing an action, and altering software configurations. The procedure used in performing an item configuration change within a selected display is as follows:

1. Depress the ITEM key.
2. Key in the item number.
3. Depress the EXEC key.

Item Data Entry

This operation allows the crew to load data into the software. Typical purposes of this operation include initializing parameters, changing software limits, and specifying memory locations. The procedure used in performing an item data entry is as follows:

1. Depress the ITEM key.
2. Key in the item number. Item numbers are ordered sequentially (1, 2, 3, ...) on each display. They are located next to the parameter to which they are assigned. Some item numbers must be inferred by their surrounding item numbers.
3. Key in a delimiter ("+" or "-"). A delimiter serves to separate item number codes from their corresponding data. The delimiter whose sign corresponds to the sign of the data should be used, but if no sign is associated with the data, it doesn't matter which delimiter is used. A "[" after the data field indicates that the entry is sign-dependent.
4. Key in the data. Data size specifications depend on the format established for that particular data load. Usually, the data size will be indicated with an underline for each digit. As a general rule, leading and trailing zeros need not be entered. Remember that the sign of the delimiter is the sign of the data.
5. Depress the EXEC key.

Multiple Data Entries

Multiple item configuration changes cannot be done; however, multiple item data entries can. Multiple data entries can be made with separate command strings, but because this is time-consuming, the software allows more than one data entry to be made with one command sequence. The procedure is the same as described above except step 4 (after data are keyed in). Add step 4a to make more than one item data entry at once.

- 4a. Key in a delimiter. Consecutive data entries may be loaded by using a delimiter to separate each parameter. Item entries are incremented sequentially so the item number need not be entered for each parameter following the one already entered. Just hit another delimiter, and the next item number will appear, ready to receive its associated data. To skip an item number, hit a delimiter twice. In this way, any amount of item numbers may be skipped until the desired item number is reached.

Both the "+" and the "-" keys may be used interchangeably as delimiters. However, when skipping item numbers, it is a good idea to use the delimiter corresponding to the sign of the next data entry if there is any sign associated with it. Using the sign key corresponding to the next data entry ensures that the GPC receives the proper data entry.

An example of a multiple item data keyboard entry is:

```
ITEM 7 + 2 + 1 + + 2 + - - 2 EXEC
```

In this example, Items 7, 8, 10, and 13 have no sign associated with them so the sign of the delimiters doesn't matter. Although there was room for four item entries here, the actual number allowed on the scratch pad line is a function of the size of the data.

This entry will appear on the scratch pad line of the corresponding CRT as:

```
ITEM (07) + 2 (08) + 1 (10) + 2 (13) - 2 EXEC.
```

All item operations will be one of these two basic manipulations. However, data size and form will differ for each display.

Remember, only OPS and SPEC displays allow item operations. A DISP display does not.

Special Operations and Displays

GPC/CRT Assignment

GPC assignment to a particular DEU/CRT set is determined via a predefined table of assignments. This table is stored in all the common set GPCs' systems software and can be manipulated by the crew. There is a table for each memory configuration (MC) that is valid when that MC is active (loaded in one or more GPCs), and the particular major function is selected. This table can be changed using the GPC MEMORY display (SPEC 0). The current GPC driver for a CRT is controlled by the MAJ FUNC switch. That is, the position of the MAJ FUNC switch (GNC, SM, or PL) will determine the GPC with which the DEU communicates. In some cases, a redundant set of GPCs is formed for GNC, and the GNC CRTs are normally split among them. This is done with the predefined table. The table is looked at by the GPCs when they are loaded with the applications software, and that is when the assignments take effect.

Another way to change the current GPC assignment logic is with the GPC/CRT key. The GPC/CRT key allows the crew to reassign a CRT to a different GPC commander. The steps for selecting a GPC to command a given DEU/CRT are as follows:

1. Depress the GPC/CRT key.
2. Key in the desired GPC number (1, 2, 3, 4, or 5)
3. Key in the desired CRT number (1, 2, 3, or 4). No delimiter is needed between the GPC and the CRT numbers.
4. Depress the EXEC key.

An assignment is not executed if the GPC being assigned doesn't have the applications software in memory to support the DEU/CRT in its current major function. If the GPC specified by a keyboard entry is not a valid assignment, the reassignment does not occur, and the current GPC driver retains the CRT. Thus, if a CRT is in GNC, and an attempt is made to assign a GPC that is not in the redundant set to drive it, a redundant set (or valid) GPC will drive the CRT instead of the invalid GPC. If GPC 4 is the SM machine (nominal configuration), then it is the only valid GPC to drive a CRT whose MAJ FUNC switch is in SM.

The payload's major function is usually *unsupported*. This means that none of the GPCs have payload applications software loaded in them. Any GPC can be assigned to drive a CRT in an unsupported major function. The GPC that was driving the CRT in the previous major function will retain the CRT when it is placed in PL.

If the keyboard entry specifies a valid GPC, it will override any assignment made by the software. The keyboard entry assignment will remain in effect whenever the MAJ FUNC switch is in a position supported by that GPC. A new assignment can be made via the keyboard.

The GPC/CRT key can also be used to isolate a DEU from communication with all GPCs. This is accomplished by using "0" for the number of the GPC. The PASS set can drive only three of the four CRTs at one time, so at least one DEU is always isolated from PASS.

The DEU drives a big X over an isolated CRT to remind the crew that the DEU is not receiving data. The DEU also annunciates a POLL FAIL message to inform the crew that the GPC is no longer successfully polling the DEU (not attempting to communicate with the DEU).

Memory Configurations

After a GPC has been IPL'd, the only software resident is the systems software, and the GPC is in OPS 0 when moded to RUN. Any applications software is loaded in from the MMU during an OPS transition. There are two levels of applications software: the major function base (MFB) and the OPS overlay. The MFB is that software common to all OPS in a particular major function. For GNC, the MFB contains flight-critical software and data that are retained from one mission phase to another, such as the current state vector and inertial measurement unit processing. When a GPC is transitioned from one OPS to another in the same major function (e.g., from GNC OPS 1 [ascent] to OPS 2 [orbit]), the MFB remains in main memory, and only the OPS overlay is loaded from the MMU and written over the old OPS. Of course, when the major function changes (e.g., when GPC 4 is transitioned from GNC OPS 1 to SM OPS 2), a new MFB is loaded in from the MMU along with the OPS overlay.

The controls for performing an OPS transition (i.e., loading a new memory configuration into the GPC from the MMU) are on the GPC MEMORY display (SPEC 0), which is also the OPS 0 OPS display. Item 1 determines the memory configuration (CONFIG) to be loaded. Currently, there are eight different memory CONFIGs, besides memory CONFIG 0, which is post-IPL OPS 0 (no applications software loaded).

MCC	ABBREV	
1	(G1)	GNC OPS 1 and 6 combined (ascent and aborts)
2	(G2)	GNC OPS 2 (on orbit)
3	(G3)	GNC OPS 3 (entry)
4	(S2)	SM OPS 2 (on orbit)
5	(S4)	SM OPS 4 (on orbit [not used])
6	(P9)	PL OPS 9 (preflight)
No MC 7		
8	(G8)	GNC OPS 8 (on orbit checkout)
9	(G9)	GNC OPS 9 (preflight/postflight)

Memory Configurations

Nominal Bus Assignment Table

Associated with each memory configuration is a nominal bus assignment table (NBAT). It is displayed via items 7-19 on SPEC 0 whenever a memory configuration is entered, and it tells which GPCs are in the target set and which GPCs are to be in command of each data bus. The nominal assignments are already loaded in GPC main memory preflight. However, these bus assignments may be changed any time, including when an OPS transition is performed.

An example of a typical nominal bus assignment table is shown on SPEC 0 GPC MEMORY for GNC OPS 3.

MEM/BUS CONFIG		READ/WRITE	GNC	SEQ ID
1	CONFIG 2 (G2)	DATA 20*	BIT SET 22	WRITE 25
2	GPC 1 2 0 0 0	CODE 21	BIT RST 23	HEX 27*
STRING		26	ENG UNITS	
1	7 1	ADD ID	DESIRED	ACTUAL
2	8 2	28	29	
3	9 1	30	31	
4	10 2	32	33	
P/L 1/2	11 0	34	35	
CRT	12 1	36	37	
2	13 2	38	39	
3	14 0			
4	15 2			
LAUNCH		MEMORY DUMP		STORE MC=02
1	16 1	40	START ID	45
2	17 2	41	NO WORDS	46
MM	18 1	42	WDS/FRAME	47
2	19 2	43	DUMP	
OPS 3 UPLINK 50		44 DOWNLIST GPC 1		MM AREA
OPS 3 INIT 51		OPS 0 ENR 49		PL 52 1
		ERR LOG RESET 48		GNC 53 1
				SM 54 1

Sample NBAT Data on GPC MEMORY Display (SPEC 0)

- Items 2-6 determine which GPCs will be in the OPS. They are referred to as the "target" GPCs. In this case, GPCs 1-4 are in a redundant set. If a GPC is not to be in that OPS, a 0 is entered in that GPC's item number, which is one more than the GPC number. (Item 2 is for GPC 1, etc.)
- The commanders of the flight-critical data buses or strings are entered in items 7-10. (String 1 is FF1 and FA1, etc.) In this case, each GPC is set to command its same-numbered string.
- The two PL buses are assigned together. For OPS 1 and 3 they are assigned to GPC 1 via item 11 in case the BFS fails. When the BFS is in RUN (as it is for entry), it commands the PL data buses.
- CRTs 1, 2, 3 are assigned to GPCs 1, 2, 3 respectively, via items 12-14. Since the PASS can only control three CRTs at a time, no GPC is assigned to CRT 4 during entry. Note that CRT assignments are for a particular major function only.
- The launch data buses are assigned via items 16 and 17. Since they have no function during entry, they are deassigned.
- Items 18 and 19 show that GPC 1 will command mass memory bus 1 for the OPS 3 transition, and GPC 2 will command mass memory bus 2, either if the transaction fails on mass memory bus 1 or if MMU 2 is prime selected on SPEC 1 DPS UTILITY.

MMU Assignment

Since there are two identical MMUs, there must be a method to tell the GPCs which one to use for a particular transaction. This is done on DPS UTILITY SPEC 1 display via items 1 through 8. Only one MMU (and its data bus) is assigned to each major function. A post-IPL OPS 0 GPC also has an MMU assigned to it for requesting freeze-dry software for a memory store. This display is initialized with all assigned to MMU 1, and execution of any of the item numbers causes the appropriate MMU to be assigned. Note that each of the pairs of item numbers is mutually exclusive.

When a GPC needs to access mass memory, this table tells it which MMU to use. For example, the SM GPC may need to call a roll-in SPEC or take a checkpoint (discussed later). In the case of OPS transitions, if the MMU selected is busy or fails twice, then the other is automatically tried. For a GNC OPS transition where a redundant set is involved, one GPC is assigned to each mass memory bus via items 18 and 19 on SPEC 0 GPC MEMORY. The indicated GPC will command the mass memory bus selected by item 1 or 2 on SPEC 1 DPS UTILITY, then the other GPC will command the next mass memory bus if the first transaction fails. Of course, all GPCs in the redundant set will be listening over both buses and receive the overlay.

2011/001/	DPS UTILITY	1 008/12:12:12
		000/00:25:12
MMU ASSIGN	PORT ASSIGN	
1 2	PRI SEC	UL CNTL
GNC 1* 2	STRING 1 15* 16	AUTO 35*
SM 3* 4	2 17* 18	ENA 36
PL 5* 6	3 19* 20	INH 37
OPS 0 7* 8	4 21* 22	
	P/L 1/2 23* 24	IPL SOURCE SW
MMU STATUS		MASK 38*
1 RDY		
2 RDY	VAR PARAM ID LIST	
	25 9ABA	
MMU SOURCE/BUS	26 9ABB	G3 ARCHIVE
GPC/MMU 9*	27 9ABC	LOAD 48
MMU/MMU 10	28 9ABD	RETRIEVE 49*
GPC/LDB 11	29 9ABE	
	30 9ABF	GROUND OPS
CKPT RETRV	31 9ACA	GSE POLL ENA 50
ENA 12	32 9ACB	SM GSE INH 51
	33 9ACC	SM C/O ENA 52
RTC	34 9ACD	GNC C/O ENA 53
13		BPC C/O ENA 54
CMD 14		ALT PL9 TB 55

239

DPS UTILITY Display (SPEC 1)

Software Memory Source Selection

During an initial program load (IPL), an MMU is selected as the software source via the IPL SOURCE switch on panel O6. This switch is a three-position toggle switch that will be either in the MMU 1 or MMU 2 position during the IPL sequence. At all other times, this switch will nominally be in the OFF position.

The controls for selecting the memory source for an OPS transition and the bus over which it is loaded into the GPCs are on SPEC 1 DPS UTILITY (items 9 through 11). The display is initialized with item 9 selected, which is almost always used. As part of the GPC status exchanged at common set sync, each GPC exchanges its current resident memory configuration. When a request is made for a memory configuration, the software determines

whether or not another GPC already has the requested OPS or a current major function base. If another GPC already has any of the requested software, the lowest numbered such GPC will be used as a source for the other GPCs. Such a GPC-to-GPC overlay of software will be done over the mass memory data buses. An overlay that is not available from a GPC will be loaded from an MMU. Note that the major function base may come from another GPC and the OPS overlay from mass memory. For transitions to OPS 3, the G3 archive (stored in the upper 128 k of main memory prelaunch) is simply copied to lower memory and executed.

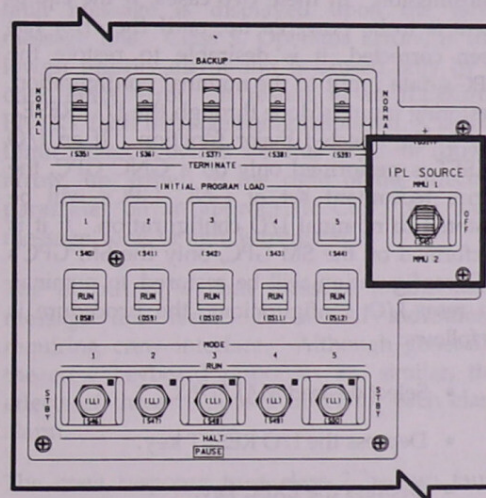

IPL SOURCE Switch on Panel O6

If there is a problem with both of the mass memory data buses, then item 11 may be selected if there is a GPC source for both overlays. In this case, the GPC-to-GPC overlay is done over the launch data buses.

Memory reconfiguration may be forced from an MMU, regardless of other GPC sources, by selection of item 10 on the DPS UTILITY display. In this case, whether both are required or not, both the major function base and the OPS overlay will be loaded from mass memory. This would only be used if the software in a current GPC was suspect for some reason.

If there is no usable GPC source and the selected MMU is off or being used for another memory transaction, the class 3 fault message OFF/BUSY MMU 1 (2) is initiated. The current status

of each MMU is shown on the DPS UTILITY display as either RDY (ready to respond) or BSY (off or currently responding to a GPC command).

Resetting I/O Configurations

When a GPC detects an error or is missing data from a piece of equipment, a fault message will be displayed on the CRTs, the *SM ALERT* light and tone will be activated, and further attempts by the GPC to communicate with the equipment will be terminated. Two common causes of detected errors or missing data are the powering down of equipment or an error in a data transmission. In these two cases, if the equipment is to be powered up, or if the error has been corrected, it is desirable to restore the GPC's data input to the nominal configuration. Restoring input is done through the I/O RESET key in the affected major function. If an I/O RESET is performed only on a GNC GPC, the entire redundant set of GNC GPCs will be restored to nominal I/O configuration. If it is performed on the SM GPC, only the SM GPC's I/O configuration will be restored to nominal. To reset I/O configurations, the procedure is as follows:

- Select desired *MAJ FUNC*.
- Depress the I/O RESET key.
- Depress the EXEC key.

If the powered down equipment has been powered on, or if a problem with a piece of equipment has been fixed, an I/O RESET will resume communication, and it will not cause another fault message annunciation. If the GPC still has a problem communicating with any piece of its assigned equipment, a fault message will reannunciate after an I/O RESET. This termination of attempts by the GPC to communicate with its assigned equipment is called a commfault (i.e., the input element has been bypassed by the GPC) and the resultant loss of input data to applications software is also referred to as a commfault.

Systems Summary Displays

Systems summary displays provide general systems status information that can be accessed quickly to aid immediate diagnosis of a

problem. They are designed to support the caution and warning (C/W) matrix located on panel F7. When a C/W alarm occurs, the crew can call a systems summary display that has general information from several systems to pinpoint the problem to a specific system, then continue troubleshooting the problem on system-specific SPECS, DISPs, and hardware panels. The systems summary displays are DISPs and provide information only.

The systems summary displays are major function-specific and are called with the SYS SUMM key. If a CRT's *MAJ FUNC* switch is in *GNC*, and the SYS SUMM key is pressed, then GNC SYS SUMM 1 will appear on that CRT. GNC SYS SUMM 1 is DISP 18 so it may also be called with a SPEC 18 PRO, but it is faster to use the SYS SUMM key.

There are four PASS systems summary displays: GNC SYS SUMM 1, GNC SYS SUMM 2, SM SYS SUMM 1, and SM SYS SUMM 2.

The SYS SUMM key is a toggle function in each major function. In SM on-orbit, hitting SM SYS SUMM will cause SM SYS SUMM (DISP 78) to appear on the CRT. If SYS SUMM is depressed again, SM SYS SUMM 2 (DISP 79) will appear, and if SYS SUMM is depressed once more, SM SYS SUMM 1 reappears.

The same toggle function exists in GNC between GNC SYS SUMM 1 (DISP 18) and GNC SYS SUMM 2 (DISP 19).

RCS		JET	ISOL				2011/ /018 GNC SYS SUMM 1 1 000/02:46:03 000/00:00:00				
MANE	FAIL	VLV	SURF	POS	MOM	DPS	1	2	3	4	5
F1		OP	L OB			GPC					
2		OP	IB			MDM FF					
3		OP	R IB			FA					
4		OP	OB								
5		OP	AIL								
L1		OP	RUD			<u>FCS CH 1 2 3 4</u>					
2		OP	SPD BRK								
3		OP	BDY FLP								
4		OP									
5		OP				<u>NAV 1 2 3 4</u>					
R1		OP				IMU					
2		OP			<u>CNTLR 1 2 3</u>	ACC					
3		OP	RHC L			RG					
4		OP	R			TAC					
5		OP	A			MLS					
			THC L			ADTA					
			A								
			SBTC L								
			R								

PASS GNC SYS SUMM 2, available in GNC OPS 1, 6, 2, 8 and 3

2011/ /019 GNC SYS SUMM 2				2 000/03:15:52			
000/00:00:00				000/00:00:00			
OMS AFT QTY L R		OMS L R		TK P HE 4070 4070		TK P HE 4070 4070	
OXID 30.2 30.2		OXID 258 258		FU 260 260		FU 260 260	
FU 30.2 30.2		N2 TK P 2260 2260		P VLV CL CL		P VLV CL CL	
RCS		JETISOL		ENG IN P		OXID 258 258	
OXID	FU	FAIL	VLV	OXID	FU	FAIL	VLV
FWD HE P 3048 2968				1 H 242 246			
TK P 247 248				2 H 250 246			
QTY 67 67				3 H 246 258			
MANF 1 P 248 242			OP	4 H 246 242			OP
2 P 248 246			OP				
3 P 250 246			OP				
4 P 246 246			OP				
5			OP				
AFT HE P 3200 3144				HE P 216 3160			
L TK P 245 249				R TK P 251 249			
QTY 82 83				QTY 84 84			
MANF 1 P 246 246			OP	1 H 242 246			OP
2 H 246 250			OP	2 H 250 246			OP
3 H 250 250			OP	3 H 246 258			OP
4 H 246 250			OP	4 H 246 242			OP
5			OP				

GNC SYS SUMM 2, available in GNC OPS 2 and 8

2011/ /078 SM SYS SUMM 1				4 000/14:44:12			
000/00:00:00				000/00:00:00			
SMOKE	1/A	2/B	3/C	DC VOLTS	1/A	2/B	3/C
CABIN	0.0			FC	30.6	30.1	31.0
L/R FD	0.0	0.0		MAIN	30.6	30.1	31.0
AV BAY	1 0.3	0.3		ESS	29.6	29.6	29.3
	2 0.3	0.4					
	3 0.3	0.3		CNTL	1 29.4	29.4	29.6
					2 29.4	29.4	29.4
					3 29.4	29.4	29.4
CABIN				VOLT	OA 118	118	117
PRESS	14.0				OB 117	117	118
GP/GT-EQ	+0.00	+0.000			OC 117	117	118
O2 CONC				AMPS	OA 4.3	6.3	2.1
PPO2	3.00	3.00			OB 5.5	6.6	2.2
FAN ΔP	5.00				OC 3.1	5.0	3.2
HX OUT T	46			FUEL CEL			
O2 FLOW	0.0	0.0		AMPS	180	232	146
N2 FLOW	0.0	0.0		REAC VLV	OP	OP	OP
IMU FAN	A B C			STACK T	+202	+206	+200
AV FC1	FC2	FC3		EXIT T	150	152	149
SS1	22	21	22	COOL P	61	60	61
SS2	22	22	23	PUMP			
SS3	23	21	21				
TOTAL AMPS	557						
KW	17						

PASS SM SYS SUMM 1, available in SM OPS 2

2011/ /079 SM SYS SUMM 2				4 000/14:44:52			
000/00:00:00				000/00:00:00			
CRYO TK	1	2	3	4	5	MANF1	MANF2
H2 PRESS	211	211	238	238	145L	238	238
O2 PRESS	834	833	858	858	515L	858	858
HTR T1	-221	-221	-212	-194	-194		
T2	-221	-221	-212	-194	-194		
APU	1	2	3	HYD	1	2	3
TEMP EGT	20	15	11	PRESS	65	65	65
B/U EGT	16	15	15	RSVR T	72	72	72
OIL IN	51	59	57	P	0	0	0
OUT	56	54	59	QTY	55	55	55
SPEED %	0	0	0	W/B			
FUEL QTY	89	88	85	H2O QTY	97	94	92
FMP LK P	15	15	15	BYP VLV	BYP	BYP	BYP
OIL OUT P	24	24	24				
AV BAY				THERM CNTL	1	2	
TEMP	50	88	82	H2O PUMP P	50	50	
FAN ΔP	3.59	3.64	3.67	FREDN FLOW	2000	2000	
				EVAP OUT T	50	50	

PASS SM SYS SUMM 2, available in SM PS 2

Fault Detection and Annunciation

Five classes of alarms have been established. Class 1, Emergency, has no interface with software. Class 2, Caution and Warning (C/W), is the second highest alarm class. It is divided into primary (hardware-driven) and backup (software-driven) systems. An alarm of the software-driven class will result in the annunciation of the *BACKUP C/W ALARM* light on the C/W matrix on panel F7, the *MASTER ALARM* lights, and an associated tone. In addition, a fault message will be displayed upon the fault message line of the CRT. Class 3, Alert, triggers the *SM ALERT* light and corresponding tone. A fault message is displayed upon the fault message line. Class 5, Operator Errors, is the lowest priority alarm and is caused only by a crew entry error. It results in an *ILLEGAL ENTRY* fault message being displayed. Class 0, Limit Sense, provides a status indicator (down arrow, up arrow) to the right of the affected parameter on an appropriate CRT. No fault message, tone, or light is triggered.

The output of a fault message to the fault message line results in several indications requiring crew interface. Although generally the crew keyboard responses are similar, the effects of these responses differ for each class alarm.

The crew response to a class 2 backup fault message is:

1. Depress the *MASTER ALARM* pushbutton indicator. This will extinguish the *MASTER ALARM* light and caution and warning tone.
2. Depress the *ACK* key (on the keyboard). The fault message will cease flashing. If the crewmember can examine the message while it flashes, this step is unnecessary. Depress the *ACK* key again to look at the next message in a stack if required.
3. Depress the *MSG RESET* key. Depression of this key removes the fault message from the fault message line. In addition, the *BACKUP C/W* light is extinguished. (Hardware-driven lights remain on until the problem is corrected.)

The crew response to a class 3 fault message is:

1. *Depress the ACK key.* This will cause the fault message to become static. Depression of the ACK key will also extinguish the *SM ALERT* light and tone. (The tone duration is set to a crew-selected length and may have stopped before the ACK key is pressed.) Depress the ACK key again to look at the next message in a stack if required.

2011/ /018		GNC SYS SUMM 1		1 000/02:46:03	
				000/00:00:00	
RCS	JET	ISOL			
MANF	FAIL	VLV	SURF	POS	MOM
F1		OP	L OB		DPS
2		OP	IB		GPC
3		OP	R IB		MDM FF
4		OP	OB		FA
5		OP	AIL		
L1		OP	RJD		FCS CH 1 2 3 4
2		OP	SPD BRK		
3		OP	BDY FLP		
4		OP			NAV 1 2 3 4
5		OP			
R1		OP			IMU
2		OP	CNTLR 1 2 3		ACC
3		OP	RHC L		RGa
4		OP	R		TAC
5		OP	A		MLS
			THC L		ADTA
			A		
			SBTC L		
			R		

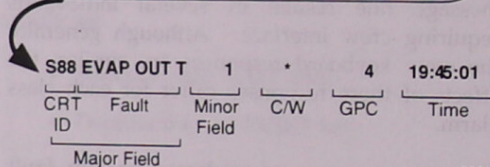

Sample CRT Fault Message

2. *Depress the MSG RESET key.* This will remove the fault message from the fault message line. If the ACK key had not been depressed, the MSG RESET key would extinguish the *SM ALERT* light and tone.

A class 5 fault message displays a flashing "ILLEGAL ENTRY" on the fault message line. The crew response is simply to depress the *MSG RESET* key. This clears the fault message from the fault message line. The *ACK* key will not clear an "ILLEGAL ENTRY." It will cause messages stacked under the "ILLEGAL ENTRY" display to be acknowledged and cleared.

Some illegal keyboard entries are detected by the DEU before being sent to the GPCs. When this occurs, a flashing "ERR" appears

immediately to the right of the erroneous entry on the scratch pad line. The crew response is simply to depress the *CLEAR* key. Upon depression of the *CLEAR* key, the "ERR" and the last keystroke will disappear. Subsequent depressions of the *CLEAR* key will remove single keystrokes, proceeding from right to left. This feature enables the crew to *CLEAR* back to the portion of the command that was incorrect, correct it, and proceed. This type of error is not identified by class, since it is not GPC-detected and is known simply as a DEU-detected error.

Fault Messages

Fault messages associated with alarm classes 2, 3, and 5 follow a standard format of five fields.

The major field is a 14-character field. The first three characters identify the display on which more information about the annunciated failure can be found. An S or a G, followed by a two digit number, indicates the major function (G for GNC and S for SM) and the number of the SPEC or DISP. If no display is associated with the fault, this field is blank. In the example below, "S88" is the CRT ID and means that information on the fault can be found on SPEC 88 in SM.

The remaining characters identify the problem or subsystem group associated with the fault. In the example, "EVAP OUT T" is the FAULT portion of the major field and indicates a fault in the flash evaporator subsystem.

The minor field is a four-character field that further identifies the fault. It will specify the subdivision, direction, location, parameter, or specific unit of the subsystem or problem identified in the major field. In the example fault message, "1" is the minor field message and means that the temperature sensor 1 is the area in which the fault was detected.

The C/W field is used only with caution and warning class 2 backup messages. An asterisk appears in this column across from the corresponding fault to denote that the condition is a class 2 backup alarm.

The GPC field identifies the GPC that detected this fault. This characteristic aids the crewmember in locating or identifying internal GPC or I/O errors.

The far right field is the TIME field. This field indicates the time at which the fault occurred. The time is MET and is displayed in hours, minutes, and seconds (HH:MM:SS).

A complete listing of all possible fault messages can be found in the Flight Data File Reference Data Book and in Section 2.2.

A class 5 alarm is annunciated by an "ILLEGAL ENTRY" in the major field, and all other fault message fields are blank. When a class 5 message is received, it is displayed instantaneously on the fault message line of the CRT where the error occurred, rather than on all CRTs like class 2 and 3 errors. To get rid of the class 5 message, a MSG RESET must be done to the CRT where the error occurred. Class 2 backup and class 3 messages are extinguished by a MSG RESET on any CRT.

The Fault Summary Display

A historical summary of class 2 backup and class 3 fault messages is provided via the FAULT display (DISP 99). Class 5 errors are not displayed as they are caused by illegal crew entries to a single DEU. The FAULT display is a DISP available in all OPS. It is selected for viewing by depression of the FAULT SUMM key.

3021/	/099	FAULT		1	006/09:39:31
					000/00:00:00
CRT	FAULT	C/W	GPC		TIME
ID					

FAULT Display (DISP 99)

The PASS fault summary display consists of up to 15 fault message lines. They appear in reverse chronological order. The oldest message appears on the bottom line. When a new fault message is generated, it appears on the top line. The other messages are pushed down, and the 15th message (the oldest) disappears.

The only difference between the fault messages on the FAULT display and the fault message on the fault message line is the TIME field. On the FAULT display, the time field includes days as well as hours, minutes, and seconds (DDD/HH:MM:SS).

Sometimes, a subsystem failure or malfunction results in the output of several fault messages, some of which may be identical. The fault detection and annunciation logic can prevent the annunciation of identical fault messages. When a fault message is generated, its major and minor fields are compared to those of the top message of the display. If the fields are the same, and if the new fault message has occurred within a 4.8 second window, the new message is inhibited.

The last message displayed on the fault message line of any CRT is not necessarily the most recent fault message. Unless the fault message line was cleared with a MSG RESET, the crewmember will not see any new messages that came in after the flashing or frozen message. In that case, the crewmembers can see if a new message has been annunciated by looking at a two-character field. This field is called the buffer message indicator and is located in the last field on the far right of the fault message line.

The buffer message indicator serves to indicate the number of messages in the fault buffer on the FAULT display since the last MSG RESET. This number includes class 2 backup and class 3 messages only. Class 5 messages and the currently displayed messages are not included in this counter. The number is enclosed by parentheses. If no fault messages are in the stack, this field is blank. To view any of these messages, the crewmember may depress the ACK key to display subsequent messages or look at the FAULT display. A MSG RESET clears both the fault message line and the buffer message indicator.

In addition to using the FAULT SUMM key, the FAULT display may also be selected by the keyboard entry "SPEC 99 PRO." However, this command will clear all fault messages from the FAULT display and the fault message lines. This capability is useful if and when the fault messages displayed are no longer significant (i.e., they are old, or they have been dealt with).

Crew Software Interface with the BFS

The crew software interface with the BFS is designed to be as much like PASS as possible, but there are some differences. This section covers the differences between the PASS's and BFS's crew and CRT interfaces. If something is not mentioned in this section, it can be assumed to operate the same as the PASS interface.

BFC CRT Switches

Panel C3 contains two switches relevant to BFS operations. The *BFC CRT DISPLAY* switch is a two-position *ON/OFF* switch. In the *ON* position, the CRT(s) specified by the *BFC CRT SELECT* switch is driven by the BFS computer. (The *BFC CRT SELECT* switch controls CRT assignment to the BFS computer.) The switch is read by the GPC only when the *BFC CRT DISPLAY* switch is in the *ON* position. The *BFC CRT SELECT* switch has three positions. In each position, the first digit is the CRT commanded by the BFS pre-engage. Post-engaged, the BFS also commands a second CRT indicated by the second number. For example, when the *BFC CRT SELECT* switch is in the 1 + 2 position, CRT 1 is connected to the BFS GPC prior to engaging the BFS. After the BFS is engaged, this switch position allows the BFS computer to command both CRT 1 and CRT 2. In the 2 + 3 position, CRT 2 is commanded by the BFS GPC prior to engaging the BFS. Post-engaged, this switch allows CRT 2 and CRT 3 to be supported by the BFS computer. In the 3 + 1 position, CRT 3 is driven by the pre-engaged BFS GPC. Upon engaging the BFS, both CRT 3 and CRT 1 will be assigned to the BFS computer.

During ascent and entry, one CRT will normally be assigned to the BFS via the *BFC CRT SELECT* switch. The nominal position of the switch is the 3+1 position. However, this switch position may be changed at any time, pre-engage or post-engage. If the BFS is engaged with the *BFC CRT DISPLAY* switch *OFF*, the BFS will automatically assume command of CRTs 1 and 2.

No set of *BFC CRT* switches exists for the CRT in the aft station.

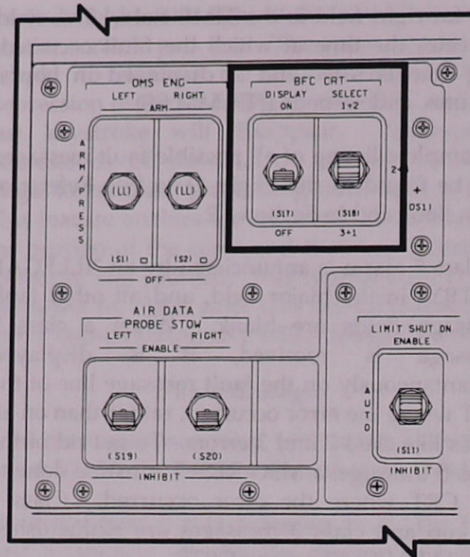

BFC CRT DISPLAY and SELECT Switches on Panel C3

BFS Functions of the MAJ FUNC Switch

The *MAJ FUNC* switches on panels C2 and R11L are also functional for the BFS. However, the display data and functional software accessed by the three-position switch are slightly different. The BFS functions of the *MAJ FUNC* switch are defined as follows:

- **GNC:** Flight critical software including limited guidance, navigation, and control software is contained in this major function. The BFS GNC major function contains only that software necessary for safe orbital insertion and return, including ascent abort logic.
- **SM:** This major function contains limited nonredundant systems management and payload software. There is no room in the BFS for the redundancy management found in PASS. When the *MAJ FUNC* switch is set in the SM position, the THERMAL display is invoked. This display is unique to the BFS.
- **PL:** This major function is not functional for the BFS. Should the *MAJ FUNC* switch be set in this position, no display change would occur. If the *BFC CRT DISPLAY* switch is turned on, allowing the BFS to drive a CRT already in the PL

major function, the CRT will be blank except for time and GPC driver fields because the BFS has no software to support this major function.

BFS ENGAGE Push Button

The BFS ENGAGE pushbutton is located on the commander's and pilot's rotational hand controllers (RHCs). During the dynamic flight phases (ascent and entry), the commander and pilot usually rest a hand on or near the RHC. In this way, BFS engagement can occur as quickly as possible. If the crew delays engagement during these flight phases, they could lose control of the vehicle, or the BFS' navigation calculations could degrade very quickly so that control would be essentially lost after engagement.

Some force (8 lb) is required to depress this pushbutton to prevent inadvertent engages. While on-orbit, the pushbutton is essentially disabled by reconfiguring the BFS OUTPUT switch. The BFS cannot track PASS while it is in OPS 2 and is moded to HALT on-orbit. If the BFS needs to be engaged on-orbit, the BFS must be "awakened", and the only software that will be of any use is entry and systems management software.

Keyboard and Display Differences for the BFS

The keyboard operates exactly the same way for the BFS as for the PASS. A few additional capabilities need to be mentioned.

- The GPC/CRT key: In addition to the *BFC CRT DISPLAY* switch, this key provides the capability to assign a CRT to (or isolate a CRT from) the BFS GPC. Both methods can be used interchangeably, but as long as the *BFC CRT DISPLAY* switch is working, it is the fastest method of allowing the BFS to drive a CRT or to change BFS CRTs. The *BFC CRT DISPLAY* switch allows PASS to automatically begin driving the CRT again when the BFS is turned off. When the BFS is assigned a CRT with the GPC/CRT key, it is the same as deassigning that screen from PASS with a GPC/CRT OX EXEC. PASS must be reassigned to resume commanding of that CRT.

- The BFS INDICATOR: When the BFS is commanding a CRT, the BFS indicator will appear on the CRT being commanded. On the second line of every BFS display a three-character space field has been reserved for the message "BFS." This field is located directly below the GPC indicator. The BFS indicator is displayed in the overbright intensity and is intended to prevent possible confusion of a PASS display with a BFS display. Often the BFS display will be identical or very close to the corresponding PASS display.

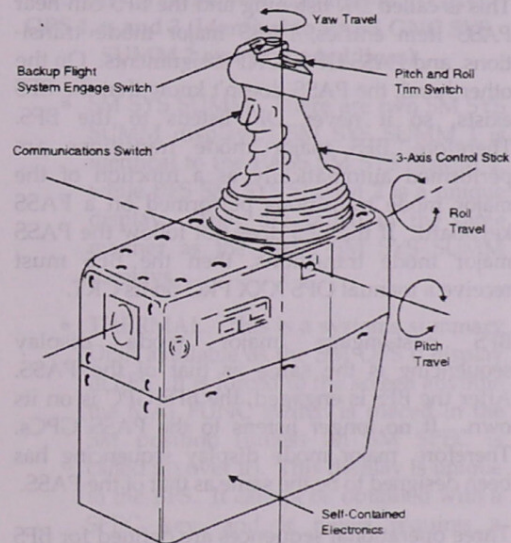

Rotational Hand Controller

1011/ /018		GNC SYS SUMM 1		5 000/02:46:03	
				BFS 000/00:00:00	
SURF		POS	MDM	DPS 1 2 3 4	
L	OB			MDM	FF
	IB				FA
R	IB				PL
	OB				
	AIL			FCS CH 1 2 3 4	
	RUD				
	SPD BRK				
	BDY FLP				
MPS		L	C	R	NAV 1 2 3 4
HE	TK P	4280	4230	4240	IMU
REG	P A	784	768	768	TAC
	B	776	766	770	ADTA
dP/dT					MPS PNEU HE P
ULL	P LH2	42.5	42.7	42.9	TK 4350
	LO2	21.1	21.0	20.8	REG 798
					ACUM 760
GHZ	OUT P	701	501	401	MANF P LH2 46
G02	OUT T	791	971	701	LO2 110

249

BFS Indicator on CRT

BFS Display Sequencing

The BFS is designed to operate in the same manner as the PASS where possible. BFS requirements, however, demanded a distinction be made between BFS pre-engage and BFS post-engage major mode transitions and associated display sequencing.

BFS pre-engage major mode display sequencing is either automatic, or it may be performed in the same manner as that of the PASS. Before the BFS is engaged, the BFS CRT is listening to the PASS CRT across the display/keyboard (DK) buses and updating its software accordingly. This is called DK listening and the BFS can hear PASS item entries, PASS major mode transitions, and PASS GPC/CRT assignments. On the other hand, the PASS doesn't know that the BFS exists, so it never DK listens to the BFS. Therefore, BFS major mode transitions are performed automatically as a function of the major mode transitions performed on a PASS keyboard. If the BFS does not follow the PASS major mode transitions, then the BFS must receive a manual OPS XXX PRO on its CRT.

BFS post-engage major mode display sequencing is the same as that of the PASS. After the BFS is engaged, the BFS GPC is on its own. It no longer listens to the PASS GPCs. Therefore, major mode display sequencing has been designed to be the same as that of the PASS.

Three operational sequences are defined for BFS GNC; one operational sequence is defined for the BFS SM. Transactions to and from these OPS displays differ considerably from the PASS. BFS keyboard and CRT peculiarities are outlined as follows:

- BFS GNC OPS 0 - BFS MEMORY display: This display is forced to the CRT when BFS is not processing either GNC OPS 1 or 3. Nominally, this occurs prior to ascent and again prior to entry. This display corresponds to the PASS GPC MEMORY display and performs the same functions for the BFS. It also performs some of the same functions as PASS SPEC 2, the TIME SPEC, in that

time updates can be performed along with selection of GMT or MET to be displayed. GPC MEMORY is the default display for PASS OPS 0, and the BFS MEMORY display is the default display for BFS GNC OPS 0.

- BFS GNC OPS 1 and 6 - Ascent: This OPS must be manually selected via a keyboard assigned to the BFS prelaunch. BFS GNC OPS 1 is available for use during the ascent portion of the mission. The OPS 6 transition is automatic upon abort selection with the ABORT rotary switch and pushbutton, or an OPS 601 PRO may be used.

0001/000/		BFS MEMORY		5 008/12:12:12	
				BFS 000/00:29:12	
READ/WRITE					
DATA 1*	BIT SET 3	SEQ ID 5			
CODE 2	BIT RST 4	WRITE 6			
7 ENG UNITS HEX 8*					
ADD ID	DESIRED	ACTUAL			
9	10				
11	12				
13	14				
15	16				
17	18				
19	20				
MEMORY DUMP			LAUNCH BUS	1 26	TFL ENA
21	START ID			2 27	29
22	NUMBER WDS		OFF 28*		
23	WDS/FRAME		PASS/BFS XFER ENA	25	
DUMP 24					
BFS TIME UPDATES		UPDATE 38	MISSION TIME		
30	GMT D []	/	:	:	GMT 39
34	MET D []	/	:	:	MET 40

250

BFS MEMORY Display

- BFS GNC OPS 3 - Entry: This OPS must be manually selected from BFS GNC OPS 0 or BFS GNC OPS 1. BFS GNC OPS 3 is available for use during the entry portion of the mission. It is a legal transition to go from the BFS GNC OPS 1 to BFS GNC OPS 3 (for aborts), but nominally, the transition will be from BFS GNC OPS 0. In both cases, the manual keyboard entry "OPS 301 PRO" is required.

The major mode displays for BFS OPS 1, 3, and 6 are similar, if not identical, to their PASS counterparts. A complete listing of PASS and BFS displays can be found in the DPS Dictionary.

0001/ /079		SM SYS SUMM 2			5 008/23:29:22		
					BFS 000/00:00:00		
CRYO TK	1	2	3	4	5	MANF1	MANF2
H2 PRESS	208	208	206	206	206	208	207
O2 PRESS	816	815	814	814	814	815	815
HTR T1	-248	-248	-248	-248	-248		
T2	-248	-248	-248	-248	-248		
APU	1	2	3	HYD	1	2	3
TEMP EGT	942	942	942	PRESS	3064	3064	3064
B/U EGT	942	942	942	ACUM P	3080	3080	3080
OIL IN	250	250	250	RSVR T	116	153	142
OUT	264	264	264				
GG BED	511H	511H	511H	QTY	72	74	71
INJ	1271	1271	1271				
SPEED %	99	102	101	W/B			
FUEL QTY	59	60	62	H2O QTY	78	73	78
PMP LK P	14	14	14	BYP VLV	BYP	BYP	BYP
OIL OUT P	42	42	41				
FU TK VLV							
A T	63	65	62	THERM CNTL	1	28	
B T	63	65	62	H2O PUMP P	23	63	
AV BAY	1	2	3	FREON FLOW	2384	2384	
TEMP	97	97	83	EVAP OUT T	38	38	
A4 14	27.439	27.435			26.324	31.873	18.48

051

**BFS SM SYS SUMM 2, available in SM OPS 0
(unique to BFS)**

BFS Fault Messages

Several crew interface characteristics of fault annunciation in the BFS differ from those in the PASS.

- The BFS FAULT display. The BFS FAULT display functions in the same manner as the PASS. The BFS FAULT display is composed of 20 fault lines as compared to 15 in the PASS. The C/W field displays an asterisk when the message annunciated is a class 2 backup

alarm. The BFS FAULT display provides a history of only class 2 backup and class 3 messages annunciated by the BFS GPC itself.

- BFS Unique CRT IDs. In BFS SM, all messages referring to SM SYS SUMM 1 or SM SYS SUMM 2 are indicated by the CRT IDs SM1 and SM2. Fault messages referring to the THERMAL display are indicated by the CRT ID SM0.

0001/		THERMAL			5 000/00:00:00		
					BFS 000/00:00:00		
HYD SYS TEMP	BDYFLP	RD/SB	L OB	L IB	R IB	R OB	
PRIME	+ 99	+ 79	+ 76	+ 79	+ 76	+ 79	
STBY 1	+ 89	+ 79	+ 79	+ 79	+ 79	+ 79	
		BRAKE PRESS					
		HYD SYS 1/3			92	92	92
		2/3			92	92	92
HTR TEMP	L/A	R/B	FREON LOOP	1	2		
PRELT			ACCUM QTY	34	34		
POD			RAD OUT T	109	109		
OMS CRSFD			H2O SUP P	0			
		TIRE PRESS					
HI LOAD			MG	LEFT	RIGHT		
TOP DUCT			IB	429	420	418	
NOZ			OB	421	421	416	
FDLN			NG	397	397	381	
				381	381		
		1			2		
HYD BLR/HTR							
APU							
GG/FU PMP HTR	H		H		H		
TK/FU LN HTR							
PUMP/VLV							

255

**BFS THERMAL, available in SM OPS 0
(unique to BFS)**

DPS Summary Data

- The DPS combines various hardware components and self-contained software to provide computerized monitoring and control.
- DPS hardware includes five GPCs, two mass memory units, a data bus network, 20 MDMs, four CRTs, and other specialized equipment.
- Each of the five GPCs consists of a CPU and an IOP stored in one avionics box. During ascent/entry, four of the GPCs are loaded with identical PASS software; the fifth is loaded with different software, the BFS.
- The data bus network transfers data between the GPCs and vehicle systems. There are seven types of data buses: flight-critical, payload, launch, mass memory, display/key-board, instrumentation/PCMMU, and intercomputer communication.
- The 13 DPS MDMs convert data to appropriate formats for transfer between the GPCs and vehicle systems.
- Two mass memory units provide bulk storage for software and data.
- Four CRTs (three on panel F7 and one on panel R11L) and associated keyboards provide the means for flight crew interaction with the GPCs.
- The two types of DPS software, system software and applications software, combine to form a memory configuration for a specific mission phase.
- The system software is operating software that always resides in GPC main memory.
- The applications software performs the functions required to fly and operate the vehicle. It is divided into three major functions: guidance, navigation, and control (GNC); systems management (SM); and payload (PL).
- Major functions are divided into mission phase oriented blocks called operational sequences (OPS).
- OPS are further divided into blocks called major modes (MM), which relate to specific portions of a mission phase.
- There are three levels of CRT displays: major mode or OPS, specialist (SPEC), and display (DISP).
- The four PASS GPCs control all GNC functions during ascent/entry mission phases; the fifth GPC is loaded with backup flight system (BFS) software to take over in case of PASS GPC failure.
- The BFS contains a limited amount of software; there are some operational differences between BFS and PASS.
- The BFS is engaged by pushbutton on the rotational hand controller.
- A GPC FAIL detection will display a class 2 GPC FAULT message with illumination of the MASTER ALARM. The GPC STATUS matrix (sometimes referred to as the computer annunciation matrix (CAM)) on panel O1 lights to indicate failure votes; any time a yellow matrix light is illuminated, the GPC caution and warning light on panel F7 also lights.
- Most DPS control switches are located on panels O6 and C2. Others may be found on panels C3, R11L, F2, F4, F6, and F7.
- CRT displays relevant to the DPS are: GPC/BUS STATUS (SPEC 6), GPC MEMORY (SPEC 0), DPS UTILITY (SPEC 1), and TIME (SPEC 2).

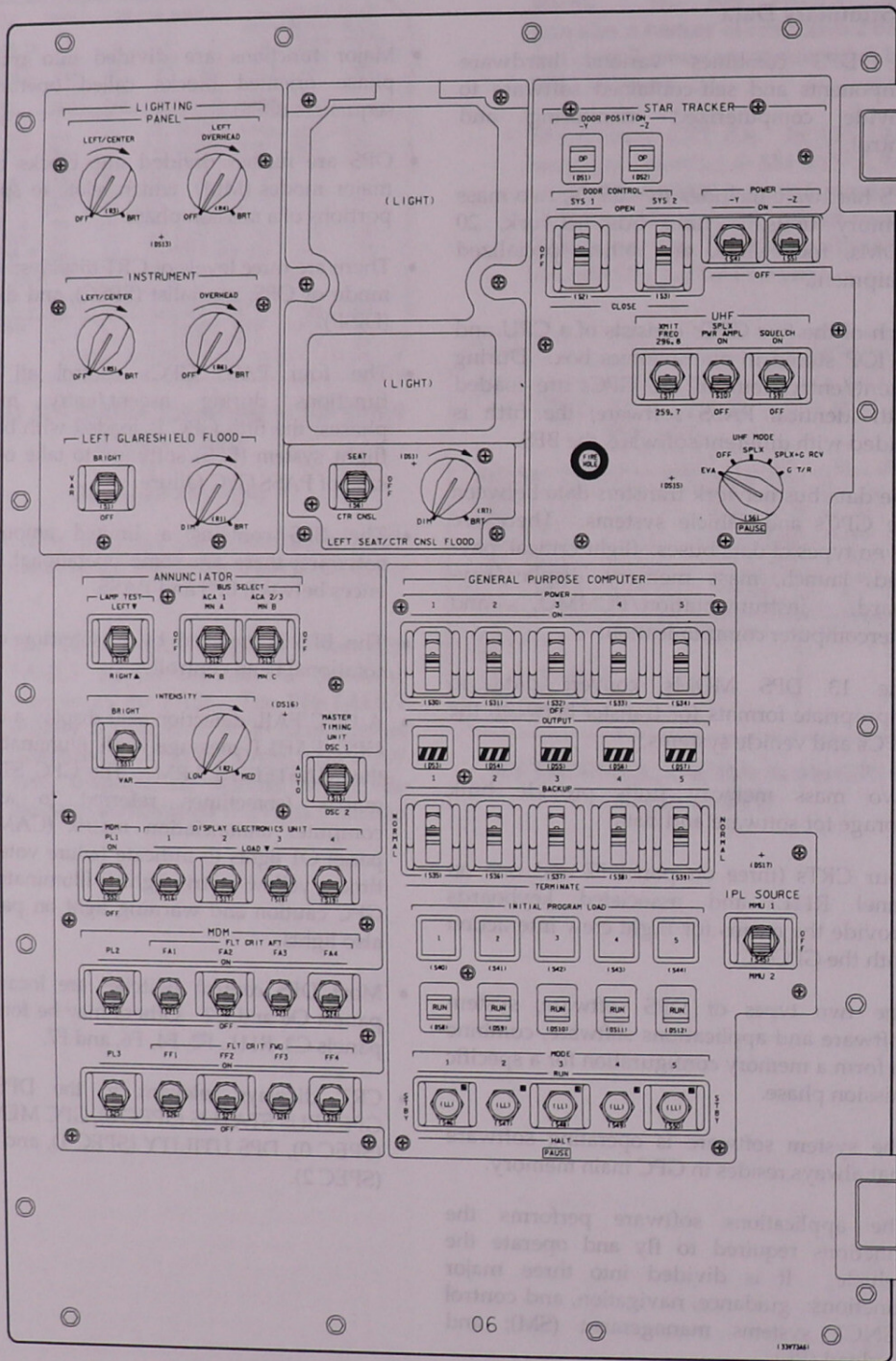

Panel O6

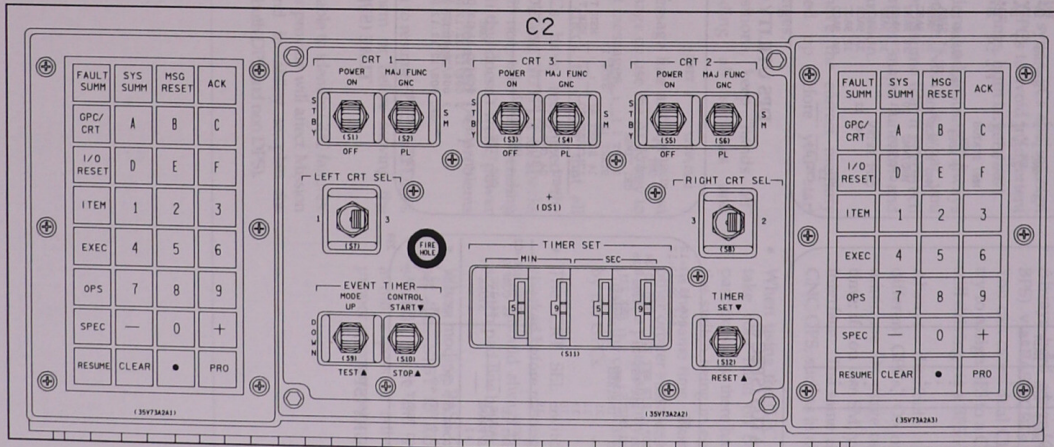

Panel C2

2011/ /006 GPC/BUS STATUS 2 008/02:56:10
000/00:11:10

GPC	1	2	3	4	5
MODE	RUN	RUN	HALT	RUN	HALT
OPS	G2	G2	0	S2	0
STRING 1	FF	*		↓	
FA	*			↓	
2	FF		*	↓	
FA	*			↓	
3	FF	*		↓	
FA	*			↓	
4	FF	*		↓	
FA	*			↓	
PL 1	↓	↓	*		
2	↓	↓	*		
LAUNCH 1	↓	↓	*		
2	↓	↓	*		
CRT 1	*			↓	
2		*		↓	
3	↓	↓		↓	
4	↓	↓		*	

GPC/BUS STATUS (SPEC 6)

202

2011/001/ DPS UTILITY 1 008/12:12:12
000/00:25:12

MMU ASSIGN	PORT ASSIGN	PRI	SEC	UL CNTL
1 2				
GNC 1* 2	STRING 1	15*	16	AUTO 35*
SM 3* 4	2	17*	18	ENA 36
PL 5* 6	3	19*	20	INH 37
OPS 0 7* 8	4	21*	22	
	P/L 1/2	23*	24	IPL SOURCE SW MASK 38*

MMU STATUS	VAR PARAM ID LIST
1 RDY	25 9ABA
2 RDY	26 9ABB
	27 9ABC
MMU SOURCE/BUS	28 9ABD
GPC/MMU 9*	29 9ABE
MMU/MMU 10	30 9ABF
GPC/LDB 11	31 9ACA
	32 9ACB
CKPT RETRV	33 9ACC
ENA 12	34 9ACD
RTC	
13	
CMD 14	

G3 ARCHIVE
LOAD 48
RETRIEVE 49*

GROUND OPS
GSE POLL ENA 50
SM GSE INH 51
SM C/O ENA 52
GNC C/O ENA 53
BFC C/O ENA 54
ALT PL9 TB 55

DPS UTILITY (SPEC 1)

239

2011/000/ GPC MEMORY 1 008/12:12:12
000/00:29:12

MEM/BUS CONFIG	READ/WRITE	GPC
1 CONFIG 2 (G2)	DATA 20*	BIT SET 22 SEQ ID 24
2 GPC 1 2 0 0 0	CODE 21	BIT RST 23 WRITE 25
	26 ENG UNITS	HEX 27*
STRING 1	7 1	ADD ID DESIRED ACTUAL
2	8 2	28 29
3	9 1	30 31
4	10 2	32 33
P/L 1/2	11 0	34 35
		36 37
CRT 1	12 1	38 39
2	13 2	
3	14 0	
4	15 2	
LAUNCH 1	16 1	MEMORY DUMP
2	17 2	40 START ID
MM 1	18 1	41 NO WORDS
2	19 2	42 WDS/FRAME
		DUMP 43
OPS 3 UPINK 50		44 DOWNLIST GPC 1
OPS 3 INIT 51		OPS 0 ENA 49
		ERR LOG RESET 48
		STORE MC=02
		45 CONFIG
		46 GPC
		STORE 47
		MM AREA
		PL 52 1
		GNC 53 1
		SM 54 1

GPC MEMORY (SPEC 0)

238

1061/002/ TIME 1 008/12:12:12
000/00:25:12

MISSION TIME	TONE
GMT 1*	3
MET 2	6
CRT TIMER	
9 SET []	20 []
START 12	STOP 13
14 START AT	MSN T 23 DURATION
17 COUNT TO	MSN T
MTU	
24 GMT Δ []	
28 MET Δ []	
UPDATE 32	MET RESET 33
GPC TIME	
MTU ACCUM 1	GMT TRY GPC
2	008/12:12:12.000 34 2 A1
3	008/12:12:12.000 35 3 A1
4	008/12:12:12.000 36 4 A1
5	008/12:12:12.000 37 5 A1
TIME SYNC 38	

TIME (SPEC 2)

214

DPS Rules of Thumb

- Always HALT fail to sync GPCs and reassign their CRTs to good GPCs to avoid inadvertent entries (NBATs /restrings, burn targets, etc.).
- Before OPS transitions and restrings, always verify the appropriate NBAT is what you want it to be; never assume that it is correct! Also check the proper major function and GPC switch configuration.
- Make sure you have the correct memory configuration called up before you start making NBAT changes.
- During OPS transitions, keep "hands off" everything, including all switches and keyboard entries.
- Clear the Fault Message line as soon as you have seen the message or use the ACK key to display subsequent messages.
- Post BFS engage, check to ensure that all active PASS GPCs have recognized the engage (both MODE and OUTPUT talkbacks are barberpole). If not, take the offending GPC to HALT (or if this doesn't work, power it OFF) immediately to avoid I/O problems on the flight critical strings.
- It is a very good idea to resume SPECS and DISPs when not using them or before moving the major function switch.
- It is important to be able to identify GPC failures. The information you provide will affect Mission Control analysis and its ability to plan for subsequent failures (both DPS and non DPS).
- Always hard assign CRTs (both PASS and BFS) via PASS CRTs (BFS will DK listen). You can cause dual CRT commanders if you try to assign BFS to a CRT that a PASS CRT is still driving via a BFS keyboard.
- Always distribute your CRTs among different GPCs. On orbit, always be sure to minimize SM usage on all CRTs at the same time; if you lose SM, you also lose PASS CRT interface. The same is true if in single GPC GNC OPS, such as in a Group B powerdown.
- When using the GPC MODE switch, always take your hand off between positions. On past missions, there have been problems with the switch being in essentially two positions at the same time. This problem can occur on other orbiter switches too. It is a good idea to always pause slightly in each switch detent to ensure the contacts are made and recognized by the GPCs.
- The CRT SEL switch should always be checked before making a keyboard entry, and data should always be checked on the CRT scratch pad line before it is entered.
- When moding PASS GPCs into the common set (i.e., STBY to RUN), always pause 10 seconds before and after switch throws to avoid a possible fail-to-sync and to ensure proper common set initialization.

2.7 DEDICATED DISPLAY SYSTEMS

CONTENTS	
Description	2.7-1
Display Driver Unit.....	2.7-2
Attitude Director Indicator (ADI)	2.7-4
Horizontal Situation Indicator (HSI)	2.7-9
Alpha/Mach Indicator	2.7-14
Altitude/Vertical Velocity Indicator	2.7-17
Surface Position Indicator	2.7-18
Flight Control System Pushbutton Indicators	2.7-19
Reaction Control System Command Lights.....	2.7-20
G-Meter (Non-MEDS).....	2.7-21
Head-Up Display.....	2.7-21
Dedicated Display Systems Summary Data	2.7-25
{ rd 02_07a.doc } { rd 02_07b.doc }	

performance. The data on the dedicated displays may be generated by the navigation or flight control system software or more directly by one of the navigation sensors. The dedicated displays are located in front of the commander's and pilot's seats and on the aft flight deck panel by the aft-facing windows.

The dedicated displays are:

- Attitude director indicators on panels F6, F8, and A1U
- Horizontal situation indicators on panels F6 and F8
- Alpha/Mach indicators on panels F6 and F8
- Altitude/vertical velocity indicators on panels F6 and F8
- Surface position indicator on panel F7
- Reaction control system activity lights on panel F6
- G-meter on panel F7 (non-MEDS)
- Head-up display on the glareshield in front of the commander's and pilot's seats

Description

Dedicated displays provide the flight crew with information required to fly the vehicle manually or to monitor automatic flight control system

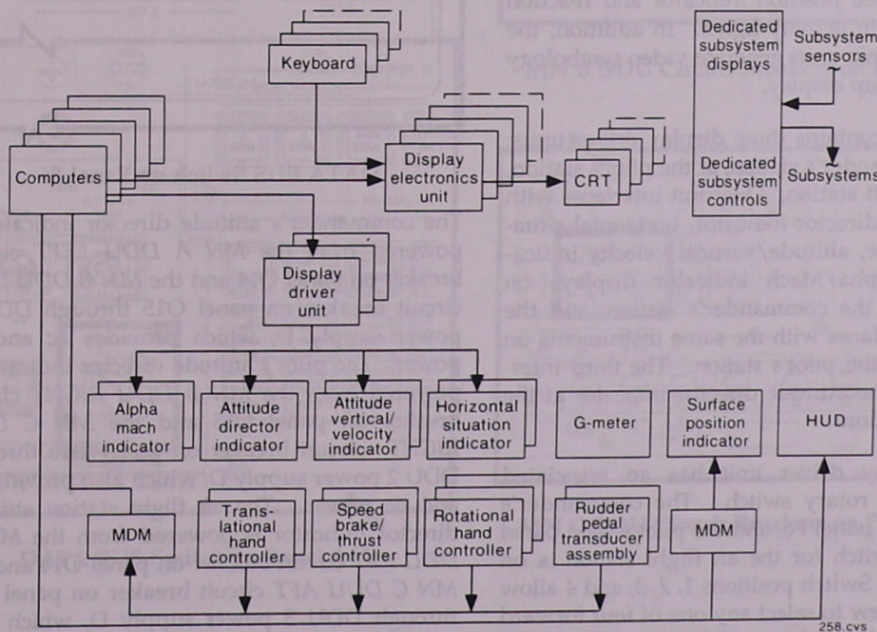

Dedicated Display and Control System

Not all the dedicated displays are available in every operational sequence or major mode. Their availability is related to the requirements of each flight phase.

Display Driver Unit

The display driver unit (DDU) is an electronic mechanism that connects the GPCs and the primary flight displays. The display driver unit receives data signals from the computers and decodes them to drive the dedicated displays. The unit also provides dc and ac power for the attitude director indicators and the rotational and translational hand controllers. It contains logic for setting flags on the dedicated instruments for such items as data dropouts and sensor failures.

All display parameters, regardless of their origin, are ultimately processed through the dedicated display subsystem operating program (SOP) software (except the g-meter, which is totally self-contained). The display parameters are then routed to the respective displays through either a DDU or multiplexer/demultiplexer (MDM); DDUs send data to the attitude director indicator, horizontal situation indicator, altitude/vertical velocity indicator, alpha/Mach indicator, and altitude/vertical velocity indicator displays; MDMs provide data for the surface position indicator and reaction control system activity lights. In addition, the HUD electronic units generate video symbology for the head-up display.

The orbiter contains three display driver units: at the commander's station, at the pilot's station, and at the aft station. One unit interfaces with the attitude director indicator, horizontal situation indicator, altitude/vertical velocity indicator, and alpha/Mach indicator displays on panel F6 at the commander's station, and the second interfaces with the same instruments on panel F8 at the pilot's station. The third interfaces with the attitude director indicator at the aft flight station.

Each display driver unit has an associated *DATA BUS* rotary switch. The commander's switch is on panel F6, and the pilot's is on panel F8. The switch for the aft flight station is on panel A6U. Switch positions 1, 2, 3, and 4 allow the flight crew to select any one of four forward flight-critical data buses (FC1 through 4) as the

data source for that display driver unit and its dedicated displays. (Because the flight-critical data buses are assigned to specific orbiter GPCs, the *DATA BUS* select switch also provides a means of assessing the health of individual computers, if they are assigned to FC1, 2, 3, or 4. See Section 2.6 for detailed data bus information.)

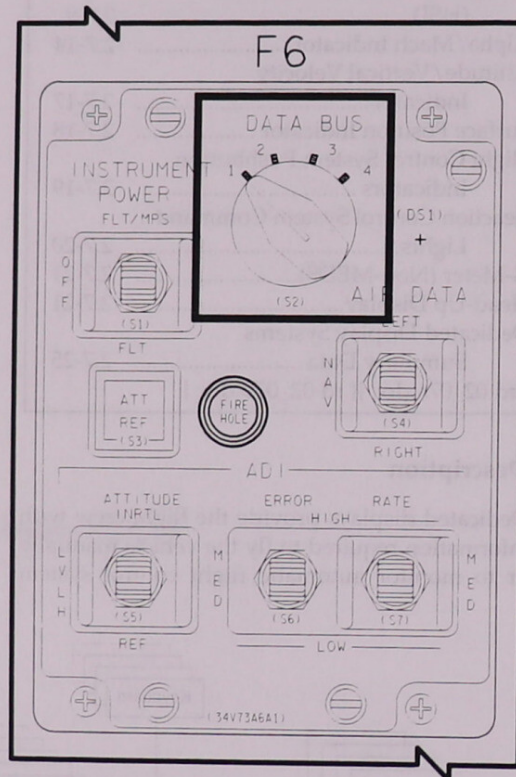

DATA BUS Switch on Panel F6

The commander's attitude director indicator is powered from the *MN A DDU LEFT* circuit breaker on panel O14 and the *MN B DDU LEFT* circuit breaker on panel O15 through DDU 1 power supply D, which provides ac and dc power. The pilot's attitude director indicator is powered from the *MN B DDU RIGHT* circuit breaker on panel O15 and the *MN C DDU RIGHT* circuit breaker on panel O16 through DDU 2 power supply D, which also provides ac and dc power. The aft flight station attitude director indicator is powered from the *MN A DDU AFT* circuit breaker on panel O14 and the *MN C DDU AFT* circuit breaker on panel O16 through DDU 3 power supply D, which provides ac and dc power.

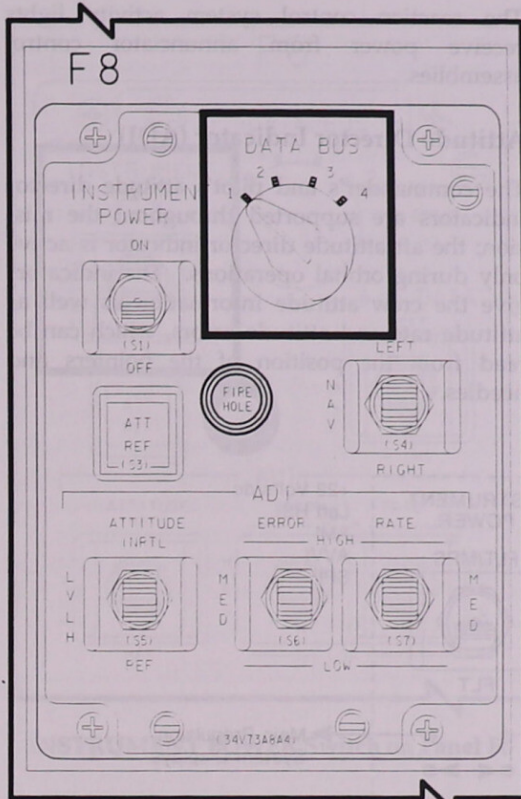

DATA BUS Switch on Panel F8

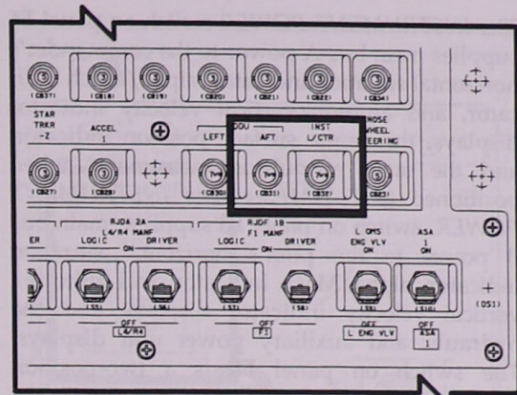

MN A DDU Circuit Breakers on Panel 014

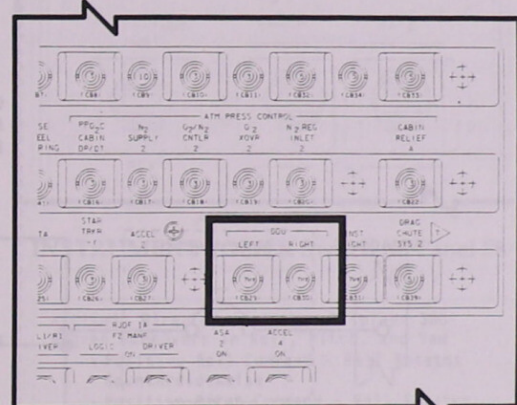

MN B DDU Circuit Breakers on Panel 015

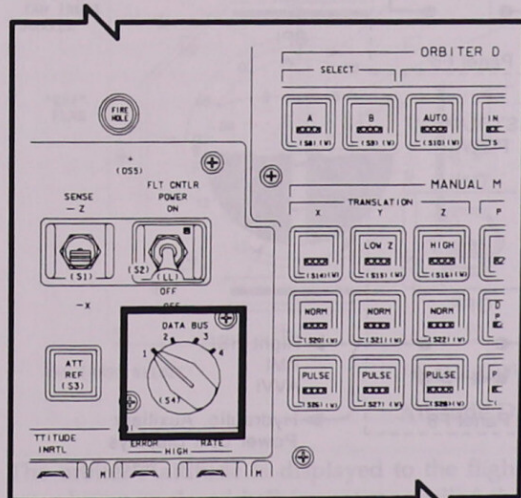

DATA BUS Switch on Panel A6U

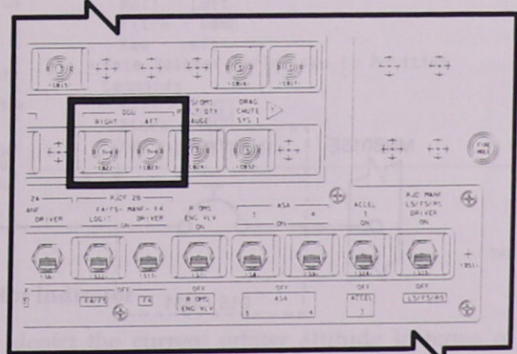

MN C DDU Circuit Breakers on Panel 016

The *INSTRUMENT POWER* switch on panel F6 supplies main bus A power to the commander's horizontal situation indicator, alpha/Mach indicator, and altitude/vertical velocity indicator displays, the single surface position indicator, and the main propulsion instruments when positioned to *FLT/MPS*. The *INSTRUMENT POWER* switch on panel F8 supplies main bus B power to the pilot's horizontal situation indicator, alpha/Mach indicator, and altitude/vertical velocity indicator displays and the hydraulic and auxiliary power unit displays. The switch on panel F8 is a two-position *ON/OFF* switch.

The reaction control system activity lights receive power from annunciator control assemblies.

Attitude Director Indicator (ADI)

The commander's and pilot's attitude director indicators are supported throughout the mission; the aft attitude director indicator is active only during orbital operations. The indicators give the crew attitude information as well as attitude rate and attitude errors, which can be read from the position of the pointers and needles.

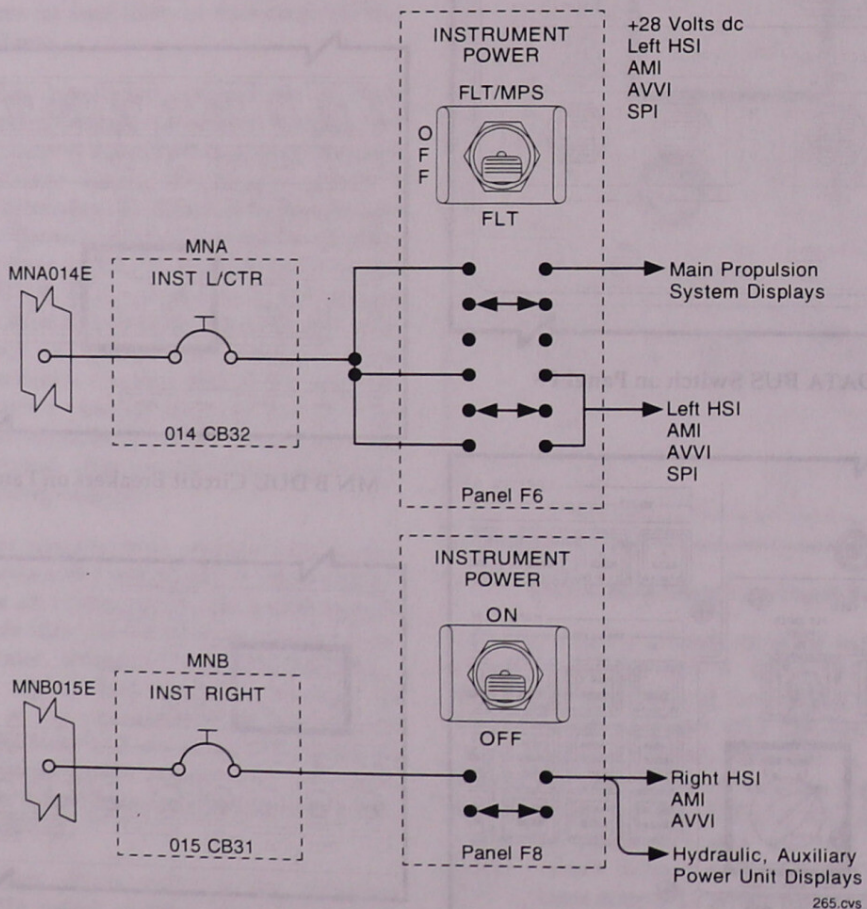

Power for Alpha/Mach Indicator, Altitude/Vertical Velocity Indicator, Horizontal Situation Indicator, and Surface Position Indicator

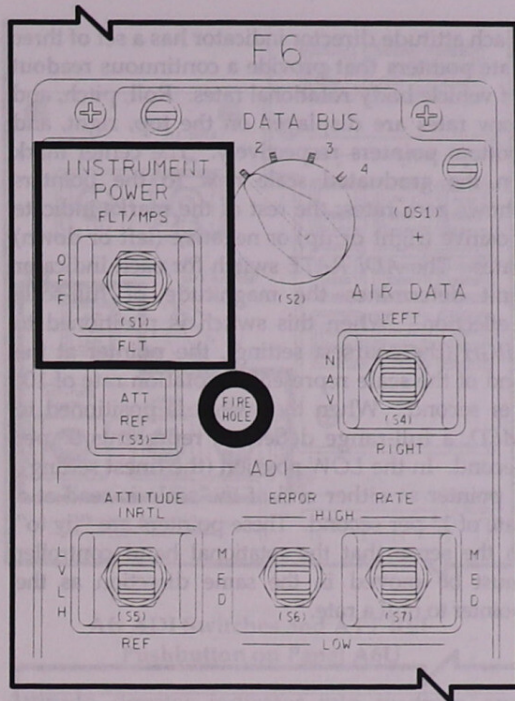

INSTRUMENT POWER Switch on Panel F6

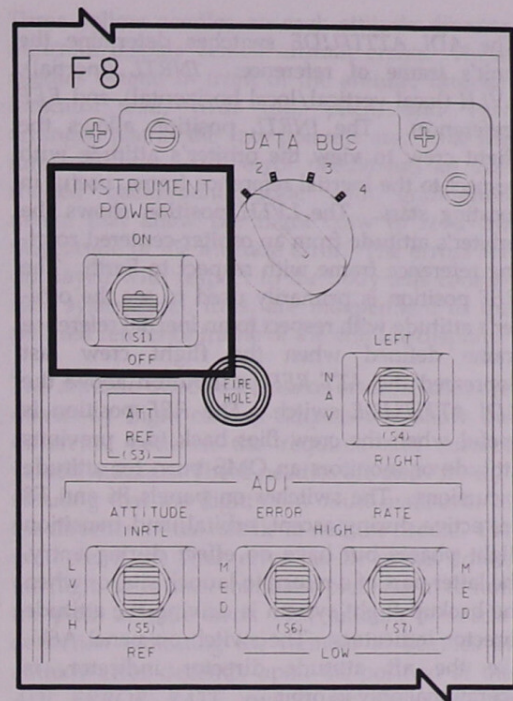

INSTRUMENT POWER Switch on Panel F8

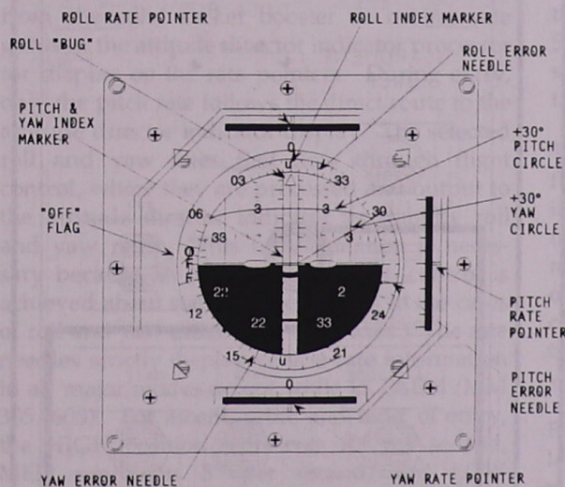

Attitude Director Indicator

Attitude Director Indicator Displays 360-Degree Maneuvers in Roll, Pitch, and Yaw

- Positive Roll Command - Ball Rotates Counterclockwise
- Positive Pitch Command - Ball Rotates From Top to Bottom
- Positive Yaw Command - Ball Rotates From Left to Right
- Error Needle Deflections to Positive Commands
 - Roll - Left
 - Pitch - Down
 - Yaw - Left
- Rate Pointer Deflection to Positive Commands
 - Roll - Right
 - Pitch - Up
 - Yaw - Right

The orbiter's attitude is displayed to the flight crew by an enclosed ball (sometimes called the eight ball) that is gimballed to represent three degrees of freedom. The ball, covered with numbers indicating angle measurements (a 0 is added as the last digit of each), moves in response to software-generated commands to

depict the current orbiter attitude in terms of pitch, yaw, and roll.

Each attitude director indicator has a set of switches by which the crew can select the mode or scale of the readout. The commander's switches are located on panel F6, the pilot's on panel F8, and the aft switches on panel A6U.

The *ADI ATTITUDE* switches determine the unit's frame of reference: *INRTL* (inertial), *LVLH* (local vertical/local horizontal), and *REF* (reference). The *INRTL* position allows the flight crew to view the orbiter's attitude with respect to the inertial reference frame, useful in locating stars. The *LVLH* position shows the orbiter's attitude from an orbiter-centered rotating reference frame with respect to Earth. The *REF* position is primarily used to see the orbiter's attitude with respect to an inertial reference frame defined when the flight crew last depressed the *ATT REF* pushbutton above the *ADI ATTITUDE* switch. The *REF* position is useful when the crew flies back to a previous attitude or monitors an OMS burn for attitude excursions. The switches on panels F6 and F8 are active during ascent, orbital, and transition flight phases but have no effect during entry, the latter part of a return to launch site, or when the backup flight system is driving the attitude director indicators. The switch on panel A6U, like the aft attitude director indicator, is operational only in orbit.

Each attitude director indicator has a set of three rate pointers that provide a continuous readout of vehicle body rotational rates. Roll, pitch, and yaw rates are displayed on the top, right, and bottom pointers respectively. The center mark on the graduated scale next to the pointers shows zero rates; the rest of the marks indicate positive (right or up) or negative (left or down) rates. The *ADI RATE* switch for each indicator unit determines the magnitude of full-scale deflection. When this switch is positioned to *HIGH* (the coarsest setting), the pointer at the end of the scale represents a rotation rate of 10° per second. When the switch is positioned to *MED*, a full-range deflection represents 5° per second. In the *LOW* position (the finest setting), a pointer at either end of the scale is read at a rate of 1° per second. These pointers are "fly to" in the sense that the rotational hand controller must be moved in the same direction as the pointer to null a rate.

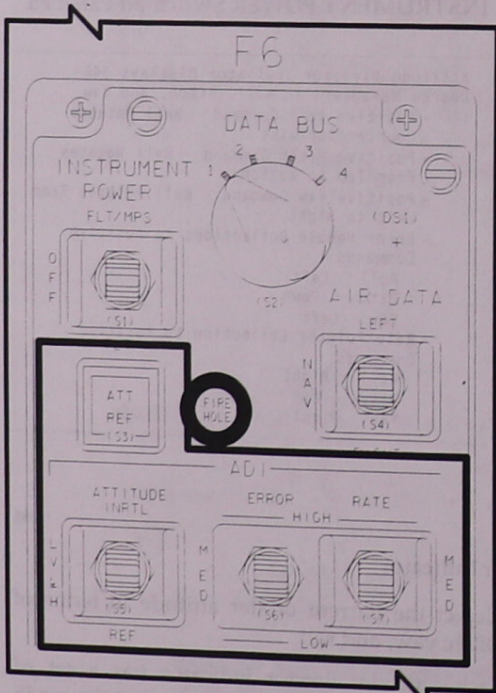

Commander's ADI Switches and ATT REF Pushbutton on Panel F6

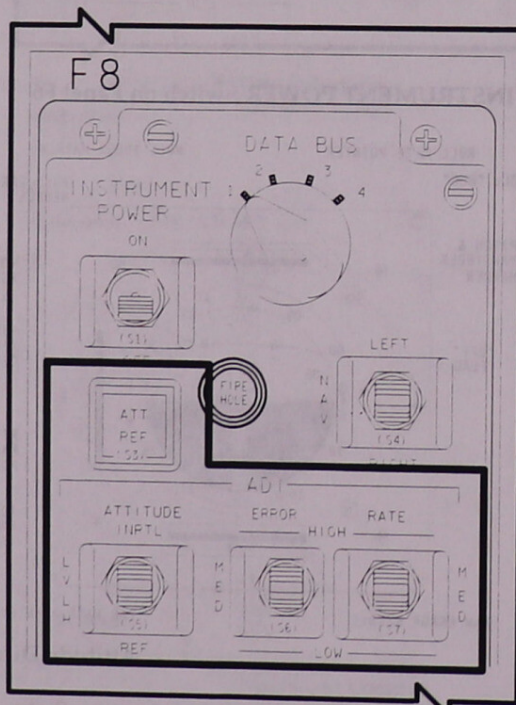

Pilot's ADI Switches and ATT REF Pushbutton on Panel F8

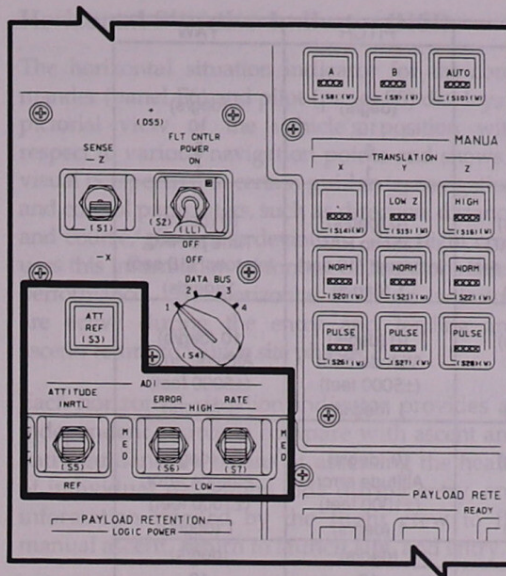

**Aft ADI Switches and ATT REF
Pushbutton on Panel A6U**

Attitude director indicator rate readings are independent of the selected attitude reference. During ascent, the selected rates come directly from the solid rocket booster or orbiter rate gyros to the attitude director indicator processor for display on the rate pointers. During entry, only the pitch rate follows the direct route to the attitude director indicator display. The selected roll and yaw rates first flow through flight control, where they are processed and output to the attitude director indicator as stability roll and yaw rates. (This transformation is necessary because, in aerodynamic flight, control is achieved about stability axes, which in the cases of roll and yaw differ from body axes.) The rate needles strictly display vehicle rate information in all major modes except while in TAEM (MM 305, 603). For ascent, orbit, and most of entry, the HIGH position represents 10° per second, MED represents 5° per second, and LOW represents 1° per second. During TAEM, the ADI rate needles can be used to help fly the proper HAC profile as long as the rate switch is in MED (see table A).

Three yellow needles on each attitude director indicator display vehicle attitude errors. These needles extend in front of the attitude director indicator ball, with roll, pitch, and yaw arranged just as the rate pointers are. Like the rate indicators, each error needle has an arc-shaped background scale with graduation marks that allow the flight crew to read the magnitude of the attitude error. The errors are displayed with respect to the body axis coordinate system and, thus, are independent of the selected reference frame of the attitude display.

The attitude director indicator error needles are driven by flight control outputs that show the difference between the required and current vehicle attitude. These needles are also "fly to," meaning that the flight crew must maneuver in the direction of the needle to null the needle. For example, if the pitch error needle points down, the flight crew must manually pitch down to null the pitch attitude error. The amount of needle deflection indicating the number of degrees of attitude error depends upon the position of the ADI ERROR RATE switch for each attitude director indicator and the flight phase. For ascent, orbit, and transition, in the HIGH position, the error needles represent 10° , MED represents 5° , and LOW represents 1° . For entry, the needles signify different errors in different phases (see table B).

The SENSE switch on panel A6U allows the flight crew to use the aft attitude director indicator, rotational hand controller, and translational hand controller in a minus X or minus Z control axis sense. These two options of the aft attitude director indicator and hand controllers correspond to the visual data out of the aft viewing (negative X) or overhead viewing (negative Z) windows.

Each attitude director indicator has a single flag labeled OFF on the left side of the display whenever any attitude drive signal is invalid. There are no flags for the rate and error needles; these indicators are driven out of view when they are invalid.

MISSION PHASE	ROLL	PITCH	YAW
Ascent (101-106, 601)			
On-orbit (201, 202, 801)			
Transition/entry (301-304, 602)	(deg/s)	(deg/s)	(deg/s)
High	10	10	10
Medium	5	5	5
Low	1	1	1
TAEM to HAC intercept (305, 603)			
High	10 (deg/s)	10 (deg/s)	10 (deg/s)
Medium	Time to HAC intercept (10 sec)	Time to HAC intercept (10 sec)	Time to HAC intercept (10 sec)
Low	1 (deg/s)	1 (deg/s)	1 (deg/s)
HAC intercept to prefinal (305, 603)			
High	10 (deg/s)	10 (deg/s)	10 (deg/s)
Medium	Stowed	Altitude error (±5000 feet)	Altitude error (±5000 feet)
Low	1 (deg/s)	1 (deg/s)	1 (deg/s)
Prefinal to 7000 ft (305, 603)			
High	10 (deg/s)	10 (deg/s)	10 (deg/s)
Medium	Stowed	Altitude error (±1000 feet)	Altitude error (±1000 feet)
Low	1 (deg/s)	1 (deg/s)	1 (deg/s)
7000 ft to landing (305, 603)			
High	10	10	10
Medium	5	5	5
Low	1	1	1

(A) ADI Rate Switch vs. Full Range Deflection

MISSION PHASE	ROLL	PITCH	YAW
Ascent/ On orbit (101-106, 601) (201, 202, 801) (301, 303)			
Transition	(Deg)	(Deg)	(Deg)
High	10	10	10
Medium	5	5	5
Low	1	1	1
ENTRY (MM 304, 602)	(Deg)	(Deg)	(Deg)
High	25	10	10
Medium	25	5	2.5
Low	10	1	2.5
MM 603 IPH = 4.6			
TAEM (MM 305, 603)	(Deg)	(g's)	(Deg)
High	25	1.25	2.5
Medium	25	1.25	2.5
Low	10	0.5	2.5
IPH ≠ 4.5 WOWLON = 0			
WOWLON = 1			
Rollout (MM 305, 603)	(Deg)	(Deg/s)	(Deg)
High	20	10	10
Medium	5	5	2.5
Low	1	1	2.5

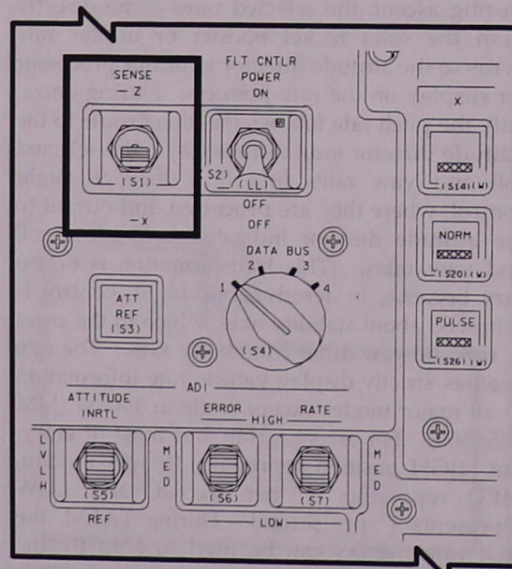

SENSE Switch on Panel A6U

(B) ADI Error Switch vs. Full Range Deflection

Horizontal Situation Indicator (HSI)

The horizontal situation indicator for the commander (panel F6) and pilot (panel F8) displays a pictorial view of the vehicle's position with respect to various navigation points and shows a visual perspective of certain guidance, navigation, and control parameters, such as direction, distance, and course/glide path deviation. The flight crew uses this information to control or monitor vehicle performance. The horizontal situation indicators are active during the entry and landing and ascent/return to launch site phases.

Each horizontal situation indicator provides an independent source to compare with ascent and entry guidance, a means of assessing the health of individual navigation aids during entry, and information needed by the flight crew to fly manual ascent, return to launch site, and entry.

HSI Ascent Displays

During ascent major modes 102 and 103 (first and second stage) and return to launch site, the horizontal situation indicator provides information about the target insertion orbit. The compass card displays heading with respect to target insertion orbit, and north on the compass card points along the target insertion orbit plane. The heading of the body plus X axis with respect to the target insertion orbit is read at the lubber line.

The course pointer provides the heading of the Earth-relative velocity vector with respect to the target insertion orbit plane. The course deviation indicator deflection indicates the estimated sideslip angle, the angle between the body X axis and the relative velocity vector.

The primary bearing pointer during major modes 102 and 103 (pre-TAL abort) is fixed on the compass card at a predetermined value to provide a turnaround heading in the event of a return to launch site (RTLS) abort. During RTLS major mode 601, or post-TAL abort, MM103, the pointer indicates the heading to the landing site runway. The secondary bearing provides the heading of the inertial velocity vector with respect to the target insertion orbit plane.

HSI Entry Displays

The commander's horizontal situation indicator switches are on panel F6, and the pilot's are on panel F8. The *HSI SELECT MODE* switch selects the mode: *ENTRY*, *TAEM*, or *APPROACH*. These Area Navigation modes are different from the Guidance phases with virtually identical names (Entry, TAEM, and Approach and Landing). The *ENTRY* position enables HSI mode auto switching from Entry through Approach. The *HSI SELECT SOURCE* switch selects TACAN, navigation, or microwave scanning beam landing system (MLS); the

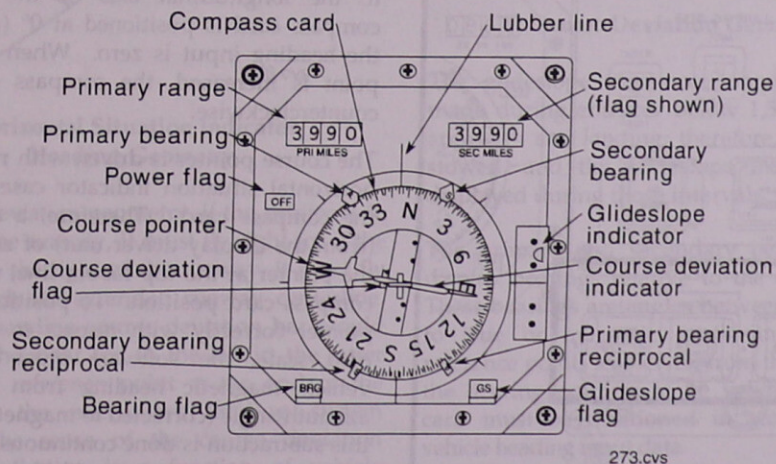

Horizontal Situation Indicator

1, 2, 3 switch selects one of the three TACAN or MLS units. When the *HSI SELECT SOURCE* switch is positioned to *NAV*, the HSI is supplied with data from the navigation processor, and the 1, 2, 3 switch is not used.

SOURCE switch selects TACAN, navigation, or microwave scanning beam landing system (MLS); the 1,2,3 switch selects one of the three TACAN or MLS units. When the *HSI SELECT SOURCE* switch is positioned to *NAV*, the HSI is supplied with data from the navigation processor, and the 1,2,3 switch is not used.

In *TACAN* or *MLS*, the horizontal situation indicator is supplied with data derived from the unit specified by the 1, 2, 3 switch.

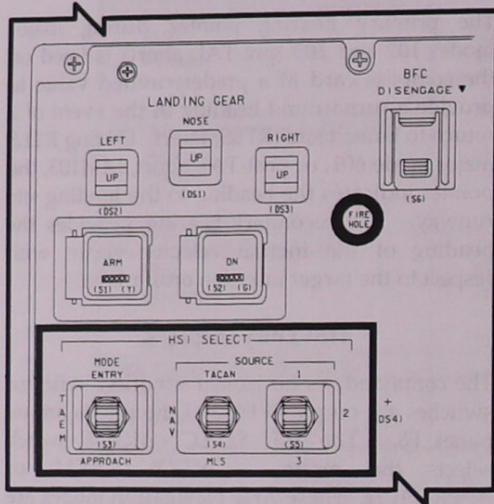

Commander's HSI SELECT Switches on Panel F6

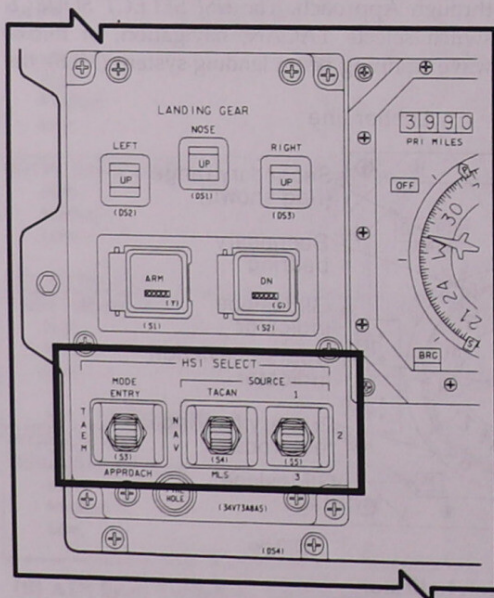

Pilot's HSI SELECT Switches on Panel F8

HSI Display Parameters

Each horizontal situation indicator displays magnetic heading (compass card), selected course, runway magnetic heading, course deviation, glideslope deviation, primary and secondary bearing, primary and secondary range, and flags to indicate validity.

Each horizontal situation indicator consists of a case-enclosed compass card measuring 0° to 360°. At the center of the card is an aircraft symbol, fixed with respect to the case and about which the compass card rotates.

The magnetic heading (the angle between magnetic north and vehicle direction measured clockwise from magnetic north) is displayed by the compass card and read under the lubber line located at the top of the indicator dial. (A lubber line is a fixed line on a compass aligned to the longitudinal axis of the craft.) The compass card is positioned at 0° (north) when the heading input is zero. When the heading point is increased, the compass card rotates counterclockwise.

The course pointer is driven with respect to the horizontal situation indicator case rather than the compass card. Therefore, a course input (from the display driver unit) of zero positions the pointer at the top lubber line, regardless of compass card position. To position the course pointer correctly with respect to the compass card scale, the software must subtract the vehicle magnetic heading from the runway azimuth angle (corrected to magnetic north). As this subtraction is done continuously, the course pointer appears to rotate with the compass card, remaining at the same scale position. An increase in the angle defining runway heading results in a clockwise rotation of the course pointer.

Course deviation is an angular measurement of vehicle displacement from the extended runway centerline. On the HSI, course deviation is represented by the deflection of the deviation bar from the course pointer line. Full scale on the course deviation scale is $\pm 10^\circ$ in terminal area energy management and $\pm 2.5^\circ$ during approach and landing. The course deviation indicator is driven to zero during entry. When the course deviation input is zero, the deviation bar is aligned with the end of the course pointer. With the pointer in the top half of the compass card, an increase in course deviation to the left (right) causes the bar to deflect to the right (left). Therefore, the course deviation indicator is a fly-to indicator for flying the vehicle to the extended runway centerline. Software processing also ensures that the course deviation indicator remains fly to, even when the orbiter is heading away from the runway.

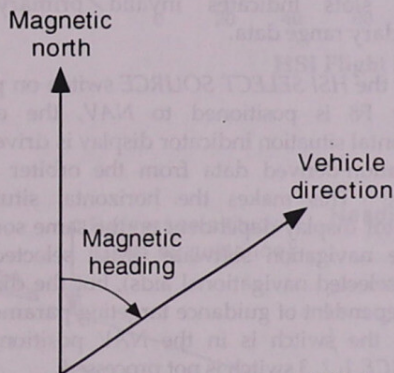

276.cvs

Horizontal Situation Indicator Heading Geometry

In course deviation geometry, if the orbiter is to the left of the runway, it must fly right (or if the orbiter is to the right of the runway, it must fly left) to reach the extended runway centerline. The corresponding course deviation bar would deflect to the right (or to the left in the latter case). The reference point at the end of the runway is the microwave landing system station. The sense of the course deviation indicator deflection is a function of vehicle position rather than vehicle heading.

Glideslope deviation, the distance of the vehicle above or below the desired glideslope, is indicated by the deflection of the glideslope

pointer on the right side of the horizontal situation indicator. An increase in glideslope deviation above (below) the desired slope deflects the pointer downward (upward); the pointer is a fly-to indicator.

The "desired glideslope" is actually only a conceptual term in horizontal situation indicator processing. At any instance, glideslope deviation is really the difference between the orbiter altitude and a reference altitude computed by Area Nav. This reference altitude may be slightly different than the reference altitude computed by Guidance. Also included in the reference altitude equation are factors for a "heavy orbiter" and for high winds.

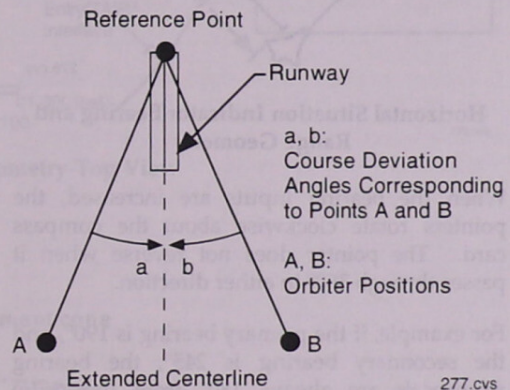

277.cvs

Course Deviation Geometry

The glideslope indicator computation is not made during entry or below 1,500 feet during approach and landing; therefore, the pointer is stowed, and the glideslope indicator flag is displayed during those intervals.

The primary and secondary bearing pointers display bearings relative to the compass card. These bearings are angles between the direction to true or magnetic north and to various reference points as viewed from the orbiter. For the bearing pointers to be valid, the compass card must be positioned in accordance with vehicle heading input data.

When the bearing inputs are zero, the pointers are at the top lubber line, regardless of compass card position. Like the course pointer, the bearing pointer drive commands are developed

by subtracting the vehicle heading from the calculated bearing values. This allows the pointers to be driven with respect to the horizontal situation indicator case but still be at the correct index point on the compass card scale.

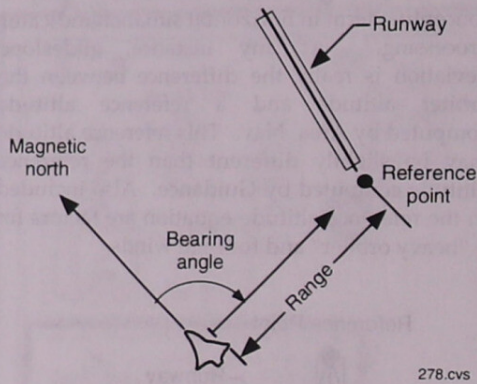

Horizontal Situation Indicator Bearing and Range Geometry

When the bearing inputs are increased, the pointers rotate clockwise about the compass card. The pointer does not reverse when it passes through 360° in either direction.

For example, if the primary bearing is 190° , and the secondary bearing is 245° , the bearing reciprocals are always 180° from (opposite) the pointers. The definition of primary and secondary bearing varies with the flight regime.

The horizontal situation indicator is capable of displaying two four-digit values in the upper left (primary range) and right (secondary range) side of its face. Each display ranges from zero to 3,999 n. mi. (4,602 statute miles). Although their meaning depends on the flight regime, both numbers represent range in nautical miles (n. mi.) from the vehicle to various points relative to the primary and secondary runways.

The horizontal situation indicator has four flags — *OFF*, *BRG* (bearing), *GS* (glideslope), and *CDI* — and two barberpole indications that can respond to separate display driver unit commands, identifying invalid data. *OFF* indicates that the entire horizontal situation indicator display is invalid because of insufficient power. *BRG* indicates invalid course, primary bearing, and/or secondary bearing data. *GS* indicates invalid glideslope deviation. *CDI* indicates invalid course deviation data. Barberpole in the range slots indicates invalid primary or secondary range data.

When the *HSI SELECT SOURCE* switch on panel F6 or F8 is positioned to *NAV*, the entire horizontal situation indicator display is driven by navigation-derived data from the orbiter state vector. This makes the horizontal situation indicator display dependent on the same sources as the navigation software (IMU, selected air data, selected navigational aids), but the display is independent of guidance targeting parameters. When the switch is in the *NAV* position, the *SOURCE 1, 2, 3* switch is not processed.

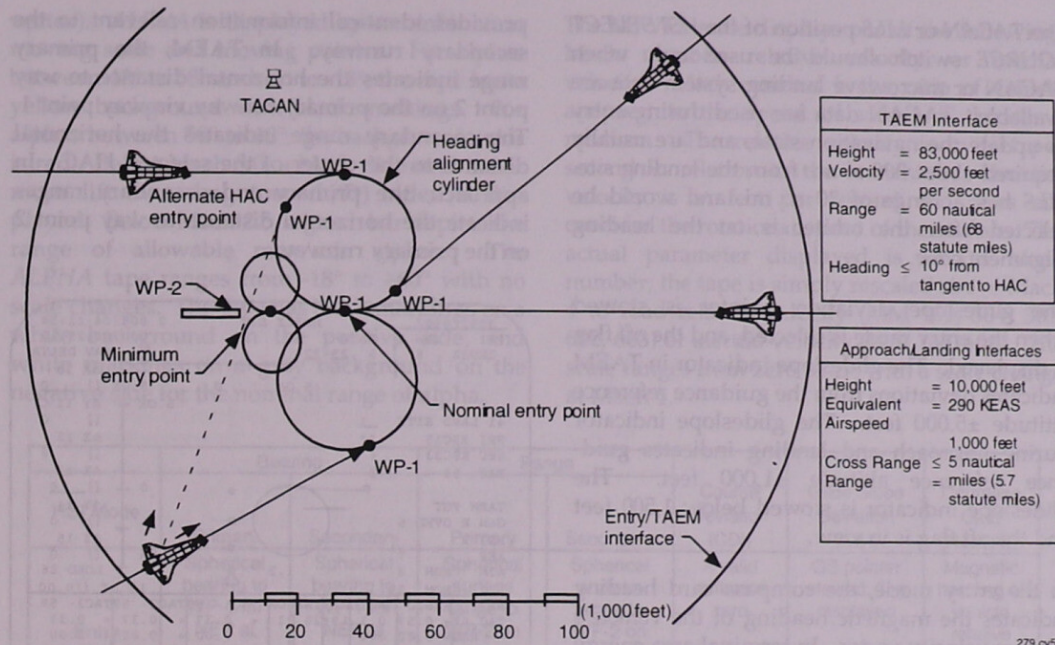

HSI Flight Path Geometry-Top View

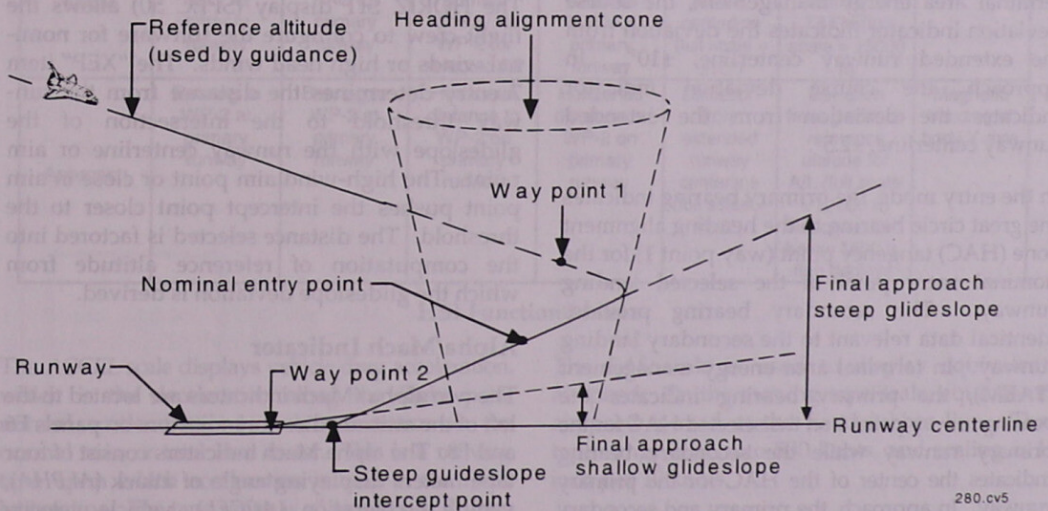

HSI Flight Path Geometry-Side View

The TACAN or MLS position of the HSI SELECT SOURCE switch should be used only when TACAN or microwave landing system data are available. TACAN data are used during entry to update the navigation state, and are usually acquired about 300 n. mi. from the landing site. MLS has a range of 20 n. mi. and would be selected after the orbiter is on the heading alignment cone.

The glideslope deviation pointer is stowed when the entry mode is selected, and the off flag is displayed. The glideslope indicator in TAEM indicates deviations from the guidance reference attitude $\pm 5,000$ feet. The glideslope indicator during approach and landing indicates guidance reference altitude $\pm 1,000$ feet. The glideslope indicator is stowed below 1,500 feet and the off flag is in view.

In the entry mode, the compass card heading indicates the magnetic heading of the vehicle's relative velocity vector. In terminal area energy management and approach, the compass card indicates magnetic heading of the body X axis.

In the entry mode, the course deviation indicator is driven to zero with no flag. In terminal area energy management, the course deviation indicator indicates the deviation from the extended runway centerline, $\pm 10^\circ$. In approach, the course deviation indicator indicates the deviation from the extended runway centerline, $\pm 2.5^\circ$.

In the entry mode, the primary bearing indicates the great circle bearing to the heading alignment cone (HAC) tangency point (way point 1) for the nominal entry point at the selected landing runway. The secondary bearing provides identical data relevant to the secondary landing runway. In terminal area energy management (TAEM), the primary bearing indicates the bearing to way point 1 on the selected HAC for the primary runway while the secondary bearing indicates the center of the HAC for the primary runway. In approach, the primary and secondary bearings indicate the bearing to the touchdown point at the primary runway (way point 2).

In the entry mode, the primary range indicates the spherical surface range to way point 1 for the primary runway via the HAC for the nominal entry point. The secondary range

provides identical information relevant to the secondary runway. In TAEM, the primary range indicates the horizontal distance to way point 2 on the primary runway via way point 1. The secondary range indicates the horizontal distance to the center of the selected HAC. In approach, the primary and secondary ranges indicate the horizontal distance to way point 2 on the primary runway.

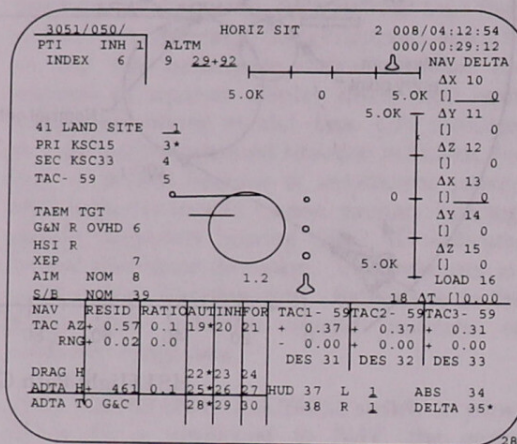

HORIZ SIT Display (SPEC 50)

The HORIZ SIT display (SPEC 50) allows the flight crew to configure the software for nominal winds or high head winds. The "XEP" item 7 entry determines the distance from the runway threshold to the intersection of the glideslope with the runway centerline or aim point. The high-wind aim point or close in aim point pushes the intercept point closer to the threshold. The distance selected is factored into the computation of reference altitude from which the glideslope deviation is derived.

Alpha/Mach Indicator

The two alpha/Mach indicators are located to the left of the attitude director indicators on panels F6 and F8. The alpha Mach indicators consist of four tape meters displaying angle of attack (ALPHA), vehicle acceleration (ACCEL), vehicle velocity (M/VEL), and equivalent airspeed (EAS). The two units are driven independently but can have the same data source.

ALPHA displays vehicle angle of attack, defined as the angle between the vehicle plus X axis and the wind-relative velocity vector (negative wind

vector). *ALPHA* is displayed by a combination moving scale and moving pointer. For alphas between 43° to 58° and -4° to -18° , the tape has a yellow background with black markings. For alphas between 58° to 60° , the background color is red. Below Mach 3.0, a black diamond maximum lift over drag (max L/D) index is displayed. Below Mach 2.5, a green bar depicts the range of allowable max/min alphas. The *ALPHA* tape ranges from -18° to $+60^\circ$ with no scale changes. The tape has black markings on a white background on the positive side, and white markings on a gray background on the negative side for the nominal range of alpha.

The M/VEL scale displays one of the following: Mach number, relative velocity, or inertial velocity. Mach number is the ratio of vehicle airspeed to the speed of sound in the same medium. The relative velocity is in feet per second in relation to the launch site. Inertial velocity is in feet per second and does not consider the rotational speed of the surface. The actual parameter displayed is always Mach number; the tape is simply rescaled above Mach 4 to read relative velocity (MM 102, 304, 305, 602, 603) or inertial velocity (MM 103, 601). The scale ranges from zero to 27, with a scale change at Mach 4.

HSI Mode	Bearing		Range		Course Deviation (CDI)	Glide Slope Deviation (GSI)	Compass Card (Heading)
	Primary	Secondary	Primary	Secondary			
Entry	Spherical bearing to WP-1 for NEP at <u>primary</u> landing runway	Spherical bearing to WP-1 for NEP at <u>secondary</u> landing runway	Spherical surface range to WP-2 on <u>primary</u> runway via WP-1 for NEP	Spherical surface range to WP-2 on <u>secondary</u> runway via WP-1 for NEP	A valid software zero (no flag)	GS pointer stowed; flag displayed	Magnetic heading of vehicle relative velocity vector
TAEM	Bearing to WP-1 on selected HAC for primary runway	Bearing to center of selected HAC for primary runway	Horizontal distance to WP-2 on primary runway via WP-2 for selected EP	Horizontal distance to center of selected HAC for primary runway	Deviation from extended runway centerline (full scale = $\pm 10^\circ$)	Deviation from guidance reference altitude for TAEM (full scale = ± 5000 ft)	Magnetic heading of body X-axis
Approach	Bearing to WP-2 at primary runway	Bearing to WP-2 at primary runway	Horizontal distance to WP-2 on primary runway	Horizontal distance to WP-2 on primary runway	Deviation from extended runway centerline (full scale = $\pm 2.5^\circ$)	Deviation from guidance reference altitude for A/L (full scale = ± 1000 ft) Not computed below 1500 ft, flag deploys	Magnetic heading of body X-axis

HSI Function Matrix

The *ACCEL* scale displays vehicle drag acceleration, which is the deceleration along the flight path, normal acceleration, which is acceleration in the normal axis, or total load factor. This is a moving tape upon which acceleration is read at the fixed lubber line. The tape range is -5 to $+10$ g's. Minus signs are displayed on the *ACCEL* scale also; the negative region has a black background and the positive side has a white background. (Normal acceleration and total load factor are measured in g's.)

The *EAS* scale is used to display equivalent airspeed. On the moving-tape scale, equivalent airspeed is read at the fixed lubber line. The tape range is zero to 500 knots, and scaling is 1 inch per 10 knots.

Each scale on the alpha/Mach indicator displays an *OFF* flag if the indicator malfunctions, invalid data are received at the display driver unit, or a power failure occurs (all flags appear).

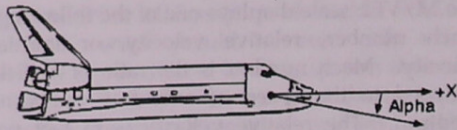

Angle of attack

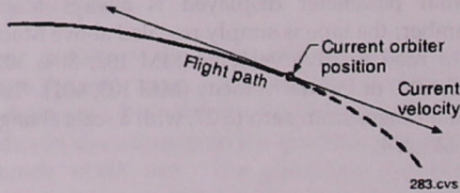

Acceleration

α	ACCEL	M/VI	KEAS
10.7	0.98	1.25	223
25	3g	0.8	—
20	2g	1.0M	210
15	1g	1.2	220
10	0g	1.4	230
5	0g	1.6	240
0	0g	—	—
-5	-1g	—	—

- Alpha -18 to +60 degrees
- Acceleration -5 to +10
- M/Vel mach 0 to 4; 4,000 to 27,000 feet per second
- Equivalent airspeed 0 to 500 knots

Alpha/Mach Indicator

281.CNV

The AIR DATA switch on panel F6 for the commander and panel F8 for the pilot determines the source of data for the alpha/Mach indicator and altitude/vertical velocity indicator. The NAV position of the AIR DATA switch displays the same parameters (ALPHA, MACH, and EAS) that are sent to guidance, flight control, navigation, and other software users; ACCEL comes from navigation software.

The LEFT and RIGHT positions of the AIR DATA switch select data from the left or right air data probe assembly after successful deployment of the left and right air data probes at Mach 5 for ALPHA, M/VEL, and EAS display. However, the data will not be accurate until the velocity is less than Mach 3.5, due to calibration of the probes. ACCEL is always derived from navigation software during entry. It is driven to zero during terminal area energy management and approach and landing.

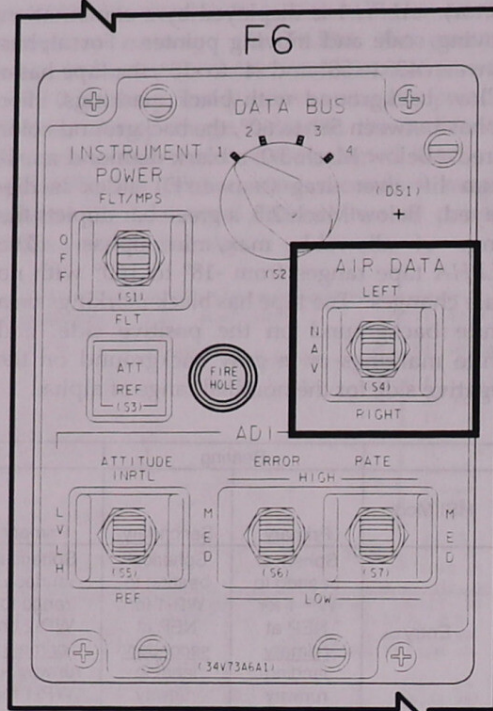

Commander's AIR DATA switch on Panel F6

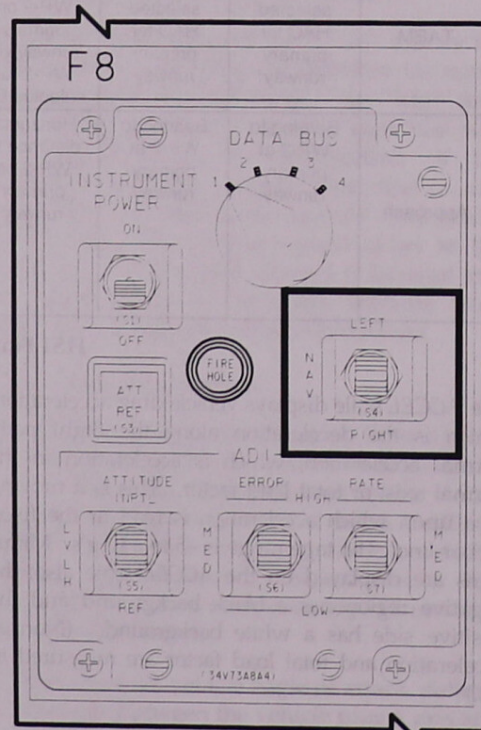

Pilot's AIR DATA Switch on Panel F8

Altitude/Vertical Velocity Indicator

The altitude/vertical velocity indicators (AVVIs) are located on panel F6 for the commander and panel F8 for the pilot. These indicators display vertical acceleration (*ALT ACCEL*), vertical velocity (*ALT RATE*), altitude (*ALT*), and radar altitude (*RDR ALT*).

The *ALT ACCEL* indicator, which displays altitude acceleration of the vehicle, is read at the intersection of the moving pointer and the fixed scale. The scale range is -10 to $+10$ feet per second squared. Software limits acceleration values to ± 12.75 feet per second squared.

The *ALT RATE* scale displays vehicle altitude rate, which is read at the intersection of the moving tape and the fixed lubber line. The scale range is $-3,000$ to $+3,000$ feet per second with scale changes at -800 feet per second and $+800$ feet per second. The negative and positive regions are color-reversed: negative numbers are white on a gray background and positive numbers are black on white.

The *ALT* scale, a moving tape read against a fixed lubber line, displays the altitude of the vehicle above the runway (barometric altitude). The scale range is $-1,100$ feet to $+165$ n. mi., with scale changes at 0 , 200 , $2,000$, $30,000$, and $+100,000$ feet. The scale is in feet from $-1,100$ to $+400,000$ and in n. mi. from $+67$ to $+165$.

The altitude tape is gray with white markings for altitudes above $2,000$ feet. The tape color is yellow for altitudes between 0 and $2,000$ feet, and white for altitudes below 0 feet.

Radar altitude is displayed by a yellow triangular pointer when the radar altitude is active below $5,000$ feet.

With the *AIR DATA* source switch in the *NAV* position, the *ALT ACCEL*, *ALT RATE*, and *ALT* scales are navigation-derived. The *RDR ALT* indicator is controlled by the *RADAR ALTM* switch on panel F7 for the commander and panel F8 for the pilot. *RADAR ALTM* positioned to *1* selects radar altimeter 1; *2* selects radar altimeter 2.

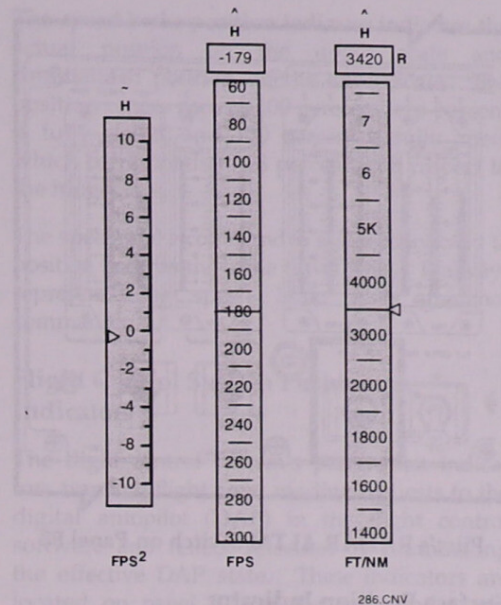

Altitude/Vertical Velocity Indicator

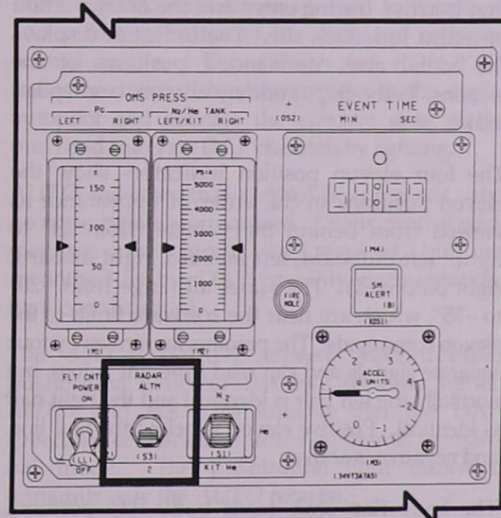

Commander's RADAR ALTM Switch on Panel F7

The *AIR DATA* switch is positioned to *LEFT* or *RIGHT* to select the left or right air data probe after air data probe deployment at Mach 5. The *ALT* and *ALT RATE* scales receive information from the selected air data probe. *ALT ACCEL* receives navigation data. The *RDR ALT* scale receives data based on the *RADAR ALTM* select switch position.

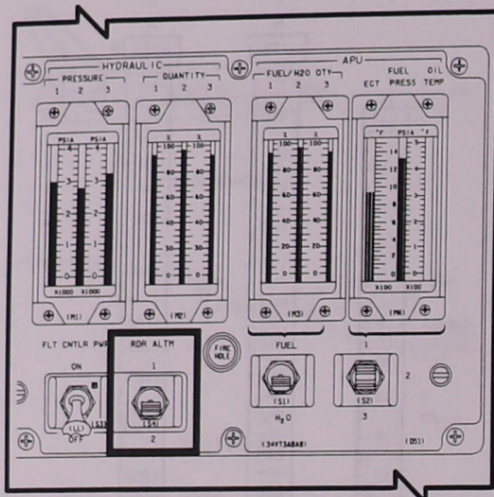

Pilot's RADAR ALTM Switch on Panel F8

Surface Position Indicator

The surface position indicator is a single display that is active during entry and the entry portion of return to launch site. The indicator displays the actual and commanded positions of the elevons, body flap, rudder, aileron, and speed brake.

The four elevon position indicators show the elevon positions in the order of appearance as viewed from behind the vehicle (from left to right: left outboard, left inboard, right inboard, right outboard). The scales all range from +20° to -35°, which are near the software limits to the elevon commands. The pointers are driven by four separate signals and can read different values, but normally the left pair is identical and the right pair is identical. Positive elevon is below the null line, and negative is above.

The body flap scale reads body flap positions from zero to 100 percent of software-allowed travel. Zero percent corresponds to full up (-11.7°); 100 percent corresponds to full down (+22.5°). The small pointer at 34 percent is fixed and shows the trail position.

Rudder position is displayed as if viewed from the rear of the vehicle. Deflection to the left of center represents left rudder. The scale is +30° (left) to -30° (right), but software limits the rudder command to ±27.1°.

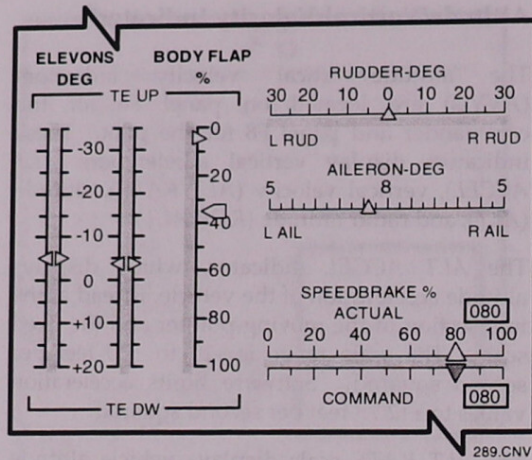

Surface Position Indicator on Panel F7

The aileron display measures the effective aileron function of the elevons in combination. Aileron position equals the difference between the average of the left and right elevon divided by two. Deflection of the pointer to the right of center indicates a roll-right configuration (left elevons down, right elevons up) and vice versa. The scale is -5° to +5°, with -5° at the left side. The aileron command can exceed ±5° (max. ±10°), in which case the meter saturates at ±5°.

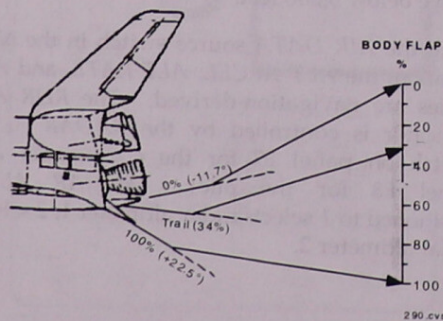
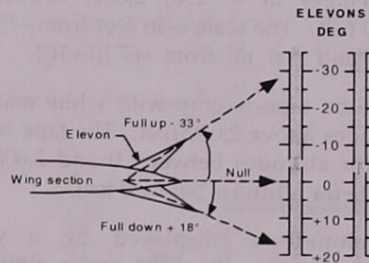

Surface Position Indicator Elevon Travel

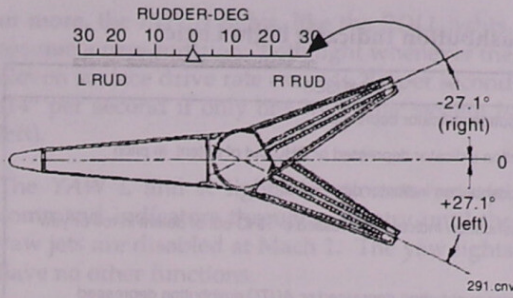

Surface Position Indicator Rudder Travel

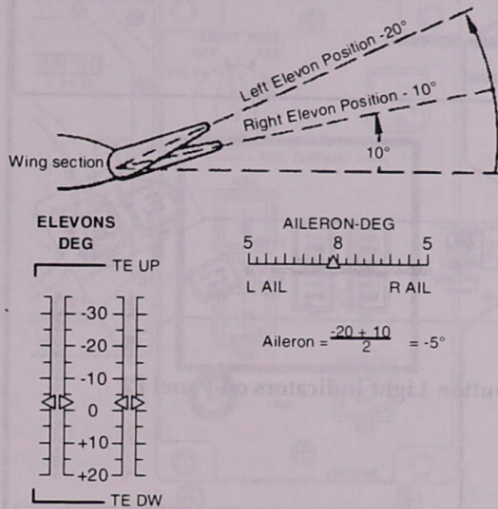

Surface Position Indicator Aileron Travel

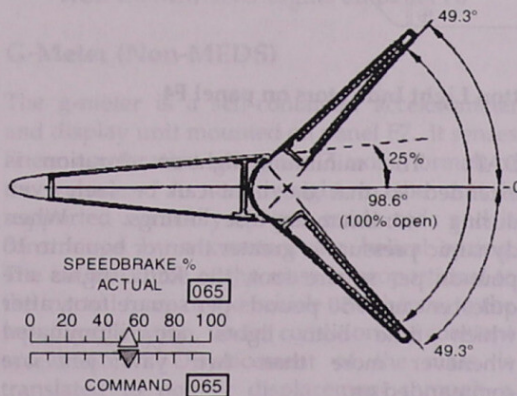

Surface Position Indicator Top View of Open Speed Brake

The speed brake position indicator indicates the actual position on the upper scale and commanded position on the lower scale. The position ranges zero to 100 percent; zero percent is fully closed, and 100 percent is fully open, which corresponds to 98 percent with respect to the hinge lines.

The speed brake command is scaled identically to position and has the same travel limits. It always represents the speed brake auto guidance command.

Flight Control System Pushbutton Indicators

The flight control system's pushbutton indicators transmit flight crew moding requests to the digital autopilot (DAP) in the flight control software and reflect selection by illuminating the effective DAP state. These indicators are located on panel F2 for the commander and panel F4 for the pilot.

The pushbutton indicators are used to command and reflect the status of the pitch and roll/yaw control modes. The *PITCH* and *ROLL/YAW* indicators transmit moding requests to the digital autopilot and indicate the effective state of the pitch and roll/yaw DAP channels by lighting.

AUTO indicates that control is automatic, and no crew inputs are required. *CSS* is control stick steering; crew inputs are required, but are smoothed by the DAP (stability augmentation, turn coordination).

The *SPD BK/THROT* (speed brake/throttle) pushbutton indicator has two separate lights, *AUTO* and *MAN*, to indicate that the DAP speed brake channel is in the automatic or manual mode. The pushbutton light indicator transmits only the *AUTO* request.

The *BODY FLAP* pushbutton indicator also has separate *AUTO* and *MAN* lights, indicating the state of the body flap channel.

Entry Flight Control System Mode Pushbutton Indicator Light Logic

LIGHTS	LEFT/RIGHT LIGHT LOGIC	CAUSES
<i>PITCH AUTO</i>	Both on or both off	Auto, CSS mutually exclusive <i>PITCH AUTO</i> pushbutton indicator depressed
<i>PITCH CSS</i>	both on or both off	
<i>ROLL/YAW AUTO</i>	Both on or both off	Auto, CSS mutually exclusive <i>ROLL/YAW AUTO</i> pushbutton indicator depressed
<i>ROLL/YAW CSS</i>	both on or both off	
<i>SPD BK/THROT</i>		
<i>AUTO</i>	Both on or both off	Auto, man. mutually exclusive Neither SBTC takeover pushbutton depressed or <i>AUTO</i> pushbutton depressed
<i>MAN</i>	One on, one off	
<i>BODY FLAP</i>		
<i>AUTO</i>	Both on or both off	Auto, man. mutually exclusive <i>AUTO</i> pushbutton indicator depressed
<i>MAN</i>	Both on or both off	<i>MAN</i> pushbutton depressed

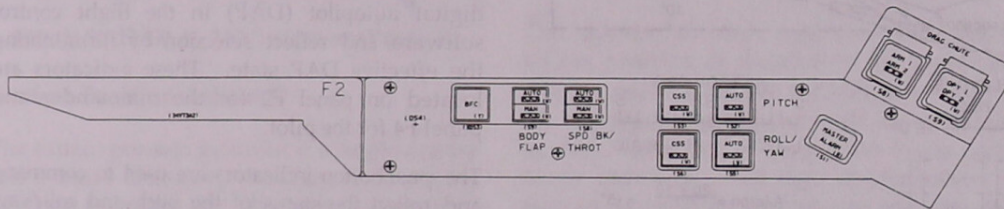

Commander's Flight Control System Pushbutton Light Indicators on Panel F2

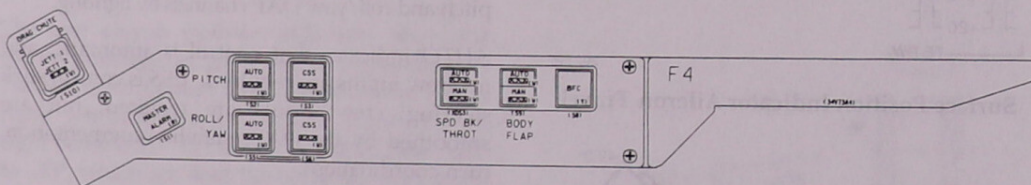

Pilot's Flight Control System Pushbutton Light Indicators on panel F4

Reaction Control System Command Lights

The *RCS COMMAND* lights on panel F6 are active during OPS 104-106 and OPS 602 and 603. Their primary function is to indicate reaction control system (RCS) jet commands by axis and direction; secondary functions are to indicate when more than two yaw jets are commanded, and when the elevon drive rate is saturated.

During major modes 301 through 304, until the roll jets are no longer commanded (dynamic pressure exceeds 10 pounds per square foot), the *ROLL L* and *R* lights indicate that left or right roll jet commands have been issued by the

DAP. The minimum light-on duration is extended so that the light can be seen even during minimum-impulse firings. When dynamic pressure is greater than or equal to 10 pounds per square foot, the *ROLL* lights are quiescent until 50 pounds per square foot, after which time both lights are illuminated whenever more than two yaw jets are commanded on.

The *PITCH U* and *D* lights indicate up and down pitch jet commands until dynamic pressure equals 40 pounds per square foot, after which the pitch jets are no longer used. When dynamic pressure is 50 pounds per square foot

Each head-up display is a single-string system, but it is connected to two data buses for redundancy. It is an electronic/optical device with two sets of combiner glasses located above the glareshield in the direct line of sight of the commander and the pilot. Essential flight information for vehicle guidance and control during approach and landing is projected on the combiner glasses and focused at infinity.

The images, generated by a small CRT and passed through a series of lenses, are displayed to the flight crew on the combiners as lighted symbology. The transmissiveness of the combiner allows the crew to look through it and see actual targets like the runway.

For instance, if the crew is 9,000 feet on the final approach course in a solid overcast, the base of which is at 8,000 feet, the lighted outline of the runway would be displayed on the combiner. However, when the orbiter exits the overcast at 8,000 feet, the lighted outline of the runway would be superimposed on the real runway. As the orbiter proceeds down the steep glideslope, the velocity vector is superimposed over the glideslope aim point. At preflare altitude, flare triangles move up to command the pullout. The pilot maintains the velocity vector symbol between the triangles. After a short period of stabilized flight on the shallow glideslope, the guidance diamond commands a pitch-up until the nose is about 8° above the horizon, which is essentially the touchdown attitude. After touchdown, during the rollout phase, the crew maintains the approximate touchdown attitude, +6° theta (nose above the horizon), until 185 knots equivalent airspeed and then commands a derotation maneuver.

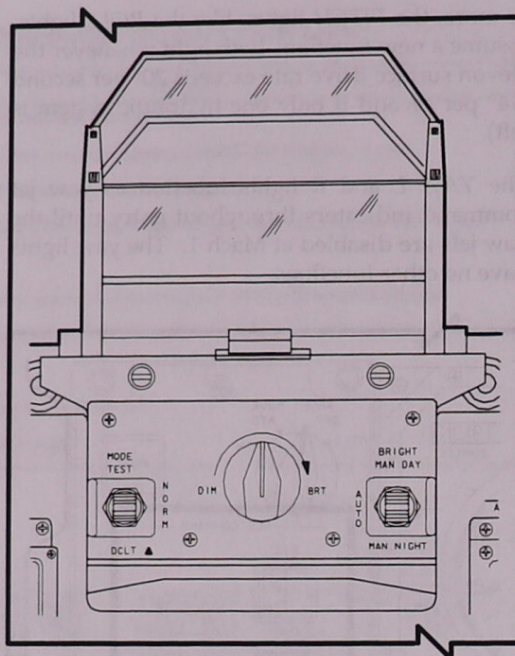

Head-Up Display and Controls on Panel F6 (Identical on Panel F8)

The head-up display has proved to be a valuable landing aid and is considered the primary pilot display during this critical flight phase.

A HUD POWER ON/OFF switch located on the left side of panel F3 provides and terminates electrical power to the commander's head-up display on panel F6. A second switch is located on the right side of panel F3 for the pilot's head-up display on panel F8.

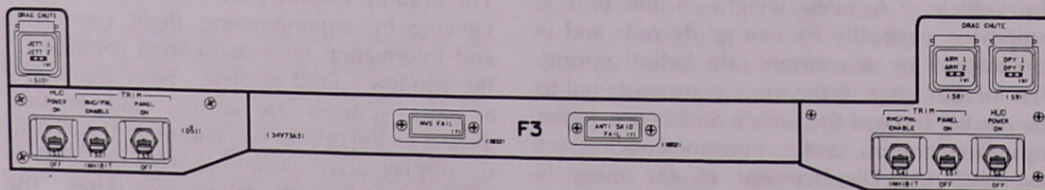

Panel F3

WARNING

A generic hardware problem has been identified in several HUD units. At 13 KFT, the flight director symbol is uncaged to become a velocity vector (⊖). Cycling HUD POWER after this transition may result in erroneous symbol positioning. Flying these false cues would result in landing short of the runway, at a very high sink rate. (Ref: JSC Memo DF6-90-053)

provided. The *TEST* position forces up a test display for 5 seconds. Selection of the momentary *DCLT* position initiates a symbol blanking routine. Successive selections of *DCLT* will serially remove display elements in the following order. The first activation removes the runway symbology. The second activation removes the airspeed and altitude tapes (replacing them with digital values) and the horizon/pitch attitude scales, but leaves the horizon line when within FOV. The third declutter level removes all symbology except for the boresight. A fourth declutter attempt will return the HUD to its original form with all symbols displayed.

A three-position *MODE* switch is located below the HUD. In the *NORM* position, automatic sequencing of formats and symbology is

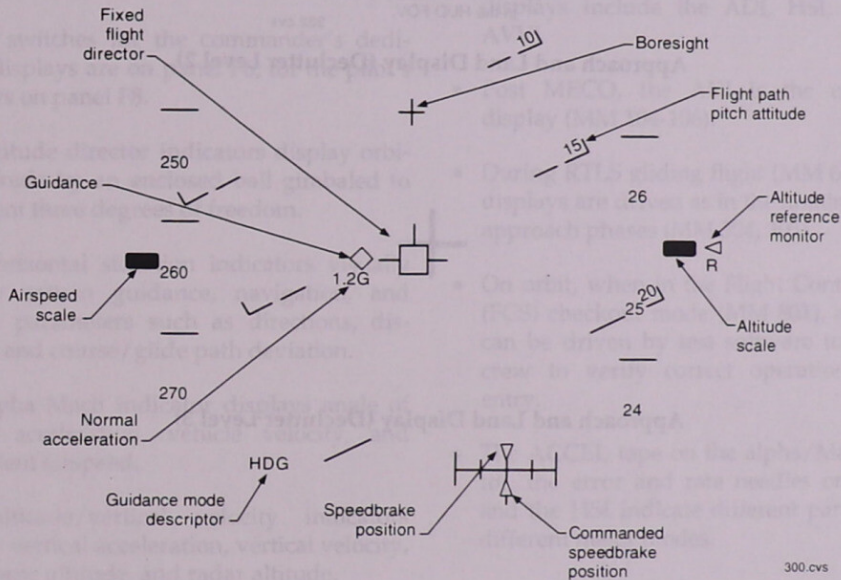

Approach and Land Display (TAEM Heading Phase); No Declutter

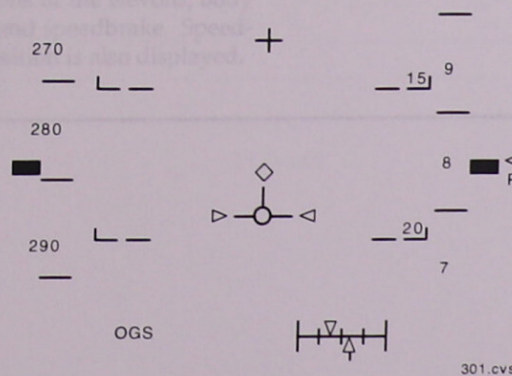

Approach and Land Display (Declutter Level 1)

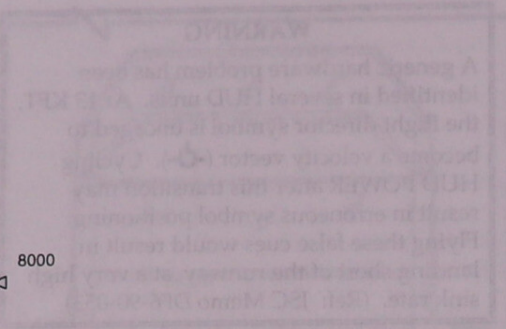
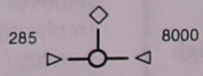

OGS

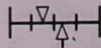

Note: Horizon is displayed when
in the HUD FOV.

302.cvs

Approach and Land Display (Declutter Level 2)



Approach and Land Display (Declutter Level 3)

Dedicated Display Systems Summary Data

- Dedicated displays are located in front of the commander's and pilot's seats and on the aft flight deck panel by the aft-facing window (panels F6, F8, and A1U).
- Dedicated displays include: attitude director indicators, horizontal situation indicators, alpha/Mach indicators, altitude/vertical velocity indicators, surface position indicator, RCS activity lights, and head-up displays.
- Circuit breakers for dedicated displays are located on panels O14, O15, and O16.
- Power switches for the commander's dedicated displays are on panel F6; for the pilot's displays on panel F8.
- The attitude director indicators display orbiter attitude by an enclosed ball gimbaled to represent three degrees of freedom.
- The horizontal situation indicators visually display certain guidance, navigation, and control parameters such as directions, distances, and course/glide path deviation.
- The alpha Mach indicator displays angle of attack, acceleration, vehicle velocity, and equivalent airspeed.
- The altitude/vertical velocity indicators display vertical acceleration, vertical velocity, barometric altitude, and radar altitude.
- The surface position indicator on panel F7 displays actual positions of the elevons, body flap, rudder, aileron, and speedbrake. Speedbrake commanded position is also displayed.
- The g-meter is a self-contained accelerometer and display unit on panel F7 (non-MEDS only).
- The head-up display cues the commander and/or pilot during final phases of entry by superimposing flight commands and information on a transparent combiner in the window's field of view. Power switches are located on panel F3.
- The ADI ball is mechanically frozen when the ball is at 270° or 90° in yaw.
- During ascent powered flight (MM 102-103) or RTLS powered flight (MM 601), active displays include the ADI, HSI, AMI, and AVVI.
- Post MECO, the ADI is the only active display (MM 104-106).
- During RTLS gliding flight (MM 602-603), all displays are driven as in the nominal TAEM/approach phases (MM 304, 305).
- On orbit, when in the Flight Control System (FCS) checkout mode (MM 801), all displays can be driven by test software to allow the crew to verify correct operation prior to entry.
- The ACCEL tape on the alpha/Mach indicator, the error and rate needles on the ADI, and the HSI indicate different parameters in different major modes.

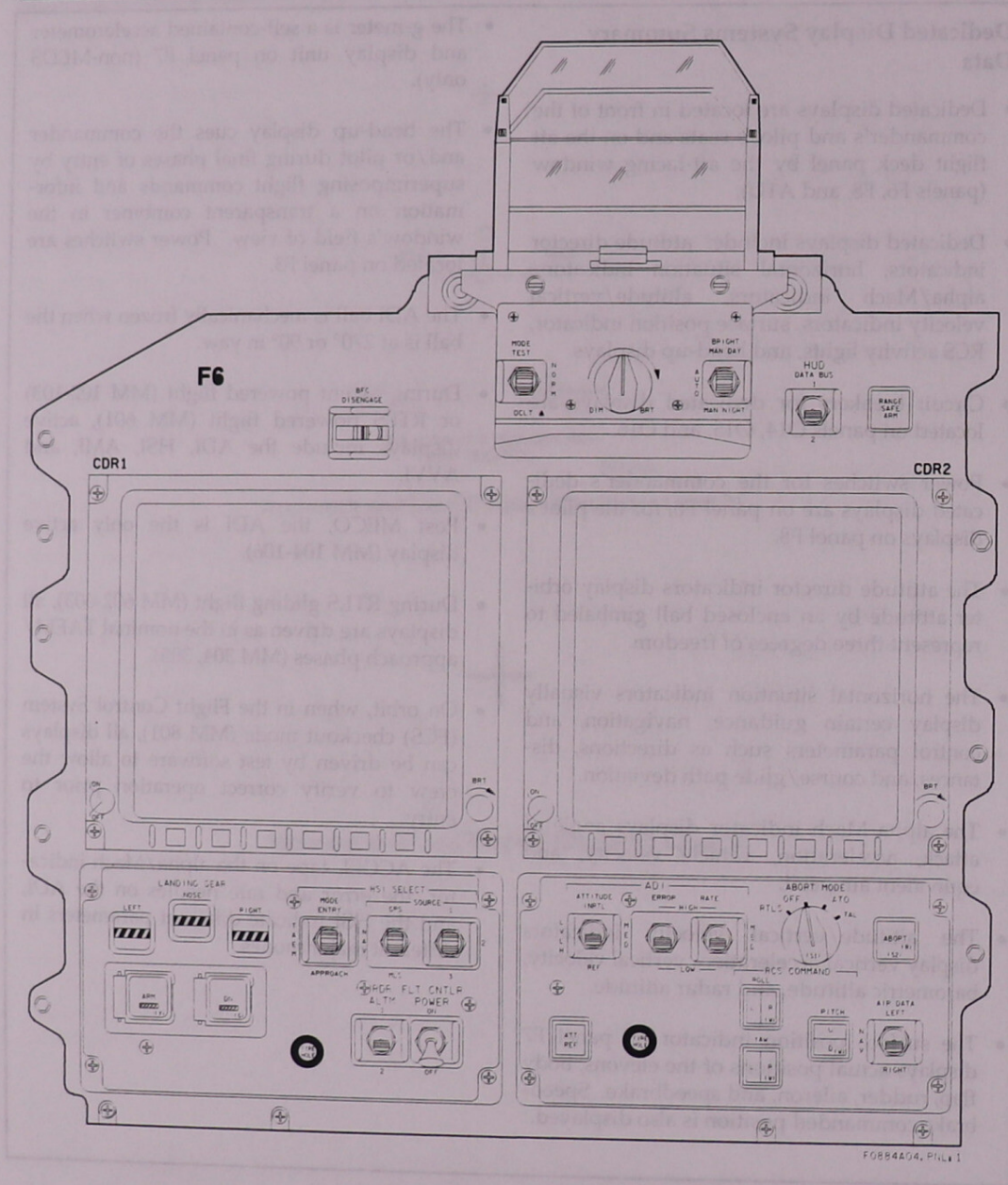

Panel F6

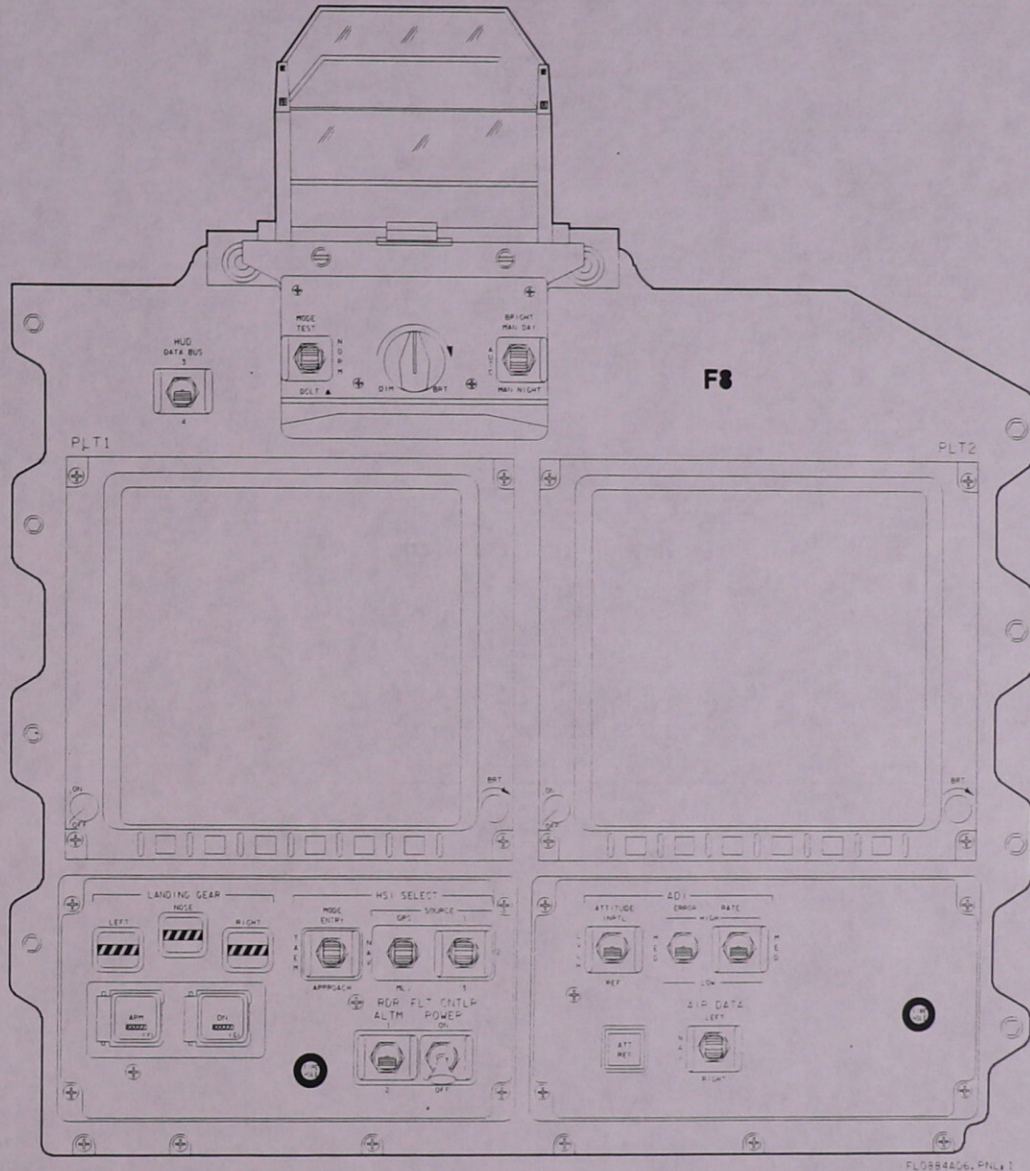

Panel F8

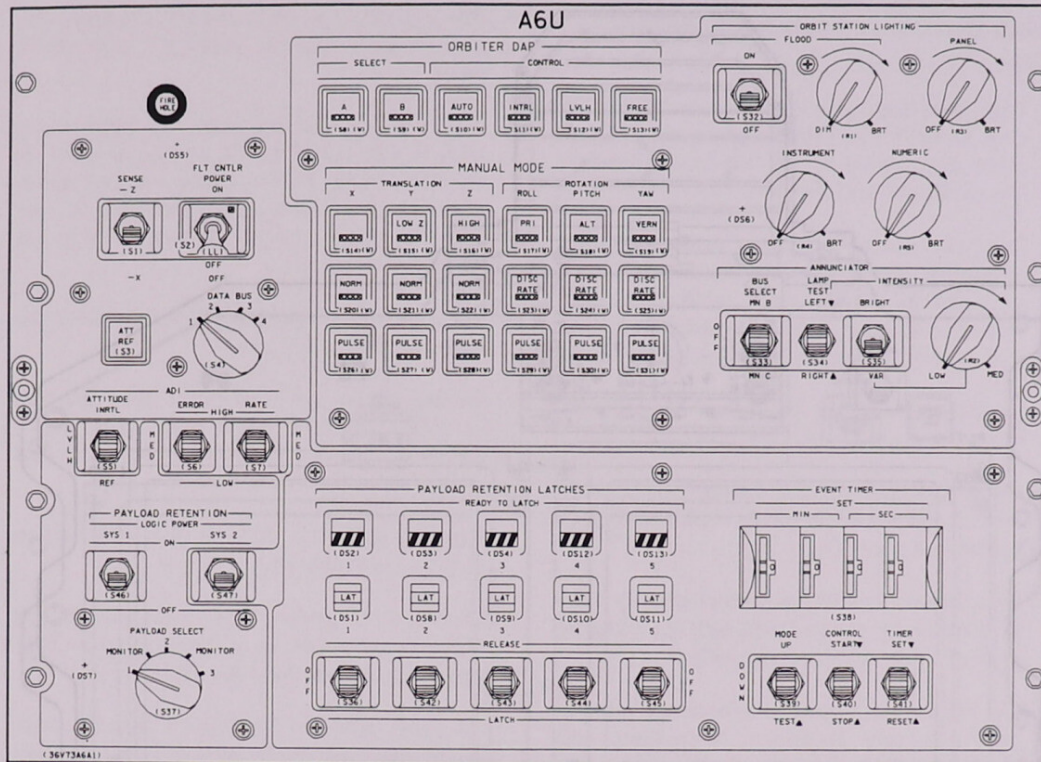

Panel A6U