

**6.10 SWITCH AND PANEL CAUTIONS**

CONTENTS	
MPS Switches.....	6.10-1
Fuel Cell Reactant Valves.....	6.10-1
CRT Power Switch.....	6.10-1
GPC/MDM .....	6.10-1
PLB Mech Power/Enable.....	6.10-1
HYD Press and APU Controller Power Switches .....	6.10-1
OMS Kit .....	6.10-1

Because the design of some orbiter controls is very similar, when they are placed in close proximity, inadvertent actuation can occur. Training, along with close attention during high workload tasks, will minimize these problems. This section discusses several potential areas where crewmembers should exercise caution to avoid pitfalls. By being aware that these situations exist, crewmembers can execute time-critical procedures confidently.

**MPS Switches**

The six *ENGINE POWER* switches and the six *He ISOLATION* switches are located in adjacent rows on panel R2. The switches are very similar, except for a yellow band around the six power switches. Caution should be exercised during MPS helium leak isolation or SSME shutdown procedures.

**Fuel Cell Reactant Valves**

Because of panel design, which represents a schematic of the PRSD and FC systems, the *FUEL CELL REAC* valve switches are arranged in a 1-3-2 order (1 on top, 3 in the middle, 2 on the bottom) on panel R1. Closing the incorrect reactant valve results in the loss of a second fuel cell and possibly two main buses.

**CRT Power Switch**

The *CRT POWER* switches on panel C2 are adjacent to the *MAJOR FUNC* switch. This makes it relatively easy to power off a CRT when intending to switch major functions. If this occurs, simply power the CRT back ON and continue.

**GPC/MDM**

During ascent and entry, the GPC and MDM switches on panel O6 are very difficult to reach. They are also hard for the CDR to see when wearing a launch/entry suit helmet. When executing DPS malfunction procedures, it is important to ensure the correct switch is actuated. One technique is to have the MS2 verify that the CDR has selected the correct switch prior to actuation.

**PLB Mech Power/Enable**

These switches are located adjacent to each other on panel R13L and perform entirely different functions. Because of their similar nomenclature and same appearance, they are easily confused. The *PL BAY DOOR SYS ENABLE* switches are used during PLBD opening/closing. The *PL BAY MECH PWR SYS* switches are used for other mechanical systems in the PLB (such as radiators, PRLAs, RMS, etc). A careful procedure crosscheck will avoid problems.

**HYD Press and APU Controller Power Switches**

The *HYD MAIN PUMP* and *APU CNTLR PWR* switches look similar and are in adjacent rows on panel R2. It is easy to confuse these two switches during the APU shutdown procedure or when taking a hydraulic system to LOW PRESS.

**OMS Kit**

*OMS KIT* switches are on the left side of panel O8. It is easy to confuse the *OMS KIT* switches with the *LEFT OMS* switches. The *OMS KIT* switches are inoperative.

### 6.11 SYSTEMS FAILURE SUMMARY

This section summarizes actual, in-flight failures that have occurred in the shuttle program. It includes major systems and selected repeat failures important to the crew. The purpose is

to give crewmembers a feel for the type and severity of equipment failures and their potential impact on operations. Complete lists of anomalies and failures for both flight and ground operations are available from the Orbiter Project Office.

System	Failure Description	Frequency	Impact
Orbiter	Loss of attitude control	1	Minor
	Loss of attitude control	1	Minor
	Loss of attitude control	1	Minor
	Loss of attitude control	1	Minor
External Tank	Structural failure	1	Major
	Structural failure	1	Major
	Structural failure	1	Major
	Structural failure	1	Major
Solid Rocket Booster	Structural failure	1	Major
	Structural failure	1	Major
	Structural failure	1	Major
	Structural failure	1	Major
Main Engine	Loss of power	1	Major
	Loss of power	1	Major
	Loss of power	1	Major
	Loss of power	1	Major
Auxiliary Power Unit	Loss of power	1	Major
	Loss of power	1	Major
	Loss of power	1	Major
	Loss of power	1	Major
Inertial Reference System	Loss of accuracy	1	Minor
	Loss of accuracy	1	Minor
	Loss of accuracy	1	Minor
	Loss of accuracy	1	Minor
Navigation System	Loss of accuracy	1	Minor
	Loss of accuracy	1	Minor
	Loss of accuracy	1	Minor
	Loss of accuracy	1	Minor
Communication System	Loss of signal	1	Minor
	Loss of signal	1	Minor
	Loss of signal	1	Minor
	Loss of signal	1	Minor
Life Support System	Loss of oxygen	1	Major
	Loss of oxygen	1	Major
	Loss of oxygen	1	Major
	Loss of oxygen	1	Major

SYSTEM	FAILURE	CAUSE
APU/HYD	<ul style="list-style-type: none"> <li>• APU lube oil temp high</li> <li>• Two APUs underspeed shutdown</li> <li>• APU shifted to high speed</li> <li>• Hydraulic leak on entry</li> <li>• APU underspeed - FCS checkout</li> </ul>	<ul style="list-style-type: none"> <li>• WSB ice</li> <li>• Hydrazine leak and fire</li> <li>• Failed control valve</li> <li>• Leak in pump hose</li> <li>• Valve contamination</li> </ul>
COMM	<ul style="list-style-type: none"> <li>• Loss of KU antenna gimbal and stow control</li> <li>• TAGS jam</li> </ul>	<ul style="list-style-type: none"> <li>• Loose screw and circuit burnout</li> <li>• Paper jam</li> </ul>
CRYO	<ul style="list-style-type: none"> <li>• O2 leak</li> </ul>	<ul style="list-style-type: none"> <li>• PCS O2 restrictor installed backwards</li> </ul>
DPS	<ul style="list-style-type: none"> <li>• GPC 2 quit</li> <li>• RS split</li> <li>• BFS failed pre-launch</li> <li>• GPC 1 and 2 failed</li> <li>• GPC 5 failed</li> <li>• GPC 4 failed on orbit</li> <li>• MDM OF3 failed pre-launch</li> <li>• MDM port failure</li> <li>• MDM failure pre-launch</li> <li>• MDM card problems</li> </ul>	<ul style="list-style-type: none"> <li>• CPU timing</li> <li>• Chip problem</li> <li>• Failed string tracking</li> <li>• Contamination</li> <li>• Engage term errors</li> <li>• Failed to sync; changed on orbit</li> <li>• Component contamination</li> <li>• Power supply fail</li> <li>• I/O errors</li> <li>• Card fail</li> </ul>
ECLSS	<ul style="list-style-type: none"> <li>• FES shutdown</li> </ul>	<ul style="list-style-type: none"> <li>• Ice, temp transducer, or thermal transient</li> </ul>
EPS	<ul style="list-style-type: none"> <li>• Hum Sep signal conditioner B circuit breaker popped</li> <li>• TAGS cable arcing</li> <li>• Fuel cell 1 failed</li> <li>• Fuel cells produced excessive hydrogen</li> <li>• High drift rates</li> </ul>	<ul style="list-style-type: none"> <li>• Wire bundles short</li> <li>• Cable short</li> <li>• H2 pump fail due to blockage</li> <li>• H2 entrainment in new filter screen</li> <li>• IMU failed</li> </ul>
GNC	<ul style="list-style-type: none"> <li>• IMU cage</li> <li>• IMU failed</li> <li>• Spurious IMU accelerometer output</li> <li>• 3 de/sec vehicle yaw rate during crew sleep</li> <li>• Radar altimeter loss of lock/intermittent lock/fail</li> <li>• TACAN no lock, up or biases</li> </ul>	<ul style="list-style-type: none"> <li>• Power supply failed (9)</li> <li>• Accelerometer component shift</li> <li>• Bad state vector uplink</li> <li>• Transmission system malfunction</li> <li>• Low receiver sensitivity</li> </ul>
Mechanical Systems	<ul style="list-style-type: none"> <li>• Air data problems</li> <li>• PLBD would not close</li> <li>• Brake damage on landing</li> <li>• Thermal blanket and PLBD seal dislodged</li> </ul>	<ul style="list-style-type: none"> <li>• Thermal warping</li> <li>• Inadequate brake capability</li> <li>• Unknown; venting suspected</li> </ul>
MPS	<ul style="list-style-type: none"> <li>• Pad abort after SSME start</li> <li>• Launch scrub</li> <li>• 14,000 lbs of LO2 drained from ET pre-launch. Launch held due to strange LO2 temp indications in engine</li> <li>• Orbiter ET/SRB structural breakup</li> <li>• SSME failed (auto shutdown) ATO</li> </ul>	<ul style="list-style-type: none"> <li>• Engine valve slow to open</li> <li>• Various component failure, including H2 leakage</li> <li>• Operator error</li> <li>• Right SRB lower field joint burnthrough</li> <li>• Failed sensor</li> </ul>
OMS/RCS	<ul style="list-style-type: none"> <li>• OMS cracks discovered post flight</li> <li>• Left OMS pod burnthrough</li> <li>• Loss of verniers</li> <li>• RCS jet failed off</li> <li>• RCS jet failed leak</li> <li>• RCS Reg leak</li> </ul>	<ul style="list-style-type: none"> <li>• Launch stresses</li> <li>• APU detonation and fire</li> <li>• F5L and F5R leak</li> <li>• OX valve failed/clogged Pc tube/ main poppet stuck/He ingestion</li> <li>• Leaks</li> <li>• Helium leaks</li> </ul>

Systems Failure Summary Chart

## 7. TRAJECTORY MANAGEMENT AND FLIGHT CHARACTERISTICS

### CONTENTS

7.1	ASCENT.....	7.1-1
7.2	ORBIT.....	7.2-1
7.3	ENTRY.....	7.3-1
7.4	TERMINAL AREA ENERGY MANAGEMENT AND APPROACH, LANDING, AND ROLLOUT (OPS 305).....	7.4-1

This section presents space shuttle flight characteristics and trajectory management during powered flight, on orbit, reentry into the atmosphere, approach, landing, and rollout. Some guidance and navigation information is included so the crewmember will be acquainted with the parameters that are important in influencing flight control. Much of the information was supplied by crewmembers who have flown the space shuttle. Additional information was derived from simulator runs in

the Shuttle Mission Simulator, Shuttle Engineering Simulator, and Vertical Motion Simulator.

For each flight phase (ascent, orbit, entry), manual control techniques are presented, along with information on vehicle handling qualities, performance monitoring, and takeover criteria.

For detailed information on these subjects, consult the appropriate Flight Procedures Handbooks, Flight Data Files, or Flight Rules.

Each subsection discusses the primary controls and displays used during each flight phase. When used, external devices, such as runway lighting, ball-bar, and aimpoints, are integrated with the flight crew techniques in order to present a coordinated picture to the crewmember.

Where the backup flight system (BFS) differs from the primary avionics system software (PASS), (also called primary flight system (PFS)), BFS characteristics are discussed separately. This generally applies to ascent and entry flight phases, because the BFS has limited capability on orbit.

Each subsection concludes with rules of thumb.

## 7.1 ASCENT

### CONTENTS

Powered Flight.....	7.1-1
Insertion OMS Burns.....	7.1-7
Backup Flight System.....	7.1-8
Sensory Cues.....	7.1-9
Ascent Rules of Thumb.....	7.1-11

### Powered Flight

During powered flight, the crew monitors orbiter performance and system status using dedicated displays, CRT displays, and cue cards. This section describes the displays used, the monitoring task, takeover criteria, and manual control.

#### CRT Displays

Several types of CRT displays are used to monitor vehicle performance during powered flight. For a more detailed description of the displays presented here, refer to the Flight Procedures Handbook and DPS Dictionary.

#### GNC TRAJ Displays

In first stage, BFS ASCENT TRAJ 1 displays a nominal trajectory plot with altitude on the y-axis and relative velocity ( $V_{REL}$ ) on the X-axis. Altitude scale is from 0 to 170,000 ft and velocity from 0 to 5,000 fps. Tick marks on the profile show attitude director indicator (ADI) pitch attitudes at appropriate reference points. Orbiter state (from NAV) is displayed by a moving triangle with a 20 sec predictor circle. An airspeed scale is marked with speeds, and the current knots equivalent airspeed (KEAS) is shown by a triangle. A staging (STG) tick mark denotes maximum q-bar for SRB SEP.

The BFS ASCENT TRAJ 1 display, along with the ascent cue cards, is used to monitor first-stage trajectory.

Two CRT displays are available in second stage, and both are used for trajectory monitoring. The PFS ASCENT TRAJ is a plot of altitude vs  $V_{REL}$ . Current vehicle state is indicated by a moving triangle with 30 and 60 sec predictors.

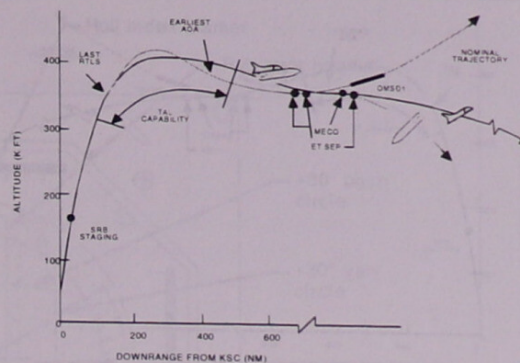

BFS Ascent TRAJ 1 CRT

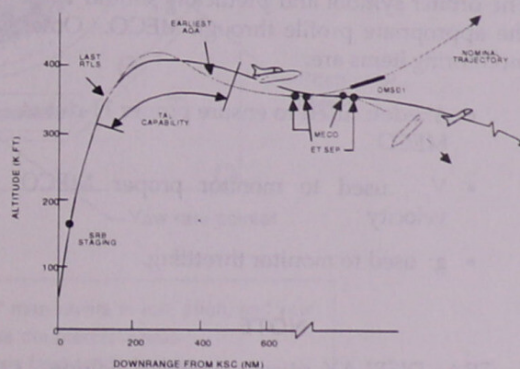

PFS Ascent TRAJ

Both altitude and velocity data are supplied by NAV. BFS ASCENT TRAJ 2 is automatically displayed at transition to major mode (MM) 103. The profile represents a nominal second stage ascent with altitude vs inertial velocity ( $V_i$ ) as the axes. Altitude scale ranges from 140,000 to 525,000 ft and velocity from 5,000 to 26,000 fps. Both PFS and BFS displays have tick marks at the last return-to-launch-site (RTLS) boundary and the point (GO) where no action is required for a single-engine failure. The BFS TRAJ 2 has a short line roughly parallel to the last part of the profile. This represents a TAL TRAJ for an engine failure at the earliest TAL opportunity. Also on the BFS display is an expanded  $V_i$  scale from 25,000 to 26,000 fps with a cutoff (CO) tick at the MECO velocity. Current  $V_i$  is indicated by a moving triangle driven by NAV. A vertical scale marked in total load factor (g) ranges from 2.0 to 3.5 g with current value indicated by a triangle.

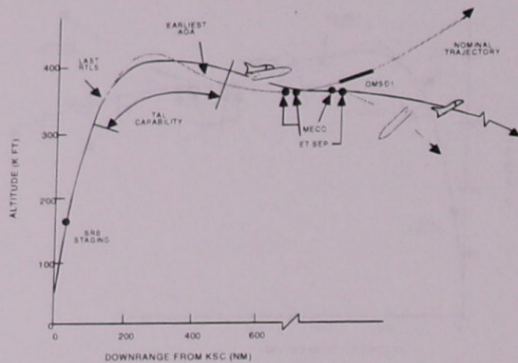

**BFS Ascent TRAJECTORY 2 CRT**

The orbiter symbol and predictors should track the appropriate profile through MECO. Other monitoring items are:

- $\Delta H\text{-dot}$ : used to ensure proper H-dot at MECO
- $V_i$ : used to monitor proper MECO velocity
- g: used to monitor throttling.

**NOTE**

TRAJ DISPLAY titles change to include the abort mode when an ascent abort is executed.

**GNC SYS SUMM Displays**

GNC SYS SUMM displays are the principal means of monitoring flight-critical systems. They should be scanned frequently during ascent to verify system status and aid in determining causes for alarms. The BFS also supports a THERMAL display and two SM SYS SUMM displays. These are accessed by placing the BFS CRT MAJ FUNC switch to SM. These displays should also be scanned frequently to detect impending system problems and are also used to deal with orbiter systems problems during ascent. CRT displays are presented in Appendix B.

**OVERRIDE Display**

The OVERRIDE display (SPEC 51) allows the crew to deselect/reselect certain line replaceable units (LRUs) to solve a redundancy management (RM) dilemma or to force RM to

consider a previously deselected LRU. The OVERRIDE display also contains various software switches that may be used to override dedicated switch failures, controls for OMS and reaction control system (RCS) dumps, and several other additional functions.

**Dedicated Displays**

Dedicated displays are also used during ascent to monitor shuttle performance.

The attitude director indicator (ADI) displays attitude, rates, and error information and is used in combination with the CRT displays and cue cards. ADI attitude depends upon the position of the ADI ATTITUDE switch on panel F6 or F8. Switch positions are:

- REF: reference frame based on nominal launch azimuth at lift-off (can be redefined)
- LVLH: Earth-referenced pitch/roll (local vertical local horizontal)
- INRTL: referenced to Mean of 1950 (M50) inertial frame (see Section 2.13 for reference frame definitions).

ADI rates are body rates driven by the rate gyro assemblies (RGAs). Scaling depends on the position of the ADI RATE switch. Switch positions are:

- HIGH: 10° per second
- MED: 5° per second
- LOW: 1° per second.

ADI errors are the difference between actual and commanded body attitude. Scaling is controlled by the ADI ERROR switch.

- HIGH: 10°
- MED: 5°
- LOW: 1°

The available scaling of ADI errors and rates is used to tailor vehicle displays for the sensitivity appropriate in each flight phase. If guidance is unconverged, the error needles will be stowed. An OFF flag is displayed for invalid or missing data.

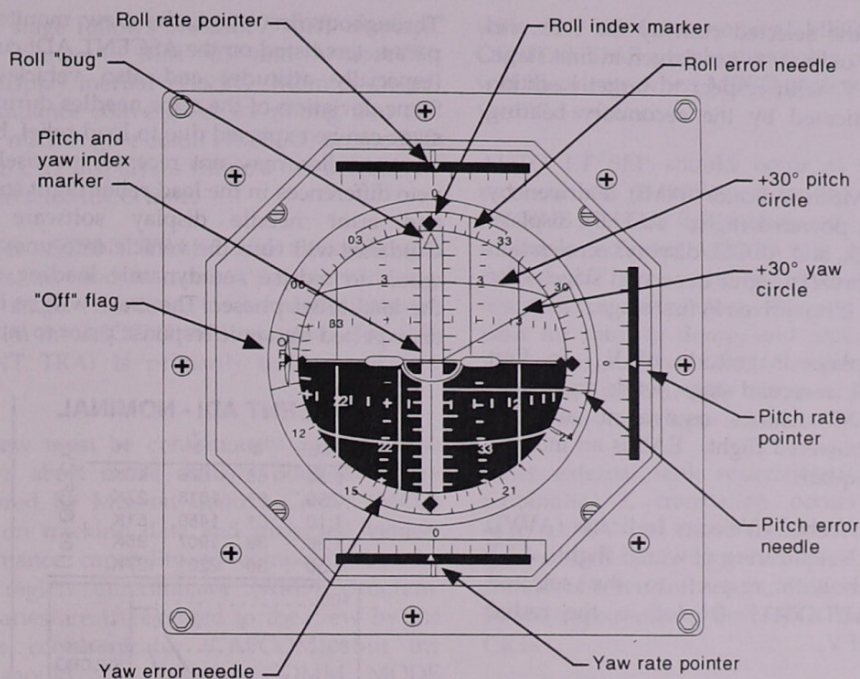

Attitude Director Indicator displays 360° maneuvers in roll, pitch, and yaw

- Positive roll command - Ball rotates counterclockwise
- Positive pitch command - Ball rotates from top to bottom
- Positive yaw command - Ball rotates from left to right
- Error needle deflections to positive commands
  - Roll - Left
  - Pitch - Down
  - Yaw - Left
- Rate pointer deflection to positive commands
  - Roll - Right
  - Pitch - Up
  - Yaw - Right

865.cvs

### Attitude Director Indicator

#### CAUTION

ADI malfunctions can occur without tripping the OFF flag. Crosscheck other displays during ascent to confirm performance is appropriate for the displayed attitude.

The horizontal situation indicator (HSI) is used to monitor AUTO guidance and provide information needed by the crew to fly manually. HSIs provide a geometric view of orbiter

location with respect to various NAV points. During powered flight, the HSI displays data relative to the target insertion orbit.

North on the compass card is the desired insertion plane. Heading of the body +X axis with respect to desired insertion plane is read at the lubber line. The difference between current heading and north is vehicle yaw. A course pointer indicates heading of  $V_{REL}$ , while the course deviation indicator shows estimated sideslip (the angle between body X-axis and  $V_{REL}$ ). The primary bearing pointer indicates

heading to the selected runway for TAL and RTLS aborts only. It is not driven in first stage. Heading of  $V_i$  with respect to target insertion plane is indicated by the secondary bearing pointer.

The Alpha/Mach Indicator (AMI) is driven by NAV during powered flight. ALPHA displays angle of attack, and ACCEL displays acceleration (computed thrust/weight) in second stage. The ALPHA tape is not driven in first stage.

M/VEL displays magnitude of  $V_{REL}$  in first stage, then  $V_i$  in second stage, while equivalent airspeed (EAS) shows equivalent airspeed throughout powered flight. EAS is an indirect indication of q-bar.

The Altitude/Vertical Velocity Indicator (AVVI) is driven by NAV during powered flight. ALT is displayed with respect to the selected runway. ALT RATE (H-dot) is the radial component of  $V_i$ .

Pushbutton indicators on the glare shield on panels F2 and F4 indicate status of *PITCH*, *ROLL/YAW*, and *SPD BK/THROT*. Lights within the pushbuttons correspond to control modes. The *BODY FLAP* pushbutton light also indicates the status of the main propulsion system (MPS) dump sequence post-MECO. The light comes on when the MPS dump is started and goes out when the dump is complete. All other pushbuttons extinguish at space shuttle main engine (SSME) zero thrust (MECO confirmed +3.75 sec). The *BFC* light illuminates when the BFS is engaged and flashes when the BFS is standalone.

### Powered Flight Monitoring

Sequential SSME start is monitored on the chamber pressure ( $P_c$ ) gauges on panel F7. After solid rocket booster (SRB) ignition (about 7 seconds after SSME start) the orbiter should perform a vertical rise for about 8 seconds, followed by a combination roll, pitch, and yaw maneuver onto the launch azimuth. Roll attitude on the ADI should be  $180^\circ$  upon completion. Switch *ADI ATT* from *REF* to *LVLH* after the roll is complete to obtain proper pitch/roll attitude information. *REF* is used for lift-offs to avoid large ADI movements at the *LVLH*  $90^\circ$  pitch singularity.

Throughout first stage, the crew monitors the parameters listed on the ASCENT ADI cue card (especially attitude) and also vehicle rates. Some deviation of the error needles during first stage can be expected due to load relief, but the error needles may not recenter precisely and veto differences in the load relief flight software and error needle display software logic. Guidance will turn the vehicle into unexpected winds to reduce aerodynamic loading during the load relief phase. The crew will be briefed on expected dynamic response prior to launch.

### ASCENT ADI - NOMINAL

TIME	$\theta$	$\dot{H}$	H	(101 OCF CY)
0:30	68	676	10K	
0:50	61	1018	27K	
1:10	51	1450	51K	
1:30	38	1907	85K	
1:50	30	2201	127K	

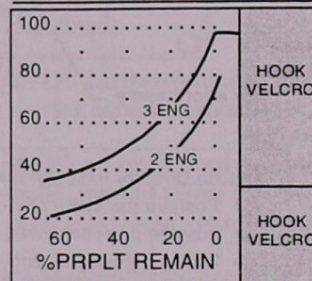

### -STAGING-

$V_i$	$\theta$	$\dot{H}$	H	ASC-14a/101/A/B
6	19	1711	218K	
7	16	1261	275	
8	13	914	310	
9	11	632	332	
10	9	402	345	
12	6	64	356	
14	8	-144	355	
16	25	-226	350	
18	23	-264	344	
20	21	-217	339	
22	19	-107	337	
24	17	57	337	
25928	13	277	343	

1097.CNV

### ASCENT ADI Cue Card

SSME throttle-down at 20 to 30 seconds and throttle-up at about 60 seconds is monitored on the  $P_c$  gauges. Throttle command (T) is displayed digitally on the BFS ASCENT TRAJ, which also displays the only trajectory information in first stage.



Second stage follows SRB SEP. CRT displays should change to MM 103, and AMI/AVVI tapes display inertial velocity. Monitor closed loop guidance convergence by noting that the time of main engine cutoff (TMECO) on the PFS and BFS CRT displays is within a few seconds of the expected MECO time.

The BFS ASCENT TRAJ 2 and the dedicated displays are used to monitor trajectory during second stage. Continue to compare displayed data with the ASCENT ADI cue card. The PFS ASCENT TRAJ is primarily used during an RTLS.

The crew must be continuously aware of the orbiter's abort mode status. Boundaries are monitored by Mission Control Center (MCC) based on tracking data and projected vehicle performance capability as computed by the abort region determinator (ARD) program. Boundaries are transmitted to the crew by the capsule communicator (CAPCOM), but the crew should use the NO COMM MODE BOUNDARY cue card to maintain onboard status if communications with MCC are lost. Boundaries listed on the CONTINGENCY ABORT cue cards should also be monitored.

NEG RETURN (104)	8100	2 ENG ZZA (104)	5700
PRESS TO ATO (104)	9400	ABORT TAL ZZA (4)	
SE OPS 3 ZZA (109)	11600	EO VI	<input type="text"/>
SE ZZA (104)	13200	SE OPS 3 ZZA (109) (13)	<input type="text"/>
PRESS TO MECO (104)	14000	SE ZZA (104) (4)	<input type="text"/>
SE PRESS (104)	17900	2 ENG MRN (104)	5600
NEG BEN (104)	18000	ABORT TAL MRN (3)	
NEG MRN (104)	20500	EO VI	<input type="text"/>
LAST PRE MECO TAL	23000	SE OPS MRN (109) (12)	<input type="text"/>
LAST TAL		SE MRN (104) (3)	<input type="text"/>
INN	23900	2 ENG BEN (104)	5600
FFA	24100	ABORT TAL BEN (2)	
ESN	24900	EO VI	<input type="text"/>
ZZA	25000	SE OPS 3 BEN (109) (11)	<input type="text"/>
KKI	25100	SE BEN (104) (2)	<input type="text"/>

867.cvs

#### NO COMM MODE BOUNDARY Cue Card

About 60 seconds prior to MECO, 3 g throttling commences and is monitored on the Pc gauges and CRT displays. MECO should be observed at guidance predicted TMECO and near the design MECO velocity on the AMI. All three red MAIN ENGINE STATUS lights on panel F7

will come on for a nominal MECO, and the ORBITAL DAP pushbutton lights on panel C3 will illuminate when MECO confirmed is set in the GPC software.

AUTO ET SEP should occur at MECO +18 seconds and is indicated by the red MAIN ENGINE STATUS lights going out. A SEP INH message indicates vehicle rate in any axis exceeds 0.7° per second or failure of a feedline disconnect valve to close. For rate exceedance, wait for rates to damp, and separation (SEP) will occur automatically. Feedline disconnect failure is handled using cue card and checklist procedures to perform a delayed ET sep..

After external tank separation (ET SEP), an automatic -Z translation occurs to obtain -4 ft/sec DV and move the orbiter away from the external tank. Upon completion, the crew should observe software transition to MM 104 by the appearance of the MNVR displays on the CRTs.

#### Takeover Criteria

During powered flight, the crew should be prepared to take whatever action is necessary in off-nominal situations in order to preserve safety and mission success. The Flight Rules define potential takeover criteria. These rules are built into the Flight Data File cue cards and checklists.

The most serious situations involve control problems. In many cases, these are time-critical and an FCS downmode (control stick steering (CSS) or BFS engage) must be rapidly performed. Downmode is an onboard decision that may be made for:

- Impending loss of control
- Failure of an expected maneuver to occur
- Unexplained attitude/rate excursions or undamped oscillatory motions.

If the roll maneuver is not initiated as scheduled, auto guidance is considered no-go, and a BFS engage should be performed.

Throughout first-stage flight, rate excursions are a parameter requiring crew action. Prior to 90 seconds, if pitch or yaw rates exceed 5° per

second, the crew should engage BFS. After 90 seconds, the crew should select CSS, followed, if necessary, by BFS engage.

#### CAUTION

With manual throttle control selected, an automatic guided MECO will not occur. To obtain the correct MECO velocity, the main engines must be shut down manually. In low performance cases, a low-level shutdown may occur prior to the planned MECO velocity.

After staging, if TMECO has not converged within 10 seconds, MCC should be consulted. In a NO COMM situation, CSS and manual throttle should be selected.

To avoid violation of range safety limits, CSS takeover may be required. MCC will provide yaw steering commands to allow the crew to fly away from limit lines. Trajectory deviations of such magnitude to require takeover are extremely unlikely. Potential causes are:

- Faulty onboard NAV
- Erroneous guidance
- Launch day winds
- SRB dispersions.

Range safety agreements for first-stage deviations allow for limit exceedance as long as control is maintained.

As the orbiter approaches 3-g acceleration, throttling commands and SSME throttle-down should be observed. If this does not occur, manual throttling must be performed using the pilot's speed brake/thrust controller (SBTC) to ensure vehicle loads do not exceed design limit constraints.

Any time the AUTO guidance is unacceptable for vehicle attitude control, it should not be allowed to control the main engines. Manual throttle should be selected whenever CSS takeover is initiated. Automatic guided MECO is inhibited with manual throttles selected.

If MCC predicted TMECO is 2 seconds different than onboard predicted TMECO, a manual SSME shutdown will be initiated on the ground-computed value.

The MCC abort region determinator (ARD) program is the prime tool for determining abort capabilities. The onboard NO COMM MODE BOUNDARIES cue card lists inertial velocity values that define flight design mode boundaries computed prior to flight using predicted ascent performance and including ground rule flight performance reserves. The ARD is a real-time computational system designed to handle:

- One or more SSME failures at any time
- Performance dispersions visible in the vehicle state
- Performance dispersions not visible in the vehicle state
- SSME mixture ratio changes.

Multiple or single-engine abort capabilities are determined throughout ascent for any combination of these failures using ground radar tracking or telemetry of current vehicle state. A discussion of performance boundaries is presented in Section 6.

Should the translational hand controller (THC) be moved out of detent post-MECO and prior to the completion of the -Z ET SEP maneuver, the maneuver will be inhibited (terminated if in progress) with no moding to MM 104. If for any reason the -Z maneuver is not completed either automatically or manually, the crew can manually mode to MM 104 by keying in OPS 104 PRO.

#### Manual Control

Manual control during powered flight is selected by depressing either the *PITCH* or *ROLL/YAW* CSS pushbutton indicator on the eyebrow panel. Any pushbutton indicator gives CSS in all axes to both commander (CDR) and pilot (PLT) RHCs. If CSS is selected, manual throttles should also be selected. The PLT can select manual throttle by

depressing the red button on the left SBTC and moving the lever to match current commanded throttle setting within 4 percent. As throttle level is matched, the *MAN SPD BK/THROT* light on the eyebrow panel will illuminate, indicating SSME throttling is completely controlled by the PLT's SBTC. Pushing either *SPD BK/THROT* pushbutton on the eyebrow panel will return control to auto throttle.

The control system in powered flight is rate control, attitude hold, with a maximum rate of about 12° per second in pitch and roll, and about 6° per second in yaw. If both RHCs are out of detent at the same time, the commands are summed.

To fly to a nominal MECO in CSS, the trajectory displays and the ASCENT ADI cue card are the prime tools. Displayed data are only as good as the NAV state, so the crew must confirm NAV state with MCC at takeover. Maintaining roll at 180° and commanding yaw to keep  $V_1$  (HSI secondary bearing pointer) on the nose is the most efficient yaw profile. Use the ASCENT ADI cue card to confirm MECO velocity and H-dot.

The BFS ASCENT TRAJ display provides performance information. Keep the current state (triangle) and the two predictors on the TRAJ line and make small (less than 5°) attitude changes. Observe the results prior to making another correction. If BFS guidance is good, BFS digital information can be used to fly the ascent profile.

Since H-dot at MECO is extremely critical, concentrate on controlling H-dot rather than altitude within 90 seconds of MECO. Attempt to achieve the nominal H-dot shown on the ASCENT ADI cue card. This will result in a nominal H-dot at MECO, although errors of ±100 fps are usually acceptable.

Whenever the CDR is flying CSS, the PLT should take manual throttle control. Maintain full throttle up to 3 g, then reduce SSME thrust to maintain 3 g. Coordinate with the CDR, since thrust changes affect attitude control. Lead target MECO by about 150 fps to allow for system lag time plus SSME tailoff. Perform manual shutdown by depressing all three shutdown pushbuttons on panel C3. This procedure should result in achieving desired  $V_1$  at MECO.

## Insertion OMS Burns

### Monitoring and Targeting

To monitor insertion OMS burns (OMS 1 and/or OMS 2), the MNVR EXEC display and BFS GNC SYS SUMM 2 are used in addition to the ADI. These displays are available in both PASS and BFS in similar formats. The MNVR EXEC display provides digital data to target and monitor orbital maneuvering system (OMS) burns. MNVR EXEC is an interactive display requiring keyboard inputs from the crew, as well as monitoring prior to and during burns. Current HA and HP are used in conjunction with the OMS 1/2 TGTING cue card to determine which OMS targets should be used. Each mission has a flight-specific card, which the crew must understand thoroughly. The MNVR display is described in detail in Section 2.18.

After the crew loads the appropriate targets, the GPC software will compute a burn solution. The target set and burn solution can be checked by comparing data on the CRT display with the expected solution listed in the OMS targeting section of the ascent check list or OMS maneuver pads.

1041/ OMS BOTH 1*	OMS 1 MNVR EXEC	1 000/00:40:23 000/00:15:37
L 2	BURN ATT	AVTOT 0
R 3	24 R 083	TGO 0:00
RCS SEL 4	25 P 195	VGO X +
S TV ROLL 180	26 Y 300	Y +
TRIM LOAD	MNVR 27*	Z +
6 P [-] 0.1	REI 4366	HA HP
7 LY [-] 5.7	TFF 24:40	TGT 130 +129
8 RY [-] 5.7	GMBL	CUR 130 + 9
9 WT 217047	L R	
10 TIG	P +0.4 +0.4	
	Y +5.8 +5.8	
TGT PEG 4	PRI 28* 29*	35 ABORT TGT
14 C1	SEC 30 31	FWD RCS
15 C2 [-]	OFF 32 33	ARM 36
16 HT	GMBL CK 34	DUMP 37
17 OT		OFF 38*
18 PRPLT [-]		SURE DRIVE
TGT PEG 7		ON 39
19 AVX [-]		OFF 40*
20 AVY [+]		
21 AVZ [-]		
LOAD 22/TIMER 23		

### MNVR Display

For a quick check, scan ΔVTOT, TGO, apogee altitude (HA) and perigee altitude (HP), burn attitude, and time of ignition (TIG) to make sure they are reasonable. Before executing a burn, automatic maneuvers to the inertial burn attitude may be performed using ITEM 27. Prior to executing the burn, crosscheck the attitude with the ADI and compare PFS and BFS solutions.

### NOTE

Burn attitudes on the MNVR display are inertial, and the *ADI MODE* switch must be in *INRTL* for a proper crosscheck of orbiter burn attitude.

The ADI is used for OMS burns in a similar fashion to its use during powered flight. BFS GNC SYS SUMM 2 is used to monitor the OMS system during insertion OMS burns.

Once the targets are loaded, and a solution is available, the crew follows ASCENT CHECKLIST/OMS Burn cue card procedures to prepare for and execute the burn. When in the correct burn attitude, error needles should be centered, and the ADI inertial attitude and commanded attitude on the MNVR display should match.

### CAUTION

Maneuvering to burn attitude should be delayed if the DAP has failed to maintain the orbiter within 10° of the ET SEP attitude during the -Z translation. This will avoid recontact with the ET.

Provided perigee is high enough to remain in orbit for a few revolutions, cutoff conditions of an ascent OMS burn are relatively unconstrained compared to a deorbit burn. Achieving the planned orbit is a mission success issue. Reaching an orbit above minimum HP is a safety issue. For failures during insertion OMS burns, the crew will downmode from 2 OMS to 1 OMS to + X RCS to forward RCS as necessary to reach at least minimum HP. Downmode procedures are listed on the INSERTION OMS BURN cue cards.

### Manual Control

Takeover criteria and manual flight characteristics during insertion OMS burns are similar to those encountered during deorbit burns. Refer to Section 7.3 for a more detailed discussion of OMS burn takeover criteria and flight characteristics.

Insertion OMS burns for ascent aborts are discussed in Section 6.2. Some special situations encountered during insertion OMS burns are discussed here.

### Backup Flight System

The BFS is unique software contained in a single GPC that supports nominal ascent and most shuttle aborts. The BFS can be engaged at any time after lift-off. Once engaged, it is irreversible until the orbiter is in orbit or back on the ground.

BFS state vector degrades very rapidly during powered flight if the BFS is standalone, since it is propagated using the last known DV from the inertial measurement units (IMUs). Therefore, if the PASS were to fail, BFS engage must be performed within 10 seconds to ensure the vehicle will remain under control.

BFS engage criteria are listed in the Flight Rules and summarized on the DPS cue cards. They include:

- Loss of redundant set
- Loss of PASS capability to control the vehicle due to general purpose computer (GPC)/multiplexer/demultiplexer (MDM)/LRU failures
- Loss of control due to divergent trajectory
- Roll maneuver not initiated as scheduled.

There are a number of functional differences between the PASS and the BFS:

- No manual control during powered flight.
- No manual throttling.
- BFS does not support contingency aborts.
- No single-engine roll control.
- BFS runs pre-engage in parallel with PASS although not in control of the orbiter.
- BFS has only one memory load. Unique ascent and entry requirements are merged into one common set of guidance requirements.

- When BFS is engaged, it takes command of all flight-critical buses.
- When BFS is engaged, two CRTs are driven unless additional CRTs are assigned with keyboard inputs.
- The BFS can drive all four CRTs simultaneously while the PASS is limited to three.
- BFS performs limited SM functions while PASS does not.
- The ADI and HSI are the only dedicated displays driven in powered flight. The AMI and AVVI are frozen and display OFF flags.
- Post ET SEP, only AUTO -Z translation is available. In the TRANS DAP, attitude maneuvers are manual only.
- OMS burn attitude must be controlled manually.

### Sensory Cues

Prelaunch, SSME gimbal checks can be felt through the shuttle structure.

First stage is characterized by a rapid g buildup to slightly over 2 g, accompanied by a great deal of noise and vibration. Instruments and CRT displays can be monitored, but precise tasks are difficult.

SRB SEP results in a large amount of flame across the windows from the SRB separation motors. When the flame disappears, forward windows appear to be coated with residue, making them nearly opaque at certain Sun angles.

At SRB SEP, g-load undergoes a nearly instantaneous reduction from 2.3 g to 1.0 g, coupled with a significant reduction in both noise and vibration. Since the orbiter is above most of the atmosphere, many crewmembers have remarked that it seems to stop accelerating.

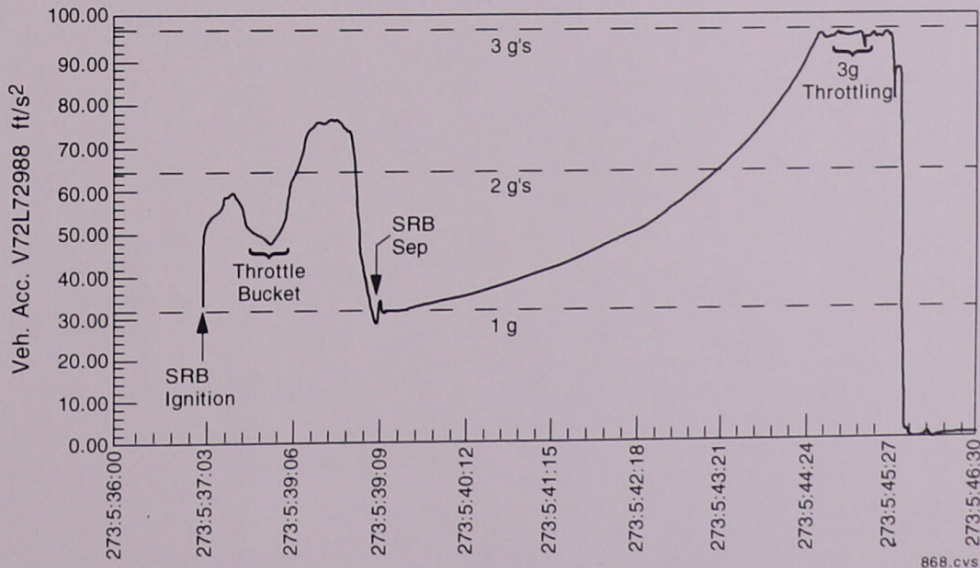

Vehicle Acceleration During Ascent

During second stage, g-load builds very gradually until 3 g's are reached and the SSMEs throttle to maintain 3 g.

A good fit of the pressure suit and harness is very important to avoid discomfort during ascent, particularly at high g loads. Centrifuge runs with actual flight equipment should be performed to ensure proper adjustment.

Some crewmembers report that the eye position in an actual orbiter differs from that encountered in the SMS. Checking seat position in an actual orbiter prior to flight is recommended for first time flight deck crewmembers.

MECO results in g-load decreasing rapidly to zero. Indication of MECO is limited to observing the red SSME status lights, Pc meter readings dropping to 0, and g-reduction.

Some crews have reported an audible thump at ET SEP which could be caused by the explosive severing of the forward attach fitting. Other crews noted that ET SEP had occurred by extinguishment of the SSME status lights.

When the forward RCS jets fire to perform the -Z translation, their ignition is accompanied by a loud boom (just like "cannons" according to some crewmembers). Aft jets produce a noticeable structural vibration, but no sound. The OMS engines do not produce sounds, but the thrust can be noted by unrestrained objects translating aft in the cabin.

Night launches are a special case. The SRB and SSME plumes appear to reflect off the air molecules and produce a "pulsing" light that is most pronounced through the overhead windows, but can be seen through the front windows also.

### Ascent Rules of Thumb

- At L/O, check Auto FCS
- Monitor roll program on the ADI and BFS ASCENT TRAJ display.
- Before L/O +90 seconds, BFS engage is the crew's only option for loss of guidance and/or control. After 90 seconds, the crew can try CSS.
- Monitor the trajectory on the ASCENT ADI cue card and the PASS and BFS TRAJ displays. The shuttle bug and predictors should follow the nominal trajectory line. Also monitor the HSI for the inertial velocity to be in the desired orbit insertion plane.
- Monitor guidance convergence by observing PASS and BFS TMECOs converging to expected time.
- If the crew takes CSS, they should take manual throttles. If the crew takes manual throttles, manual shutdown is required unless a low level shutdown occurs due to low performance. The cue for MECO is the BFS MECO cutoff bug or planned MECO  $V_1$  minus 150 fps.
- Use OMS 1 TGTING cue card for system problems and OMS 1/2 TGTING cue card for performance problems to determine proper OMS 1 and 2 targets.

7.2 ORBIT

CONTENTS	
Attitude Control .....	7.2-1
Translation.....	7.2-5
Rendezvous/Proximity Operations .....	7.2-6
Orbit Rules of Thumb .....	7.2-12

**Attitude Control**

Orbiter attitude is primarily controlled automatically using either inertial attitude hold or track mode. The universal pointing (UNIV PTG) display, combined with the digital autopilot (DAP) display and control panel C3 are used for automatic attitude control. For manual attitude control, the RHC is also used.

Orbit flight control software includes the RCS DAP, OMS TVC DAP, an attitude processor to calculate vehicle attitude, and logic to govern which DAP is selected. Attitudes calculated by the attitude processor are displayed on the ADI and UNIV PTG. Vehicle attitude is used by the DAP to determine attitude and rate errors.

As part of mission planning, an attitude timeline (ATL) is generated. While the Flight Plan is being developed, the ATL is also developed using information about payloads, experiments, and other constraints. An ATL is produced for both the Basic and Final versions of the Flight Plan. When complete, the ATL is incorporated into the Flight Plan, although it is not usually flown. Missions with large numbers of time-critical maneuvers may carry the ATL onboard and use it to perform maneuvers.

**Common Attitudes**

While each shuttle mission is unique, some attitudes are used frequently and are briefly described in this section.

*Top/Bottom Sun*

These are inertial attitudes that point either the +Z or -Z body axis at the Sun. They are normally used for thermal control of payloads. Obviously, a rotation angle about the pointing axis must be defined to constrain the attitude. This is usually flight-specific and is driven by look angles, communications coverage, or other constraints.

*Tail Sun*

Another inertial attitude, but with the -X axis pointed toward the Sun. This is one of the coldest attitudes.

*Nose Sun*

Opposite to tail Sun. A semi-cold attitude used to cool the aft section of the orbiter or to warm the nose area, particularly the nose wheelwell.

*Deorbit Prep Tail Sun*

A special case of the tail Sun attitude designed to "cold soak" the radiators prior to entry. This is a track attitude using body vector of pitch = 184°, yaw = 0°, and OMICRON either 90° or 270°.

*Tail Sun Rotation*

The coldest attitude for the payload bay. This is an inertial attitude that keeps the -X axis pointed at the Sun while phasing rotation to keep the payload bay pointed away from the Earth. It is used for thermal bending tests or to meet specific payload requirements.

*Passive Thermal Control (PTC)*

This is another inertial attitude rotation about the + or -X axis, but it maintains the Sun in the Y-Z plane. The result is even warming of the orbiter. PTC is sometimes called the "barbecue" mode. It is used to meet various payload thermal constraints.

*Gravity Gradient*

A stable attitude controlled by balancing differential gravitational and aerodynamic forces. The RCS is not used. Combined forces are very small, and only a few stable attitudes exist. These are difficult to establish and vary according to altitude, inclination, time of year, and many other variables. Gravity gradient is used to conserve propellant or to inhibit RCS firings during certain payload tests and experiments.

*Local Vertical Local Horizontal (LVLH)*

This attitude maintains a constant orbiter orientation to the earth. Typically, the -Z axis is pointed at the center of the earth with the +Y axis aligned with the -H bar. For circular orbits,



the X axis will be along the velocity vector. The -ZLV (payload bay to the earth) attitude provides excellent extended earth viewing for the crew and PLB experiments.

### Displays

Attitude data for the attitude processor are provided by the inertial measurement units (IMUs). Rate data are derived from the IMUs by dividing attitude delta by the time interval between attitude measurements.

ADIs provide an analog attitude display relative to three selectable reference frames. These are selectable via the *ADI ATTITUDE* switch. Inertial (*INRTL*) and reference (*REF*) positions represent inertial reference frames. Local vertical/local horizontal (*LVLH*) represents the orbiter in a fixed position relative to a rotating reference frame.

In addition to the forward ADIs, which always operate in the +X sense, the aft ADI may operate in either a -X or -Z sense. Selection is made using the *ADI SENSE* switch. This allows proper orientation, depending on whether the crewmember is viewing through the payload bay (-X) windows (W 9/10) or the overhead (-Z) windows (W 7/8).

The ADIs also display attitude errors that are calculated from the difference between current attitude and required attitude. The error needles are mechanized to indicate a "fly-to" sense. Rate needles are also fly-to. To correct attitude or rate errors, the RHC is deflected in the direction indicated by the needle.

### Control

Attitude control on-orbit is provided by the RCS. The RCS is designed to control the orbiter independently in each of three axes. Minimum on/off cycle time for the jets is 80 milliseconds. Vernier jets (25 lb thrust) are normally used on orbit for attitude control since the primary jets (870 lb thrust) use more propellant for fine attitude control. Primary jets are used for translation and higher rate attitude maneuvers. ALT PRCS DAP uses the primary jets but limits the number, duration, and spacing of jet firings to achieve attitude control and RMS loading similar to vernier jets.

OI-23 added notch filter capability. Simply stated, notch filtering allows the crew to select different frequencies to attenuate. This new capability was driven by the previous need for extensive preflight stability analysis in regard to the acceptable RMS/payload position envelope. Without notch filtering, the DAP may tend to excite rather than damp attitude oscillations caused by an unstable RMS/payload position.

For OMS burns, the OMS TVC DAP controls OMS engine gimbaling, allowing OMS engine thrust vectors to be independently pointed several degrees in any direction relative to the orbiter c.g. This allows complete attitude control with the OMS engines alone during normal two-engine burns. For single-engine OMS burns, the RCS is used for roll control. The OMS TVC DAP also contains an RCS "wraparound" capability. If the attitude error exceeds 10° in pitch or yaw, or 5° in roll during an OMS burn, RCS jets are fired to correct the attitude.

### DAP Configuration

The DAP uses current attitude to determine attitude and rate errors.

Rotation rates and deadbands are functions of DAP configuration. Values may be changed on orbit using SPEC 20 DAP CONFIG. For convenience, each planned DAP configuration is assigned a number. The crew uses these numbers, which are called out in flight data file procedures, to select the proper DAP mode for maneuvers. Typically, DAP A has lower rates and smaller deadbands than DAP B. Wide deadbands minimize propellant usage, while smaller deadbands allow more precision in executing maneuvers or holding attitude.

### Attitude Control

Rotation and pointing maneuvers are required to achieve correct attitudes for deployments, on-orbit burns, star tracker operations, thermal control, flyarounds during proximity operations, and pointing.

The RCS controls rotation independently in three axes. Jets are appropriately located and oriented to provide this control. Two independent sets of jets, primary (PRI) and vernier (VERN) are capable of attitude control. Most on-orbit rotation maneuvers are performed with the VERN jets.

```

2011/ / UNIV PTG 2 000/02:44:58
CUR MNVR COMPL 02:55:29 000/00:00:00
1 START TIME 0/000:00:00
CUR FUT CUR FUT
MNVR OPTION START MNVR 18 RBST 25 X X
5 R 0.00 TRK 19 * CNCL 26
6 P 0.00 ROT 20 DURATION 27
7 Y 0.00 CNCL 21 XX:XX:XX:XX

TRK/ROT OPTIONS ATT MON
8 TGT ID 2 22 MON AXIS 1 +X
ERR TOT 23 *
ERR DAP 24

9 RA 0.000
10 DEC ( ) 0.000
11 LAT ( ) 0.000
12 LON ( ) 0.000
13 ALT ( ) 0.0

14 BODY VECTOR 3
CUR ROLL PITCH YAW
REQD 163.59 40.77 338.38
ERR + 74.86 - 62.92 + 86.93
RATE - 0.266 - 0.367 + 0.443

15 P 90.00
16 Y 0.00
17 OM 270.00

```

### UNIV PTG Display

The UNIV PTG display is used to control automatic attitude maneuvers input by the crew. By entering data on the UNIV PTG display, the crew can command automatic maneuvers to point a specific body axis at a specified target, maneuver to a predetermined attitude, rotate about a specified body axis, or maintain attitude hold. The UNIV PTG display also shows attitude information, errors, and completion time for current maneuvers. Types of automatic attitude maneuvers are presented in the following summaries.

To perform an automatic maneuver, the crew first enters the required data on the UNIV PTG display for the desired maneuver. To start the maneuver at a set time, that time is also entered on the UNIV PTG display. After checking the data, the crew enters an Item 18, 19, or 20, as appropriate, to start the maneuver. With AUTO DAP selected, an auto maneuver will begin at the set time or as soon as Item 18, 19, or 20 is entered if the maneuver start time is in the past. Item 21 is used to cancel a maneuver.

#### Maneuver

The maneuver (MNVR) option is used to maneuver the orbiter from current attitude to a new inertial attitude specified on UNIV PTG. AUTO maneuvers are three-axis at the rate specified on SPEC 20. Maximum acceptable error in any axis is the SPEC 20 attitude deadband (ATT DB). Total error, displayed on UNIV PTG, is the difference between required and current attitude. Allowable rate error in any axis is specified by the rate deadband

(RATE DB) on SPEC 20. When the flight control software determines the orbiter is at the required attitude, attitude hold is initiated.

#### NOTE

Manually maneuvering away from a commanded attitude is possible. However, the DAP will return the orbiter to the commanded attitude when AUTO is reselected.

#### Track

The track (TRK) option is by far the most complex in universal pointing software. There are six subcases: orbital object tracking, center of Earth, Earth-relative target, center of Sun, celestial target (e.g., planet, Moon), and navigation star target. Each subcase is selected by a target ID (TGT ID) on UNIV PTG. The TGT ID is the line of sight or target vector from the orbiter c.g. to one of the defined targets.

The track option is used in conjunction with a body pointing vector, which is centered at the orbiter c.g. and is defined by a pitch and yaw combination. These angles are referenced to the orbiter +X axis.

Track software allows the crew to point a specified body vector at one of the defined targets. Attitude is not completely constrained until body orientation about the body pointing vector has been specified. Rotation about the body pointing vector is called OMICRON. By selecting a pitch, yaw, and OMICRON, a body pointing vector and the orbiter's orientation with respect to that vector are specified.

When a TRK option is initiated, TRK software performs a three-axis maneuver at the rate specified by the current DAP, then begins active track of the target. TRK subcases perform the following functions:

#### Orbital object tracking (TGT ID = 1)

State vectors of the orbiter and another orbiting target are used to determine a relative target vector. The target state vector is maintained by the REL NAV software. This mode is used post-deploy to track a payload. It is also used extensively during rendezvous operations.

**NOTE**

It is important to have REL NAV (RNDZ NAV) enabled (SPEC 33, ITEM 1) prior to tracking another orbiting body. It is also important to disable a TGT ID = 1 prior to OPS 8 or OPS 3 transition. Although UNIV PTG remains active in OPS 8, REL NAV does not. Excessive fuel usage could occur due to universal pointing chasing a stale state vector.

Center of Earth (TGT ID = 2)

Selected body vector is pointed at the Earth, with orientation specified by OMICRON, and maintained. This is, in effect, an LVLH attitude hold, requiring the orbiter to establish a small rotation rate that matches orbital rate. Center of Earth tracking is frequently used on orbit for normal operations that do not require specific attitudes.

Earth-relative target (TGT ID = 3)

Latitude, longitude, and altitude of an Earth target are entered on UNIV PTG. This determines target line of sight from the orbiter. TRK maintains this attitude. Latitude and longitude are entered in degrees. Altitude is entered in nautical miles. Typically, primary jets will be required to maintain this track as the orbiter flies over the target.

Center of Sun (TGT ID = 4)

Present values of right ascension (RA) and declination (DEC) are used to determine line of sight to the center of the Sun. TRK then maintains the proper attitude. RA and DEC on the UNIV PTG display are updated with each new recall of TGT ID=4 as the Sun RA and DEC change. This mode is used primarily for thermal control.

Celestial target (TGT ID = 5)

RA and DEC of a desired celestial object are entered. TRK will then point the defined body vector at this target and commence tracking it. An astronomical target can be tracked in this mode to point specific instruments. It may also be used during payload deployment to provide illumination or shading.

Navigation star target (TGT ID = 11-110)

TRK software contains the RA and DEC of 100 navigation stars that are defined by a number (11-110). Selecting a particular star and defining a body vector allows TRK to point the body vector at the star and track it. Obviously, this mode can be used for star sightings. It may also be used to point instruments.

**Rotation**

The rotation (ROT) option takes the body vector defined by pitch and yaw and initiates a rate (specified on DAP CONFIG, SPEC 20) about it.

**NOTE**

Transitioning to OPS 8 with an active rotation continues the rotation. Ensure correct DISC RATE is selected prior to transition, since neither UNIV PTG nor DAP CONFIG (SPEC 20) is available.

**Cancel**

Executing the cancel (CNCL) item on UNIV PTG snapshots and maintains current inertial attitude. All other current and future options (MNVN, TRK, ROT) are terminated. CNCL is selected automatically when entering OPS 2 from any OPS except OPS 8. Otherwise, the crew must select CNCL via an ITEM entry.

**Manual Attitude Control**

The RHC controls roll, pitch, and yaw movements on orbit with the OMS and RCS. Flight characteristics depend totally on DAP configuration. Various DAP configurations have been optimized for certain tasks, using off-line simulation. With the DAP mode in *INRTL*, and *DISC RATE* selected on panel C3 or A6U, deflecting the RHC out of detent fires appropriate RCS jets until an angular rate is achieved in that axis equal to the rate specified in the DAP CONFIG display (SPEC 20). Different rates may be specified for DAP A and B, and for PRI or VERN jets. When the rate is achieved, the jets are turned off until the RHC is returned to detent or deflected in another axis. Jets also fire to maintain attitude or rates within selected DAP CONFIG deadbands. Returning the RHC to detent snapshots the attitude, and jets are fired to stop rates and hold the snapshot attitude.

Deflecting the RHC beyond the soft stop causes jets to fire continuously, producing a constant angular acceleration. When the RHC is repositioned inside the soft stop, jets are turned off, but rates continue until the RHC is returned to detent.

With *PULSE* selected, RHC deflection fires jets to achieve the angular rate change specified by rotational pulse (ROT PLS) on SPEC 20. *PULSE* is also a free drift mode.

For manual rotation maneuvers, modes generally used are:

- *INRTL DISC* for inertial attitude hold and small attitude maneuvers
- *INRTL PULSE* for large manual maneuvers

#### *High Rate Attitude Maneuvers*

To quickly maneuver to attitude in an emergency, a high maneuver rate may be required. Bump the RHC past the soft stop and back within the soft stop several times until the desired rate is achieved, being careful not to let the RHC return to detent. Stop the maneuver by returning the RHC to the detent. It will be necessary to lead the desired attitude by an amount proportional to the rotation rate.

#### *Flying Techniques for COAS /HUD Calibrations and COAS IMU Alignments*

To perform a COAS (or HUD) calibration or IMU alignment, the orbiter must be maneuvered manually to align the COAS reticle (or HUD test pattern) with a preselected star. The largest portion of the maneuver will be performed using a coarse control DAP with rates and deadbands selected to minimize maneuver time without exceeding propellant allotments.

Once the star is near the center of the COAS reticle, the crew must switch to a DAP optimized for fine attitude control. A vernier DAP will provide the finest attitude control with minimum fuel consumption.

Patience is very important when attempting to center the star in the COAS reticle. After making an RHC input, wait until movement is

noticed, and the star is near the desired position before releasing the RHC. This will minimize jet firings and fuel consumption. The coarse control DAP will usually allow higher maneuver rates than the fine control DAP. The higher rates require more time to start and stop so pilots will notice a requirement to lead RHC inputs when using the coarse control DAP (i.e., return the RHC to the center detent slightly before the star reaches the desired position in the COAS reticle).

#### **Translation**

Orbit translation maneuvers can be conducted using the OMS engines or RCS jets. The OMS engines are usually used for larger maneuvers. Burn targets for preplanned orbit OMS or RCS burns are normally transmitted to the crew from Mission Control. The crew will then load those (or verify auto-loaded) targets and execute the burn at the appropriate time. OMS/RCS burn monitoring and control for orbit burns is similar to that discussed in Section 7.3.

#### **RCS Translation**

The RCS is used to control translation when small velocity changes are required. For example, the RCS might be used for the initial maneuvers used to separate from a payload after deploy. In these situations, the CDR/PLT uses the THC and DAP panel to transmit control commands to the GPCs and ultimately to the RCS jets.

Translation flight characteristics depend on DAP panel configuration and the DAP parameters listed on the DAP CONFIG display. DAP parameters are optimized for planned tasks preflight, using off-line simulation.

THC deflection with *PULSE* selected on the *ORBITAL DAP* panel fires jets to cause a velocity change as specified on SPEC 20. Selecting *NORM* allows continuous acceleration as long as the THC is deflected. *HIGH Z* is a submode available for +Z translations only. Selection of this submode fires all nine up-firing jets and should be used only in an emergency.

*LOW Z* is a submode that allows +Z translations by firing +X and -X jets simultaneously to minimize payload/Space Station pluming.

LOW Z translations also affect pitch and roll, since upfiring jets are inhibited. There are significant translational cross-coupling effects in this mode.

### Rendezvous/Proximity Operations

Rendezvous and proximity operations require coordinated attitude and translation maneuvers to join with or maintain position relative to another orbiting object. This section covers some of the tasks and problem areas encountered during rendezvous and proximity operations along with some suggested techniques. The normal rendezvous sequence is presented in the orbit mission events summary in Section 5. For a more detailed discussion of Rendezvous/Proximity Operations, refer to the Flight Procedures Handbook.

#### Plume Impingement

For translations near targets, there is a concern about contamination and also the resultant induced body rates and torques caused by an RCS jet plume striking the target. Certain types of payloads may be sensitive to propellant molecules. For example, a payload with delicate optical equipment could be damaged by an intense blast from an RCS jet at a short distance. Selecting which jets to fire, as well as distance and orientation of the orbiter with respect to the target, may be adjusted to reduce contamination.

Nearly all payloads are sensitive to the overpressure and resultant body rates/torques caused by an RCS jet firing at close range. Usually, a sphere of influence is identified, and no upfiring jet firings at the target are allowed within it; typically, 200 ft to grapple range from the target.

#### Braking Techniques

Braking is used to reduce relative velocity between the orbiter and a target. Three techniques will be discussed: normal Z, low Z, and orbital mechanics effects.

Normal Z axis technique uses upfiring jets to generate braking in a +Z direction. Since the jets pointing toward the target provide the braking force, plume impingement is a concern.

Low Z reduces plume impingement by using the cant of the +X jets and scarfing (design of the nozzle) of the -X jets to produce a resultant force in the +Z direction. Jet firing is controlled by the DAP to produce a near zero force in X axis direction. Low Z braking can use up to 12 times the amount of propellant as normal Z. This mode should only be used where plume impingement must be minimized. When in low Z, Y-axis jet firings induce higher closing rates, requiring expensive braking maneuvers.

#### CAUTION

Due to severe cross-coupling effects, minimize Y-axis translations when flying in low Z mode.

Orbital mechanics may provide small separation forces for various approaches. This may be used effectively for plume-sensitive targets and to help minimize propellant usage. The best illustration of this concept is the +R-bar approach, where "natural" braking (slowing of the orbiter) lessens the requirement for +Z thrusting.

#### Stationkeeping

Stationkeeping is the technique used to maintain the orbiter at a desired relative position, attitude, and attitude rate with respect to a target vehicle. When stable in a stationkeeping position, the crew has time to obtain navigation information and determine and set up approach maneuvers. Stationkeeping most commonly is performed on the target's velocity vector (V-bar) or the radius vector of the target to the center of the Earth (R-bar).

V-bar stationkeeping can be accomplished either ahead of (+V-bar) or behind (-V bar) the target. The only completely stable stationkeeping position is on the target's V-bar.

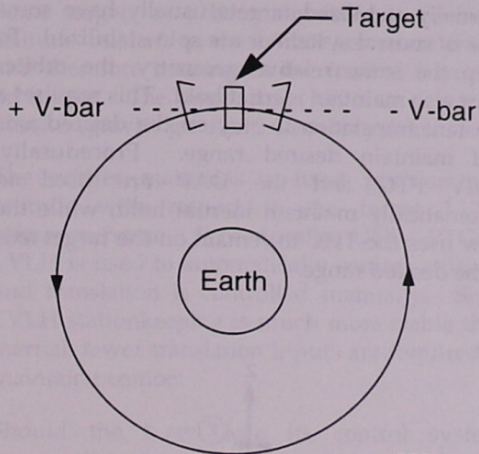

869.cvs

### V-Bar Stationkeeping

This results in the most efficient type of stationkeeping because minimal propellant is required to maintain the orbiter at the same altitude and coplanar with the target. At about 1,000 ft on the V-bar, position can be maintained for about 100 pounds of propellant per orbit, using optimum techniques.

Similarly, R-bar stationkeeping can occur either below (+R-bar) or above (-R-bar) the target.

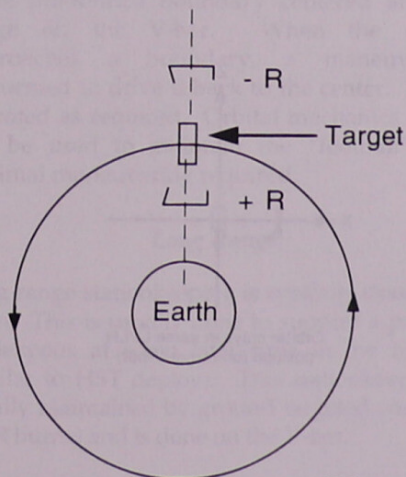

870.cvs

### R-Bar Stationkeeping

This is an unstable configuration, since orbital mechanics effects will result in the orbiter and target changing their relative positions over an extended period. R-bar stationkeeping is more

complex and requires higher propellant usage. About 0.5 lb/ft range per rev, above and beyond V-bar usage, is required.

ISS docking flights nominally involve +R-bar stationkeeping at various ranges to either set up approach timing or to correct shuttle/station attitude misalignment.

Stationkeeping position is maintained using the COAS, rendezvous radar, lasers, and CCTV triangulation. The crew must judge when attitude and translation corrections are necessary and make corrections manually. Typically, attitude is controlled by UNIV PTG so the crew has only translation corrections to maintain position.

For convenience, stationkeeping operations are classified by range (close in, short, medium, and long). There are significant differences between techniques used at different ranges.

RANGE	DISTANCE
Close in	35 - 200 ft
Short	200 - 1000 ft
Medium	8 miles
Long	40 miles

### Stationkeeping Ranges

#### Close In

Close in techniques are required after the orbiter has achieved a stable position near the target. Alignment with the desired target axis may or may not have been completed. Orbital mechanics effects are minimal, and flying is done using a combination of out-the-window and CCTV cues. Most payloads will be below the RCS plume impingement area, so NORM Z operations can be performed. Very large payloads may require use of LOW Z. Also, if the payload drifts too far forward or aft, LOW Z may be required to avoid plume impingement. Close in stationkeeping requires constant attention by the crew. A flyaround or matching the target's rates may be required to effect a capture.

#### Short Range

Short range techniques are used after the orbiter is positioned on the desired target axis or

immediately after target deploy. Orbital mechanics effects cannot be ignored, and plume impingement must be considered. The primary tasks are matching attitude rates and translating to maintain correct relative position on the desired target axis. These require visual translation guidance techniques that can be described by three types of targets: inertially stabilized, fixed in LVLH frame, and arbitrary rate.

Inertially stabilized targets usually have some type of control system or are spin-stabilized. To keep the same relative geometry, the orbiter must also maintain inertial hold. This requires a constant translation to stay on the desired axis and maintain desired range. Procedurally, UNIV PTG and the DAP are used to automatically maintain inertial hold, while the crew uses the THC to remain on the target axis at the desired range.

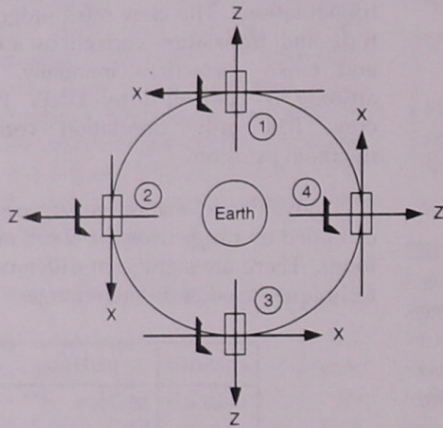

Stationkeeping WRT inertially stabilized target

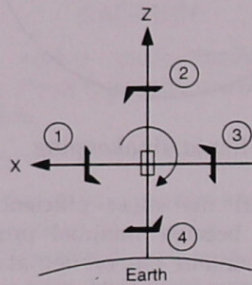

872.cvs

### Inertial Stationkeeping

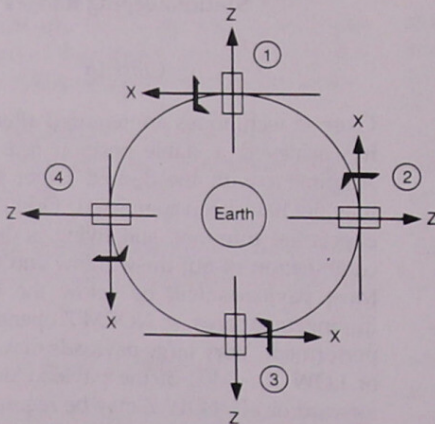

Stationkeeping WRT target rotating in inertial frame at orbital rate (i.e., target attitude fixed relative to LVLH frame)

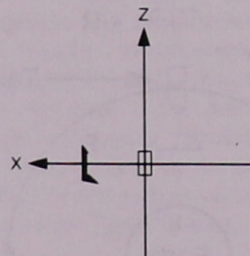

Orbiter stays in same LVLH position (on target V-bar)

873.cvs

### LVLH Stationkeeping

Some targets may be maintaining a constant attitude relative to the LVLH reference frame and therefore rotating in the inertial frame at orbit rate. The target may have an active or passive (gravity gradient) control system.

The orbiter maintains a fixed position and attitude with respect to the target LVLH reference frame. Procedurally, UNIV PTG or LVLH is used to automatically control attitude, and translation is controlled manually. Since LVLH stationkeeping is much more stable than inertial, fewer translation inputs are required to maintain position.

Should the target lose its control system, causing it to rotate at an arbitrary rate about a principal axis of inertia, stationkeeping becomes more difficult. Either an inertial or LVLH mode may be used, depending on the situation.

#### Medium Range

Medium range stationkeeping may be required during long-term payload checkout or activation. Operations are usually automatically controlled using NAV state data. The radar should provide relative position information. One AUTO technique, called a "football," attempts to keep the orbiter within some predefined boundary centered at some range on the V-bar. When the orbiter approaches a boundary, a maneuver is performed to drive it back to the center. This is repeated as required. Orbital mechanics effects can be used to maintain the "football" with minimal maneuvering required.

#### Long Range

Long range stationkeeping is typically done at 40 n. mi. This is usually done to support a possible rendezvous at some later time in the mission (similar to HST deploy). This stationkeeping is usually maintained by ground targeted coelliptic (NSR burns) and is done on the V-bar.

#### Techniques

Whenever possible, use the DAP and UNIV PTG to automatically maintain attitude. Select vernier jets for attitude control to conserve fuel.

Aim for an "ideal" target position in the -Z COAS reticle. At 1,000 ft, the target should be  $2.5^\circ$  low. This places the orbiter c.g. on the V-bar, since the c.g. is aft of the COAS position. At 500 ft, the target should be at the bottom of the COAS, and at 200 ft, it should be  $13^\circ$  below the center of the COAS.

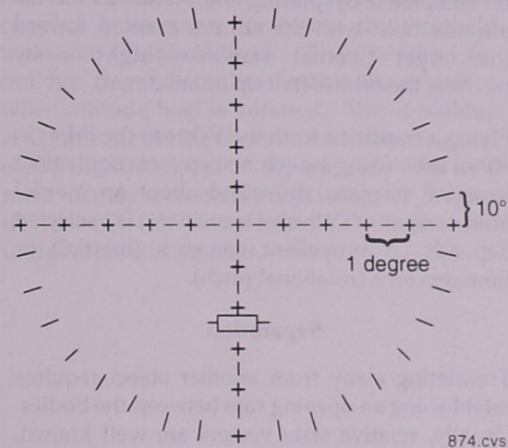

COAS Sight Picture

Translate using the THC to maintain this position. Small inputs and patience are essential. Use the smallest translational pulse size available. Use vernier jets for attitude control. Maintain the payload in an imaginary box, sized to reflect attitude deadbands, about the "ideal" position and translate only when the target moves out of the box.

This will reduce fuel consumption and take maximum advantage of orbital mechanics effects.

Use radar and REL NAV (SPEC 33) to maintain distance and range rate.

#### NOTE

The tendency is to focus on keeping target position fixed in the COAS. A good scan and crew coordination are necessary to control range rate and maintain distance.

#### Transition

Transitions are maneuvers that maintain the orbiter at a constant distance from the target while it moves from one position to another.



The orbiter will continue pointing a specified body vector (usually -Z) at the target. In contrast to a flyaround, which requires the orbiter to actually fly around the target in an inertial sense, a transition involves moving the orbiter around the target in a target-centered, rotating LVLH reference frame without regard to the target's inertial attitude. Transitions can be completed by placing the orbiter in inertial attitude hold with the -Z axis pointed toward the target (inertial stationkeeping), or by pitching the orbiter (tail up or tail down).

Flying a transition from the V-bar to the R-bar in  $90^\circ$  of orbit using a pitch maneuver is equivalent to a  $90^\circ$  in-plane flyaround about an inertial hold target. Which transition is selected depends on propellant concerns (inertial) or time concerns (rotational pitch).

### Separation

Translating away from another object requires establishing an opening rate between the bodies. Usually, relative state vectors are well known, and a planned sequence can be followed to minimize propellant usage. However, payload sensitivity to plume impingement and unknown payload control system characteristics tend to complicate separation maneuvers. Long and short term recontact must be considered; therefore, some separation sequences require multiple separation maneuvers. Separation is usually performed in two stages. A small separation burn ( $< 1$  fps) is performed to start opening, then a larger burn is performed when the orbiter is further away. The second burn typically occurs 22 minutes after the first burn.

### Cross-Coupling Effects

Because the thrust of the RCS jets is not through the orbiter c.g., commanded translation/rotation maneuvers in one axis tend to induce motion in other axes. This effect is called "cross-coupling," and it can have a significant impact during rendezvous terminal phase and proximity operations.

With the orbiter on the target V-bar, tail-to-Earth, and payload bay toward target, the crew should be aware of cross-coupling effects as follows:

- **NORM ROLL:** affects every degree of freedom. Much worse in LOW Z than NORM Z.
- **LOW Z and NORM  $\pm X$ :** induces significant braking (+Z) translations, requiring closing rate to be reestablished and pitch cross-coupling. May look like translation in the COAS. When flying Prox Ops, use the 1 to 5 Rule: 1 +Z input for every 5  $\pm X$  inputs
- **NORM -Z:** significant +X translation. Same effect in LOW Z.
- **LOW Z +Z:** major negative pitch if in free drift. In attitude hold, translation pulse loses half its force due to counteraction of attitude firings.
- **LOW Z  $\pm Y$ :** in attitude hold, major closing (-Z) rates induced, more than half the size of commanded Y-axis translation.
- **ROLL/PITCH deadbanding:** in NORM jets, induces a small opening (+Z) rate. In LOW Z, causes a major closing (-Z rate). Minus pitch also produces a significant +X translation when in LOW Z.
- **TAIL ONLY:** an off-nominal control mode used to conserve forward RCS propellant. Pitch maneuvers induce a powerful Z translation and a significant +X translation. Yaw induces a powerful Y translation and noticeable X and Z translations. All other control mode effects are identical to normal control (NOSE and TAIL).
- **NOSE ONLY:** for pitch, translational effects are mirror image of TAIL ONLY, except no X effects. Yaw is also opposite to TAIL ONLY, but significantly reduced.

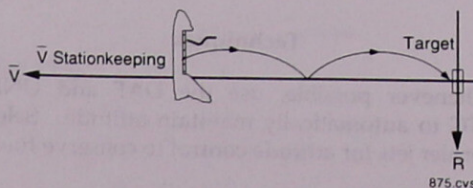

V-Bar Approach

These effects point out the requirements for patience after performing translation pulses. Crewmembers should observe the line of sight motion after deadbanding (keep ADI rate needles and UNIV PTG in scan) and not be misled by initial line of sight rates. Rotation-induced components must be understood. Techniques are developed through practice in simulation facilities.

Vernier jets, when used for attitude control, induce their own cross-coupling effects. Even though verniers produce much smaller forces than primary jets, their geometry is even more awkward. All vernier firings induce translational cross-coupling of roughly equivalent size in the -Z direction. The firings do not randomly cancel out; rather, they accumulate in one body direction. This can induce significant downtrack errors in orbiter position that are important during rendezvous over long periods.

Pitch/yaw deadbanding in LOW Z, or vernier attitude control during PROX OPS can quickly introduce a -Z translation (closing rate). Expending about 35 - 40 lb of RCS propellant to maintain attitude using vernier jets results in a cross-coupling translation of 1 fps in the -Z direction. AVG G on REL NAV (SPEC 33) is not a reliable source for this information, since IMU noise accumulation and much of the cross-coupled acceleration are below the threshold measurement of AVG G. Time required for buildup depends on how stable the orbiter is when attitude hold is initiated. The -Z buildup is significant during close-in stationkeeping and especially during gentle separations. The crew must closely monitor R-dot using all ranging devices (CCTV, radar, laser, COAS) to avoid undesirable closing rates.

### Orbit Rules of Thumb

- In propellant-limited situations, use the following guidelines:
  - Stay in VERN as much as possible.
  - To conserve forward RCS, use TAIL ONLY control mode.
  - During prox ops, when controlling out-of-plane errors, start as early as possible, wait for the node to make inputs to null rates, watch the deadbands, and do not fight orbital mechanics effects.

7.3 ENTRY

CONTENTS	
Overview of Entry Flying Tasks.....	7.3-1
Deorbit Burn.....	7.3-1
Entry .....	7.3-4
Backup Flight System.....	7.3-11
Sensory Cues.....	7.3-12
Ground Controlled Approach.....	7.3-12
Entry Rules Of Thumb.....	7.3-14

**Overview of Entry Flying Tasks**

The entry phase of flight covers the transition from Earth orbit to the end of landing rollout. Guidance phases for portions of the entry phase are deorbit burn guidance, entry guidance, TAEM guidance, and approach/land guidance.

**Monitoring**

Crew monitoring of performance is required throughout entry. This subsection presents the information necessary to monitor and control the vehicle during the deorbit burn and entry phases of guidance. This task consists of monitoring vehicle displays to determine if guidance, navigation, and flight control are performing correctly and taking action, if required, to ensure a safe landing. An in-depth knowledge of how these systems work, along with an understanding of the reference trajectory and orbiter flight control system (FCS) will enable crewmembers to recognize off-nominal situations and correct them before serious performance or control problems develop.

**Takeover**

Takeover rules and criteria are described in the Flight Rules. Interpretation of onboard information will aid the crew in their assessment of when to manually intervene. From the available information, the crew assesses the performance of the automatic guidance system and remains prepared to take over with manual guidance for off-nominal situations. Some of the conditions requiring crew takeover are:

- Navigation errors
- L/D dispersions
- Atmosphere variations
- Winds
- Deorbit execution errors
- GNC failures
- Degraded performance.

Any of these conditions, if left uncorrected, could lead to unrecoverable range problems or loss of vehicle control.

Guidance and flight control perform well. It is highly unlikely manual takeover will be required. MCC is also available to help with a ground controlled approach (GCA).

**Manual Control**

In some instances, the crew will be required to take manual control and fly the orbiter. The Deorbit Burn and Entry sections contain the basic principles for CSS flying, although these portions of the flight profile are normally flown in AUTO. Manual flight control is the normal mode of operation from .96 Mach until the completion of rollout. (This portion of the flight profile is discussed in detail in Section 7.4.) Self-generated guidance based on navigation information will be discussed, but if guidance is good, flying the error needles in CSS will result in the most consistent tracking of the planned entry trajectory.

**Deorbit Burn**

**Monitoring**

Normally, the deorbit burn will be flown in AUTO using both OMS engines. The OMS engines are gimballed to control orbiter attitude in all three axes. Capability exists to downmode from both OMS engines to one OMS engine, to the aft +X RCS jets, or to the forward -X RCS jets. The burn time of ignition (TIG) is selected to protect for one OMS engine failure at TIG or at any time during the burn. A single OMS engine can control pitch and yaw, but roll must be controlled by the RCS. If flight control does not recognize the OMS engine failure, control will be sloppy but acceptable. Deorbit burns using the RCS only must be flown manually.

The DEORBIT BURN, DEORBIT BURN MONITOR, and the DEORBIT BURN FLIGHT RULES cue cards are used to determine the required actions for malfunctions affecting the burn. The philosophy embodied in these cards is to either safely complete the burn or stop the burn above a safe altitude.

The ADI error needles are used to monitor guidance and control during deorbit burns. The body axis burn velocity components ( $VGO_x$ ,  $VGO_y$ , and  $VGO_z$ ), along with TGO and  $\Delta VTOT$ , should also be cross checked.

3021/	DEORB MNVR EXEC	1 006/09:40:23
OMS BOTH 1*		000/00:15:37
L 2	BURN ATT	$\Delta VTOT$ 321.9
R 3	24 R 083	TGO 2:58
RCS SEL 4	25 P 195	VGO X +303.40
S TV ROLL 180	26 Y 300	Y +14.42
TRIM LOAD	MNVR 27*	Z +106.60
6 P [+10.4	REI 4366	HA HP
7 LY[-15.7	TFF 24:40	TGT 130 + 9
8 RY[+35.7	GMBL	CUR 130 +129
9 WT 217047	L R	
10 TIG	P +0.4 +0.4	
006/09:56:00.0	Y +5.8 +5.8	
TGT PEG 4	PRI 28* 29*	35 ABORT TGT —
14 C1 15339	SEC 30 31	FWD RCS
15 C2 [-70.6124	OFF 32 33	ARM 36
16 HT 65.831		DUMP 37
17 $\theta$ T 113.720		OFF 38*
18 PRPLT[-] 6824	GMBL CK 34	SURF DRIVE
TGT PEG 7		ON 39
19 $\Delta VX$ [-] 208.7		OFF 40*
20 $\Delta VY$ [+] 225.6		
21 $\Delta VZ$ [-] 95.6		
LOAD 22/ TIMER 23		

10016.CNV

### DEORB MNVR Display

Monitoring the VGOs in addition to the error needles provides insight into the status of guidance during the burn. Noting the VGOs prior to TIG will tell the crew whether guidance thinks the vehicle is in attitude for the burn and whether the OMS burn will ignite at all. Attitude must be within  $\pm 90^\circ$  of required burn attitude for OMS ignition. If  $VGO_x$  is positive, the OMS will probably light and steer the vehicle to the burn attitude.

To monitor burn progress, the crew can watch VGOs, HA, and HP during the burn. The VGOs display how much  $\Delta V$  is left to go in orbiter body axis coordinates. For any OMS or  $\pm$ RCS burn, most of the burn should be in the appropriate X direction. HP will gradually increase or decrease, depending on whether the OMS burn is posigrade or retrograde. For deorbit burns, HP should always decrease.

### WARNING

The RHC is "hot" during an OMS burn. The DAP will mode to manual if the RHC is bumped

An SM alert and "DAP DNMODE RHC" message will annunciate with OI-28 and subs software.

### NOTE

Propellant-wasting, out-of-plane deorbit burns will have a PEG 7 delta  $V_y$  (LVLH) component. If no propellant is wasted then the PEG 7 delta  $V_y$  is typically zero.

OMS burn thrust vector control (TVC) is calculated independently from the ADI error needles.

- OMS TVC gimbals the OMS engines to null vehicle rates and point sensed thrust in the desired  $\Delta VTOT$  direction.
- ADI error needles display vehicle attitude error from the attitude that would point the net thrust through the c.g., as defined by the trim angles, and in the desired  $\Delta VTOT$  direction. If trim angles are incorrect or flight control does not recognize an engine failure, the ADI error needles will not display correct error information.

For a +X RCS burn, the ADI error needles are correct, as long as flight control recognizes that it is an RCS burn. Error needles are never correct for a -X RCS burn.

Approaching cutoff, the crew should monitor current HP approaching targeted HP, TGO approaching zero, and  $\Delta VTOT$  approaching zero. If TGO goes to zero, and the OMS engines do not cut off (chamber pressure zero and engine valves closed), the OMS engine switches should be turned OFF to prevent an overburn.

#### NOTE

OMS guidance will cut off, based on VGOX. If out of attitude, there will be large residuals in VGOY or VGOZ after the burn is complete. VGOZ residuals should be trimmed by the CDR using the THC, per the Deorbit Burn cue card procedure.

If an early cutoff occurs, the appropriate procedure from the Deorbit Burn cue card should be executed to achieve deorbit targets. OMS propellant, aft RCS, forward RCS, and prebank may be used to recover the underburn. If the underburn magnitude exceeds RCS and prebank capability, landing site redesignation may be required. For more detailed information on OMS burn downmoding, consult the appropriate Flight Procedures Handbook.

#### Takeover

Deorbit burns are normally flown in AUTO flight control and are started and stopped by GPC commands. Duration of the burn, as well as maintaining proper attitude during the burn, are the two most important criteria.

Deorbit burns that cut off at a perigee greater than Safe HP will generally be retargeted for another burn one orbit later or up to 24 hours later, since Safe HP orbital lifetime allows the delay. Deorbit burns that cut off at perigee less than Safe HP must be completed to attain acceptable Entry Interface (EI) conditions.

EI targets will be met within allowable tolerances if post burn residual DV is within 2 fps. Specifically, a 2 fps underburn equates to a 30 nautical mile (n. mi.) energy error at EI, which is well within guidance capability.

A 3° attitude deadband is used in the TRANS DAP. Attitude error or deviation greater than 3° prior to the burn indicates a flight control malfunction. The crew should check ITEM 27 on the MNVR display or downmode to MAN DAP and maneuver back to ignition attitude. The deorbit burn attitude is entered in a controlled, timely manner, and the burn can be postponed for an unacceptable attitude error.

Deadband in the TVC DAP is very small. If ignition has occurred, a manual takeover should be performed for unexplained deviations greater than 5°.

#### NOTE

Engine out transients may cause a momentary attitude deviation greater than 10°. These transients are an excellent confirmation of an engine out. Manual takeover should not be required.

#### Manual Control

Fly the error needles or the ADI REF ball if available. Cross-check the VGO components. During OMS TVC DAP attitude maneuvers, keep rates reasonable (less than 2 deg/sec). Approximate VGO component fractions of DVTOT depend on the type of burn. If only one OMS engine is used, yaw the vehicle about 10° into the good engine. Normally, manual flight control during an OMS burn requires very few RHC inputs once the guidance needles are centered, and the TVC DAP begins attitude hold.

For an RCS-only burn, the attitude deadband is 3°, and the burn is flown manually using the RHC for attitude control and the THC for the burn with four +X aft RCS jets.

One technique for +X RCS burns is to fly the correct attitude as displayed on the MNVR EXEC display, check the VGOs, set a REF ball, pitch up 3° on the ADI, let go of the RHC, and start the burn with the THC. The vehicle will pitch down to the correct attitude, since aft RCS jets are above the c.g., and the 3° deadband will hold it there. Another technique is to start the burn in attitude with the THC, allow the vehicle to pitch down toward the 3° deadband limit, then pitch up 6° to the other side of the deadband. The vehicle will slowly pitch back down and hold the desired attitude. This technique is called the Patterson maneuver.

It is also acceptable to just keep the needles centered using small RHC inputs. This technique requires constant inputs in pitch and will use more propellant to hold attitude, but is easier to remember than the Patterson maneuver. For short RCS burns, the extra propellant usage is minimal.

The VGO ratio table below lists appropriate ratios of  $VGO_{x,y,z}$  to VTOT for different burn maneuvers.

	BOTH OMS	L (R) OMS	+X RCS	-X RCS
VGO <sub>x</sub>	1	1	1	-1
VGO <sub>y</sub>	0	1/5 (-1/5)	0	0
VGO <sub>z</sub>	1/4	1/4	1/6	1/3

#### VGO Ratios

#### NOTE

A BFS OMS burn is targeted in the same manner as PASS, but must be flown manually.

### Entry

#### Monitoring

During the entry phase, guidance provides steering commands for trajectory control from initial penetration of the atmosphere (about 400,000 ft) at a range of about 4100 n. mi. from the landing site, until TAEM (2500 fps, about 60 n. mi. from landing site at an altitude of about 80,000 ft). The primary objectives of entry guidance are:

- Guide the orbiter along a path that prevents exceeding structural, thermal, and stability design limits.
- Deliver the orbiter to a satisfactory energy state and vehicle attitude at initiation of TAEM guidance.

Entry guidance is based on drag control. The correct drag level is calculated, based on Mach (velocity) and range. Bank is then used to control lift until the desired drag is established. Entry trajectory constraints are shown in the following chart.

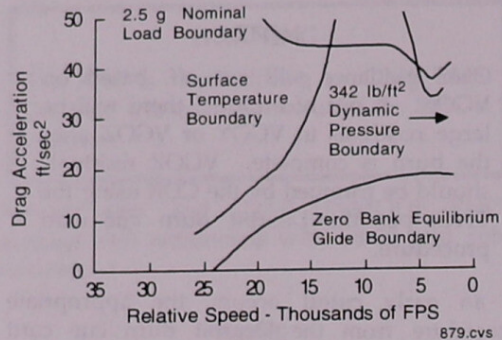

#### Entry Trajectory Constraints

Entry navigation (NAV) computes the orbiter's position, velocity, and distance/direction to the landing site. NAV also computes Mach, q-bar, and alpha. There are numerous interfaces between NAV and flight control. The crew optimizes NAV performance by accepting or inhibiting four types of sensed data: drag-H, TACAN, air data, and MLS. Bad NAV information can cause flight control problems, since NAV information is used to tailor flight control for the varying flight regimes encountered. Mission Control monitors navigation performance during entry using tracking data. TACAN and air data should not be accepted to NAV, or air data accepted to G&C without a go from Mission Control, unless communication capability is lost.

#### WARNING

Large NAV errors can cause loss of vehicle control, because NAV data are used to select control effectors and set control gains.

Dedicated instruments, CRT displays, and cue cards are available to assist the crew in monitoring entry performance. The ADI, alpha/Mach indicator (AMI), and the altitude/vertical velocity indicator (AVVI) are the primary dedicated instruments for monitoring entry performance. Five ENTRY TRAJ CRT displays are available for monitoring entry guidance. ENTRY cue cards are used as references to compare actual and predicted performance.

After the deorbit burn, the crew transitions to MM 303 and maneuvers to the EI-5 attitude that was uplinked with the deorbit targets and voiced up in the DEL PAD.

During the early part of entry, the RCS command lights are a good indication of DAP activity. If the crew transitions to MM 304 at EI-5, the vehicle will be very close to attitude, and only occasional jet firings will occur as attitude drifts back and forth between DAP deadbands. If the crew is late transitioning to MM 304, or if an attitude error has been allowed to develop while working system problems, a large number of jet firings can occur. Up to 250 lb of RCS propellant can be wasted. Crews should closely check that the orbiter is in the proper attitude prior to MM 304.

From  $q\text{-bar} = 0$  to  $q\text{-bar} = 0.5$ , the RCS only is used for attitude control. From  $q\text{-bar} = 0.5$  (12 KEAS) to  $q\text{-bar} = 8.0$  (48 KEAS), the elevons will trim in response to pitch jet firings. At  $q\text{-bar} = 2.0$  (24 KEAS), the elevons are used for control. At  $q\text{-bar} = 40$  (109 KEAS), the pitch jets are turned off.

At  $q\text{-bar} = 10$  (54 KEAS), the roll jets are deactivated. Yaw jets continue to fire for bank control until Mach is less than 1.0. Yaw jets should fire from both pods at a similar rate (symmetric firings).

At  $q\text{-bar} = 50$  (122 KEAS), the RCS *PITCH* and *ROLL* activity lights are reconfigured. Illumination of the *PITCH* light indicates elevon or aileron rate saturation. Three or more yaw jet commands turn on the *ROLL* light. The yaw jets are terminated at Mach 1. The *PITCH* jet light will continue to indicate elevon and aileron rate saturation.

Orbiter performance during bank maneuvers is the pilot's cue to dynamic stability characteristics. The two most important factors the crew must monitor are *YAW* jet activity lights and roll rate. The first roll command is at 3 deg/sec; subsequent roll reversals are commanded at 5 deg/sec. The rate of roll maneuvers is important to minimize H-dot and drag excursions. Prompt execution of roll commands will minimize the bank angle required to establish the desired drag profile.

Using the ADI, AMI, and AVVI, in conjunction with the ENTRY ALPHA cue card, allows the crew to monitor vehicle performance relative to pre-mission planned trajectory. Comparing alpha, range, altitude, H-dot, and roll reference to actual values is a good crosscheck on guidance. The data on this card is flight (and planned entry) specific, but most of the data is useful on any entry. The only data that changes significantly is the direction of Rref (reference roll angle). The magnitude of Rref does not change much.

#### *ENTRY ALPHA Cue Card*

Five CRT displays are the primary displays for entry monitoring or manually flying entry. ENTRY TRAJ 1 appears at MM 304 (OPS 304 PRO). TRAJ 2 through 5 appear at predetermined velocity breakpoints. Each display is a continuation of the previous one.

In the center of the ENTRY TRAJ display there is a dynamic plot of velocity (Y-axis) vs. range (X-axis). An orbiter "bug" is placed on this display as a function of range and velocity. The dashed drag lines are used to determine the desired drag for the current range and velocity. Interpolation is required. For example, the orbiter bug on TRAJ 1 shows desired drag of 12.



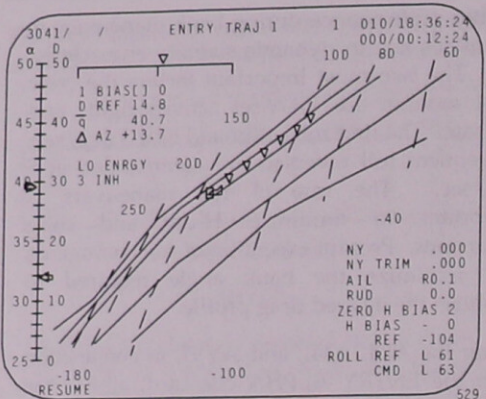

ENTRY TRAJ 1 Display (Mach 25-Mach 17)

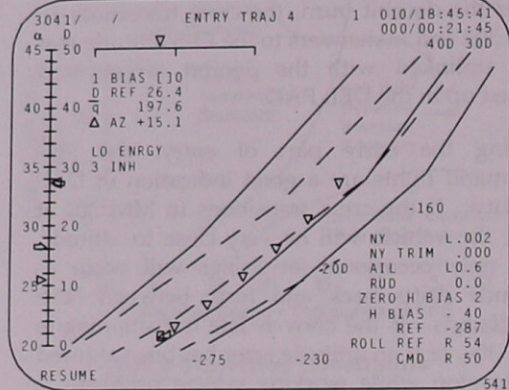

ENTRY TRAJ 4 Display (Mach 10-Mach 5)

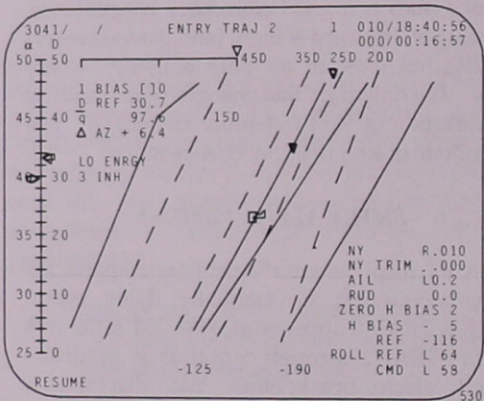

ENTRY TRAJ 2 Display (Mach 17-Mach 14)

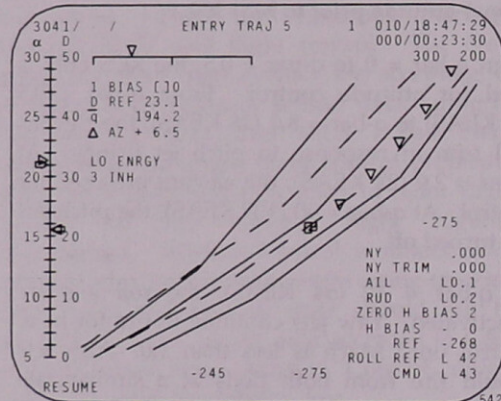

ENTRY TRAJ 5 Display (Mach 5-Mach 2.5)

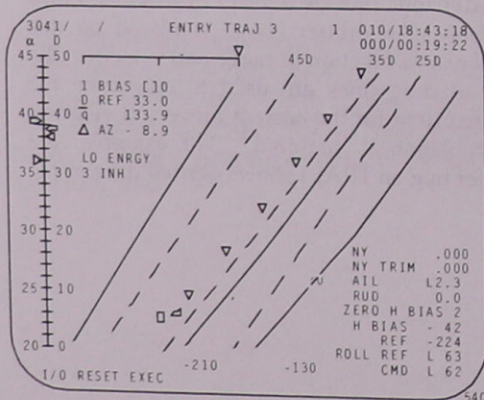

ENTRY TRAJ 3 Display (Mach 14-Mach 10)

## NOTE

On TRAJ 4 and 5, the orbiter bug is placed by energy (E/W) vs. range. This difference does not change the operational use of the displays.

## NOTE

Desired, reference, and commanded drag are interchangeable terms; they mean the same thing.

The entry guidance algorithm is also running real time to calculate desired drag. The output of this algorithm is indicated by the arrow on the drag scale (left side of the ENTRY TRAJ display). Remember, the arrow points to where you want to be.

The current drag, as sensed by the IMUs, is displayed as a triangle on the TRAJ display.

Guidance commands a roll angle that will dump lift as required to achieve the desired drag. H-dot control is an essential part of this operation. Guidance will bank until it sees an acceptable H-dot, then bank to an H-double-dot that equals zero to maintain this H-dot.

The desired H-dot is a function of reference H-dot and drag error. Reference H-dot is the H-dot required to maintain desired drag. If current drag is less than reference drag, guidance will fly to a higher H-dot (more negative).

Guidance displays reference H-dot on the lower right corner of the TRAJ display. The crew can also look directly below the orbiter bug and read a rough estimate of reference H-dot at the bottom of the TRAJ display.

Entry guidance will also modulate alpha to remove drag errors. By changing alpha  $\pm 3^\circ$ , guidance can instantly change the drag by about 10 percent (3 degree modulation is the limit). Alpha modulation is much faster than roll control. If guidance is using alpha modulation to remove drag errors, it will roll to achieve an H-dot that will eventually put the orbiter in the correct air density. In a few minutes, the drag error will be removed without using alpha modulation.

As the orbiter bug proceeds down the trajectory lines, it leaves triangular trailers every 15 guidance cycles (28.8 sec) that are used for trend analysis. For ENTRY TRAJ 3, 4, and 5, the trailers are displayed every 8 guidance cycles (15.36 sec). Only six trailers can be displayed at one time.

A guidance box appears upon initiation of closed loop guidance and moves relative to the shuttle symbol to reflect drag errors ( $D-D_{REF}$ ). The guidance box leaves trailer dots. Ideally, the nose of the shuttle symbol will be inside the box, and a dot will be located in every triangle. The first roll command will be visible on the TRAJ display shortly after the initiation of closed loop guidance. Timely execution of the first roll command will minimize the bank angle required to establish desired drag.

If the guidance box is to the left of the shuttle symbol, drag is too small (you will land long) and the guidance trend is toward high energy. The opposite condition indicates drag is too high.

Alpha is monitored on the AMI and ENTRY TRAJ displays. Measured alpha is displayed on the AMI and ENTRY TRAJ. These parameters should be compared with the values on the ENTRY ALPHA cue card. ENTRY TRAJ displays reference alpha (computed by guidance) via an arrow and nav-derived (actual) alpha by a triangle. Normally, these overlay each other. However, guidance will add small biases to alpha to remove drag errors. If the ADI pitch error needle is centered and the alpha triangle is offset from the arrow, it is an indication of alpha modulation. Alpha modulation is expected during and after a roll reversal.

Heading error is defined as delta azimuth (DEL AZ or  $\Delta AZ$  on the ENTRY TRAJ displays) and is the angle between the velocity vector and the great circle direction to the runway. DEL AZ is displayed on the HSI as the difference between the primary bearing pointer and the lubber line. There is also a digital value of DEL AZ on the ENTRY TRAJ displays. Bank angle controls drag, and therefore energy, during entry. Because the bank angle causes the orbiter to continually turn, a crossrange capability of approximately 750 n. mi. can be obtained. This gives the orbiter the advantage of using landing sites that are not directly under the orbital groundtrack. Roll reversals are performed to keep DEL AZ within limits. The velocities at which the reversals occur are a function of crossrange.

Initiation of a roll reversal is indicated by a flashing orbiter bug and phugoid damper bar on the ENTRY TRAJ and a full scale deflection of the roll error needle on the ADI. The first roll reversal will occur at a DEL AZ of  $10.5^\circ$ . Subsequent roll reversals occur at a DEL AZ of  $17.5^\circ$  until Mach = 4 when DEL AZ limit ramps to  $10.0$  by Mach 2.8.

The ENTRY MANEUVERS cue card itemizes important events that the crew must monitor during entry. Off-nominal activities are indicated by asterisks (\*). Crew action items are keyed to velocity. Items to be verified only are marked with a check ( $\checkmark$ ).

See section 5.4 for more detail on this card.

#### NOTE

V in Kft/sec is equal to Mach; e.g.,  
 $V=10K=Mach\ 10.$

Automatic program test inputs (PTIs) may be included as part of entry trajectories to obtain aero data postflight. These data are used to further define the aerodynamic characteristics of the shuttle, help expand the operational envelope, and reduce aero data base uncertainties. PTIs are executed automatically by the entry DAP and are input into the flight controls downstream of gains and filters so that a known control deflection or jet firing can be made. The crew enables PTIs on SPEC 50, and flight control must be in AUTO. Execution of PTIs is monitored on the SPI and GNC SYS SUMM 1 for control deflections, by the RCS activity lights for jet firings, and by data on the PTI Monitor Cue Card. Normal vehicle performance parameters also must be continuously monitored to ensure there is no trajectory degradation introduced by the PTIs.

#### Takeover

The entry trajectory is normally flown in AUTO until subsonic, when the crew modes to CSS. Upon moding the GPCs to MM 304, dedicated displays and ENTRY TRAJ displays become available. DAP controls for the AEROJET DAP are located on each eyebrow panel. Manual takeover can be executed using the pushbuttons or by moving the RHC more than 7° out of detent.

#### NOTE

During entry, moding to CSS is separate for the pitch axis and roll/yaw axes. It is possible to be in CSS pitch control and AUTO roll/yaw or vice versa.

#### Low Energy

A ROLL REF "down" arrow on the ENTRY TRAJ display indicates a low energy condition. In addition to the down arrow, a fault message will be generated. If DEL AZ is allowed to go out to 10.5, the small roll angles required to fly low energy may not be able to bring DEL AZ back in. The crew should select R/Y CSS and initiate the first roll reversal when DEL AZ = 5°.

AUTO flight control may be reengaged after completion of the first roll reversal.

#### Delta State Update

If the NAV state of the orbiter goes bad on entry, MCC can uplink a good state vector (position and velocity). This is normally done by using the command uplink. If the command uplink is not available, data from the GPS unit will be forced to update the orbiter state vector, the delta state will be read up on the voice uplink, and the crew will have to enter the values on SPEC 50.

The crew must also take manual control (CSS) before a velocity uplink is incorporated into the GPCs. MCC will remind the crew when to take CSS.

#### Undesirable Transients

Prior to any event capable of introducing an unwanted transient into the flight control system, such as a delta state update that includes a velocity component, the crew should select CSS to prevent undesirable transients. Automatic flight control may be reengaged upon completion of the event and reconvergence of the guidance needles. RCS Critical Entry (No Yaw Jet).

The ENTRY CONTROL Cue Card contains two procedures that cover possible DAP problems during entry.

**ARCS QTY (L + R) <10%:** This procedure contains propellant conservation actions if the ARCS quantity (L + R) drops below 10 percent during entry.

#### WARNING

Going NYJ with  $q\text{-bar} < 10$  may cause roll opposite to RHC command. Reverse aileron also gives reverse roll jets. Roll jets are turned off at  $q\text{-bar} = 10$ .

When  $q\text{-bar}$  is below 20 psf and any RCS propellant remains, stay in AUTO because the No Yaw Jet mode is not certified. If no RCS propellant remains, select No Yaw Jet and the FIXED elevon schedule to get the elevons deflected down to a more effective position.

When  $q\text{-bar} > 20$  ( $\approx 77$  KEAS), select No Yaw Jet (certified mode) and the FIXED elevon schedule. If control problems arise, select AUTO and use the remaining RCS to save you.

At Mach 6, any gaugeable propellant should support the remainder of the flight (jet activity is terminated at Mach 1).

At Mach 5, trip ailerons to  $\leq 1^\circ$ . This allows the rudder to pick up the trim load.

**AIL TRIM  $\geq 3^\circ$ :** This procedure contains the appropriate actions to take when aileron trim reaches  $3^\circ$  during entry. The software limit for aileron trim is  $3^\circ$  for the baseline DAP (default for TAL) and  $5^\circ$  for wrap DAP (default EOM). Possible causes for large aileron trim include Y c.g., bent airframe, and asymmetric boundary layer trip (ABLT).

If TAL, activate wrap DAP to increase the software trim limit from  $3^\circ$  to  $5^\circ$ .

If aileron trim saturates at  $5^\circ$ , raise the body flap to get the elevons down into the airstream.

If aileron trim continues to saturate, the following additional actions are required. The combination of No Yaw Jet and saturated aileron trim requires low rate maneuvers to prevent loss of control. At Mach 13, begin to get as close to  $\alpha 30^\circ$  as allowed by entry alpha limits ( $3^\circ$  below reference). At Mach  $< 5$ , when rudder is active, trim ailerons back to  $< 1^\circ$ .

**WARNING**

Never trim the ailerons back until the rudder is active at Mach 5.

At Mach 2, return the body flap to AUTO for the transonic region and approach and land transition.

**High Freq OSC or Surf/Jet Cycle**

The DAP includes bending filters in all axes that protect the DAP from coupling with the orbiter structure in a resonant oscillation. If the

bending filter constants were wrong, it could be possible to cause an oscillation.

Symptoms are a high frequency oscillation (4 Hz), accompanied by airframe vibration caused by oscillation of the aero surfaces. The crew may observe these oscillations on the SPI or the ADI rate needles. A yaw jet limit cycle may also occur.

The procedure ensures that the correct body bending filter is in use (SPEC 51) and then takes CSS. It may be a problem with AUTO.

If the condition persists, select Low Gain on the ENTRY MODE switch to cut the DAP gains in half. Return the ENTRY MODE switch and P, R/Y to AUTO when the oscillation or cycling stops.

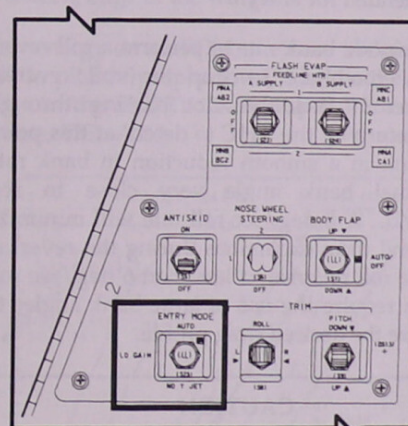

**ENTRY MODE Switch on Panel L2**

**Manual Control**

**WARNING**

If possible, do not downmode to CSS without consulting MCC. Deviations from the desired entry drag profile can cause violation of thermal limits or failure to reach the planned landing site.

In MM 304, prior to closed-loop guidance, allow alpha to deadband  $\pm 3^\circ$  and bank to drift  $\pm 10^\circ$ . This can save up to 200 lb of RCS propellant.

After closed loop guidance, the first bank command should be in the direction of the

landing site (primary bearing pointer on the HSI). This maneuver is usually done in AUTO. It should occur at an H-dot of -240.

If CSS is required, move the RHC to about half deflection, watch the roll rate needle on the ADI, and bank at about 3 deg/sec. Prompt execution of the first roll command will minimize the bank angle required to establish the entry profile.

To fly the most fuel-efficient entry, hawk the guidance needles, and always center the pitch needle first. Keep rates small and try not to start and stop the rate more often than necessary. Minimize the number of discrete RHC movements to reduce unnecessary RCS jet firings. Overly aggressive control during entry can cause depletion of available RCS propellant. The MED position of the ADI ERROR switch is recommended for entry.

Use 6 deg/sec bank rate to perform a roll reversal. A good cue to stop the roll reversal maneuver is H-double dot passing through zero. Returning the RHC to detent at this point will result in a smooth reduction in bank rate with final bank angle very close to roll command. A 6 deg/sec roll rate will minimize H-dot and drag excursions during the reversal. A gentle roll reversal at less than 6 deg/sec roll rate can require the use of large bank angles to recapture the desired drag profile.

#### CAUTION

Monitor DEL AZ carefully when flying R/Y CSS, especially at lower velocity. Azimuth errors can quickly make it impossible to reach the desired landing area.

A good instrument crosscheck of actual drag ( $D_{ACT}$ ), reference drag ( $D_{REF}$ ), bank angle, H-dot, and H-double dot is required when flying a CSS entry.

The following is a summary of tasks required during a CSS entry:

- Fly scheduled alpha per the cue card or ENTRY TRAJ.
- Bank as required to maintain  $H\text{-dot} \approx H\text{-dot REF} + 20 (D_{ACT} - D_{REF})$

- Perform roll reversals based on DEL AZ ( $10.5^\circ$  for first reversal,  $17.5^\circ$  for subsequent reversals) to Mach = 4. The DEL AZ limit then ramps down to  $10^\circ$  at Mach 2.8.

#### No Yaw Jet/RCS Critical Entry

The hypersonic handling characteristics of the orbiter are very different when in no yaw jet. The primary difference is the time required to start and stop roll rates. This difference is so great that the flight control system automatically downmodes to CSS and manual flying is required.

When in no yaw jet, the flight control system uses adverse yaw to start and stop a bank. The crew will see this by an initial roll opposite the commanded direction. This adverse yaw decreases with Mach. By Mach 5, the rudder becomes active and the orbiter flies much better. When performing roll reversals, it is important to use the recommended 5 deg/sec roll rate to minimize altitude descent rate and drag fluctuations. A gentle roll rate of less than 5 deg/sec may feel more comfortable, but the trajectory dispersions it will cause will make the ride uncomfortable later.

To initiate a roll reversal in no yaw jet, the RHC should be moved smoothly to establish a roll rate of 5 deg/sec. To stop a roll reversal, a large lead is required to prevent overshooting the desired bank angle. This lead varies with Mach. The following is a list of typical lead angles required to capture the desired bank from a 5 deg/sec roll. The roll is stopped by centering the RHC.

<u>Mach</u>	<u>Lead Angle (deg)</u>
>22	55
22-7	35
<7	15

After the roll reversal, the roll needle should be kept centered. Control will be sloppy, so the needle cannot be kept perfectly centered. It takes a lot of work. It helps to try and lead the roll needle by monitoring H-dot and predicting what guidance is going to do next. For example, if guidance is commanding to a large negative H-dot, you can expect that guidance will command a roll out of bank in the near future. Developing good skills in flying manual entries helps in predicting what guidance will do next.

**NOTE**

Do not compensate for the sloppy control by lagging behind the needles. Adding lag to the system will cause large, low-frequency oscillations in H-dot and drag.

The most critical region of a no yaw jet entry is between Mach 12 and Mach 8, where control margins are smallest. This is empirically derived from 6 degree-of-freedom simulations. With the aero uncertainties present today, a control problem is not expected in the no yaw jet mode. If control problems are encountered at any velocity, and RCS control is still an option, reenable the yaw jets by returning the ENTRY MODE switch to AUTO. Once control is restored, and the orbiter is in a stable attitude, return to the no yaw jet mode.

**Off Nominal Trajectory Control**

Should the orbiter be outside the CRT-displayed nominal energy envelope, for whatever reason, corrections are necessary to recover. Both the high and low energy cases are discussed from a manual control point of view.

**High Energy Recovery**

If the orbiter is very high energy on entry, guidance will calculate a drag that is larger than the orbiter can withstand. This can be seen when the orbiter bug is to the left of the high energy line on the ENTRY TRAJ display. The high energy line is the solid line furthest to the left on the TRAJ display. In this case, the crew must take CSS and manually fly to the maximum drag that the orbiter can withstand.

The details of this procedure are beyond the scope of the SCOM, and are taught in the Entry Guidance Workbook, CBT, and classes.

**WARNING**

It is very easy to overshoot maximum drag while flying high energy entries. It is better to be high energy at TAEM interface than to be at TAEM interface without wings.

**Low Energy Recovery**

If the orbiter bug is to the right of the low energy line, guidance is calculating a drag that is smaller than the orbiter can sustain. In this case, the orbiter must fly into air that is so thin that there is not enough lift. The low energy line is the farthest right line on the ENTRY TRAJ display.

If on a TAL abort, the crew should enable LOW ENERGY logic on the TRAJ display. Low energy logic automatically lowers alpha to 31° (or low alpha, or max L/D), and flies a bank angle of approximately 2.2 times delta azimuth. Although this software will function on an end of mission (EOM) return, it is not certified. It is possible that lowering alpha to 31° at the higher Mach numbers found on an EOM will overtemp the leading edge of the wings.

If low energy on an EOM, the crew should take CSS. In pitch, fly alpha low (3° below the alpha arrow on the ENTRY TRAJ display), in roll fly 2.2 times DEL AZ.

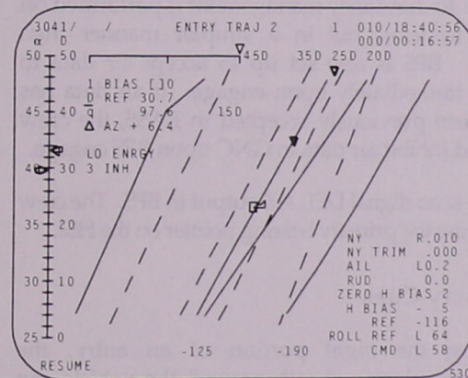
**ENTRY TRAJ 2 Display****Backup Flight System**

The backup flight system (BFS) is capable of performing nearly all of the primary flight system functions (controlled by PASS software) during deorbit, entry, approach, and landing. This section presents the major differences, from the flight crew viewpoint, between the two systems. Differences in handling qualities between the PASS and the BFS are very small in the training simulators, and no large differences are expected if BFS is engaged onboard the

orbiter. A moderate control transient should be expected when BFS is engaged.

### Deorbit

Automatic maneuvers are not available in BFS. The crew must manually fly to deorbit burn attitude using the error needles, MNVR EXEC display, and ADI attitude. The TRANS DAP supports both *DISC RATE* and *PULSE* modes, but all three axes are switched when *DISC RATE* or *PULSE* is selected.

During the burn, attitude must be maintained manually using the ADI error needles and REF ball. Upon completion of the burn, the maneuver to EI-5 attitude is a manual maneuver.

### Entry

BFS does not support PTIs. Upon entering MM 304, flight control mode is CSS through landing/rollout.

The BFS maintains only one state vector during entry. Redundancy management is performed on most systems, but in a simpler manner than PASS. BFS is also set up to accept air data to GNC immediately upon engage. If air data has not been previously accepted in PASS, the crew should inhibit air data to GNC upon BFS engage.

There is no digital DEL AZ output in BFS. The crew must use the primary bearing pointer on the HSI.

### Sensory Cues

During the night portion of an entry, the glowing plasma sheath around the vehicle can be observed through the orbiter windows. The pulsing light has not interfered with tasks inside the vehicle. The plasma glow is less visible during daylight portions of entry and may not be noticeable.

Returning from orbit, some crewmembers have reported increased sensitivity to g as it builds during entry. One crewmember observed that "when you hit a quarter g on entry, it seems like two g's in the T-38." Crewmembers should be aware that their ability to perform entry tasks may be degraded from that experienced in the SMS during training. Keep in mind that Gs stay around 1.3 until Mach 2.5.

Roll reversals on entry will feel different than pure roll maneuvers in a conventional aircraft due to the orbiter's entry angle of attack. Pilots will probably notice the yaw rate required during the bank change as much as the roll rate. Some mission specialists have stated that they could barely feel the roll reversals.

At high Mach numbers, a slight vehicle buffet may be noticed as well as some light structural vibration as dynamic pressure increases during entry.

### Ground Controlled Approach

Although GCA techniques are available, they are emergency alternatives only. Control should be quickly returned to autoguidance when conditions permit.

During entry, trajectory is monitored via the Tracking and Data Relay Satellite (TDRS) and ground radars. Should the trajectory diverge and approach energy limits, a GCA will be performed.

MCC, via the CAPCOM, will provide the crew with bank attitude, heading, airspeed, and speed brake information.

#### WARNING

On a high energy GCA, the crew should help monitor Gs. If the crew thinks that the current bank angle is leading to an over-g, the crew should call MCC and roll out of bank to not exceed Nz limit (2.0 to 2.5 g's, depending on orbiter weight).

Important—H-dot leads an over g. An H-dot of about -300 will maintain about 2.0 g's. If H-dot is bigger (more negative) than about -300, and Gs are headed up to the limit (~2.0 - 2.5 g's), roll angle should be decreased. MCC should be notified before roll angle is decreased.

GCAs are divided into three phases, based on energy: high velocity (Mach 10 - Mach 3), TAEM (Mach 3 - Mach 0.9), and final approach.

Criteria for electing to perform a GCA depend upon autoguidance capability to achieve a nominal trajectory by Mach 5.

In the high velocity phase, MCC provides bank magnitude information to control drag and bank direction to control crossrange. To keep workload under control, fly roll/yaw CSS and pitch, speed brake, and body flap AUTO.

During TAEM, a more conventional technique of heading to control ground track and airspeed to control energy is used. Fly both pitch and roll/yaw in CSS. Perform turns using 30° bank angle unless MCC requests a steeper bank. Control airspeed by modulating alpha and bank angle.

Final approach GCAs are similar to traditional airplane GCAs. Heading information controls alignment with the runway centerline, and position information references glide slope. Speed brake is used to control airspeed.

Off-nominal energy situations could be caused by incorporating erroneous navigation data into guidance or selecting an incorrect landing site. If this is the case, the GCA will be used to control the entry profile until NAV can be updated via a ground uplink or a manual state vector update. Once the NAV state is correct, MCC will terminate the GCA and call for a return to AUTO flight control.



**Entry Rules of Thumb**

- 2 OMS:  $TGO \approx \Delta VTOT / 2$ .
- 1 OMS:  $TGO \approx \Delta VTOT$ .
- RCS:  $TGO \approx 1.7 \times \Delta VTOT$ .
- Adjust H-dot reference 20 ft/sec for every  $1 \text{ fps}^2$  of drag error. [ $H\text{-dot} \sim H\text{-dot}_{REF} + 20 (D_{ACT} - D_{REF})$ ]
- As an approximation,  $1^\circ$  of bank change produces  $0.7 \text{ ft/sec}^2$  H-double-dot change. However, there is no lag in the H-double-dot tape. You can roll until the H-double-dot tape reads the desired value.
- A  $3^\circ$  change in alpha produces a 10 percent drag change.
- First bank (H-dot capture) should occur at an H-dot approximately -240 ft/sec.
- Monitor the trajectory on the ENTRY ALPHA cue card, and the PASS and BFS TRAJ displays:
  - The shuttle bug superimposed on guidance box superimposed on nominal trajectory line
  - Actual drag equal to reference drag
  - Appropriate bank angle, H-dot, range and altitude.
- Attempt to contact MCC before taking CSS.
- If you must take CSS:
  - Control range by controlling drag.
  - Control drag by controlling H-dot.
  - Control H-dot by controlling H-double-dot.
  - Control H-double-dot by controlling roll angle.
  - Control everything slowly by small corrections.

**7.4 TERMINAL AREA ENERGY MANAGEMENT AND APPROACH, LANDING, AND ROLLOUT (OPS 305)**

CONTENTS	
Definition and Overview .....	7.4-1
Terminal Area Energy Management .....	7.4-1
Heading Alignment Cone .....	7.4-8
Outer Glideslope .....	7.4-9
Preflare .....	7.4-14
Inner Glideslope .....	7.4-15
Touchdown .....	7.4-16
Derotation .....	7.4-18
Rollout .....	7.4-19
Handling Qualities .....	7.4-20
Wind Effects on Trajectory .....	7.4-22
Backup Flight System .....	7.4-23
Off-Nominal Approaches .....	7.4-23
Sensory Cues .....	7.4-24
Autoland .....	7.4-24
Terminal Area Energy Management and Approach, Landing, and Rollout Rules of Thumb .....	7.4-27

**Definition and Overview**

This section presents information required to pilot the orbiter from Mach 2.5 (3.2 for RTLS), where terminal area energy management (TAEM) begins, all the way through approach, landing, and rollout on the runway. TAEM guidance provides information to the pilot and guides the orbiter until the transition to approach/landing guidance at an altitude of 5000 to 10,000 feet. Derotation and rollout logic take over after the orbiter touches down on the runway. Procedural information for the TAEM and approach/landing guidance phases are contained in the Entry Checklist and cue cards. Pilots sometimes refer to the flight phase from .95 Mach to touchdown as the approach and landing phase of flight. This is the phase of flight in which the crew normally controls the vehicle manually (CSS) and in which the Shuttle Training Aircraft operates. By this definition, the approach and landing portion of the trajectory includes both subsonic TAEM guidance and the approach/landing guidance regions.

TAEM and approach/landing guidance trajectories allow the orbiter to handle a large variety of dispersions. Certain specified ground rules and constraints such as weight, c.g., aerodynamic limits, distance past runway threshold, velocity, altitude rates, lateral rates, and energy margin must be observed to ensure guidance is capable of directing the orbiter to a safe landing. Mission Control monitors these limits closely. Carefully following guidance commands (error needles) will generally provide the crew the best chance for coping with environmental dispersions.

TAEM is divided into four segments: S-turn, acquisition, heading alignment, and prefinal. Approach and landing trajectories are divided into five segments: trajectory capture, outer glideslope (OGS), preflare and inner glideslope (IGS), final flare, and touchdown. TAEM and approach and landing regions are jointly designed to allow the orbiter to land safely. This section presents information for monitoring and takeover during the early portions of TAEM and then details the manual flying tasks during each segment of the trajectory.

General information on handling qualities, flight control surfaces, priority rate limiting (PRL), winds, limits, BFS, sensory cues, and autoland is presented at the end of this section.

**Terminal Area Energy Management**

**Monitoring**

TAEM guidance is initiated automatically as the orbiter decelerates through  $V_{rel} = 2500$  fps ( $\approx$ Mach 2.5, Mach 3.2 for RTLS). This normally occurs at about 82,000 ft altitude and about 60 n. mi. from the runway. The crew should note transition to MM 305 and appearance of the VERT SIT displays. Head-up display (HUD) symbology also appears at TAEM interface. TAEM guidance controls the orbiter by flying an altitude vs. range profile—glideslope. TAEM also has energy airspeed limiting features (and angle of attack for RTLS), which are rarely seen.

The outputs of TAEM guidance are functions of errors from these profiles. The validity of the output commands depends upon the accuracy of NAV and air data. Guidance is only as good as the NAV state.

### TAEM Guidance

TAEM guidance operates by phases. S-turn, if required, dissipates energy by turning away from the HAC until energy conditions allow a nominal approach. Acquisition turns the orbiter until its ground track is pointed at the HAC.

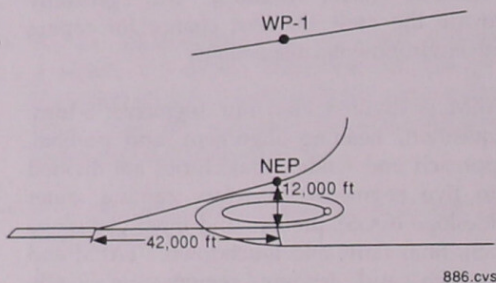

### Heading Alignment Cone (HAC) Profile

Heading alignment turns around the HAC until the orbiter is near the runway centerline. Prefinal transitions from the HAC to the runway centerline.

Outputs of TAEM guidance are:

- Pitch command ( $N_z$ )
- Roll command
- Speed brake command

At TAEM interface, if vehicle energy is too high and the HAC turn angle is  $<200^\circ$  (for OPS 3 entries), an S-turn will be commanded. During the S-turn, the orbiter will fly a constant bank angle of  $30^\circ$  for end-of-mission ( $45^\circ$  for RTLS) until the total energy/weight decreases to nominal +10,000 ft. Acquisition phase is then resumed, and the orbiter turns back toward the HAC tangency point.

Between Mach 0.95 and 14,000 ft, the speed brake is controlling energy. Below 9000 ft, it is controlling airspeed to 300 KEAS. The logic is blended between 14,000 and 9000 ft.

### CAUTION

Energy can be dissipated very rapidly. Ensure a high energy condition exists (MCC or visual) if an S-turn is triggered.

### Tracking the HAC

Guidance uses an algorithm for roll command that is a function of error with respect to HAC radius ( $\Delta R$ ) and the rate of change of distance to the center of the HAC ( $\Delta R\text{-dot}$ ). Primary and secondary bearing pointers are referenced to the HAC tangency point and HAC center respectively as computed by Area Nav. Wind magnitude affects HAC tracking. Roll angle is larger when flying with a tailwind and smaller with a headwind. On average, the HAC roll angle is  $45^\circ$ .

### Prefinal

When the orbiter is 8 miles away from the runway, guidance transitions to prefinal. At prefinal, the roll error needle may become very sensitive. The crew should either aggressively fly the roll needle or manually fly to the runway. Lagging the needles will only add to the oscillation of the roll error needles.

If the orbiter is flying into a headwind when prefinal starts, the roll needle may command a roll to wings level. This is more likely in the STA, which is not usually flying as fast as the orbiter does at this point. This rollout is due to a small Y-dot, where Y-dot is the closure rate to the runway center line.

At prefinal, the flight director marker changes from a square to a circle. It also points to the orbiter's velocity vector at this time.

Overshooting the runway centerline may cause the CDI and GSI on the HSI to disappear momentarily. Area Nav thinks the orbiter wants to go around another HAC. This will clear itself momentarily, but the crew can ensure having a glideslope indicator by placing the HSI SELECT MODE switch on panel F6 or F8 to APPROACH. This will force the glideslope indicator to display deviation from final approach glide path.

## Pitch and Roll Commands

The output of TAEM pitch channel is Nz command. If AA feedback in the normal direction is lost, the crew must fly pitch CSS and ignore the pitch error needles. If the orbiter is down to two AAs, it is fail critical (i.e., one more failure will cause bad feedback). In this case, the crew will fly pitch CSS and closely monitor the pitch error needles by cross-checking the other data.

The crew has a great deal of data to monitor to make sure the pitch channel of TAEM is working correctly. There are five different sources of glideslope (altitude) information.

Glideslope data source	Type of glideslope	Type of HAC	Scaling
GSI on HUD	Reference	Cylinder	±5000 ft till about Prefinal, then ±1000 ft
Orbiter bug on VERT SIT	Nominal	Spiral	Scale: 30K to 100K
GSI on HUD	Reference	Spiral	±5000 ft till 10,000 ft then a linear ramp down of scaling to ±500 ft at 5000 ft altitude
Vertical scale on PASS SPEC 50 HORIZ SIT	Reference	Spiral	±5000 ft until Prefinal, then ±1000 ft
ADI pitch rate pointer	Reference	Spiral	±5000 ft until Prefinal, then ±1000 ft

### Glideslope Parameters

In addition to glideslope information, the crew must monitor energy and airspeed. Both energy and airspeed are used in the pitch channel. In addition to the onboard displays, MCC is calling "energy" based on radar tracking data. This data must be incorporated by the crew. Before HAC intercept, MCC measures energy and calls energy. On the HAC, MCC measures glideslope (altitude) and will make calls based on the following:

- < ±1000 ft altitude error – ON
- 1000 to 2000 ft altitude error – slightly high or low
- >2000 ft altitude error – high or low

The term "energy" is no longer used.

### NOTE

It is essential not to confuse glideslope and energy. TAEM guidance does certain things based on energy (mainly move the speed brake) and certain things based on glideslope. There are also glideslope displays and energy displays. People often use these terms interchangeably.

### WARNING

TAEM limits the supersonic roll limit to 30° to protect the ground from a large sonic boom. The HAC cannot be flown at 30°. If supersonic on the HAC, crew intervention is required to go over 30°.

### Large HAC Turn Angles (270°)

Several unusual things happen with a large HAC turn angle.

First, the difference between the HSI and the other displays is greater. The primary bearing pointer can be 45° off at HAC intercept. The GSI is not very useful until 270° on the HAC.

Second, guidance will command an energy dump, a pull-up maneuver, and a pull-up recovery maneuver. The crew has very little insight into what is happening inside of guidance. In general, the vehicle will pitch down for the energy dump, pitch up to get subsonic, then pitch down to recover. The crew must faithfully fly the pitch error needles until 270° on the HAC. At this time, a normal instrument scan may be used.

### WARNING

The pull-up maneuver is performed in TAEM by lowering maximum airspeed to about 200 KEAS. If TAEM does not have air data, it will command an uncontrollable pitch up at about Mach 1.3.

Third, the crew will have very little time flying before HAC intercept on an entry with a large HAC turn angle.

### Displays

The primary glideslope/energy displays for TAEM are the vertical situation displays (VERT SIT 1 and VERT SIT 2). The VERT SIT plot is scaled with altitude on the Y-axis and range to the runway on the X-axis. Three trajectory guidelines represent maximum airspeed, nominal, and maximum lift-to-drag (L/D) ratio. Numerical values along the lines are EASs that should be flown to maintain that reference. An orbiter symbol shows current altitude versus range (glideslope). Pitch attitude of the orbiter symbol indicates H-dot. Use of theta limits is discussed later in this section.

The HSI is driven by Area Nav, which can be independent of shuttle guidance and navigation calculations. This gives the crew a source of navigation processed differently from the onboard state vector and based only on data taken from TACAN or MLS. The HSI and Area Nav are driven according to the *HSI SELECT SOURCE* switches on panels F6 and F8. There are three options available: *NAV* (NAV state vector to Area Nav), *TACAN* (raw TACAN data to Area Nav), and *MLS* (raw MLS data to Area Nav). An additional switch allows selection of the individual TACAN or MLS LRU (1, 2, or 3).

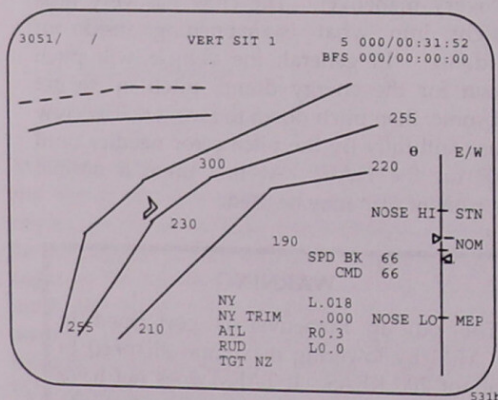

VERT SIT 1 Display (PFS/BFS)

Instead of the HAC inverted cone geometry, Area Nav defines (and the HSI displays) the HACs as 15,500 ft radius cylinders. This causes the HSI and guidance ground track information to differ slightly. During TAEM, the HSI primary bearing pointer indicates the bearing toward the HAC intercept point called way point 1 (WP1), and the secondary bearing pointer indicates bearing to the center of the HAC. Range displayed in the HSI DME windows corresponds to range to the runway via the HAC (PRI MILES) and range to the HAC center (SEC MILES). Range to the runway can be varied by moving the HAC using ITEM 6 and 7 on SPEC 50. The HAC on SPEC 50 is an imaginary inverted cone tangent to the runway centerline at 12,000 ft altitude and nominally centered about a point 7 n. mi. from the runway threshold. For low energy situations, the crew can shift the HAC to a point 4 n. mi. from the threshold by executing ITEM 7. The point where the HAC is tangent to the runway centerline is called the entry point. For a nominal HAC configuration, the entry point is called the nominal entry point (NEP). Executing ITEM 7 repositions the HAC to a minimum entry point (MEP), which is tangent to the runway centerline at 6000 ft.

ITEM 6 allows selection of an overhead (OVHD) approach or a straight-in (STRT) approach. This allows the crew to position the HAC on either side of the runway centerline. OVHD/STRT and NEP/MEP can be combined to define four HACs that are available to the crew for energy management purposes. Guidance is always initialized to the OVHD NEP HAC.

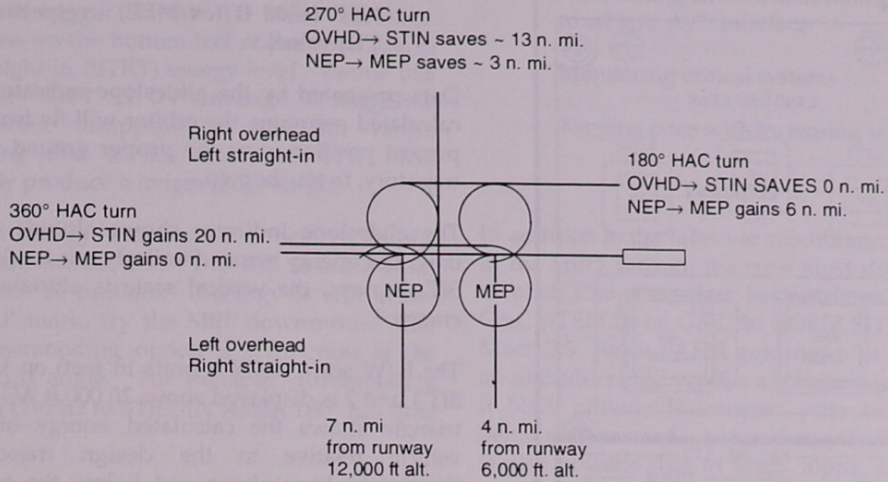

887.cvs

HAC Turns

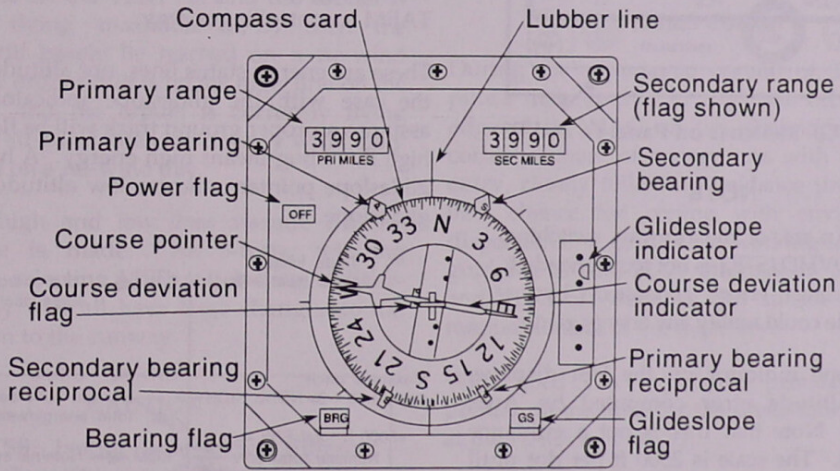

273.cvs

Horizontal Situation Indicator

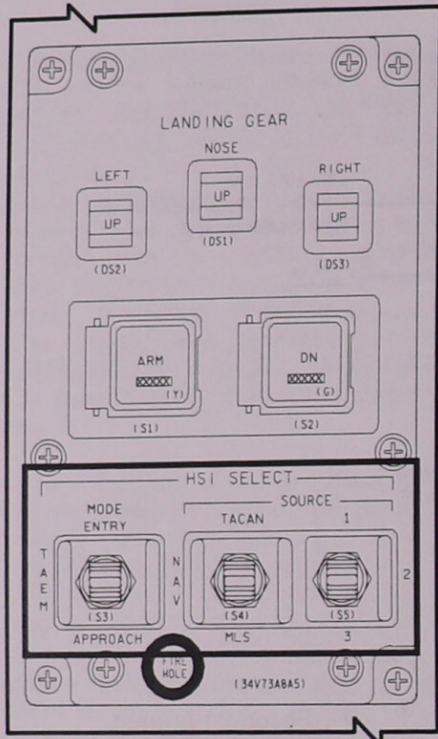

HSI SELECT Switches on Panel F6 and F8

**NOTE**

Within 35 n. mi. of the runway, switching between OVHD/STRT is not recommended. The heading error generated by a downmode could nullify any energy gains.

The glideslope indicator on the HSI displays calculated altitude error computed by Area Navigation. Note that this is not a guidance computation. The scale is 2500 ft per dot until Area Nav transitions to Approach (usually within 2.5° of Course Deviation), then it becomes 500 ft per dot. Crewmembers can force this scale change by selecting APPROACH on the HSI SELECT MODE switch on panel F6 or F8. With the HSI MODE switch in ENTRY, HSI mode, auto switching from TAEM to Approach will occur under the following conditions:

- Orbiter altitude is less than 18,018 ft for NEP (12,000 ft for MEP), and the absolute value of the CDI is less than 2.5°.

- Orbiter altitude is less than 12,018 ft for NEP (6000 ft for MEP) irrespective of CDI value).

Data presented by the glideslope indicator are calculated assuming the orbiter will fly from its present position, over the proper ground track trajectory, to touchdown.

The glideslope indicator shows altitude error only, not energy error. Similarly, on the VERT SIT displays, the vertical scale is altitude, not energy.

The E/W scale (E/W = units in feet) on VERT SIT 1 and 2 is displayed above 20,000 ft AGL. A triangle shows the calculated energy of the vehicle relative to the design trajectory. Overbright lines above and below the center NOM indication show 8000 ft high and 4000 ft low on total specific energy. If the pointer is between the +8000 and -4000 ft marks, TAEM is controlling glideslope. If out of this band, TAEM is controlling energy.

These are energy status lines, not altitude. As is the case with the glideslope indicator, E/W assumes a proper ground track will be flown. A high E/W bug means high energy. A high HSI glideslope pointer indicates low altitude on the glideslope.

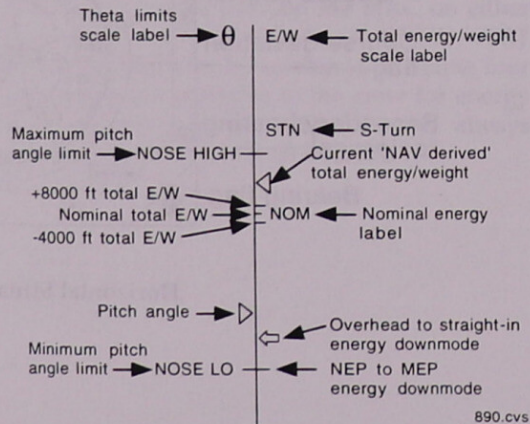

E/W Scale on VERT SIT 1

Above the nominal energy marks is a mark labeled STN (S-turn). When vehicle energy, represented by the triangle, is above the STN mark, guidance may command an S-turn to dissipate energy. Near the bottom of the scale is

another mark labeled MEP. Energy below this mark will trigger an "SW TO MEP" message. An arrow on the bottom half of the scale marks the straight-in (STRT) energy level. Below this mark, an "OTT ST IN" message is triggered. The arrow disappears at 45 n. mi. range, signifying that a downmode to STRT will probably produce a longer range-to-go.

For low energy situations, it is best to try the STRT downmode first. This will avoid a short OGS prior to preflare. If energy is still below the MEP mark, try the MEP downmode. The best downmoding option is a function of the HAC turn angle. For example, downmoding from an OVHD to STRT-IN within 180° has little effect.

Unfortunately, the energy pointer is not very useful in deciding if the orbiter can make the runway. The orbiter bug combined with airspeed must be used. If the orbiter bug is on the low line on the VERT SIT and the orbiter is currently flying maximum L/D, then the runway will barely be reached on a no-wind day. If the orbiter bug is on the high line on the VERT SIT and the orbiter is currently flying maximum airspeed, then the runway will barely be reached on a no-wind day.

Both the high and low lines assume that no downmode is made. An S-turn, selecting straight-in, selecting MEP, or selecting a different runway will all have large changes to the range flown to the runway.

#### CAUTION

Take CSS before evaluating different downmodes. This way the displays can be assessed without committing a turn in the new direction. If the downmode is accepted, AUTO flight control can be resumed.

In summary, crew concerns during TAEM are:

- Remaining within critical flight control and structural limits (q-bar,  $N_z$ , beta, roll angle, angle of attack)
- Ensuring timely and accurate data are input to the NAV state

- Maintaining E/W within limits required to achieve A/L interface
- Monitoring critical systems
- Keeping pace with increasing workload

#### Takeover

In addition to the takeover conditions discussed in the Entry section, the crew must downmode to pitch CSS if air data has not been taken to G&C (ITEM 28 on GNC 50 HORIZ SIT) prior to Mach 2.5. Since TAEM guidance tries to set up an altitude/range profile, a transient is possible if NAV altitude is incorrect prior to air data being incorporated. A step change in FCS gains is also possible due to Mach, alpha, and q-bar errors. If air data is not incorporated into guidance and control by Mach 2, the crew must go CSS and fly theta limits. Flying theta limits is discussed later in this section.

#### Manual Control

During the supersonic portion of TAEM, the pilot's main goal is to guide the orbiter to the edge of the HAC on the glideslope with the correct amount of energy. As with the rest of entry, closely following guidance provides the best chance for coping with environmental dispersions—if guidance is working correctly. If guidance is bad, NAV information on the HSI and VERT SIT displays may still be usable for manual control of the trajectory.

With good NAV, put the primary bearing pointer on the nose (or the predictors will point at the HAC on SPEC 50).

The most precise pitch control indicator is the orbiter bug on the VERT SIT. Pitch up and down until an H-dot that drives the orbiter bug back to the nominal line is achieved. Make sure not to fly slower than max L/D or faster than maximum airspeed. Max L/D is best flown by using max L/D alpha. L/D alpha is not a function of weight and roll angle and responds much faster than airspeed.

The maximum airspeed of the orbiter is now 333 KEAS. TAEM and the displays still have the old limit of 305 KEAS supersonic built in. Because of worst case air data errors, it is recommended



not to go over 321 KEAS (actual indicated airspeed).

If very low, fly maximum range alpha (max L/D) and change the HAC or runway selection if required. Back up navigation with real world visual cues if weather permits.

In extreme cases where guidance and navigation are bad, a GCA, along with the view out the windows, can be used to arrive overhead the field for landing. GCA procedures are discussed in Section 7.3.

Manual control during the subsonic portion of TAEM is discussed later in this section.

### Heading Alignment Cone

The HAC is intercepted at various altitudes, depending on HAC turn angle. The altitude varies between about 50,000 ft for a 360° HAC to 20,000 ft for a 90° HAC (straight in). The SPEC 50 HORIZ SIT horizontal scale, and the ADI roll rate pointer, provide a HAC turn time-to-go indication.

A proper lead is the easiest way to keep the roll guidance needle centered. Leading the HAC turn correctly will quickly establish the orbiter on the HAC without calling for more than 45° bank nominally or up to a maximum of 60° with a strong tailwind. As long as NAV and guidance are good, closely following guidance on the HAC will optimize the chances of staying within vehicle g limitations and countering wind effects.

HSI glideslope data (GSI) can also be used to maintain situational awareness while flying the HAC in order to anticipate guidance commands and minimize deviations from the reference altitude profile. The GSI calculations assume a heading alignment cylinder instead of a heading alignment cone, and computes errors assuming the orbiter is on the proper horizontal ground track. For reasonable deviations from the HAC, these errors are small and the GSI display is still useful.

### NOTE

The GSI has significant differences from TAEM guidance and the other glideslope displays until 270° on the HAC. The GSI should not be used to correlate with the pitch error needles until on the HAC with <270° of HAC turn to go.

The circle displayed on SPEC 50 is based on the instantaneous radius of the HAC at the orbiter's current position. For large HAC turn angles, the extended runway centerline will initially be projected inside, rather than tangent to, the SPEC 50 circle. As the orbiter continues around the HAC, the circle will become tangent to the runway extended centerline. Since the displayed circle is based on the instantaneous HAC radius, there will be a very slight trajectory error if the predictor dots are overlaid on the circle. For most situations, these errors are small and do not affect the usefulness of the SPEC 50 display. To fly precisely on the HAC requires that the guidance predictor dots be maintained slightly inside the SPEC 50 circle.

### CAUTION

Any delay in following the guidance commanded roll on the HAC can result in going below glideslope, even if the guidance needles are flown perfectly after the delay.

The SPEC 50 HORIZ SIT and ADI rate pointer scales for crosstrack error and glideslope error may also be used to fly the HAC. Keeping the reference triangle or pointer centered on the scales ensures flying the reference trajectory.

### HAC Options

Profile options are included in the guidance and navigation system to improve low energy situations. The options include:

- Straight-in approach
- HAC shrink (spiral adjust)
- MEP

Selecting the straight-in approach option on SPEC 50 will reduce the HAC turn angle to 180° or less. When guidance computes the orbiter to

be well below glideslope, the second option is invoked automatically by TAEM guidance. The HAC radius shrinks, allowing the orbiter to fly a shorter approach profile.

#### NOTE

A spiral adjust will occur only if the remaining HAC turn angle is greater than  $90^\circ$  and the orbiter is on the HAC.

The MEP option moves the HAC center point 3 n. mi. closer to the runway. MEP is selected by ITEM 7 on SPEC 50.

Range savings using these options vary as a function of HAC turn angle.

None of the options are nominal procedures. They are used only when the orbiter is in a low energy situation.

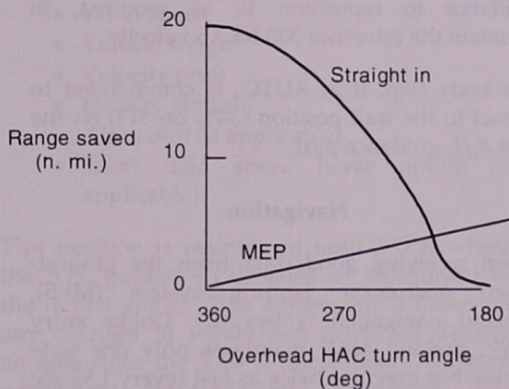

#### Range Saved vs. HAC Turn Angle

#### Default Air Data and Theta Limits

If air data has not been incorporated to G&C by Mach 1.5, default air data values will be used to set DAP parameters. Default air data should insure adequate flight control for a safe landing, although flying qualities may be slightly degraded.

Although default air data ensures that the flight control gains are set correctly, it essentially removes the airspeed limiting features on TAEM. Default air data will never tell TAEM it is flying too slow or too fast.

Theta limits are a set of pitch attitude limits that will keep the orbiter between minimum and maximum airspeeds. Vehicle pitch attitude, as well as the NOSE HI and NOSE LO limits, is displayed on the VERT SIT display. A  $50^\circ$  bank angle limit is imposed when flying theta limits. With no air data to G&C, theta limits apply from 1500 fps (2000 fps operational constraint) until rolling out on final.

#### WARNING

Operationally, do not exceed  $50^\circ$  angle of bank during theta limits. Bank angles greater than  $57^\circ$  will exceed maximum and/or minimum theta limits.

#### WARNING

No warning is provided when pitch up alpha limits are exceeded. Crewmembers should closely monitor theta limits and air speed to prevent loss of control. The pitch error needle will command past this limit if in a low energy situation or approaching a HAC greater than  $300^\circ$ . Mach 1.5 to 1.0 is the most critical phase.

#### CAUTION

Theta limits and a tailwind combination can rapidly cause a low energy situation, requiring aggressive corrections. This is one of the situations where the crew will take the last ADTA data, if available, rather than fly theta limits.

#### Outer Glideslope

The OGS is an equilibrium glide path that provides sufficient energy at preflare for a safe landing. Sufficient energy includes:

- Having enough energy to compensate for deceleration between preflare and touchdown
- Allowing a minimum of 5 seconds of stable flight time on the IGS for the pilot to make final corrections

To provide sufficient energy at preflare, the OGS design must handle both high and low energy dispersions over the entire weight span of the orbiter. The OGS is a sloped-line segment that intercepts the ground at the aim point.

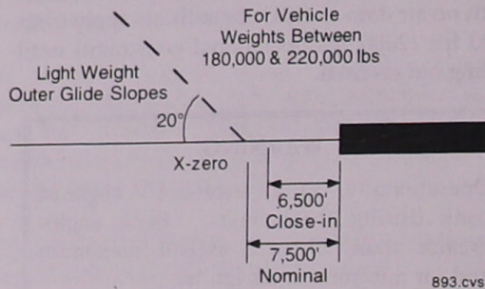

OGS Profile

Time to correct trajectory dispersions is provided by the altitude at which the OGS is acquired. Nominally, this occurs at 12,000 ft. Transition from TAEM to A/L guidance normally occurs at 10,000 ft, but if the transition criteria have not been satisfied by 5000 ft, A/L transition is forced. The criteria for transition from TAEM to A/L get tighter as altitude decreases.

TAEM TO APPROACH/LAND TRANSITION CRITERIA			
10,000 FT		5000 FT	
< 4	DEG	FLIGHT PATH ANGLE ERROR	< 0.5 DEG
< 1000	FT	CROSSRANGE ERROR	< 100 FT
< 1000	FT	ALTITUDE ERROR	< 50 FT
< 24	PSF	DYNAMIC PRESSURE ERROR	< 24 PSF
(288-312 KEAS)		(288-312 KEAS)	

**TAEM to A/L Transition Criteria**

This allows A/L equations to cycle through initial transients and time for the rate terms to reach their damping values.

Reference velocity on the OGS is 300 KEAS for all vehicle weights. This velocity is required to compensate for the expected deceleration on the IGS. The design goal is to fly as fast as possible while remaining within maximum airspeed limits (333 KEAS)/q-bar (375 psf).

A 20° OGS is used for lightweight vehicles, and an 18° OGS is used for heavyweight vehicles. The design goal was to fly as shallowly as possible while maintaining sufficient speed brake reserve to cope with winds and trajectory

dispersions. Since both high and low energy dispersions are possible, GSs were selected that resulted in a speed brake setting of 65 percent for midrange weights. One of the reasons for not forcing A/L guidance until 5000 ft is that TAEM has direct q-bar control limits that will keep the orbiter on the front side of the L/D curve.

**Guidance and Control**

Guidance attempts to maintain the reference-altitude-range profile by computing a normal acceleration command to guide the orbiter along the selected OGS trajectory. The  $N_z$  command is converted to a pitch command and displayed on the ADI and HUD. If the pitch command results in a velocity that is different than 300 KEAS, the speed brake responds to correct the velocity error.

Leaving the speed brake in AUTO allows guidance to reposition it, as required, to maintain the reference 300 KEAS velocity.

The body flap, if in AUTO, is commanded to retract to the trail position (34% on SPI) on the first A/L guidance pass.

**Navigation**

Upon receiving good data from the ground-based microwave landing system (MLS), preland navigation is begun. Unlike entry NAV, preland NAV maintains only one state vector, but executes twice as fast (every 1.92 sec vs 3.84 sec).

The MLS provides extremely accurate azimuth, range, and elevation, which correct the onboard NAV state. Typical errors are about 5 ft altitude, 21 ft downtrack, and 17 ft crosstrack when processing MLS data.

**NOTE**

Both range and azimuth data "good" flags are required to process MLS data. Without an elevation data "good" flag, azimuth and range will still be processed, but if either the azimuth or the range data "good" indicator is lost, all MLS processing will cease.

If MLS data are lost for any reason (above 1500 ft) after processing has begun, TACAN and ADTA information will again become available to NAV until 1500 ft and 500 ft respectively. If MLS data are lost below 1500 ft, ADTA altitude processing is not possible.

#### NOTE

With TACAN data in FORCE mode, MLS data cannot be processed.

#### Smart Speed Brake Logic

To control orbiter touchdown energy, the speed brake is retracted at 3000 ft to a value calculated by onboard guidance that will target the remaining velocity profile to a fixed touchdown energy. The calculated speed brake position is a function of:

- Wind speed
- Vehicle weight
- Velocity error
- Density altitude
- Aim point (if applicable)
- Short field speed brake option (if applicable).

This position is maintained until 500 ft where the A/L guidance calculates an adjustment to the retract angle. This adjustment is based on any changes in winds and predicted density altitude since the 3000 ft calculation. No more adjustments are made until touchdown. The 500 ft adjustment altitude was selected because the time to fly from 3000 to 500 ft is approximately the same time it takes to fly from 500 ft to touchdown. This allows time for the adjustment to have an effect on the vehicle energy state.

When the close-in aim point is selected, 1000 ft are directly added to the downrange total. The idea is to keep the same touchdown energy target even though the geometry has been shifted in by 1000 ft. This lets the vehicle respond to atmospheric conditions that required the close-in aim point.

Selecting the short field option on SPEC 50 forces Autoland guidance to dissipate an additional 1000 ft of touchdown energy. The energy dissipation is achieved by carrying an

additional 12° to 13° of speed brake from 3000 ft altitude to touchdown. When this option is used, the pilot lands the orbiter 10 kt slower than the planned touchdown velocity and maintains the same nominal 2500 ft touchdown range. From an energy point of view, the additional 1000 ft of dissipated downrange can be converted to a velocity 10 kt slower than nominal touchdown velocity.

The short field speed brake retract option may also be used on all missions if the touchdown ground speed is predicted to be greater than the flight rule limit (214 knots). Using the short field option for this reason on a non-TAL landing will be decided by the flight director and will require an item 39 entry by the crew. The goal is to provide additional margin from the 225 KGS certified tire speed limit. It is for this safety concern and for common training procedures that when the short field option is used, the crew should land 10 knots slower rather than 1000 ft shorter. This option may be selected for TAL runways to ensure an adequate rollout margin or to prevent tire failure due to a high groundspeed touchdown.

The maximum allowable speed brake command at 500 ft is 50°, due to degradation of orbiter handling qualities near touchdown. This maximum limit is not invoked when short field option is selected.

After the speed brake setting is adjusted at 500 ft, the guidance command remains constant until the weight-on-wheels signal is sent to the GPCs. When this signal is latched, the speed brake is commanded to full open.

#### Visual Aids

##### *Aim Points*

The OGS aim point location was determined by energy requirements for landing and geometry constraints for transition between the two glideslopes. Distance from preflare to touchdown is proportional to orbiter deceleration time. This distance is directly related to aim point location.

The nominal aim point is located 7500 ft from the runway threshold. A close-in aim point is located 6500 ft from the runway threshold. Use

of the close-in aim point provides an immediate energy increase by moving the OGS intercept point 1000 ft closer to the runway.

The nominal aim point is a rectangle, whereas the close-in aim point is a triangle. Colors are chosen to contrast with the local terrain. Aim points on lakebeds and light-color terrain are usually black. For tree- or vegetation-covered terrain, aim points are usually white. A dark background is preferred for the precision approach path indicator (PAPI) lights, which are placed on each aim point.

To enhance the flight crew's ability to acquire the aim points and PAPI lights, a strobe light system is installed at the close-in aim point. Six high-intensity, directional strobe lights are located adjacent to the aim point. The lights flash at 90 cycles per minute (cpm) with an intensity of 1

million candlepower. For night operations, this intensity is reduced to 10,000 candlepower by means of a capacitor step and red filter.

**PAPI Lights**

The PAPI lights define the OGS. On a nominal approach, the crew should see two red and two white lights (20° GS). For heavyweight landings, an 18° GS is flown (three red and one white PAPI).

Three intensity settings are available for the PAPI lights: day, dusk, and night.

At fixed installations such as Kennedy Space Center and some Edwards and Northrup runways, intensity is controllable from the tower. Portable PAPIs must be adjusted at the aim point.

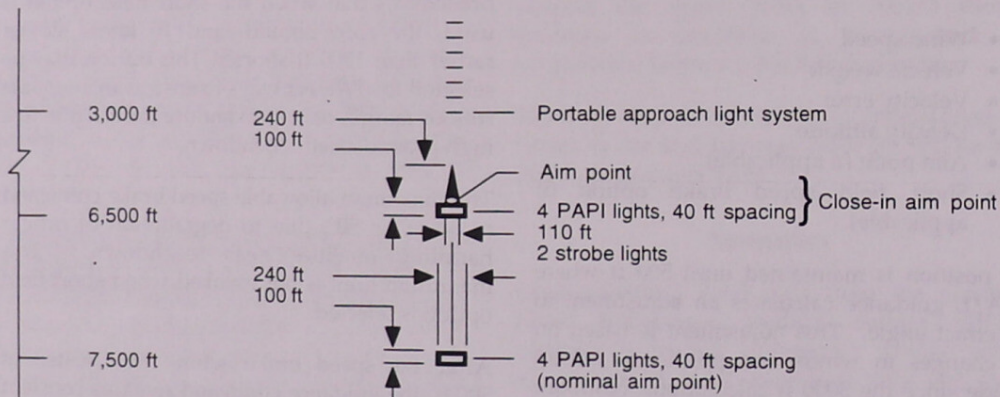

895.cvs

**Aim Points**

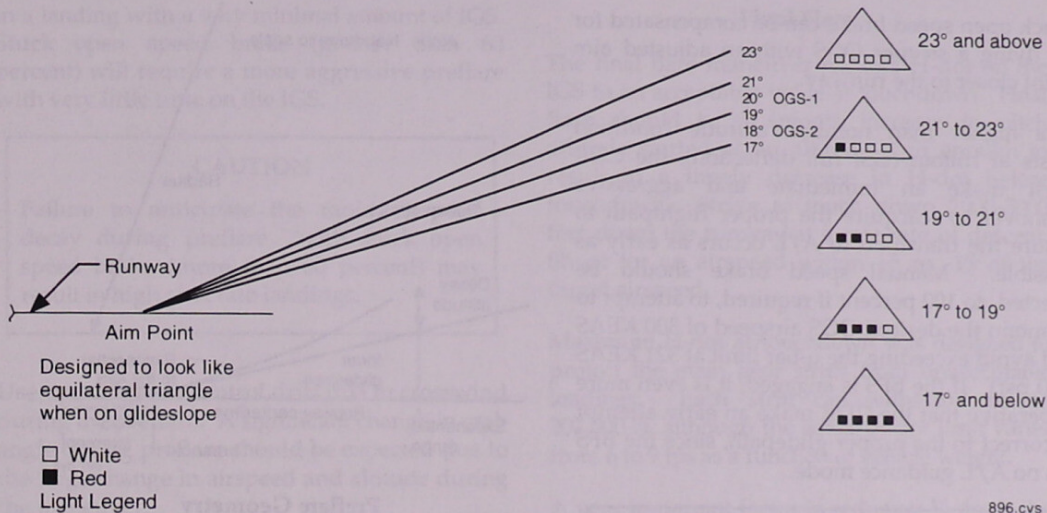

### PAPI Light Diagram

#### Techniques

When established on the OGS, the HUD runway should overlay the actual runway. Differences indicate the amount of NAV error. If the overlay is good, then NAV and guidance should be good, and declutter level one or two may be selected and the guidance symbol followed. If excessive NAV error exists, declutter but do not follow guidance. The HUD gamma reference marks should lie next to the aim point if the vehicle is on the proper trajectory.

Without a HUD, use the ADI error needles as long as the NAV state is good. With MLS data, the NAV state will generally be very good. Use of TACAN only will produce errors requiring the pilot to fly the OGS primarily using the HUD and external references.

Since the PAPI lights only show an instantaneous GS status, they must be continuously monitored for trends. If the onboard NAV state is reasonably good, and the crew tracked guidance around the HAC, energy should be close to nominal, and the HUD velocity vector should be positioned near the aim point after rolling wings level on final. If the PAPI lights are not operational, use the rectangle on the ground at the nominal aim point (or the triangle at the close aim point), and align the gamma reference marks on the HUD with the appropriate aim point on the ground.

Night approaches should be considered instrument approaches. Due to lack of outside references, bank control is more difficult. Sink rate is not apparent until after preflare.

When flying a manual speed brake approach, maintain 300 KEAS on the OGS, then close the speed brake at 2500 ft. If speed brake settings are known, the pilot not flying the approach should set the speed brake at 3000 ft and 500 ft.

High energy conditions are best corrected by deploying the speed brake to 100 percent. S-turns on final are not recommended because the turn dissipates an uncontrollable amount of energy leading to a low energy condition.

For low energy cases, close the speed brake and fly the wings level max L/D of 10.5° alpha. Push over no later than 5000 ft in order to have enough energy to preflare.

#### CAUTION

Entering preflare with less than 240 KEAS does not allow enough energy to rotate the nose to a safe touchdown attitude.

With speed brake stuck closed, lowering the landing gear early results in equivalent drag of 60 percent speed brake.

Stuck open speed brake can be compensated for by flying a steeper OGS with an adjusted aim point closer to the runway.

If a higher than nominal altitude condition exists at rollout (GSI full deflection), the CDR must make an immediate and aggressive pushover to reacquire the proper flightpath to ensure the transition to A/L occurs as early as possible. Manual speed brake should be selected, to 100 percent if required, to attempt to maintain the desired OGS airspeed of 300 KEAS and avoid exceeding the q-bar limit at 321 KEAS (350 psf). If the BFS is engaged, it is even more imperative that the CDR make an early attempt to correct to the proper glidepath, since the BFS has no A/L guidance mode.

#### CAUTION

When rolling onto the OGS with excess altitude, TAEM prefinal guidance gains may not be aggressive enough to command the orbiter back into the A/L envelope. If guidance is followed, the resulting flightpath will parallel the reference OGS with the aim point displaced down the runway. When A/L is forced (not later than 5000 ft AGL), guidance will give excessive pitch commands to attempt to reacquire the OGS. If followed, these commands could result in an excessive dive angle requiring as much as a 2.0 g pullout for the preflare maneuver. This can be avoided by the CDR closely monitoring the HSI glideslope indicator while flying the HAC and bearing in mind that the ADI pitch steering needle provides a much more noticeable indication of Nz command than the HUD.

#### Preflare

The preflare maneuver is used to transition from the OGS to the IGS. Flight path geometry is a sector of a circle tangent to the OGS and an exponential to the IGS. H-dot of about 190 fps must be reduced to less than 3 fps at touch-down. Preflare reduces H-dot to about 12 fps, with the remainder taken out in final flare. Pullup is about 1.35 g.

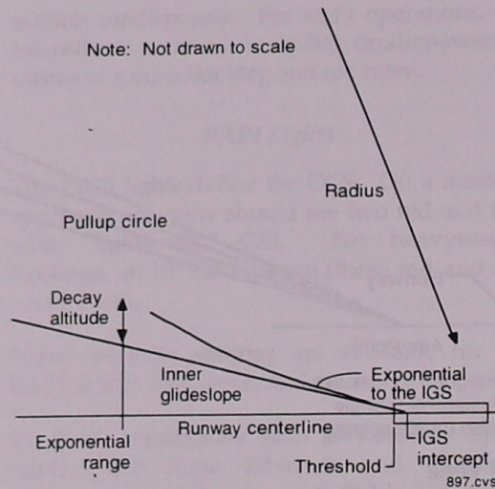

#### Preflare Geometry

Since the speed brake is retracted at 3000 ft and preflare nominally occurs at 2000 ft, the orbiter's velocity will increase about 10 KEAS. As flight path angle nears the minimum steady state value ( $-12^\circ$ ), velocity will begin to decrease.

#### Techniques

There is a strong tendency, especially with inexperienced pilots, to be too aggressive in the preflare or to anticipate the maneuver, ending up high and slow. This tendency is aggravated at night, when closure rate and depth perception cues are reduced.

#### CAUTION

The preflare is a gentle maneuver. Early and/or aggressive preflare may result in a high and slow inner glideslope from which a hard landing can occur.

Utilizing the HUD flare markers will generally result in good preflare maneuvers. Approaching 1000 ft to 800 ft, use the ball bar to intercept the IGS at about 300 ft. Without a HUD, the ball bar is the best reference during preflare.

For some low energy cases, delaying preflare to as late as 1000 ft may help to correct the situation. Perform a flare maneuver that results

in a landing with a very minimal amount of IGS. Stuck open speed brake (greater than 60 percent) will require a more aggressive preflare with very little time on the IGS.

#### CAUTION

Failure to anticipate the rapid airspeed decay during preflare with stuck open speed brake (more than 60 percent) may result in high sink rate landings.

Use crab angle to control drift due to crosswind during the preflare. A significant change in crab angle during preflare should be expected due to the large change in airspeed and altitude during the maneuver.

### Inner Glideslope

Transition to the IGS begins at 300 ft. Once the landing gear is deployed, and the orbiter is on the IGS, deceleration is fairly constant at 4 KEAS per sec. Each additional second the orbiter remains airborne results in a 4 knot slower touchdown velocity. The 1.5° IGS was designed to give the pilot at least 5 sec of stable flight before final flare.

Once stabilized on the inner glideslope, since the orbiter is decelerating, some pitch attitude changes will be required to maintain the desired trajectory.

### Landing Gear

The landing gear creates a great deal of aerodynamic drag, which can significantly alter touchdown energy. The landing gear is deployed on an altitude cue by the pilot who is not flying the approach. Current flight procedures are to arm the gear at preflare (2000 ft) and lower the gear at 300 ± 100 ft. The design requirement is to have the gear down and locked at least 5 sec before touchdown. Gear deploy should not be delayed beyond 200 ft. A 100 ft difference in gear deploy altitude equals about 250 ft of touchdown energy. A nominal 300 ft deploy is assumed in landing energy predictions.

### Final Flare

The final flare maneuver reduces H-dot on the IGS to an acceptable value at touchdown. Final flare should be a smooth increase in pitch attitude started at an altitude high enough to result in a timely decrease in H-dot before touchdown. Strive to touch down 2000-3000 feet down the runway at a safe rate of descent. Shoot for an airspeed within +5 to -15 of the target airspeed.

Maximum H-dot at touchdown was designed to protect the main gear struts from unacceptable loadings. Each strut can withstand up to 207,000 lb, although the actual H-dot limit varies from 6 to 9 fps as a function of vehicle weight.

A very important factor in reducing H-dot is the powerful aerodynamic ground effect of the orbiter. This effect grows as altitude decreases, increasing L/D by about 25 percent. Minimize RHC inputs prior to touchdown, and expect ground effect to cushion sink rate.

The 1.5° IGS used by guidance is a compromise. It does not require a large maneuver to land, yet maintains a reasonable ground clearance when coming out of preflare.

### Techniques

A negative handling quality of the orbiter is that initial vehicle response to pitch control inputs is backwards from the desired performance. This is due to relative locations of the c.g., aerodynamic center, control surfaces, and the pilot's seat. For example, a pitchup command from the RHC causes an upward elevon deflection. The up elevon initially causes a decrease in lift (approximately 2000 lb per degree), and the wheels actually move closer to the ground at a faster rate. The expected positive lift increment will not occur until the orbiter has rotated to a higher angle of attack.

#### CAUTION

Attempting to reduce H-dot may actually increase the rate, and, if timed incorrectly, can result in an early touchdown.



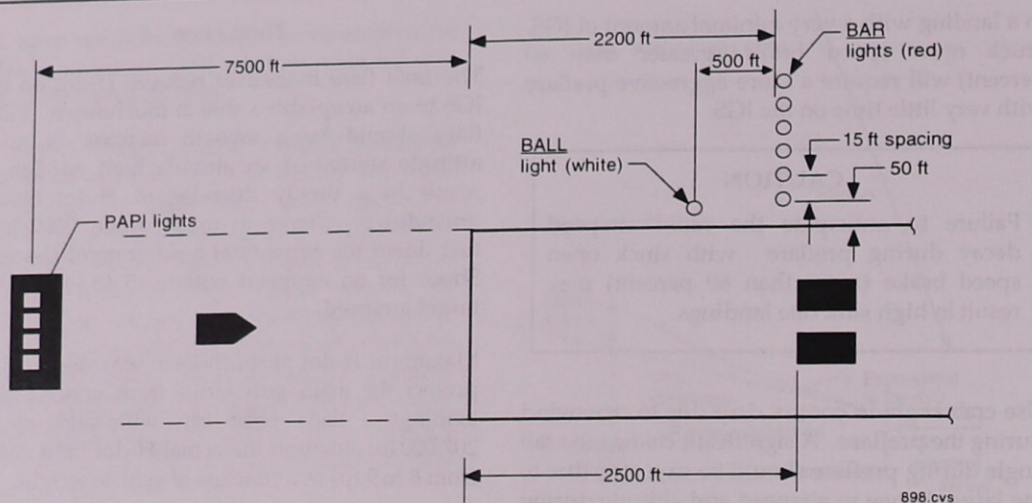

Ball Bar Geometry

Pilot eye height just prior to landing is nearly constant. Therefore, out-the-window cues are poor indicators of actual H or H-dot after control inputs.

The HUD should be used to monitor pitch attitude and make precise adjustments both on the IGS and for final flare. For no-HUD approaches, use the far end of the runway or the horizon, since pitch attitude changes are very difficult to see due to a lack of references.

A "bang-bang" technique of pitch attitude corrections on the IGS has proven to be effective for some pilots. Small pitch inputs are made, and the RHC is quickly returned to detent. After each input (or series of inputs for larger corrections), wait until the effect is apparent before making another correction. This technique is less effective as landing weight increases and c.g. moves forward.

#### Ball Bar

The ball bar defines a 1.5° GS. Overlaying the center of the ball across the center of the bar results in a threshold crossing height of 26 ft. Normal guidance profile changes due to winds will result in some difference in threshold crossing heights. Try to shoot for 20-30 feet threshold crossing height during training.

Touchdown rectangles on the runway surface may also be used. The leading edges of the marks are 2500 ft from the threshold, and the

marks are 200 ft long and 40 ft wide. Aiming the orbiter straight toward the marks from ball bar intercept until final flare results in good IGS control and safe threshold crossing heights. This technique is especially helpful for no-HUD approaches.

For the final flare, matching digital altitude and digital airspeed on the HUD (40, 240 . . . 30, 230 . . . 20, 220) will result in a smooth maneuver from the IGS to touchdown.

#### Touchdown

A/L trajectory was designed to result in touchdowns about 2500 ft past the runway threshold at a safe speed and sink rate.

The same touchdown speeds are usually targeted by the pilot when flying CSS to provide a more consistent energy reserve and orbiter pitch attitude at touchdown. Energy reserve is the time (in sec) that the orbiter could have flown until pitch attitude reached tailscrape angle (15°). Energy reserve varies with weight, since heavier vehicles must fly faster than lighter vehicles in order to produce aerodynamic lift equal to weight. Consistent energy reserve and consistent pitch attitude are very important factors that help pilots land with sink rates within vehicle limits. CSS target touchdown speed is 195 KEAS for weights less than or equal to 220,000 lb and 205 KEAS for weights greater than 220,000 lb.

GUIDANCE MODE	T/D Point (ft)	T/D velocity by vehicle weight (KEAS)			
		< 200 K	200 K - 220 K	> 220 K	> 245 K
Nominal guidance - all aim points	2500	195*	195	205	205
• Auto or CSS					
Short field speed brake	2500	185	185	195	195
• Auto or CSS					

\* 185 KEAS is acceptable for certain touchdown energy cases.

### Ball Bar Geometry

#### Energy Reserve/Tailscape

Starting with STS-50, the speed brake (in AUTO) targets 2500 ft at 195 KEAS touchdown energy for lightweight vehicles and 205 KEAS for heavyweight vehicles. A rough rule of thumb is 90 ft of touchdown distance corresponds to 1 knot of airspeed.

$$\text{ENERGY RESERVE} = \frac{V_{\text{Tailscape}} - V_{\text{Touchdown}}}{\text{Deceleration}_{\text{Avg}}}$$

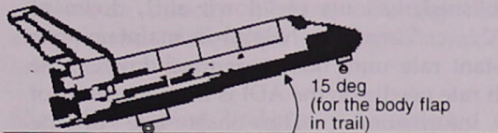

**TAILSCAPE** — The maximum pitch attitude (deg) the vehicle can land at and not scrape the tail (body flap).

**ENERGY RESERVE** — The time (sec) the vehicle could have continued flying after touchdown until the tailscape condition.

899.cvs

The most significant factors influencing touchdown energy are:

- Winds
- Density altitude
- Vehicle weight
- Velocity error at 3000 ft

Off-nominal factors such as landing gear deploy altitude, GNC air data SOP, tile damage, stuck speed brake, and NAV errors may also be significant.

Variations in touchdown energy of  $\pm 500$  feet due to the factors listed above are not unusual. Pilots should strive to touch down 2000-3000 feet down the runway at a safe rate of descent within  $+5/-15$  knots of the target airspeed,

allowing touchdown airspeed to vary slightly with touchdown energy dispersions. Minimal RHC activity prior to touchdown is desired to preclude pilot induced oscillations.

For crosswind landings, use crab angle to control drift. Maintain the required crab angle all the way to touchdown.

#### Weight on Wheels Discretes and Flight Control Moding

At touchdown, the weight on wheels (WOW) discrete must be set to properly mode flight control for derotation and rollout. The crew can set the WOW/weight on nose gear (WONG) discrete manually by selecting the SRB or ET SEPARATION MAN mode and depressing the appropriate pushbutton. To avoid derotation transients, this action is deferred until after nose gear touchdown.

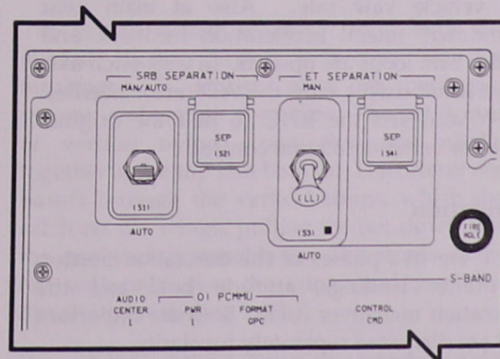

SRB SEPARATION and ET SEPARATION Switches and Pushbuttons on Panel C3

**CAUTION**

Failure to set the WOW discrete allows the DAP to remain in A/L mode. Gains are not optimized for derotation and rollout and may cause control problems.

Crews are trained to routinely set WOW/WONG manually at nose gear touchdown to protect for a WOW and/or WONG discrete failure. If a manual SEP pushbutton is depressed at main gear touchdown, the rollout discrete will be set when pitch attitude decreases below 0°.

Flight software performs other checks to ensure the WOW discrete is not set while the orbiter is still airborne.

Once the WOW discrete is set, the speed brake opens to 100 percent to help slow down the vehicle. The WOW discrete also sets flat turn and HUD discrettes, which cause mode changes in the aerogjet DAP. Setting WOW also modes the pitch channel to AUTO for auto load relief. In the roll/yaw channel, when WOW is set, rudder trim freezes, aileron trim freezes, and auto load balancing becomes active. Auto load balancing uses aileron commands generated through the roll channel to balance loads on the main tires. These commands are computed as a function of true airspeed, lateral acceleration, and vehicle yaw rate. Also at main gear touchdown, lateral acceleration feedback and rudder trim loops are opened. In CSS, pitch axis information drives only the ADI error needles. WOW also sets the RHC to half the original gains for better derotation control.

**Derotation**

There are two phases of the derotation portion of orbiter landings, attitude hold and the derotation maneuver itself. Both are important and are discussed separately for clarity.

**Attitude Hold**

This phase is designed to reduce maximum loads on the main landing gear. Pitch attitude is held constant until EAS decreases to 185 KEAS, when beep trim is used to perform the

derotation. This speed was selected as a compromise between maximum load on the main gear, maximum load on the nose gear, time between touchdown and start of derotation, and the need to have the nose gear on the runway surface in time to start braking.

**Derotation Maneuver**

The manual backup derotation maneuver will be used if beep trim is inoperable or inhibited. The recommended pitch rate in CSS is 1 to 2 deg/sec. Input the derotation command smoothly over a period of 1 to 2 seconds.

Executing a manual derotation requires good crew coordination and must be practiced in the simulator. The pilot not flying the approach and landing should call out airspeeds, with a "derotate" statement at 185 KEAS. A positive nosedown command must be input and held with the RHC to generate the desired 1 to 2 deg/sec pitch rate. When pitch rate is established, callouts of "down at 1, down at 1-1/2, . . ." are very helpful in maintaining a constant rate until nose gear touchdown. The pitch rate needle on the ADI is the best source of this information. The onset rate of the derotation rate command is critical for minimizing main gear loading during and after derotation. Too quick an onset can result in main gear oscillations and load spikes that go over the max limit. Too slow an onset can result in high nose gear loads. Heavy gross weight landings on lakebeds (high rolling friction coefficient) are the most difficult to control.

**CAUTION**

Derotation is a critical maneuver. Do not delay derotation, especially on lakebeds at heavy gross weight. Loss of elevon effectiveness can cause hard nose gear slapdowns and possible structural damage. Derotation must also be initiated at the proper rate. If the derotation command is input too quickly, main gear loads may be exceeded at high landing weights due to strut oscillations. If the derotation is input too slowly or at the wrong rate, nose gear limit loads may be exceeded.

Derotation must be commenced at the proper speed and the pitch rate maintained throughout the maneuver. Attempts to significantly slow or stop the pitchdown rate can cause a dangerous PIO. The beep trim switch ramps up to a commanded 1.5 deg/sec rate and gives a smooth derotation.

## Rollout

Two phases of rollout are coast and braking. Rollout margin and brake energy limits are defined to ensure the orbiter can stop prior to the end of the runway. Generally, high-energy rollout margin is considered to be 2000 ft and is measured either from the end of the runway or the end of the usable overrun. Brake energy is limited to 42 M ft-lb for end of mission landings. If predicted brake energy exceeds these values, runway redesignation will be considered.

Shorter abort site runways will have a barrier to protect against brake failures. Note that crosswinds directly increase resulting brake energy when differential braking is used for lateral control during rollout.

Short field speed brake may be selected on SPEC 50 to achieve required rollout margin or brake energy limits. This software logic adjusts the speed brake retract function to target a touchdown velocity 10 KEAS slower at 2500 ft past the threshold for all weights.

### Coast

Coast phase begins when the weight on nose gear (WONG) signal is set. Elevons are moved automatically from the position required to control derotation to 10° down in order to reduce loads on the main landing gear. The crew should monitor auto load relief on the SPI. If it does not occur, manual load relief should be initiated.

#### WARNING

Failure to perform load relief can cause unacceptably high loads on the main gear, resulting in potential tire failures and loss of control.

Deceleration on the runway during coast is about the same 4 KEAS per sec as on the IGS.

### Nose Wheel Steering

HUD rollout discrete and groundspeed enable are nominally set at nose gear touchdown. Nose wheel steering (NWS) is available once ground speed enable is set. Steering may be accomplished with differential braking, rudder inputs (above 100 KGS), or NWS. Two modes of NWS are available:

1. NWS 1(2): Rudder pedal deflections incorporated as biases to  $N_y$  feedback.
2. OFF: No steering commands; nose wheels caster.

### Braking

The start of braking is normally determined by groundspeed, although distance remaining on the runway is also considered. Braking begins when groundspeed is less than 140 KGS and the orbiter has passed the midfield point, or if distance remaining is less than 5000 ft. Deceleration rate of 8 to 10  $\text{fps}^2$  should be maintained until below 40 KGS where the rate is decreased to about 6  $\text{fps}^2$ . Maximum braking is applied if distance remaining is less than 5000 ft at more than 140 KGS.

### Barrier

The barrier system is similar to systems used aboard aircraft carriers to recover damaged airplanes. It consists of a net, positioning system, and energy absorbers. The net is made of vertical nylon straps that are bundled together at the top and bottom. The orbiter nose passes through the vertical straps, which then catch on the wings, pulling the net down from the positioning stanchions. The straps spread out uniformly over the wings and provide a distributed retarding load.

On each side of the runway, two spools of nylon tape are attached to the side of the net. As the orbiter pulls the net, the spools unwind, paying out tape. The spools are mounted on water turbines that convert kinetic energy into heat. The system is capable of stopping a 260,000 lb orbiter that engages the net at 100 KGS.

Barriers are placed about 800 ft from the end of the runway overruns on short abort runways (less than 12,000 ft).

Some damage will occur to gear doors, probes, and tiles during barrier engagement. The crew module and fluid systems will remain intact.

Barrier systems are portable and can be transported via C-130 aircraft and stored at landing sites. Setup time is about 6 hours, using an eight-person crew. The stanchions can be raised or lowered in about 10 sec.

To engage the barrier, try to be as slow as possible and as close to the runway centerline as possible. Nose wheel steering or differential braking may be required to keep the vehicle on the runway.

### Techniques

NWS should be used for directional control and brakes used for stopping unless differential braking is required. NWS operations in NWS 1(2) are crisp and responsive with no tendency to overshoot or overcontrol.

The *NOSE WHEEL STEERING* switch on panel L2 has an extension device mounted on the shaft to make it easier to locate.

If NWS 1 fails during fallout, NWS 2 may be susceptible to the same failure and inoperative. NWS 2 may still be selected in extreme cases such as runway departure.

With NWS in *NWS 1(2)*, the orbiter will tend to turn into a crosswind during rollout. With NWS in *caster (OFF)*, the orbiter will tend to turn away from a crosswind.

If a tire failure occurs during rollout, the orbiter will turn toward the failed tire. When the turning moments due to crosswind and tire failure are in the same direction, large control inputs will be required to maintain runway centerline. When the turning moments are in opposite directions, smaller control inputs will be required, and pilots must be careful not to overcontrol.

Rollout performance is best demonstrated in the vertical motion simulator (VMS) at NASA Ames Research Center. NWS and tire failures are

realistically modeled, allowing crewmembers to experience actual orbiter dynamics while making corrections. Crew coordination and skills are practiced in the Shuttle Mission Simulator (SMS). Crewmembers should ensure that different rolling friction coefficients and wind conditions are seen, as well as appropriate system failures that disable or downgrade the NWS system.

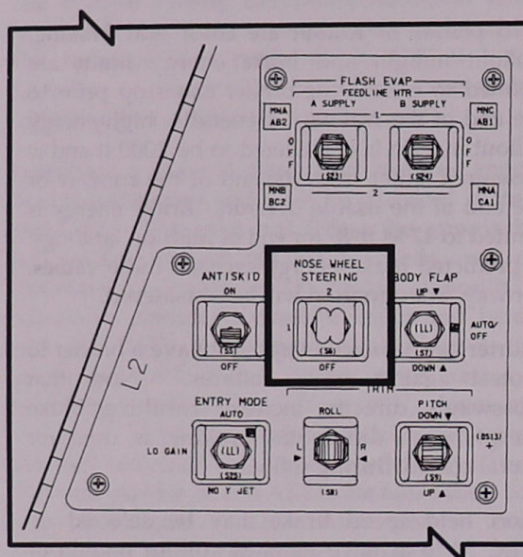

NOSE WHEEL STEERING  
Switch on Panel L2

### Handling Qualities

The space shuttle DAP is a rate command system. When the RHC is moved from detent, aerosurfaces are deflected to command a bank or pitch rate. Due to control requirements during high speed flight, the aerosurfaces are very large and can generate large rates, even with a heavyweight vehicle. Smooth control inputs will minimize transients and the initial tendency to overcontrol.

Control harmony is excellent in all axes, with crisp response and essentially deadbeat damping. Returning the RHC to detent reduces vehicle rates to zero (plus or minus rate deadbands). Control surfaces remain active and will attempt to maintain attitude.

The shuttle training aircraft (STA) is an extremely accurate simulator of orbiter flying qualities below 35,000 ft altitude. Training for

high and low energy cases in the STA will prepare crewmembers to handle the actual vehicle from about the 180° point on the HAC. The STA also has the capability to demonstrate navigation state errors up to 6500 ft short, 2000 ft long, and 1,200 ft laterally from the desired touchdown point.

### Elevons

During subsonic flight, all four elevons are commanded up and down simultaneously for pitch control. For roll control, the elevons are commanded differentially, similar to ailerons on a conventional aircraft.

### Body Flap

The body flap is used to trim the elevons during entry and TAEM. When guidance transitions to the A/L phase, the body flap is commanded to trail. Normally, the body flap is operated in AUTO. If the body flap is not in AUTO, the crew should return to AUTO or manually position the body flap to trail at A/L transition.

### CAUTION

The body flap is a large control surface and exerts a powerful pitching moment on the vehicle. Proper positioning is required to ensure adequate control margins.

### Speed Brake

Although energy is controlled primarily by bank angle and the resulting drag in hypersonic and supersonic flight, the speed brake is the primary energy control device in subsonic flight. A/L guidance modulates the speed brake to control airspeed, when operated in AUTO. Speed brake position is constrained to a lower limit of 15° to prevent physical binding of mechanical linkages when the rudder is deflected. Postlanding, the minimum speed brake retract angle is 25 percent, denoted by a fixed marker on the SPI.

It is important to take manual control of the speed brake if guidance or NAV is questionable. For example, erroneous air data could cause flight control to generate erroneous position commands, resulting in high or low energy or a flight control transient at a critical moment. At

3000 ft AGL, the speed brake is closed automatically to a computed value based on wind, weight, density altitude, velocity error, aim point, and short field option. At 500 ft AGL, guidance can command a final adjustment of the speed brake position based on density altitude and wind velocity.

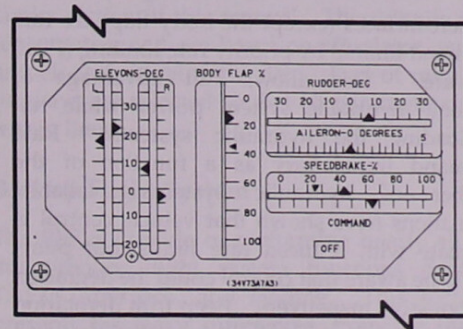

Surface Position Indicator on Panel F7

The speed brake is normally operated in AUTO throughout approach and landing. Speed brake position and command are displayed on the SPI and the HUD.

### WARNING

The speed brake is a very powerful drag device. Overlooking a stuck speed brake or neglecting to retract the speed brake when operating in MAN can result in dangerously low energy.

### Rudder

Corrected body roll rate is used in the DAP yaw channel as a yawing rate error to generate rudder commands. This essentially provides turn coordination. Rudder pedal deflection serves only to bias the  $N_y$  feedback. Since rudder deflection is largely a function of the automatic stability loops, crewmember rudder pedal input should not be required prior to touchdown.

### Trim

Automatic trim loops in the shuttle flight control system work very well, and although manual capability is available, it is not usually required in the approach and landing flight phase. One

exception is after a BFS engage. In this case, the trim values initialize at zero, and the pilot can help the flight control system return to a trimmed condition more quickly by trimming manually.

### Priority Rate Limiting

All aerosurfaces (except the body flap) are rate command limited by priority rate limiting (PRL) software. This allows full advantage of available hydraulic system power while not overloading the hydraulic systems. Rate command limits vary as a function of the number of hydraulic systems available. Simulations have shown that vehicle control is adequate with reduced rate limits, but pilots should be aware that control could be degraded in aggressive maneuvers. Beep trim derotation will be used to prevent elevon saturation and high nose gear slapdown loads.

HYD SYSTEMS	ELEVONS	AILERONS	SPEED BRAKE	RUDDER
1	13.9	13.9	3.8	7.0
2	20.0	20.0	6.86 (closing)	12.0
3	20.0	20.0	6.1 (opening)	14.0

### PRL Rate Limits in Degrees per Second

Automatic PRL normally requires little crew interaction. Hydraulic pressure from all three sensors in each system is sent to the GPCs via flight aft (FA) multiplexer/demultiplexers (MDMs). A hydraulic subsystem operating program (HYD SOP) provides redundancy management (RM) for fault detection and isolation of failed transducers. A selection filter generates one pressure from each system.

HYD SOP declares a hydraulic system failed if the selected system pressure drops below 1760 psi. Fail flags are provided to PRL software, which then rate-limits aerosurface commands based on number of good systems. PRL status and management are on SPEC 51.

Utilizing item numbers, the crew can place PRL in automatic systems management, deselect a system, or invoke manual systems management. A failed system is indicated by a down arrow in the system status column. Failed systems are not used by PRL. Loss of hydraulic

pressure information can cause a PRL dilemma and a question mark (?) is displayed next to the affected system. When a dilemma is declared, PRL leaves the system status as it was prior to the dilemma. The crew can then either manually deselect or reselect the system after determining its real status using other cues.

3051/051/		VERRIDE	2 008/04:13:37	
			000/00:29:56	
ABORT MODE	ENTRY FCS			
TAL 1	ELEVON	FILTER	ATMOSPHERE	
ATO 2	AUTO 17*	NOM 20*	NOM 22*	
ABORT 3	FIXED 18	ALT 21	N POLE 23	
MAX THROT 4	SSME REPOS 19	ENA	S POLE 24	
PRPLT DUMP		IMU STAT	ATT DES	PRL
		1	3 25	SYS AUT DES
		2	26	1 28* 31
		3	27	2 29* 32
INH ICNCT 5		3 30* 33		
OMS DIMP		ADTA	H	α M DES
ARM 6		L 1	20466	+ 7.0 0.58 34
START 7		3	20466	+ 7.0 0.58 35
STOP 8		R 2	20892	+ 6.9 0.58 36
9 QUAN/SIDE 78		4	20892	+ 6.9 0.58 37
OMS DUMP TTG 520		ET SEP	ROLL MODE AUTO	
		AUTO	38	AUTO SEL 42
AFT RCS 13 INH		SEP	39	WRAP MODE 45
14 TIME -0		ET UMB DR	VENT DOOR CNTL	
		CLOSE	40	OPEN 43*
FWD RCS 15 INH		RCS RM MANF	CLOSE 44	
16 TIME -0		CL OVRD 41		

PRL STAT/MGMT ON OVERRIDE  
SPEC 51 Display

### Wind Effects on Trajectory

Winds affect the orbiter's capability to fly the desired HAC trajectory and can result in high or low energy situations if not handled correctly. Since the onboard navigation and guidance systems cannot predict winds, the crew must be prepared to anticipate high wind conditions and compensate for them. Information on wind speed and direction is passed to the crew prior to the deorbit burn. This information is updated as required during entry. Data are provided for the following altitudes:

ALTITUDE	HAC POSITION
50K	
38K	270
28K	180
20K	90
12K	FINAL
7K	
3K	
SURF	

Wind Data Table

The current speedbrake energy-control logic in TAEM guidance compensates for wind conditions prior to and on the HAC to maintain a nominal energy profile. Manual flying techniques should not be required to counter wind conditions. Normal piloting techniques, flying the guidance needles, should be sufficient.

Wind data is obtained by the Flight Dynamics Officer (FDO) in the MCC from the NASA meteorologists. Wind data is forecast based on balloon data and later compared to winds observed by the STA weather aircraft. Since the wind conditions that can cause low energy have much more serious consequences, they are discussed in more detail here.

#### *Constant Headwind*

For a given reference airspeed, any headwind greater than zero will result in less kinetic energy (less ground speed) than the no wind or tailwind case.

#### *Sudden Headwind Increase*

For a given initial energy state, a headwind shear will cause more drag and greater energy loss, until the pilot compensates for the immediate drag increase.

#### *Tailwind Below 50 Feet*

Tailwinds, or reduction in headwinds, are normally favorable in a glider because of the reduction of drag. However, at less than about 50 ft, the beneficial effects of drag reduction, integrated over such a short period of time, are outweighed by the sudden loss of available energy caused by the instantaneous decrease in KEAS. Large sink rates and hard landings may result.

#### **Crosswinds**

Use crab angle to control lateral drift due to crosswind from outer glideslope intercept until touchdown. Expect a noticeable change in crab angle during preflare and on the inner glideslope due to the large changes in velocity and the change in wind speed as altitude decreases.

Post touchdown, align the fuselage with the runway to reduce nose gear side loads at nose gear touchdown. During rollout, the orbiter will

tend to turn into a crosswind with NWS in NWS 1(2). With NWS inactive, the orbiter will tend to turn away from a crosswind.

#### **Limits**

Headwind, tailwind, and crosswind limits are listed in the Flight Rules and summarized in the Limits section of this manual. These limits are conservative and are based on simulator, wind tunnel, and actual flight data. End of mission runways are selected so that all parameters are within limits.

#### **Backup Flight System**

The BFS is capable of performing nearly all of the primary flight system functions during TAEM, approach, and landing. This section presents the major differences, from the flight crew viewpoint, between the two systems. Differences in handling qualities between the PASS and the BFS are very small in the training simulators, and no large differences are expected if BFS is engaged onboard the orbiter. A moderate control transient should be expected when BFS is engaged.

The BFS does not support PTIs. Flight control mode is CSS from engage through landing rollout.

The BFS maintains only one state vector during entry. Redundancy management is performed on most systems, but in a simpler manner than PASS. BFS is also set up to accept air data to GNC immediately upon engage. If air data has not been previously accepted in PFS, the crew should inhibit air data to GNC after BFS engage.

The HUD is not supported in BFS. MLS is not supported. Guidance terminates in BFS at 2000 ft, ADI error needles are stowed, and the speed brake is commanded closed at 2000 ft. On a BFS landing, the crew must remember at 3000 ft to set the speed brake to the DEL PAD setting.

#### **Off-Nominal Approaches**

This section briefly summarizes the procedures used to correct problems typically encountered during STA training. More detailed information is available in the Approach and Landing Flight Procedures Handbook.



### Navigation Errors

A bad navigation state can put the orbiter in a high or low energy condition. If the error is detected early in entry or TAEM, Mission Control will declare a GCA and provide guidance to the landing site until the navigation state can be corrected with a state vector uplink or manual state vector update. If errors are observed after the field is in sight, pilots can use visual cues in addition to MCC calls to fly to the runway.

### Stuck Speed Brake

Procedures for stuck speed brake approaches vary with speed brake setting and are summarized in the following table. These procedures depend on detection of the stuck speed brake prior to the HAC, where energy can be adjusted more easily without using the speed brake.

SB Setting (Stuck)	TAEM	All/	Aim Point
>60	FLY 1-2 dots high throughout TAEM	< 220 K: 25° GS > 220 K: 21° GS	* 4000 ft
40 - 60	AUTO P, R/Y	Fly needles	CLSE
30 - 40	Fly 1 - 2 dots low Mtn EAS < 300	15° GS	CLSE
< 30	AUTO P, R/Y At M < .95 deploy gear	Fly needles	CLSE

\* Aim 1/2 way between 7500 aim point and threshold.

### Stuck Speed Brake Procedures

#### Early Gear Deploy

If the gear is deployed early (on the HAC), pilots should manually close the speed brake and select the close-in aim point. The EAS should be monitored, and if it exceeds 300 knots, return the speed brake to AUTO to protect the 312-knot gear limit. Monitor vehicle conditions and reclose the speed brake, if required. At 3000-ft altitude, manually close the speed brake. In general, if the auto speed brake retract command is less than 30 percent, expect to land short/slow. If the auto retract command is greater than 40 percent, expect to land long.

#### Sensory Cues

Most crewmembers report a fairly smooth ride throughout TAEM to landing, with the exception of some buffet during the transonic region. On final, the orbiter responds very little

to turbulence in comparison to the STA due to the orbiter's higher wing loading.

When returning from orbit, crewmembers should be aware of the potential for some change in vestibular sensations. Head movements will tend to make these changes more noticeable. Flight crewmembers should avoid exaggerated head movements during landing to reduce the possibility of disorientation.

Sun glare and residue on the windows from the SRB separation motors can reduce visibility during landing, especially at low Sun angles.

Gear deploy causes very little structural vibration and may be difficult to detect.

The orbiter landing gear absorbs touchdown loads very well, and for low sink rate landings, it may be difficult to feel touchdown. The first cue to the mission specialists that the orbiter has landed may be the beginning of derotation followed by nose gear touchdown. For some flights, depending on runway surface, vehicle weight, and center of gravity, derotation and nose gear touchdown could be quite dramatic.

After returning from orbit, crewmembers need to be aware that some degree of decreased balance and coordination, as well as dizziness, may be experienced when getting out of their seats. Studies are in progress to quantify these effects and improve current countermeasures. At present, crewmembers should exercise caution when leaving their seats and preparing for egress.

#### Autoland

Although the orbiter has been certified for hands-off automatic landings, this capability has not been verified. Simulations indicate that performance is acceptable under reasonable wind conditions for most weight and c.g. combinations.

Although the orbiter may be flown in AUTO for the entire approach and landing, CSS control until MLS acquisition is recommended. This is due to possible transients as the NAV state is updated by MLS data. A runway equipped with MLS is required for autoland.

Based on SMS and STA data, the autoland system tightly controls azimuth and elevation tracking during the approach. Corrections may be abrupt if not close to the nominal trajectory when AUTO is selected.

As with any automatic control system, the crew's task is to monitor the approach and take over manually if performance is not acceptable or to recover from system failures. Since there is no onboard independent monitor, the crew's visual perception of the approach determines takeover criteria. This may differ somewhat among crewmembers and requires a significant number of automatic approaches in the SMS and STA to achieve a reasonable level of proficiency. Both the HUD and ADI should be monitored during the approach. Splitting crewmember duties between the pilots has proven to be an effective method of monitoring autoland performance.

#### CAUTION

Pilots must use extreme care when executing a manual takeover from automatic flight control after commencement of pre-flare. Very little time exists before touchdown to damp vehicle attitude transients which may be induced by the takeover.

#### Techniques

After OGS intercept, MLS acquisition, and A/L transition, engage *AUTO PITCH* and *ROLL/YAW*. Attempt to have ADI error needles centered or tracking toward the center position prior to engagement. Should a takeover be required, the *CSS PITCH* and *ROLL/YAW* pushbuttons should be used to downmode. This avoids undesirable transients caused by a "hot-stick" downmode. Takeover should be performed only during stable flight conditions, if possible. A manual takeover on the OGS or IGS is much less demanding than during a dynamic phase of the approach such as preflare.

With good autoland performance, the crew should only be required to lower the gear at 300 ft and apply brakes after nose wheel touchdown. Rollout guidance is provided by the MLS and lateral control by the NWS.

RWY	MLS	PAPI 7500 FT (NOMINAL)	PAPI 6500 FT (CLOSE-IN)	MARKING		BALL BAR	TACAN (PRIMARY)	TACAN (BACKUP)	REMARKS
				7500 FT ■	6500 FT ▲				
EDW 17L	√ JR CH 6	√	√	√	√	√	EDW 111 (SS)	PMD 92 (SS)	
EDW 23L	—	•	•	√	√	•			Threshold & TD MK
EDW 35R	—	•	•	√	√	•			Threshold & TD MK
EDW 05R	—	—	—	—	√	•			Threshold & TD MK
EDW 15	√ JR CH 6	√	√	√	√	√			Threshold & TD MK XENON
EDW 33	—	•	√	√	√	√			Threshold & TD MK
EDW 22	√ SR CH 8	√	√	√	√	√			XENON **
EDW 04	—	√	√	√	√	√			Underrun unusable/ displaced threshold XENON **
EDW 18L	—	•	•	√	√	•			Threshold & TD MK XENON **
KSC 15	√ SR CH 8	√	√	—	(1)	√	TTS 59Y (DS)	COF 97 (DS)	XENON
KSC 33	√ SR CH 6	√	√	—	(1)	√	SNG 121Y (SS)	HMN 92 (SS)	XENON
NOR 17	√ JR CH 6	√	√	√	√(1)	√			XENON
NOR 23	—	√	√	√	√	√			
NOR 35	—	√	—	√	√	√			
NOR 05	—	—	—	√	√	—			
BEN 36	√ SR CH 6	√	√	√	√ (1)	√	BEN 118 (DS)	CBA 116 (DME)	XENON
BEN 18	—	√	√	√	√(1)	√			
MRN 20	√ SR CH 6	√	√	—	(1)	√	MRN 100 (SS)	AOG 23 (DS)	Barrier 800 ft from end of overrun, XENON **
ZZA 30	√ SR CH 6	√	√	—	(1)	√	ZZA 64 (DS)	MLA 58 (DME)	Barrier 800 ft from end of overrun, XENON **
BYD 32	√ 2JRS CH 6	√	√	—	(1)	√	BYD 121Y (DS)	BJ 76 (DME)	Barrier 800 ft from end of overrun, XENON **
HNL 08R	√ JR CH 6	—	—	—	(1)	√	HNL 95	CKH 86	Barrier 800 ft from end of Rwy, XENON **
GUA 06L	√ JR CH6	—	√	—	(1)	√	UAM 54	UNZ 100	Barrier 800 ft from end of overrun, XENON **

**NOTE**

THIS CHART REFLECTS CAPABILITIES AND CONFIGURATIONS WHICH ARE DEPENDENT ON MISSION CHARACTERISTICS; i.e., INCLINATION, AND DAY VS NIGHT RTLS, TAL, AOA CASES. \* SURVEYED POINTS WHERE PAPI LIGHTS/BALL BAR CAN BE INSTALLED. (1) AIM POINT IDENTIFICATION LIGHT SYSTEM (APILS) AVAILABLE. \*\* XENON lights can be installed at these locations for mission requirements. AIM POINT MARKING @ 6500 FT IS A TRIANGLE, 7500 FT MARKING IS A RECTANGLE. (2) SINGLE GENERATOR ONLY. (DS) REFERS TO DUAL STRING TACAN TRANSPONDERS, (SS) IS A SINGLE STRING UNIT.

### Nav aids/Landing Aids Hi/Low Inclination

### Terminal Area Energy Management and Approach, Landing, and Rollout Rules of Thumb

- A 100 ft difference in gear deploy altitude equals about 250 ft of touchdown energy. Gear deploy should not be delayed past 200 feet altitude.
- 90 ft of touchdown distance corresponds to 1 knot of airspeed.
- TAEM guidance uses pitch to control glideslope, bank angle to control ground track, and speed brake to control energy above about 14,000 ft and airspeed below this altitude.
- Overhead HAC with NEP allows the most downmode options for energy.
- Fly theta limits at Mach 2 (NLT Mach 1.5) if air data is not incorporated to G&C. Maximum bank angle is 50°.
- For an early gear deploy, immediately close the speed brake.
- OGS is 20° lightweight (< 220,000 lb) and 18° heavyweight (> 220,000 lb). Aim point is 7500 ft nominal and 6500 close in. Touchdown speed is 205 knots heavyweight and 195 knots lightweight. When short field speed brake is selected, touch down 10 knots slower than nominal.
- Deploy the drag chute just before starting the derotation. Start the derotation at 185 KEAS using beep trim. At nose gear touchdown, manually back up WOW/WONG by taking the SRB SEP switch to MAN and pushing the pushbutton.
- During training, pilots should strive for a threshold crossing height of 20 - 30 feet on nominal approaches. Touchdown goals are airspeed within +5/-15 knots of the target value, sink rate within structural limits, negligible lateral drift, and minimal RHC activity. A good target value for sink rate is 3 fps or less, ensuring ample margin before violating limits.
- With NWS in *NWS 1(2)*, the orbiter will tend to turn into a crosswind. With NWS *OFF*, the orbiter will tend to turn away from a crosswind.
- If the orbiter is landing with a known failed tire, the second tire on that axle is expected to fail during derotation at the point of maximum loading.
- If both main gear tires fail on one side, the orbiter will tend to turn toward that side. The turning moment due to crosswind can either reinforce or reduce this effect.
- If the turning moments due to tire failure and crosswind are in the same directions, large control inputs will probably be required.
- If the turning moments due to tire failure and crosswind are in opposite directions, the control inputs required to counteract tire failure will be reduced. In this situation, pilots must be careful not to overcontrol. A good rule of thumb is to be more cautious with the rudder pedal, matching the crosswind turning tendency.
- Flight Rules call for landing with an existing crosswind on the same side as a known or expected bad tire.

**8. INTEGRATED OPERATIONS**

CONTENTS	
8.1	FLIGHT CREW DUTIES AND COORDINATION ..... 8.1-1
8.2	WORKING WITH MISSION CONTROL ..... 8.2-1
8.3	PRELAUNCH ..... 8.3-1
8.4	LAUNCH..... 8.4-1
8.5	ASCENT..... 8.5-1
8.6	ORBIT..... 8.6-1
8.7	ENTRY ..... 8.7-1
8.8	POSTLANDING ..... 8.8-1

The most successful teams are those that have learned to work together and know each other's responsibilities, strengths, and weaknesses. In a system as complex as the space shuttle, the Mission Control Center (MCC), the Launch Control Center (LCC), and the flight crew must work as an integrated team with each part supporting and contributing to the performance of the other.

Each team member must be completely aware of his or her responsibilities and realize that safety and mission success depend on proper

coordination among team members. The duties and coordination functions discussed in this section are typical of the responsibilities assigned by the CDR and the Flight and Launch Directors. Specific assignments will vary from mission to mission.

Preplanned decisions that have been approved by the Space Shuttle Program are published in the Flight Rules and Launch Commit Criteria. These are designed to minimize the amount of real-time discussions when off-nominal situations occur. The Flight Rules also serve as the basis for real-time decisions. Rules are developed using system performance capabilities documented in the Shuttle Operational Data Book (SODB), along with program certified capability. Where circumstances do not allow staying within the operating base (SODB + certified capability), the Mission Management Team may choose to take any necessary action to ensure the safety of the crew and shuttle.

During prelaunch and flight operations, the Mission Management Team (MMT) chairman is responsible for near real-time policy decision. The launch team and the flight teams consult with the MMT chairman as soon as possible whenever operations outside the shuttle operating base are required.

## 8.1 FLIGHT CREW DUTIES AND COORDINATION

CONTENTS	
Dynamic Flight Phases .....	8.1-1
Orbit Phase .....	8.1-1
Intercom Protocol .....	8.1-2

### Dynamic Flight Phases

For a shuttle flight crew to work well together, each crewmember needs to have his or her job clearly defined. This definition includes the tasks assigned and when they are to be performed. Individual responsibilities will be assigned by the mission commander based on mission requirements. One way in which duties might be divided for dynamic flight phases is summarized in the following table.

POSITION	PRIMARY	SECONDARY
CDR	Trajectory/Nav Abort Boundaries * DPS ECLSS Nominal Timeline Nav aids ** Mission Success Mission Safety Voice Transmissions to MCC	Communications Flight Control Channels OMS RCS Contingency Abort Boundaries *
PLT	MPS EPS APU/HYD OMS RCS Flight Control Channels	Trajectory/Nav Nav aids ** Mission Success Mission Safety Voice Transmissions to MCC
MS2	Overhead Panels Overhead Gauges Communications	Abort Boundaries * Nav aids ** Nominal Timeline Reference Data
MS1	Contingency Abort Boundaries ** Photography Reference Data	Nominal Timeline Overhead Panels Overhead Gauges
MS3	Stowage Middeck Panels/Actions	Photography

\* Ascent only

\*\* Entry only

### Flight Crew Duties for Dynamic Flight Phases

It is critical for the crew to lay out responsibilities early during training and follow their plan. As malfunctions occur, the division of responsibilities may change. For example, the PLT may have to concentrate on the trajectory

while the CDR deals with an ECLSS malfunction. To ensure the trajectory is being monitored, especially during the early portion of crew training, the CDR could verbally ask the pilot to watch the gauges. As training progresses, crews gain an understanding of when another crewmember requires assistance and usually provide backup without being asked.

Another way crews work together is to monitor keyboard entries and switch throws. By allowing someone else to check a keyboard entry before it is fed to the GPCs or check that the correct switch is being actuated before it is moved, crewmembers can greatly reduce the chance of errors. For crewmembers to provide a good crosscheck for each others' activities, they must remain together as they work nominal and malfunction procedures. Calling out page numbers, procedural titles, and step numbers will help everyone follow through the procedures.

During dynamic flight phases, or any time when dealing with several malfunctions, it may be best to divide into groups or detail individuals to separate tasks to successfully deal with all problems in a timely manner. The CDR usually takes the lead in assigning tasks. As the proficiency of crews increases, crewmembers often assume responsibility without being formally assigned by the CDR. Whenever groups/individuals begin working separate problems, they should attempt to periodically update the other members of the crew on their progress. This is especially critical when the problems being worked are interrelated. The CDR and PLT must exercise care to ensure that at least one member of the crew monitors the vehicle trajectory and maintains awareness of the nominal timeline when their attention is drawn to different problems.

### Orbit Phase

On orbit tasks are usually less time critical and responsibilities are redistributed as necessary. It is important that more than one crewmember is trained for each flight task to protect for the occasion when the prime crewmember might be ill or busy with another task. Mission specialists usually assume the prime responsibility for major payload activities. For Spacelab flights, the senior mission specialist will be assigned as the Payload Commander and charged with

successful payload operations. The following table lists a sample division of duties for the orbit phase.

POSITION	CDR	PLT	MS1	PS2	MS2	MS3	PS2
EVA					X		
EVA 2						X	
IVA		X					
MEDIC	2				1		
IFM		1			2		
EARTH OBS		2			1		
PHOTO/TV		2			1		
Prime Payload	2	1					
Secondary Payloads			X	X			
DTO XXX	1					2	
DSO XXX						1	2

1 Prime

2 Backup

### On-Orbit Division of Responsibilities

### Intercom Protocol

During ascent or entry most crews have a standard protocol of voice callouts to help them keep track of mission events. Typical callouts and associated displays for ascent and entry are listed in the following tables.

MET	EVENT	CALLOUT
00:00	SRB Ignition	DCR: Lift-off/102
00:30	Throttle Bucket	PLT: Throttle down
01:00	Throttle Up	PLT: Three at 104
02:12	SRB Sep	DCR: Pc < 50, Sep, 103, TMECOs converged
03:00		MS2: EVAP OUT 1 coming down
08:00	MECO -30 sec	DCR: Coming up on MECO
08:32	MECO	DCR: MECO, MECO confirm, ET sep, 104, check targets
10:32	MECO +2.00	PLT Dump/start

### Ascent Displays and Callouts

EVENT	CREWMEMBER	CALL
MLS to state vector	MS	MLS
A/L	MS	Approach & land, BF trail
-5 K ft	PLT	Radar altimeter, 1 & 2 check good
4K ft	PLT	4,000
3K ft	PLT	3000
	MS	Boards ___%
2K ft	PLT	2,000, Preflare next
	DCR	Preflare, arm the gear
	PLT	Gear is armed
1K ft	PLT	1,000 ft ___kts(PLT call max EAS in preflare)
500 ft	PLT	500
400 ft	PLT	400
300 ft	DCR	Gear down
	PLT	Gear coming
	MS	Boards ___%, gear is down
300		
200		
100		
70		
50	PLT	___ft, ___ knots (steady rhythm)
40		
30		
20		
10		
5		
TD	PLT	Touchdown
	DCR	Drag chute (if abort landing or high energy.)
WOWLON	PLT	WOWLON (Call WOWLON when it occurs, HUD format changes.)
185kts (Lakebed)	PLT	185/175 Derotate (Even without WOWLON)
175KTS (Concrete)		
Drag chute deploy	DCR	Drag chute
Derotation	PLT	Pitch rate ___ (Report at a regular cadence during derotation. Target 1"-2" per sec concrete on 2"-3" per sec lakebed).
Nosegear TD	PLT	WOW set (Manual by depressing ET SEP or SRB SEP PB)
	MS	Load relief (or no load relief)
		NWS Fail - (if NWS light is on)
Midfield	PLT	Midfield
5K ft remaining	PLT	5,000 ft remaining
140		
130		
120		
110		
100	PLT	___ft, ___ (Decel reading) (Target 6-8 ft/sec <sup>2</sup> )
90		
80		
70		
60		
50		
60 kts (±20)	DCR	Jettison (drag chute)
40 kts	PLT	40 kts, ease off
Wheels Stopped	DCR	Wheels Stopped

### Landing Comm Protocol

**8.2 WORKING WITH MISSION CONTROL**

<b>CONTENTS</b>	
MCC Resources.....	8.2-1
Operations Monitoring and Control .....	8.2-1
Air-to-Ground Voice Communications.....	8.2-2
Telemetry Uplink .....	8.2-3

To work well together, the flight crew and MCC must be aware of each other's capabilities. Integrated simulations, where members practice their roles on an actual mission, are one way in which the team members learn about each other. Another way is for members of the flight crew to observe in MCC during integrated simulations and for Flight Controllers to ride along and observe flight crews operating in the Shuttle Mission Simulator (SMS).

**MCC Resources**

While visiting MCC, crewmembers will notice that an immense amount of downlist data is available for Flight Controllers to analyze the performance of orbiter systems and follow mission activities. The downlist data is formatted on various displays with orbiter DPS keyboard entries, fault messages, and switch discrettes available, as well as numerical parameters. Many of the parameters in the downlist data stream are not displayed onboard the orbiter. The flight control team also has access to inputs from the customer, direction from NASA management, weather observations and forecasts, engineering test data and analysis, systems performance histories, and radar tracking data.

To properly utilize this data, personnel are divided into groups concentrating on specific vehicle systems or operational functions, with each group led by a Flight Controller. The Flight Controllers pass information and recommendations over the intercom voice loops to the Flight Director. The Flight Director uses the information to make decisions on the proper conduct of the mission, and manages the flow of information to the crew via the CAPCOM or uplink commands.

**Operations Monitoring and Control**

Optimum MCC performance depends on successful receipt of telemetry and tracking data. Orbiter DPS or instrumentation failures, as well as communications failures, can quickly degrade the amount of assistance available from the ground. If possible, the CAPCOM will inform the crew whenever downlist data is lost or regained.

To track the crew's progress through the nominal timeline, Flight Controllers observe individual crew keyboard entries and switch throws via MCC displays. It is usually possible for the ground to follow the crew's progress without voice calls, but an occasional status call can be helpful. The crew can also help the ground by closely following the nominal timeline and by loading maneuvers with future start times well before they are required.

MCC will try to anticipate points in the timeline where an MCC GO is required for the crew to proceed, and call before the crew reaches that point. If the crew reaches a point where an MCC GO is required before MCC calls, they should ask for a GO.

When malfunctions occur, the controllers in MCC will usually see a trend develop in their data before the crew hears an onboard alarm. Whenever possible, and especially on orbit, MCC will attempt to warn the crew and advise a course of action before a fault message occurs. For failures that occur more rapidly, the crew will see a fault message first and the ground will see the problem a few seconds later in the telemetry data stream. After a few seconds to diagnose the problem, the responsible Flight Controller will advise the Flight Director on the proper course of action. On direction from the Flight Director, the CAPCOM will then relay the necessary information to the crew. Usually this transmission will include instructions to follow a procedure in the FDF, specific switch actions, or information on why a false alarm occurred. CAPCOMs will strive to use the precise FDF procedural titles and the same switch nomenclature listed on orbiter panels to minimize confusion. If the situation permits, the CAPCOM will also try to pass to the crew the rationale for the decisions that have been made, especially those involving resources not available to the crew.



## Air-to-Ground Voice Communications

Flight crews should be aware that the monitoring of crew voice calls is given very high priority in MCC. Whenever the crew calls on air-to-ground, all discussions cease on the Flight Director's loop in order to concentrate on the crew's transmission. Crew calls to inform MCC of fault messages or advise the ground on progress through normal procedures can interrupt information flow in MCC. Advisory calls on progress through nominal procedures should be reserved for periods of reduced communications activity or for when the ground is having problems with downlist data. For confirmation of noncritical system problems, one plan that works well is to wait 15 to 20 seconds after the appearance of a noncritical fault message before calling the ground. This allows the ground time to digest the problem and call the crew, without interruption. Waiting for MCC to make the first call when noncritical fault messages occur should result in the quickest possible problem confirmation.

Of course, flight crew calls can be extremely helpful when MCC is experiencing data problems or when failures occur which require immediate attention. A crew call in these instances will focus MCC's attention on the problem brought up by the crew. Following are some appropriate calls to MCC that are not specifically required by procedure:

### Acknowledging MCC transmissions.

- Reporting deviations from the timeline or from a procedure.
- Beginning/Ending postinsertion, deorbit prep, or major payload activities.
- Beginning/Ending malfunction procedures. (This call is generally not made for critical malfunctions or during periods of high workload.)
- Beginning major DPS reconfigurations or cockpit switch configurations.
- Shutting down a main engine, APU, or fuel cell, or taking electrical buses off line unless previously directed by MCC.

- Reporting engine failure, fire, DPS set splits, or flight control problems. (These problems may not be immediately apparent in downlist data.)
- Reporting any problem the crew desires MCC to give immediate attention.
- Calling MCC prior to MDM port mode/power cycle.
- Changing telemetry formats.
- Switching to alternate ACCU or PCMMU.
- Reporting headset, CCU, or ATU problems.

If practical, flight crews should obtain MCC confirmation of a malfunction before working a malfunction procedure. By the same token, crews should call MCC whenever beginning a malfunction procedure for deviating from the nominal timeline without MCC direction, if the pace of activities and communication status permits. During periods of high activity, MCC will assume that the flight crew is prioritizing problems and automatically working the necessary malfunction procedures as problems arise. In these cases, MCC will save voice confirmation and direction to work malfunction procedures for the most critical problems.

To minimize verbiage and confusion, standard phraseology is frequently used in calls between the orbiter and MCC. Some of these calls are summarized in the table on the next page. Standard abort mode boundary calls are presented in Section 6, Emergency Procedures.

Unplanned downmodes to manual flight control should be discussed with MCC if time and flight control performance permit.

Aborts or redesignation of landing site/runway should only be performed at the direction of MCC if air-to-ground communication is available. If air-to-ground communication is not available, or if mission safety is in question, the CDR assumes ultimate authority for mission decisions. In this case, the crew will use onboard procedures and flight rule summaries to take whatever action is required to safely conclude the mission.

CALL	MEANING
Roger	Your transmission has been received.
Wilco	Will comply with received instructions.
Say again/repeat	Repeat your last transmission.
Read back	Repeat the list of information just transmitted.
Good read-back	The information just repeated was correct.
Stand by	Wait, we will have an answer or be ready to listen shortly.
Stand by on the xx procedure	Wait, we will have a plan of procedure/action soon, do not execute the xx procedure.
Hold...	Stop executing the mentioned procedure at the current step.
You are go for...	You have permission to execute...
The xx system is go	The xx system is working adequately.
Expect ratty comm due to...	Expect degraded communication due to...
...in the blind	We can't hear you, but we're transmitting, hoping that you can hear us.
Lost data	MCC has lost vehicle downlink data, expect reduced MCC troubleshooting assistance.
Regained data	MCC has regained downlist data.
...UHF only	MCC or orbiter transmitting or receiving on UHF only. May also mean loss of orbiter downlink data.
Comm check	Voice communication check, acknowledge and describe quality of transmission.
LOS	Loss of signal/without comm. Sometimes used to mean star/object no longer in view.
AOS	Acquisition of signal/good comm. Sometimes used to mean star/object in view.
Abort...	Execute the ...abort mode. MCC will also uplink an abort light.
Take TACAN	Accept TACAN for use by NAV software.
Take Air Data	Accept Air Data information for use by NAV and GNC software.
Go...CSS	Take pitch and/or roll/yaw CSS as called.
Go...Auto	Return to Auto Pitch and/or Roll/Yaw flight control. For Orbit Ops, select Auto DAP.
Check DAP...	Ensure the DAP mode matches the mode mentioned in call.

### Standard Air-to-Ground Voice Calls

### Telemetry Uplink

In addition to voice communication, MCC has the capability to electronically uplink information to the orbiter. This capability is frequently used to reduce crew workload, uplink large amounts of information, or to uplink information where accuracy is critical. Crews may request that MCC uplink information rather than using a voice transmission if they feel it would be beneficial and if there is sufficient time for the ground to prepare the uplink. In extreme cases, the MCC also has the capability to uplink keyboard entries to the orbiter GPCs in the form of DEU equivalent uplinks. Common uplink information is shown below:

- Communication system configuration commands.
- State vector updates.
- Table maintenance block updates (TMBU) to alter software caution and warning limits.
- IMU compensation.
- OMS burn targets.
- Alternate landing site information.
- TIPS messages for daily execute packages. Contains flight plan and procedural changes, amplifying information, news from home, systems, and consumables status.
- Unscheduled TIPS messages containing information not conveniently passed using voice transmission.

## 8.3 PRELAUNCH

### CONTENTS

Flight Crew .....	8.3-1
Mission Control Center.....	8.3-1
Launch Control Center .....	8.3-1

Prelaunch activities begin at KSC with the start of the launch countdown. For purposes of discussing responsibilities of the flight crew as they relate to the LCC and MCC teams, pre-launch is considered to start upon flight crew arrival at KSC.

### Flight Crew

Crew activities at KSC are outlined in a letter promulgated by the Director of Flight Crew Operations Directorate (FCOD). All activities are coordinated by the FCOD Vehicle Integration Test Office. Each mission has different timelines, and activities vary among pilots, mission specialists, and payload specialists.

The flight crew is subject to Health Stabilization Plan restrictions. These limit direct contact to a small group of individuals who are especially badged as Primary Contacts. Thus, exposure of the crew to communicable diseases with short incubation periods is minimized.

Typical activities for the flight crew at KSC include:

- Shuttle systems briefing
- Countdown status briefing
- STA flights
- Weather briefing
- FDF review
- Preflight physical exam
- Equipment checks
- T-38 flights

Unless mission requirements dictate a different timeline, the crew will arrive at KSC 3 days prior to launch. Circadian shifts are performed during this period, except for flights requiring large shifts and 24-hour operations. Those crews start their circadian shift prior to departing Houston.

Crew activities are conducted per a relaxed timeline until the actual launch day, when the schedule is tightly controlled. Basically, crew

members are responsible for their scheduled events.

### Mission Control Center

The MCC is in a monitor mode during most of the launch countdown. Active participation is required for communication checks, weather coordination, and inputs to the MMT on shuttle systems anomalies.

Flight controllers and MCC support personnel are responsible for their own readiness for flight. This includes console and computer systems configuration and checks. All necessary materials required to support flight operations are positioned. The MCC shift teams usually begin their circadian shift during the countdown.

### Launch Control Center

LCC personnel man consoles around the clock once the launch countdown commences. Each shuttle and ground system is monitored by one or more members of the launch team. The countdown is managed by an Orbiter Test Conductor (OTC) who has responsibility for accomplishment of all steps listed in the countdown Operations and Maintenance Instructions (OMI). Prelaunch OMI's implement checkout requirements designed to demonstrate operation of all testable subsystems within prescribed limits. The launch countdown OMI is performed under strict quality control. Any deviation is documented and must be accounted for, either by repair, replacement, or a waiver from the MMT. In certain areas, launch may be permitted with equipment losses, provided they are well understood to be isolated occurrences and not symptomatic of a generic problem.

LCC responsibilities include the conduct of the countdown OMI under the OTC's direction, systems monitoring, test and checkout, recording any deviations, making recommendations on system problems, and ensuring any violations of the Launch Commit Criteria are brought to the attention of the Launch Director.

The launch team is stationed in one of the firing rooms of the Launch Control Center building at KSC.

## 8.4 LAUNCH

### CONTENTS

Flight Crew.....	8.4-1
Mission Control Center.....	8.4-2
Launch Control Center .....	8.4-2

Shuttle launches are complex interactive tasks, where each member of the LCC, MCC, and flight crew performs an integral part. For purposes of discussing responsibilities of each element, launch activities are considered to start at flight crew ingress into the shuttle.

### Flight Crew

The flight crew enters the orbiter about 2 hours 45 minutes before launch. Prior to ingress, final weather and systems briefings are conducted and the crew dons their launch/entry suits (LESs).

Ingress is accomplished with the assistance of a suit technician and an astronaut support person (ASP). These individuals are part of the closeout crew who perform final shuttle checks on the launch pad.

Upon completion of ingress, activities are governed by the FDF Ascent Checklist, which summarizes crew tasks from the countdown OMI. These activities are presented in Section 5.

Crew responsibilities include responding to LCC and MCC requests per the checklist. Emergency procedures are discussed in Section 6.

As the launch countdown progresses, crewmembers will be asked to configure certain systems and make various keyboard entries. This direction will come from the OTC via air-to-ground loops. The NASA Test Director (NTD) may also communicate with the crew via air-to-ground loops, especially if an off-nominal situation occurs. MCC inputs are voiced to the crew by the CAPCOM, who also utilizes the air-to-ground loops. The crew normally uses air to ground to respond to LCC or MCC calls during the launch count.

The LCC has the capability to transmit to the crew using A/G 1, A/G 2, or A/A loops. Normally, only one loop is used at a time. The MCC transmits simultaneously on all three loops. Occasionally, this causes an echo because of different time delays. The crew should report this phenomenon to MCC because the delays can be adjusted in real time to remove the echo. Normally the LCC OIS 212 loop, which is used for the direction of launch activities, will be patched into the A/G loop for the crew to monitor.

The LCC also has the capability to talk and listen on ICOM 1 and ICOM 2. Transmission on these loops is restricted to a small number of consoles in the Firing Room. If the LCC enables a patch, the entire launch team can receive ICOM conversation. This patch is normally disabled. ICOM is used only as an emergency backup to the A/G and A/A loops. The ICOM loops are routed through the T-0 umbilical. A/G and A/A loops are RF transmissions through the MILA ground station.

Weather aircraft observations may be patched directly into one of the RF loops if necessary. This will allow the shuttle crew to communicate directly with the weather aircraft crew.

Certain other consoles in the LCC have the capability to transmit directly to the crew. These include the Launch Director, Landing Recovery Director, and Shuttle Operations Director.

All voice loops are recorded continuously. This includes both ICOM loops, all three RF loops, and all LCC/MCC channels.

The maximum time the crew will remain in the shuttle in the event of a launch scrub is 5 hours 15 minutes, excluding safing and egress time. This allows 2-1/2 hours of hold time after the earliest planned launch time.

Prior to actuation of any shuttle switches or controls other than those called out in the checklist, the crew should inform the OTC. This will prevent the LCC team from recording an unplanned configuration change that could cause a launch hold. This is particularly important in the final minutes of the countdown.

## Mission Control Center

The MCC Flight Director is responsible for calling a launch "hold" for all problems that jeopardize the ability to safely monitor and recover the shuttle and crew after launch. This includes problems in:

- MCC
- Spacecraft tracking and data network
- Landing area facilities
- Abort landing area weather

In addition, the Flight Director is responsible for overall control of the MCC command uplink capability.

Individual flight controllers are responsible for monitoring their systems and interfacing in real time with their counterparts in the LCC.

## Launch Control Center

The LCC Launch Director is responsible for giving the launch team the final go for launch. A formal poll of all elements is taken by the chairman of the MMT during a planned countdown hold at T-9 minutes. If all elements are go, the Launch Director is given permission to proceed with the launch countdown.

The Launch Director is also responsible for making a decision on weather acceptability at the launch pad for ascent trajectory.

When the countdown clock is restarted at T-9 minutes, all operations are under control of a computer system called the Ground Launch Sequencer (GLS). Shuttle systems are automatically configured and monitored by the GLS.

Preplanned hold points for troubleshooting are available in the final 9 minutes of the countdown. These hold points, called GLS milestones, allow the countdown clock to be restarted without recycling back to some previous time. GLS milestones are shown in the following table.

TIME TO LAUNCH	EVENT
9 min	GLS sequence start
7 min 30 sec	Access arm retract
5 min	APU start
4 min	Purge sequence 4
2 min 55 sec	LOX pressurization
1 min 57 sec	LH2 terminals replenish
31 sec	Go for RSLs auto sequence

If a hold command is issued between T-9 minutes and T-31 seconds, the countdown clock will be restarted upon successful resolution of the problem without a "GO" survey made of all elements. After T-31 seconds, only a cutoff is available. Cutoff will result in a recycle to T-20 minutes. Depending on launch window, another launch attempt may be possible.

At T-31 seconds, the GLS issues a command to the onboard GPC Redundant Set Launch Sequencer (RSLs) software. This command, GO FOR AUTO SEQUENCE START, enables the RSLs to reconfigure certain onboard systems such as the vent doors, start the main engines, and issue the SRB ignition commands. Throughout this period, the GLS continuously monitors various system parameters and will issue an automatic cutoff should the Launch Commit Criteria be violated.

If a cutoff command is issued, the RSLs will automatically shift control back to the GLS. A program is then automatically started, which safes the shuttle systems. If this GLS safing program does not run automatically, then LCC controllers safe the systems manually by issuing appropriate commands.

Throughout the countdown, individual LCC controllers are responsible for monitoring their systems and executing commands per the countdown OMI. Any deviations or anomalies are reported to the OTC.

## 8.5 ASCENT

### CONTENTS

Flight Crew.....	8.5-1
Mission Control Center.....	8.5-1

The ascent flight phase starts at SRB ignition and continues through OMS-2 cutoff. This is one of the most dynamic phases of a shuttle flight.

### Flight Crew

The flight crew is responsible for monitoring vehicle performance and systems and executing procedures on the nominal timeline. Flight crew and MCC coordination is most critical in this phase of flight because of the time-critical nature of most activities. General crew and MCC coordination is discussed in Sections 8.1 and 8.2.

### Mission Control Center

The Flight Director is responsible for overall direction of shuttle flights from SRB ignition until crew egress after landing. The Flight Director, after analysis of the flight condition, may choose to take any necessary real-time action required to ensure the safety of the crew and shuttle.

MCC has the prime responsibility for abort mode determination, since the abort region determinator (ARD) program can assess shuttle abort capabilities in real time. Data from independent ground radar tracking, along with telemetry of the current onboard state, is used in the ARD.

Each flight controller on the MCC team has specific responsibilities, based on discipline. For example, the Booster Officer monitors SRB, SSME, and MPS performance and informs the Flight Director of malfunctions and recommended actions.

Many voice loops are used within the MCC. All controllers have a responsibility to monitor the Flight Director loop and air-to-ground loops, in addition to their own internal and external communication loops. Because the workload can be quite high during off-nominal situations, the crew can help by minimizing air-to-ground calls when possible. Also, allowing time for the MCC to formulate an action, coordinate it among several disciplines, and transmit it back to the crew prior to making additional transmission will aid in MCC/crew teamwork.

**8.6 ORBIT**

**CONTENTS**

Flight Crew.....	8.6-1
Mission Control Center.....	8.6-1

The orbit flight phase starts at OMS-2 cutoff and continues through deorbit burn ignition. Nearly all mission objectives are accomplished during the orbit phase.

**Flight Crew**

The crew is responsible for monitoring vehicle systems and executing the nominal timeline. Operating primary and secondary payloads is the major user of available time. This is the most benign portion of a shuttle mission in that time is usually available to perform in-depth troubleshooting of any malfunctions. Crews and MCC will take advantage of the available time to thoroughly troubleshoot malfunctions. General crew and MCC coordination is discussed in Sections 8.1 and 8.2.

Execution of on-orbit tasks, as called out in the Flight Plan and other FDF documents, is the responsibility of the crew. Some tasks must be accomplished on a very strict timeline. Deployment of a payload or experiment operations fall into this category. Other activities are not time critical. For example, crew exercise can be accomplished on a not-to-interfere basis.

Based on preflight assignments and training, each crewmember will have certain responsibilities. Most crews designate backup crewmembers for critical activities. These backup crewmembers receive nearly all of the training that the prime crewmember receives. This policy provides the necessary redundancy that might be required in the event of unforeseen circumstances, such as an injured crewmember or an unplanned contingency. A typical list of duty assignments is shown in Section 8.1.

**Mission Control Center**

The MCC is responsible for onboard navigation maintenance. Adequate navigation and maneuver definition will be maintained onboard to provide runway landing capability after loss of communication. The Flight Rules specify navigation state requirements.

Individual flight controllers monitor onboard systems and make recommendations to the Flight Director for any changes or reconfiguration. In some cases, uplink commands may be used to perform certain tasks such as antenna management or limit changes (to prevent nuisance alarms).

The Flight Activities Officer and the Payloads Officer are responsible for tracking the Flight Plan and payload activities, respectively. When there is a remote Payload Operations Control Center (POCC), responsibility for the major payload activity (such as Spacelab) resides with the POCC Director. Other payloads, such as middeck experiments, are still controlled by the MCC Payloads Officer. Changes to the Flight Plan, updates to the orbiter attitude and pointing, and replanning are the responsibility of the Flight Activities Officer.

The Integrated Communications Officer (INCO) in the MCC is responsible for operation of the MCC and shuttle command system. Status of the communications link and the command system is included in this responsibility. The INCO is the designated control point and representative of the Flight Director for approval of all types of commands, including those sent to payloads. With the exception of routine communications systems commands and nonhazardous commands, most command uplinks directly affect the systems being used by the flight crew for control of the orbiter or payload. To ensure that the flight crew has current shuttle and payload system status, if communication is lost, MCC has a responsibility to inform the flight crew when command uplinks are transmitted. Typically, several hundred commands are sent during each mission. The majority of these are transparent to the crew and do not require coordination.

## 8.7 ENTRY

### CONTENTS

Flight Crew .....	8.7-1
Mission Control Center .....	8.7-1

The second dynamic phase of a shuttle mission is entry. For purposes of discussing team responsibilities, entry activities are considered to start at deorbit burn ignition and continue through rollout.

### Flight Crew

The crew is responsible for monitoring vehicle trajectory and systems and execution of the nominal timeline. The pace of activities during entry is generally not as severe as that experienced during ascent until the beginning of TAEM. Depending on inclination and altitude, communication with MCC may not be available for the deorbit burn and part of entry. Crews should be mentally prepared to carry out mission activities without MCC assistance during the deorbit burn and early portion of entry.

Crew duty assignments during entry are similar to those for ascent. General crew coordination and working with MCC are discussed in Sections 8.1 and 8.2.

### Mission Control Center

MCC has the prime responsibility for deorbit burn targets. Factors in the selection include shuttle systems status, consumables, c.g. control, weather, and other landing site information. Although the crew has onboard capability to generate deorbit targets in an emergency, the MCC team, with their extensive capability, will normally calculate and uplink planned targets.

Upon completion of the deorbit burn, MCC is responsible for monitoring the entry trajectory and status of the onboard systems. Should a malfunction occur and be confirmed by the MCC, the crew is expected to work the appropriate cue card or pocket checklist procedure with no further direction. Activities outside the published procedures will be requested by the MCC.

If the trajectory diverges and approaches energy limits, the Flight Dynamics Officer will perform a GCA. Procedures are discussed in Section 7.

The communication workload during entry is similar to ascent with numerous loops in use. The crew can help to simplify the process by minimizing air-to-ground calls and allowing time for the MCC to develop a coordinated decision.



## 8.8 POSTLANDING

### CONTENTS

Flight Crew.....	8.8-1
Mission Control Center.....	8.8-1
Launch Control Center.....	8.8-1

Postlanding activities start at completion of rollout and continue through crew egress. The LCC and convoy commander have certain responsibilities during this phase.

### Flight Crew

After wheels stop, crew activities are controlled by the FDF Entry Checklist which summarizes crew procedures from the postlanding OMI. Normal activities include shuttle safing and systems reconfiguration for extended power up. These are described in Section 5, Normal Procedures.

The crew responds to MCC requests for activities outside the normal procedures. For example, certain reconfiguration procedures might be modified because of previous systems failures.

Communication with the convoy commander is established shortly after wheels stop. The convoy commander controls postlanding activities in the vicinity of the shuttle and can pass information about hazardous situations to the flight crew.

### Mission Control Center

The MCC retains responsibility for orbiter systems until crew egress or ground support equipment (GSE) cooling activation, whichever occurs later. At this time the Flight Director hands over control to the Ground Operations Manager (GOM). Should MCC voice and telemetry be lost, or if an emergency crew egress is required, handover to the GOM will be accomplished ASAP.

While the MCC is controlling ground operations, flight controllers are responsible for monitoring their systems and interfacing in real time with their counterparts in the LCC.

### Launch Control Center

Until handover, the LCC monitors the progress of shuttle safing and reconfiguration. LCC data monitoring is available to the GOM if loss of MCC system insight and communications capability occurs. In this case, handover will occur ASAP so that normal postlanding operations can continue. Should LCC monitoring capability be lost, the MCC will continue to support until LCC capability is regained or the shuttle is powered down.

Once handover is complete, the GOM and OTC have responsibility for all shuttle activities. The OTC coordinates completion of postlanding procedures and preparation for turnaround operations.

9. PERFORMANCE

CONTENTS

9.1	ASCENT.....	9.1-1
9.2	ORBIT.....	9.2-1
9.3	ENTRY (OPS 304).....	9.3-1

This section contains information regarding the performance capability of the space shuttle during ascent, orbit, and entry (EI to wheels stop). Some performance related material is

also included. The information presented is accurate but is usually derived from representative 28.5° and 57° missions. It is not intended for mission planning. The information is presented only for the purpose of broadening the crew's fundamental understanding of the vehicle's performance capabilities during each flight phase under the stated conditions. Mission-specific questions or requests for more detailed explanations should be referred to the appropriate Flight Design and Dynamics Division (DM) personnel.

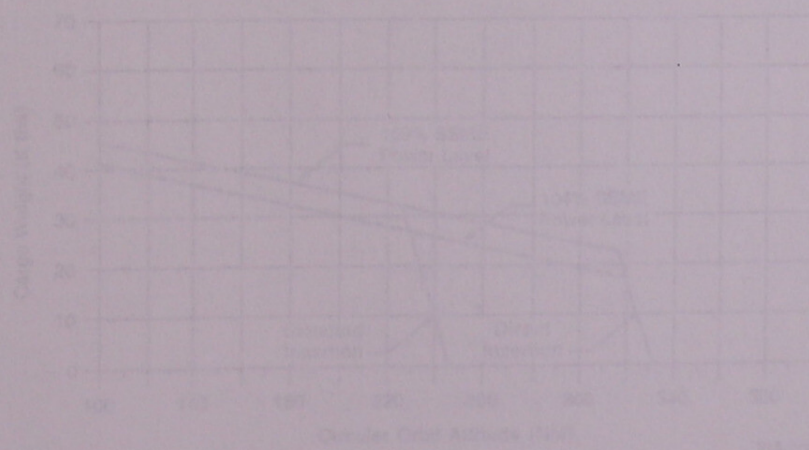
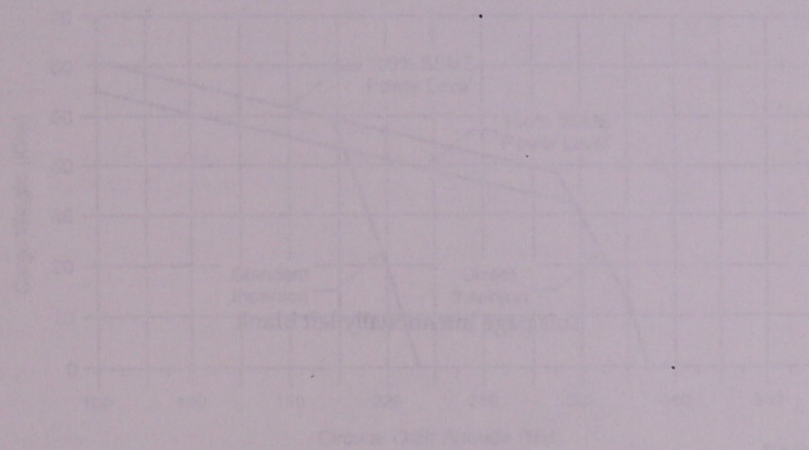

## 9.1 ASCENT

## Payload

### CONTENTS

Payload .....	9.1-1
Launch Window .....	9.1-2
Squatcloids .....	9.1-4
Main Engines .....	9.1-5
Altitude, Velocity, and Dynamic Pressure.....	9.1-5
MECO Targets .....	9.1-8
ET Impact .....	9.1-8
Abort Mode Boundaries.....	9.1-9
Minimum Safe Orbit .....	9.1-10

The graphs below indicate the maximum weight payload that can be launched to a particular circular orbit with a 28.5° or 57° inclination. Also shown is the higher altitude capability of a direct insertion versus standard insertion mission profile, as well as the performance increase available using 109 percent versus 104 percent main engine power.

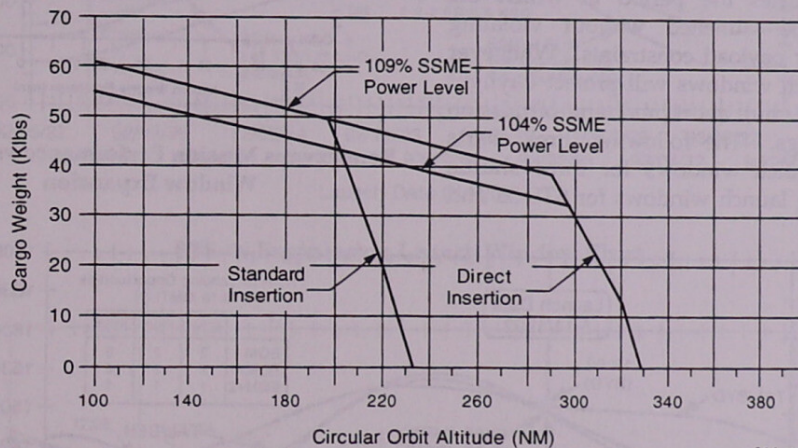

Cargo Weight vs. Circular Orbital Altitude 28.5° Inclination

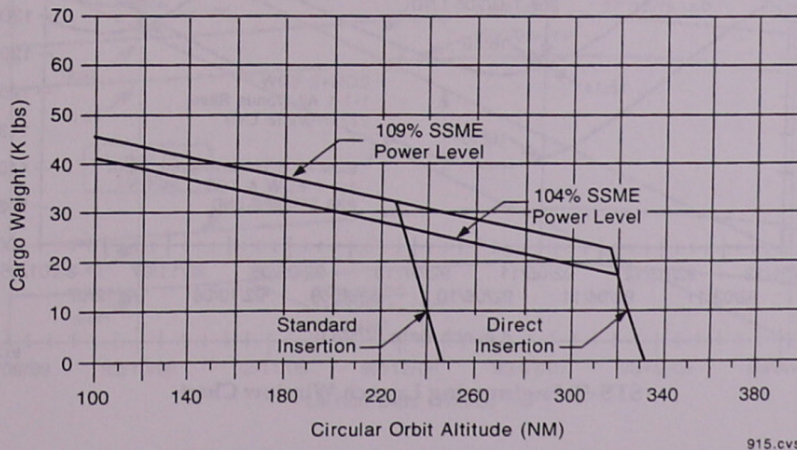

Cargo Weight vs. Circular Orbital Altitude 57° Inclination

### Launch Window

The launch window for a rendezvous mission must satisfy several constraints. A major factor determining the window is ensuring that the orbiter has sufficient performance capability (plus reserves) to achieve a coplanar orbit. The chart at the right (for a 28.5° mission) indicates the additional performance required if the launch occurs prior to the "in-plane" time. The window for a 57° mission is approximately 15 minutes (such a rendezvous has not been required).

The launch window developed for each shuttle mission delineates the period in which the orbiter can be launched without violating shuttle and/or payload constraints. Whenever possible, launch windows will protect daylight (sunset + 15 min) abort and end-of-mission (EOM) landings. The following three charts depict the launch windows for three shuttle missions. The launch windows for STS-50 and

STS-46 were constrained by lighting. The shape of the STS-53 launch window was dictated by the right ascension ascending node (RAAN) requirements of the mission payload.

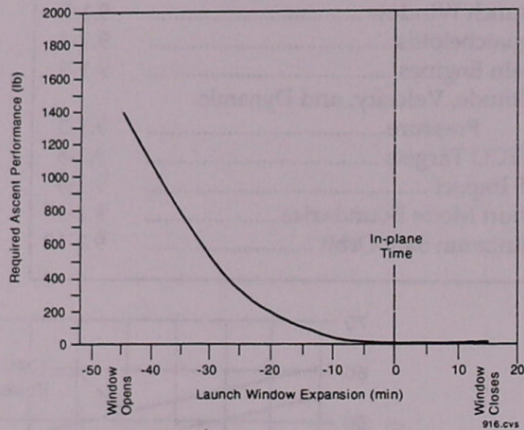

Rendezvous Mission Performance vs. Launch Window Expansion

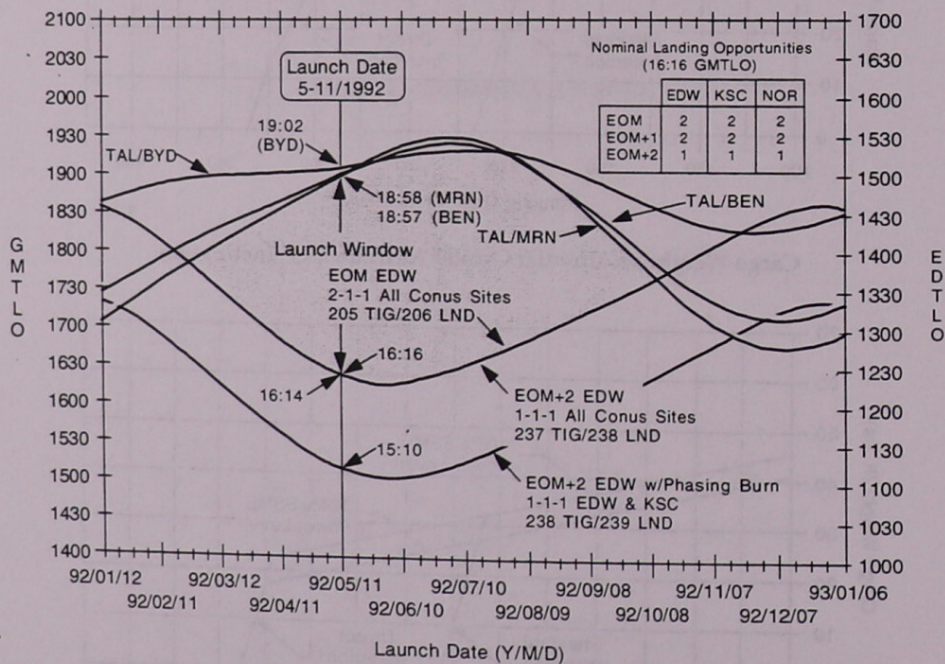

STS-50 Engineering Launch Window Chart

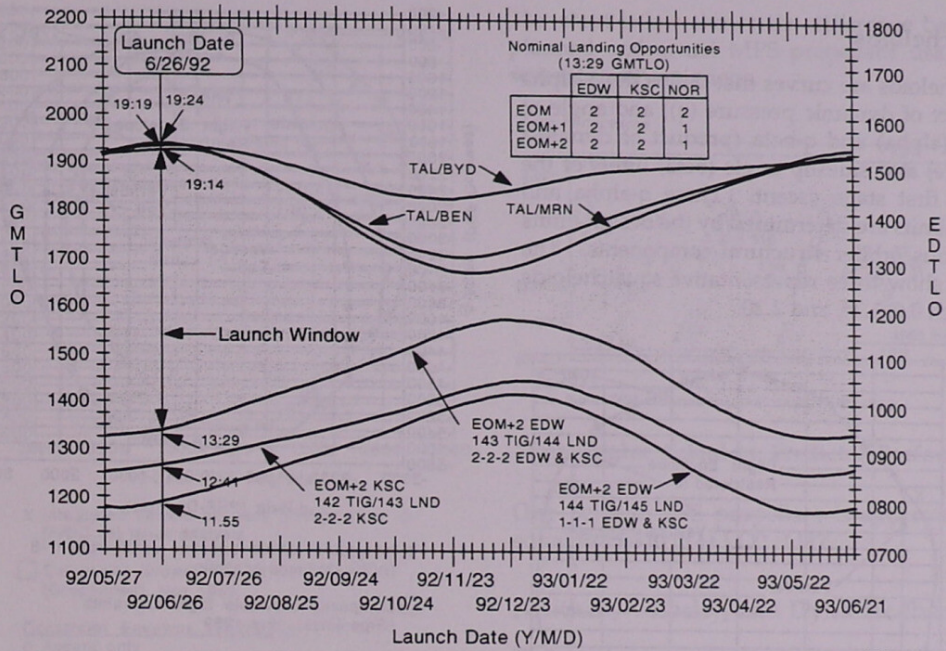

918.cvs

STS-46 Engineering Launch Window Chart

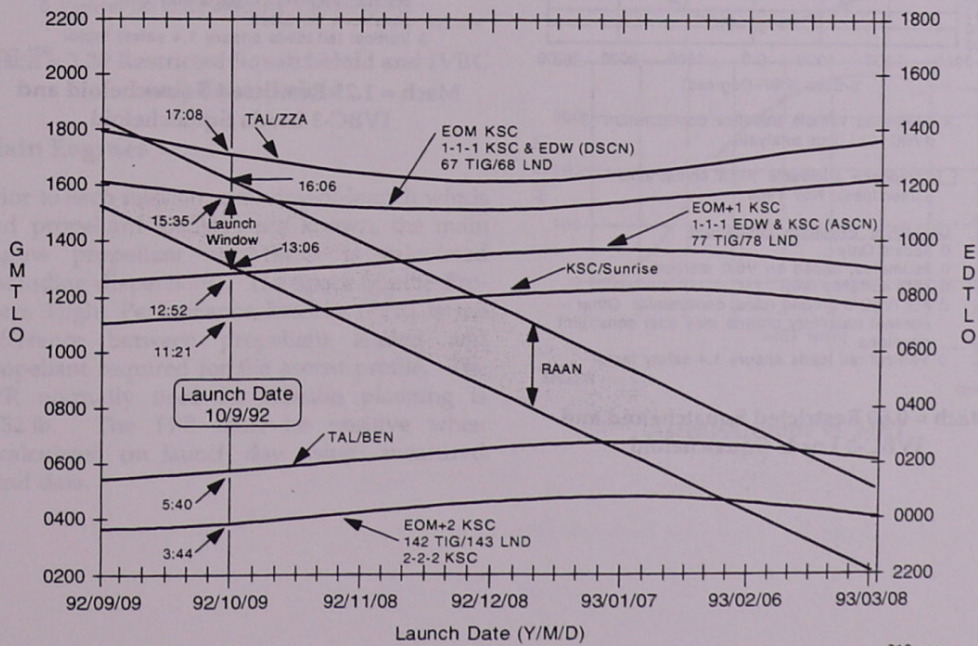

919.cvs

STS-53 Conceptual Launch Window Chart

### Squatcheloids

Squatcheloids are curves that define the q-alpha (product of dynamic pressure (q) and angle of attack (alpha) and q-beta (product of dynamic pressure) and sideslip angle (beta) limits of the orbiter first stage ascent. These q-alpha and q-beta limits are determined by the design limits of various orbiter structural components. The graphs show three representative squatcheloids for Mach 0.6, 1.25, and 2.20.

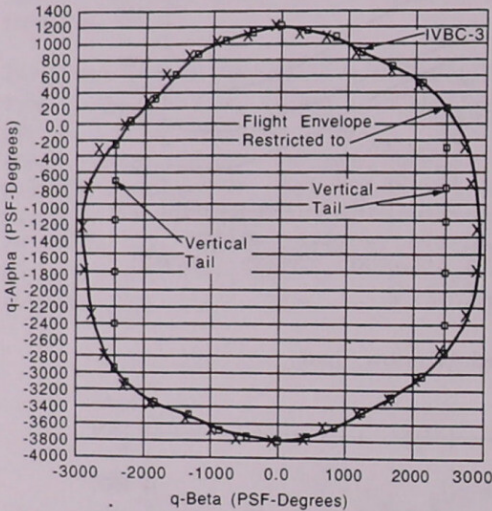

X Integrated vehicle baseline configuration -3 (IVBC -3) Loads analysis

O Composite allowable flight constraints (Greenlines), Nov 1989

Constraint Envelope Limitations

- O Ascent Only
- O Estimated, based on V6.0 margins
- O Aero surfaces only
- O For IVBC-3 ground rules, constraints: Other nominal trajectory criteria may alter constraint envelope
- O Vertical tail loads ensure 1.4 safety factor

920.cvs

### Mach = 0.60 Restricted Squatcheloid and IVBC-3 Loads Squatcheloid

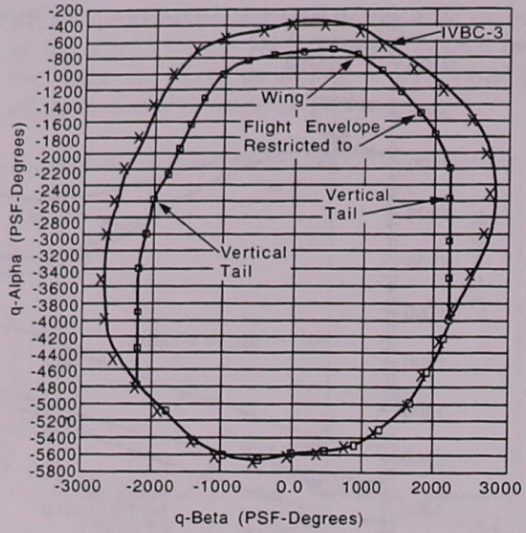

X Integrated vehicle baseline configuration -3 (IVBC -3) loads analysis

O Composite allowable flight constraints (Greenlines), Nov 1989

Constraint Envelope Limitations

- O Ascent only
- O Estimated, based on V6.0 margins
- O Aero surfaces only
- O For IVBC-3 ground rules, constraints: Other nominal trajectory criteria may alter constraint envelope
- O Vertical tail loads ensure 1.4 safety factor

921.cvs

### Mach = 1.25 Restricted Squatcheloid and IVBC-3 Loads Squatcheloid

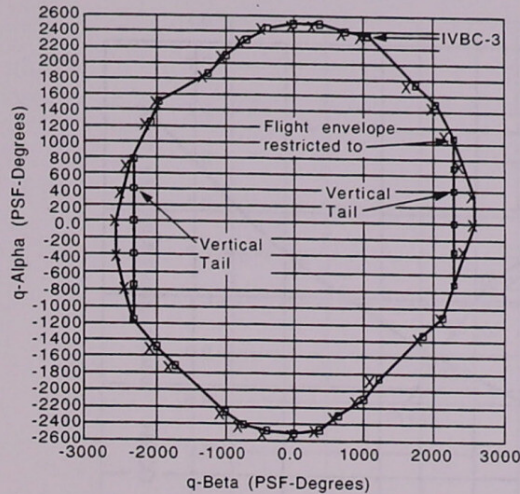

X Integrated vehicle baseline configuration -3 (IVBC -3) loads analysis

□ Composite allowable flight constraints (Greenlines), Nov 1989

Constraint Envelope Limitations

- 0 Ascent only
- 0 Estimated, based on V6.0 margins
- 0 Aero surfaces only
- 0 For IVBC-3 ground rules, constraints: other nominal trajectory criteria may alter constraint envelope
- 0 Vertical tail loads ensure 1.4 safety factor

922.cvs

**Mach = 2.20 Restricted Squatcheloid and IVBC Loads Squatcheloid**

**Main Engines**

Prior to each mission, after day-of-launch winds and propellant loadings are known, the main engine propellant at MECO is calculated (including dispersions). The Space Shuttle Program Flight Performance Reserve (FPR) is the difference between propellant loaded and propellant required for the ascent profile. The FPR normally used for mission planning is 4652 lb. The FPR must be positive when recalculated on launch day using measured wind data.

The chart below shows the difference between planned and actual MPS propellant usage for several shuttle missions.

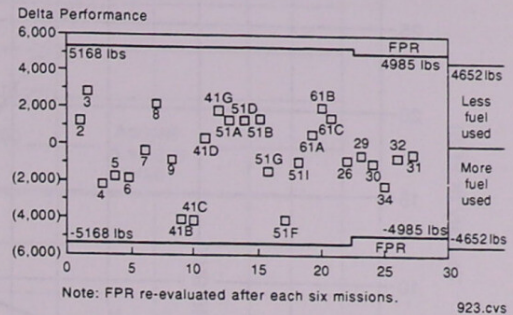

**Main Engine Actual vs. Predicted Performance**

One percent MPS propellant is approximately equal to 15,310 lb of LO<sub>2</sub>/LH<sub>2</sub>.

**Altitude, Velocity, and Dynamic Pressure**

The following three charts depict ascent altitude, velocity, and dynamic pressure as a function of MET for actual 28.5° and 57° missions.

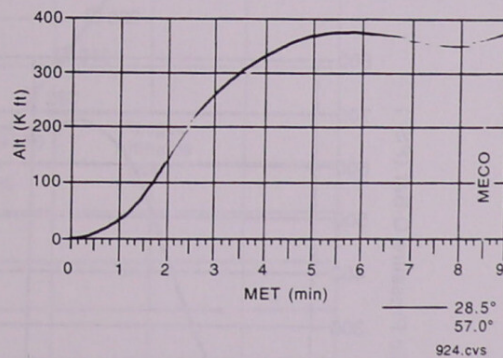

**Ascent Altitude vs. MET**

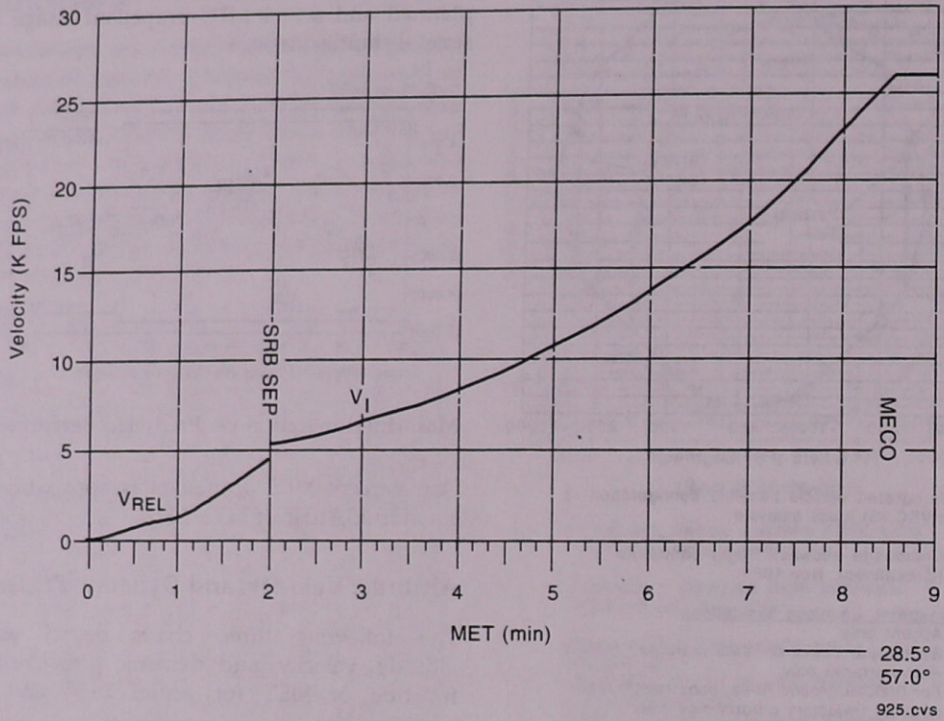

Ascent Velocity vs. MET

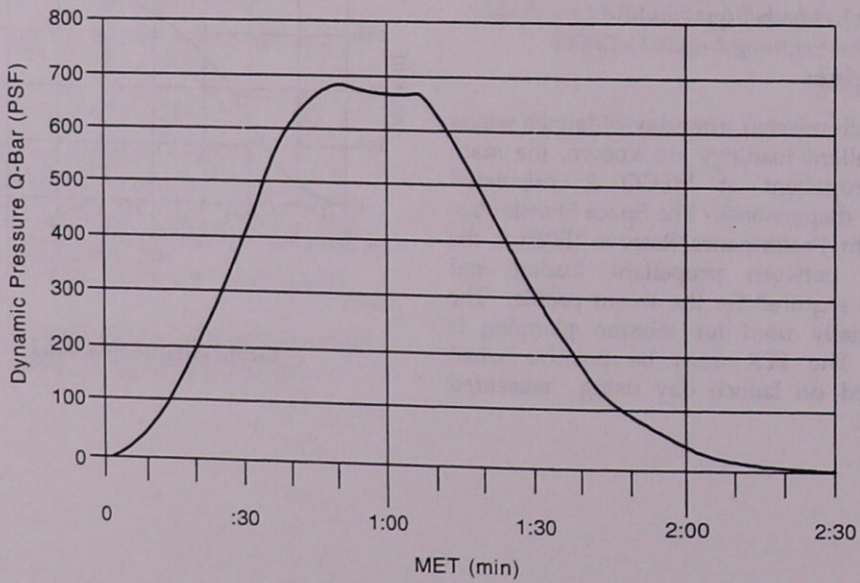

Ascent Dynamic Pressure vs. MET



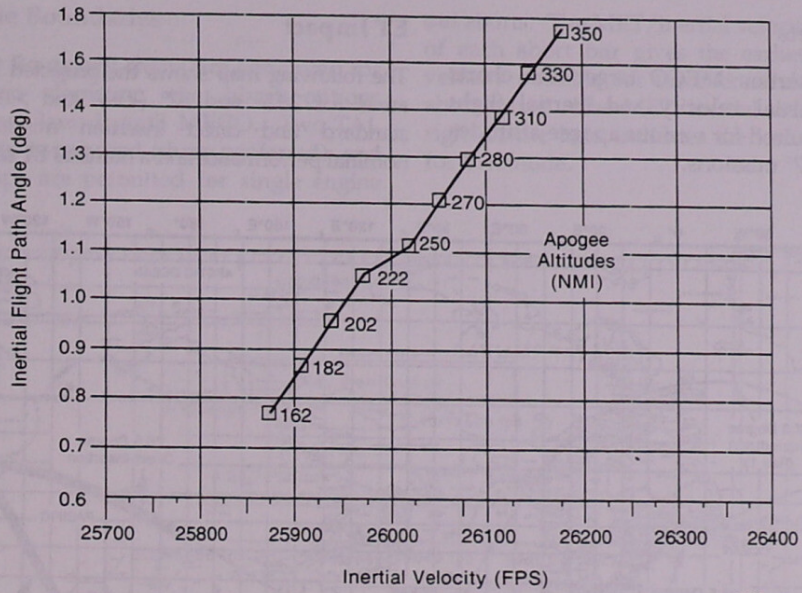

Direct Insertion MECO Target Line 28.5

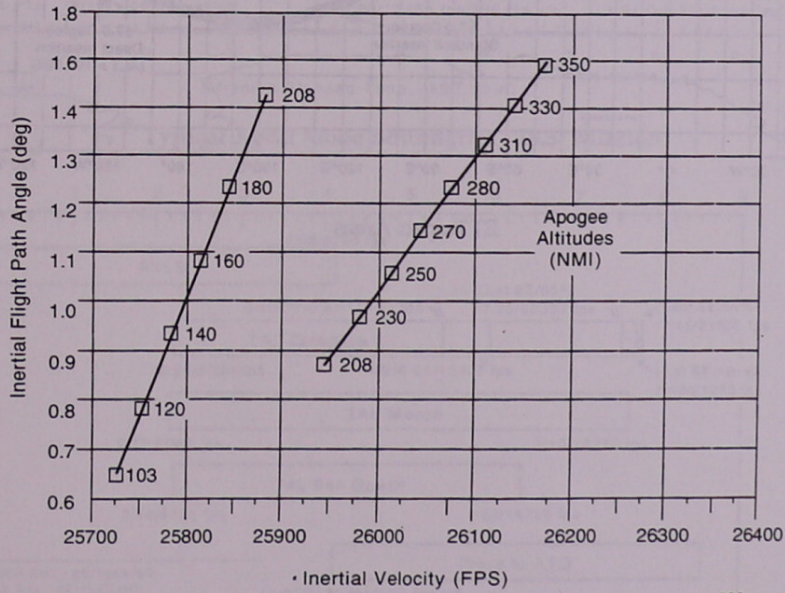

Direct Insertion MECO Target Line 57°

### MECO Targets

The direct insertion MECO target line charts depict the inertial velocity and inertial flight path angle required for various apogee altitudes for 28.5° and 57° missions.

### ET Impact

The following map shows the projected ET impact areas for 28.5° and 57° (<190 and >190 n. mi.) standard and direct insertion missions given nominal performance and a nominal ET separation.

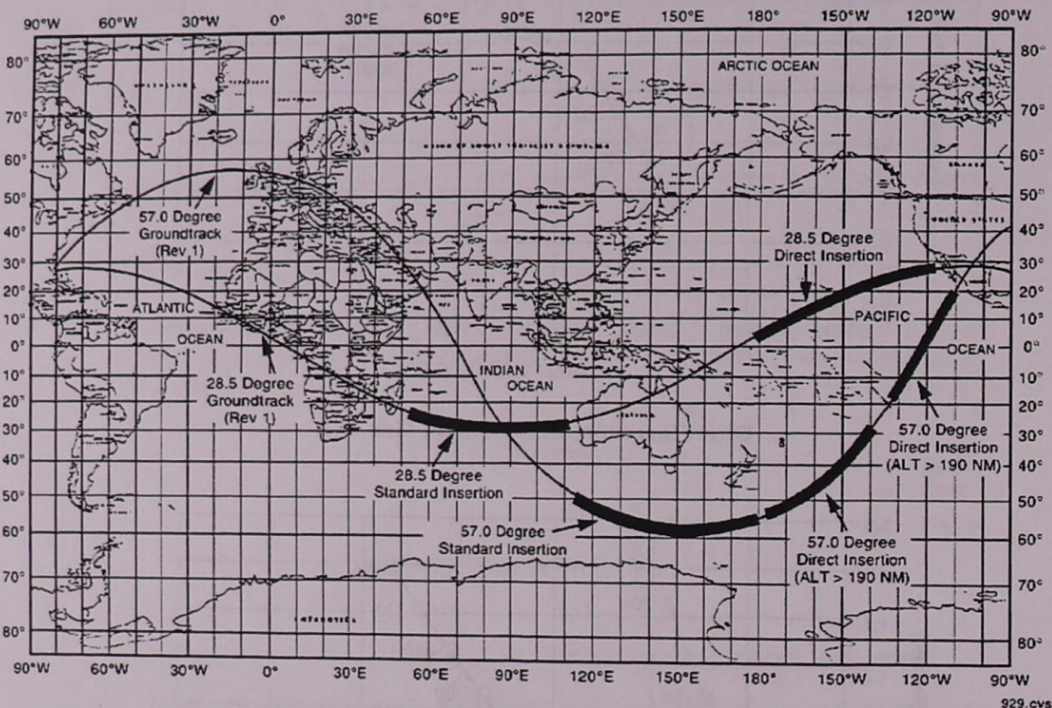

ET Impact Areas

### Abort Mode Boundaries

Abort Mode Boundary charts are computed for each mission depicting the abort options available from launch until MECO. Two TAL site capability is required (three preferred), and no abort gaps are permitted for single engine

out aborts. The MET/inertial velocity on the left of each abort bar gives the earliest time and velocity possible for the successful use of that abort mode. The MET/inertial velocity on the right of the bars indicates the last opportunity for that mode.

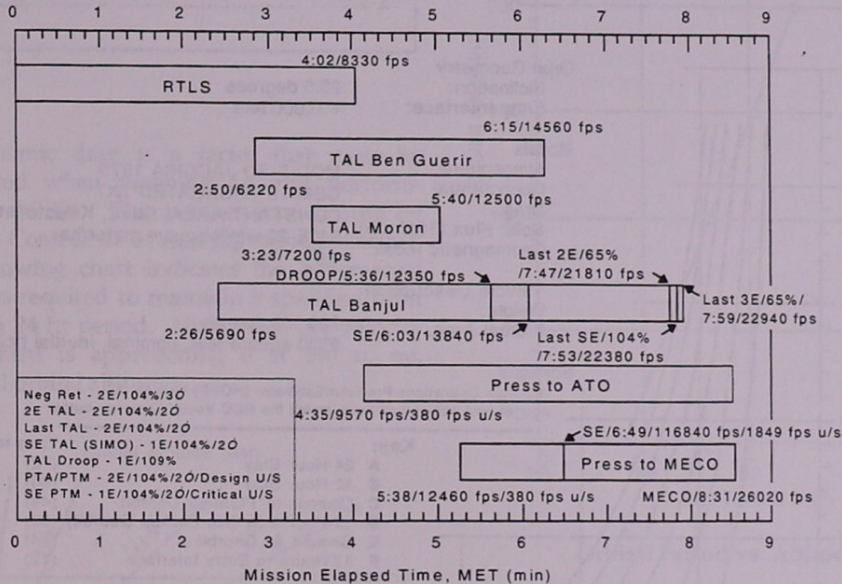

### Typical Abort Mode Boundaries - 28.5° Mission

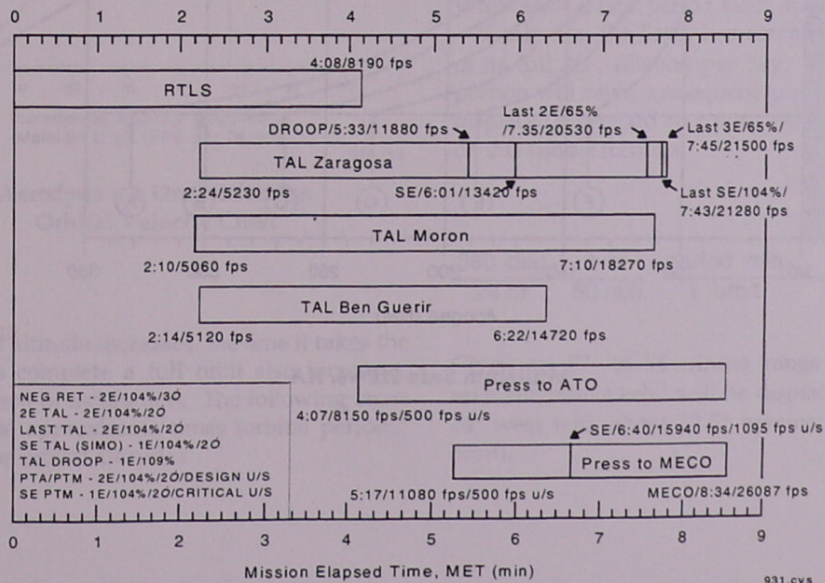

### Abort Mode Boundaries - 28.5° Mission

### Minimum Safe Orbit

If the orbiter is inserted into an off-nominal orbit, Mission Control will ensure that the vehicle has sufficient orbital lifetime. The lowest perigee that will guarantee the minimum

orbital lifetime is a function of apogee and the delta time to the next prime deorbit opportunity. Reference Flight Rule 4-51 for more details. The following chart shows approximate time on orbit versus apogee and perigee for low inclination insertion.

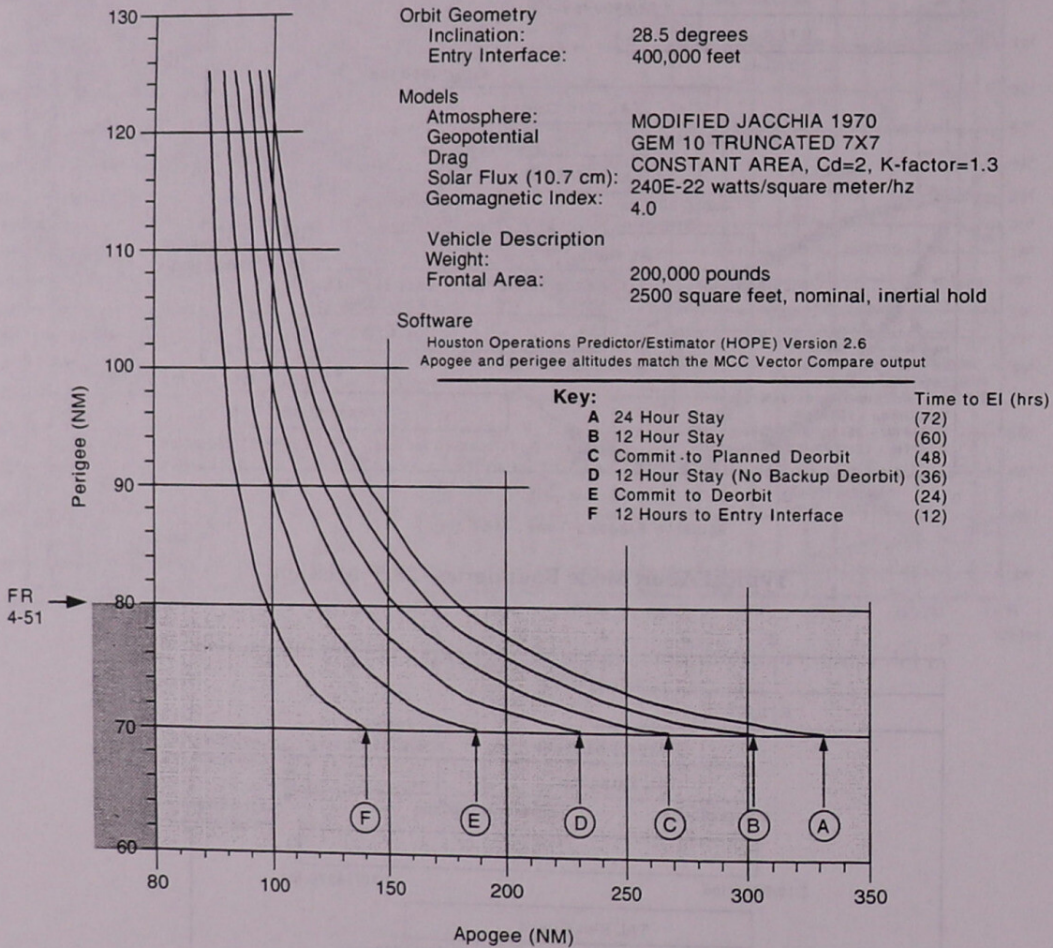

932.cvs

Minimum Safe HP vs. HA

## 9.2 ORBIT

### CONTENTS

Drag .....	9.2-1
Period .....	9.2-1
Perturbations .....	9.2-1
OMS/RCS .....	9.2-2

### Drag

Aerodynamic drag is a factor that must be considered when planning on-orbit performance capabilities. This is taken into account by Mission Control in evaluating orbital lifetime. The following chart indicates the incremental velocities required to maintain a specified orbit during a 24 hr period. Notice that the velocity requirement is approaching 0 at 160 n. mi. (nominal orbital altitude).

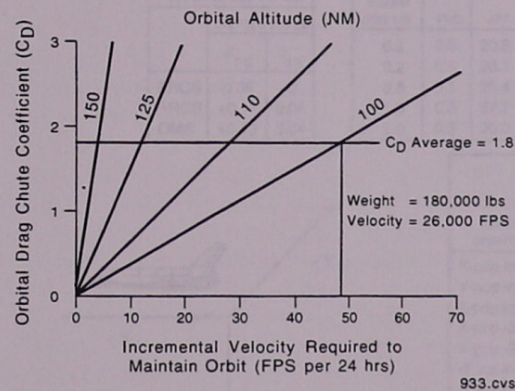

**Aerodynamic Drag Effect On Orbital Velocity Chart**

### Period

As orbital altitude increases, the time it takes the shuttle to complete a full orbit also increases, independent of inclination. The following chart plots these approximate times (orbital periods) for various orbital altitudes.

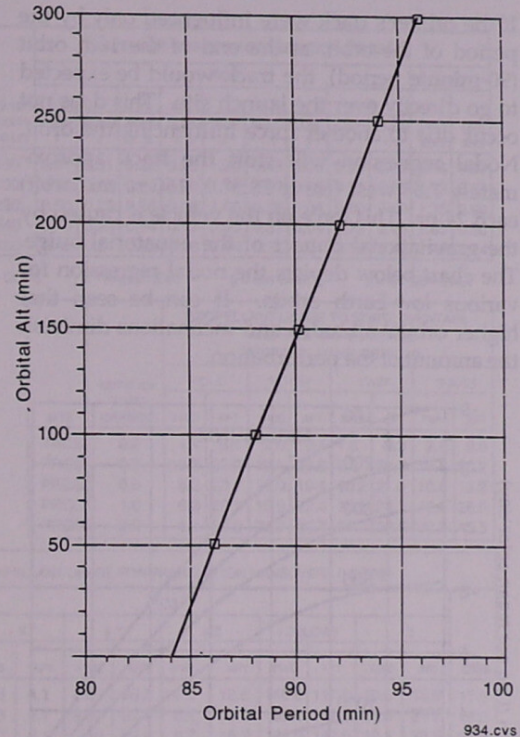

**Orbital Period vs. Altitude**

### Perturbations

While each orbital period takes approximately 87 - 96 minutes, the Earth has completed a fraction of its full 360° rotation per day. That fractional portion will cause subsequent groundtracks to be displaced westward an equivalent amount, based on this simple formula:

$$\frac{360 \text{ deg}}{24 \text{ hr}} \times \frac{1 \text{ hr}}{60 \text{ min}} \times \frac{\text{period min}}{1 \text{ orbit}} = \frac{\text{Westward Displacement deg}}{1 \text{ orbit}}$$

Given an 87- to 96-minute range of periods, each successive orbit will be displaced 21.75° to 24° west with about 22.5° nominal (160 n. mi. orbit).

If the orbiter's track were influenced only by the period of the orbit, at the end of the 16th orbit (90-minute period), the track would be expected to go directly over the launch site. This does not occur due to another force influencing the orbit. Nodal regression will shift the track approximately 7.5° west (for a 28.5° X 160 n. mi. orbit) each 24 hr. This force on the vehicle is caused by the gravitational impact of the equatorial bulge. The chart below depicts the nodal regression for various low-Earth orbits. It can be seen that higher orbital altitudes and inclinations diminish the amount of the perturbation.

### OMS/RCS

On orbit, the vehicle's performance capability is dictated by the amount of usable OMS/RCS propellant minus the amount required for deorbit, entry, and reserve. This performance capability can be maximized by using the most efficient burns possible for mission accomplishment and attitude/altitude control. The charts on the next page provide a convenient "quick look" method for determining the performance penalty for OMS/RCS use.

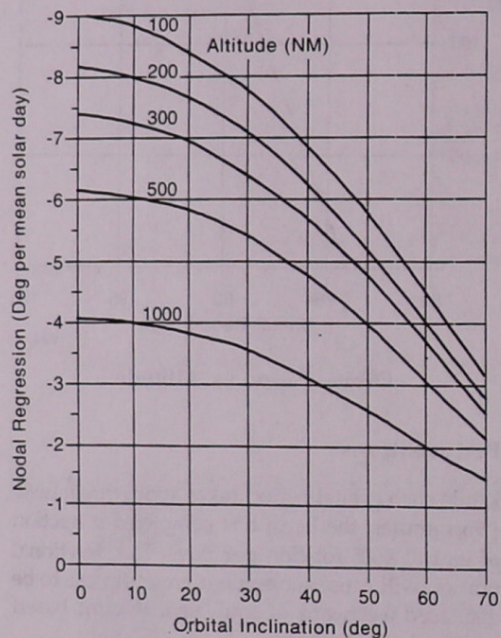

Nodal Regression

935.cvs

1% OMS = 130 lbs propellant

1% RCS = 22 lbs propellant

ORBITER WEIGHT (1000 LB)	AVERAGE ORBITER ACCELERATION (FT/SEC <sup>2</sup> )										OMS	
	RCS										TWO ENG	ONE ENG
	+ X			- X			± Y		+ Z			
	HIGH 1	NORM 2	NORM 1,2	NORM 1,2	HIGH 2	NORM 1,2	LOW 2	HIGH 3	NORM 1,2			
180	0.61	0.31	0.32	0.22	1.29	0.43	0.05	0.98	0.61	2.14	1.07	
200	0.55	0.28	0.29	0.20	1.16	0.39	0.05	0.88	0.55	1.93	0.97	
220	0.50	0.25	0.26	0.18	1.06	0.35	0.04	0.80	0.50	1.75	0.88	
240	0.46	0.23	0.24	0.17	0.99	0.33	0.04	0.72	0.46	1.60	0.80	
260	0.42	0.21	0.22	0.16	0.94	0.32	0.04	0.65	0.42	1.48	0.74	

DAP CODE 1 = TRANSITION 2 = ON ORBIT 3 = ET SEP ONLY

AVERAGE ORBITER ACCELERATION (DEG/SEC <sup>2</sup> )				
ROTATION MANEUVER	NORM PRCS	LOW PRCS		YRCS
		FWD	AFT	
± Roll	0.923			0.021
+ Pitch	1.230	0.696	0.534	0.019
- Pitch	0.851	0.478	0.373	0.008
± Yaw	0.703	0.449	0.242	0.014

JETS	ROTATION RATE (DEG/SEC)	PROPELLANT USAGE TO START, MAINTAIN, AND STOP A 115 DEGREE ROTATION MANEUVER (LB)							
		ROLL		PITCH		YAW		3-AXIS	
		FWD	AFT	FWD	AFT	FWD	AFT	FWD	AFT
VRCS	0.2	1.4	5.7	2.0	6.5	1.6	8.3	2.0	9.6
PRCS	0.2	10.3	23.9	13.1	28.3	9.0	20.3	8.8	20.2
PRCS	0.5	8.2	20.7	10.0	19.4	10.2	21.0	10.6	18.2
PRCS	1.0	6.8	23.7	12.9	22.4	13.2	24.1	16.5	26.9
PRCS	2.0	6.4	34.2	22.0	32.7	21.0	36.6	30.2	45.5

ORBITER C.G. SHIFT FOR OMS/RCS USAGE		
	INCHES/100 LB	
	X <sub>c.g.</sub>	Y <sub>c.g.</sub>
FRCS	-0.36	0
ARCS	+0.11	0.04
OMS	+0.13	0.04

ORBITER WEIGHT (1000 LB)	PROPELLANT USAGE FOR TRANSLATION MANEUVERS (LB/FPS)												OMS
	RCS												
	+ X		- X		± Y		+ Z		+ Z (LOW)		- Z		
	FWD	AFT	FWD	AFT	FWD	AFT	FWD	AFT	FWD	AFT	FWD	AFT	
0.2	0.5	20.8	19.6	4.1	8.6	25.2	7.5	12.5	140.0	117.0	10.5	18.9	17.9
0.2	0.5	23.1	21.8	5.1	9.3	27.4	8.1	14.1	159.0	132.0	11.3	21.2	19.8
0.5	0.5	25.4	24.0	6.1	10.0	29.6	8.7	15.7	178.0	147.0	12.1	23.5	21.8
1.0	0.5	27.7	26.2	7.1	10.7	31.8	9.3	17.3	197.0	162.0	12.9	25.8	23.8
2.0	0.5	30.0	28.4	8.1	11.4	34.0	9.9	18.9	216.0	177.0	13.7	28.1	25.8

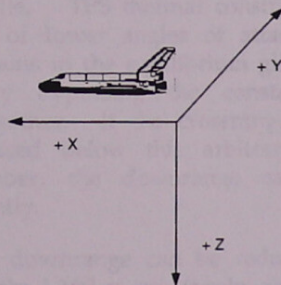

ORBITER ORIENTATION	PRIMARY RCS THRUSTERS PROPELLANT USAGE (LB/HOUR) (ATTITUDE DEADBANDS = 3.5 DEG/AXIS)									
	100 NM		120 NM		150 NM		200 NM		300 NM	
	FWD	AFT	FWD	AFT	FWD	AFT	FWD	AFT	FWD	AFT
X-pop inertial	10.5	20.2	10.2	19.8	9.8	19.3	9.3	18.6	8.8	18.0
Y-pop inertial	11.0	24.0	10.2	19.9	9.4	17.7	8.4	15.7	7.6	14.6
Z-pop inertial	8.6	21.0	8.6	20.2	8.6	19.3	8.6	18.5	8.6	18.0
X-pop -Z-LV	9.8	21.2	9.3	20.8	8.4	20.4	7.3	19.8	6.0	19.0
Y-pop -Z-LV	10.3	18.0	10.1	17.8	9.8	17.5	9.5	17.1	9.1	16.5
-X sol inertial	10.4	20.8	10.4	20.4	10.4	19.9	10.4	19.4	10.4	19.0
-Z sol inertial	10.0	19.9	10.0	19.9	10.0	19.9	10.0	19.9	10.0	19.9
X-PSL PTC	9.3	19.0	9.3	19.0	9.3	19.0	9.3	19.0	9.3	19.0

ORBITER ORIENTATION	VERNIER RCS THRUSTERS PROPELLANT USAGE (LB/HOUR) (ATTITUDE DEADBANDS = 1.0 DEG/AXIS)									
	100 NM		120 NM		150 NM		200 NM		300 NM	
	FWD	AFT	FWD	AFT	FWD	AFT	FWD	AFT	FWD	AFT
X-pop inertial	3.0	11.6	1.5	5.7	0.9	3.8	0.7	3.0	0.6	2.8
Y-pop inertial	1.9	6.3	1.6	4.7	1.5	4.5	1.4	4.3	1.3	3.9
Z-pop inertial	2.9	11.5	2.0	8.1	1.6	6.8	1.5	6.5	1.4	5.9
X-pop -Z-LV	4.1	13.3	1.6	5.1	0.7	1.3	0.4	0.6	0.4	0.4
Y-pop -Z-LV	0.5	1.0	0.5	0.8	0.5	0.7	0.5	0.6	0.5	0.5
-X sol inertial	2.9	10.6	2.2	7.7	1.8	6.7	1.8	6.5	1.8	6.1
-Z sol inertial	3.6	8.8	2.6	5.5	2.3	4.8	2.2	4.7	2.2	4.5
X-PSL PTC	5.6	10.9	4.8	7.2	4.2	4.9	3.8	3.4	4.3	3.6

ENGINE	SPECIFIC IMPULSE (SEC)	THRUST PER ENGINE (LB)	PROP FLOW RATE (LB/SEC)	PROP MIXTURE RATIO (OX/FU)
OMS	313.2	6000	19.16	1.65
PRCS	280.0	870	3.11	1.60
VRCS	265.0	24	0.09	1.60

936.cvs

OMS/RCS Estimated Performance

## 9.3 ENTRY (OPS 304)

## CONTENTS

Downrange/Crossrange.....	9.3-1
Trajectory.....	9.3-2
Entry History.....	9.3-2
Entry RCS Use Data.....	9.3-2
Rollout/Braking.....	9.3-6
Loss of Braking.....	9.3-6
Rollout History.....	9.3-6
Performance Rules of Thumb.....	9.3-11

## Downrange/Crossrange

TAL, emergency deorbit, or a waveoff to the secondary landing site can result in mission-critical assessments of the orbiter's downrange and crossrange capabilities. Once the orbiter has committed to its descent, only a carefully flown profile can put it on the runway safely.

The orbiter begins entry at EI (400,000 ft) on average 4,176 n. mi. from the landing site. Given a crossrange situation of about 500 n. mi. (414 n. mi. being the average), the vehicle has the ability to stretch the descent approximately 800 n. mi. downrange by flying a lower drag profile. TPS thermal constraints prevent the use of lower angles of attack. The orbiter remains in the equilibrium glide phase longer, likely bypassing the constant drag phase altogether. If the crossrange requirement is reduced below this arbitrary (but realistic) number, the downrange can be increased slightly.

The downrange can be reduced by approximately 1,100 n. mi. (again given a 500 n. mi. crossrange) by flying higher drag profile. This results in higher temperatures on the TPS as the vehicle descends more quickly into the atmosphere. TPS thermal constraints are the initial limiting factor in this profile. During the

descent, as the vehicle's mach and alpha decrease, maximum drag is limited by "g" (~ Mach 16) and eventually q-bar (~ Mach 5), thereby limiting downrange reduction.

In the event of an emergency deorbit, the orbiter's crossrange capability becomes a significant factor. The following charts list the dispersed and undispersed crossrange limits for 28.5° and 57° missions at the stated entry weights. The dispersed crossrange limits protect for 3-sigma entry dispersions. However, for an emergency deorbit, the crew could deorbit to a landing site that is within the undispersed crossrange limit if there were no site within the dispersed limit.

APPROACH DIRECTION	RANGE N. MI.
Ascending, left	753
Descending, left	753

*Dispersed crossrange limits*  
28.5°,  
160 n. mi. orbit, 197 k lb

APPROACH DIRECTION	RANGE N. MI.
Ascending, left	815
Descending, left	815

*Dispersed crossrange limits*  
28.5°,  
160 n. mi. orbit, 197 k lb

APPROACH DIRECTION	RANGE N. MI.
Ascending, left	774
Ascending, right	828
Descending, left	781
Descending, right	818

*Dispersed crossrange limits*  
57°,  
160 n. mi. orbit, 217 k lb

APPROACH DIRECTION	RANGE N. MI.
Ascending, left	850
Ascending, right	904
Descending, left	857
Descending, right	894

*Undispersed crossrange limits*  
57°,  
160 n. mi. orbit, 217 k lb



**Trajectory**

The following chart plots nominal performance in terms of altitude, VREL, q-bar, flight path angle, g, and alpha against time from EI.

**Entry History**

The following table lists flight history performance and performance related data for the first 74 space shuttle missions.

**Entry RCS Use Data**

Typically, the orbiter deorbits with approximately 50 percent aft RCS (ARCS)

propellant in each pod (~1100 lb). RCS propellant use during entry averages about 13 percent (600 lb) of full ARCS tanks. Certain missions are selected to conduct Program Test Inputs (PTIs) which are modifications to flight control software to collect entry performance data. In addition to nominal RCS use, other jet firings are used to collect RCS PTI data or to correct for aerosurface PTIs. Missions conducting PTIs will typically use in excess of 23 percent (1000 lb) of full ARCS tanks during entry. The chart on the right shows the predicted ARCS usage and the actual flight usage for selected missions. Analysis of actual versus predicted use is underway.

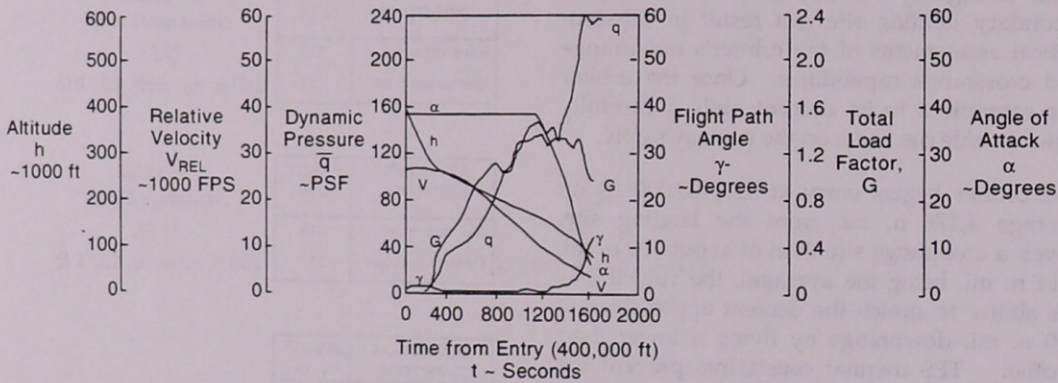

938.cvs

**Orbiter Entry Trajectory**

### ENTRY AERODYNAMICS

Miss Seq. No.	STS- No.	Orb. OV-	Notes	Entry Interface				Cross Range, nmi.	Max. Load Factor, g	Max. Dyn. Press., psf	First Roll Rev. Vel., fps	Term. Area Energy Mgmt				Approach and Landing		
				Velocity, lps	Fit. Pth. Angle, deg	Range, nmi.	I/F Range, nmi.					Load Factor, g	Max. Dyn. Press., psf	I/F Alt ft.	Glide Slope, deg	Velocity, Keas		
																Max.	Over thld	At MGD
1	1	102		25,731.	-1.19	4372	228	1.6	217	18,310.	58.9	1.7	286	10,000	20	315	250	183
2	2	102		25,726.	-1.17	4474	63	1.61	215	20,297.	59.7	1.93	280	5,000	19	276	206	197
3	3	102		25,659.	-1.13	4136	276	1.62	220	17,784.	59.1	1.54	295	10,000	19	302	232	220
4	4	102		25,797.	-1.28	3817	581	1.77	241	11,461.	59.4	1.46	278	10,000	19	295	215	204
5	5	102		25,758.	-1.24	4036	580	1.59	219	11,397.	59.8	1.59	280	10,000	19	298	216	198
6	6	99		25,755.	-1.24	4045	378	1.53	207	15,808.	59.9	1.41	257	10,000	19	293	213	190
7	7	99		25,771.	-1.25	4040	738	1.59	220	7,143.	59.6	1.65	305	9,834	19	295	232	202
8	8	99		25,649.	-1.12	4037	519	1.54	223	12,900.	58.9	1.56	281	5,000	19	309	226	195
9	9	102		25,696.	-1.18	4349	69	1.6	232	21,581.	59.9	1.52	280	10,000	17	285	203	185
10	41B	99		25,752.	-1.2	4137	524	1.57	220	12,957.	59.4	1.59	289	10,000	19	292	218	196
11	41C	99		25,998.	-1.52	4089	381	1.54	216	16,208.	59.4	1.43	293	10,000	19	313	234	213
12	41D	103		25,776.	-1.26	4112	474	1.54	208	14,072.	60	1.42	285	10,000	19	299	227	200
13	41G	99		25,684.	-1.12	4308	614	1.54	241	11,927.	60.2	1.4	285	10,000	19	296	216	208
14	51A	103		25,869.	-1.35	4141	486	1.56	225	14,063.	60.5	1.46	285	10,000	19	299	217	186
15	51C	103		25,855.	-1.32	4144	380	1.54	211.8	16,118.	60.1	1.5	281	10,000	19	293	223	185
16	51D	103		25,955.	-1.45	4064	518	1.59	211.1	13,573.	60.9	1.4	294	10,000	19	301	215	200
17	51B	99		25,857.	-1.26	4264	274	1.57	241.6	18,500.	59.1	1.5	282	10,000	19	300	219	204
18	51G	103		25,850.	-1.34	4050	694	1.58	217.7	8,680.	59.3	1.6	218	5,000	19	301	0	198
19	51F	99		25,813.	-1.19	4221	603	1.58	235.6	11,537.	59.7	1.54	290	10,000	19	306	244	190
20	51I	103		25,829.	-1.31	4004	092	1.58	215.3	8,626.	59.7	1.56	274	10,000	19	307	204	191
21	51J	104	a															
22	61A	99		25,830.	-1.19	4345	69	1.55	241	22,257.	59.8	1.3	319	10,000	19	303	231	203
23	61B	104		25,882.	-1.35	4106	533	1.54	232	13,172.	59.1	1.4	286	10,000	19	293	224	189
24	61C	102		25,815.	-1.31	4154	661	1.56	224	9,480.	59.2	1.42	292	10,000	19	311	233	217
25	51L	99	a												0			
26	26	103		25,790.	-1.25	4117	383	1.56	203	15,774.	60	1.3	288	10,000	19	297	219	187
27	27	104		25,121.	-1.5	4220	520	1.61	206	14,564.0	60.2	1.4	294	10,000	19	297	211	194
28	29	103		25,787.	-1.23	4163	384	1.54	207	15,852.	60.1	1.6	287	10,000	19	307	218	205
29	30	104		25,798.	-1.22	4155	350	1.56	207	16,452.	60.08	1.5	287	9,957	19	295	206	196
30	28	102		25,803.	-1.11	4332	186	1.54	213	19,494.	58.8	1.6	295	10,000	19	299	224	155
31	34	104		25,784	-1.19	4156	498	1.54	219	13,653.	60.1	1.7	286	10,000	19	305	220	165
32	33	103		25,998.	-1.48	4068	226	1.52	215	16,988.	60.2	1.5	301	10,000	19	300	211	199
33	32	102		25,823	-1.25	4317	372	1.62	253	16,293.	58.8	1.7	295	10,000	17	300	230	207
34	36	104		25,713.	-1.18	4338	255	1.57	204	18,520.	59.5	1.9	325	5,000	19	298	218	199
35	31	103		26,120.	-1.61	4121	420	1.6	205	15,905.	60.2	1.54	279	10,000	19	299	194	177

a - Data not Available - DOD Mission  
 b - Report containing data not as yet published

Source: JSC/DM5 Flight Design and Dynamics Division,  
 Descent Post-flight summaries

### Orbiter Entry Trajectory

9.3-3

9. PERFORMANCE

9.3 ENTRY

SFOC-FL0894  
 Rev. B

ENTRY AERODYNAMICS

Miss Seq. No.	STS- No.	Orb. OV-	Notes	Entry Interface			Cross Range, nmi.	Max. Load Factor, g	Max. Dyn. Press., psf	First Roll Rev. Vel., Ips	Term. Area Energy Mgmt			Approach and Landing					
				Velocity, Ips	Flt. Pth. Angle, deg	Range, nmi.					I/F Range, nmi.	Load Factor, g	Max. Dyn. Press., psf	I/F Alt, ft.	Glide Slope, deg	Velocity, Kees			
																Max.	Over thld	At MGD	
36	41	103		25,762	-1.2	4147	492	0	212.7	13,639.	60	1.67	291	9,777	19	306	224	192	
37	38	104		25,729	-1.16	4146	3	1.57	207	20,816	60.3	1.42	273	9,819	19	301	218	199	
38	35	102		25,858.	-1.32	4266	426	1.58	245.8	15,406.	59.15	1.59	279	8,052	17	300	217	201	
39	37	104		24,612.	-1.4	4175	375	1.57	205	16,455.	59	1.66	276	5,048	19	288	161	168	
40	39	103		25,765.	-1.06	4502	616	1.57	246.5	11,543.	60.2	1.5	295	9,862	19	302	222.1	218	
41	40	102		25,772.	-1.23	4339	211	1.56	245.4	18,904.	58.9	1.7	298	10,014	17	311	218.6	203	
42	43	104		25,794.	-1.16	4312	180	1.57	294	19,141	60.3	1.4	223	10,000	19	295	221	197	
43	48	103		26,077.	-1.58	4194	690	1.56	286	11,167.	59.9	1.5	217.5	10,000	19	297	219	203	
44	44	104		25,868.	-1.28	4195	379	1.6	285	16,190.	60.5	1.74	222.5	9,833	19	295	222	180	
45	42	103		25,785.	-1.12	4358	536	1.81	232	14,053.	59.6	1.4	308	10,000	19	310	229	196	
46	45	104		25,785.	-1.13	4231	679	1.56	241.23	10,840.6	60.4	1.82	328	7,451	19	309	212	192	
47	49	105		25,841.	-1.28	4162	410.8	1.56	215	15,850.	59.2	1.57	293	9,931	19	299	217	194	
48	50	102		25,786.	-1.18	4347	389	1.51	248.4	15,984.3	59.7	1.51	313	9,895	17	311	229	203	
49	46	104		25,898.	-0.99	4397	499	1.57	225	13,624.	59.7	1.45	299	9,869	19	303	216	195	
50	47	105		25,803.	-1.11	4341	669	1.57	240.1	11,228.4	60.6	1.39	307	9,917	17	305	233	202	
51	52	102		25,666.	-0.94	4454	223	1.58	247	18,350.	60.1	1.51	297	9,820	19	302	224	211	
52	53	103		25,813.	-1.26	4297	791	1.56	210	7,202.	60	1.96	287	9,431	19	301	226	212	
53	54	105		25,780.	-1.2	4213	320	1.56	211	17,043.	60.5	1.8	295	9,873	19	302	232	212	
54	56	103		25,797.	-1.23	4375	6	1.83	227	21,354.	60.1	1.69	291	9,844	19	304	219	206	
55	55	102		25,779.	-1.16	4299	640	1.66	260	10,463.	68.8	1.5	309	9,848	17	319	238	217	
56	57	105		25,988.	-1.43	4210	687	1.58	252	12,389.	58.9	1.38	320	9,907	17	313	233	207	
57	51	103		25,794.	-1.22	4250	89	1.56	221	20,253.	59.9	1.43	281	9,840	19	302	222	194	
58	58	102		25,755.	-1.21	4378	144	1.58	250	19,625.	59.2	1.51	323	9,898	18	315	237	198	
59	61	105		26,096.	-1.56	4220	3	1.54	231	21,281.	60.8	1.68	312	9,787	20	312	236	201	
60	60	103		25,858.	-1.35	4346	376	1.57	230	16,900.	59.9	1.72	308	9,866	20	315	235	205	
61	62	102		25,708.	-1.13	4391	116	1.59	250	19,802.	59.5	1.49	309	9,964	18	306	236	207	
62	59	105		25,660.	-1.02	4468	721	1.57	252	9,331.	59.2	1.62	318	9,937	18	315	231	215	
63	85	102		25,720.	-1.1	4381	180	1.59	265	19,114	59	1.45	315	9,986	18	305	233	199	
64	64	103		25,727.	-0.98	4433	110	1.54	228	20,344.	59.7	1.77	305	9,892	20	311	229	198	
65	68	105		25,658.	-1.02	4479.5	746	1.57	258	8,866.	58.4	1.75	314	9,841	18	305	234	193	
66	66	104		25,798.	-1.09	4387	310	1.58	251	17,796.	59.7	1.5	309	9,914	20	314	232	193	
67	63	103		25,903.	-1.36	4329	469	1.56	243	15,176.	59.7	1.81	316	9,897	20	319	229	212	
68	67	105		25,852.	-1.26	4216	628	1.56	242	10,780.	59.9	1.5	309	9,843	20	317	227	209	
69	71	104		25,913.	-1.19	4320	645	1.6	245	11,299.	60	1.5	308	9,972	-20	311	221	201	
70	70	103	b	25,789.	-1.14	4265	430	1.56					1.35	297	9,805	-20	310	225	198

a - Data not Available - DOD Mission  
b - Report containing data not as yet published

Source: JSC/DMS Flight Design and Dynamics Division,  
Descent Post-flight summaries

Orbiter Entry Trajectory (continued)

### ENTRY AERODYNAMICS

Miss Seq. No.	STS- No.	Orb. OV.	Notes	Entry Interface			Cross Range, nmi.	Max. Load Factor, g	Max. Dyn. Press., psf	First Roll Rev. Vel., fps	Term. Area Energy Mgmt				Approach and Landing			
				Velocity, fps	Fl. Pth. Angle, deg	Range, nmi.					I/F Range, nmi.	Load Factor, g	Max. Dyn. Press., psf	I/F All ft.	Glide Slope, deg	Velocity, Keas		
																Max.	Over thld	At MGTD
71	69	105		25,839.	-1.23	4332	202	159	255	18,979.	59.6	1.55	309	9,839	-16	309	233	201
72	73	102	b	26,744.	-1.1	4619	231	168				1.56	319	9,939	-18	313		214
73	74	104	b	25,840	-1.29	4346	612	158				1.45	313	9,802	-20	321		196
74	72	105	b	25,799.	-1.17	4340	220	156				1.7	309	9,891	-20	306		193

.0 setgray print/Draft \*

9.3-5

9. PERFORMANCE

9.3 Entry

- a - Data not Available - DOD Mission
- b - Report containing data not as yet published

Source: JSC/DM5 Flight Design and Dynamics Division,  
Descent Post-flight summaries

SFOC-FL0884  
Rev. B

**Rollout/Braking**

The design rollout chart depicts a nominal touchdown to wheels stop profile for a 15 k ft runway.

FLT	INCLINATION	PREDICTED ARCS USAGE (LB)	ACTUAL FLIGHT ARCS USAGE (LB)	PERCENT AFRCS	PTI ARCS/FRCS
32	28.5	827.4	1340	30	ARCS
31	28.5	1113.0	1095	25	ARCS
41	28.5	488.5	855	19	ARCS
35	28.5	1157.6	1036	24	ARCS
37	28.5	876.9	1240	28	ARCS
39	57	846.9	1070	24	ARCS
40	39	756.1	870	20	ARCS
43	28.5	441.6	1020	23	ARCS
48	57	405.4	553	13	ARCS

**Loss of Braking**

Although the data is still being reduced and analyzed, some general comments can be made about the impact of the new drag chute (STS 49, OV-105). The 40 ft partially reefed chute deployed 75 ft behind the lower trailing edge of the vertical tail can reduce the orbiter's stopping

distance 2.5K to 3.5K ft. It will provide increased directional control with two blown tires (NWS engaged) and in the absence of NWS will greatly reduce the speed at which the vehicle departs the runway. It also will significantly reduce the speed at which a heavy weight orbiter engages the barrier at a TAL site.

The new structural carbon brakes, while not dramatically reducing the braking distance (300 to 500 ft), will substantially improve the energy absorption capability over the beryllium/carbon brakes. Vibration induced brake damage and heat damage (including heat induced blown tires) should be virtually eliminated. All four orbiters are now equipped with structural carbon brakes.

**Rollout History**

The Landing Rollout Flight History Table reflects the landing environment and the orbiters' performance from main gear touchdown to wheels stop for the first 42 shuttle missions.

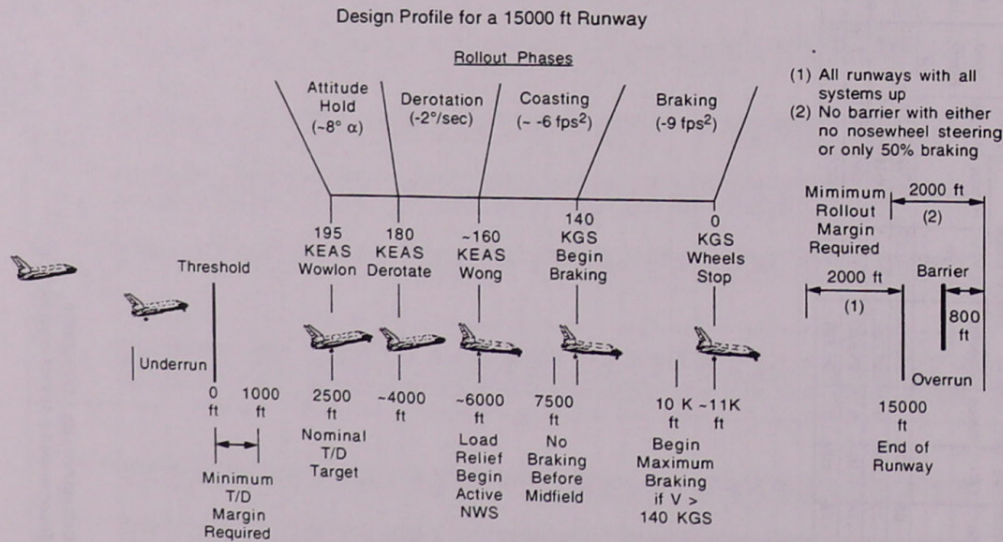

941.cvs

**Design Rollout Phases**

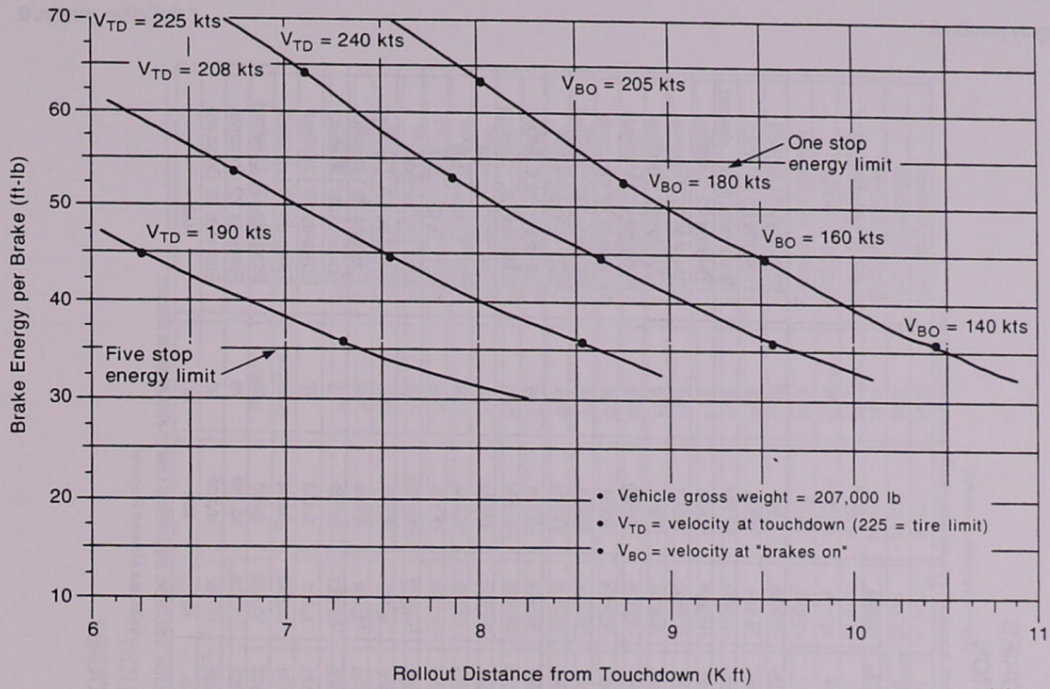

Rollout Distance/Brake Energy

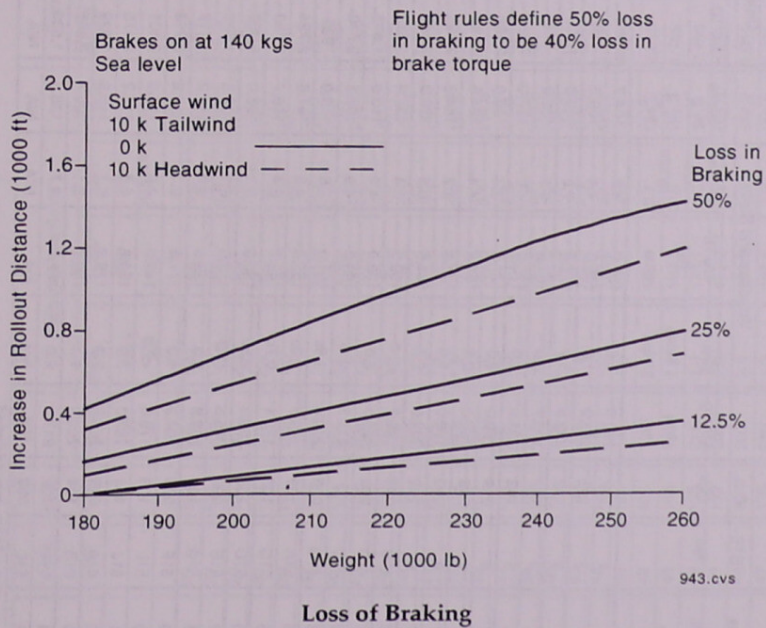

SHUTTLE FLIGHT HISTORIES  
LANDING DECELERATION

Miss Seq. No.	STS- No.	Orb. OV.	Velocities and Rates					Distance from Threshold, ft <sup>b</sup>				Total Rollout, ft	Rollout time, sec	Runway Data	
			MGTD	Sink	NGTD	Pitch	Brake	MGTD	NGTD	Brake	Stop				
			kgs a	rates fps	kgs a	rate deg/sec	inlt., kgs a			inlt.					
1	1	102	190.3	0.8	152.9	4.8	104.7	6,053	9,152	12,025	15,046	8,993	60	Edwards 23 Lakebed	
2	2	102	185.9	1.0	135.0	4.4	109.5	780	4,429	5,780	8,491	7,711	53	Edwards 23 Lakebed	
3	3	102	232.5	5.7	177.4	7.2	149.0	1,092	6,261	8,159	14,824	13,732	83	White Sands 17 Lakebed	
4	4	102	195.7	2.0	161.2	9.2	133.2	948	4,988	7,839	10,826	9,878	73	Edwards 22 Concrete	
5	5	102	201.0	1.0	175.9	4.0	167.0	1,637	4,675	5,286	11,190	9,553	83	Edwards 22 Concrete	
6	6	099	180.0	2.0	147.0	3.4	136.0	2,026	4,970	5,072	9,270	7,244	49	Edwards 22 Concrete	
7	7	099	200.0	2.5	154.4	4.4	124.5	2,728	6,843	7,040	13,176	10,450	75	Edwards 15 Concrete	
8	8	099	196.0	1.6	174.6	3.7	154.3	2,793	5,515	7,403	12,164	9,371	50	Edwards 22 Concrete	
9	9	102	204.0	2.5	144.6	8.5	126.0	1,649	5,897	6,749	10,105	8,456	53	Edwards 17L Lakebed	
10	41B	099	198.2	<2.0	159.5	2.4	135.9	1,930	5,789	7,448	12,737	10,807	67	KSC 15 Concrete	
11	41C	099	220.0	2.0	138.0	4.0	110.0	1,912	7,167	8,538	10,628	8,716	49	Edwards 17L Lakebed	
12	41D	103	216.3	<2.0	166.0	4.8	106.5	2,510	6,713	10,018	12,785	10,275	60	Edwards 17L Lakebed	
13	41G	099	208.4	1.8c	161.0	2.0	113.0	902	5,506	8,980	11,527	10,565	54	KSC 33 Concrete	
14	51A	103	193.7	2.0c	157.8	4.0	141.6	2,724	6,380	7,550	12,178	9,454	58	KSC 15 Concrete	
15	51C	103	179.1	0.7c	142.7	3.4	116.7	2,753	5,752	7,677	10,105	7,352	50	KSC 15 Concrete	
16	51D	103	209.0	2.8c	180.0	5.1	156.0	1,639	4,303	6,667	11,937	10,298	83	KSC 33 Concrete	
17	51B	099	206.5	<1.0	153.0	6.1	106.0	1,576	5,528	7,589	9,893	8,317	59	Edwards 17L Lakebed	
18	51G	103	202.3	5.0	159.6	6.9	154.2	1,117	4,900	5,248	8,550	7,433	42	Edwards 23 Lakebed	
19	51F	099	204.3	4.0	171.8	6.1	126.2	3,713	6,412	9,059	12,282	8,569	55	Edwards 23 Lakebed	
20	51I	103	175.0	<2.0	142.0	4.8	114.0	2,101	4,384	5,571	8,201	6,100	47	Edwards 23 Lakebed	
21	51J	104	187.0	3.0	154.8	4.8	117.2	2,476	4,873	7,421	10,532	8,056	65	Edwards 23 Lakebed	
22	61A	099	209.9	1.0	173.8	6.7	110.9	1,829	4,767	7,923	10,133	8,304	45	Edwards 17L Lakebed	
23	61B	104	201.3	1.0	165.7	3.1	126.4	2,388	5,909	9,321	13,145	10,759	78	Edwards 22 Concrete	
24	61C	102	217.0	2.0	162.9	2.7	138.4	1,530	6,300	7,831	10,197	10,202	59	Edwards 22 Concrete	
25	51L	099	N/A	N/A	N/A	N/A	N/A	N/A	N/A	N/A	N/A	N/A	N/A	N/A	N/A

a. kgs = knots, ground speed

b. Based on runway measurements except for brake initiation (onboard service)

c. Based on LaRC analysis of KSC spin-up measurement

Source: JSC/ES6, Mechanical Design and Analysis Branch  
In-house Mission Reports

### SHUTTLE FLIGHT HISTORIES LANDING DECELERATION

Miss Seq. No.	STS- No.	Orb. OV-	Velocities and Rates					Distance from Threshold, ft <sup>b</sup>				Total Rollout, ft	Rollout time, sec	Runway Data
			MGTD	Sink	NGTD	Pitch	Brake	MGTD	NGTD	Brake	Stop			
			kgs a	rates fps	kgs a	rate deg/sec	init., kgs a			init.				
26	26	103	195	1.0	154	4.0	134	2,569	5,671	6,750	10,020	7,451	46.0	Edwards 17L Lakebed
27	27	104	204	1.0	168	3.8	134	1,469	4,423	5,908	8,592	7,123	43.0	Edwards 17L Lakebed
28	29	103	204	2.9	163	1.7	130	1,195	5,027	7,550	10,534	9,339	52.7	Edwards 22 Concrete
29	30	104	204	2.4	164	2.0	139	1,314	5,088	6,028	11,609	10,295	64.3	Edwards 22 Concrete
30	28	102	158	1.0	128	7.6	82	5,311	7,993	9,776	11,326	6,015	46.5	Edwards 17L Lakebed
31	34	104	204	1.0	157.9	3.4	77.6	1,871	5,355	10,063	11,548	9,077	60.4	Edwards 23L Lakebed
32	33	103	191	3.0	159.4	2.9	148	740	3,982	4,856	8,504	7,764	46.1	Edwards 04 Concrete
33	32	102	209	1.0	161.5	2.2	141.3	2,399	6,606	8,096	12,495	10,096	62.2	Edwards 22 Concrete
34	36	104	187	1.0	143.2	3.8	97.0	1,622	4,862	6,405	9,522	7,900	52.9	Edwards 23L Lakebed
35	31	103	180	3.0	144.4	2.9	118.6	1,176	4,560	6,718	10,065	8,889	60.7	Edwards 22 Concrete
36	41	103	194	1.0	155.5	2.3	135.7	2,295	6,359	7,713	10,827	8,532	49.2	Edwards 22 Concrete
37	38	104	196	1.0	162.0	2.6	130.5	1,414	4,600	6,966	10,417	9,003	56.3	KSC 33 Concrete
38	35	102	207	1.0	169.5	3.4	134.5	1,535	5,559	8,465	12,101	10,566	57.7	Edwards 22 Concrete
39	37	104	156	2.3	131.8	7.3	93.6	-623	1,200	3,197	5,741	6,364	53.9	Edwards 33 Lakebed
40	39	103	210	2.0	159.8	2.5	136.5	168	4,700	6,316	9,403	9,235	55.5	KSC 15 Concrete
41	40	102	199	2.0	153.3	3.5	135.2	1,485	5,914	7,323	10,923	9,438	54.6	Edwards 22 Concrete
42	43	104	203	2.0	166.8	2.4	132.5	1,968	5,517	8,243	11,876	9,890	58.9	KSC 15 Concrete
43	48	103	215	1.0	172.0	2.5	145.4	1,235	4,882	6,851	10,619	9,384	49.8	Edwards 22 Concrete
44	44	104	183	1.0	150.0	4.5	15.2	2,607	5,077	13,570	13,798	11,191	106.6	Edwards 05R Lakebed
45	42	103	199	2.0	169.0	3.7	134.8	2,835	5,901	8,769	12,676	9,841	58.3	Edwards 22 Concrete
46	45	104	187	1.0	162.6	3.6	135.3	1,765	4,393	6,721	10,992	9,227	59.6	KSC 33 Concrete
47	49	105	211	1.0	175.1	3.0	96.3	2,156	5,770	9,923	11,646	9,490	57.7	Edwards 22 Concrete
48	50	102	209	2.0	151.2	4.4	112.9	2,321	7,832	10,573	12,995	10,674	58.6	KSC 33 Concrete
49	46	104	203	2.0	156.0	3.7	132.2	1,805	6,521	8,510	12,725	10,800	65.6	KSC 33 Concrete
50	47	105	210	1.0	137.0	1.9	115.6	2,458	7,651	8,591	11,025	8,567	50.9	KSC 33 Concrete

a. kgs = knots, ground speed

b. Based on runway measurements except for brake initiation (onboard service)

c. Based on LaRC analysis of KSC spin-up measurement

Source: JSC/ES8, Mechanical Design and Analysis Branch  
In-house Mission Reports



### SHUTTLE FLIGHT HISTORIES LANDING DECELERATION

Miss Seq. No.	STS- No.	Orb. OV.	Velocities and Rates					Distance from Threshold, ft <sup>b</sup>				Total Rollout, ft	Rollout time, sec	Runway Data
			MGTD kgs a	Sink rates fps	NGTD kgs a	Pitch rate deg/sec	Brake inil., kgs a	MGTD	NGTD	Brake inil.	Stop			
51	52	102	219.	1.0	151.4	3.0	101.1	1,080	6,949	9,321	11,788	10,708	63.1	KSC 33 Concrete
52	53	103	208.	3.0	144.9	1.9	106.2	1,108	6,320	7,927	11,273	10,165	72.8	Edwards 22 Concrete
53	54	105	205.	2.0	150.2	2.7	106.8	1,536	6,249	8,233	10,260	8,724	49.2	KSC 33 Concrete
54	56	103	196.	3.0	143.8	2.9	128.0	1,075	5,567	6,295	10,605	9,530	63.1	KSC 33 Concrete
55	55	102	210.	3.5	149.0	3.9	85.0	1,819	7,283	10,030	11,944	10,125	60.9	Edwards 22 Concrete
56	57	105	203.	1.5	135.0	2.9	99.7	2,297	7,498	9,371	12,251	9,954	65.3	KSC 33 Concrete
57	51	103	198.	1.5	144.1	3.3	113.4	2,099	6,539	7,977	10,370	8,271	50.1	KSC 15 Concrete
58	58	102	204.	2.0	167.6	3.2	137.2	3,380	6,948	8,772	13,020	9,640	60.9	Edwards 22 Concrete
59	61	105	192.	1.5	148.7	3.0	118.0	2,903	6,635	8,029	10,825	7,922	53.4	KSC 33 Concrete
60	60	103	191.	2.0	118.2	3.52	97.5	2,463	7,455	8,295	10,234	7,771	49.8	KSC 15 Concrete
61	62	102	210.	3.0	148.2	3.2	122.4	3,004	8,746	10,044	13,155	10,151	54.5	KSC 33 Concrete
62	59	105	228.	3.5	171.4	3.80	117.9	1,664	7,067	9,819	12,355	10,691	53.7	EAFB 22 Concrete

a. kgs = knots, ground speed

b. Based on runway measurements except for brake initiation (onboard service)

c. Based on LaRC analysis of KSC spin-up measurement

Source: JSC/ES6, Mechanical Design and Analysis Branch  
In-house Mission Reports

## Performance Rules of Thumb

ASCENT	DESCENT	PROPELLANT															
<p><u>Ascent Performance Margin</u>  <u>Management Reserve Req. (lbs)</u>            Pre Flight Design Requirements            Document = 3500            Flight Design Requirements            Document = 2500            Cargo Integration Review = 1500            Flight Planning Stowage            Review = 1500            FPR = 4652</p> <p><b>ORBIT</b></p> <p>1 hr launch delay = change in orbital noon by 4 minutes</p> <p><u>Ascending node</u>            28.5 deg - 1st ascending node is @ Long = 173.38 East            57 deg = 121.55 West</p> <p><b>MISCELLANEOUS</b></p> <p><u>Orbiters</u>            OV101 - Enterprise            OV102 - Columbia            OV103 - Discovery            OV104 - Atlantis            OV105 - Endeavor            OV102 weighs 7000 lbs more than OV103/104</p> <p>Min planned fit duration = 96 hours</p> <p><u>Max/Min Beta Angle</u>            Max = 23.5 + orbital inclination            Min = 23.5 - orbital inclination</p> <p><u>Time</u>            CDT = GMT - 5 hr            CST = GMT - 6 hr            Daylight savings time from 1st Sunday in April to last Sunday in October</p>	<p><u>Xcg Limits</u>            FW D = 1076.7 in (RTLS = 1079.0 in)            AFT = 1109.0 in            CONT AFT = 1119.0 in</p> <p><u>D/O Delta V's</u>            Descending approach is worst case <math>\Delta V</math>            90 deg prebank will decrease <math>\Delta V</math> - 10 ft/s (function of altitude)</p> <p>If Xcg &gt; 1091.5: 1 in Xcg = 2.2 miles            If Xcg &lt; 1091.5: 1 in Xcg = 1.1 miles            As Xcg increases (more aft), XR decreases            1 nm XR = 5780 lbs EI weight            1 nm XR = 4.38 nm D/O altitude            As altitude and weight increase, XR increases            As inclination increases, XR increases (non-linear)            As temp increases, XR increases (non-linear)</p> <p><u>Touchdown speeds</u>            185 kts if TD weight &lt; 200 k lbs            195 kts if 200 K lbs &lt; TD weight &lt; 220 k lbs            205 kts if TD weight &gt; 220 k lbs</p> <p style="border: 1px solid black; padding: 2px;">10 kts slower if short field speedbrake guidance mode is used if 200 k lb &lt; TD weight &lt; 245 k lbs</p> <p>Derotation 185 KGS with beep trim            175 with RHC (manual) derotation</p> <p><u>Mass Moment</u>  <math>MM = TD \text{ Weight} * (1172.3 - Xcg) / 12</math>            for medium lakebed runways            If MM &gt; 1.47 M ft-lbs Concrete desire            If MM &gt; 1.54 M ft-lbs Concrete required            Note: If TD Xcg not known, use  <math>Xcg @ M = 3.5 + 1.5 \text{ in}</math></p> <p><u>Landing Weight Limits</u>            EOM 233 k lbs            RTLS 242 - 248 k lbs *            TAL 241 - 248 k lbs *            AOA 233 - 240 k lbs *            (Abort limits a function of inclination)</p> <p><u>Noctilucent Clouds</u>            If Inc &gt; 50, do not enter on descending opportunity            June through August.</p> <p><b>RENDEZVOUS</b></p> <p>1 deg of phasing/hour = 10 nm of <math>\Delta</math> height            1 deg of phasing = 60 nm            17.5 ft/s burn changes other side of orbit 10 nm            440 ft/s burn will change plane by 1 deg of wedge            1 deg of <math>\Delta</math> RAAN occurs for each relative lap</p>	<p>1 deg of plane change = 440 ft/s</p> <p><u>OMS philosophy</u>            1 ft/s = 21.8 lbs OMS @ 220 k lbs - 1/6%            1.78 ft/s = 1 nm</p> <p><u>Maximum OMS load</u>            OV102 = 25156 lbs            OV103/4 = 25064 lbs            Min = 10800 lbs            Max OMS ballast = 4000 lbs            1% OMS = 130 lbs/side</p> <p><u>Hard Ballast</u>            OV102 - can be installed in the aft compartment            OV103/104 - Bay 13</p> <p><u>RCS philosophy</u>            1 ft/s = 25 lbs (+ X) or 35 - 40 lbs (multi axis) @ 220 k lbs            Max burn = 250 sec = 55 fps            Full FRCS = 2446 lbs            ET blowdown offload = 2225 lbs            Min FRCS - 1862 lbs            Full ARCS = 4970 lbs (over 100%)            1% ARCS = 22 lbs/side</p> <p><u>INTERCONNECT logic</u>            If OMS &lt; 14,000 lbs, <math>\sqrt{C}</math> off            If OMS &gt; 17,000 lbs, <math>\sqrt{C}</math> on            If 14 k &lt; OMS &lt; 17 k, analysis req.</p> <p><b>ECN - N2</b></p> <p><u>OV102</u>            6.28 lbs/day for 4 person crew @ 14.7 psi            add .114 lbs/day for additional crew member            4.35 lbs/day for 4 person crew @ 10.2 psi            add .079 lbs/day for additional crew member</p> <p><u>OV103/4</u>            5.28 lbs/day for 4 person crew @ 14.7 psi            add .114 lbs/day for additional crew member            3.66 lbs/day for 4 person crew @ 10.2 psi            add .079 lbs/day for additional crew member</p> <table border="0"> <tr> <td></td> <td><u>Dry wt</u></td> <td><u>Fully loaded wt</u></td> </tr> <tr> <td>N2</td> <td>83 lbm</td> <td>143 lbm</td> </tr> </table> <p><b>EPS</b></p> <table border="0"> <tr> <td></td> <td><u>Dry wt</u></td> <td><u>Fully loaded wt</u></td> </tr> <tr> <td>H2</td> <td>227 lbm</td> <td>319 lbm</td> </tr> <tr> <td>O2</td> <td>215 lbm</td> <td>996 lbm</td> </tr> </table> <p>.09 lbm Hydrogen = 1 kwh            .7 lbm Oxygen = 1 kwh            .07 lbm Oxygen/hour = cabin leak rate</p>		<u>Dry wt</u>	<u>Fully loaded wt</u>	N2	83 lbm	143 lbm		<u>Dry wt</u>	<u>Fully loaded wt</u>	H2	227 lbm	319 lbm	O2	215 lbm	996 lbm
	<u>Dry wt</u>	<u>Fully loaded wt</u>															
N2	83 lbm	143 lbm															
	<u>Dry wt</u>	<u>Fully loaded wt</u>															
H2	227 lbm	319 lbm															
O2	215 lbm	996 lbm															

\* Orbiter Engineering Memo VE3-90-096.

## APPENDIX A PANEL DIAGRAMS

## CONTENTS

Forward

F1.....	A2
F2.....	A2
F3.....	A2
F4.....	A2
F5.....	A3
F6.....	A4
F7.....	A5
F8.....	A6
F9.....	A7

Overhead

O1.....	A8
O2.....	A9
O3.....	A10
O5.....	A11
O6.....	A12
O7.....	A13
O8.....	A14
O9.....	A15
O13.....	A16
O14.....	A17
O15.....	A18
O16.....	A19
O17.....	A20
O19.....	A20

Left

L1.....	A21
L2.....	A22
L4.....	A23
L5.....	A24
L9.....	A24
L11.....	A25
L15.....	A26

Center Console

C2.....	A27
C3.....	A28
C5.....	A29
C6.....	A29
C7.....	A29

Right

R1.....	A30
R2.....	A31
R4.....	A32
R6.....	A32
R7.....	A33
R11U.....	A34
R11L.....	A34
R10.....	A35
R12U.....	A35
R12L.....	A35
R13U.....	A36
R13L.....	A37
R15.....	A38

Aft

A1U.....	A39
A1L.....	A40
A1R.....	A41
A2.....	A42
A3.....	A42
A4.....	A43
A6U.....	A43
A6L.....	A44
A7U.....	A44
A7L.....	A45
A8U.....	A46
A8L.....	A47
A11.....	A47,48
A12.....	A49
A13.....	A49,50
A14.....	A50
A15.....	A51

Middeck

MA73C.....	A52
MD24K.....	A53
MD44F.....	A53
ML18F.....	A53
ML26C.....	A53
ML31C.....	A54

ML85E.....	A54
ML86B.....	A55
MO10W.....	A56
MO13Q.....	A57
MO29J.....	A58
MO30F.....	A58
MO32M.....	A58
MO39M.....	A58
MO42F.....	A59
MO51F.....	A59
MO52J.....	A60
MO58F.....	A60
MO62M.....	A61
MO69M.....	A61
WCS.....	A61
Thermal Impulse Printer.....	A62

Airlock

AW18A.....	A63
AW18D.....	A63
AW18H.....	A64
AW82B.....	A65
AW82D.....	A65
AW82H.....	A66

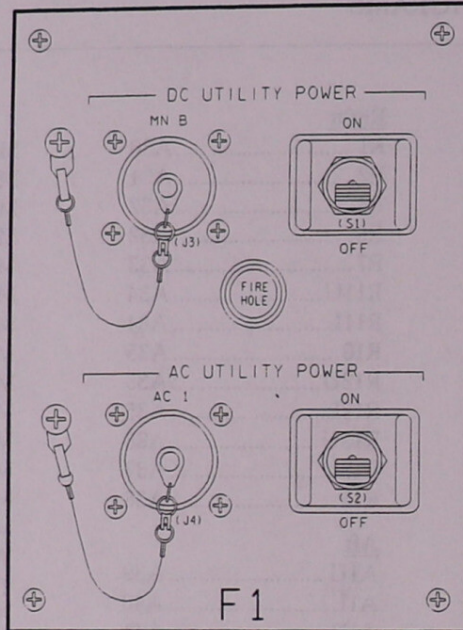

PanelF1

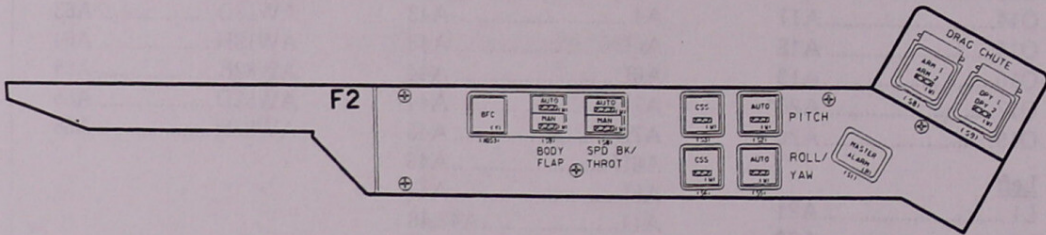

PanelF2

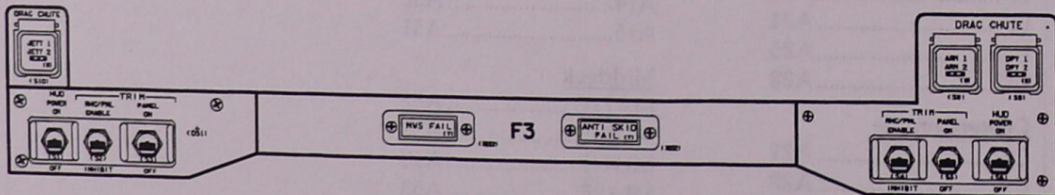

PanelF3

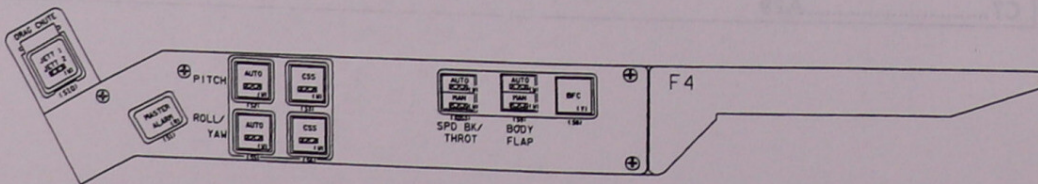

PanelF4

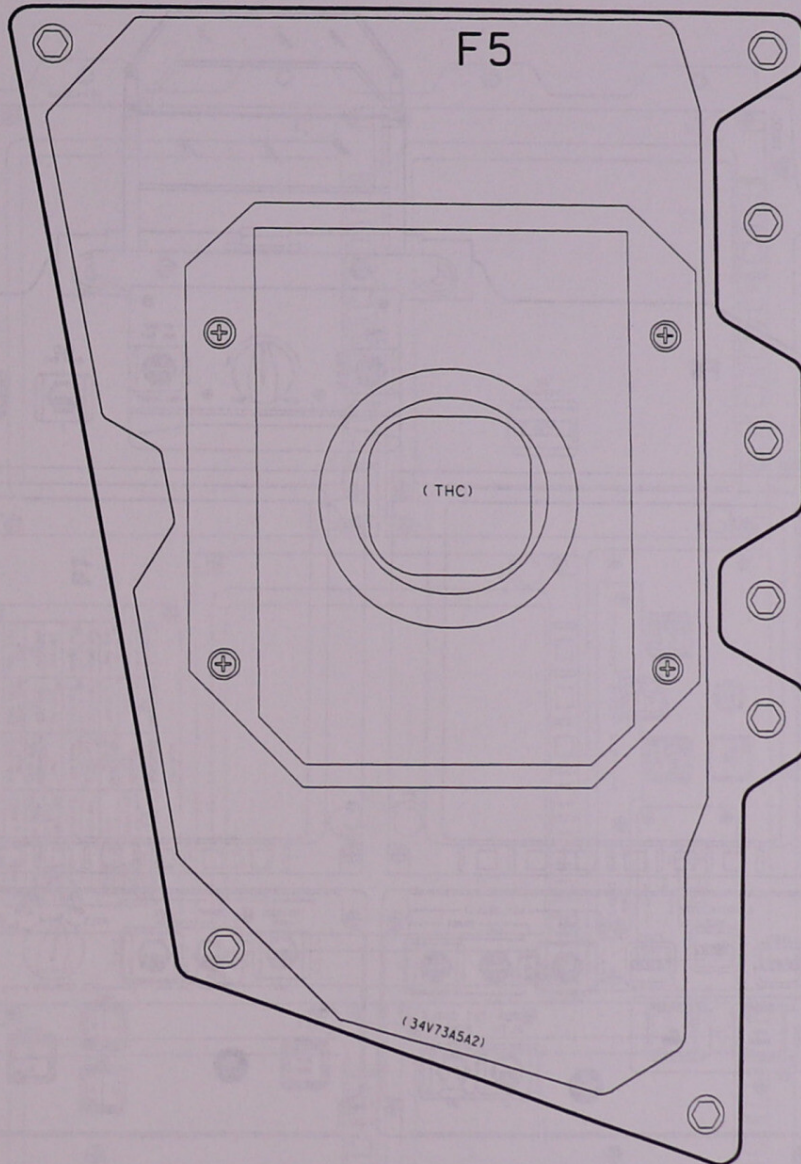

Panel F5

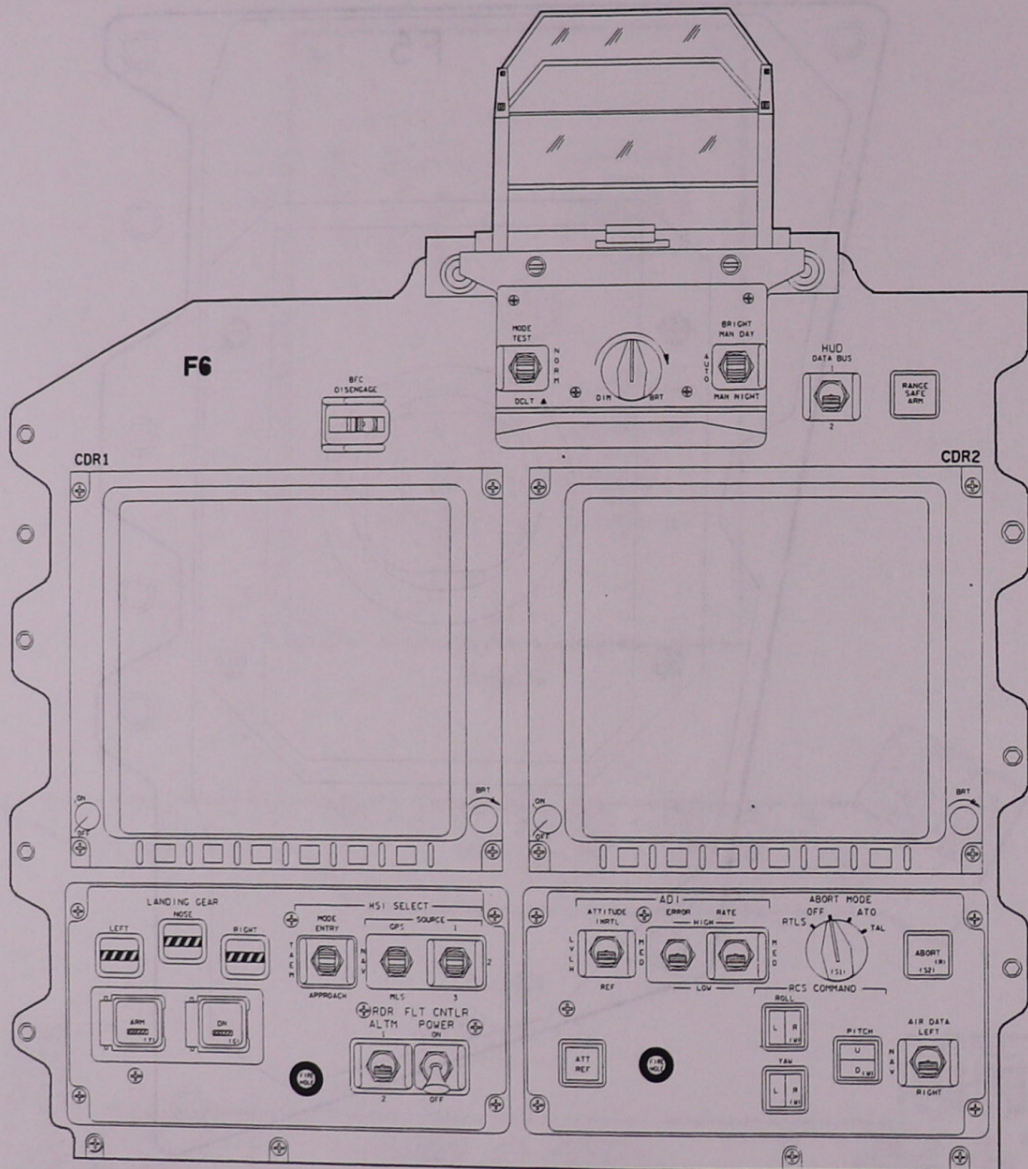

F0884A04, PNL 1

PanelF6

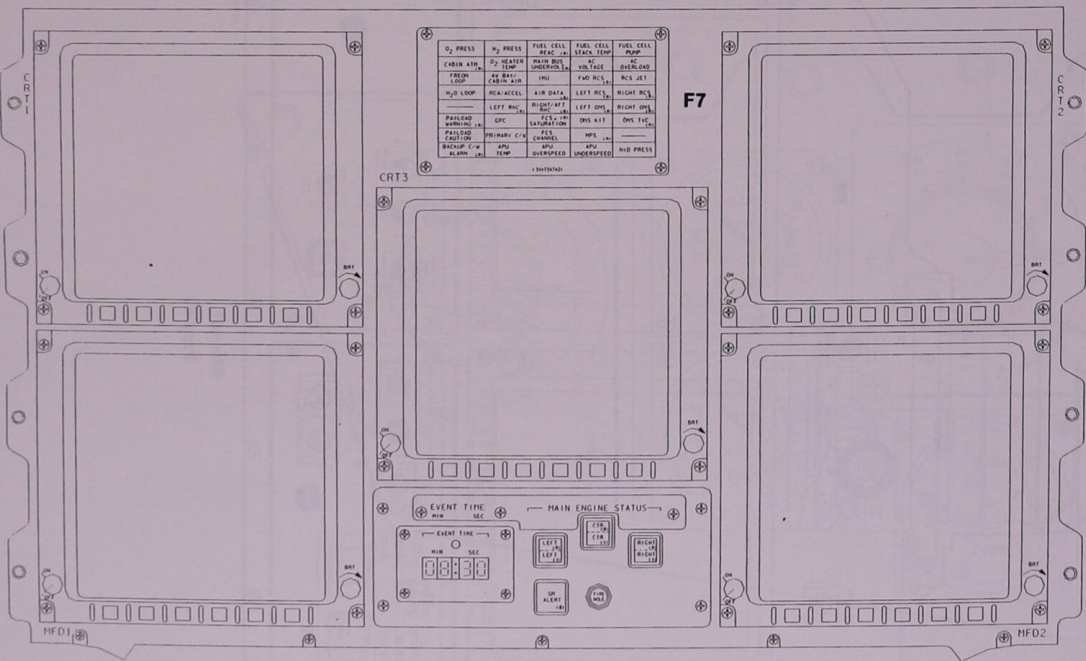

FLOBB4A05, PNL 1

Panel F7

SFOCF10884  
Rev.B

A5

APPENDIX A: PANEL DIAGRAMS

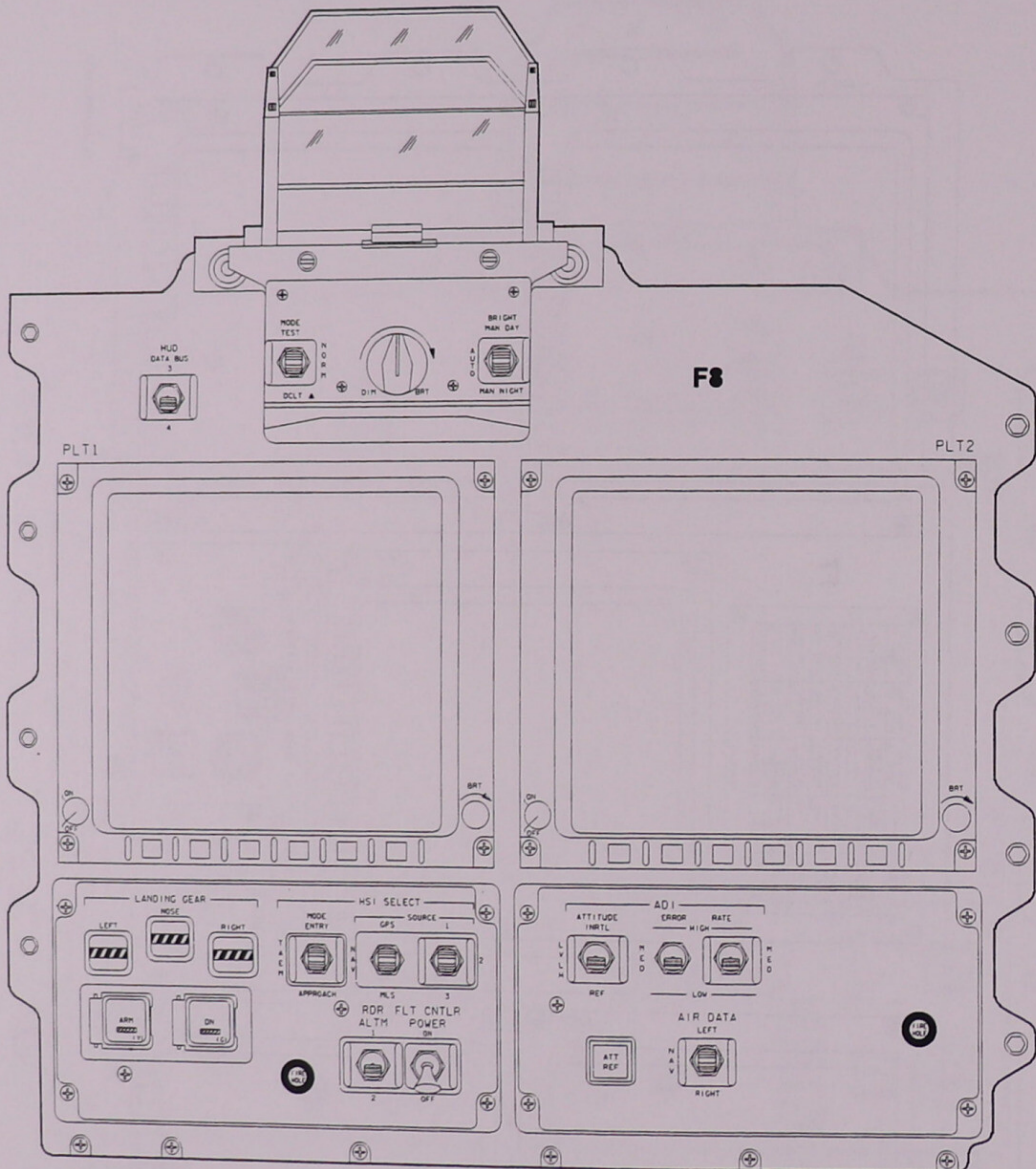

FLO884A06, PNL 1

PanelF8



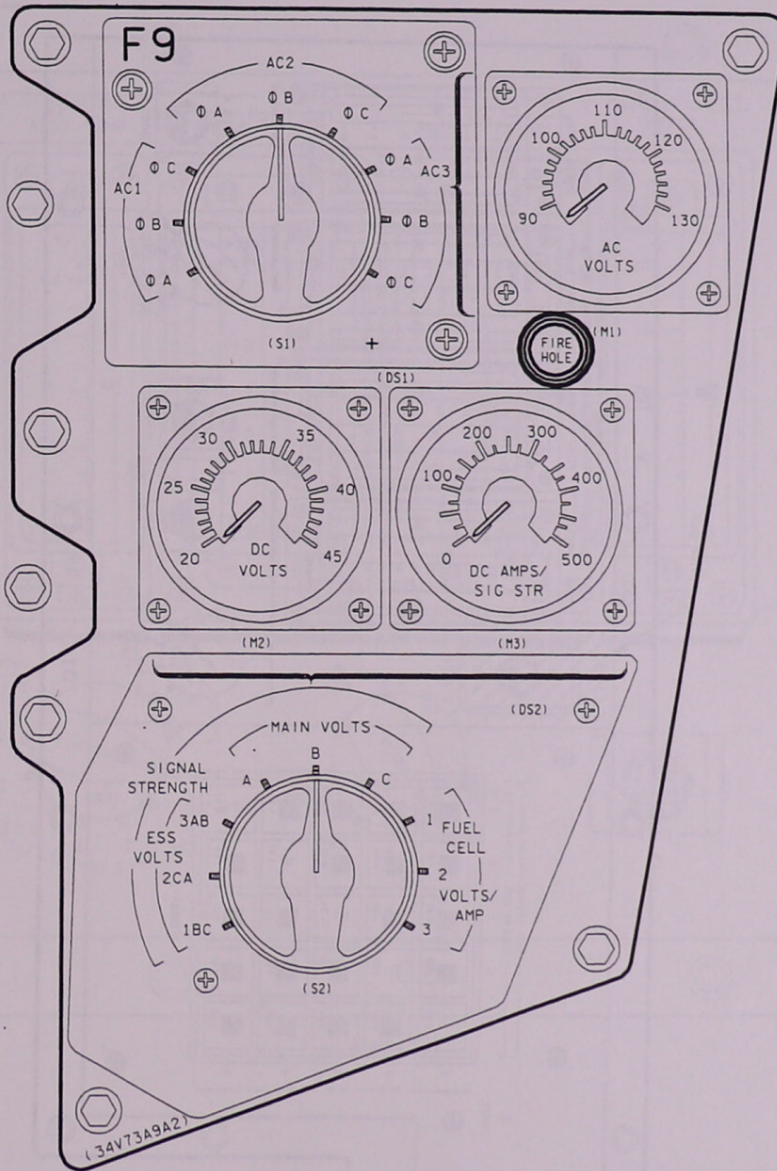

Panel F9

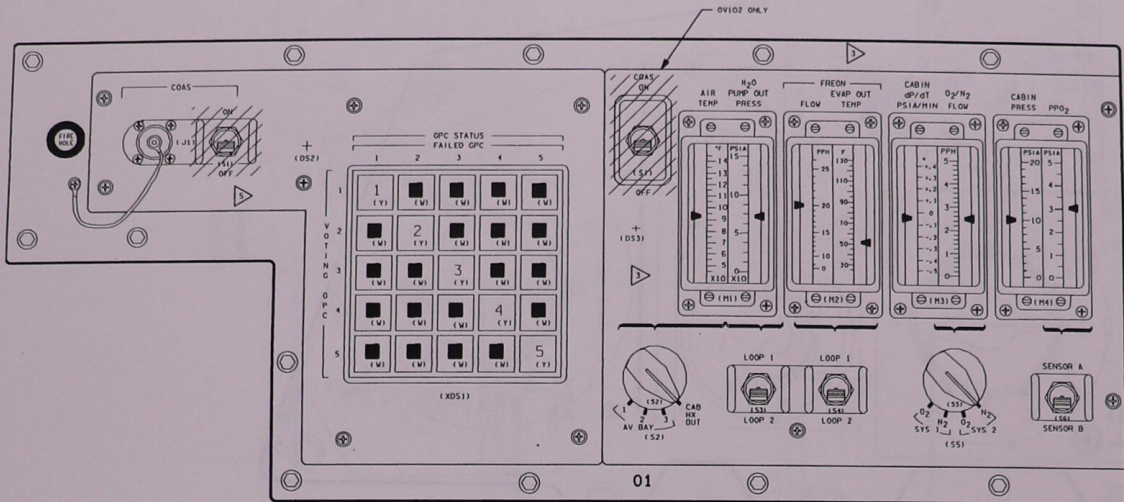

Panel O1

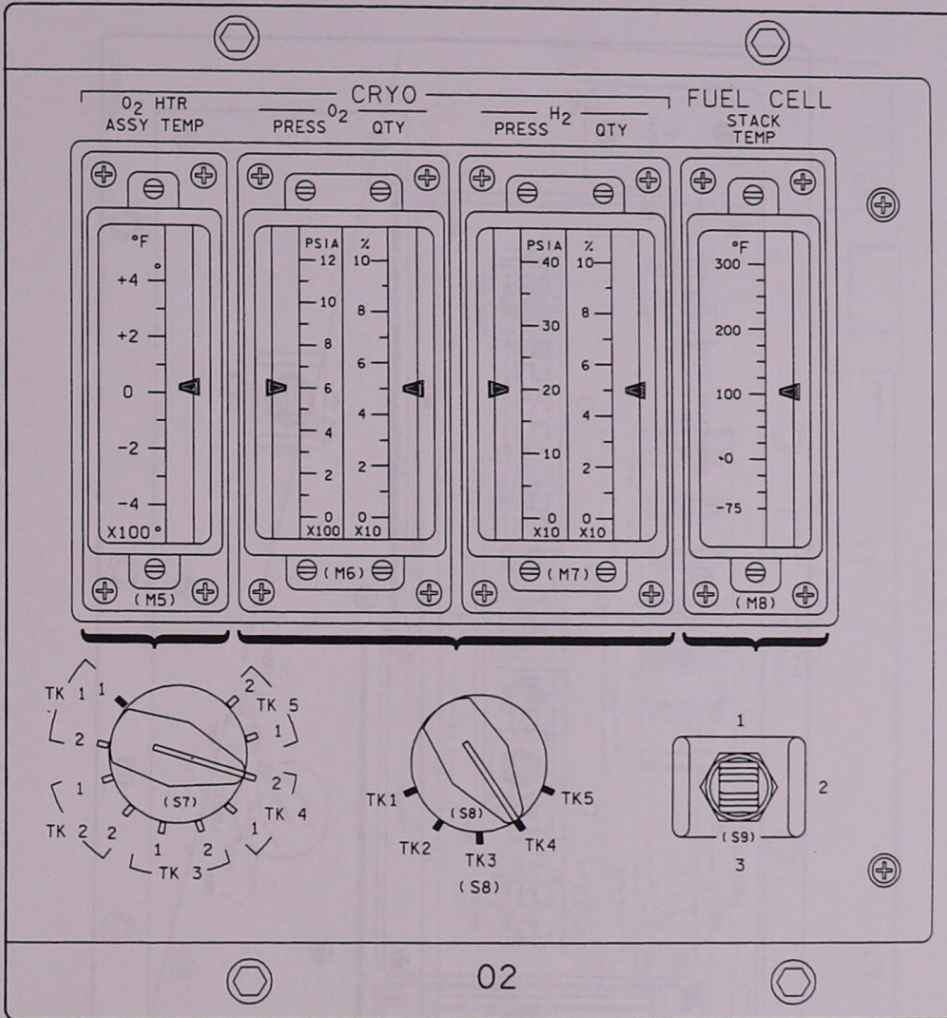

Panel O2

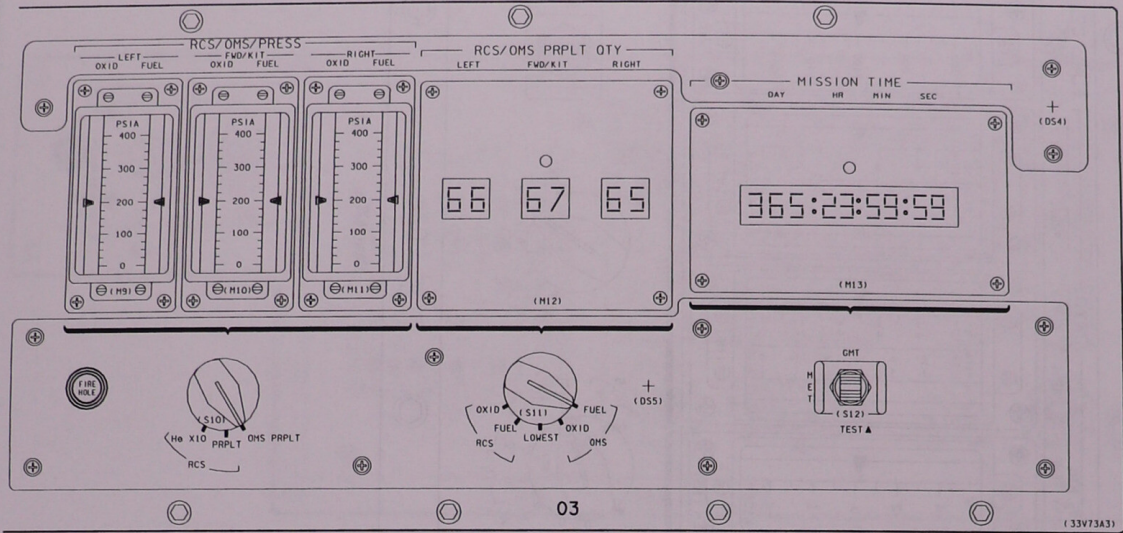

Panel O3

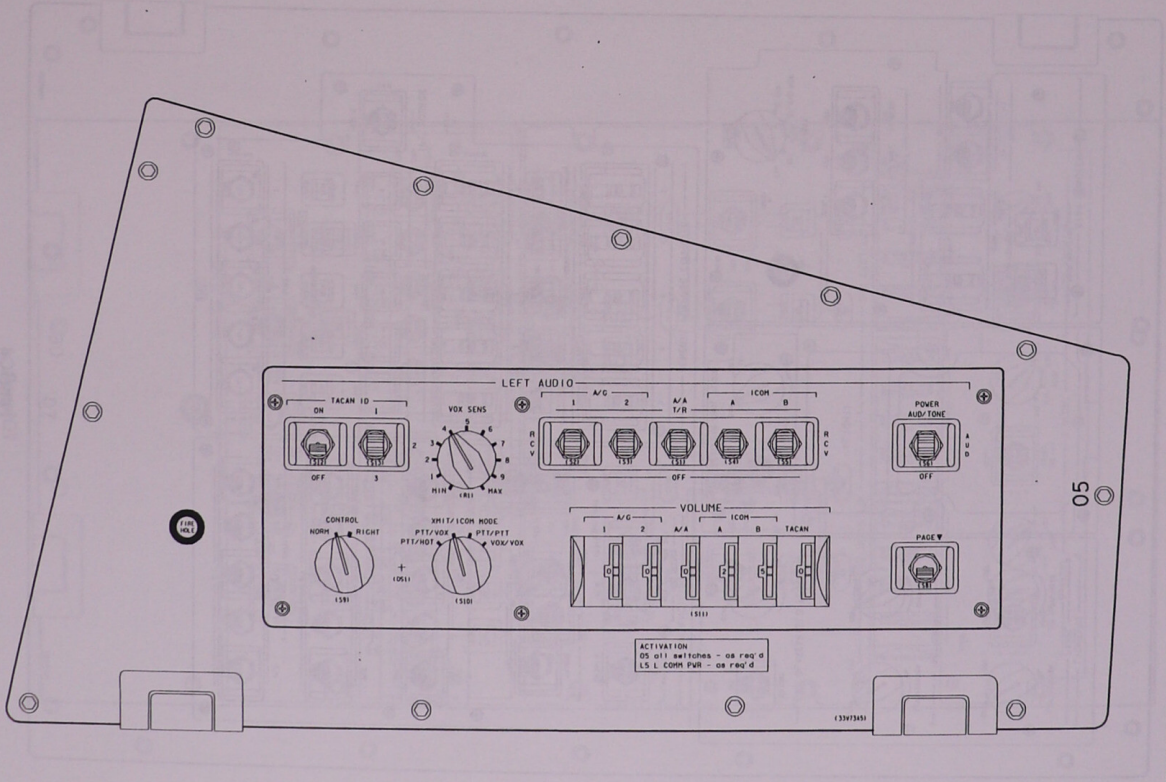

Panel O5

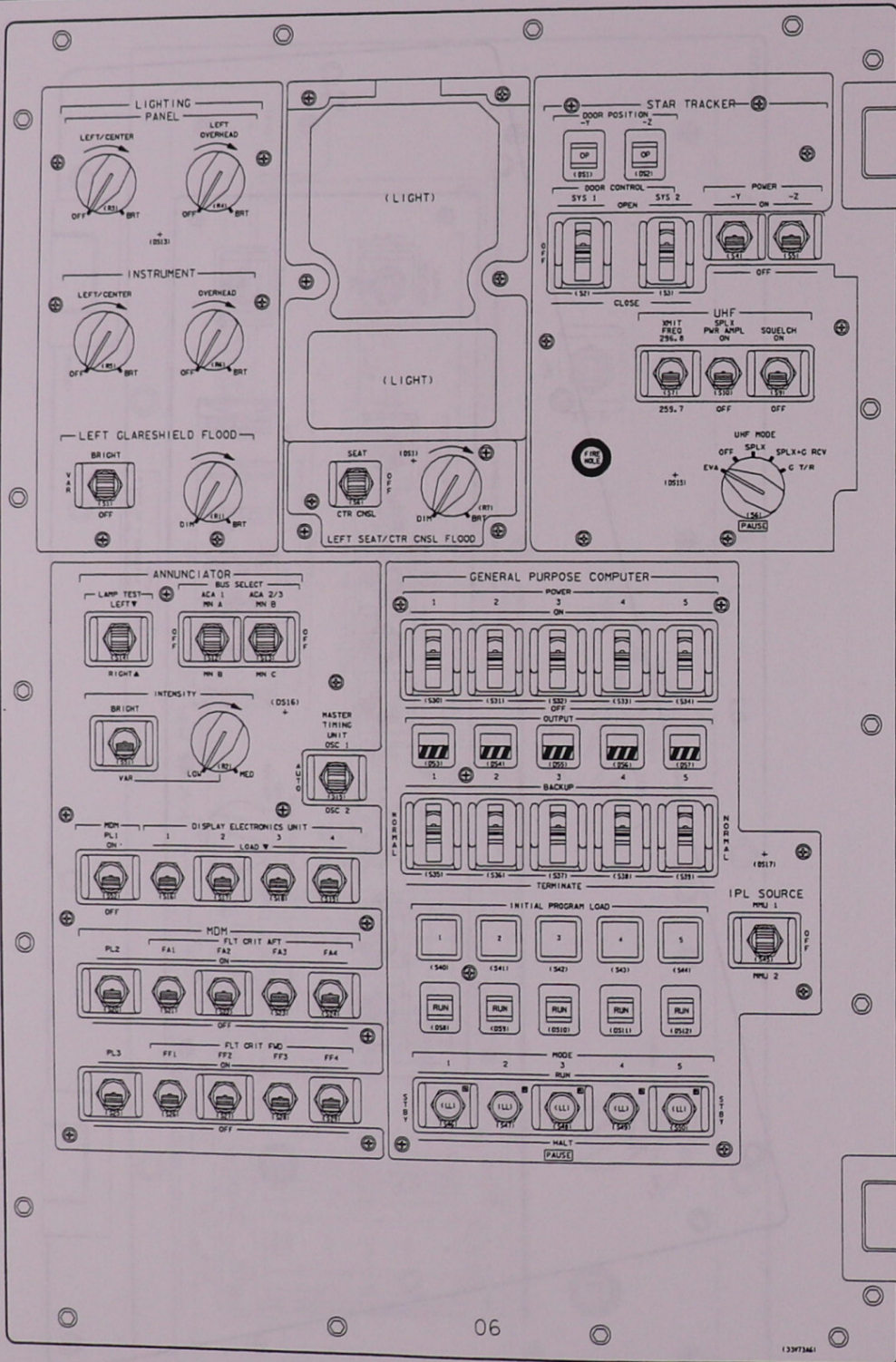

Panel O6

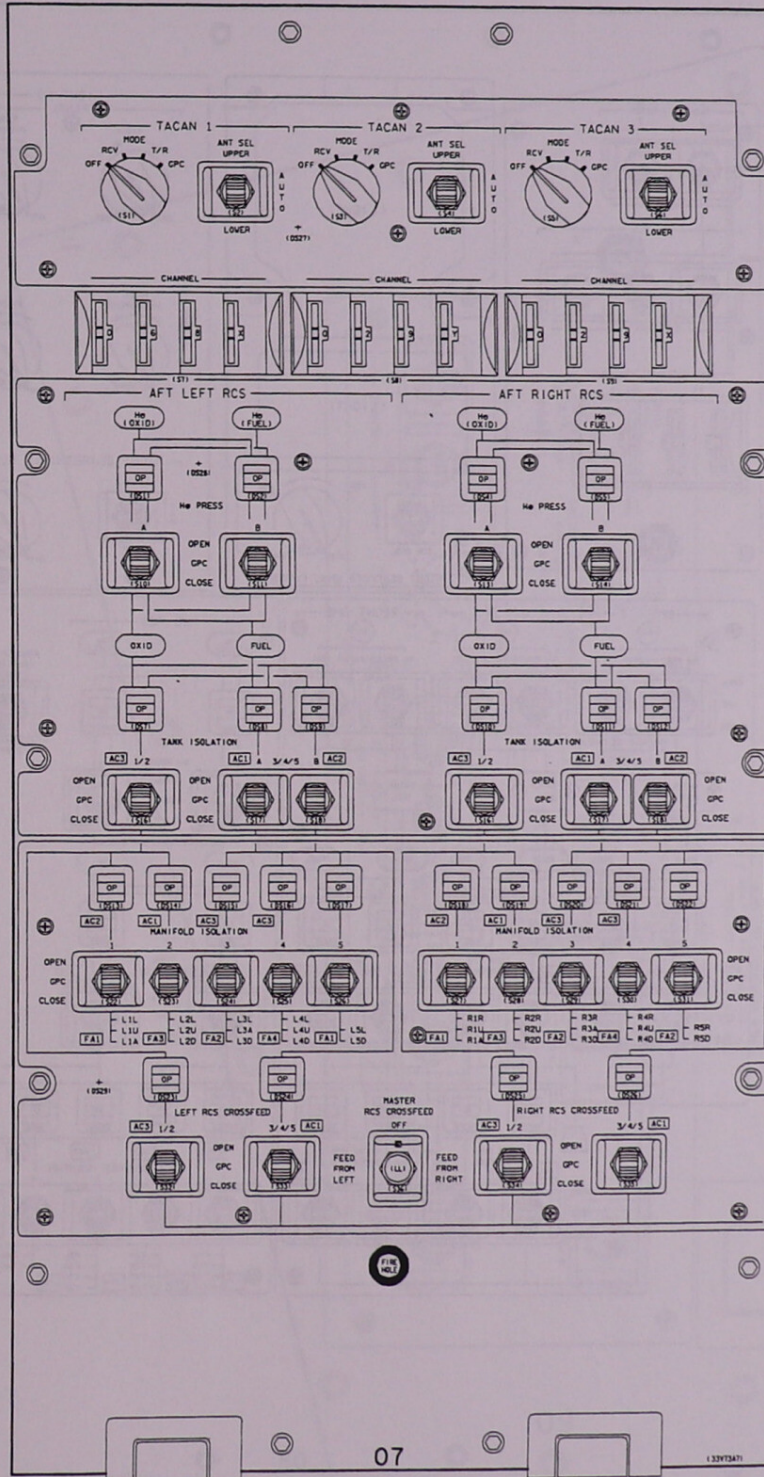

Panel 07

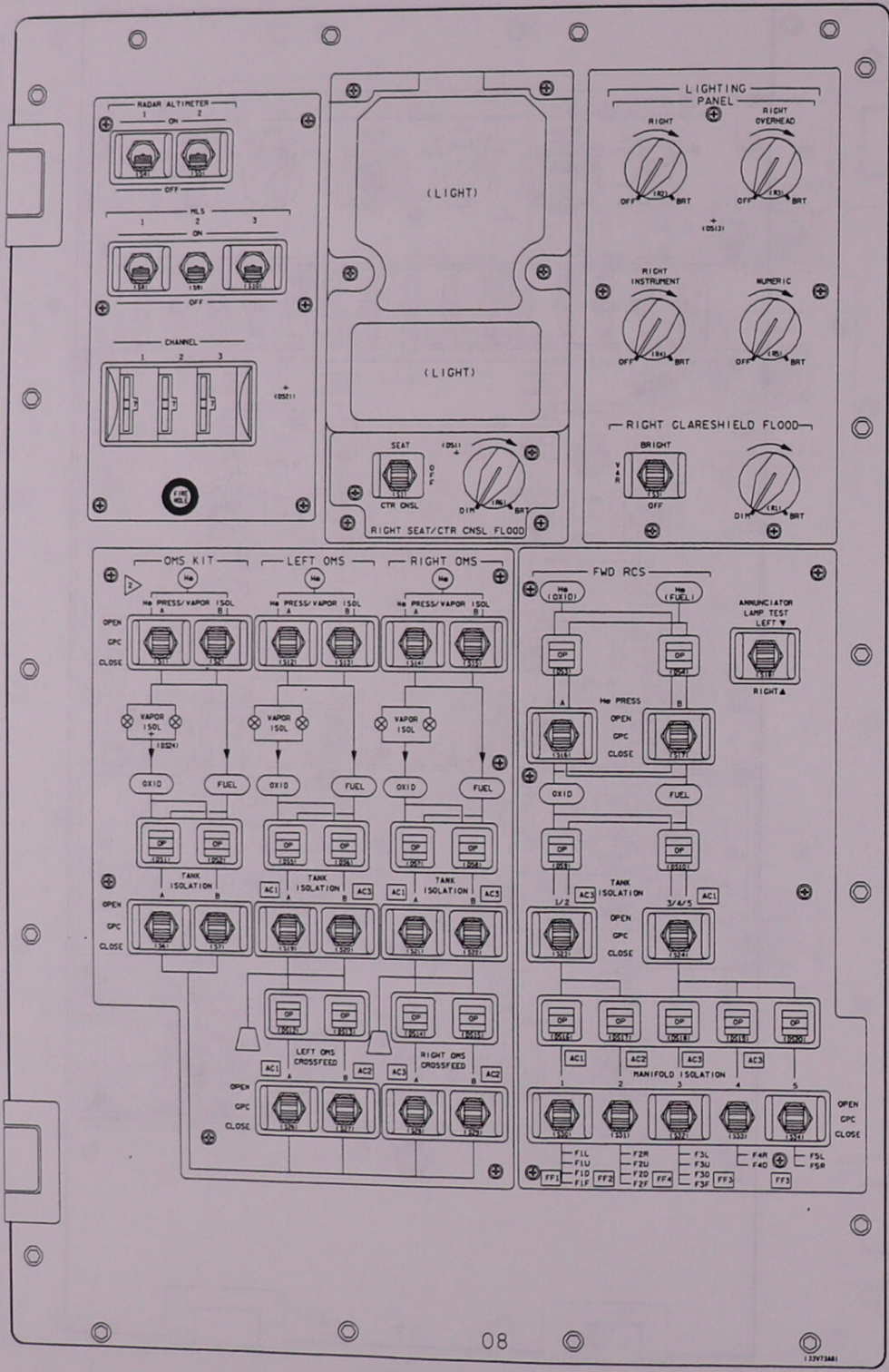

Panel O8



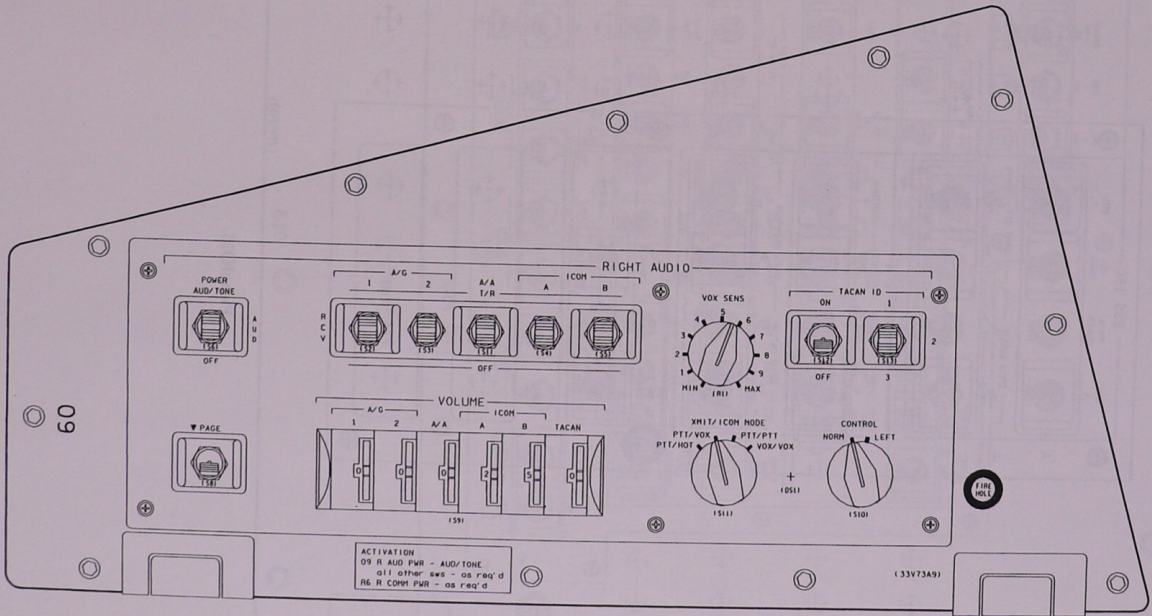

Panel O9

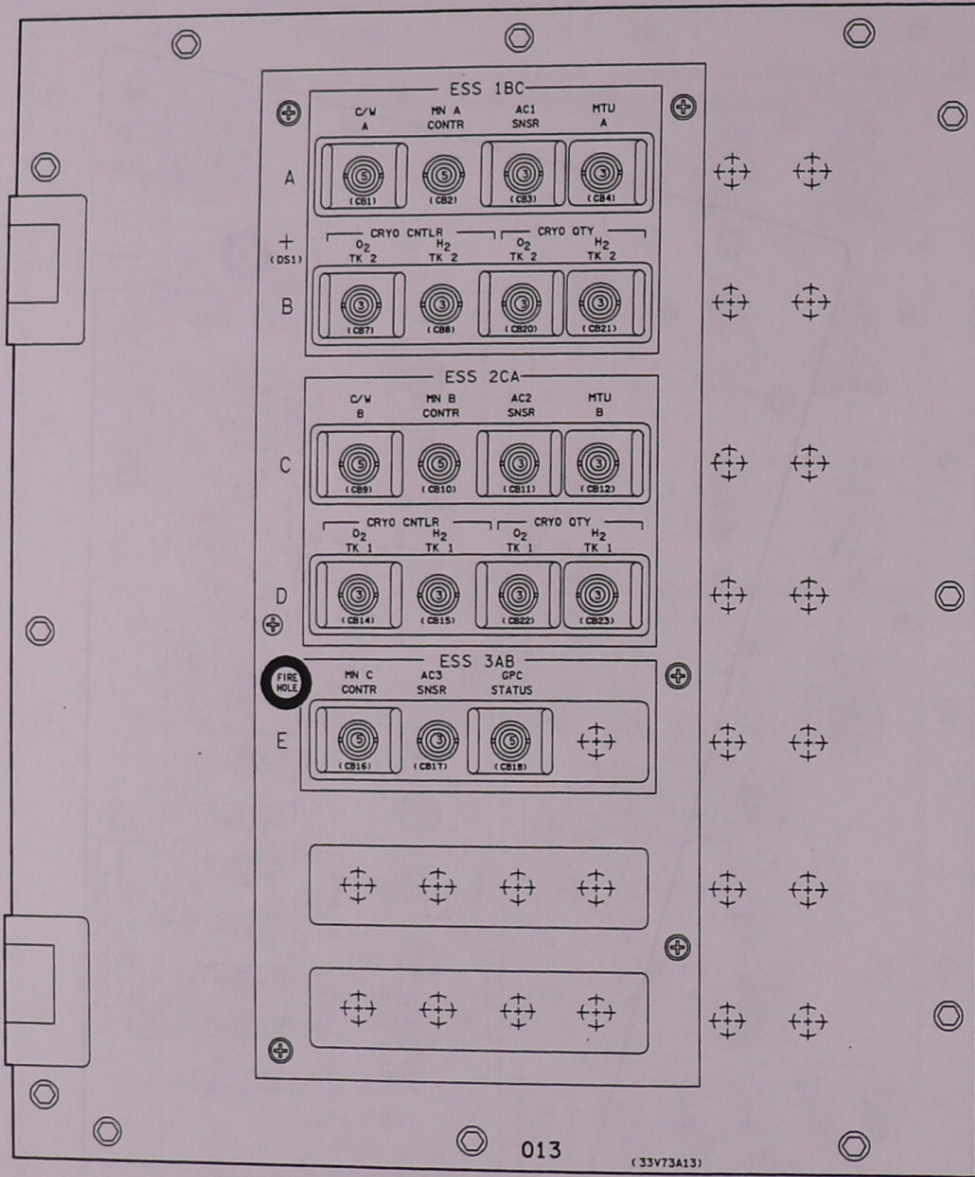

Panel O13

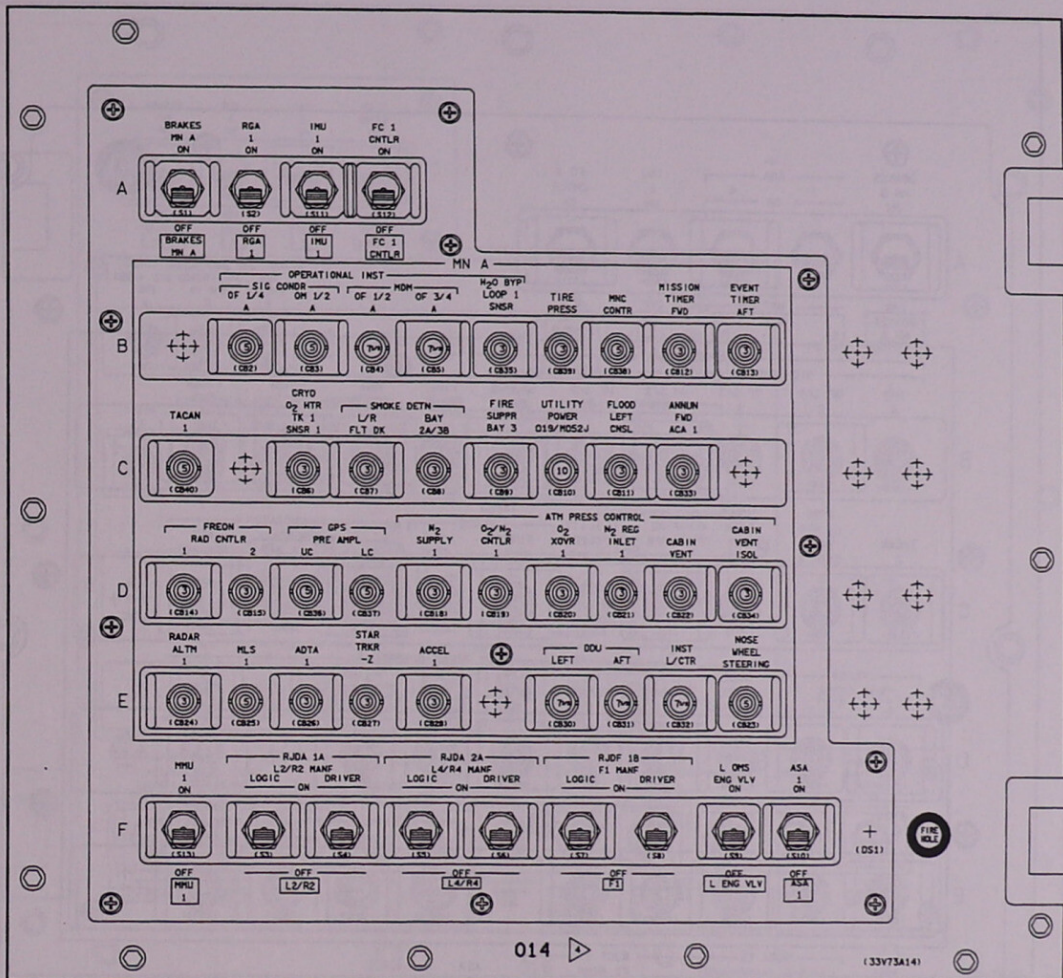

PanelO14

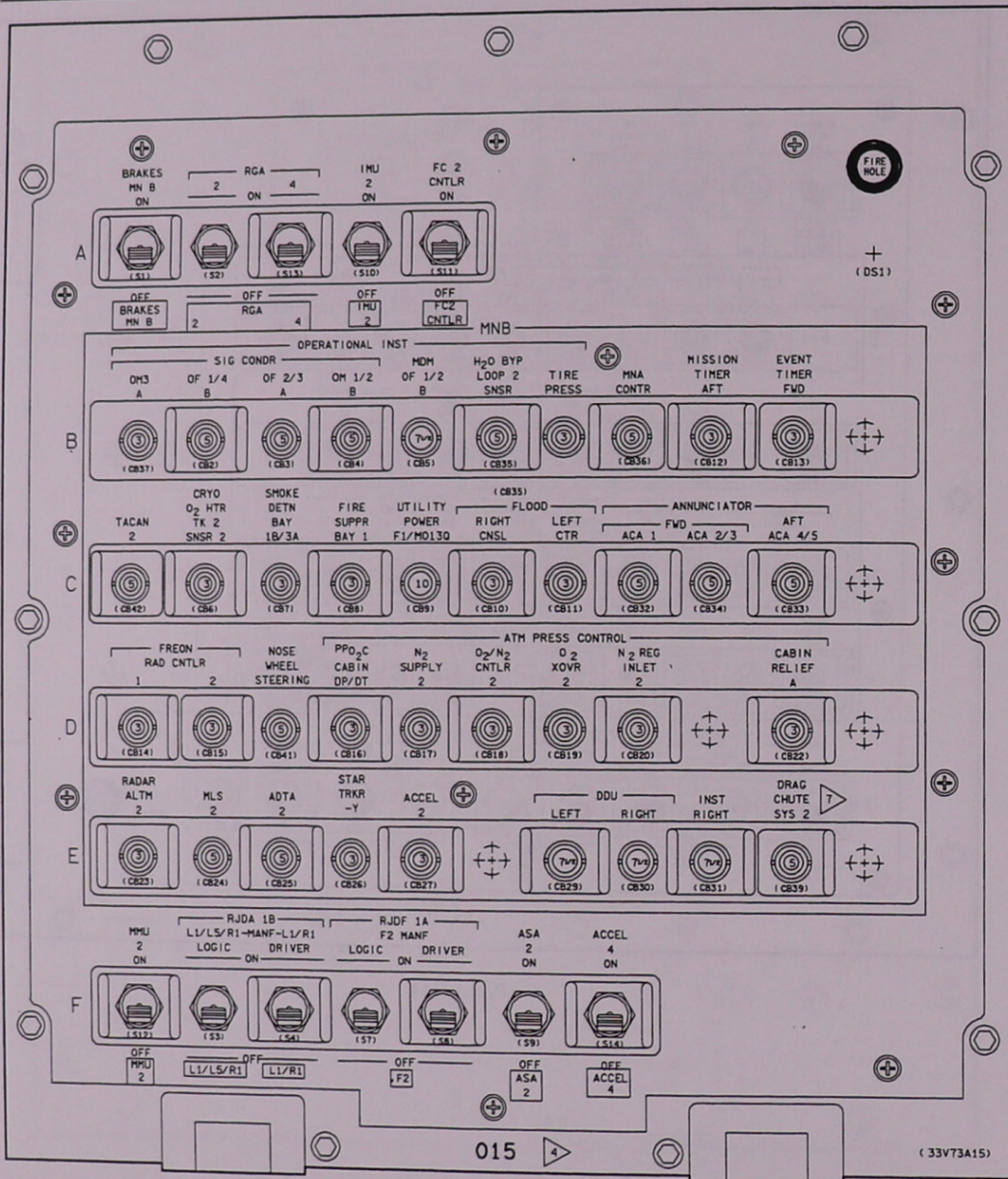

PanelO15

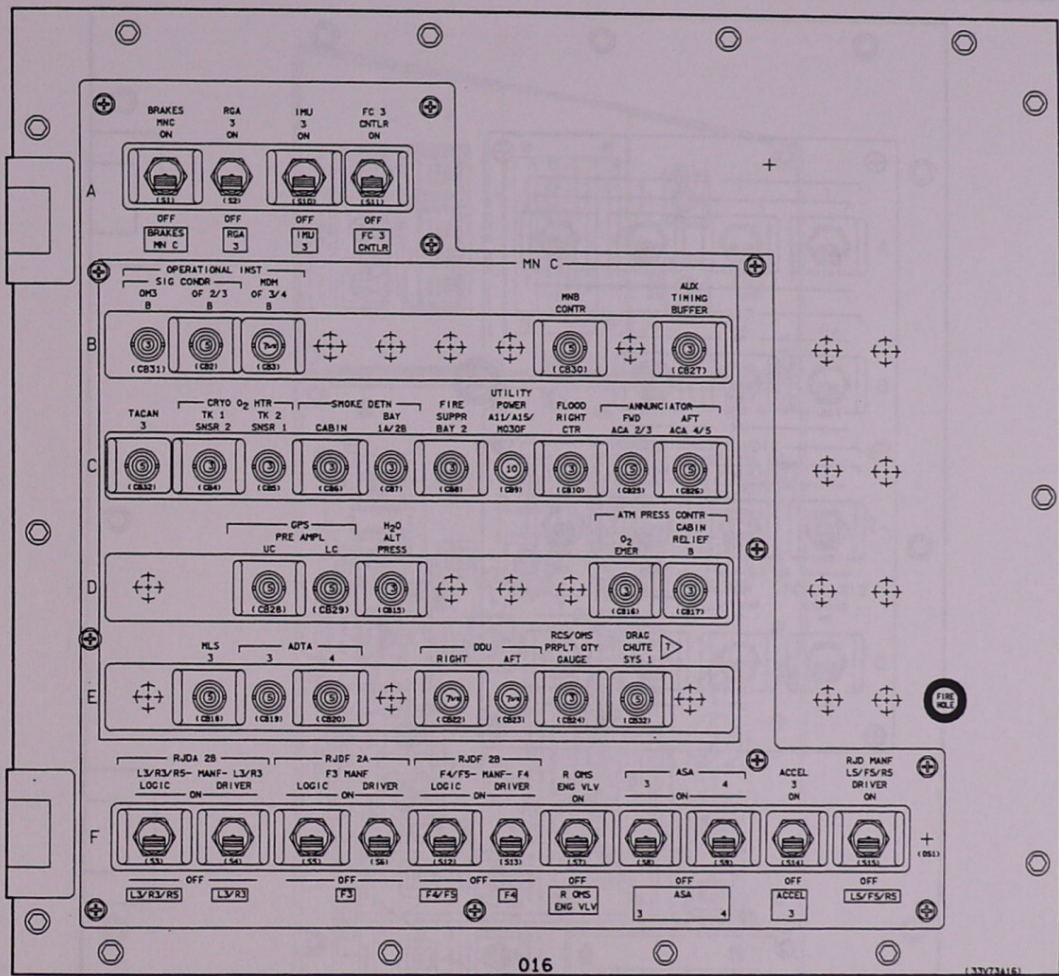

016

Panel O16

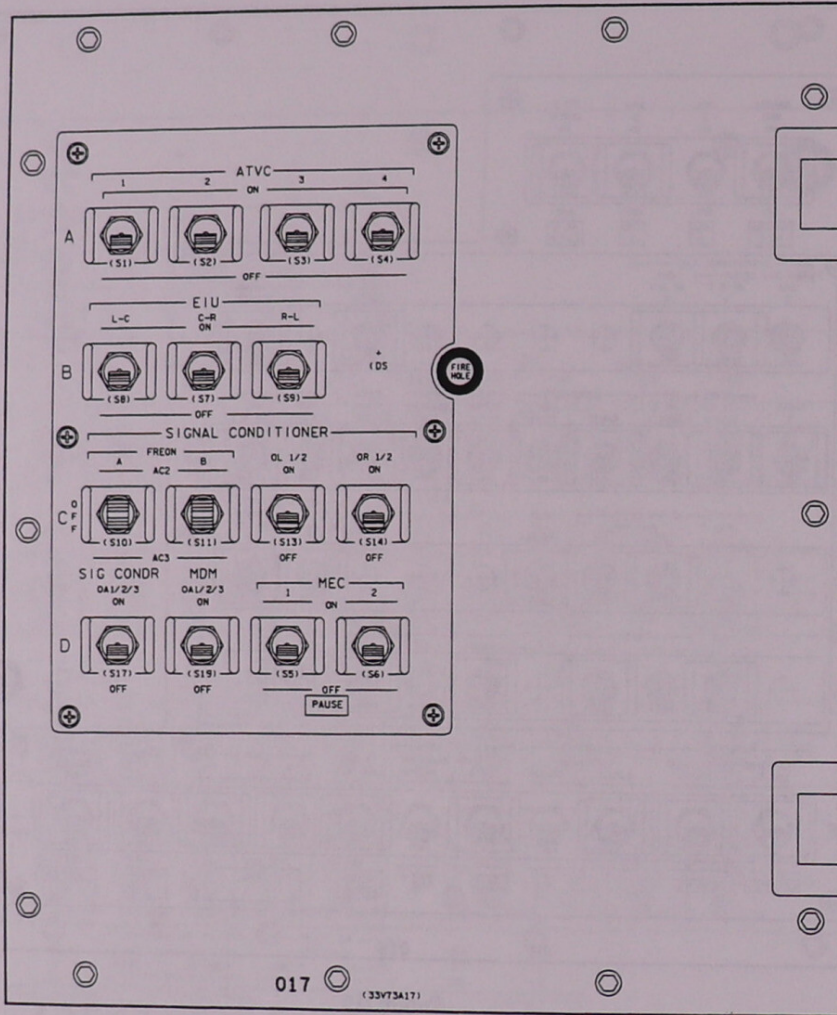

PanelO17

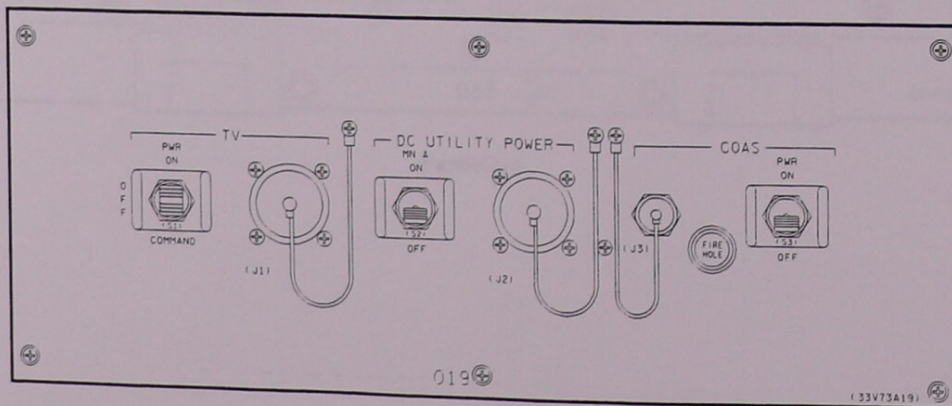

PanelO19

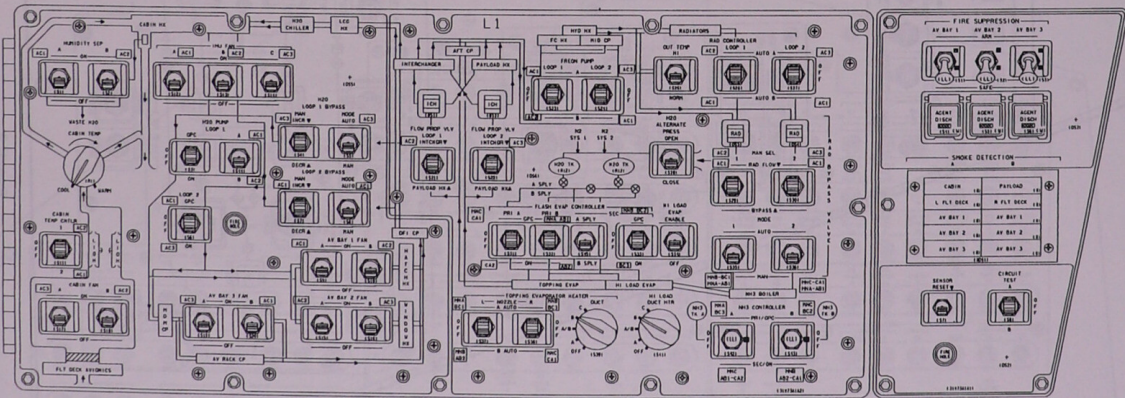

Panel L1

A21

APPENDIX A: PANEL DIAGRAMS

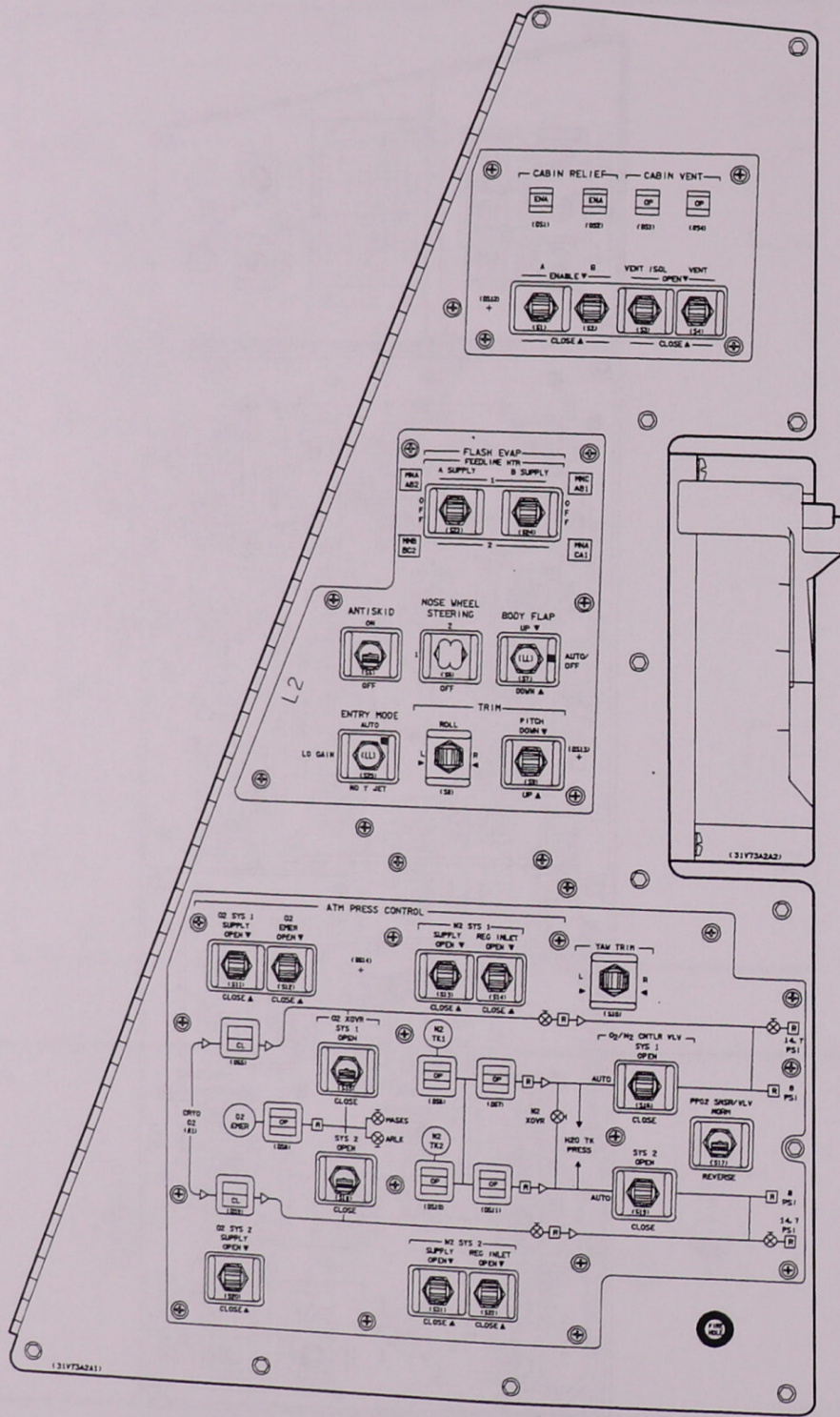

Panel L2



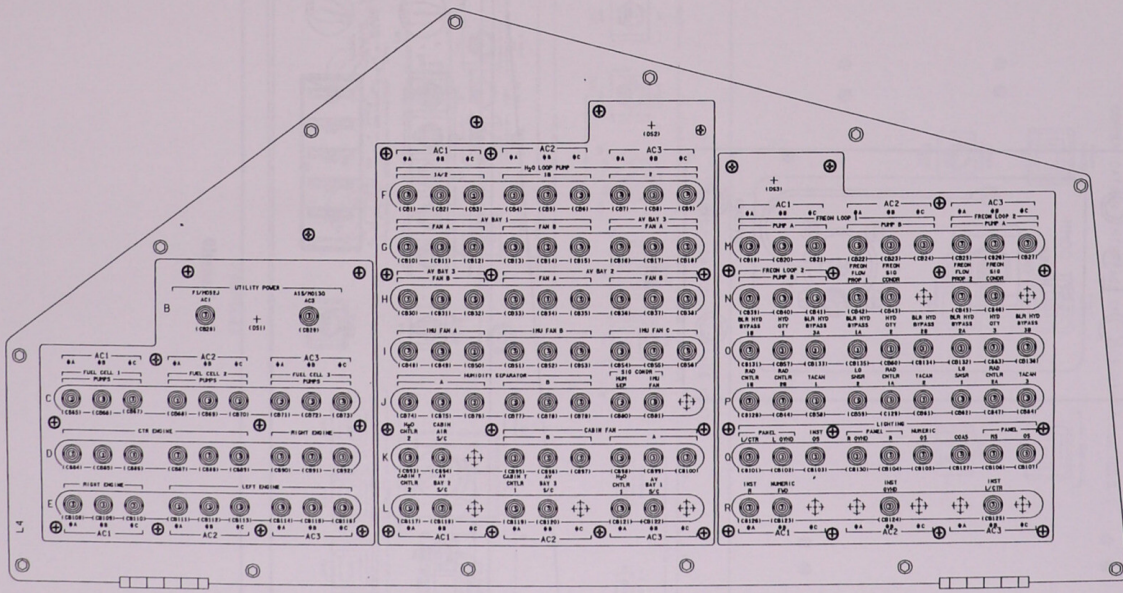

Panel L4

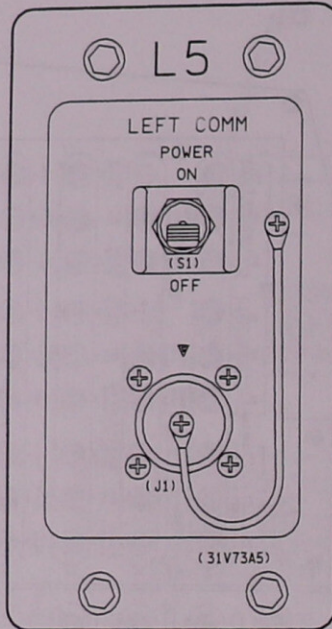

PanelL5

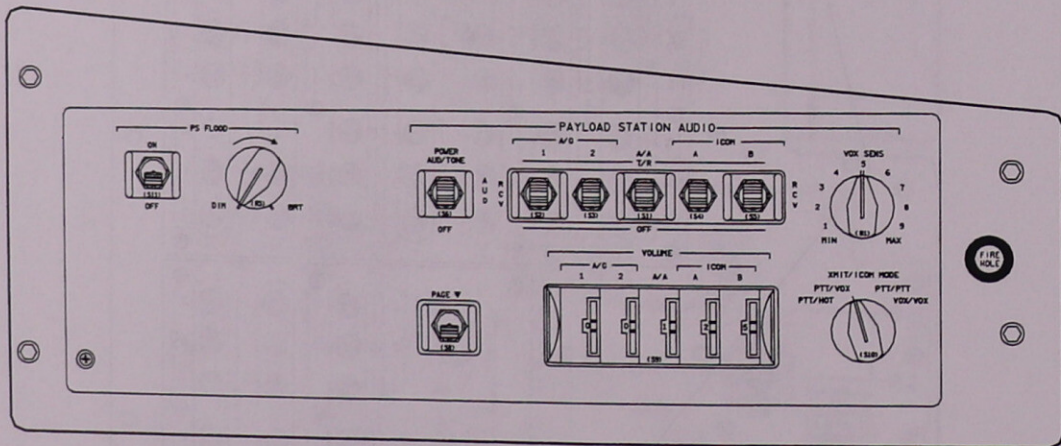

Panel19

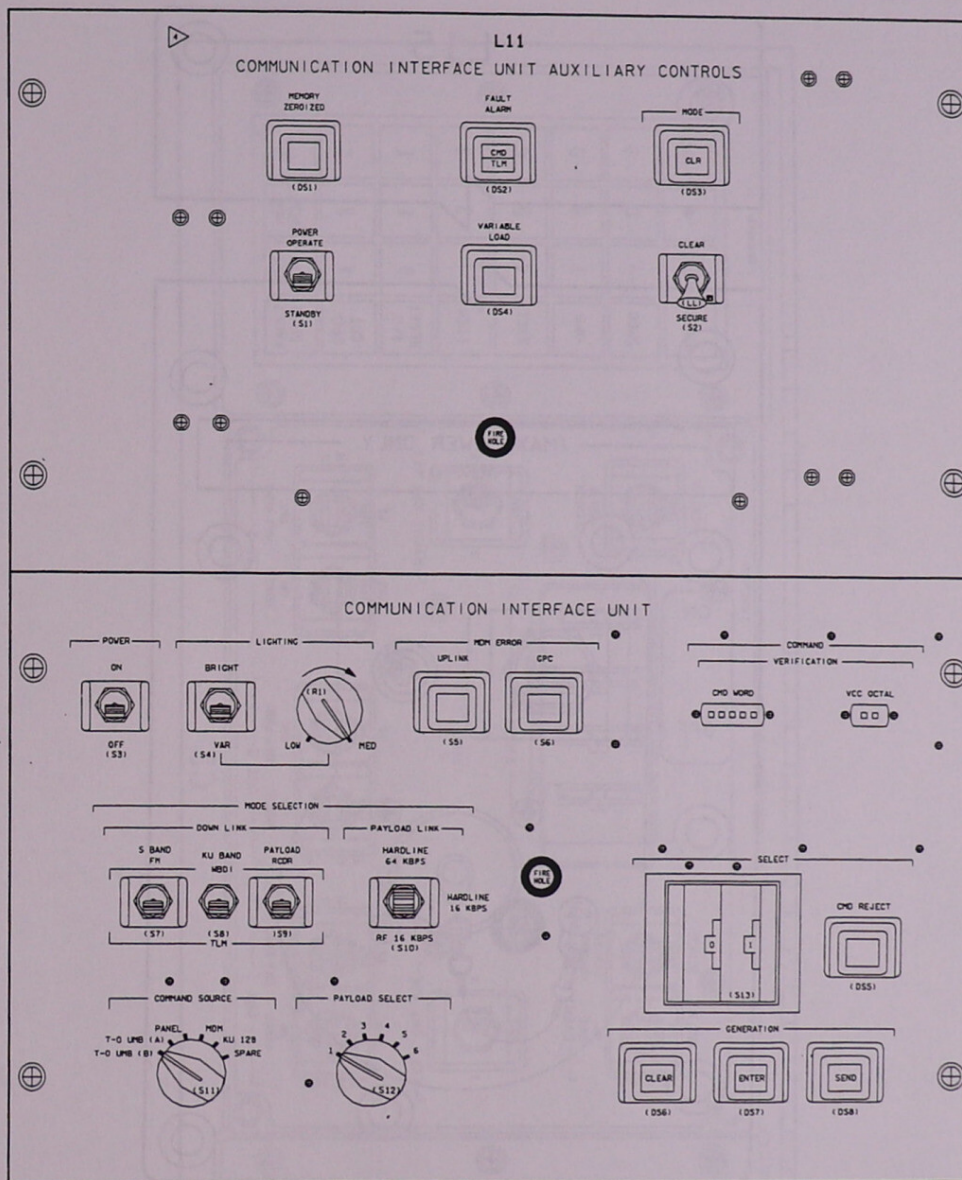

PanelL11

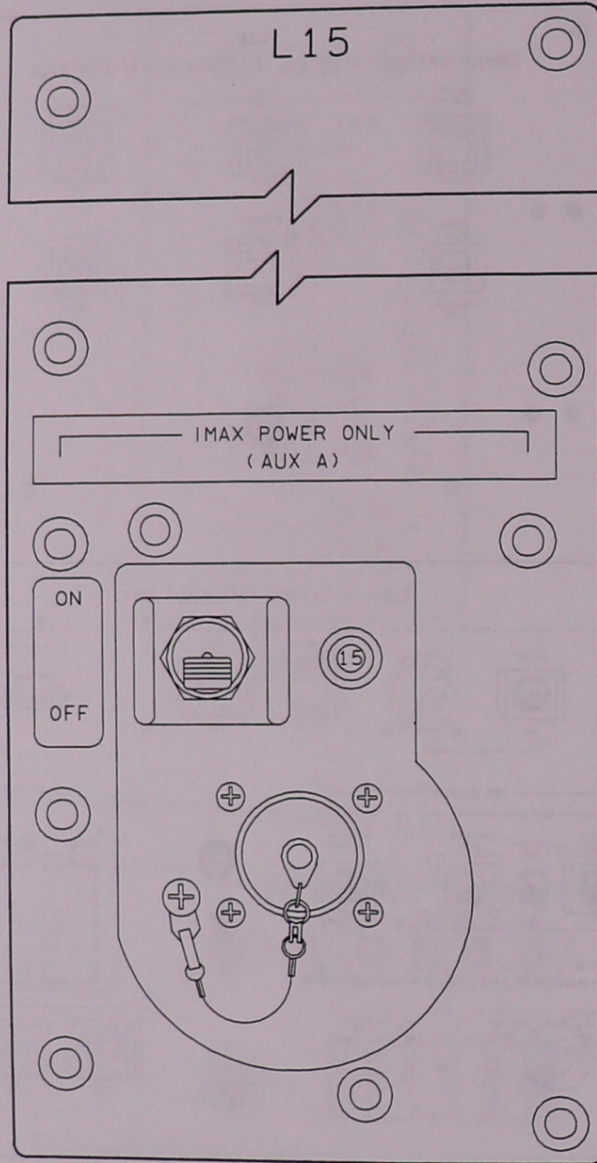

PanelL15

C2

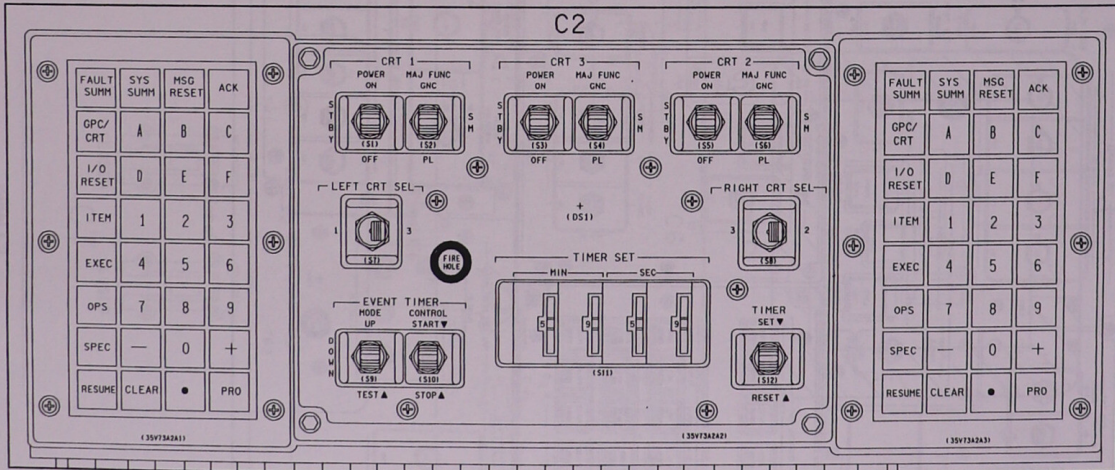

Panel C2

A27

APPENDIX A: PANEL DIAGRAMS

SFOCF10884  
Rev.B

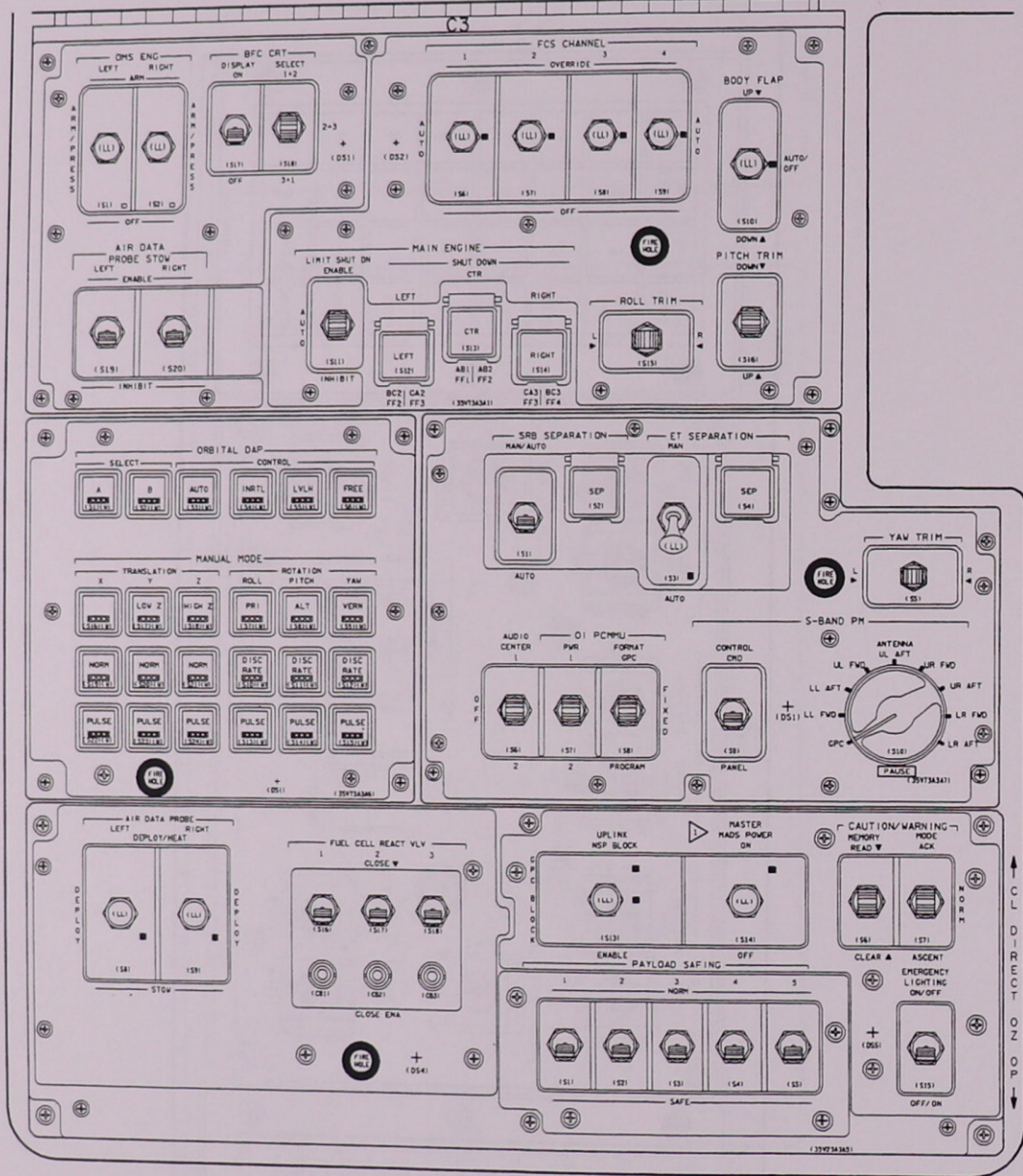

Panel C3

C5

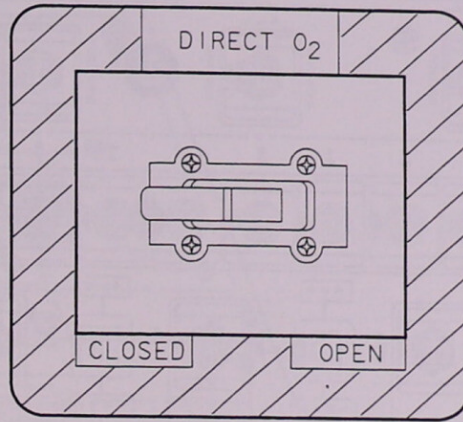

Panel C5

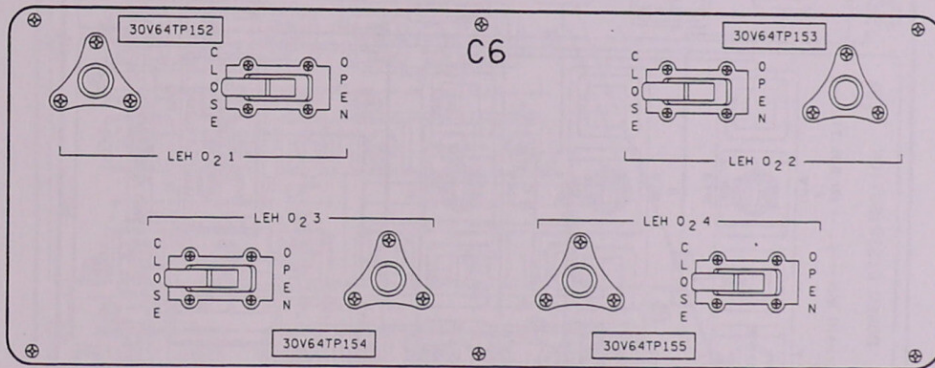

Panel C6

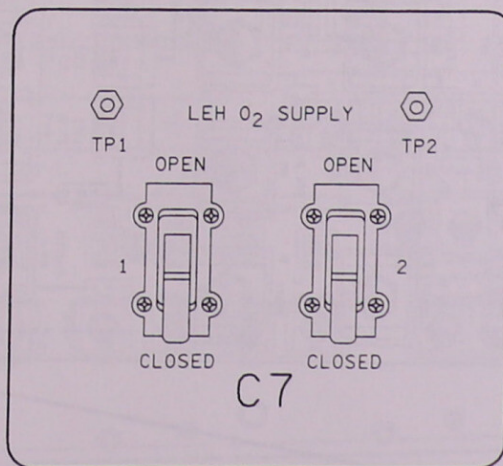

Panel C7

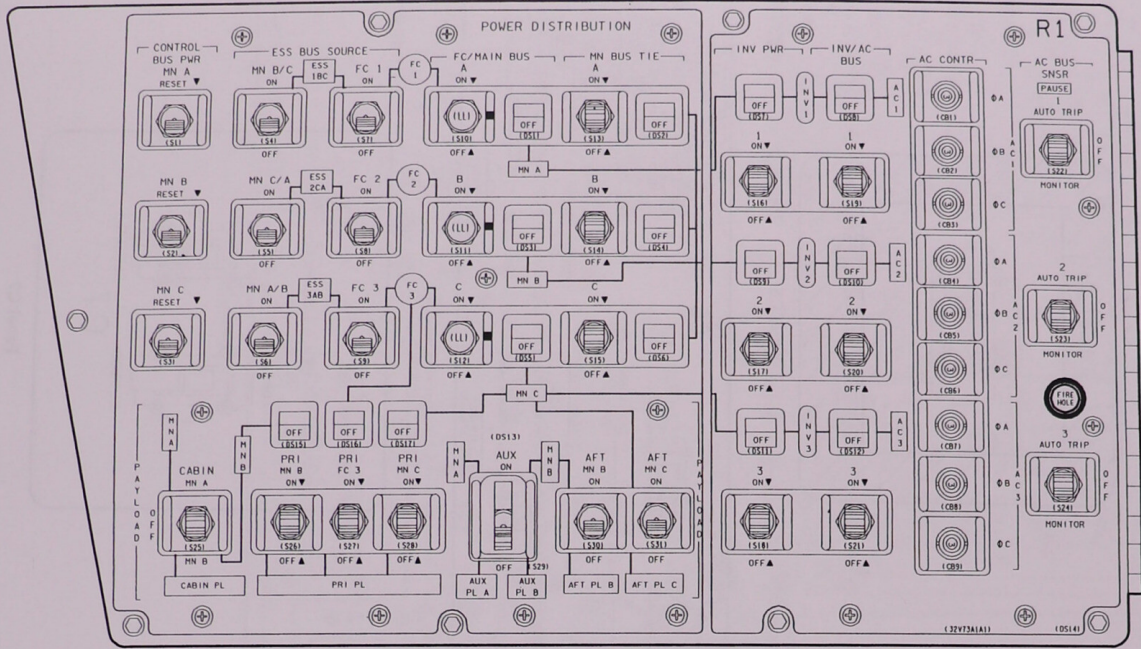

Panel R1



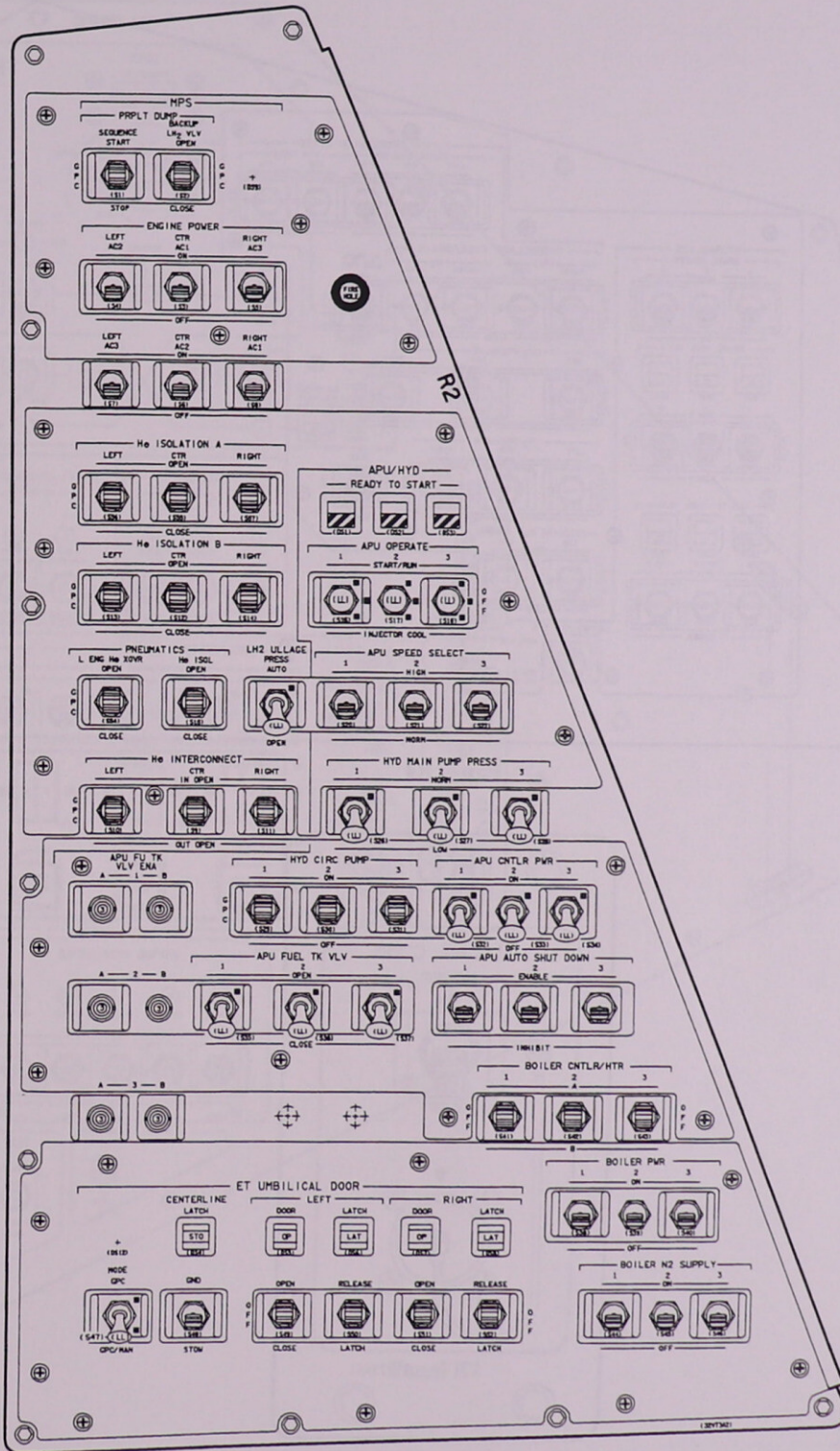

Panel R2

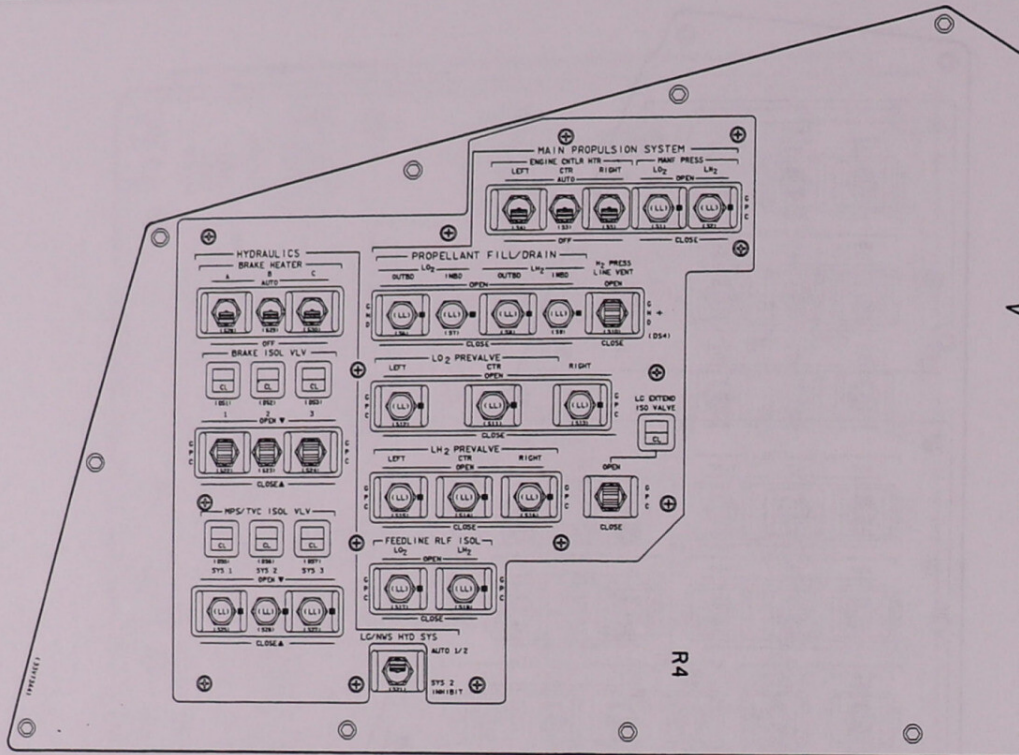

Panel R4

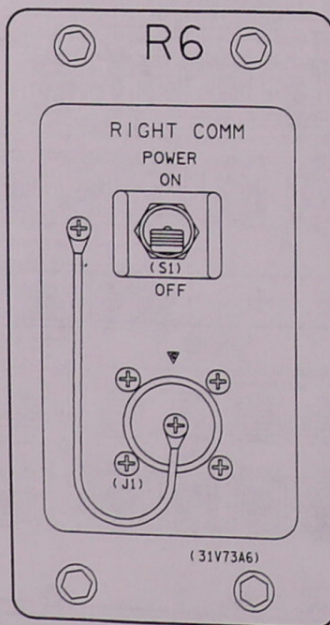

Panel R6

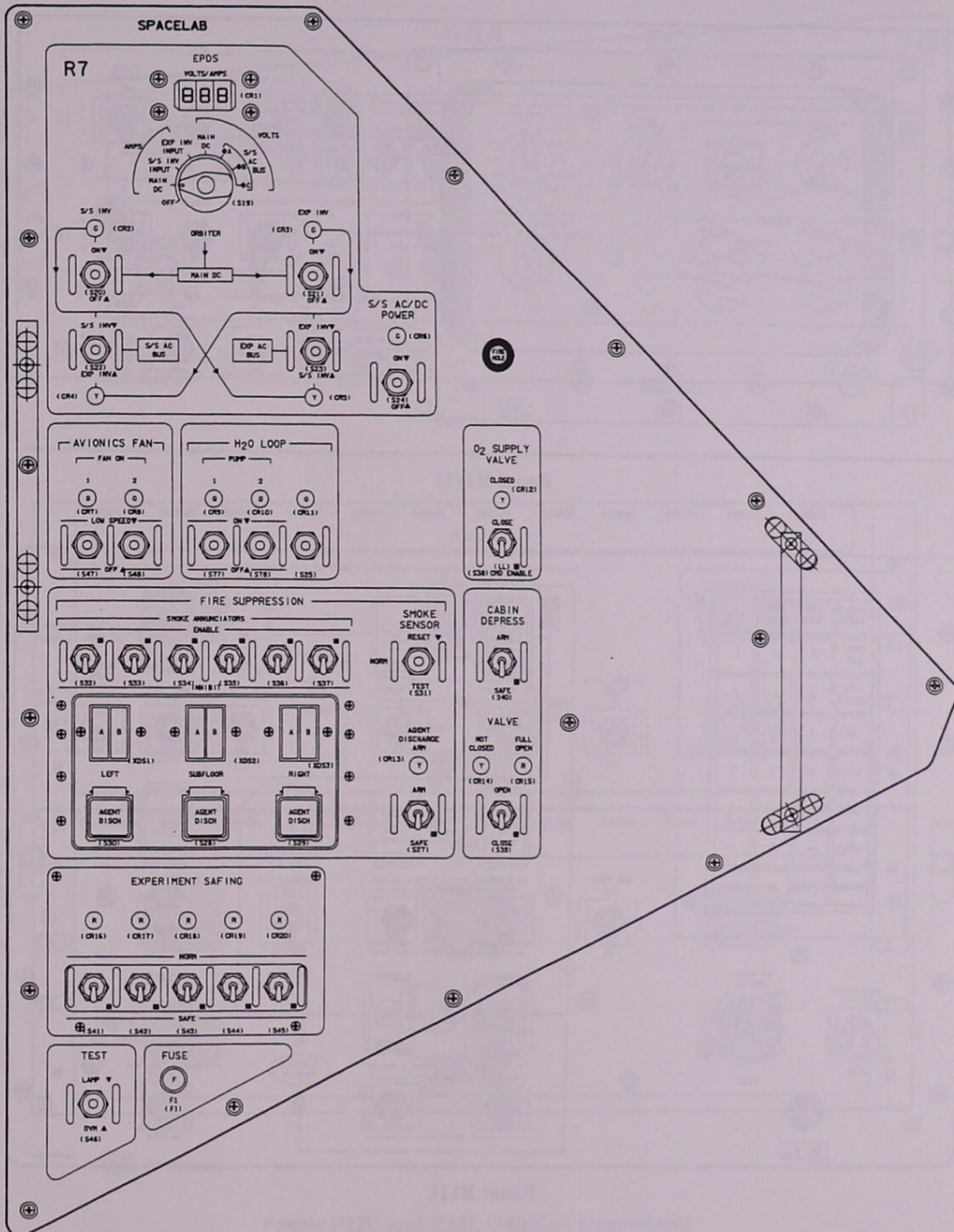

Panel R7

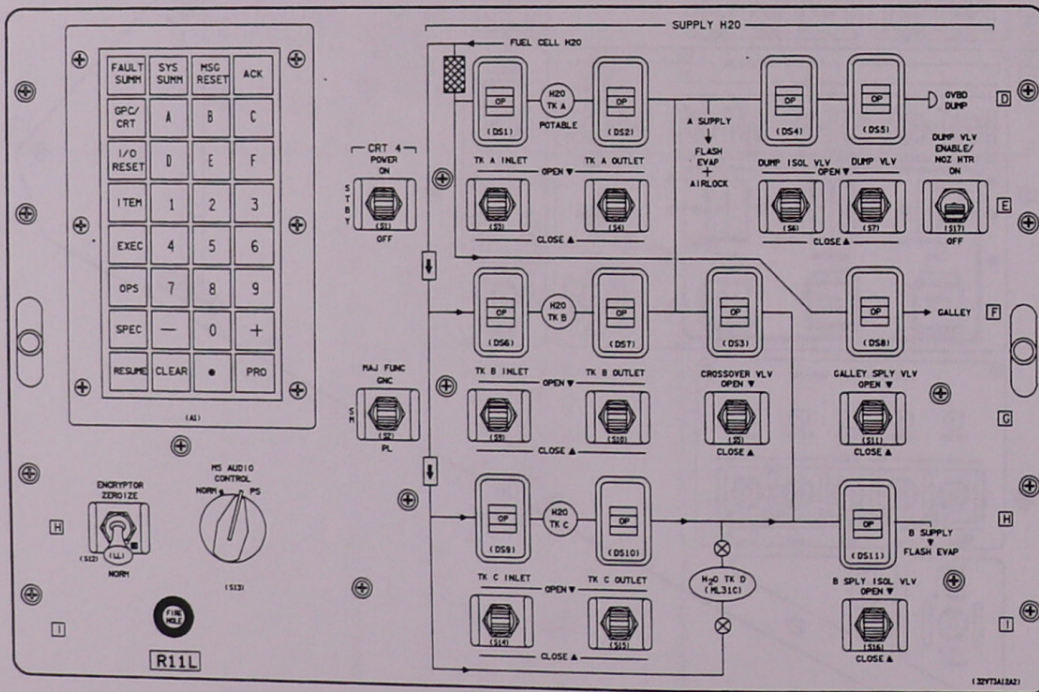
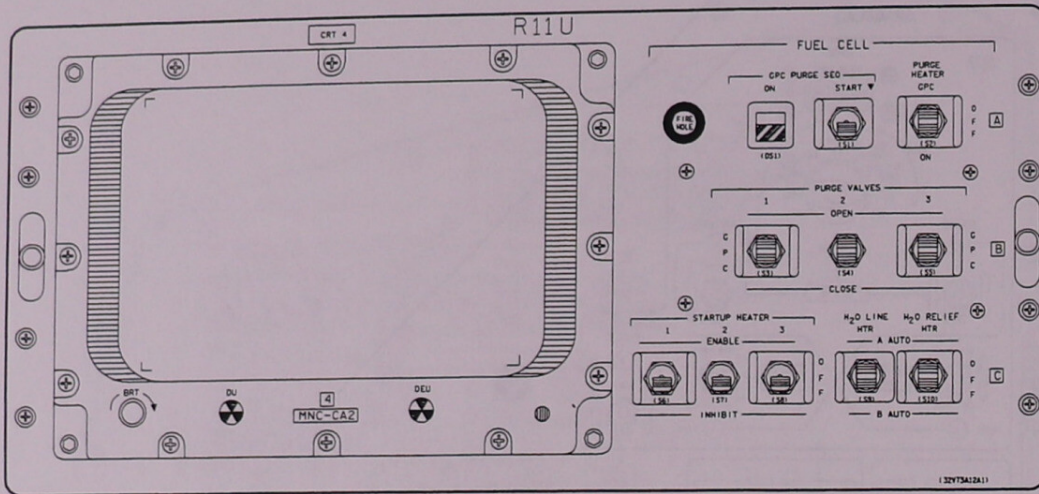

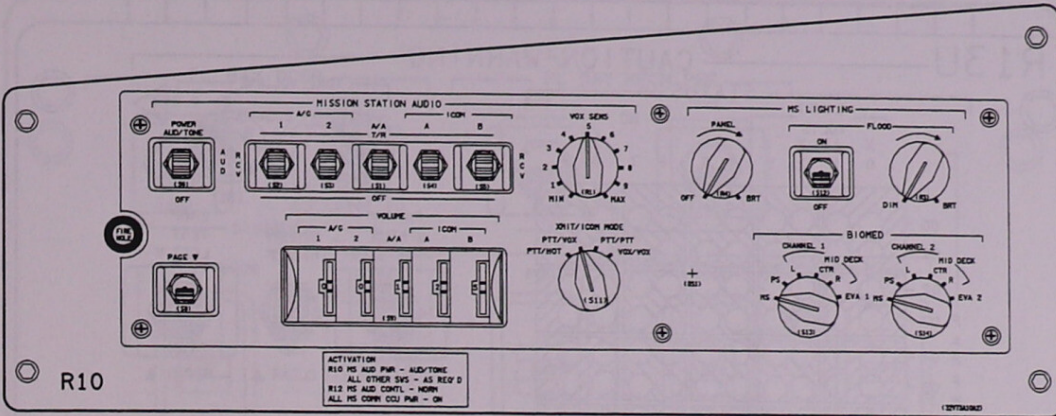

Panel R10

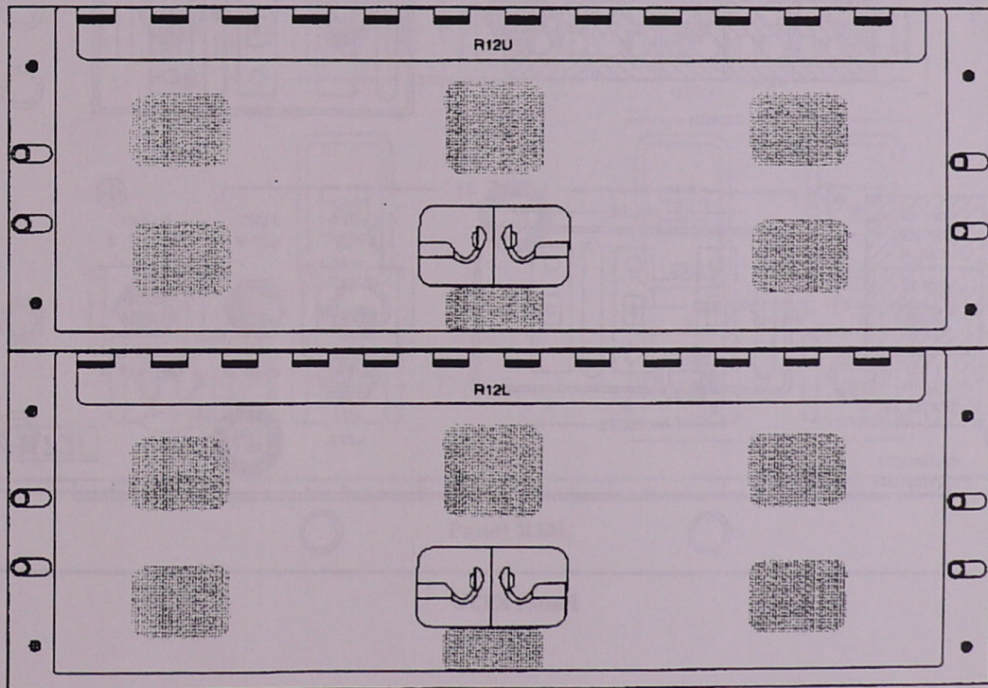

Plis Velcro

Panels R12U and R12L (Mission Dependent)

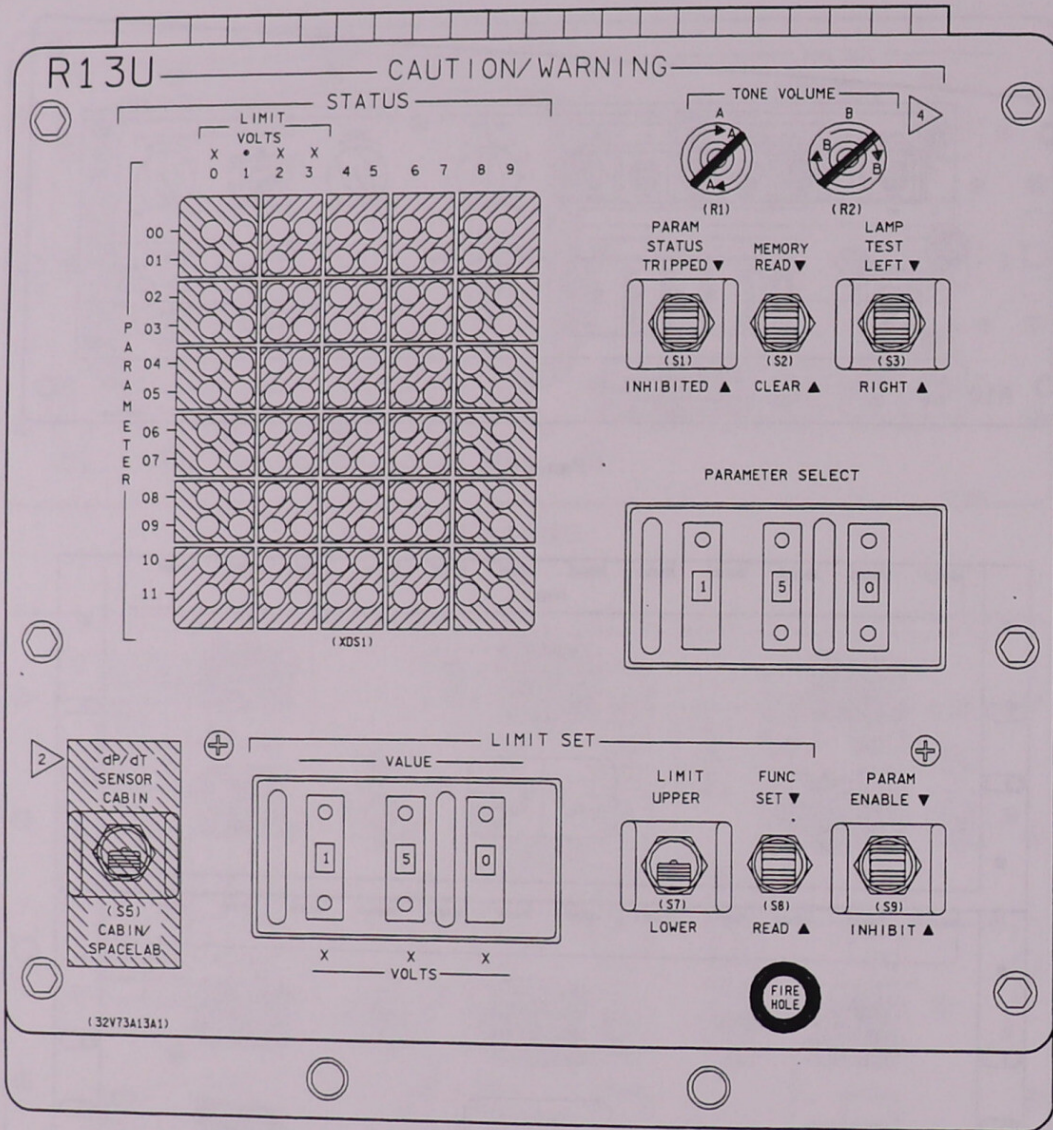

Panel R13U

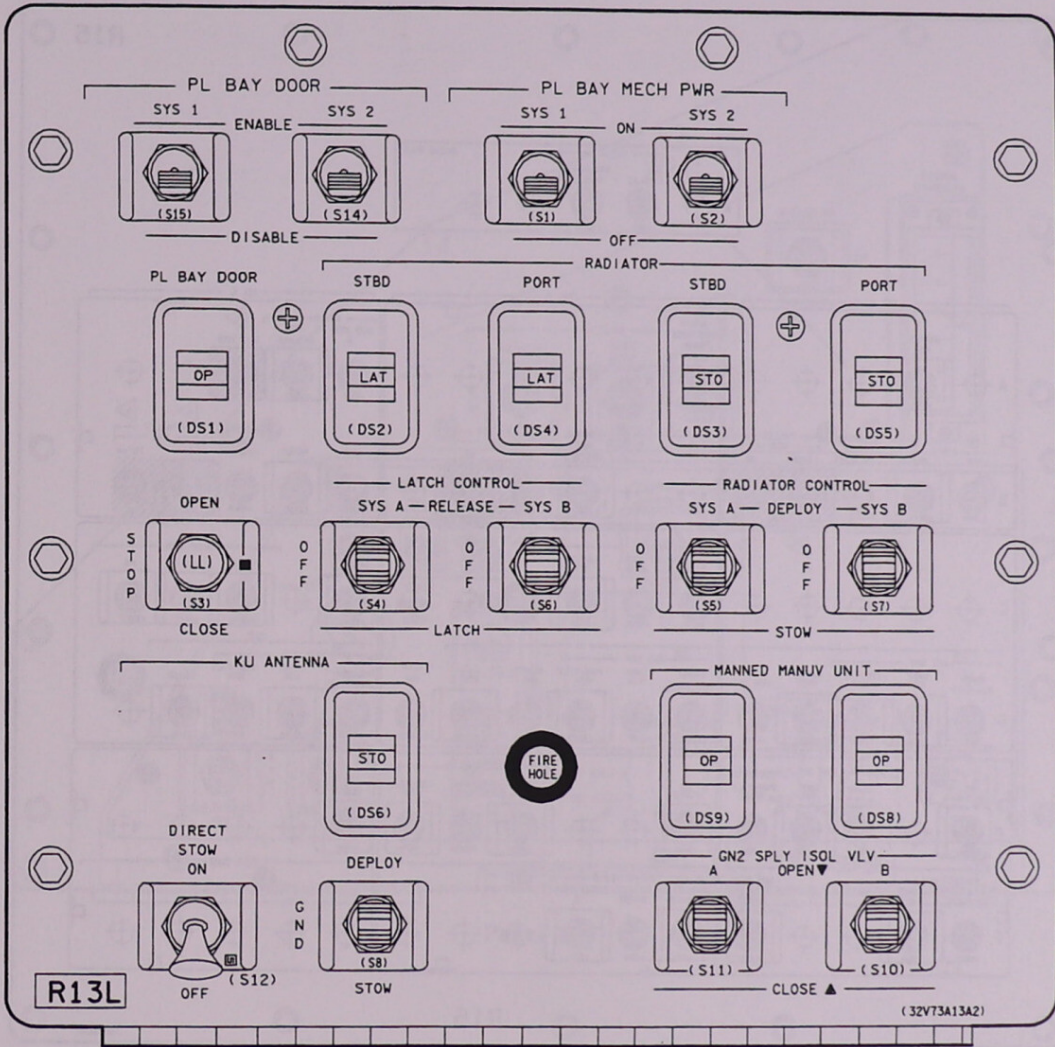

Panel R13L

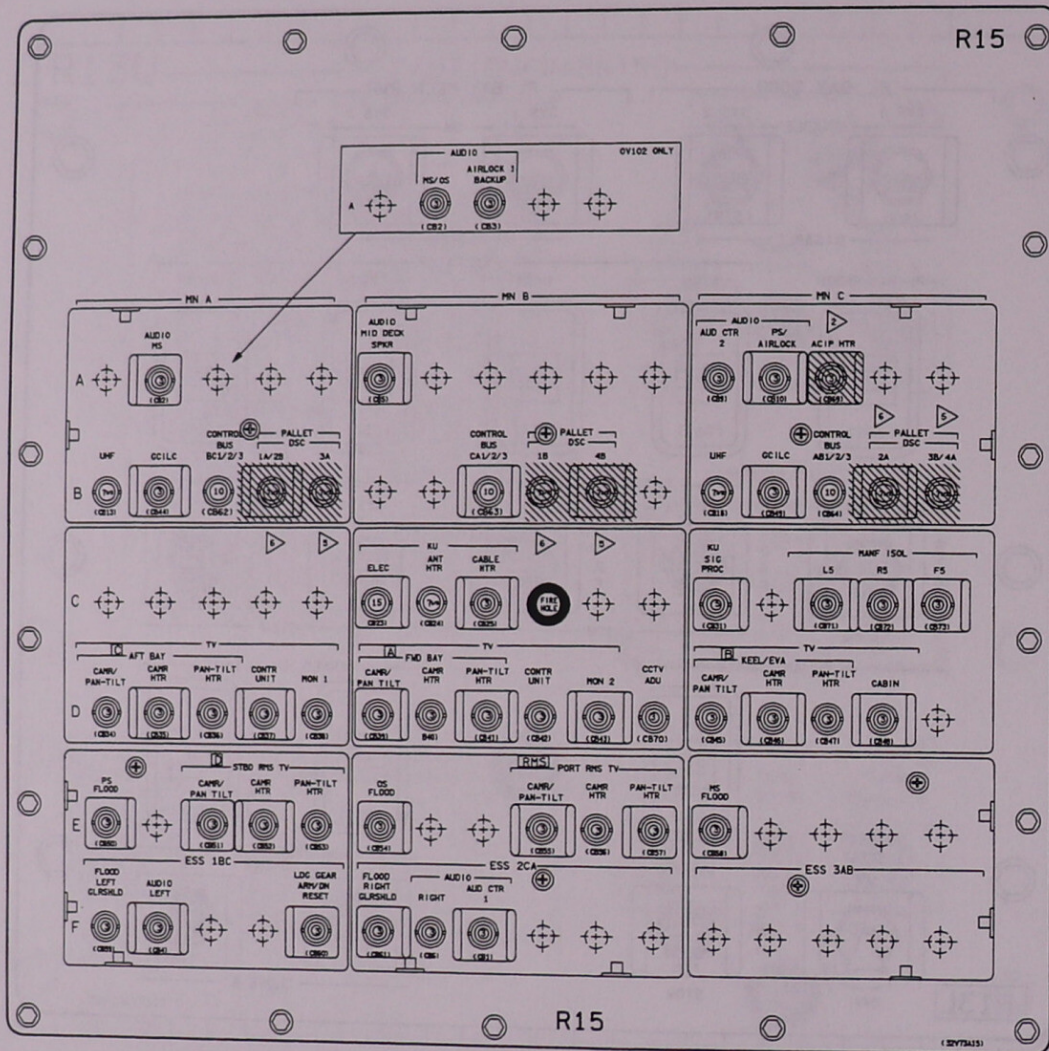

Panel R15



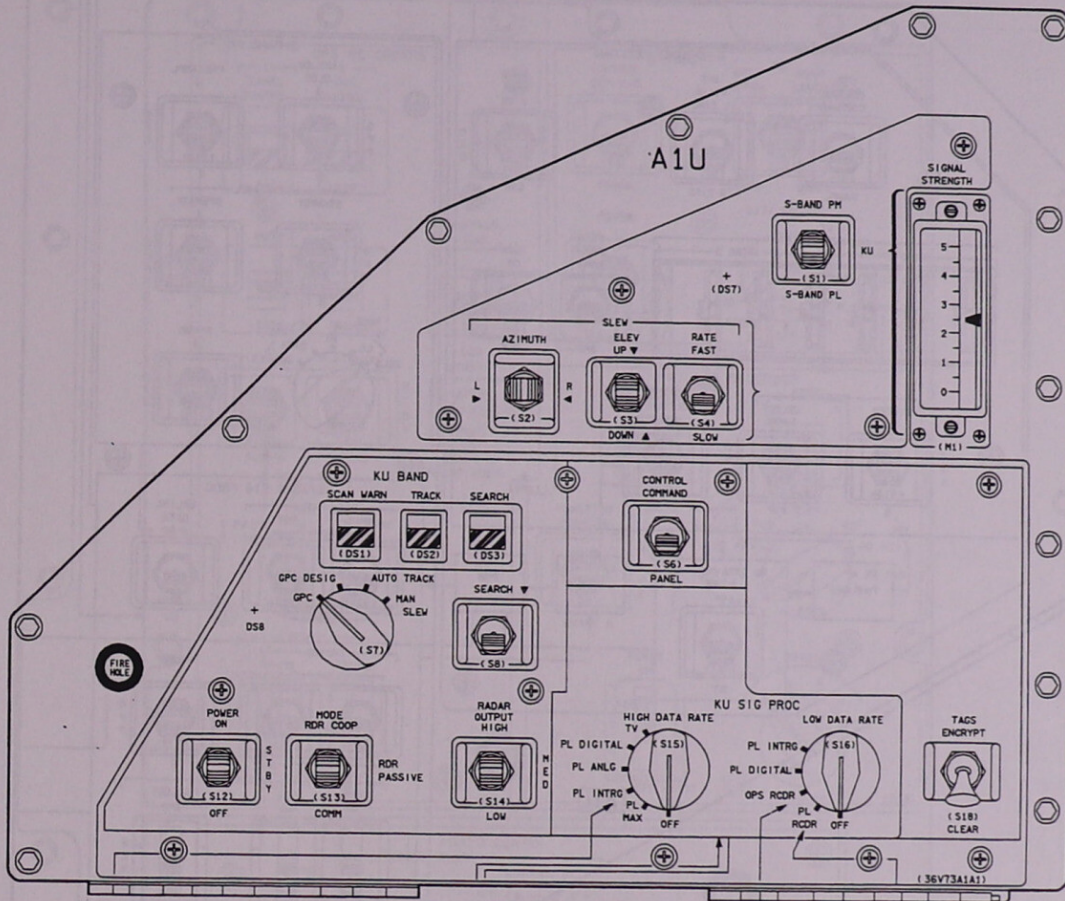

Panel A1U

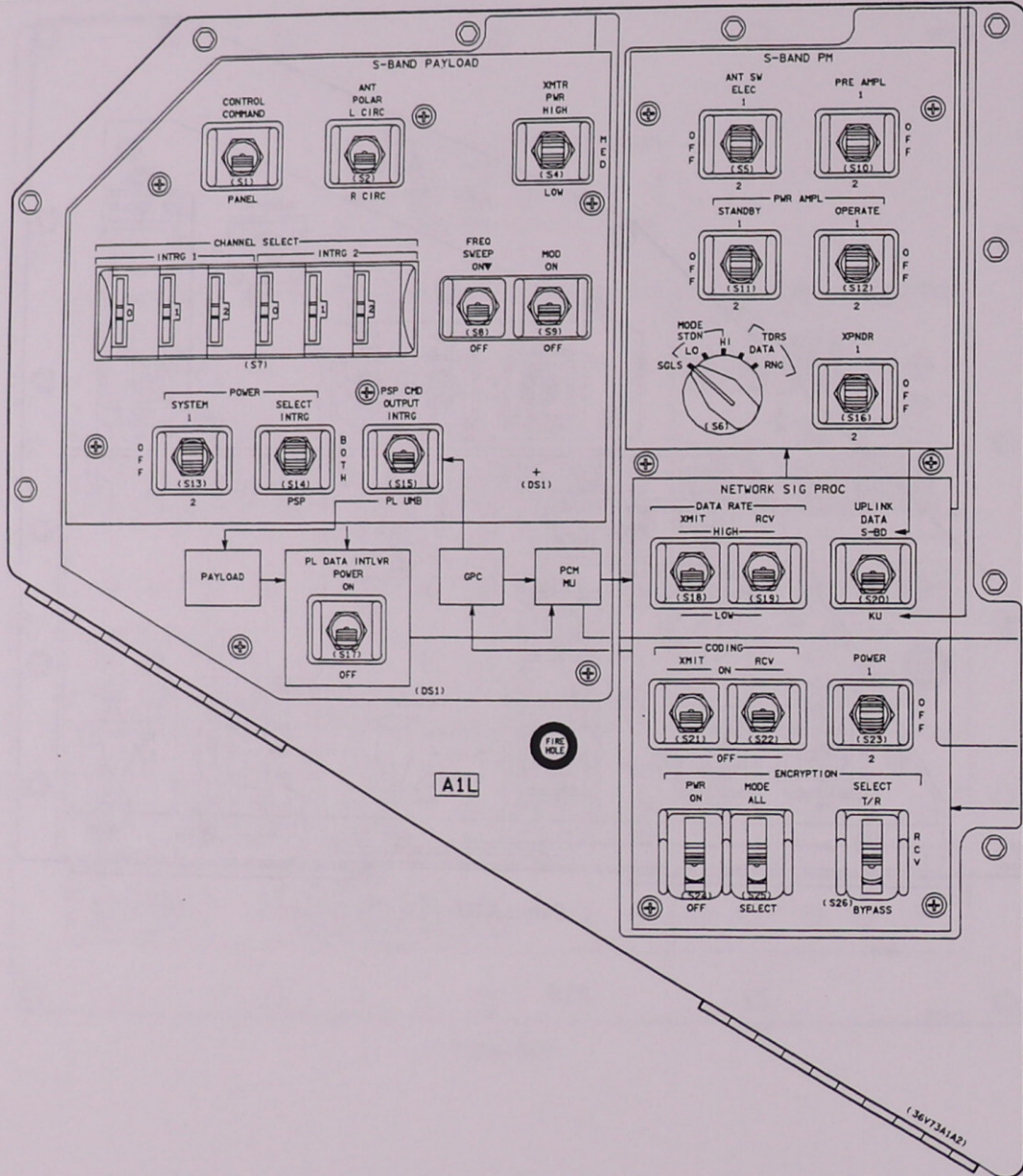

Panel A1L

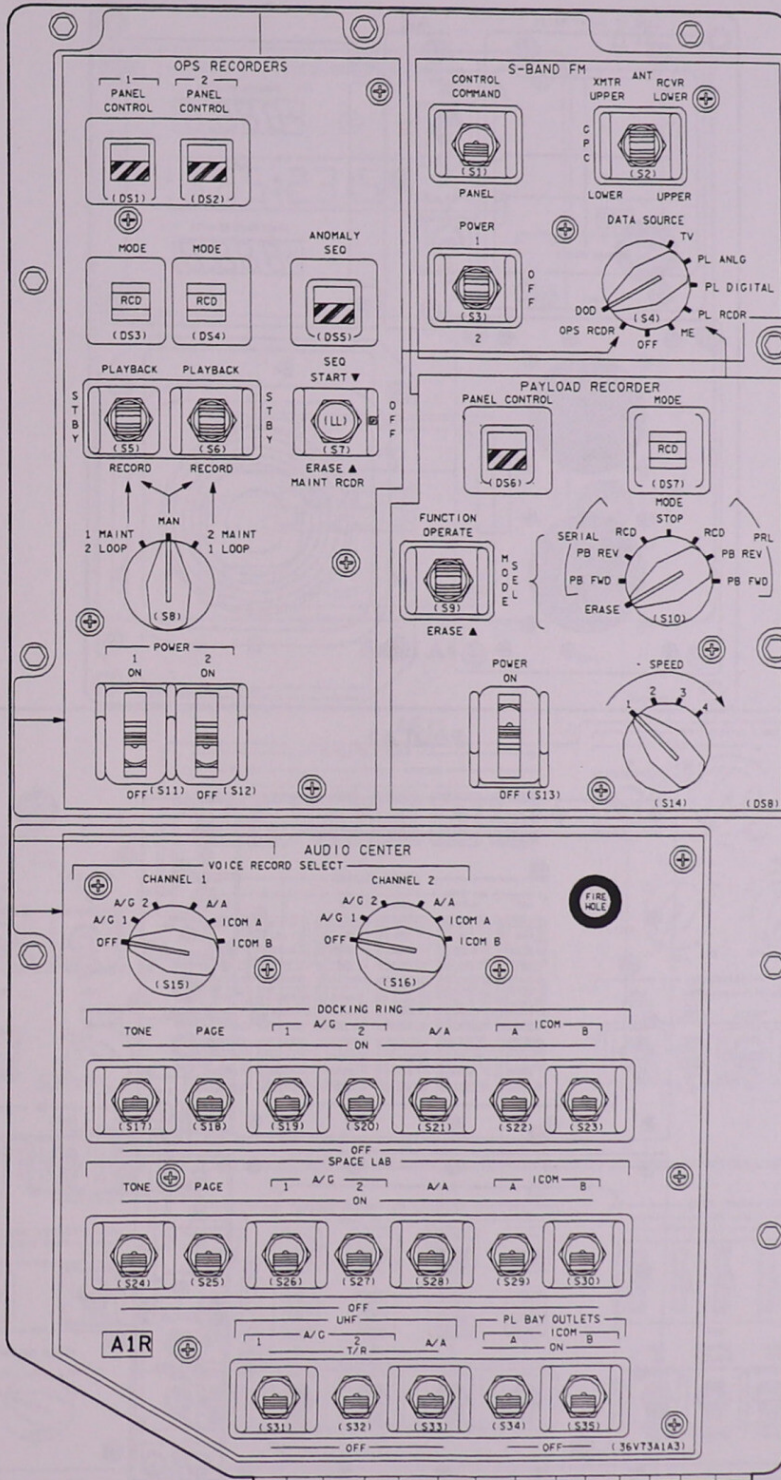

Panel A1R

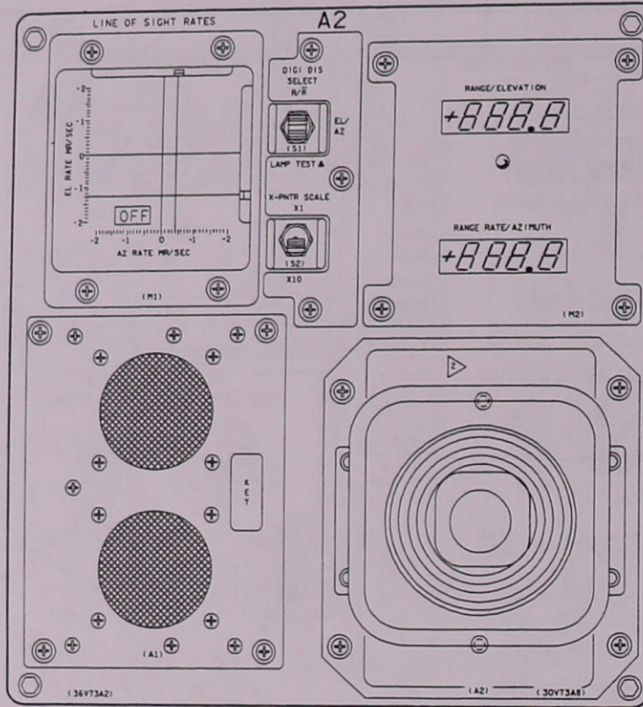

Panel A2

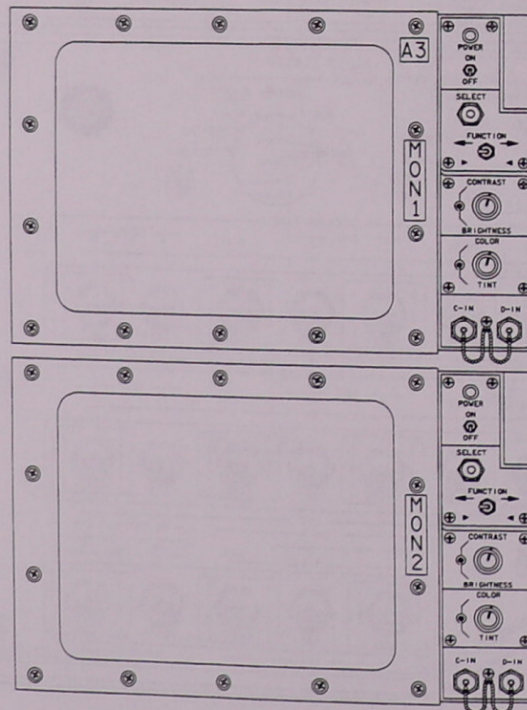

Panel A3

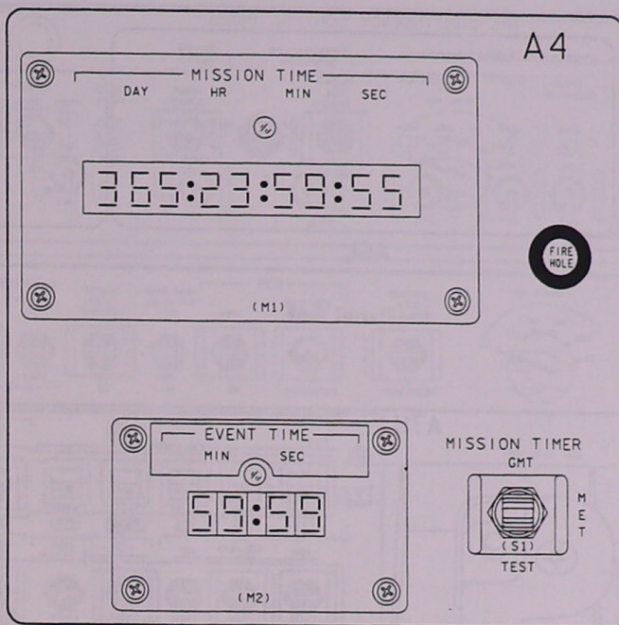

Panel A4

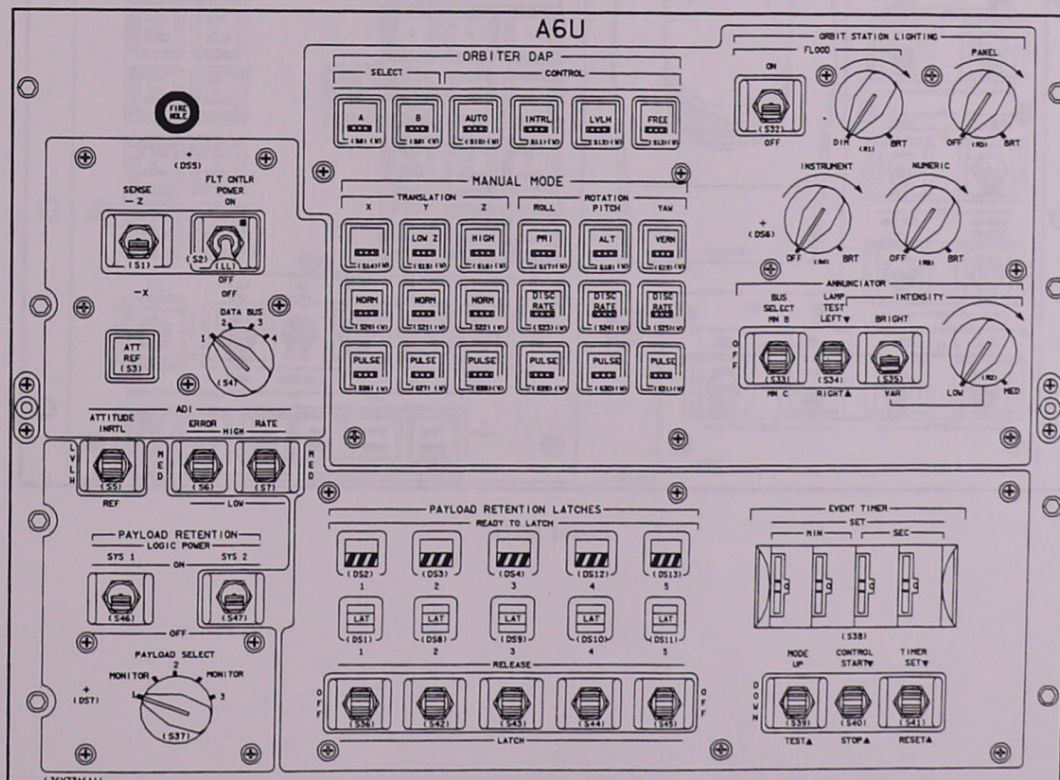

Panel A6U

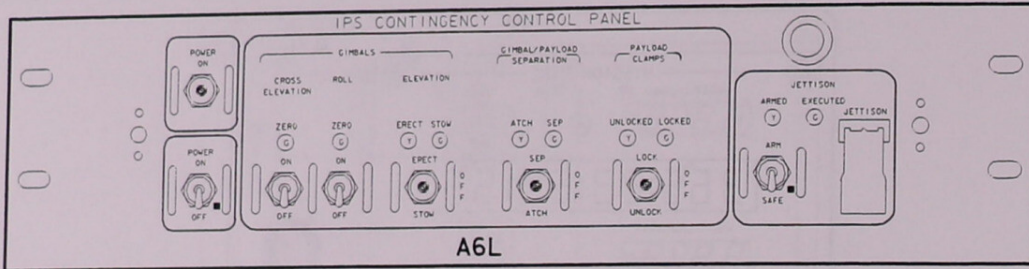

Panel A6L

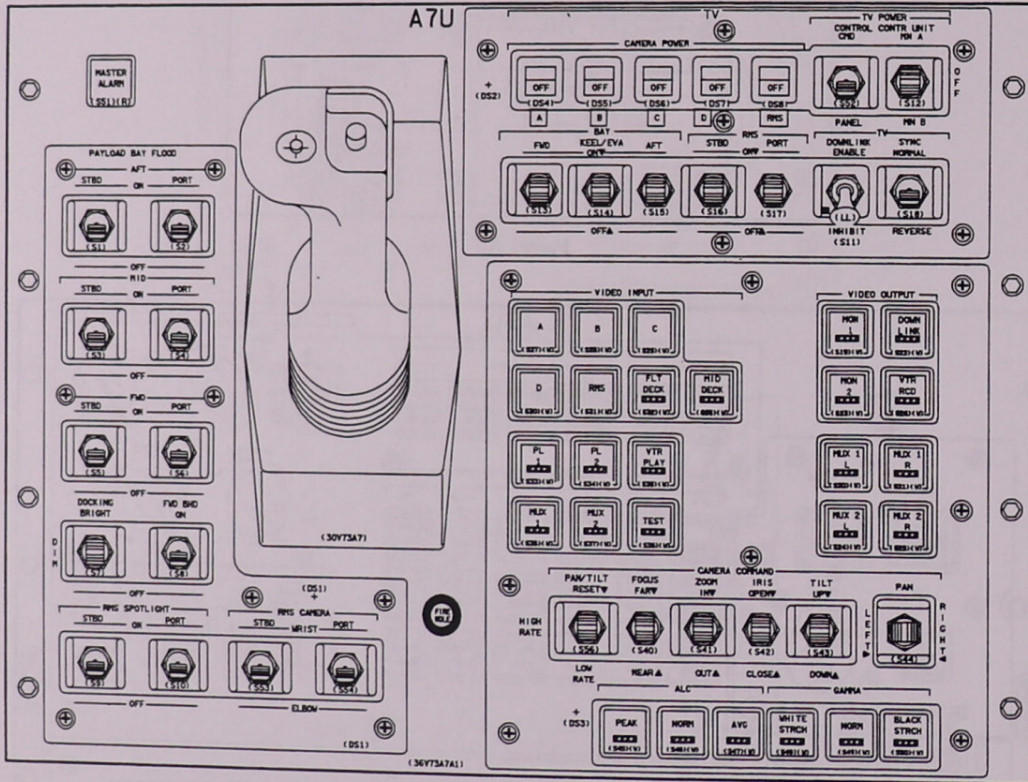

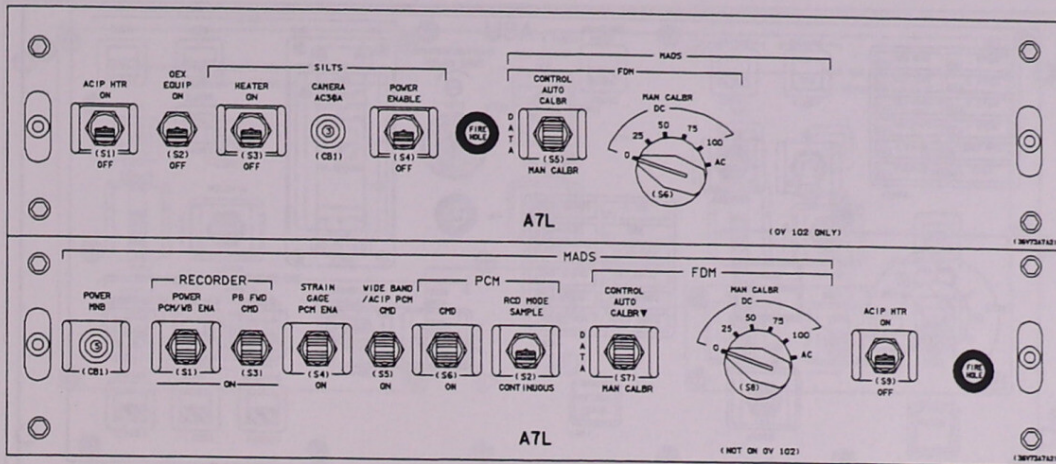

Panel A7L

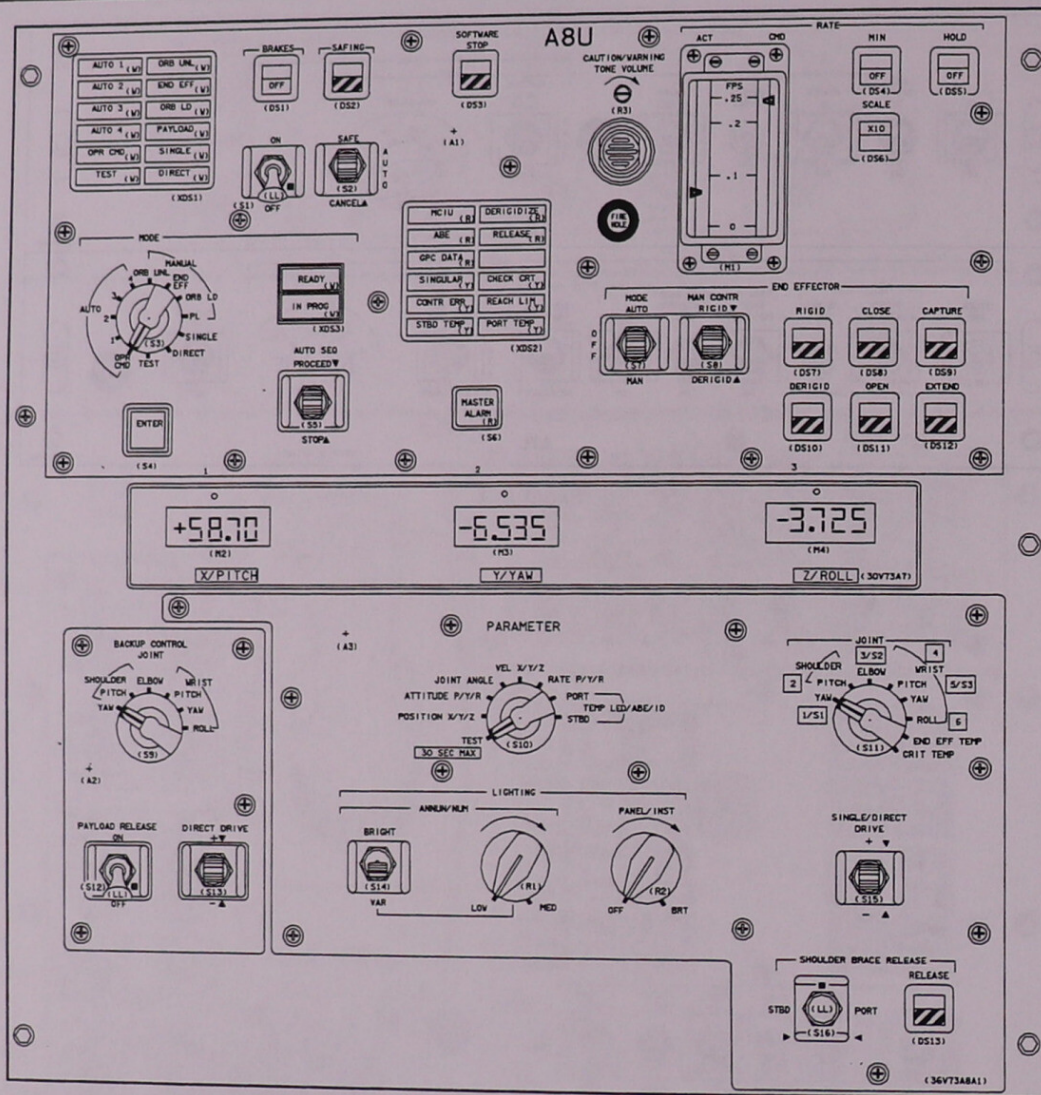

Panel A8U



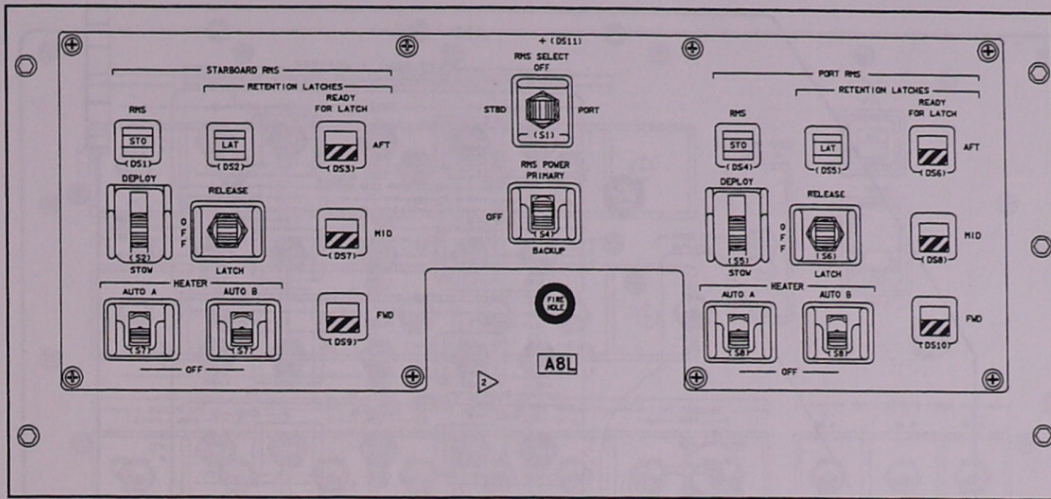

Panel A8L

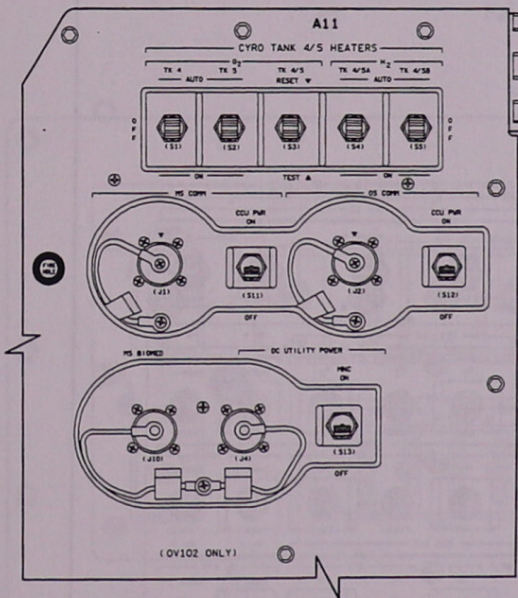

Panel A11 (OV10 only)

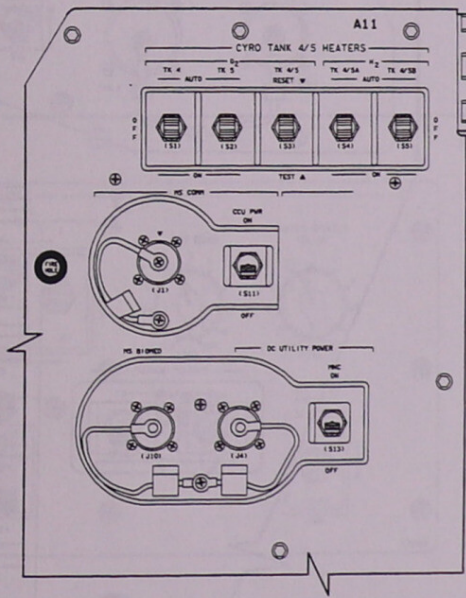

Panel A11 (OO103 and OV104 only)

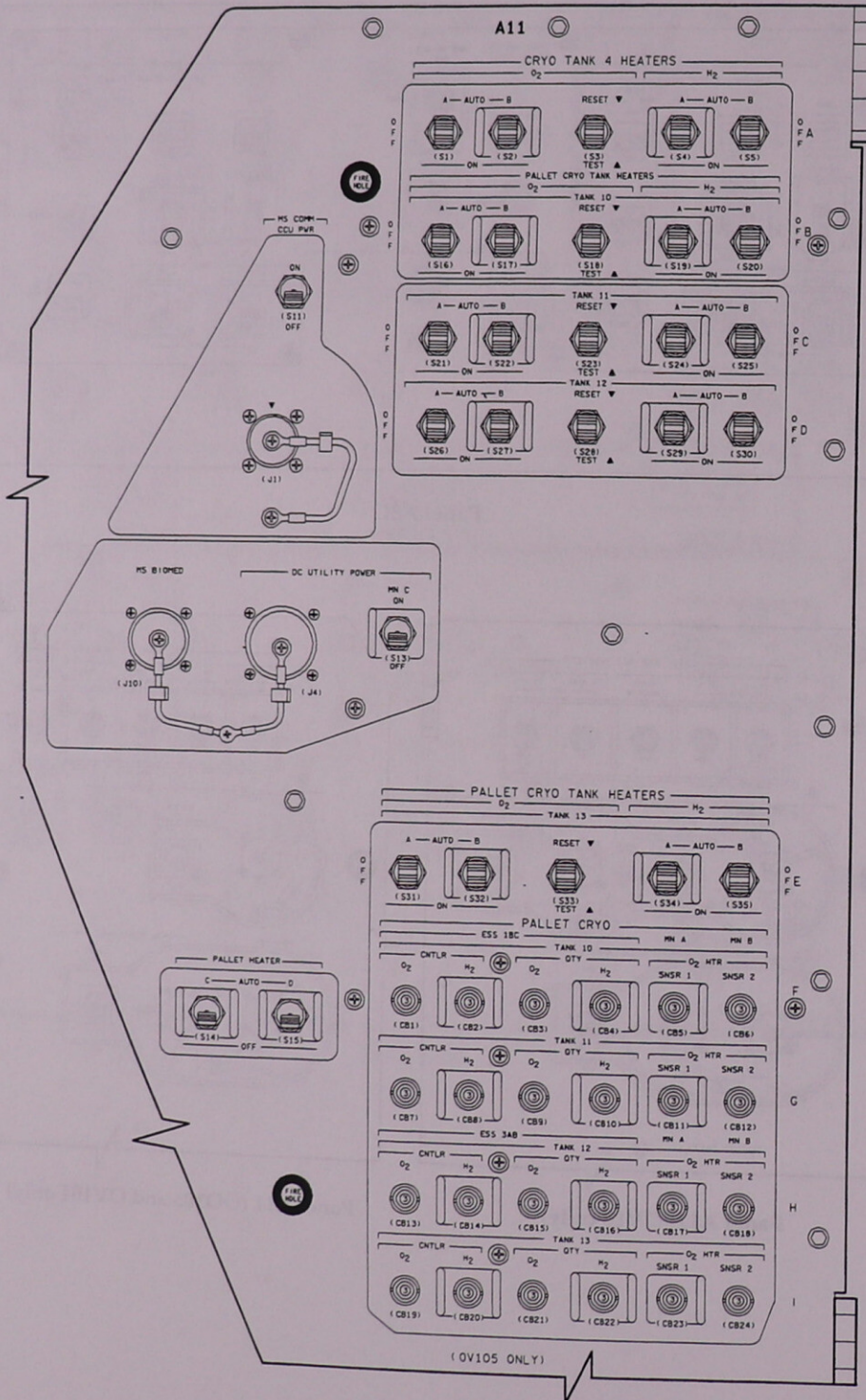

Panel A11  
 (OV105 only)

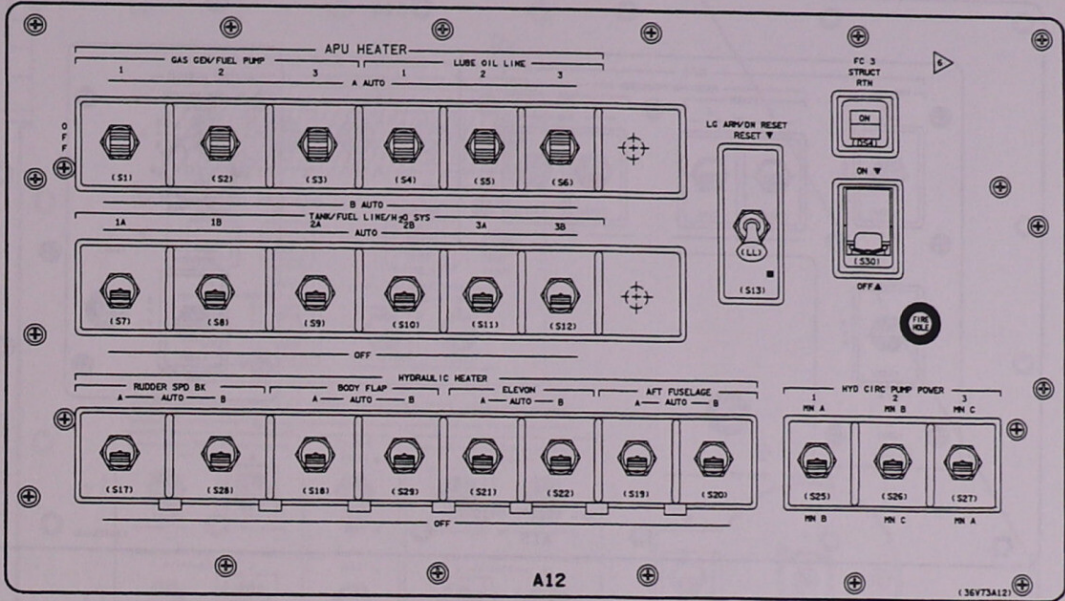

Panel A12

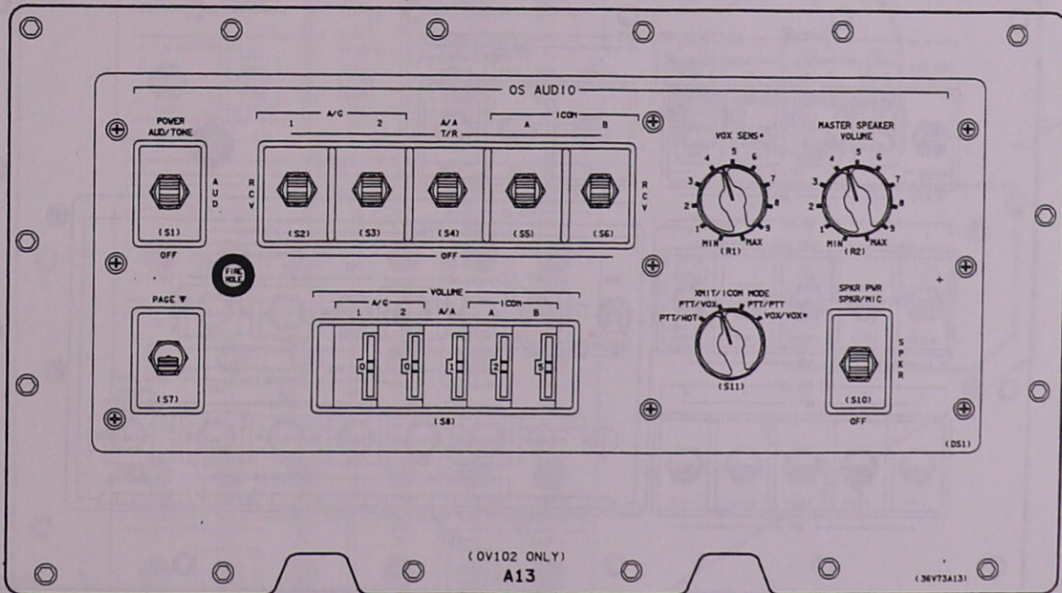

Panel A13  
(OV-102 only)

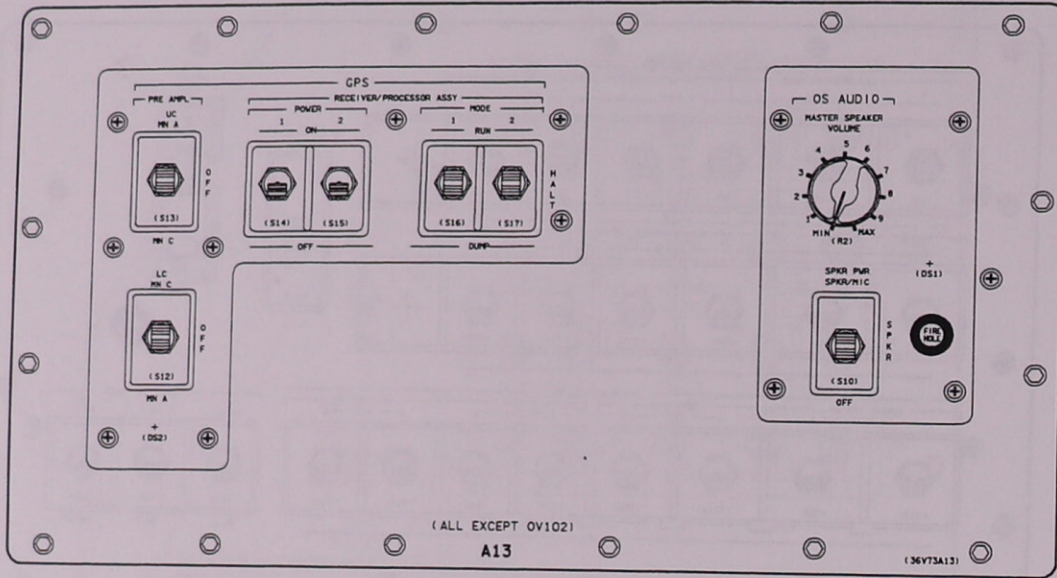

Panel A13  
(All vehicles except OV-102)

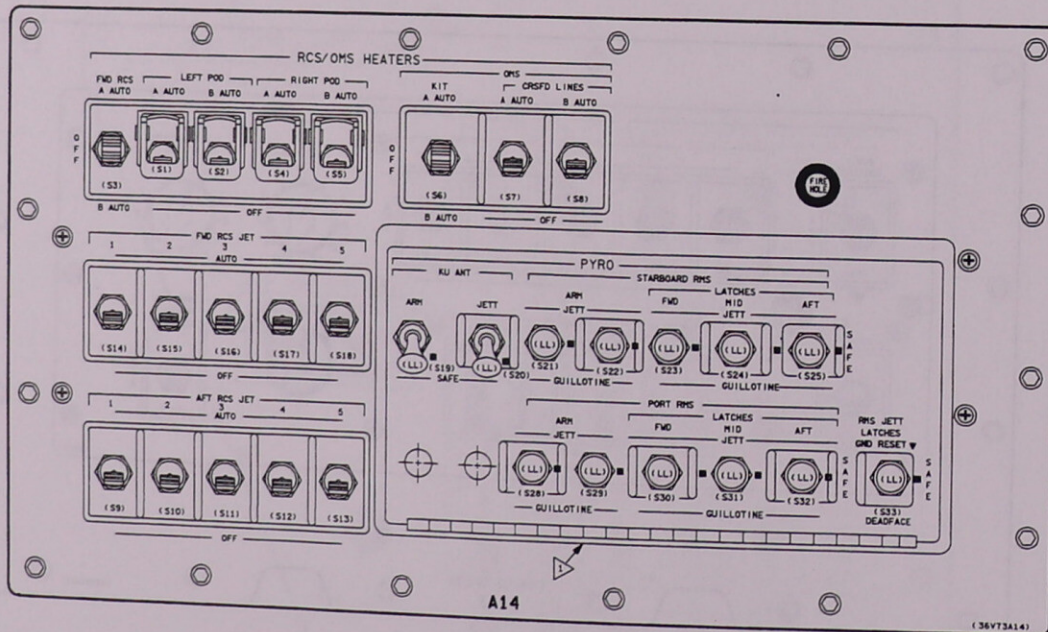

Panel A14

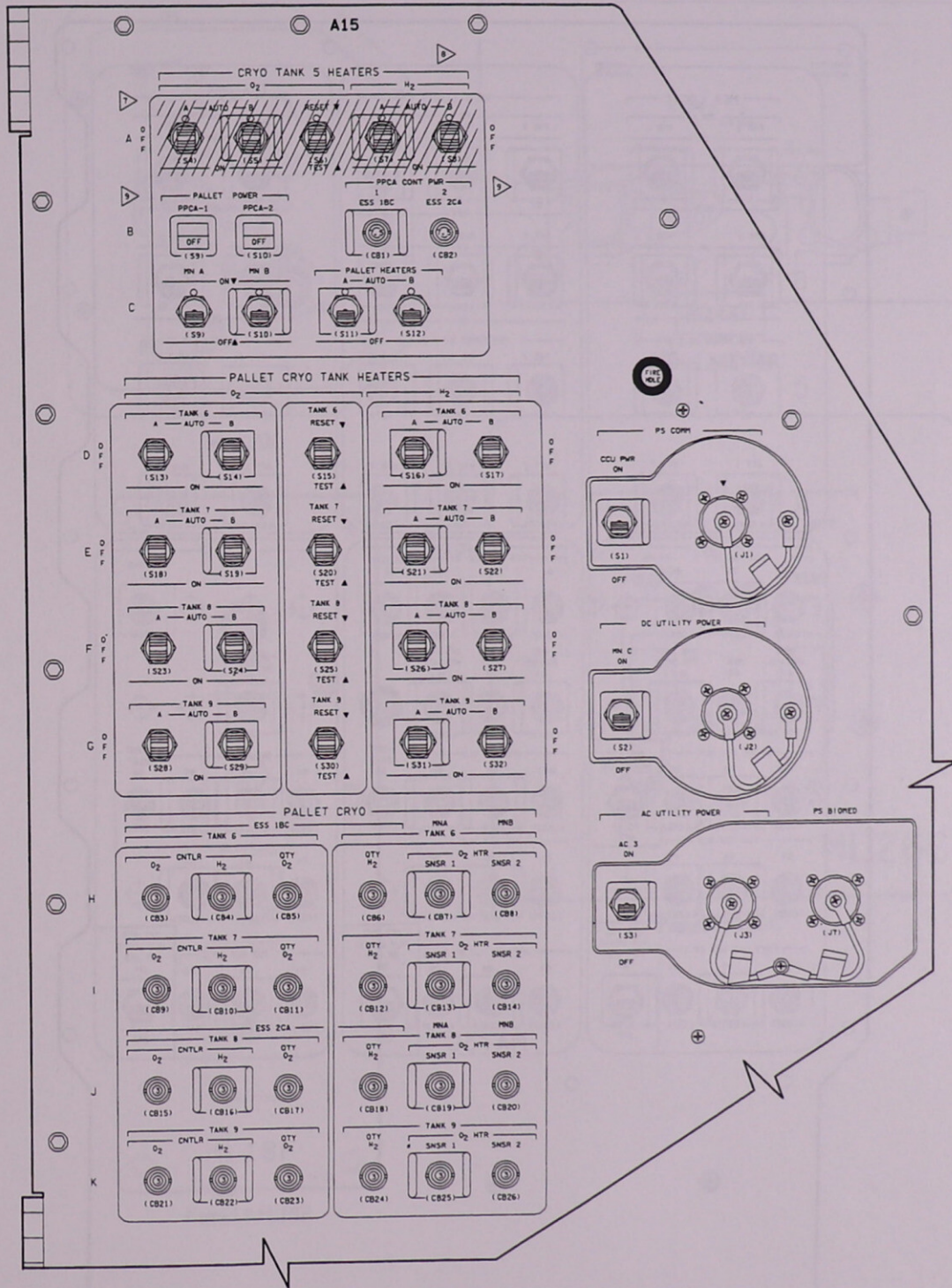

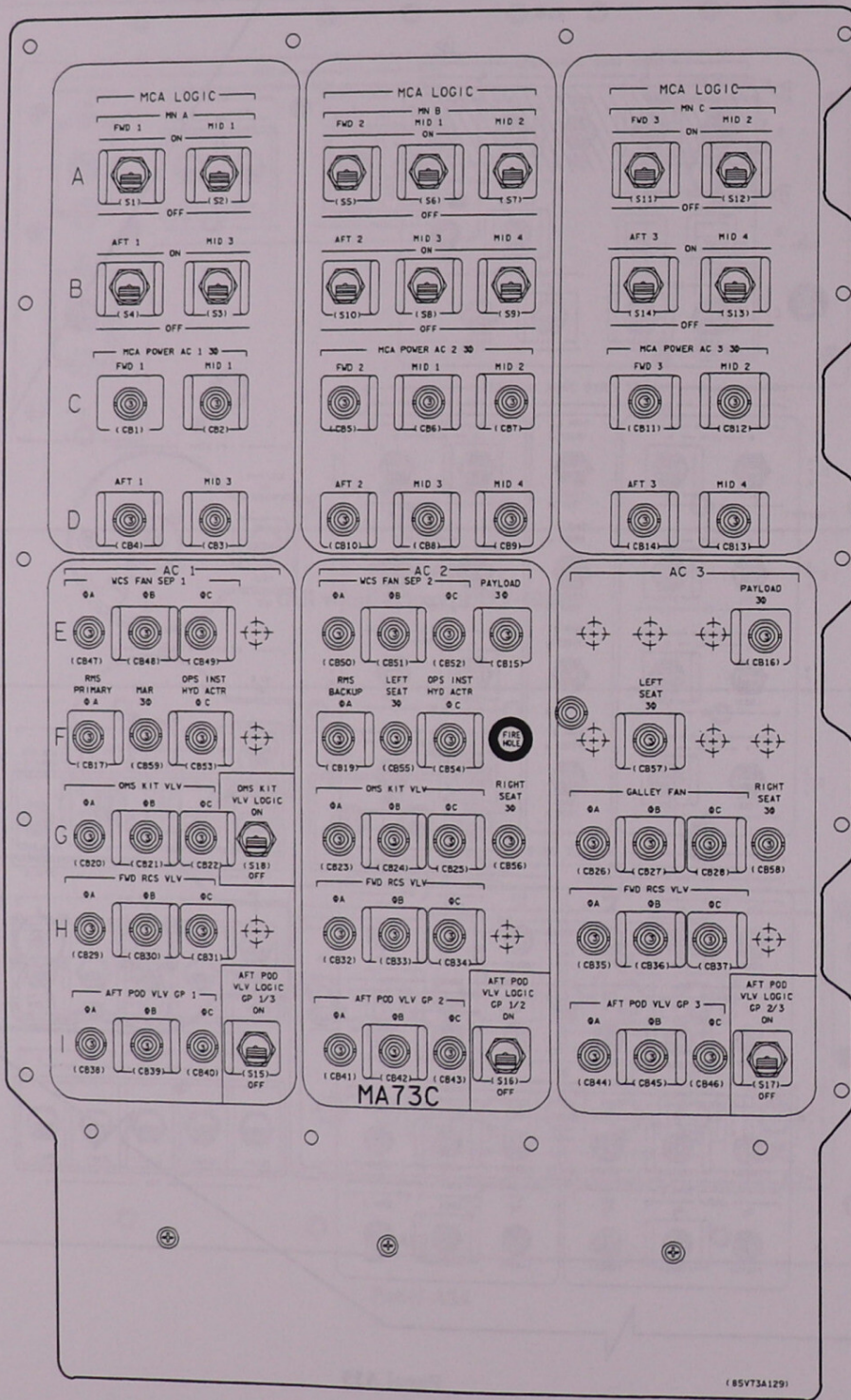

Panel MA37C

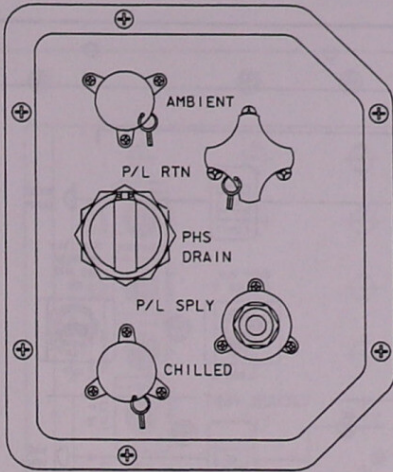

MD24K

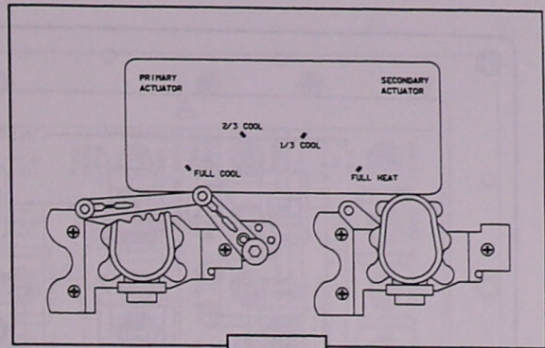

MD44F

Panel MD44F

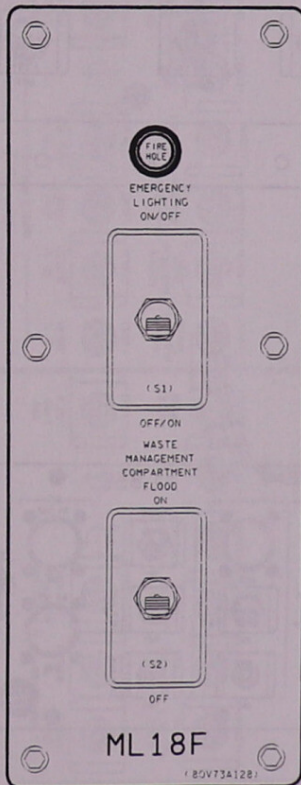

ML18F

Panel ML18F

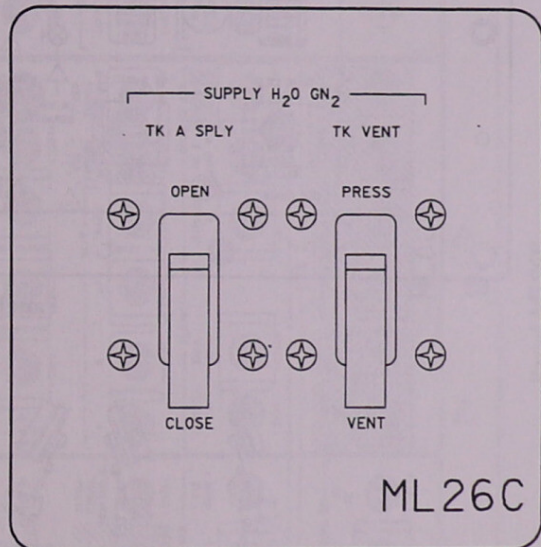

ML26C

Panel ML26C

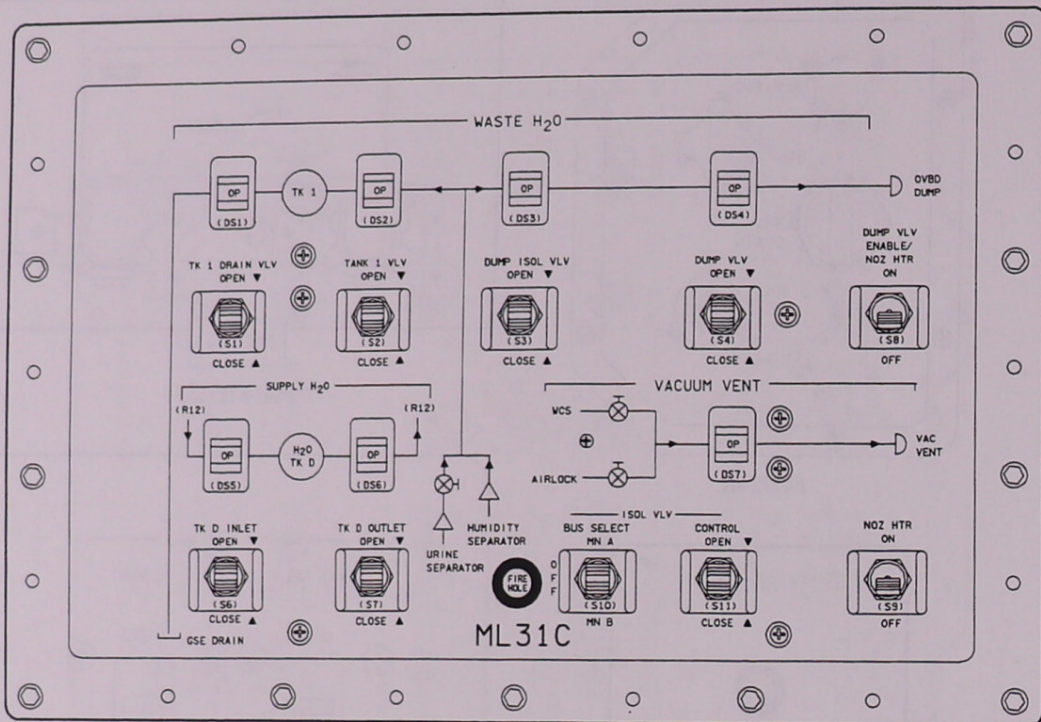

Panel ML31C

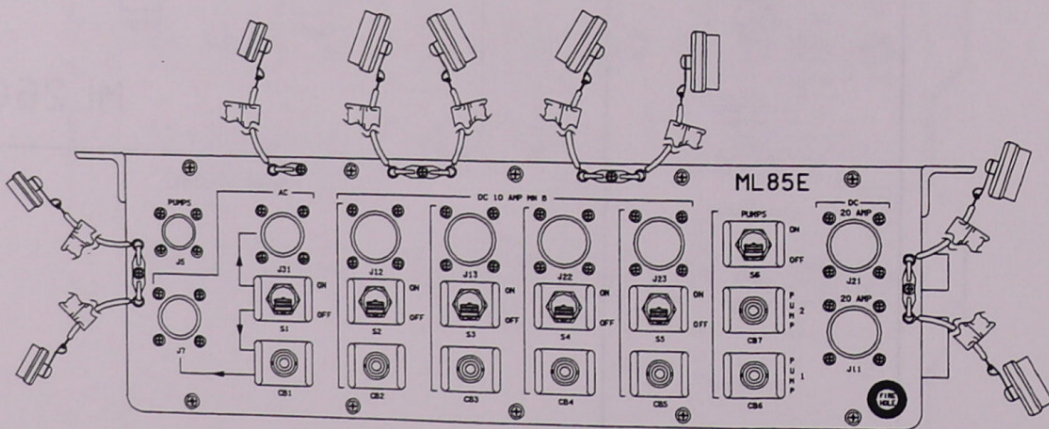

Panel MI85E



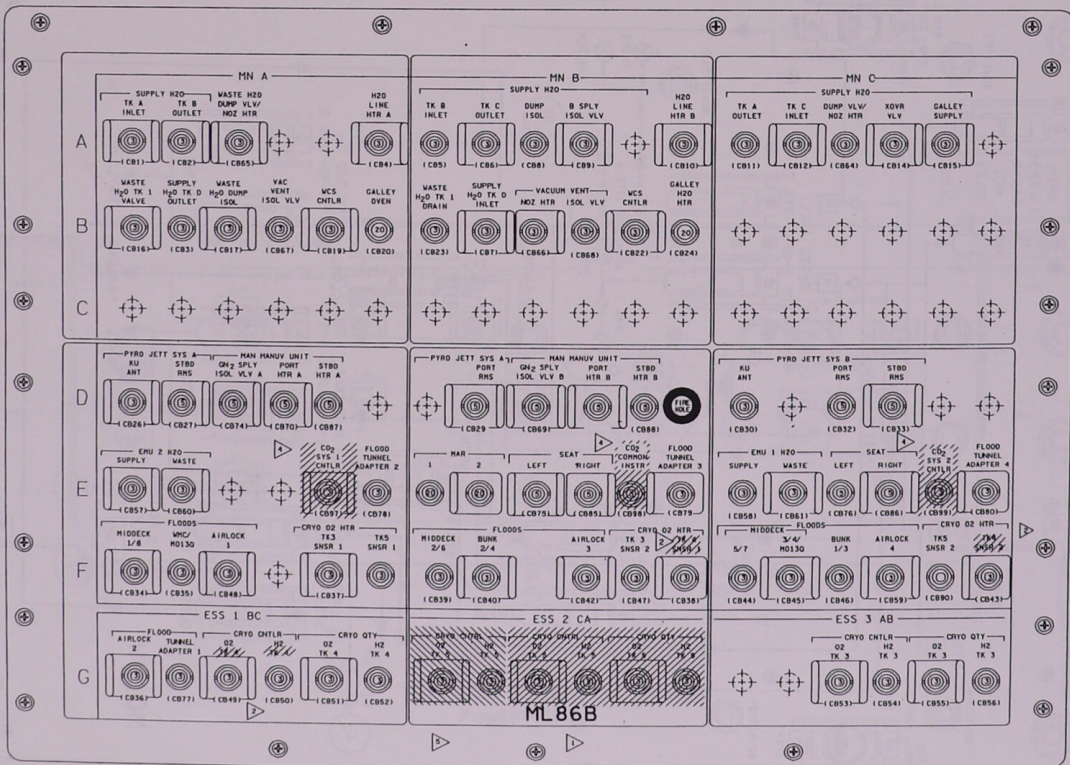

Panel ML86B

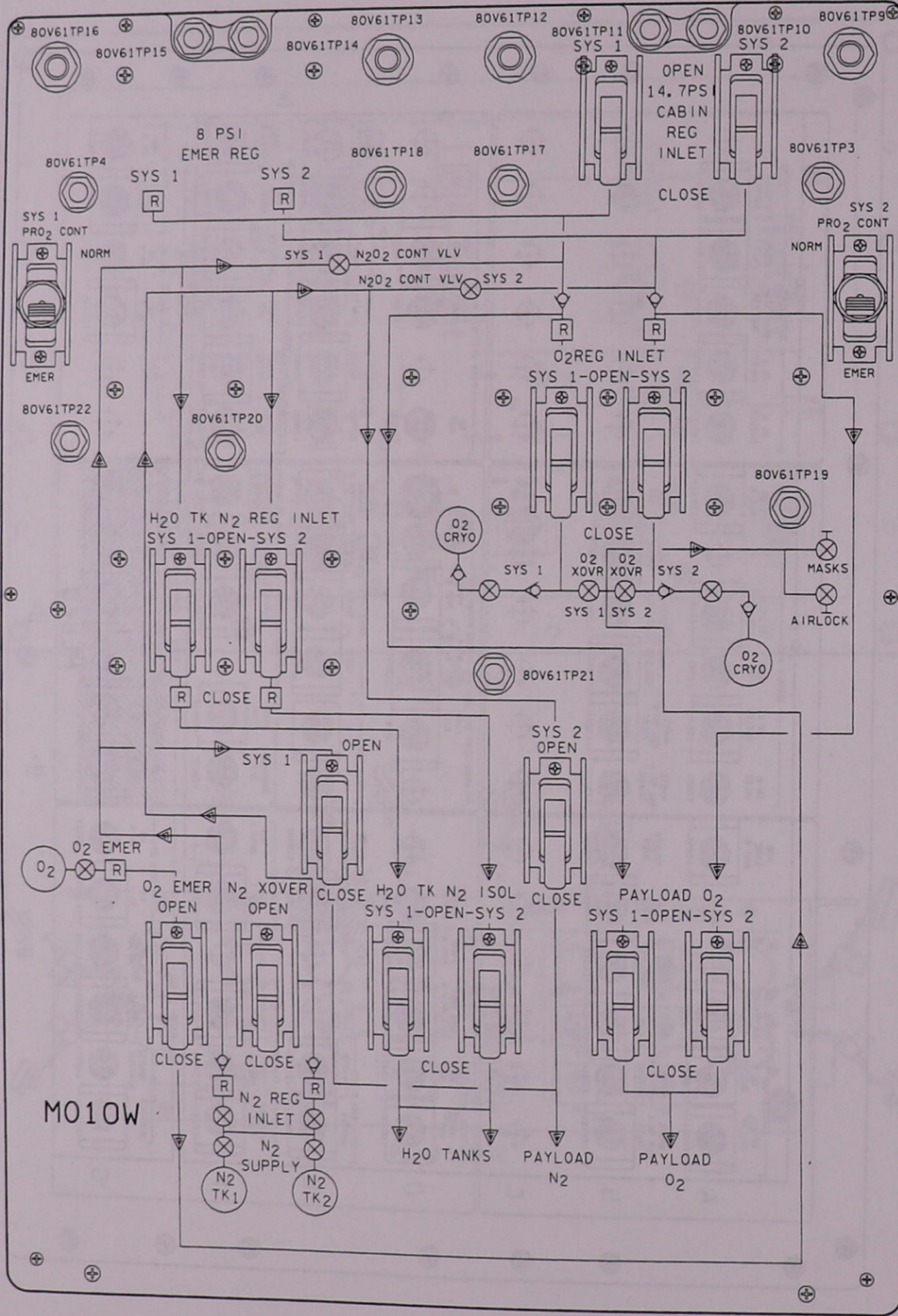

Panel MO10W

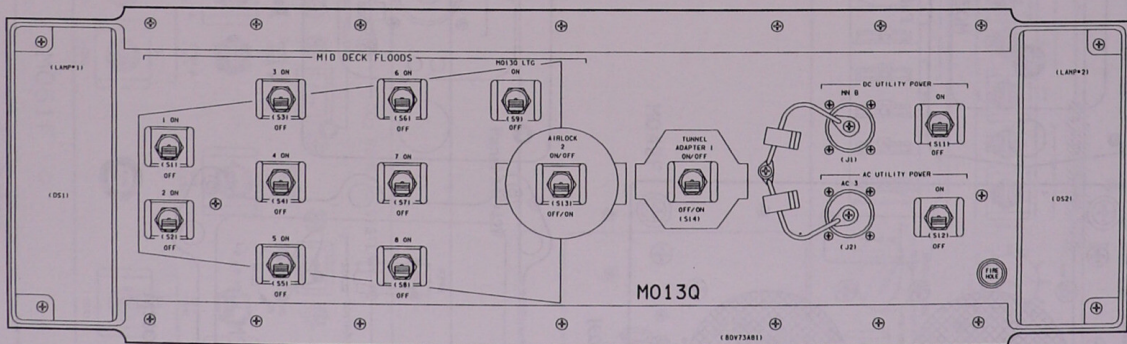

Panel MO13Q

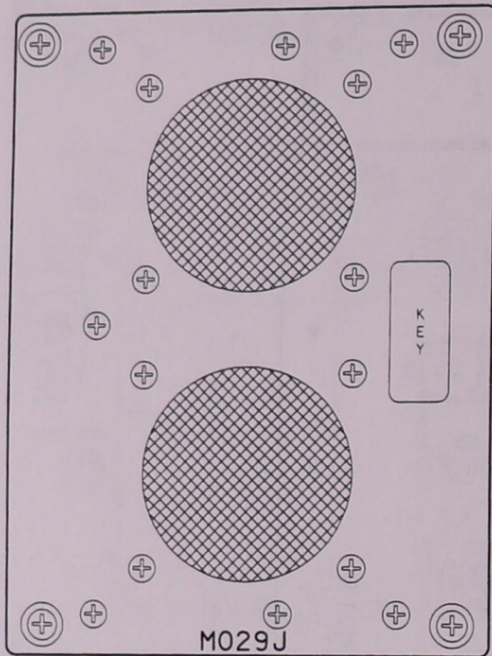

Panel M029J

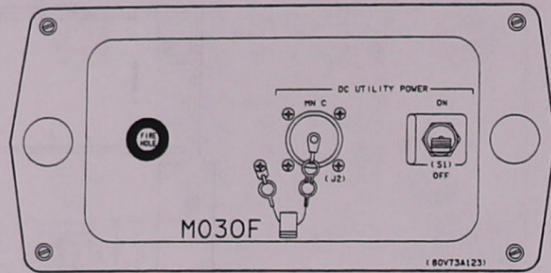

Panel M030F

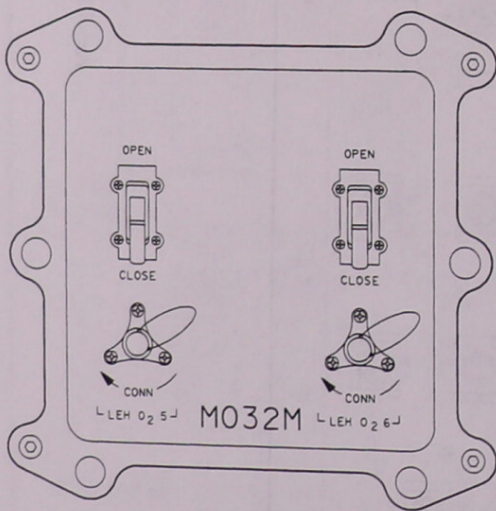

Panel AM032M

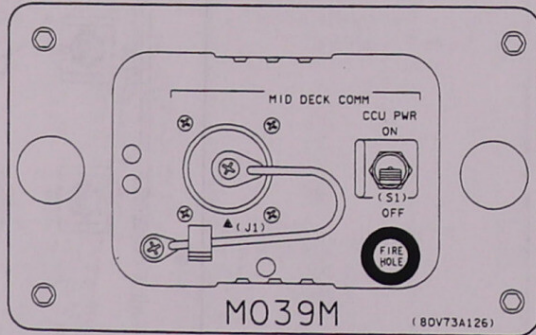

Panel M039M

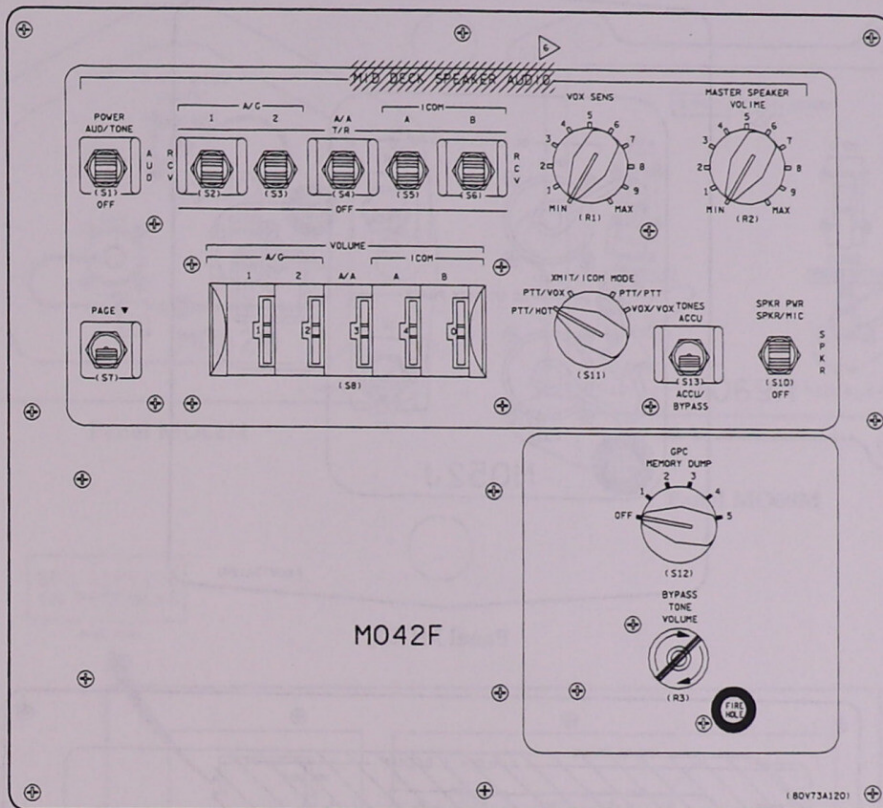

Panel MO42F

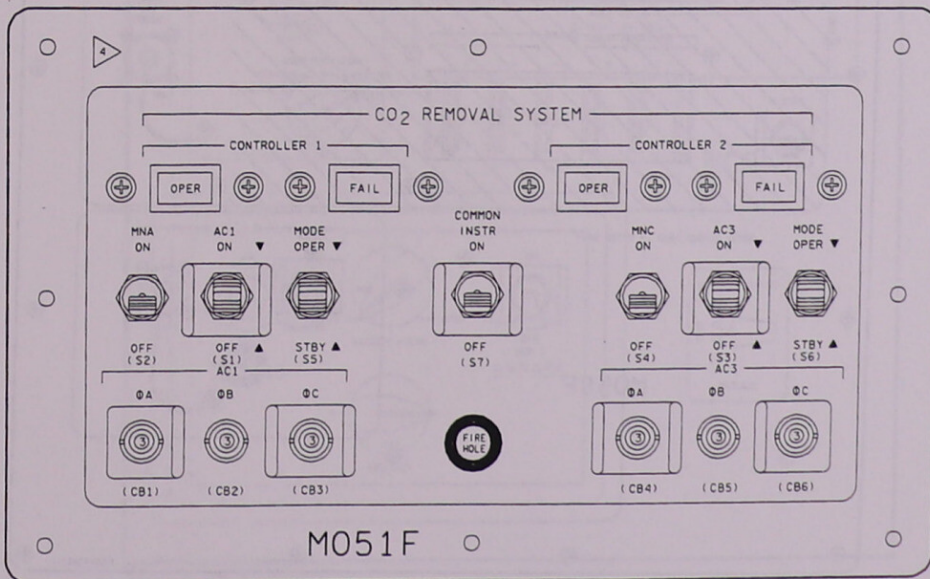

Panel MO51F

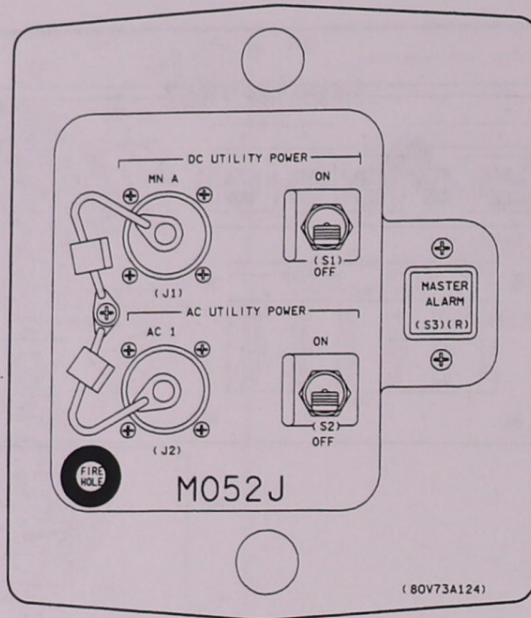

Panel MO52J

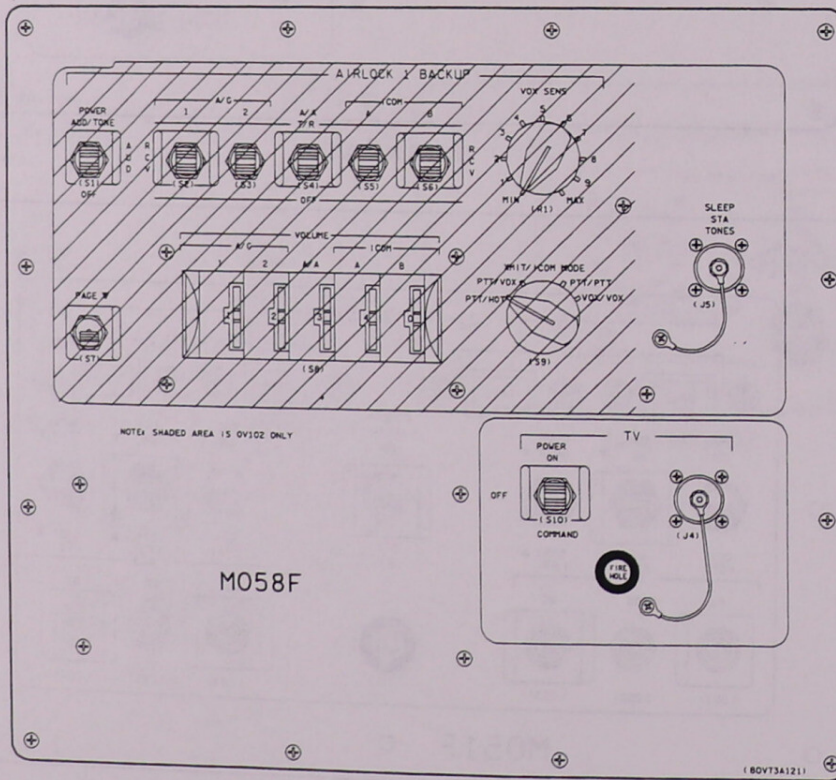

Panel MO58F

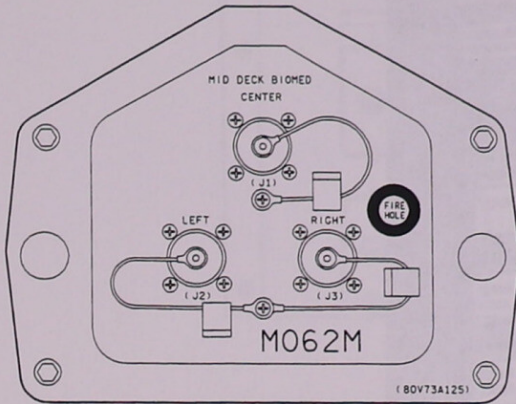

Panel MO62M

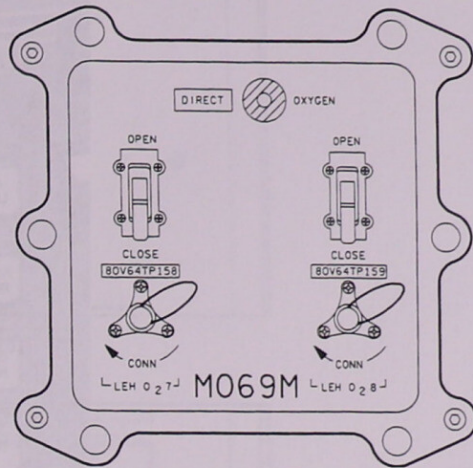

Panel MO69M

EMU SERVICE  
IN PROGRESS

SIDE VIEW

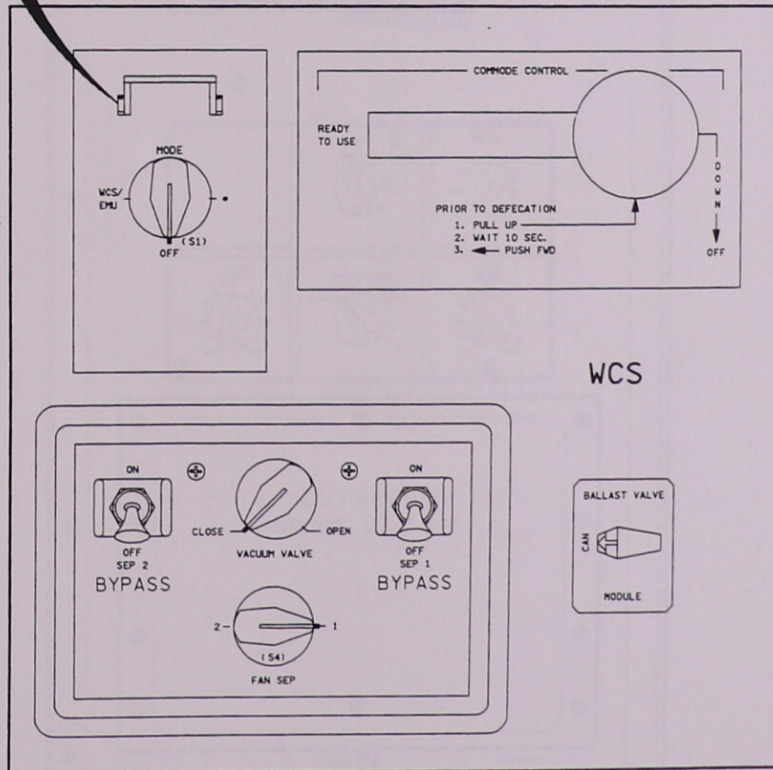

WCS

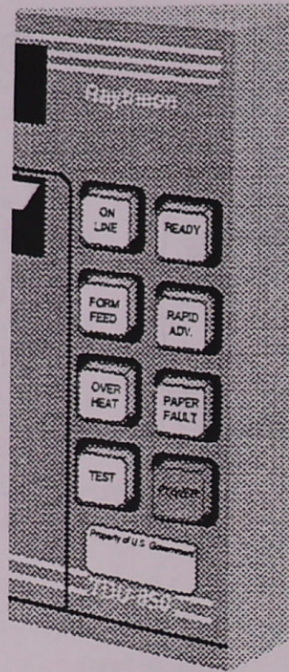

Thermal Impulse Printer



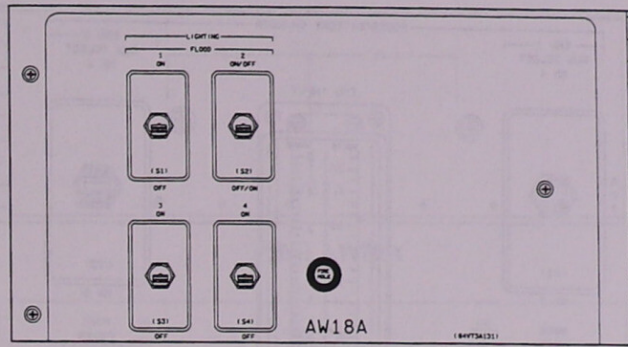

Panel AW18A

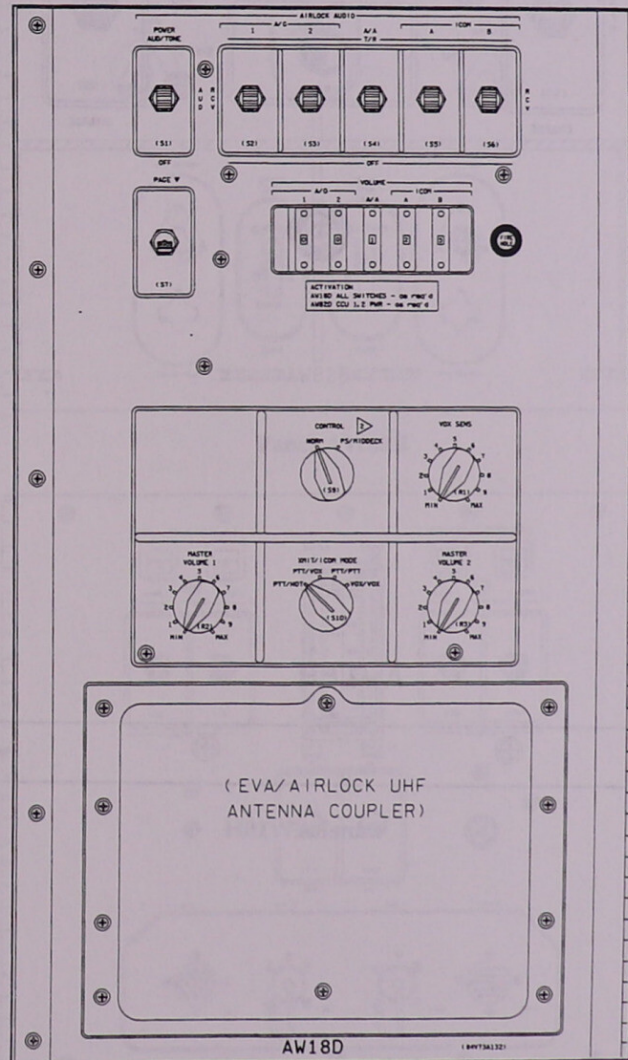

Panel AW18D

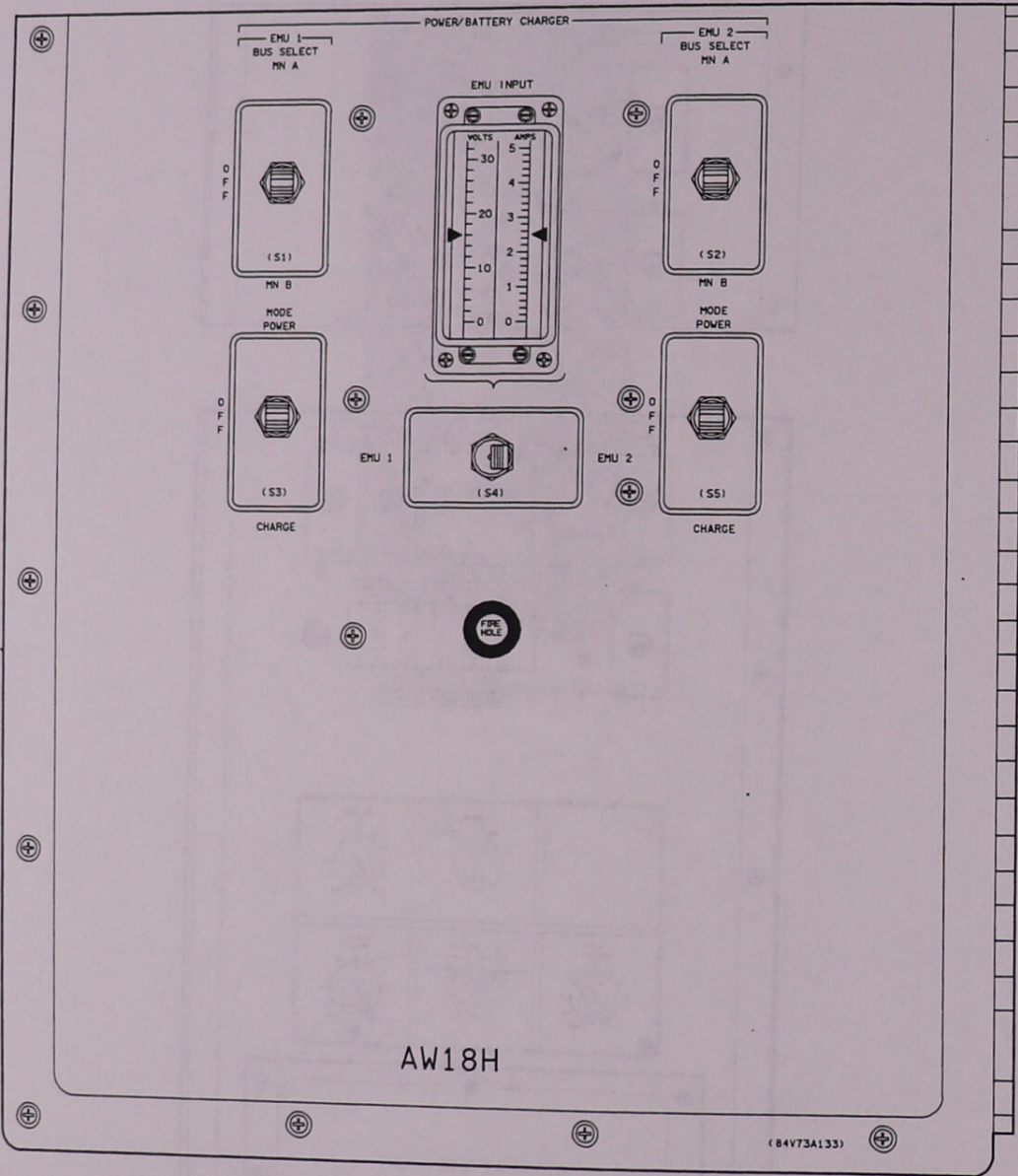

Panel AW18H

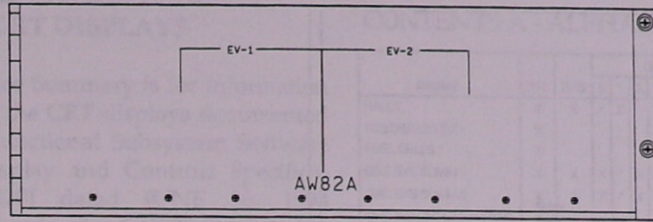

Panel AW82A

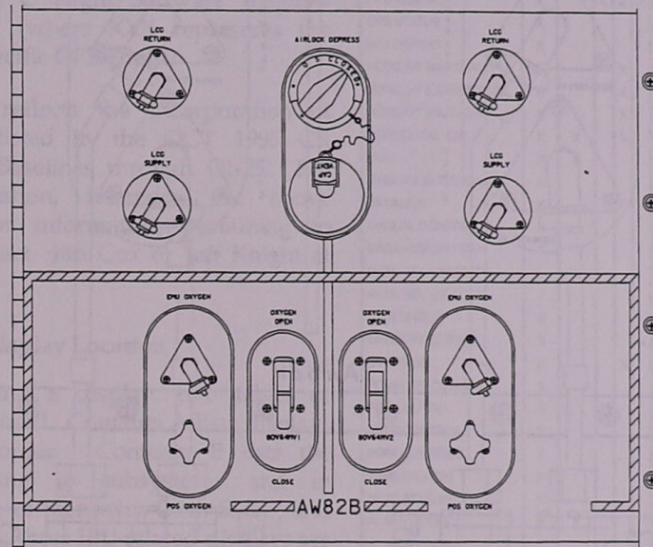

Panel AW82B

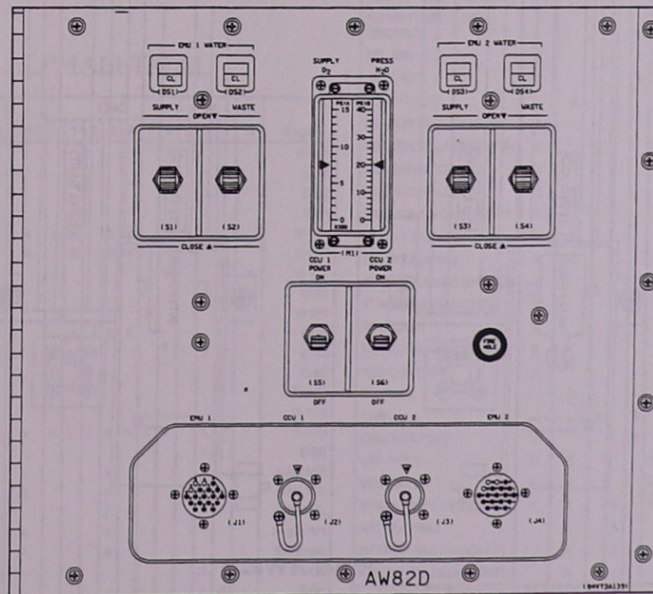

Panel AW82D

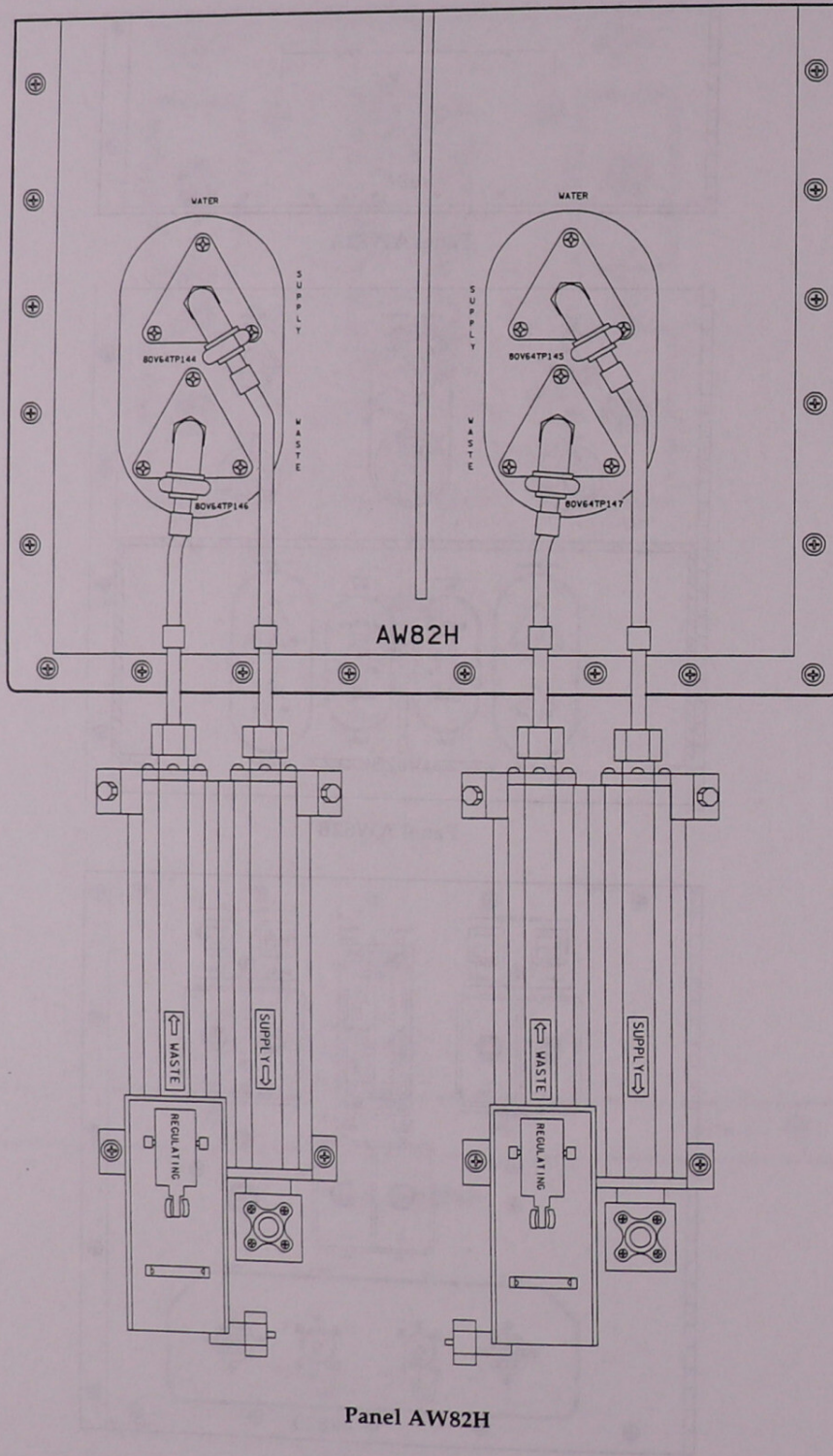



## CONTENTS B-OPS DISPLAYS

OPS No.	Display	PFS	BFS	GNC	SM	PL	Page
0001	GPC MEMORY	X		X			B-11C
0001	BFS MEMORY		X	X			B-15A
0001	THERMAL		X		X		B-15B
1011	XXXXXX TRAJ	X		X			B-3A
1011	XXXXXX TRAJ 1		X	X			B-15C
1021	XXXXXX TRAJ	X		X			B-3A
1021	XXXXXX TRAJ 1		X	X			B-15C
1031	XXXXXX TRAJ	X		X			B-3A
1031	XXXXXX TRAJ 2		X	X			B-15D
1041	XXXXX MNVR YYYY	X	X	X			B-3B
1051	XXXXX MNVR YYYY	X	X	X			B-3B
1061	XXXXX MNVR YYYY	X	X	X			B-3B
2011	ANTENNA	X			X		B-7A
2011	UNIV PTG	X		X			B-3C
2021	PL BAY DOORS	X		X	X		B-7B
2021	XXXXX MNVR YYYY	X	X	X			B-3B
3011	XXXXX MNVR YYYY	X	X	X			B-3B
3021	XXXXX MNVR YYYY	X	X	X			B-3B
3031	XXXXX MNVR YYYY	X	X	X			B-3B
3041	ENTRY TRAJ 1	X		X			B-3D
3041	ENTRY TRAJ 1		X	X			B-15E
3041	ENTRY TRAJ 2	X		X			B-3E
3041	ENTRY TRAJ 2		X	X			B-15F
3041	ENTRY TRAJ 3	X		X			B-3F
3041	ENTRY TRAJ 3		X	X			B-15G
3041	ENTRY TRAJ 4	X		X			B-3G
3041	ENTRY TRAJ 4		X	X			B-15H
3041	ENTRY TRAJ 5	X		X			B-3H
3041	ENTRY TRAJ 5		X	X			B-16A
3051	VERT SIT 1	X	X	X			B-4A
3051	VERT SIT 2	X	X	X			B-4B
4011	ANTENNA	X		X	X		B-7A
6011	XXXXXX TRAJ	X		X			B-3A
6011	RTLS TRAJ 2		X	X			B-16B
6021	VERT SIT 1	X	X	X			B-4A
6021	VERT SIT 1 (GRTLS)	X		X			B-4C
6031	VERT SIT 1	X	X	X			B-4A
6031	VERT SIT 2	X	X	X			B-4B
6031	VERT SIT 2 (GRTLS)	X		X			B-4D
8011	FCS/DED DIS C/O	X		X			B-12A
9011	MASS MEMORY RW	X			X	X	B-12B
9011	GPC MEMORY			X			B-11C

## SPECIAL DISPLAYS

Display	Page
XXXXPL MENU NO. 1	B-11A
GPC/PL MENU NO. 2	B-11B
DEU STAND-ALONE SELF-TEST	B-14C

## HEAD-UP DISPLAYS

Display	Page
FORMAT 1 PRE-WOW	B-18A
FORMAT 1 AFTER WOW	B-18B
OPS 8 LOW	B-18C
OPS 9 LOW	B-18D

## CONTENTS B-SPEC and DISP DISPLAYS

SPEC No.	Display	PFS	BFS	GNC	SM	PL	Page
001	DPS UTILITY	X		X	X	X	B-18D
002	TIME	X		X	X	X	B-11E
006	GPC/BUS STATUS	X		X	X	X	B-11G
018	GNC SYS SUMM 1	X		X			B-6C
018	GNC SYS SUMM 1		X	X			B-16F
019	GNC SYS SUMM 2	X	X	X			B-6D
020	DAP CONFIG	X		X			B-4E
021	IMU ALIGN	X		X			B-4F
022	S TRK/COAS CNTL	X		X			B-4G
023	RCS	X		X			B-4H
025	RM ORBIT	X		X			B-5A
033	REL NAV	X		X			B-5B
034	ORBIT TGT	X		X			B-5C
040	SENSOR TEST	X		X			B-12C
041	RG/A/DTA/RCS	X		X			B-12D
042	SWITCH/SURF	X		X			B-12E
043	CONTROLLERS	X		X			B-12F
044	SWITCHES	X		X			B-12G
045	NWS CHECK	X		X			B-12H
050	HORIZ SIT (IN-RIGHT)	X		X			B-5D
050	HORIZ SIT (IN-LEFT)	X		X			B-5E
050	HORIZ SIT (OUT-RIGHT)	X		X			B-5F
050	HORIZ SIT (OUT-LEFT)	X		X			B-5G
050	HORIZ SIT		X	X			B-16C
051	OVERRIDE	X					B-6A
051	BFS OVERRIDE		X				B-16D
053	CONTROLS	X					B-6B
055	GPS STATUS		X				B-5H
060	SM TABLE MAINT	X		X	X		B-7C
062	PCMMU/PL COMM	X			X		B-7D
063	PL BAY DOORS	X	X		X		B-7B
064	SM GROUND CHECKOUT	X					B-7E
066	ENVIRONMENT	X			X		B-8A
067	ELECTRIC	X			X		B-8B
068	CRYO SYSTEM	X		X	X		B-8C
069	FUEL CELLS	X			X		B-8D
076	COMMRCDR	X			X		B-8E
077	EVA/MMU/FSS	X			X		B-8F
078	SM SYS SUMM 1	X			X		B-8G
079	SM SYS SUMM 2	X			X		B-8H
079	SM SYS SUMM 2		X		X		B-16H
085	MASS MEMORY RW	X			X		B-12B
086	APU/HYD	X			X		B-9A
087	HYD THERMAL	X			X		B-9B
088	APU/ENVIRON THERM	X			X		B-9C
089	PRPLT THERMAL	X			X	X	B-9D
090	PDRS CONTROL	X					B-7F
094	PDRS CONTROL		X	X			B-7G
095	PDRS OVERRIDE	X		X	X		B-7H
096	PDRS FAULTS	X		X	X	X	B-9E
097	PL RETENTION	X		X		X	B-9F
098	FAULT	X		X	X	X	B-11E
099	FAULT		X	X	X	X	B-16C
100	GTS DISPLAY	X		X			B-13A
101	SENSOR SELF-TEST	X		X			B-13B
102	RCS/RGA/DTA TEST	X		X			B-13C
104	GND IMU CNTL/MON	X		X			B-13D
105	TCS CONTROL	X		X			B-13E
106	MANUAL CONTROLS	X		X		X	B-14B
110	BUS/BTU STATUS	X		X		X	B-13F
111	SL MEMORY DUMP	X					B-13G
112	GPC/BTU I/F	X		X			B-13H
113	ACTUATOR CONTROL	X					B-14A
167	DOCKING STATUS	X			X		B-10A
168	SM CRYO PALLET	X			X		B-10B
168	SM CRYO PALLET	X	X				B-17A
169	PDRS STATUS	X			X		B-10C

GUIDANCE, NAVIGATION,  
AND CONTROL (GNC)

A

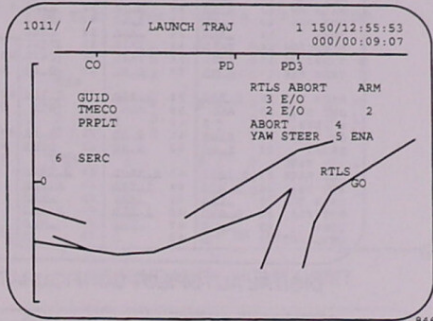

XXXXXX TRAJECTORY

E

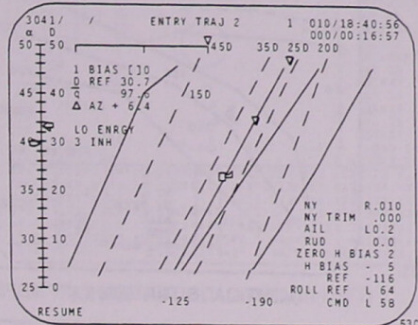

ENTRY TRAJECTORY 2

B

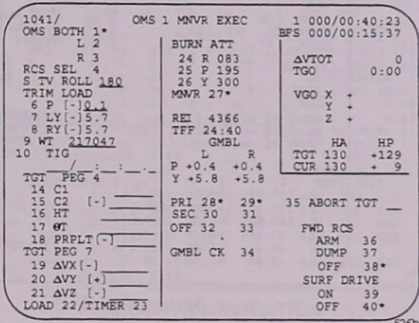

XXXXXX MANEUVER UUUUU (PFS/BFS)

F

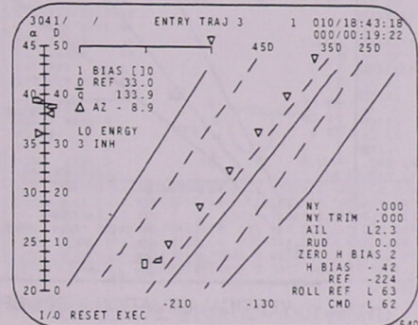

ENTRY TRAJECTORY 3

C

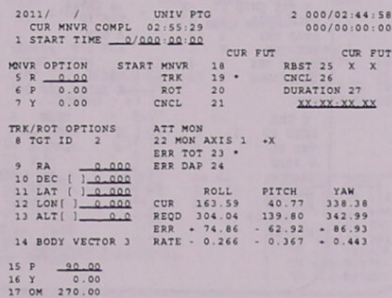

UNIVERSAL POINTING

G

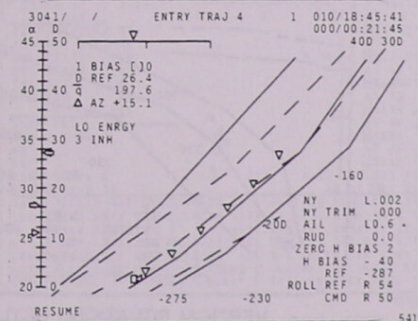

ENTRY TRAJECTORY 4

D

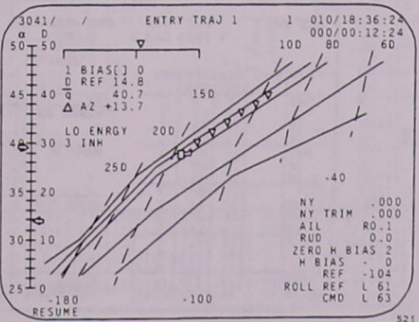

ENTRY TRAJECTORY 1

H

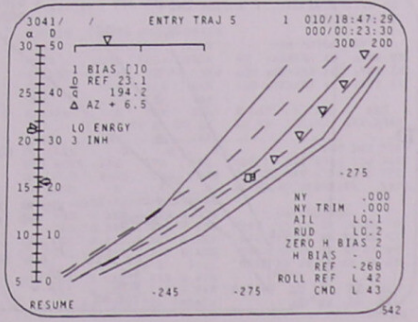

ENTRY TRAJECTORY 5

A

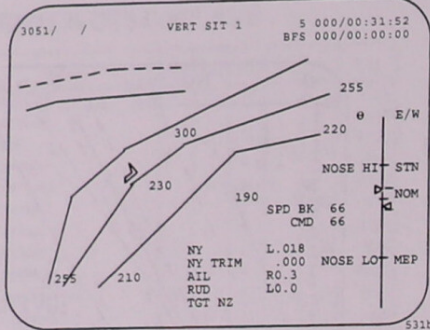

VERTICAL SITUATION 1 (PFS/BFS)

B

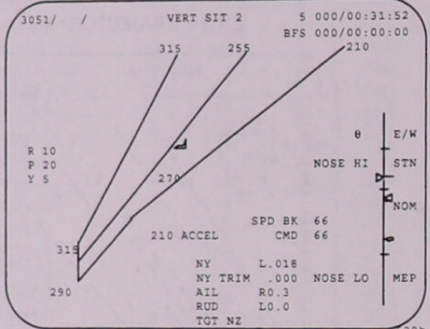

VERTICAL SITUATION 2 (PFS/BFS)

C

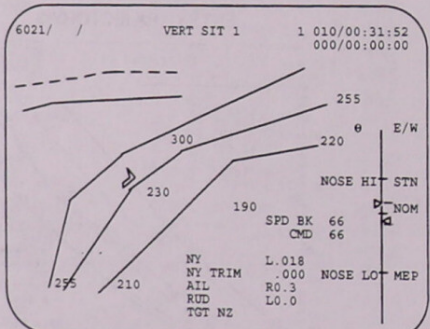

VERTICAL SITUATION 1 GRTLs

D

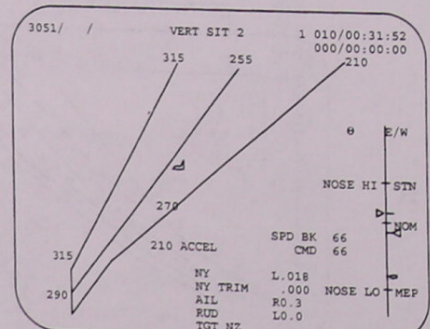

VERTICAL SITUATION 2 GRTLs

E

2011/020/ DAP CONFIG 1 000/19:07:32  
000/00:00:00

PRI 1	DAP A08	2 DAP B08	PRI	DAP EDIT
ROT RATE 10	0.2000	30 0.2000	50	0.2000 3 DAP A08
ATT DB 11	1.000	31 1.000	51	1.000 4 DAP B
RATE DB 12	0.100	32 0.100	52	0.100 5 LOAD
ROT PLS 13	0.100	33 0.100	53	0.100
COMP 14	0.000	34 0.000	54	0.000
P OPTION 15	TAIL	35 TAIL	55	TAIL
Y OPTION 16	TAIL	36 TAIL	56	TAIL
TRAN PLS 17	0.000	37 0.000	57	0.000
ALT			58	0.2000
RATE DB 18	0.2000	38 0.2000	59	ALL
JET OPT 19	ALL	39 ALL	60	2
# JETS 20	2	40 2	61	0.000
ON TIME 21	0.000	41 0.000	62	0.000
DELAY 22	0.000	42 0.000	63	0.2000
VERN			64	1.000
ROT RATE 23	0.2000	43 0.2000	65	0.000
ATT DB 24	1.000	44 1.000	66	0.000
RATE DB 25	0.100	45 0.100	67	0.000
ROT PLS 26	0.100	46 0.100	68	0.000
COMP 27	0.000	47 0.000		
CNTL ACC 28	0	48 0		

NOTCH FLTR ENA 6X  
KJETS ROT ENA 7X  
REBOOST 8 CFG X  
9 INTVL XXX XX

52:

DIGITAL AUTOPILOT CONFIGURATION

F

3011/021/ IMU ALIGN 1 006/09:34:09  
000/00:00:00

STAT	CK	CK	CK	IMU	1 10	STAR ALIGN	13*
STBY	21	22	23		2 11	14 IMU/IMU	
OPER	4*	5*	6*		3 12	MATRIX	15
DES	7	8	9				

EXEC 16  
TERM 17

ACC	1	2	3	
X	-0.03	+0.01	-0.03	IMU BITE MASK
Y	-0.02	-0.01	+0.03	1 0000 24
Z	-0.01	-0.02	-0.03	2 0000 25
				3 0000 26

ANG	1	2	3	
X	299.07	299.16	299.12	NAV AV THRESH
Y	335.17	339.09	339.14	18 3840
Z	160.65	160.72	160.64	
ΔX	+0.00	+0.00	+0.00	MM READ 19
ΔY	+0.00	+0.00	+0.00	
ΔZ	+0.00	+0.00	+0.00	

463

IMU ALIGNMENT

G

3011/022/ S TRK/COAS CNTL 1 006/09:35:06  
000/00:00:00

S TRK CNTL	-Y	-Z	S TABLE	1	2	3
SELF-TEST	1	2	TRK ID	15	43	0
STAR TRK	3	4	Δ MIN	1	1	0
TGT TRK	5	6	ANG DIF	84.1	0.0	0.0
BREAK TRK	7	8	ERR	0.02	0.00	0.00
TERM/IDLE	9*	10*	SEL	17*	18*	19
			S TABLE CLR	20		

S TRK	-Y	-Z	COAS	
REQD ID	11	0	12	0
TRK ID	0	0	REQD ID	21
S PRES			ΔDEG X	-0.2
ΔANG	+0.00	+0.00	Y	+0.3
THOLD	13	0	14	0
SHUTTER	CL	CL	SIGHT MODE	22
MAN OP	15	16	ACCEPT	23
			CAL MODE	24
			DES	25
			POS	+X 26 -Z 27*
			ΔBIAS	0.00 0.00
			UPDATE	28 29

468

STAR TRACKER/COAS CONTROL

H

2011/023/ RCS 1 000/03:14:16  
000/00:00:00

RCS FWD	1	PRI	JET	OMS PRESS	ENA
L	2	4	FAIL LIM	2	L 0.00
R	3*				R 0.00

JET	FAIL	DES	JET	PTY	
R4R	8	9	2		
2R	10	11	1		
Y 3R	12	13	2		
1P	14	15	1		
R4U	16	17	2		
2U	18	19	1		
Z 1U	20	21	1		
R	22	23	2		
4D	24	25	1		
2D	26	27	2		
3D	28	29	1		
R1A	30	31	1		
X 3A	32	33	3		
	34	35	2		
R5R	36	37			
V 5D	38	39			

HE	P	3376	3360
PREPLT	TK	P	247 250
	T	77	79
	QTY	20	91
MANF	P	1 242	246
		2 250	246
		3 248	248
		4 246	242
MANF	VILVS	STAT	QVBD
		OP	40
		OP	41
		OP	42
		OP	43
		OP	44
		OP	44
XFEED	P	254	254
JET	RESET	45	

678

REACTION CONTROL SYSTEM



A

2011/025/ RM ORBIT 2 000/02:50:38  
000/00:00:00

THC	TX	TY	TZ	DES	RHC	R	P	Y	DES	
L	1				L	1	0	0	0	7
2					2	0	0	0	0	8
3					3	0	0	0	0	9
A	1				R	1	0	0	0	10
2					2	0	0	0	0	11
3					3	0	0	0	0	12
ANG	1	2			A	1	0	0	0	13
					2	0	0	0	0	14
					3	0	0	0	0	15

SW RM INH 16

REDUNDANCY MGMT ORBIT

1034

E

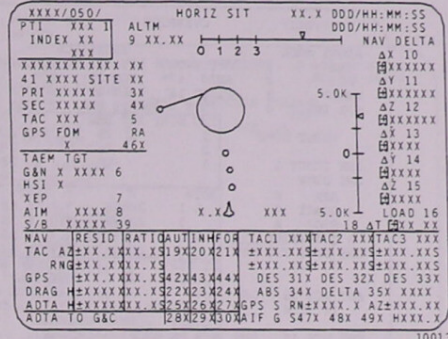

HORIZONTAL SITUATION (IN-LEFT)

10013

B

2011/033/ REL NAV 2 004/23:05:28  
000/00:00:42

RNDZ	NAV	ENA	1*	SV	UPDATE	AVG G ON	5X
KU	ANT	ENA	2*	POS	0.01		
MEAS		ENA	3*	VEL			

NAV  
SV SEL 4 FLTR RR GPC  
RNG 97.692 R 97.567  
R - 41.55 R - 41.30  
θ 11.35 EL - 0.7  
Y - 0.04 AZ - 0.1  
Y - 0.3 ωP - 1.1  
NODE 23:48:54 ωP - 0.0

STAT P 1c DES  
15 XXXX XXXX 31X  
25 XXXX XXXX 32X  
35 XXXX XXXX 33X

SV TRANSFER  
FLTR MINUS PROP  
POS 3.74  
VEL 4.57

FLTR TO PROP 8  
PROP TO FLTR 9  
ORB TO TGT 10  
TGT TO ORB 11  
EDIT OVDR

RESID RATIO ACPT REJ AUT INH FOR  
RNG ±XX.XX X.X XXX XXS 17X 18X 19X  
R ±XX.XX X.X XXX XXS 20X 21X 22X  
V/EL/X ±.XX X.X XXX XXS 23X 24X 25X  
H/AZ/X ±.XX X.X XXX XXS  
GPS X ±XXX.XX X.XS 42XS 43X 44X  
X ±XXX.XX X.XS

RELATIVE NAVIGATION

527

F

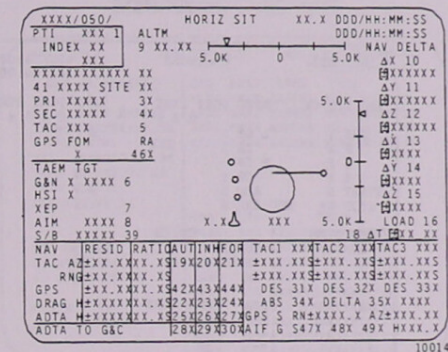

HORIZONTAL SITUATION (OUT-RIGHT)

10014

C

2011/034/ ORBIT TGT 2 002/13:24:45  
000/00:55:36

MNVR	TIG	ΔVX	ΔVY	ΔVZ	ΔVP
10	2/14:20:21	+ 9.1	- 0.5	+ 0.8	+ 9.1

FRED MATCH= 13

INPUTS  
1 TGT NO 10  
2 T1 TIG 2/14:20:21  
6 EL 0.00  
7 ΔX/DNRIG - 49.39  
8 ΔY + 0.00  
9 ΔZ/ΔH - 1.39  
10 ΔX - 14.96  
11 ΔY + 0.49  
12 ΔZ - 0.50  
13 T2 TIG 2/15:42:26  
17 AT ± 82.1  
18 ΔX 0.00  
19 ΔY 0.00  
20 ΔZ 0.00  
21 BASE TIME 2/14:20:21

CONTROLS  
T2 TO T1 25  
LOAD 26  
COMPUTE T1 28  
COMPUTE T2 29

ORBITER STATE  
302/ 8:32:38.114  
X +17213.696  
Y -4052.945  
Z +13379.393  
VX +13.793848  
VY +16.958777  
VZ -12.548509

ORBIT TARGETING

528

G

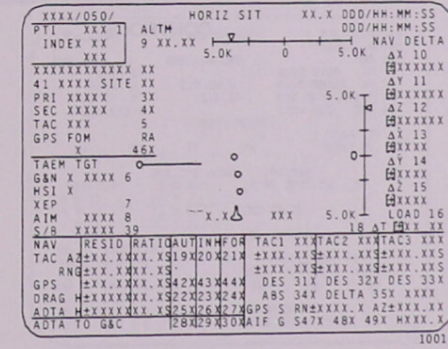

HORIZONTAL SITUATION (OUT-LEFT)

10015

D

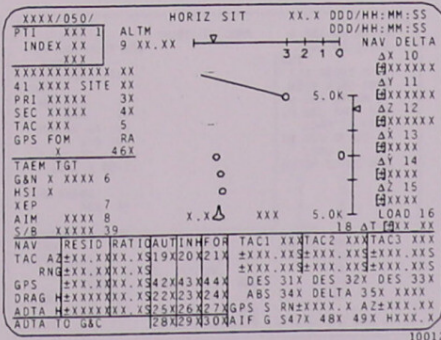

HORIZONTAL SITUATION (IN-RIGHT)

10012

H

XXXX/055/ GPS STATUS XX.X DDD/HH:MM:SS  
DDD/HH:MM:SS

I/O	10	GPS1S	GPS2S	GPS3S	GPS MINUS NAV
STAT	XXXX	XXXX	XXXX		
MODE	XXXX	XXXX	XXXX	ΔH ±XXXXXX ΔH ±XXX.XX	
S/TEST	11XS	12XS	13XS	ADR ±XXXXXX ADR ±XXX.XX	
INIT	14X	15X	16X	ACR ±XXXXXX ACR ±XXX.XX	
NAV	17X	18X	19X		
RESTART	20X	21X	22X	X LAT X LON ALT	
IMU	23 X	24 X	25 X	XX.XX XX.XX XXX.XXXX	
GDOP	XX	XX	XX		
DG FAIL	S	S	S	AUT INH FOR	
DES RCVR	26X	27X	28X	GPS TO G&C S12X 33X 34X	
QA OVDR	29XS	30XS	31XS	GPS TO NAV S35X 36X 37X	
SF CAND	X	X	X	METERING OVERLOAD 38X	
QA1 P	1±XXXXXX	XXXXXX	XXXXXX		
QA2 POS	X.XXS	X.XXS	X.XXS	SATELLITES	
VEL	X.XXS	X.XXS	X.XXS	TRKD C1 C2 C3 C4 C5 C6	
QA3 POS	X.XXS	X.XXS	X.XXS	GPS1 XX XX XX XX XX XX	
VEL	X.XXS	X.XXS	X.XXS	GPS2 XX XX XX XX XX XX	
	1-2	2-3	3-1	GPS3 XX XX XX XX XX XX	
QA4 POS	X.XXS	X.XXS	X.XXS		
VEL	X.XXS	X.XXS	X.XXS	DES 43 XX XX XX XX	
XXX.X	LAST SEL	FIL	UPDATE	XX XX XX XX	

GPS STATUS

10087

A

3051/051/		OVERRIDE		2 008/04:13:37	
				000/00:29:56	
ABORT MODE					
TAL	1	ELEVON	FILTER	ATMOSPHERE	
ATO	2	AUTO 17*	NOM 20*	NOM 22*	
ABORT	3	FIXED 18	ALT 21	N POLE 23	
MAX THROT	4	SSME REPOS	19 ENA	S POLE 24	
PRFLT DUMP					
IMU STAT		ATT DES		PRL	
1	3	25		SYS	AUT DES
2		26		1	28* 31
3		27		2	29* 32
4				3	30* 33
INH IGCT 5					
OMS DUMP					
ARM	6	ADTA	H	α	M DES
START	7	L 1	20466	+ 7.0	0.58 34
STOP	8	3	20466	+ 7.0	0.58 35
9 QUAN/SIDE	78	R 2	20892	+ 6.9	0.58 36
OMS DUMP ITG	520	4	20892	+ 6.9	0.58 37
AFT RCS 13 INH					
14 TIME	0	ET SEP			
FWD RCS 15 INH					
16 TIME	0	ROLL MODE AUTO			
CL OVRD 41					

741

OVERRIDE

B

3011/053/		CONTROLS		1 000/03:03:04	
				000/00:00:00	
SEC ACT CK					
CH1	1	L OB	1	L P	
2	2	IB	2	Y	
3	3	R IB	3	C P	
4	4	OB	4	Y	
START	5	RUD	5	R P	
STOP	6*	SPD BRK	6	Y	
NEG STIM					
ENA	7	8 BYPASS	00	ACT/CH	
9 RESET 00					
LRU AA DES RGA SURF FDBK					
1	10	14*	18	DES	
2	11	15*	19		
3	12	16*	20		
4	13	17	21		

1036

CONTROLS

C

2011/ /018		GNC SYS SUMM 1		1 000/02:46:03	
				000/00:00:00	
RCS	JET	ISOL		DPS	1 2 3 4 5
MANF	FAIL	VLV	SURF POS MCM		
F1		OP	L OB		GPC
2		OP	R IB		MDM FF
3		OP	OB		FA
4		OP	ALL		
5		OP	RUD		FCS CH 1 2 3 4
L1		OP	SPD BRK		
2		OP	BDY FLP		
3		OP			NAV 1 2 3 4
4		OP			IMU
R1		OP	CNTLR 1 2 3		ACC
2		OP	RHC L		RGA
3		OP	R		TAC
4		OP	A		MLS
5		OP	THC L		ADTA
SBTC L					
R					

203

GNC SYSTEM SUMMARY 1

D

3011/ /019		GNC SYS SUMM 2		5 015/20:25:34	
				BFS 000/00:26:24	
OMS	AFT	QTY	L R	OMS	L R
	HE	P	28.6 28.6	TK	P HE 2610 2680
	TK	P	28.3 28.3		CMID 260 258
	FU	INVT	79 79		FU 267 258
JET/SOL					
RCS	CMID	FU	FAIL	VLV	
FWD	HE	P	464 1264	N2	TK P 2220 2220
	TK	P	248 244	ENG	IN P 319 319
	QTY	0	0		P VLV CL CL
MANF	1	P	248 242		CMID 257 258
	2	P	248 244		FU 258 258
	3	P	250 246		VLV 1 - 2 - 2
	4	P	244 244		2 0 0
	5				0 0 0
JET/SOL					
AFT	HE	P	2800 2672	OXID	FU FAIL VLV
L	TK	P	244 249		
	QTY	63	63		
MANF	1	P	244 246		
	2	P	246 250		
	3	P	248 250		
	4	P	246 250		
	5				

242

GNC SYSTEM SUMMARY 2 (PFS/BFS)

SYSTEM MANAGEMENT (SM)

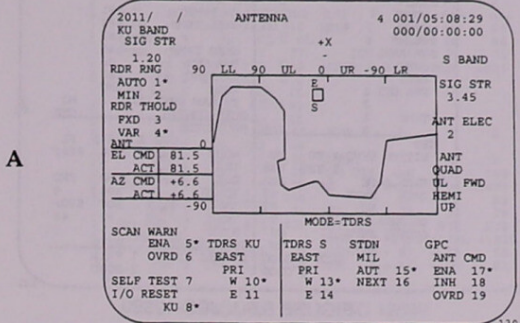

ANTENNA

2011/064/ SM GROUND CHECKOUT 4 000/02:32:11  
000/00:00:00

INPUTS INHIBITED  
ENA INH 2\* 3  
PROCESS INH/ENA INH  
FL ANNNUN 4\* S P O/P 15  
SM ANNNUN 5\*

DOWNLIST  
6 SEL FMT  
LOAD 7

RMS TOOLS  
SOFT STOP/REACH  
TURNAROUND 8  
REINSTALL 9  
SINGULARITY 10  
JOINT  
RATE LIMIT 11  
12 JOINT SEL 1  
13 ATTN LIM 1  
14 ARM SELECT

OPS ACTIVATE 1

SM GROUND CHECKOUT

2021/ / PL BAY DOORS 4 000/02:00:00  
000/00:00:00

AC POWER ON 1\*  
OFF 2 PBD SW-CL  
AUTO MODE SEL 3

CENTER LATCHES	MAN SEL	OP/CL	AUTO SEQ	MICRO-SW LATS	STAT DOORS
5-8	4	OP	0011	CC00	CRRO
9-12	5	OP	0011	ABAB	ABC
1-4	6	OP	0011		
13-16	7	OP	0011		
FWD LATCHES	8	OP	0011	0000	
AFT LATCHES	9	OP	0011	0000	
DOOR	10*				
FWD LATCHES	11	CL	1100	1111	
AFT LATCHES	12	CL	1100	1111	
DOOR	13	CL			

STED  
PBD SW BYPASS 14  
OPEN 15  
STOP 16  
CLOSE 17

PAYLOAD BAY DOORS (PFS/BFS)

XXX1/090/ PCS CONTROL XX X DDD/HH:MM:SS  
DDD/HH:MM:SS

SEQ	STAT	NAME	GMT
1	SET	XX XXXXXX	XXXX XXX XXXXXXXX XXX/XX:XX:XX
2	SEQ	XXXX XXXXXX	XXXX XXX XXXXXXXX XXX/XX:XX:XX
3	GMT	XXX/XX:XX:XX	XXXX XXX XXXXXXXX XXX/XX:XX:XX
7	HOLD	STEP XXX	XXXX XXX XXXXXXXX XXX/XX:XX:XX
ENA	8	HOLD 9X	
TERM	10	RESUME 11	
TERM	ALL	12	
CLEAR	TEXT	13	

SEQ STEP TEXT  
XXXX XXX XXXXXXXX  
XXXX XXX XXXXXXXX  
14 STEP XXX  
XXXX XXX XXXXXXXX  
15 DELAY XX:XX  
XXXX XXX XXXXXXXX  
CURRENT XXX  
ERROR XXX/X  
XXXX XXX XXXXXXXX

PCS CONTROL

9011/060/ SM TABLE MAINT 4 000/02:31:37  
SM COM BUFF RDY 000/00:00:00  
PARAM  
1 ID  
VALUE= []

ALERT	LIMITS	BACKUP C&W
2 []	3 []	11 []
4 []	5 []	12 []
6 []	7 []	
8 FILTER		13 FILTER
ENA 9		ENA 14
INH 10		INH 15

CONSTANT  
16 ID  
17 VALUE= []

CHECKPT 0/00:00:00 FDA  
INITIATE 18 ENA 19\*  
STATUS INH 20

SM TABLE MAINTENANCE

2011/094/ PDRS CONTROL 4 000/02:32:45  
000/00:00:00

RMS SEL: RMS PWR OFF ENA INH  
PORT 1\*  
STBD 2 I/O ON 5 AUTO BRAKE 9\* 10  
3 PL ID 0 OFF 6\* POS ENG CK 11\* 12  
4 END EFF 1 POHS NTL 28\* 29

AUTO MODES  
1 2 3 4 17 START PT  
13 14 15 16 18 LAST PT

END POS OPR CMD MODES / POR REF  
END ATT 24 PL INIT ID 0  
18 X [] 21 Z [] CMD CK 25  
19 Y [] 22 Y []  
20 Z [] 23 R [] POR DISPLAY 30 ORB

RMS STO/DPLY  
SHLD 0 0 0 0 ORB LD CMD REF  
NORM FLY-CAMR FLY-PL

RMS LAT/REL/RDY 31 32 33  
AFT 0 0 0 0 0  
MID 0 0 0 0 0  
FWD 0 0 0 0 0

26 WR RANGE 4  
AUTO BRAKE CK 27

PDRS CONTROL

2011/062/ PCMMU/PL COMM 4 001/05:03:16  
SM COM BUFF RDY 000/00:00:00

PCMMU  
BITE WORD FFFD  
FMT  
SEL FXD 1  
PGM 2\*  
PGM ID 64 103  
128 184  
3 SEL ID 184  
LOAD 4 CPLT

I/O RESET  
PCM 5\*

PSP PL INTRG  
I/O RESET 1 CHANNEL 301  
PSP1 6\* 2 CHANNEL 2 15  
PSP2 7 PHASE LOCK YES 3 16\*  
SYNC BIT YES ERR 17 4 17  
FRAME YES XMIT PWR 1.05  
LOAD PL SIG STR 1.75 18 TFL GPC SEL 0

PDI  
I/O RESET 8\*  
BITE WORD FFFF  
9 SEL DECOM 5  
10 SEL FMT 501  
LOAD 11 CPLT  
12 SEL INPUT  
LOAD 13  
DECOM INPUT FMT  
1 6 4  
2 5 5  
3 6 14  
4 5 15  
5-FPM 501

PCMMU/PAYLOAD COMMUNICATION

2011/095/ PDRS OVERRIDE 4 000/02:33:08  
000/00:00:00

MODE SW OVRD 1	JNT SW OVRD 17	RATE SW OVRD 26
MODE SEL IND	JOINT SEL	VERNIER 27*
ORS UNL 2	SH YAW 18	COURSE 28
SINGLE 3	SH PITCH 19	
END EFF 4	EL PITCH 20	AUTO SW OVRD 29
OPR LD 5	WR PITCH 21	PROCEED 30
PL 6	WR YAW 22	STOP 31
OPR CMD 7	WR ROLL 23	
AUTO 1 8	EE TEMP 24	HC AXIS CHG 32
AUTO 2 9	CRIT TEMP 25	THC 33
AUTO 3 10		RHC 34
AUTO 4 11		
TEST 12		
ENTER 13		

MCIU OVERRIDE  
SAFING CAN 35  
ABE OVRD A 36  
ABE OVRD B 37  
ABE OVRD C 38

LOADED RATE 14  
STOWED OPS 15  
SIN/DIR SW REASSIGN 16

PDRS OVERRIDE



A

2011/ /086	APU/HYD	4 000/02:36:12	000/00:00:00
APU	1 2 3	HYD	1 2 3
B/U	EGT 313 313 310	B/U	P 644 644 644
EGT	313 313 310	RSVR	T 58 64 66
SPEED	% OL OL OL	P	58 66 66
FUEL	QTY 76 77 77	QTY	74 75 73
TK	P 209 210 212	ACCUM	P 2616 2624 2624
OUT	P 209 210 212		
TK	VLV A CL CL CL		
A	T 61 62 62		
B	T 61 62 62	W/B	1 2 3
OIL	T 64 63 62		
OUT	T 63 62 60	CNTLR	A A A
OUT	P 25 25 25	H2O QTY	100 100 100
GEK	P 25 25 25	NZ	P 2499 2506 2492
N2	P 141 142 140	T	57 58 55
BRG	T 82 81 84	REG	P 28 28 28
GG	BED T 426 423 421	BYP	VLV BYP BYP
PUMP/	VLV	VENT	T +122L +122L +122L
PMP	T 94 92 90	TANK	T +57 +58 +55
VLV	T 114 111 107	ELR	T +60 +58 +61

FIGURE 6.9-1. JSC 19590

D

2011/ /082	PRFLT THERMAL	4 000/02:37:12	000/00:00:00
OD	L R		
OMS	TK CX 80 80		
ENG	I/F OX 70 70	OMS	CRSFD L R C
	FU 70 70	XFD	OX 68 68 67
	OX VLV 71 71	DRN	GMBL LN 68 68 67
	FU INJ 81 81		OX 65 65 64
WEB	KEEL 1 70 70		
	2 70 70	ELD	AFT FUS 65 66
	Y OB 74 74		PL BAY 65 67
	UP 74 74		OX QD 66 67
OX	DRN PNL 1 67 67		
ENG	COVER 71 73	FWD	RCS FU OX
SERV	PNL 70 70	LINE	T1 67 66
GSE	SERV PNL 74 73	T2	67 66
TEST	HE/OX 1 70 70		
	2 70 70	AFT	RCS L R
		MANF	PNL OX 69 68
		DRN	PNL 1 68 66
			2 68 66
		VERN	PNL 1 67 67
			2 67 67

FIGURE 6.12-1. JSC-19590

B

2011/ /087	HYD THERMAL	4 000/02:36:29	000/00:00:00
		CIRC PUMP CONTROL	
HYD	1 2 3	LINE	TEMPS 1 2 3
CIRC	PMP H 64 66 66	ELEVON	LOB+ 94 +61 +59
CIRC	PMP H 64 66 66	ELEVON	LOB+ 94 +61 +59
PMP	BDY H 61 +47 +67	LIB	+94 +61 +61
RSVR	H 58 64 +66	RIB	94 61 61
ACCUM	H 2616 2624 2624	ROB	94 +59 +61
HX	IN H 75 +75 +75	RD/SB	PDU+ 97 +59 +59
OUT	H 59 +54 +54	FUS	+97 +59 +59
SW	VLV PR S1 S2	BDYFLP	PDU+ 97 +59 +59
ELEV	L OB 3* 1 2	FUS	+97 +59 +59
IB	2* 1 3	L	BRAKE WHL +70 +45
R	IB 3* 1 2	R	BRAKE WHL+ 62 +70 +61
OB	2* 1 3	FUS	+40 +67 +61
RUD/	SPDBK 1* 2 3	NG	UPLN+ 40
		MFUS	1+40
TIRE	PRESS	MG L	UPLN+ 40
MG	LEFT	MG R	UPLN+ 40
IB	377 377 377 377		
OB	378 378 376 376		
NG	369 369 364 364		

FIGURE 6.10-1. JSC 19590

E

2011/ /086	PDRS FAULTS	4 000/02:37:34	000/00:00:00
ABE	- OLD / NEW	SY	SP EP WP MY WE
JPC	BLTE /		
MDA	BLTE / MDA O/C	MCIU	
SPA	CMTR / SPA CMTR	MPC	
TACH	/ TACH PLL	ICF	
	/ TACH TCO		
	/ CPU	ABE	
	/ MDA DMD	COMM	
	/ A/D CNV		
	/ BRAKE	CHK CRT:	
	/ POS ENG	DC/MCIU	
	/ DIR DRV	EXT FS	
	/ B/U RELAY	EE FLAG	
SPA	+28V /	EEU	
		EE CMOS	
CONF	ERROR	HC	
CKRT	- POS	MCIU	HC
REACT	LIMIT	TME	CKT
CKRT	- SPA:	SY	SP EP WP MY WE
BLTE	TEST	LOSS	LOSS LOSS LOSS LOSS

FIGURE 6.13-1. JSC-19590

C

2011/ /088	APU/ENVIRON THERM	4 000/02:36:51	000/00:00:00
FREC	LOOP 1 2	H2O	LOOP 1 2
ACCUM	QTY 27 27	PUMP	OUT P 64 62
FREC	FLOW 2193 2190	OUT	T 64 63
PL	HX FLOW 290 286	P	30L 38
AFT	CP FLOW 279 278	ICH	FLOW 564L 777
RAD	IN T 38 38	OUT	T 41 38
EVAP	OUT T 38 38	CAB	HX IN T 42 38
EVAP	TEMP 38 38	ACCUM	QTY 45 55
HI	LOAD INED 259	APU	FUEL T 1 2 3
OUTED	259 312	TK	SURF +69 +67 +68
TOPPING	FWD 257	TK	HTR +70 68 +69
	AFT 257	TEST	IN 1 +62 +62 +63
	L 162 50	TEST	IN 2 +62 +63 +63
	R 162 50	FEED	IN +57 +58 +58
EVAP	FOLDN T A B	PUMP	IN +57 +58 +58
	FWD 80 80	DRN	IN 1 +62 +62 +63
	MID 1 80 80	DRN	IN 2 +62 +62 +63
	MID 2 79 75	OUT	+92 +90 +88
	AFT 75 79	BYP	LN +108 +106 +102
	TOPPING 75 79	GG	SPLY LN 113 111 107
	ACCUM 75 79		
	HI LOAD 75 79	H2O	LN INJ- 71 92 +72

FIGURE 6.11-1. JSC 19590

F

2011/ /C97	PL RETENTION	4 000/02:37:49	000/00:00:00
		LATCH	LATCH LATCH LATCH LATCH
		1	2 3 4 5
		AB/AB	AB/AB AB/AB AB/AB
PL	SEL 1		
RDY	-FOR-LAT	/	/ / / / /
LAT/REL			
PL	SEL 2		
RDY	-FOR-LAT	/	/ / / / /
LAT/REL			
PL	SEL 3		
RDY	-FOR-LAT	00	00 00 00 00 00
LAT/REL		00/00	00/00 00/00 00/00 00/00

FIGURE 6.14-1. JSC-19590

A

2011/ /167		DOCKING STATUS		4 000/02:38:17	
				000/00:00:00	
RNE ALIGN	OFF	QNTL PNL PWR	///	RING DR BUS	///
CONTACT	ON	HTR/DCU PWR	///	HOOK DR BUS	///
CAPTURE	ON	APDS PWR	///	DAMPER BUS	///
DAMPING	ON	QNTL CMD PWR	ON	FIXER BUS	///
		ARDS CIRC PROT	OFF		
RING POS	///	HOOK PYRO LOGIC PWR	///		
DRV CMD	ON	PYRO CIRC PROT	OFF/OFF		
FIXERS	ON				
PETAL POS	1 2 3	BASE T	1 2 3		
RING	0 0 0	CAP LAT T	0 0 0		
BASE	0 0 0	BALL DR T	0 0 0		
RDY TO HOOK	ON	HOOK DR T	0 0 0		
HOOK DRV CMD	ON	RING DR T	0		
POS	///	VESTIBULE			
IND	0	DEF VLV 1	///		
HOOK DRV CMD	ON	ISOL VLV 1	///		
POS	///	DEF VLV 2	///		
IND	0	ISOL VLV 2	///		
UNDOCK CMPLT	OFF	TEMP 1/2	- 13/- 13		
CAP LAT CMD	ON	EXT AIRLOCK T	0		
IND	///	EXT AIRLOCK P	14.84		
MAN REL	CL	AIRLOCK-VEST AP	14.88		

FIGURE 6.17-1. JSC 19590

C

2011/ /169		PDRS STATUS		4 000/02:39:10	
				000/00:00:00	
RMS SEL:	OFF	X/P	Y/Y	Z/R	
POSITION		M	M	M	
ATTITUDE		M	M	M	
TRANS RATES	ACT	M	M	M	
	CMD				
ROT RATES	ACT	M	M	M	
	CMD				
JOINT ANGLES			END EFFECTOR		
SV	SP	EP	RIGID	CLOSE	CAPTURE
M	M	M	0	0	0
WP	WY	ER	DERIG	OPEN	EXTEND
M	M	M	0	0	0

FIGURE 6.13-1. JSC-19590

B

2011/ /168		CRYO PALLET				4 000/02:38:52	
						000/00:00:00	
		TK					
O2	6	7	8	9			
P	515L	515L	515L	515L	PALLET		
TK P	OL	OL	OL	OL	STB		
QTY	- 5L	- 5L	- 5L	- 5L	STB		
T	-417L	-417L	-417L	-417L	POP		
HTR T 1	-417L	-417L	-417L	-417L	POP		
2	-417L	-417L	-417L	-417L			
HTR 1A					PALLET		
CUR 1B					PPO		
SNSR 2A							
2B							
H2							
P	145L	145L	145L	145L			
TK P	OL	OL	OL	OL			
QTY	- 6L	- 6L	- 6L	- 6L			
T	-417L	-417L	-417L	-417L			
HTR T	-417L	-417L	-417L	-417L			

FIGURE 6.18-1. JSC-19590

SYSTEMSLEVEL

A

```

GPCIPL MENU (1) 5 000/00:00:11
000/00:00:00
PASS1 1 PASS5 9
BFS1 2 BFS5 10 STP/PURGE CYC CNT 1
PASS2 3 PASS6 11 ERROR/MSG CODE 132
BFS2 4 BFS6 12 ERROR/MSG CODE CNT 1
PASS3 5 PASS7 13 TOTAL ERR/MSG CNT 2
BFS3 6 BFS7 14 MSGS STILL IN LIST 2
PASS4 7 PASS8 15
BFS4 8 BFS8 16

MCDS BITE
MODE 0340
BSR1 8200
BSR2 8000
SWSW 0000

17 DEU FORMAT LOAD _

START GPC SELF TEST 18
STOP GPC SELF TEST 19
START DEU SELF TEST 20
STOP STP ON ERROR 24
CONTINUE STP ON ERR 25
INHIBIT CKPT LOAD 26

MEMORY PURGE
27 OPTION -
START 28
STOP 29
    
```

1041

IPL MENU NO. 1 (PFS/BFS)

B

```

GPCIPL MENU (2) 5 000/00:01:11
000/00:00:00
17 DEU FORMAT LOAD _
STP/PURGE CYC CNT 1
ERROR/MSG CODE 137
START GPC SELF TEST 18
STOP GPC SELF TEST 19
START DEU SELF TEST 20
STOP STP ON ERROR 24
CONTINUE STP ON ERR 25
INHIBIT CKPT LOAD 26

MCDS BITE
MODE 0340
BSR1 8200
BSR2 8000
SWSW 0000

OLD PSW 0000 0000 0000 0000
REGISTER 0-3 02250011 00080000 00000000 00000000
SET 0 4-7 00000000 00000000 00000000 00000000

REGISTER 0-3 013F0011 00080000 00000000 00000000
SET 1 4-7 00000000 00000000 00000000 00000000

FLOATING 0-3 00000000 00000000 00000000 00000000
PT REGS 4-7 00000000 00000000 00000000 00000000
MAJ= 0 MIN= 0 SCHEDWRD=00000000 CLOCK1= 0
    
```

1042

GPCIPL MENU NO. 2

C

```

2011/000/ GPC MEMORY 1 008/12:12:12
000/00:29:12
MEM/BUS CONFIG READ/WRITE GNC
1 CONFIG 2 (G2) DATA 20* BIT SET 22 SEQ ID 24
2 GPC 1 2 0 0 0 CODE 21 BIT RST 23 WRITE 25
26 ENG UNITS HEX 27*
STRING 1 7 1
2 8 2
3 9 1
4 10 2
P/L 1/2 11 1
CRT 1 12 1
2 13 2
3 14 3
4 15 4
LAUNCH 1 16 1
2 17 2
MM 1 18 1
2 19 2
CPS 3 UPLNK 50
OPS 3 INIT 51

MEMORY DUMP STORE MC=02
40 START ID 45 CONFIG
41 NO WORDS 46 GPC
42 WDS/FRAME STORE 47
DUMP 43

44 DOWNLIST GPC 1 MM AREA
OPS 0 ENA 49 PL 52 1
GNC 53 1
SM 54 1
ERR LOG RESET 48
    
```

238

GPS MEMORY

D

```

2011/001/ DPS UTILITY 1 008/12:12:12
000/00:25:12
MMU ASSIGN PORT ASSIGN UL CNTL
1 2
GNC 1* 2 STRING 1 15* 16 AUTO 35*
SM 3* 4 2 17* 18 ENA 36
PL 5* 6 3 19* 20 INH 37
OPS 0 7* 8 4 21* 22
P/L 1/2 23* 24 IPL SOURCE SW
MMU STATUS 1 RDY
2 RDY VAR PARAM ID LIST
25 9ABA
26 9ABE
MMU SOURCE/BUS 27 9ABC LOAD 48
GPC/MMU 9* 28 9ACB RETRIEVE 49*
MMU/MMU 10 29 9ABD
GPC/LDB 11 30 9ABF
CKPT RETRV 31 9ACA GROUND OPS
ENA 12 32 9ACB GSE POLL ENA 50
33 9ACC SM GSE INH 51
34 9ACD SM C/O ENA 52
GNC C/O ENA 53
BFC C/O ENA 54
ALT PL9 TB 55
RTC 13
CMD 14
    
```

239

DPS UTILITY

E

```

1061/002/ TIME 1 008/12:12:12
000/00:25:12
MISSION TIME TONE
GMT 1* 3 MSN T
MET 2 6
CRT TIMER
9 SET [ ] : : : : : CRT T
START 12 : : : : : STOP 13 : : : : :
14 START AT : : : : : MSN T 23 DURATION
17 COUNT TO : : : : : MSN T

MTU
24 GMT Δ [ ] / : : : : :
28 MET Δ [ ] / : : : : :
UPDATE 32 MET RESET 33

GPC TIME GMT TRY GPC
MTU ACCUM 1 008/12:12:12.000 34 2 AI
2 008/12:12:12.000 35 3 AI
3 008/12:12:12.000 36 4 AI
GPC 008/12:12:12.000 37 5 AI

TIME SYNC 38
    
```

214

TIME

F

```

3021/ /099 FAULT 1 006/09:39:31
000/00:00:00

CRT FAULT C/W GPC TIME
ID

246
    
```

FAULT

G

```

2011/ /006 GPC/BUS STATUS 2 008/02:56:10
000/00:11:10
GPC 1 2 3 4 5
MODE RUN RUN HALT RUN HALT
OPS G2 G2 0 S2 0
STRING 1 FF * * * *
2 FF * * * *
3 FF * * * *
4 FF * * * *
PL 1 1 1 *
LAUNCH 2 1 1 1
3 1 1 1
CRT 1 * * * *
2 * * * *
3 1 1 1
4 1 1 1
    
```

202

GPC/BUS STATUS

VEHICLE UTILITY

8011/ / FCS/DED DIS C/O 2 000/03:17:10  
000/00:00:00

DED DIS MODE LT AVG G ON 9\*  
FND 1\* HIGH 3 ON 7  
AFT 2 LOW 4 OFF 8  
FLAG 5  
OFF 6

SURF DR START 10 STOP 11

BODY FLP DES  
VIV 1 ENA 12 SURF OMD POS 1 2 3 4  
2 ENA 13  
3 ENA 14

ELEV L CB U 7.9 U 7.9  
R IB U 7.8 U 7.8  
R IB U 7.8 U 7.8  
R IB U 7.9 U 7.9  
RUD 0.0 0.0  
SPD BRK 45.0 45.0  
BDY FLP 50.3 50.3

SEC ACT CK  
CH 1 15  
CH 2 16  
CH 3 17  
CH 4 18  
STOP 19  
POS STIM  
ENA 20\*

SEC ACT  
21 BYPASS 0  
22 RESET 0

A

FCS DEDICATED DISPLAY CHECKOUT

8011/042/ SWITCH/SURF 2 000/03:18:31  
000/00:00:00

	ORIDE	DES		ORIDE	DES
1	1	3	1	7	
2	2	2	2	8	
3	3	1	3	9	
4	4	1	4	10	
5	5	2	5	11	
6	6	1	6	12	

	P	R/Y	SPD BRK	BDY FLP	
	AUT/CSS	AUT/CSS	AUT MAN	AUT	DES
L	*	*	*	*	13
FCS	*	*	*	*	14
MODE	*	*	*	*	15
R	*	*	*	*	16
	*	*	*	*	17
	*	*	*	*	18

	L	OR	L	OR	R	OR	R	OR	RUD	SPD	BDY
SURF	10	7.9	U	7.8	U	7.8	U	7.9	0.0	45	50
	20	7.9	U	7.8	U	7.8	U	7.9	0.0	45	50
	30	7.9	U	7.8	U	7.8	U	7.9	0.0	45	50
	40	7.9	U	7.8	U	7.8	U	7.9	0.0	45	50

E

RM SWITCHEDS/SSURFACES FEEDBACK

9011/ / MASS MEMORY R/W XX X DDD/HH:MM:SS  
SM COM BUFF XXX DDD/HH:MM:SS

DESIRED	ACTUAL	DESIRED	ACTUAL	SELECT
1 XXXX	XXXX	21 XXXX	XXXX	
2 XXXX	XXXX	22 XXXX	XXXX	MMU 1 40X
3 XXXX	XXXX	23 XXXX	XXXX	MMU 2 41X
4 XXXX	XXXX	24 XXXX	XXXX	42 S/W SYSTEM X
5 XXXX	XXXX	25 XXXX	XXXX	43 PHASE XXX
6 XXXX	XXXX	26 XXXX	XXXX	44 LOAD BLK XXX
7 XXXX	XXXX	27 XXXX	XXXX	45 OFFSET XXXX
8 XXXX	XXXX	28 XXXX	XXXX	46 NUMBER XX
9 XXXX	XXXX	29 XXXX	XXXX	47 PATCH ID XXXX
10 XXXX	XXXX	30 XXXX	XXXX	VIOLATE XXX
11 XXXX	XXXX	31 XXXX	XXXX	READ LOAD BLK 48X
12 XXXX	XXXX	32 XXXX	XXXX	MERGE 49X
13 XXXX	XXXX	33 XXXX	XXXX	WRITE LOAD BLK 50X
14 XXXX	XXXX	34 XXXX	XXXX	COMPARE 51X
15 XXXX	XXXX	35 XXXX	XXXX	STATUS XXXX
16 XXXX	XXXX	36 XXXX	XXXX	ERROR CODE X
17 XXXX	XXXX	37 XXXX	XXXX	REGISTER A XXXX
18 XXXX	XXXX	38 XXXX	XXXX	B XXXX
19 XXXX	XXXX	39 XXXX	XXXX	MM VERSION XX.XX
20 XXXX	XXXX	40 XXXX	XXXX	CHECKSUM XXXX DUMP VIA DL 52X

B

MASS MEMORY READ/WRITE

8011/043/ CONTROLLERS 2 000/03:19:07  
000/00:00:00

	THC											
1	1	1										
L2	2	2										
3	3	3										
4	4	4										
A2	5	5										
3	6	6										
1	7	7										
L2	8	8										
3	9	9										
SPD	10	10										
BK	R2	11										
3	12	12										
1	13	13										
L2	14	14										
RUD	15	15										
PED	16	16										
R2	17	17										
3	18	18										

F

RM CONTROLLERS

8011/040/ SENSOR TEST 2 000/03:17:38  
000/00:00:00

	DES	STAT	RNG	AZ	EL
MLS	1	OFF	0.0M	0.0M	0.00M
	2	OFF	0.0M	0.0M	0.00M
	3	OFF	0.0M	0.0M	0.00M
	DES	STAT	RNG	AZ	
TAC	4	OFF	0.0	0.00	
	5	OFF	0.0	0.00	
	6	OFF	0.0	0.00	
	DES	STAT	ALT		
RA	7	OFF	8191		
	8	OFF	0		
	DES		Y	Z	
AA	9		0.0	0.0	
	10		0.0	0.0	
	11		0.0	0.0	
	12		0.0	0.0	

START 13 STOP 14

C

SENSOR TEST

8011/044/ SWITCHES 2 000/03:19:34  
000/00:00:00

	ENTRY	ROLL	MODE
	LOW	NO	
	GAIN	Y/J	DES
1			1
2			2
3			3
4			4

G

SWITCHES

8011/041/ RGA/ADTA/RCS 2 000/03:18:09  
000/00:00:00

	DES	STAT	R	P	Y
R1	1*	SMRD	0.0	0.0	0.0
G2	2*	SMRD	0.0	0.0	0.0
A3	3*	SMRD	0.0	0.0	0.0
	4	SMRD	0.0	0.0	0.0
	DES	STAT	PS	PaC	PaL
A1	5		0.000M	0.000M	0.000M
D3	6		0.000M	0.000M	0.000M
T2	7		0.000M	0.000M	0.000M
A4	8		0.000M	0.000M	0.000M

TEST HI 9 LOW 10 STOP 11

RCS DRIVERS  
RJDF 3 12 TEST EXEC 15 TEST  
RJDA-A 13 CONTINUE 16 JET  
-B 14 STOP 17

D

RGA/ADTA/RCS

8011/045/ NWS CHECK 2 000/03:19:57  
000/00:00:00

	HVD				
	SYS	FRESS			
	SEL	HIGH	ENABLE	CURRENT	POSITION
NWS1		A	0.00		A 0.01
		B			B 0.01
					C 0.01
NWS2		A	0.00		
		B			

STIMULI  
ENABLE 1  
RIGHT TURN (+) 2  
LEFT TURN (-) 3  
STOP 4\*

H

NWS CHECK



A

```

9011/100/      GTS DISPLAY      2 150/12:40:30
                000/00:24:30
HDA CONTROL    DED DISP
ENA 1*  INH 2      FMD 18*  APT 19  DRIVE 24
DES PMU 40 PL 41  HIGH 20  LOW 21
                FLAG 22  OFF 23
CSL/RML TEST
UF1 3  UF4 6      CRIT MEC CMDS  ELEV LMT SEL
UF2 4  UF5 7      ENA 25*  HORIZ 27
UF3 5  IFA 8      INH 26  VERT 28
9 FAIL GPC SEL Q  OMPS 29*
TEST EXEC 10
RESET 11          SL COMM  SSC  EXC
                CM A ENA 30  35
                B ENA 31  36
DL FORMAT      DSEL 32*  37*
                MDM TESTS
                RTRM CHW 33  38
                RTRM MSG 34  39
GSE POLL ENA 14*
PASS/BFS XFER 15  STATE  BUSY  BUSY
RJD TOGGLER     ERR CD  0
CN 16  OFF 17*
    
```

GENERAL TEST SUPPORT

1050

E

```

9011/105/      TCS CONTROL      1 008/23:48:03
                000/00:35:14
1 SELECT ID 0  NAME
MM READ 2  STATUS
STEP 0  TIME
STOP 3  4 STOP AT 0  CANCEL 5
RESUME 6  7 RSM AT 0  CLEAR MSGS 8

TIME          TEXT
    
```

TCS CONTROL

1053

B

```

9011/101/      SENSOR SELF-TEST  1 008/23:47:04
                000/00:34:13
ENA STAT  RNG  AZ  EL
M1 1  6.0  +8.18  0.96
L2 2  5.8  +8.18  0.96
S3 3  5.6  +8.18  0.96

ENA STAT  RNG  AZ
T1 4  6.5  0.00
A2 5  6.5  0.00
C3 6  6.5  0.00

TEST CONTROL:
START 13
AUTO SEQ 14
TERM 15

ENA STAT  ALT
R1 7  9
A2 8  9
                INH ALL 16

ENA  Y  Z
A1 9  0.0  +31.9
A2 10 0.0  +31.9
3 11  0.0  +31.9
4 12  0.0  +31.9
    
```

SENSOR SELF-TEST

1051

F

```

9011/110/      BUS/BTU STATUS  1 008/23:52:42
                000/00:39:51
FFIP 0 0 0 0  LP1P 0 0 0 0  BTOP 0 0 0 0
1S 0 0 0 0  1S 0 0 0 0  PMU 0 0 0 0
MODE R 2P 0 0 0 0  LA1P 0 0 0 0  EIUDA 0 0 0 0
MC 9  2S 0 0 0 0  1S 0 0 0 0  1B 0 0 0 0
MF G9 3P 0 0 0 0  PM1P 0 0 0 0  1C 0 0 0 0
3S 0 0 0 0  1S 0 0 0 0  1D 0 0 0 0
CPU 24 4P 0 0 0 0  LL1P 0 0 0 0  2A 0 0 0 0
FF4S 0 0 0 0  1S 0 0 0 0  2B 0 0 0 0
FALP 0 0 0 0  2P 0 0 0 0  2C 0 0 0 0
PRI/SEC 1S 0 0 0 0  2S 0 0 0 0  2D 0 0 0 0
PORTS 2P 0 0 0 0  LR1P 0 0 0 0  3A 0 0 0 0
2S 0 0 0 0  1S 0 0 0 0  3B 0 0 0 0
PRI 1* 3P 0 0 0 0  2P 0 0 0 0  3C 0 0 0 0
SEC 2 3S 0 0 0 0  2S 0 0 0 0  3D 0 0 0 0
4P 0 0 0 0  MCIU 0 0 0 0  MECLA 0 0 0 0
FA4S 0 0 0 0
MMUL 0 0 0 0  LDIUP 0 0 0 0  1C 0 0 0 0
2 0 0 0 0  S 0 0 0 0  1D 0 0 0 0
DEUL 0 0 0 0  FF1P 0 0 0 0  2A 0 0 0 0
2 0 0 0 0  1S 0 0 0 0  2B 0 0 0 0
3 0 0 0 0  2S 0 0 0 0  2C 0 0 0 0
4 0 0 0 0  2P 0 0 0 0  MECID 0 0 0 0
    
```

BUS/BTU STATUS

1054

C

```

9011/102/      RCS/RGA/ADTA TEST  1 008/23:47:33
                000/00:34:42
RCS DRIVERS
RJDF 1  START TEST 4  STAT
RJDA-A 2  CONT 5  JET
-B 3  TERM 6  STEP

SENSORS
TEST CONTROL
HIGH START 15
LOW START 16
R1 7  0.0  0.0  0.0  0.0  AUTO SEQ 17
G2 8  0.0  0.0  0.0  0.0  TERM 18
A3 9  0.0  0.0  0.0  0.0
4 10 0.0  0.0  0.0  0.0  INH ALL 19

ENA STAT  PoC  PS  PoJ  PoL  TT
A1 11 27.530 27.535 26.579 31.991 18.62
D3 12 27.530 27.535 26.579 31.991 18.62
T2 13 4.388 1.834 3.106 2.720 38.20
A4 14 27.439 27.435 26.324 31.873 18.48
    
```

RCS/RGA/ADTA TEST

1052

G

```

9011/111/      SL MEMORY DUMP  3 000/03:23:22
                000/00:00:00
SM COM BUFF RDY

SL COMP SEL
SS 1*
EXP 2
SL COUPLER
SEL A 3*
B 4
5 START ADD 0
6 LENGTH 1
DUMP 7
WORDS ACQ 0
FAIL RHW 0
AW 0
LAST ADD 0
    
```

SPACELAB MEMORY DUMP

1055

D

```

9011/104/      GND IMU CNTL/MON  2 150/12:20:13
                000/00:44:47
IMU 3 2 3
X 1 -0.00 4 -0.00 7 -0.00  SEL IMU 1 16*
Y 2 0.00 5 0.00 8 0.00  2 17*
Z 3 0.00 6 0.00 9 0.00  3 18*

O 83.62 192.88 297.47 ATT DET 19
M 23.65 301.81 26.65 HNGR CAL 20
I 99.91 42.01 351.09 21
IR 0.00 0.00 0.00 C 22
DV X -10.72 +9.50 +25.73 PREFLT CAL 23
Y +27.14 +6.88 -9.28 GYROCOMP 24
Z -13.24 +29.74 -16.57
DVRSS 32.04 31.96 31.98 INERTIAL 25*
HIW 8000 8000 8000 TERM/IDLE 27
I S/W 00 00 00
TESTAT 3F 3F 3F 28 MM WRITE 1
PWR ON * * * MM STATUS READ 29
I/O
STBY 10 11 12 30 SIZE SEL 2
OPER 13* 14* 15* ACTUAL 398
    
```

GROUND IMU CONTROL/MONITOR

464

H

```

9011/112/      GPC/BTU I/F  1 008/23:52:10
                000/00:39:19
BTU SELECTION TEST STATUS
FF1 1  FCMMU 12 MEM OUTPUT TEST
2 2  MMUL 13 BTU ITEM MODULE
3 3  2 14 STEP
4 4  MECL 15 RDM ANLOG OUTPUTS
FAL 5  2 16 BCE STAT RG 0 1
2 6  EIUL 17 2 3
3 7  2 18 4 5
4 8  3 19 PORT SEL 1 31* 6
FF1 9  DDU 20 2 32 8 9
2 10 MCIU 21 10 11
CMD 22 12 13
SRB 23 14 15

ALL DES
MIMS 11 ALL 24 DISCRETE OUTPUTS
                CHANNEL 0
                CHANNEL 1
                CHANNEL 2
TEST LEVEL 1 25
LEVEL 2 26
MEM OUTPUT 27
CONTROL TERMINATE 28
CONTINUE 29 BTU CYCLIC BITE 30
    
```

GPC/BTU INTERFACE

1056

A

```

9011/113/ ACTUATOR CONTROL 1 008/23:53:05
MONITOR FAIL 000/00:40:14
CMD POS ACT FAIL ABCD ACTUATOR GIMBALING
+98.61 SB 1 RATE 29 DEG/SEC
+00.00 RUD 2 FIN POS 30 DEG
+09.68 LIE 3 START 31 STOP 32
+09.96 RIE 4 HND DR STATUS
+09.74 LOE 5 1 3072 ECP ERR 0
+10.02 ROE 6 2 3072 BF MON 33
-00.00 1P 7 3 3072
+00.00 1Y 8 AI SRB/NW 34
-10.04 2P 9 ME ISO V
-03.50 2Y 10 IC 2C 3C FC LIM CHNG
-10.04 3P 11 R/SB MAT 35
+03.50 3Y 12 R/SB RFG/FRT 36
+05.75 RPA 13 MAT P 40MS 37
+05.75 RPS 14 AI MODES NOP CA RFG 38
-06.01 RYA 15 0 SAFE 22 NOP CA FRT 39
-06.01 RYS 16 1 MDM 23 NOP OMS 40*
+05.75 LPA 17 2 FERY 24 SRB S/S LIM 41
+05.75 LPS 18 3 RAIN 25 EL POS LIM 42
+06.01 LYA 19 4 GRAV 26 S/B POS LIM 43
+06.01 LYS 20 5 NULL 27 R RATE .5 PCM 44
+00.39 BF 21 6 TURN 28
    
```

ACTUATOR CONTROL

1057

B

```

9011/ /106 MANUAL CONTROLS 1 008/23:49:01
000/00:36:10
RHC R P Y L 1 - 2
2 R 0 U 0 R 0 S 2 - 2
3 R 0 U 0 R 0 B 3 - 2
R 1 R 0 U 0 R 0 T R 1 - 2
2 R 0 U 0 R 0 C 2 - 2
3 R 0 U 0 R 0 3 - 2
A 1 R 0 U 0 R 0 L 1 R 0
2 R 0 U 0 R 0 R 2 R 0
3 R 0 U 0 R 0 F 3 R 0
TRIM SW R P Y EDY FLP T R 1 R 0
RNL L 1 L 1 A 2 R 0
2 2 3 R 0
R 1 R 1 THC TX TY TZ
2 L 1
RHC L 1 2
2 3
R 1 A 1
2 2
2 3
    
```

MANUAL CONTROLS

1058

C

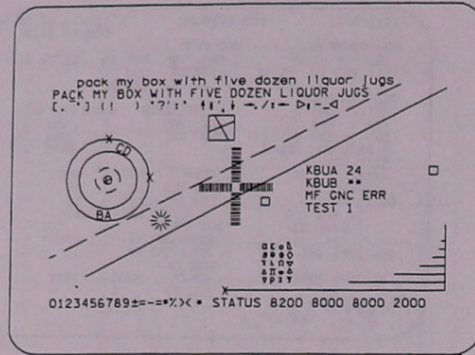

DEU STAND-ALONE SELF TEST

10017

A

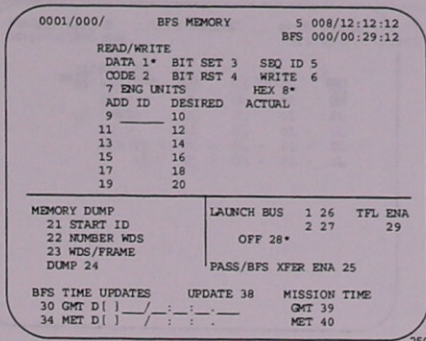

BFS MEMORY

E

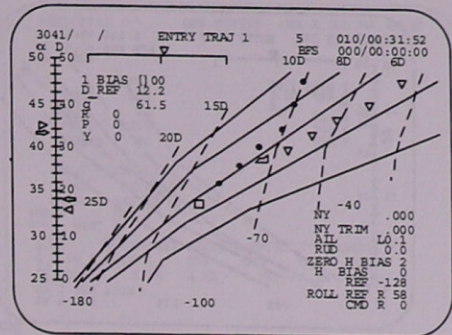

ENTRY TRAJECTORY 1

B

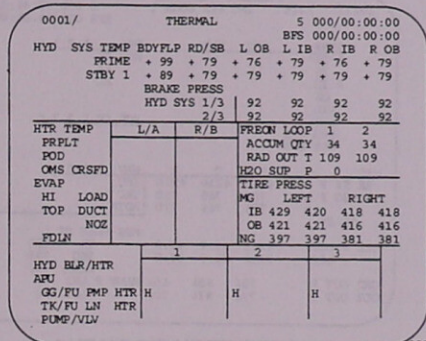

THERMAL

F

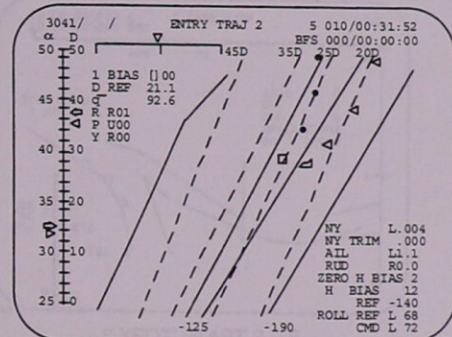

ENTRY TRAJECTORY 2

C

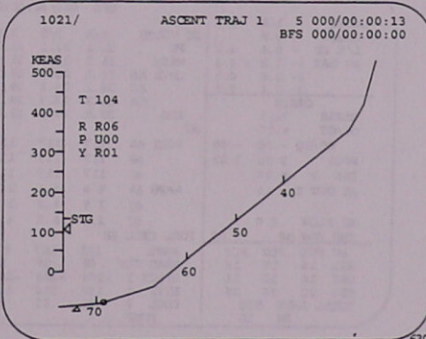

ASCENT TRAJECTORY 1

G

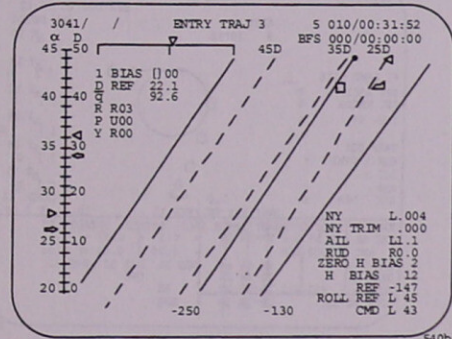

ENTRY TRAJECTORY 3

D

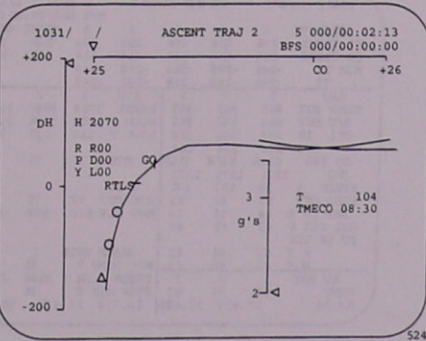

ASCENT TRAJECTORY 2

H

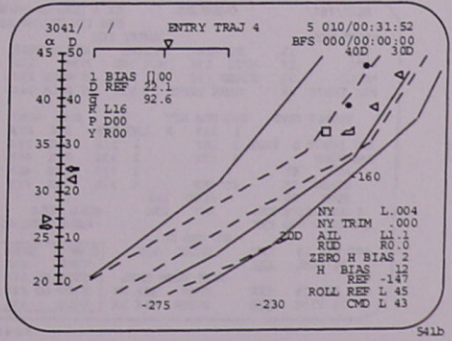

ENTRY TRAJECTORY 4

A

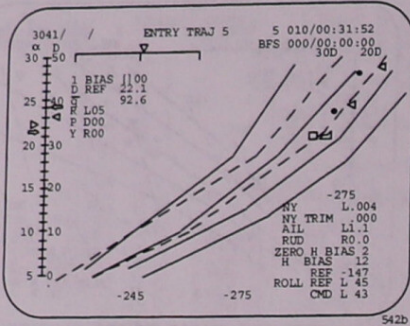

ENTRY TRAJECTORY 5

E

3021/ /099	FAULT	1	006/09:39:31	
			BFS 000/00:00:00	
CRT ID	FAULT	C/W	GPC	TIME

246b

FAULT

B

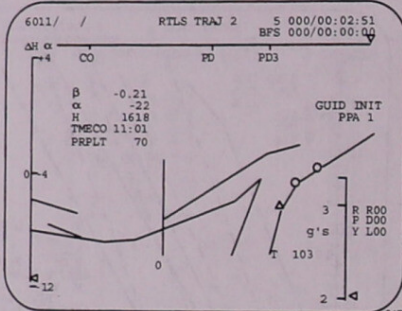

RTLS TRAJECTORY 2

F

1011/ /018	GNC SYS SUMM 1	5	000/02:46:03	
			BFS 000/00:00:00	
SURF	POS	MDM	DPS	1 2 3 4
L OB			MDM	FF
IB			FA	
R IB			PL	
OB				
AIL				
RUD				
SPD BRK				
BDY FLP				
FCS CH 1 2 3 4				
MPS	L	C	R	NAV 1 2 3 4
HE TK P	4280	4230	4240	IMU
REG P A	784	768	768	TAC
dP/dT	776	766	770	ADTA
ULL P LH2	42.5	42.7	42.9	MPS PNEU HE P
LO2	21.1	21.0	20.8	TK 4350
				REG 798
				ACUM 760
GHZ OUT P	701	501	401	MANF P LH2 46
GO2 OUT T	791	971	701	LO2 110

249

GNC SYSTEM SUMMARY 1

C

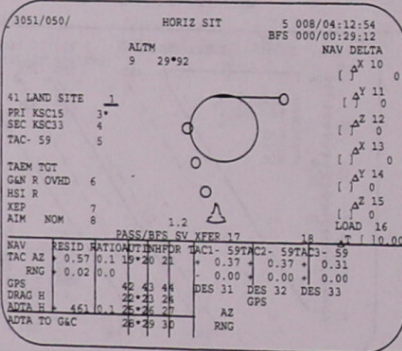

HORIZONTAL SITUATION

G

0001/ /078	SM SYS SUMM 1	5	000/03:13:09
			BFS 000/00:00:00
SMOKE	1/A	2/B	
CABIN	-0.9	DC VOLTS	1/A 2/B 3/C
L/R FD	-0.4 0.2	FC	31.2 31.1 31.1
AV BAY	1- 1.2 -0.0	MAIN	31.0 31.1 31.0
	2- 0.6 0.3	CNTL AB	29.3 29.3 29.3
	3- 0.1 -0.9	BC	29.3 29.3 29.3
		CA	29.3 29.3 29.3
		ESS	29.8 29.8 29.8
PRESS	14.7	AC	
g/dT	+0.0	VOLT	117 117 117
BU/EQ	-0.0 +0.0	117	117 117
PFC2	3.02 3.02	117	117 117
FAN P	5.79	117	117 117
HX OUT T	49	AMPS	4.4 4.1 2.7
		3.9	4.2 3.2
		2.4	3.2 4.8
N2 FLOW	0.0	FUEL CELL PH	
IMU FAN AP	4.62	AV FC1 FC2 FC3	AMPS 172 167 178
		SS1 15 18 18	REAC VLV OP OP OF
		SS2 16 20 11	STACK T +204 +203 +203
		SS3 22 26 26	EXIT T 150 150 151
		TOTAL AMPS	510 61 61 61
		KW	15 PUMP

085

SM SYSTEM SUMMARY 1

D

XXXX/051/	VERRIDE	XX X DDD/HH:MM:SS	
		BFS DDD/HH:MM:SS	
ABORT MODE	ENTRY FCS		
TAL 1X	ELEVON	FILTER	ATMOSPHERE
ATO 2X	AUTO 17X	NOM 20X	NOM 22X
ABORT 3X	FIXED 18X	ALT 21X	N POLE 23X
MAX THROT 4X	SME REPOS 19 XXX	S POLE 24X	
PROFLT DUMP	IMU DES ATT	AA	RGA SURF
1 25X	X LRU DES	DES	DES
XXX LONCT 5 XXXX	2 26X	1 31X	35X 39X
ONS DMP 3	27X	2 32X	36X 40X
ARM 6X		3 33X	37X 41X
START 7X	ET SEP	4 34X	38X 42X
STOP 8X	AUTO 28X		
9 QUAN/SIDE XXXX	SEP 29X		
ONS DMP TTG XXXX			
AFT RCS 13 XXX	ET UMB DR		
14 TIME XXX	CLOSE 30X	COMM XXXX	46X
		TDRS	47X
FWD RCS 15 XXX	VENT DOOR CNTL	STDN-HI	48X
16 TIME XXXX	OPEN 43X XX	STDN-LO	49X
	CLOSE 44X XX	SGLS	49X

1098.cnv

BFS OVERRIDE

H

0001/ /079	SM SYS SUMM 2	5	008/23:29:22				
			BFS 000/00:00:00				
CRVO TK	1	2	3	4	5	MANF1	MANF2
H2 PRESS	208	208	206	206	206	208	207
O2 PRESS	816	815	814	814	814	815	815
HTR T1	-248	-248	-248	-248	-248	-248	-248
T2	-248	-248	-248	-248	-248	-248	-248
AFU	1	2	3	HYD	1	2	3
TEMP EGT	942	942	942	PRESS	1064	1064	1064
E/U EGT	942	942	942	ACUM P	3080	3080	3080
OIL IN	250	250	250	RSVR T	116	153	142
OUT	264	264	264				
GG BED	511H	511H	511H	QTY	72	74	71
INJ	1271	1271	1271				
SPEED	99	102	101	W/B			
FUEL QTY	59	60	62	H2O QTY	78	73	78
RMP LK P	14	14	14	BYP VLV	BYP	BYP	BYP
OIL OUT P	42	42	41				
FU TK VLV							
A T	63	65	62	THRM CNTL	1	28	
B T	63	65	62	H2O PUMP	P	23	63
AV BAY	1	2	3	FREDN FLOW	2384	2384	
TEMP	97	97	83	EVAP OUT T	38	38	
A4 14	27.439	27.435	26.324	31.873	18.48	18.48	

051

SM SYSTEM SUMMARY 2

A

```

2011/ /168 CRYO PALLET          5 000/03:22:07
                                BFS 000/00:00:00

PALLET TK   6   7   8   9
H2 PRESS   OL  OL  OL  OL
TK P       OL  OL  OL  OL
O2 PRESS   OL  OL  OL  OL
TK P       OL  OL  OL  OL
HTR T1 +   OL + OL + OL + OL
          T2 + OL + OL + OL + OL
    
```

CRYO PALLET

3141

B

```

XXXX/055/          GPS STATUS   XX X DED/HH:MM:SS
                                BFS DED/HH:MM:SS

                                GPS1
STAT   XXX
DES    1X
MODE   XXXX
FOM    XS

ALT   XXXXXXX
LAT   XX.XX X
LON   XXX.XX X

CHANNEL STATE & SATELLITE NUMBER
CH1  CH2  CH3  CH4  CH5
GPS1  X XX X XX X XX X XX X XX
    
```

GPS STATUS

055b

HEAD-UP DISPLAY (HUD)

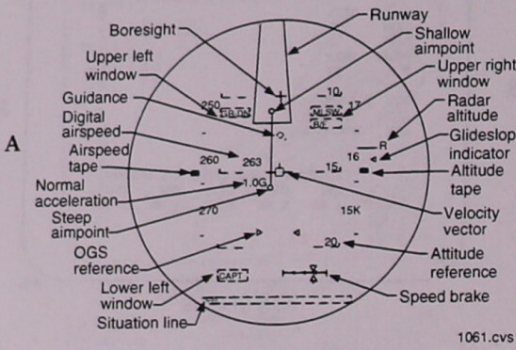

FORMAT 1 PRE-WOW

NOTE: THIS FIGURE IS NOT A VALID FLIGHT CONFIGURATION

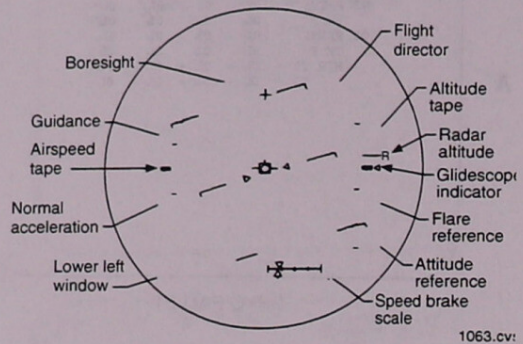

OPS 8 LOW

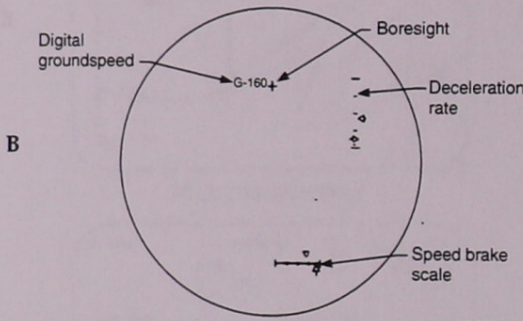

FORMAT 1 AFTER WOW

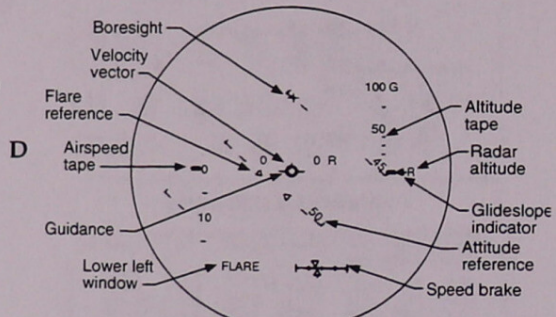

OPS 9 LOW

APPENDIX C STUDY NOTES

APU/HYD

CONTENTS

APU/HYD.....	C-1
Comm-Voice Data .....	C-3
Cryo .....	C-4
DPS .....	C-5
ECLSS.....	C-6
EPS .....	C-7
GNC .....	C-9
Instrumentation .....	C-12
Mechanical Systems .....	C-13
OMS .....	C-16
RCS .....	C-18

This appendix contains a set of study notes originally developed by Ron Grabe in September 1989. They have been extensively modified and updated by several crewmembers and reviewed for technical content by the Training Division.

The purpose of these notes is to provide crewmembers with a set of critical "need-to-know" items that can be reviewed in their entirety at one sitting. The notes are directed at the PLT crew position, but should be useful for other crewmembers as well.

The Study Notes are organized alphabetically by major system. Under each system heading, notes on critical subsystems and malfunctions are presented. The text is written in Flight Data File shorthand using switch nomenclature and CRT display terminology, which results in a somewhat cryptic format. Although directed primarily toward Generic and Flight-Specific training, they should be readily understood by crewmembers who have progressed through at least part of Pilot Pool training.

Preparation for Shuttle Mission Simulator (SMS) training sessions is difficult due to the complexity of the Space Shuttle and the many flight phases that crewmembers are required to understand. A quick review of these Study Notes prior to SMS sessions should help make training more productive.

General

- Ascent: all APUs will be kept running through MECO if possible.
  - Loss of one APU means hydraulic lock on one engine.
  - Loss of two APUs means 2 SSMEs in hydraulic lock plus loss of TVC for one SSME.
- Entry
  - Pre-TAEM, a sick APU (high oil temperature, high hydraulic temperature, pump leak P, H<sub>2</sub>O leak) may be manually shut down, cooled down, and restarted near Mach 1 to support landing.
  - Post-TAEM, APUs will generally be kept running except for high oil temperature. An APU will be shut down for high oil temperature if Mach > 1. A gearbox failure for high oil temperature is not catastrophic.

Auto Shutdown

- Controller will issue an auto shutdown command, if auto shutdown is enabled, for RPM less than 80% or above 129% (auto shutdown is inhibited for the first 9.5 seconds after start to allow turbine spinup).
- Auto shutdown closes secondary fuel control valve and fuel tank valves.
- An APU with an underspeed shutdown is a candidate for cooldown and restart.
- APUs with overspeed shutdown will not be restarted.
- If auto shutdown inhibited and APU speed is confirmed above 129%, manual shutdown is required as soon as possible.

### Single APU Loss

- APU 1 means loss of nose wheel steering (OI-21 and subs, hydraulic system 2 can also be used for nose wheel steering).
- Single APU loss will not affect braking (loss of APU 3 plus either 1 or 2 means half brakes).

### Switching Valves

- Supply either primary or one of two back-up hydraulic systems to the aerosurface actuators.
- Valve status only visible on SPEC 86 (SM OPS 2).
- During FCS checkout, check active hydraulic system selected.

### Fuel Tank

- Supply supports about 110 minutes of operations (AOA).
- Nitrogen pre-charge required for start-up.
- Pressure displayed on panel F8 meter.
- Quantity (CRT and meter) is a PVT calculation.
- Isolation valves must be closed (de-powered) when APU is not running. No fuel cooling of solenoid valves.
  - Post APU shutdown, if fuel tank valve temperature high, pull circuit breakers.
  - Solenoid short may overtemp valves while APU is still running. Pull circuit breaker for second valve in parallel. Will keep APU running.

### Fuel Pump

- Gear driven pump delivers fuel under pressure post start.
- "APU PUMP LK P" shows build-up of leaking oil or fuel in catch bottle. Bottle relieves overboard.

### Cooling

- GG bed cooled by separate H<sub>2</sub>O injection system for re-start. H<sub>2</sub>O system not used during normal ops.
- Cooling required for 3.5 minutes in *INJECTOR COOL* prior to start. If no cooling of GG injector apparent, do not perform restart.
- If APU not started immediately following cool-down, injector temperature will rise again rapidly.
- Common tank for all APUs. Cooling capacity is 21 minutes.
- Fuel pump and fuel control valves are cooled passively by heat sinks and radiation shields.
- Water spray boiler cools hydraulic and lube oil.
  - Bypass valve isolates hydraulic cooling feature when not required.
  - Two controllers (A and B) use common water lines but have different spray logic.
  - Water quantity should not decrease during ascent. Pre-charge in H<sub>2</sub>O boiler immerses oil lines. No spraying until MET about 11:00.

### Hydraulic Accumulator

- Maintains pressure of about 2600 psi when APU not running (hydraulic pressure still about 65 psi).
- Prevents hydraulic pump cavitation.
- Low accumulator pressure on orbit indicates nitrogen leak or internal priority valve or unloader valve failure.

### Circulation Pump

- Two-stage pump. First stage low pressure, high volume. Second stage high pressure, low volume. High pressure fluid can be diverted to repress accumulator. Otherwise, high pressure fluid mixes with low pressure fluid.



- On orbit, automatically turns on (when pressure < 1960 psi) to maintain accumulator pressure.
- Circ pumps keep hydraulic fluid moving for thermal conditioning on orbit. Automatically turn on for low hydraulic line temperatures.
- Only one circ pump operates at a time in GPC control for electrical loads considerations. The system with low accumulator pressure has higher priority than the system with low hydraulic line temperatures. For thermal reasons, two circ pumps at a time are OK if needed to recharge two accumulators.

#### Priority Rate Limiting

- Gets 3 hydraulic pressure inputs from each system.
- Crew can see 2 of the inputs on BFS SYS SUMM and F8 meter. MCC has access to all three inputs.
- Crew can also see hydraulic accumulator pressure which PRL doesn't see.
  - Use hydraulic accumulator pressure and RPM to resolve dilemma.
  - Accumulator pressure = 3000 means hydraulic system OK.
- PRL will show down arrow if declaring system down.
- SPEC 51 data:
  - AUT\* means auto logic is active
  - DES\* means manual deselection (toggle to reselect).
- For PRL ? and system good, leave auto logic selected.
  - Subsequent transducer fail may require deselect of auto logic and a manual deselect or reselect.
- For PRL down arrow and system good, deselect auto logic to reinstate hydraulic system into PRL.

#### Manual Shutdown

- Used to back up auto shutdown.
- Controller power off protects against uncommanded hot re-start.
- Must identify over or underspeed shutdown prior to controller power off (caution and warning light extinguished).

#### Ready-To-Start Talkback Gray

- Low press selected.
- H<sub>2</sub>O spray boiler ready.
- APU fuel isolation valves open.
- GG bed temperature > 190 degrees.
- APU speed below 80%.
- Underspeed immediately after start is probably caused by 9.5 second timer failure. Auto shutdown is normally disabled during first 9.5 seconds of start. *AUTO SHUT-DOWN* to *INHIBIT* may allow start.

#### Comm-Voice Data

##### General

- *PANEL/CMD* on panel C3 switch passes S-band control to system selected on aft panel. One step total reconfiguration to alternate system.
- Normally, INCO manages system on LRU by LRU basis. All LRUs are system 1/system 2 redundant.

##### ACCU

- Routes all audio to ATUs.
- No voice (ICOM and A/G), switch ACCUs.
- CDR and PLT can talk to each other on same ATU without an ACCU.

**Antenna Electronics Unit**

- Switches antenna per GPC or RTC command.
- BFS commands for ascent and entry.
- SM GPC command on orbit with BFS in *STBY* or *HALT*.
- Commands routed to antenna electronics 1/2 over PL MDM 1/2. No cross-strapping capability.
- Manual selection available with loss of auto select.

**Ascent/Entry Configuration**

- S-band system 2 active in STDN mode.
  - STDN sites prime for comm.
  - On orbit, 1 to 2 hour call up.
- A/G 1 and A/G 2 selected simo.
- UHF T/R on A/A loop.
- TDRS available post-MECO on ascent and TAL.
  - On ascent, stored program command will mode to TDRS.
  - Active S-band system switches automatically if INCO does not clear command, or if BFS fails.
  - Manual reconfiguration of back panel to TDRS may be required post-MECO to restore comm if S-band failure, ground site failure, or BFS command failure occurs late in powered flight.

**Encryptor, Transponder, and Power Amp**

- In-line LRUs.
- Power amp and preamp not required if reconfigured to STDN low mode.
- Encryption is normally on uplink only.
  - Encryptor dedicated to one NSP. Not selectable separately.
  - Bypass selected for encryption failure.

**NSP**

- Processes uplink and downlink (voice, commands, and data), except UHF which bypasses NSP.
- Failure means no S-band voice, commands or data to/from ground.
  - "I/O ERROR NSP X" where X = active FF MDM (1 or 3). Could be just command failed. Check data/voice with MCC.

**Cryo****General**

- Separate transducers for CRT digitals and overhead meters.
- CRT data goes off scale low for big leaks.

**Heaters**

- Each tank has A and B heaters.
- Separate controls/logic for O<sub>2</sub> and H<sub>2</sub> heaters.
- O<sub>2</sub> heaters have two elements with two current sensors per heater.
- Crew insight into sensor status in OPS2 only.
- If any current sensor trips (short), that heater is disabled.
- Heater logic (applies separately to O<sub>2</sub> and H<sub>2</sub>)
  - Both tanks in a ganged pair must have low P before heaters in either tank are turned on.
  - Only one high P is needed to turn both heaters off.
  - During leak isolation, pressure in good tank may prevent heaters in leaking tank from coming on with both tanks' heaters enabled.

- Control points for heaters:

H<sub>2</sub> tank 1 and 2 pressure = 203 to 223

O<sub>2</sub> tank 1 and 2 pressure = 811 to 846

- Tank 3, 4, and 5 set points slightly higher so tank 3, 4, and 5 will preferentially feed on orbit with all tanks in *AUTO*.

### Leaks

- First step in ascent and entry cryo leak procedure is to determine number of tanks with pressure decreasing.
  - Only one tank leaking, leave configuration as is (manifold isolation valves open). Leak is a tank leak. Isolating tank will starve its fuel cell.
  - If all tanks decreasing, close manifold valves to isolate leak. Must react quickly for large multi-tank leaks.
  - If leak internal to fuel cell 3, need to reopen manifold valves ASAP. Manifold 3 does not have a relief valve.

## DPS

### General

- It is important to be able to identify GPC failures, for MCC often has little insight. Crew information affects MCC analysis and planning for subsequent failures (both DPS and non DPS).
- When using the *GPC MODE* switch, remove your hand between positions. On past missions, there have been problems with the switch being in two positions at the same time. This problem can occur on other orbiter switches also. It is good practice to always pause slightly in each switch detent to ensure the contacts are made and recognized by the GPCs.
- Always clear fault message line as soon as messages have been seen. This will avoid missing annunciations of subsequent failures.
- Resume SPECS and DISPs from CRTs when not in use or prior to switching to another major function on that CRT.
- Hard assign CRTs (both PASS and BFS) via PASS CRT keyboard (BFS will DK listen). Dual CRT commanders can be caused by trying to assign a CRT to BFS that a PASS GPC is still driving.

- When moding PASS GPCs into the common set (i.e., *STBY* to *RUN*), always pause 10 seconds before making switch throws to avoid possible fail-to-sync and ensure proper common set initialization.

### BFS Engage

- Post BFS engage, check to ensure that all active PASS GPCs have recognized the engage (both *MODE* and *OUTPUT* talkbacks are barberpole). If not, take the offending GPC to *HALT* (or power it off) immediately to avoid I/O problems on the flight critical strings.

### Restraining

- Deassign CRTs from Fail To Sync GPCs and reassign to good GPCs to avoid inadvertent entries.
- Before OPS transitions and restrings, verify the NBAT. Check proper *MAJOR FUNCTION* and GPC switch configuration.
- Ensure the correct memory configuration is displayed prior to making NBAT changes.
- Dynamic flight
  - Use the cue card.
  - Must take failed GPC to *HALT* (or *STBY*, *HALT*) prior to OPS MODE RECALL.
  - Must deselect IMU on failed GPC for OPS 3 restraining, then follow OPS MODE RECALL with NAV DELTA ZERO update prior to IMU RESELECT.
  - Deselect surface feedbacks prior to OPS MODE RECALL. Reselect following OPS MODE RECALL.
  - Follow OPS MODE RECALL with BFS I/O RESET (or PRO to OPS 3 if TAL).
  - Avoid assignment of all three CRTs to the same GPC, especially on orbit.
  - Keep hands off of everything during OPS transitions, especially switches and CRT keyboards.

- Rules
  - Powered flight. Recover stuck throttle if necessary for uphill performance.
  - Post MECO, pre ET SEP. Recover jets for SEP.
  - Pre OMS-1. Recover single OMS ignition capability (delay burn). Regain critical system insight (if engagable BFS still available). Maintain single fault tolerance.
  - Entry. Regain vent door commands. Regain nose wheel steering for abort landing site or known directional control problems during rollout. Maintain ASA command and body flap command.
  - In general, port moding is preferred over restrung to regain lost capability.
  - Prior to EI-5, restrung for any failed GPC.

#### Set Split

- 2 on 2 or 2 on 1 on 1 split during ascent
  - Engage BFS.
  - If desired, the PASS set can be reconfigured pre-MECO if BFS is tracking and no additional complicating failures are present, rather than engaging the BFS.
    - Treat simplex machines or undesired set as failed GPCs.
    - BFS engage required on ascent for MPS commands if simplex machines or undesired set cannot be taken to HALT pre-MECO.
    - Restrung may be performed with MCC coordination, in accordance with Flight Rules.
    - Be prepared for BFS engage if sets begin force fight or total set split.
- BFS engage decisions for set splits.
  - On seeing multiple GPC fault and CAM lights, call "SET SPLIT".
  - Check BFS and PASS GNC SYS SUMM.

- If BFS tracking 2 PASS GPCs, check them for 1 IMU, 2 FCS channels, 1 RGA, and 1 AA. Minimum for good PASS set. BFS engage will be required for MPS commands on ascent if simplex computer is failed to sync and cannot be taken to HALT.
- If BFS standalone, check PASS if time permits. Time available is based on NAV state without IMU data:

Powered flight - 10 seconds

Entry - 45 seconds

Orbit - plenty of time.

- Distribute CRTs among different GPCs. On orbit, ensure all CRTs are not assigned to the SM GPC or a single GNC OPS GPC. Loss of the GPC with all CRTs loses PASS CRT interface.

#### ECLSS

##### General

- During ascent, only switch avionics bay fans and freon pumps. Water pumps may be switched if avionics bay temps are increasing out of limits.
- NH<sub>3</sub> Boiler A/B control based on temperature in freon loop 1/2.
  - If no flow in freon loop, must use NH<sub>3</sub> boiler corresponding to good loop.
  - If slightly degraded flow in loop with NH<sub>3</sub> boiler selected, undertemp may result in degraded loop, if NH<sub>3</sub> boiler controlling based on temp in good loop. Select NH<sub>3</sub> boiler for loop with degraded flow.

##### Cabin Pressure

- First reaction to cabin leak is to close cabin relief isolation valves one at a time.
- Double check leak indications with MCC. May be due to cabin expansion or thermal effects.
- N<sub>2</sub>/O<sub>2</sub> leak into cabin will cause rise in cabin pressure and for O<sub>2</sub> leak, PPO<sub>2</sub> will also rise (O<sub>2</sub> concentration available on orbit).

- dP/dT on meter and CRT come from dP/dT sensor.
- EQ dP/dT is calculated from cabin pressure sensor by BFS and standardized to a 14.7 cabin. EQ dP/dT is used when available to make ascent abort decisions for cabin leak. Backup dP/dT is also calculated from cabin pressure, but not standardized for a 14.7 cabin.
- AC voltage high
  - Ride until MECO unless volts exceed 130, or affected main engine controllers are lost.
  - Trip bus off line with *AUTO TRIP* selection on bus sensor.
- AC phase shift/phase-to-phase short (three-phase motors stop)
  - Verified by multi-phase amps high.
  - Multiple three-phase motors fall off line, fuel cell pump, Freon pump, H<sub>2</sub>O pump.
  - Take individual phases off line separately to find bad phase.

## EPS

### General

- Do not reset popped circuit protection device (RPC or circuit breaker) without consulting MCC.
- For critical actions, MCC may call for momentary reset of failed control or essential bus while crew holds switch for affected system in desired position (three finger trick).

### AC Bus

- Surge on AC bus can cause main engine controller to trip off line. Avoid actuation or switching of AC powered equipment during powered flight unless called for in malfunction procedures.

- Loads that can be switched in powered flight:

- Avionics bay fans
- Freon pumps
- H<sub>2</sub>O loops (only for an avionics bay temp high)

- AC bus sensors *OFF* on ascent to protect SSMEs for:
  - Loss of first engine
  - Loss of SSME controller redundancy on any engine
  - Loss of a single AC phase (takes down an SSME controller on two engines)
  - When AC bus sensors are *OFF*, no hardware caution and warning lights will illuminate (no AC VOLTS or AC OVERLOAD light).

### Bus Tie Actions

- If re-establishing power to a main bus (main bus volts < 20), always unpower the AC inverters before tying to a good bus (prevents surges). Use long form bus tie procedure on cue card.
- If a tie results in a short, immediately untie.
- Never tie 3 main buses during powered flight. OK post-MECO, on orbit, and entry.
- Never tie into a short.
- Payload primary bus can be used to tie Main B to Main C (back door bus tie), or connect FC3 to Main C.
- Unless absolutely necessary, do not bus tie in first stage.

### Fuel Cell

- Coolant pump and H<sub>2</sub> pump both driven by same AC bus and both pumps controlled by fuel cell ECU and *START/STOP* switch.
- Coolant pump draws 0.5 amps, H<sub>2</sub> pump draws 0.3 amps.
- Coolant pump delta P indication
  - Ground can see immediately if loss of fuel cell coolant pump is real (stop/start to check run current not required).
  - No comm, can stop fuel cell and check for 0.8 amp drop. This indicates both pumps were running (bad sensor). Restart gives full recovery (should see 0.8 amp increase).
- *START* switch sends pump start commands
  - Pressure should be sensed in 3 seconds. *Delta P* talkback goes gray.
  - *READY FOR LOAD* talkback requires 30 second timer and good heaters.
  - *Delta P* relay failure may prevent fuel cell ECU from latching on fuel cell start command. *DELTA P* talkback won't stay gray. OK to hold *START* switch in *START*. After 30 seconds, second relay should latch command on (can release *START* switch).
- Coolant pump failure stagnates coolant loop
  - Stack T measured at outlet of stack. May actually decrease immediately after coolant pump failure.
  - Exit T measured in H<sub>2</sub>/H<sub>2</sub>O loop.
  - If H<sub>2</sub> pump running, exit T will progressively increase after coolant pump failure.
  - Nine minutes of run time available after coolant pump failure, assuming normal fuel loading.
- O<sub>2</sub> is entirely consumed. H<sub>2</sub> is circulated continuously through power section and condenser.
- H<sub>2</sub>O is drawn out of stack by mixing with H<sub>2</sub>.
- H<sub>2</sub>O is separated at the H<sub>2</sub>/H<sub>2</sub>O pump.
- Dual gas regulator maintains proper pressure of reactants (about 60 psia). O<sub>2</sub> pressure feeds coolant loop accumulator.
- Dual gas regulator problem indicated by COOL P HIGH/LOW. Tie buses and monitor fuel cell for degradation.
- If O<sub>2</sub> reactant valve closes, coolant pressure will drop.
- Failure of the H<sub>2</sub>/H<sub>2</sub>O pump will lead to fuel cell flooding since water is not removed.
  - Ascent and entry: PH status fail followed by slow degrade and exit temperature decreasing may be first signatures of flooding.
  - Indicated on orbit by H<sub>2</sub> pump status fail.
- Crossover (uncontrolled O<sub>2</sub> and H<sub>2</sub>O mixing)
  - Highly unlikely to happen rapidly without warning signs.
  - Fuel cell delta volts increasing is a warning.
  - PH high may occur, but not necessarily.
  - Fuel cell degradation will eventually occur.
- Separate PH sensor for each fuel cell and common sensor in H<sub>2</sub>O manifold.
  - PH fail may indicate pending breakdown of Fuel Cell matrix (fuel cell crossover). Potential explosive mixing of H<sub>2</sub> and O<sub>2</sub>.
  - High fuel cell delta volts provides confirming cue.
  - Assume matrix failure for PH fail and bus tie as soon as possible. Problem may be an H<sub>2</sub>/H<sub>2</sub>O pump failure.
  - Common PH sensor can confirm individual fuel cell sensor. Will announce about 10 minutes after individual fuel cell PH (common PH only seen by crew on orbit).

- In normal configuration, redundantly powered loads are load shared.
  - Hot running fuel cell (real STACK T high) will grab more than its share of the load. Indication is high amps.
  - Flooding (real EXIT T low) will cause fuel cell to shed load.
- Water output of all fuel cells feeds common manifold.
  - Water expulsion for fuel cell is preferentially: Tank A (primary), Tank B (alternate), Dumped overboard (relief).
  - FC H<sub>2</sub>O LINE HTR controls heaters on each fuel cell primary and alternate path.
  - FC RELIEF LINE HTR controls heaters on each fuel cell relief line.
  - Each fuel cell relief line merges into one common manifold that vents H<sub>2</sub>O overboard.
- Purge process pumps extra O<sub>2</sub> and H<sub>2</sub> through fuel cell.
  - Removes contaminants.
  - Excess O<sub>2</sub> and H<sub>2</sub> dumped overboard. All three fuel cell purge lines merge into one O<sub>2</sub> and one H<sub>2</sub> manifold.
  - Purge only one fuel cell at a time.
- Nominal load is 7 kw per fuel cell. For powerdown operations, 13 kw OK on one fuel cell for 4 hours.

#### Main Bus Short

- Fuel cell will overheat in time. Amps high, fuel cell and main volts low.
  - Short before the fuel cell main bus switch will have high amps and will not drop when fuel cell is isolated from main bus. Fuel cell and main volts will remain low. Should be treated like a fuel cell short.
  - Fuel cell internal short. Amps low, fuel cell and main volts low.

- Fuel cell inadvertent disconnect. Amps low (should be zero), fuel cell volts greater than 32, main volts near zero. OK to attempt reconnect.

#### GNC

##### BCE STRG X "D" Fail

- Will commfault feedback on affected FCS channel.
- Command path on that channel will remain good.
- Ports will not pop unless feedback goes bad under "D" failure.

##### Body Flap Commands

- Go out on FCS channels 1, 2, and 3 only.
- Each channel uses separate hydraulic system.
- FDIR is QMVS.

##### FCS Channels

- Each channel equally supplies every actuator (TVC and aerosurface).
- Each channel should get same command from GPCs.
- Never have more active channels on one GPC than another
- Position feedbacks on aerosurfaces for each channel.
  - Feedbacks go to FDIR to determine surface position for GPC computations.
  - Feedbacks also used individually in closed loop servo to position each FCS channel's input to actuator. Inputs are summed hydraulically.
  - Port bypass, or port pop, is an electro-mechanical means to remove bad command/avoid force fights. Feedback deselection is a software means to avoid a bad input into the selection filter.

- A bad feedback will result in a bad actuator input for that FCS channel. Result will be a port pop (bypass), removing input.
- Single port pop with no other failures: no action.
- Two failures on any surface/TVC actuator. Take good channels to *OVER-RIDE*. Protects remaining two channels from port pop if a force fight develops (wrong channel might port pop). Take 2 seconds between switch throws to *OVER-RIDE*.
- All port pop indications should be verified with MCC.
- If verified, single port pops may be bypassed in software on SPEC 53. Allows taking channel to *OVER-RIDE* later if subsequent failures on other channels.
- Feedback deselection on SPEC 53 deselects all feedbacks on channel, and terminates FDIR on all aerosurfaces.
- If there are two failures on the same actuator, take the remaining FCS channels to *OVER-RIDE*.
- Feedback RM for aerosurfaces.
  - PASS uses first 3 inputs (channels 1, 2, and 3).
  - RM will throw out a bad feedback and substitute channel 4.
  - RM shuts down after first manual or auto deselect, including commfault.
  - PASS FDIR will never pass a comm-faulted feedback.
  - PASS may lose control if 3 feedbacks erroneous due to combination of comm-faults, channels off, or bad feedbacks on individual surface.
  - Any *OFF* channel should have feedbacks deselected. If channel is recovered, reselect feedback after channel is taken to *ON*.
- Always maintain two good commands and one good feedback on each aerosurface.
- In OPS 6, only works in MM 602 and 603.
- BFS feedback RM.
  - Selection filter uses feedbacks on all four channels.
  - No redundancy management.
  - Only manual downmoding of selection filter.
  - Selection filter uses IMVS.
- ASA power fail.
  - Results in all ports bypassed and zero voltage feedback input to GPCs.
  - Deselect feedbacks on channel with an ASA power fail if failure is confirmed. On board signature is not conclusive.

#### FCS Channel Switches

- *OFF* bypasses ports on all actuator inputs for given FCS channel (turns off command). Also sends zero voltage feedback to FDIR.
- *AUTO* allows port popping to bypass bad FCS channel.
- *OVER-RIDE* inhibits port pop on associated channel.
- Pause between all FCS channel switch position changes. Switches are break before make. Switch actuation can result in momentary loss of channel.

#### FDIR

- PASS FDIR for the RGAs, AAs, and aerosurfaces terminates after the first failure, and crew management of the selection filter is required. However, PASS has an RGA SMRD FDIR that will continue to deselect any power failed RGAs. For the BFS selection filter, crew management is always required. Proper selection filter management is required for proper control.



### GPC and MDM Failures

- Take associated FCS channel OFF.
- Removes what may be a command latched at the MDM.
- Also requires deselection of feedback (SPEC 53). Feedback to GPCs would be zero voltage if I/O restored.

### IMU

- SPEC 21 shows IMU status.
  - OFF, BITE, blank in status field.
  - Mode designated by \*: STBY (caged) or OPER (operate)
- GPC send operate command through FF MDMs.
  - IMU returns status (operate discrete) over FF MDM card A.
  - IMU returns digital data over FF MDM serial I/O card
  - STBY and power off conditions available on SPEC 21 after "BCE STRG X IMU", but not after FF MDM lost.
- GPC or FF MDM port failure.
  - IMU will maintain operate command. Commands and output of MDMs are latched at last value.
  - IMU will operate without pulse torquing compensation. Should maintain reasonable align for several hours.
- FF power cycle.
  - HAINS IMU can maintain OPER CMD LATCH for approximately 8 seconds.
- FF power fail.
  - IMU loses operate command and goes to STBY (upon recovery of I/O).
  - In STBY IMU spins down and cages.
- FF 1,2,3 power failure signature (following "I/O ERROR FF X") is loss of SSME Pc tape (ascent). Deselect IMU PASS and BFS after FF power fail (IMU will come back caged when I/O regained). PASS will automatically deselect a commfaulted IMU in OPS 3.
- BCE STRG IMU.
  - Could be result of IMU losing power. SPEC 21 (orbit and entry only) shows IMU status OFF, mode STBY.
  - Could be loss of IMU data to the FF MDM (serial I/O card down). Status and data blank on SPEC 21. Mode will still show operate, received over card A.
- Standby mode.
  - If IMU has moded to STBY, it will begin startup sequencing once the operate discrete is restored.
  - Transient power fail, causes startup sequence which cages IMU (approximately 90 seconds).
  - When IMU completes startup sequence (caged), it will mode to operate and be available to selection filter (PASS and BFS). Hence, any caged IMU should be deselected (PASS and BFS), if not already.
- PASS selection filter.
  - Any IMU not commfaulted (M) or deselected is a candidate.
  - An IMU in STBY is not a candidate.
  - Attitude selection is MVS at 3 level.
  - Downmode or upmode to 2 level. Maintain previously selected if available. Otherwise lowest numbered IMU.
  - Velocity is MVS at 3 level (component basis). Averaged at 2 level.
- PASS RM.
  - Either attitude or velocity fail removes IMU from selection filter.

- PASS will not RM fail an IMU for a BITE (H/W or S/W) at 3 level.
- IMU with BITE will fail RM if dilemma at 2 level.
- If IMU miscompare at 2 level and PASS sees no BITE, IMU dilemma declared. Manual deselection required to break dilemma. Use MCC or deselect IMU. BFS is prime selecting to break tie.
- BFS RM and selection
  - Only commfaults, power loss, hardware BITE, and manual deselect will remove an IMU from candidacy.
  - Selection is MVS at 3 level.
  - Once downmoded to 2 level, BFS will only upmode to 3 level if taken through OPS 0 and up to OPS 3.
  - Selection on downmode to 2 level is lowest numbered IMU.
  - At 2 level, BFS can be taken off lowest numbered IMU with deselect followed by reselect.
  - BFS uses first deselected, last reselected logic after MVS broken.
  - IMU deselected for H/W BITE will not be upmoded if other IMUs lost.
  - Can only recover IMU with a H/W BITE if it is IMU 3 and the BFS is moded through OPS 0 (and IMUs 1 and 2 are deselected).
  - BFS will stay on an IMU with a H/W BITE if it is already on that IMU, and all others are not candidates.
- IMU dilemma
  - If MCC comm available, ask MCC which IMU to deselect (PASS and BFS).
  - No comm, deselect lowest numbered IMU in PASS. BFS will use lowest numbered.
  - Let NAV run to determine which IMU is better.

### Nav aids

- For TACAN and ADTA management, talk to MCC before incorporating. Without communication, use the NO COMM TACAN MGMT and ADTA MGMT cue card.

### SBTC/RHC

- During ascent, only the PLT SBTC is active. To get manual throttles, the PLT must depress the takeover button and then match the commanded throttle setting.
- During entry, both SBTCs are active. Manual speed brake control is selected by depressing the takeover button.
- For ascent, manual RHC control is available only in PASS and must be both PITCH and ROLL/YAW axes.
- For entry, manual RHC control is available in either PITCH or ROLL/YAW in PASS. BFS is always manual.

### Instrumentation

#### General

- MDM loss results in parameters showing Ms.
- Signal conditioner loss shows data on respective parameters as L.
- Loss of OI MDM does not affect data to meters, but some digital data may be lost. DSC loss will affect most meters.
- OI DSC loss section of REF DATA is accurate only for DSC parameters, not MDMs.

#### Data

- Runs through signal conditioners and/or MDMs
  - Data from OI MDMs goes through PCMMU for most SM data.
  - PCMMU swap reads alternate ports on OI MDMs.
  - OR, OL, and OF DSCs (GNC data) go directly through MDMs to GPCs.

## Mechanical Systems

### General

- ET doors and latches, vent doors, star tracker doors, air data probes, payload bay doors and latches, RMS latching gear, and payload retention latches are powered by dual AC motors linked through a differential.
  - One motor fail results in double actuation time. Actuation times are listed in the FDF.
  - Most actuators have dual microswitch pairs for open and close indications.
- Failed mid motor controllers or popped circuit breakers on MA73C are a frequent cause of payload bay door, ET door, or vent door single motor ops. Chart in post insertion book lists circuit breakers and motors affected.

### Payload Bay Doors

- *PL BAY DOOR SYS ENABLE* switches only enable payload bay doors. Other systems in payload bay use *PAYLOAD BAY MECH POWER* switches to allow operation.
- "PAYLOAD BAY DOOR CONFIG" message means a microswitch is indicating differently than required by software for auto operations. Can occur any time during auto open/close sequence. May require manual door operation.
- "PAYLOAD BAY SEQUENCE FAIL" message caused by failure of proper microswitch indications within single motor actuation time. Can occur during auto sequence.

### ET Doors

- Close automatically in OPS 304 if TAL flag is set in software. Always double check doors closed before AOA OPS 3 transition or TAL flag set before late TAL OPS3 transition. No software backup to close doors in OPS 3 without TAL flag set. Only available in OPS 1.

## MPS

### General

- Propellant (PRPLT) numbers on ASCENT TRAJ display calculated by guidance, not measured directly from tank.
- SSME will consume about 4% propellant per engine per minute at 104% throttles.
  - Total fuel consumption 1% every 5 seconds with 3 engines.
- Consumption is 2.5% per engine per minute at 65% throttles.
  - Total fuel consumption 1% every 8 seconds with 3 engines.
- Actual throttle setting in bucket will vary with SRB performance.
- Loss of an APU will cause hydraulic lockup. CMD PATH fail message post-MECO is possible. No action required.
- Selection of manual maximum throttles (109%) is not to be taken lightly. Estimated risk is increased by a factor of ten.

### Command Path

- Command path failures require a manual shutdown with AC switches and MPS pushbuttons. This will create a data path fail.
- Engine with command path fail may not get guided shutdown command and will not shutdown with pushbutton only.

### Data Path

- Must determine engine and command status.
  - Loss of acceleration indicates engine down.
  - Down arrows (↘) in  $\text{GH}_2$  pressure and  $\text{GO}_2$  temperature indicate engine is down.
  - Helium  $dP/dT > 40$  for a few seconds, then zero indicating engine shutdown.

- If SSME down, use pushbutton to mode guidance, then AC bus sensor OFF.
- Assume bad command path until throttling is observed. No comm - assume command path.
- Engine shutdown auto *ENA/INH* logic inhibits shutdown for redline exceedance (limits) for a data path failure. *ENA/AUTO* resets limits to *ENABLE*. Crew has no indication of actual limit status. MCC does have status.
- Engine with data path fail will get a shutdown command if GPCs see other 2 SSMEs with  $P_c < 30\%$ . Two  $P_c < 30$  plus data path sets MECO confirm. MECO confirm will shut down engine if still running behind data path, even if before guided MECO.
- Engine with a data path fail will not display a red status light after engine shutdown (pre-BFS engage).  $P_c$  meter will also be inaccurate.

#### Engine Failure

- First priority is to ensure GPCs recognize it.
  - Check for CRT message "SSME FAIL L (C, R)". If no message, depress pushbutton.
- When time permits, *AC BUS SENSORS - OFF*.
- If second SSME fail:
  - Check interconnect for single engine roll control.
  - Check SERC ON on ASCENT TRAJ.
  - Contingency abort actions if appropriate.

#### Entry

- If MPS caution and warning during entry, check BFS SYS SUMM 1 reg pressure and close appropriate regulator. Helium reg fail high and subsequent venting could be catastrophic.

#### Helium Leaks

- MPS caution and warning for low helium reg not expected for normal entry. Might occur on RTLS due to additional helium usage.

#### Helium Leaks

- Non-isolatable leak requires interconnect at 1150 psi.
  - Use previously failed SSME helium supply, if available.
  - Interconnect to pneumatics results from *IN-OPEN*.
  - Return all helium interconnect valves to GPC post-MECO.
- Non-isolatable leak may require SSME manual shutdown using pushbutton. Helium available may not support zero-g shutdown at MECO.
  - Shutdown must be with pushbutton (hydraulic cutoff) to conserve helium.
  - Helium interconnect may be called for to allow SSME to run to MECO. Interconnect may be well before 1150 psi cue.
  - Crew assumes shutdown is required at velocity on MPS cue card unless MCC advises that helium is adequate for zero-g shutdown.
- If MPS helium reg pressure starts to drop due to helium depletion, limits must be enabled to prevent catastrophic main engine shutdown (given the proper scenario).
- MPS pneumatic helium leak with leak in accumulator requires steps to repress accumulator at TMECO minus 30 seconds.
- Loss of ALC 1, 2, 3/APC 4, 5, 6 causes the A helium isolation valve to close for the C,L,R engines.
  - Helium leak isolation must not be attempted on the affected engine.
  - $LH_2/LO_2$  ullage pressure indications on BFS GNC SYS SUMM display will go to 12.0/0.0 for engine with ALC/APC failure.

### Manual Shutdown

- Required for manual throttles, command path, and some stuck throttle cases.
- Low level cutoff will still work in manual throttle mode if command path is good.
- If any doubt about shutdown function, use AC switches and follow with pushbuttons to inform GPCs of shutdown.
- Shutdown with AC switches no-ops the MPS dump for affected SSME. Manual inerting may be required.
- When manual SSME shutdown is required, use the AC switches followed by the pushbutton except for:
  - Shutdown with pushbutton(s) only for manual MECO. Never shutdown with AC switches and pushbuttons at MECO.
  - Shutdown with pushbutton for helium leak.
  - Use pushbutton to mode guidance when GPCs don't know SSME is already down.

### Manual Throttle

- CSS requires manual throttle, which requires manual shutdown.
  - Manual MECO for uphill cases at target  $V_r$ .
  - Shutdown TAL and RTLS cases at BFS cutoff cue. This cue is based on NAV and indicates cutoff when on R-V line.
- Any manual MECO, depress 3 pushbuttons to ensure MECO confirmed.
- Secondary shutdown cue is PASS/BFS TMECO on TRAJ display.

### MECO Confirmed Flag

- Set by any of the following:
  - Three shutdown commands with engine safing flags set (no data failures, 3 Pc's < 30%).
  - One data path plus 2 Pc's < 30%.

- Manually depress 3 pushbuttons. PASS sets MECO confirm for three pushbuttons pushed separately or together. Can power cycle any FF MDM associated with bad control bus (printed near pushbutton).
- OPS 104 PRO (OPS 602 PRO will not set MECO confirm).
- Fast sep.

### Net Positive Suction Pressure

- Requirement for engines down.
- If two engines are running, throttling at 3-g will bring good engines below 91% (OK for shutdown).
- Single engine press to TAL, ATO, or MECO
  - Manual throttle back to 67% at 2% propellant remaining.
  - Manual cutoff at guidance cue required.
  - If low level sensors uncovered, fuel depletion cutoff will be commanded.
  - NPSP requirements will be protected.

### Pc Gauges

- Data for Pc gauges and status lights:
  - Left: FF2
  - Center: FF1
  - Right: FF3
- Pc on gauge goes to zero for MDM power fail. Freezes for port failure.
- Status lights go out for power failures and freeze for port failures.

### Status Lights

- Amber = data path, electronic (fuel flow or Pc sensors) or hydraulic lockup.
- Red = engine in shutdown or redline exceedance.
- Second engine fail with limits inhibited may show amber plus "MPS ELEC" message in SMS. Likely cues "real world" are data path fail and loss of acceleration. Red light for limit exceedance also possible.

### SSME Pushbuttons

- Control two functions, shutdown and GPC recognition.
- Pushbutton shutdown requires good command path and no pushbutton faults. Command path fail takes out pushbutton for shutdown.
- GPC recognition of SSME fail (to mode guidance) may be accomplished with pushbutton if no switch faults.
  - FF/pushbutton fault: must create data path fail with AC switches and depress pushbutton.
  - Control bus fault: AC switches (data path), power cycle associated FF MDM, depress pushbutton.
  - BFS requires good FF and control bus to mode guidance.

### Stuck Throttles

- Command paths always require manual shutdown.
- With hydraulic and electric lockups, shutdown hydraulic.
- With two hydraulic lockups caused by hydraulic systems failures, shutdown highest priority from the cue card based on ATVC loss.
- One hydraulic or electric, only shutdown with three engines running, uphill, and performance low.
- Stuck throttle shutdown cues of 23K, 22.5K and 24.5K for three engine uphill, TAL, and two engine uphill correspond roughly to 30 seconds before MECO.

### OMS

#### General

- Standard insertion OMS-1 burn at MECO+2 is critical.

- Take status of OMS engines post-MECO following FA/GPC failures coupled with ALC/MN or CNTL bus failures.
- If one engine not available, re-target for single engine burn.
- Restraining not allowed by flight rules to regain dual OMS engine capability if 4 +X jets still available for redundancy.
- Underspeed at MECO, always burn OMS-1 at TTA = 2 for optimum efficiency.
- For large underspeed at MECO (> 500 fps), supplement a single OMS engine with 4 RCS +X jets.

- Gauging active only with at least one OMS engine burning. Otherwise, overhead and aft quantity readings dormant.
- Overhead gauging ceases actual measurement between 45 and 30%.
  - Software routine decrements quantity with engine burning. Software assumes single engine flow rates.
  - Pick up accurate readings when aft probes active below 30% prop.
- If only one pod prop is available and 2 engines, feeding both engines from one pod is certified.

- OMS probes are historically inaccurate.

#### Burn Cues

- PASS MNVR display decrements TTG 2 seconds per display update.
- BFS MNVR display decrements TTG 1 second per display update.
- At ignition
  - Check Pc.
  - Check ball valves approach 100%.
  - Check fuel injector temperatures = about 220°.
  - Monitor engine inlet pressures.

### Delta V Available

- 1% OMS prop (either side or total) = 6 fps delta V.
- 1% RCS (either side or total) = 1 fps delta V.
- 2 fps required for 1 nm HP change.

### DPS Failures

- FA 3(4) failures commfault L(R) ARM/PRESS switches.
  - Guidance will not downmode to 1 OMS or RCS burns when switch turned off.
  - Guidance needles in error.
  - DAP remains in TVC DAP on downmode to RCS. This results in sluggish control.
- Set split or IMU dilemma, terminate burn if above safe HP. Determine bad IMU post burn by which IMU accel is not zero.

### Thrust Loss

- At first indication of OMS thrust loss (usually Pc low), check for OMS engine down arrow. PASS requires Pc low and loss of acceleration for down arrow.
- BFS shows down arrow with loss of Pc only. Pc transducer fail will give false engine down cue.
- Check for ball valve fail. If not confirmed and ignition path is good, must assume prop fail. Cue card procedure will identify engine or prop fail.
- Orbiter will initially yaw into dead engine and then yaw into good engine.
- Know without doubt which engine is down before turning engine off.
- Ensure prop or engine fail identified.
- Simple OMS engine fail, crossfeed at 1/2 delta V.
  - Protect aft quantity. Crossfeed at minimum on PRPLT PAD.
  - Maintain good flow path to prop source.

- For OMS-1 with large delta V, interconnect failed OMS to RCS and supplement with 4 +X RCS.

- For prop fail, consider engine lost. Use cue card to determine proper course of action.
- If both engines down, complete burn with RCS.
  - Interconnect good OMS prop to RCS, note OMS helium pressure, convert to burn time, and time RCS burn.
  - FA failures may cause only 2 +X jets available. Required burn time is almost doubled.
  - OMS gauging not active without an OMS engine burning.
  - Must protect RCS system from helium ingestion at OMS prop depletion.
  - For any prop failure, isolate bad prop from crossfeed lines.

### Leaks

- Tank leaks must be confirmed with decreasing inlet pressure.
  - Tank leaks may be isolated by closing tank isolation valves.
  - If inlet pressures goes to zero and tank stable, inlet line leak.

### Gimbals

- Trim for 2 engine burns has parallel thrust vectors.
- Single engine burn trim is through CG.
- Gimbals move to trim position 15 seconds prior to TIG.

### Nitrogen System

- Used to open ball valves and supply purge post burn.
- If N<sub>2</sub> tank fail, but good reg P available, save engine for deorbit.
- If reg P fails, ball valves will close and engine will fail.

### OMS Dumps

- Time the dump. System failures can prevent automatic cutoff.

### RCS

#### General

- Talkbacks get hardware fuel and oxidizer inputs (no MDMs involved).
  - Inputs must agree for open or close indication.
  - Miscompare results in barberpole.
  - RCS helium isolation valves are magnetically latched open. A and B valves are mounted next to each other at various helium tanks. Occasionally the vibration of operating a valve can jar the adjacent valve out of the open position. Crew procedures account for this. A momentary barberpole talkback may occur when an adjacent valve is operated.
- Quantity calculations are PVT determination based on helium in prop tank.
  - PASS calculation allows for substitution of inputs.
  - If any helium leakage, prop calculation will be erroneous.

#### Crossfeed

- Master crossfeed available in PASS OPS 1, 3, and 6.
  - *TANK ISOL* and *CROSSFEED* switches must always be returned to *GPC* to protect master crossfeed sequence.
  - Master crossfeed selection valves have simo jet firing limit, even if auto crossfeed not used (all OPS, both PASS and BFS).
- Auto crossfeed sequence in PASS OPS 1, 3, and 6.
  - Initiates crossfeed in response to low pressure in prop tank.
  - Protects against helium reg fail low (primarily for ET SEP).

### Dumps

- OMS prop interconnected dumps
  - Smart interconnect handles FA MDM and EPS failures for intact dumps.
  - Dump time compensated for inactive manifolds.
  - Time the dump. System failures can prevent automatic OMS cutoff.

### Heaters

- Pod heater, crossfeed line heaters, and jet thruster heaters (by manifold ) on panel A14.
- Turned on post insertion. Some heaters redundant and switchable.

### Interconnect

- RCS crossfeed requires check of left to right tank pressures.
- OMS to RCS interconnect requires low delta pressure and OMS tank pressure higher than RCS tank pressure.
- OMS PRES ENABLE must be toggled off when breaking interconnect. Software computation assumes OMS prop feeding when L or R OMS has \*.

### Jet Availability

- Monitor on SPEC 23.
- Software considers a jet available (no DES\*) unless:
  - Deselected by RM.
  - Manifold status in software = closed.
  - Manual DES item entry.
- RM will not deselect more than jet deselect limit.
  - Intialized at 2 per pod.
  - Limit does not apply to manual deselect or vernier jets.



### Jet RM

- BFS RM is inactive (display and PASS monitor), unless engaged.
- Any detected RCS fault lights RCS JET caution and warning light.
- For jet fail ON, RM does not auto deselect.
- On the PASS, a jet fail OFF is auto deselected by RM. In the BFS, only the first jet fail OFF is auto deselected and only if it is not previously failed ON.
- Fail LEAK results in PASS auto deselect. Not available in BFS.

### Leaks

- Isolation during ascent and entry
  - Always confirm decreasing helium pressure (CRT and meter) before isolating.
  - Confirm talkbacks reflect switch throws.
  - Reselect GPC position of *TANK ISOL* and *XFEED* switches.
  - Monitor prop remaining. Crossfeed before quantity reaches zero.
  - Helium leaks invalidate quantity computations.
  - Auto crossfeed may be used to open/close valves if manual switch functions lost due to control bus failures.
- Confirmed jet fail LEAK, do not reselect jet since leaking prop will probably freeze in jet.
- RCS secure for leak isolation performed by first closing the manifold isols, then isolating from the bottom of the panel working up. When re-opening, must ensure prop supply before manifolds opened.

### Manifold RM

- Software looks at open and close discretes.
- Any indeterminate combination results in "CL?".

- Crew can override manifold status on SPEC 23.
- SPEC 51, ITEM 7 overrides all manifolds in hardware "?" to open. No effect on manifold with commfaults.
- RCS RM loss occurs with "BCE STRG X B" (forward), or "BCE STRG X D" (aft). Manifold goes CL?.

### Manual Reselection

- ITEM entry to remove \* in DES column.
- Will not work if deselect due to manifold closure.
- Does not reset RM. Jet will not RM fail for same fault.
- DES INH item entry reprioritizes jets and disables RM auto deselect. Does not reselect jet.
- Double DES INH resets jet RM (toggling RM).
- ITEM 45 resets RM of all available jets at once. No effect on deselected jets.

### On Orbit Burns

- Normally 2 jet burns.
- Will downmode to 1 jet burn if no jets available on one side.

### OPS 1 and 3 Burns

- Aft RCS burns use 4 jets and downmode to 3, 2, and 1.
- Forward RCS burns use 3 jets and downmode to 2 and 1.
- Asymmetric +X burns require a lot of propellant for attitude control.

### Tank Press High

- Indication of helium reg failure.
  - Close both helium regs to minimize helium loss.
  - Monitor low prop tank pressure and repress to protect manifold pressure. Jets will fail OFF if manifold pressure < 190.

### Valves

- Prop valves are AC with control bus for switch power. Will operate on 2 phases if 1 phase lost.
- Helium valves are DC with control bus for switch power.

### Vernier Jets

- Two side-firing forward jets.
- Two side-firing aft, two down-firing aft.
- Only aft side-firing jets can be lost and still have vernier mode (may still be lost for RMS loaded operations).

## APPENDIX D RULES OF THUMB

## CONTENTS

APU/HYD.....	D-1
Ascent.....	D-1
CCTV System.....	D-1
Communications System.....	D-2
C/W System.....	D-2
DPS .....	D-2
ECLSS.....	D-3
Entry .....	D-3
EPS .....	D-4
EVA .....	D-4
GNC .....	D-4
Landing/Deceleration System.....	D-5
Lighting System.....	D-5
Mechanical Systems .....	D-5
MPS .....	D-5
OMS .....	D-6
Orbit .....	D-6
PDRS .....	D-9
RCS .....	D-10
TAEM.....	D-10

This appendix is a compilation of the rules of thumb from the body of this manual. Topics are organized alphabetically keyed on commonly used acronyms and abbreviations.

## APU/HYD

- APU fuel usage rates vary with loading, but average 1% per minute (3 to 3.5 lbs/minute). Usage rates are reduced by about half if the hydraulic main pump is taken to low pressure (*HYD MAIN PUMP PRESS* switch on panel R2 set to *LOW*), as is done during the abort once around deorbit coast period.
- The APU injector cooling tank shared by all three APUs contains enough water for 21 minutes of continuous flow. This is enough for six complete 3.5-minute hot restart injector cooling cycles.
- If all water spray boiler cooling is lost to the lube oil after an APU reaches full operating temperatures, only 4 to 5 minutes of operating time are available before bearing seizure occurs.

## Ascent

- Monitor roll program on the ADI and BFS ASCENT TRAJ display.
- Before L/O +90 seconds, BFS engage is the crew's only option for loss of guidance and/or control. After 90 seconds, the crew can try CSS.
- Monitor the trajectory on the ASCENT ADI cue card and the PASS and BFS TRAJ displays. The Shuttle bug and predictors should follow the nominal trajectory line. Also monitor the HSI for the inertial velocity to be in the desired orbit insertion plane.
- Monitor guidance convergence by observing PASS and BFS TMECOs converging to expected time.
- If the crew takes CSS, they should take manual throttles. If the crew takes manual throttles, manual shutdown is required unless a low level shutdown occurs due to low performance. The cue for MECO is the BFS MECO cutoff bug or planned MECO  $V_1$  minus 150 fps.
- Use OMS 1 TGTING cue card for system problems and OMS 1/2 TGTING cue card for performance problems to determine proper OMS 1 and 2 targets.

## CCTV System

- When the VCU is powered on, the crew must wait 10 seconds before any CCTV commands can be accepted. This time is used to initialize the VCU.
- Always wait at least 4 seconds after powering off a camera before powering it back on. This gives the iris enough time to fully close.
- Always wait at least 4 seconds after switching from the RMS wrist camera to the RMS elbow camera before switching back to wrist, and vice versa. This gives the iris enough time to fully close.
- When ejecting OAST VTR tapes, always wait at least 10 seconds after selecting *STOP* before you attempt to eject the tape. Never unpower the OAST VTR while it is in a mode other than *STOP*. Either of these will result in tape breaking or fouling.

- Never leave a payload bay camera in a manual mode (either semi- or full) while in direct sunlight or any bright light. Damage to the camera will result.
- If neither you nor Mission Control is using a camera for extended periods, power it off to conserve energy and to keep it cool.

### Communications System

- When the TDRS has an elevation of greater than +70 degrees or less than -60 degrees relative to the orbiter (as shown on OPS 201), there is a risk of degraded communications as the orbiter nose or tail blocks line of sight between the orbiter antenna and the TDRS.
- Power amplifiers are specified to have a minimum power output of 100 watts. Flight experience has shown that a good downlink can be sustained with a power output of 65 watts.
- Payload interrogator output power, when in low power mode, will read zero. This measurement is meaningless as the output power is too small to be output by the instrumentation system.

### C/W System

- The *SENSOR RESET* switch on panel L1 should be pressed when smoke concentration goes below 1.8. This prevents masking of alarms.
- When panel R13U is not in use, the *PARAMETER SELECT* thumbwheels should be set to a value greater than 119.
- Crewmembers should reset fault messages as quickly as possible after review to avoid covering other messages.
- The fault summary should be reviewed regularly to avoid missed fault messages.

### DPS

- Always deassign CRTs from fail to sync GPCs and reassign to good GPCs to avoid inadvertent entries (NBATs/restrings, burn targets, etc.).

- Before OPS transitions and restrings, always verify the appropriate NBAT is what you want it to be; never assume that it is correct! Also check the proper major function and GPC switch configuration. Post OPS transitions and restrings, check good configuration with SPEC 6.
- Make sure you have the correct memory configuration called up before you start making NBAT changes.
- During OPS transitions, keep "hands off" everything, including all switches and CRT entries.
- Always clear the Fault Message line as soon as you have seen the message; otherwise, you will likely miss subsequent annunciations from other failures.
- Post BFS engage, check to ensure that all active PASS GPCs have recognized the engage (both *MODE* and *OUTPUT* talkbacks are barberpole). If not, take the offending GPC to *HALT* (or if this doesn't work, power it *OFF*) immediately to avoid I/O problems on the flight critical strings.
- It is a very good idea to resume SPECs and DISPs from CRTs when not using them or before going to another major function on that CRT.
- When moding PASS GPCs into the common set (i.e., *STBY-RUN*), always pause 10 seconds before making switch throws to avoid a possible fail-to-sync and to ensure proper common set initialization.
- It is important to be able to identify GPC failures, for Mission Control often has little insight. The information you provide will affect Mission Control analysis and its ability to plan for subsequent failures (both DPS and non DPS).
- Always hard assign CRTs (both PASS and BFS) via PASS CRTs (BFS will DK listen). You can cause dual CRT commanders if you try to assign BFS a CRT that a PASS CRT is still driving.

- Always distribute your CRTs among different GPCs. On orbit, always be sure SM is not on all CRTs at the same time; if you lose SM, you also lose PASS CRT interface. The same applies for single GPC GNC OPS configuration.
- When using the *GPC MODE* switch, always take your hand off between positions. On past missions, there have been problems with the switch being in two positions at the same time. This problem can occur on other orbiter switches too. It is a good idea to always pause slightly in each switch detent to ensure the contacts are made and recognized by the GPCs.
- The *CRT SEL* switch should always be checked before making a keyboard entry, and data should always be checked on the CRT scratch line before it is entered.
- When moving GPC mode switches from RUN to STBY or STBY to RUN, refrain from moving any other GPC monitored switches for 10 seconds.
- NH<sub>3</sub> boiler supply is good for 25 minutes of ground cooling.
- A single cryo O<sub>2</sub> tank is good for about 2 to 3 days of orbit usage depending on crew size and power level. H<sub>2</sub> tanks are sized to match O<sub>2</sub> usage.
- A single LiOH canister is usable for about 48 man-hours.

### Entry

- 2 OMS:  $TGO \approx \Delta VTOT/2$ .
- 1 OMS:  $TGO \approx \Delta VTOT$ .
- RCS:  $TGO \approx 1.7 \times \Delta VTOT$ .
- As an approximation, 1 degree of bank change produces 0.7 ft/sec<sup>2</sup> H-dot change. Large bank errors cause corresponding errors in H-dot, allowing a phugoid to develop more quickly.
- A 1 degree change in alpha produces a 1.7 ft/sec<sup>2</sup> drag change, which is equal to an 8 degree roll change.
- Prior to the first bank, monitor vehicle attitude at 0 degrees bank and 40 degrees alpha.
- First bank (flight path angle capture) should occur at a drag acceleration of approximately 3 fps<sup>2</sup> and/or q-bar of approximately 8 psf.
- Monitor the trajectory on the ENTRY ALPHA cue card, and the PASS and BFS TRAJ displays:
  - The Shuttle bug superimposed on guidance box superimposed on nominal trajectory line.
    - Actual drag equal to reference drag.
    - Appropriate bank angle, H-dot, range and altitude.
  - For an off-nominal trajectory, check that guidance is working to put the guidance box back on the Shuttle bug (zero range error) within the trajectory envelope.
- Attempt to contact MCC before taking CSS.

### ECLSS

#### NOTE

Numbers presented here are for typical orbit power and heat loads and may vary significantly depending on attitude and power loading.

- Supply water tanks fill at about 1.5 percent per hour depending on fuel cell load (.8 lb/kW hr ÷ 16 lb over 1%; 14 kW typical orbit power load).
- Water tanks empty at about 100 percent per hour for a water dump, about 50 percent per hour when using the FES high load evaporator for cooling with payload bay doors closed, and about 16 percent per hour when using the FES topping evaporator for supply water dumps on orbit with the doors open.
- On-orbit cold soak is good for 20 to 30 minutes of cooling. Prelaunch Freon conditioning is good for 2 to 3 minutes of cooling.

- If you must take CSS:
  - Control range by controlling drag.
  - Control drag by controlling H-dot.
  - Control H-dot by controlling H-double dot.
  - Control H-double dot by controlling bank angle.
  - Control everything slowly by small corrections.

### EPS

- *Never* close a circuit breaker or reset an RPC found out of configuration without MCC coordination.
- Loss of cooling to a fuel cell requires crew action within 9 minutes to prevent a catastrophic loss of crew/vehicle due to possible fuel cell fire and explosion.
- Any interruption of continuous ac power during ascent may result in the loss of main engine controller redundancy. Reconfiguration of ac powered equipment prior to MECO should be avoided.
- *Never* connect or reconnect power to a known shorted or failed component; this includes switch throws, circuit protection device resets, or bus ties.
- Fuel cell run limit prior to shutdown for loss of cooling is 9 minutes at a 7 kW nominal load. Run time varies inversely with fuel cell load.
- Three oxygen and hydrogen tanks are good for up to 8 days on orbit; five oxygen and hydrogen tanks are good for up to 12 days on orbit; eight oxygen and hydrogen tanks are good for up to 18 days on orbit. Duration varies with crew complement and power load.
- A fuel cell hydrogen pump uses 0.3 amps/AC phase; a coolant pump uses 0.5 amps/AC phase.

### EVA

- Always use "make before break" tether protocol.
- Don't use the glove as a hammer.
- EVA crewmember must remain tethered at all times.
- Slow and deliberate motion provides much greater stability than quick, jerky motions.
- Body positioning is 90 percent of the task.
- Each EVA crewmember should check out his or her own EMU.

### GNC

- The PASS FDIR for the RGAs, AAs, and aerosurfaces terminates after the first failure. After the first failure, crew management of the selection filter is required. For the BFS selection filter, crew management is always required. Proper selection filter management is required for proper control.
- For FCS channel management:
  - Never have more active channels on one GPC than another.
  - If there are two failures on the same actuator, take the remaining FCS channels to *OVERRIDE*.
  - Always maintain two good commands and one good feedback on each aerosurface.
  - Delay 2 seconds between switch throws when moving FCS *CHANNEL* switches to *OVERRIDE*.
  - Port bypass, or port pop, is a mechanical means to avoid force fights; feedback deselection is a software means to avoid a bad input into the selection filter.
- For ascent, only the pilot's SBTC is active. To get manual throttles, the pilot must depress the *TAKEOVER* button and then match the commanded throttle setting. Manual rotational control is available only in PASS and must be both pitch and roll/yaw.

- For entry, both SBTCs are active. To get manual speed brake, the CDR or pilot must depress the *TAKEOVER* button. Manual rotational control is available in either pitch or bank in *PASS*, and required in both axes in *BFS*.
- For *TACAN* and *ADTA* management, talk to *MCC* before incorporating.
- Without communication, the crew will use the *NO-COMM TACAN MGMT* and *ADTA MGMT* cue card.
- When an engine fails, the helium  $dP/dT$  is greater than 40 for several seconds, due to engine shutdown, and then it goes to zero. This is a good crosscheck to confirm engine shutdown.
- The selection of max throttle is not to be taken lightly. It increases the risk of catastrophic failure of an *SSME* by 10 times.
- Five ways to set *MECO* confirmed are: three *Pc*'s less than 30, two *Pc*'s less than 30 plus one data path failure, three *SSME PB*'s, *OPS 104 PRO*, and *FAST SEP*.

### Landing/Deceleration System

- Landing gear should not be deployed at equivalent airspeeds greater than 297 knots.
- $\pm 1$  knot of touchdown speed corresponds to  $\pm 100$  feet of distance.
- *PASS* will downmode a commfaulted *MAIN ENGINE SHUT DOWN* push button and allow the push button to safe an engine under a data path failure. *BFS* does not allow this. If a *MAIN ENGINE SHUT DOWN* push button is commfaulted in *BFS*, it is inoperative.

### Lighting System

- Power consumption of cockpit lighting can be as much as 1 to 2 kW with all lights on.
- When payload bay floodlights are turned off, they should remain unpowered for 10 to 16 minutes prior to repowering.
- An *OPS 602 PRO* does not set *MECO* confirmed.
- *BFS* requires all three *MAIN ENGINE SHUT DOWN* push buttons *SIMO* to set *MECO* confirmed; *PASS* only requires to see the *PBs* once.

### Mechanical Systems

- Always use a timer when operating mechanical systems, noting either dual or single motor time. Do not continue driving if greater than the single motor time has elapsed without the mechanism reaching the desired state.
- To shut an engine down, both contacts on the *MAIN ENGINE SHUT DOWN* push button must be good. If one contact is commfaulted, the button can be used to set the safing flag on an engine that failed under a data path failure. If a contact is power-failed, the button is inoperative unless it is commfaulted.

### MPS

- Direct insertion *MECO* is usually close to 8 minutes 30 seconds.
- For three engines at 104 percent, fuel consumption is about 1 percent propellant/5 seconds. For three engines at 65 percent, fuel consumption is about 1 percent/8 seconds.
- An *SSME* will consume approximately 4 percent propellant per engine per minute at 104 percent. Propellant remaining is displayed on the *ASCENT TRAJ* display and is a guidance-calculated number.
- An *SSME* command path failure must always be shut down manually with the *A/C* switches and *PBs*.
- An *SSME FAIL C (L, R)* message indicates that the *GNC* software has recognized an engine shut down. Two of these messages will enable single engine roll control mode.
- An engine in data path failure will never display a red *MAIN ENGINE STATUS* light, pre-engage.

- There are no direct indications to the crew of limit shutdown enable/inhibit status. The status is available to Mission Control, or it can be deduced by the crew.
- Limits must be enabled on an engine when the helium regulator pressure begins to decay due to a helium leak. An SSME will almost certainly fail catastrophically if there is insufficient helium, and limit shutdown is inhibited.
- Manual shutdown of hydraulically or electrically locked SSME is dependent on which issues the performance call, due to low-level C/O sensor timing.
- Actual throttle levels on the first stage throttle bucket can vary due to SRB thrust level dispersions. This is an artifact of "first stage adaptive guidance."
- Loss of an APU means hydraulic lockup. SSME CMD C (L, R) messages are possible post-MECO. No action is necessary.
- 23 k, 22.5 k, and 24.5 k  $V_1$  are about 30 seconds before MECO on the three-engine uphill, TAL, and two-engine uphill cases respectively. Note that  $V_1$  indication is lost to the crew post-engage.
- *MPS ENGINE POWER* switches look very similar to *He ISOLATION* switches and are located close together on panel R2. *Use caution.*
- Shutdown with A/C switches will always cause a data path failure.
- Loss of ALC 1, 2, 3 (APC 4, 5, 6) will cause SSME helium isolation A to close on the C, L, R SSME with no direct indication to the pilot. Do not attempt subsequent helium leak isolations.
- One OMS engine causes approximately 1  $\text{fps}^2$  acceleration.
- For OMS ignition, there must be power and command to at least one coil on both control valves.
- OMS TVC requires an enable discrete from the FF MDM, and commands from the FA MDM.
- FUEL INJECTOR TEMP message may be a signature of a bad temperature transducer or a fuel blockage.
- CHAMBER PRESSURE message may be a signature of a bad pressure transducer or an oxidizer blockage.
- There are several failures that inop OMS FDI (FA MDM commfault or Pc transducer failed high).
- Always check redundant sources to confirm any malfunction.
- An OMS engine failure post-MECO should be signified by a down arrow on the MNVR display.
- Max blowdown on the OMS is approximately 39 percent.
- 1,000 lbs of OMS (approximately 8 percent) moves the X c.g. 1.5 inches aft and the Y c.g. 0.5 inches left or right.
- Max OMS quantity for landing = 21 percent.

### Orbit

- In propellant-limited situations, use the following guidelines:
  - Stay in VERN as much as possible.
  - To conserve forward RCS, use TAIL ONLY control mode.
  - During prox ops, when controlling out-of-plane errors, start as early as possible, wait for the node to make inputs to null rates, watch the deadbands, and do not fight orbital mechanics effects.

### OMS

- 1 percent of OMS propellant
  - = 6  $\text{fps } \Delta V$
  - = 3 n.m.  $\Delta H_p$
  - = 130 lbs (80 lbs oxidizer, 50 lbs fuel) uses 40 psi of helium for long burns.



- TRAJECTORY:
  - NC: sets up 2-rev transfer to Ti (usually retrograde) - NCC: 1st Onboard, based on 2 ST Passes, Targets to Ti
  - Ti: 1st to target intercept, uses RADAR Data (usually posigrade)
  - MC1-4: Trim Burns Targeted to intercept
  - OOPN: Usually between MC1 and MC2, Tgt and Orb co-planar ( $Y = 0$ )
  - Ti Delay: Football, Posigarde (2 x Ti DVX)

NEED: New Ti TIG

LOAD new Base Time

Start FDF at NCC intermediate solution (may not burn new NCC).

SOURCE OF ERRORS

Attitude maneuvers and jet cross coupling

Burn trims

Orbiter Vents (APU, FES, etc.)

Drag uncertainties.

- ST PASSES:
  - DES IMU (Prime sel IMU for Attitude at 2 level)
  - Monitor RESIDS < .05 (Star Lock - BREAK TRACK)
  - 1st PASS:  
Assumes on PROP  
Gives Criteria to select FLTR
  - 2nd PASS:  
Assumes FLTR  
Verify 1st PASS  
Gives Criteria to do FLTR to PROP.

SOURCE OF ERRORS

Prime selected IMU going bad

Star tracker bias

Maneuvers and length of time since last SV update

Taking marks on a star

Either IMU accelerometer going bad.

- RADAR PASS:

- Use if < 135 k (Range eclipsing)
- Procedure handles either FLTR or PROP selected
- Gives criteria to select FLTR -or- to do FLTR to PROP
- Verifies star tracker passes
- INH angles during maneuvers to burn attitude
- RR MODE = ATRK during maneuvers to burn attitude.

SOURCE OF ERRORS

Range eclipsing

EL/AZ greater than 30 deg

Ku biases (Range).

- TARGETING:

- Load BASE TIME (Ti TIG) to TGT SET #1
- Load TGT SET (ITEM 1 +)
- Verify
- Compute (ITEM 28)
- Plot T1 Position
- MC2 (El Angle for ILOS rates = 0 approach)  
  
Note Nominal Time  
  
Compute TIG Change  
  
TIG will be new BASE TIME  
  
-3 and +7 limits for lighting.

- NAV MANAGEMENT:
    - FLTR to PROP (before taking DATA)
    - After new sensor acquisition
    - Reacquisition of Sensor Data
    - RNDZ NAV enable creates the PROP
    - Always have a FLTR vector
    - COMM FAULT or suspect bad data INHIBIT then ask questions.
  - BURNS:
    - POSIGRADE: TVR = 0
    - RETROGRADE: TVR = 180
    - < 4 - Multi-Axis (DAP:LVLH)
    - > 4 - +X Mnvr to Attitude (DAP:INTL)
    - > 6 - OMS
    - TRANS: NORM until VGO < 1 fps then ULSE
    - VGO Z is negative: Burn Z, X, Y
    - Preliminary solution for NCC and Ti can be considered the PROP solution.
  - PTG/DAP MANAGEMENT:
    - -Z target track
    - A/VERN - Attitude hold (.2 deg/sec and 1 deg deadband)
    - B/PRI - Maneuver (.5 deg/sec and 2 deg deadband)
    - TRANS PULSE = .1 RNDZ and .05 Prox ps
    - Config for VBAR at +RBAR
    - PROX OPS DAP - when stable (VBAR).
  - SYSTEMS CONCERNS (single point):
    - GNC GPC FAIL:
      - 2 required for Ti and PROX OPS
- RNDZ NAV disables at OPS MODE ECALL
- Saves FLTR Vector when RNDZ NAV Disables
- CNCL pointing (TGT ID = 1) before OPS MODE recall
- MDM FF3:
    - Loss of VERN (1-2-3 rule)
    - RADAR to NAV panel A2 is still good -Y Tracker
  - MDM FA1 or 2:
    - Loss of VERNs (1-2-3 rule)
  - MDM FF1:
    - Z tracker
  - PL 1:
    - Auto Ku Pointing (KU MODES: GPC and GDSG lost)
  - Loss of IMU 2 - Restrung 1221.
- Expending about 35 to 40 lb of RCS propellant to maintain attitude results in a cross-coupling translation of 1 fps in -Z direction.
  - .3 fps posigrade or retrograde = .9 nm downtrack/rev.
  - 1 fps posigrade or retrograde =:
    - 16 kft downtrack/rev
    - 3.5 kft radial/.5 rev
    - .5 nm altitude change (HA or HP).
  - 1 fps radial =:
    - 3.5 kft downtrack/.5 rev
    - 900 ft radial/.25 and .75 rev (decoupled from the other axis).
  - 1 fps Out Of Plane = 900 ft/.5 rev (decoupled from the other axis)

- (SMA error)  $\times (-10)$  = ft/rev downtrack error.
- High +Z DV for MC2-4 = short trajectory.
- MC2 Positive TIG slip = Early sunrise.
- TGT EL ANG message = Very short case.
- High in COAS = Short traj (subtract from ADI pitch for THETA)
- High at Ti ( $> 1.4$  deg) = MC2 TIG slip should be positive.
- ORB RATE = .06 deg/sec; 4 deg/min; 360 deg/90 min; 1.1 mr/sec.
- Ti done at orbital noon -3 min.
- +Y = South or going South.
- Sep Rate =  $10 \times \Delta H$ .
- $(3/2) W\Delta V$  for Coeliptic.
- MPM motion may cease during deployment or stowage before the expected microswitches are made. This is due to the fact that the last part of travel in either direction is when the overcenter lock is locking. Therefore, don't turn off the *PORT RMS* switch when visible motion stops. Wait for the microswitches.
- Practice safety habits, the most important of which are brakes on, then power off (if required) for abnormal joint response and use EE CC for abnormal EE ops during the specified conditions.
- During arm cradling, periodically check all joint angles to make sure that joints that you have already aligned to zero have not moved. During soft stop, position hold does not work; therefore, external forces can move joints out of desired alignment.

## PDRS

- Whenever there are both talkbacks and CRT displays that reflect microswitch status, they should ALWAYS both be checked during any operation affecting them.
- Whenever troubleshooting RMS malfunctions in the long-form MAL book, always READ AHEAD. The MALs have a knack for having page breaks in extremely bad locations, and if you don't know what you're supposed to look for before you turn the page, you could be in trouble.
- The hand controllers are rate-proportional and are extremely sensitive. They should be held in such a way that you can control the full range of inputs without ever stopping to rearrange your hand. Care must be taken to not overcontrol the inputs. A good practice is to slowly and steadily input a desired command, wait patiently until you see the reactions of that command on the arm, and as the desired motion is achieved, slowly back off the input. Ideally, you should reach the axis detent at the same time the arm achieves the desired position and attitude.
- CCTV cameras have a tendency to malfunction at the most inconvenient times. Expect this and know how to perform all operations without cameras.
- Develop a scan pattern that encompasses window, CCTV, and panel status.
- Never rotate the *MODE* switch through *DIRECT* while the brakes are on. This actually puts the arm in mode, and sets you up for a possible runaway if a *SINGLE/DIRECT DRIVE* switch failure occurs or is present.
- Verify the *RATE* switch setting by feel and talkback status. This should be done EVERY TIME prior to moving the arm, regardless of mode.
- Make sure you know the proper definitions of "cradling," "stowing," and "berthing."
- Rates for berthing/unberthing: Usually maintain rates at about 0.4 to 0.5 ft/sec between  $Z = 414$  and  $-438$ . For  $Z < -438$  (away from the bay), rates can be increased somewhat.
- For berthing or unberthing of payloads with keel trunnions: the keel pin enters/exits the AKA when the longeron trunnions are at the top of the built-in 8-inch PRLA guides.

**RCS**

- 1% RCS prop = 1 fps  $\Delta V$ .
- 1% RCS prop = 22 lbs.
- 1,000 lbs of ARCS prop moves X c.g. 1.2 in, X c.g.  $\pm$  0.4 in.
- 1,000 lbs of FRCS prop moves X c.g. -3.5 in.
- ARCS max blowdown qty 24%.
- FRCS max blowdown qty 22%.
- Loss of a single downfiring vernier jet is loss of vernier mode.
- If fuel tank pressure is 20 psi higher than the oxidizer tank pressure, then verniers are no-go.
- Always secure the RCS from the manifolds to the helium tanks.
- Always open the RCS from the helium tanks to the manifolds.
- For an early gear deploy, immediately close the speed brake.
- OGS is 19 degrees lightweight (< 220,000 lbs) and 17 degrees heavyweight (> 220,000 lbs). Aimpoint is 7,500 ft nominal and 6,500 close-in. Touchdown speed is 205 knots heavyweight and 195 knots lightweight and short field speed brake.
- At main gear touchdown, manually deploy the speed brake. Start derotation at 185 KEAS at approximately 2 degrees per sec. At nose gear touchdown, manually back up WOW.
- During training, pilots should strive for a threshold crossing height of 15 to 20 feet on nominal approaches. Touchdown goals are airspeed within 5 knots of the target value, sink rate within structural limits, negligible lateral drift, and minimal RHC activity. A good target value for sink rate is 3 fps or less, insuring ample margin before violating limits.
- With NWS in *GPC* or *DIRECT*, the orbiter will tend to turn into a crosswind. With NWS *OFF*, the orbiter will tend to turn away from a crosswind.

**TAEM**

- A 100 ft difference in gear deploy altitude equals about 250 ft of touchdown energy. Gear deploy should not be delayed past 200 feet altitude.
- 90 ft of touchdown distance corresponds to 1 knot of airspeed.
- TAEM guidance uses pitch to control range, bank angle to control ground track, and speed brake to control q-bar.
- Overhead HAC with NEP allows the most downmode options for energy.
- Fly theta limits at Mach 2 (NLT Mach 1.5) if air data is not incorporated to G&C. Maximum bank angle is 50 degrees. Speed brake should be controlled manually when flying theta limits.
- Manual HAC techniques are only used when requested by Mission Control. To execute the manual HAC procedure, fly 220 to 230 KEAS and follow roll commands. At 120 degrees turn to go, resume flying pitch and roll guidance.
- If the orbiter is landing with a known failed tire, the second tire on that axle is expected to fail during derotation at the point of maximum loading.
- If both main gear tires fail on one side, the orbiter will tend to turn toward that side. The turning moment due to crosswind can either reinforce or reduce this effect.
- If the turning moments due to tire failure and crosswind are in the same directions, large control inputs will probably be required.
- If the turning moments due to tire failure and crosswind are in opposite directions, the control inputs required to counteract tire failure will be reduced. In this situation, pilots must be careful not to overcontrol. A good rule of thumb is to be more cautious with the rudder pedals, matching the crosswind turning tendency.
- Flight Rules call for landing with an existing crosswind on the same side as a known or expected bad tire.

ASCENT	DESCENT	PROPELLANT															
<p><u>Ascent Performance Margin</u>  <u>Management Reserve Req. (lbs)</u>            Pre Flight Design Requirements Document = 3500            Flight Design Requirements Document = 2500            Cargo Integration Review = 1500            Flight Planning Stowage Review = 1500            FPR = 4652</p> <p><b>ORBIT</b></p> <p>1 hr launch delay = change in orbital noon by 4 minutes</p> <p><u>Ascending node</u>            28.5 deg - 1st ascending node is @ Long = 173.38 East            57 deg = 121.55 West</p> <p><b>MISCELLANEOUS</b></p> <p><u>Orbiters</u>            OV101 - Enterprise            OV102 - Columbia            OV103 - Discovery            OV104 - Atlantis            OV105 - Endeavor            OV102 weighs 7000 lbs more than OV103/104</p> <p>Min planned flt duration = 96 hours</p> <p><u>Max/Min Beta Angle</u>            Max = 23.5 + orbital inclination            Min = 23.5 - orbital inclination</p> <p><u>Time</u>            CDT = GMT - 5 hr            CST = GMT - 6 hr            Daylight savings time from 1st Sunday in April to last Sunday in October</p>	<p><u>Xcg Limits</u>            FW D = 1076.7 in (RTLS = 1079.0 in)            AFT = 1109.0 in            CONT AFT = 1119.0 in</p> <p><u>D/O Delta V's</u>            Descending approach is worst case <math>\Delta V</math>            90 deg prebank will decrease <math>\Delta V</math> - 10 ft/s (function of altitude)</p> <p>If Xcg &gt; 1091.5: 1 in Xcg = 2.2 miles            If Xcg &lt; 1091.5: 1 in Xcg = 1.1 miles            As Xcg increases (more aft), XR decreases            1 nm XR = 5780 lbs EI weight            1 nm XR = 4.38 nm D/O altitude            As altitude and weight increase, XR increases            As inclination increases, XR increases (non-linear)            As temp increases, XR increases (non-linear)</p> <p><u>Touchdown speeds</u>            185 kts if TD weight &lt; 200 k lbs            195 kts if 200 K lbs &lt; TD weight &lt; 220 k lbs            205 kts if TD weight &gt; 220 k lbs</p> <p style="border: 1px dashed black; padding: 2px;">10 kts slower if short field speedbrake guidance mode is used if 200 k lb &lt; TD weight &lt; 245 k lbs</p> <p>Derotation 185 KGS with beep trim            175 with RHC (manual) derotation</p> <p><u>Mass Moment</u>            MM = TD Weight * (1172.3 - Xcg)/12 for medium lake bed runways            If MM &gt; 1.47 M ft-lbs Concrete desire            If MM &gt; 1.54 M ft-lbs Concrete required            Note: If TD Xcg not known, use            Xcg @ M = 3.5 + 1.5 in</p> <p><u>Landing Weight Limits</u>            EOM 233 k lbs            RTLS 242 - 248 k lbs *            TAL 241 - 248 k lbs *            AOA 233 - 240 k lbs *            (Abort limits a function of Inclination)</p> <p><u>Noctilucent Clouds</u>            If Inc &gt; 50, do not enter on descending opportunity            June through August.</p> <p><b>RENDEZVOUS</b></p> <p>1 deg of phasing/hour = 10 nm of <math>\Delta</math> height            1 deg of phasing = 60 nm            17.5 ft/s burn changes other side of orbit 10 nm            440 ft/s burn will change plane by 1 deg of wedge            1 deg of <math>\Delta</math>RAAN occurs for each relative lap</p>	<p>1 deg of plane change = 440 ft/s</p> <p><u>OMS philosophy</u>            1 ft/s = 21.8 lbs OMS @ 220 k lbs - 1/6%            1.78 ft/s = 1 nm</p> <p><u>Maximum OMS load</u>            OV102 = 25156 lbs            OV103/4 = 25064 lbs            Min = 10800 lbs            Max OMS ballast = 4000 lbs            1% OMS = 130 lbs/side</p> <p><u>Hard Ballast</u>            OV102 - can be installed in the aft compartment            OV103/104 - Bay 13</p> <p><u>RCS philosophy</u>            1 ft/s = 25 lbs (+ X) or 35 - 40 lbs (multi axis) @ 220 k lbs            Max burn = 250 sec = 55 fps            Full FRCS = 2446 lbs            ET blowdown offload = 2225 lbs            Min FRCS - 1862 lbs            Full ARCS = 4970 lbs (over 100%)            1% ARCS = 22 lbs/side</p> <p><u>INTERCONNECT logic</u>            If OMS &lt; 14,000 lbs, V/C off            If OMS &gt; 17,000 lbs, V/C on            If 14 k &lt; OMS &lt; 17 k, analysis req.</p> <p><b>ECS - N2</b></p> <p><u>OV102</u>            6.28 lbs/day for 4 person crew @ 14.7 psi            add .114 lbs/day for additional crewmember            4.35 lbs/day for 4 person crew @ 10.2 psi            add .079 lbs/day for additional crewmember</p> <p><u>OV103/4</u>            5.28 lbs/day for 4 person crew @ 14.7 psi            add .114 lbs/day for additional crewmember            3.66 lbs/day for 4 person crew @ 10.2 psi            add .079 lbs/day for additional crewmember</p> <table border="0"> <thead> <tr> <th></th> <th><u>Dry wt</u></th> <th><u>Fully loaded wt</u></th> </tr> </thead> <tbody> <tr> <td>N2</td> <td>83 lbm</td> <td>143 lbm</td> </tr> </tbody> </table> <p><b>EPS</b></p> <p>.09 lbm Hydrogen = 1 kwh            .7 lbm Oxygen = 1 kwh            .07 lbm Oxygen/hour = cabin leak rate</p> <table border="0"> <thead> <tr> <th></th> <th><u>Dry wt</u></th> <th><u>Fully loaded wt</u></th> </tr> </thead> <tbody> <tr> <td>H2</td> <td>227 lbm</td> <td>319 lbm</td> </tr> <tr> <td>O2</td> <td>215 lbm</td> <td>996 lbm</td> </tr> </tbody> </table>		<u>Dry wt</u>	<u>Fully loaded wt</u>	N2	83 lbm	143 lbm		<u>Dry wt</u>	<u>Fully loaded wt</u>	H2	227 lbm	319 lbm	O2	215 lbm	996 lbm
	<u>Dry wt</u>	<u>Fully loaded wt</u>															
N2	83 lbm	143 lbm															
	<u>Dry wt</u>	<u>Fully loaded wt</u>															
H2	227 lbm	319 lbm															
O2	215 lbm	996 lbm															

\* Orbiter Engineering Memo VE3-90-096.

945.cnv

## APPENDIX E OI UPDATES

### CONTENTS

OI-28 SUMMARY .....	E-1
Change Requests .....	E-1
Other CRs Included in the Baseline ....	E-4
Discrepance Reports (DRs) Fixed On OI-28.....	E-5
OI-27 SUMMARY .....	E-5
GPS Updates .....	E-5
Miscellaneous Change Requests (CRs) Not Associated With GPS .....	E-5
Significant DRs Fixed On OI-27 .....	E-6
OI-26A SUMMARY.....	E-7
Ascent Performance Enhancement CRs.....	E-7
Significant GN&C CRs.....	E-11
Other Significant CRs.....	E-15

### OI-28 SUMMARY

Unlike OI-27 FSW, the OI-28 FSW is not dedicated to one specific upgrade or new capability. OI-28 adds many new capabilities as well as corrections to existing capabilities. Some of the new capabilities include: ECAL automation, single engine RTLS rolloff elimination, variable intact abort throttle limits, and GPS corrections and automatic reboost. In addition, many other CRs and DRs were included to clean up the FSW. A brief summary of the CRs that might be of interest to the flight crew is listed below.

### Change Requests

#### CR 90704F: DAP Hot Stick Downmode (PASS Only)

Generates an SM alert light, tone, and CRT message if the RHC is moved out of detent while the DAP is in AUTO in MM103-106, OPS 2, 8 and 3.

#### CR 90724D: ECAL Automation (PASS Only)

This modifies the RTLS TAEM guidance to use entry ECAL pitch and roll logic during an ECAL or Bermuda abort. It also modifies displays and controls to allow crew to enable/disable ECAL logic and display ECAL logic status on VERT SIT 1. The main benefit of this CR is that it

allows the CDR/PLT to work other "cockpit fires" while monitoring the ECAL entry. It also eliminates (except for pull-up after ET SEP) the possibility of crew error or lag behind guidance due to distractions associated with working the major emergencies that initiated the ECAL scenario.

#### CR 90914C: Delay MOV MPS Dump/FRCS Dump @ MM602 (PASS/BFS)

Part of the forward c.g. expansion package. Beginning with OI-23, GRTLS forward c.g. relief was obtained by delaying the LO2 8-inch fill/drain dump from q-bar 20 to q-bar 20 + an I-loaded timer and by utilizing a forward RCS dump. Additional c.g. relief can be obtained by delaying initiation of the LO2 dump through the MOVs from MM 602 + an I-loaded timer. These changes provide flexibility to adjust the MPS LO2 and FRCS propellant dump initiation times with respect to MM 602. This will expand the payload manifesting capability and help manage the vehicle weight and Xcg position during RTLS entry.

#### CR 91050C: Improved Fault Tolerance for Beep Trim (PASS ONLY):

The beep trim switch is a two-contact switch that is processed per the normal RM scheme. Prior to this CR, a single switch contact failed "OFF" would have disabled the function of the beep trim switch. This CR modifies the beep trim processing after WOW to output a negative pitch trim derotation rate command if either beep trim contact is set when EAS is less than or equal to an I-loaded value. This effectively makes the beep trim switch two-fault tolerant.

#### CR91062D: Multiple TDRS State Vector Capability (PASS/BFS)

This modifies the current 2 TDRS satellite system in both SM and BFS to be able to use either 3 BFS or 4 SM TDRS state vectors for antenna management. It also modifies uplink to allow single TDRS SV to be uplinked in each command load. PASS SM will have four state vector slots that can be selected to either an A or B target for display and priority usage. PASS SM SV management will be crew controllable via the OPS 2 SPEC and ground controllable via

both real-time U/L and time execute commands.

**CR92100B: BFS Communications  
Reconfiguration Capability (BFS Only)**

This change adds the capability for a crew-member to perform S-band PM communications system reconfiguration via item entry on the BFS Override display. This is needed because the Bermuda S-band station is being phased out and requires a mode handover to TDRSS at 6:00 minutes MET. This change will restore the single fault fail OPS capability to the S-band PM communications system.

**CR 92175D: Uplinking Second-Stage I-loads  
(PASS/BFS)**

Uplinking the RTLS and TAL dump timers allows for c.g. adjustments without offloading payload, and uplinking mass and trim I-loads allows for manifest changes late in the flow.

**CR 92186A: Single-Engine RTLS Rolloff  
Elimination (PASS/BFS)**

This adjusts the vehicle roll during RTLS flyback to improve single-engine roll control. It limits change in the vehicle yaw command for engine out (EO) during RTLS flyback. Essentially, it eliminates the Red Region Rolloff for RTLS.

**CR 92187F: Automatic Reboost (PASS Only)**

This adds the capability to automatically perform translation firings for reboost of a directly mated payload while monitoring rate and attitude errors. The reboost firings are interrupted when the DAP has a requirement for a rate or attitude correction and they are resumed when the DAP's rotational requirements are satisfied. The reboost firings can be defined for selection of jets, firing times, and frequency to meet the load constraints imposed by the payload and propellant distribution constraints.

**CR 92188B: Modification of OMS/TVC  
No-Back Software (PASS/BFS)**

This modifies the No-Back Fail logic to ensure that the OMS actuators are not erroneously powered should the active actuator feedback

fail or experience a bias during powered flight. The active and standby position measurements are compensated and compared with a threshold to determine if an actuator should be powered. Currently the logic may erroneously power an actuator if the active actuator feedback measurement fails.

**CR 92194A: RMS Direct Drive Bite Masking  
Correction (PASS Only)**

During normal operations, the circuitry will detect a false direct drive failure on all undriven joints. The direct drive BITE is designed to detect failures of the direct drive circuit. There is a mask to prevent annunciation of the false alarm, however, the mask is incorrectly applied to all joints. This change will correct the direct drive BITE annunciation logic to mask annunciation on all but the driven joint.

**CR 92198A: SERC OMS/RCS Interconnect  
Delay (PASS Only)**

This inserts a delay into the SERC processing in the Abort Control sequence to delay the configuration of the OMS/RCS interconnect. By delaying this configuration, the orbiter will have access to the RCS jets for single-engine roll control maneuvers at the front end of two-engine-out scenarios.

**CR 92208C: GPS Issues for Correction on  
OI-28 (PASS Only)**

This CR fixes six requirements issues remaining from the PASS OI-26B single-string GPS and OI-27 three-string GPS implementation. It includes:

DR 109124	GPS Dilemma Display Problem
DR 109120	GPS QA2 Tolerance Reset
DR 109123	T_GPS_LAST_UPDATE Initialized Early
DR 109121	GPS Downlist Comps Integer Overflow
DR 110439	Self Test PASS/FAIL Status on Spec 55
DR 109122	SATS_TRACKED Values Stale in Init/Test Modes

In addition, this CR corrects misleading GAX messages for GPS QA failures and removes

restrictions on QA2 limits that are best handled via I-loads. This CR eliminates six user notes that would otherwise become permanent for this OI release and subs. The GPS processing and displays of GPS status data is more consistent, improving the ability of crew and ground personnel to monitor and understand GPS performance.

**CR 92209D: Runway and Navaid Location Data Uplink Capability in OPS 1/6/3 (PASS/BFS)**

Adds the capability to uplink runway and TACAN location data in OPS 1/6 and MSBLS data in OPS 1/6/3. Currently, if runway or TACAN location data change after the I-load change window, new data must be uplinked in OPS 3. The PASS and BFS software does not accommodate uplink of runway or TACAN location data in OPS 1/6 or MSBLS location data in OPS 1/6/3. This new capability will expand intact abort landing capability.

**CR 92210: Allow for Vent Door Single-Motor Operations (PASS Only)**

Changes the vent door 8/9 position status check time from 5 seconds to 6.4 seconds, preventing a launch scrub for a single-motor failure during the RSLs checks. This hard-coded value controls the amount of time that is allowed between the issue of vent door operation commands and checking the vent door position that is used to build the status word. This would assist the vent door system in meeting the RSLs requirements if a vent door motor failed during launch countdown.

**CR 92228B: Addition of SRB Sep Cues to the Downlist (PASS Only)**

During STS-71, Range Safety personnel received a false indication of early SRB sep. Investigation revealed that they were using the SRB Sep Sequencer discrete that indicates Sep commanded, not actual physical sep. This CR would add four discrettes to downlist, which indicate power loss at several connectors during SRB sep. This is in response to a Range Safety Panel action. However, several breakup cues are used: visual via TV or airborne/ground observers (PRIME CUE), tracking via SRB C-band beacon tracking system, and the

downlisted SRB sep indication. BREAKUP MUST BE CONFIRMED for action to be taken - telemetry alone is NOT sufficient.

**CR 92232B: Variable Intact Abort Throttle Limits (PASS/BFS)**

With this change, use of higher I-loaded SSME intact abort throttle limits can be used for TAL and ATO (106 percent), while limiting the throttle limit at a lower I-loaded maximum for intact RTLs and late uphill aborts (104.5 percent). The benefit of this CR is expansion of TAL/ATO windows, while limiting unnecessary engine stress for RTLs. Also, in the event of systems and/or contingency aborts, crew flexibility is maintained by placing nominal and abort maximum throttle limit selection item entries on the PASS and BFS Override displays.

**CR 92235B: Fix AOA Propellant Wasting Calculation (BFS Only)**

For an AOA declared in MM 105 (PASS) or declared in MM 104(BFS), the OMS propellant wasting calculation for the OMS-2 burn (deorbit burn) is too large by the amount of the OMS assist burn. If the burn were performed without crew update of the prop wasting value (via Item 18), the burn would cut off early because all the usable OMS propellant would be consumed, precluding successful de-orbit. This CR adjusts the MM 104 guidance mass for pre-MECO OMS dumps (OMS assist burn).

**CR 92252: Switchable NNY Filter (PASS/BFS)**

By converting non-switchable NNY (yaw axis) bending filter in ascent DAP to a bilevel switchable filter (based on Vrel), one can reduce commit-to-flight (CTF) payload screening effort for SLWT missions in the high q-bar flight regime. This regime is very restrictive (15 K payload only) for the yaw axis "payload flex envelopes" developed for the SLWT configuration.

**CR 92259A: Z Translation Mode Change Reinitialization (PASS Only)**

This causes the translational pulse module to be reinitialized for a change in the Z translation mode. The current mode of operation can result



in a much larger Z translation impulse than what was commanded or intended. This CR will eliminate that erroneous command.

**CR 92260B: Six Jet VFAIL(PASS Only)**

This allows for automatic VRCS downmode to RCS whenever any of the six vernier jets fail, rather than just for the four down-firing jets.

**Other CRs Included in the Baseline**

CR92152: BFS HAL/S Compiler Baseline Upgrade to REL 11V1 (BFS Only)

CR92157: IDD Clarification to Remove Blanks from FSSR Names (PASS Only)

CR92177A: Eliminate Erroneous CMD Path FAIL Annunciation (DR 109686) (BFS Only)

CR92189B: Deletion of MM SSME Controller Load Capability (PASS Only)

CR 92193A: RMS Tachometer Failure Override Calculation Update (PASS Only)

CR 92201C: Uplink V\_MSSN\_CNTN I-load (PASS/BFS)

CR 92207B: Correction to BFS Throttle CHG Logic (BFS Only)

CR 92221C: PSP Port Mode Processing Changes (PASS ONLY)

CR 92222C: RMS Software Updates for Full Fleet SPA (PASS Only)

CR 92230: Display FSSR Documentation Cleanup (PASS/BFS)

CR 92231: Fix BFS Scaling of SIG-V-COV-OUT (DR 109701) (BFS Only)

CR 92234: Calibration of MPS Helium Bottle Pressure Transducers (BFS Only)

CR 92237: IDD Documentation cleanup of Uplink Data (PASS Only)

CR 92238B: FSW CR 91062D – Multi TDRS Cleanup (PASS/BFS)

CR 92239A: OI-28 BFS Flight Control PRD Cleanup (BFS Only)

CR 92240: OI-28 BSS PRD Cleanup (BFS Only)

CR 92245A: OI-28 BFS GN&C HIP PRD Cleanup (BFS Only)

CR 92251A: Correction for CR 92188 – OMS TVC No Back Failure Logic (PASS Only)

CR 92253: Rescind Implementation of CR 92206B in OI-28 (PASS/BFS)

CR 92256B: MPS Dump Sequence Doc Changes (PASS/BFS)

CR 92258A: BFS OI-28 Documentation Cleanup for Sequencing PRD (BFS Only)

CR 92261C: Add PPS Erase Key MSID's to Three String GPS Downlist (PASS Only)

CR 92263A: Correct Inconsistent Dolilu and BFS Oneshot Contiguous Memory (PASS/BFS)

CR 92264B: Correction CR for CR 90724D – OPS 6 Entry ECAL Automation (PASS Only)

CR 92267: Add Illegal Entry Requirements for HSD Items 10-15 (BFS Only)

CR 92268B: O2 Quantity Computation Deletion (PASS ONLY)

CR 92270A: Freon Coolant Loop Bypass Noise Filter Eval Change(DR 109136) (PASS ONLY)

CR 92271A: Downlist Cleanup of CR's 91062D & 92238B (PASS ONLY)

CR 92272: Step Up to the OI-28 DFG(PASS ONLY)

CR 92273: Delete Downlist Requirement for DECP (PASS Only)

CR 92275C: Preclude BFS Nav Nuisance Alarms (DR109712) (BFS Only)

CR 92278A: Automatic Reboost Cleanup (PASS Only)

CR 92284A: Add Explicit Rejection of MM SSME Controller Load Requests (PASS Only)

CR 92286B: KU-Band RF Protection Boxes added to an Antenna Management (PASS Only)

CR 92287B: New Categories for OPS1 & OPS3 Drag Constants (PASS/BFS)

CR 92291: Downlist Time Consistency for RA Altitude & Nav Comp Altitude (PASS Only)

CR 92292B: GPS Related Category Modifications for OI-28 (PASS/BFS)

CR 92293: OMS-TVC No Back Failure Logic Enhancements (BFS Only)

CR 92295D: PSP Port Mode Reject Added to Spec 62 (PASS Only)

CR 92300: Downlist Corrections to CR 92261C (PASS Only)

CR 92303 : Automatic Reboost Cleanup II (PASS Only)

CR 92305: Correction for Nz Limiting of Roll Command for CR 90724D (PASS Only)

### Discrepancy Reports (DRs) Fixed On OI-28

DR 108073A: Incorrect S/W Clock Initialization

DR 108694A: Pitch Paralleling After MECO in 3EO case

DR 108852E: Transient Spike in Horiz Sit Indicator Heading

DR 109179: Disable Block in GLJRCV Violates SAM 2 Timing Exceptions

DR 109182: DT\_GPS\_OFF\_MIN not Assigned Homogeneously

DR 109183: Speedbrake Deflection Command not Updated on Transition to AUTO

DR 109189: Violation of BFS ICD MTU Listen (WIX 12) Timing Requirement

DR 109200: Fix Underscores on Item \* of UNIV Ptg Display - AIDS

DR 109700B: Scratch Pad Line Not Cleared When BFS Takes CRT

DR 109706: MEDS HSI Course Pointer Fluctuates 90 Degrees During Approach/Landing

DR 110263: TCS Error Response Incorrect for Operator 5 (GMEM READ) I/O

DR 110277A: LDB "Duplicate Transaction ID" Indicator Incorrectly Set

DR 110284C: FC Channel Failure Caused By Incorrect Speedbrake Command Init.

DR 110382A: Possible Pitch Paralleling in 3EO Case

DR 110456: SPEC 2011 Item Entry Disables Antenna Handover Capability

DR 110500A: Bogus Bits Brought into Buffer

### OI-27 SUMMARY

#### GPS Updates

OI-27 increases the capability of the flight software to incorporate a three-string global positioning system (GPS) into the PASS and BFS when the TACANs are removed. However, until triple-string hardware is installed on all vehicles (over approximately 2 years), a mixed fleet operation of either single-string GPS (with TACANs) or triple-string GPS will continue. The driver behind mixed fleet operations is the orbiter maintenance down period (OMDP) schedule. The OI-27 FSW will support both single- and triple-string GPS operations. Removal of excess code from the general purpose computer (GPC) software, as a result of mixed fleet GPS/TACAN operations, is targeted for OI-29. STS-96 will be the first OI-27 flight, which will be a single-string GPS flight. STS-92 is the first three-string GPS flight.

#### Miscellaneous Change Requests (CRs) Not Associated With GPS

In addition to the changes associated with GPS, OI-27 includes several SM-related CRs. Significant, non-GPS related changes are summarized below.

#### CR 92088B: Add Uplink Reset of PSP to SM GPC Capability

Implements the capability for MCC to perform PSP I/O resets via ground command. This eliminates the last communications related

activity that, until now, has been controllable only by the crew (via SPEC 62).

**CR 92154A: Control of Ku-Band EVA Protect Mode via TEC**

CR90850C added a Ku-band EVA protect capability, which allowed the ground to define a protection "box" for Ku-band operations during EVA. If the Ku-band antenna points into this box, the flight software turns off the Ku's traveling wave tube, preventing the antenna from radiating within the box. CR92154A allows for ground enabling or disabling of the Ku-band protection mode via a time executed command (TEC).

**CR 92169C: Automation of Communications Forward Link Management**

This CR allows the SM GPC to automatically select Ku-band for the uplink source to the NSP. The SM GPC will automatically switch back to S-band if the Ku-band is configured to Standby or Radar mode, or if the Ku-band DATA GOOD flag is invalid for more than 5 seconds. The intent is to use the Ku-system whenever possible because of its superior forward link margin over the S-band system (improved directionality and signal-to-noise ratio).

**CR 92184A: Freon Radiator Isolation Valve Automation**

This change automates control of the Freon radiator isolation valves in the event of a puncture of the Freon cooling loop located within the payload bay doors while on orbit. If Freon accumulator quantity drops below 12 percent for 5 seconds, the SM GPC will issue commands via the payload MDM to close the isolation valves. Resetting the isolation valves back to the "flow" position is via manual switch only. In the event of a false accumulator low annunciation and subsequent manual reset, the SM GPC will resume its monitor/auto-command function when the auto/manual switch is returned to auto. A reconfigurable I-load is used to disable the auto-isolation feature for vehicles that do not have the isolation valve hardware installed.

**Significant DRs Fixed On OI-27**

The following DRs will be source-fixed for STS-98 and subsequent flights. These discrepancies were discovered too late in the OI-27 development flow to allow for a source fix for the first two OI-27 flights (STS-92 and 97), and it was determined that the risks associated with a software patch were not warranted.

**DR 108075: Item Entries Rejected on the OPS Mode Page**

If a new SPEC is requested within approximately 1 second after a major mode transition is initiated, item entries and the single EXEC key on the OPS page will be rejected with "ILLEGAL ENTRY" for the duration of the major mode. A transition, when possible, to another major mode (forward or backward) will clear the item entry lockout. If the problem occurs during a MM102-to-MM103 transition, the crew will not be able to select a contingency abort should one be required. If the problem occurs during the MM103-to-MM104 transition and if OMS 1 is required, OMS 1 retargeting will be necessary because of the loss of the single EXEC key. The crew will have to mode to MM105 for the OMS 1 targeting/burn.

**DR 110610 (PASS): OMS Assist Impact to AOA Prop Wasting Calculation**

If an OMS assist burn is executed pre-MECO during a nominal ascent (no ATO) and an AOA is selected in MM105, the guidance estimate of the remaining OMS propellant for the deorbit burn targeting will be too high by the amount of propellant burned in the OMS assist. This could result in excessive out-of-plane OMS propellant wasting (ITEM 18 too large) and premature deorbit burn termination. The crew must verify proper ITEM 18 value when checking targets for a MM105 AOA.

**DR 110609 (BFS): OMS Assist Impact to AOA Propellant Wasting Calculation**

If an orbital maneuvering system (OMS) assist burn is executed pre-MECO and an abort to orbit (ATO) or AOA is required, but not executed until MM104, the guidance estimate of the remaining OMS propellant will be too high by the amount of propellant burned in the OMS

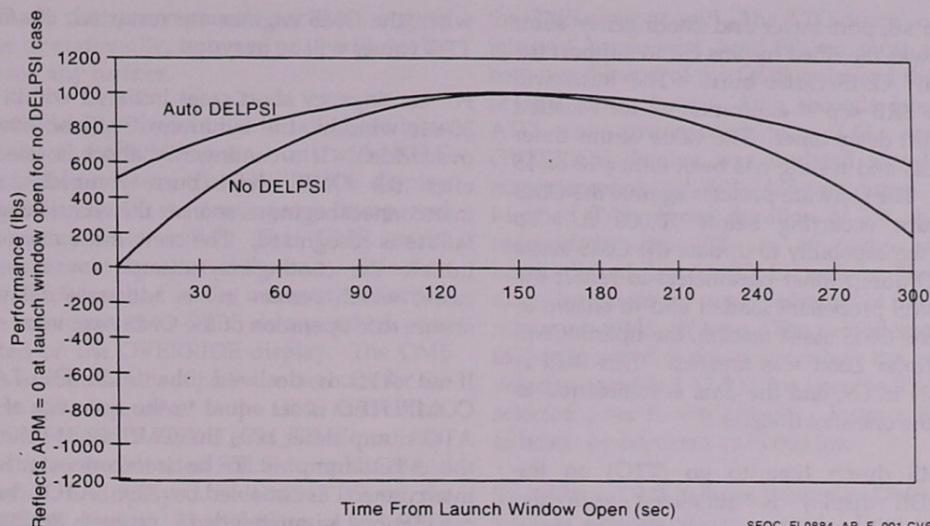

Yaw Steering Performance

assist. This could cause excessive out-of-plane OMS propellant wasting (ITEM 18 too large) and premature burn termination. Note that this DR is the same as DR 110610 for PASS, except that with BFS this condition begins with the transition to MM104 (vice MM105 for PASS).

## OI-26A SUMMARY

### Ascent Performance Enhancement CRs

#### CR 90958: Onboard Delta Psi Computation (PASS/BFS)

Also referred to as automated first-stage yaw steering, this CR allows delta psi to be calculated onboard, based on the Greenwich mean time (GMT) of lift-off for rendezvous missions not launched in-plane, thus minimizing performance loss. Delta psi defines the amount of first-stage yaw steering to be performed. Prior to OI-26, it was a fixed value that was uplinked as part of the launch targeting load. While the purpose of this CR is a performance gain, it can be used to expand the launch window. It has been stated that for a 51.6° inclination mission with a 5-minute launch window, this CR would either gain 500 lb of performance or expand the launch window to 7.5 min. The figure on the next page demonstrates that although the ascent performance margin is increased by 500 lb at the opening and closing of the launch window, the

best performance is actually achieved in the window. The Apollo program incorporated an onboard delta psi computation, but the Space Shuttle Program did not because there were no plans for high inclination rendezvous missions. With this CR, the launch azimuth will be computed onboard just prior to solid rocket booster (SRB) ignition if the I-load Earth-Fixed Plane Constraint Switch is set to OFF. The I-loads DELTA\_PSI\_LIM and DELTA\_PSI\_FAC are used to limit and then scale the delta psi value computed onboard. For PE certification, the I-load values chosen for DELTA\_PSI\_LIM and DELTA\_PSI\_FAC limited the onboard delta psi to within  $\pm 4.6^\circ$ . Also, second-stage guidance was changed with CR 90958. If the launch time is greater than the value of T\_GMTLO\_PHASE, which is uplinked as part of the launch targeting load, a node adjustment is automatically made to the orbit plane to account for switching to the second planar window.

#### CR 91014: OMS Assist Performance Enhancement Burn (PASS/BFS)

By loading excess OMS above orbital requirements, and burning the excess in major mode (MM)103 post-SRB sep, between 350 and 600 lb of performance is gained for 4000 lb of excess OMS. The OMS assist burns are reserved for performance-critical missions and require the I-load OMS\_ASSIST to be set to ON. The Abort Control Sequencer, which was designed

solely to support intact and contingency abort dumps, was modified by this CR to support the "nominal" OMS assist burn. The burn will begin at SRB sep + expiration of an I-loaded OMS assist delay timer. The value of this timer in analysis and testing has been either 10 or 15 seconds. The software protects against the OMS assist burn occurring below 70,000 ft. To provide the capability to update the OMS assist and ATO dump timer parameters to reflect the actual OMS propellant loaded and to enable or disable the OMS assist feature, the uplink OMS Dump Timer Load was created. This load is valid only in G9, and the data is transferred to BFS via the one-shot transfer.

The OMS dump time to go (TTG) on the OVERRIDE display is initialized with the contingency dump timer. Upon initiation of the OMS assist burn, the OMS dump TTG will reflect the OMS assist burn timer and the interconnect will indicate INH (the OMS assist burn will always be non-interconnected). To ensure that the interconnect is maintained if single engine roll control (SERC) is enabled, a test is made for SERC prior to initiation of the OMS assist burn. This is to protect in case two engines are out in MM102 and in the 15 seconds that it is estimated it would take the crew to arm and start the 2 EO on the TRAJ display, an OMS assist burn is initiated, terminating the interconnect needed to support SERC.

For an OMS assist burn downmode to an abort, the burn will continue until the dump timers have expired. If return to launch site (RTLS) or transoceanic abort landing (TAL) are selected during the OMS assist burn, the burn will continue until the dump timers have expired. If the RTLS or TAL are selected immediately after completion of the OMS assist burn, the RTLS or TAL dump and interconnect (if selected) are delayed until expiration of the required minimum OMS off-time (30 sec). The minimum engine off-time between firings is 240 sec for normal operation. However, the engine can be restarted after 30 sec, if required, for crew safety. This incurs some risks if the first burn was less than 15 sec. When the abort selection is made within this 30-sec window, PASS and BFS will show different values for the OMS TTG because PASS calculates the abort value for display, while the BFS does not. However,

when the OMS engines are restarted, the OMS TTG values will be in sync.

For contingency abort cases initiated within the 30-sec window, the minimum OMS off-time is overridden. If a contingency abort is selected after the OMS assist burn completes, the interconnect begins as soon as the second engine failure is recognized. The crew must manually initiate the contingency dumps for two EO cases, which results in an adequate delay to ensure safe operation of the OMS engines.

If an ATO is declared, the OMS DELTA T COMPUTED is set equal to the quantity of the ATO dump timer plus the OMS assist timer; if the ATO dump is to be interconnected, the interconnect is enabled. The ATO dump calculation is intended to protect against a violation of the Shuttle Operational Data Book (SODB) constraint, which restricts the orbiter main engines (OMEs) from firing for less than 2 seconds. Engine firings of less than 2 sec are prohibited. If an engine shuts off less than 2 sec after starting, it must not be restarted for at least 30 min.

How the dump timers are affected by the OMS assist is best illustrated by the following three LM test cases. All of the PEs were enabled in these test cases; therefore, to understand each test case summary, a review of the appropriate PE CR may be required.

In all cases, the OMS dump parameters on the OVERRIDE display were initialized with the contingency dump values, and were updated with the OMS assist values upon initiation of the burn. LM test case no. 1 was a nominal ascent with first-stage trim, pitch steering during SRB tailoff, and the extended space shuttle main engine (SSME) parallel pitch phase active. The roll to heads up occurred when Vrel exceeded 12,500 fps. Pitch gimbal relief was not activated because SSME no. 1 was not failed. Second stage throttle-up to 106% occurred on the first pass of second-stage guidance because manual throttling was not active and there were no SSME failures. LM test case no. 2 was identical to test case no. 1, except that the right OMS engine was failed approximately halfway through the OMS assist burn. Because the failure of the OMS engine had very little affect other than a loss of thrust, and the decision has

been made not to compensate for OMS engine failures operationally, test case no. 2 will not be discussed any further.

LM test case no. 3 had an SSME fail 15 sec after the start of the OMS assist burn with RTLS selected 15 sec later. The OVERRIDE display was initialized with the contingency dump, and then updated to reflect the OMS assist configuration at the start of the burn. Selection of the RTLS resulted in the automatic selection of the interconnected RTLS dump, which was reflected on the OVERRIDE display. The OMS TTG is automatically adjusted to account for the amount already burned in the OMS assist burn. The OMS EQUIVALENT\_ON\_TIME is subtracted from the I-loaded RTLS dump timer and the result is displayed as OMS TTG on the OVERRIDE display. The OMS assist and RTLS dumps consumed a total of 21,081 lb of propellant. The second-stage throttle-up to 106% did occur on the first pass of second-stage guidance since the SSME failure had not yet occurred. However, SSME no. 1 was failed prior to ME\_RETRIM, which meant that the SSME pitch parallel phase was not extended to main engine cutoff (MECO). Because this was an RTLS, there was no second-stage roll to heads up nor was pitch gimbal relief activated.

In LM test case no. 4, SSME no. 2 was failed 15 sec prior to completion of the OMS assist, with ATO selected 5 sec following completion of the burn, and a downmode to TAL 5 sec later. The OMS assist burn was initiated at SRB sep +10 sec, and was not affected by the failure of SSME no. 2. Five seconds after completion of the burn, ATO was selected, and the dump was changed to a non-interconnected/45%/200-sec dump. The onboard calculated 200-sec dump duration represents 30% of the OMS loading, but 15% was already dumped through the OMS assist, so the targeted total dump percentage is 45%. ATO dumps are treated differently from other abort dumps in that in an RTLS or TAL, the total amount to be dumped is known prelaunch and the I-loaded dump timers are preset with the total targeted dump time. The amount to be dumped during ATO is computed onboard and is a tradeoff between ascent performance and conserving OMS propellant for orbit operations. For all aborts, the total targeted dump times represent a dump of some portion of the "operational" OMS load plus a dump of all of

the OMS assist (if any). The ATO dump was not initiated because at least 30 sec must elapse between the end of the OMS assist and the start of any other dump. Five seconds later, the ATO was downmoded to a TAL, and the OVERRIDE display was updated to reflect a non-interconnected/80%/435-sec dump. The I-loaded TAL dump duration of 537 sec was reduced by the 102 sec of dump already accomplished by the OMS assist. The TAL dump was delayed until expiration of the 30-sec minimum OMS off time. The second-stage roll to heads up did not occur when the relative velocity exceeded 12,500 fps because TAL was selected prior to this velocity. Instead, the roll to heads up occurred at 14,000 fps.

To address OMS failures during an OMS assist, various options were assessed. Doubling the burn time was disregarded as an option as that would result in a full dump coming out of one OMS pod, resulting in a large Ycg offset. A crossfeed was deemed impossible because the switches on the overhead panel are too difficult to reach, and a flight software change to automate this would be very complex. The consensus was to do nothing. The AFSIG concurred with this recommendation, based on the rationale that although an OMS engine failure could result in a technical violation of the OMS tank landing constraints, downweight constraints, and/or the Ycg constraints, there was sufficient conservatism in all of these constraints such that when combined with the low probability of an OMS engine failure, this was not a safety of flight issue.

Test case no. 1: Nominal ascent		
Event	MET	OVERRIDE Display
Lift-off	0:00:00	ICNCT = ENA QUAN/SIDE = 84 OMS DUMP TTG = 563
SRB sep	2:04:37	
MM103	2:04:45	
OMS dump ON (SRB sep +10 sec)	2:14:51	ICNCT = INH QUAN/SIDE = 15 OMS DUMP TTG = 100
OMS dump OFF	3:56:57	ICNCT = INH QUAN/SIDE = 15 OMS DUMP TTG = 0
Roll to heads up	5:51:00	
3g throttling	7:15:48	
MECO	8:19:58	
ET sep	8:38:97	

<p><b>Test case no. 3:</b> Intact RTLS with SSME no. 1 failed 15 sec after the start of OMS assist. RTLS was selected 15 sec later</p>
--

**Test case no. 3:** Intact RTLS with SSME no. 1 failed 15 sec after the start of OMS assist. RTLS was selected 15 sec later

Event	MET	OVERRIDE Display
Lift-off	0:00:00	ICNCT = ENA QUAN/SIDE = 84 OMS DUMP TTG = 563
SRB sep	2:04:37	
MM103	2:04:45	
OMS dump ON (SRB sep +10 sec)	2:14:51	ICNCT = INH QUAN/SIDE = 15 OMS DUMP TTG = 100
SSME no. 1 failed	2:29:49	
RTLS selected	2:44:48	
OMS/RCS interconnected	2:44:78	
MM601	2:44:78	ICNCT = ENA QUAN/SIDE = 86 OMS DUMP TTG = 540
Start flyback	4:40:15	
PPA complete	4:53:41	
OMS/RCS RTN	6:04:91	
OMS dump OFF	6:05:05	ICNCT = INH QUAN/SIDE = 86 OMS DUMP TTG = 0
PPD	10:43:47	
MECO	11:02:18	
ET sep	11:16:09	

**CR 91015: Pitch Steering During SRB Tailoff (PASS/BFS)**

In the software, the first-stage pitch command is computed in the boost guidance task from an I-loaded attitude table that specifies the pitch, roll, and yaw for a given Vrel. Linear interpolation is performed between each point in the table to smooth the attitude commands over the trajectory. Because the commanded pitch rate follows the slope of the pitch attitude vs. Vrel profile, the pitch rate command will trend toward zero in the SRB tailoff region. This results in the vehicle essentially being at an attitude hold for several seconds prior to the software commanding an attitude hold at SRB sep. Second-stage guidance then has to compensate for the "extended" attitude hold.

This CR snapshots the current pitch steering angle at a mission elapsed time (MET) of 100 sec, then propagates the pitch profile at a constant pitch rate of 0.44°/s (0.5°/s for an EO prior to 100 sec) until SRB sep is approached. In other words, when MET ≥ 100 seconds, the pitch command is decreased at a constant rate so that the pitch rate command stays at a constant 0.44°/s for an I-loaded number of seconds (NYSEP\_DELAY) past the event

**Test case no. 4:** Fail SSME no. 2 15 sec before completion of OMS assist. Select ATO 5 sec after completion of OMS assist. Downmode to TAL 5 sec after ATO selection

Event	MET	OVERRIDE Display
Lift-off	0:00:00	ICNCT = INH QUAN/SIDE = 84 OMS DUMP TTG = 563
SRB sep	2:04:33	
MM103	2:04:42	
OMS dump ON (SRB sep +10 sec)	2:14:47	ICNCT = INH QUAN/SIDE = 15 OMS DUMP TTG = 102
SSME no. 2 failed	3:41:49	
OMS dump OFF	3:56:54	
ATO selected	4:01:45	ICNCT = INH QUAN/SIDE = 45 OMS DUMP TTG = 200
TAL selected	4:06:64	ICNCT = INH QUAN/SIDE = 80 OMS DUMP TTG = 435
OMS dump ON	4:26:51	
Roll to heads up	7:55:77	Vrel = 14,000 fps
OMS dump OFF	10:01:03	ICNCT = INH QUAN/SIDE = 80 OMS DUMP TTG = 101
MECO	10:10:07	
ET sep	10:29:49	

NYSEP\_DISABLE. The event NYSEP\_DISABLE is set by Ascent Flight Control and is the point at which the Ny feedback is faded out. Once MET becomes greater than NYSEP\_DISABLE plus the I-loaded delay (NYSEP\_DELAY), the software holds the pitch command constant, allowing the pitch rate command to gradually bleed off to zero. This provides approximately 50 lb of performance as well as a more benign transient at second-stage guidance initiation. In a nominal ascent performance test case, with the CR both enabled and disabled, the primary difference between the two cases was the angle of attack at SRB separation, which was approximately 3.5° more positive in the enabled case.

**CR 91016: Extend Pitch Parallel to MECO (PASS/BFS)**

Today, pitch parallel biases are added to the SSME commands, beginning at AUTOTRIM\_ENABLE (about 12 sec into second-stage) and removed at ME\_RETRIM (approximately 60 sec prior to MECO) to avoid thrust vector control (TVC) saturation. With this CR, instead of setting the biases to zero at ME\_RETRIM, a limiting function is applied to the pitch bias for SSME no. 1, enabling the parallel pitch bias to be gradually reduced in a linear fashion without sacrificing

adequate gibal authority. The bias plus the trim on the center engine is constrained by an I-loaded value, and the biases for the lower engines are constrained in a proportional manner to maintain moment balance. When limiting the sum of the bias plus the trim on the center engine to 7° in the test cases, the limit was encountered about 25 sec prior to MECO for a performance gain of approximately 140 lb. The biases are removed for any SSME or hydraulic failures.

**CR 91018: Ascent DAP Trim for Performance  
(PASS/BFS)**

This CR adds the capability to reduce the included angle between the SSME and SRB thrust vectors during first stage. The SSME thrust vector is moved by adding a pitch trim increment to the main engines; i.e., PBIAS\_E1 for the top and PBIAS\_E23 for the side SSMEs. To compensate for the resulting moment imbalance, an increment will be added to the SRB trim in the opposite direction. The trim will be faded out before SRB separation or immediately following an SSME or hydraulic failure.

**CR 91045: 106% Throttle in Second Stage  
(PASS/BFS)**

This CR allows first-stage and second-stage guidance to use two different nominal throttle settings for Space Station missions that are performance critical. At the time this CR was presented, the engineering community believed that the 106% throttle with the expendable SRB would add unacceptable loading in first stage. On the first pass of second-stage guidance, the throttle command will be set to the I-load K\_CMD\_STG2 if manual throttling is not engaged and an engine failure has not occurred. This provides the flexibility to recover approximately 1500 lb.

**CR 91056: LO2 Step Pressurization  
(PASS/BFS)**

This CR would reduce the LO2 tank pressure prior to MECO to provide more usable LO2 to the SSMEs for impulse propellant. Reducing the tank pressure requirement at MECO from 21 psia to 17.7 psia would provide an additional 320 lb of GO2 pressurant mass for the SSMEs, which would result in net performance gain of 292 lb. The lower ullage pressure is achieved by "stepping down" the GO2 flow control valves to the low flow

position in flight. This logic will be inhibited via I-load because the active GO2 flow control valves and related electrical power distribution and control (EPDC) modifications were canceled, per PRCBD S052333CE on May 31, 1996.

**Significant GN&C CRs**

**CR 90711: Auto Body Flap Performance  
Enhancement (PASS/BFS)**

This CR addresses three separate functions. The first two functions apply to both PASS and BFS. The third function is a contingency abort item and, as such, applies only to PASS. First, the pitch and body flap channels were modified so that the elevator and body flap become active at the same time. By standardizing aerosurface activation to occur at q-bar greater than or equal to 2 psf, body flap excursions that occur prior to elevator activation will be eliminated. Currently, the body flap becomes active in MM304, and attempts to trim with the elevator frozen. This does not affect OPS 6 because the MM602 transition for an intact abort occurs at q-bar greater than 2 psf.

Secondly, this CR modifies the body flap output hysteresis to have different negative and positive inner deadbands. The "smart body flap" elevator/body flap profile was modified to keep the aerosurfaces away from the SSME nozzle "bluing" region. However, this change introduced a potential for body flap limit cycling, which was observed on STS-48. The limit cycling occurs because there is too much lag in the feedback signal. The body flap passes its intended position before the drive commands cease being issued. The limit cycling is not a safety of flight issue and the hardware community does not have an issue with the extra body flap usage. However, the flight design community believes the limit cycling is a deficiency in the design and recommends eliminating it.

Thirdly, this CR automates the manual body flap procedures used during a contingency abort (PASS only). With the current body flap logic, the body flap is driven to keep the elevator on a predefined Mach schedule. This increases the likelihood of stalling or losing the aerosurface when the body flap actuators become overloaded because of high q-bar



pullouts in contingency abort situations. The saturation of the body flap actuators can result in a loss of control even though plenty of margin exists with the elevons. Engineering developed a manual body flap schedule for each flight, which balanced the aerodynamic forces between the body flap and elevon; the crew then trimmed the body flap using this schedule. However, due to funding cutbacks, the generation of these flight-unique schedules was eliminated. With this CR, the hinge moment between the elevator and the body flap is balanced by driving the body flap with the elevator. This will increase safety by properly balancing the actuator loads for all contingency aborts and will react to a real situation better than the limited cases that are analyzed preflight.

**CR 90974: Orbit Targeting Lambert Iteration Loop Exit Logic Correction (PASS Only)**

On flight day 6 of STS-49 (OI-21), 5 of 10 attempts to perform targeting resulted in a TGT ITER alarm, indicating failure to converge within the specified number of cycles. The failure to converge was isolated to the use of mixed precision parameters (double and single) in the Lambert targeting convergence algorithm. Contributing to this occurrence was a tighter value for the I-load EPS\_U, which is used in the convergence criteria. A mode team was convened, which determined that in addition to the mixed precision problem, an additional exit criterion was required in the Lambert task. This addition was to ensure that the Lambert iteration loop would be exited as soon as a value of U was found that was "close enough" to be considered the correct solution (reference DR 106633). The lack of this exit criterion was explained as the reason why the problem occurred repeatedly during the Ti maneuver on rendezvous no. 3 and why it was not observed at any other time. Apparently, the desired transfer orbit was nearly circular, which resulted in a U\_STEP size that was small, but not small enough to terminate iterating. CR 90701, Orbit Targeting Iteration Loop Correction, was then approved for OI-22 to correct the mixed precision problem and to exit the criterion to exit the Lambert task if  $U\_STEP < EPS\_U$ . Subsequently, a TGT ITER occurred during a Ti computation in an STS-51 (OI-22)

integrated sim (DR 106677). The problem was traced to an incomplete set of calculations when the Lambert routine was exited on the step size criterion, which was implemented in OI-22. The result is an inconsistent set of variables, which are then passed from the Lambert task to the precision velocity required task. Since the occurrence of this problem is highly sensitive to the initial conditions, and therefore rare, and the signature of the error is unique, a crew procedure was adopted as a workaround. The crew procedure depends upon the value of PRED MATCH. The step size criterion is now known through analysis and study to be unnecessary to meet shuttle program requirements, and is deleted in OI-26 with this CR.

**CR 90991: Continuous Issuing of Shutdown Enable/Shutdown Command (PASS/BFS)**

This CR modifies the SSME OPS to continue toggling the Shutdown Enable and Shutdown commands after receipt of the Shutdown Phase until verification of post-shutdown phase. This closes Unsatisfactory Condition Report (UCR) A031485, the only known open UCR to date, which documents an extremely low probability, catastrophic shutdown scenario that closes the prevalves on a running engine. This condition can only occur if multiple power interruptions take place within a 2 sec window, and the probability of a required failure scenario was determined to be 1 in 185,000,000 flights. However, because of the severity of the consequences and the simplicity of the software change, the decision was made to fix the condition. This CR will allow a sole surviving digital computer unit (DCU), which is recovering from a power interruption, to recognize that an engine shutdown sequence is in progress and proceed with the shutdown that the other halted DCU had begun.

**CR 90996: ADI and HUD Display Integrator Mods (PASS Only)**

Originally, this CR was planned for PASS and BFS implementation, but because of the resources required, it was only approved for PASS implementation. This CR adds logic to attitude direction indicator (ADI) processing to integrate the Nz (pitch) and roll errors while in control stick steering (CSS) during MM305 and MM603 terminal area energy management

(TAEM) guidance (not approach and landing (A&L) guidance). It also integrates the Nz (pitch) error while in CSS during the RTLS Nz hold phase (MM602, IPHASE=5). The pitch and roll errors are integrated for display on the ADI error needles and the head up display (HUD). The purpose of the integrator is to increase the "sensitivity" of the displayed error as a function of the accumulated error (i.e., the longer the error exists, the larger the displayed error).

The input to the integrators is grounded an I-loaded period of time whenever large guidance commands are expected as well as when CSS mode is entered, which avoids saturating the integrator. The pitch and roll error integrators are set to zero upon transition to MM 305 or MM 603, at guidance phase transitions, for runway redesignation, for OVHD/STRT IN HAC change, for main entry point/normal entry point (MEP/NEP) heading alignment cone (HAC) change, upon transition from AUTO to CSS, and upon transition to the glide return to launch site (GRTLS) Nz hold phase (no roll error integration during the GRTLS Nz hold phase). The I-loaded period of time is determined by the I-loads TIDELAY, TIDELAYC (AUTO to CSS), and TIDELAY5 (GRTLS IPHASE=5), all of which are set to 19 cycles. Because the ADI processing runs every 160 ms, 19 cycles correlates to a 3.04 sec delay.

If the pitch error is greater than the I-loaded pitch error deadband, the error is "gained up," otherwise it is "gained down" (likewise for roll errors). For the GRTLS Nz hold phase, the pitch error deadband PERR\_DB5 = 0.025 g, the pitch error gain up GP\_INTUP5 = 0.15, the pitch error gain down GP\_INTDN5 = 3.0, and the pitch error integration limit PINT\_LIM5 = 1.0 g. For MM305 and MM603 TAEM guidance, the pitch error deadband PERR\_DB = 0.2 g, the pitch error gain up GP\_INTUP = 0.15, the pitch error gain down GP\_INTDN = 1.5, and the pitch error integration limit PINT\_LIM = 1.0 g. Also for MM305 and MM603 TAEM guidance, the roll error deadband RERR\_DB = 10.0°, the roll error gain up GR\_INTUP = 0.15, the roll error gain down GR\_INTDN = 1.5, and the roll error integration limit RINT\_LIM = 20.0°.

All I-load values were determined from testing with various crewmembers in Shuttle Engineering Simulator (SES) and Ames Vertical Motion

Simulator (VMS) testing and were set via DCR 3660A.

#### CR 91003: Addition of $\pm X$ Jets for On-Orbit Rotational Control (PASS Only)

This CR adds the capability for the Alt primary reaction control system (PRCS) to use the  $\pm X$  jets for rotational pitch control if selected by the crew via the DAP CONFIG display. The DAP CONFIG display was modified, deleting the inertia item entries 7, 8, and 9, and adding a new item 7 (XJETS ROT ENA) to allow the crew to turn the  $\pm X$  jets on or off. The  $\pm X$  jets provide improved pitch control authority for those configurations in which the Z component of the center of gravity (c.g.) is significantly different from the orbiter only position due to the Z moment arm. Prior to this CR, the  $\pm X$  jet groups (groups 1, 7, and 8) were considered translation only groups, and not considered for attitude control firings. When Alt PRCS is active, the  $\pm X$  jets can be included to supplement the 11 rotational jet groups for a total of 14 jet groups. The jet options are:

- BOTH  $\Rightarrow$  14 jets (all 14 PRCS jet groups)
- LOW Z  $\Rightarrow$  11 jets (8 low +Z rotational PRCS jets and  $\pm X$  jets)
- TAIL  $\Rightarrow$  8 jets (6 tail only rotational PRCS jets and +X jets only)

LM executed four test cases using the minimum angle jet select algorithm with and without the  $\pm X$  jets and the maximum dot product jet select algorithm with and without the  $\pm X$  jets. Each test case consisted of a 50-minute inertia hold in an inertial attitude, which is perturbed by a gravity gradient torque in the pitch axis. The mass properties were similar to the expected 6A configuration and represented a very massive system (about 510,000 lb) with a high Zcg. The jet firing comparisons are as follows:

Case	Total Firings	Total Fwd Firings	Total Aft Firings	Total ±X Jet Firings	Prop Used (in lb)
Min. angle with ±X	71	38	33	66	17.7
Min. angle	96	45	51	0	23.9
Max. dot with ±X	70	24	46	44	17.4
Max. dot	124	58	66	0	30.8

**CR 91013: Convert Second Stage Trim K-loads to I-loads (PASS/BFS)**

This CR converts the second-stage trim table parameters from K-loads, which require a CR in order to be changed to I-loads, which are mission reconfigurable. This is to support mixed fleet usage of the lightweight tank (LWT) and SLWT. The second-stage trim table is used to provide c.g. tracking from SRB sep to software zero thrust. The mated coast deadbands as well as the nominal and TAL translation delta Vz parameters and the open loop drift time following external tank (ET) sep were also converted to I-loads with this CR. This was done in anticipation that these values may need to be changed in the future as a result of PEs and mission profile changes (i.e., roll to heads up and 52 n. mi. MECO). Converting the RTLS ET sep inhibits was also included in this CR for the purpose of "no-opting" the RTLS ET sep inhibits. Removal of the SRB and RTLS ET sep inhibits arose back in 1992 during the RTLS heavyweight certification process. The SRB sep inhibits were no-opted beginning with STS-73, per PRCBD S052891; however, since the RTLS ET sep inhibits were K-loads, the decision was made to wait until OI-26 to convert these K-loads to I-loads, and then to redefine the inhibit limits. Note that protection for the angle of attack remains. The table below summarizes the difference between the current RTLS inhibit limits and the values contained in DCR 3655 for OI-26.

**RTLS ET Sep Inhibit Limits**

Parameter	Current Inhibit Limits	Inhibit Limits in DCR 3655
RTLS pitch rate limits	-5.0°/s to +0.25°/s	-20.0°/s to +0.25°/s
RTLS roll rate limits	-5.0°/s to +5.0°/s	-20.0°/s to +20.0°/s
RTLS yaw rate limits	-0.5°/s to +0.5°/s	-20.0°/s to +20.0°/s
RTLS angle of attack limits	-89.0° to -2.0°	-89.0° to -1.5°
RTLS sideslip limits	-2.0° to +2.0°	-20.0° to +20.0°

**CR 91019: Guidance K-load to I-loads for Second Stage Roll to Heads Up (PASS/BFS)**

This CR converts the three guidance parameters PHI\_2STG, VRHO\_PHI, and TVR\_ROLL to I-loads. This will allow a roll to heads up in second-stage. PHI\_2STG is the desired second-stage roll angle, VRHO\_PHI controls the timing of the roll to heads up, and TVR\_ROLL is the roll angle of the vehicle during orbit insertion and deorbit. No software logic changes are made by this CR. This CR is often confused as a PE; while it is not, it was included in the PE certification. The orbiter/ET roll to heads up maneuver at approximately T +6 min is required to allow an early handover to tracking and data relay satellite east (TDRS E). MILA will be used for tracking until the roll maneuver is performed because the Bermuda tracking station is being closed as a cost reduction.

**CR 91042: Second-Stage Pitch Gimbal Relief (PASS/BFS)**

This CR is not a PE; it is required to maintain control under specific conditions as a result of performance enhancements. The SLWT is approximately 8000 lb lighter than the currently used ET and causes the vehicle c.g. to move about 6 to 8 inches further up into the Z-axis at MECO. This higher c.g. makes controlling the vehicle difficult on press to MECO cases with SSME no. 1 failed when the orbiter Zcg is near the top of the entry c.g. box. The result is that the SSME no. 3 pitch gimbal will hit the hard stop due to thrust deformation before MECO. The control impact is an uncommanded pitch rate on the vehicle, the magnitude of which depends on the Zcg, the thrust structure deformation, and the thrust vector misalignment.

The thrust structure deformation that this CR alleviates is a function of pitch and yaw SSME gimbal deflections, SSME thrust, and normal and longitudinal vehicle accelerations. It results in different effective pitch (and yaw) gimbal angles for engines, even though they are sent the same command. This deformation becomes important when the engines are no longer capable of pointing through the vehicle c.g. in pitch or yaw. The yaw c.g. is always within reach, but the pitch c.g. for heavy, high Zcg payloads may be unreachable when the top SSME has failed. The thrust deformation is asymmetrical; i.e., the structure of SSME no. 2 is more rigid than that of SSME no. 3; thus, SSME no. 3 deflects more than SSME no. 2 for a given pitch command. These asymmetrical deflections produce a roll moment through "de facto" scissoring of the engines. As a result, even though SSME no. 2 still has pitch gimbal authority when SSME no. 3 has hit its pitch stop, it cannot help SSME no. 3 in pitch without inducing a roll moment on the vehicle; instead, it must back off to prevent the roll moment. A throttle down to minimum power level reduces the deformation magnitude, providing about 0.5 to 0.7° of pitch gimbal relief. This CR provides for an automatic throttle down to 67%, instead of 91%, if a pitch gimbal command exceeds an I-loaded value during the last 15 sec of powered flight with SSME no. 1 failed. The throttle down would only be commanded if all of the following are true:

- Manual throttling is not active
- SSME no. 1 has failed
- A pitch gimbal command exceeds an I-loaded threshold (10°)
- Vehicle mass is less than an I-loaded mass (i.e., near MECO)

For early EO cases that result in a low level cutoff, the throttle down to 67% causes an underspeed that is approximately 15 fps greater than for the 91% throttle case. This results in a 5 to 7 n. mi. reduction in apogee altitude. The larger underspeed occurs because 300 additional lb of LO2 is in the propellant line when the LO2 low level cutoff is commanded at 67% vs. 91%.

#### **CR 91044: Star Catalog Uplink Capability (PASS Only)**

This CR adds the capability to uplink changes to the vector components of the last 10 stars in the star catalog. It also replaces five stars with near neighbors and updates vector components of all stars in the catalog to Epoch 2005. At the March 24, 1995 SASCB, it was stated that the planned shuttle/station docking flights put the orbiter in a configuration where the orbiter -Z star tracker is blocked and the -Y star tracker is pointed to a region with minimal stars. Flight rules require that inertial measurement unit (IMU) alignment be maintained to within 0.5° to support an emergency deorbit. This would require maneuvering of the combined stack once a day to perform the required IMU alignments.

#### **CR 91054: SRB Sep Yaw Gain Enhancement (PASS/BFS)**

The integrated performance of the shuttle was found not to meet the Volume X requirements for SRB separation for certain worst-on-worst combinations of maximum body rates. The Volume X violation was not the result of any flight software problem; rather, an error was found in the RI/D simulator used for generic certification. As a result, a smaller SRB staging envelope was defined and verified, which is roughly half the size of the previous envelope (reference PRCBD S052829). This CR increases the separation clearances between the SRBs and the ET, providing more margin for the SLWT and "hedging" against any possible violations of the new sep box with heavyweight missions and performance enhancements. This is accomplished by reducing the SSME yaw moments and lateral forces immediately following SRB sep by setting the yaw gain to zero at SRB sep command and fading it back to full value over an I-loaded time period.

#### **Other Significant CRs**

##### **CR 90961: Expansion of Orbiter SPC Buffer for BFS and SM (PASS/BFS)**

This CR expands the existing stored program command (SPC) buffer from 10 slots to 25 slots in both the systems management (SM) GPC and in the BFS. The driver for this change was the increasingly complex command scenarios that

required multiple SPC loads to be built, stored in the MCC, and sent as SPC buffer space became available. Payloads are now requiring more Ku-band mode changes to accommodate science data return, and these are best performed by SPC sequences to keep the onboard and ground systems in sync. Furthermore, at certain latitudes, radio frequency interference (RFI) is heavy and can continue for extended periods of time. This can occur before and after the zone of exclusion (ZOE). BFS was included due to MOD's desire to incorporate the command loads for the TDRS and Diego Garcia handovers onboard. The TDRS handover alone requires eight SPCs.

**CR 90962: Payload Throughput Buffer Addition (PASS Only)**

This CR adds a new command buffer to the SM major function for exclusive use of payload and Payload Operations Control Center (POCC) commands. Currently, all payload and orbiter SM command loads (such as TDRS handover, and table maintenance block updates (TMBUs)) must share the same SM two-stage buffer. This often results in contention over buffer usage and requires frequent voice coordination between various MCC console disciplines. Instances have occurred when simultaneous POCC and orbiter command requirements have resulted in a delay of the desired POCC command sequences. Since payload commanding is done primarily in a throughput mode and does not require buffering and downlisting of the two-stage buffer before execution, the payload throughput commands (PTCs) will now be buffered in a dedicated PTC buffer. Once they are completely received, immediately they will be made available for processing without a buffer execute command. The SM GPC will not downlist the buffer contents, nor will it continue to buffer the data if it is received while the link to the specified payload is busy. A PTC buffer clear op code is added to purge the contents of the PTC buffer.

**CR 91081: Clearing the GPC Soft Error Counter (PASS Only)**

Currently, the only way to clear the soft error counter (SEC) is by moding the GPC to STBY or HALT. Each GPC has an SEC for upper and lower memory. The SEC can record up to 127

counts per page. The maximum number of counts recorded on the lower page was 109 on STS-60. With future Space Station missions, engineering believes that the SEC will reach its maximum capability, and will no longer be useful unless it can be cleared. MOD has expressed the need to clear the SEC while keeping the GPC in RUN mode during Space Station operations. This CR adds the SEC as an additional item to be cleared/reset with the execution of Item 48 on SPEC 0. Currently, ITEM 48 EXEC restarts the sync trace log, resets GPC fail votes, clears the input/output (I/O) error log, GPC error log, and display electronics unit (DEU) initial program load (IPL) log. KSC will need to modify their Launch Control Center (LCC) monitoring software to account for the clearing of the SEC when an ITEM 48 is performed.

**CR 92014: Space Vision System Auto-Control of Closed Circuit TV Cameras (PASS Only)**

This CR implements a mission-dependent process in the SM GPC to allow the space vision system (SVS) to control the closed-circuit television (CCTV) cameras. The SM GPC will acquire the SVS camera commands via the PF1 multiplexer/demultiplexer (MDM) and translate them for output to the CCTV system via the PF2 MDM. The SM GPC will use a look-up table to convert the SVS camera commands into CCTV commands, such as pan, tilt, zoom, and focus. The output to the CCTV is indistinguishable from an uplink command; therefore, ground commanding of SVS-controlled cameras must be managed procedurally. The crew will initiate this new process with an item entry to a reconfigurable SPEC.

**CR 92026: RMS PL ID Initialization Correction (PASS Only)**

DR 107968 identified a deficiency in the position and orientation hold submode (POHS) logic implemented on OI-23, where changing payload identifications (PL IDs) could cause POHS to generate uncommanded motion or cause a trajectory tracking alarm. This condition occurs if the PL ID is changed without a payload attached while in orbiter loaded or payload mode with POHS active. This will also occur if the end effector (EE) ID is changed while in any manual augmented mode, loaded or unloaded, with POHS

active. Since crew procedures call for the application of brakes when changing the PL ID, and the EE ID is only changed in unique situations, the SASCB community agreed not to patch the flight software. This CR corrects the deficiency by

- Ensuring that POHS resets any time the payload ID is changed.
- Correcting the auto mode logic to ensure operator commanded auto sequence (OCAS) is executed with the proper EE ID.
- Inhibiting EE ID changes while in auto mode, manual augmented mode, or test mode.

**A**

Abort Mode Boundaries .....	9.1-9
Abort to Orbit.....	6.6-1
Acceleration Limitations.....	4.9-1
Active Thermal Control System .....	2.9-22
Active Vent System .....	2.17-2
Additional Support Documents .....	3.2-2
Aft Fuselage .....	1.2-10
Air Sampling System .....	2.5-14
Airlock .....	2.11-11
Airspeed Limitations .....	4.3-1
Air-to-Ground Voice Communications .....	8.2-2
Alarms.....	2.2-2
Alpha/Mach Indicator .....	2.7-14
Altitude, Velocity, and Dynamic Pressure.....	9.1-5
Altitude/Vertical Velocity Indicator .....	2.7-17
Androgynous Peripheral Docking System.....	2.20-2
Angle of Attack Limitations.....	4.4-1
APDS Avionics Overview .....	2.20-2
APDS Operational Sequences (OPS).....	2.20-5
Approach and Landing .....	5.4-8
APU 1 and Multiple Prox Box Failures .....	6.9-1
APU Heaters .....	2.1-11
APU/HYD Caution and Warning Summary .....	2.1-23
APU/HYD Rules of Thumb.....	2.1-24
APU/HYD Summary Data .....	2.1-24
APU/Hydraulics .....	6.8-2
Ascent .....	4.3-1, 4.9-1, 5.2-1, 7.1-1, 8.5-1, 9.1-1
Ascent Aborts.....	6.2-1
Ascent Checklist .....	3.1-1
Ascent/Entry Systems Procedures Book .....	3.3-1
Ascent Rules of Thumb.....	7.1-11
Atmospheric Revitalization System.....	2.9-12
Attitude Control .....	7.2-1
Attitude Director Indicator (ADI) .....	2.7-4
Audio Communication Subsystem .....	2.24-4
Audio Distribution System .....	2.4-28
Autoland.....	7.4-24
Auxiliary Power Unit/Hydraulics (APU/HYD).....	2.1-1

**B**

Backup Flight System.....	7.1-8, 7.3-11, 7.4-23
Bailout Procedures .....	2.10-17
Basic FDF Documents .....	3.5-1
BFS Self Engage .....	6.9-3
Body Flap.....	1.2-12

**C**

C/W Rules of Thumb .....	2.2-19
C/W Summary Data.....	2.2-19
Cabin Cameras.....	2.3-12
Caution and Warning System (C/W) .....	2.2-1
Caution and Warning .....	2.24-3
CCTV Accessories .....	2.3-20
CCTV Camera Lens Control .....	2.3-11
CCTV Cameras .....	2.3-6
CCTV System Summary .....	2.3-22
Center of Gravity Limitations.....	4.8-1
Circulation Pump and Heat Exchanger.....	2.1-19
Closed Circuit Television (CCTV).....	2.3-1
Closed Circuit Television Subsystem .....	2.24-4
Command and Data Management System.....	2.25-10
Command and Data Subsystem.....	2.24-3
Communications.....	2.4-1, 6.8-5
Communications System Rules of Thumb.....	2.4-55
Communications System Summary .....	2.4-45
Configurations .....	2.24-1
Contingency Abort.....	6.7-1
Contingency Deorbit Preparation Book .....	3.3-2
Contingency EVA Operations Checklist .....	3.3-2
Control Documents .....	3.1-1
Crew Clothing/Worn Equipment.....	2.5-1
Crew Compartment .....	1.2-3
Crew Escape System Pyrotechnics.....	2.10-11
Crew Systems.....	2.5-1
CRT Power Switch.....	6.10-1
Cryo.....	6.8-6
Cryo Leak with Failed Manifold Valve .....	6.9-3

**D**

Data Bus Network.....	2.6-7
Data Processing System (DPS).....	2.6-1, 6.8-6
Data Processing System Dictionary .....	3.4-1
Dedicated Display Systems.....	2.7-1
Dedicated Display Systems Summary Data .....	2.7-25
Deorbit Burn.....	5.4-3, 7.3-1
Deorbit Prep .....	2.16-35, 5.4-1
Deorbit Preparation Book.....	3.1-1
Deploy Checklist.....	3.2-2
Derotation.....	7.4-18
Descent Rate Limitations .....	4.7-1
Digital Autopilot.....	2.13-46
Display Driver Unit.....	2.7-2
Downrange/Crossrange.....	9.3-1
DPS Rules of Thumb .....	2.6-49

DPS Summary Data .....	2.6-45
Drag .....	9.2-1
Drag Chute .....	2.14-4
Dynamic Flight Phases .....	8.1-1

**E**

ECLSS Caution and Warning Summary .....	2.9-46
ECLSS Rules of Thumb .....	2.9-58
ECLSS Summary Data .....	2.9-47
Egress Pole System .....	2.10-12
Electrical Power .....	2.25-6
Electrical Power Distribution .....	1.4-5
Electrical Power Distribution and Control .....	2.8-20
Electrical Power Subsystem .....	2.24-3
Electrical Power System (EPS) .....	2.8-1, 6.8-10
Electronic Controller .....	2.1-6
Emergency Egress Slide .....	2.10-12
Emergency Procedures .....	6-1
Engine Limitations .....	4.2-1
Engines .....	2.19-3
Entry .....	2.16-35, 4.3-1, 4.4-1, 4.9-1, 5.4-1, 6.7-3, 7.3-1, 7.3-4, 8.7-1
Entry (OPS 304) .....	9.3-1
Entry Checklist .....	3.1-2
Entry Flying Tasks .....	7.3-1
Entry History .....	9.3-2
Entry Interface .....	5.4-6
Entry RCS Use Data .....	9.3-2
Entry Rules of Thumb .....	7.3-14
Environmental Control and Life Support System (ECLSS) .....	2.9-1, 6.8-8
Environmental Control Subsystem .....	2.24-3
EPS Caution and Warning Summary .....	2.8-32
EPS Rules of Thumb .....	2.8-38
EPS Summary Data .....	2.8-38
Escape Systems .....	2.10-1
Escape Systems Summary Data .....	2.10-18
ET Impact .....	9.1-8
ET Separation .....	6.7-2
EVA Rules of Thumb .....	2.11-22
EVA Summary Data .....	2.11-22
EVA Support Equipment .....	2.11-15
Exercise Equipment .....	2.5-4
Exterior Lighting .....	2.15-12
External Airlock .....	2.20-2
External Tank .....	1.3-1
External Tank Umbilical Doors .....	2.17-5
Extravehicular Activity (EVA) .....	2.11-1
Extravehicular Activity Checklists .....	3.2-1
Extravehicular Mobility Unit .....	2.11-2
EZ482 .....	3.5-2

**F**

F7 Light Summary .....	2.2-20
Fault Detection and Identification .....	2.19-21
Fault Message Summary .....	2.2-23
FDF Fabrication .....	3.5-1
FDF Flight-Specific Final Documentation .....	3.5-3
FDF On-Orbit Flight Documents .....	3.5-3
FDF Operational Use .....	3.5-1
FDF Prep, Preliminary .....	3.5-1
Fire Suppression Subsystem .....	2.24-4
Flexible Containers .....	2.26-4
Flight Control System Hardware .....	2.13-26
Flight Control System Pushbutton Indicators .....	2.7-19
Flight Crew .....	8.3-1, 8.4-1, 8.5-1, 8.6-1, 8.7-1, 8.8-1
Flight Crew Duties and Coordination .....	8.1-1
Flight Data File .....	3-1
Flight Deck Interfaces .....	2.24-2, 2.25-5
Flight Plan .....	3.1-1
Form 482 and EZ482 .....	3.5-2
Forward Fuselage .....	1.2-1
Forward Fuselage and Crew Compartment Windows .....	1.2-6
Fuel Cell Reactant Valves .....	6.10-1
Fuel Cell System .....	2.8-10
Fuel System .....	2.1-2

**G**

Galley/Food .....	2.12-1
Gas Generator and Turbine .....	2.1-5
General Purpose Computers (GPCs) .....	2.6-2
Gliding RTLS .....	6.3-6
G-Meter (Non-MEDS) .....	2.7-21
GNC Caution and Warning Summary .....	2.13-62
GNC Rules of Thumb .....	2.13-70
GNC Summary Data .....	2.13-63
GPC/MDM .....	6.10-1
Ground Controlled Approach .....	7.3-12
Guidance, Navigation, and Control (GNC) .....	2.13-1, 6.8-12

**H**

HAC Profile .....	7.4-2
Handling Qualities (Orbiter) .....	7.4-20
Hardware .....	2.18-1
Hardware and Instrumentation .....	1.3-3
Heading Alignment Cone (HAC) .....	7.4-8
Head-Up Display .....	2.7-21
Helium System .....	2.16-19, 2.19-9, 2.23-9
Hold-Down Posts .....	1.4-3
Horizontal Situation Indicator (HSI) .....	2.7-9



Housekeeping Equipment.....	2.5-4	Loss of Two APUs/Hydraulic Systems .....	6.9-1
HYD Press and APU Controller		Loss of Two Freon/Water Loops .....	6.9-2
Power Switches.....	6.10-1	Loss of Two Fuel Cells.....	6.9-2
Hydraulic Accumulator.....	2.1-19	Lubricating Oil.....	2.1-5
Hydraulic Heaters.....	2.1-21		
Hydraulic Power Units.....	1.4-5	<b>M</b>	
Hydraulic Reservoir.....	2.1-19	Main Engines .....	9.1-5
<b>I</b>		Main Gear Touchdown.....	4.7-1
In-Flight Maintenance Checklist.....	3.3-1	Main Hydraulic Pump.....	2.1-16
Injector Cooling System.....	2.1-10	Main Landing Gear Brakes .....	2.14-5
Inner Glideslope (IGS).....	7.4-15	Main Propulsion System (MPS).....	2.16-1, 6.8-12
Insertion OMS Burns.....	7.1-7	Malfunction Detection .....	2.16-25
Instrument Markings.....	4.1-1	Malfunction Procedures Book .....	3.3-1
Instrument Pointing Subsystem (IPS).....	2.25-5	Manipulator Positioning Mechanism .....	2.22-10
Instrumentation.....	2.4-40	Maps and Charts Book .....	3.4-1
Integrated Operations.....	8-1	Mass Memory Units.....	2.6-12
Intercom Protocol.....	8.1-2	Master Timing Unit.....	2.6-15
Interior Lighting .....	2.15-1	Maximum Landing Weight.....	4.6-1
Intertank .....	1.3-2	MCC Resources.....	8.2-1
		Mechanical Systems .....	2.17-1
<b>J</b>		Mechanical Systems Failures .....	6.8-12
Jet System .....	2.23-3	Mechanical Systems Rules of Thumb .....	2.17-21
		Mechanical Systems Summary Data.....	2.17-18
<b>K</b>		MECO Targets .....	9.1-8
Ku-Band System .....	2.4-13	Medical Checklist .....	3.3-2
		Medical System.....	2.5-10
<b>L</b>		Middeck Accommodations Rack.....	2.26-5
Landing.....	4.3-2	Midfuselage.....	1.2-9
Landing/Deceleration System.....	2.14-1	Minimum Safe Orbit .....	9.1-10
Landing/Deceleration System		Mission Control Center.....	8.3-1, 8.4-2, 8.5-1 8.6-1, 8.7-1, 8.8-1
Rules of Thumb.....	2.14-17	Mode 1 – Unaided Egress/Escape .....	6.1-1
Landing/Deceleration System		Mode 2 – Aided Escape .....	6.1-1
Summary Data.....	2.14-17	Mode 3 – Aided Escape .....	6.1-2
Landing Gear .....	2.14-1	Mode 4 – Aided Escape .....	6.1-2
Landing Weight Limitations.....	4.6-1	Module Environmental Control and Life	
Last Full On-Orbit Day .....	5.3-7	Support (ECLS).....	2.25-13
Launch .....	8.4-1	Monitors.....	2.3-18
Launch Abort Modes and Rationale.....	6.1-1	MPS Caution and Warning Summary .....	2.16-37
Launch and Entry Suits .....	2.10-4	MPS He Leak with APC/ALC Failure .....	6.9-1
Launch and Landing Sites.....	1.1-5	MPS Hydraulic Systems .....	2.16-23
Launch Control Center .....	8.3-1, 8.4-2, 8.8-1	MPS Rules of Thumb .....	2.16-42
Launch Pad Egress Systems.....	2.10-1	MPS Summary Data.....	2.16-39
Launch Window .....	9.1-2	MPS Switches.....	6.10-1
Lighting System.....	2.15-1	Multifunction CRT Display System .....	2.6-13
Lighting System Rules of Thumb .....	2.15-14	Multifunction Electronic Display System	
Lighting System Summary Data .....	2.15-14	(MEDS).....	2.18-1
Liquid Hydrogen Tank.....	1.3-3	Multiple Failure Scenarios .....	6.9-1
Liquid Oxygen Tank .....	1.3-2	Multiplexers/Demultiplexers (MDMs).....	2.6-11
Location Codes (on the Orbiter).....	1.1-8		
Loss of Braking .....	9.3-6	<b>N</b>	
Loss of FES .....	6.9-2	Navigation Hardware.....	2.13-5
		Nominal Mission Profile.....	1.1-2

Nominal Transoceanic Abort Landing.....	6.4-1	Orbiter Passive Thermal Control .....	1.2-14
Normal Procedures Summary.....	5-1	Orbiter Structure .....	1.2-1
Nose Gear Touchdown .....	4.7-1	Outer Glideslope.....	7.4-9
Nose Wheel Steering.....	2.14-9	Overview of Entry Flying Tasks .....	7.3-1
<b>O</b>			
ODS Operational Notes of Interest.....	2.20-7	Pallet .....	2.25-4
Off-Nominal Approaches .....	7.4-23	Panel F9 Meters .....	4.1-5
Off-Nominal Documents.....	3.3-1	Panel O1 Meters .....	4.1-6
OMS-1.....	6.6-1	Panel O2 Meters .....	4.1-9
OMS-2.....	6.6-1	Panel O3 Meters .....	4.1-11
OMS Burns.....	5.2-3	Pan/Tilt Units (PTUs) .....	2.3-11
OMS (RCS) Burns.....	5.3-4	Payload and General Support Computer ..	2.21-1
OMS Caution and Warning Summary.....	2.19-24	Payload Bay Camera Operations .....	2.3-20
OMS Failures .....	6.9-2	Payload Bay Door System.....	2.17-9
OMS Kit.....	6.10-1	Payload Communication System.....	2.4-21
OMS/RCS .....	9.2-2	Payload Deployment and Retrieval System (PDRS).....	2.22-1
OMS/RCS Leak with DPS/EPS Failures.....	6.9-2	Payload Deployment and Retrieval System Operations Checklist.....	3.2-1
OMS Rules of Thumb .....	2.19-31	Payload Operations Checklist .....	3.2-2
OMS Summary Data.....	2.19-31	Payload Retention Mechanisms.....	2.22-14
Operating Limitations (FDF) .....	4-1	Payload Systems Data and Malfunction Procedures Book.....	3.3-1
Operational Bioinstrumentation System.....	2.5-12	Payload Systems Data/Malfunction Book ..	3.4-1
Operations (APU/HYD) .....	2.1-21	Payload (Ascent).....	9.1-1
Operations (C/W).....	2.2-12	PDRS Caution and Warning Summary.....	2.22-21
Operations (DPS) .....	2.6-23	PDRS Rules of Thumb .....	2.22-26
Operations (ECLSS).....	2.9-43	PDRS Summary Data .....	2.22-22
Operations (EPS) .....	2.8-30	Performance (Ascent, Orbit, Entry).....	9-1
Operations (EVA).....	2.11-19	Performance Aborts.....	6.2-1
Operations (GNC).....	2.13-53	Performance Rules of Thumb.....	9.3-11
Operations (Landing/Deceleration).....	2.14-10	Personal Hygiene Provisions.....	2.5-1
Operations (MEDS).....	2.18-10	Personal Parachute Assembly .....	2.10-8
Operations Monitoring and Control.....	8.2-1	Perturbations .....	9.2-1
Operations (MPS).....	2.16-28	PGSC Equipment .....	2.21-1
Operations (OMS).....	2.19-23	Photo/TV Checklist.....	3.2-1
Operations (PDRS).....	2.22-17	Photographic Equipment .....	2.5-8
Operations (RCS) .....	2.23-16	PLB Mech Power/Enable.....	6.10-1
Operations (WMS).....	2.27-4	Pocket Checklists.....	3.3-1
Orbit.....	2.16-35, 5.3-1, 7.2-1, 8.6-1, 9.2-1	Post Insertion .....	2.16-34, 5.2-5
Orbit Operations .....	5.3-1	Post Insertion Book .....	3.1-1
Orbit Operations Checklist .....	3.2-1	Post MECO Transoceanic Abort Landing.....	6.4-3
Orbit Phase.....	8.1-1	Postlanding .....	5.5-1, 8.8-1
Orbit Rules of Thumb.....	7.2-12	Power Reactants Storage and Distribution System.....	2.8-1
Orbital Maneuvering System (OMS).....	2.19-1	Powered Flight .....	5.2-1, 6.6-1, 6.7-1, 7.1-1
Orbital Maneuvering System (OMS) Engines.....	4.2-2	Powered RTLS.....	6.3-2
Orbital Maneuvering System/Reaction Control System.....	6.8-14	Preflare .....	7.4-14
Orbital Maneuvering System/Reaction Control System (OMS/RCS) Pods.....	1.2-11	Prelaunch Procedures.....	5.1-1, 8.3-1
Orbital Periods .....	9.2-1	Pressure Control System .....	2.9-3
Orbiter Docking System .....	2.20-1	Propellant Management System (PMS) ....	2.16-13
Orbiter Ground Turnaround .....	1.1-6		
Orbiter Handling Qualities.....	7.4-20		
<b>P</b>			

Propellant Storage and Distribution .....	2.19-11	Space Shuttle Main Engine Controllers .....	2.16-8
Propellant System .....	2.23-4	Space Shuttle Main Engines (SSMEs) .....	2.16-3, 4.2-1
<b>R</b>		Space Shuttle Overview .....	1.1-1
Radiation Equipment .....	2.5-14	Space Shuttle Requirements .....	1.1-1
Range Safety .....	6.2-4	Spacehab .....	2.24-1
Range Safety System .....	1.3-4, 1.4-7	Spacelab .....	2.25-1
Rapid Cabin Depressurization .....	2.2-11	Spacelab Module .....	2.25-3
RCS Caution and Warning Summary .....	2.23-18	Spacelab Summary Data .....	2.25-18
RCS Jets .....	4.2-3	SPEC 60, SM Table Maintenance .....	2.2-15
RCS Redundancy Management .....	2.23-12	Special Purpose Video .....	2.3-17
RCS Rules of Thumb .....	2.23-25	Squatcheloids .....	9.1-4
RCS Summary Data .....	2.23-25	SRB Descent and Recovery .....	1.4-8
Reach and Visibility Aids .....	2.5-6	SRB Ignition .....	1.4-4
Reaction Control System (RCS) .....	2.23-1	SRB Rate Gyro Assemblies .....	1.4-6
Reaction Control System Command Lights .....	2.7-20	SRB Separation .....	1.4-6
Reference Data Book .....	3.4-1	Stowage .....	2.26-1
Reference Documents .....	3.4-1	Stowage Containers .....	2.5-5
Remote Manipulator System .....	2.22-1	Stuck Throttle in the Bucket .....	6.9-1
Rendezvous .....	5.3-4	Supply and Wastewater Systems .....	2.9-34
Rendezvous Checklist .....	3.2-1	Support Documents (Generic and Flight Supplements) .....	3.2-1
Rendezvous/Proximity Operations .....	7.2-6	Surface Position Indicator .....	2.7-18
Repackaged Galley .....	2.12-1	Switch and Panel Cautions .....	6.10-1
Rescue Procedures .....	2.10-17	Systems .....	2-1
Restraints and Mobility Aids .....	2.5-5	Systems Abort Once Around Book .....	3.3-1
Return to Launch Site .....	6.3-1	Systems Aborts .....	6.2-3
Rigid Containers .....	2.26-1	Systems Data Book .....	3.4-1
Rollout .....	7.4-19	Systems Failures .....	6.8-1
Rollout/Braking .....	9.3-6	Systems Failure Summary .....	6.11-1
Rollout History .....	9.3-6		
RTLS Abort Propellant Dump Sequence .....	2.16-35	<b>T</b>	
<b>S</b>		TAL Abort Propellant Dump Sequence ...	2.16-36
S-Band Frequency Modulation .....	2.4-10	Telemetry Uplink .....	8.2-3
S-Band Phase Modulation .....	2.4-2	Terminal Area Energy Management and Approach, Landing, and Rollout (OPS 305) .....	7.4-1
Second Hydraulic Failure and 1 SSME Failed .....	6.9-1	Terminal Area Energy Management (TAEM) .....	5.4-8, 7.4-1
Secondary Emergency Egress .....	2.10-16	TAEM and Approach, Landing, and Rollout Rules of Thumb .....	7.4-27
Sensory Cues .....	7.1-9, 7.3-12, 7.4-24	TAEM Definition and Overview .....	7.4-1
Set Splits During Ascent .....	6.9-1	Thermal Control .....	2.19-19, 2.23-11
Shuttle Orbiter Medical System .....	2.5-10	Thermal Protection System .....	1.2-14, 1.3-3
Sideslip Limitations .....	4.5-1	Three-Engine-Out Automation .....	6.7-2
Sighting Aids .....	2.5-10	Thrust Vector Control .....	1.4-6, 2.19-20
Simplified Aid for EVA Rescue (SAFER) .....	2.11-17	Total Loss of FES .....	6.9-2
Sleeping Provisions .....	2.5-1	Total Loss of FES with BFS Failure .....	6.9-2
Smoke Detection and Fire Suppression .....	2.2-5	Touchdown .....	7.4-16
Software .....	2.18-5, 2.6-18	Trajectory .....	9.3-2
Solid Rocket Boosters .....	1.4-1	Trajectory Management and Flight Characteristics .....	7-1
Space Shuttle Coordinate Reference System .....	1.1-7	Translation .....	7.2-5

Transoceanic Abort Landing .....6.4-1  
Truss Assembly .....2.20-2  
Two APUs/Hydraulic Systems (Loss of) .....6.9-1  
Two Freon/Water Loops (Loss of) .....6.9-2  
Two Fuel Cells (Loss of) .....6.9-2

**U**

Ultrahigh Frequency System .....2.4-24

**V**

Vertical Tail .....1.2-13  
Video Processing Equipment .....2.3-2  
Video Tape Recorders (VTRs) .....2.3-15  
Vn Diagrams .....4.9-1  
Volume A - Pantry .....2.12-3

**W**

Waste Management System (WMS) .....2.27-1  
Water Spray Boilers .....2.1-12  
Water Survival Procedures .....2.10-17  
Weather Limitations .....4.10-1  
Wind Effects on Trajectory .....7.4-22  
Window Shades and Filters .....2.5-10  
Wing .....1.2-7  
Working with Mission Control .....8.2-1

## TITLE: Shuttle Crew Operations Manual

<u>NASA-JSC</u>				<u>USA-HOUSTON</u>	
AA	G. W. Abbey	DM46	M. R. Abbott (2)	H10H-150	V. Atkins
AB	B. Duffy	DO	L. D. Davis	USH-101A	J. R. Lang
AP	D. K. Ward	DO2	J. L. Clement	USH-110A	G. P. Neilsen
BV	L. Myers	DO3	R. Galvez	USH-121G	SFOC Tech
CA	E. Hawley	DO4	R. D. Snyder		Library
	D. C. Leestma	DO44	R. H. Nute	USH-303L	B. Chase
	K. A. Abotteen	DO45	B. E. Ferguson (3)	USH-400A	H. Draughon
CA44	C. A. Bertrand	DO47	G. A. Schneider (2)	USH-410A	W. Platt
CB	All astronauts (181)	DO6	G. L. Shinkle (5)	USH-421A	R. Khatri
	B. M. Hajek	DO62	D. D. Pawkett	USH-423C	FDD Tech Trg
	K. Colgan	DO65	J. H. Cavallaro (2)		Library
CC52	K. J. Baker		J. C. Haensly (3)		(Jordan)
DA	B. R. Stone	DO66	Gauthier (2)	USH-423L	M. Contella
DA2	MOD Library (Betts)	DT	S. M. Jordan (2)	USH-423L	FD Tng
DA4	L. J. Uljon		H. J. Davila		Library
DA5	Anderson		R. D. Dell'Osso	USH-423T	B. Heilman
DA6	D. R. Davidson		F. E. Hughes	USH-433L	J. Bores
DA8	Library (24)	DT2	C. V. Spencer	USH-441R	Garza
DB	G. W. Bull	DT3	R. Weitenhagen		J. Woodford
DD	J. F. Whiteley	DT31	P. J. Beauregard	USH-441S	B. Daugherty
DF	Bachik	DT32	S. Hartwig	USH-452E	G. S. Turner
	Fitts		D. I. Jenkins-Todd	USH-702L	W. Adigun
	N. D. Knight		Librarian (Pitre)		M. Sparks
	Library:	DT33	W. L. Todd		
	(C. Wood) (55)	DT34	S. Williams		
DF2	H. Clancy		Librarian	<u>BNA-HOUSTON</u>	
DF22	Library	DT35	Librarian (2)	ZC01-555	R. Prosser
	C. C. Sham	DT36	B. L. Jackman		
DF24	F. S. Markle (2)	DT37	Librarian (3)	<u>BNA-DOWNEY</u>	
DF4	R. T. Neal	DT38	Librarian (4)	AD60	E. Shvartz
DF42	R. McDaniel	DT7	Librarian		
DF44	D. E. Pallesen (2)		J. O'Keefe		
DF52	R. C. Doremus (2)	EC	Library		
DF55	K. J. Dwyer (2)	EG2	(Henderson) (13)		
DF6	S. J. Elsner	MA	D. C. Oswald	Dryden Flt Research Ctr	
DF62	S. J. Schaefer (3)		G. G. McSwain	Mail Stop 2063	
DF63	Ceccacci (2)	MV3	Space Shuttle	P.O. Box 273	
DF7	K. E. Jackson		Program Office (2)	Edwards, CA 93523	
DF73	P. M. Joyce	MV3/LM	K. Brown		
DF8	R. E. Floyd (2)	NS4	D. Adlis		
DK	R. K. Holkan	NS62	MER Library		
DM	R. C. Epps	OS/NDA	T. C. Adams		
	J. Fields		Cooper		
	E. P. Gonzalez	SD	NASDA:		
DM2	R. Schmidgall		NASA JSC (2)		
DM3	R. T. Gavin	ZR1	Medical Sciences		
DM32	R. T. Silvestri (2)		Library		
	Sitch (3)		Air Force Tech		
DM33	P. J. Bertsch (2)		Library		
DM34	Fletcher (2)		(Engle)		
DM4	G. T. Oliver				
DM43	L. E. Cain (2)				

Submit NASA distribution changes to JSC Shuttle Acquisition Data Management/BV, including initiator's name and phone number, or e-mail [LMYERS@EMS.JSC.NASA.GOV](mailto:LMYERS@EMS.JSC.NASA.GOV) or call 281-483-9649. Submit USA distribution changes to USA Data Management/USH-121E, or e-mail [TRACI.L.WILLIAMS@USAHQ.UNITEDSPACEALLIANCE.COM](mailto:TRACI.L.WILLIAMS@USAHQ.UNITEDSPACEALLIANCE.COM). Most documents are available electronically via USA Intranet Web ([usa1.unitedspacealliance.com](http://usa1.unitedspacealliance.com)), Space Flight Operations Contract (SFOC), SFOC Data and Deliverables.